

LR265 NRG TENDL-2015, AKONING

Principal cross sections

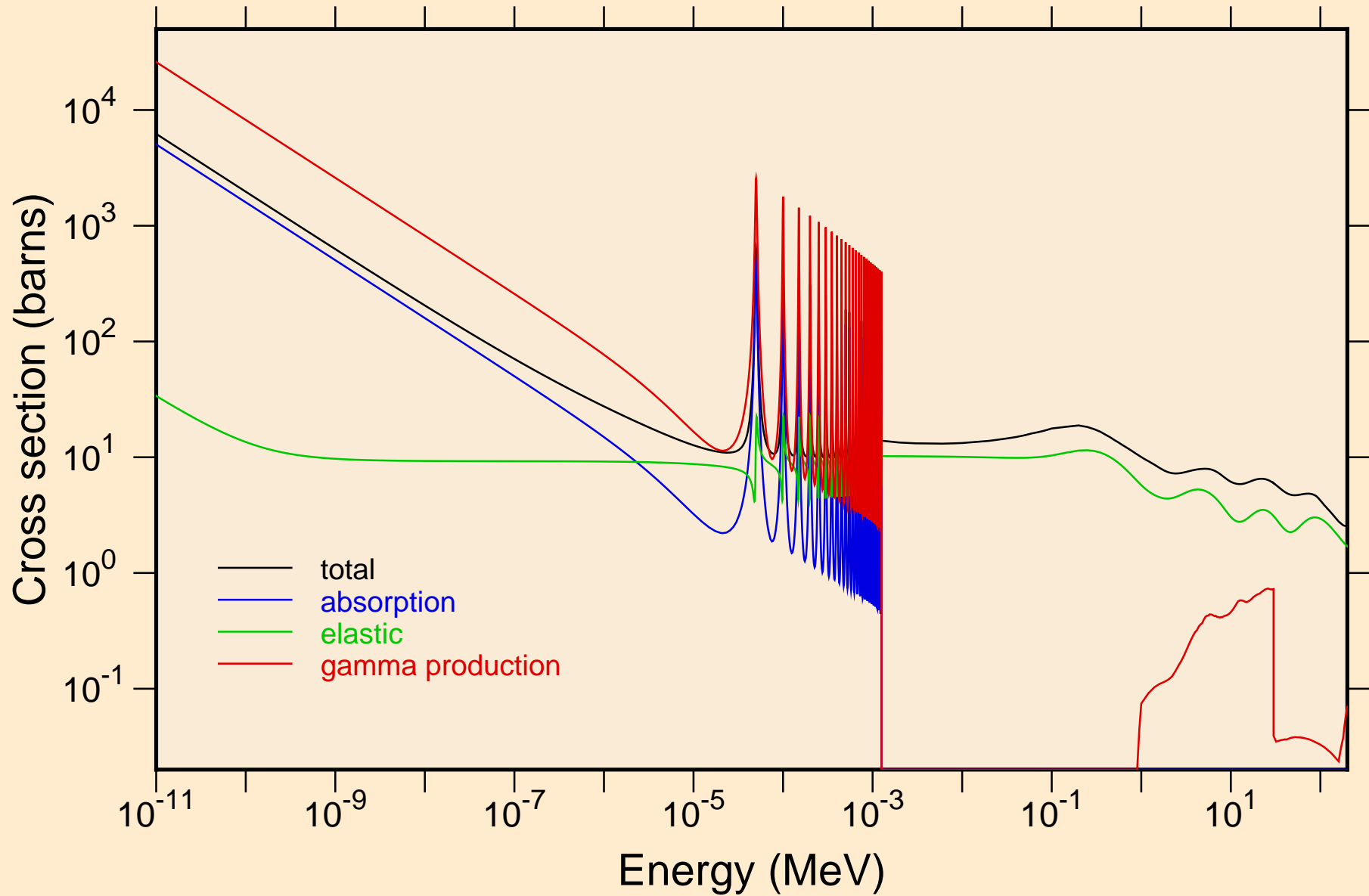

LR265 NRG TENDL-2015, AKONING
resonance total cross section

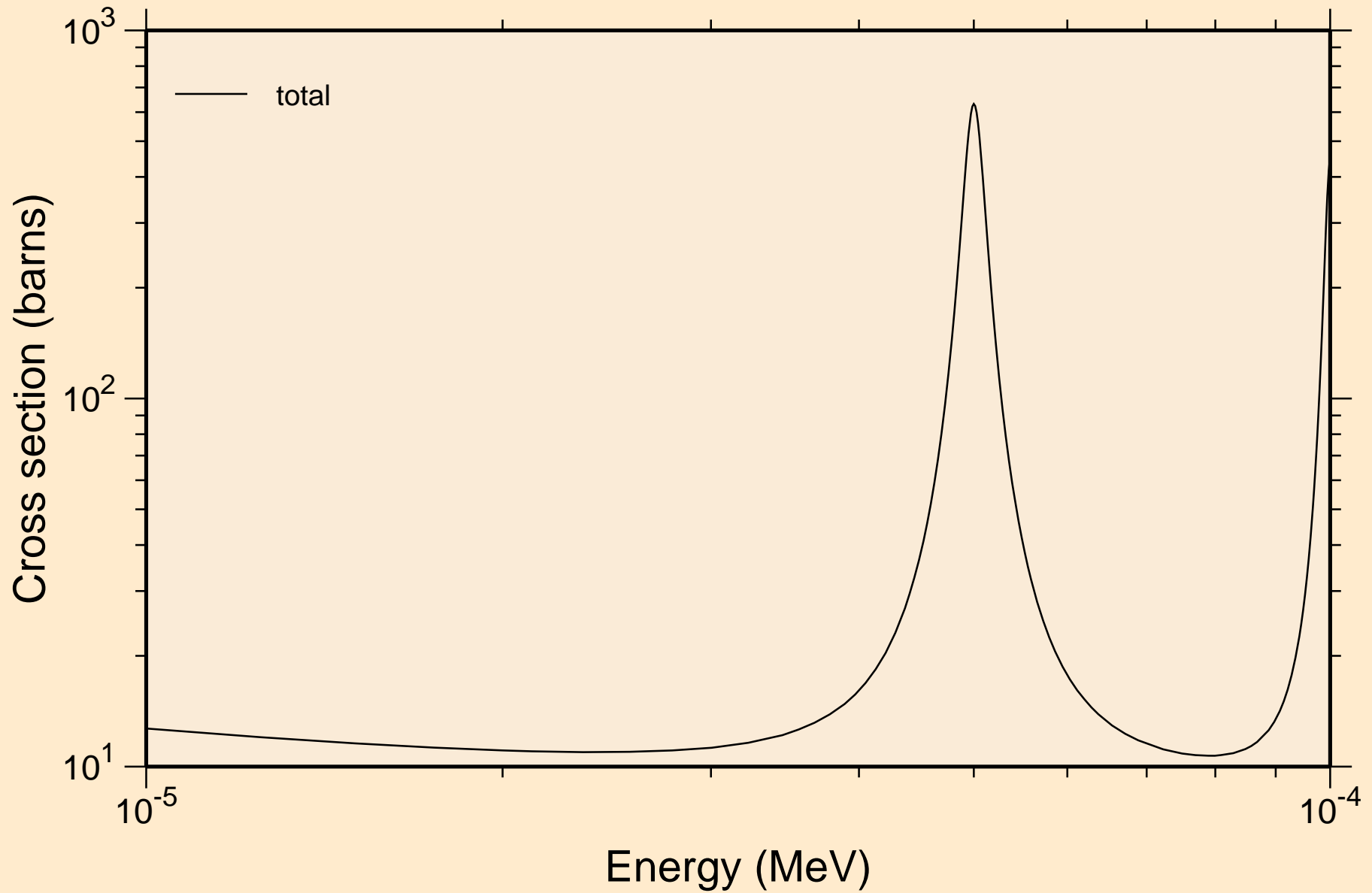

LR265 NRG TENDL-2015, AKONING
resonance total cross section

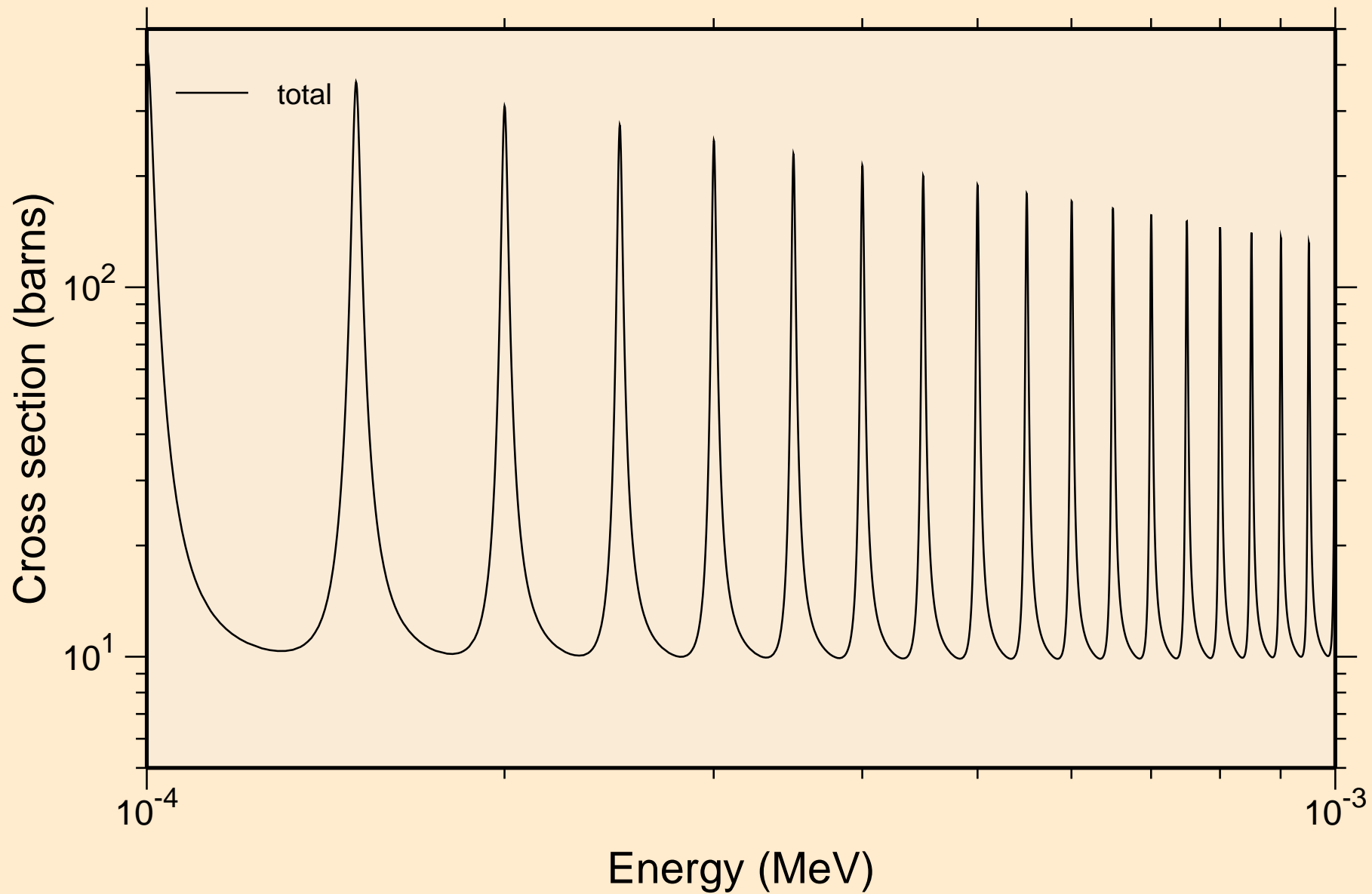

LR265 NRG TENDL-2015, AKONING
resonance total cross section

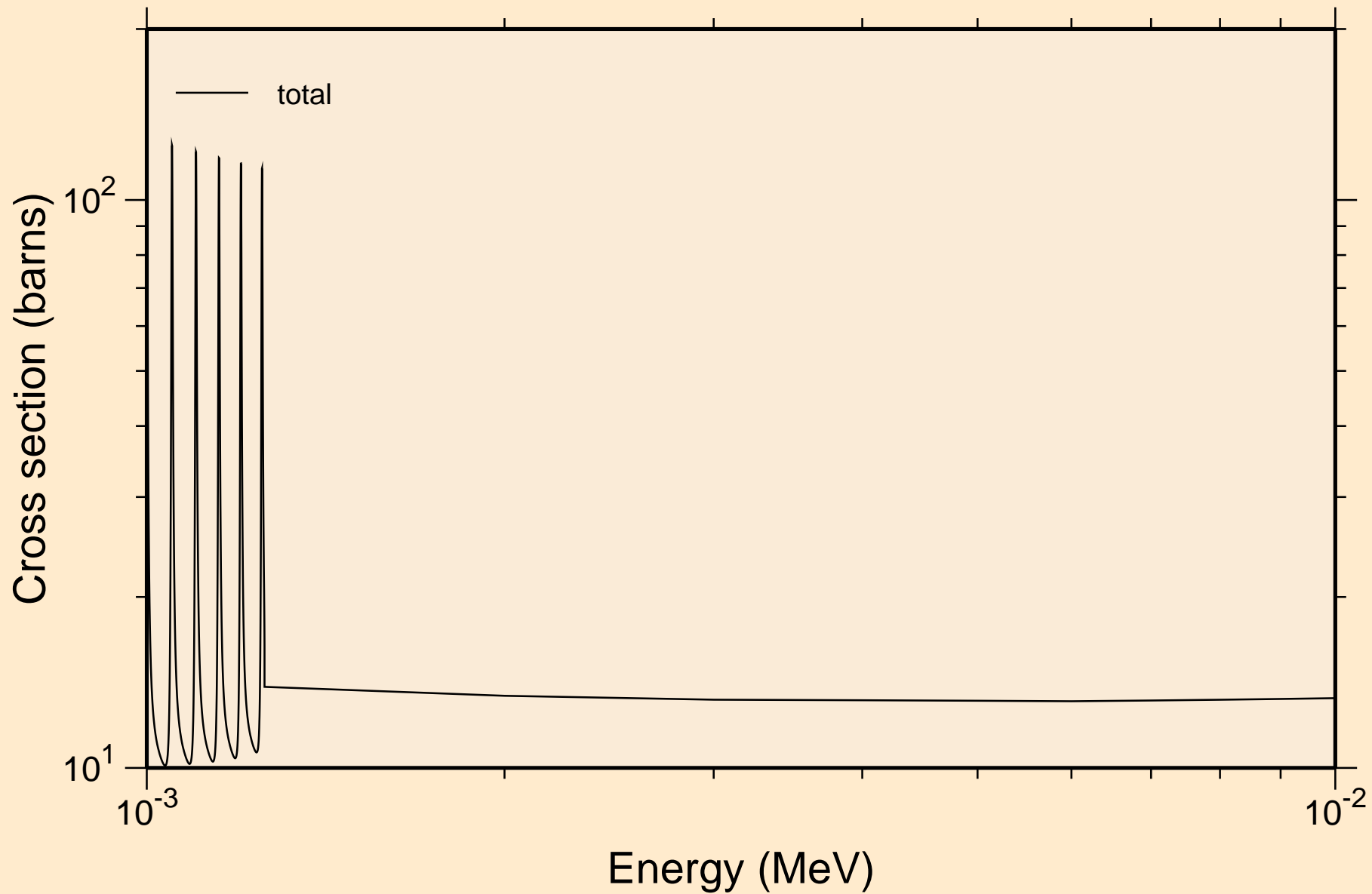

LR265 NRG TENDL-2015, AKONING
resonance total cross section

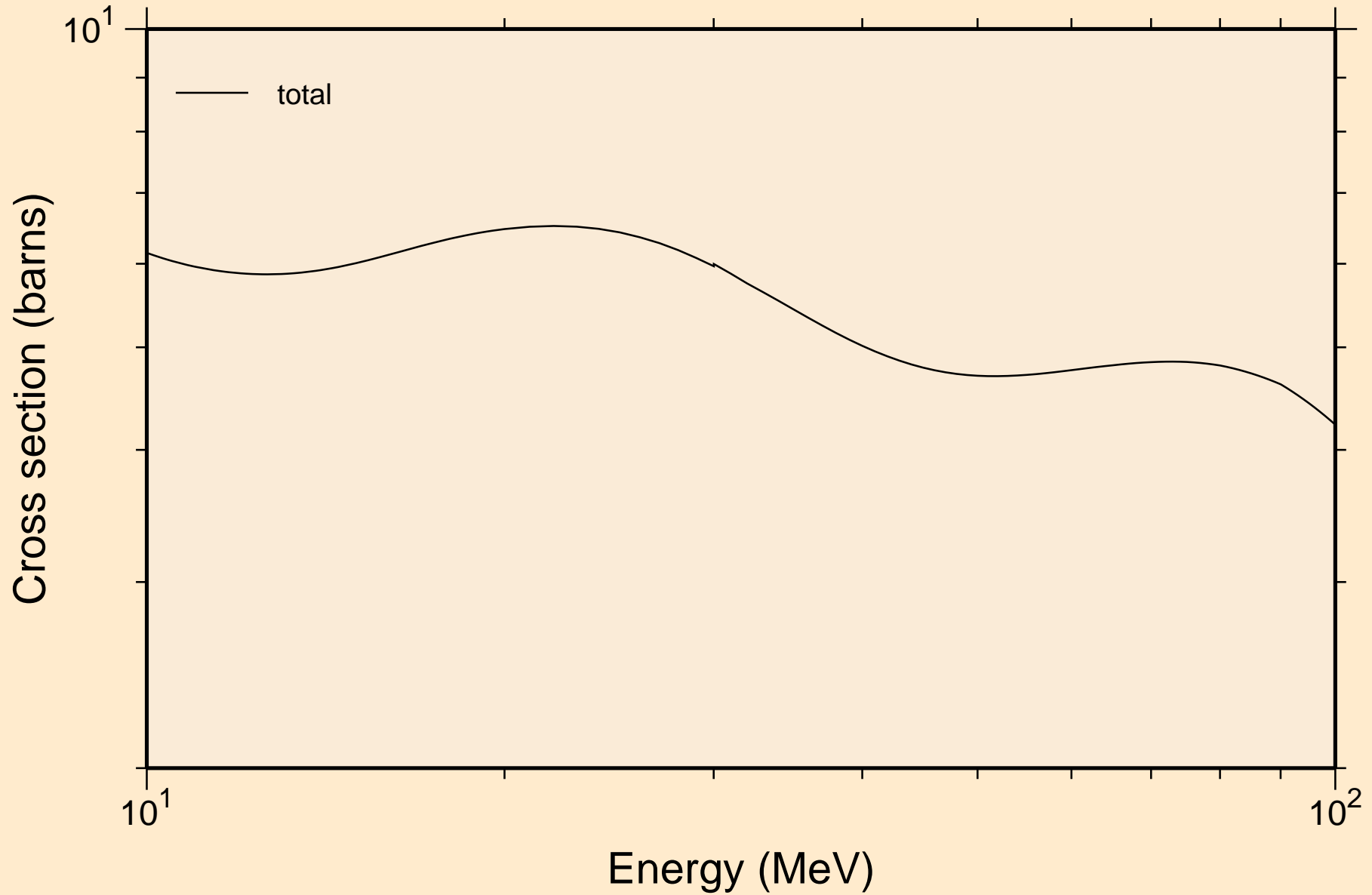

LR265 NRG TENDL-2015, AKONING
resonance absorption cross sections

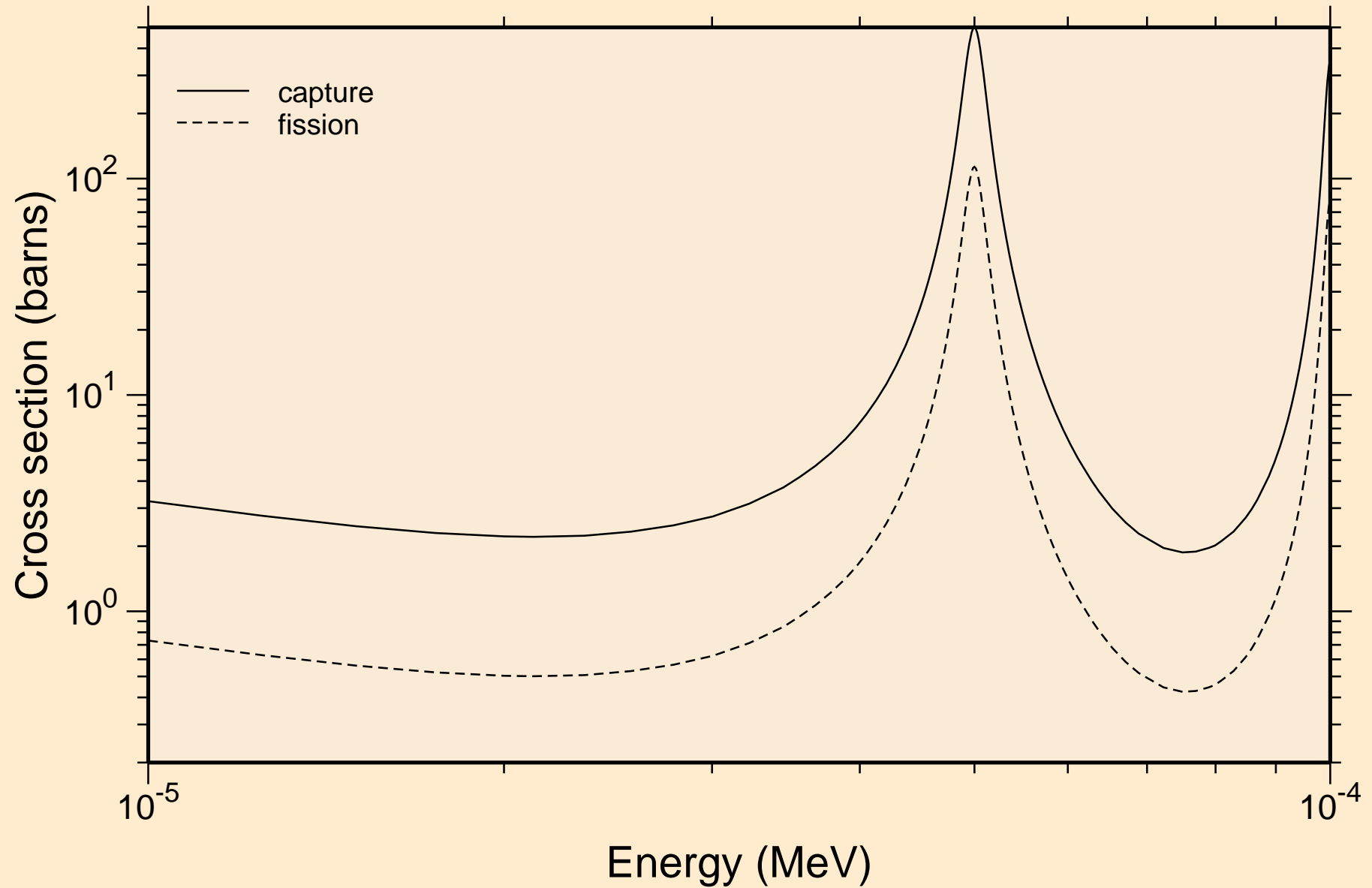

LR265 NRG TENDL-2015, AKONING
resonance absorption cross sections

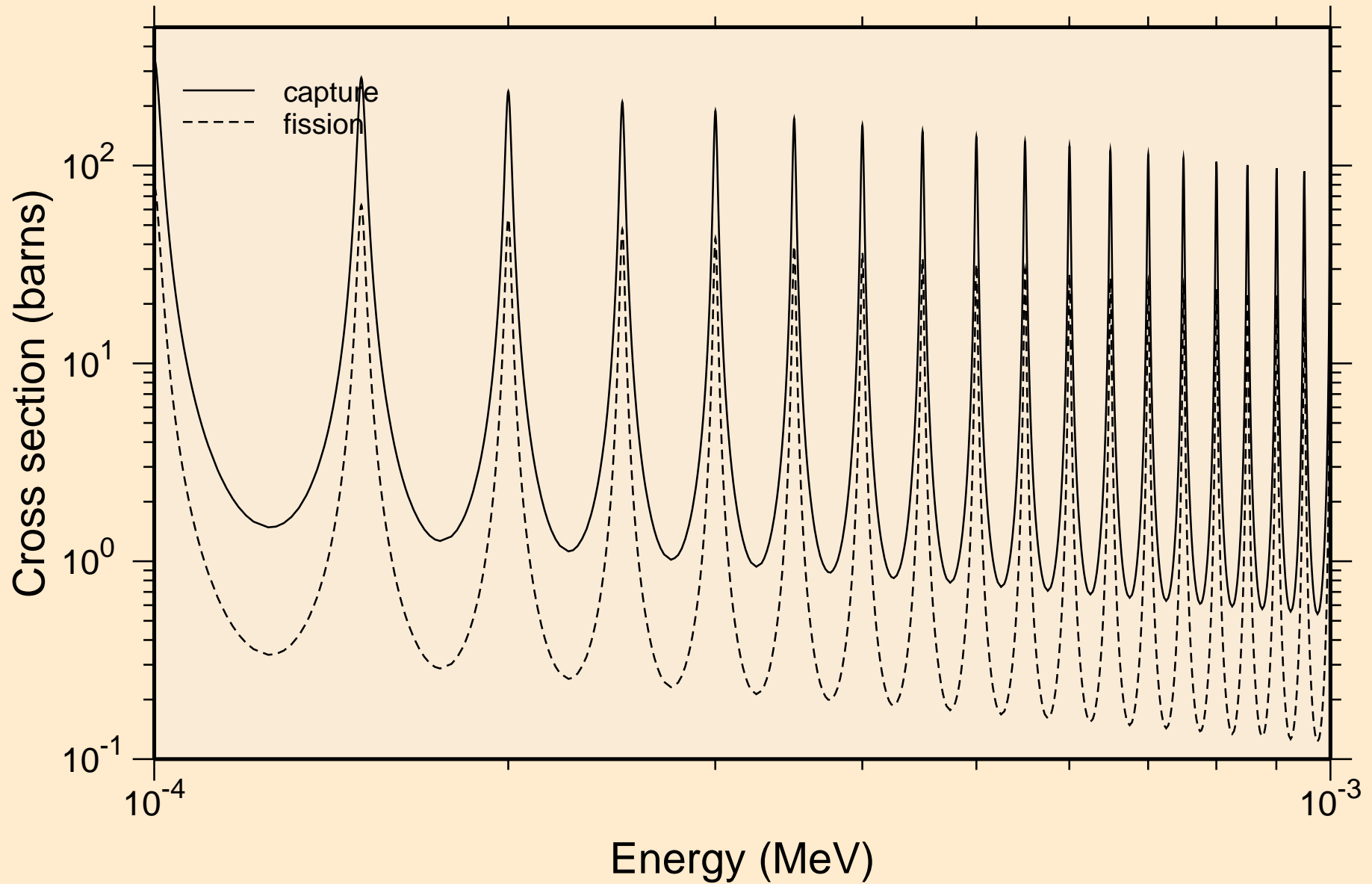

LR265 NRG TENDL-2015, AKONING
resonance absorption cross sections

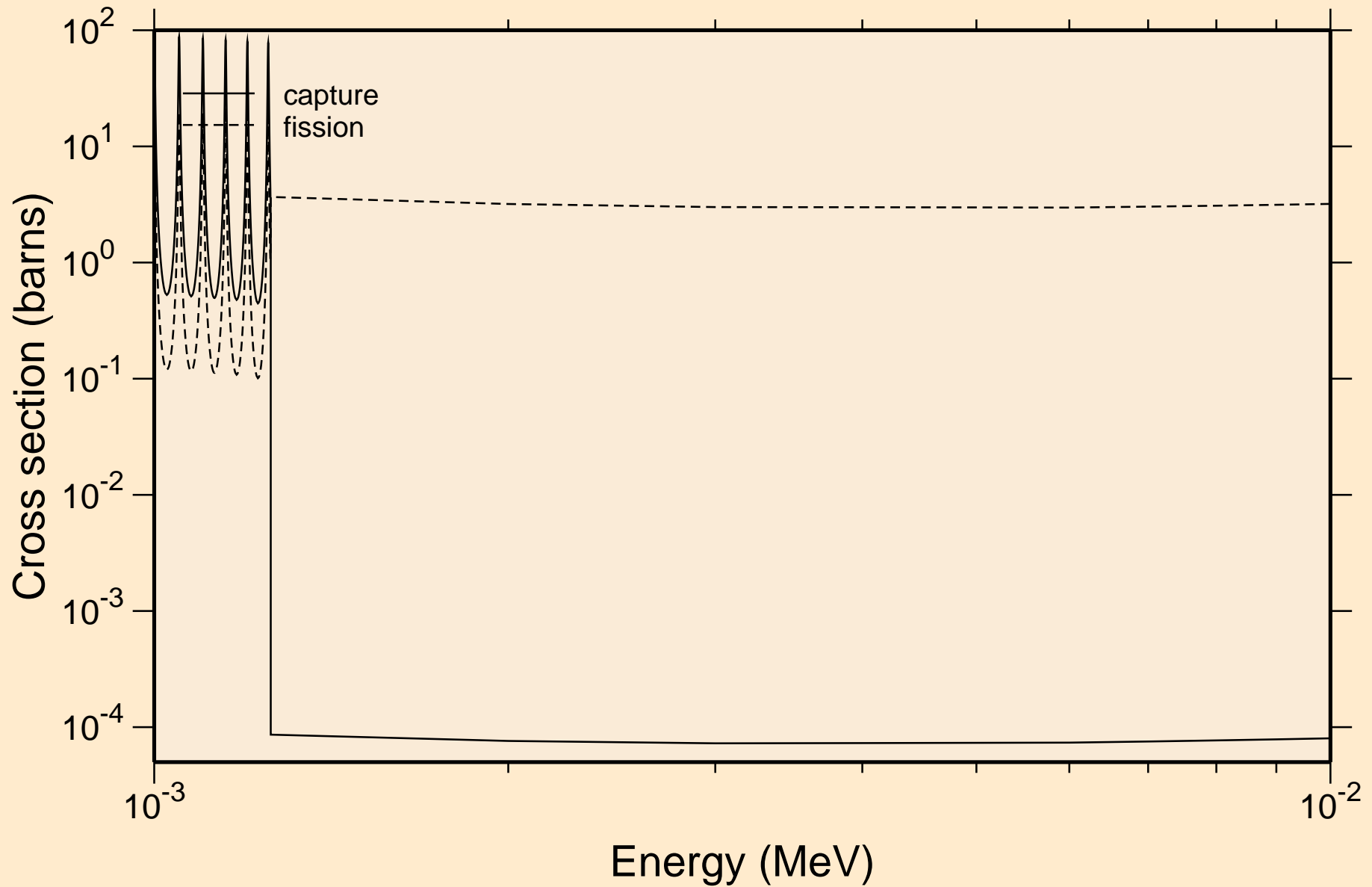

LR265 NRG TENDL-2015, AKONING

resonance absorption cross sections

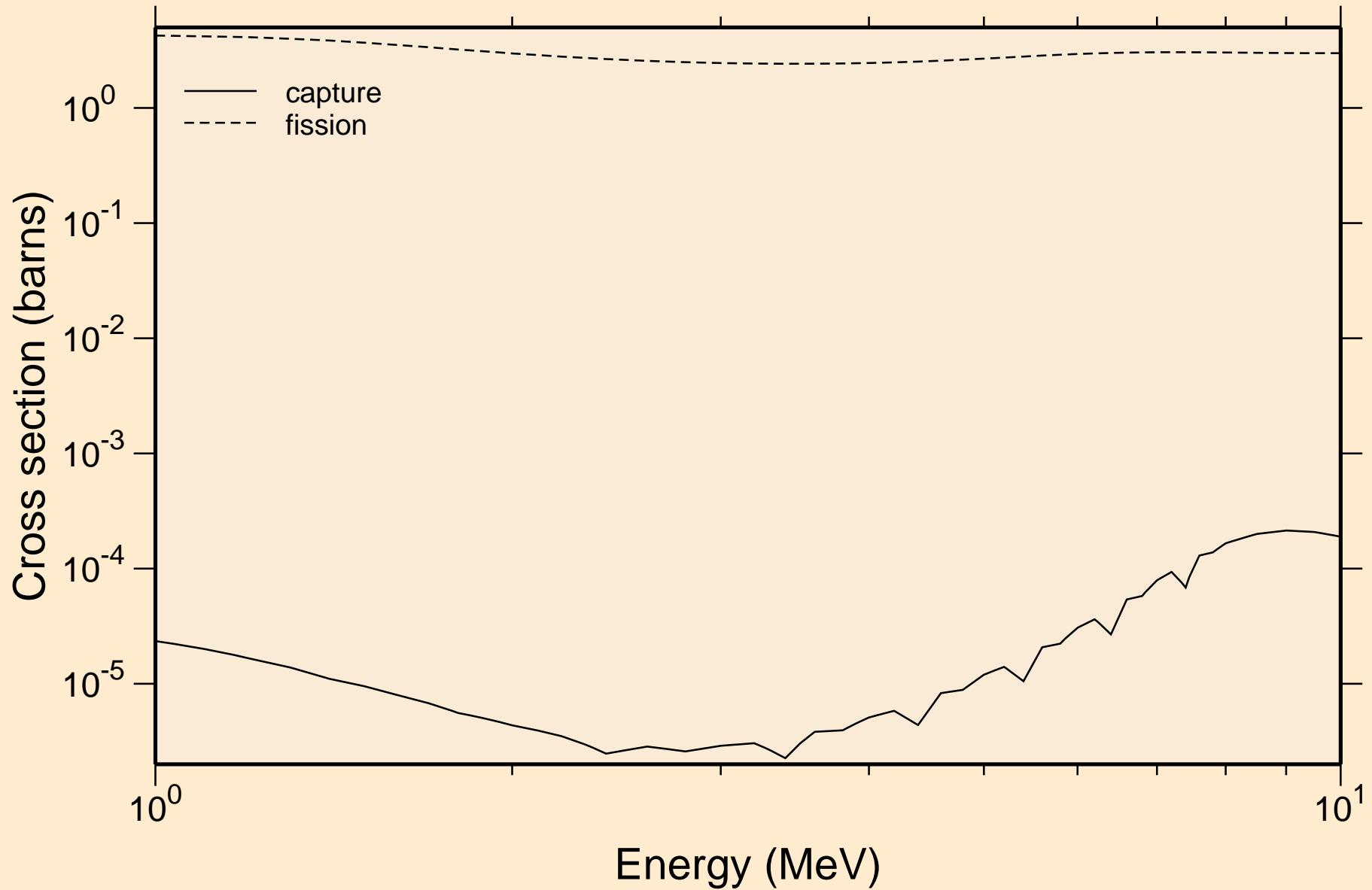

LR265 NRG TENDL-2015, AKONING

Non-threshold reactions

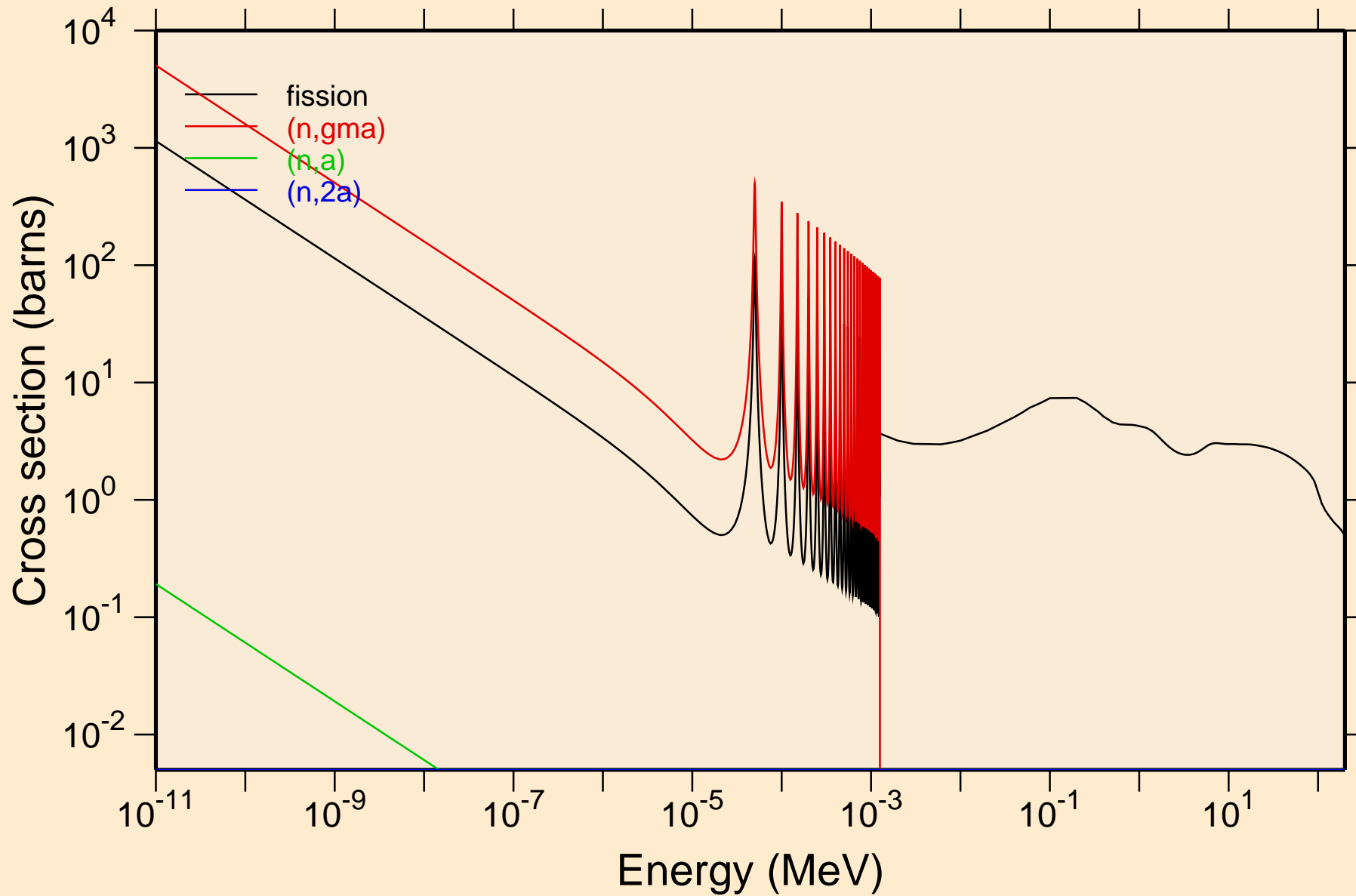

LR265 NRG TENDL-2015, AKONING

Principal cross sections

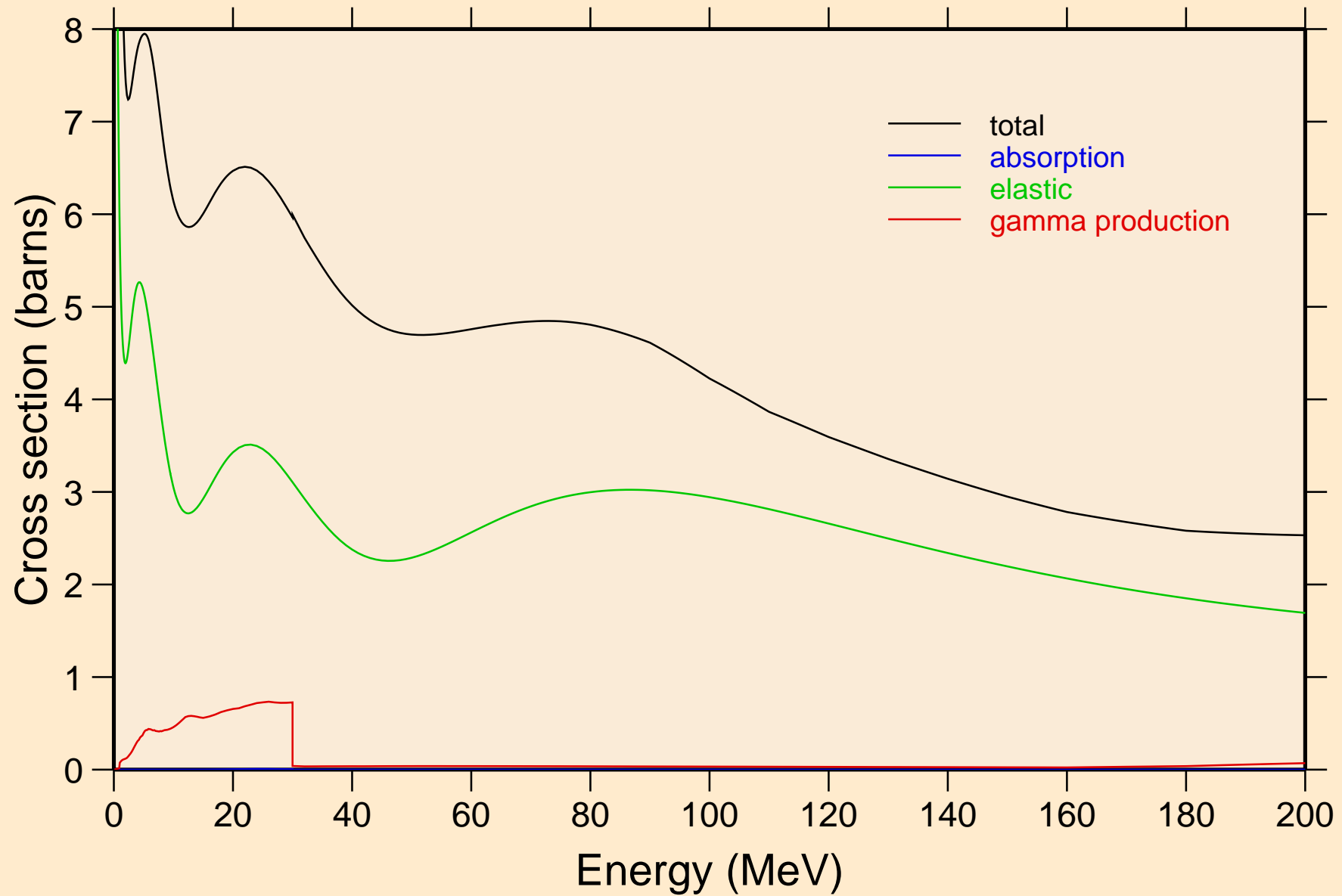

LR265 NRG TENDL-2015, AKONING

Non-threshold reactions

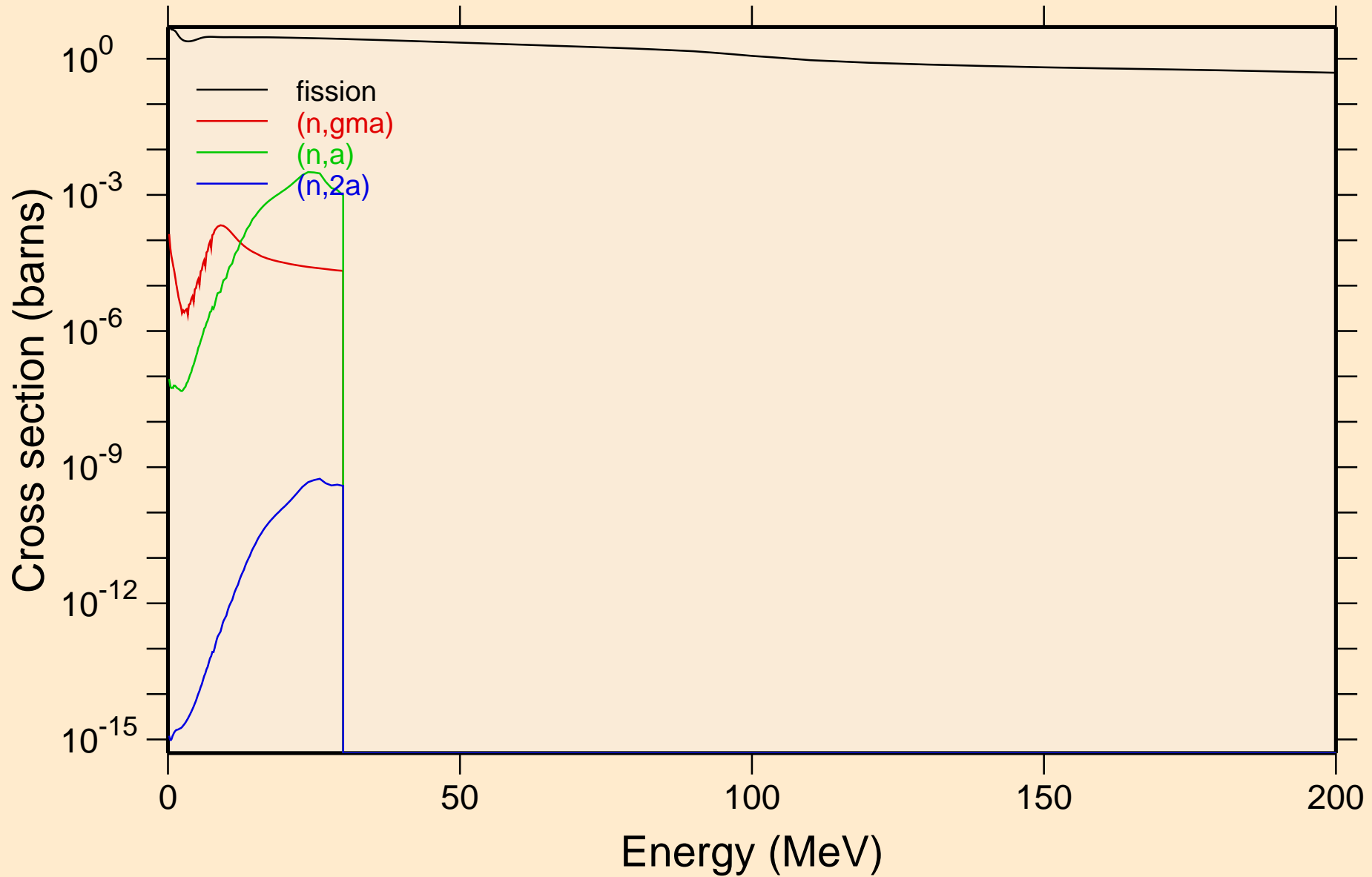

LR265 NRG TENDL-2015, AKONING
Inelastic levels

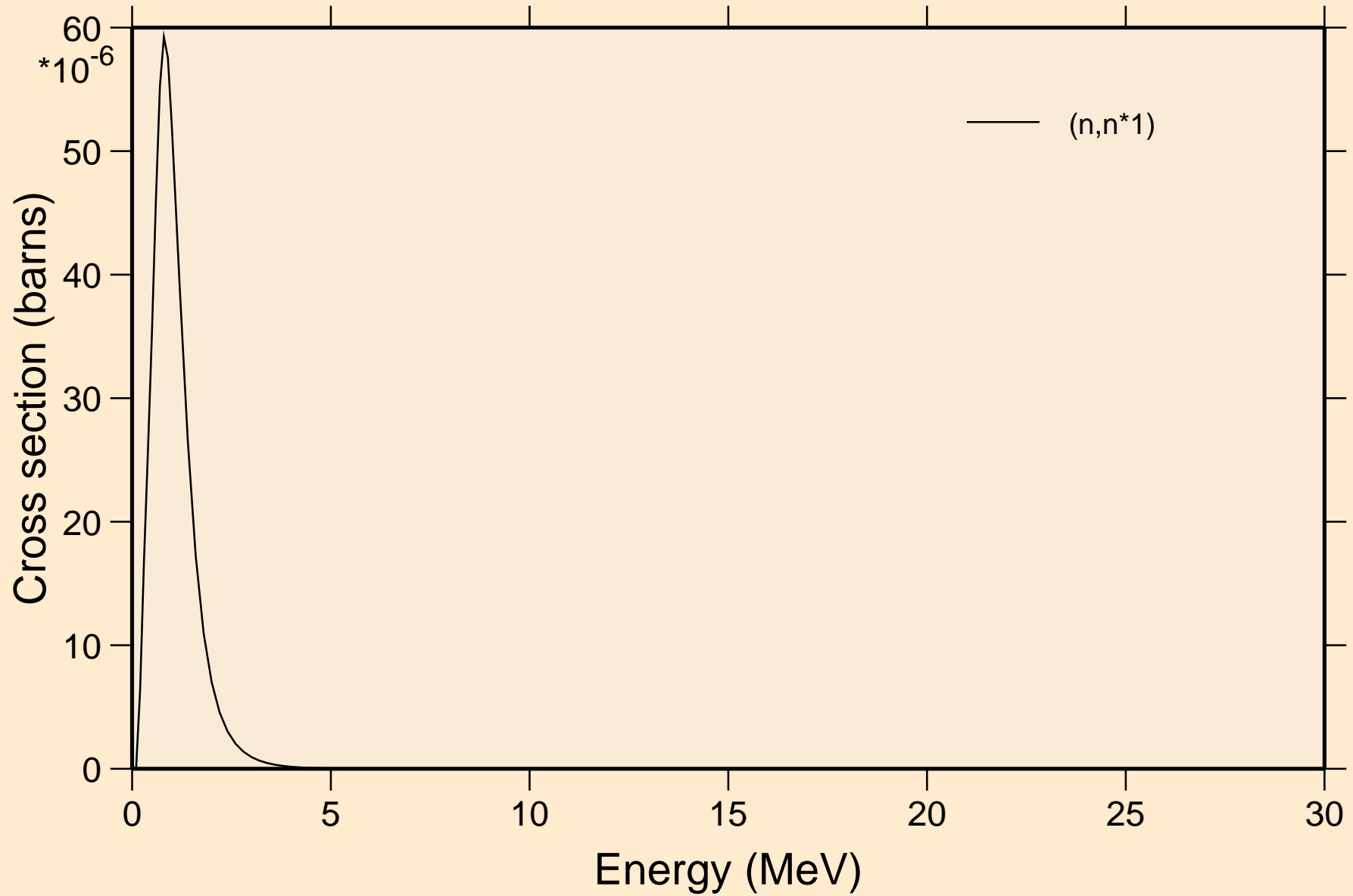

LR265 NRG TENDL-2015, AKONING

Threshold reactions

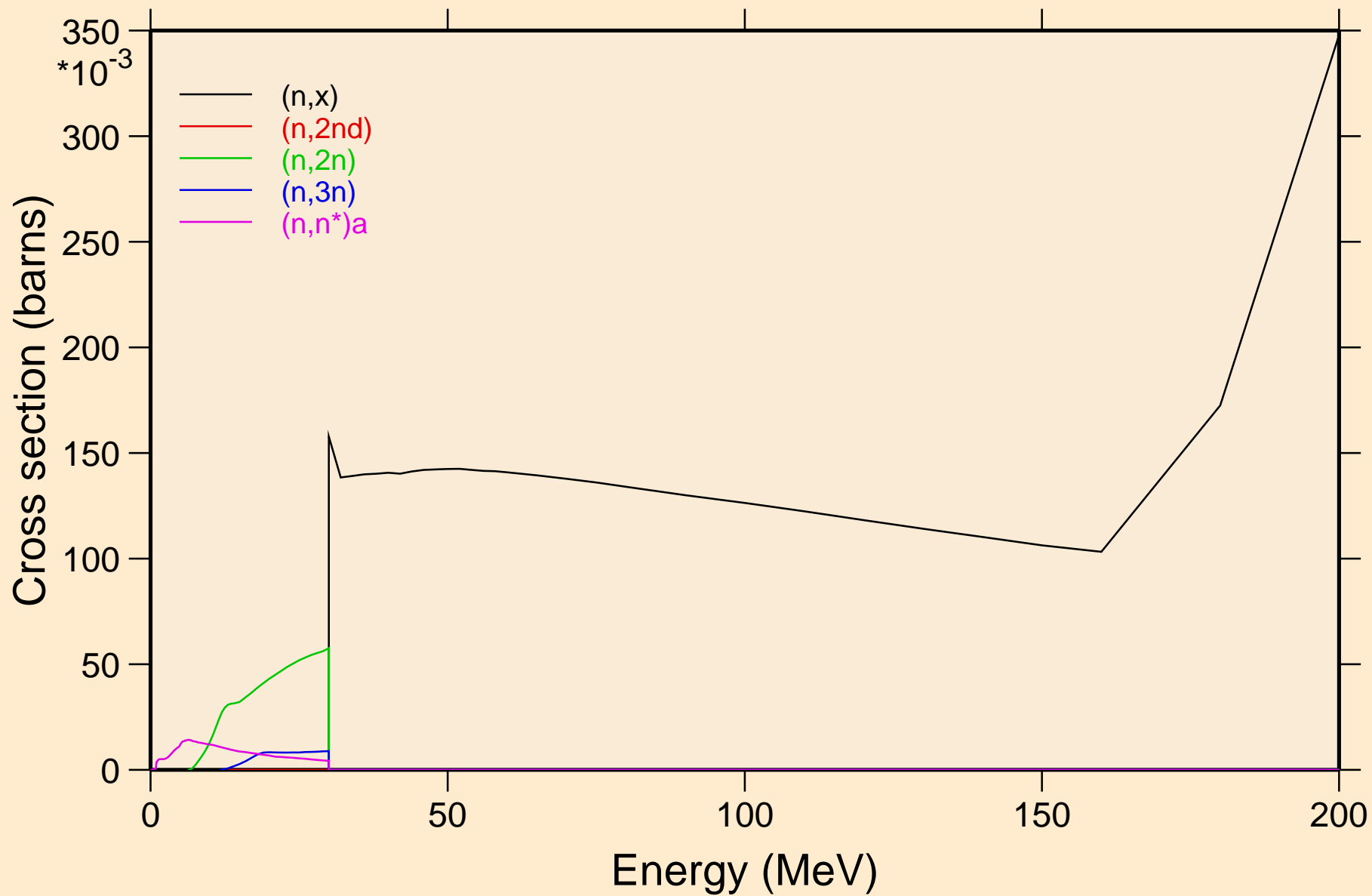

LR265 NRG TENDL-2015, AKONING

Threshold reactions

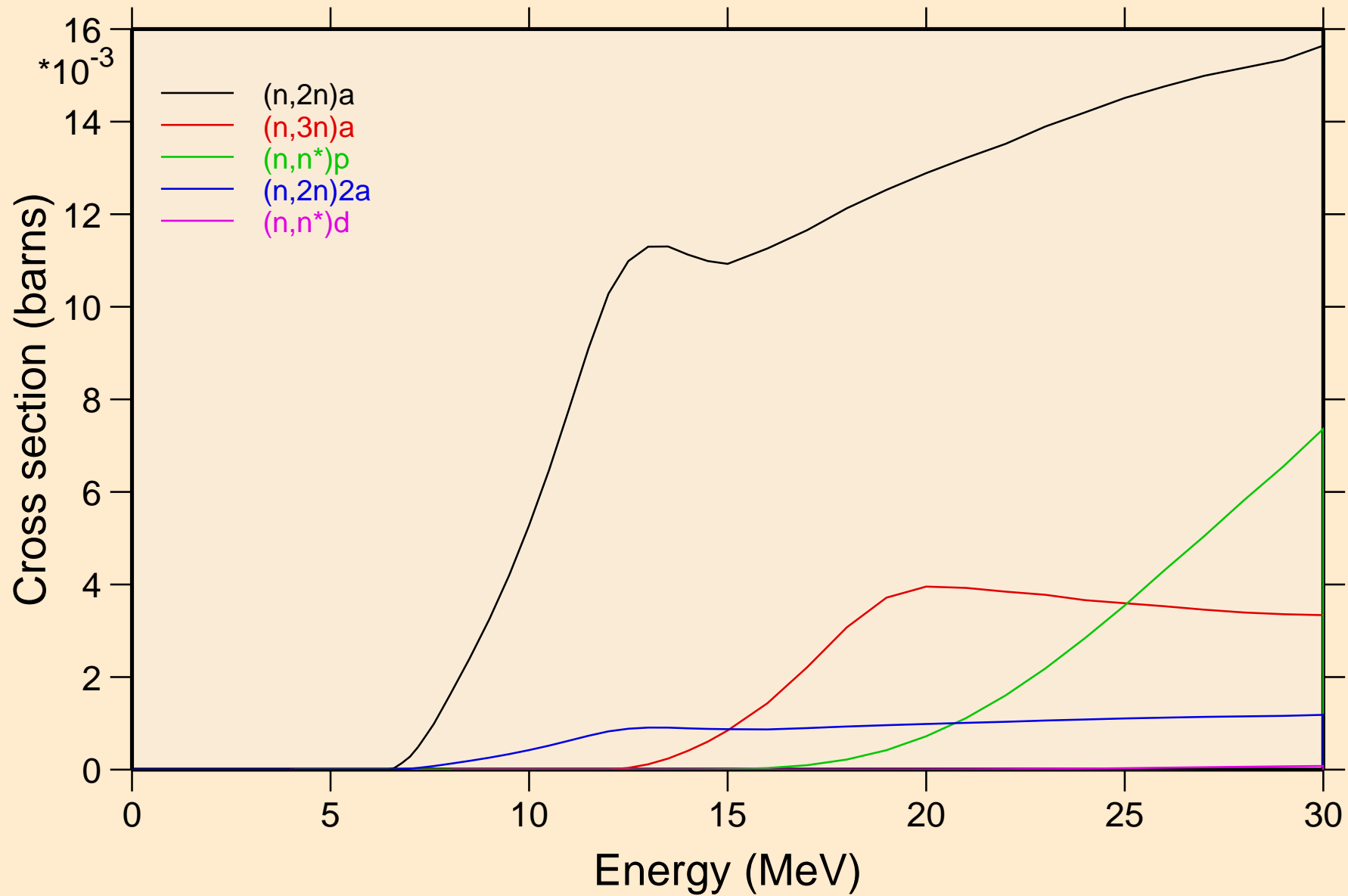

LR265 NRG TENDL-2015, AKONING

Threshold reactions

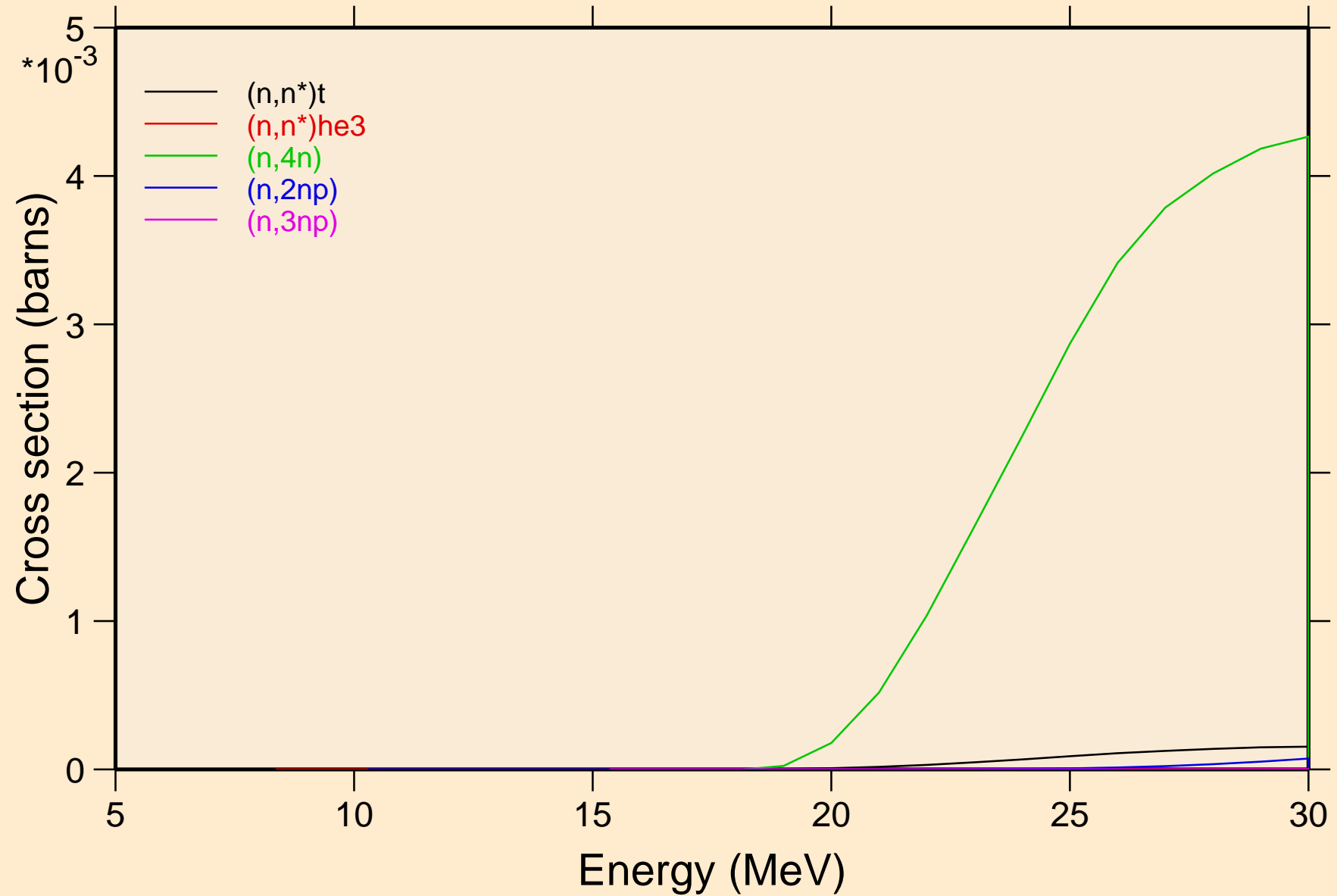

LR265 NRG TENDL-2015, AKONING

Threshold reactions

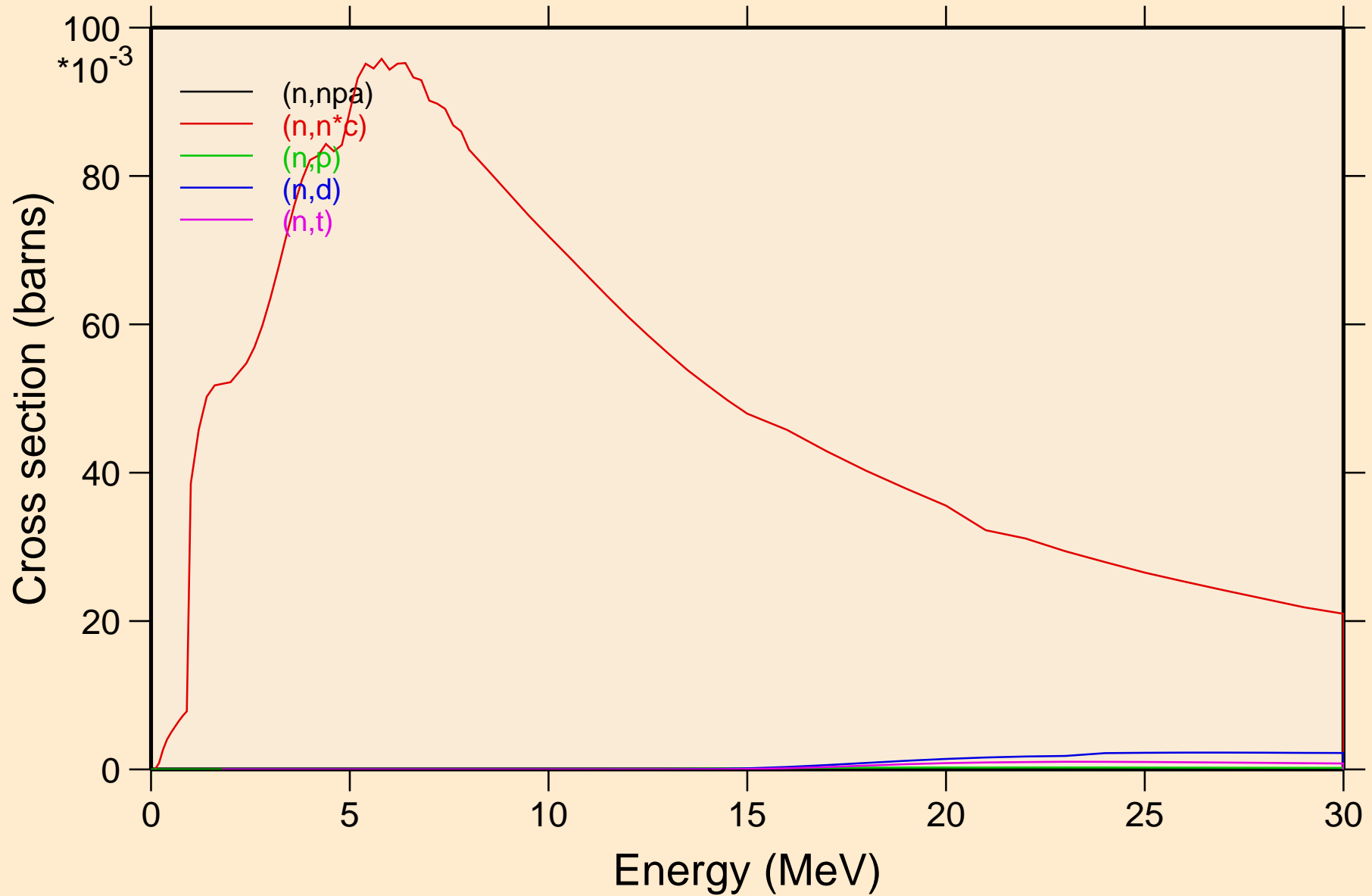

LR265 NRG TENDL-2015, AKONING

Threshold reactions

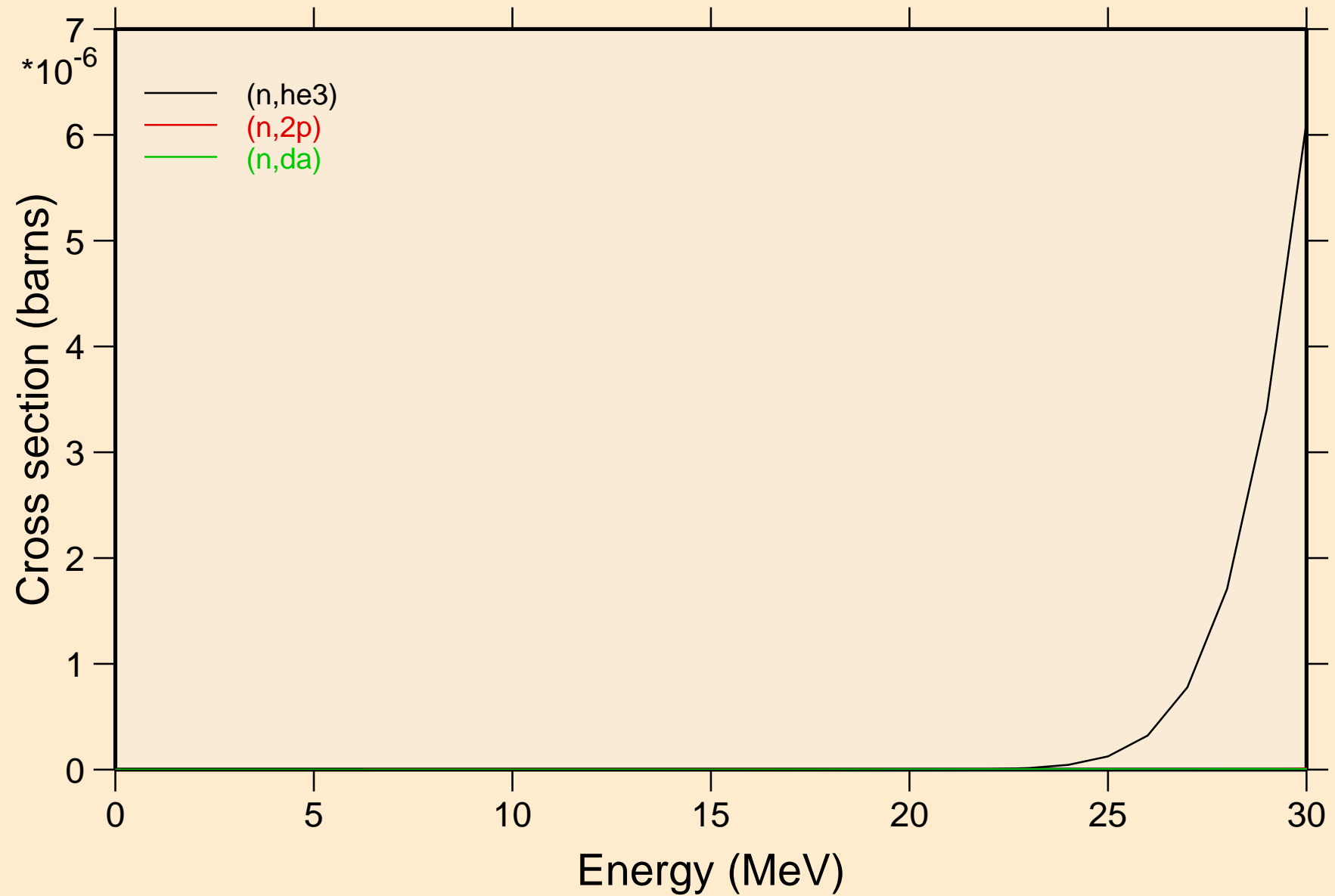

LR265 NRG TENDL-2015, AKONING
angular distribution for elastic

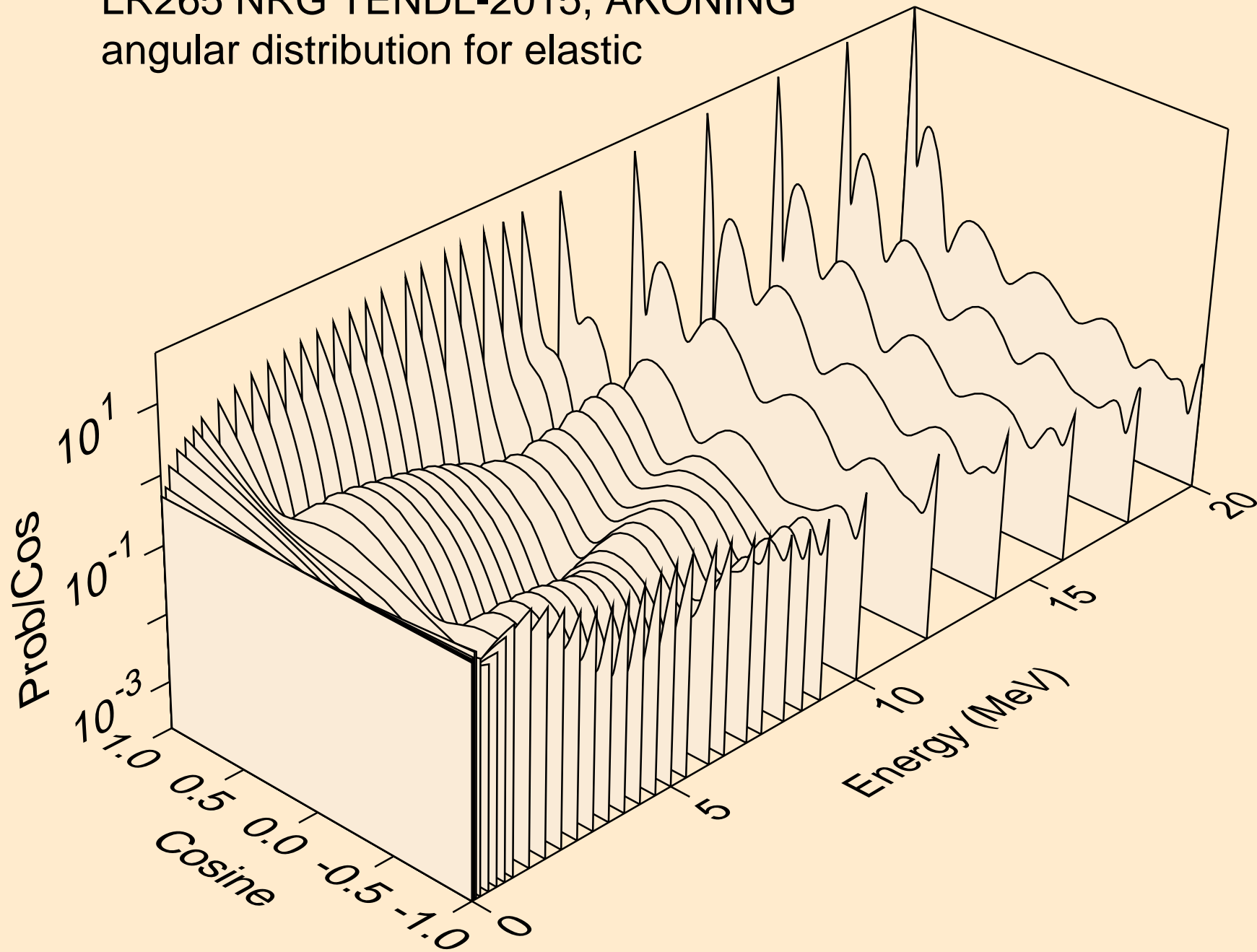

LR265 NRG TENDL-2015, AKONING
angular distribution for elastic

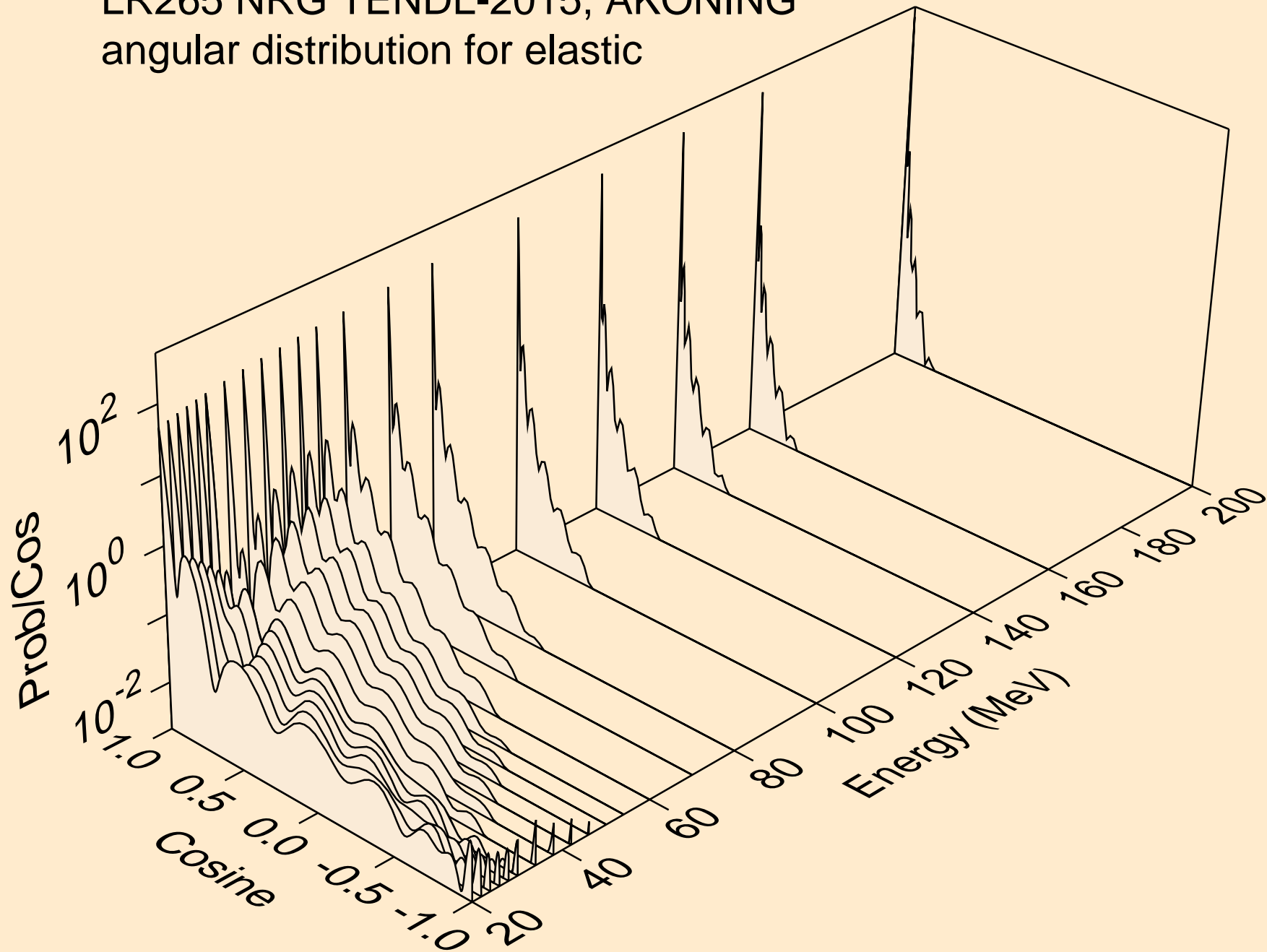

LR265 NRG TENDL-2015, AKONING
angular distribution for (n,n*1)

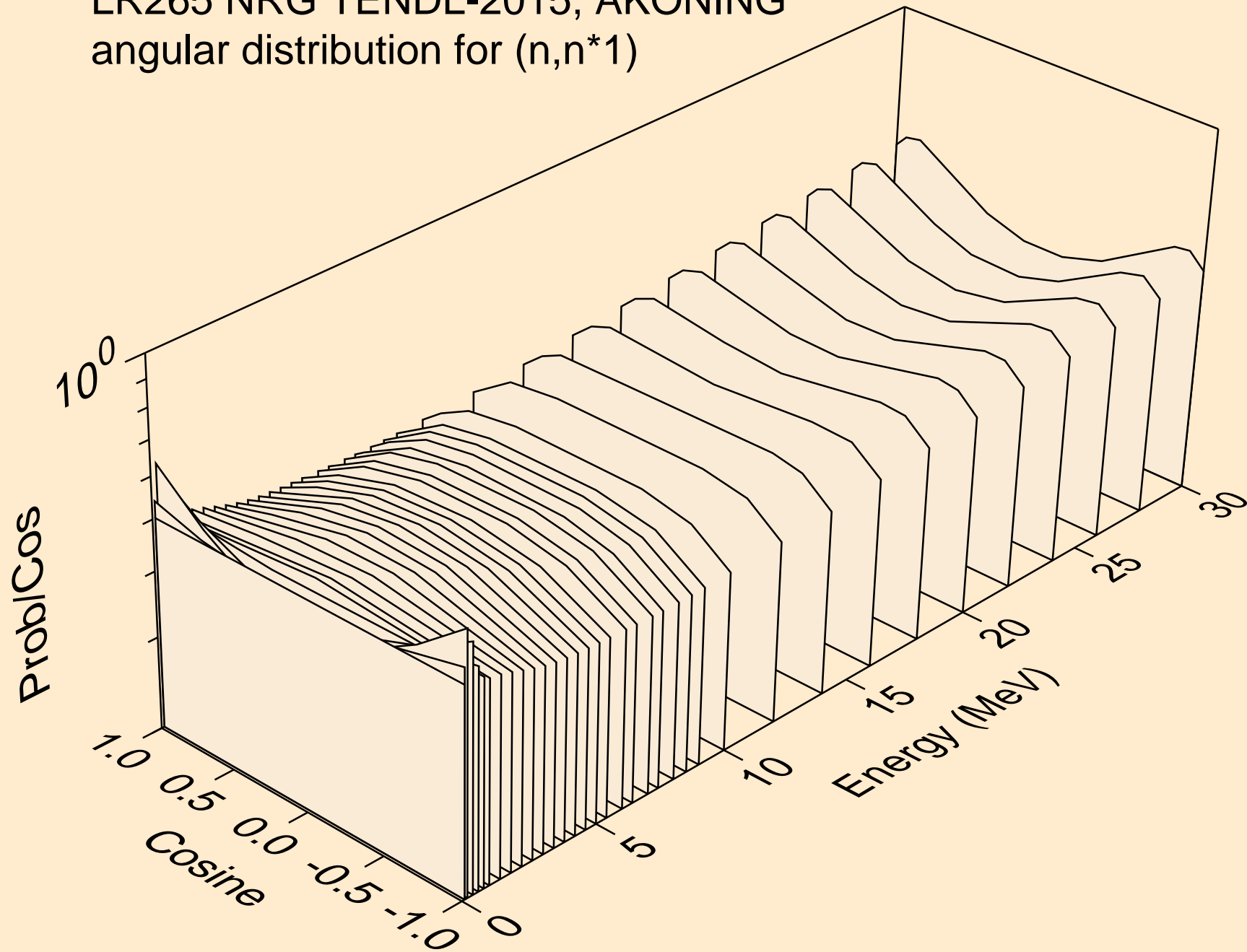

LR265 NRG TENDL-2015, AKONING

Total fission nubar

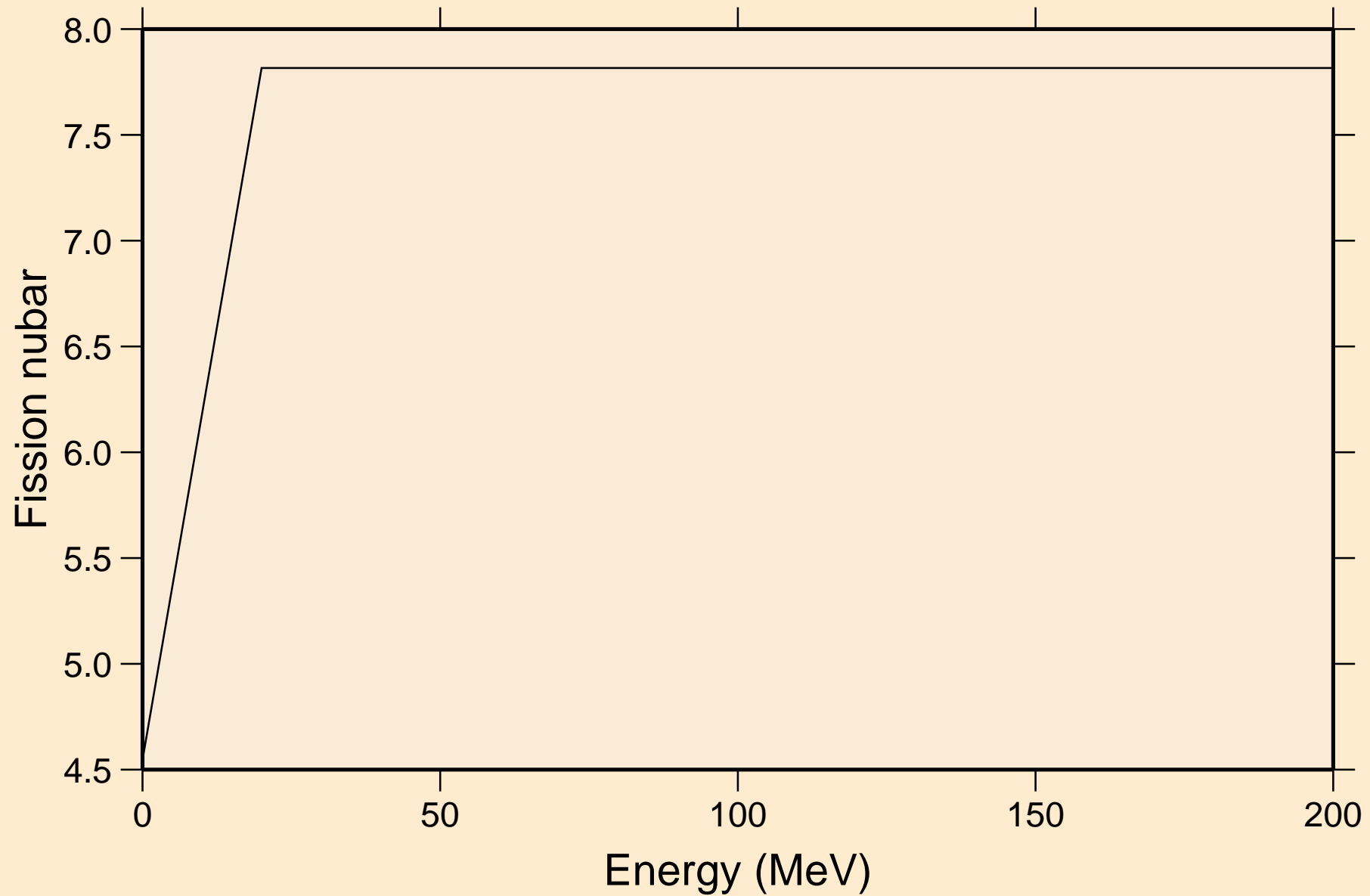

LR265 NRG TENDL-2015, AKONING
Neutron emission for (n,x)

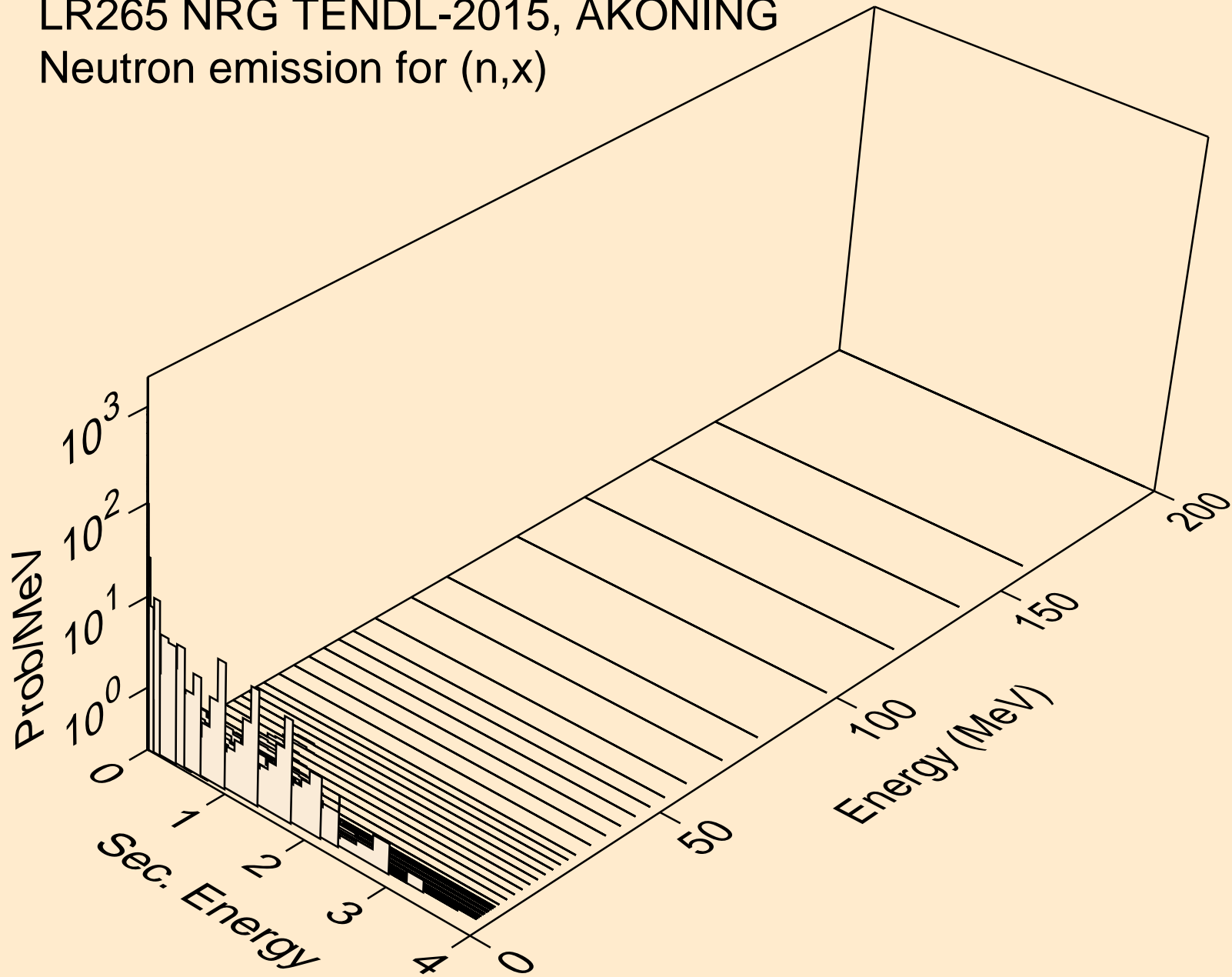

LR265 NRG TENDL-2015, AKONING
Neutron emission for (n,2nd)

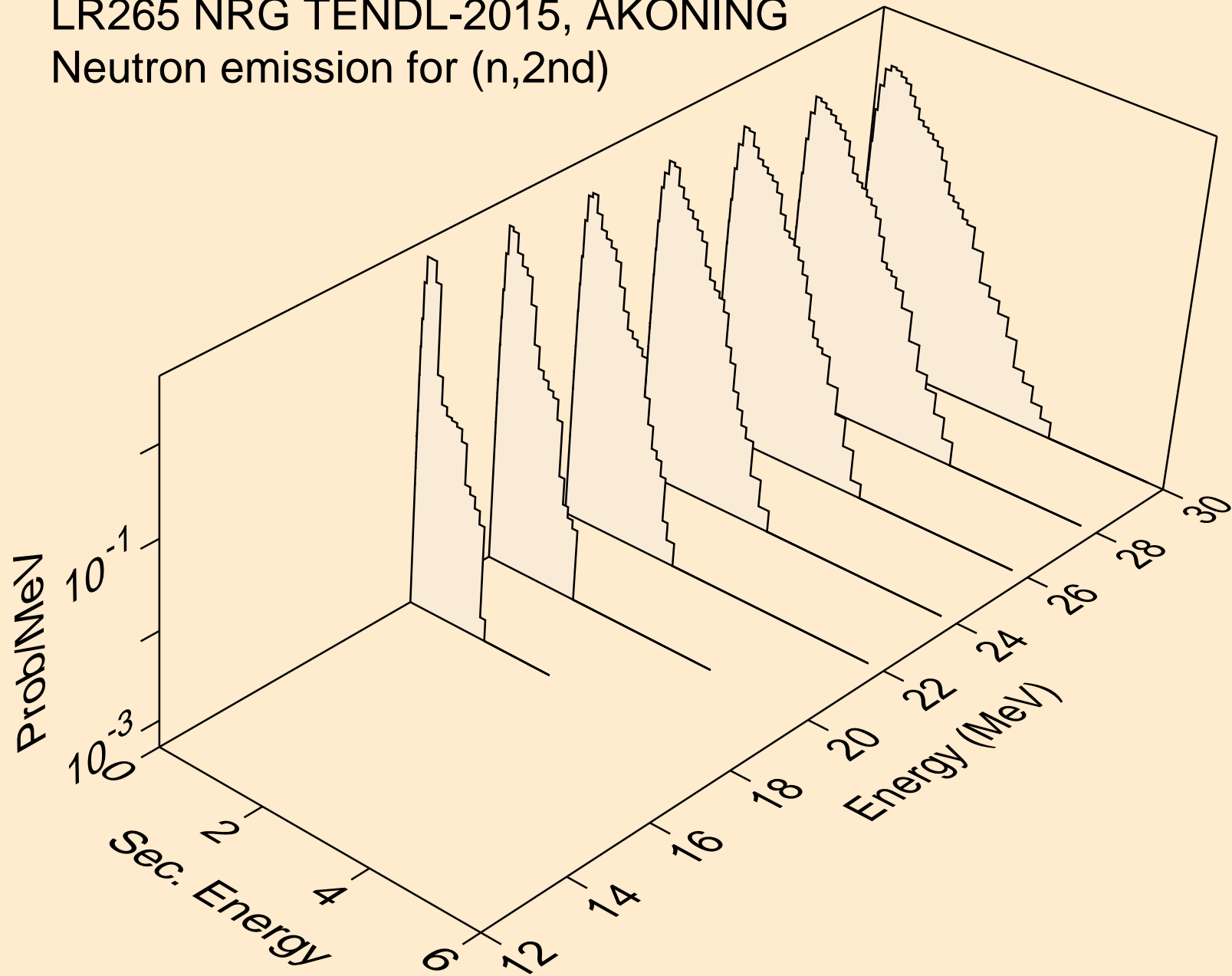

LR265 NRG TENDL-2015, AKONING
Neutron emission for (n,2n)

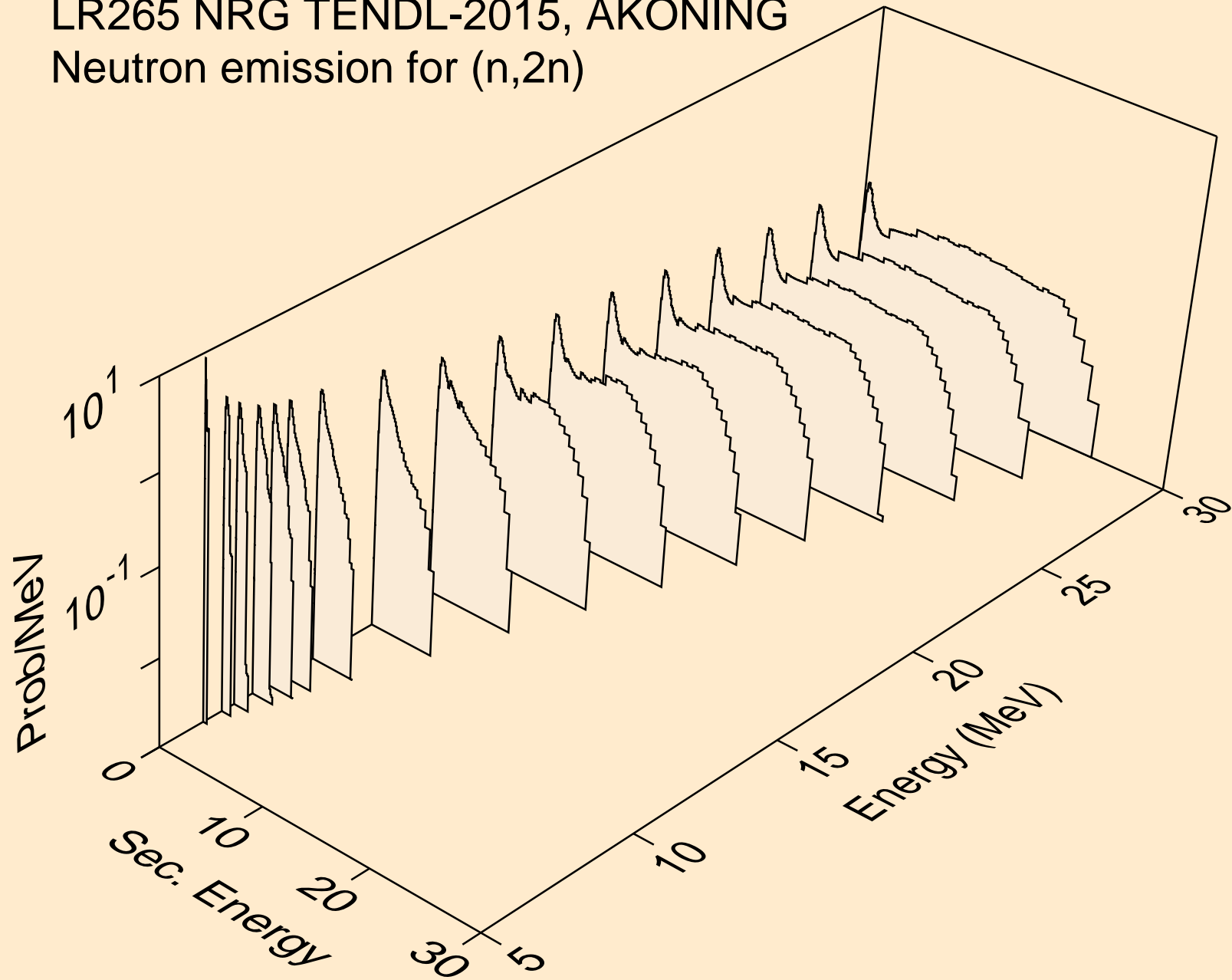

LR265 NRG TENDL-2015, AKONING
Neutron emission for (n,3n)

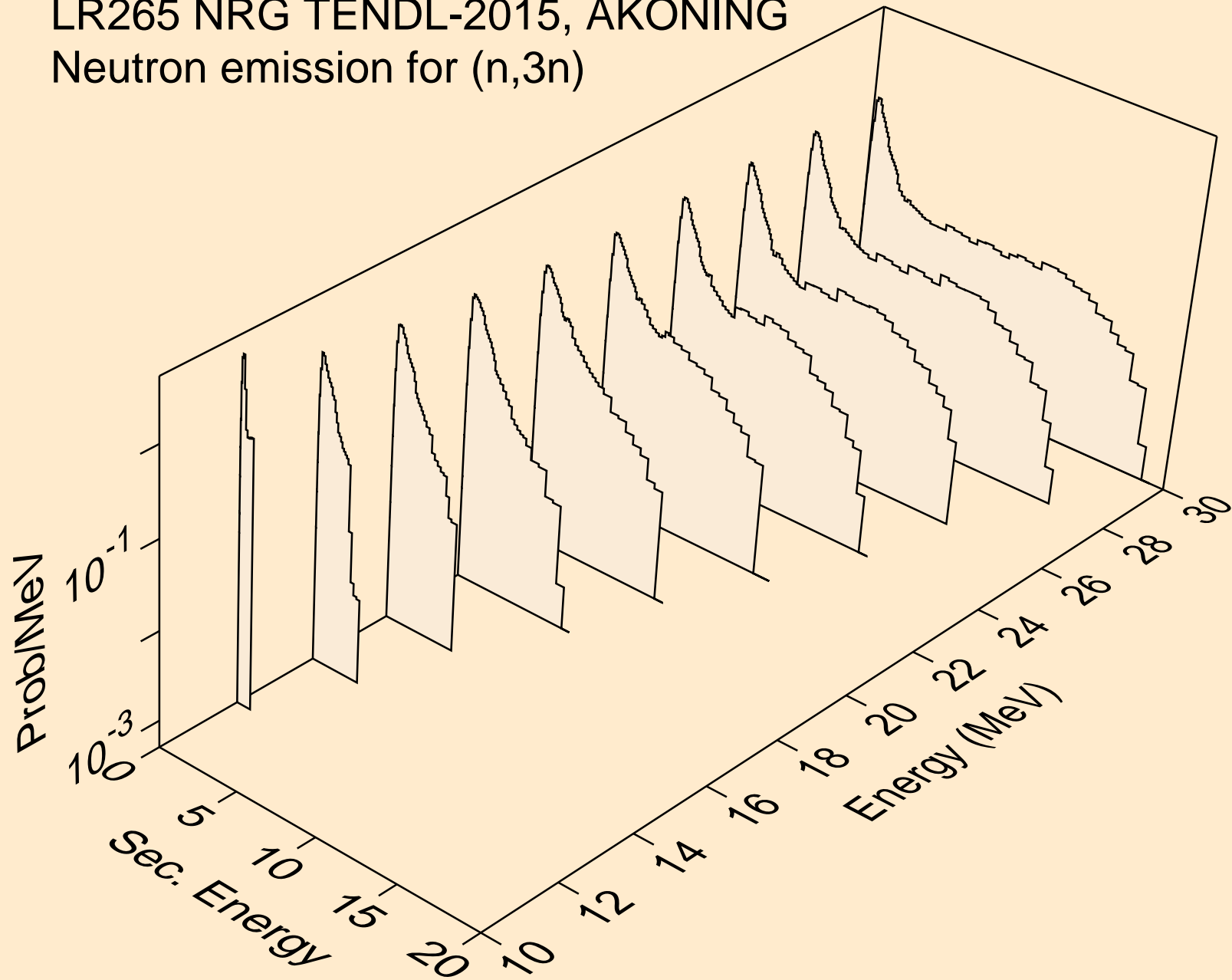

LR265 NRG TENDL-2015, AKONING
Neutron emission for fission

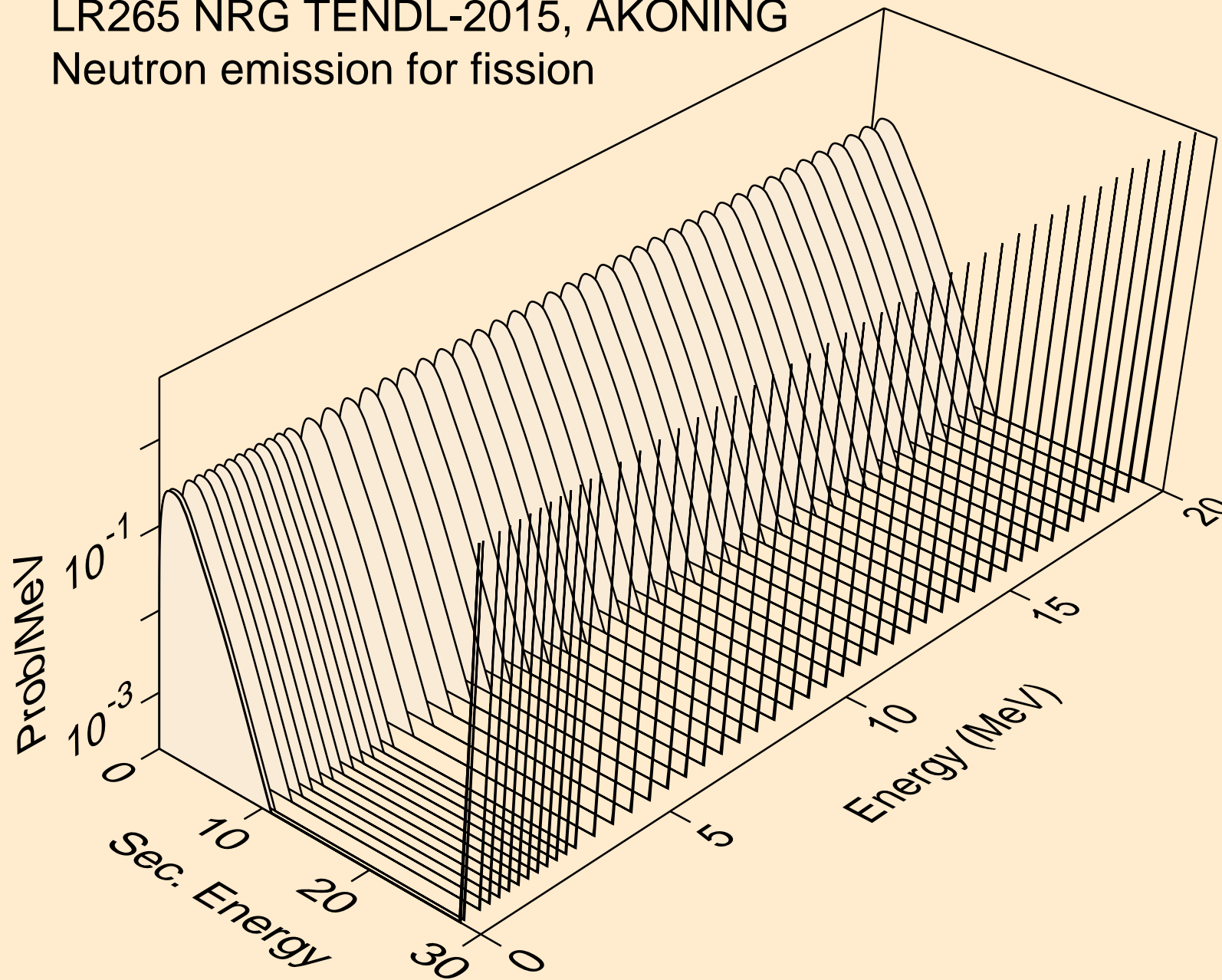

LR265 NRG TENDL-2015, AKONING
Neutron emission for (n,n*)a

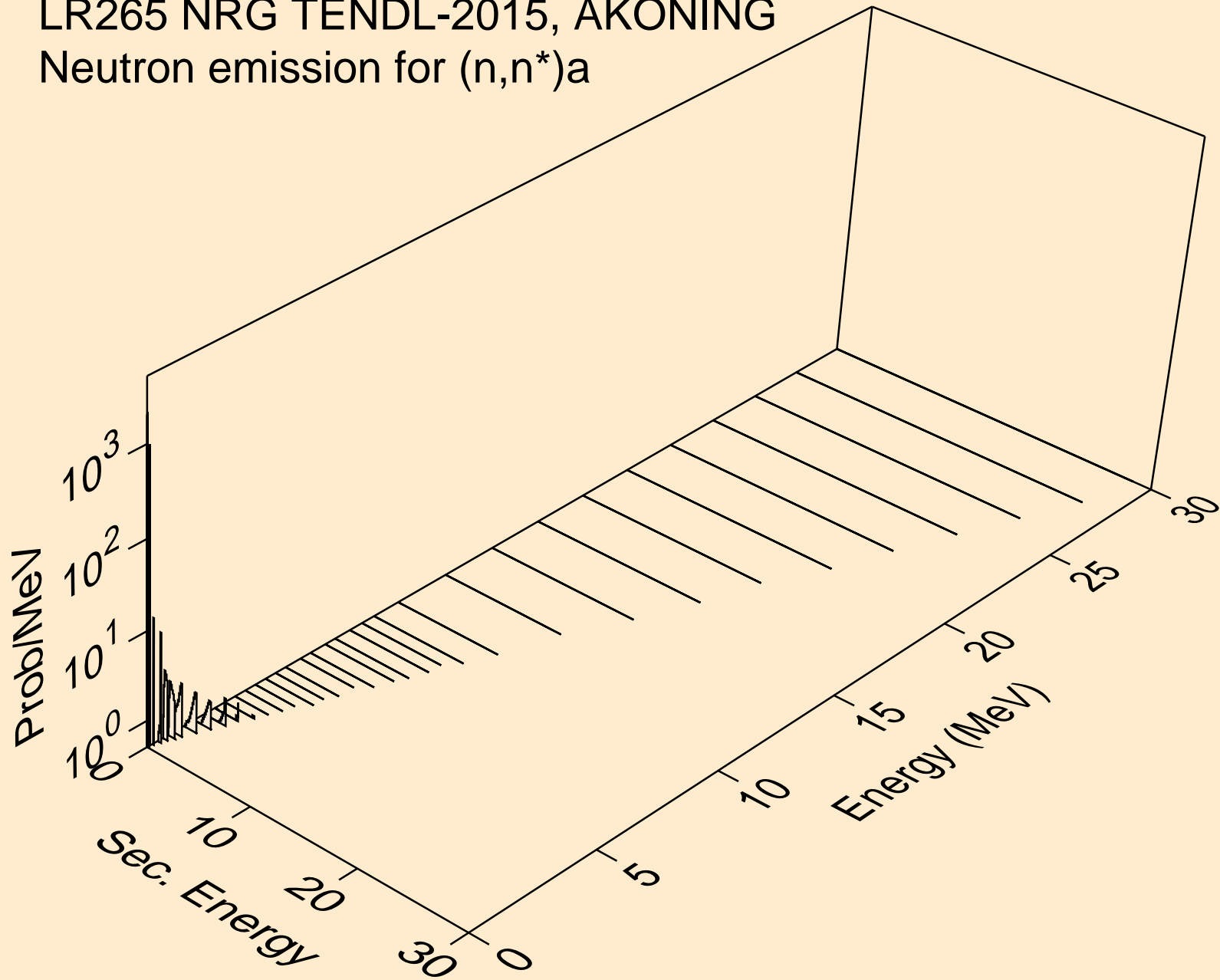

LR265 NRG TENDL-2015, AKONING
Neutron emission for (n,2n)a

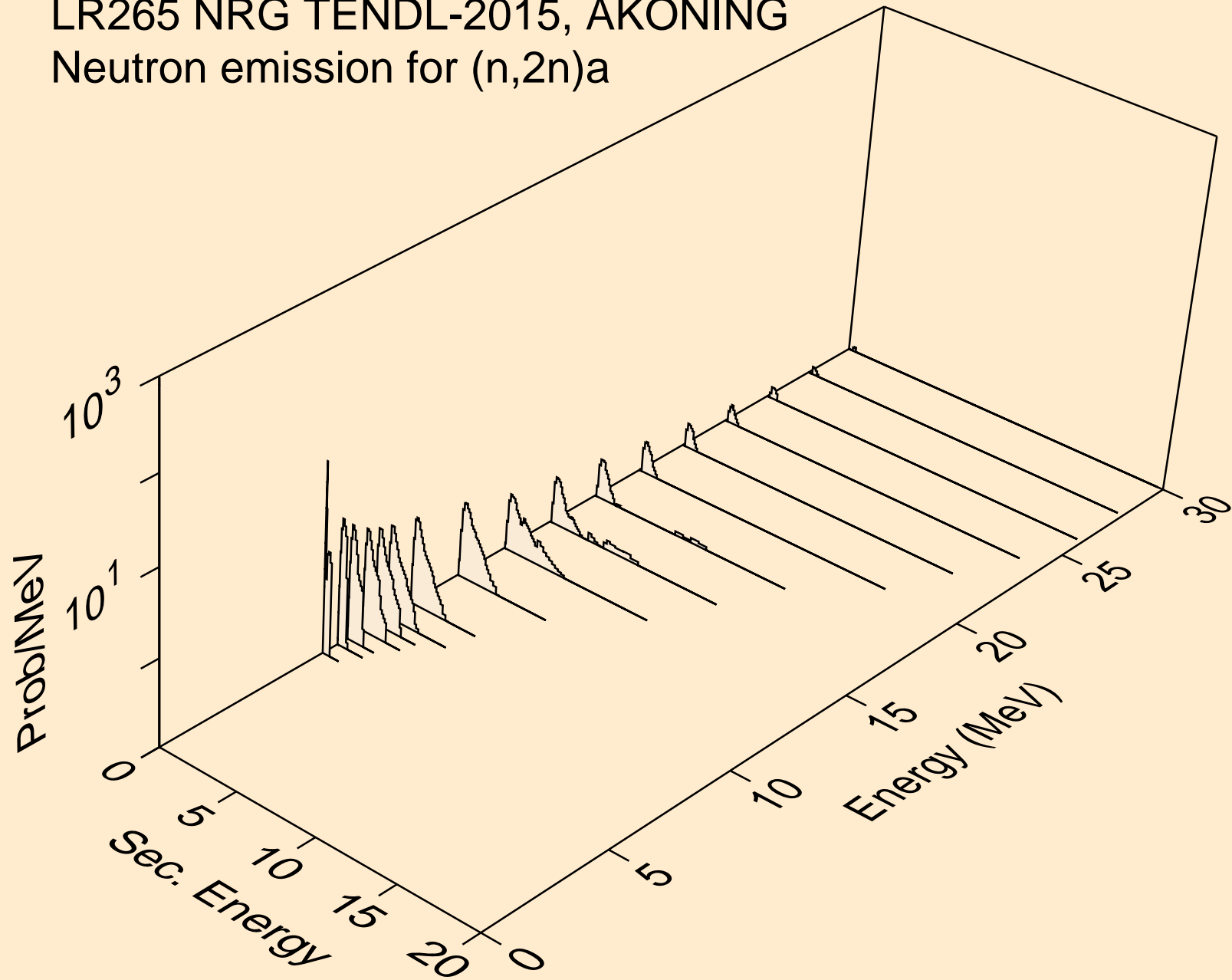

LR265 NRG TENDL-2015, AKONING
Neutron emission for (n,3n)a

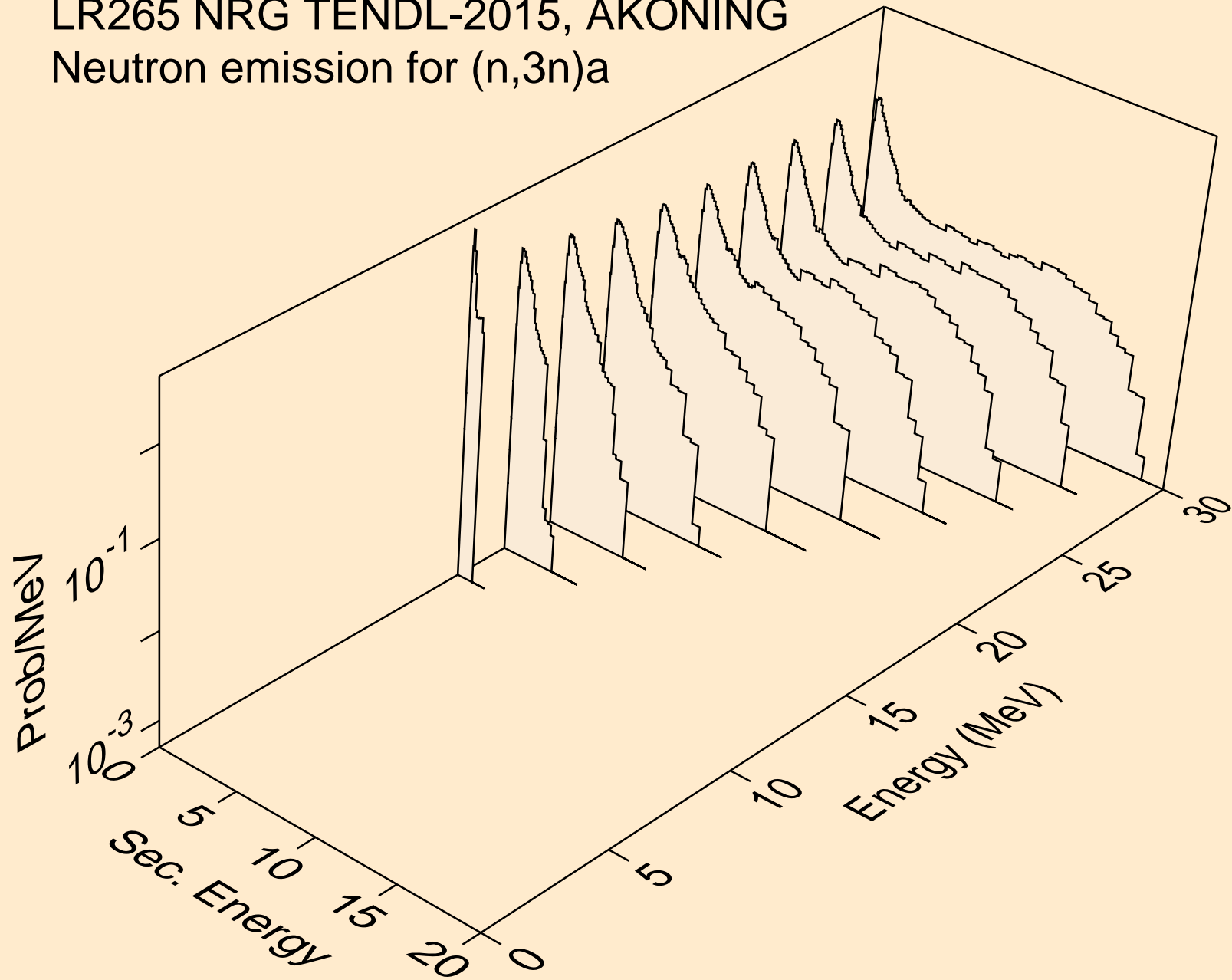

LR265 NRG TENDL-2015, AKONING
Neutron emission for (n,n*)p

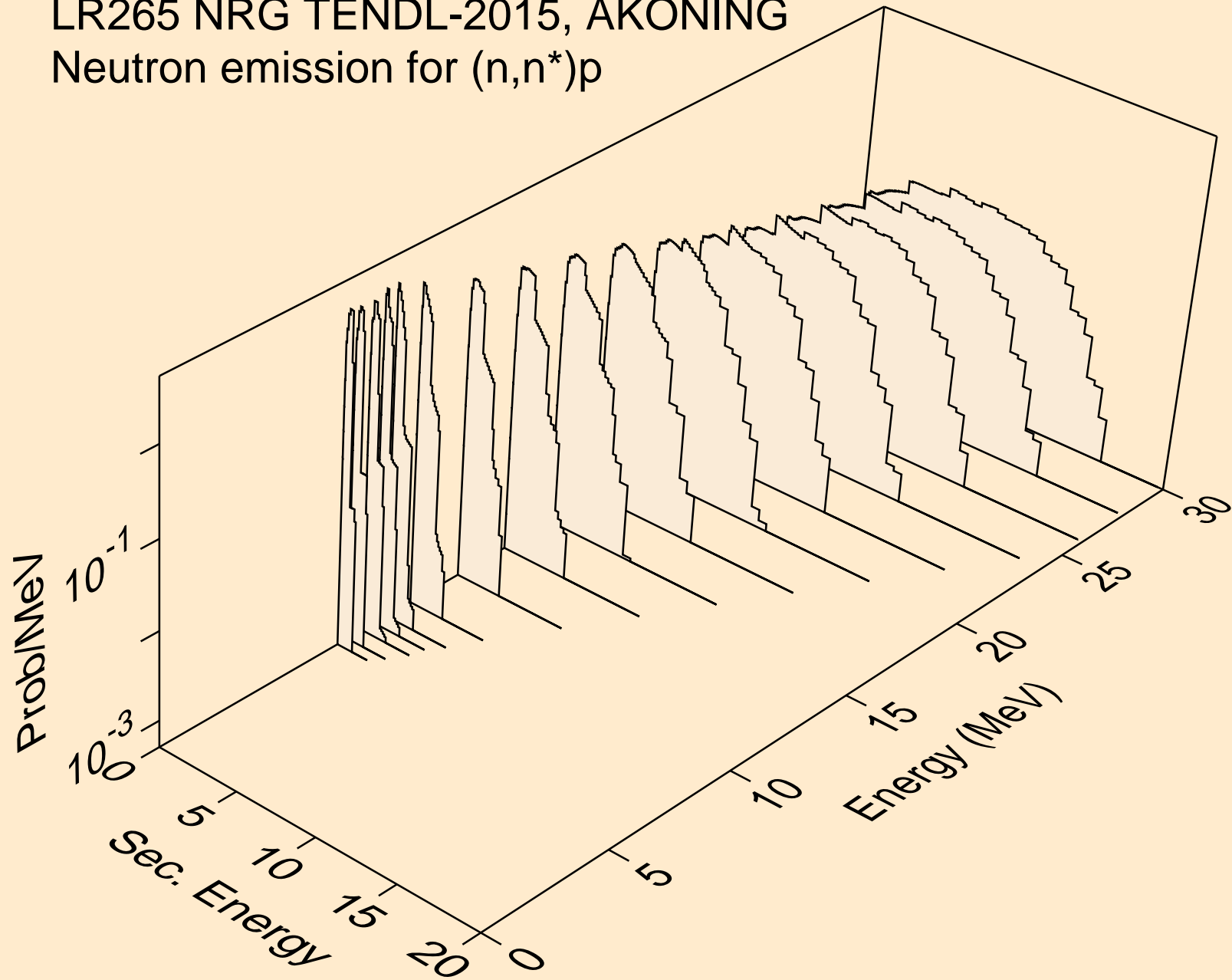

LR265 NRG TENDL-2015, AKONING
Neutron emission for (n,2n)2a

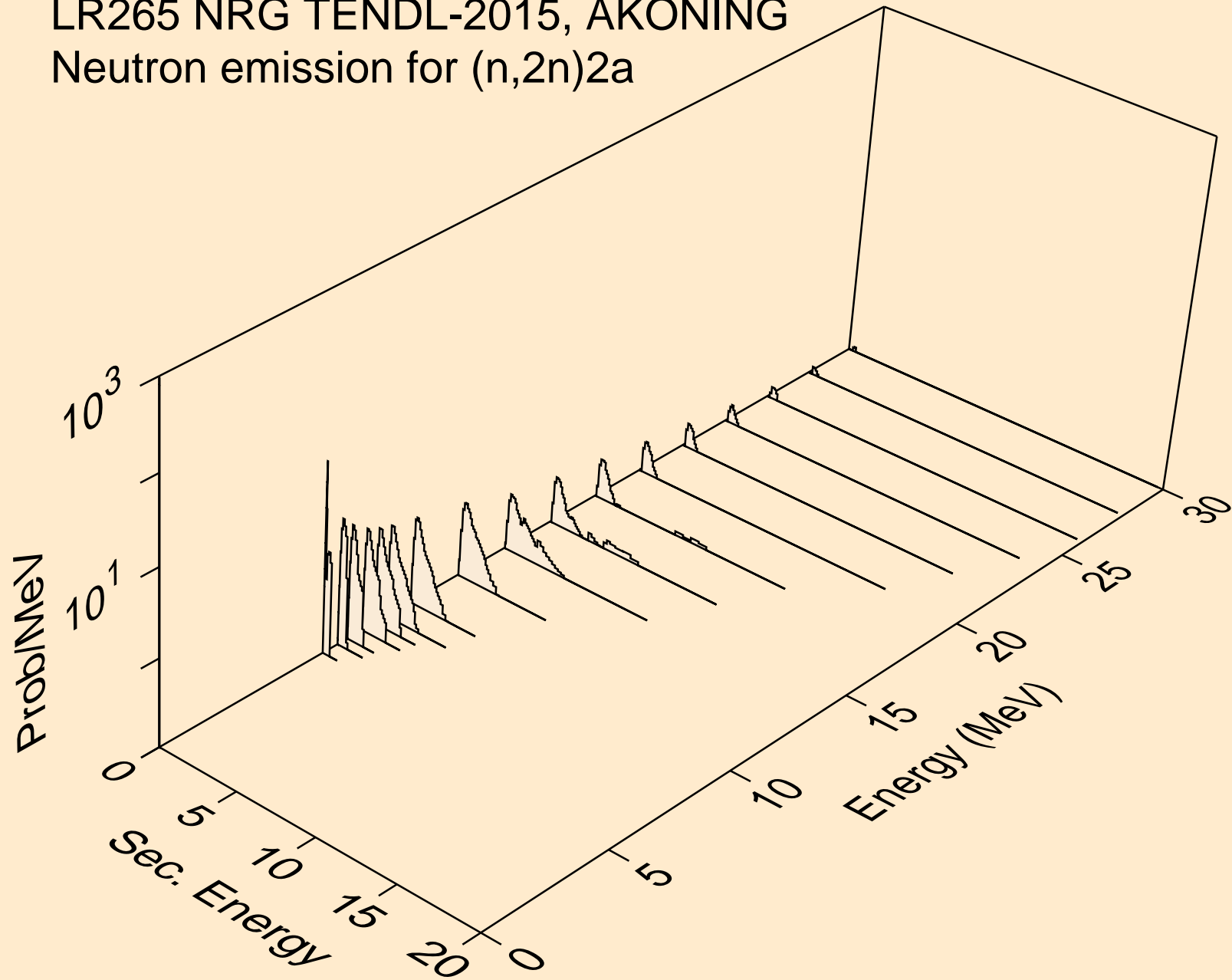

LR265 NRG TENDL-2015, AKONING
Neutron emission for (n,n*)d

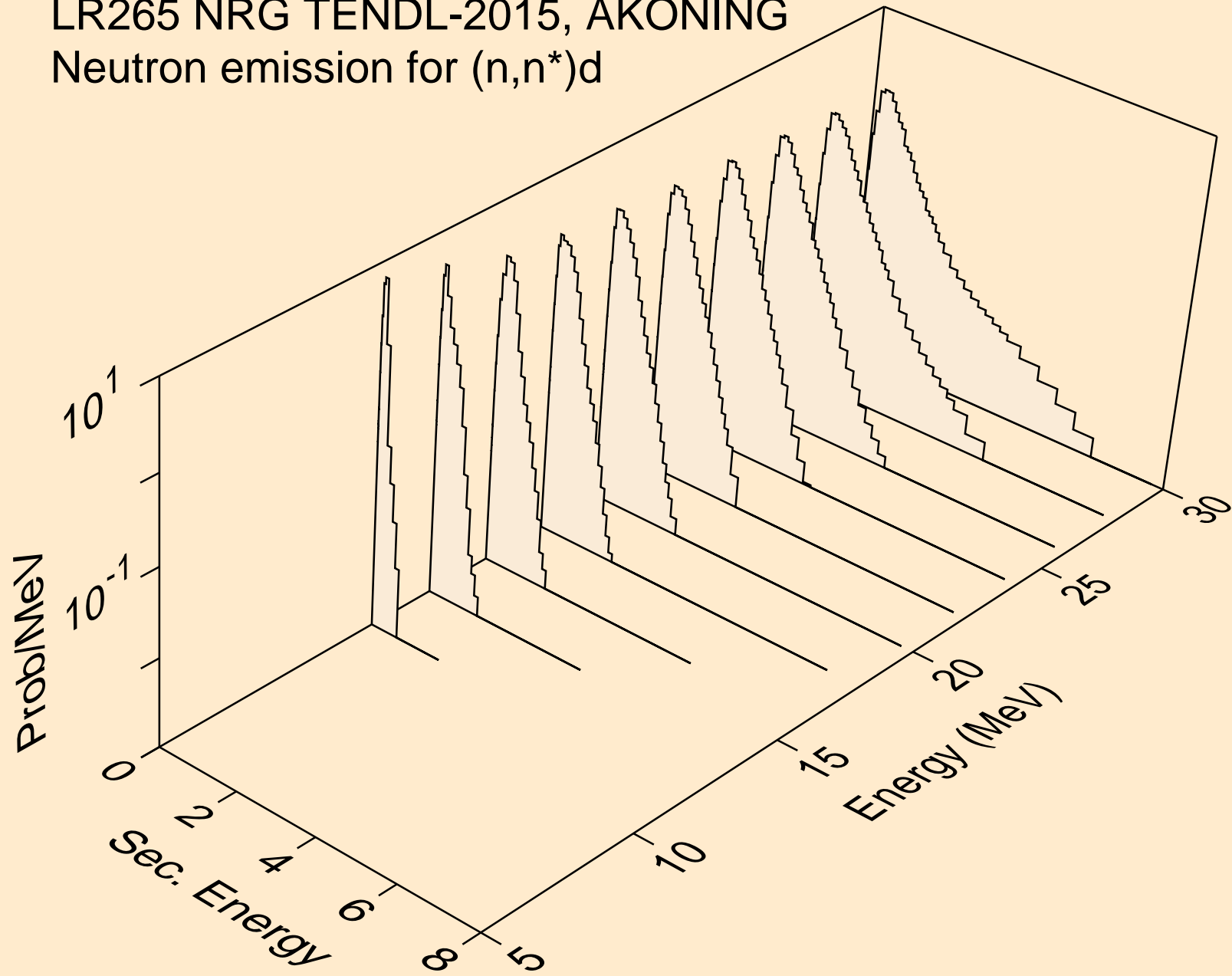

LR265 NRG TENDL-2015, AKONING
Neutron emission for (n,n*)t

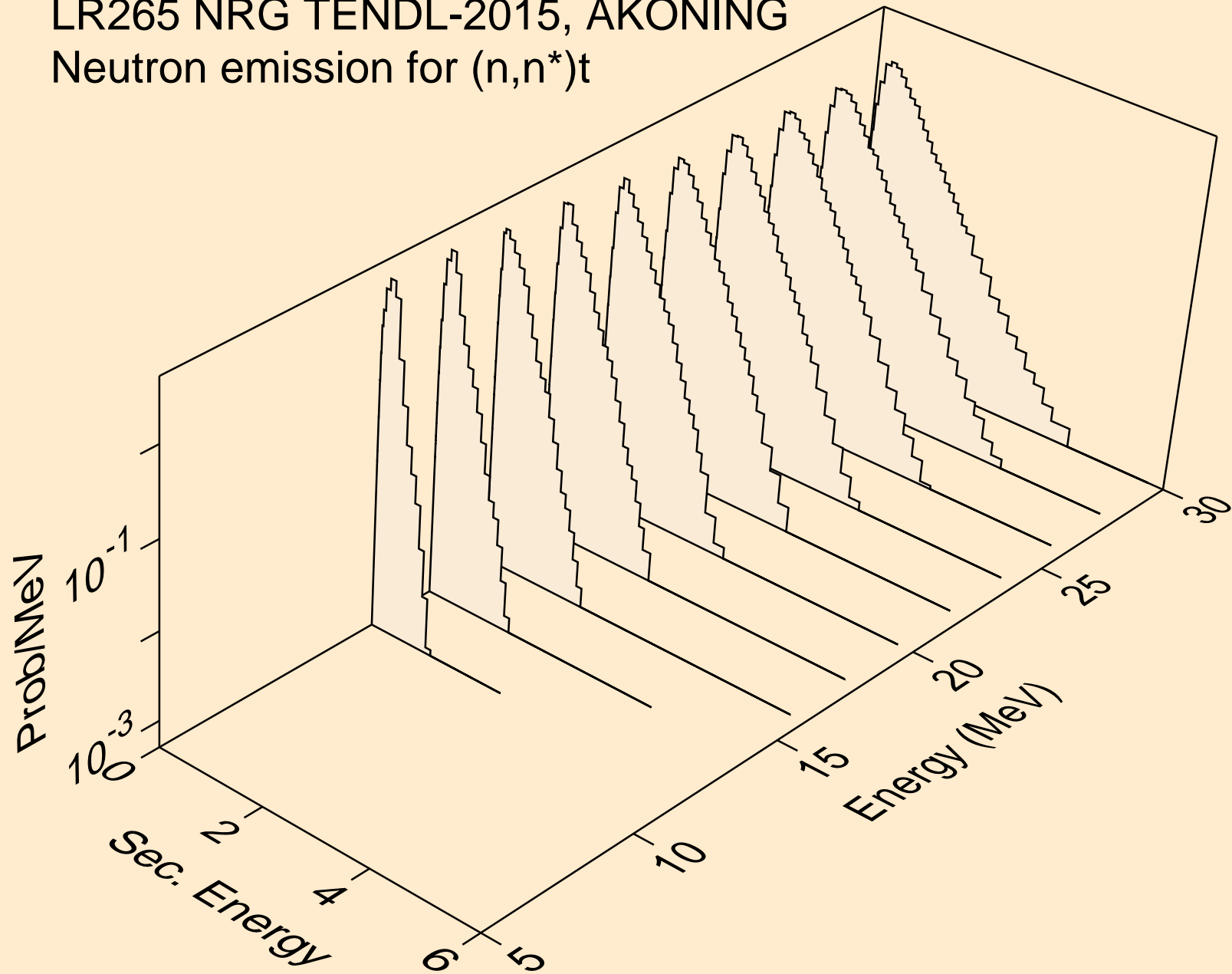

LR265 NRG TENDL-2015, AKONING
Neutron emission for (n,n*)he3

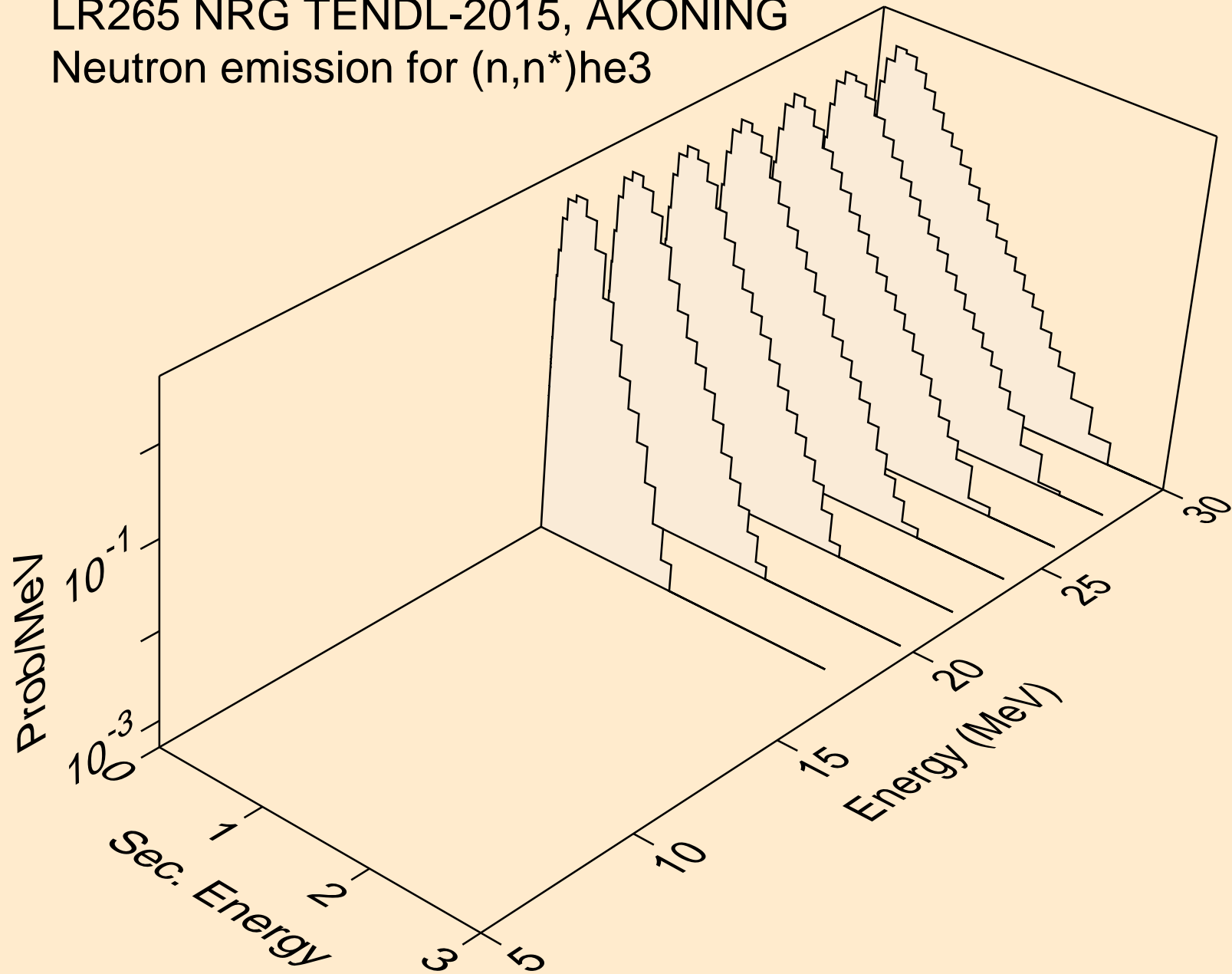

LR265 NRG TENDL-2015, AKONING
Neutron emission for (n,4n)

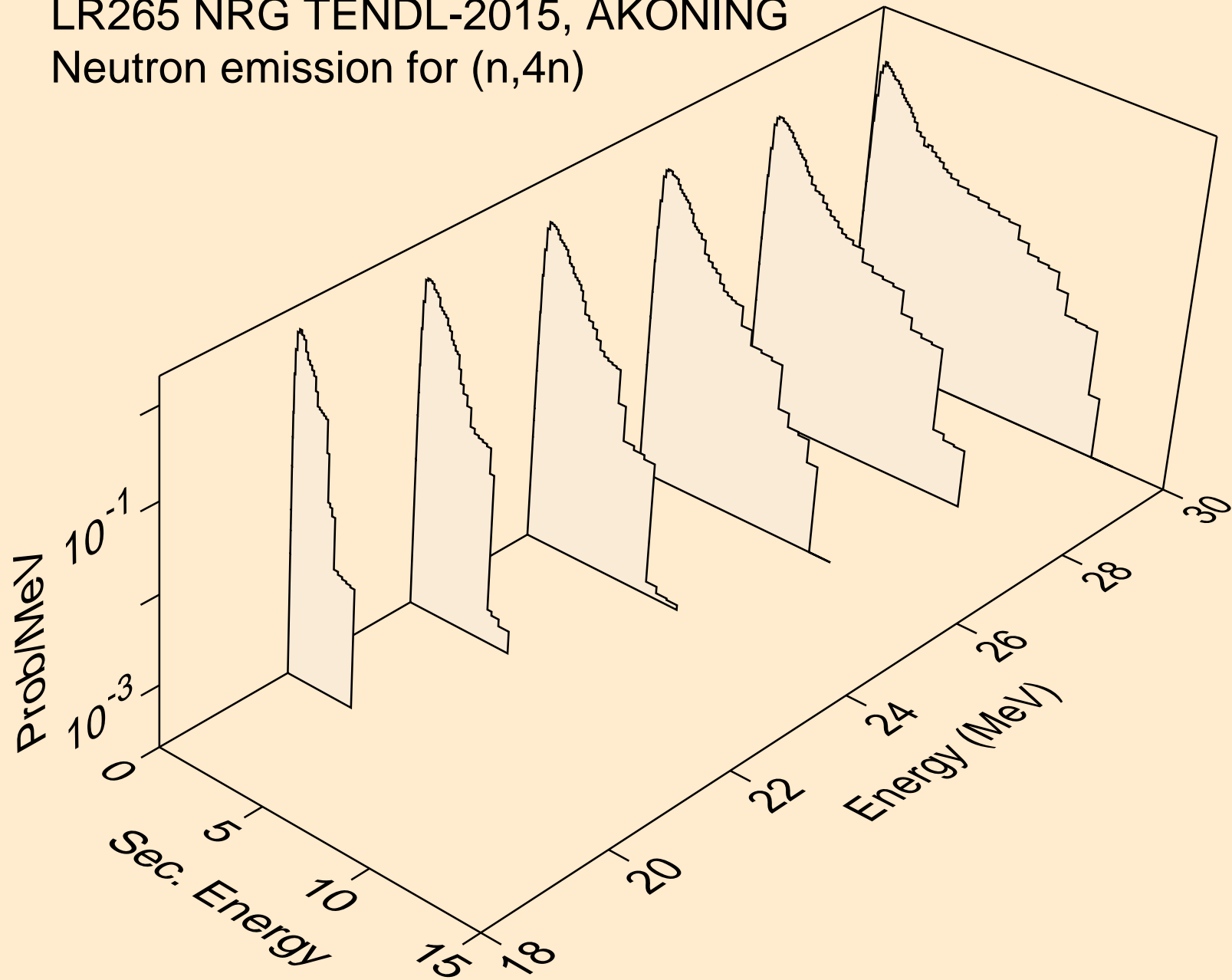

LR265 NRG TENDL-2015, AKONING
Neutron emission for (n,2np)

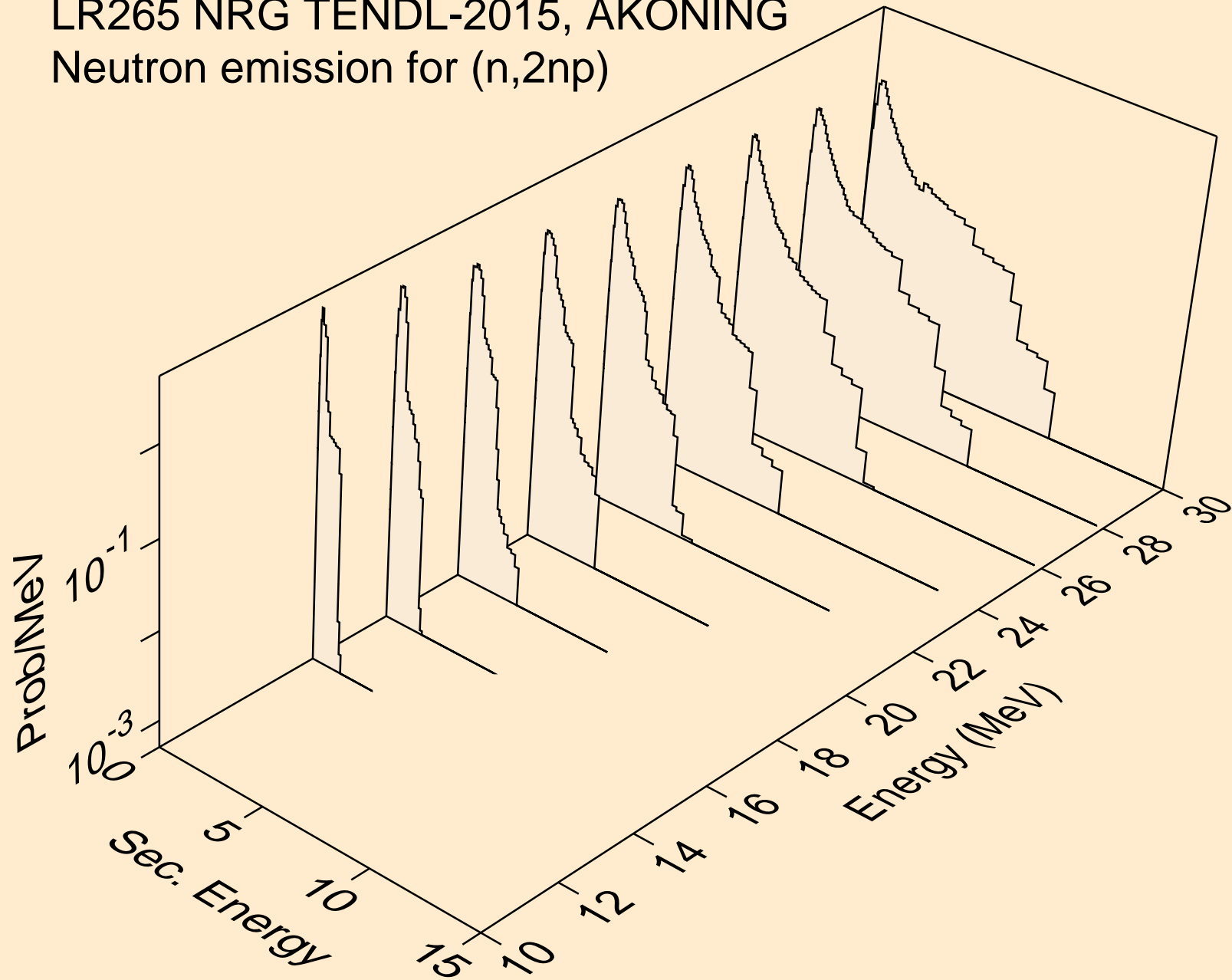

LR265 NRG TENDL-2015, AKONING
Neutron emission for (n,3np)

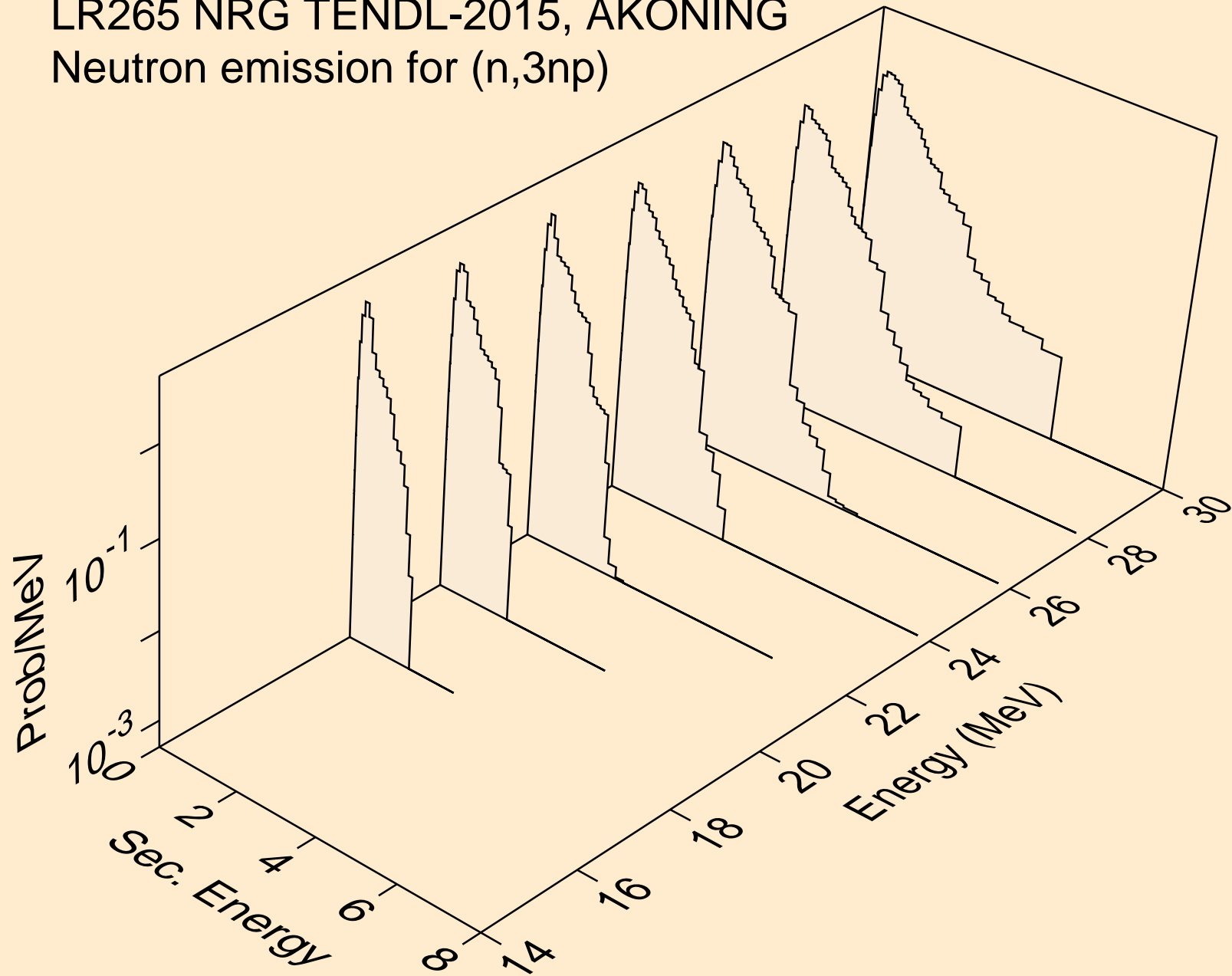

LR265 NRG TENDL-2015, AKONING
Neutron emission for (n,npa)

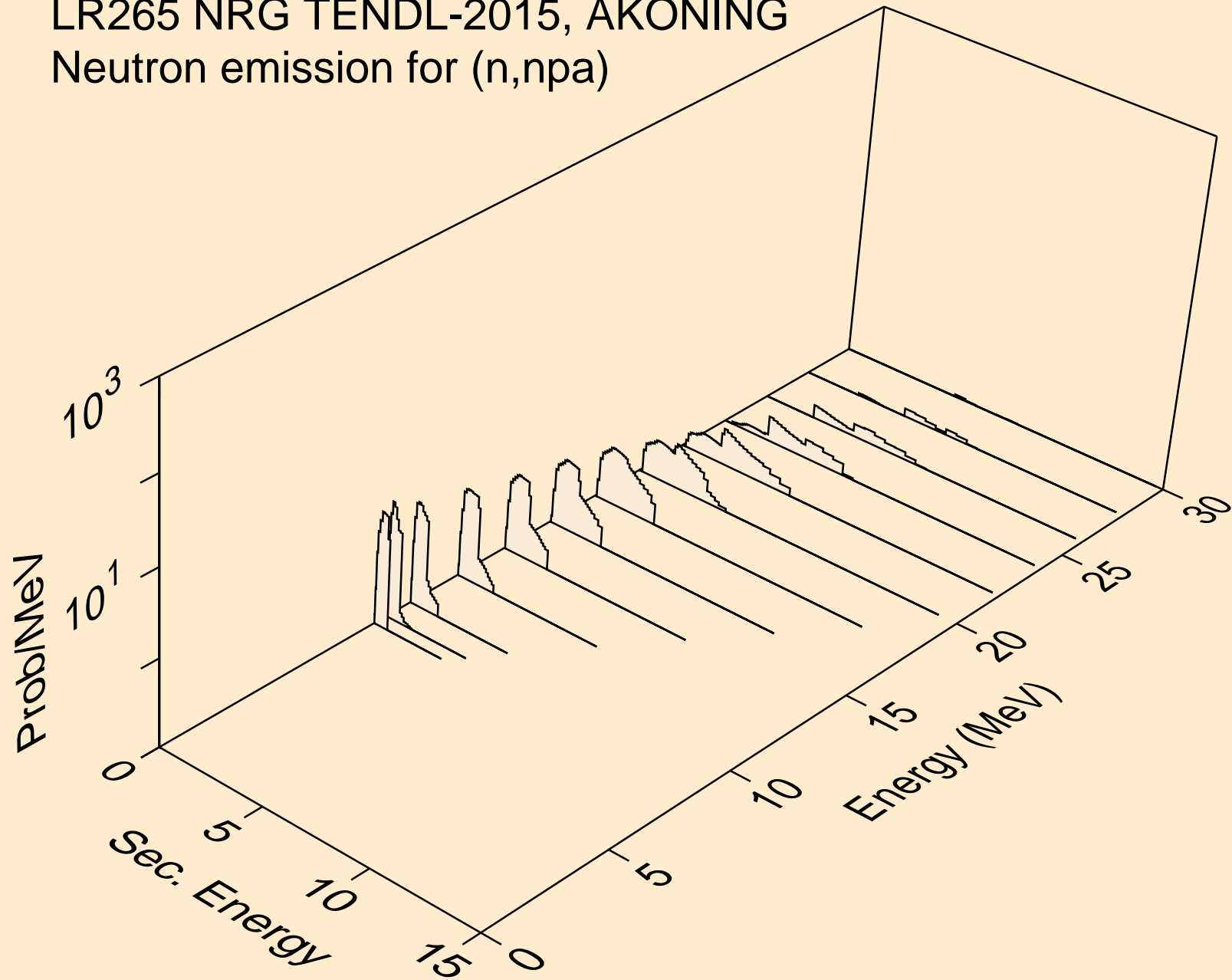

LR265 NRG TENDL-2015, AKONING
Neutron emission for (n,n*c)

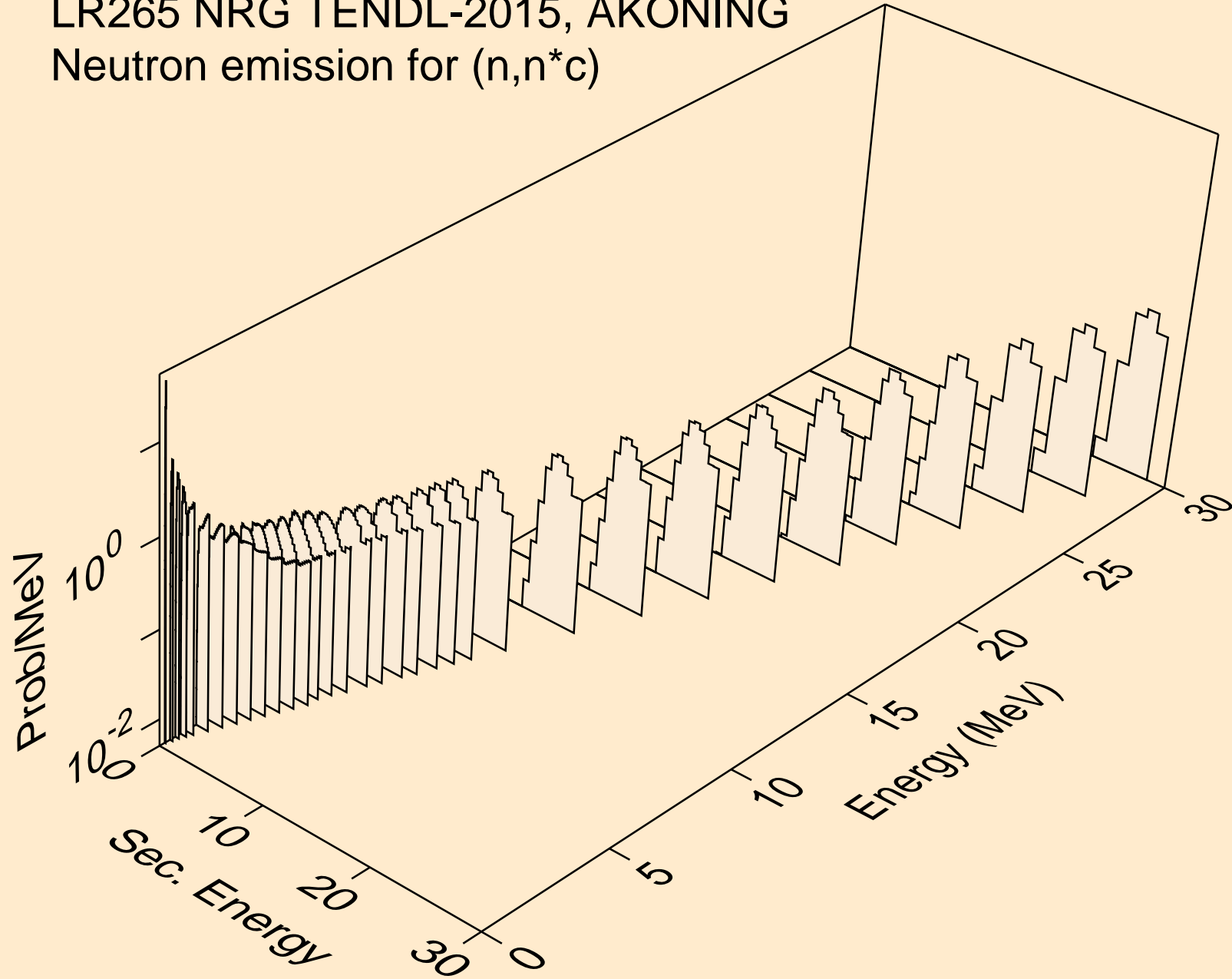

LR265 NRG TENDL-2015, AKONING

Delayed nubar

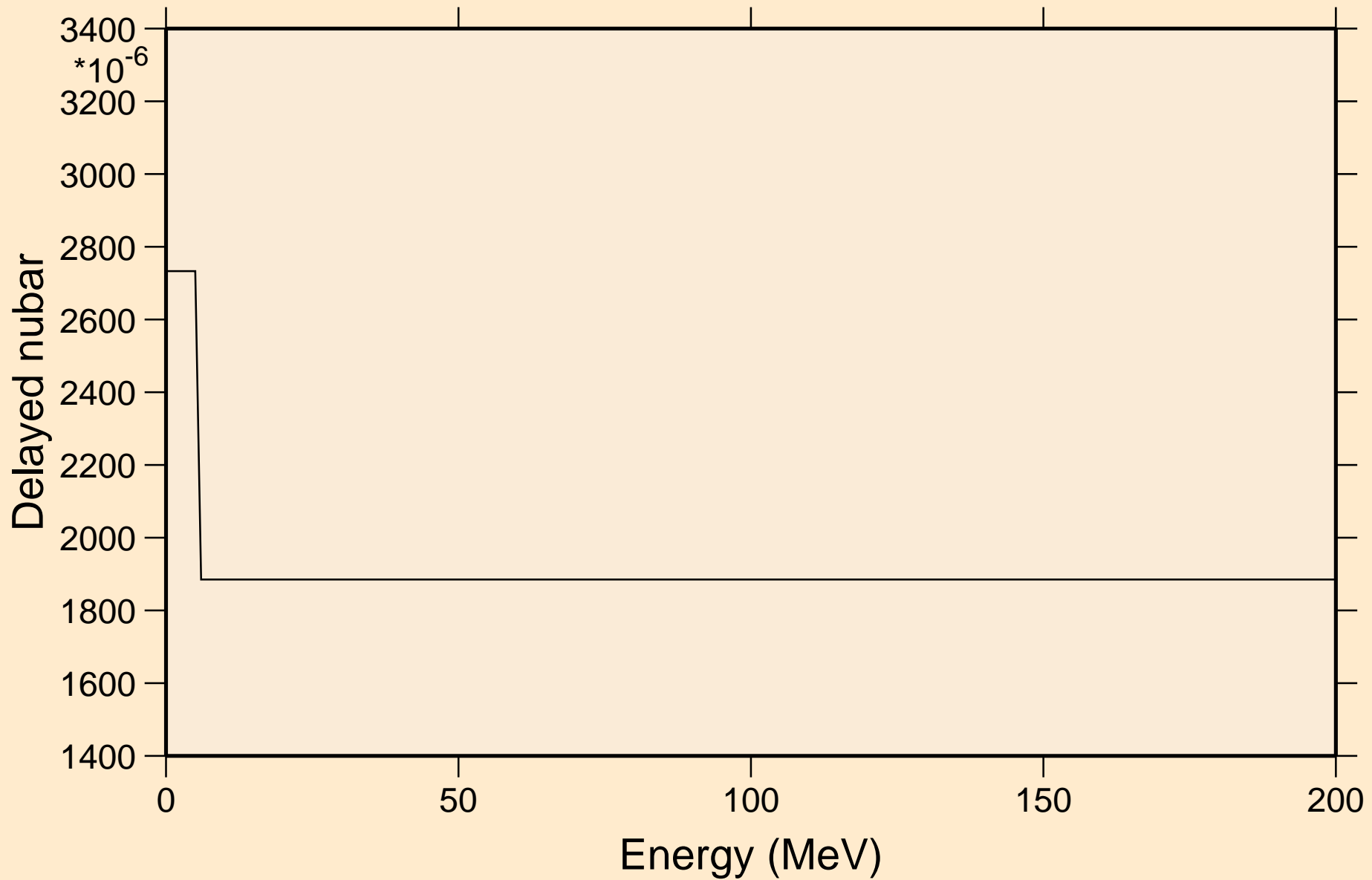

LR265 NRG TENDL-2015, AKONING

Delayed neutron spectra

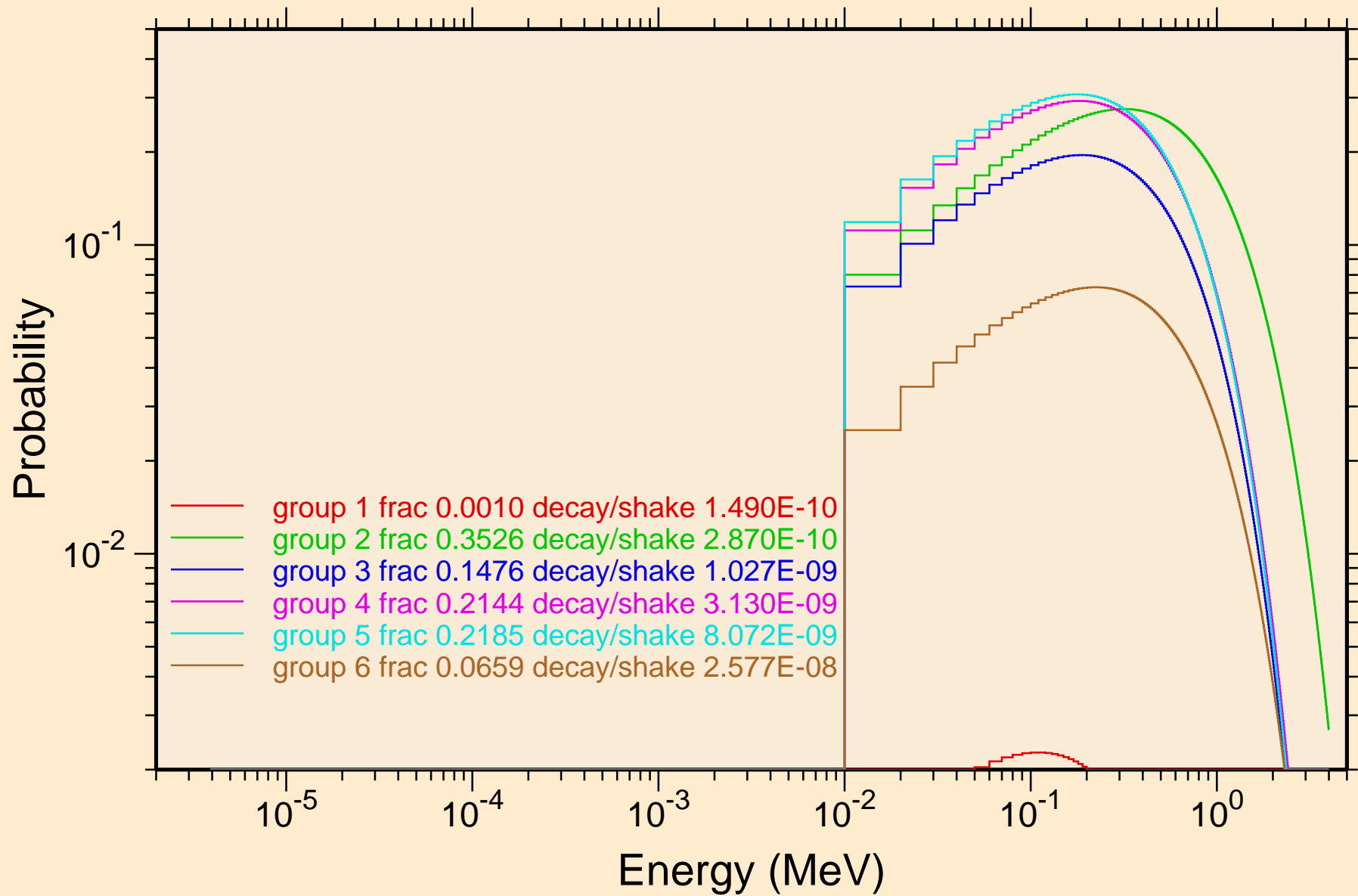

LR265 NRG TENDL-2015, AKONING
Photon emission for (n,x)

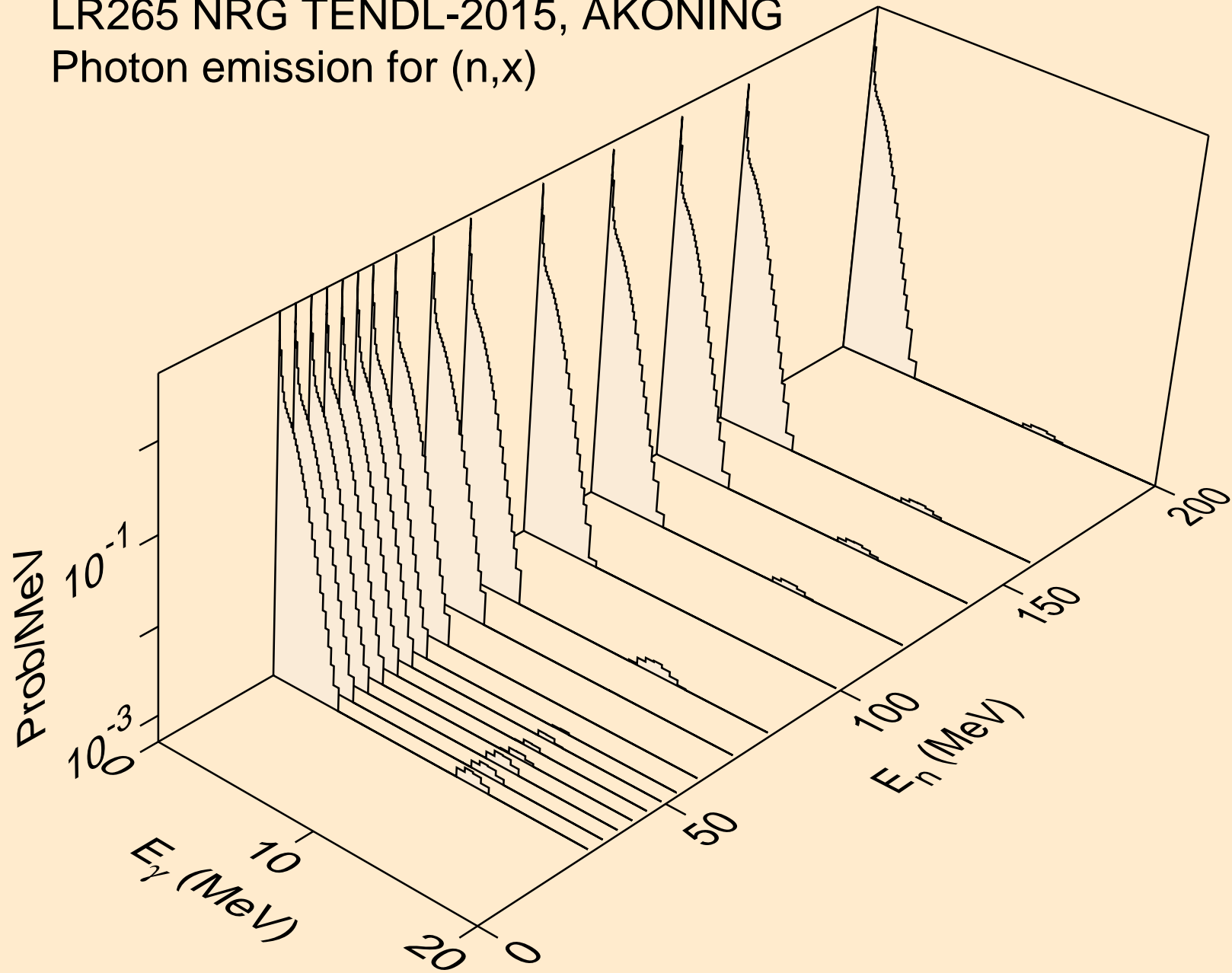

LR265 NRG TENDL-2015, AKONING
Photon emission for (n,2nd)

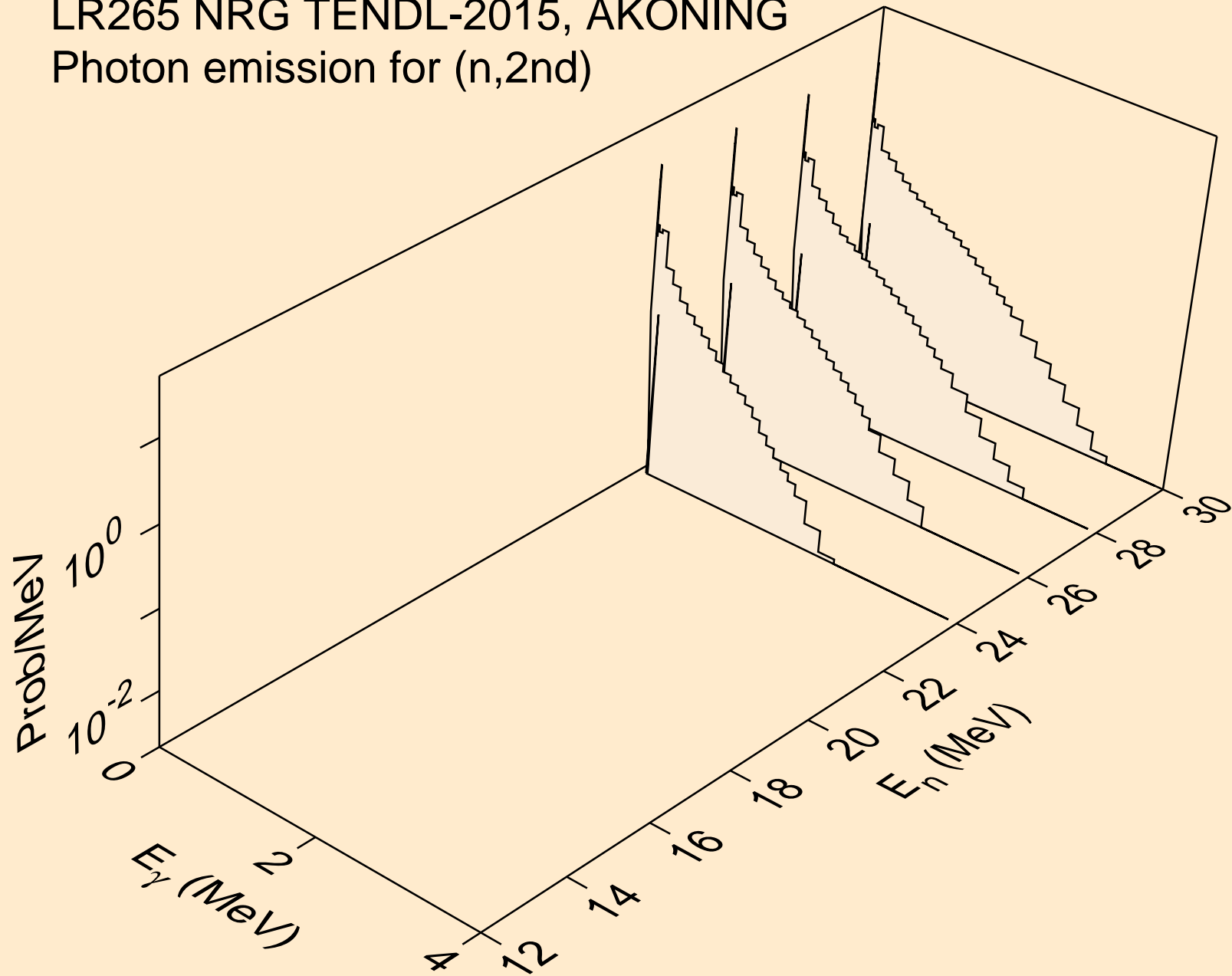

LR265 NRG TENDL-2015, AKONING
Photon emission for (n,2n)

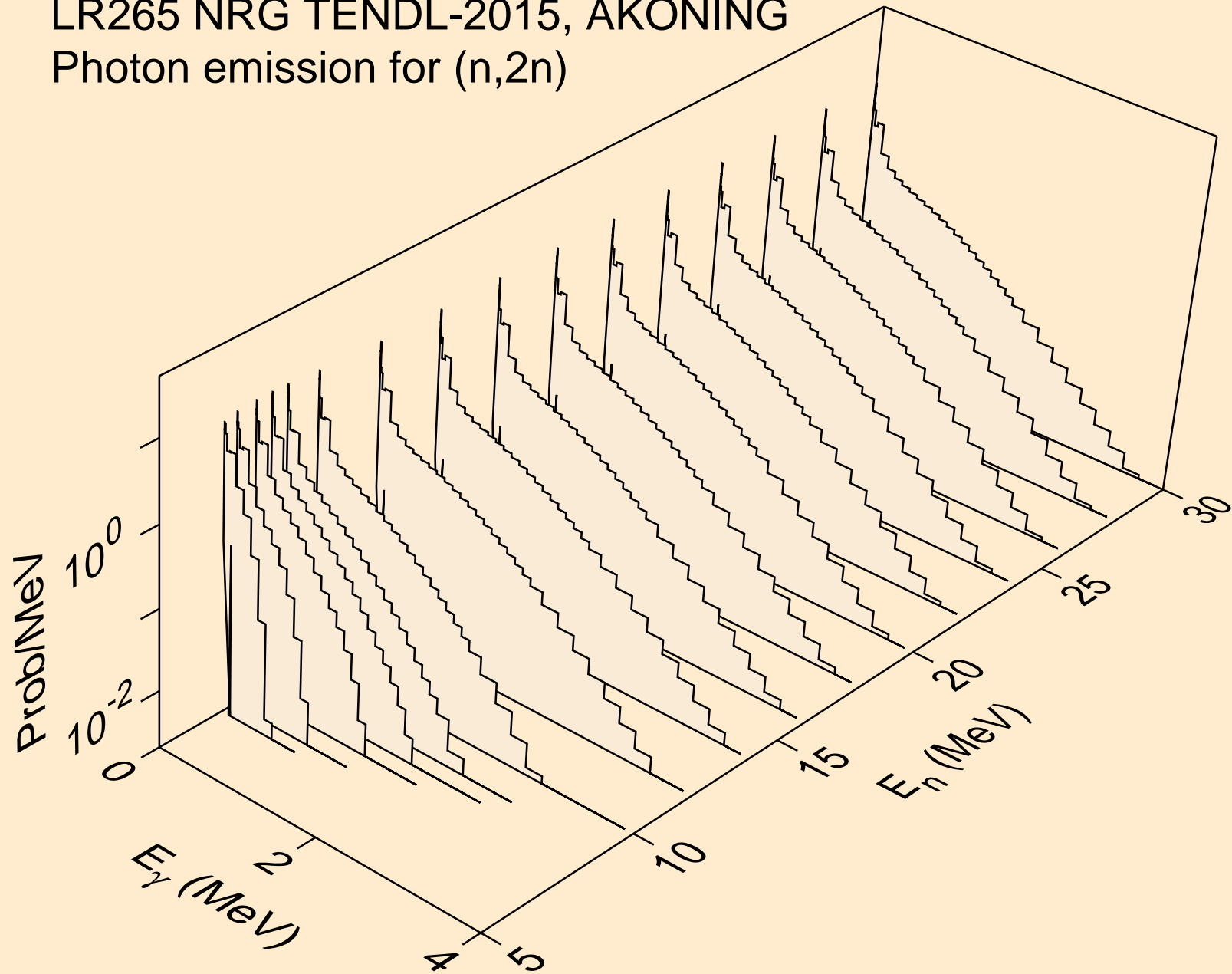

LR265 NRG TENDL-2015, AKONING
Photon emission for (n,3n)

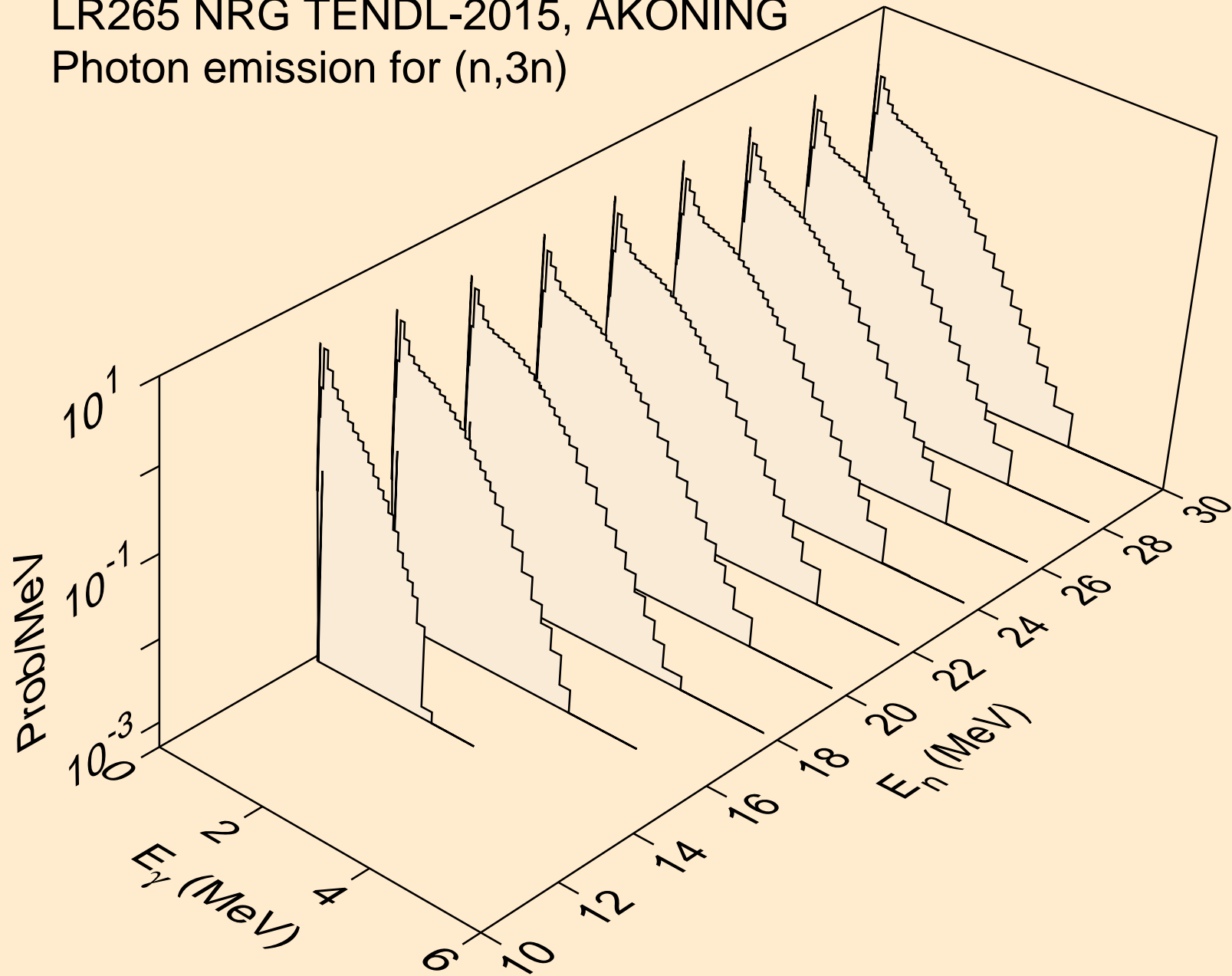

LR265 NRG TENDL-2015, AKONING
Photon emission for (n,n*)a

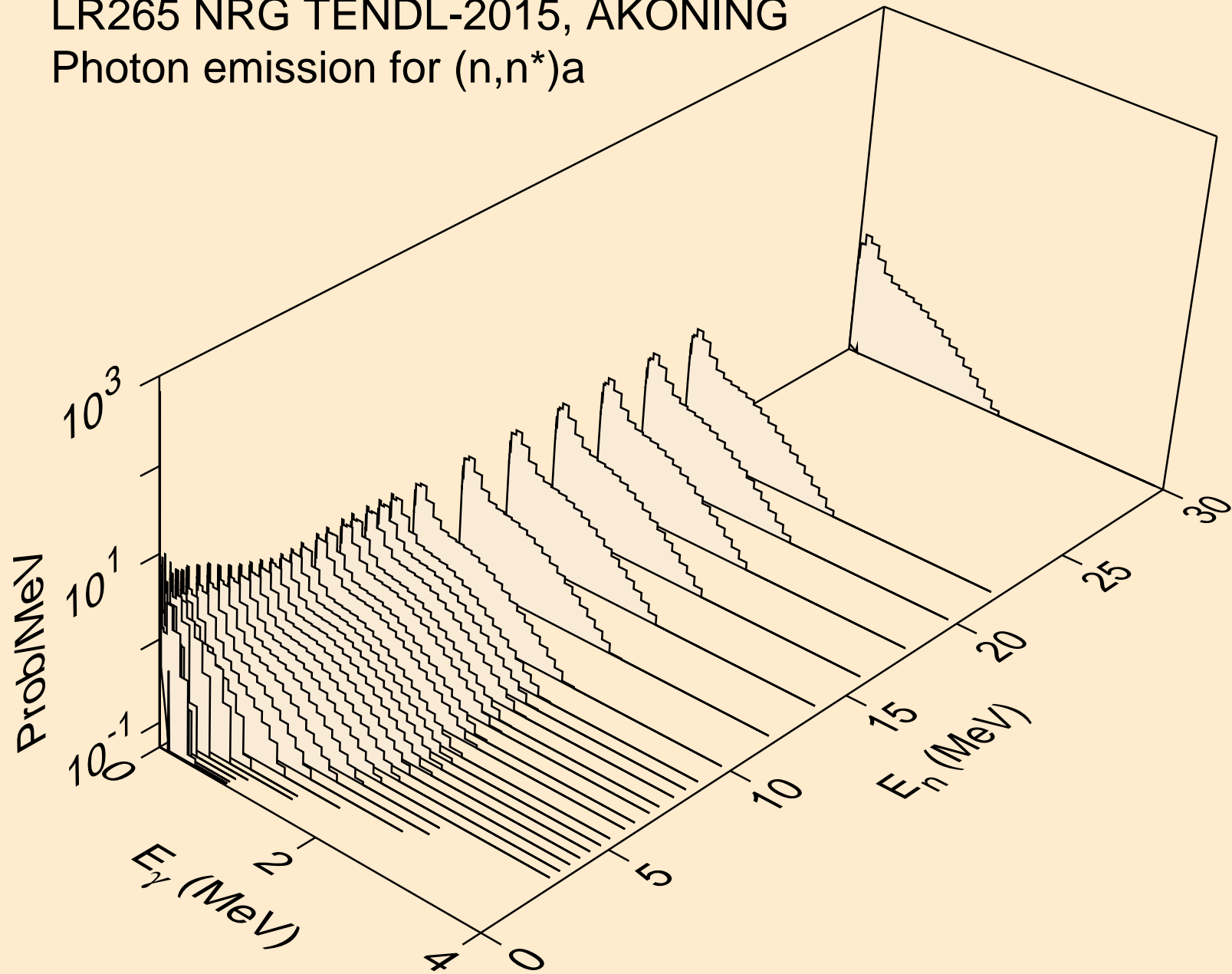

LR265 NRG TENDL-2015, AKONING
Photon emission for (n,2n)a

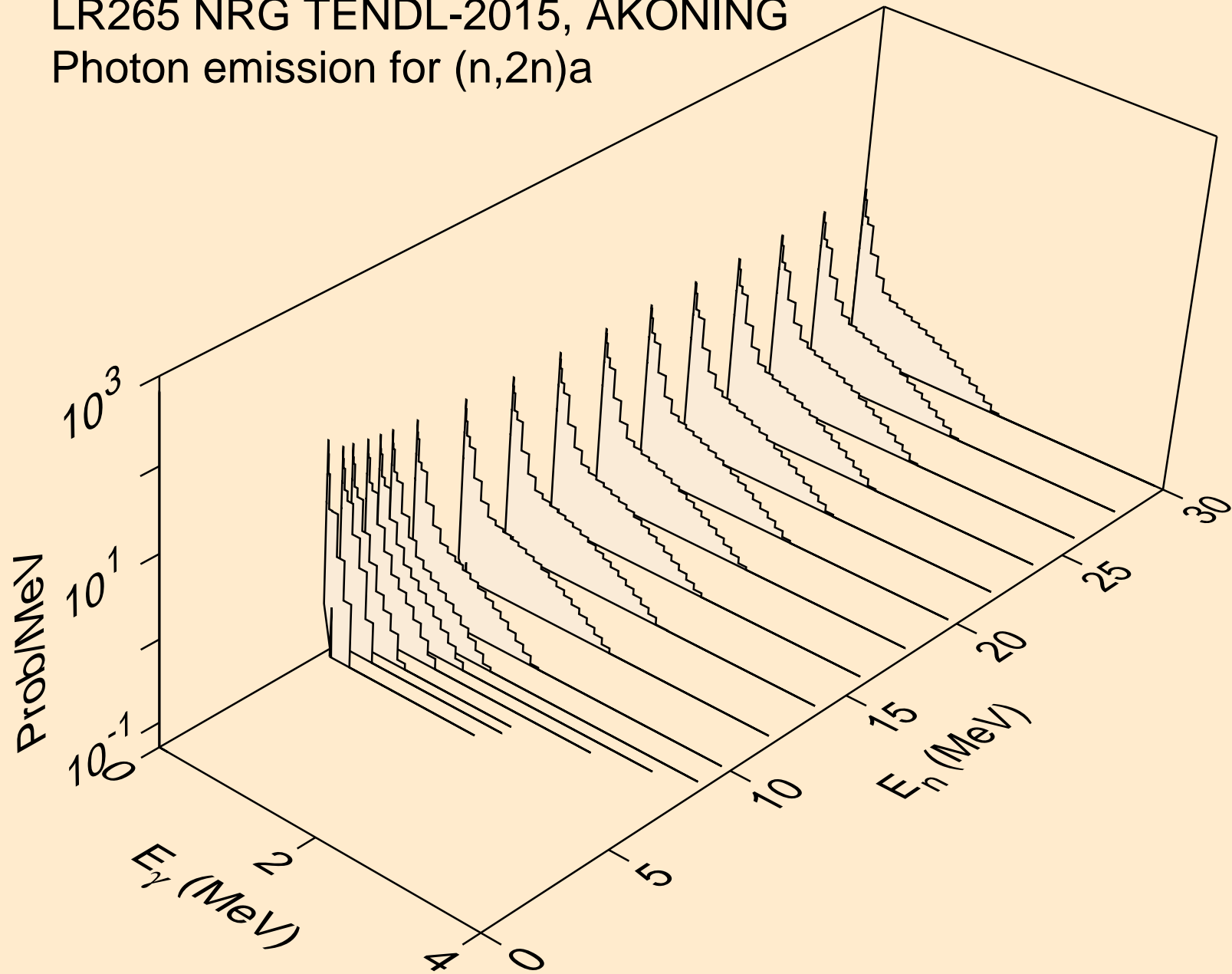

LR265 NRG TENDL-2015, AKONING
Photon emission for (n,3n)a

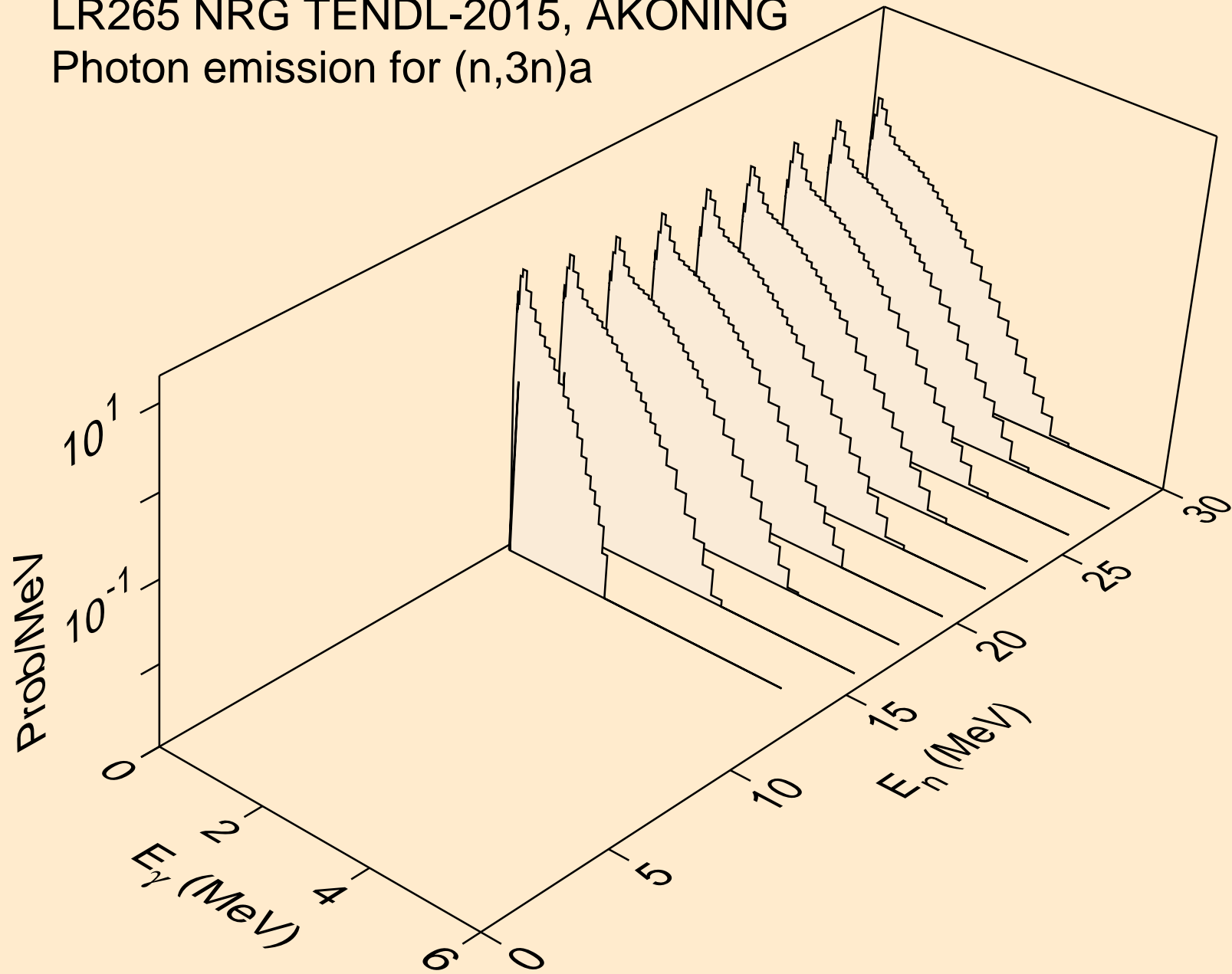

LR265 NRG TENDL-2015, AKONING
Photon emission for (n,n*)p

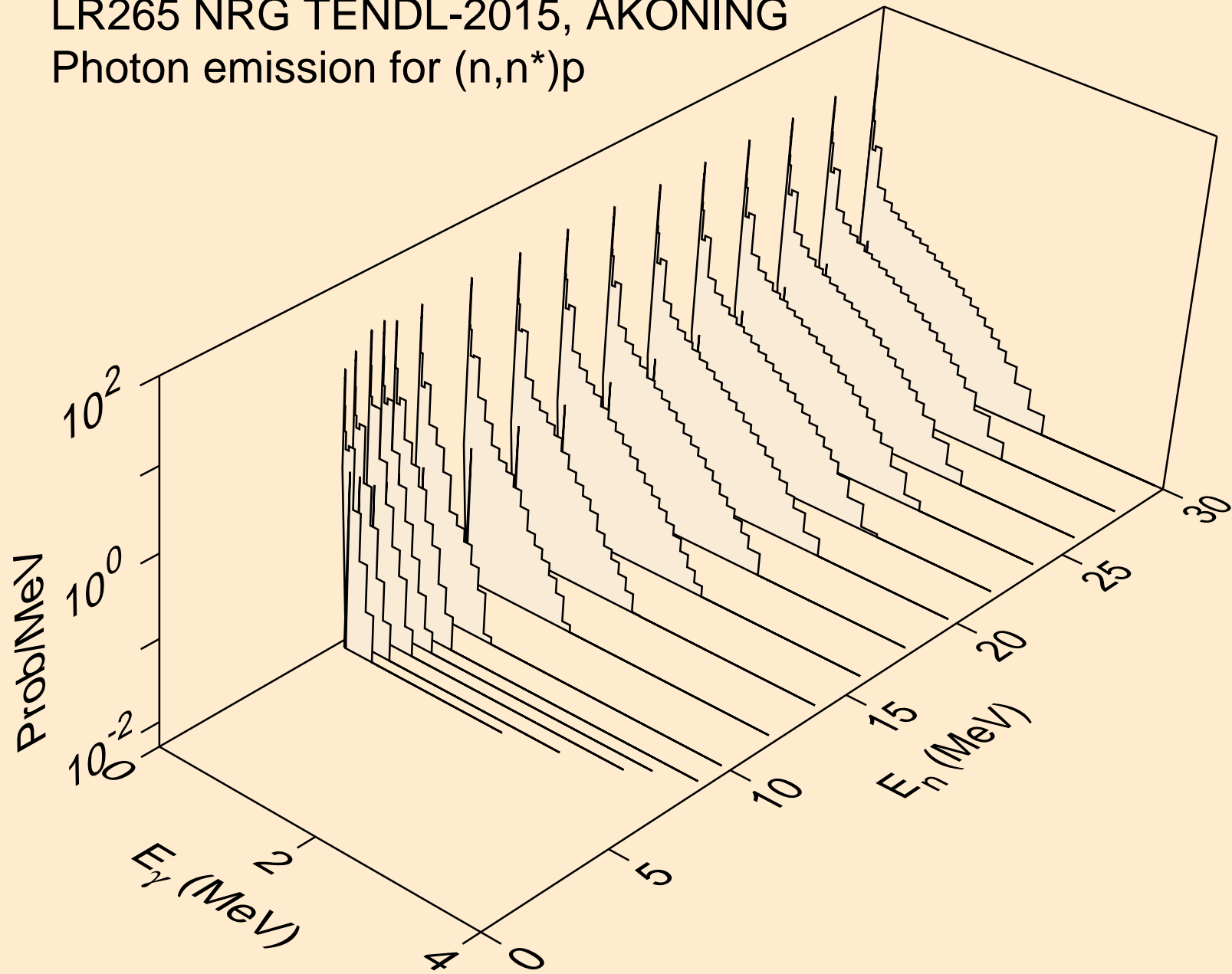

LR265 NRG TENDL-2015, AKONING
Photon emission for (n,2n)2a

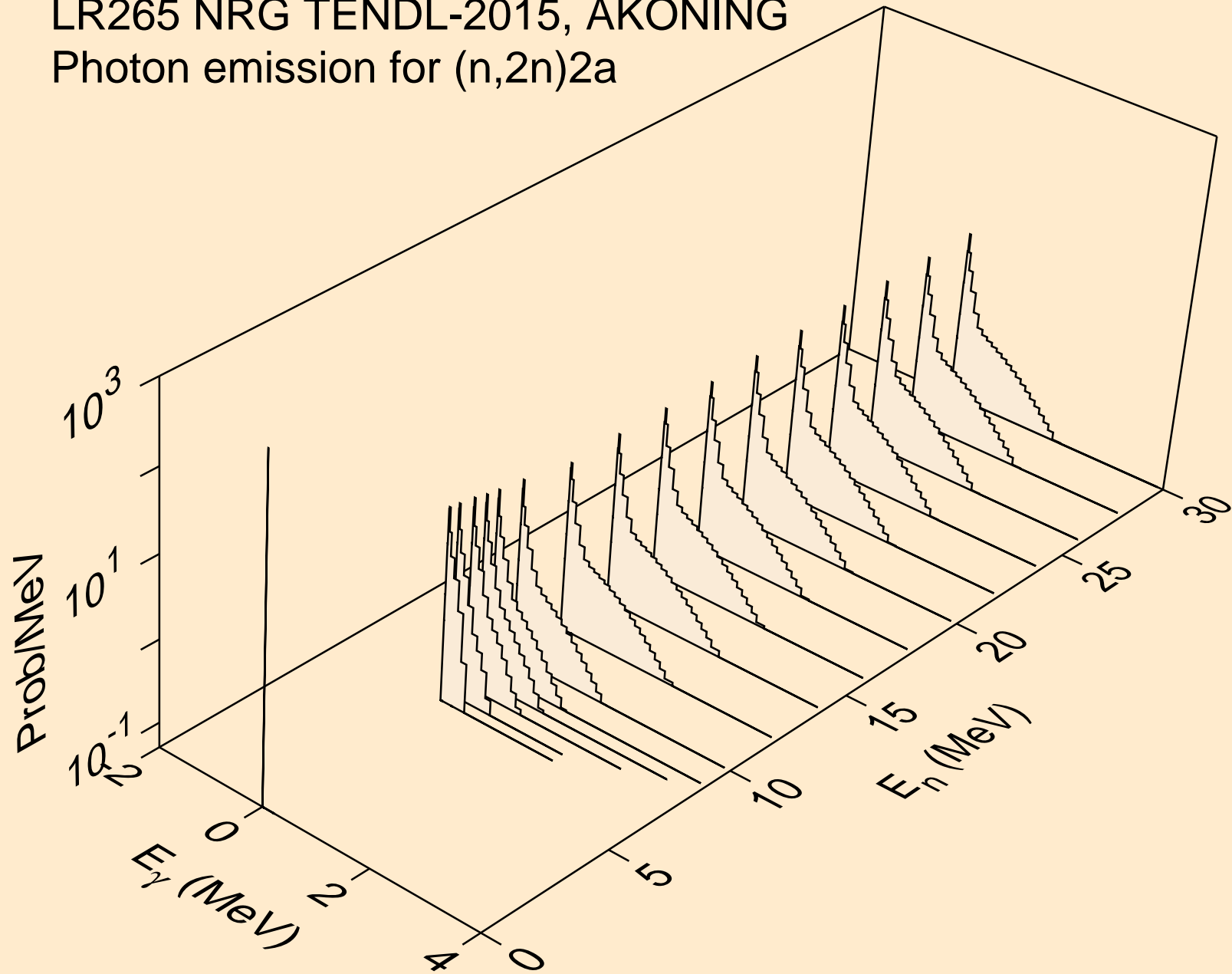

LR265 NRG TENDL-2015, AKONING
Photon emission for (n,n*)d

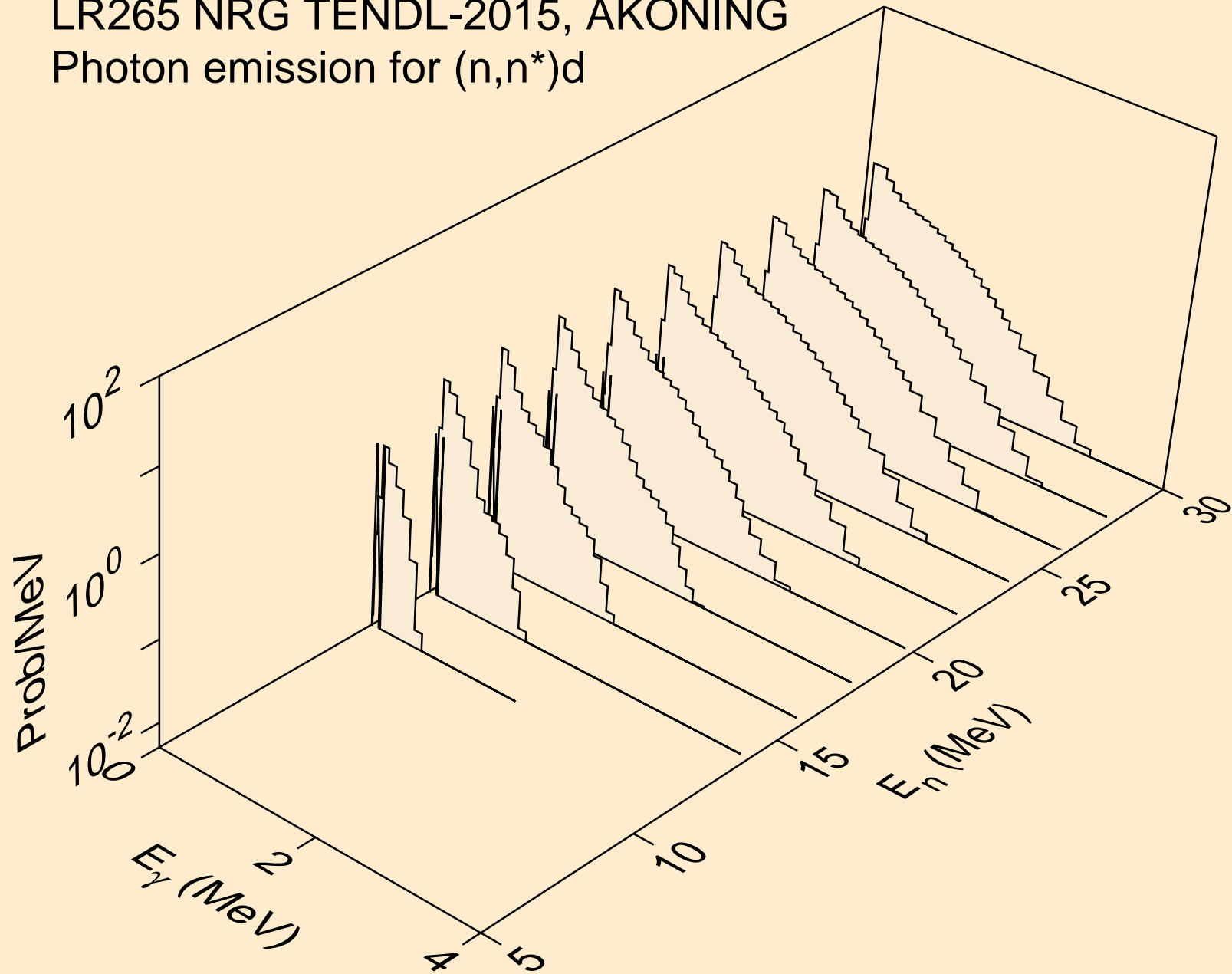

LR265 NRG TENDL-2015, AKONING
Photon emission for (n,n*)t

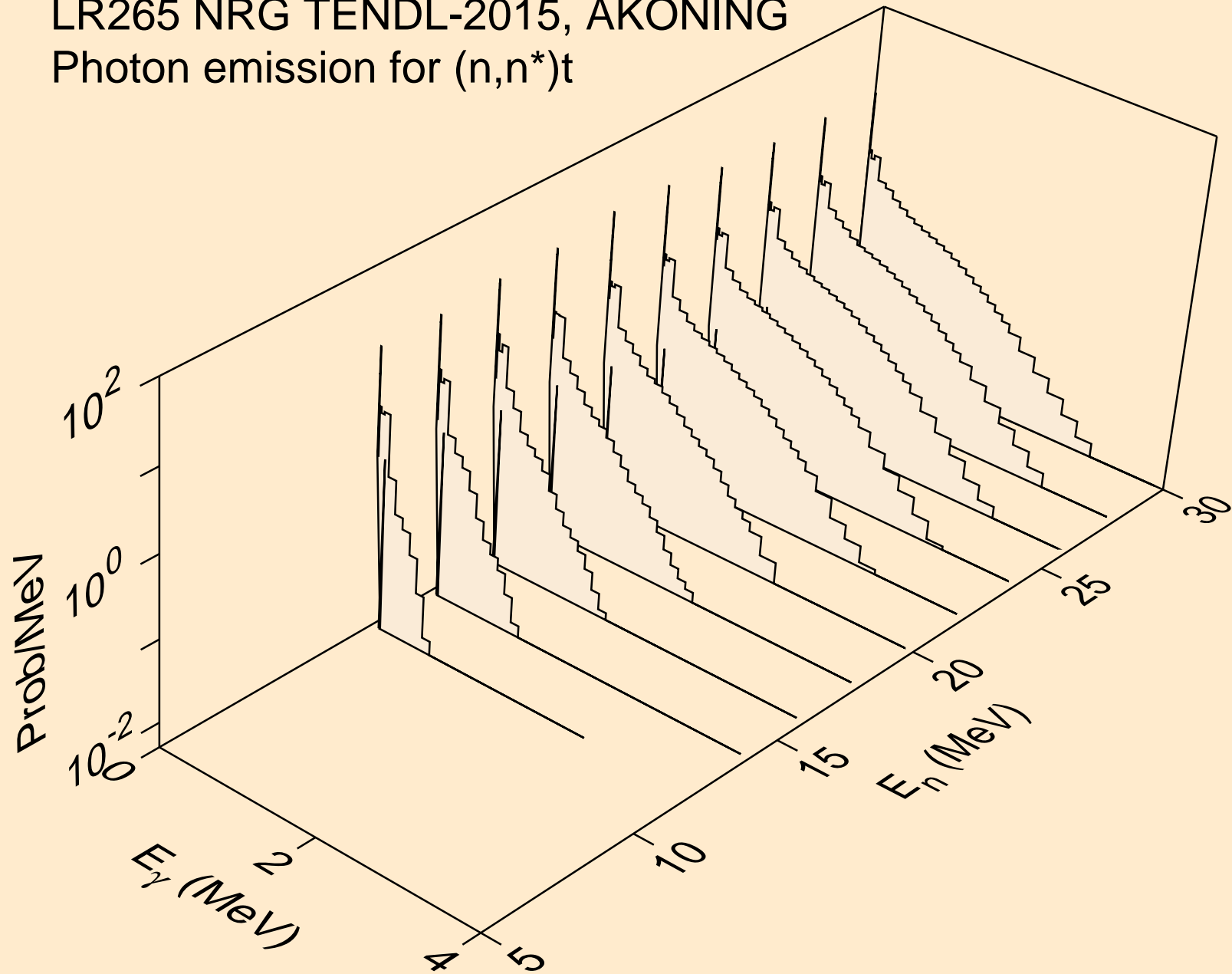

LR265 NRG TENDL-2015, AKONING
Photon emission for (n,n*)he3

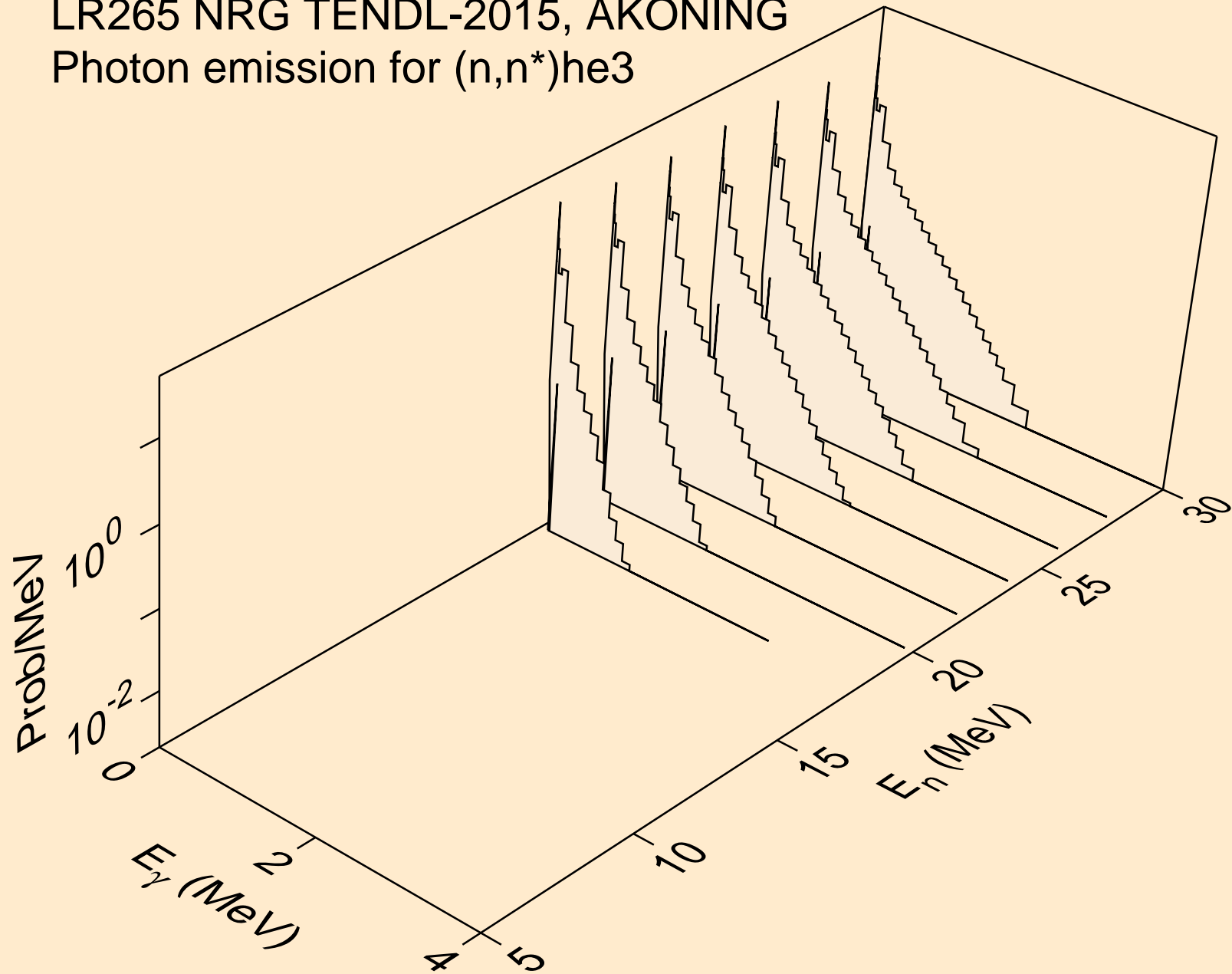

LR265 NRG TENDL-2015, AKONING
Photon emission for (n,4n)

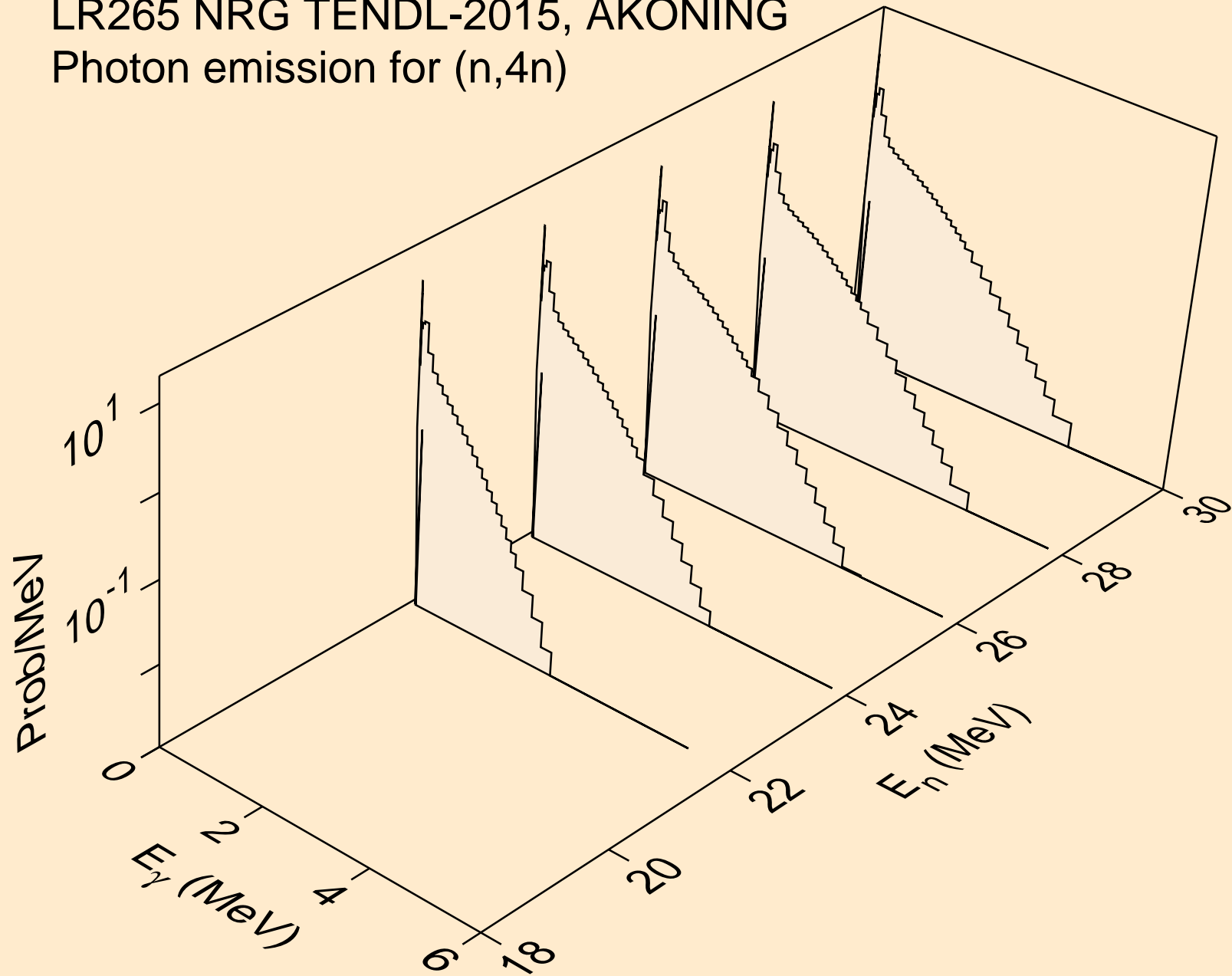

LR265 NRG TENDL-2015, AKONING
Photon emission for (n,2np)

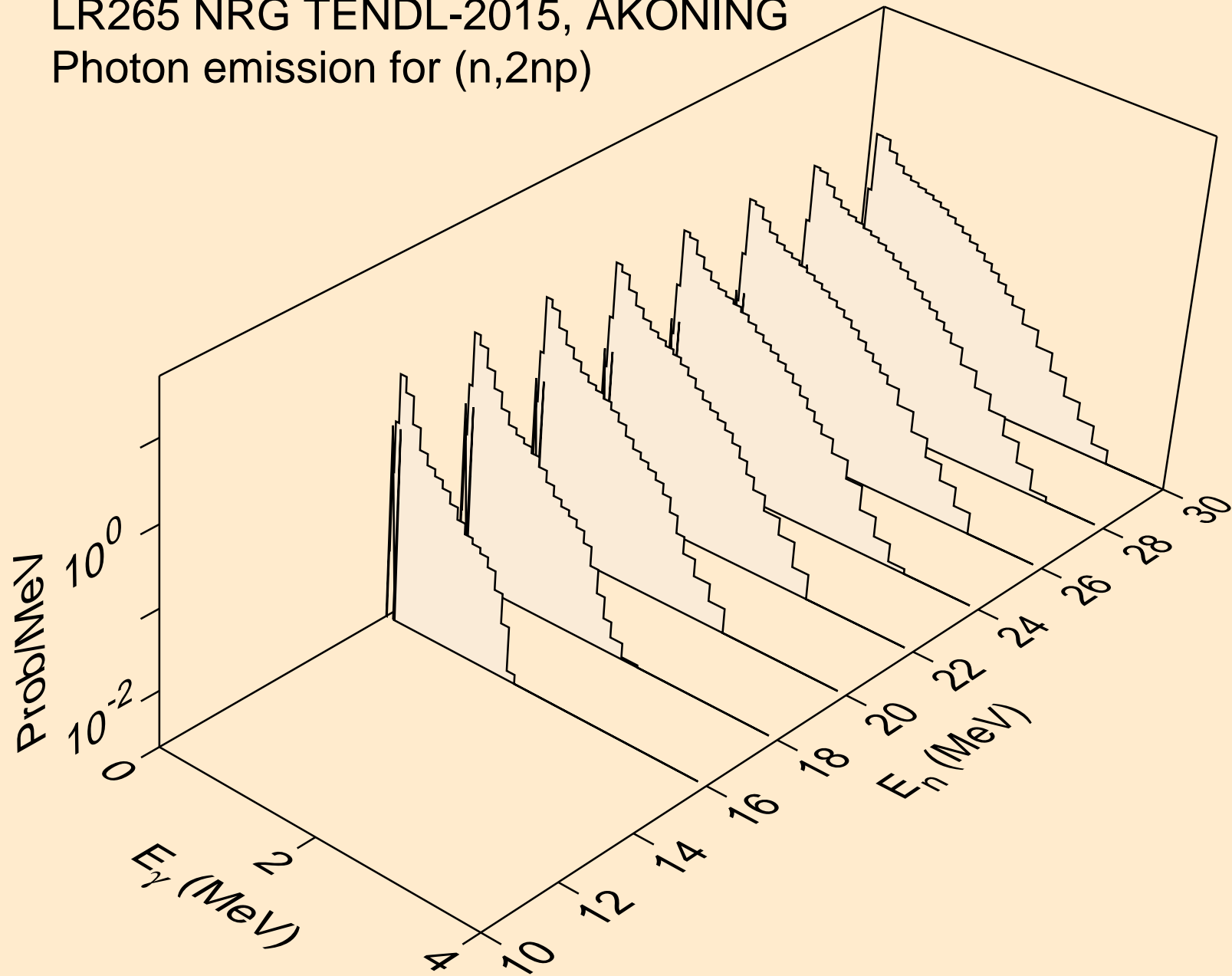

LR265 NRG TENDL-2015, AKONING
Photon emission for (n,3np)

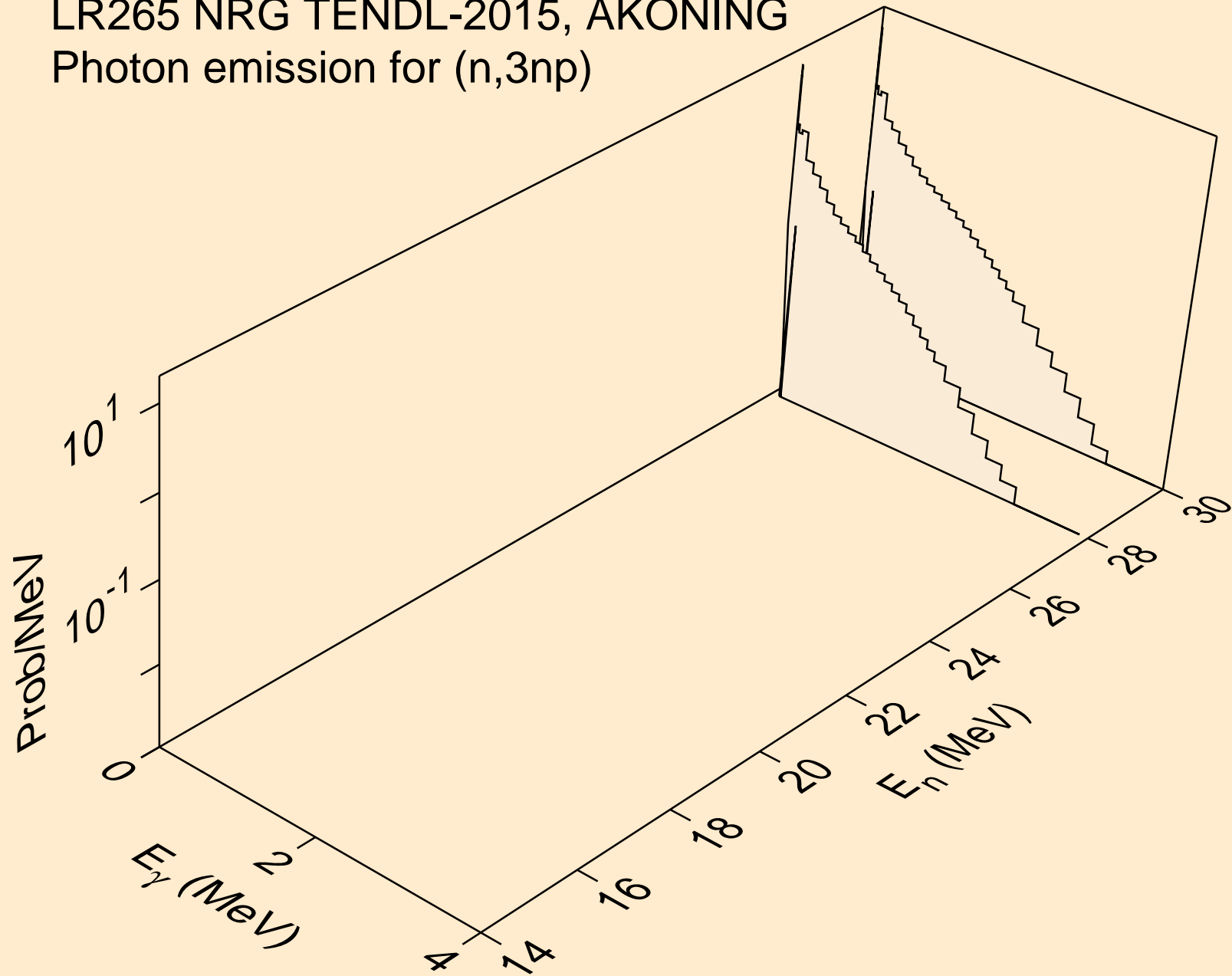

LR265 NRG TENDL-2015, AKONING
Photon emission for (n,npa)

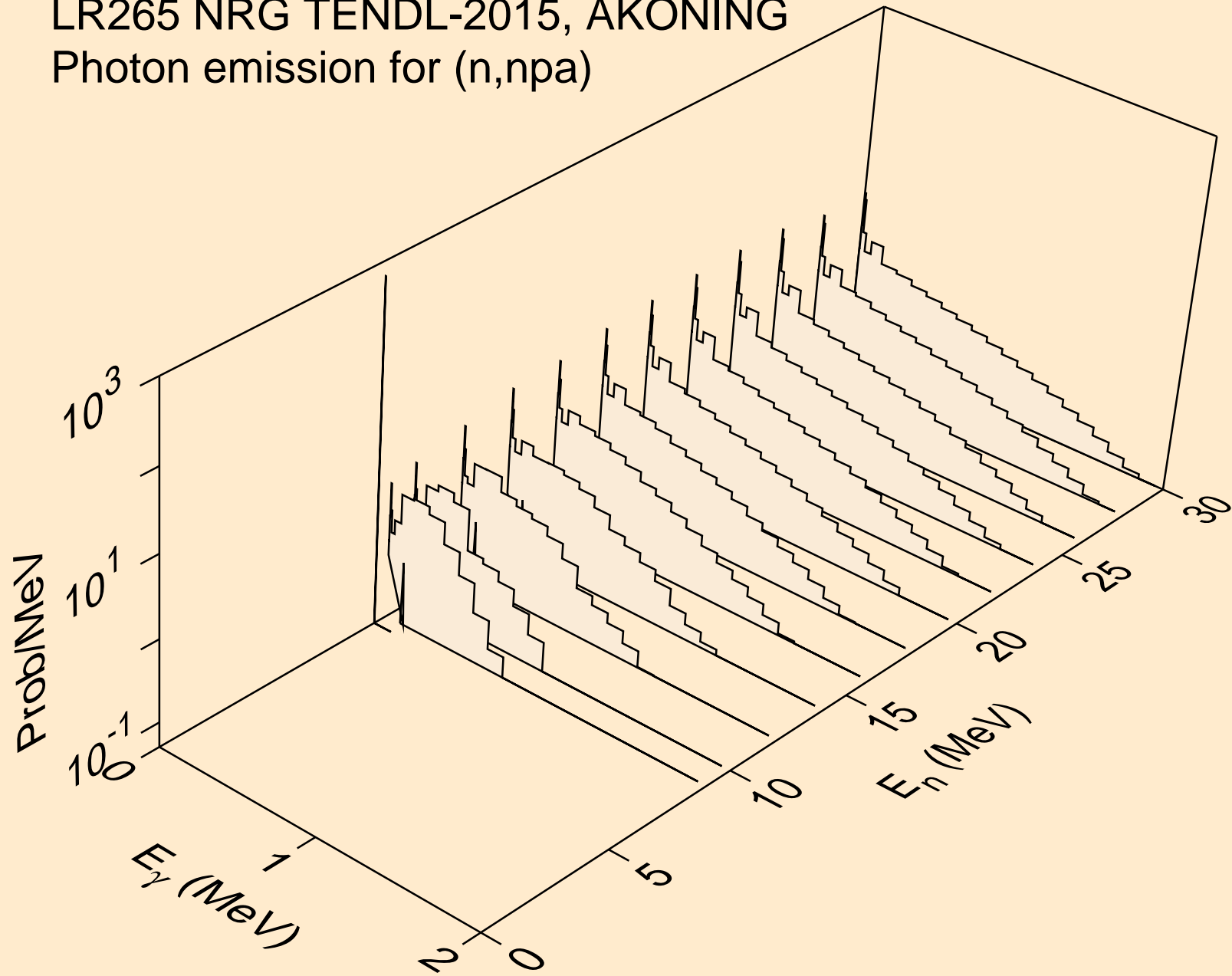

LR265 NRG TENDL-2015, AKONING
Photon emission for (n,n*c)

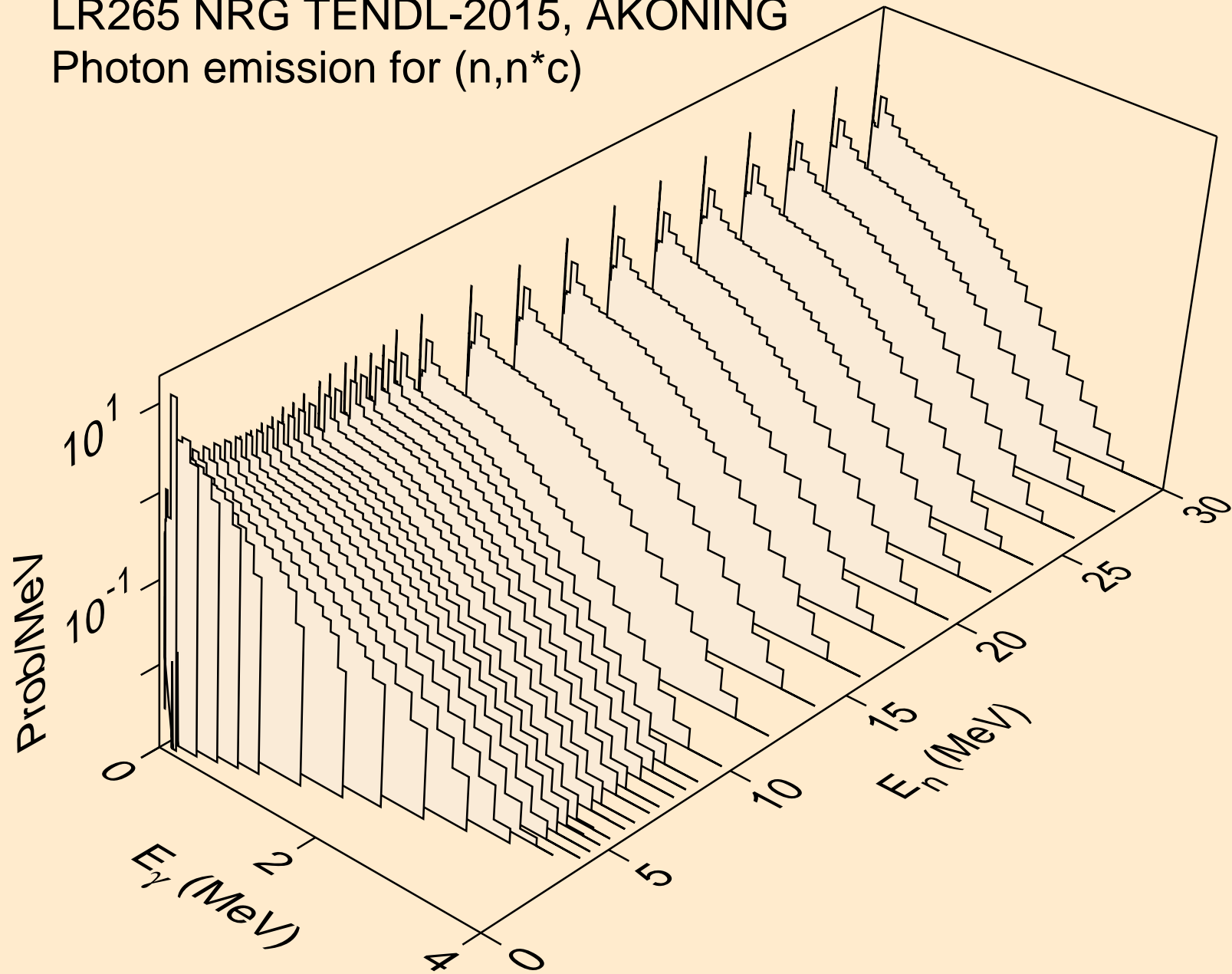

LR265 NRG TENDL-2015, AKONING
Photon emission for (n,gma)

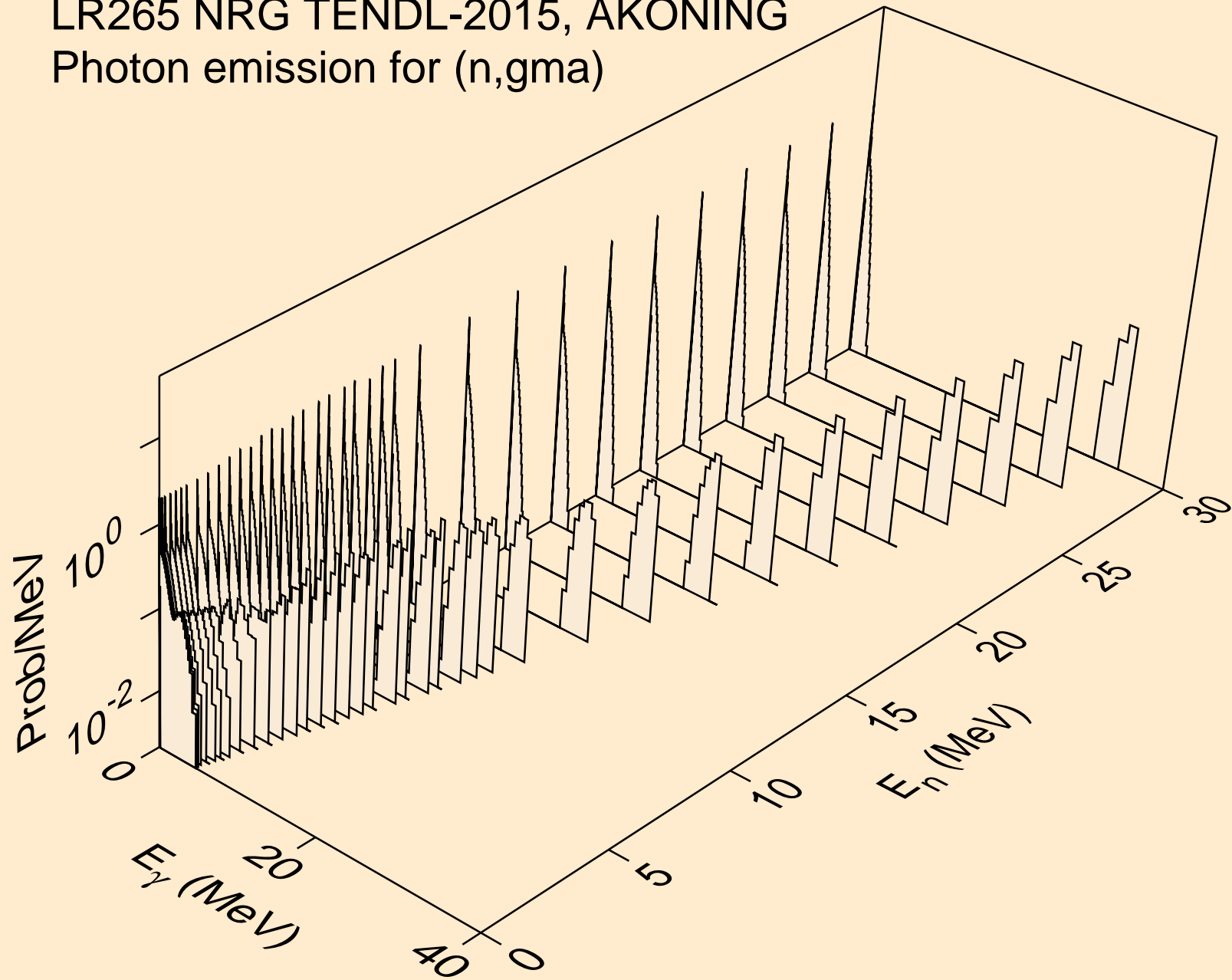

LR265 NRG TENDL-2015, AKONING
Photon emission for (n,p)

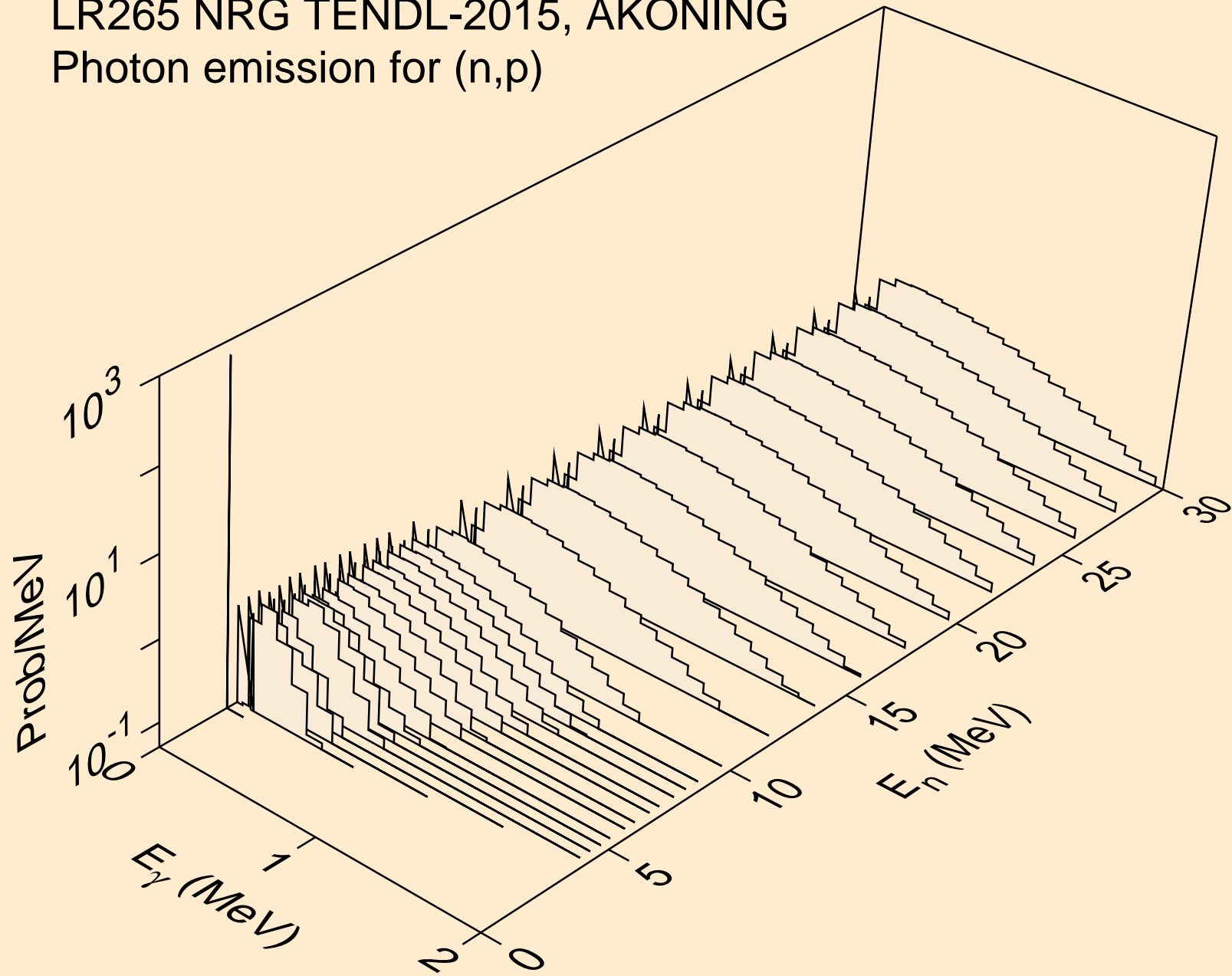

LR265 NRG TENDL-2015, AKONING
Photon emission for (n,d)

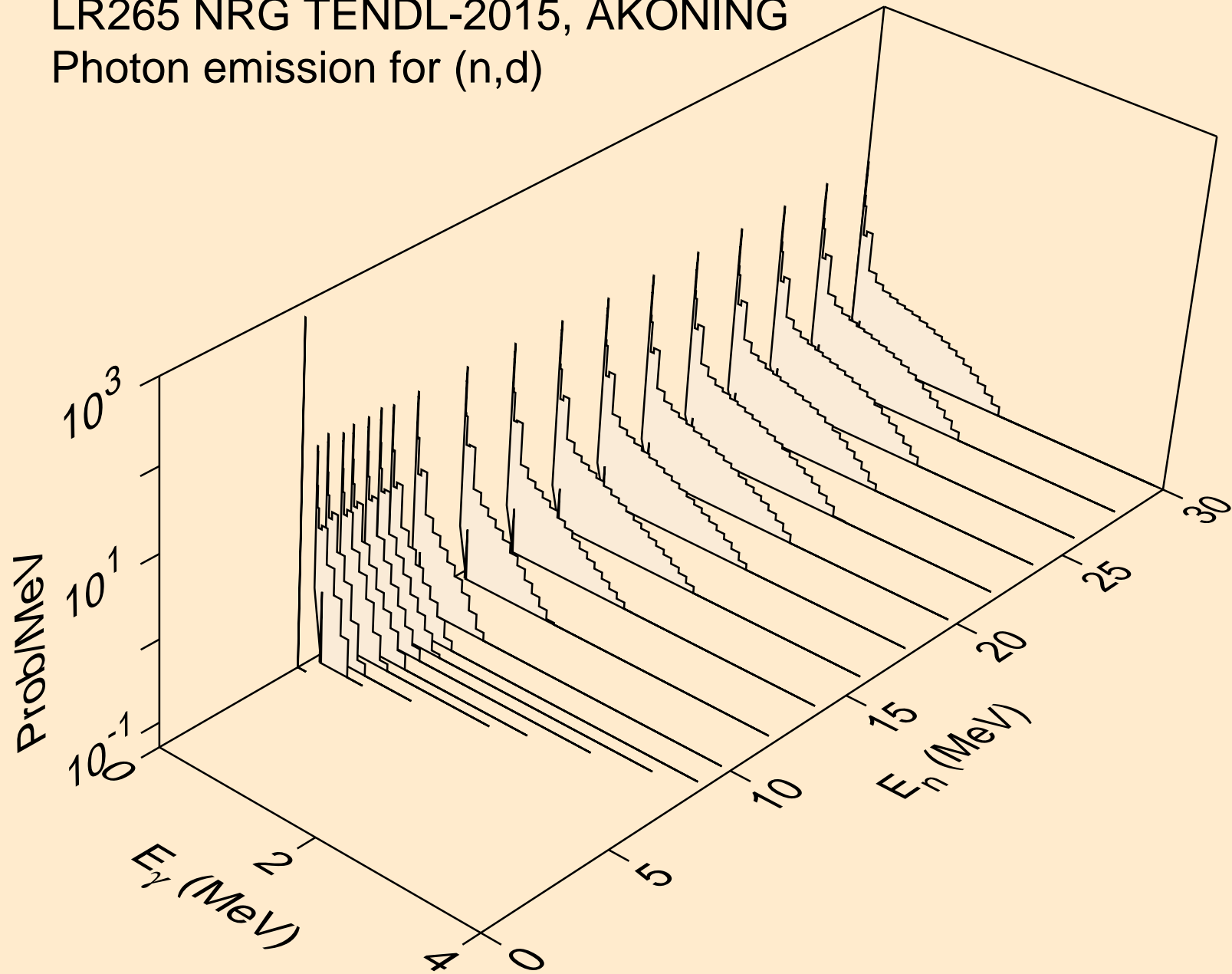

LR265 NRG TENDL-2015, AKONING
Photon emission for (n,t)

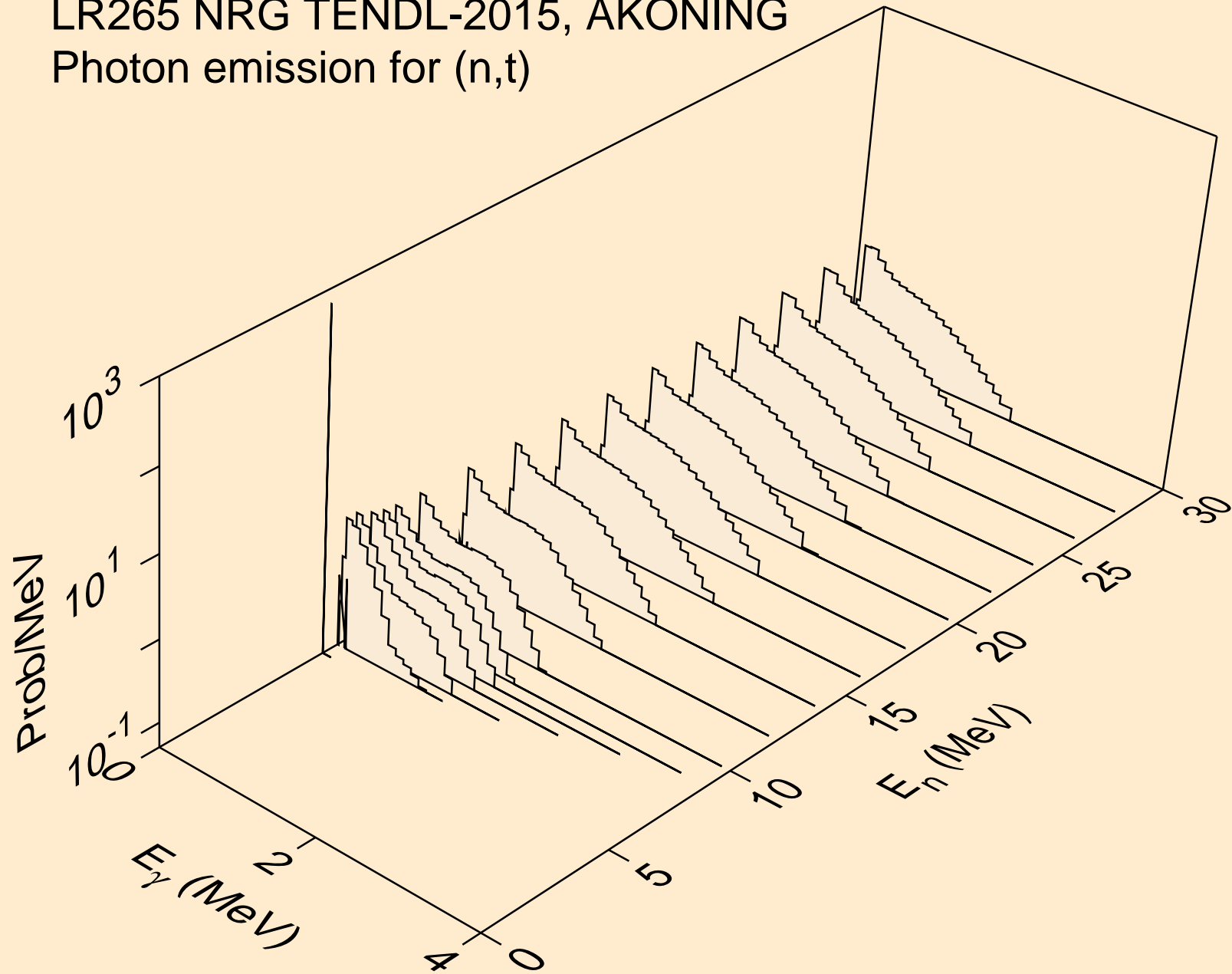

LR265 NRG TENDL-2015, AKONING
Photon emission for (n,he3)

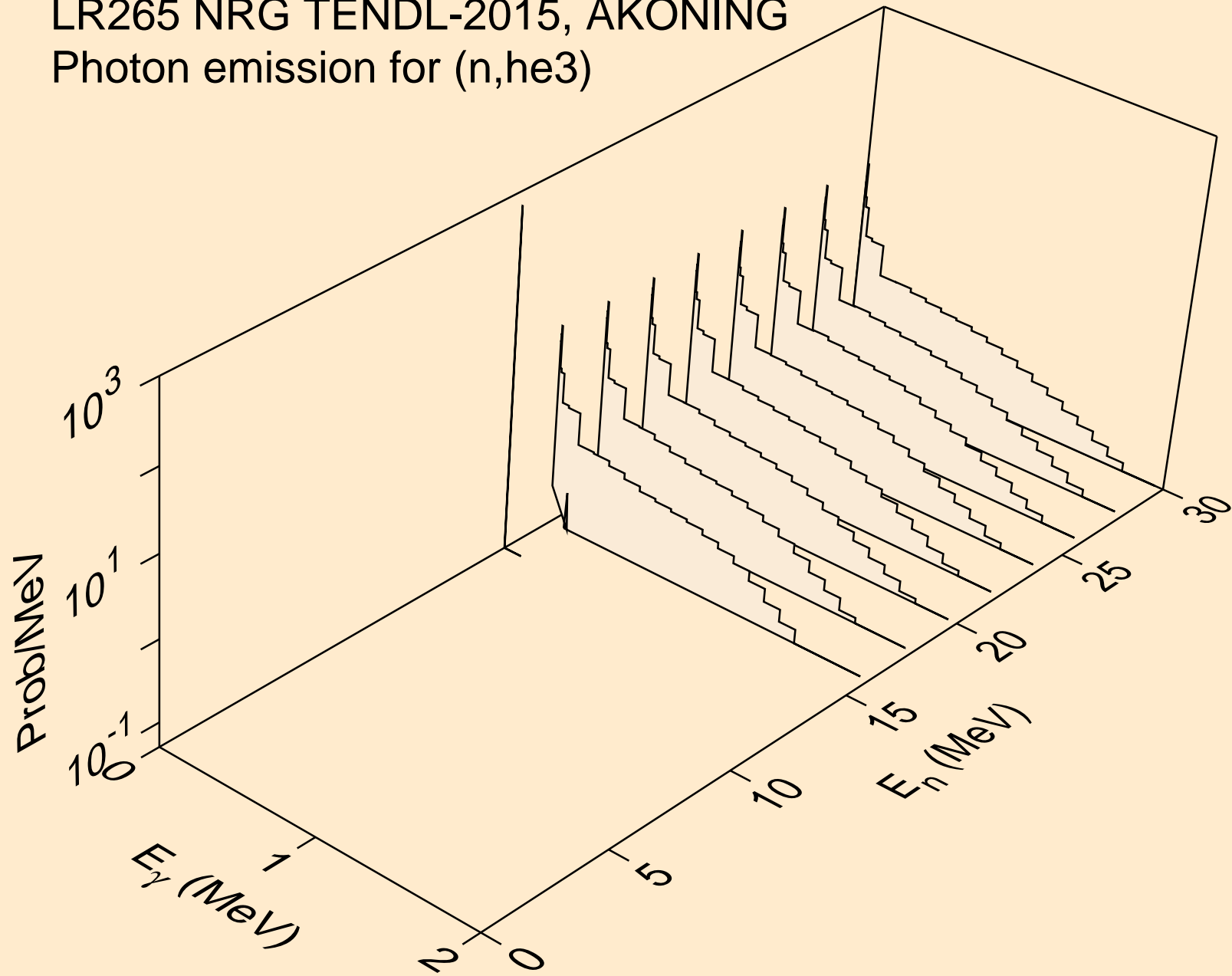

LR265 NRG TENDL-2015, AKONING
Photon emission for (n,a)

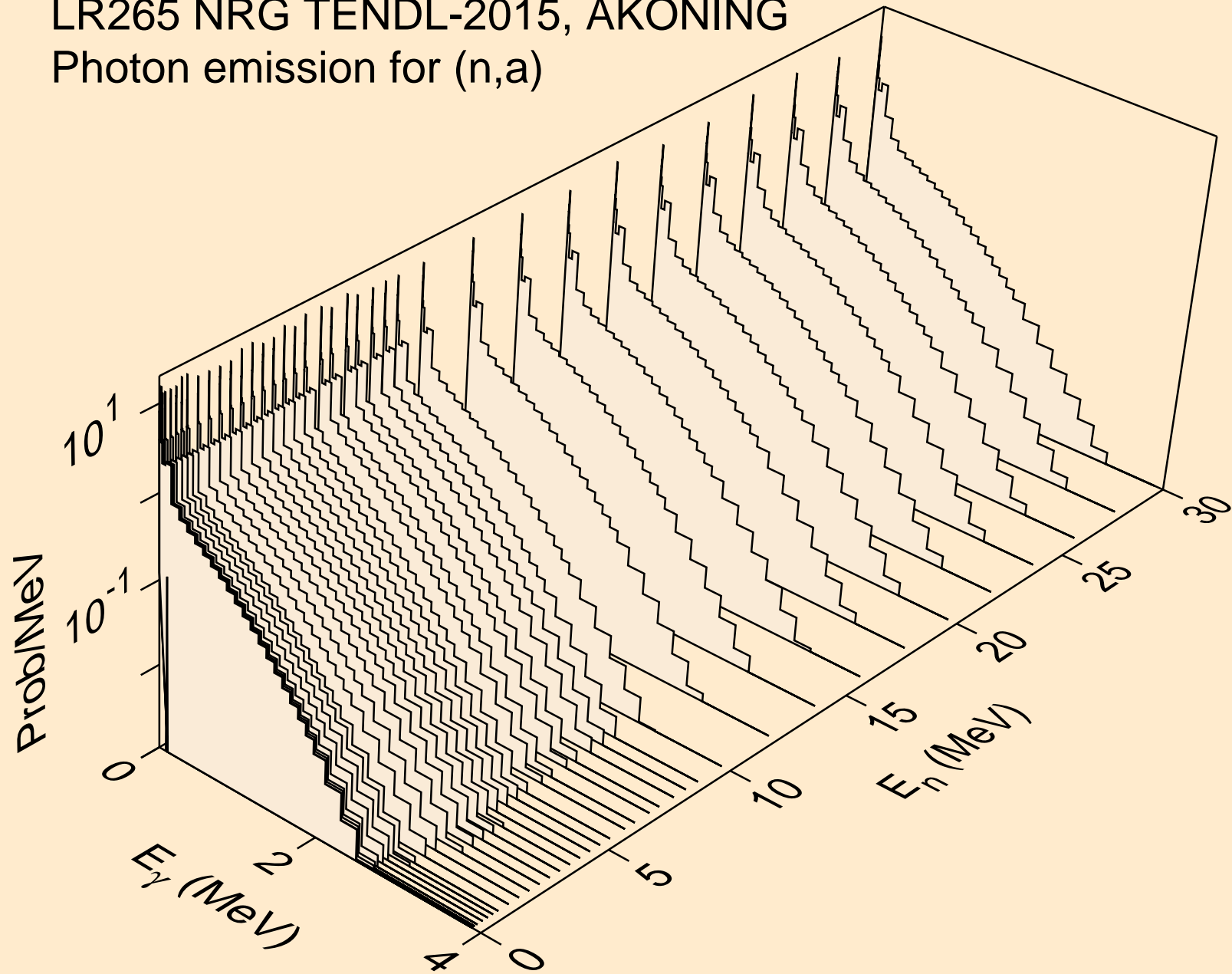

LR265 NRG TENDL-2015, AKONING
Photon emission for (n,2a)

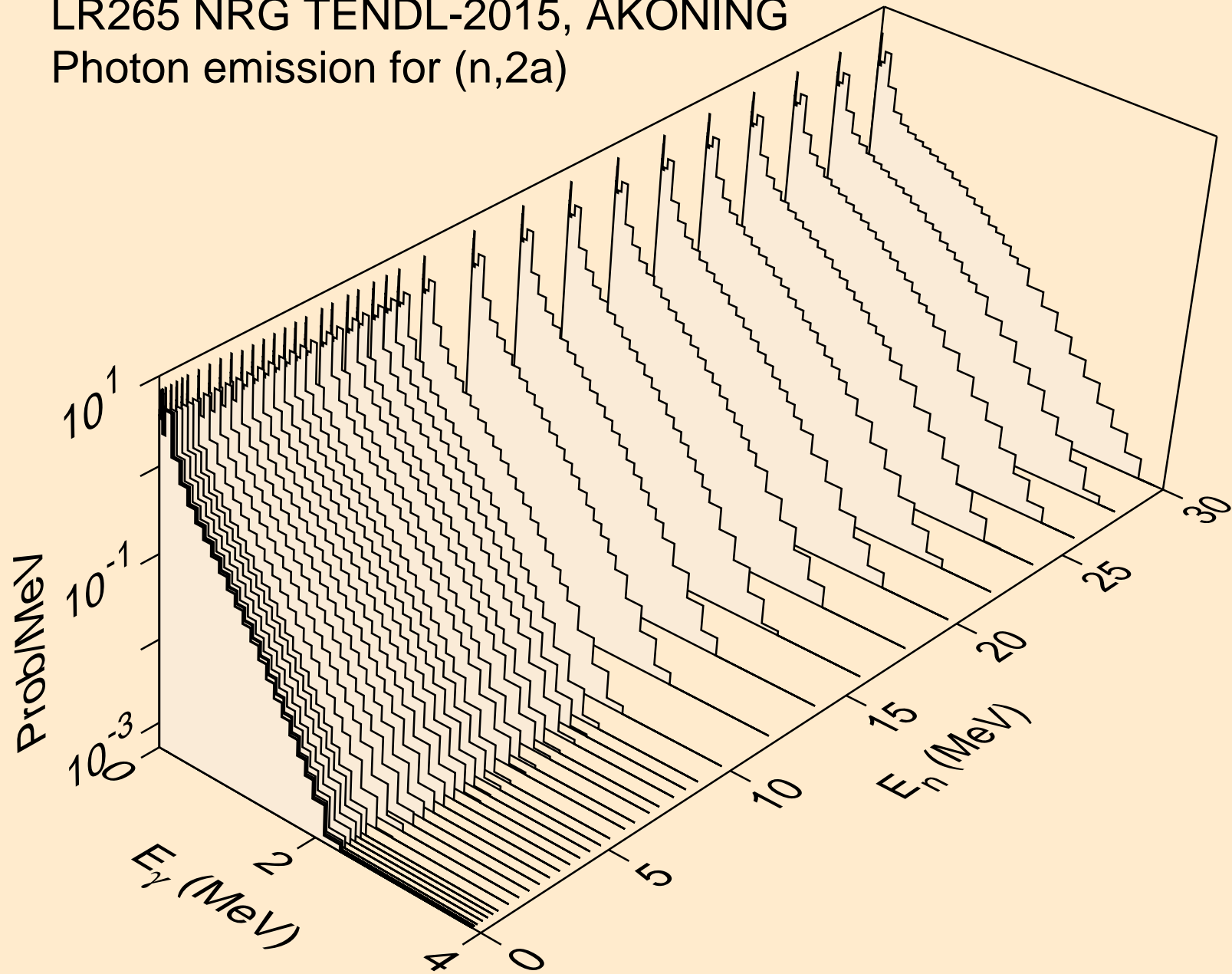

LR265 NRG TENDL-2015, AKONING
Photon emission for (n,2p)

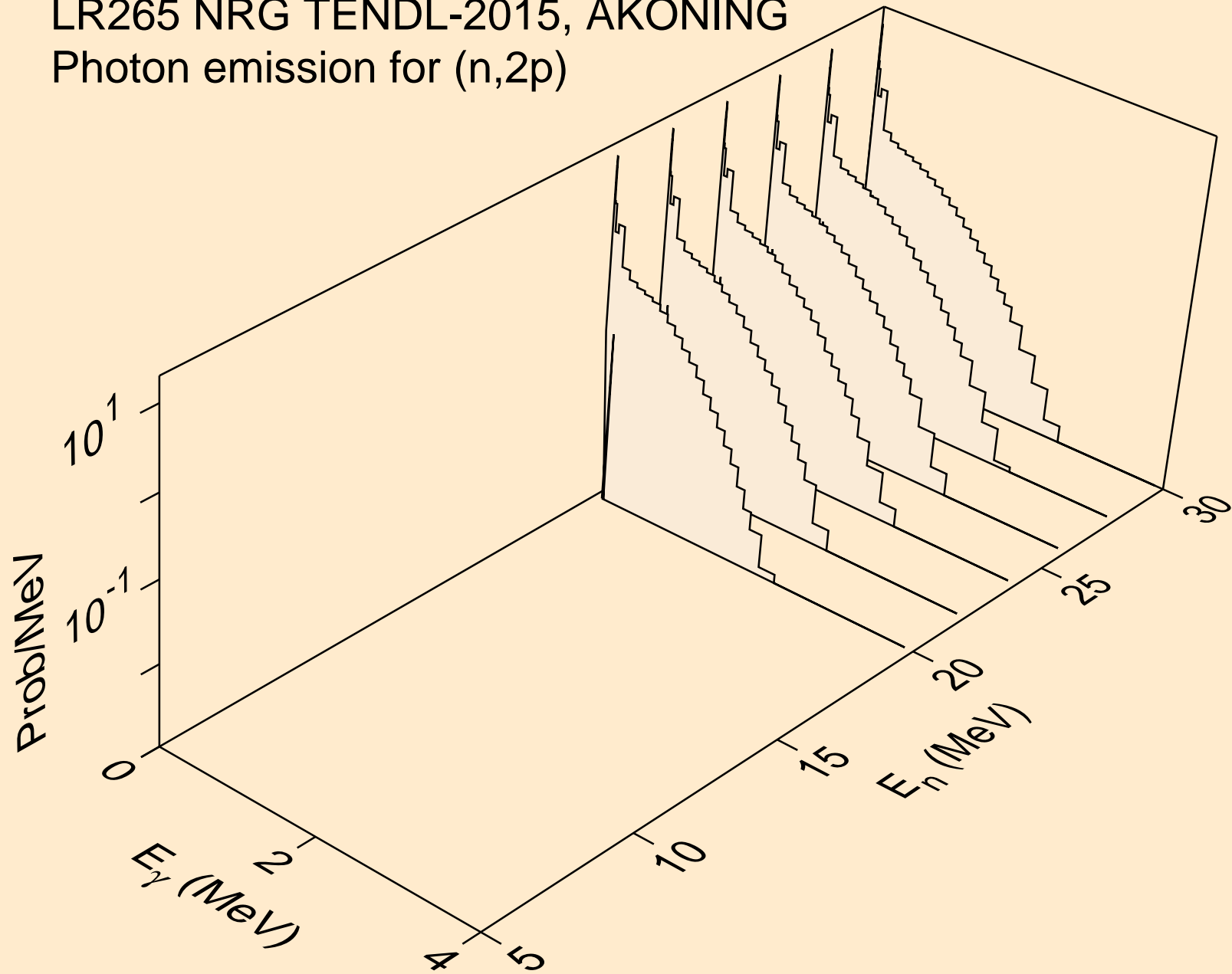

LR265 NRG TENDL-2015, AKONING
Photon emission for (n,da)

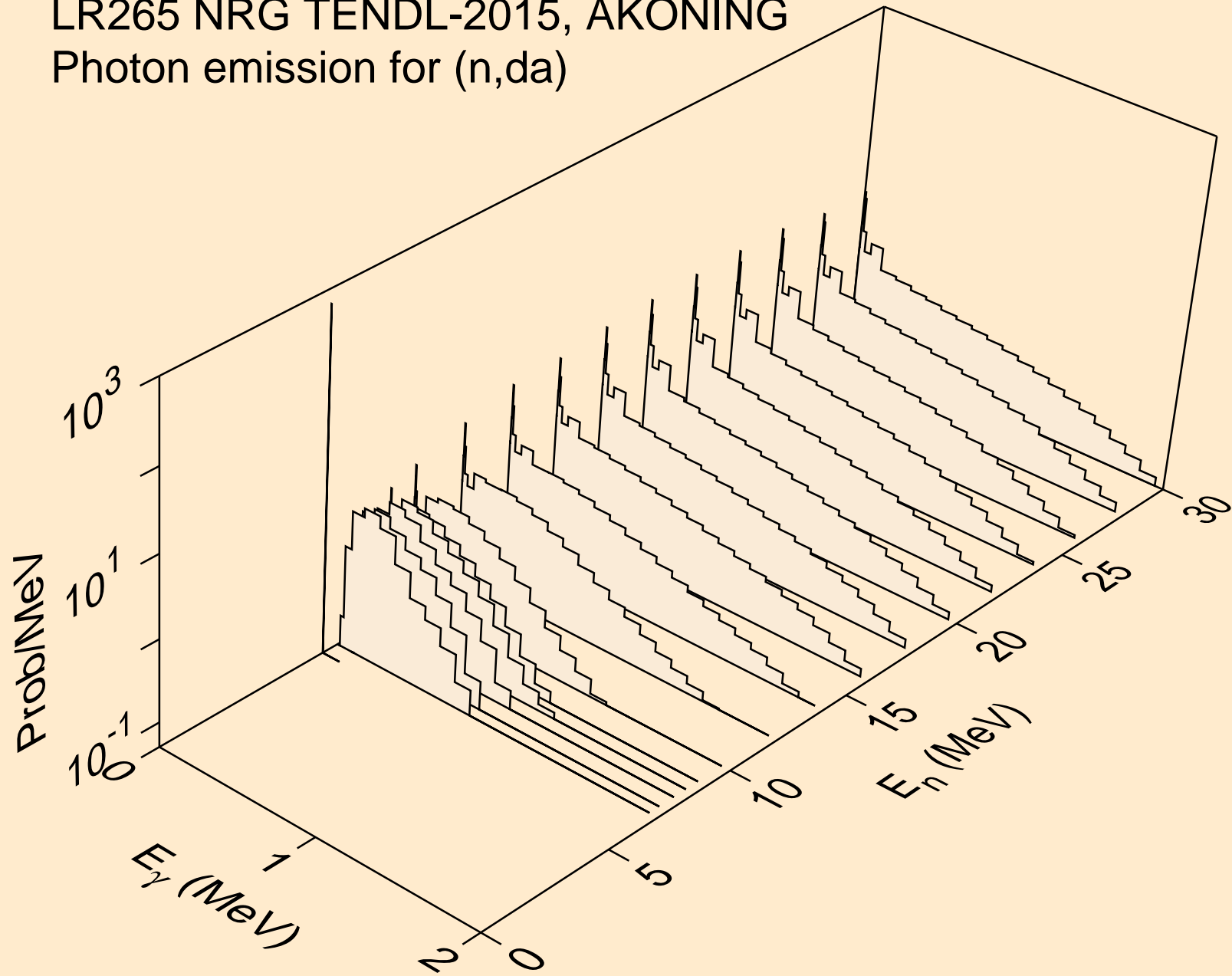

LR265 NRG TENDL-2015, AKONING
thermal capture photon spectrum

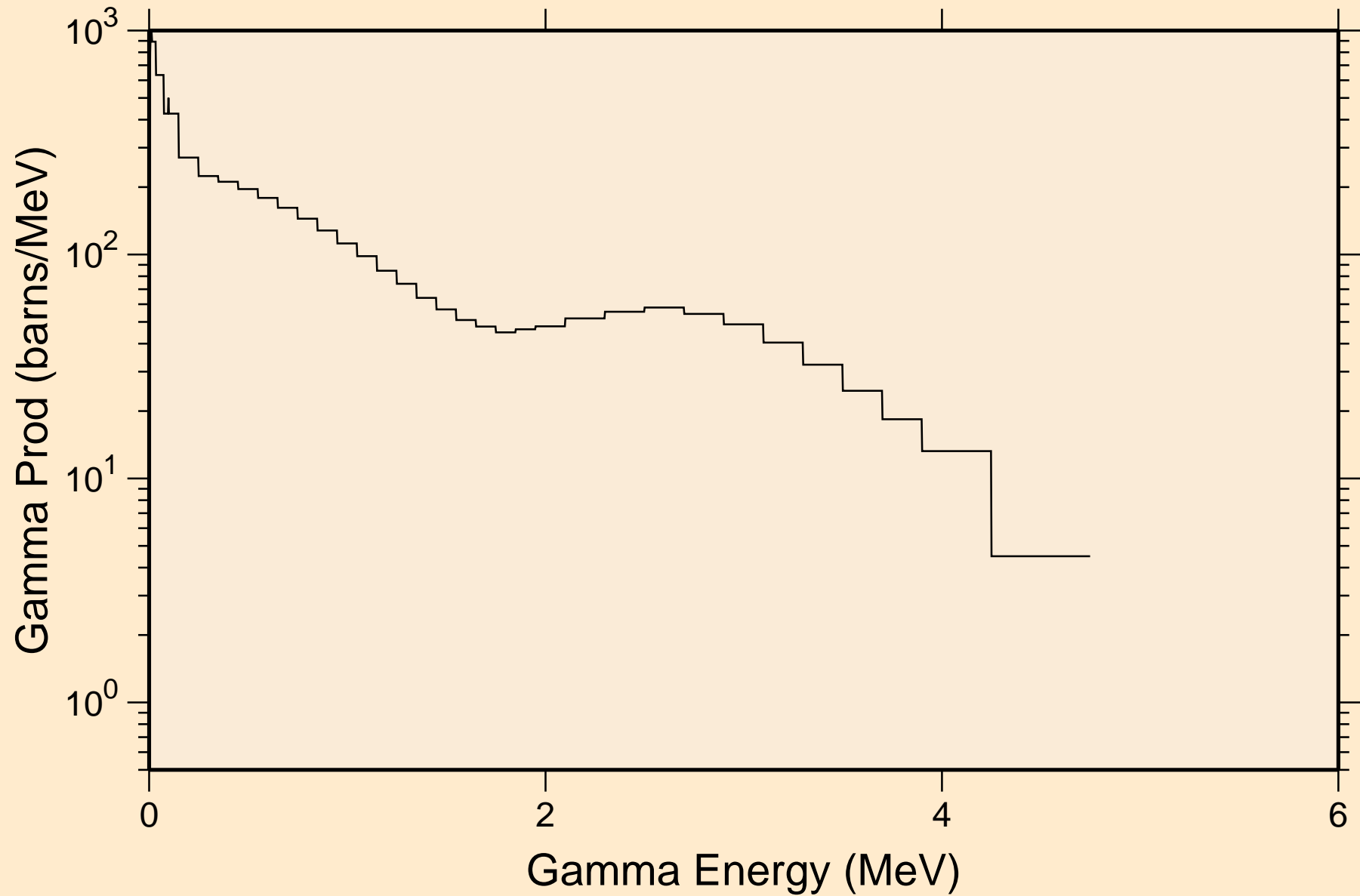

LR265 NRG TENDL-2015, AKONING
14 MeV photon spectrum

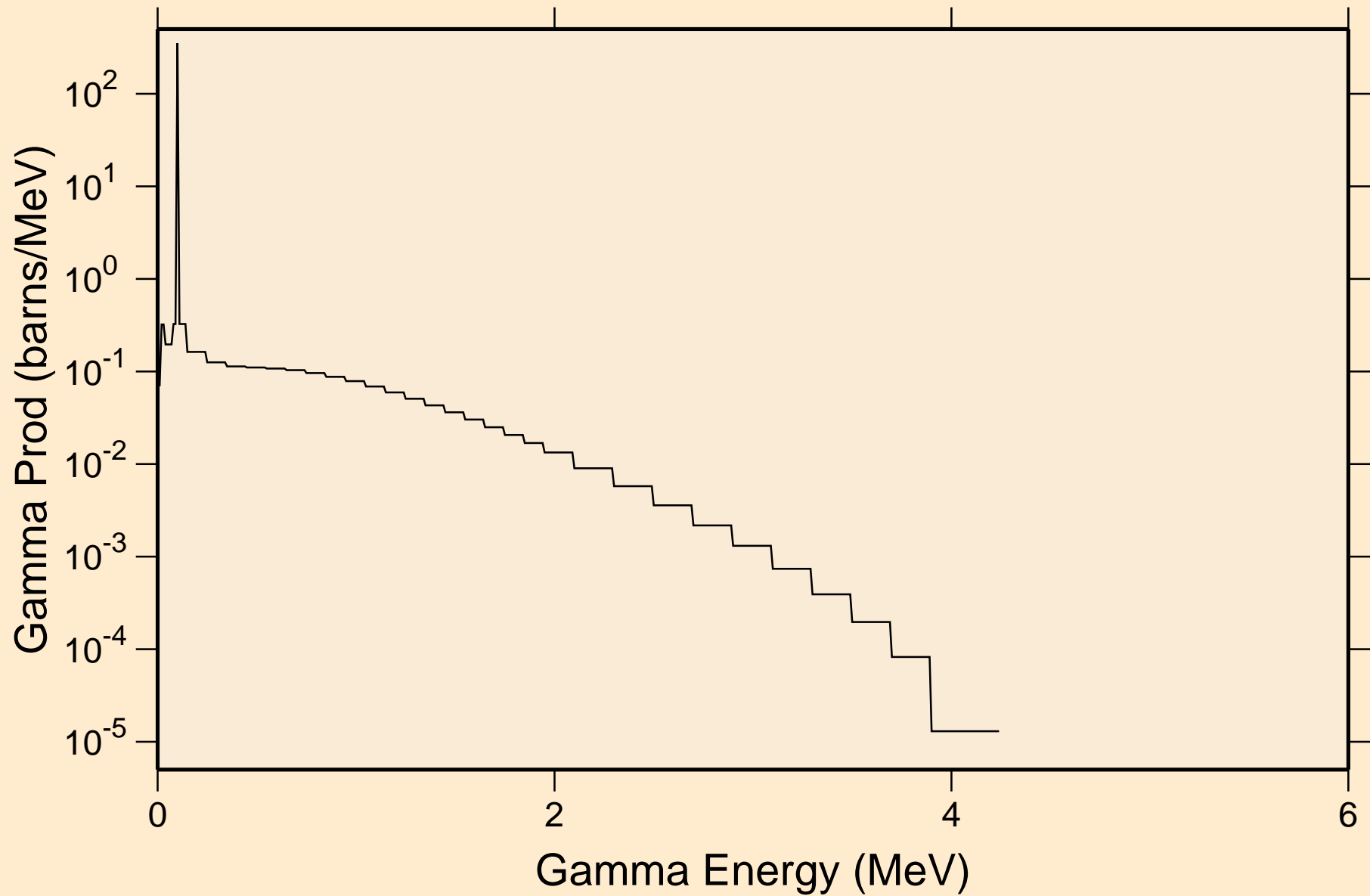

LR265 NRG TENDL-2015, AKONING

Particle heating contributions

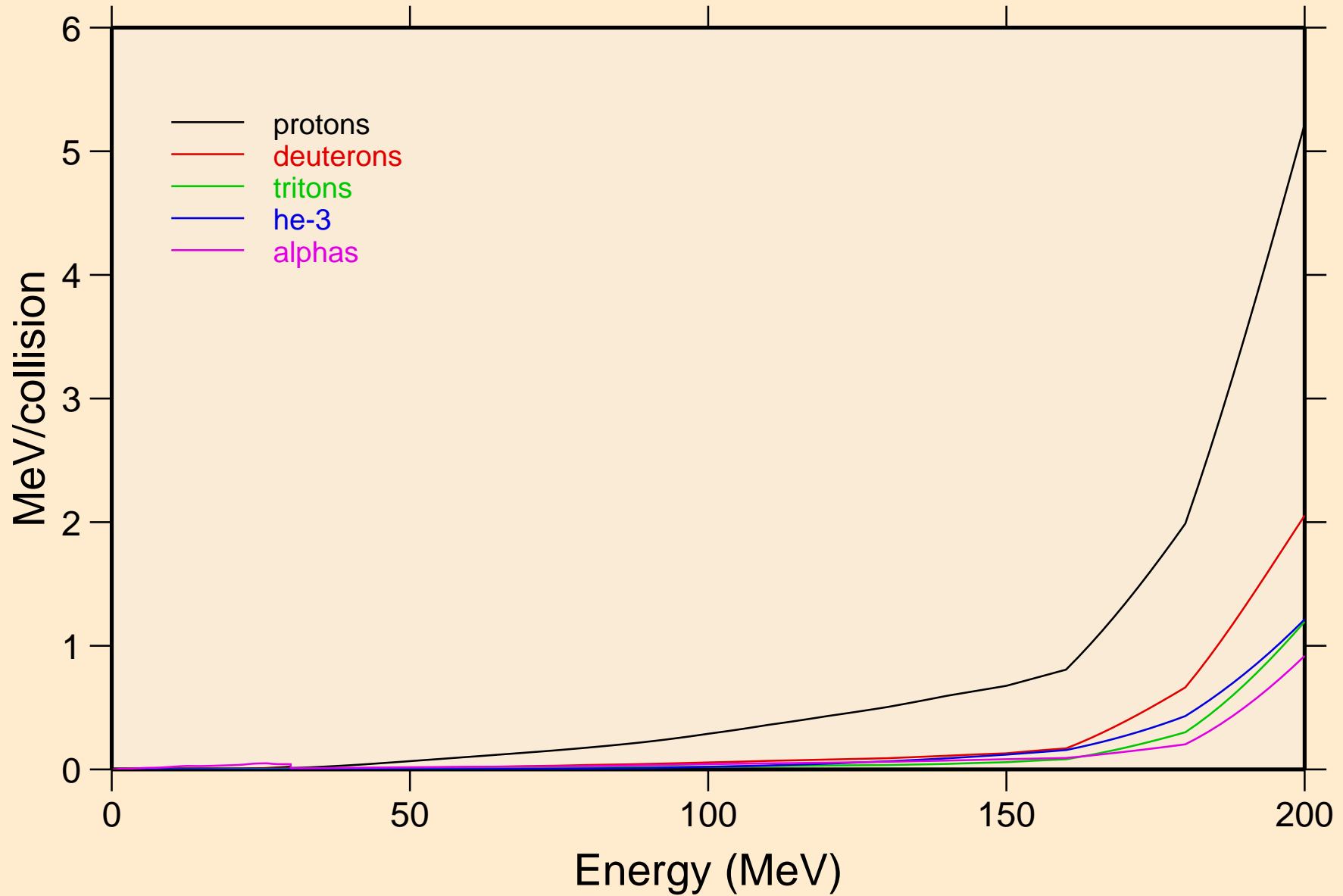

LR265 NRG TENDL-2015, AKONING

Recoil Heating

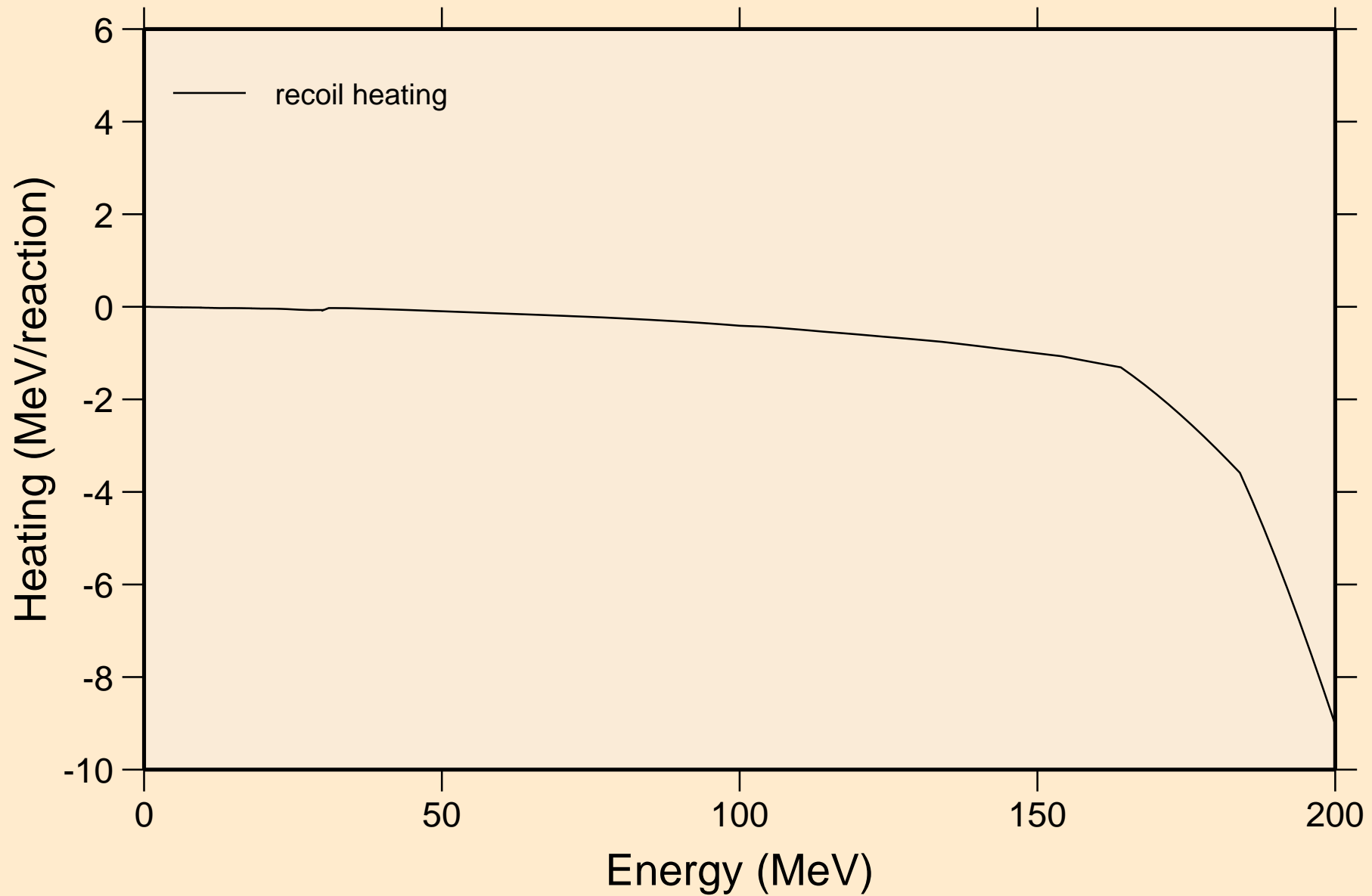

LR265 NRG TENDL-2015, AKONING

Particle production cross sections

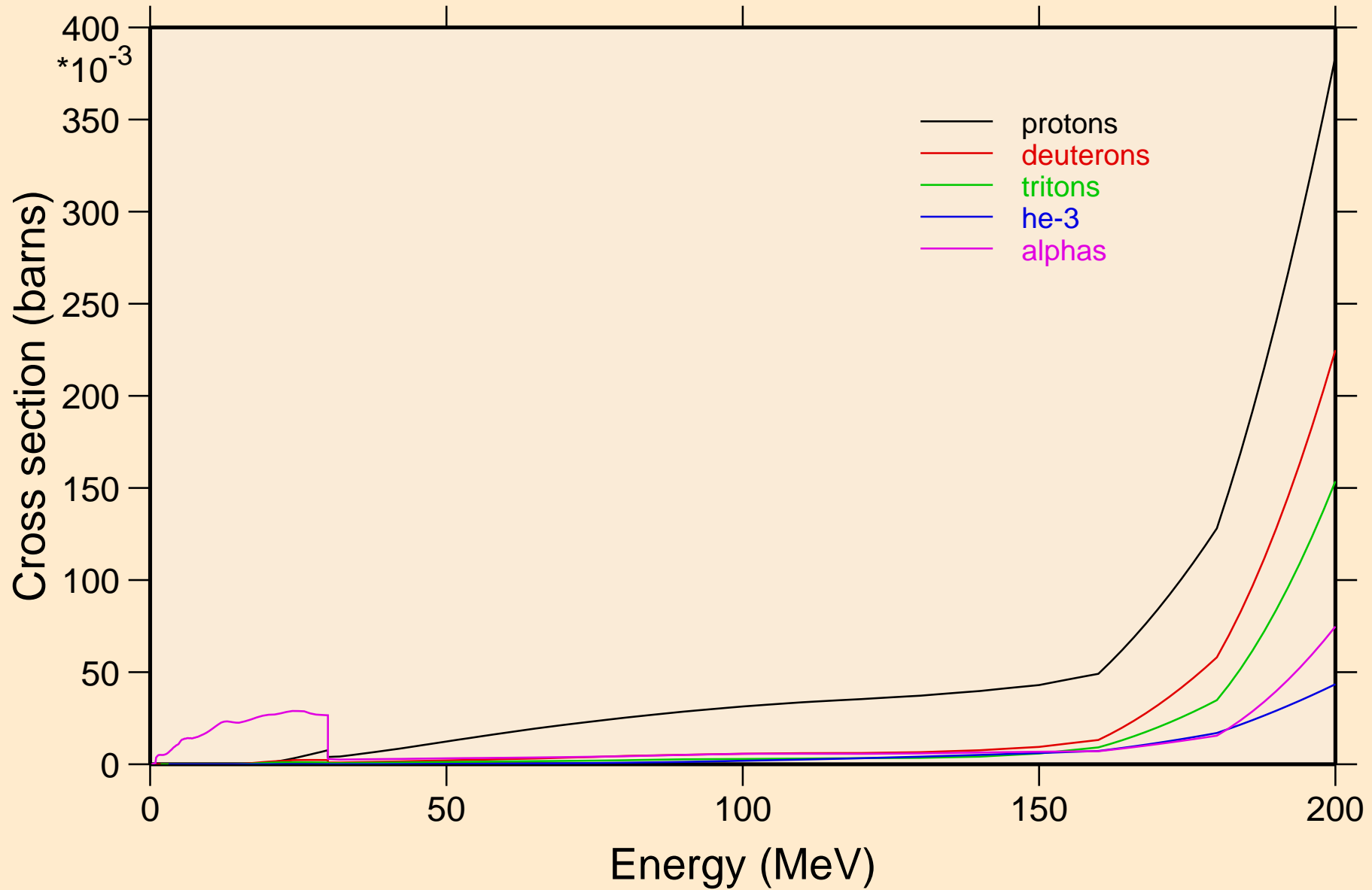

LR265 NRG TENDL-2015, AKONING
protons from (n,x)

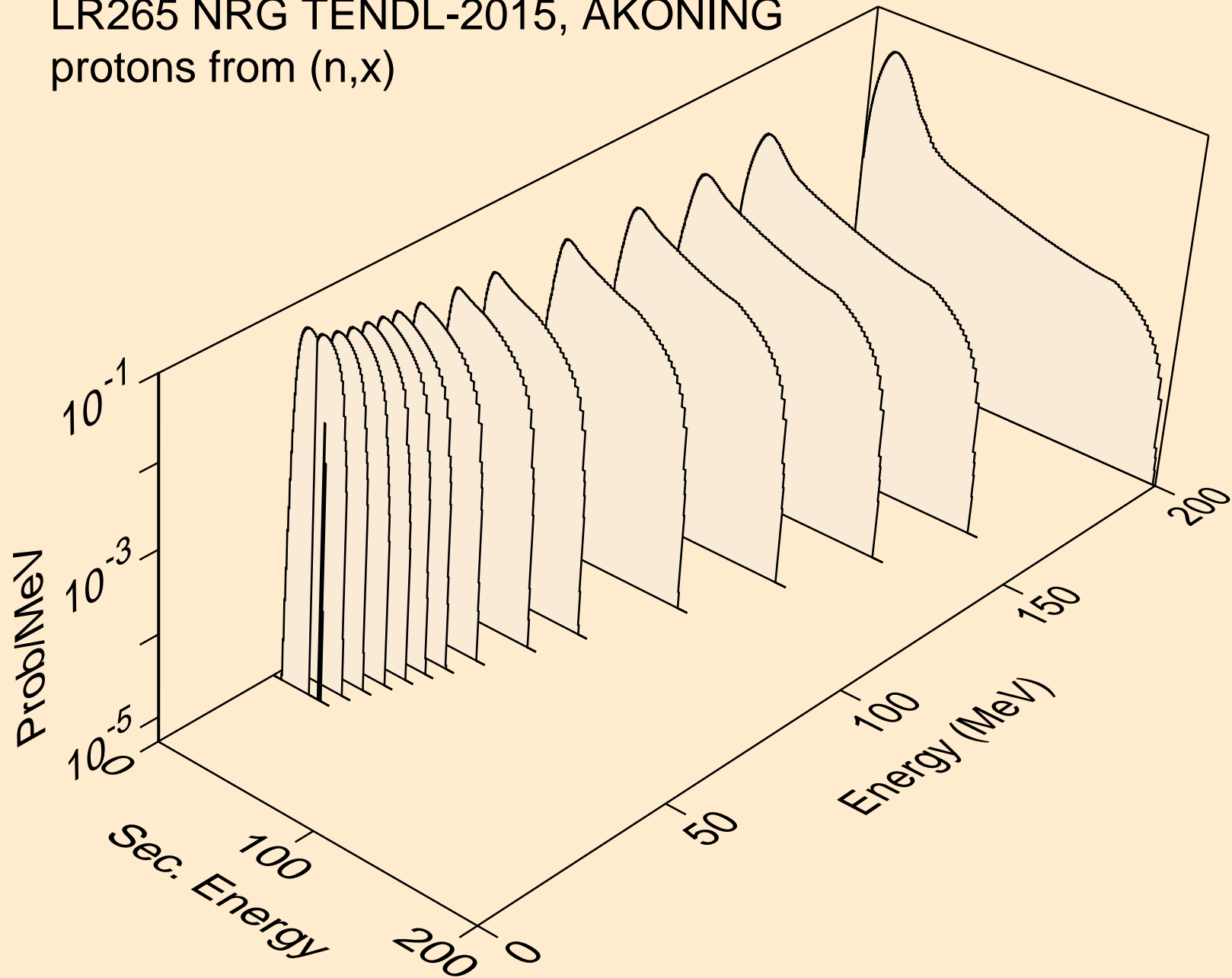

LR265 NRG TENDL-2015, AKONING
protons from (n,n*)p

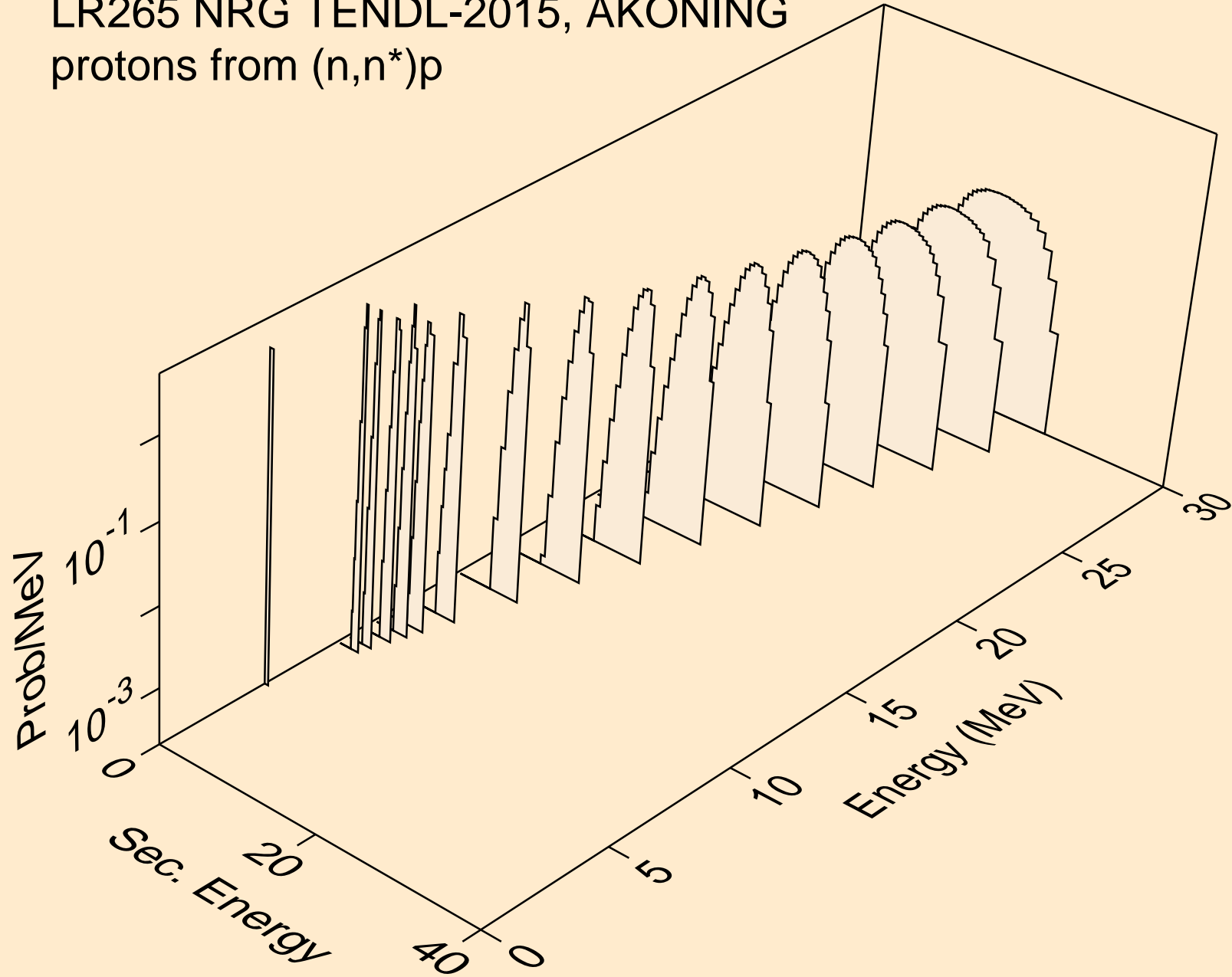

LR265 NRG TENDL-2015, AKONING
protons from (n,2np)

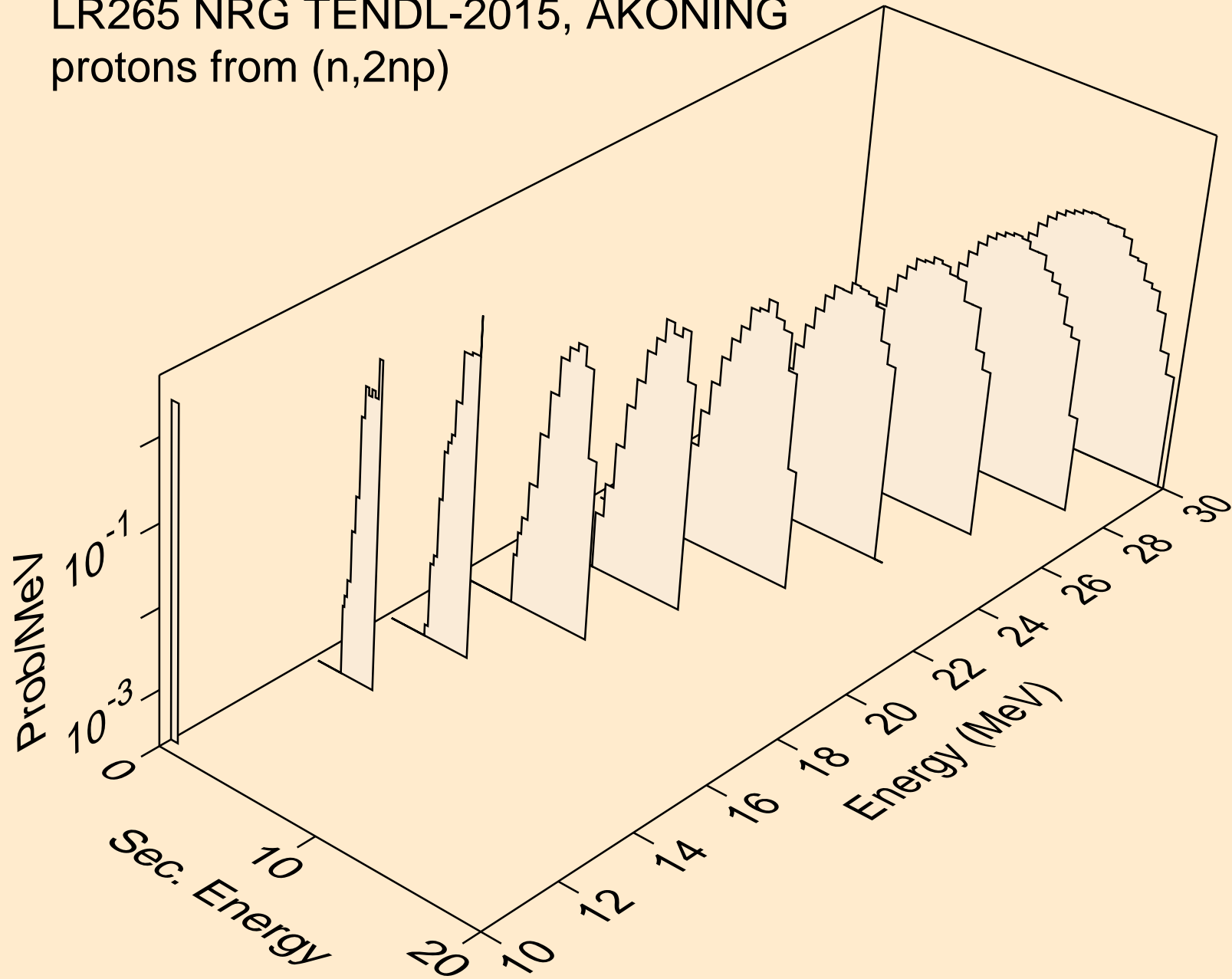

LR265 NRG TENDL-2015, AKONING
protons from (n,3np)

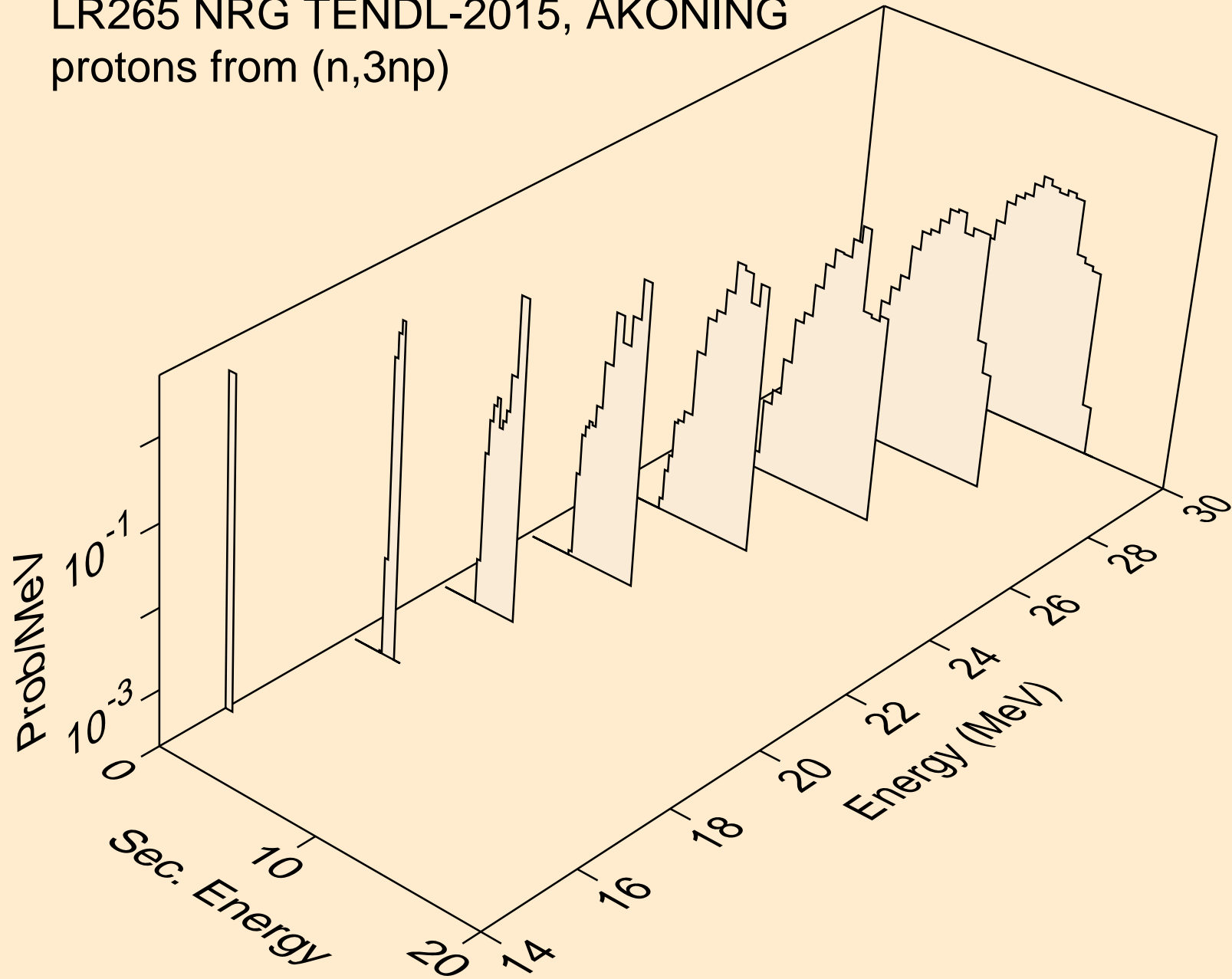

LR265 NRG TENDL-2015, AKONING
protons from (n,npa)

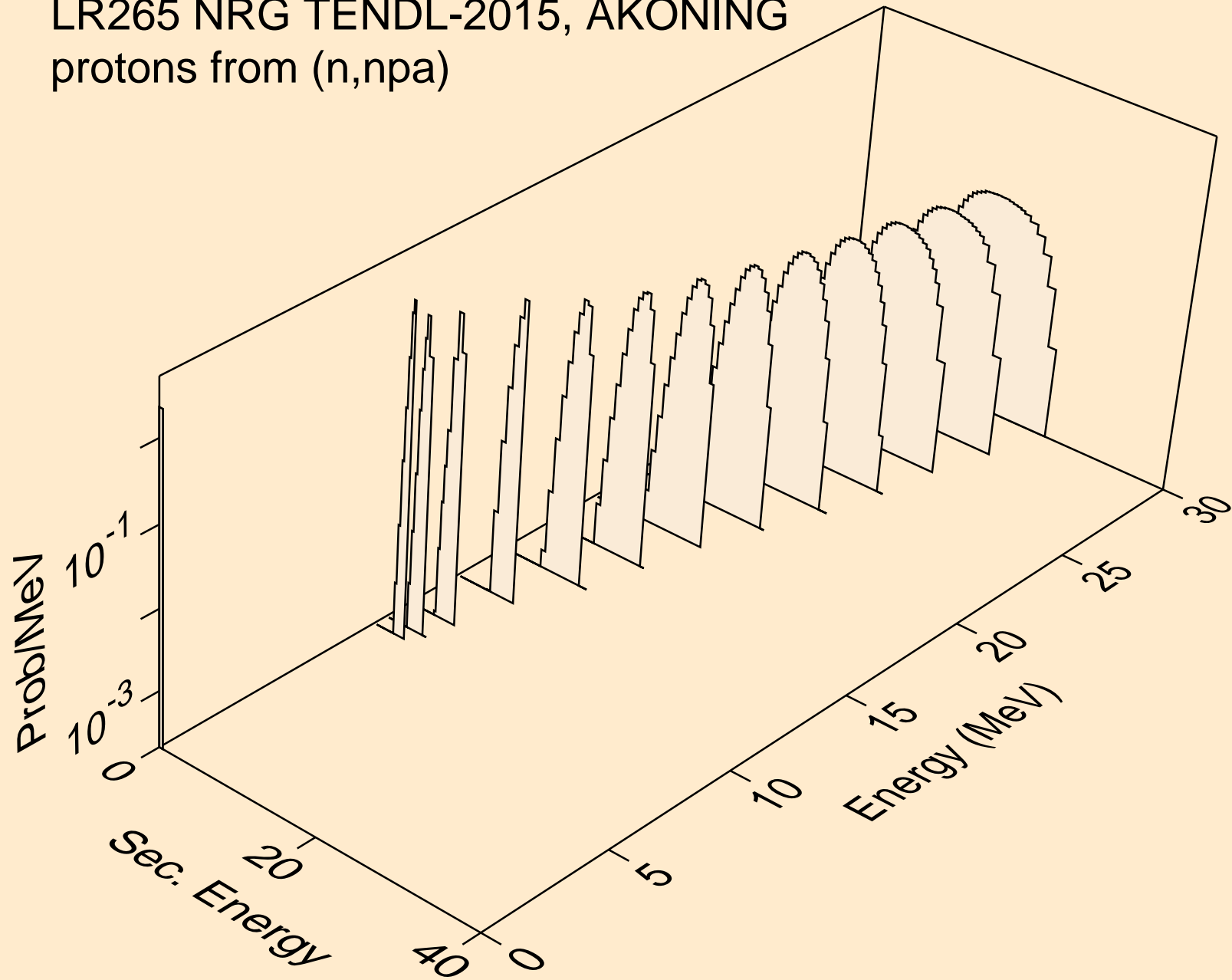

LR265 NRG TENDL-2015, AKONING
protons from (n,p)

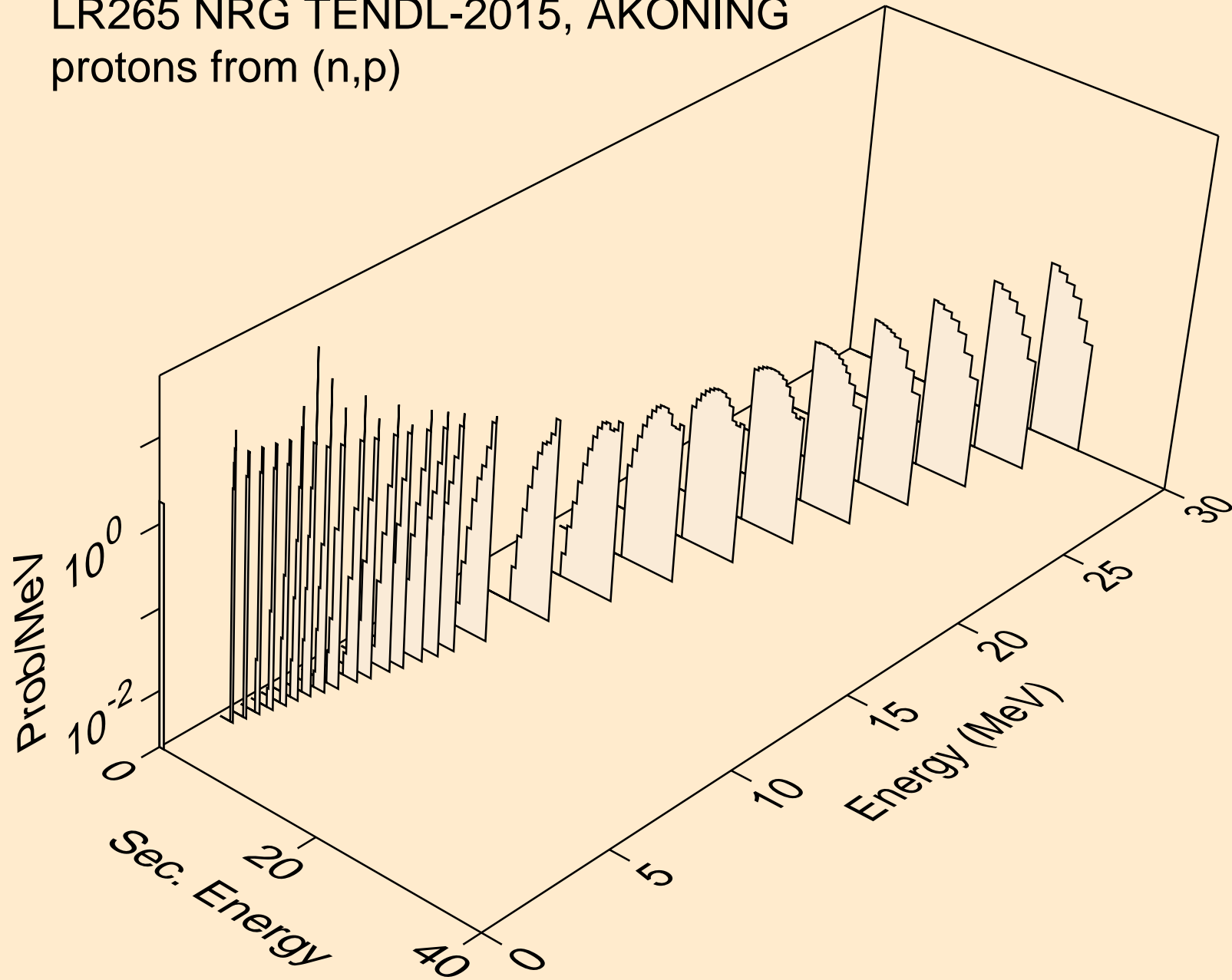

LR265 NRG TENDL-2015, AKONING
protons from (n,2p)

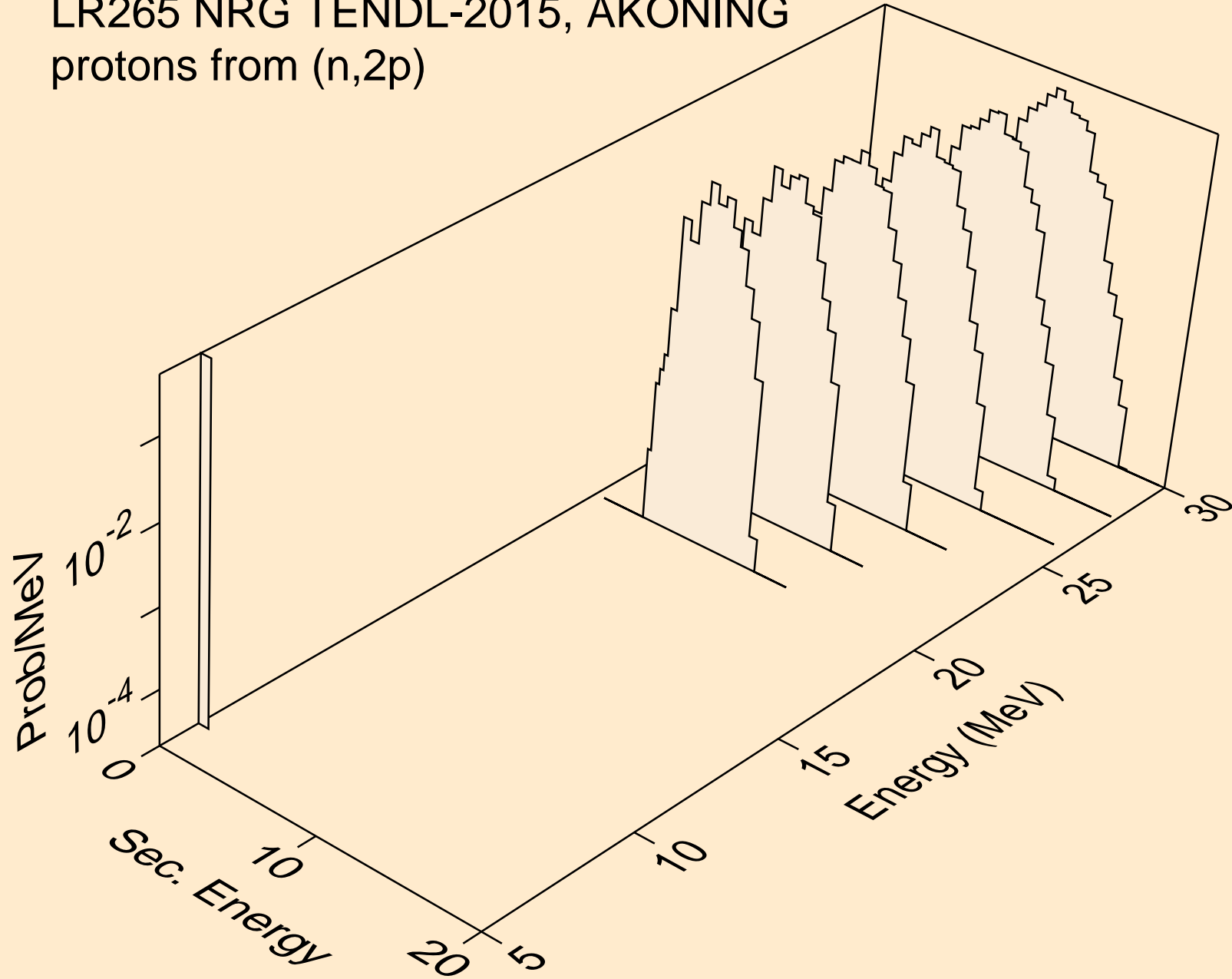

LR265 NRG TENDL-2015, AKONING
deuterons from (n,x)

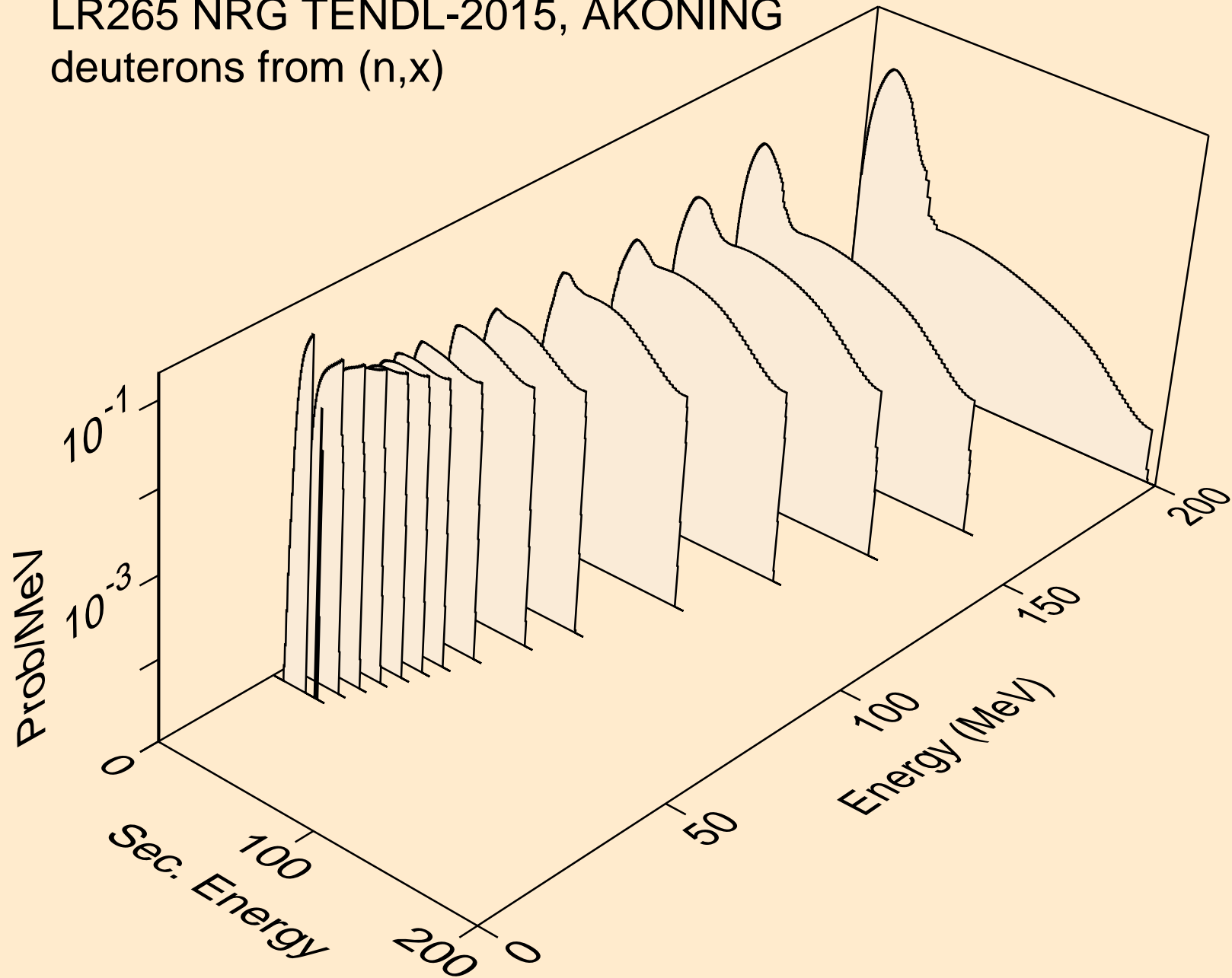

LR265 NRG TENDL-2015, AKONING
deuterons from (n,2nd)

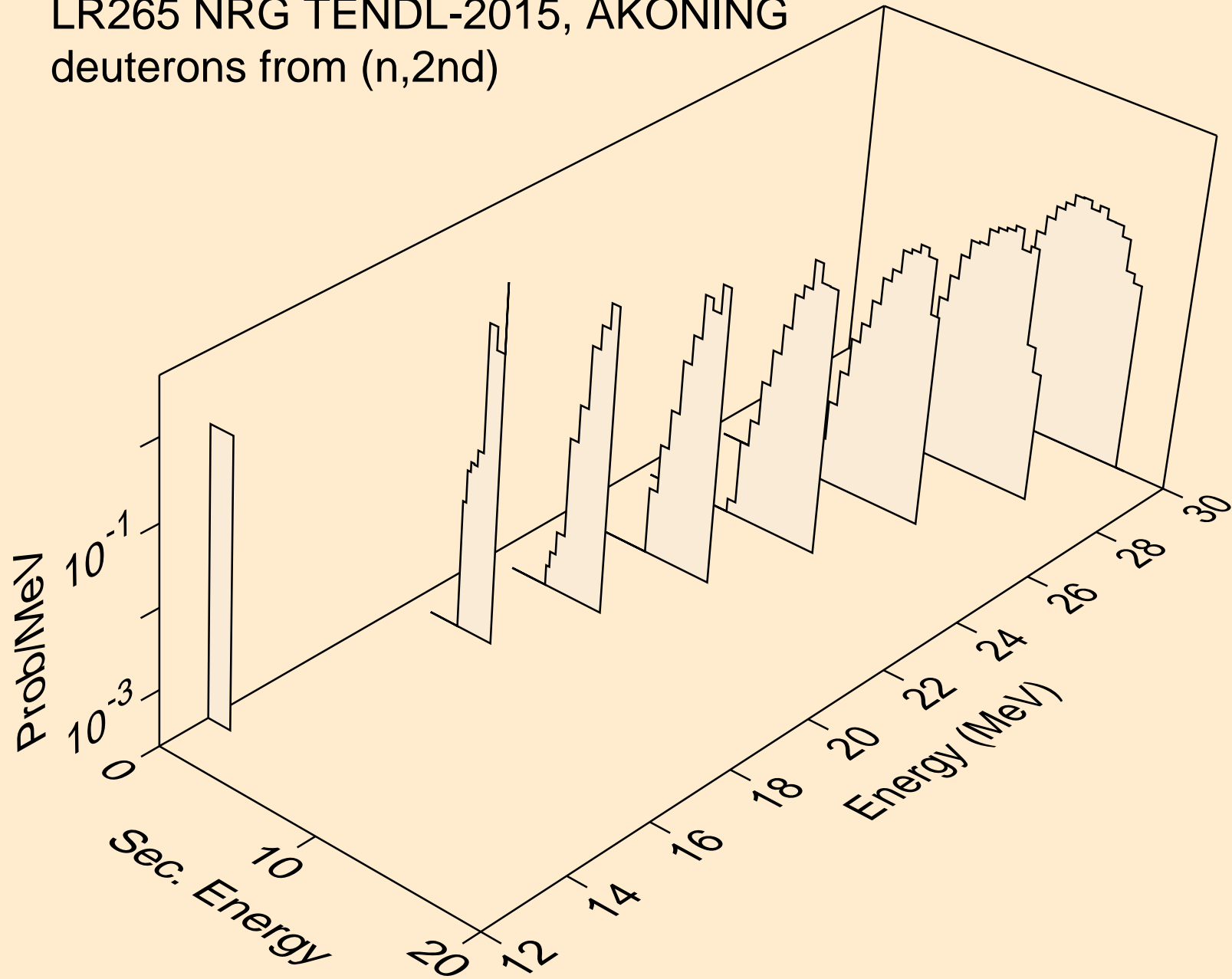

LR265 NRG TENDL-2015, AKONING
deuterons from (n,n*)d

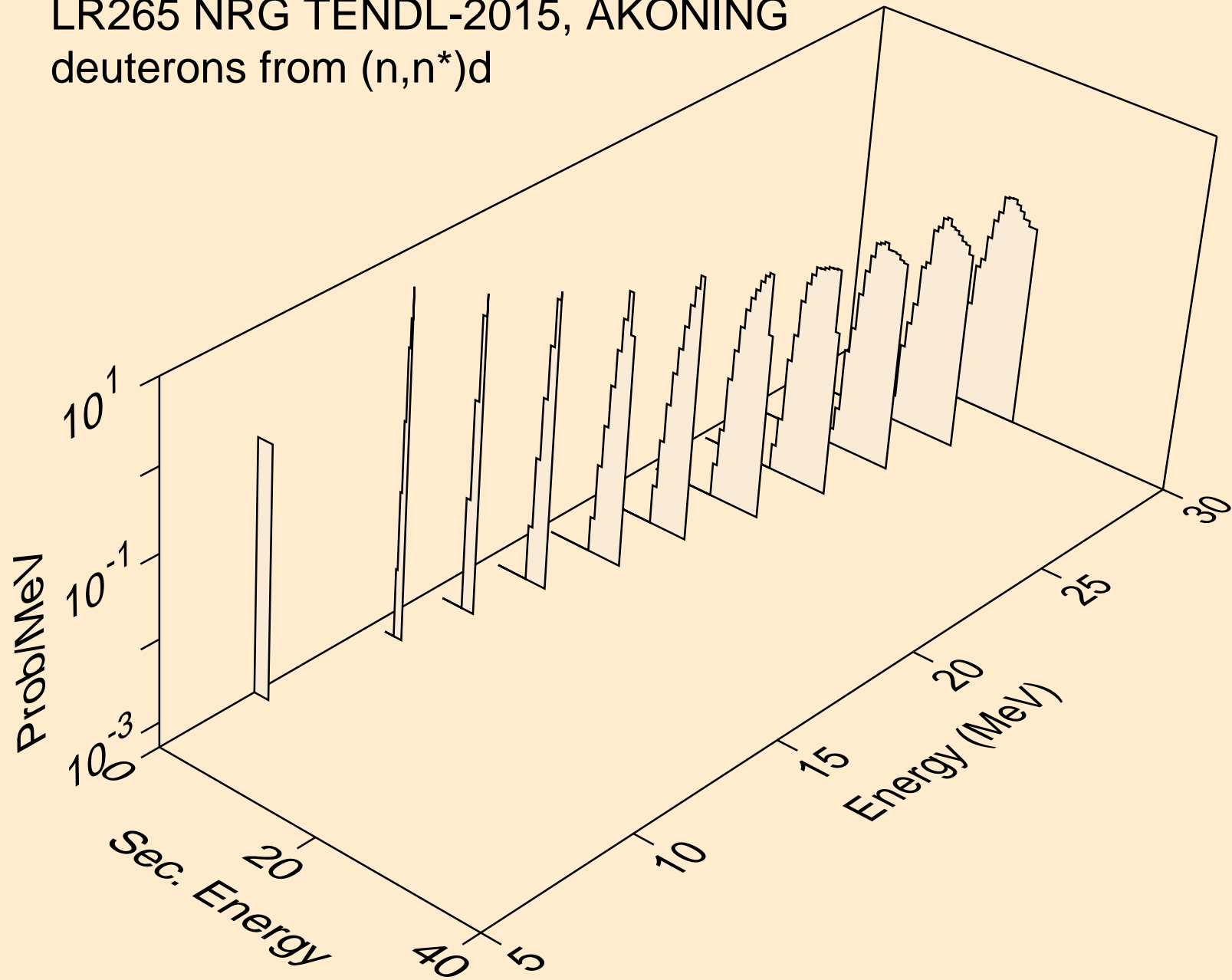

LR265 NRG TENDL-2015, AKONING
deuterons from (n,d)

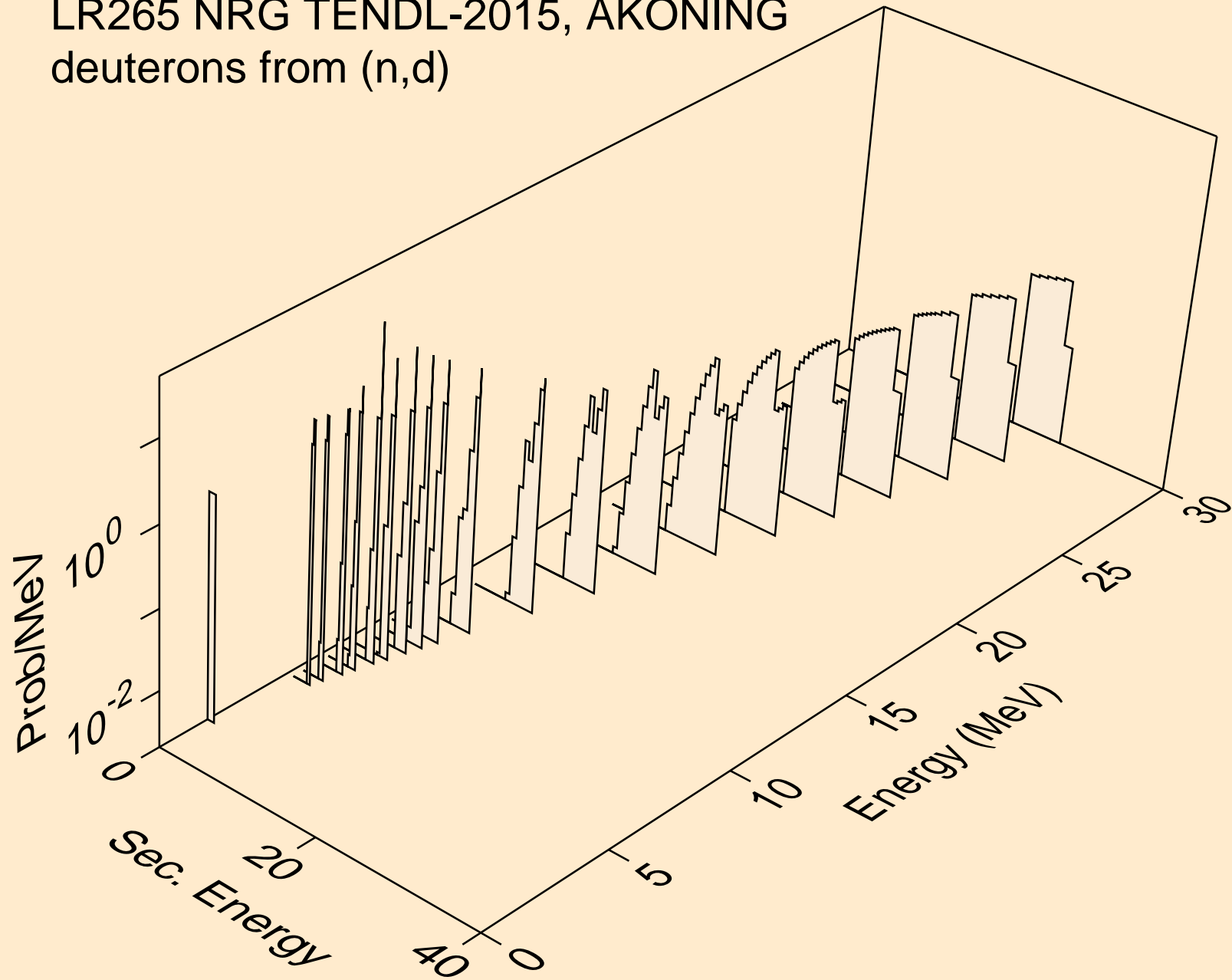

LR265 NRG TENDL-2015, AKONING
deuterons from (n,da)

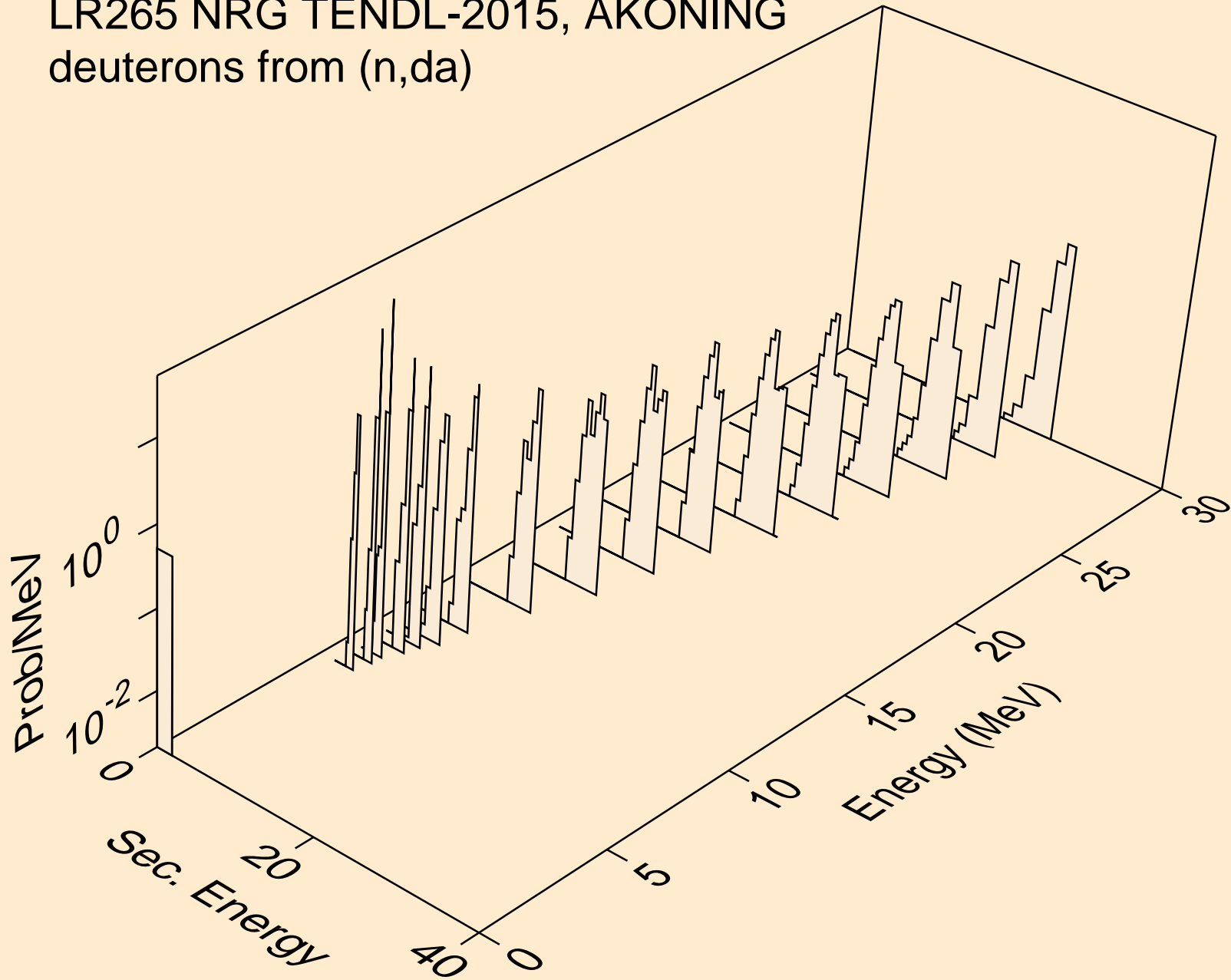

LR265 NRG TENDL-2015, AKONING
tritons from (n,x)

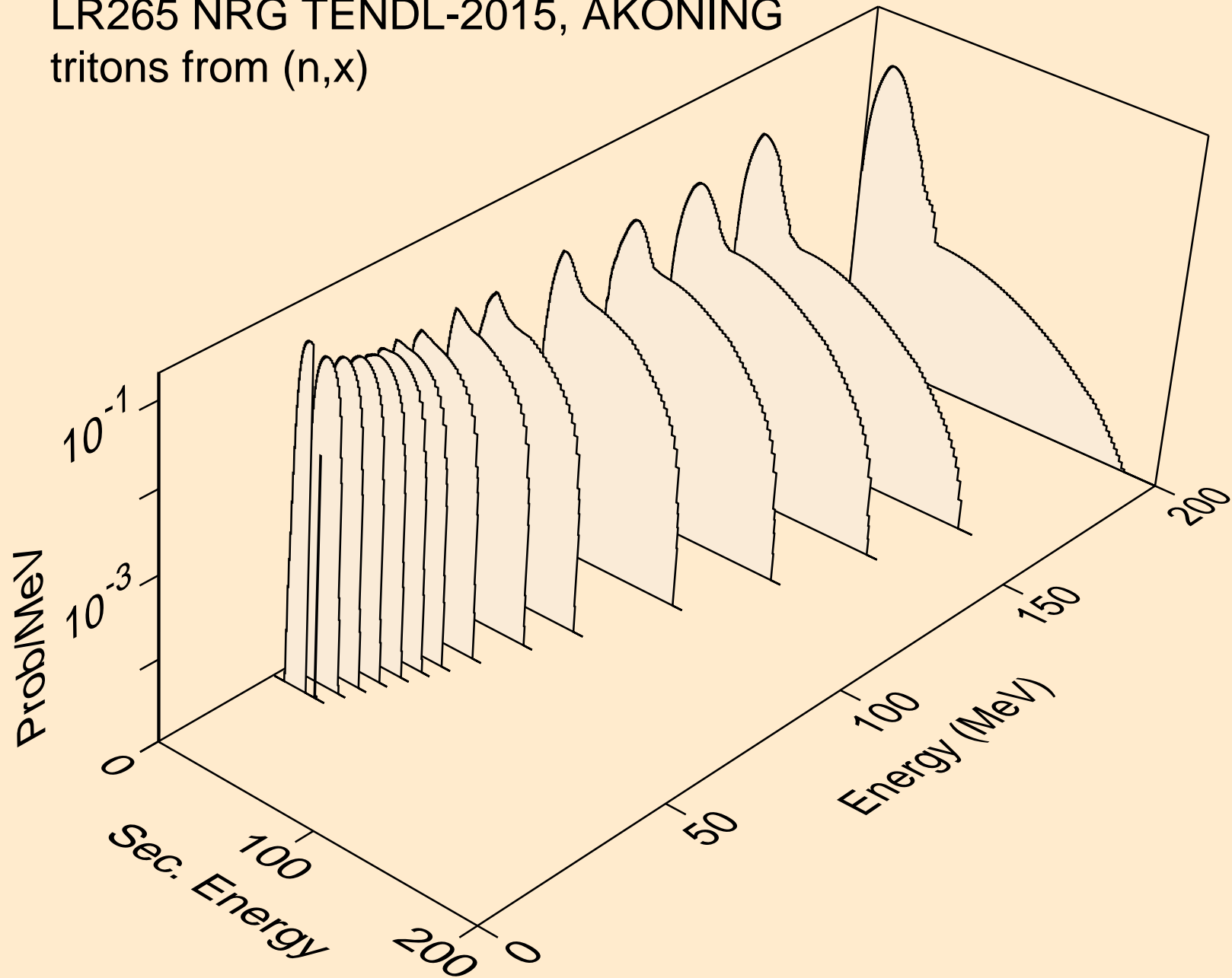

LR265 NRG TENDL-2015, AKONING
tritons from (n,n*)t

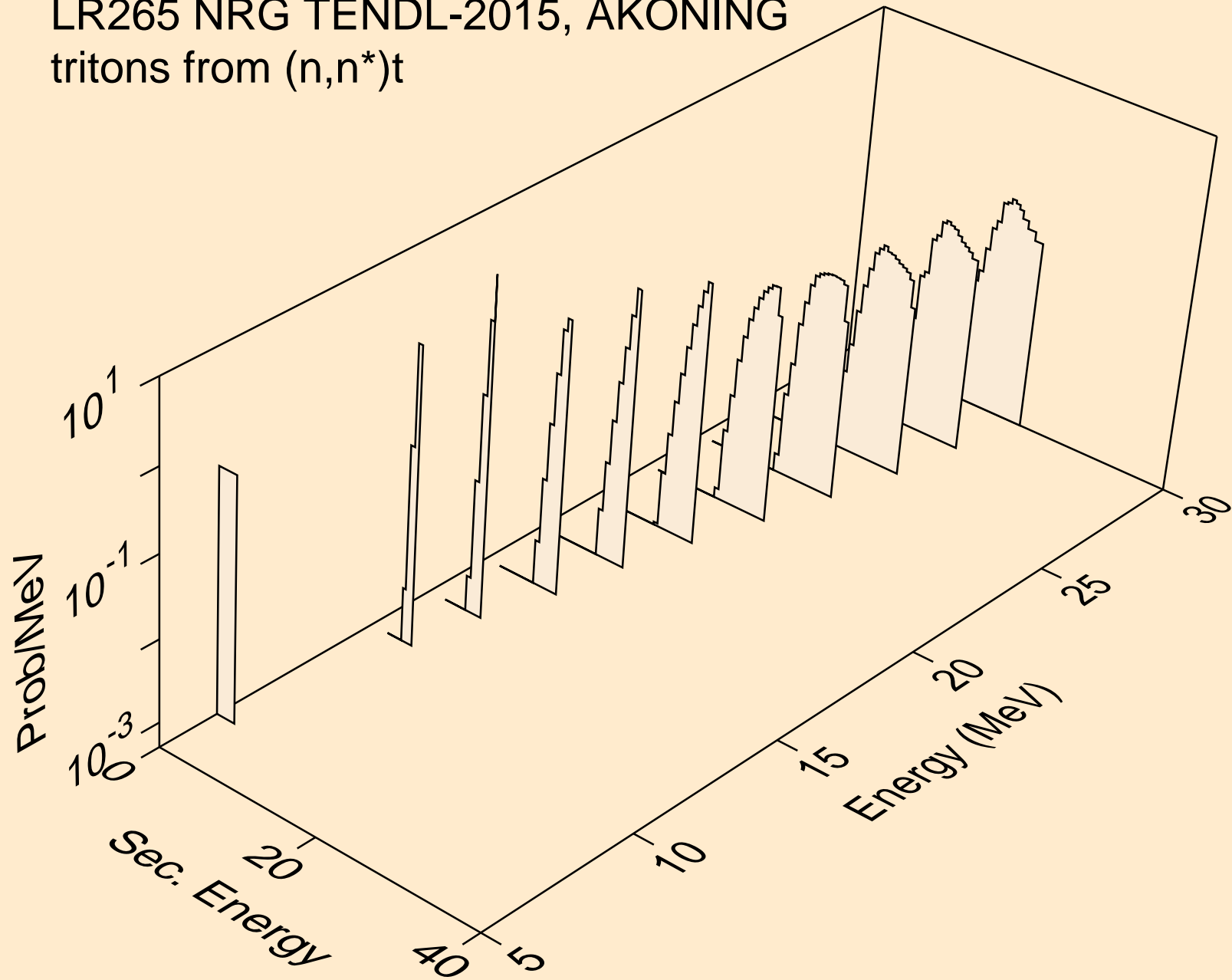

LR265 NRG TENDL-2015, AKONING
tritons from (n,t)

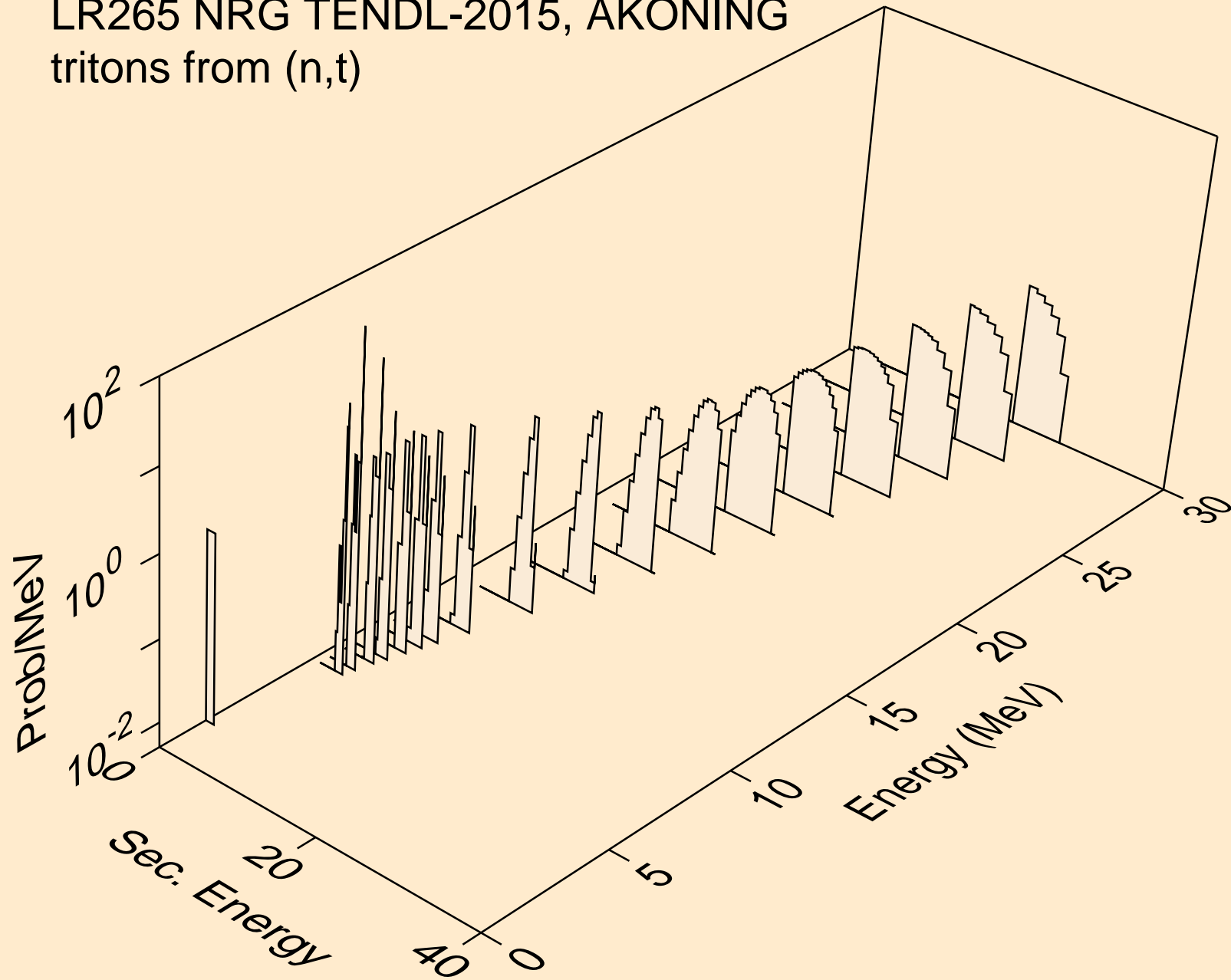

LR265 NRG TENDL-2015, AKONING
he3s from (n,x)

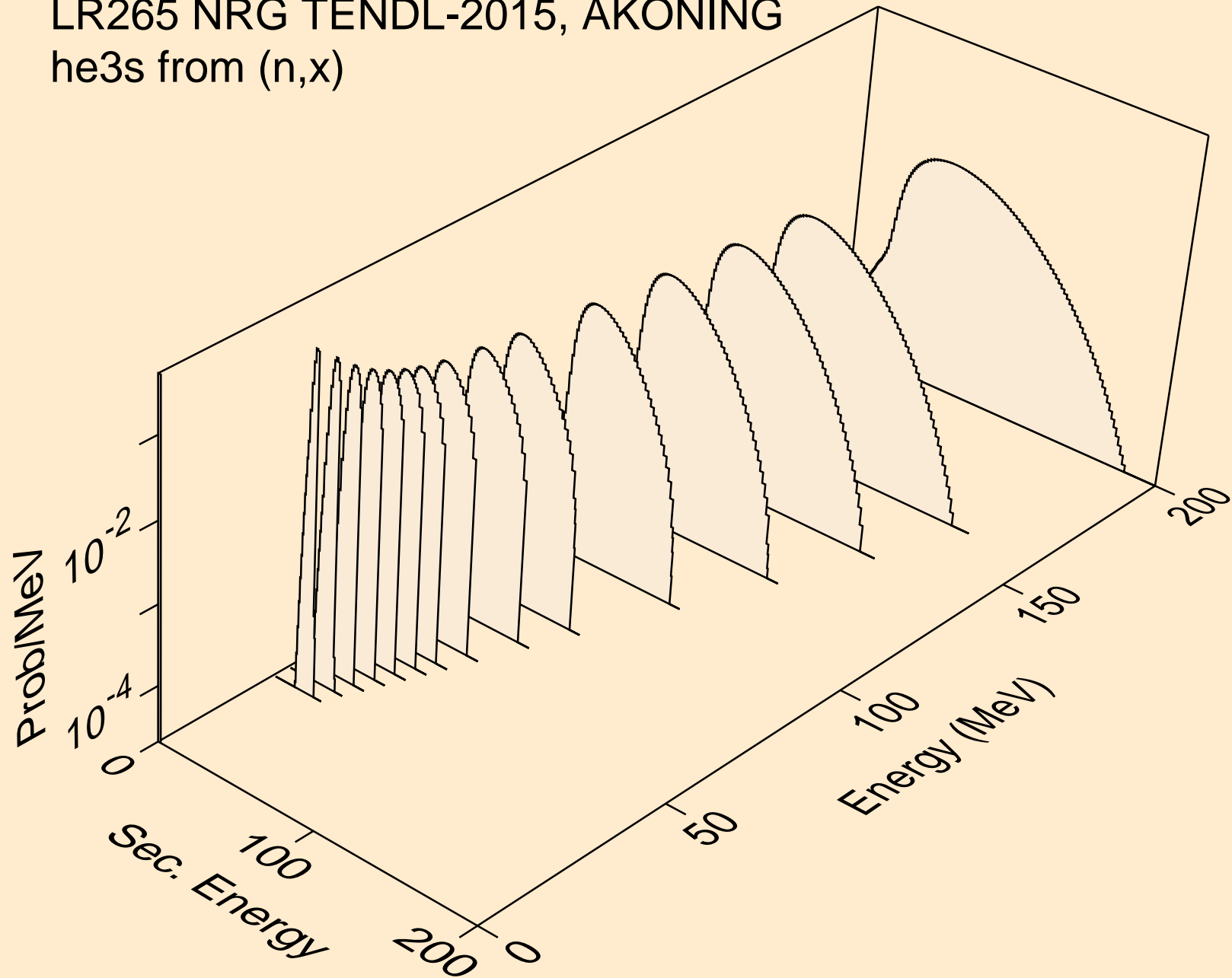

LR265 NRG TENDL-2015, AKONING
he3s from (n,n*)he3

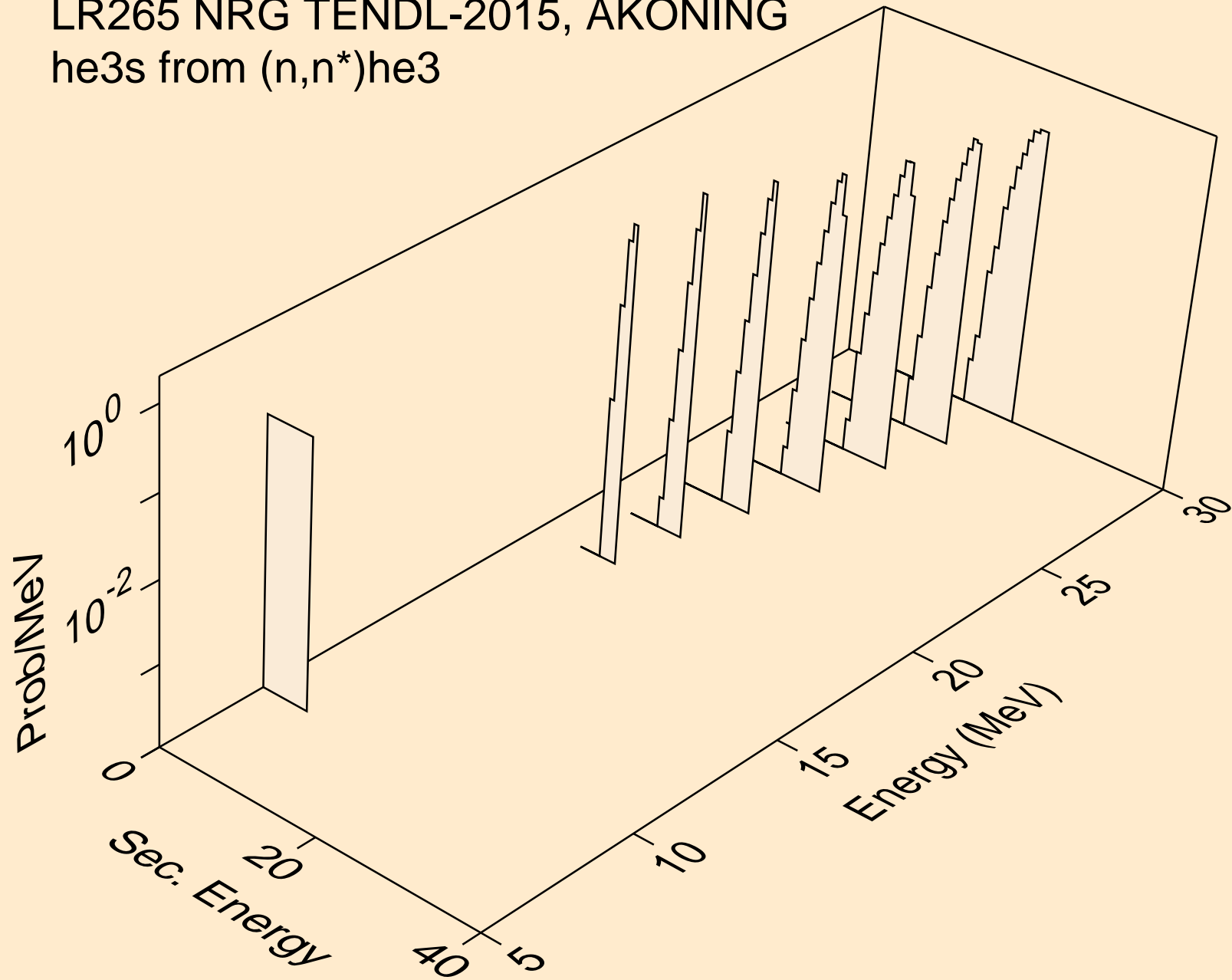

LR265 NRG TENDL-2015, AKONING
he3s from (n,he3)

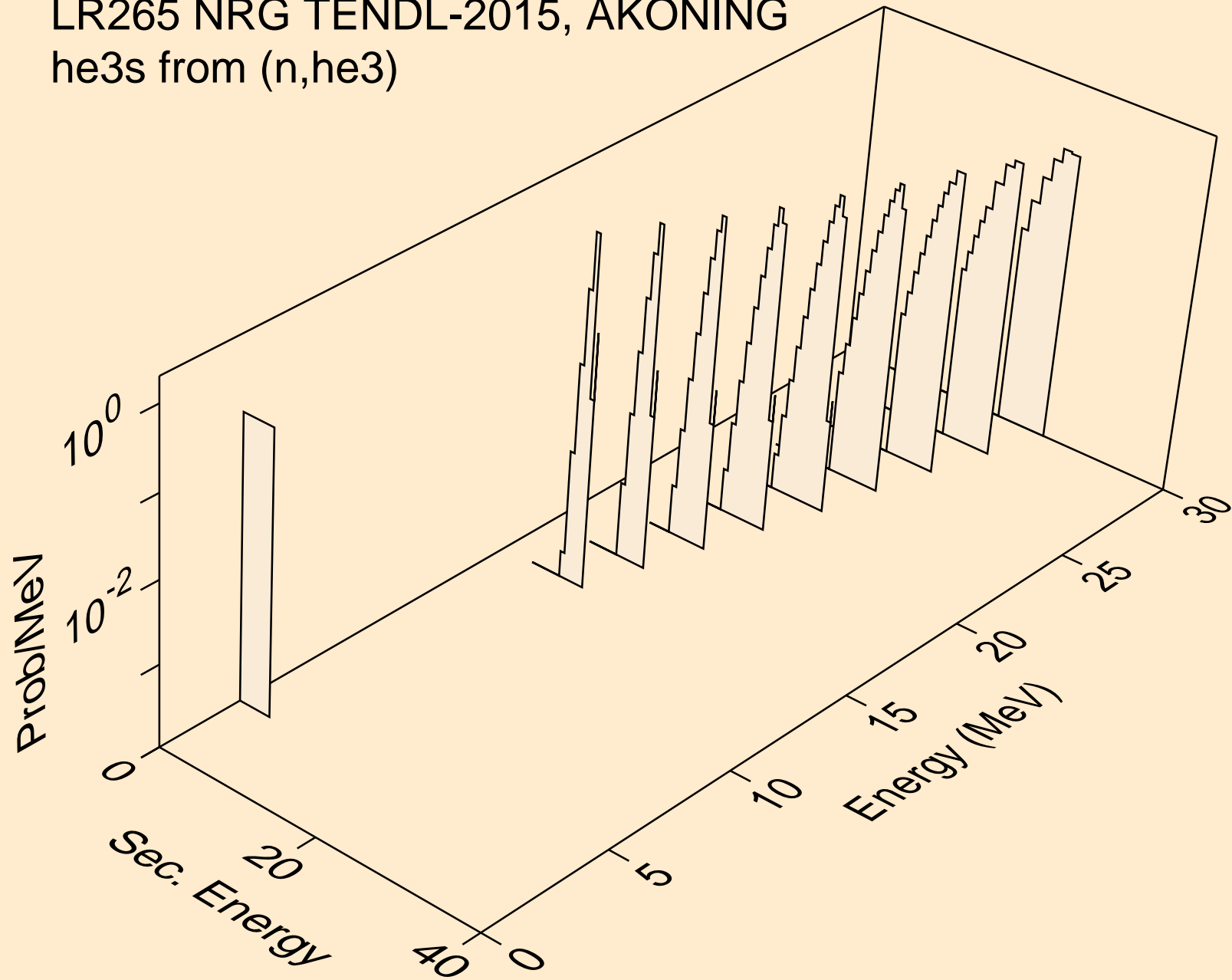

LR265 NRG TENDL-2015, AKONING
alphas from (n,x)

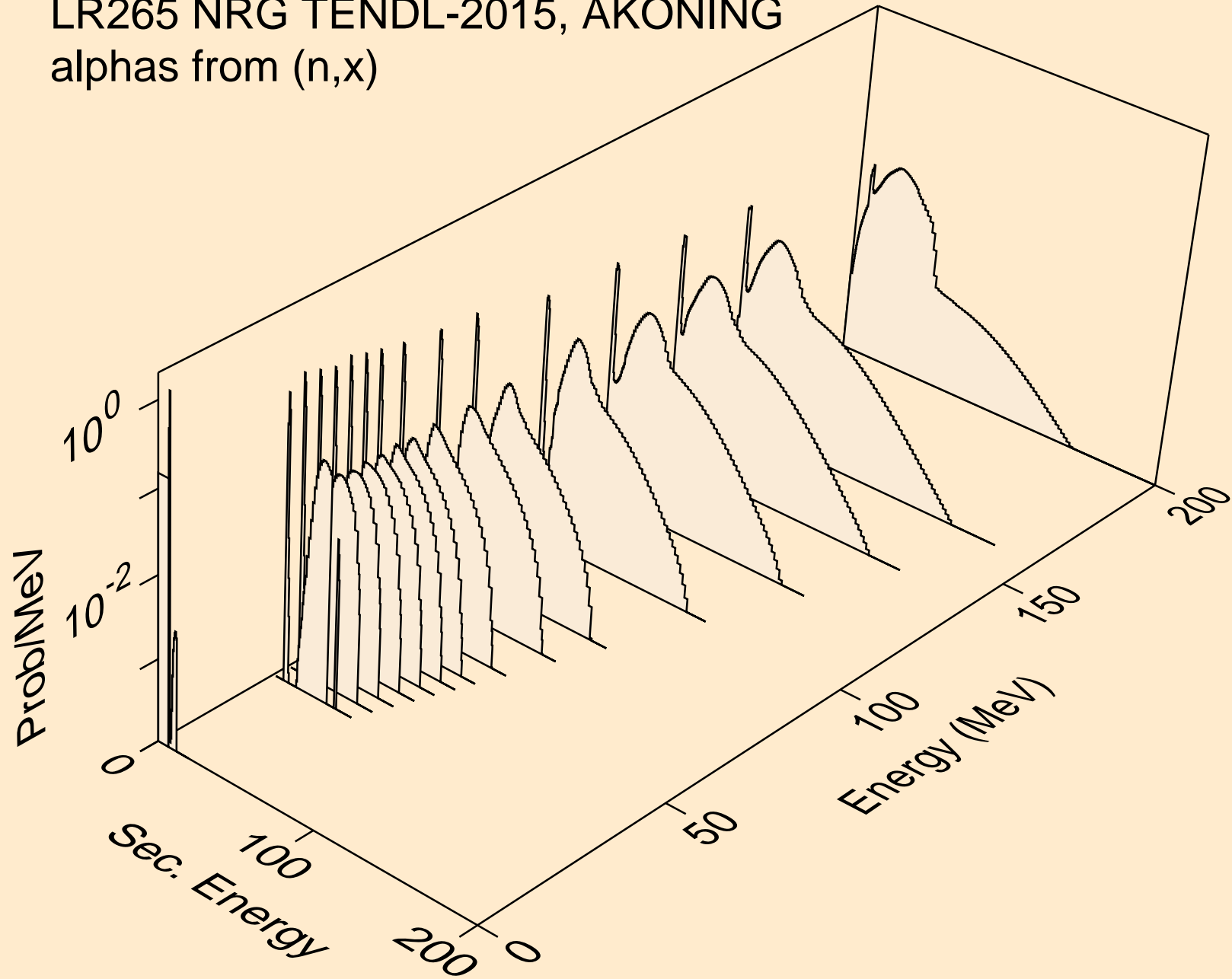

LR265 NRG TENDL-2015, AKONING
alphas from (n,n*)a

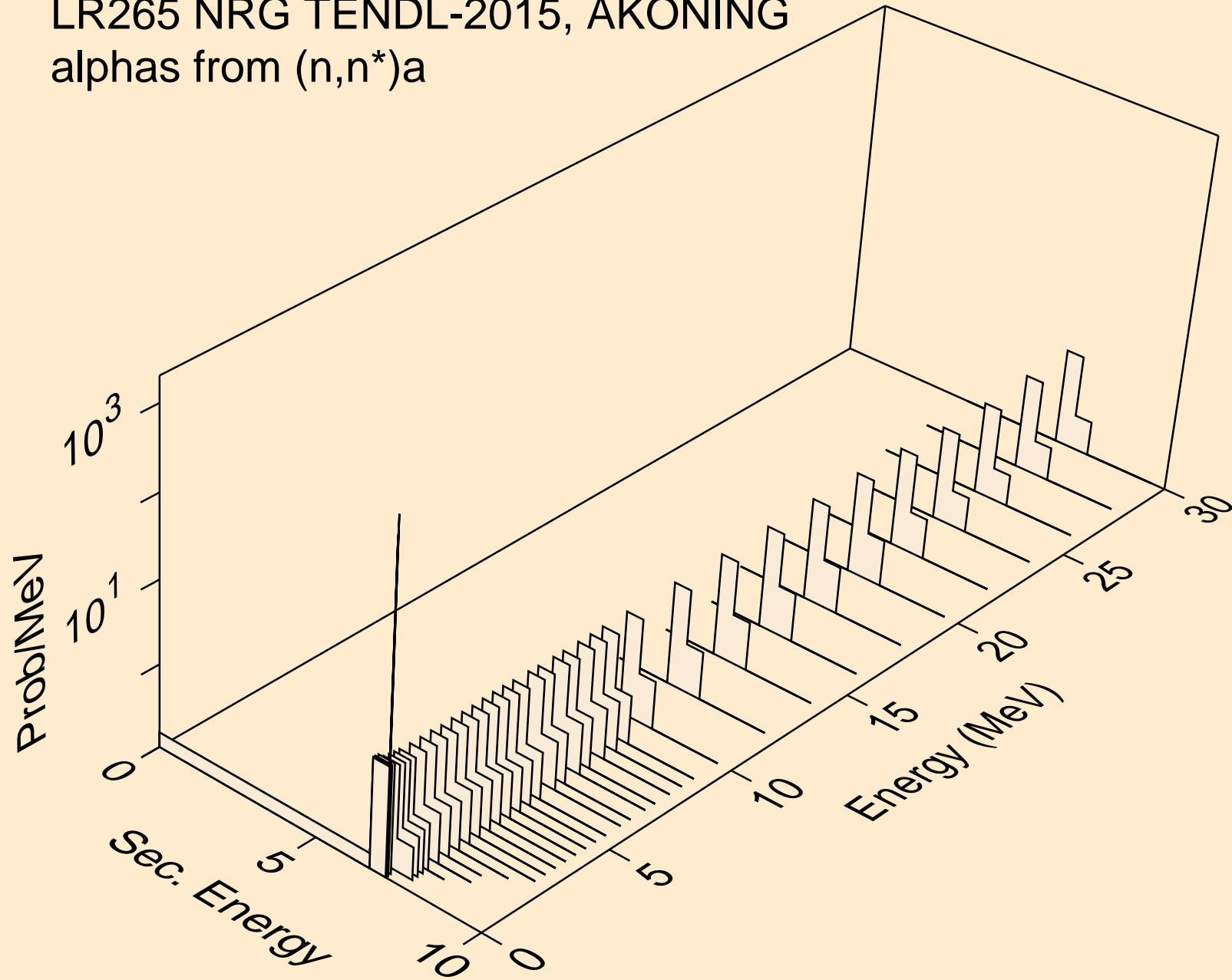

LR265 NRG TENDL-2015, AKONING
alphas from (n,2n)a

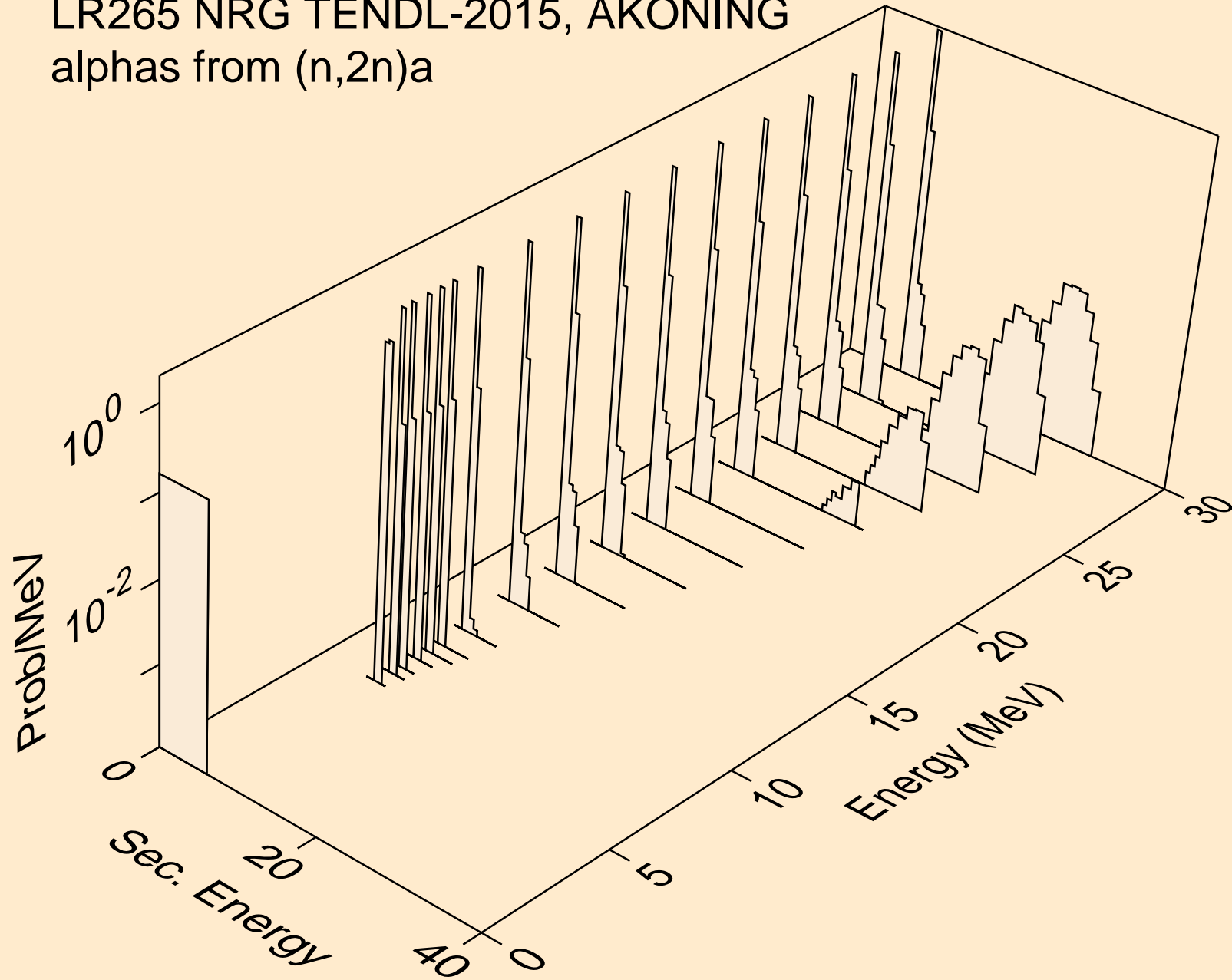

LR265 NRG TENDL-2015, AKONING
alphas from (n,3n)a

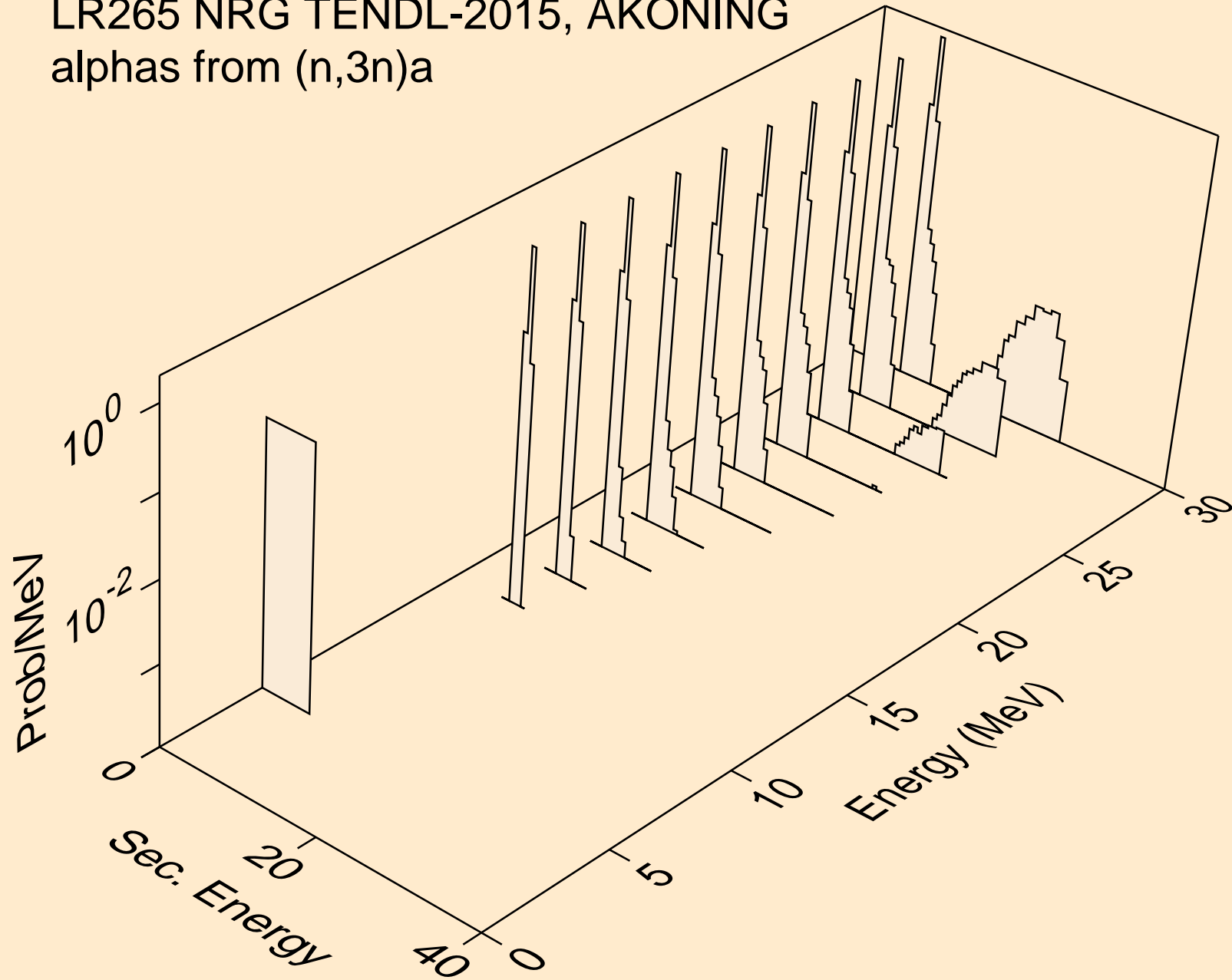

LR265 NRG TENDL-2015, AKONING
alphas from (n,2n)2a

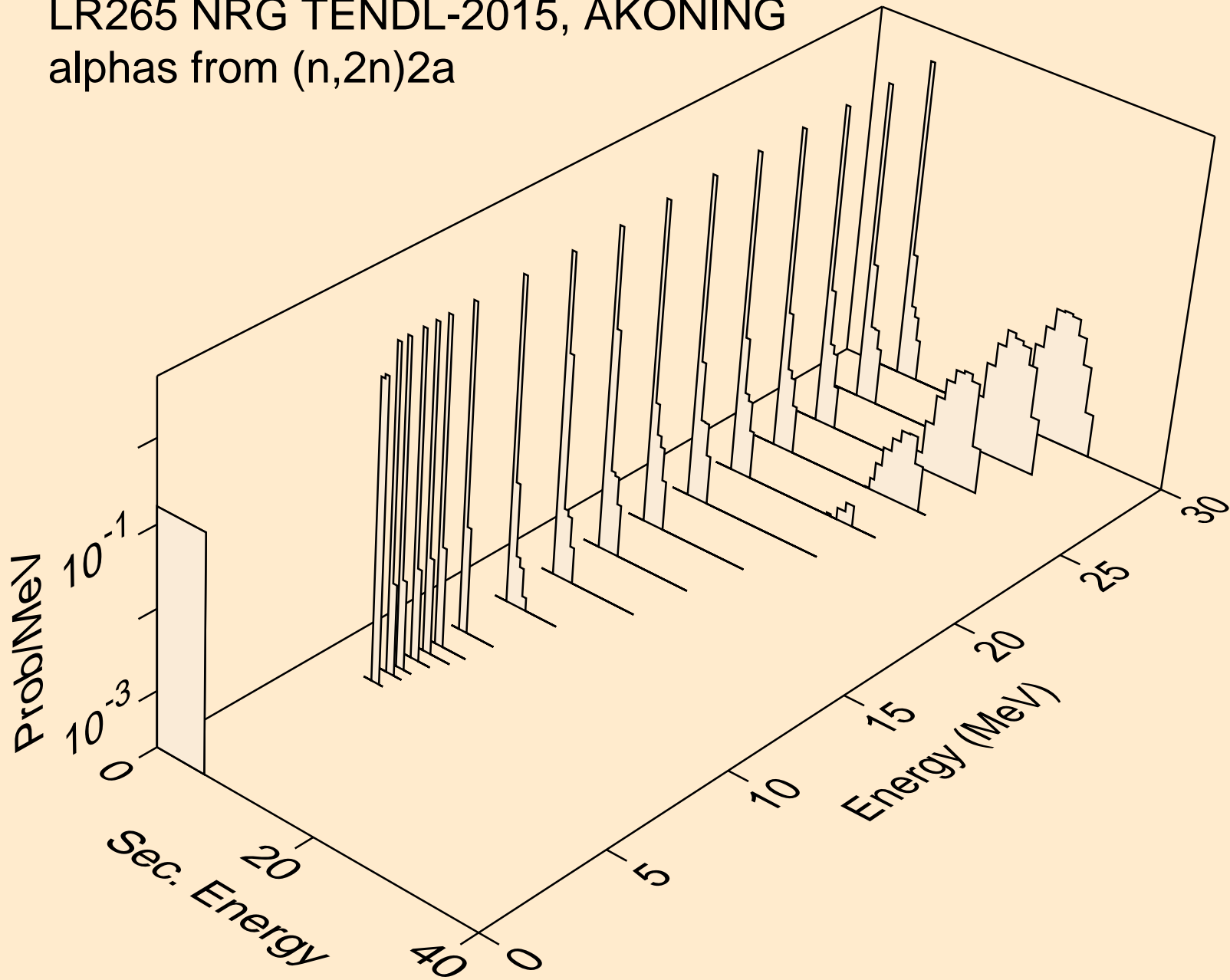

LR265 NRG TENDL-2015, AKONING
alphas from (n,npa)

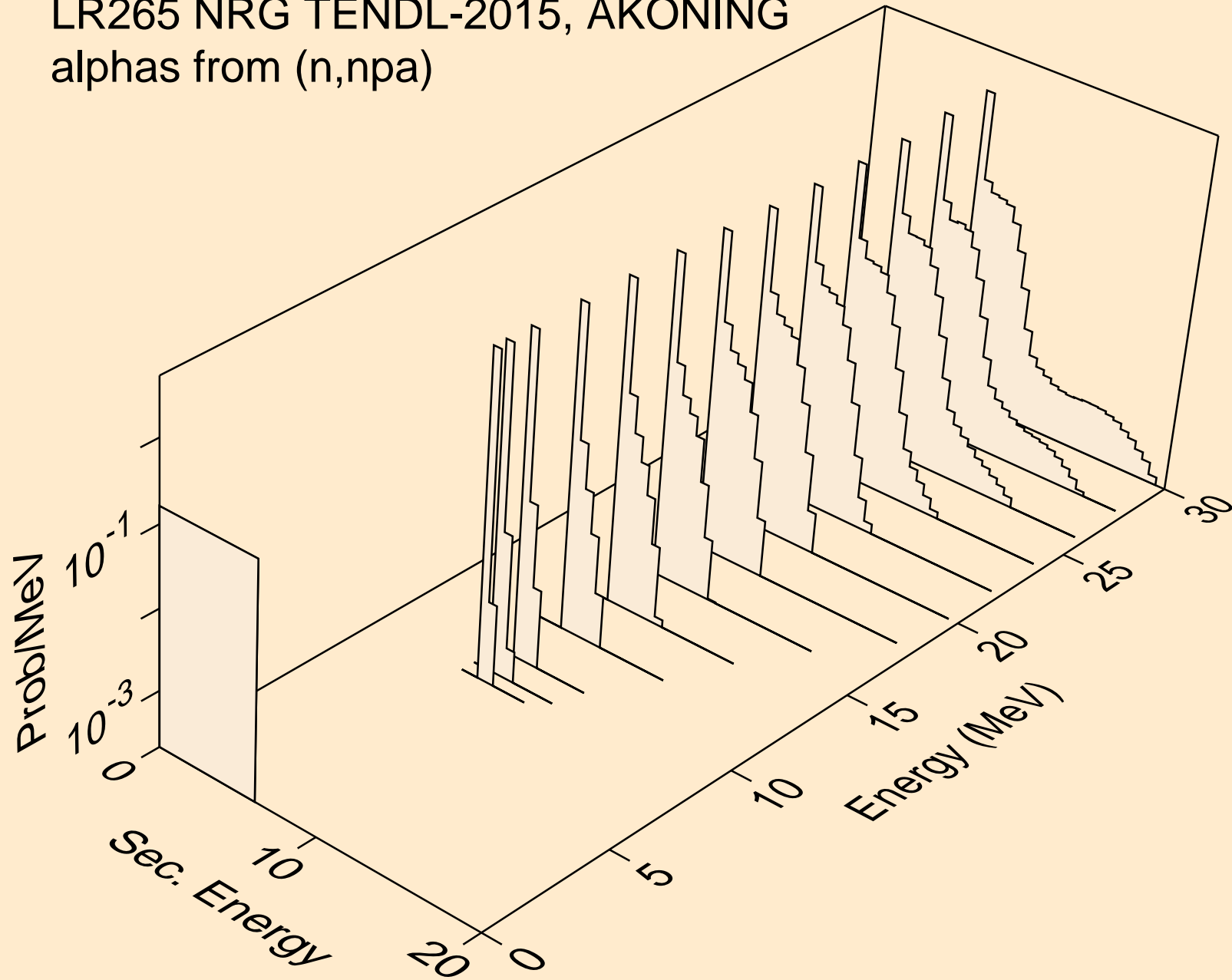

LR265 NRG TENDL-2015, AKONING
alphas from (n,a)

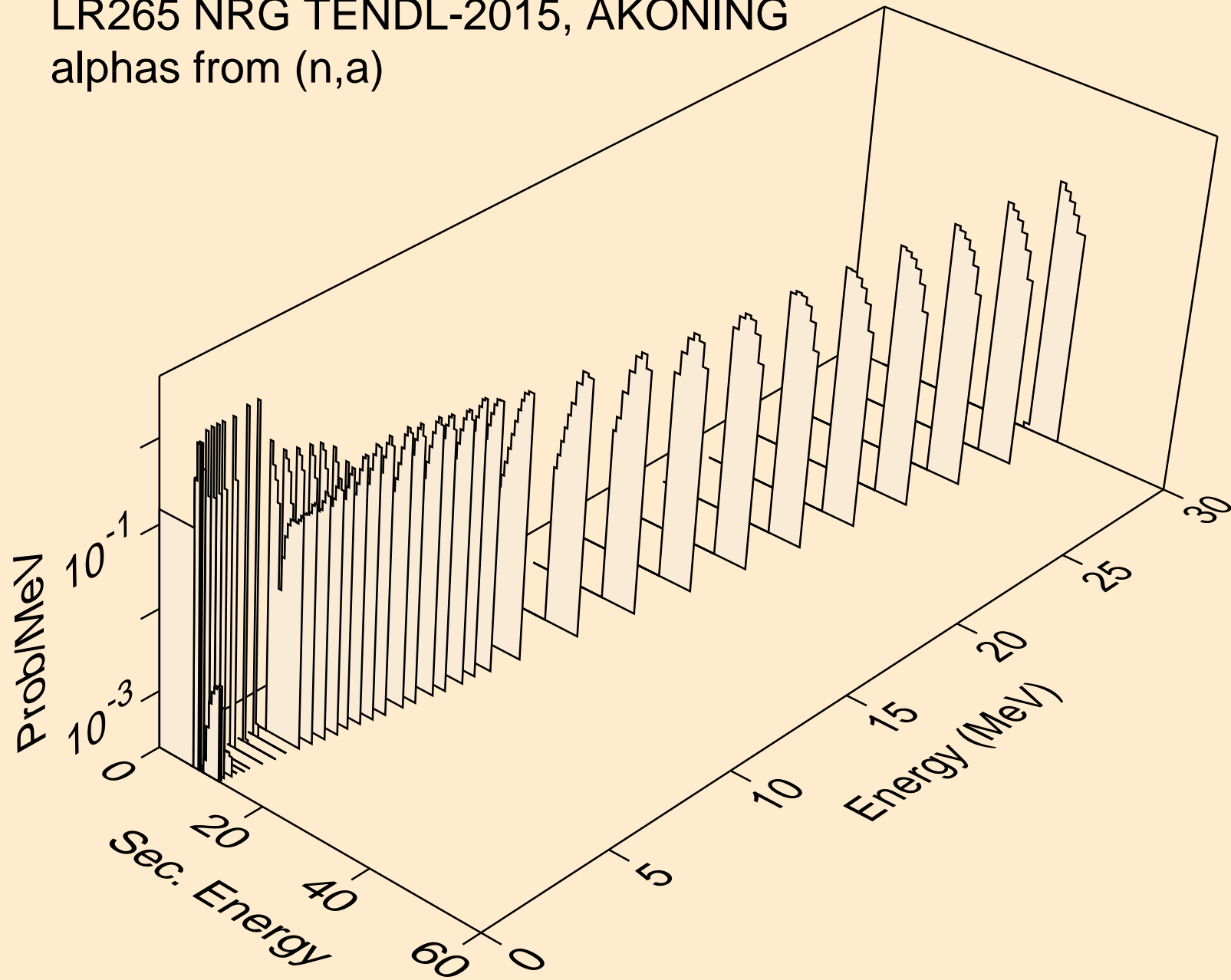

LR265 NRG TENDL-2015, AKONING
alphas from (n,2a)

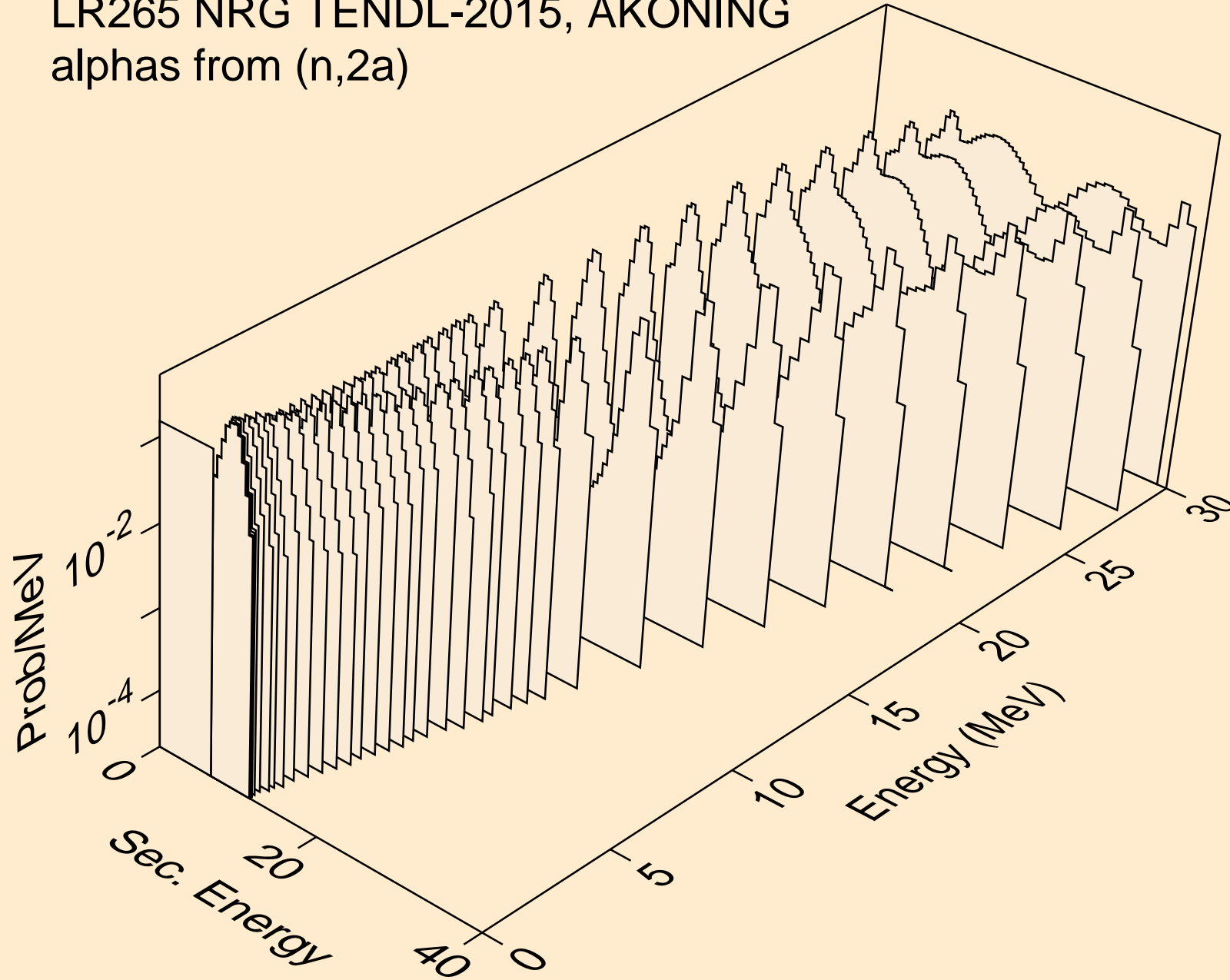

LR265 NRG TENDL-2015, AKONING
alphas from (n,da)

