

LR266 NRG TENDL-2015, AKONING

Principal cross sections

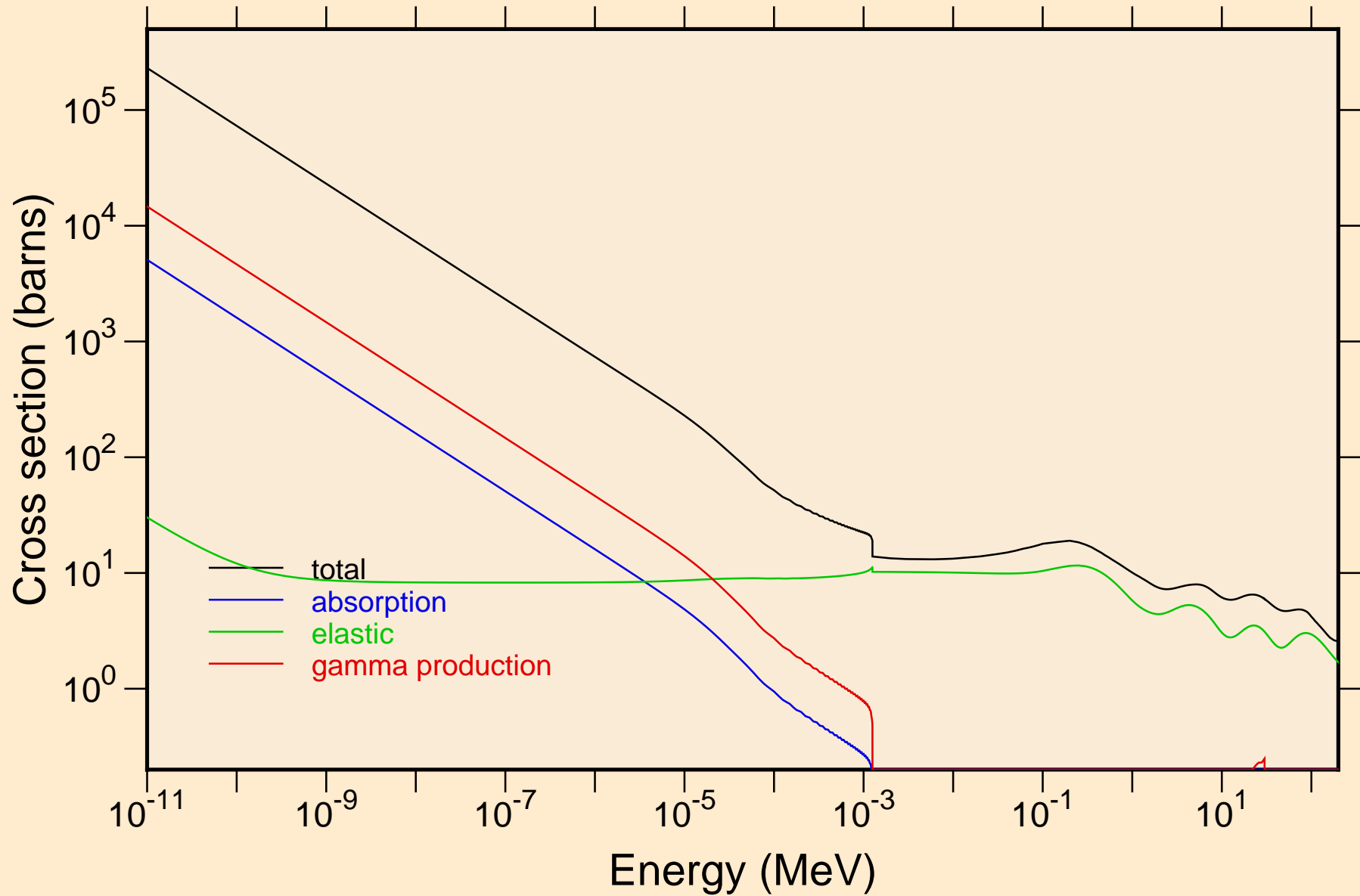

LR266 NRG TENDL-2015, AKONING

Non-threshold reactions

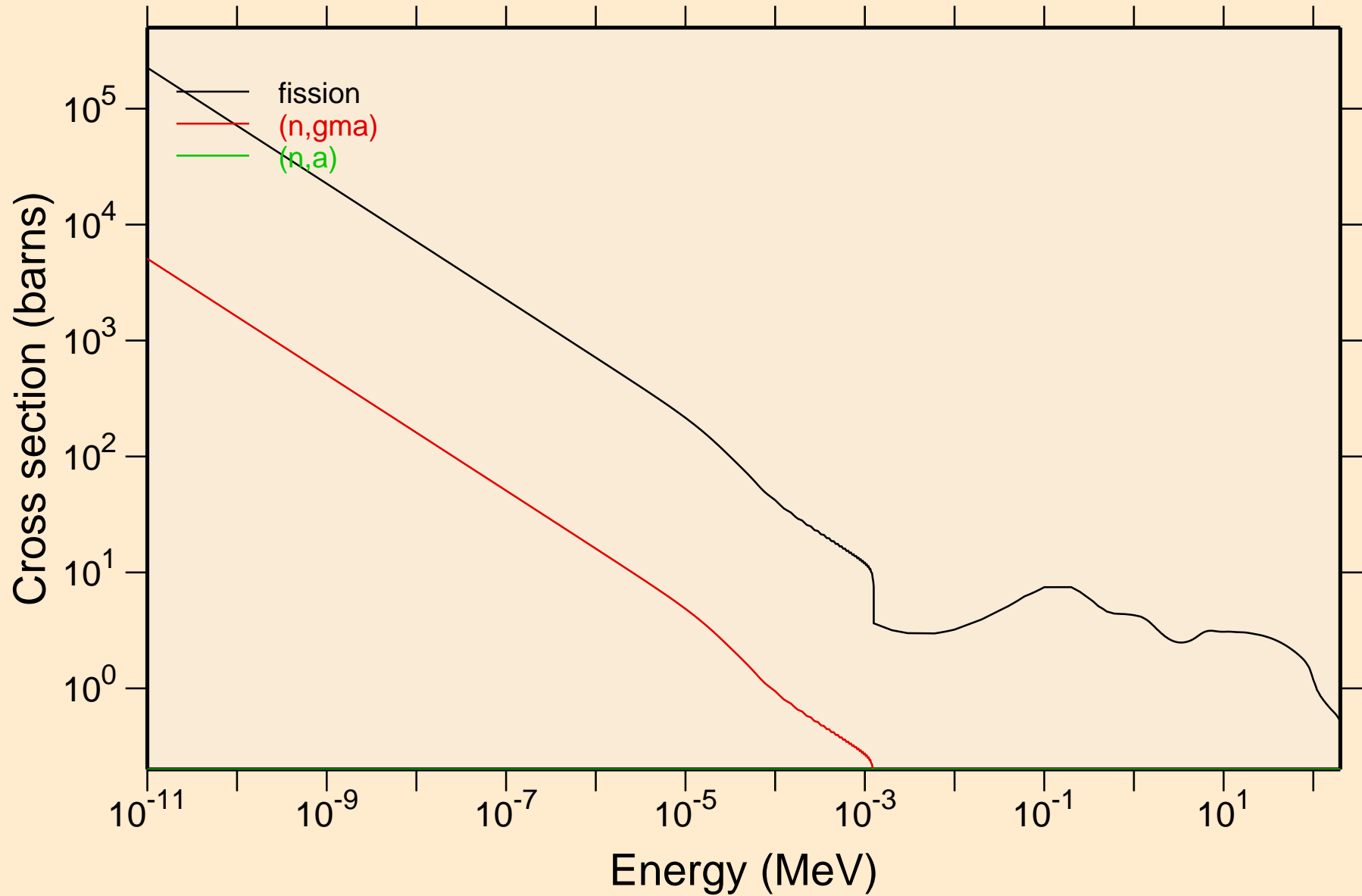

LR266 NRG TENDL-2015, AKONING

Principal cross sections

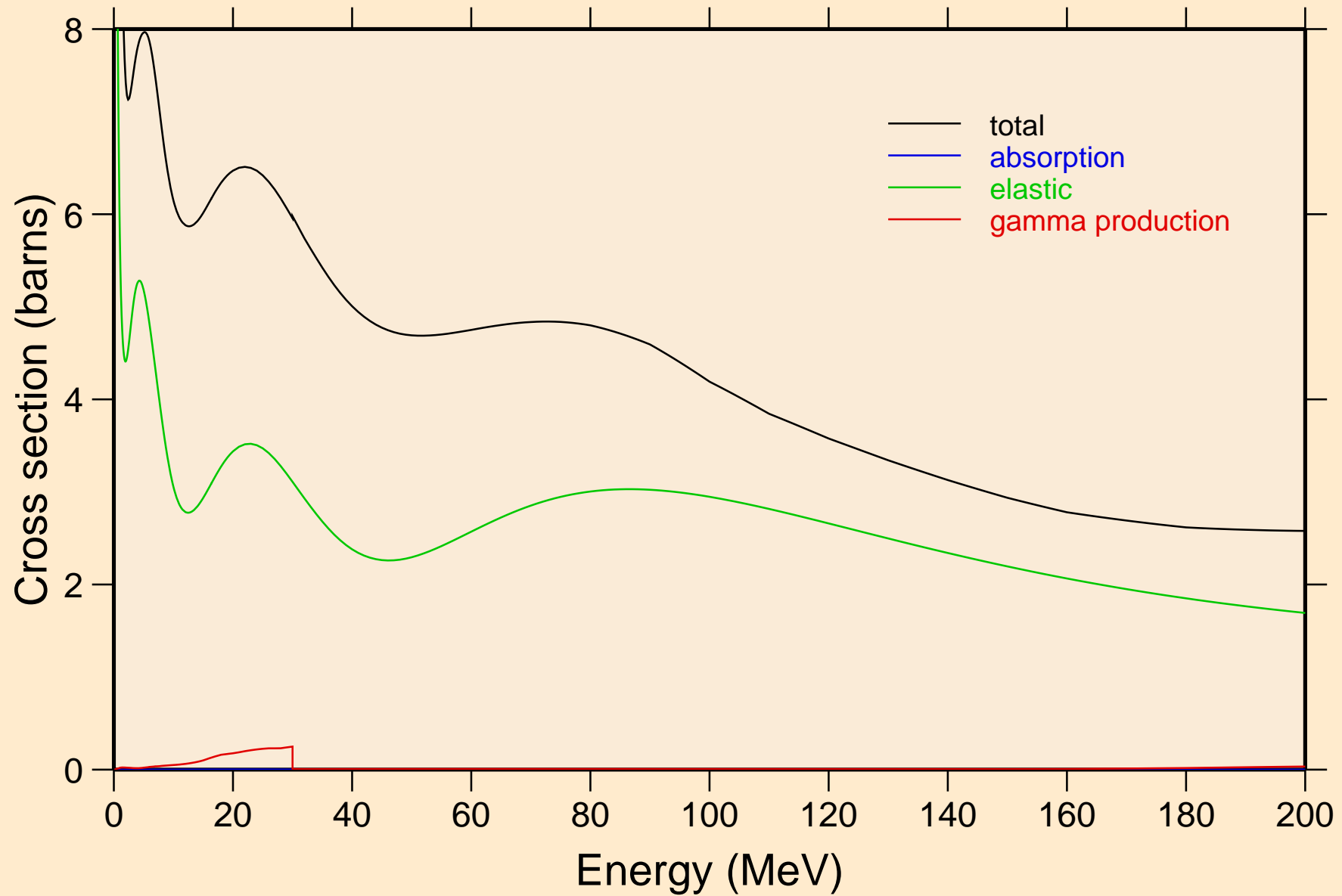

LR266 NRG TENDL-2015, AKONING

Non-threshold reactions

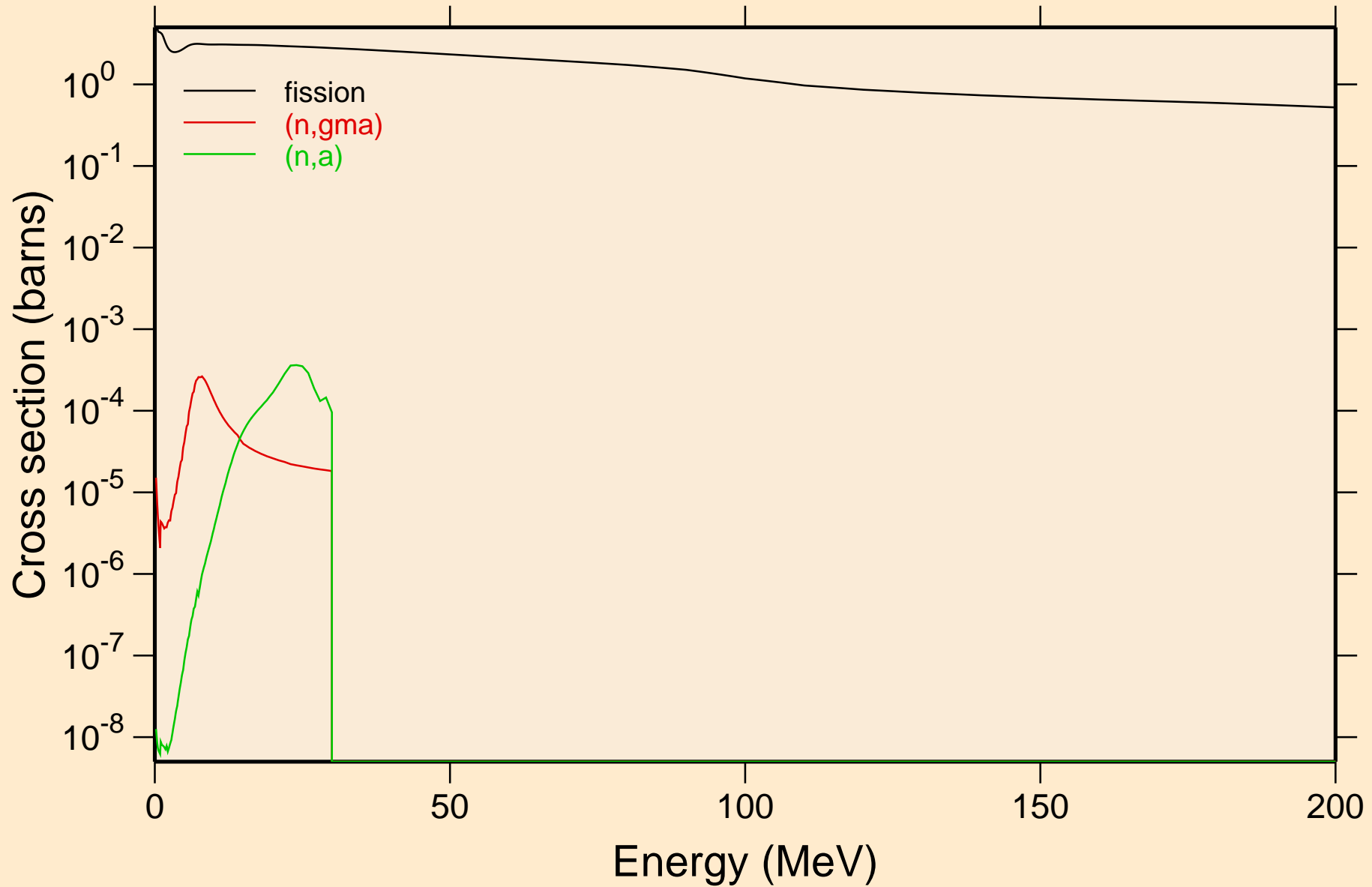

LR266 NRG TENDL-2015, AKONING
Inelastic levels

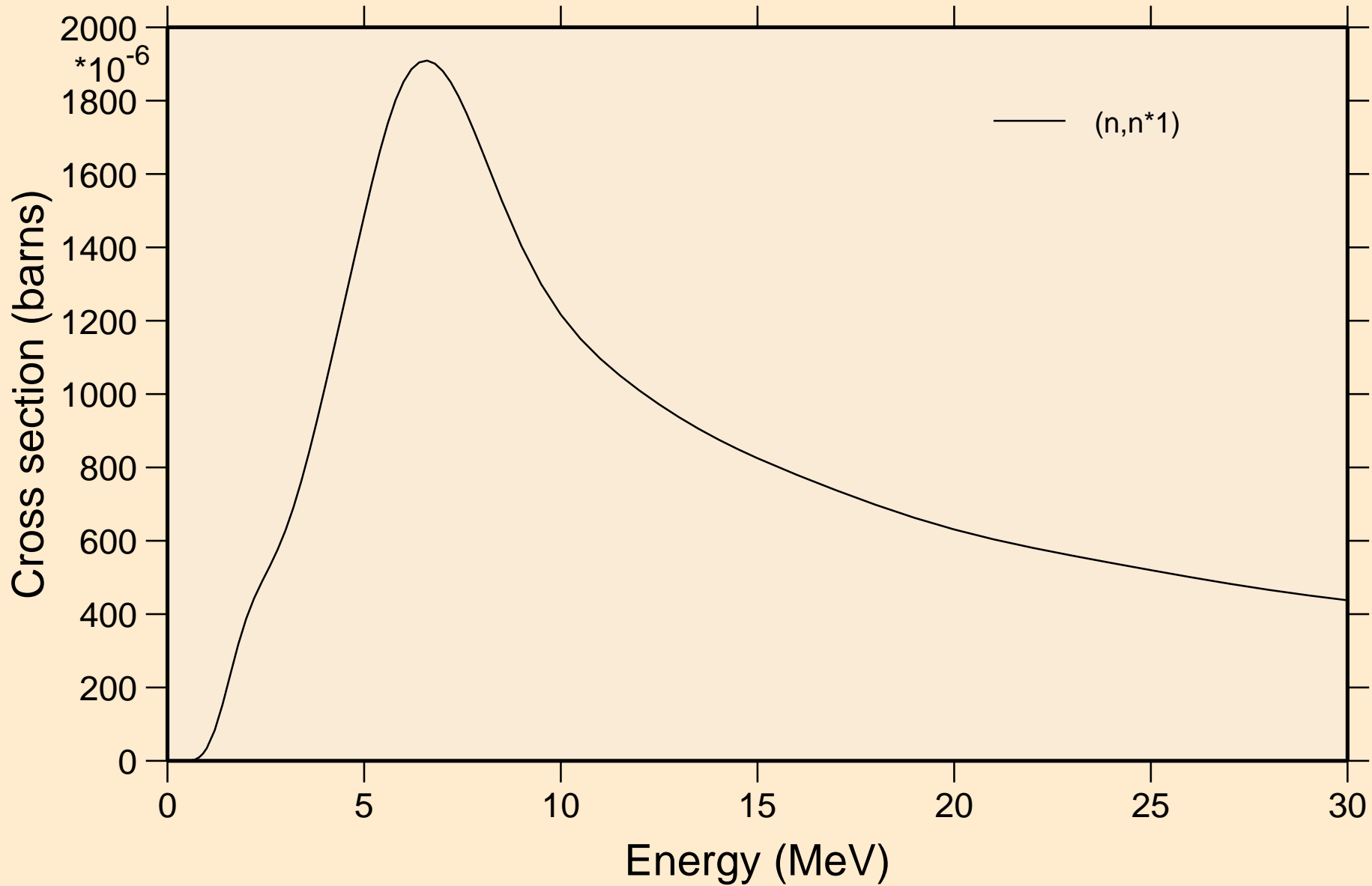

LR266 NRG TENDL-2015, AKONING

Threshold reactions

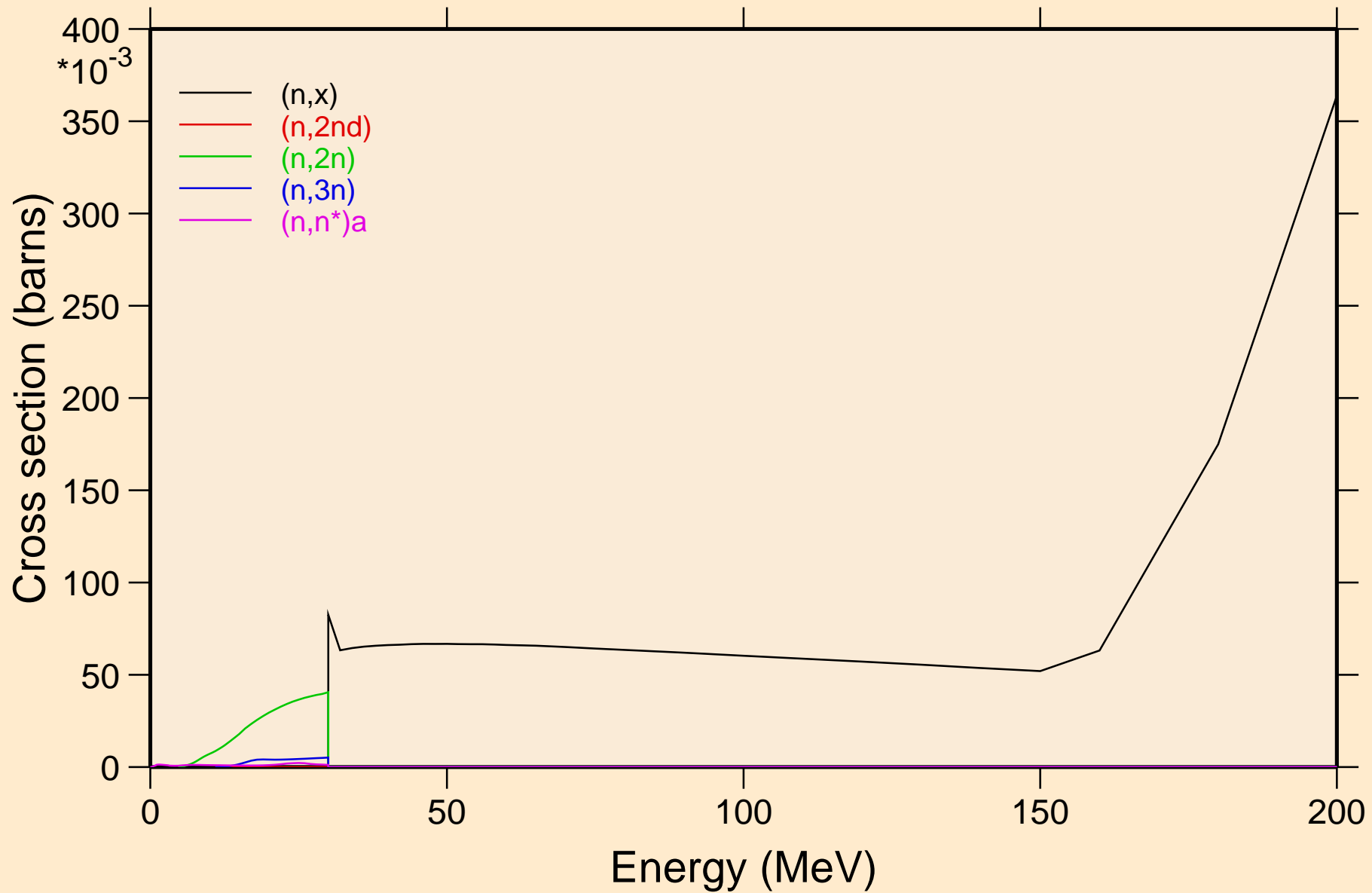

LR266 NRG TENDL-2015, AKONING

Threshold reactions

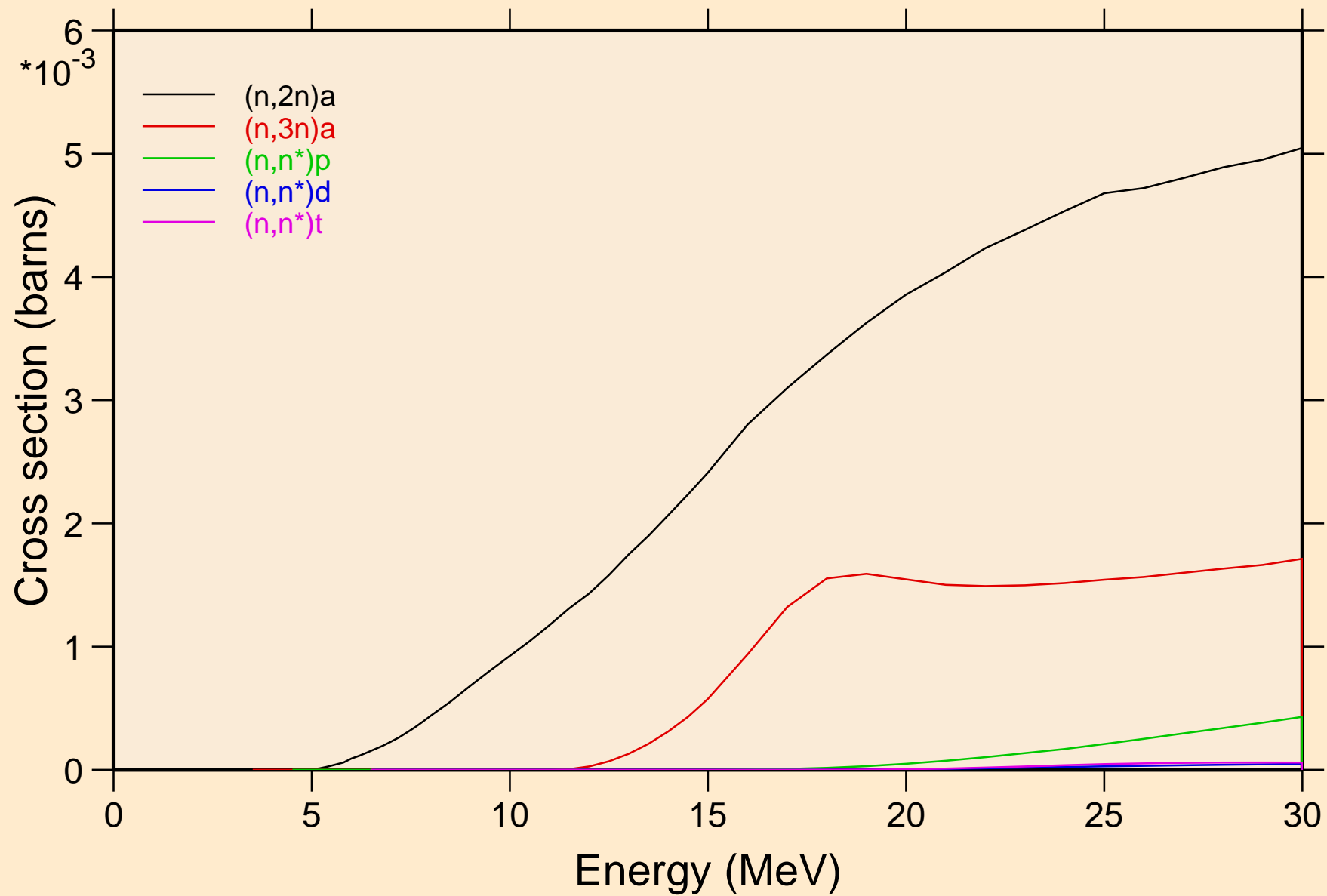

LR266 NRG TENDL-2015, AKONING

Threshold reactions

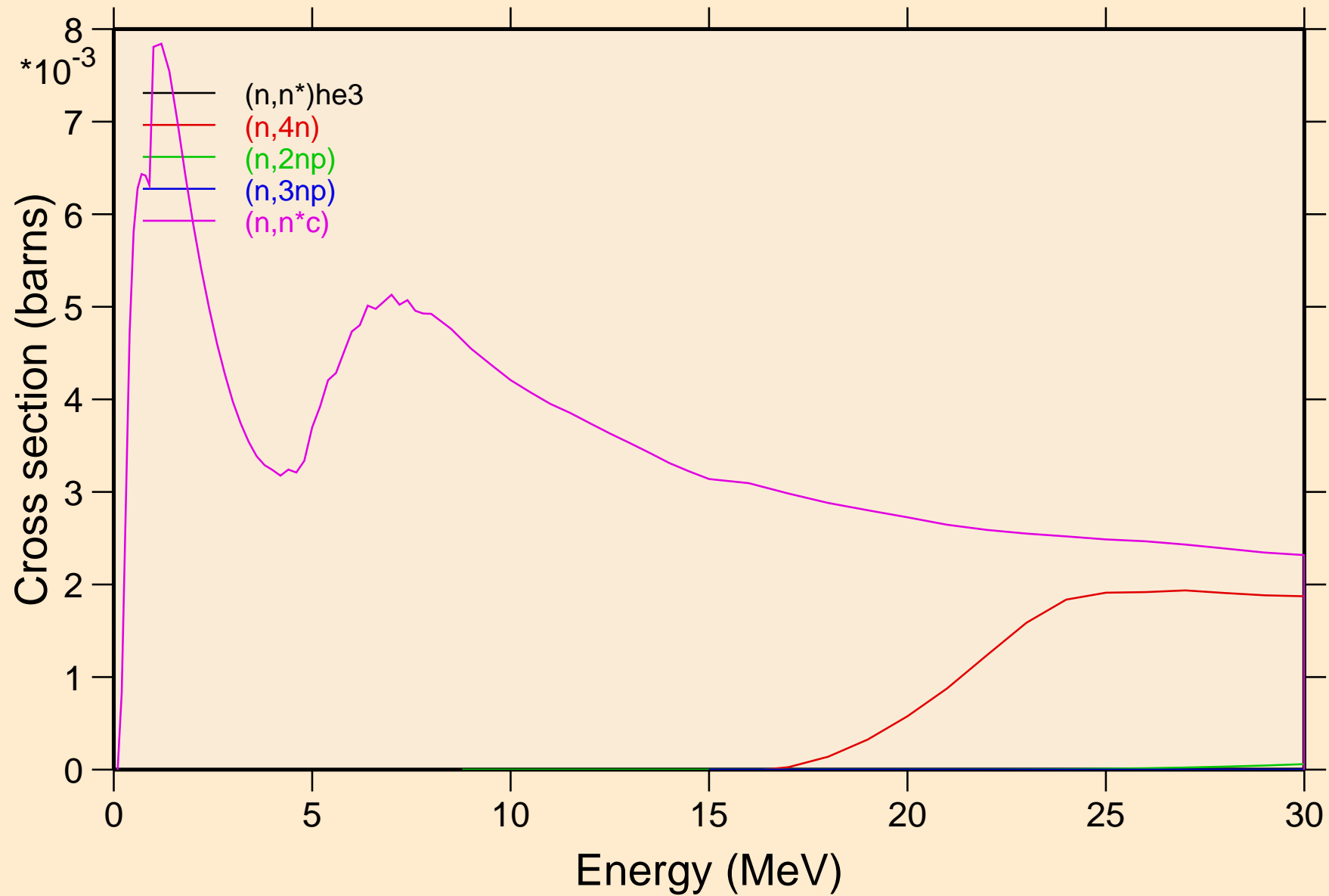

LR266 NRG TENDL-2015, AKONING

Threshold reactions

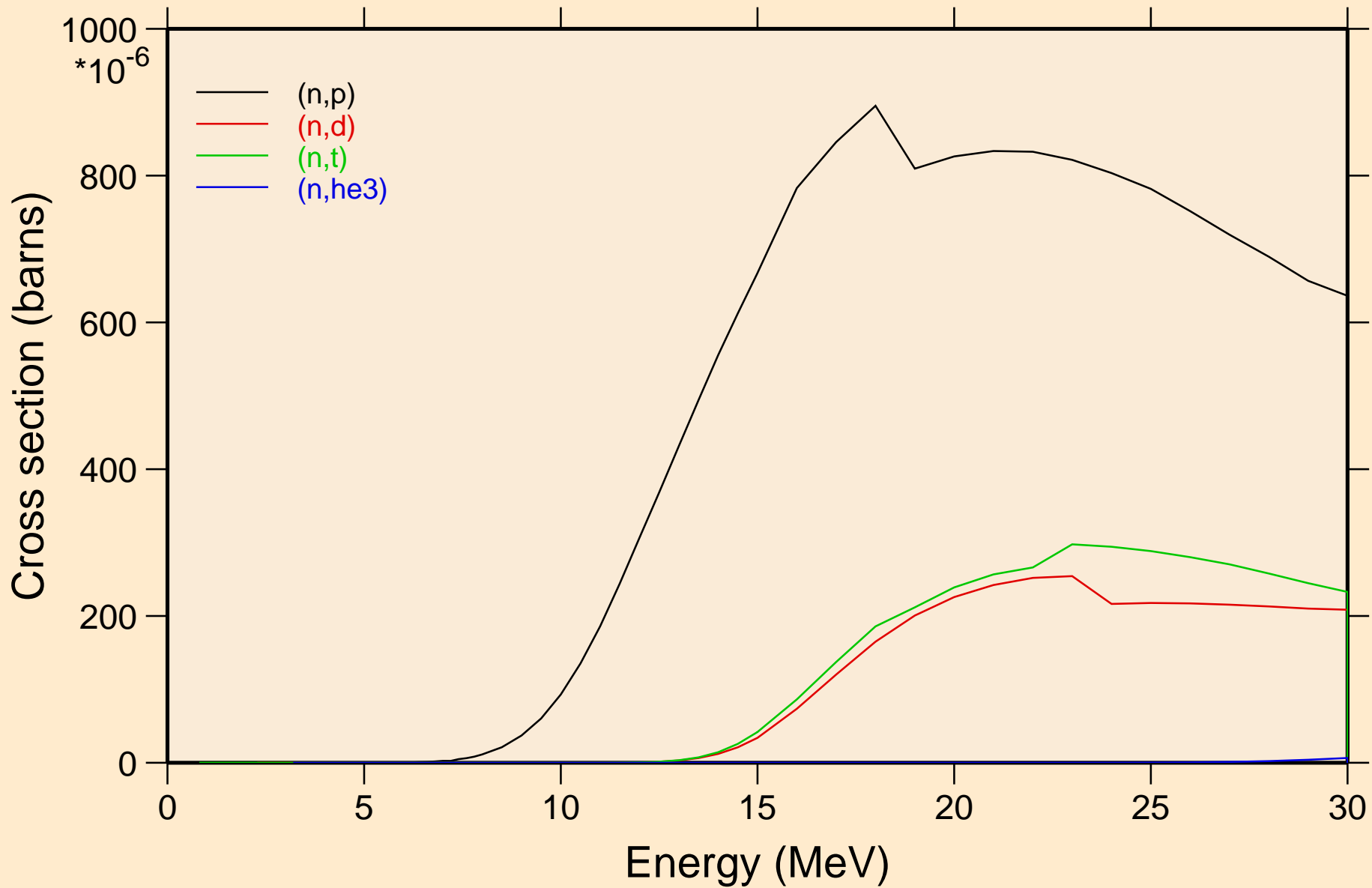

LR266 NRG TENDL-2015, AKONING
angular distribution for elastic

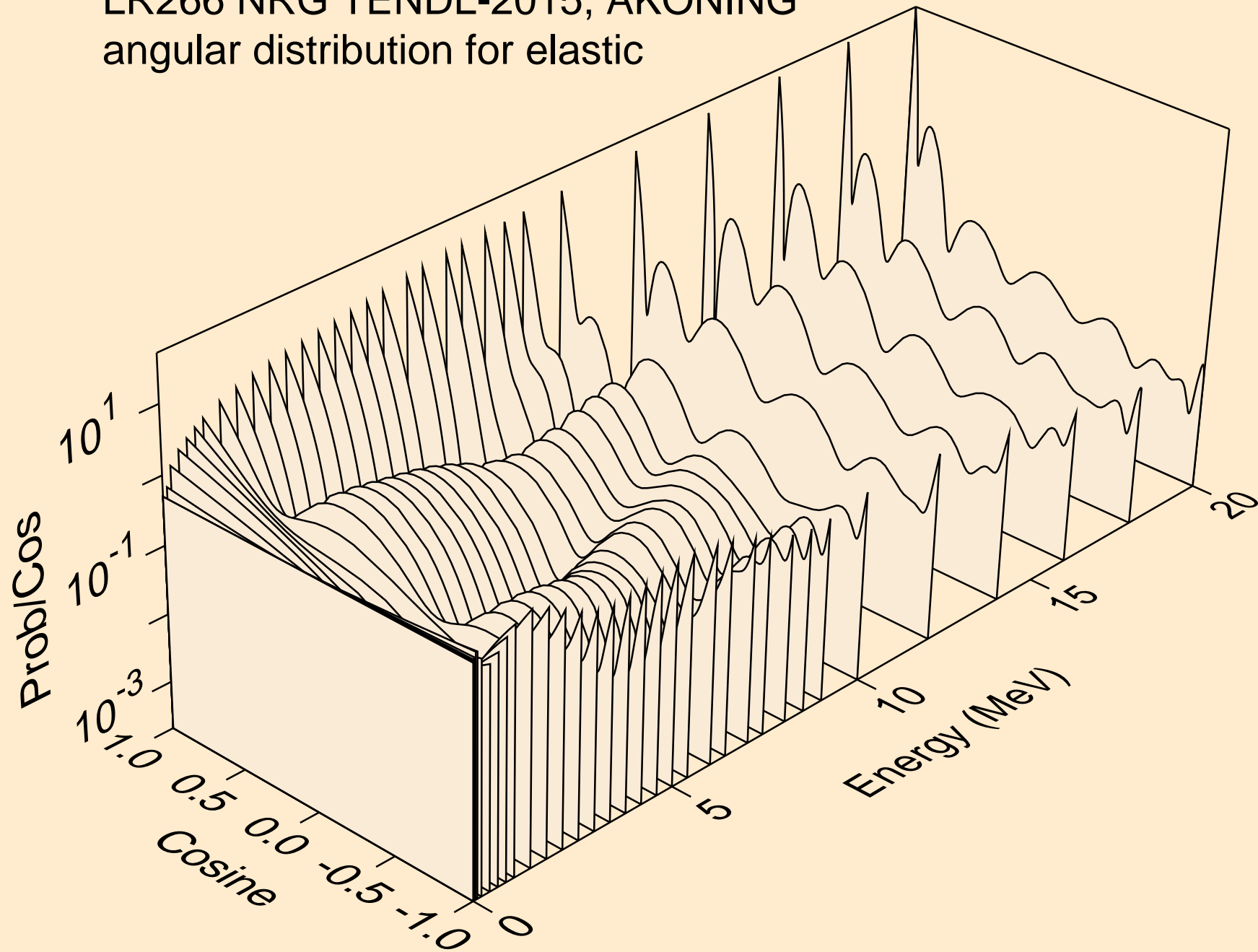

LR266 NRG TENDL-2015, AKONING
angular distribution for elastic

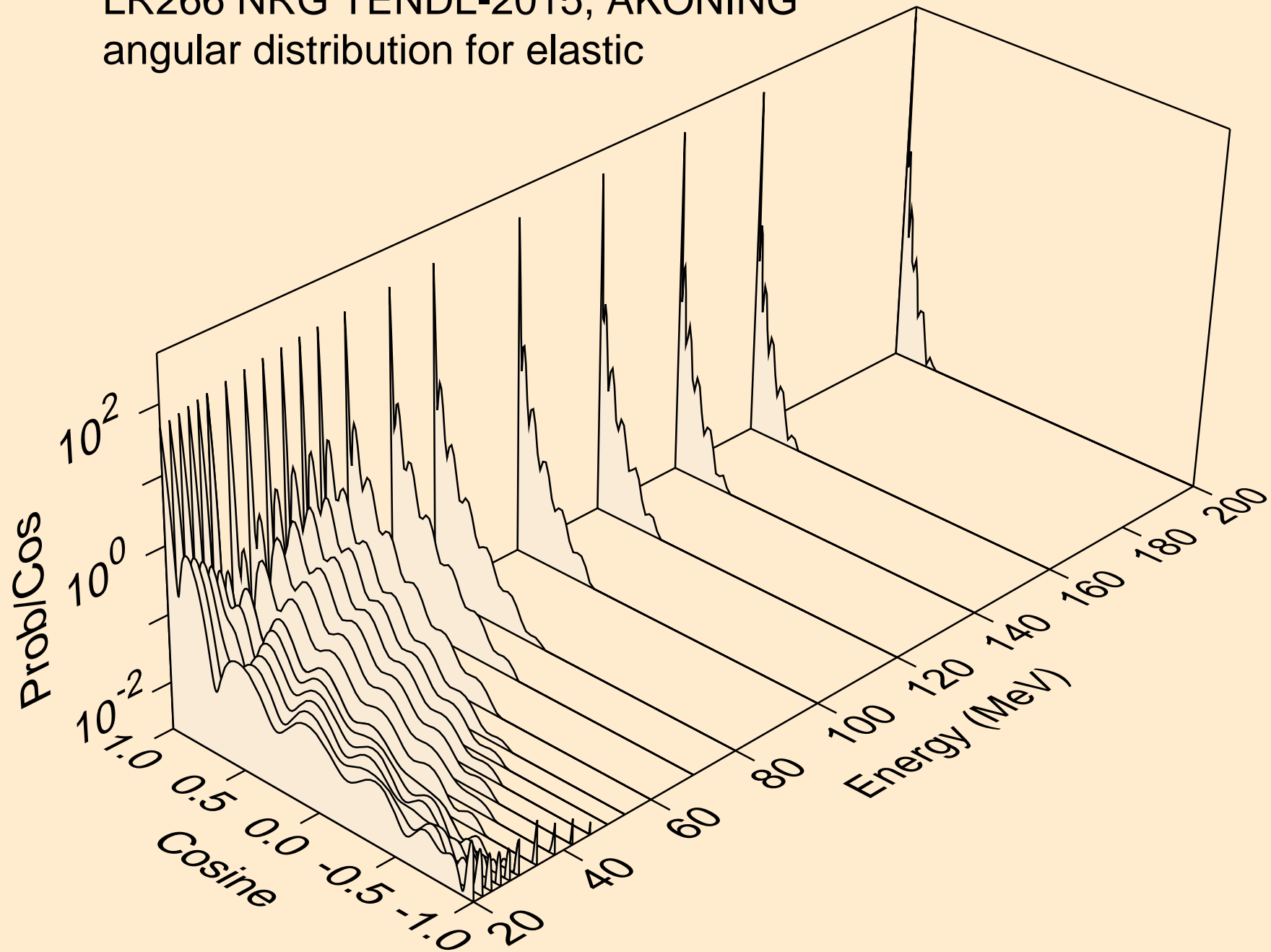

LR266 NRG TENDL-2015, AKONING
angular distribution for (n,n*1)

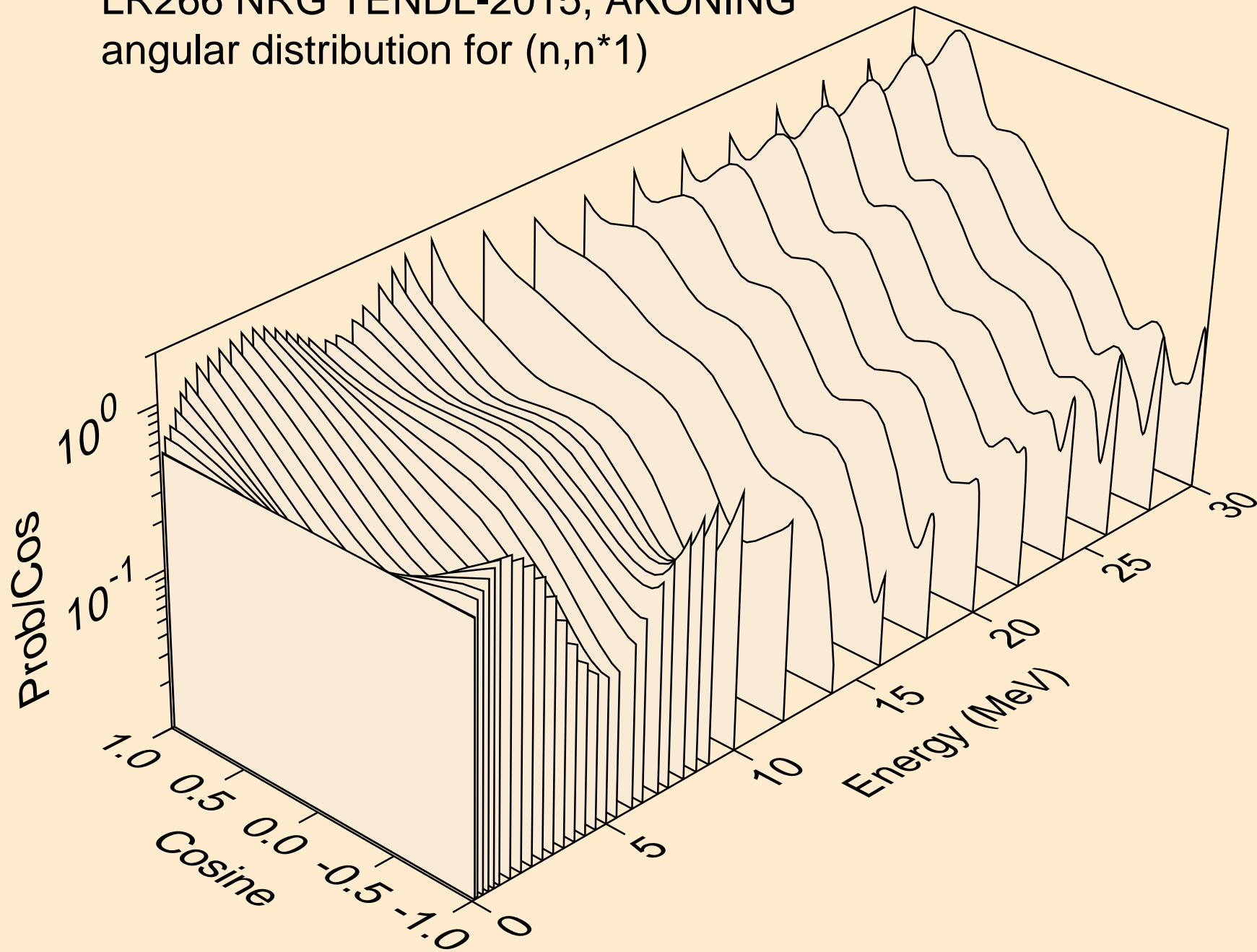

LR266 NRG TENDL-2015, AKONING

Total fission nubar

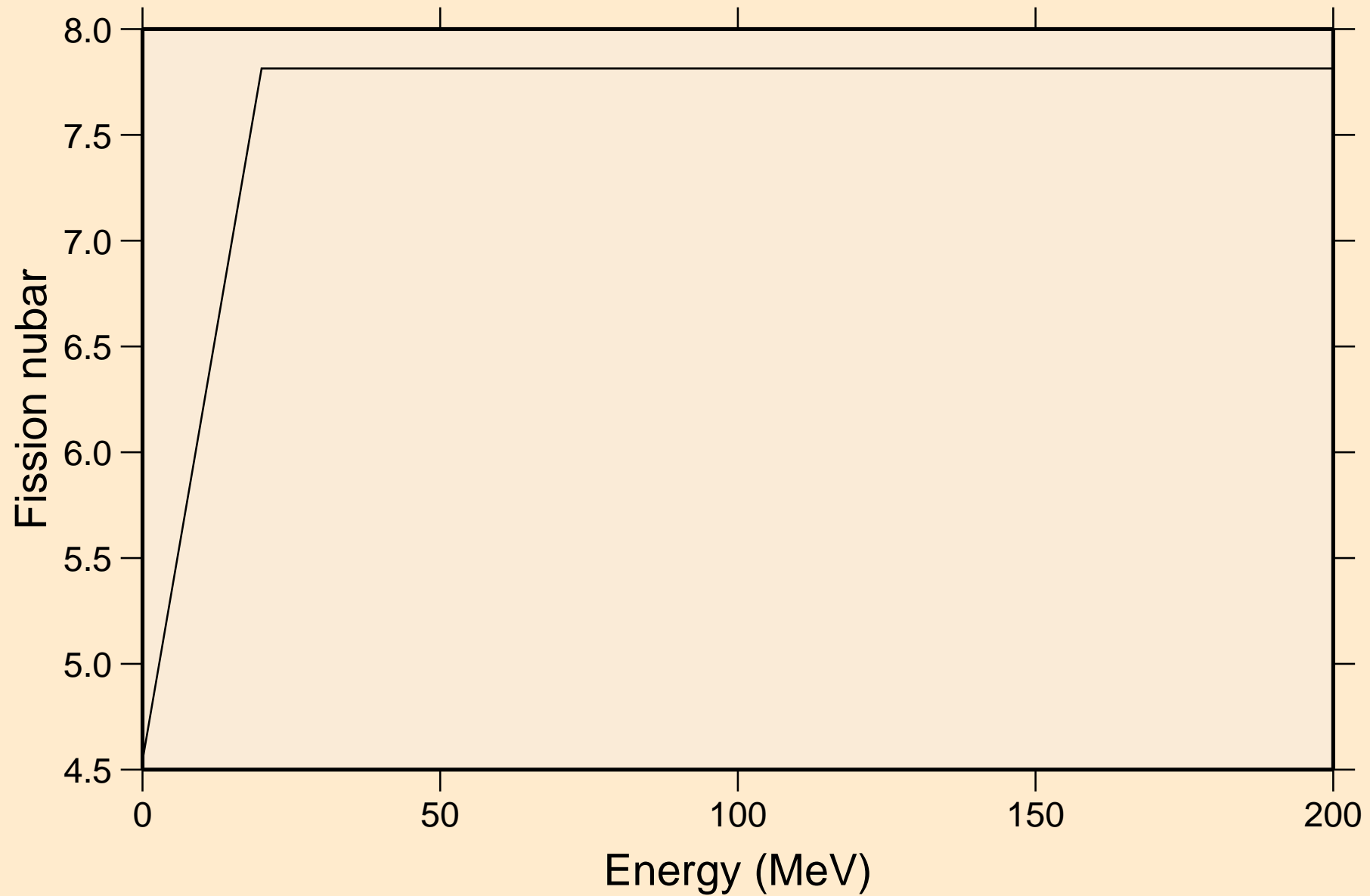

LR266 NRG TENDL-2015, AKONING
Neutron emission for (n,x)

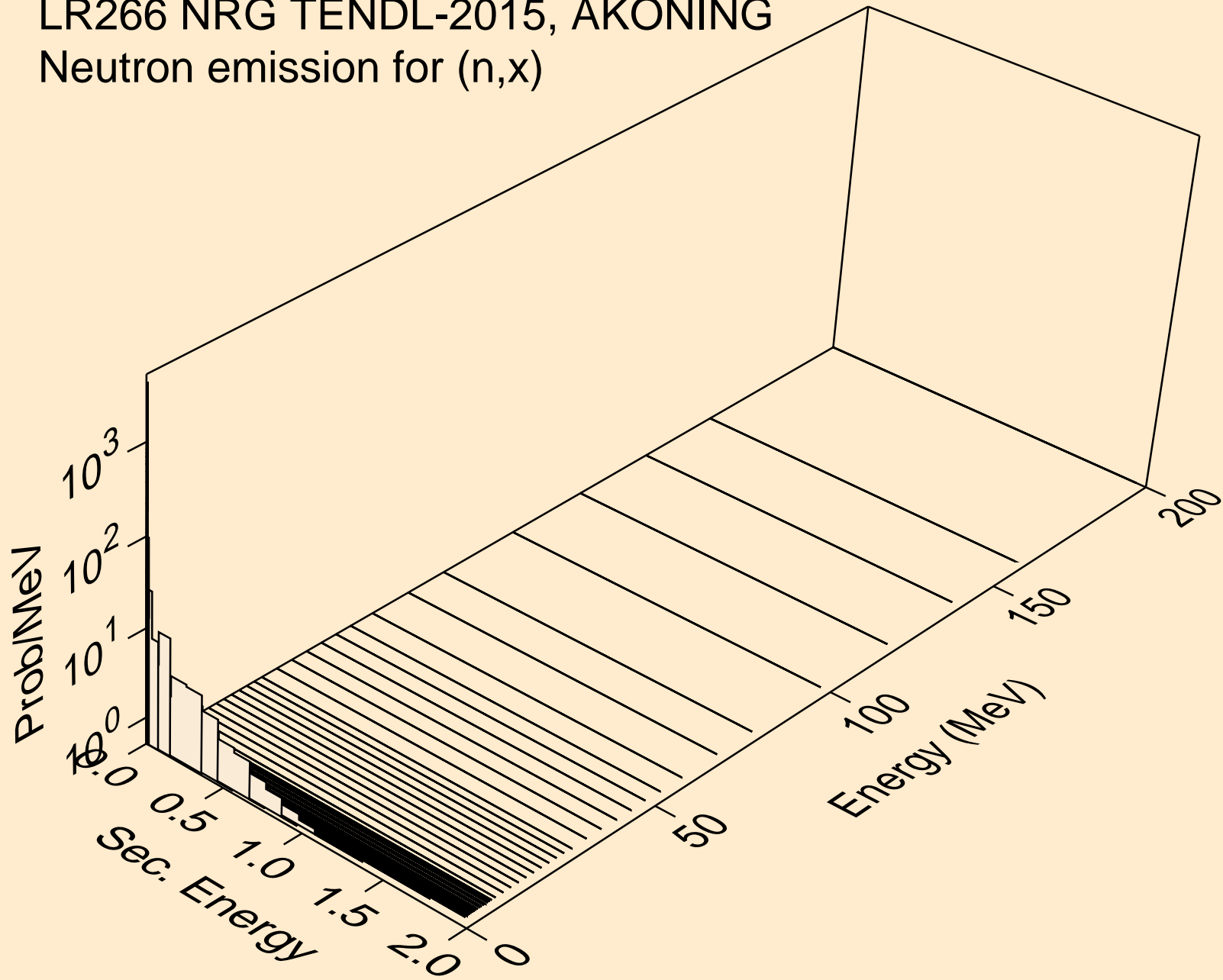

LR266 NRG TENDL-2015, AKONING
Neutron emission for (n,2nd)

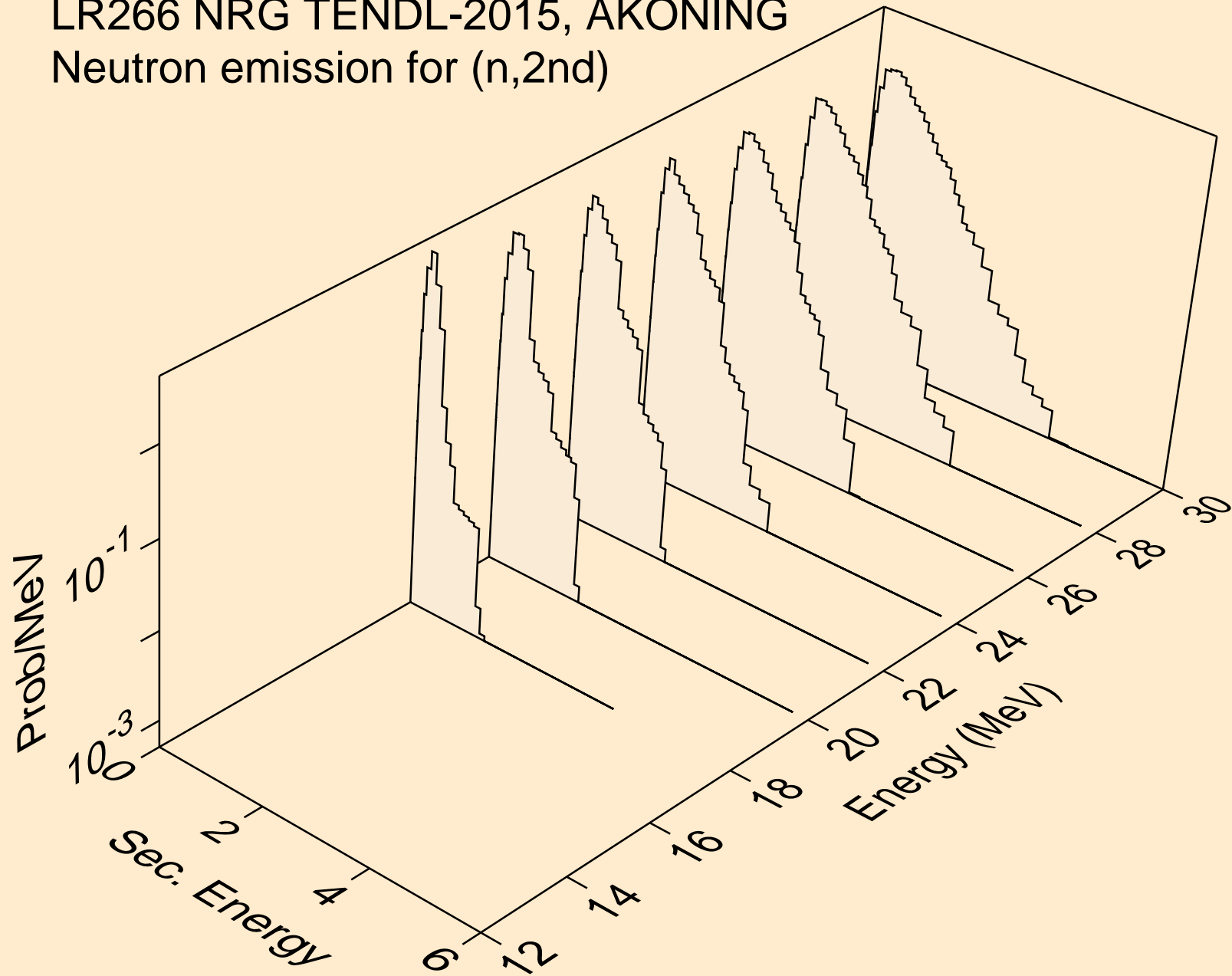

LR266 NRG TENDL-2015, AKONING
Neutron emission for (n,2n)

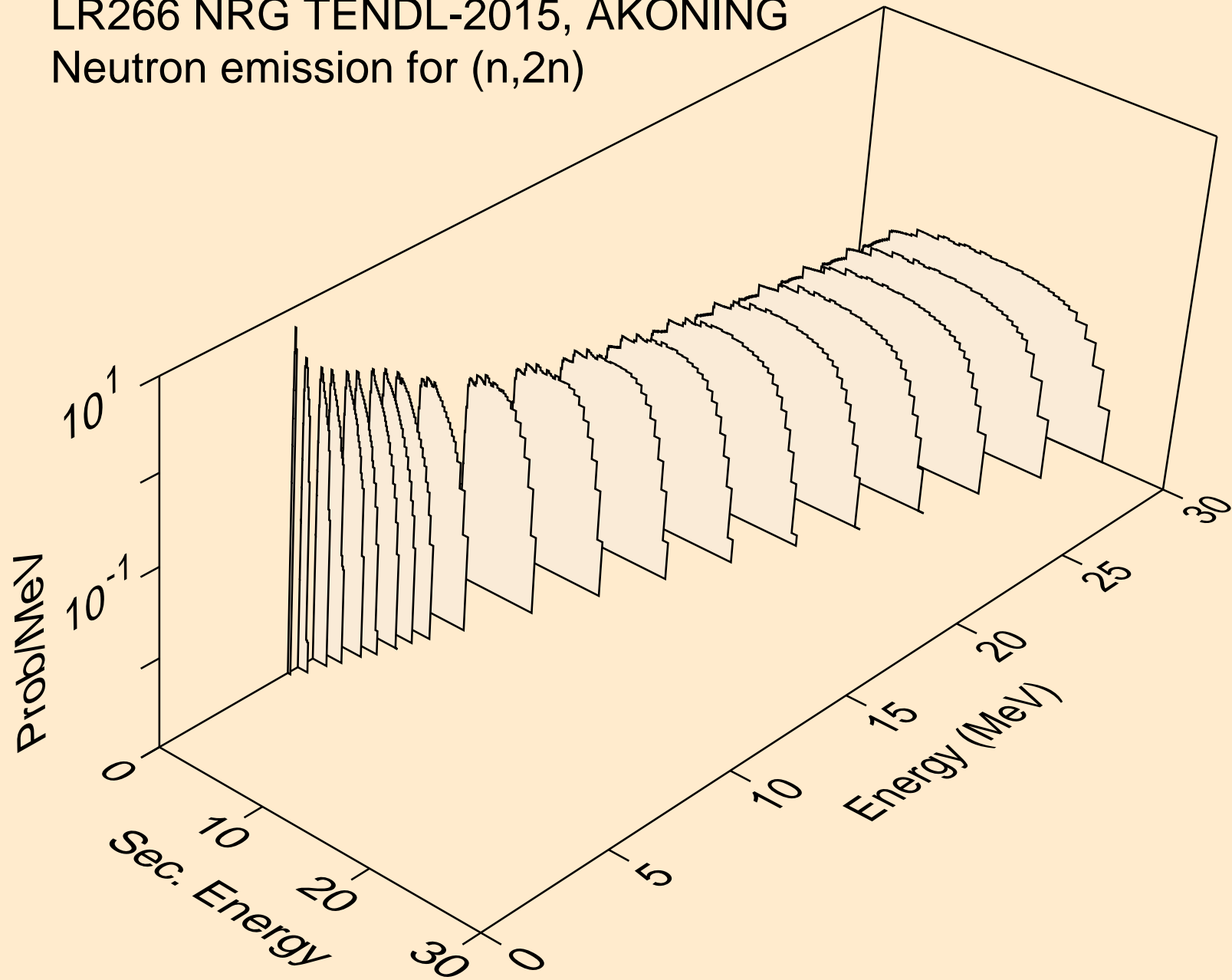

LR266 NRG TENDL-2015, AKONING
Neutron emission for (n,3n)

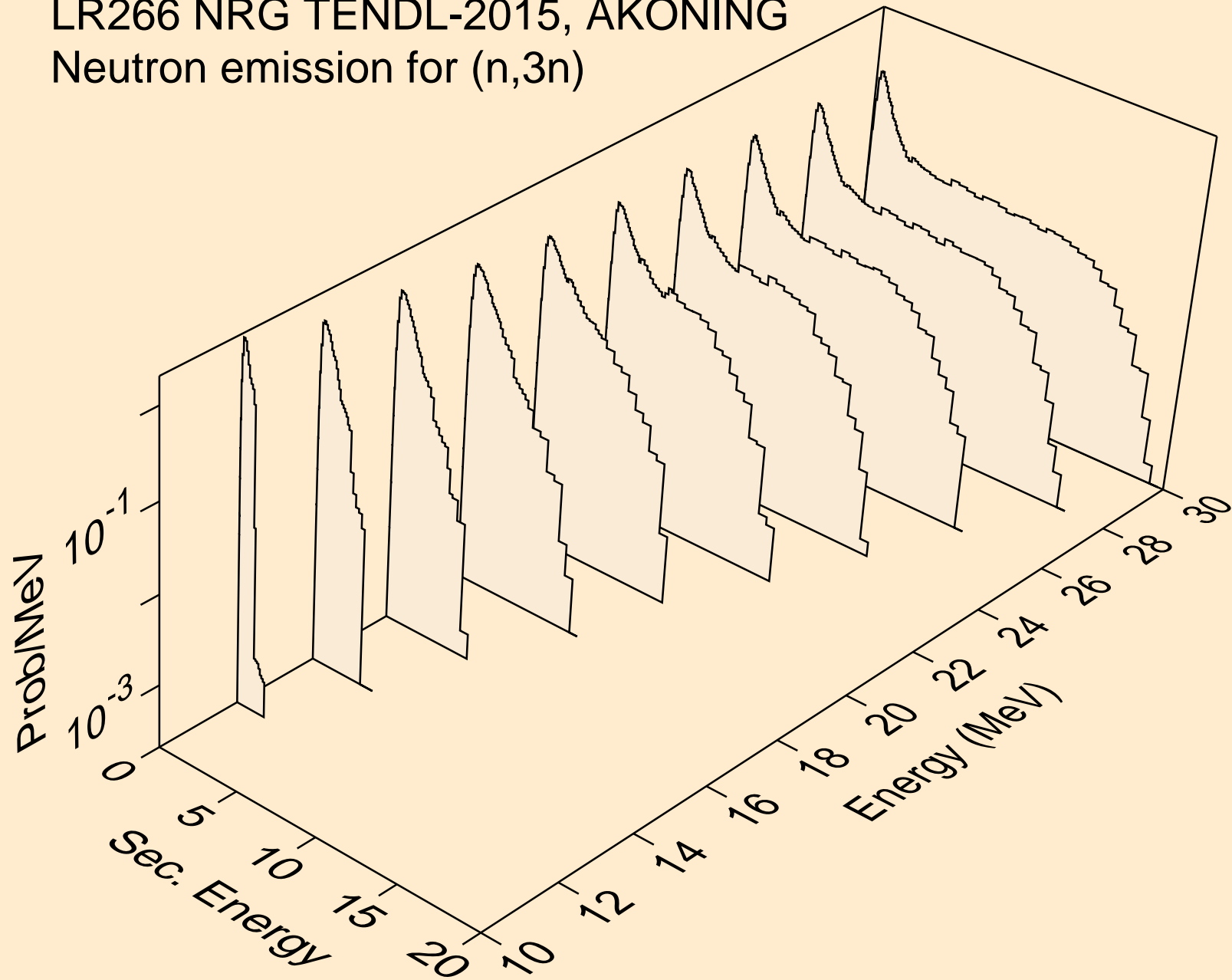

LR266 NRG TENDL-2015, AKONING
Neutron emission for fission

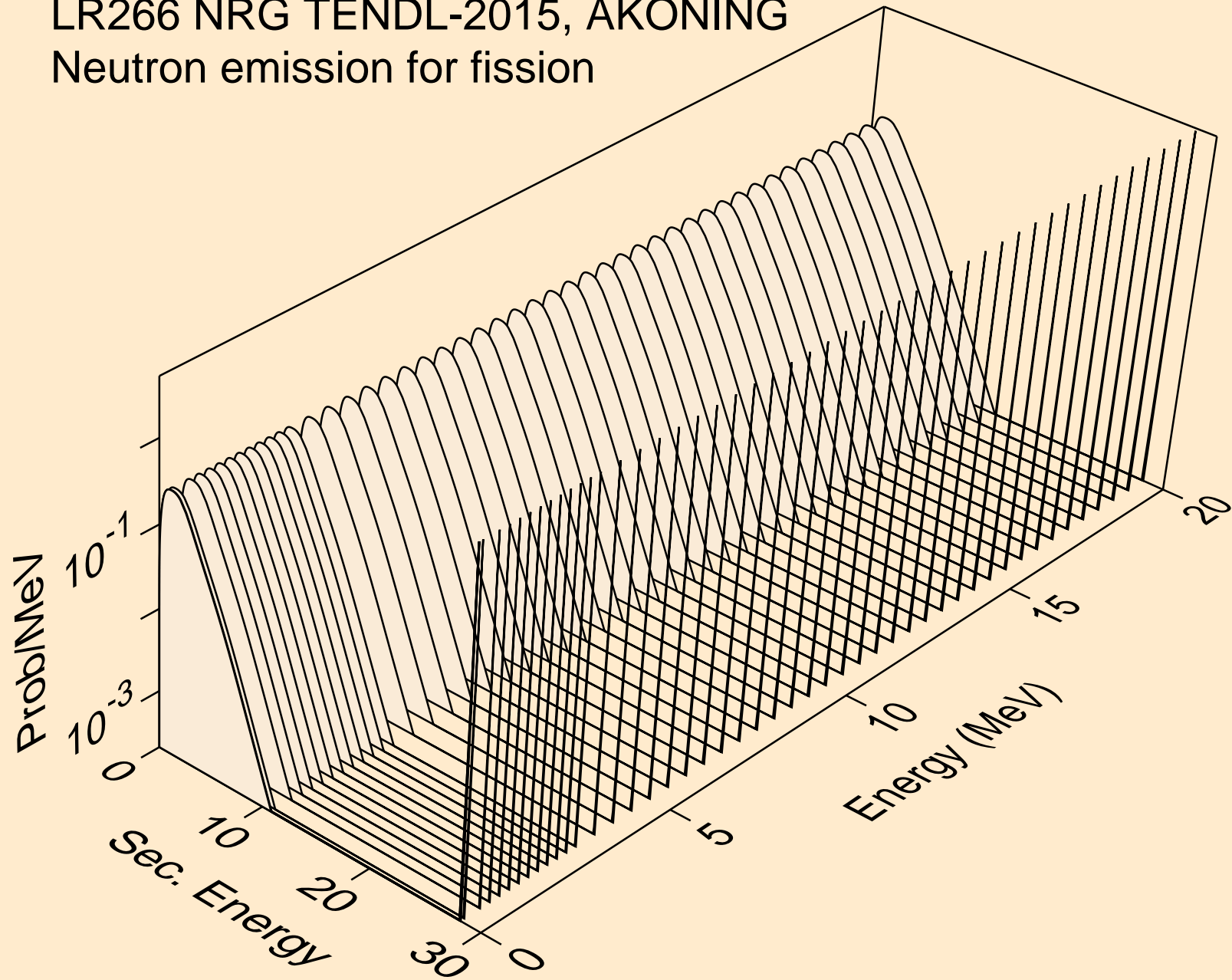

LR266 NRG TENDL-2015, AKONING
Neutron emission for (n,n*)a

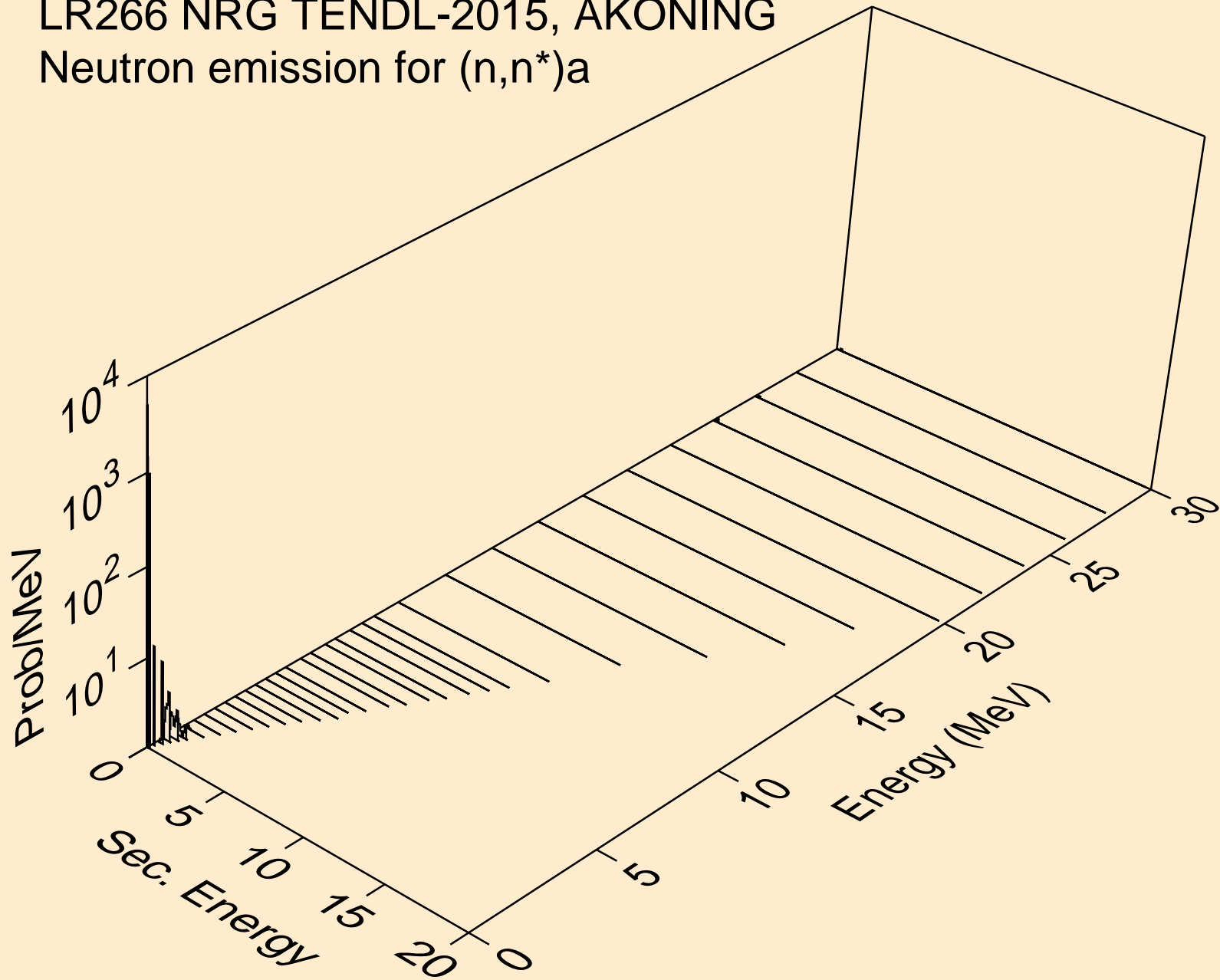

LR266 NRG TENDL-2015, AKONING
Neutron emission for (n,2n)a

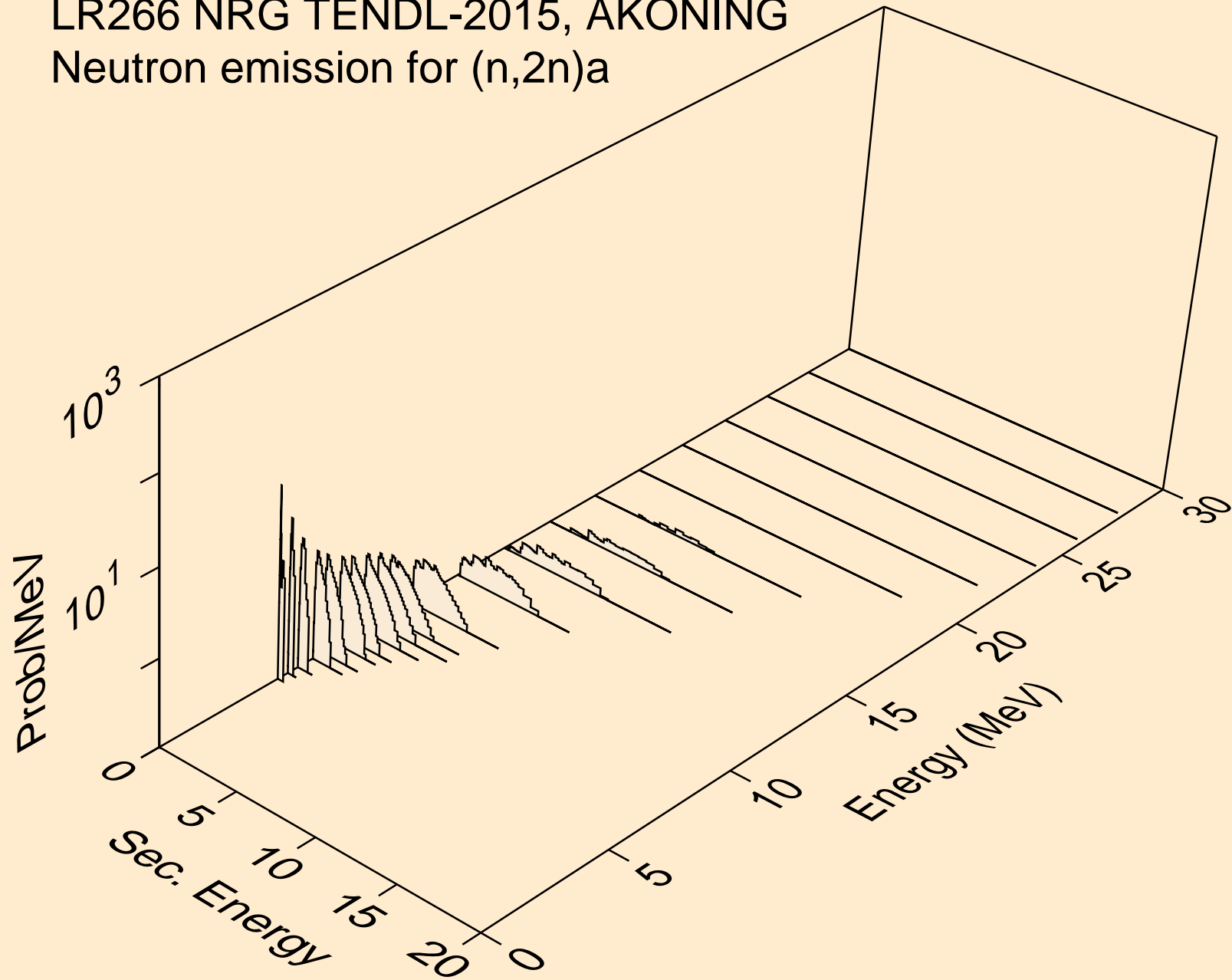

LR266 NRG TENDL-2015, AKONING
Neutron emission for (n,3n)a

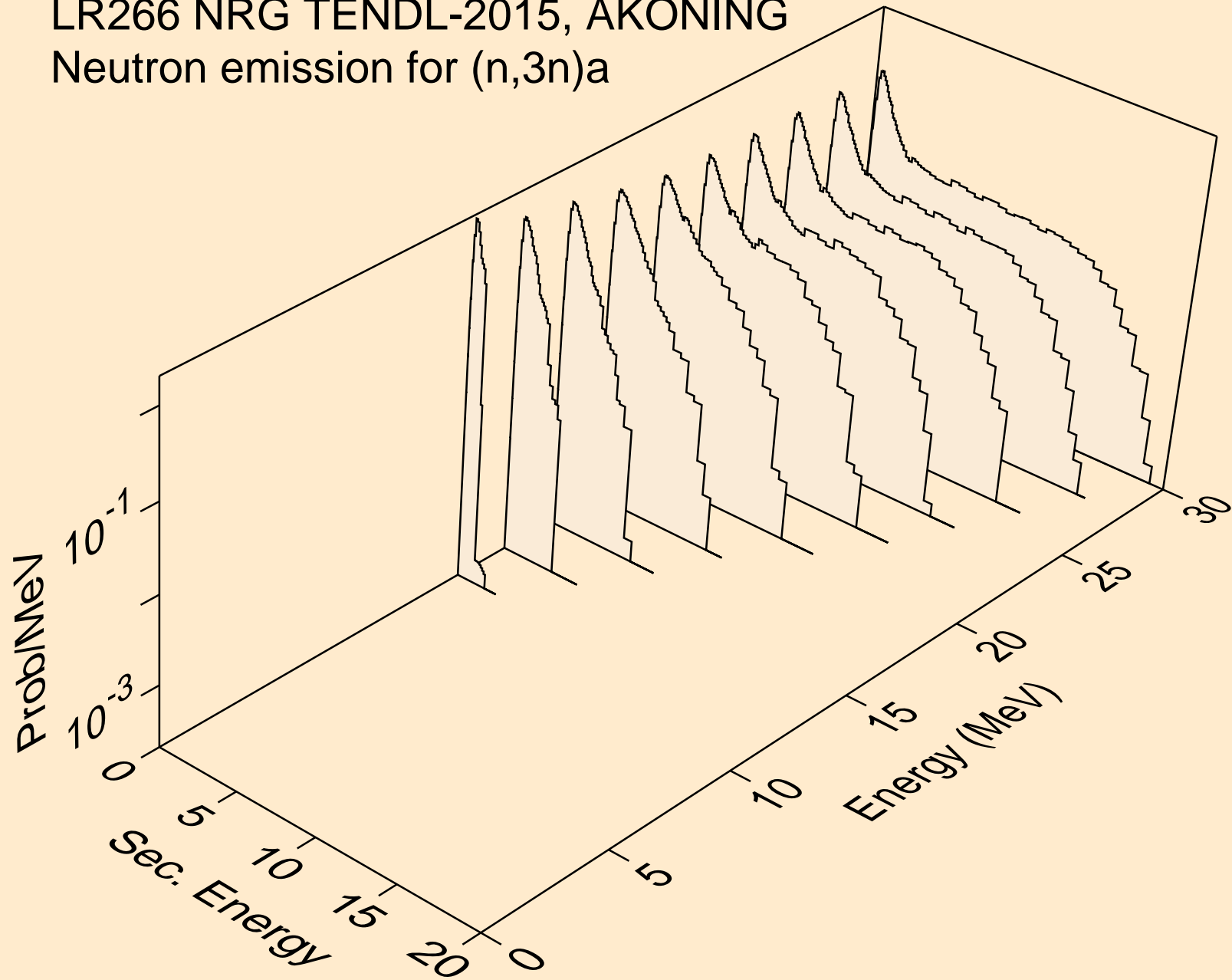

LR266 NRG TENDL-2015, AKONING
Neutron emission for (n,n*)p

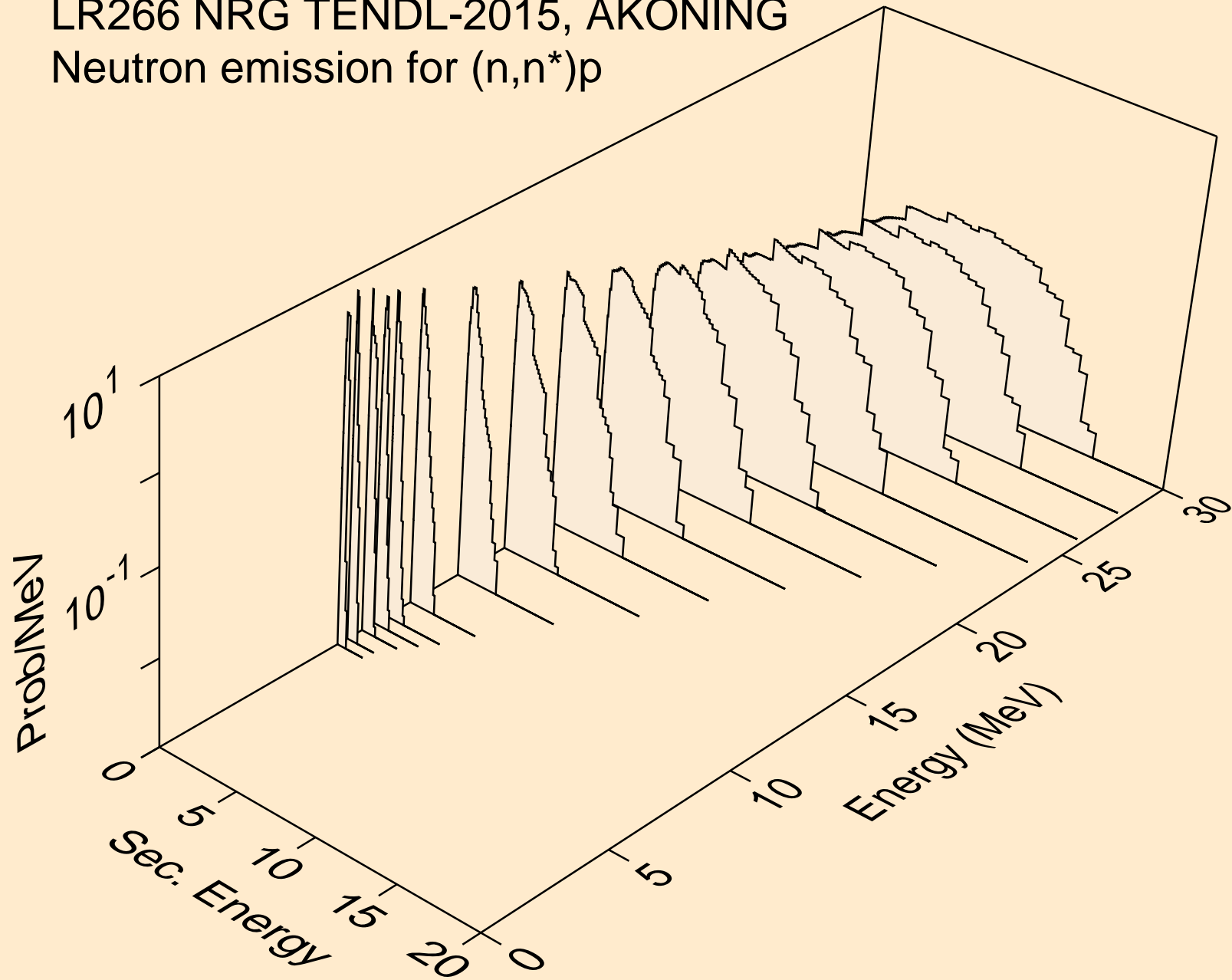

LR266 NRG TENDL-2015, AKONING
Neutron emission for (n,n*)d

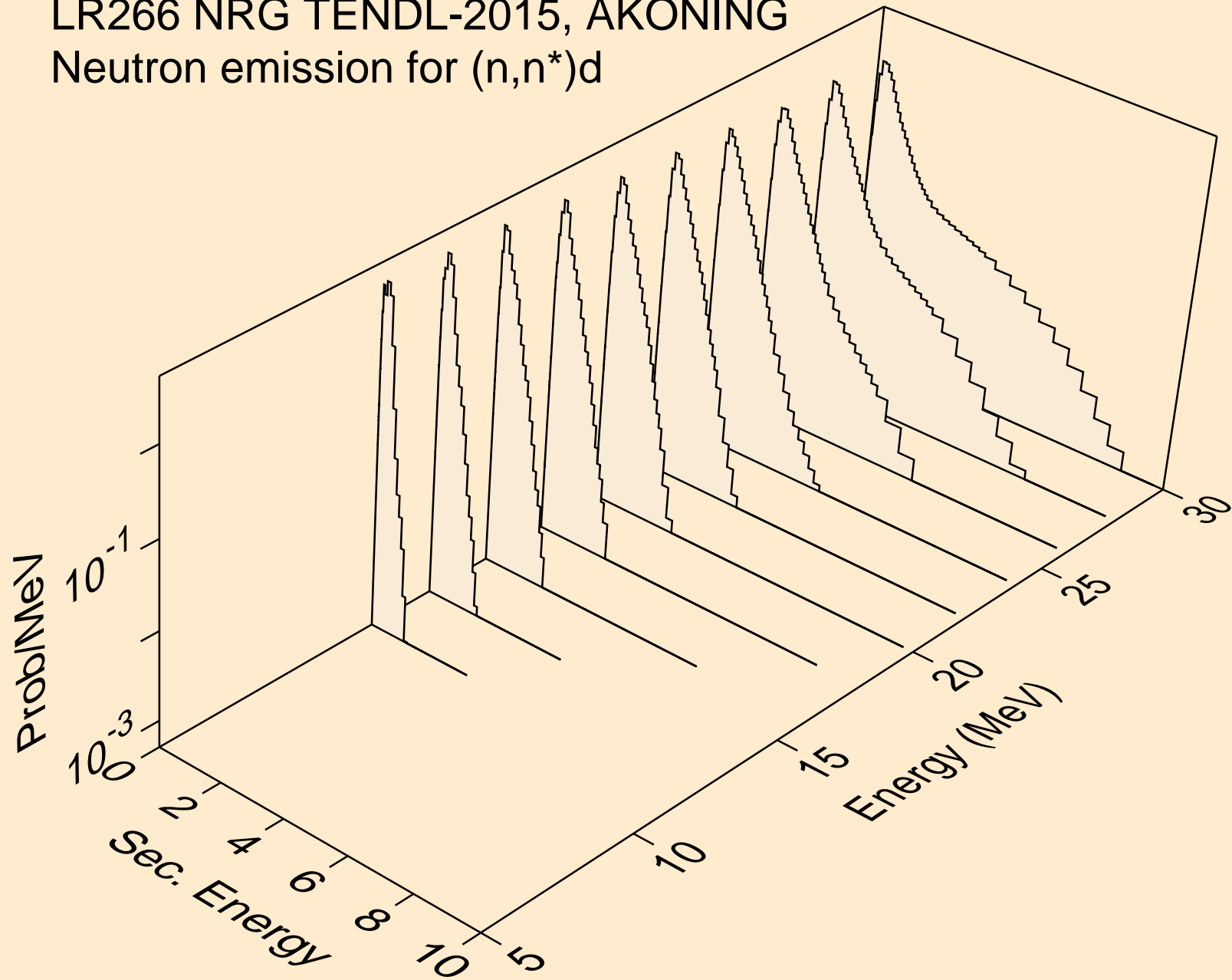

LR266 NRG TENDL-2015, AKONING
Neutron emission for (n,n*)t

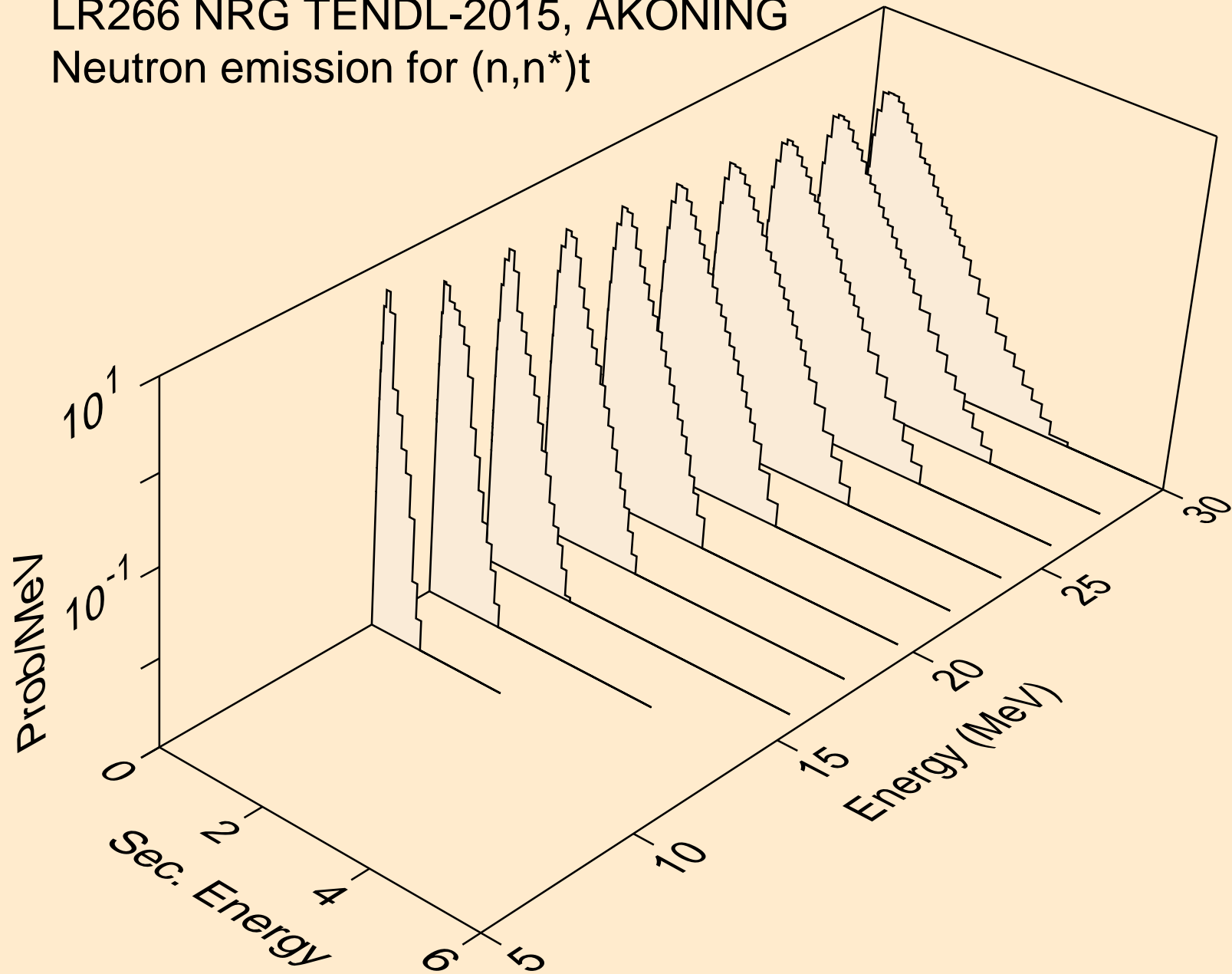

LR266 NRG TENDL-2015, AKONING
Neutron emission for (n,n*)he3

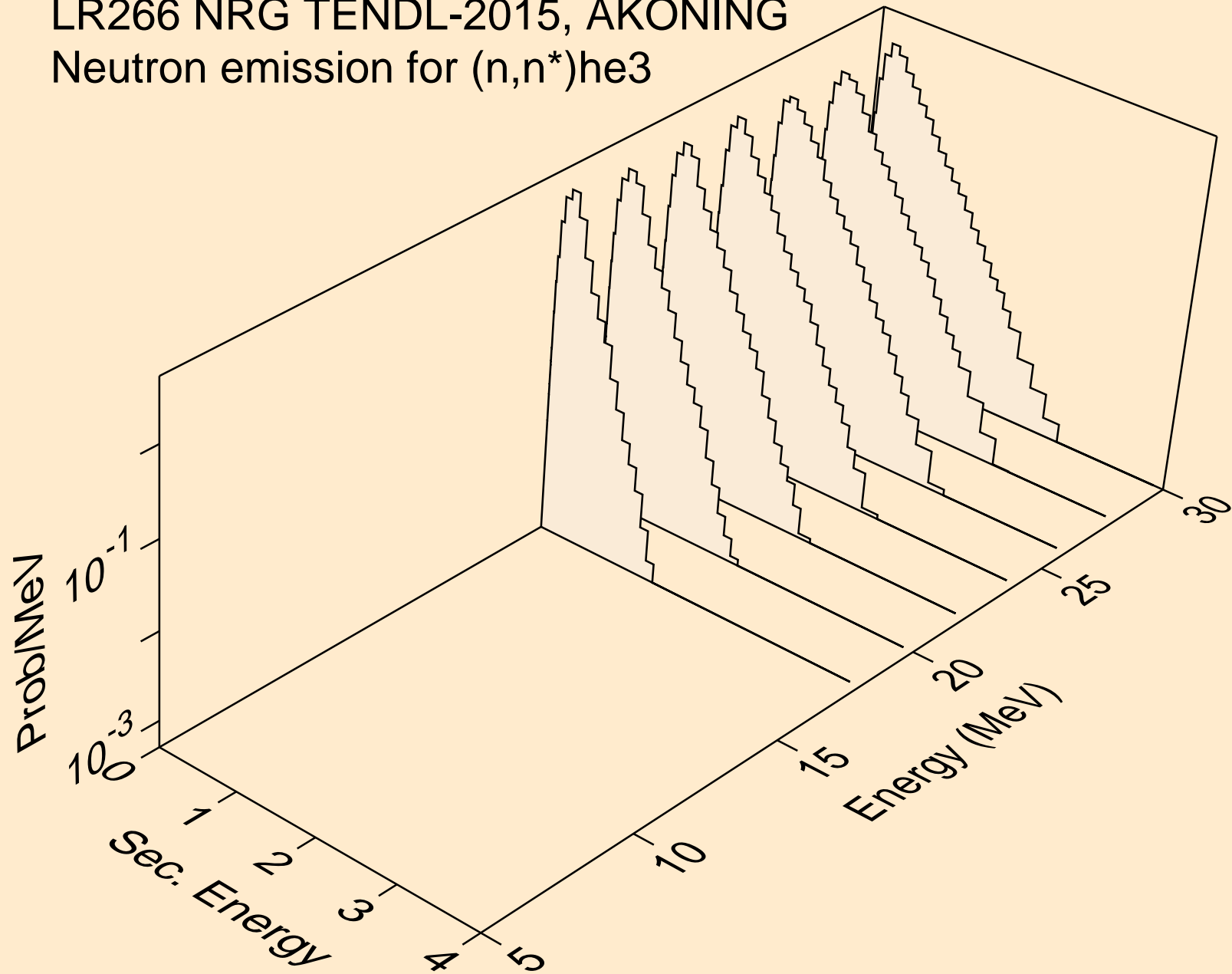

LR266 NRG TENDL-2015, AKONING
Neutron emission for (n,4n)

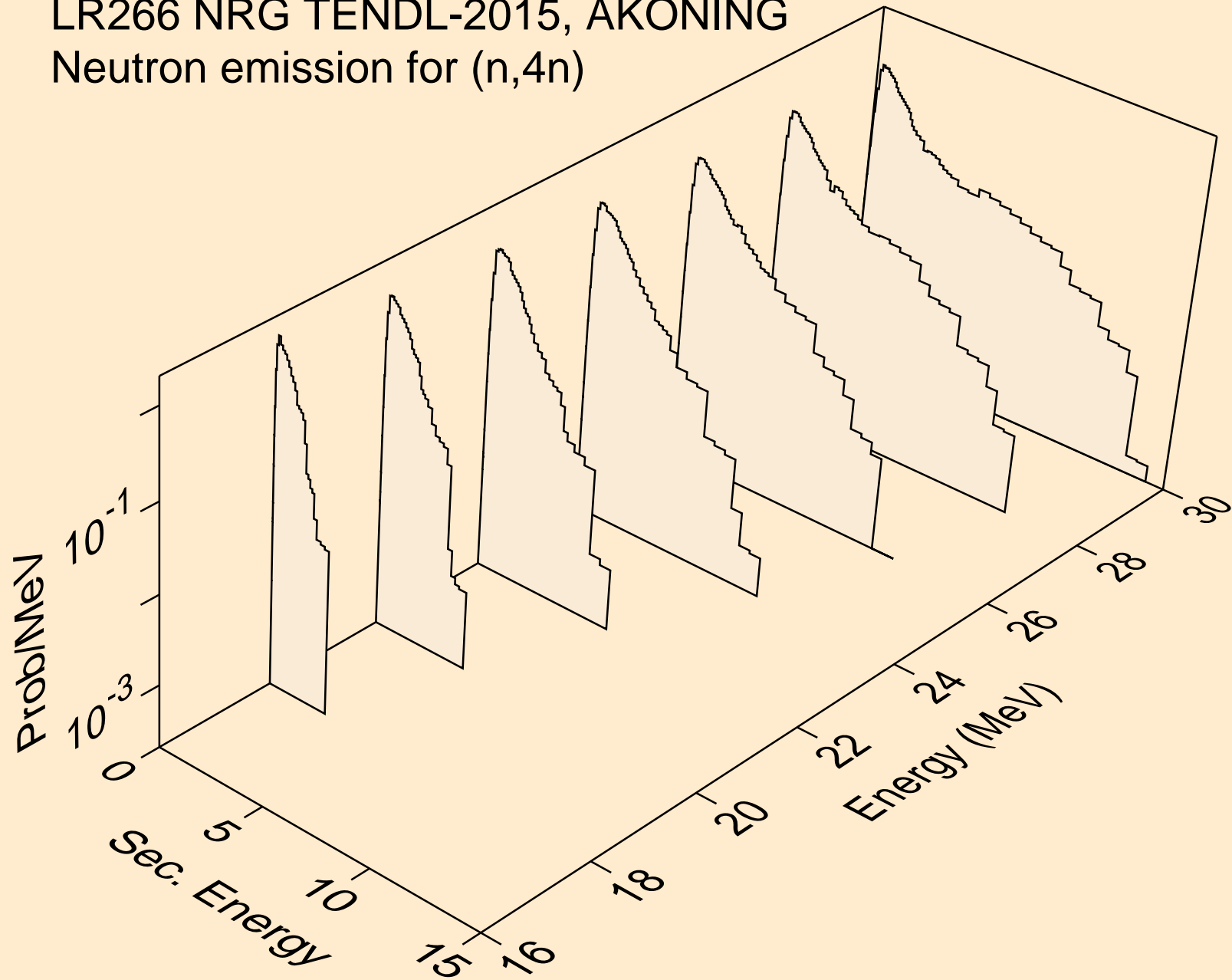

LR266 NRG TENDL-2015, AKONING
Neutron emission for (n,2np)

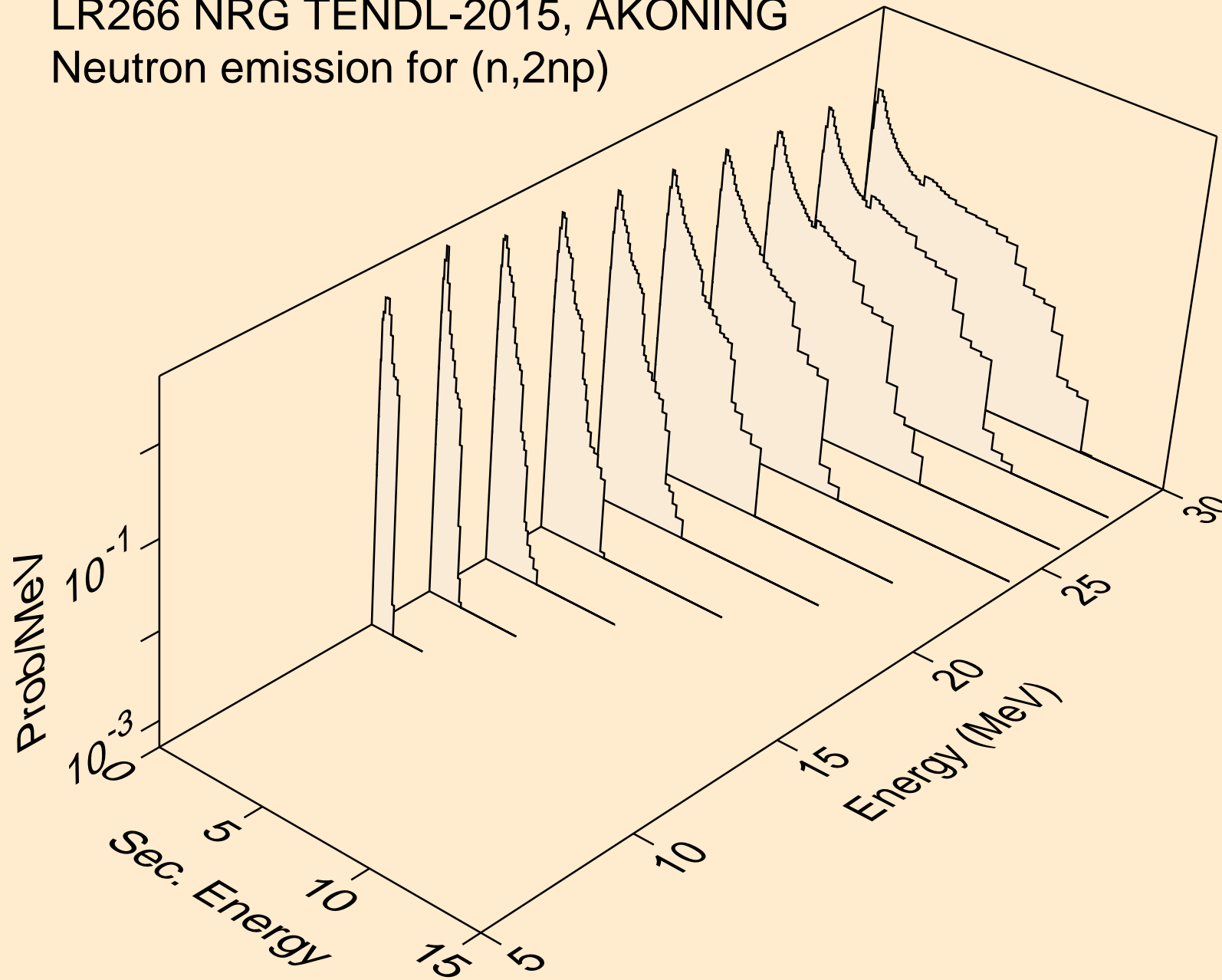

LR266 NRG TENDL-2015, AKONING
Neutron emission for (n,3np)

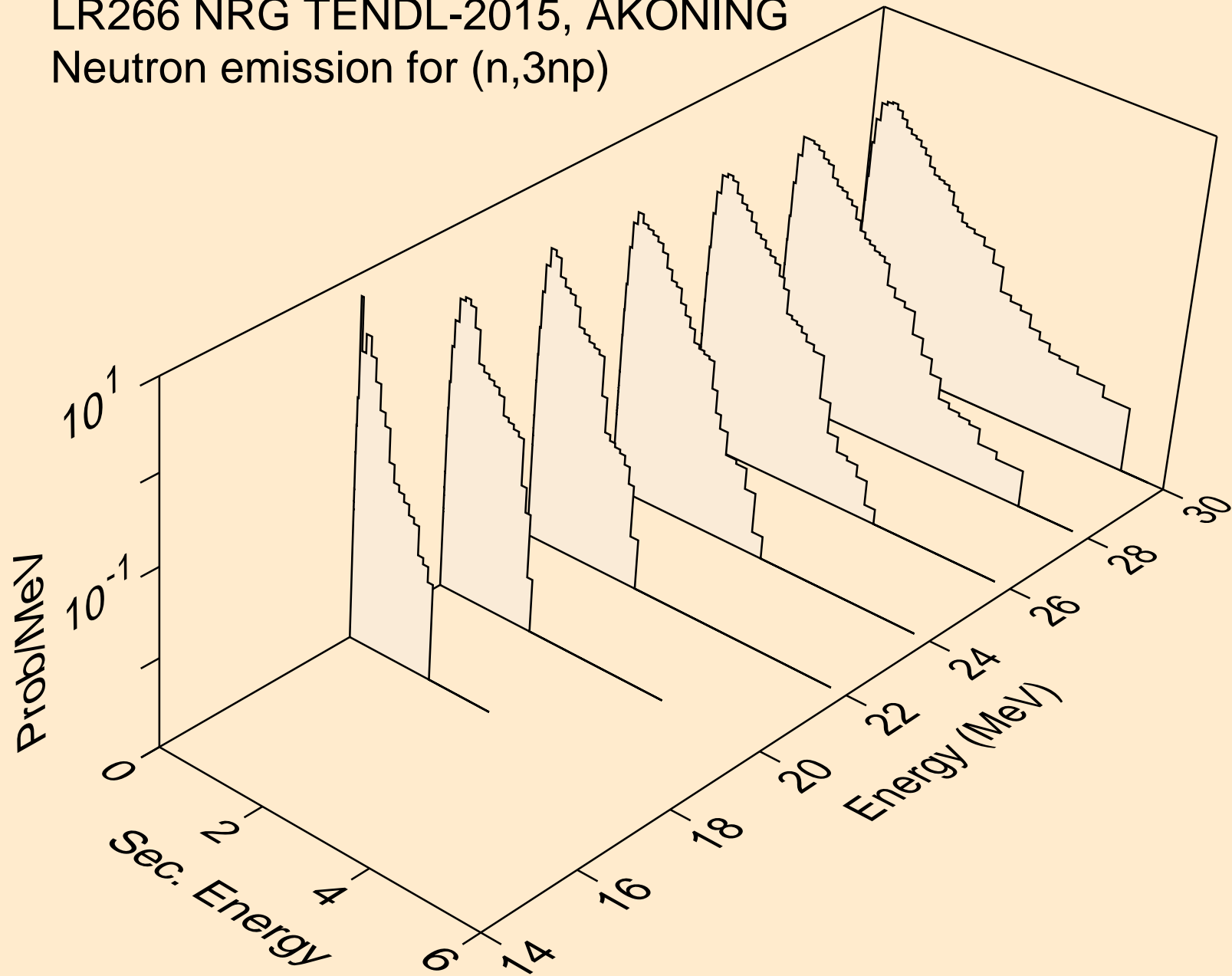

LR266 NRG TENDL-2015, AKONING
Neutron emission for (n,n*c)

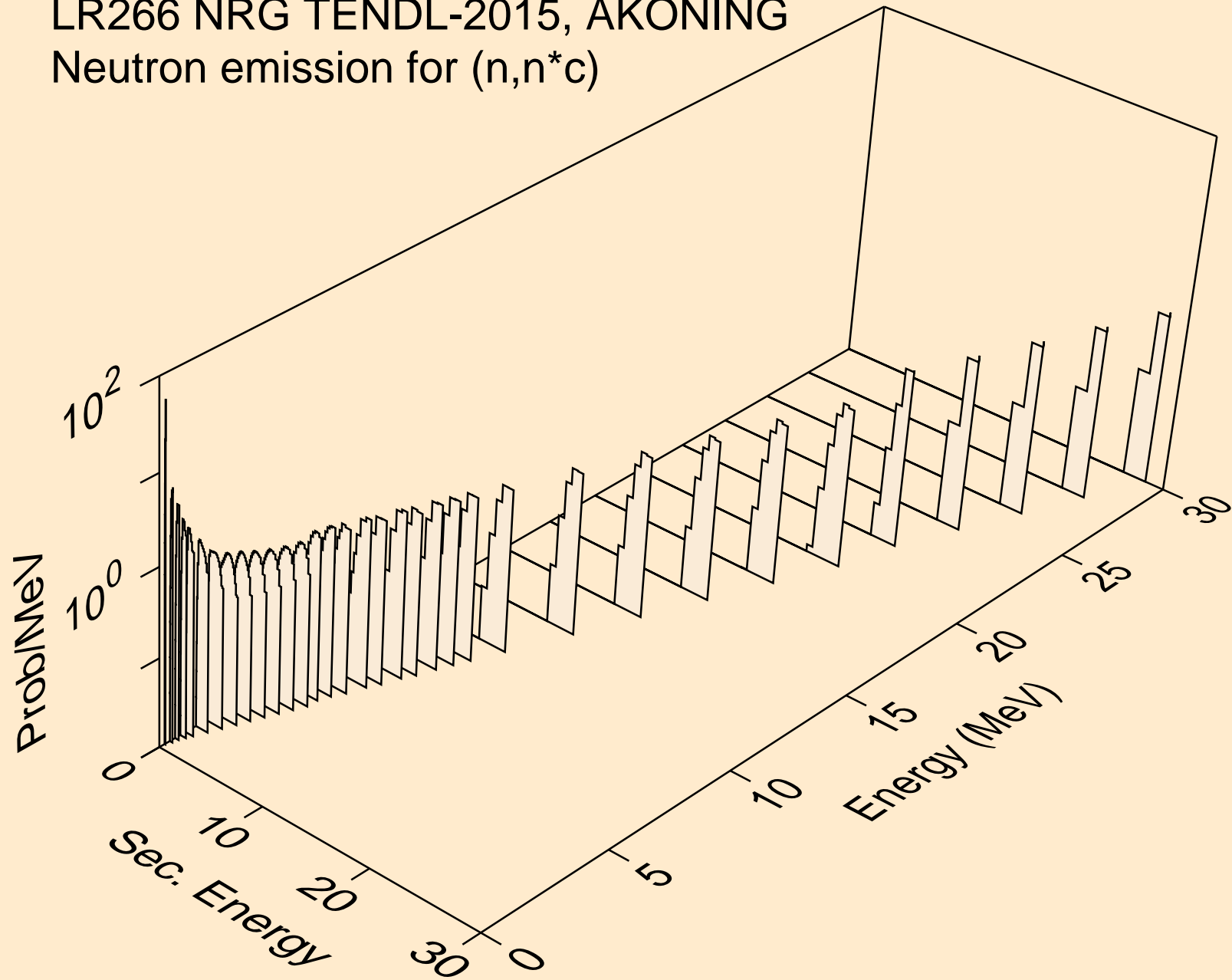

LR266 NRG TENDL-2015, AKONING

Delayed nubar

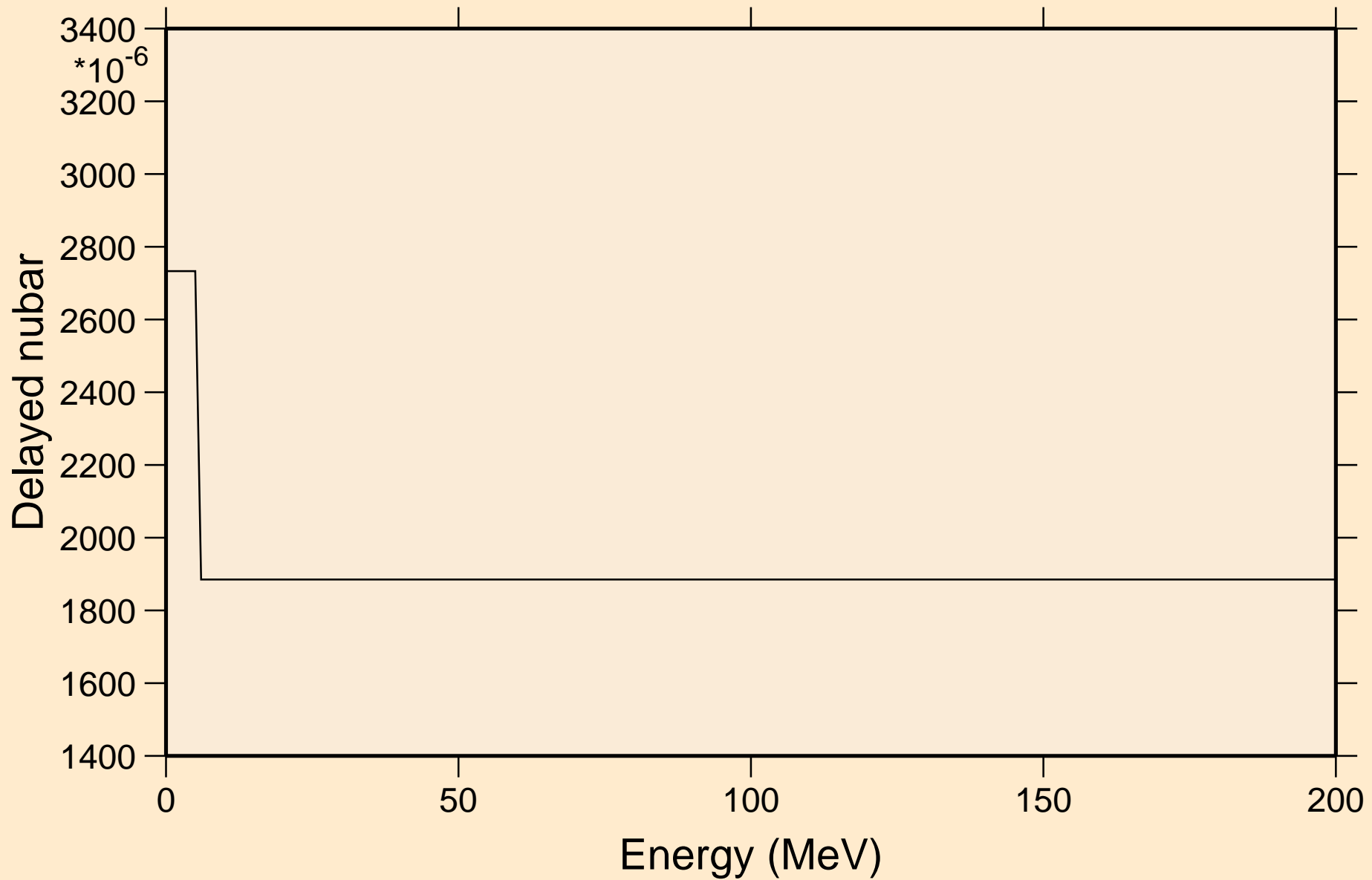

LR266 NRG TENDL-2015, AKONING

Delayed neutron spectra

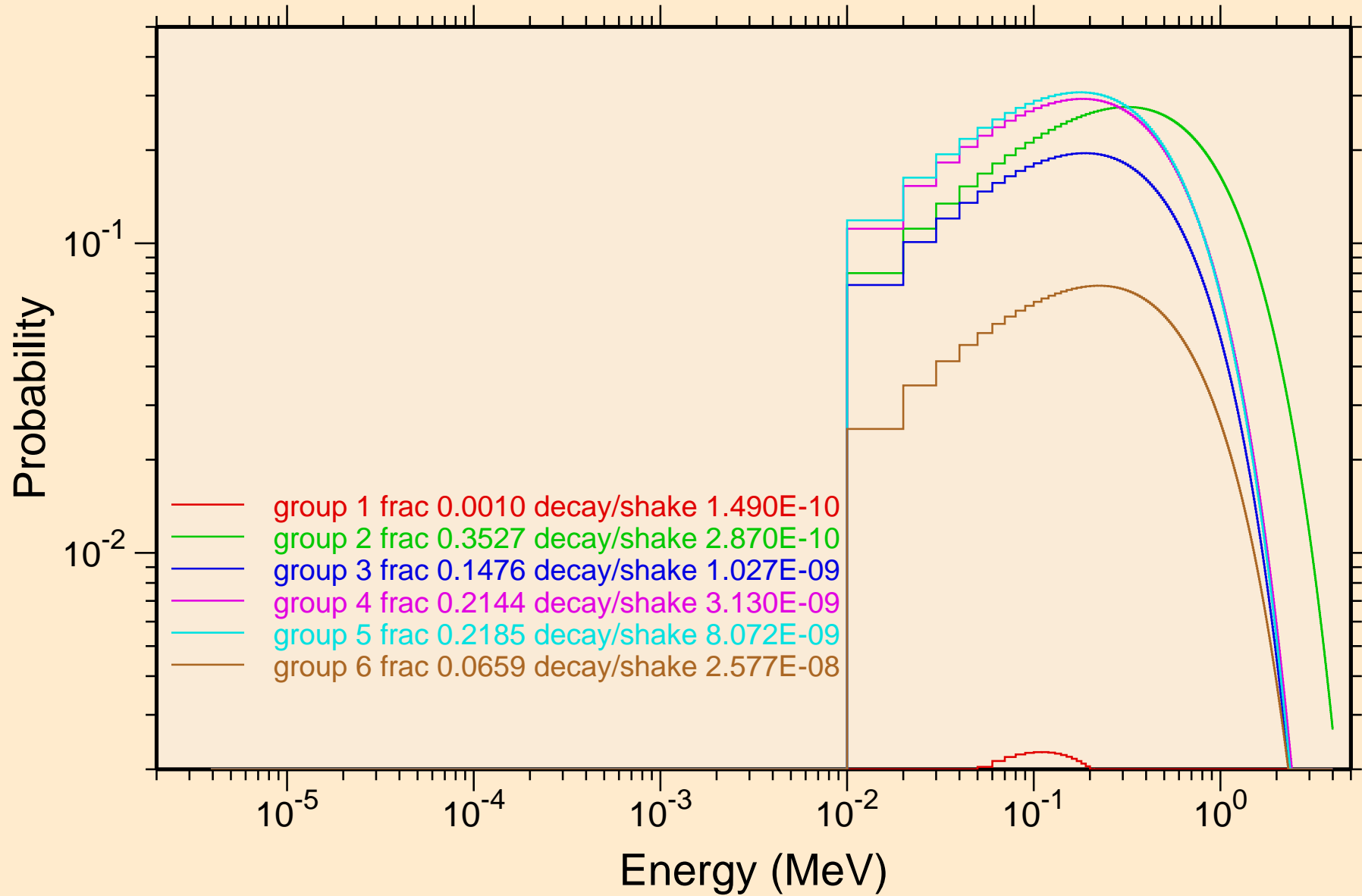

LR266 NRG TENDL-2015, AKONING
Photon emission for (n,x)

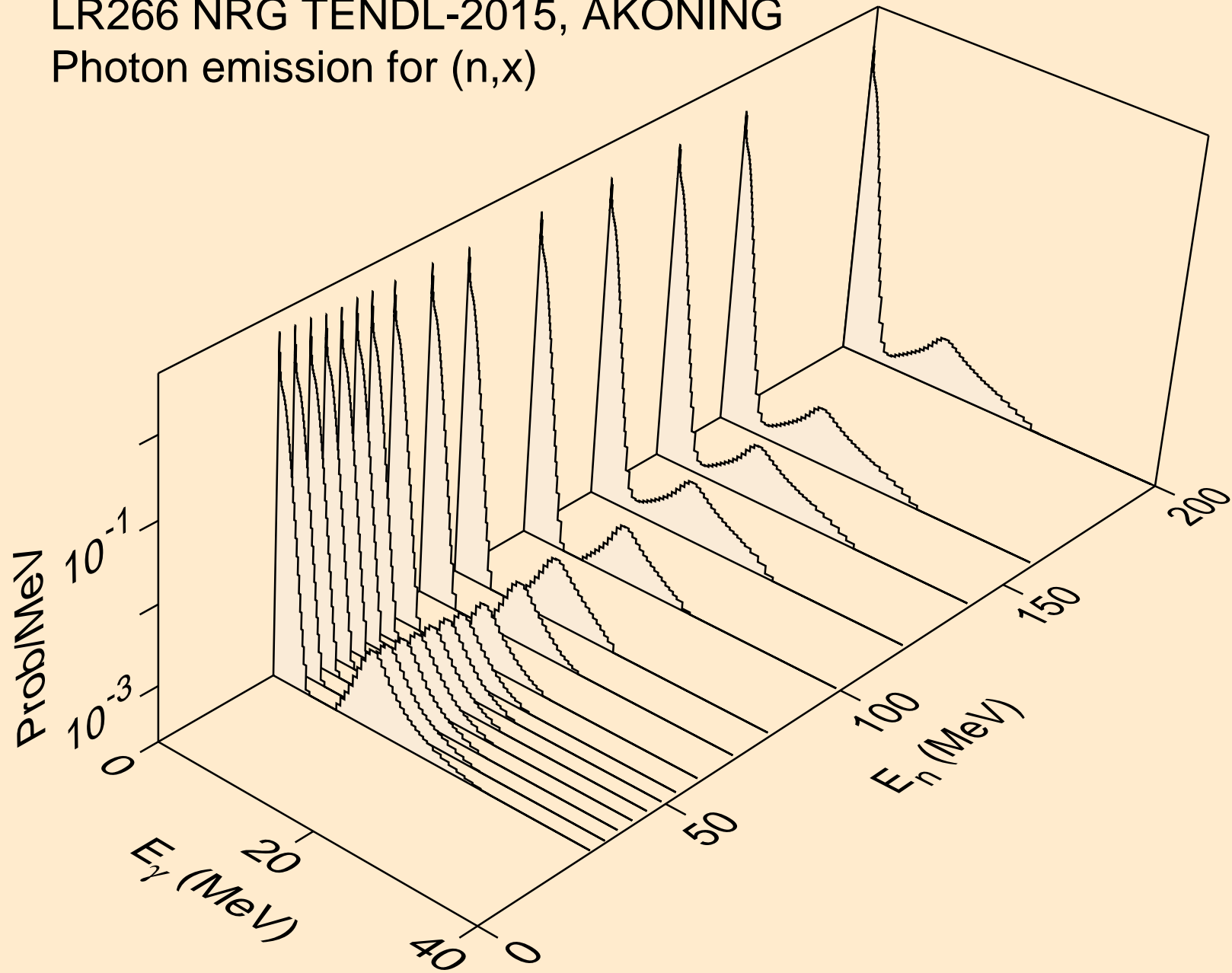

LR266 NRG TENDL-2015, AKONING
Photon emission for (n,2nd)

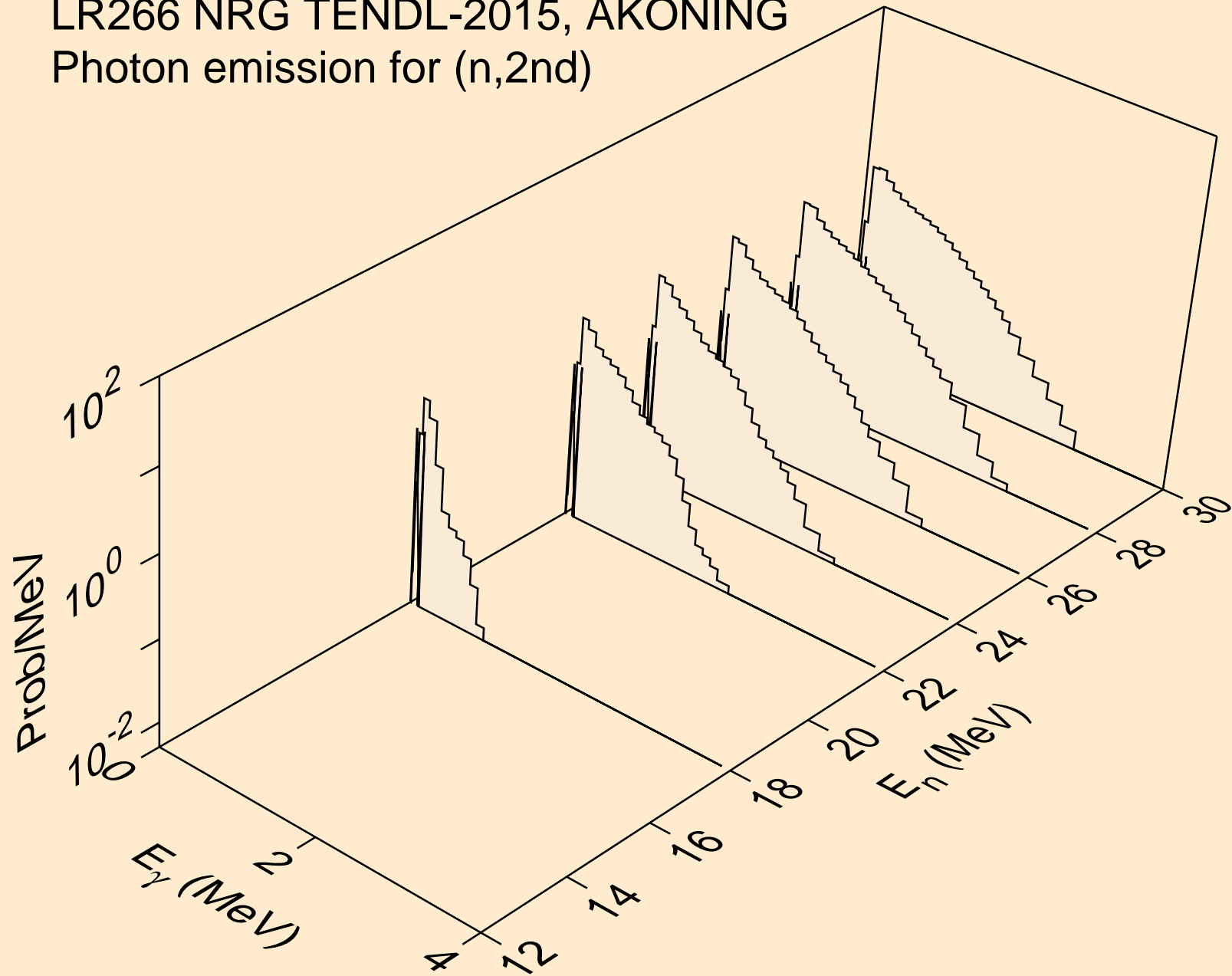

LR266 NRG TENDL-2015, AKONING
Photon emission for (n,2n)

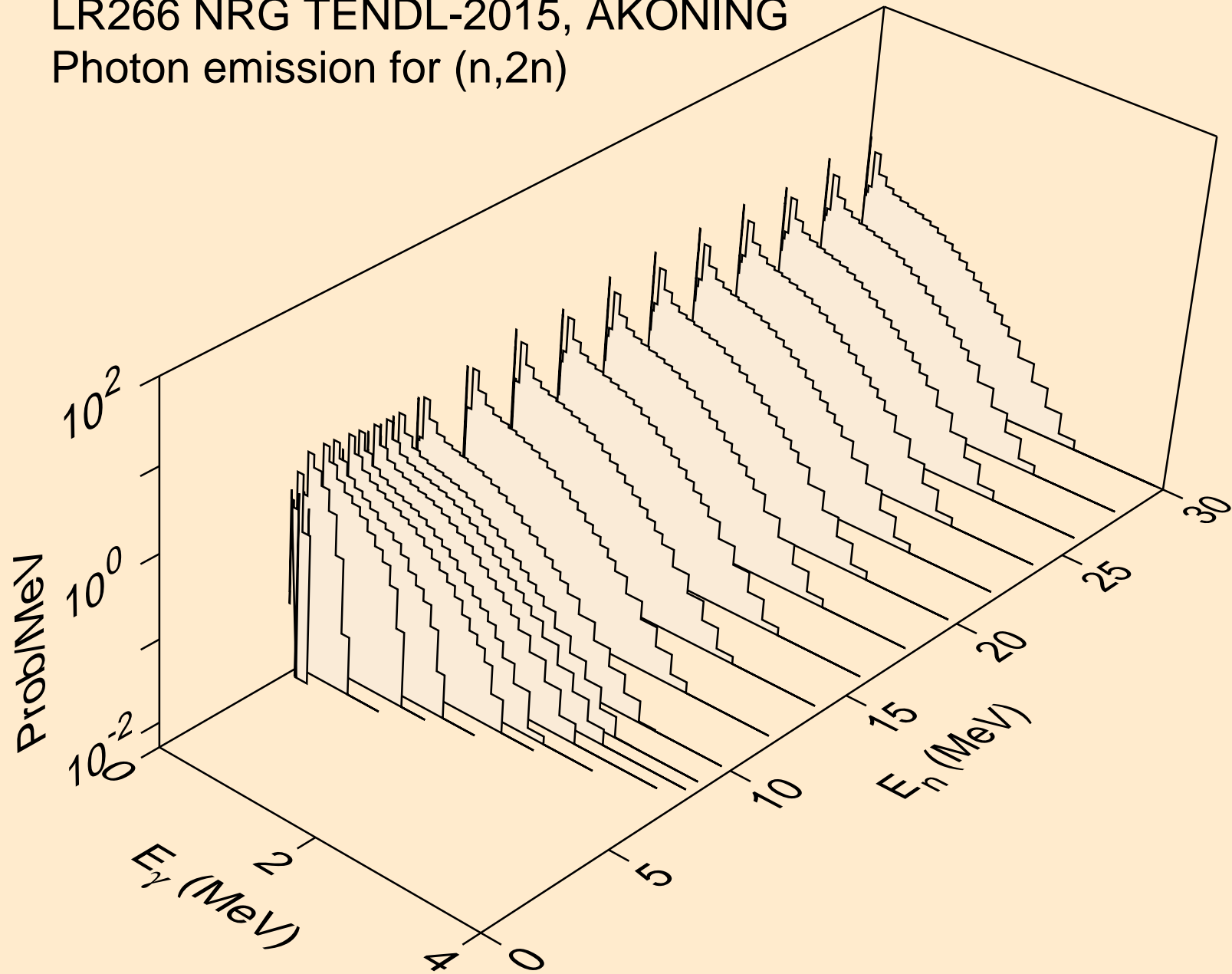

LR266 NRG TENDL-2015, AKONING
Photon emission for (n,3n)

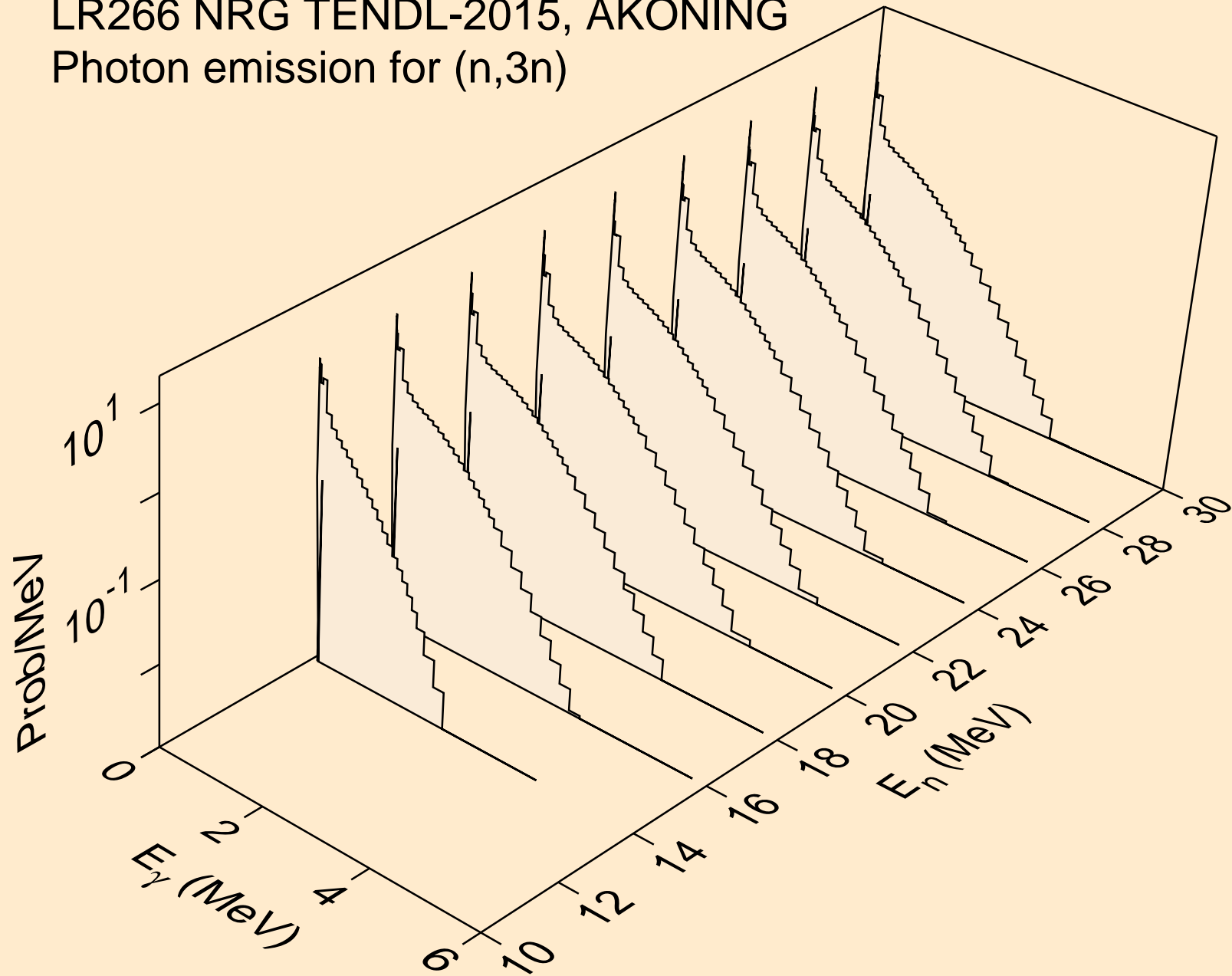

LR266 NRG TENDL-2015, AKONING
Photon emission for (n,n*)a

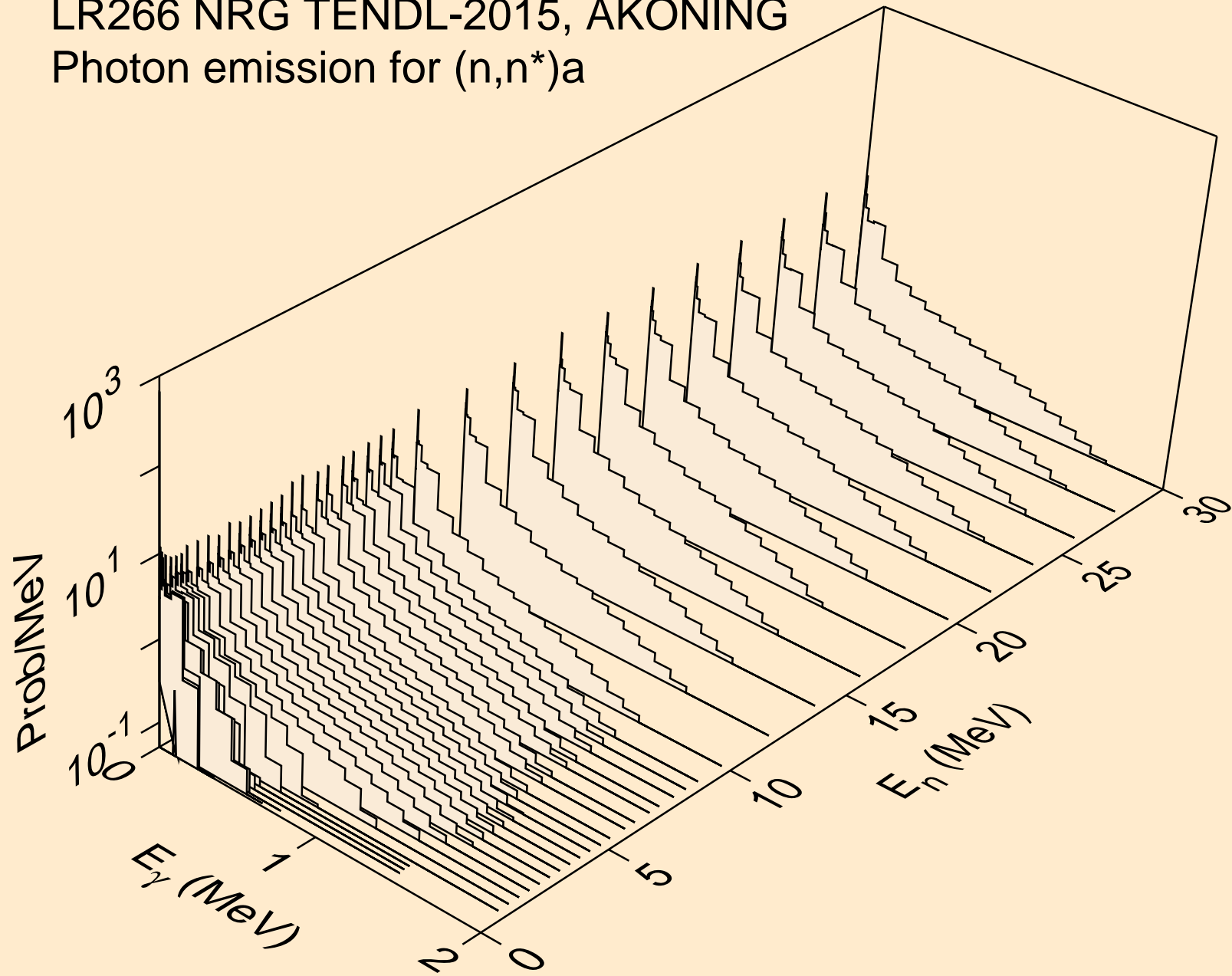

LR266 NRG TENDL-2015, AKONING
Photon emission for (n,2n)a

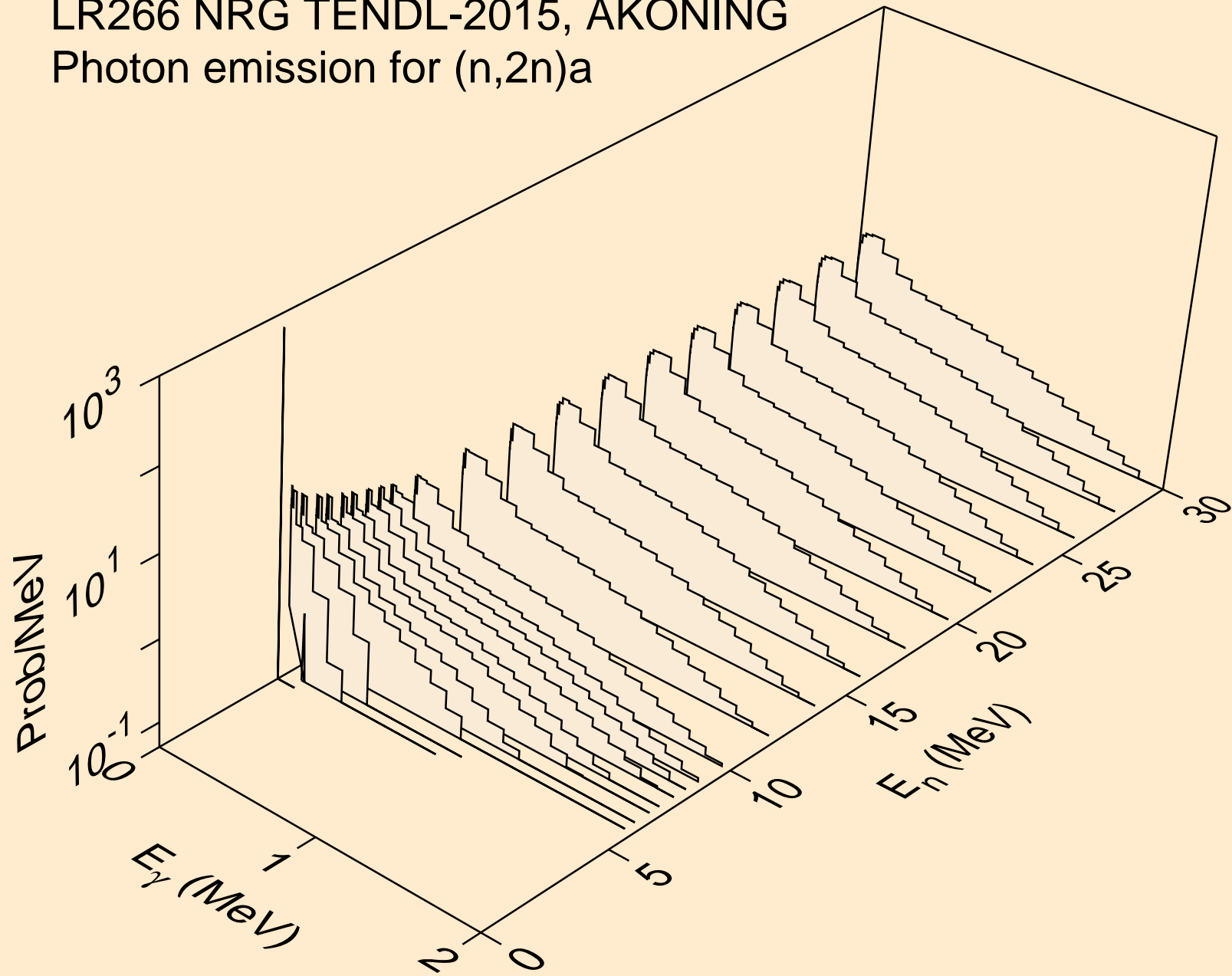

LR266 NRG TENDL-2015, AKONING
Photon emission for (n,3n)a

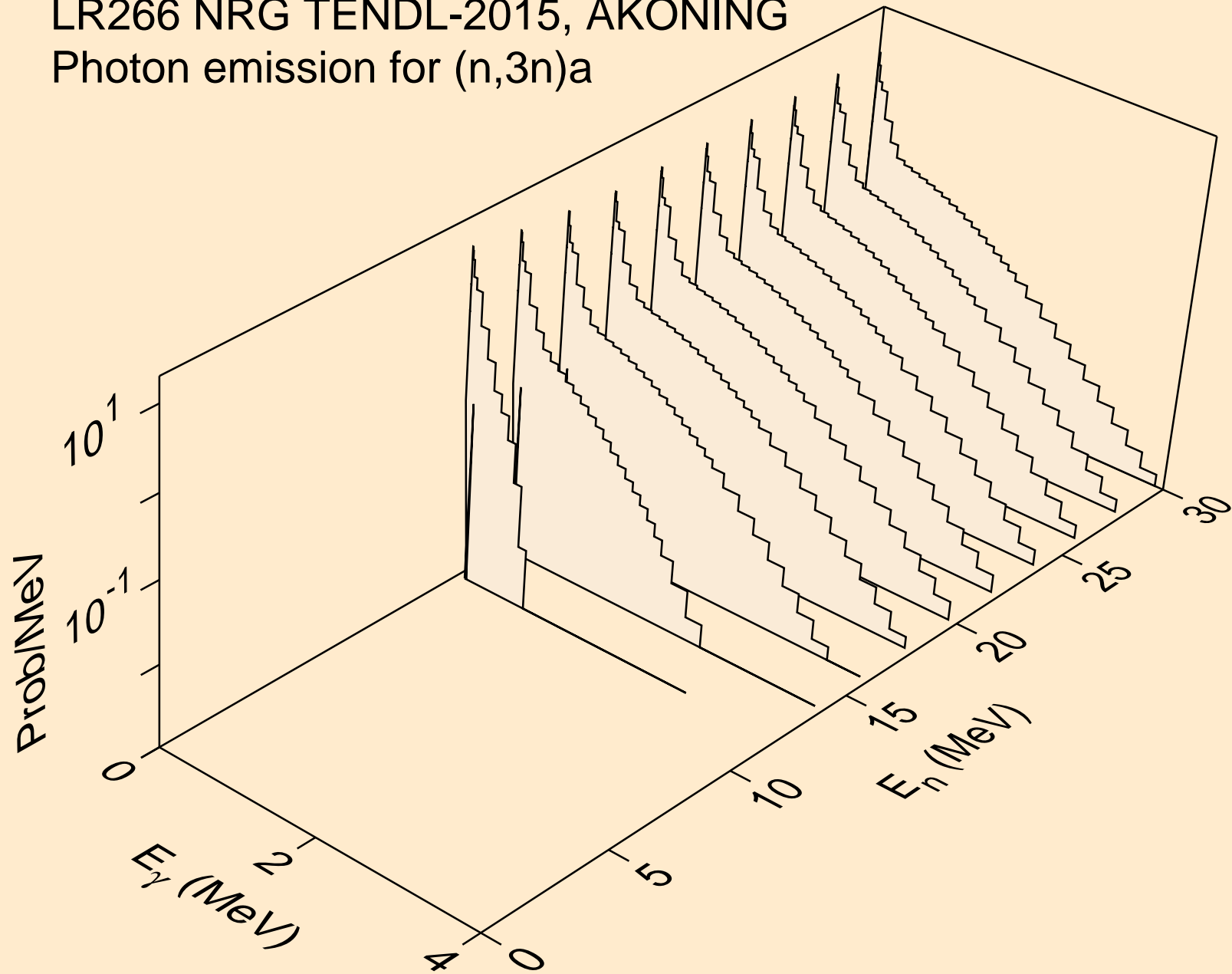

LR266 NRG TENDL-2015, AKONING
Photon emission for (n,n*)p

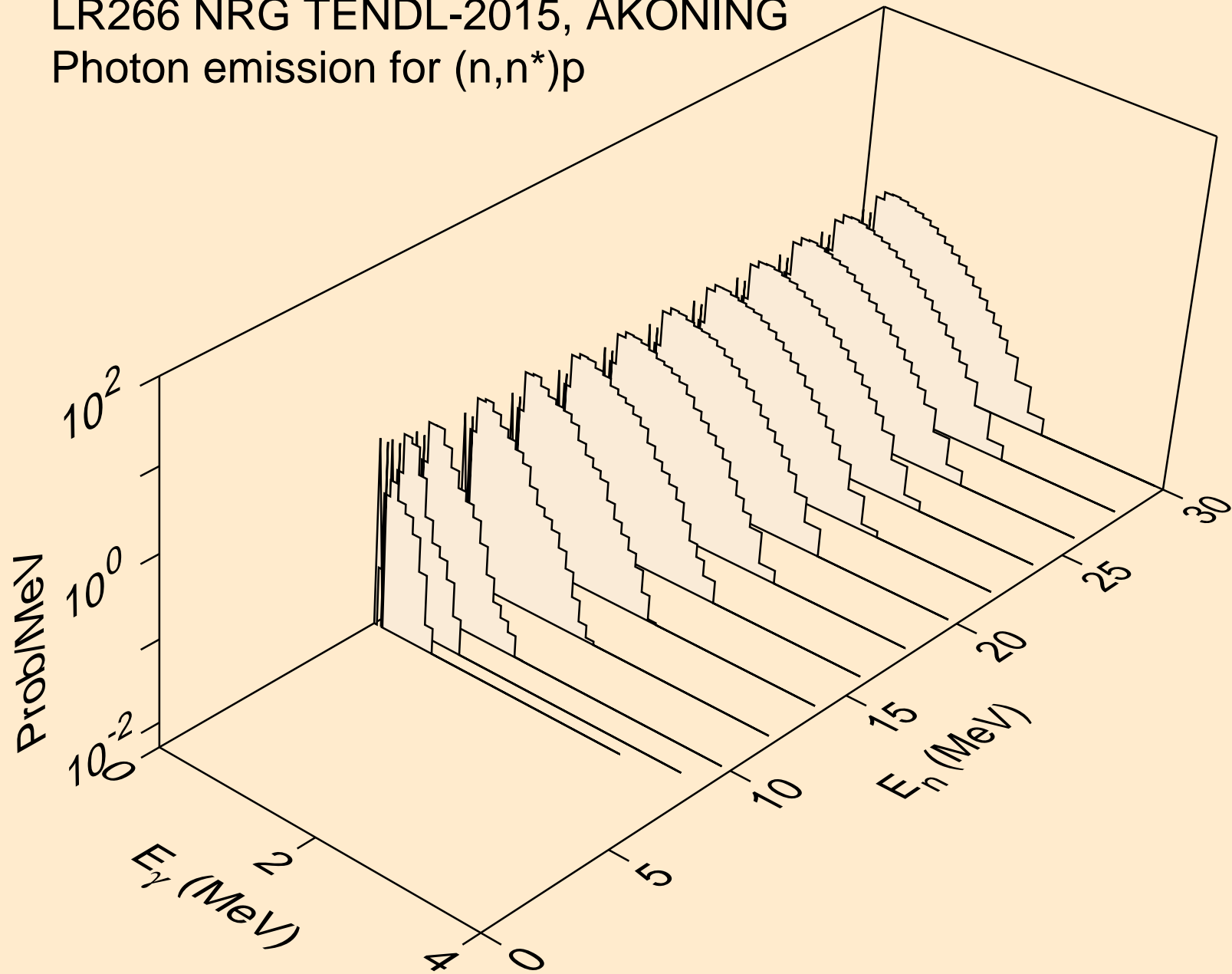

LR266 NRG TENDL-2015, AKONING
Photon emission for (n,n*)d

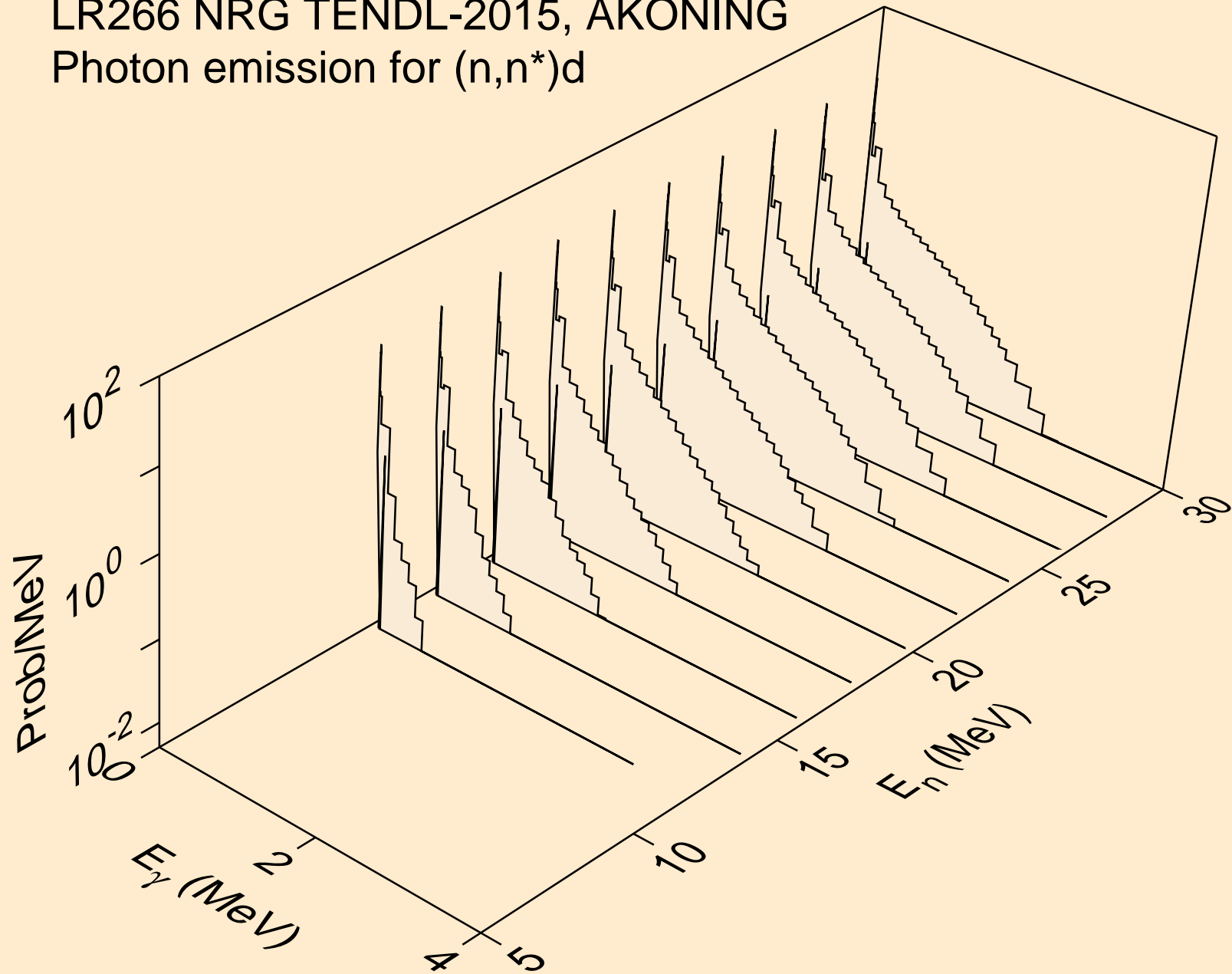

LR266 NRG TENDL-2015, AKONING
Photon emission for (n,n*)t

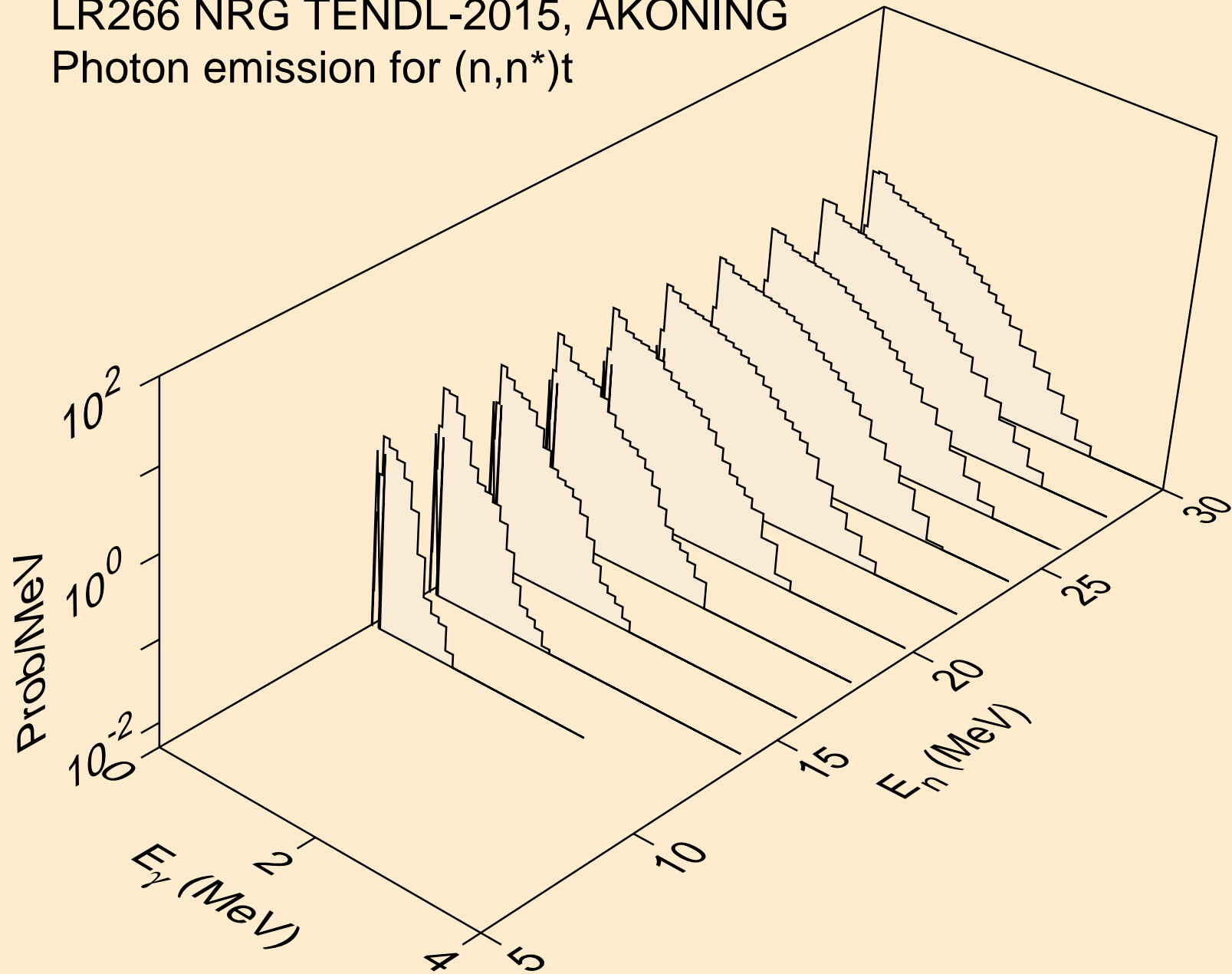

LR266 NRG TENDL-2015, AKONING
Photon emission for (n,n*)he3

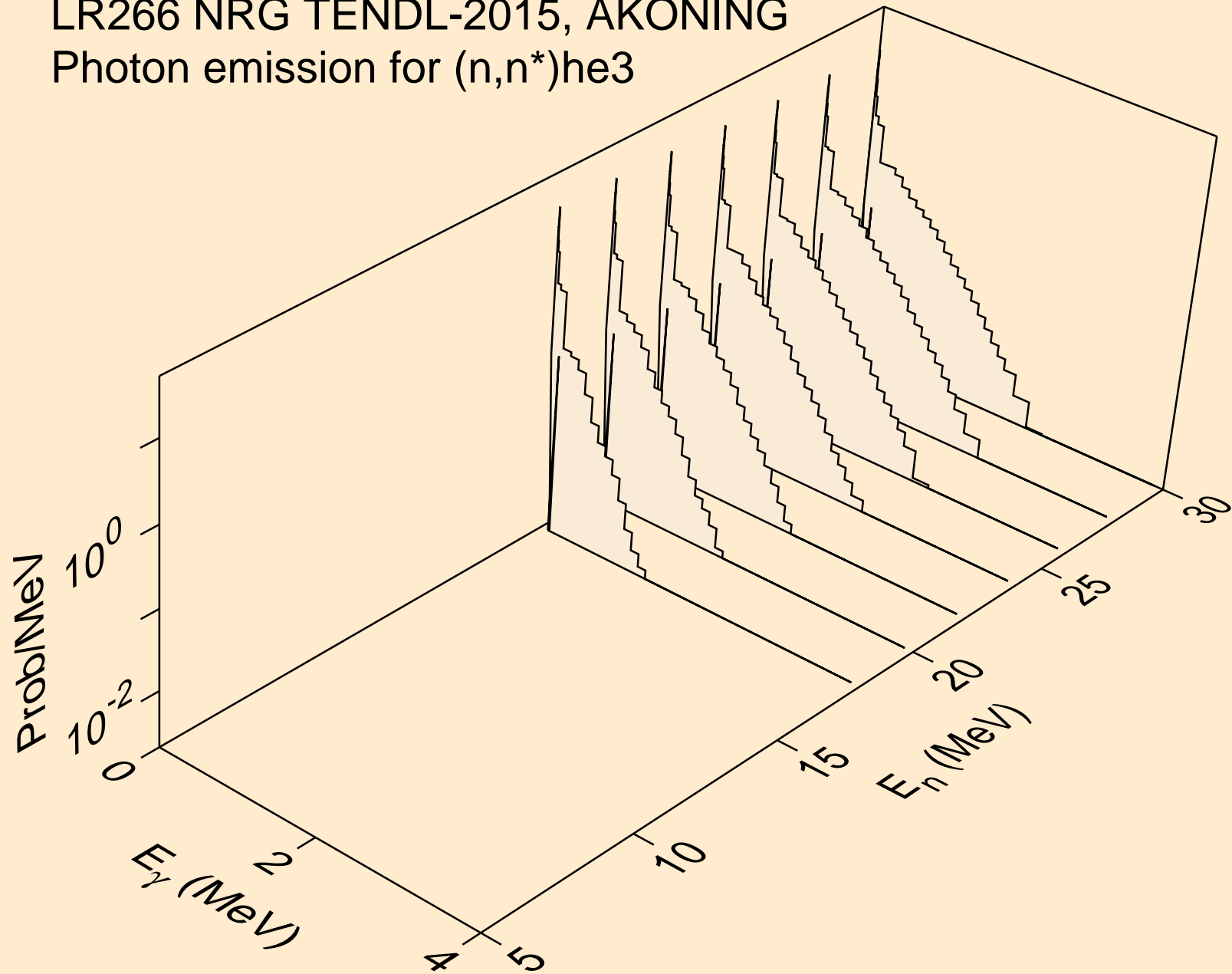

LR266 NRG TENDL-2015, AKONING
Photon emission for (n,4n)

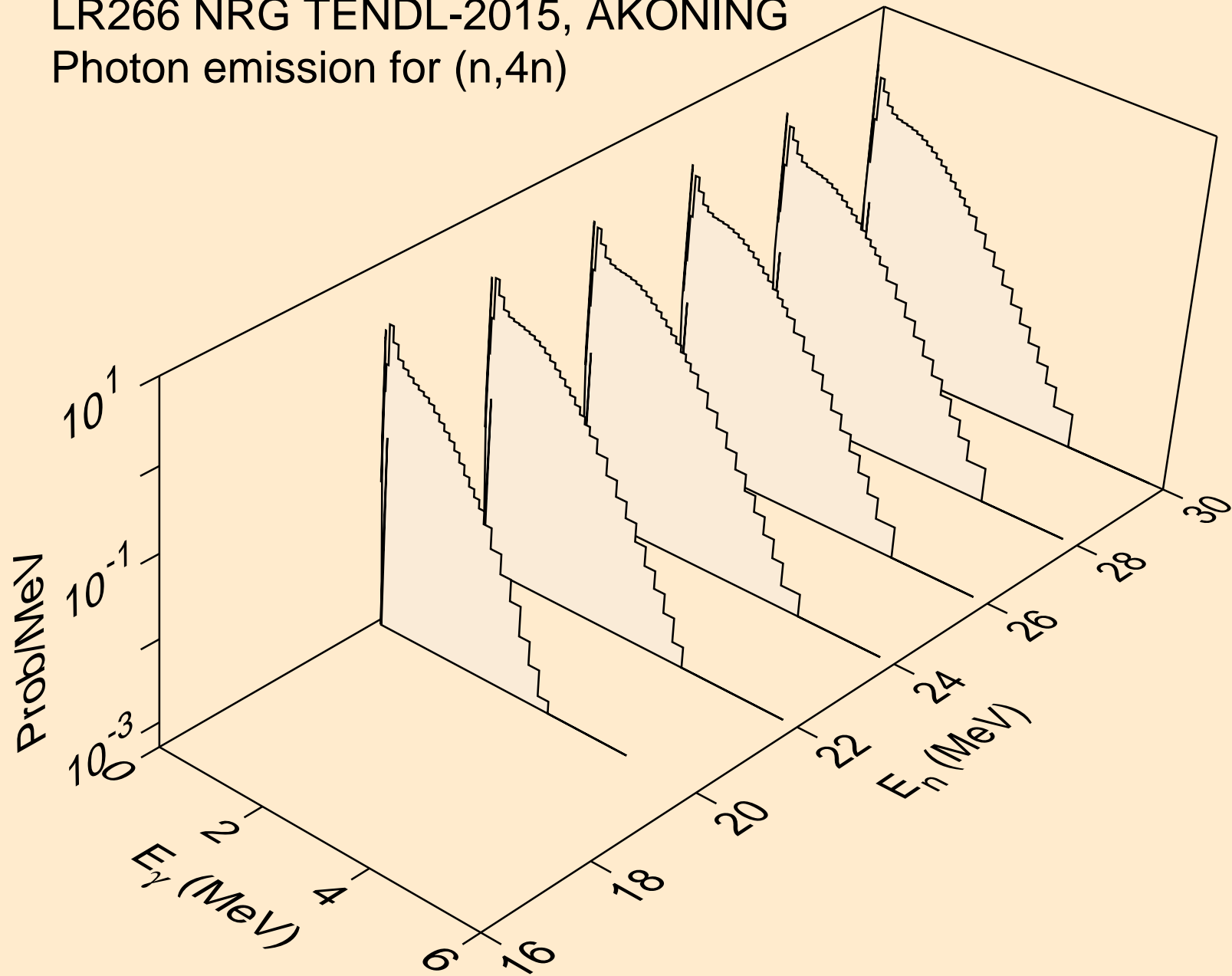

LR266 NRG TENDL-2015, AKONING
Photon emission for (n,2np)

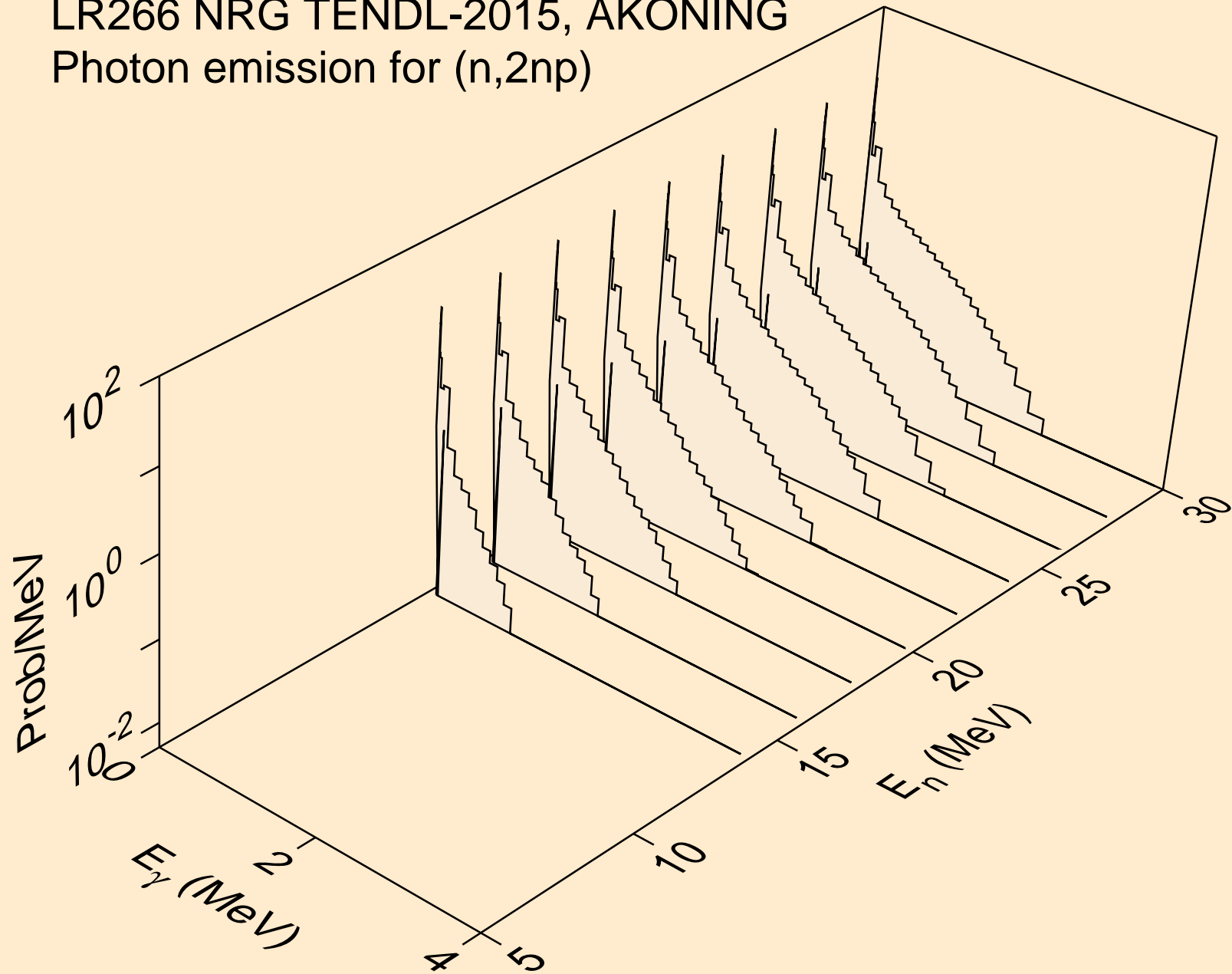

LR266 NRG TENDL-2015, AKONING
Photon emission for (n,3np)

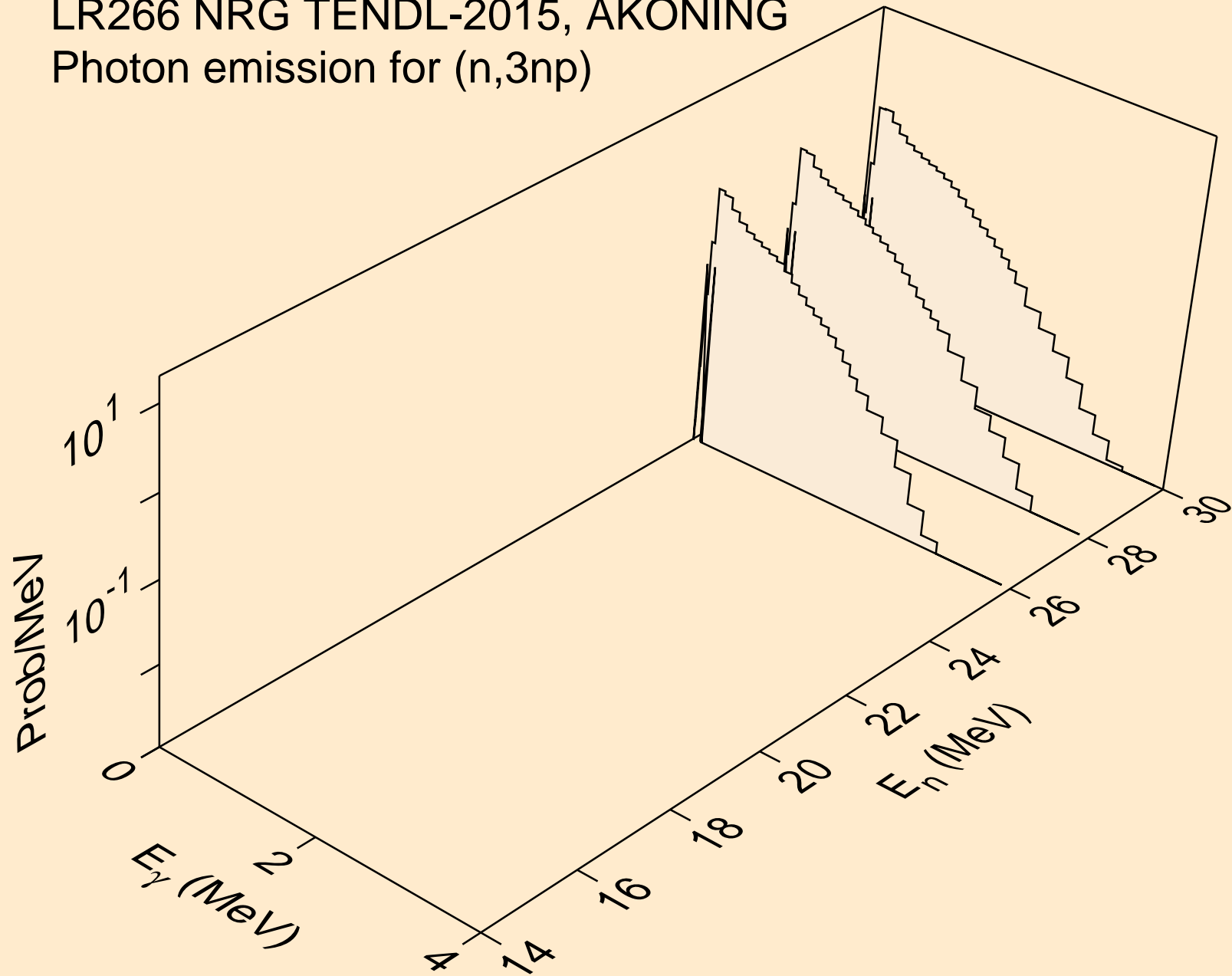

LR266 NRG TENDL-2015, AKONING
Photon emission for (n,n*c)

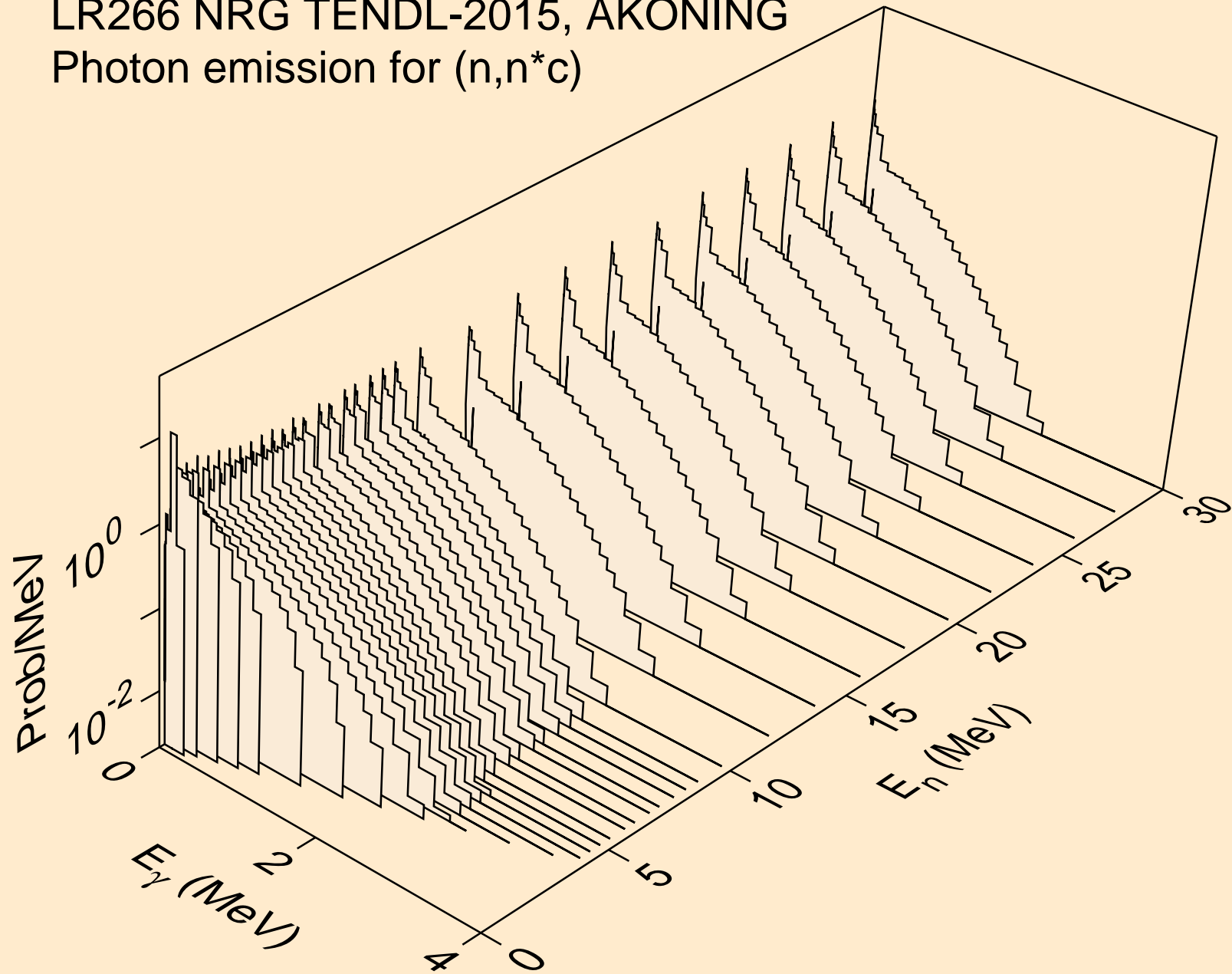

LR266 NRG TENDL-2015, AKONING
Photon emission for (n,gma)

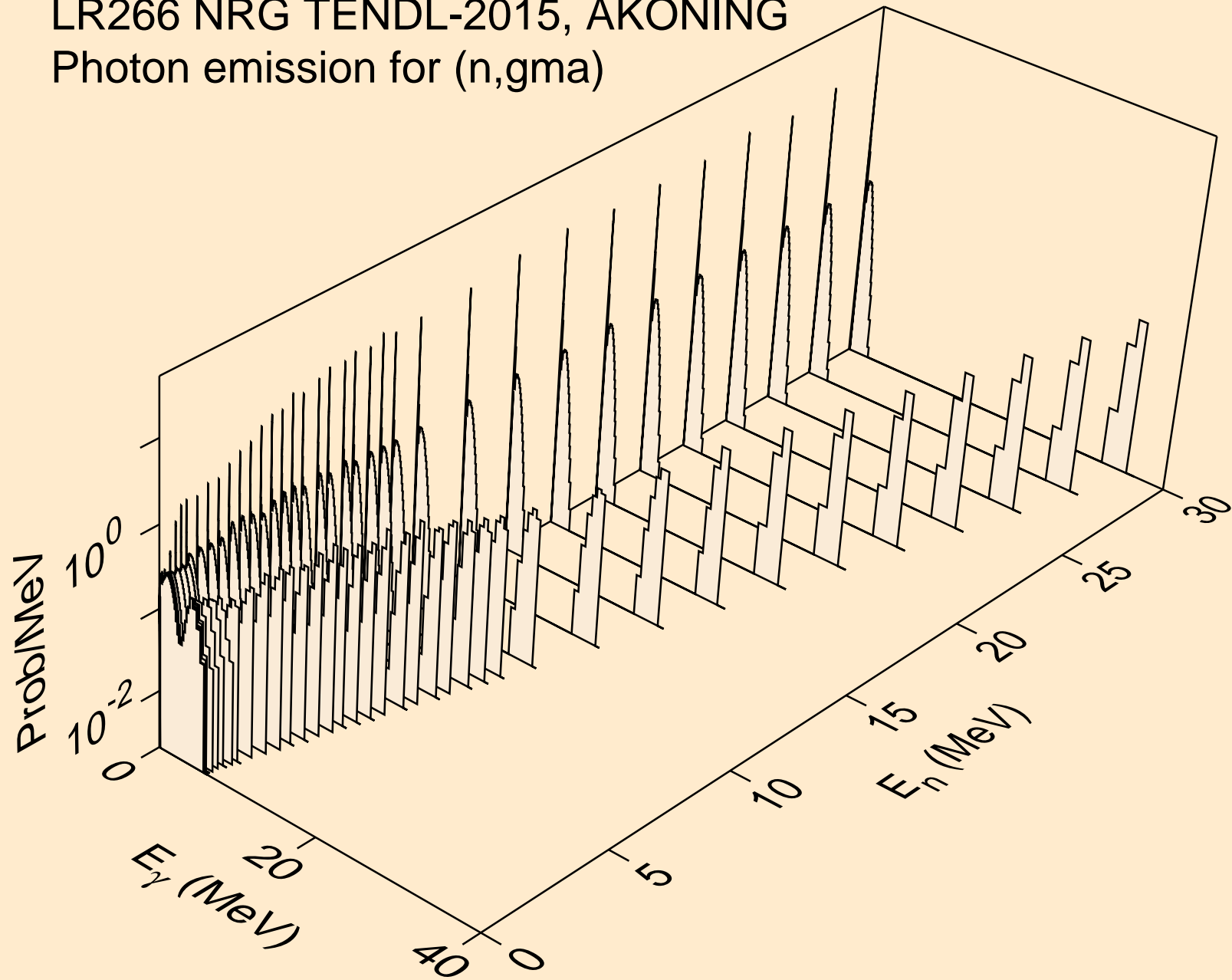

LR266 NRG TENDL-2015, AKONING
Photon emission for (n,p)

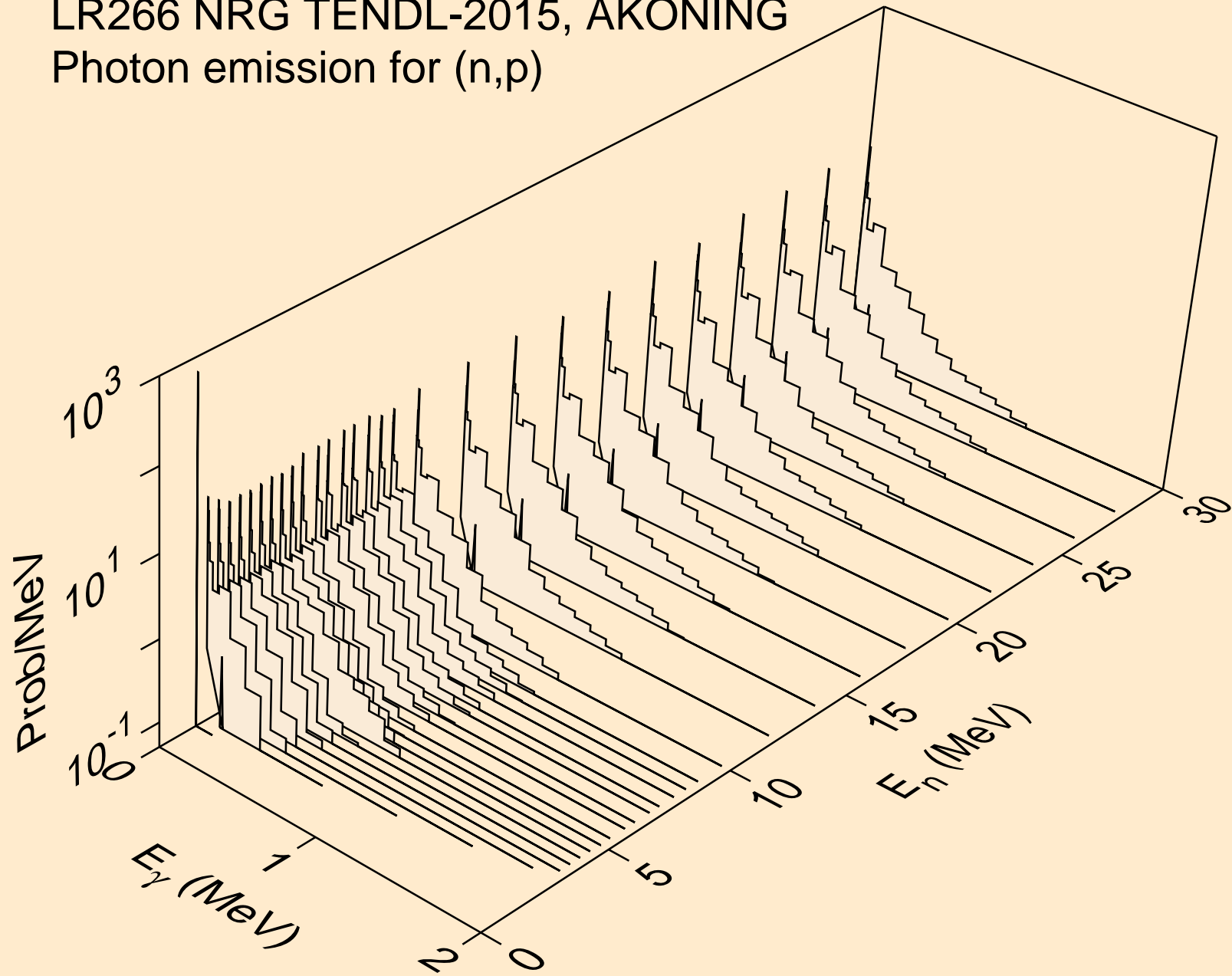

LR266 NRG TENDL-2015, AKONING
Photon emission for (n,d)

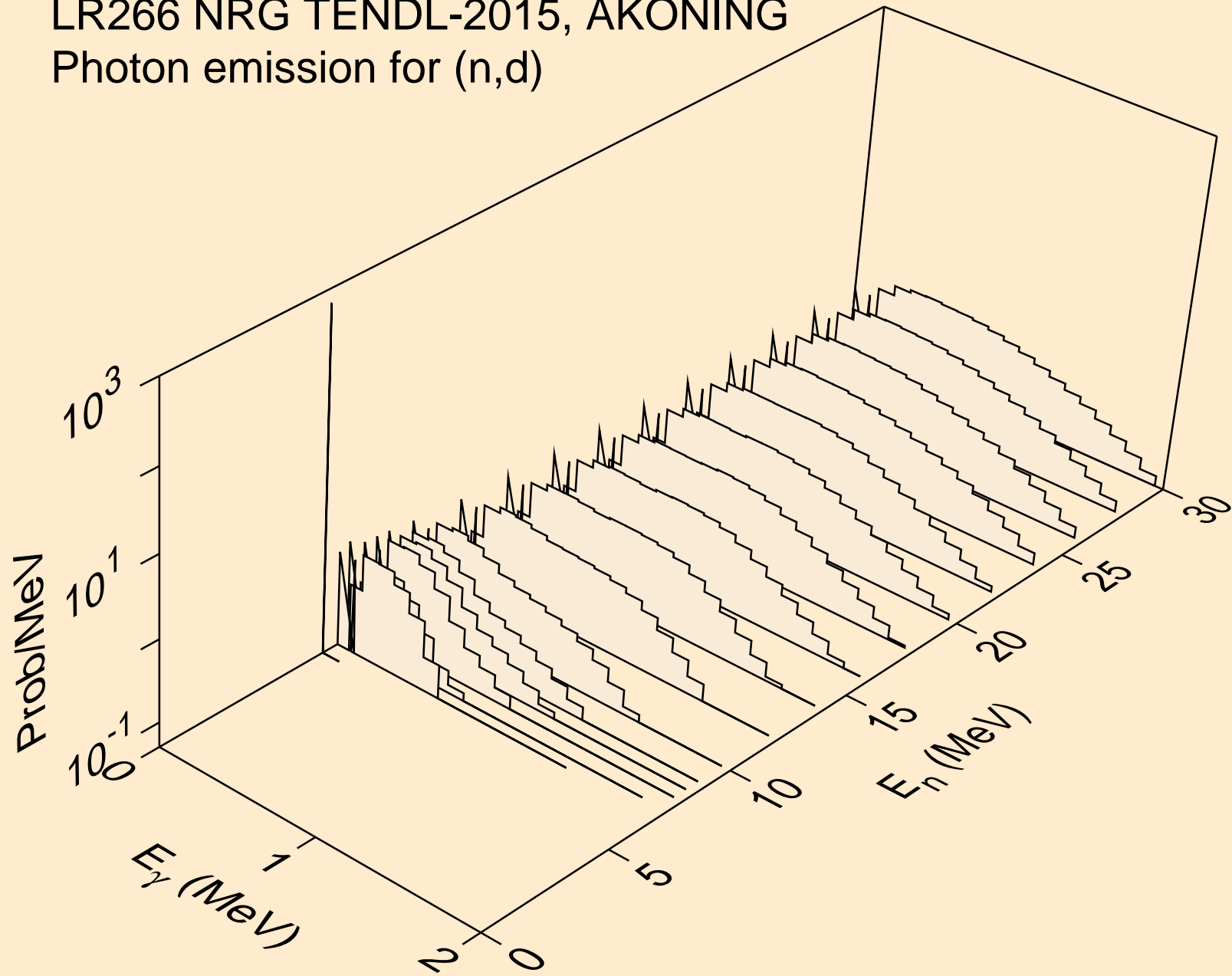

LR266 NRG TENDL-2015, AKONING
Photon emission for (n,t)

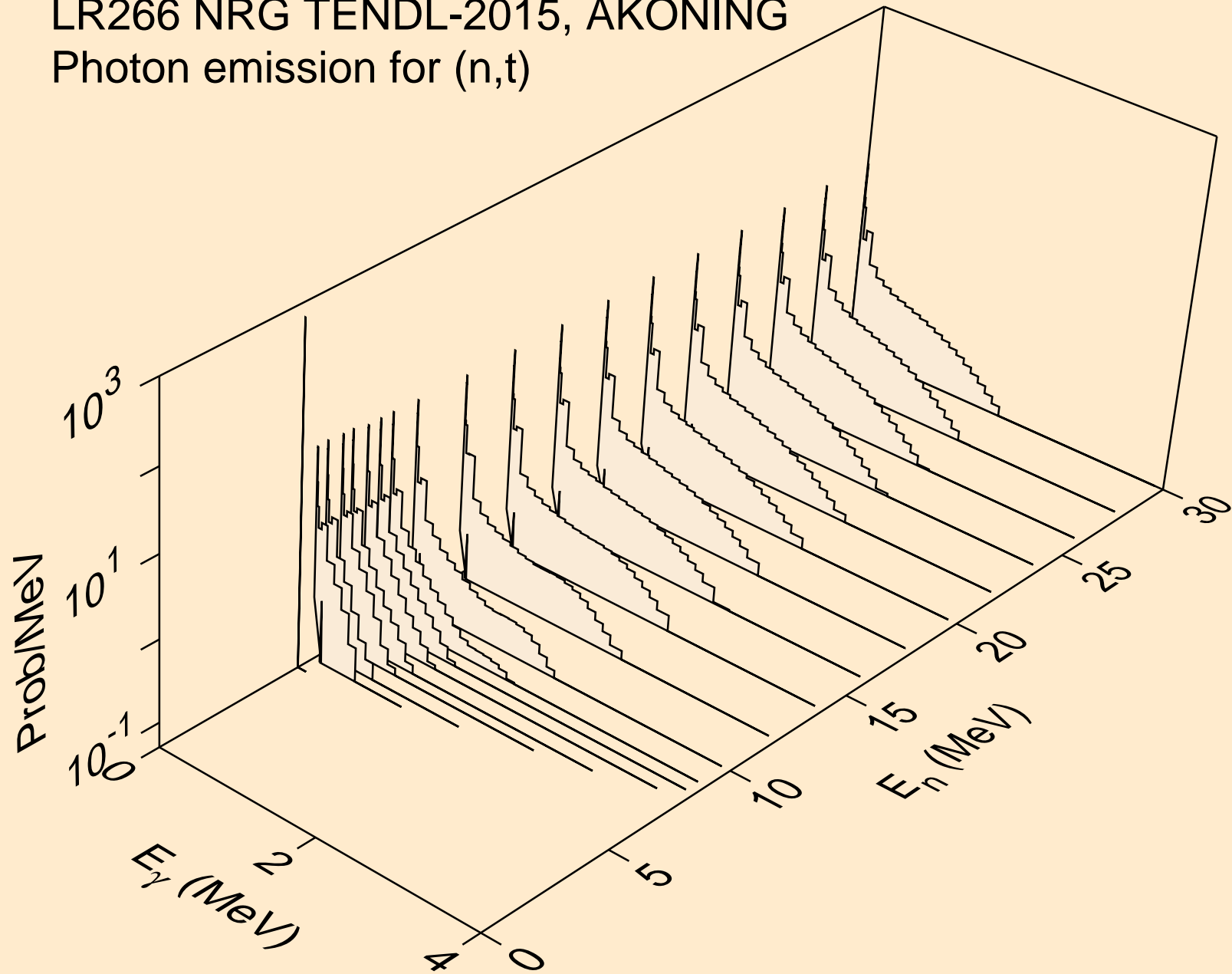

LR266 NRG TENDL-2015, AKONING
Photon emission for (n,he3)

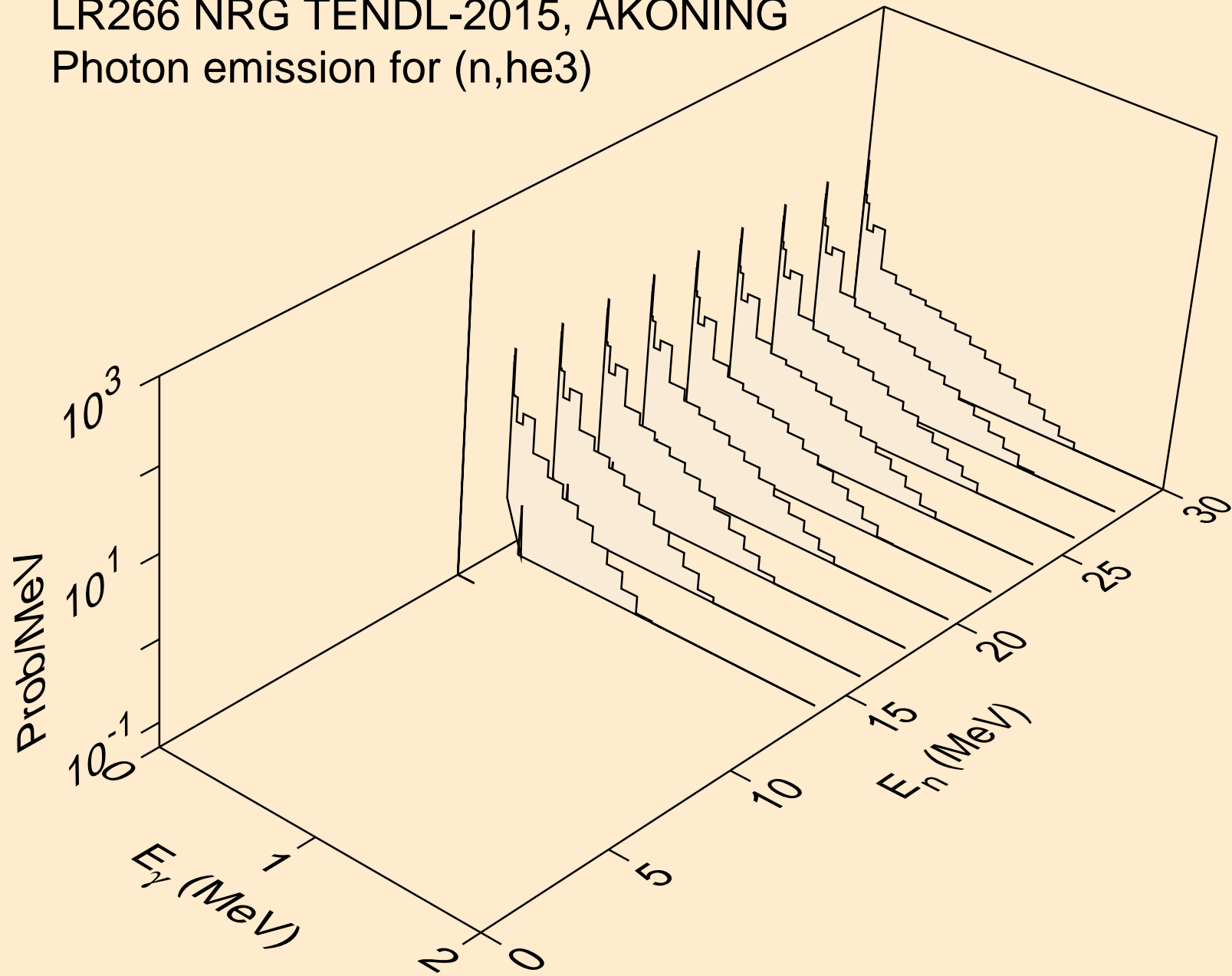

LR266 NRG TENDL-2015, AKONING
Photon emission for (n,a)

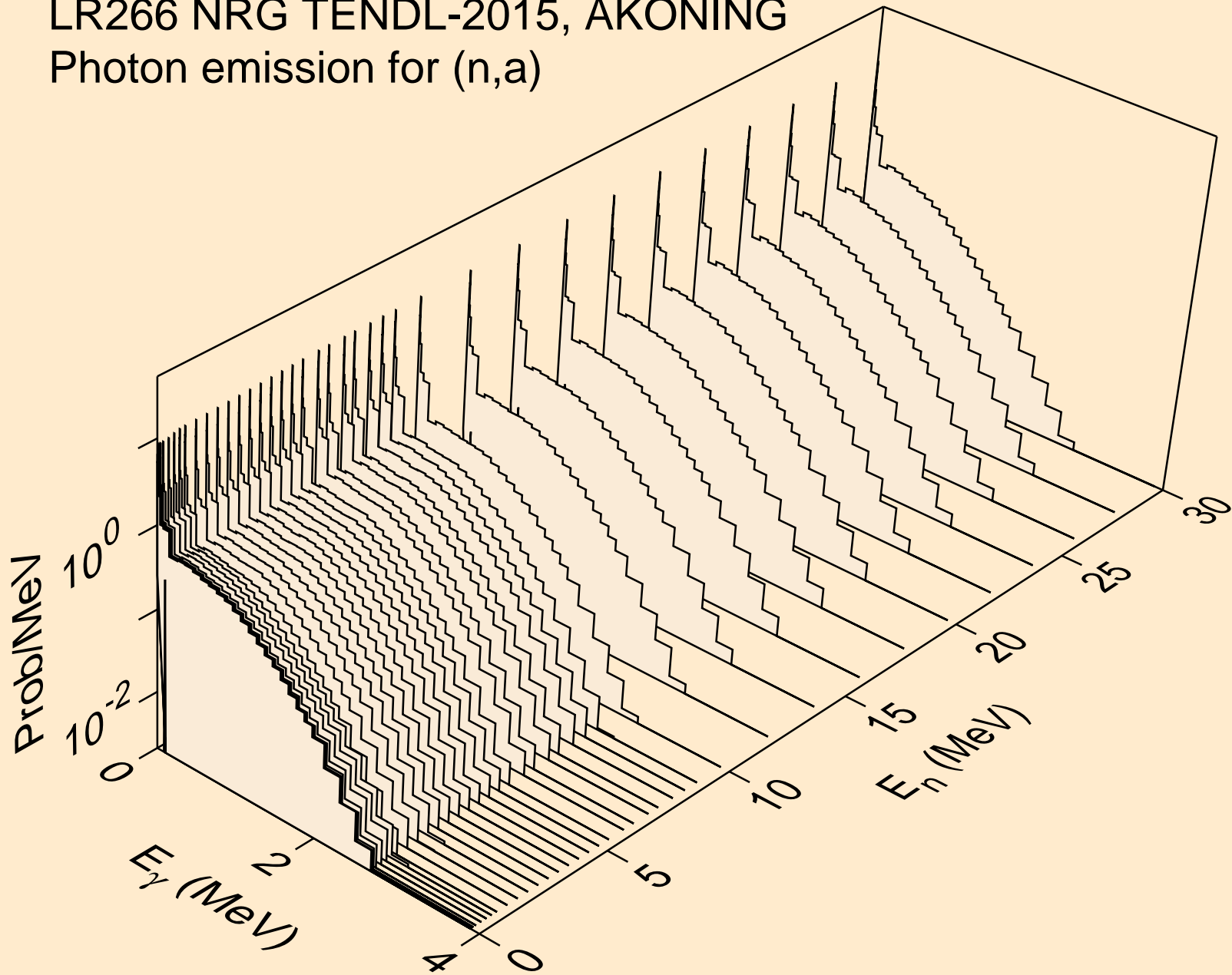

LR266 NRG TENDL-2015, AKONING
thermal capture photon spectrum

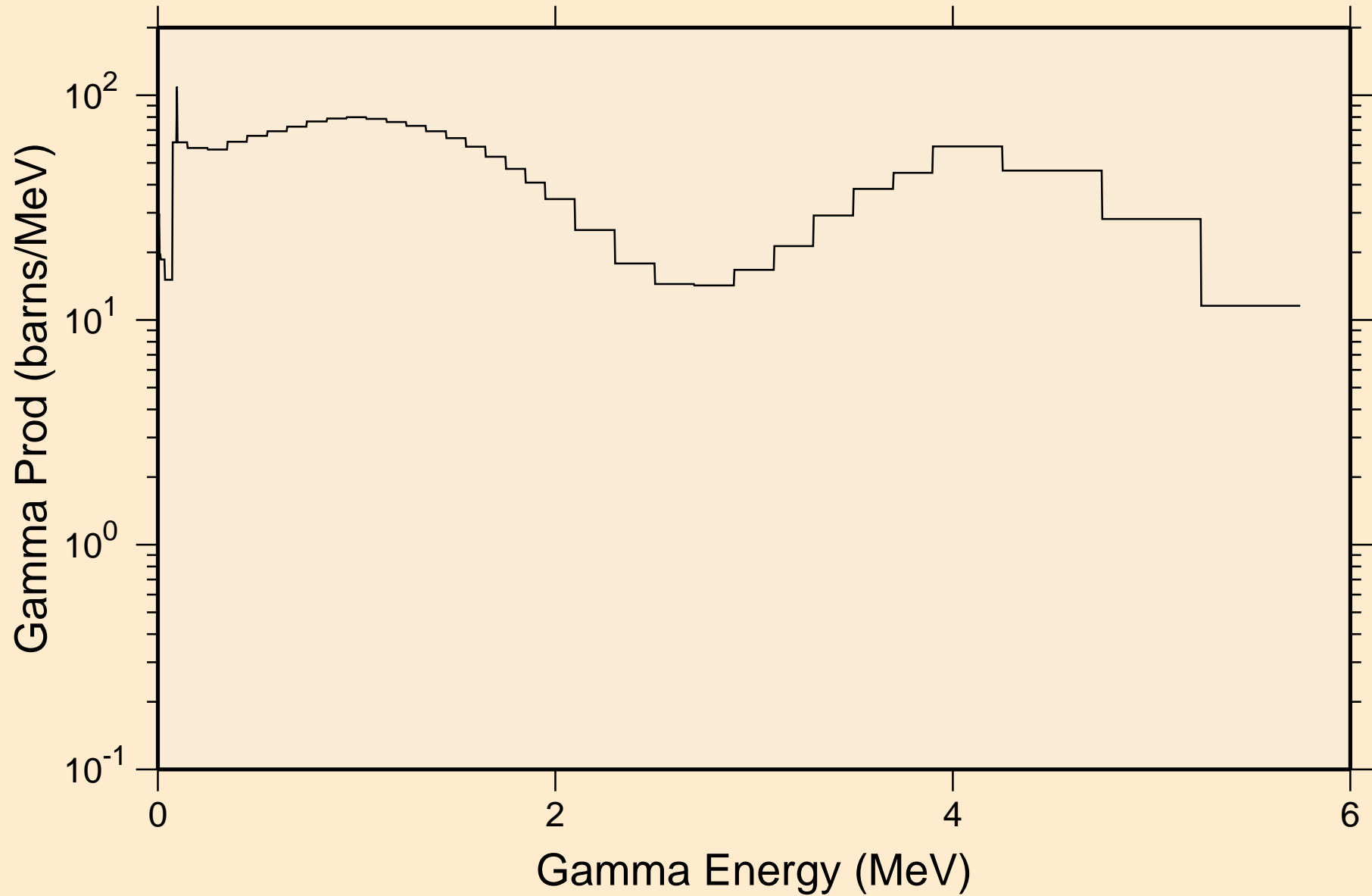

LR266 NRG TENDL-2015, AKONING
14 MeV photon spectrum

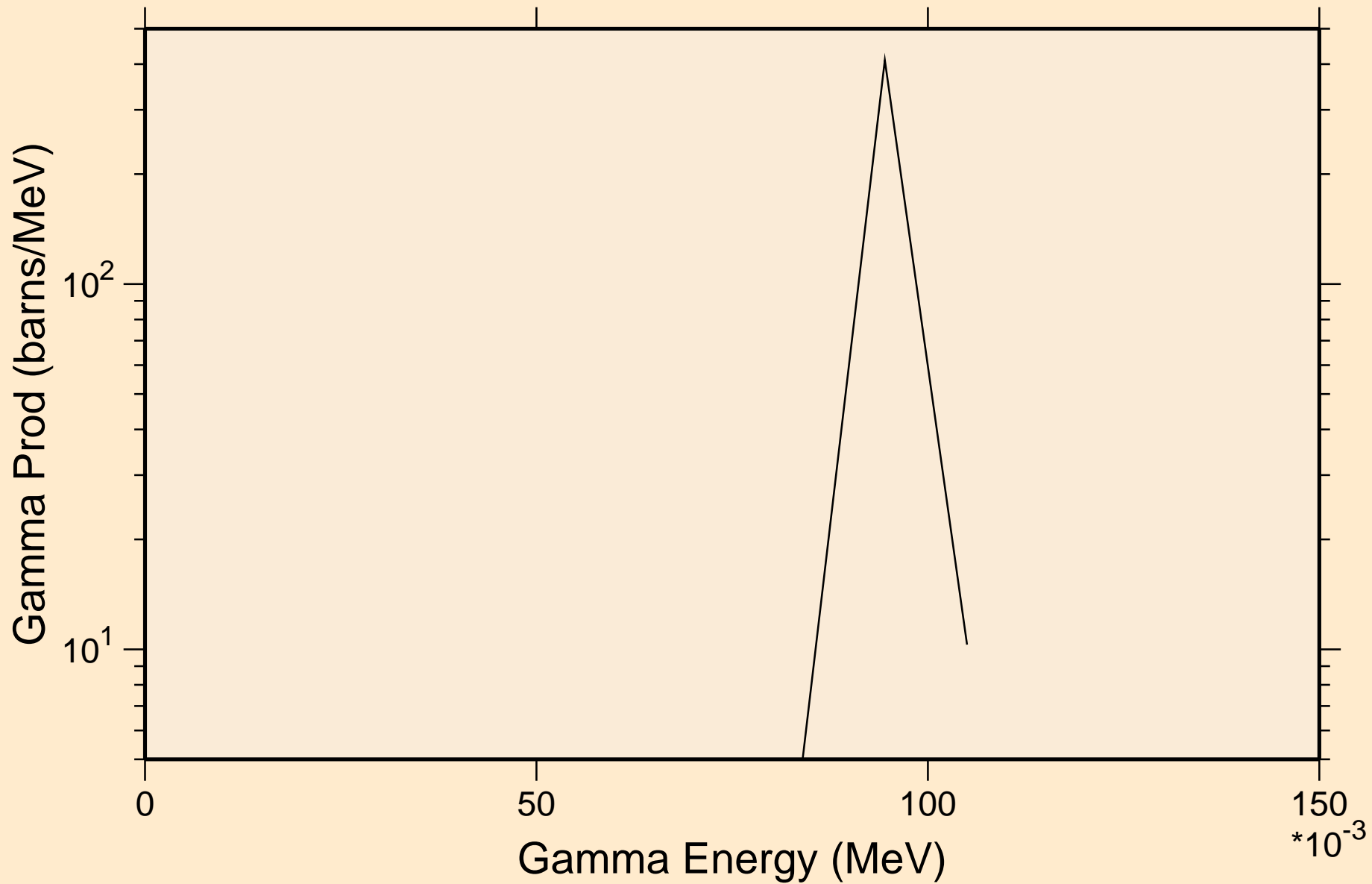

LR266 NRG TENDL-2015, AKONING

Particle heating contributions

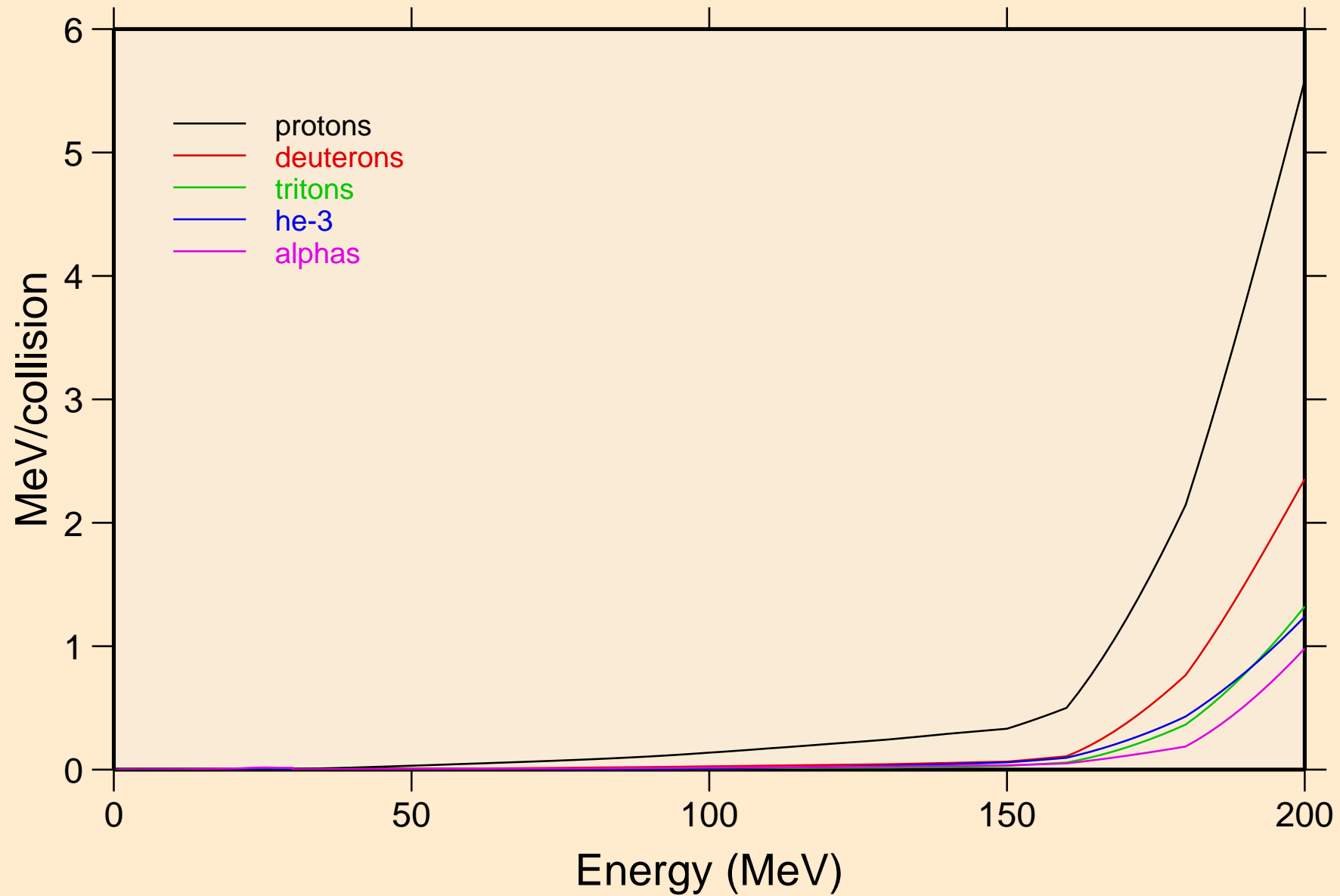

LR266 NRG TENDL-2015, AKONING

Recoil Heating

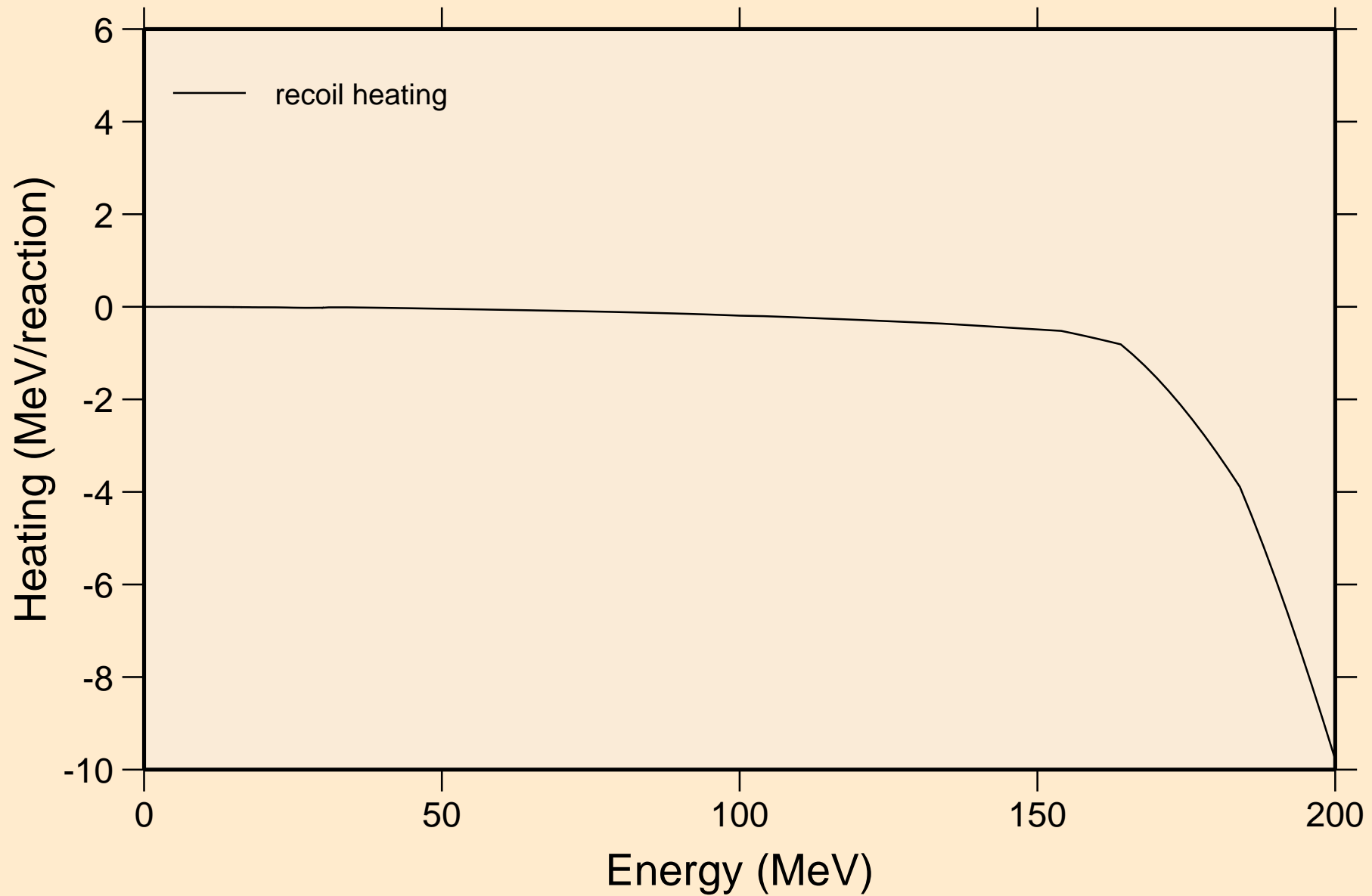

LR266 NRG TENDL-2015, AKONING

Particle production cross sections

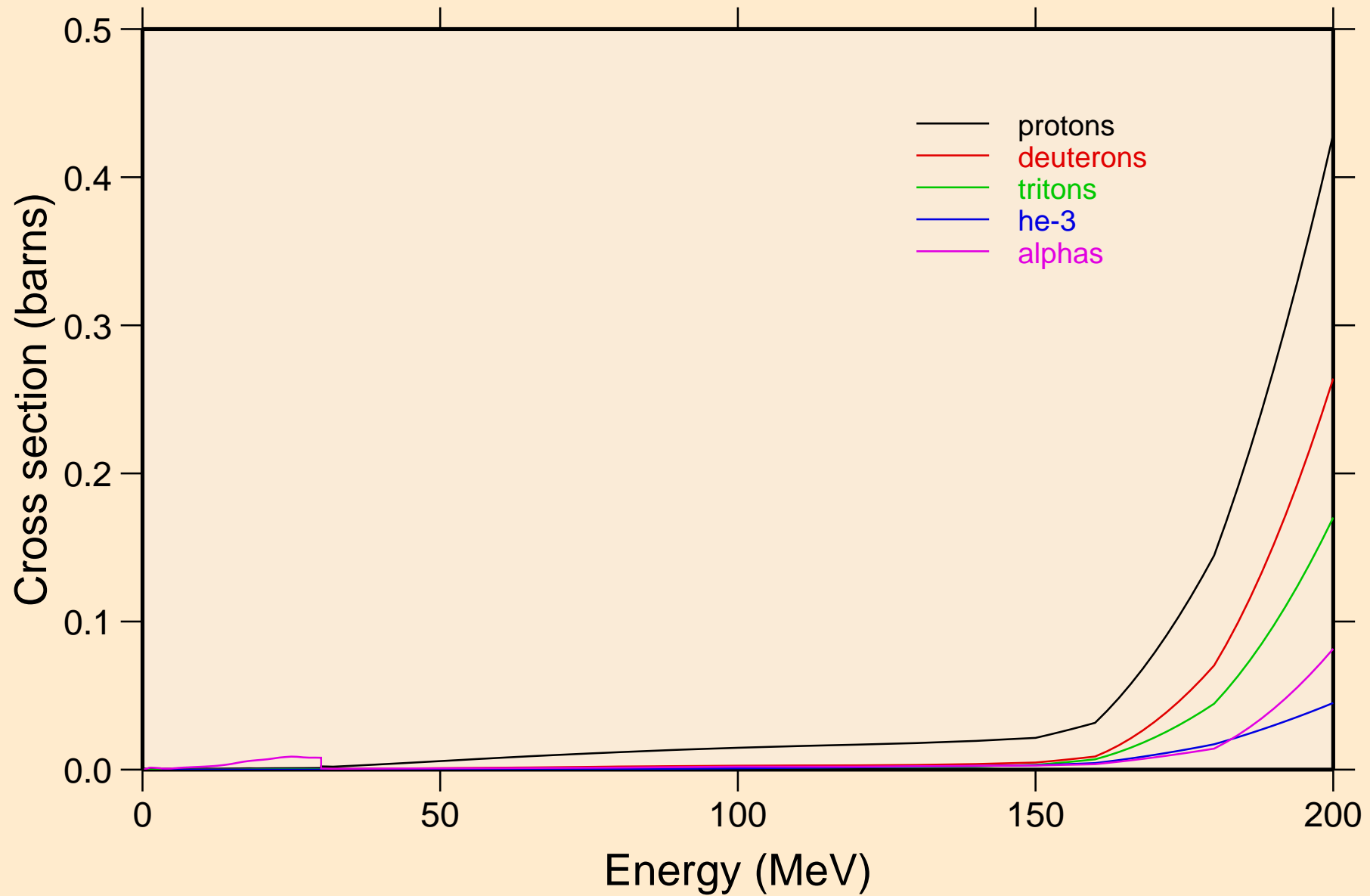

LR266 NRG TENDL-2015, AKONING
protons from (n,x)

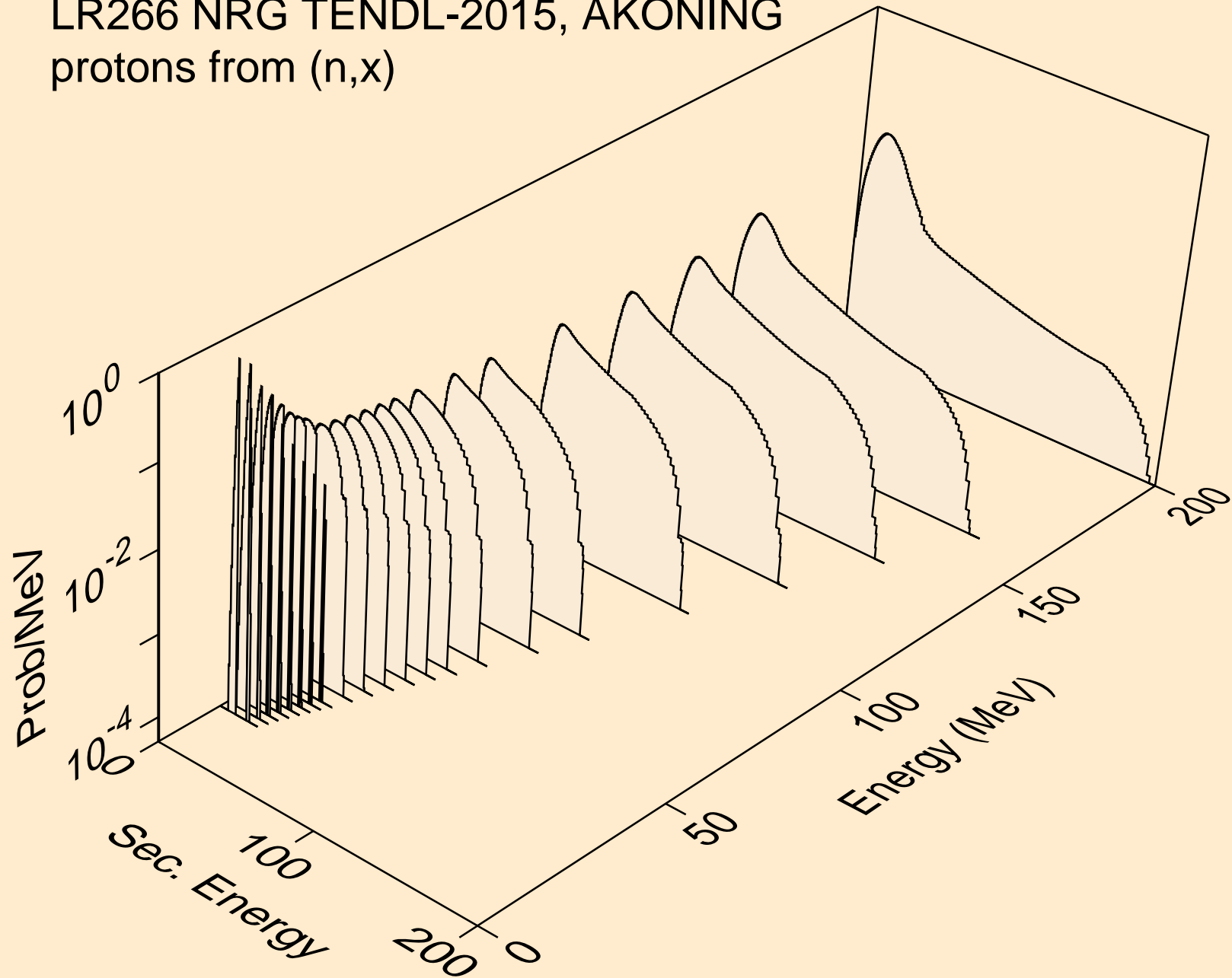

LR266 NRG TENDL-2015, AKONING
protons from (n,n*)p

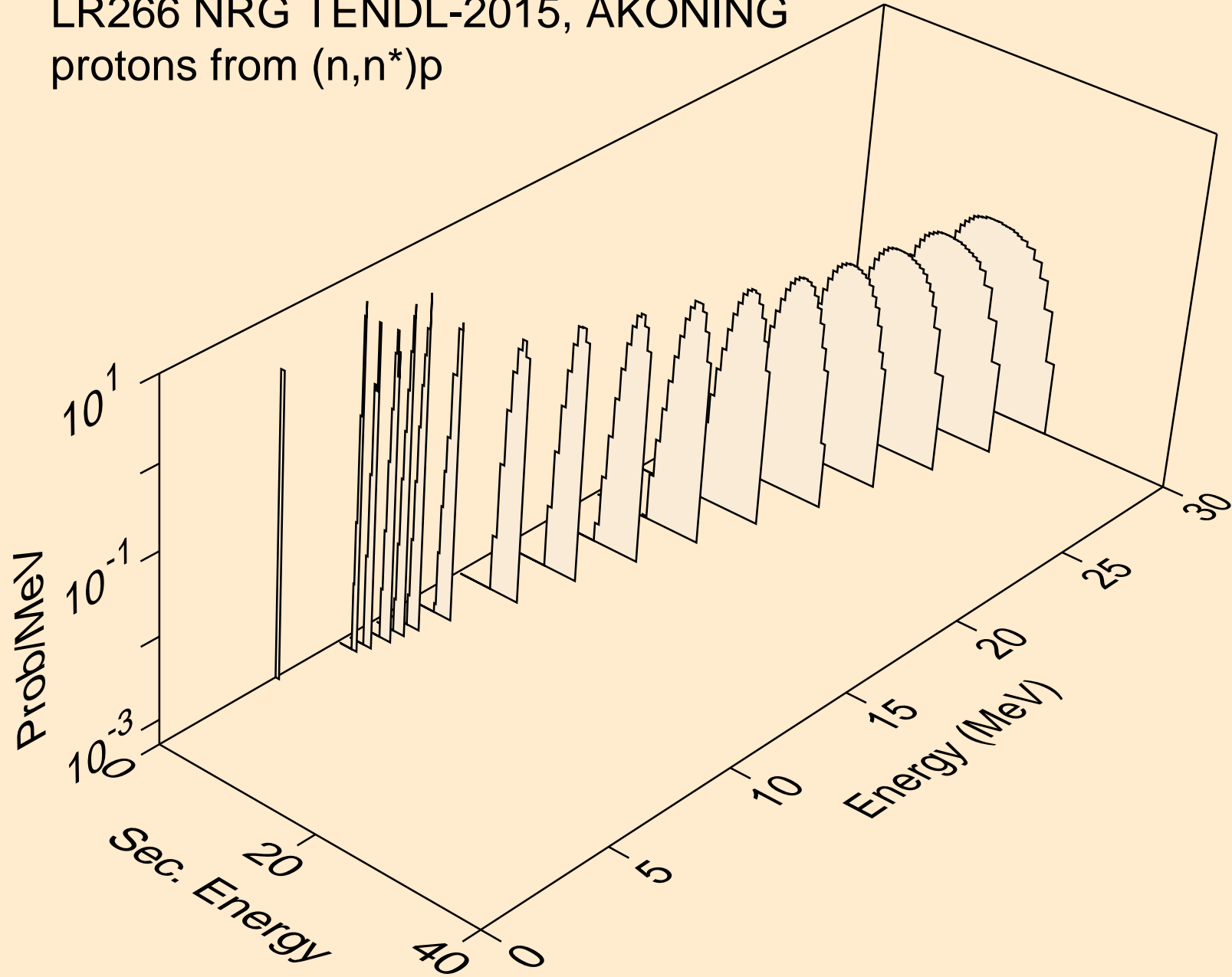

LR266 NRG TENDL-2015, AKONING
protons from (n,2np)

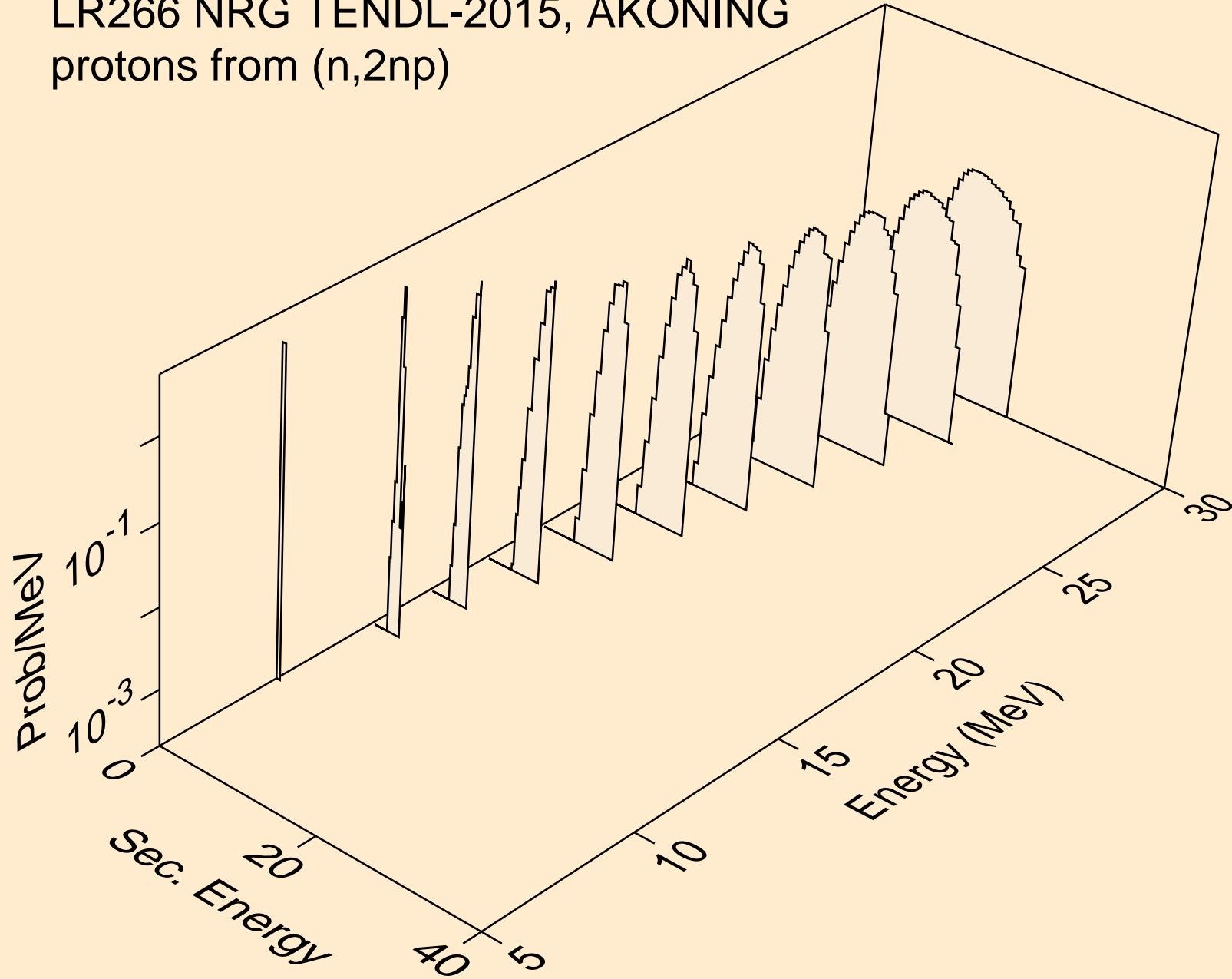

LR266 NRG TENDL-2015, AKONING
protons from (n,3np)

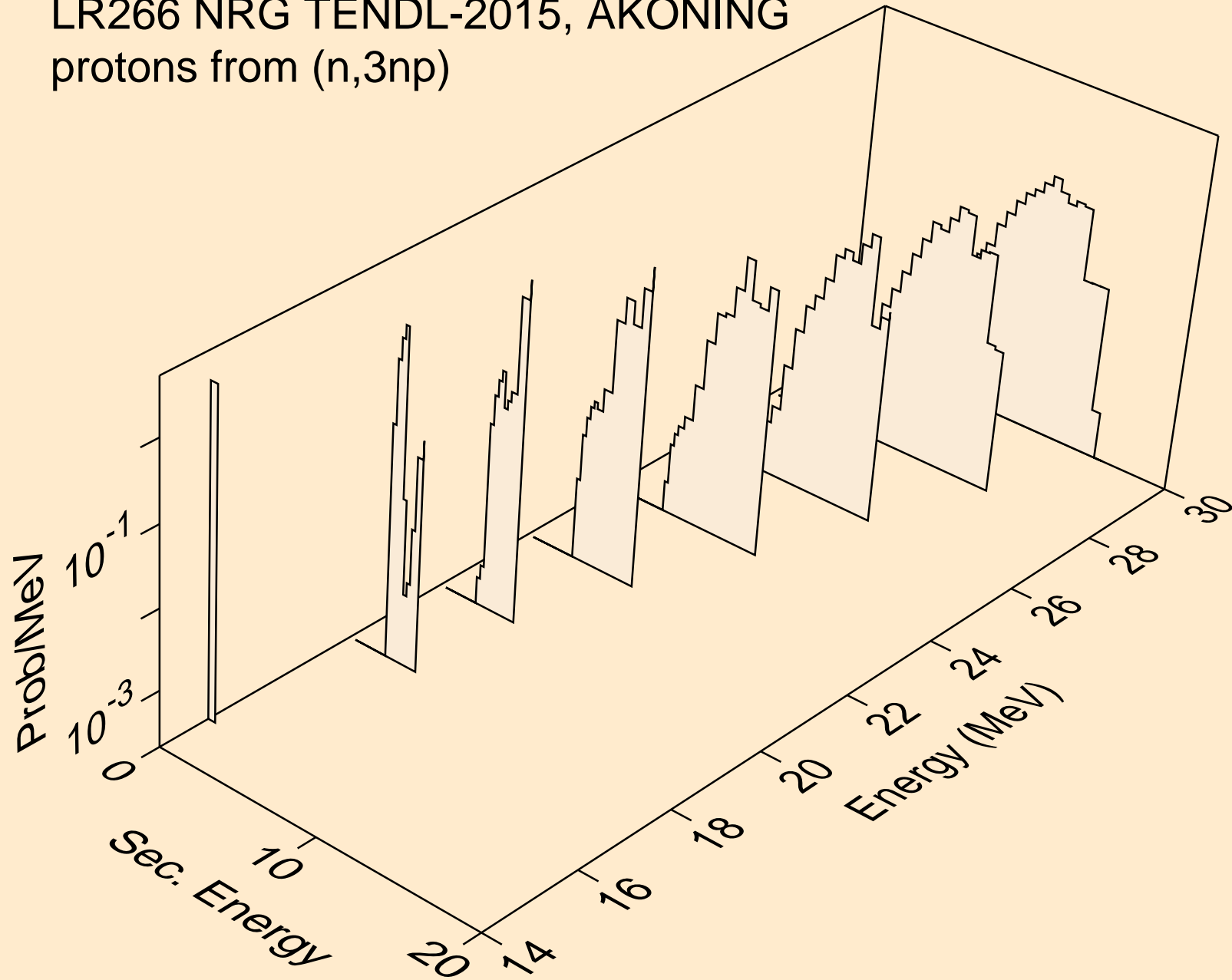

LR266 NRG TENDL-2015, AKONING
protons from (n,p)

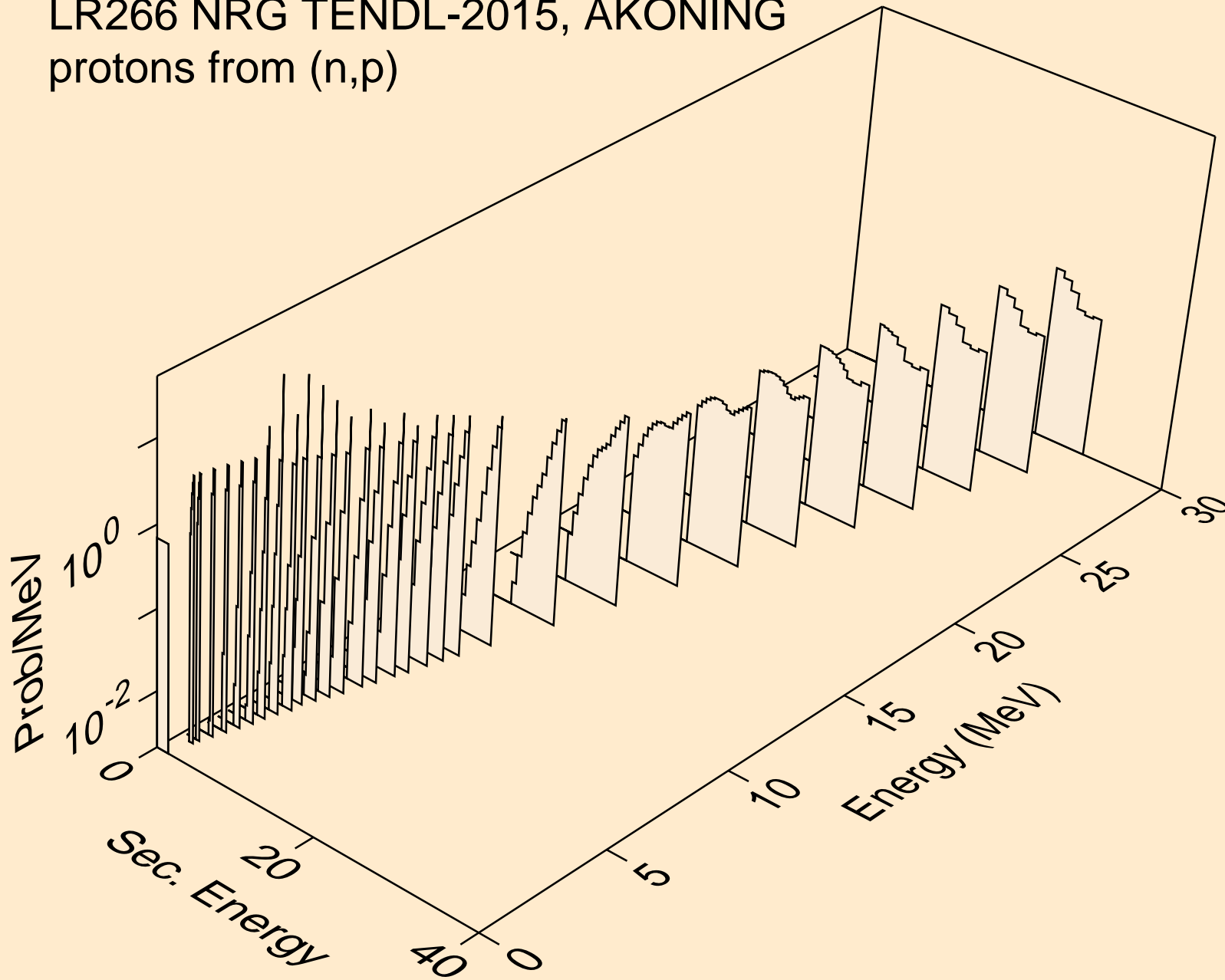

LR266 NRG TENDL-2015, AKONING
deuterons from (n,x)

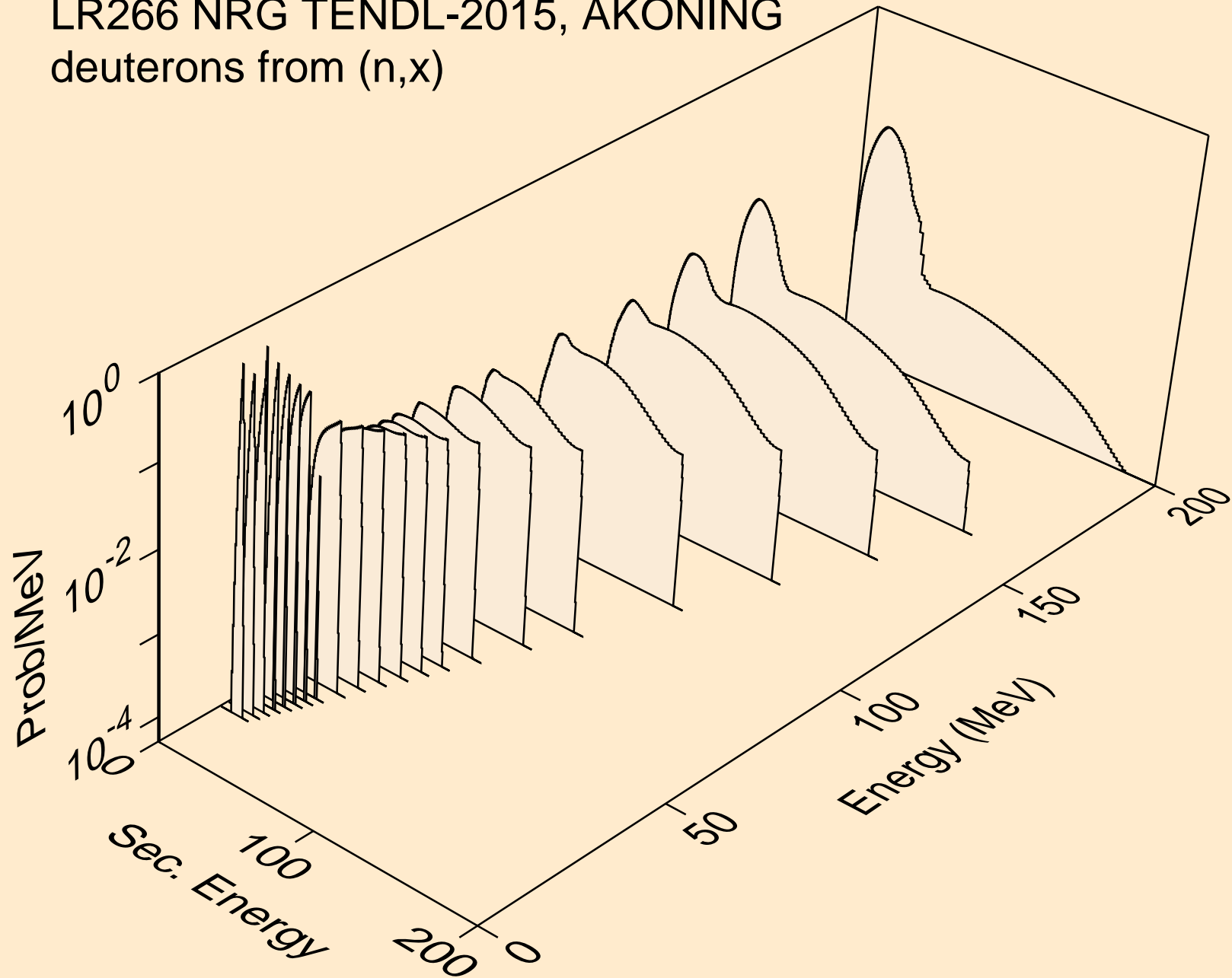

LR266 NRG TENDL-2015, AKONING
deuterons from (n,2nd)

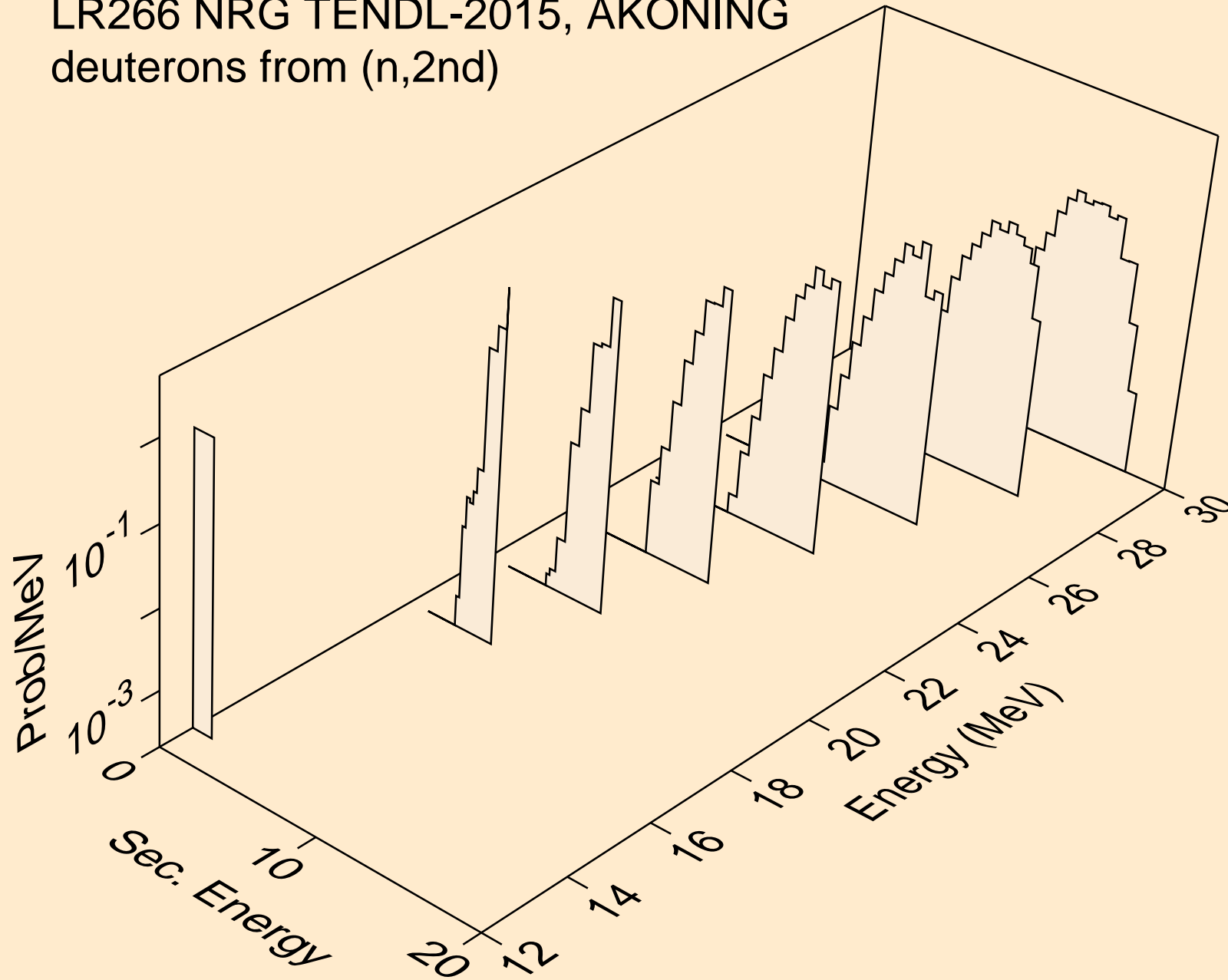

LR266 NRG TENDL-2015, AKONING
deuterons from (n,n*)d

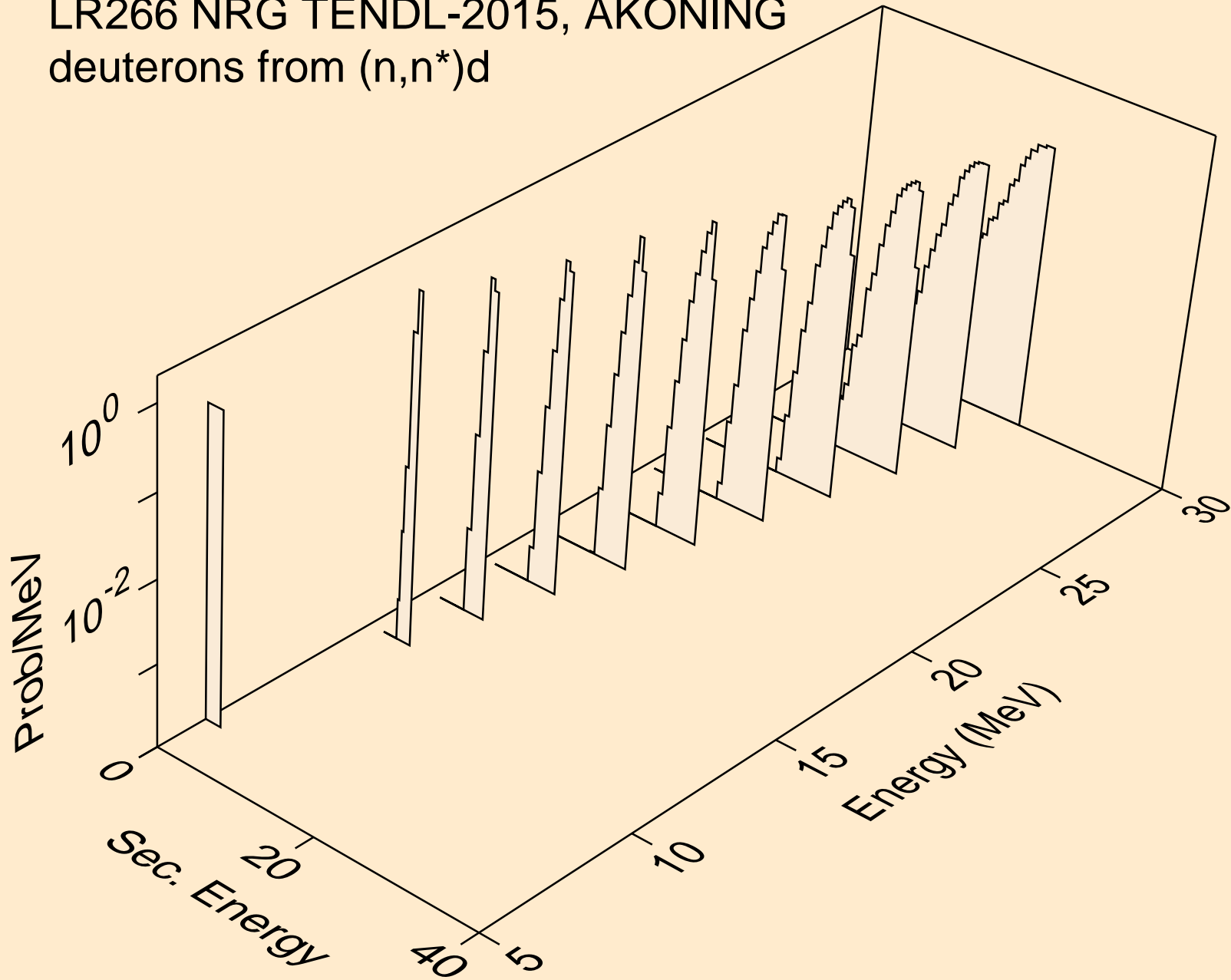

LR266 NRG TENDL-2015, AKONING
deuterons from (n,d)

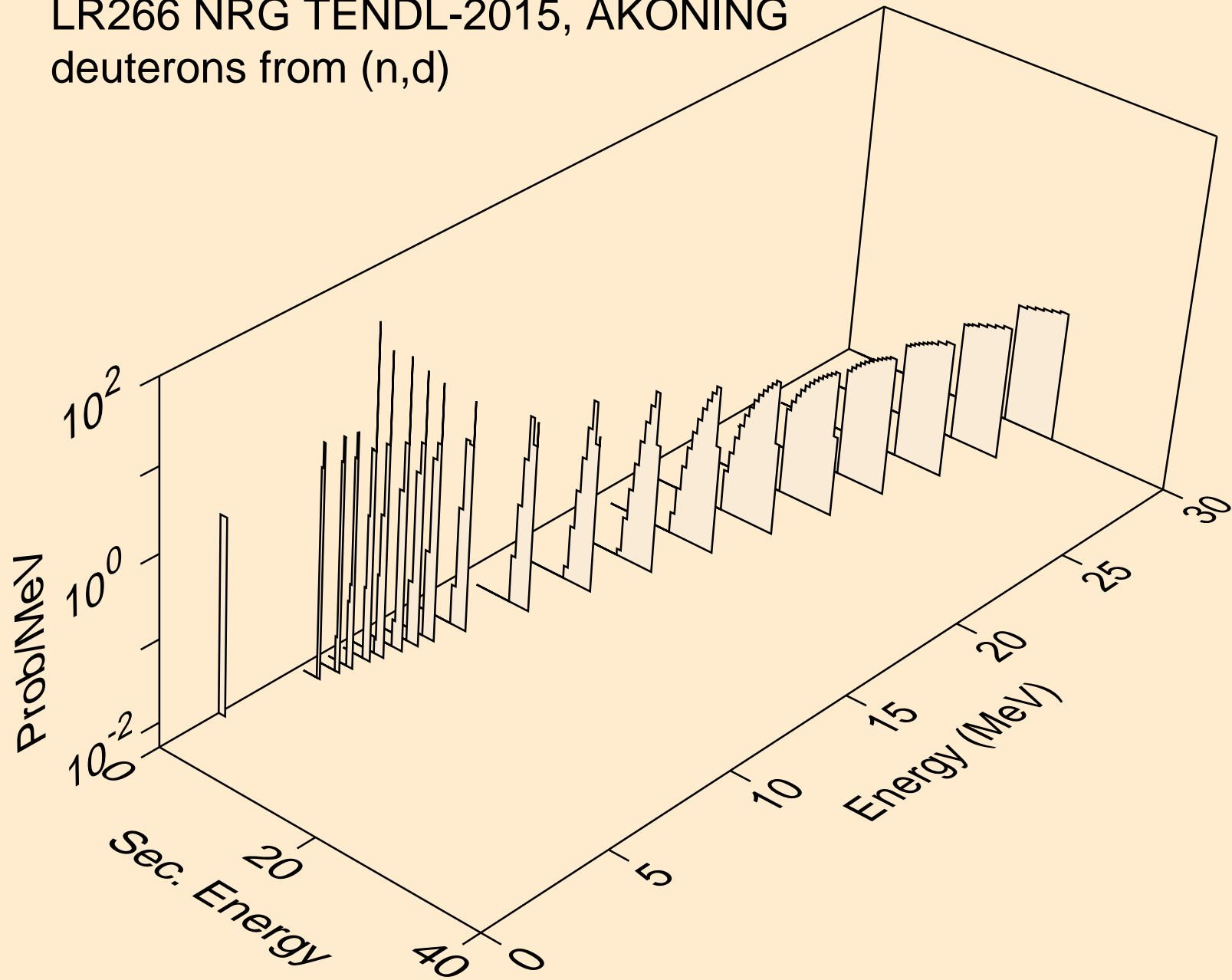

LR266 NRG TENDL-2015, AKONING
tritons from (n,x)

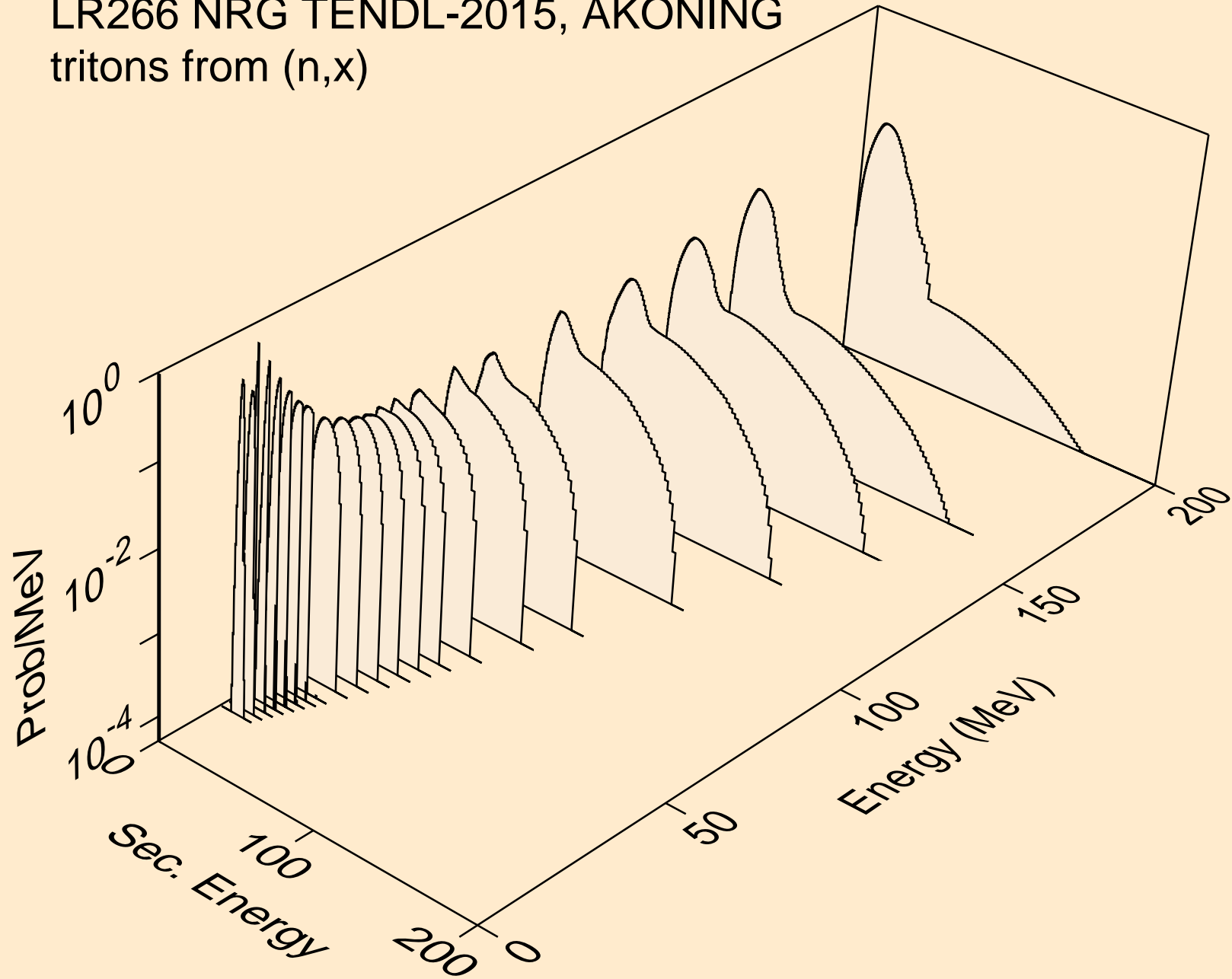

LR266 NRG TENDL-2015, AKONING
tritons from (n,n*)t

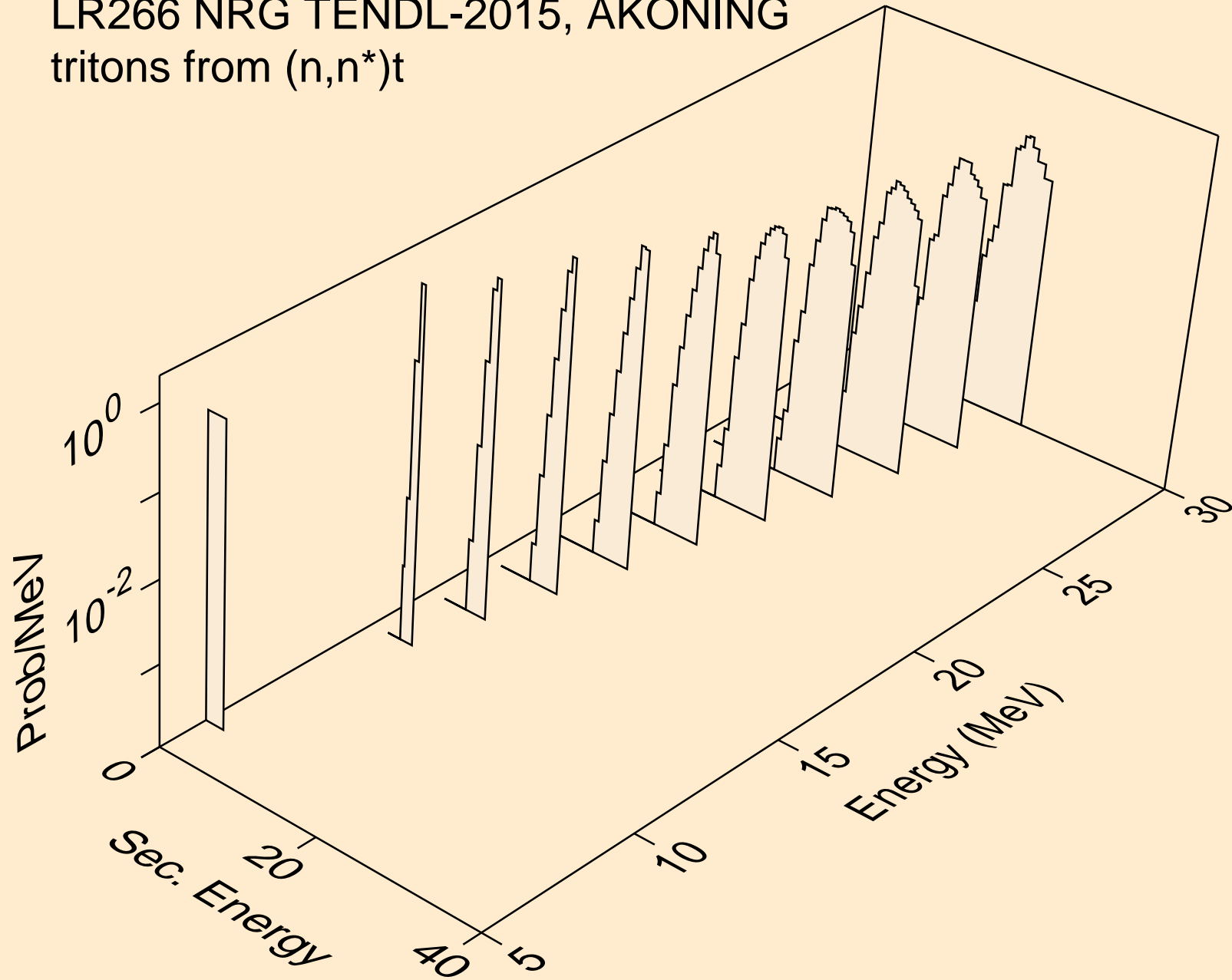

LR266 NRG TENDL-2015, AKONING
tritons from (n,t)

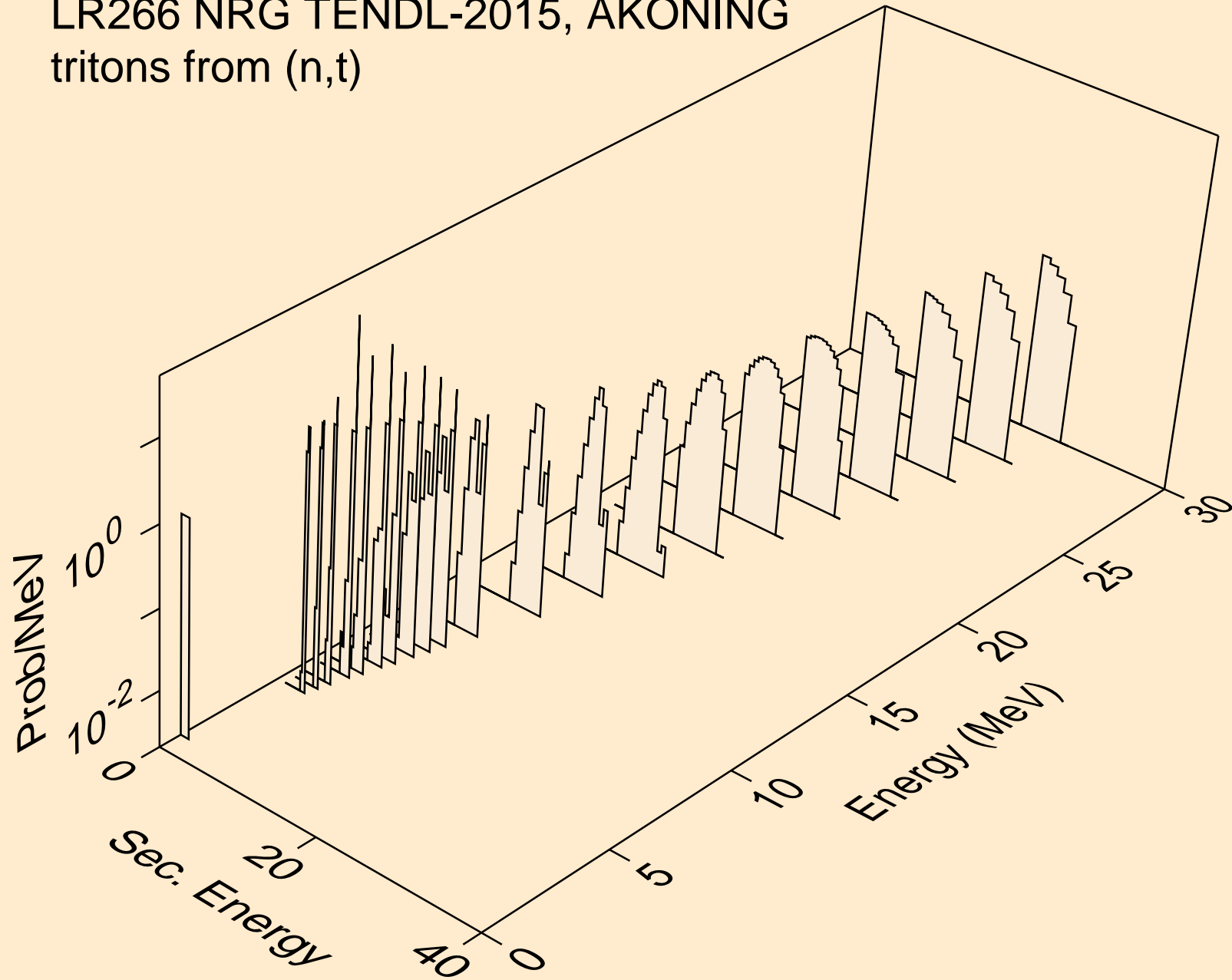

LR266 NRG TENDL-2015, AKONING
he3s from (n,x)

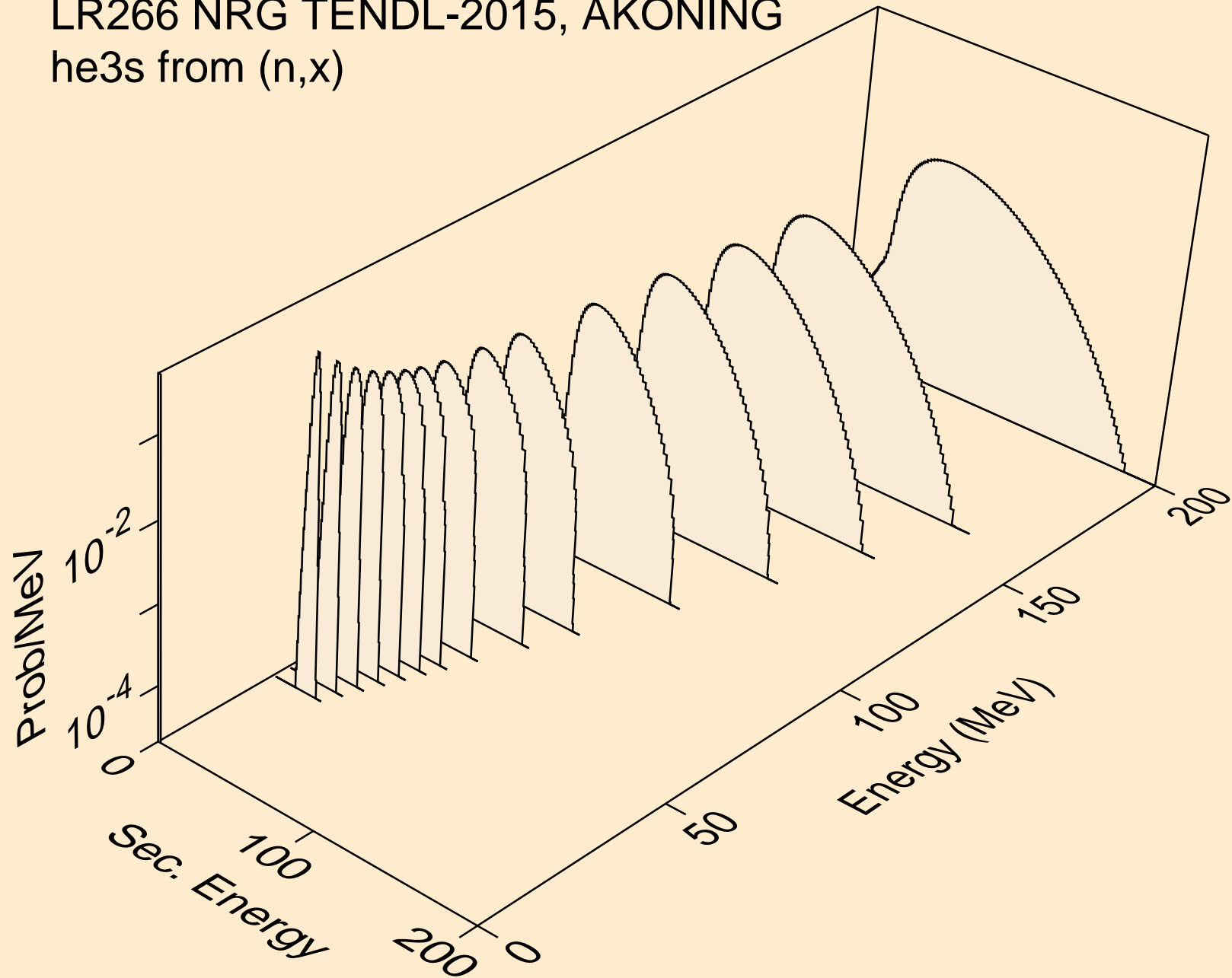

LR266 NRG TENDL-2015, AKONING
he3s from (n,n*)he3

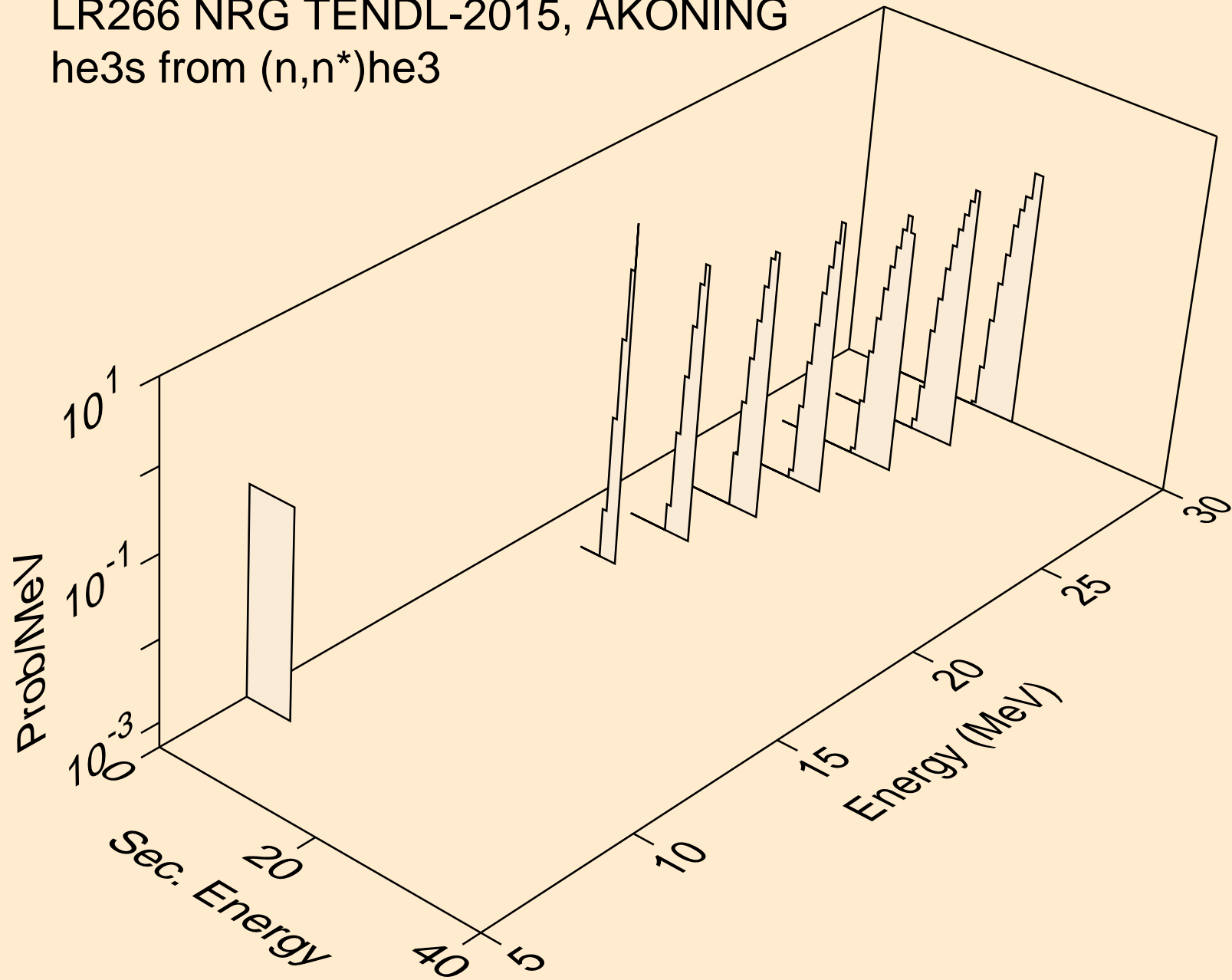

LR266 NRG TENDL-2015, AKONING
he3s from (n,he3)

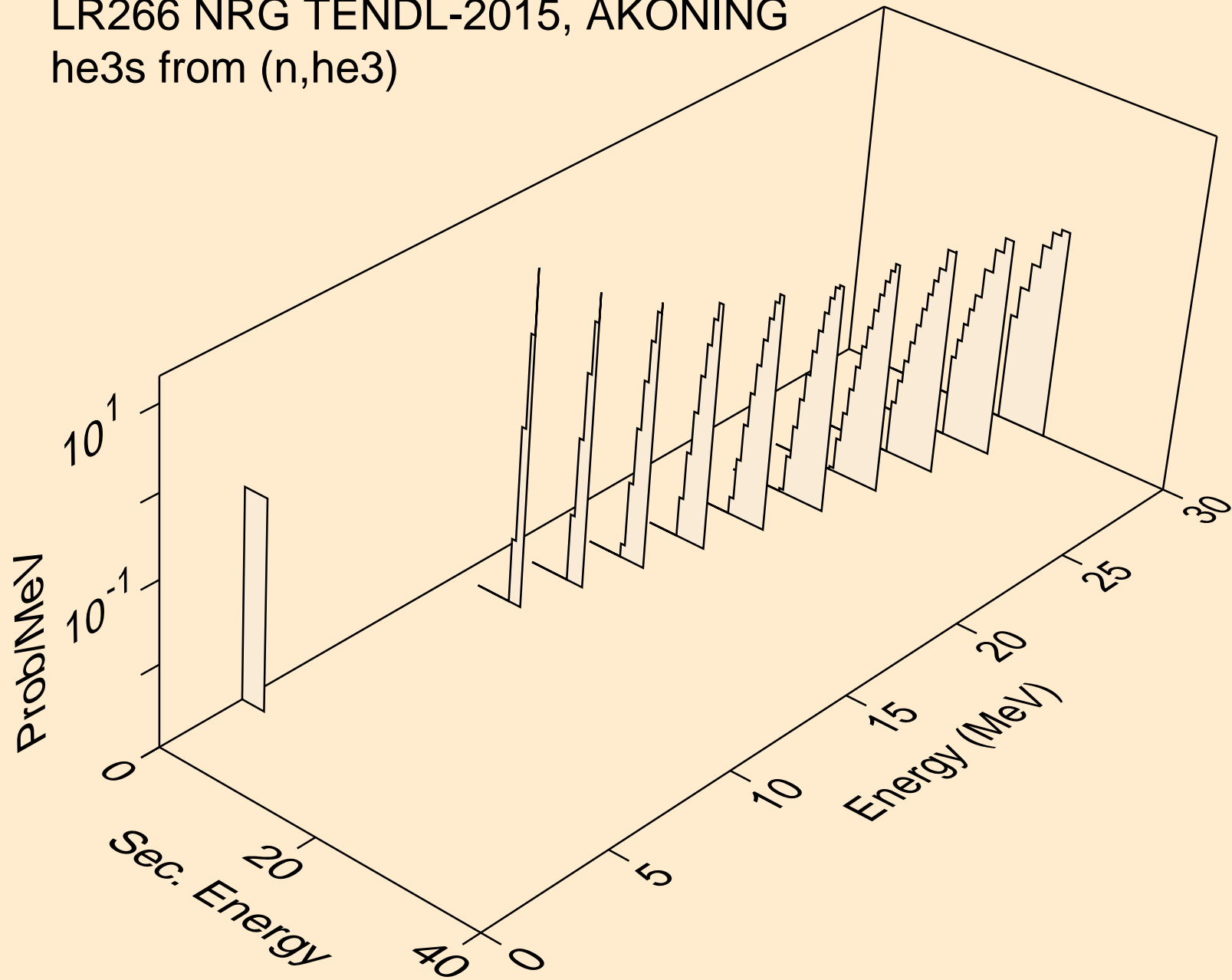

LR266 NRG TENDL-2015, AKONING
alphas from (n,x)

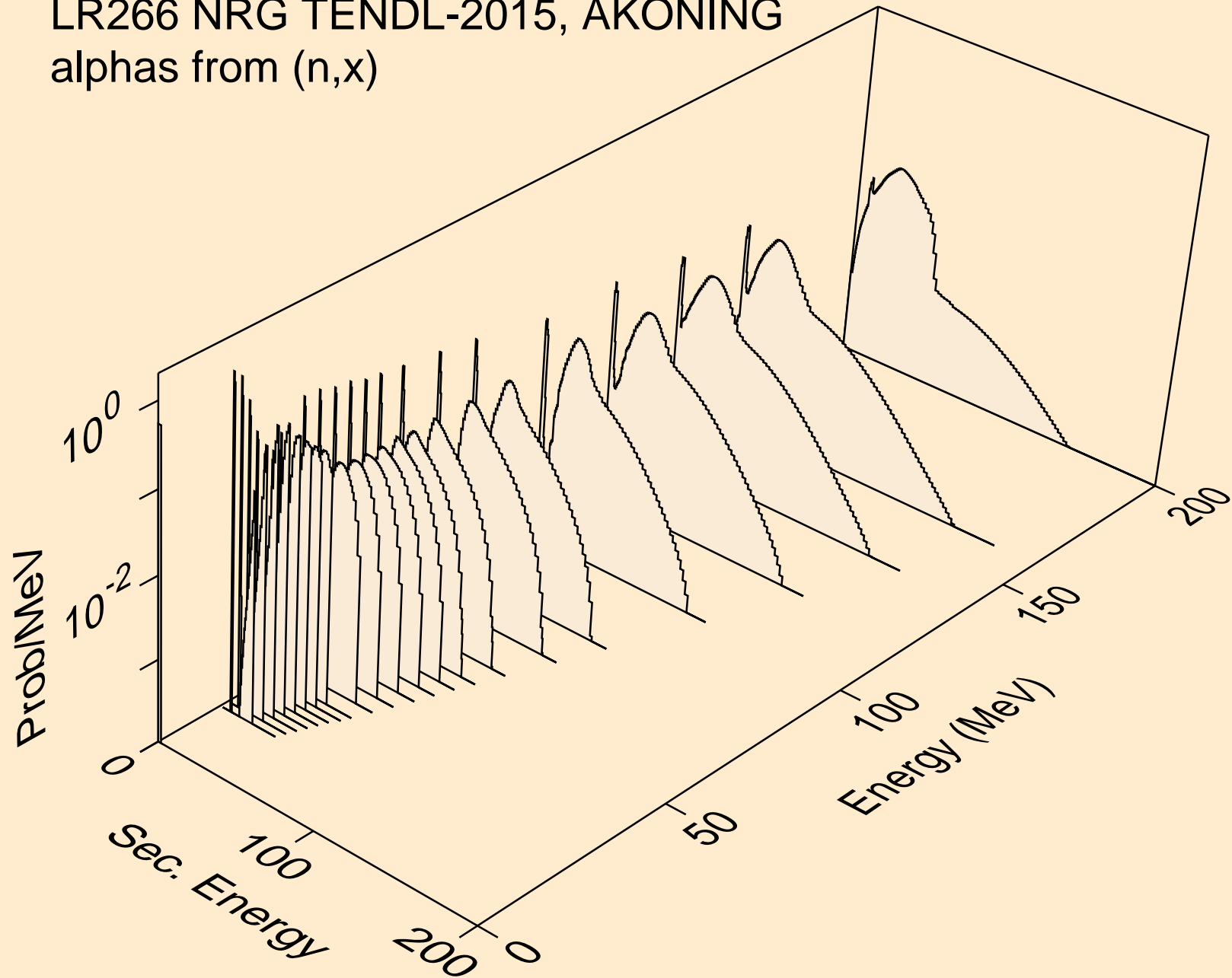

LR266 NRG TENDL-2015, AKONING
alphas from (n,n*)a

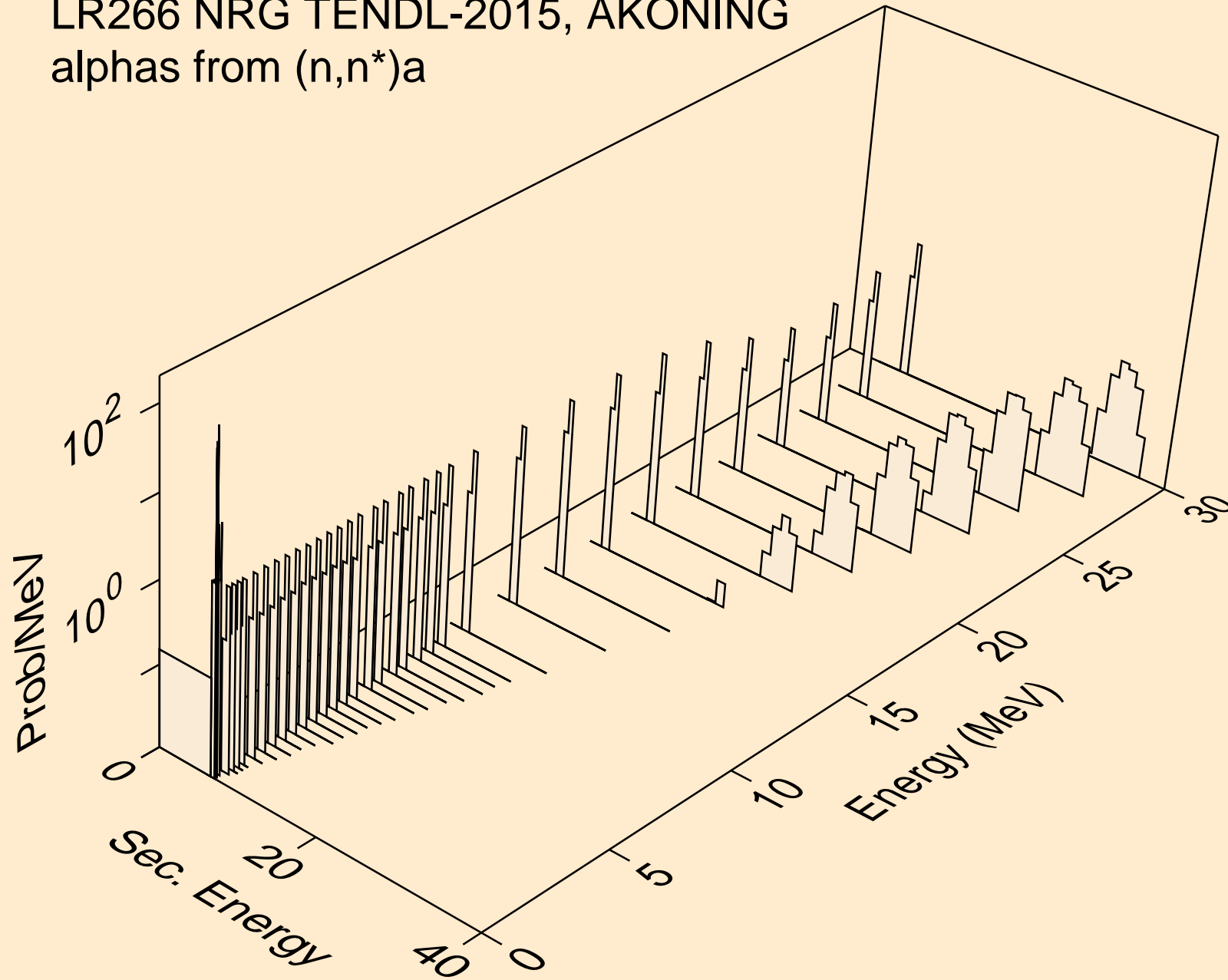

LR266 NRG TENDL-2015, AKONING
alphas from (n,2n)a

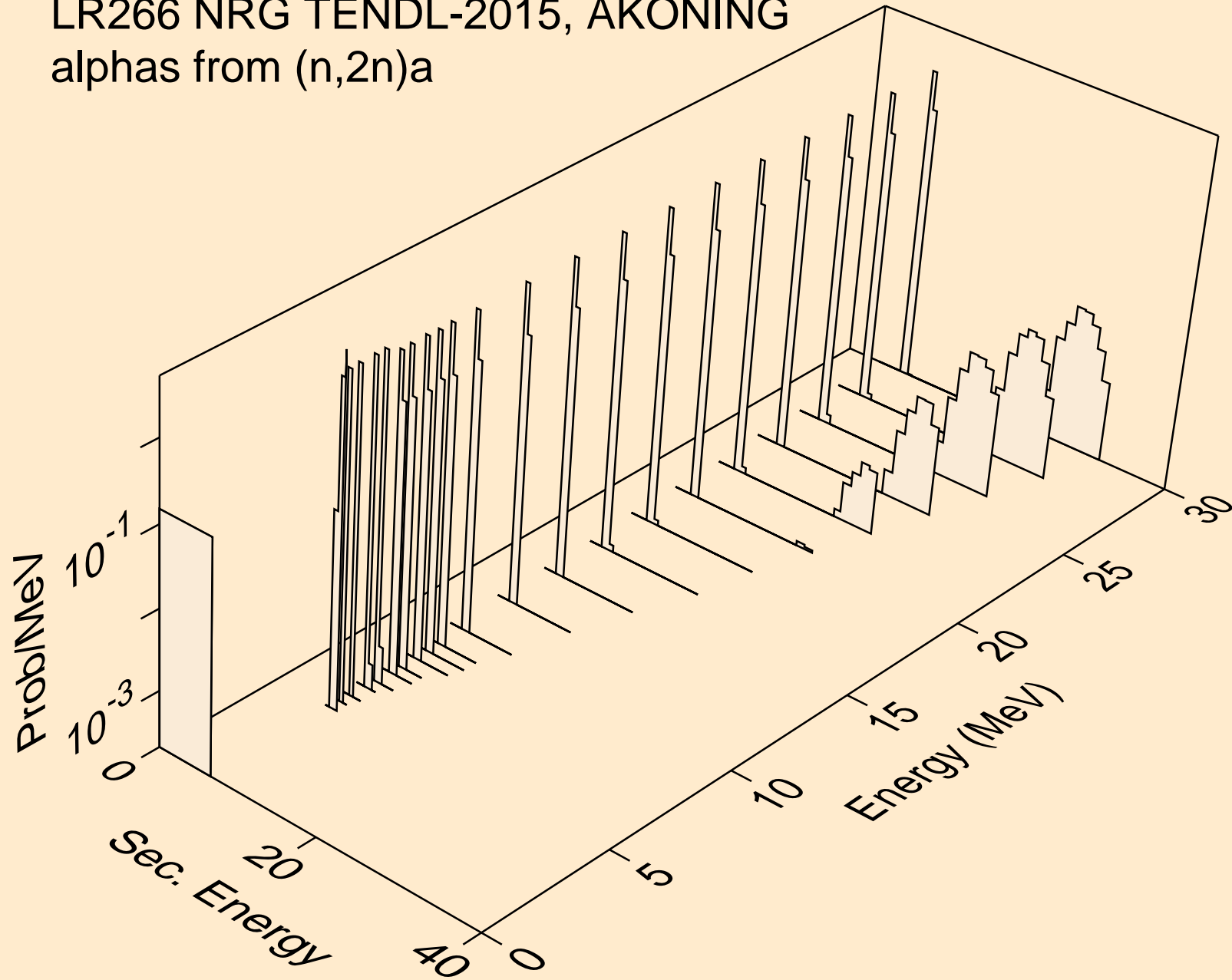

LR266 NRG TENDL-2015, AKONING
alphas from (n,3n)a

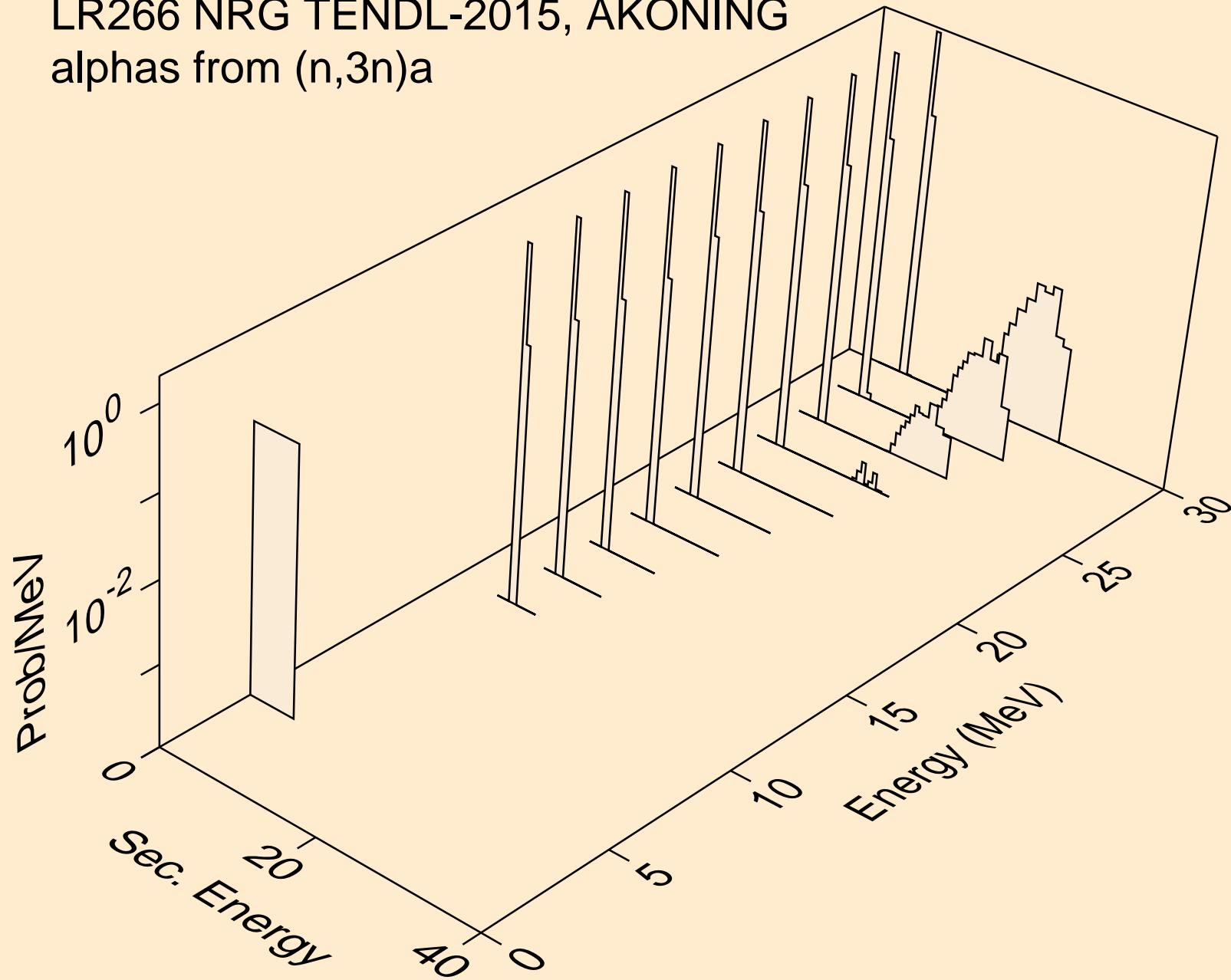

LR266 NRG TENDL-2015, AKONING
alphas from (n,a)

