

LU159 NRG TENDL-2015, AKONING

Principal cross sections

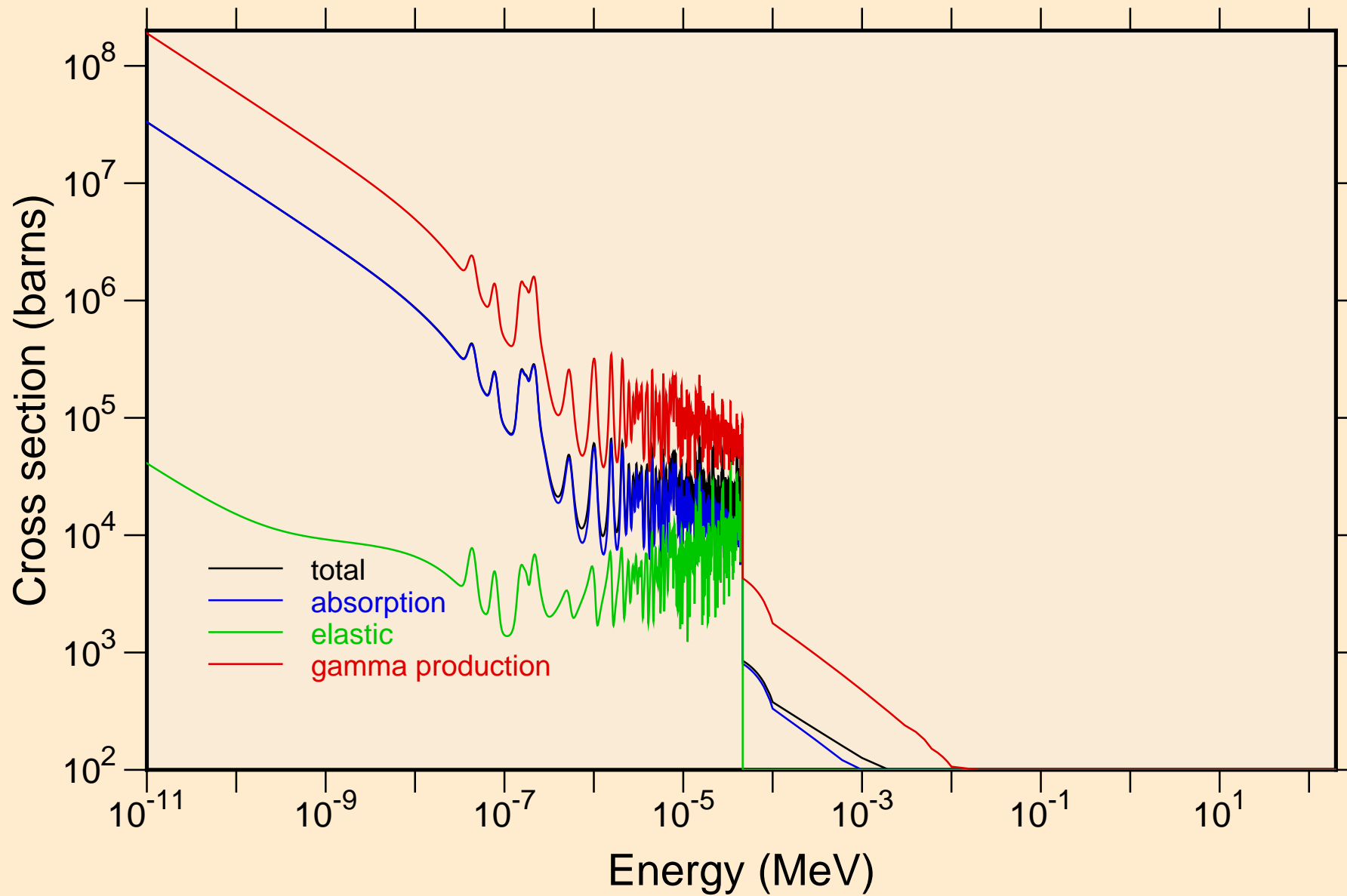

LU159 NRG TENDL-2015, AKONING
resonance total cross section

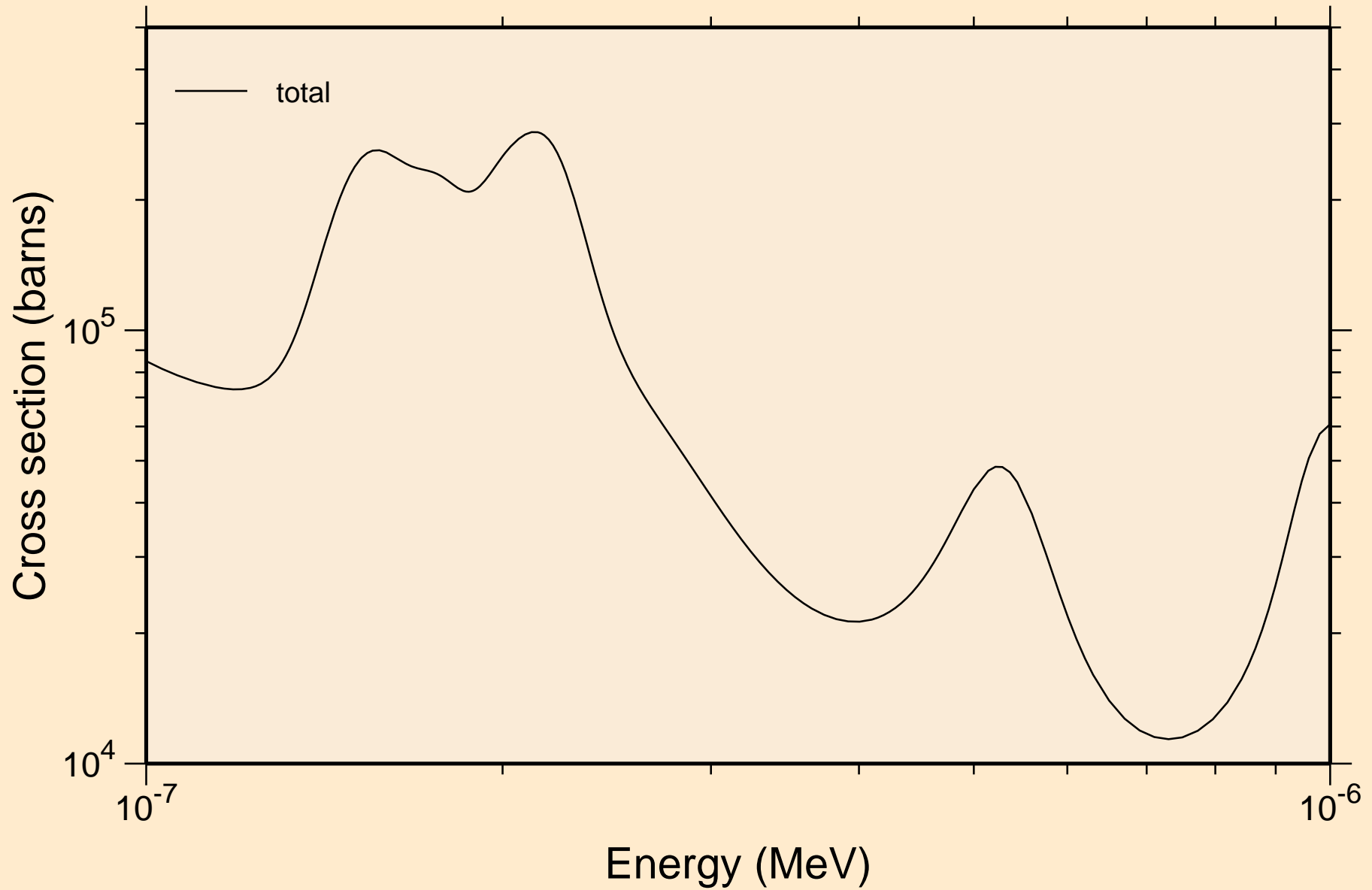

LU159 NRG TENDL-2015, AKONING
resonance total cross section

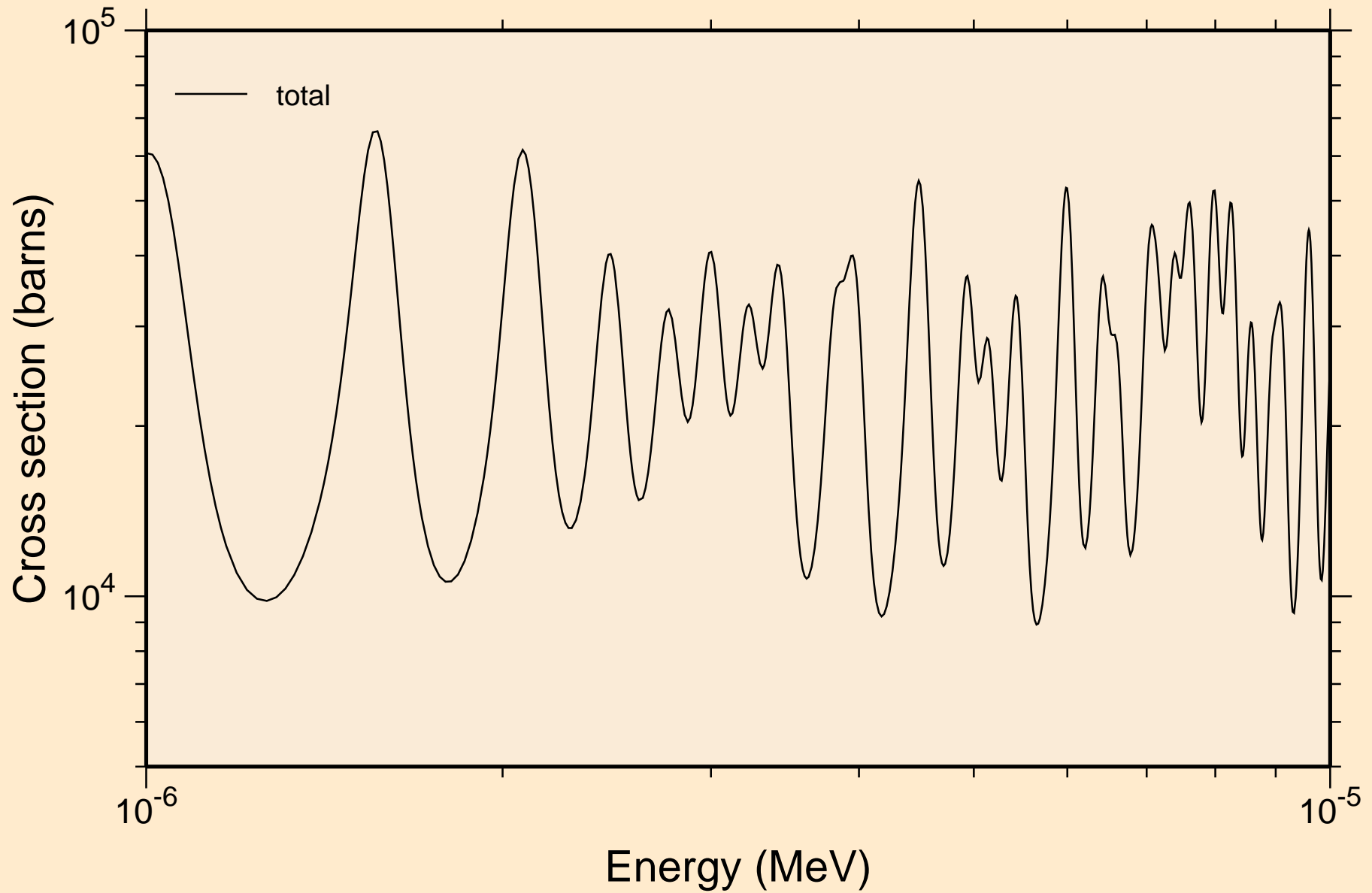

LU159 NRG TENDL-2015, AKONING
resonance total cross section

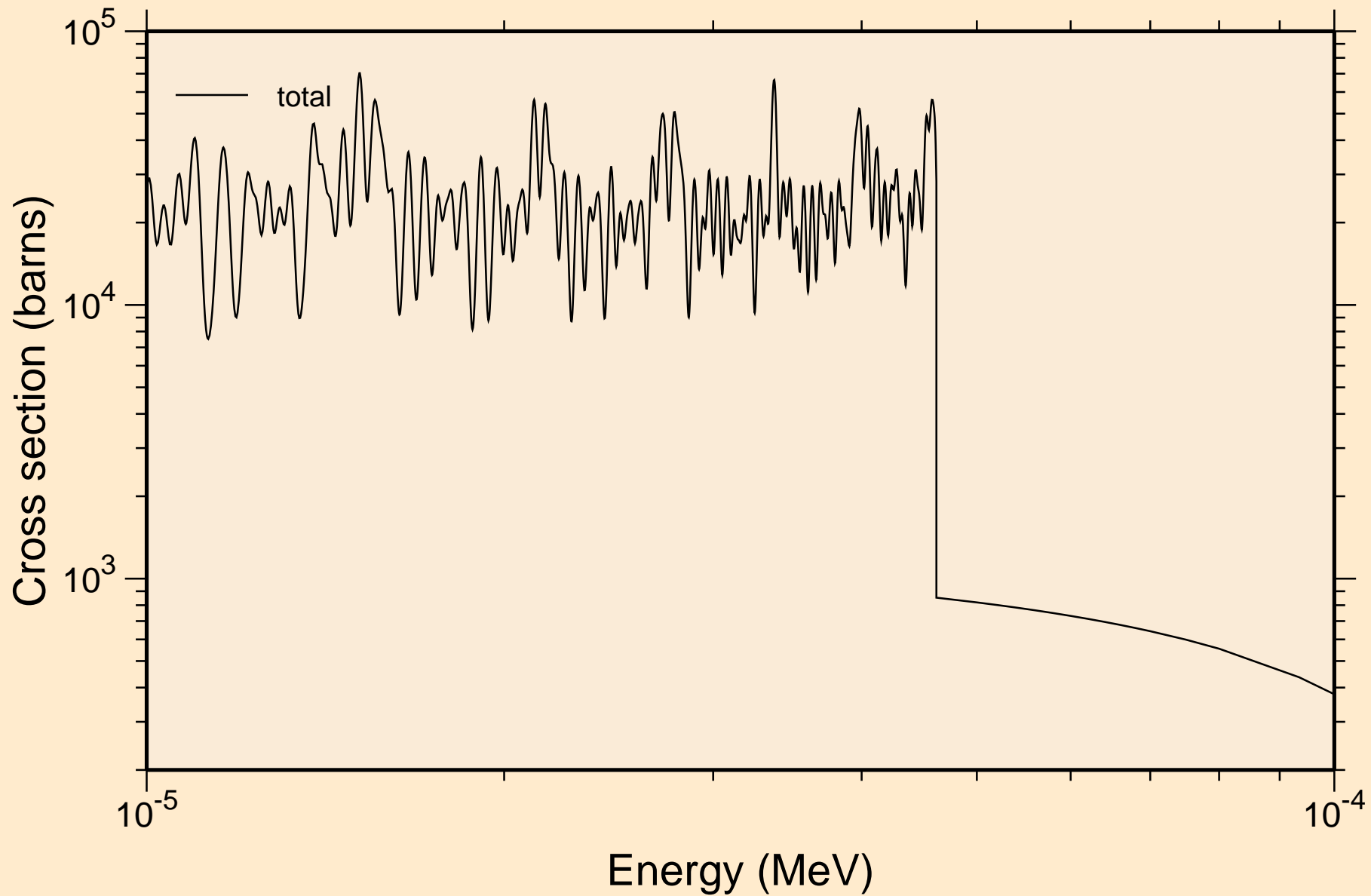

LU159 NRG TENDL-2015, AKONING
resonance total cross section

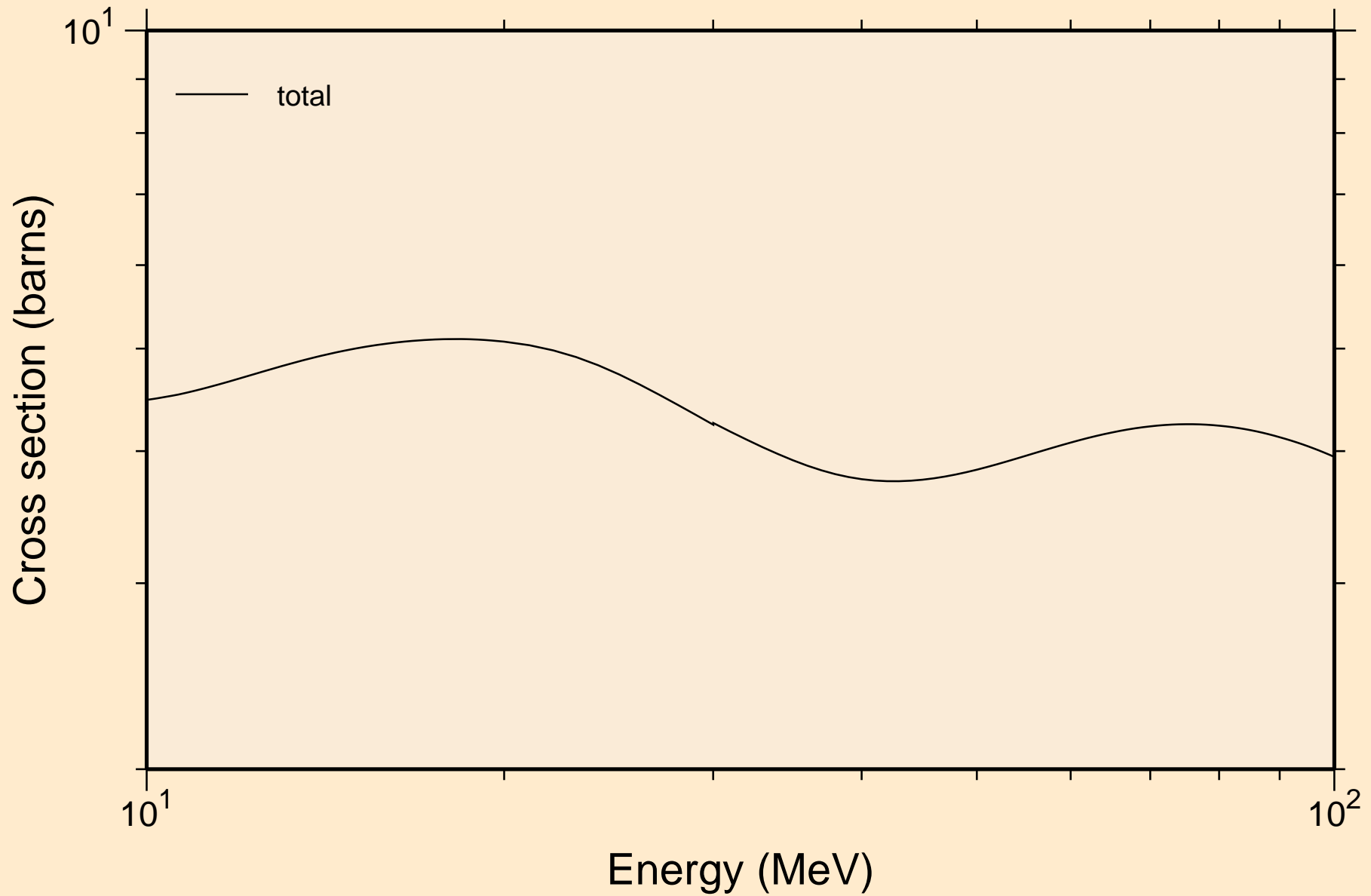

LU159 NRG TENDL-2015, AKONING
resonance absorption cross sections

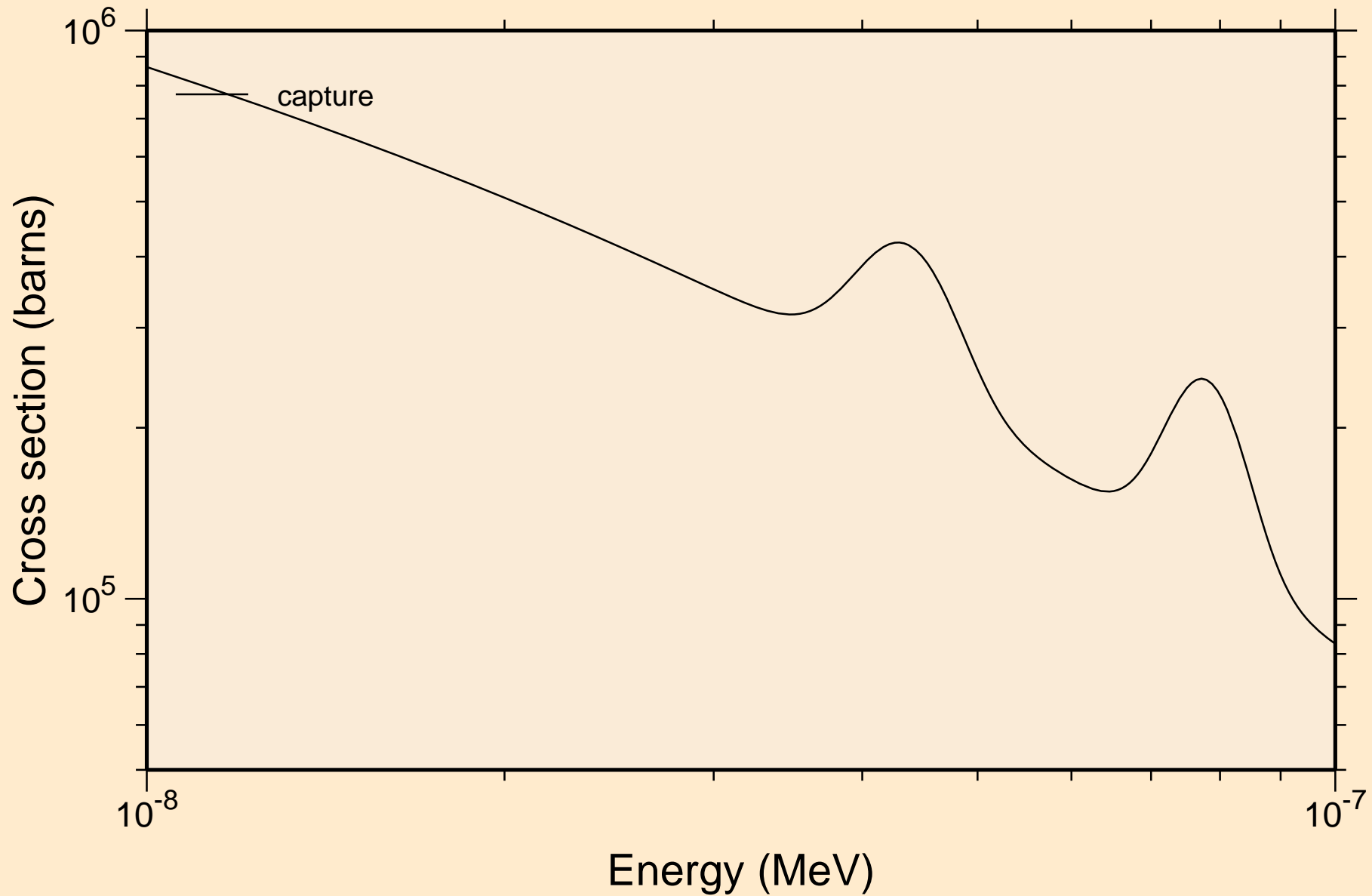

LU159 NRG TENDL-2015, AKONING
resonance absorption cross sections

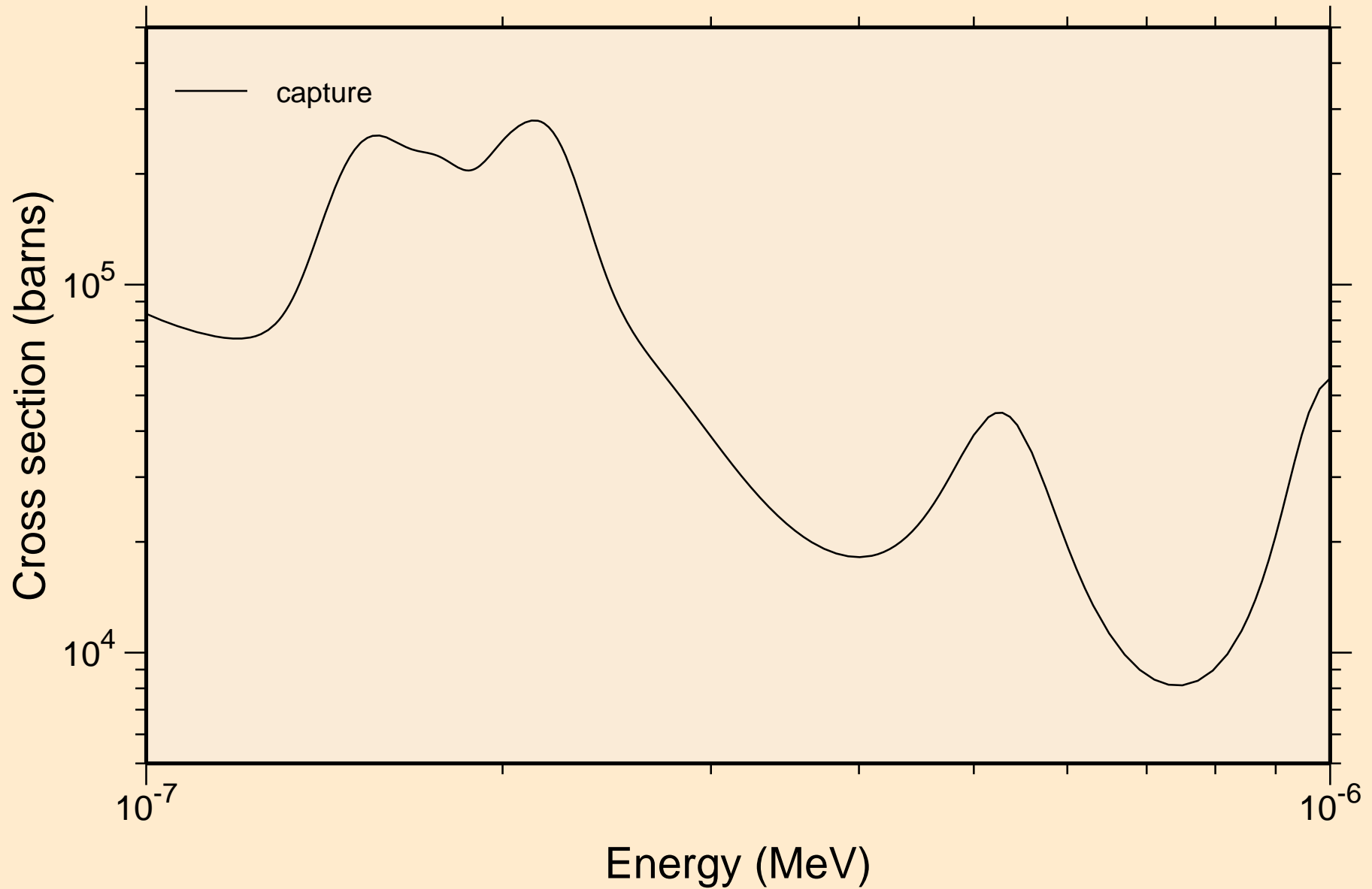

LU159 NRG TENDL-2015, AKONING
resonance absorption cross sections

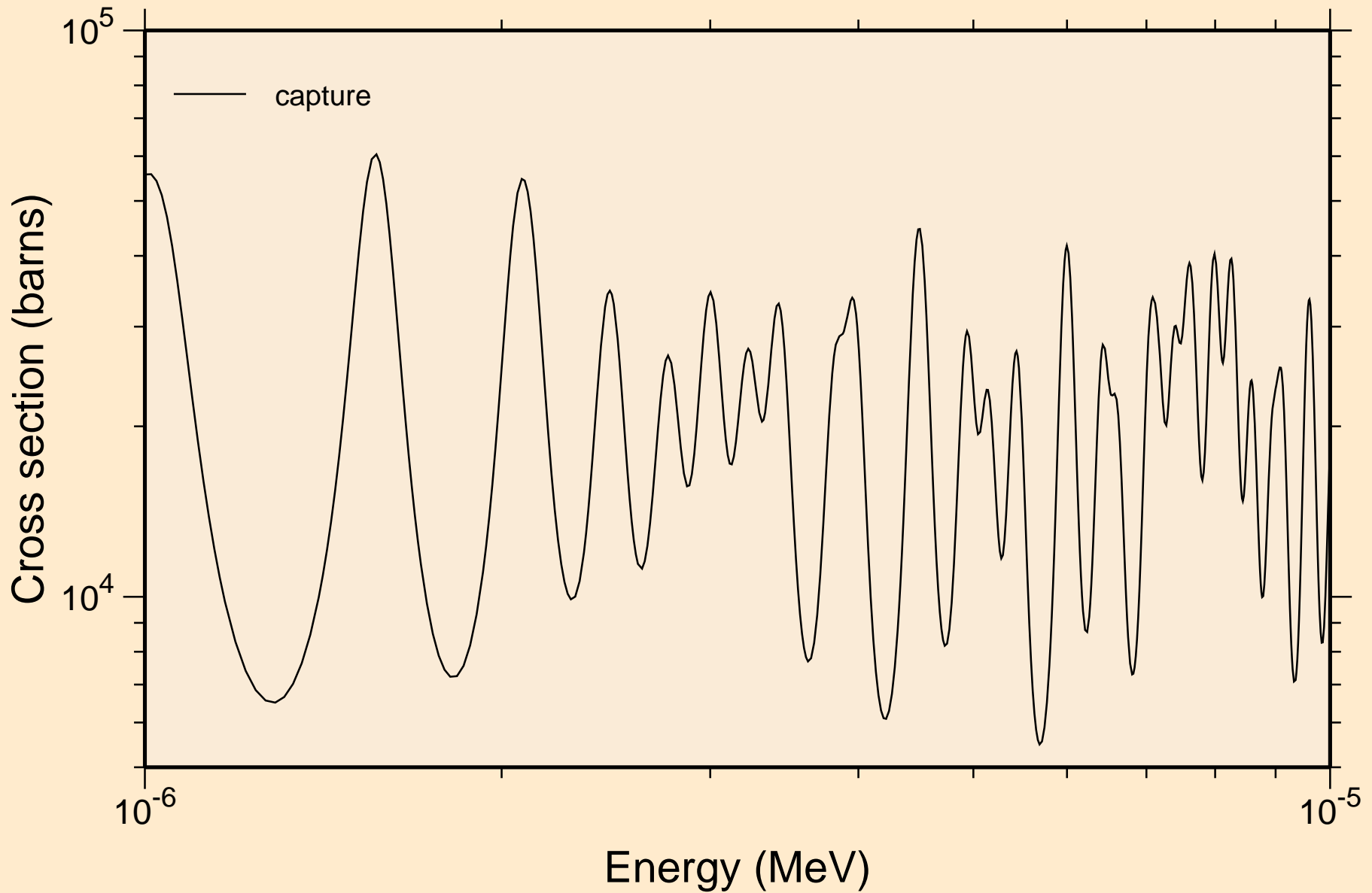

LU159 NRG TENDL-2015, AKONING
resonance absorption cross sections

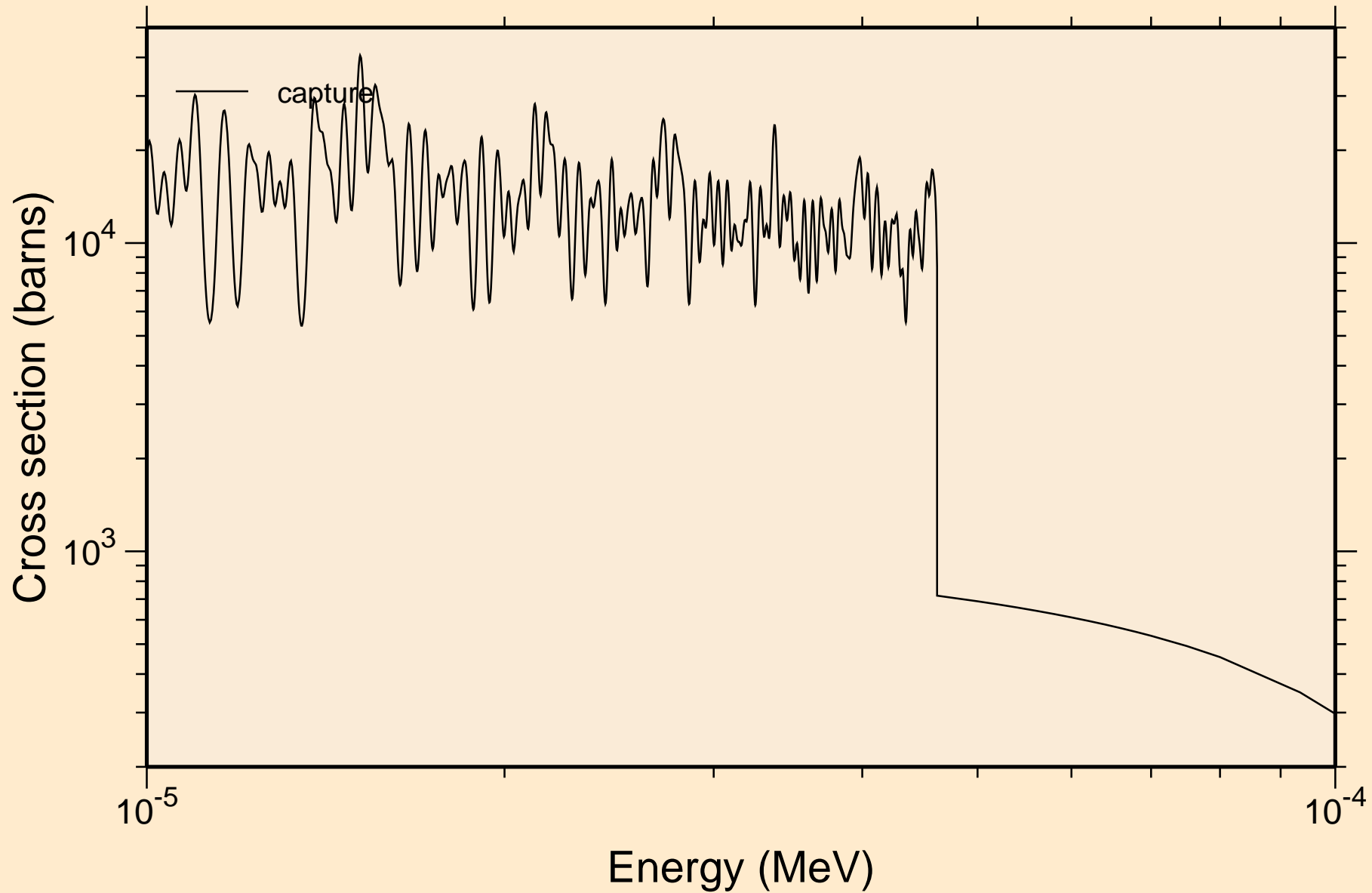

LU159 NRG TENDL-2015, AKONING
resonance absorption cross sections

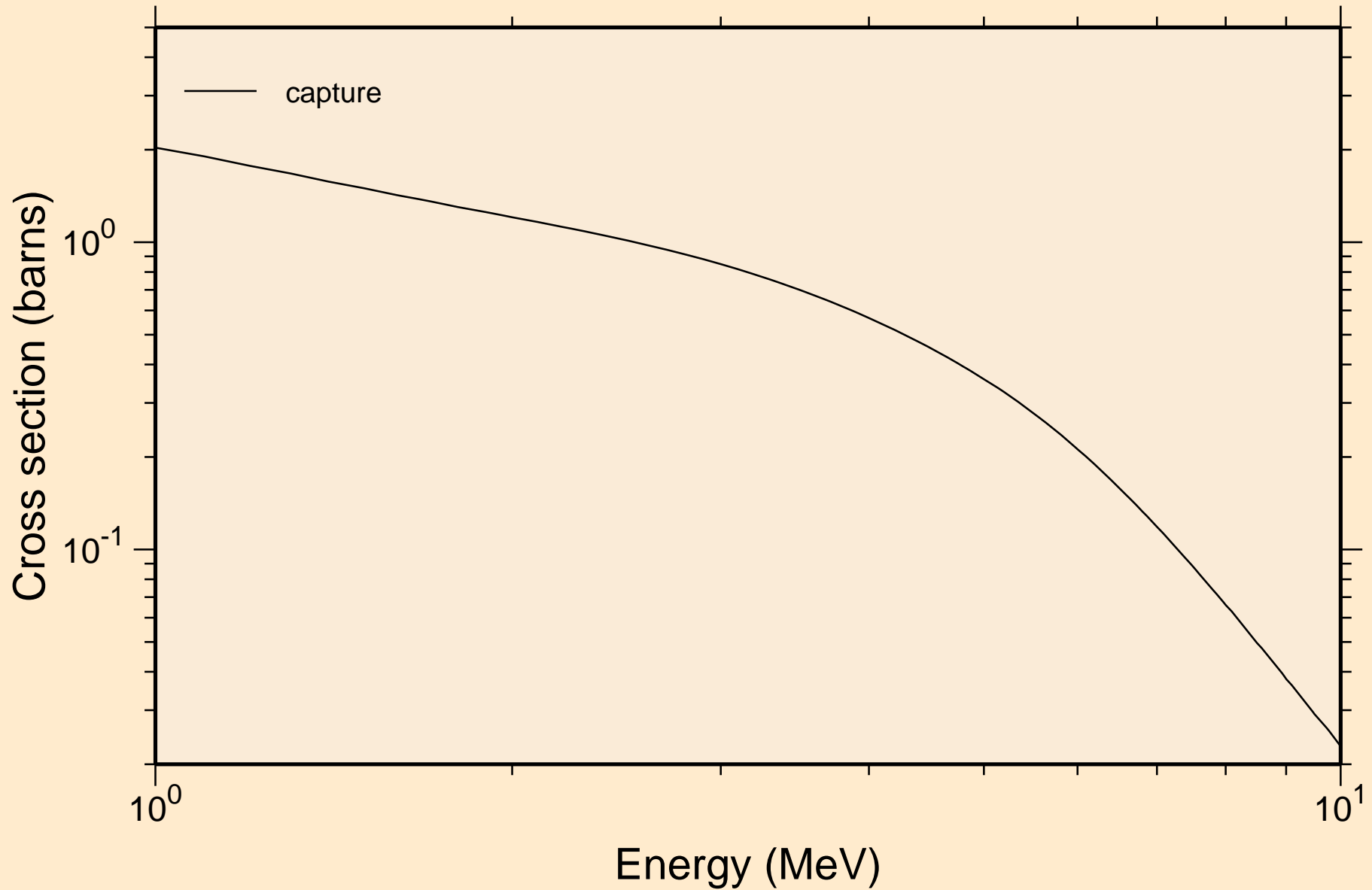

LU159 NRG TENDL-2015, AKONING

Non-threshold reactions

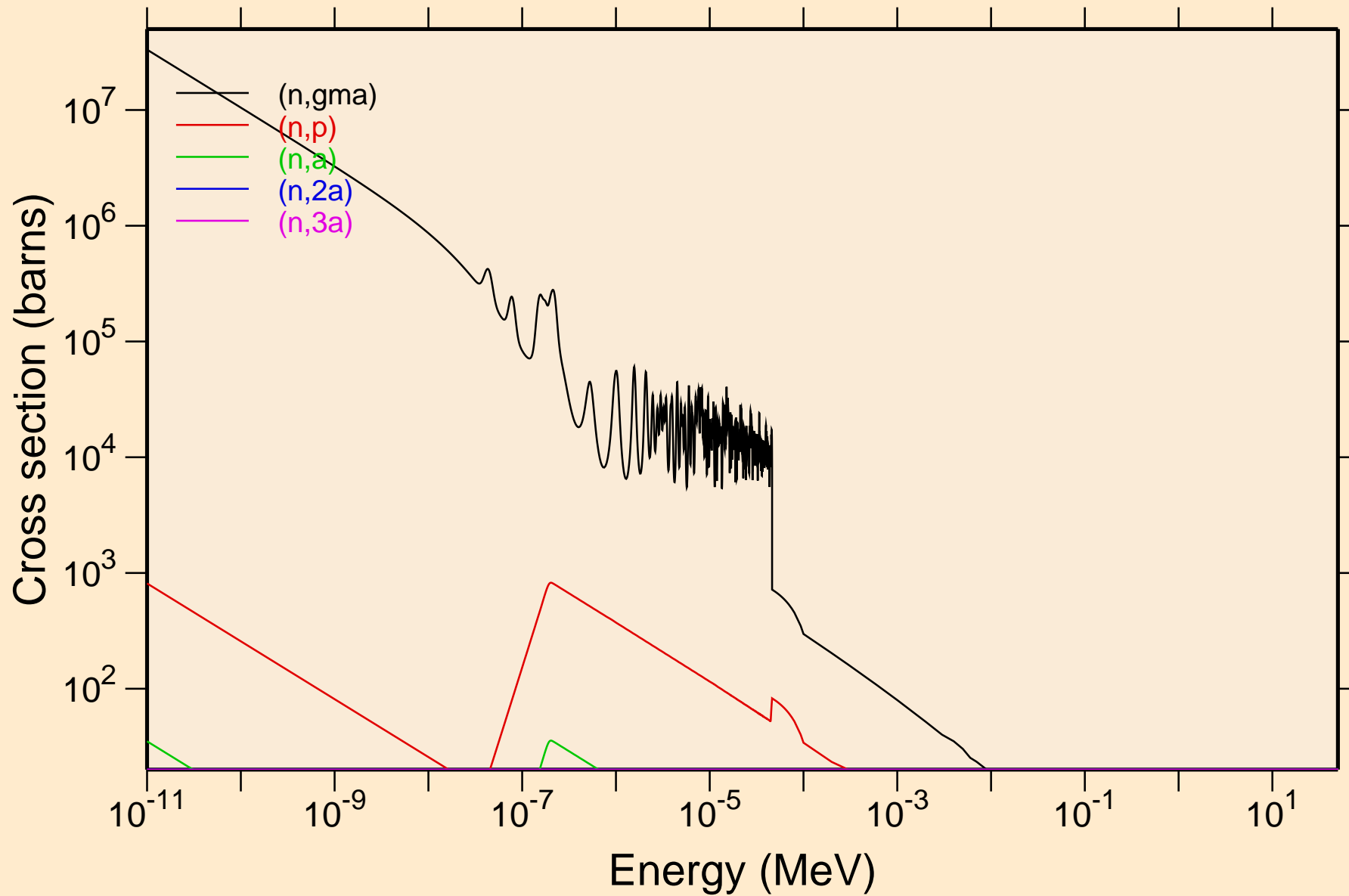

LU159 NRG TENDL-2015, AKONING
Non-threshold reactions

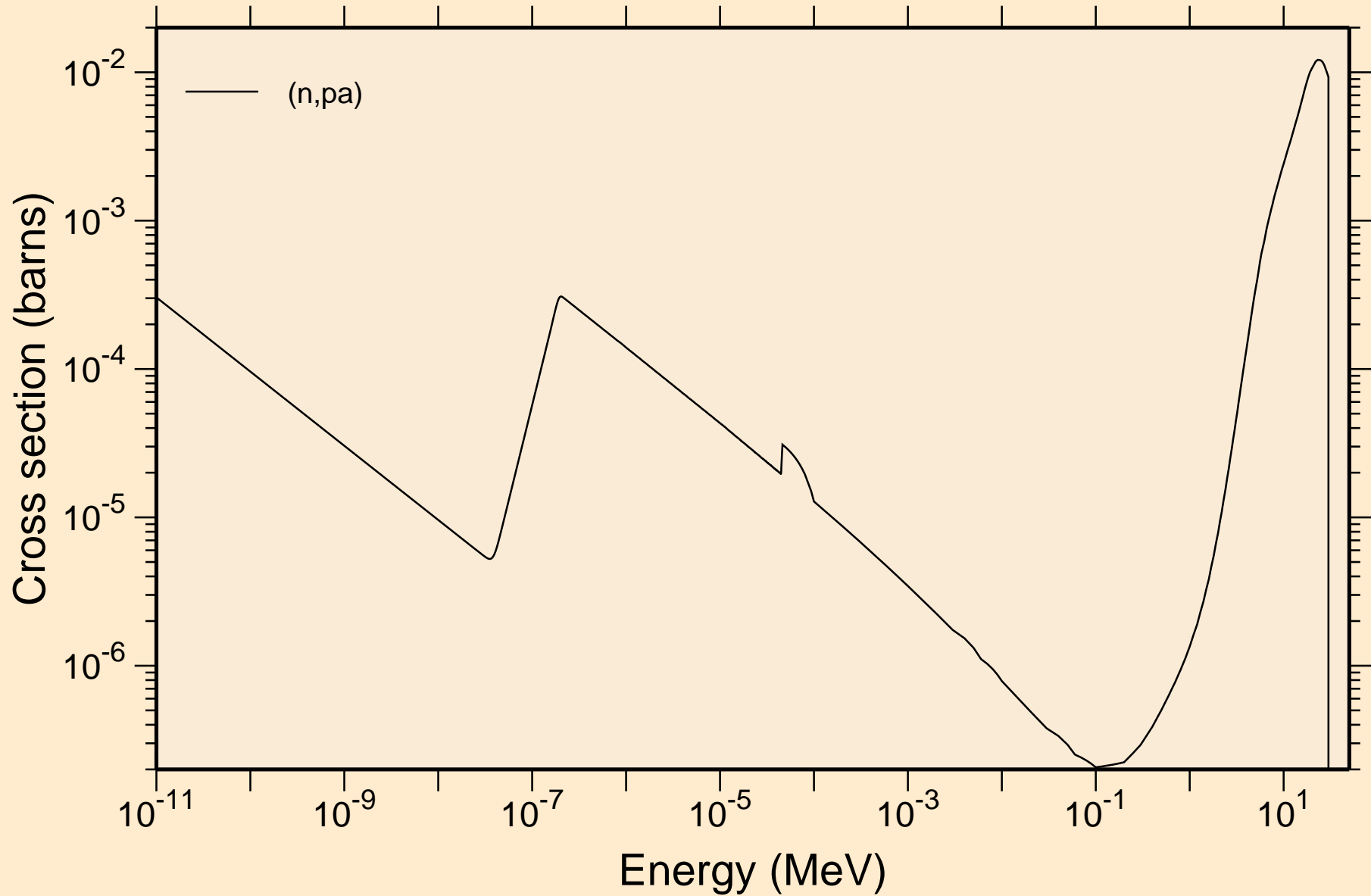

LU159 NRG TENDL-2015, AKONING

Principal cross sections

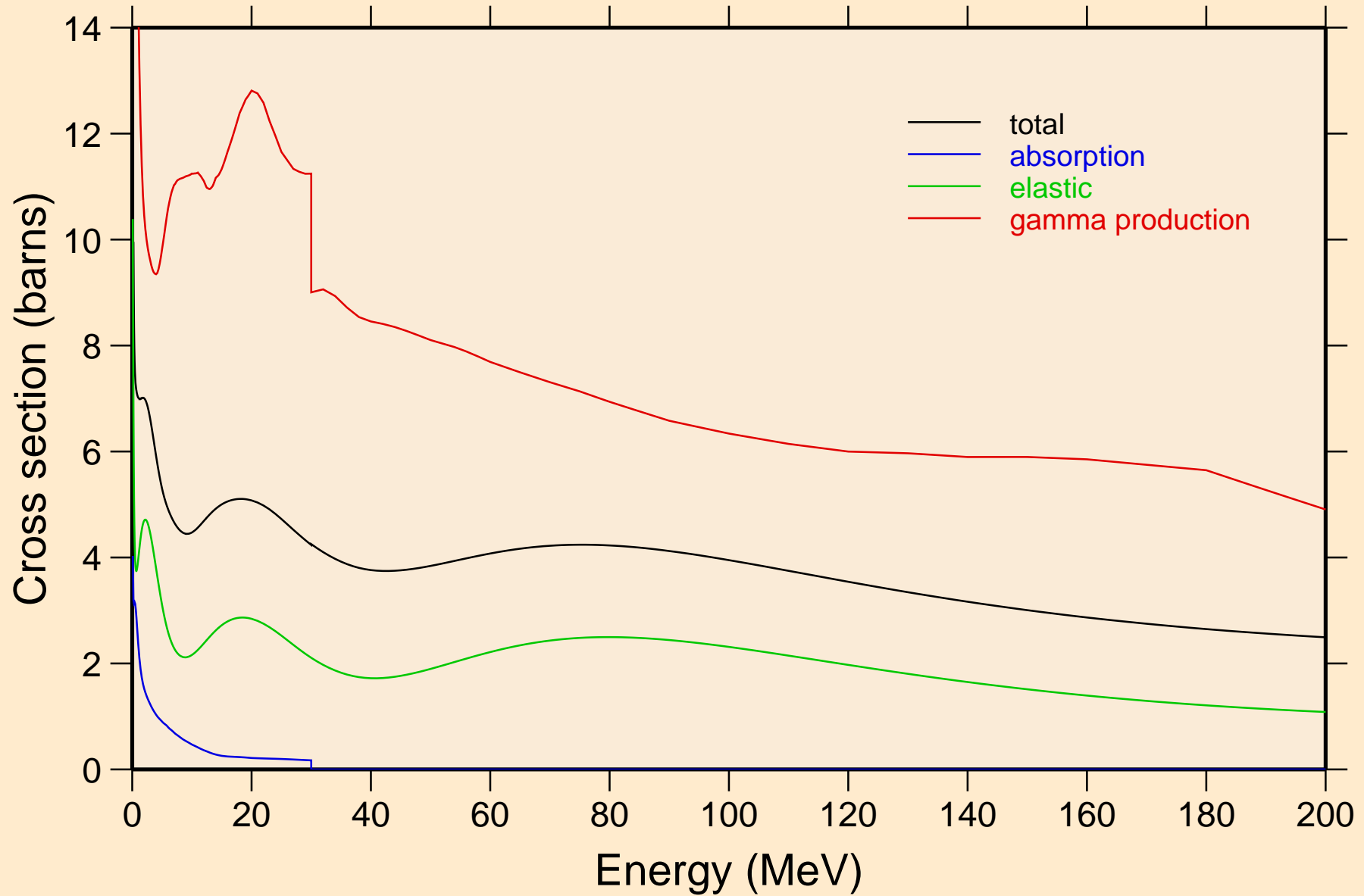

LU159 NRG TENDL-2015, AKONING

Non-threshold reactions

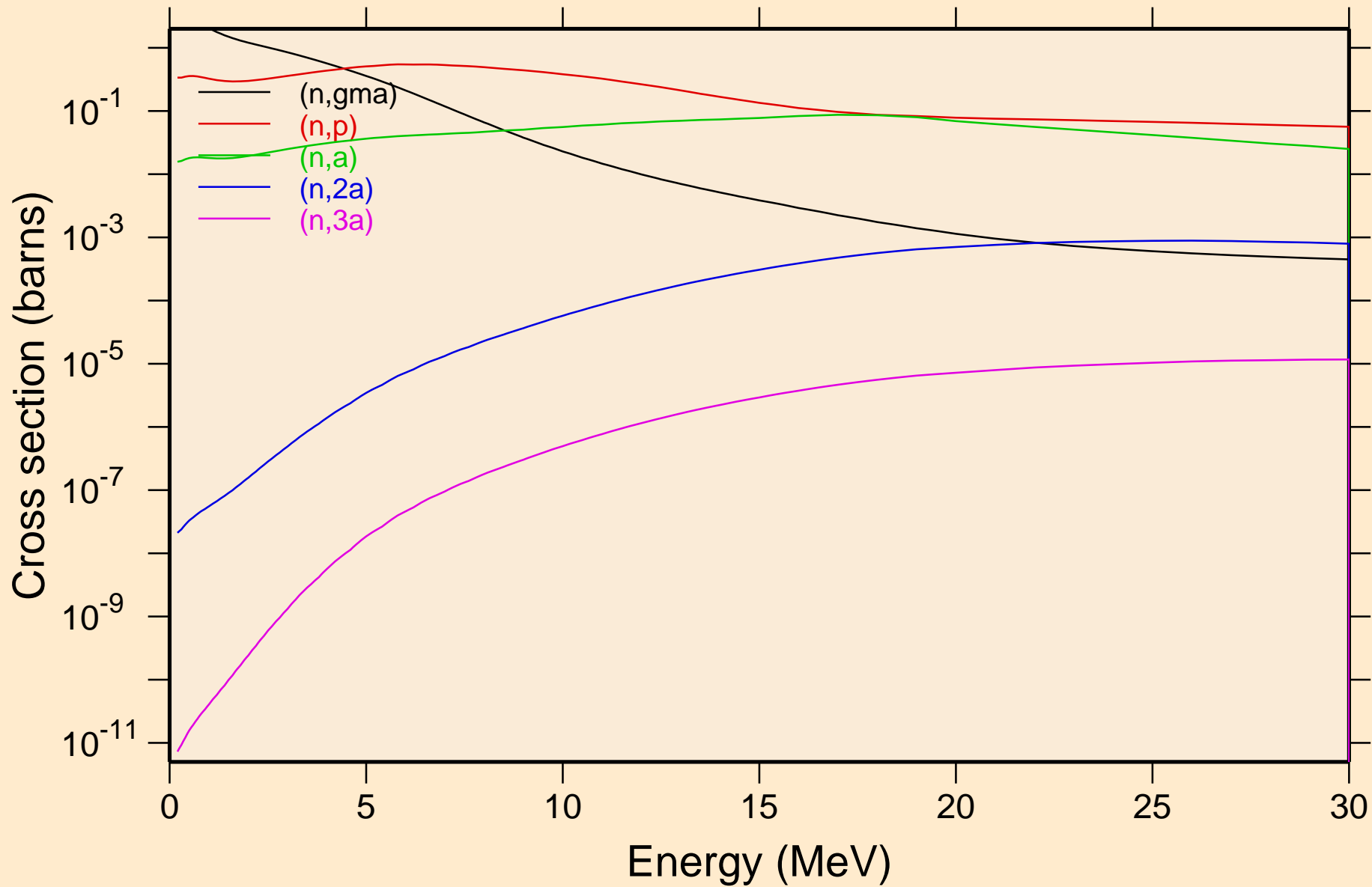

LU159 NRG TENDL-2015, AKONING
Non-threshold reactions

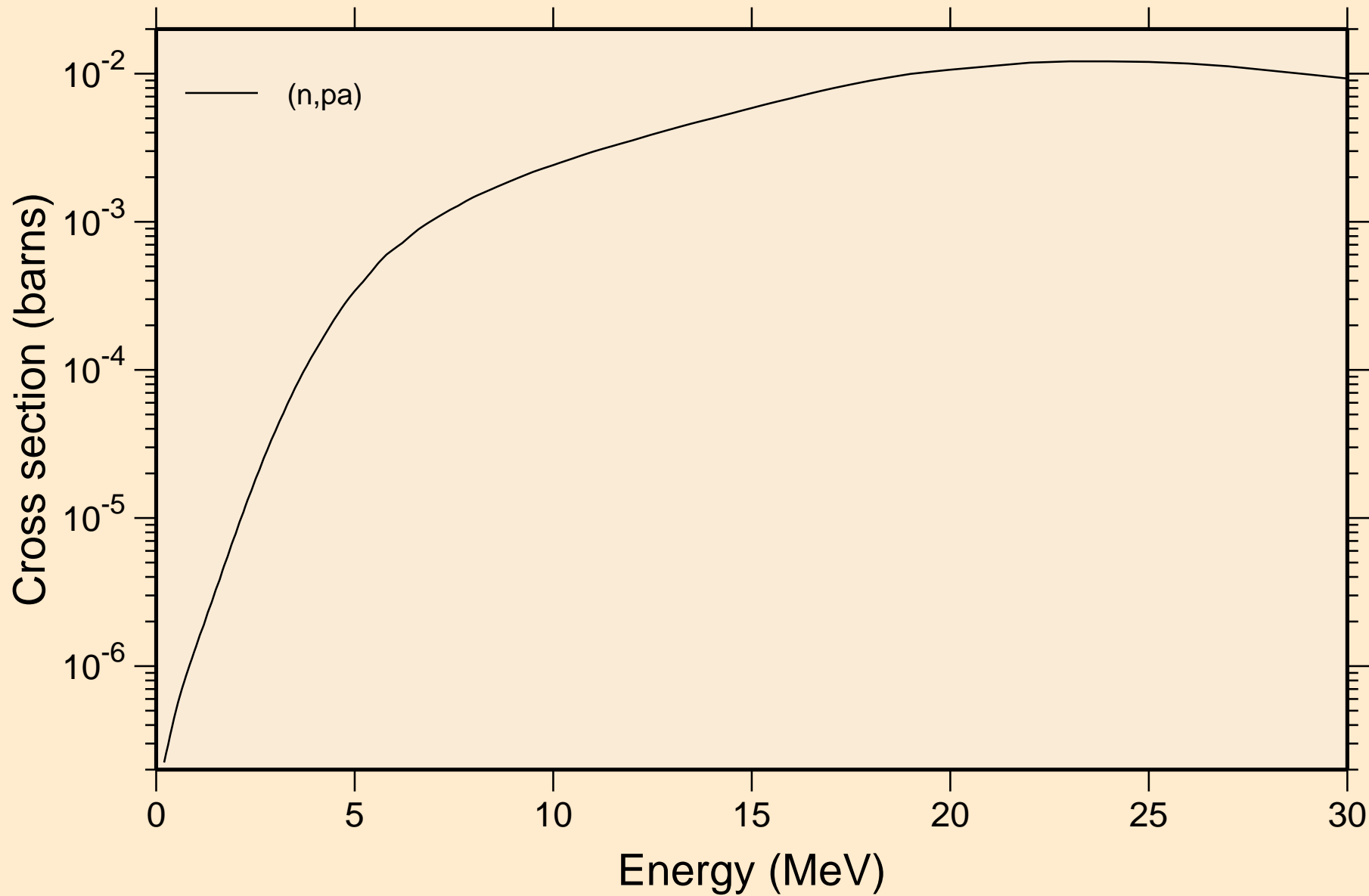

LU159 NRG TENDL-2015, AKONING
Inelastic levels

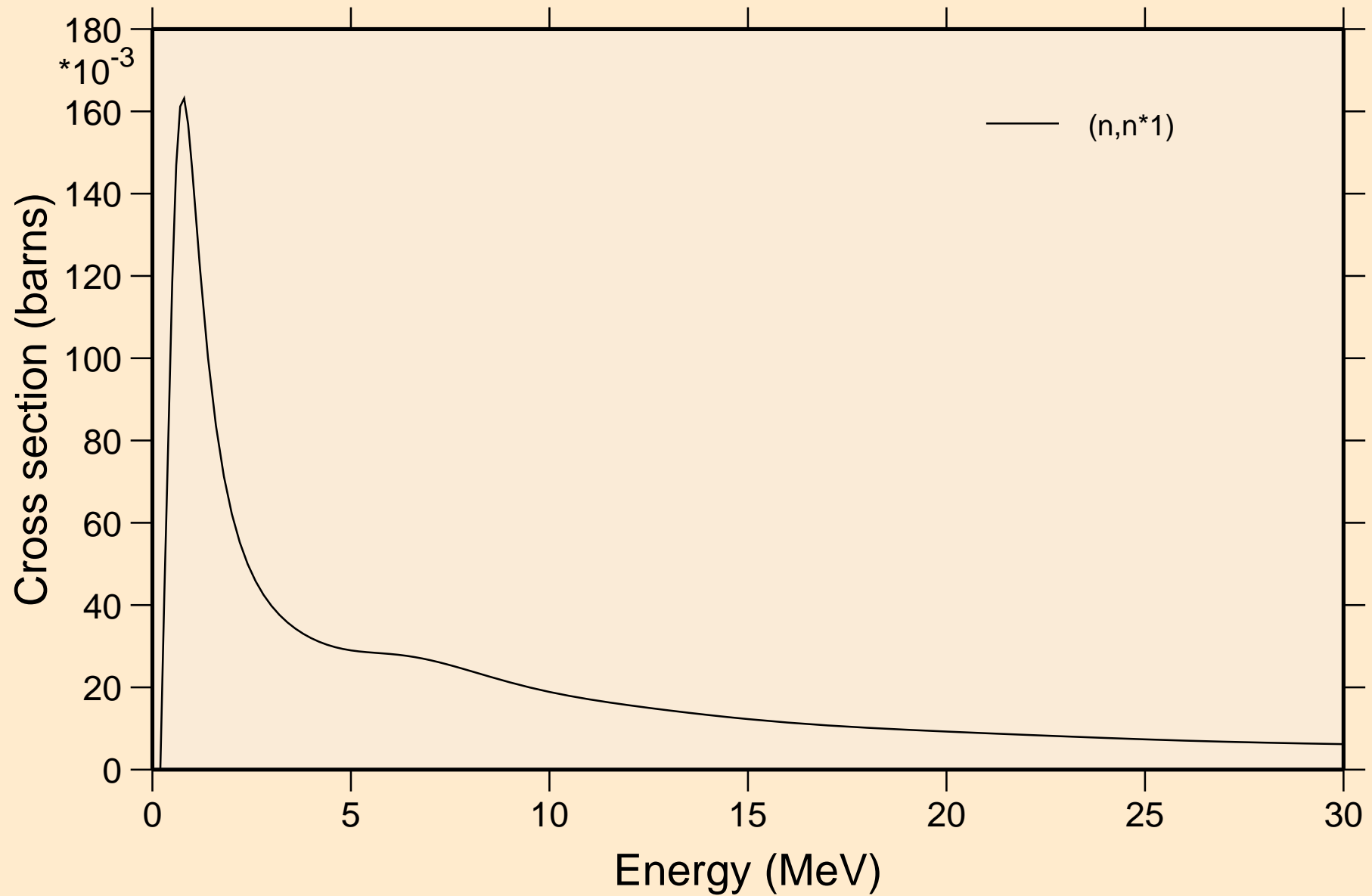

LU159 NRG TENDL-2015, AKONING

Threshold reactions

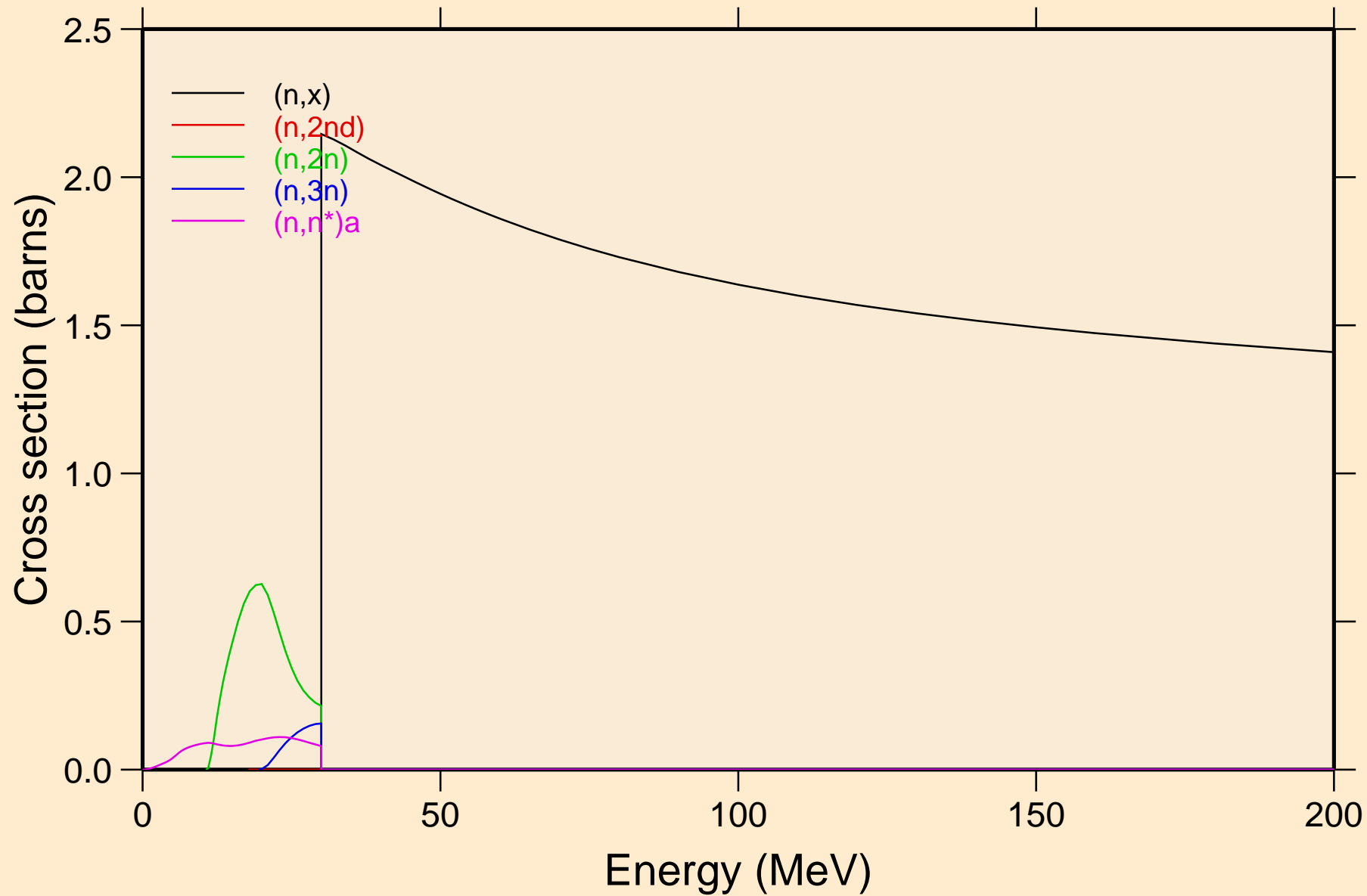

LU159 NRG TENDL-2015, AKONING

Threshold reactions

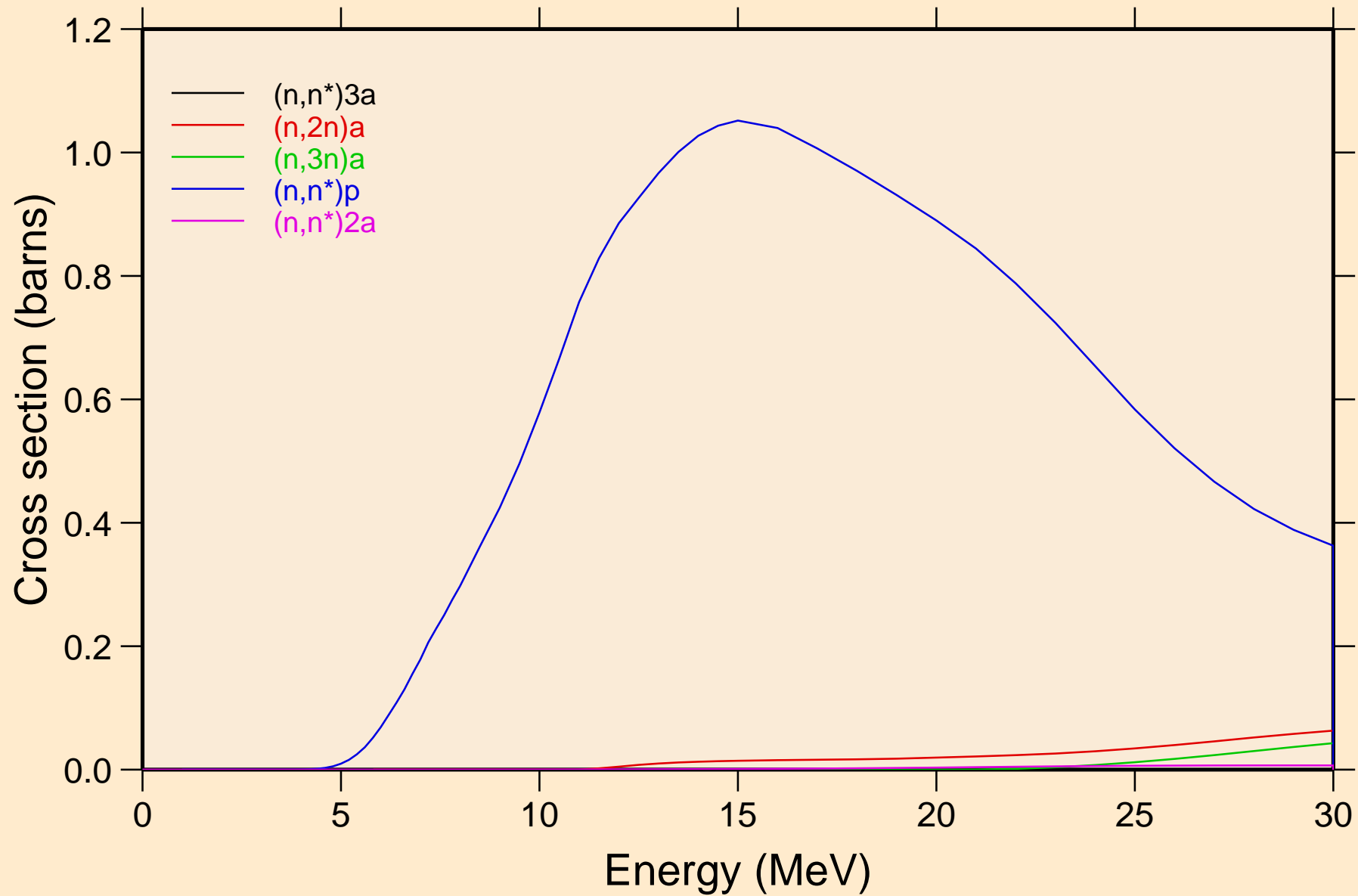

LU159 NRG TENDL-2015, AKONING

Threshold reactions

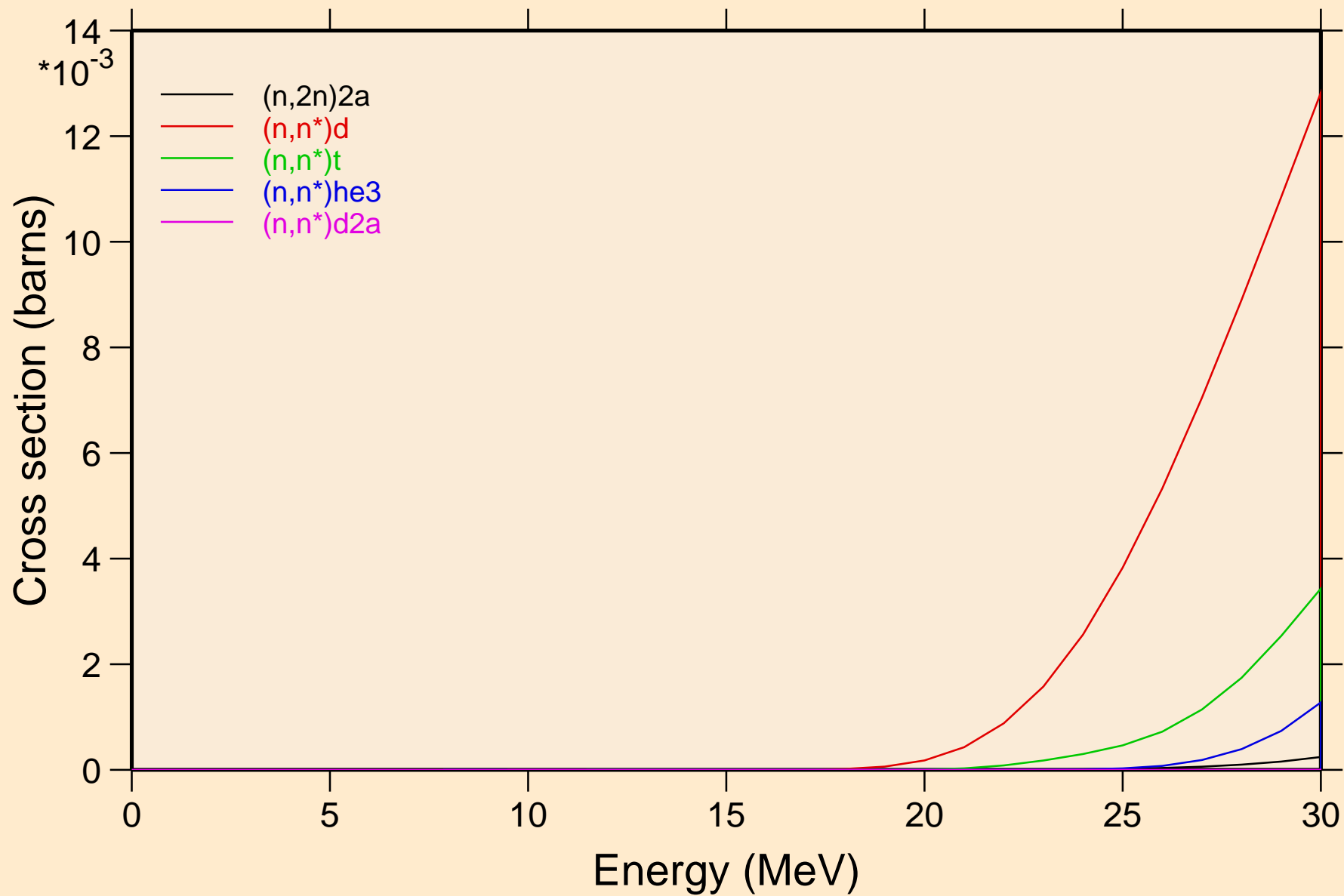

LU159 NRG TENDL-2015, AKONING

Threshold reactions

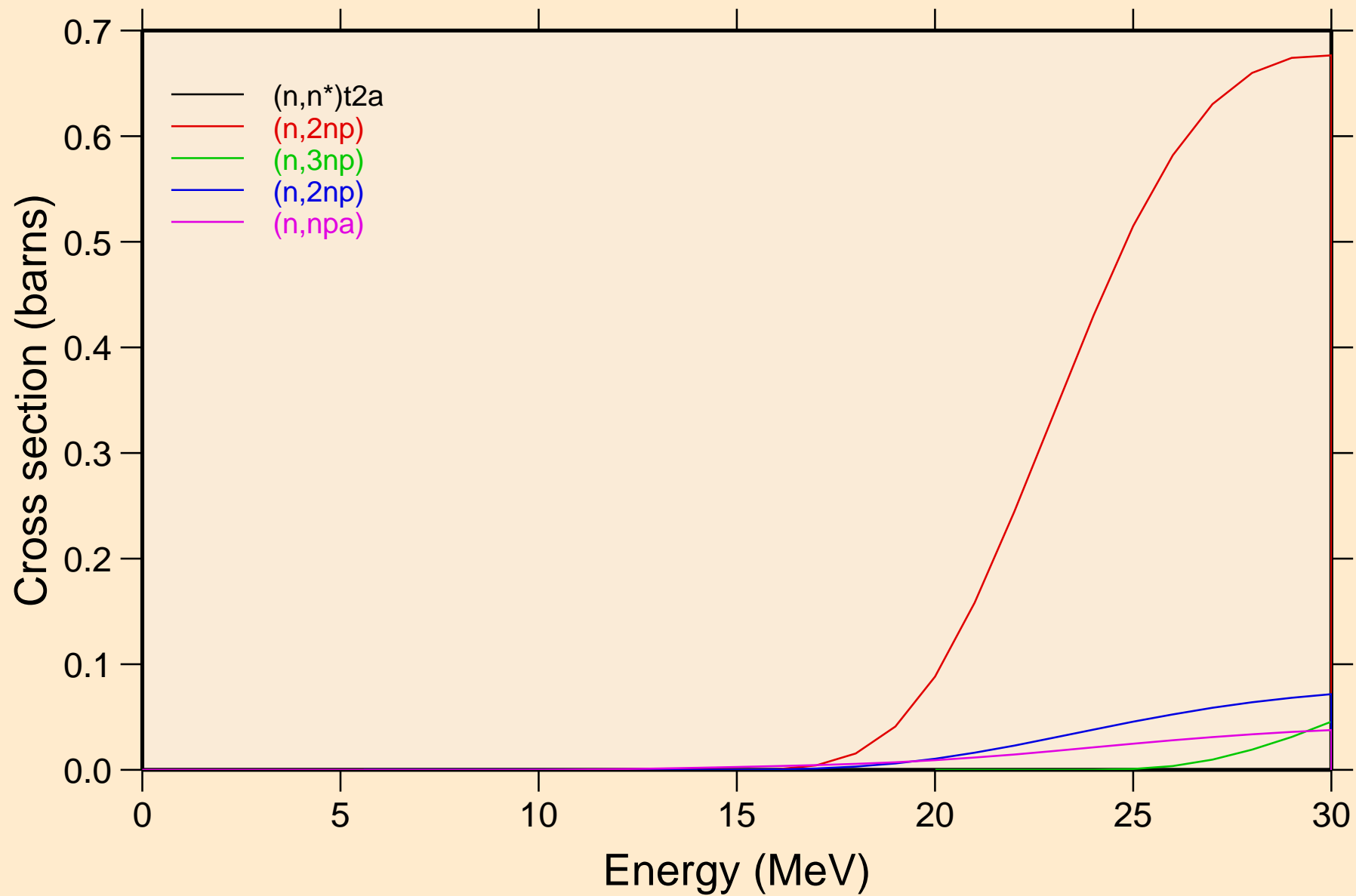

LU159 NRG TENDL-2015, AKONING

Threshold reactions

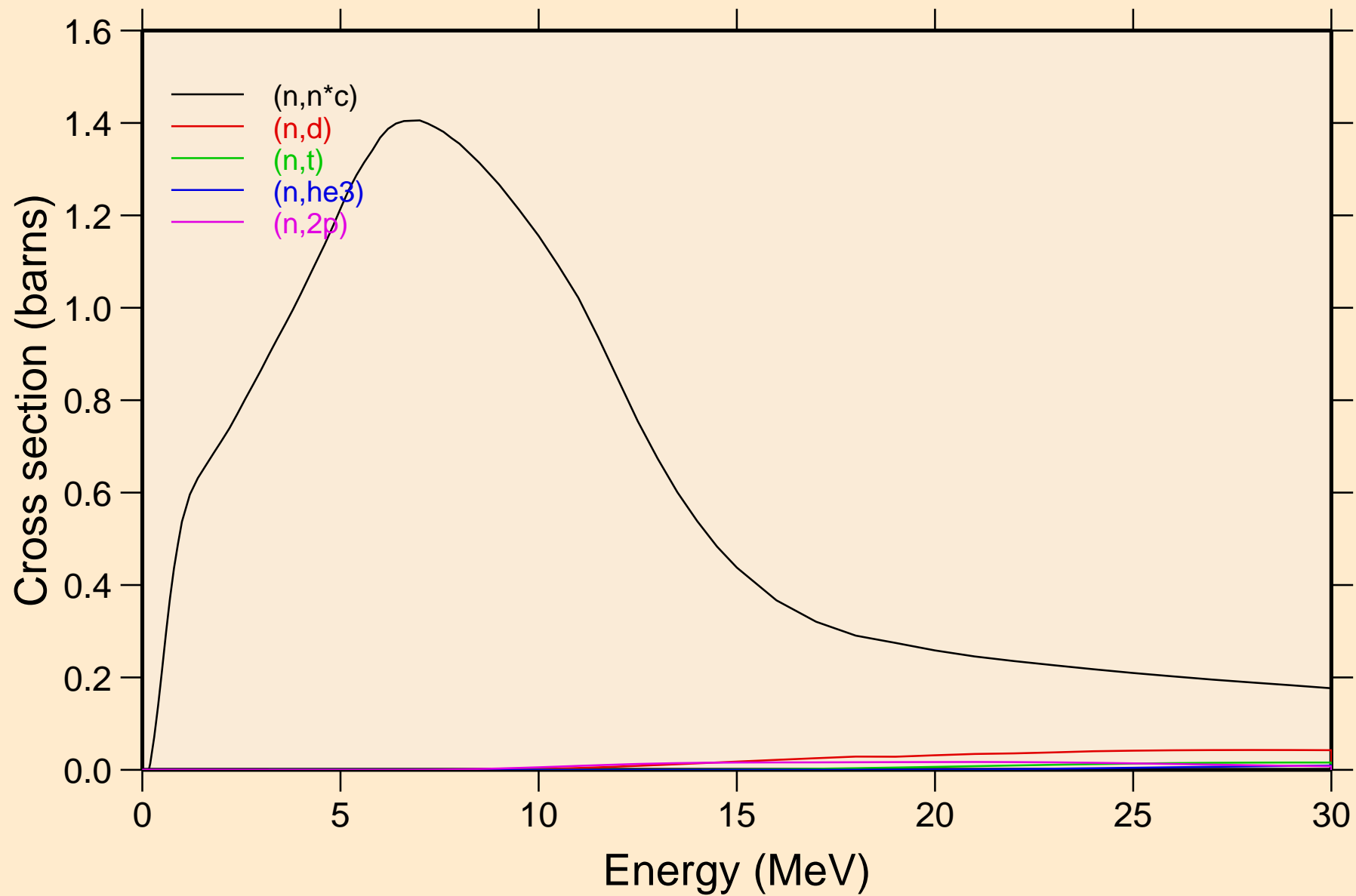

LU159 NRG TENDL-2015, AKONING

Threshold reactions

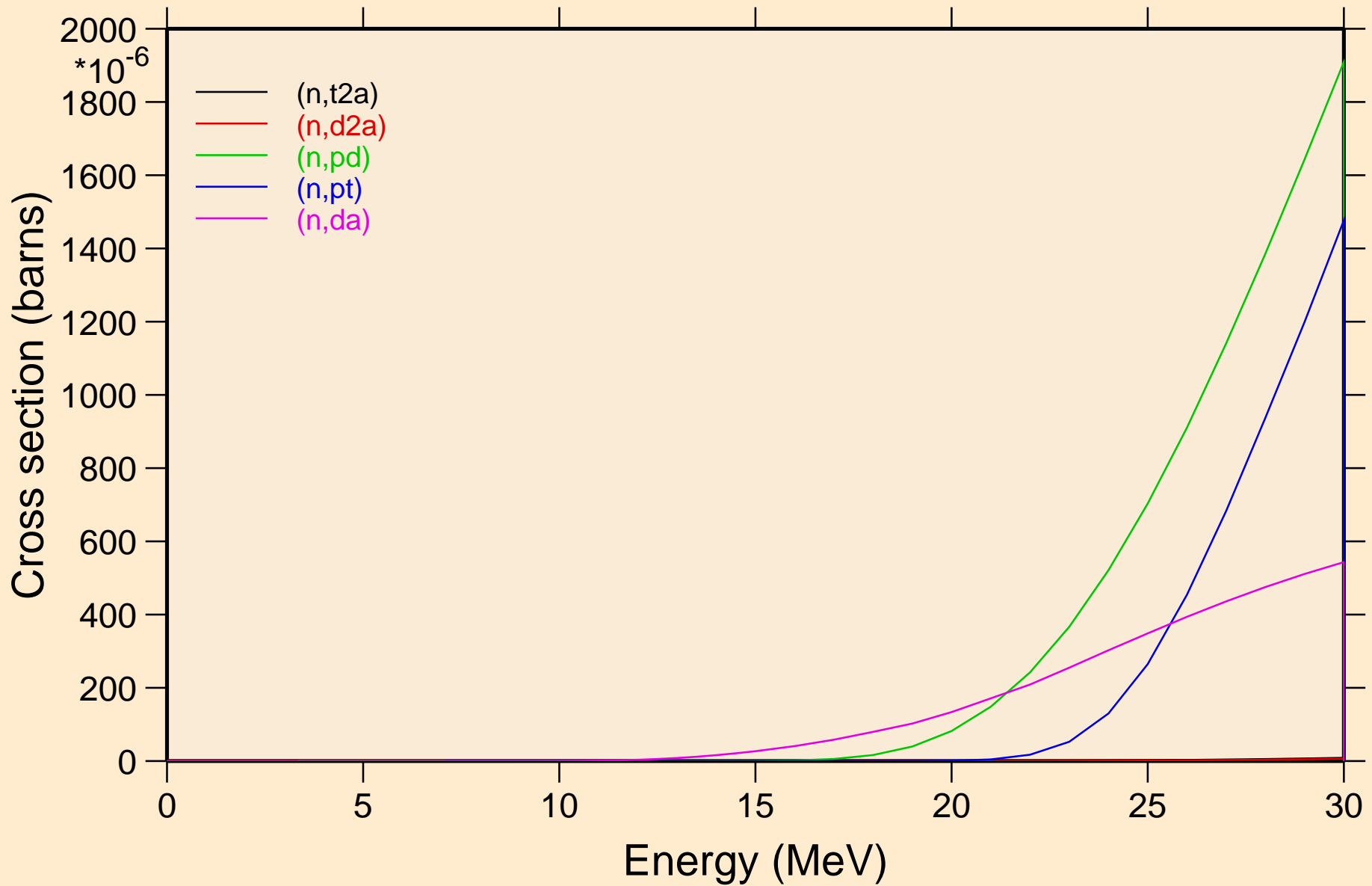

LU159 NRG TENDL-2015, AKONING
angular distribution for elastic

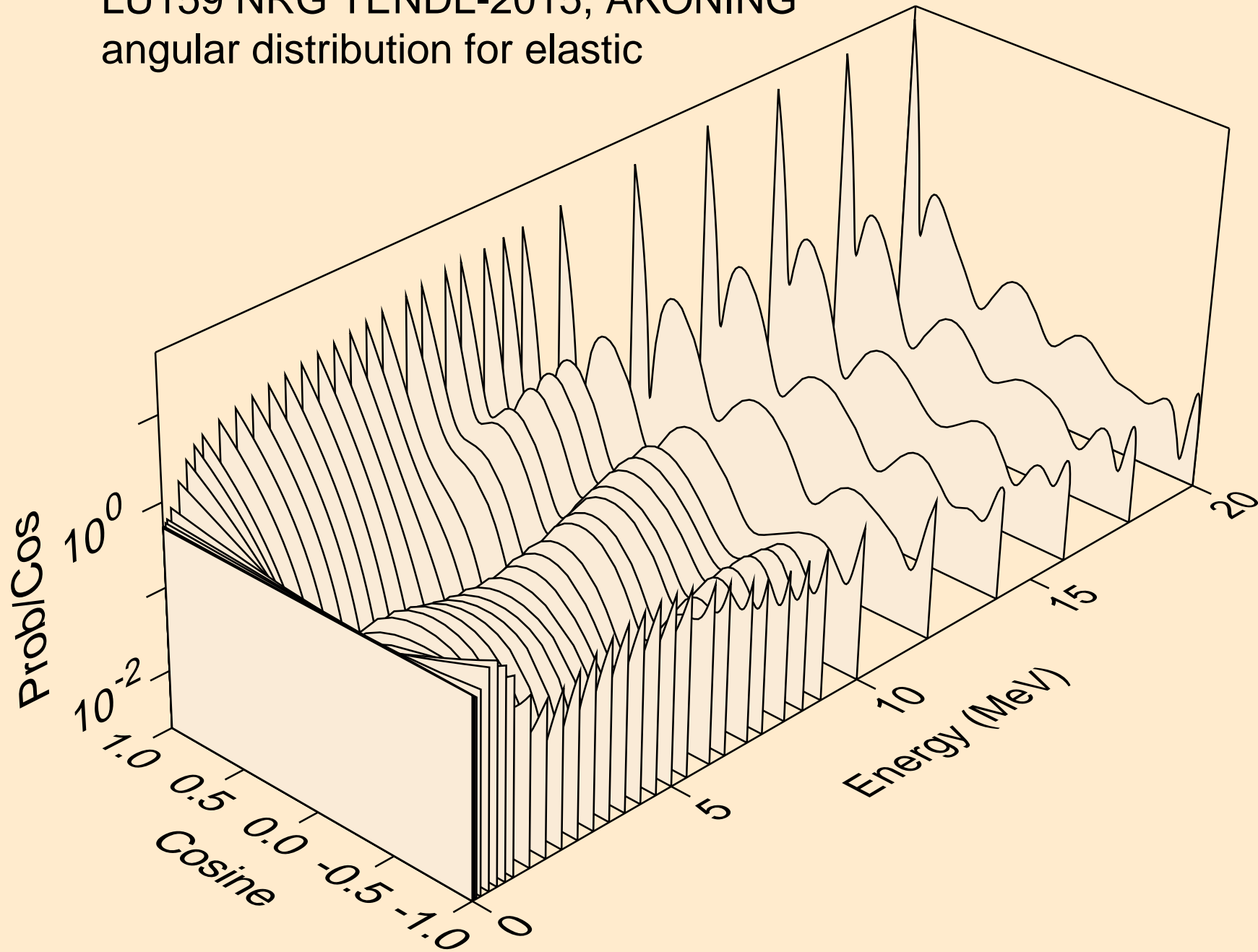

LU159 NRG TENDL-2015, AKONING
angular distribution for elastic

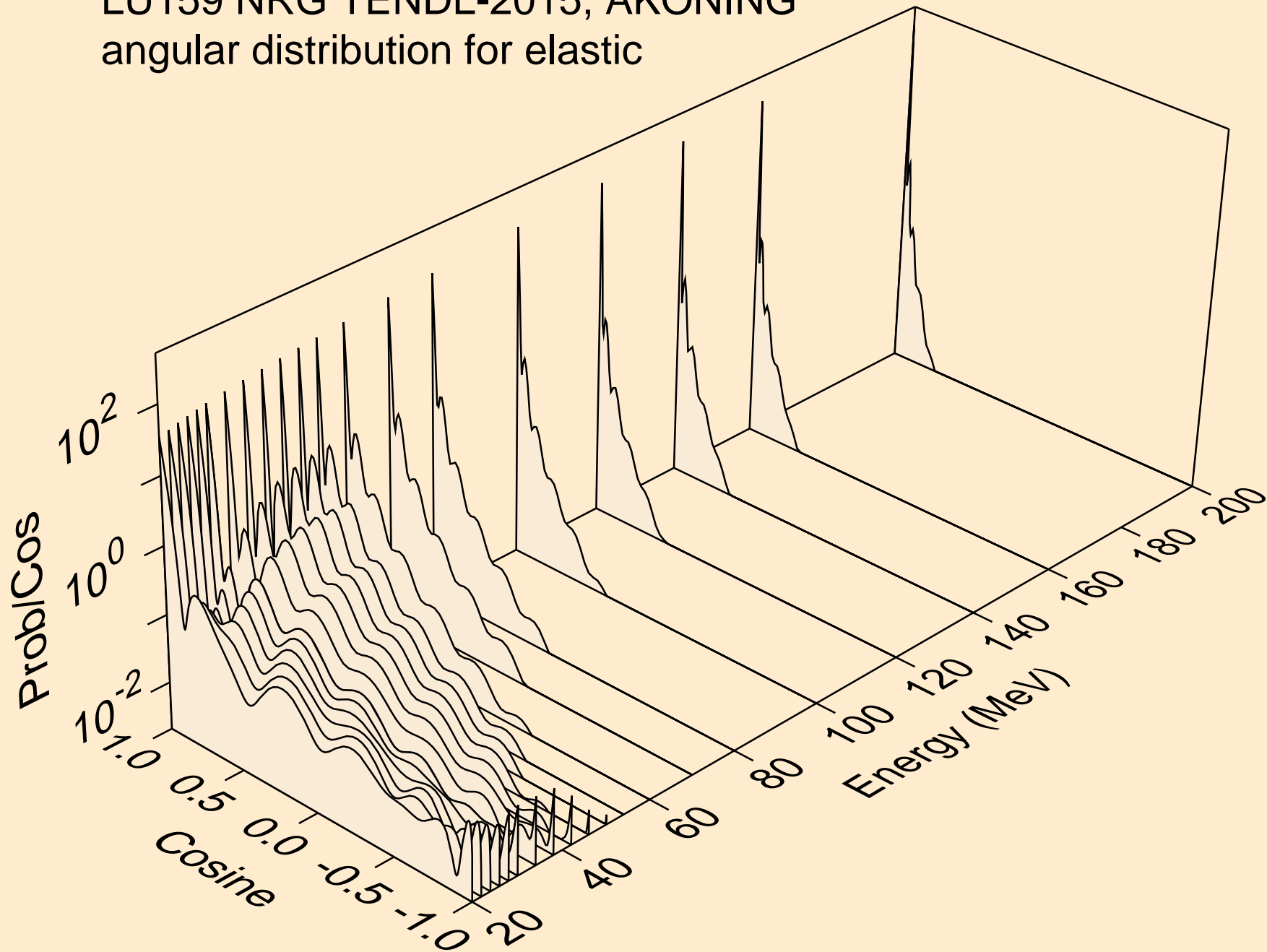

LU159 NRG TENDL-2015, AKONING
angular distribution for (n,n*1)

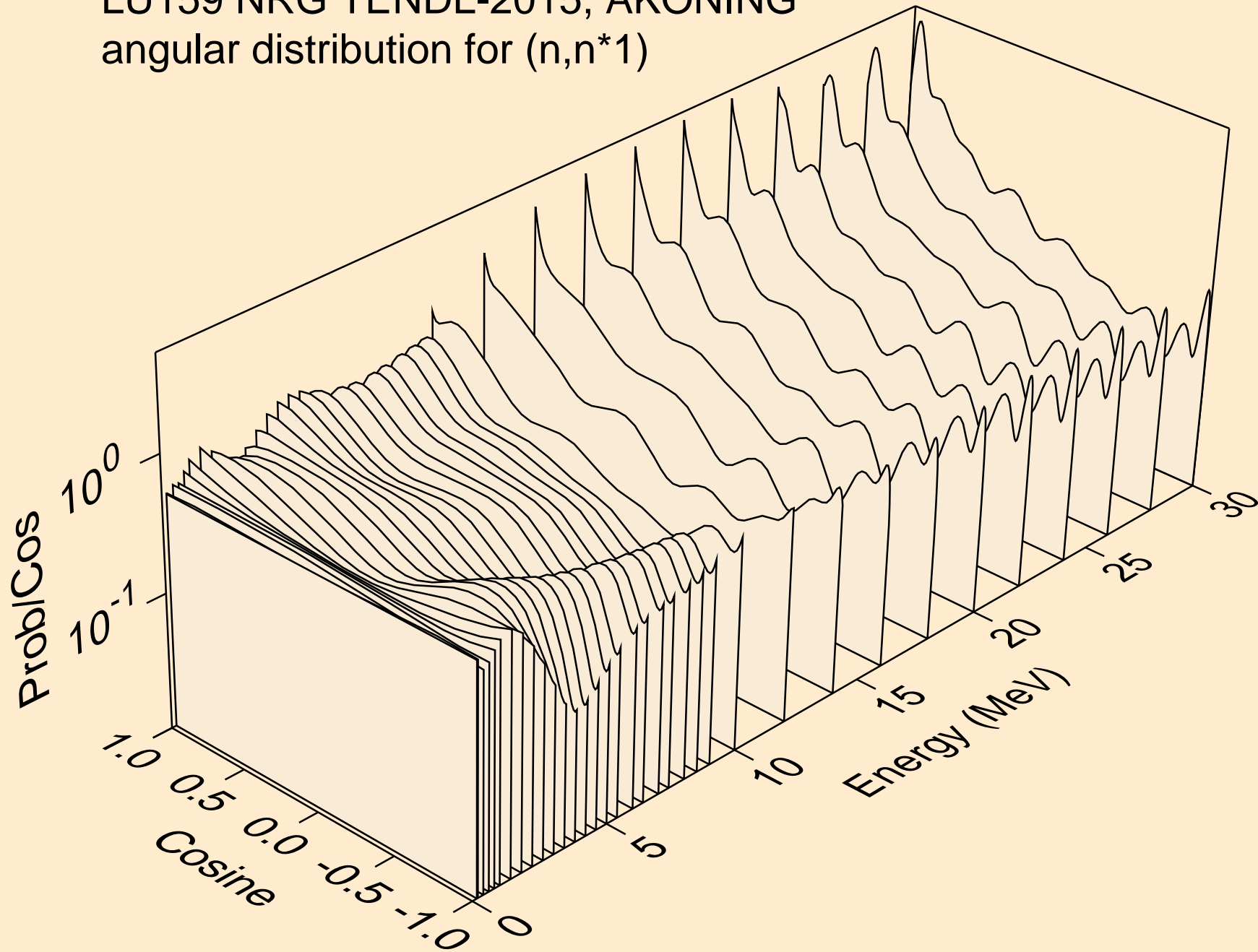

LU159 NRG TENDL-2015, AKONING
Neutron emission for (n,x)

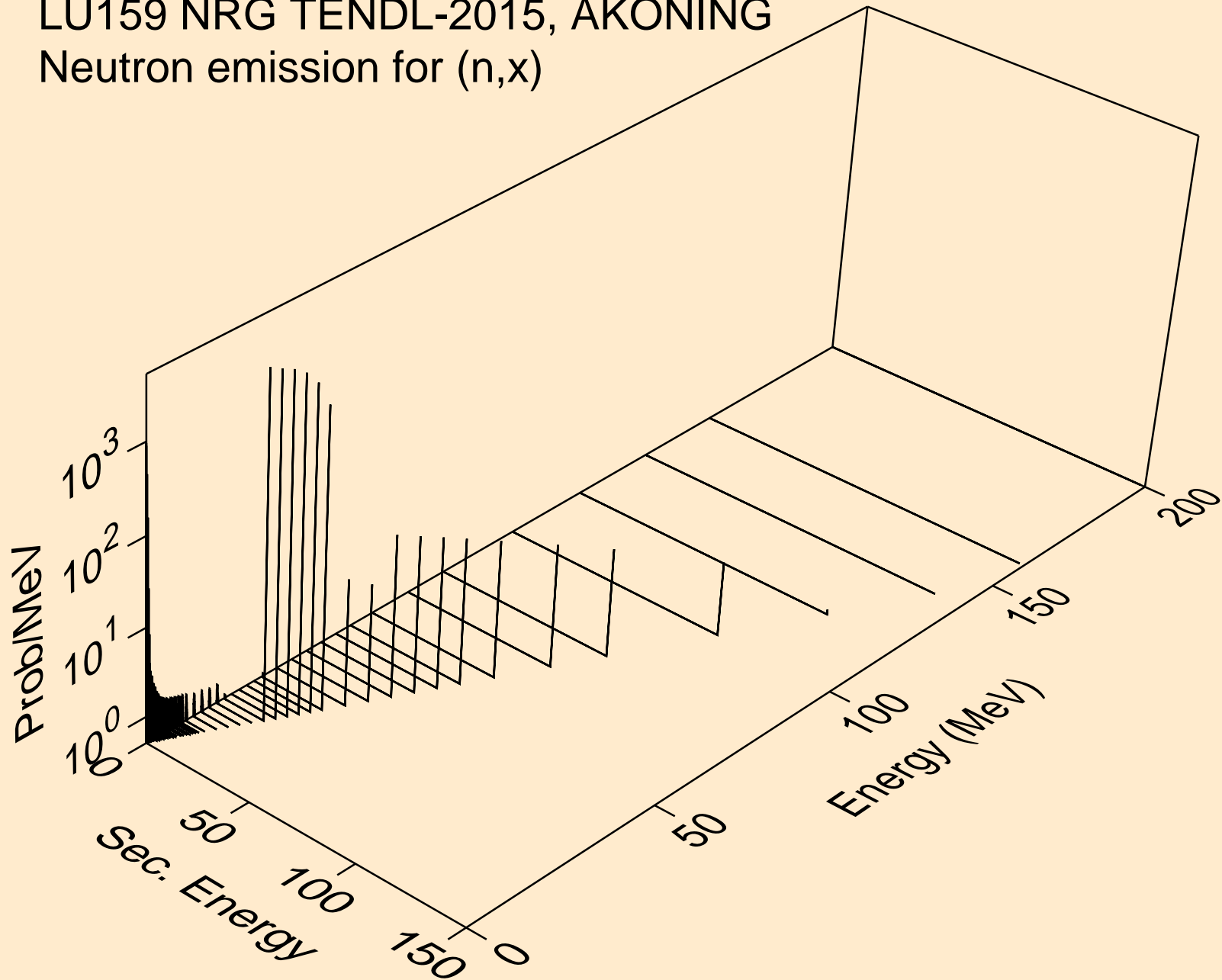

LU159 NRG TENDL-2015, AKONING
Neutron emission for (n,2nd)

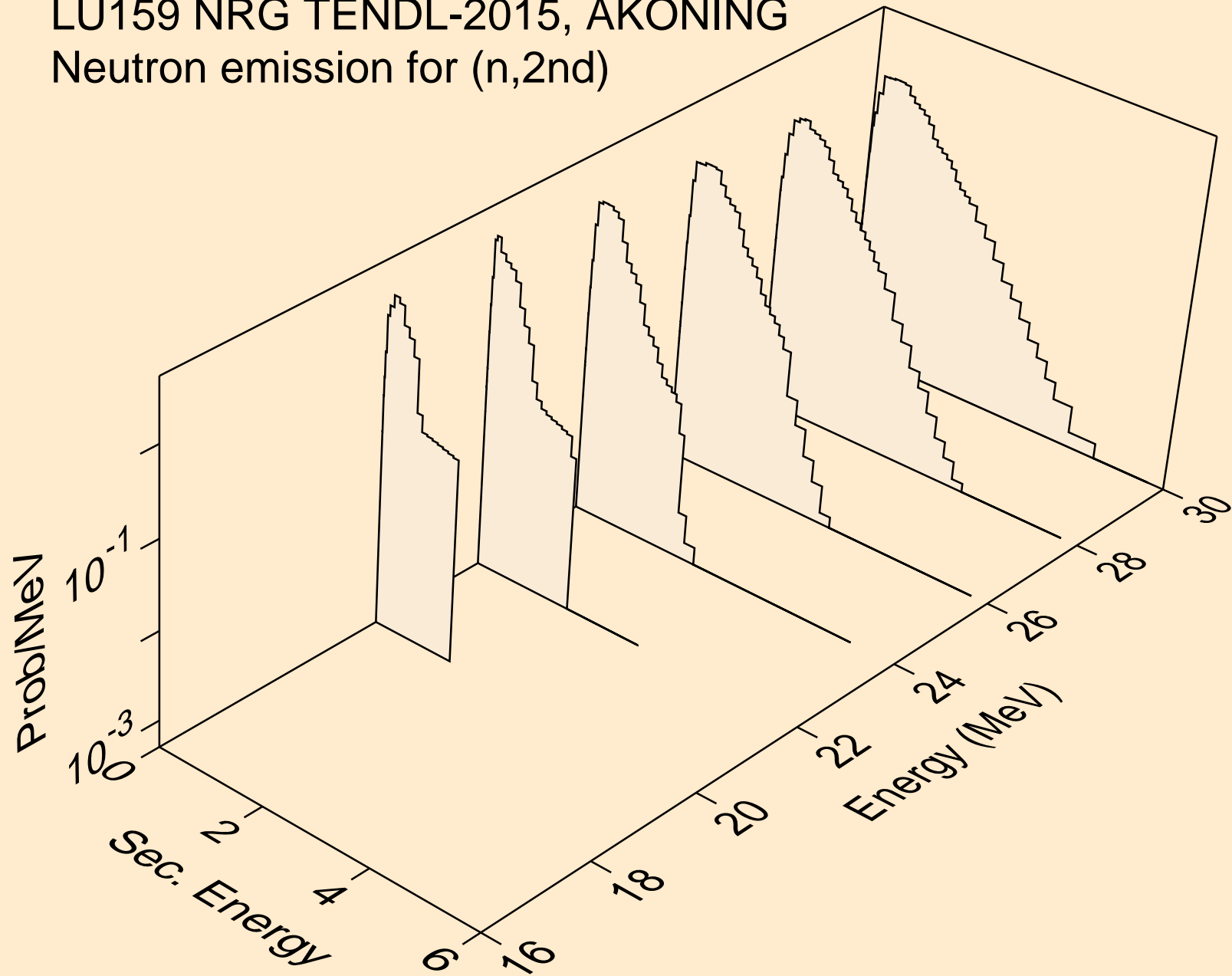

LU159 NRG TENDL-2015, AKONING
Neutron emission for (n,2n)

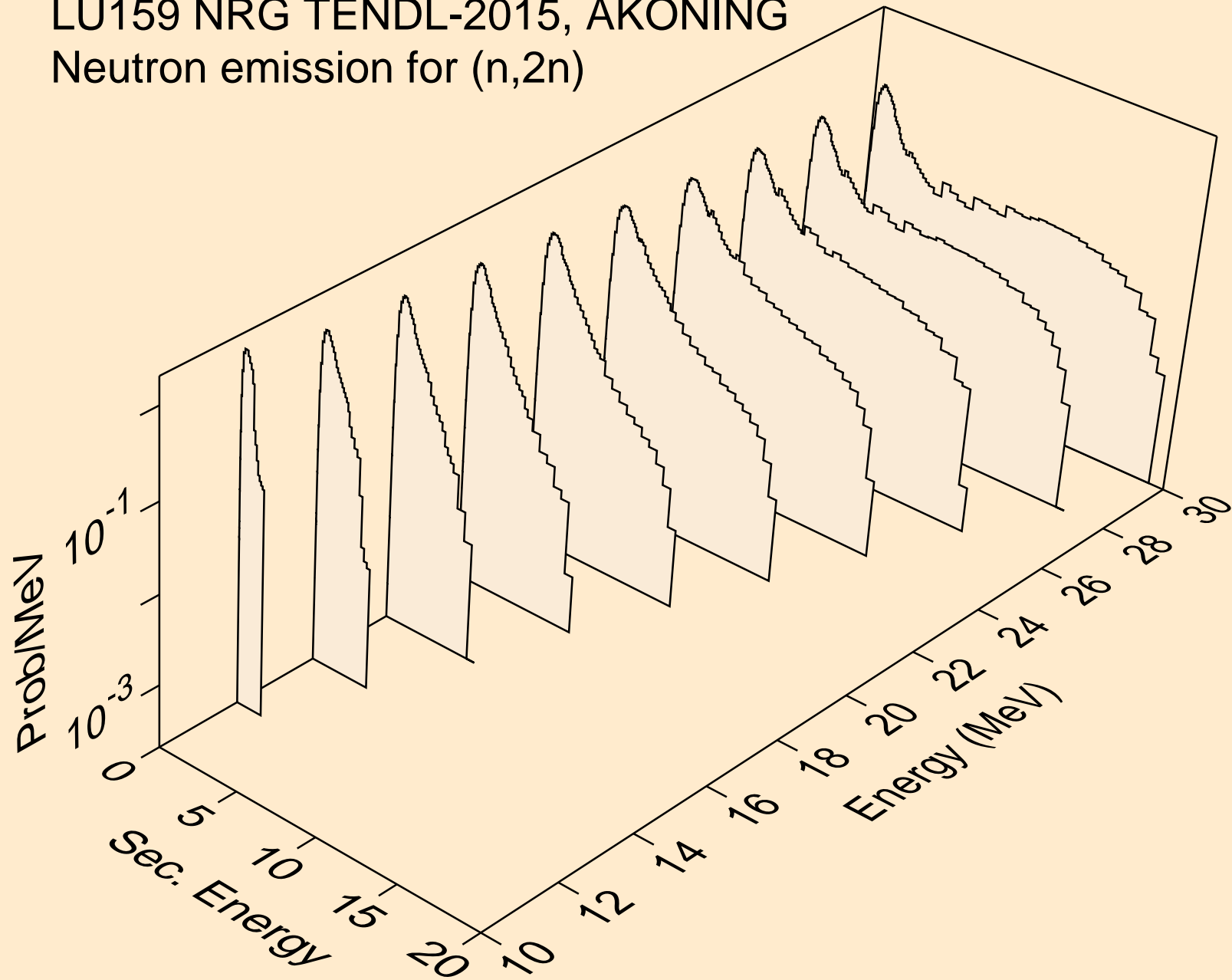

LU159 NRG TENDL-2015, AKONING
Neutron emission for (n,3n)

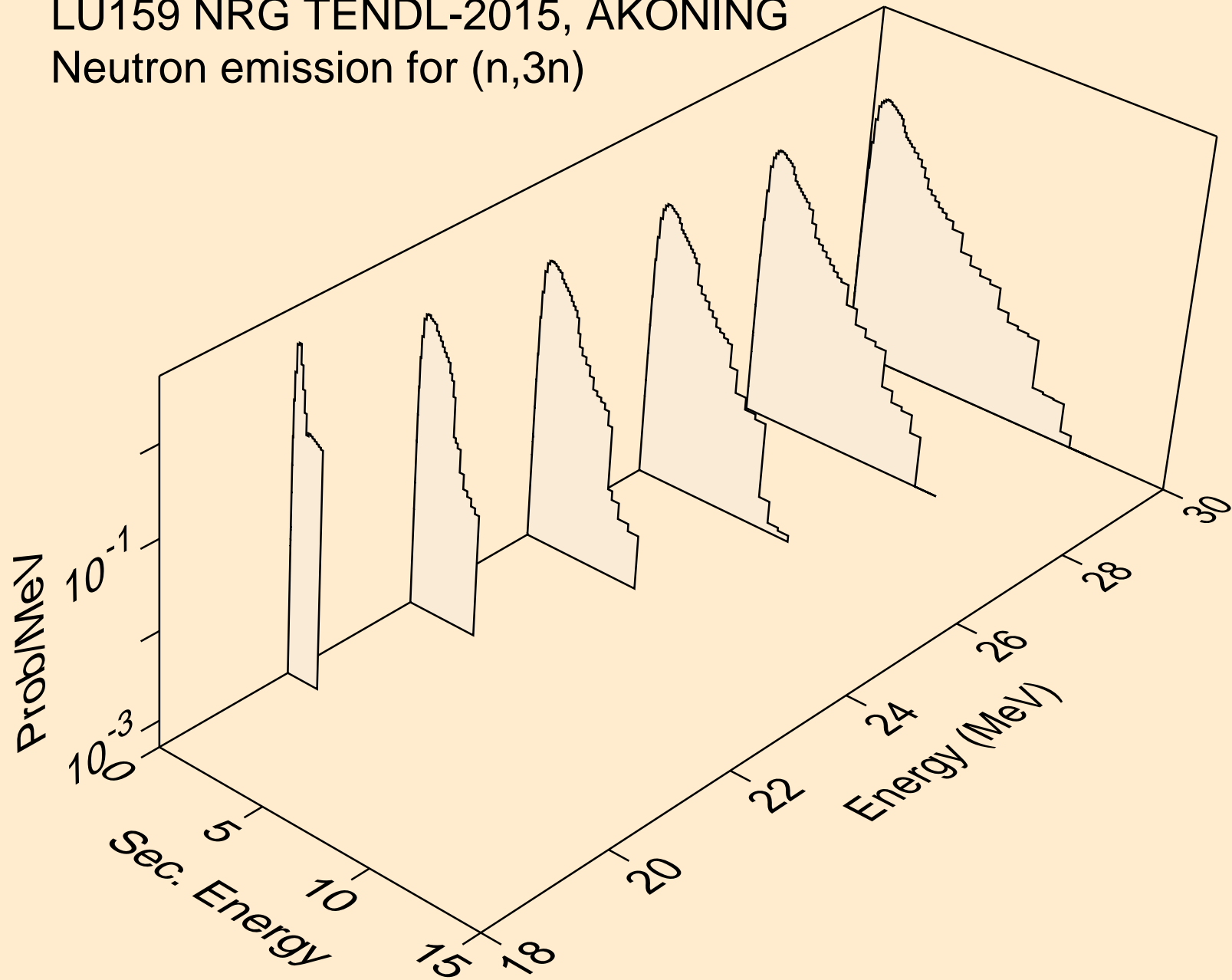

LU159 NRG TENDL-2015, AKONING
Neutron emission for (n,n*)a

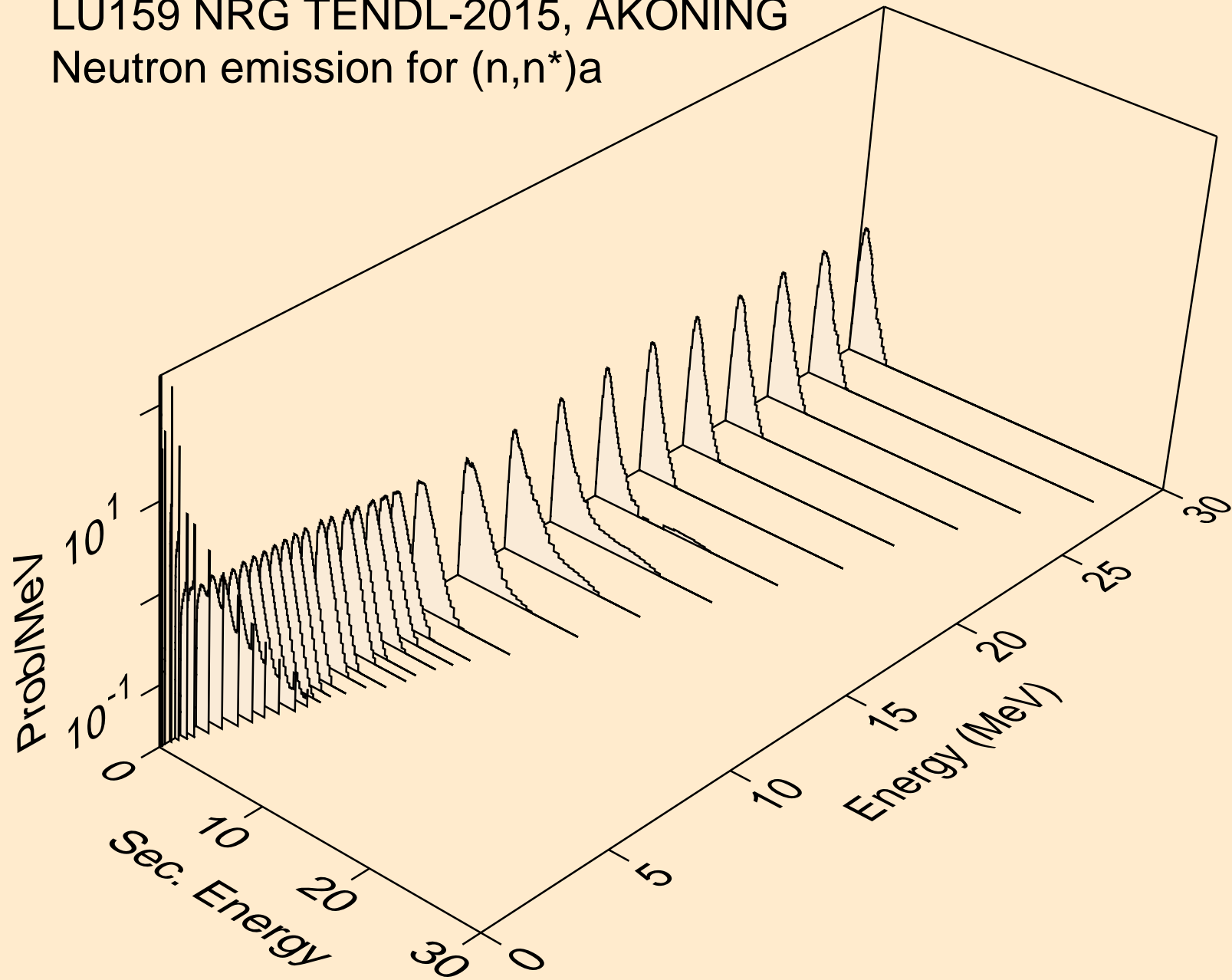

LU159 NRG TENDL-2015, AKONING
Neutron emission for (n,n*)3a

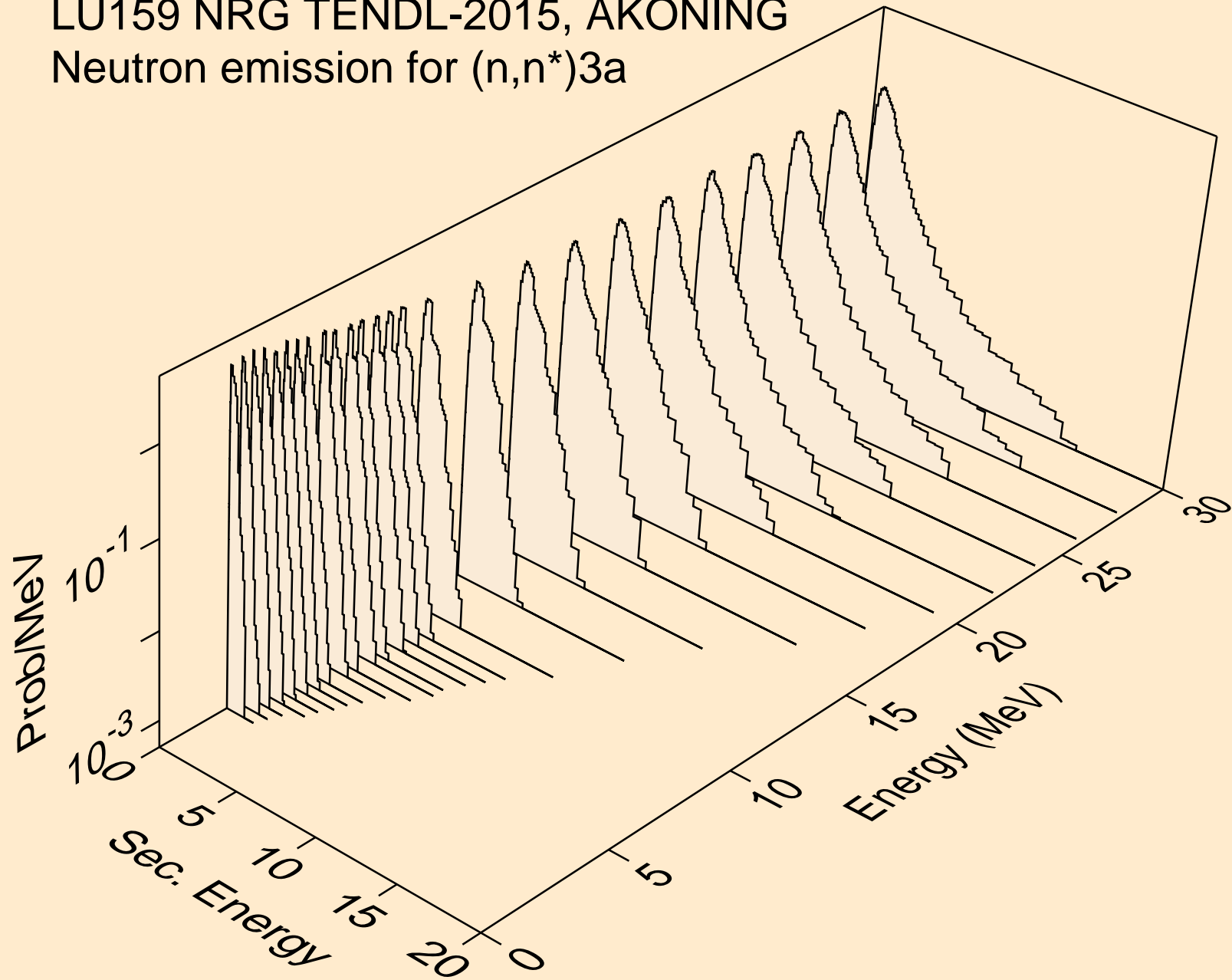

LU159 NRG TENDL-2015, AKONING
Neutron emission for (n,2n)_a

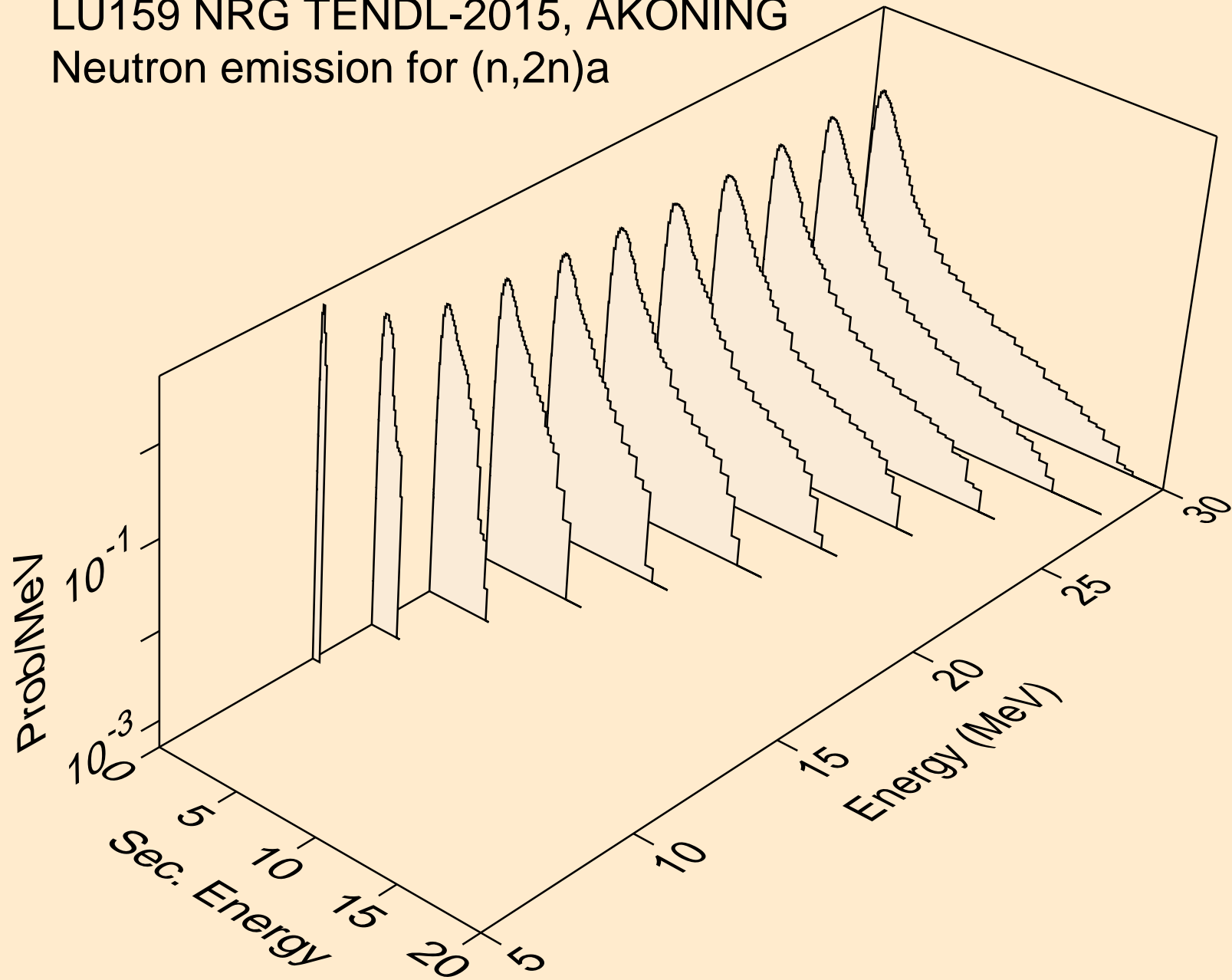

LU159 NRG TENDL-2015, AKONING
Neutron emission for (n,3n)a

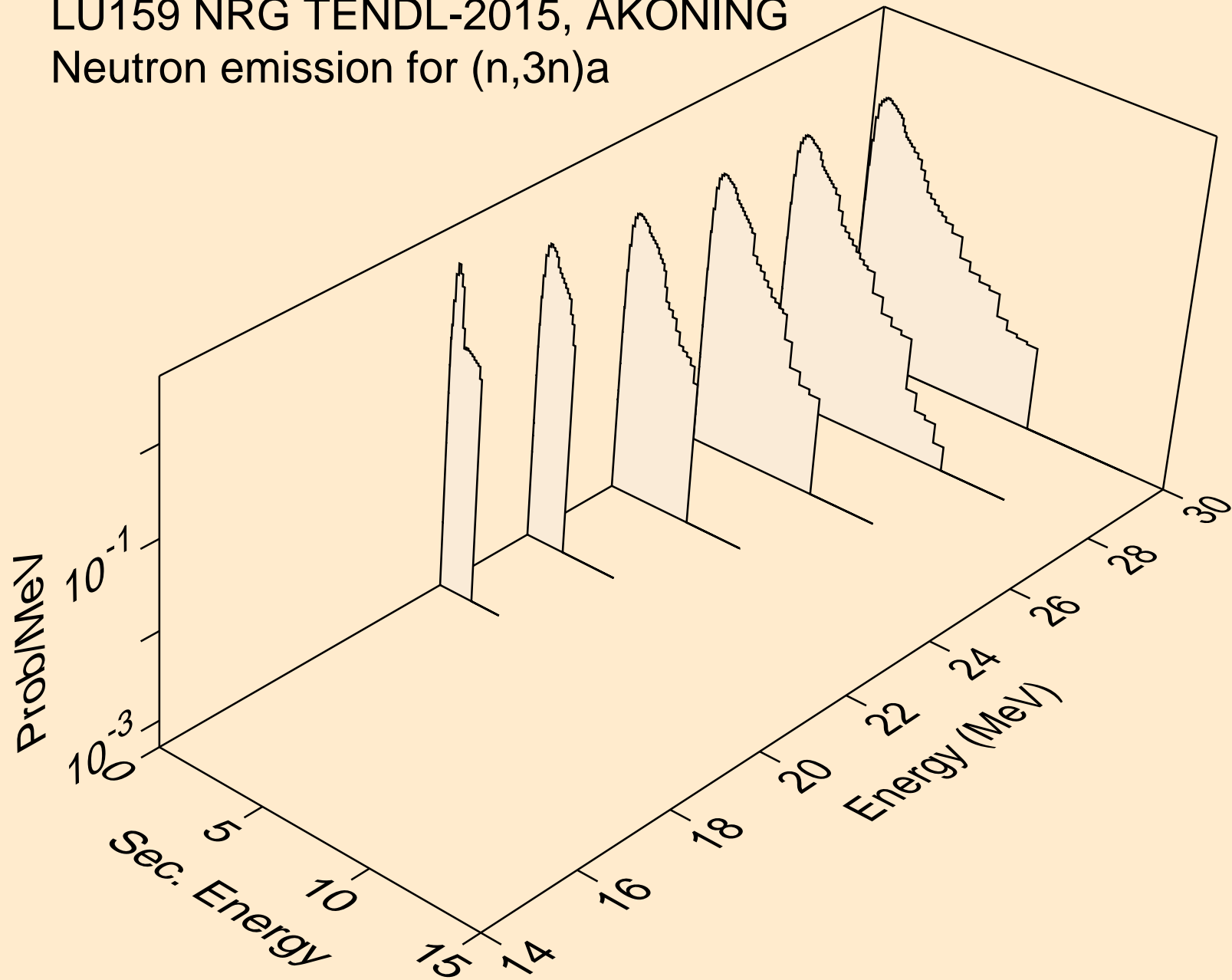

LU159 NRG TENDL-2015, AKONING
Neutron emission for (n,n*)p

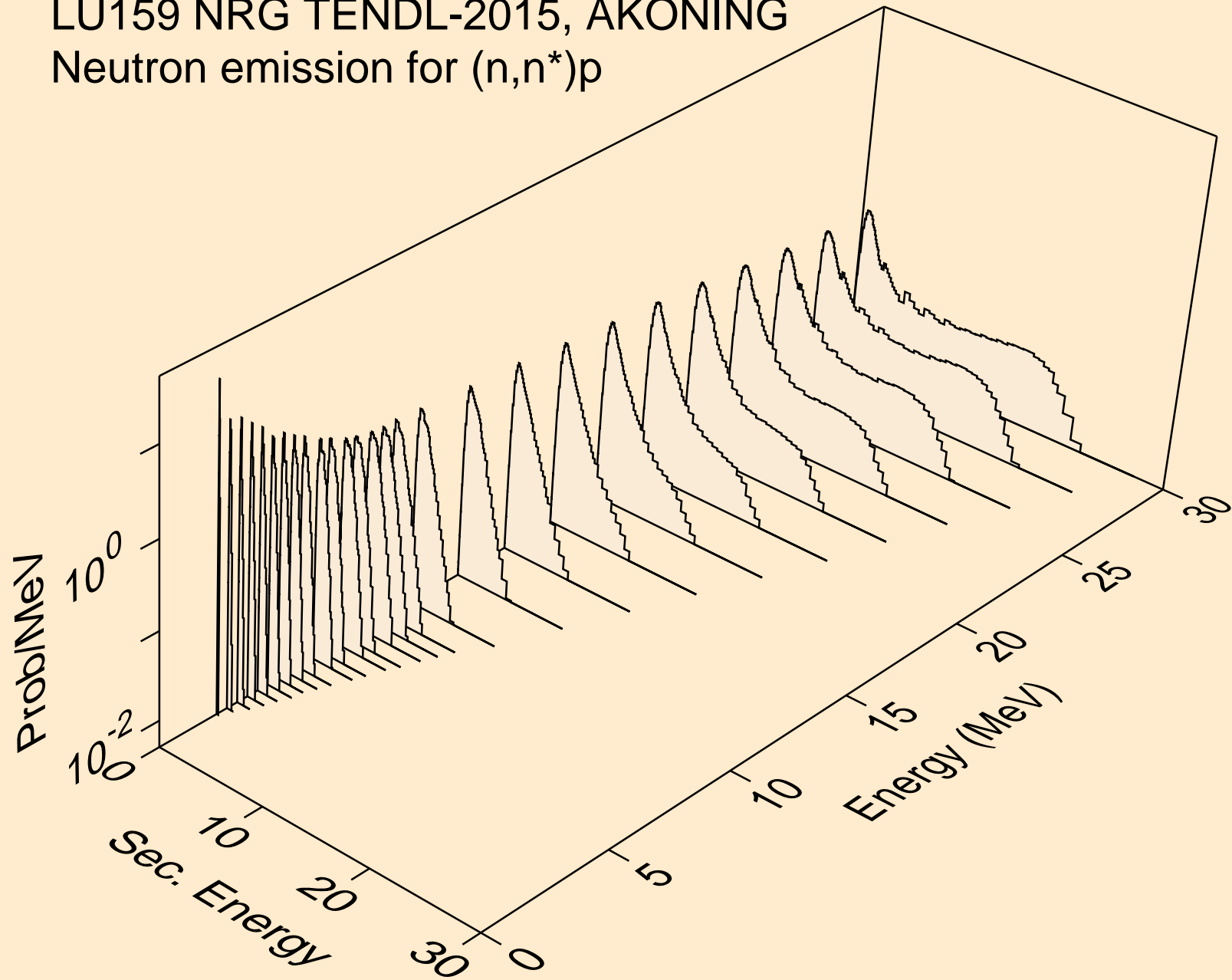

LU159 NRG TENDL-2015, AKONING
Neutron emission for (n,n*)2a

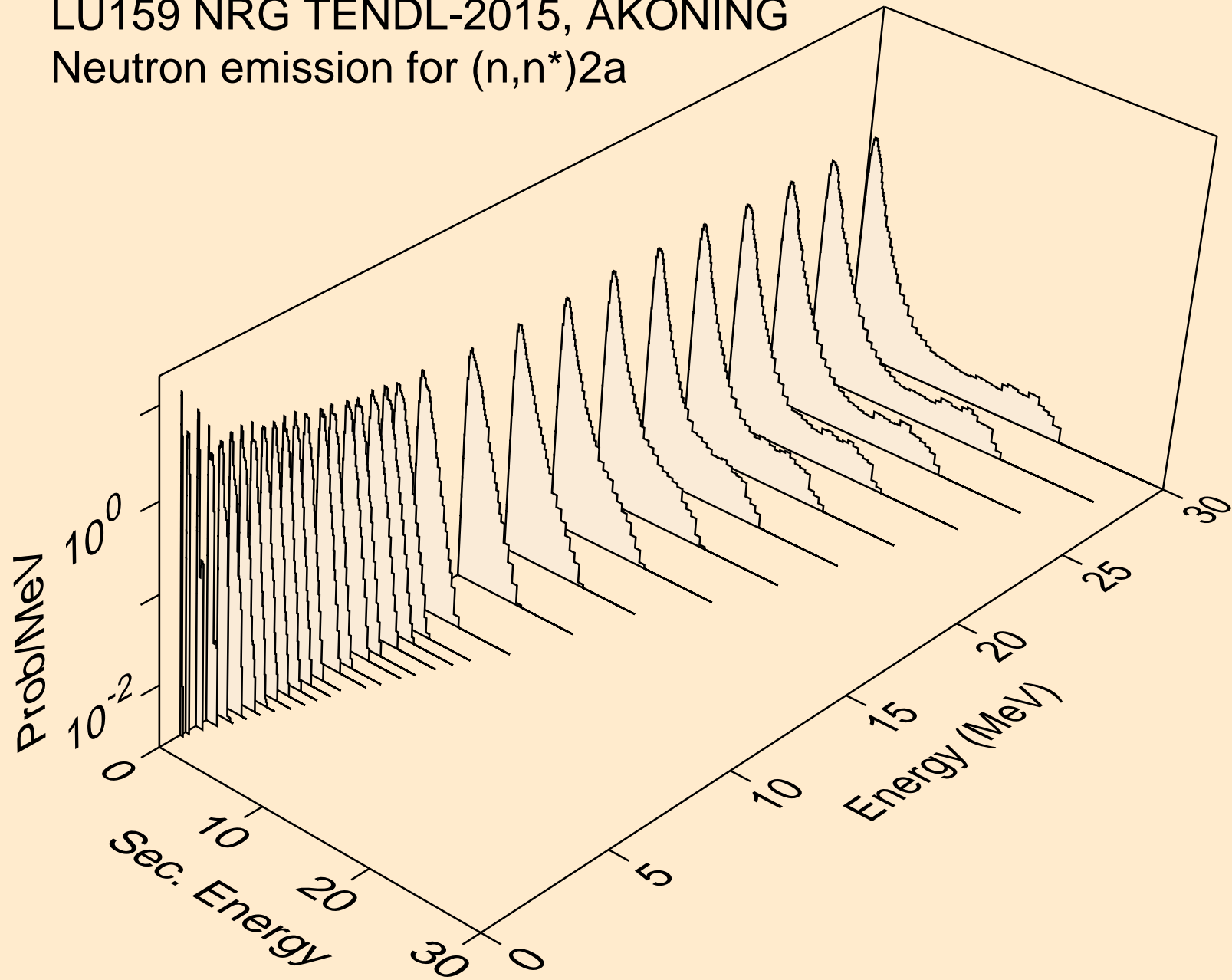

LU159 NRG TENDL-2015, AKONING
Neutron emission for (n,2n)2a

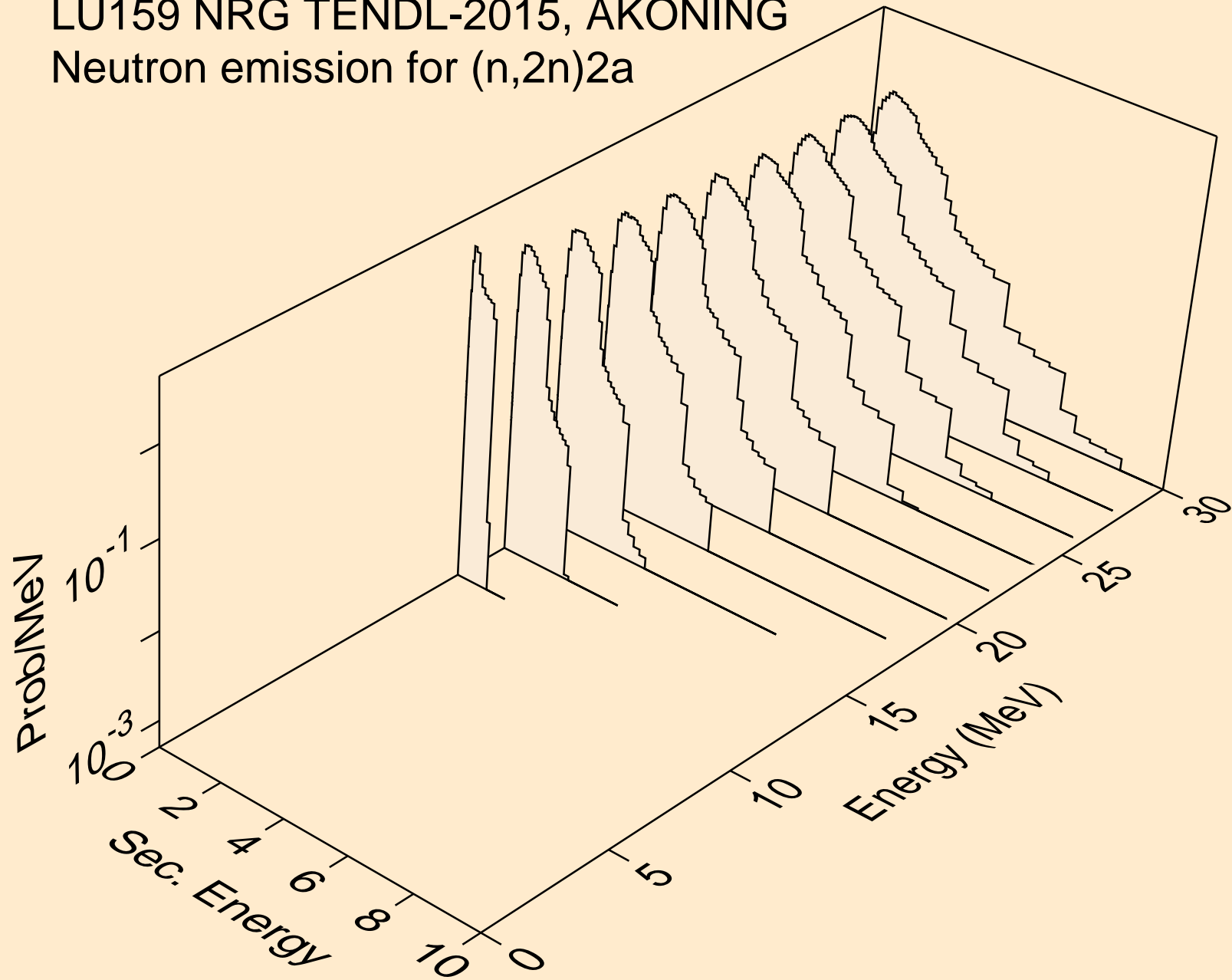

LU159 NRG TENDL-2015, AKONING
Neutron emission for (n,n*)d

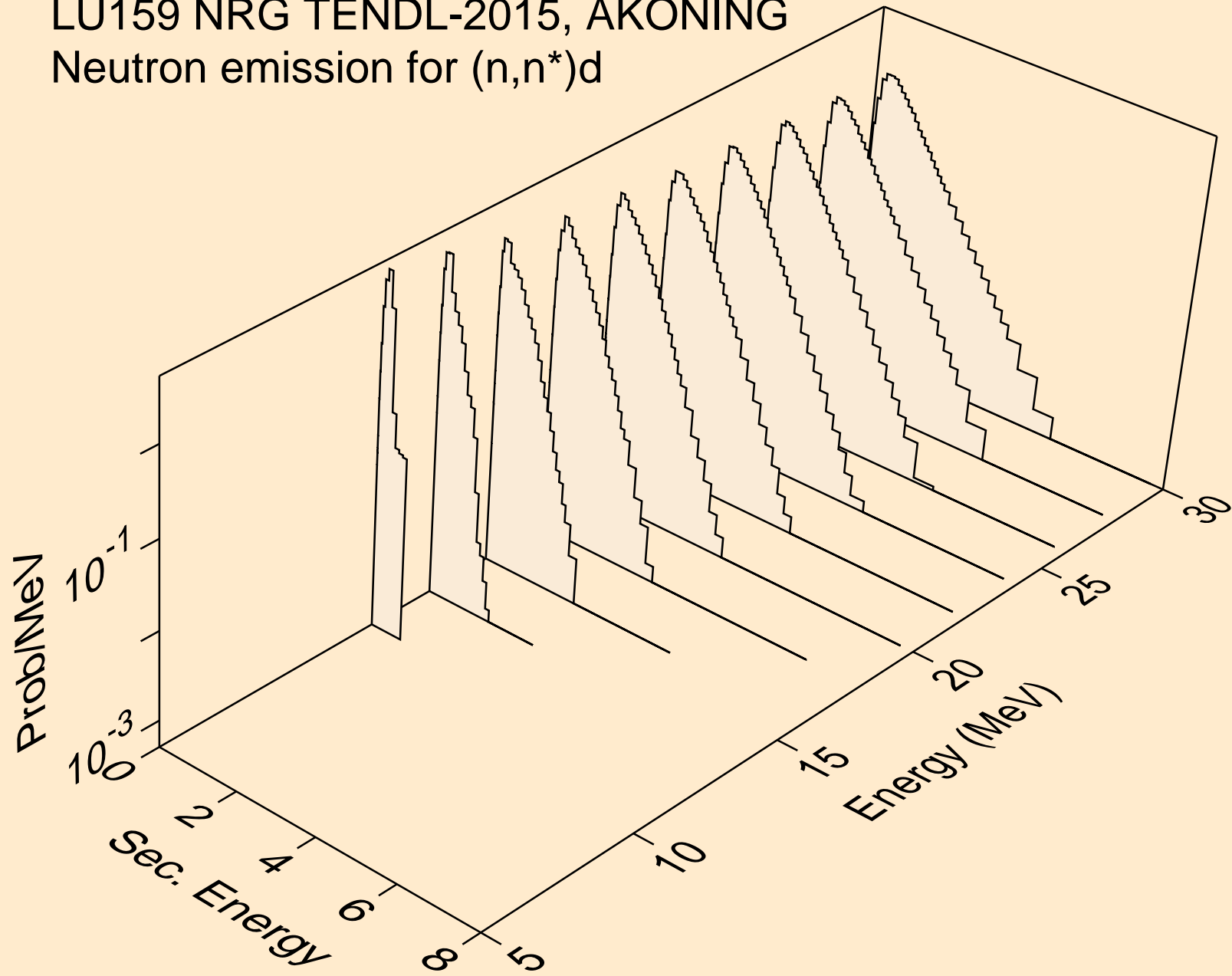

LU159 NRG TENDL-2015, AKONING
Neutron emission for (n,n*)t

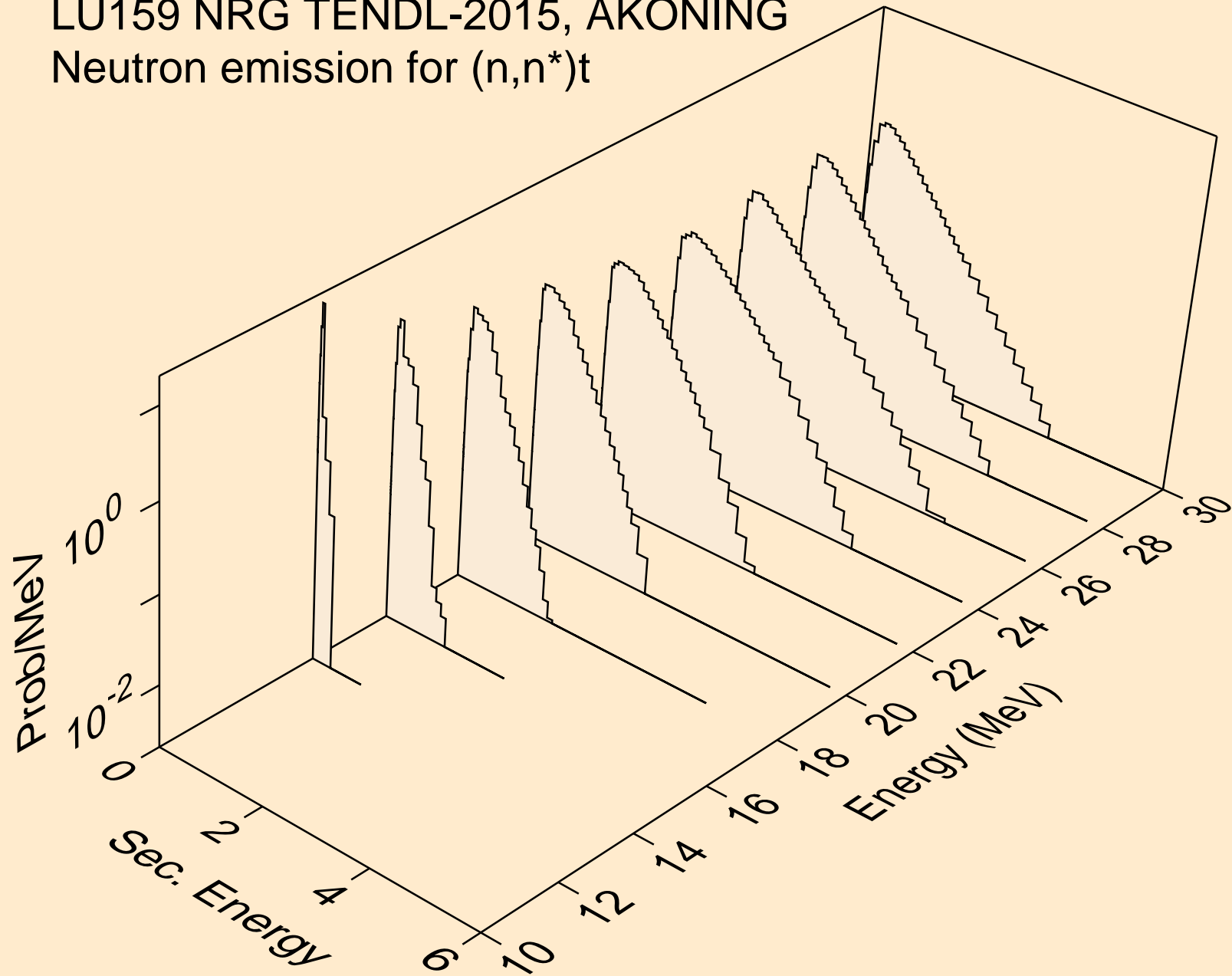

LU159 NRG TENDL-2015, AKONING
Neutron emission for (n,n*)he3

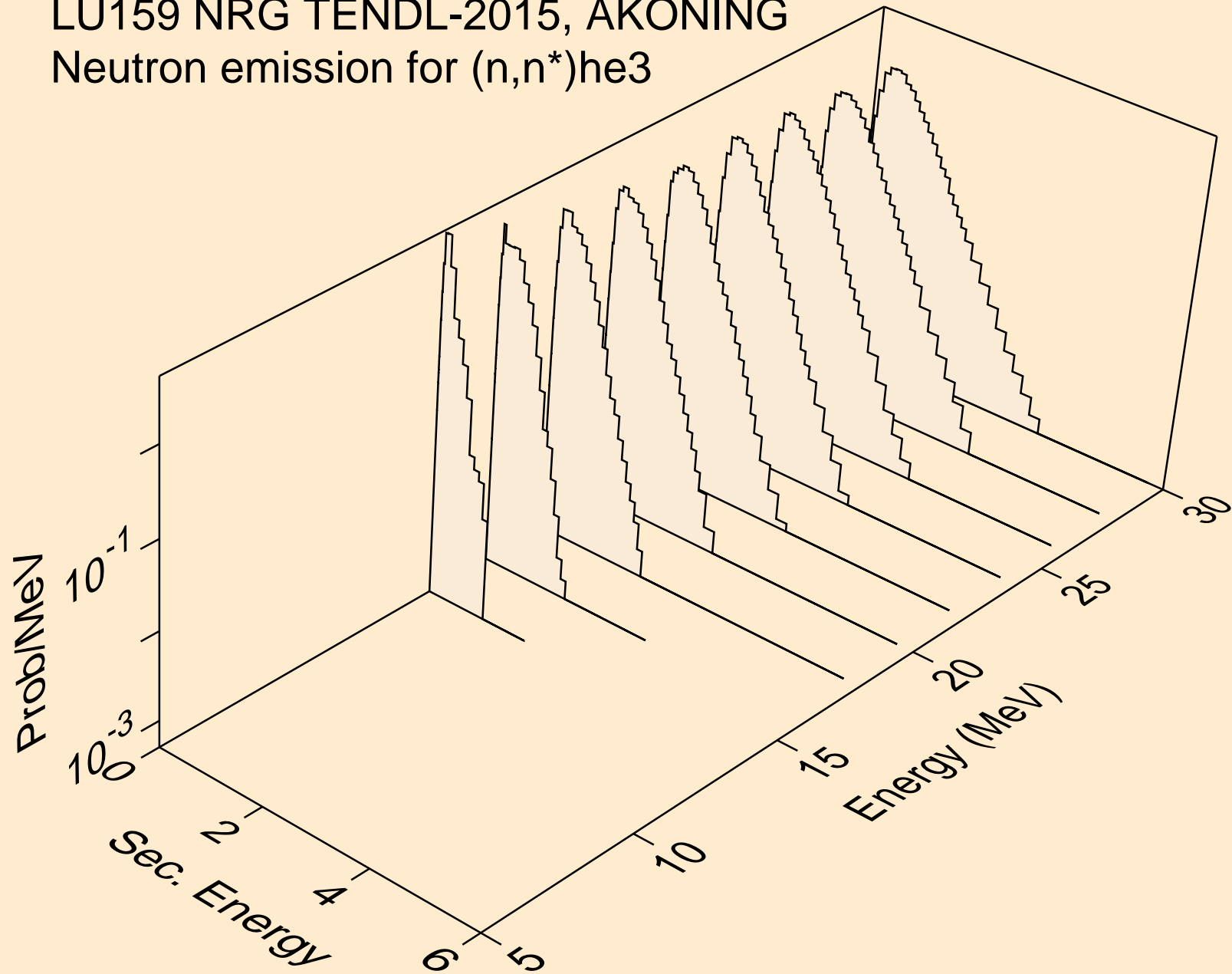

LU159 NRG TENDL-2015, AKONING
Neutron emission for (n,n*)d2a

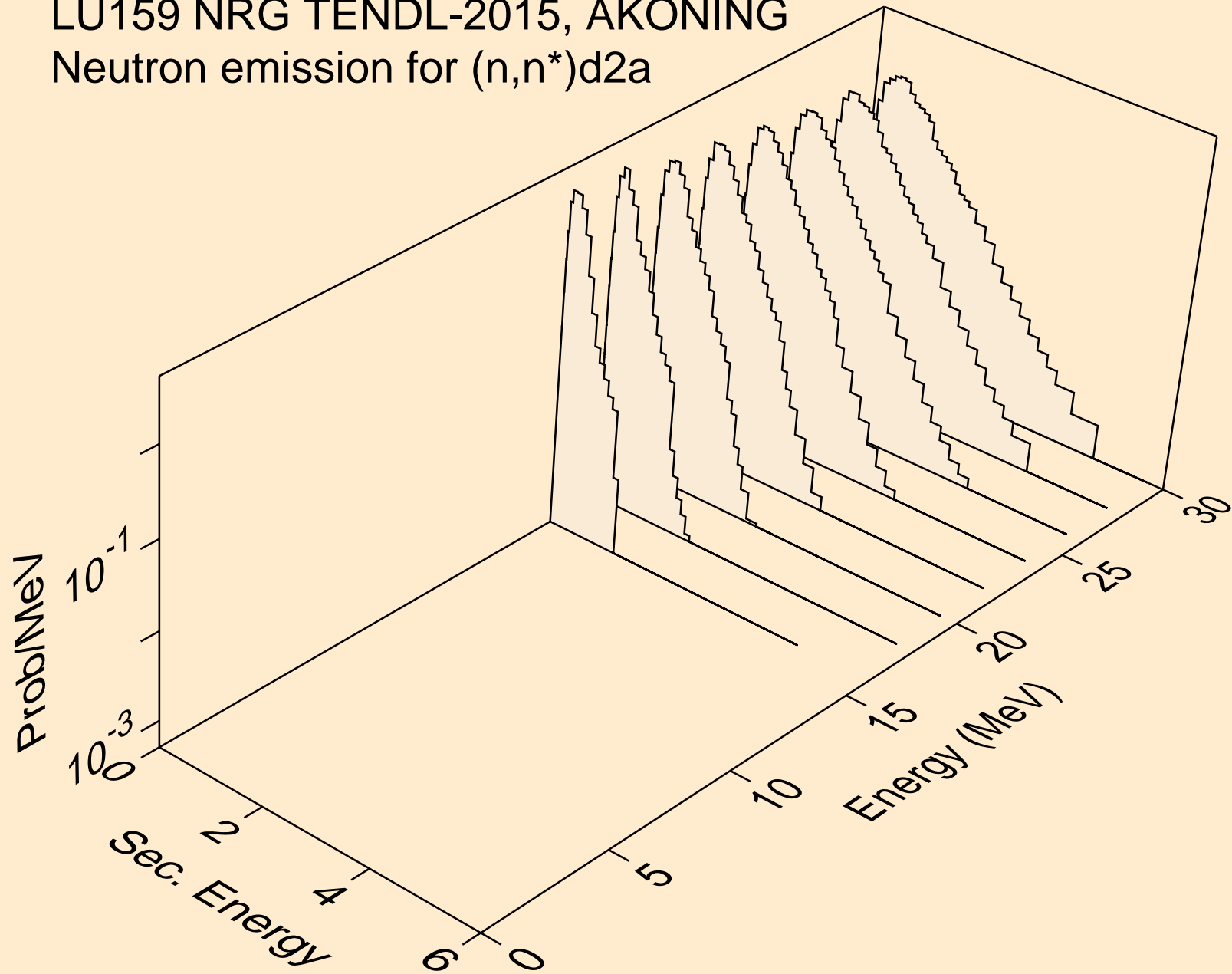

LU159 NRG TENDL-2015, AKONING
Neutron emission for (n,n*)t2a

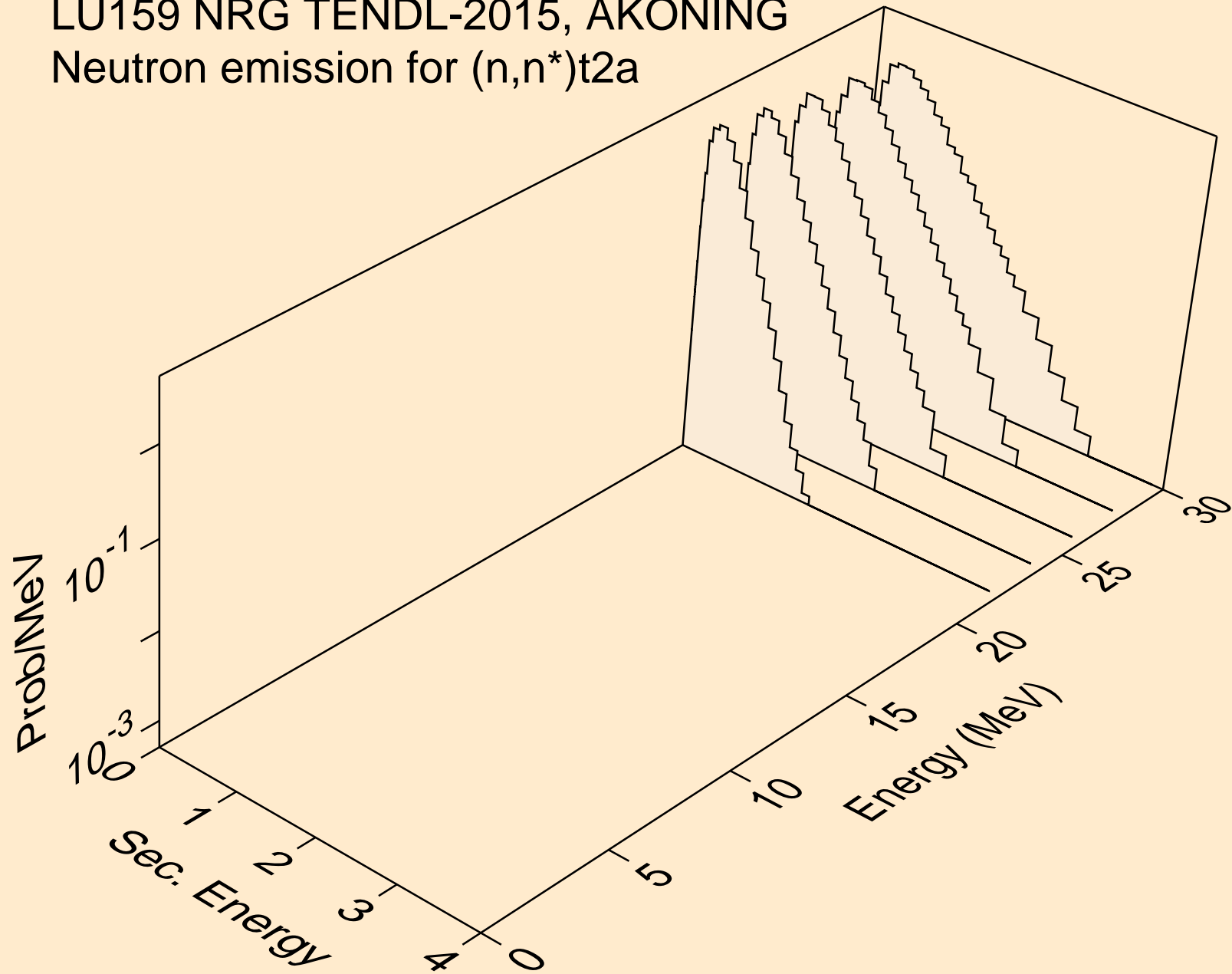

LU159 NRG TENDL-2015, AKONING
Neutron emission for (n,2np)

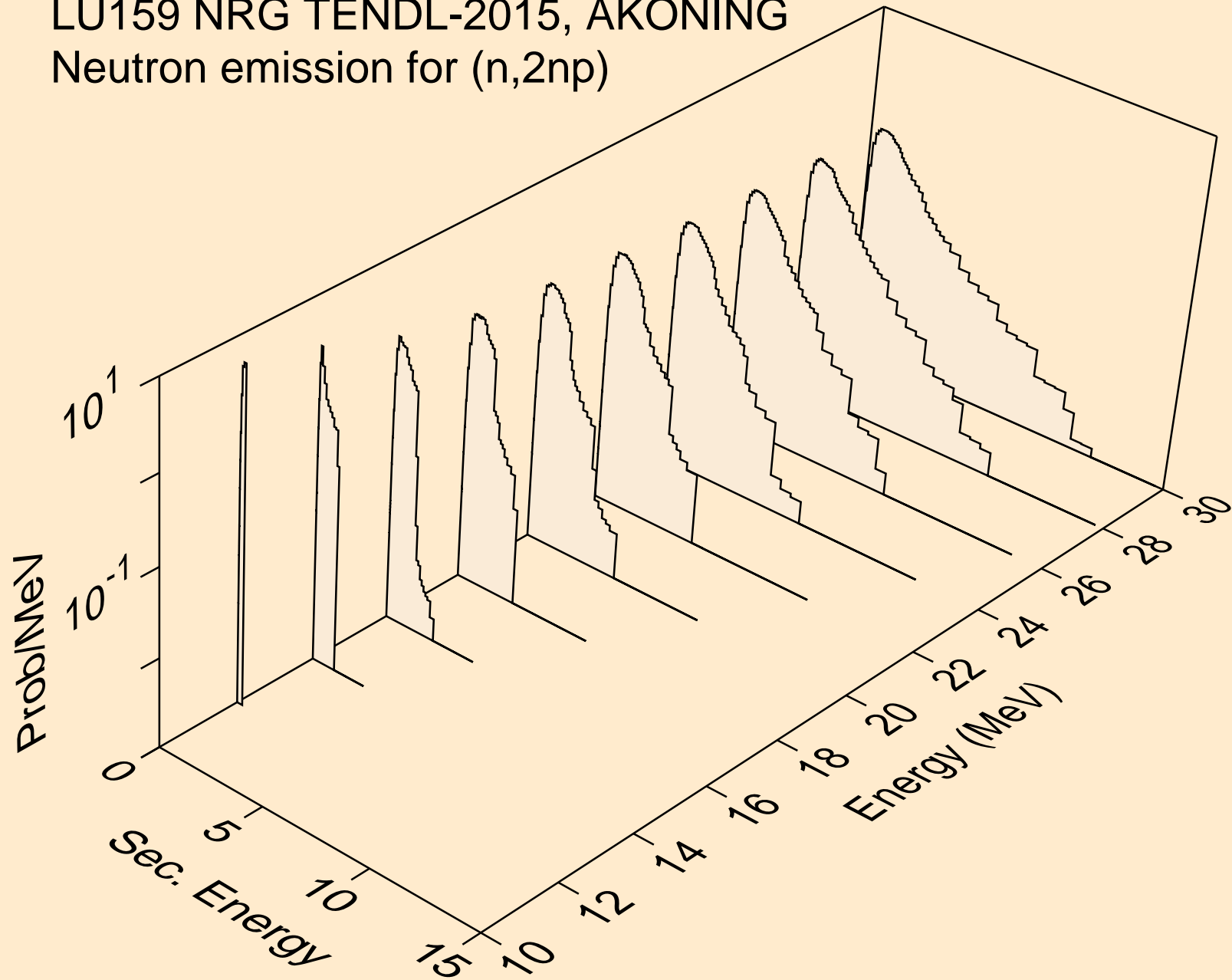

LU159 NRG TENDL-2015, AKONING
Neutron emission for (n,3np)

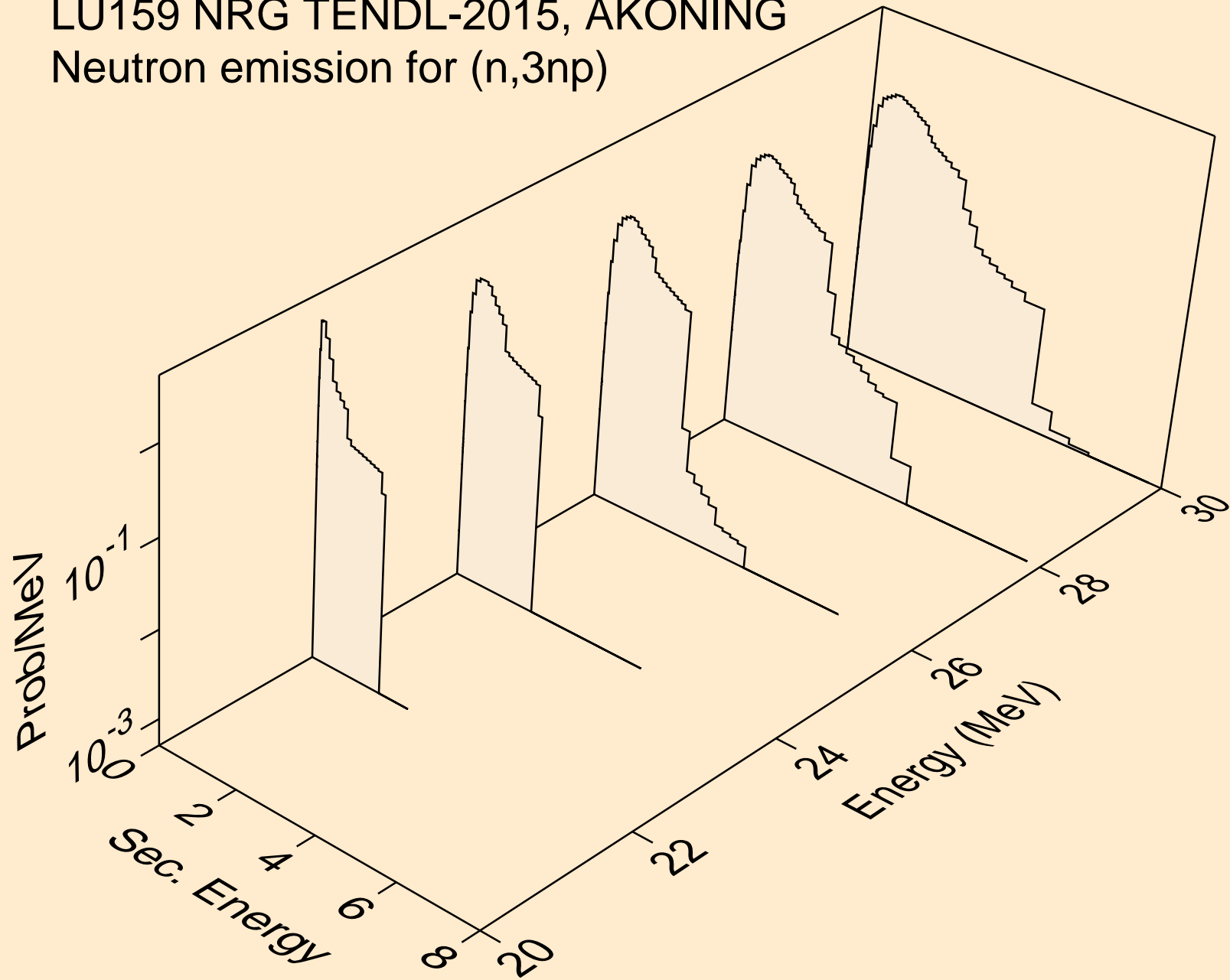

LU159 NRG TENDL-2015, AKONING
Neutron emission for (n,2np)

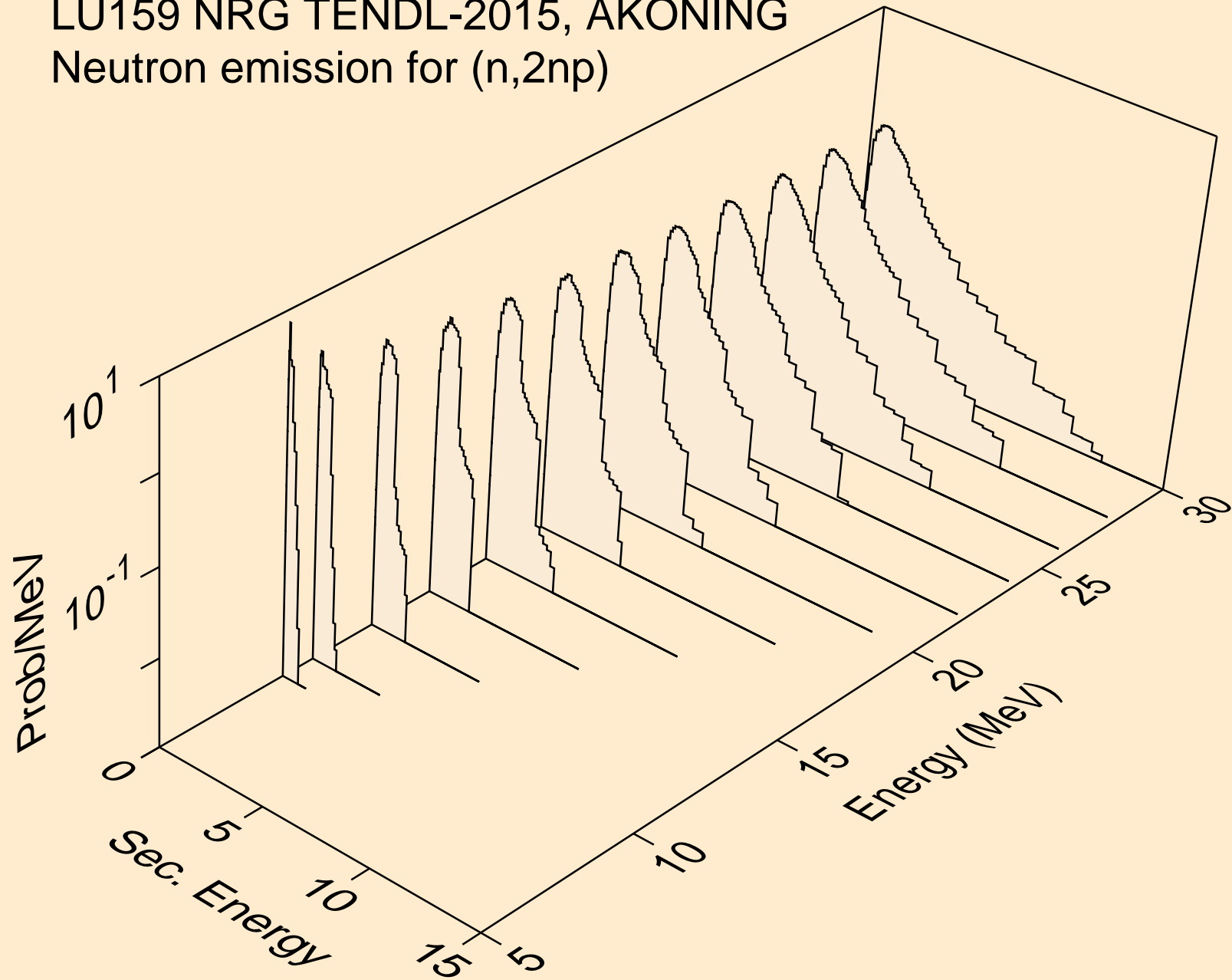

LU159 NRG TENDL-2015, AKONING
Neutron emission for (n,npa)

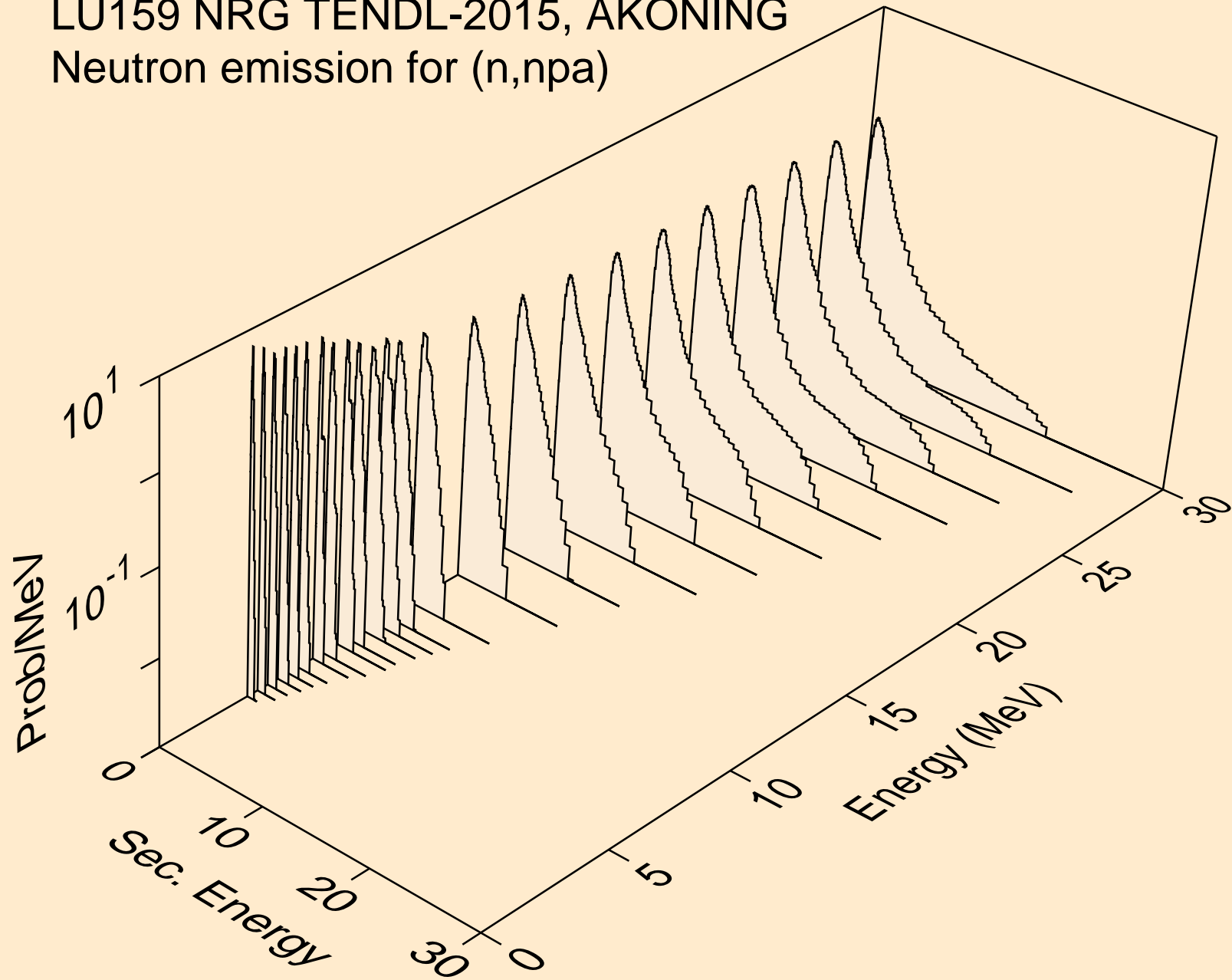

LU159 NRG TENDL-2015, AKONING
Neutron emission for (n,n*c)

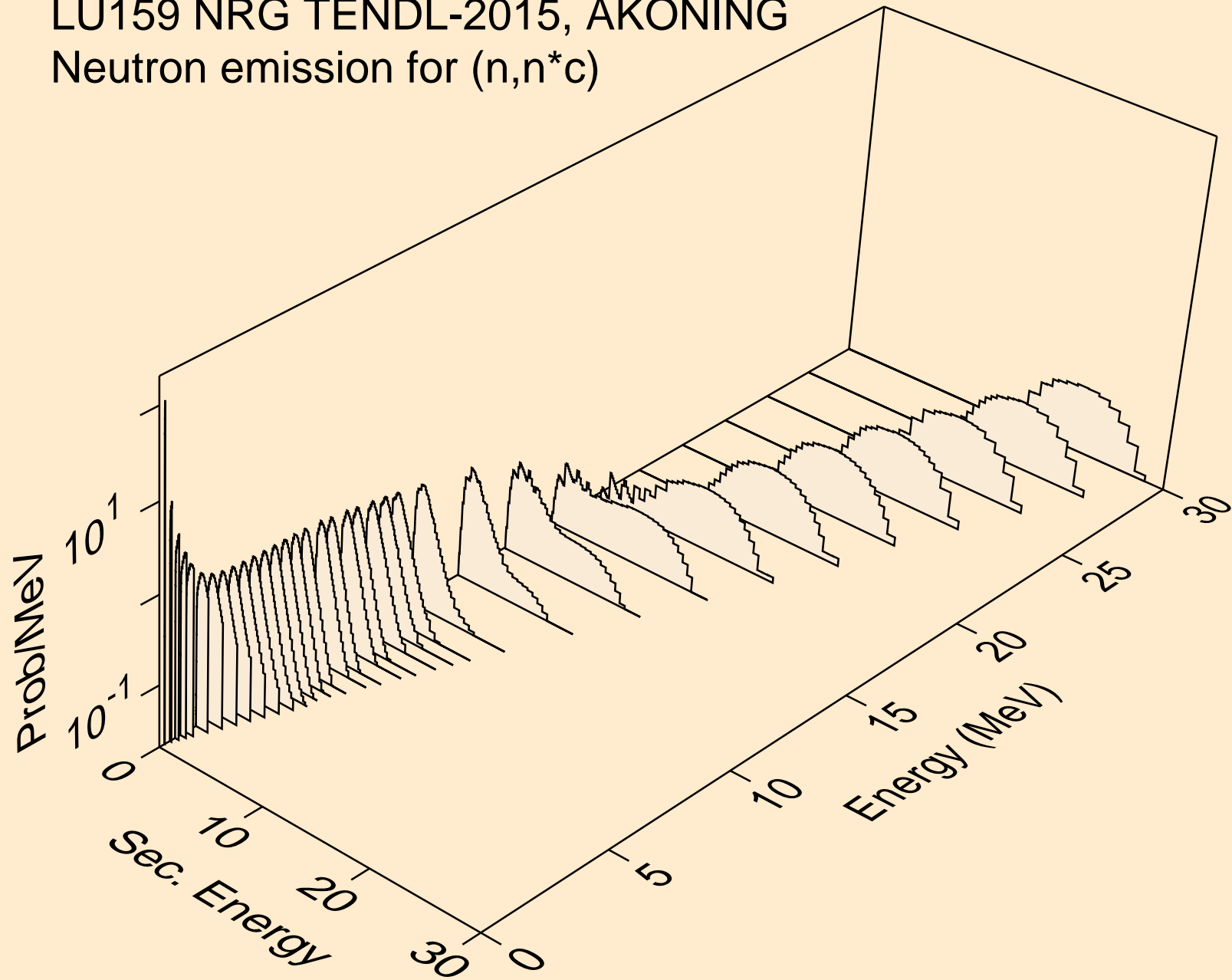

LU159 NRG TENDL-2015, AKONING
Photon emission for (n,x)

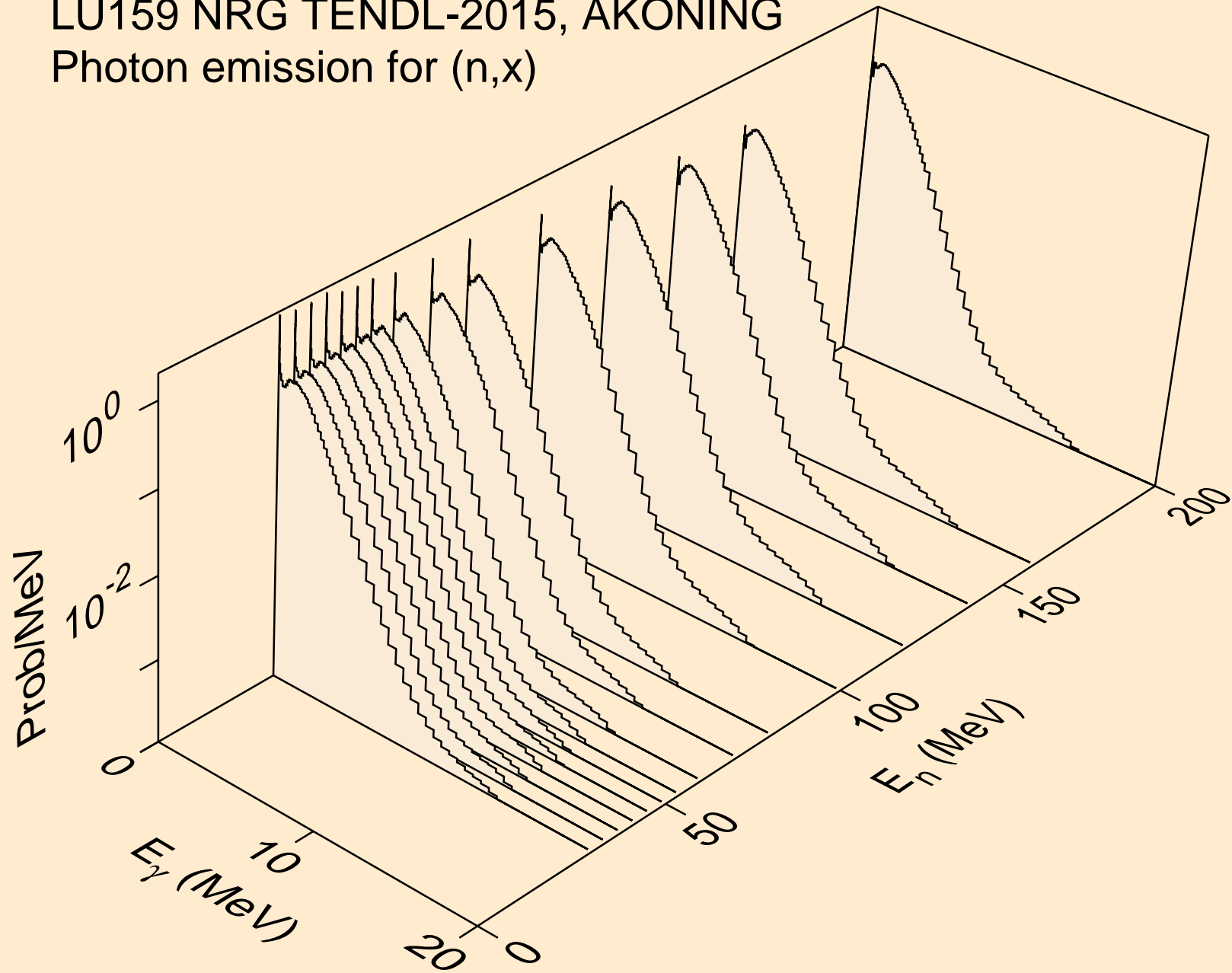

LU159 NRG TENDL-2015, AKONING
Photon emission for (n,2nd)

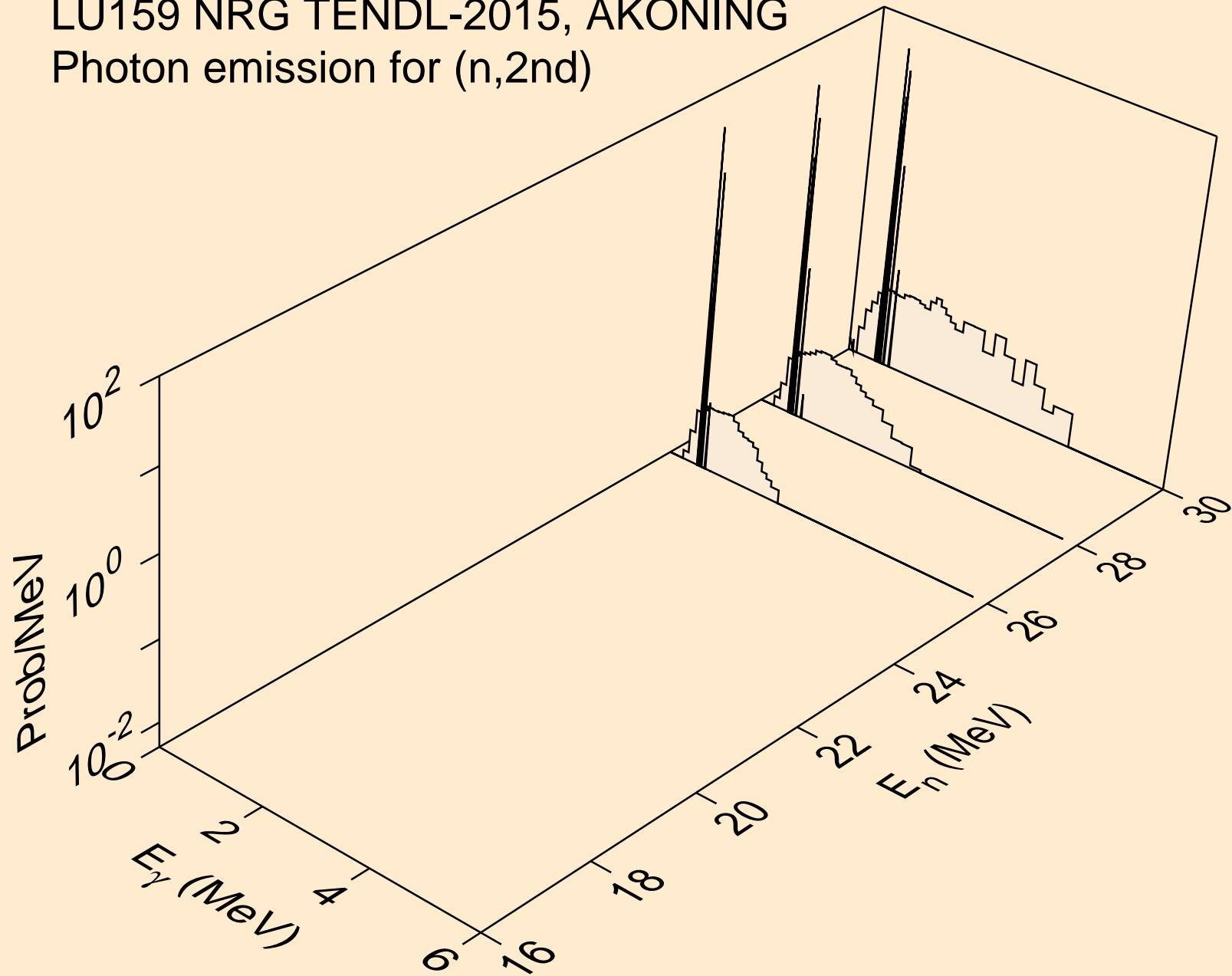

LU159 NRG TENDL-2015, AKONING
Photon emission for (n,2n)

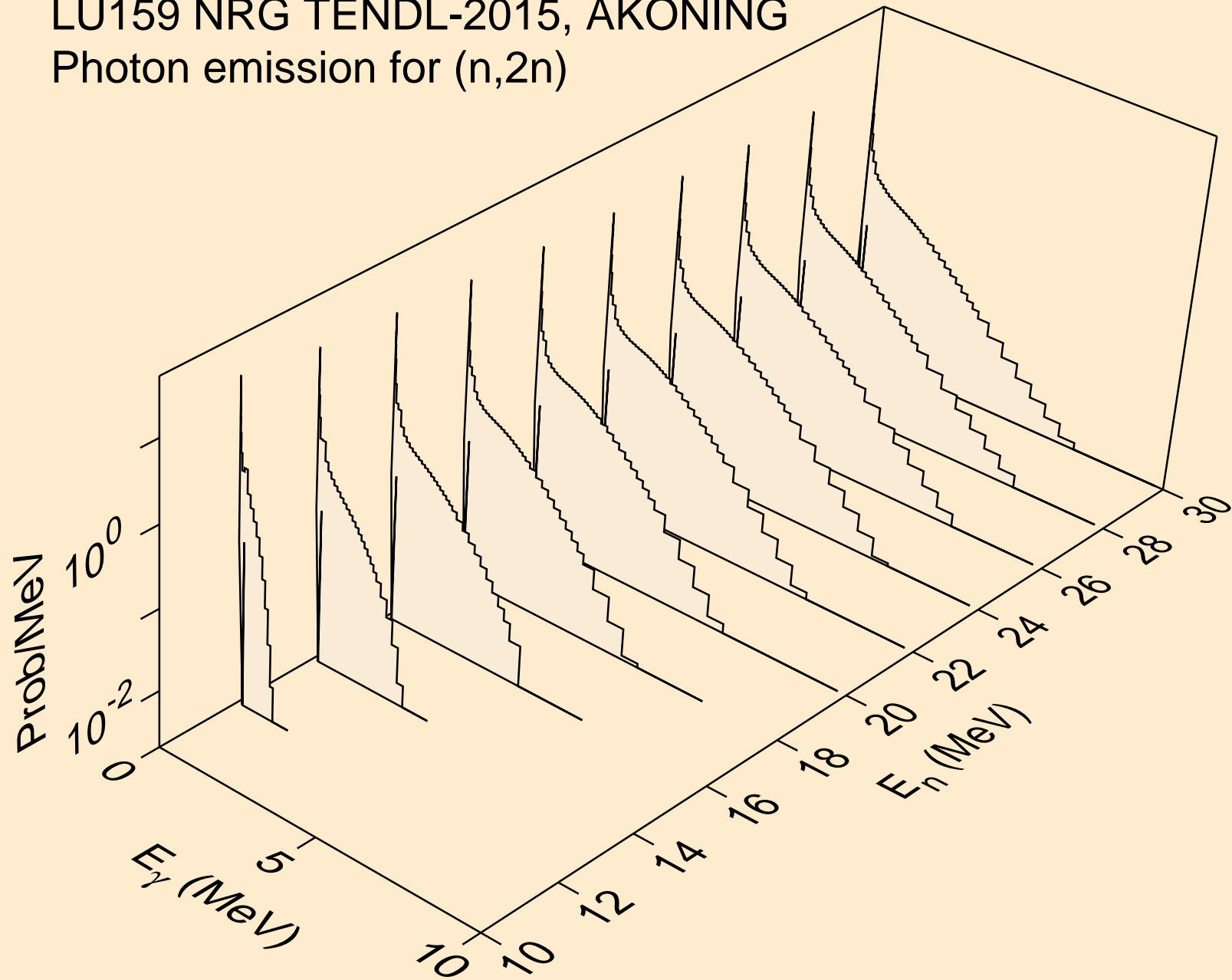

LU159 NRG TENDL-2015, AKONING
Photon emission for (n,3n)

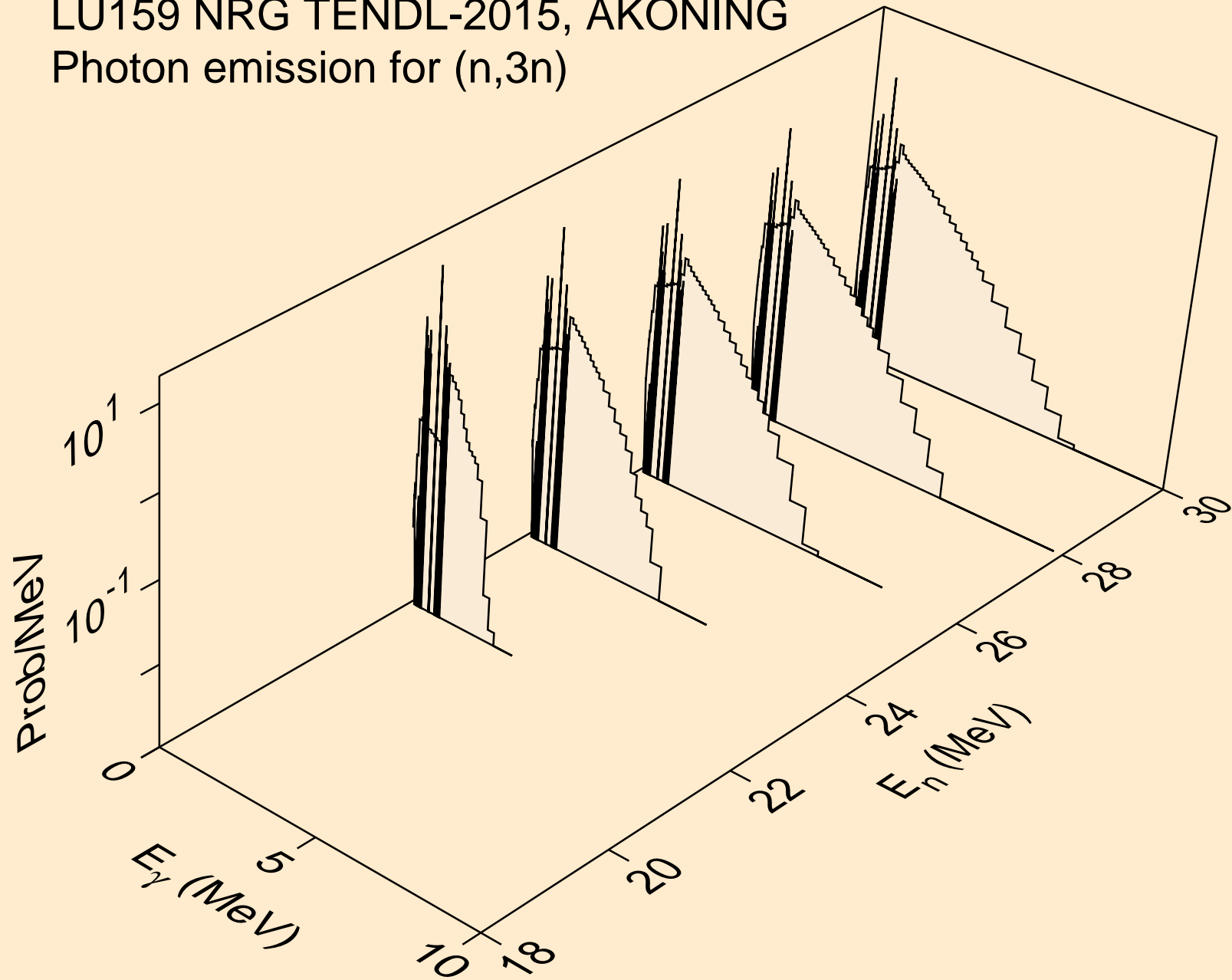

LU159 NRG TENDL-2015, AKONING
Photon emission for (n,n*)a

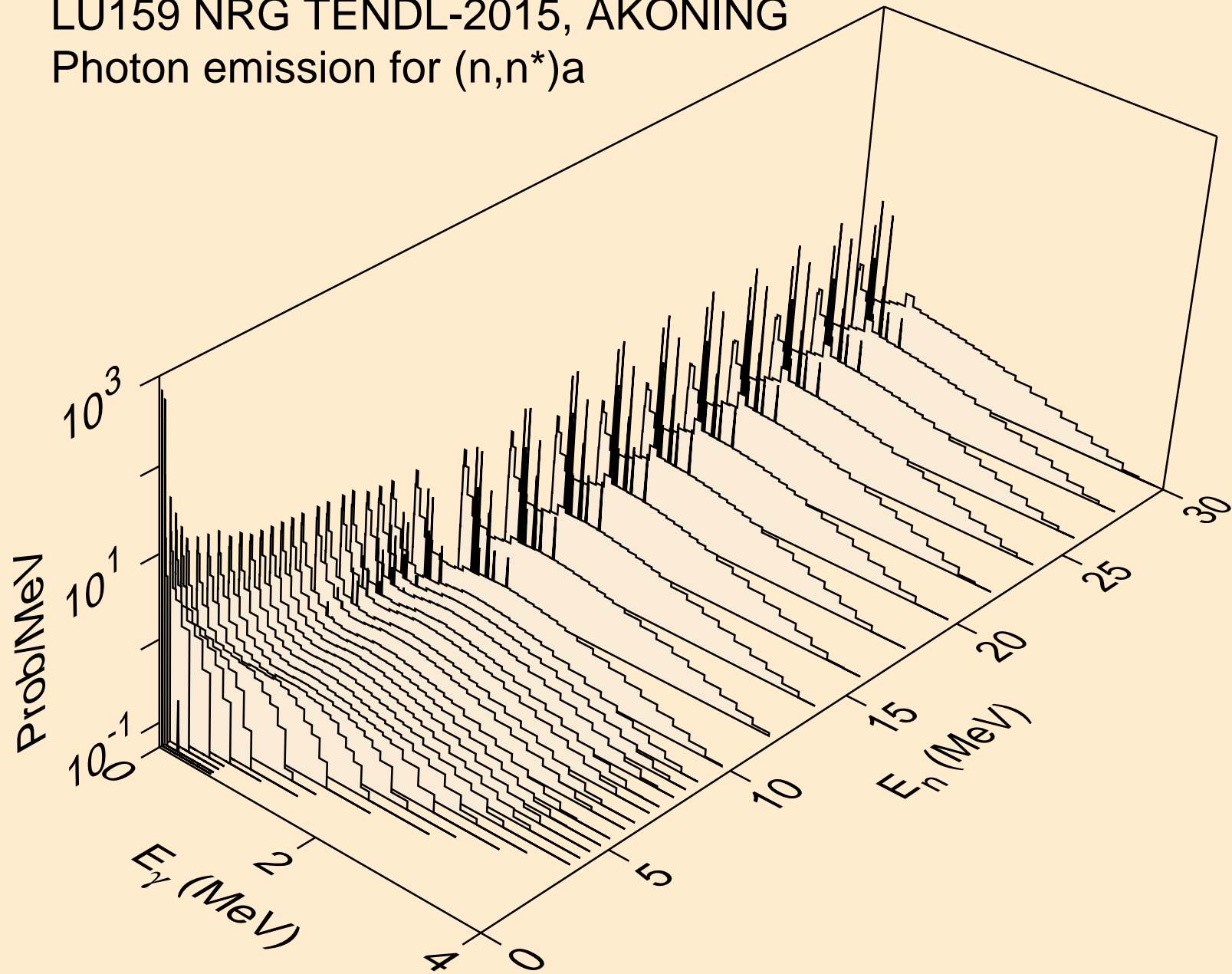

LU159 NRG TENDL-2015, AKONING
Photon emission for (n,n*)3a

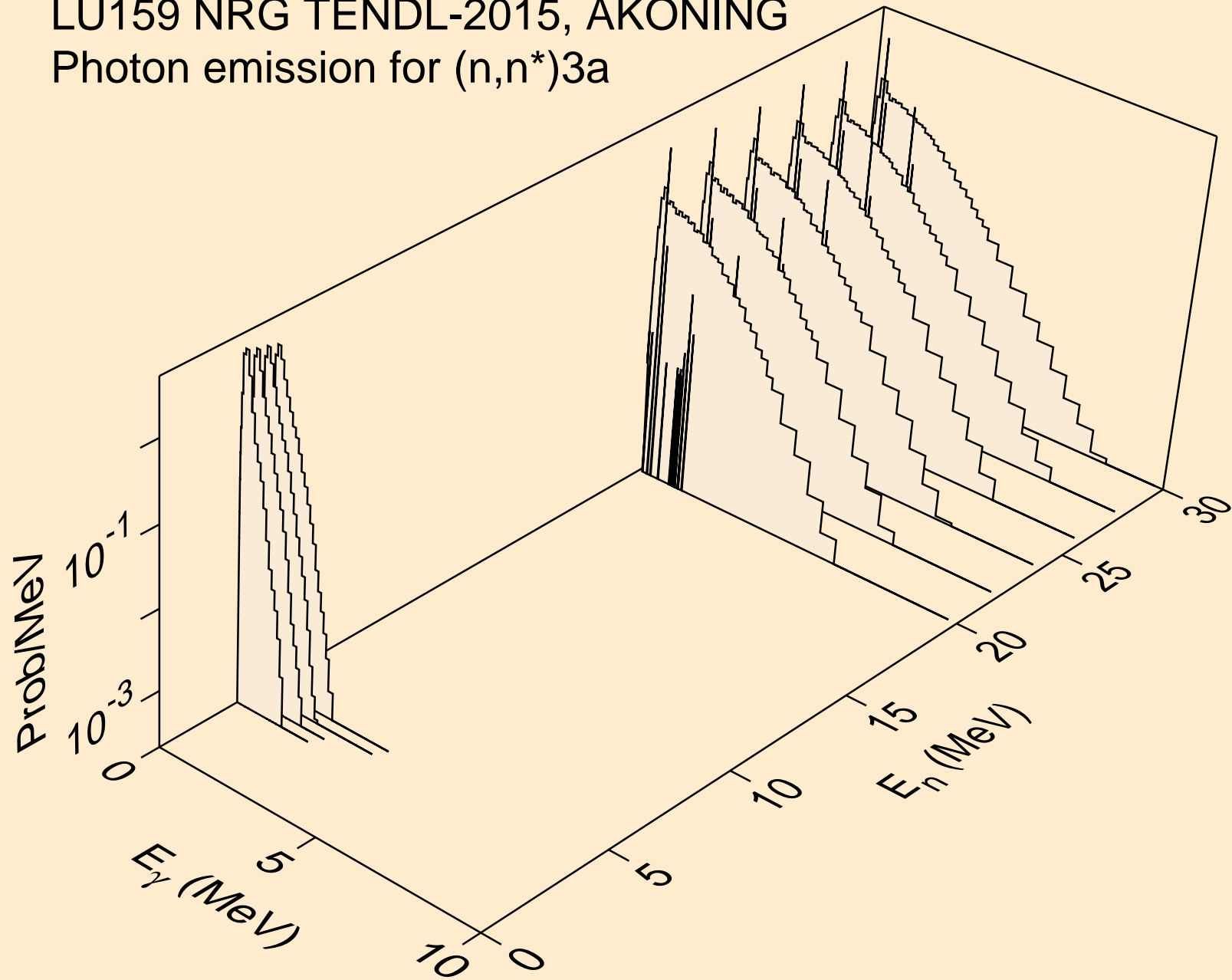

LU159 NRG TENDL-2015, AKONING
Photon emission for (n,2n)a

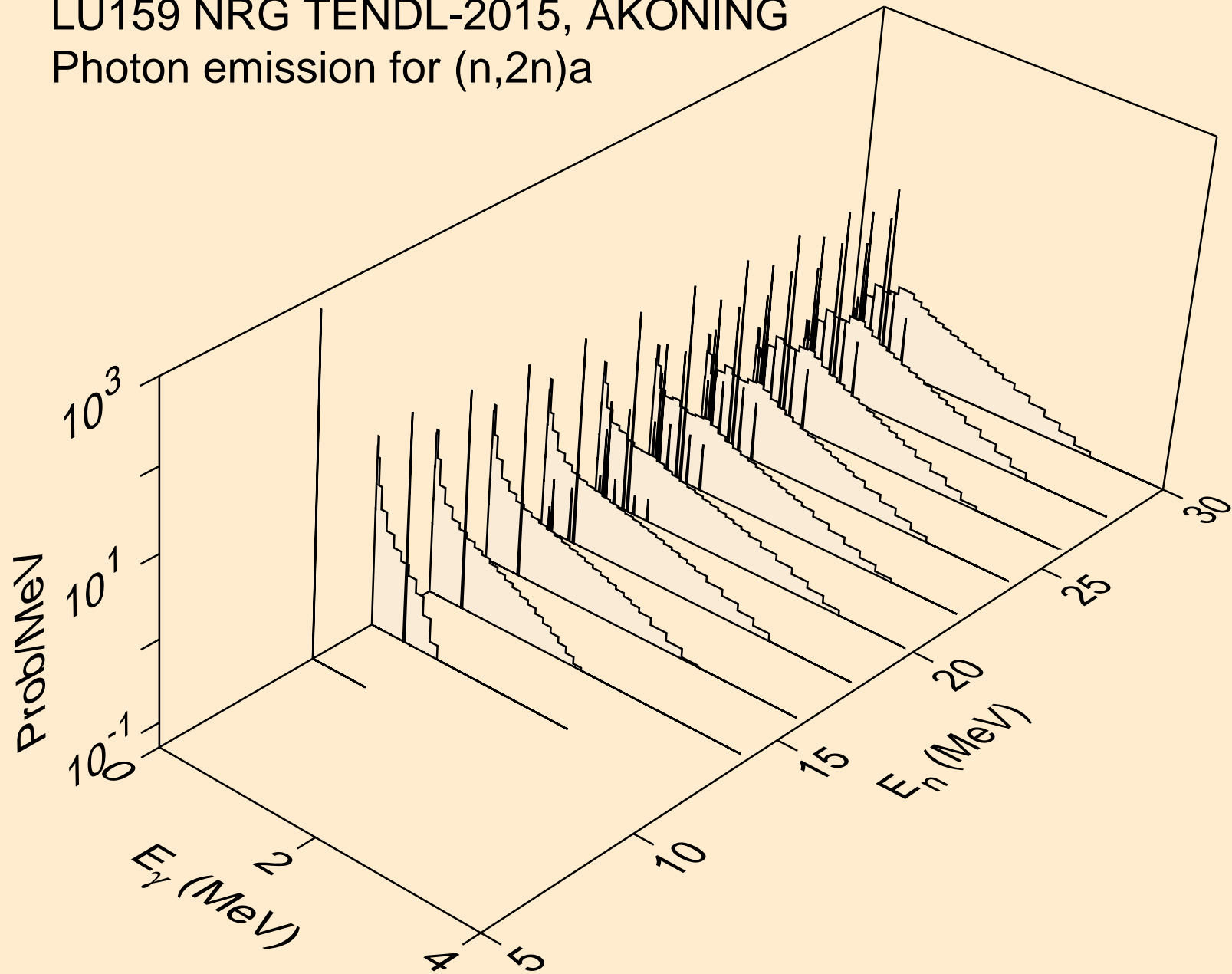

LU159 NRG TENDL-2015, AKONING
Photon emission for (n,3n)a

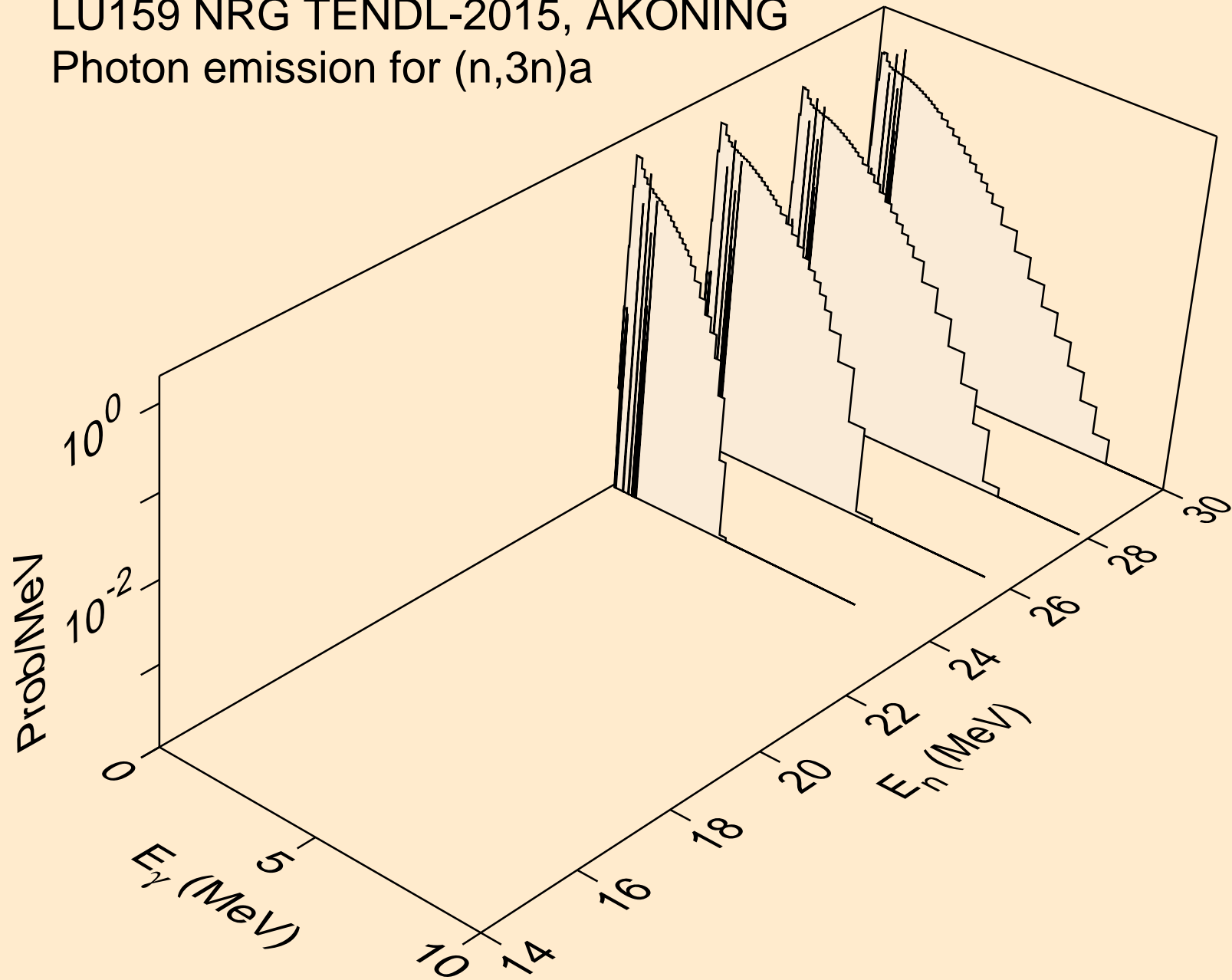

LU159 NRG TENDL-2015, AKONING
Photon emission for (n,n*)p

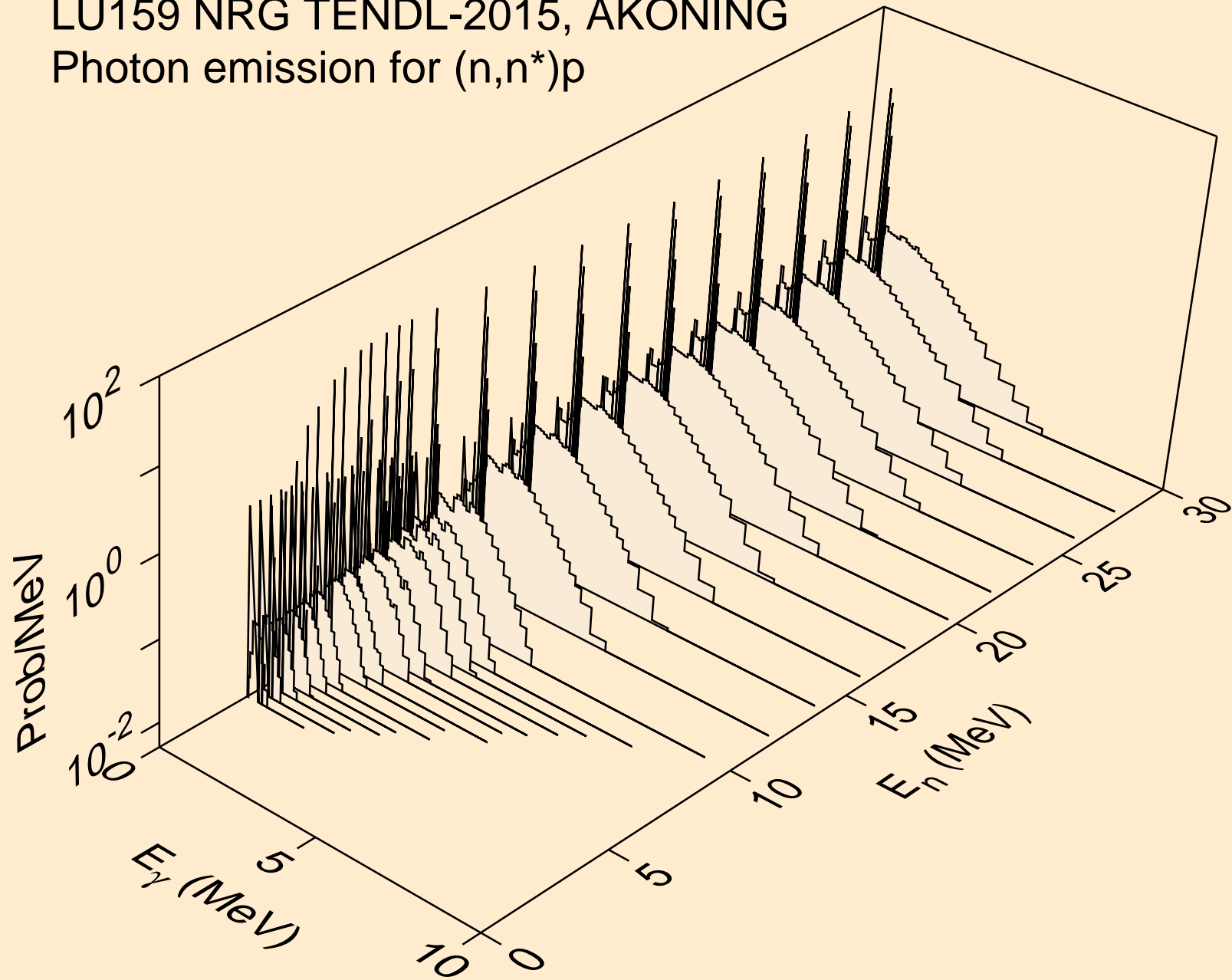

LU159 NRG TENDL-2015, AKONING
Photon emission for (n,n*)2a

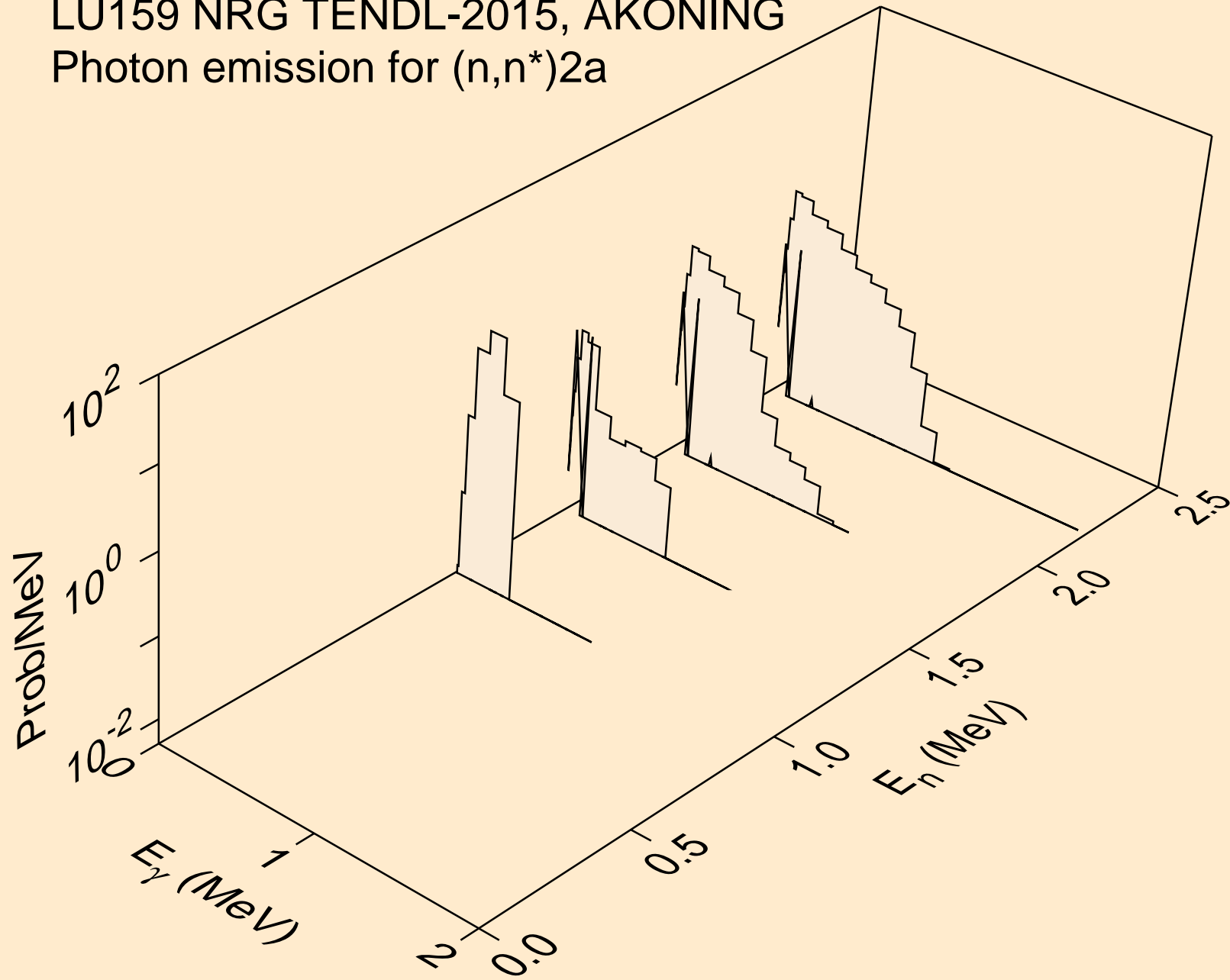

LU159 NRG TENDL-2015, AKONING
Photon emission for (n,2n)2a

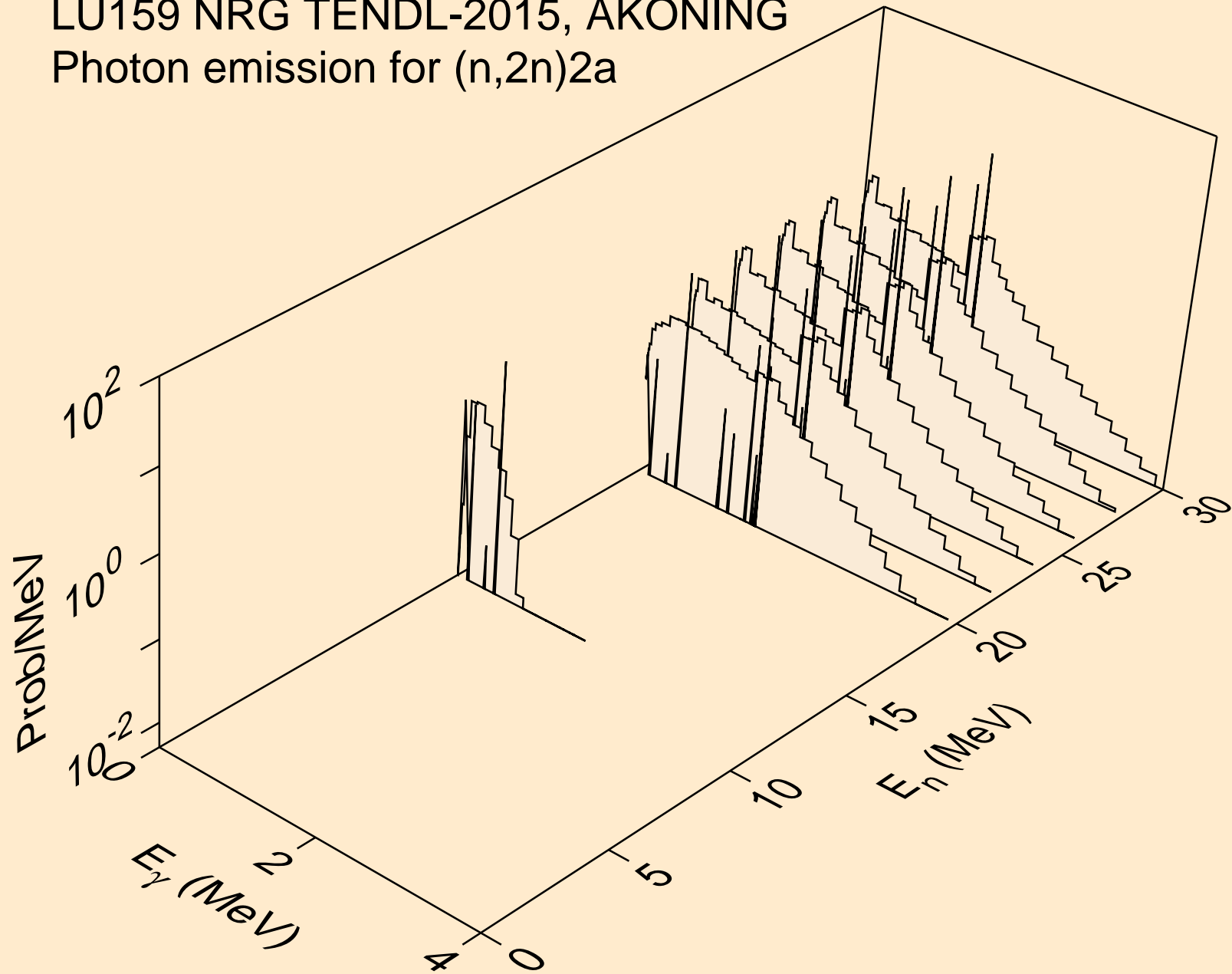

LU159 NRG TENDL-2015, AKONING
Photon emission for (n,n*)d

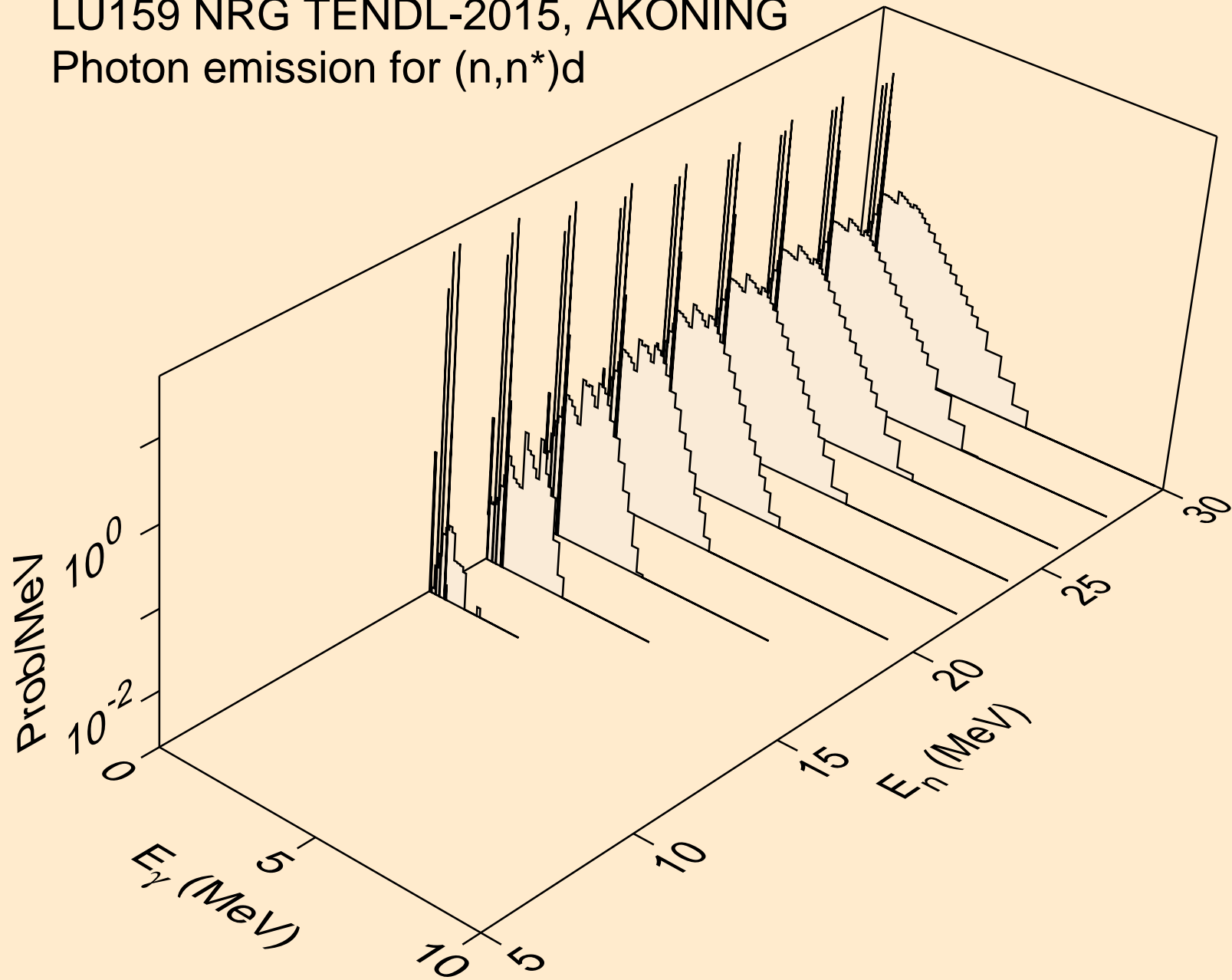

LU159 NRG TENDL-2015, AKONING
Photon emission for (n,n*)t

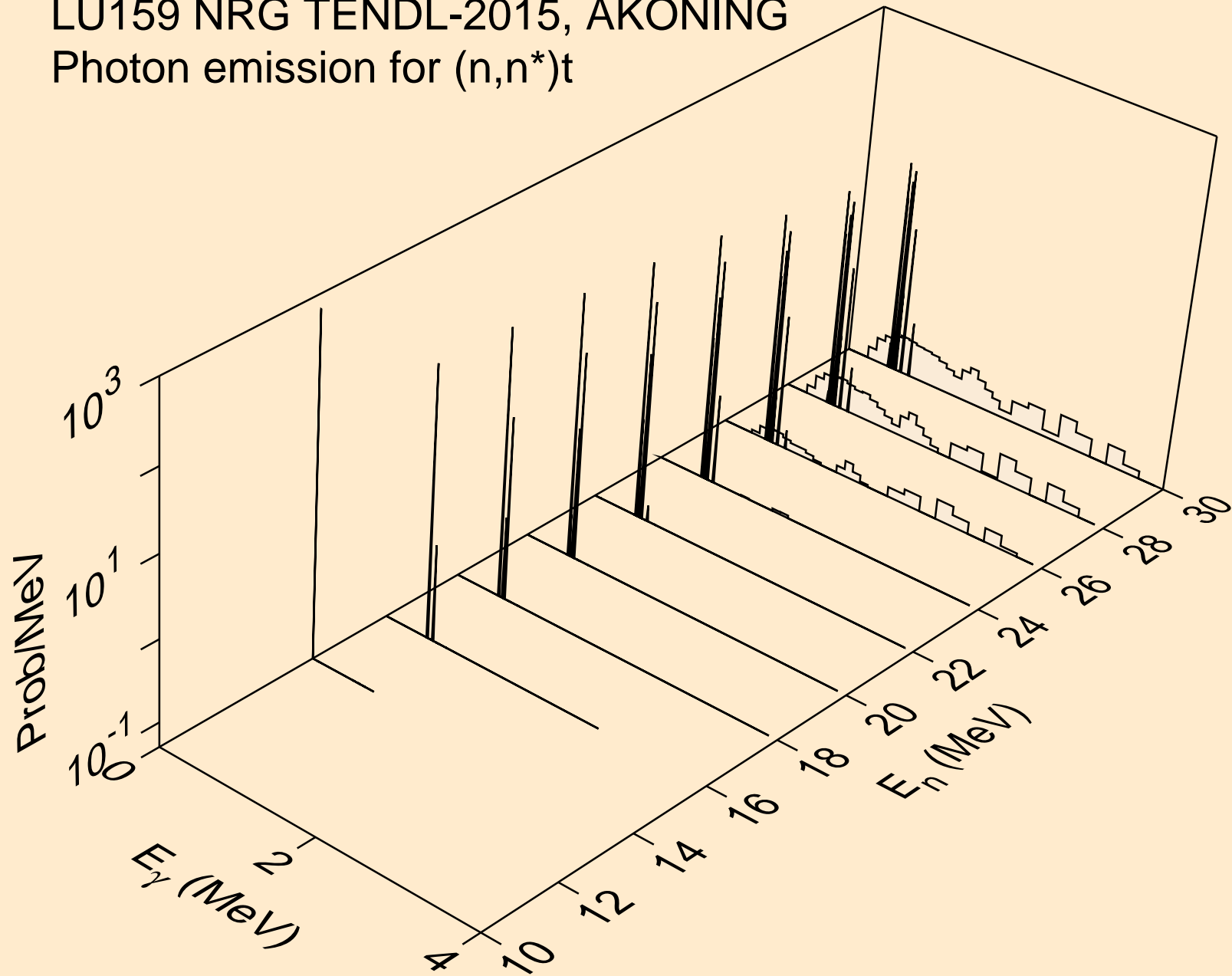

LU159 NRG TENDL-2015, AKONING
Photon emission for (n,n*)he3

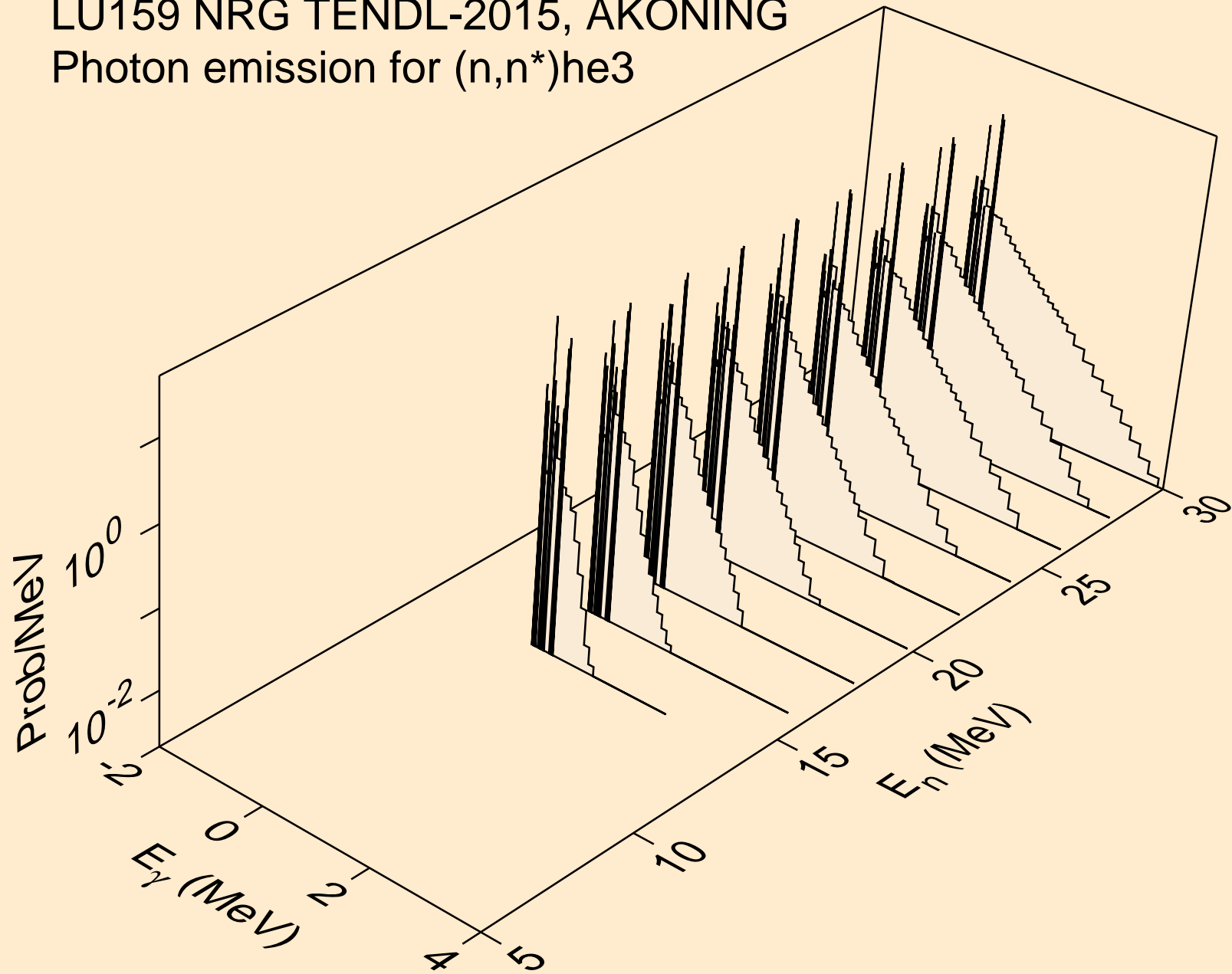

LU159 NRG TENDL-2015, AKONING
Photon emission for (n,n*)d2a

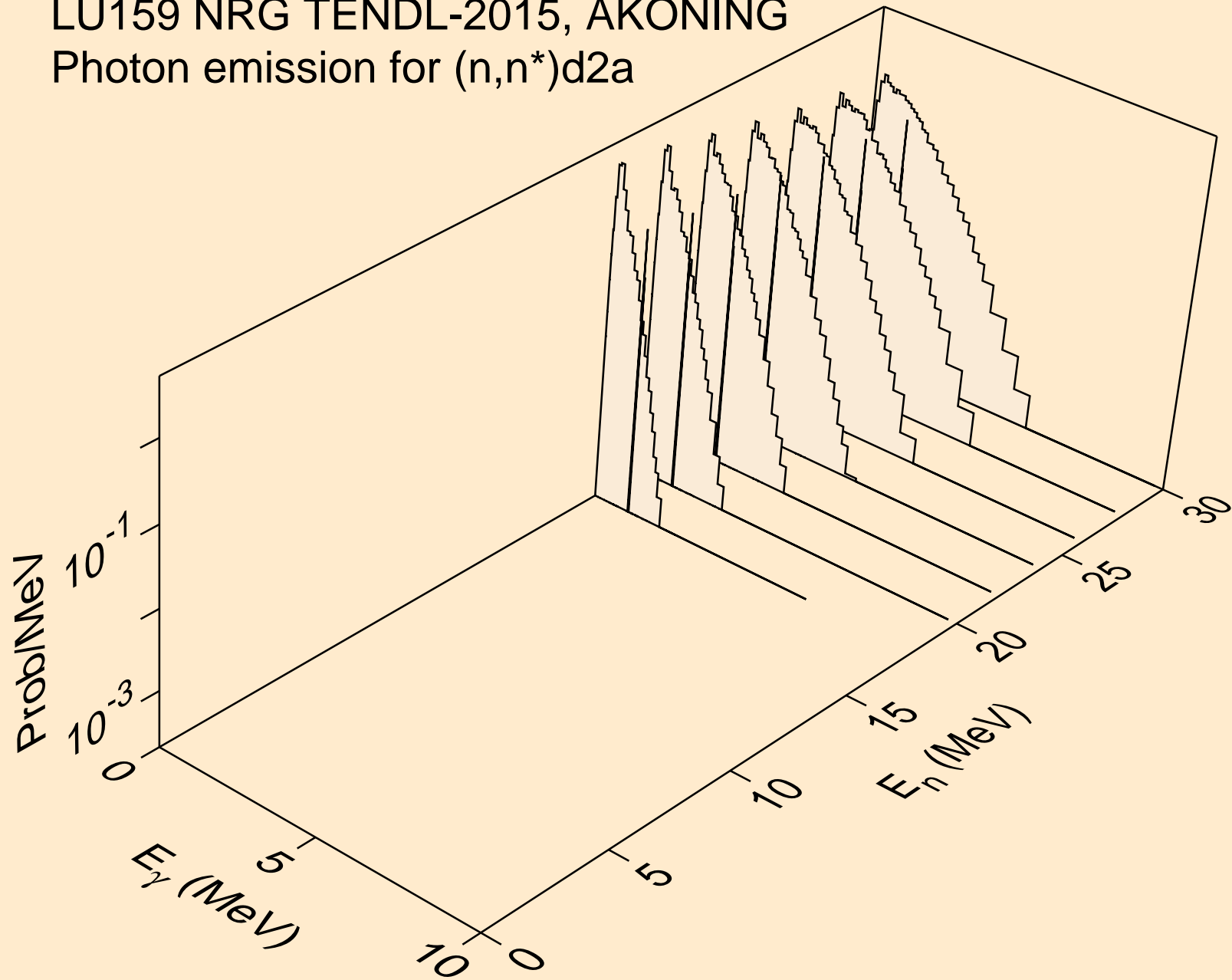

LU159 NRG TENDL-2015, AKONING
Photon emission for (n,n*)t2a

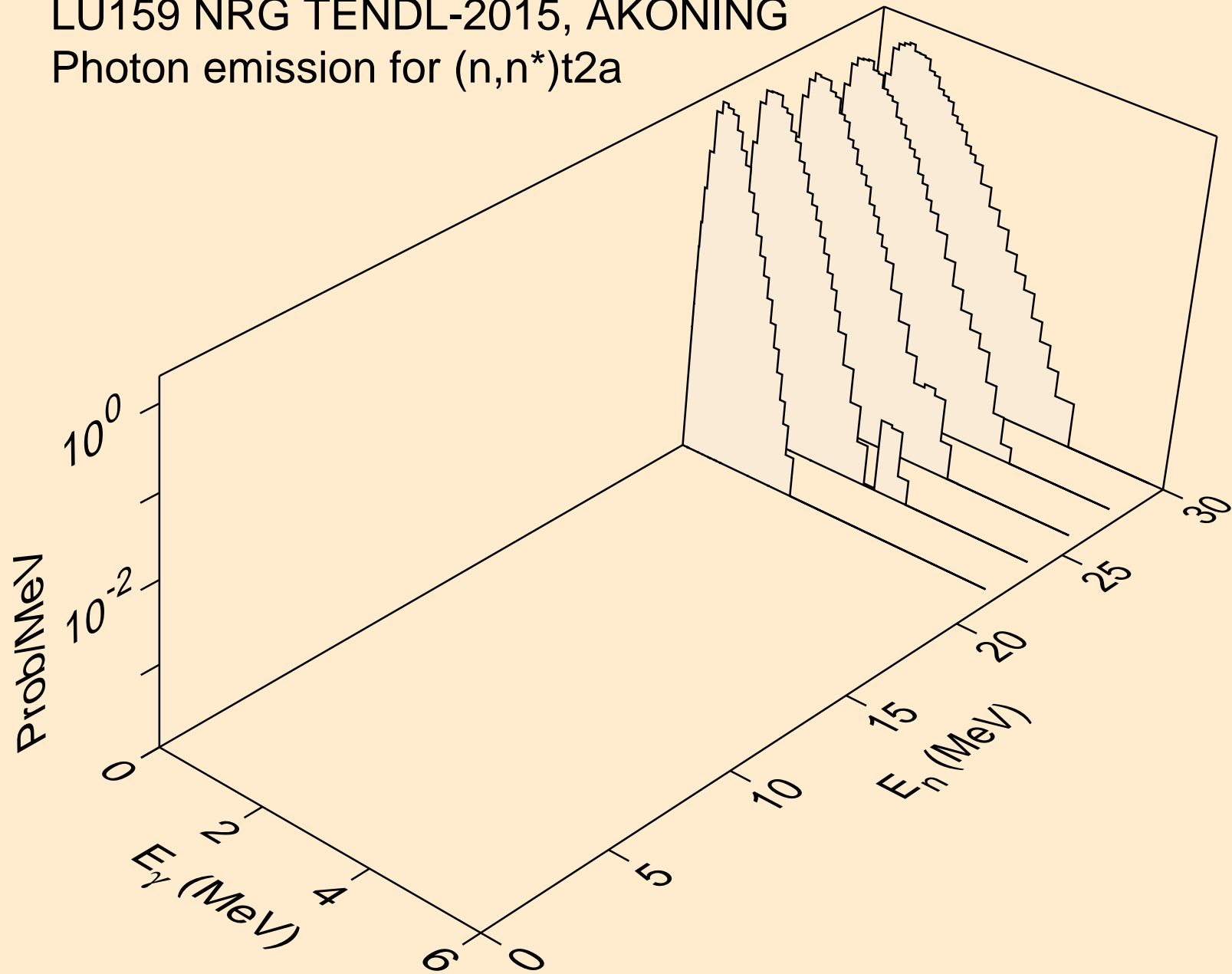

LU159 NRG TENDL-2015, AKONING
Photon emission for (n,2np)

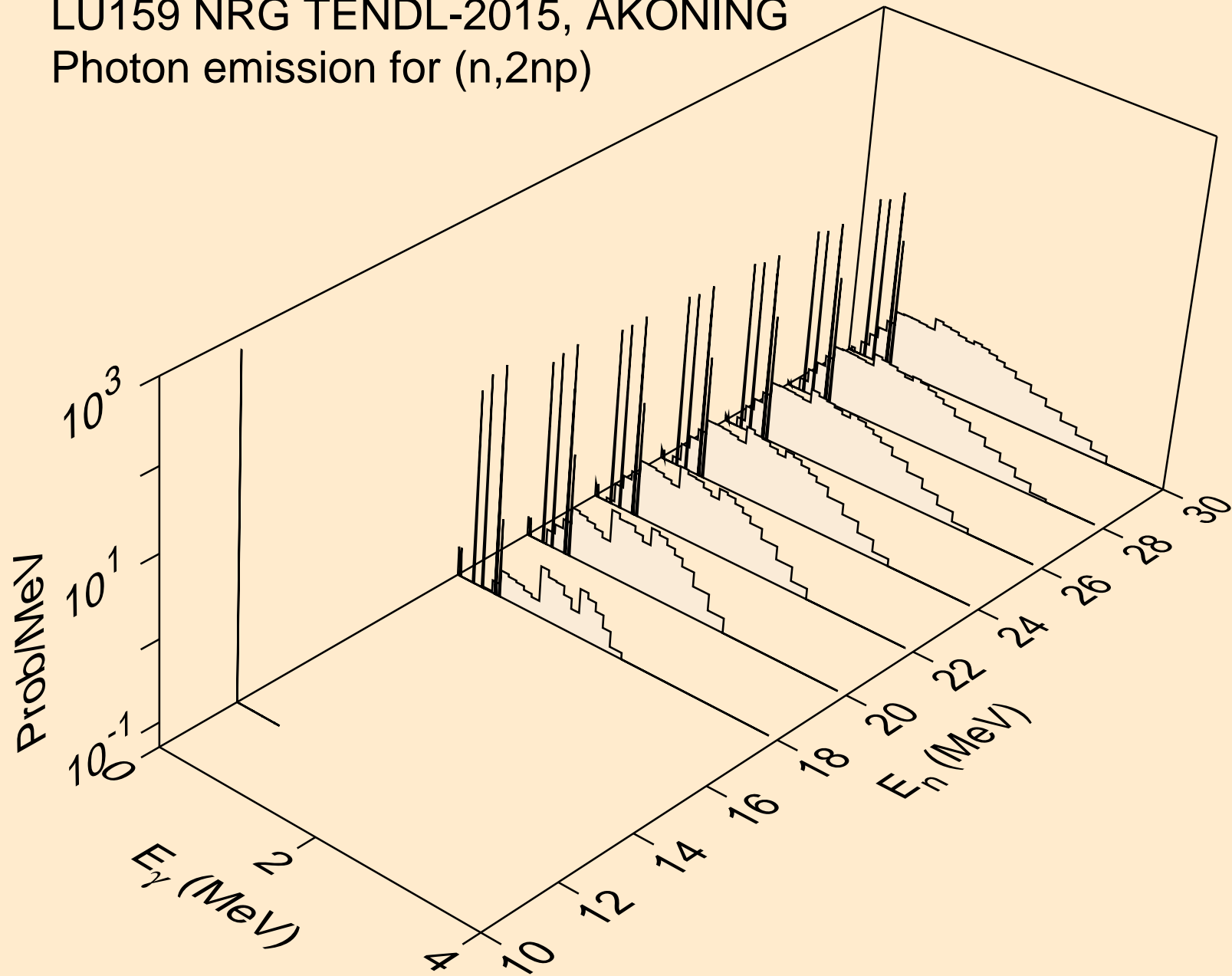

LU159 NRG TENDL-2015, AKONING
Photon emission for (n,3np)

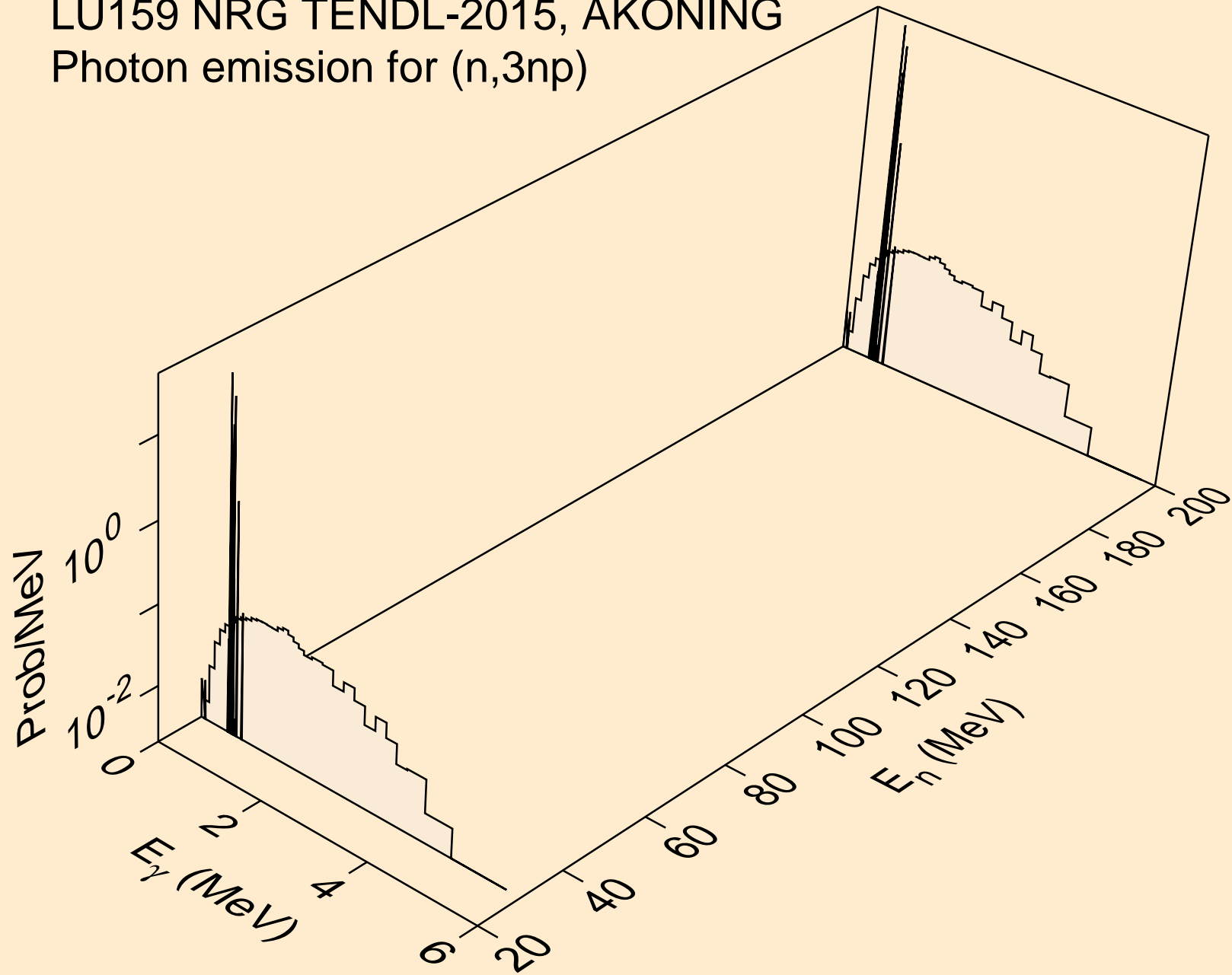

LU159 NRG TENDL-2015, AKONING
Photon emission for (n,2np)

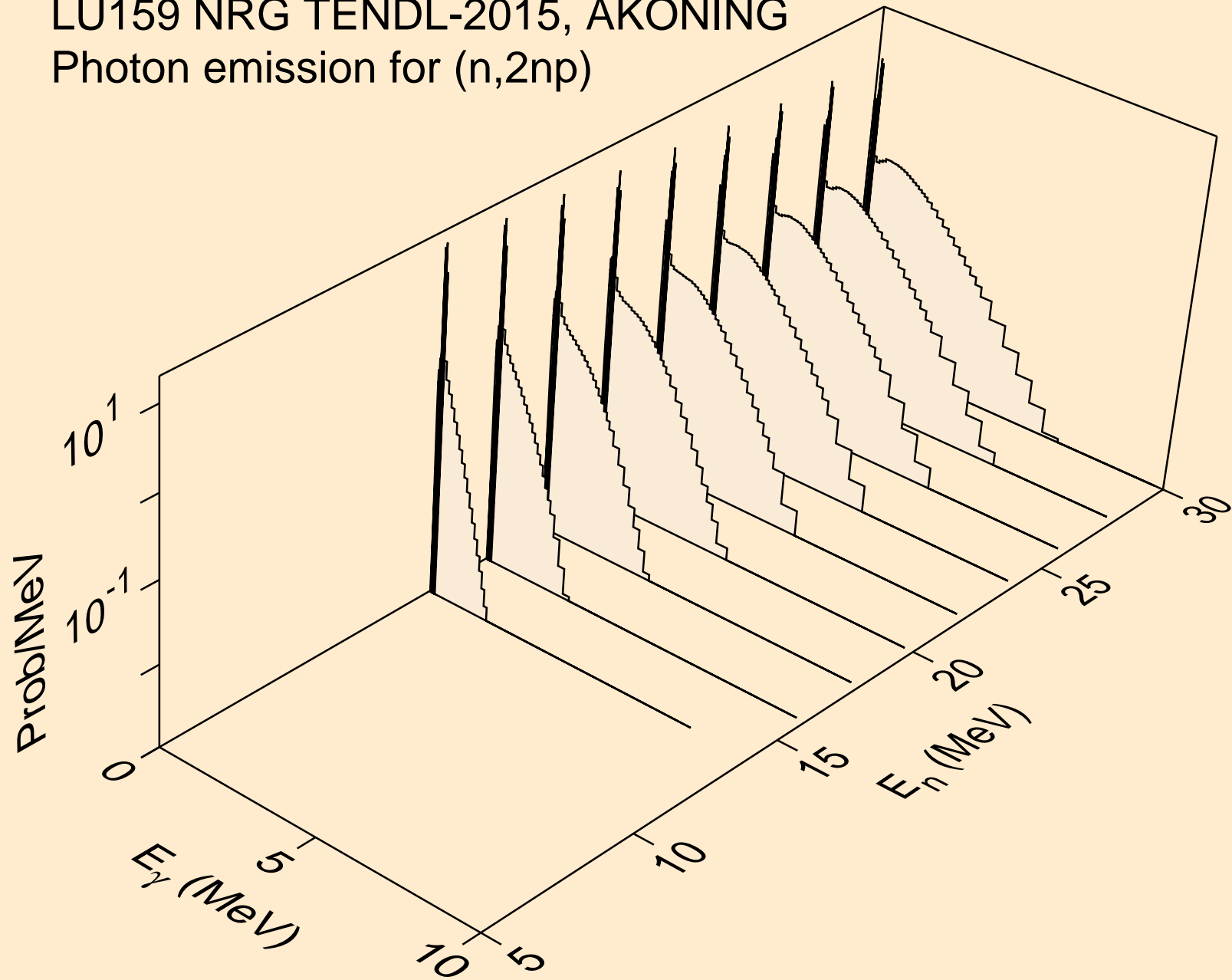

LU159 NRG TENDL-2015, AKONING
Photon emission for (n,npa)

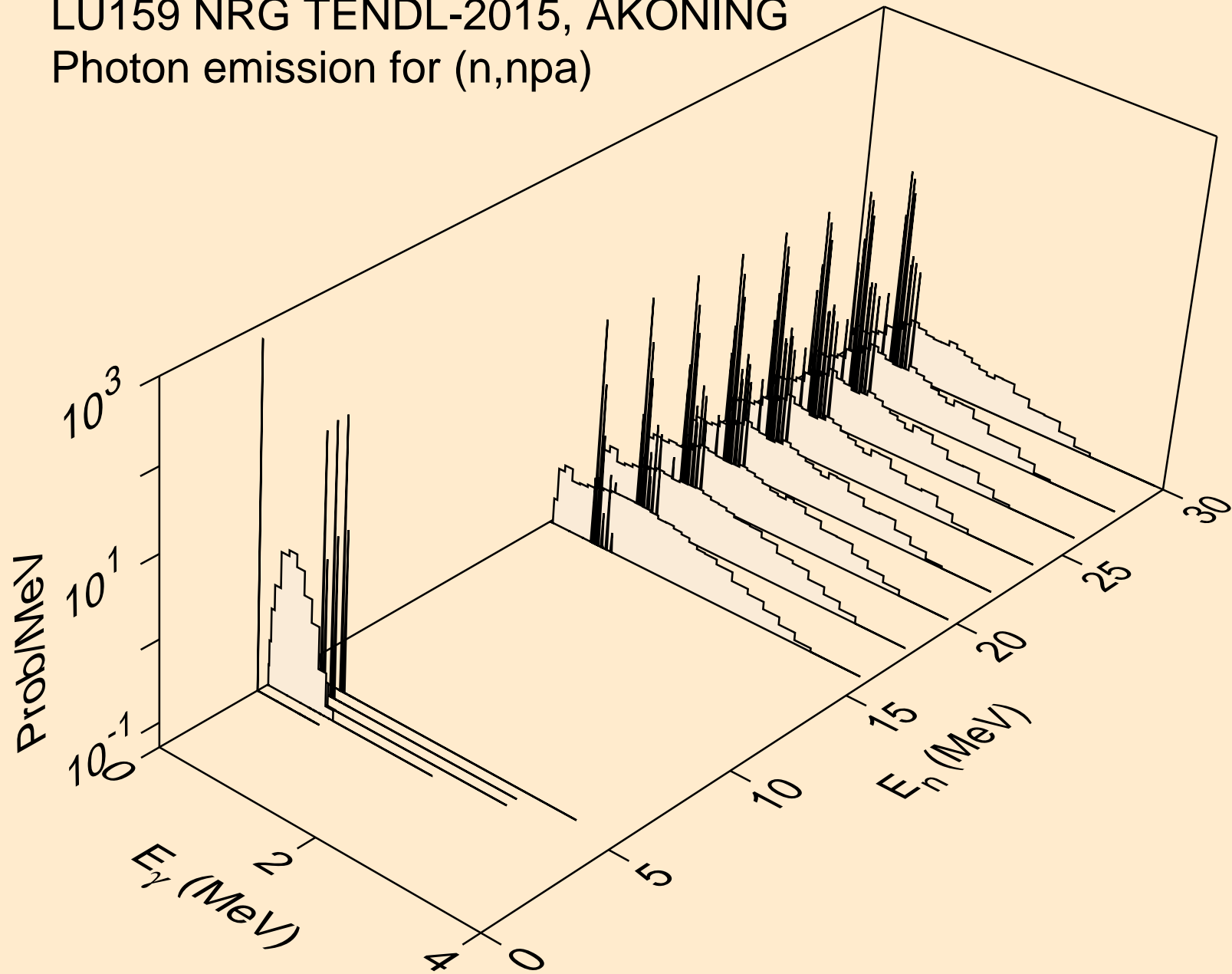

LU159 NRG TENDL-2015, AKONING
Photon emission for (n,n*c)

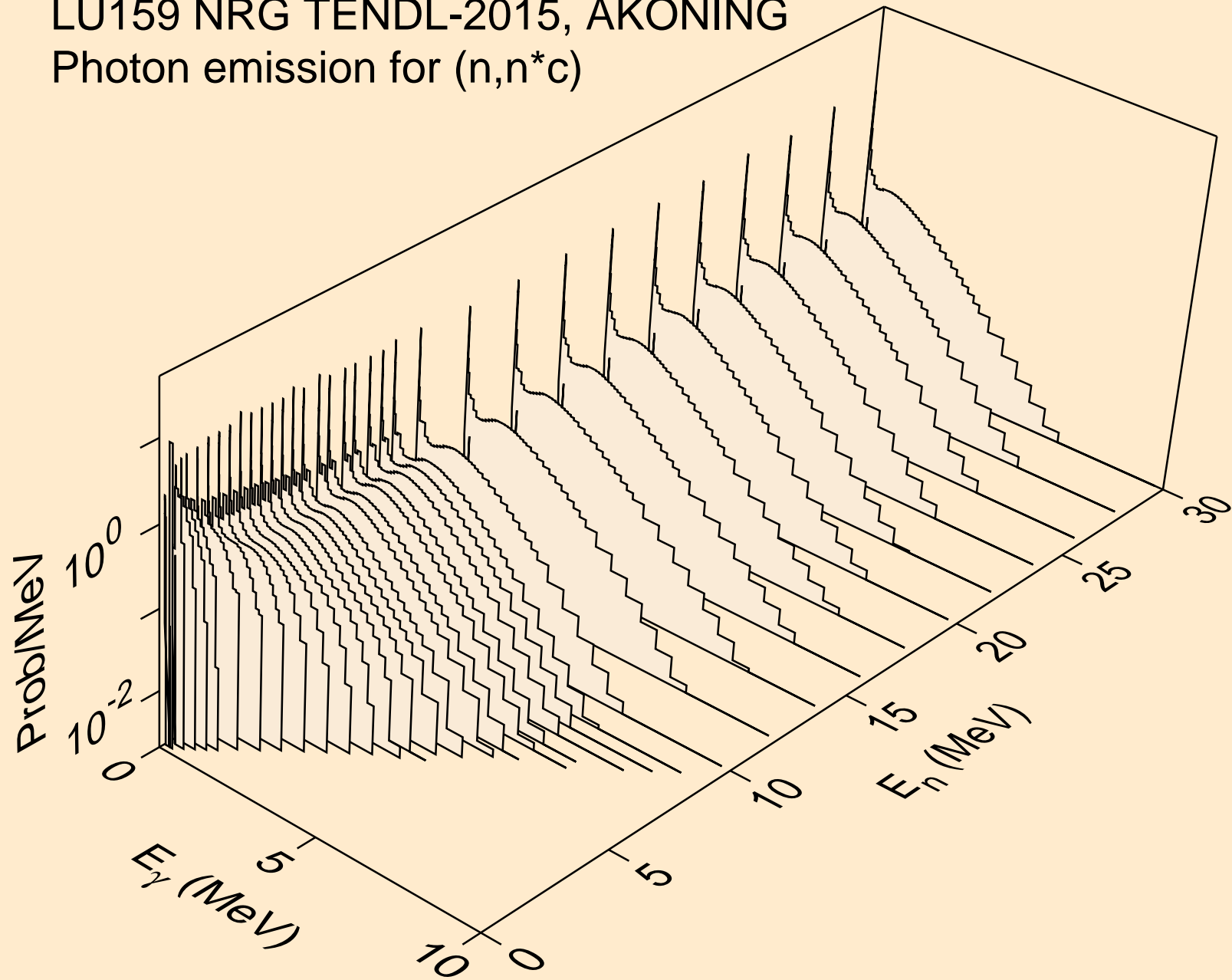

LU159 NRG TENDL-2015, AKONING
Photon emission for (n,gma)

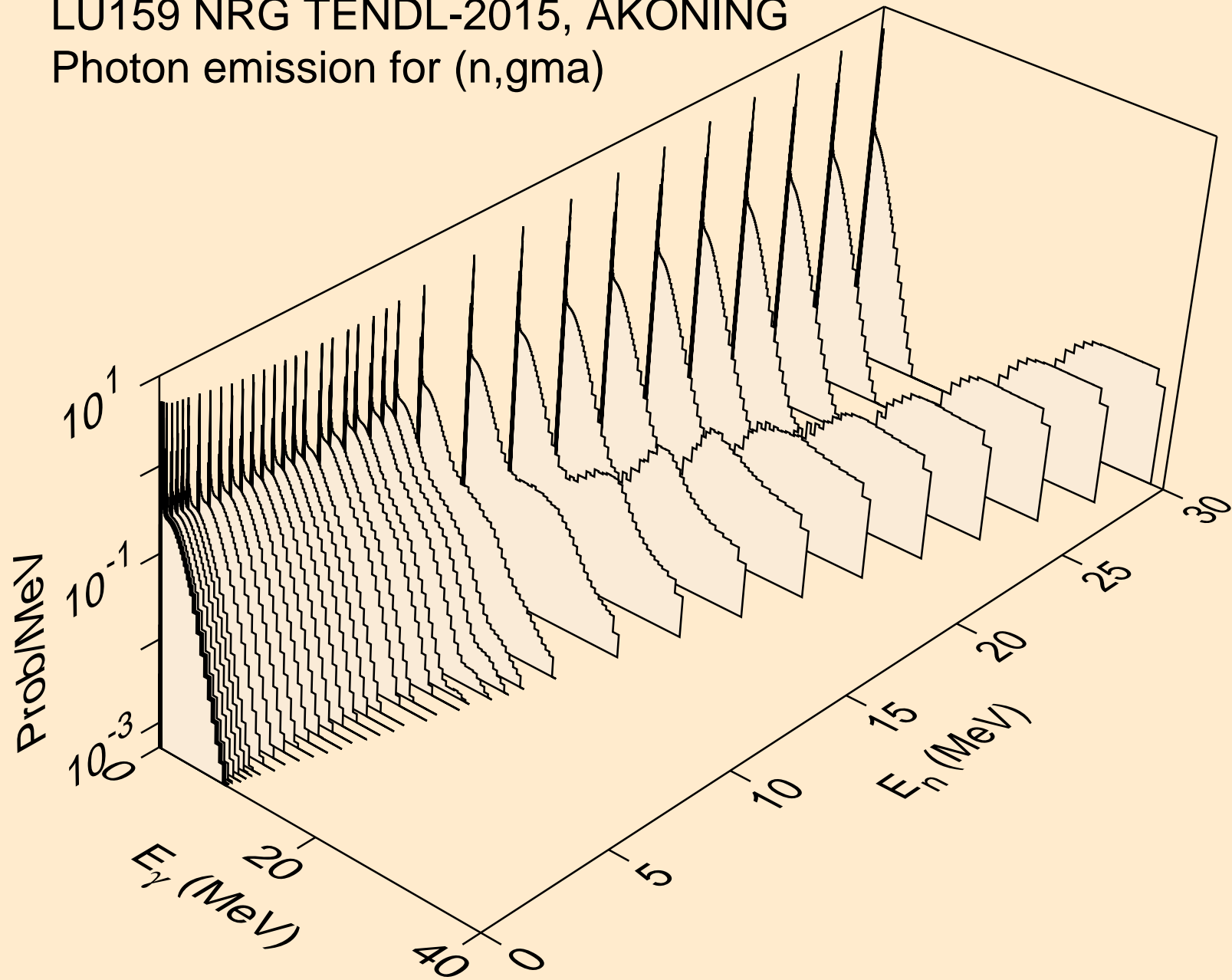

LU159 NRG TENDL-2015, AKONING
Photon emission for (n,p)

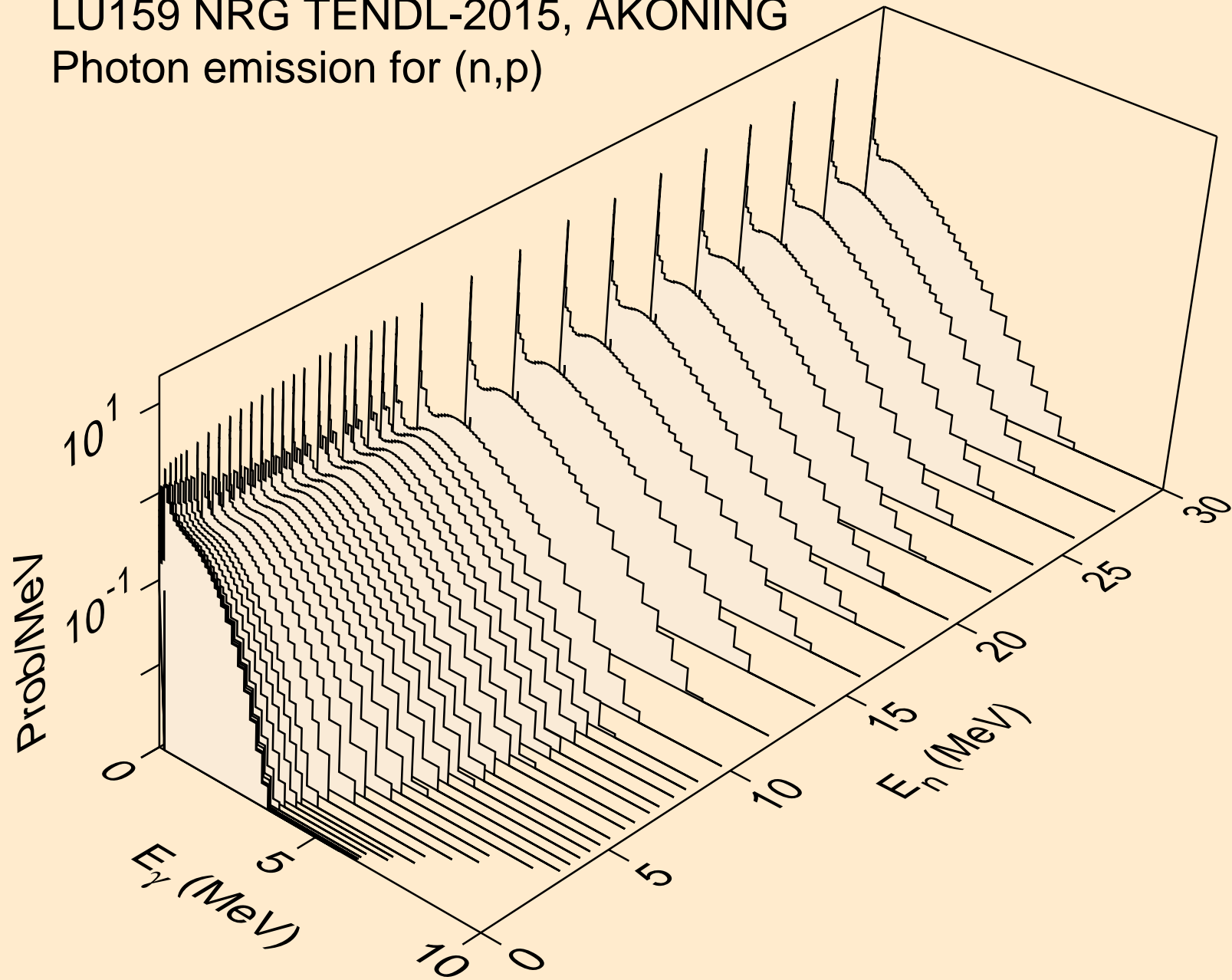

LU159 NRG TENDL-2015, AKONING
Photon emission for (n,d)

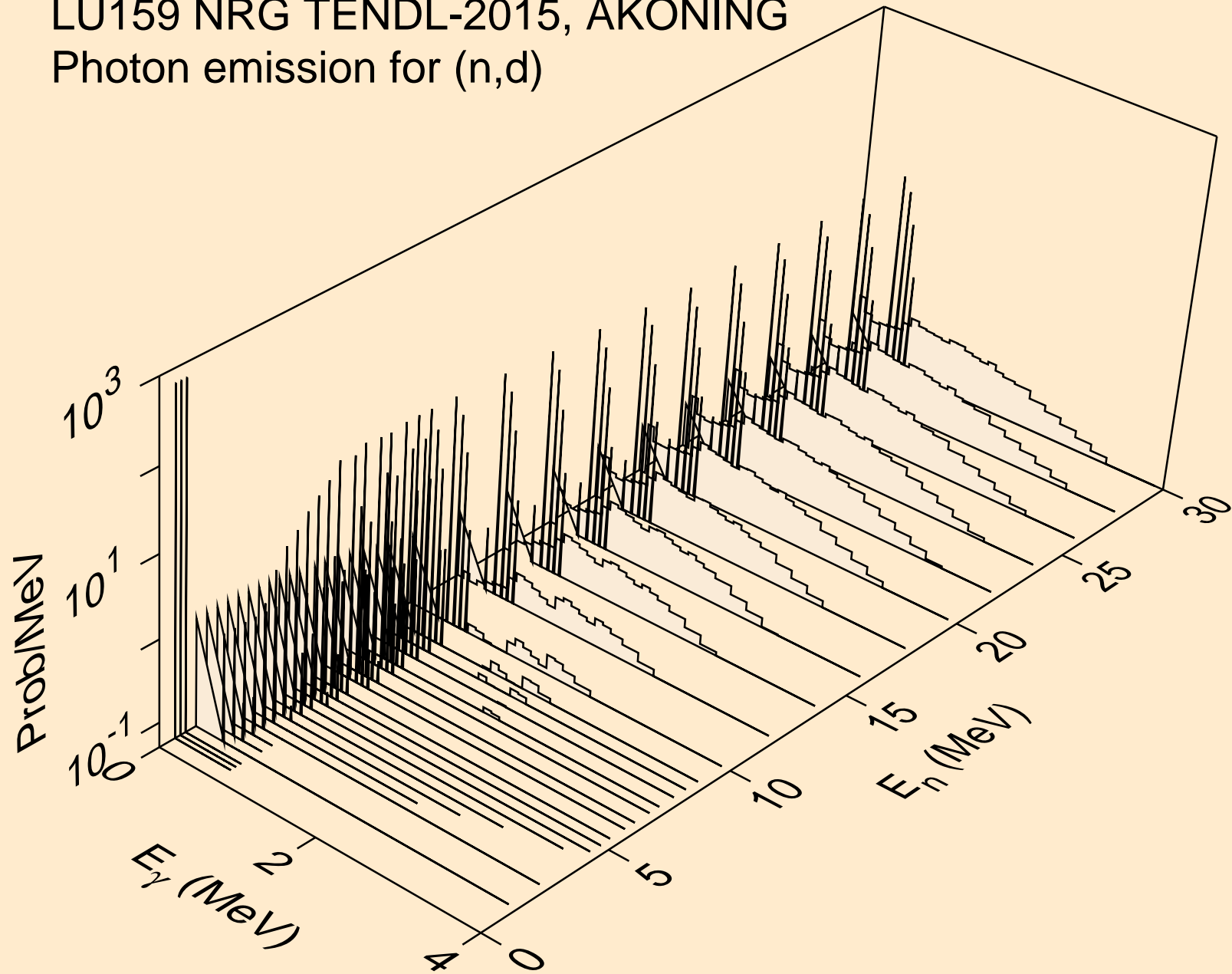

LU159 NRG TENDL-2015, AKONING
Photon emission for (n,t)

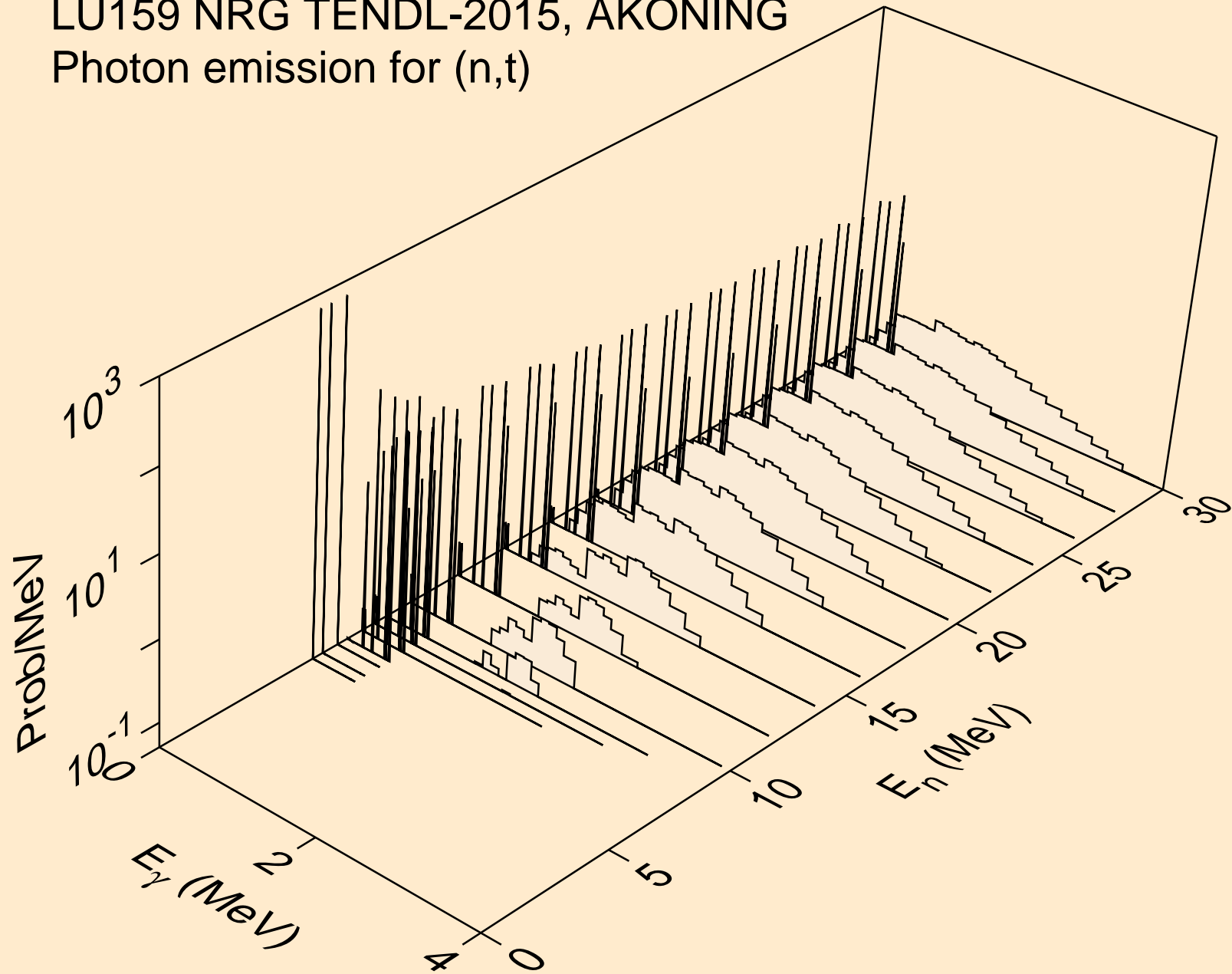

LU159 NRG TENDL-2015, AKONING
Photon emission for (n,he3)

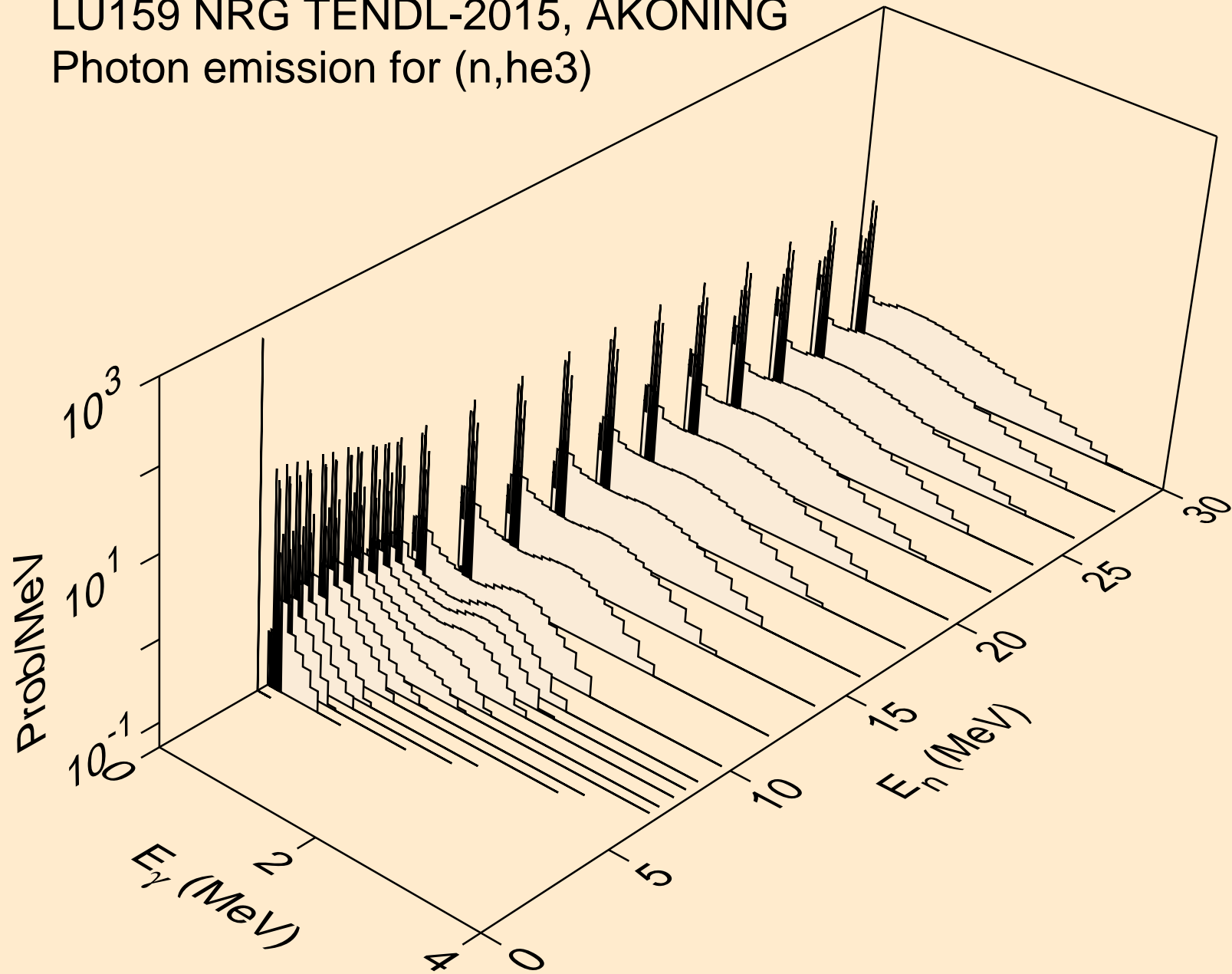

LU159 NRG TENDL-2015, AKONING
Photon emission for (n,a)

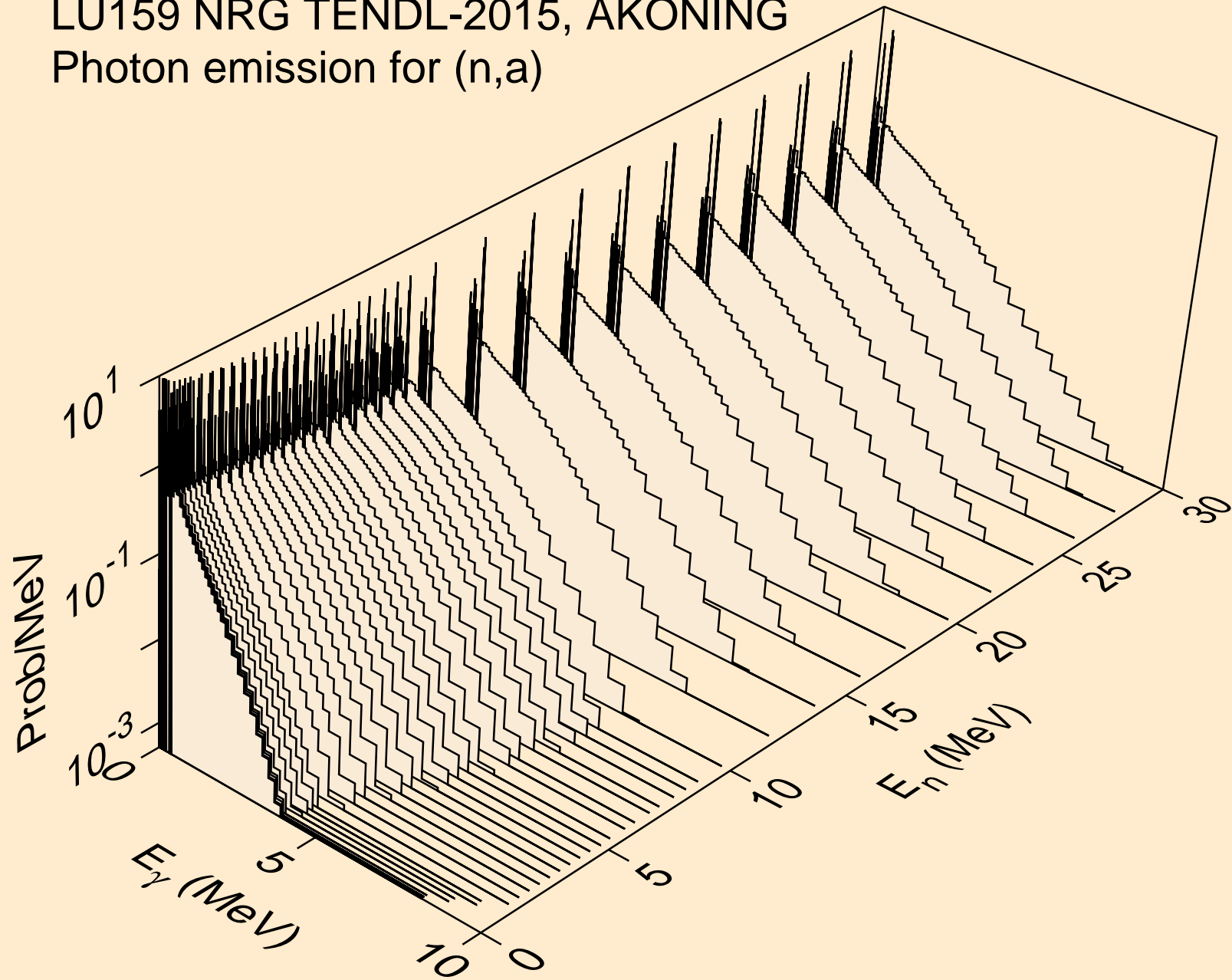

LU159 NRG TENDL-2015, AKONING
Photon emission for (n,2a)

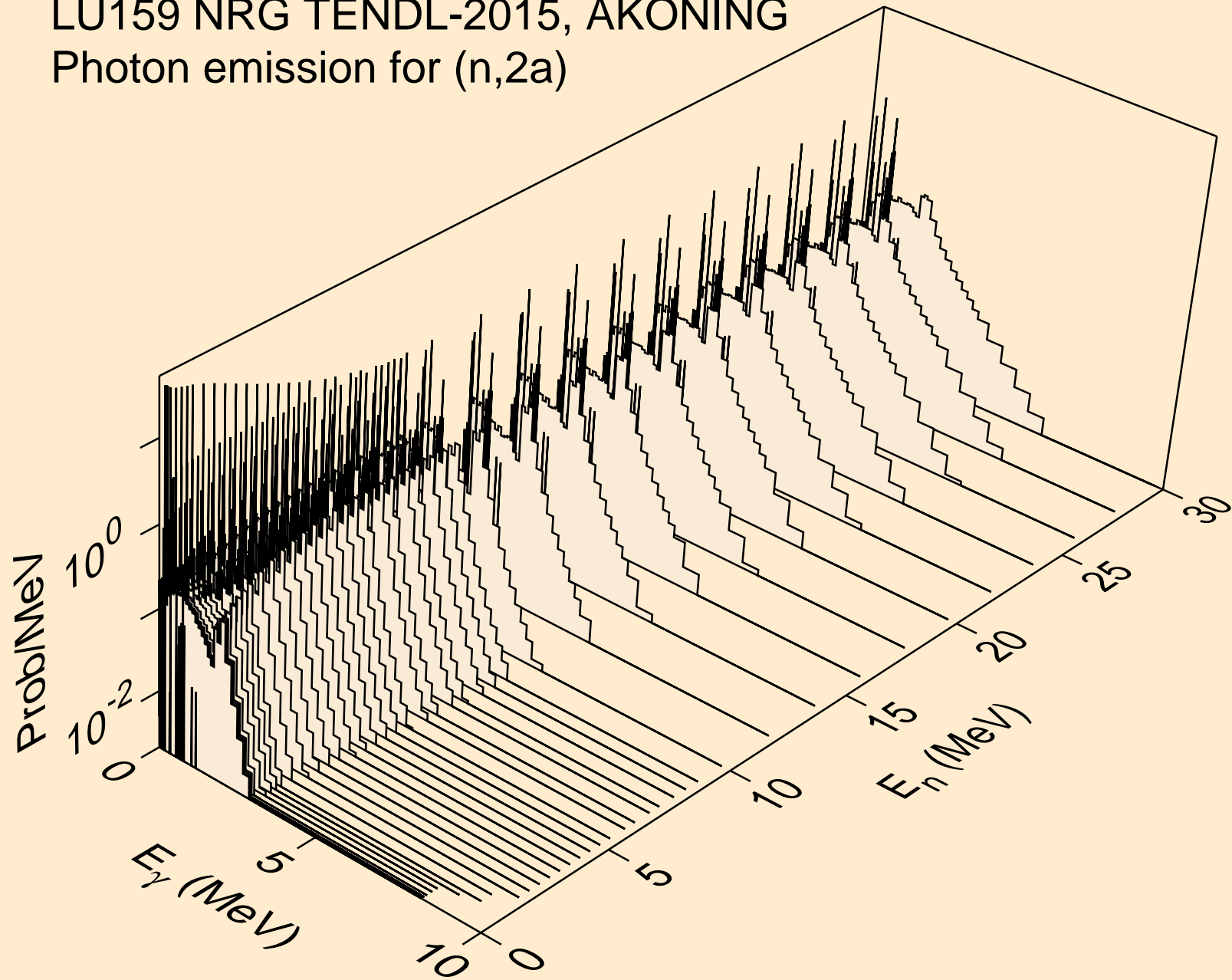

LU159 NRG TENDL-2015, AKONING
Photon emission for (n,3a)

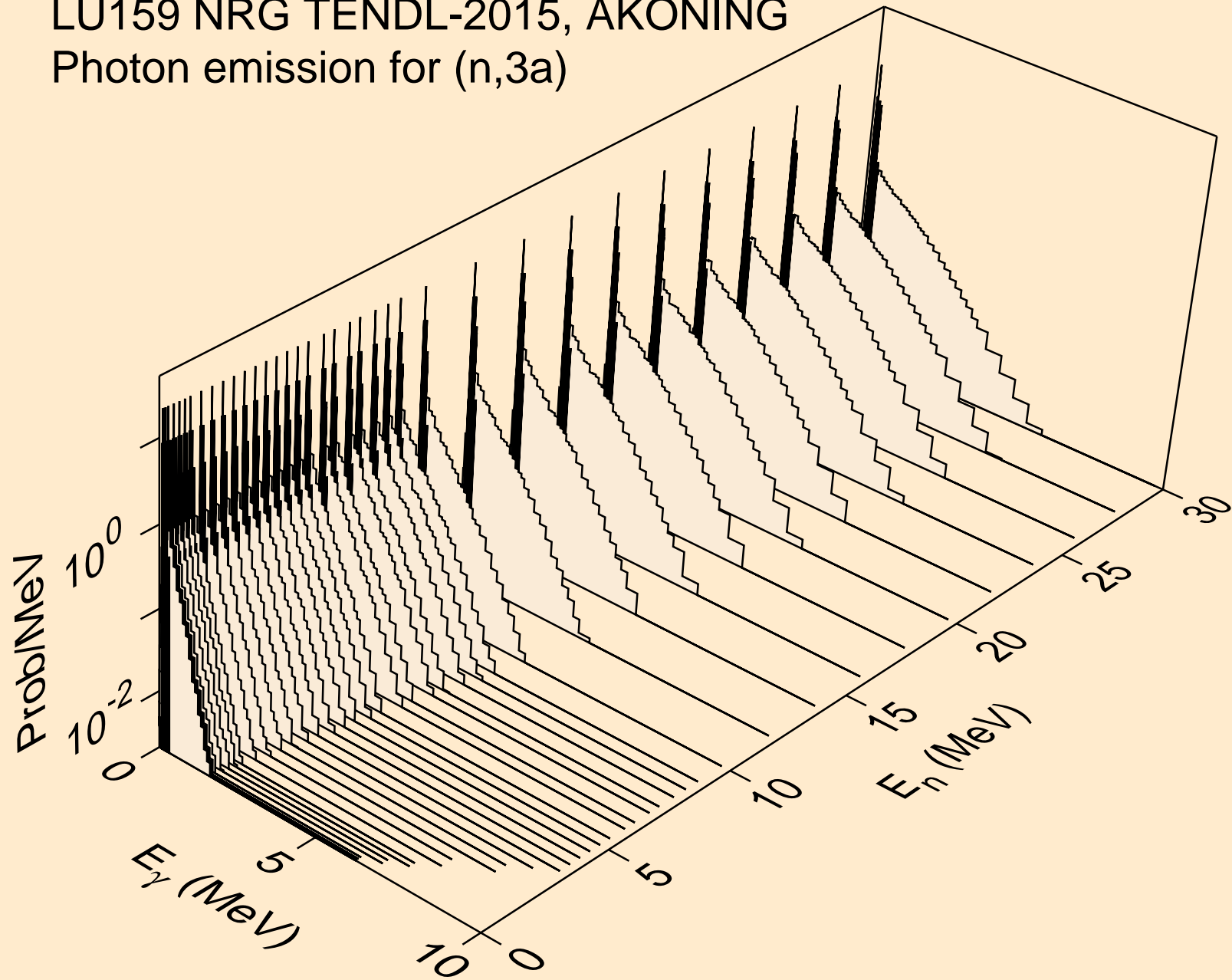

LU159 NRG TENDL-2015, AKONING
Photon emission for (n,2p)

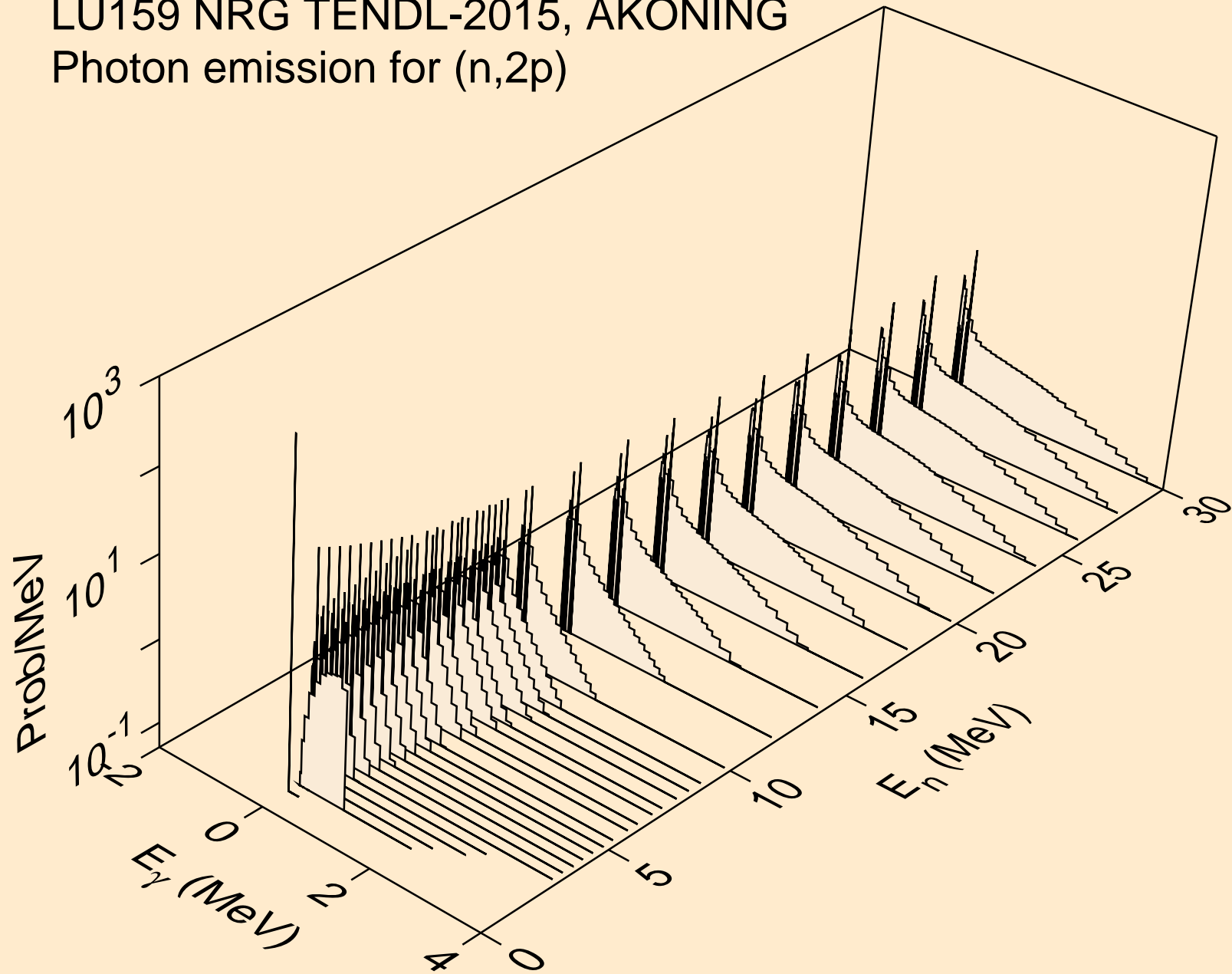

LU159 NRG TENDL-2015, AKONING
Photon emission for (n,p α)

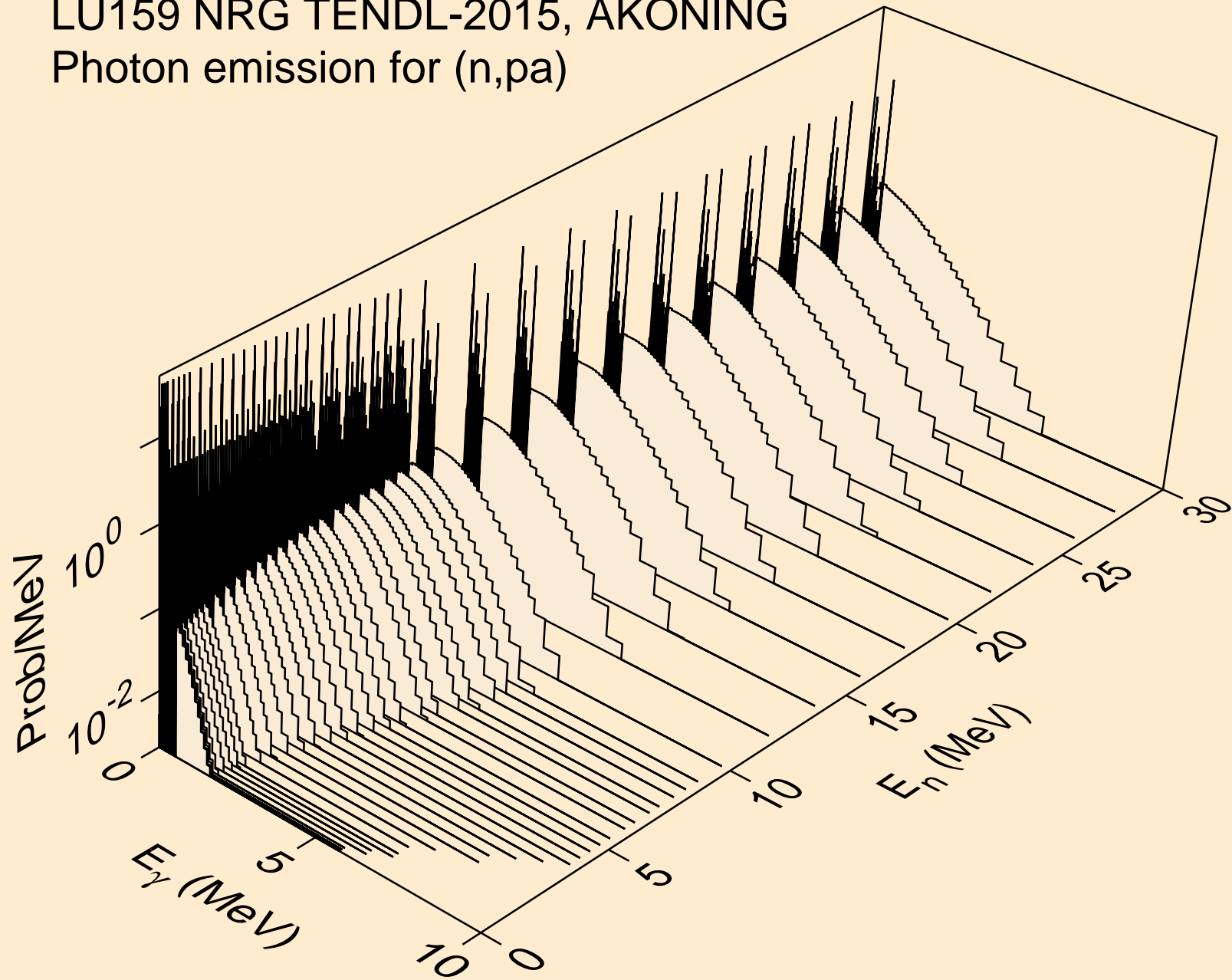

LU159 NRG TENDL-2015, AKONING
Photon emission for (n,t2a)

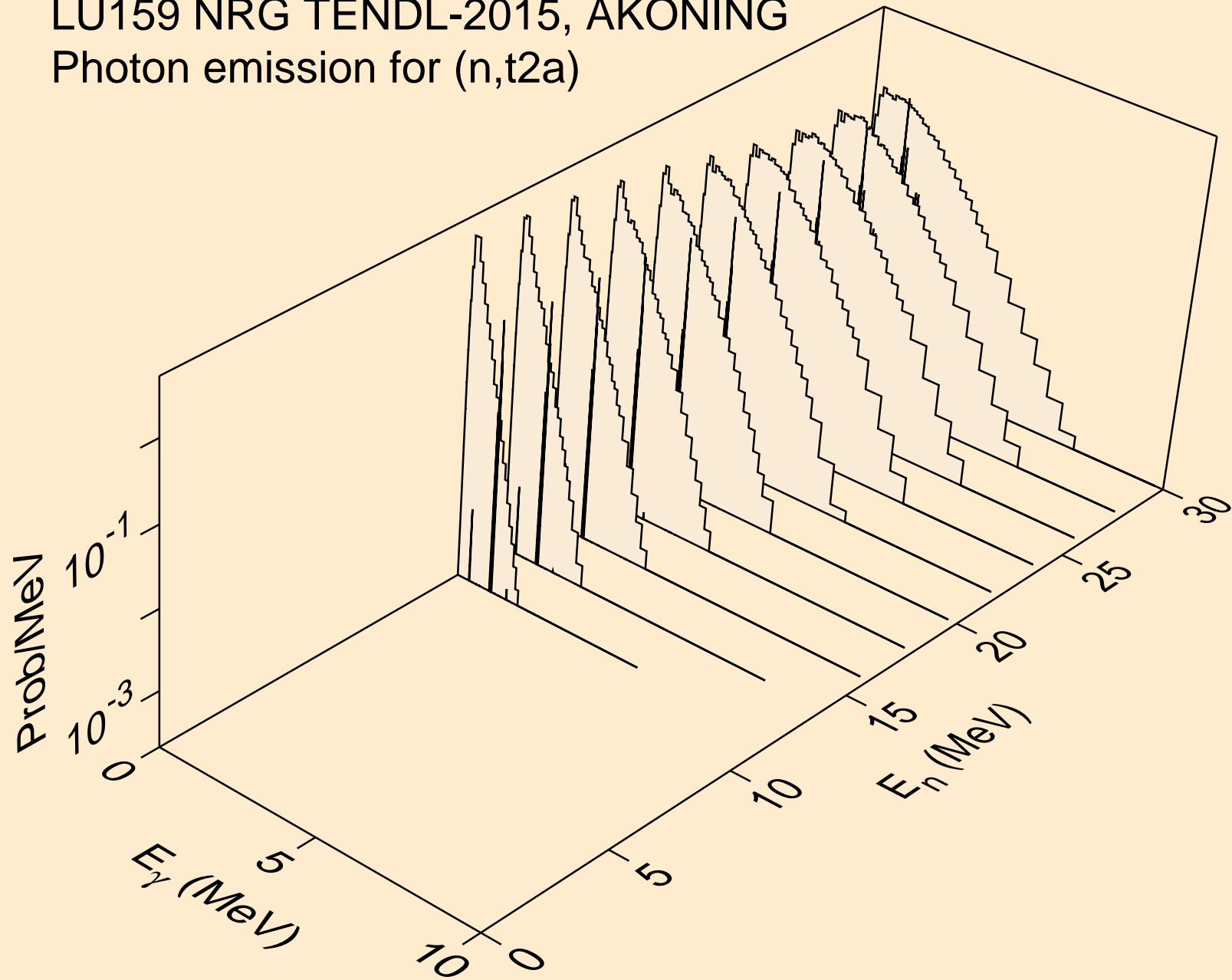

LU159 NRG TENDL-2015, AKONING
Photon emission for (n,d2a)

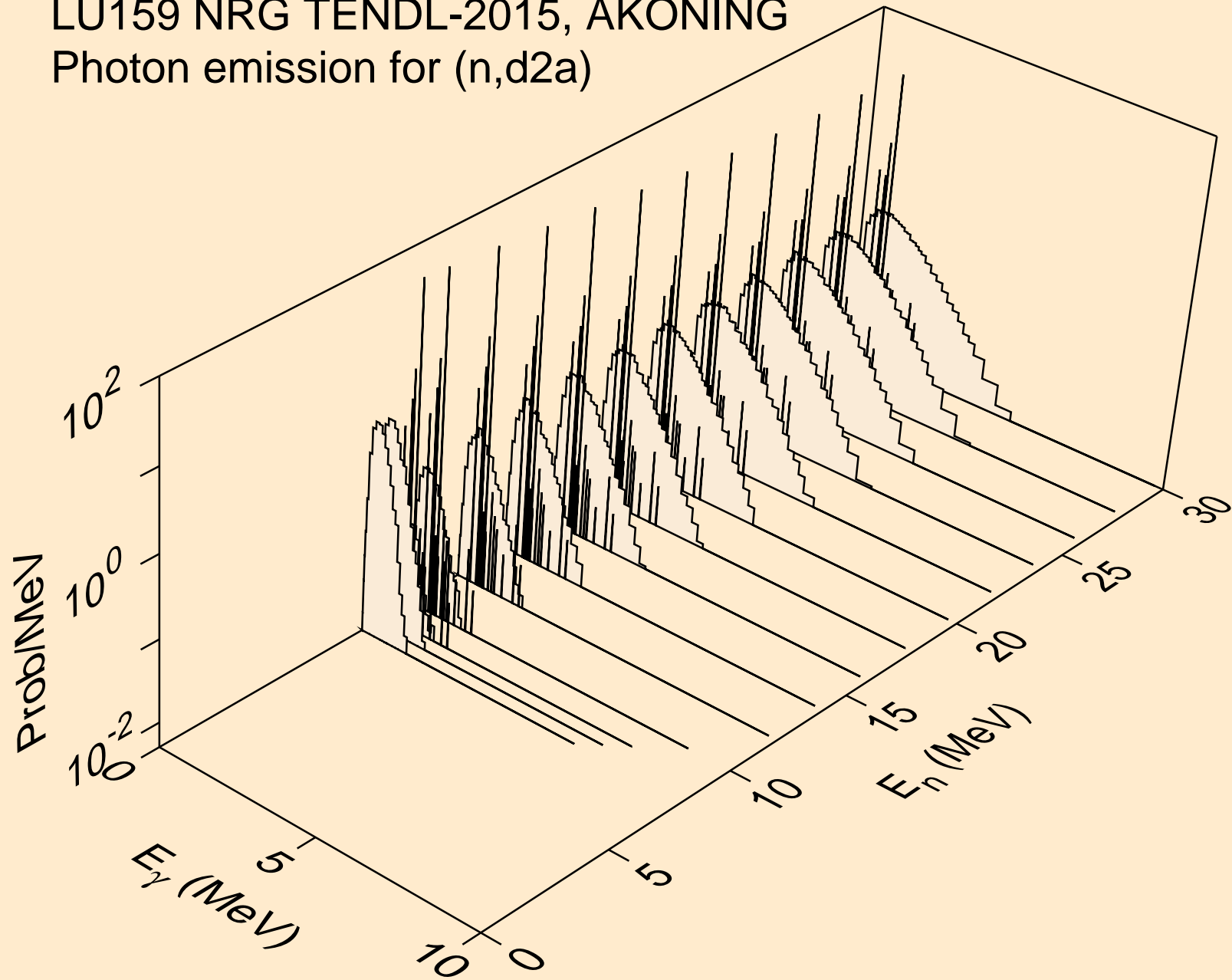

LU159 NRG TENDL-2015, AKONING
Photon emission for (n,pd)

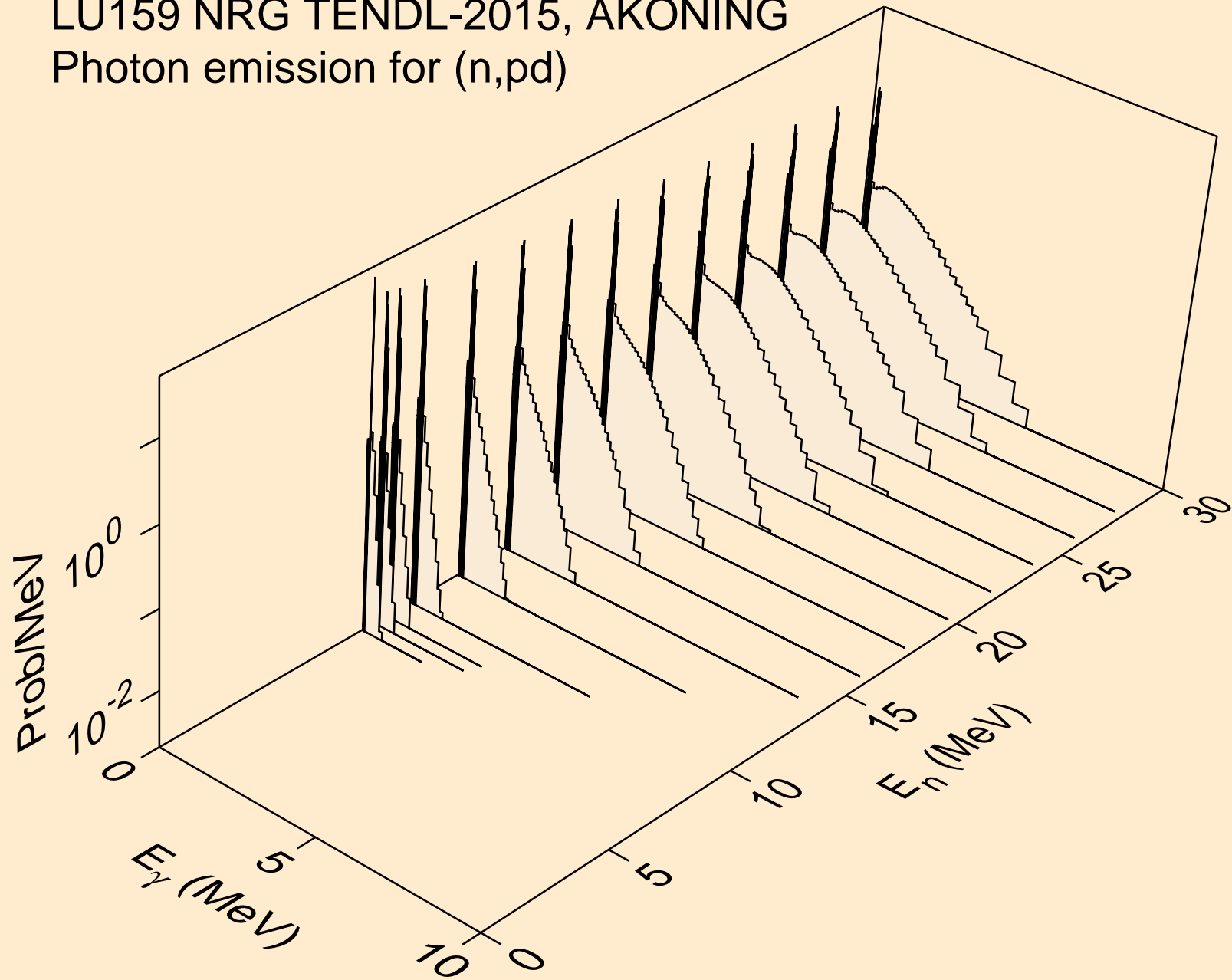

LU159 NRG TENDL-2015, AKONING
Photon emission for (n,pt)

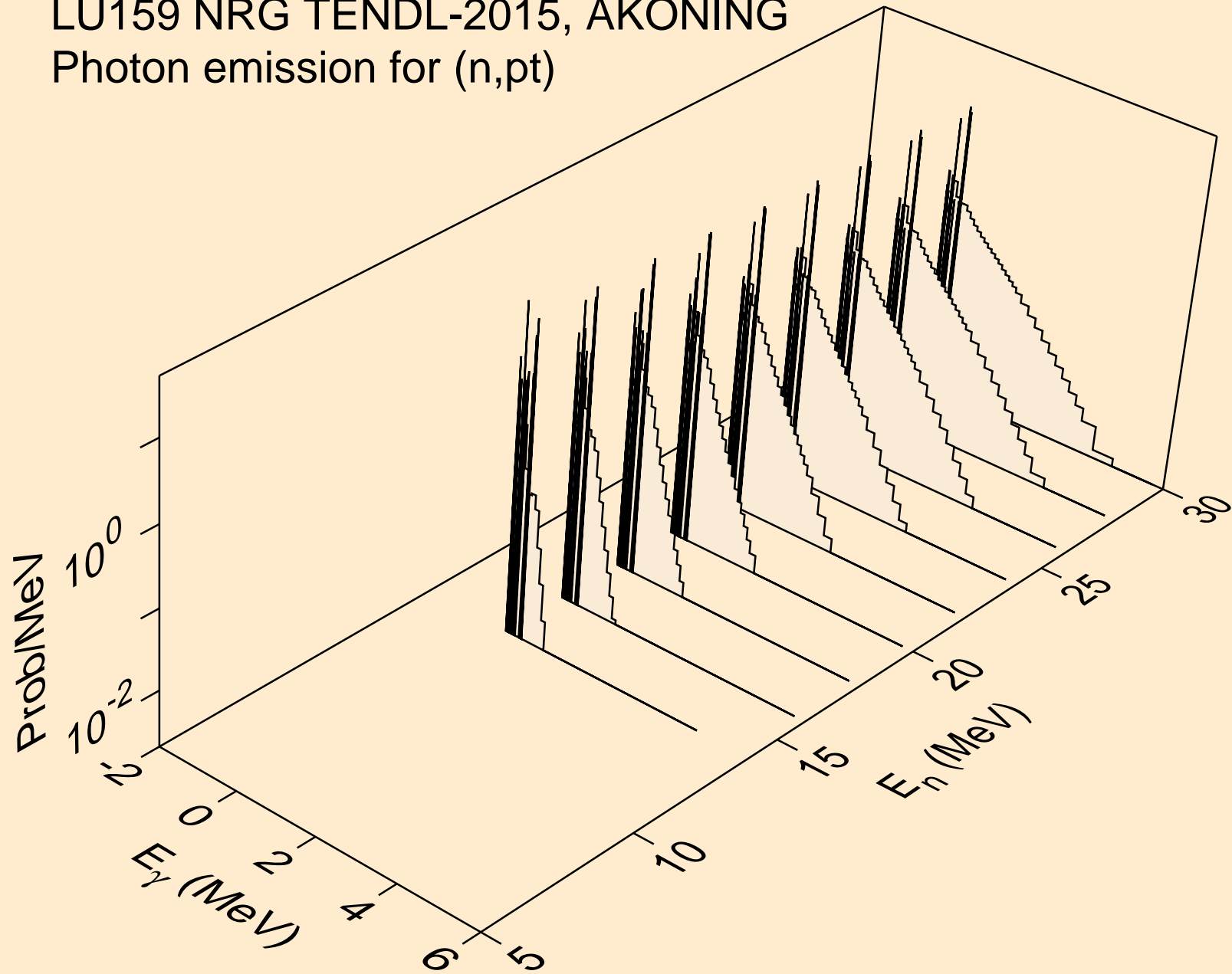

LU159 NRG TENDL-2015, AKONING
Photon emission for (n,da)

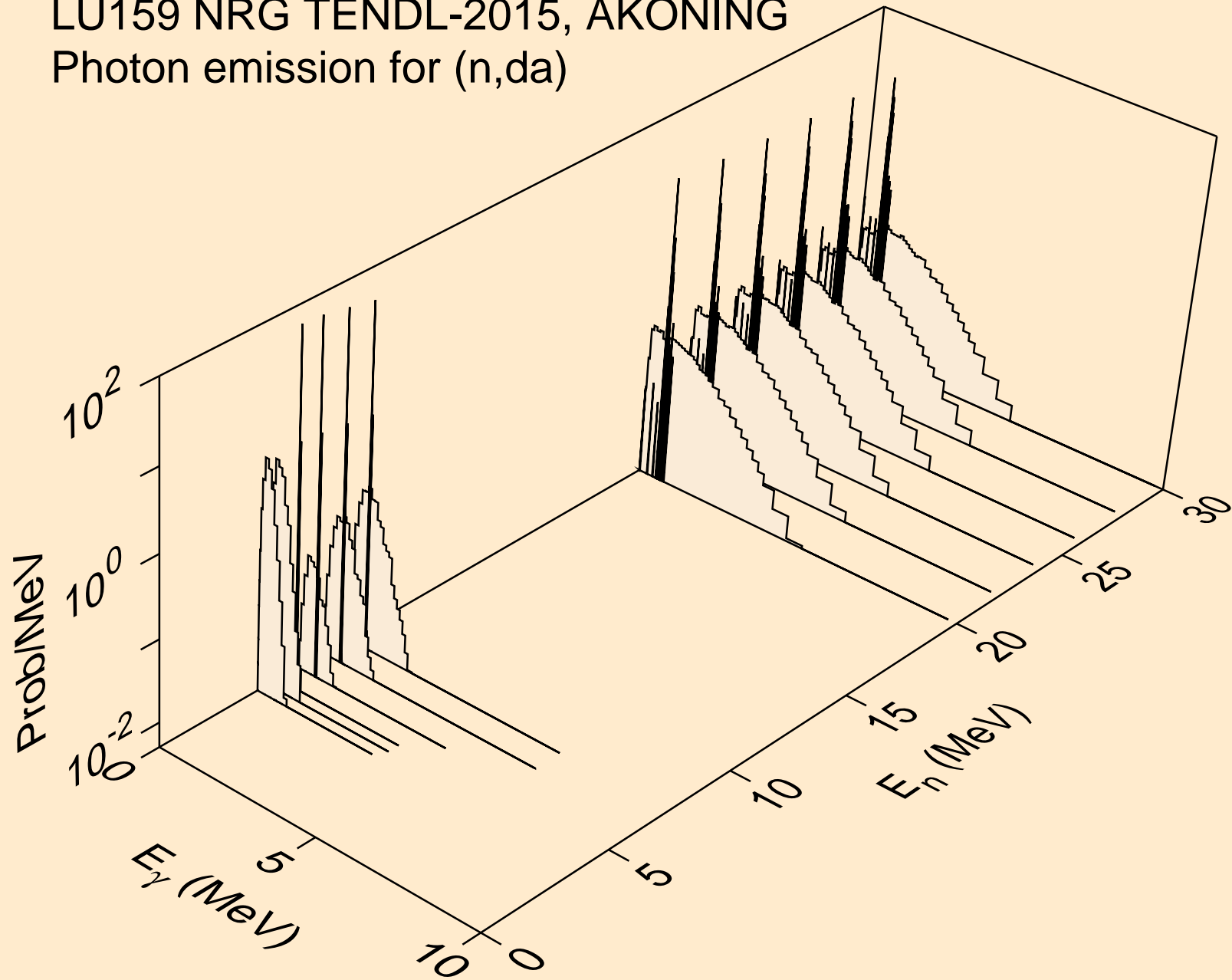

LU159 NRG TENDL-2015, AKONING
thermal capture photon spectrum

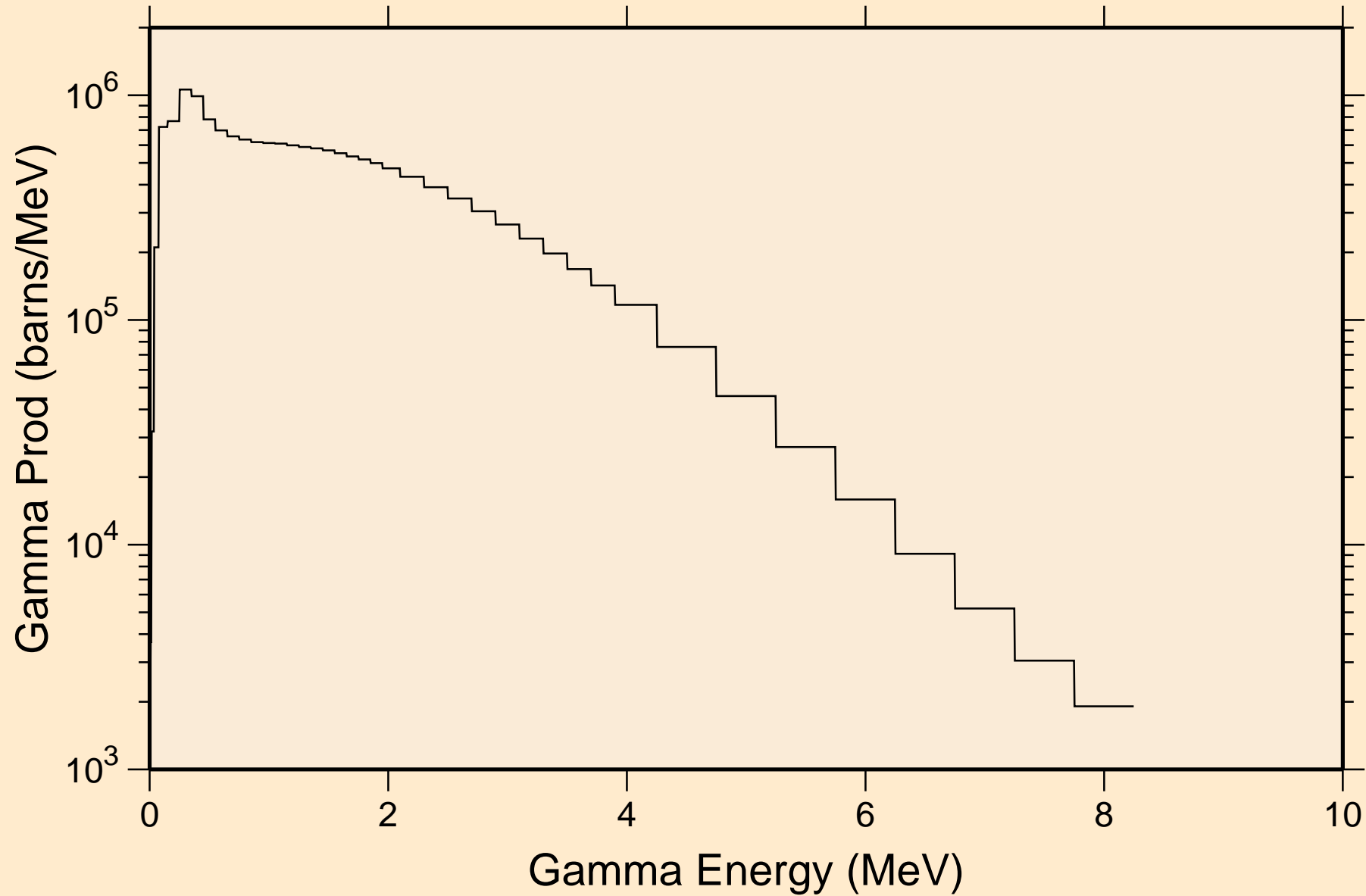

LU159 NRG TENDL-2015, AKONING
14 MeV photon spectrum

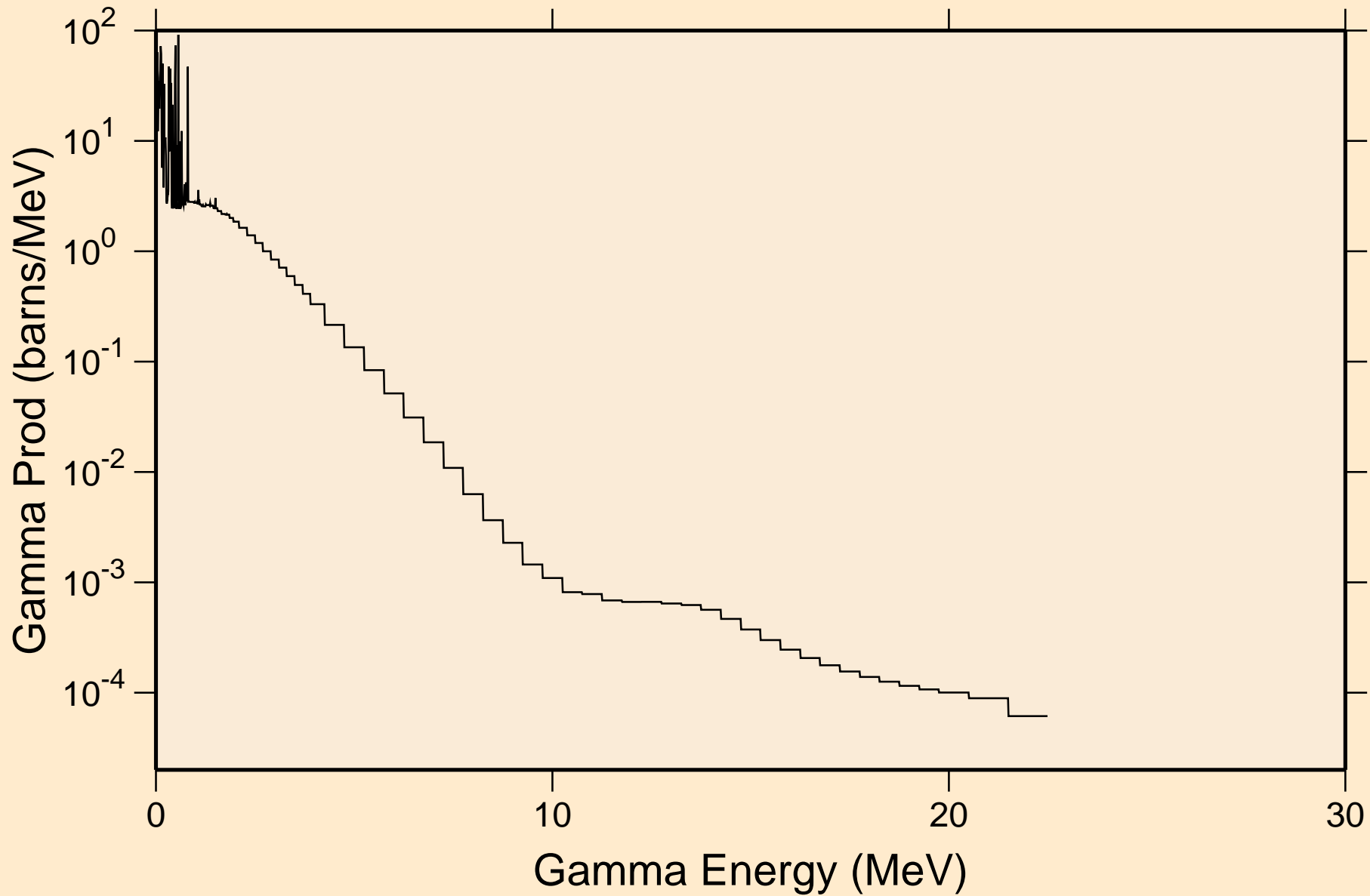

LU159 NRG TENDL-2015, AKONING

Particle heating contributions

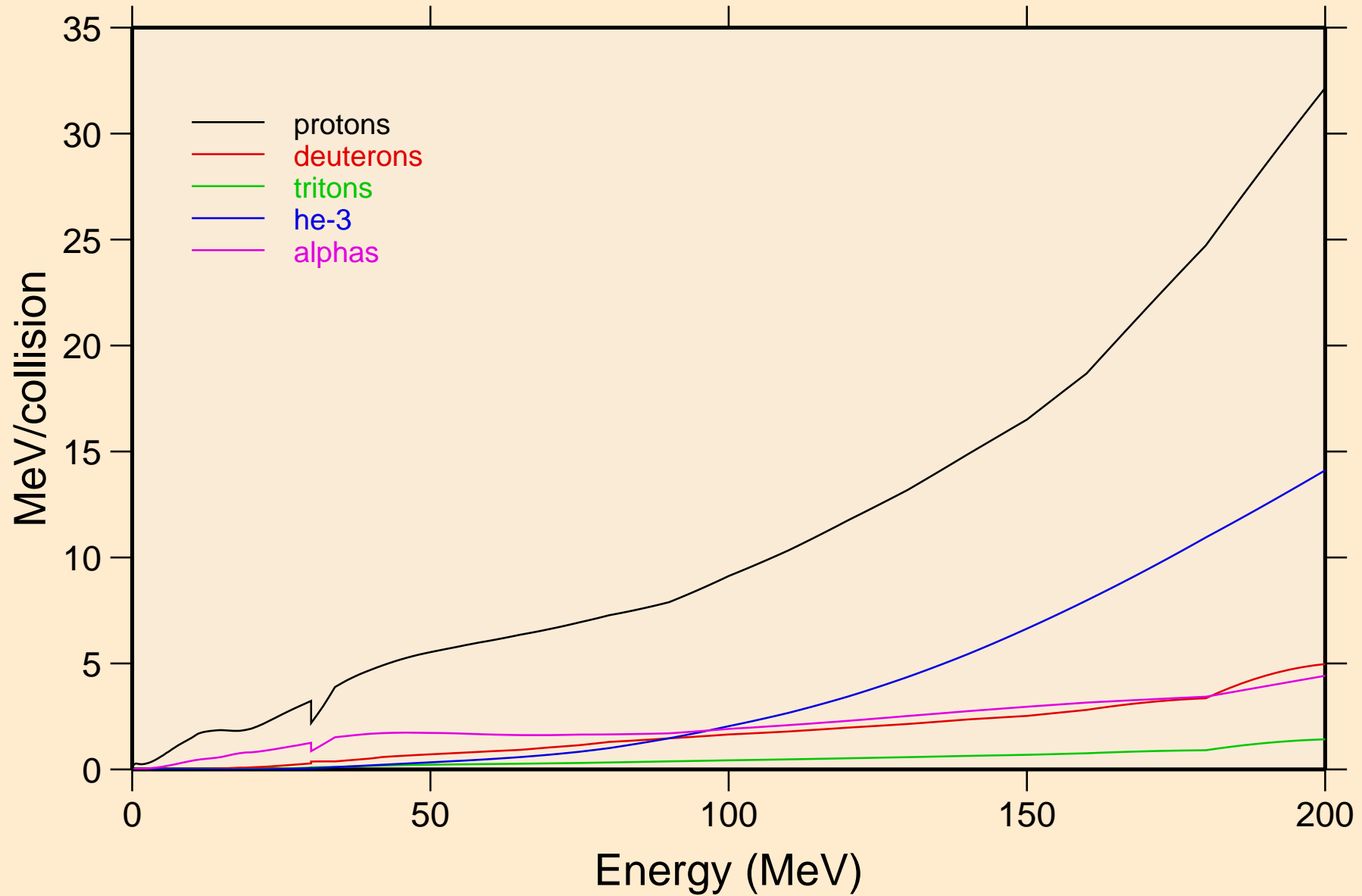

LU159 NRG TENDL-2015, AKONING

Recoil Heating

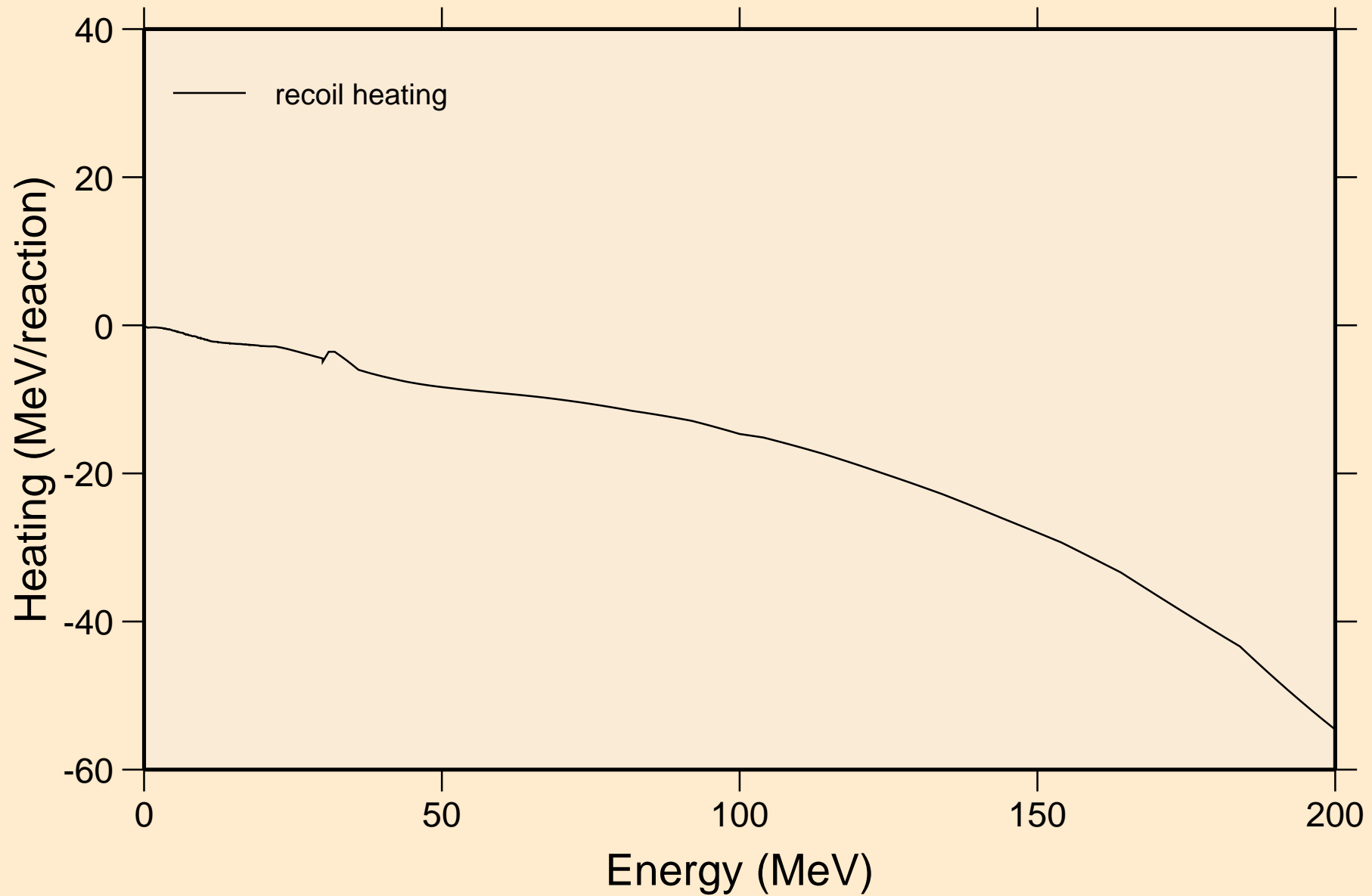

LU159 NRG TENDL-2015, AKONING

Particle production cross sections

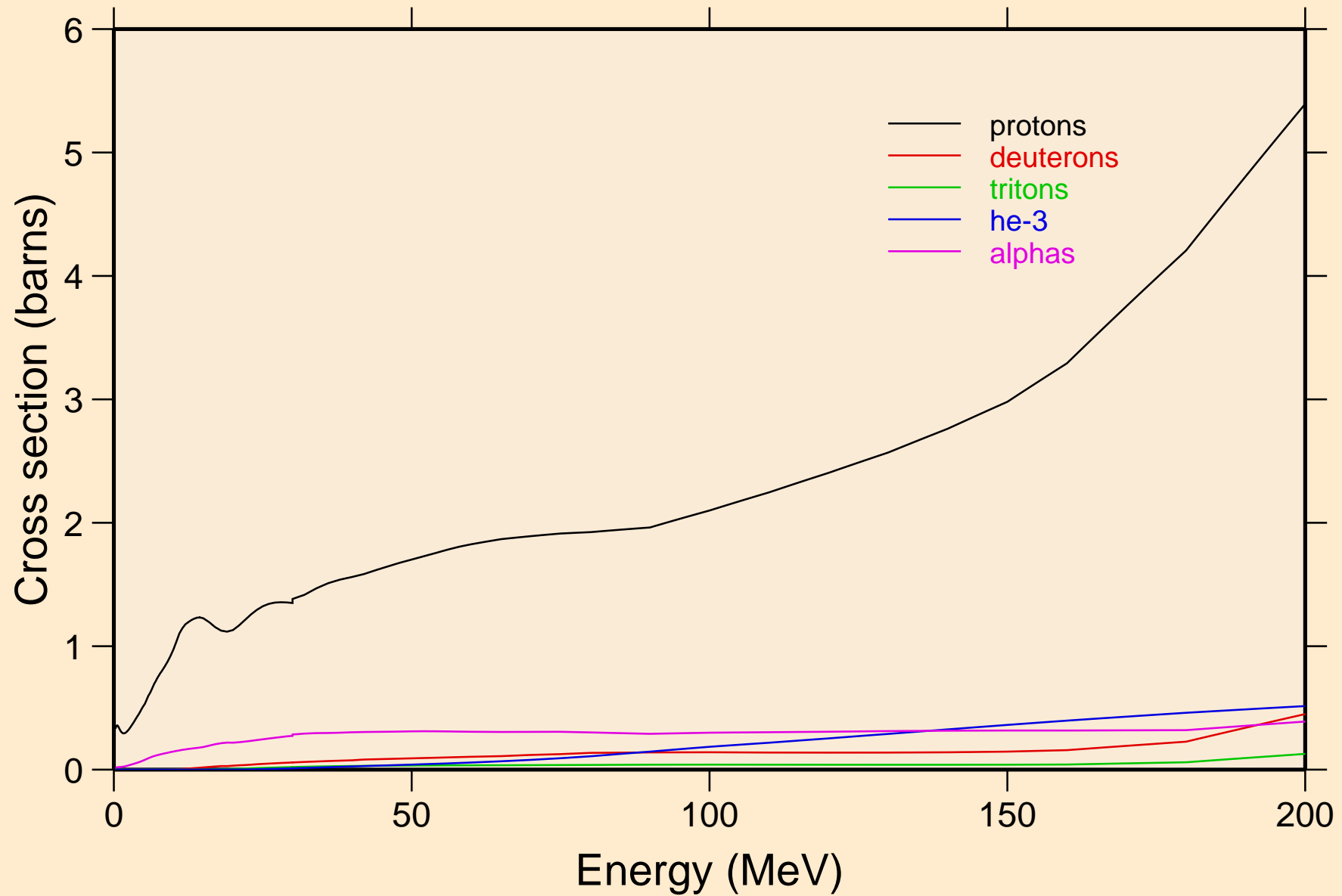

LU159 NRG TENDL-2015, AKONING
protons from (n,x)

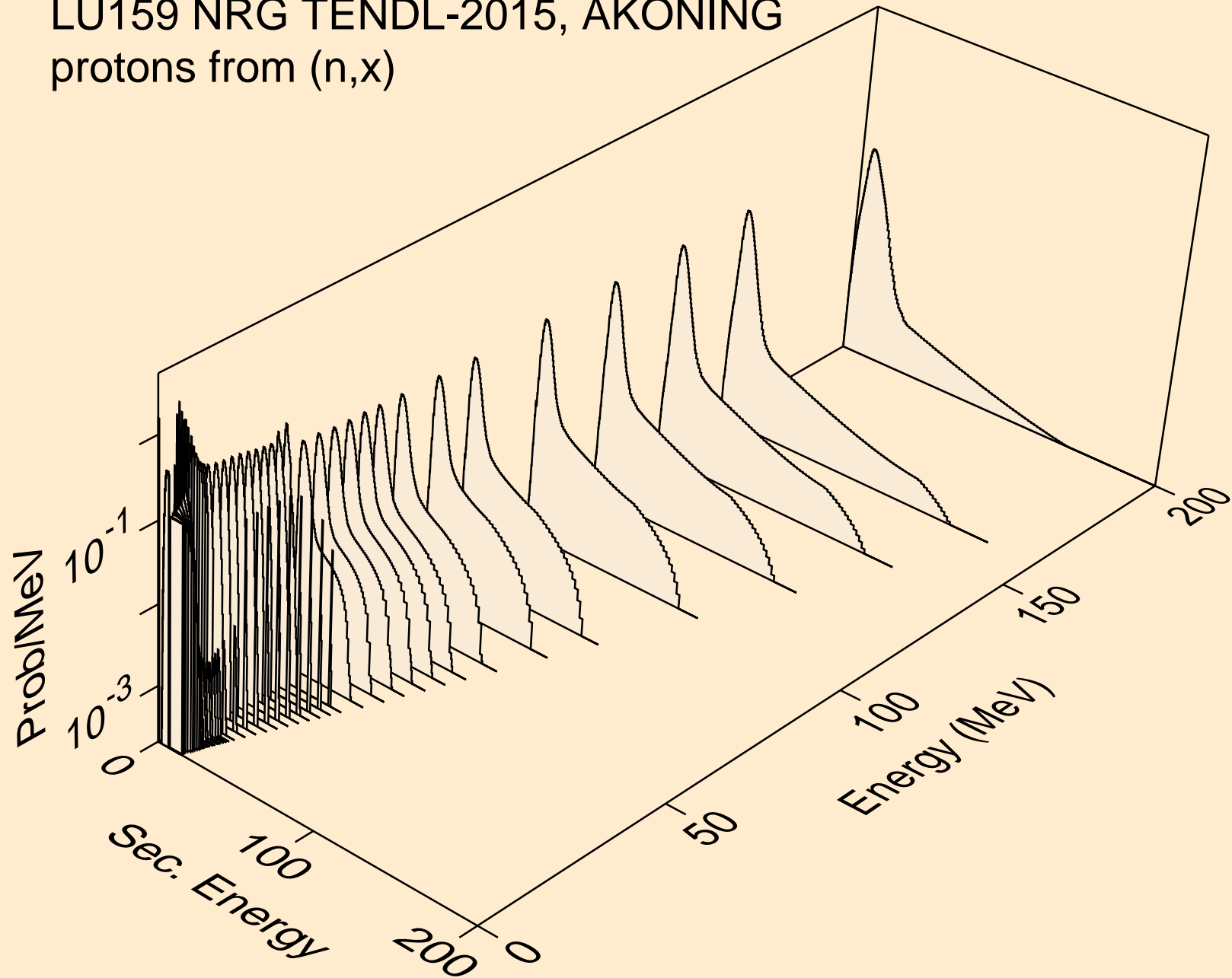

LU159 NRG TENDL-2015, AKONING
protons from (n,n*)p

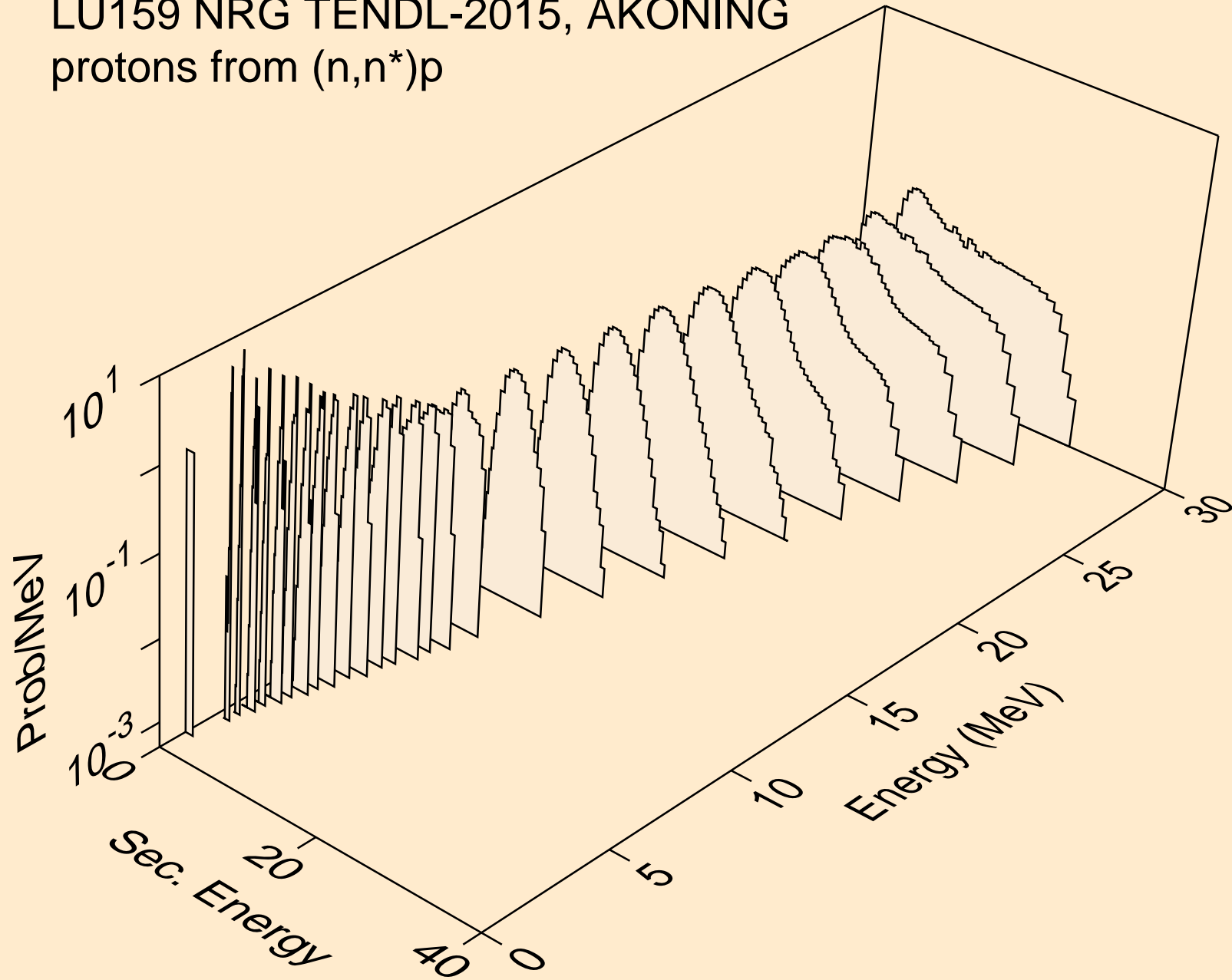

LU159 NRG TENDL-2015, AKONING
protons from (n,2np)

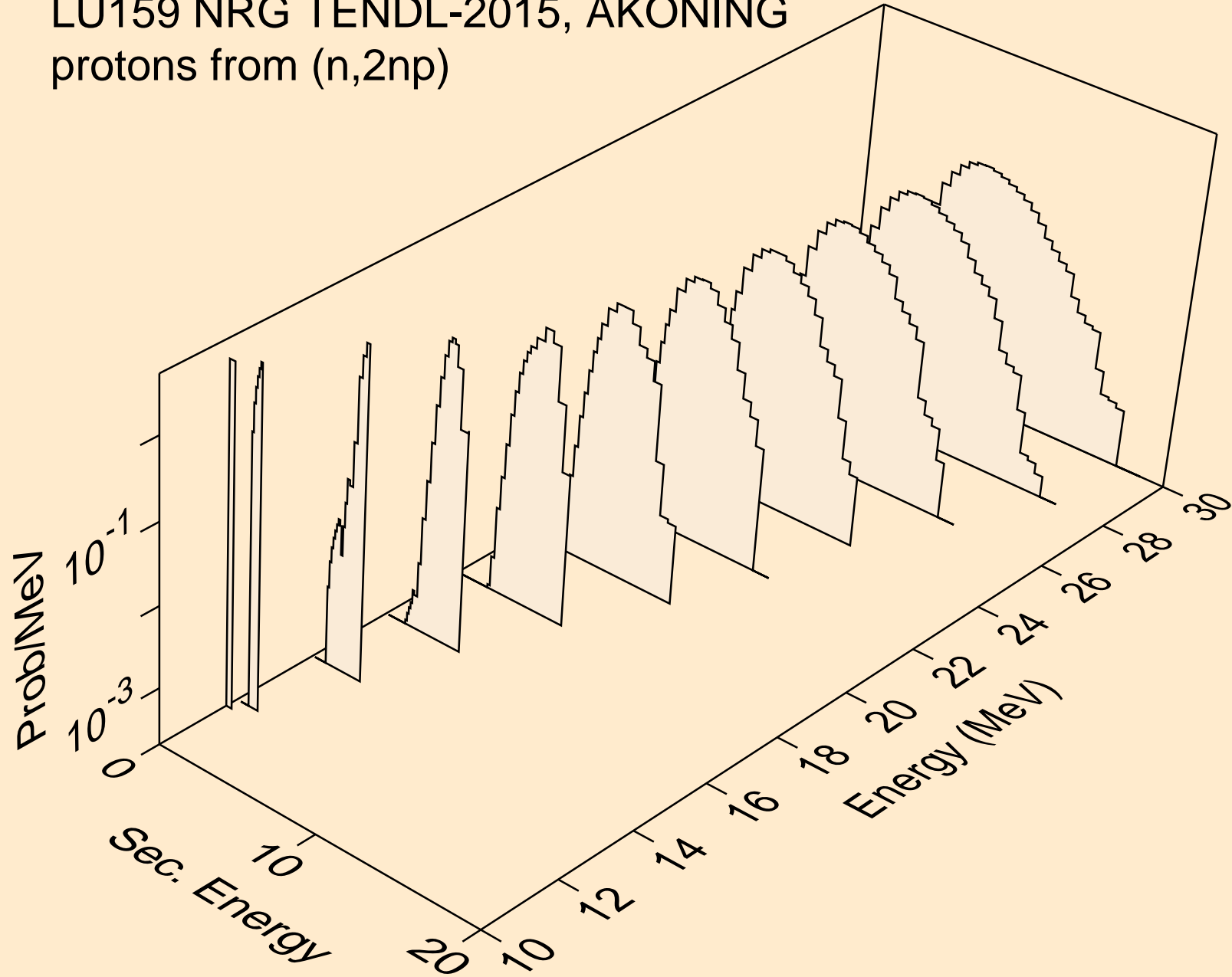

LU159 NRG TENDL-2015, AKONING
protons from (n,3np)

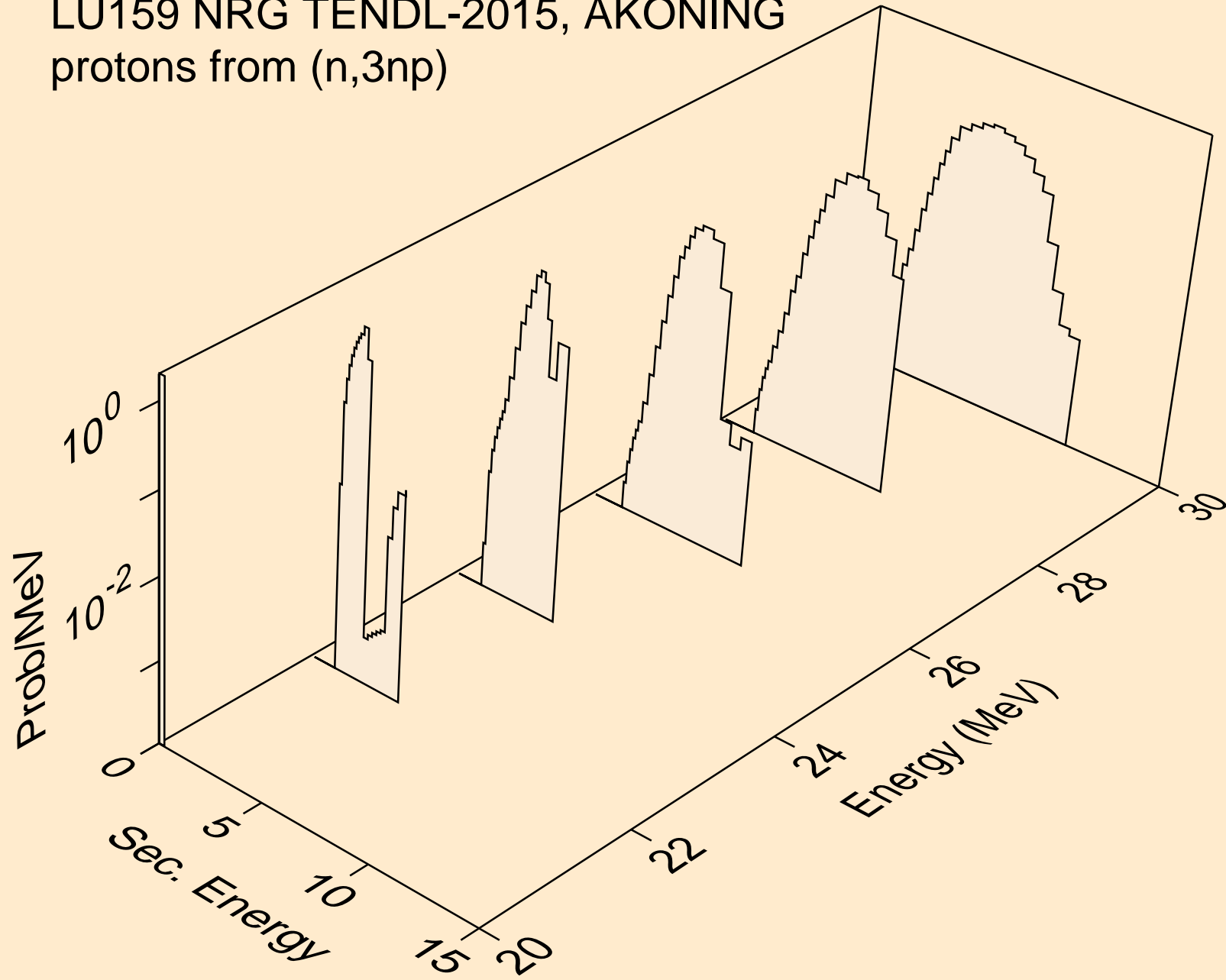

LU159 NRG TENDL-2015, AKONING
protons from (n,2np)

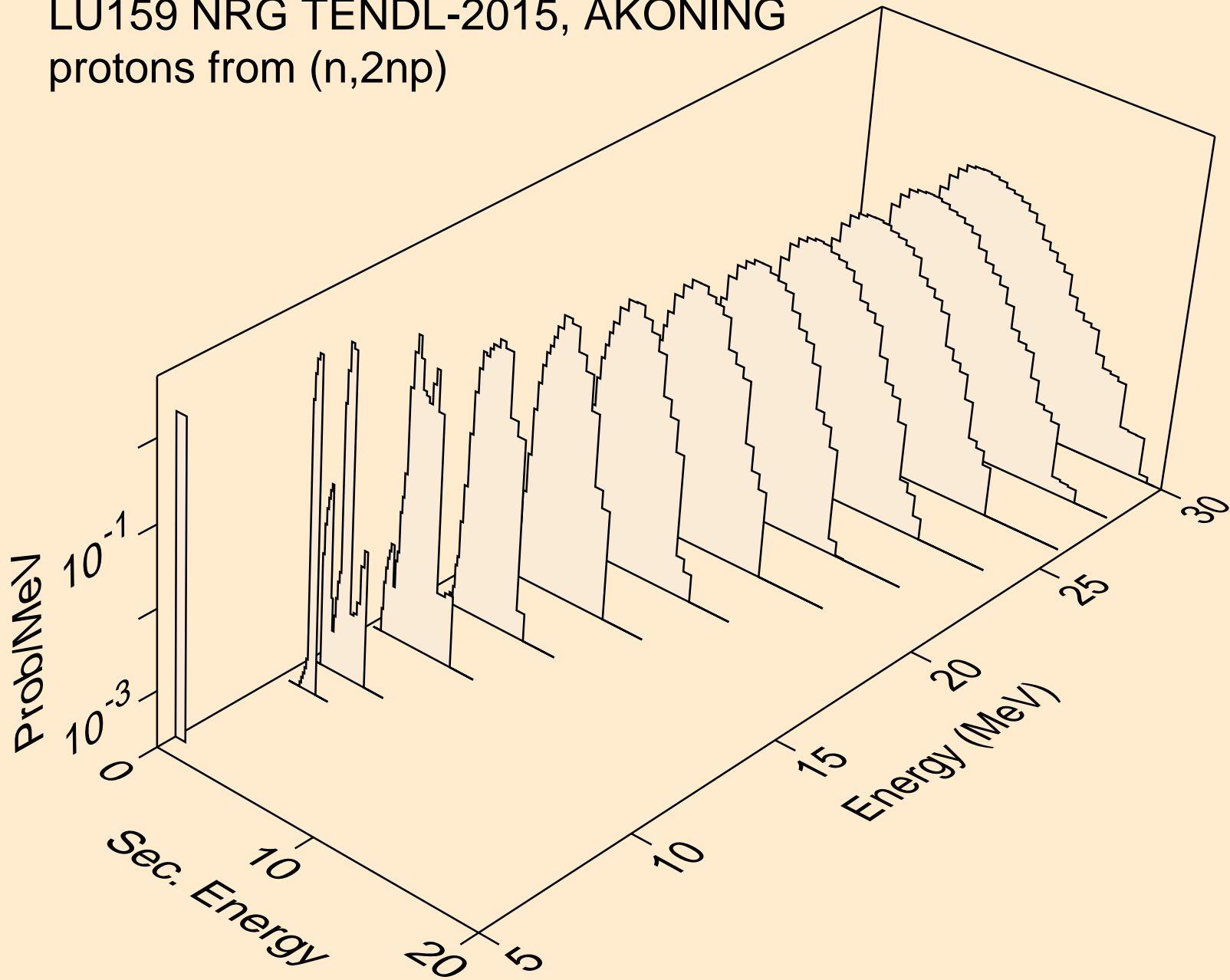

LU159 NRG TENDL-2015, AKONING
protons from (n,npa)

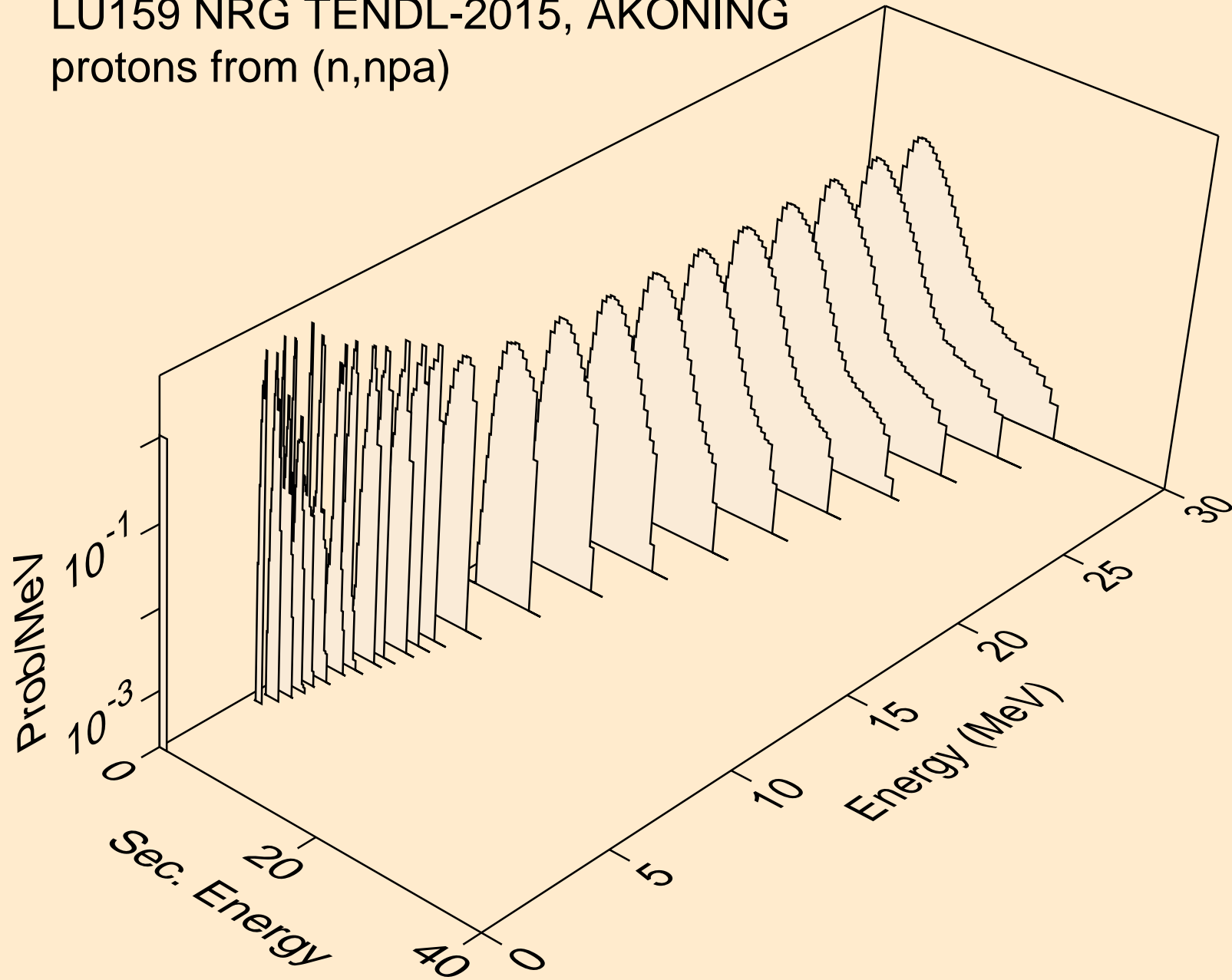

LU159 NRG TENDL-2015, AKONING
protons from (n,p)

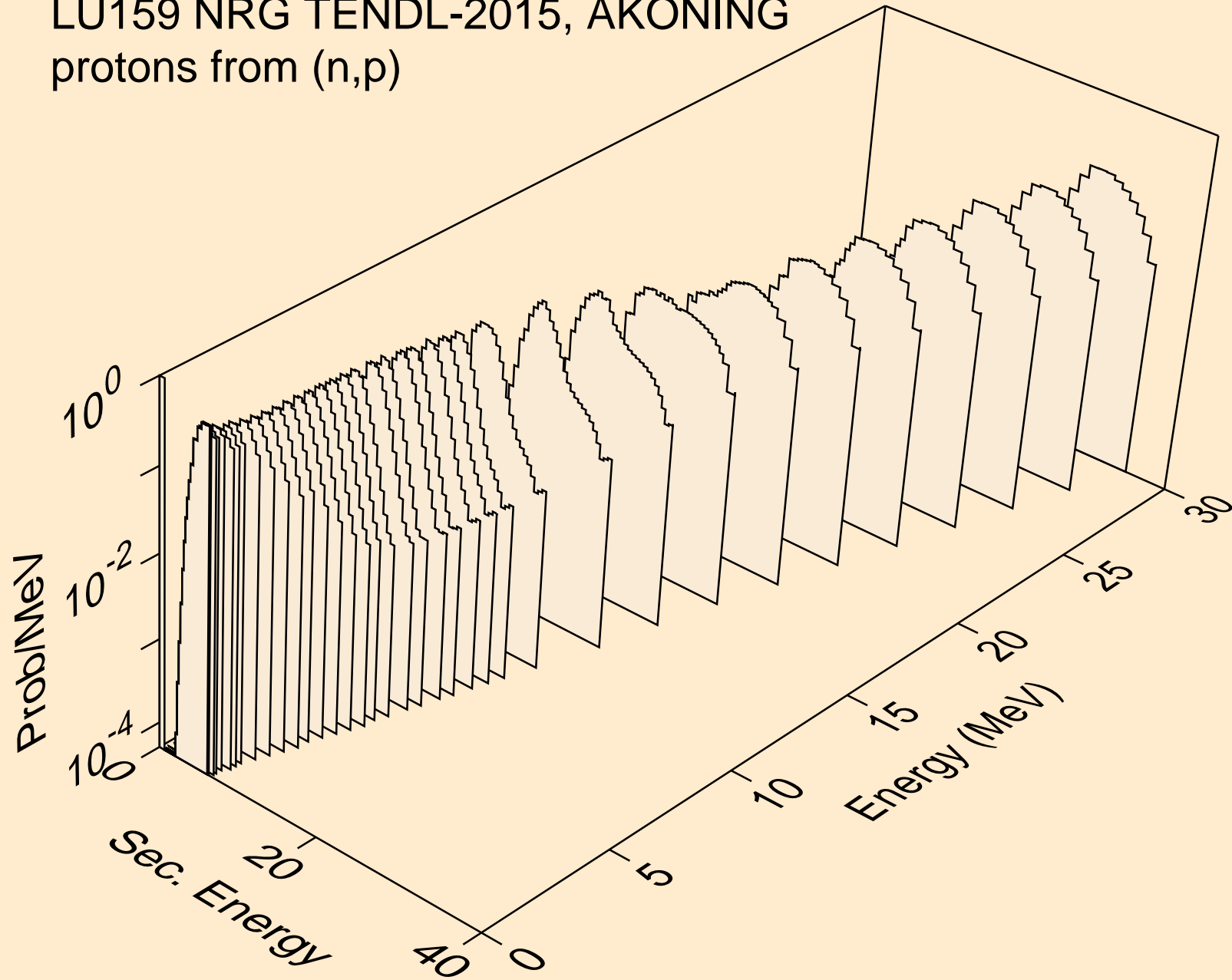

LU159 NRG TENDL-2015, AKONING
protons from (n,2p)

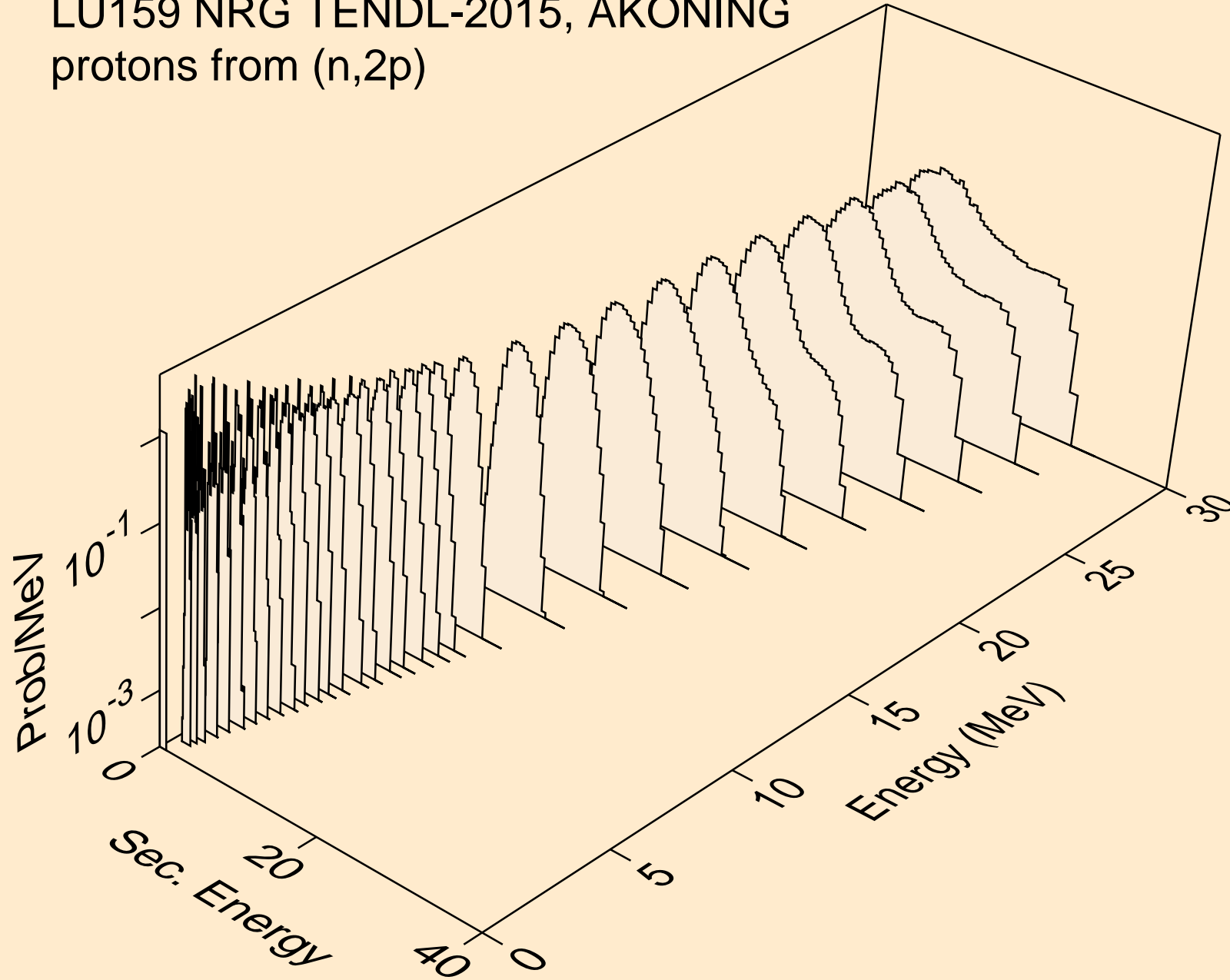

LU159 NRG TENDL-2015, AKONING
protons from (n,pa)

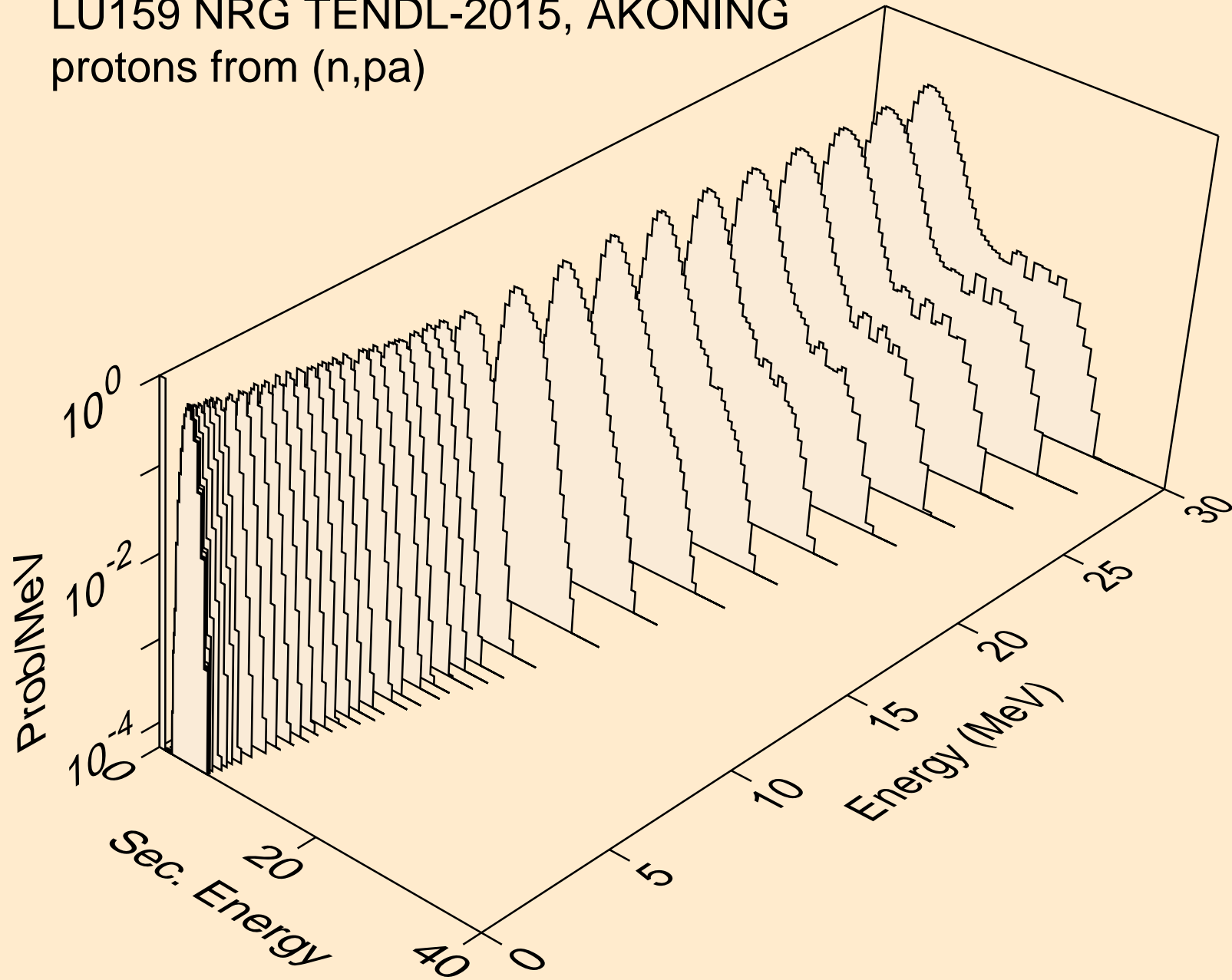

LU159 NRG TENDL-2015, AKONING
protons from (n,pd)

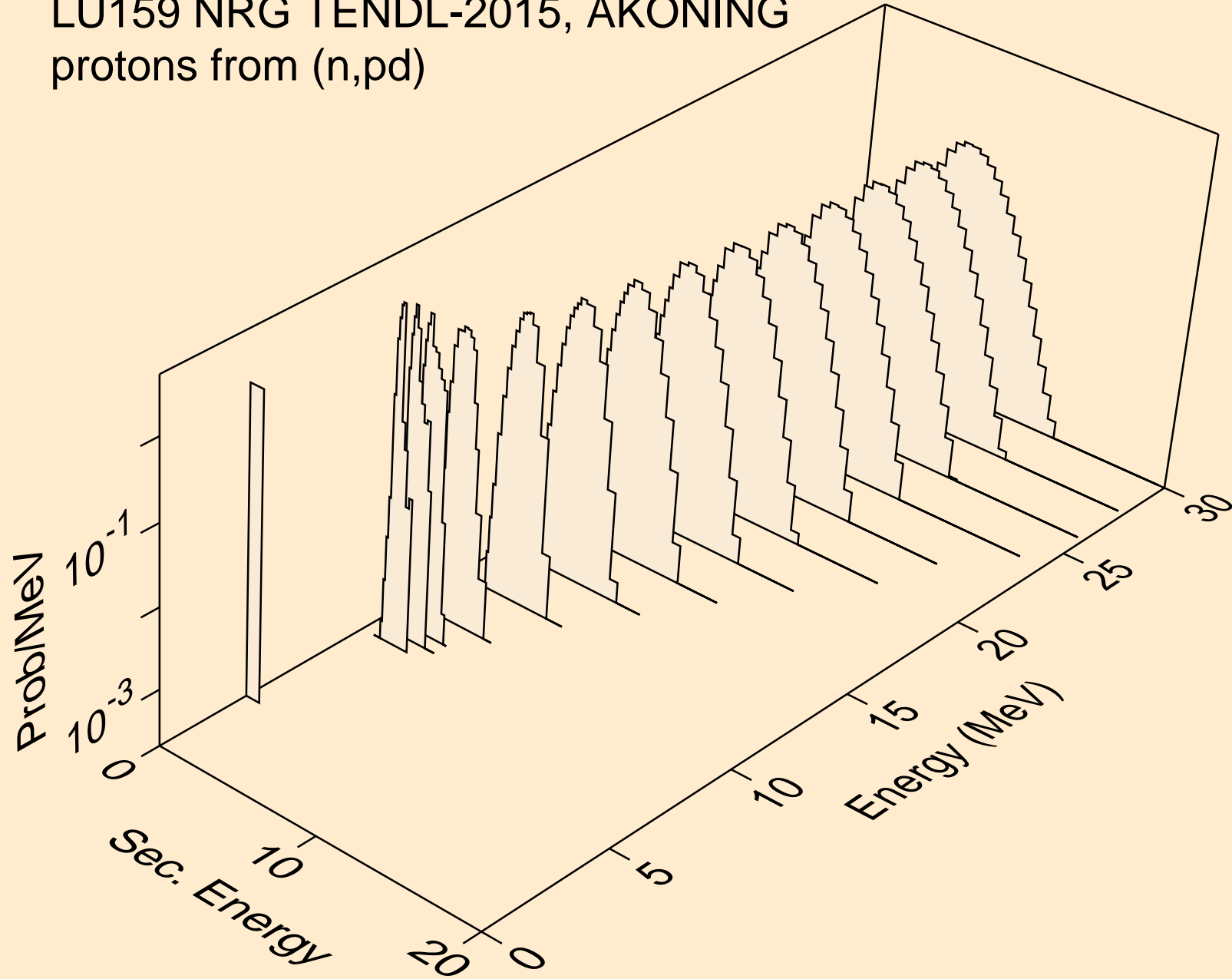

LU159 NRG TENDL-2015, AKONING
protons from (n,pt)

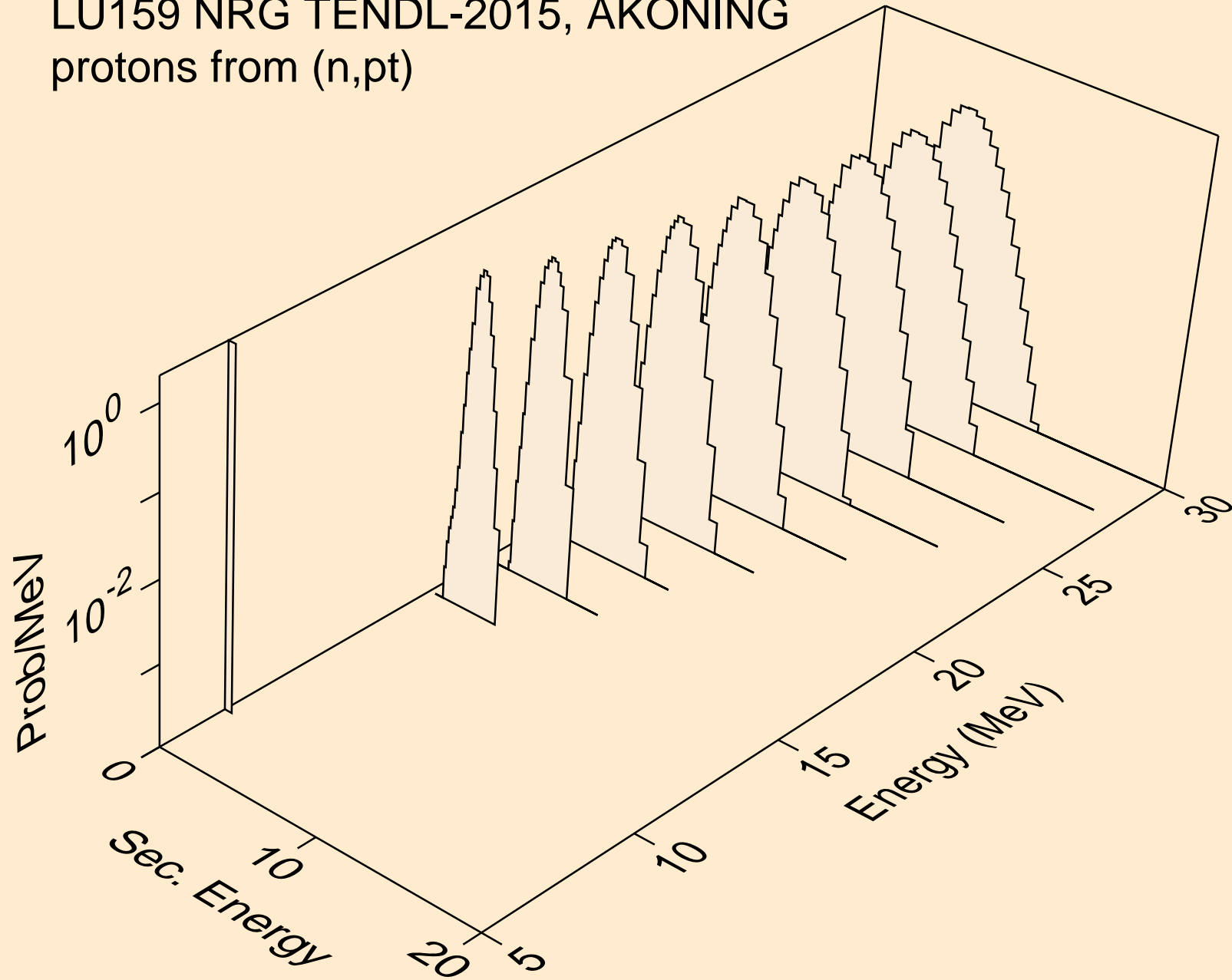

LU159 NRG TENDL-2015, AKONING
deuterons from (n,x)

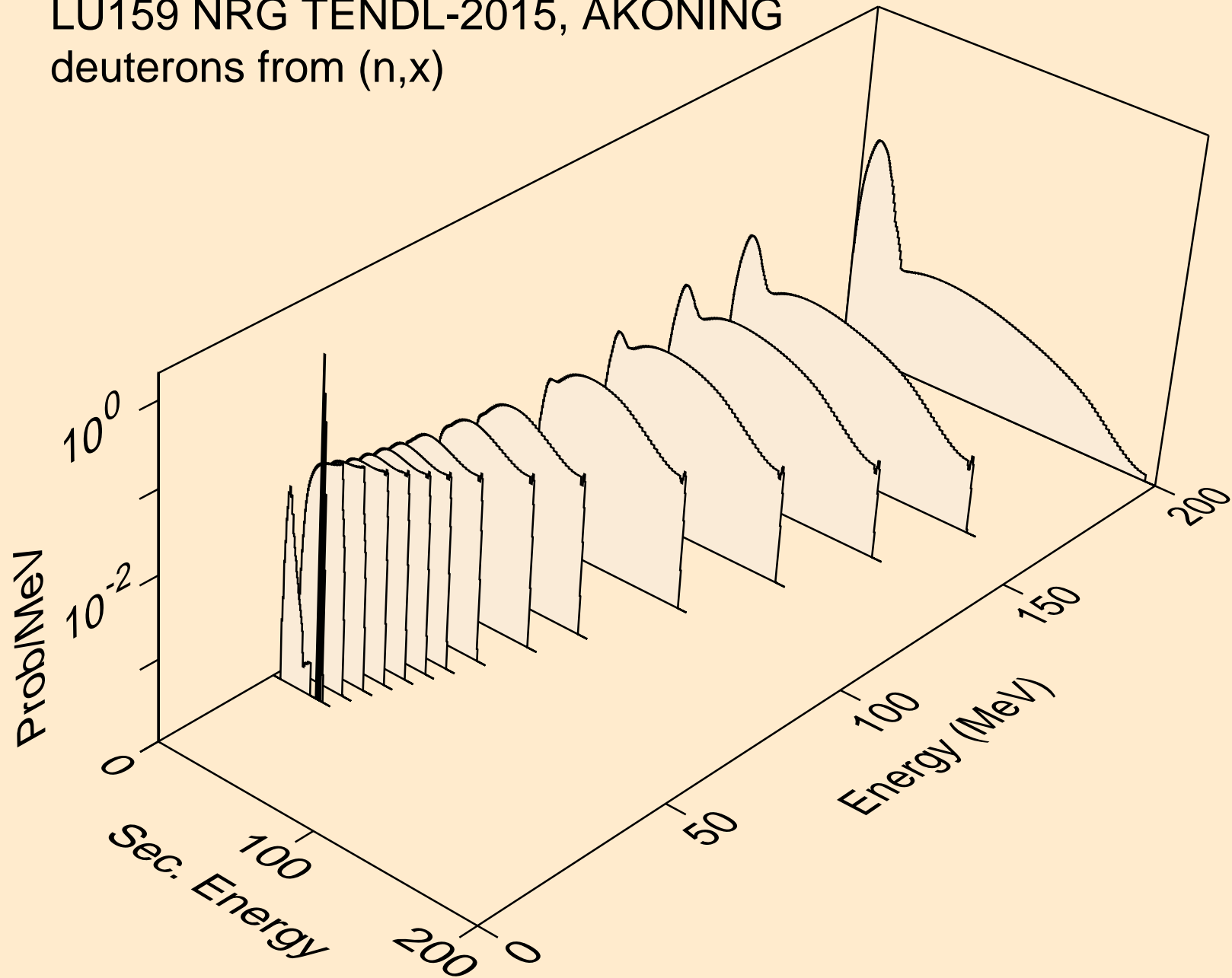

LU159 NRG TENDL-2015, AKONING
deuterons from (n,2nd)

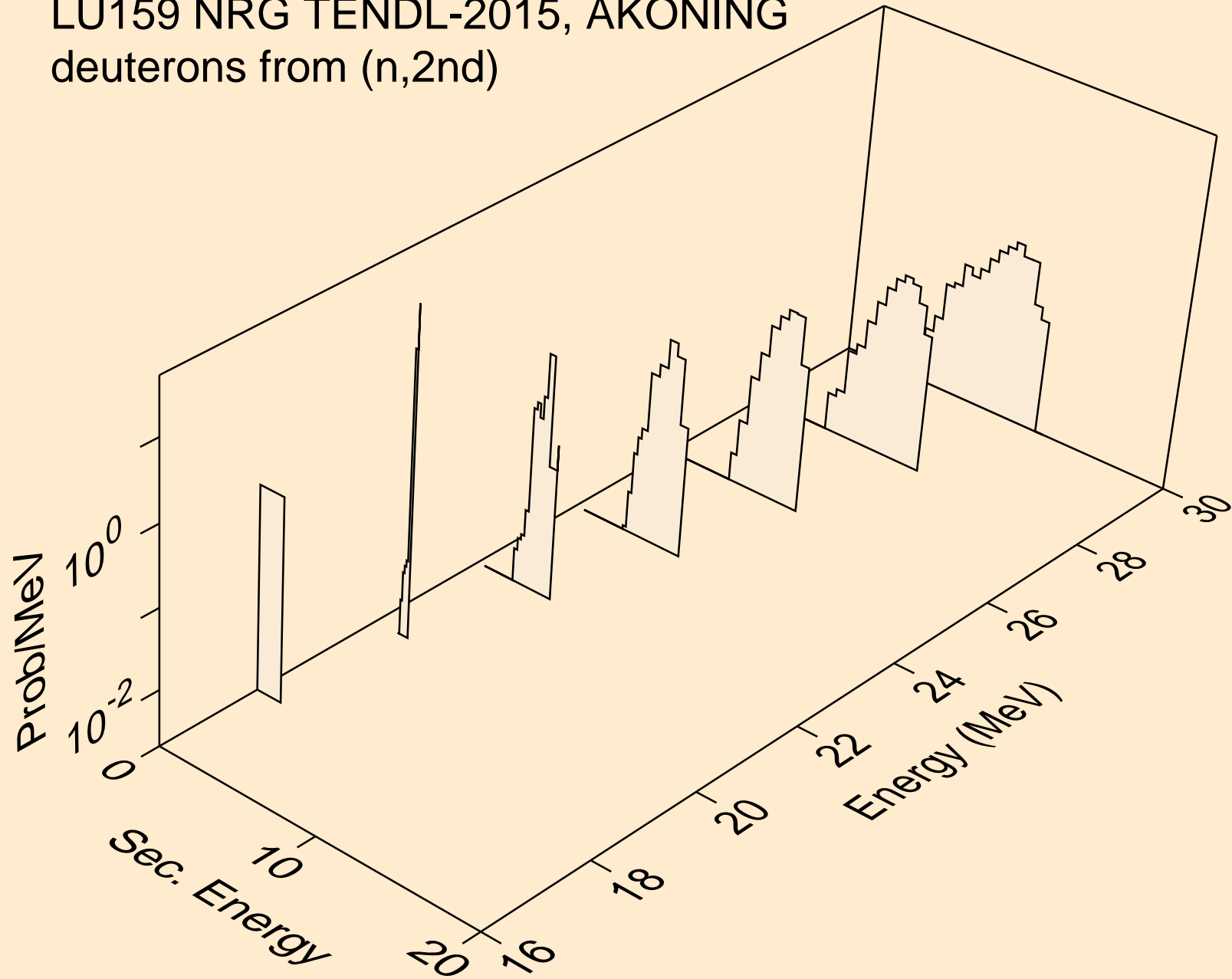

LU159 NRG TENDL-2015, AKONING
deuterons from (n,n*)d

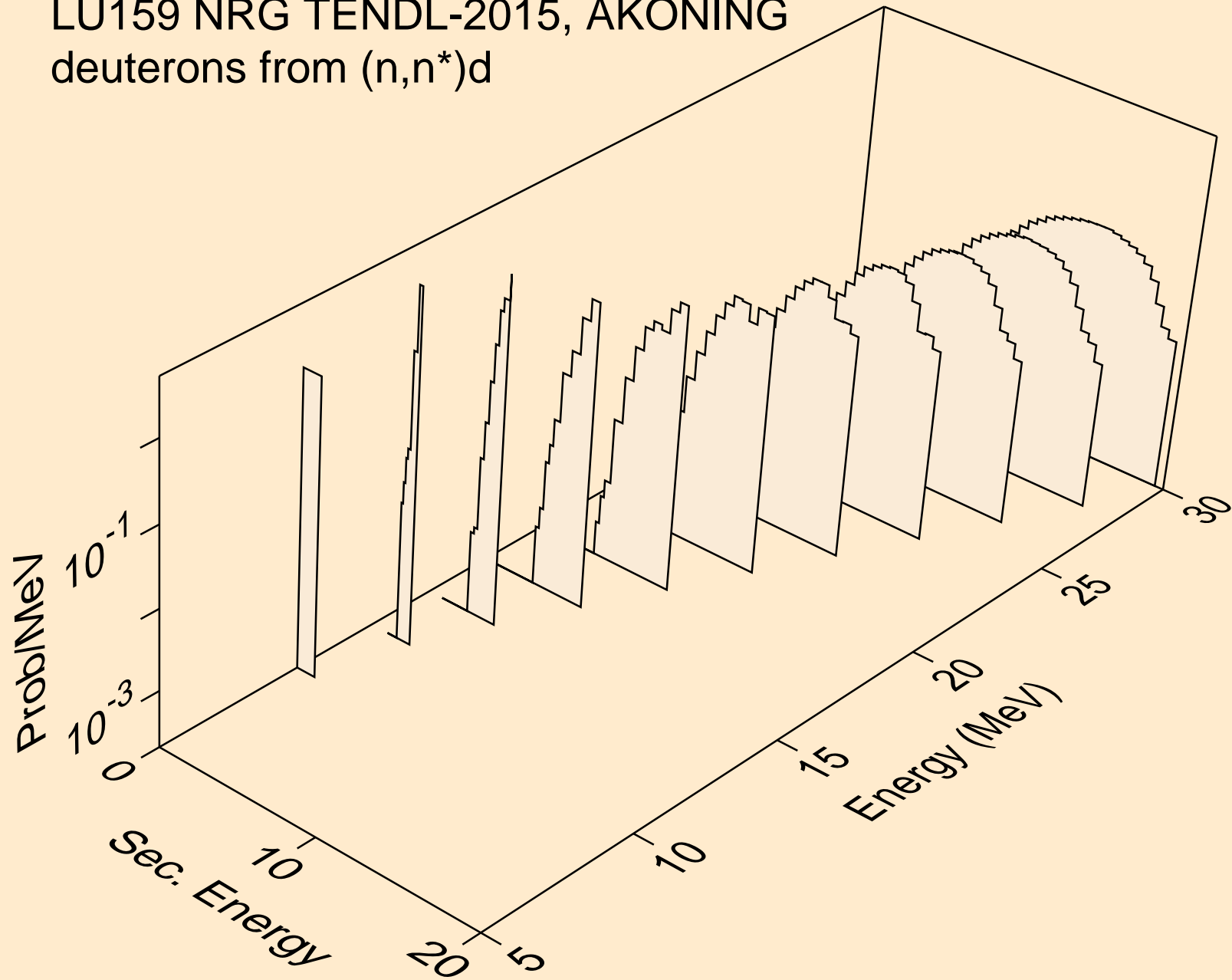

LU159 NRG TENDL-2015, AKONING
deuterons from (n,n*)d2a

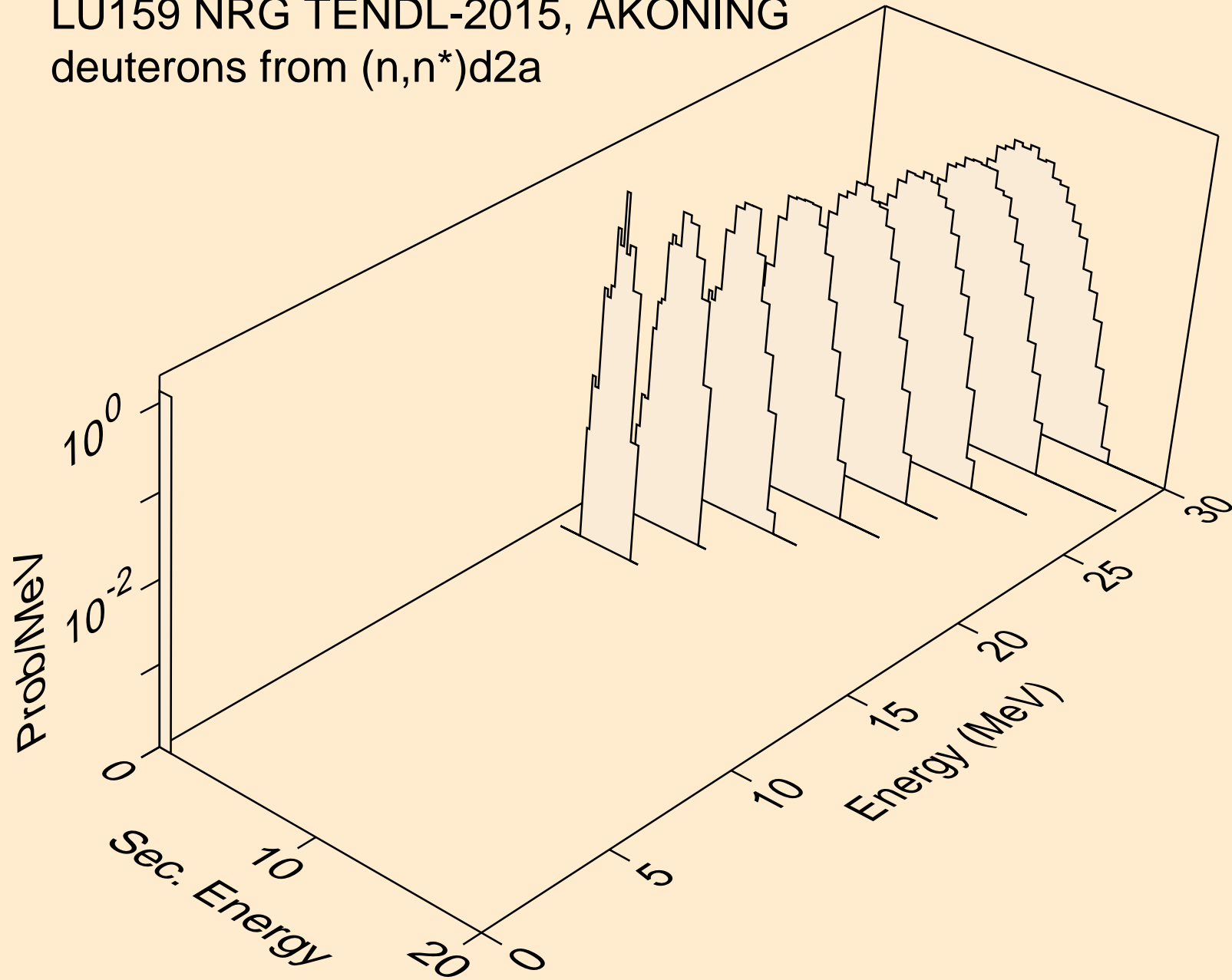

LU159 NRG TENDL-2015, AKONING
deuterons from (n,d)

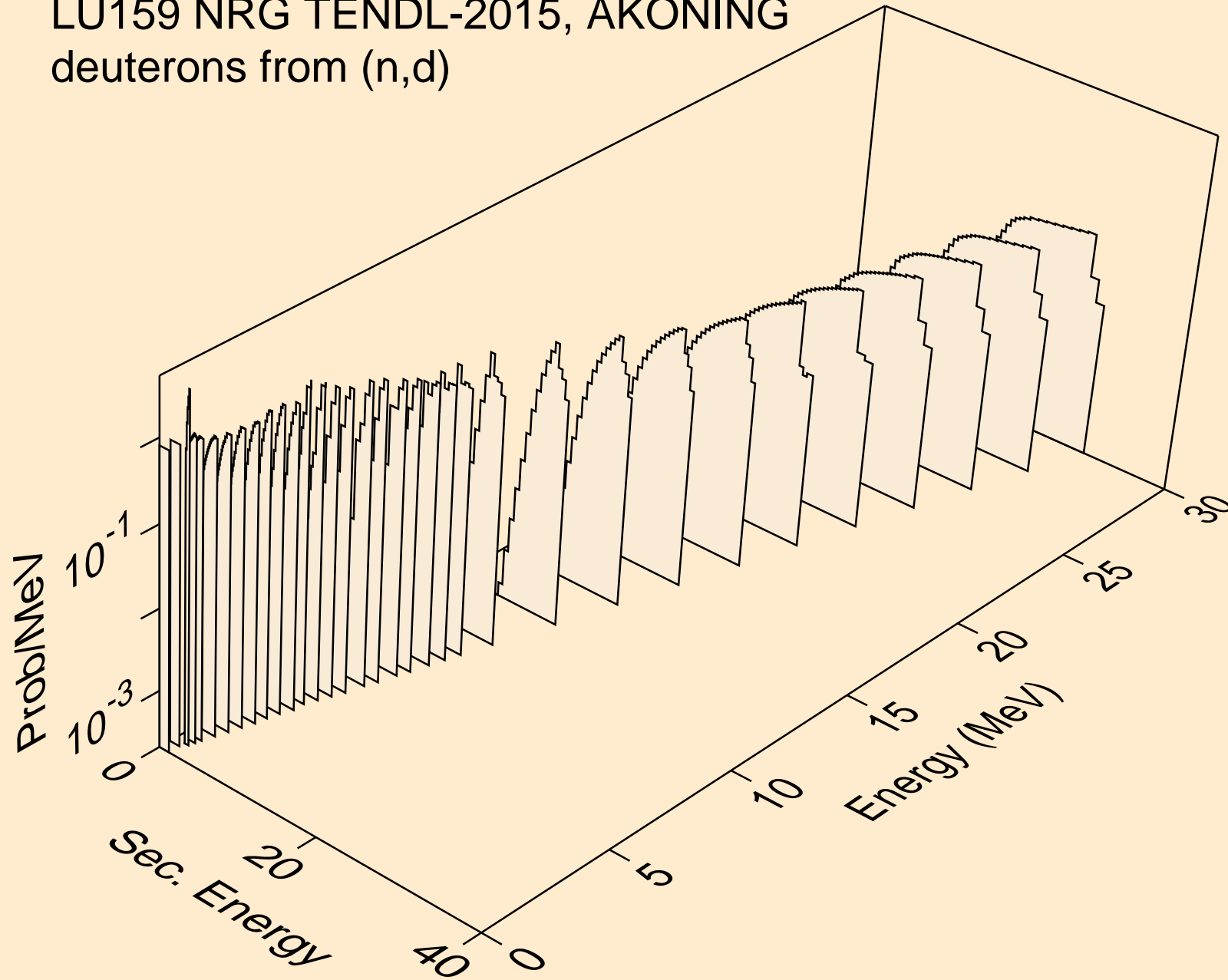

LU159 NRG TENDL-2015, AKONING
deuterons from (n,d2a)

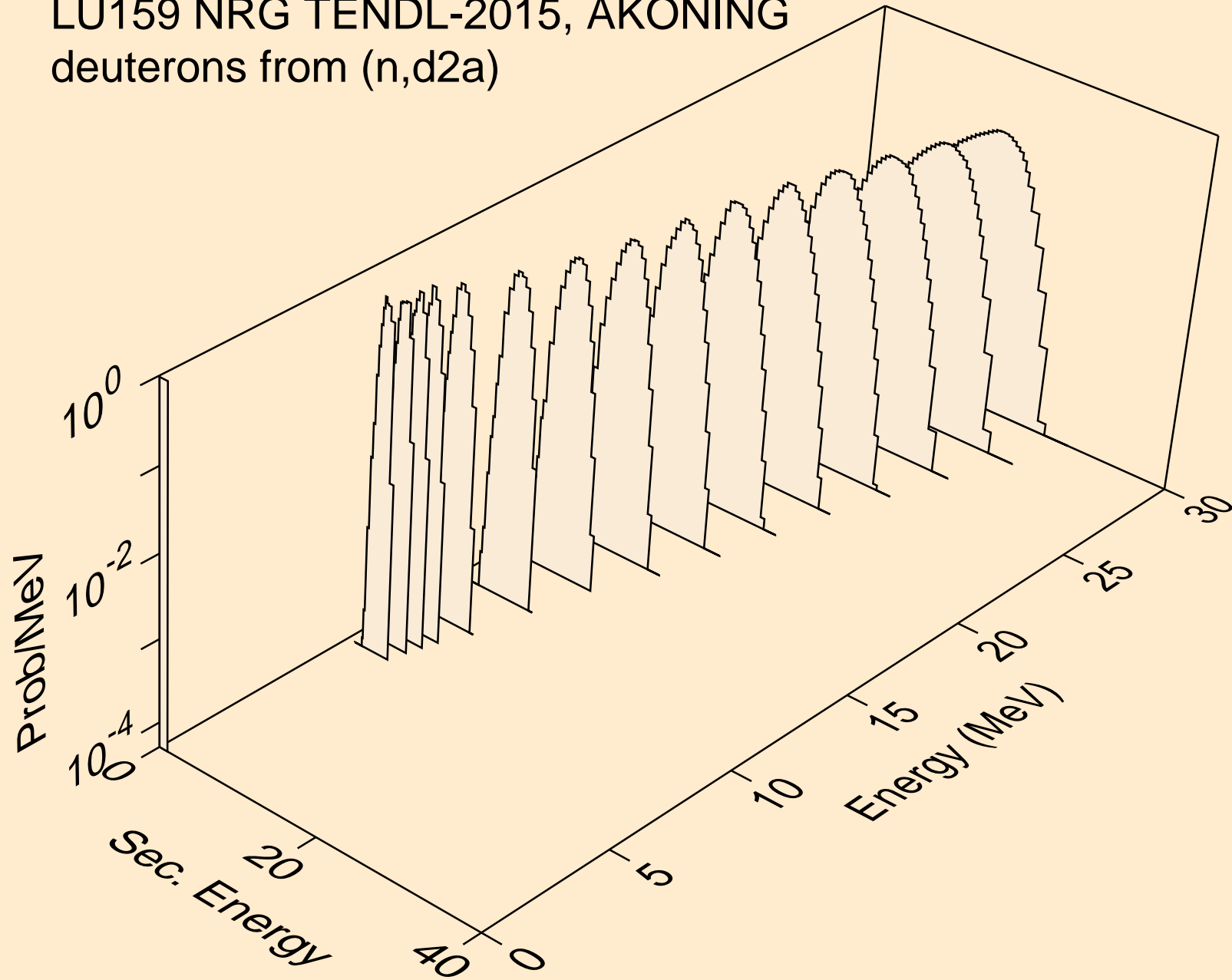

LU159 NRG TENDL-2015, AKONING
deuterons from (n,pd)

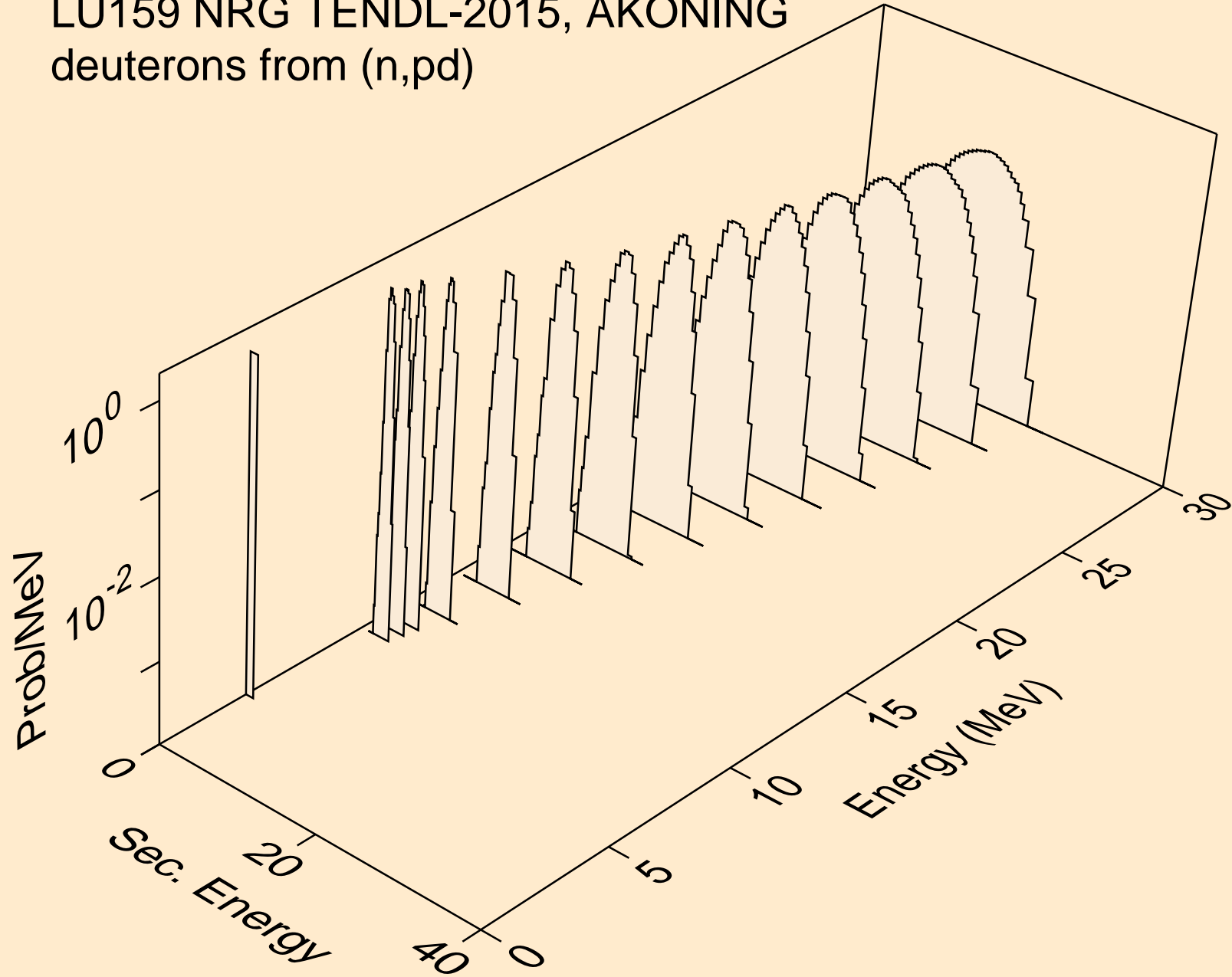

LU159 NRG TENDL-2015, AKONING
deuterons from (n,da)

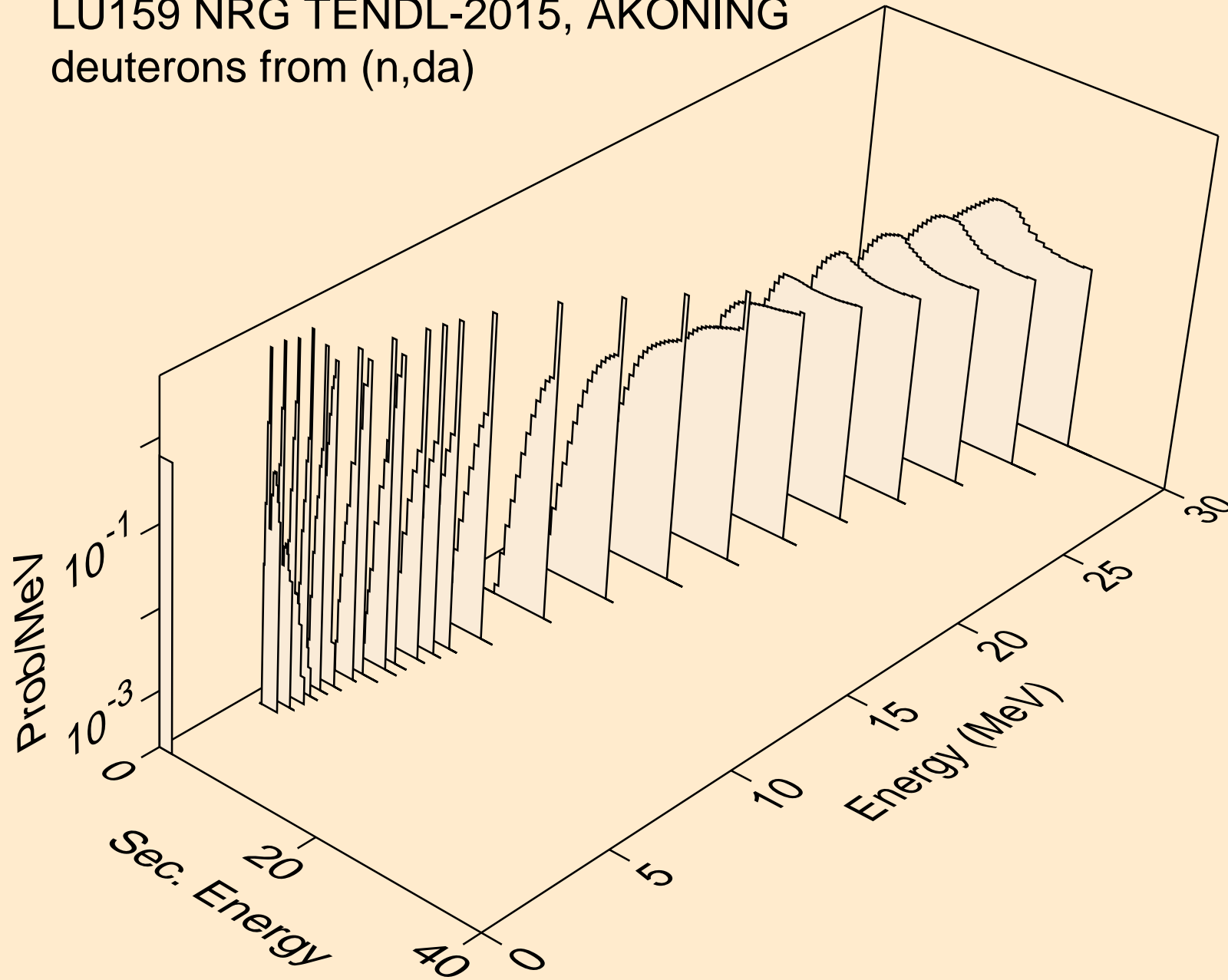

LU159 NRG TENDL-2015, AKONING
tritons from (n,x)

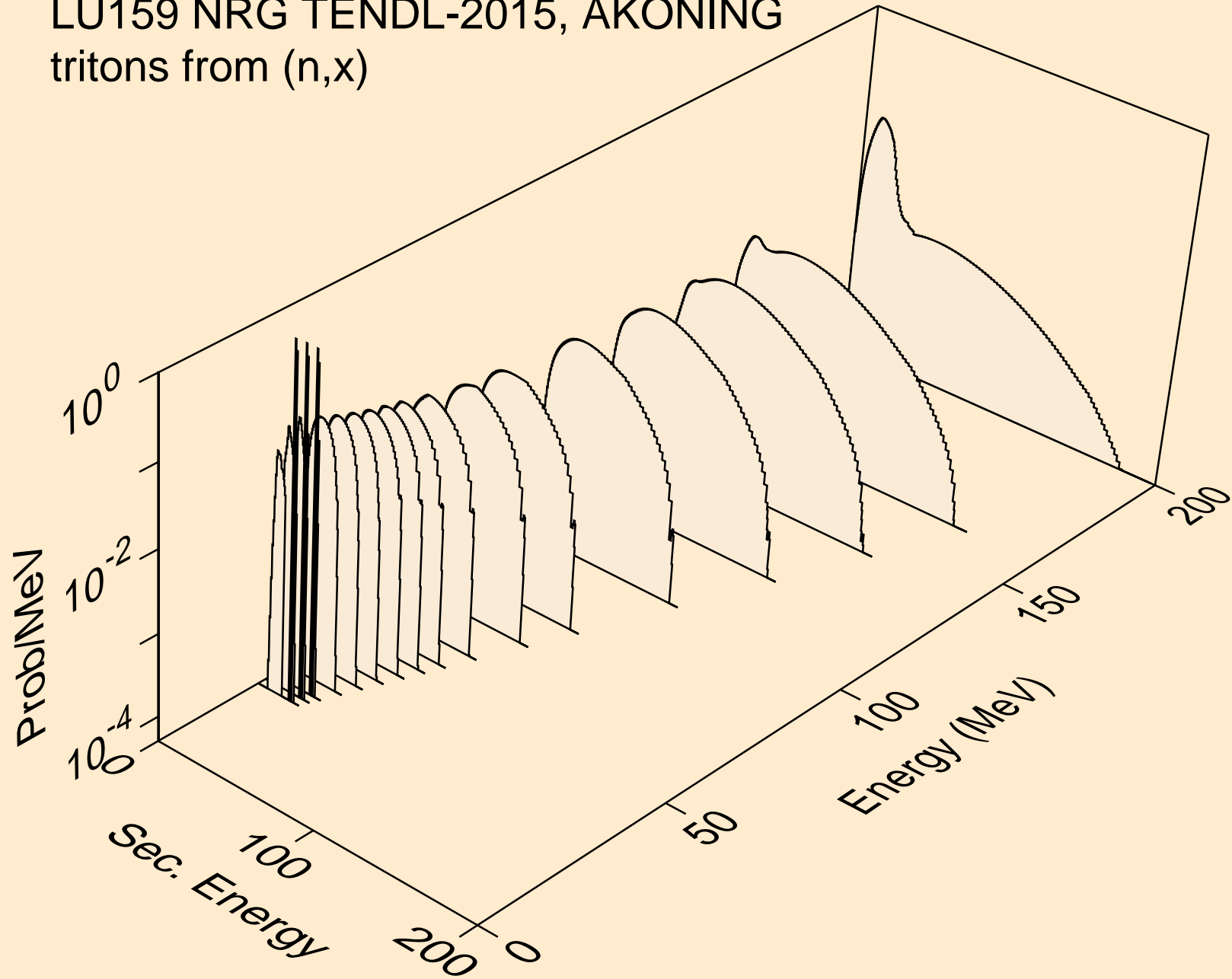

LU159 NRG TENDL-2015, AKONING
tritons from (n,n*)t

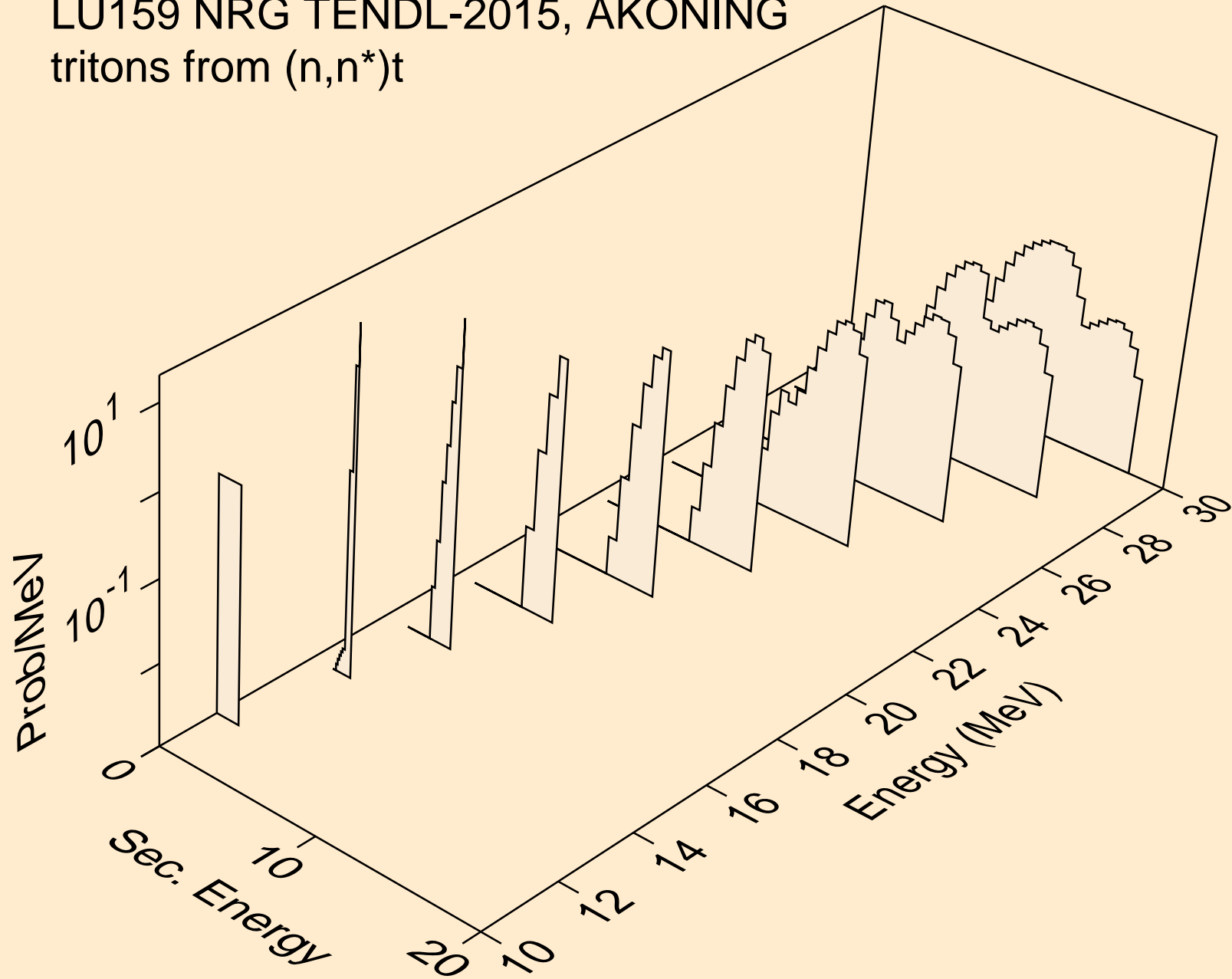

LU159 NRG TENDL-2015, AKONING
tritons from (n,n*)t2a

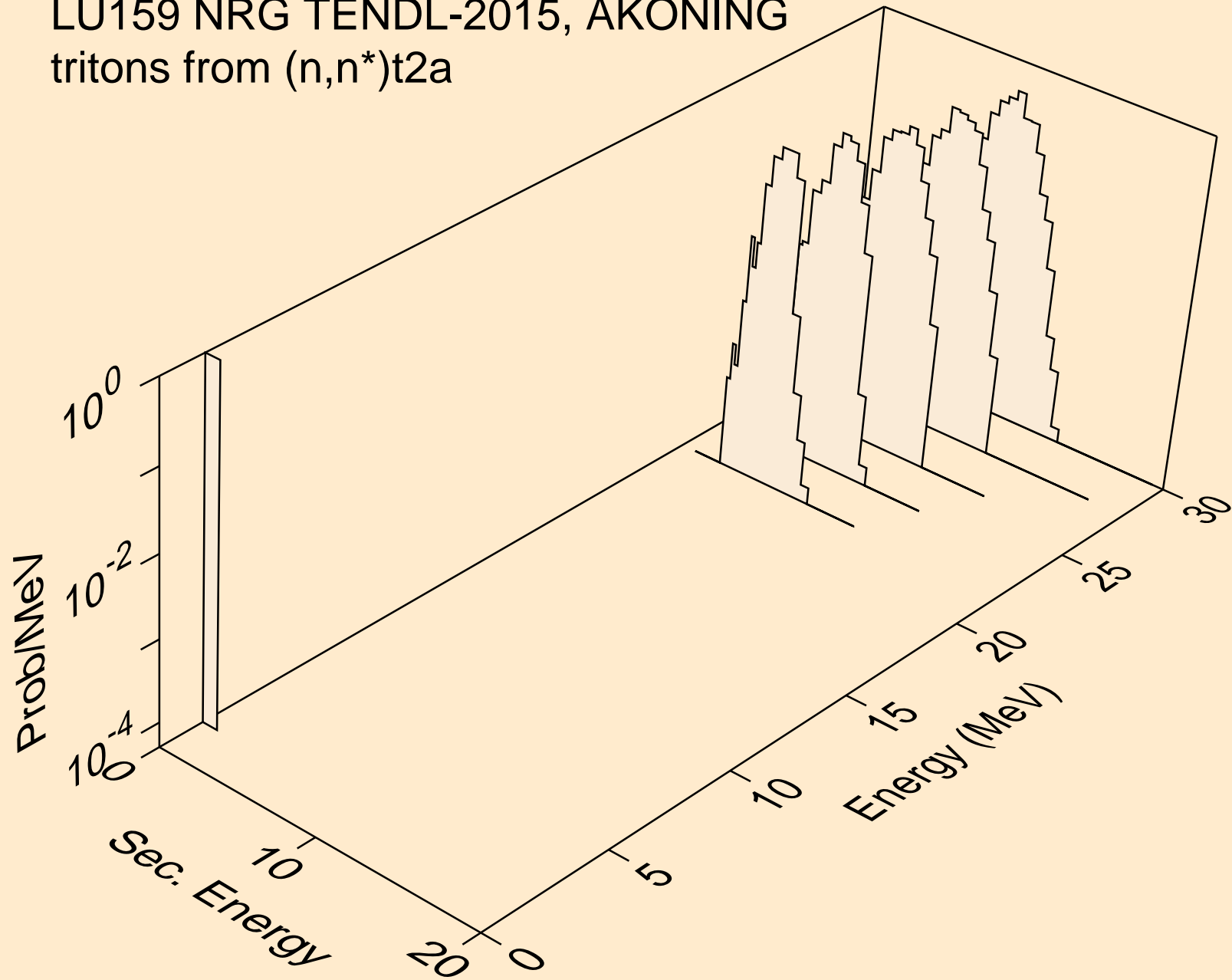

LU159 NRG TENDL-2015, AKONING
tritons from (n,t)

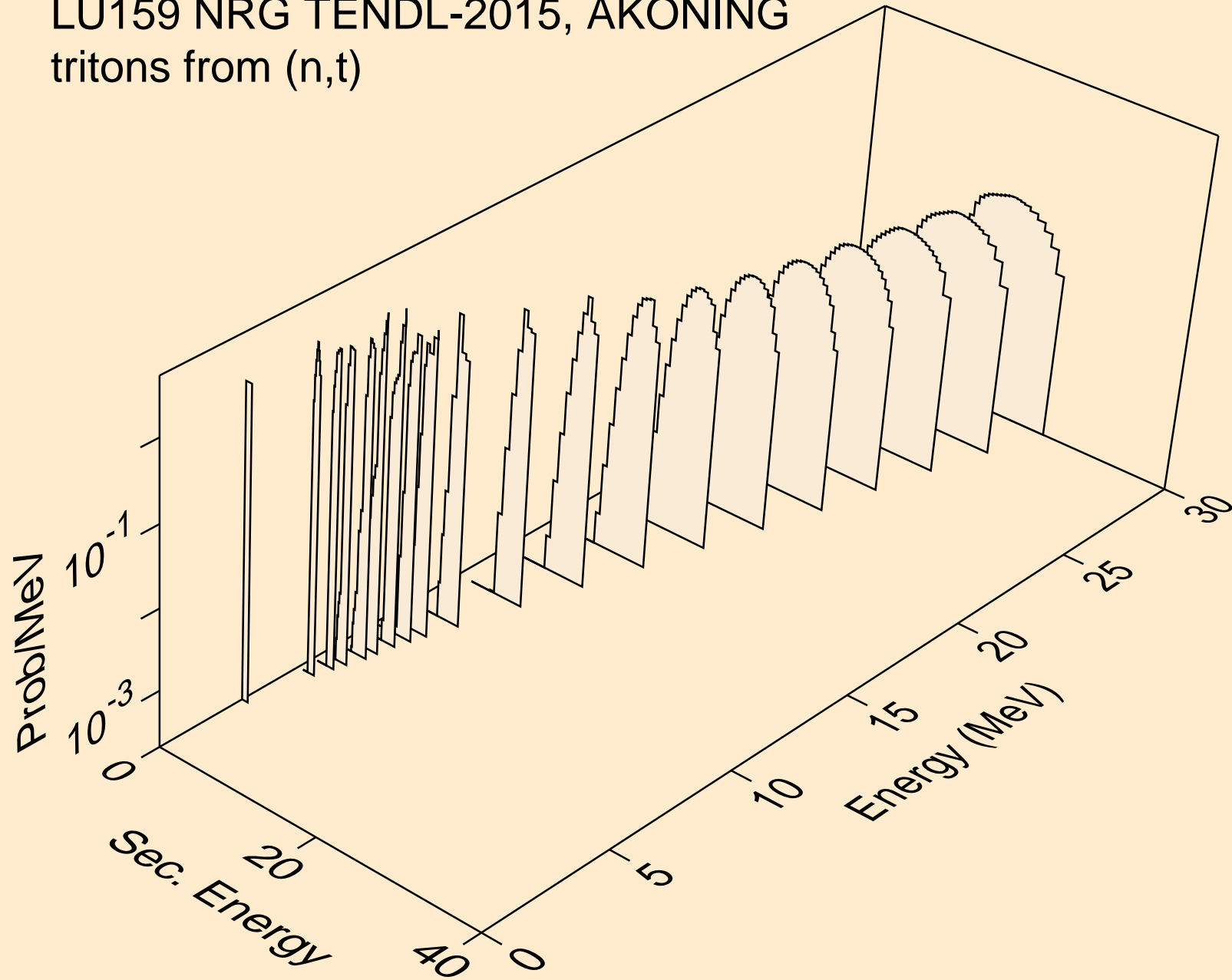

LU159 NRG TENDL-2015, AKONING
tritons from (n,t2a)

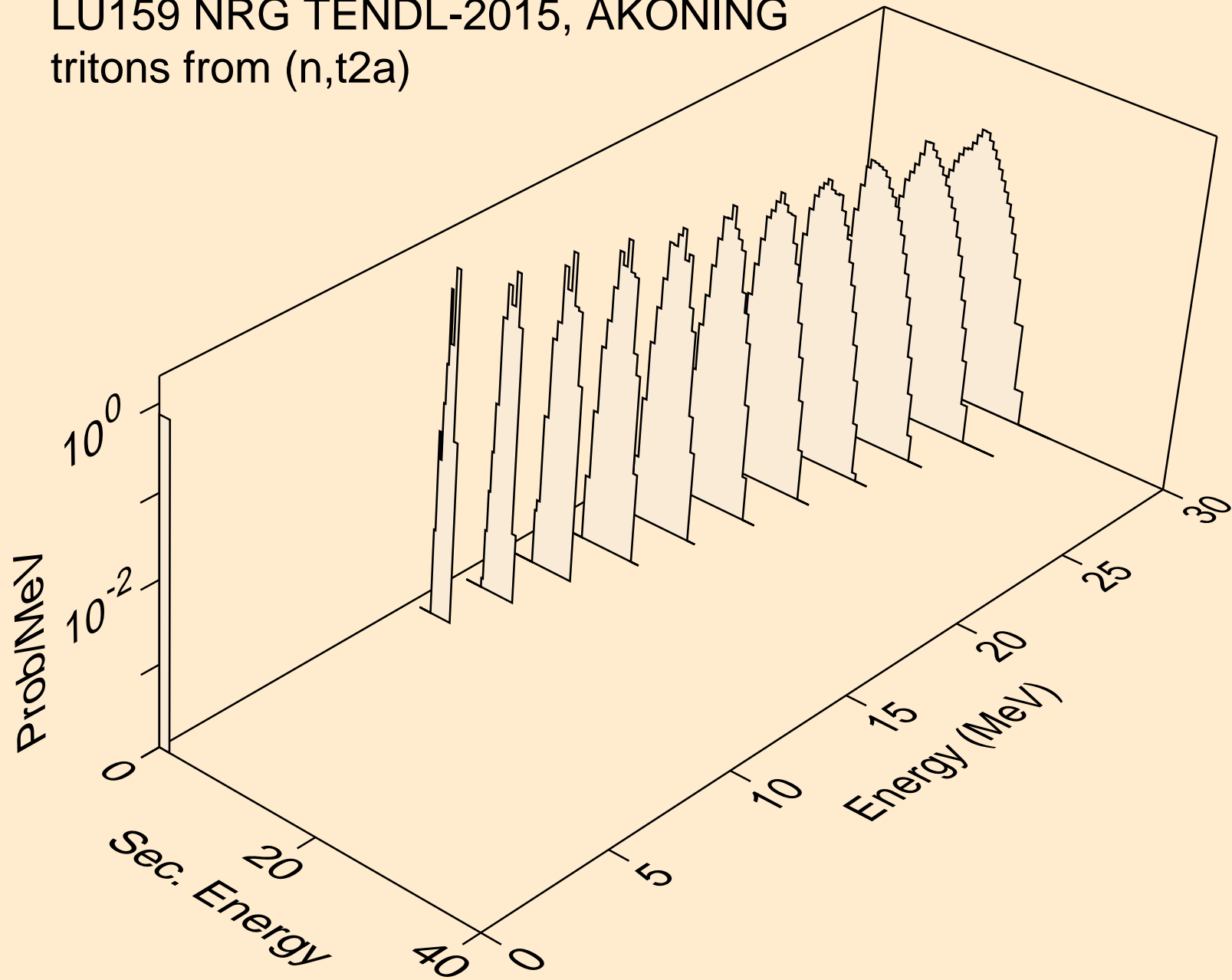

LU159 NRG TENDL-2015, AKONING
tritons from (n,pt)

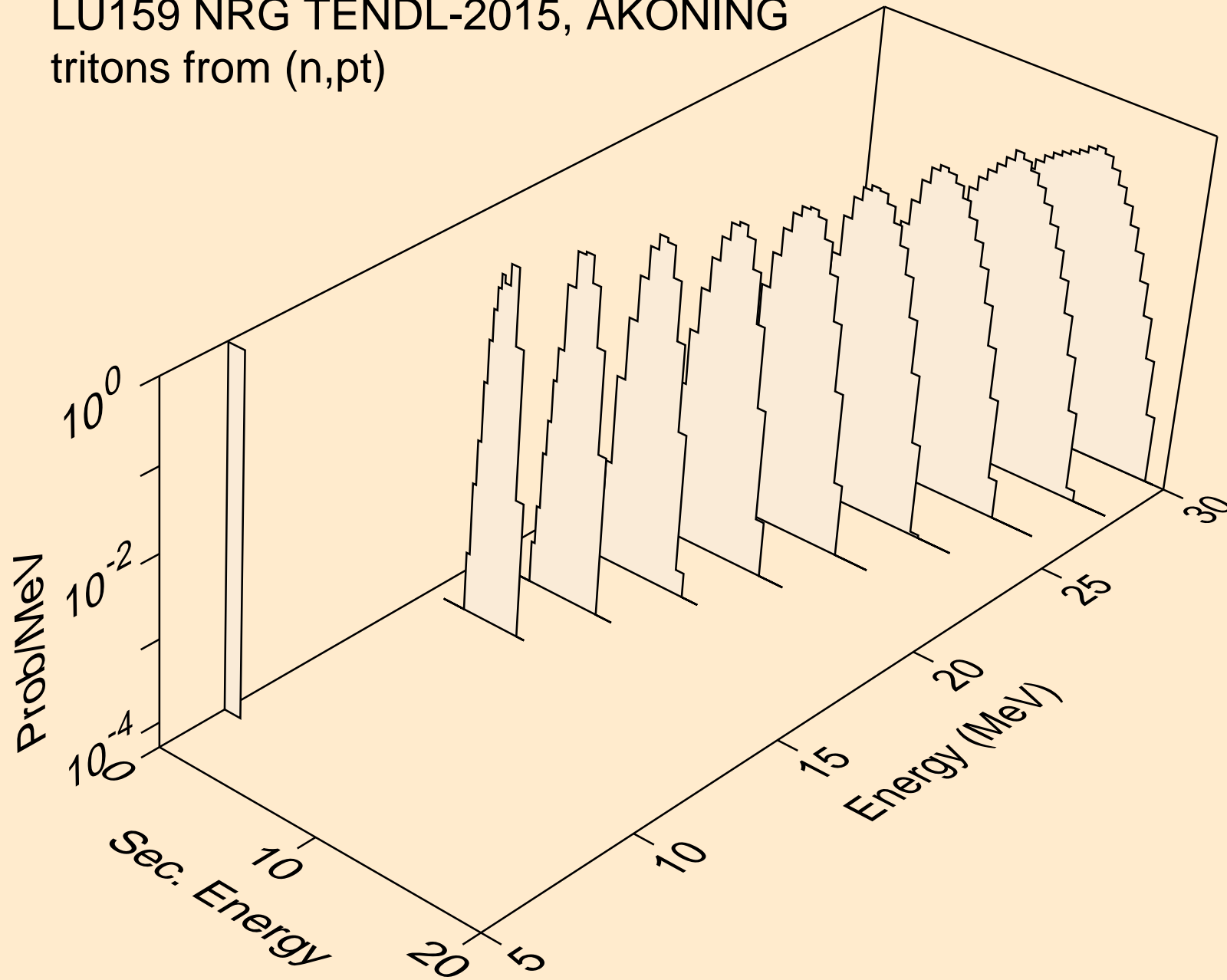

LU159 NRG TENDL-2015, AKONING
he3s from (n,x)

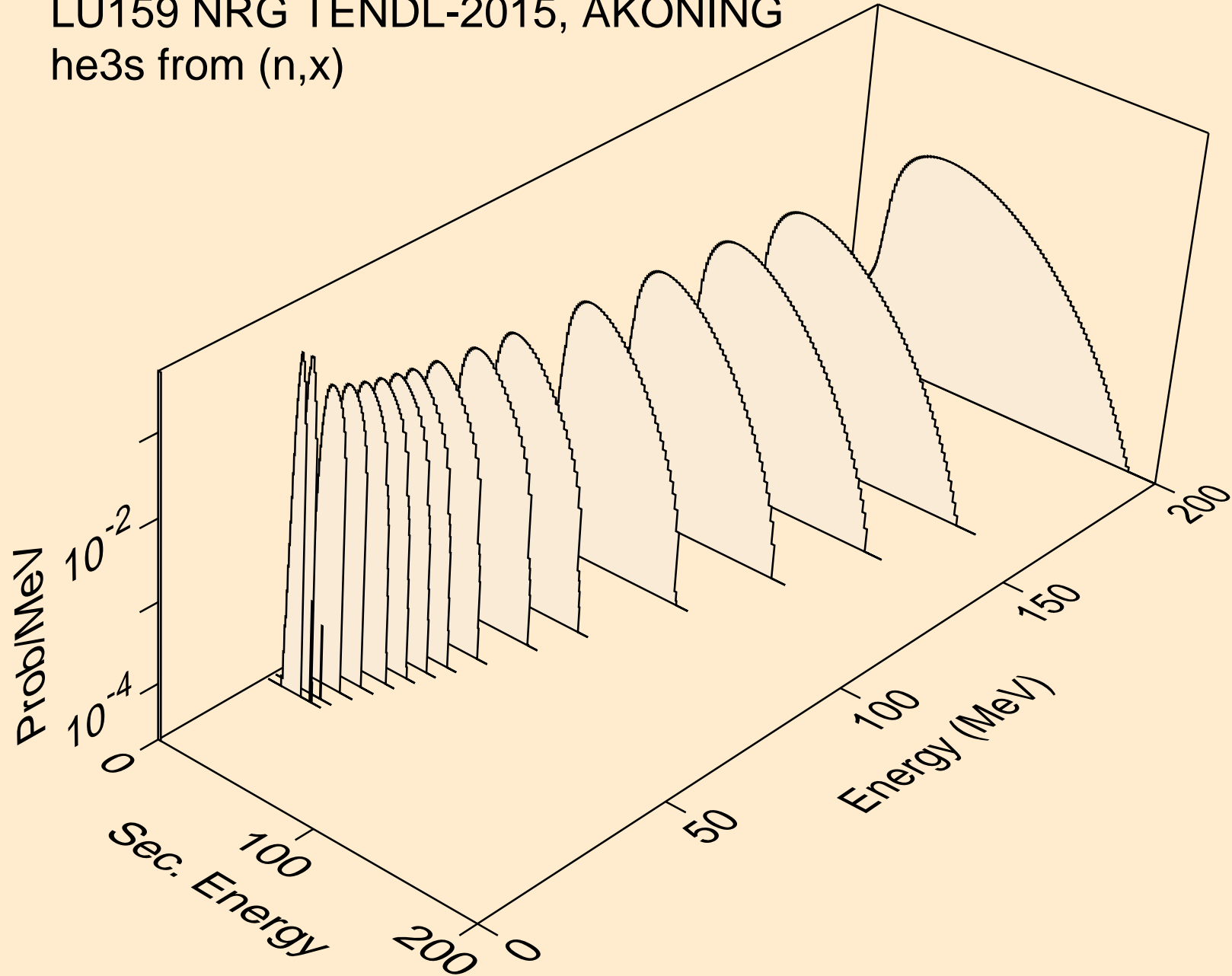

LU159 NRG TENDL-2015, AKONING
he3s from (n,n*)he3

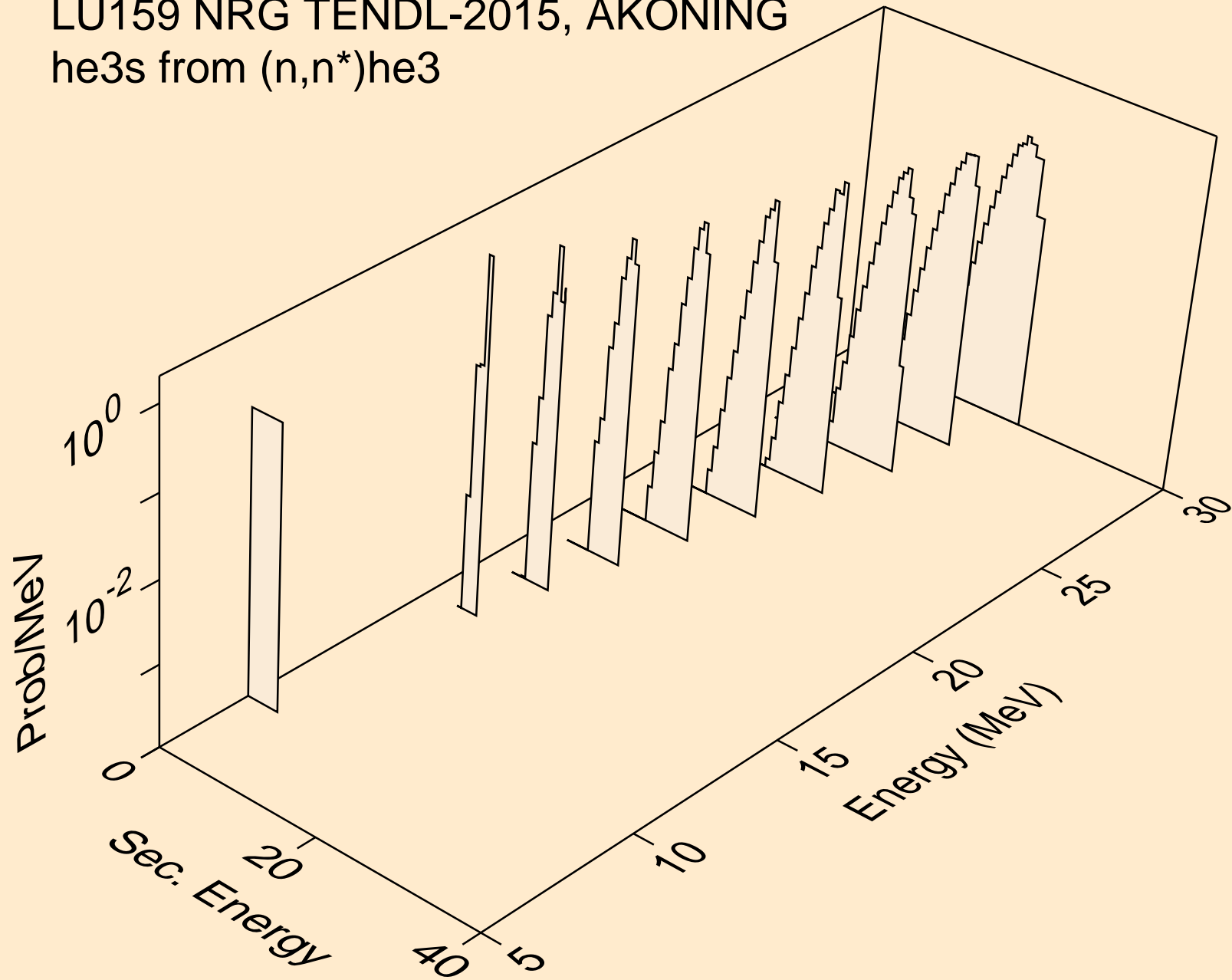

LU159 NRG TENDL-2015, AKONING
he3s from (n,he3)

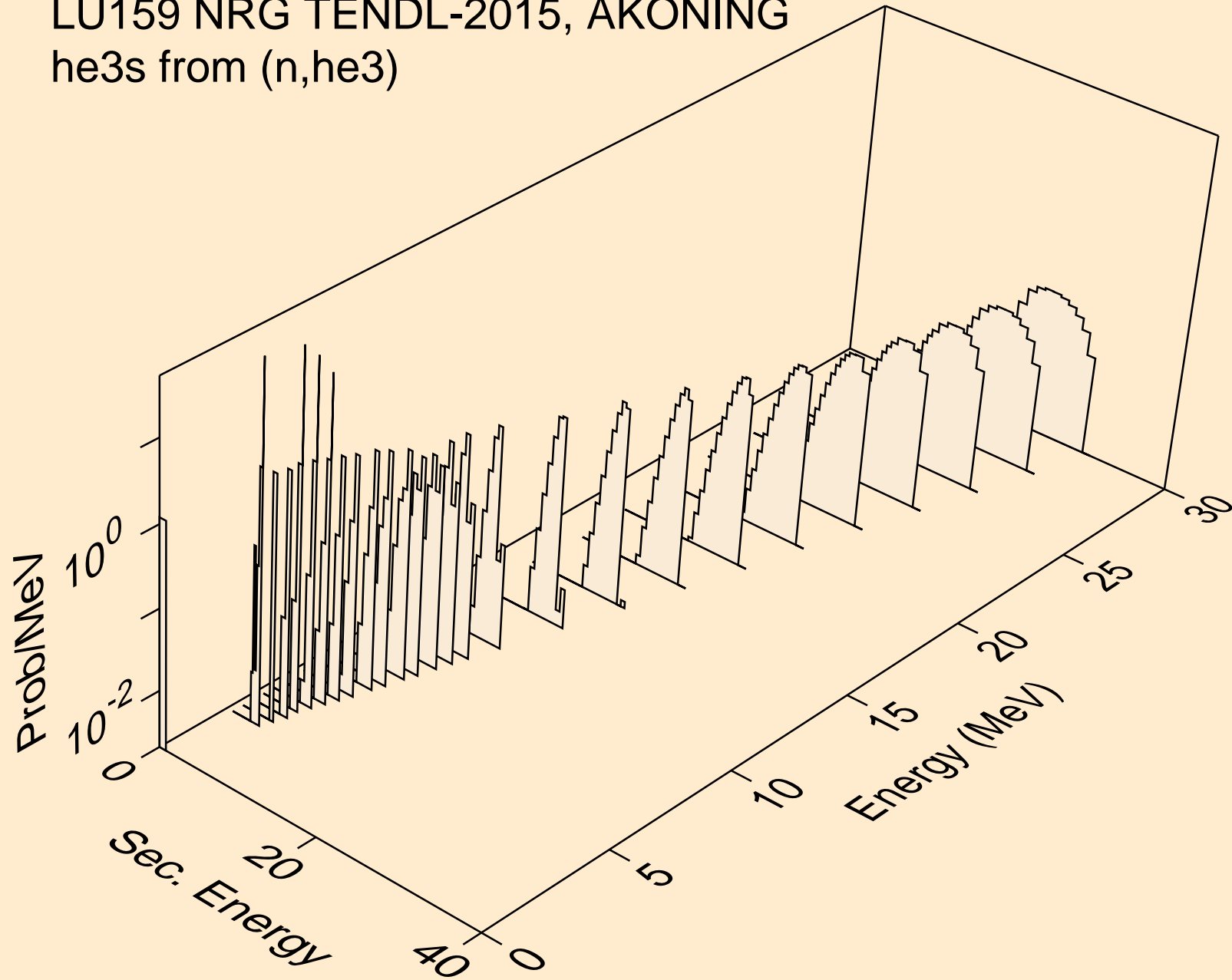

LU159 NRG TENDL-2015, AKONING
alphas from (n,x)

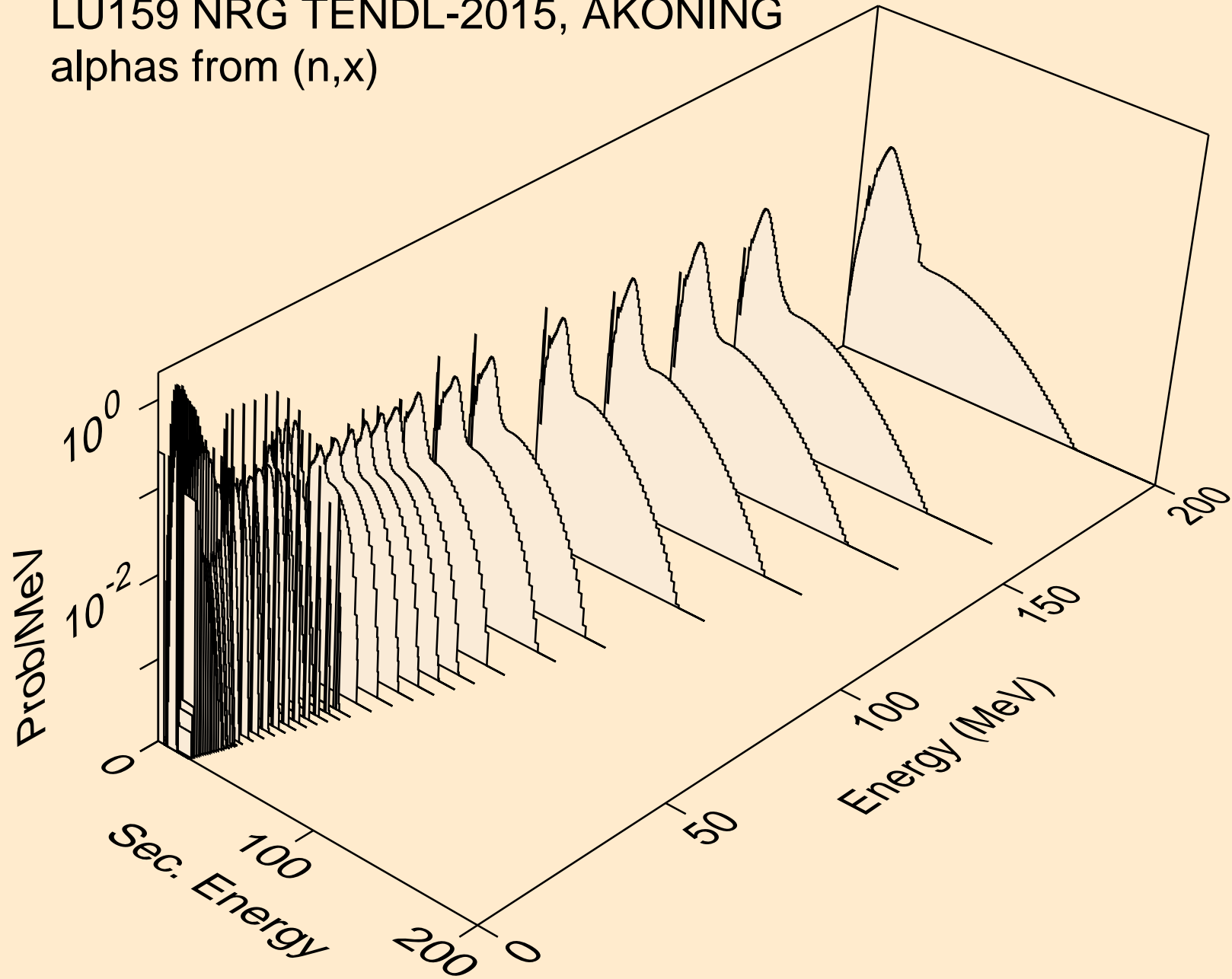

LU159 NRG TENDL-2015, AKONING
alphas from (n,n*)a

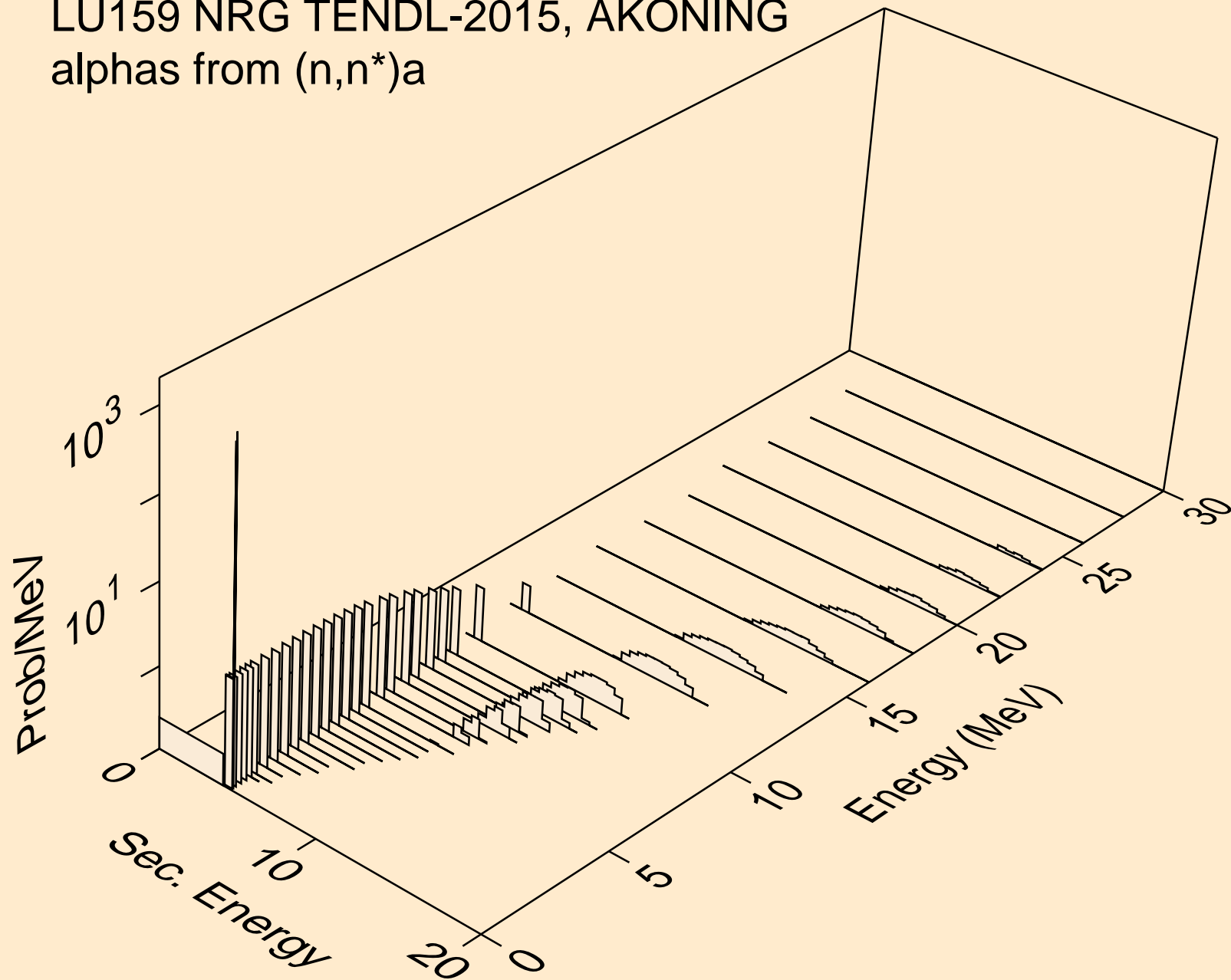

LU159 NRG TENDL-2015, AKONING
alphas from (n,n*)3a

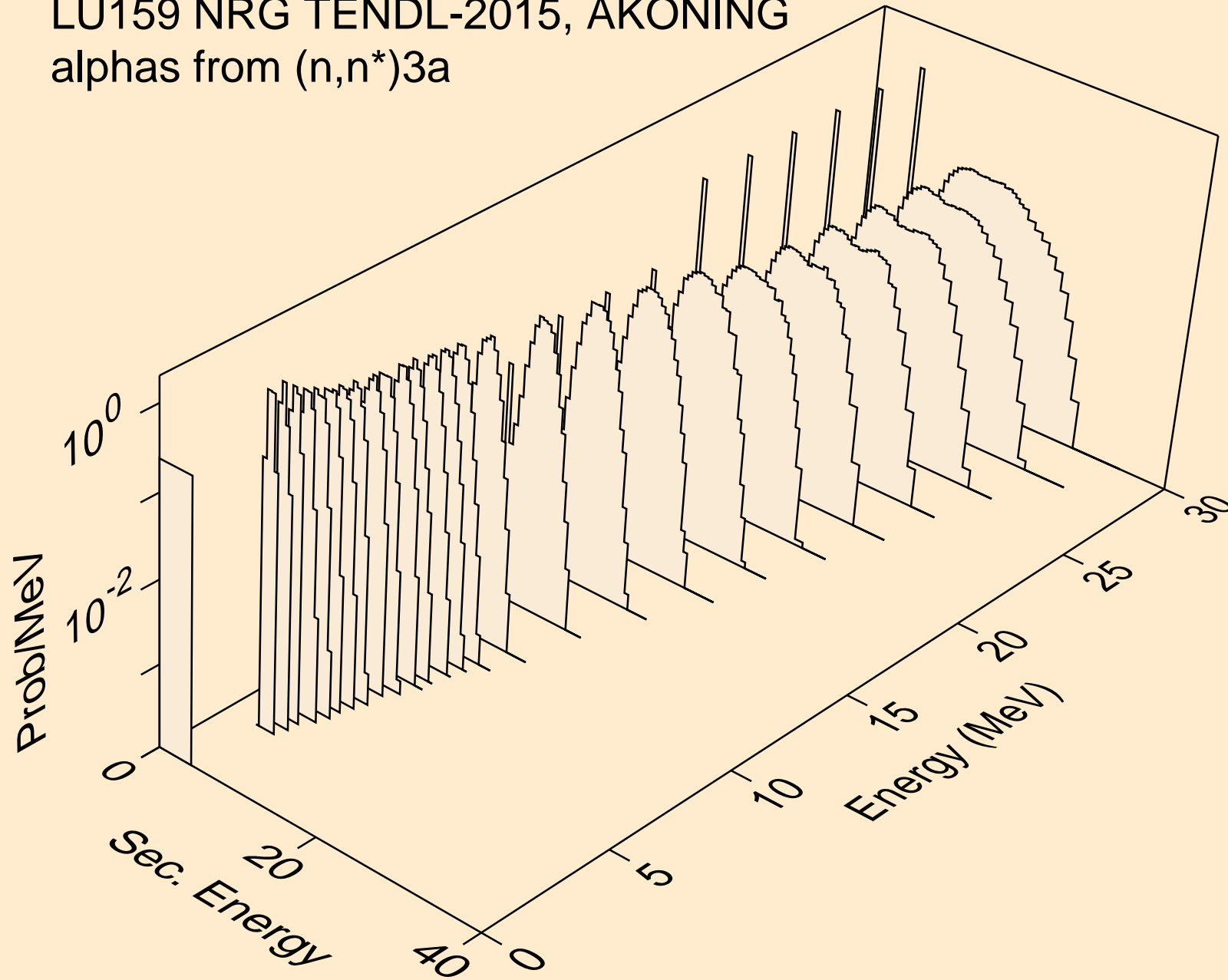

LU159 NRG TENDL-2015, AKONING
alphas from (n,2n)a

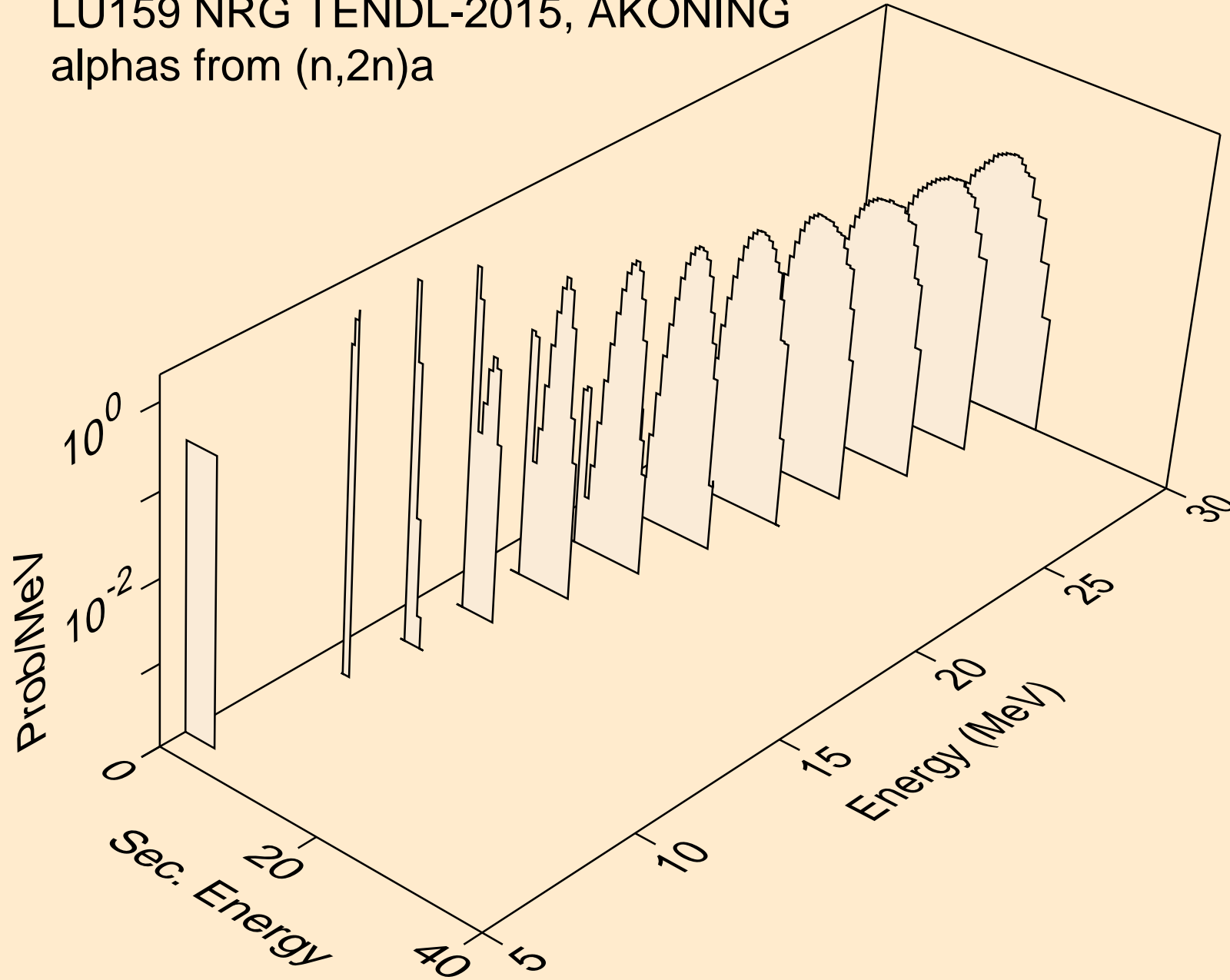

LU159 NRG TENDL-2015, AKONING
alphas from (n,3n)a

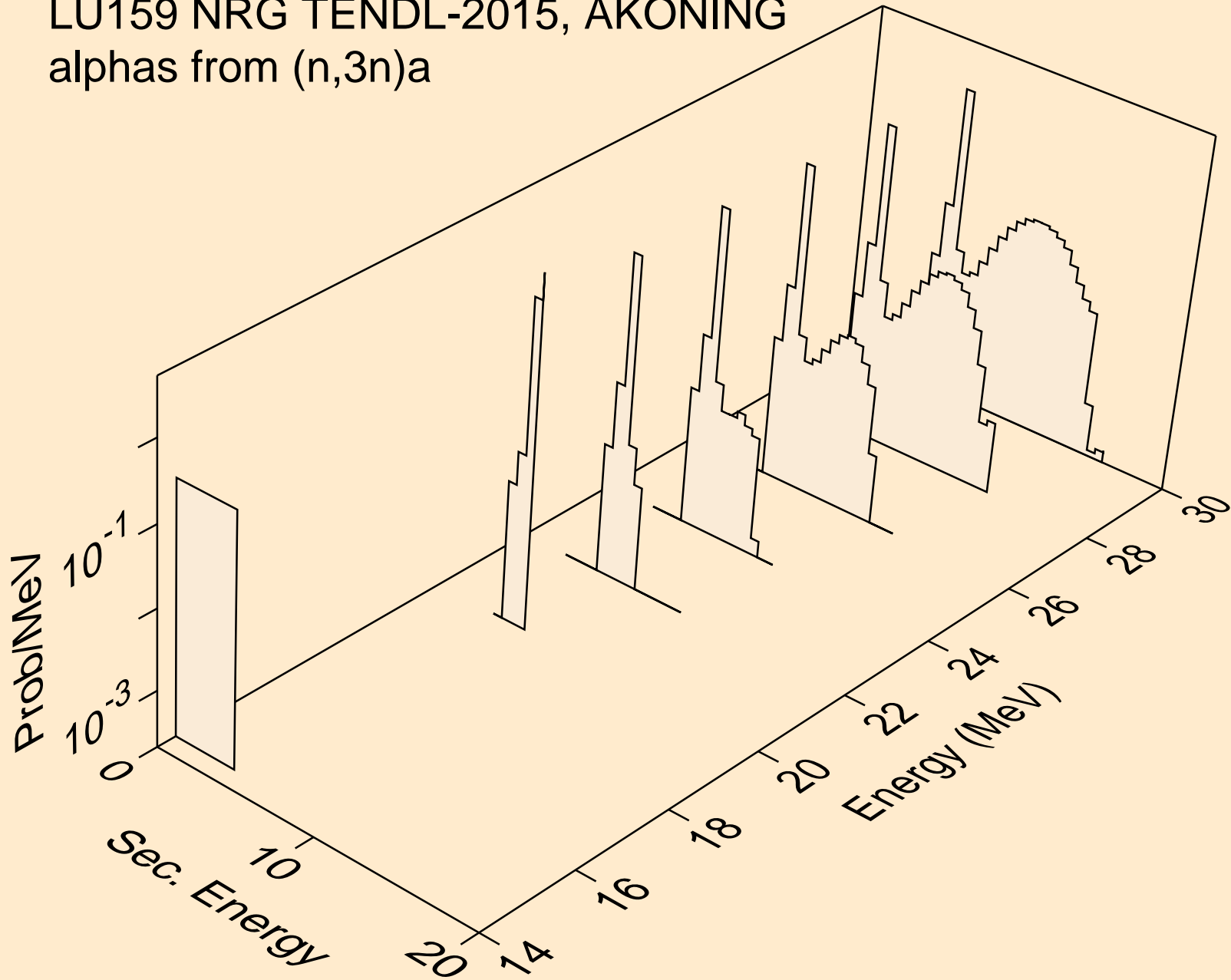

LU159 NRG TENDL-2015, AKONING
alphas from (n,n*)2a

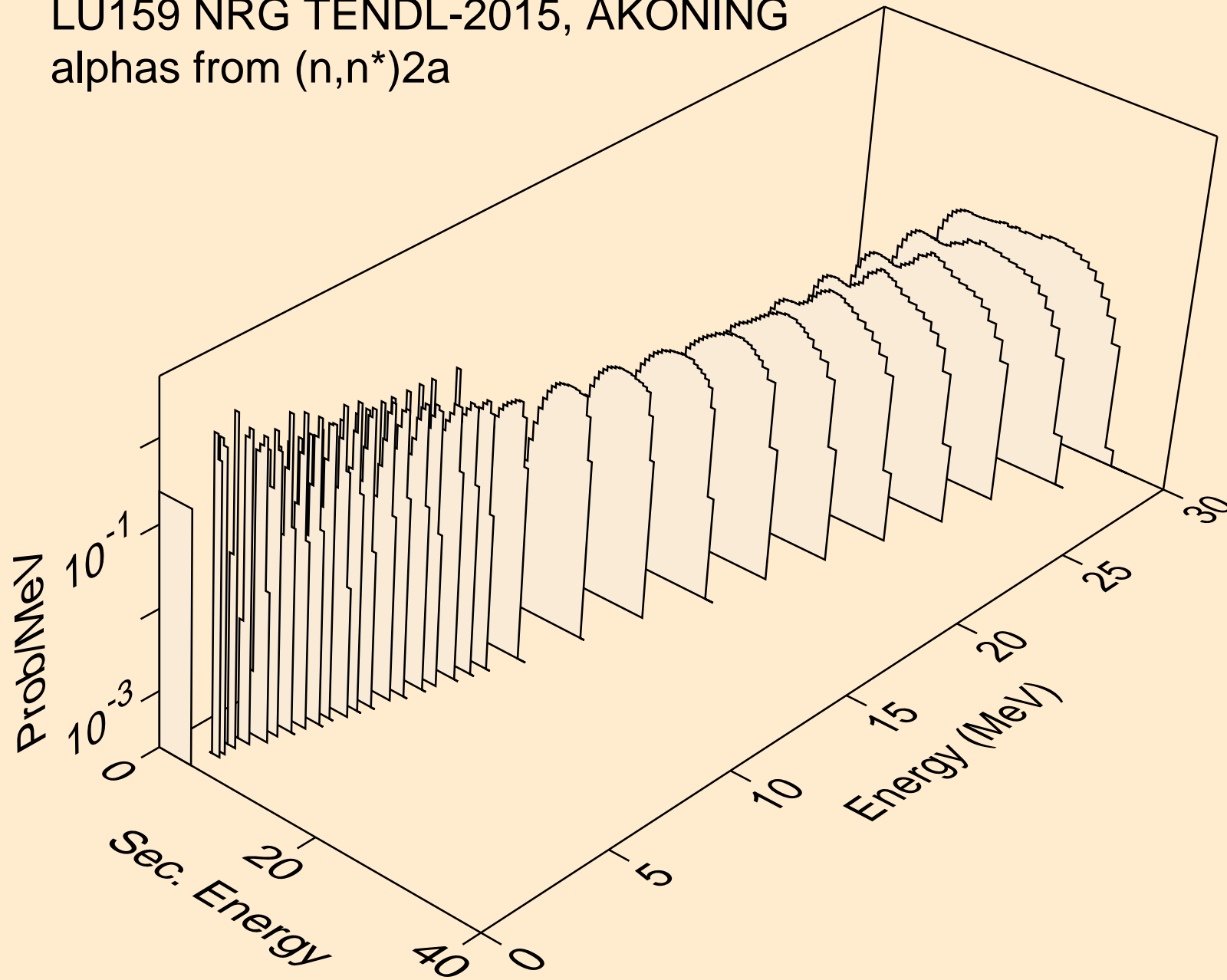

LU159 NRG TENDL-2015, AKONING
alphas from (n,2n)2a

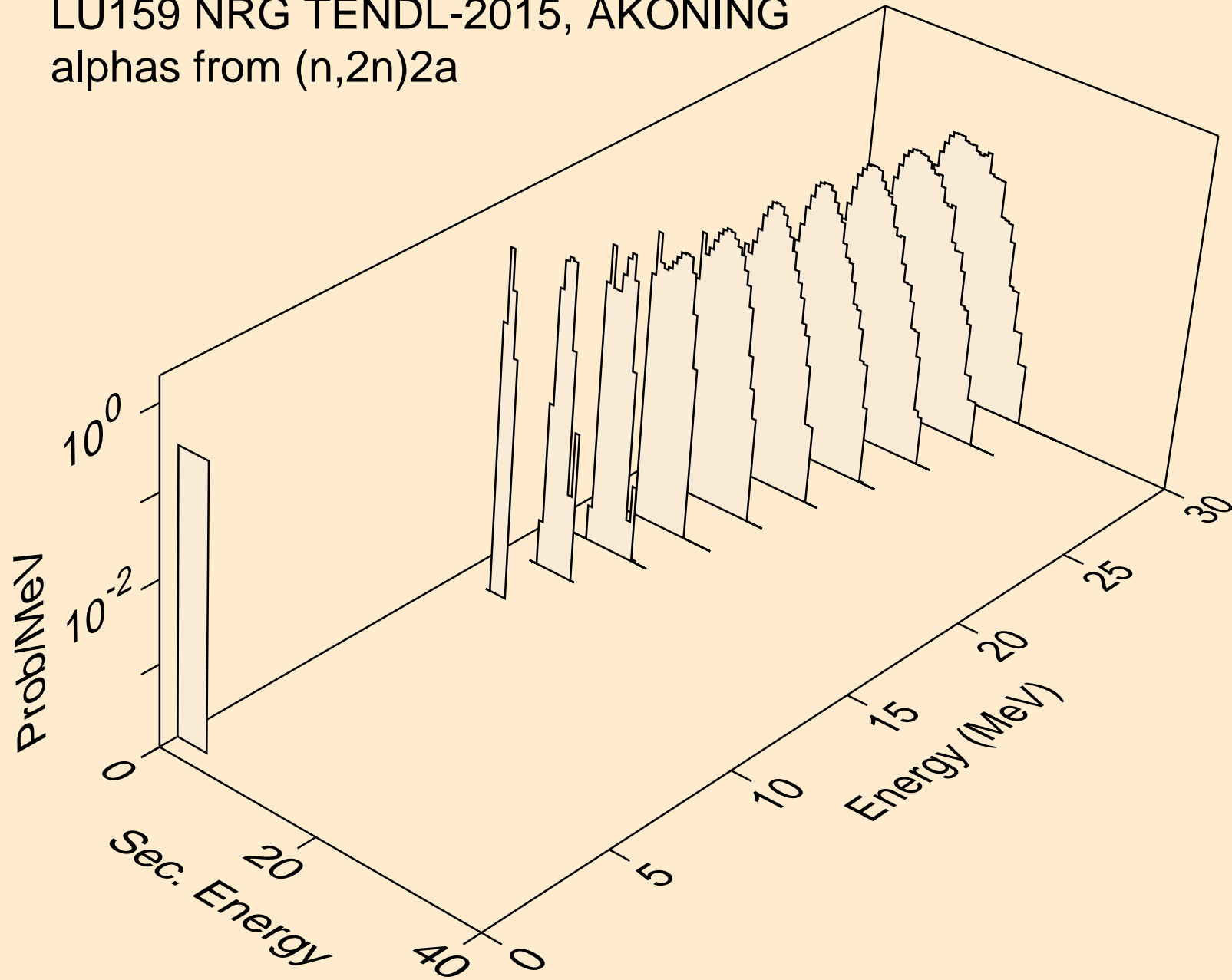

LU159 NRG TENDL-2015, AKONING
alphas from (n,n*)d2a

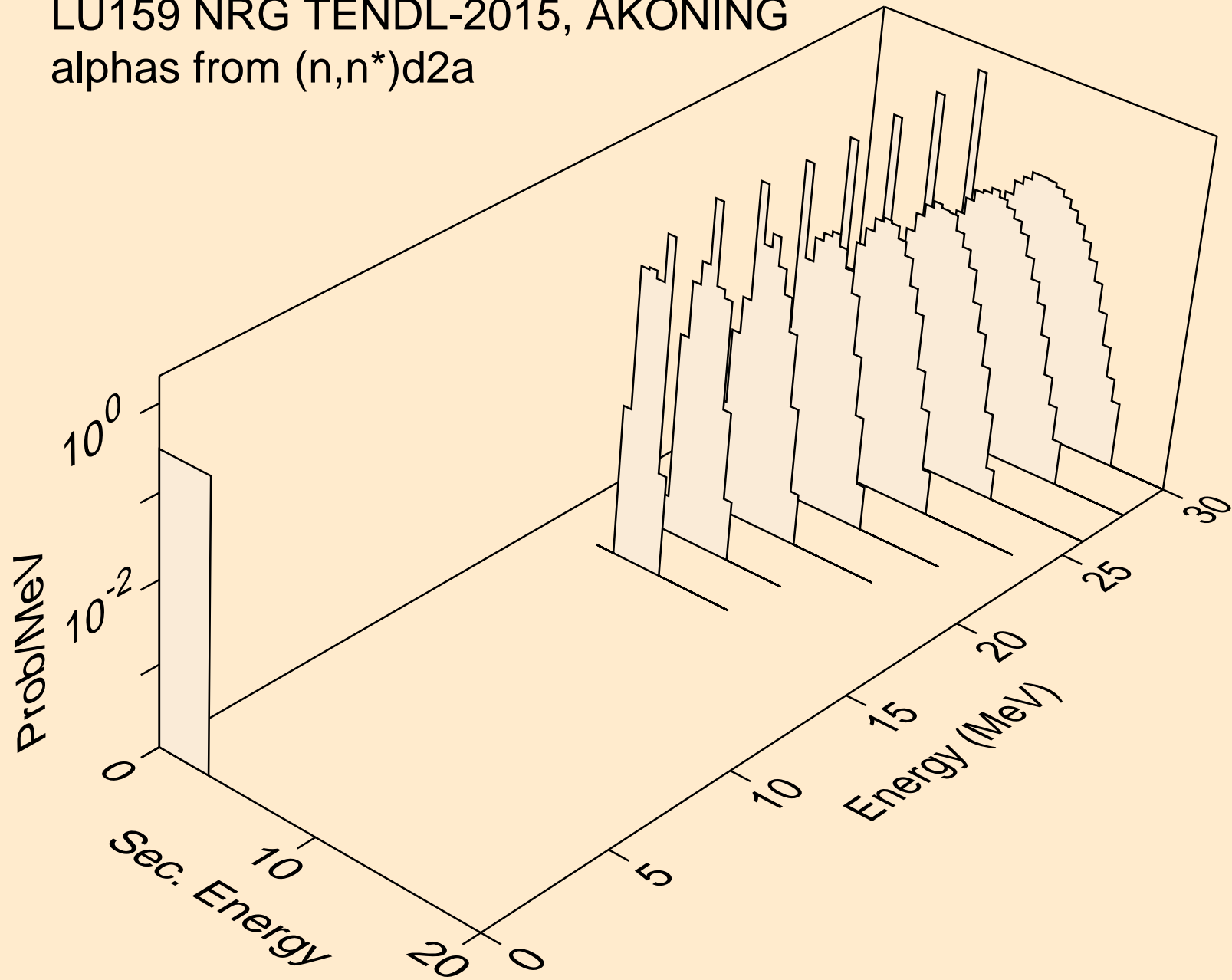

LU159 NRG TENDL-2015, AKONING
alphas from (n,n*)t2a

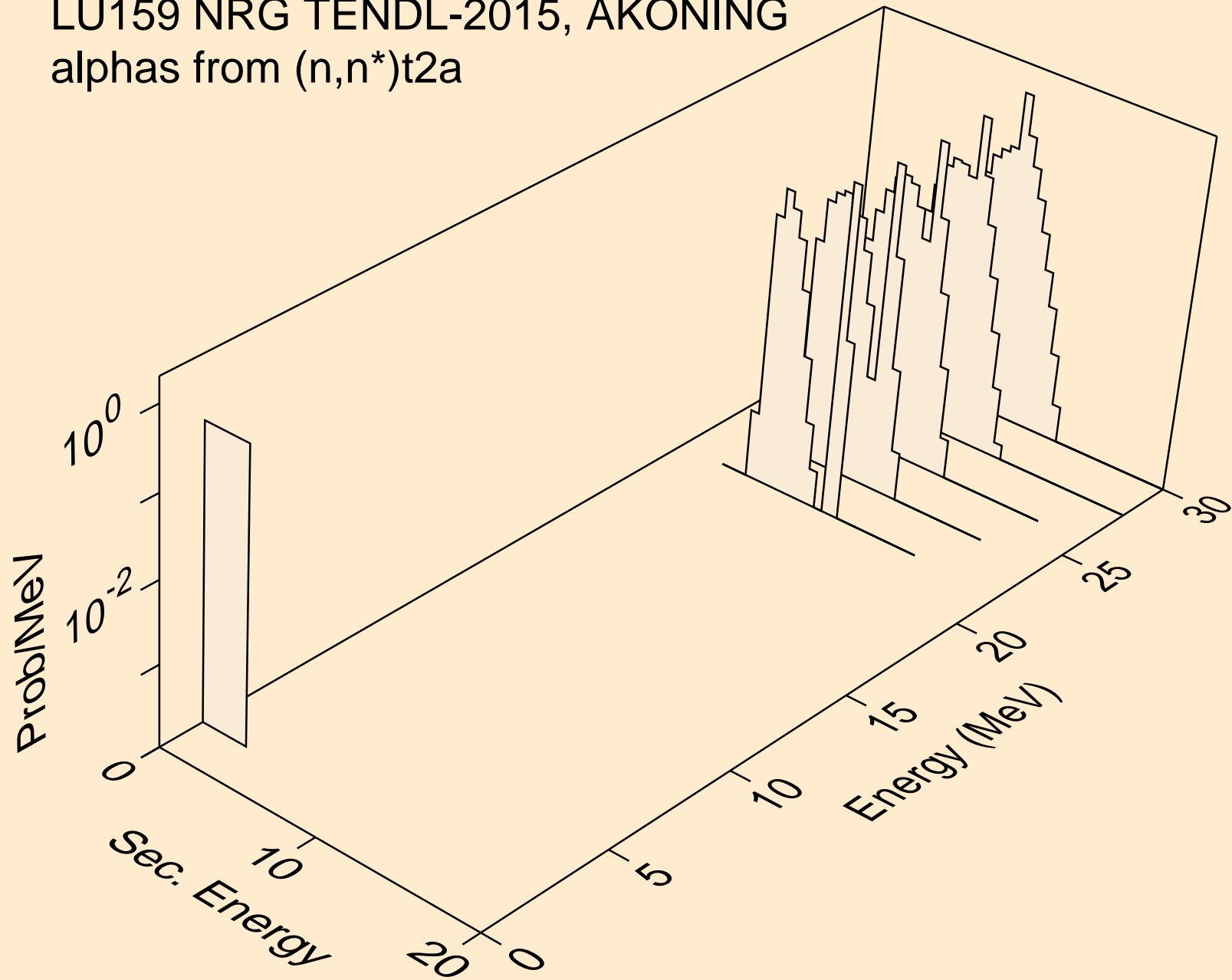

LU159 NRG TENDL-2015, AKONING
alphas from (n,npa)

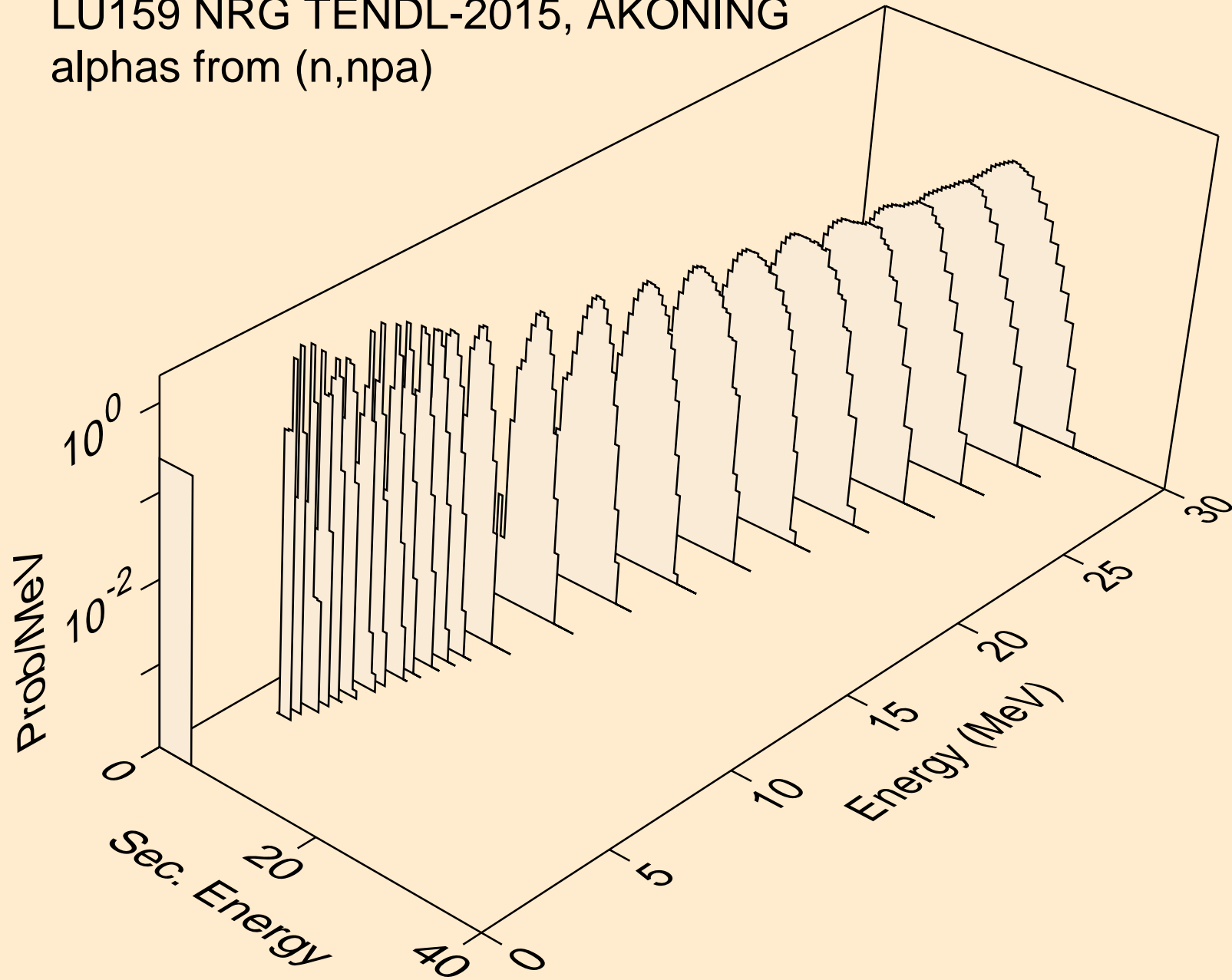

LU159 NRG TENDL-2015, AKONING
alphas from (n,a)

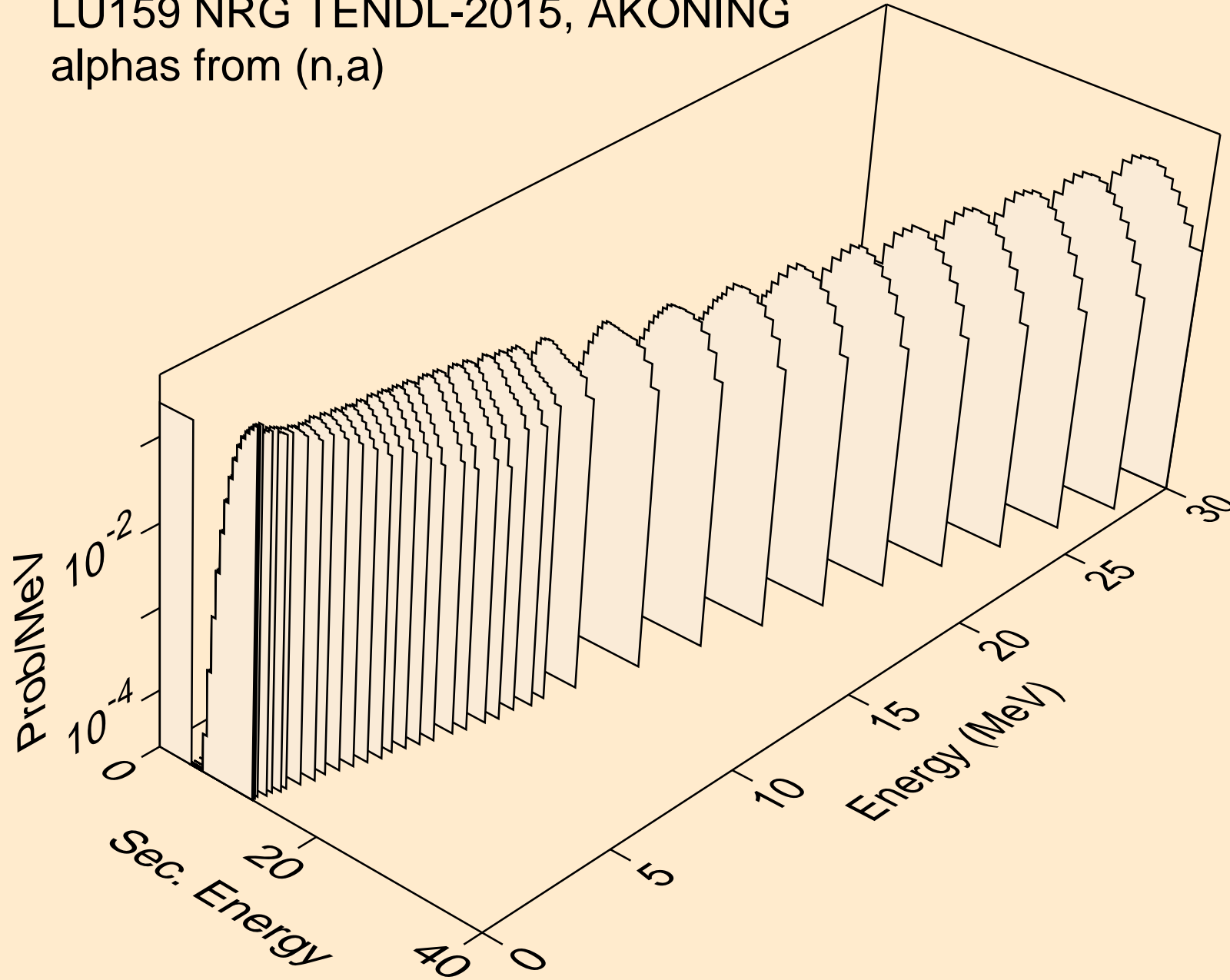

LU159 NRG TENDL-2015, AKONING
alphas from (n,2a)

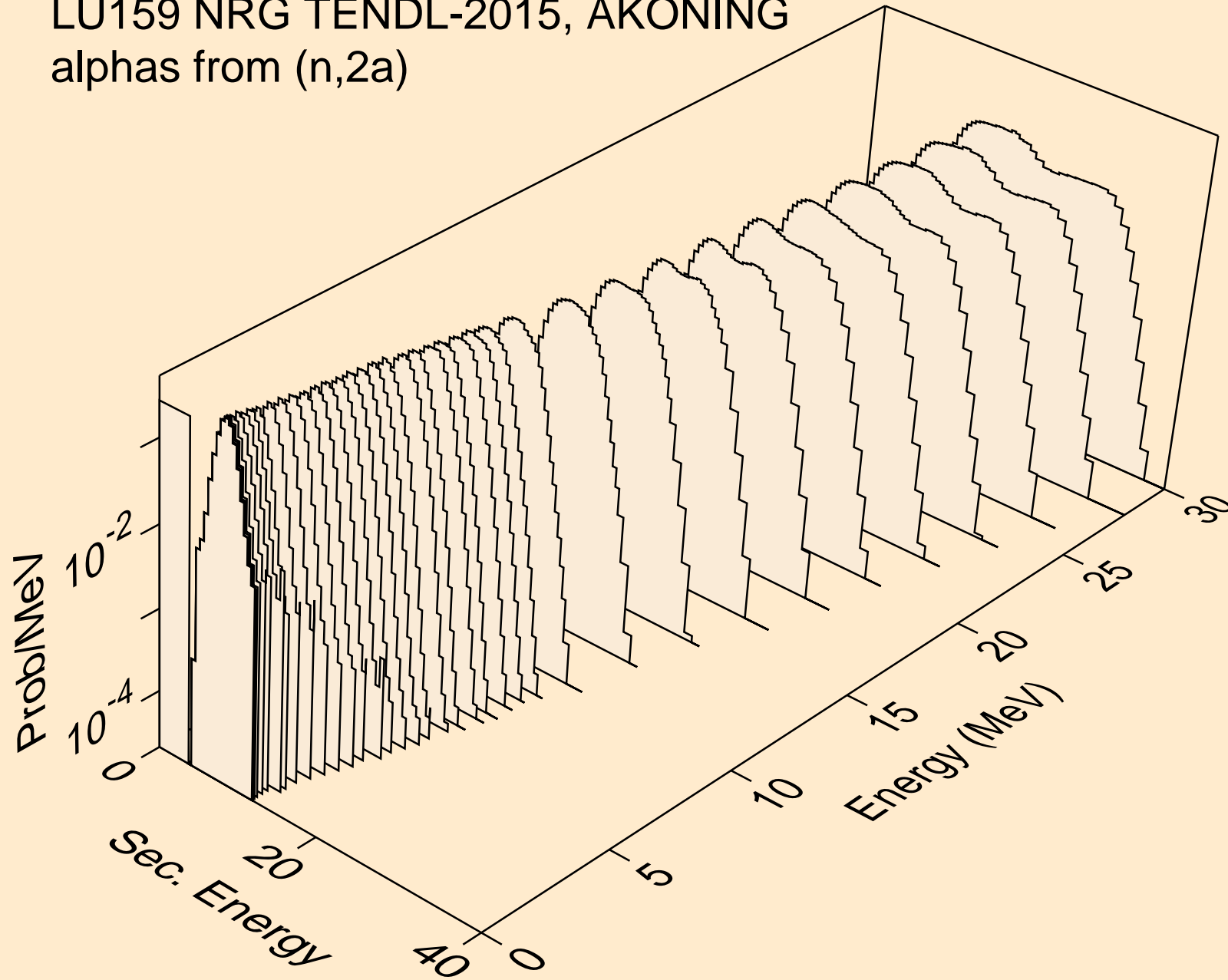

LU159 NRG TENDL-2015, AKONING
alphas from (n,3a)

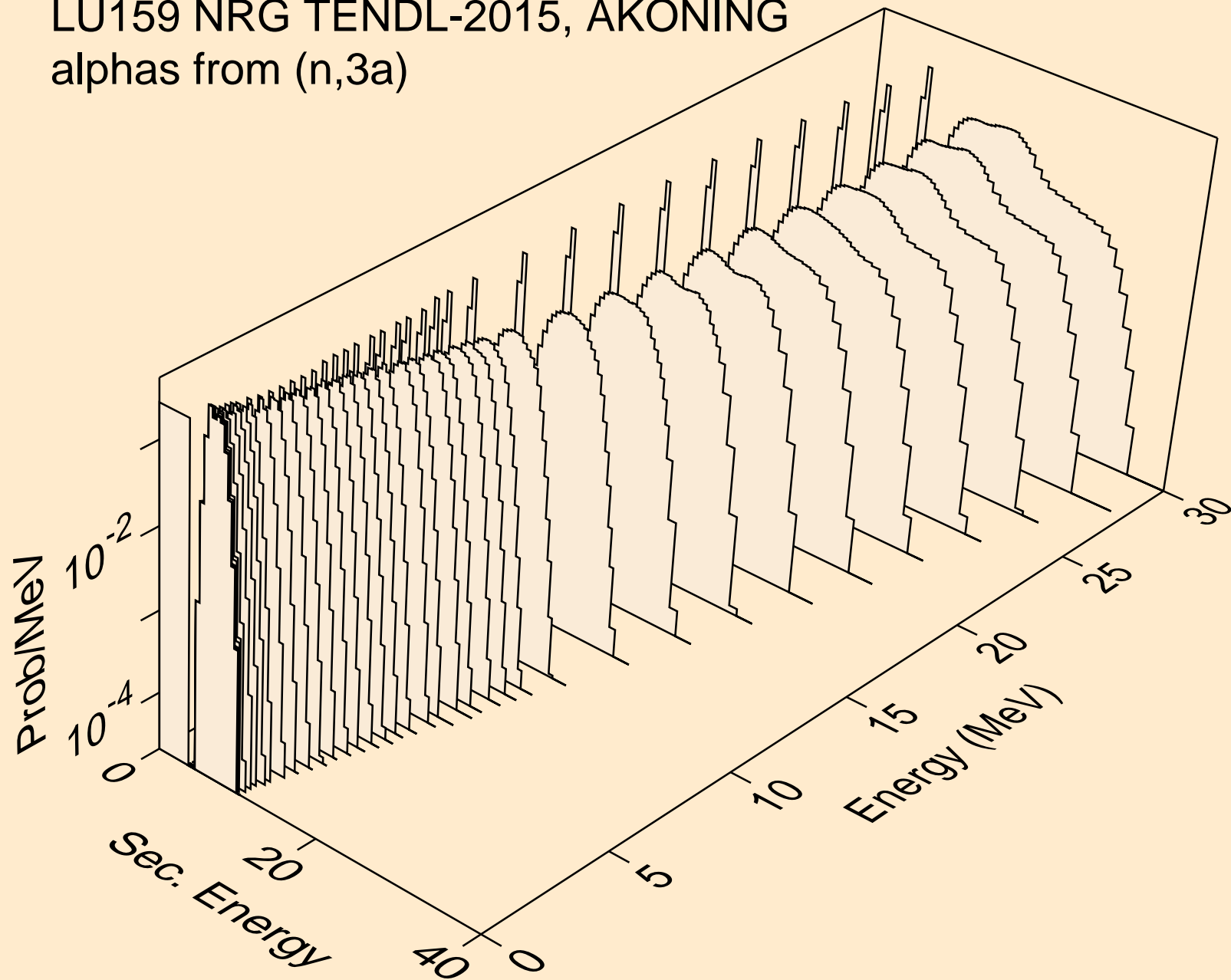

LU159 NRG TENDL-2015, AKONING
alphas from (n,pa)

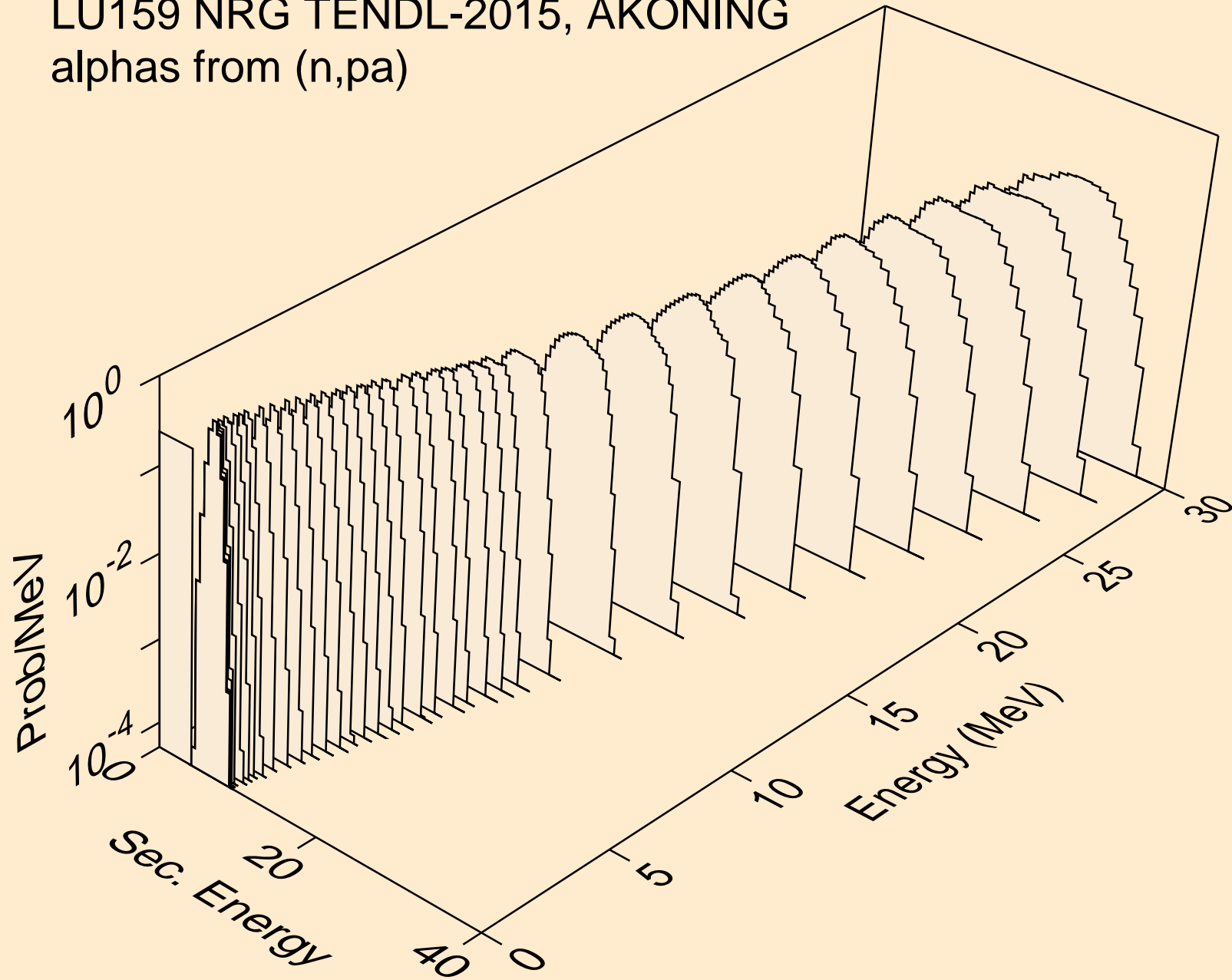

LU159 NRG TENDL-2015, AKONING
alphas from (n,t2a)

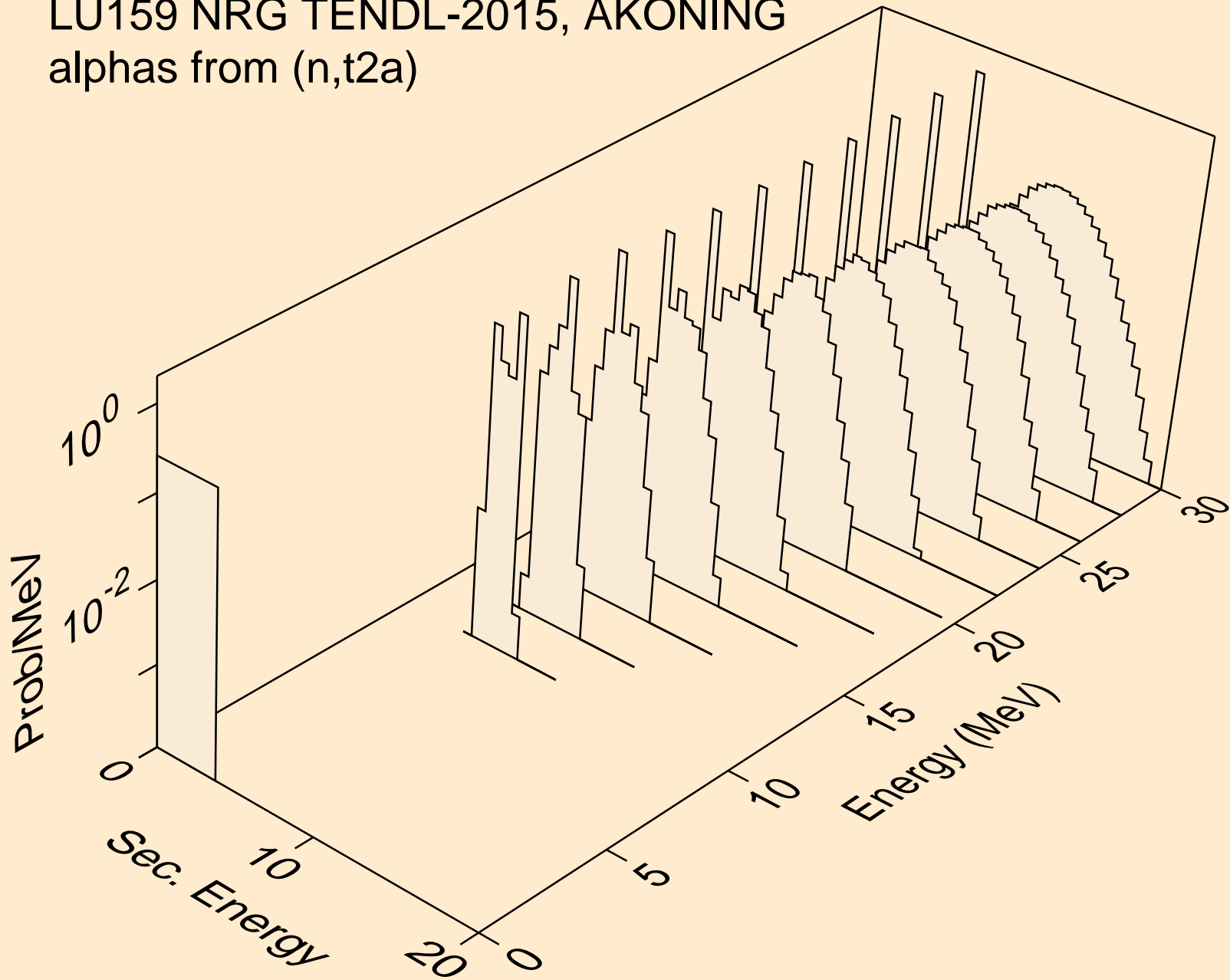

LU159 NRG TENDL-2015, AKONING
alphas from (n,d2a)

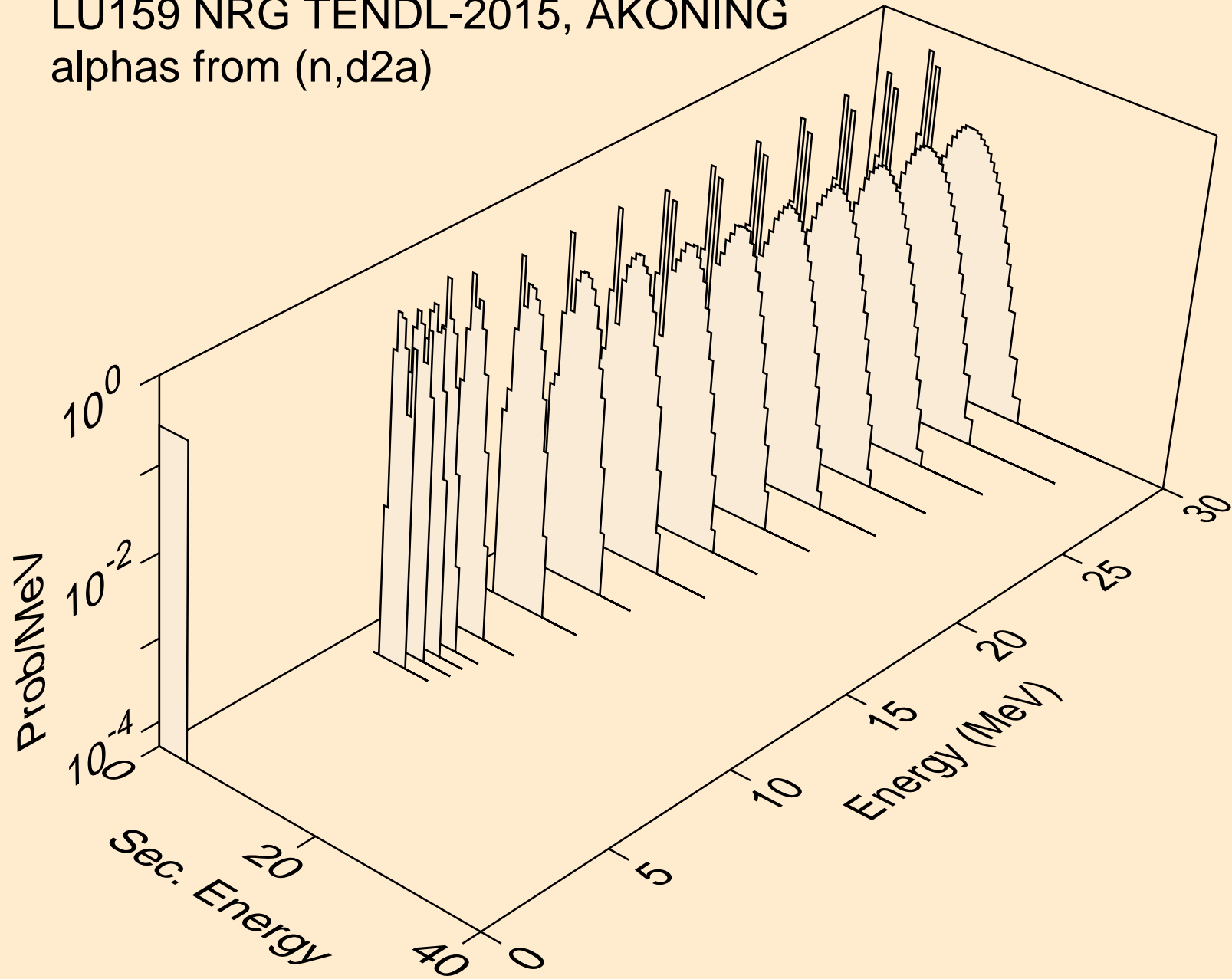

LU159 NRG TENDL-2015, AKONING
alphas from (n,da)

