

MD250 NRG TENDL-2015, AKONING

Principal cross sections

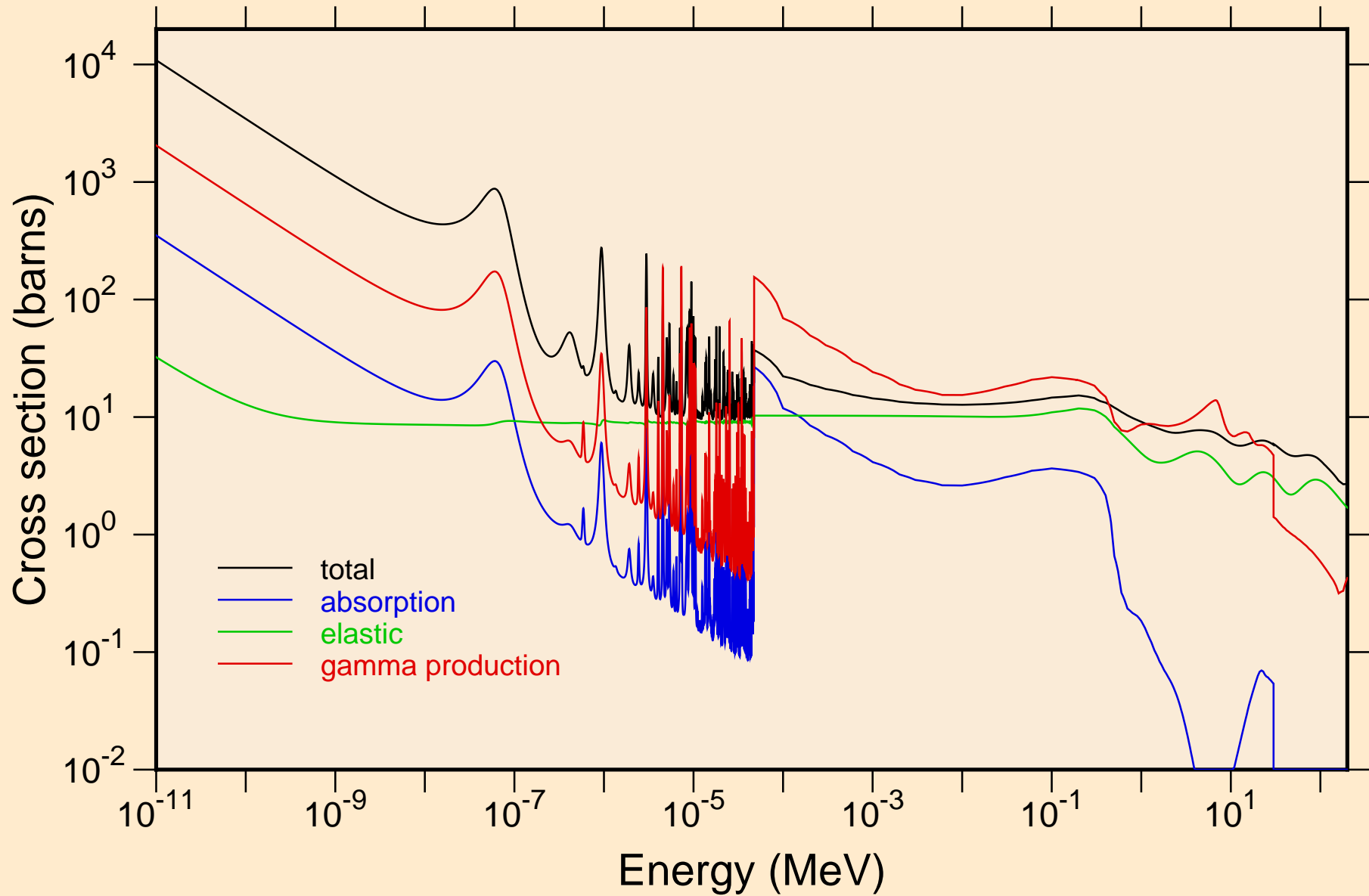

MD250 NRG TENDL-2015, AKONING
resonance total cross section

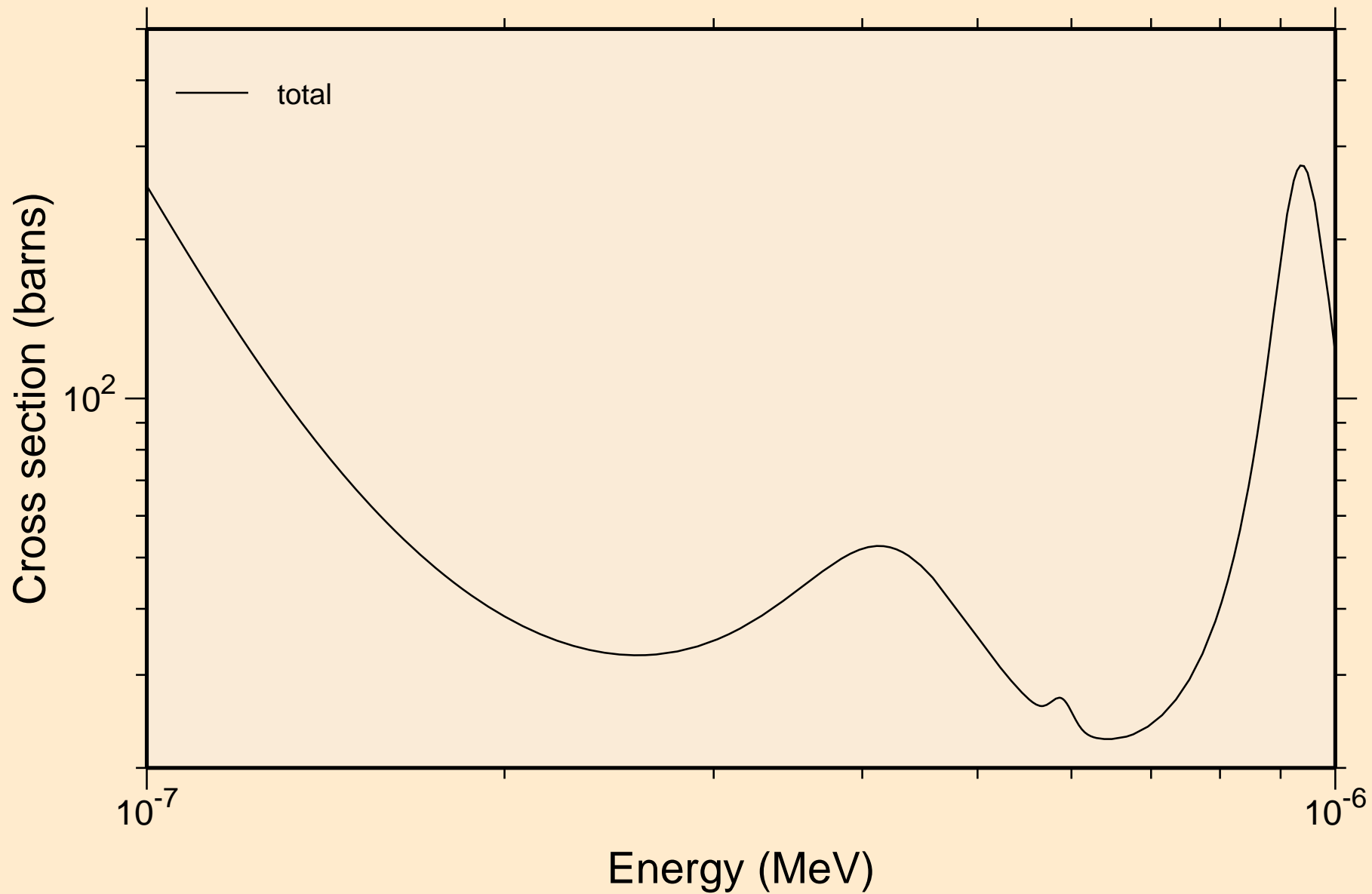

MD250 NRG TENDL-2015, AKONING
resonance total cross section

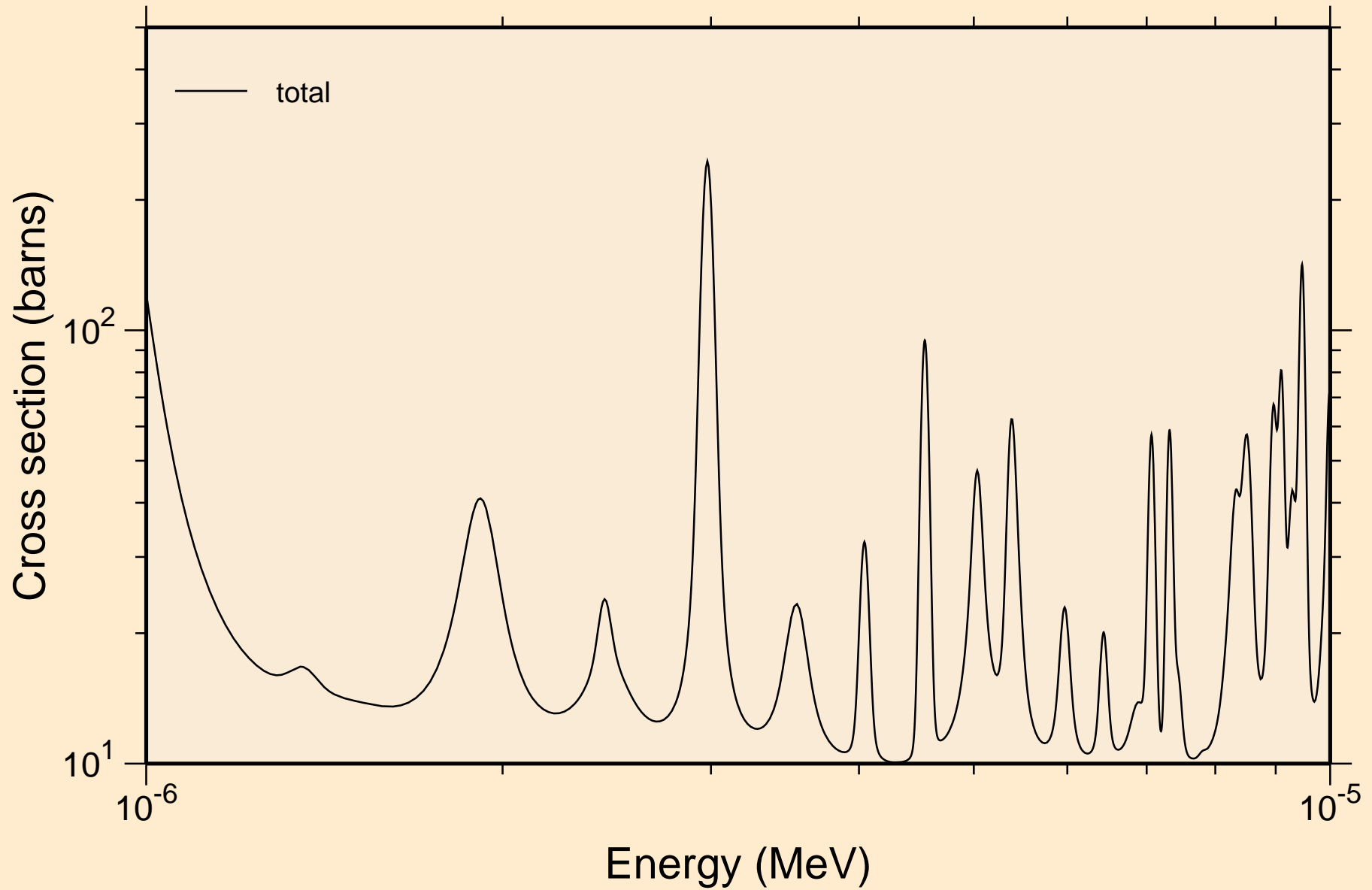

MD250 NRG TENDL-2015, AKONING
resonance total cross section

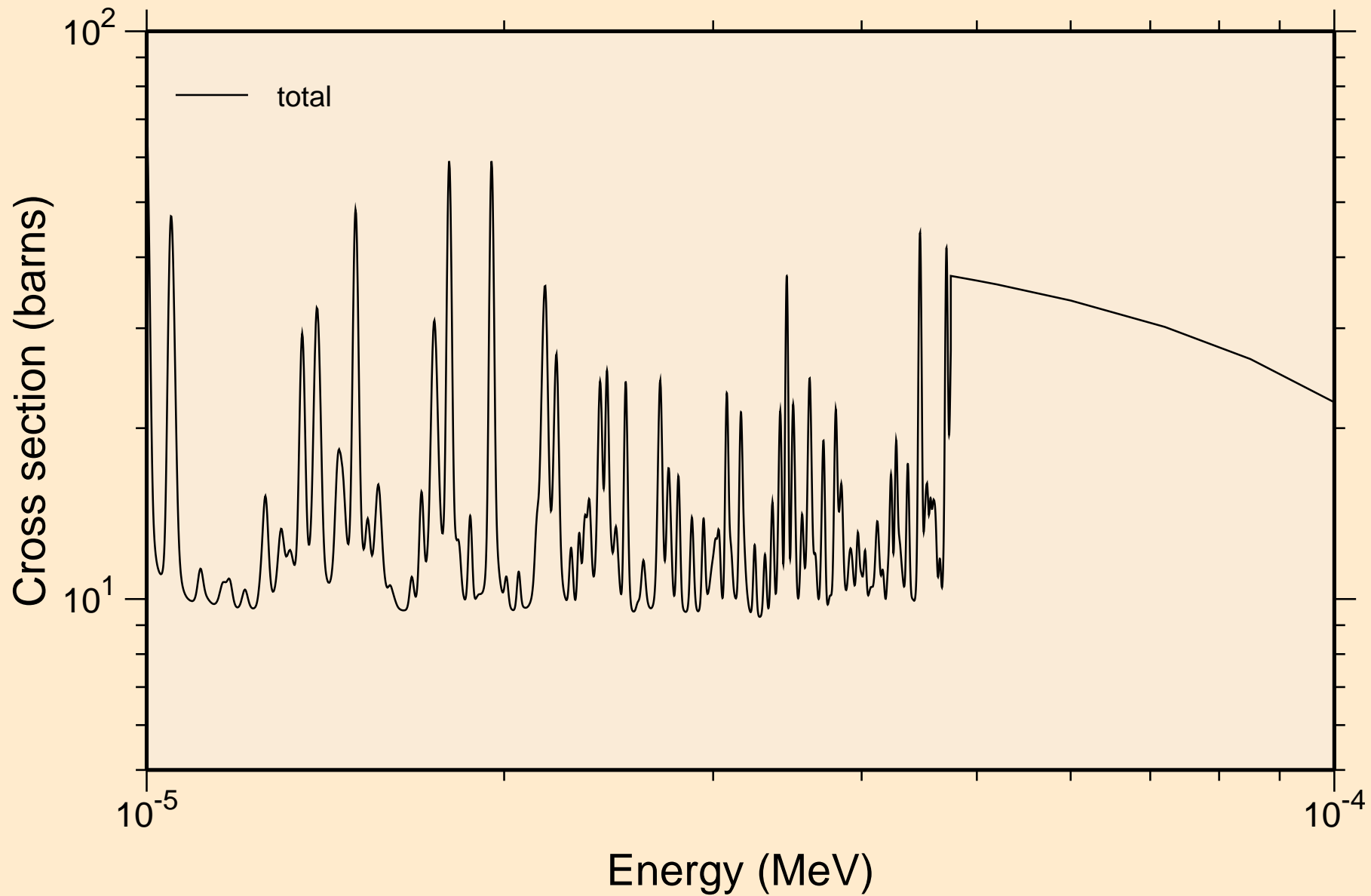

MD250 NRG TENDL-2015, AKONING
resonance total cross section

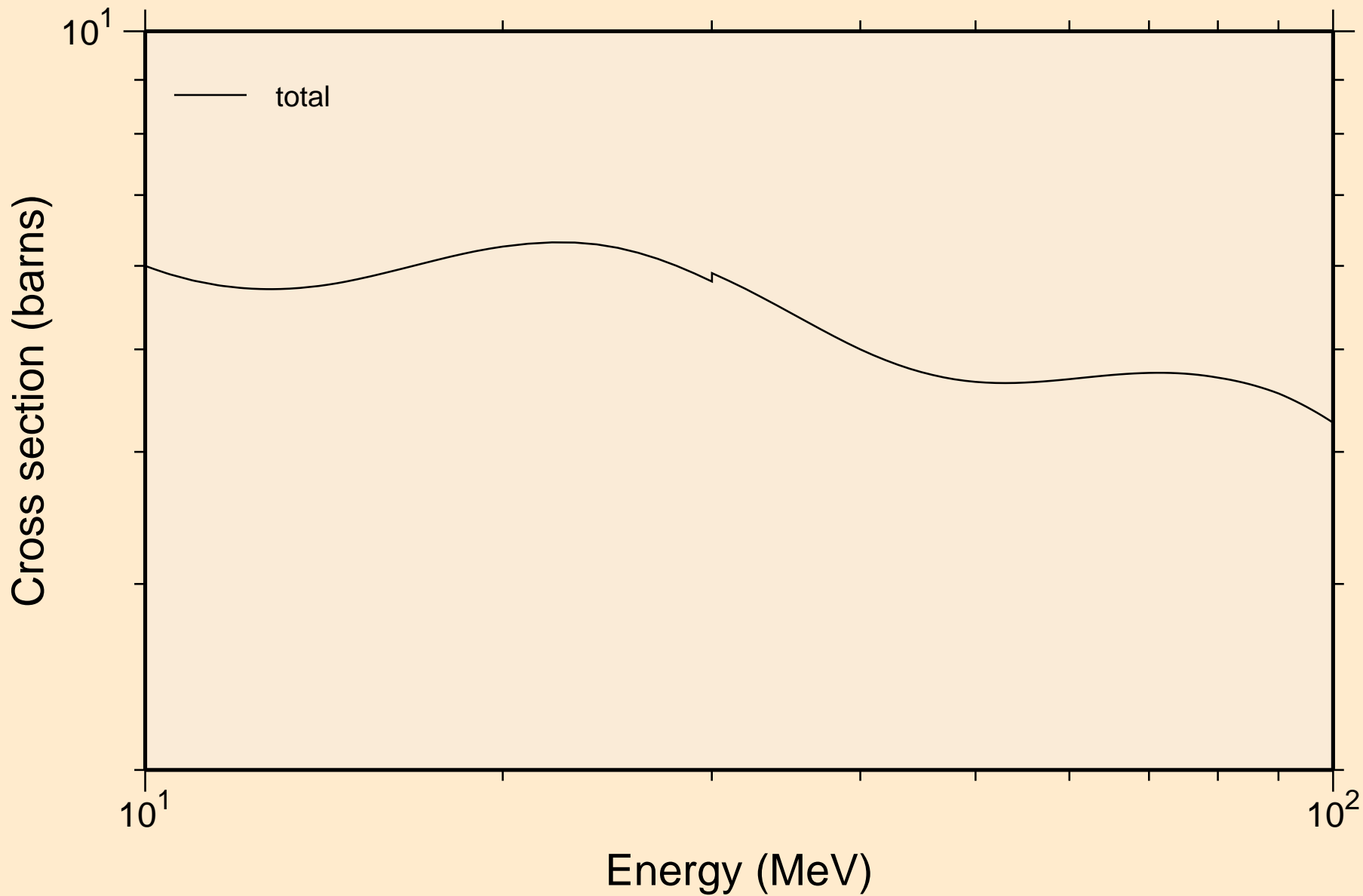

MD250 NRG TENDL-2015, AKONING
resonance absorption cross sections

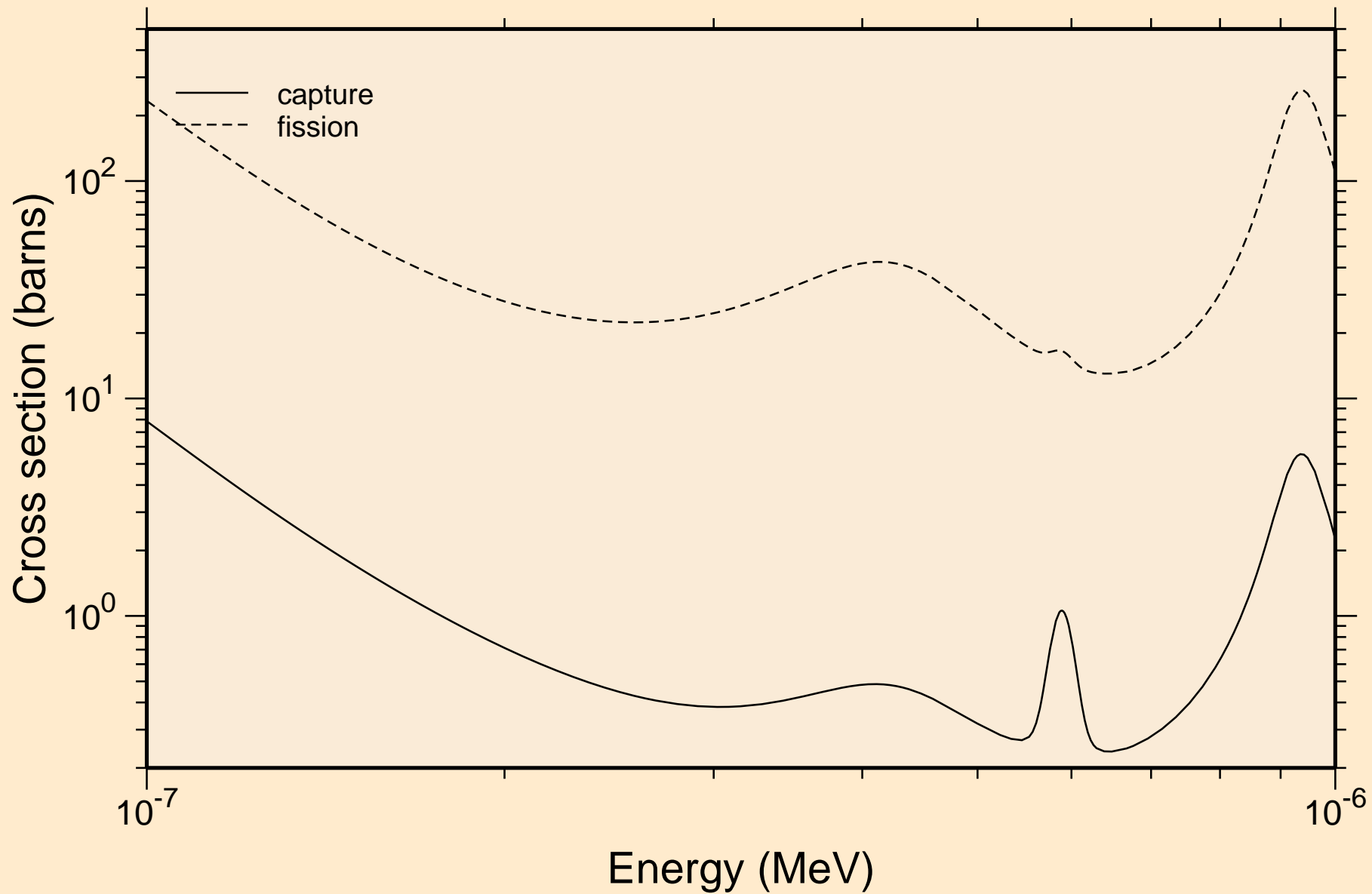

MD250 NRG TENDL-2015, AKONING
resonance absorption cross sections

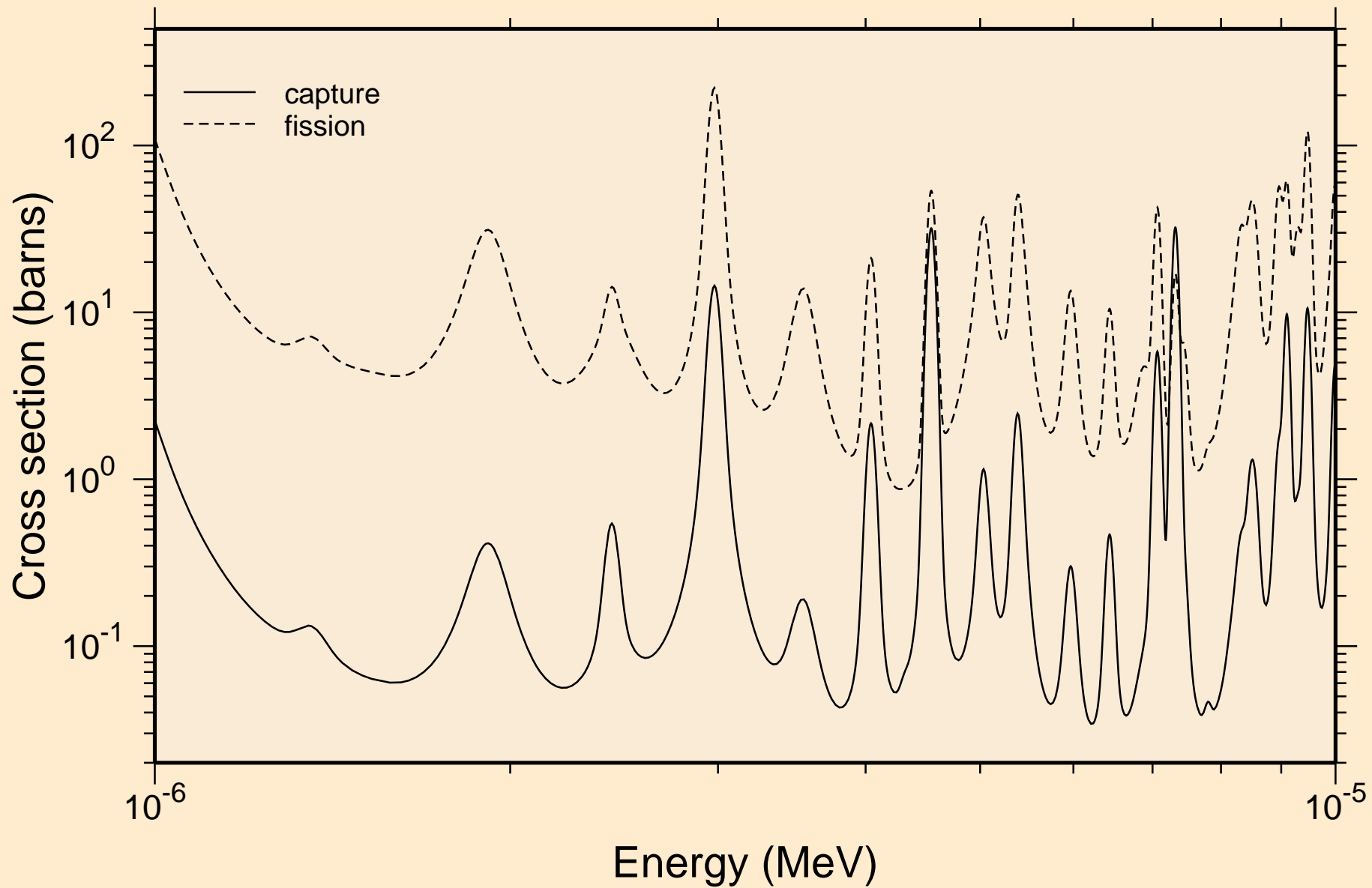

MD250 NRG TENDL-2015, AKONING resonance absorption cross sections

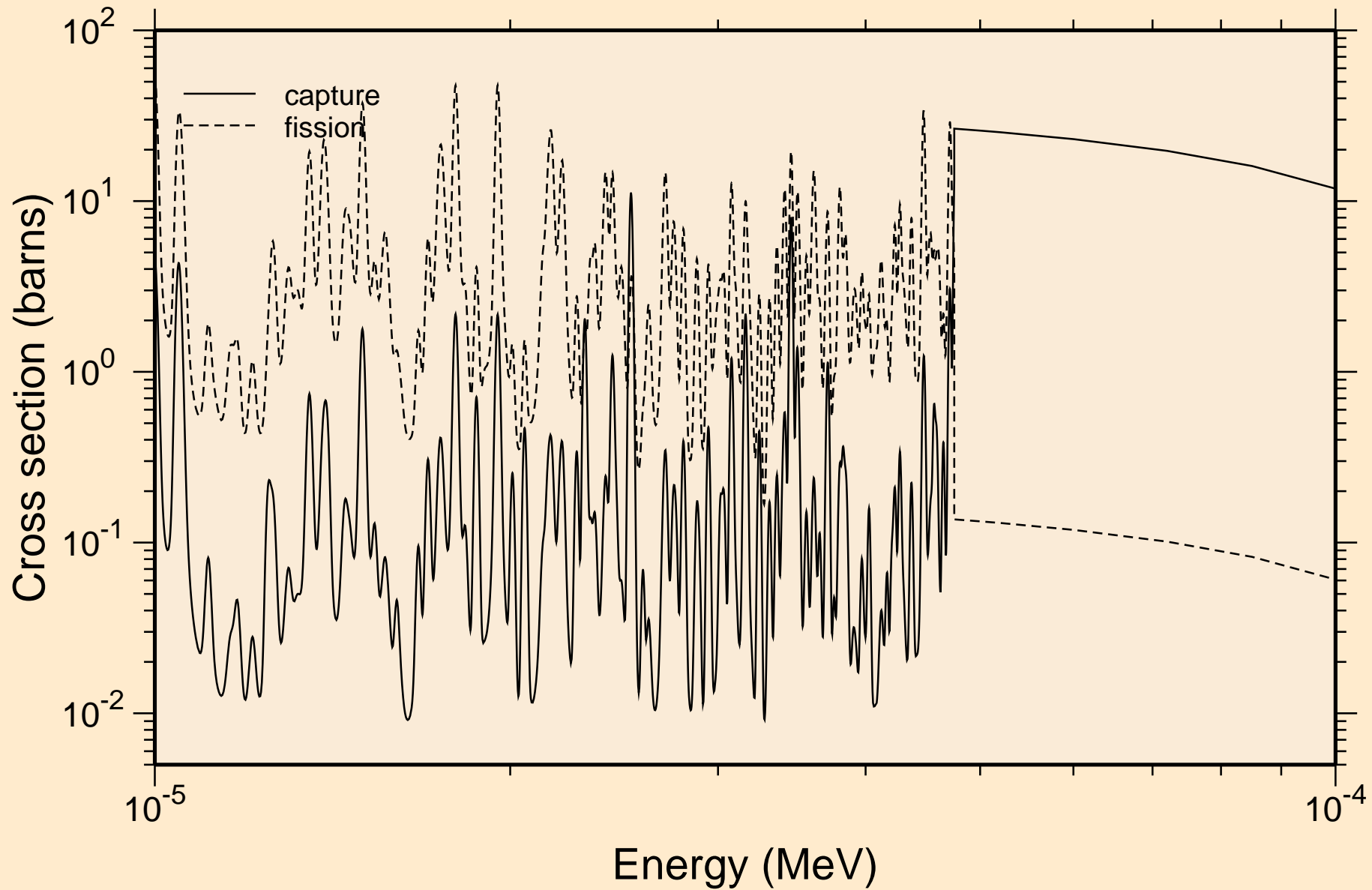

MD250 NRG TENDL-2015, AKONING
resonance absorption cross sections

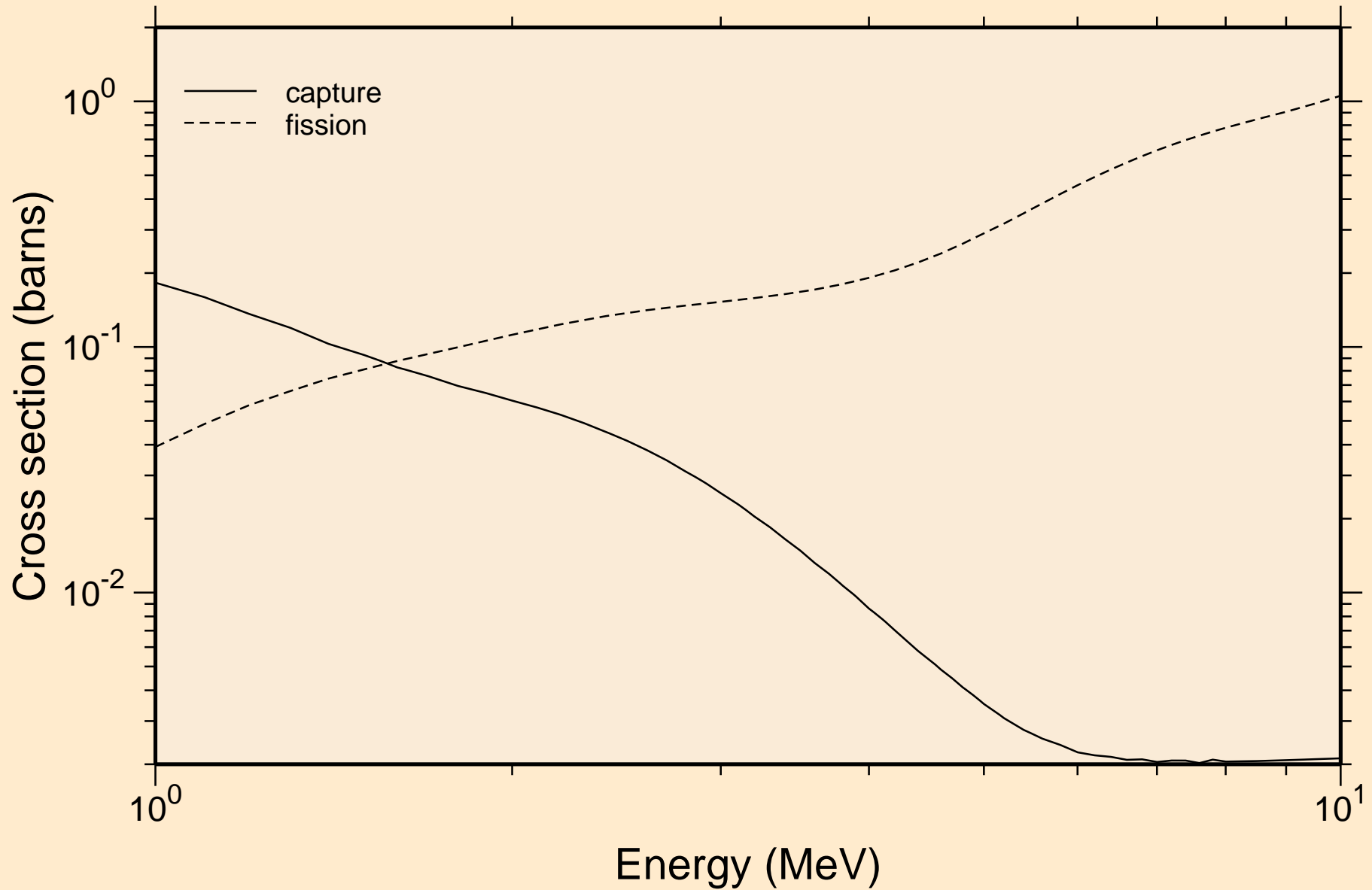

MD250 NRG TENDL-2015, AKONING

Non-threshold reactions

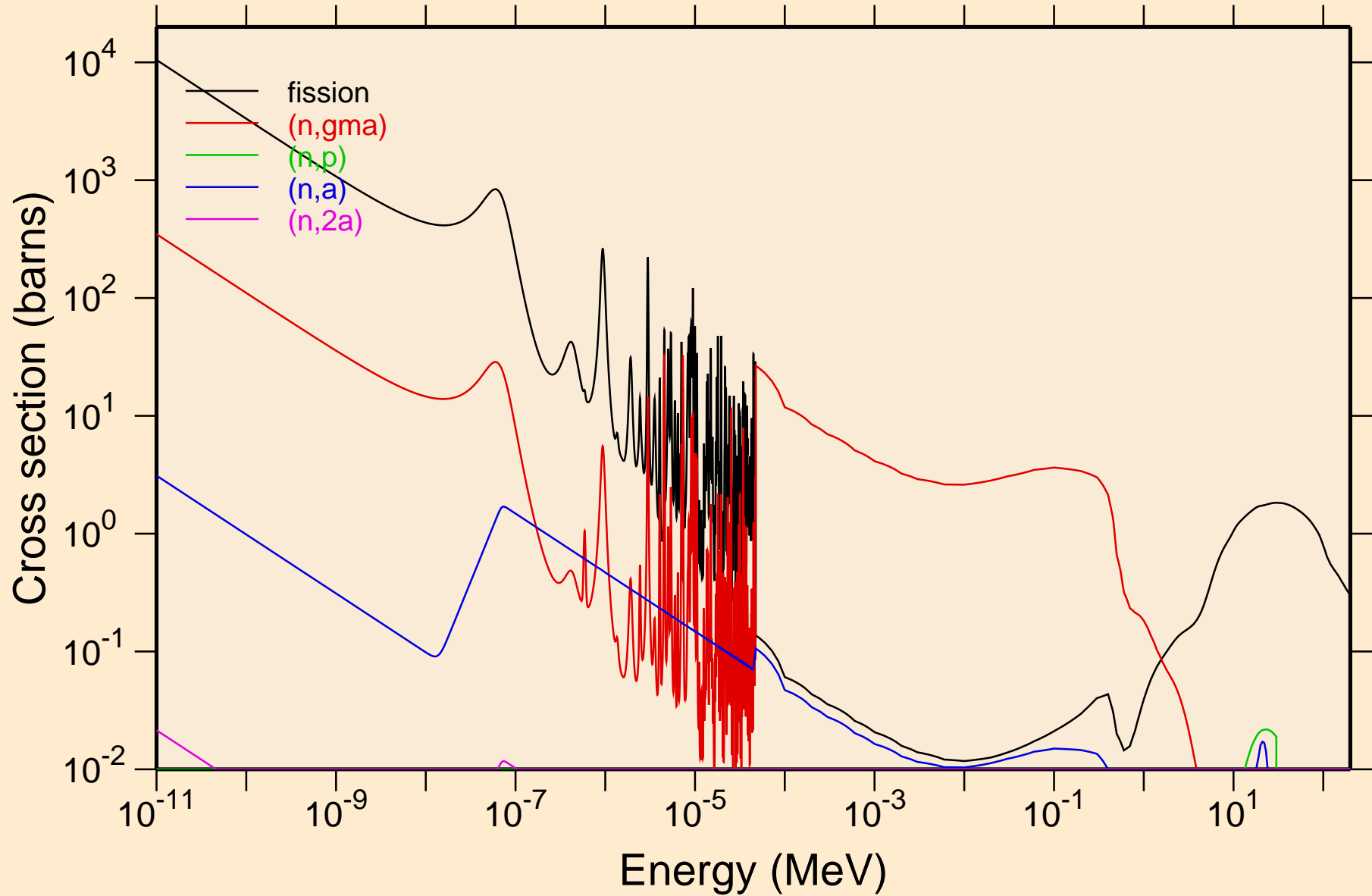

MD250 NRG TENDL-2015, AKONING

Non-threshold reactions

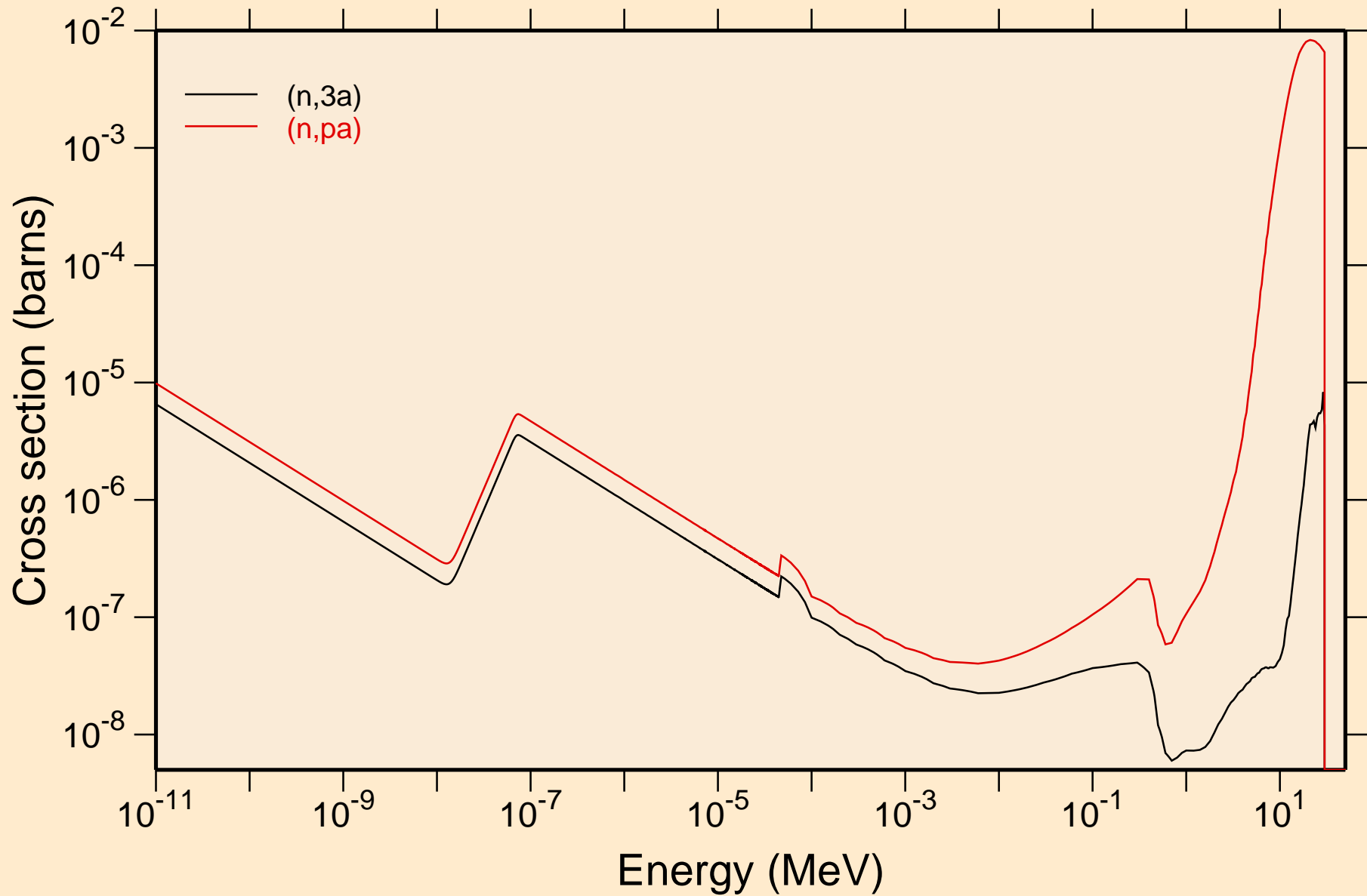

MD250 NRG TENDL-2015, AKONING

Principal cross sections

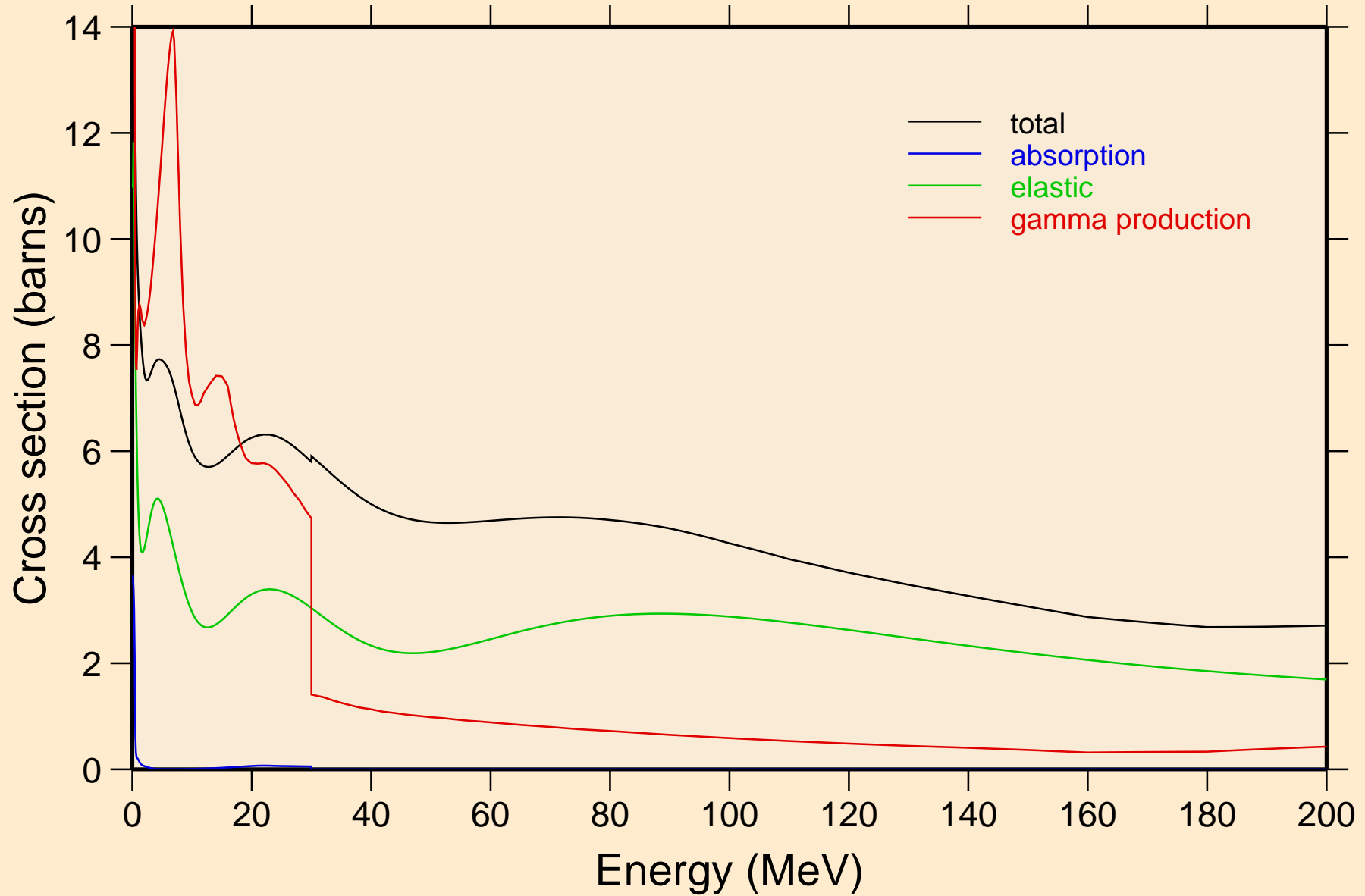

MD250 NRG TENDL-2015, AKONING

Non-threshold reactions

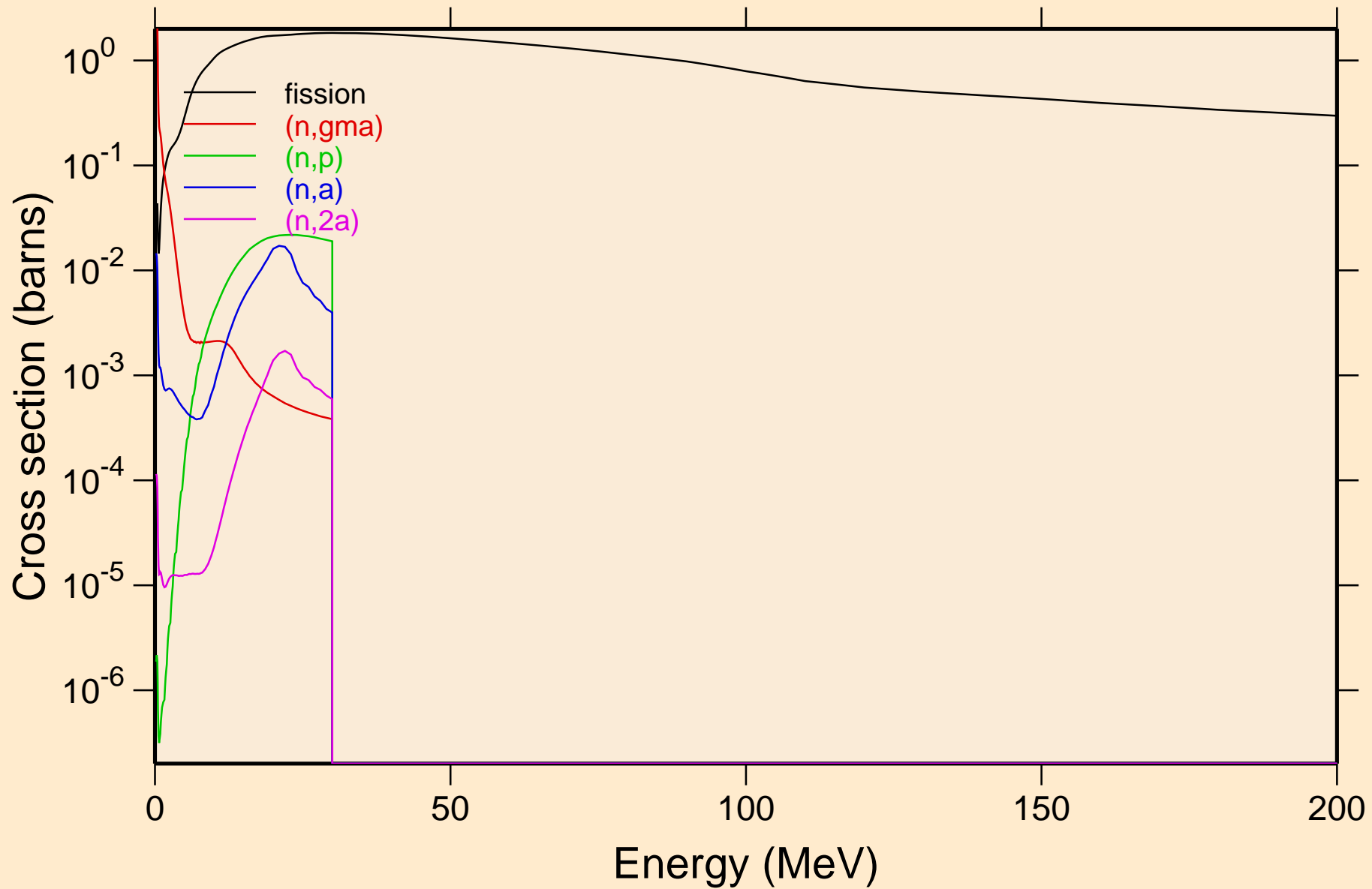

MD250 NRG TENDL-2015, AKONING
Non-threshold reactions

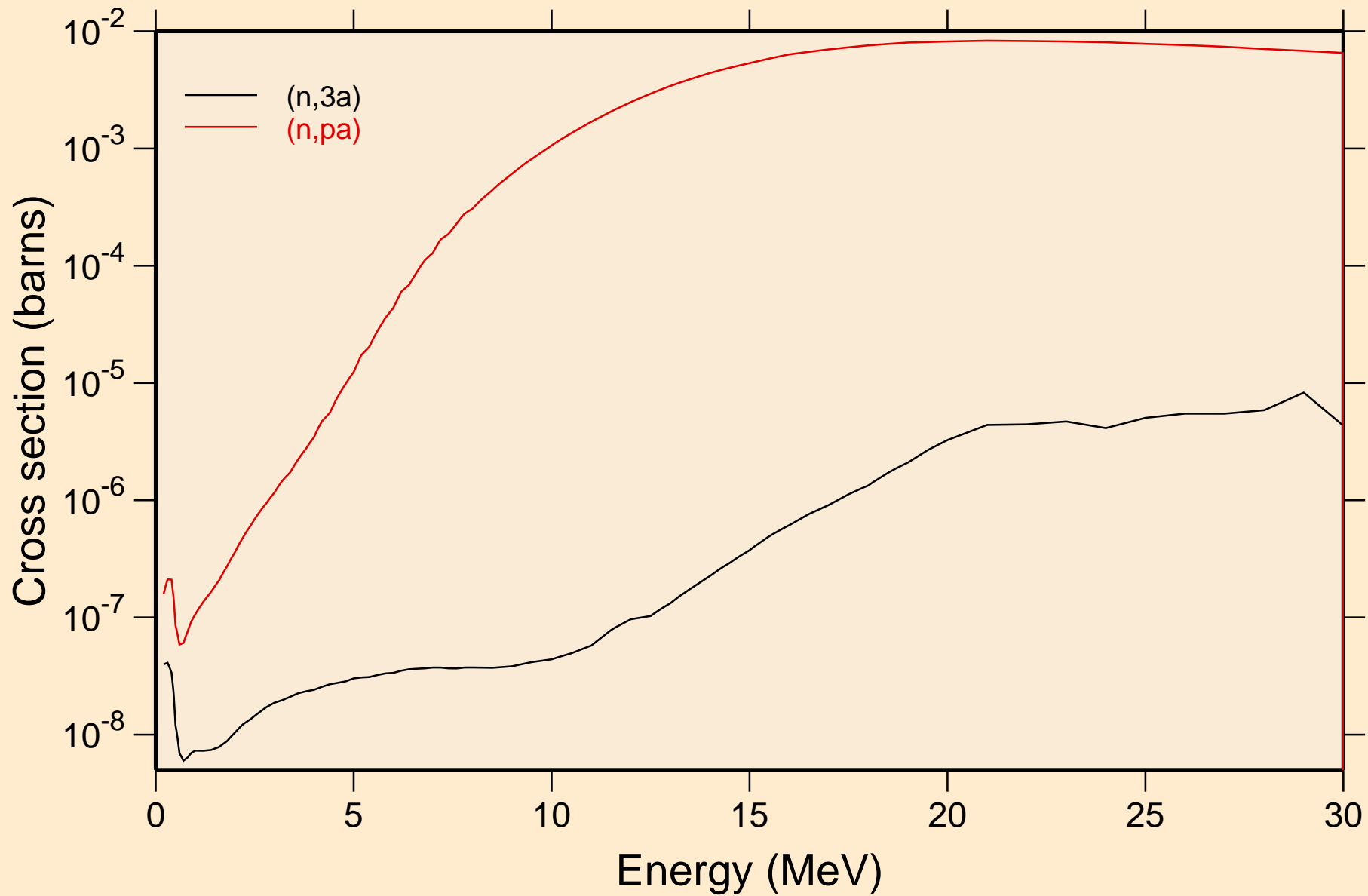

MD250 NRG TENDL-2015, AKONING

Inelastic levels

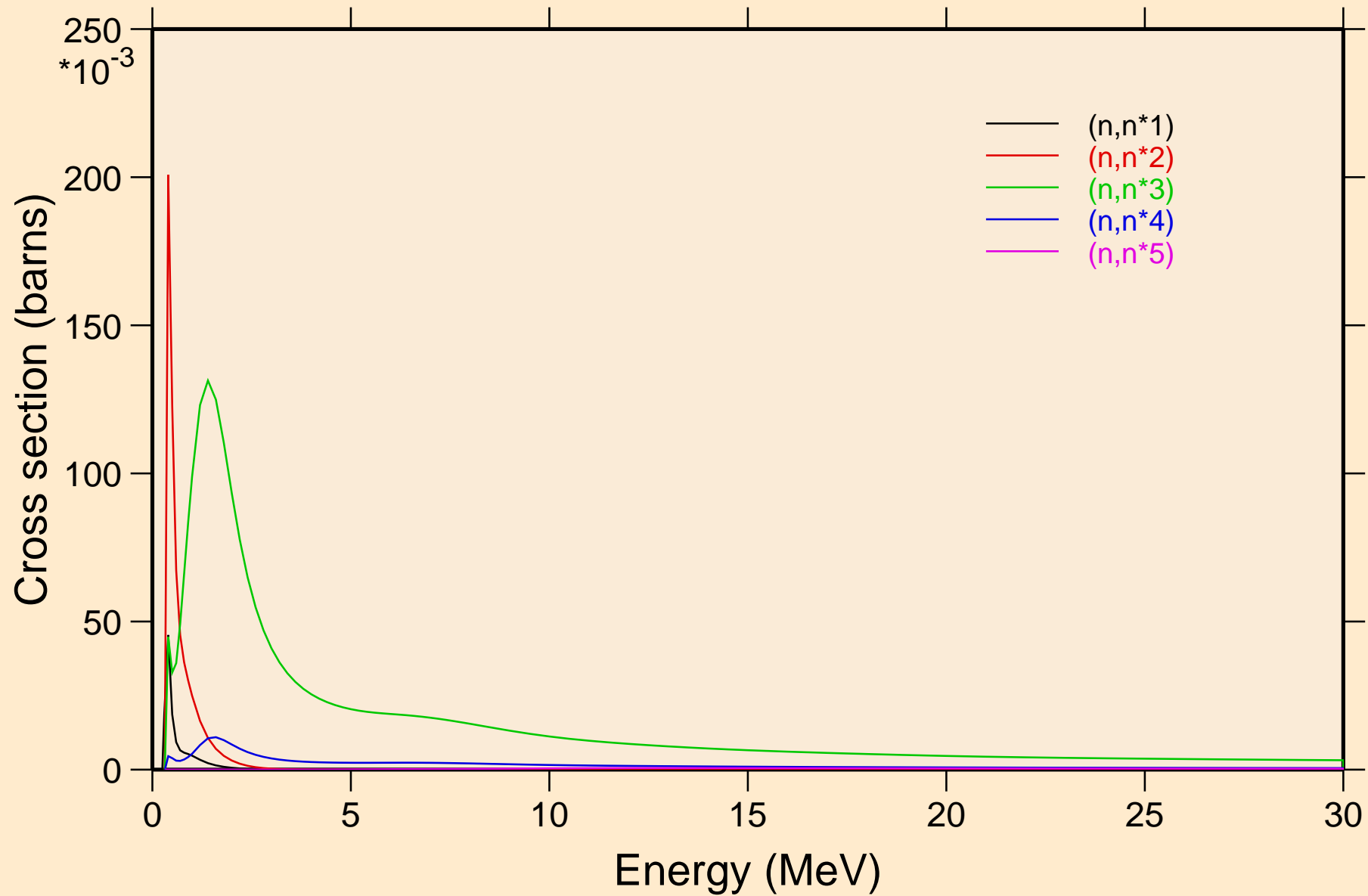

MD250 NRG TENDL-2015, AKONING
Inelastic levels

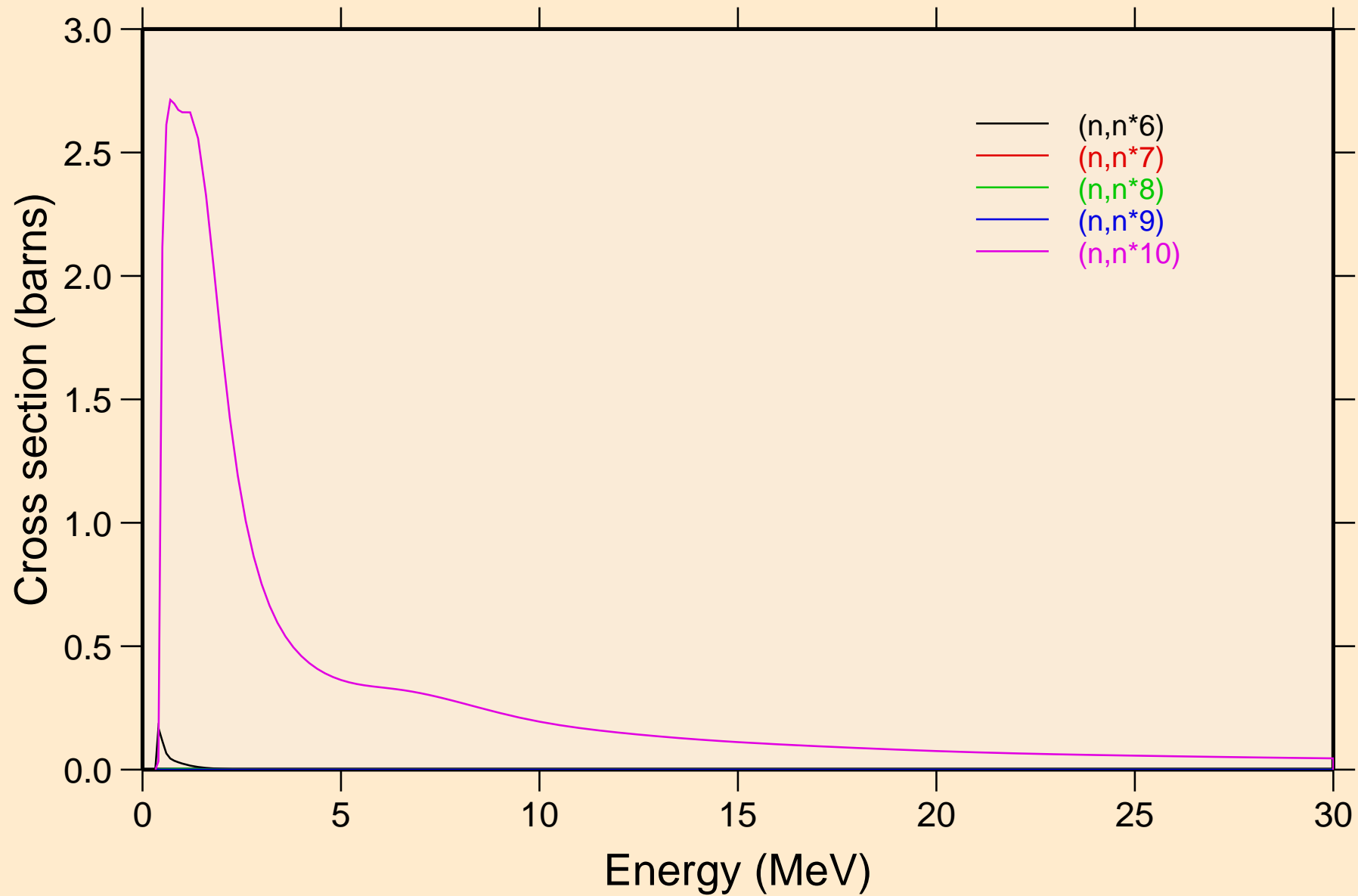

MD250 NRG TENDL-2015, AKONING

Inelastic levels

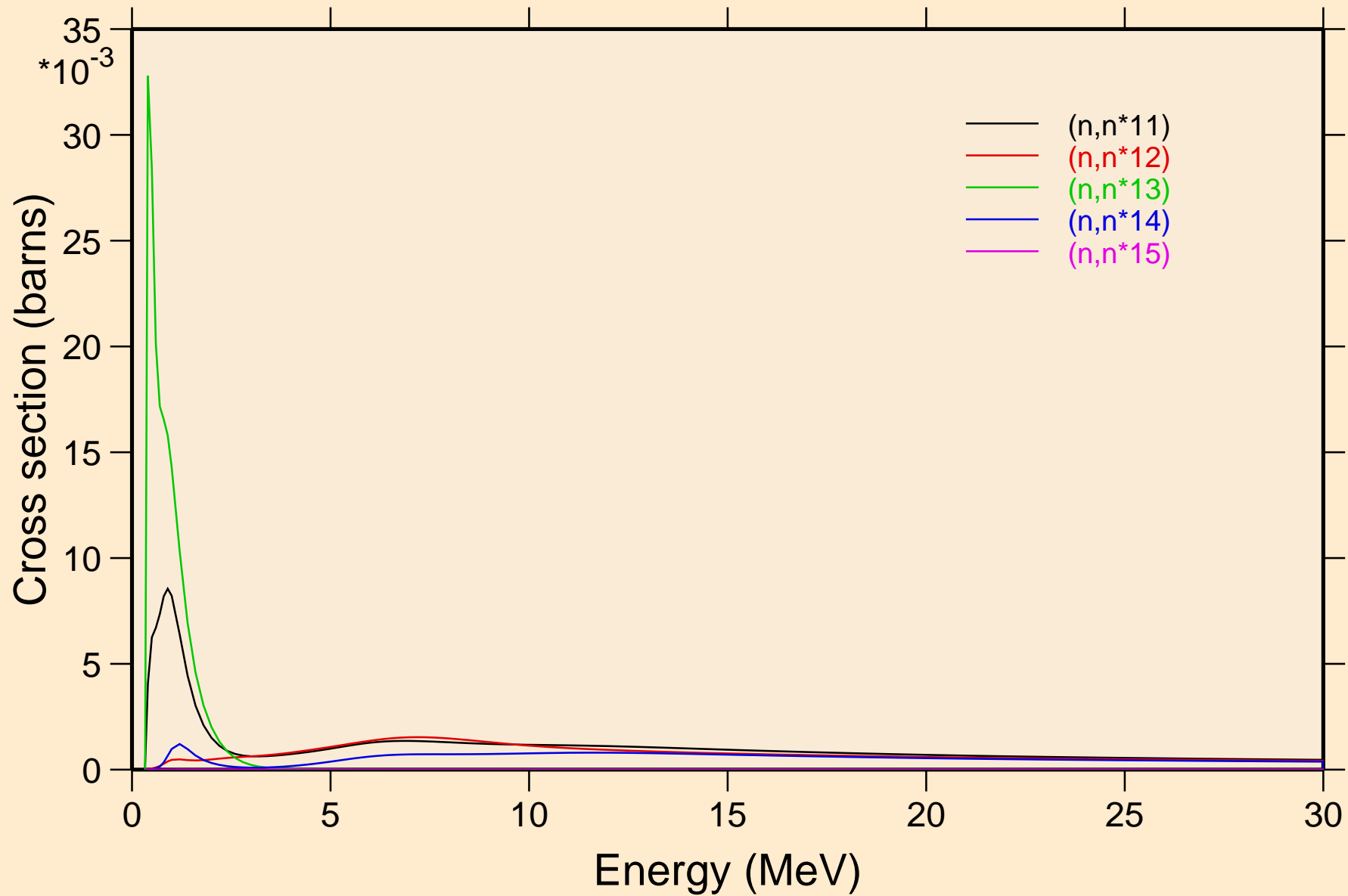

MD250 NRG TENDL-2015, AKONING

Inelastic levels

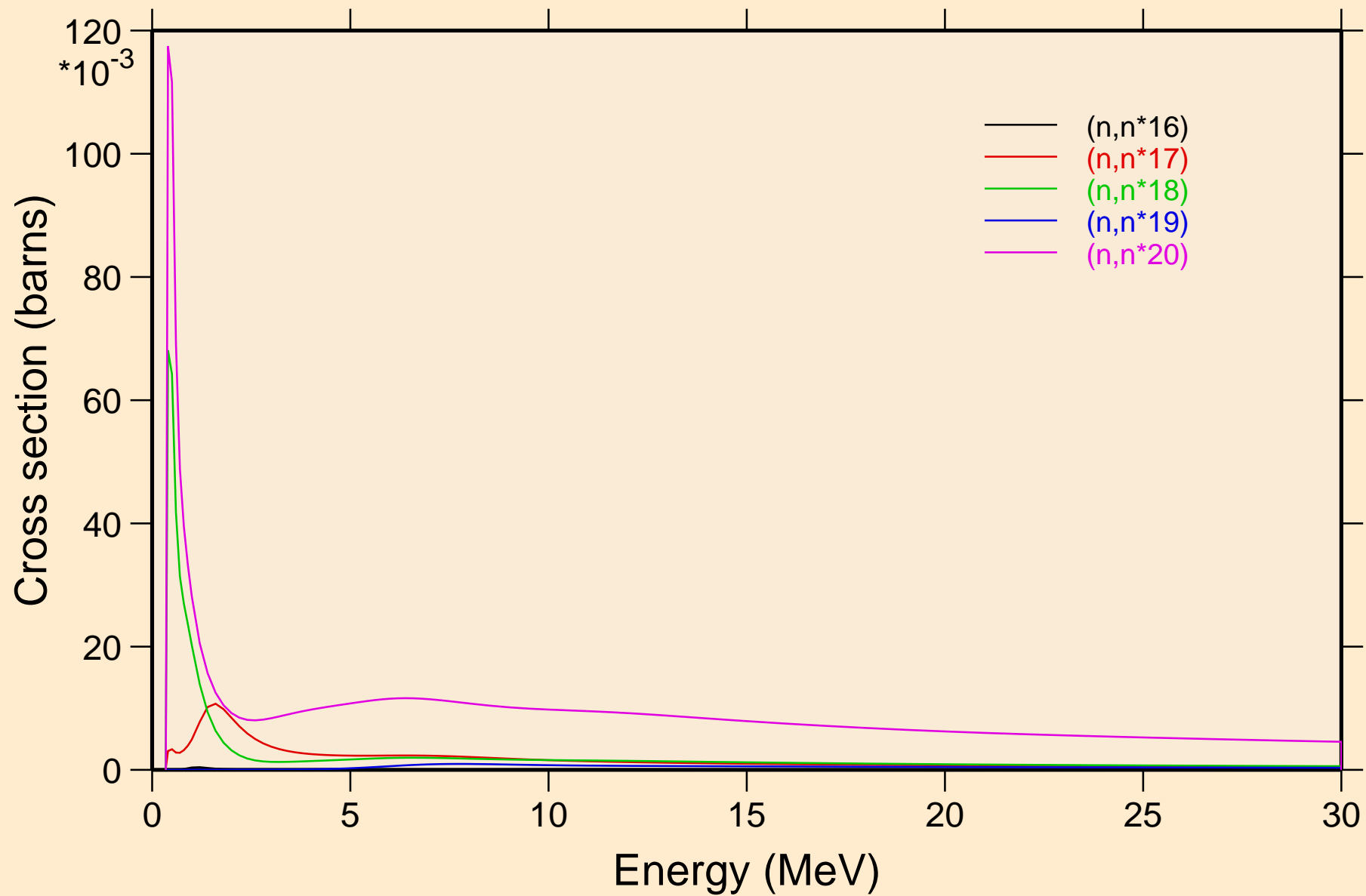

MD250 NRG TENDL-2015, AKONING

Inelastic levels

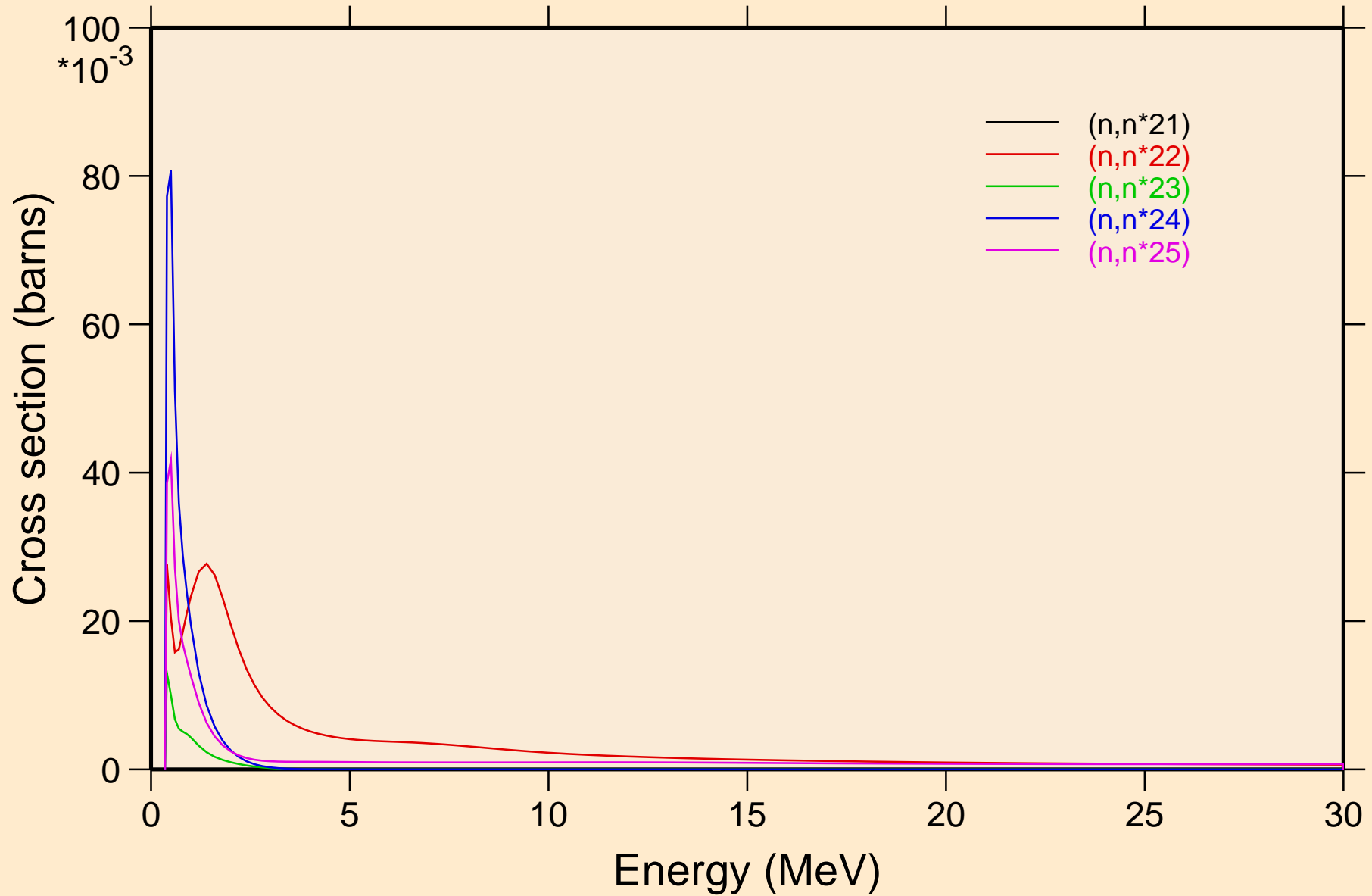

MD250 NRG TENDL-2015, AKONING

Inelastic levels

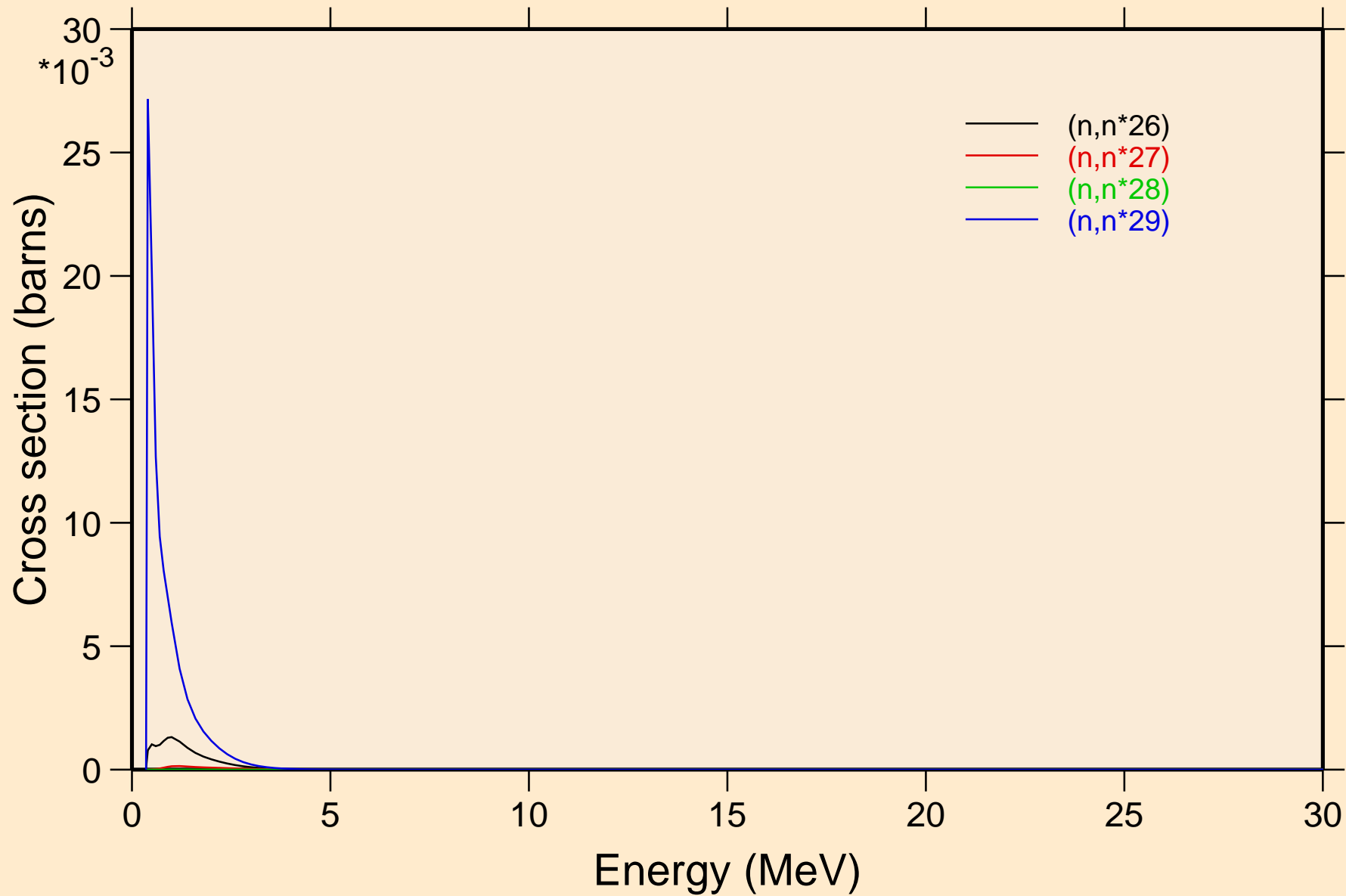

MD250 NRG TENDL-2015, AKONING

Threshold reactions

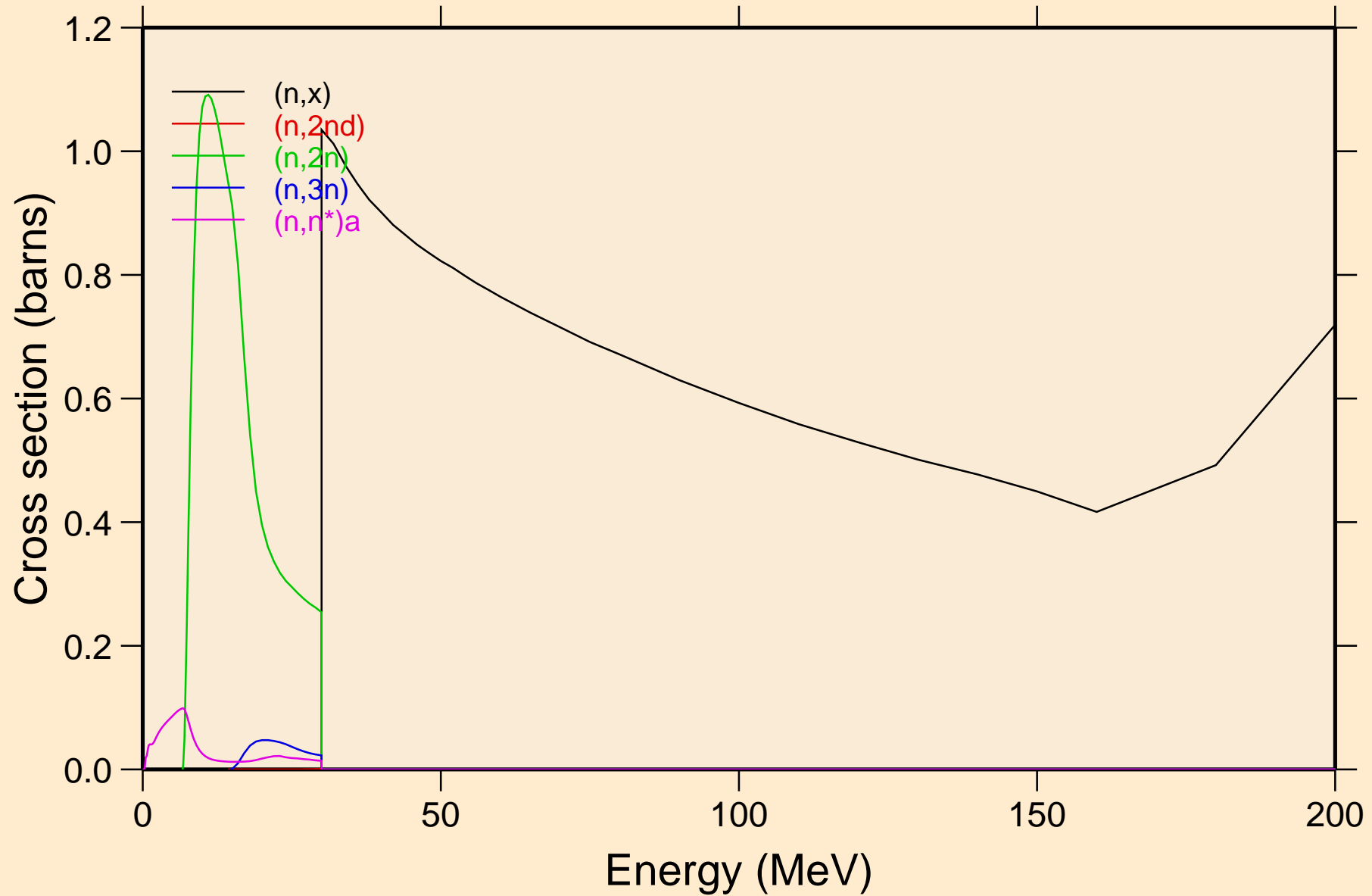

MD250 NRG TENDL-2015, AKONING

Threshold reactions

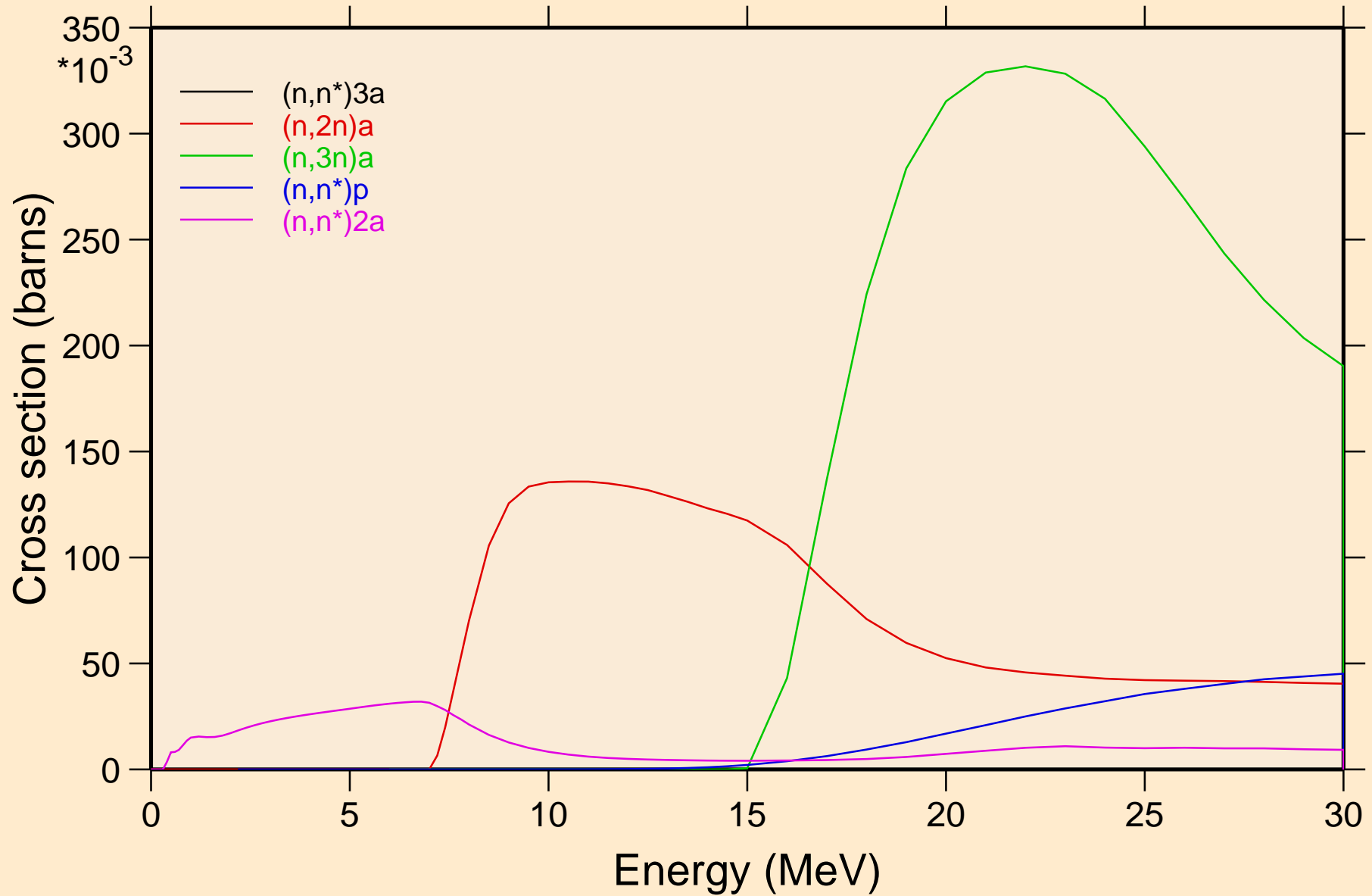

MD250 NRG TENDL-2015, AKONING

Threshold reactions

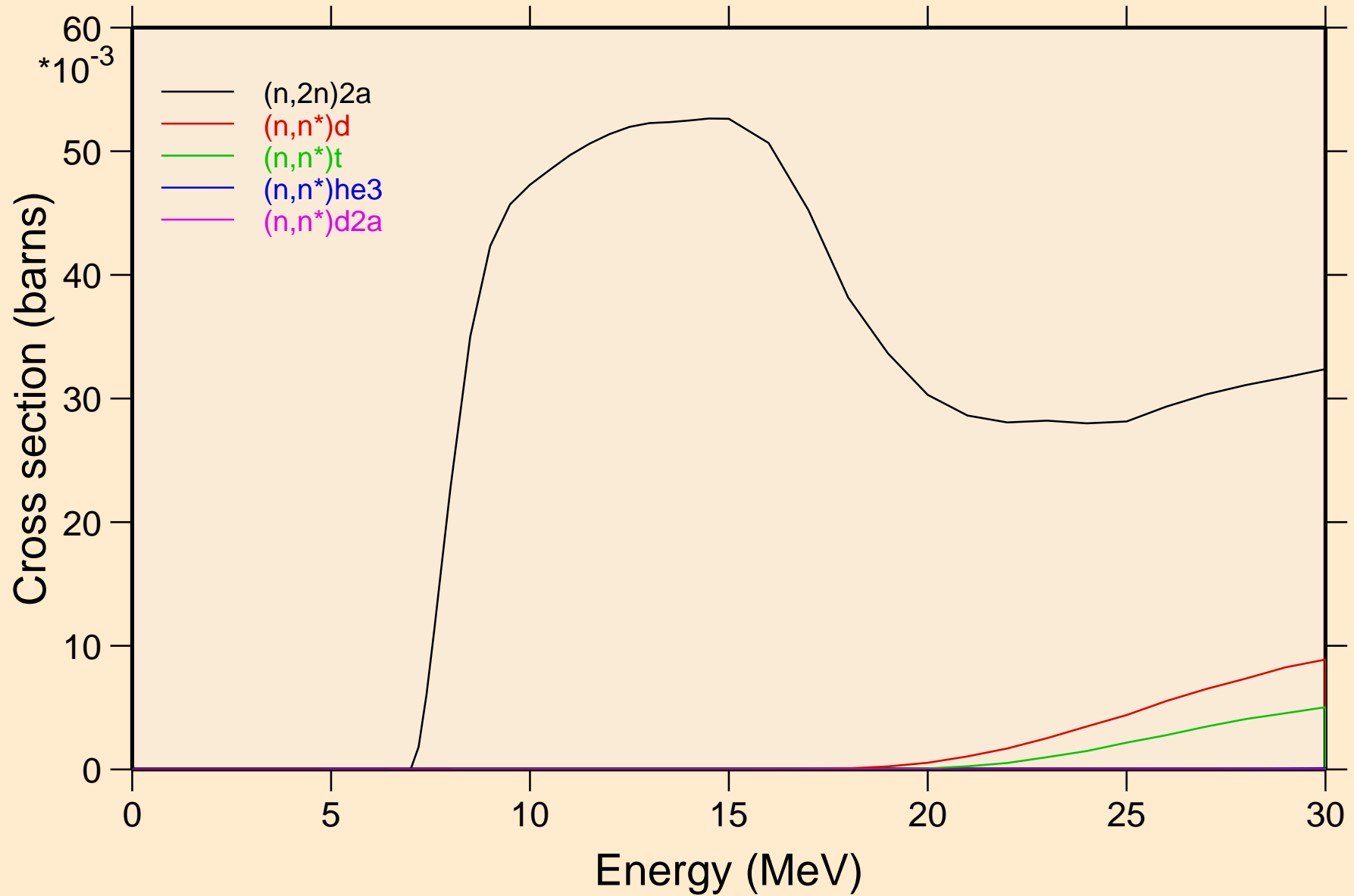

MD250 NRG TENDL-2015, AKONING

Threshold reactions

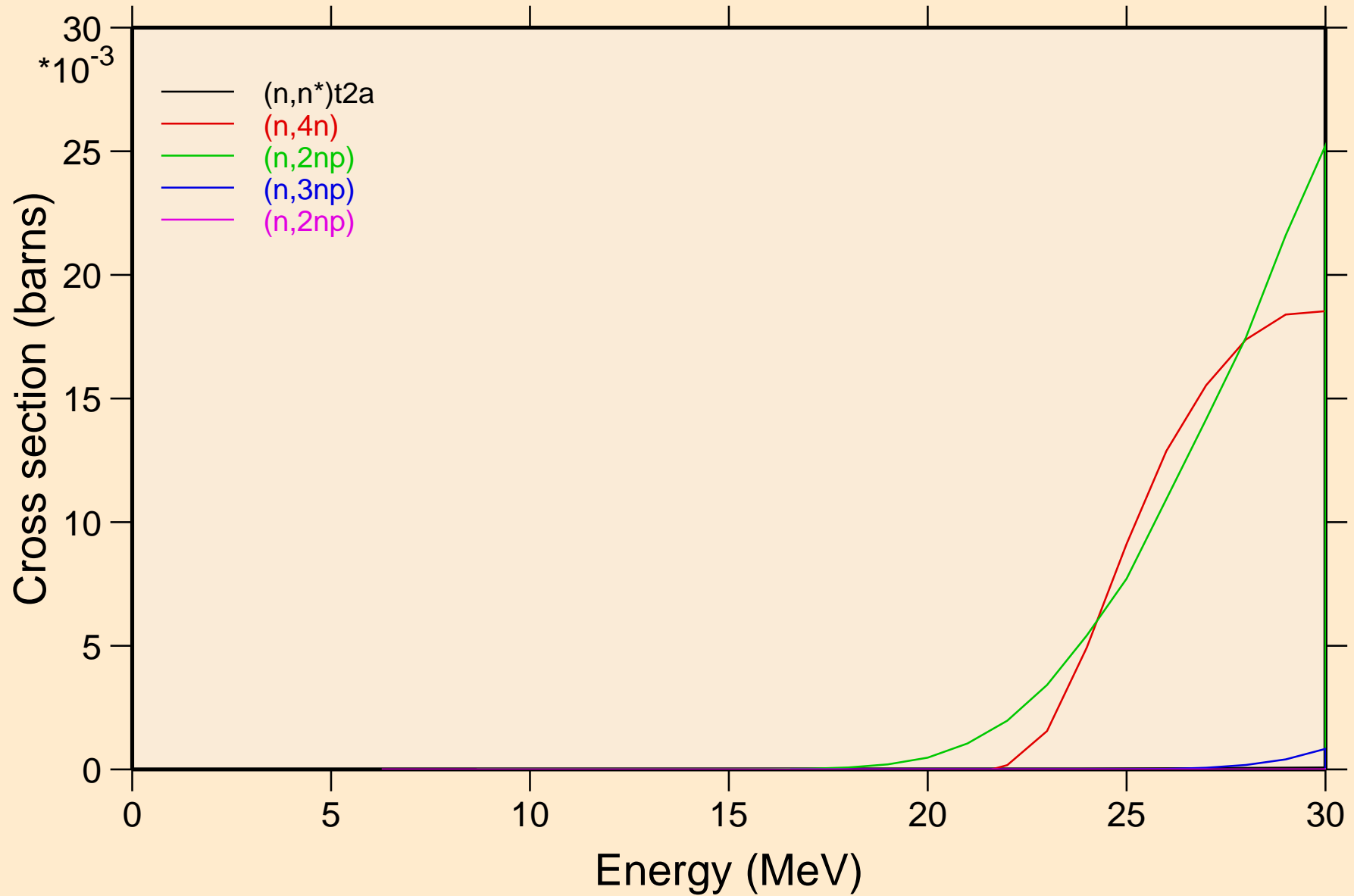

MD250 NRG TENDL-2015, AKONING

Threshold reactions

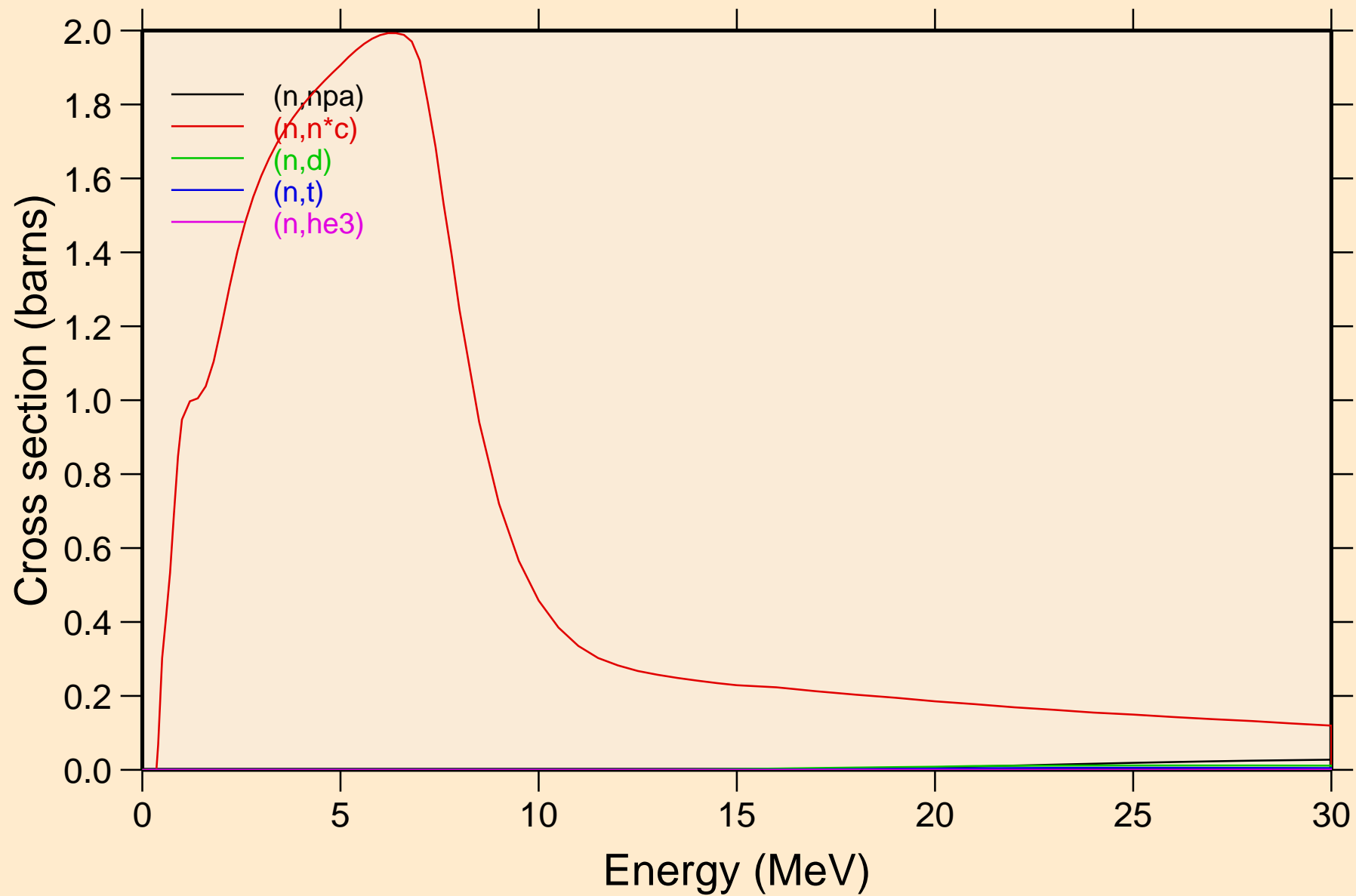

MD250 NRG TENDL-2015, AKONING

Threshold reactions

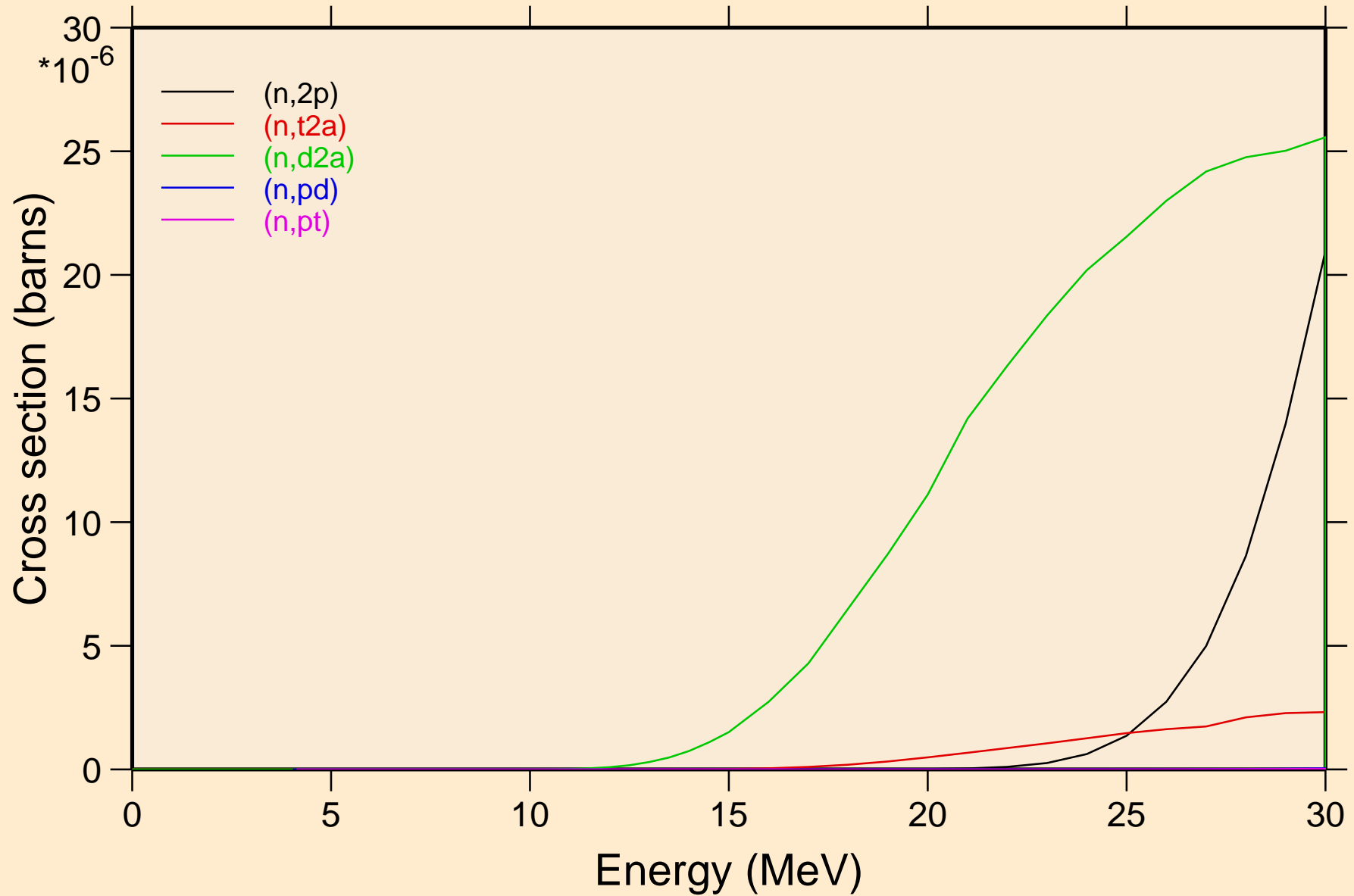

MD250 NRG TENDL-2015, AKONING

Threshold reactions

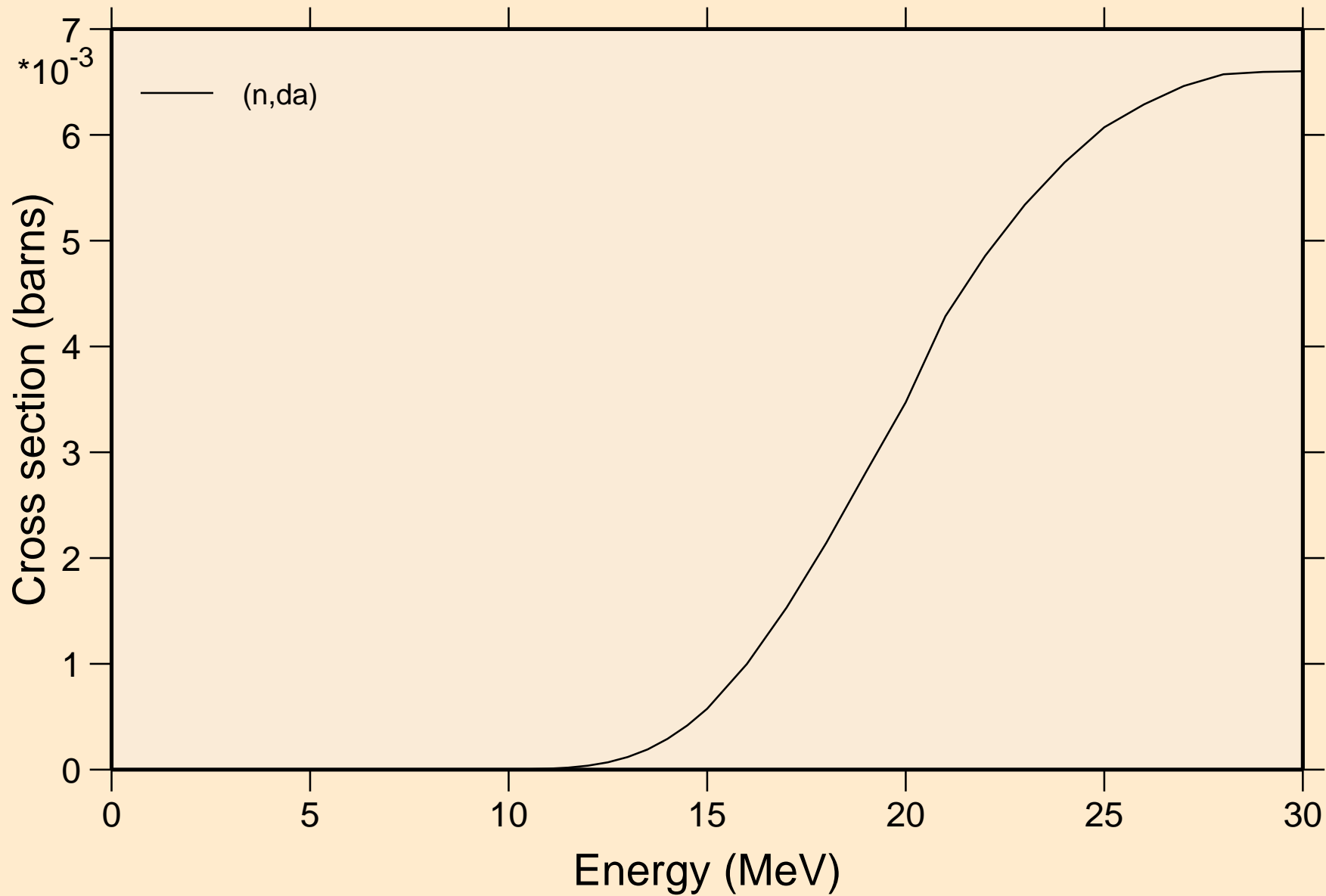

MD250 NRG TENDL-2015, AKONING
angular distribution for elastic

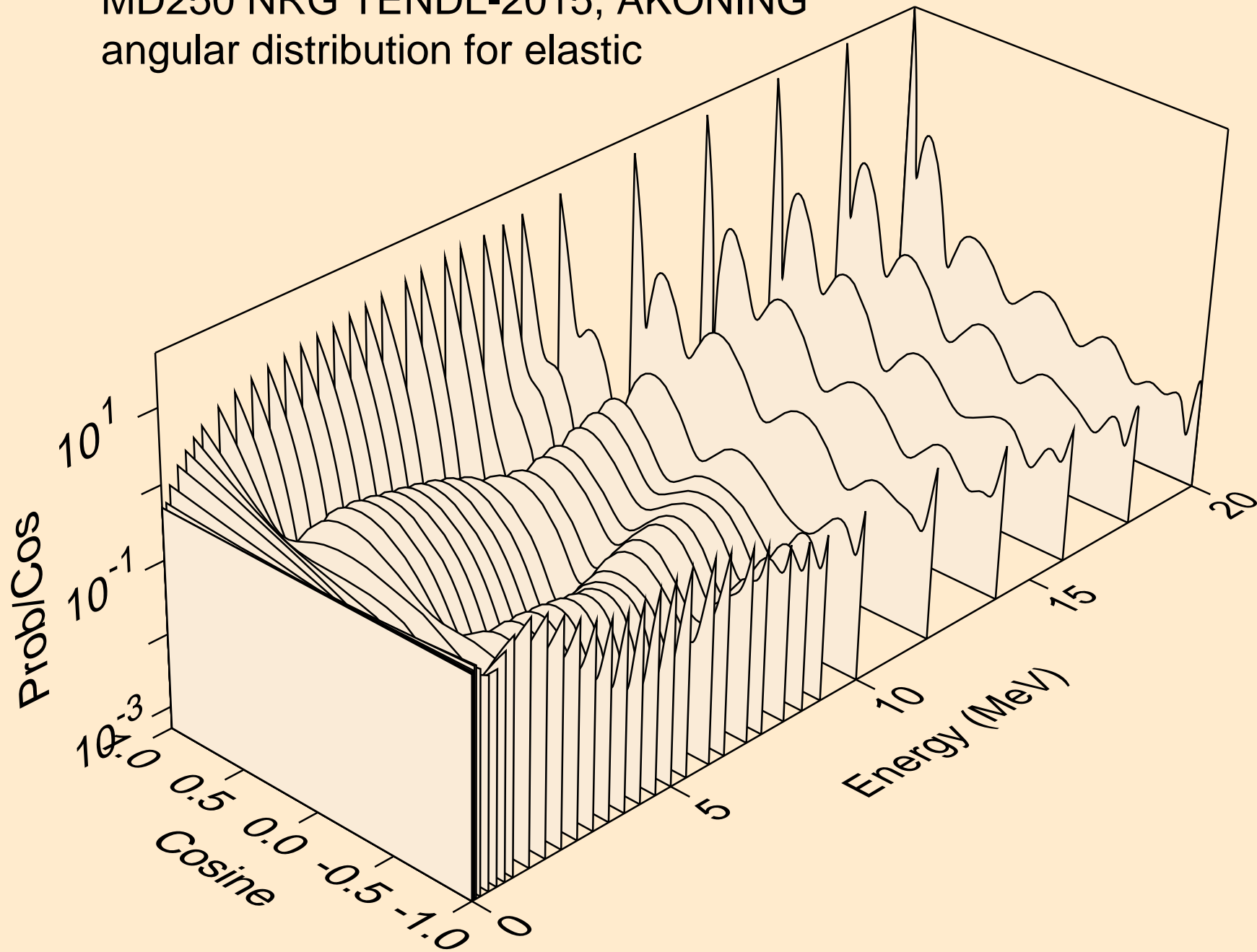

MD250 NRG TENDL-2015, AKONING
angular distribution for elastic

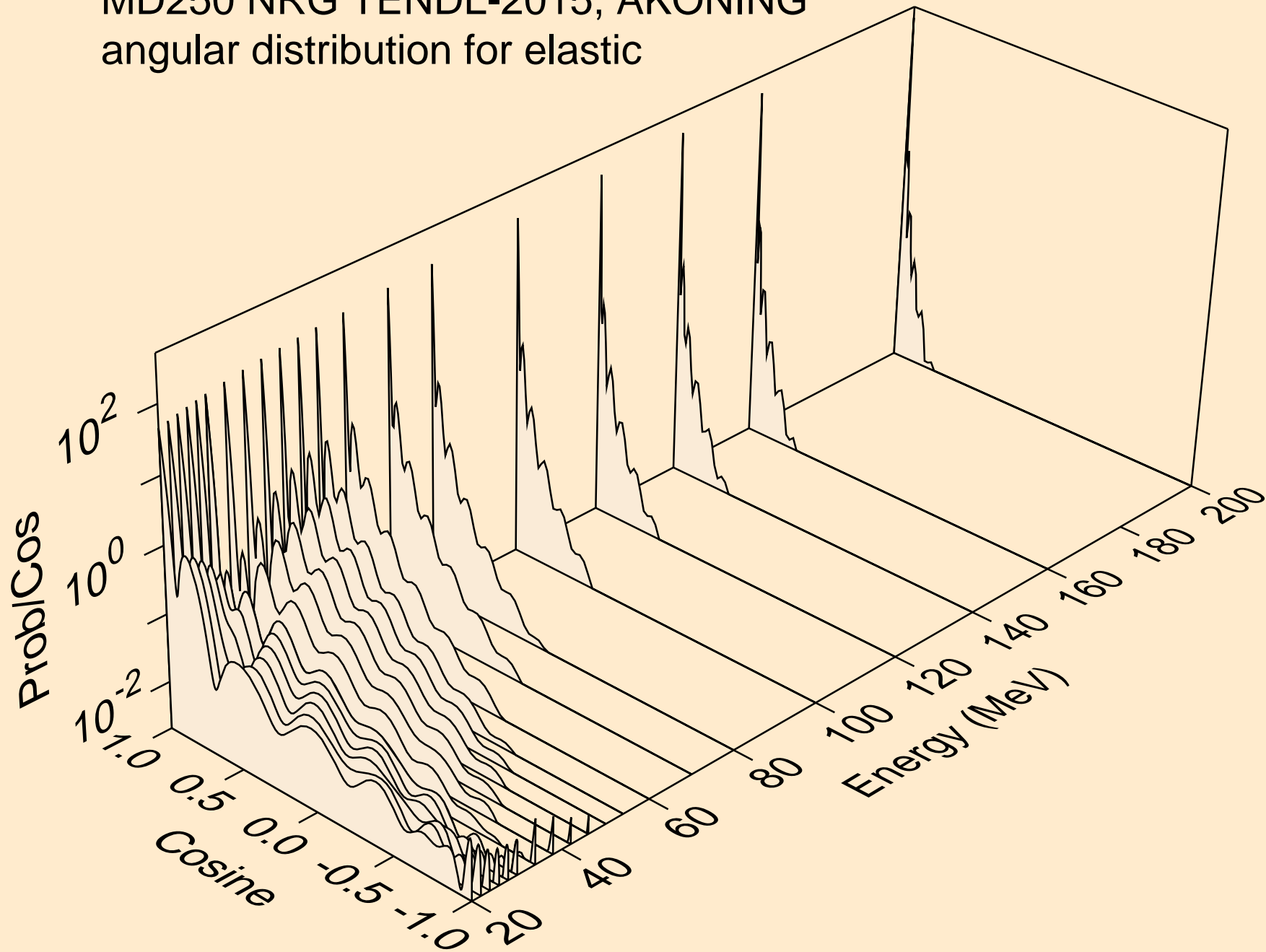

MD250 NRG TENDL-2015, AKONING
angular distribution for (n,n*1)

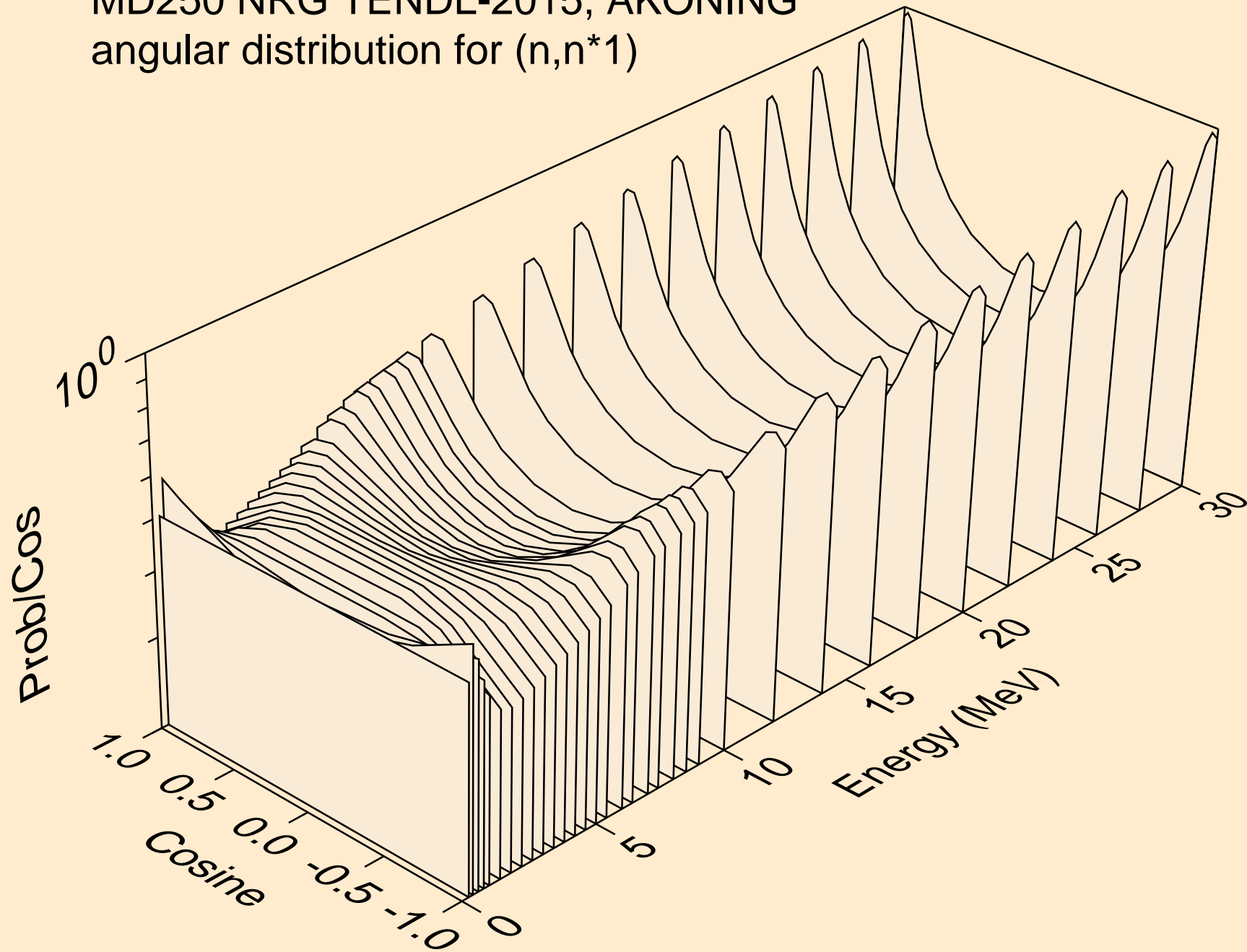

MD250 NRG TENDL-2015, AKONING
angular distribution for (n,n*2)

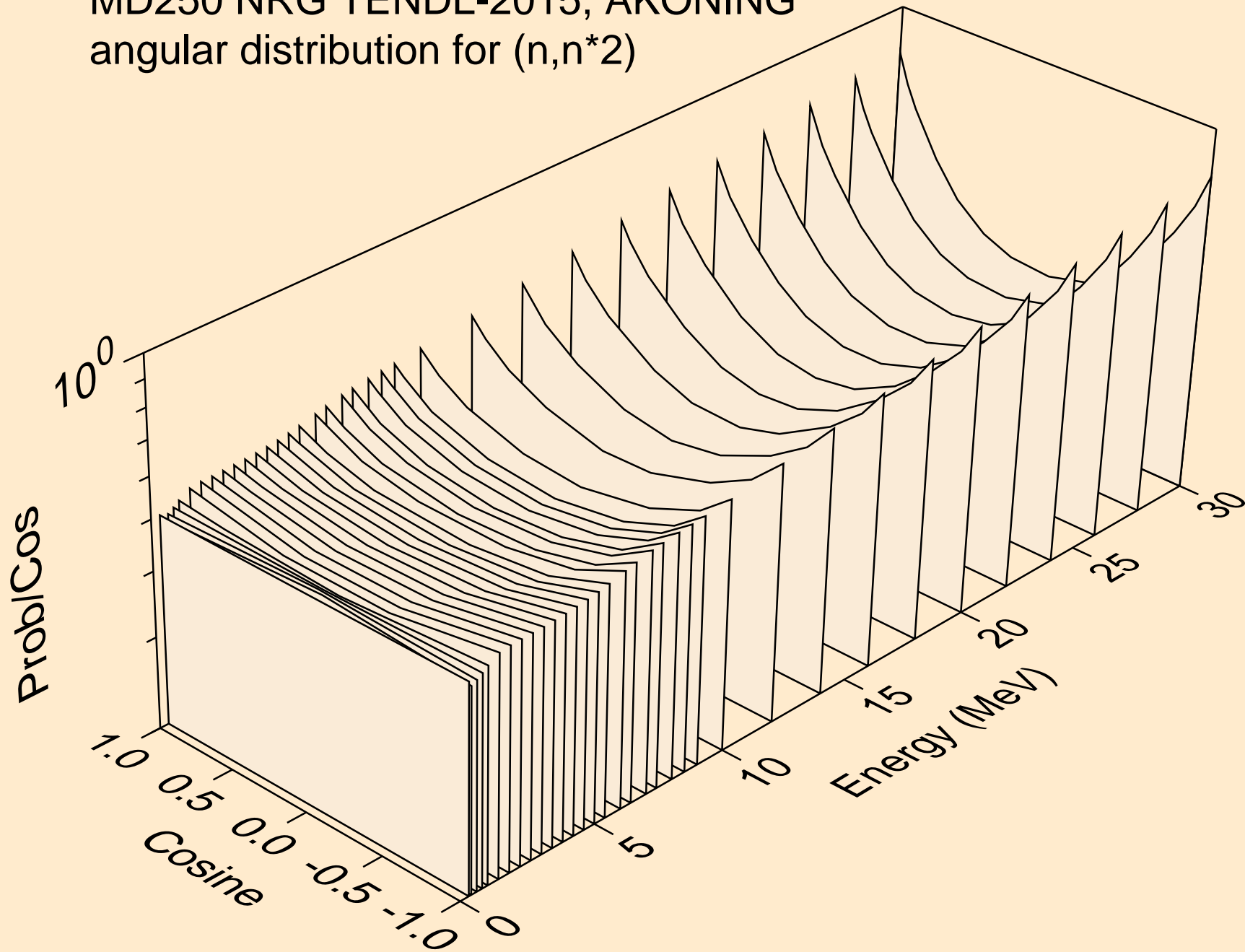

MD250 NRG TENDL-2015, AKONING
angular distribution for (n,n*3)

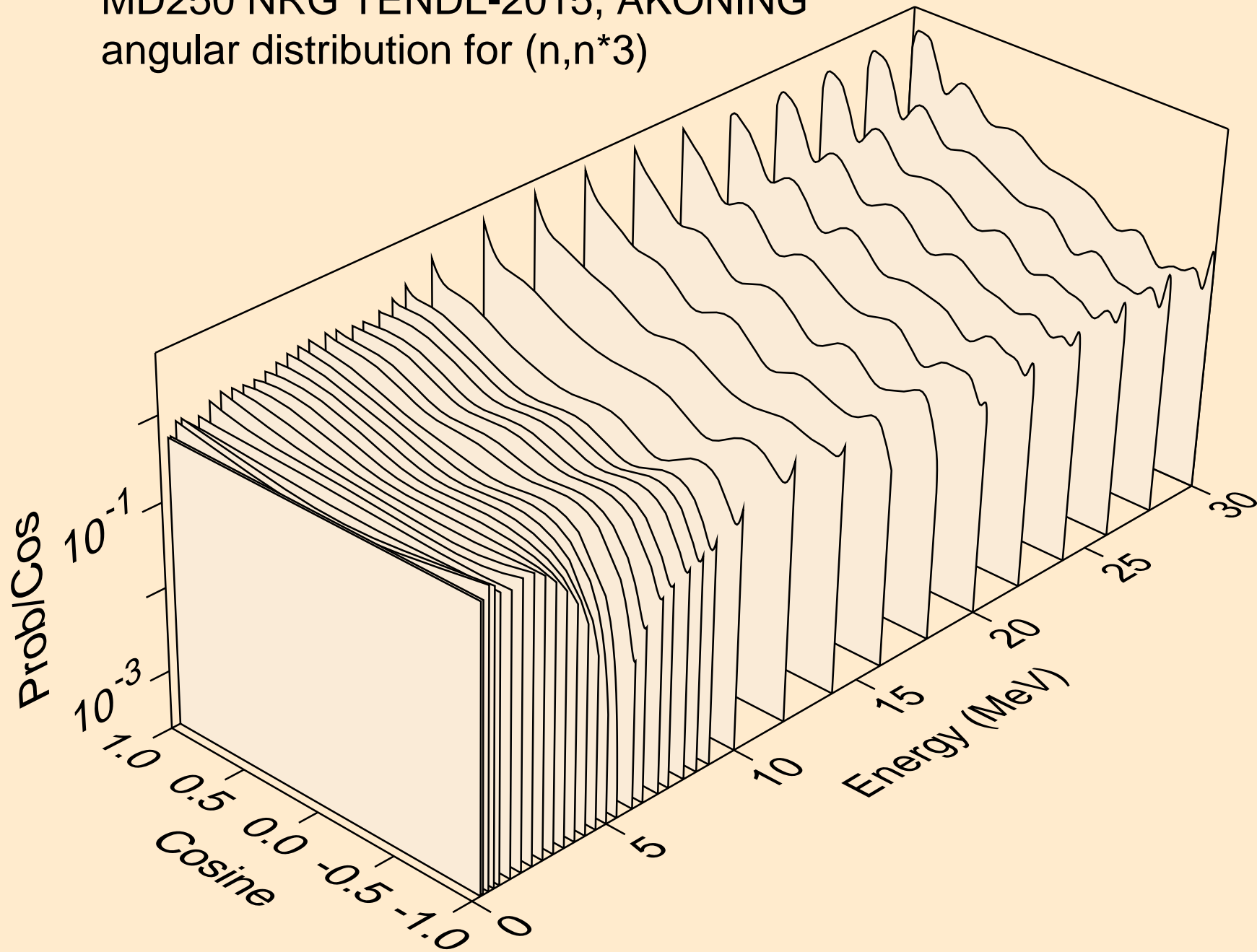

MD250 NRG TENDL-2015, AKONING
angular distribution for (n,n*4)

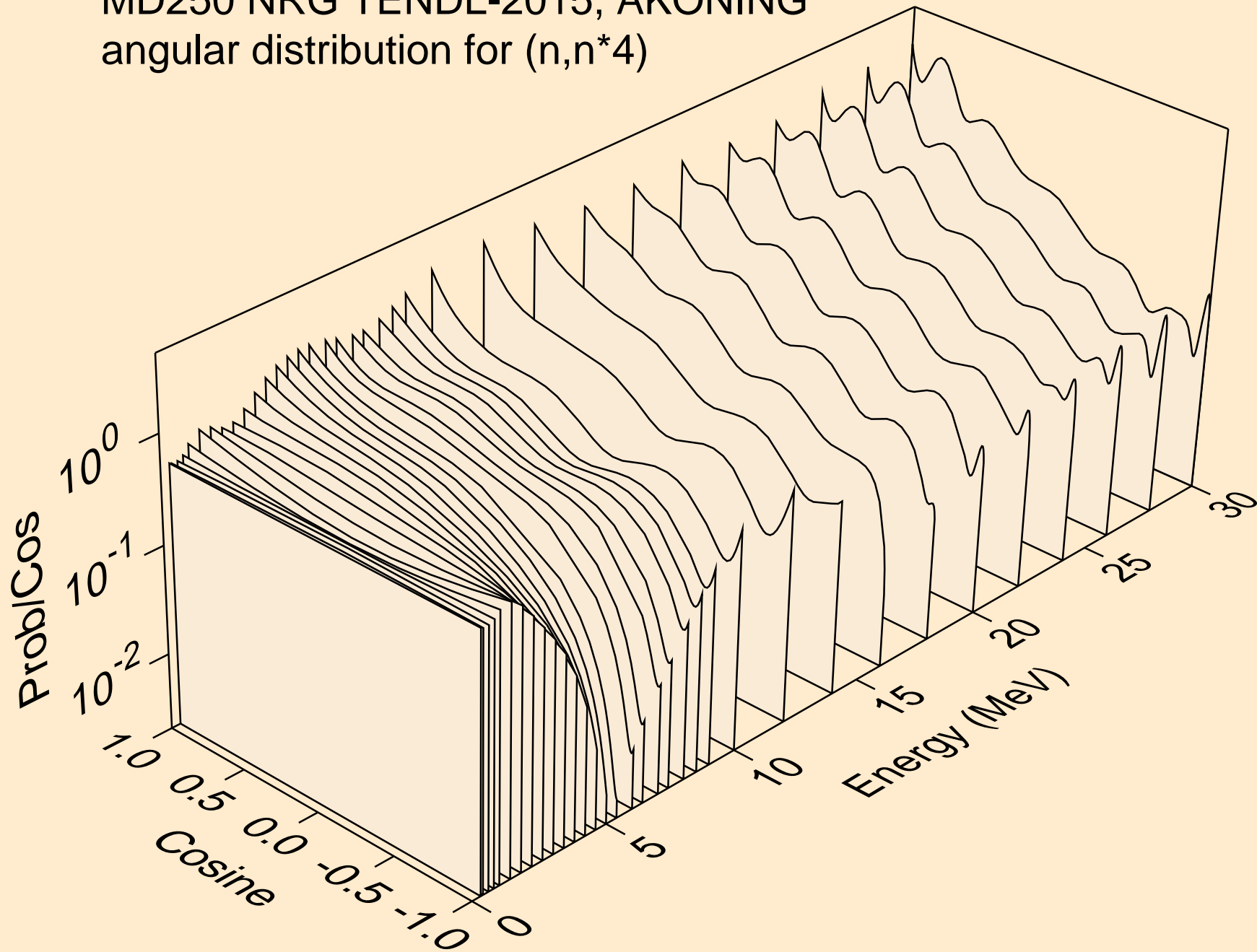

MD250 NRG TENDL-2015, AKONING
angular distribution for (n,n*5)

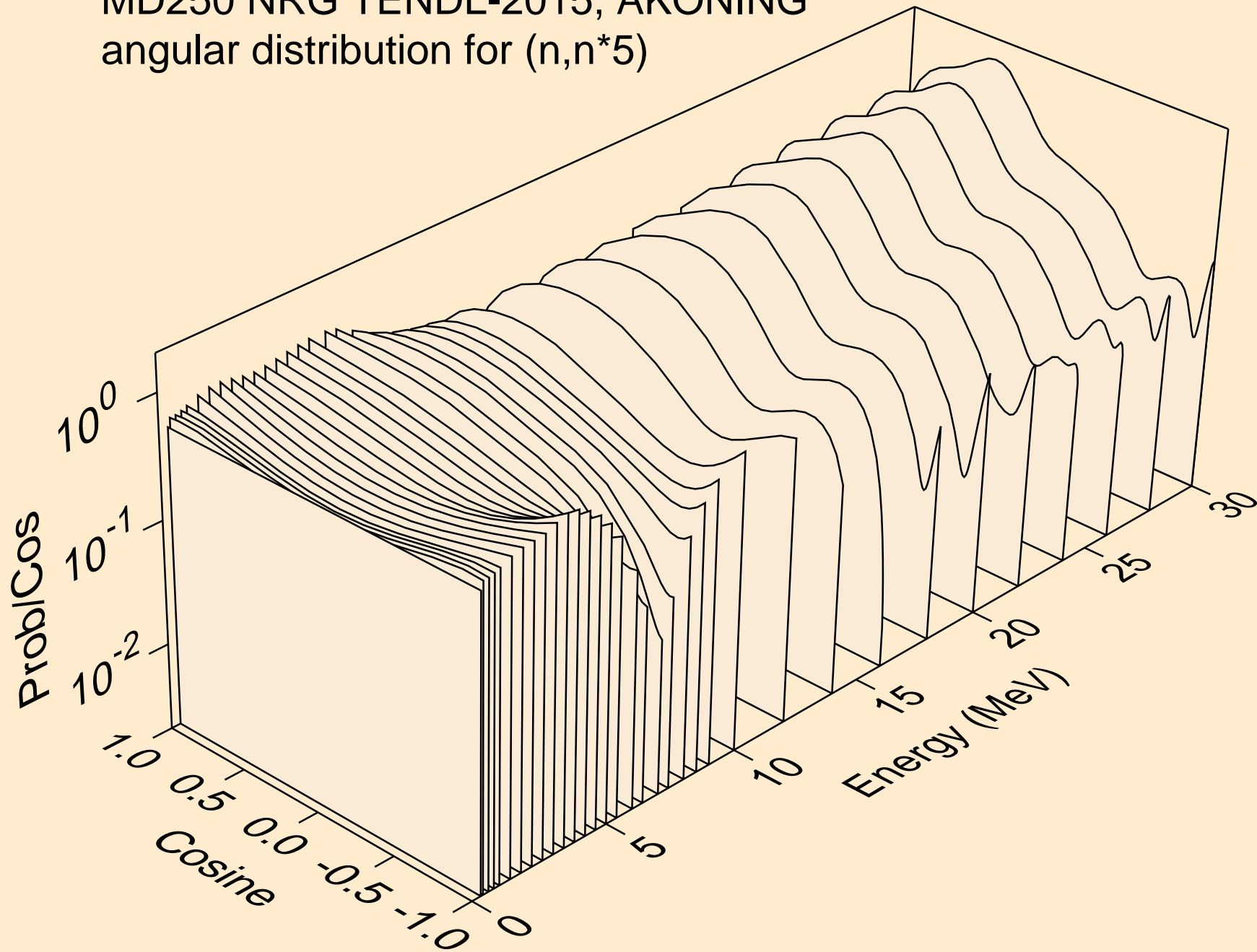

MD250 NRG TENDL-2015, AKONING
angular distribution for (n,n*6)

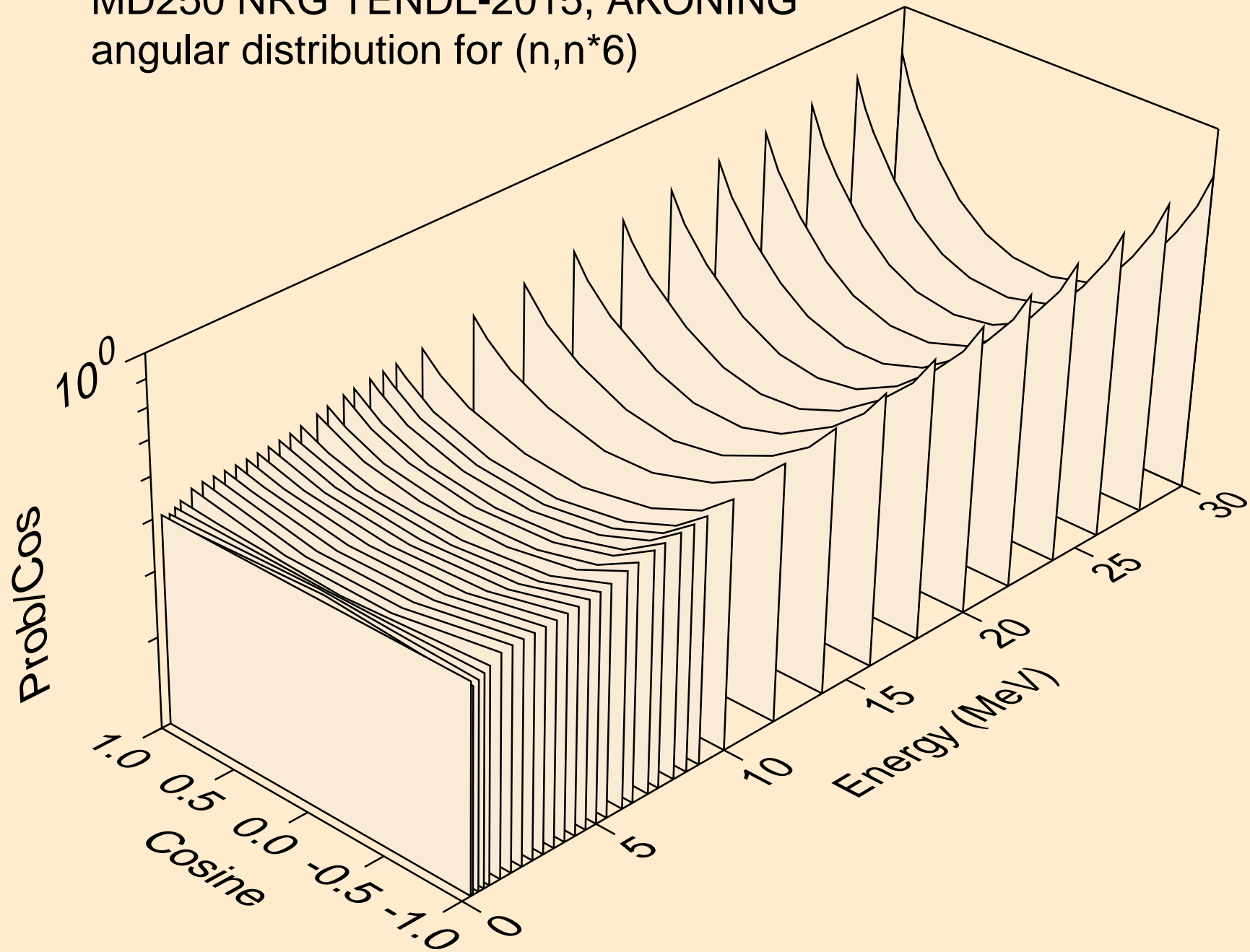

MD250 NRG TENDL-2015, AKONING
angular distribution for (n,n*7)

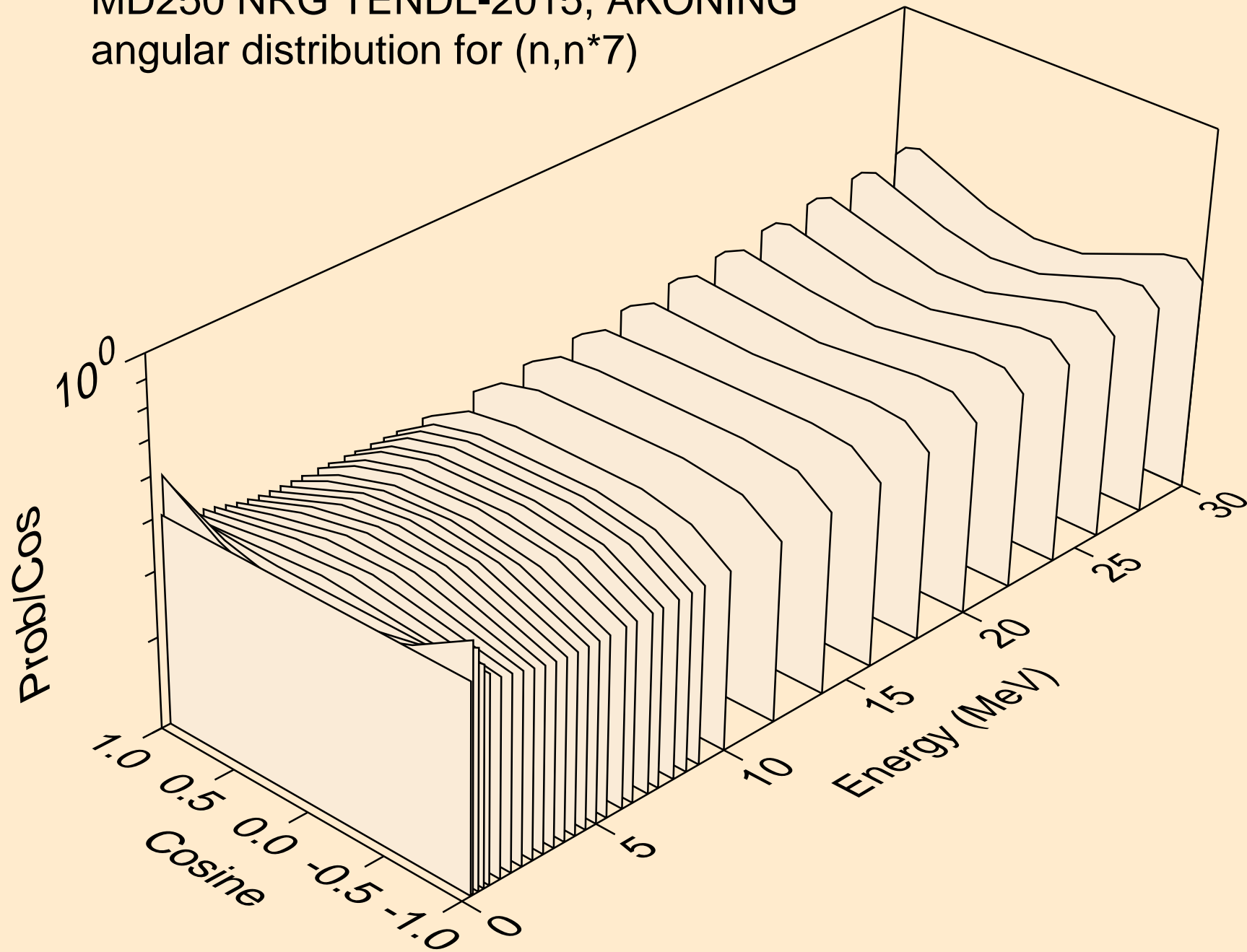

MD250 NRG TENDL-2015, AKONING
angular distribution for (n,n*8)

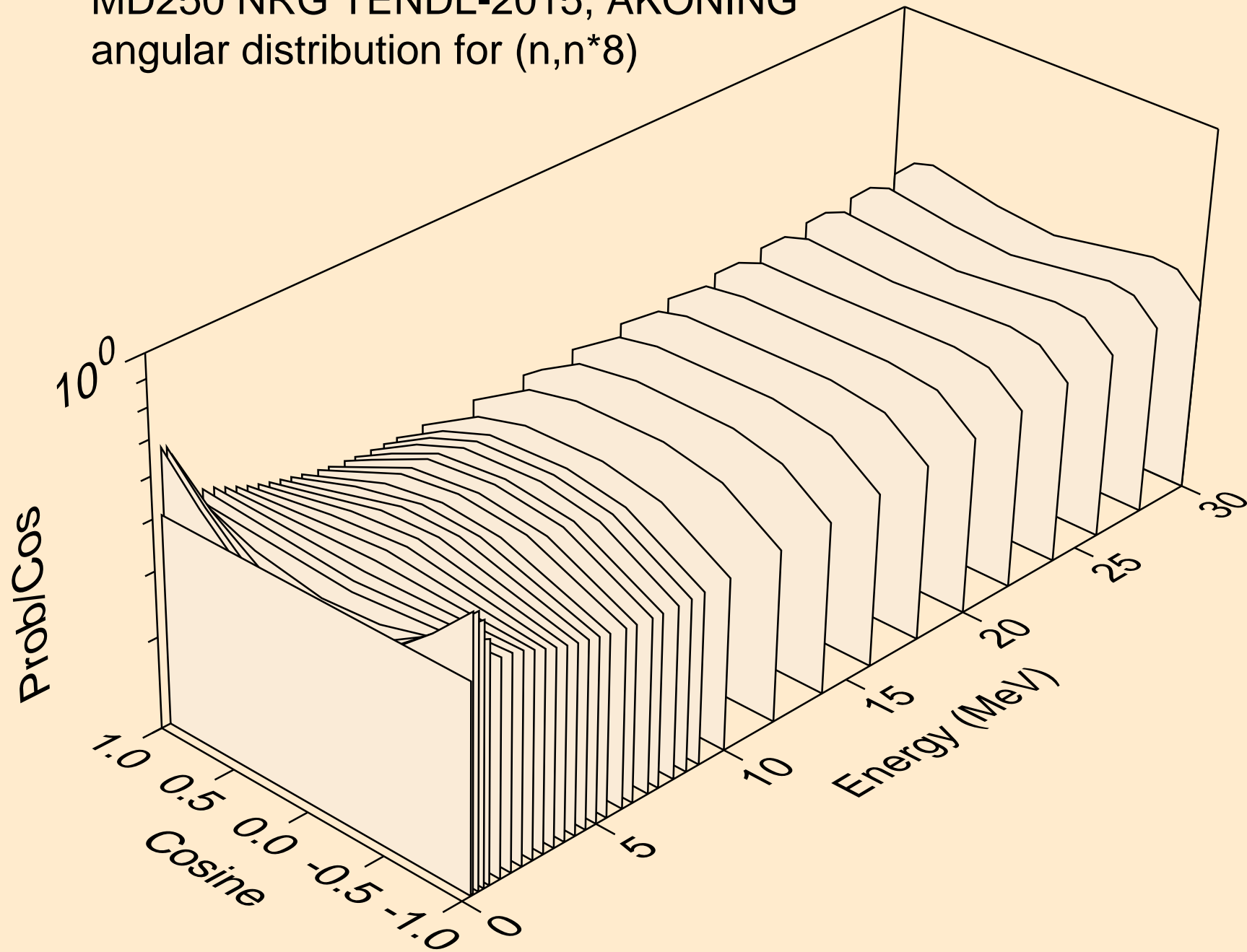

MD250 NRG TENDL-2015, AKONING
angular distribution for (n,n*9)

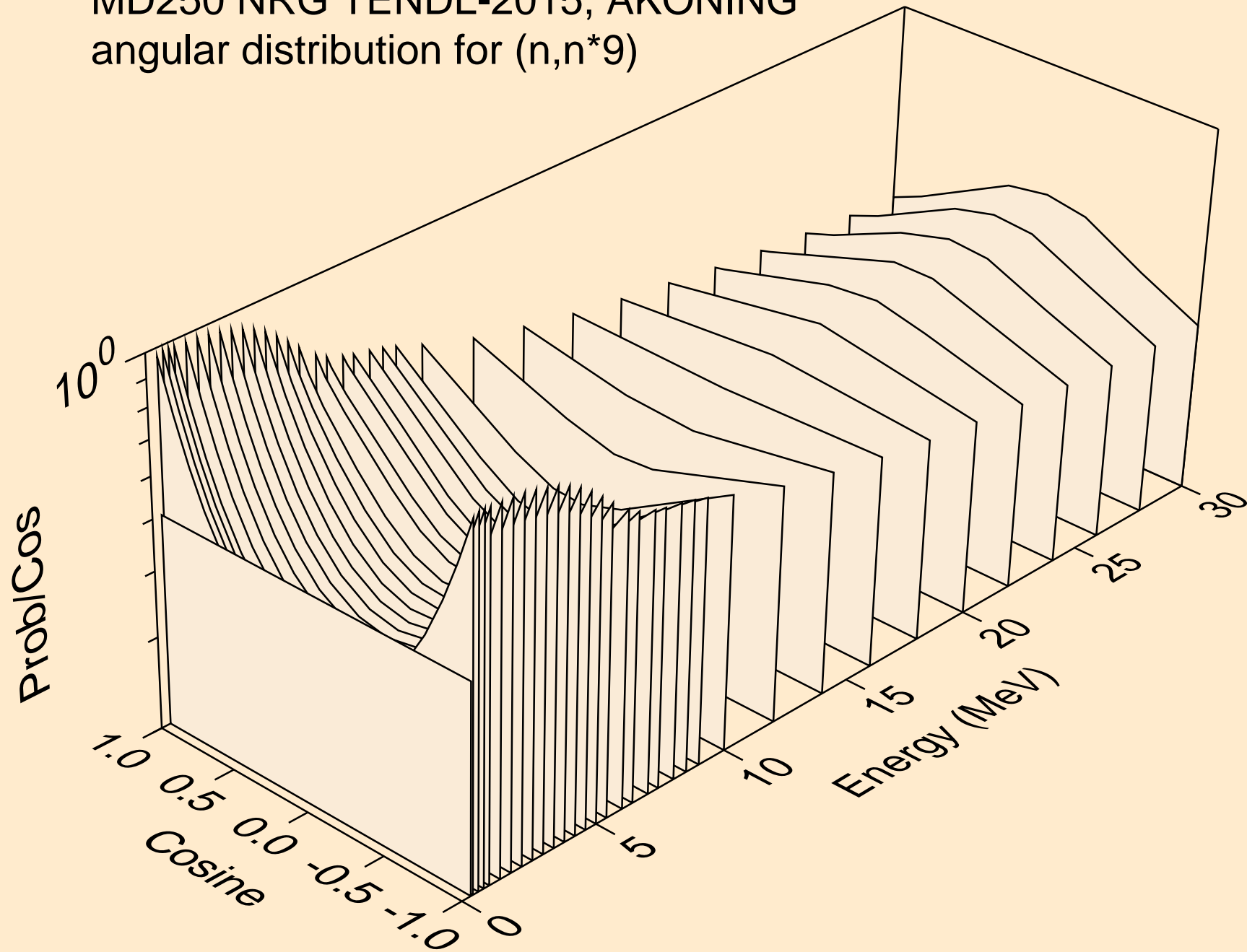

MD250 NRG TENDL-2015, AKONING
angular distribution for (n,n*10)

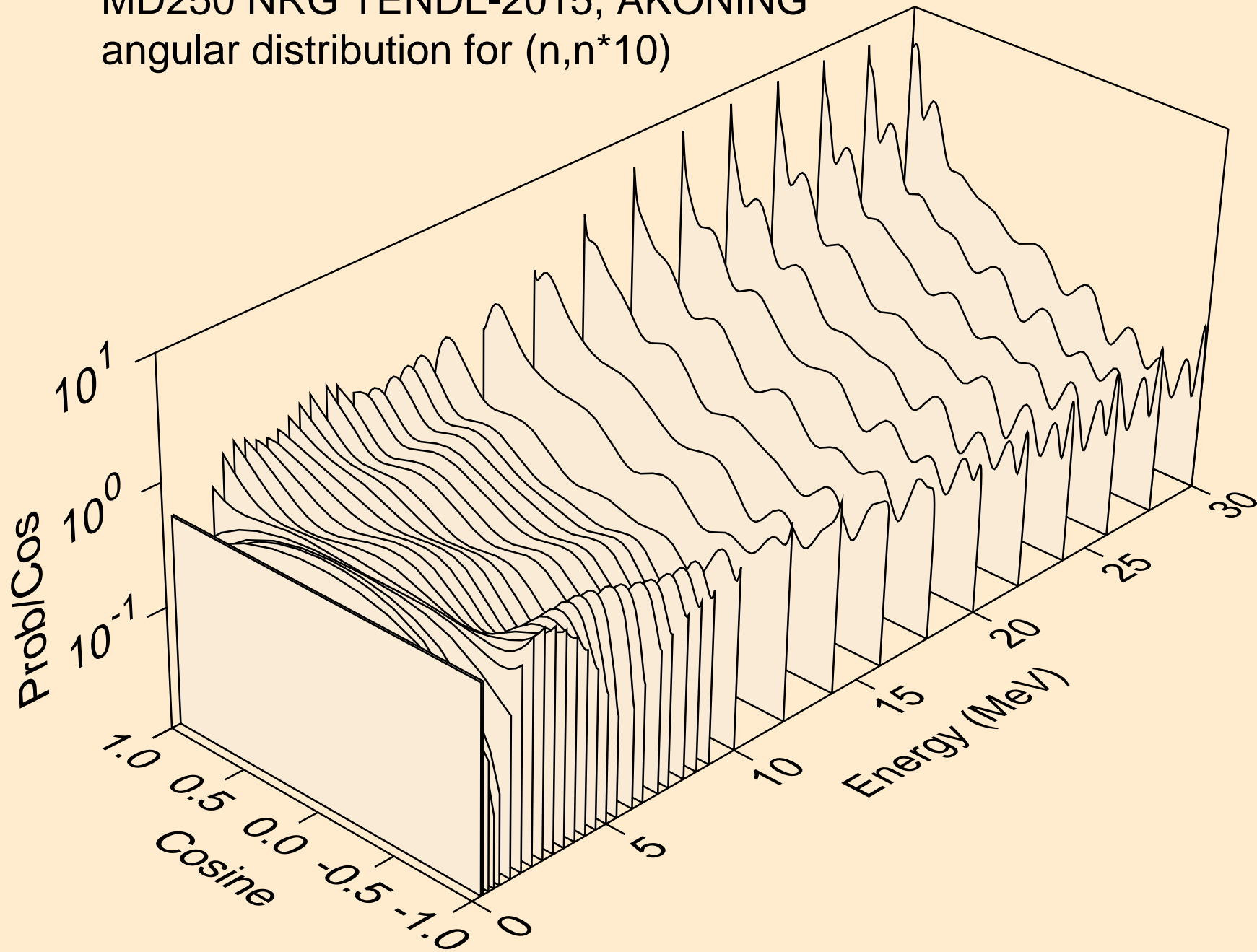

MD250 NRG TENDL-2015, AKONING
angular distribution for (n,n*11)

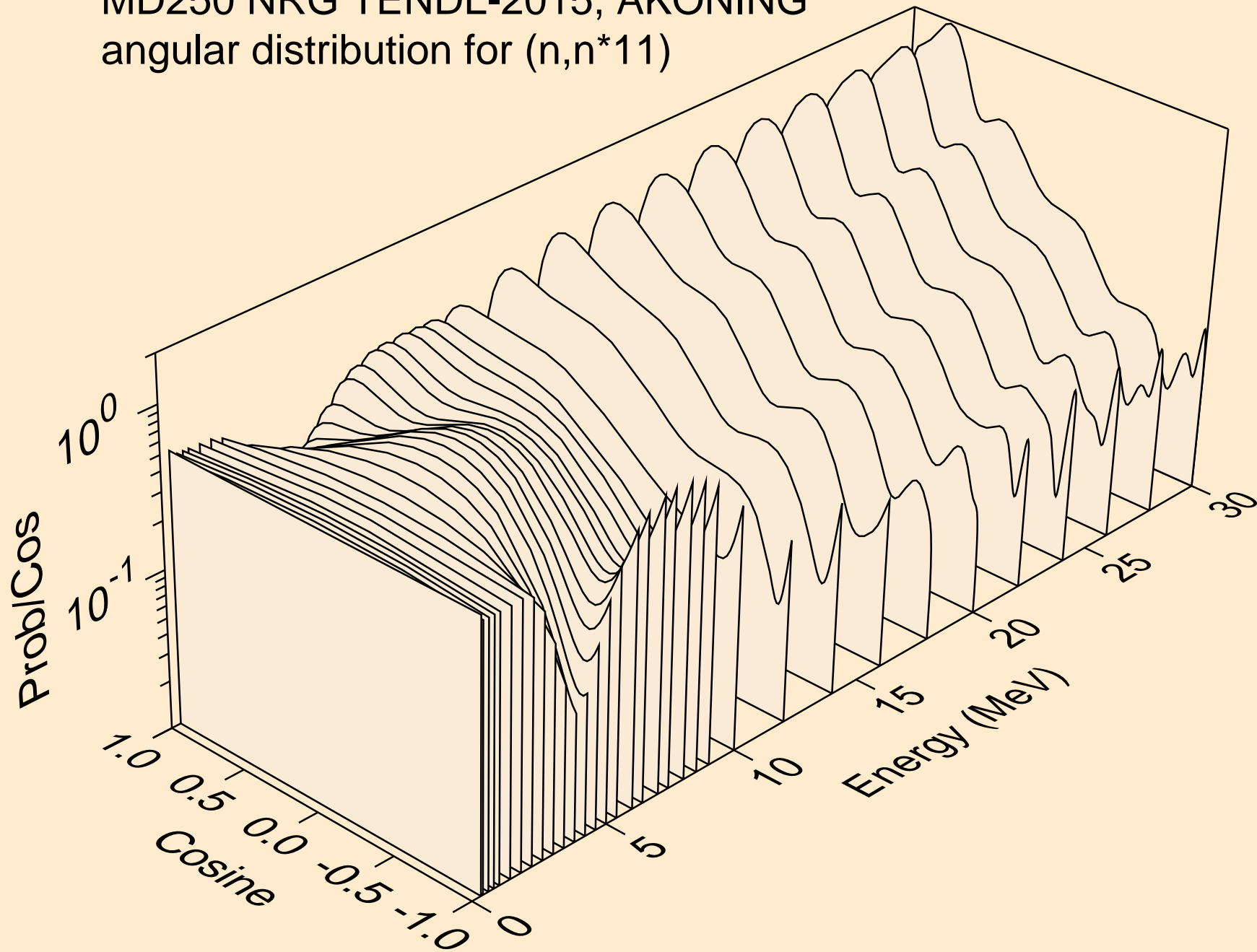

MD250 NRG TENDL-2015, AKONING
angular distribution for (n,n*12)

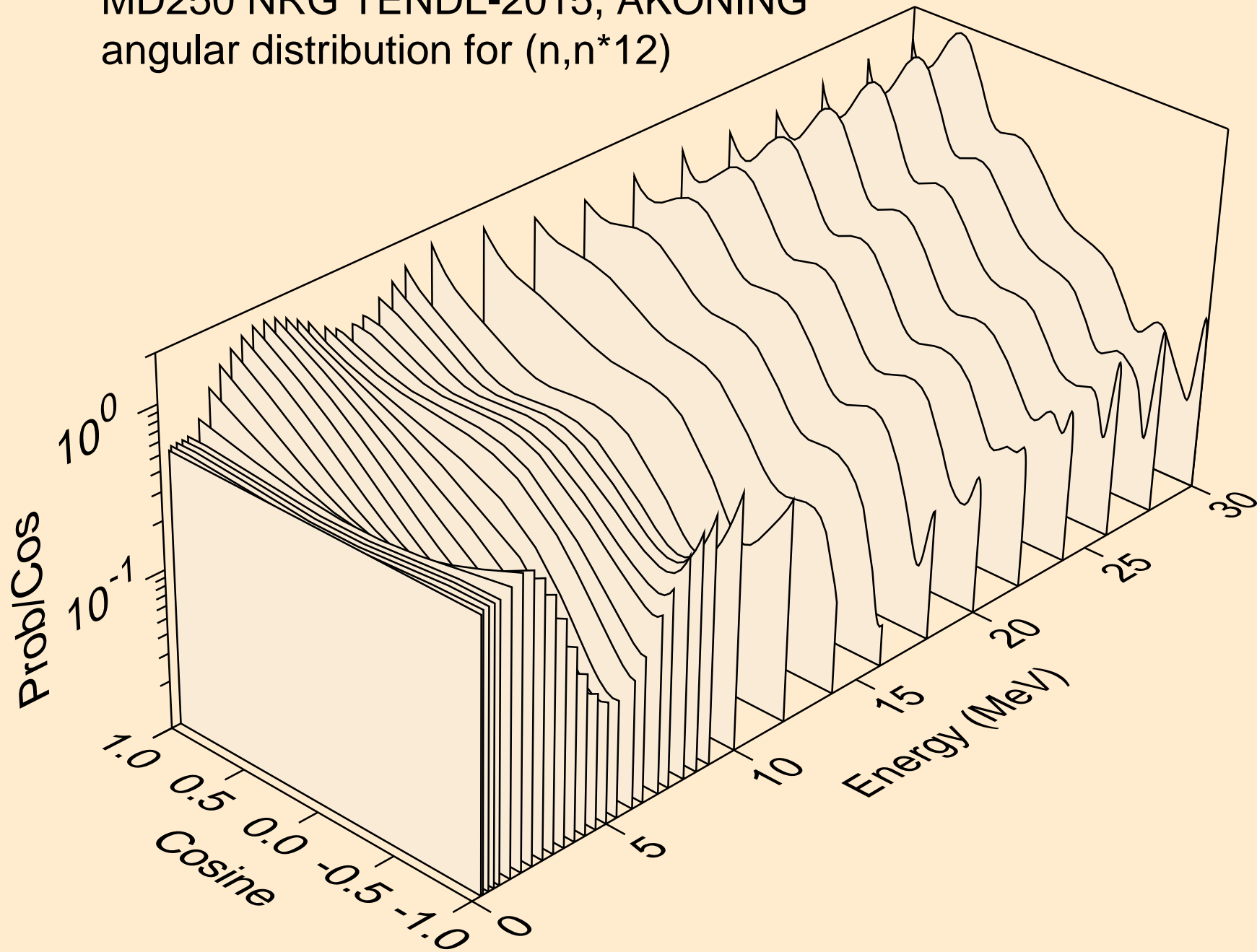

MD250 NRG TENDL-2015, AKONING
angular distribution for (n,n*13)

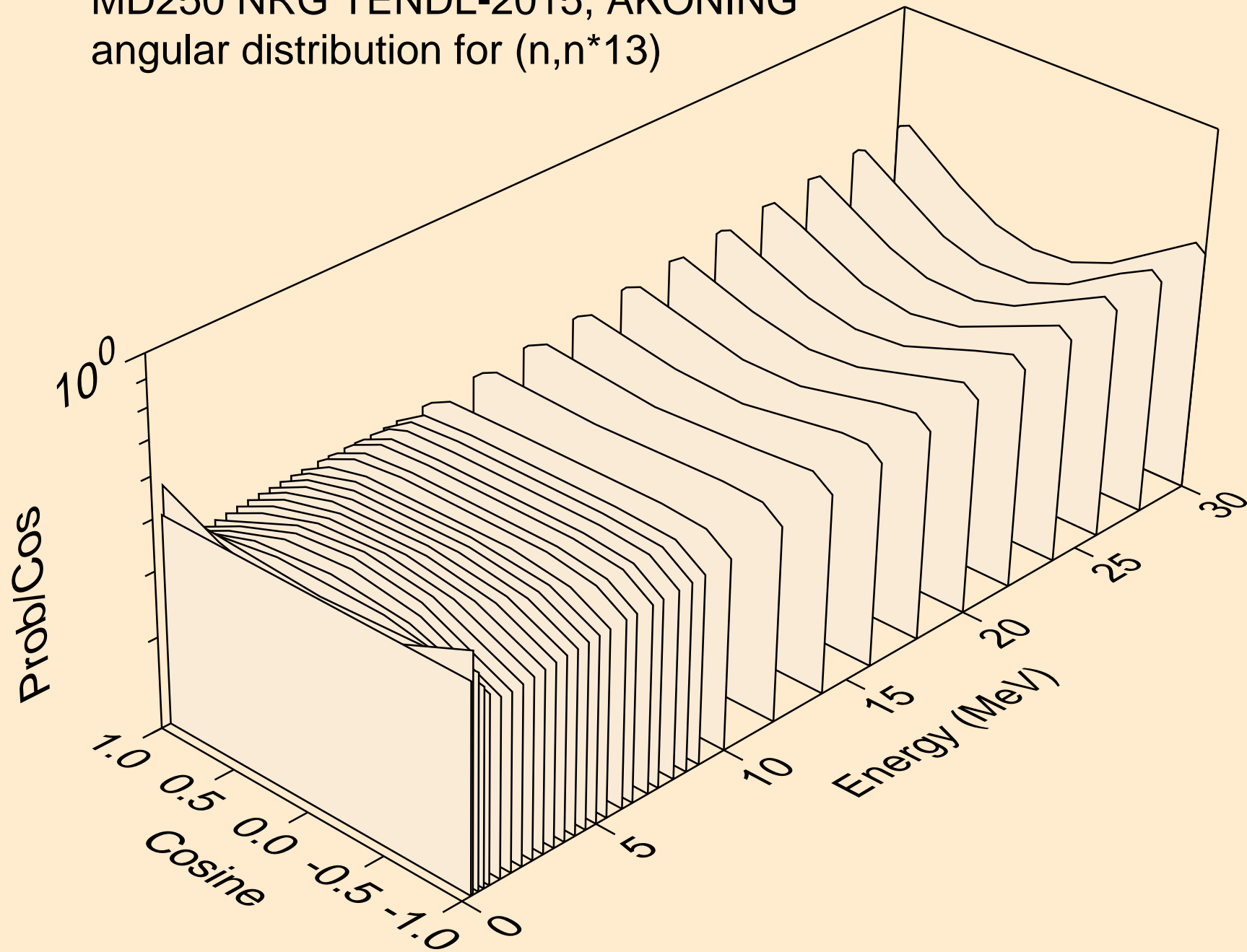

MD250 NRG TENDL-2015, AKONING
angular distribution for (n,n*14)

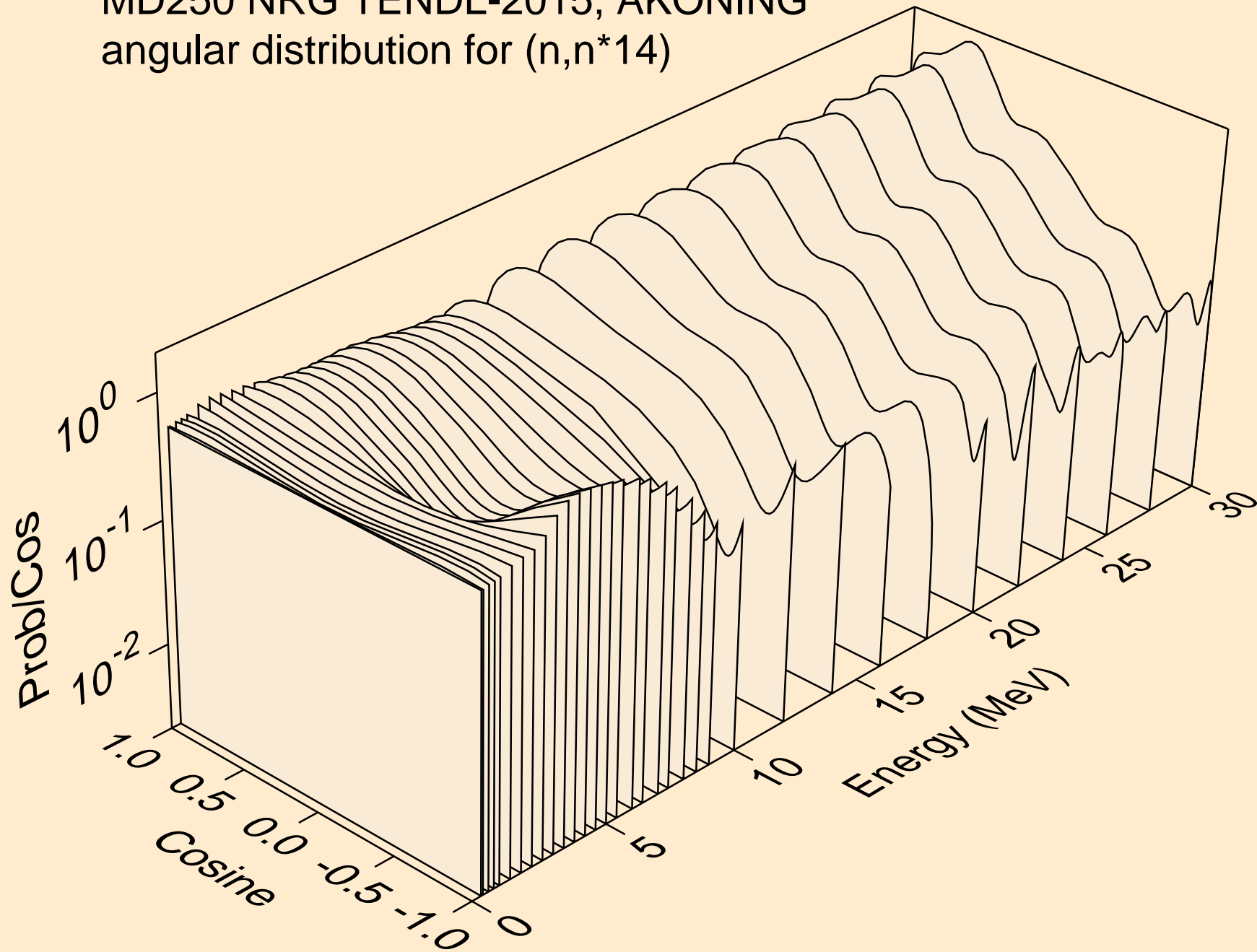

MD250 NRG TENDL-2015, AKONING
angular distribution for (n,n*15)

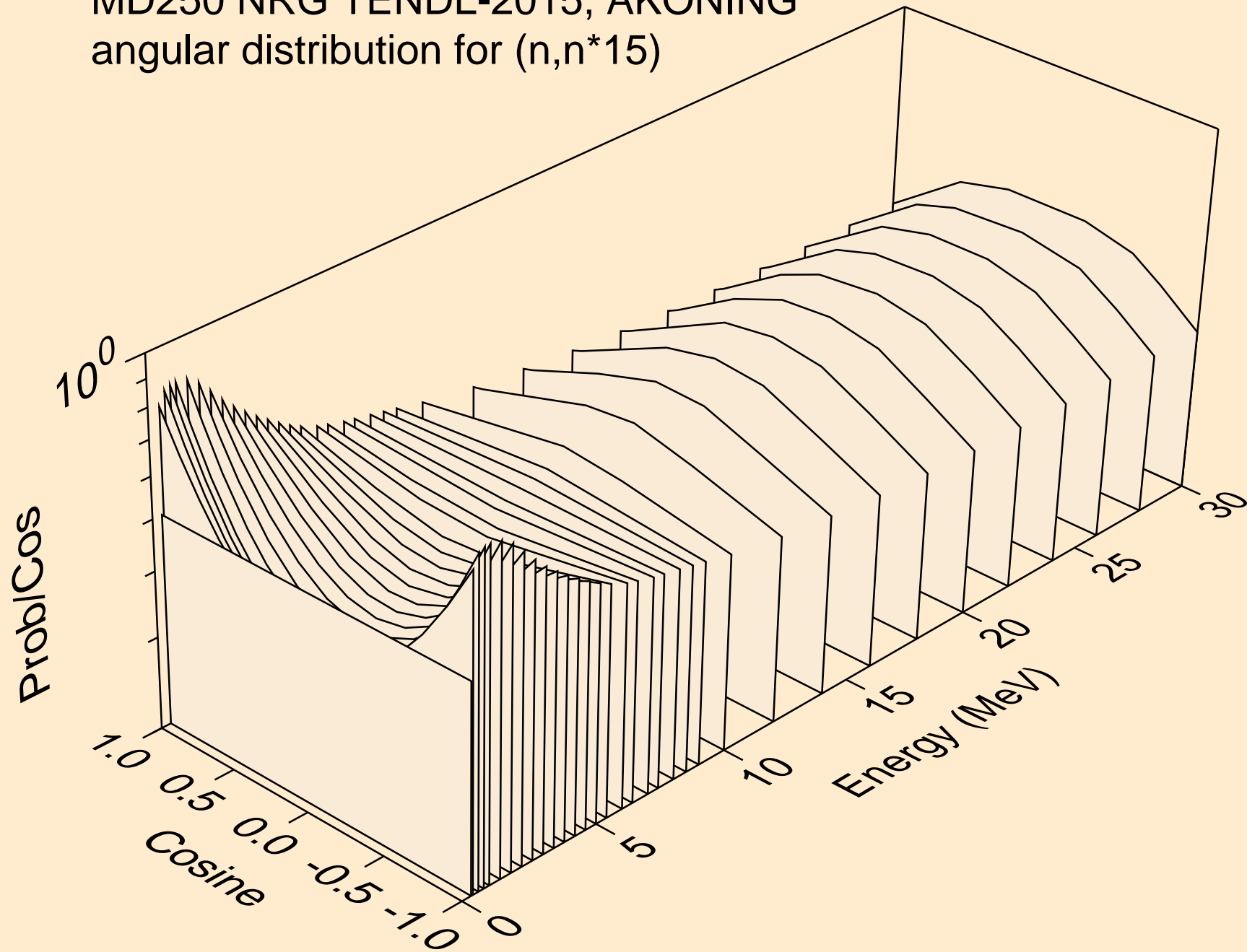

MD250 NRG TENDL-2015, AKONING
angular distribution for (n,n*16)

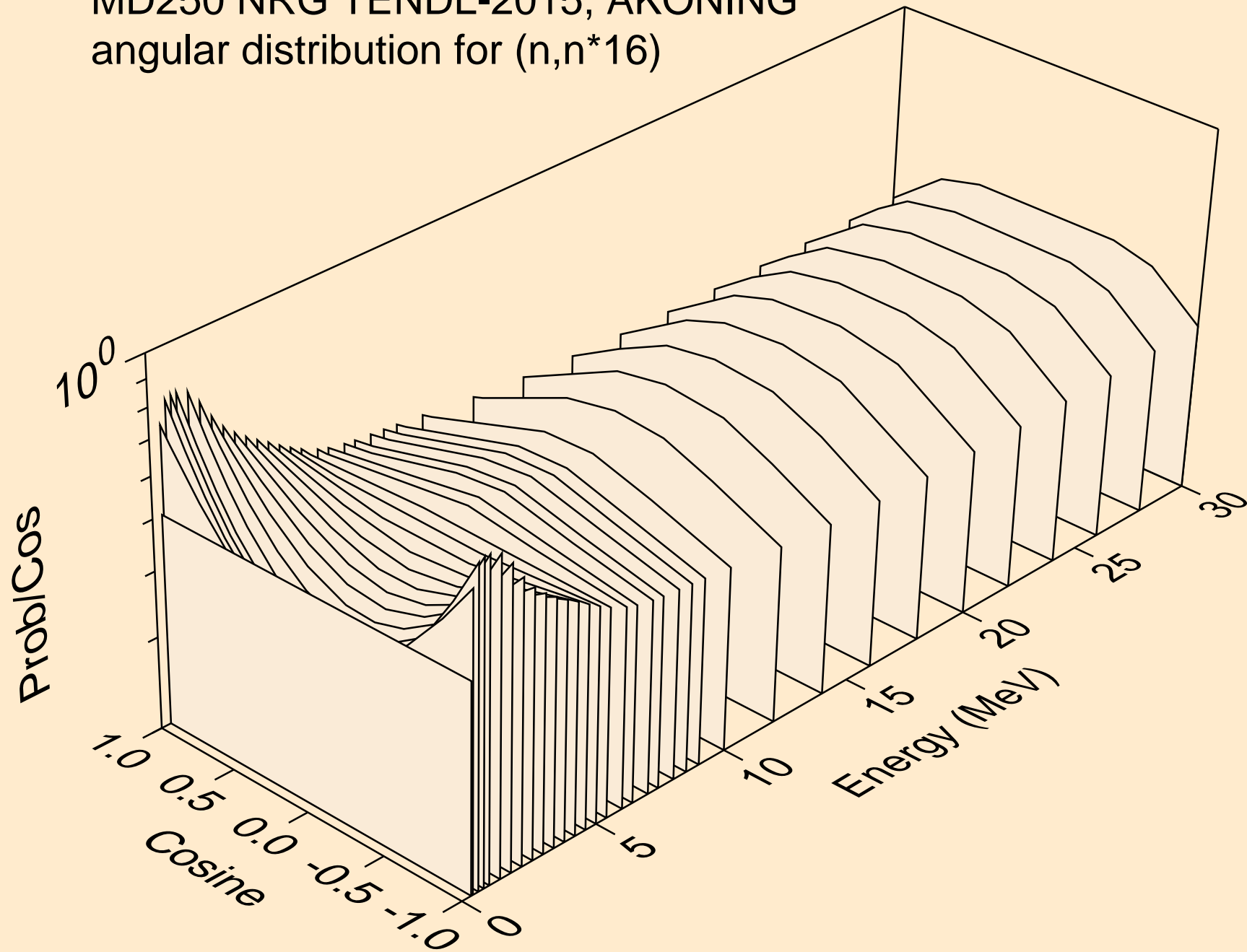

MD250 NRG TENDL-2015, AKONING
angular distribution for (n,n*17)

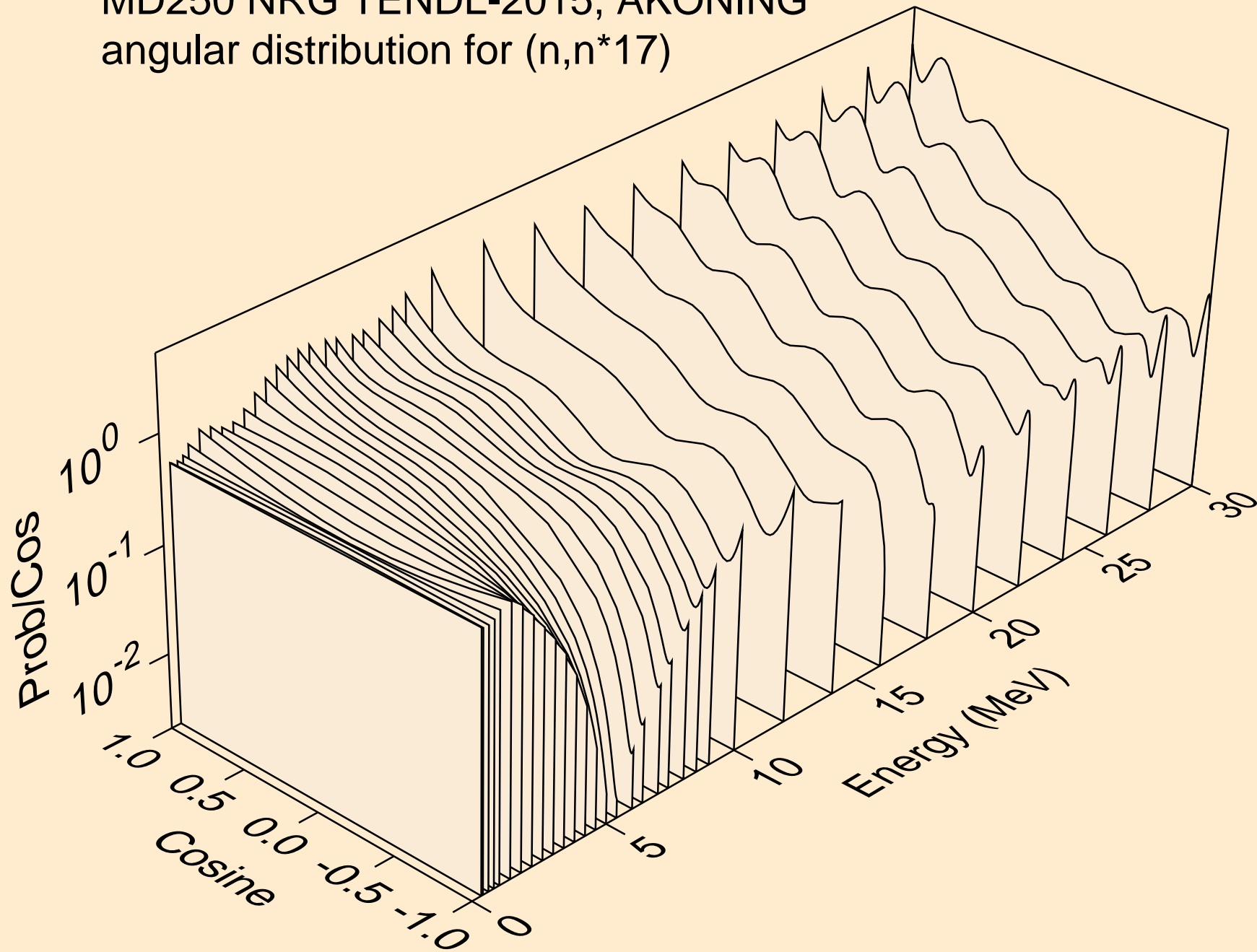

MD250 NRG TENDL-2015, AKONING
angular distribution for (n,n*18)

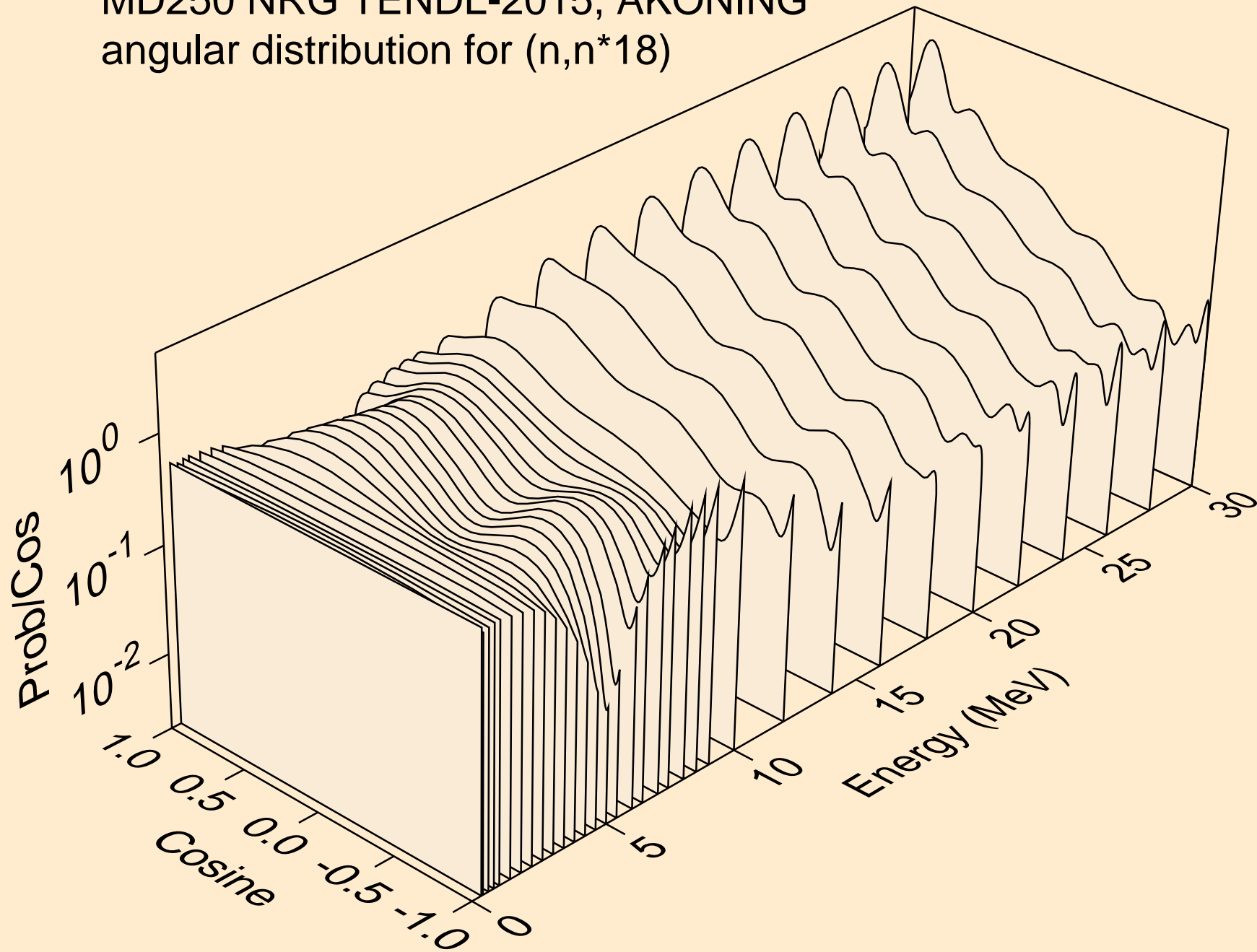

MD250 NRG TENDL-2015, AKONING
angular distribution for (n,n*19)

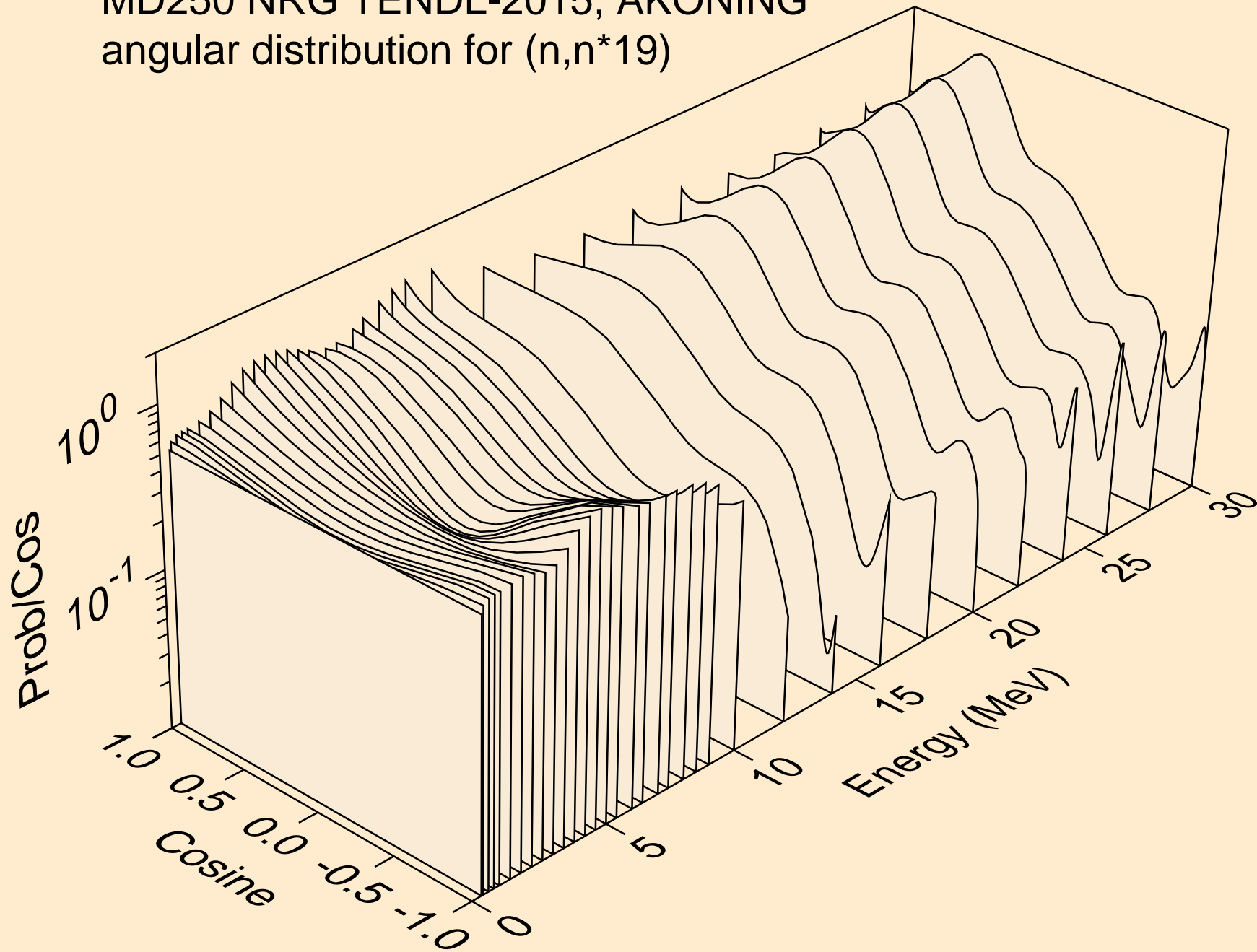

MD250 NRG TENDL-2015, AKONING
angular distribution for (n,n*20)

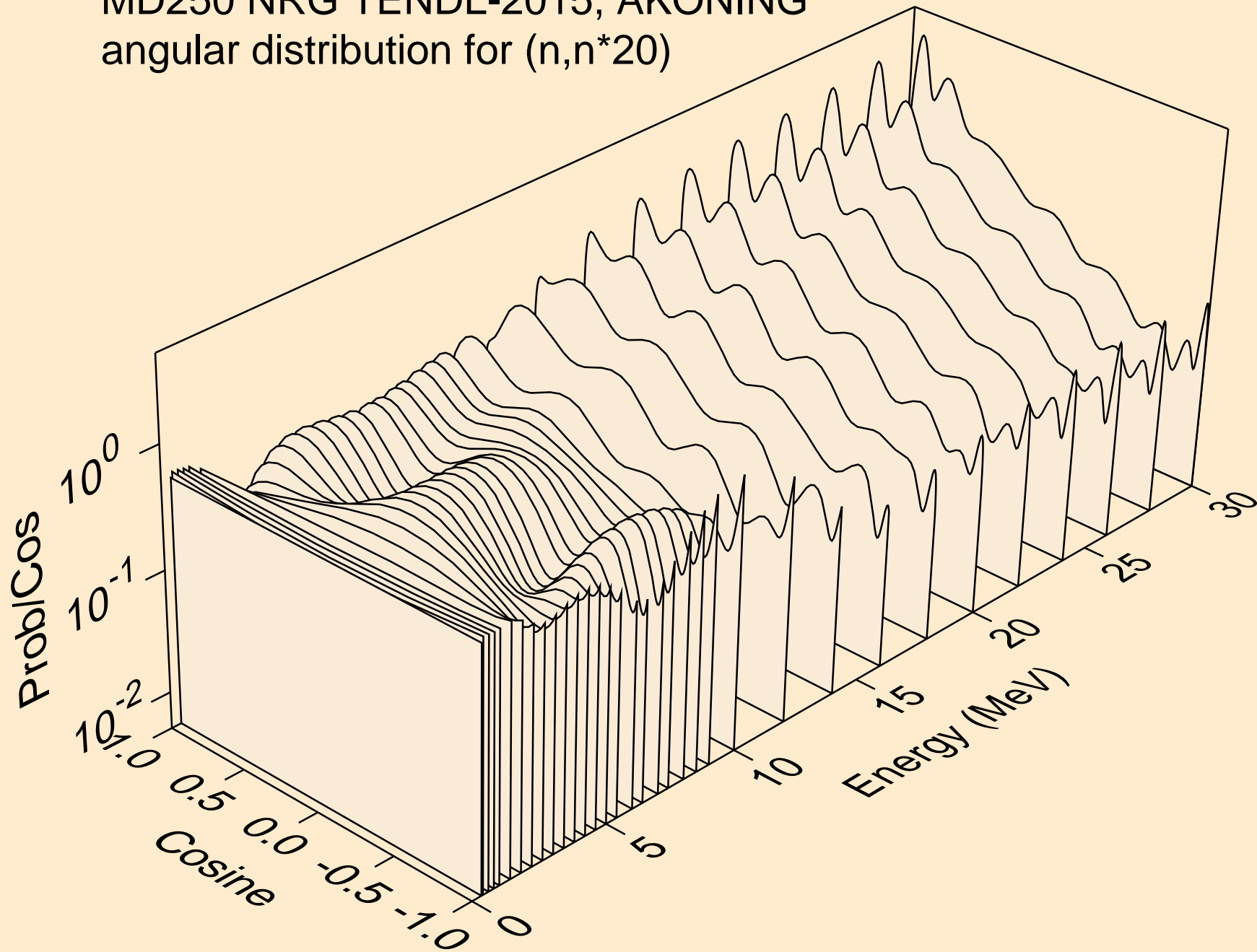

MD250 NRG TENDL-2015, AKONING
angular distribution for (n,n*21)

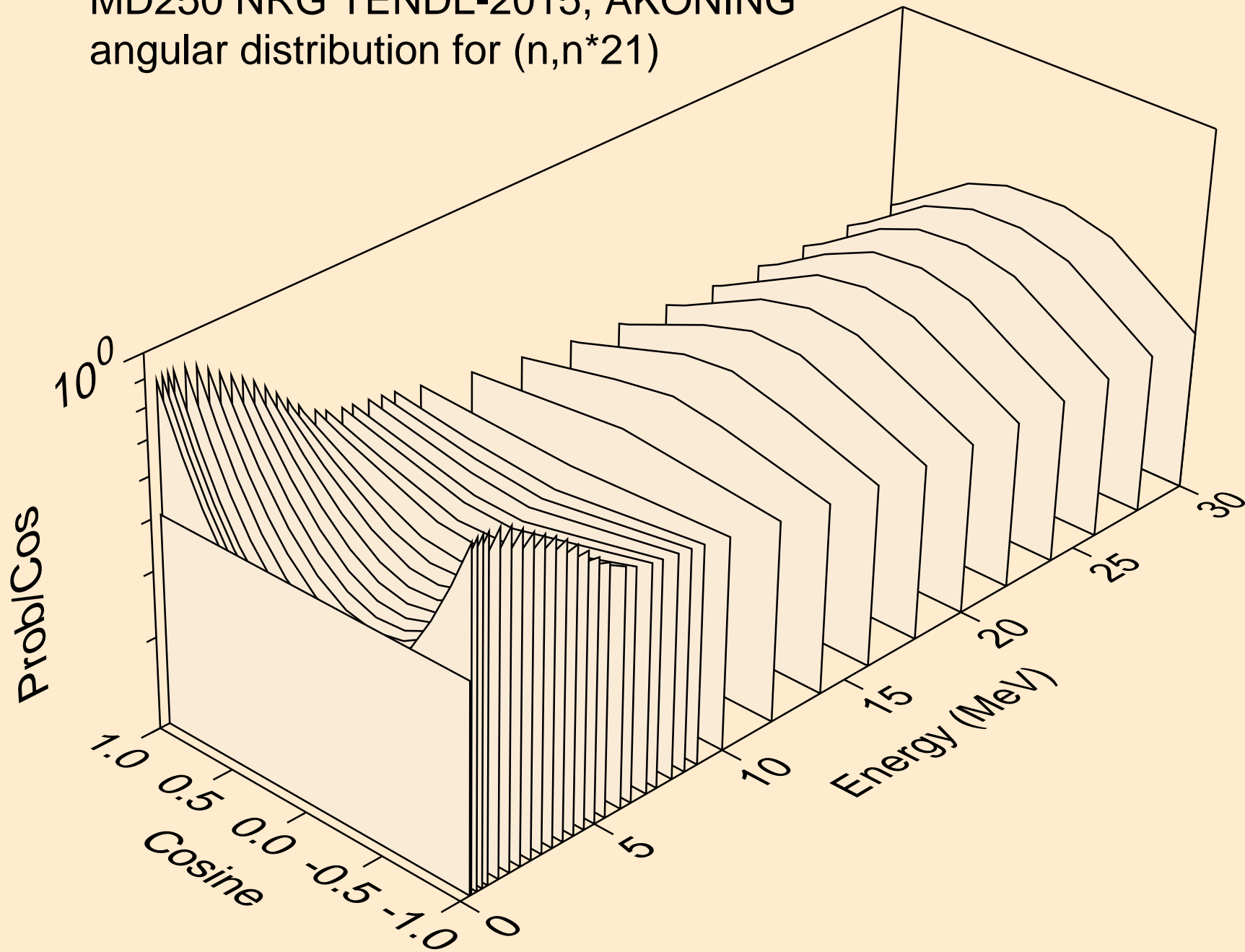

MD250 NRG TENDL-2015, AKONING
angular distribution for (n,n*22)

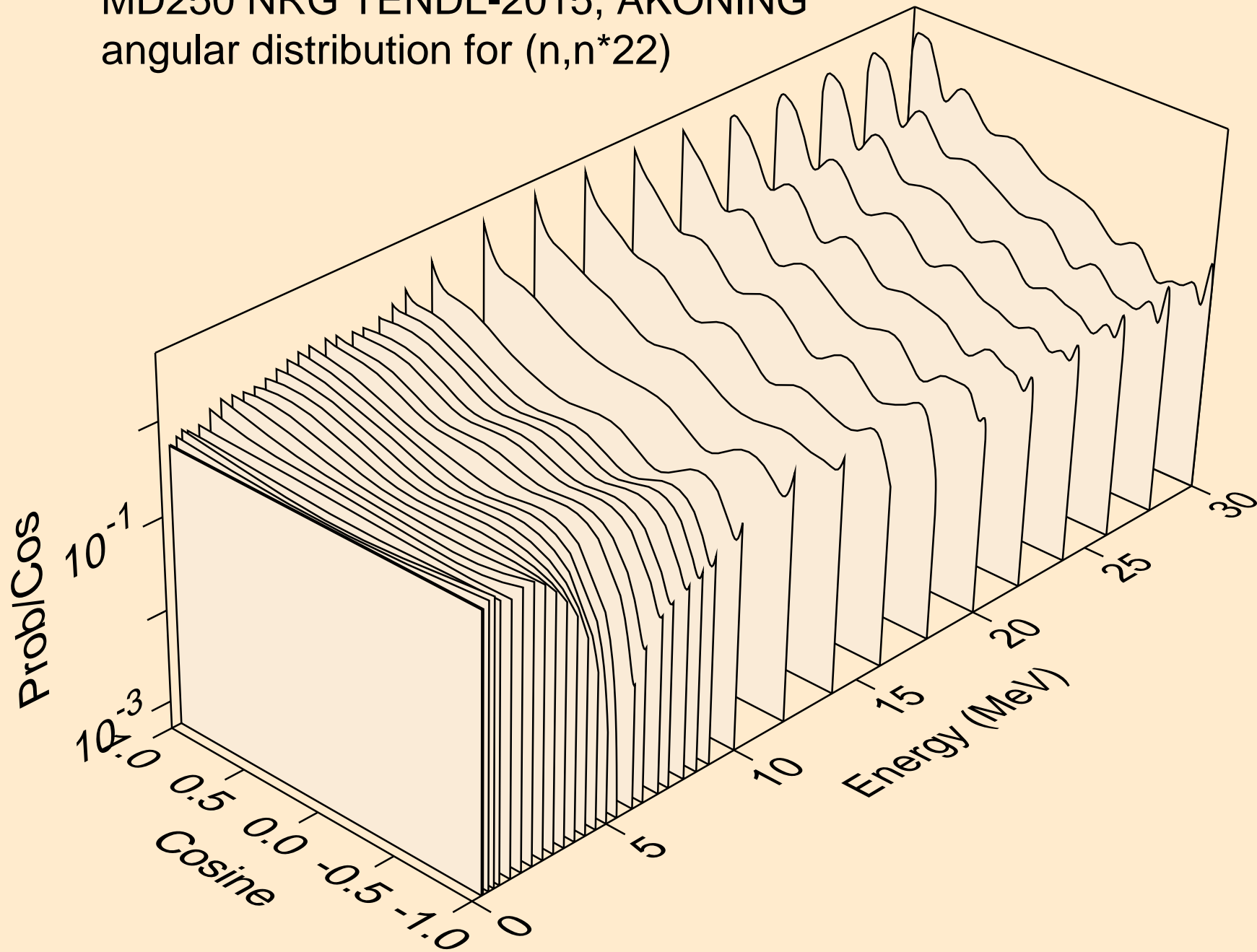

MD250 NRG TENDL-2015, AKONING
angular distribution for (n,n*23)

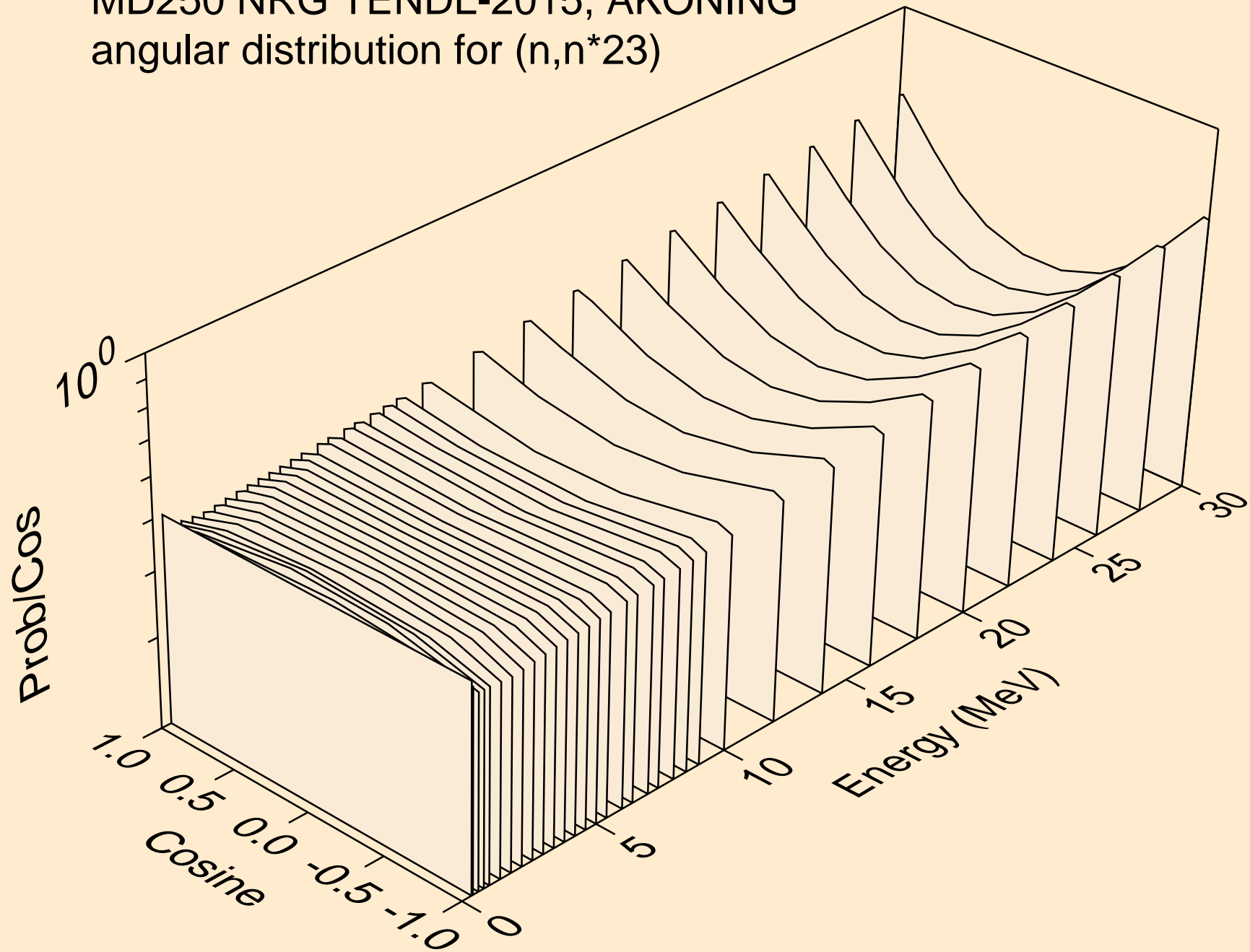

MD250 NRG TENDL-2015, AKONING
angular distribution for (n,n*24)

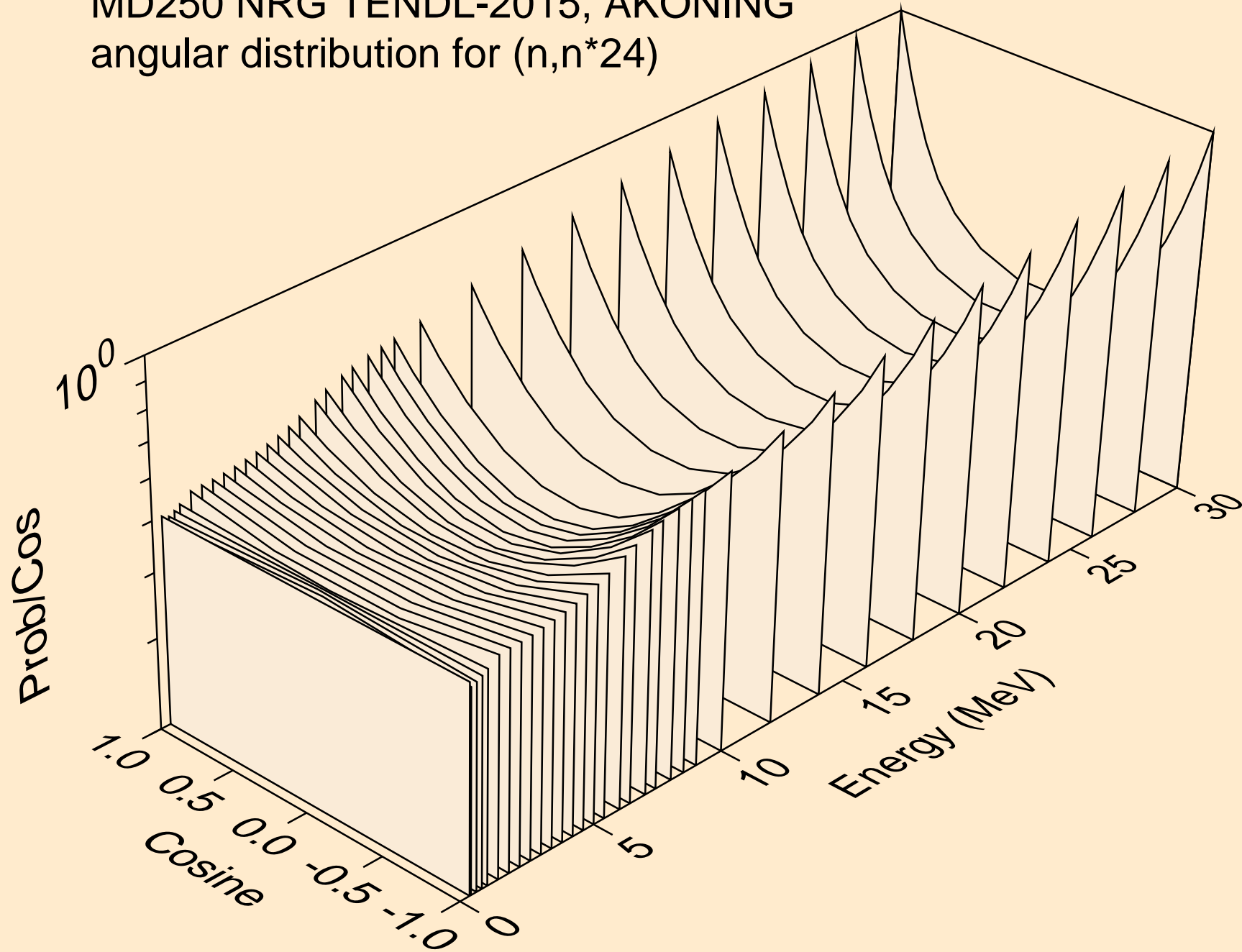

MD250 NRG TENDL-2015, AKONING
angular distribution for (n,n*25)

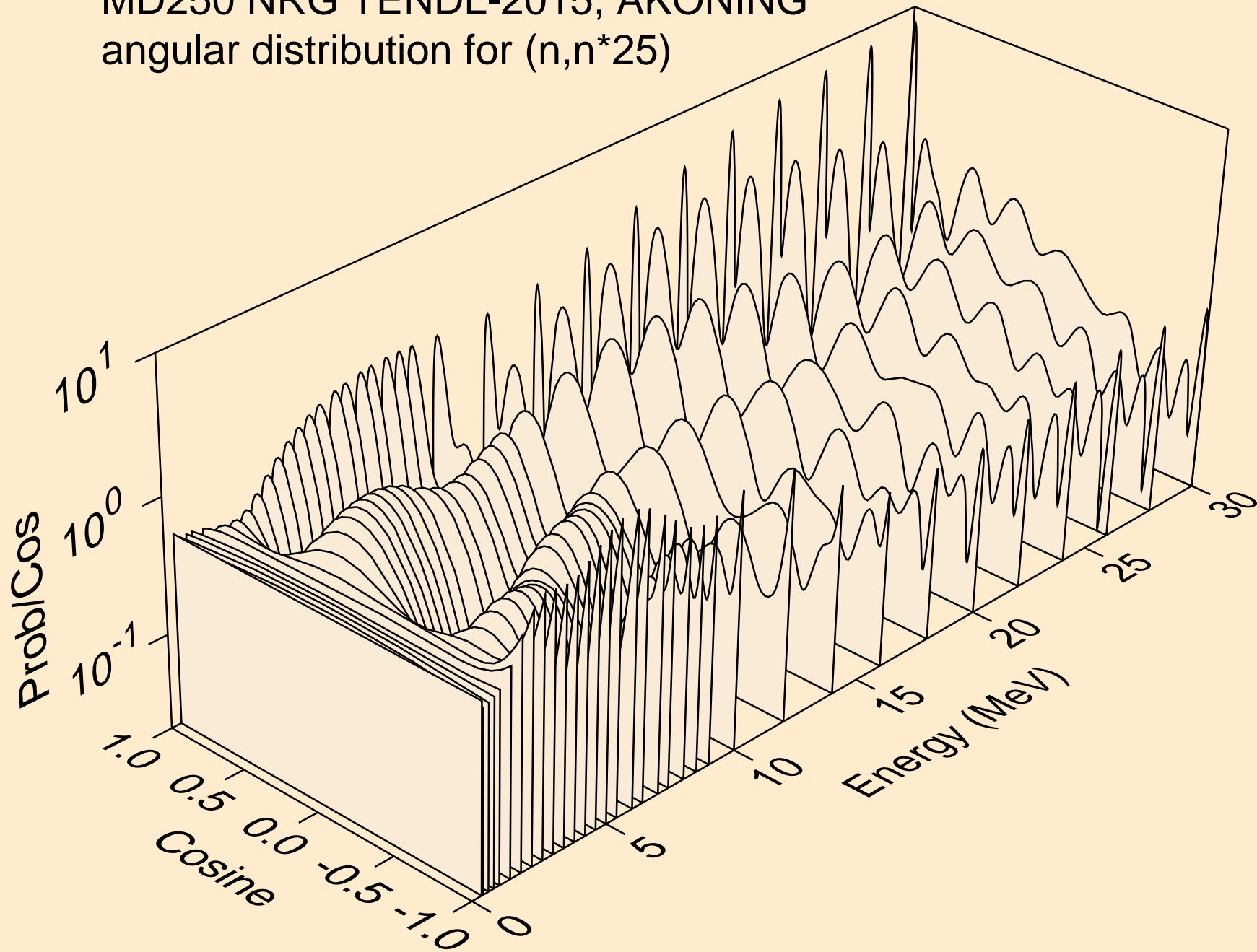

MD250 NRG TENDL-2015, AKONING
angular distribution for (n,n*26)

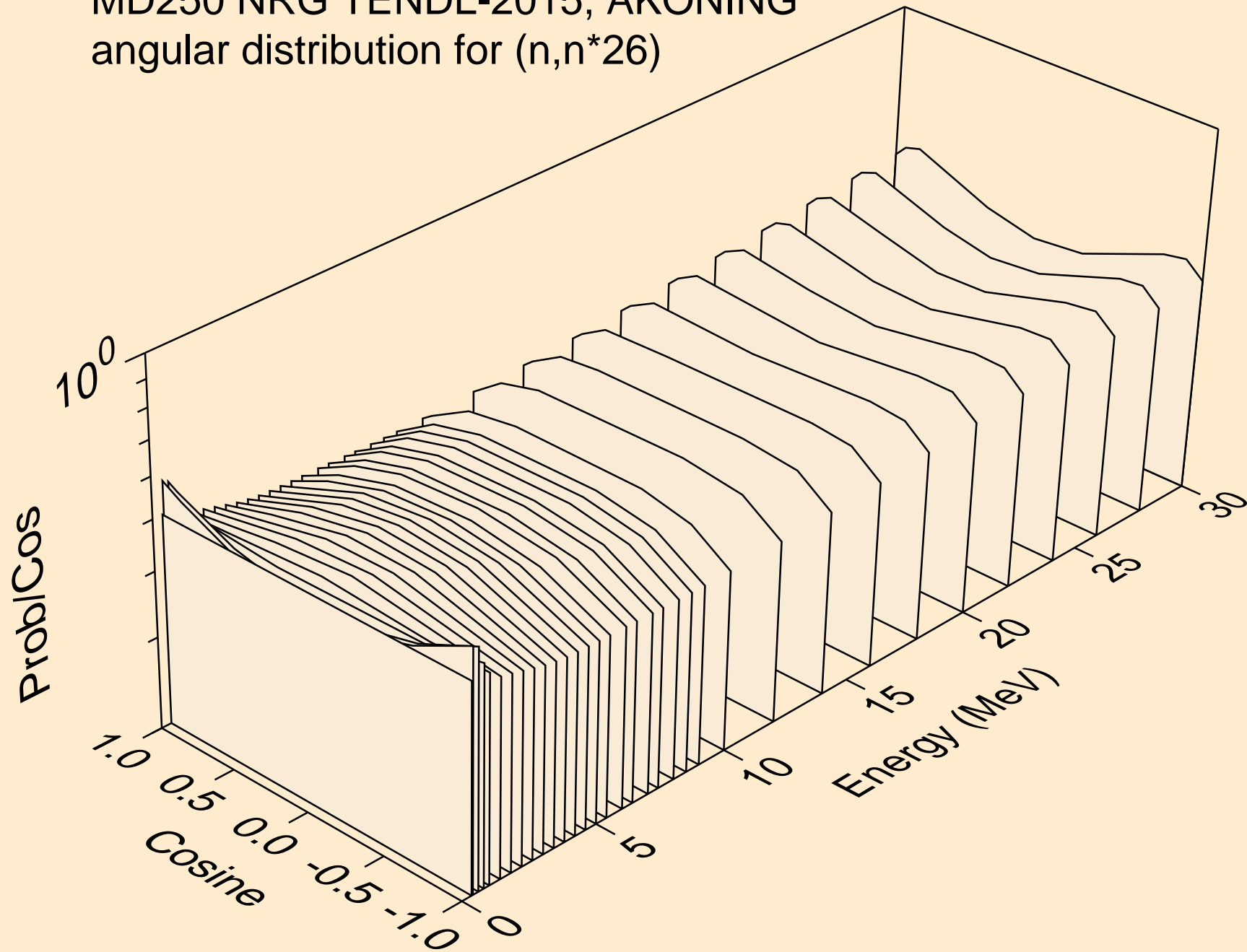

MD250 NRG TENDL-2015, AKONING
angular distribution for (n,n*27)

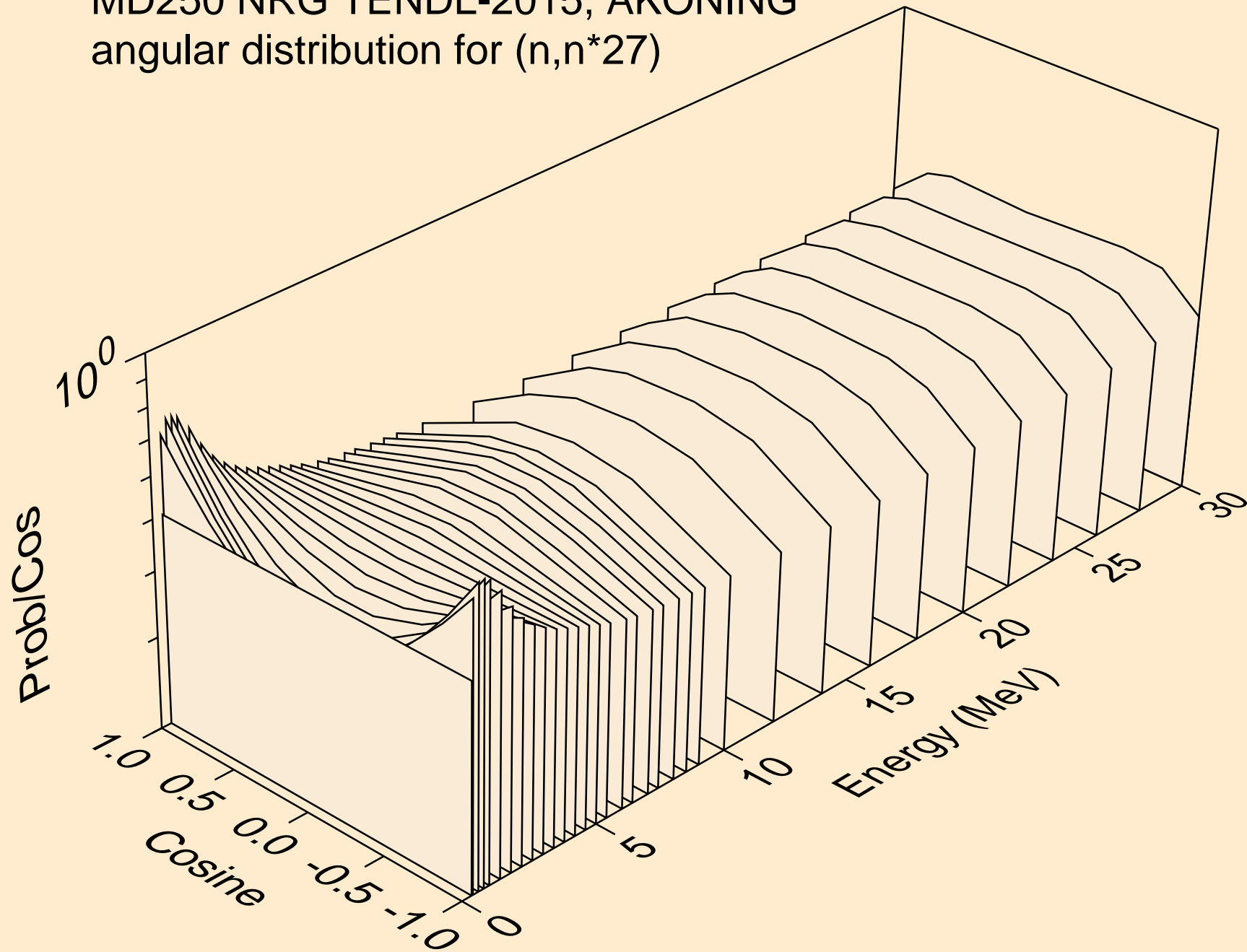

MD250 NRG TENDL-2015, AKONING
angular distribution for (n,n*28)

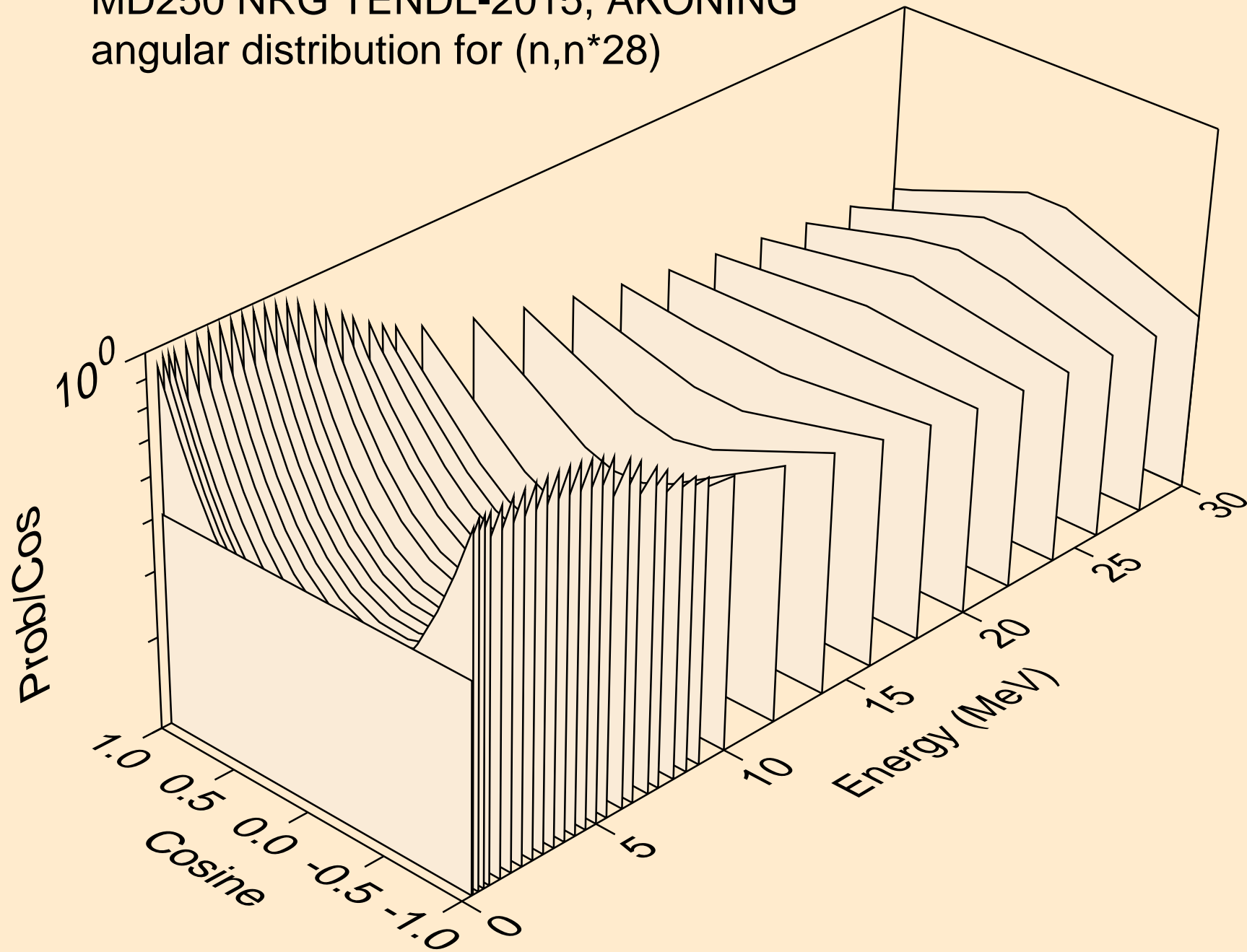

MD250 NRG TENDL-2015, AKONING
angular distribution for (n,n*29)

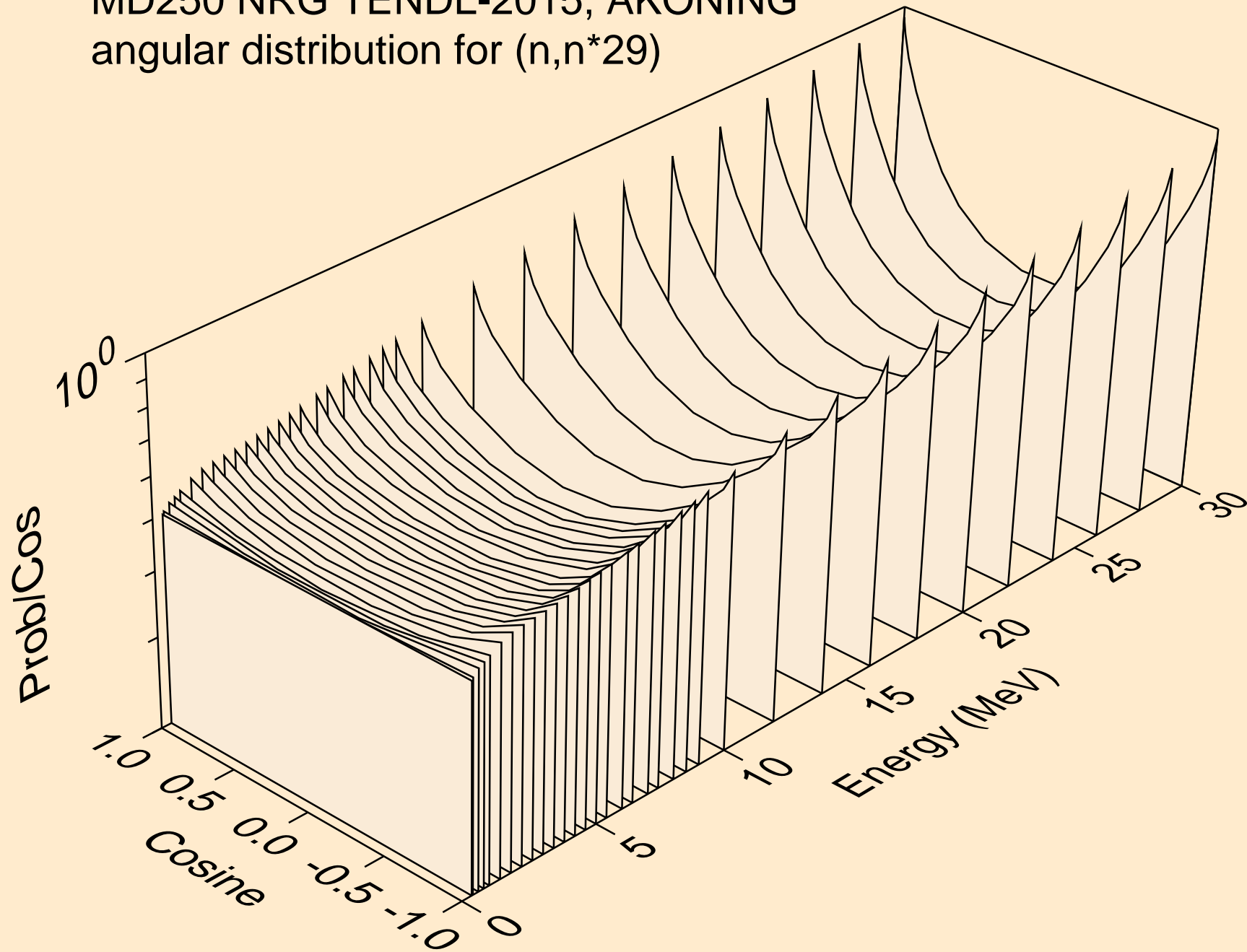

MD250 NRG TENDL-2015, AKONING

Total fission nubar

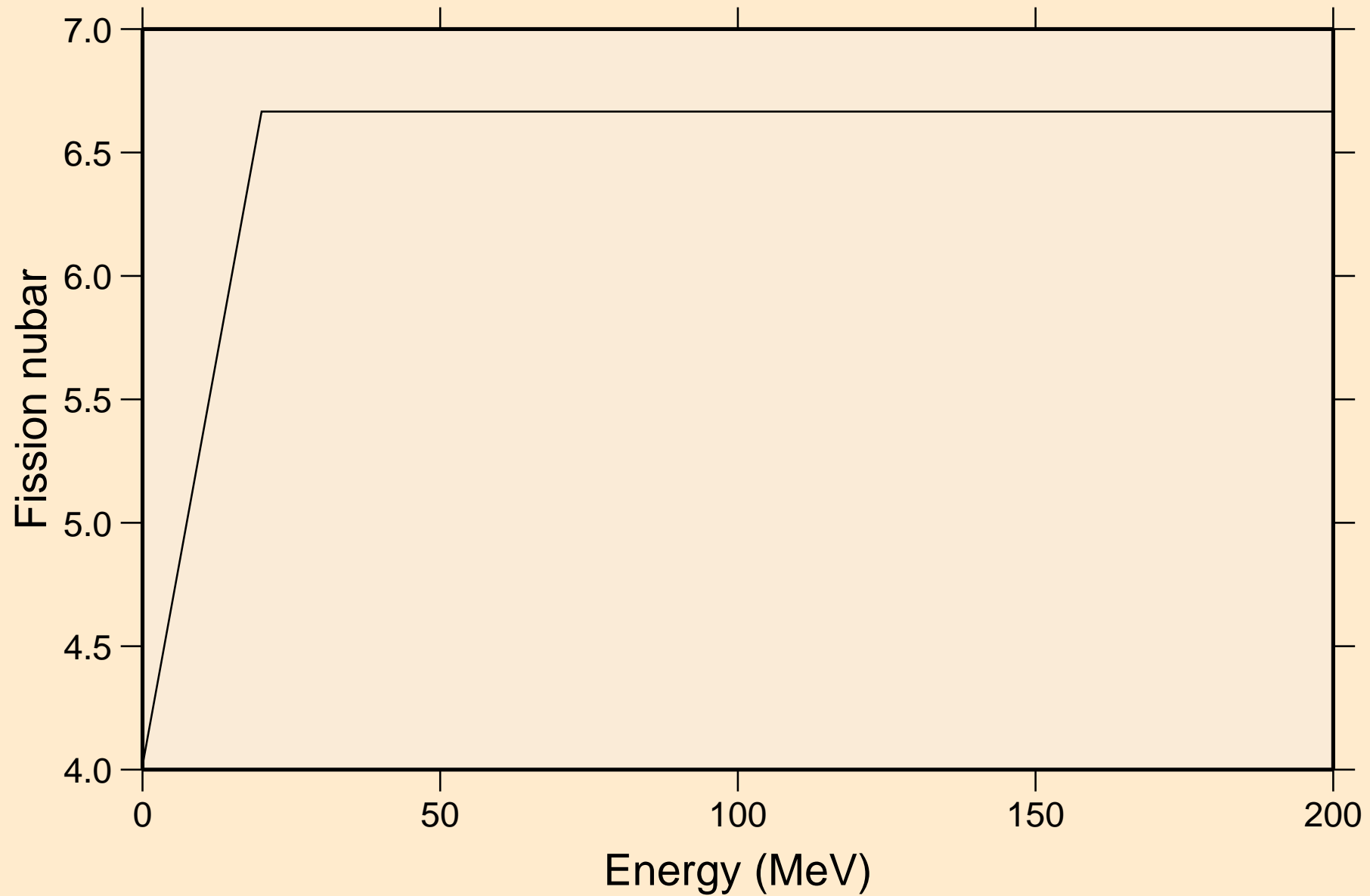

MD250 NRG TENDL-2015, AKONING
Neutron emission for (n,x)

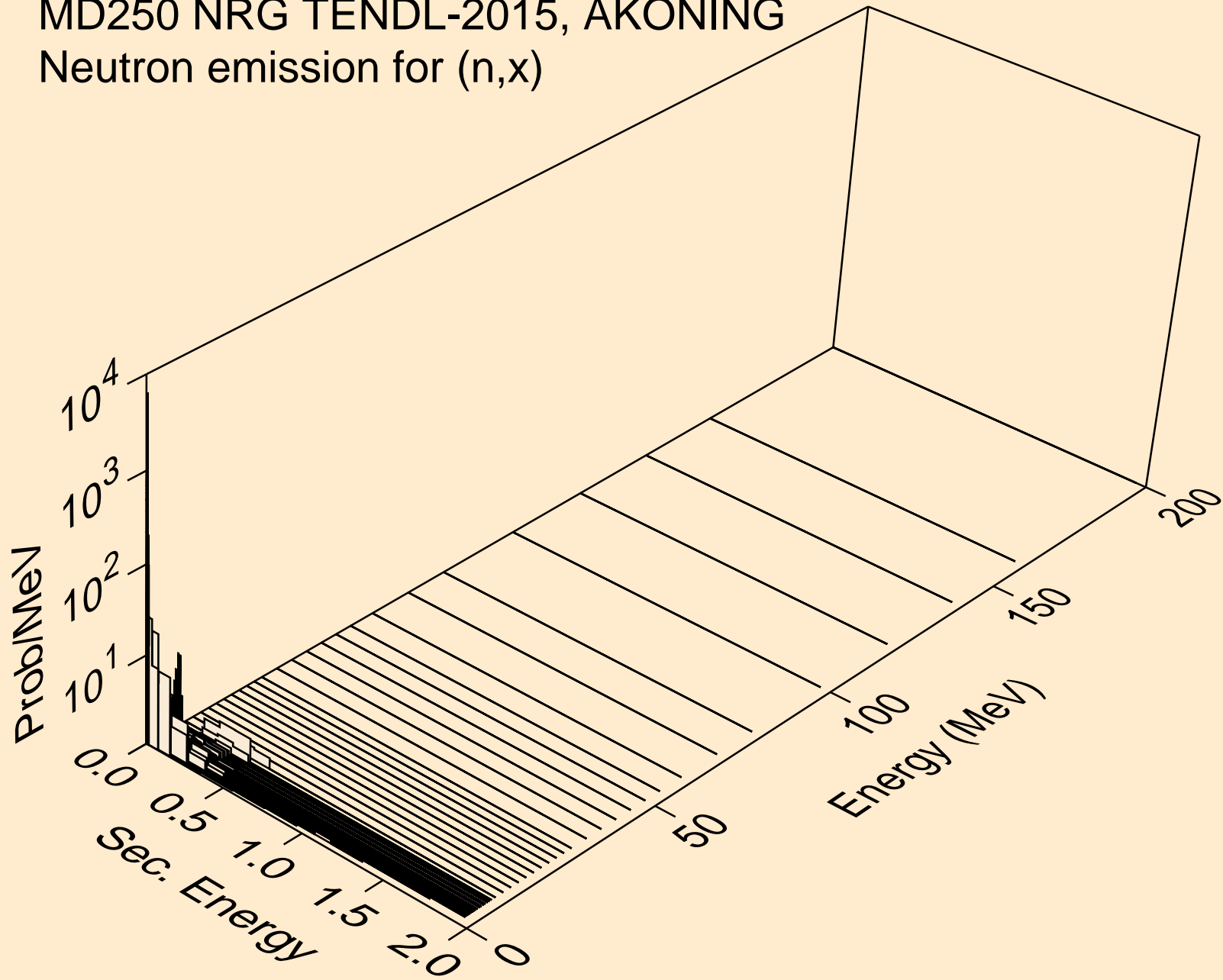

MD250 NRG TENDL-2015, AKONING
Neutron emission for (n,2nd)

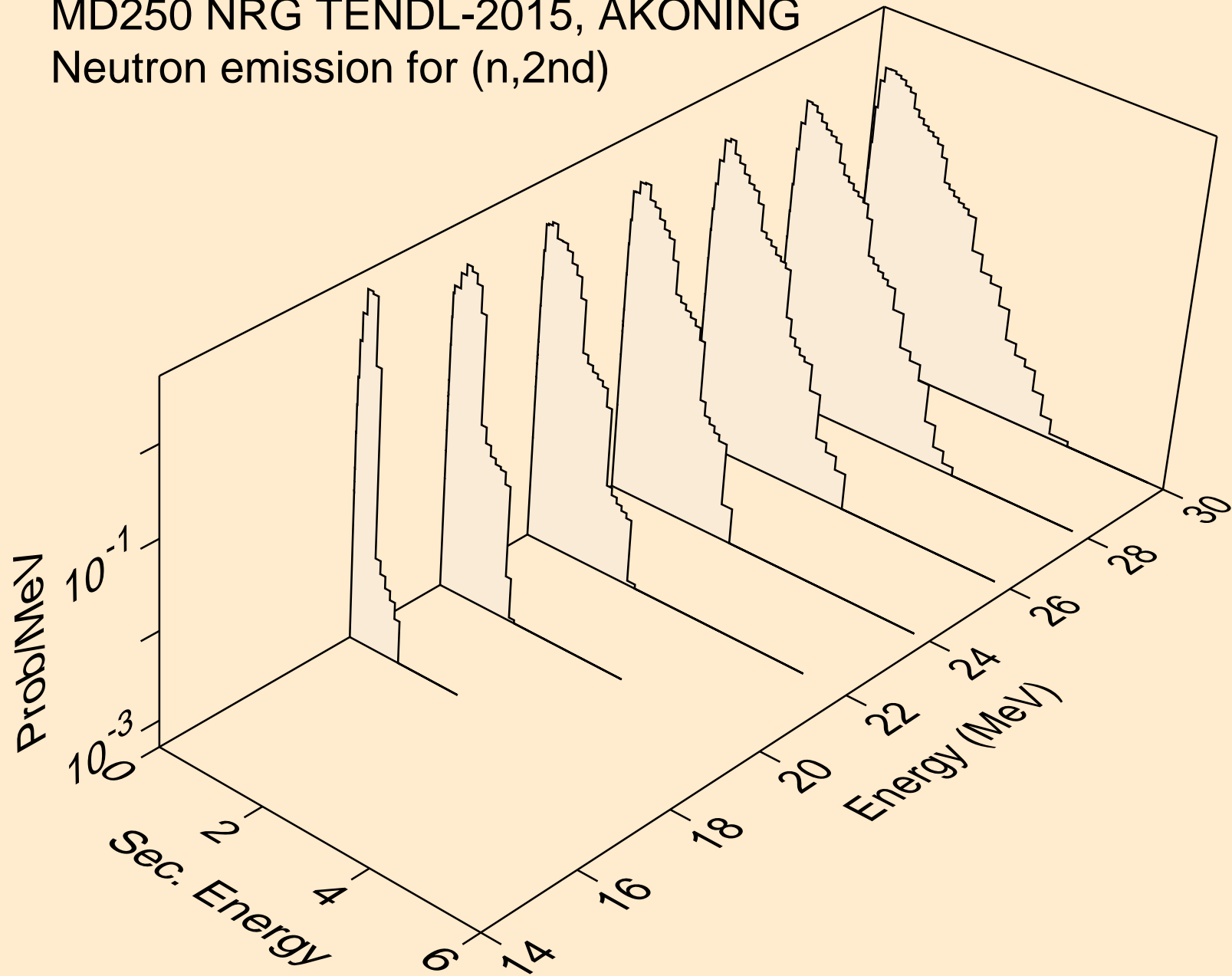

MD250 NRG TENDL-2015, AKONING
Neutron emission for (n,2n)

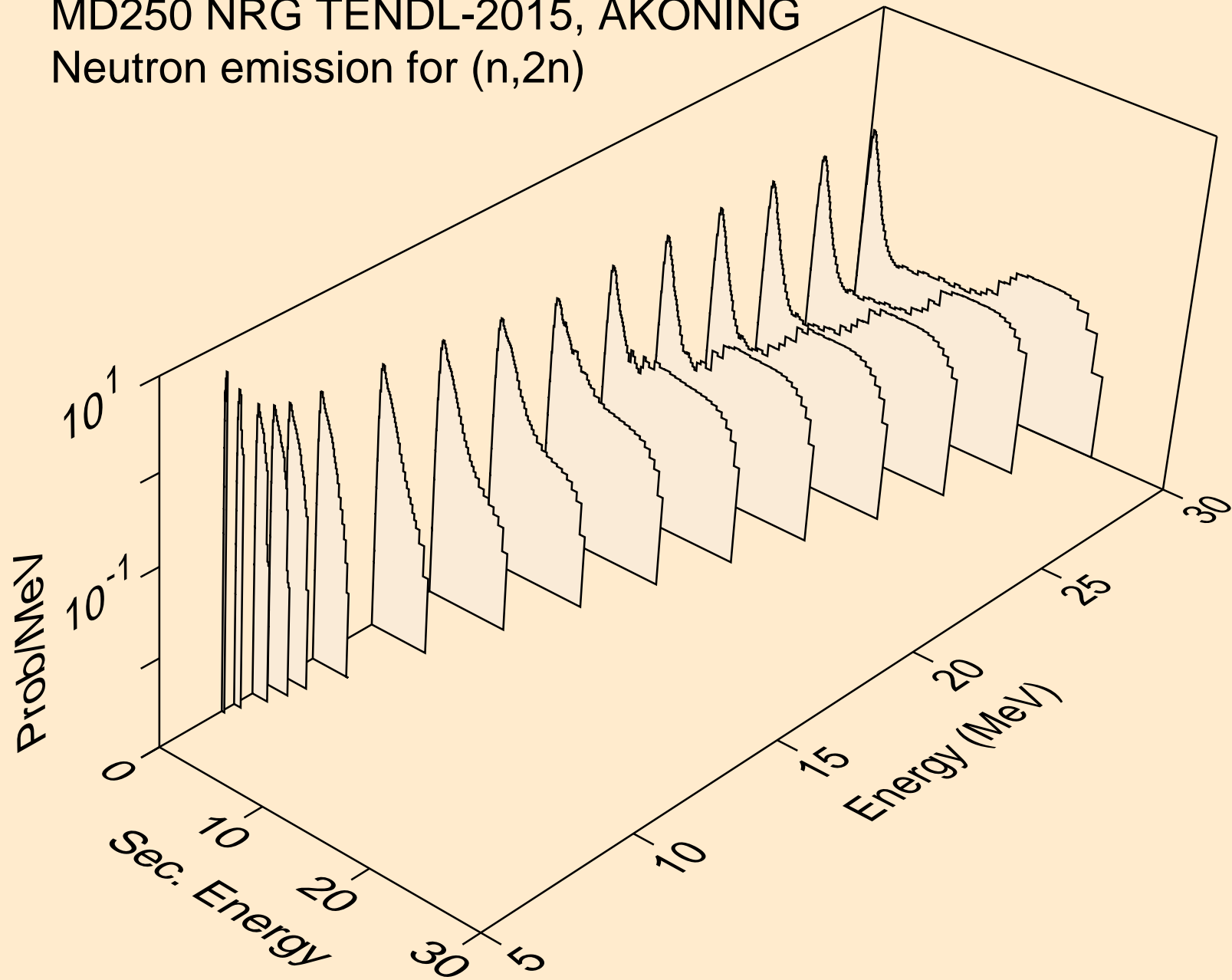

MD250 NRG TENDL-2015, AKONING
Neutron emission for (n,3n)

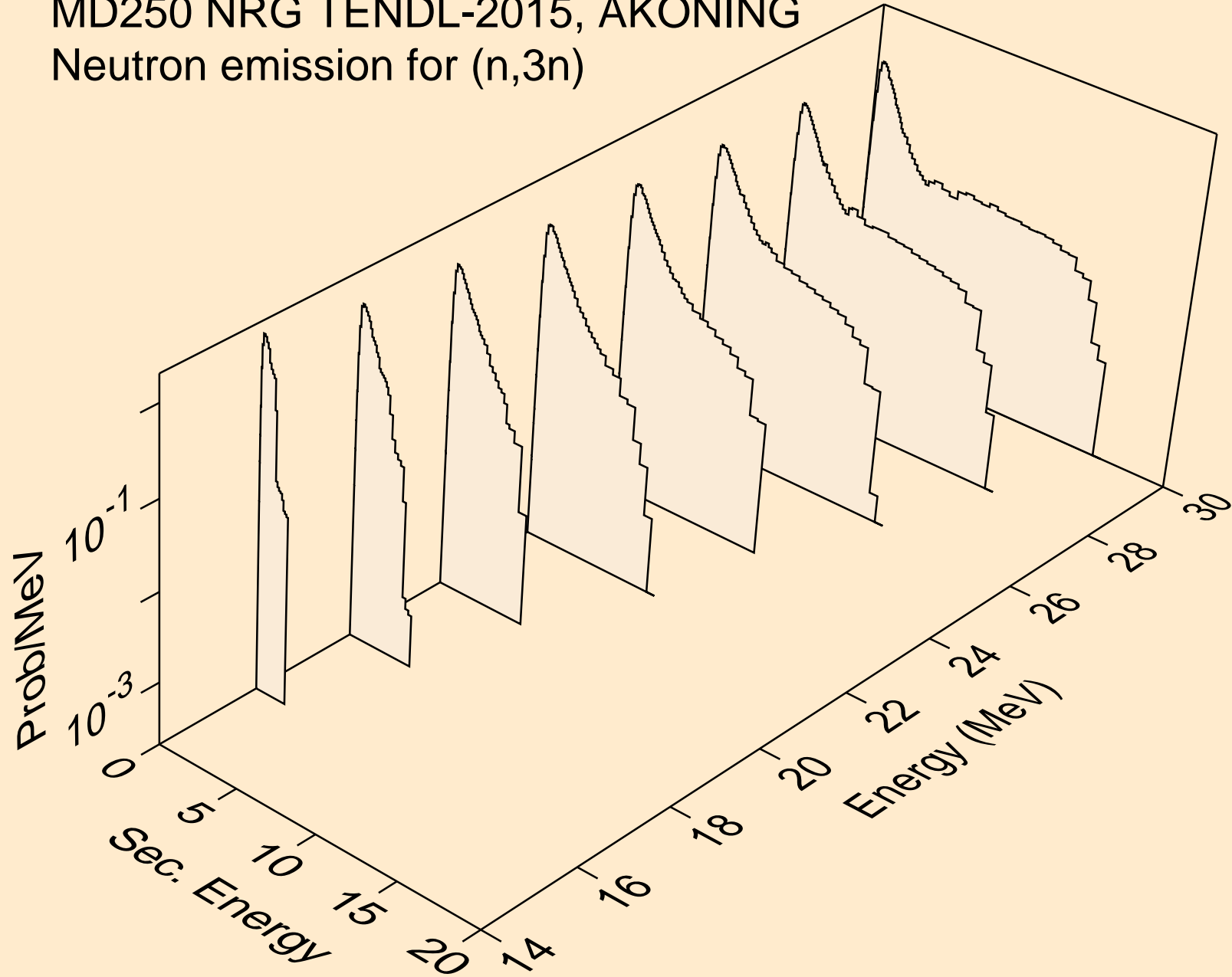

MD250 NRG TENDL-2015, AKONING
Neutron emission for fission

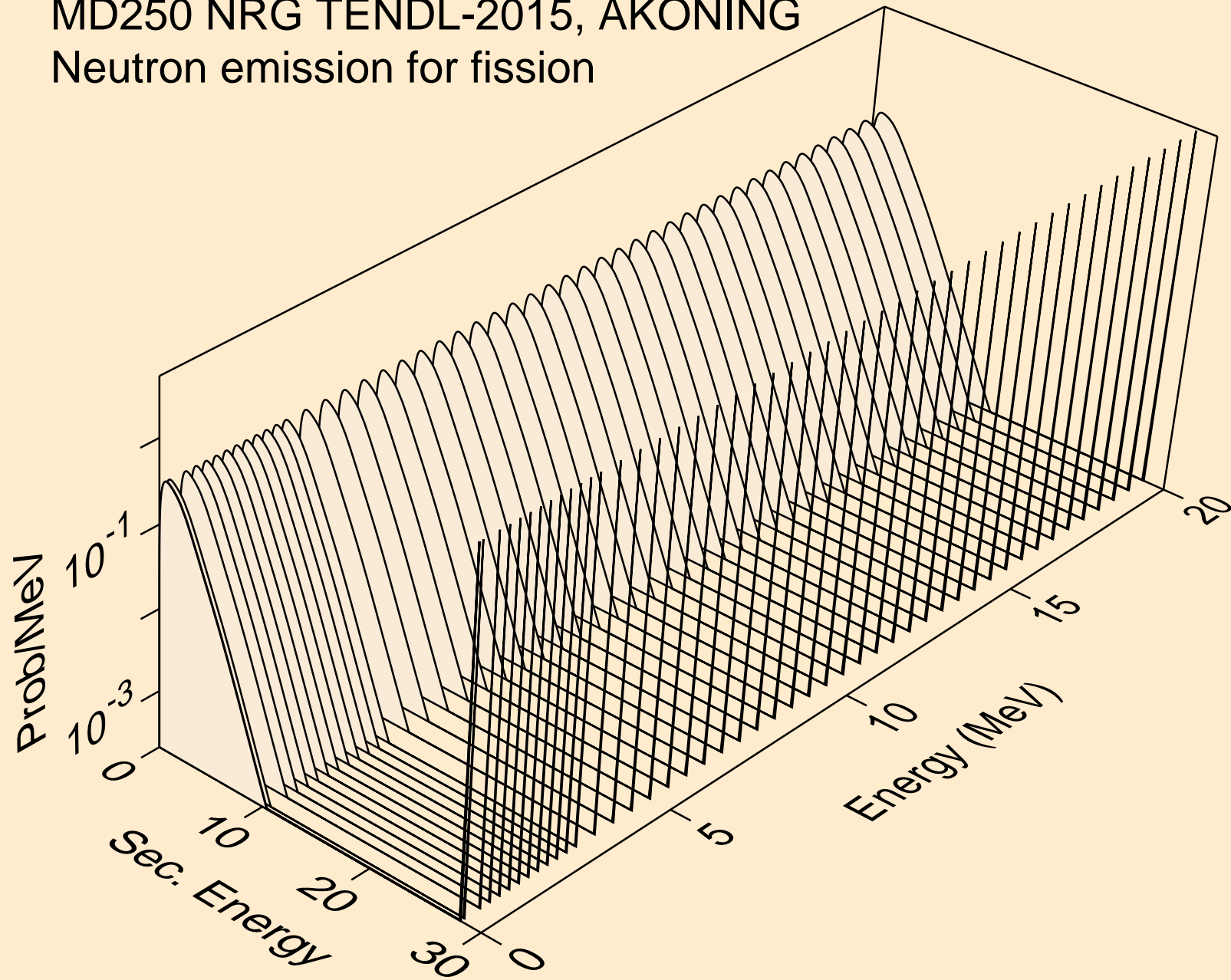

MD250 NRG TENDL-2015, AKONING
Neutron emission for (n,n*)a

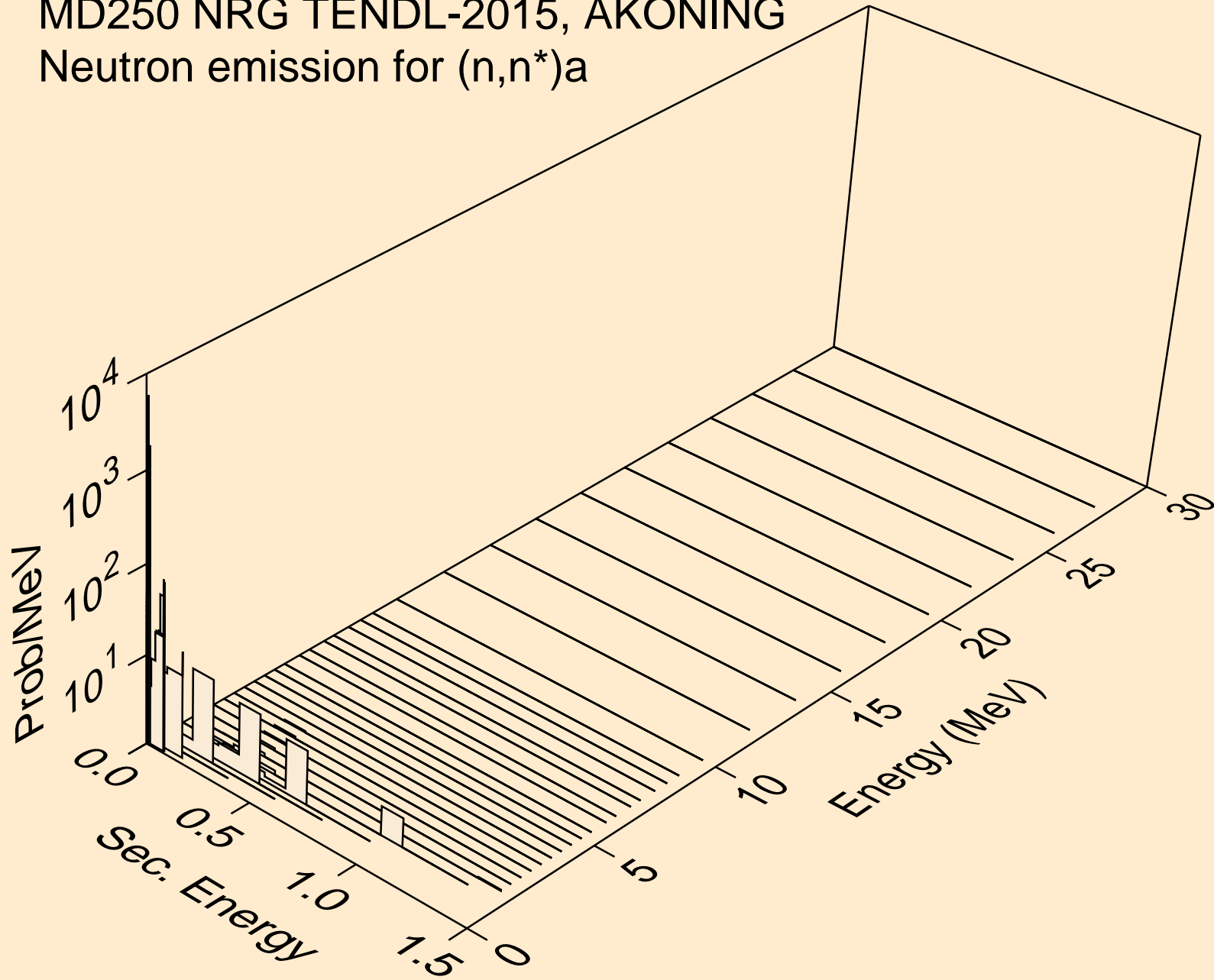

MD250 NRG TENDL-2015, AKONING
Neutron emission for (n,n*)3a

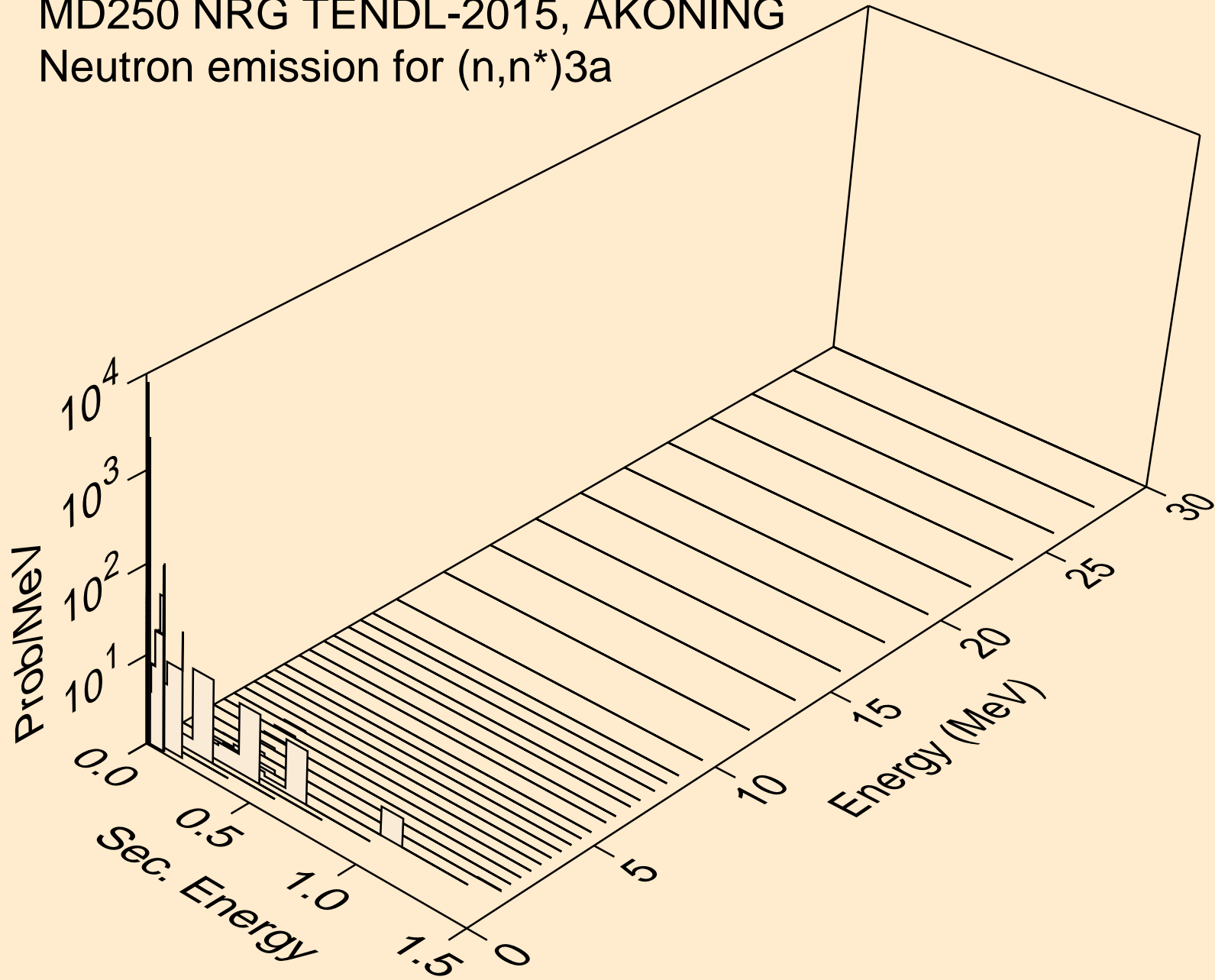

MD250 NRG TENDL-2015, AKONING
Neutron emission for (n,2n)a

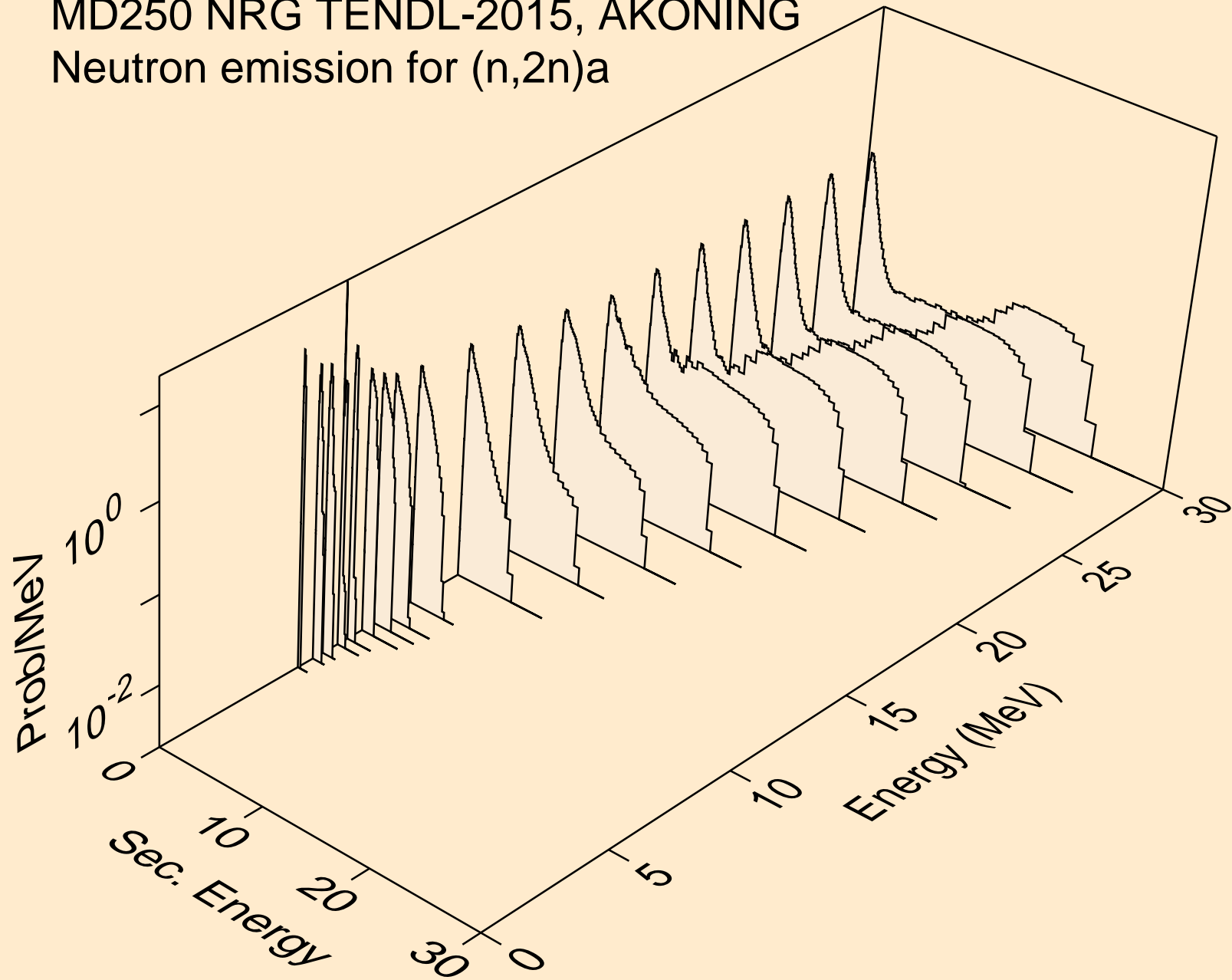

MD250 NRG TENDL-2015, AKONING
Neutron emission for (n,3n)a

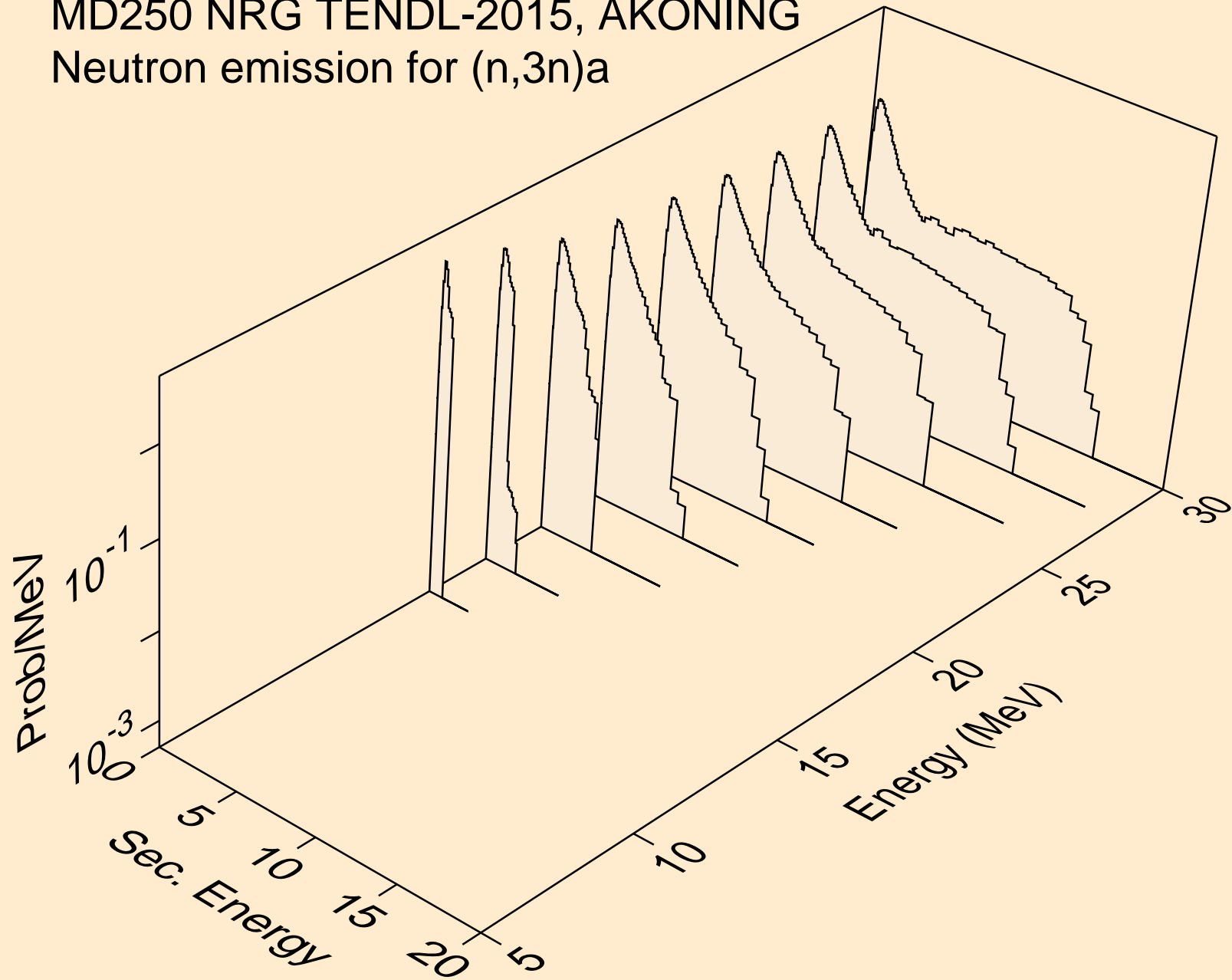

MD250 NRG TENDL-2015, AKONING
Neutron emission for (n,n*)p

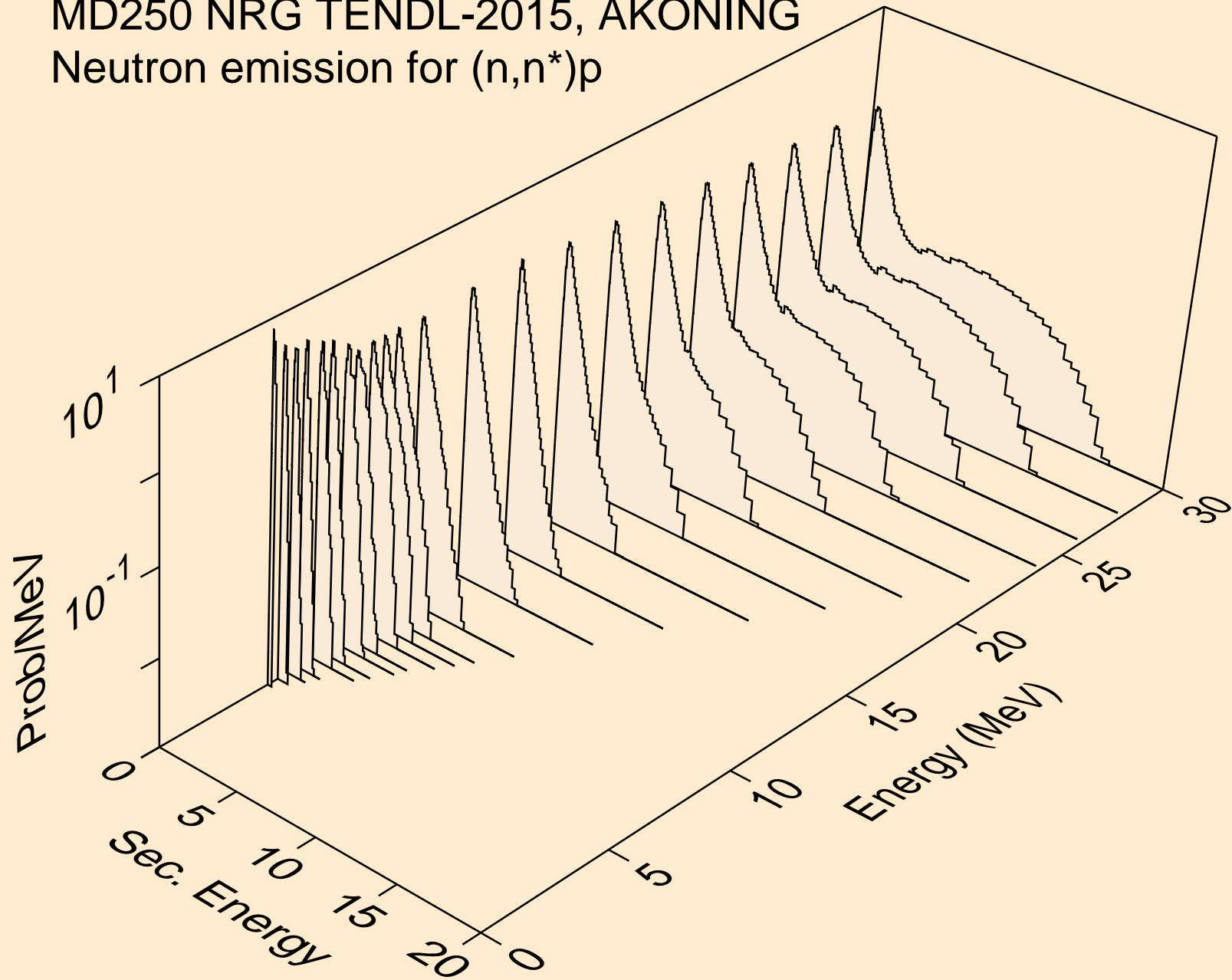

MD250 NRG TENDL-2015, AKONING
Neutron emission for (n,n*)2a

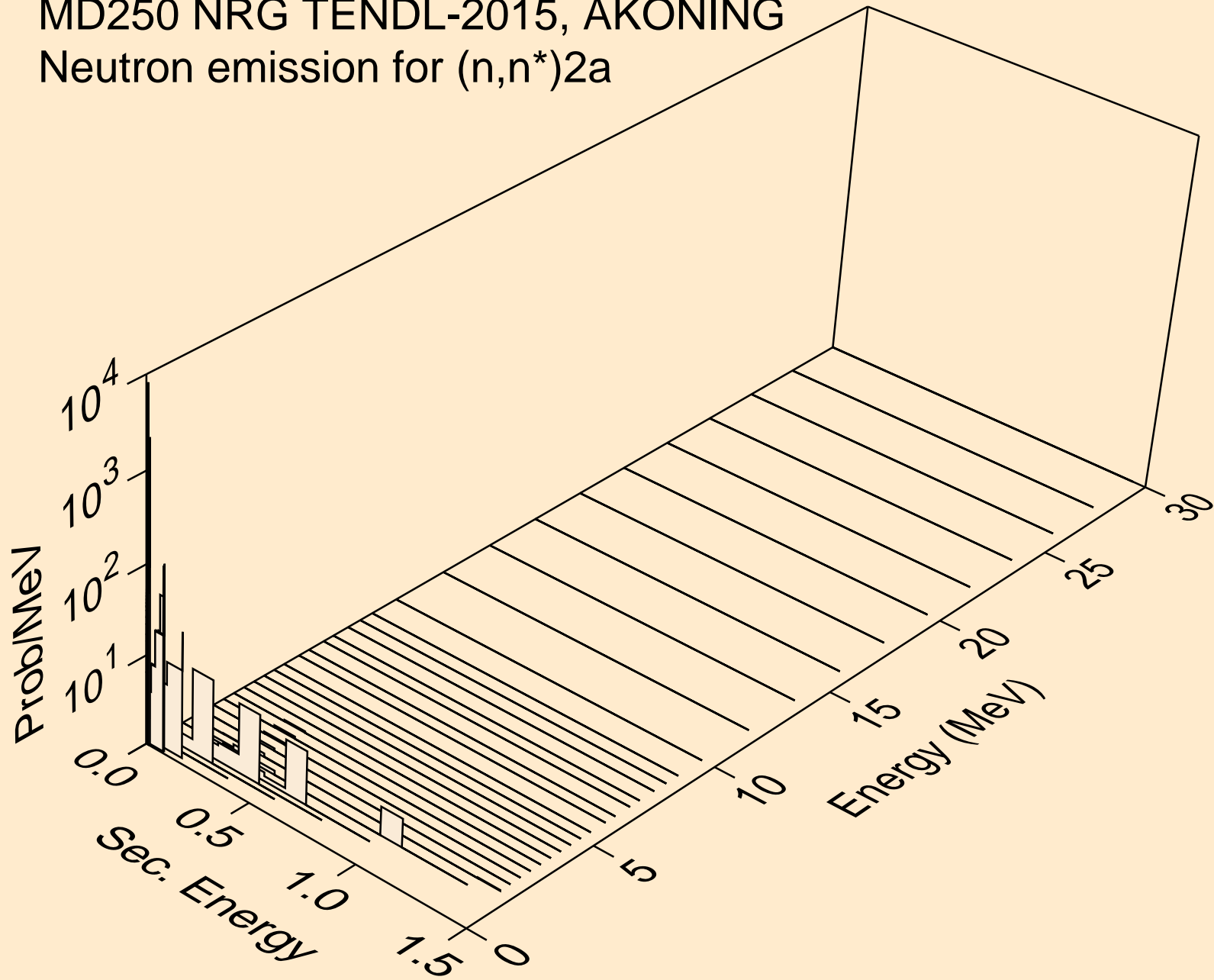

MD250 NRG TENDL-2015, AKONING
Neutron emission for (n,2n)2a

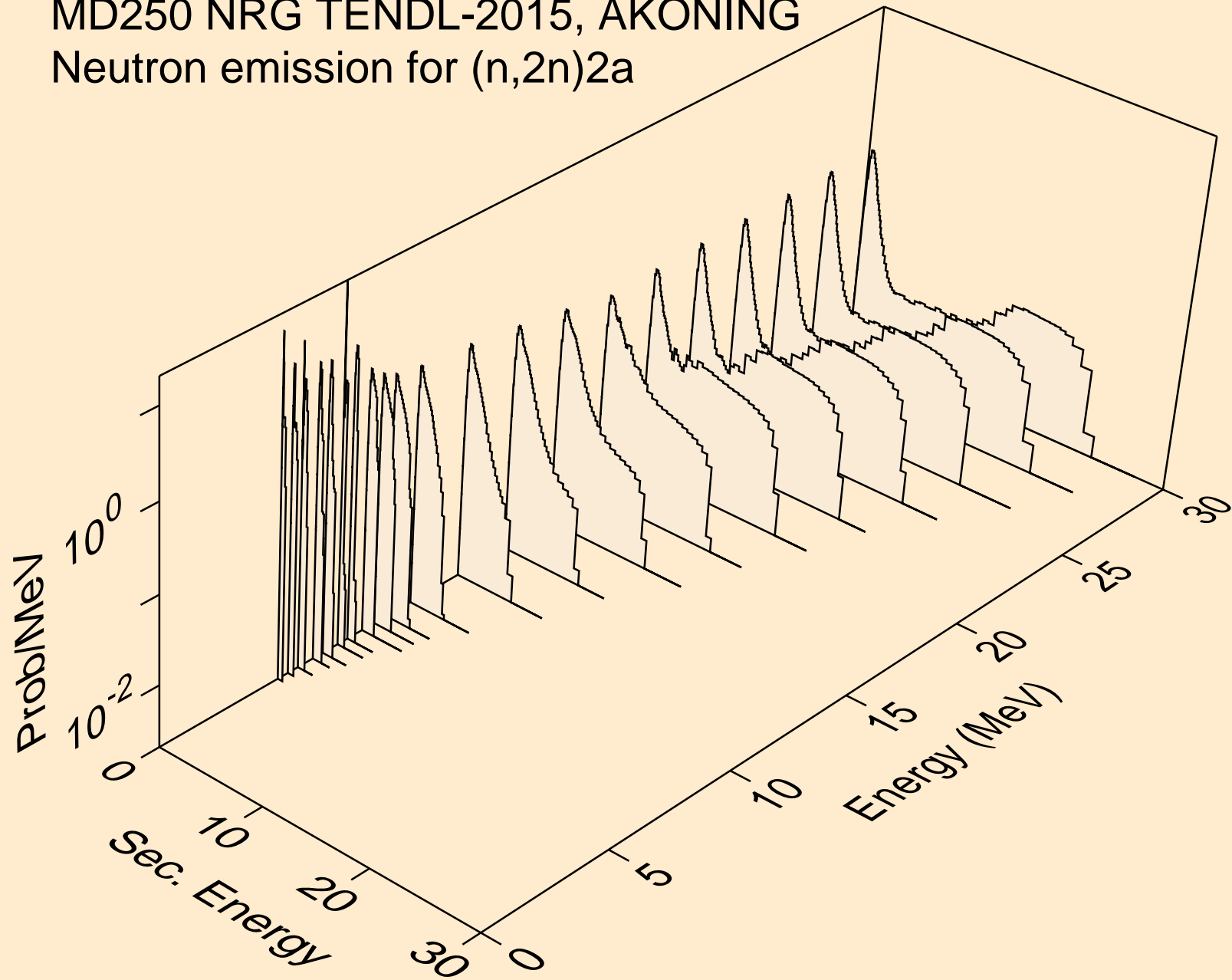

MD250 NRG TENDL-2015, AKONING
Neutron emission for (n,n*)d

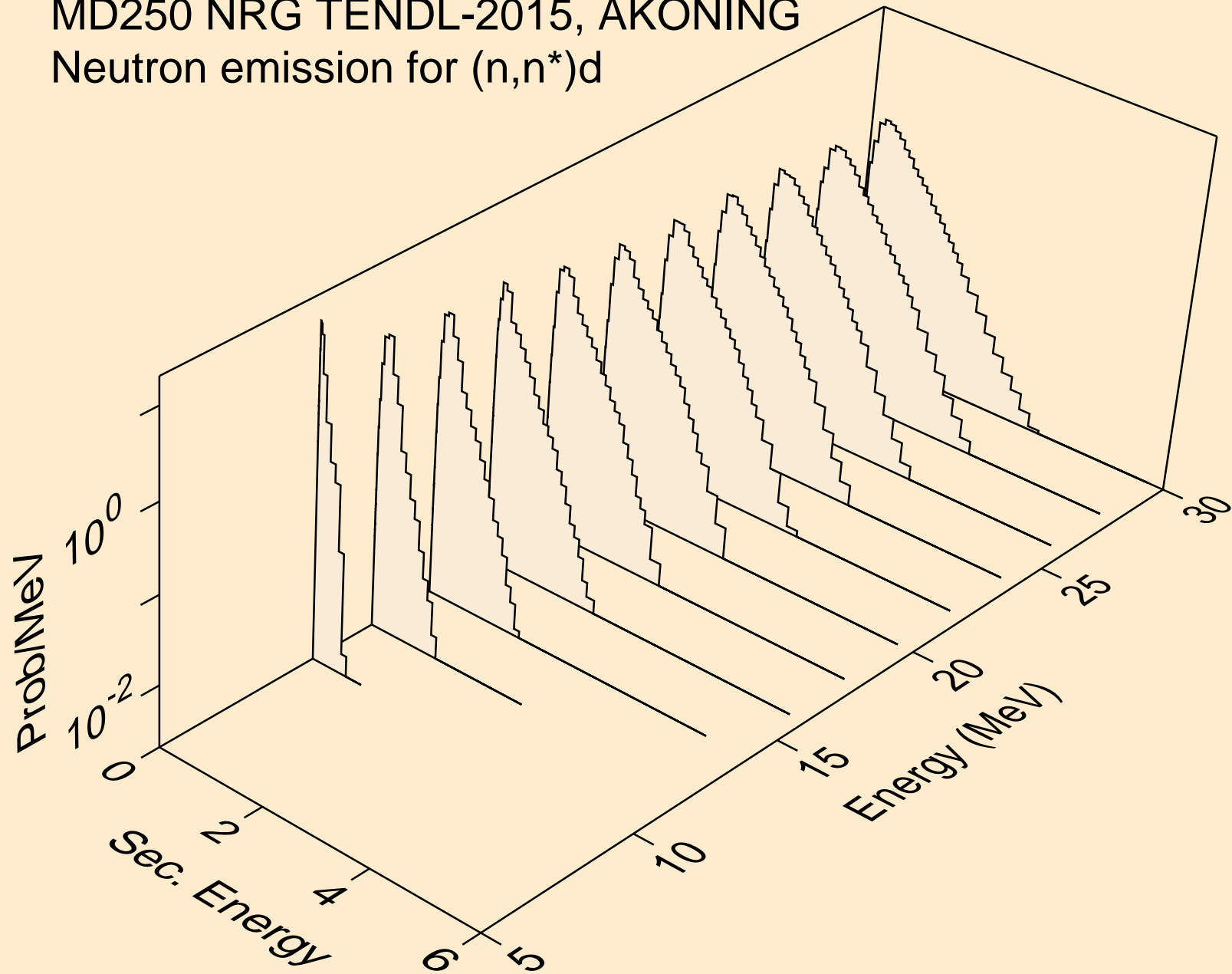

MD250 NRG TENDL-2015, AKONING
Neutron emission for (n,n*)t

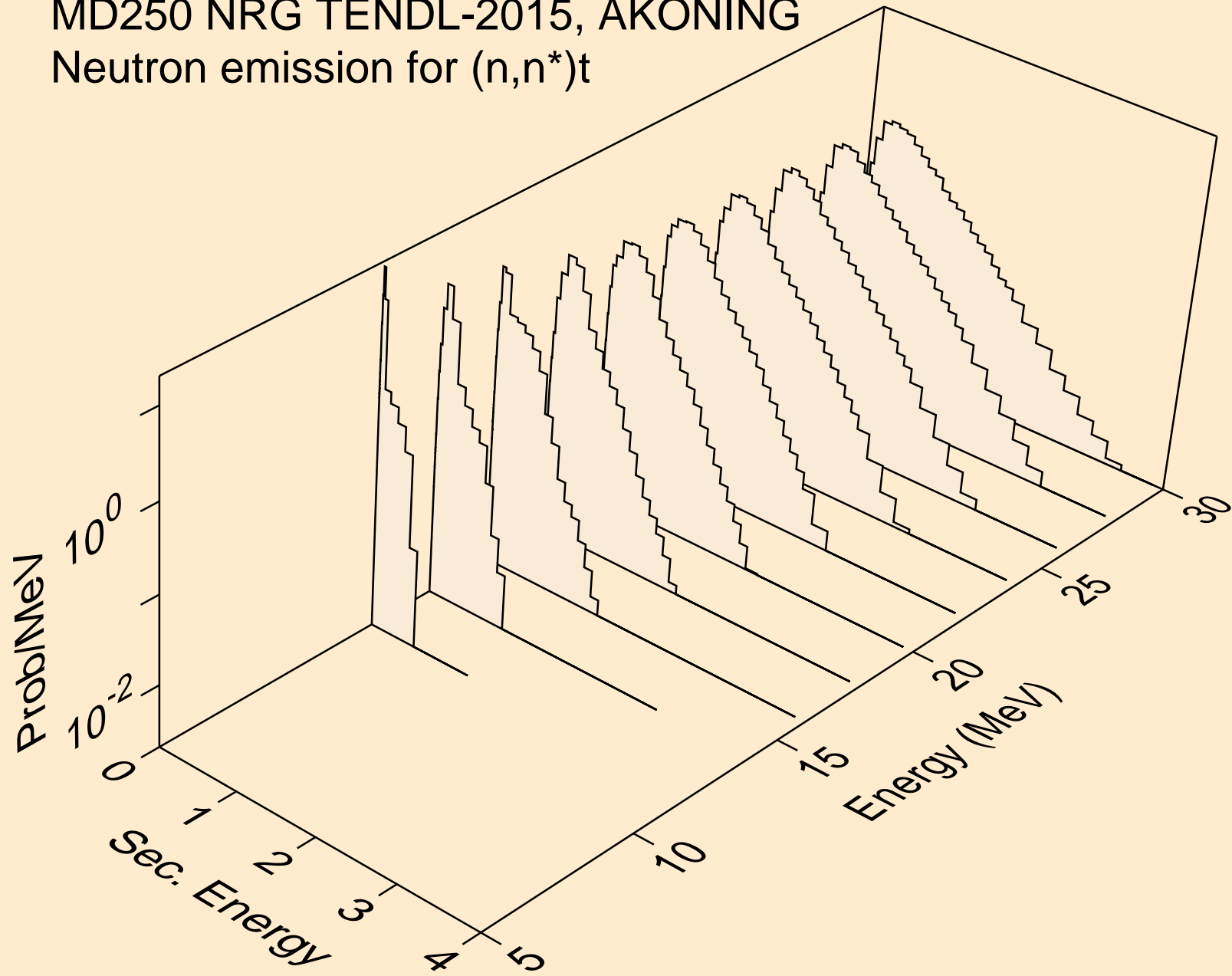

MD250 NRG TENDL-2015, AKONING
Neutron emission for (n,n*)he3

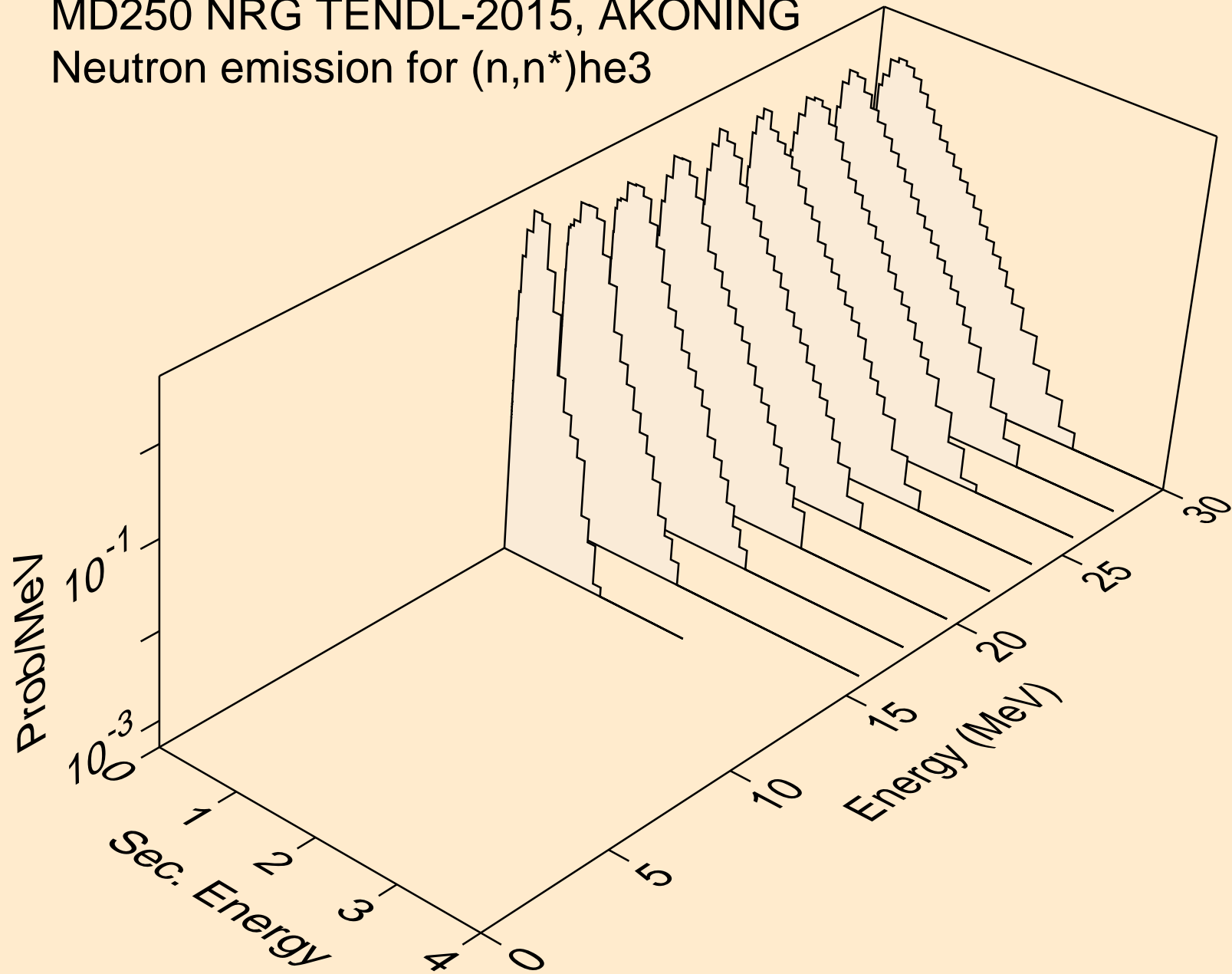

MD250 NRG TENDL-2015, AKONING
Neutron emission for (n,n*)d2a

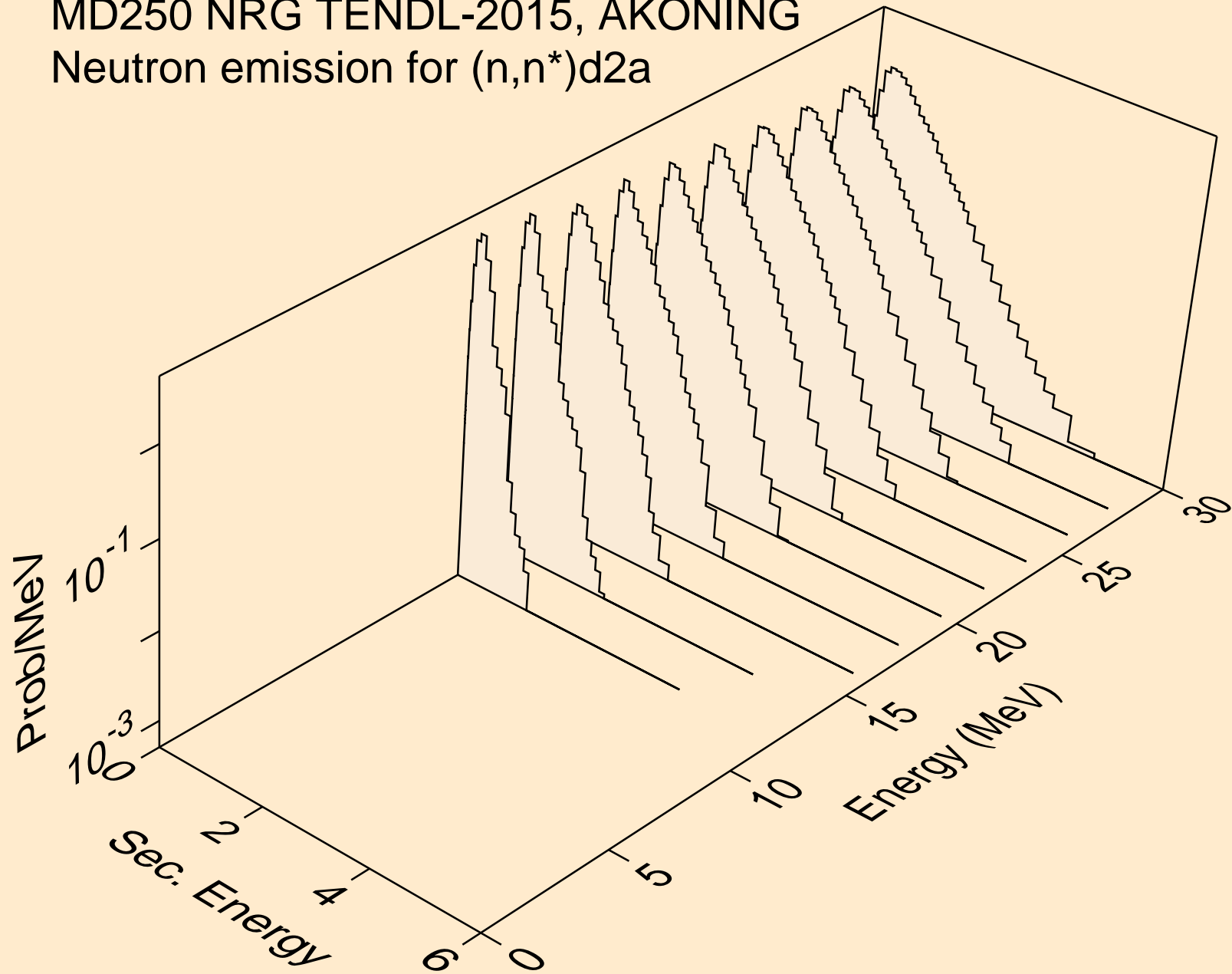

MD250 NRG TENDL-2015, AKONING
Neutron emission for (n,n*)t2a

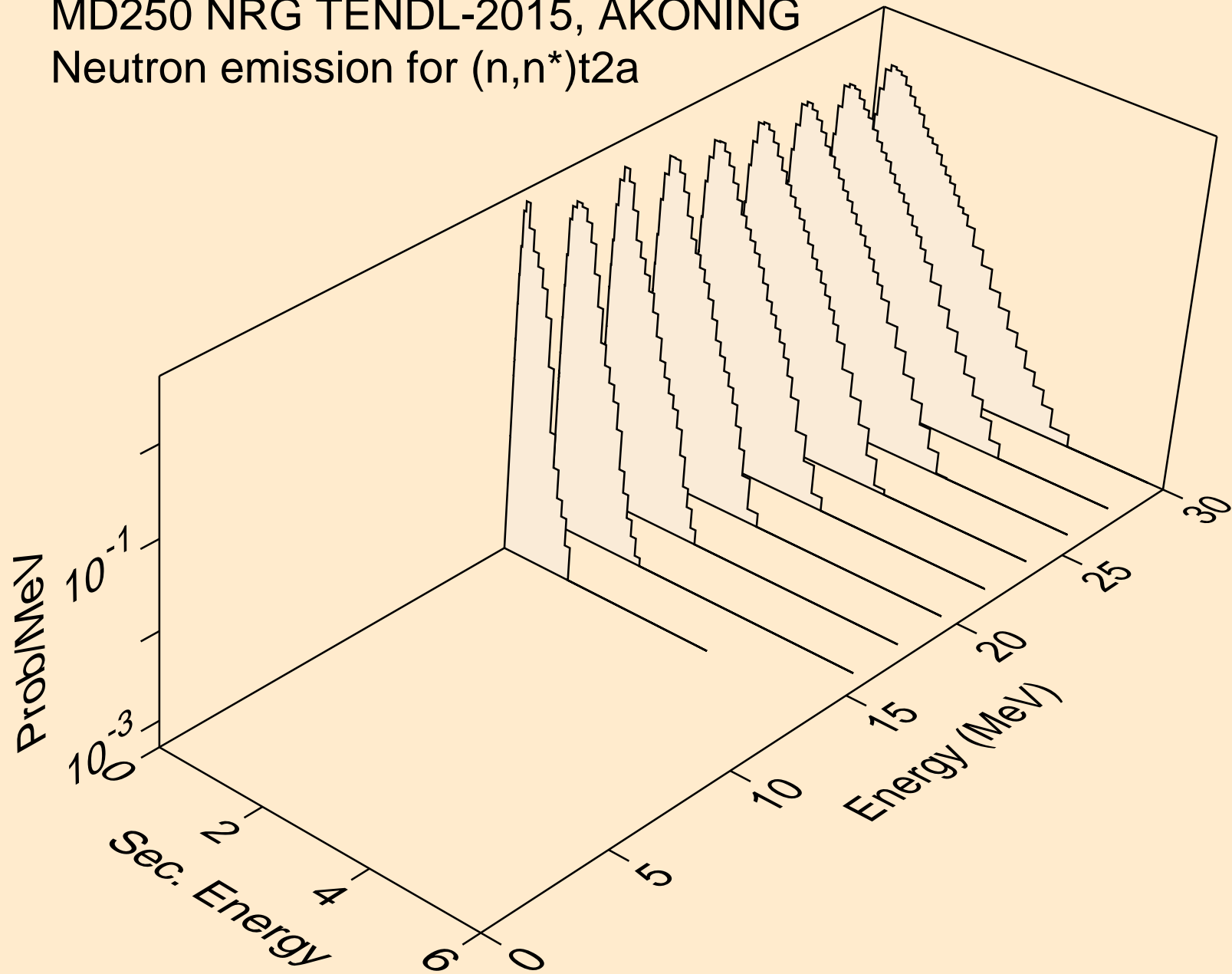

MD250 NRG TENDL-2015, AKONING
Neutron emission for (n,4n)

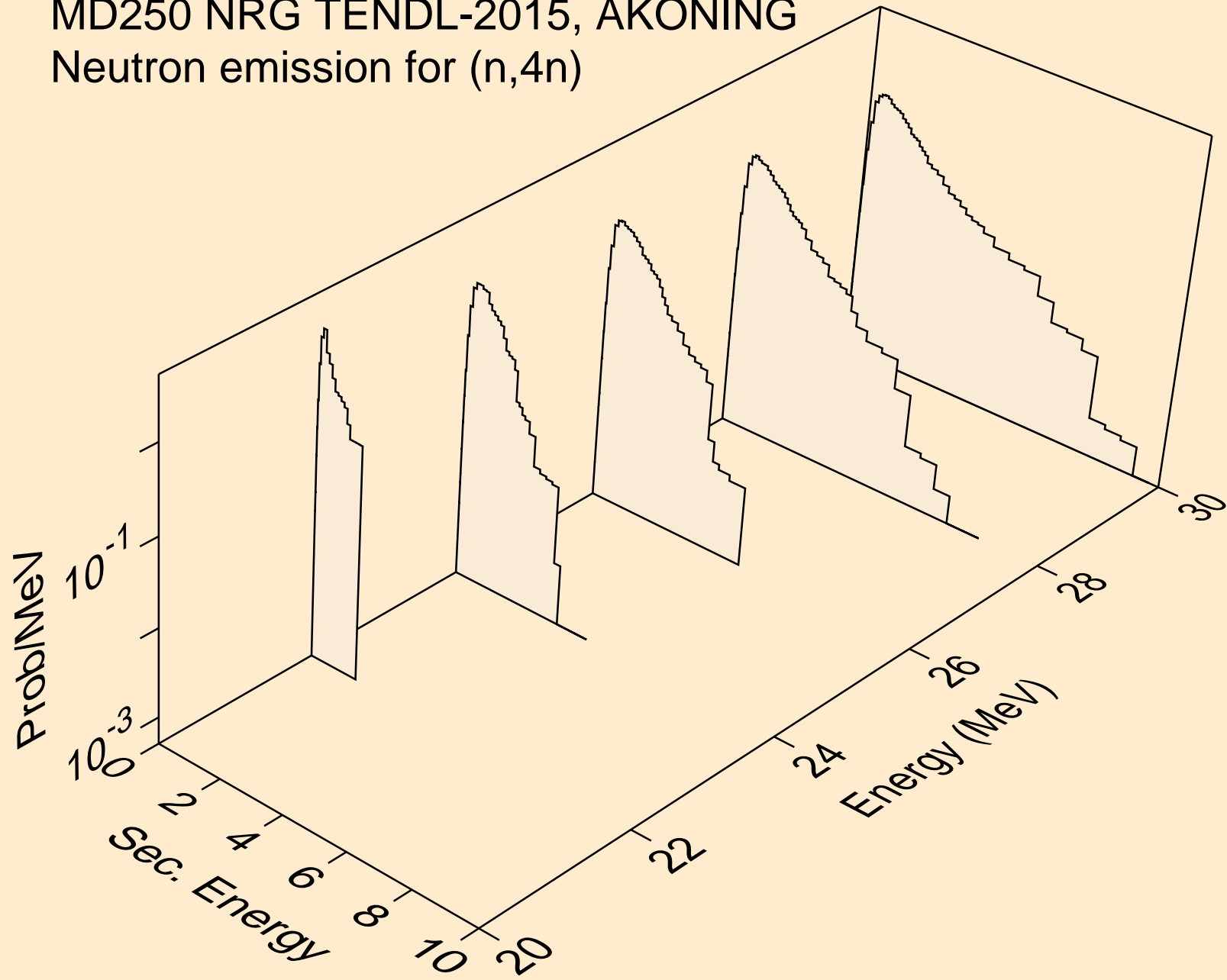

MD250 NRG TENDL-2015, AKONING
Neutron emission for (n,2np)

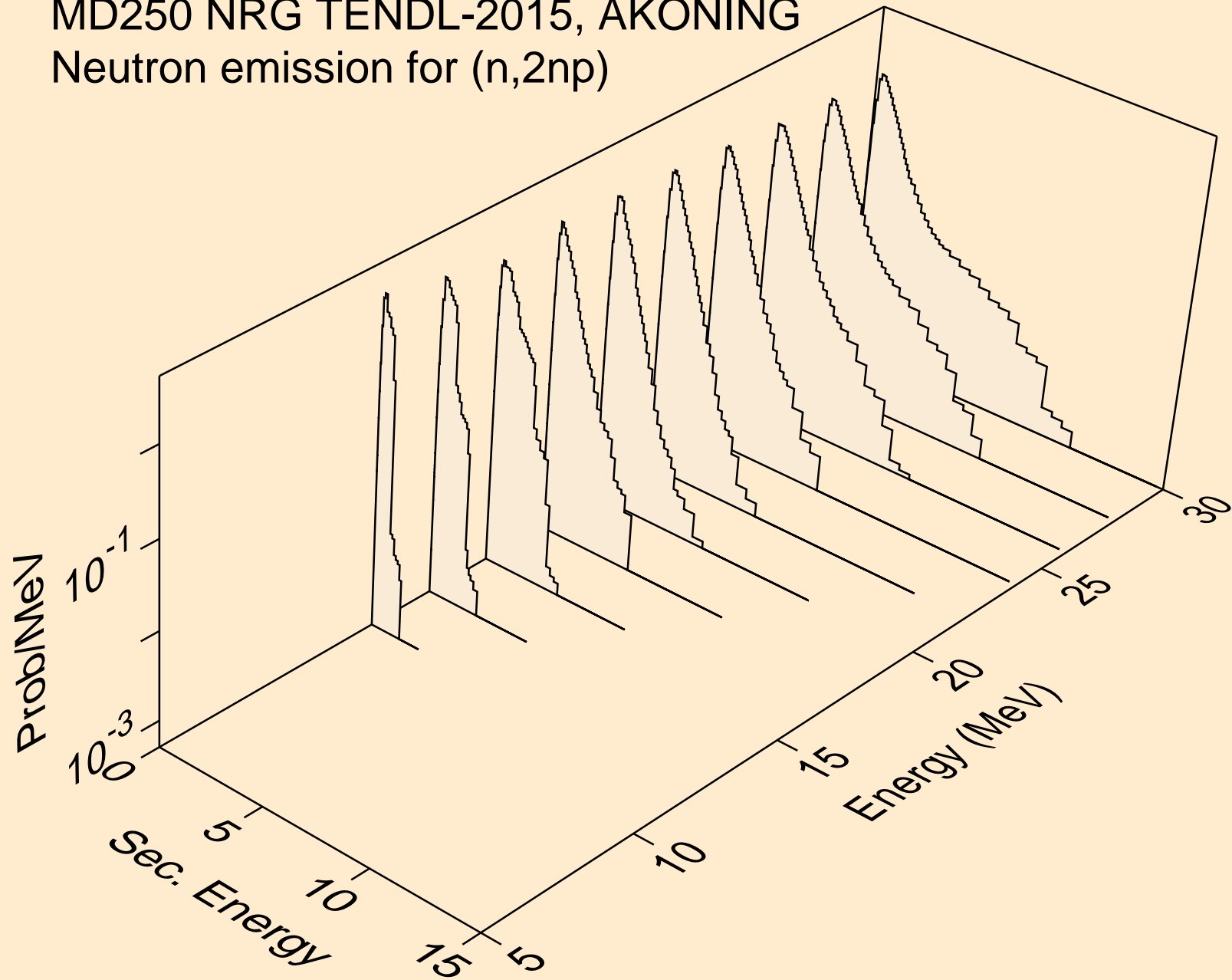

MD250 NRG TENDL-2015, AKONING
Neutron emission for (n,3np)

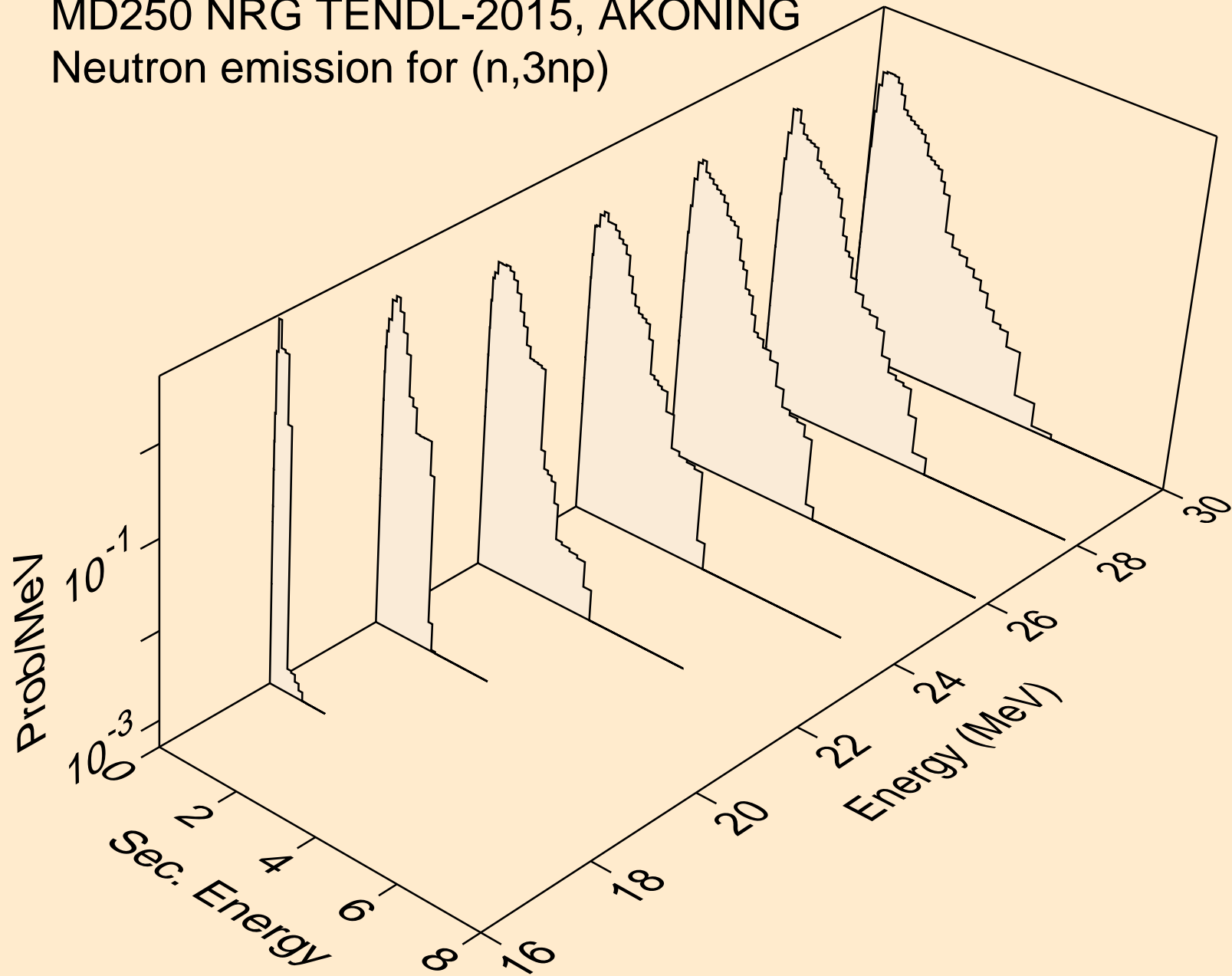

MD250 NRG TENDL-2015, AKONING
Neutron emission for (n,2np)

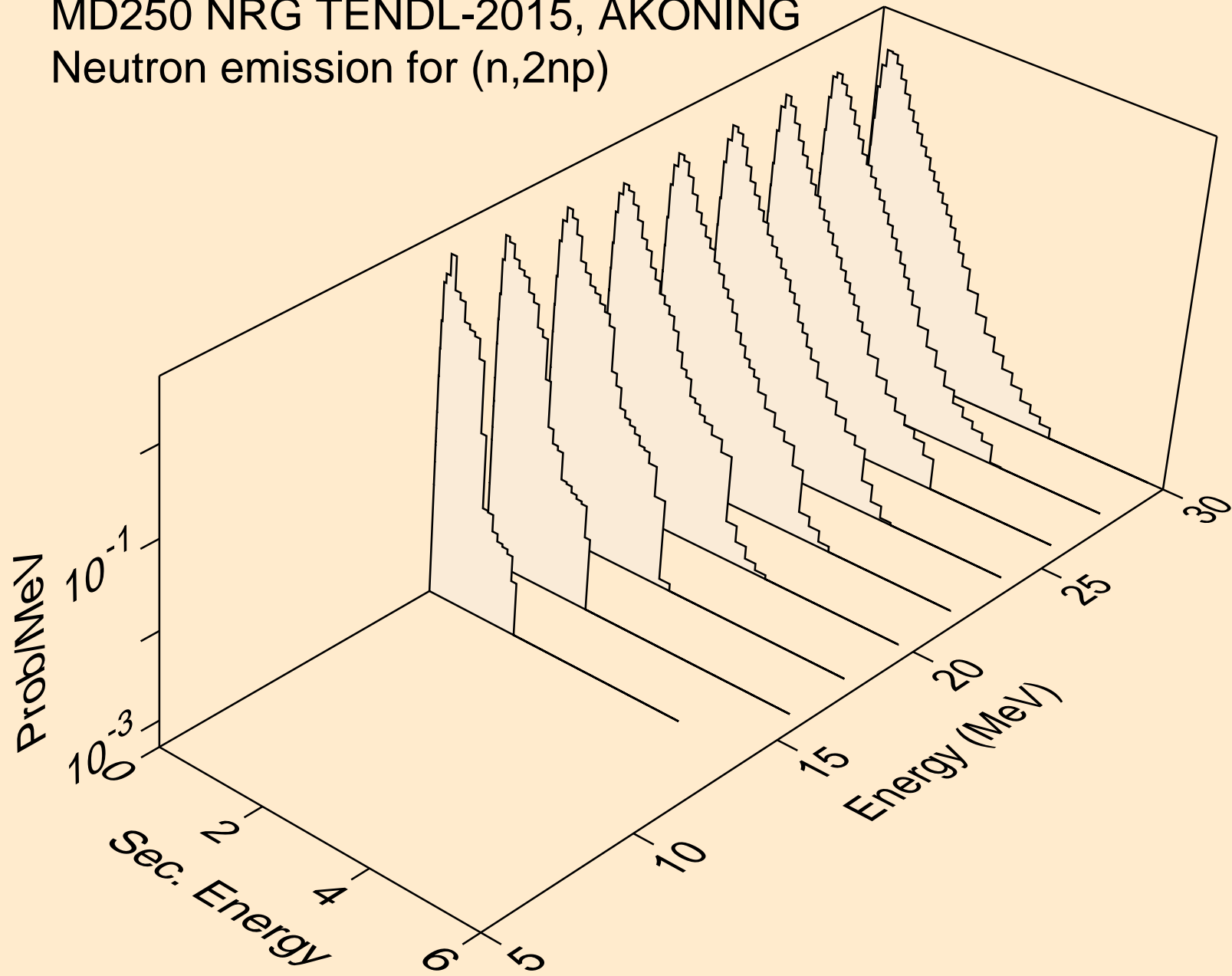

MD250 NRG TENDL-2015, AKONING
Neutron emission for (n,npa)

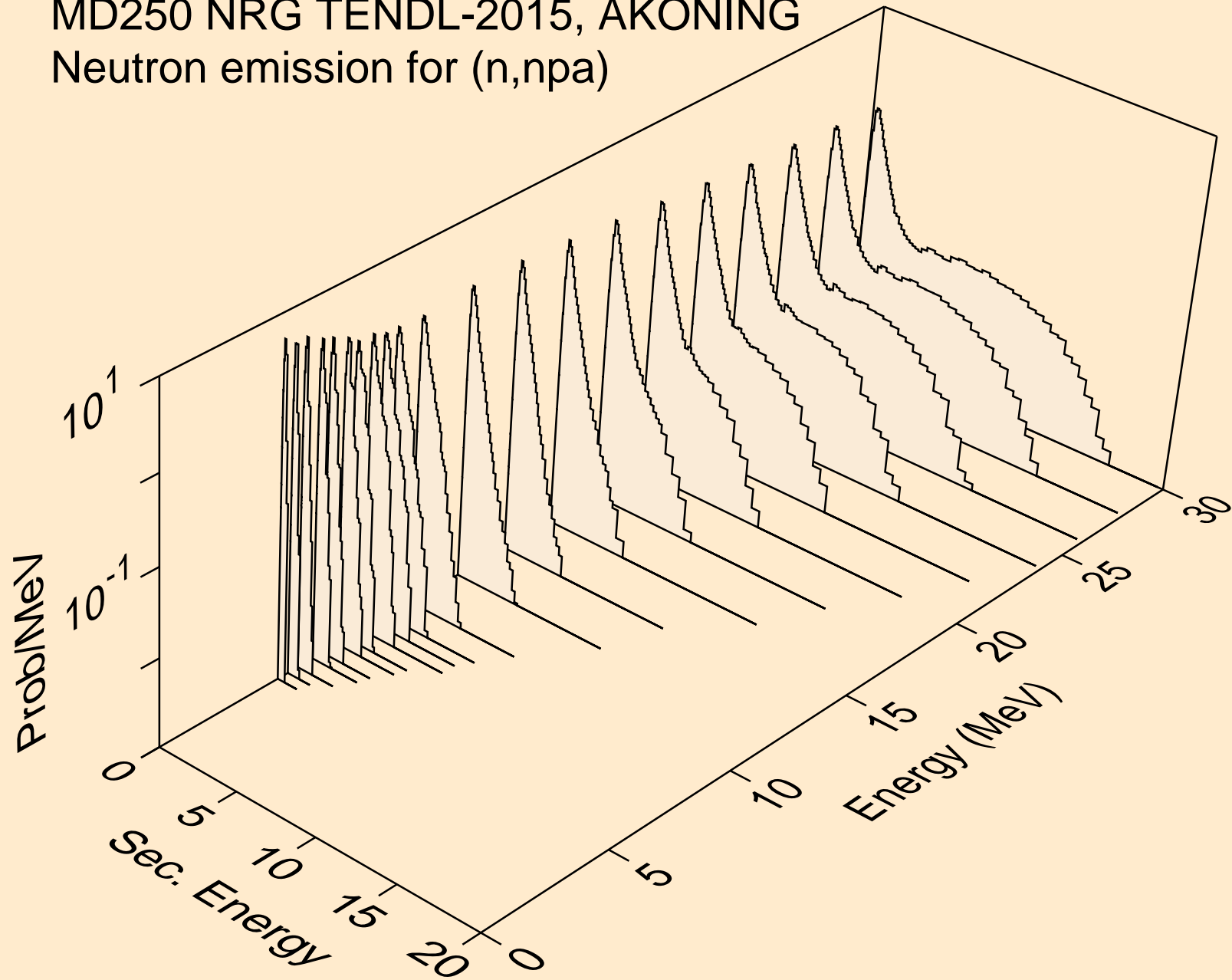

MD250 NRG TENDL-2015, AKONING
Neutron emission for (n,n*c)

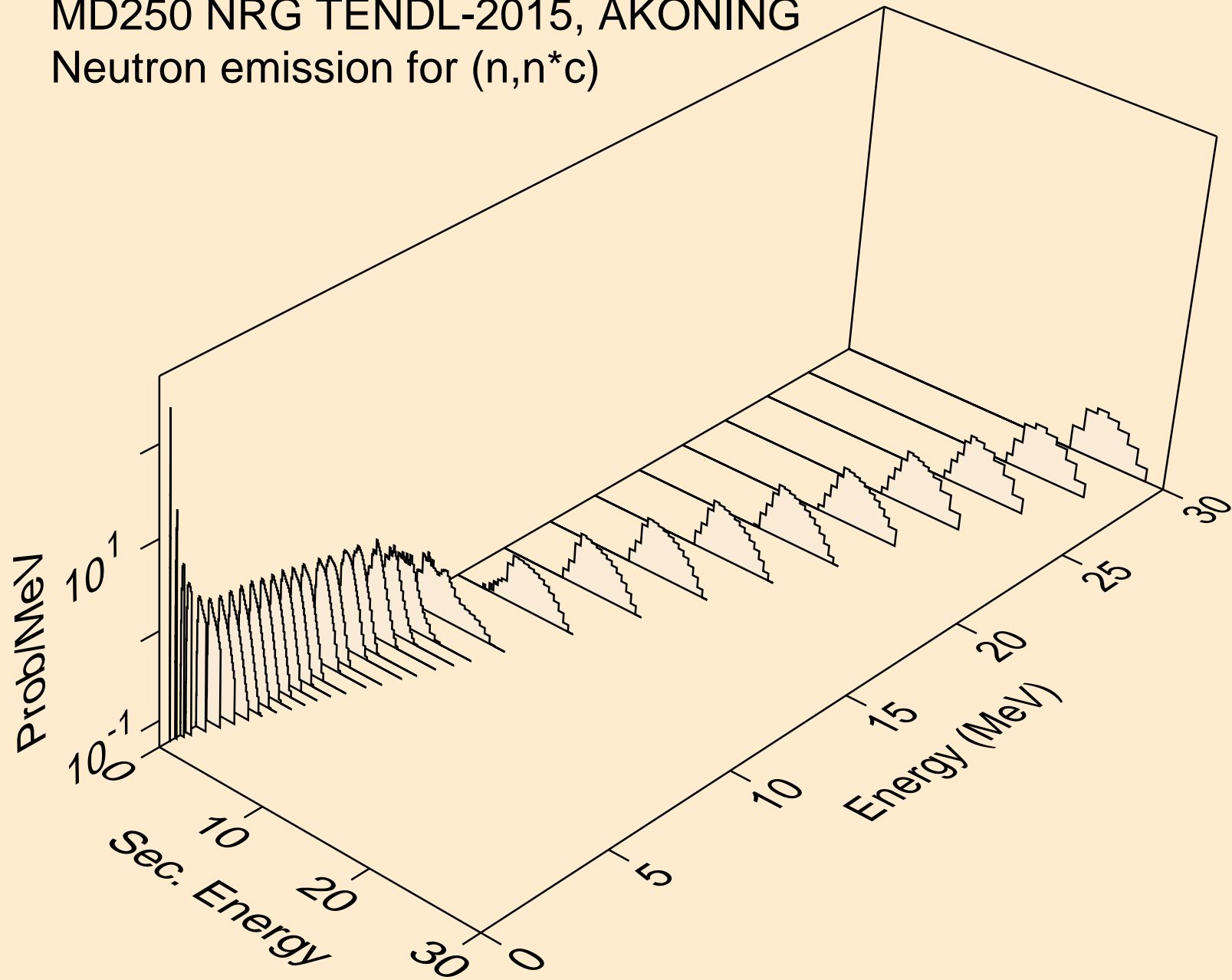

MD250 NRG TENDL-2015, AKONING

Delayed nubar

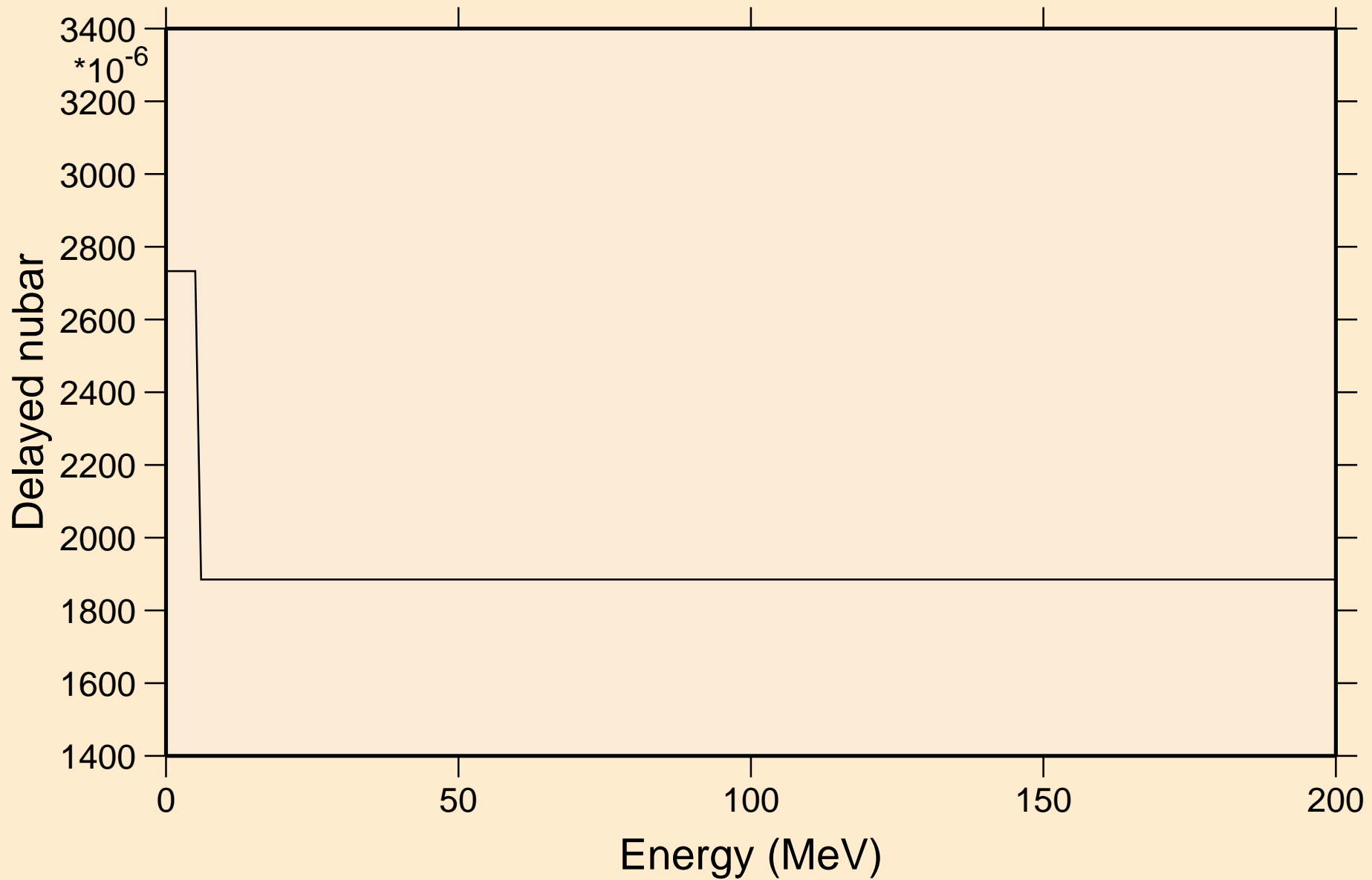

MD250 NRG TENDL-2015, AKONING

Delayed neutron spectra

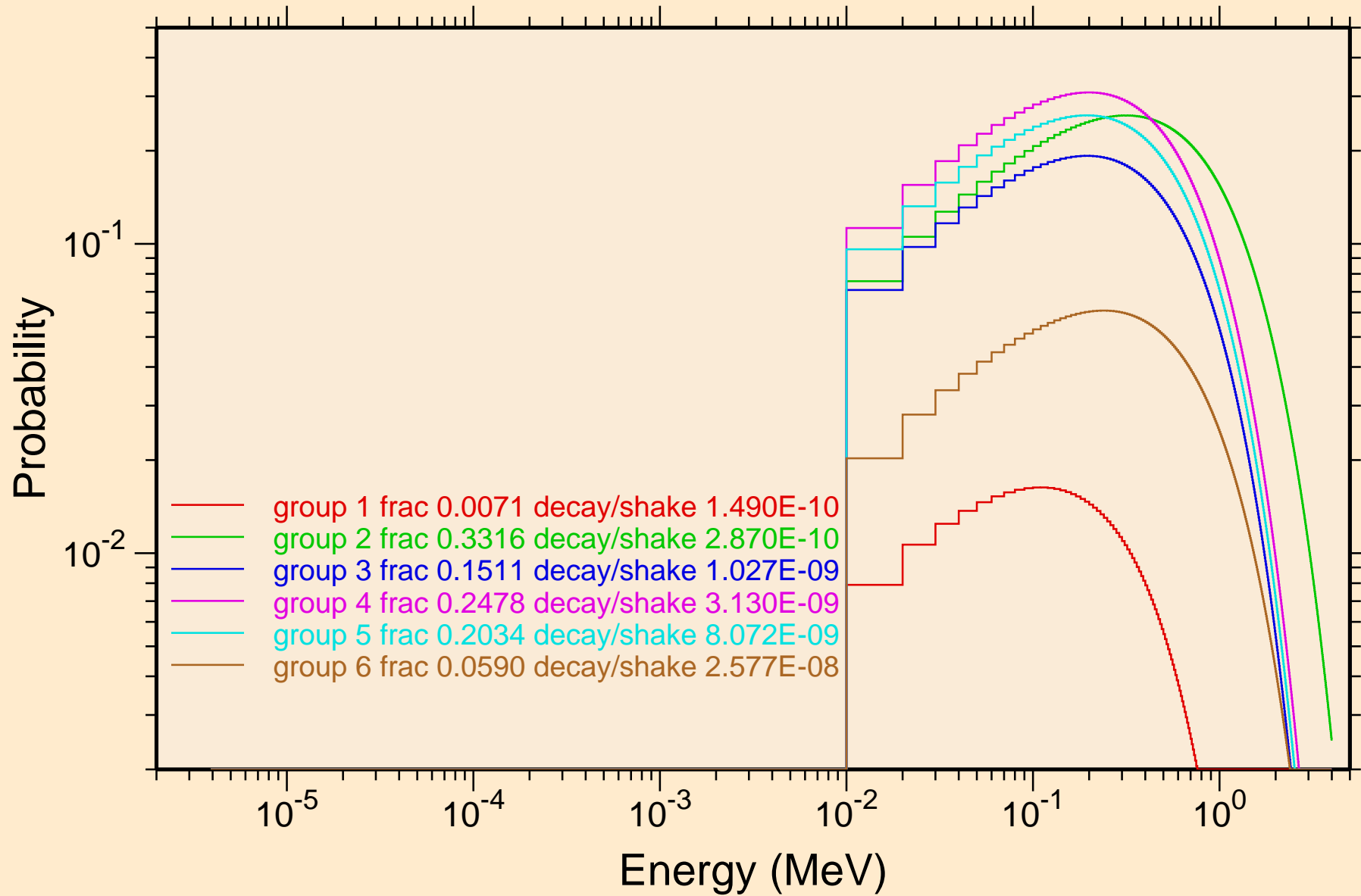

MD250 NRG TENDL-2015, AKONING
Photon emission for (n,x)

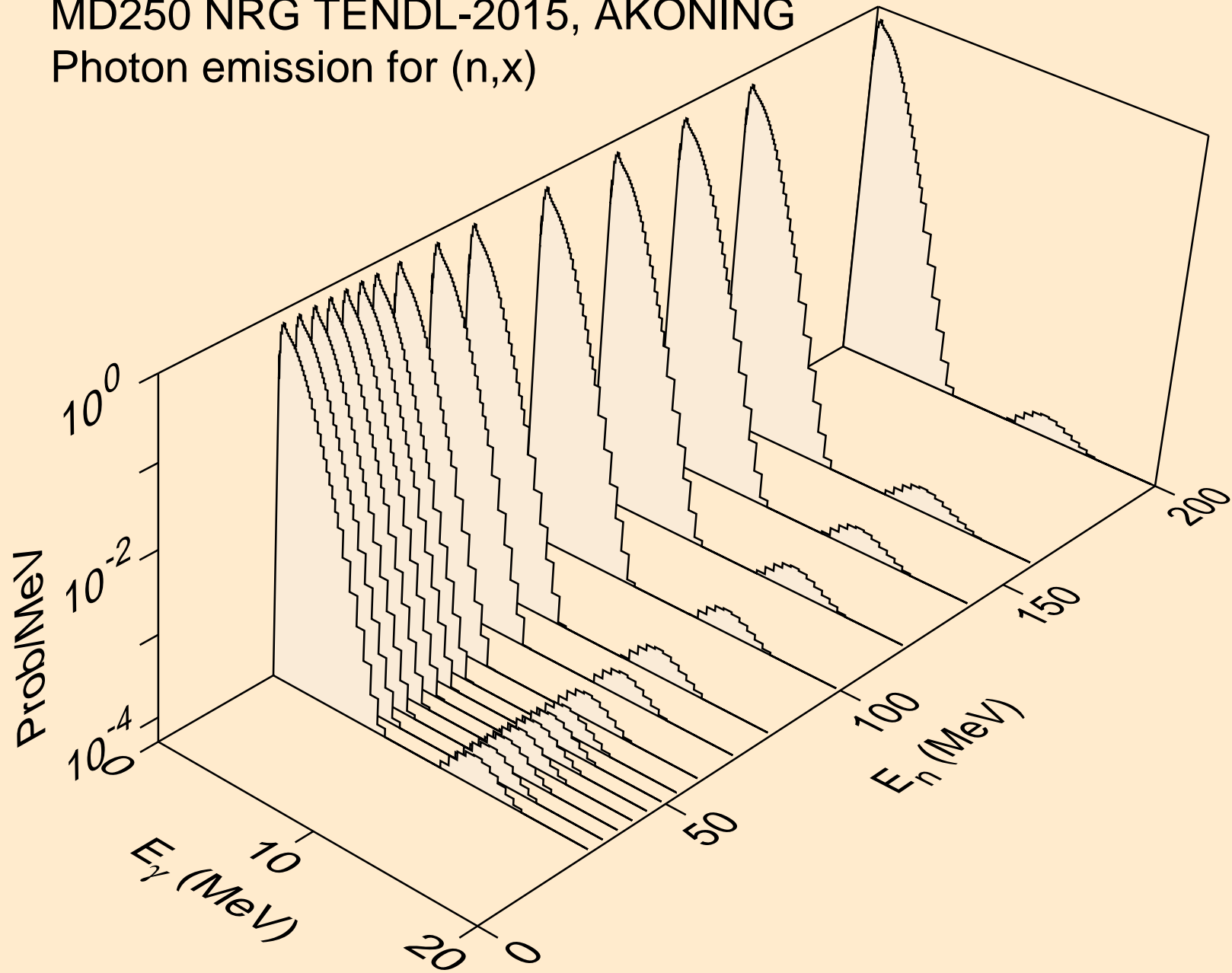

MD250 NRG TENDL-2015, AKONING
Photon emission for (n,2nd)

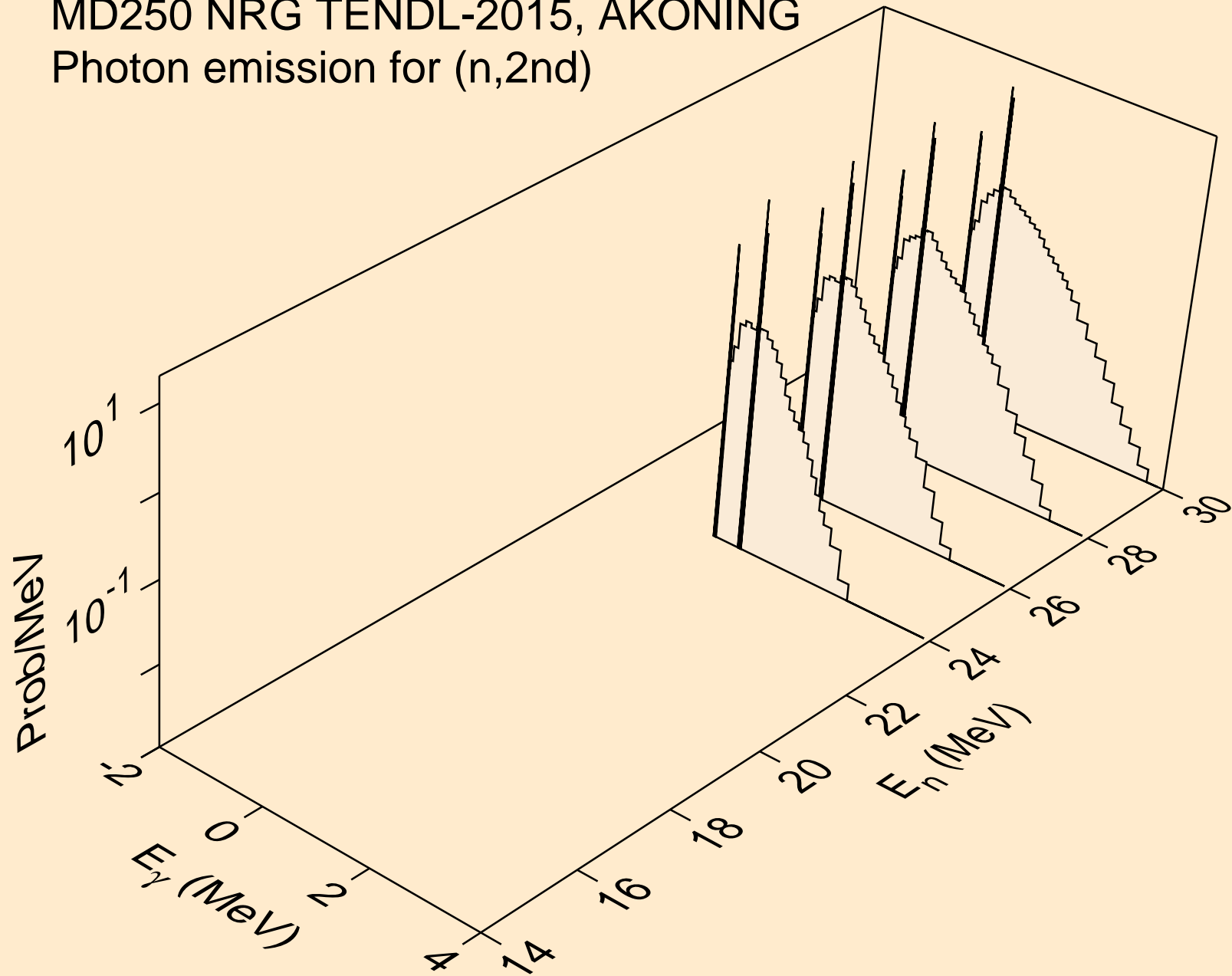

MD250 NRG TENDL-2015, AKONING
Photon emission for (n,2n)

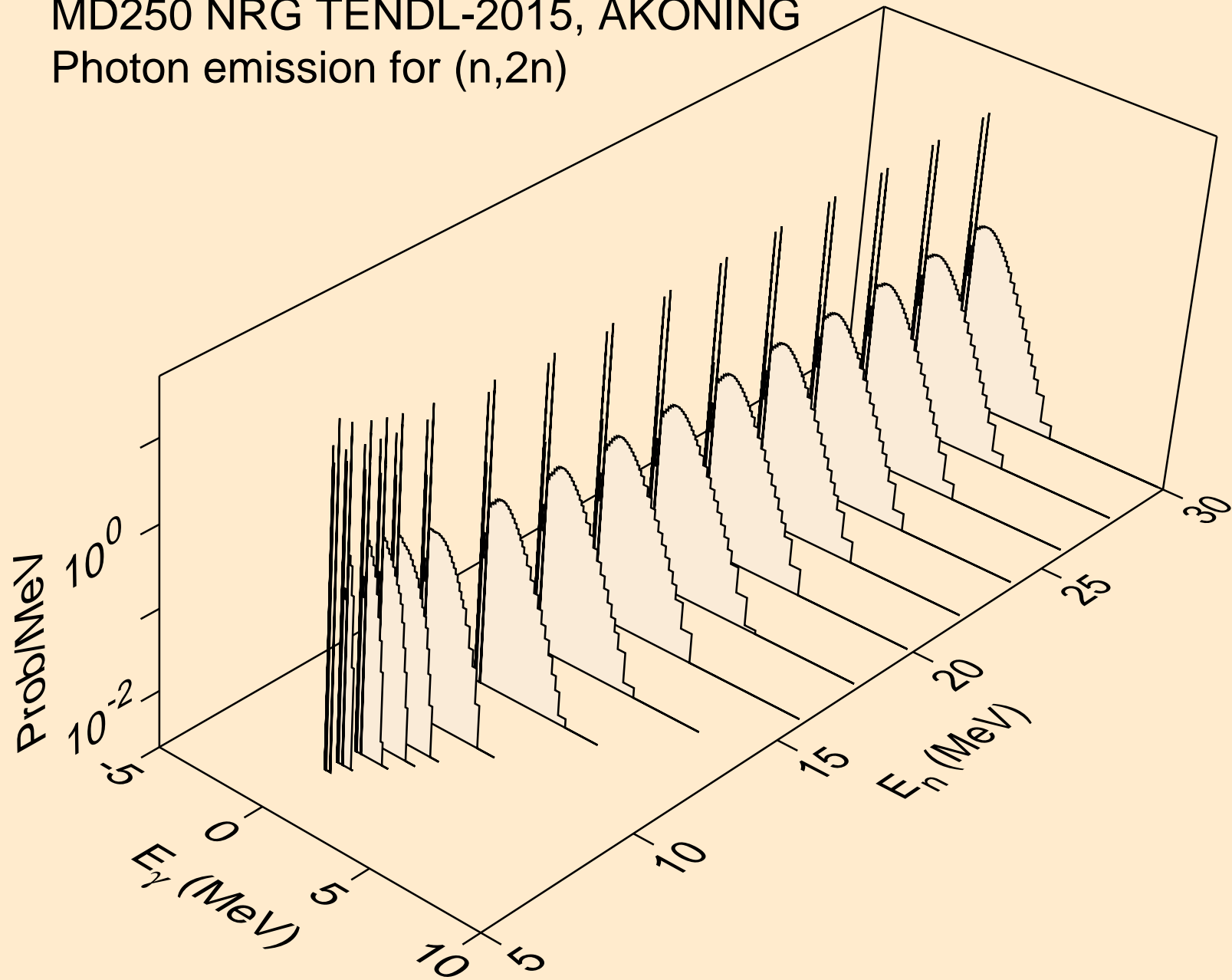

MD250 NRG TENDL-2015, AKONING
Photon emission for (n,3n)

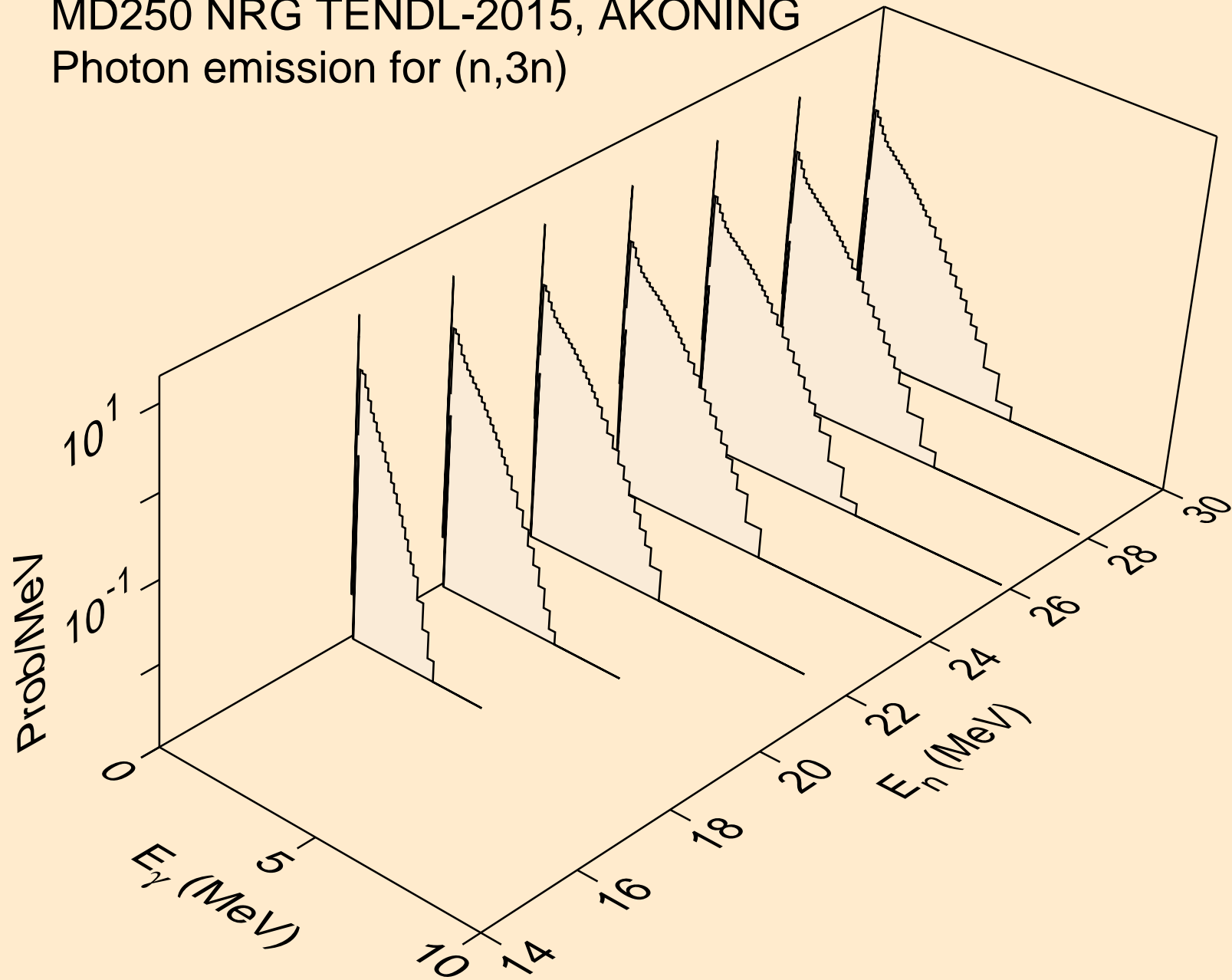

MD250 NRG TENDL-2015, AKONING
Photon emission for (n,n*)a

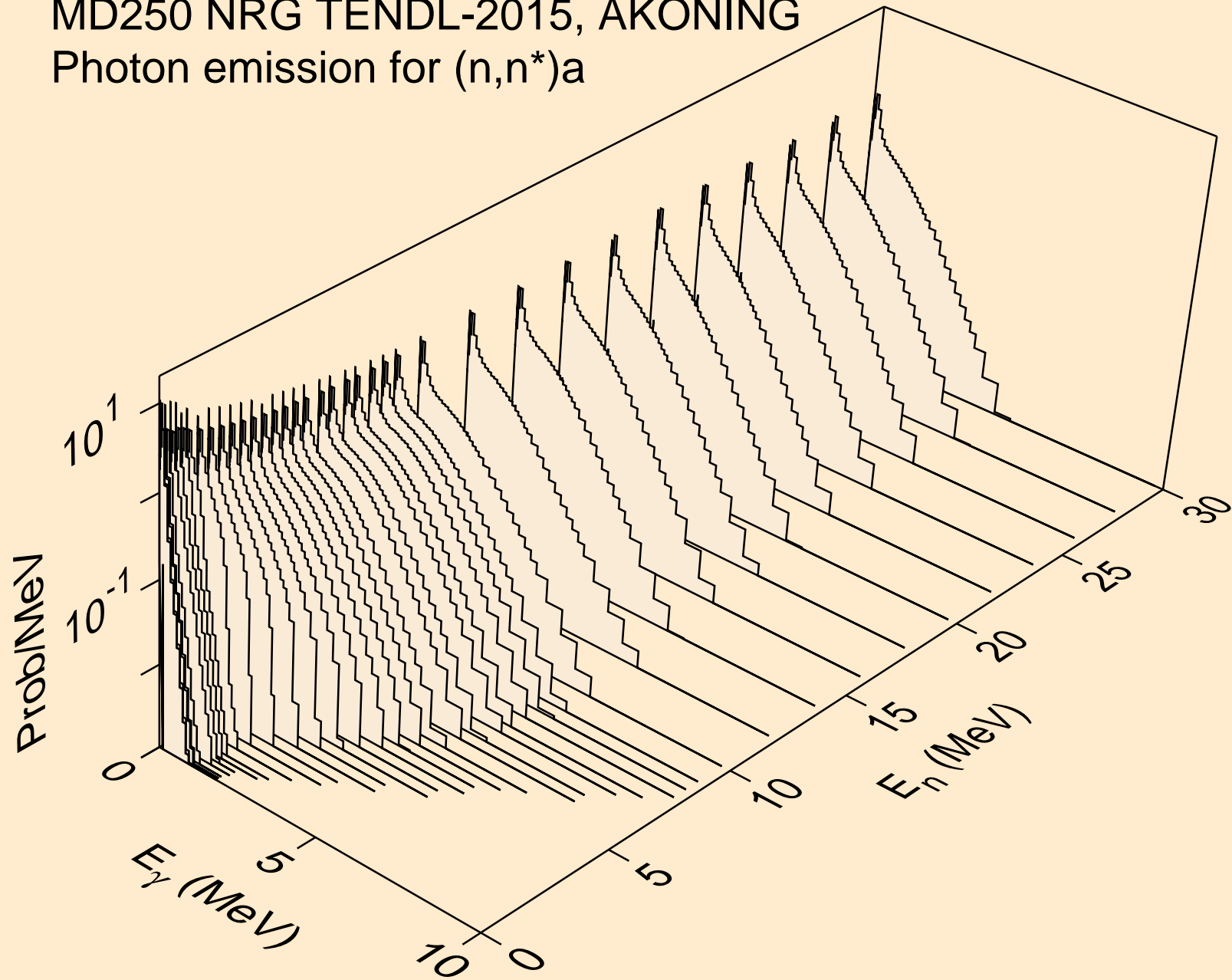

MD250 NRG TENDL-2015, AKONING
Photon emission for (n,n*)3a

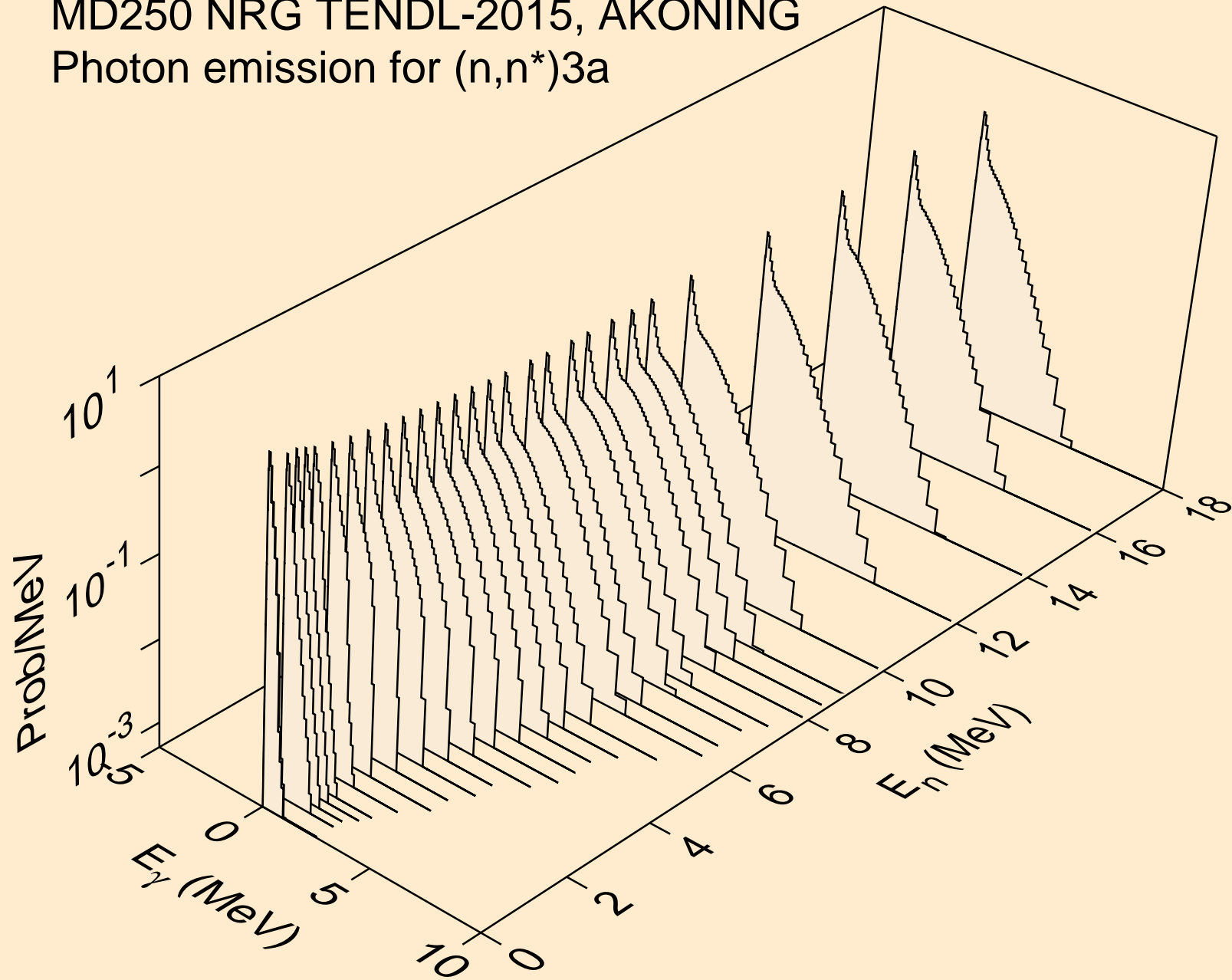

MD250 NRG TENDL-2015, AKONING
Photon emission for (n,2n)a

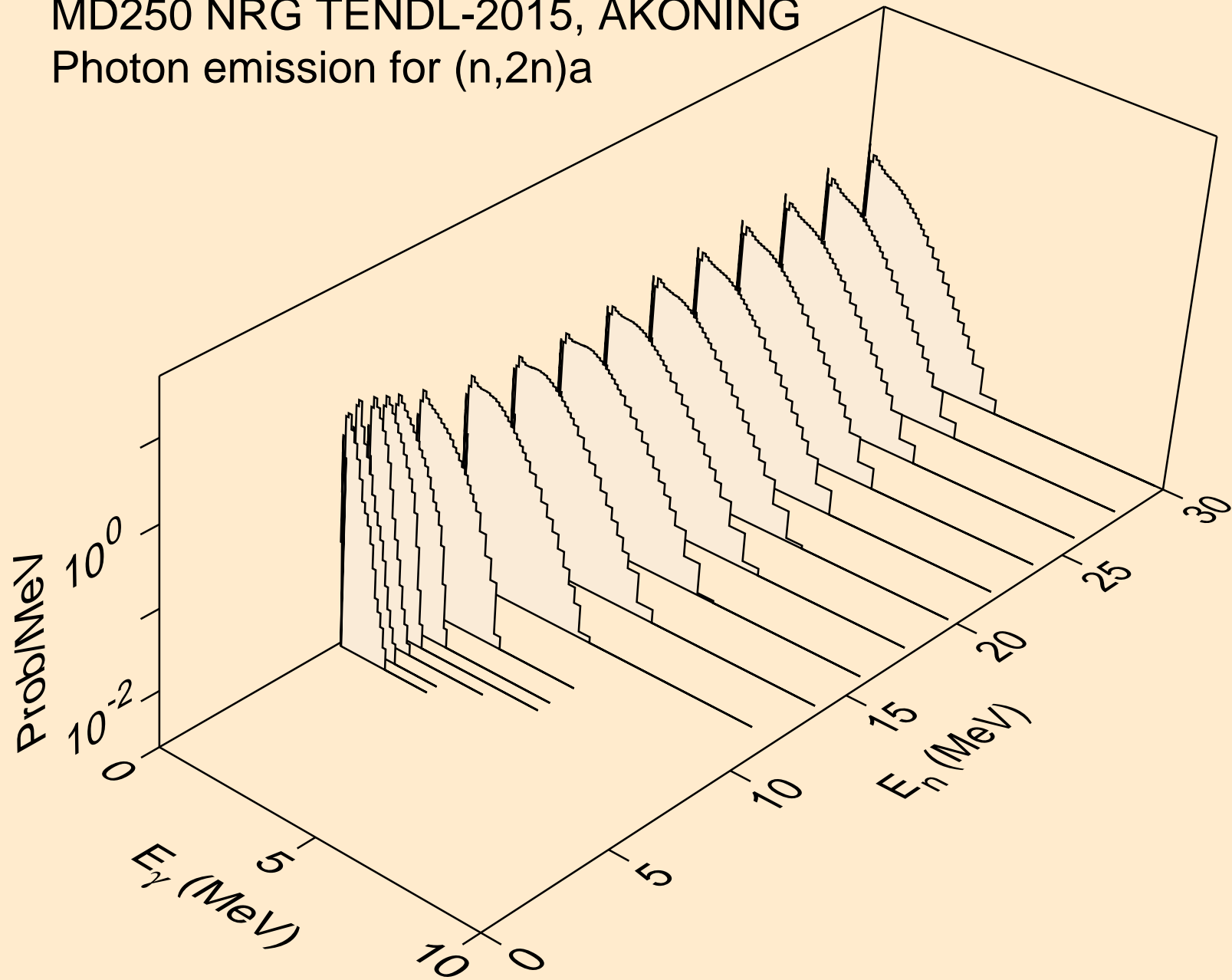

MD250 NRG TENDL-2015, AKONING
Photon emission for (n,3n)a

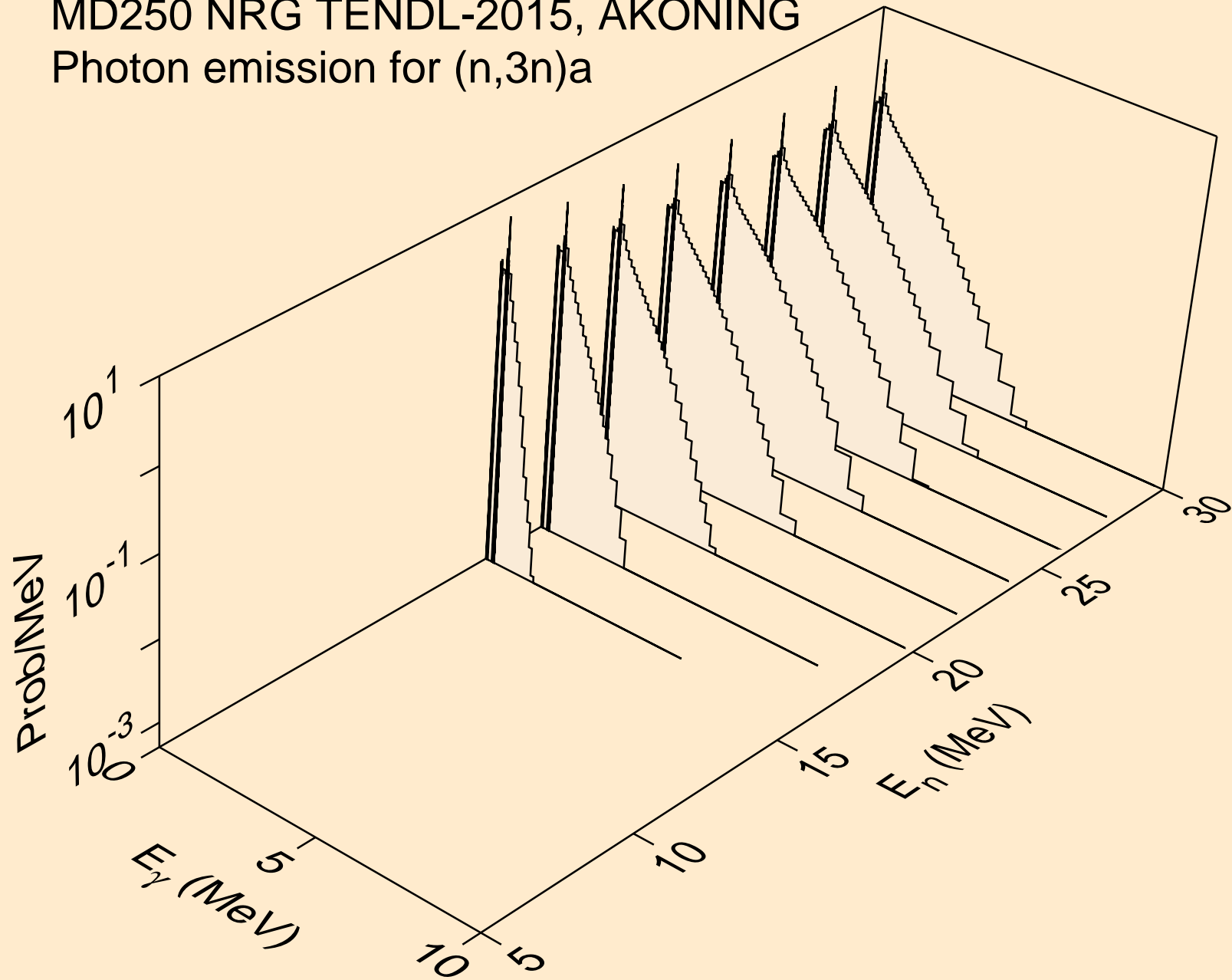

MD250 NRG TENDL-2015, AKONING
Photon emission for (n,n*)p

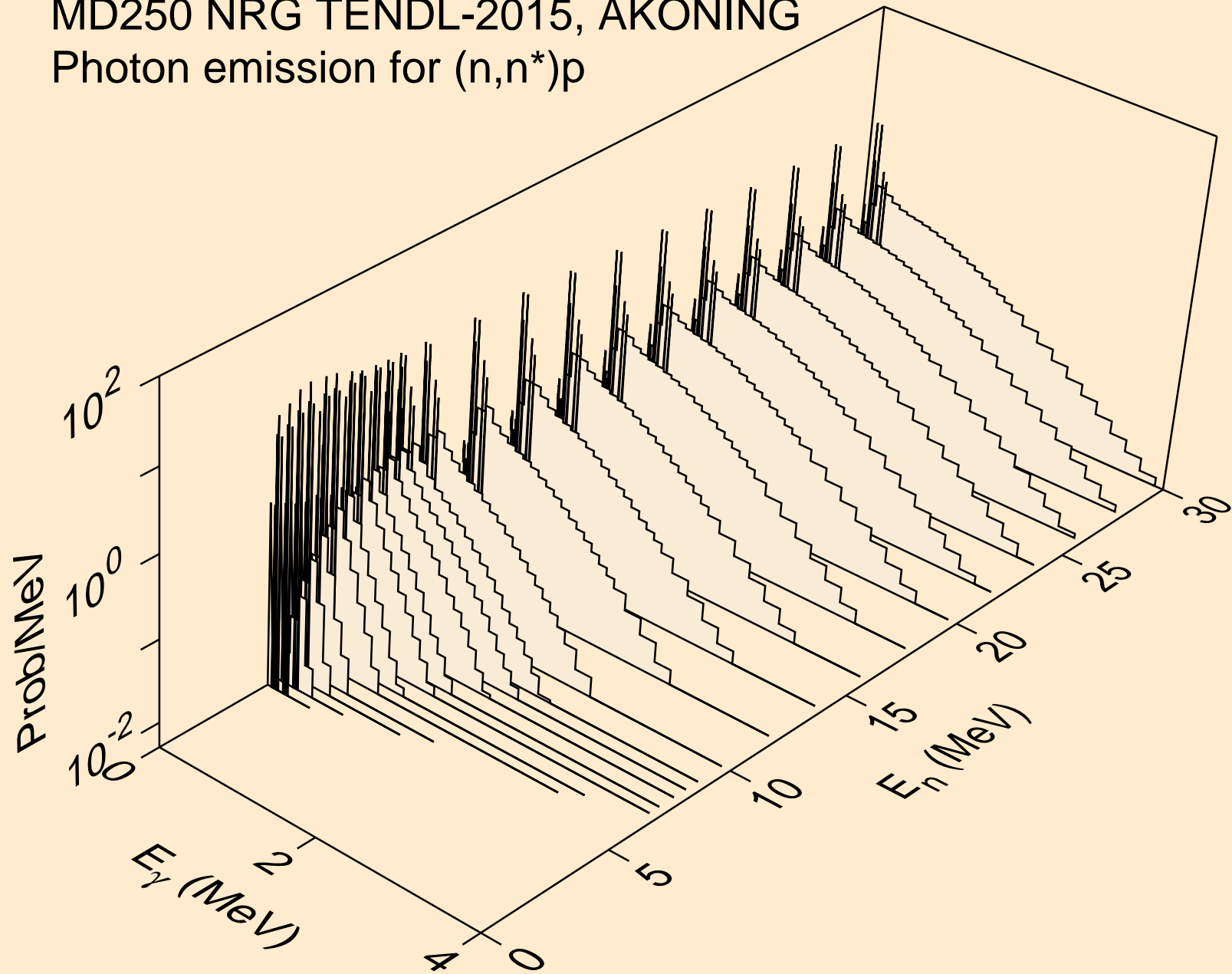

MD250 NRG TENDL-2015, AKONING
Photon emission for (n,n*)2a

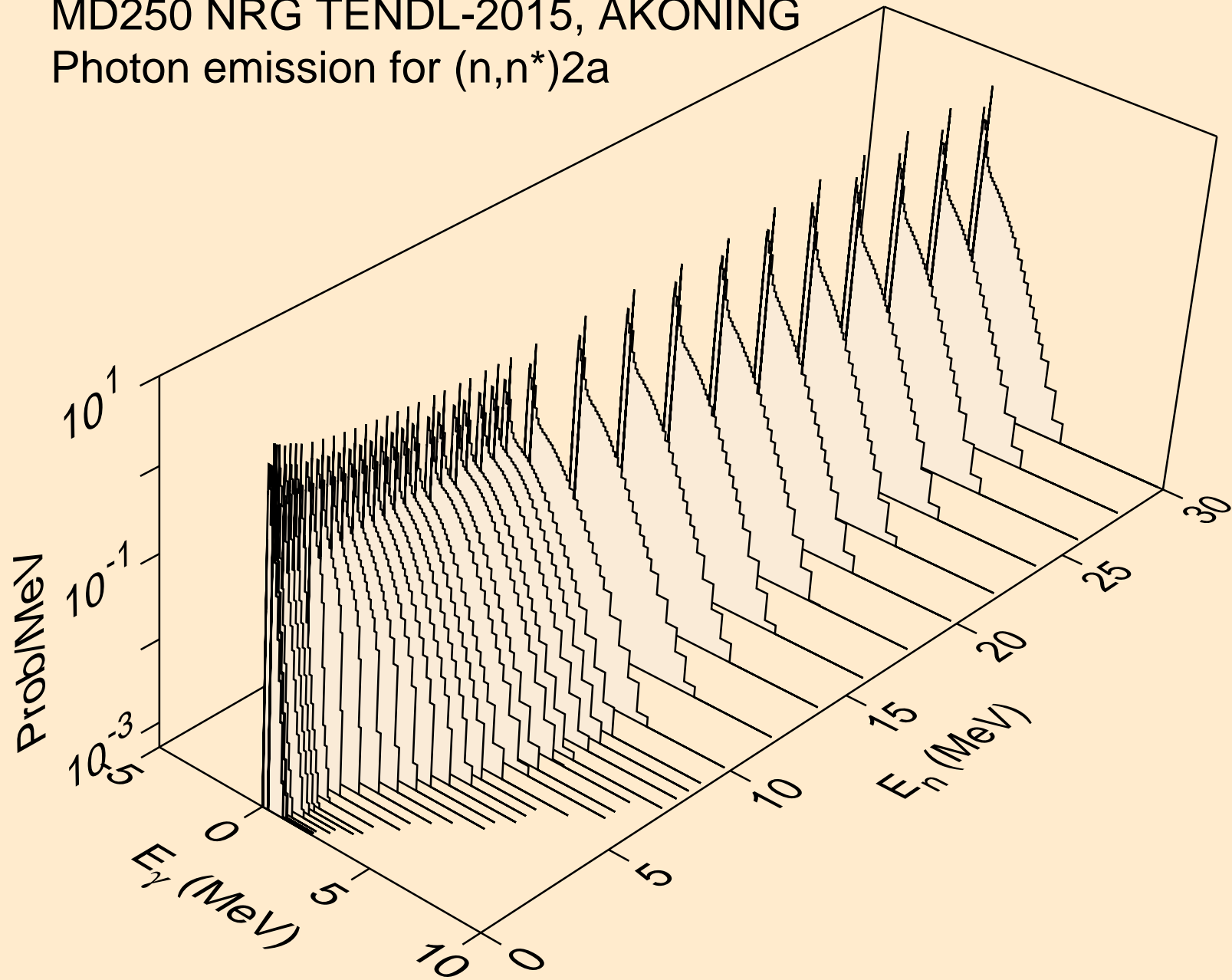

MD250 NRG TENDL-2015, AKONING
Photon emission for (n,2n)2a

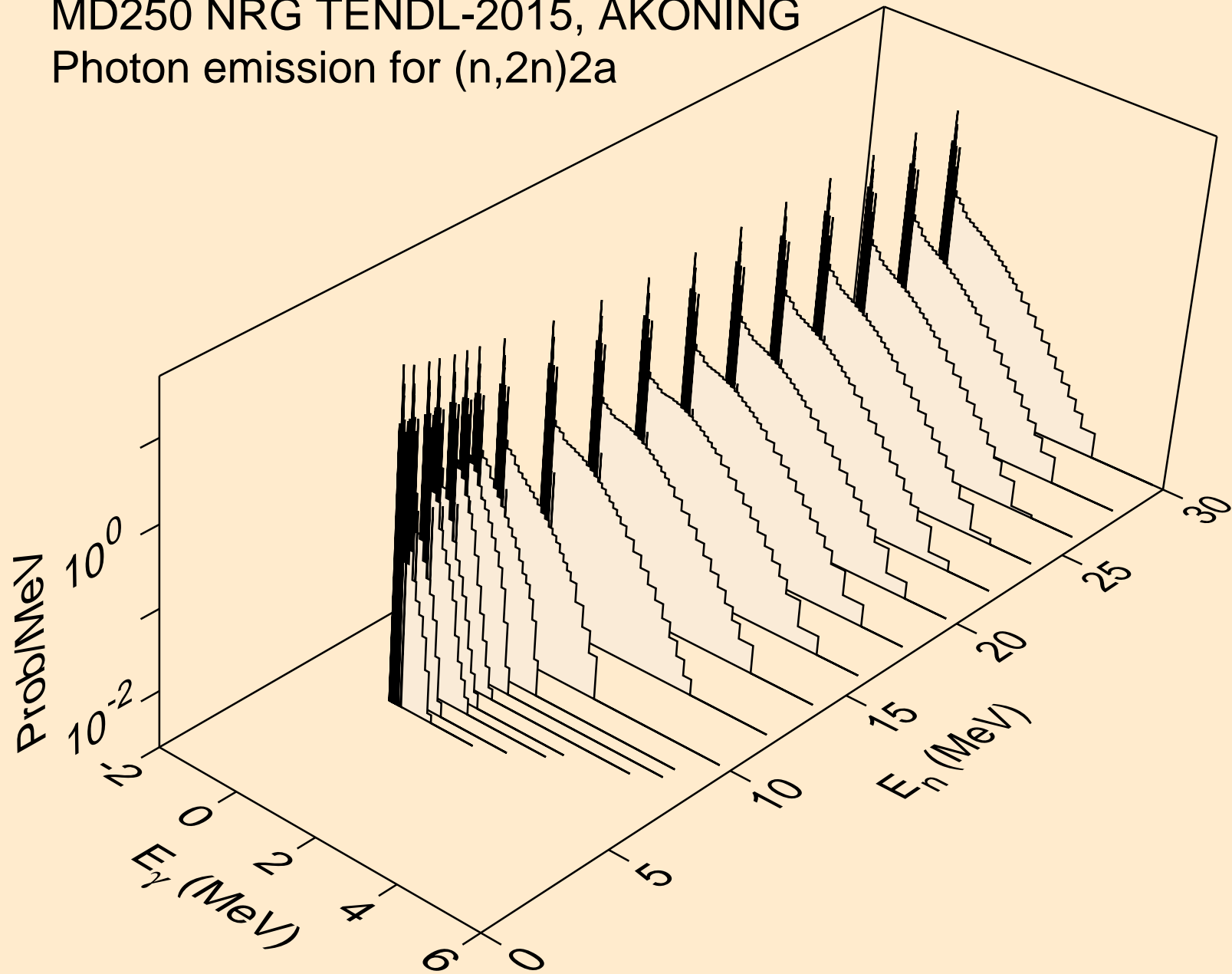

MD250 NRG TENDL-2015, AKONING
Photon emission for (n,n*)d

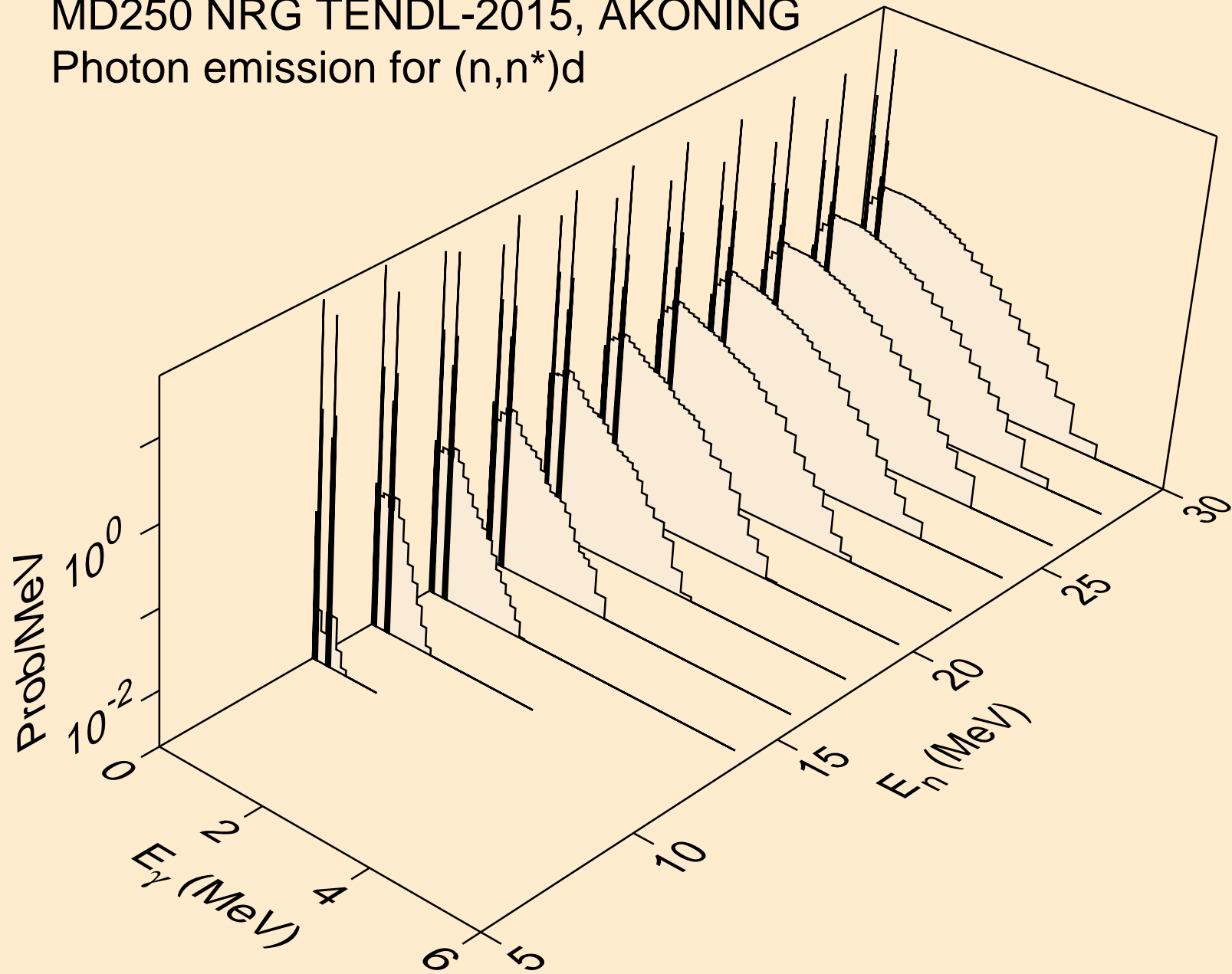

MD250 NRG TENDL-2015, AKONING
Photon emission for (n,n*)t

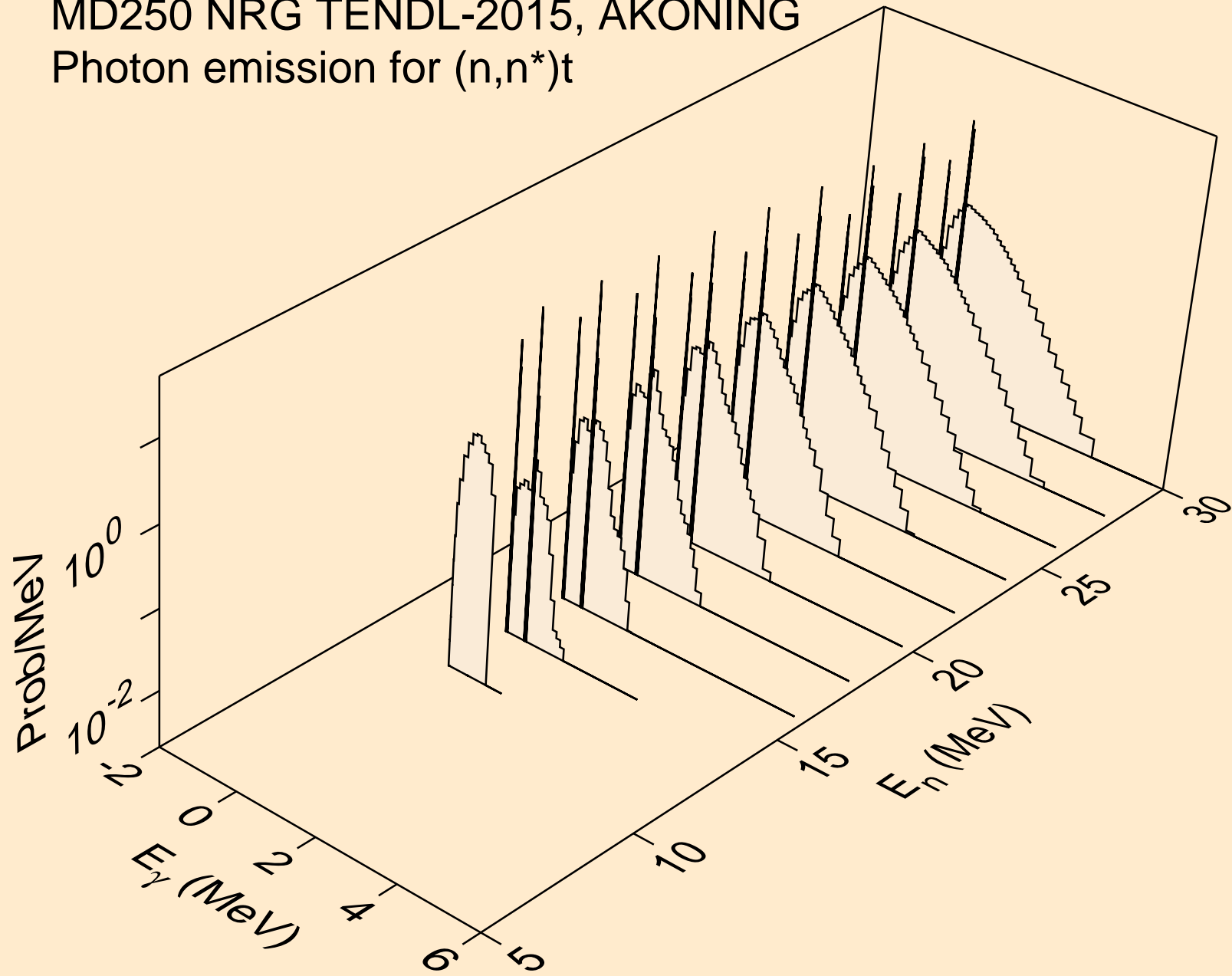

MD250 NRG TENDL-2015, AKONING
Photon emission for (n,n*)he3

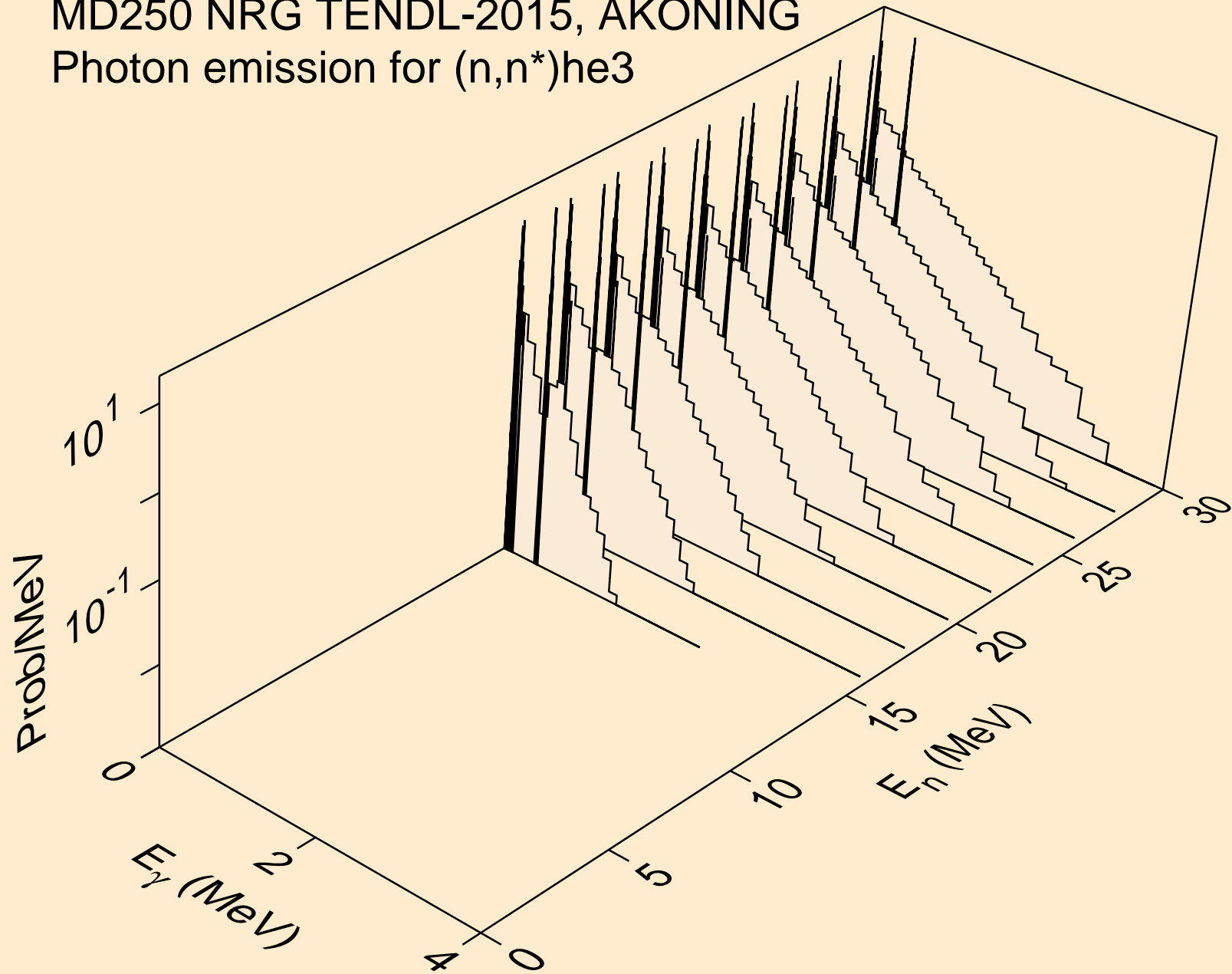

MD250 NRG TENDL-2015, AKONING
Photon emission for (n,n*)d2a

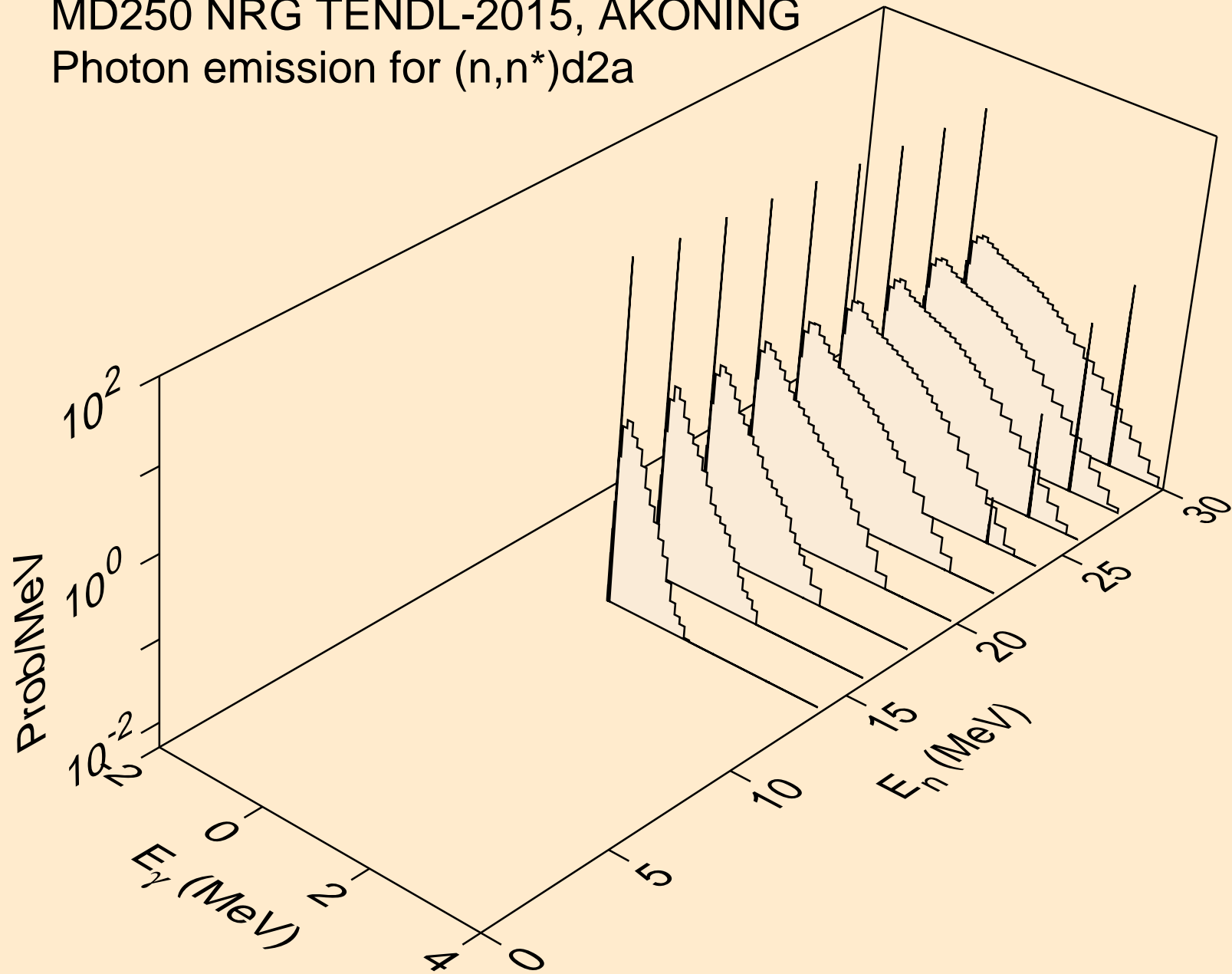

MD250 NRG TENDL-2015, AKONING
Photon emission for (n,n*)t2a

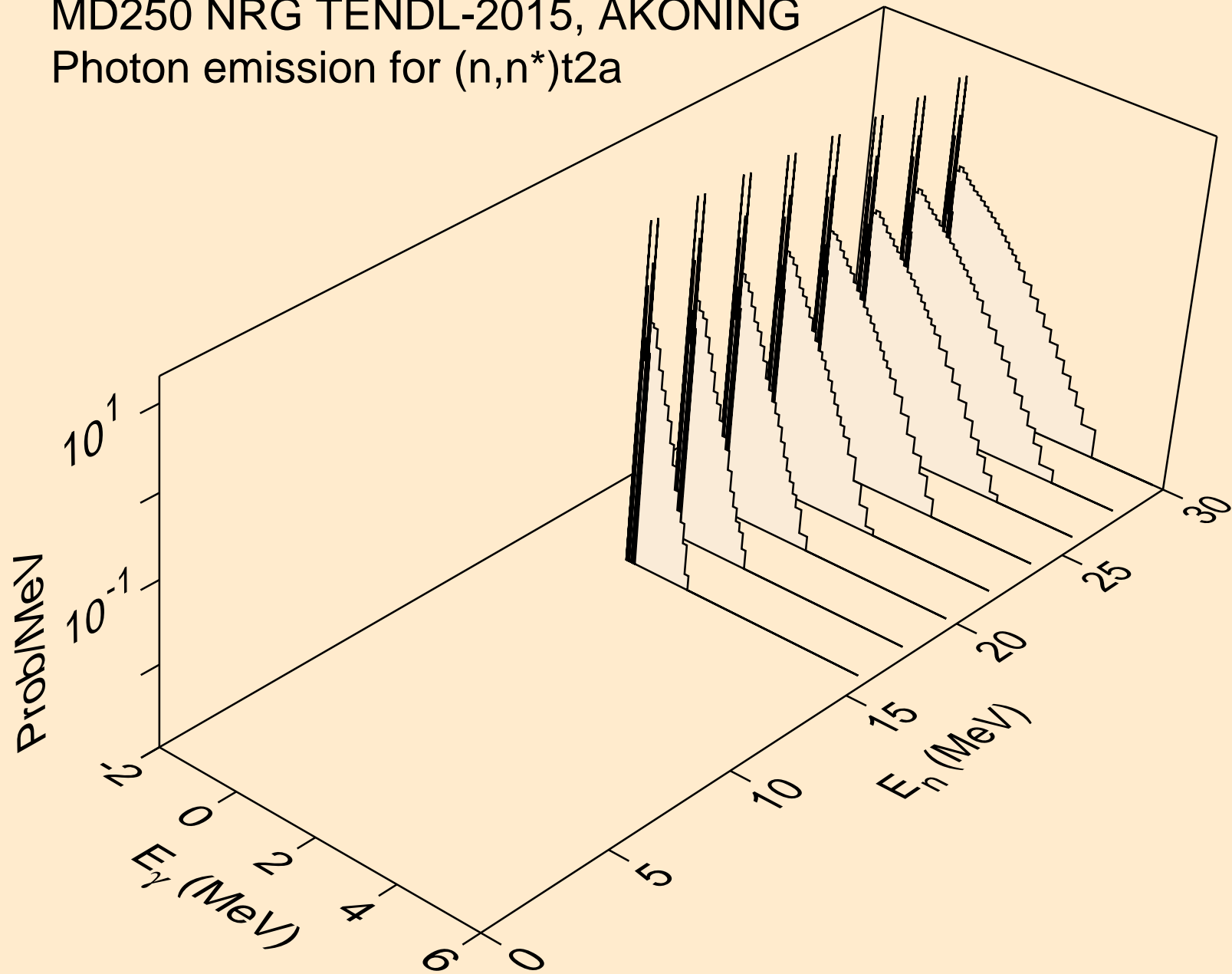

MD250 NRG TENDL-2015, AKONING
Photon emission for (n,4n)

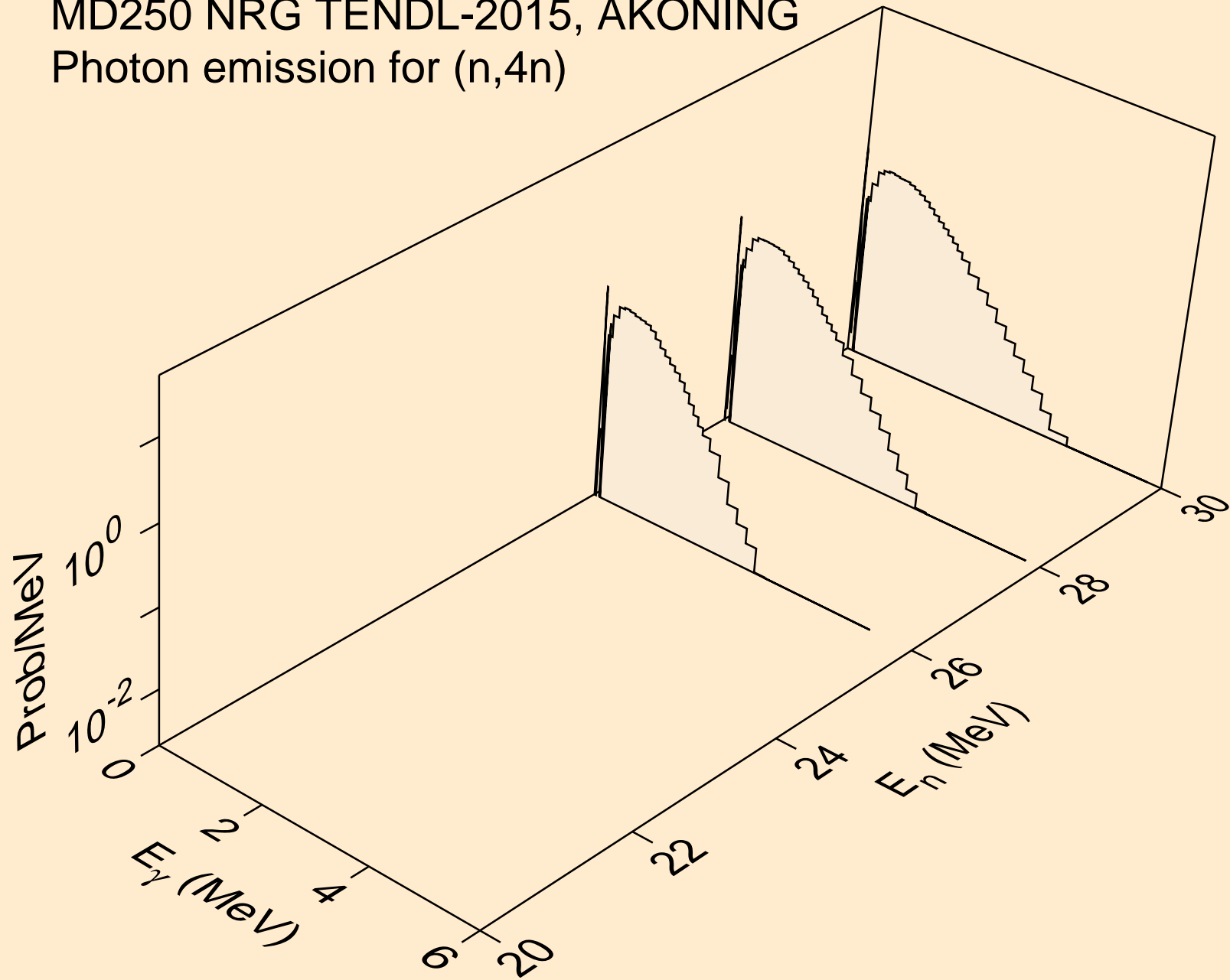

MD250 NRG TENDL-2015, AKONING
Photon emission for (n,2np)

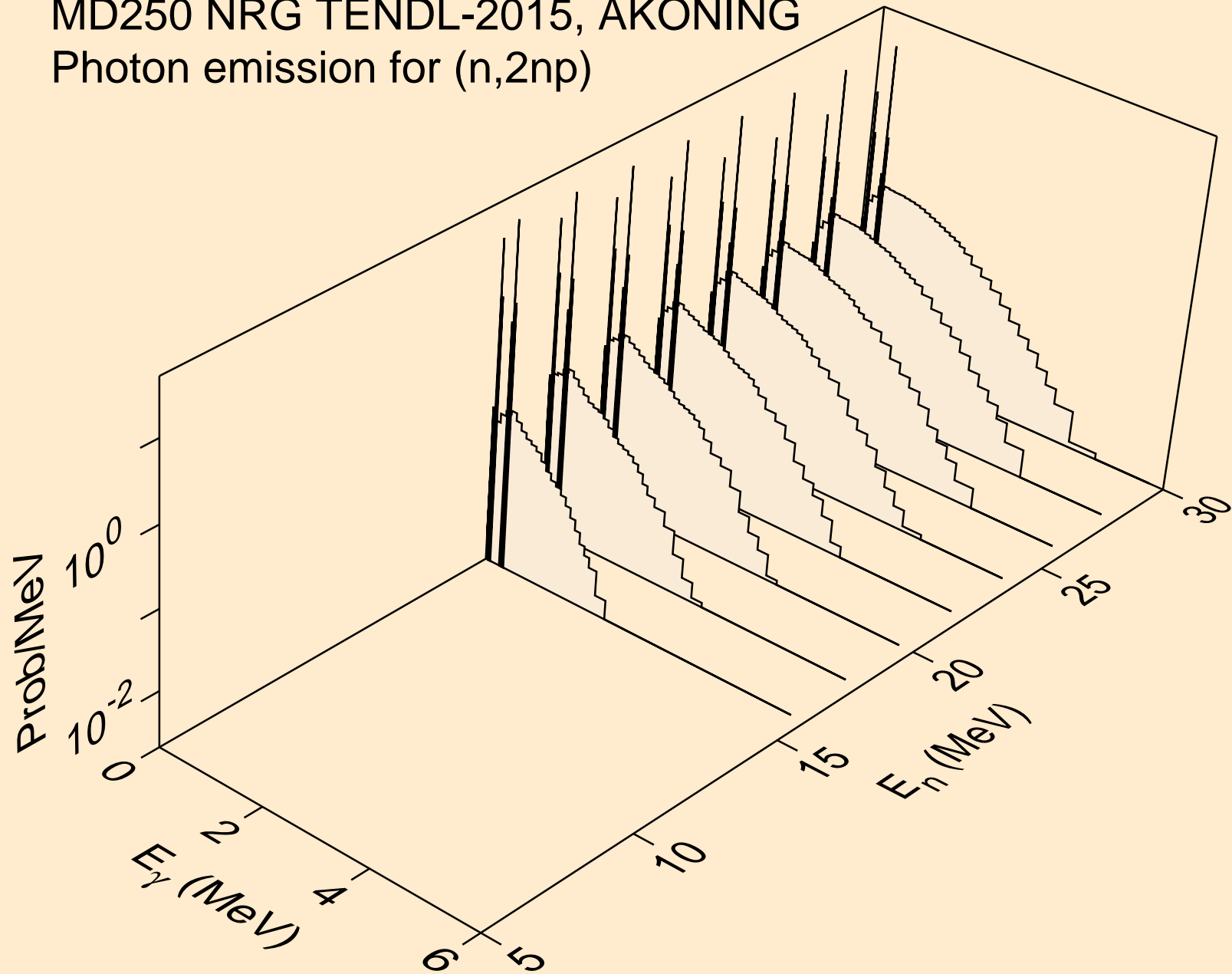

MD250 NRG TENDL-2015, AKONING
Photon emission for (n,3np)

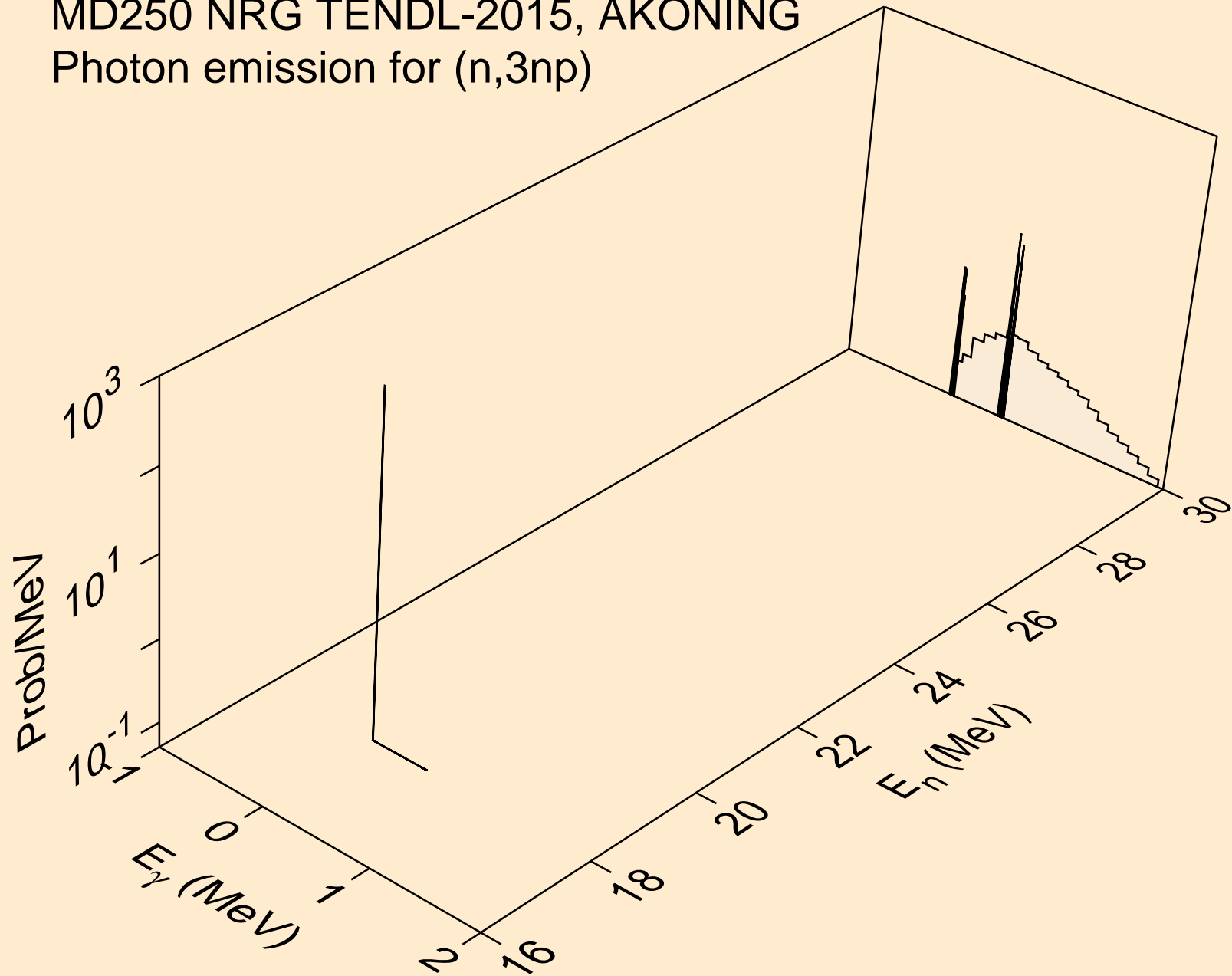

MD250 NRG TENDL-2015, AKONING
Photon emission for (n,2np)

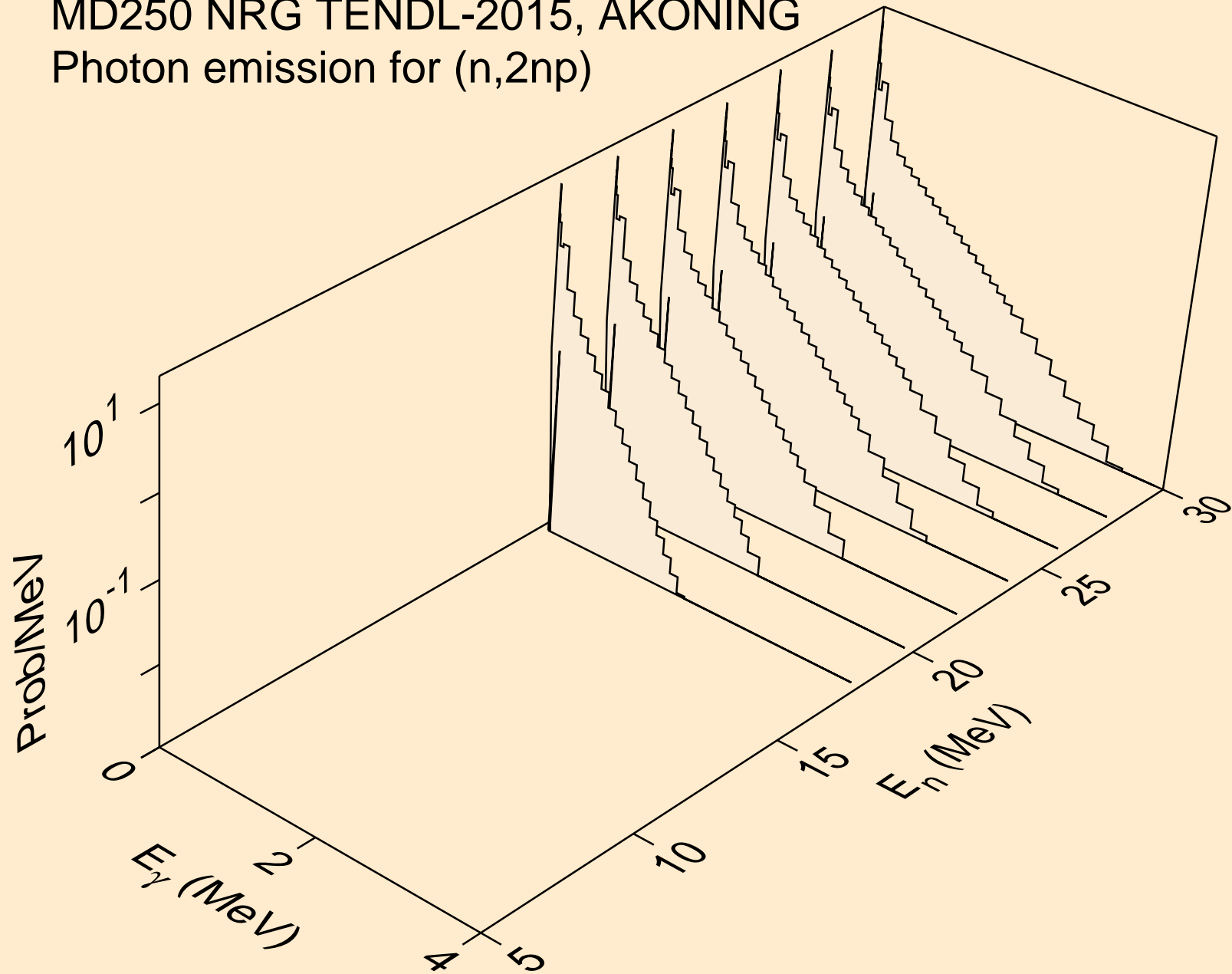

MD250 NRG TENDL-2015, AKONING
Photon emission for (n,npa)

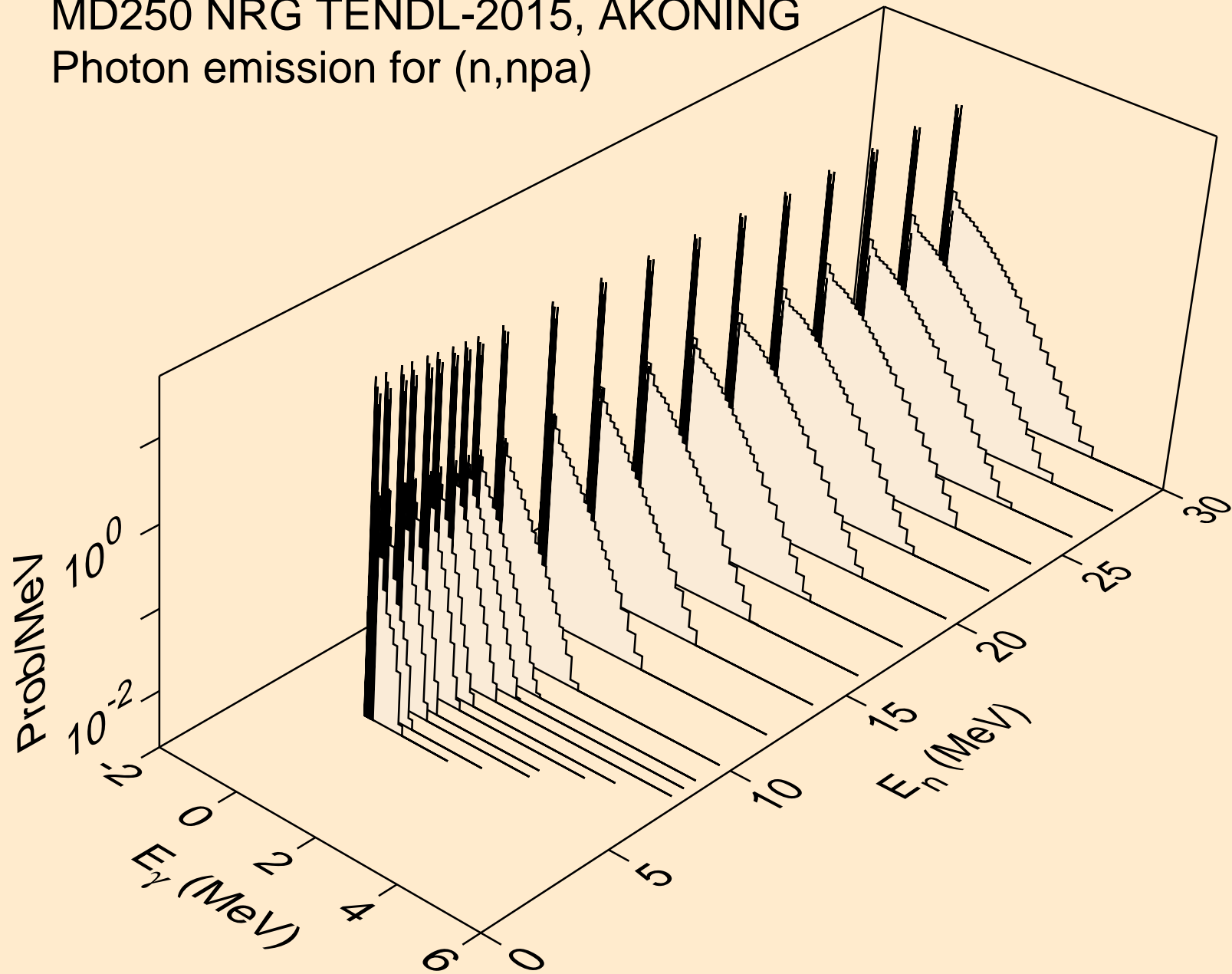

MD250 NRG TENDL-2015, AKONING
Photon emission for (n,n*c)

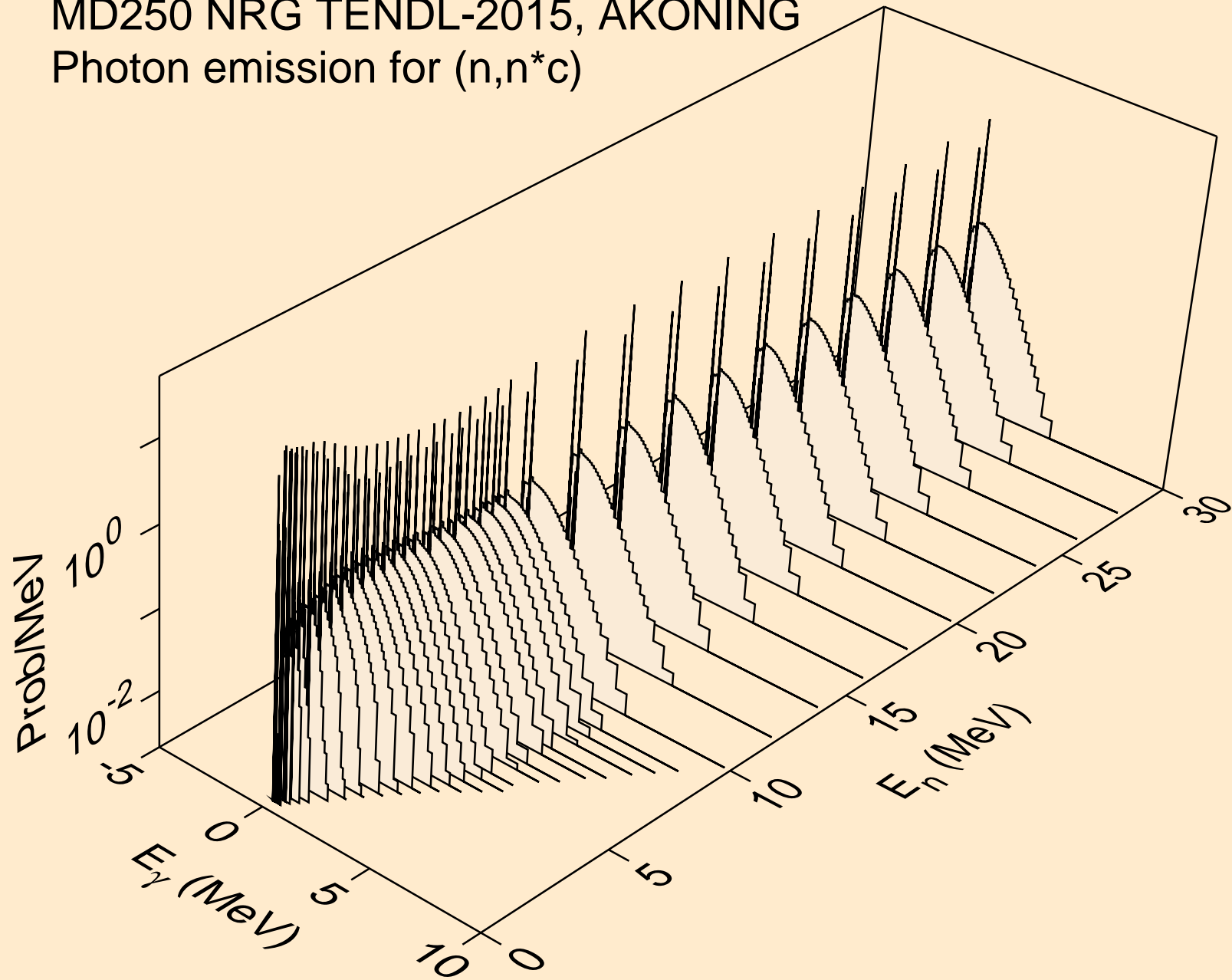

MD250 NRG TENDL-2015, AKONING
Photon emission for (n,gma)

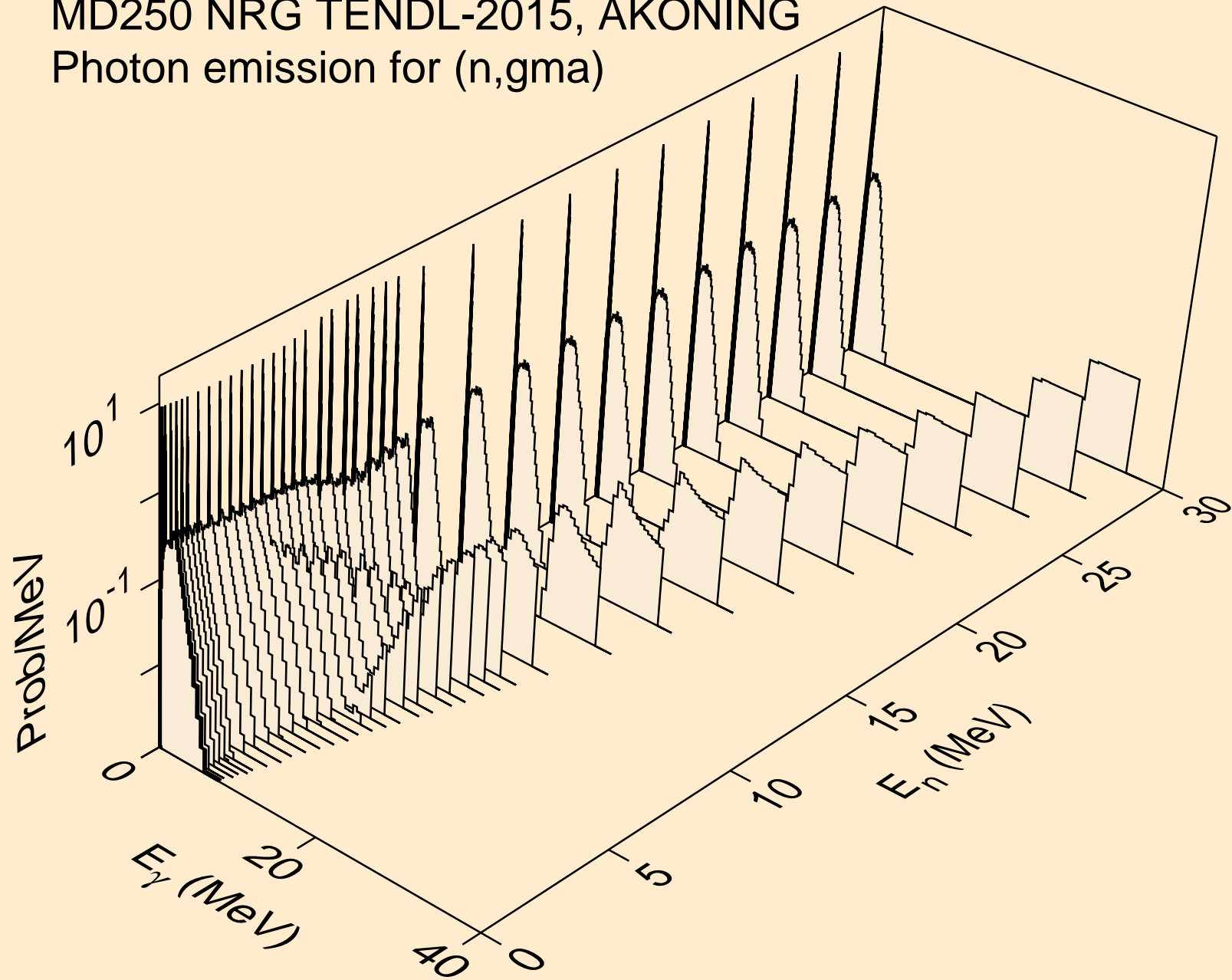

MD250 NRG TENDL-2015, AKONING
Photon emission for (n,p)

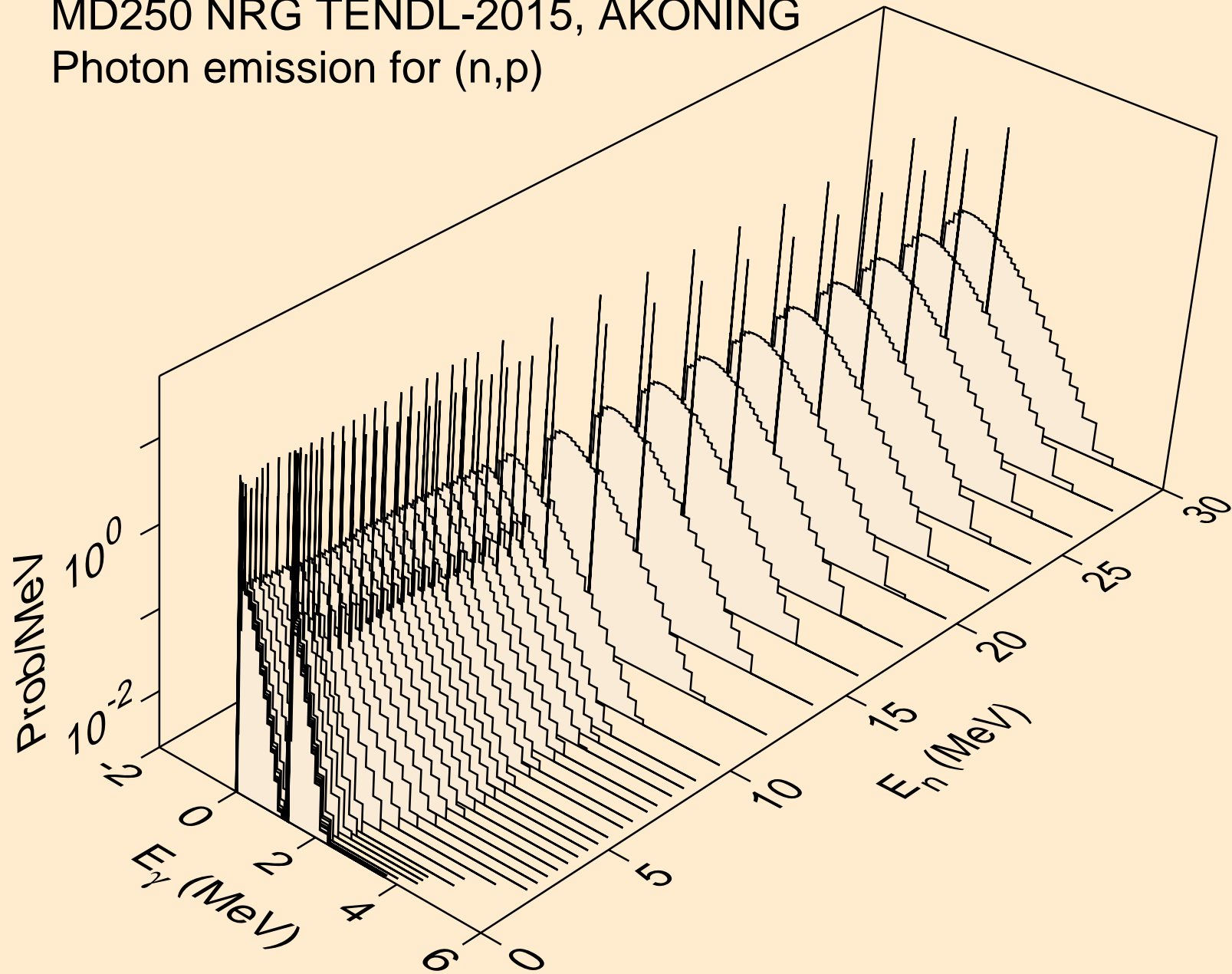

MD250 NRG TENDL-2015, AKONING
Photon emission for (n,d)

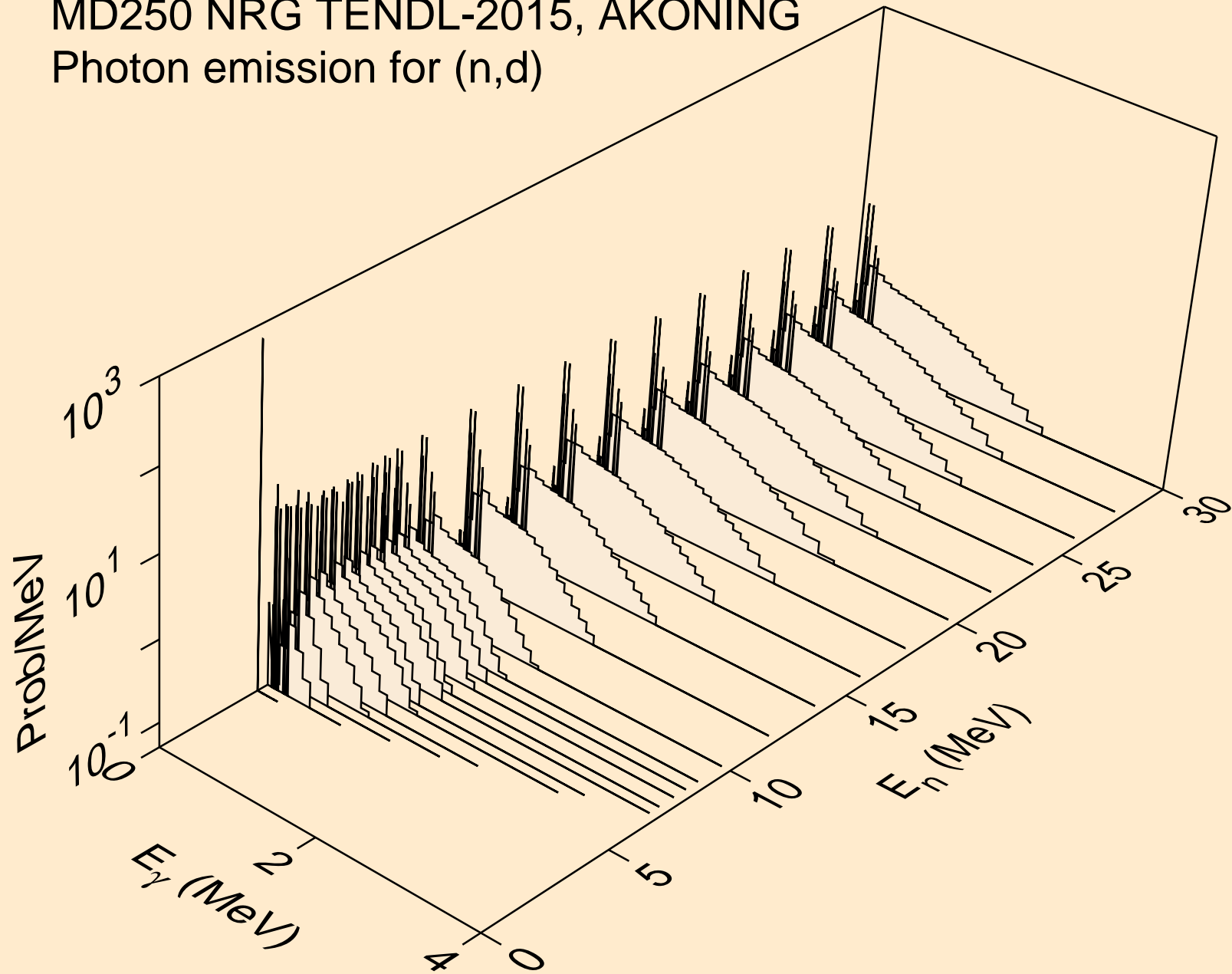

MD250 NRG TENDL-2015, AKONING
Photon emission for (n,t)

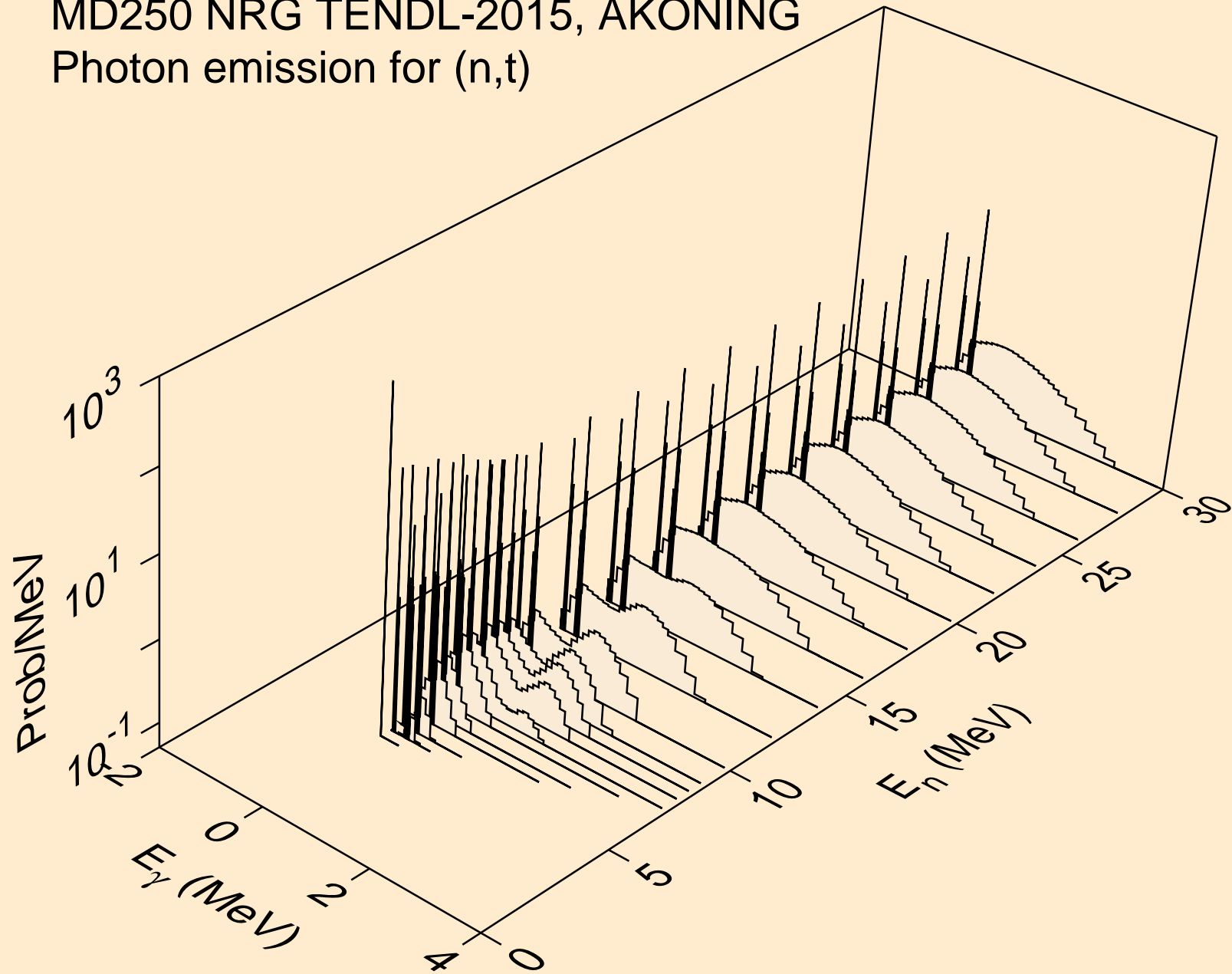

MD250 NRG TENDL-2015, AKONING
Photon emission for (n,he3)

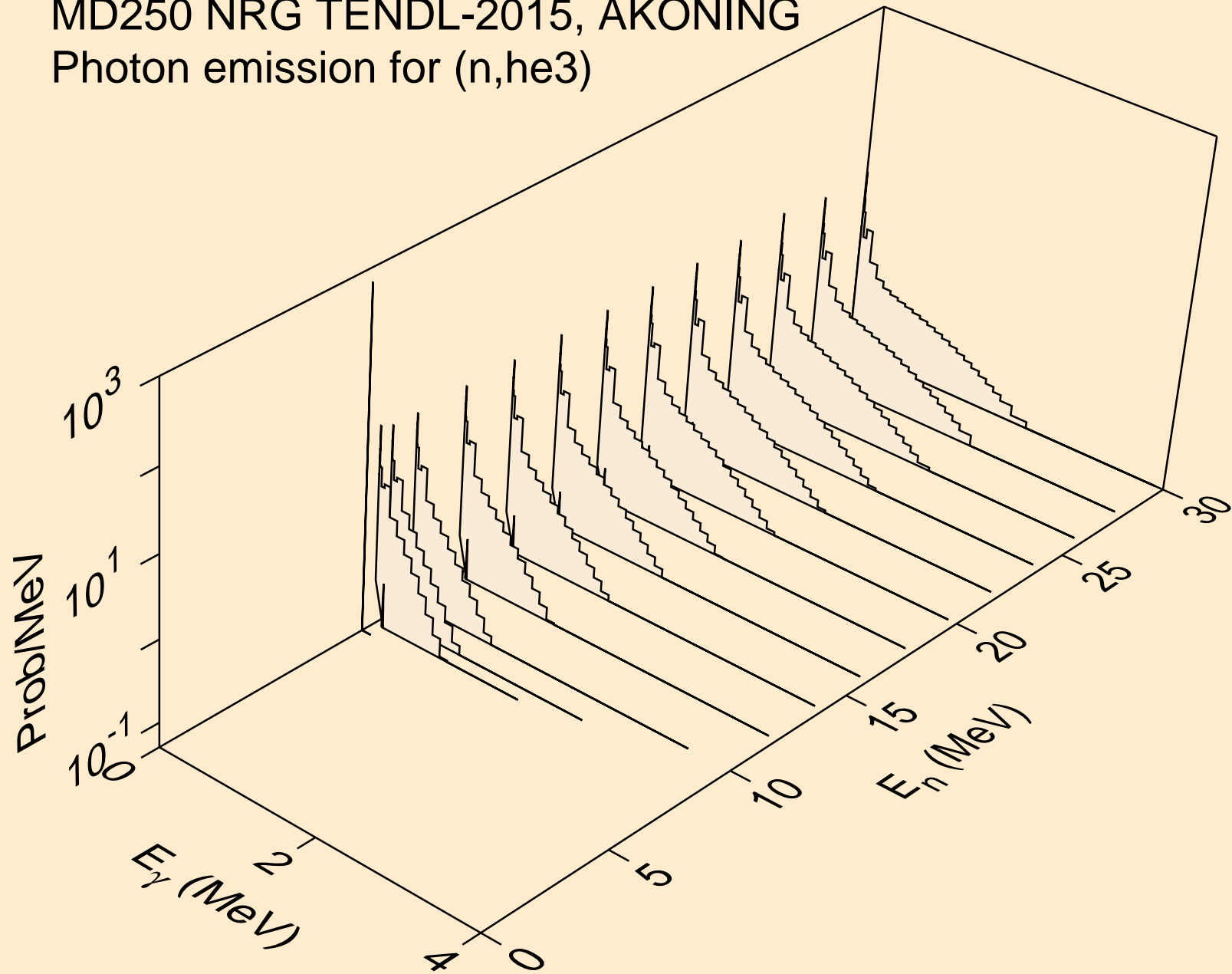

MD250 NRG TENDL-2015, AKONING
Photon emission for (n,a)

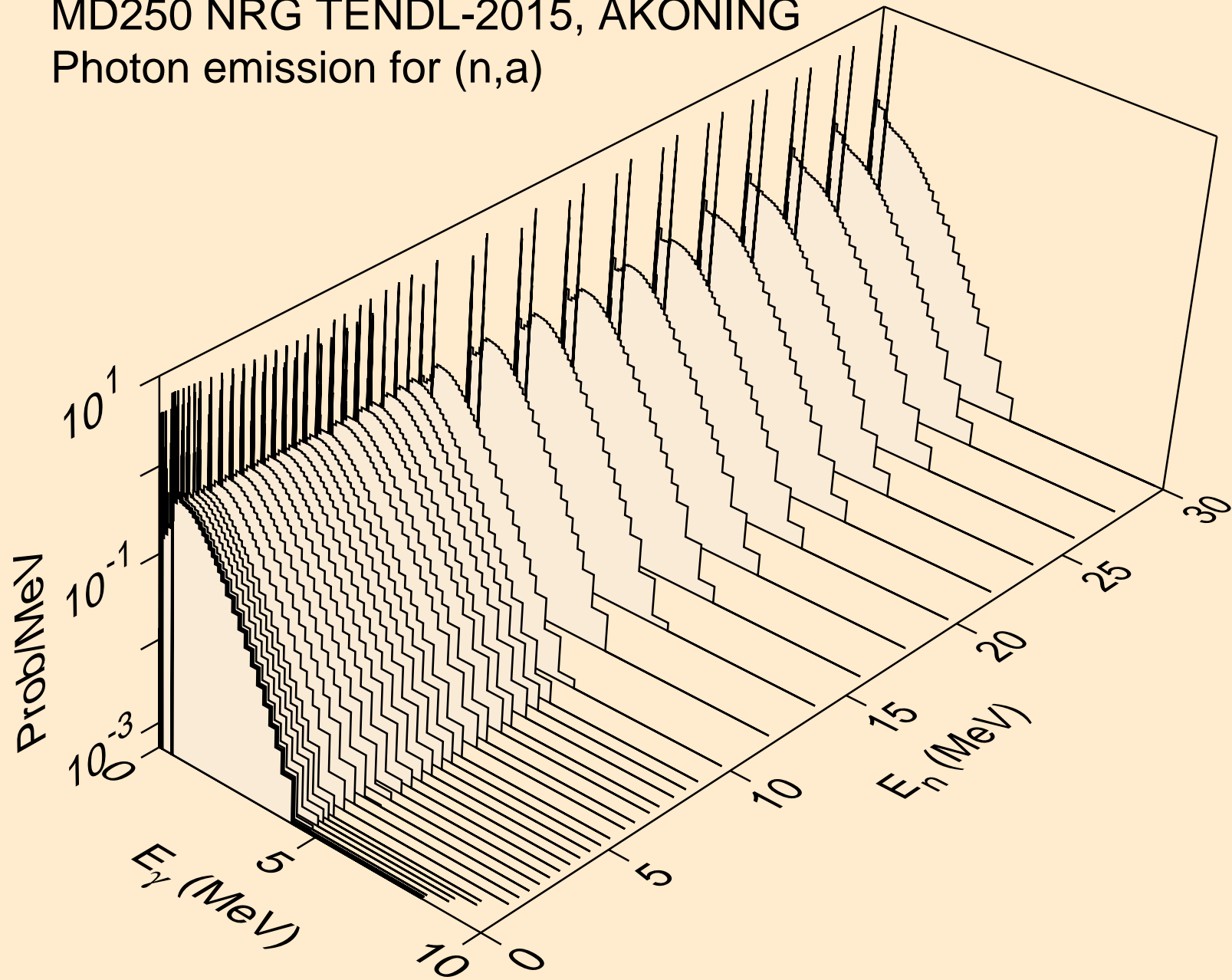

MD250 NRG TENDL-2015, AKONING
Photon emission for (n,2a)

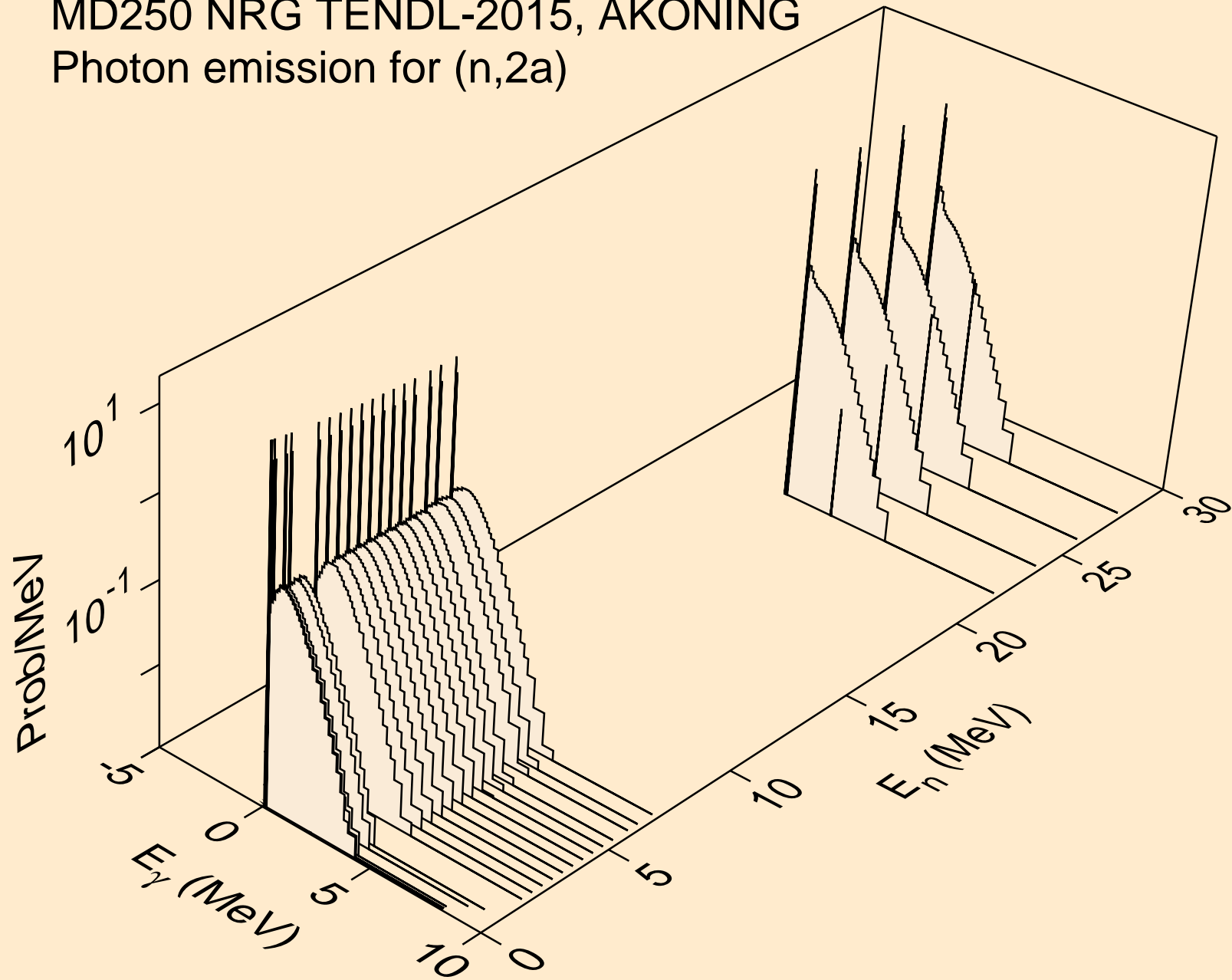

MD250 NRG TENDL-2015, AKONING
Photon emission for (n,3a)

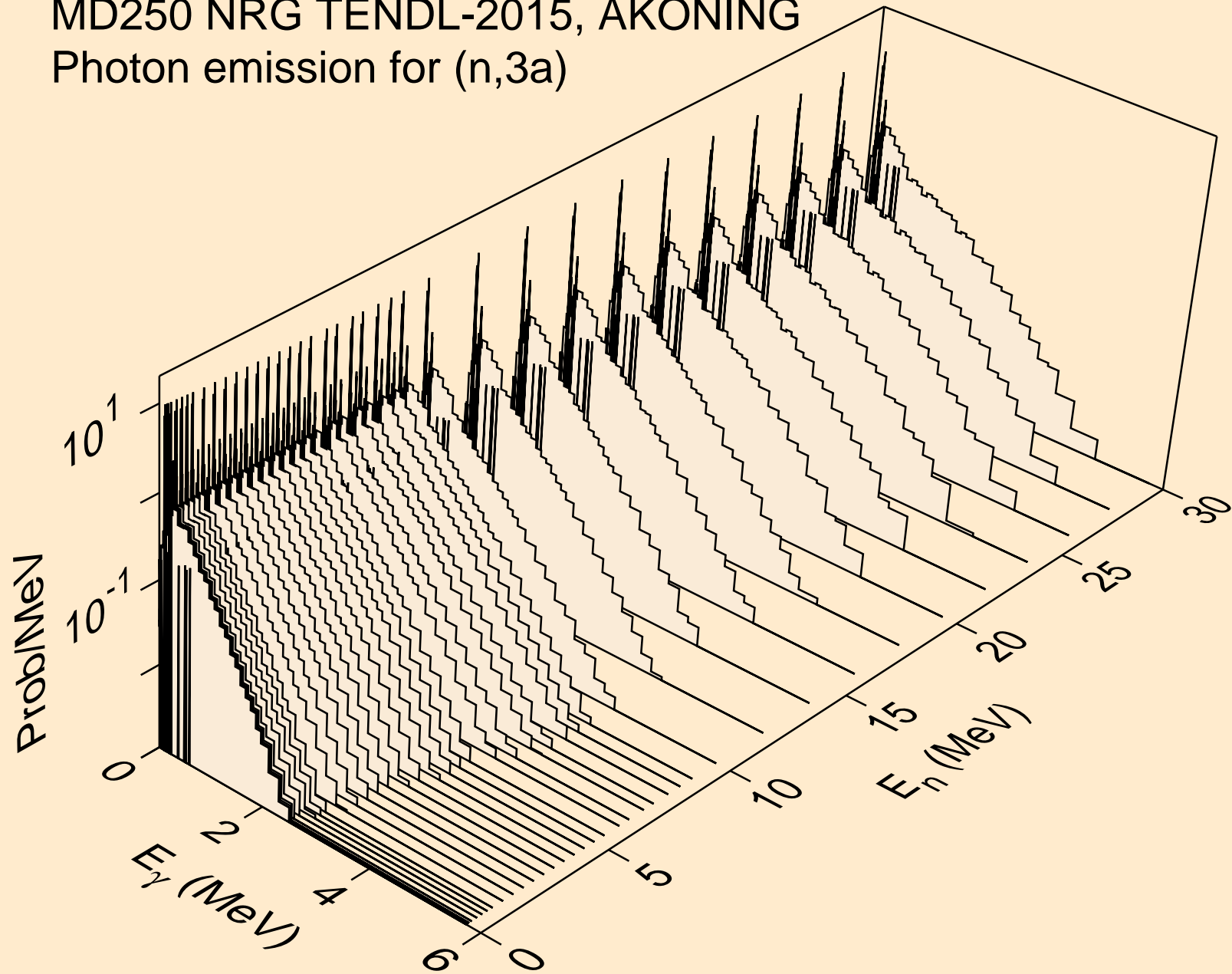

MD250 NRG TENDL-2015, AKONING
Photon emission for (n,2p)

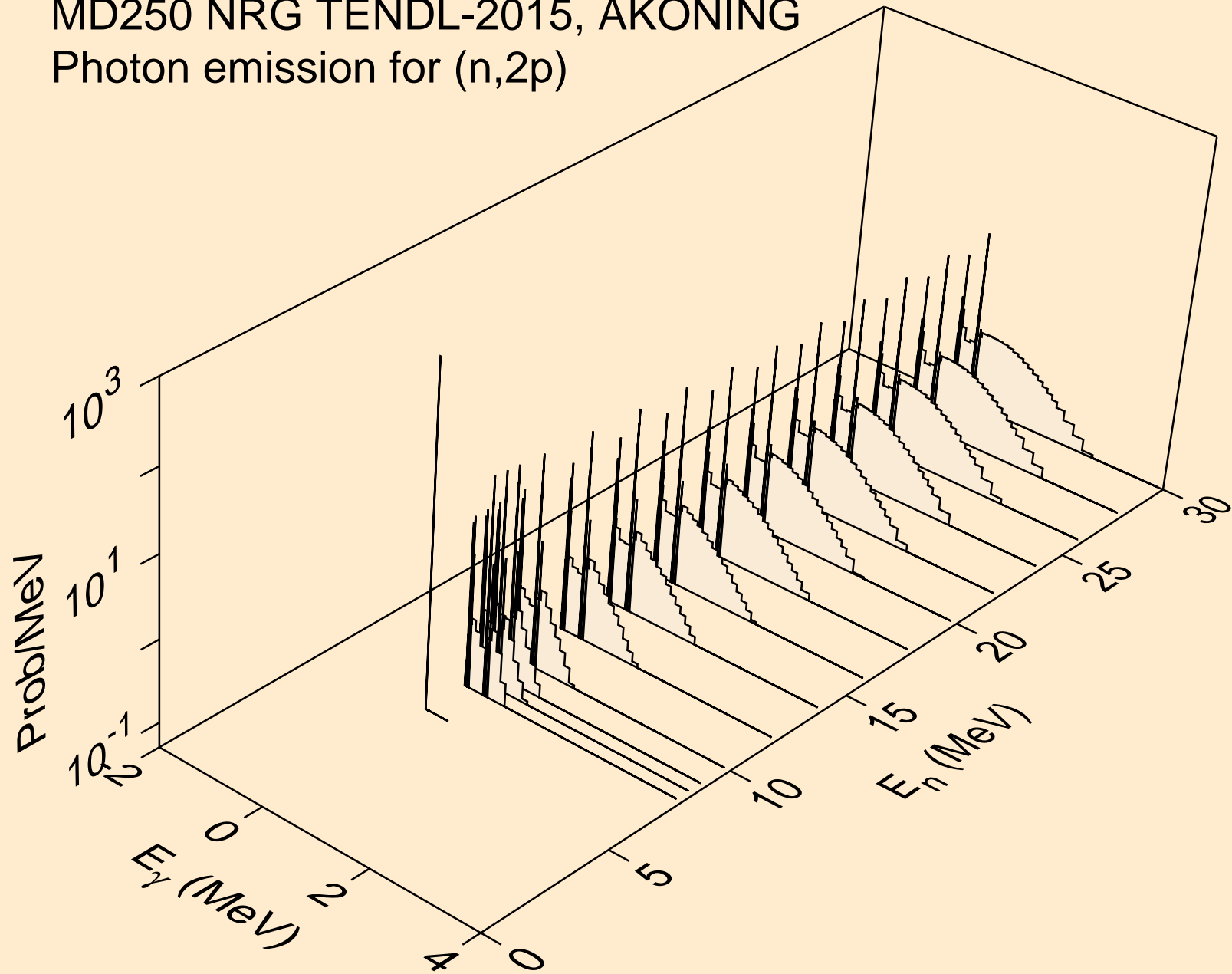

MD250 NRG TENDL-2015, AKONING
Photon emission for (n,p)

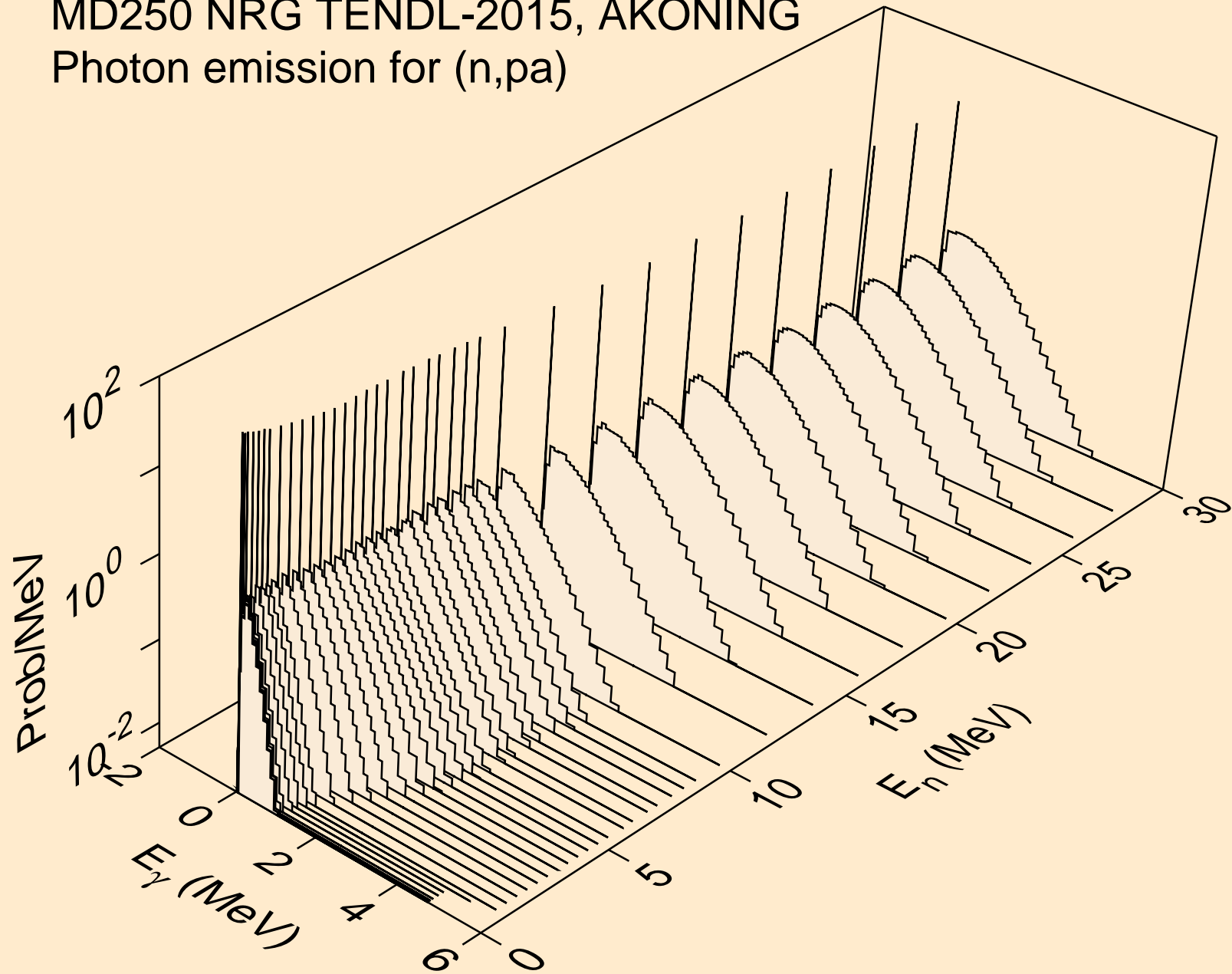

MD250 NRG TENDL-2015, AKONING
Photon emission for (n,t2a)

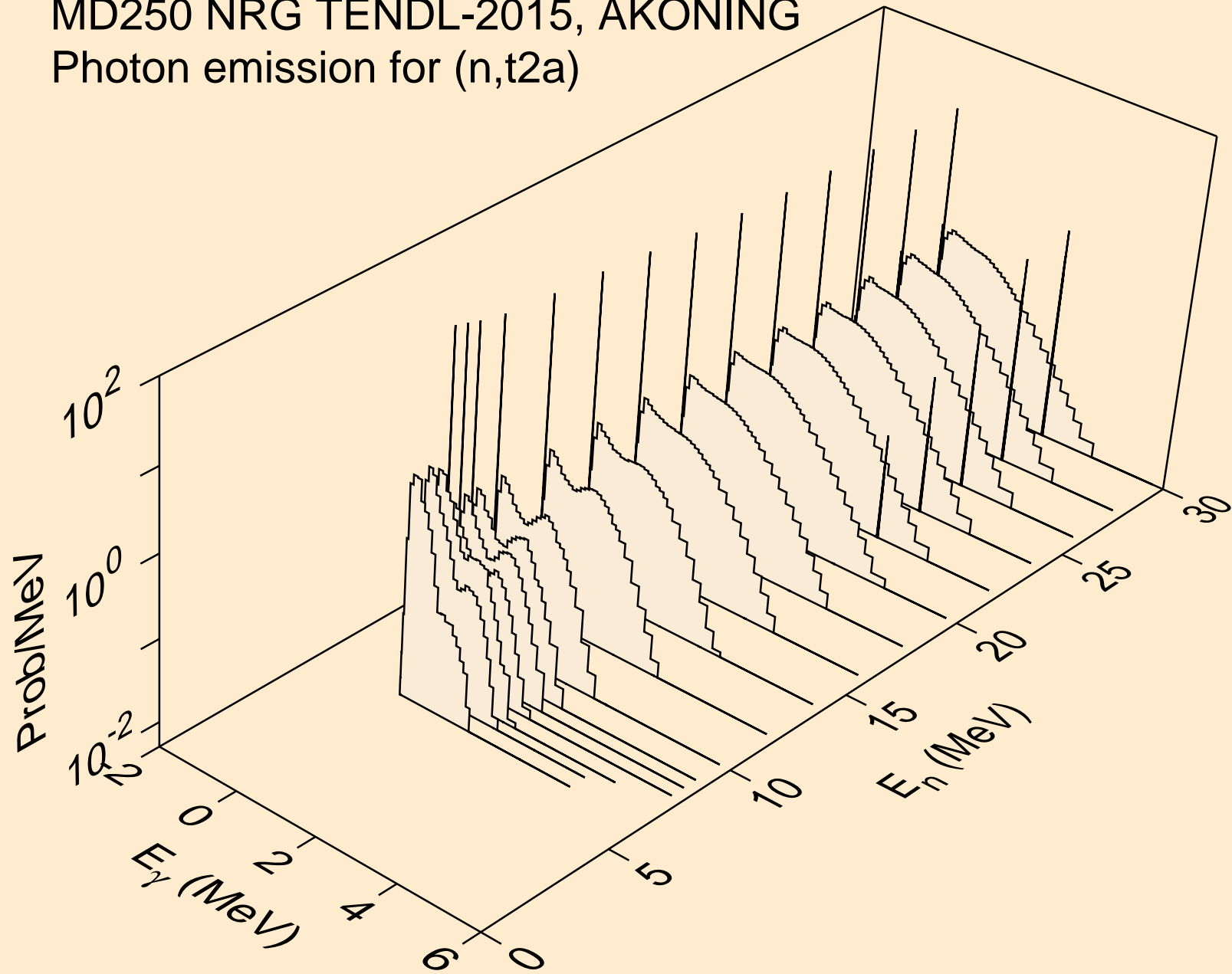

MD250 NRG TENDL-2015, AKONING
Photon emission for (n,d2a)

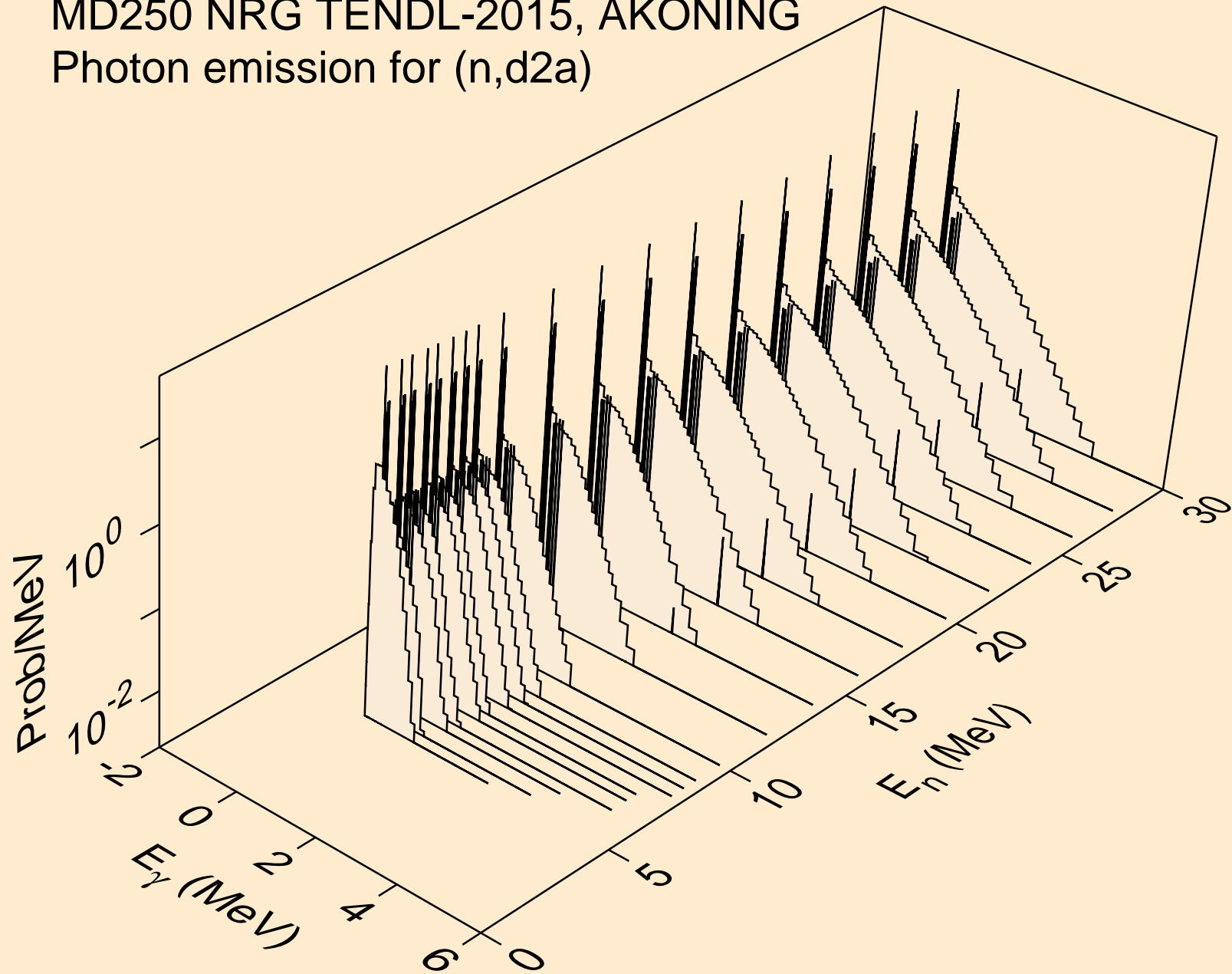

MD250 NRG TENDL-2015, AKONING
Photon emission for (n,pd)

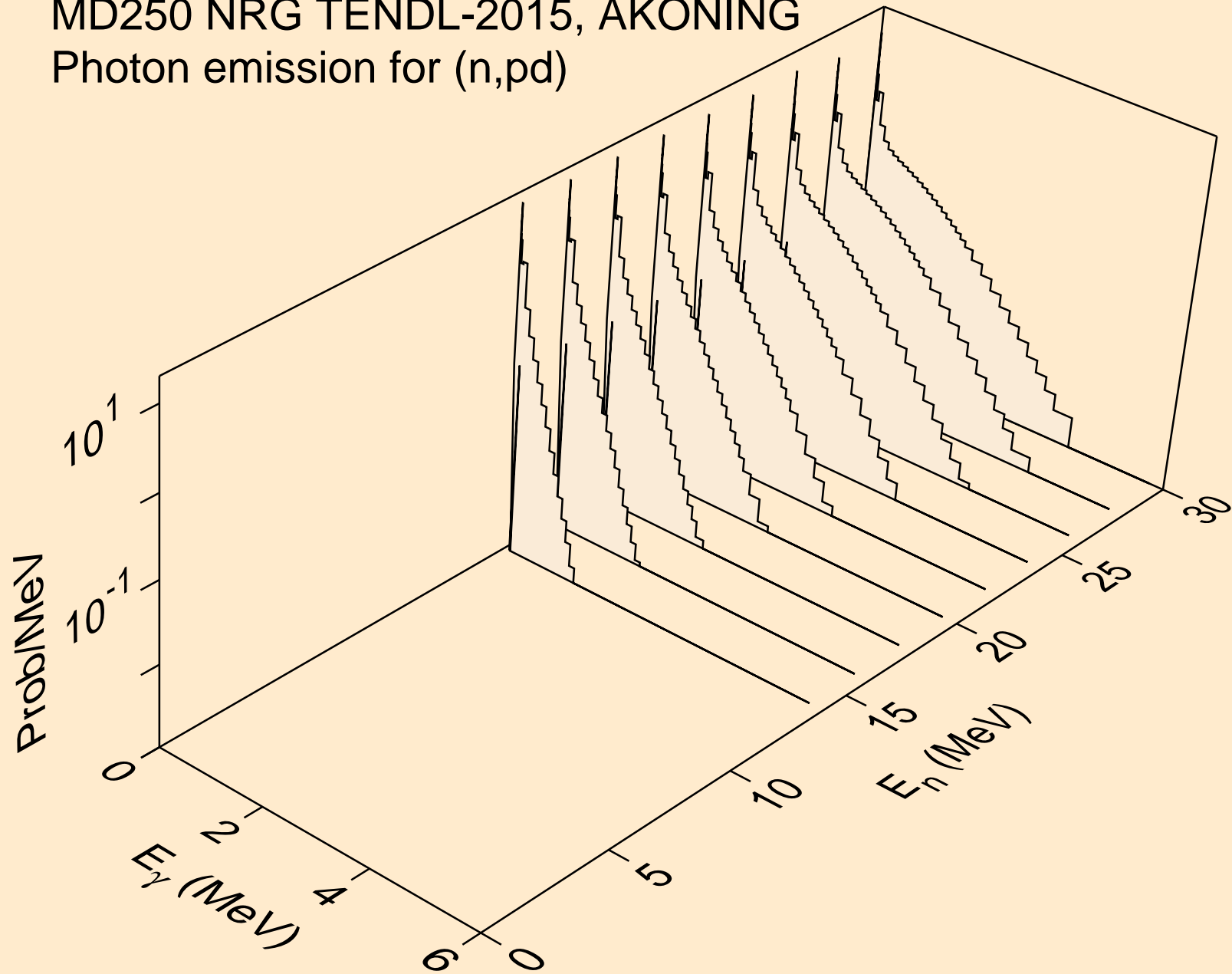

MD250 NRG TENDL-2015, AKONING
Photon emission for (n,pt)

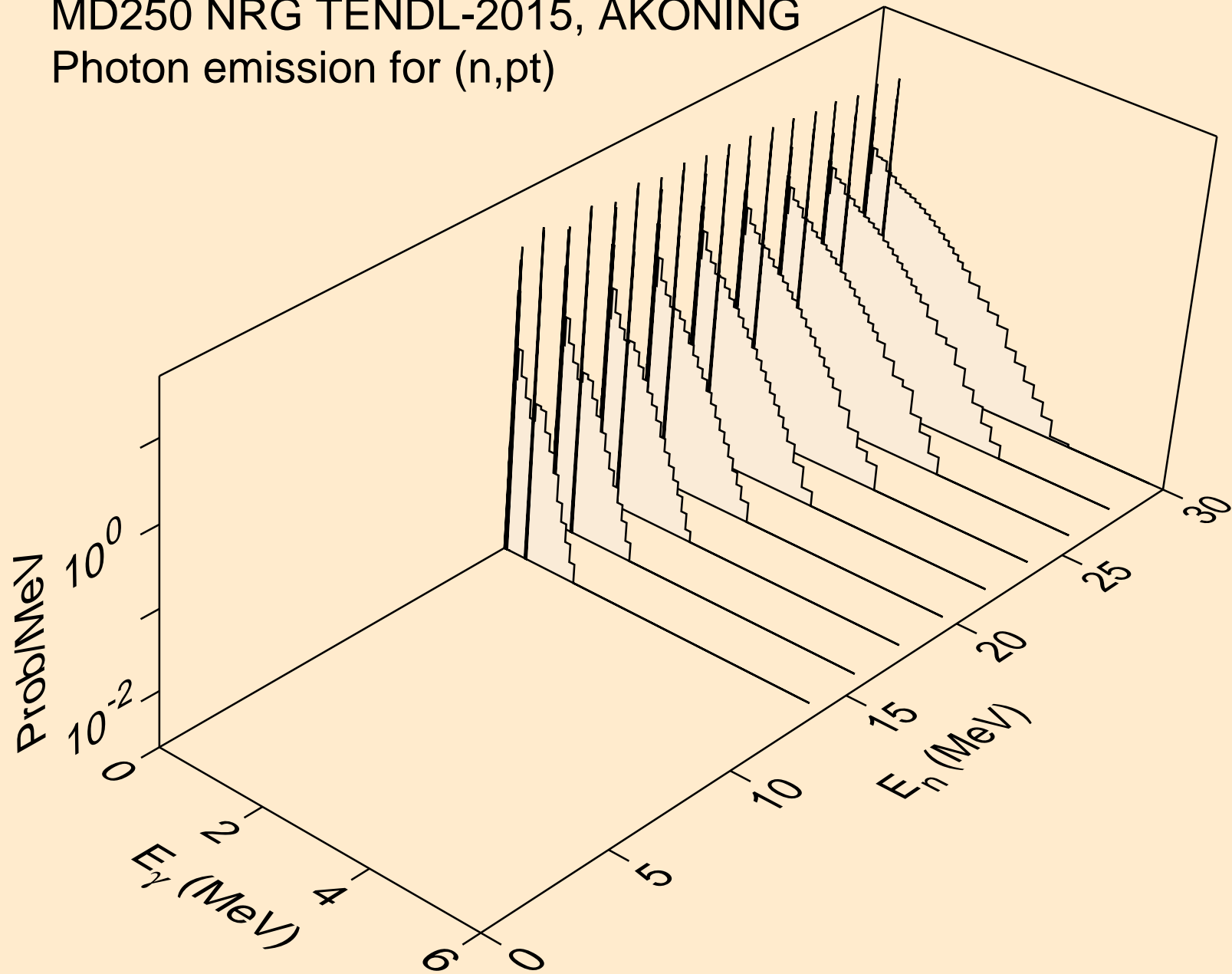

MD250 NRG TENDL-2015, AKONING
Photon emission for (n,da)

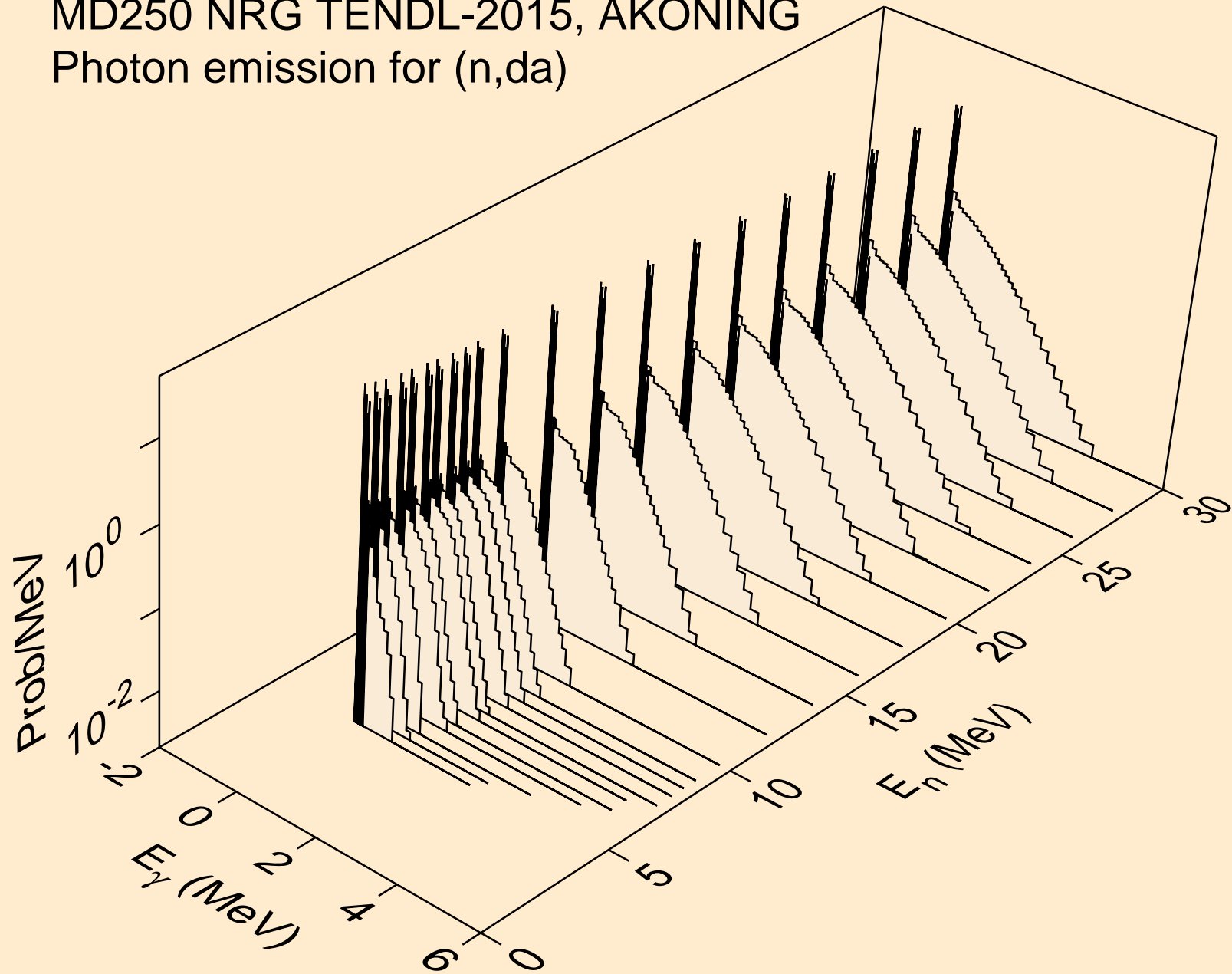

MD250 NRG TENDL-2015, AKONING
thermal capture photon spectrum

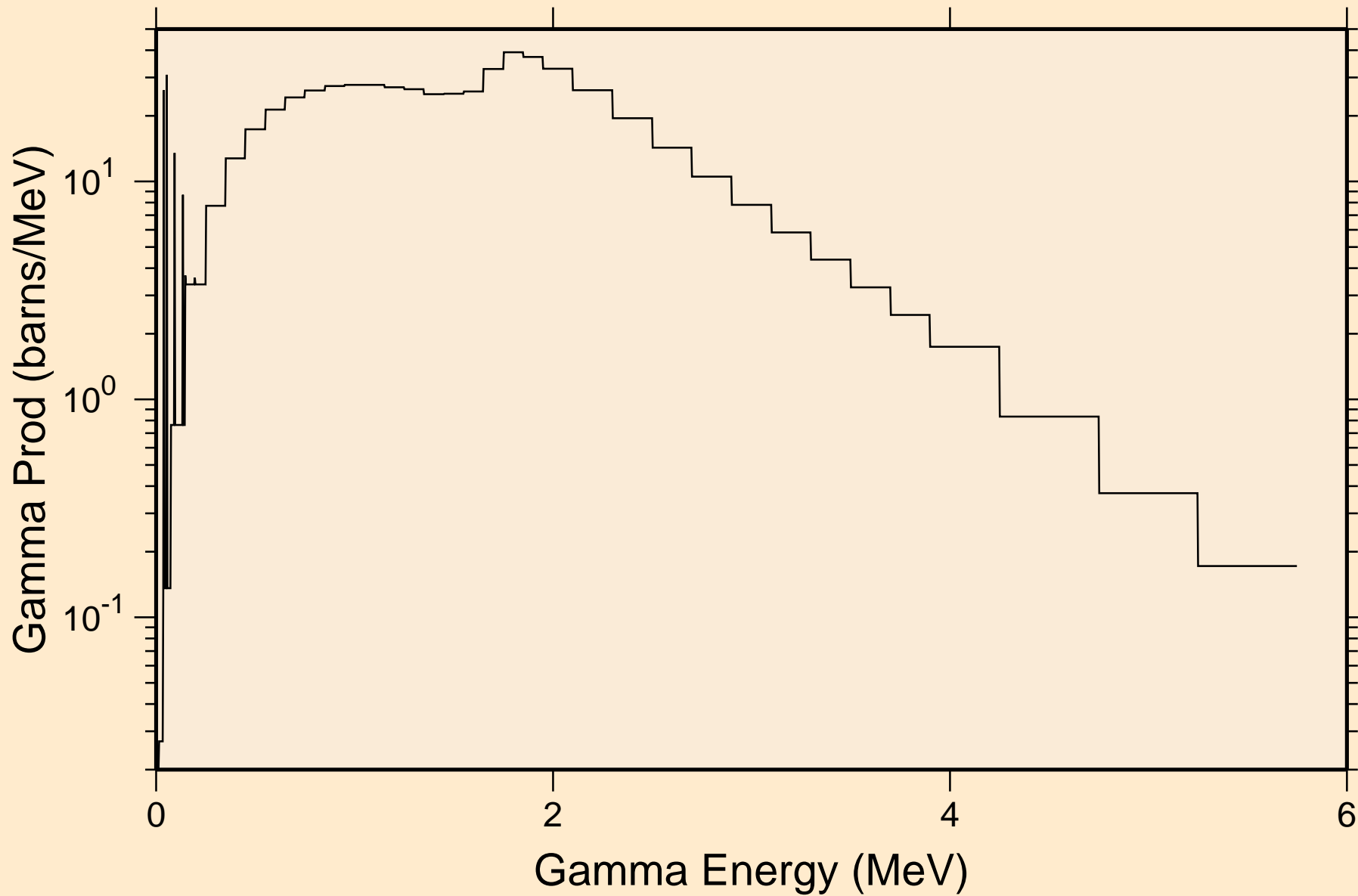

MD250 NRG TENDL-2015, AKONING
14 MeV photon spectrum

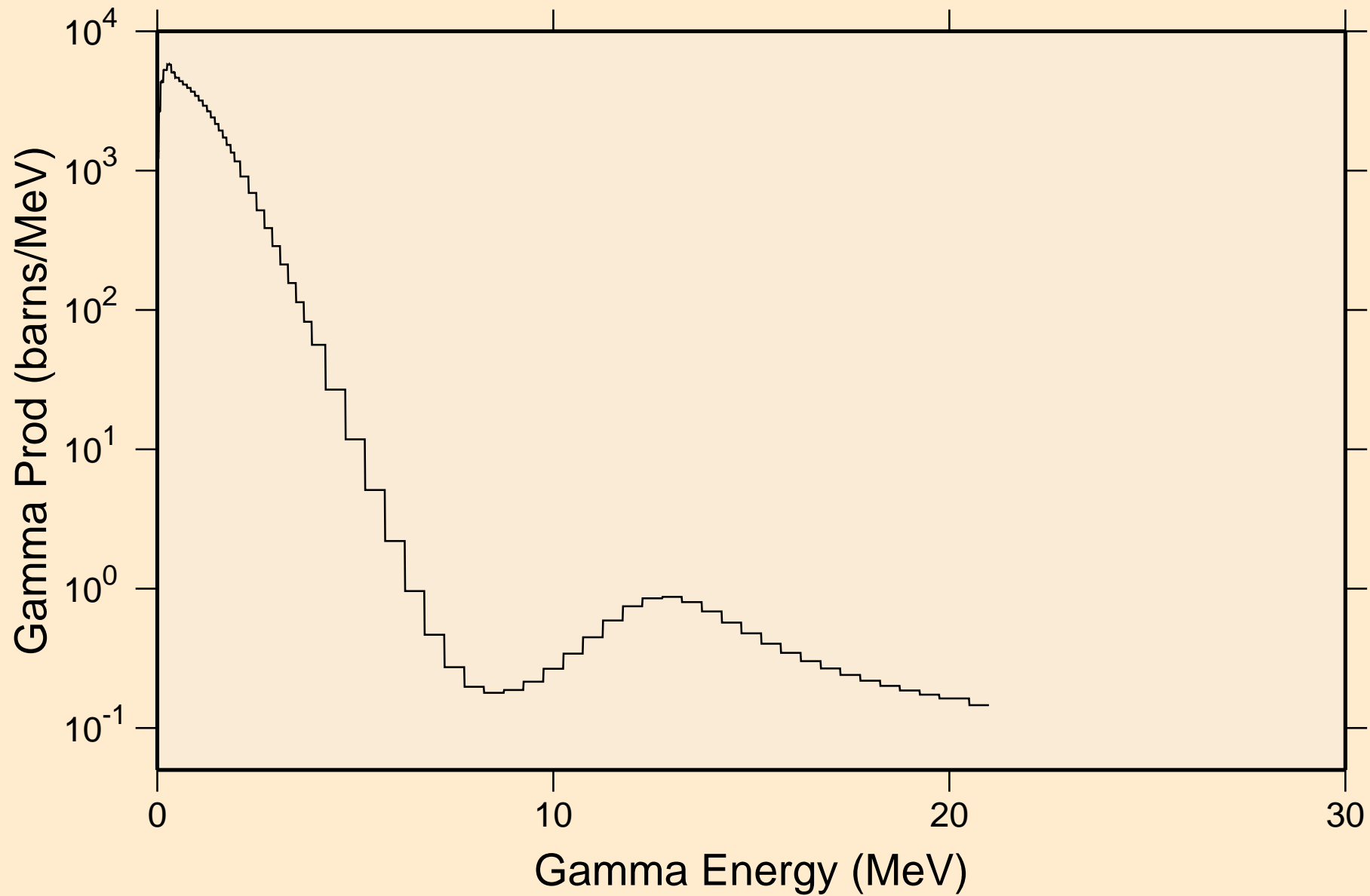

MD250 NRG TENDL-2015, AKONING

Particle heating contributions

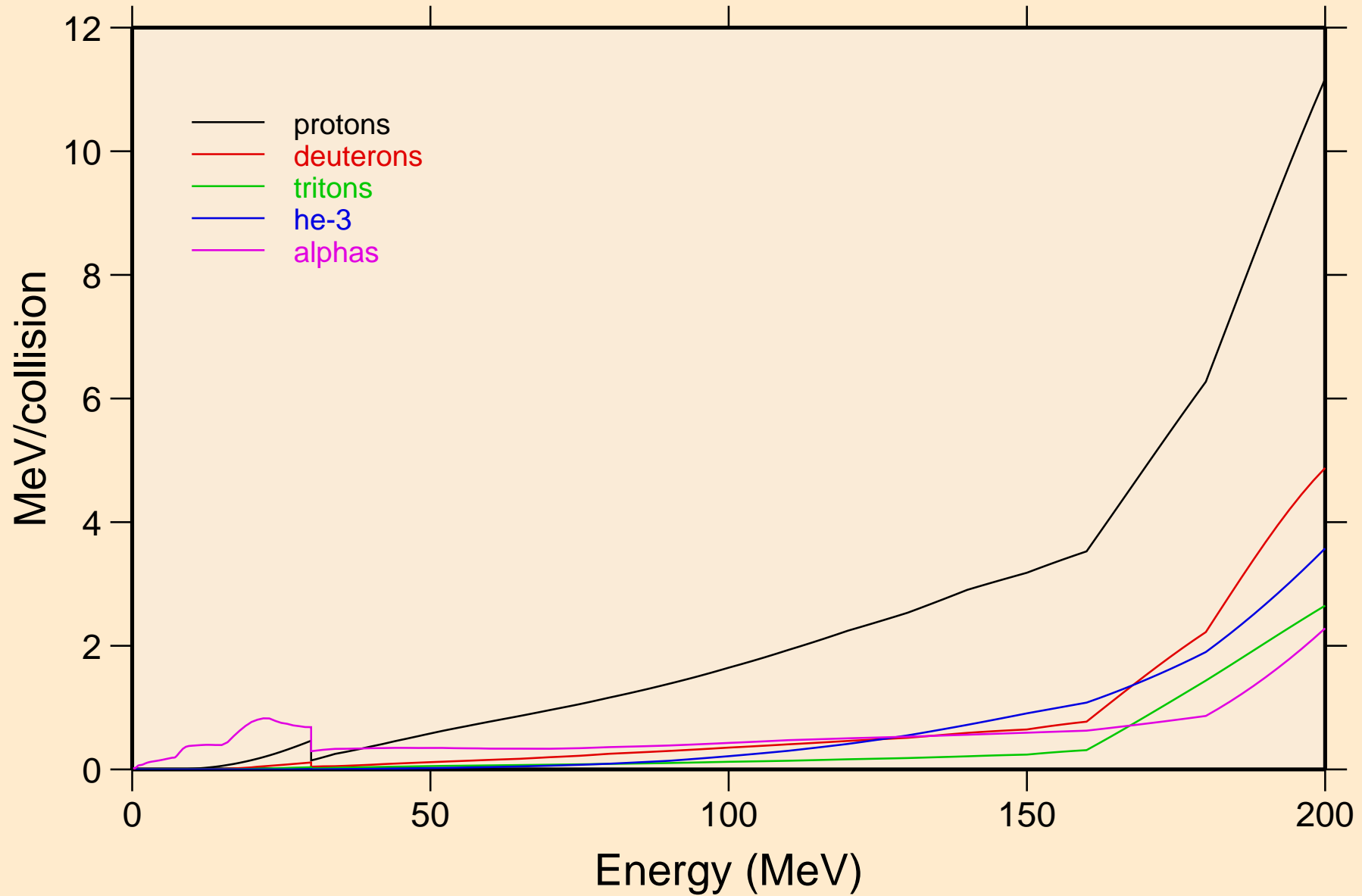

MD250 NRG TENDL-2015, AKONING

Recoil Heating

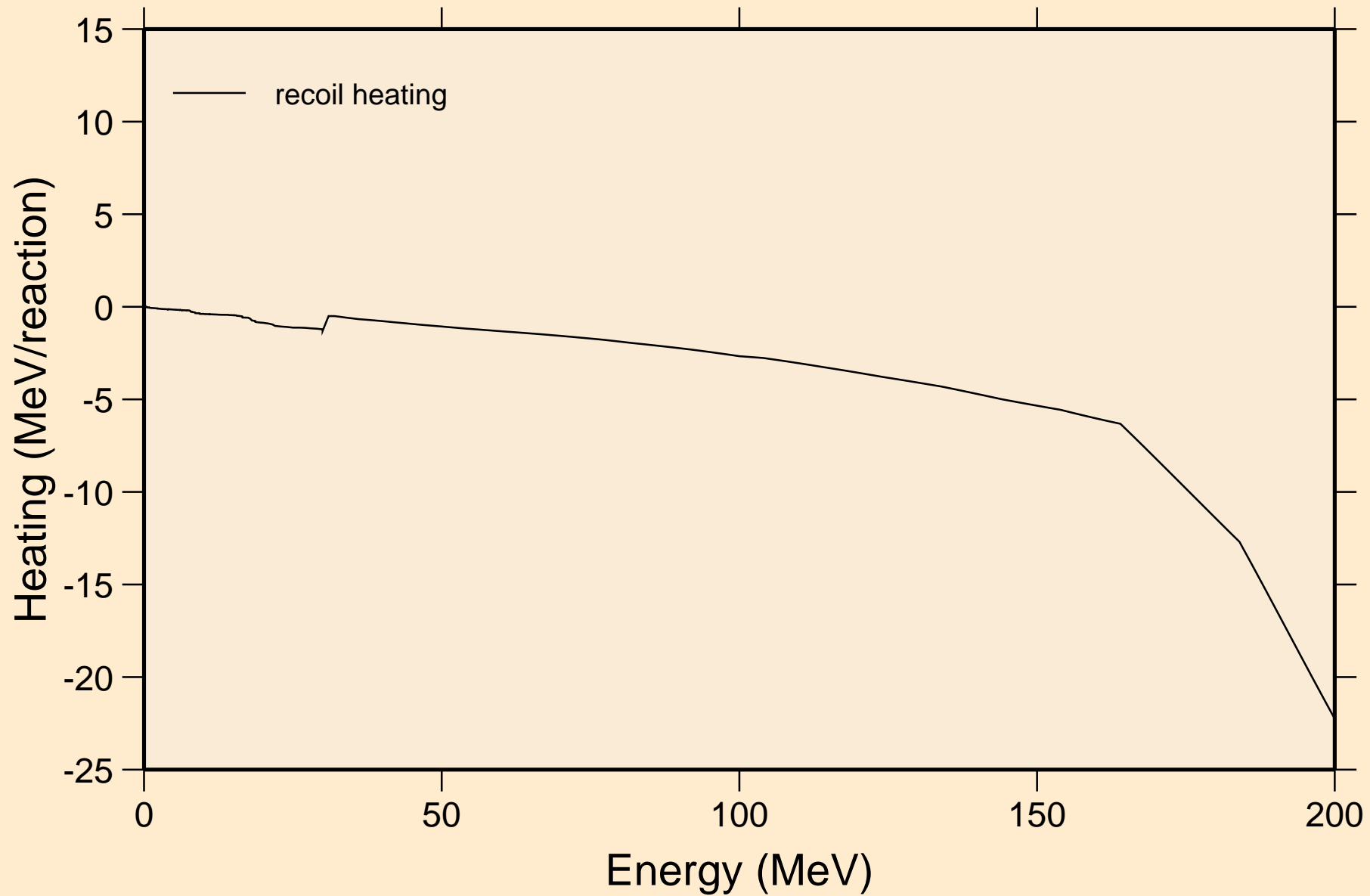

MD250 NRG TENDL-2015, AKONING

Particle production cross sections

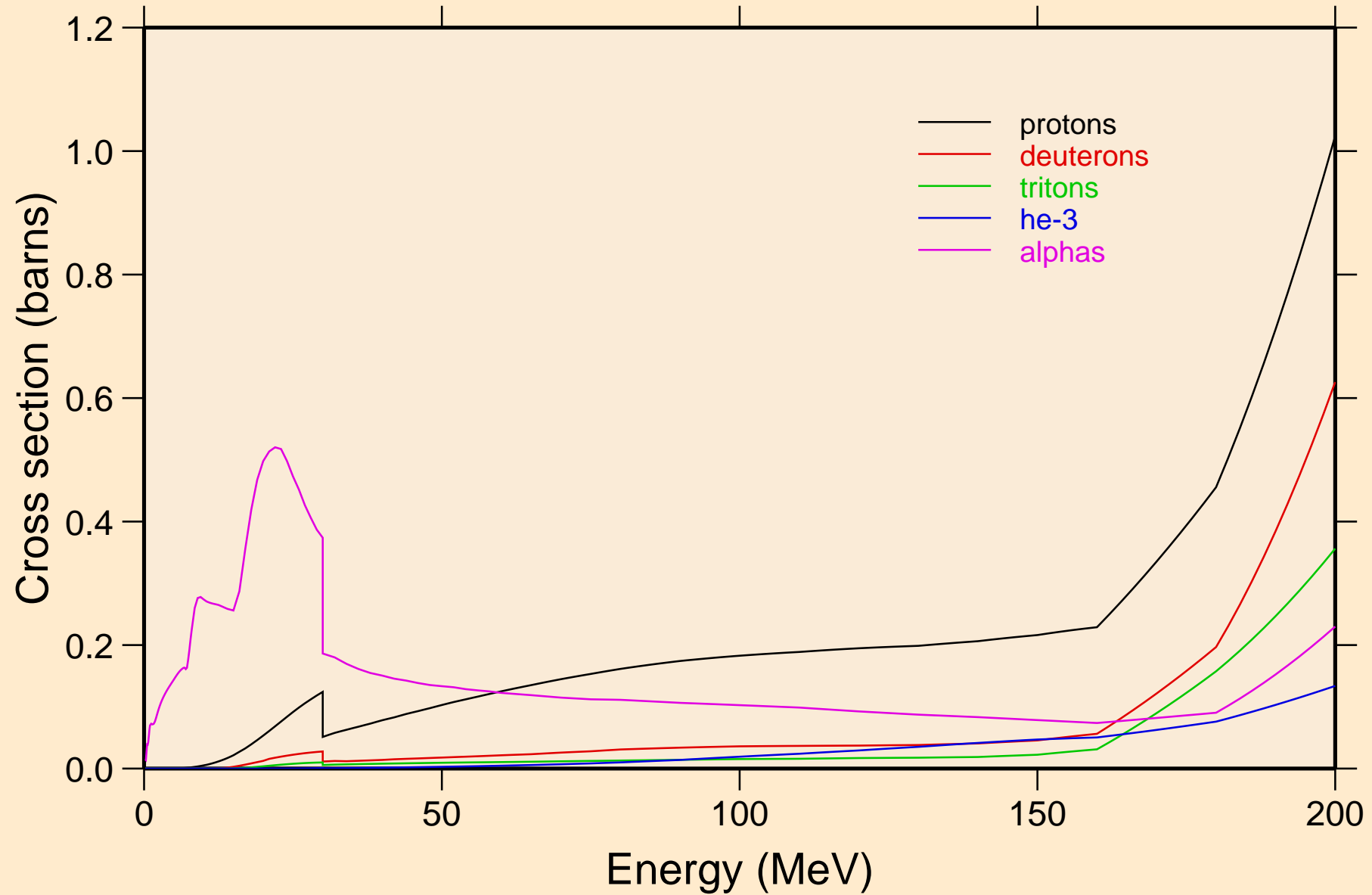

MD250 NRG TENDL-2015, AKONING
protons from (n,x)

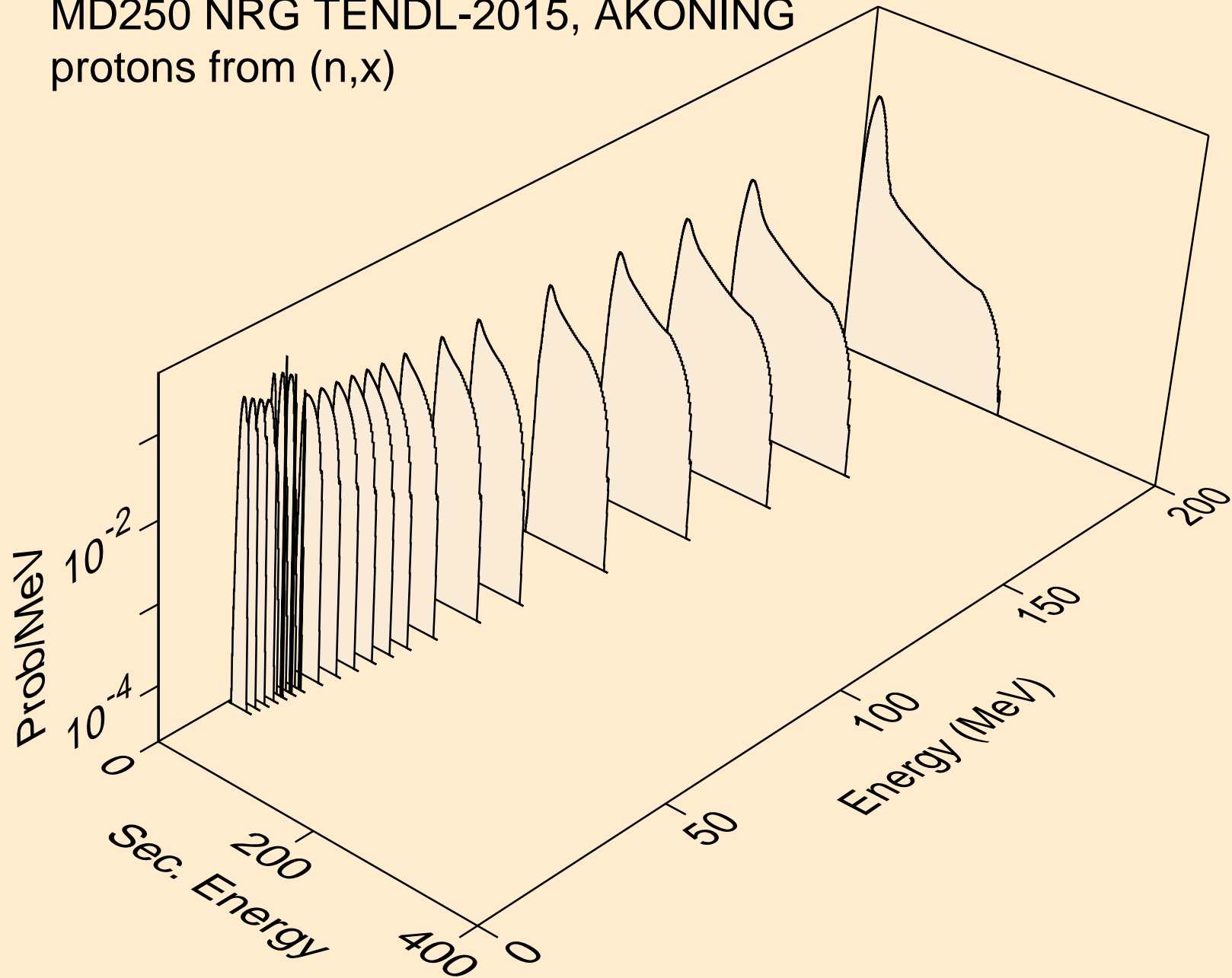

MD250 NRG TENDL-2015, AKONING
protons from (n,n*)p

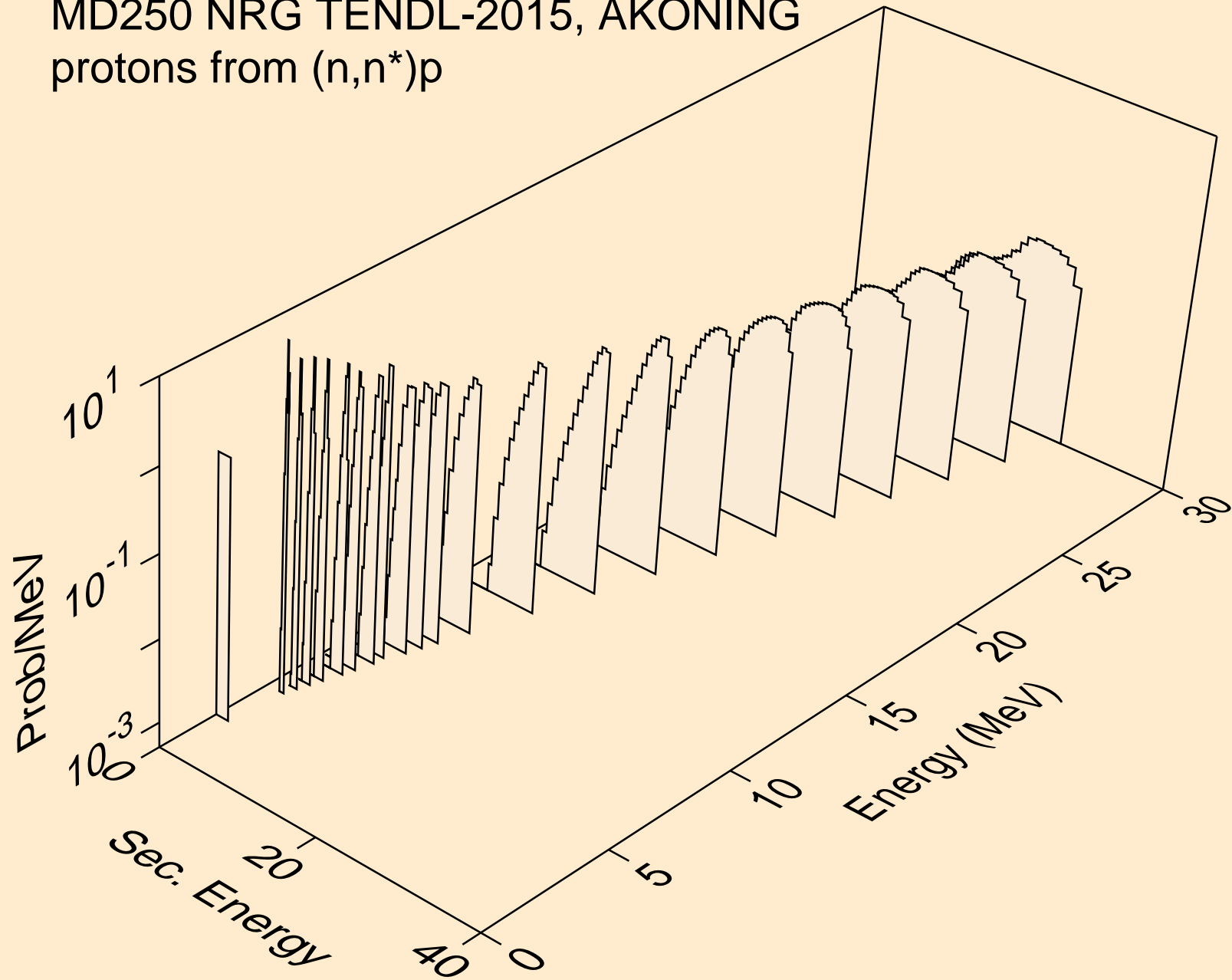

MD250 NRG TENDL-2015, AKONING
protons from (n,2np)

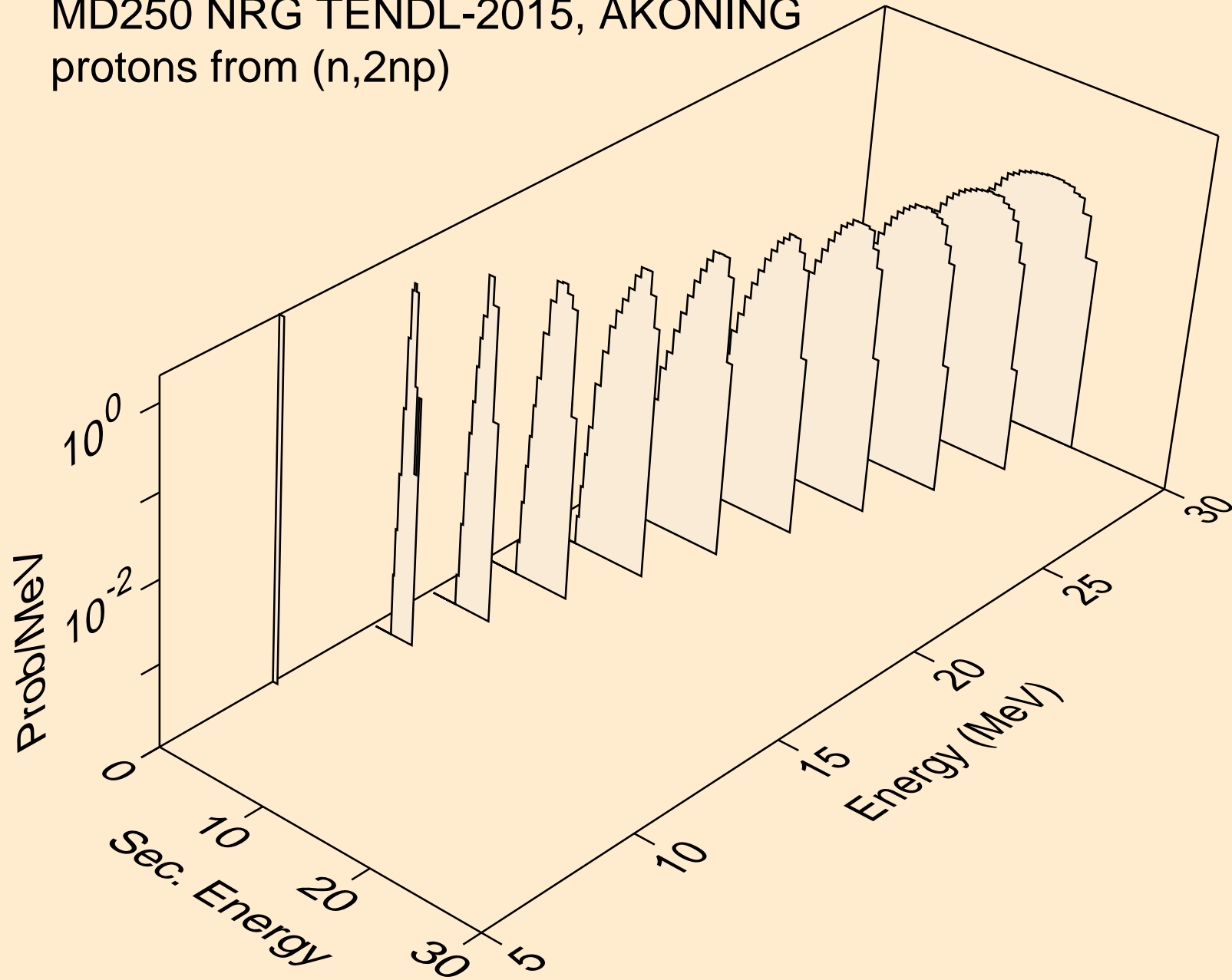

MD250 NRG TENDL-2015, AKONING
protons from (n,3np)

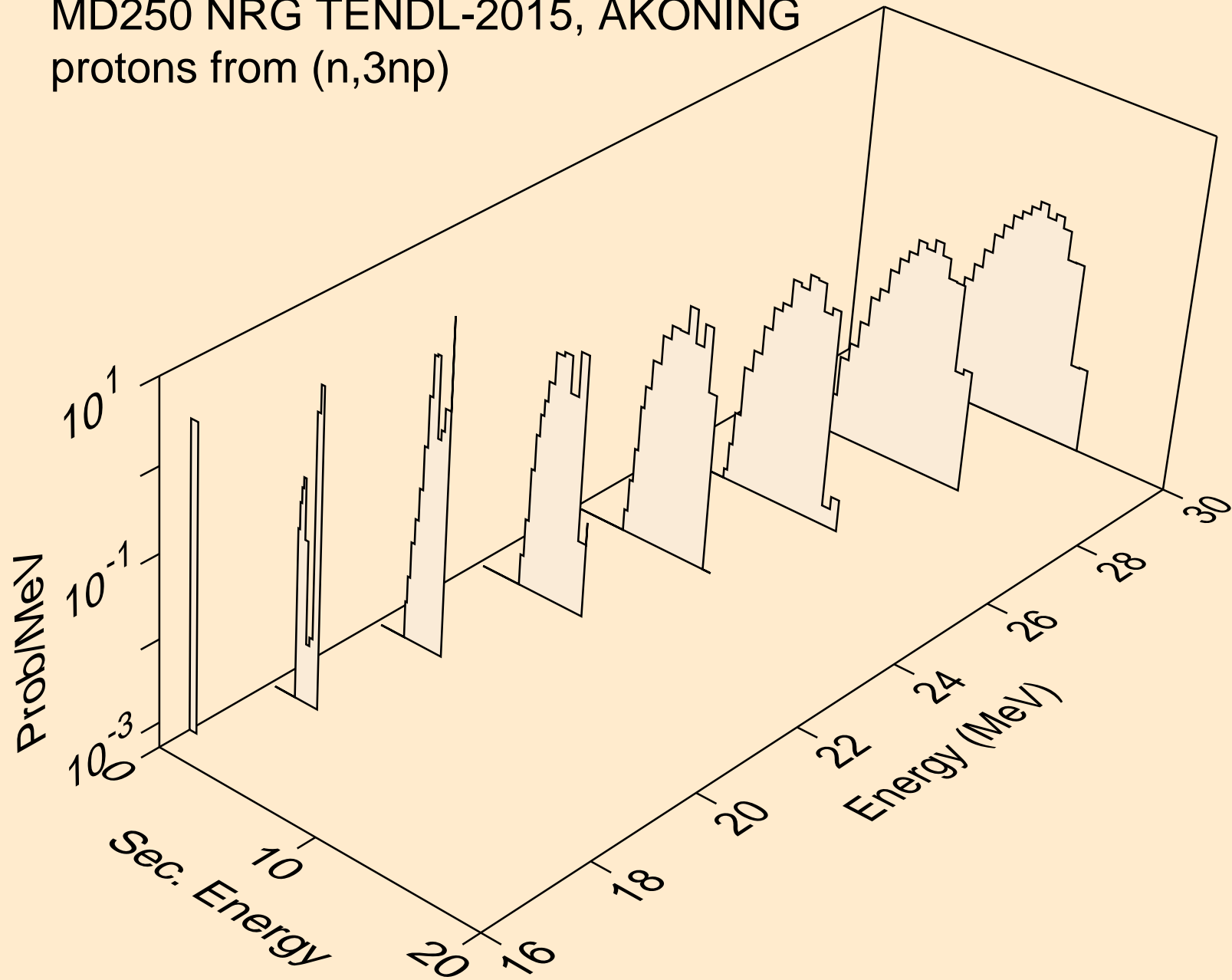

MD250 NRG TENDL-2015, AKONING
protons from (n,2np)

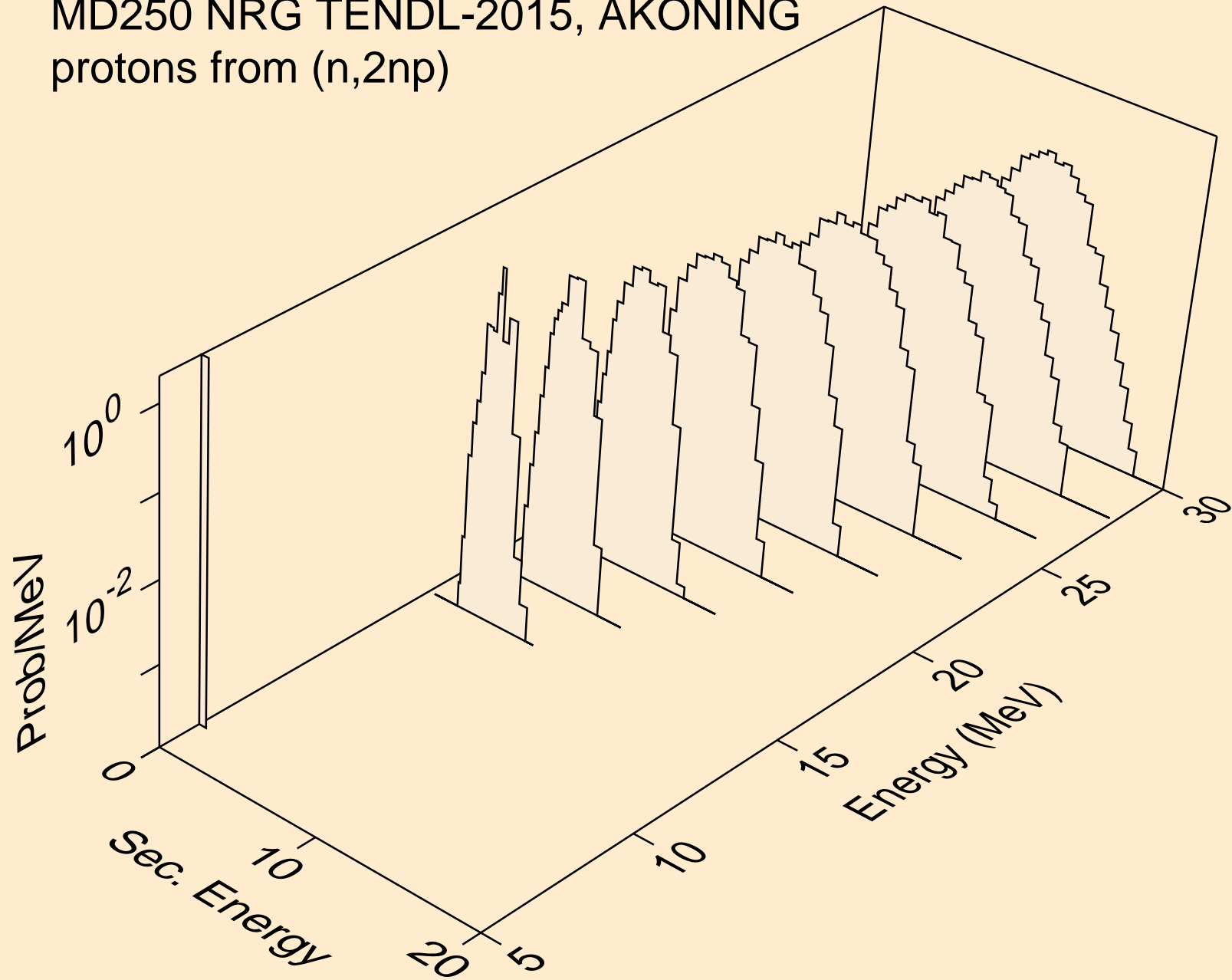

MD250 NRG TENDL-2015, AKONING
protons from (n,npa)

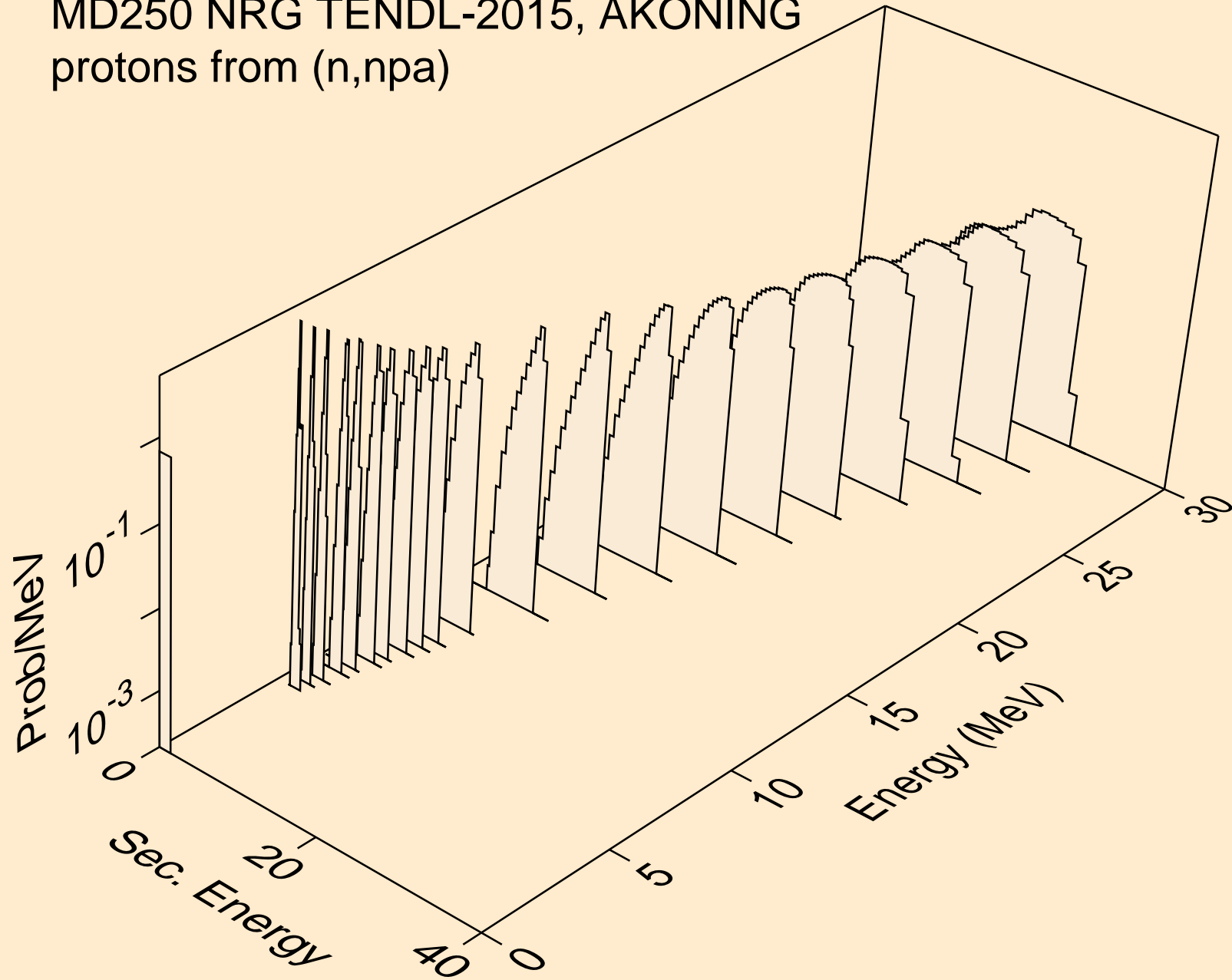

MD250 NRG TENDL-2015, AKONING
protons from (n,p)

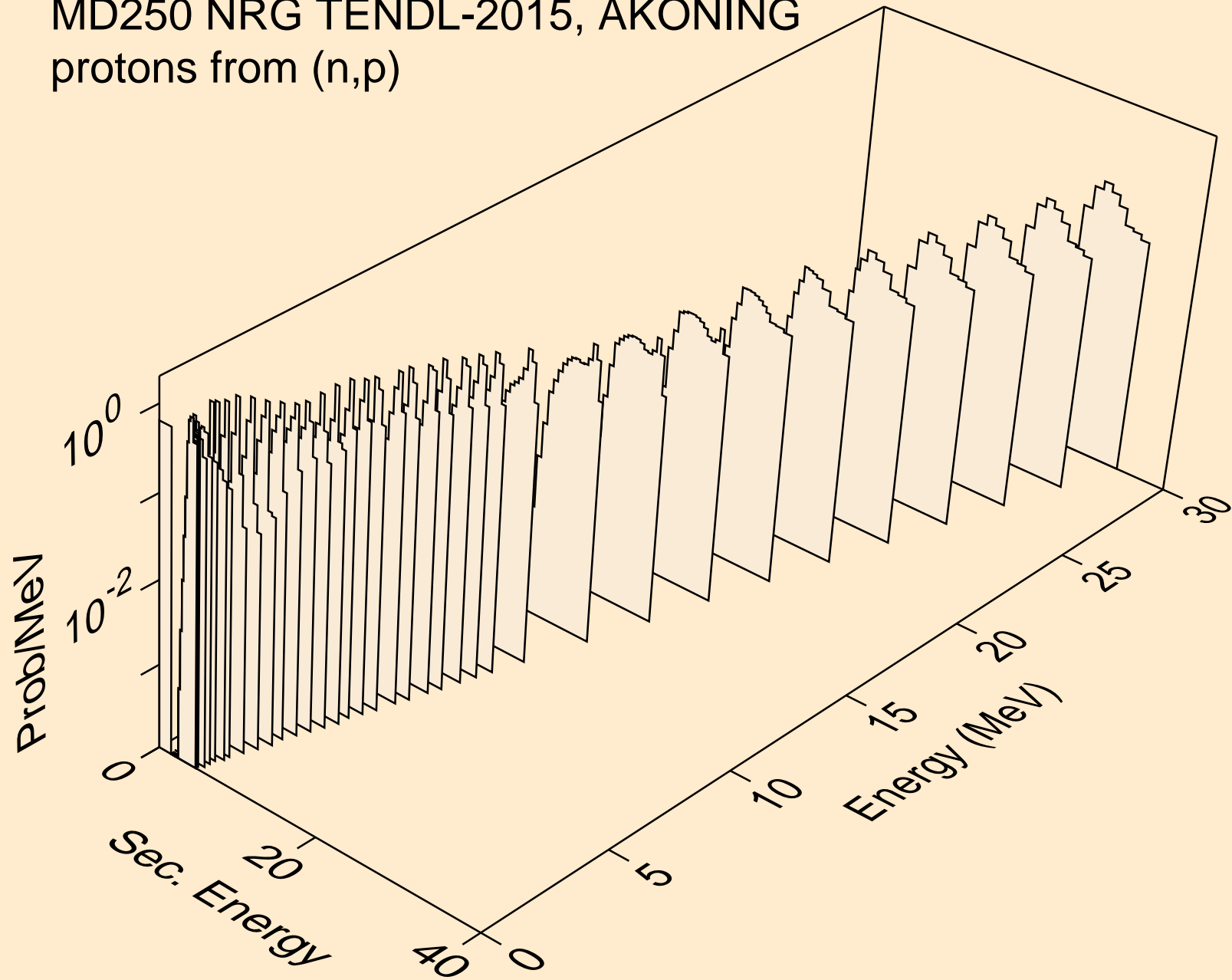

MD250 NRG TENDL-2015, AKONING
protons from (n,2p)

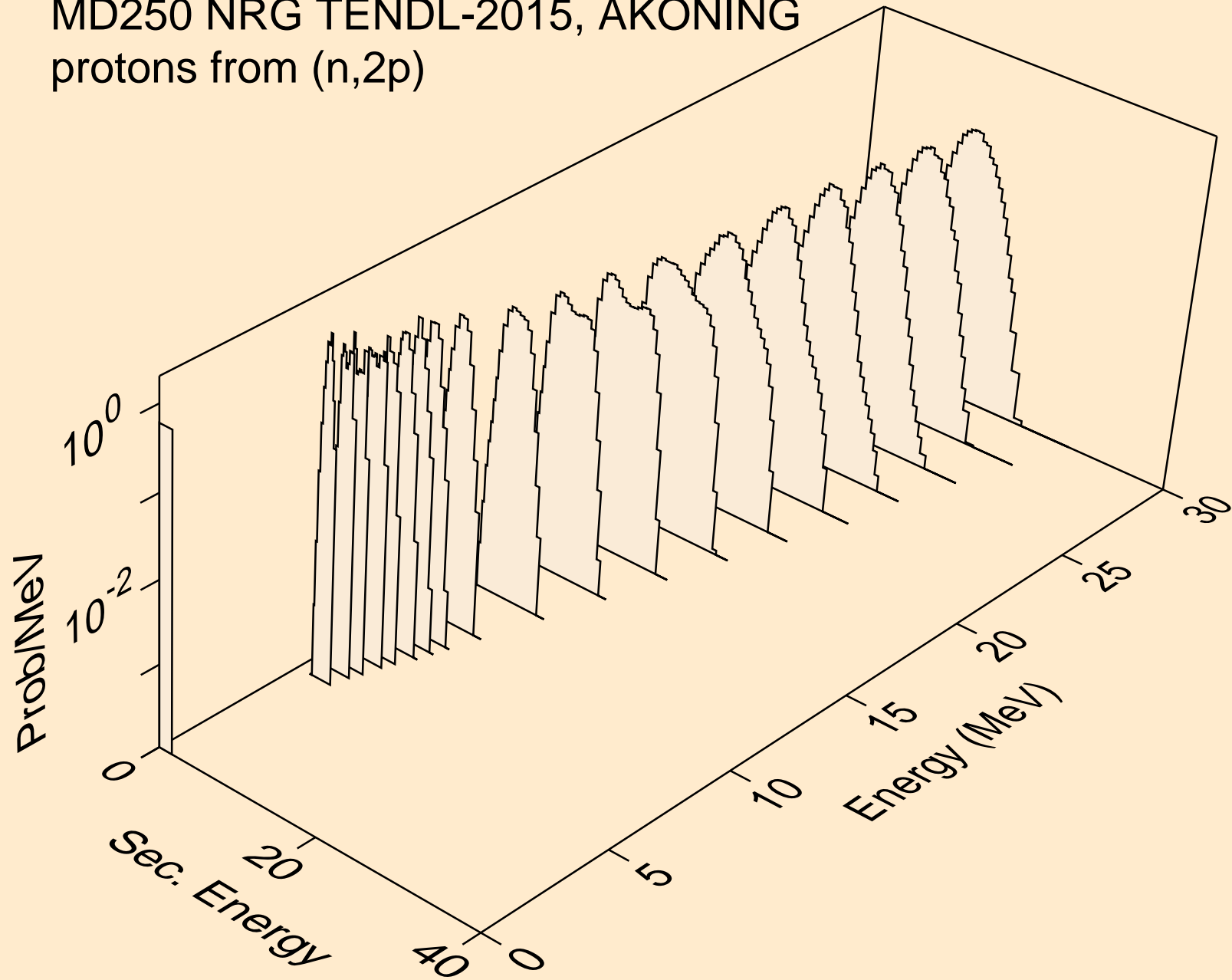

MD250 NRG TENDL-2015, AKONING
protons from (n,pa)

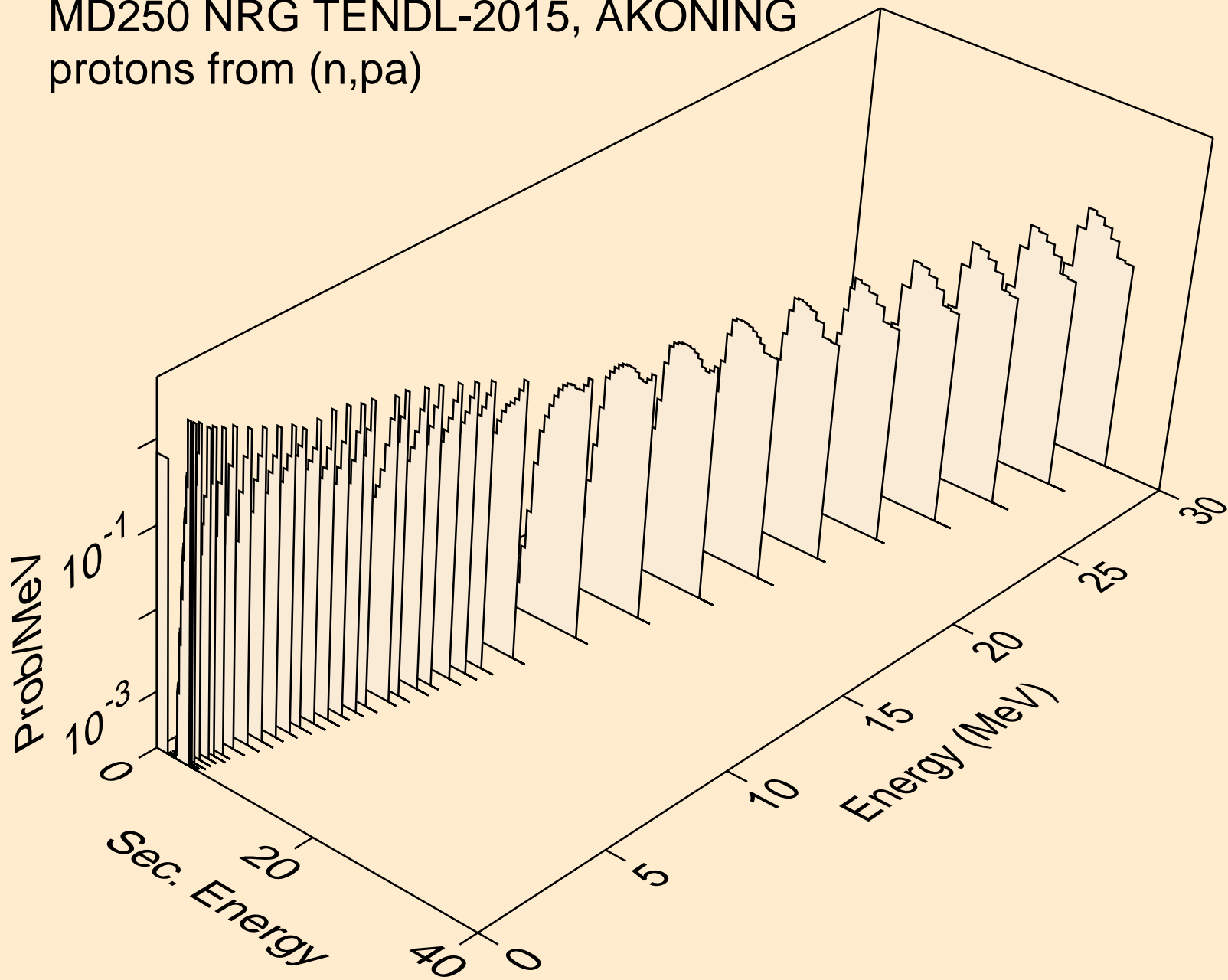

MD250 NRG TENDL-2015, AKONING
protons from (n,pd)

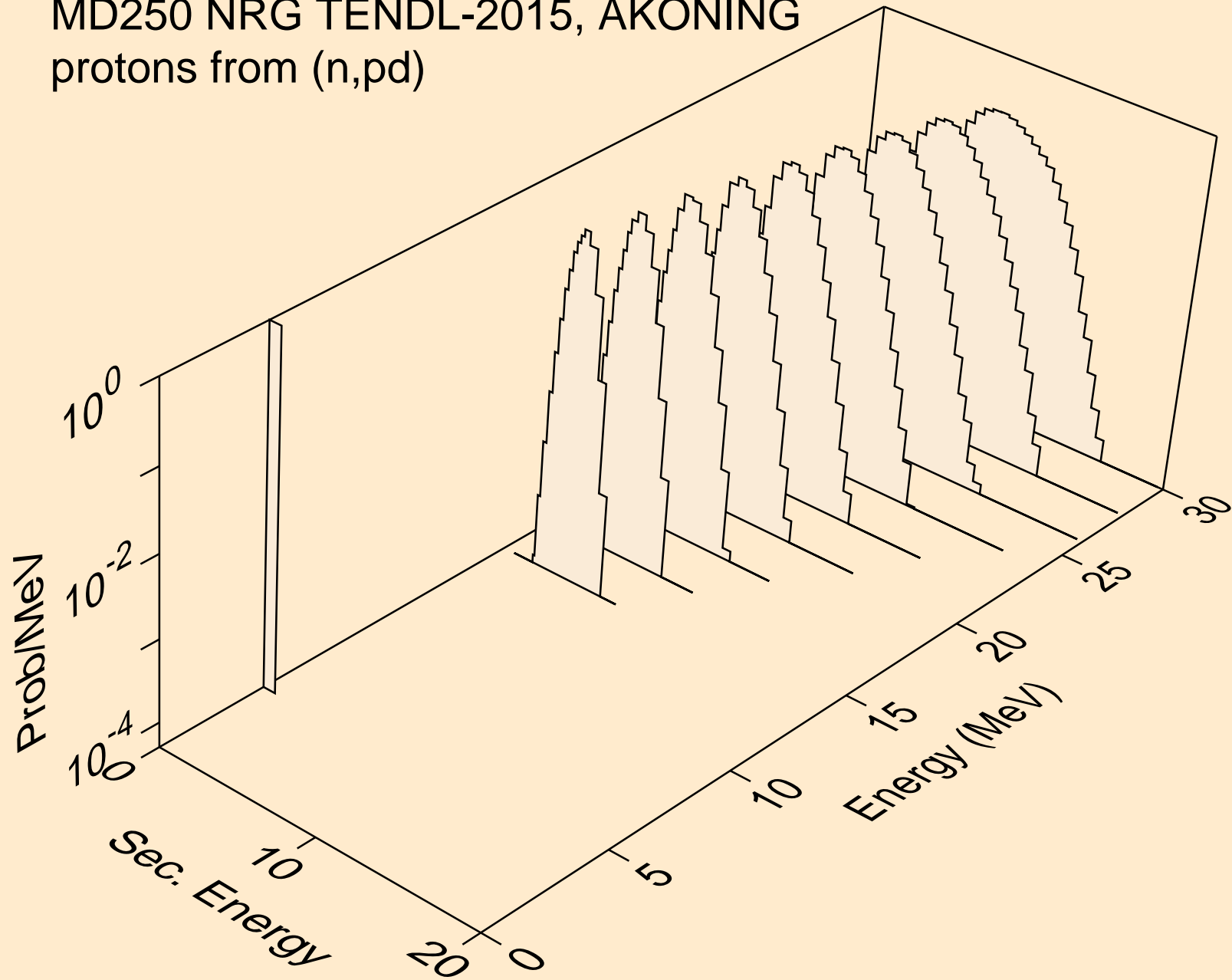

MD250 NRG TENDL-2015, AKONING
protons from (n,pt)

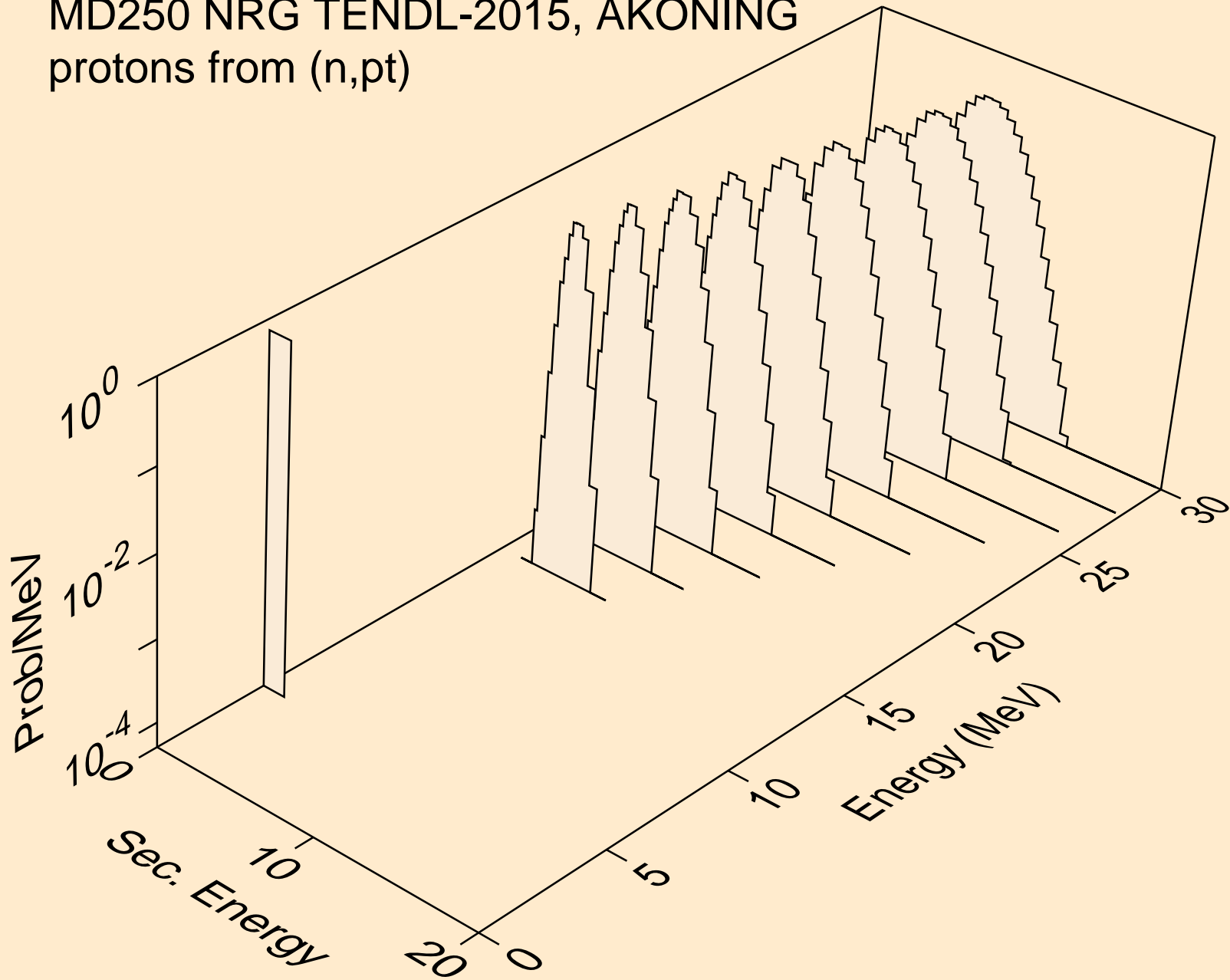

MD250 NRG TENDL-2015, AKONING
deuterons from (n,x)

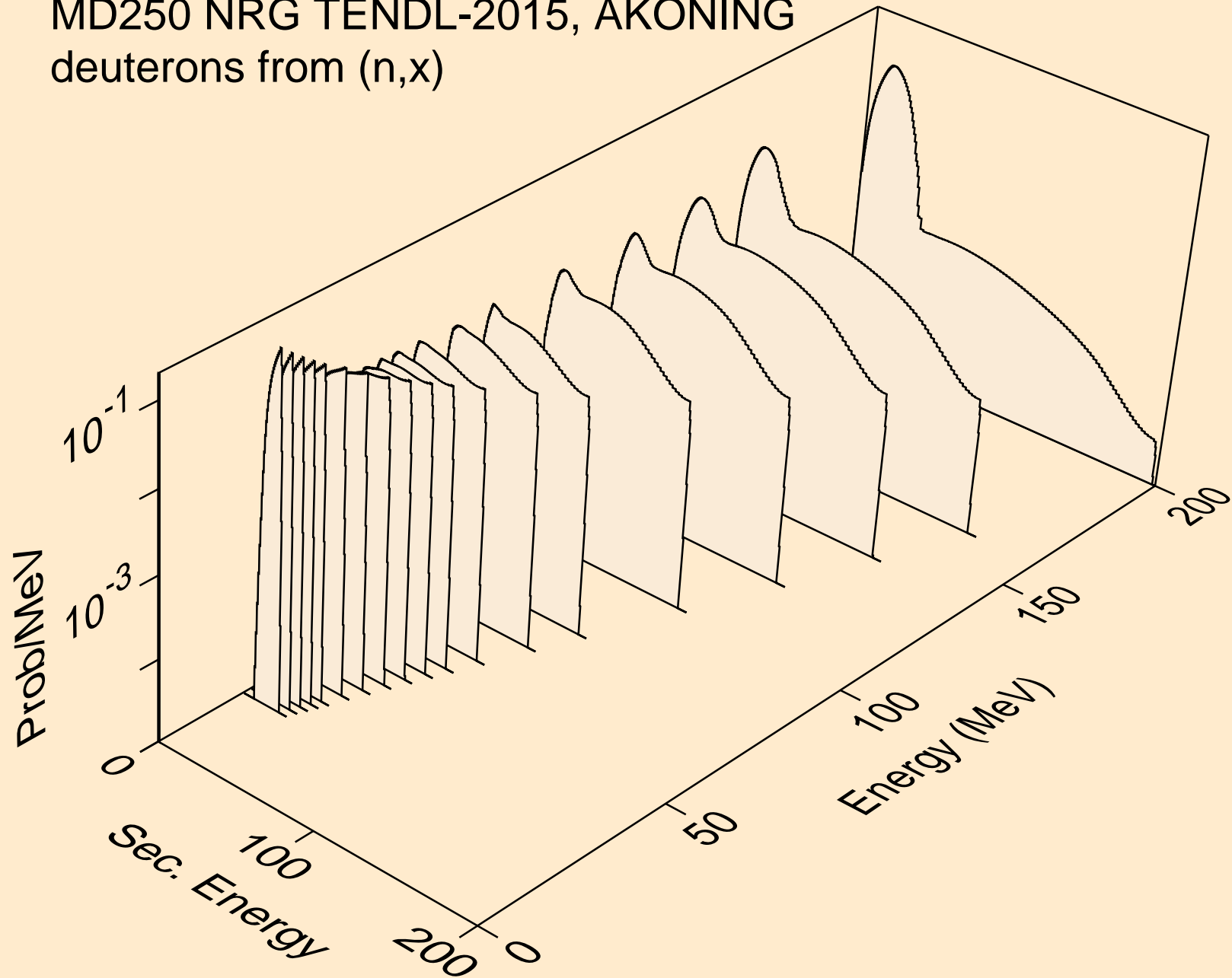

MD250 NRG TENDL-2015, AKONING
deuterons from (n,2nd)

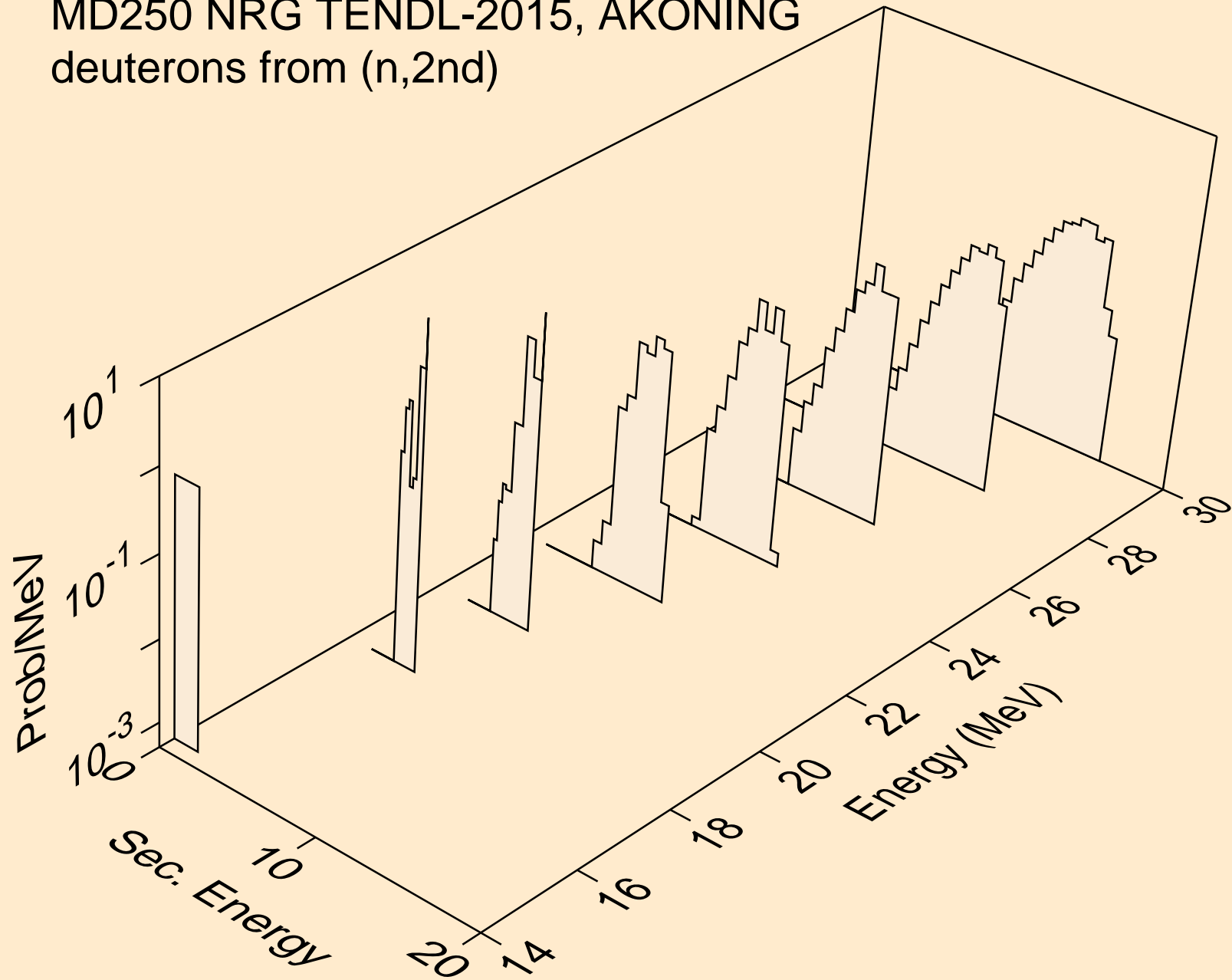

MD250 NRG TENDL-2015, AKONING
deuterons from (n,n*)d

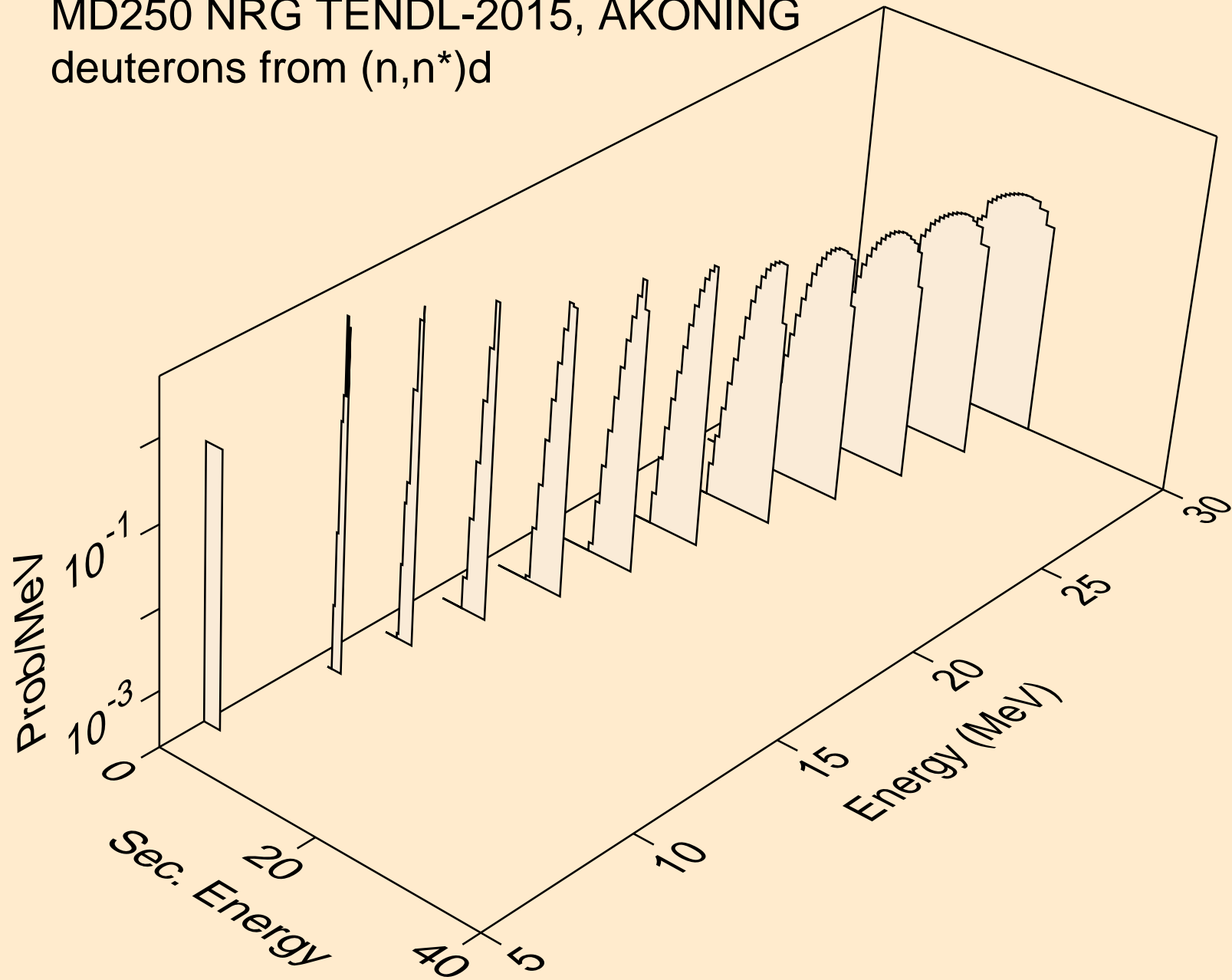

MD250 NRG TENDL-2015, AKONING
deuterons from (n,n*)d2a

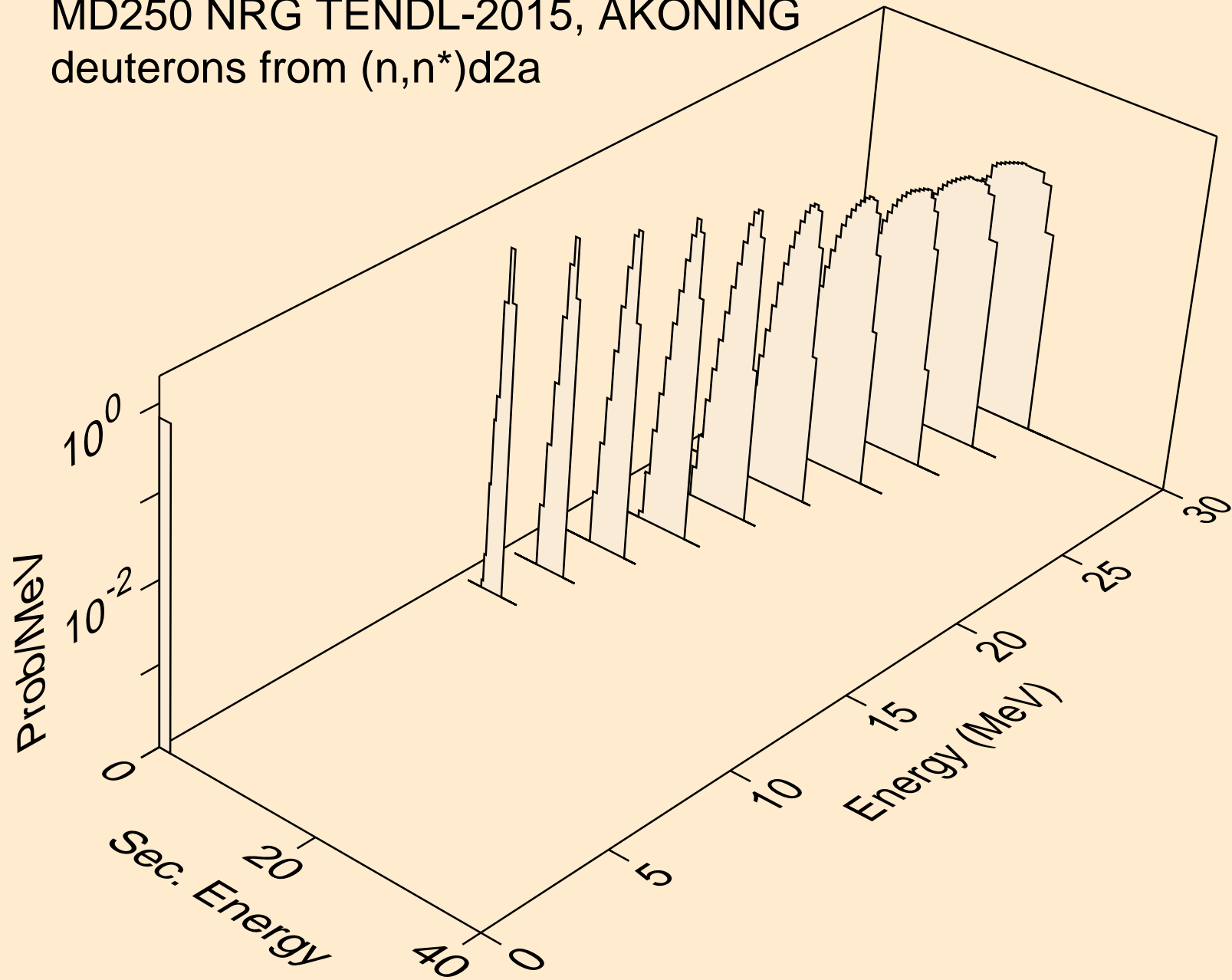

MD250 NRG TENDL-2015, AKONING
deuterons from (n,d)

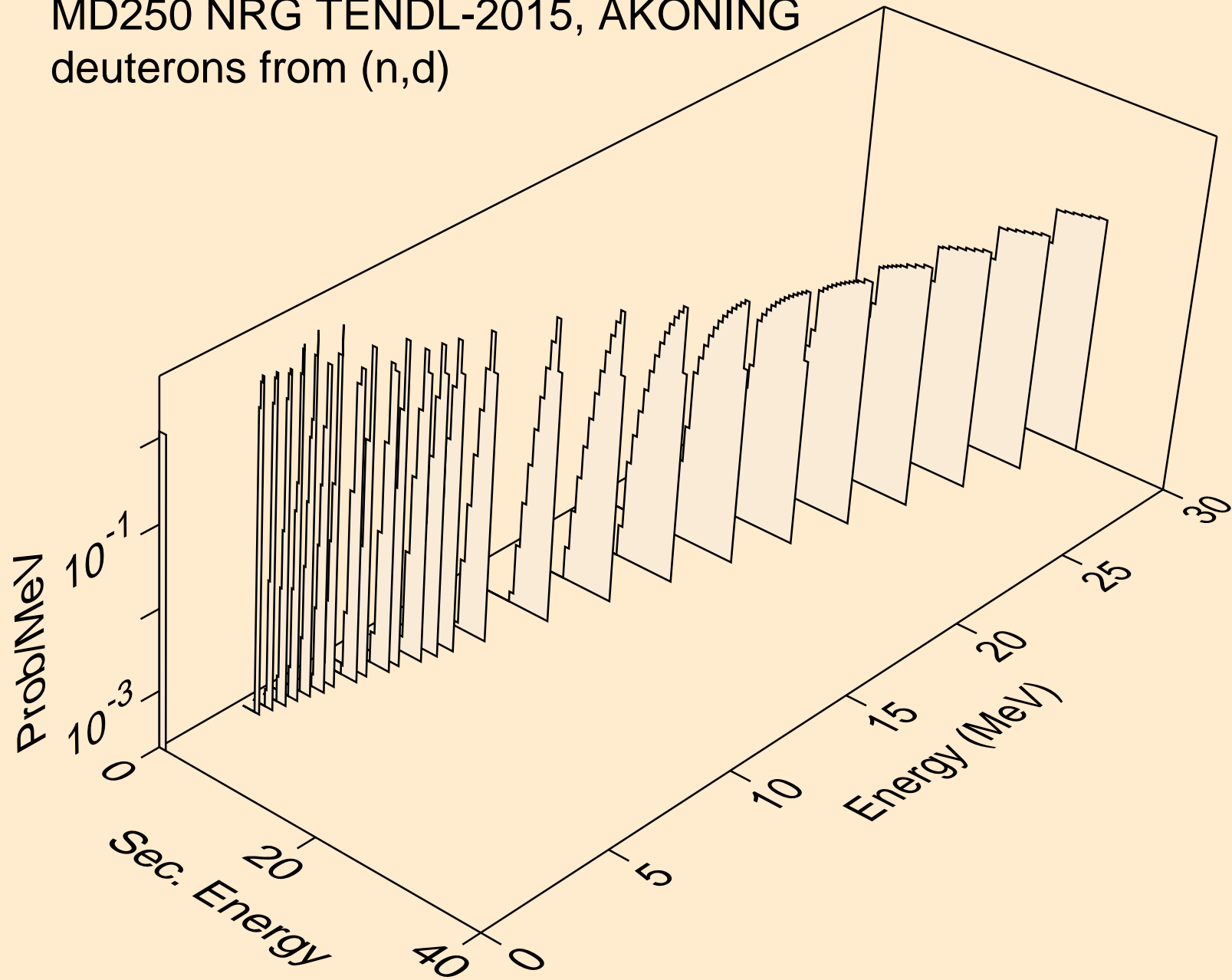

MD250 NRG TENDL-2015, AKONING
deuterons from (n,d2a)

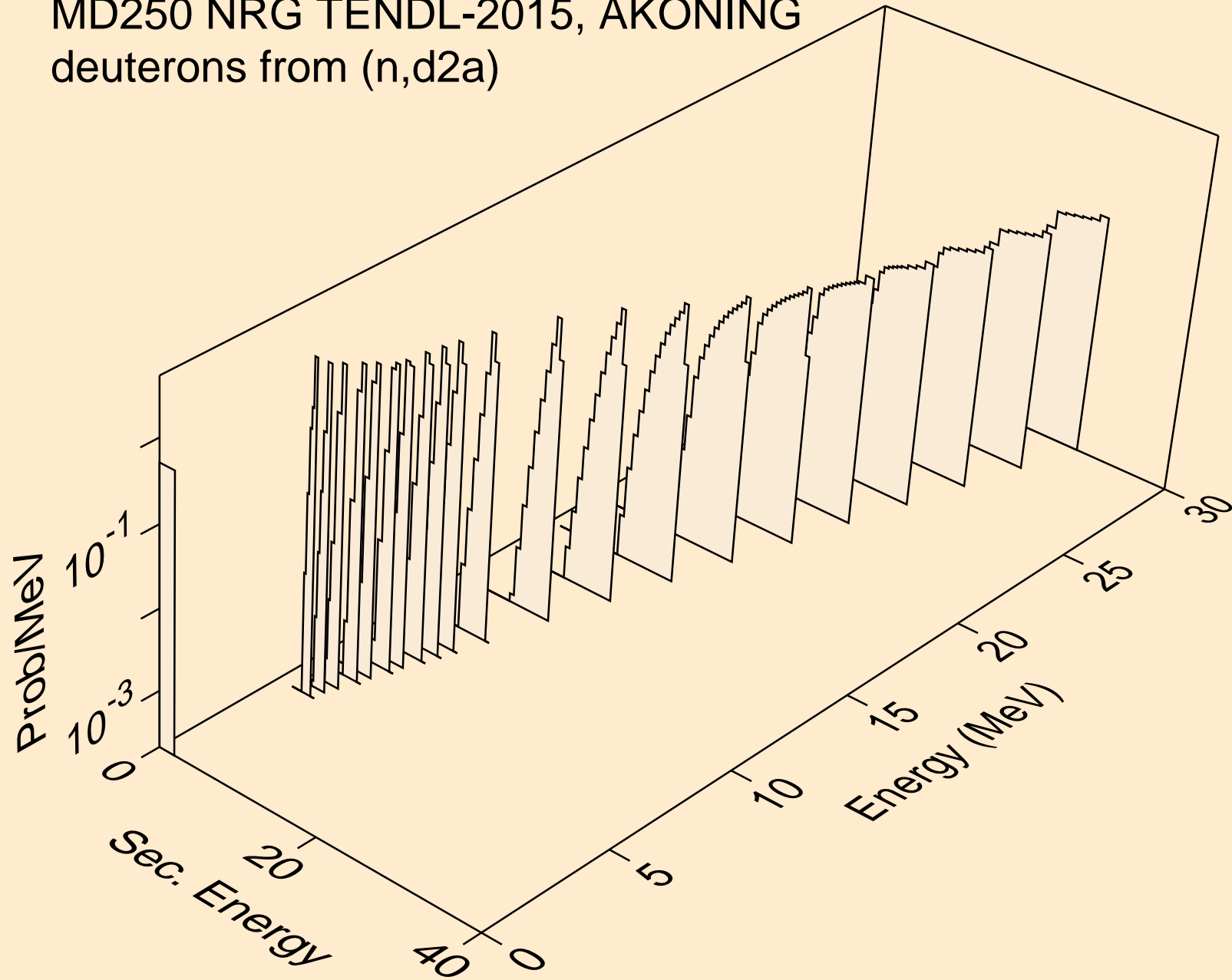

MD250 NRG TENDL-2015, AKONING
deuterons from (n,pd)

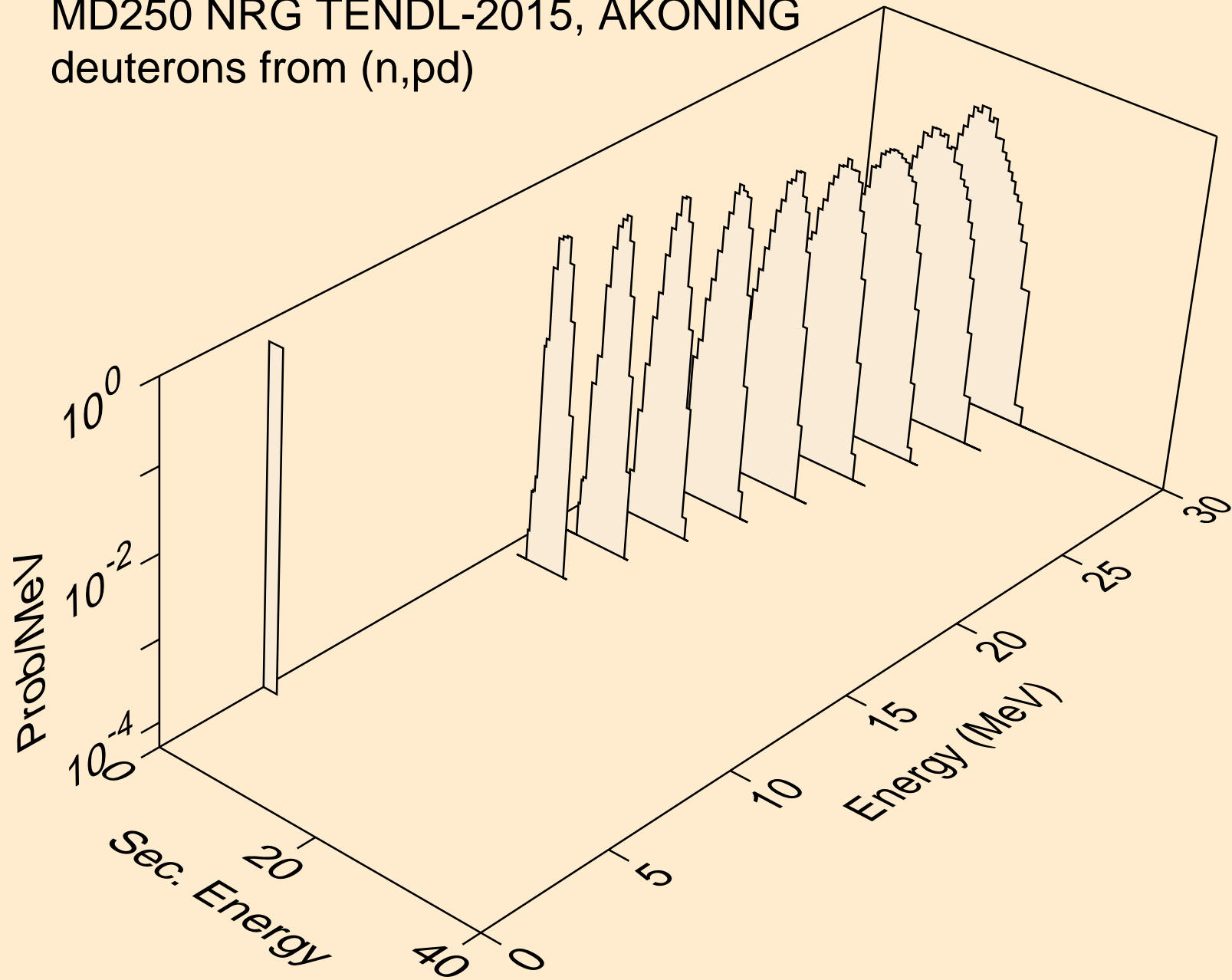

MD250 NRG TENDL-2015, AKONING
deuterons from (n,da)

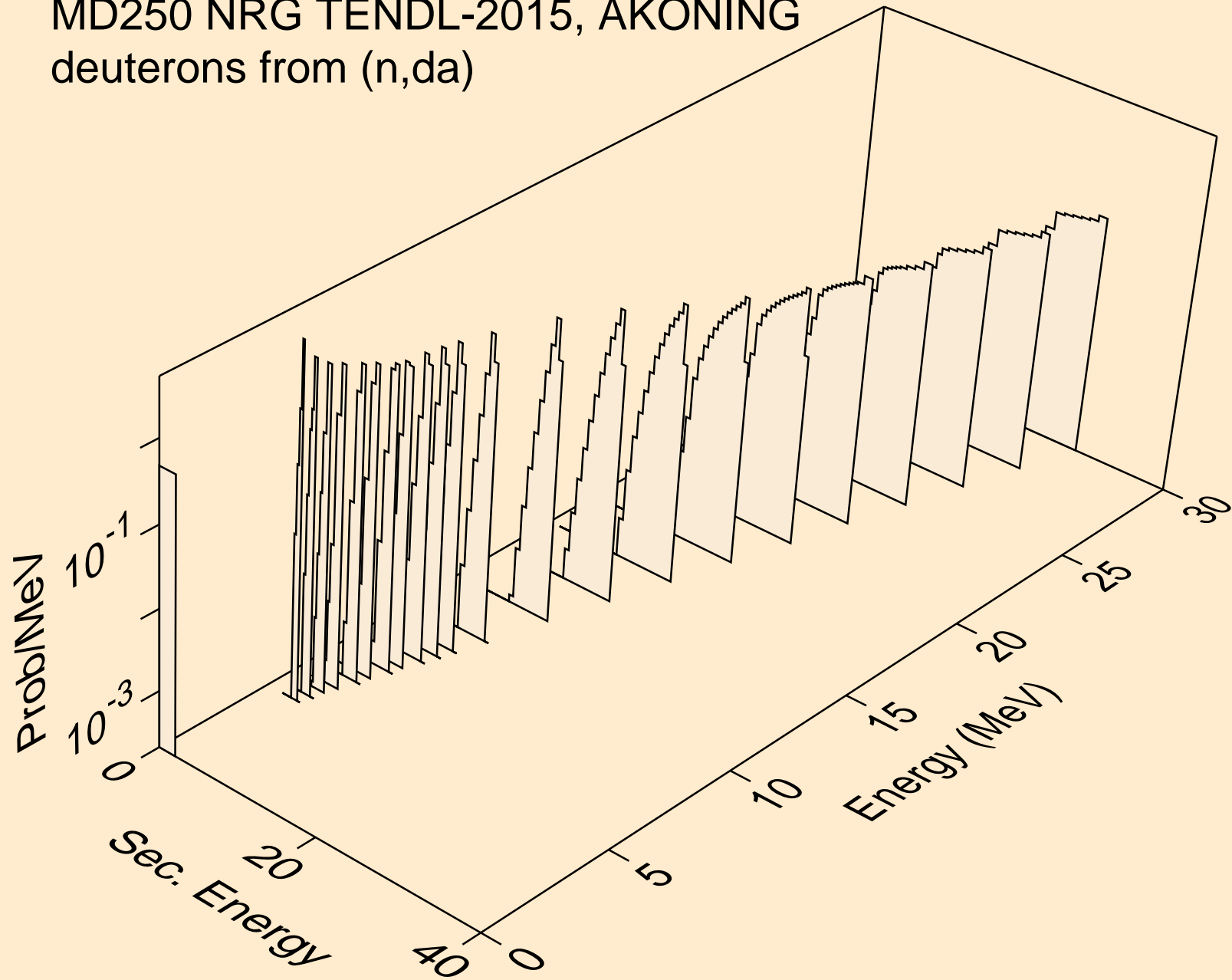

MD250 NRG TENDL-2015, AKONING
tritons from (n,x)

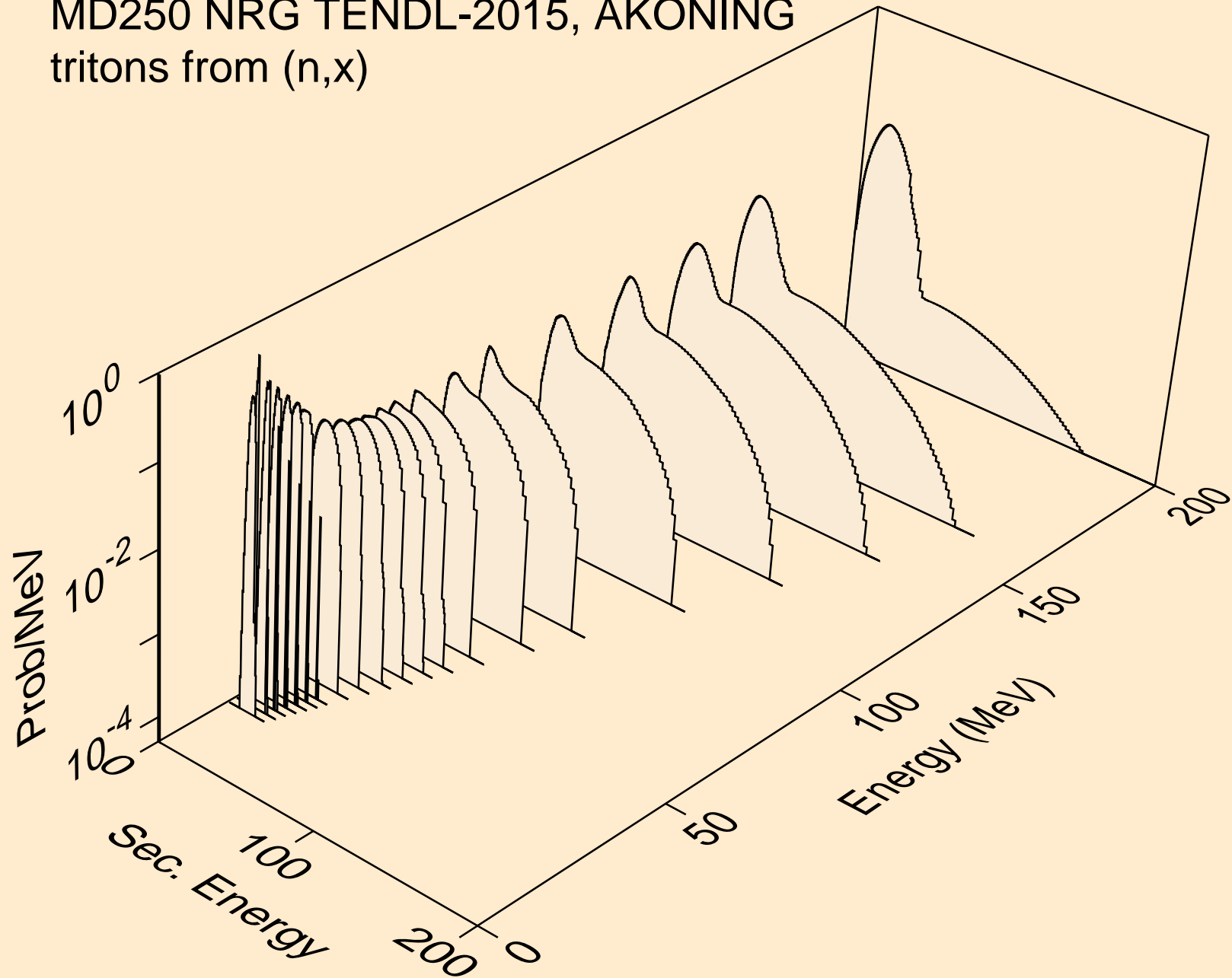

MD250 NRG TENDL-2015, AKONING
tritons from (n,n*)t

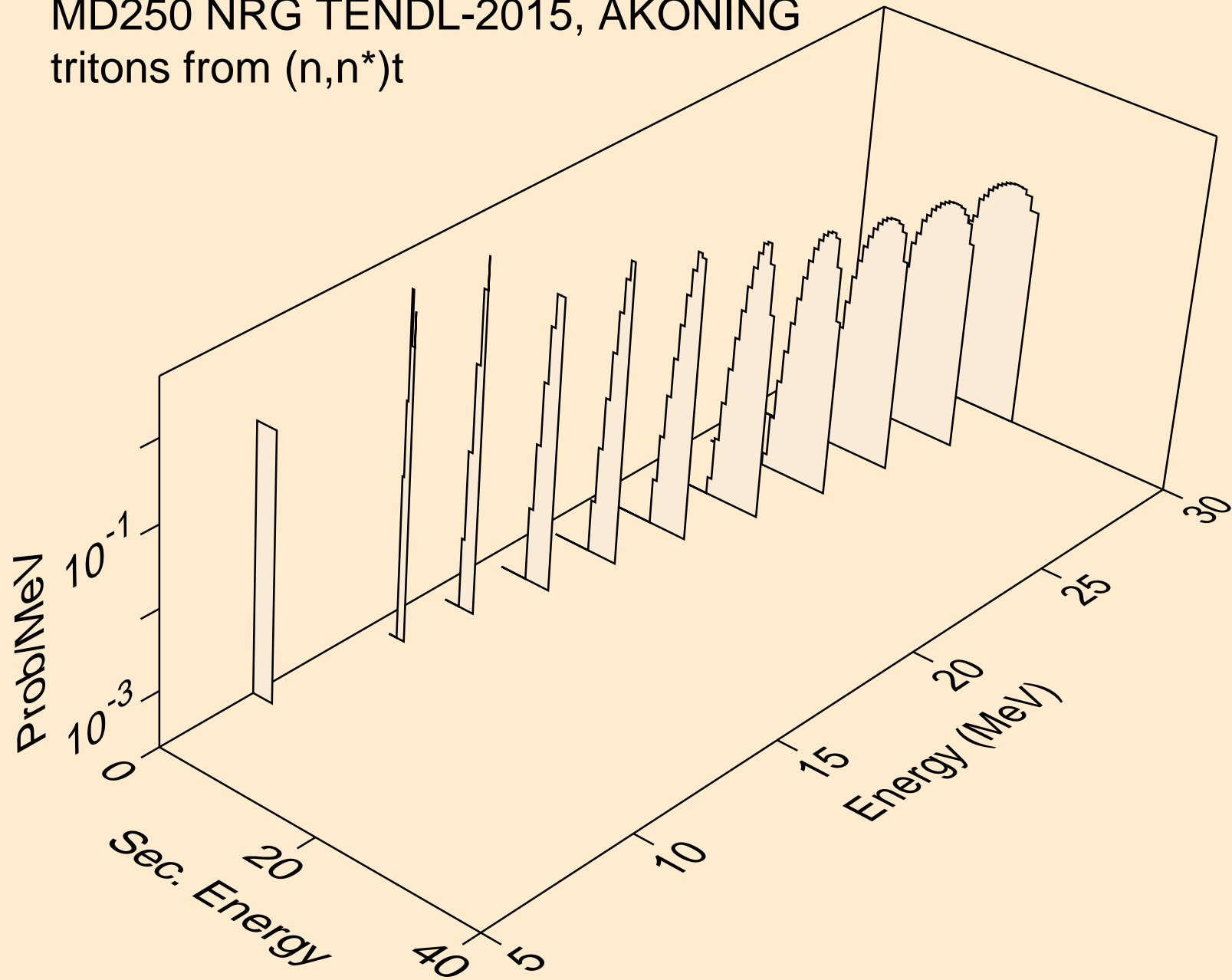

MD250 NRG TENDL-2015, AKONING
tritons from (n,n*)t2a

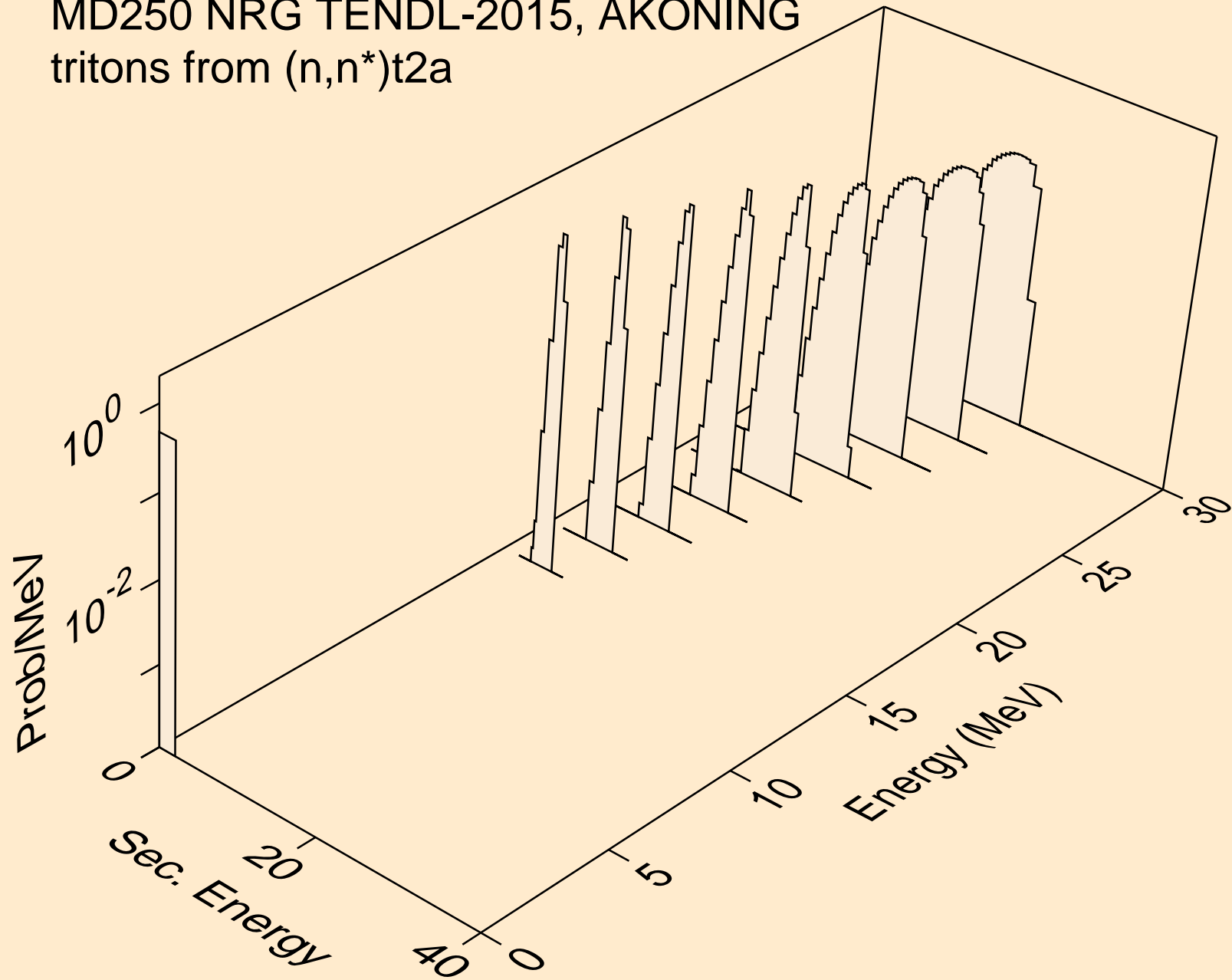

MD250 NRG TENDL-2015, AKONING
tritons from (n,t)

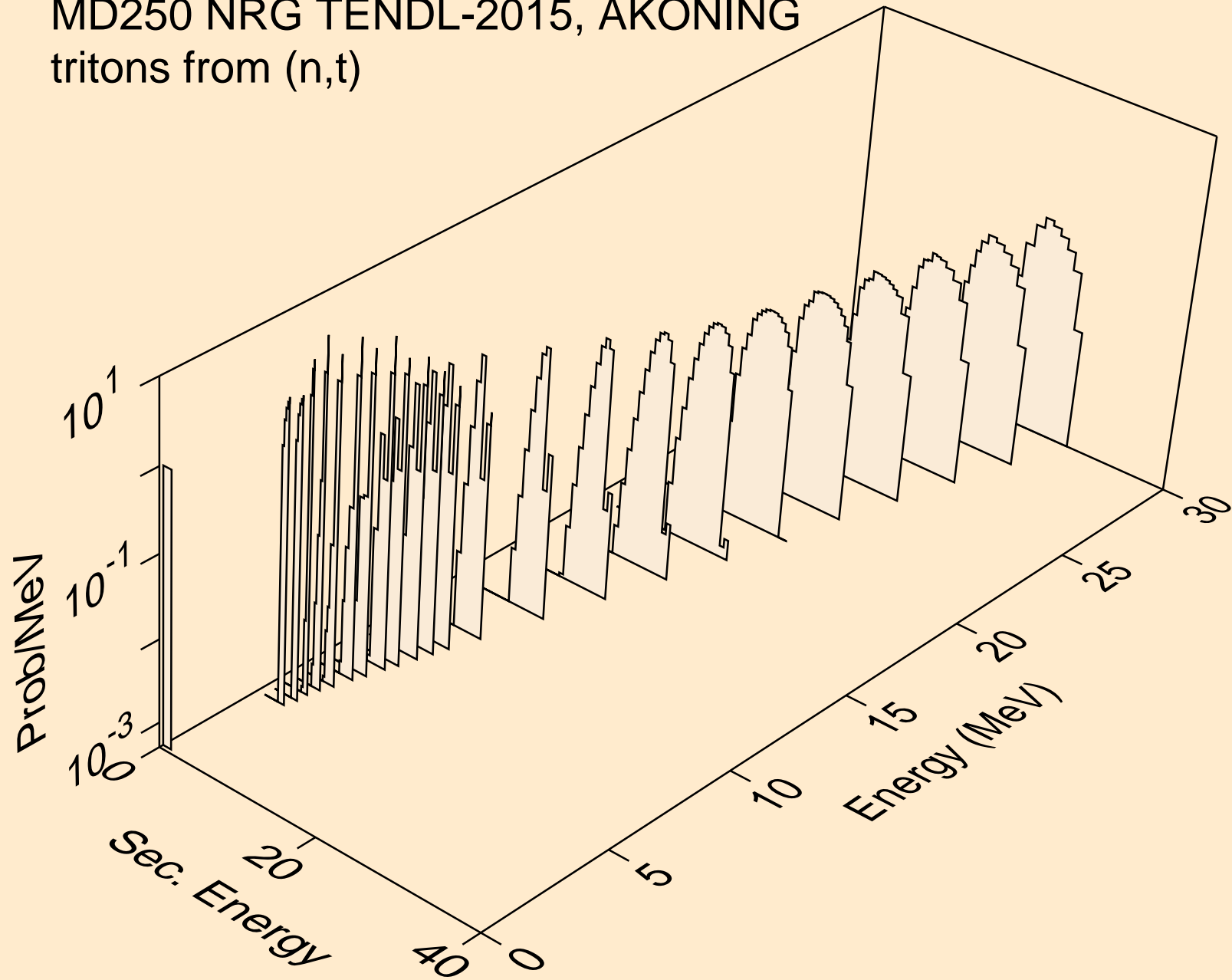

MD250 NRG TENDL-2015, AKONING
tritons from (n,t2a)

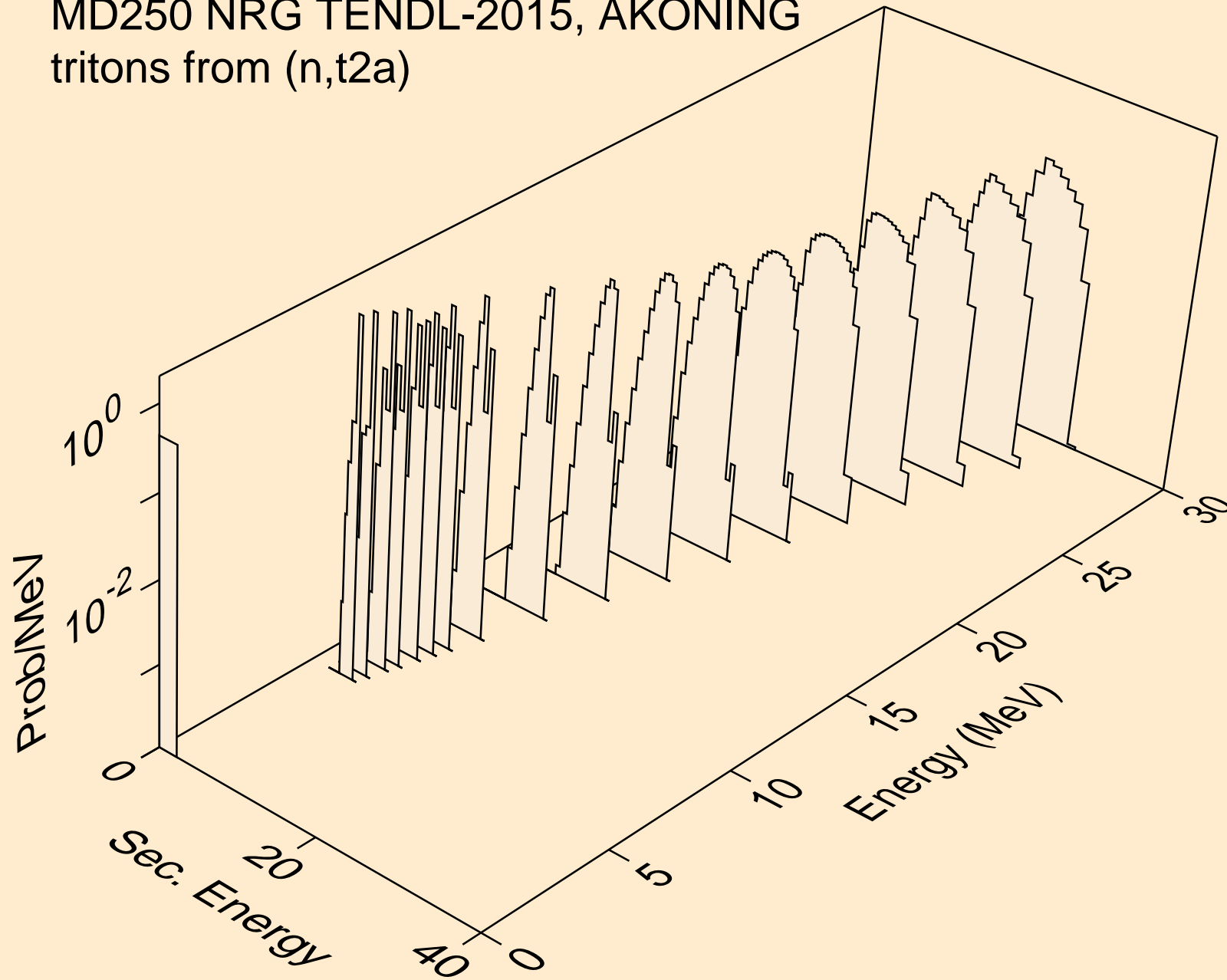

MD250 NRG TENDL-2015, AKONING
tritons from (n,pt)

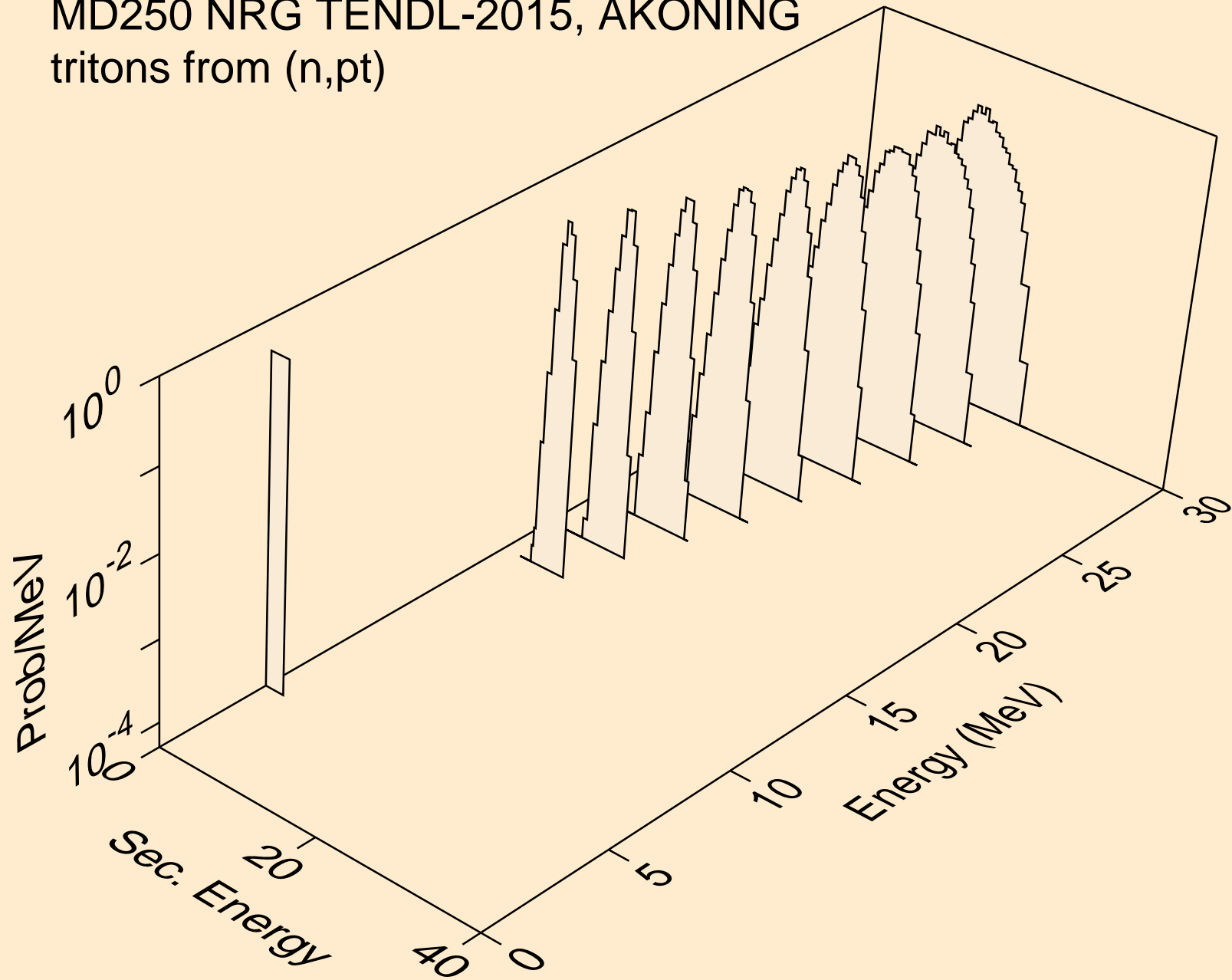

MD250 NRG TENDL-2015, AKONING
he3s from (n,x)

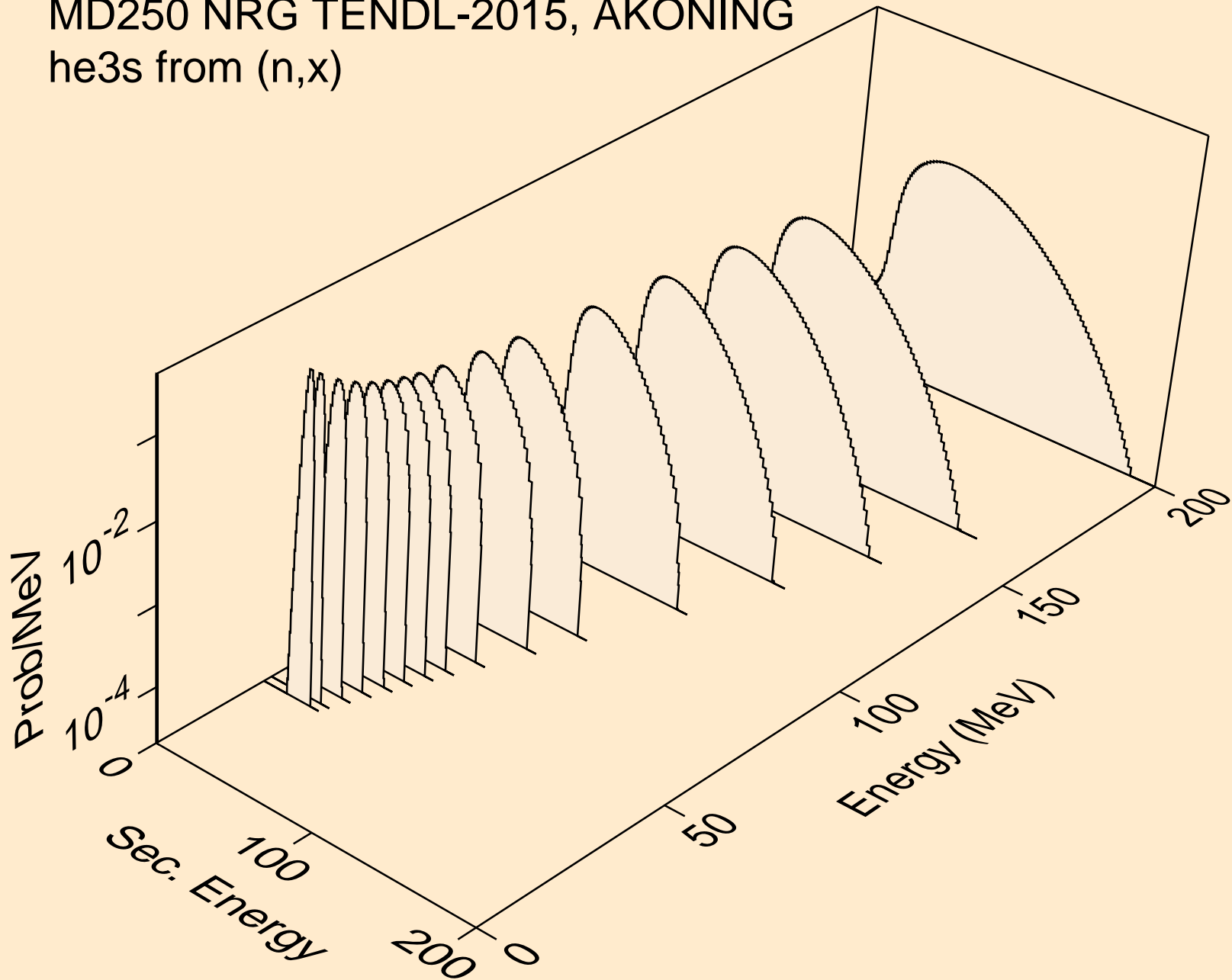

MD250 NRG TENDL-2015, AKONING
he3s from (n,n*)he3

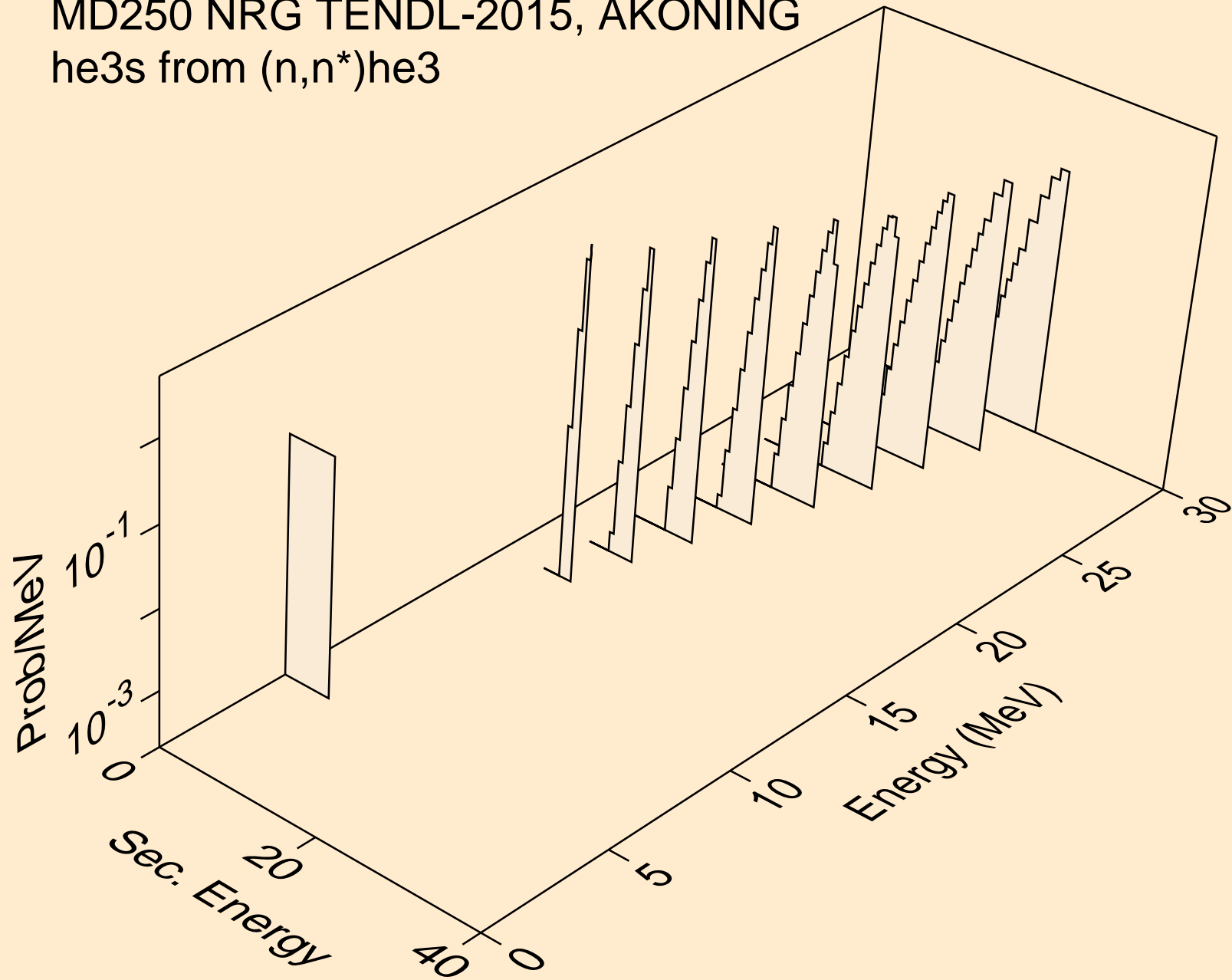

MD250 NRG TENDL-2015, AKONING
he3s from (n,he3)

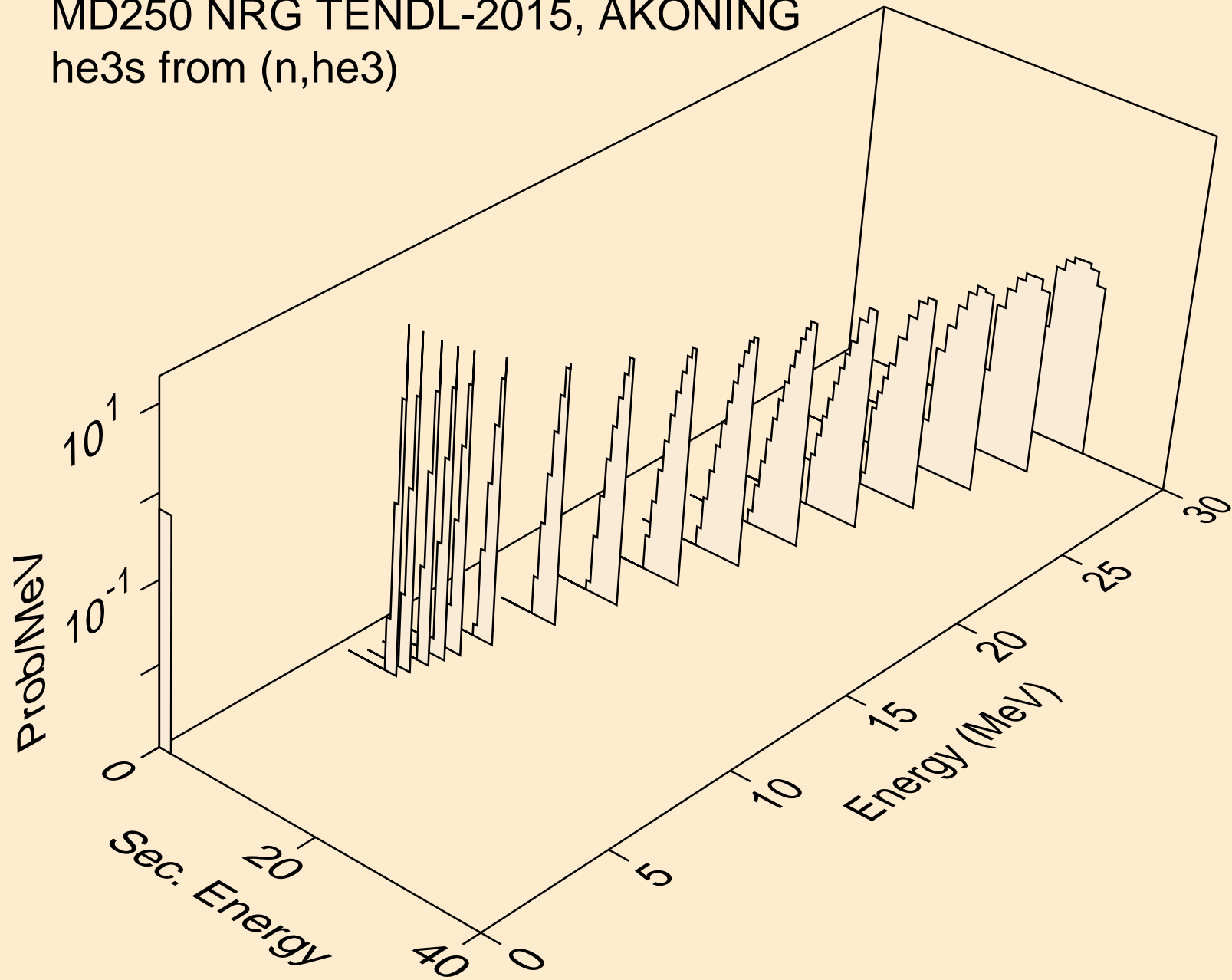

MD250 NRG TENDL-2015, AKONING
alphas from (n,x)

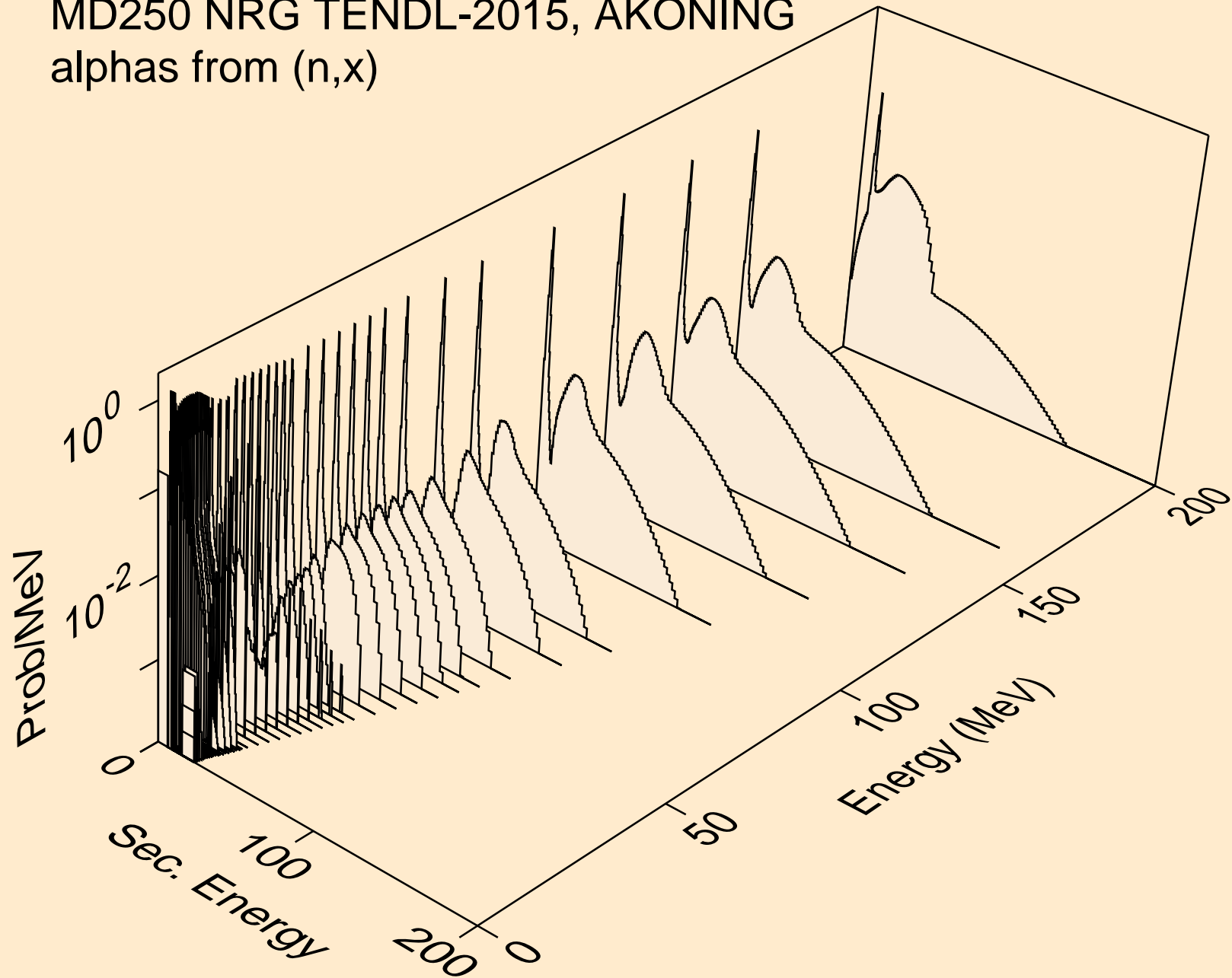

MD250 NRG TENDL-2015, AKONING
alphas from (n,n*)a

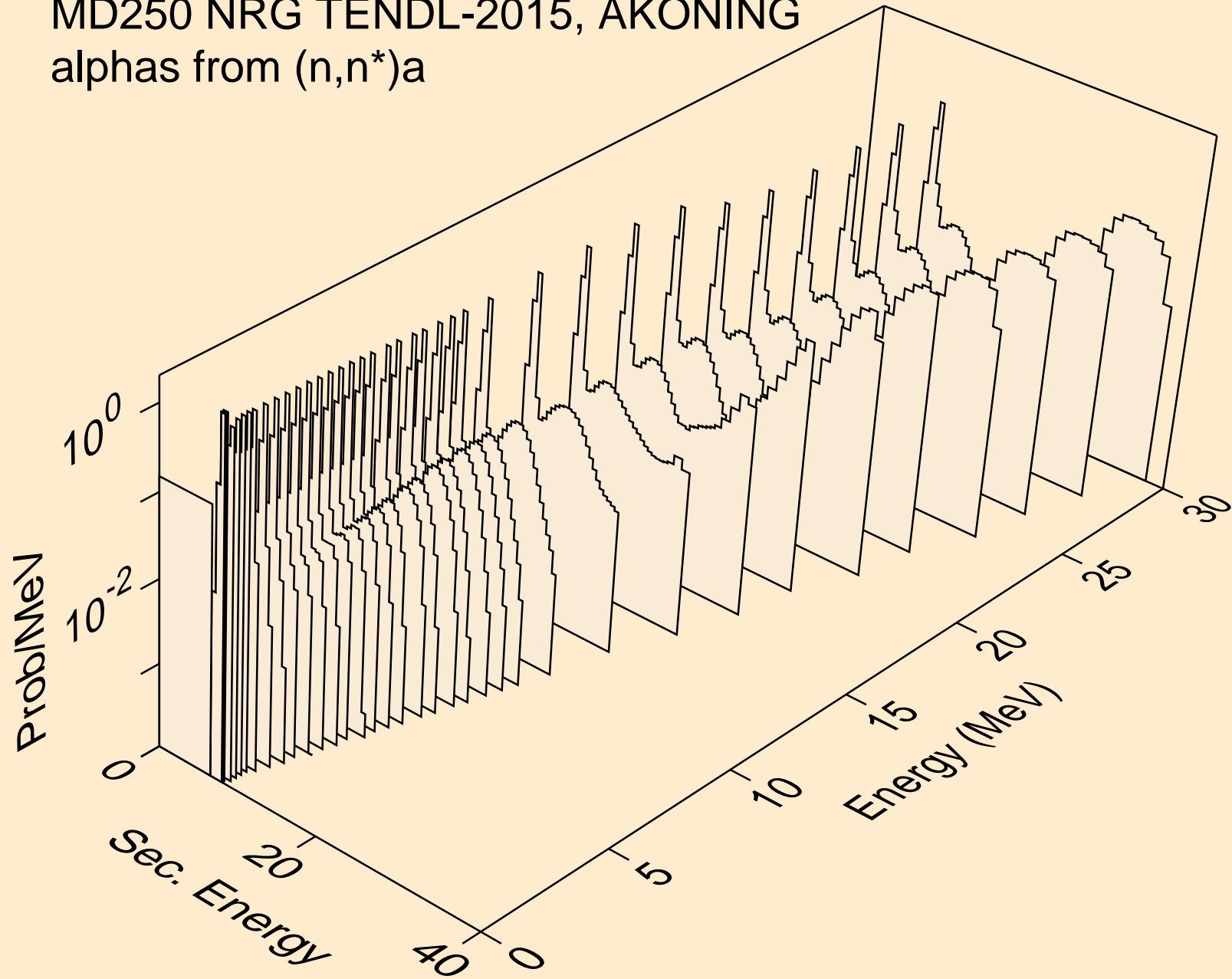

MD250 NRG TENDL-2015, AKONING
alphas from (n,n*)3a

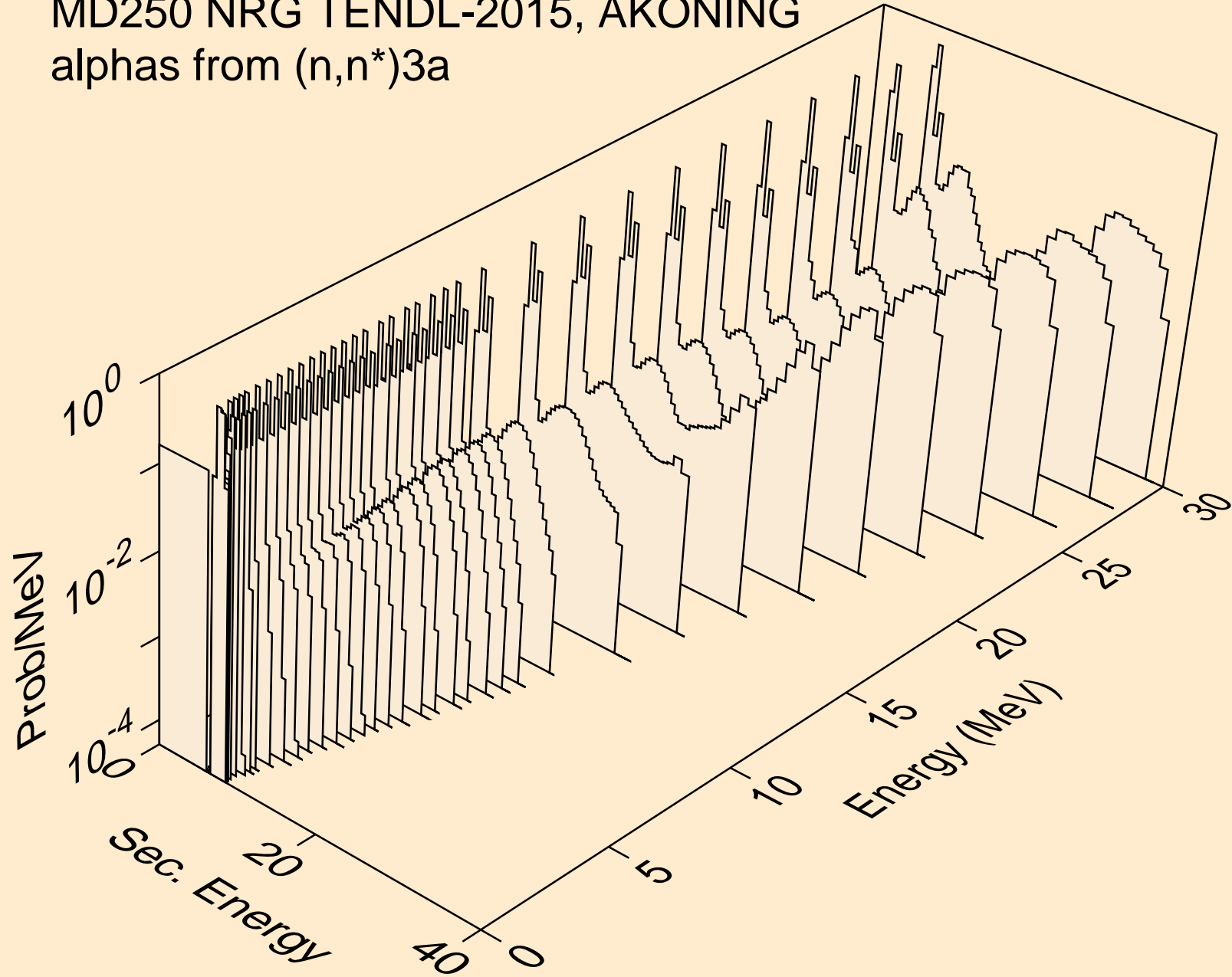

MD250 NRG TENDL-2015, AKONING
alphas from (n,2n)a

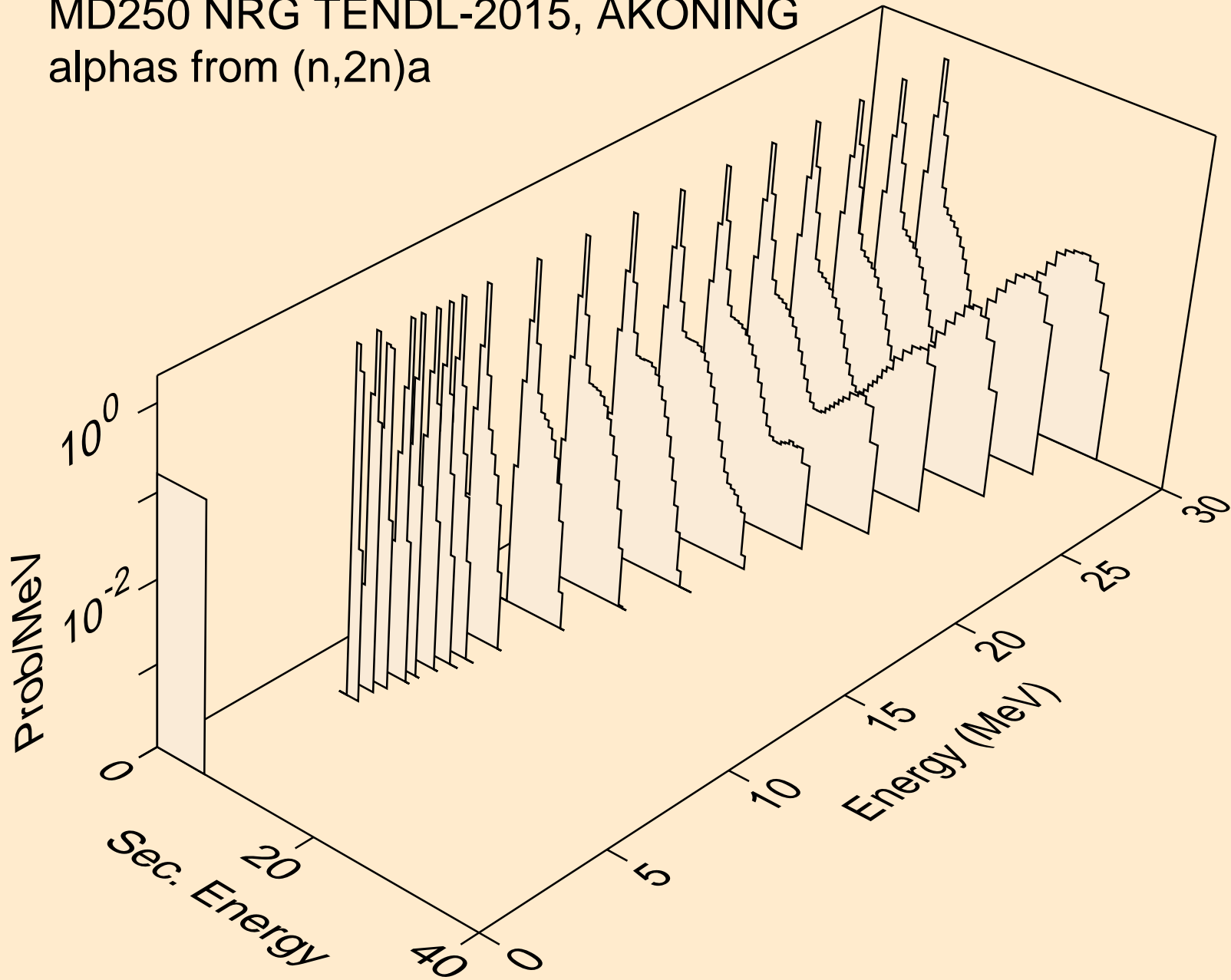

MD250 NRG TENDL-2015, AKONING
alphas from (n,3n)a

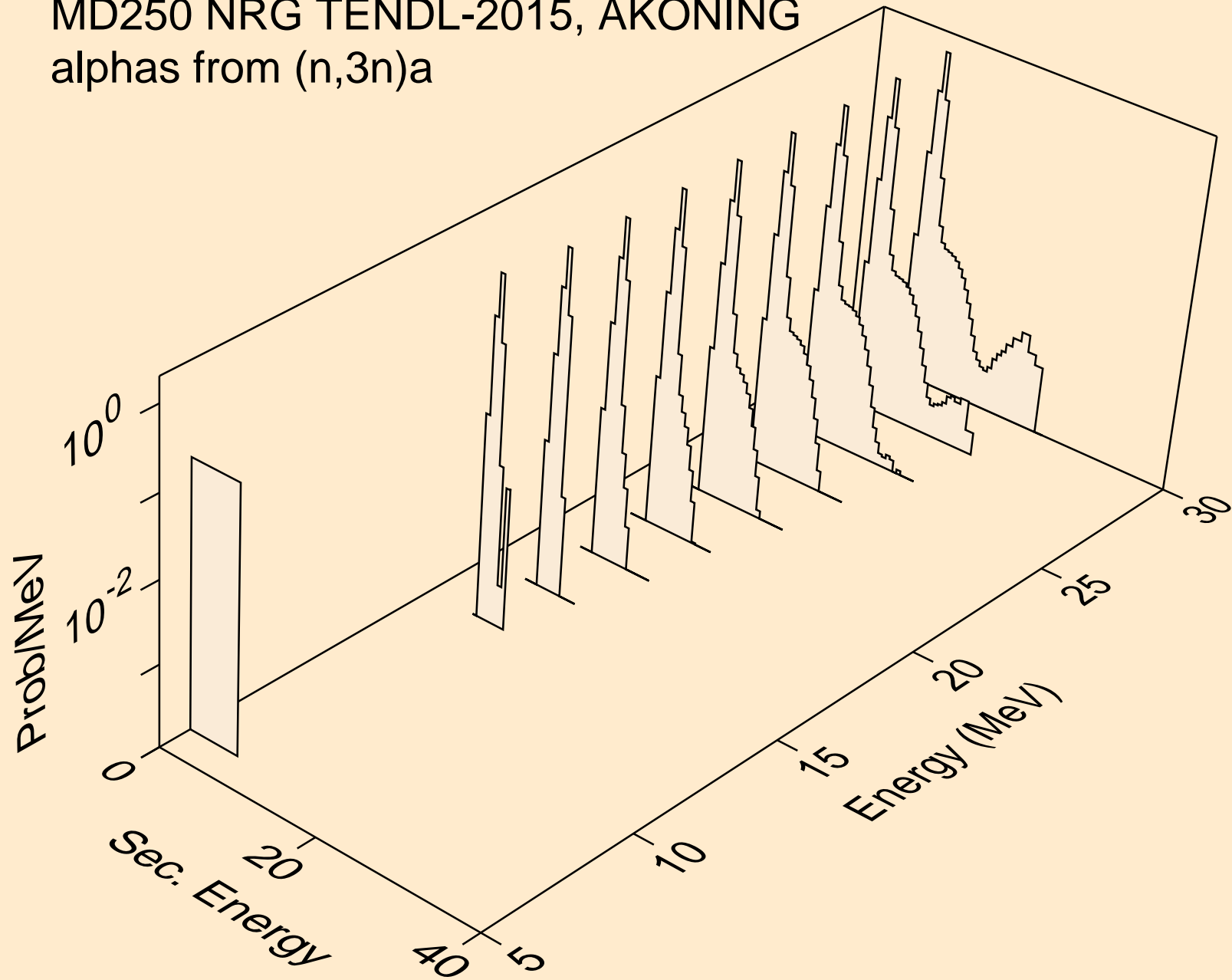

MD250 NRG TENDL-2015, AKONING
alphas from (n,n*)2a

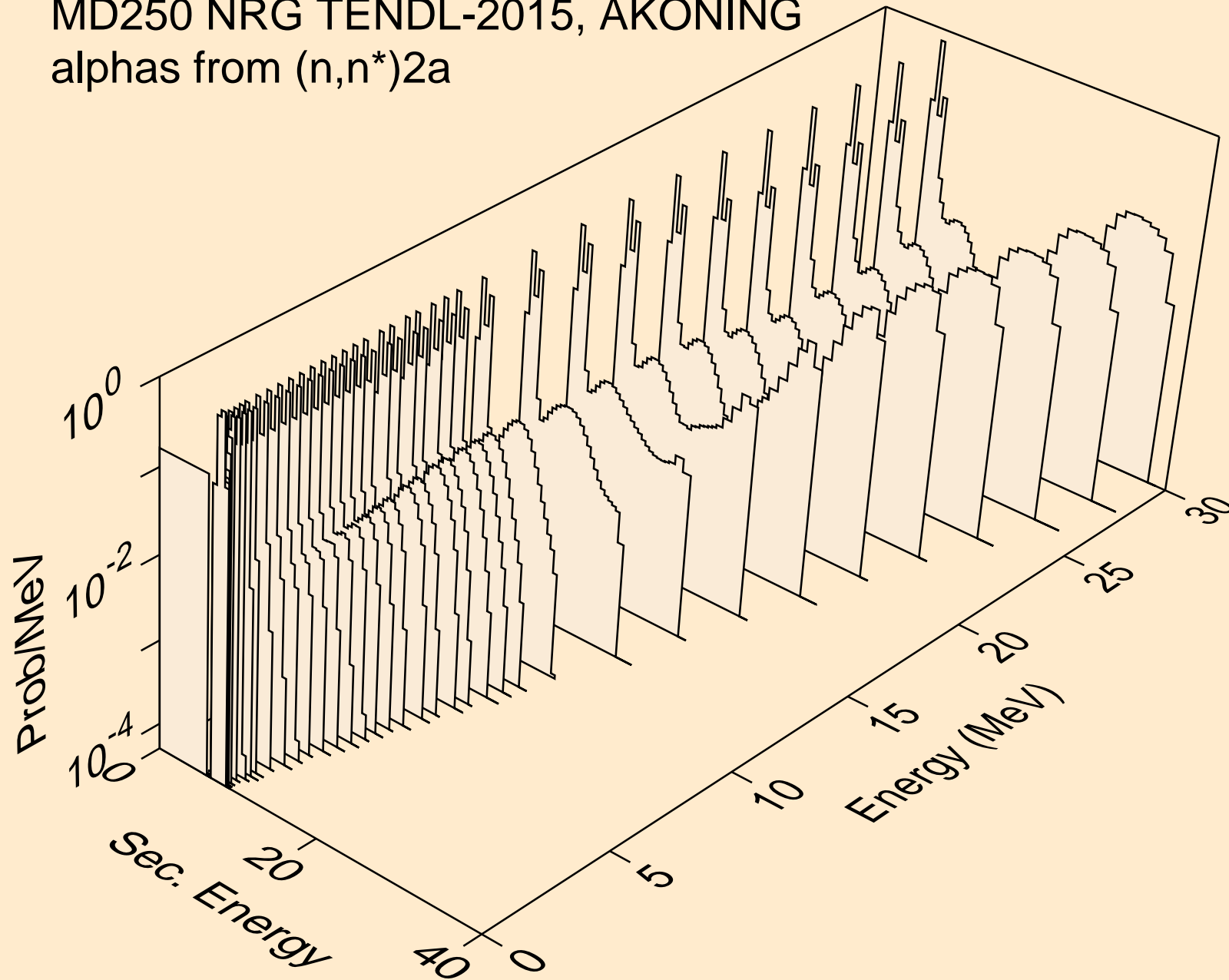

MD250 NRG TENDL-2015, AKONING
alphas from (n,2n)2a

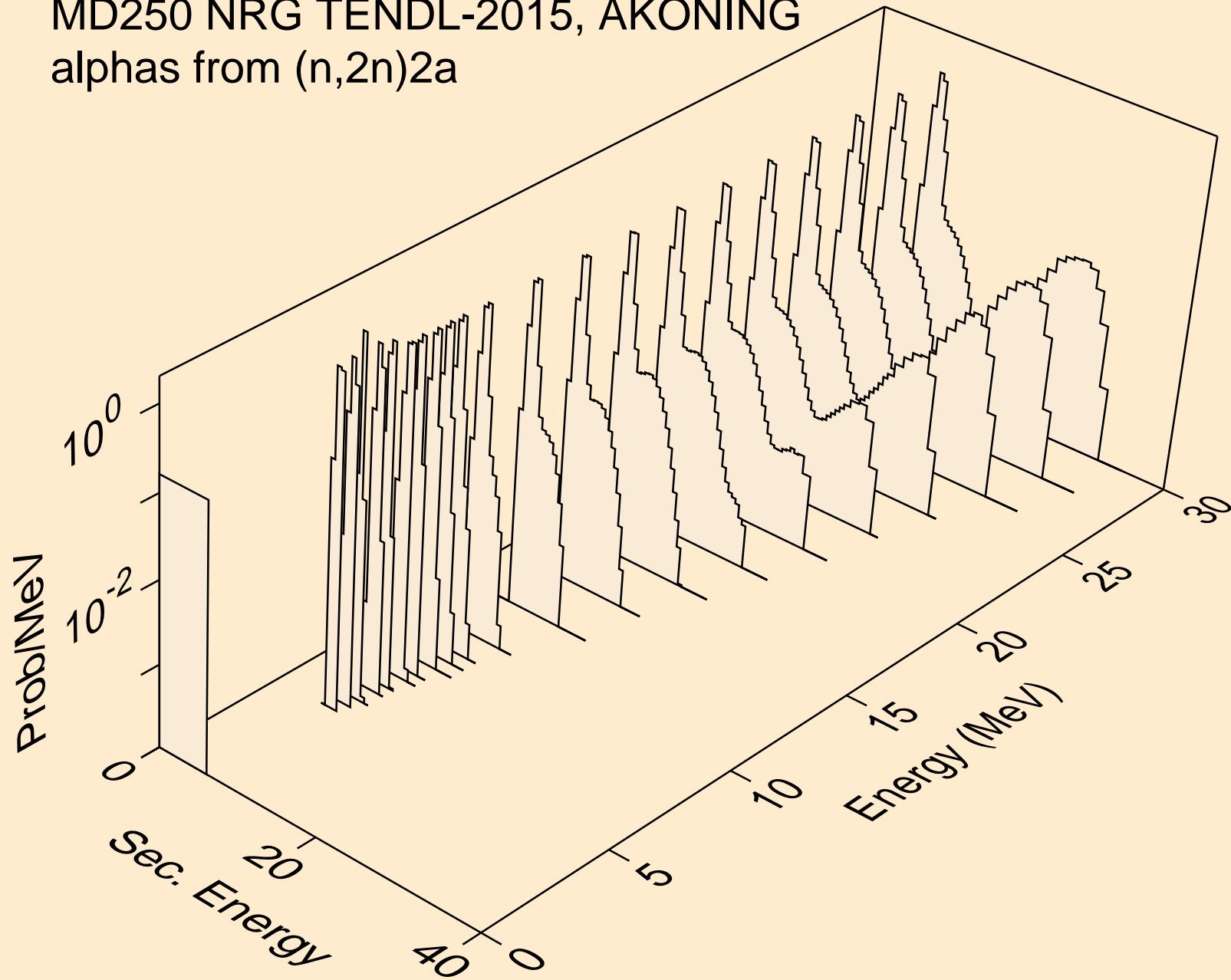

MD250 NRG TENDL-2015, AKONING
alphas from (n,n*)d2a

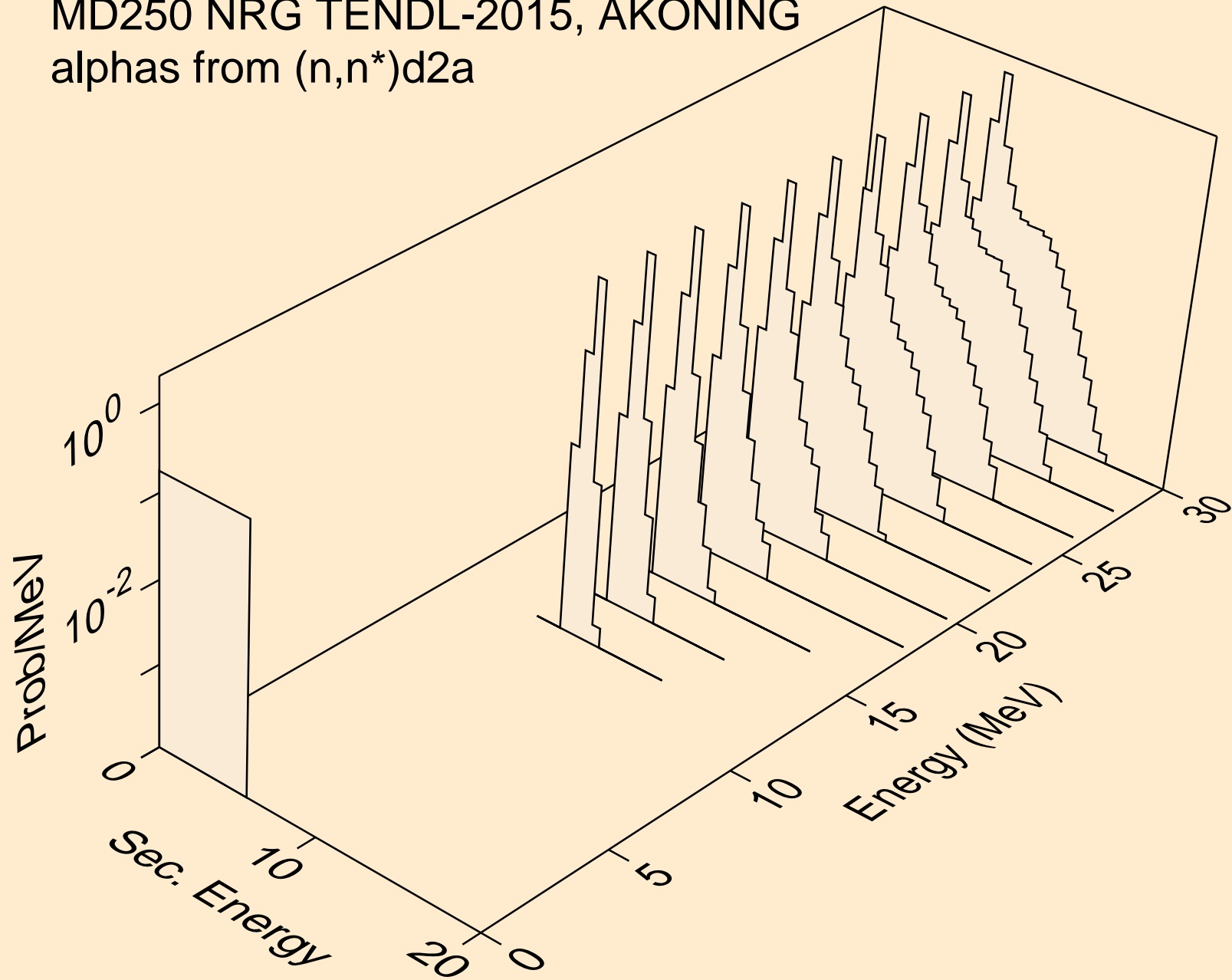

MD250 NRG TENDL-2015, AKONING
alphas from (n,n*)t2a

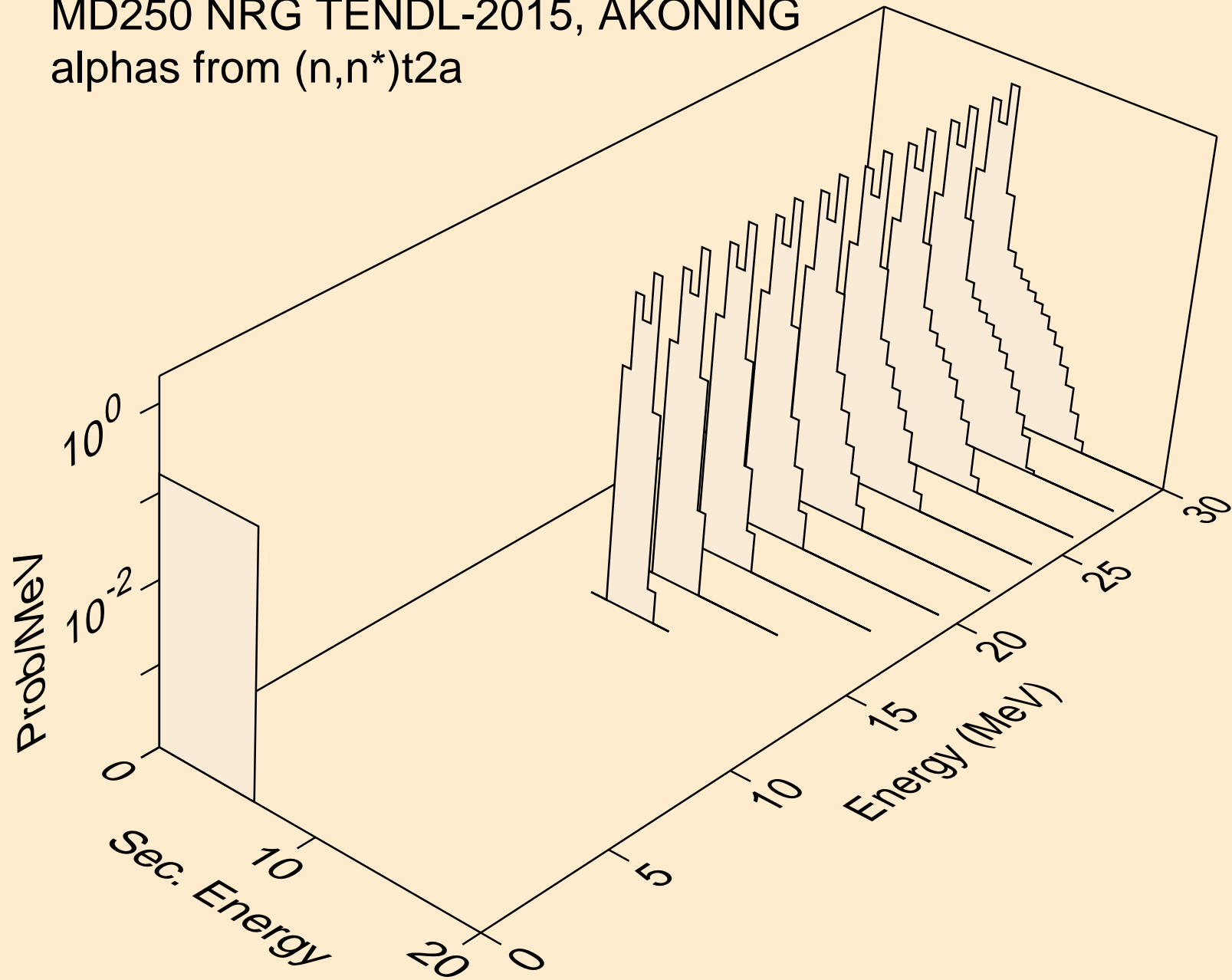

MD250 NRG TENDL-2015, AKONING
alphas from (n,npa)

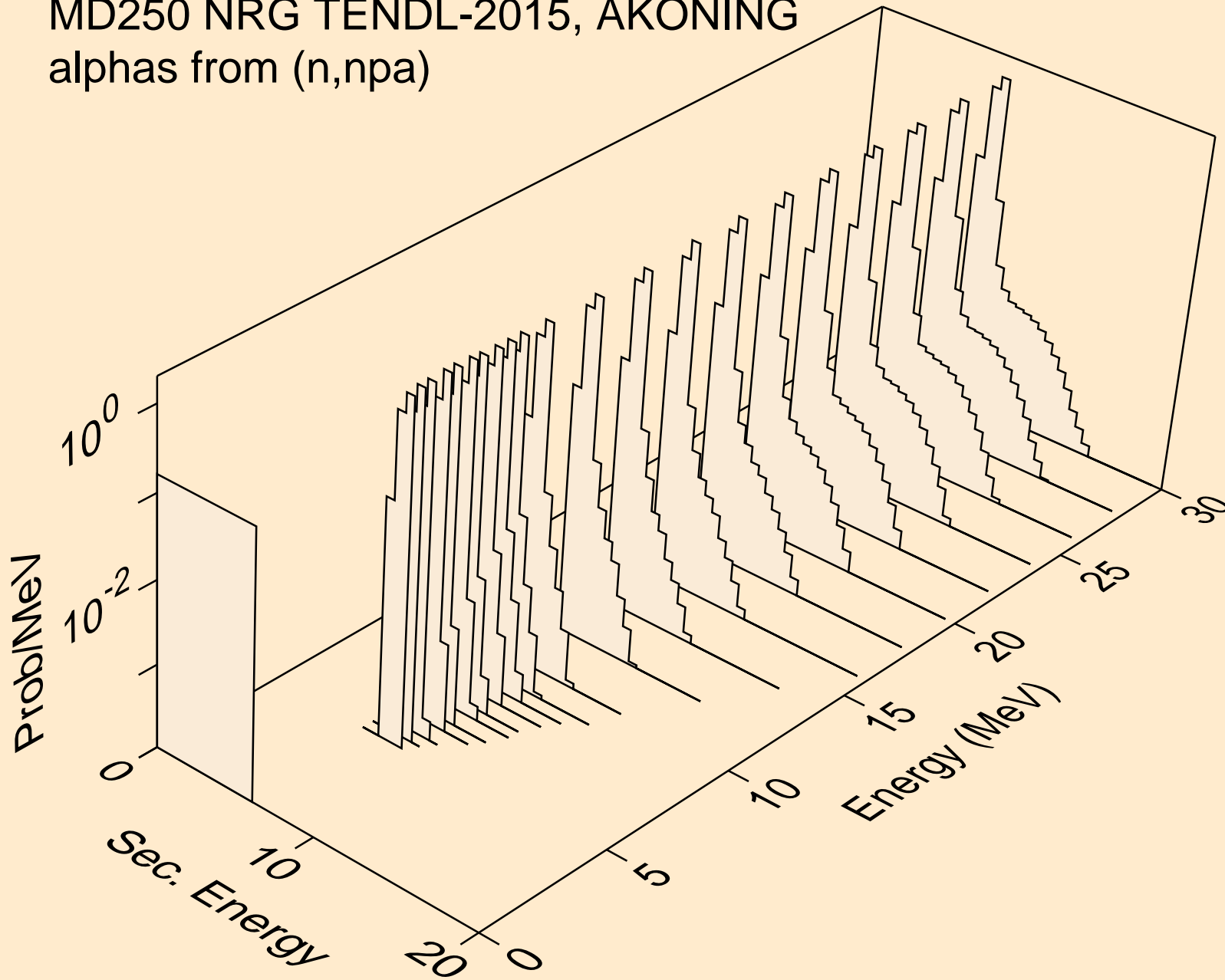

MD250 NRG TENDL-2015, AKONING
alphas from (n,a)

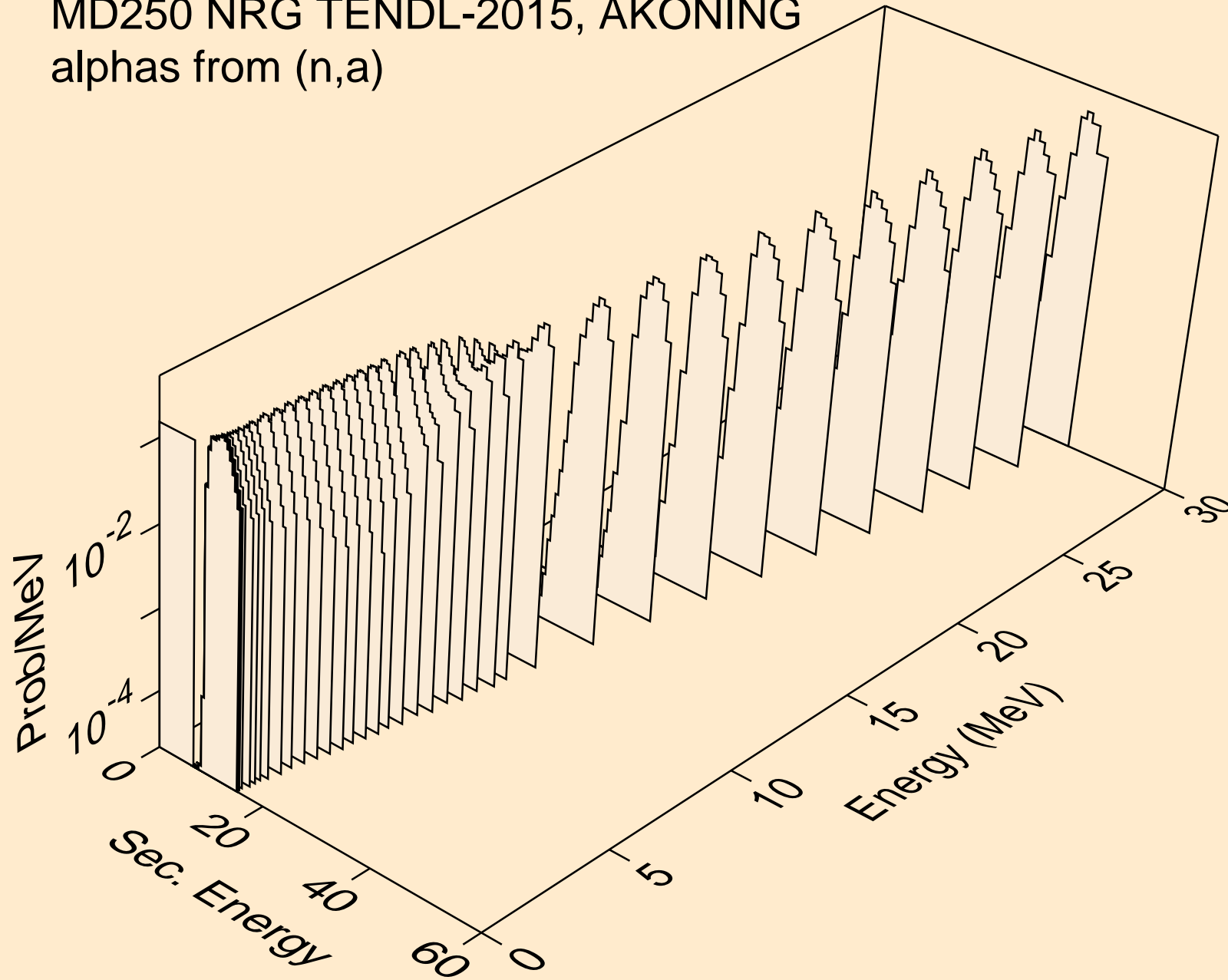

MD250 NRG TENDL-2015, AKONING
alphas from (n,2a)

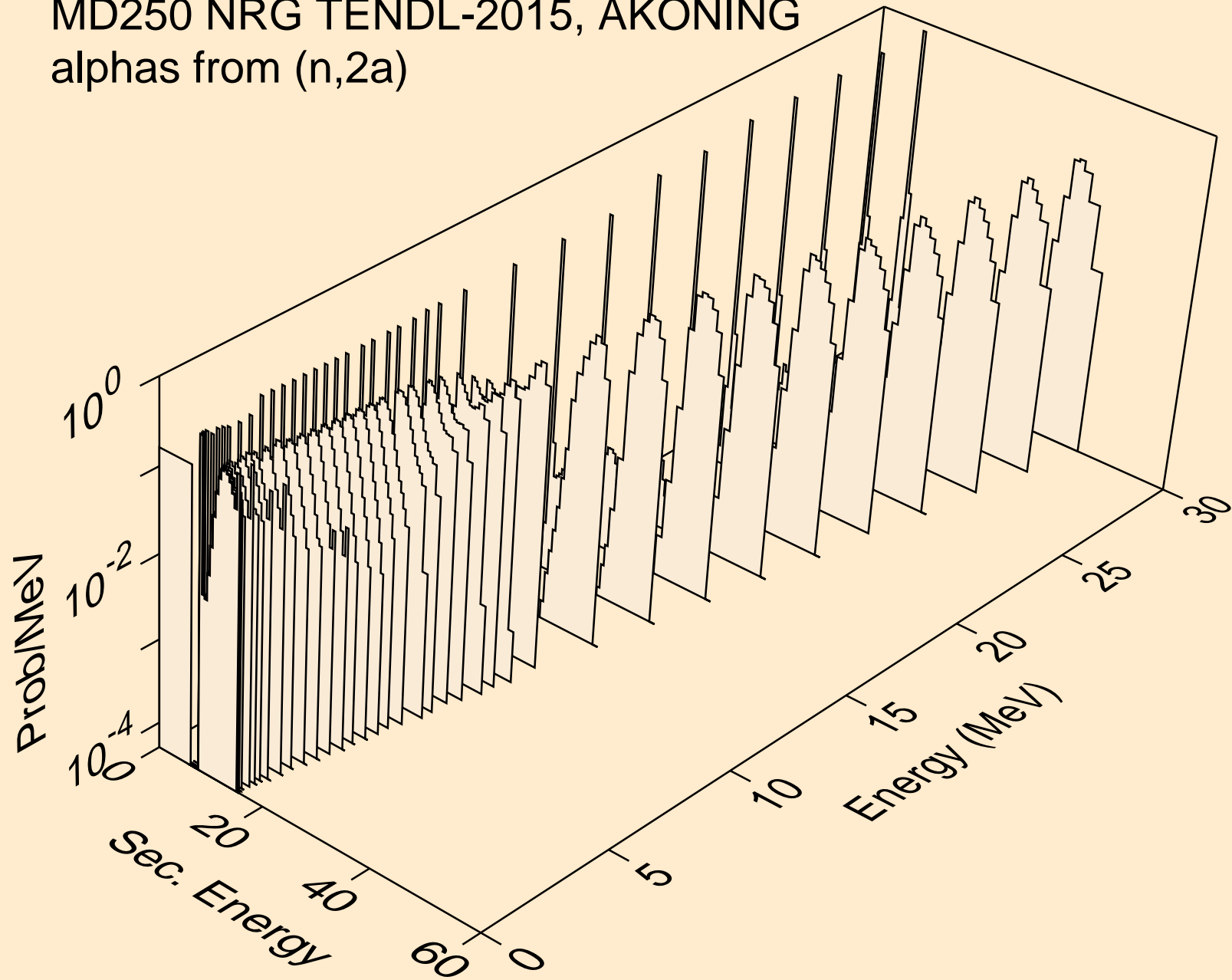

MD250 NRG TENDL-2015, AKONING
alphas from (n,3a)

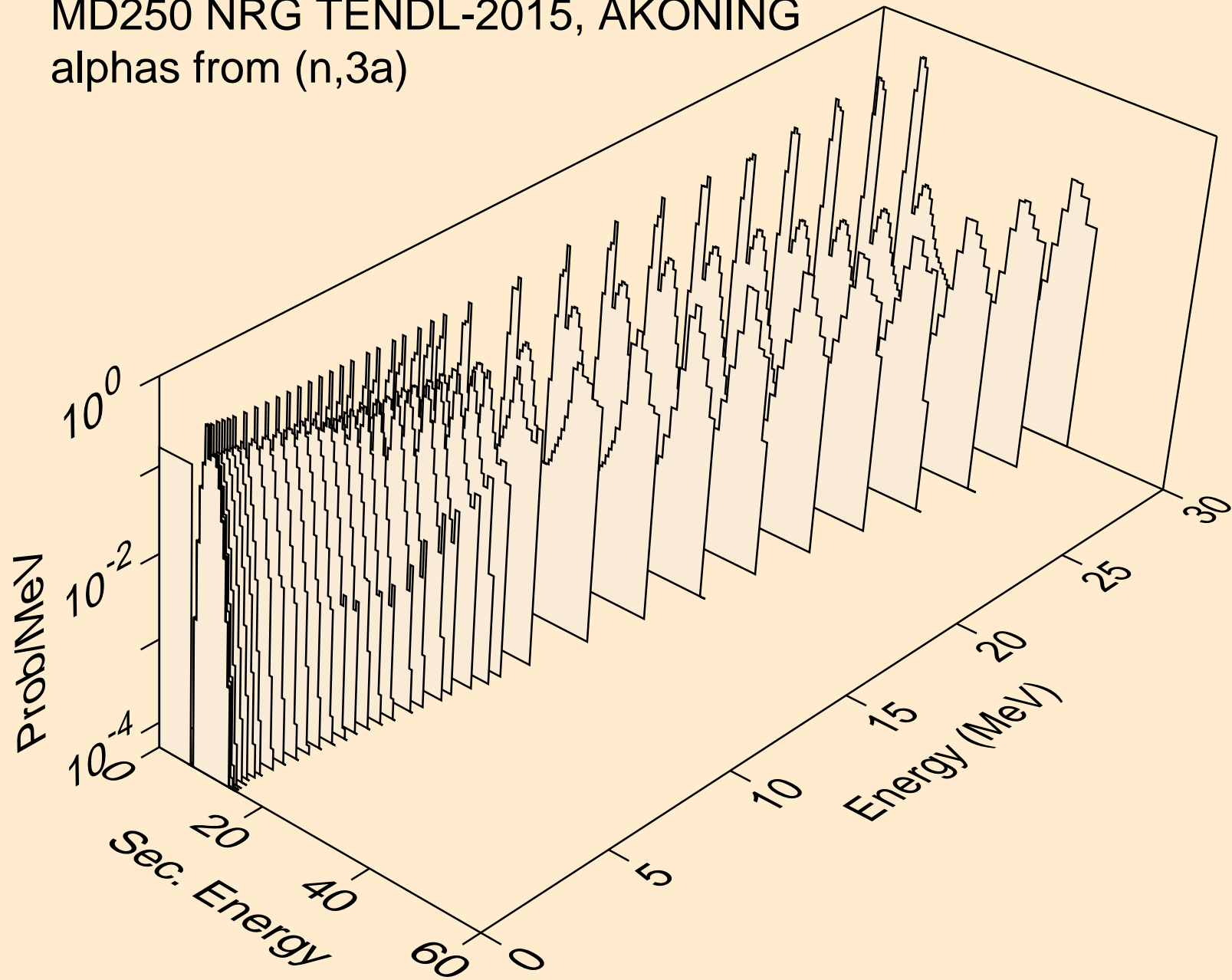

MD250 NRG TENDL-2015, AKONING
alphas from (n,pa)

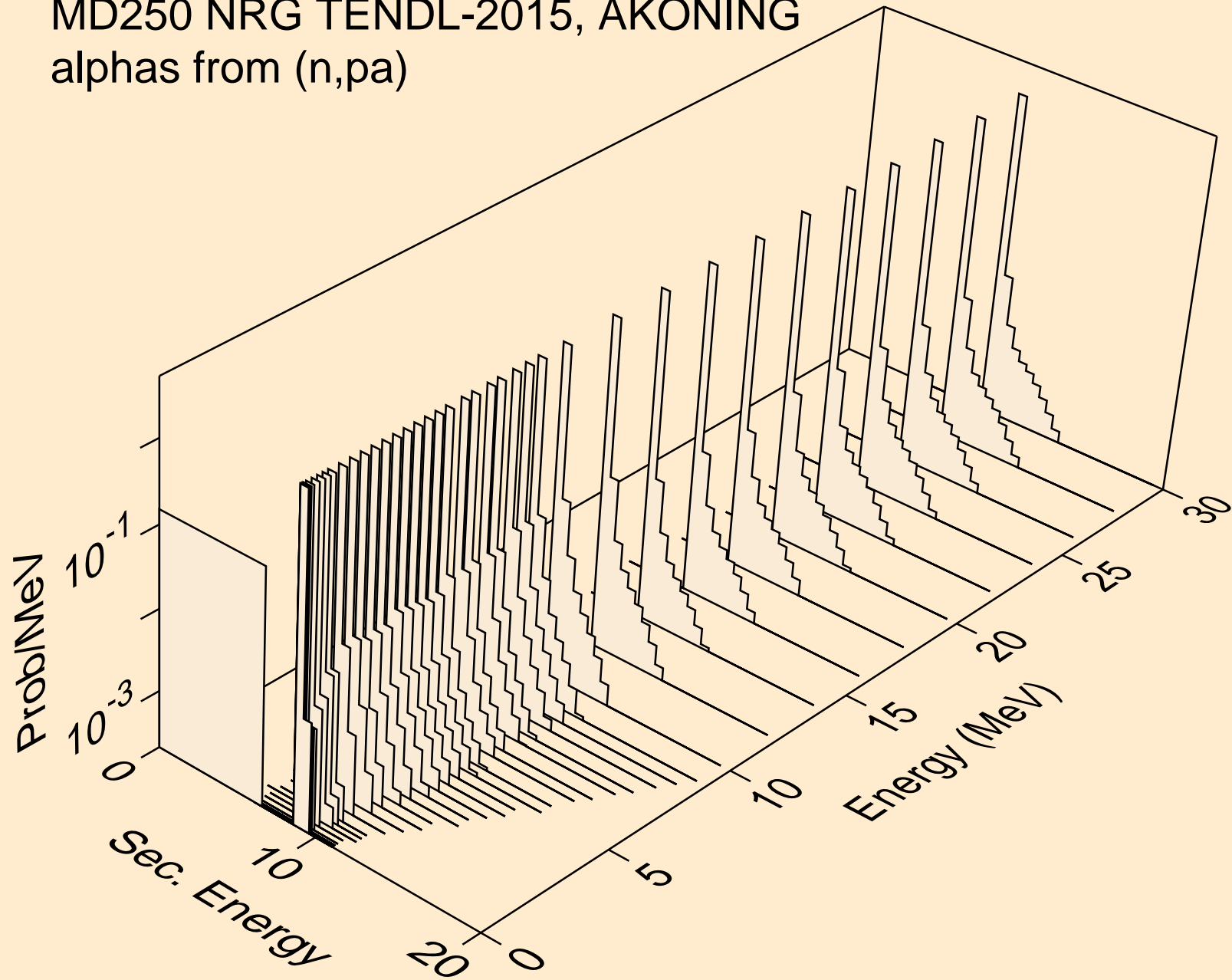

MD250 NRG TENDL-2015, AKONING
alphas from (n,t2a)

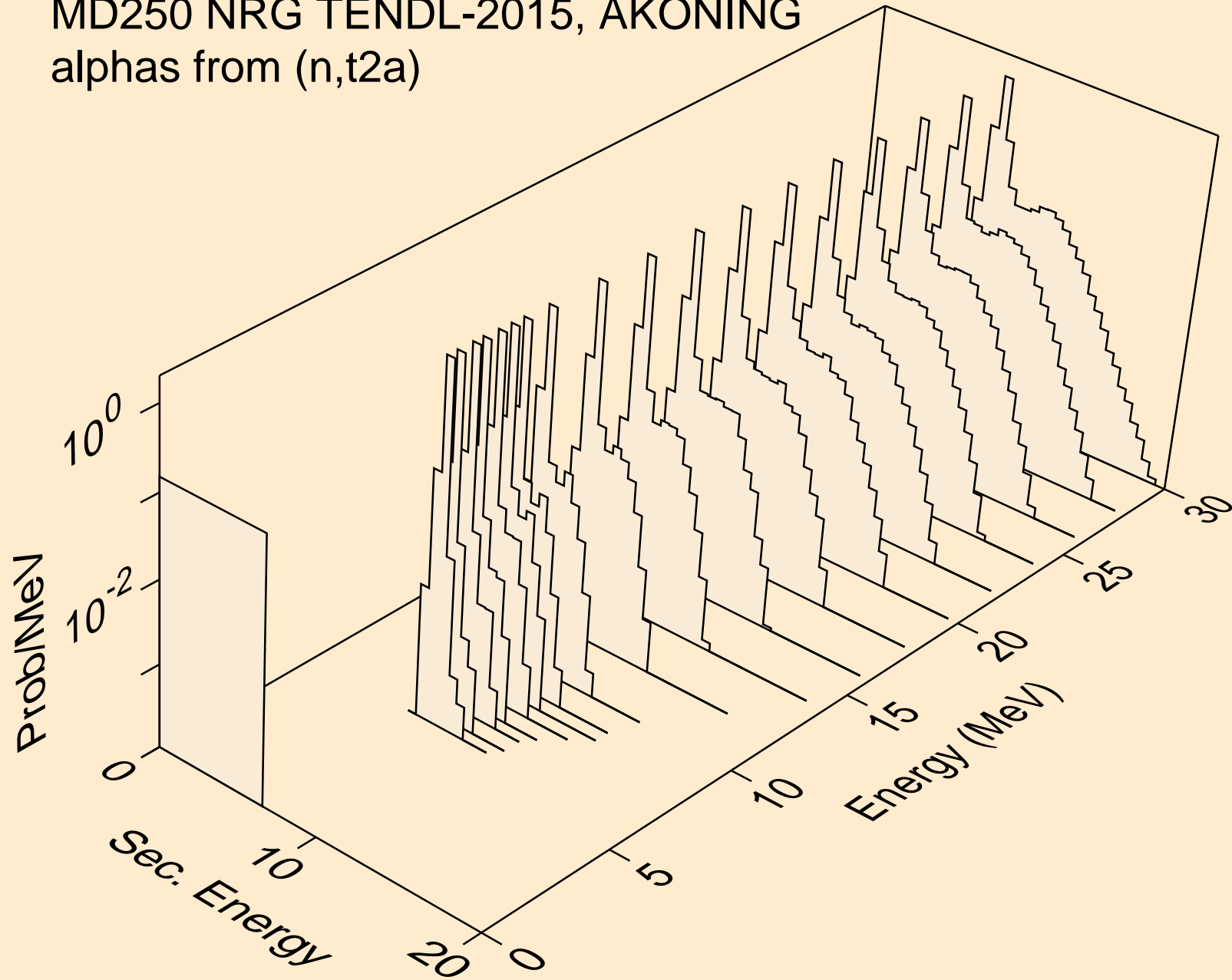

MD250 NRG TENDL-2015, AKONING
alphas from (n,d2a)

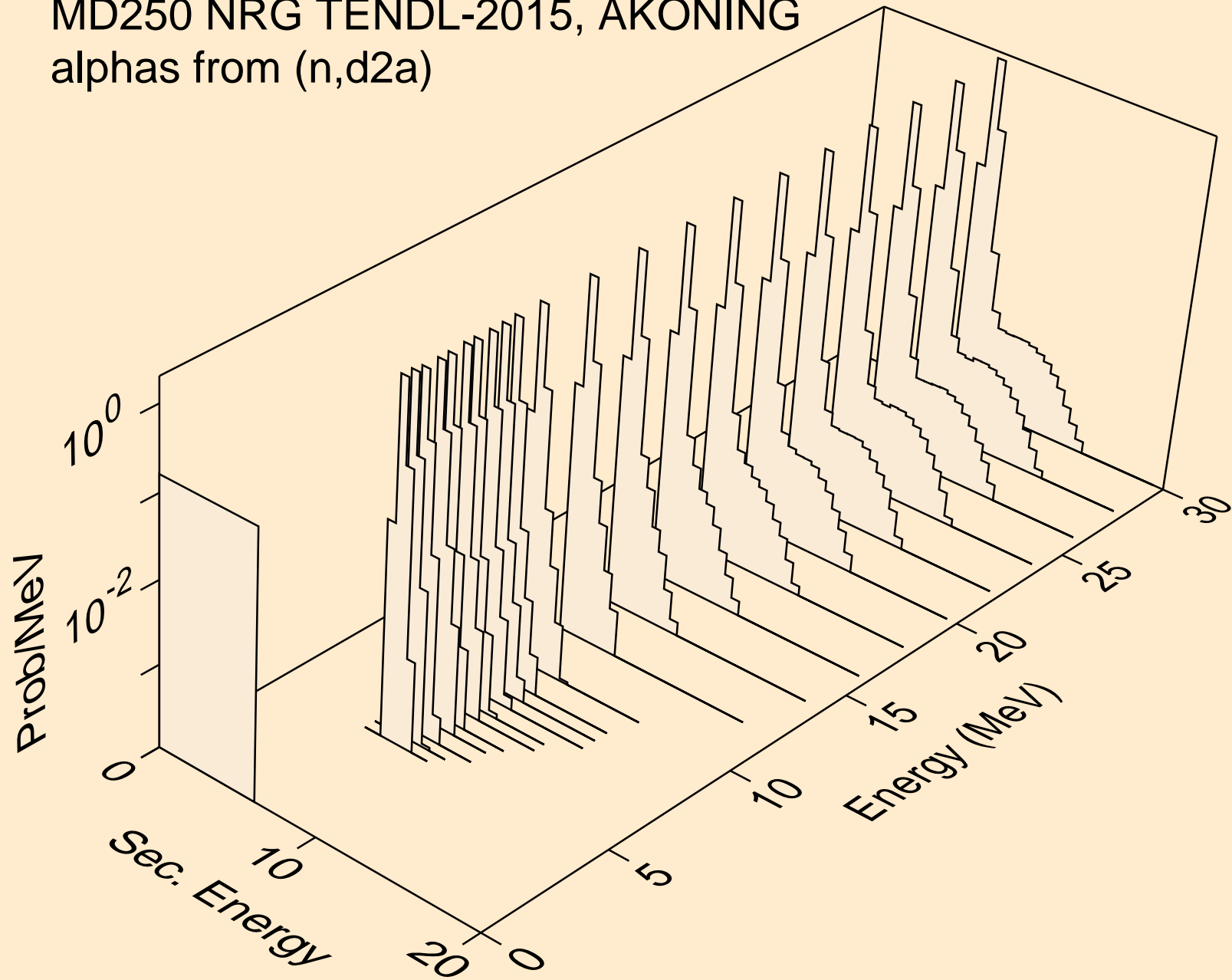

MD250 NRG TENDL-2015, AKONING
alphas from (n,da)

