

MT277 NRG TENDL-2015, AKONING

Principal cross sections

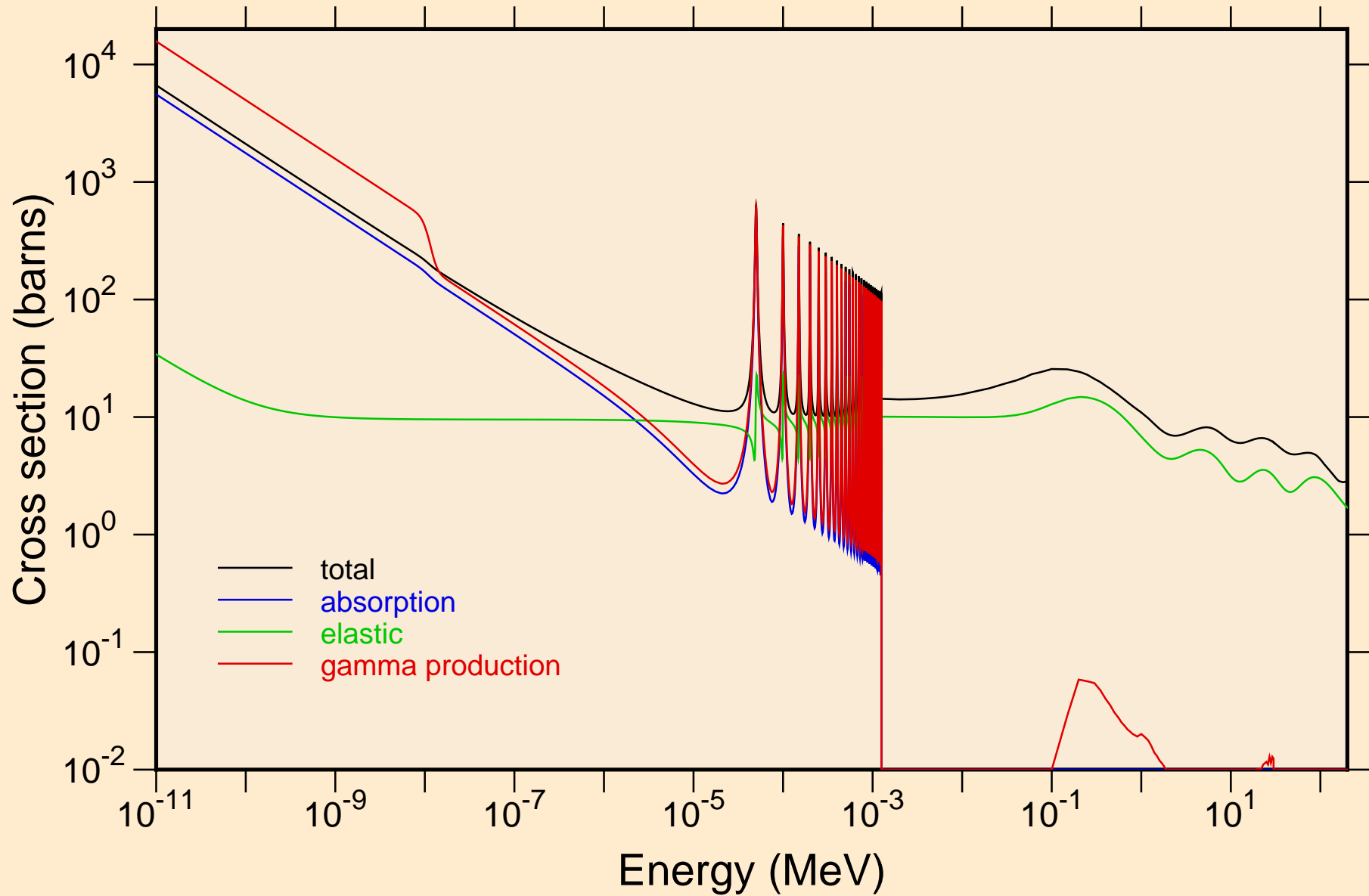

MT277 NRG TENDL-2015, AKONING
resonance total cross section

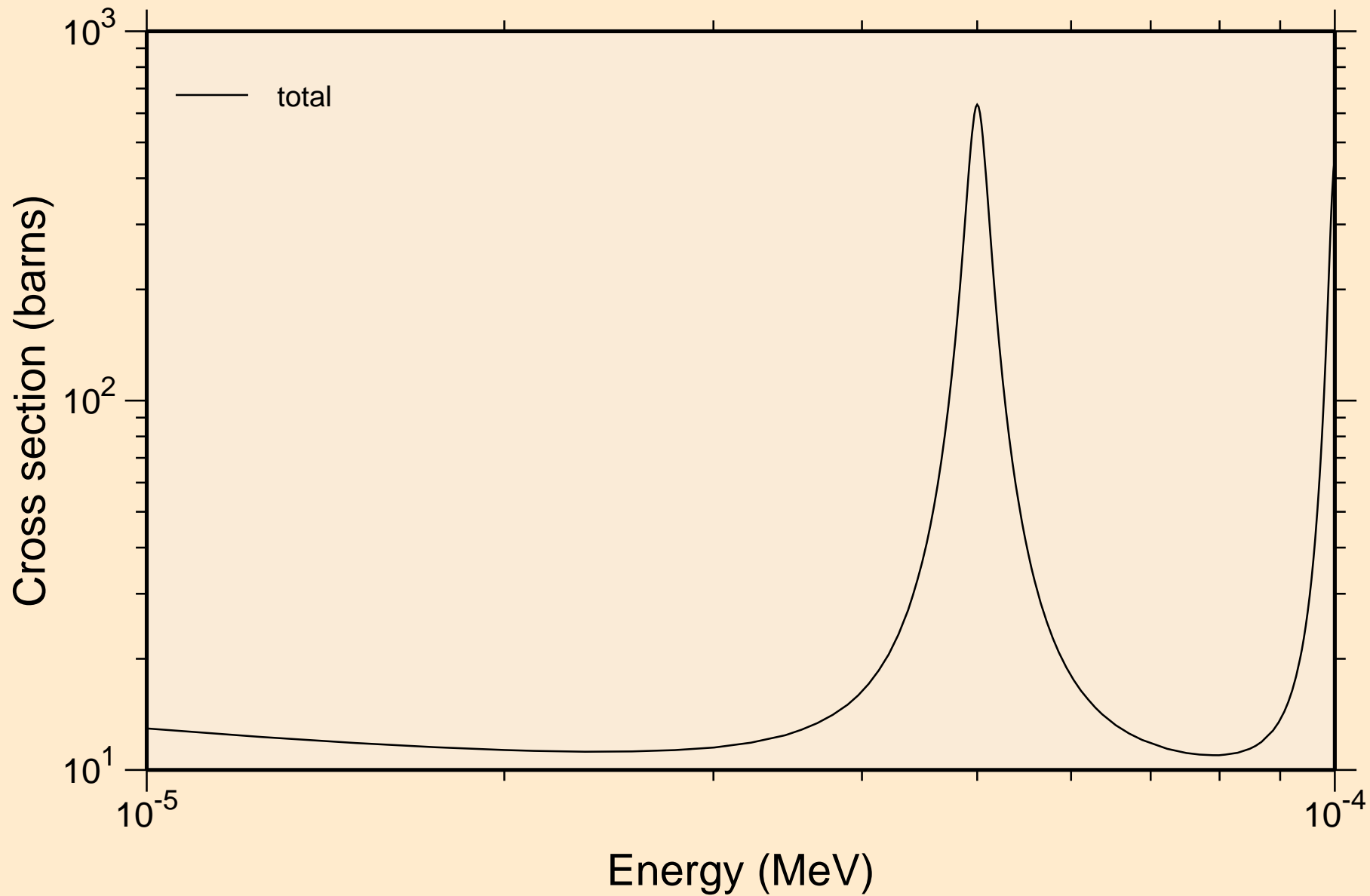

MT277 NRG TENDL-2015, AKONING
resonance total cross section

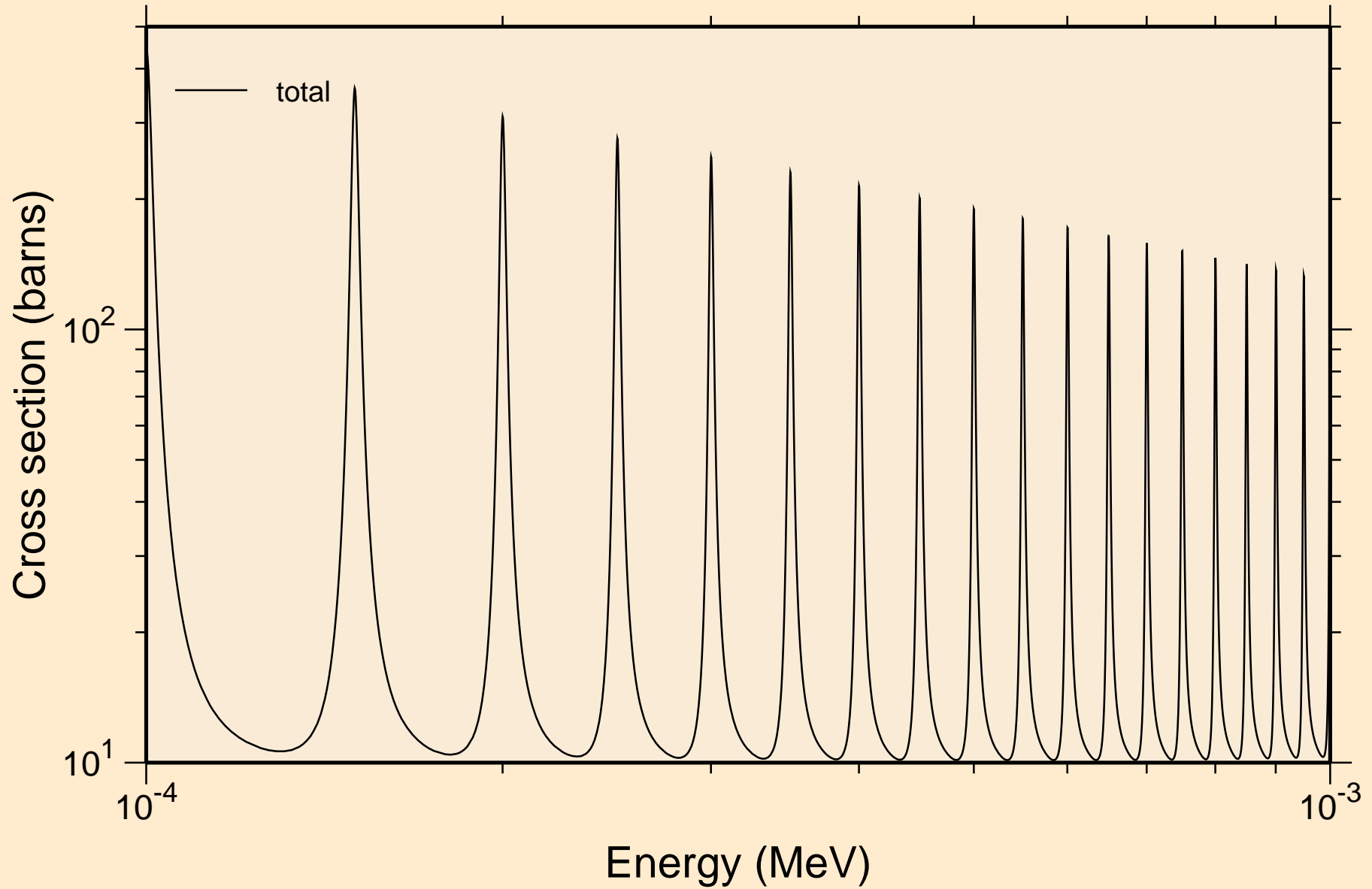

MT277 NRG TENDL-2015, AKONING
resonance total cross section

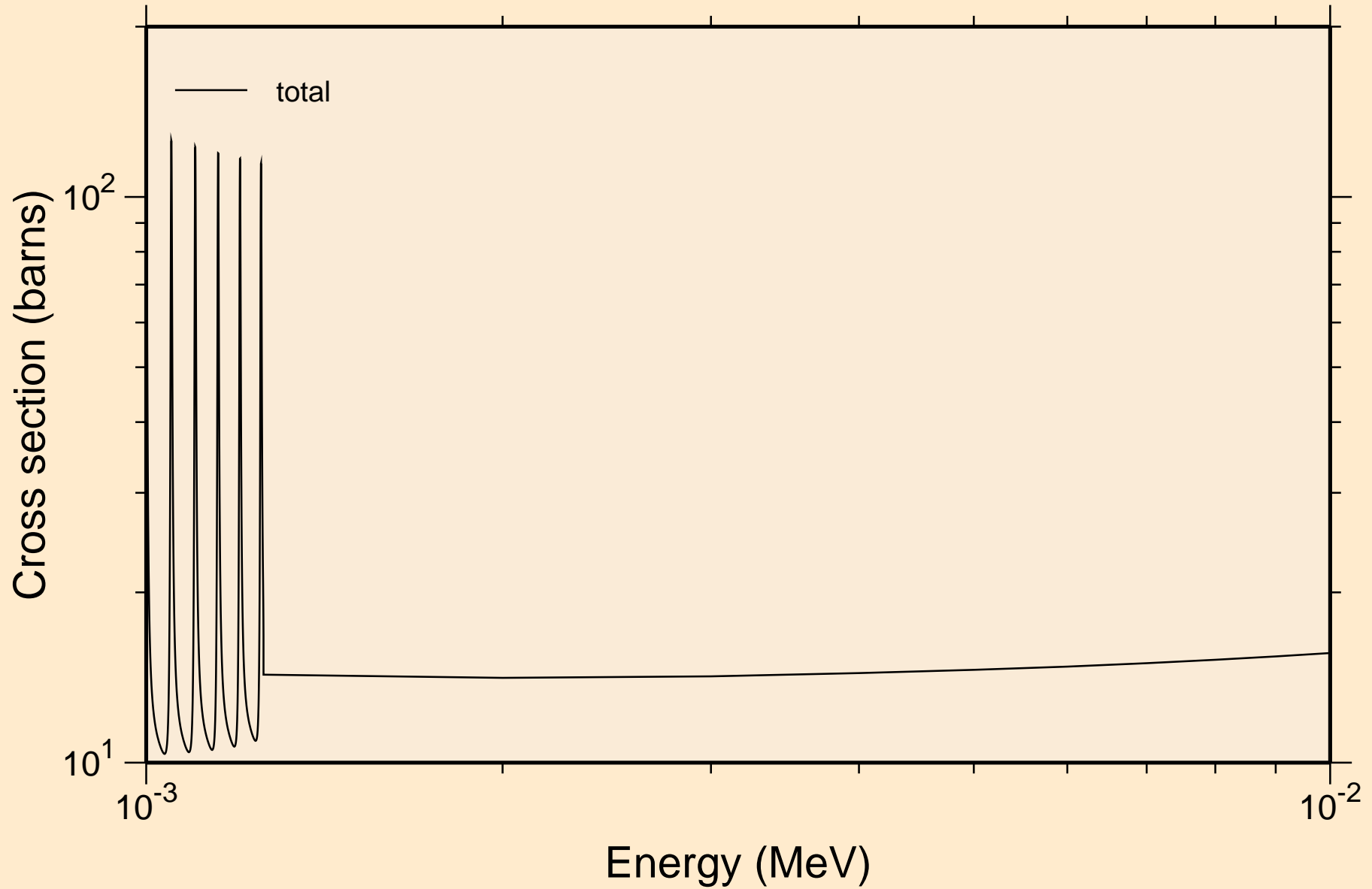

MT277 NRG TENDL-2015, AKONING
resonance total cross section

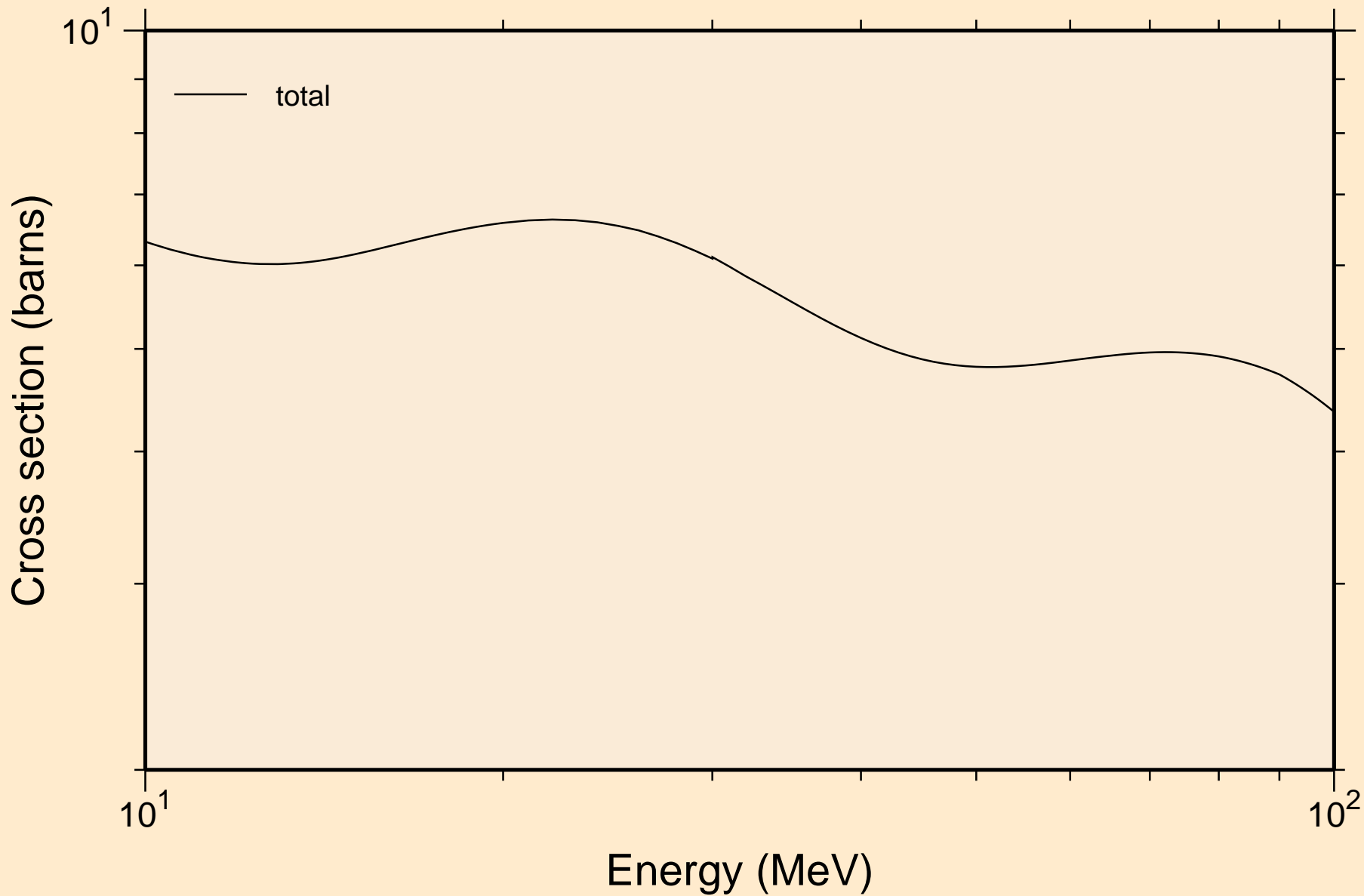

MT277 NRG TENDL-2015, AKONING
resonance absorption cross sections

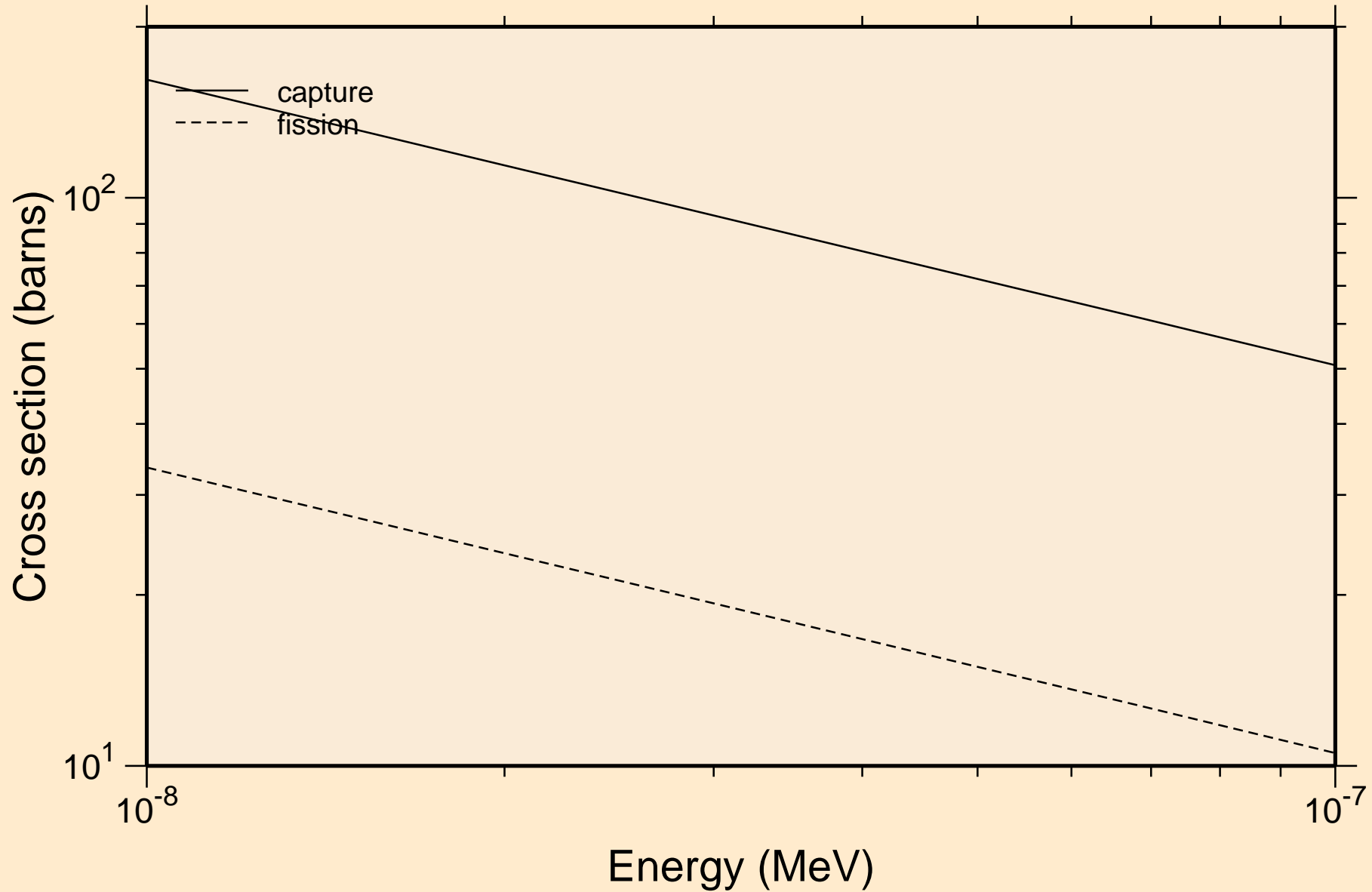

MT277 NRG TENDL-2015, AKONING
resonance absorption cross sections

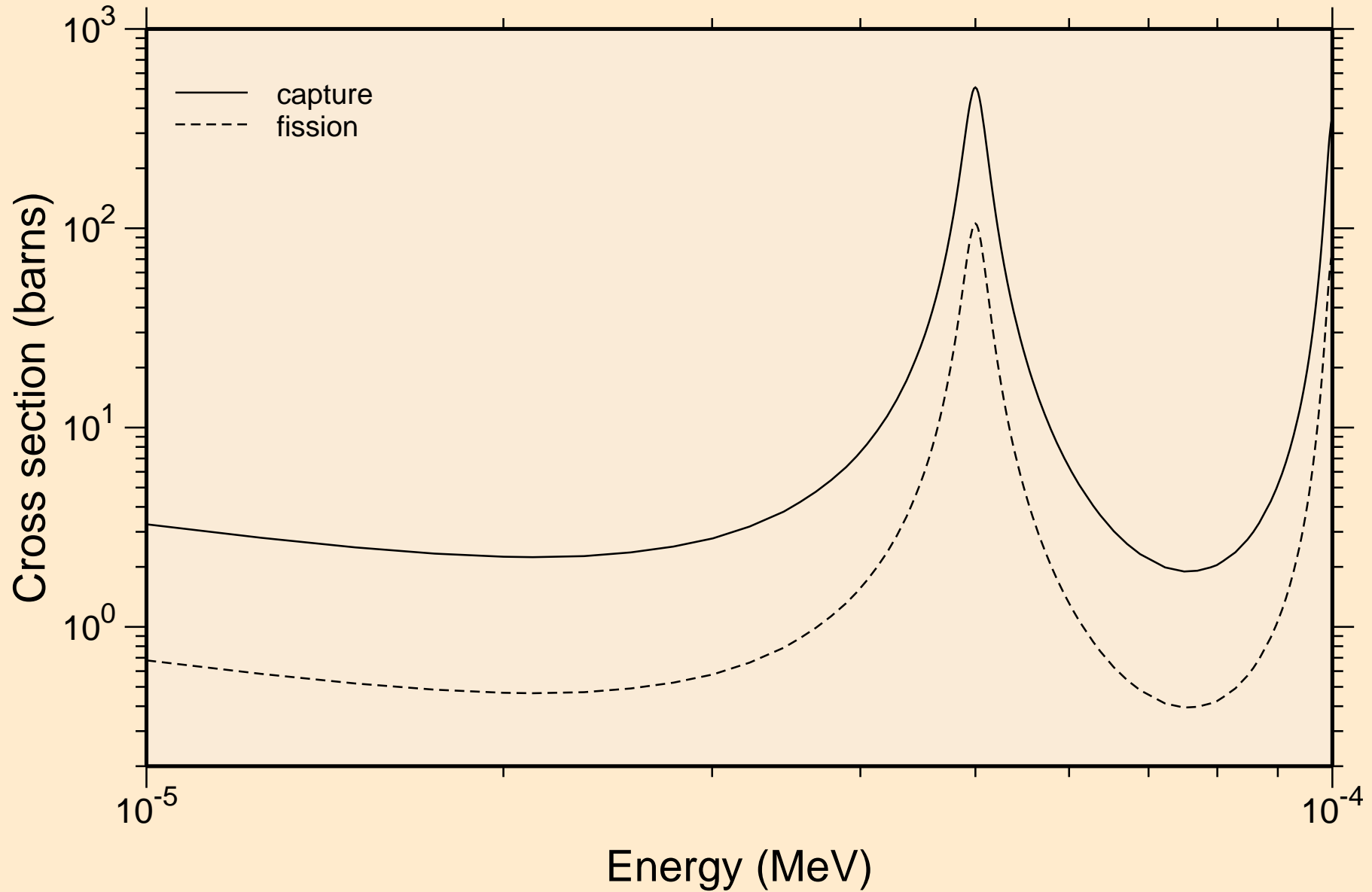

MT277 NRG TENDL-2015, AKONING

resonance absorption cross sections

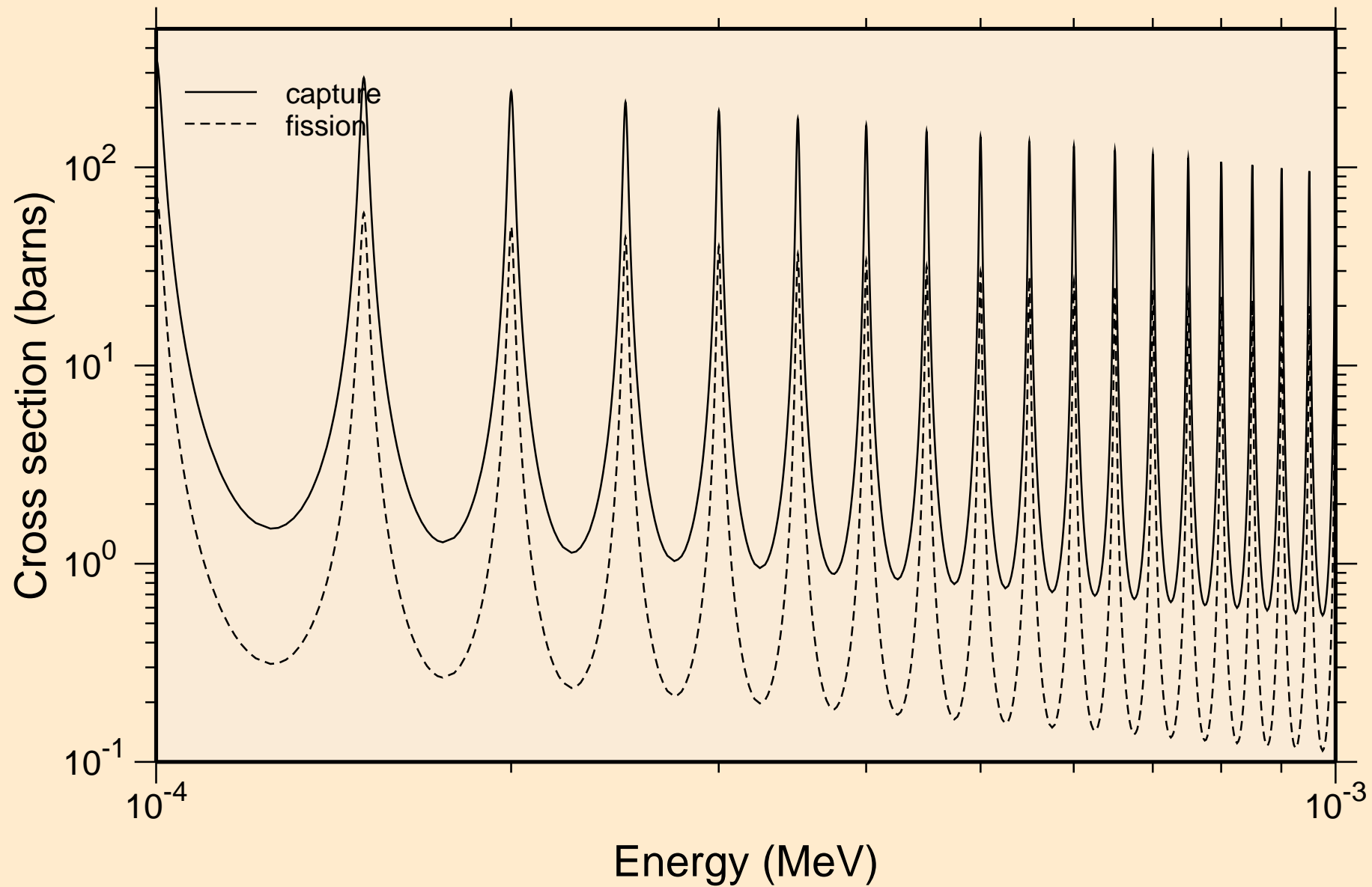

MT277 NRG TENDL-2015, AKONING resonance absorption cross sections

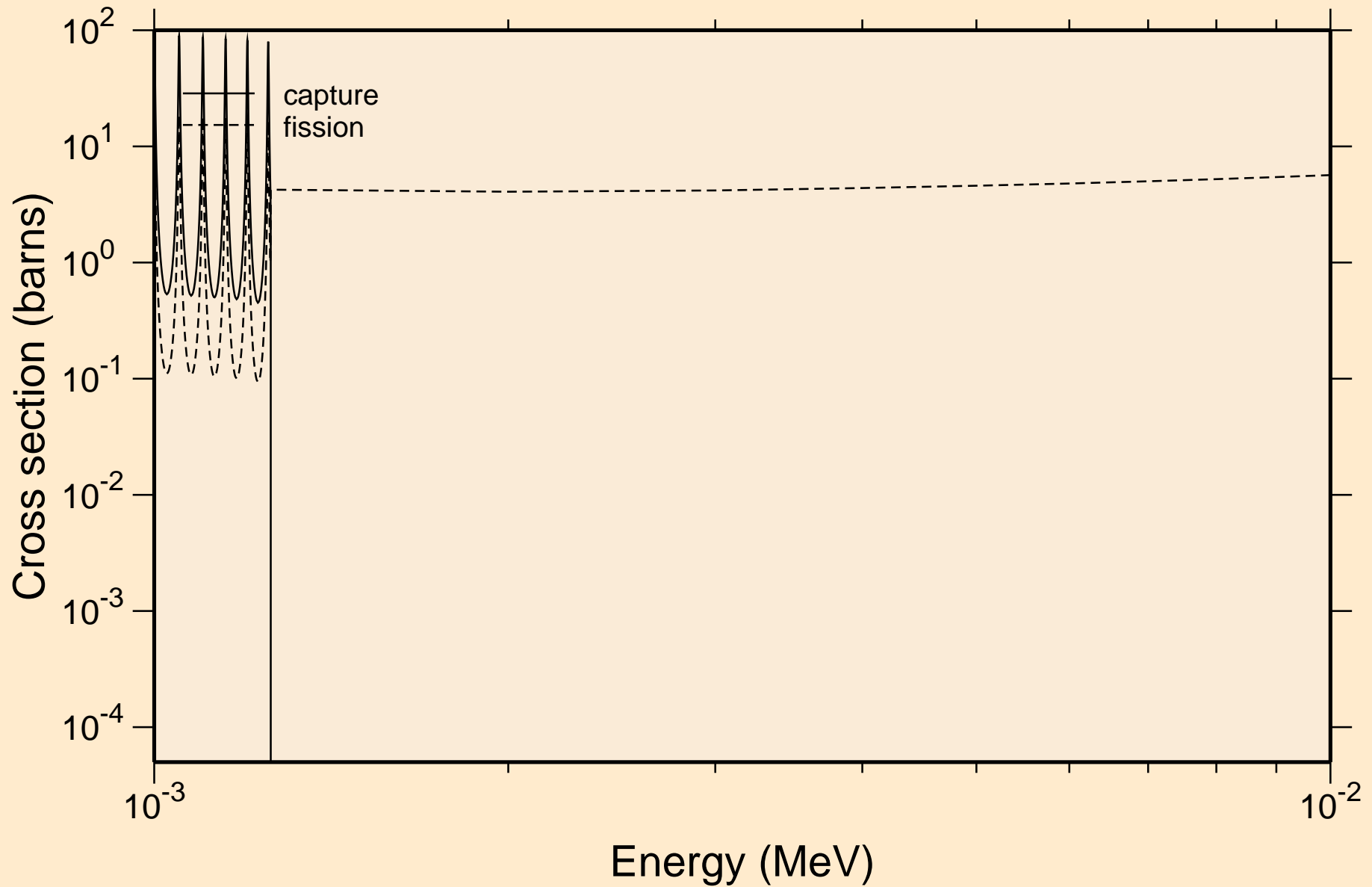

MT277 NRG TENDL-2015, AKONING

resonance absorption cross sections

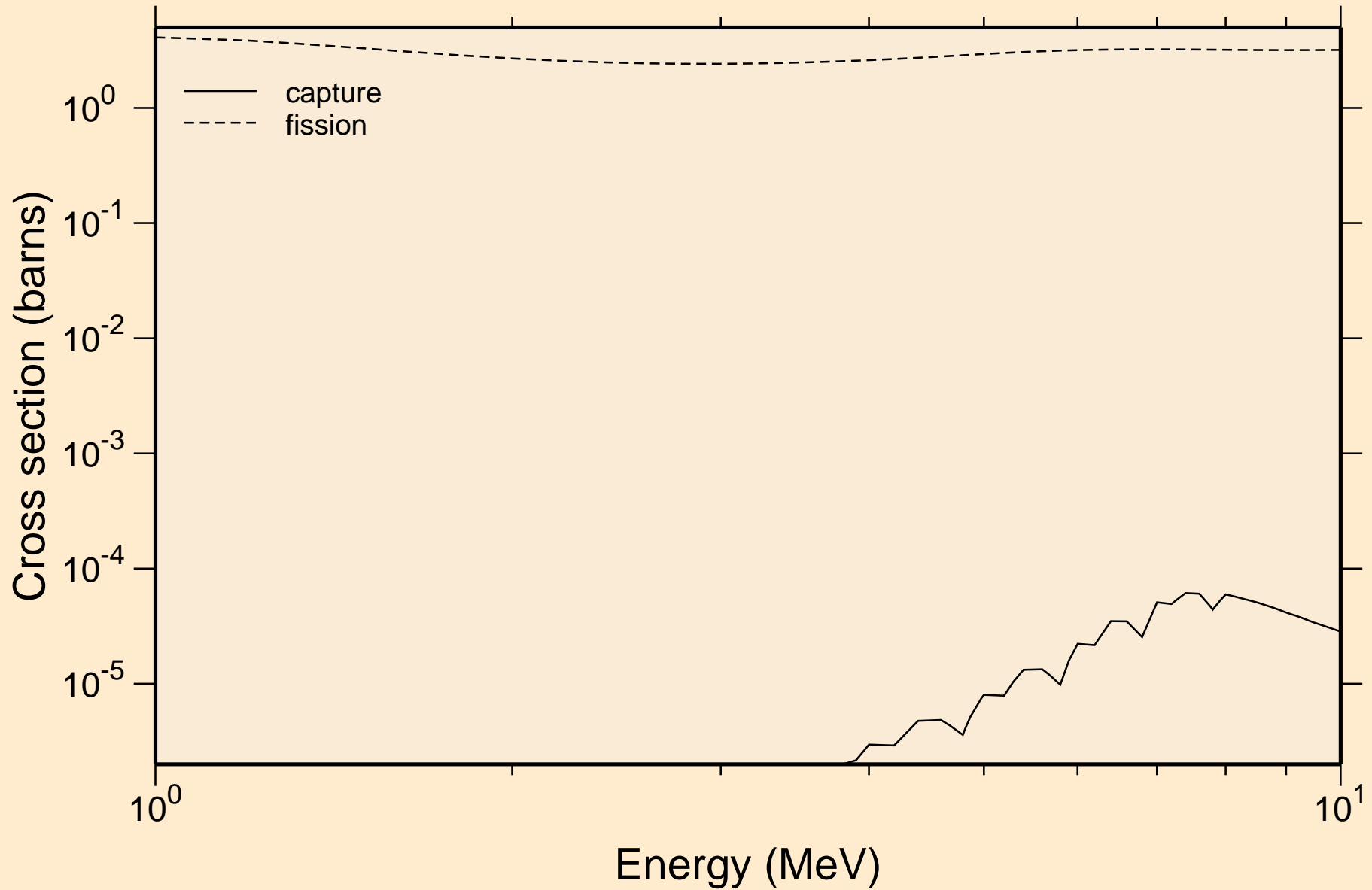

MT277 NRG TENDL-2015, AKONING

Non-threshold reactions

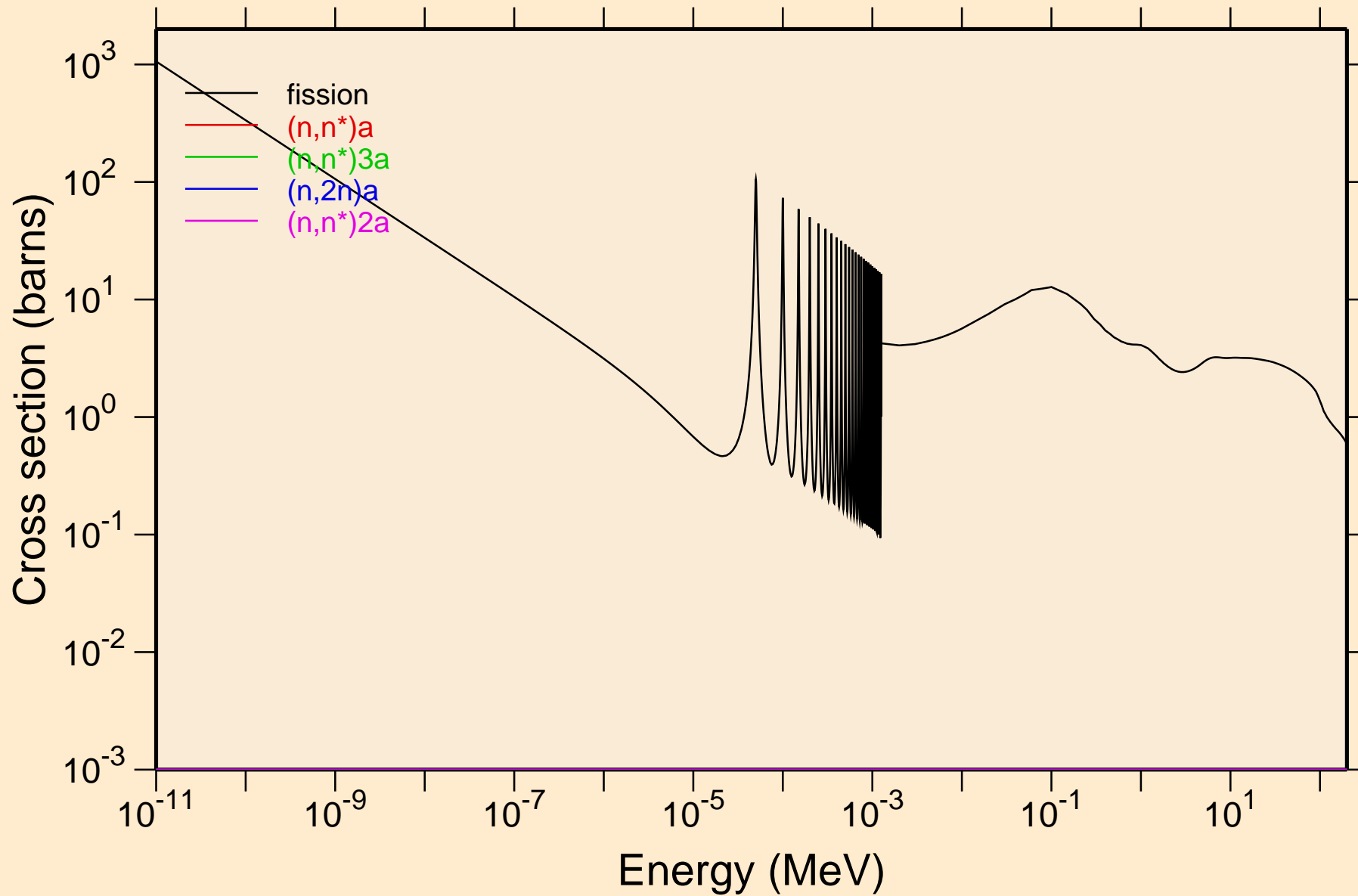

MT277 NRG TENDL-2015, AKONING

Non-threshold reactions

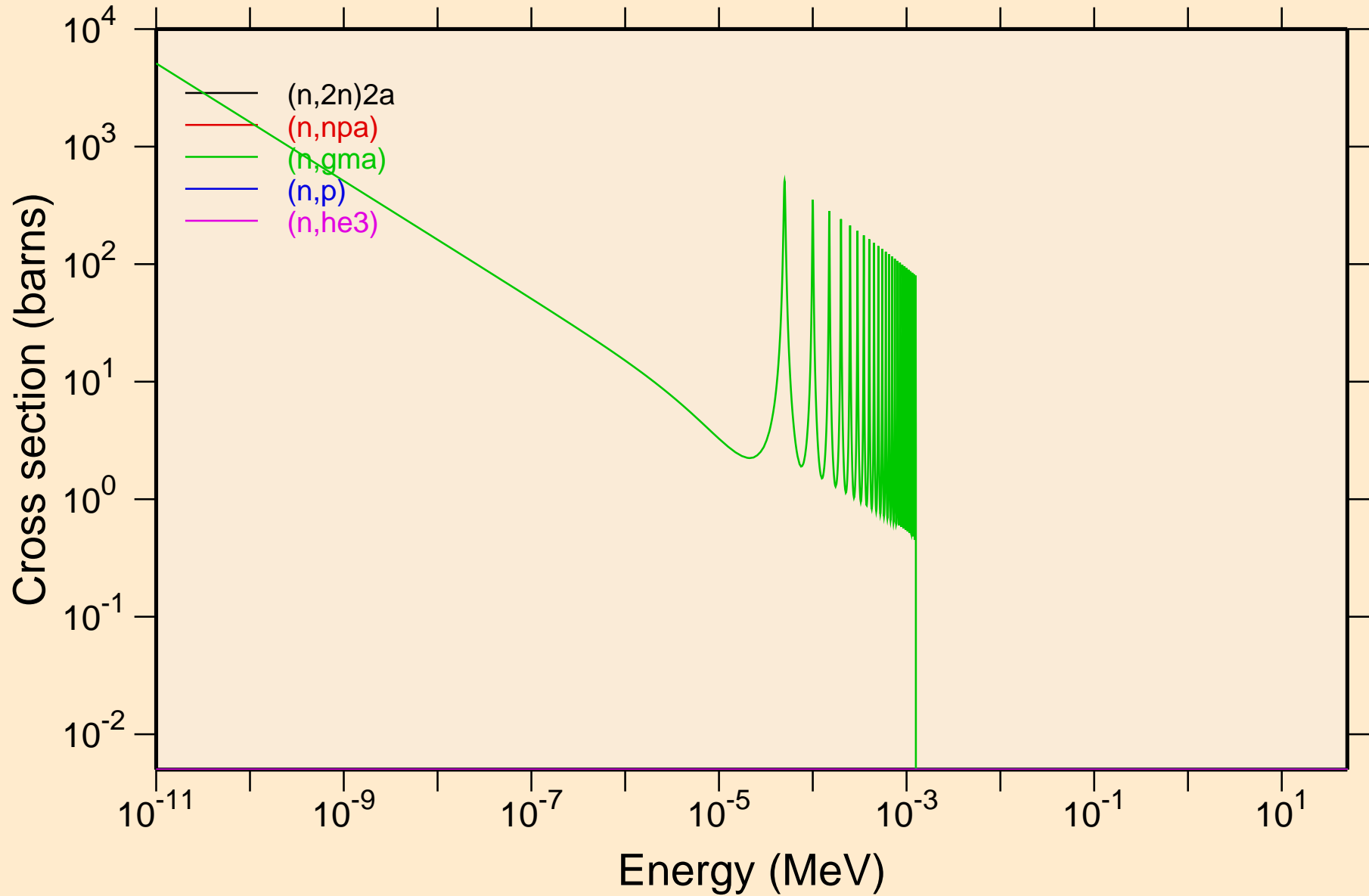

MT277 NRG TENDL-2015, AKONING

Non-threshold reactions

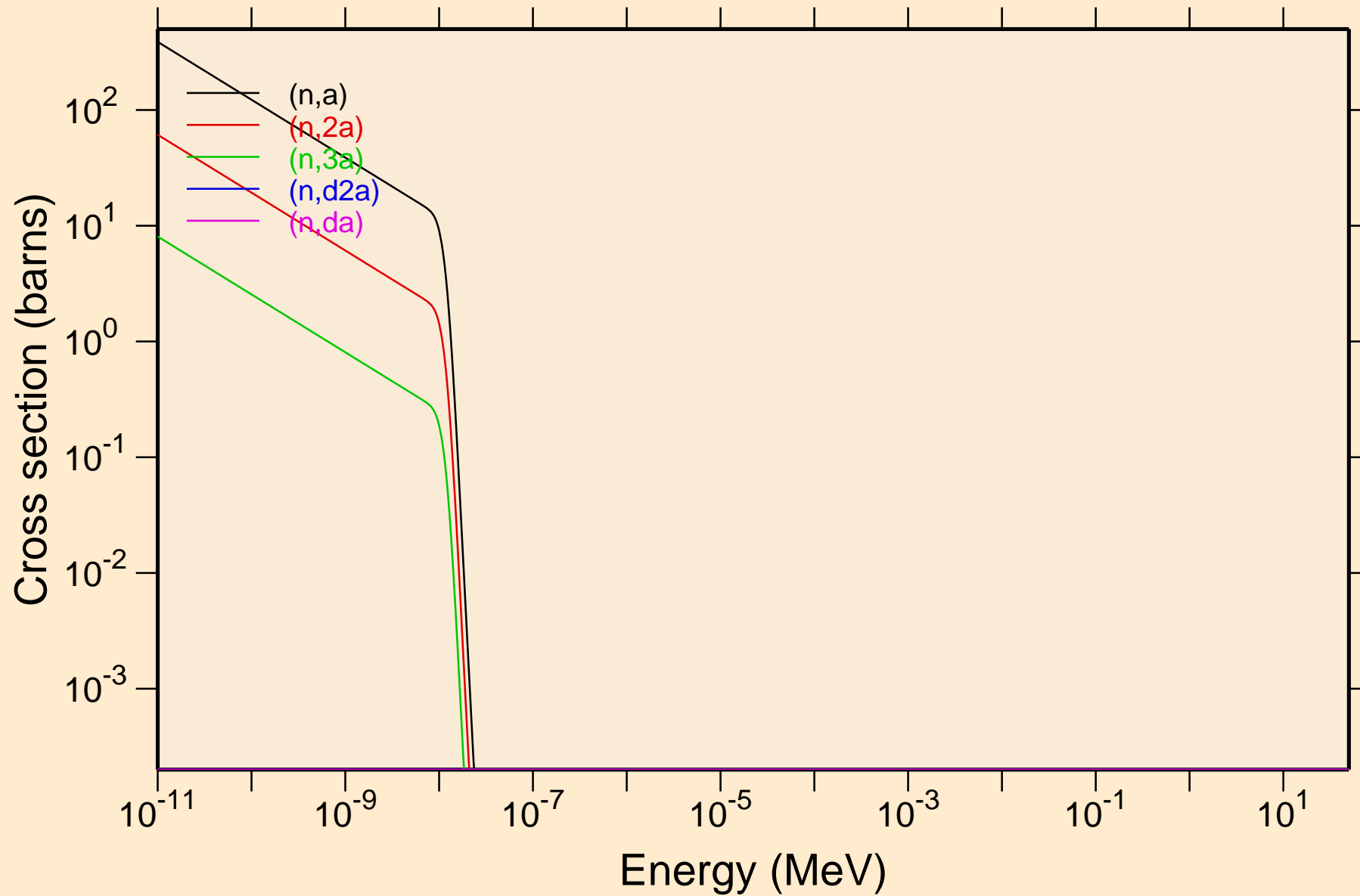

MT277 NRG TENDL-2015, AKONING

Principal cross sections

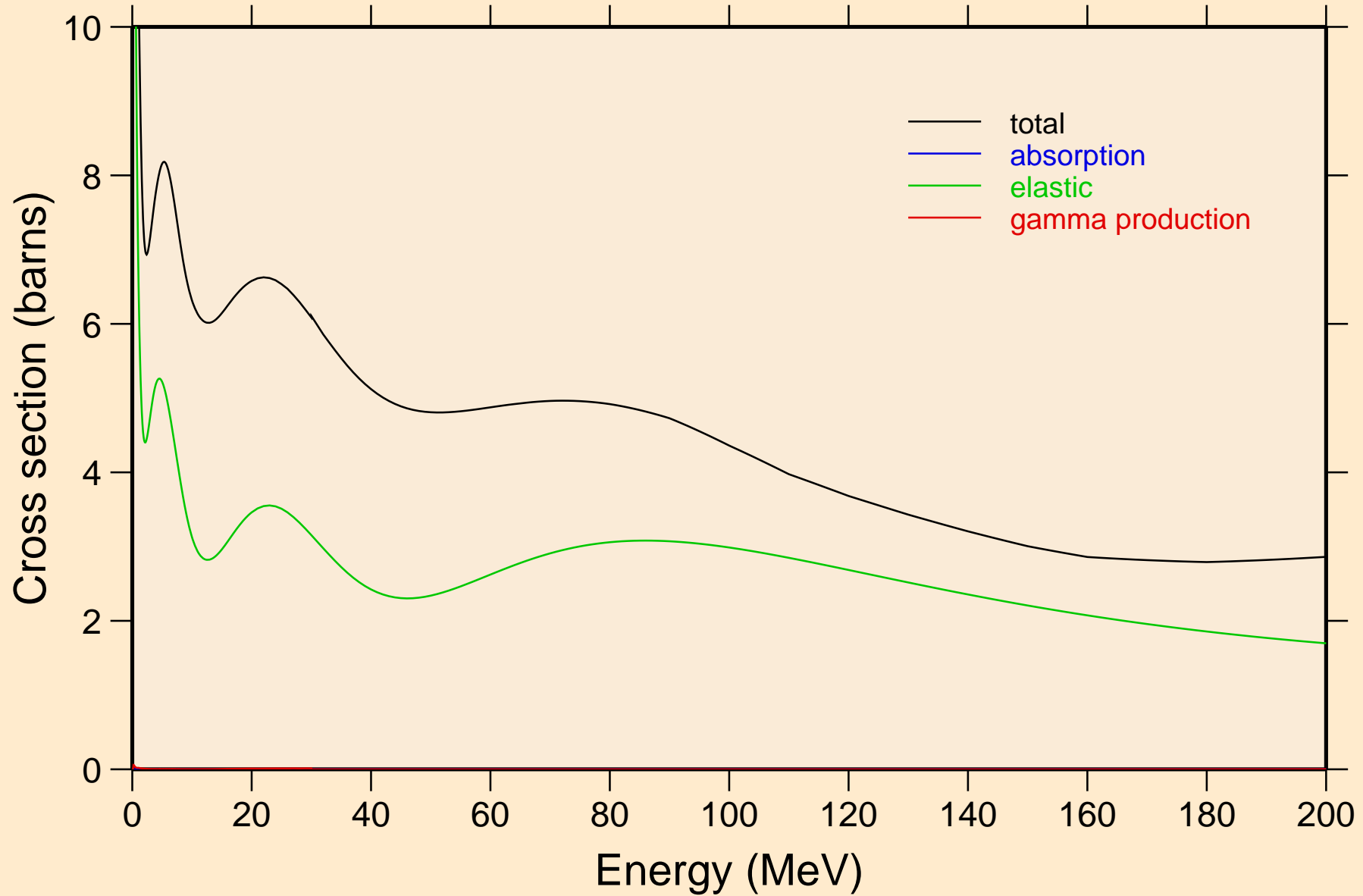

MT277 NRG TENDL-2015, AKONING

Non-threshold reactions

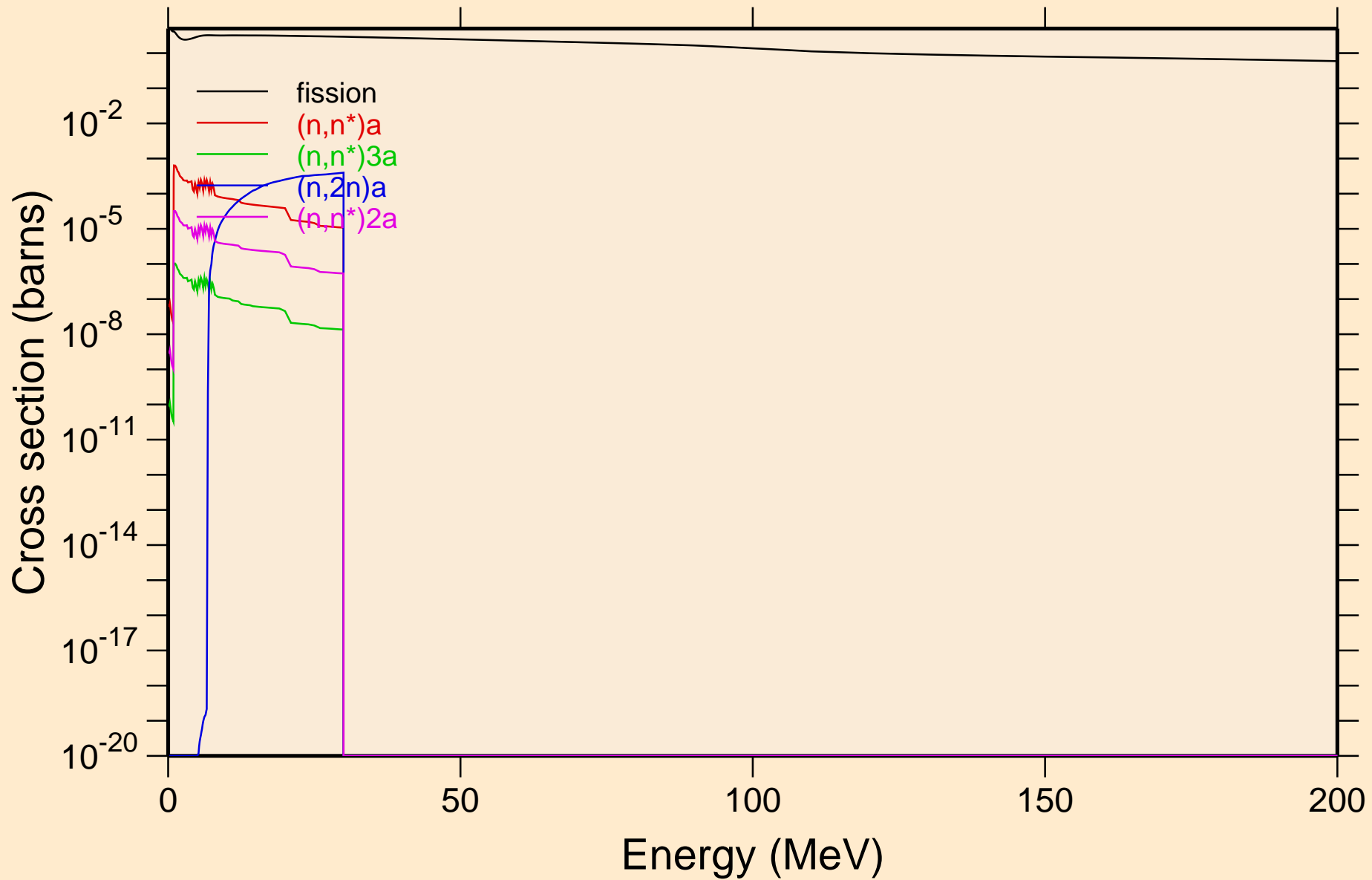

MT277 NRG TENDL-2015, AKONING

Non-threshold reactions

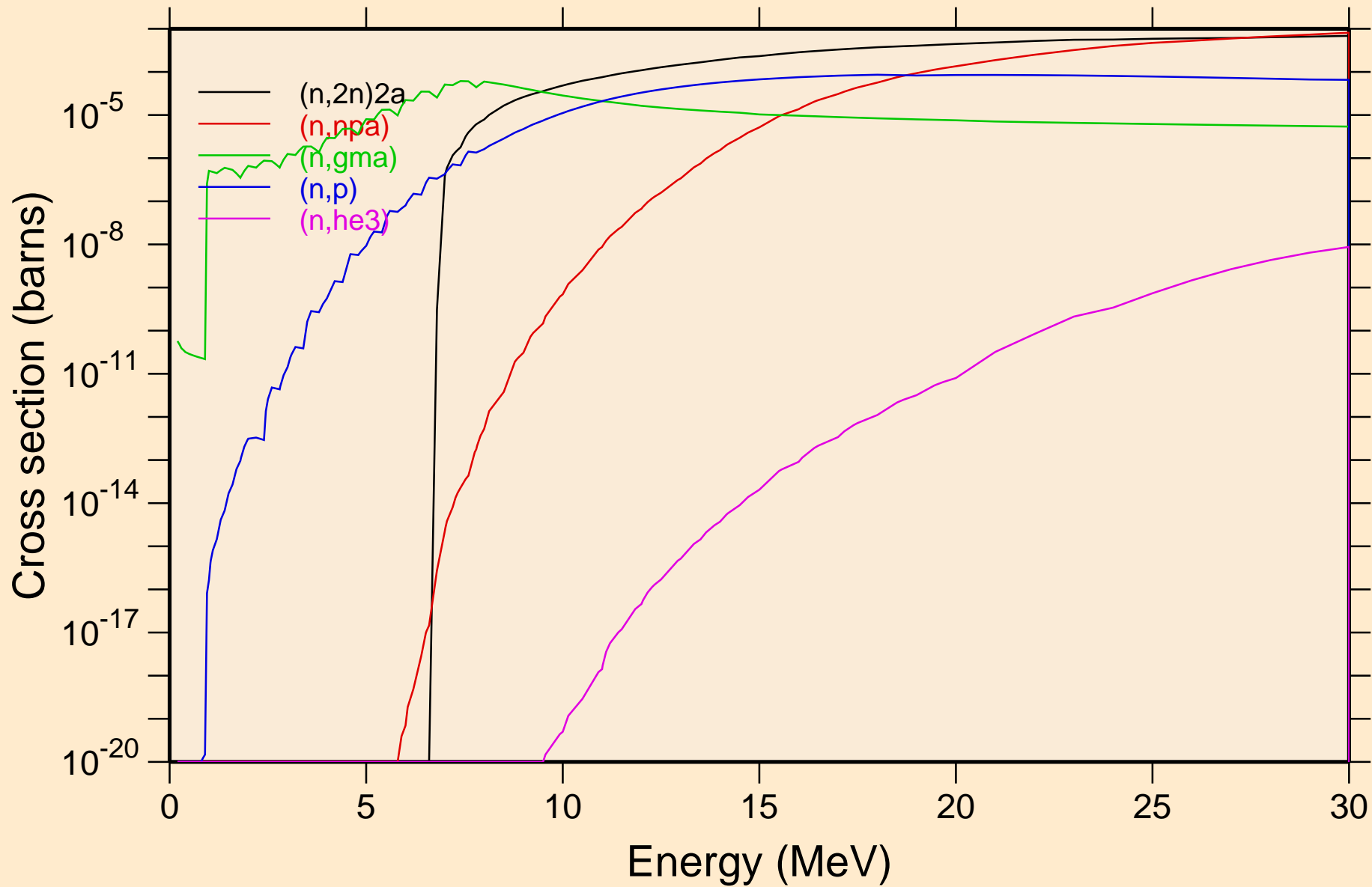

MT277 NRG TENDL-2015, AKONING

Non-threshold reactions

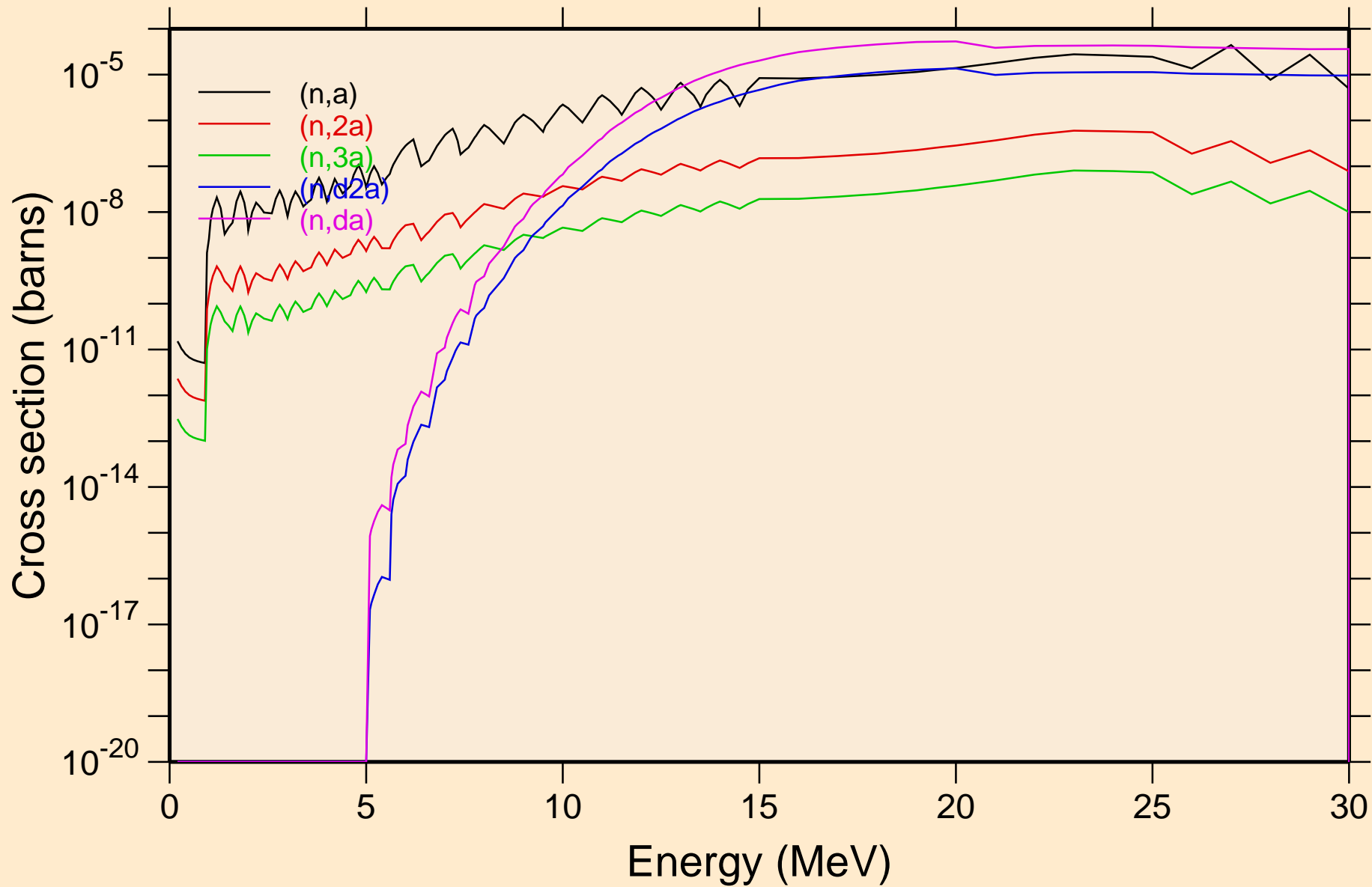

MT277 NRG TENDL-2015, AKONING
Inelastic levels

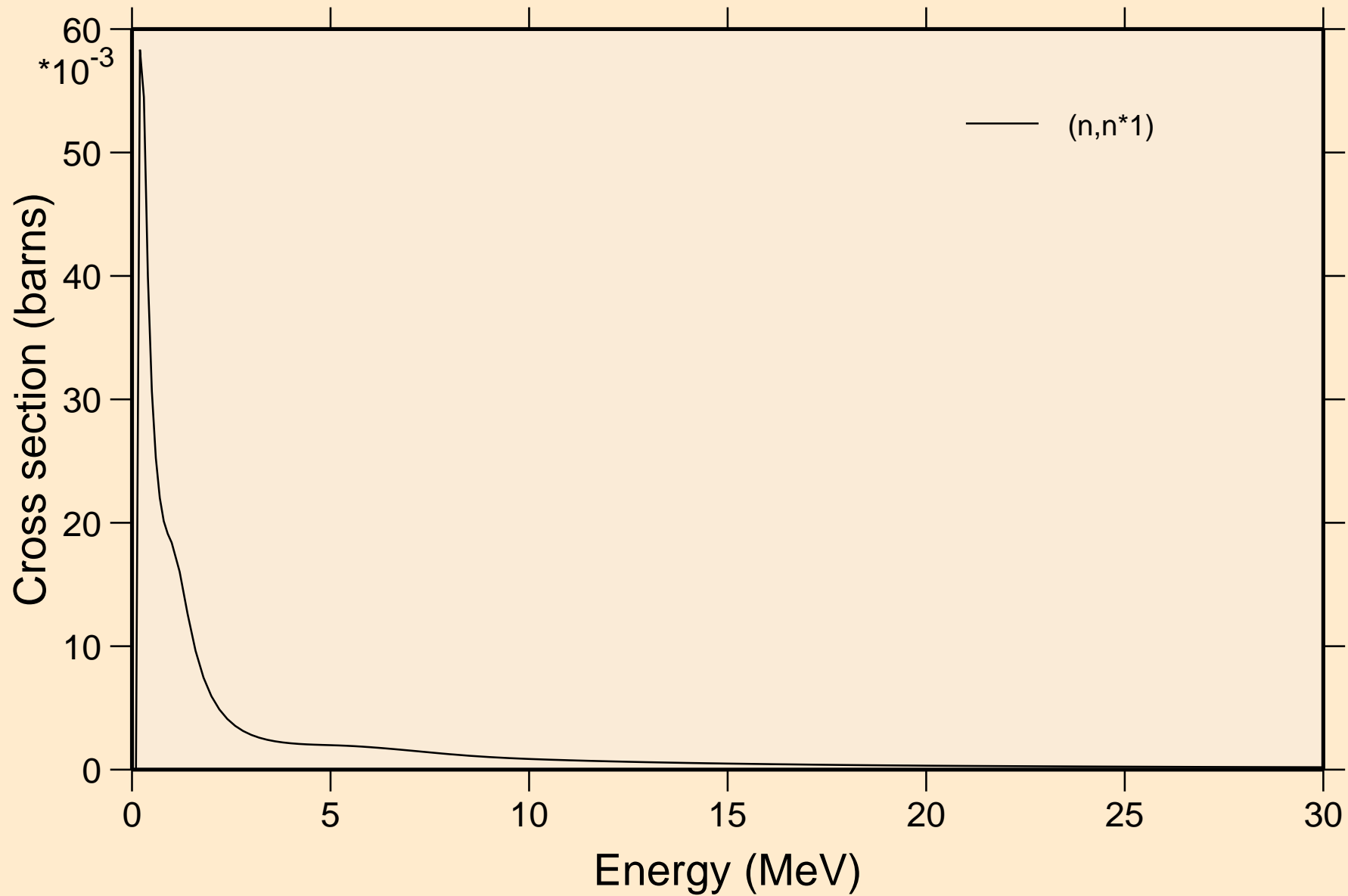

MT277 NRG TENDL-2015, AKONING

Threshold reactions

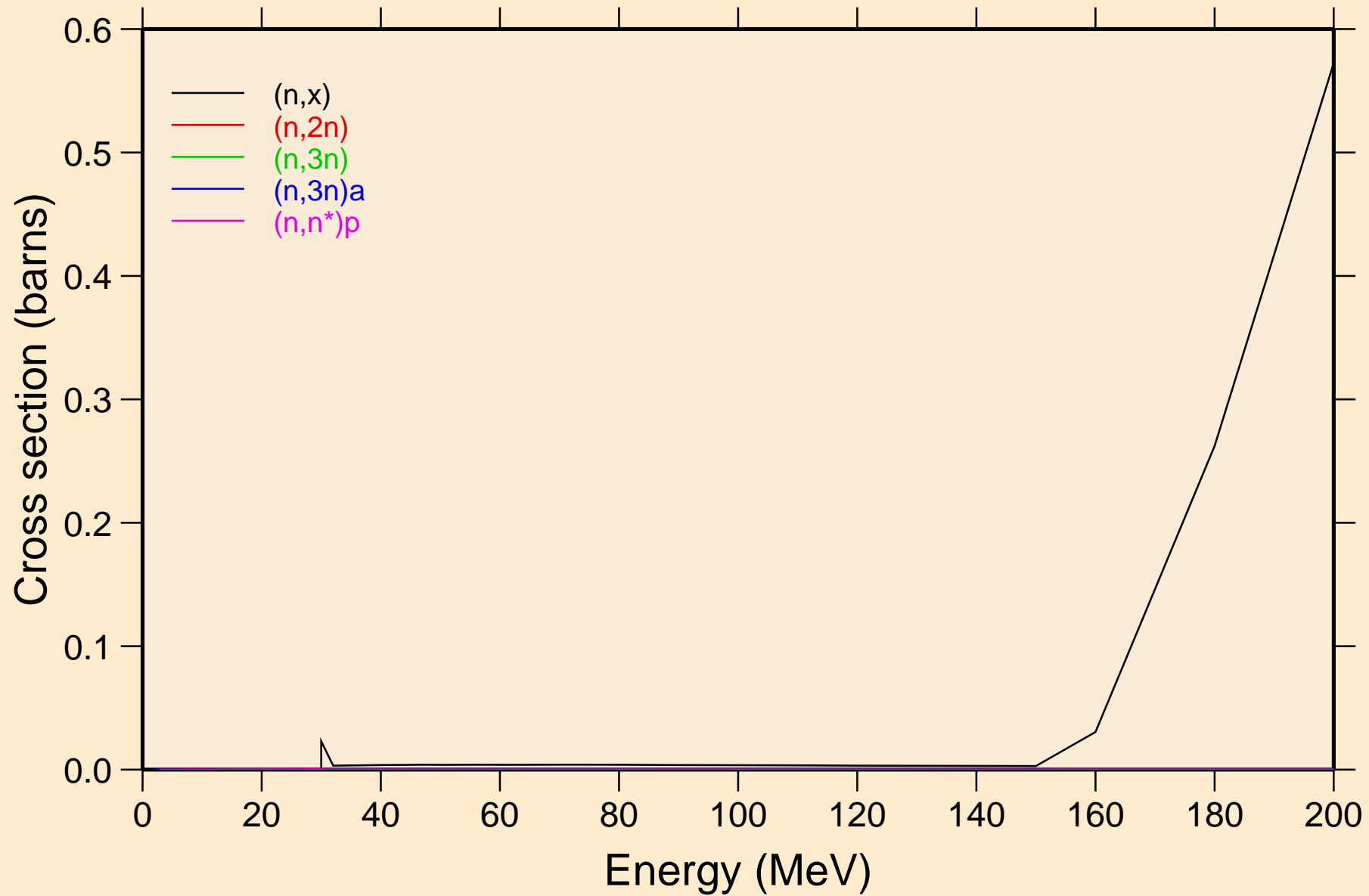

MT277 NRG TENDL-2015, AKONING

Threshold reactions

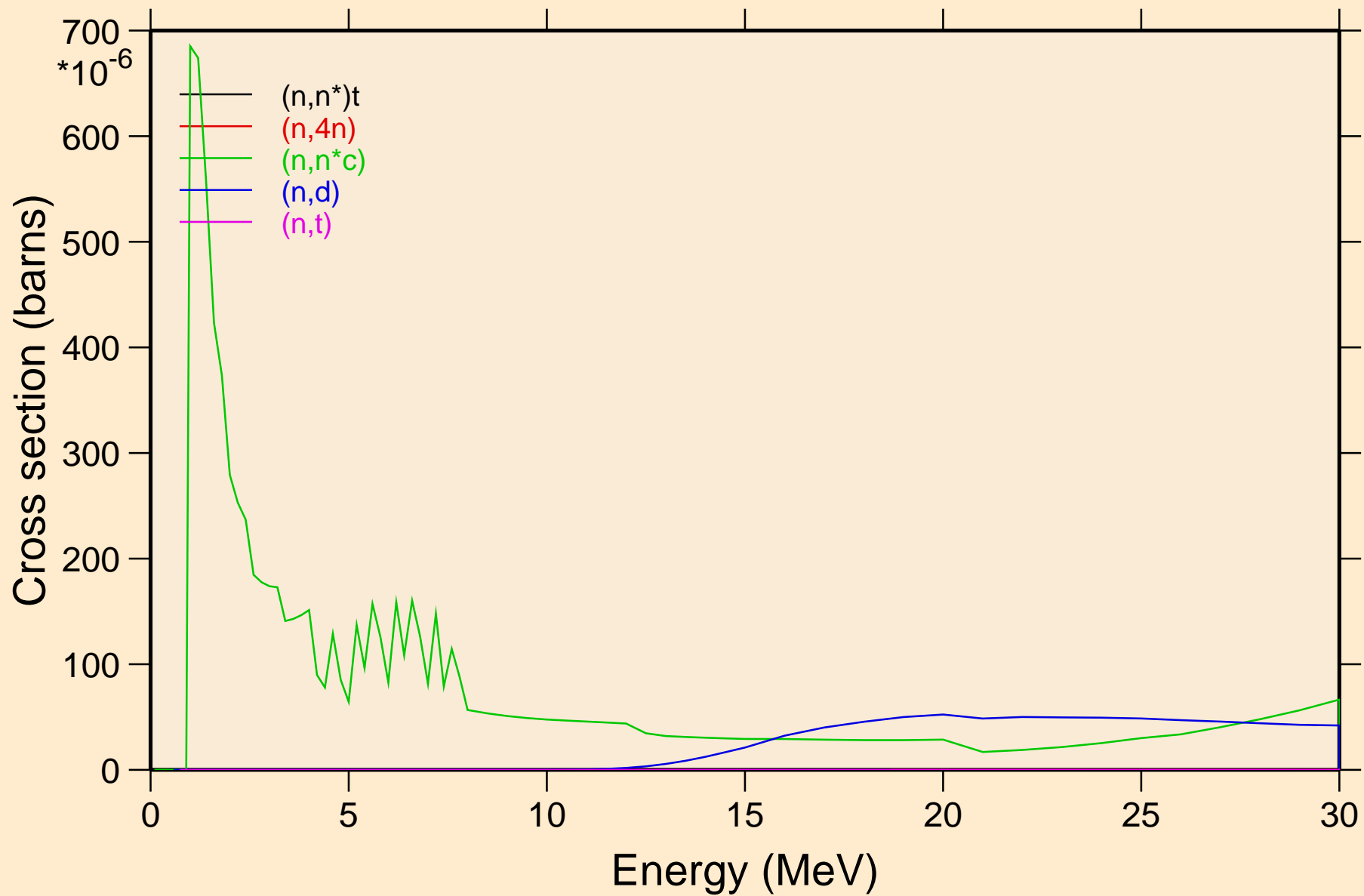

MT277 NRG TENDL-2015, AKONING
angular distribution for elastic

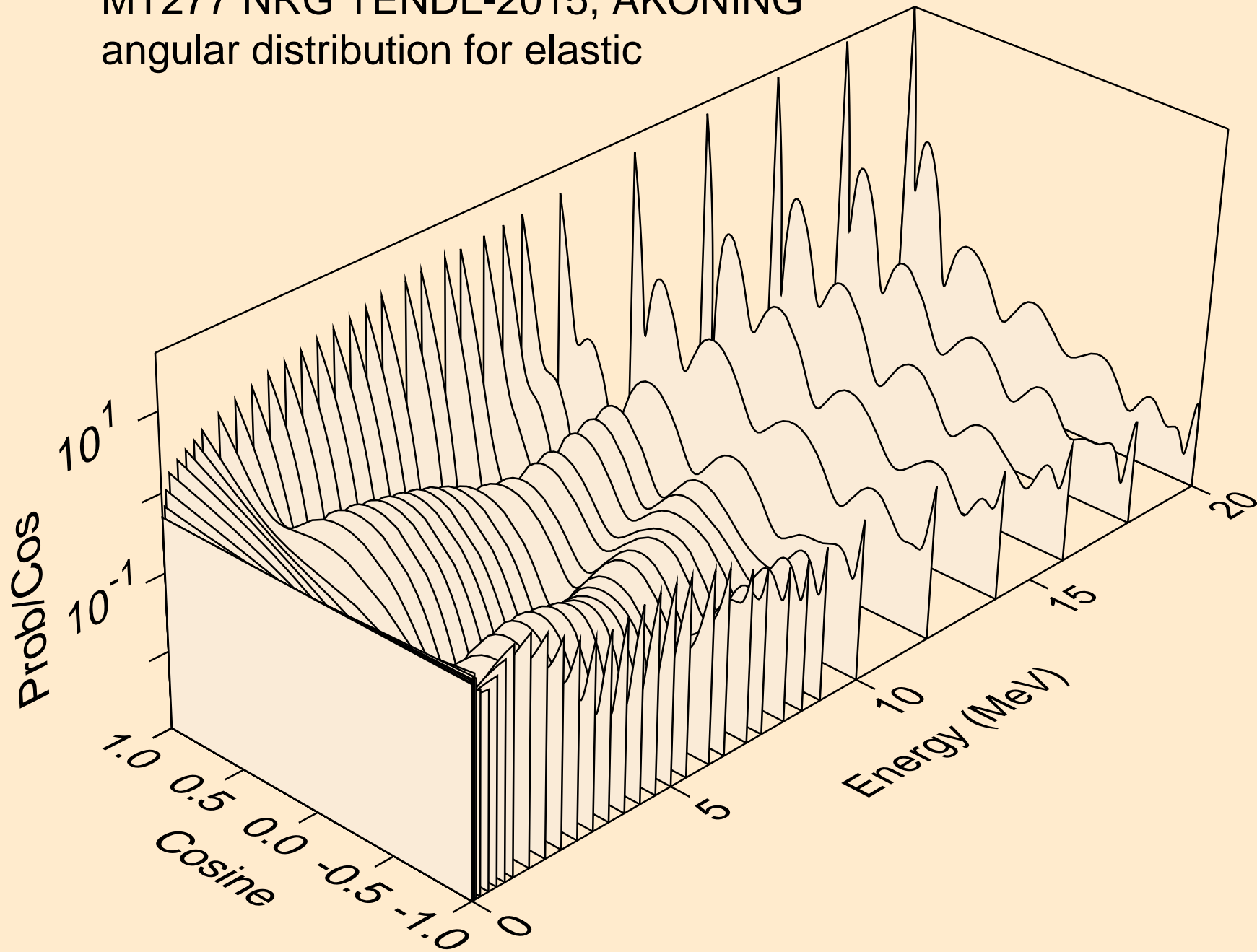

MT277 NRG TENDL-2015, AKONING
angular distribution for elastic

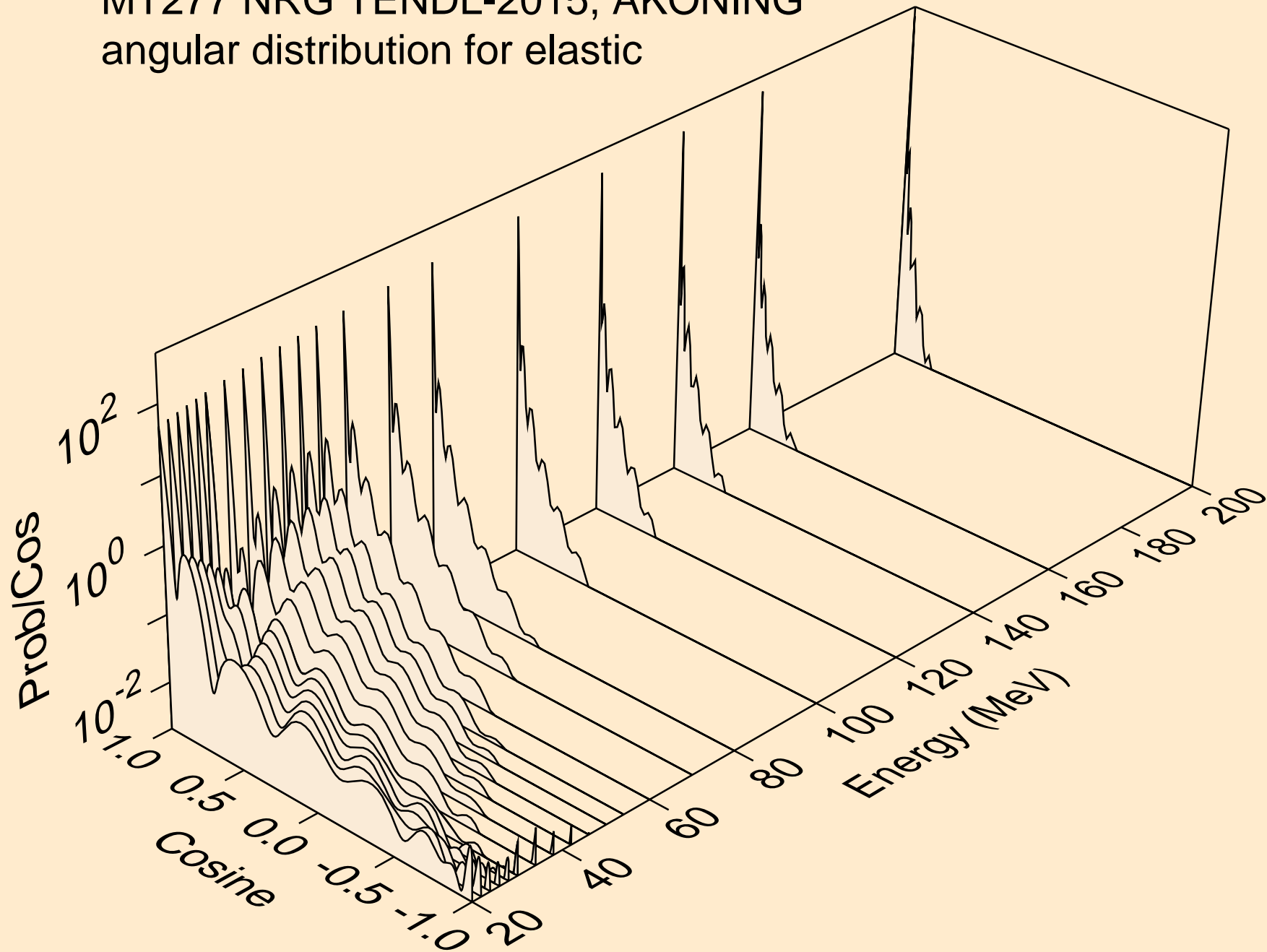

MT277 NRG TENDL-2015, AKONING
angular distribution for (n,n*1)

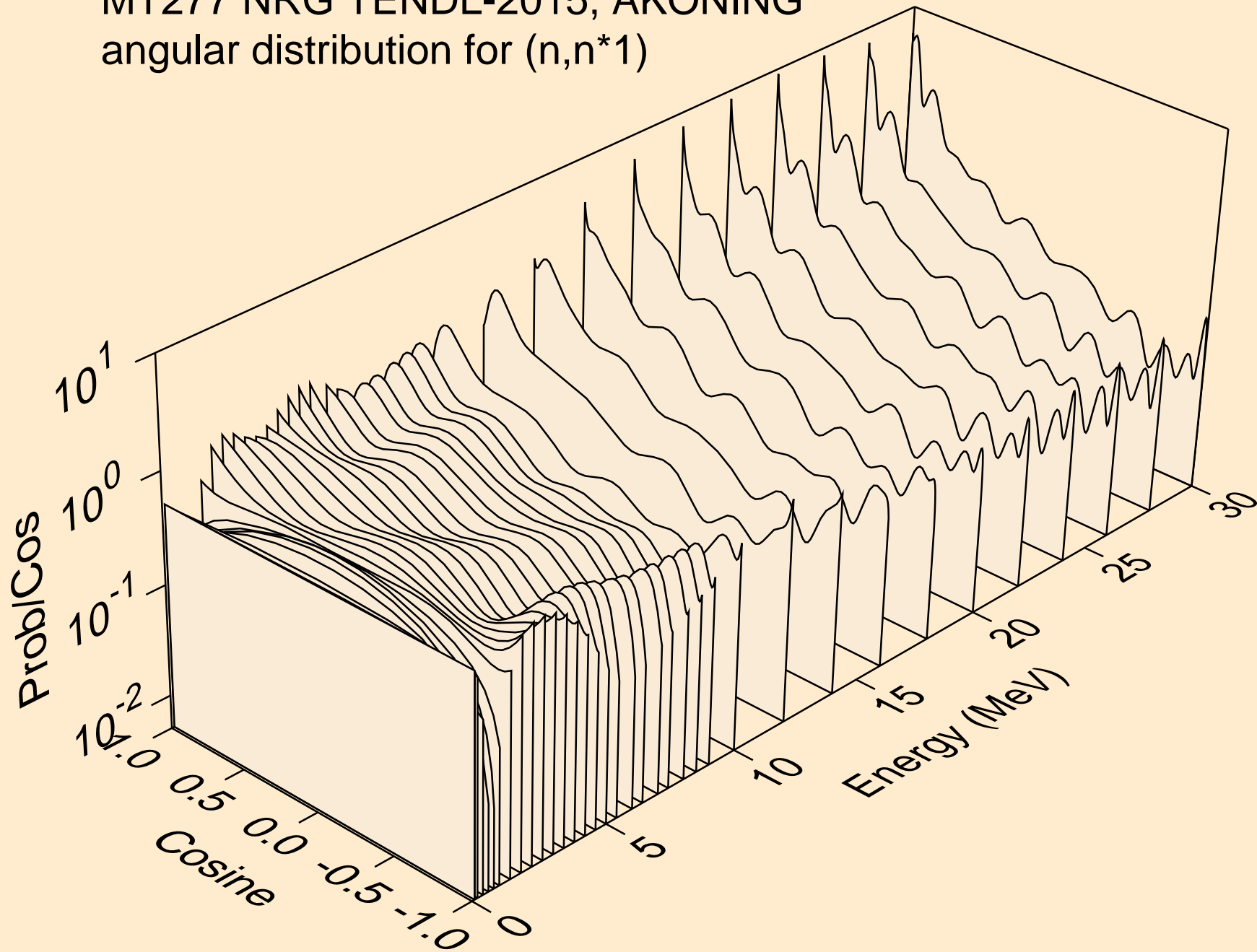

MT277 NRG TENDL-2015, AKONING

Total fission nubar

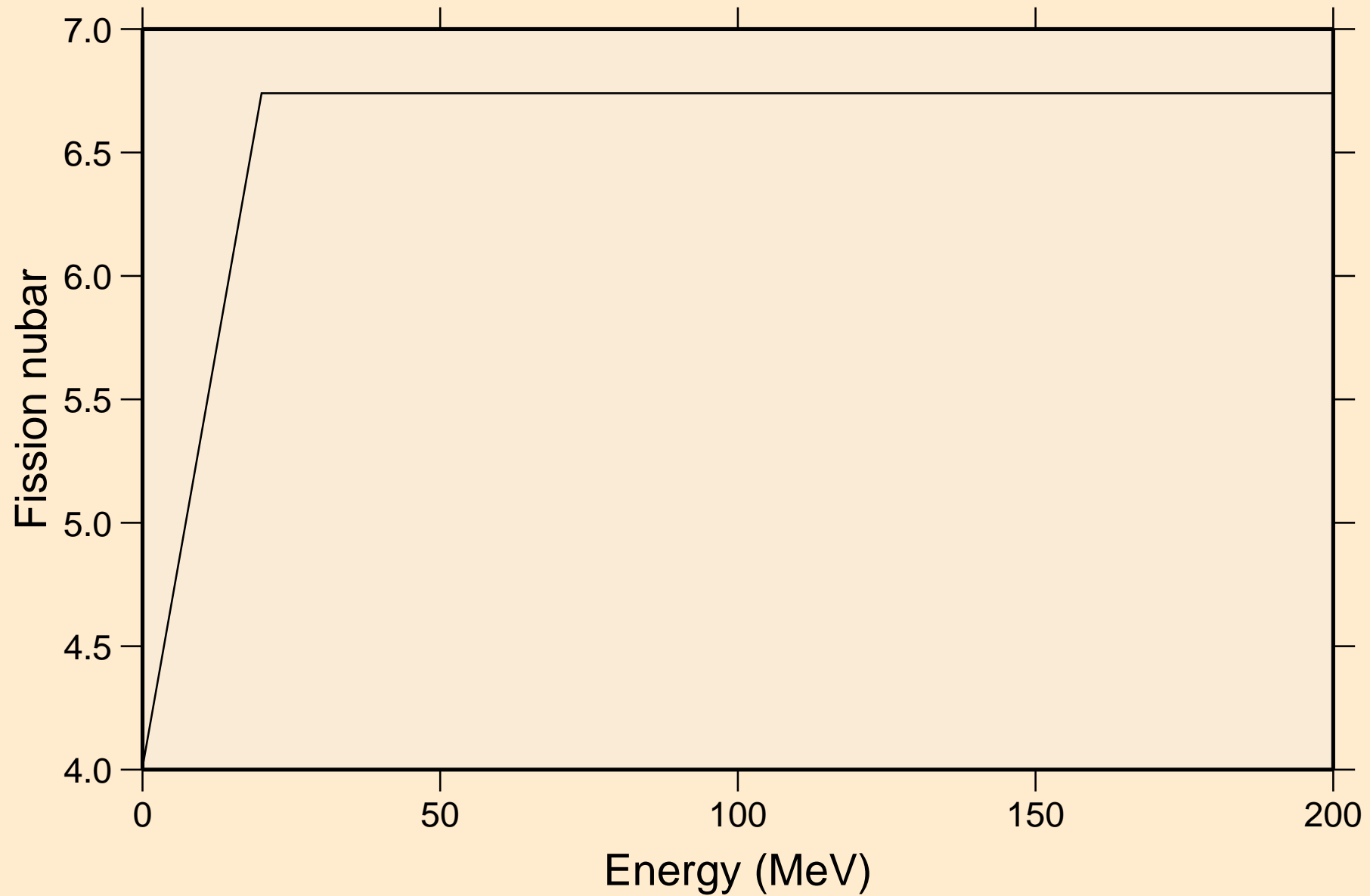

MT277 NRG TENDL-2015, AKONING
Neutron emission for (n,x)

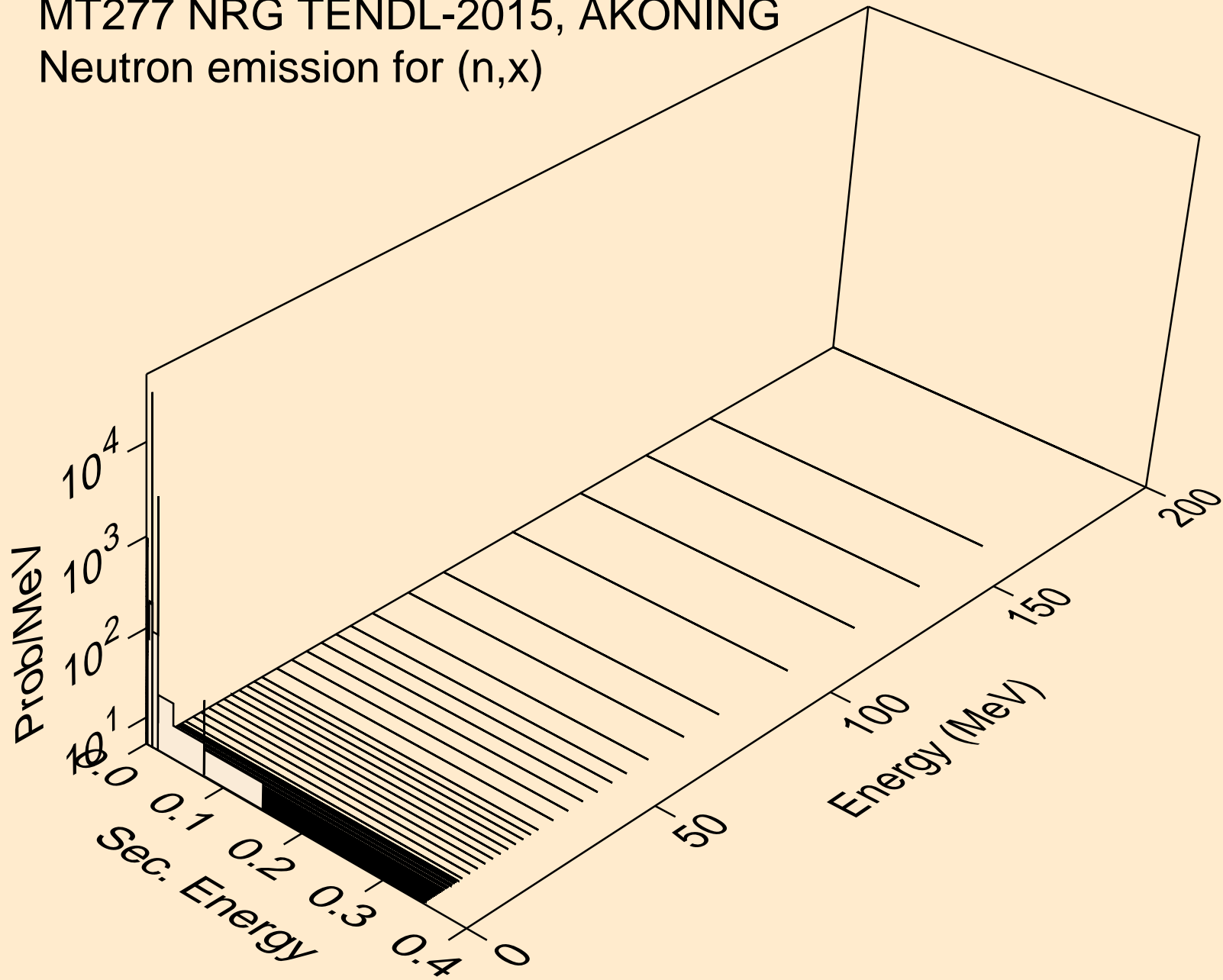

MT277 NRG TENDL-2015, AKONING
Neutron emission for (n,2n)

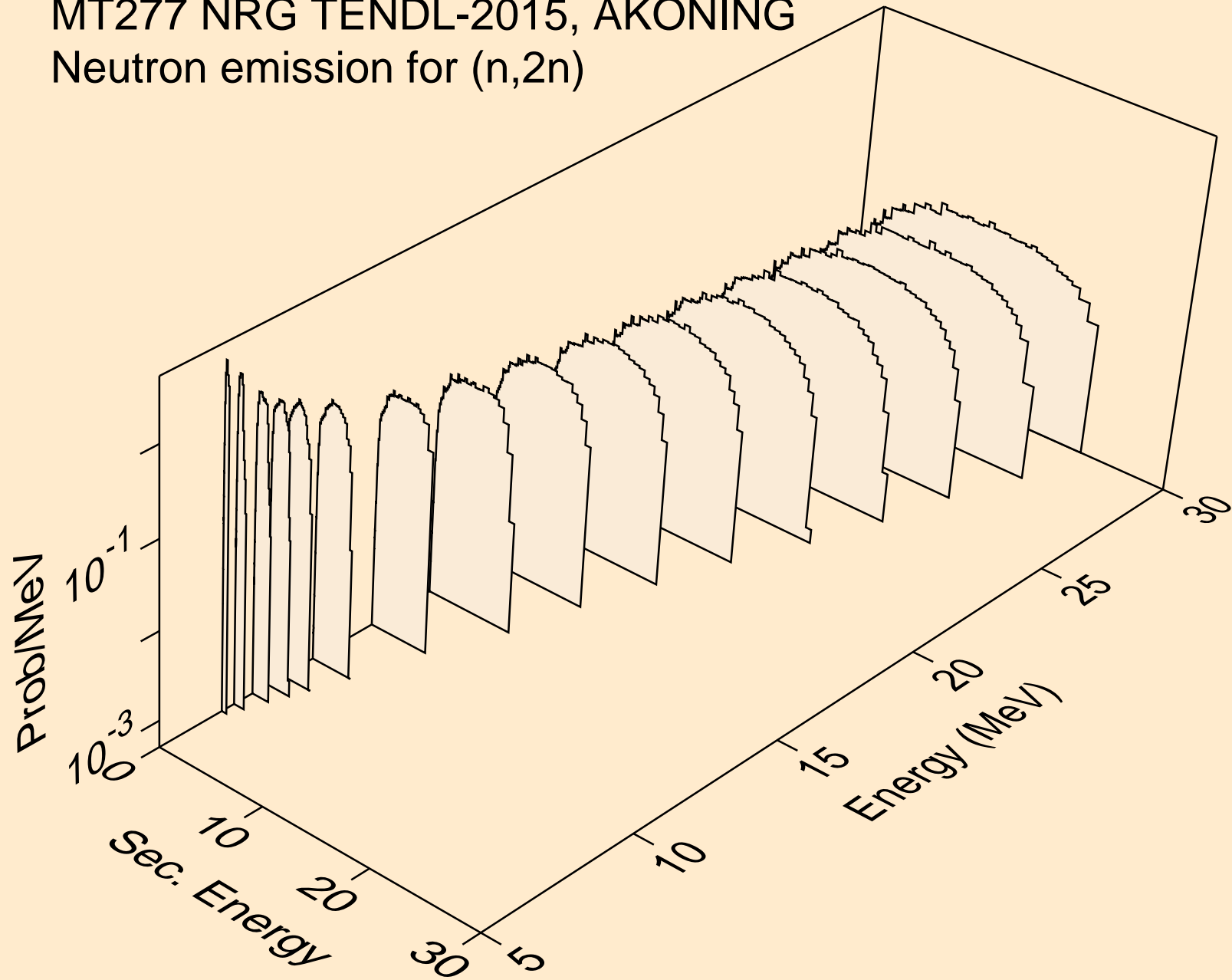

MT277 NRG TENDL-2015, AKONING
Neutron emission for (n,3n)

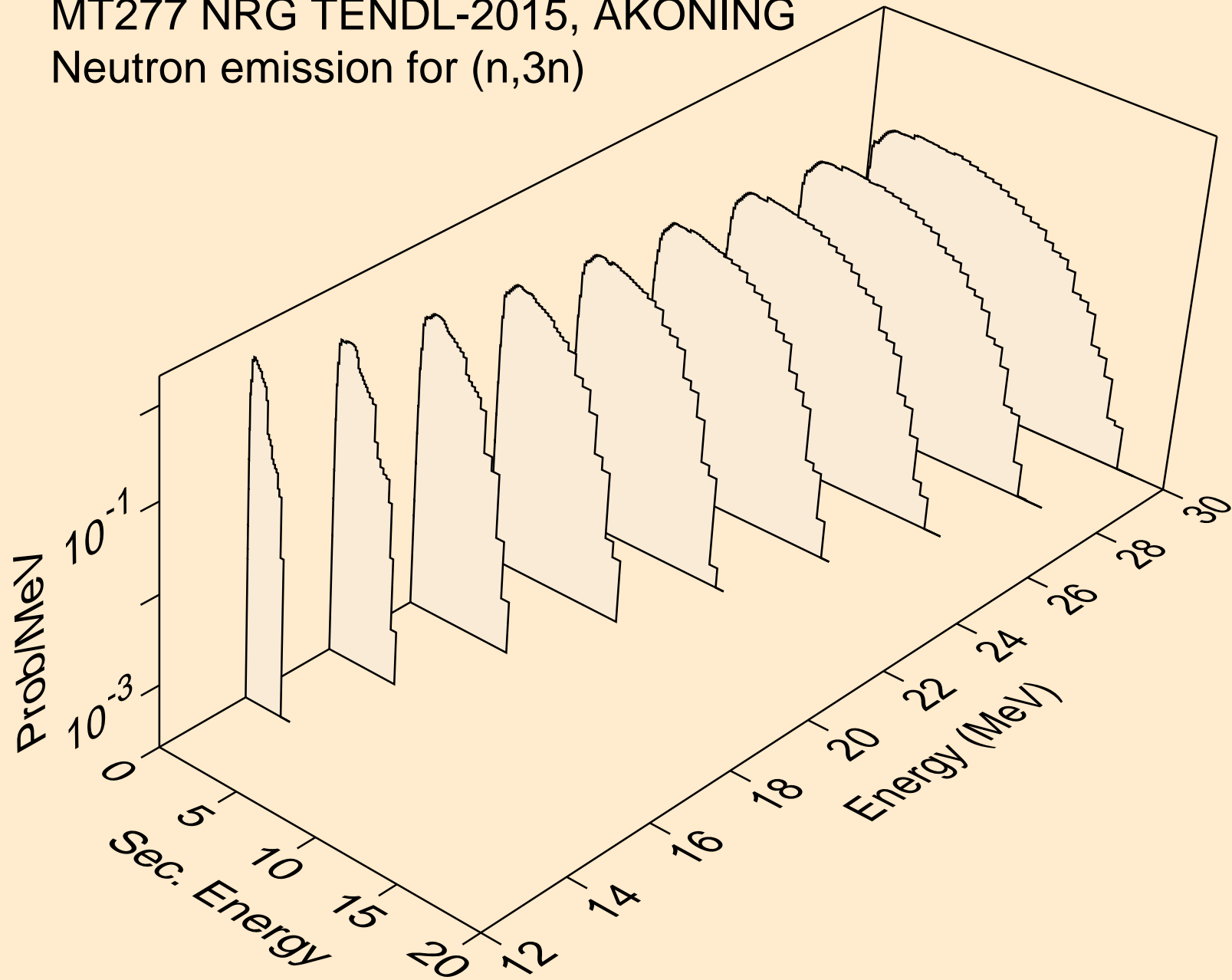

MT277 NRG TENDL-2015, AKONING
Neutron emission for fission

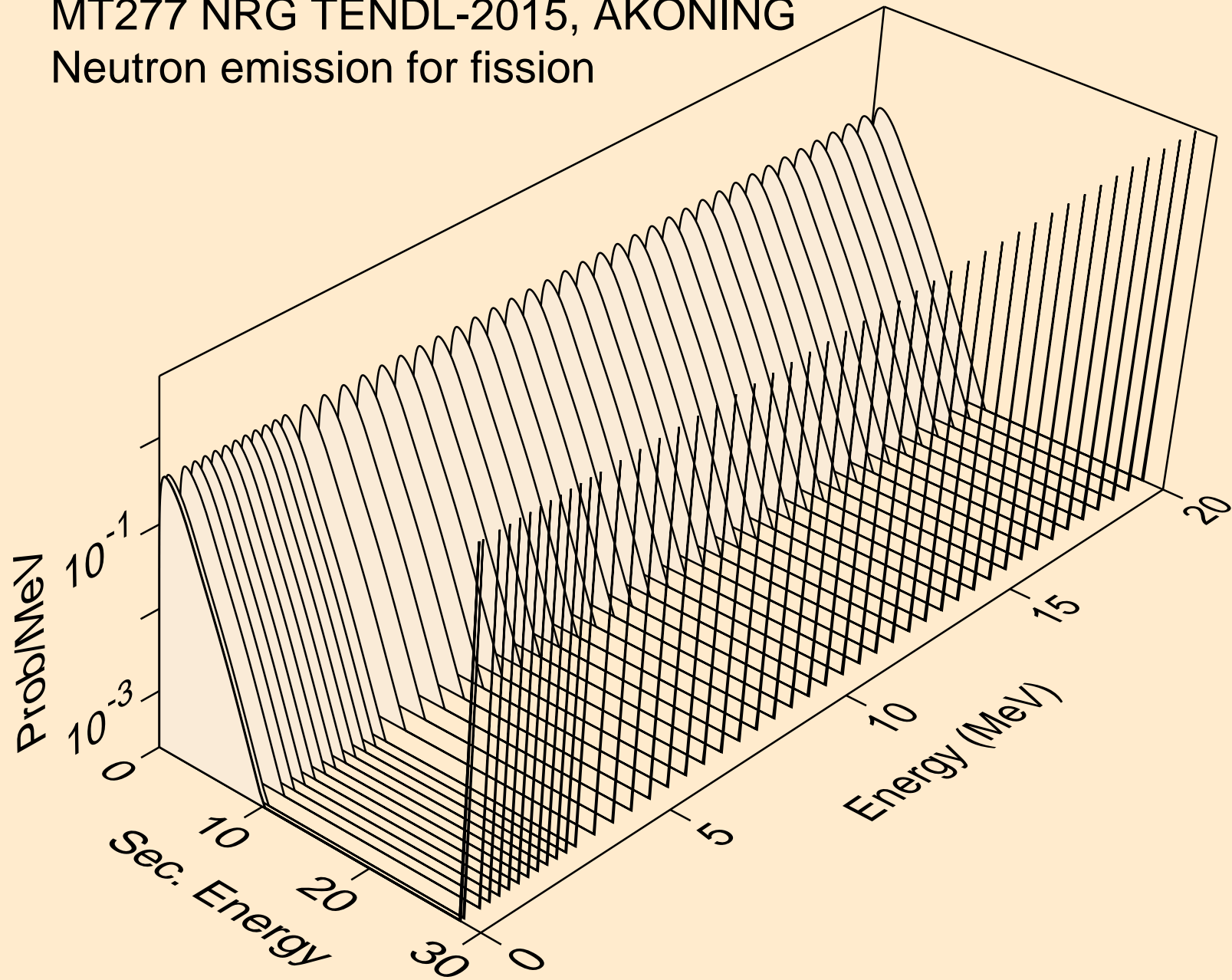

MT277 NRG TENDL-2015, AKONING
Neutron emission for (n,n*)a

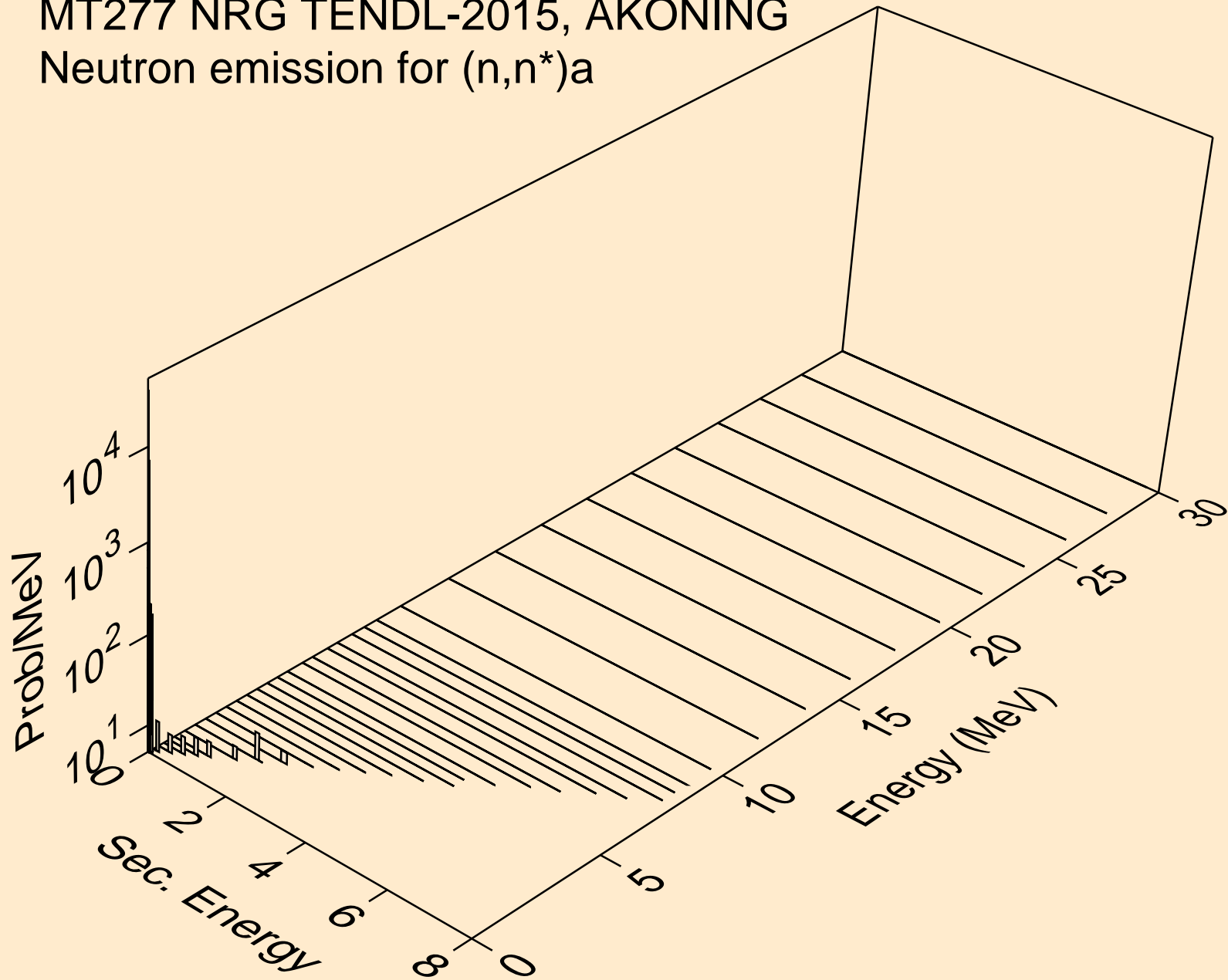

MT277 NRG TENDL-2015, AKONING
Neutron emission for (n,n*)3a

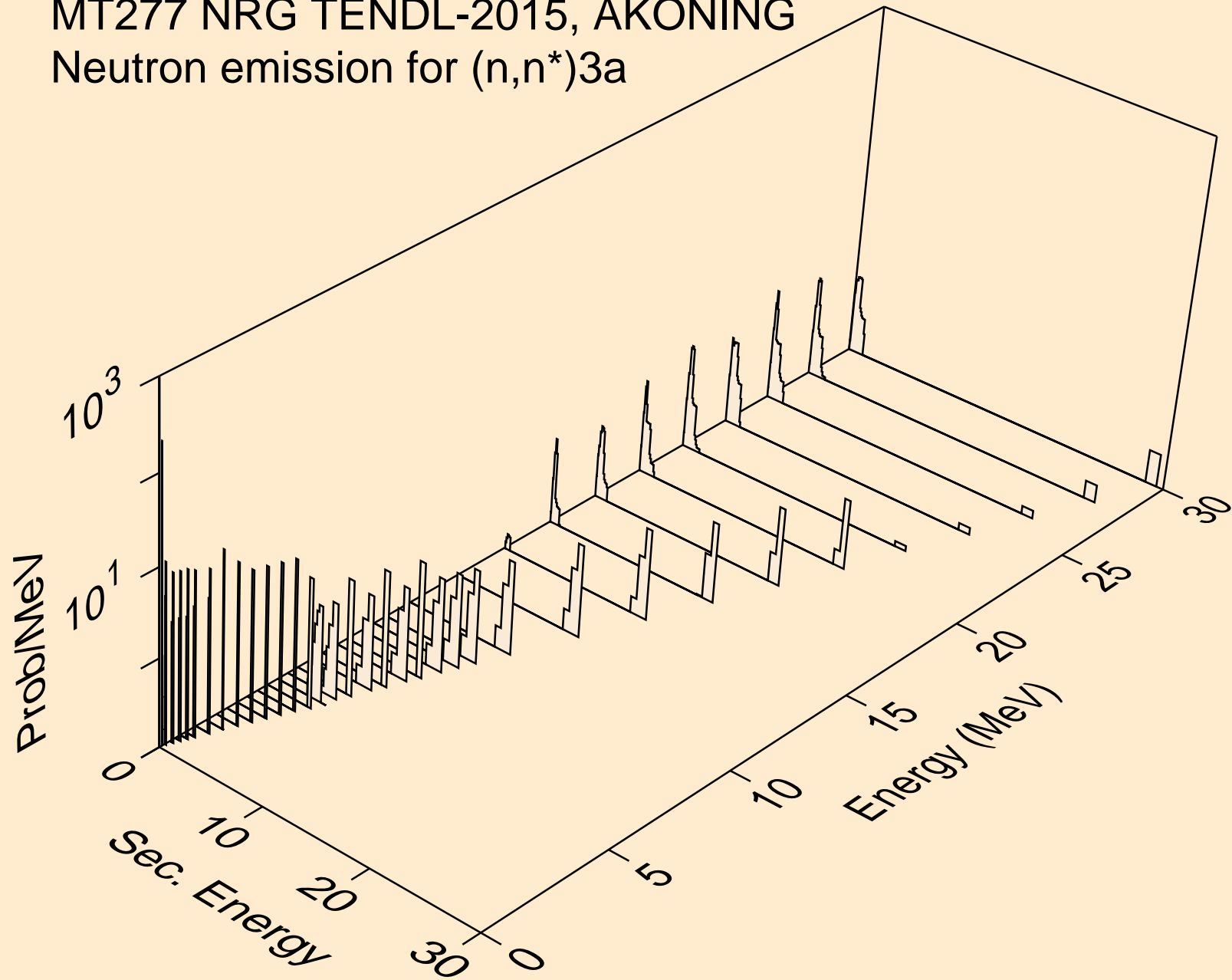

MT277 NRG TENDL-2015, AKONING
Neutron emission for (n,2n)a

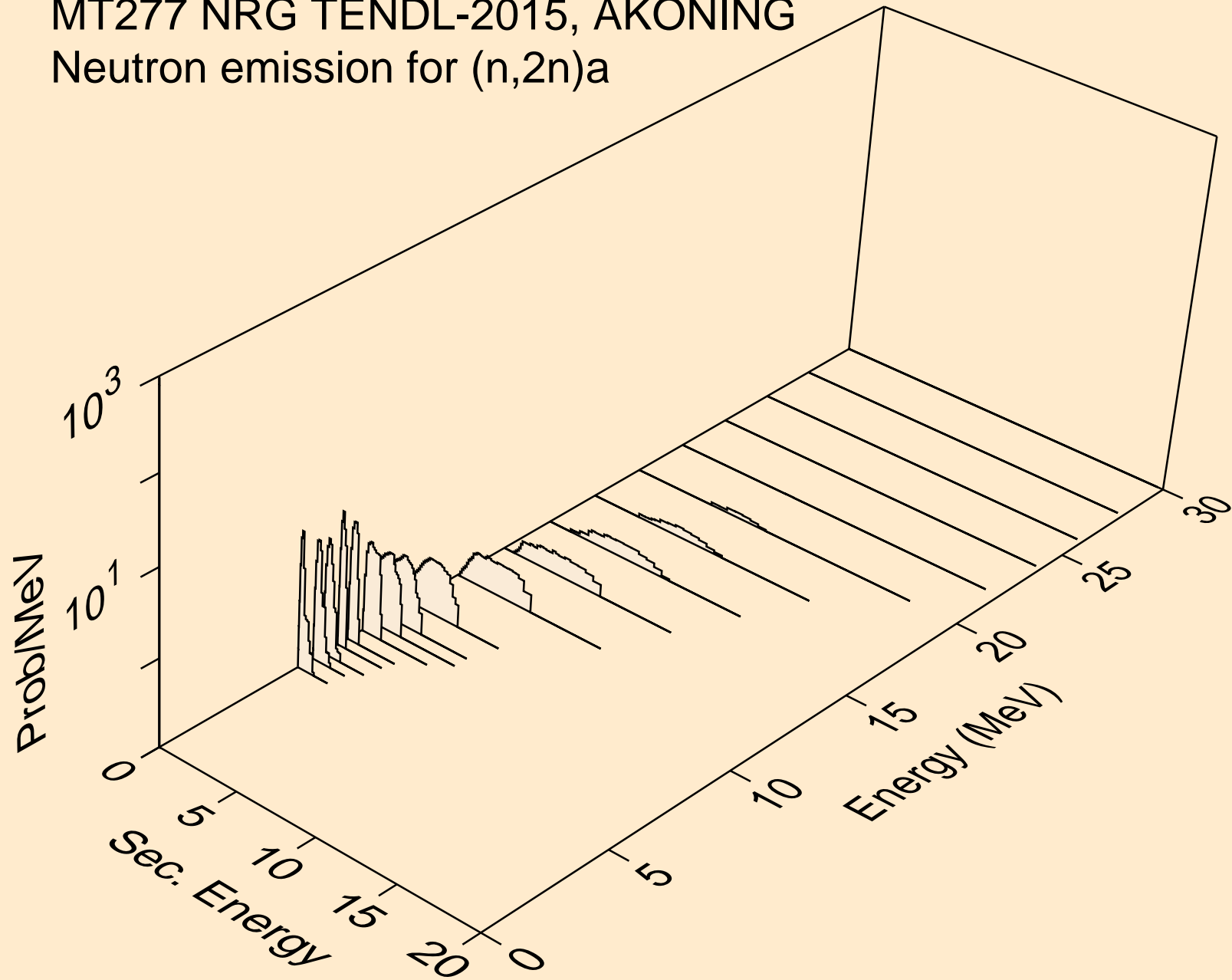

MT277 NRG TENDL-2015, AKONING
Neutron emission for (n,3n)a

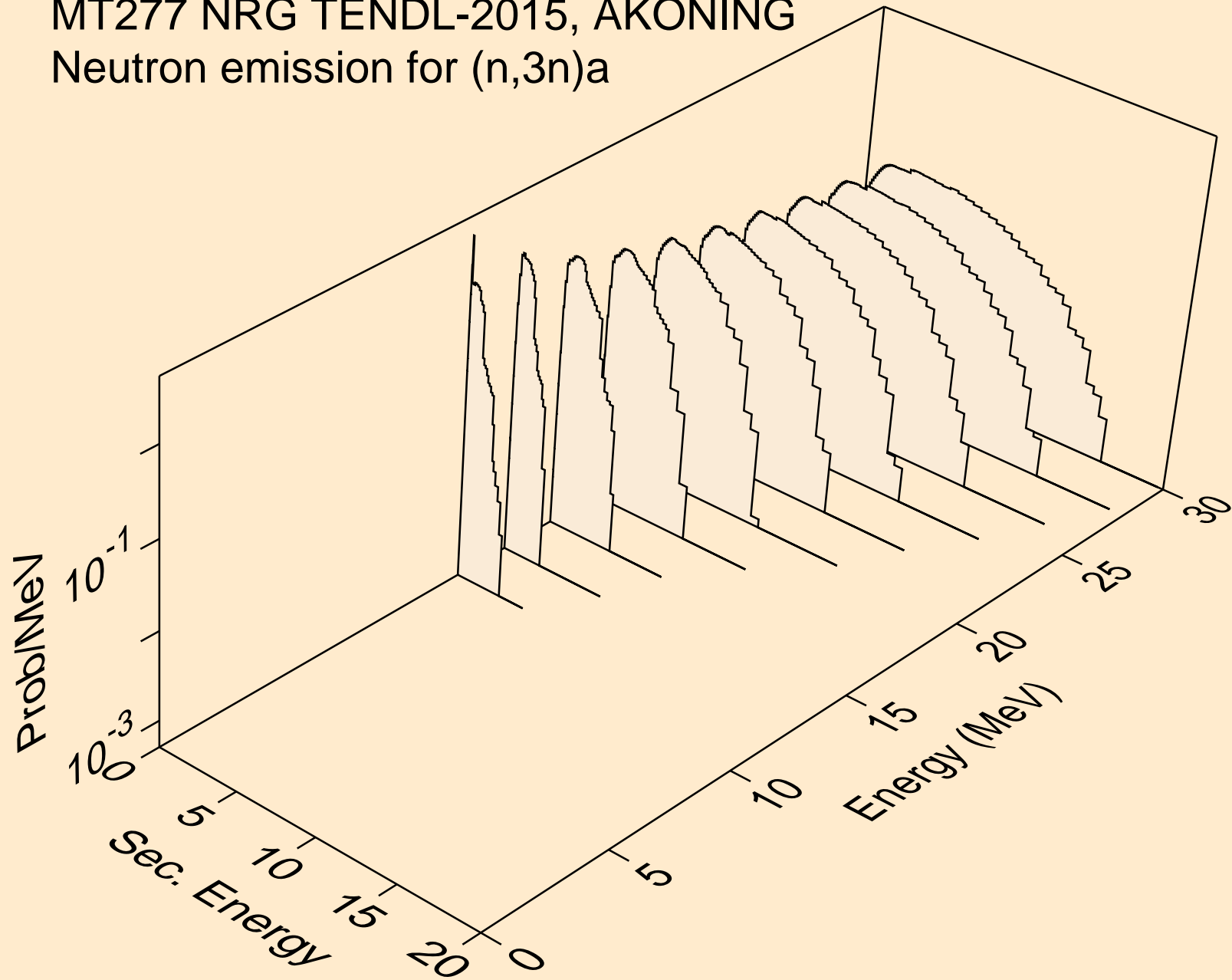

MT277 NRG TENDL-2015, AKONING
Neutron emission for (n,n*)p

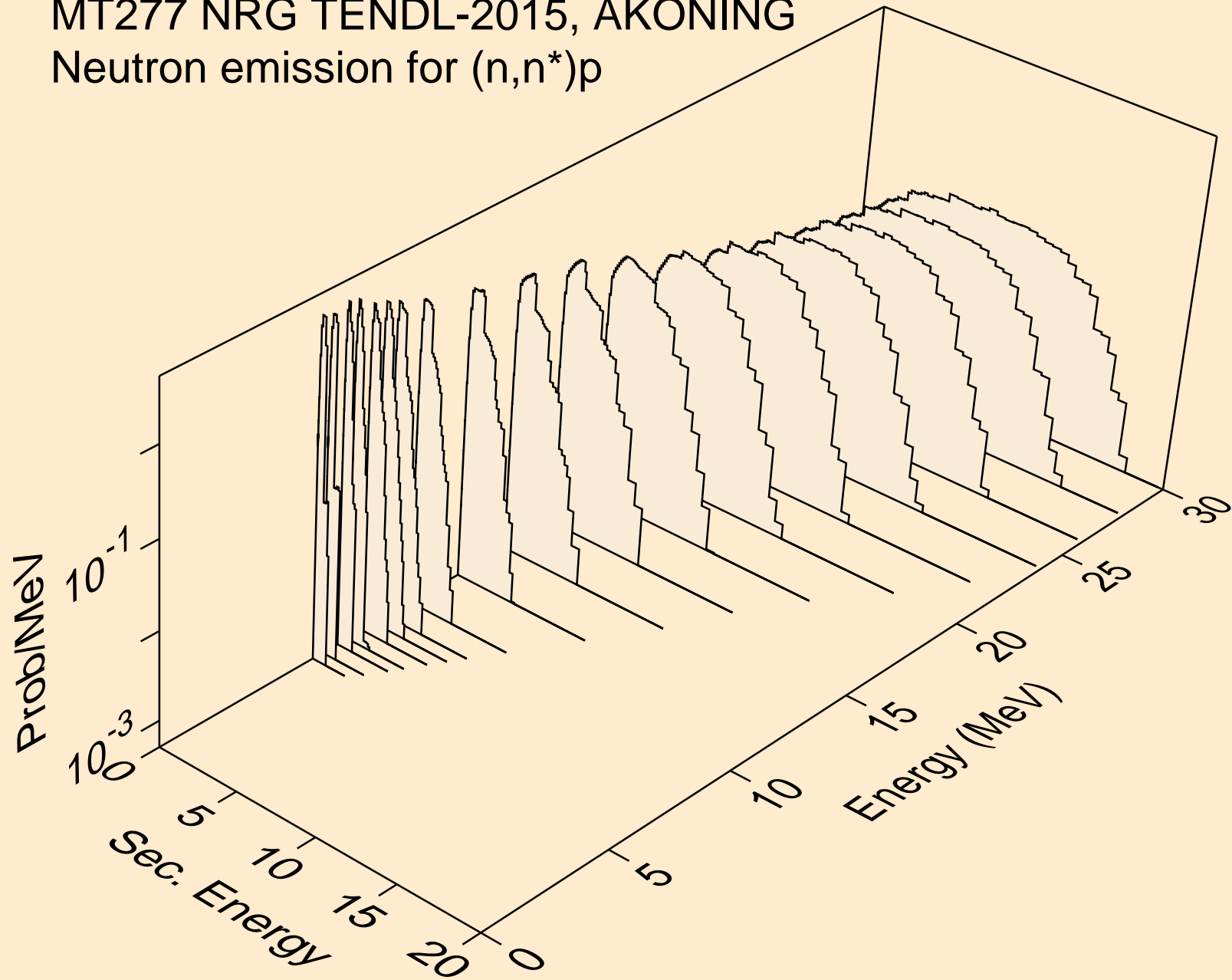

MT277 NRG TENDL-2015, AKONING
Neutron emission for (n,n*)2a

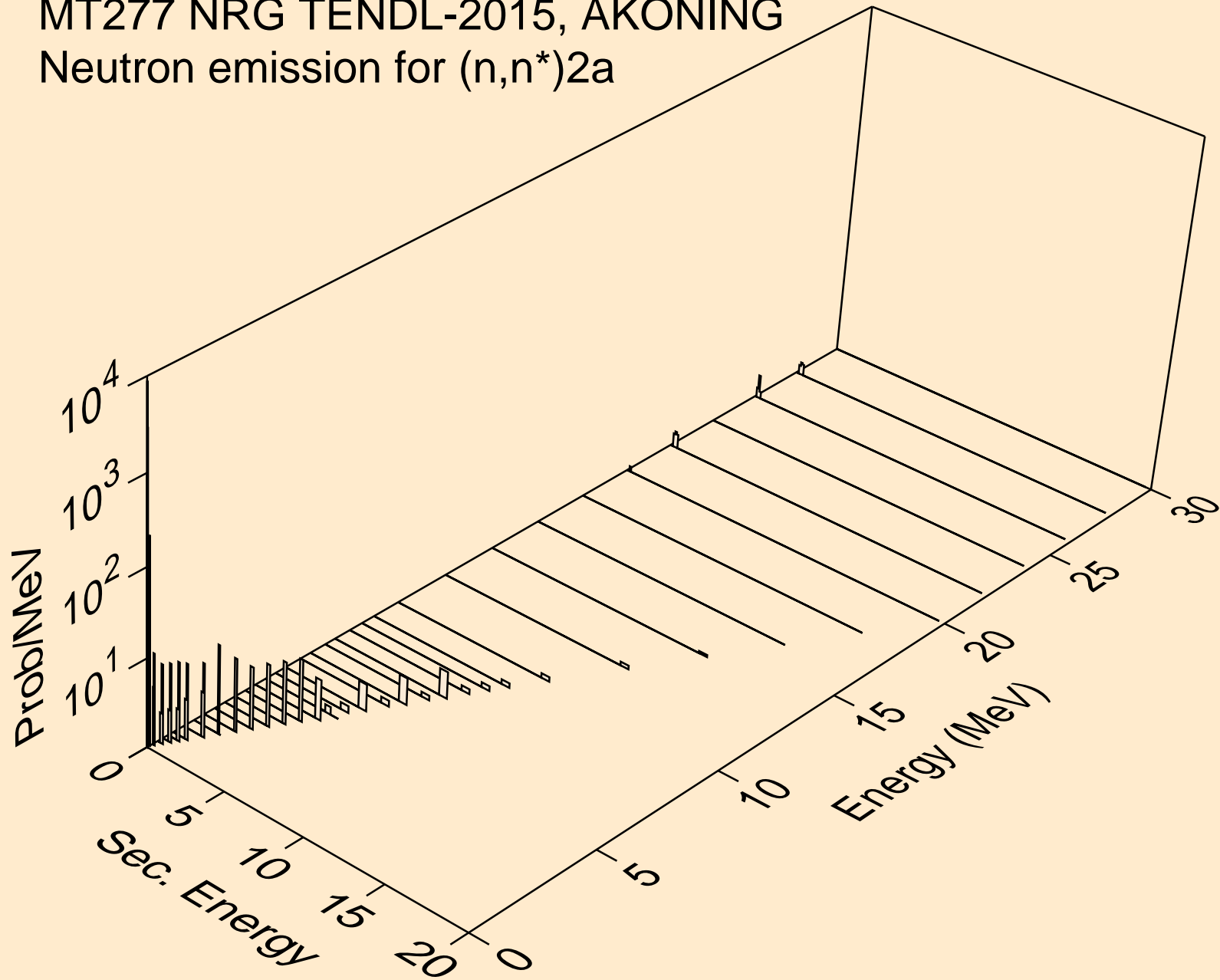

MT277 NRG TENDL-2015, AKONING
Neutron emission for (n,2n)2a

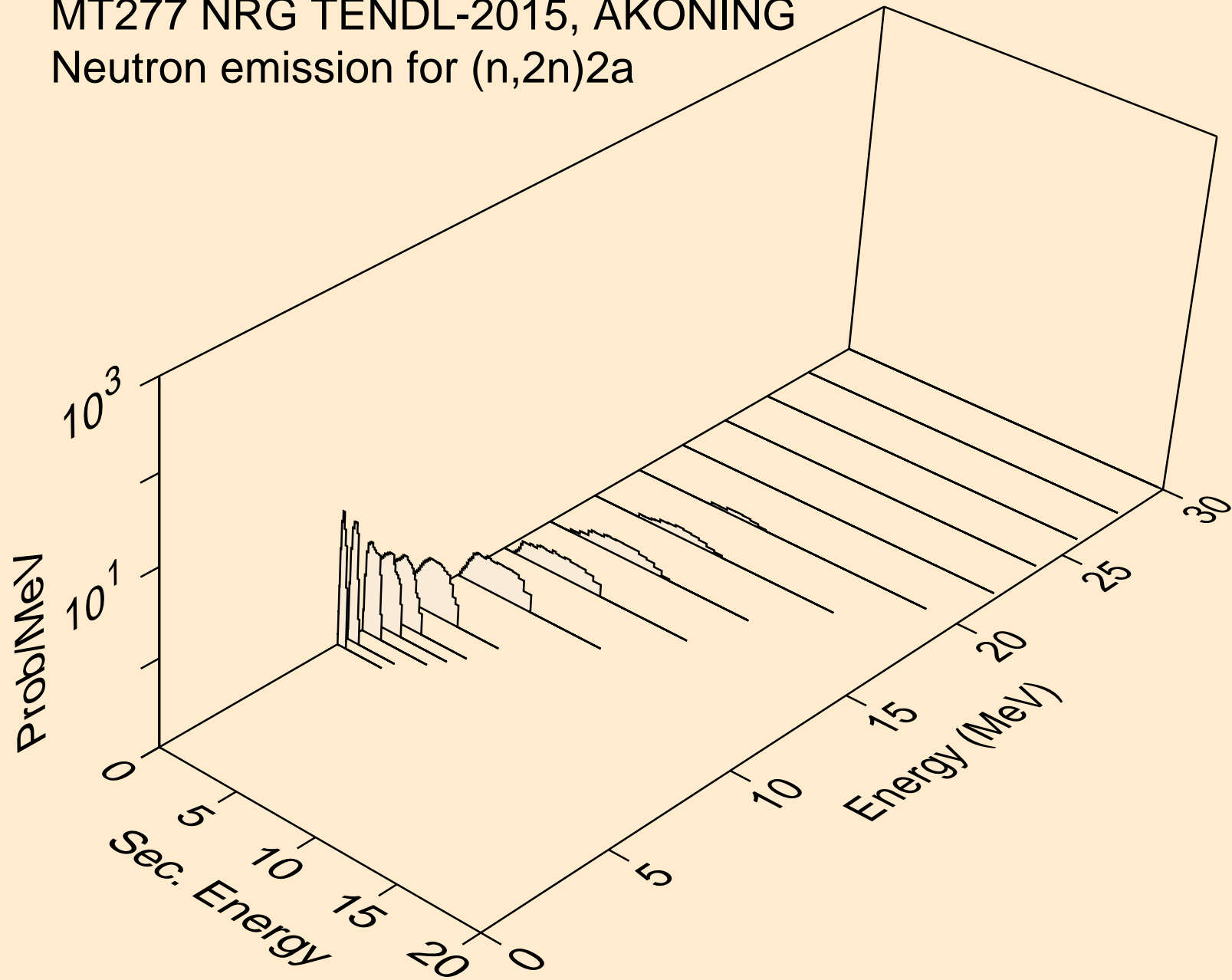

MT277 NRG TENDL-2015, AKONING
Neutron emission for (n,n*)t

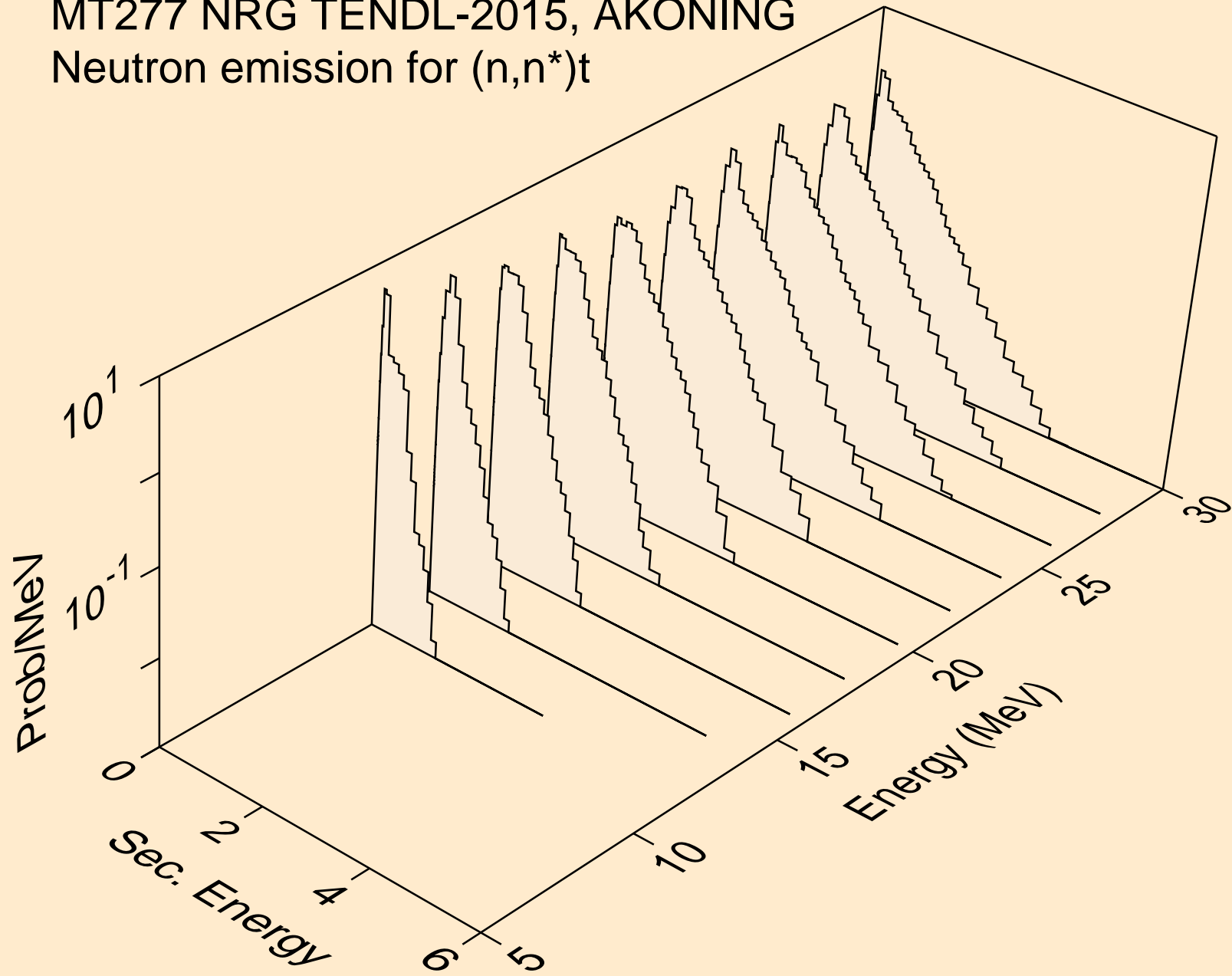

MT277 NRG TENDL-2015, AKONING
Neutron emission for (n,4n)

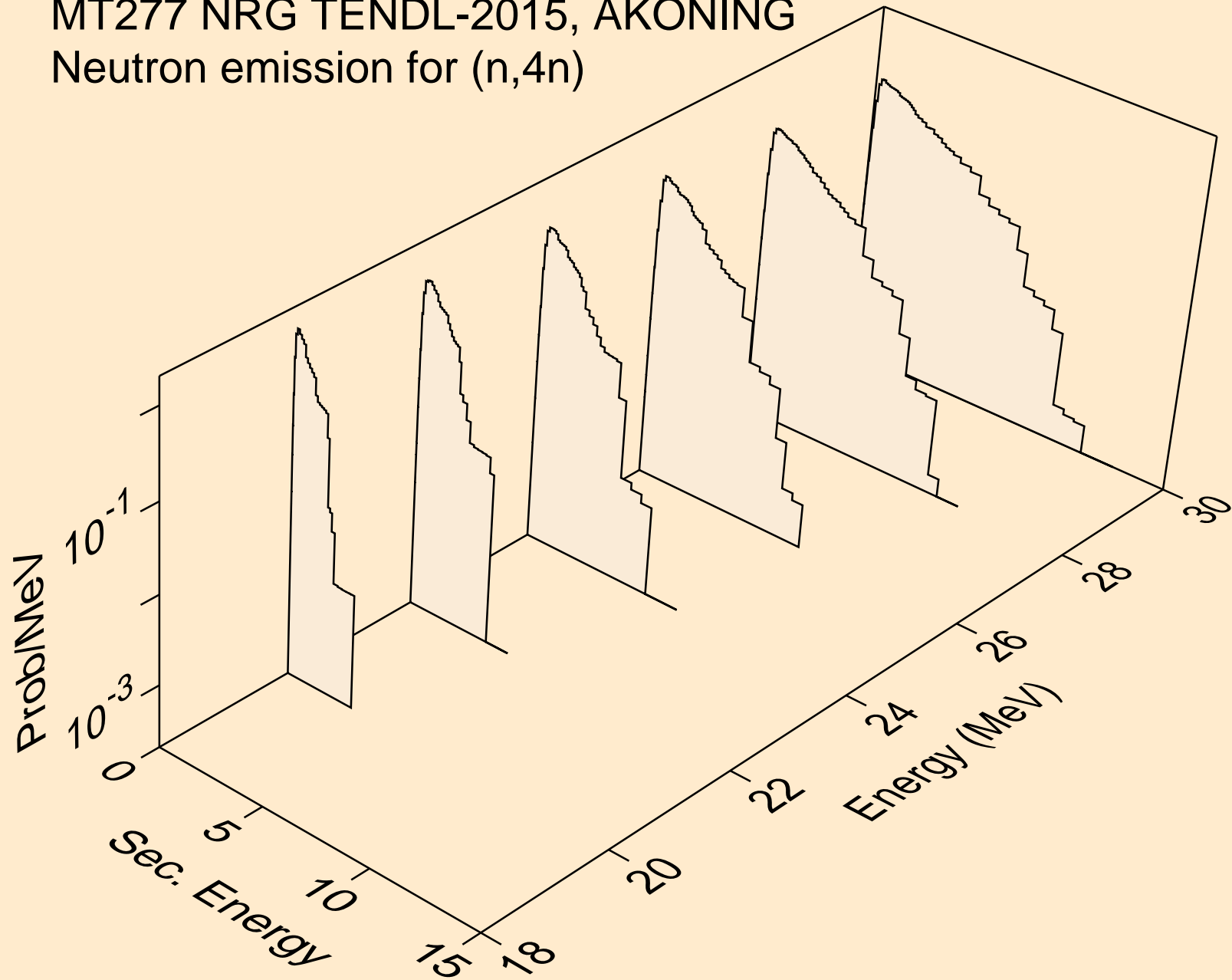

MT277 NRG TENDL-2015, AKONING
Neutron emission for (n,npa)

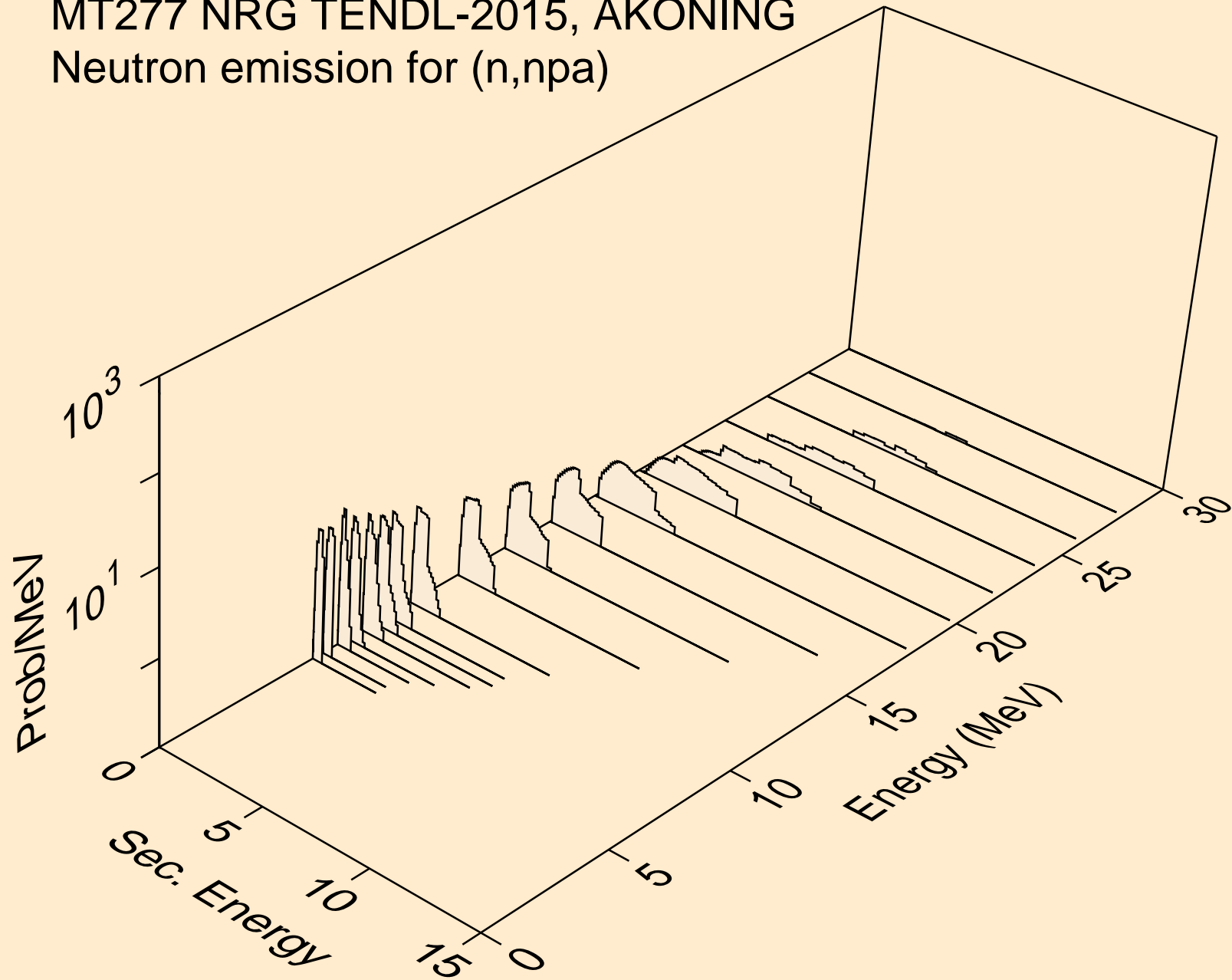

MT277 NRG TENDL-2015, AKONING
Neutron emission for (n,n*c)

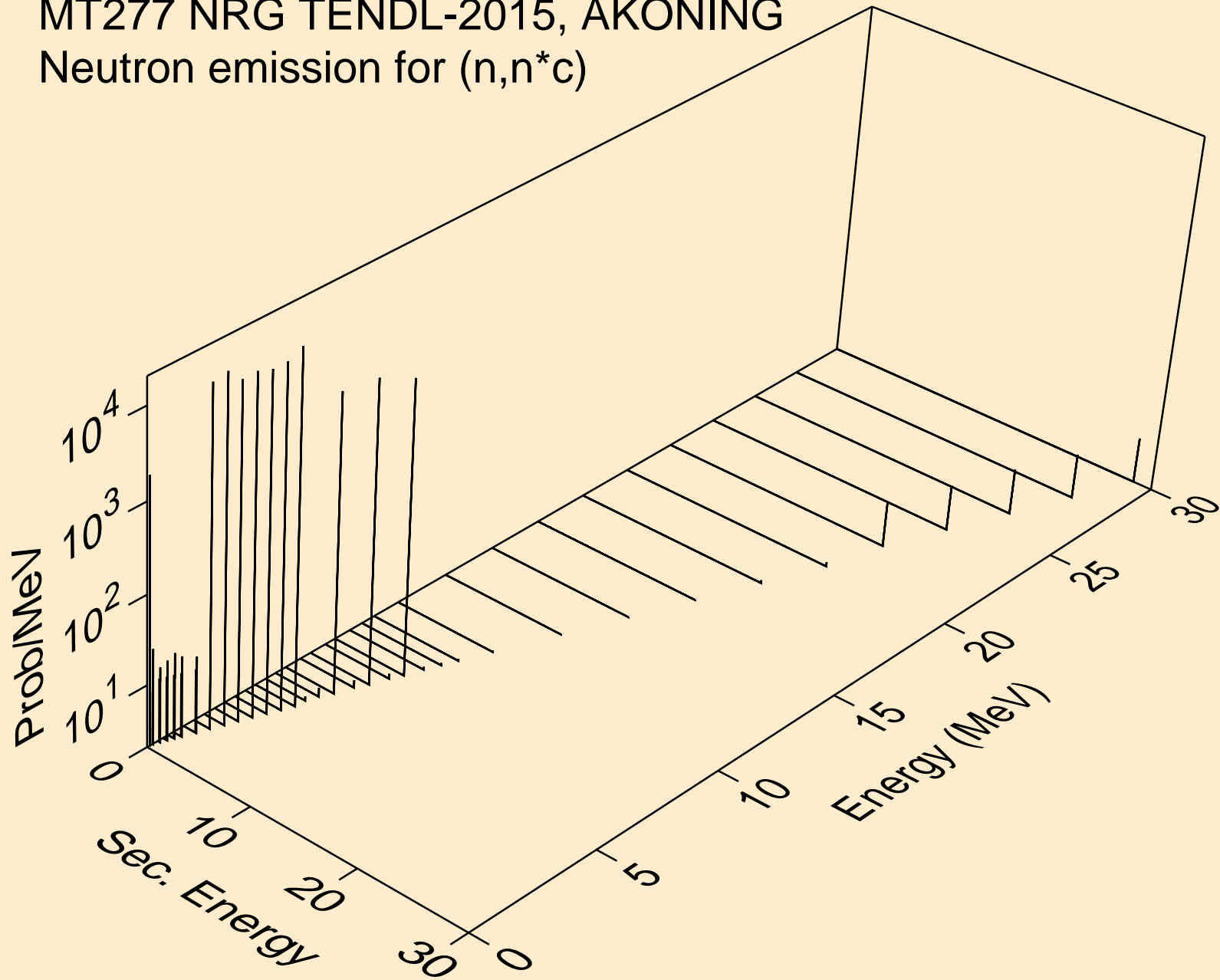

MT277 NRG TENDL-2015, AKONING

Delayed nubar

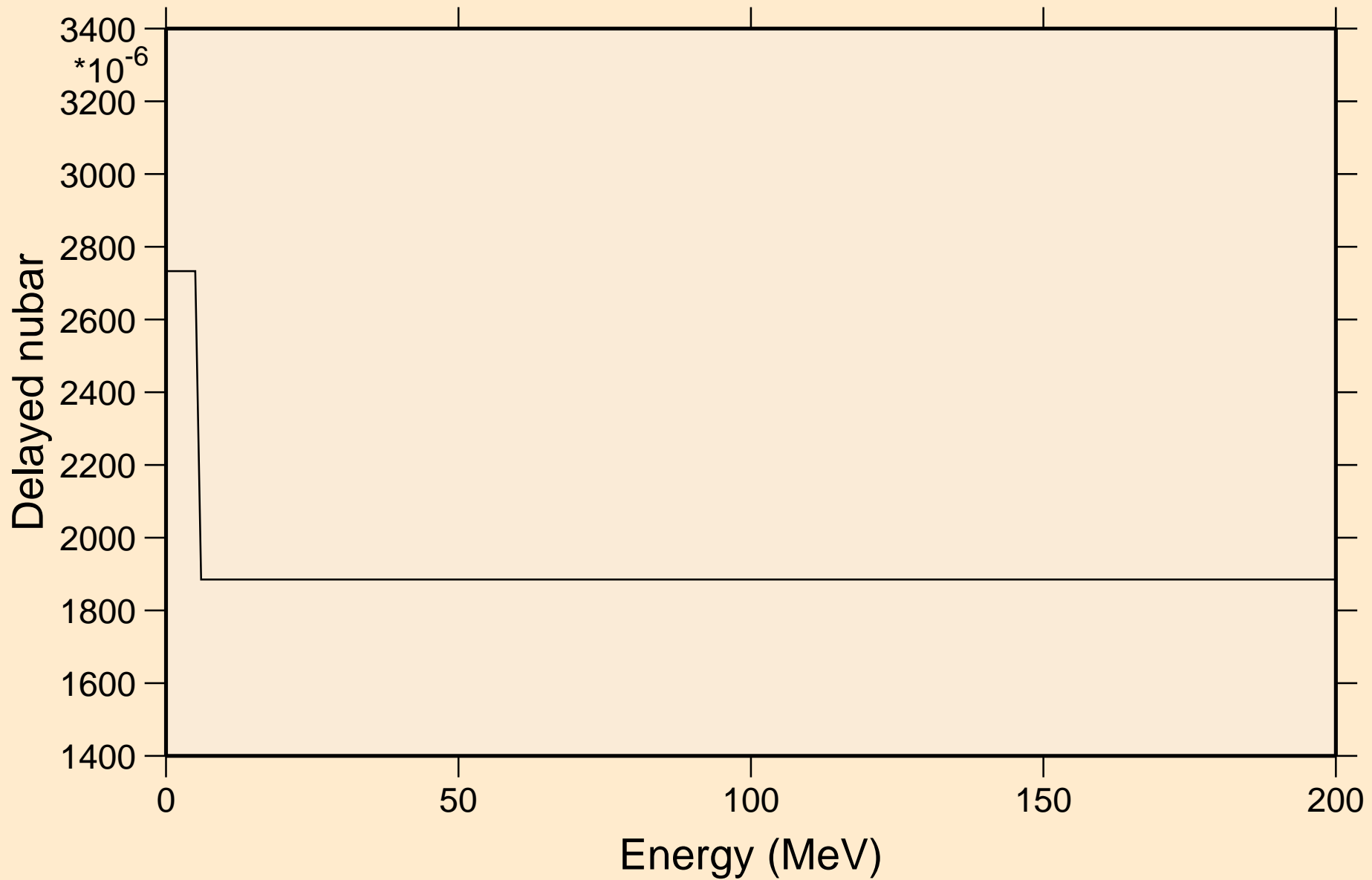

MT277 NRG TENDL-2015, AKONING

Delayed neutron spectra

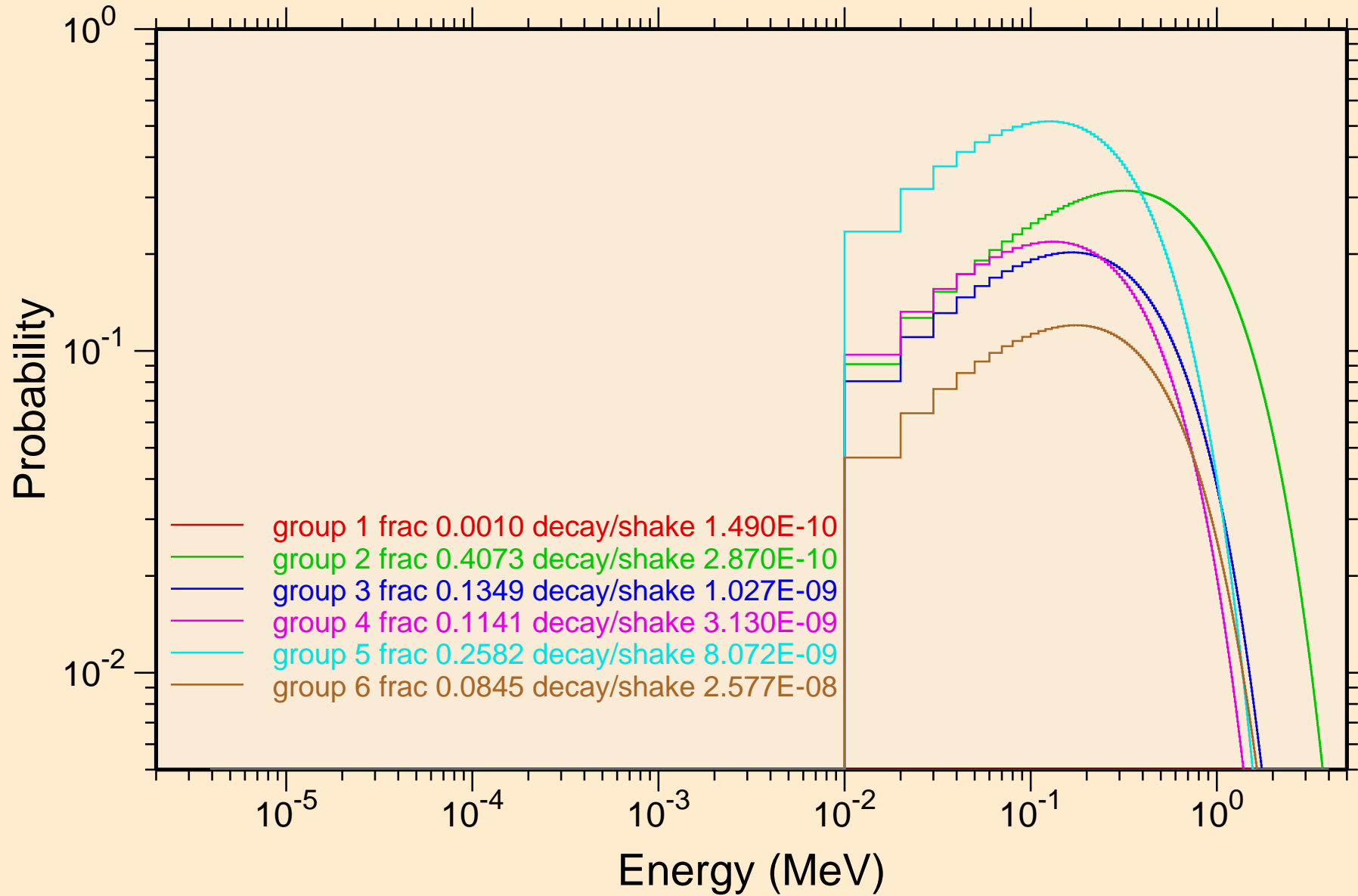

MT277 NRG TENDL-2015, AKONING
Photon emission for (n,x)

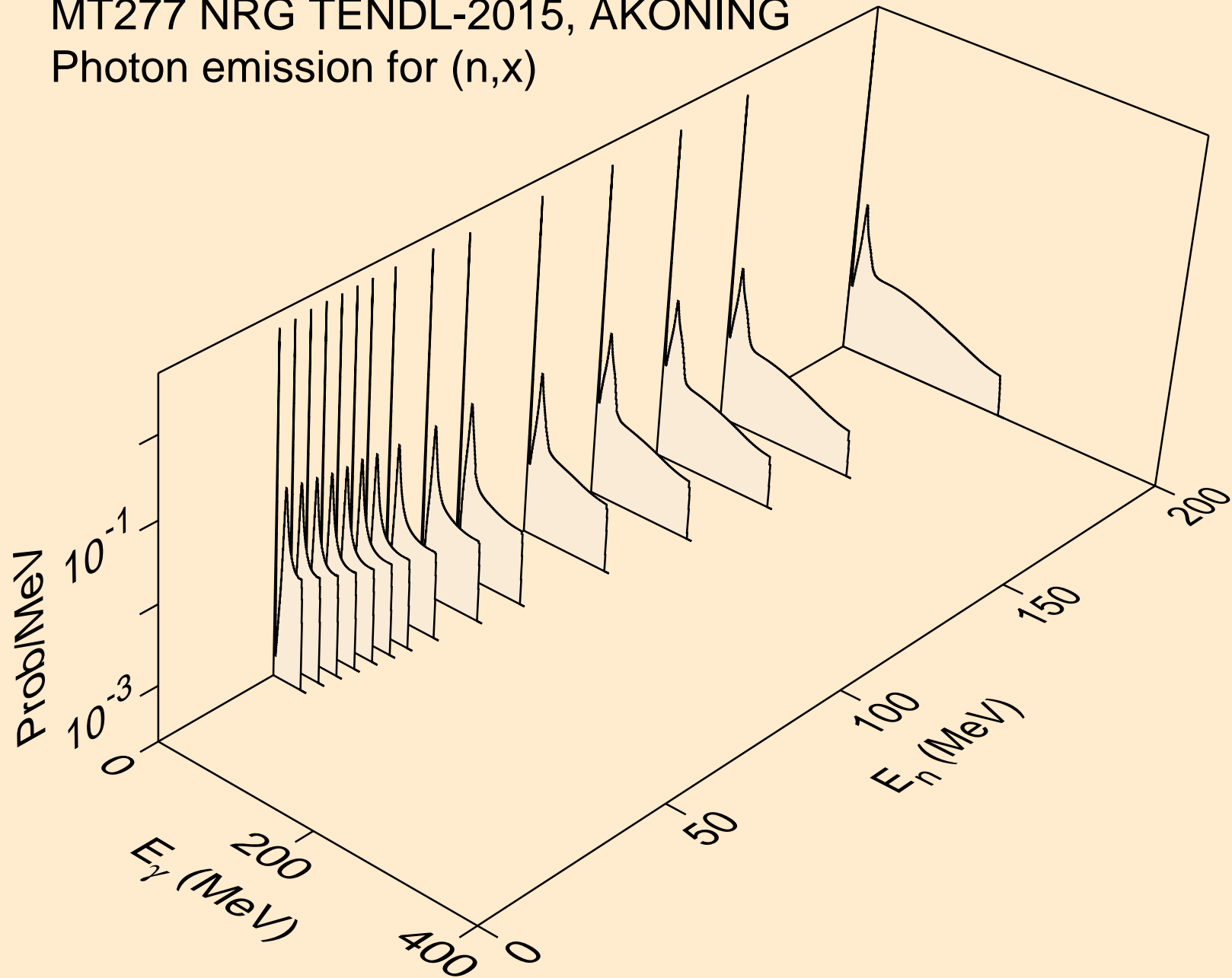

MT277 NRG TENDL-2015, AKONING
Photon emission for (n,2n)

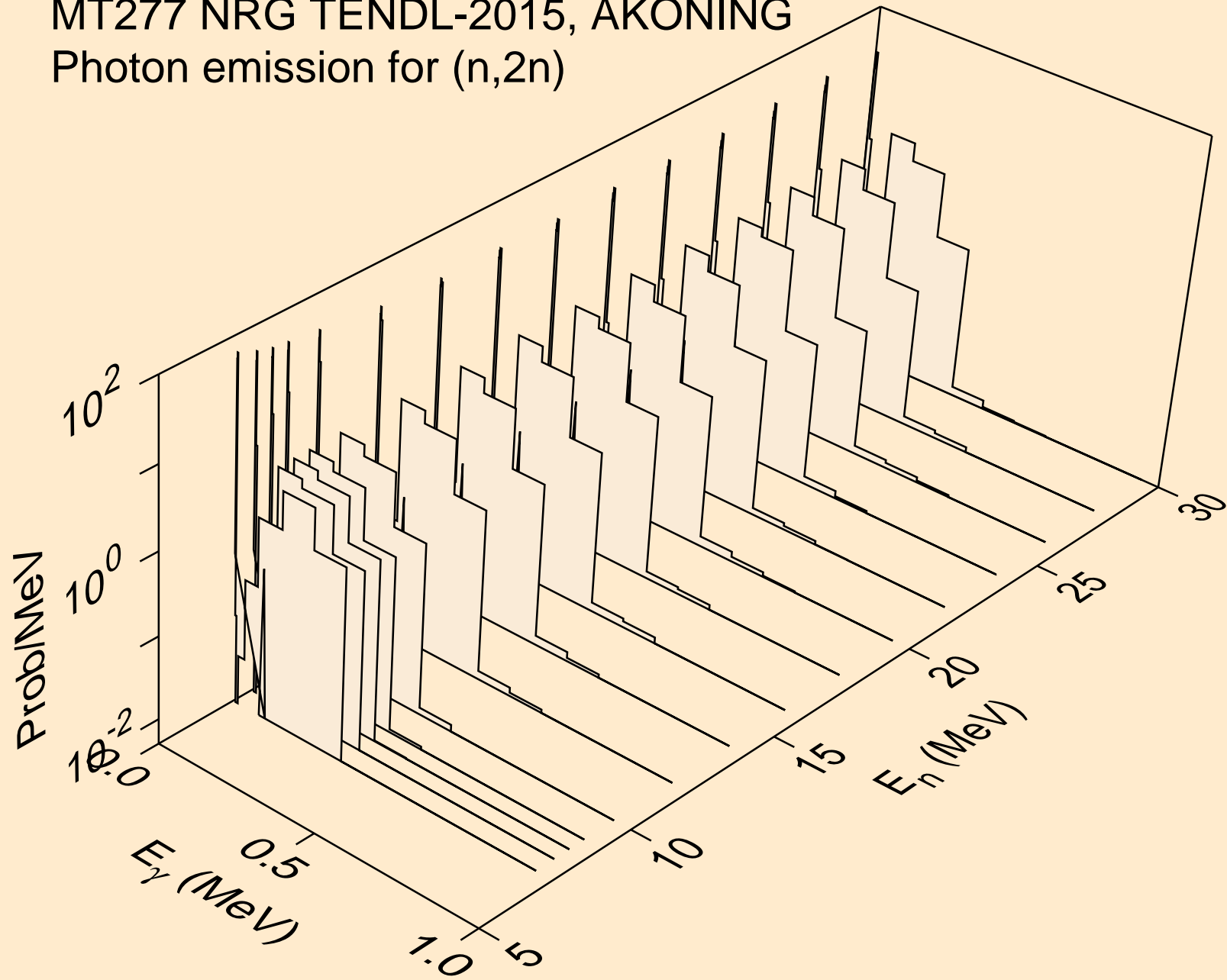

MT277 NRG TENDL-2015, AKONING
Photon emission for (n,3n)

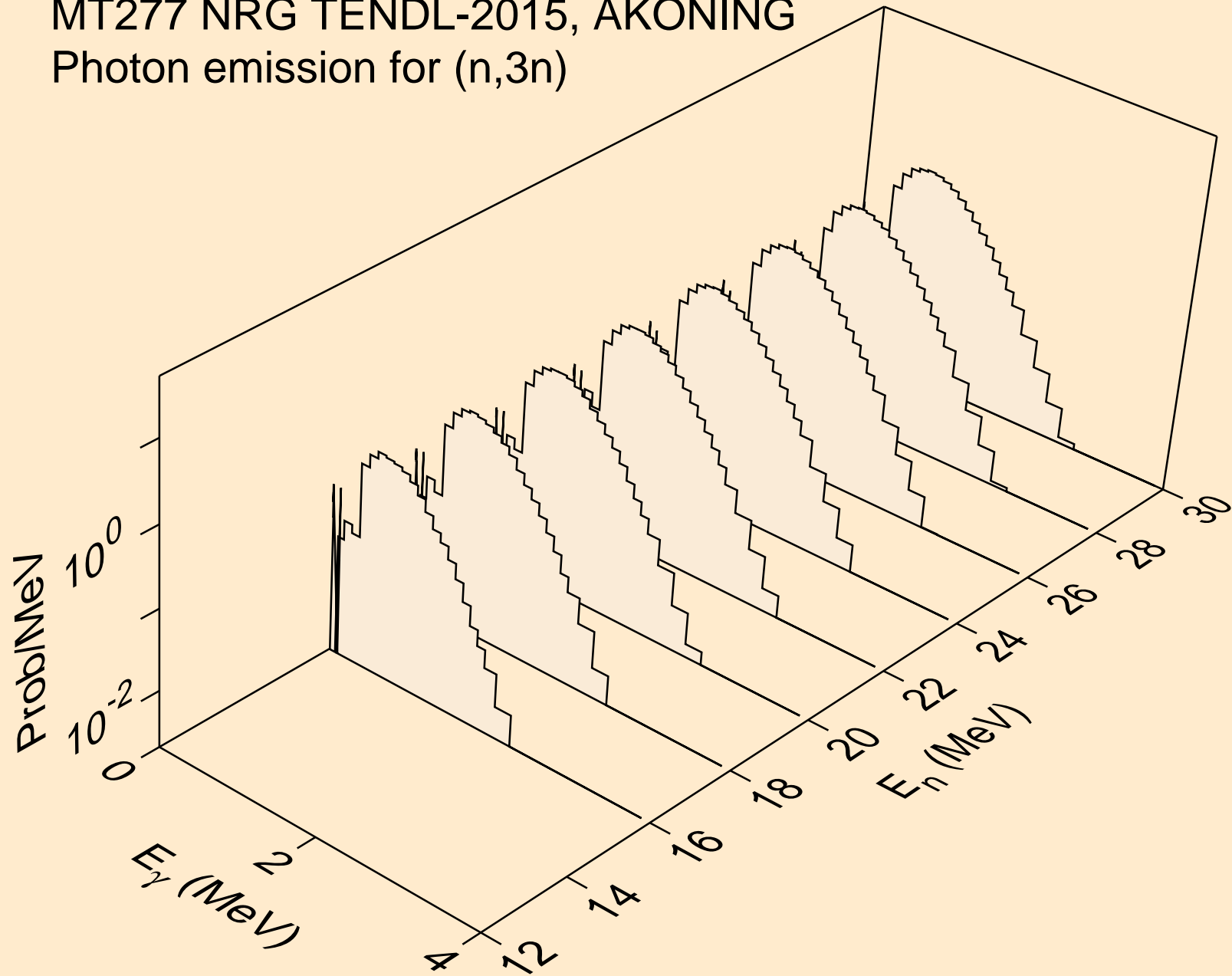

MT277 NRG TENDL-2015, AKONING
Photon emission for (n,n*)a

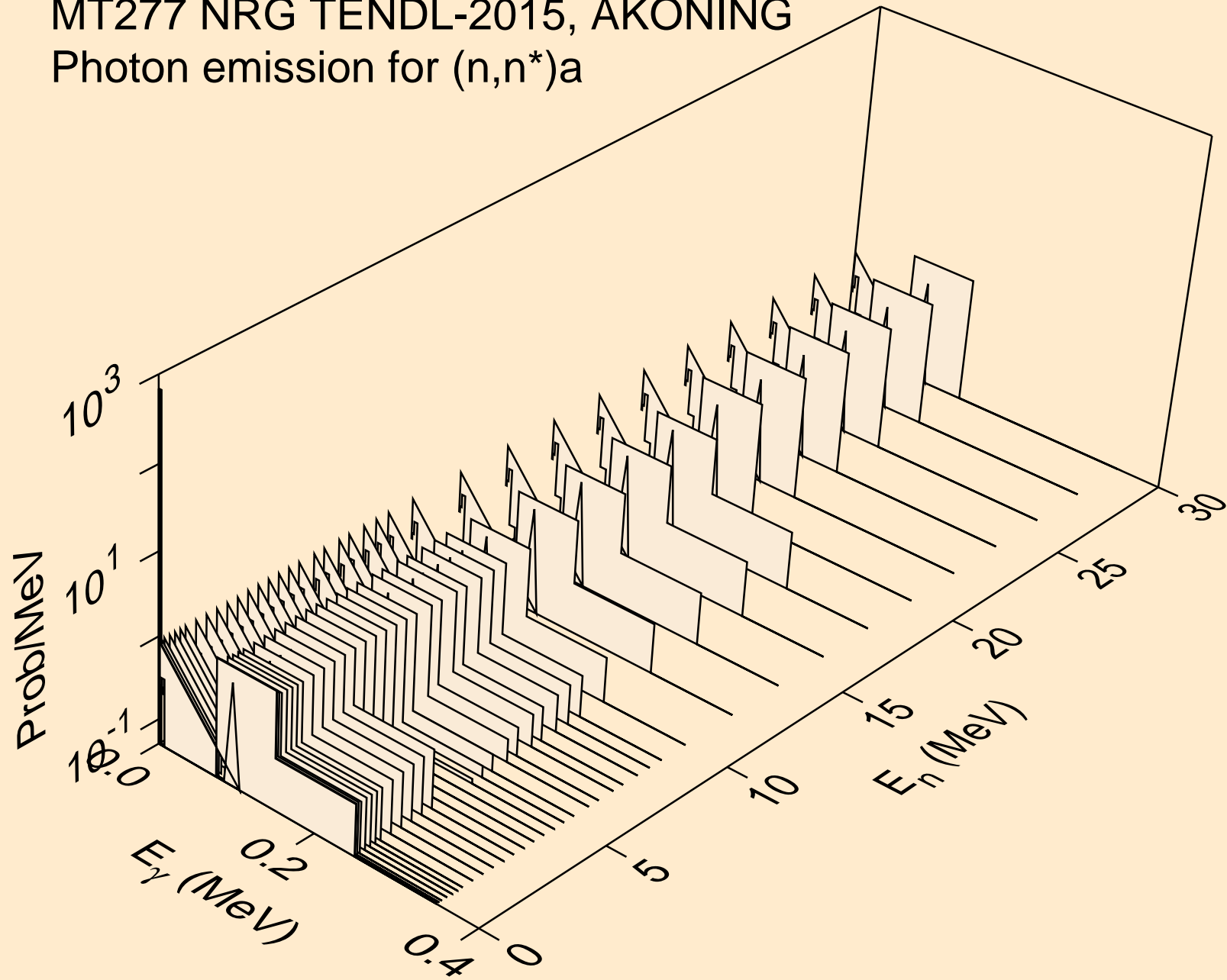

MT277 NRG TENDL-2015, AKONING
Photon emission for (n,n*)3a

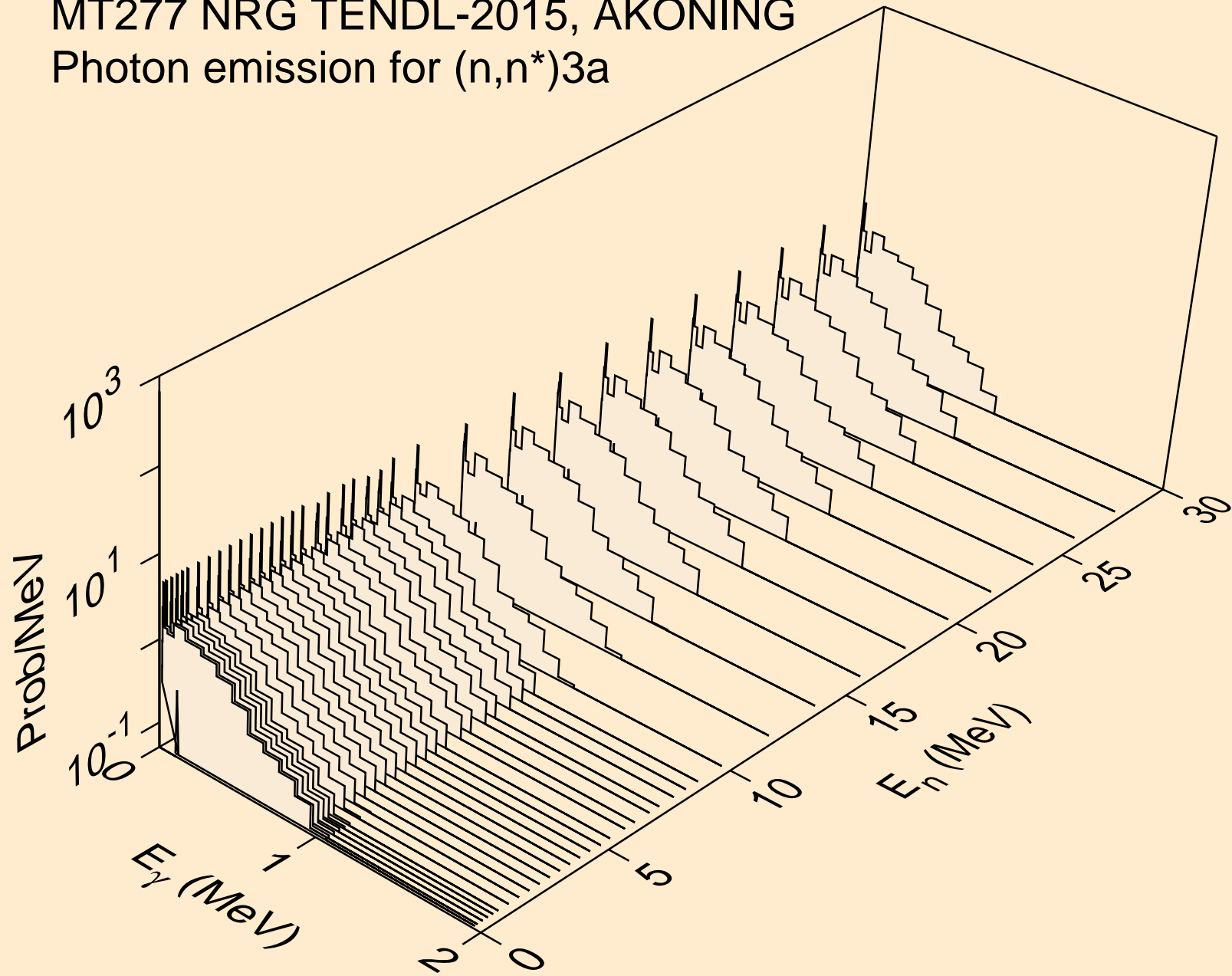

MT277 NRG TENDL-2015, AKONING
Photon emission for (n,2n)a

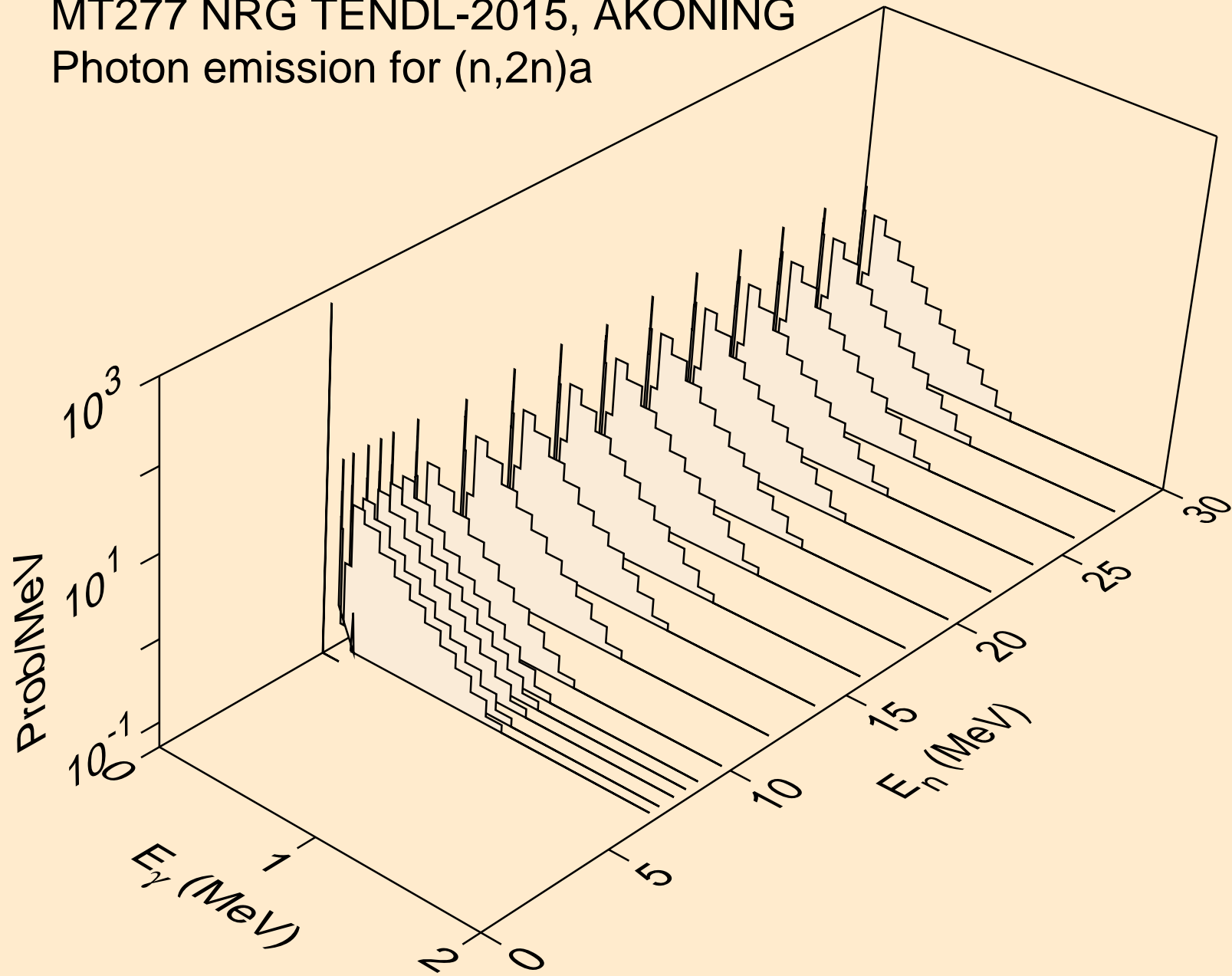

MT277 NRG TENDL-2015, AKONING
Photon emission for (n,3n)a

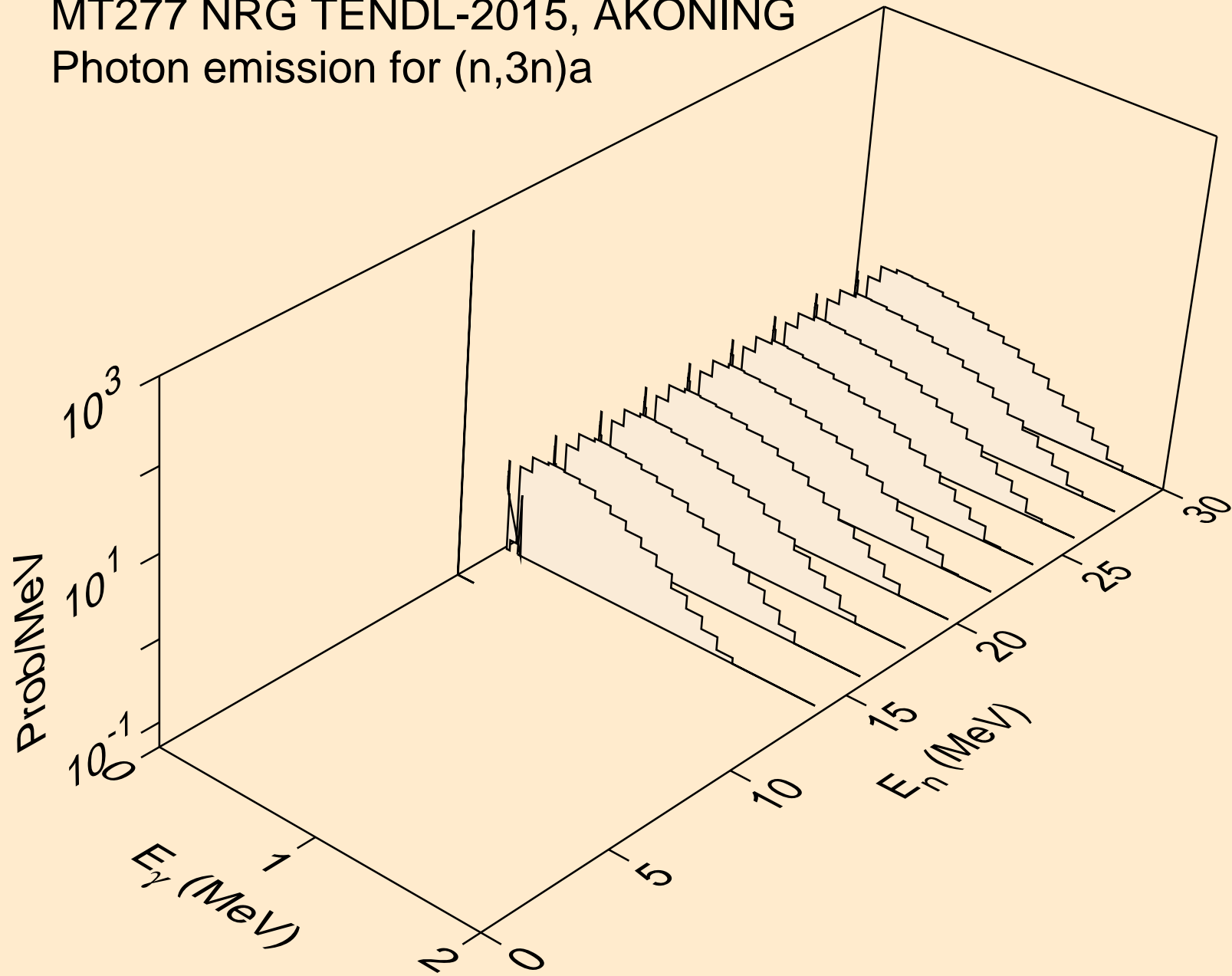

MT277 NRG TENDL-2015, AKONING
Photon emission for (n,n*)p

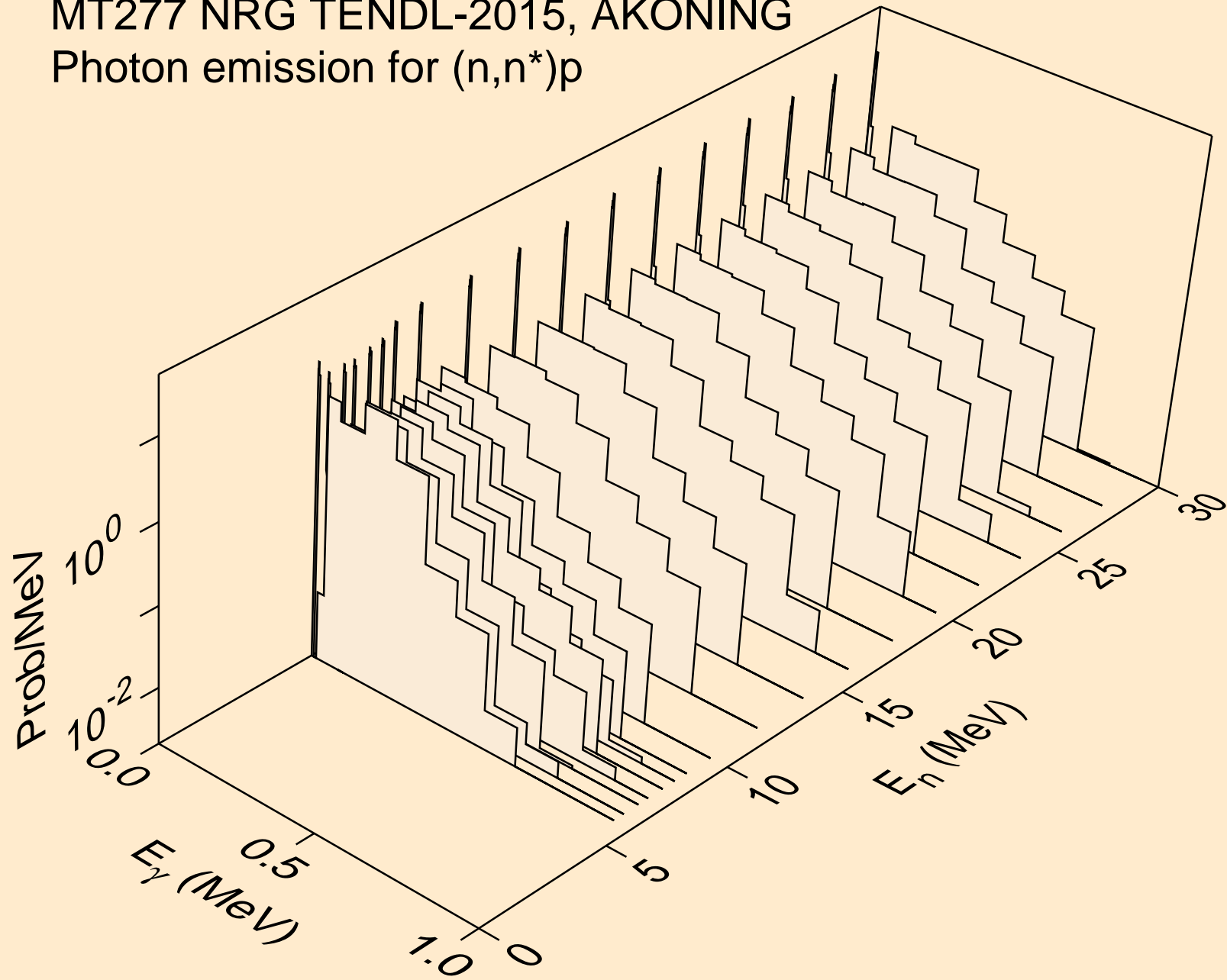

MT277 NRG TENDL-2015, AKONING
Photon emission for (n,n*)2a

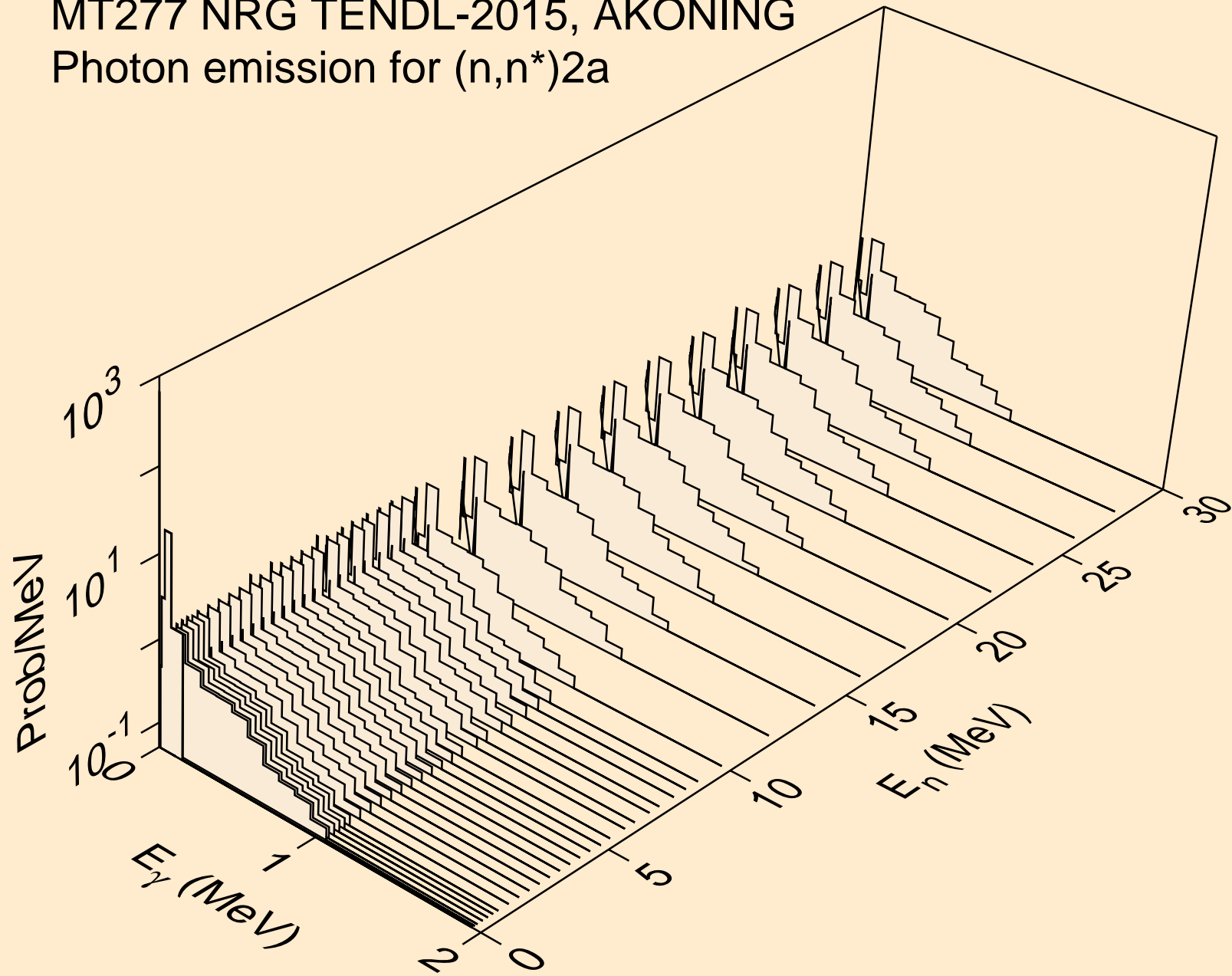

MT277 NRG TENDL-2015, AKONING
Photon emission for (n,2n)2a

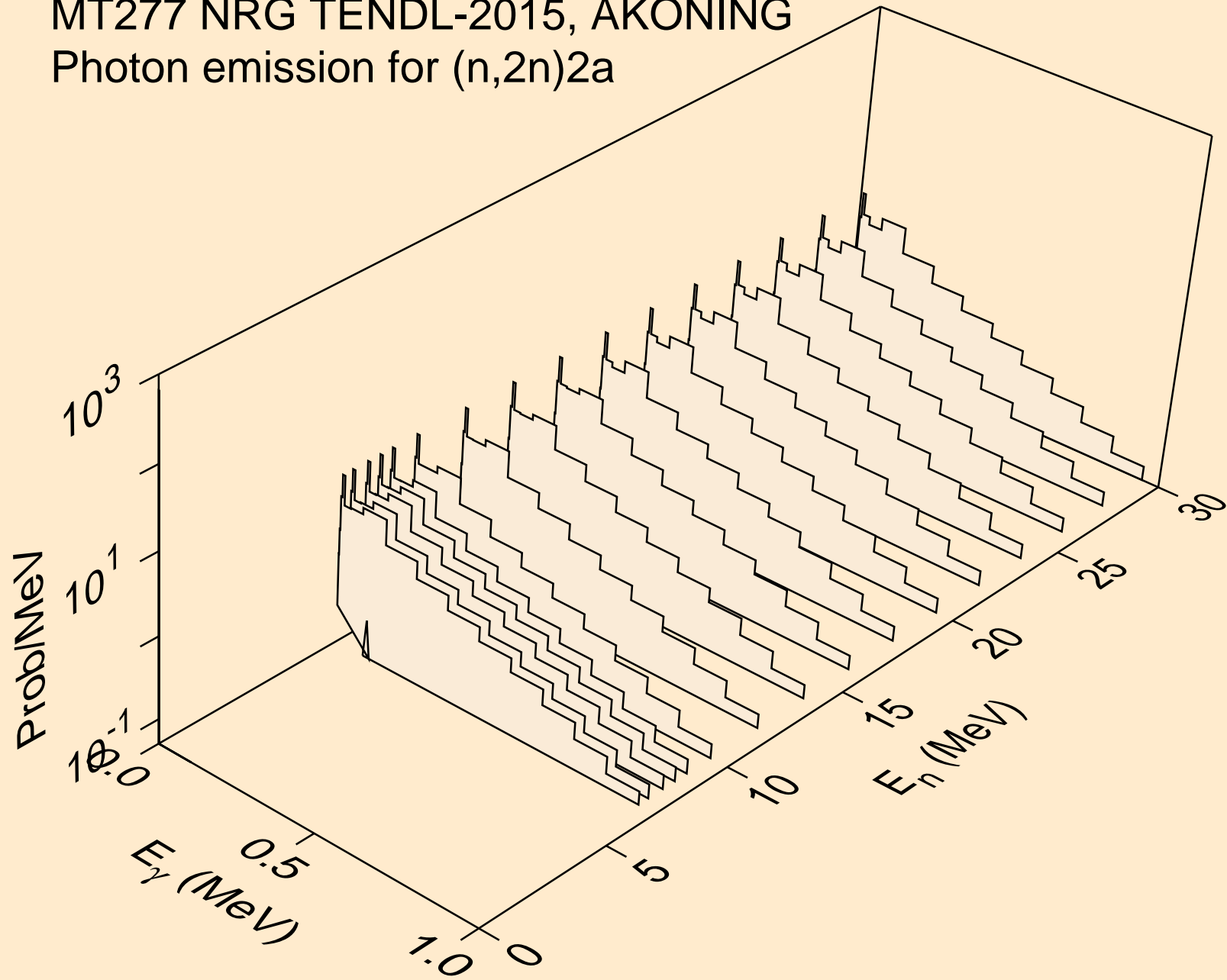

MT277 NRG TENDL-2015, AKONING
Photon emission for (n,n*)t

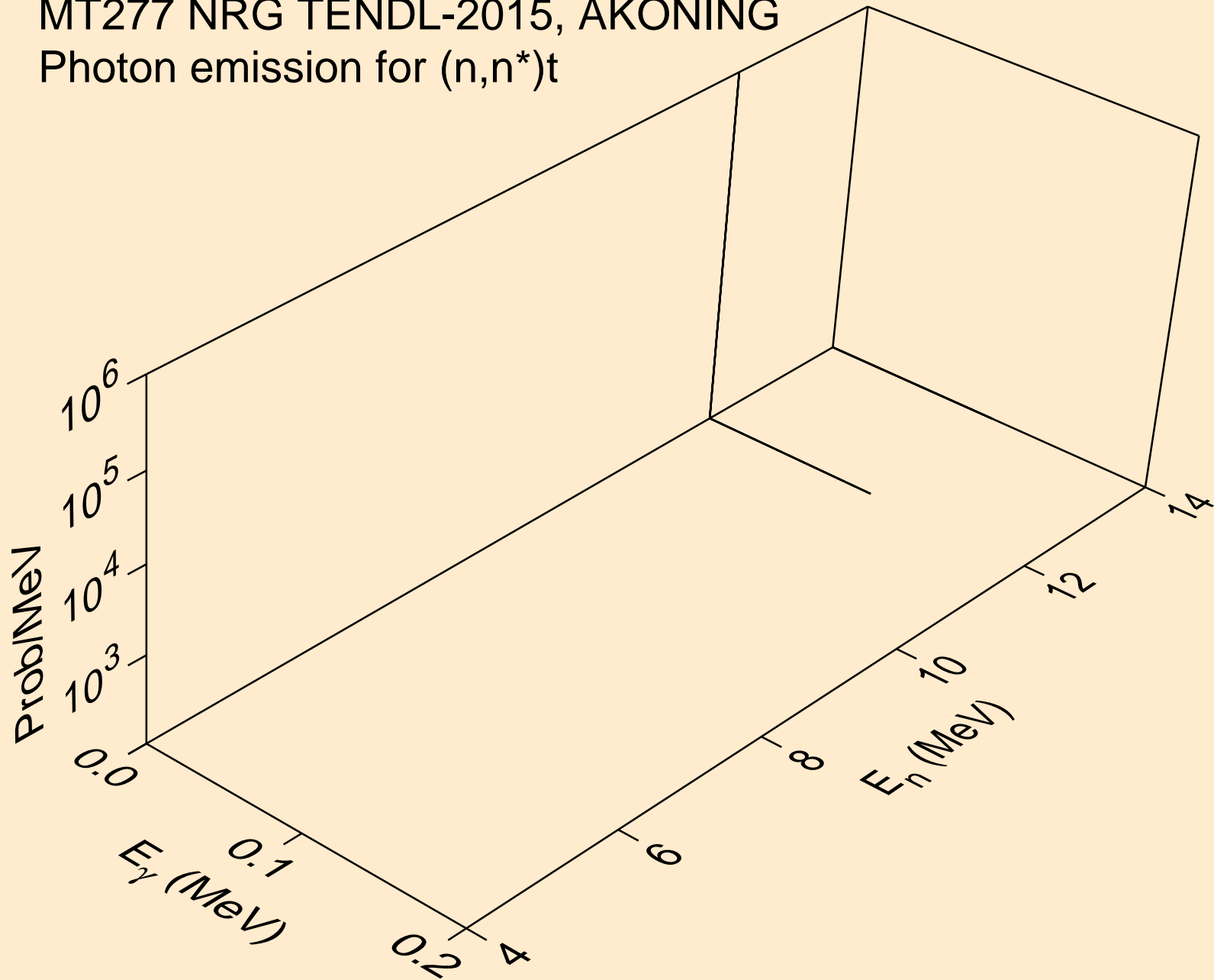

MT277 NRG TENDL-2015, AKONING
Photon emission for (n,4n)

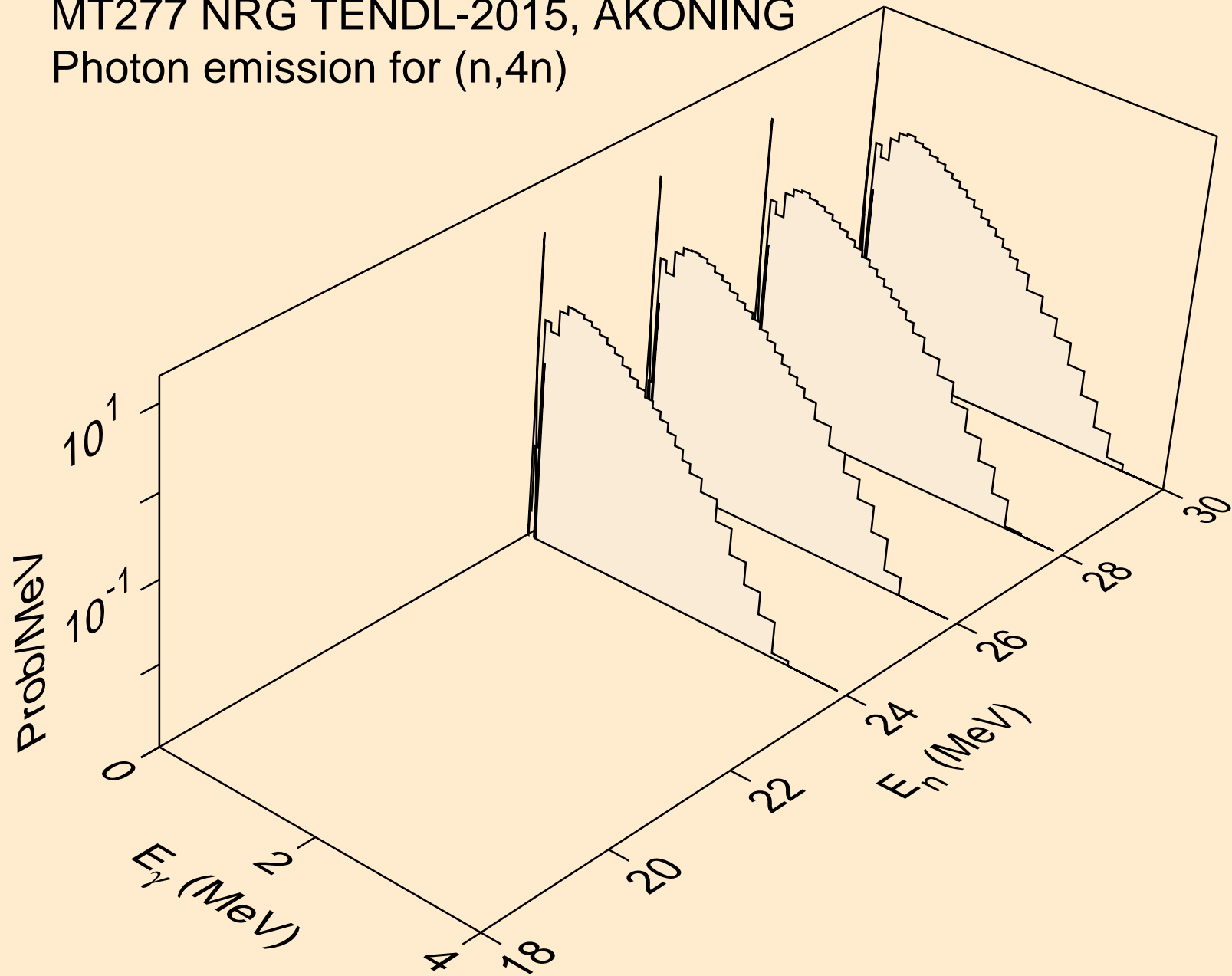

MT277 NRG TENDL-2015, AKONING
Photon emission for (n,npa)

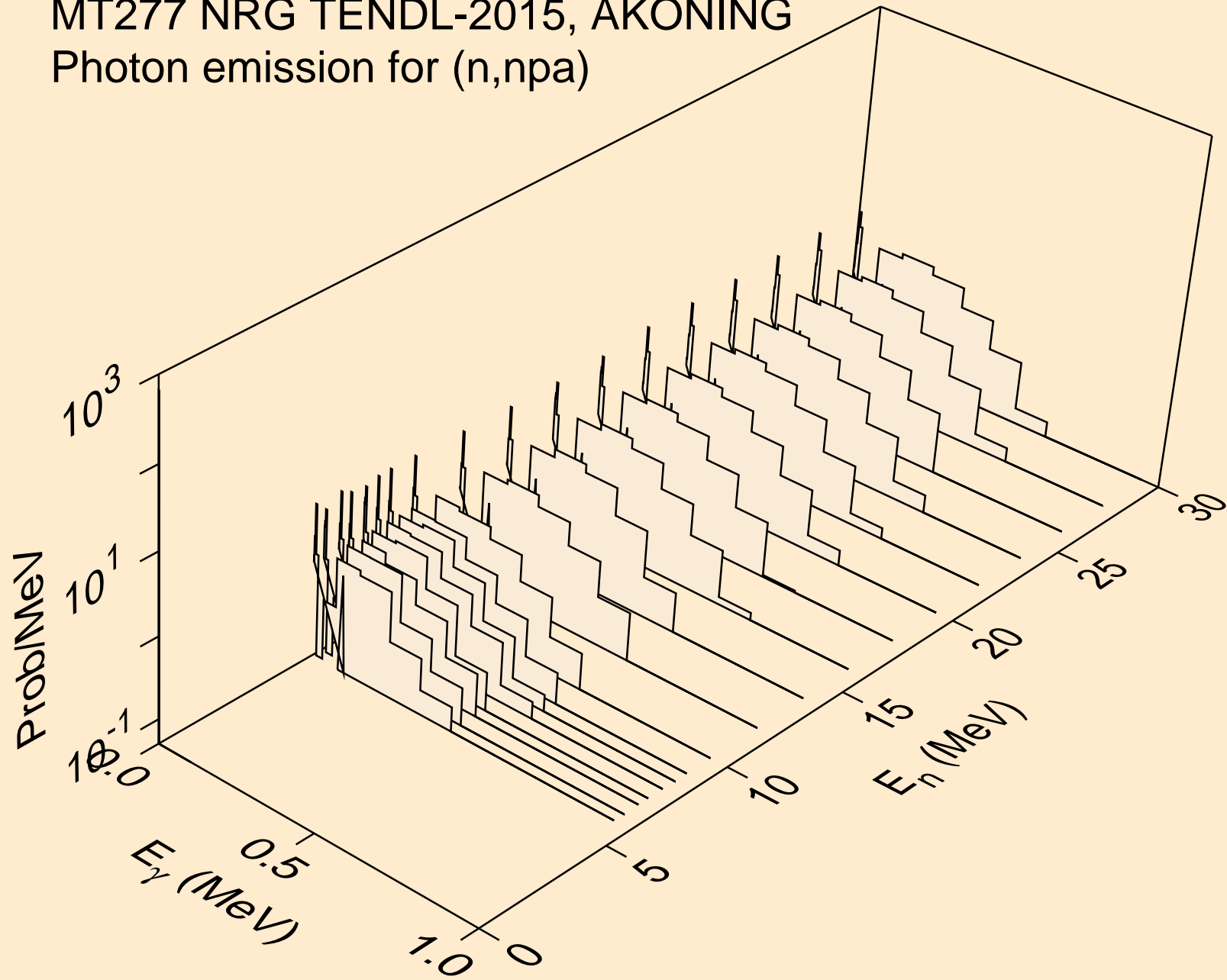

MT277 NRG TENDL-2015, AKONING
Photon emission for (n,n*c)

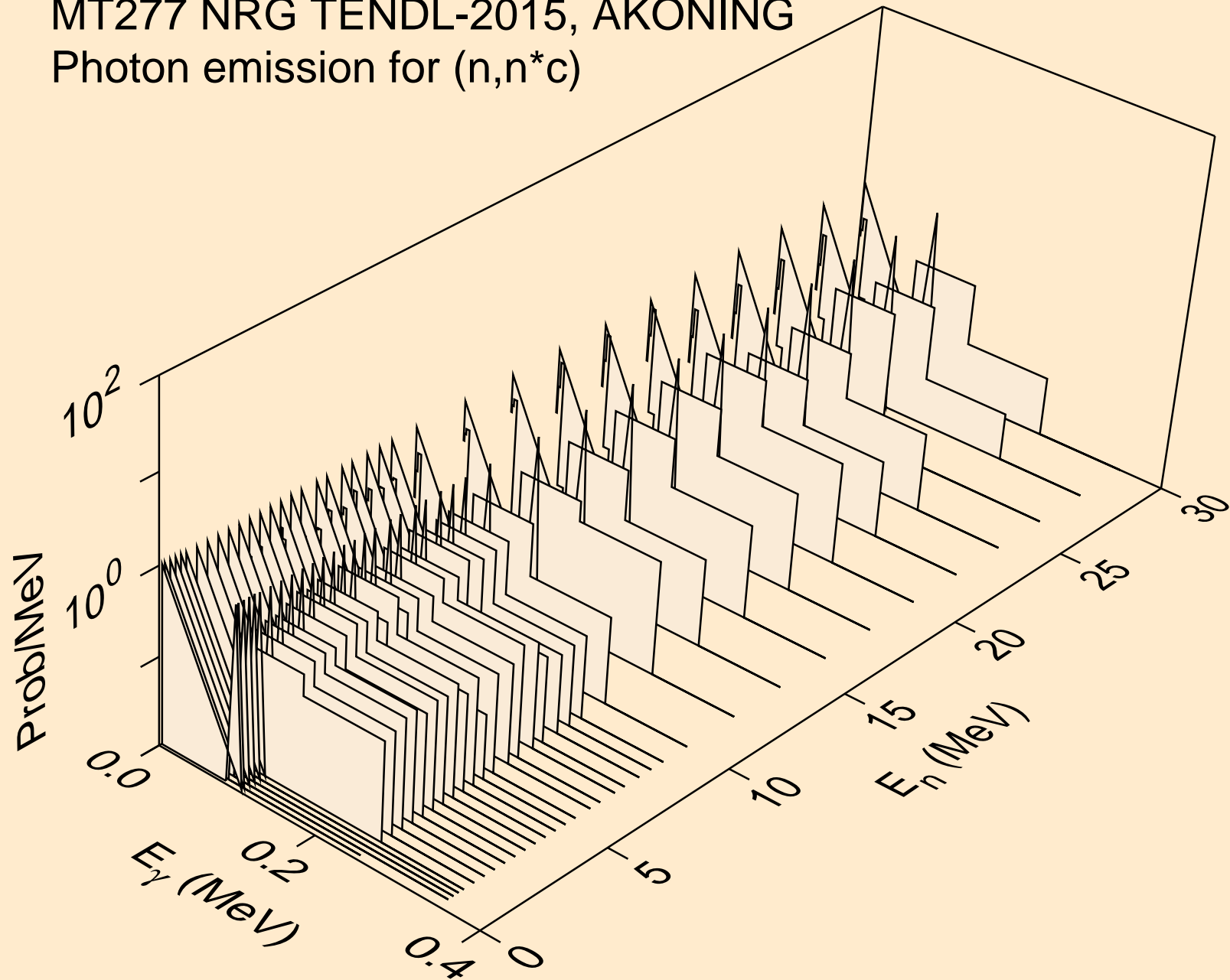

MT277 NRG TENDL-2015, AKONING
Photon emission for (n,gma)

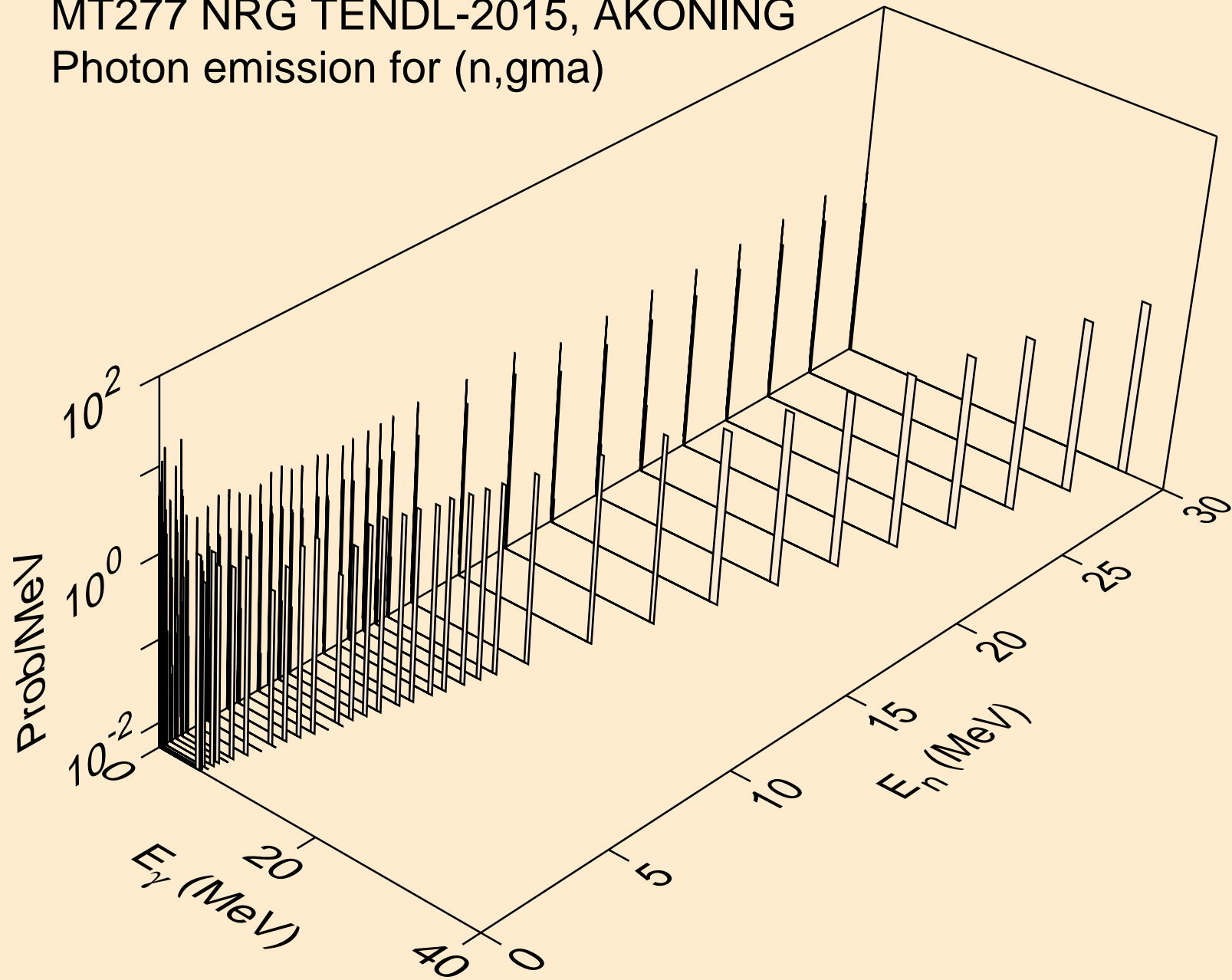

MT277 NRG TENDL-2015, AKONING
Photon emission for (n,p)

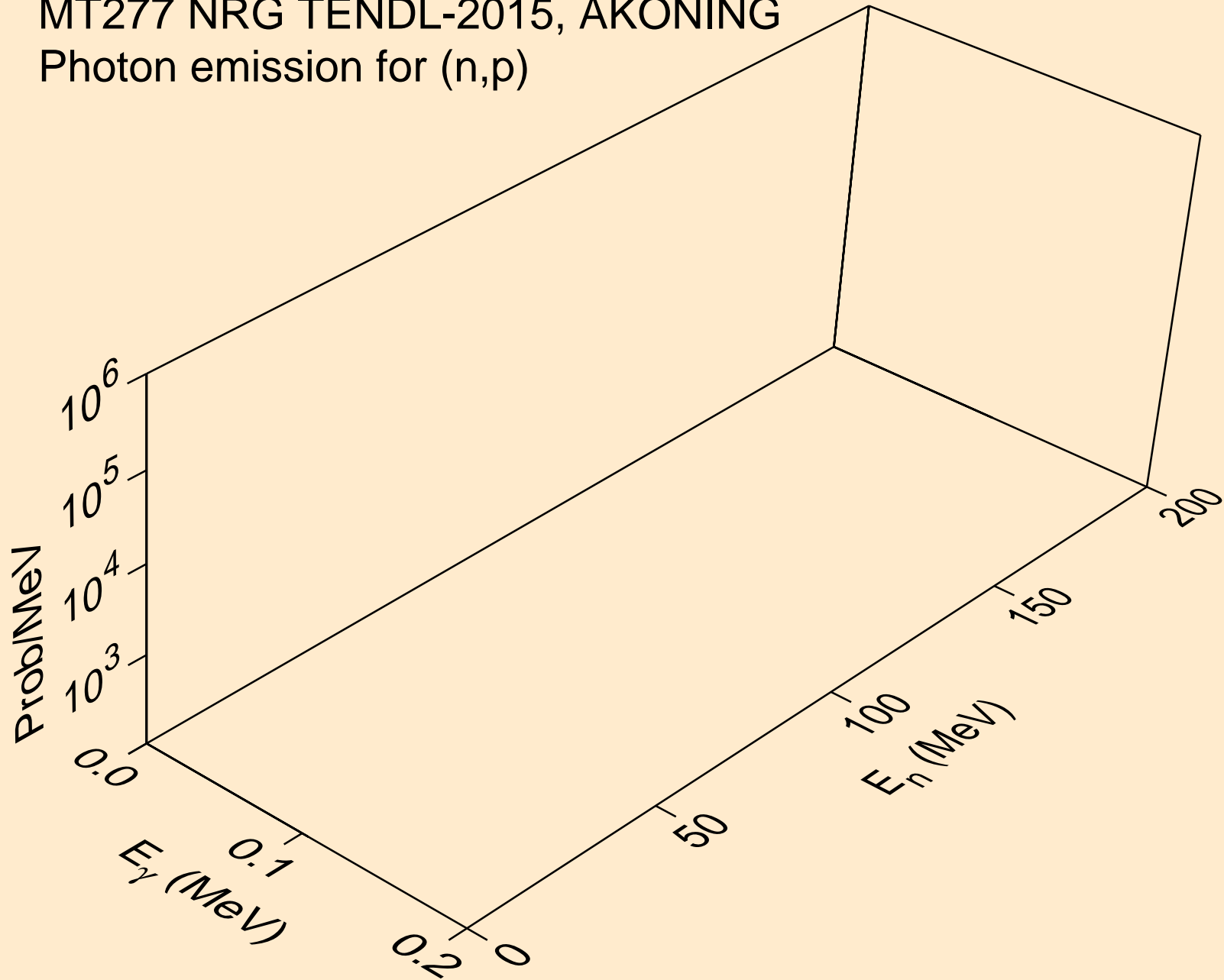

MT277 NRG TENDL-2015, AKONING
Photon emission for (n,d)

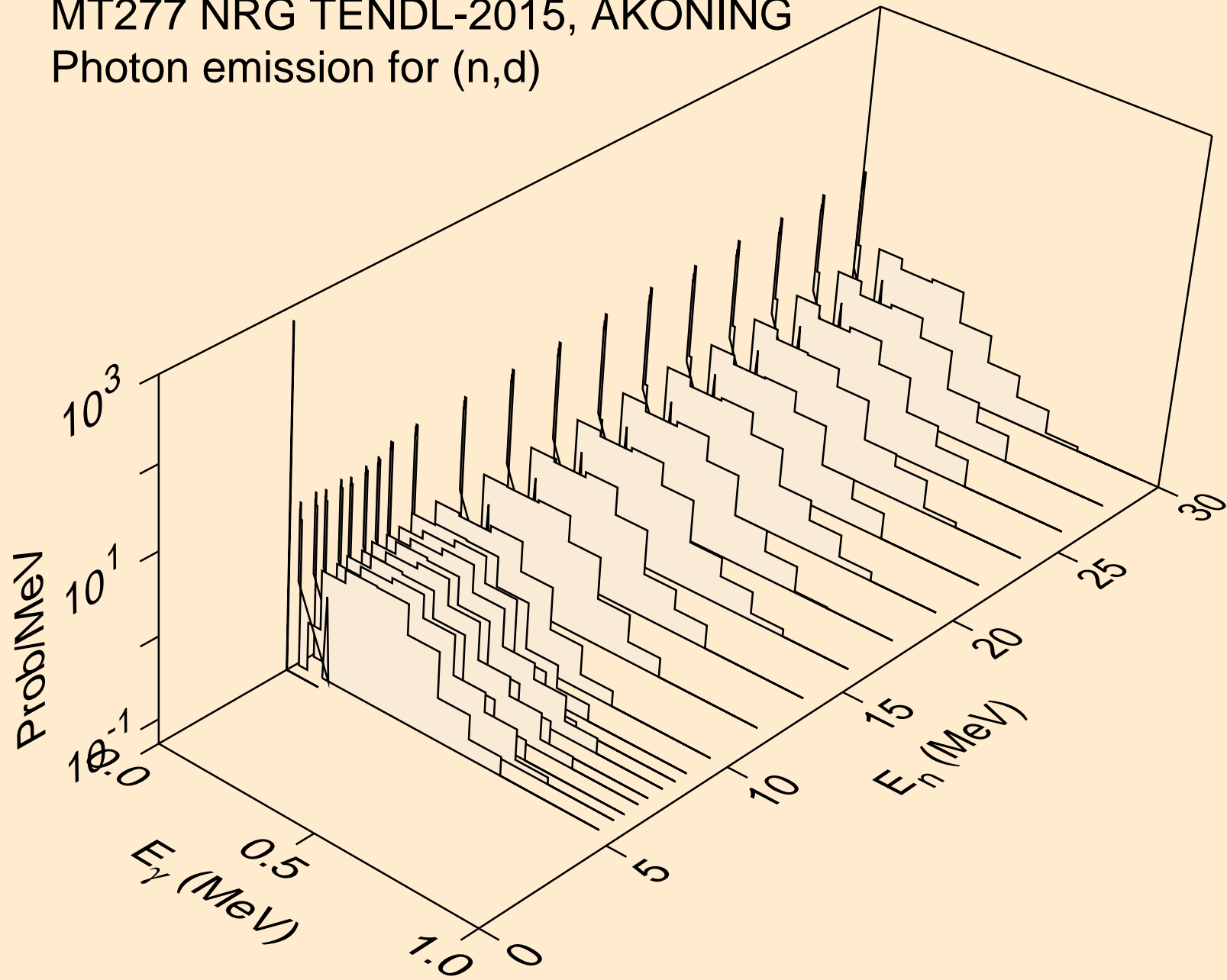

MT277 NRG TENDL-2015, AKONING
Photon emission for (n,t)

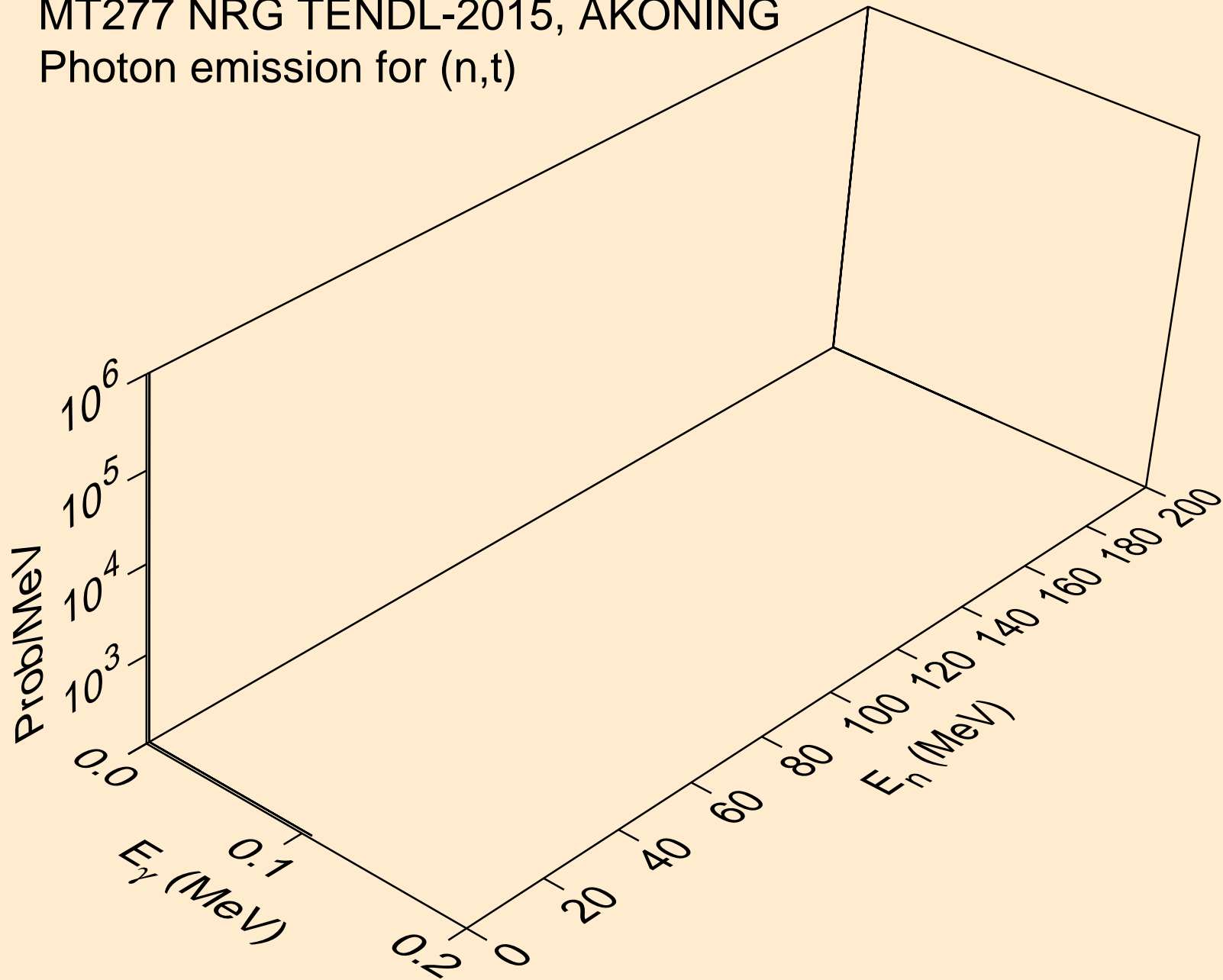

MT277 NRG TENDL-2015, AKONING
Photon emission for (n,he3)

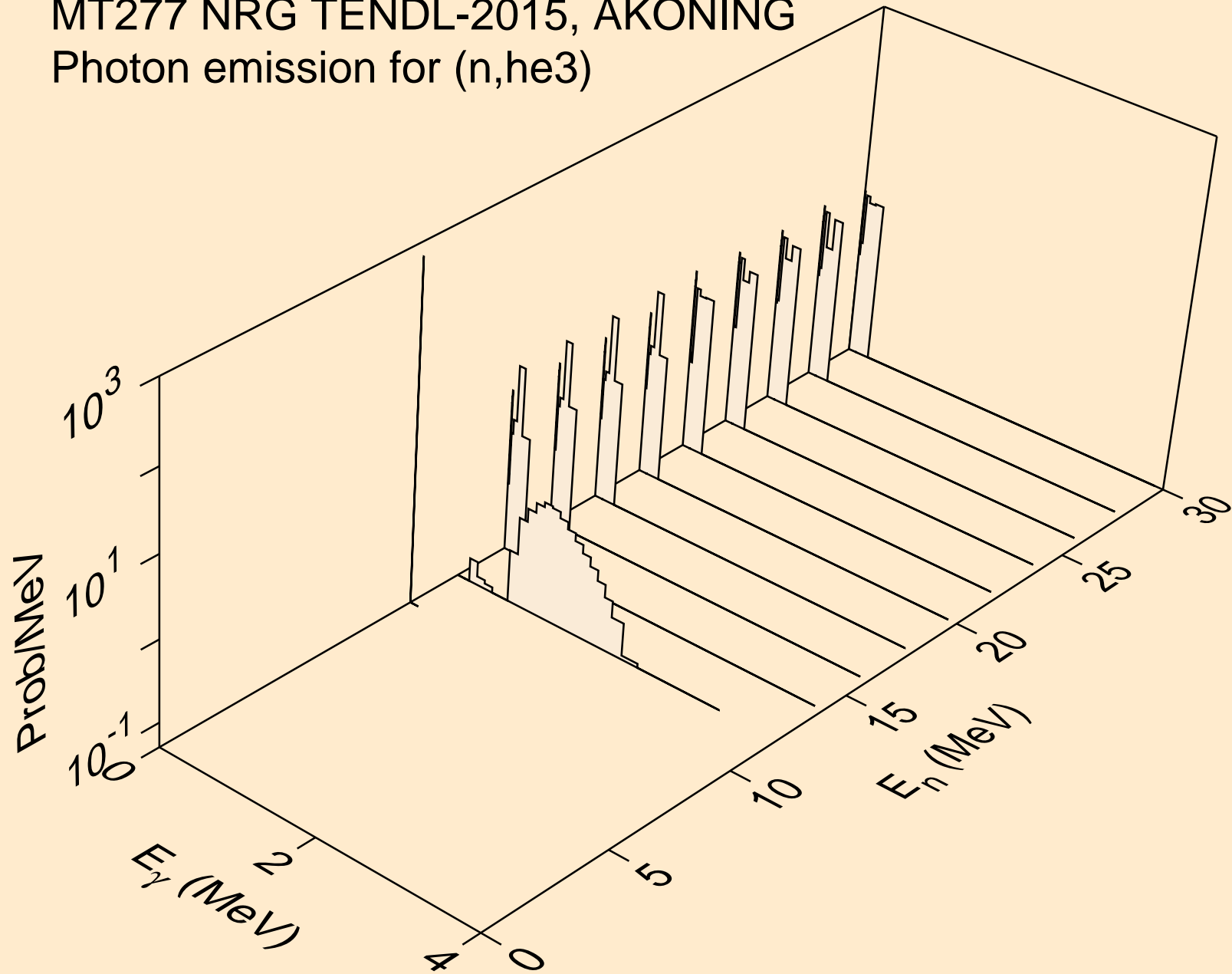

MT277 NRG TENDL-2015, AKONING
Photon emission for (n,a)

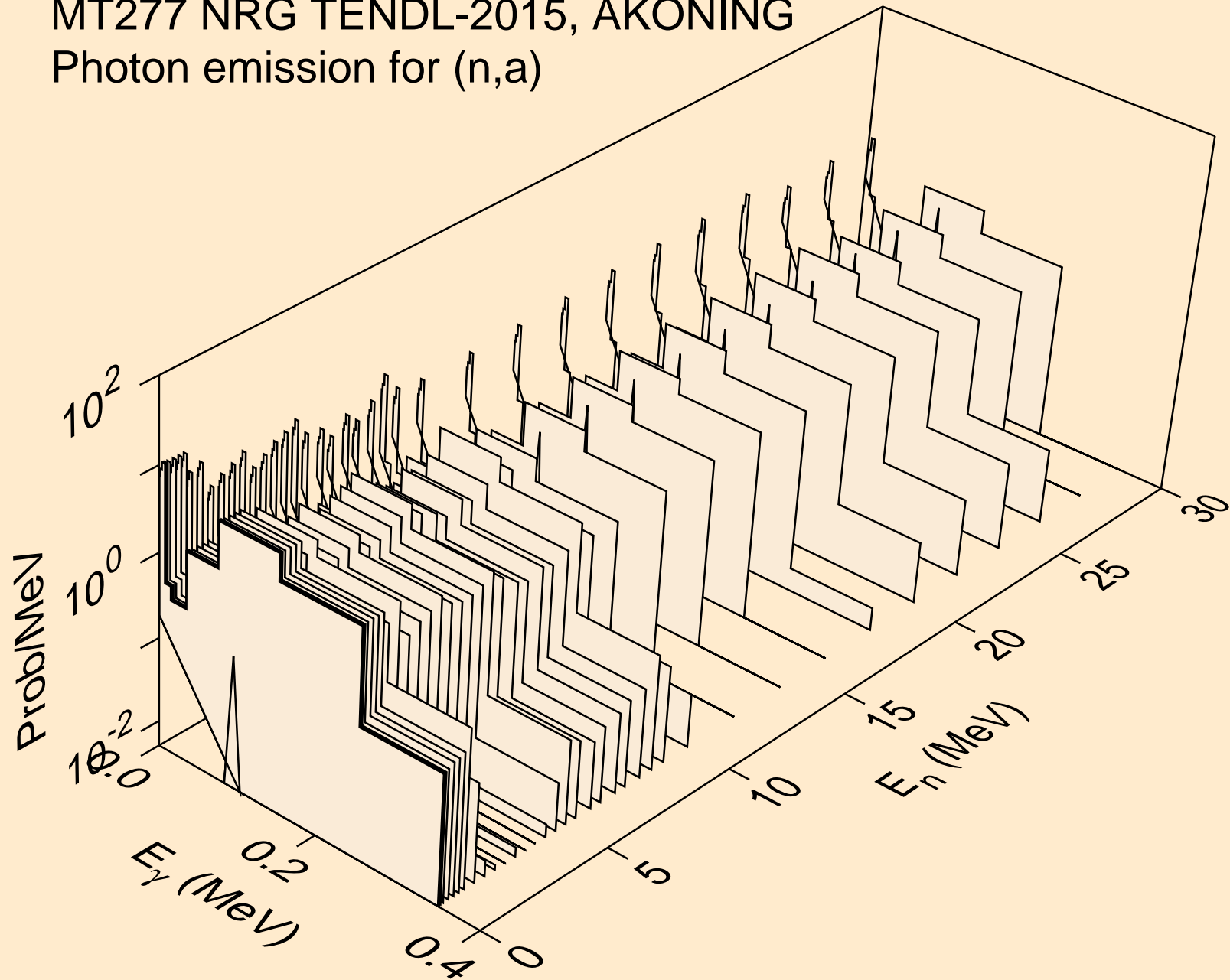

MT277 NRG TENDL-2015, AKONING
Photon emission for (n,2a)

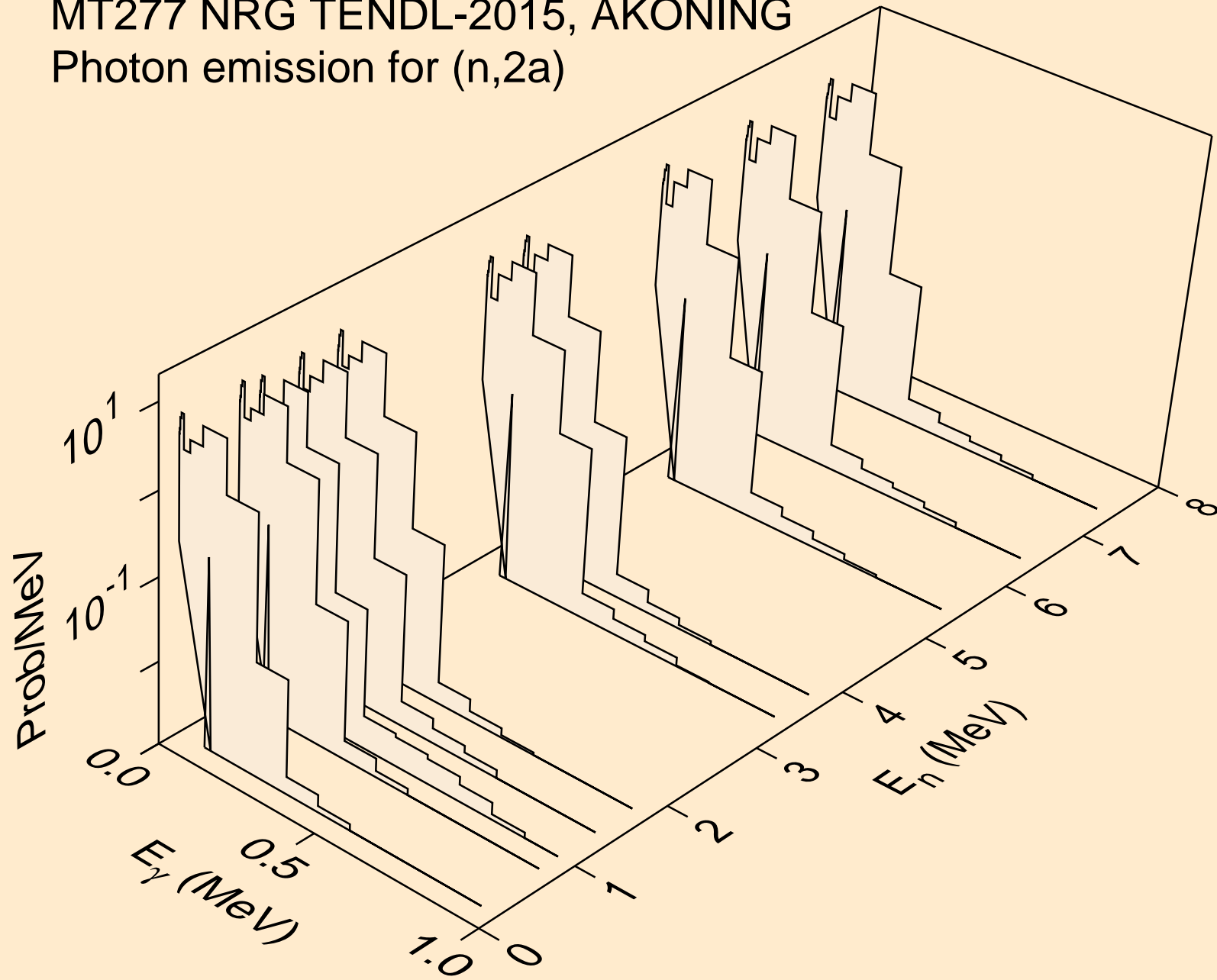

MT277 NRG TENDL-2015, AKONING
Photon emission for (n,3a)

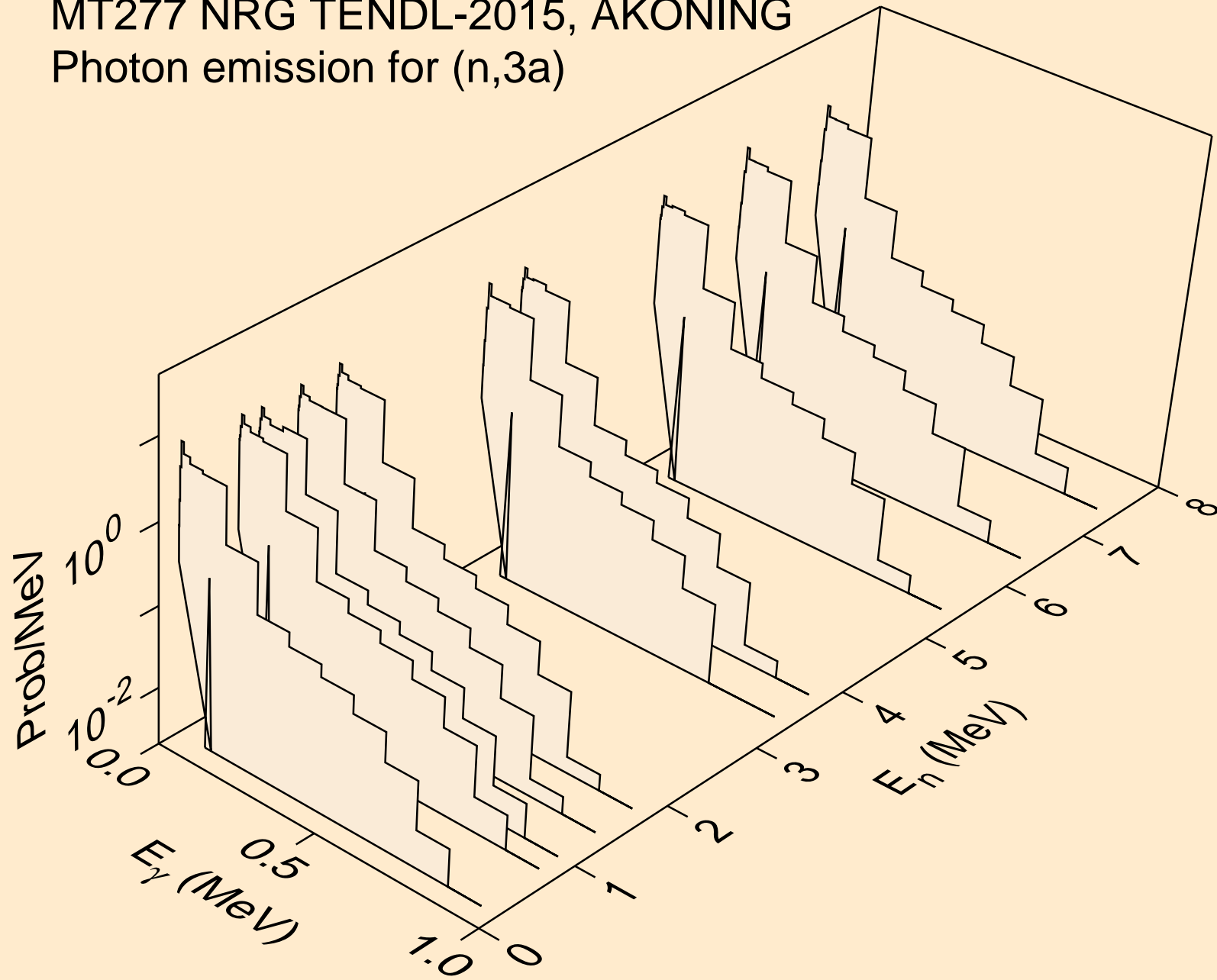

MT277 NRG TENDL-2015, AKONING
Photon emission for (n,d2a)

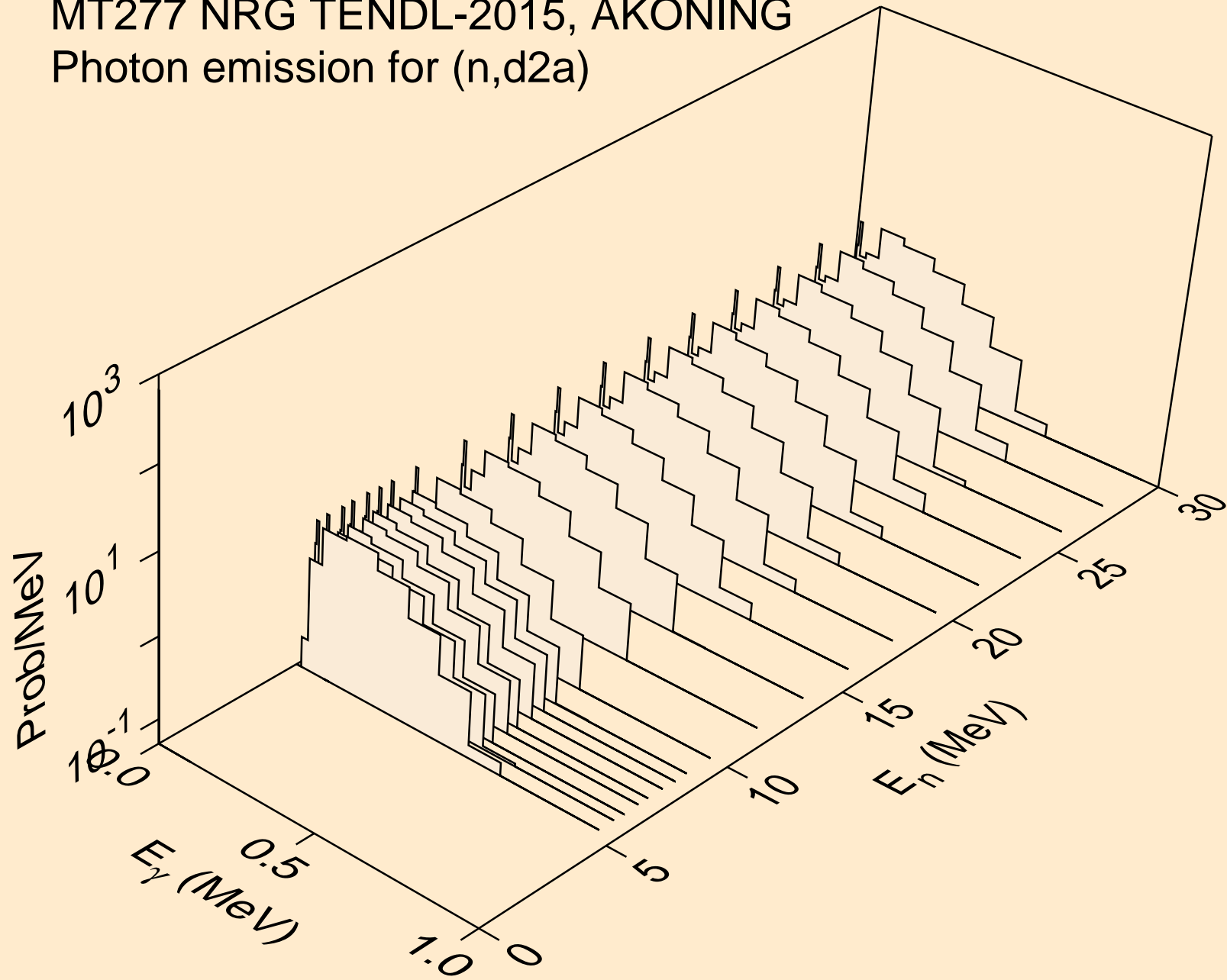

MT277 NRG TENDL-2015, AKONING
Photon emission for (n,da)

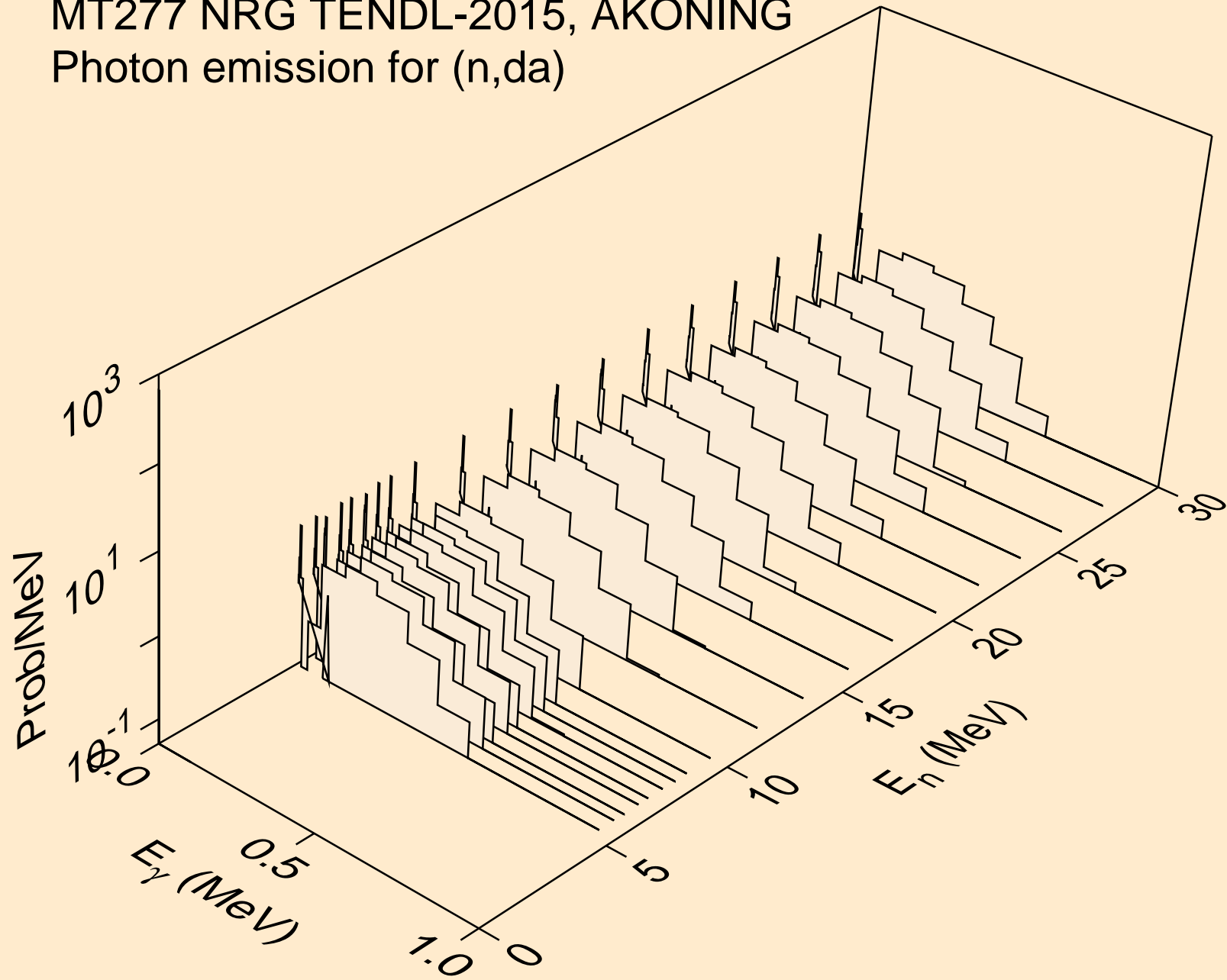

MT277 NRG TENDL-2015, AKONING
thermal capture photon spectrum

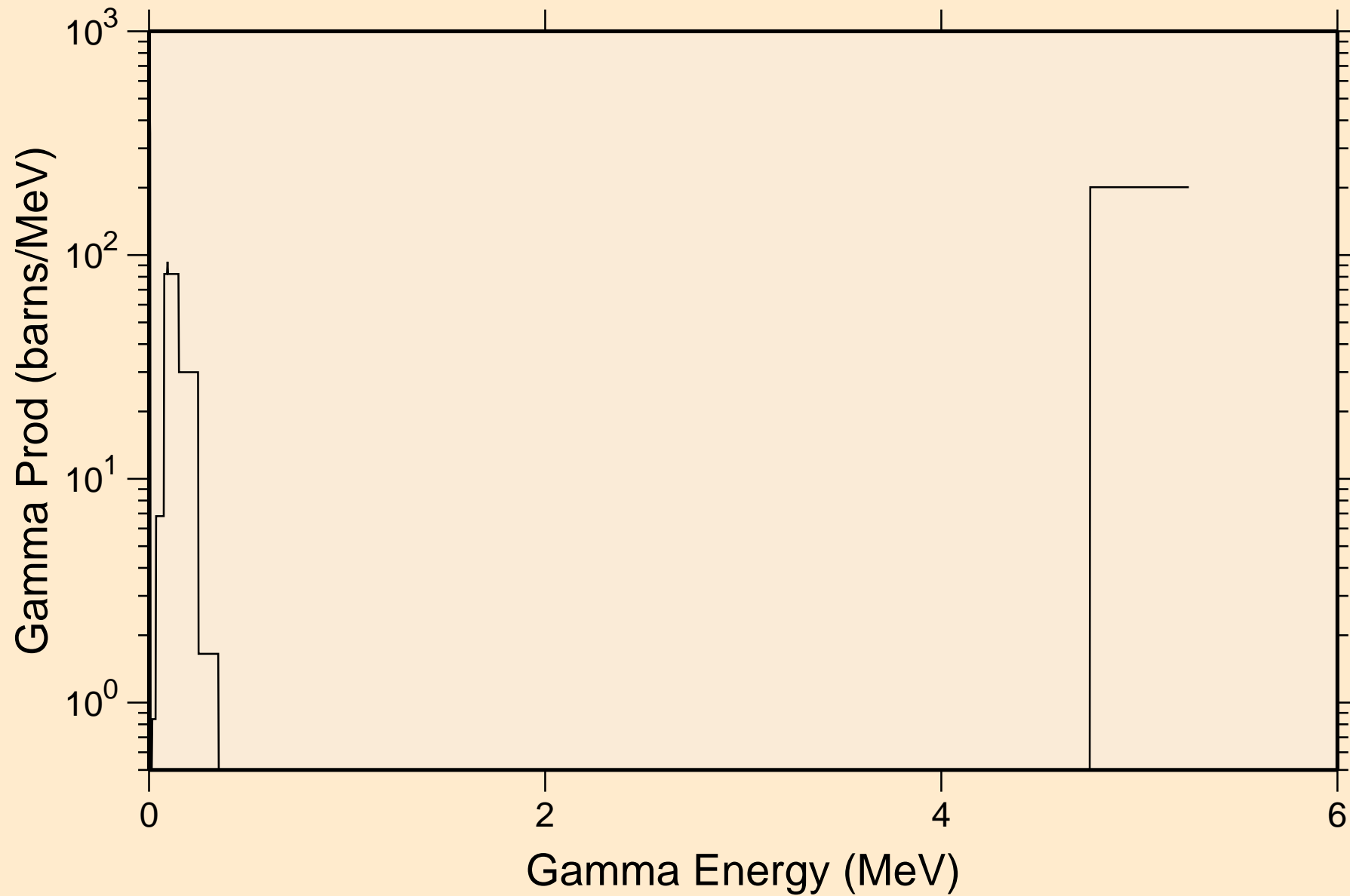

MT277 NRG TENDL-2015, AKONING
14 MeV photon spectrum

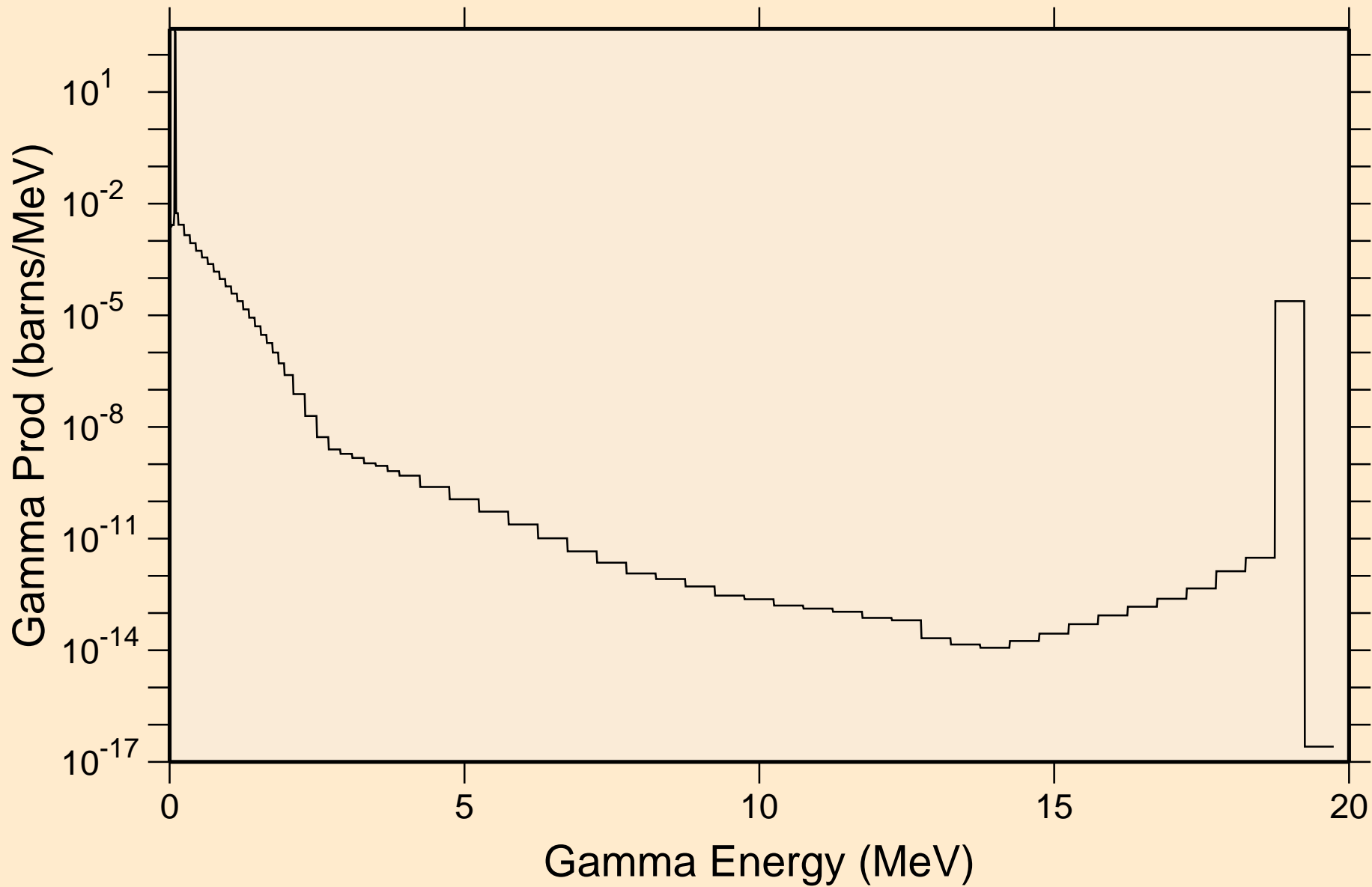

MT277 NRG TENDL-2015, AKONING

Particle heating contributions

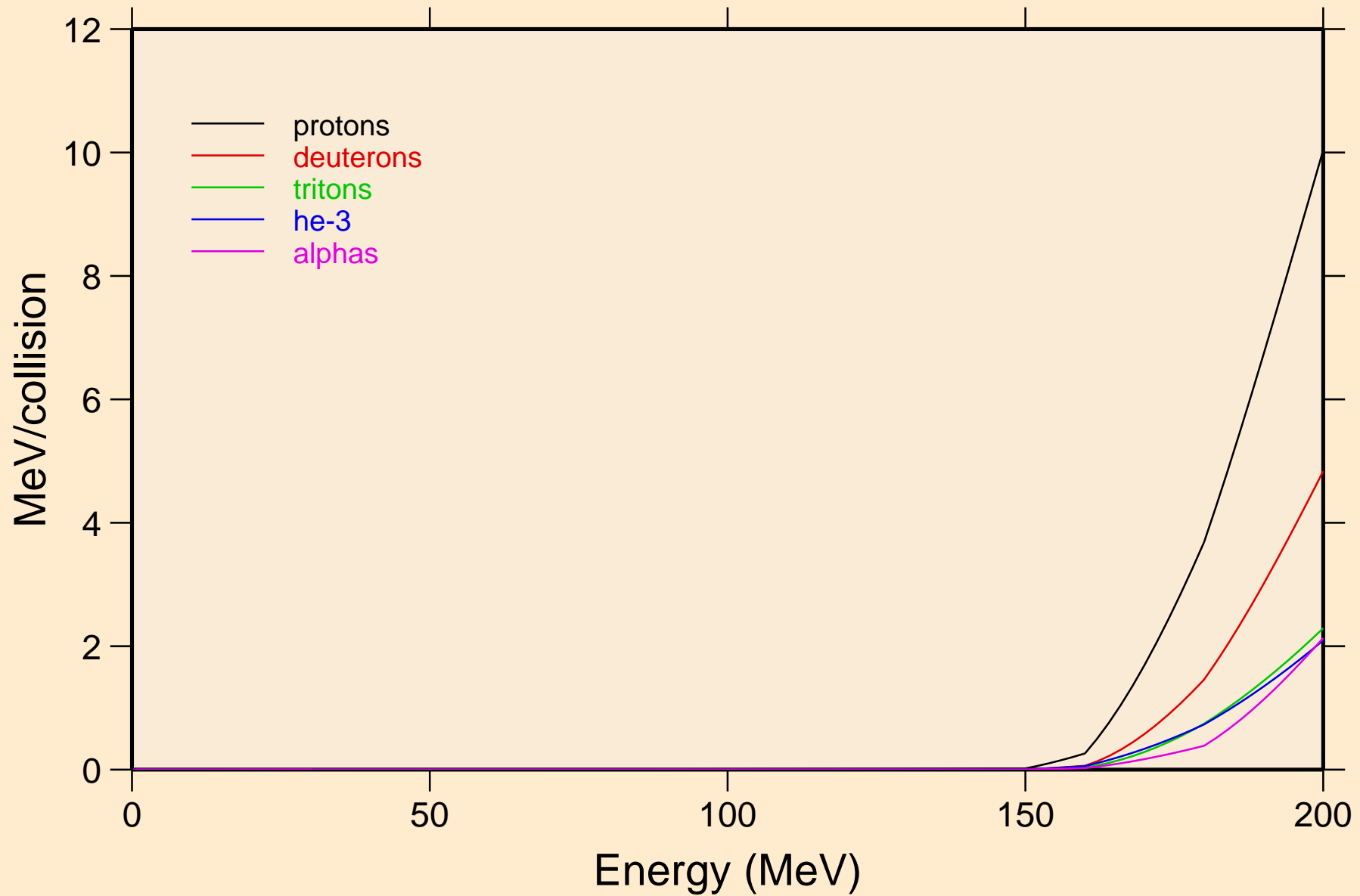

MT277 NRG TENDL-2015, AKONING

Recoil Heating

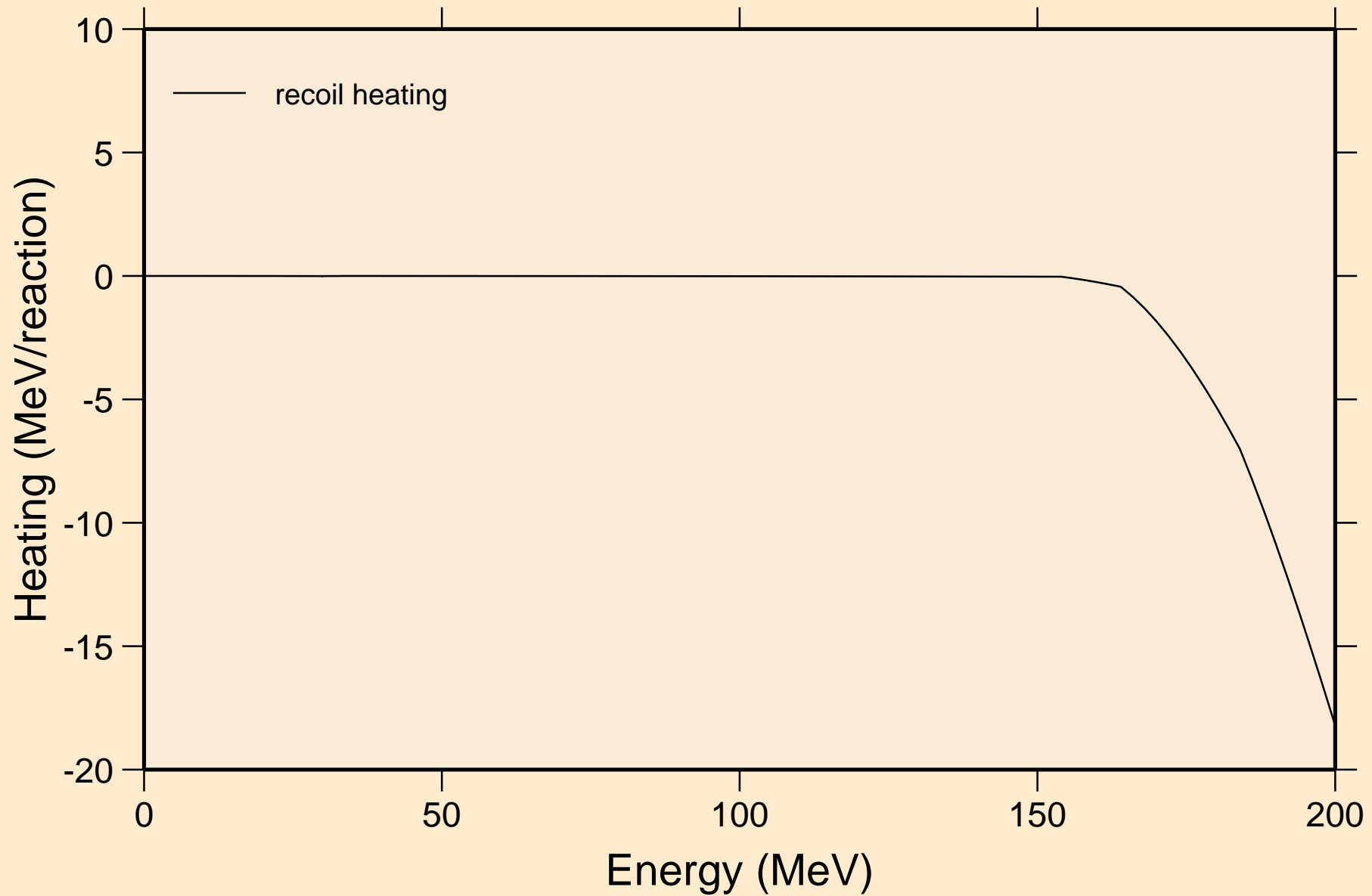

MT277 NRG TENDL-2015, AKONING

Particle production cross sections

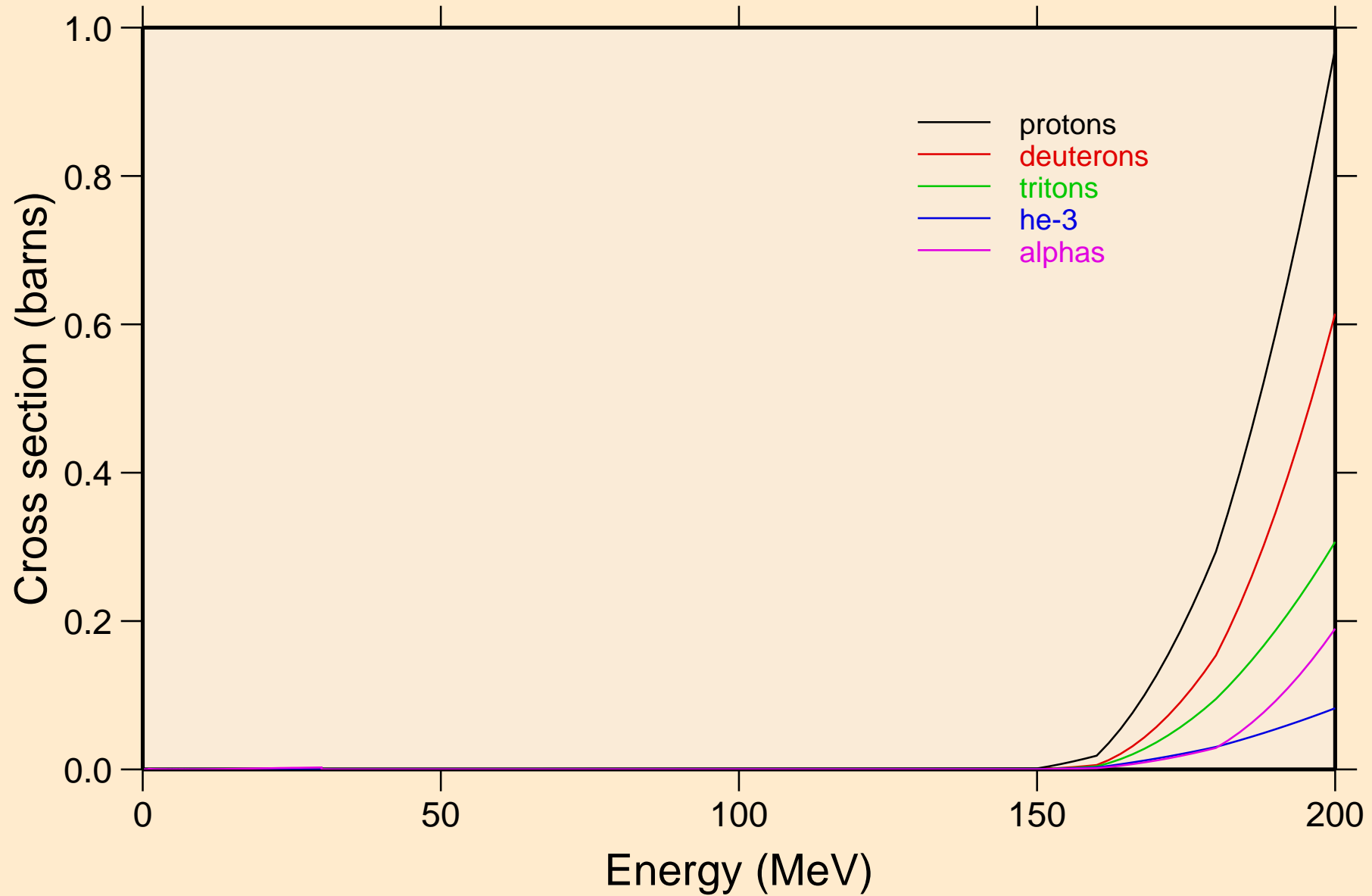

MT277 NRG TENDL-2015, AKONING
protons from (n,x)

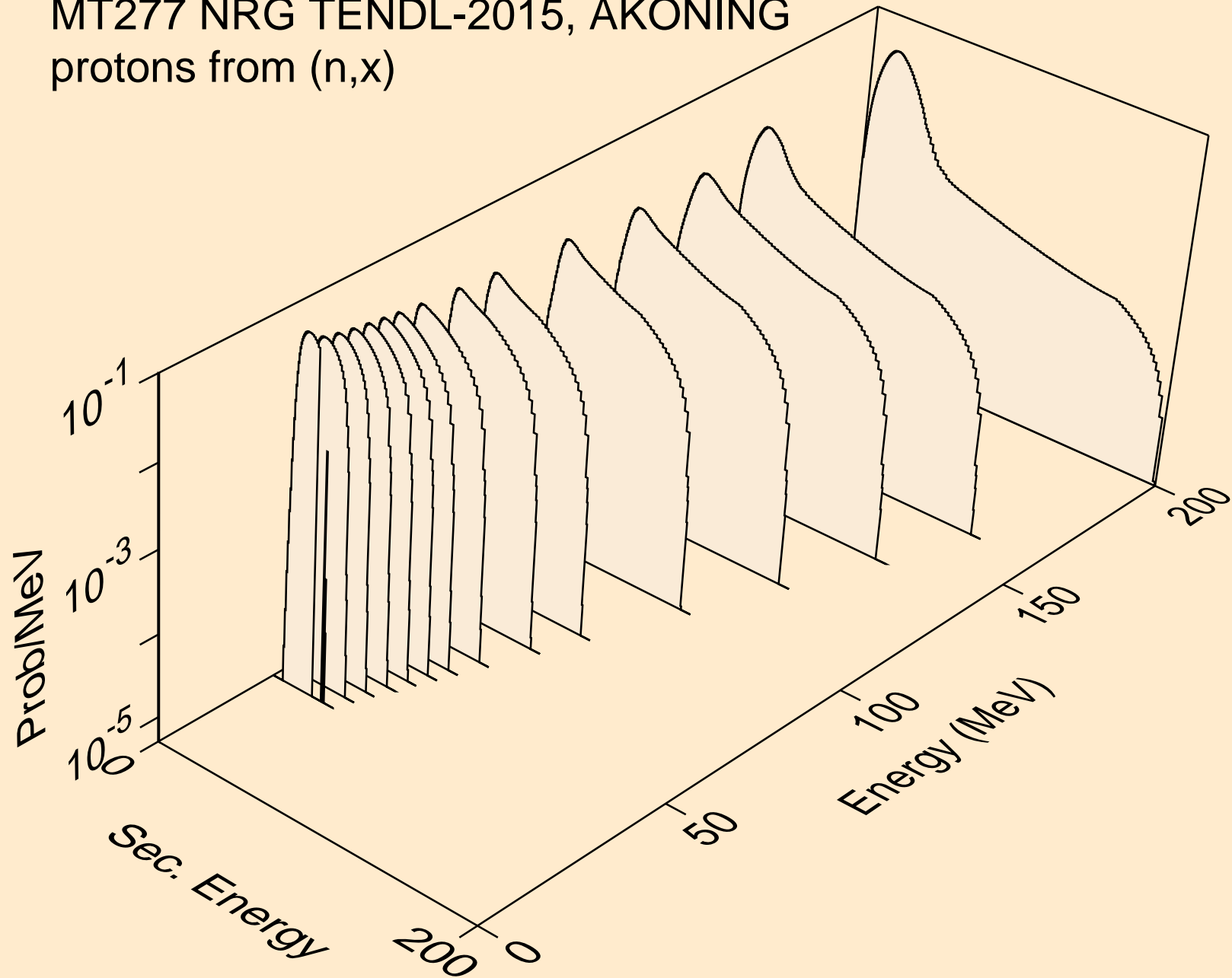

MT277 NRG TENDL-2015, AKONING
protons from (n,n*)p

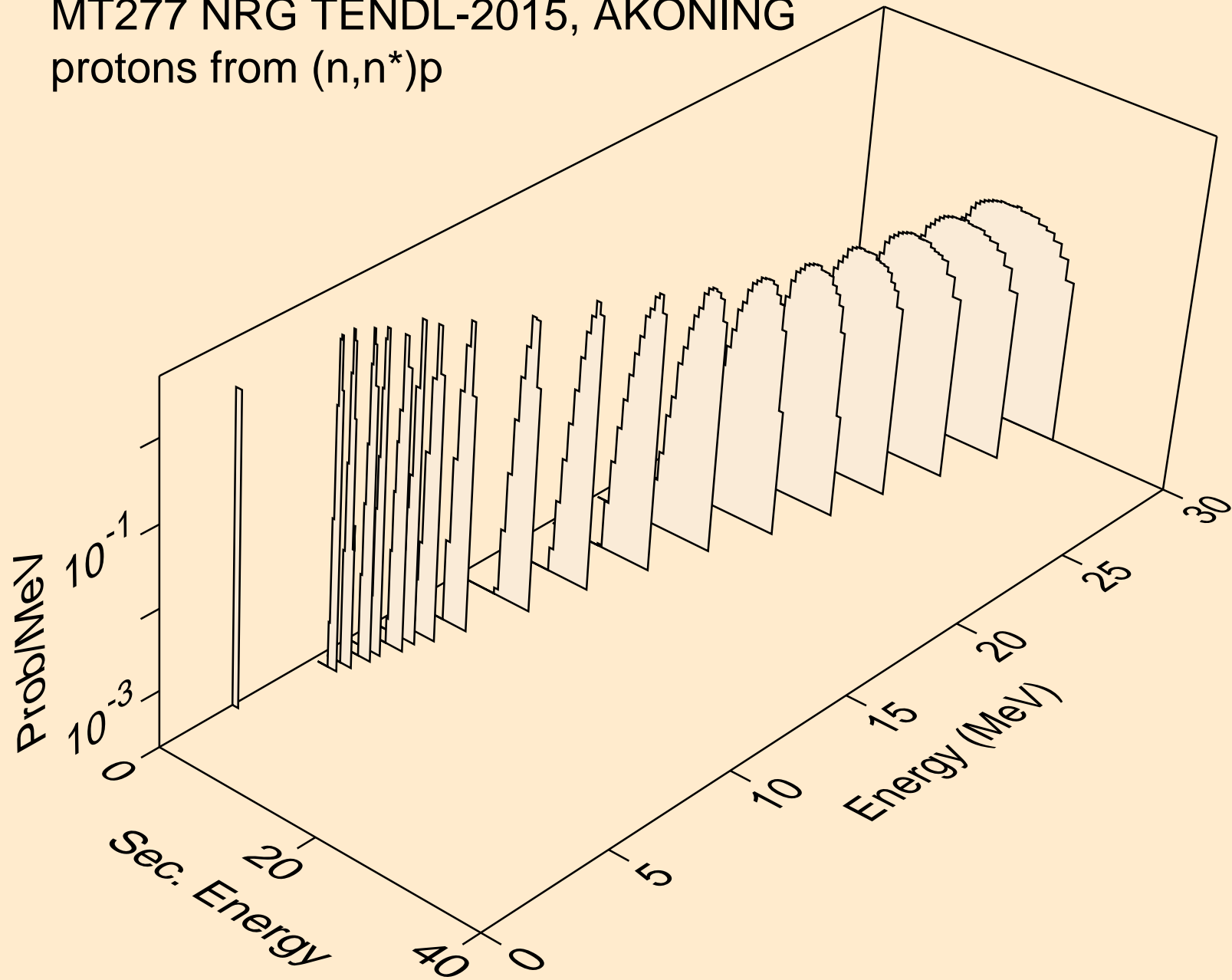

MT277 NRG TENDL-2015, AKONING
protons from (n,npa)

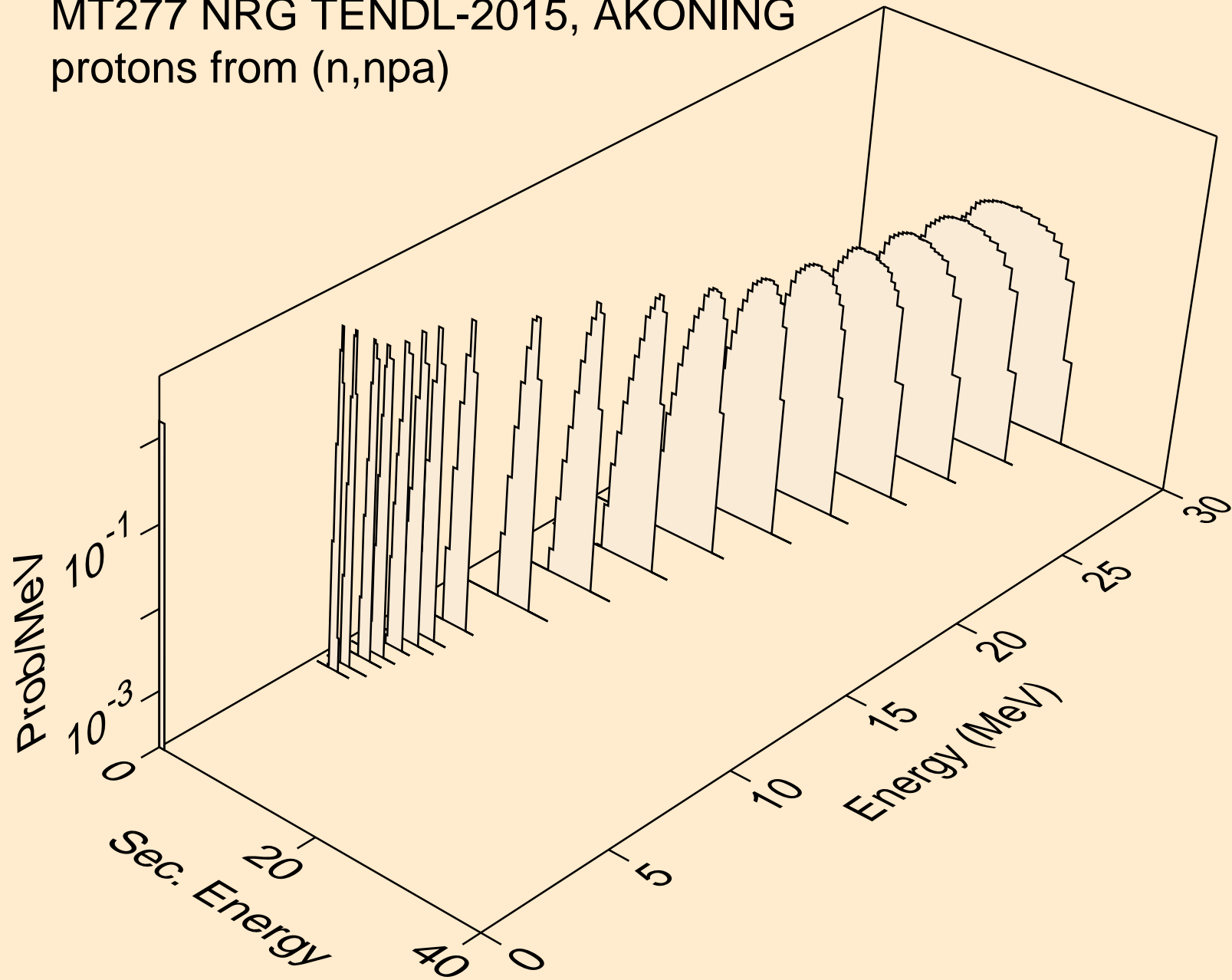

MT277 NRG TENDL-2015, AKONING
protons from (n,p)

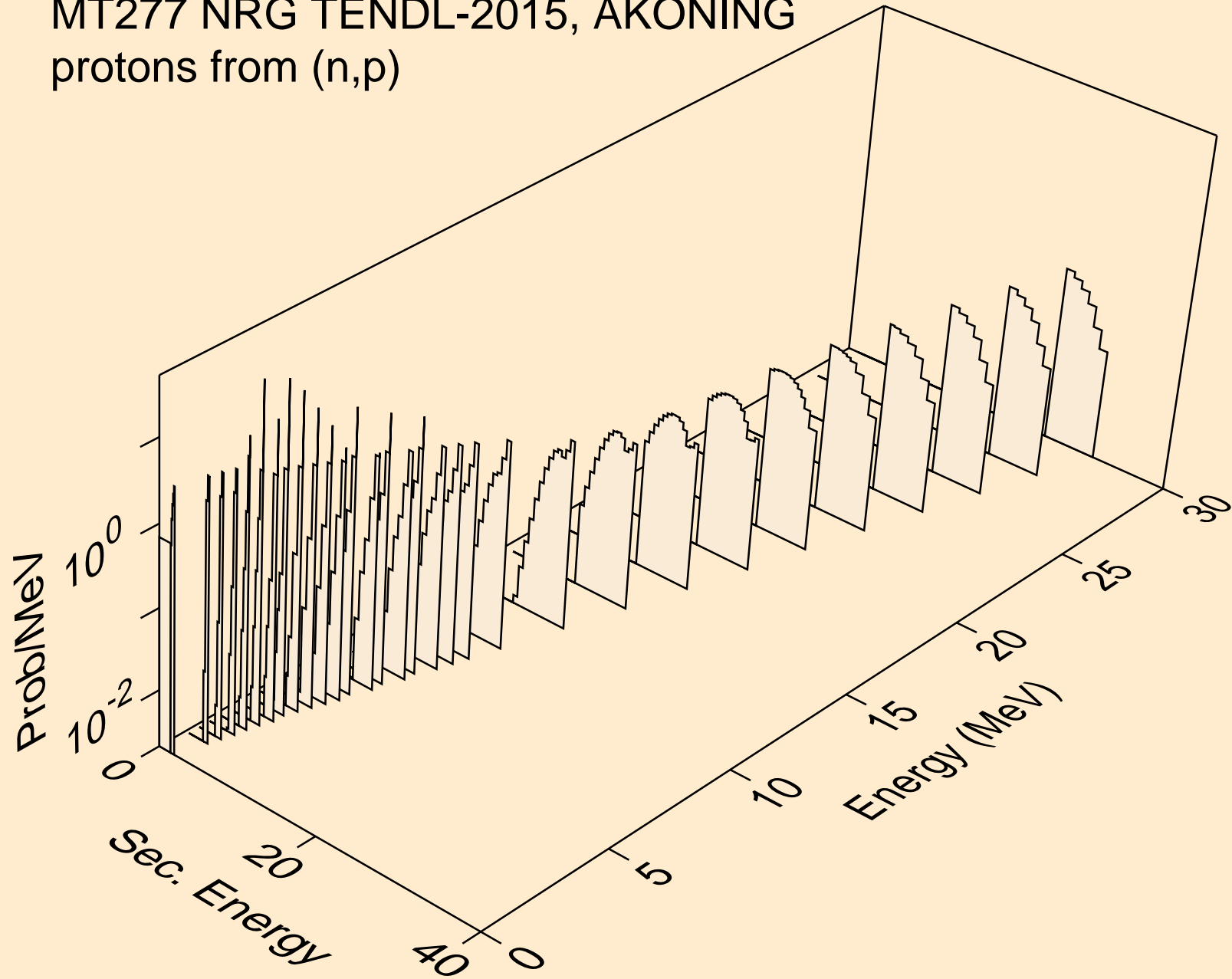

MT277 NRG TENDL-2015, AKONING
deuterons from (n,x)

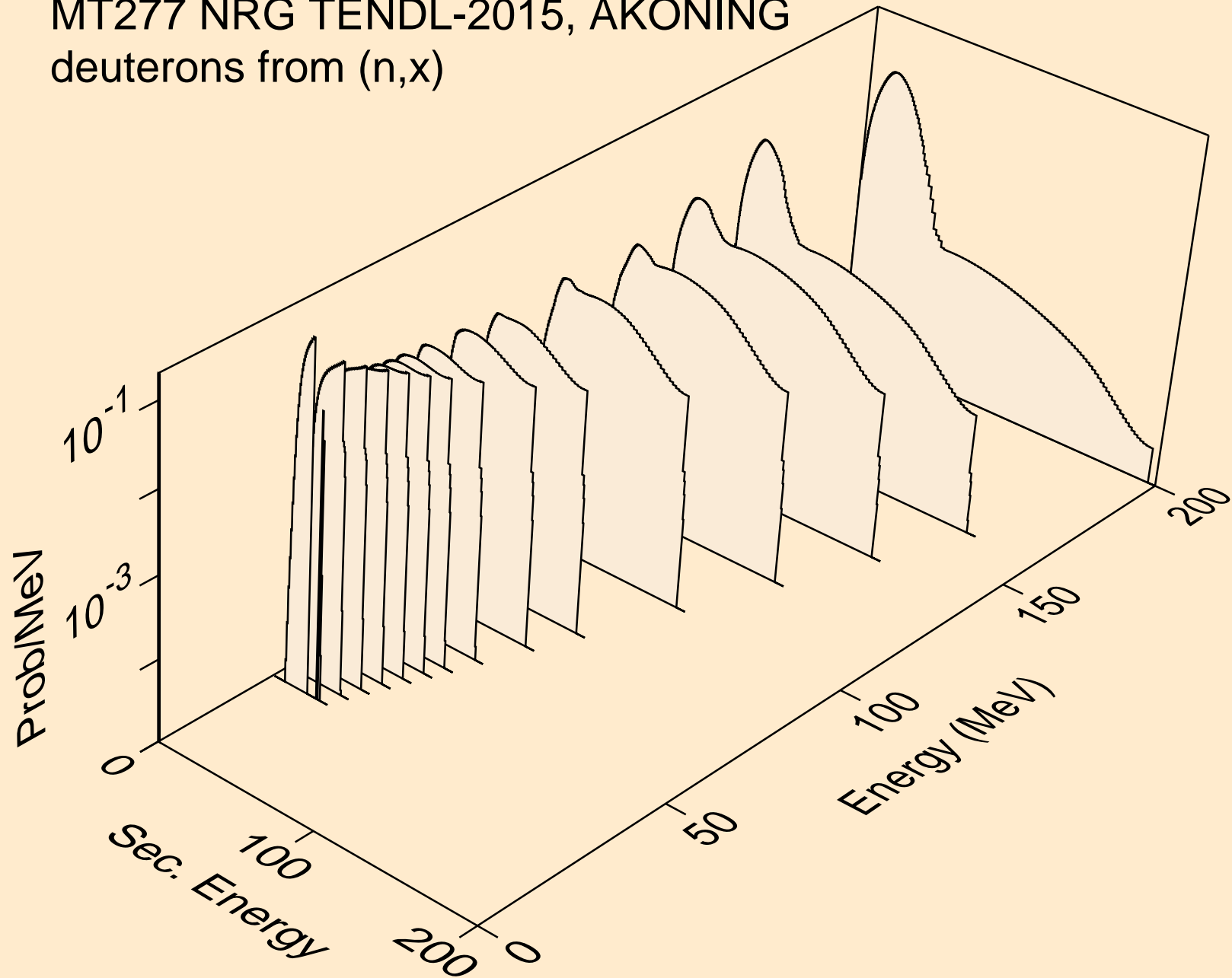

MT277 NRG TENDL-2015, AKONING
deuterons from (n,d)

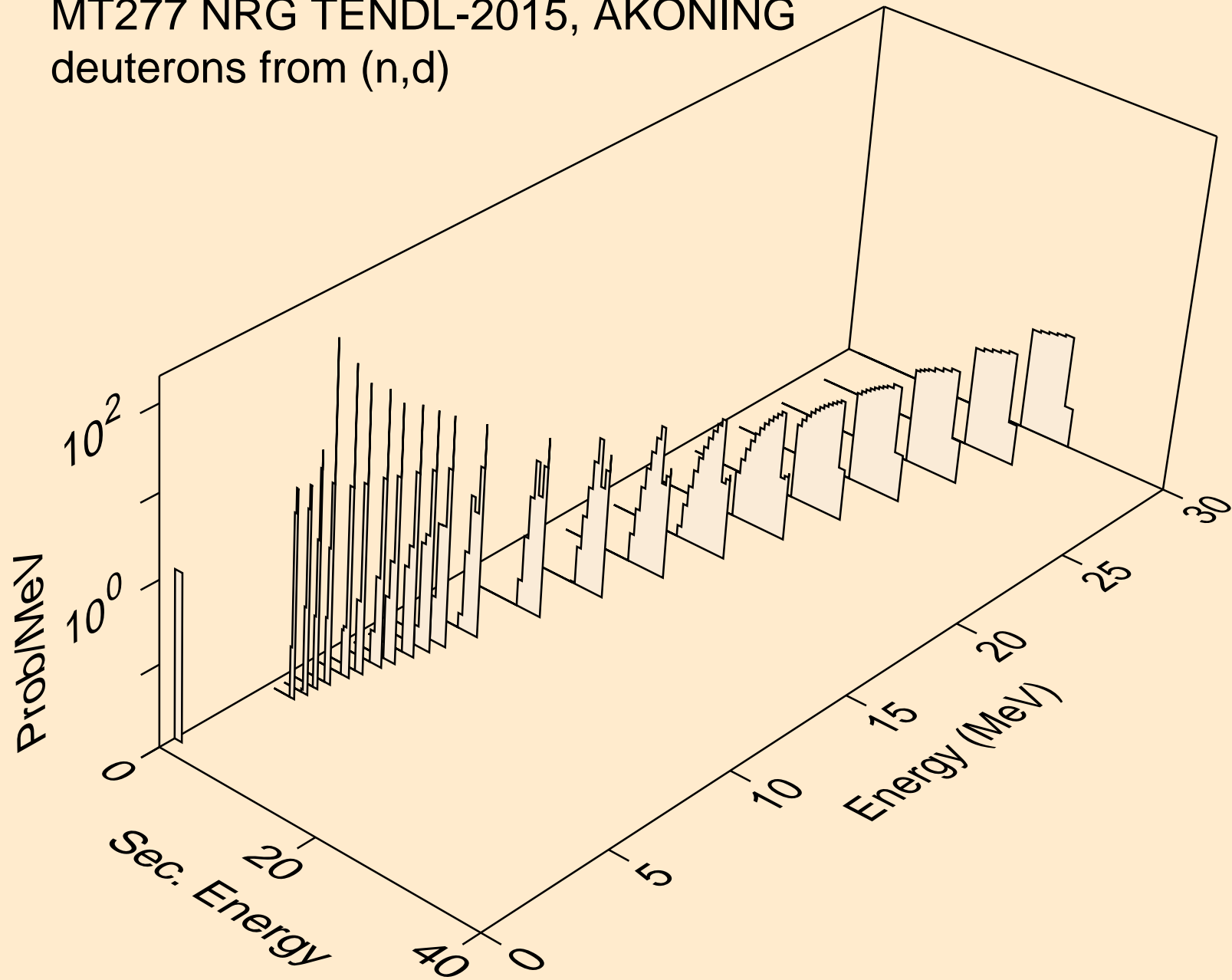

MT277 NRG TENDL-2015, AKONING
deuterons from (n,d2a)

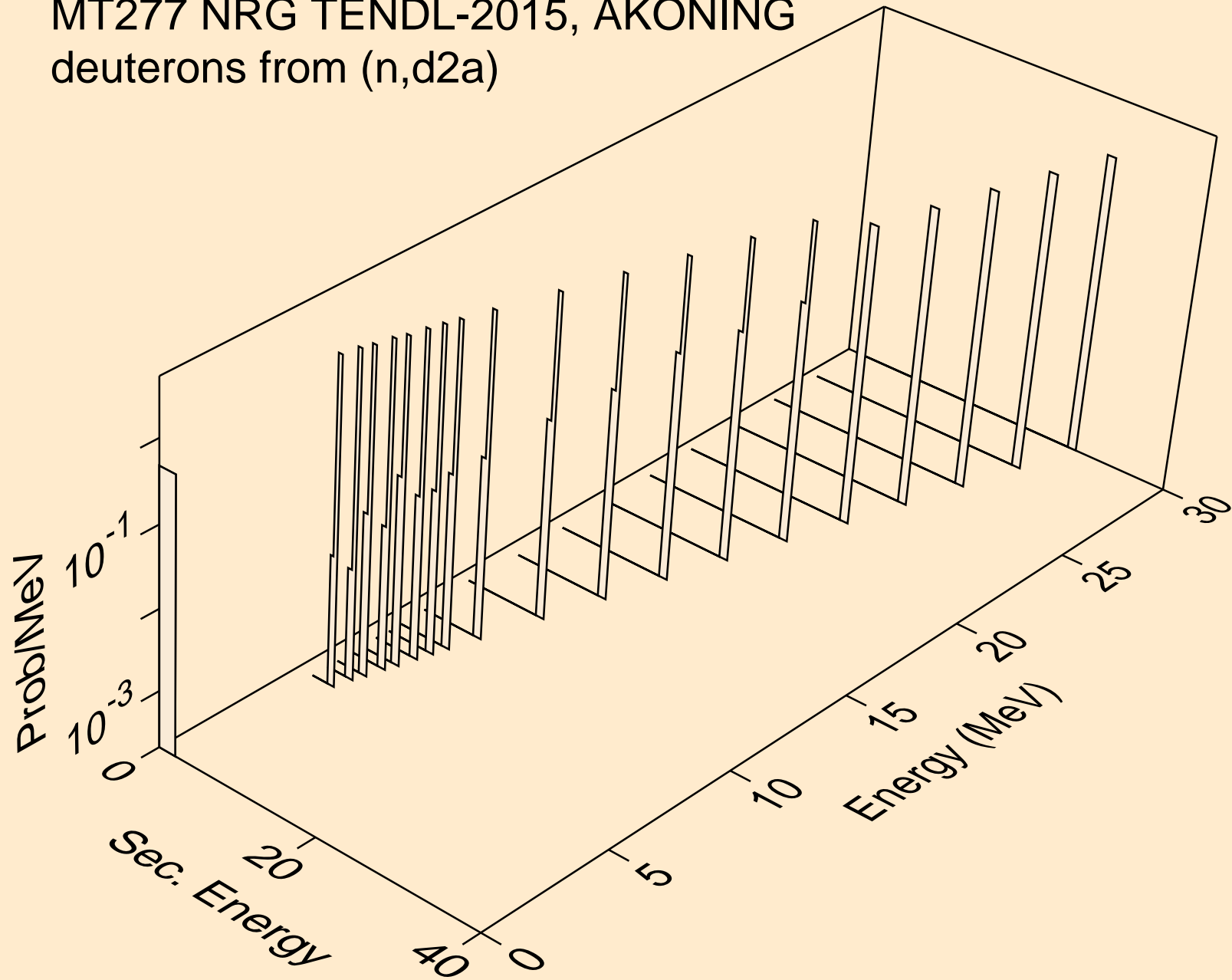

MT277 NRG TENDL-2015, AKONING
deuterons from (n,da)

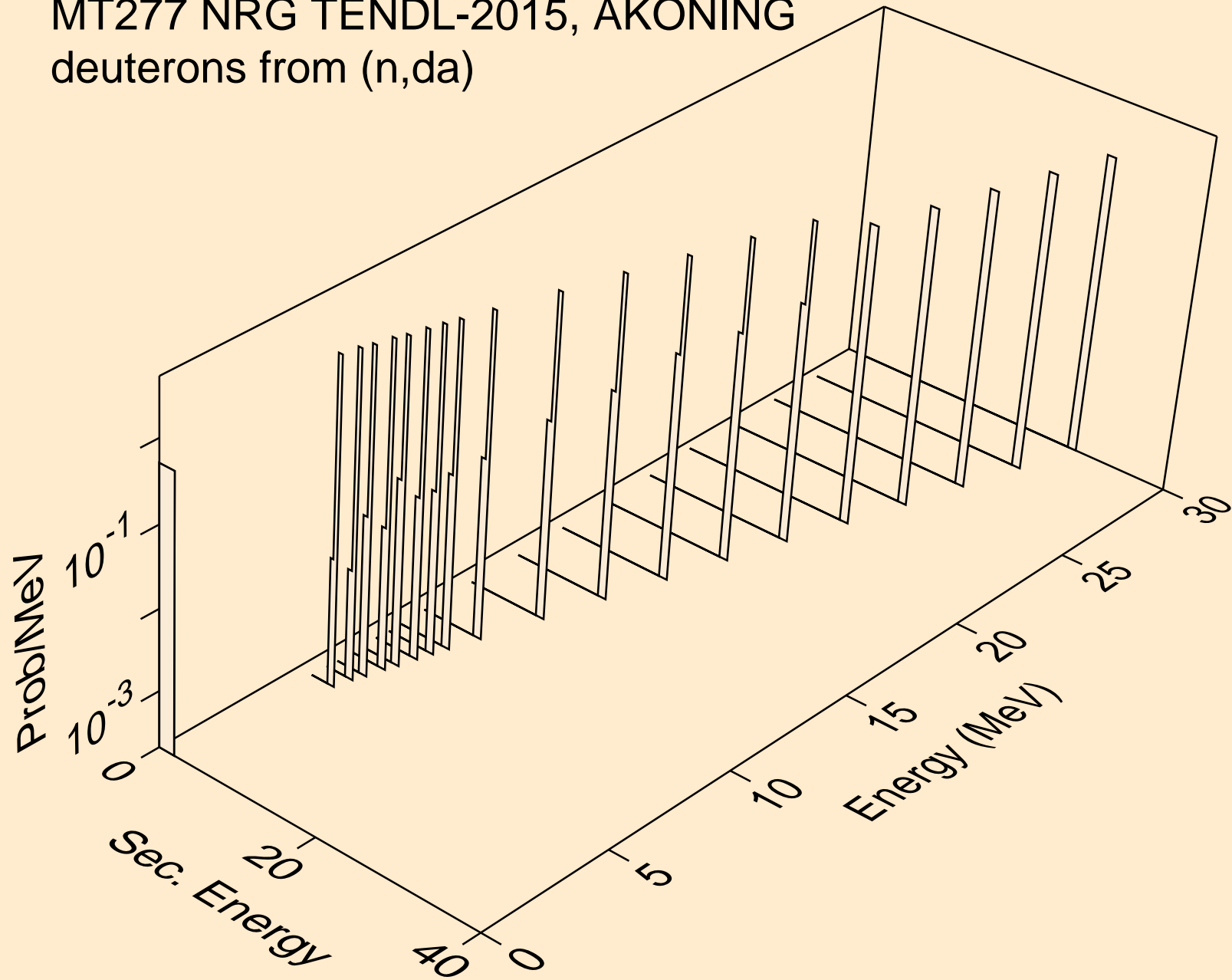

MT277 NRG TENDL-2015, AKONING
tritons from (n,x)

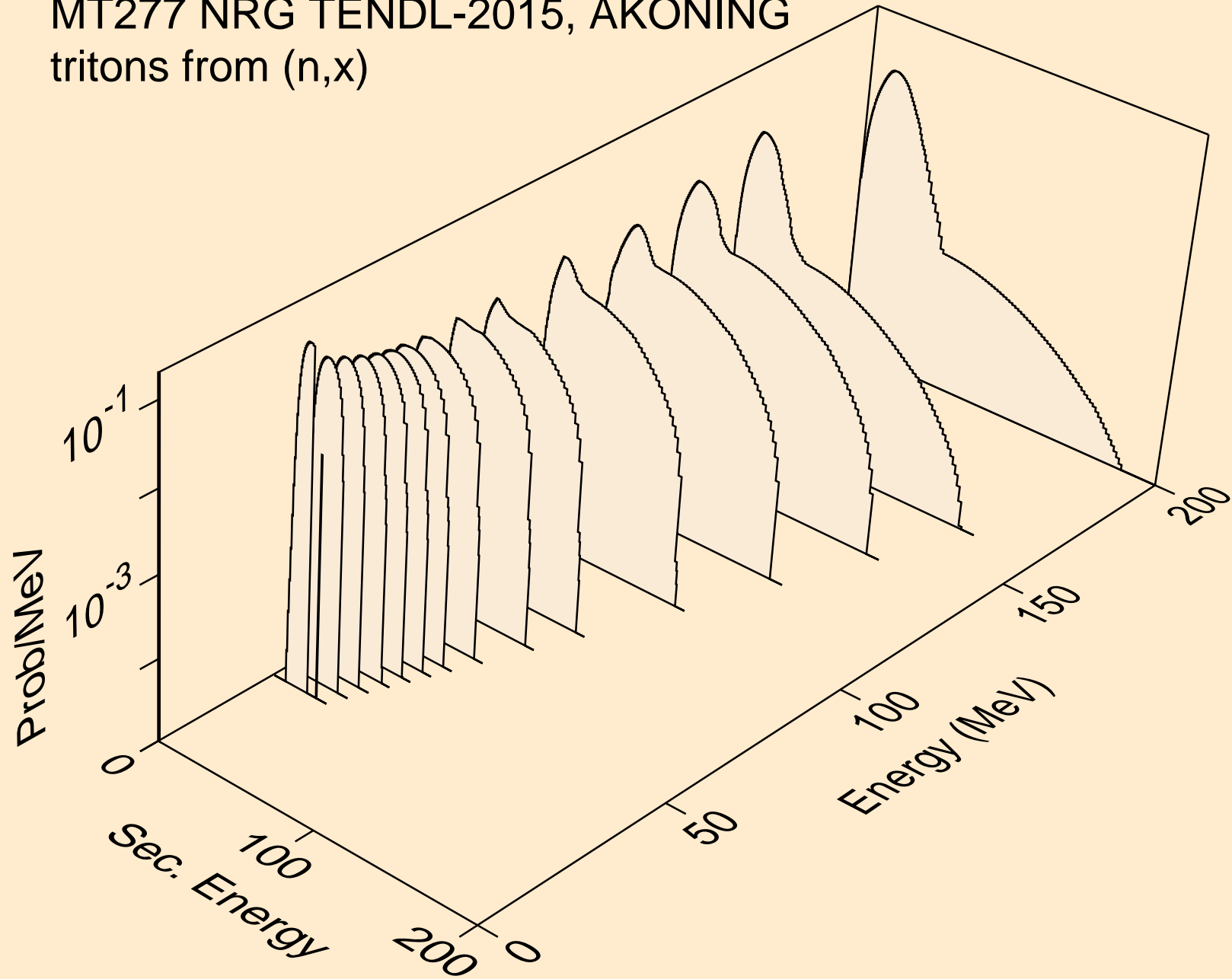

MT277 NRG TENDL-2015, AKONING
tritons from (n,n*)t

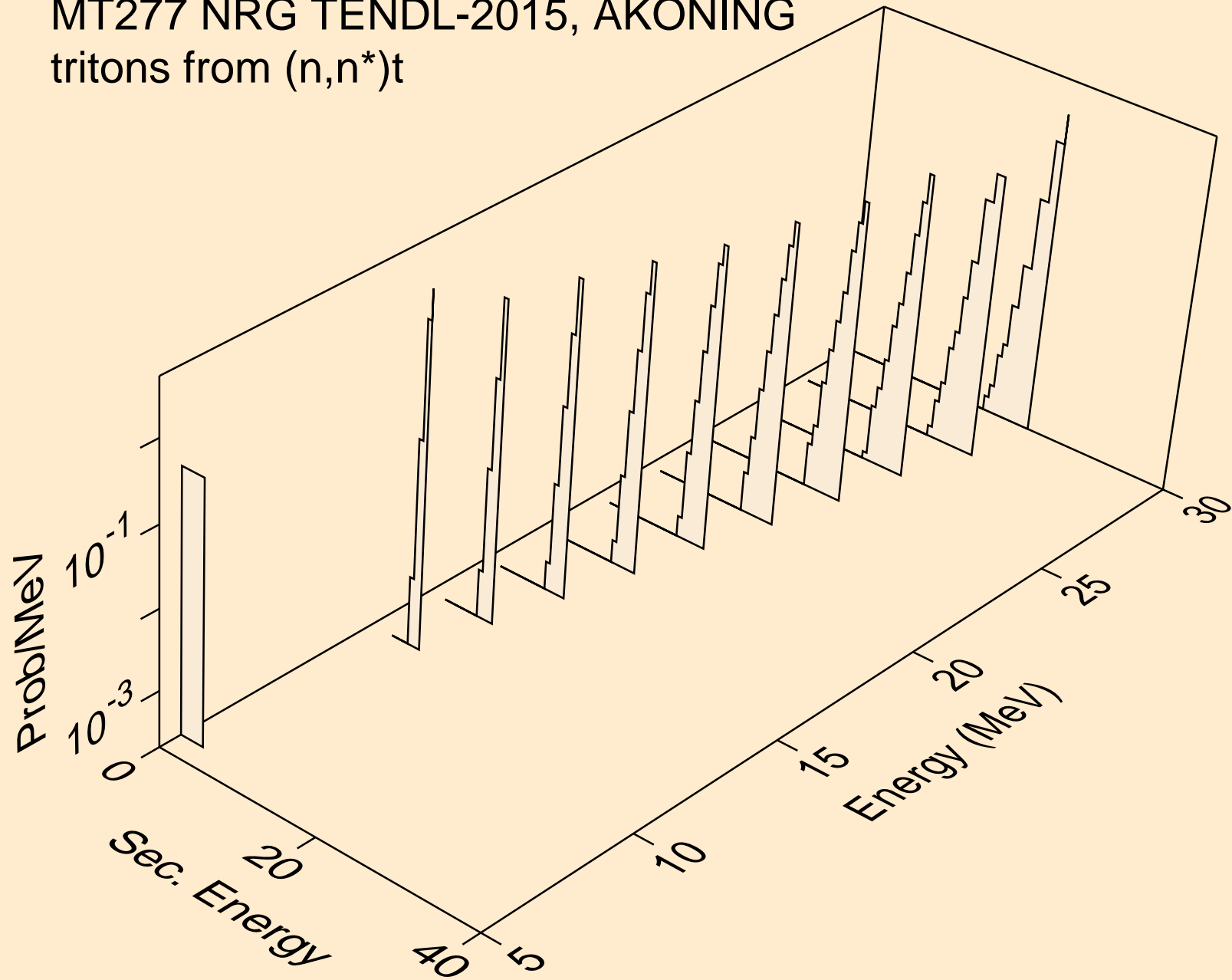

MT277 NRG TENDL-2015, AKONING
tritons from (n,t)

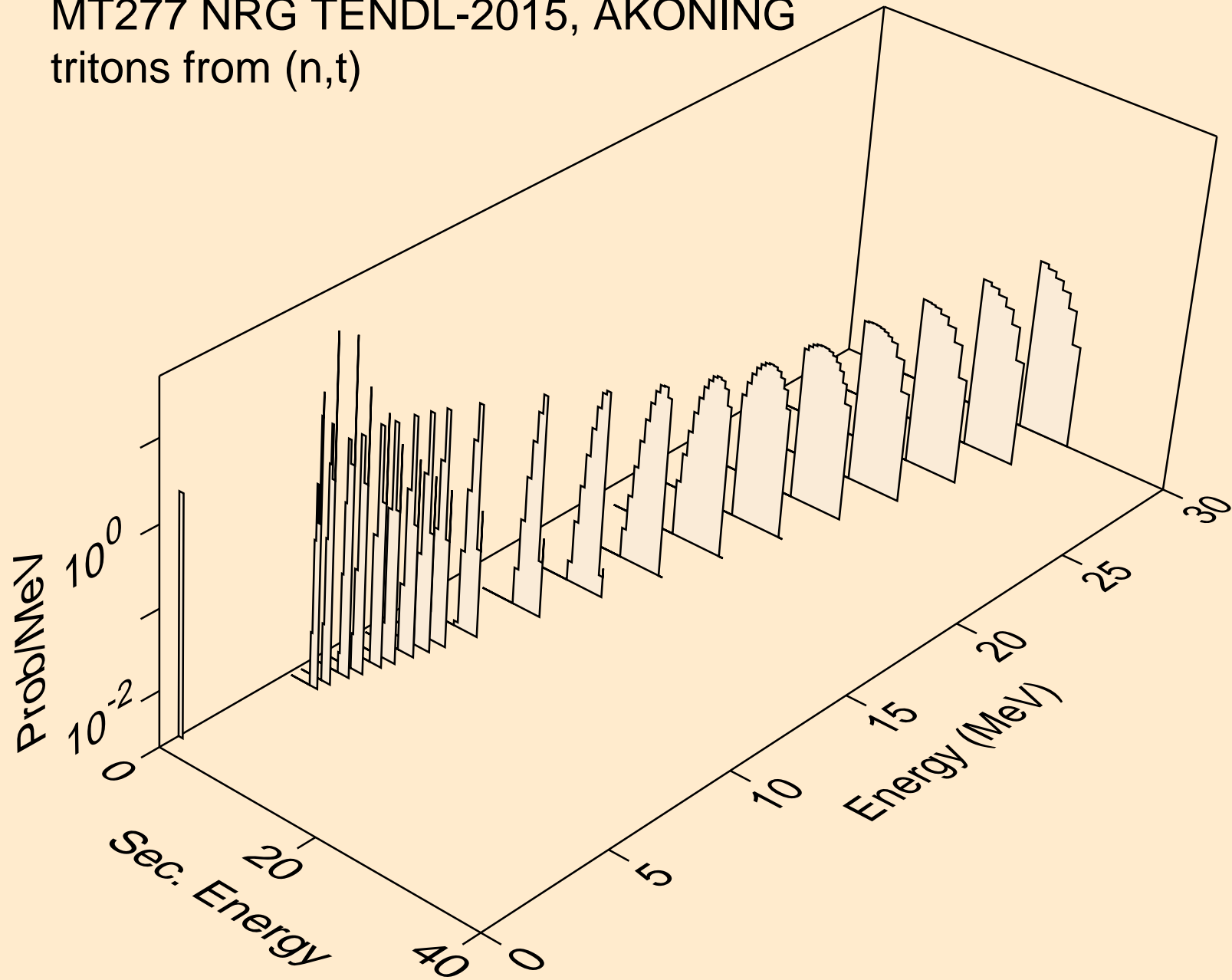

MT277 NRG TENDL-2015, AKONING
he3s from (n,x)

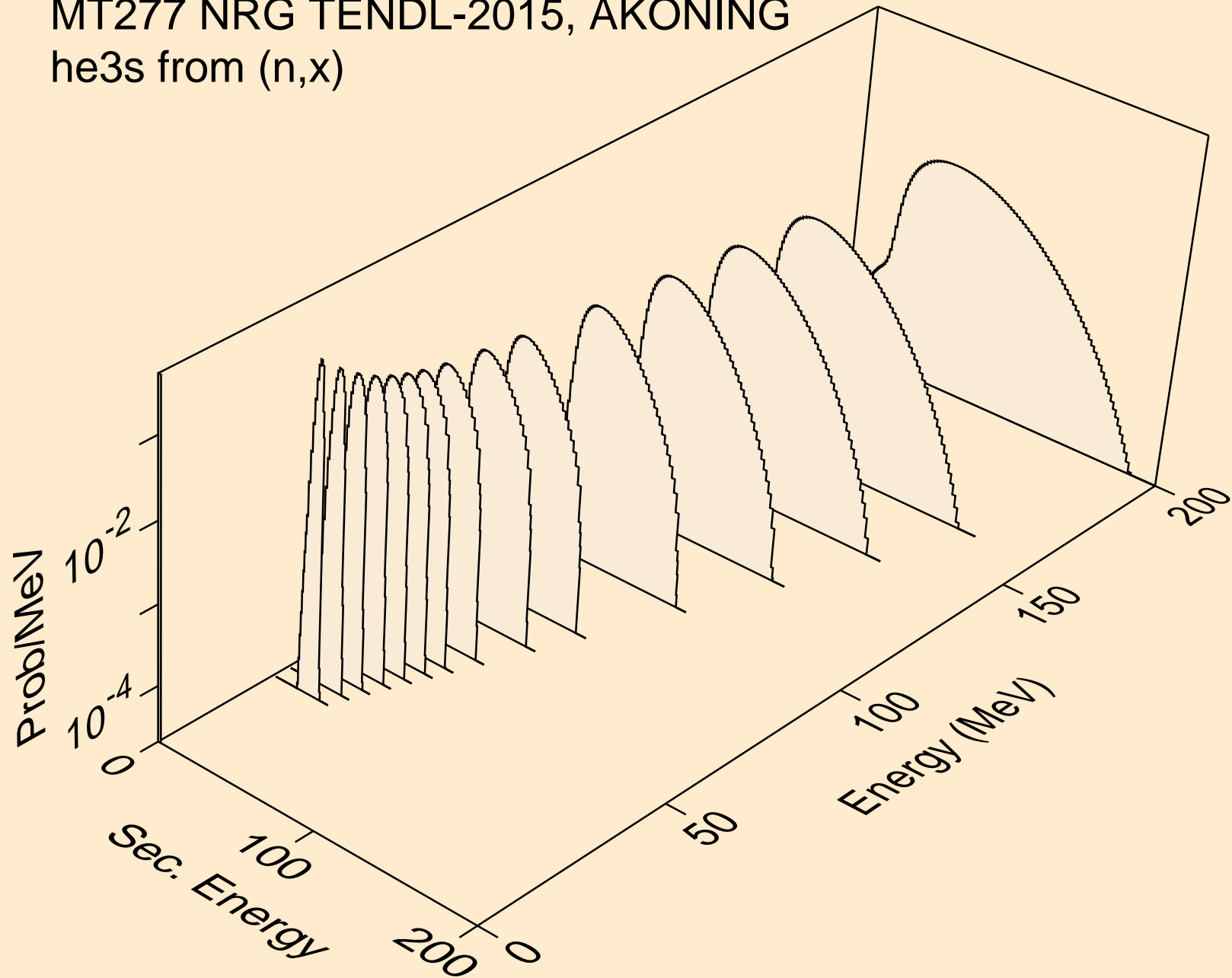

MT277 NRG TENDL-2015, AKONING
he3s from (n,he3)

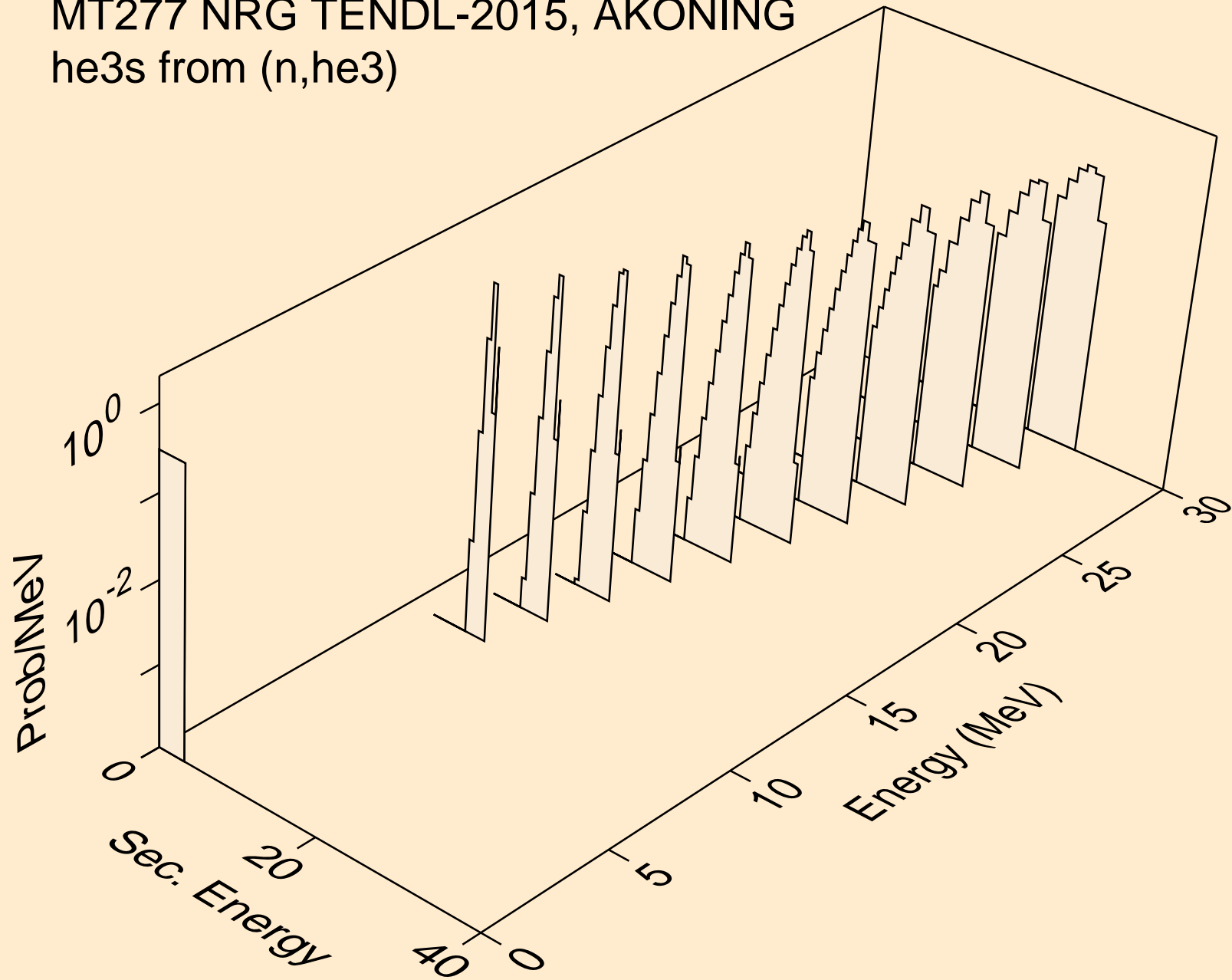

MT277 NRG TENDL-2015, AKONING
alphas from (n,x)

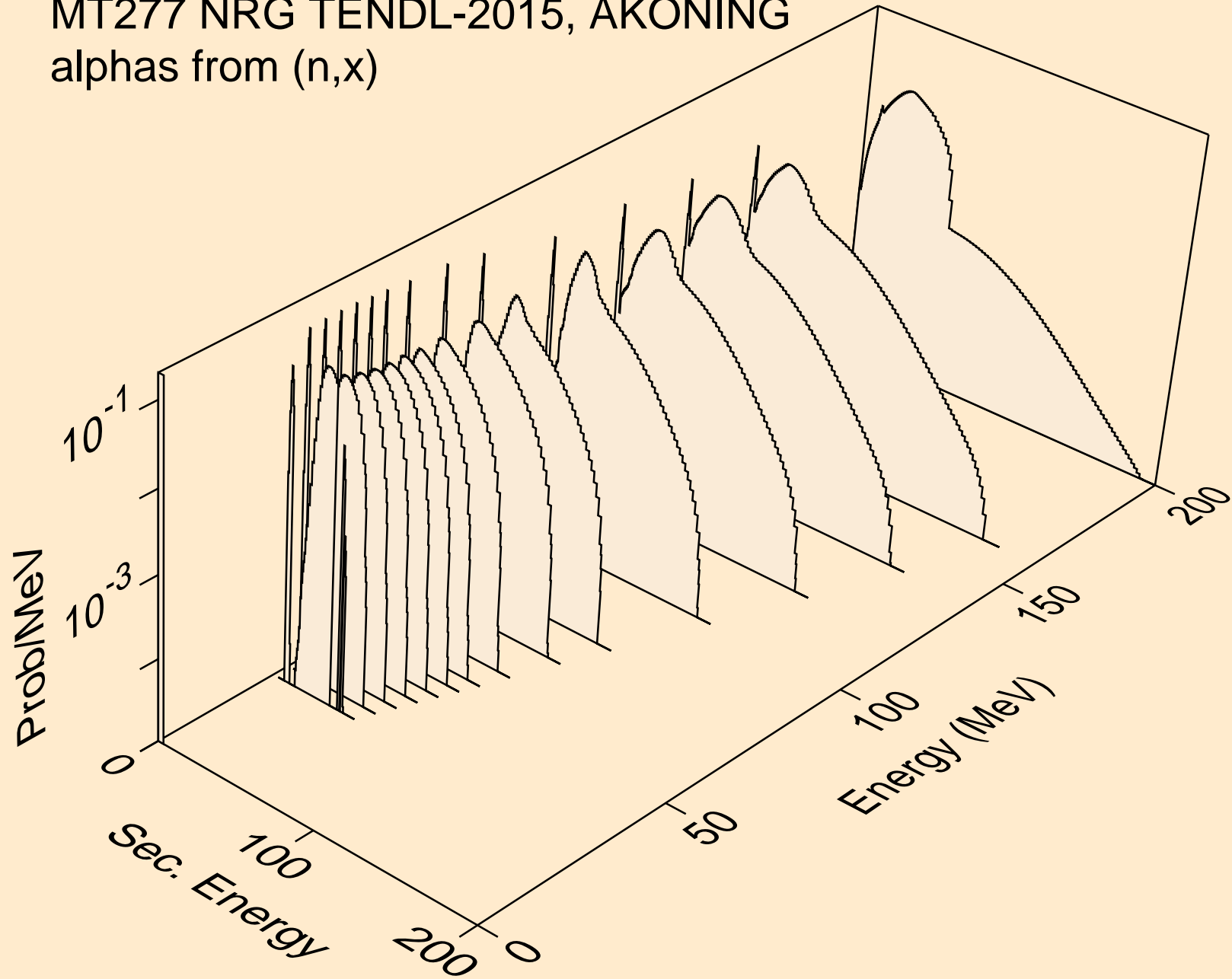

MT277 NRG TENDL-2015, AKONING
alphas from (n,n*)a

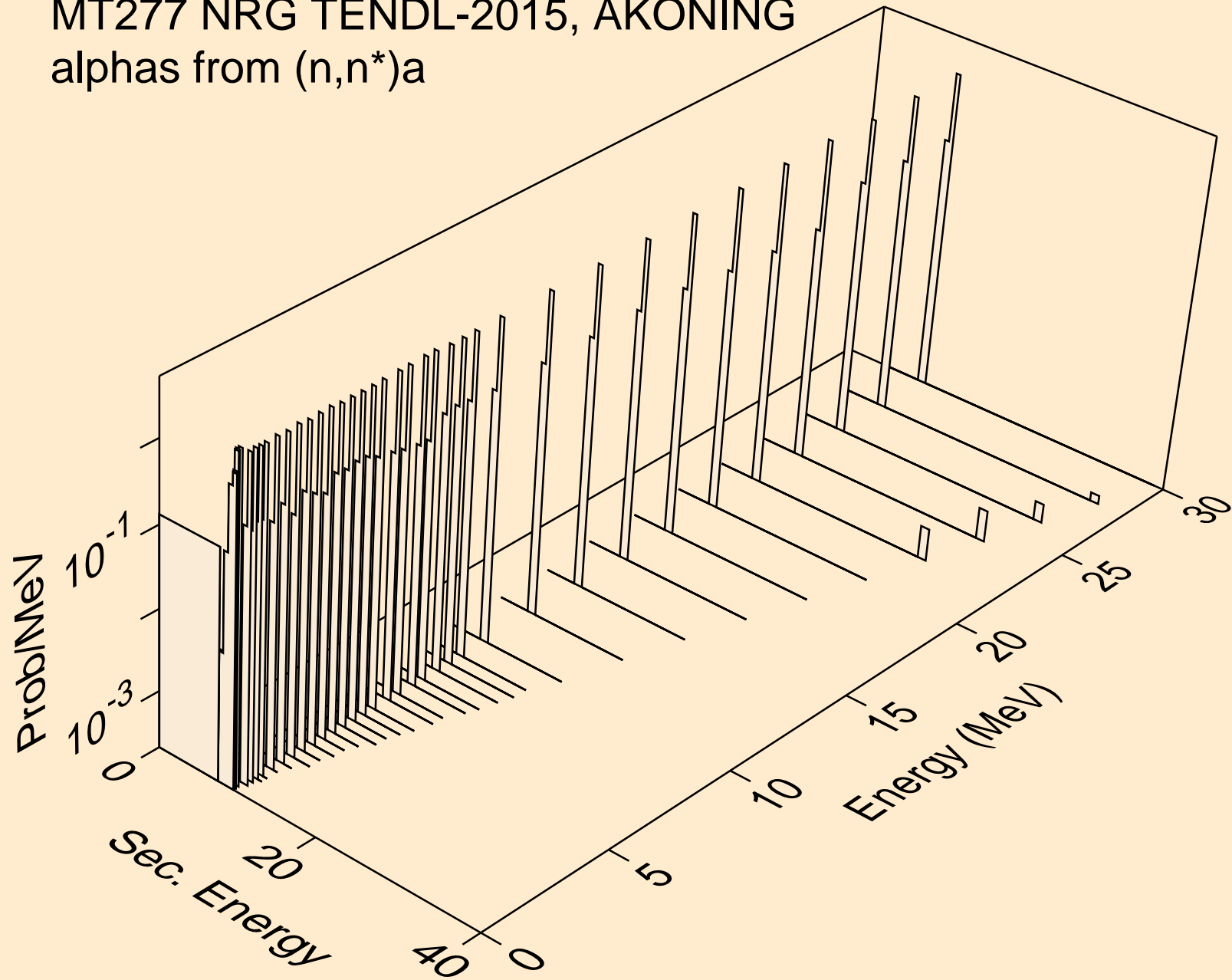

MT277 NRG TENDL-2015, AKONING
alphas from (n,n*)3a

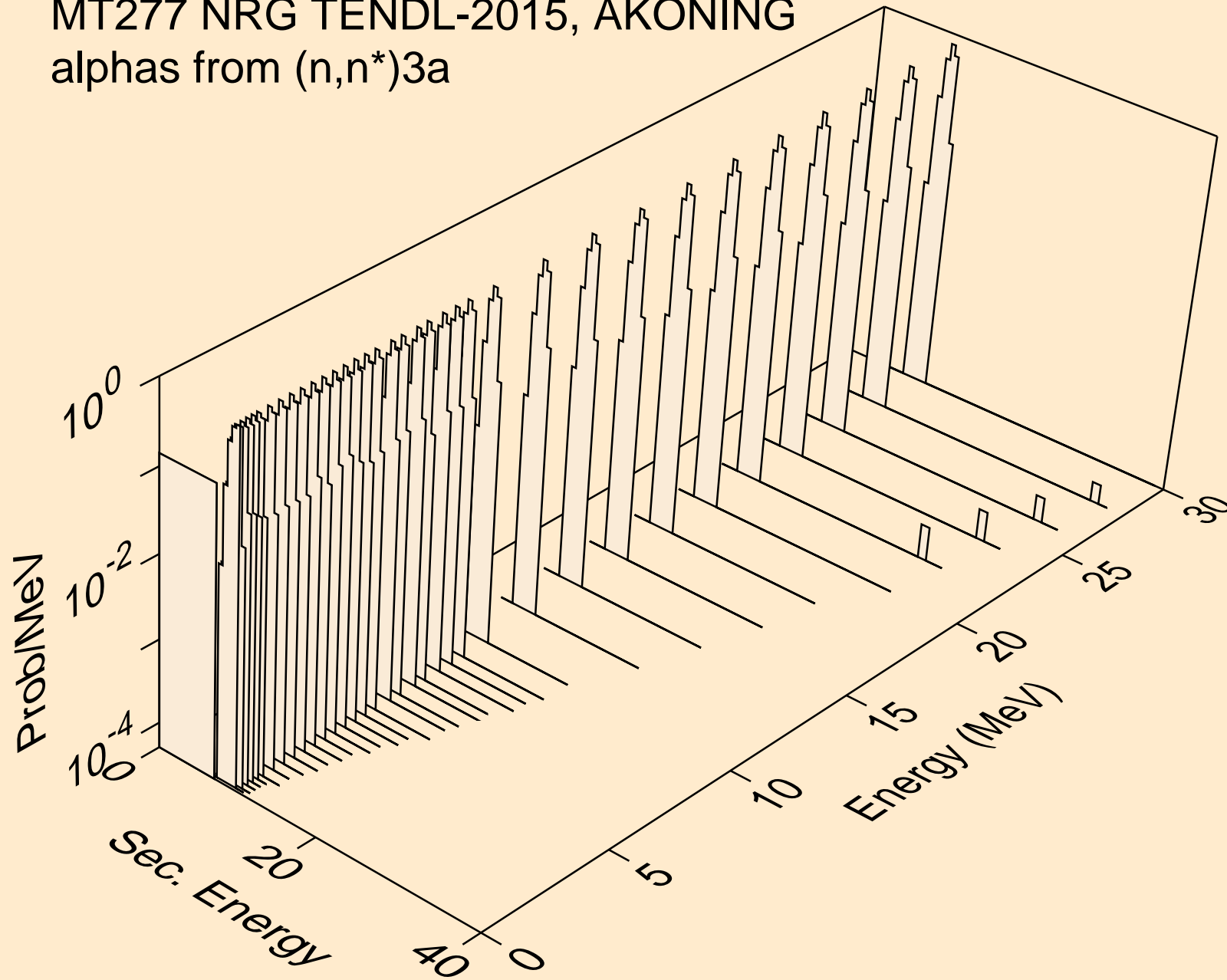

MT277 NRG TENDL-2015, AKONING
alphas from (n,2n)a

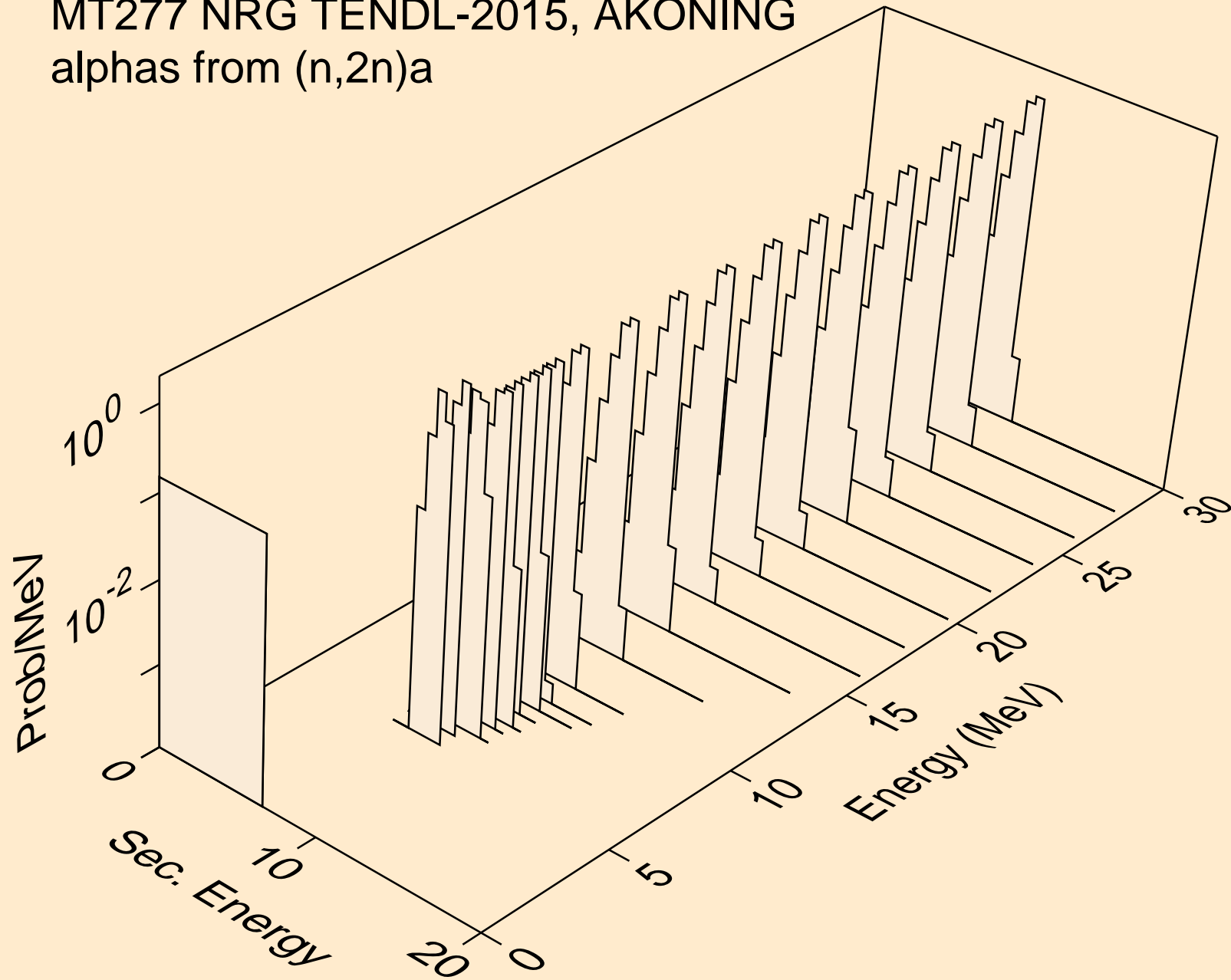

MT277 NRG TENDL-2015, AKONING
alphas from (n,3n)a

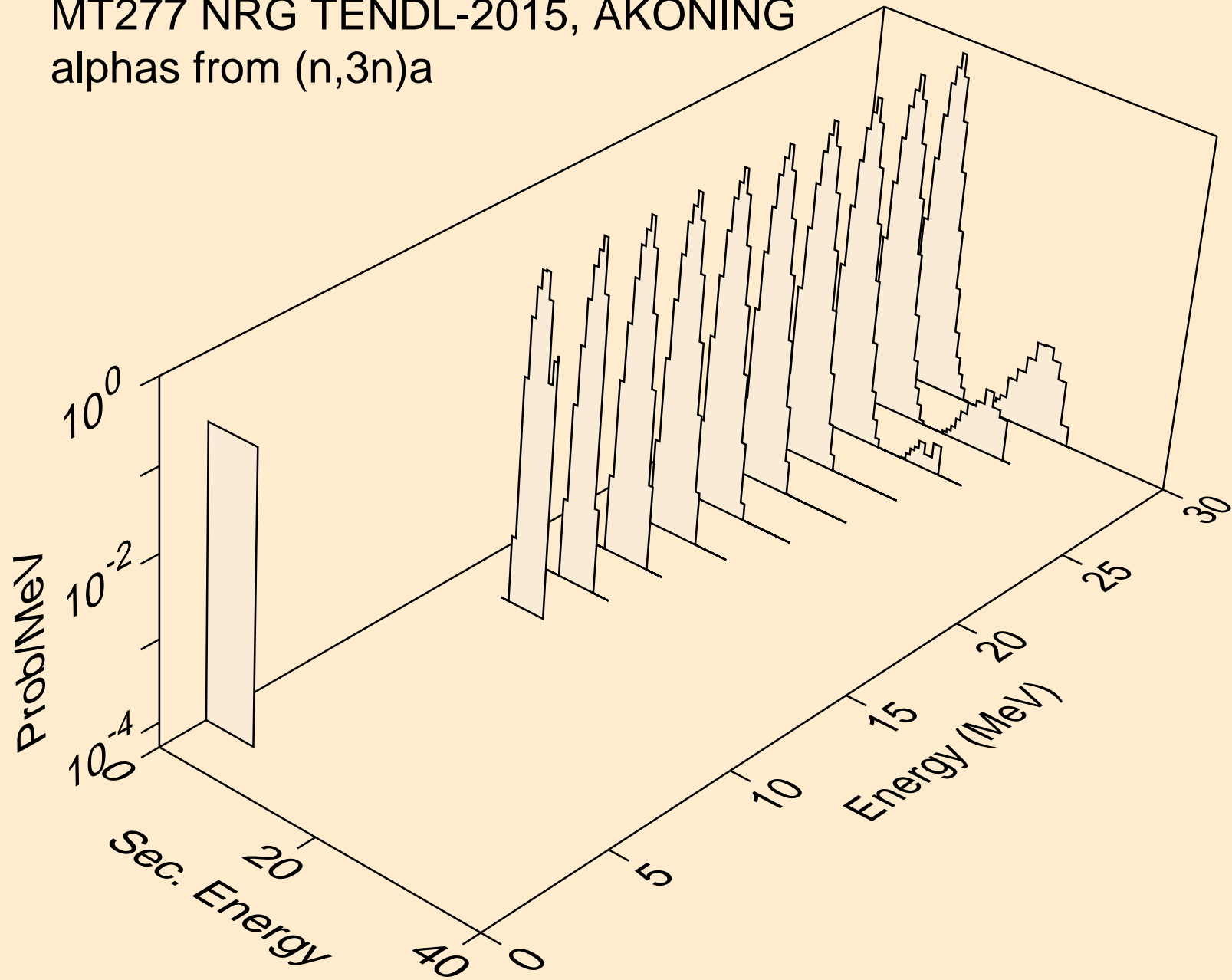

MT277 NRG TENDL-2015, AKONING
alphas from (n,n*)2a

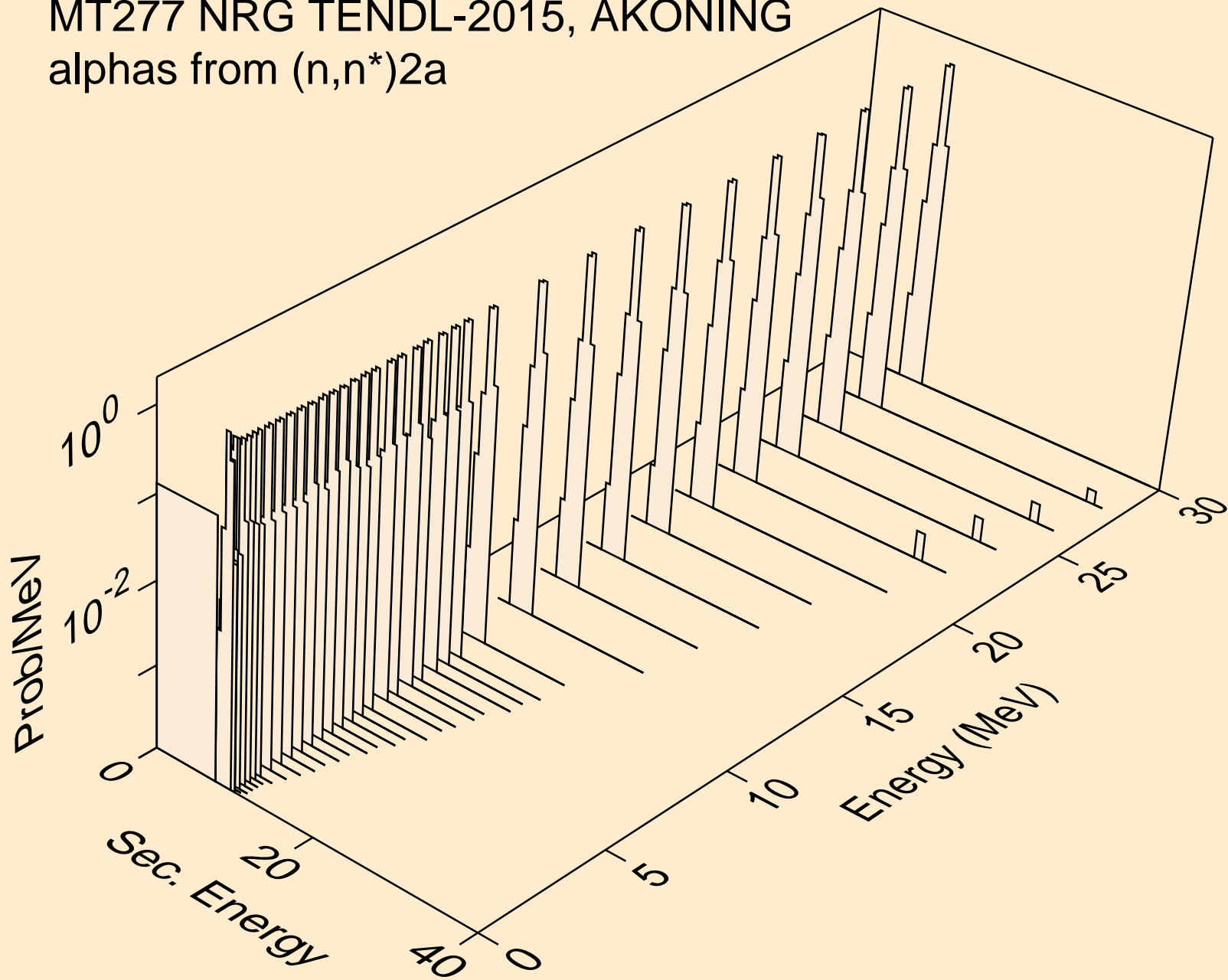

MT277 NRG TENDL-2015, AKONING
alphas from (n,2n)2a

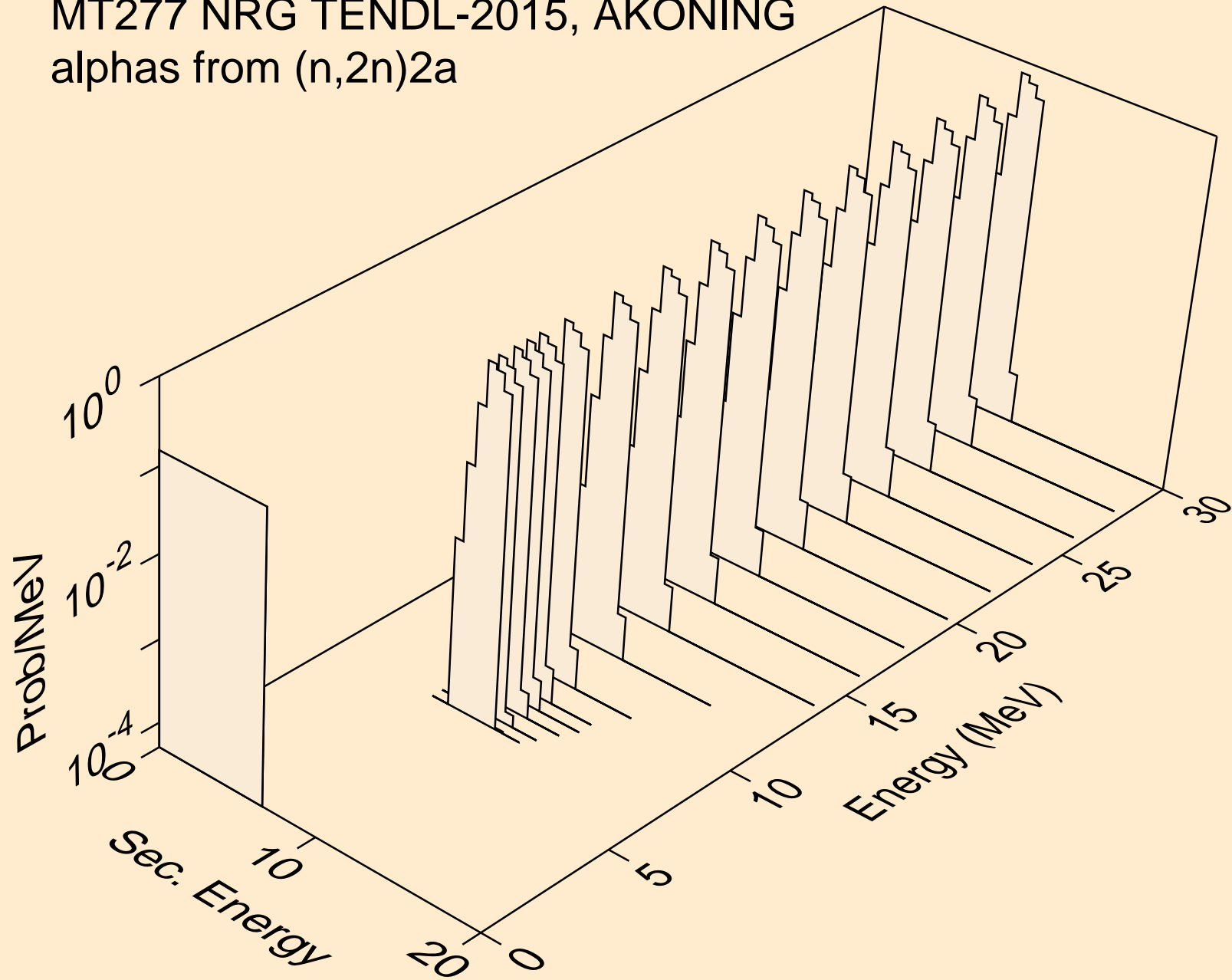

MT277 NRG TENDL-2015, AKONING
alphas from (n,npa)

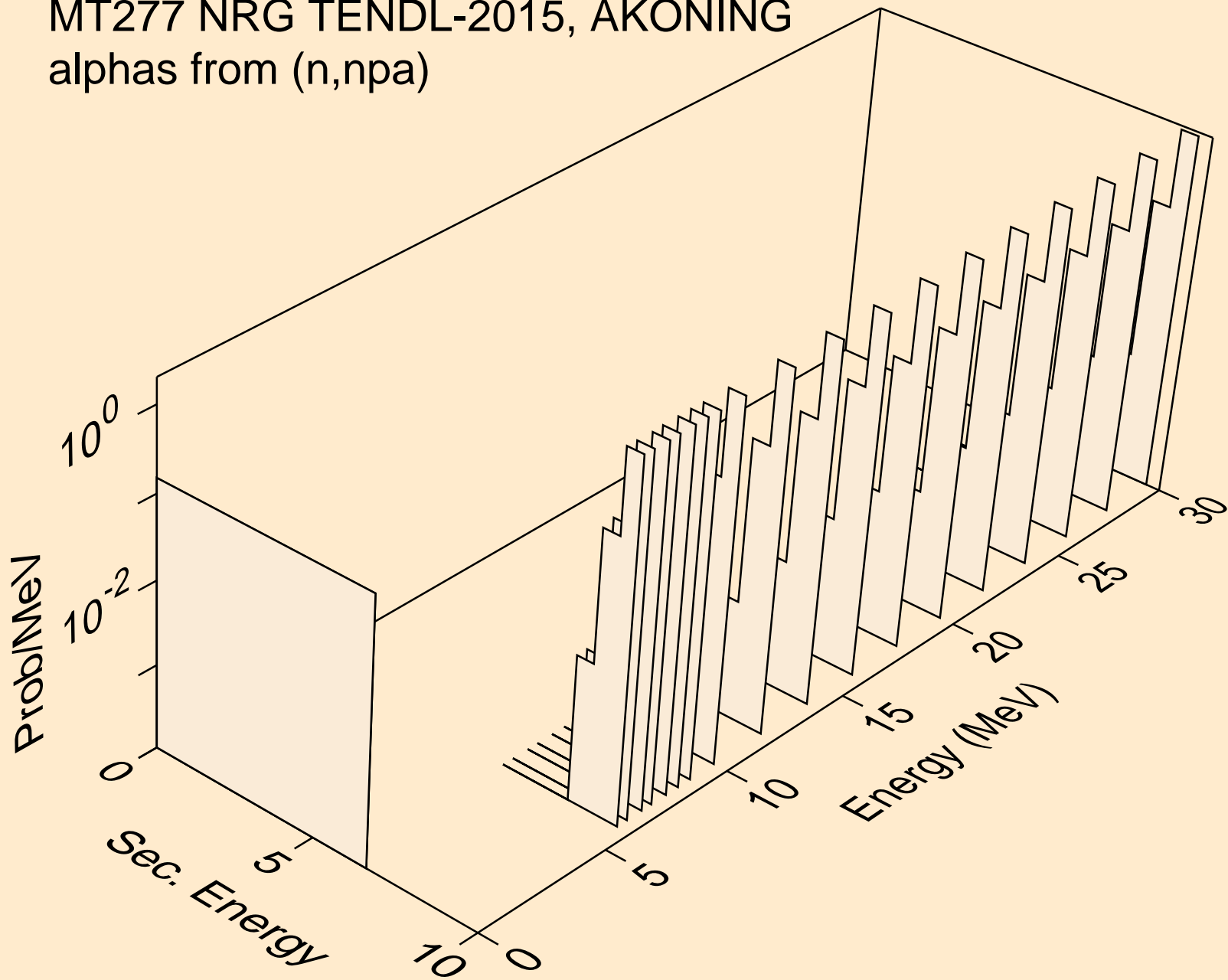

MT277 NRG TENDL-2015, AKONING
alphas from (n,a)

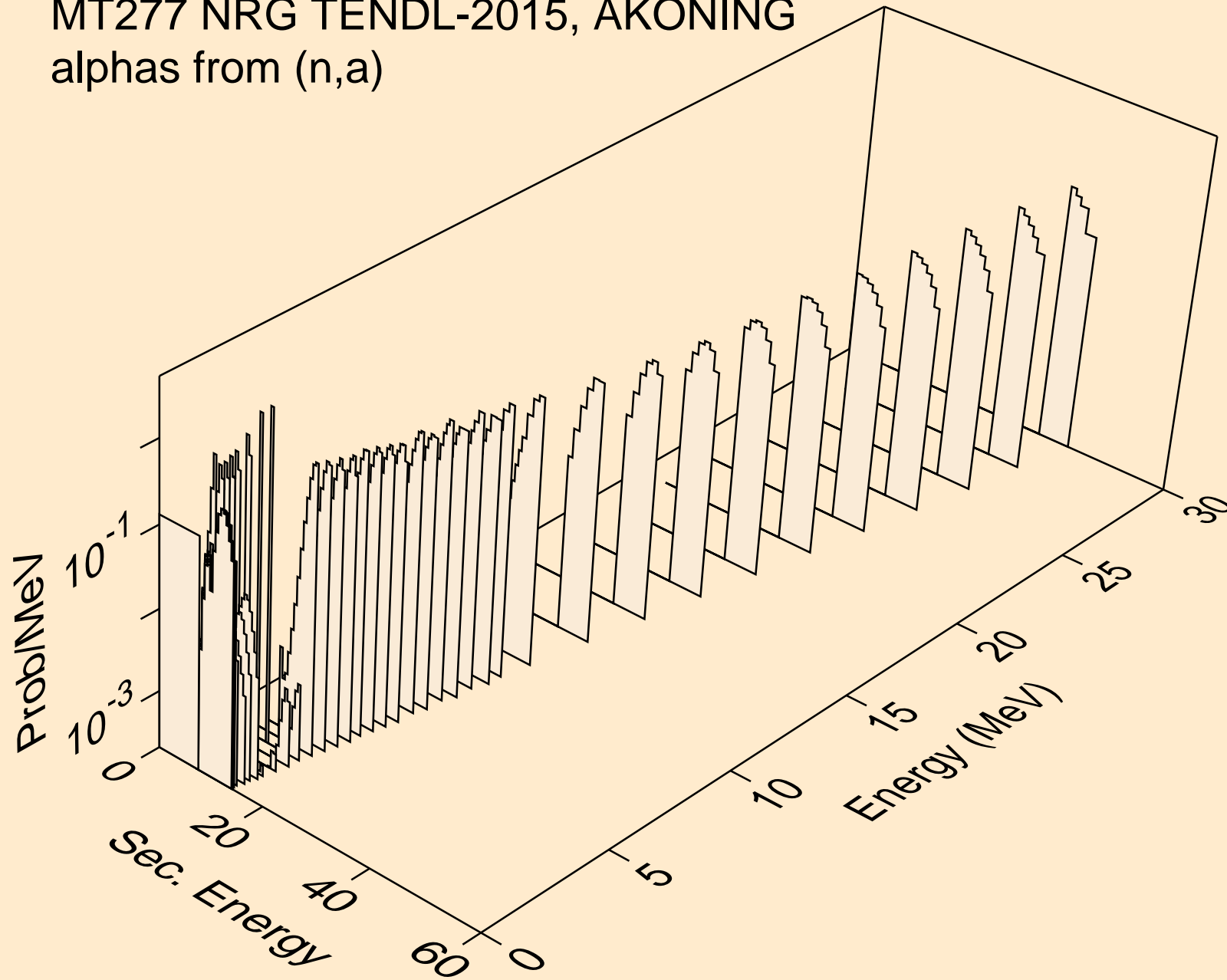

MT277 NRG TENDL-2015, AKONING
alphas from (n,2a)

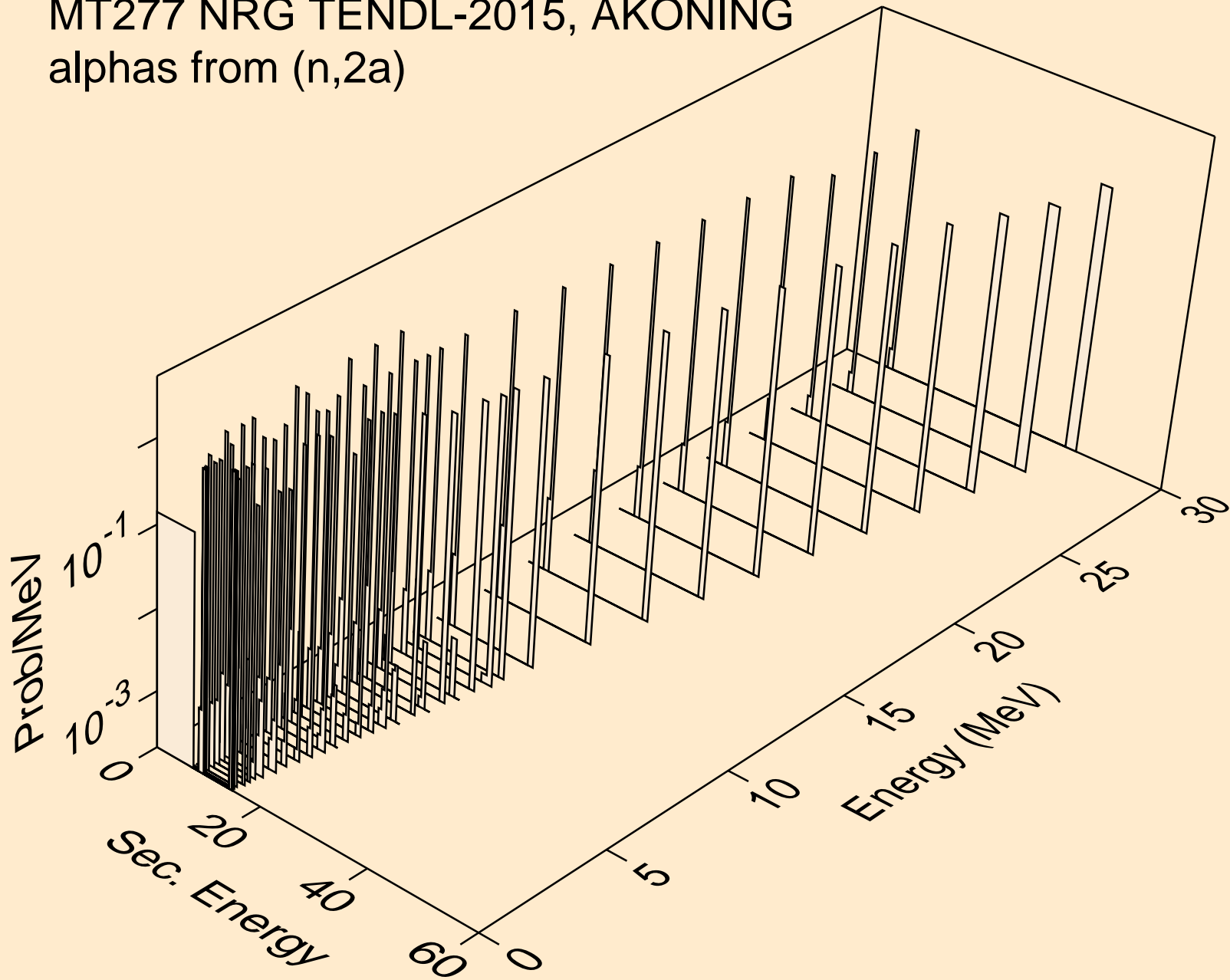

MT277 NRG TENDL-2015, AKONING
alphas from (n,3a)

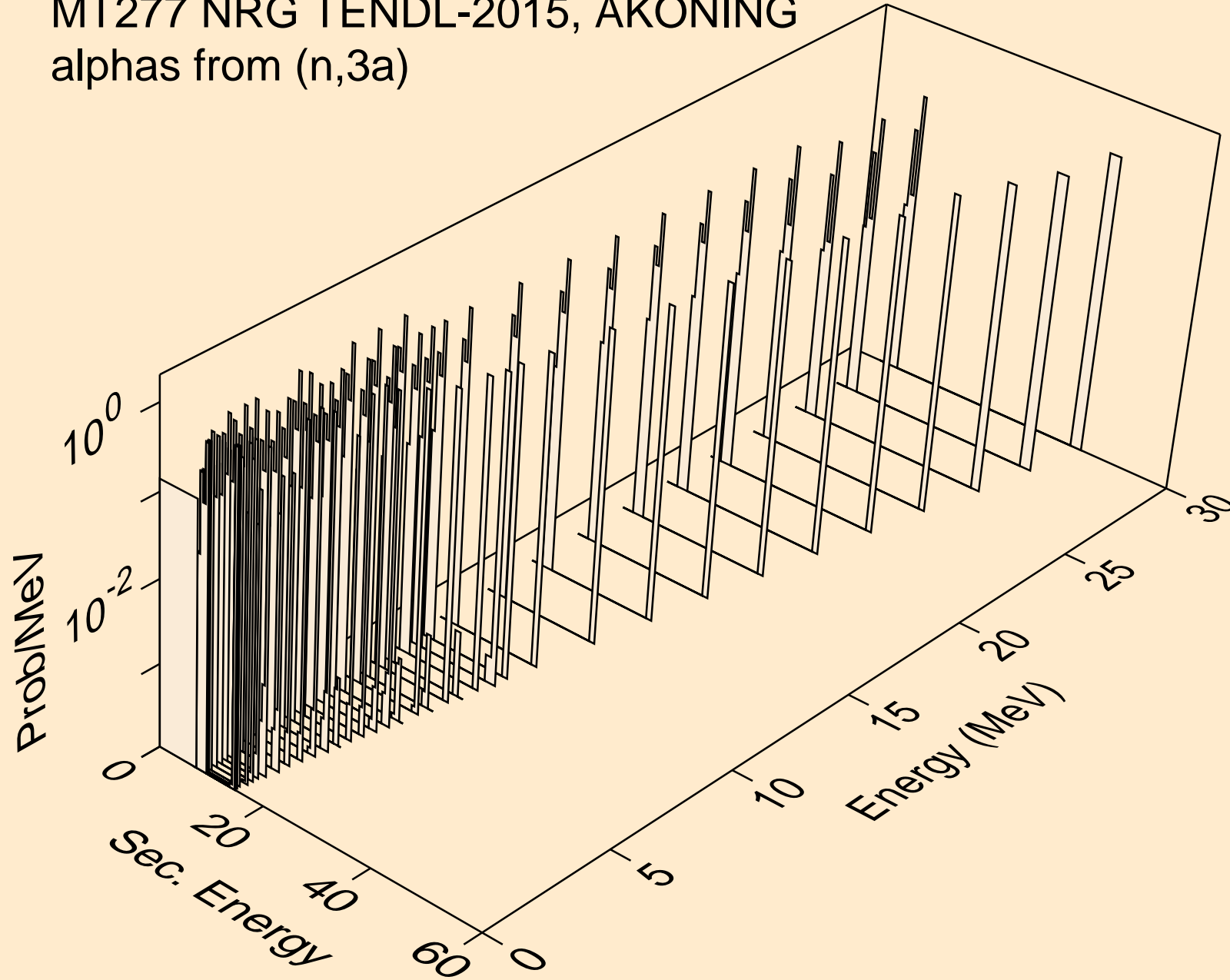

MT277 NRG TENDL-2015, AKONING
alphas from (n,d2a)

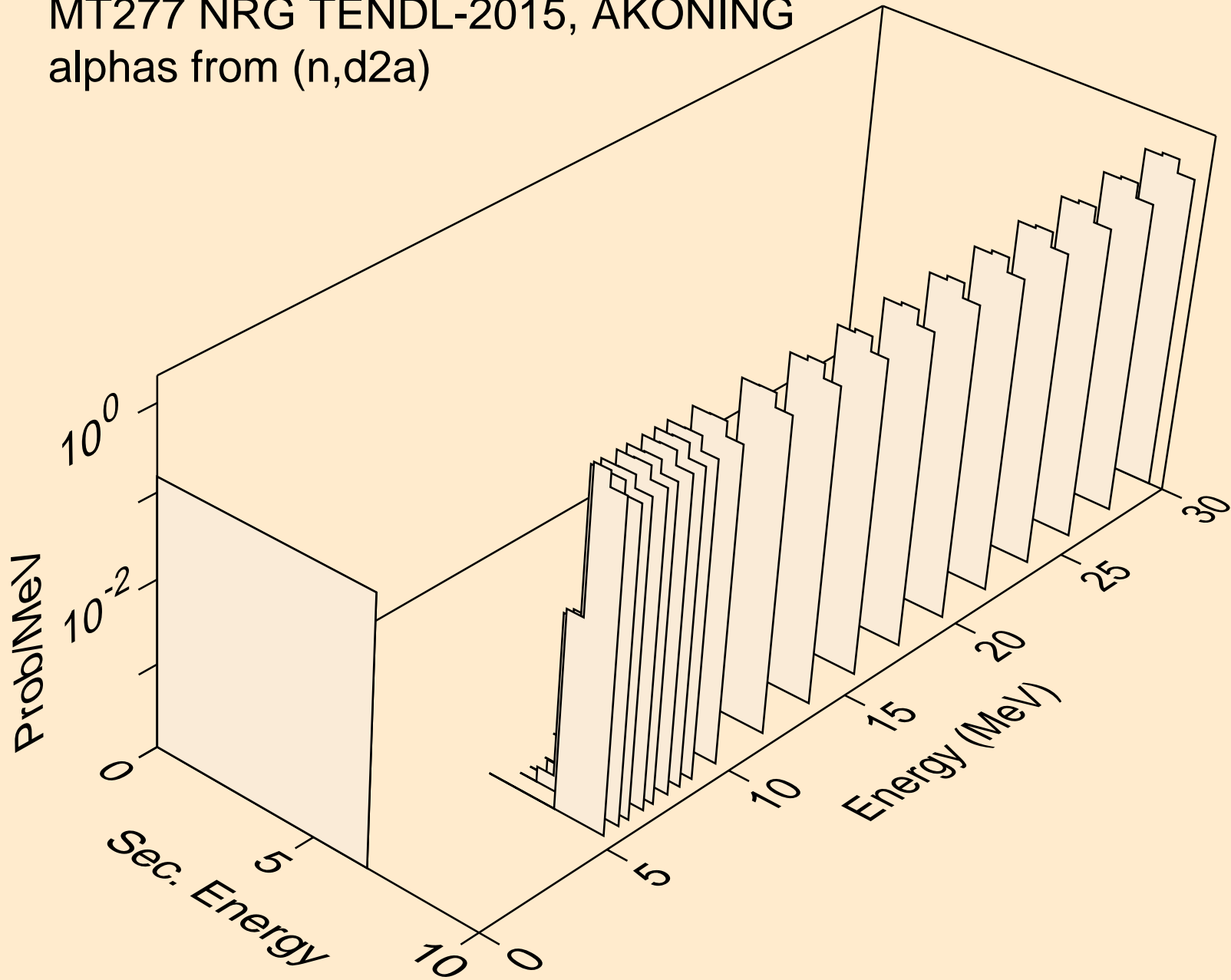

MT277 NRG TENDL-2015, AKONING
alphas from (n,da)

