

NB084 NRG TENDL-2015, AKONING

Principal cross sections

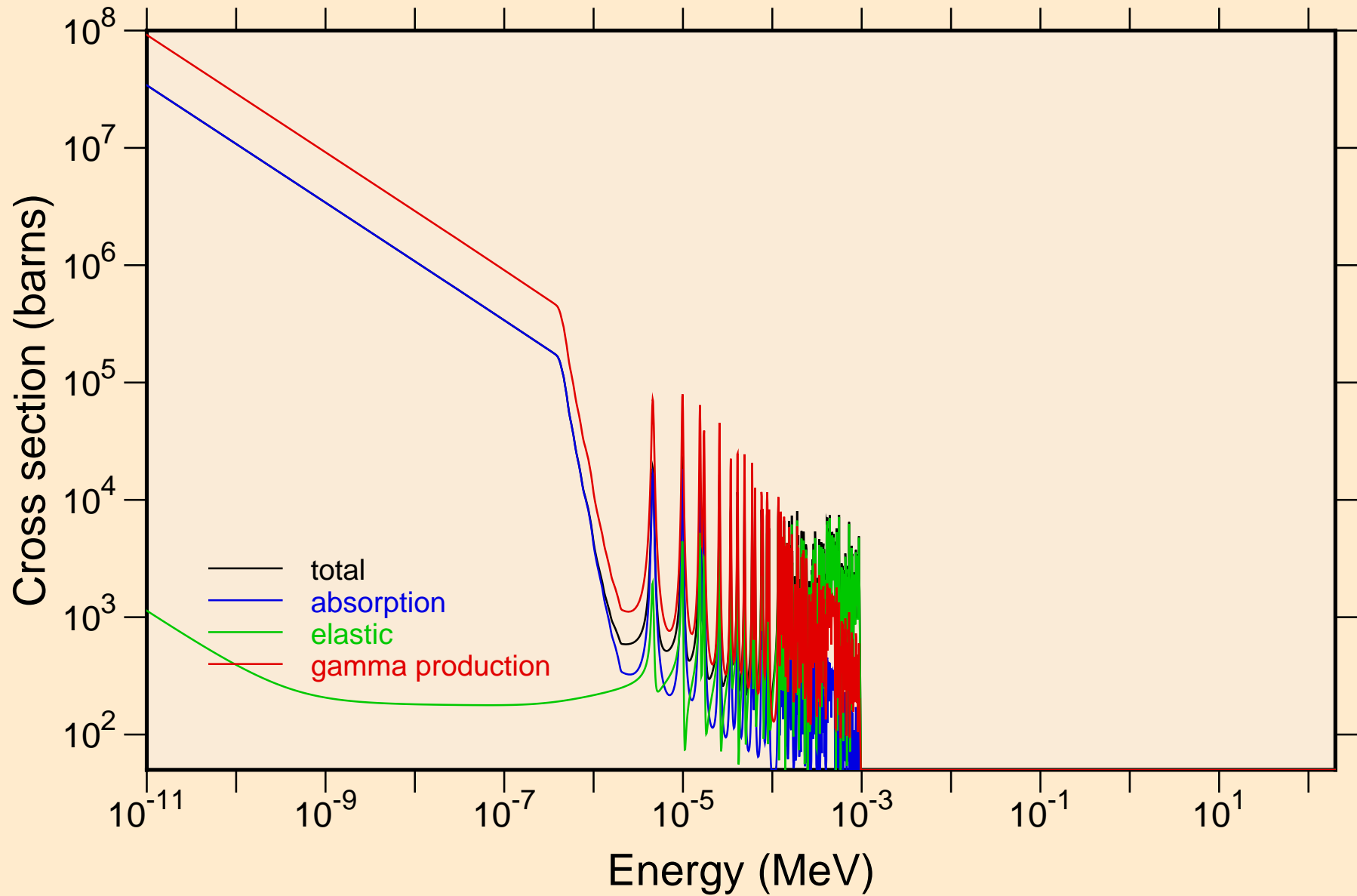

NB084 NRG TENDL-2015, AKONING
resonance total cross section

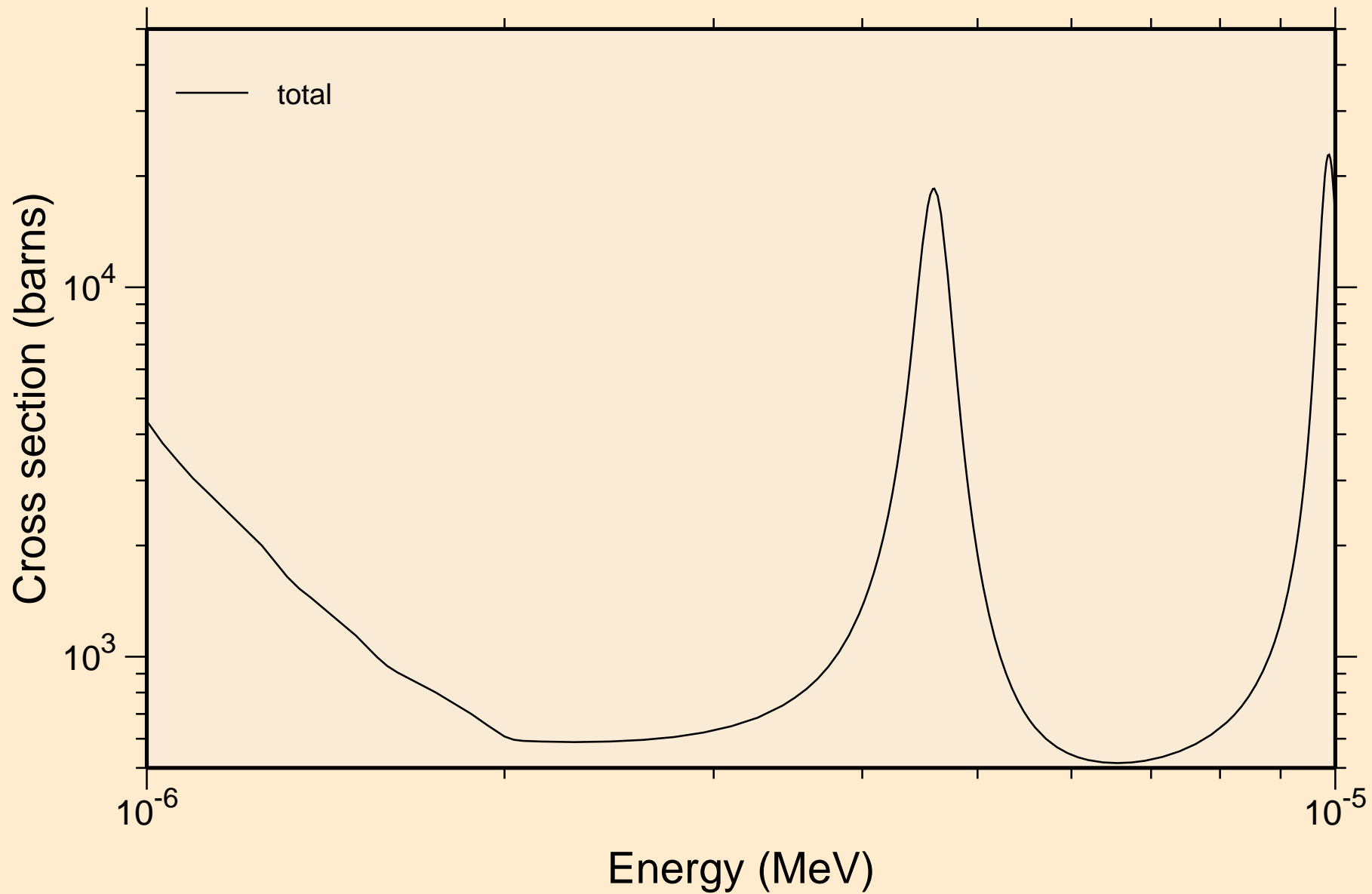

NB084 NRG TENDL-2015, AKONING
resonance total cross section

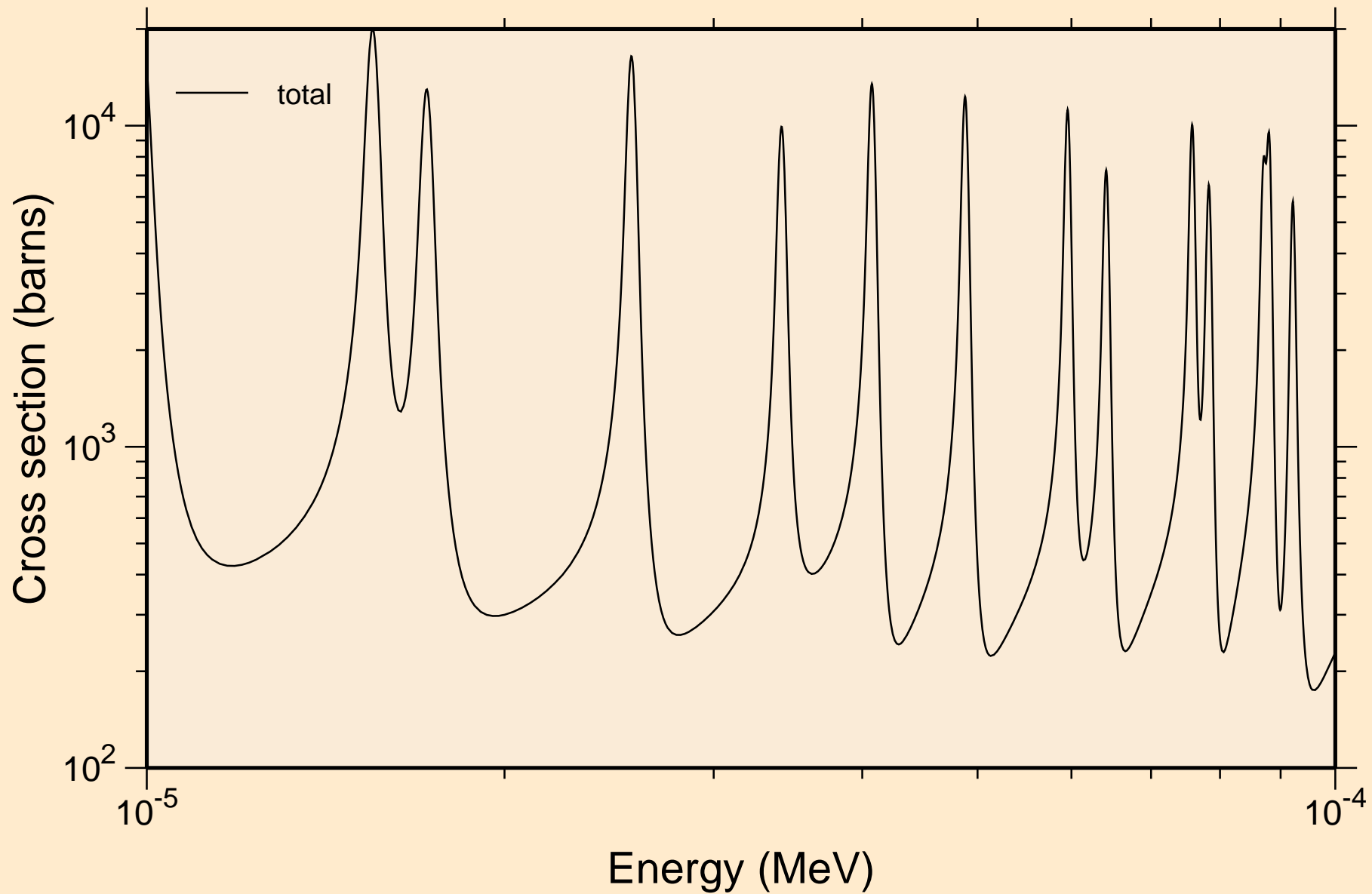

NB084 NRG TENDL-2015, AKONING
resonance total cross section

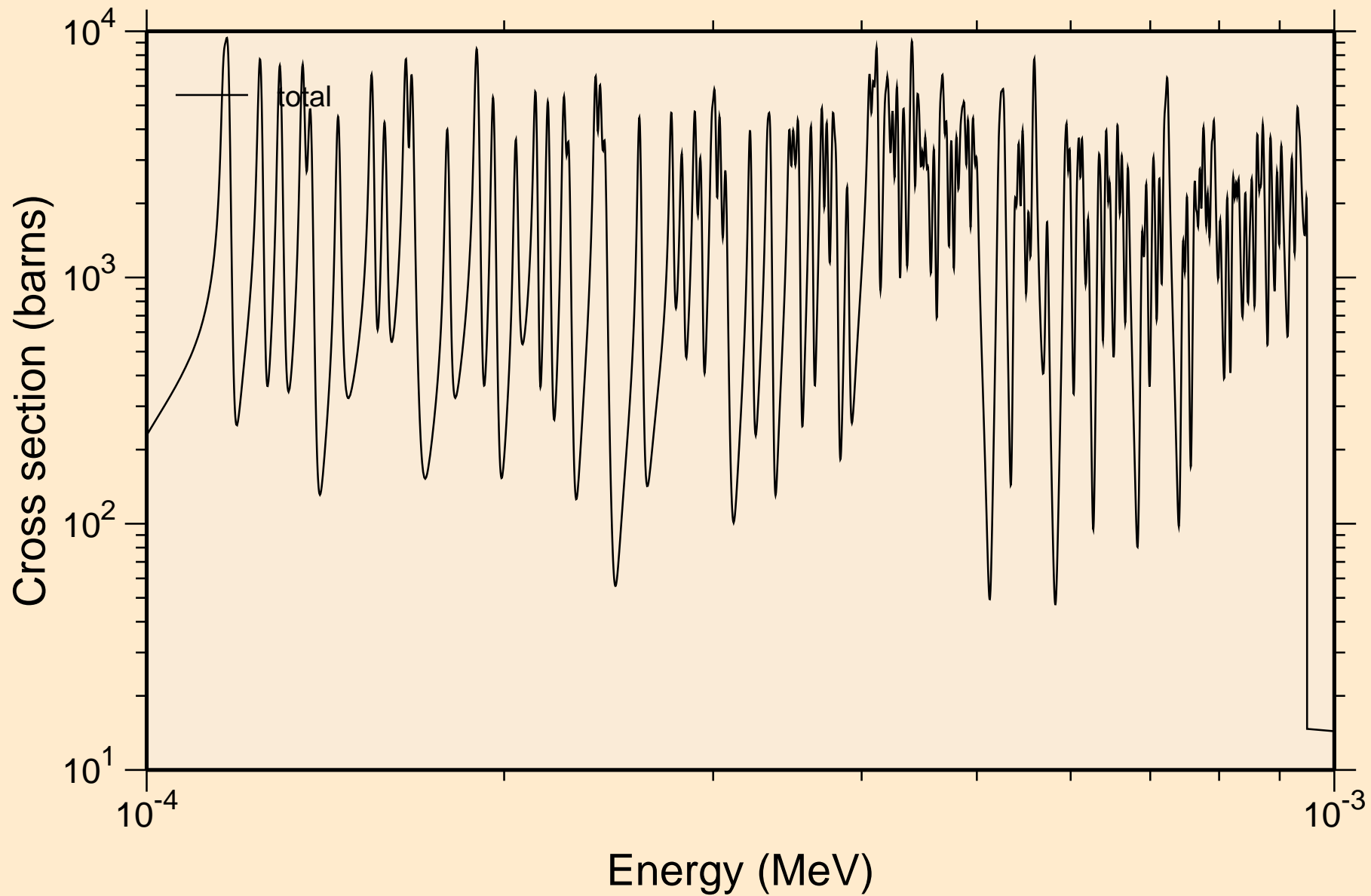

NB084 NRG TENDL-2015, AKONING
resonance total cross section

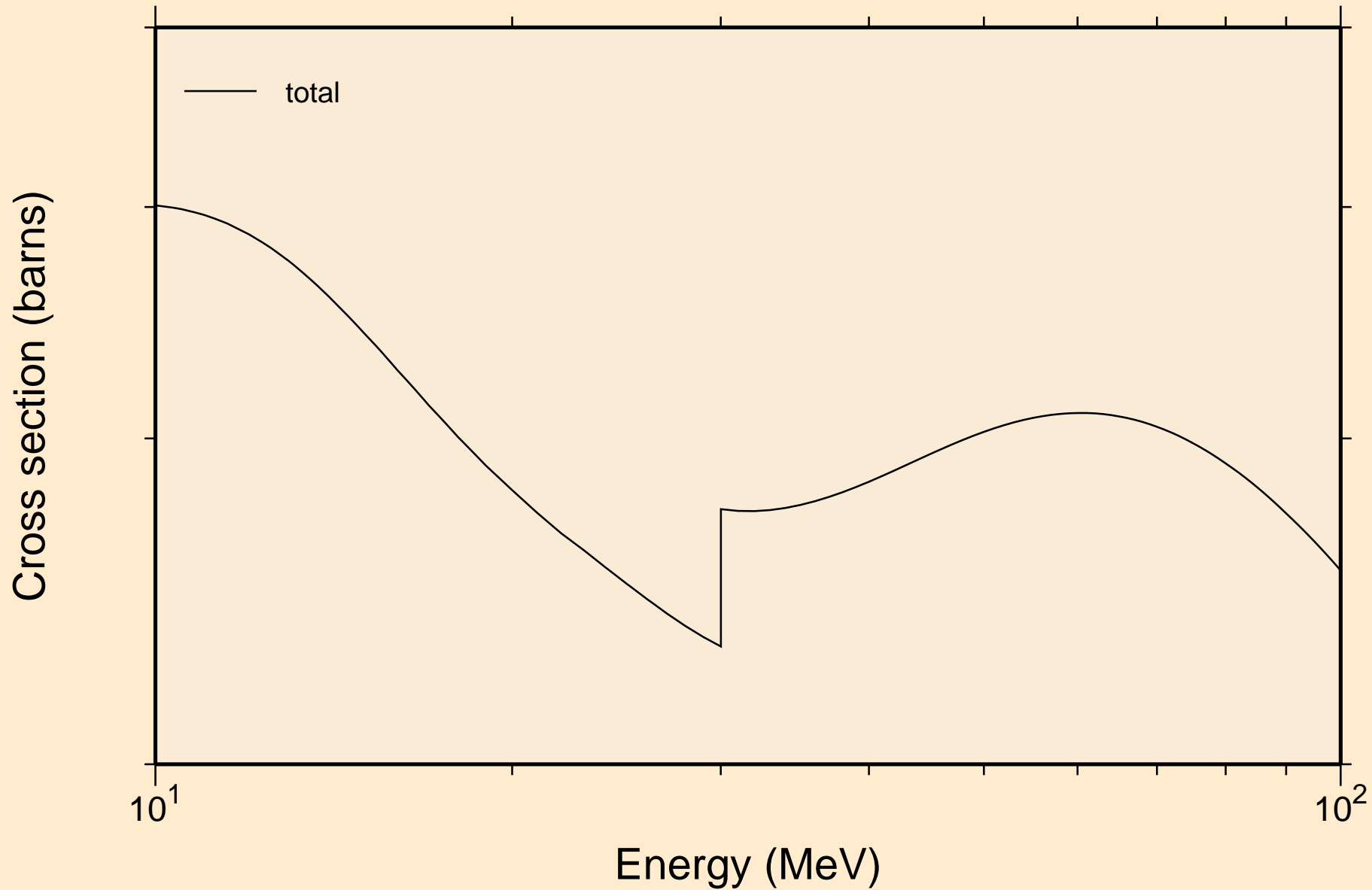

NB084 NRG TENDL-2015, AKONING
resonance absorption cross sections

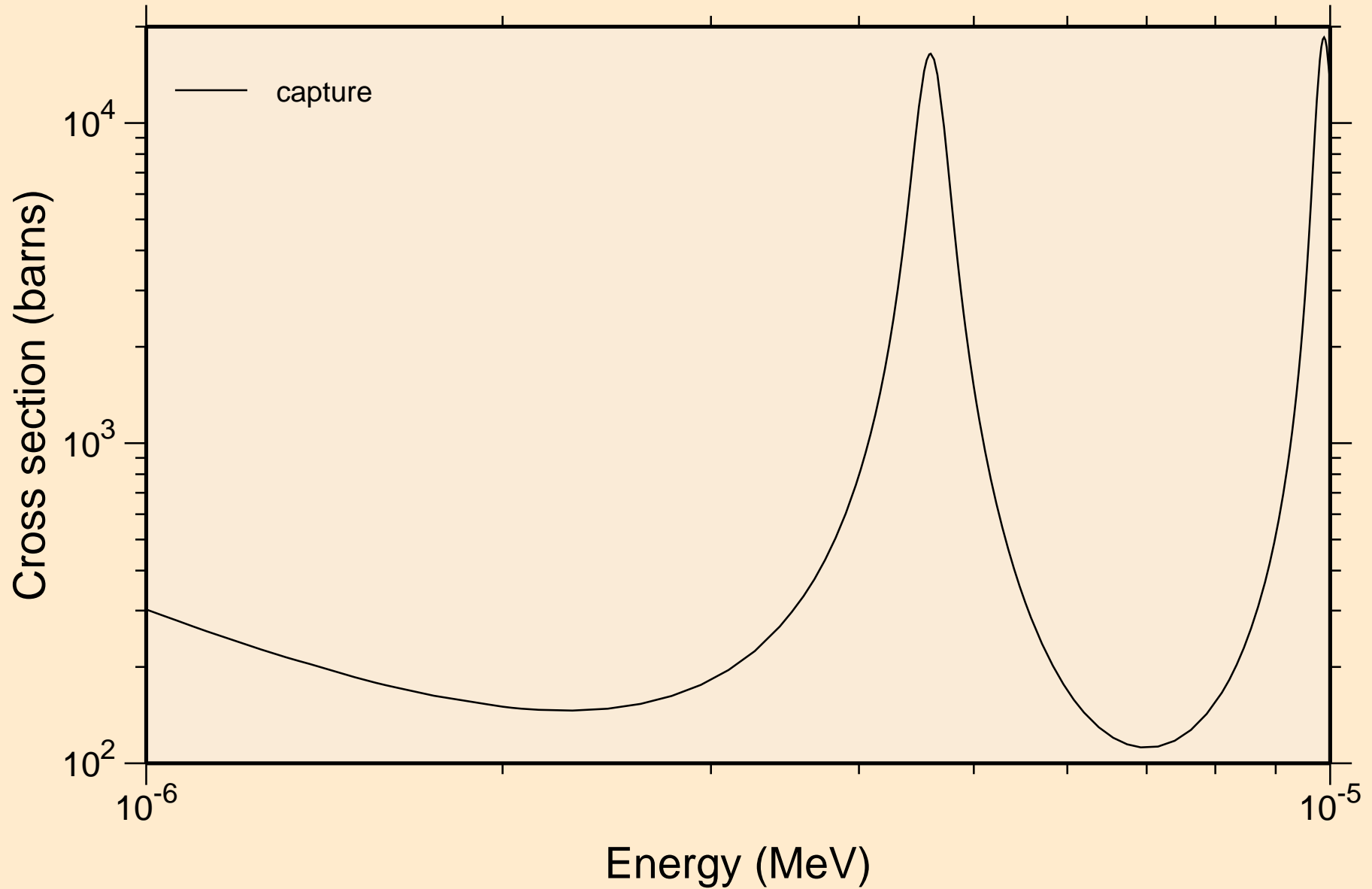

NB084 NRG TENDL-2015, AKONING
resonance absorption cross sections

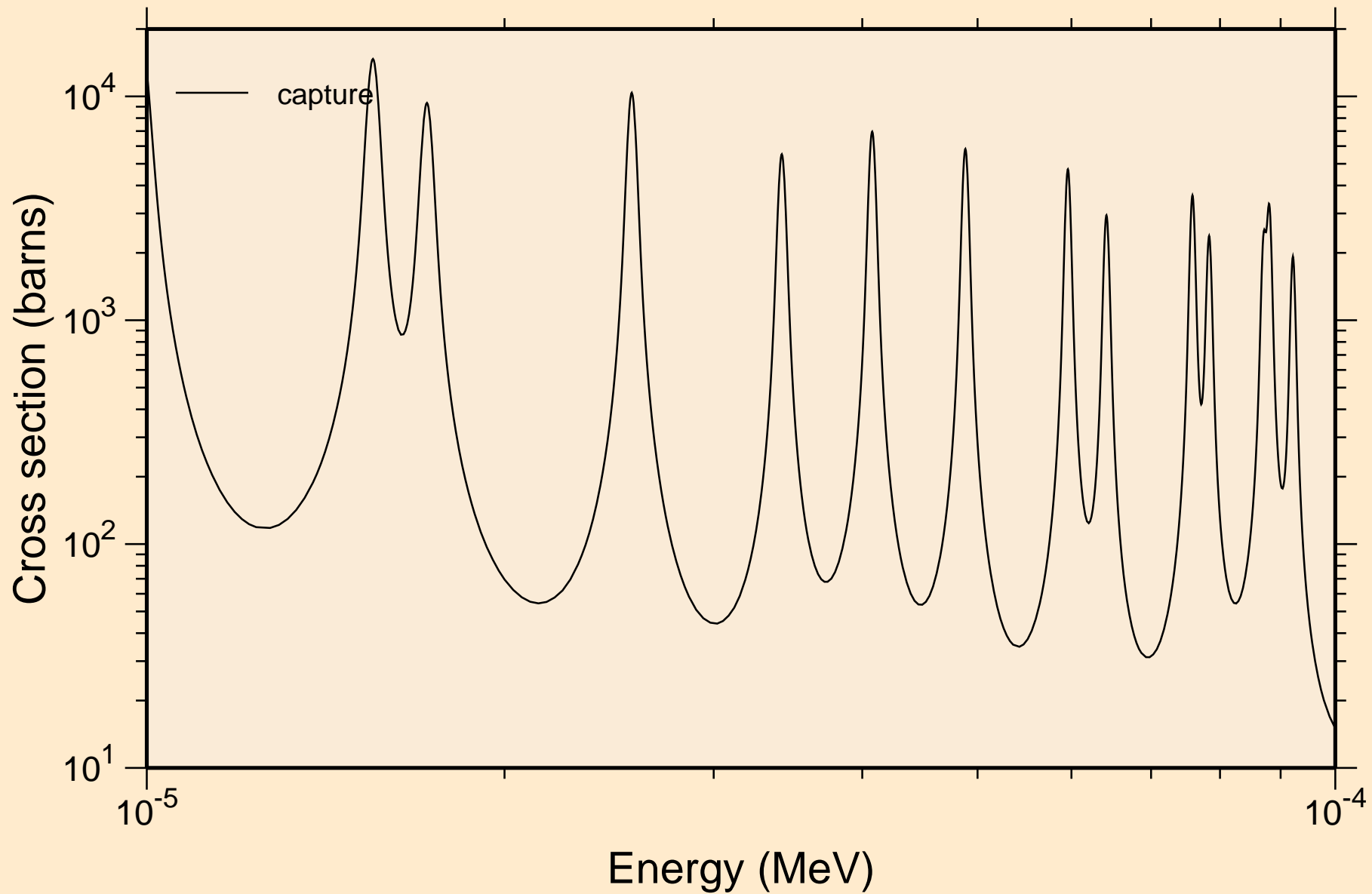

NB084 NRG TENDL-2015, AKONING
resonance absorption cross sections

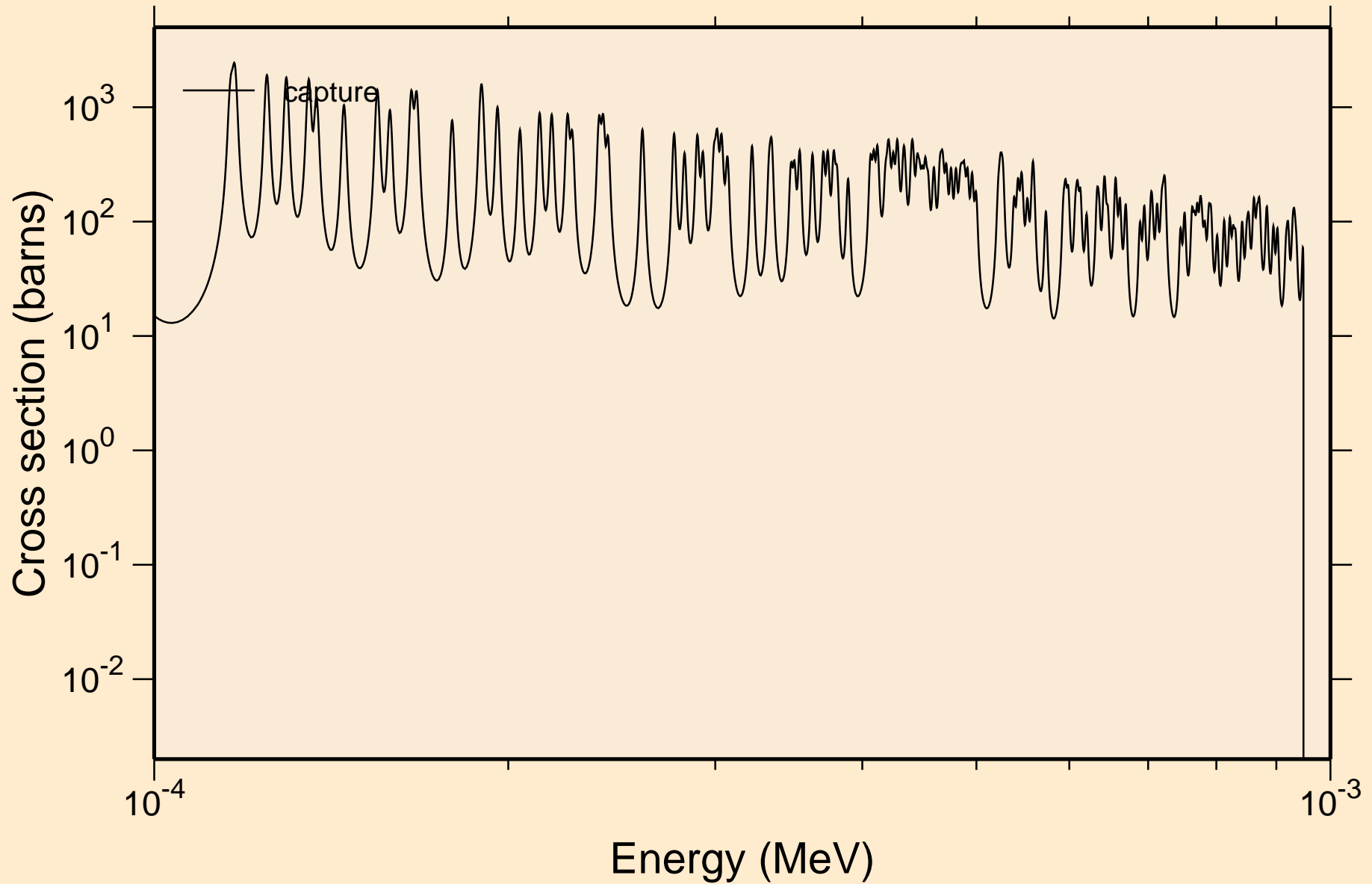

NB084 NRG TENDL-2015, AKONING
resonance absorption cross sections

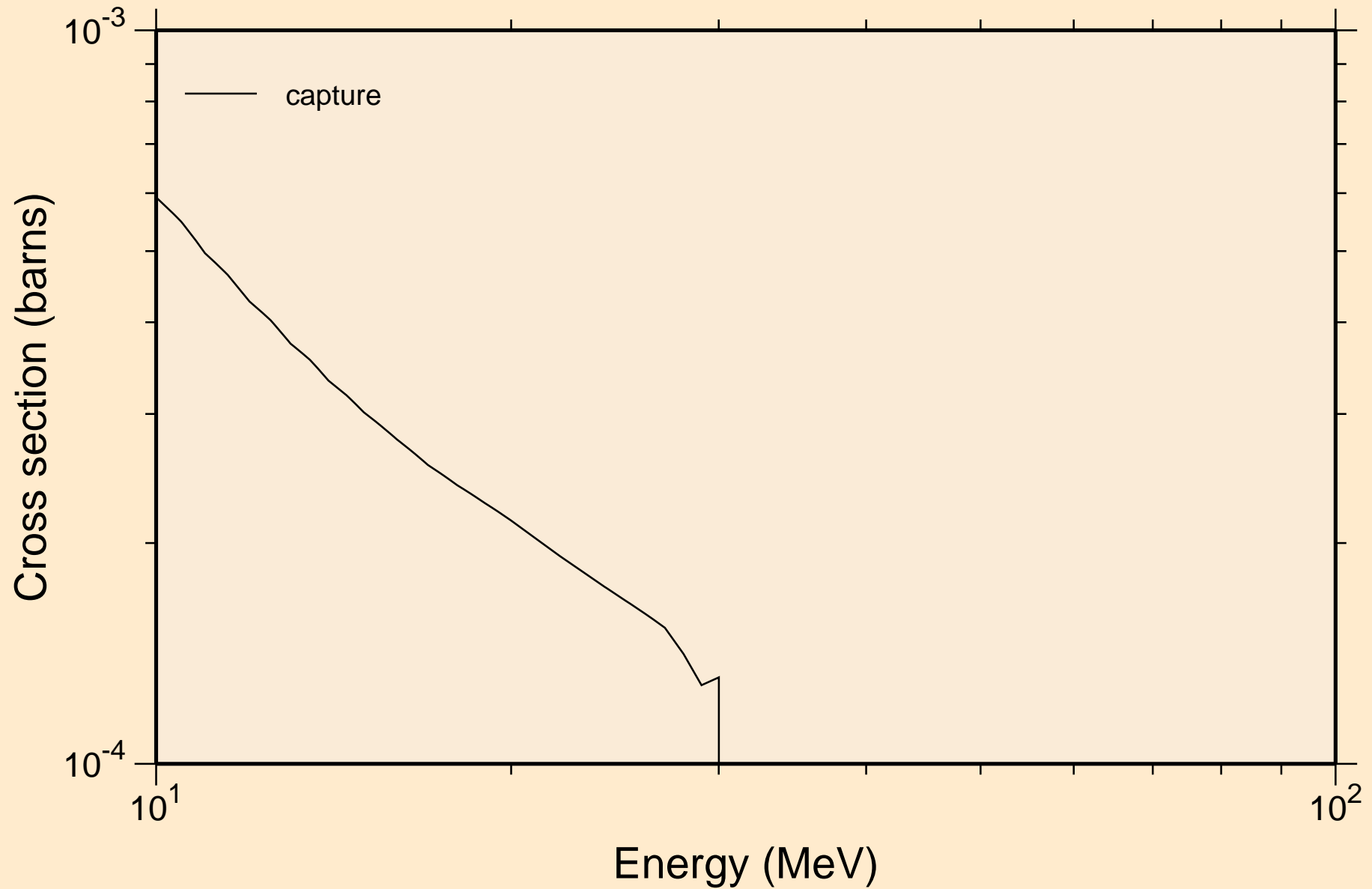

NB084 NRG TENDL-2015, AKONING

Non-threshold reactions

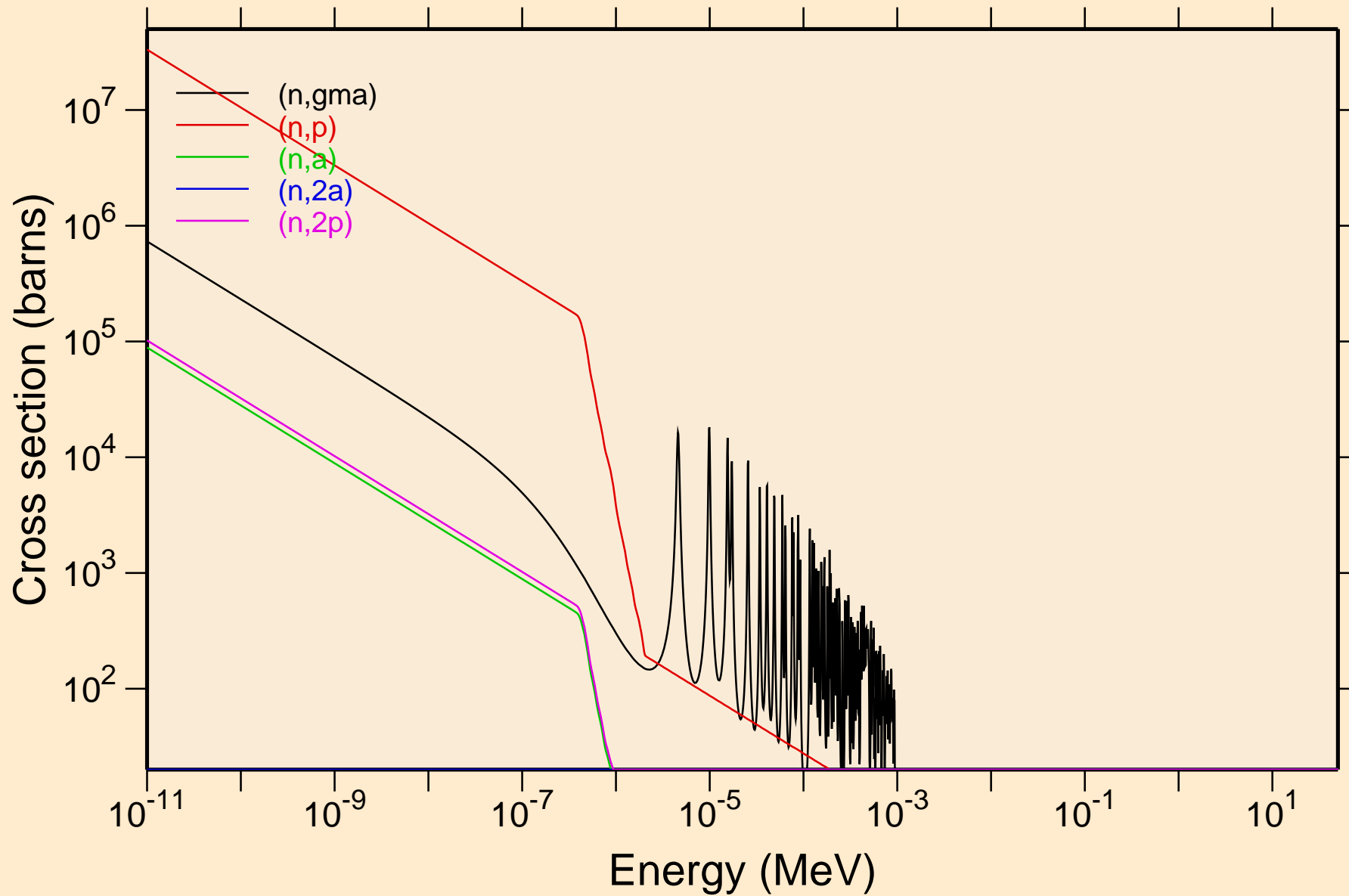

NB084 NRG TENDL-2015, AKONING
Non-threshold reactions

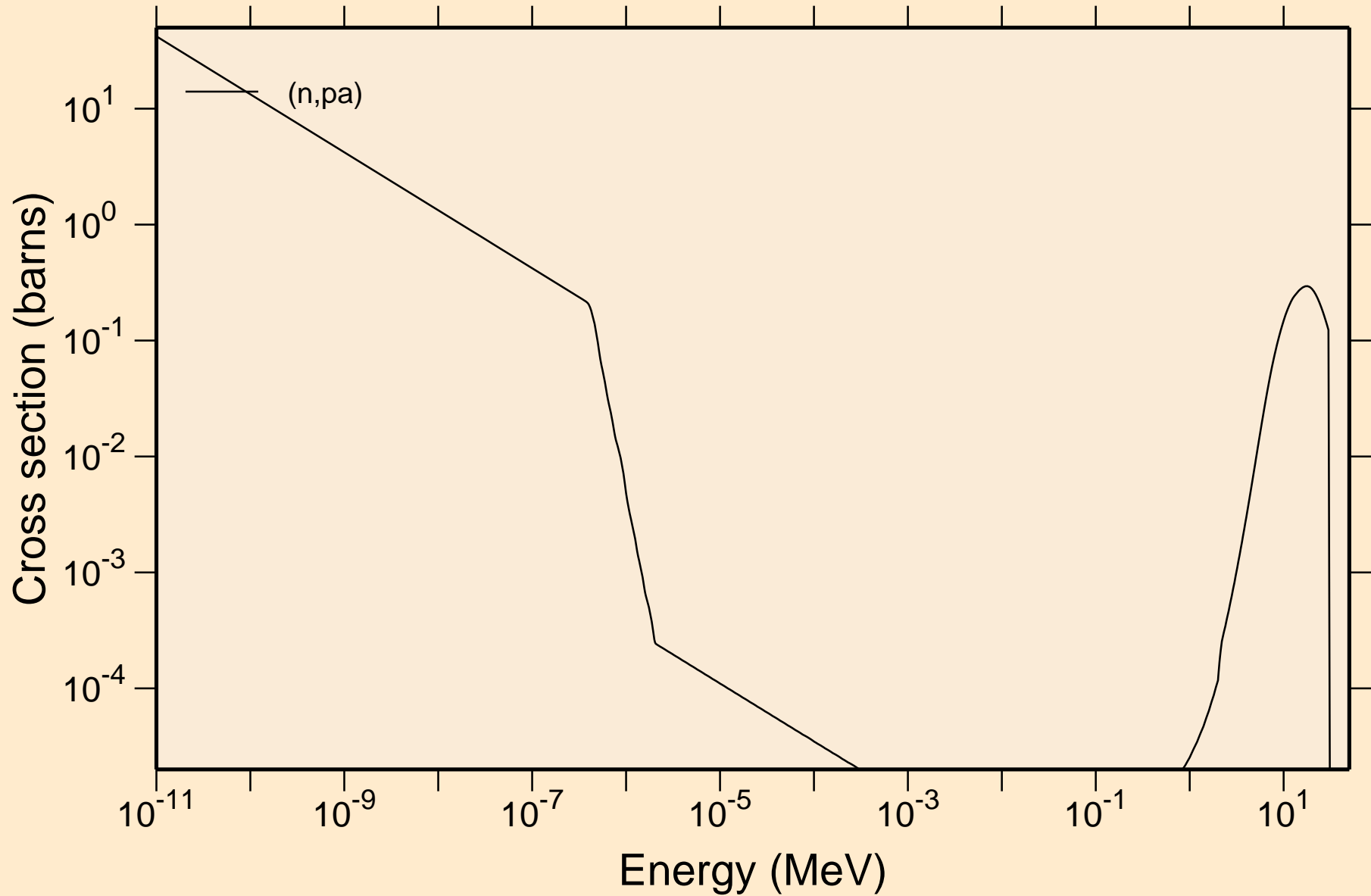

NB084 NRG TENDL-2015, AKONING

Principal cross sections

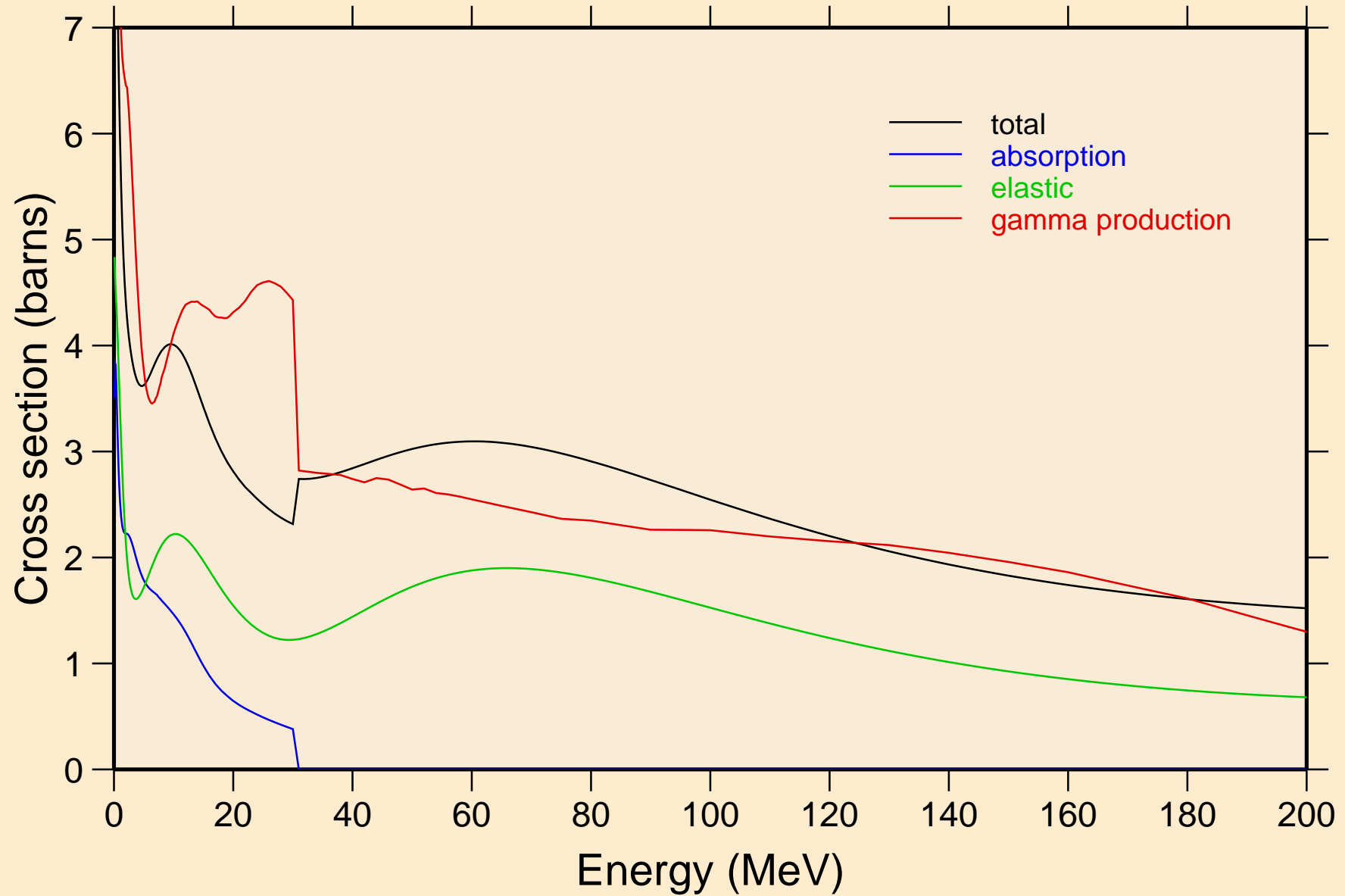

NB084 NRG TENDL-2015, AKONING

Non-threshold reactions

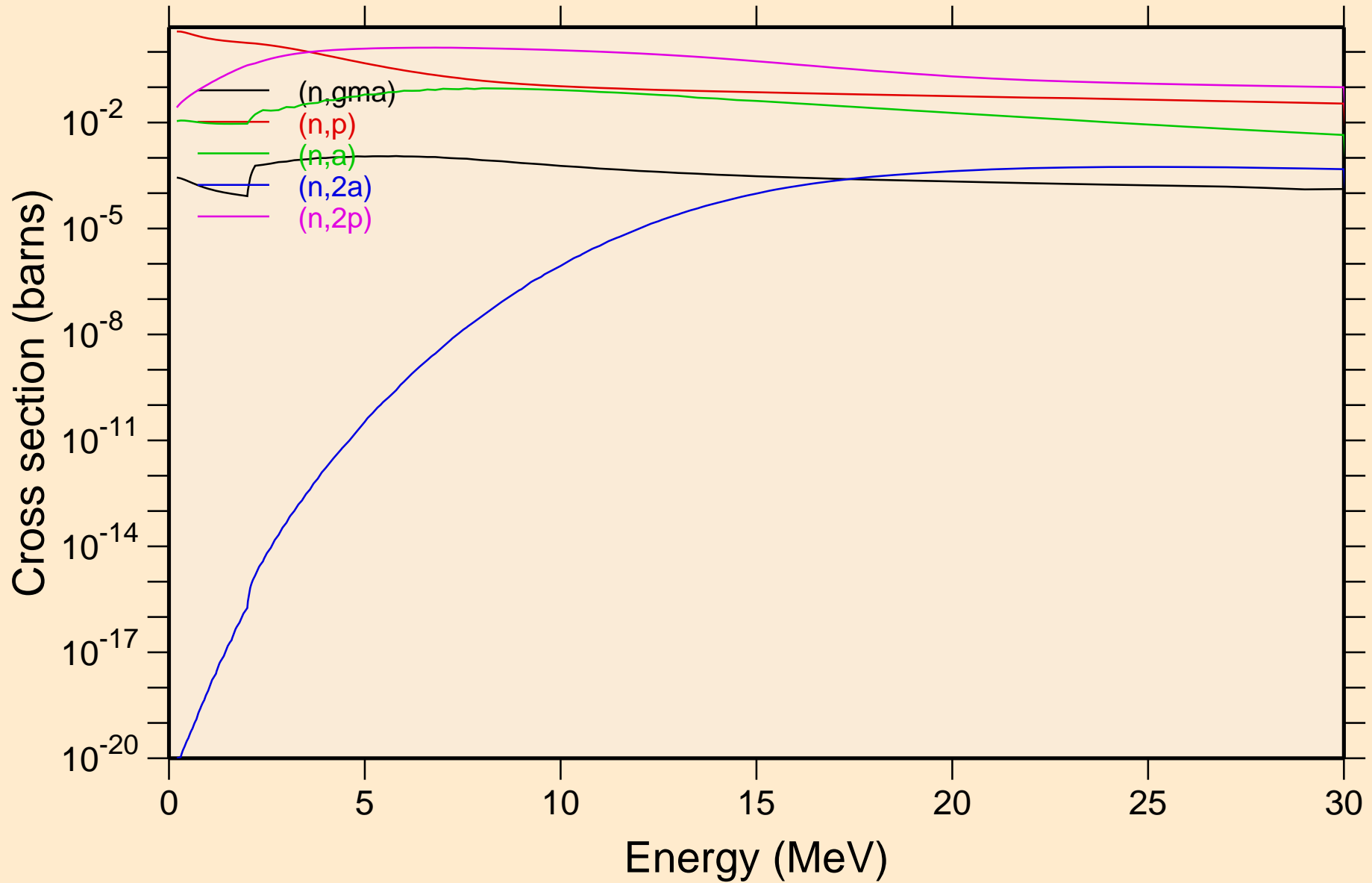

NB084 NRG TENDL-2015, AKONING
Non-threshold reactions

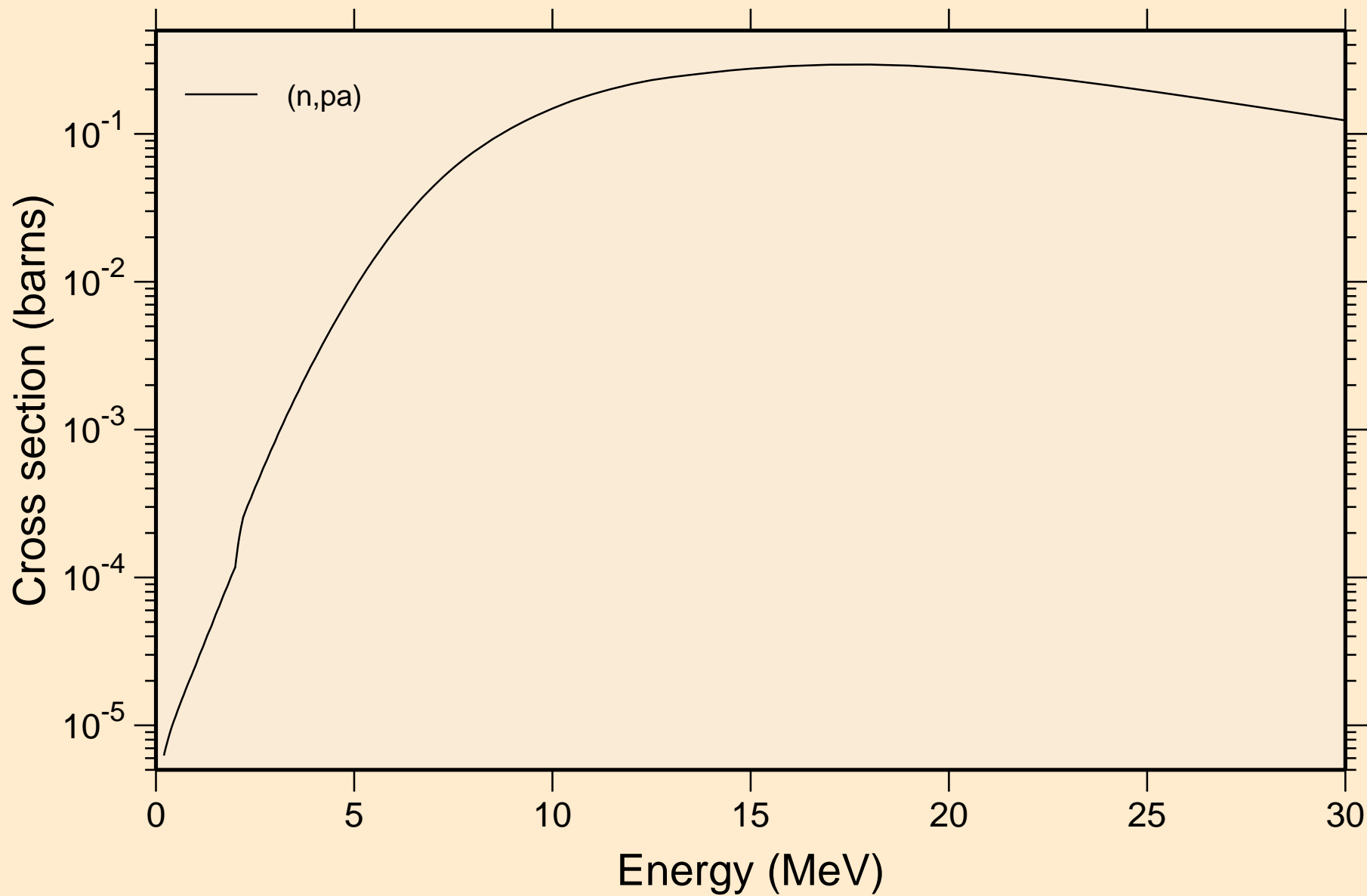

NB084 NRG TENDL-2015, AKONING
Inelastic levels

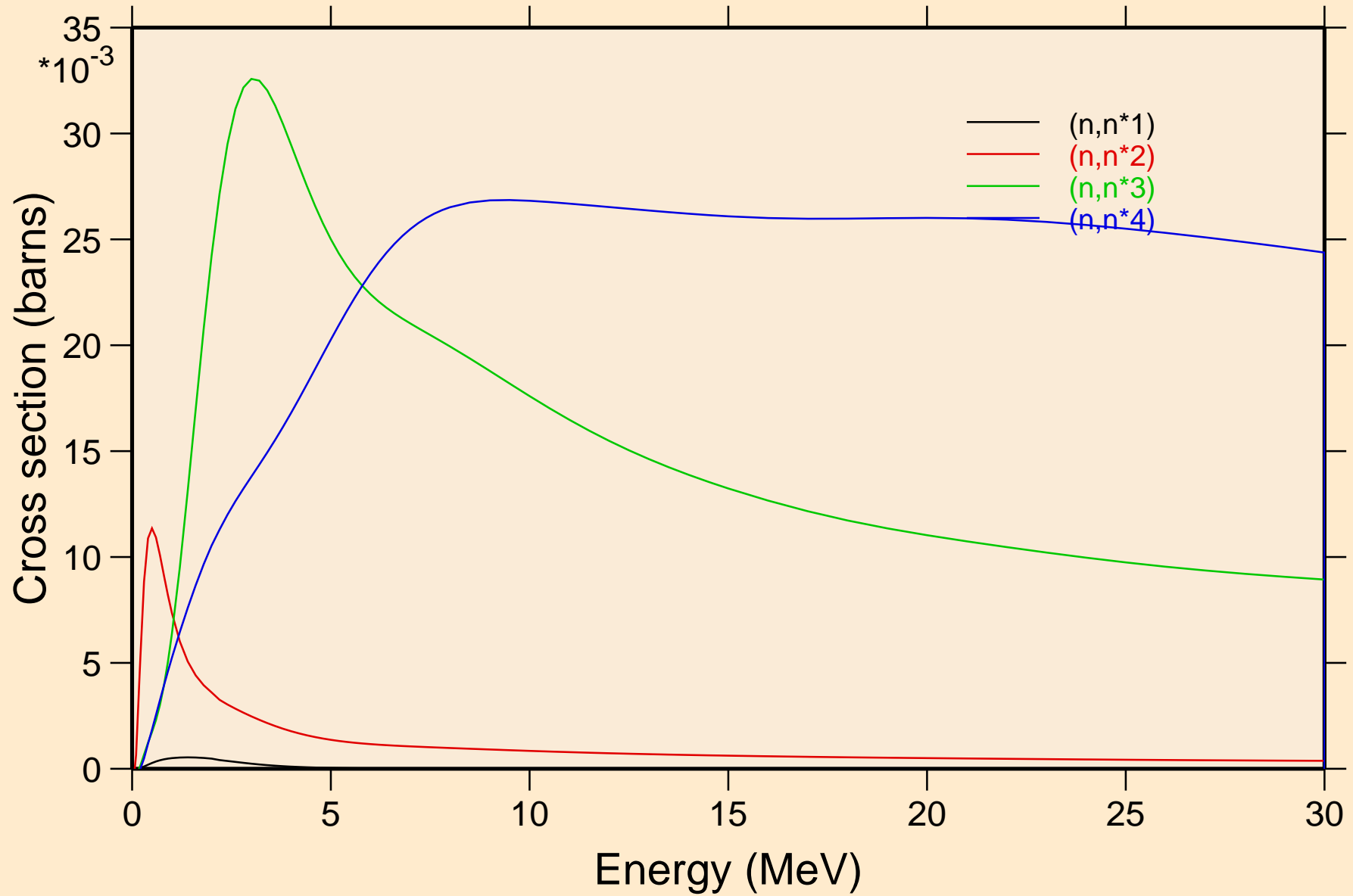

NB084 NRG TENDL-2015, AKONING

Threshold reactions

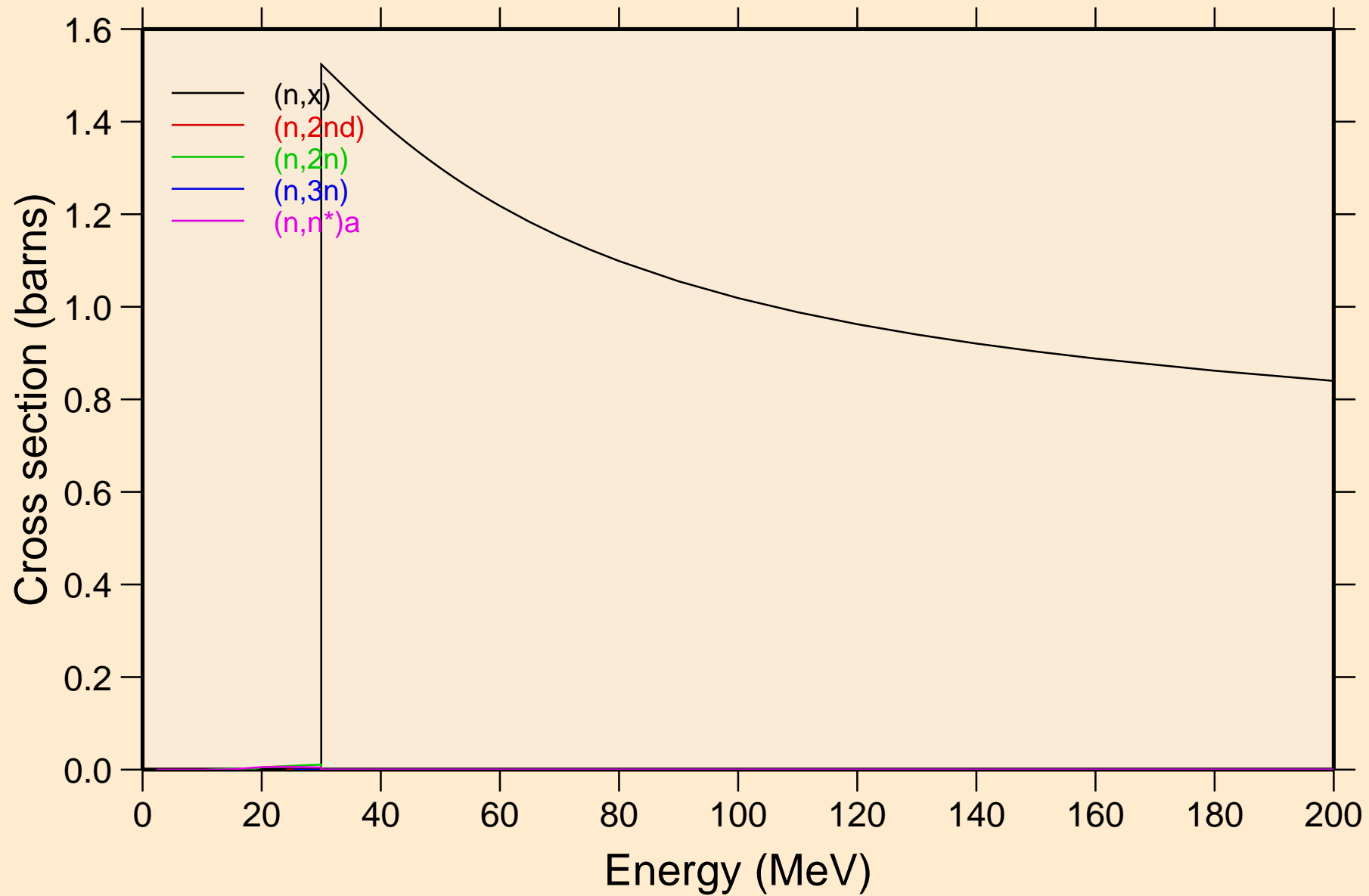

NB084 NRG TENDL-2015, AKONING

Threshold reactions

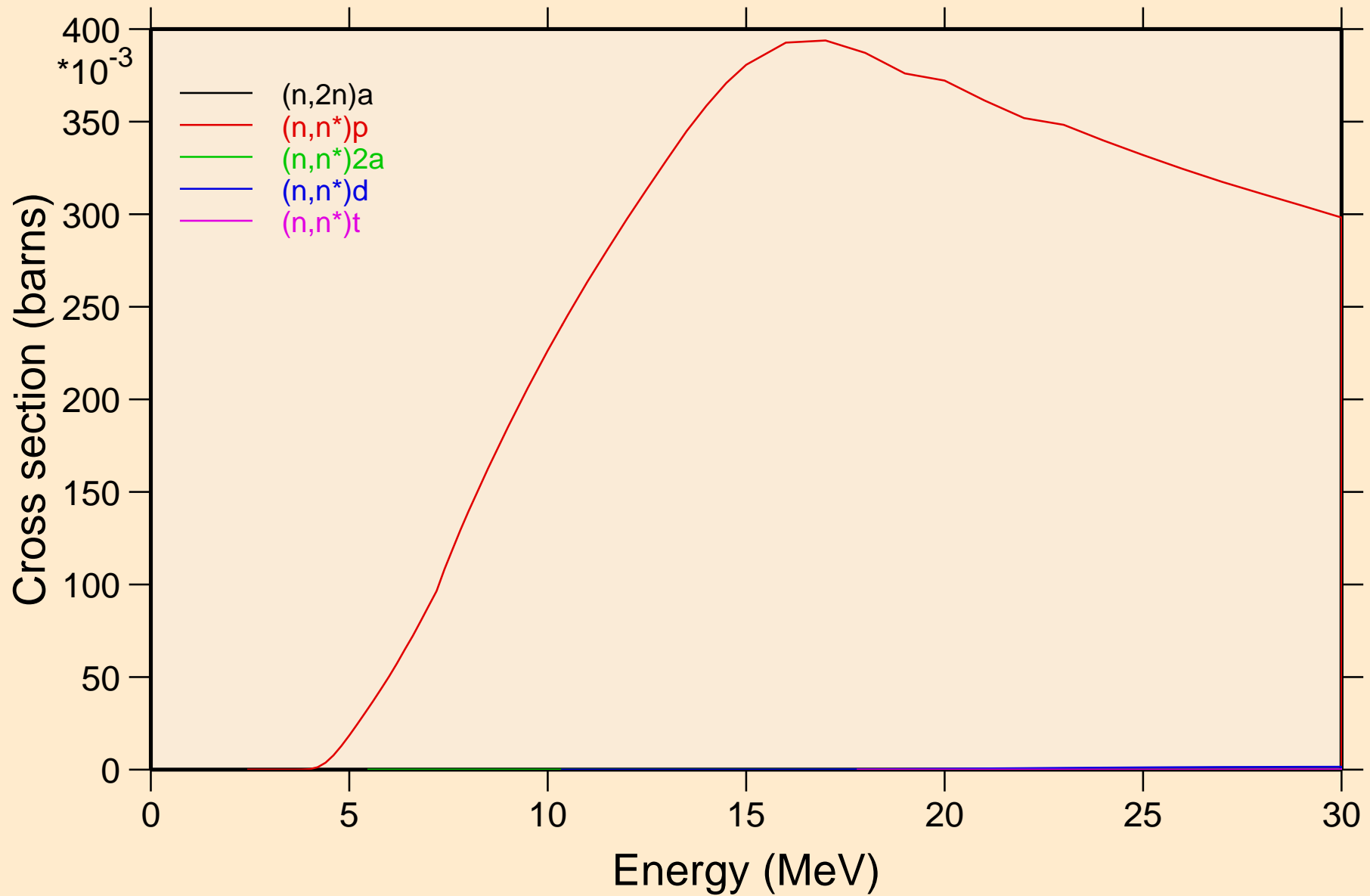

NB084 NRG TENDL-2015, AKONING

Threshold reactions

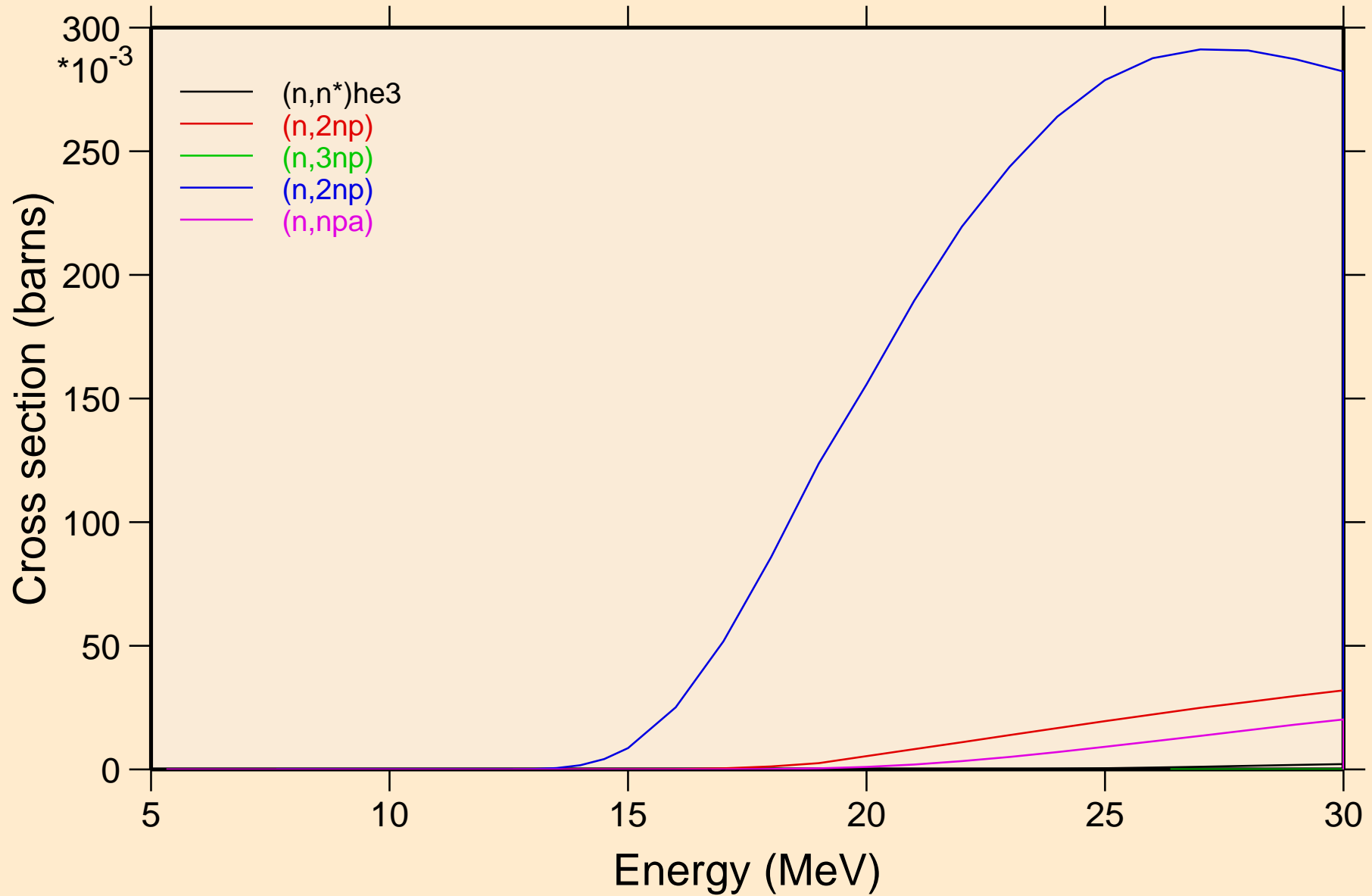

NB084 NRG TENDL-2015, AKONING

Threshold reactions

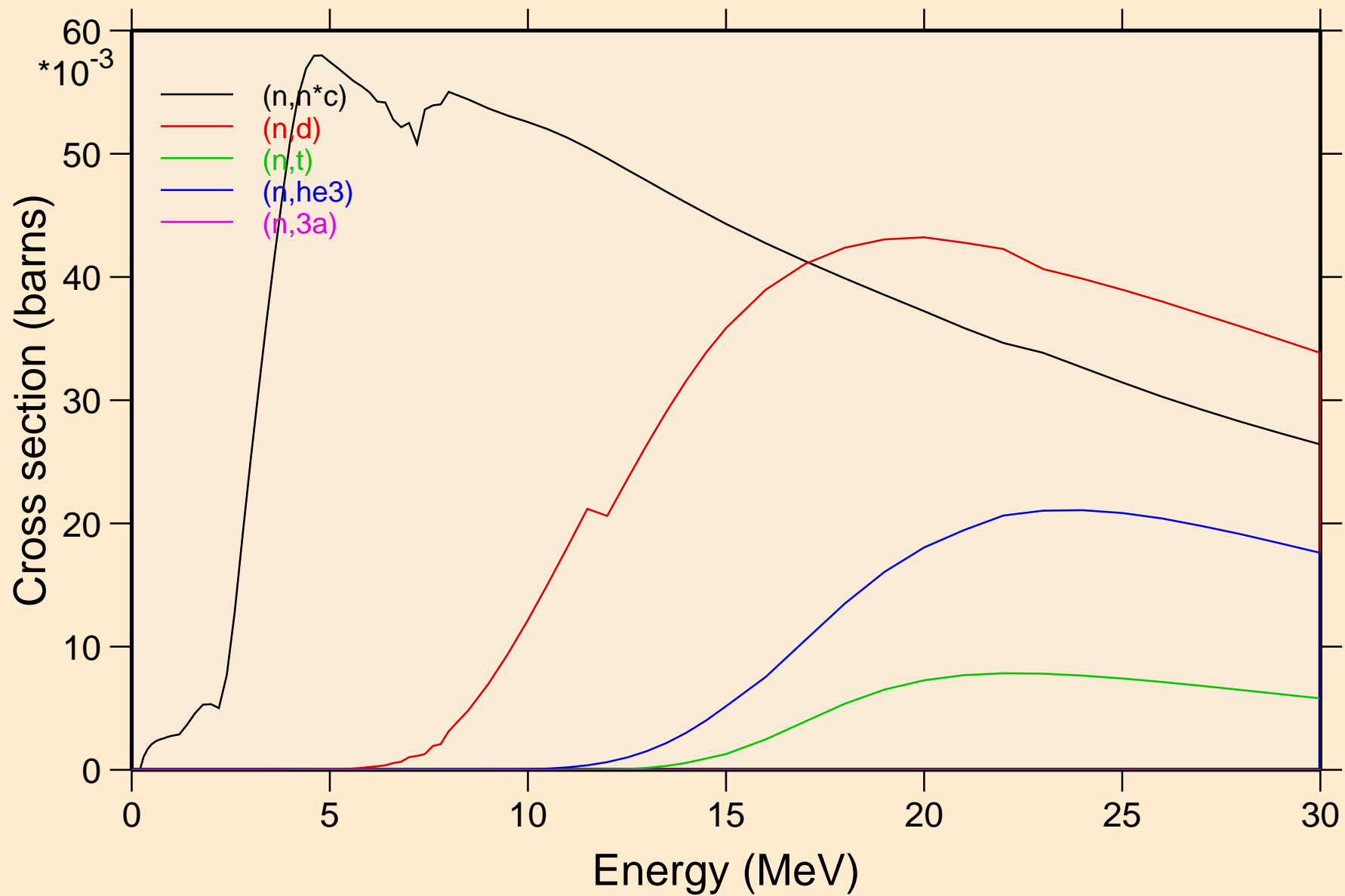

NB084 NRG TENDL-2015, AKONING

Threshold reactions

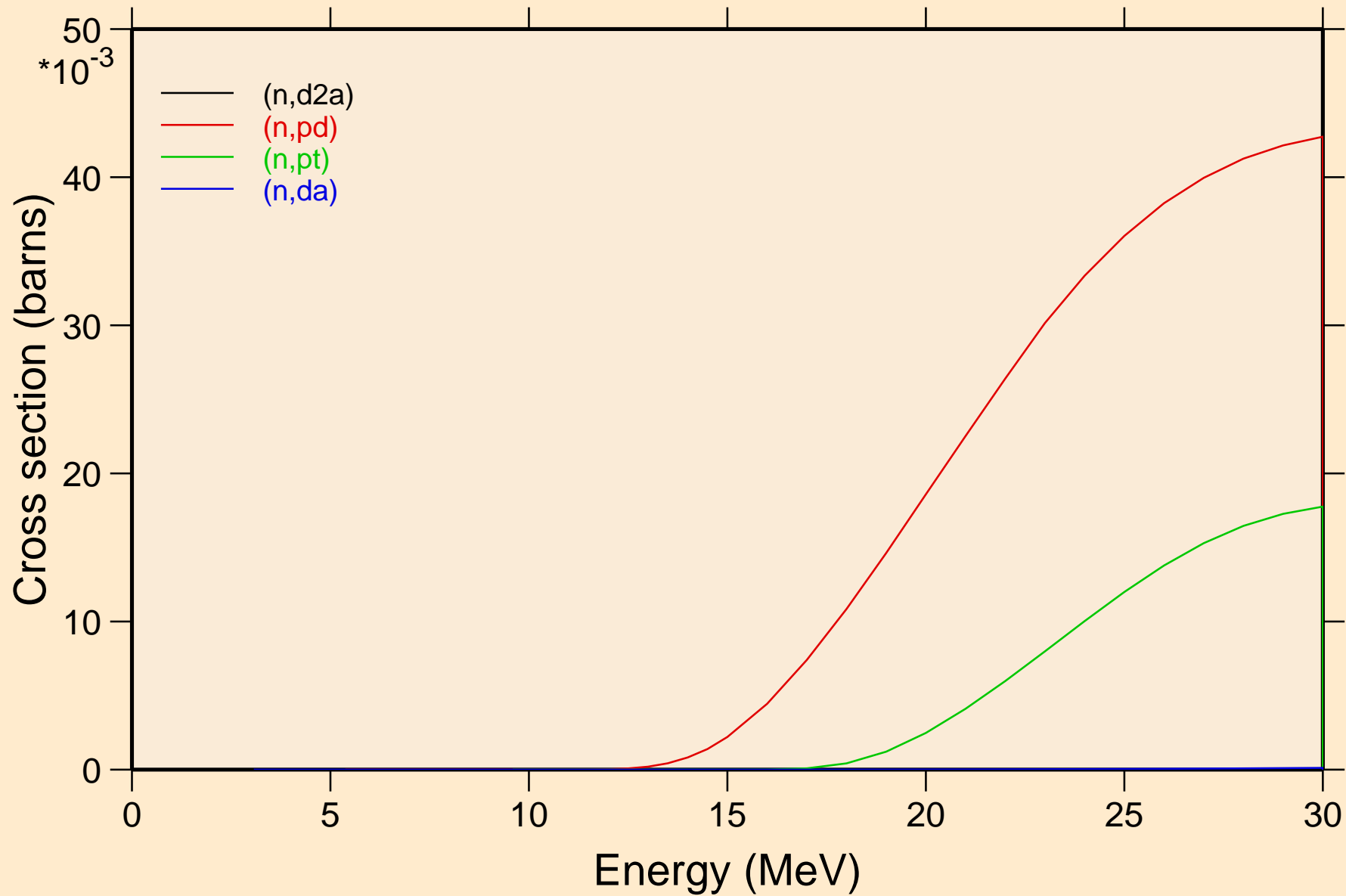

NB084 NRG TENDL-2015, AKONING
angular distribution for elastic

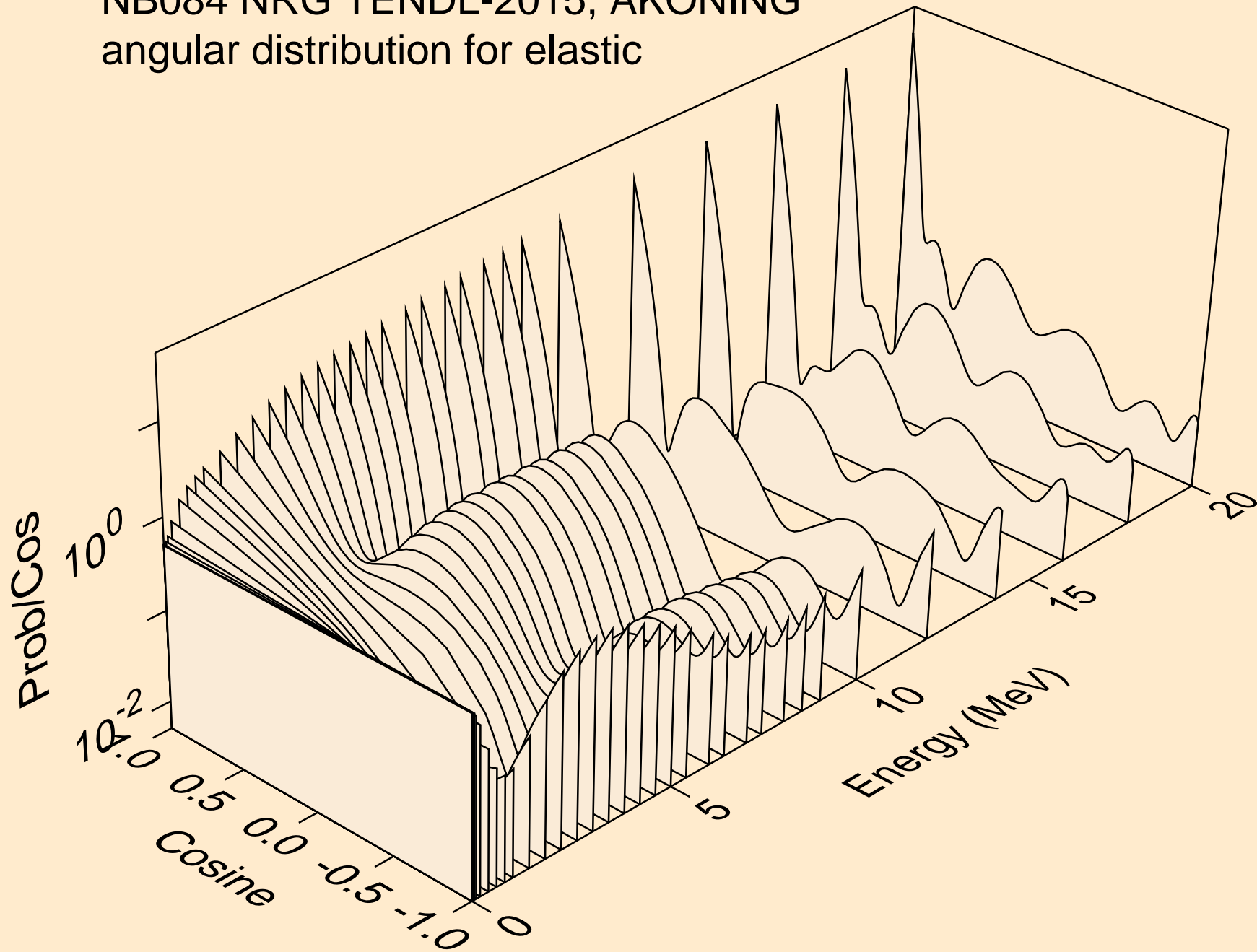

NB084 NRG TENDL-2015, AKONING
angular distribution for elastic

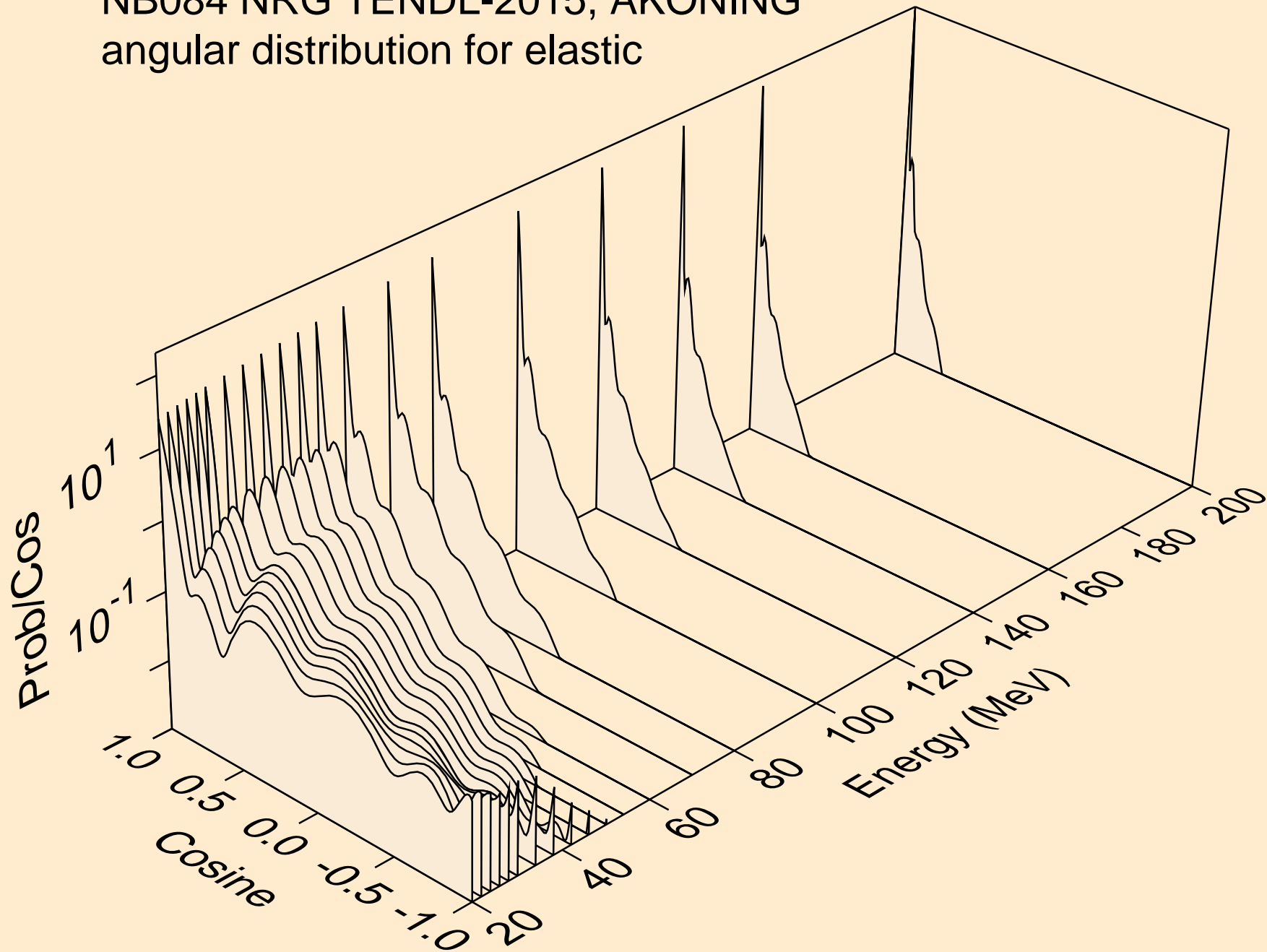

NB084 NRG TENDL-2015, AKONING
angular distribution for (n,n*1)

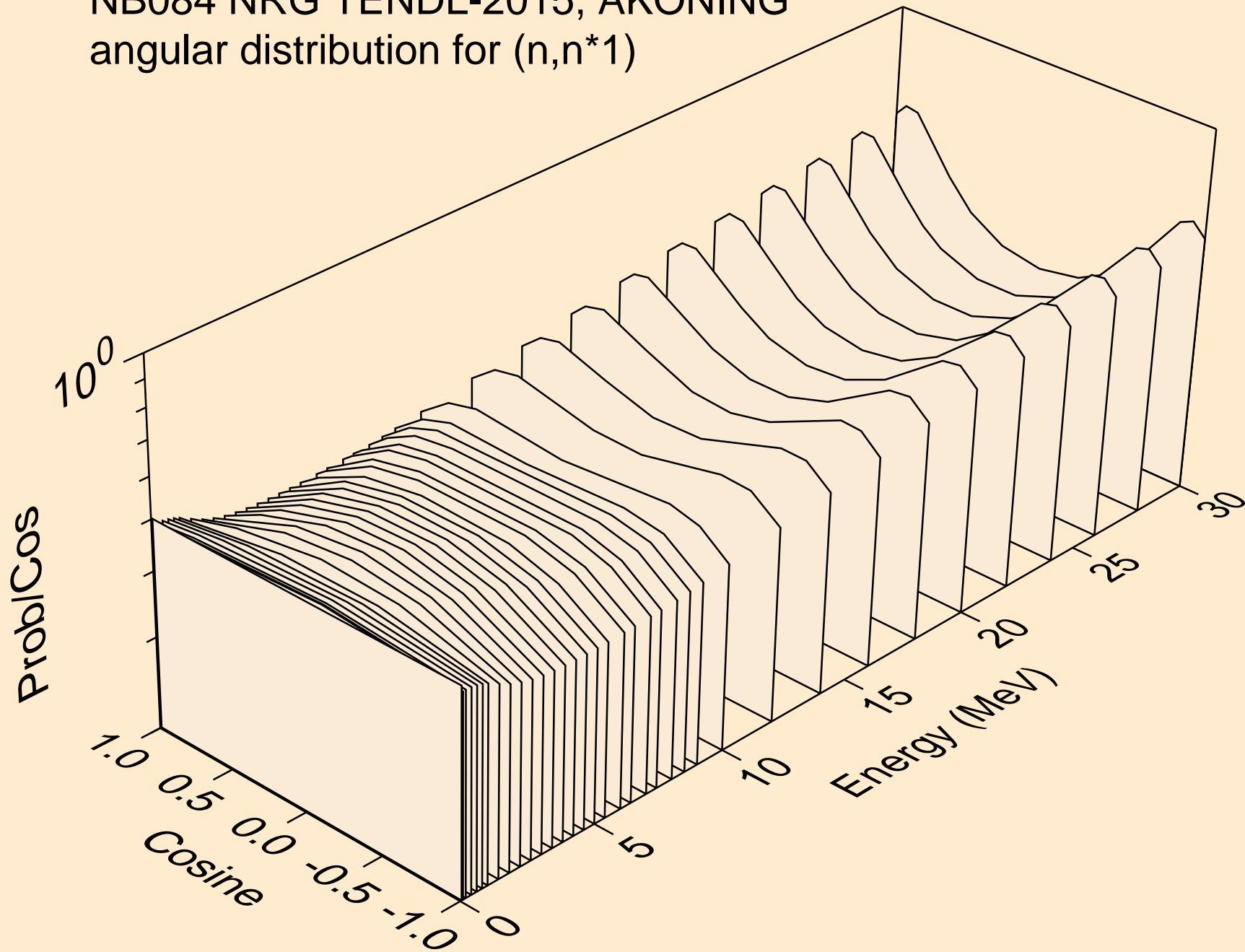

NB084 NRG TENDL-2015, AKONING
angular distribution for (n,n*2)

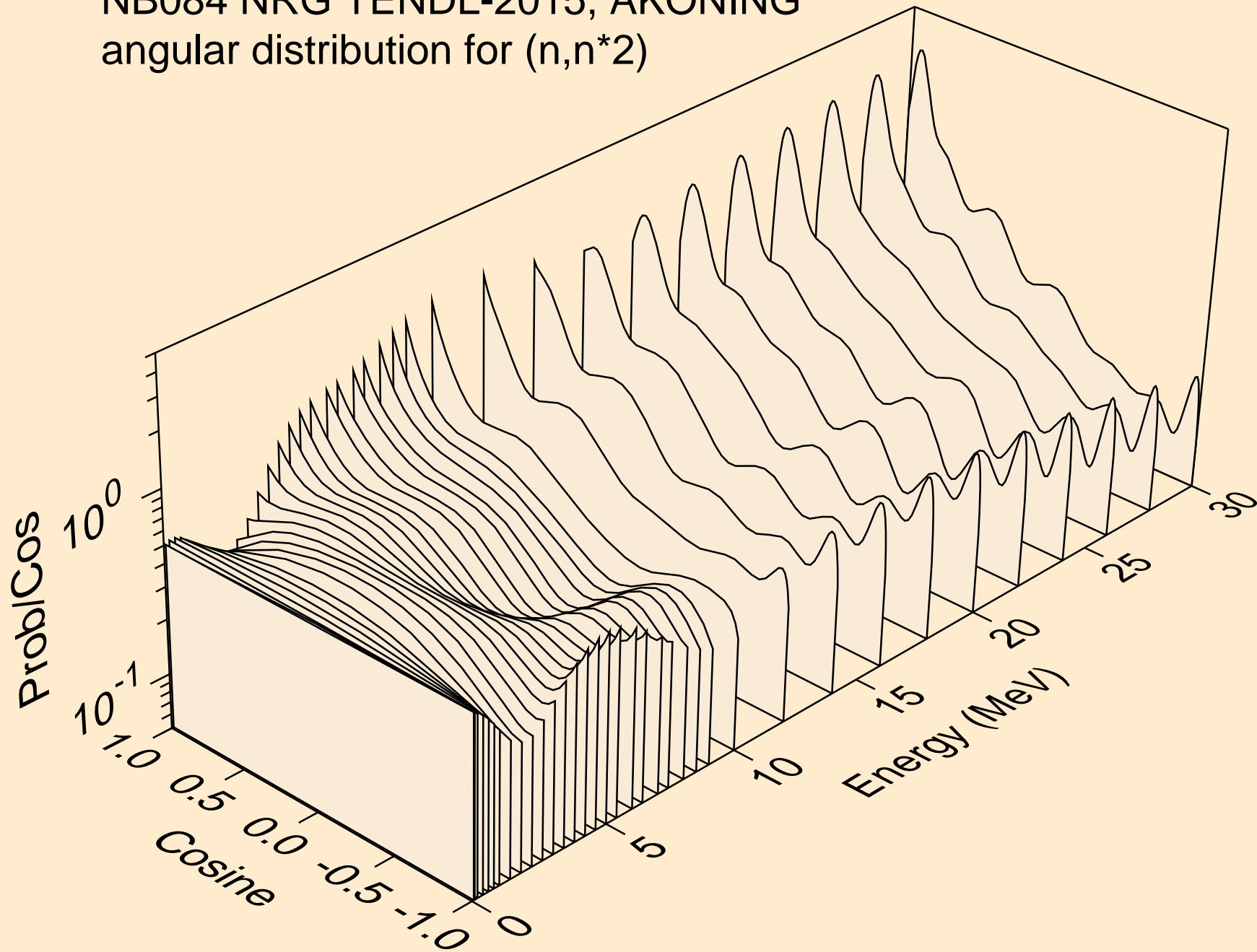

NB084 NRG TENDL-2015, AKONING
angular distribution for (n,n*3)

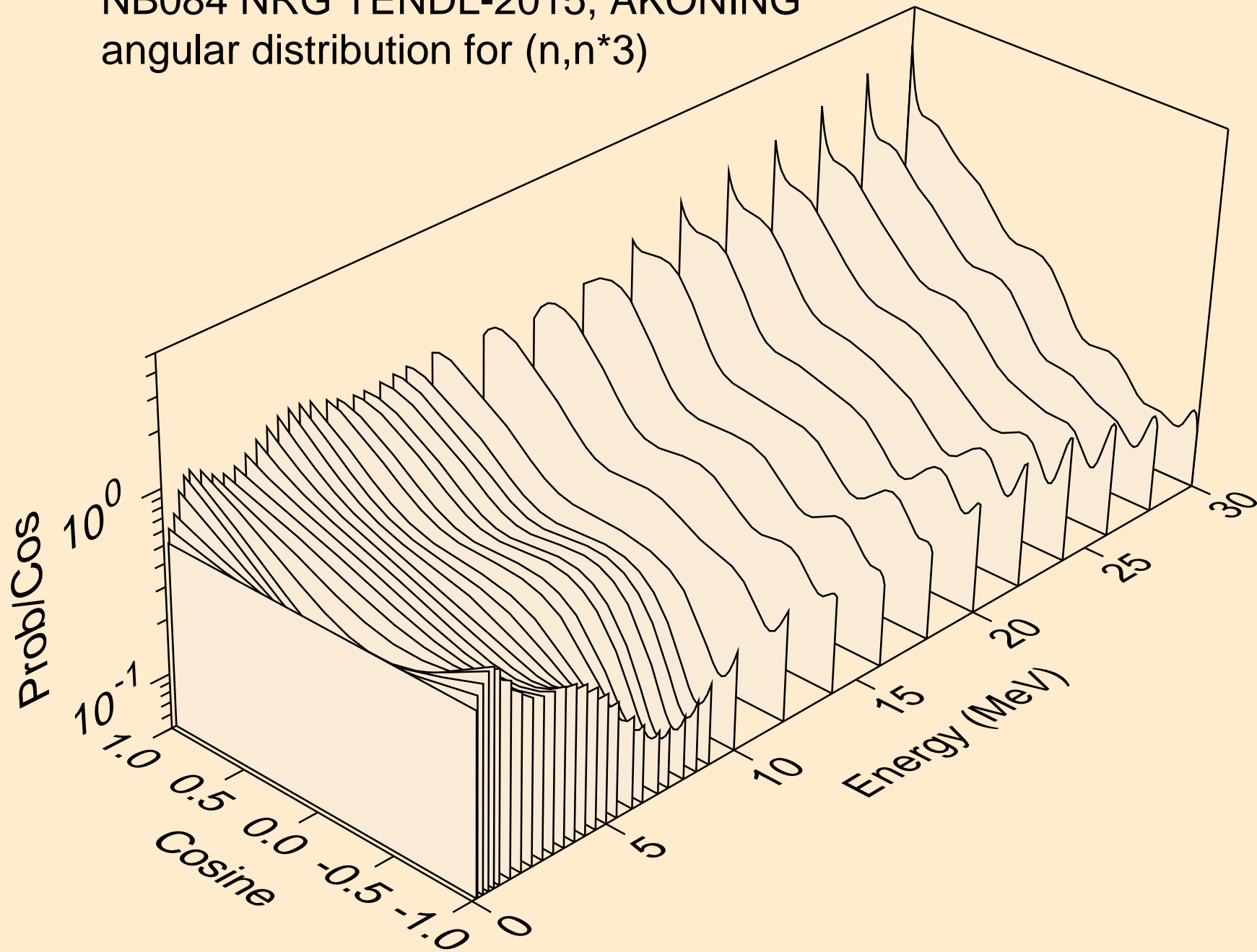

NB084 NRG TENDL-2015, AKONING
angular distribution for (n,n*4)

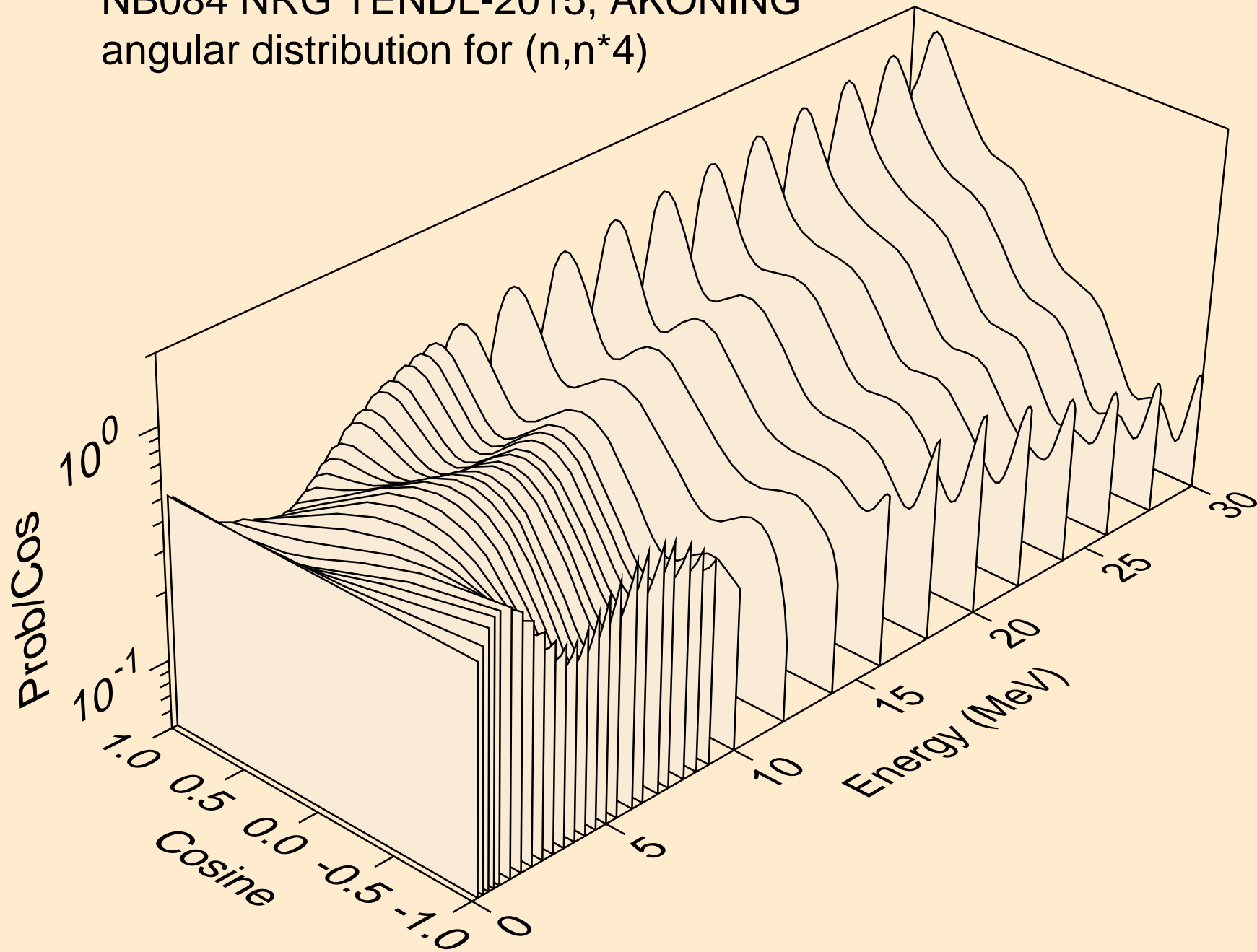

NB084 NRG TENDL-2015, AKONING
Neutron emission for (n,x)

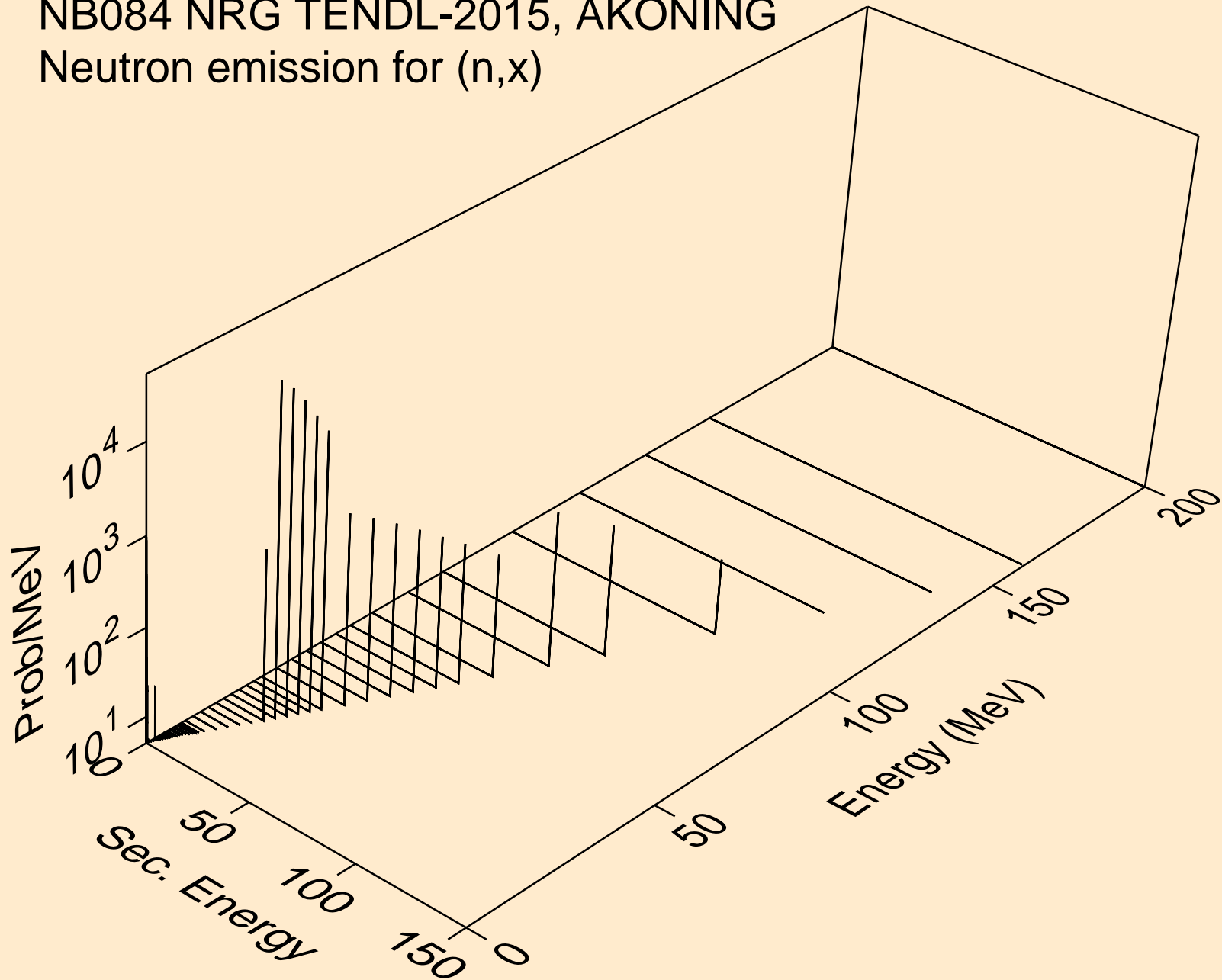

NB084 NRG TENDL-2015, AKONING
Neutron emission for (n,2nd)

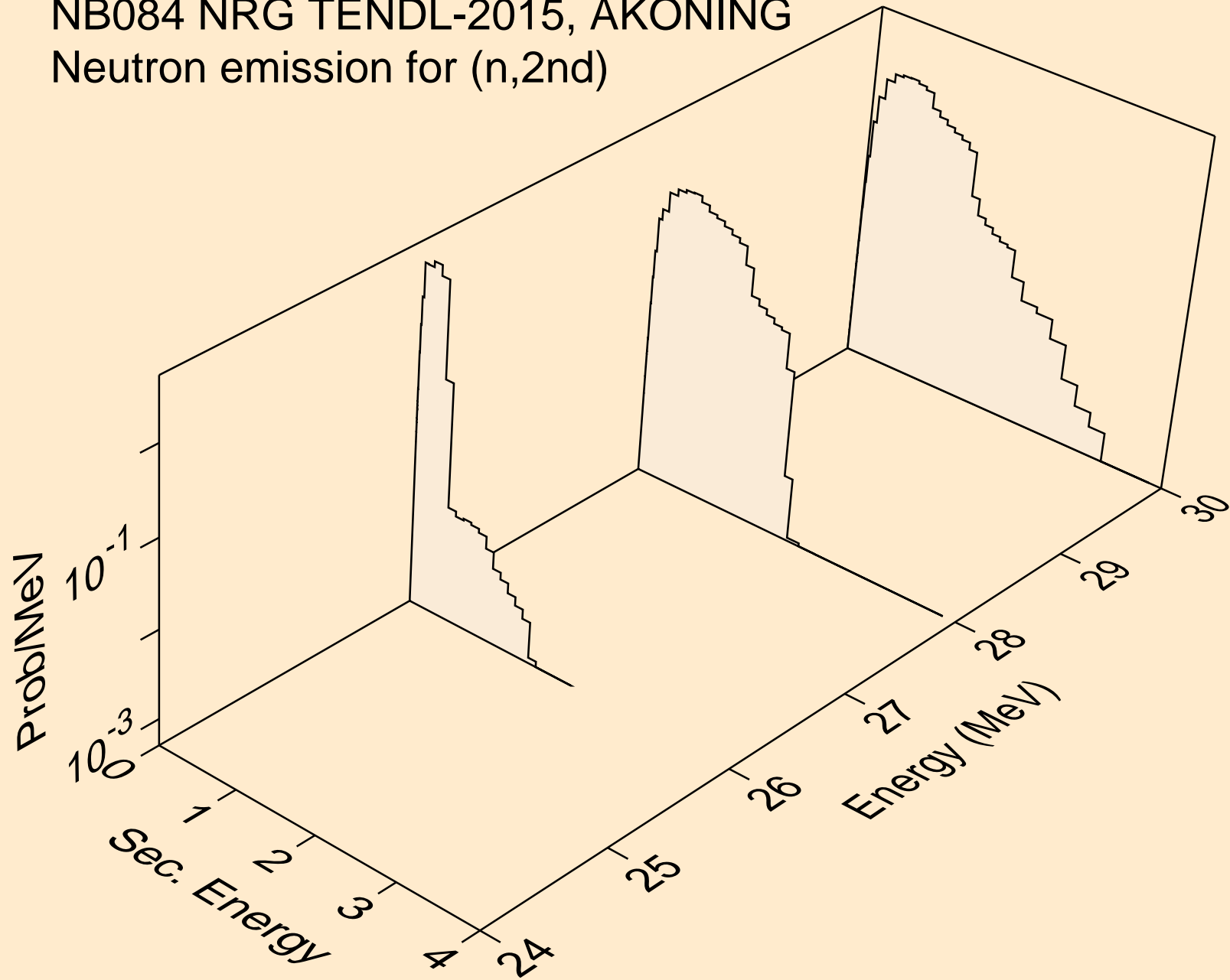

NB084 NRG TENDL-2015, AKONING
Neutron emission for (n,2n)

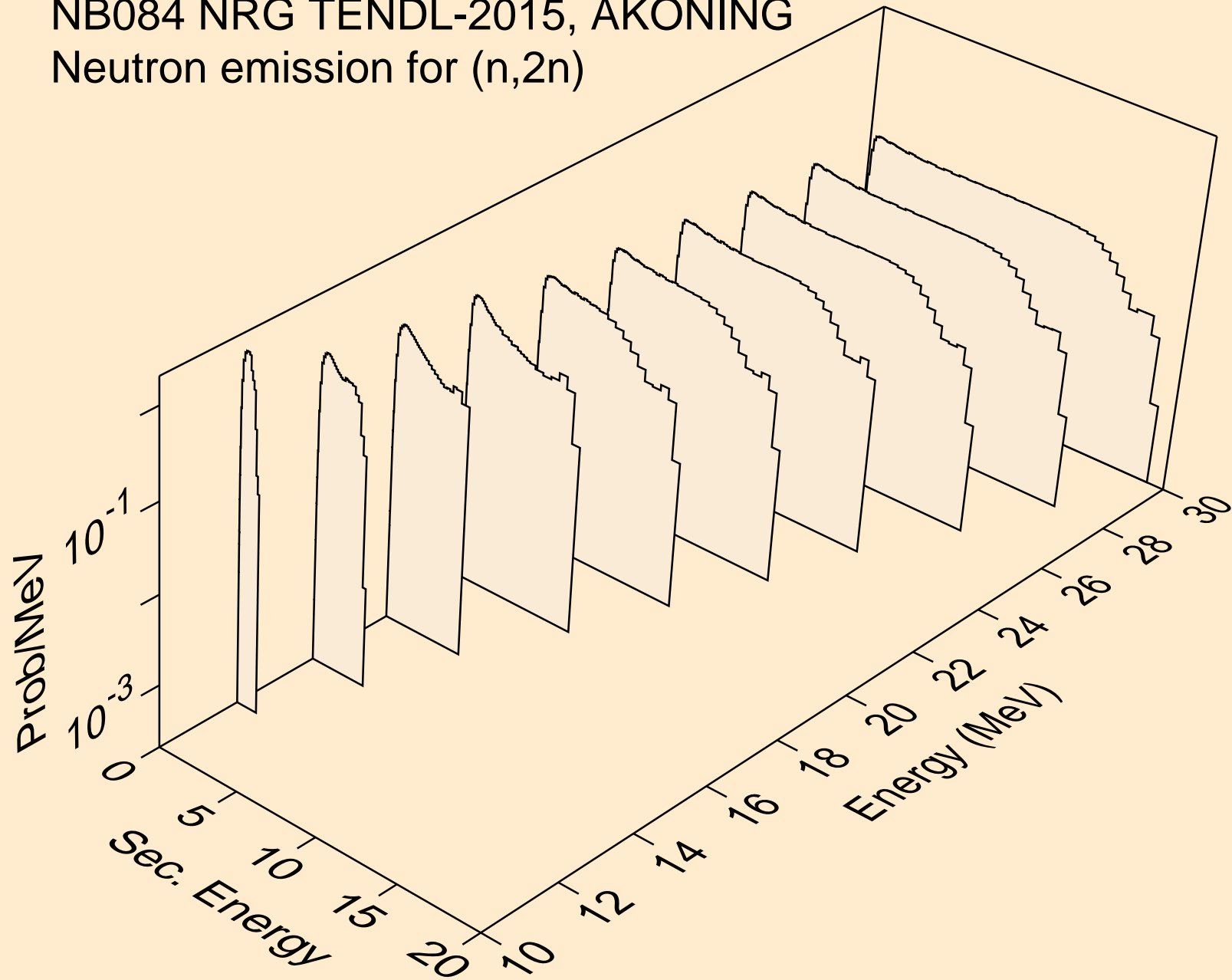

NB084 NRG TENDL-2015, AKONING
Neutron emission for (n,3n)

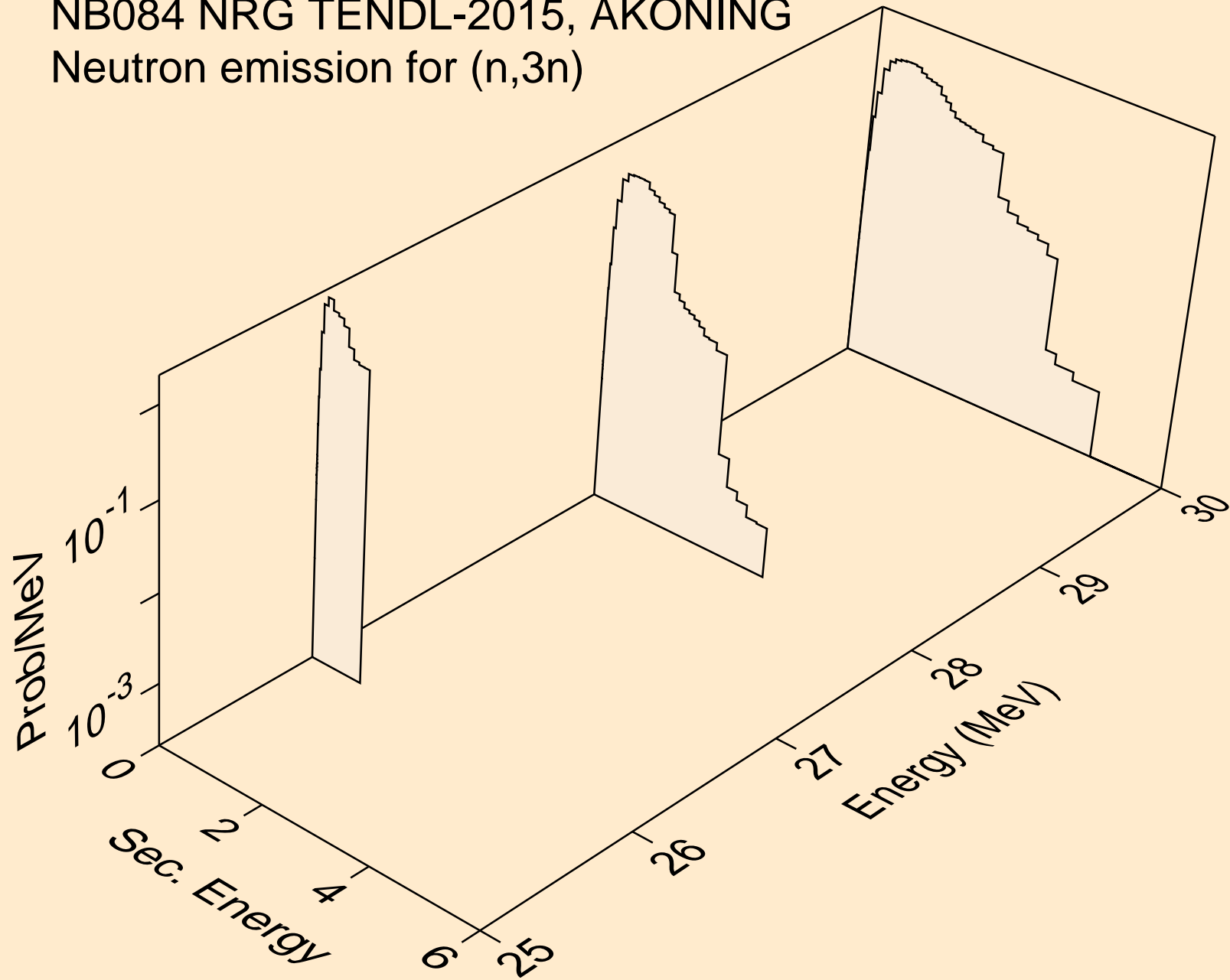

NB084 NRG TENDL-2015, AKONING
Neutron emission for (n,n*)a

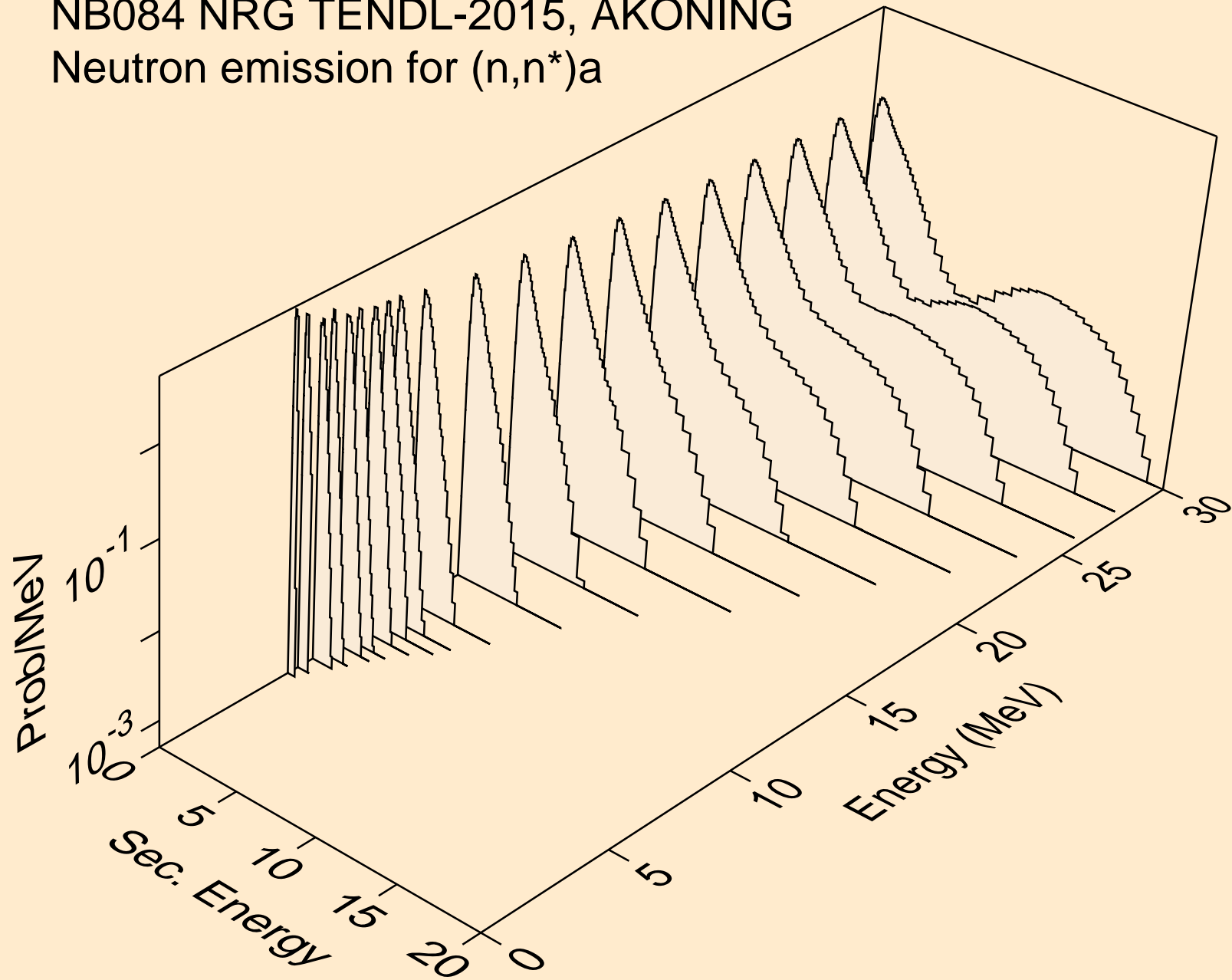

NB084 NRG TENDL-2015, AKONING
Neutron emission for (n,2n)a

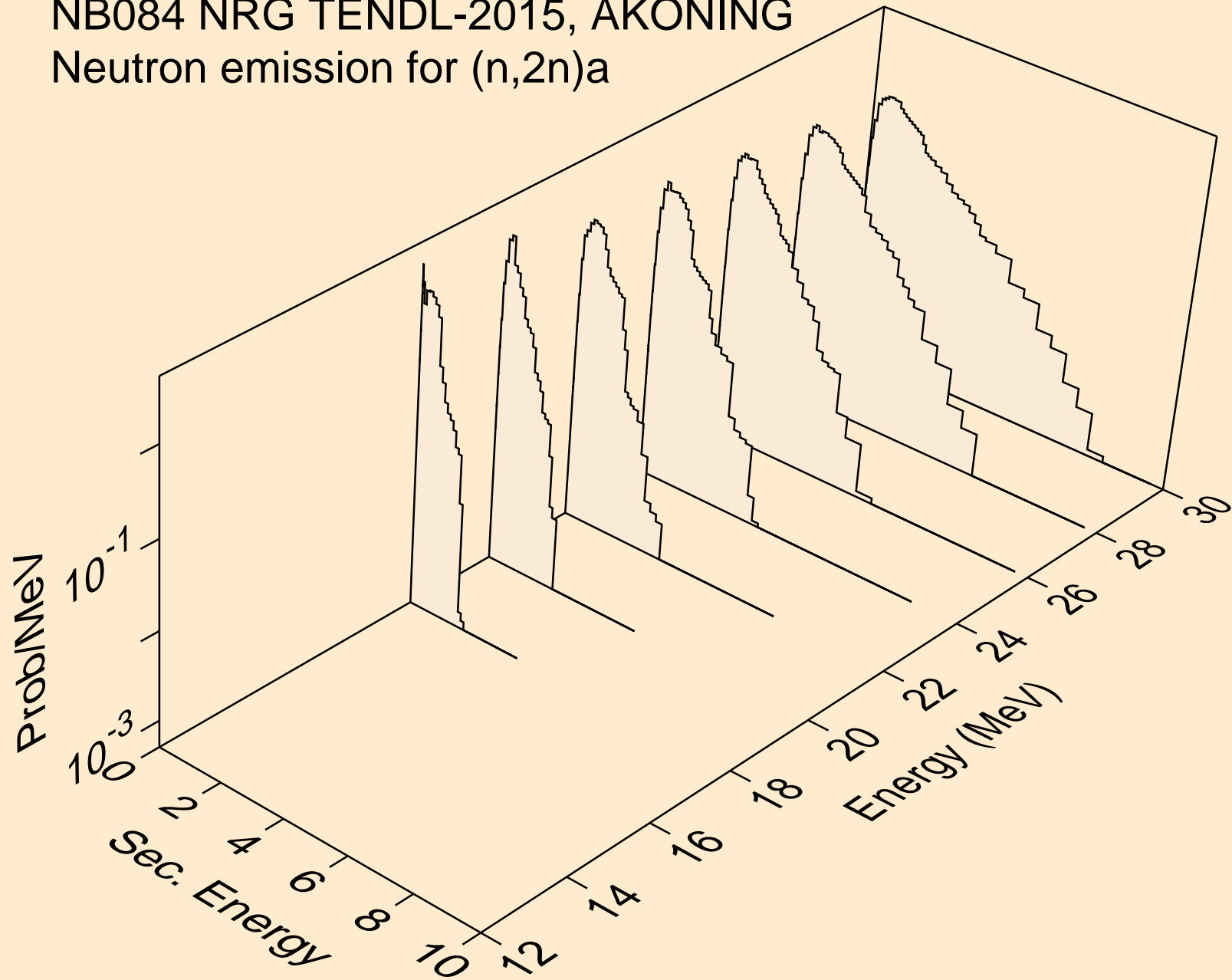

NB084 NRG TENDL-2015, AKONING
Neutron emission for (n,n*)p

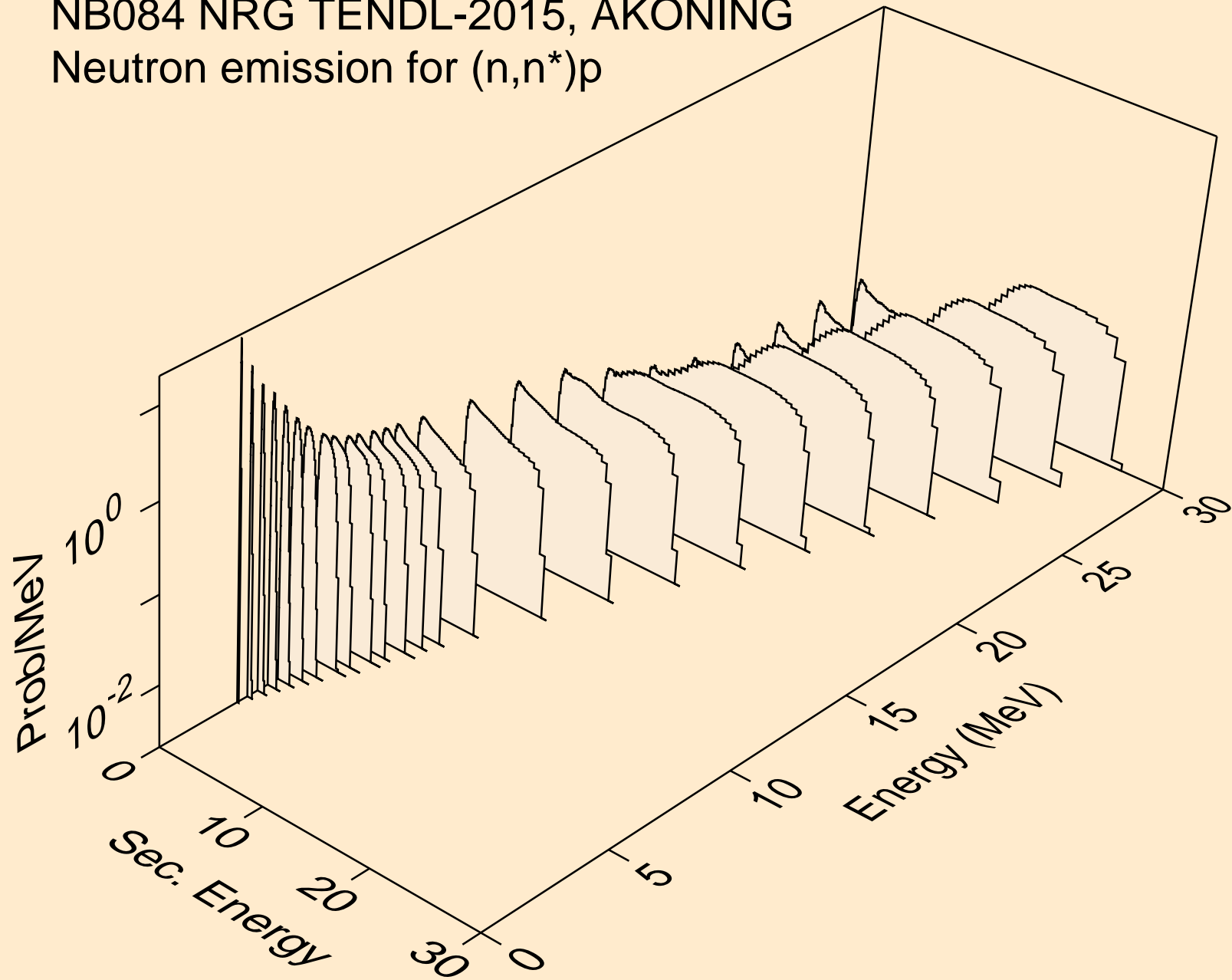

NB084 NRG TENDL-2015, AKONING
Neutron emission for (n,n*)2a

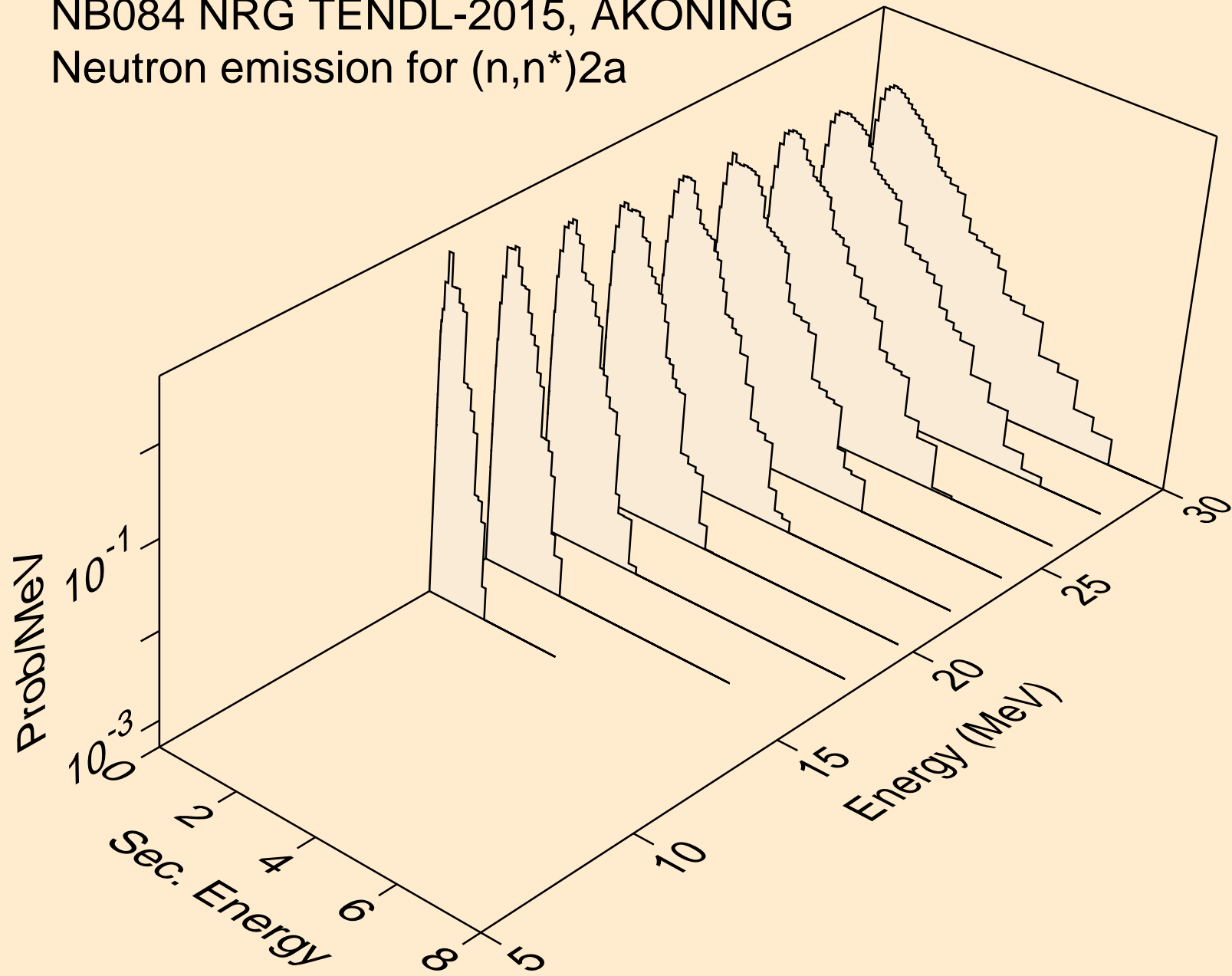

NB084 NRG TENDL-2015, AKONING
Neutron emission for (n,n*)d

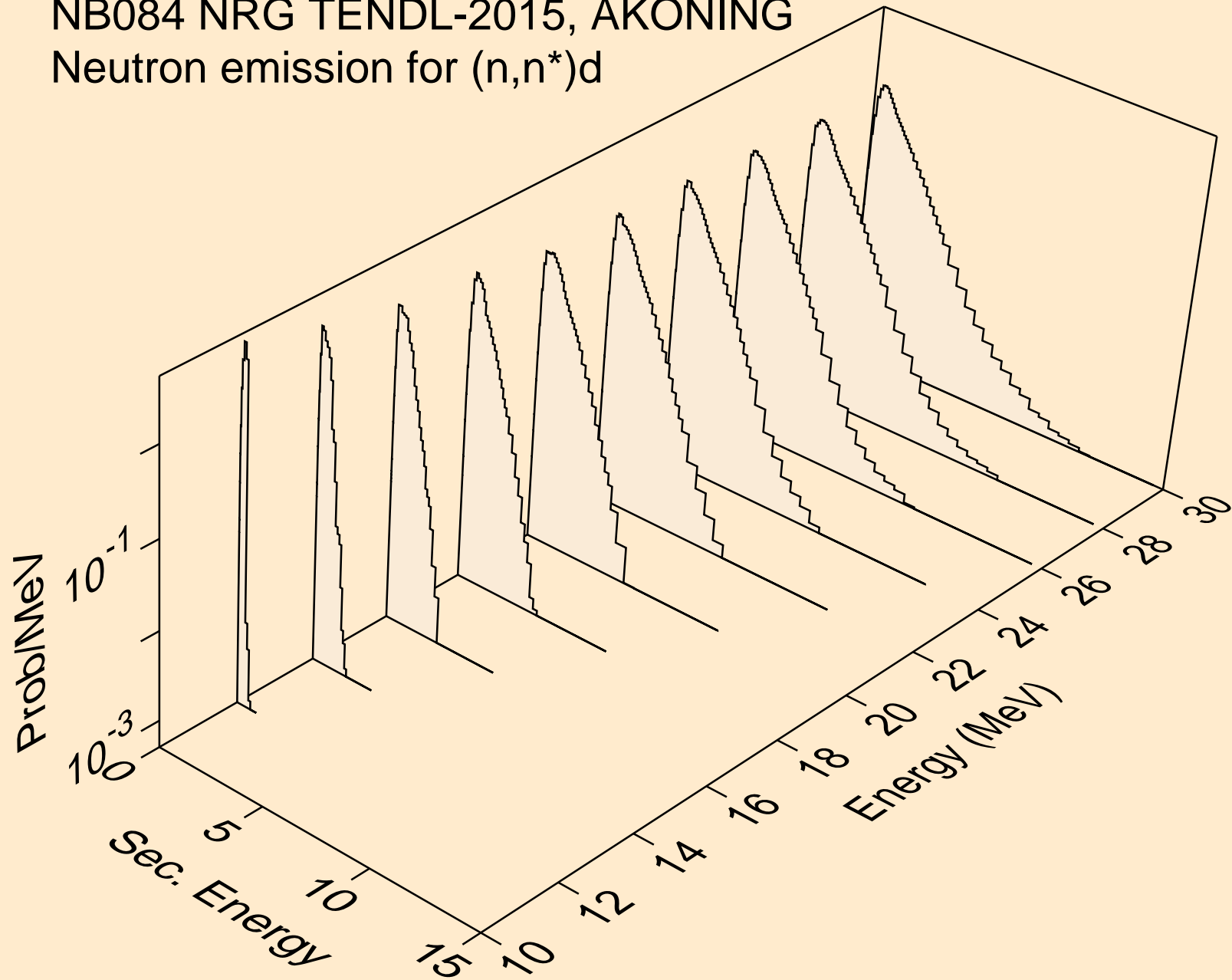

NB084 NRG TENDL-2015, AKONING
Neutron emission for (n,n*)t

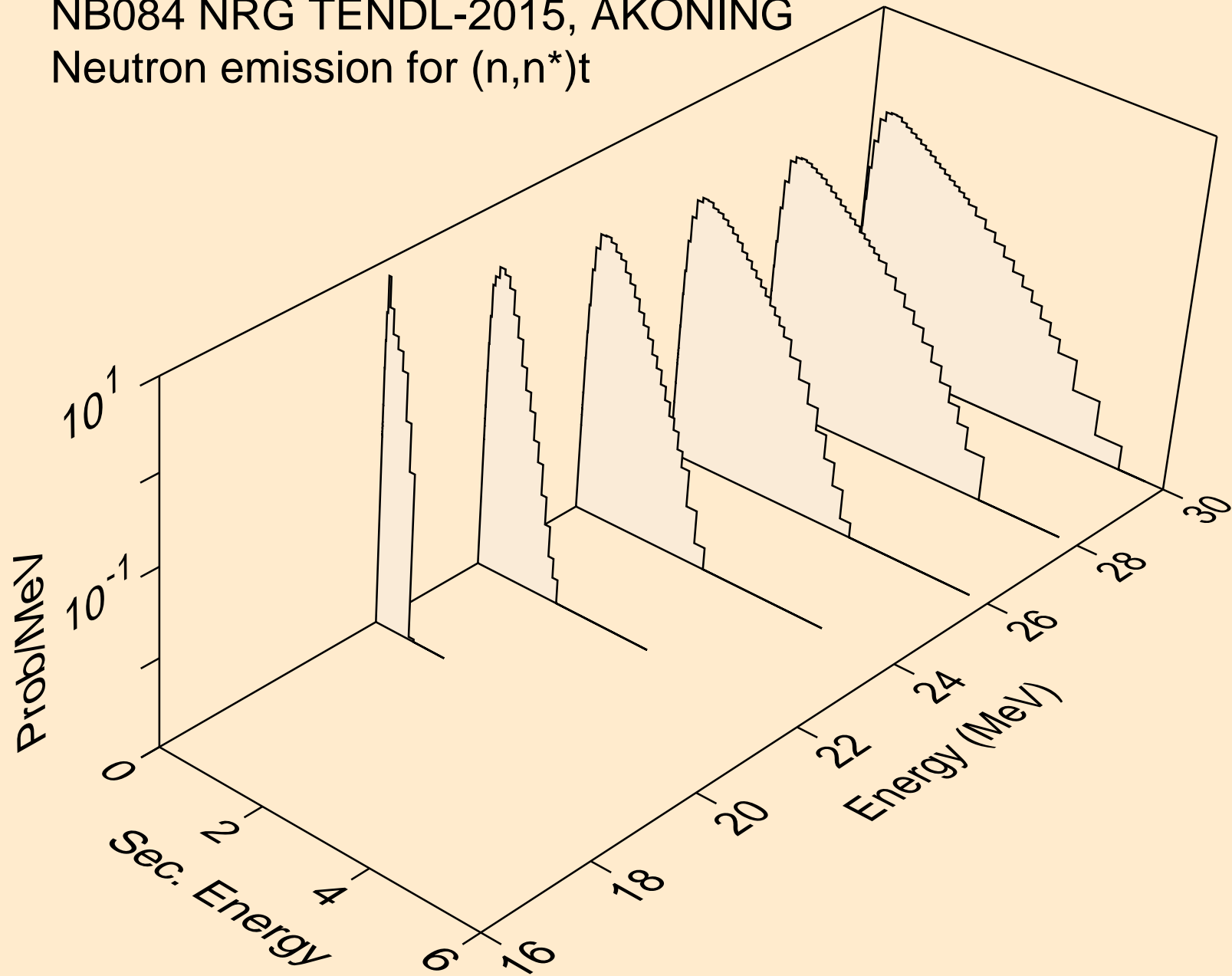

NB084 NRG TENDL-2015, AKONING
Neutron emission for (n,n*)he3

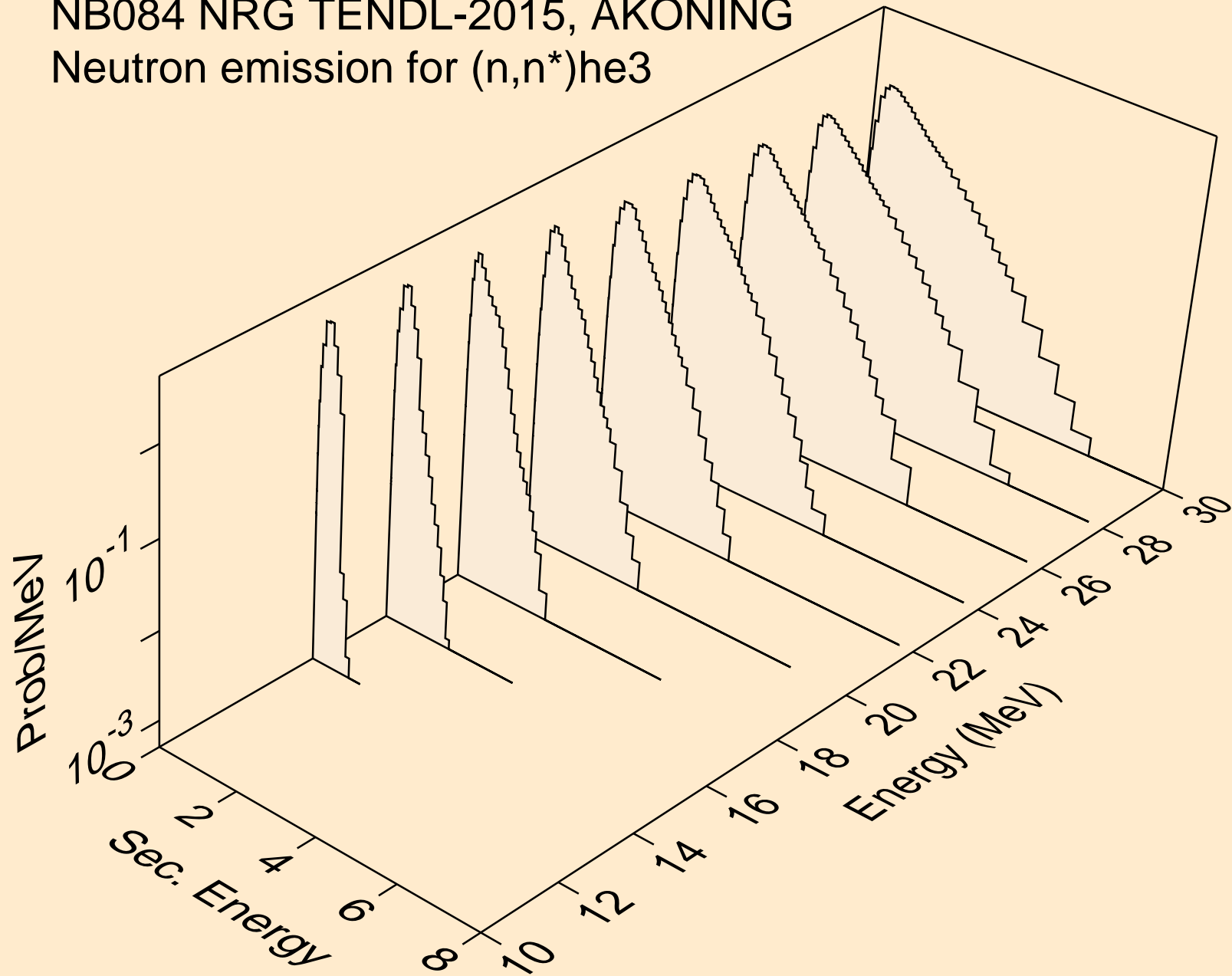

NB084 NRG TENDL-2015, AKONING
Neutron emission for (n,2np)

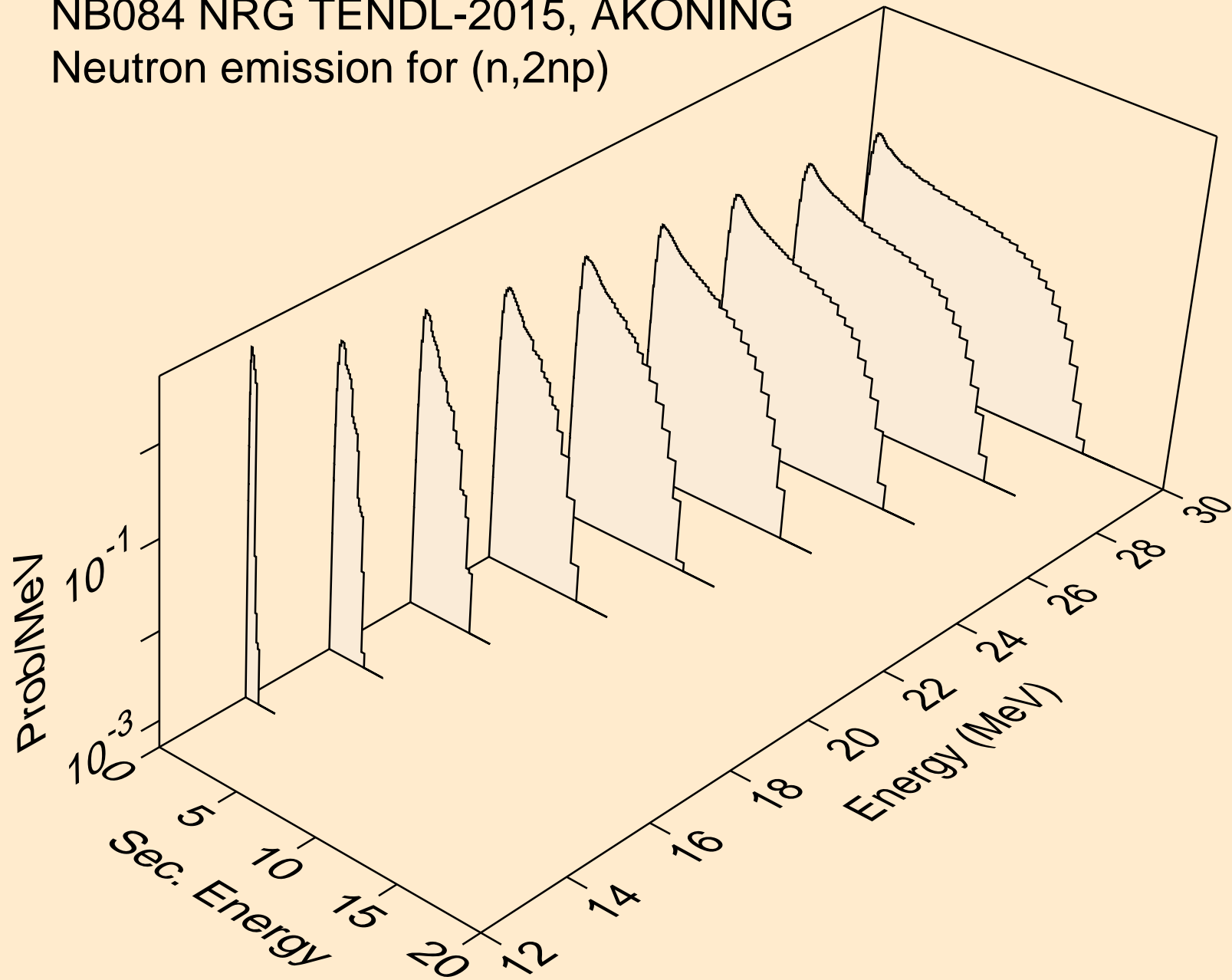

NB084 NRG TENDL-2015, AKONING
Neutron emission for (n,3np)

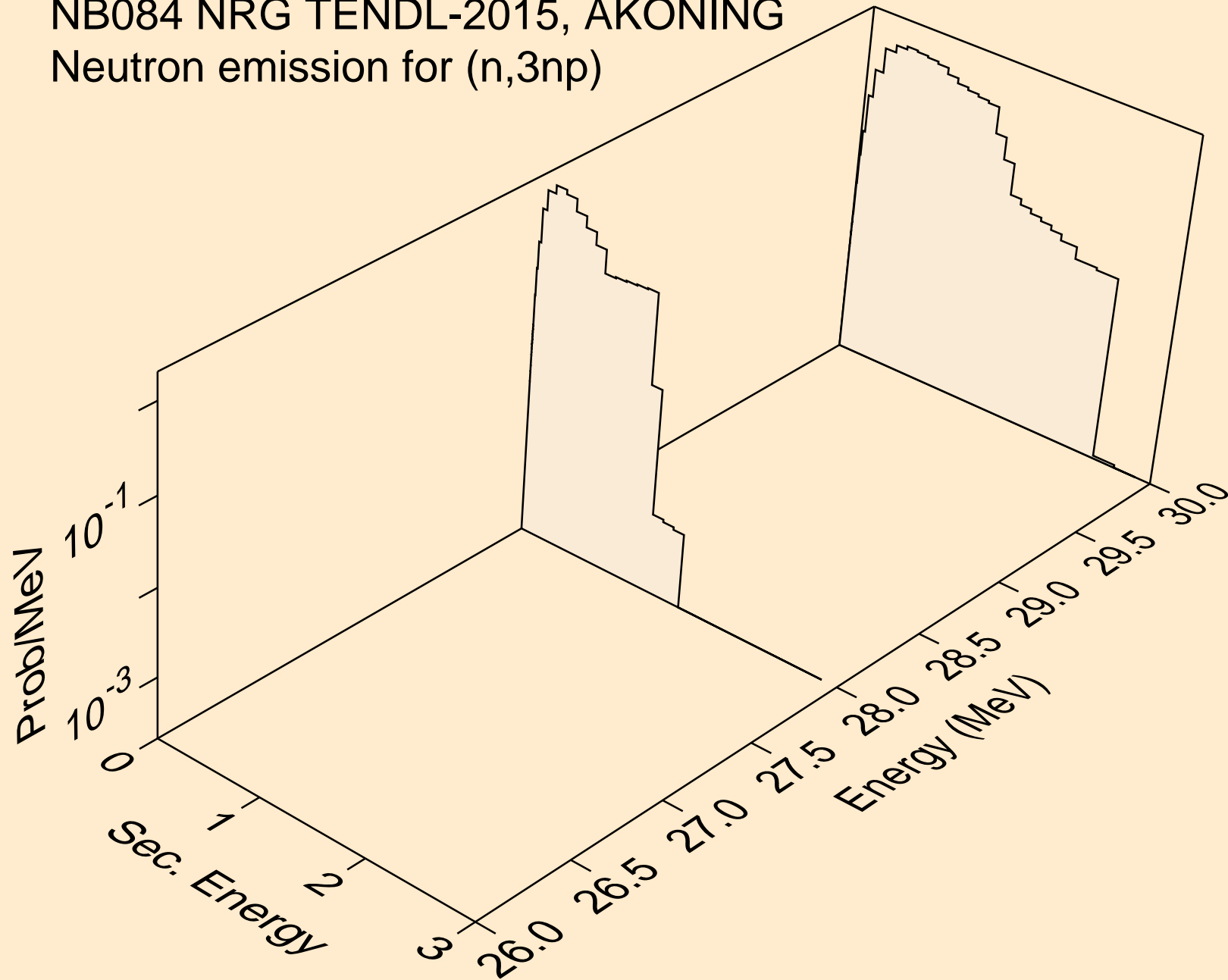

NB084 NRG TENDL-2015, AKONING
Neutron emission for (n,2np)

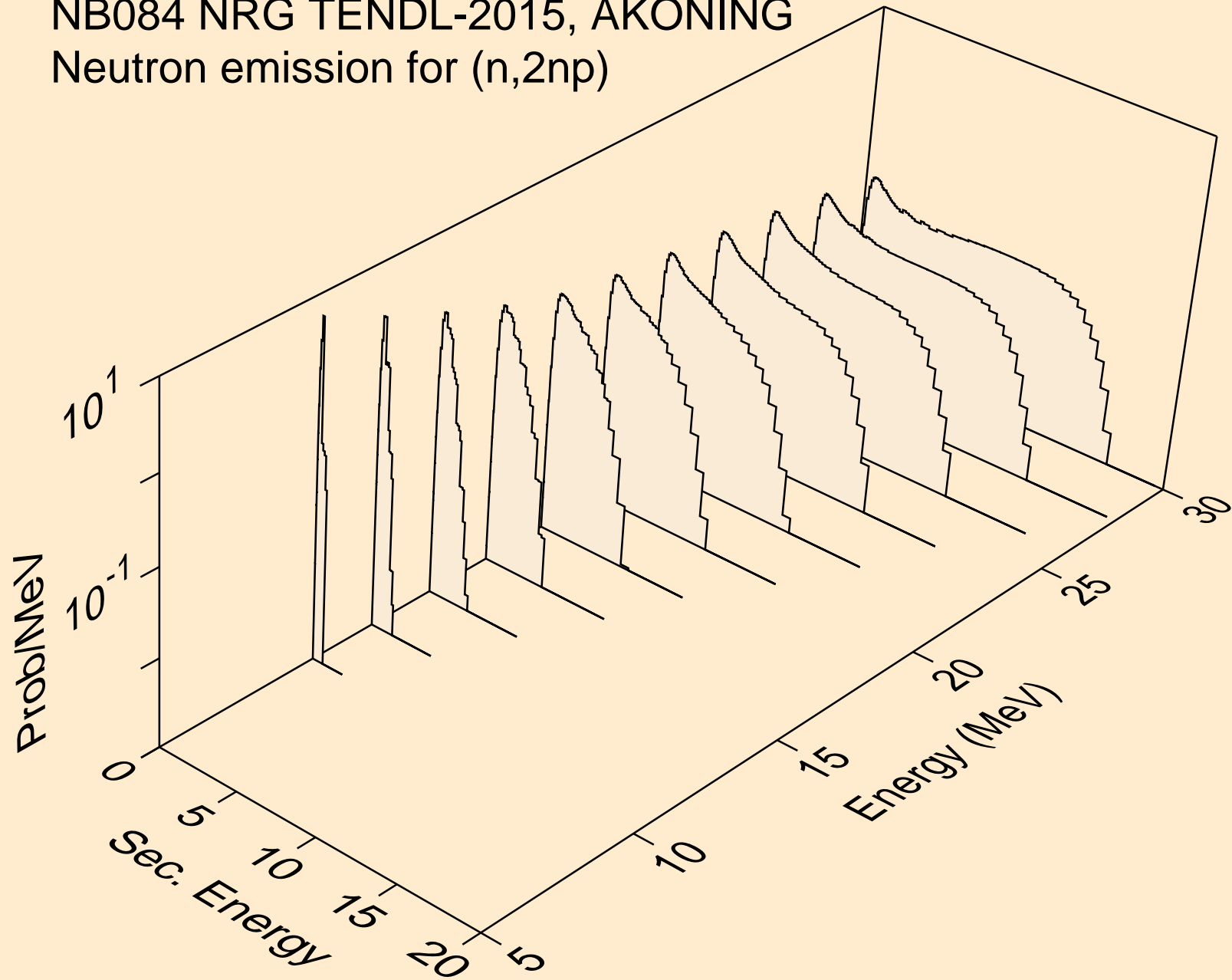

NB084 NRG TENDL-2015, AKONING
Neutron emission for (n,npa)

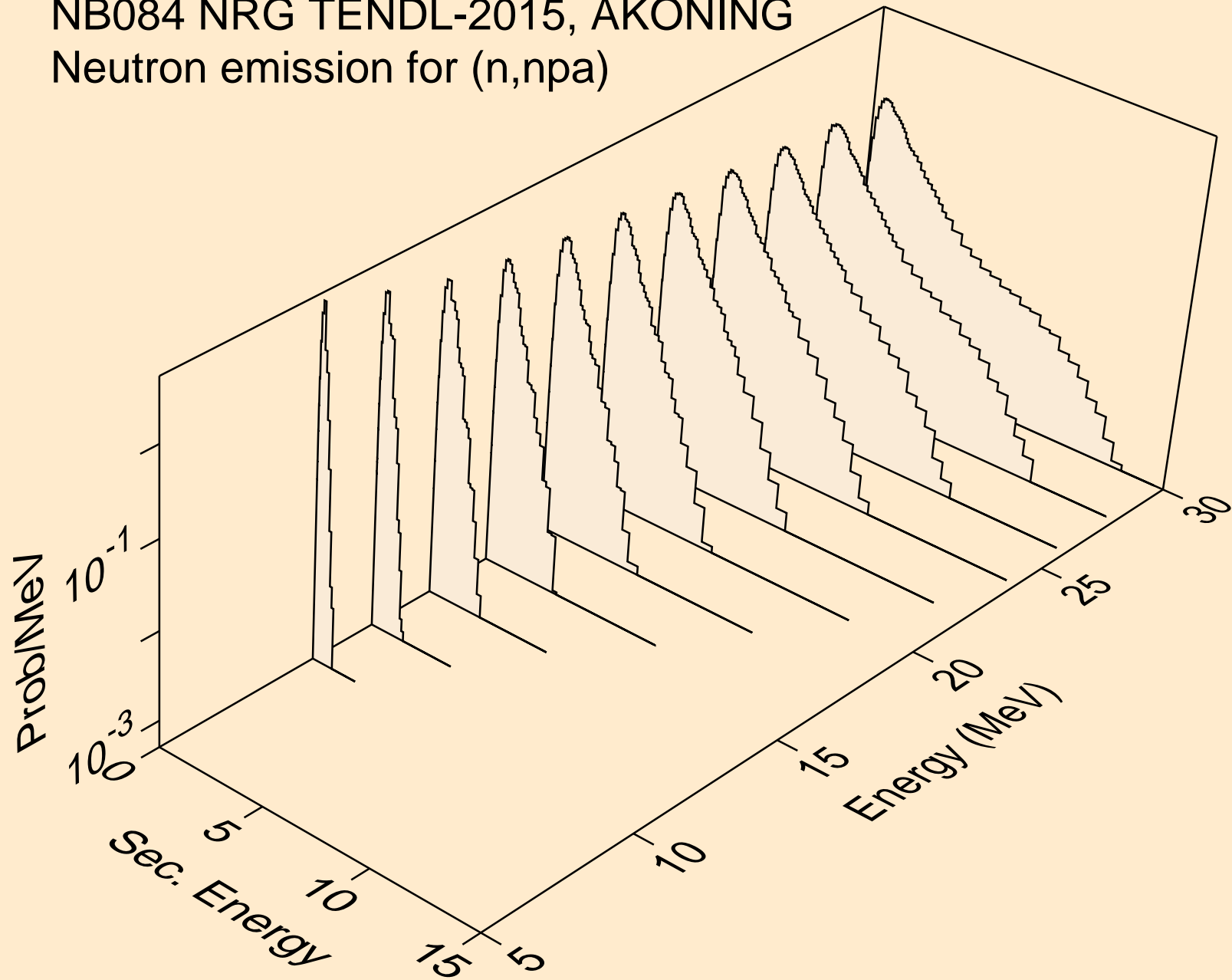

NB084 NRG TENDL-2015, AKONING
Neutron emission for (n,n*c)

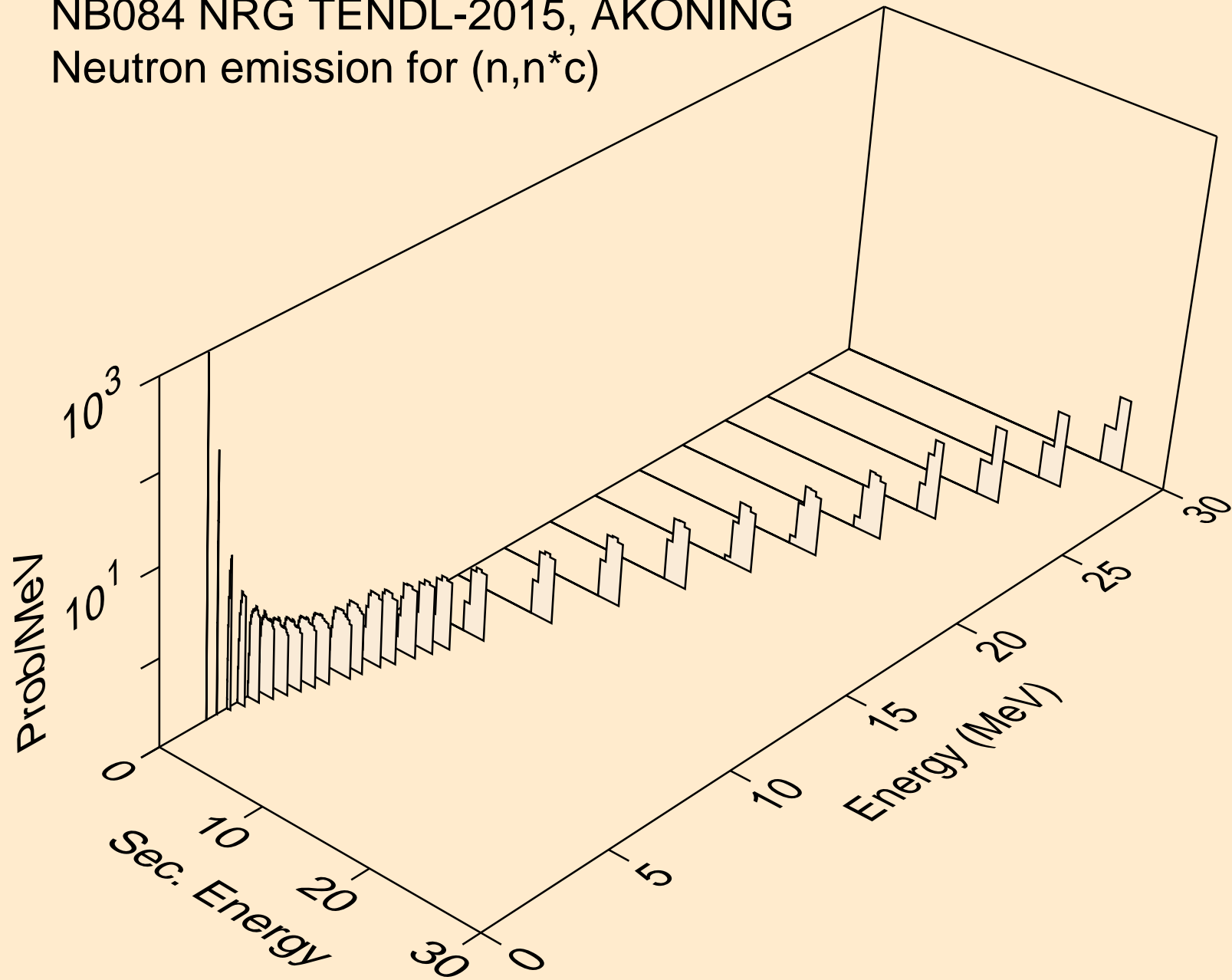

NB084 NRG TENDL-2015, AKONING
Photon emission for (n,x)

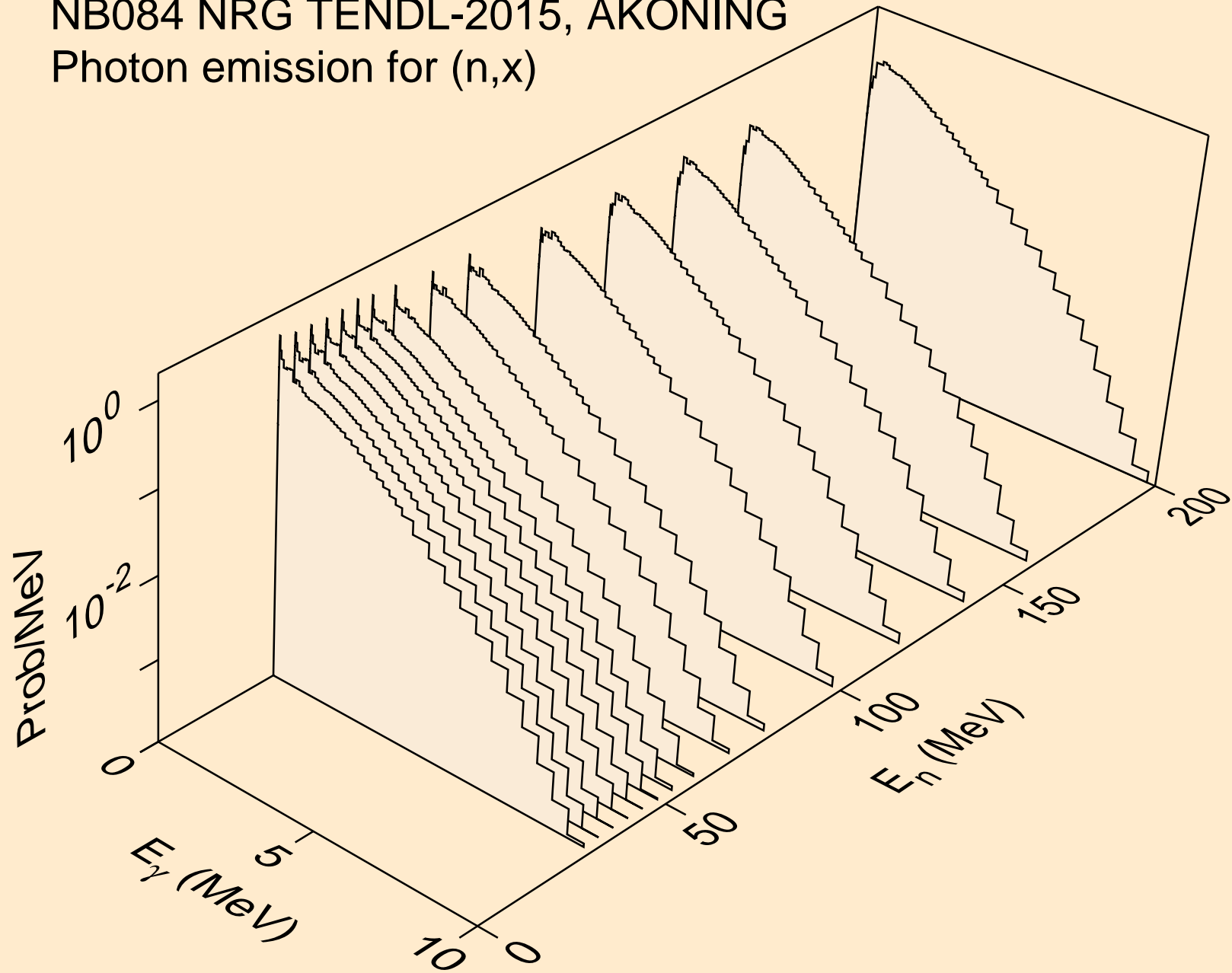

NB084 NRG TENDL-2015, AKONING
Photon emission for (n,2nd)

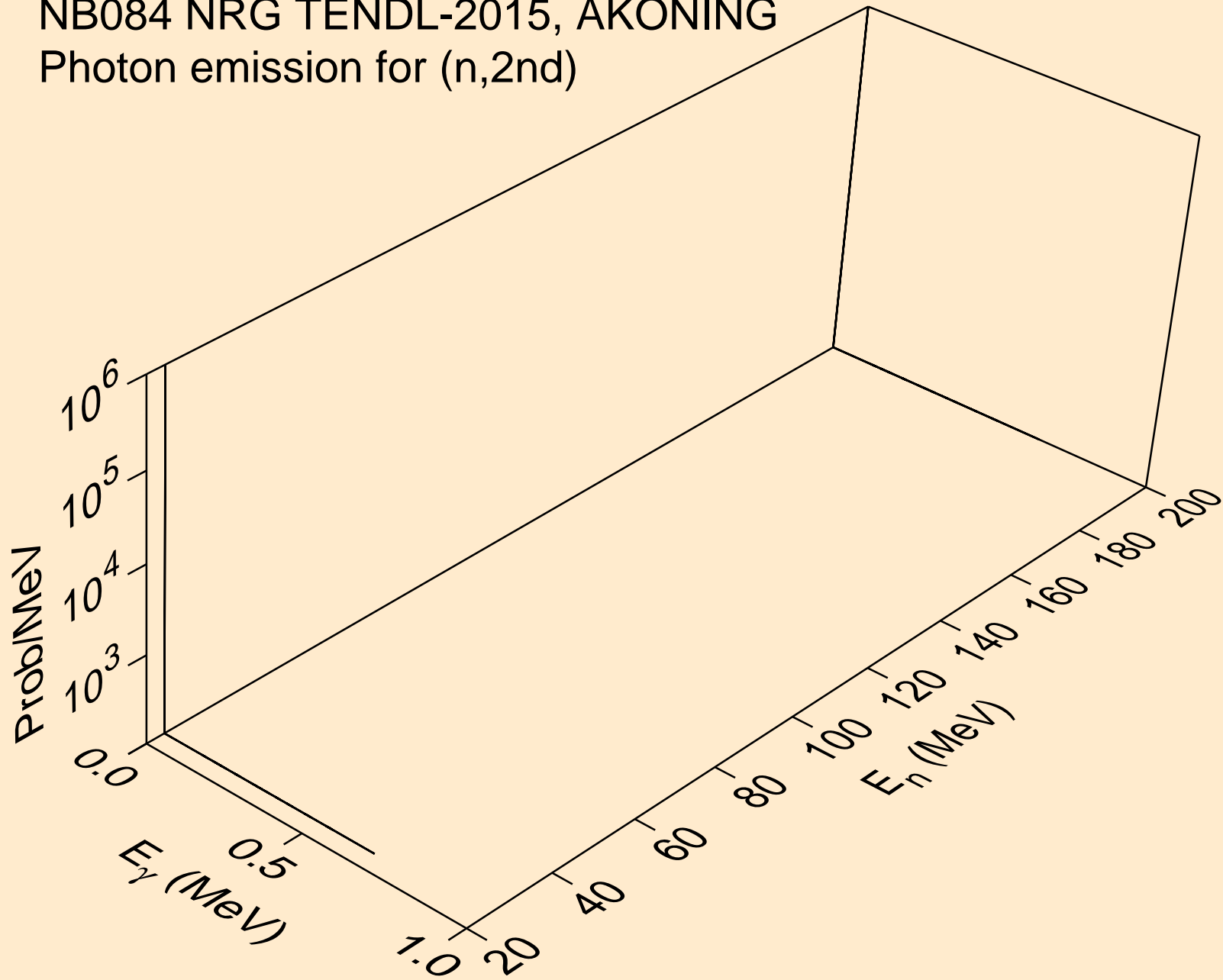

NB084 NRG TENDL-2015, AKONING
Photon emission for (n,2n)

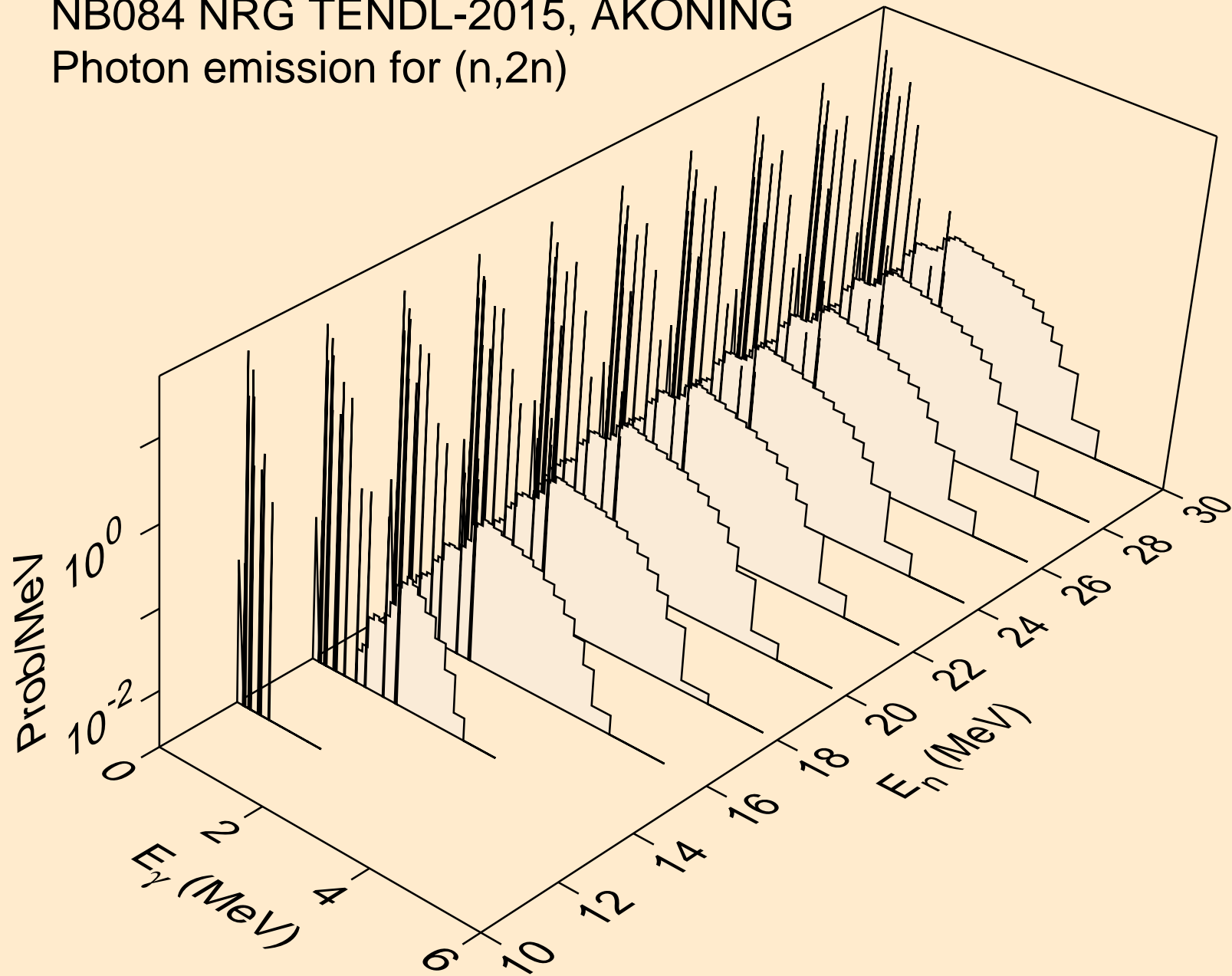

NB084 NRG TENDL-2015, AKONING
Photon emission for (n,3n)

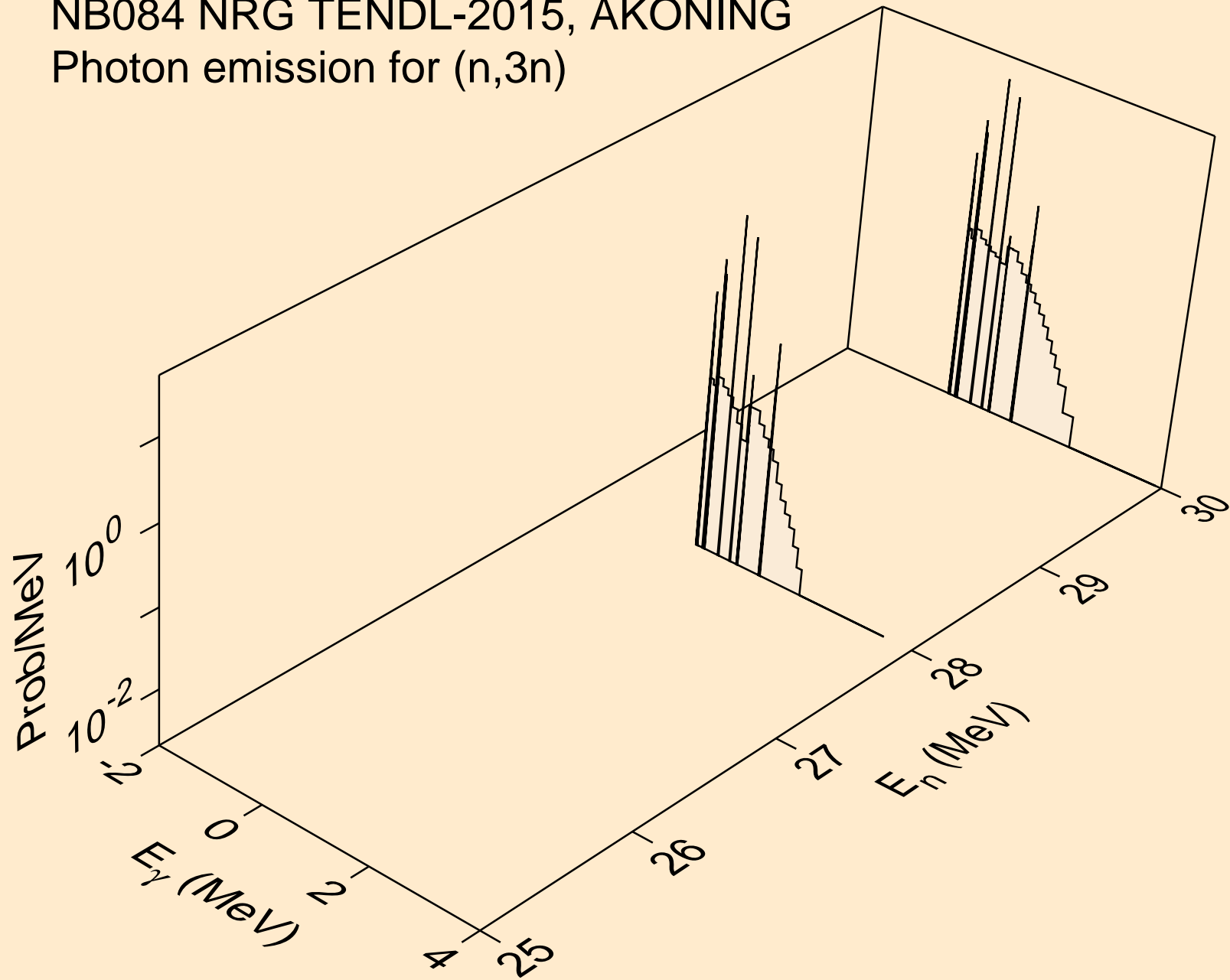

NB084 NRG TENDL-2015, AKONING
Photon emission for (n,n*)a

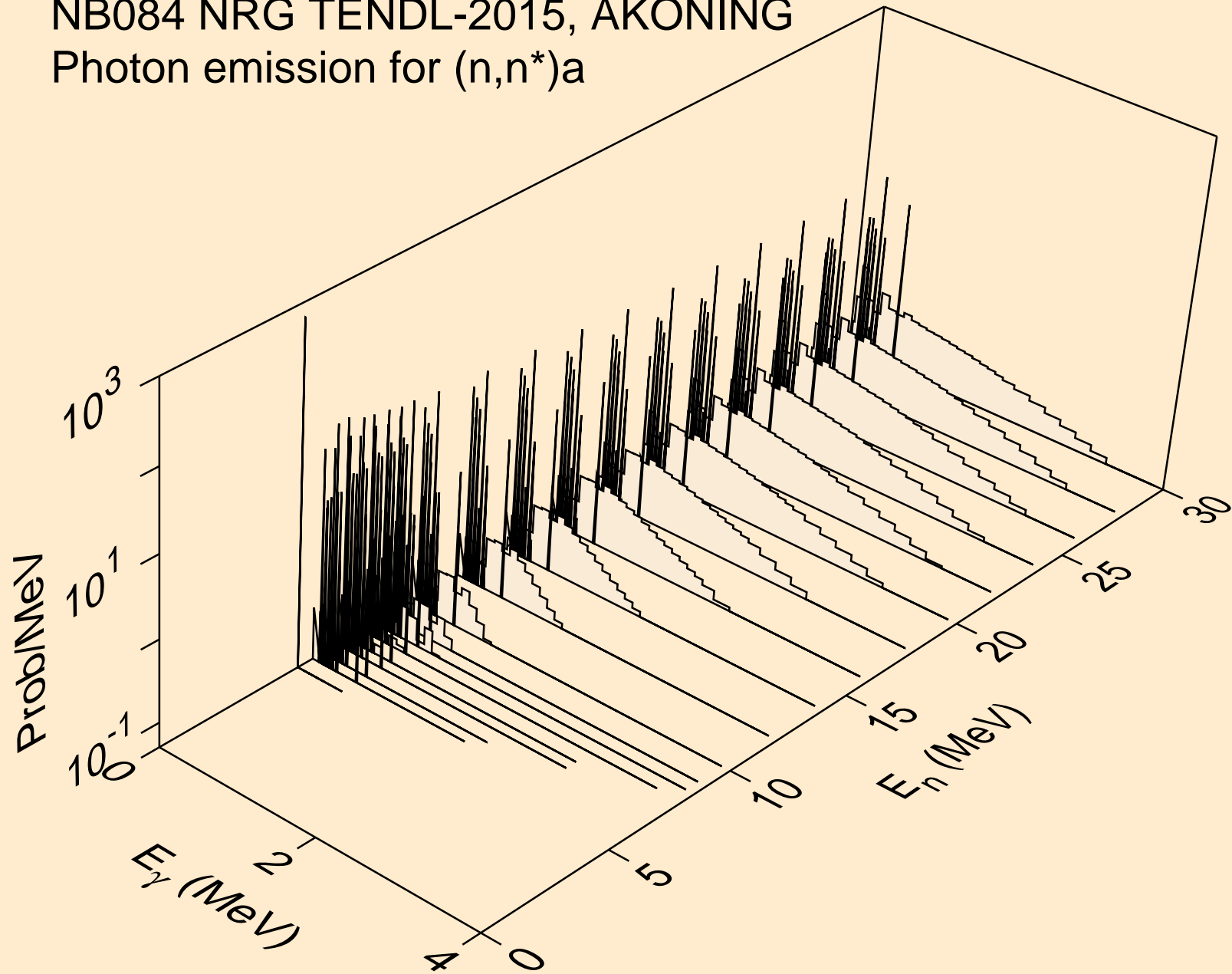

NB084 NRG TENDL-2015, AKONING
Photon emission for (n,2n)a

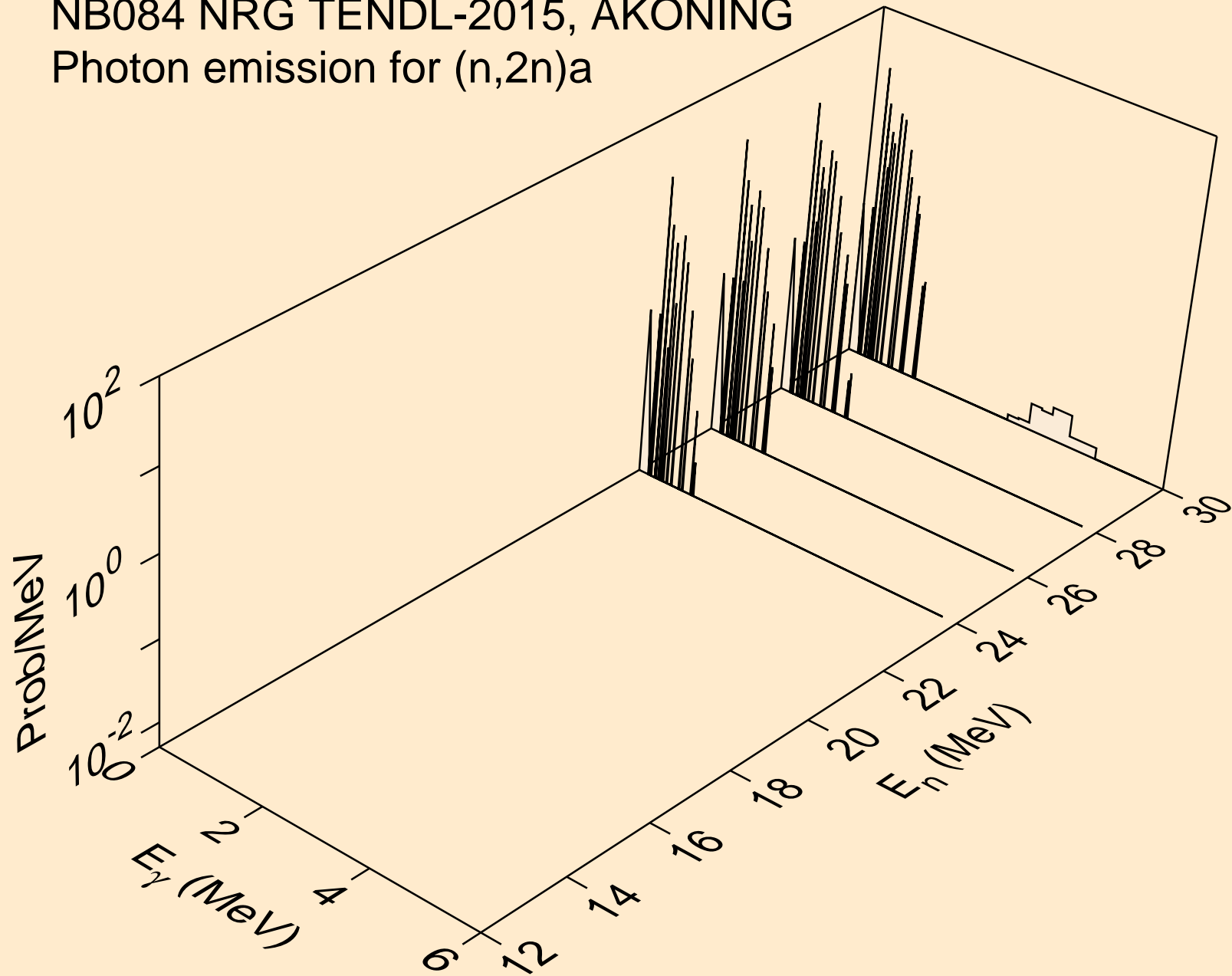

NB084 NRG TENDL-2015, AKONING
Photon emission for (n,n*)p

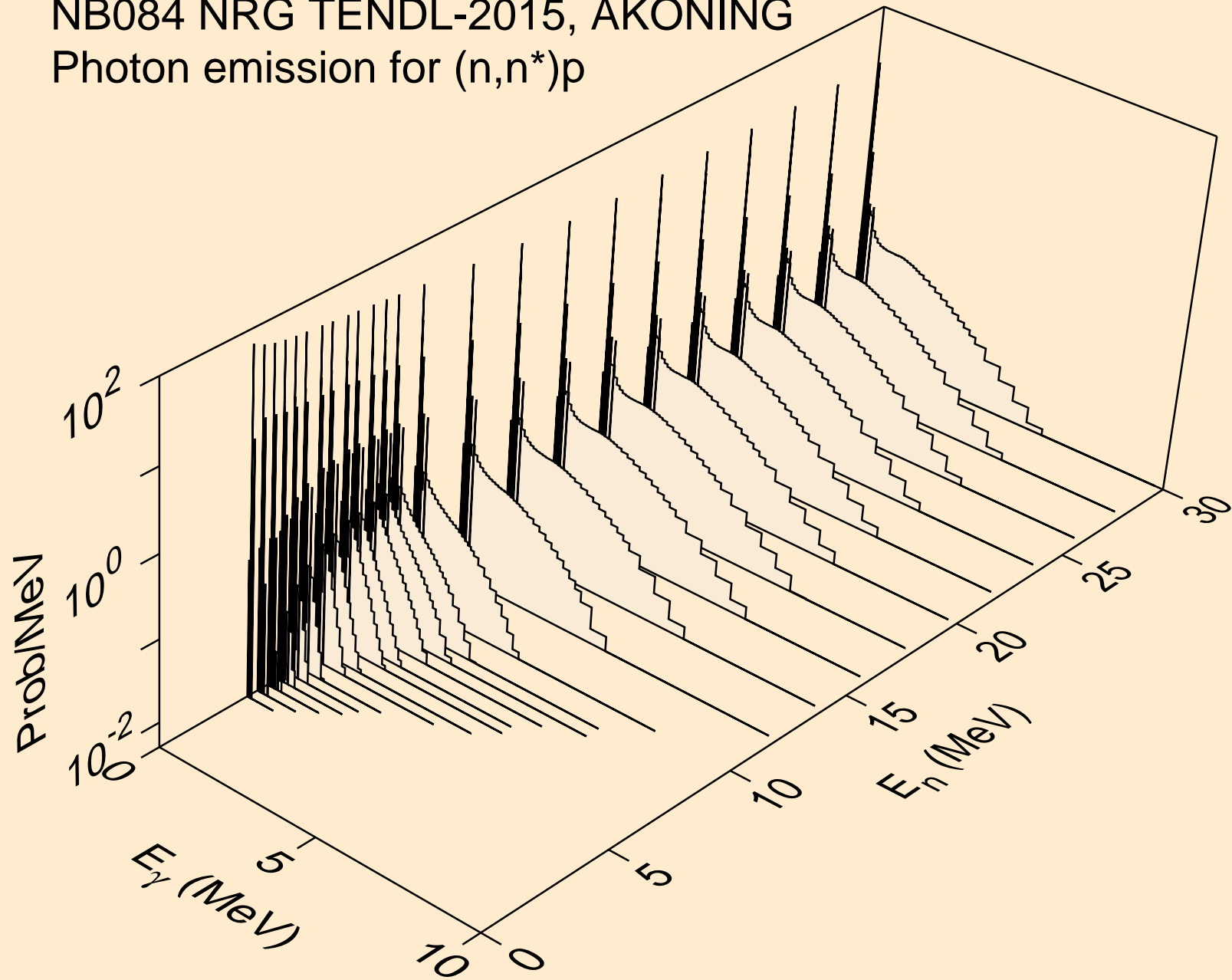

NB084 NRG TENDL-2015, AKONING
Photon emission for (n,n*)2a

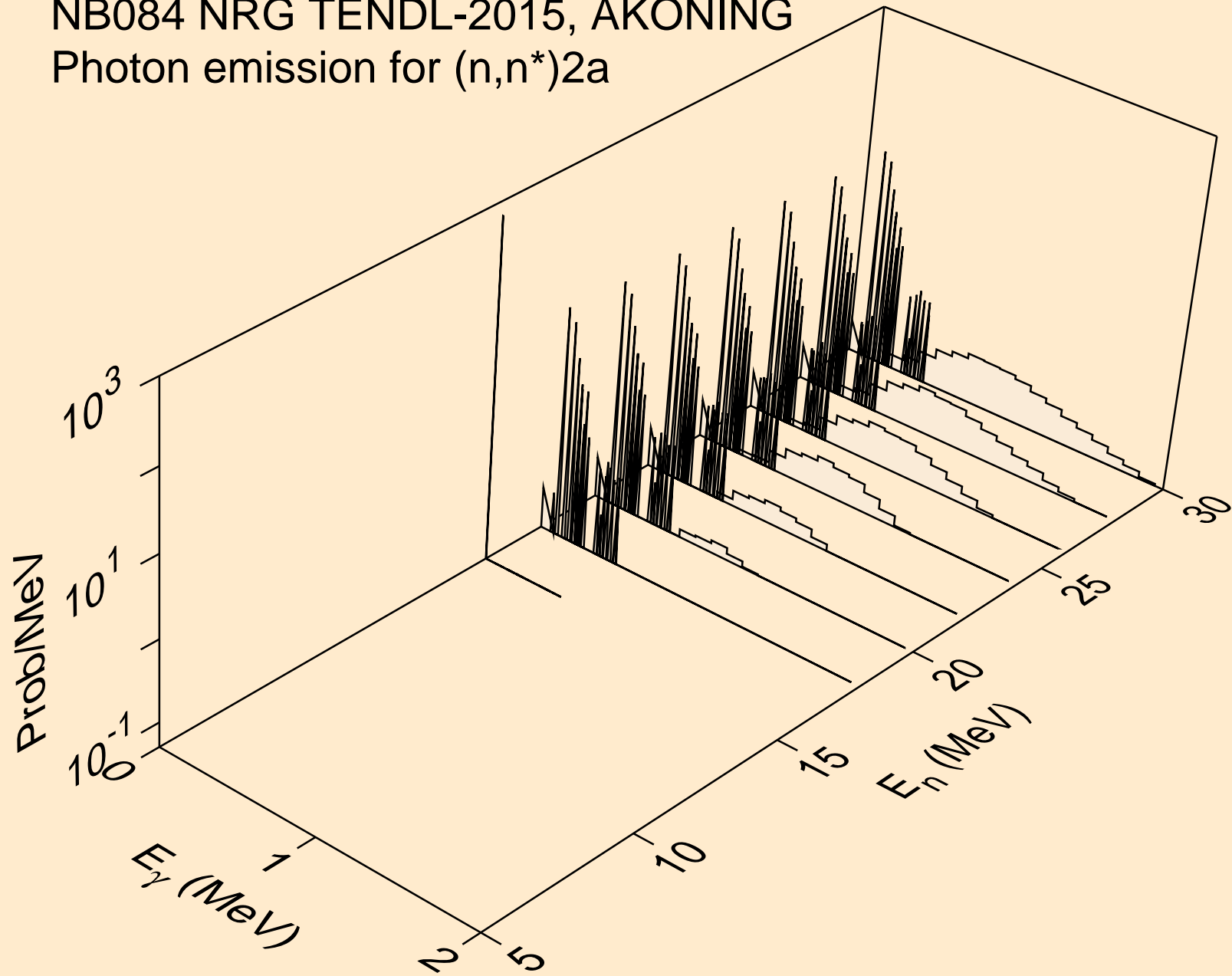

NB084 NRG TENDL-2015, AKONING
Photon emission for (n,n*)d

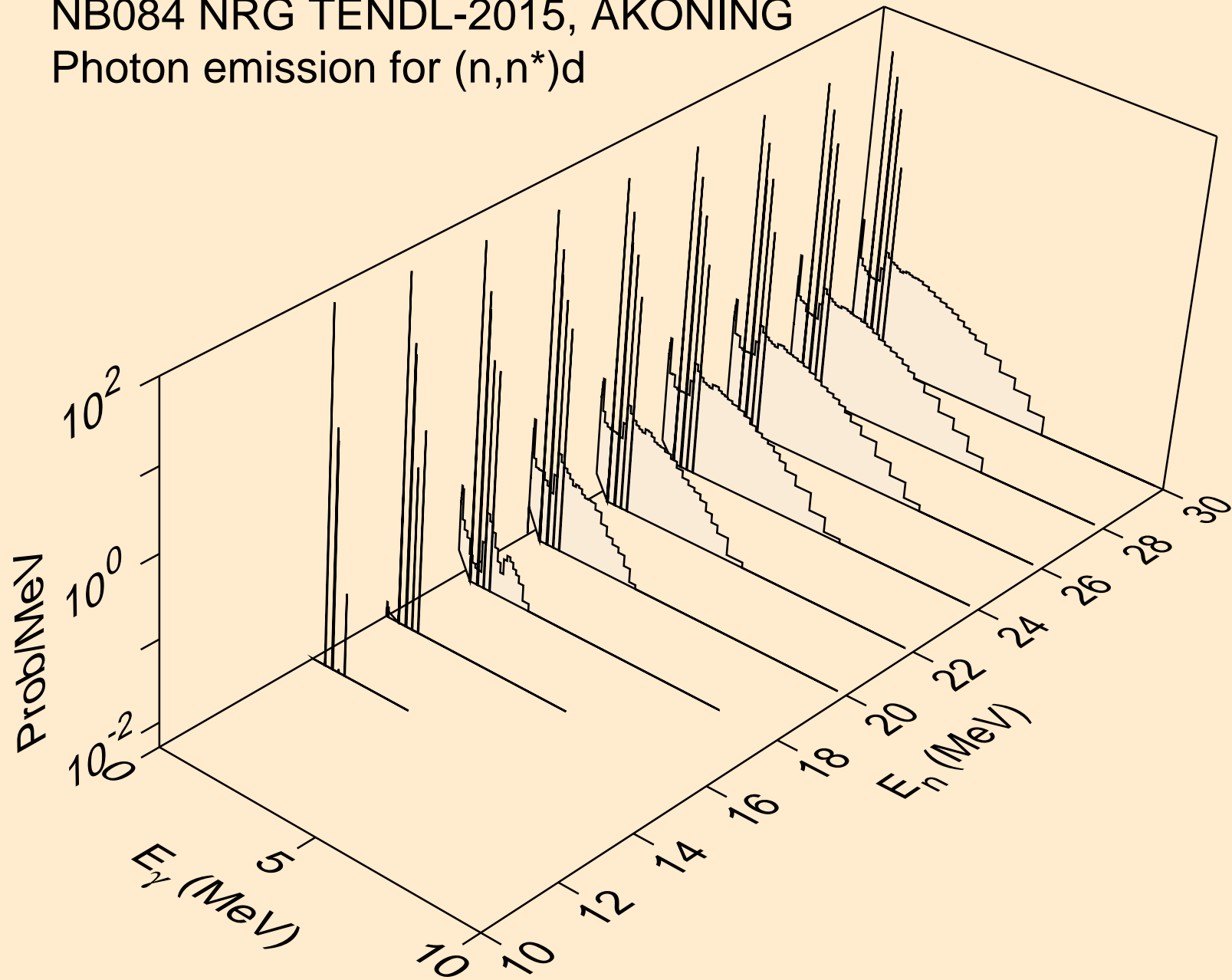

NB084 NRG TENDL-2015, AKONING
Photon emission for (n,n*)t

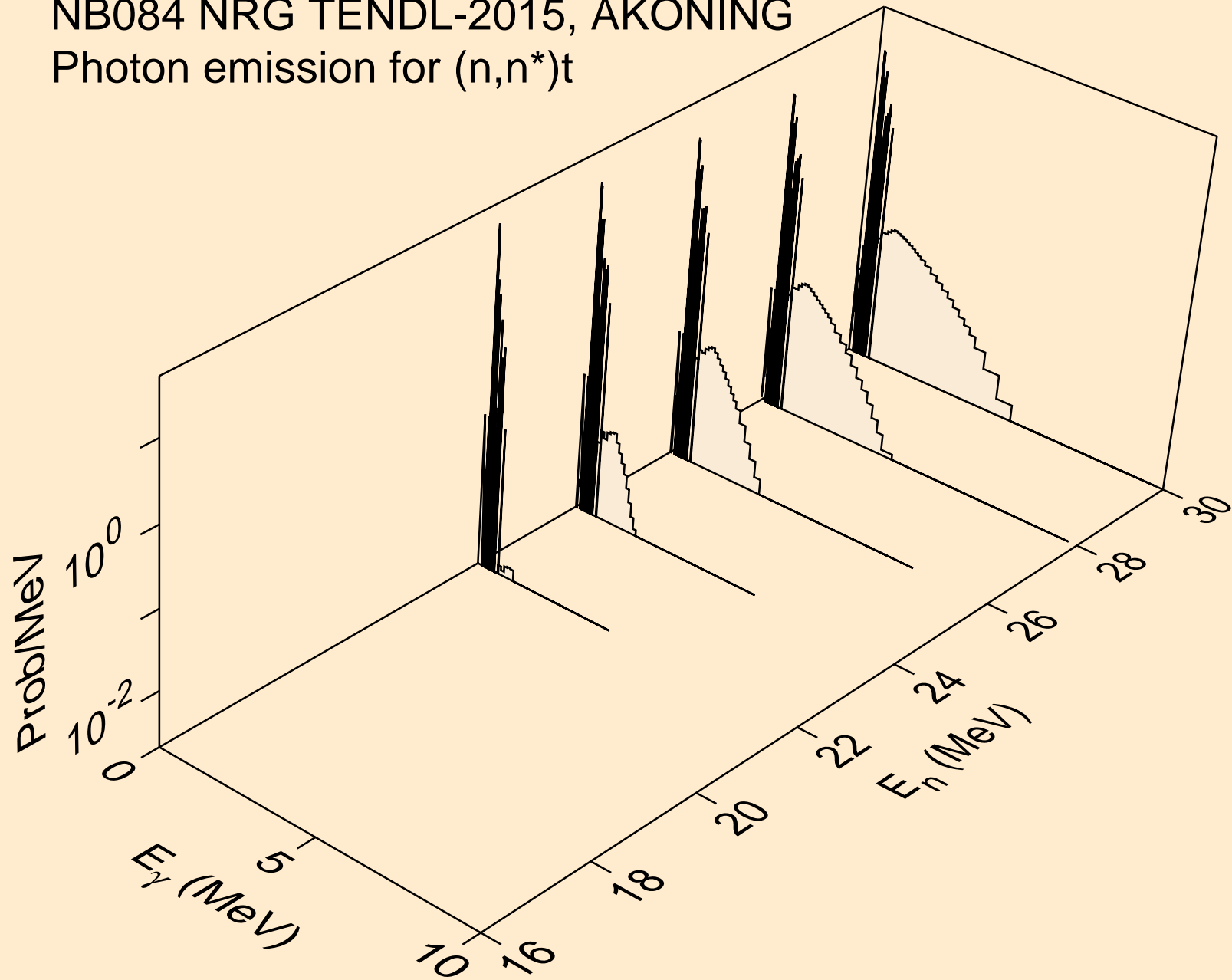

NB084 NRG TENDL-2015, AKONING
Photon emission for (n,n*)he3

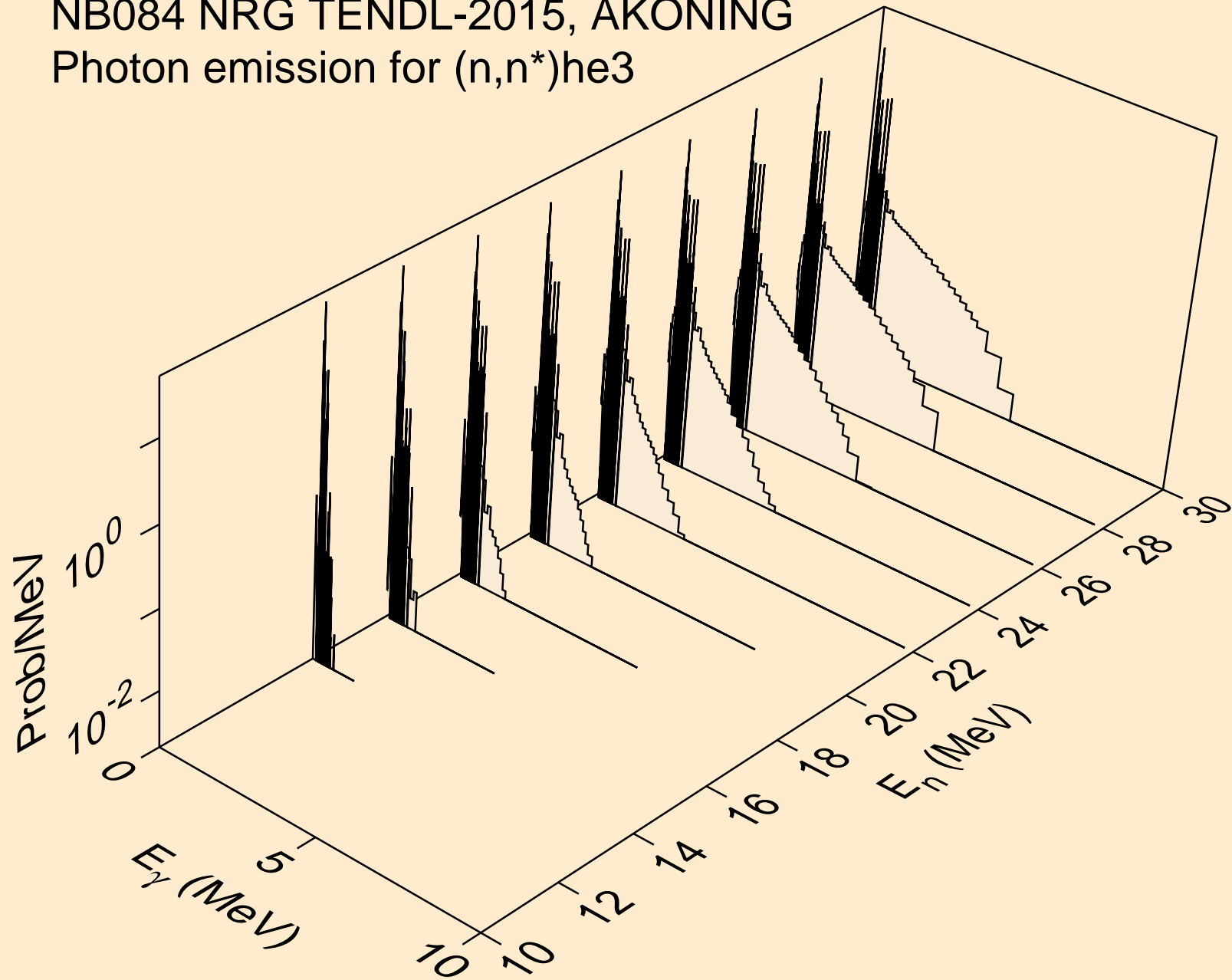

NB084 NRG TENDL-2015, AKONING
Photon emission for (n,2np)

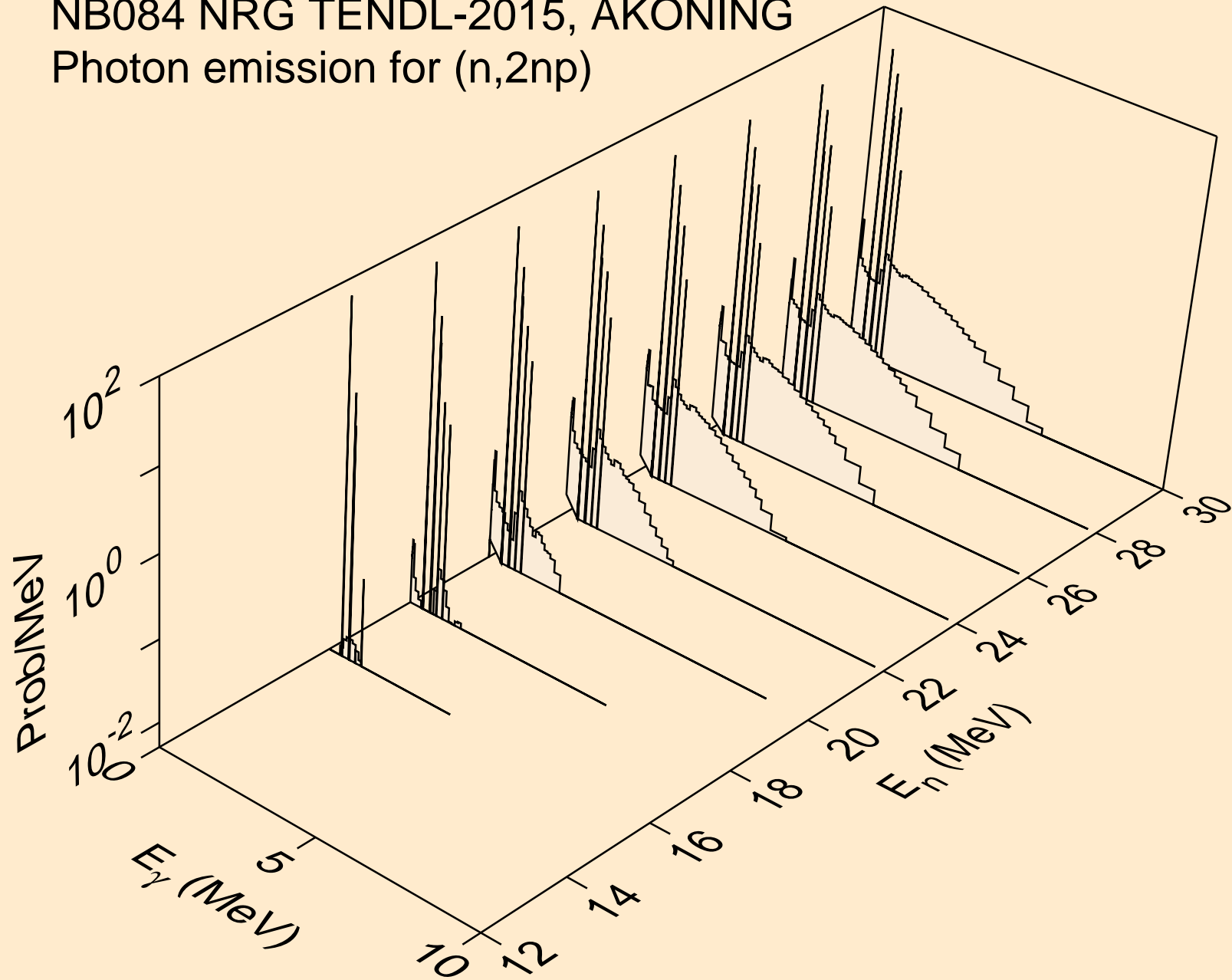

NB084 NRG TENDL-2015, AKONING
Photon emission for (n,3np)

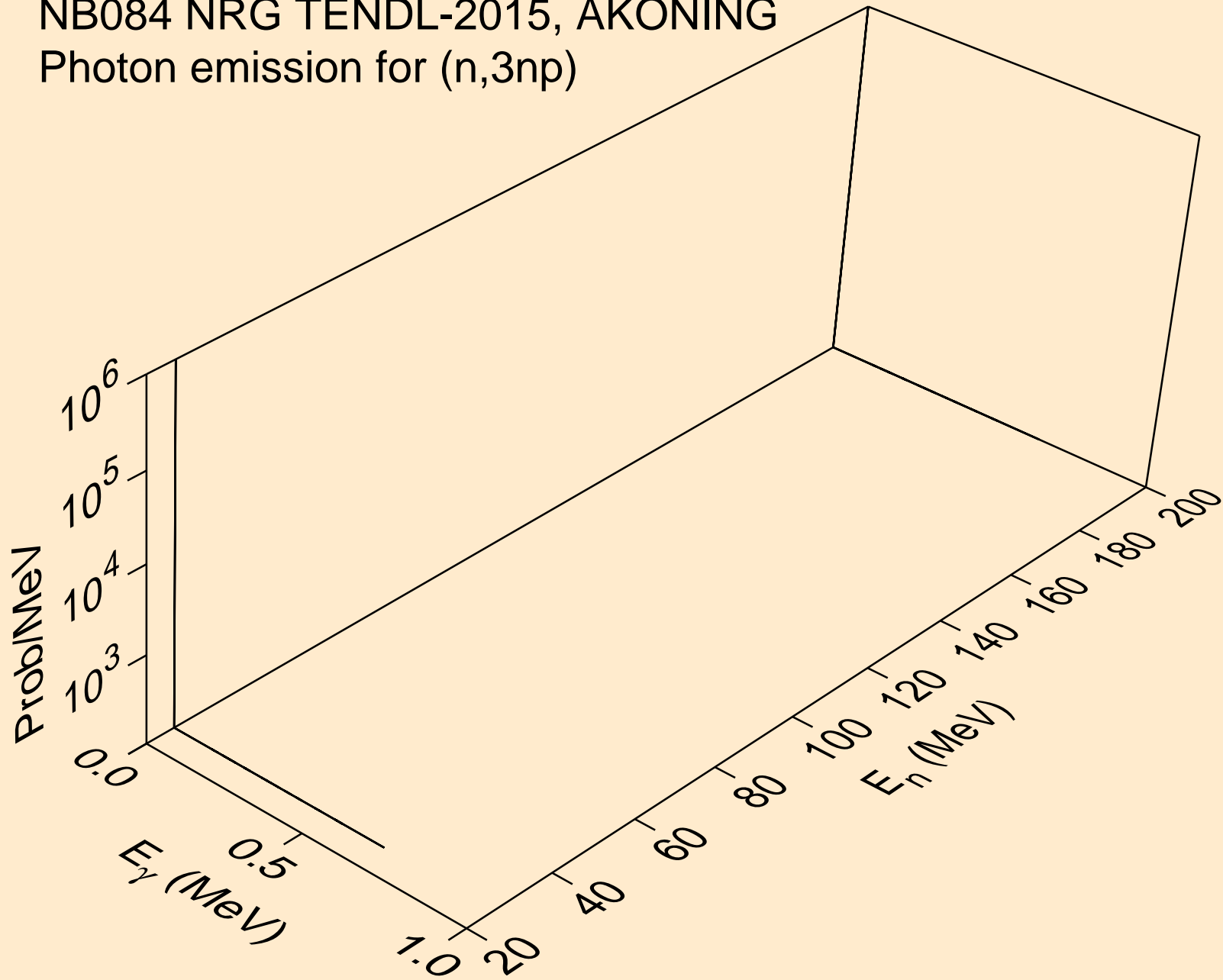

NB084 NRG TENDL-2015, AKONING
Photon emission for (n,2np)

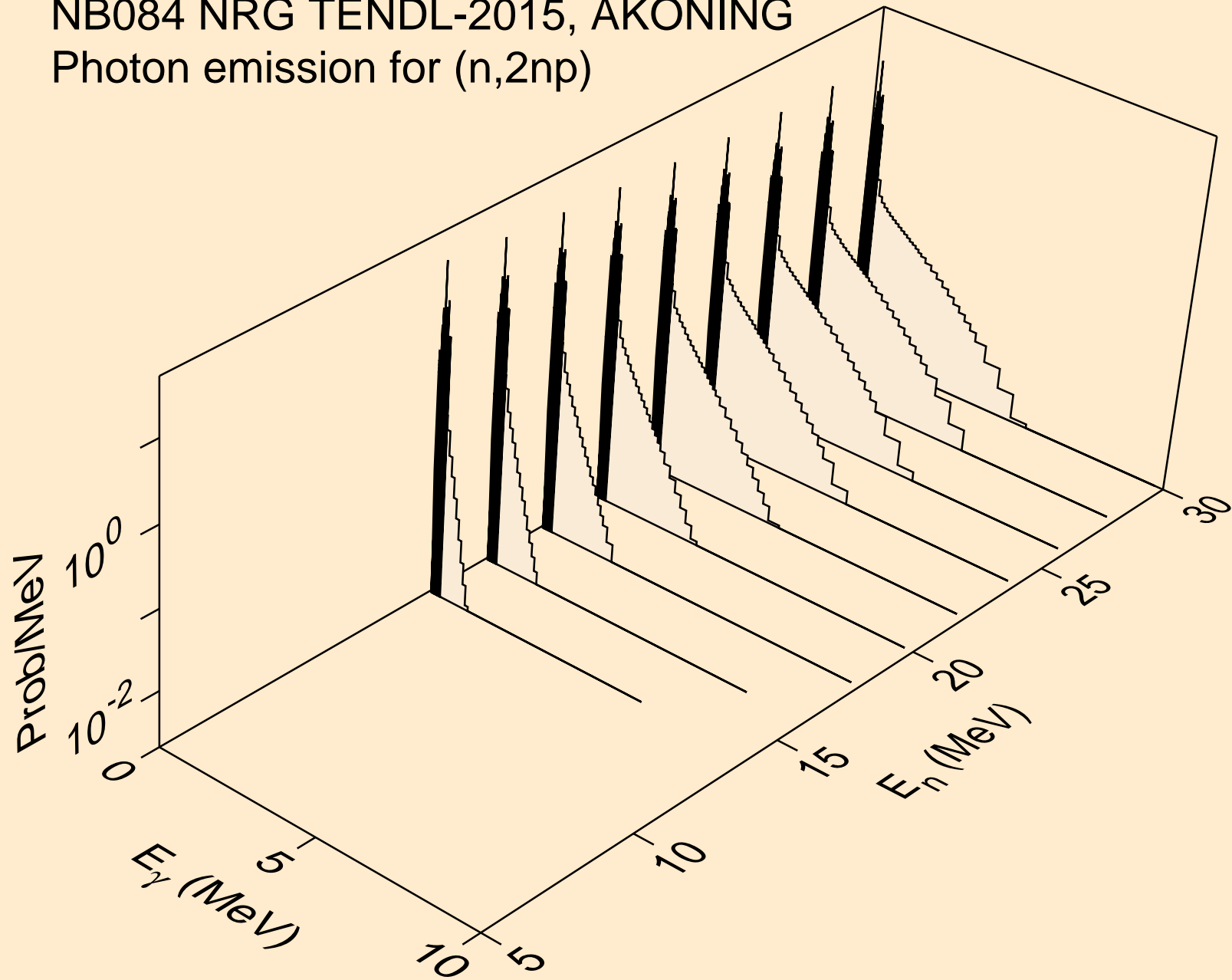

NB084 NRG TENDL-2015, AKONING
Photon emission for (n,npa)

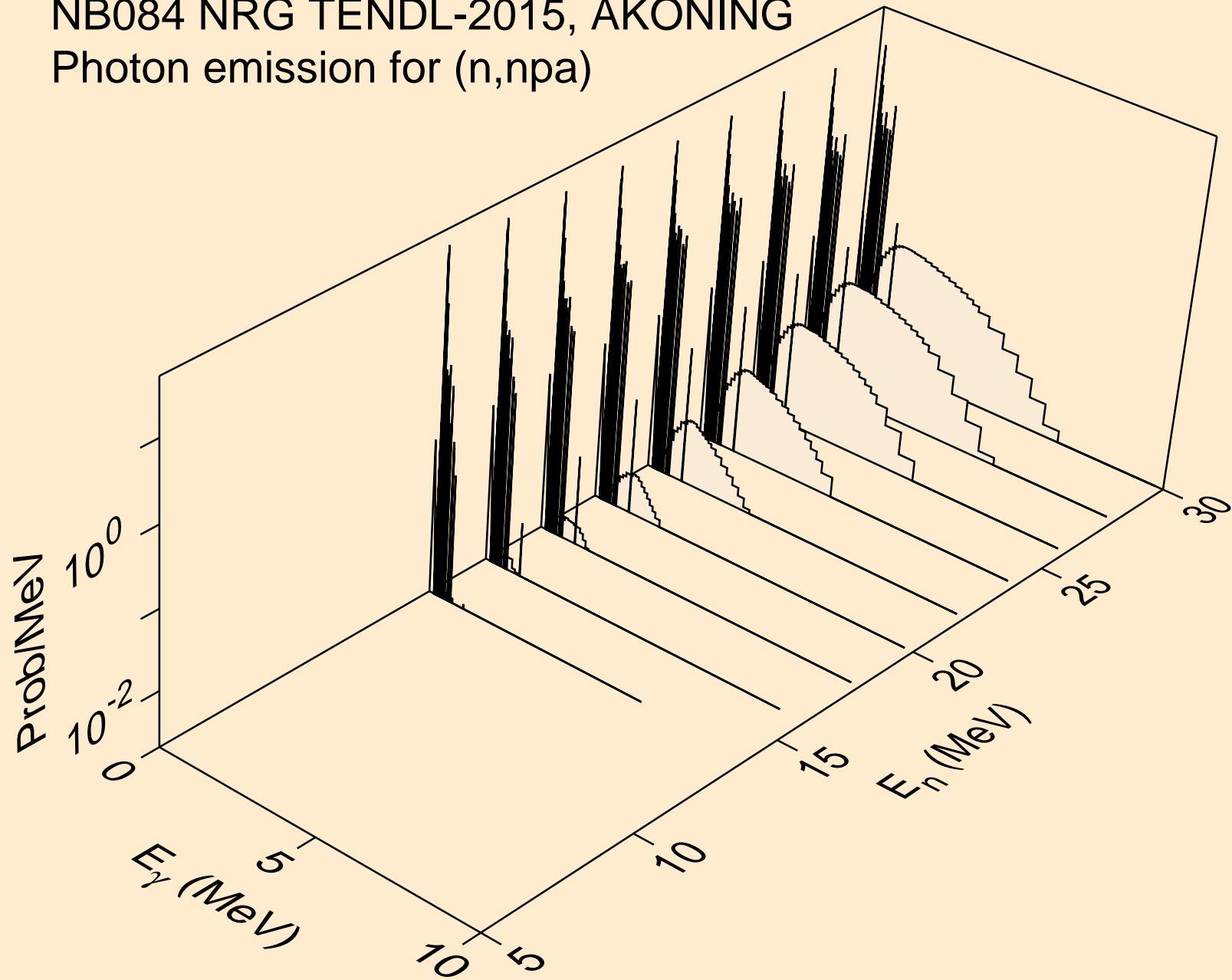

NB084 NRG TENDL-2015, AKONING
Photon emission for (n,n*c)

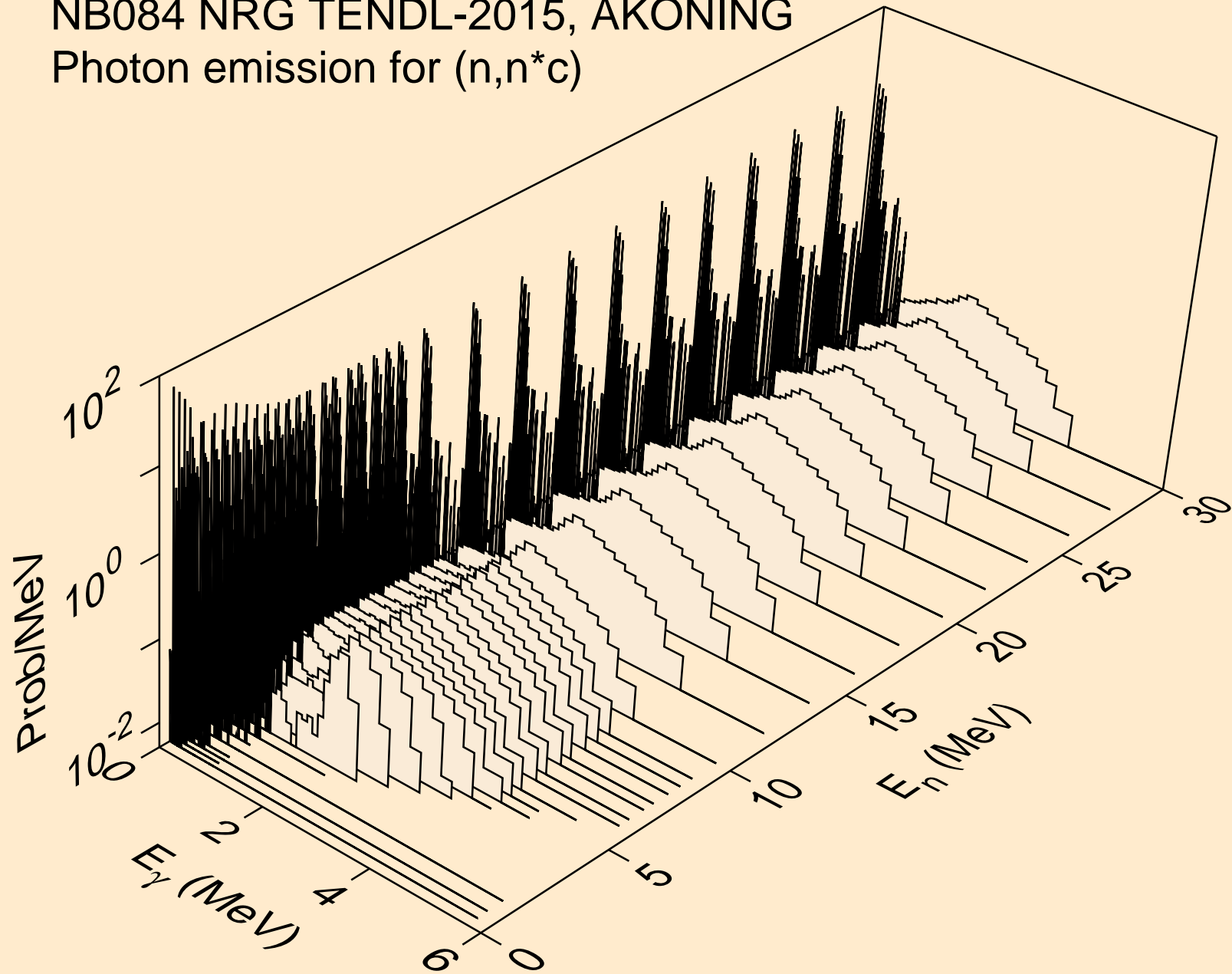

NB084 NRG TENDL-2015, AKONING
Photon emission for (n,gma)

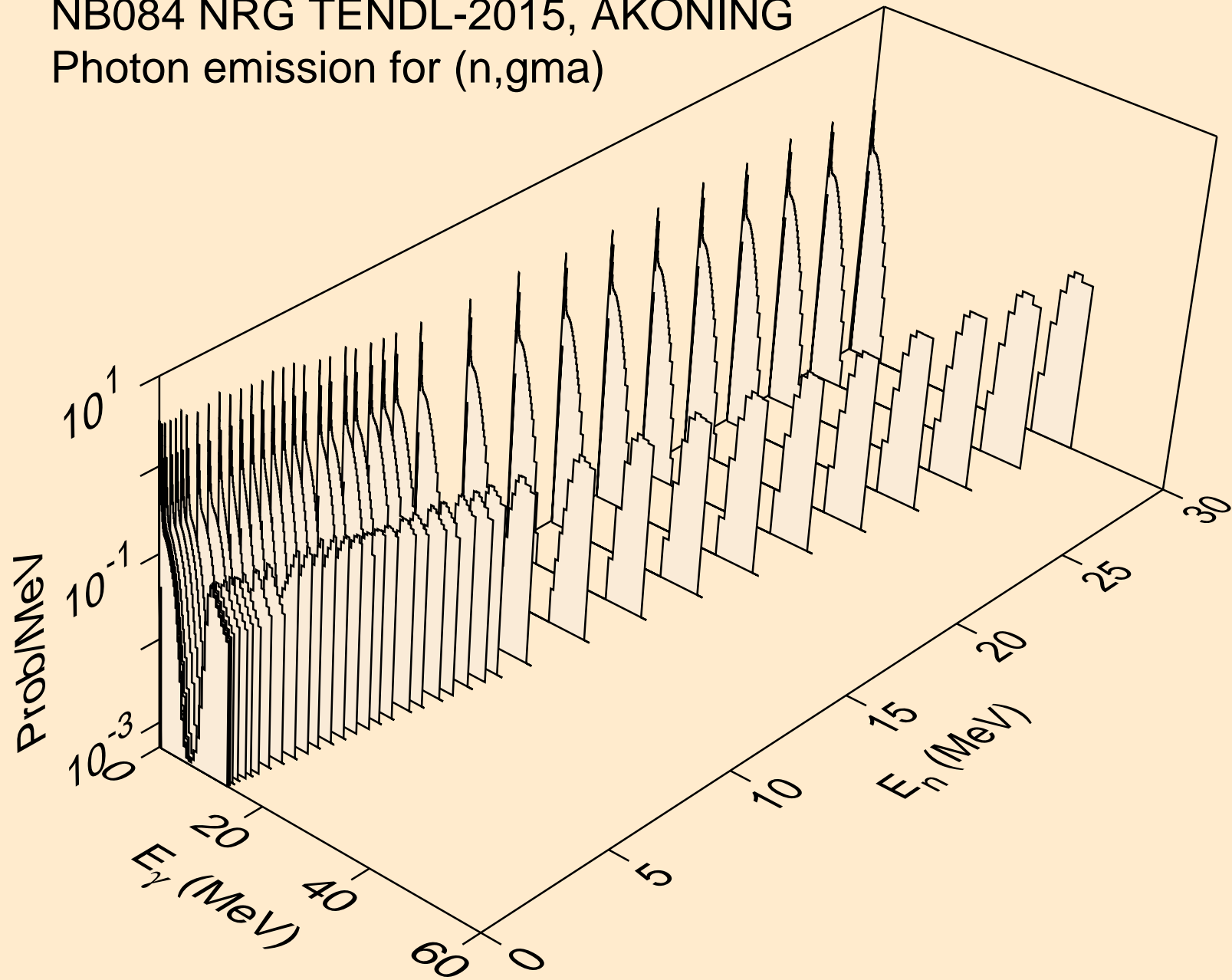

NB084 NRG TENDL-2015, AKONING
Photon emission for (n,p)

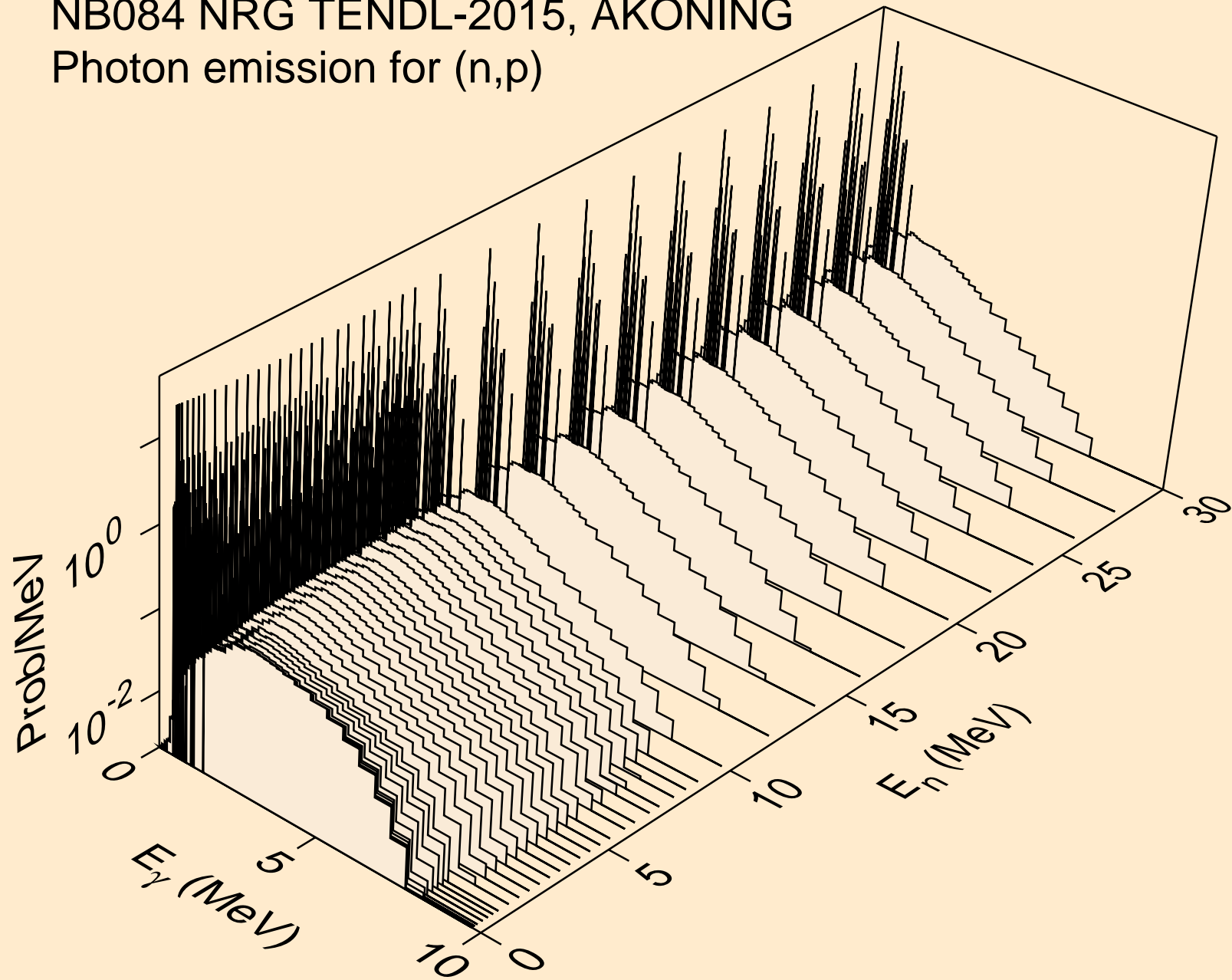

NB084 NRG TENDL-2015, AKONING
Photon emission for (n,d)

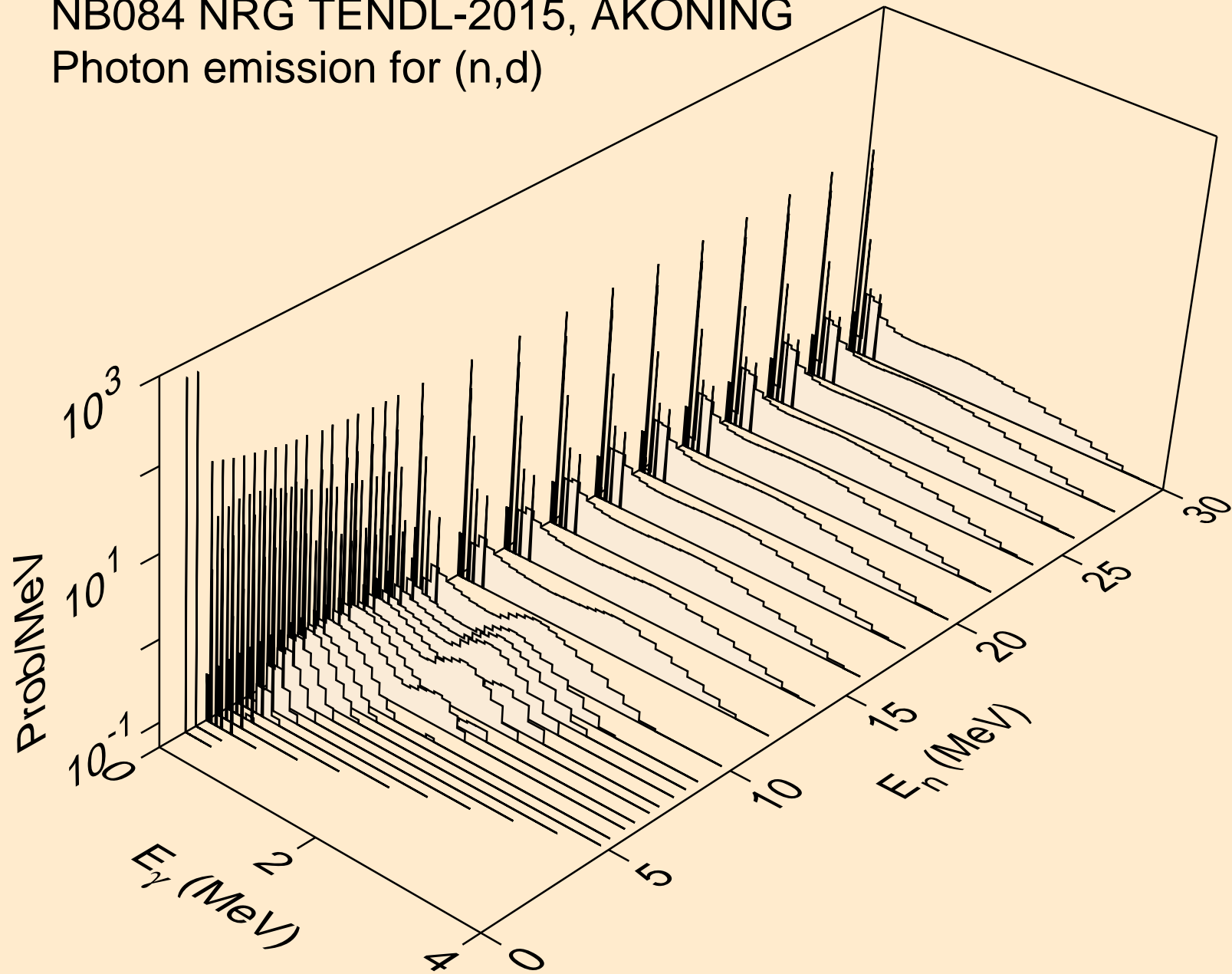

NB084 NRG TENDL-2015, AKONING
Photon emission for (n,t)

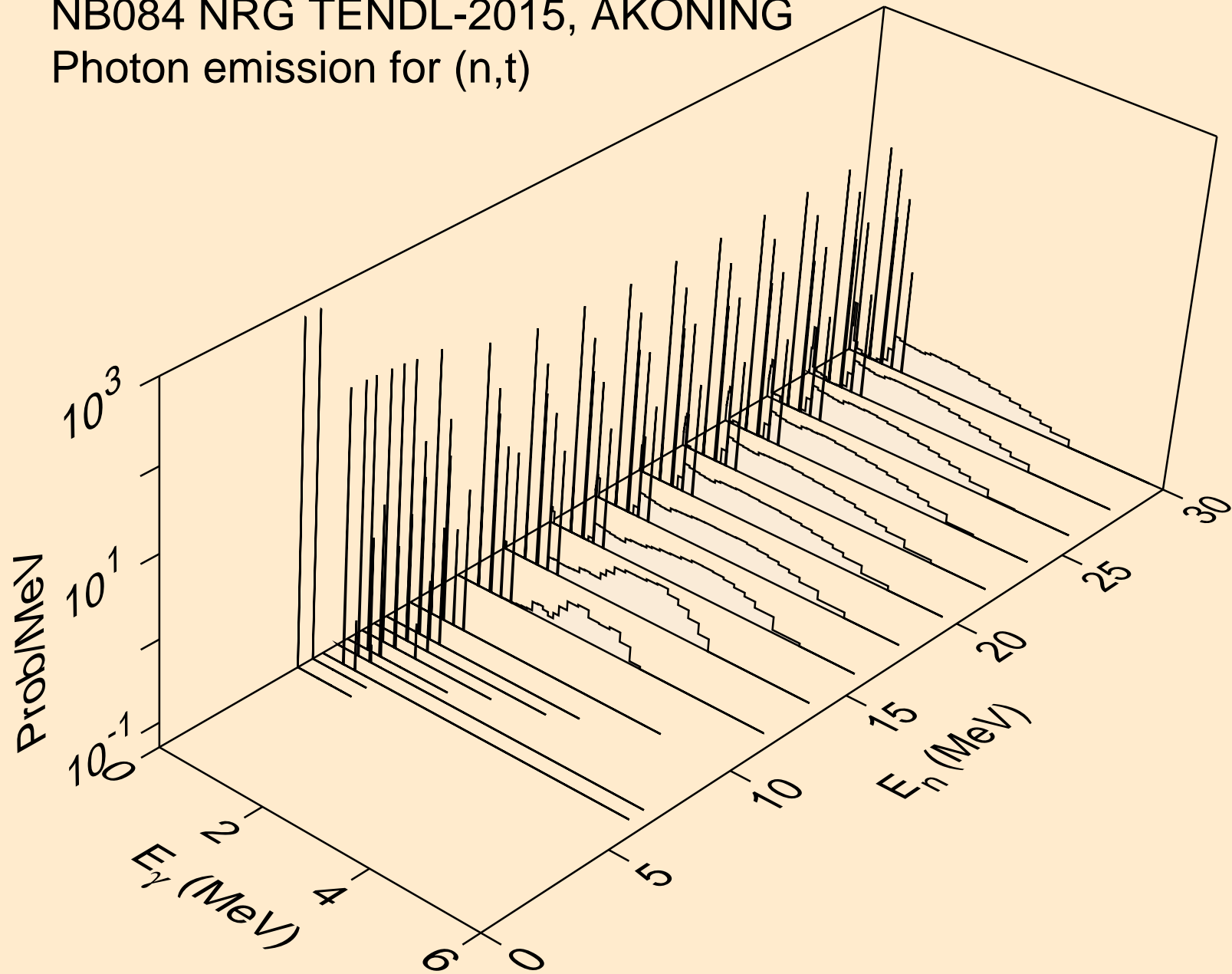

NB084 NRG TENDL-2015, AKONING
Photon emission for (n,he3)

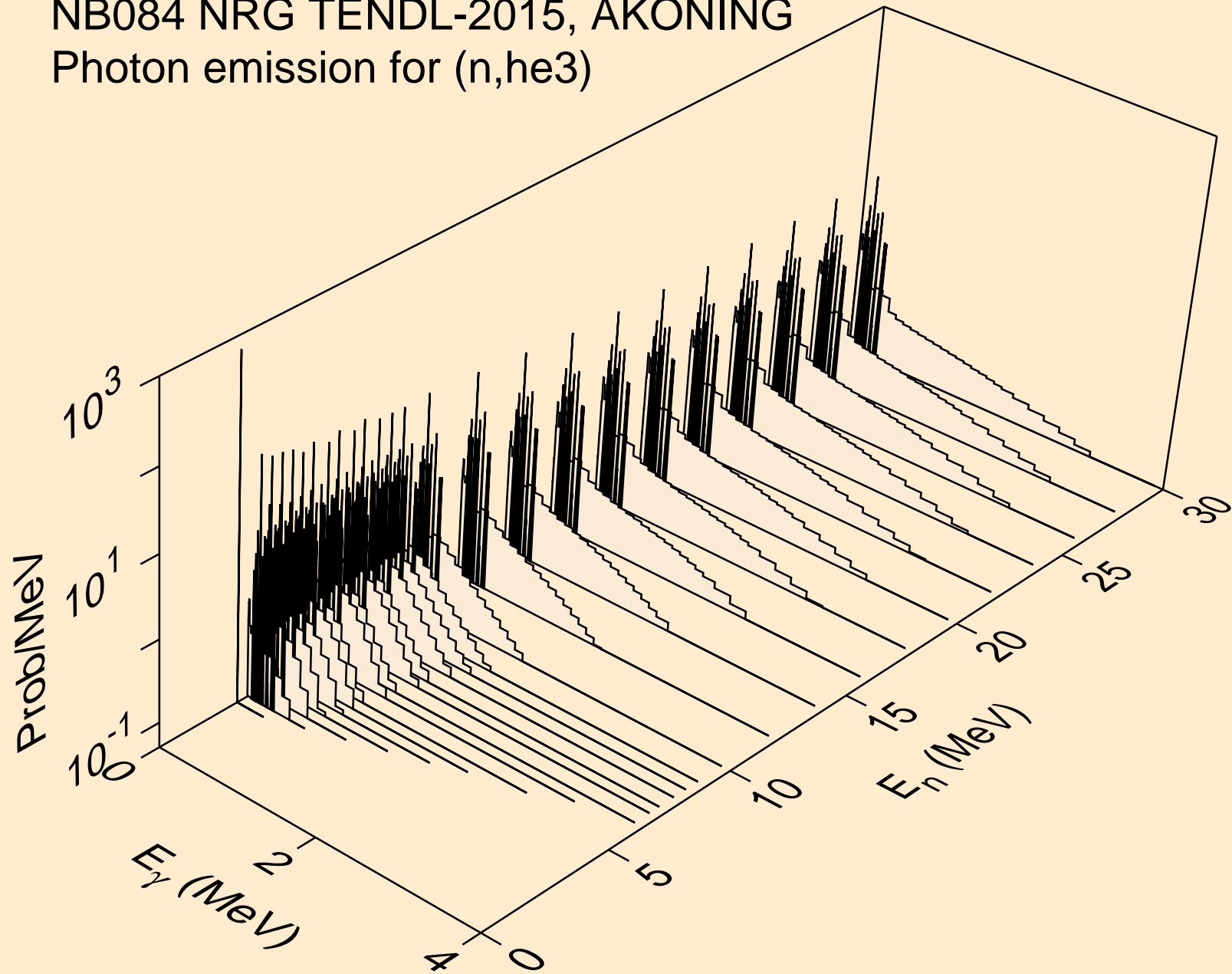

NB084 NRG TENDL-2015, AKONING
Photon emission for (n,a)

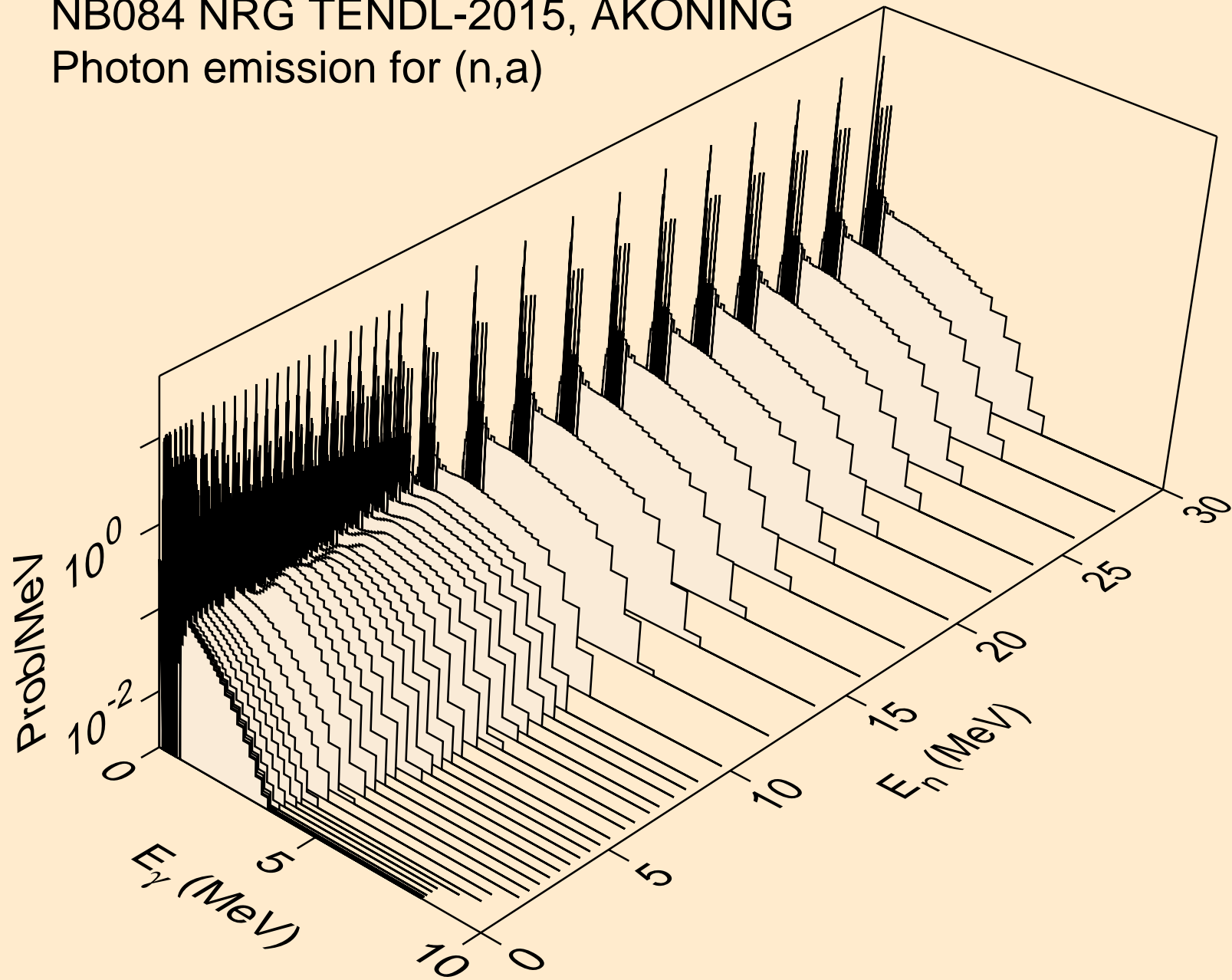

NB084 NRG TENDL-2015, AKONING
Photon emission for (n,2a)

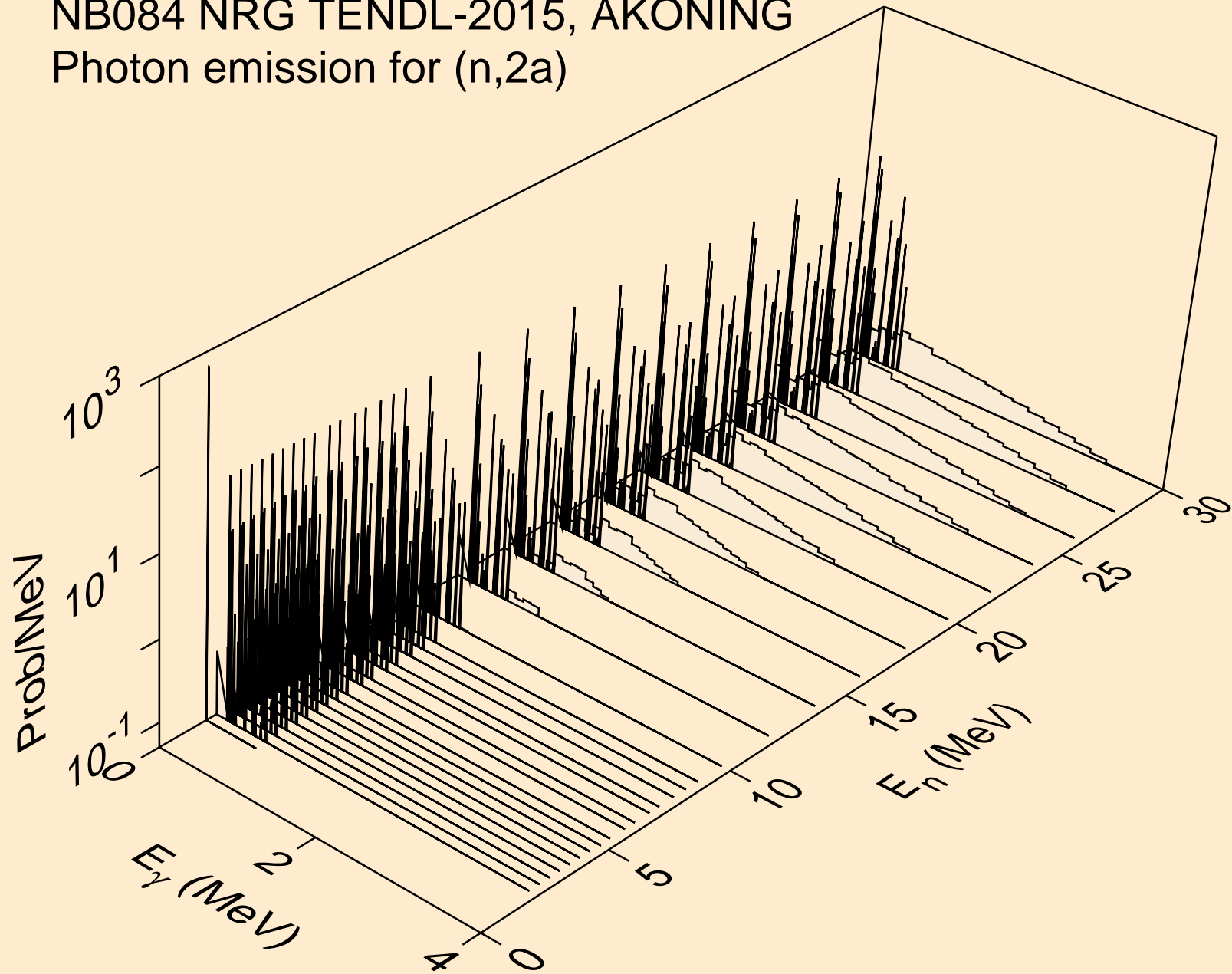

NB084 NRG TENDL-2015, AKONING
Photon emission for (n,3a)

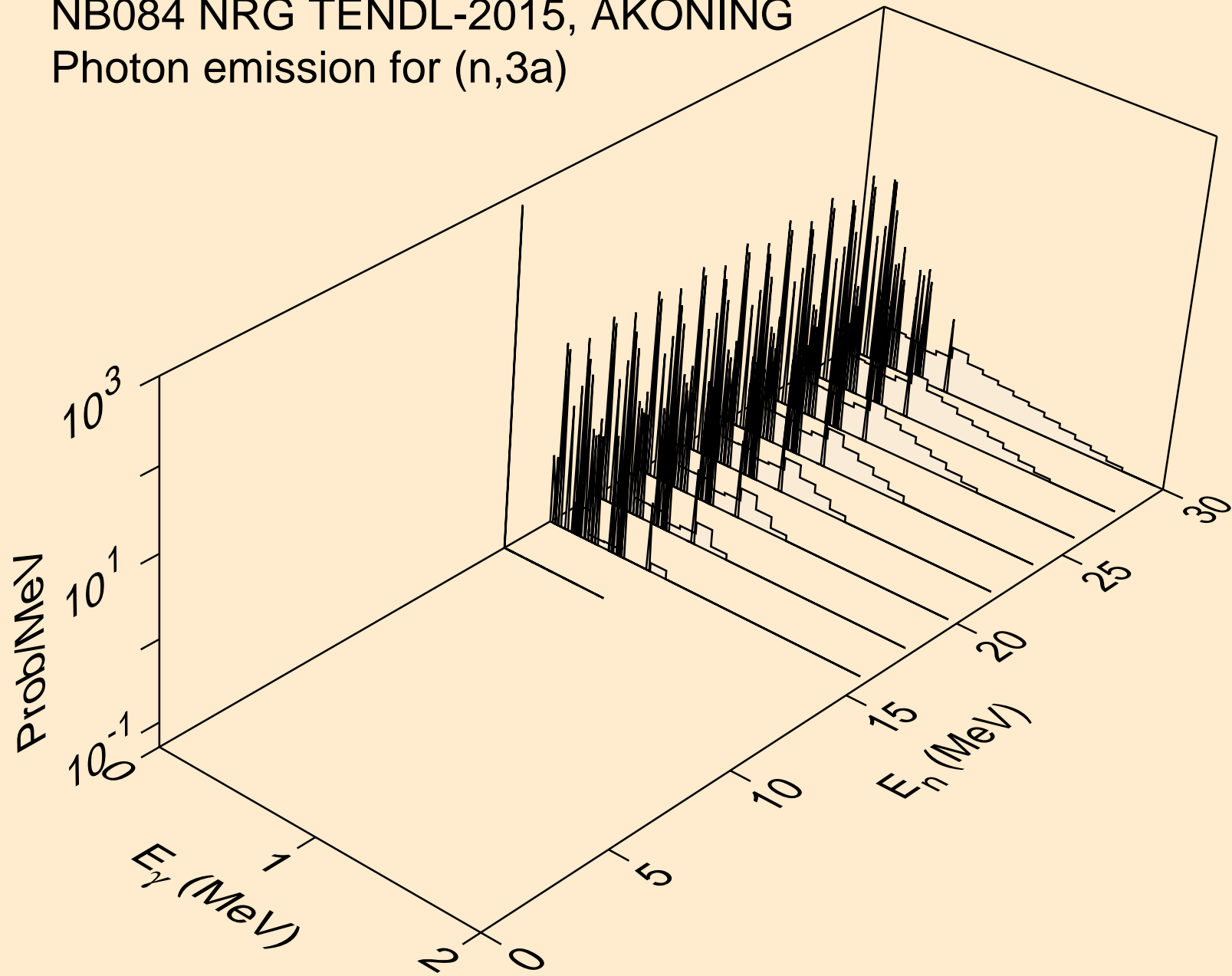

NB084 NRG TENDL-2015, AKONING
Photon emission for (n,2p)

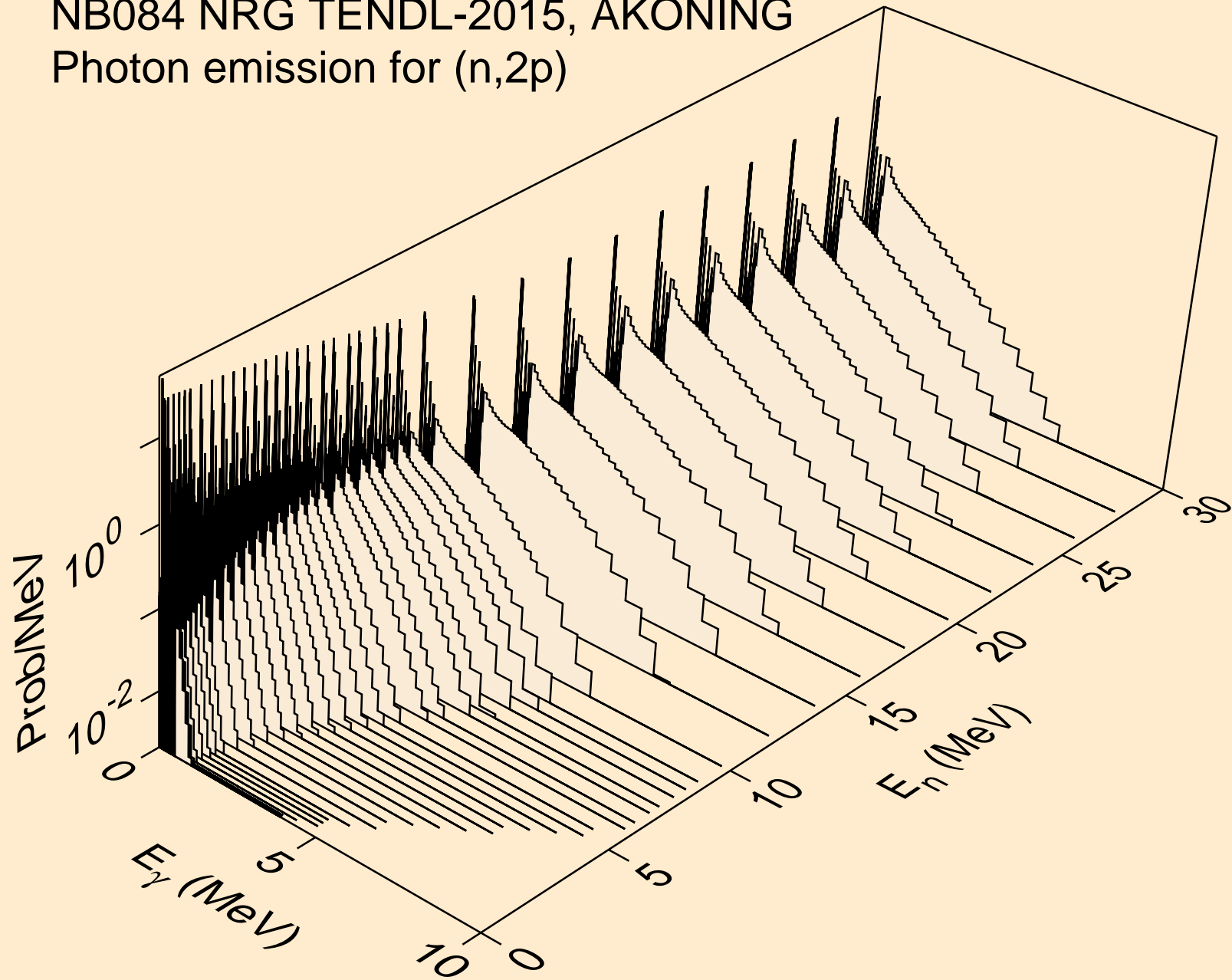

NB084 NRG TENDL-2015, AKONING
Photon emission for (n,p α)

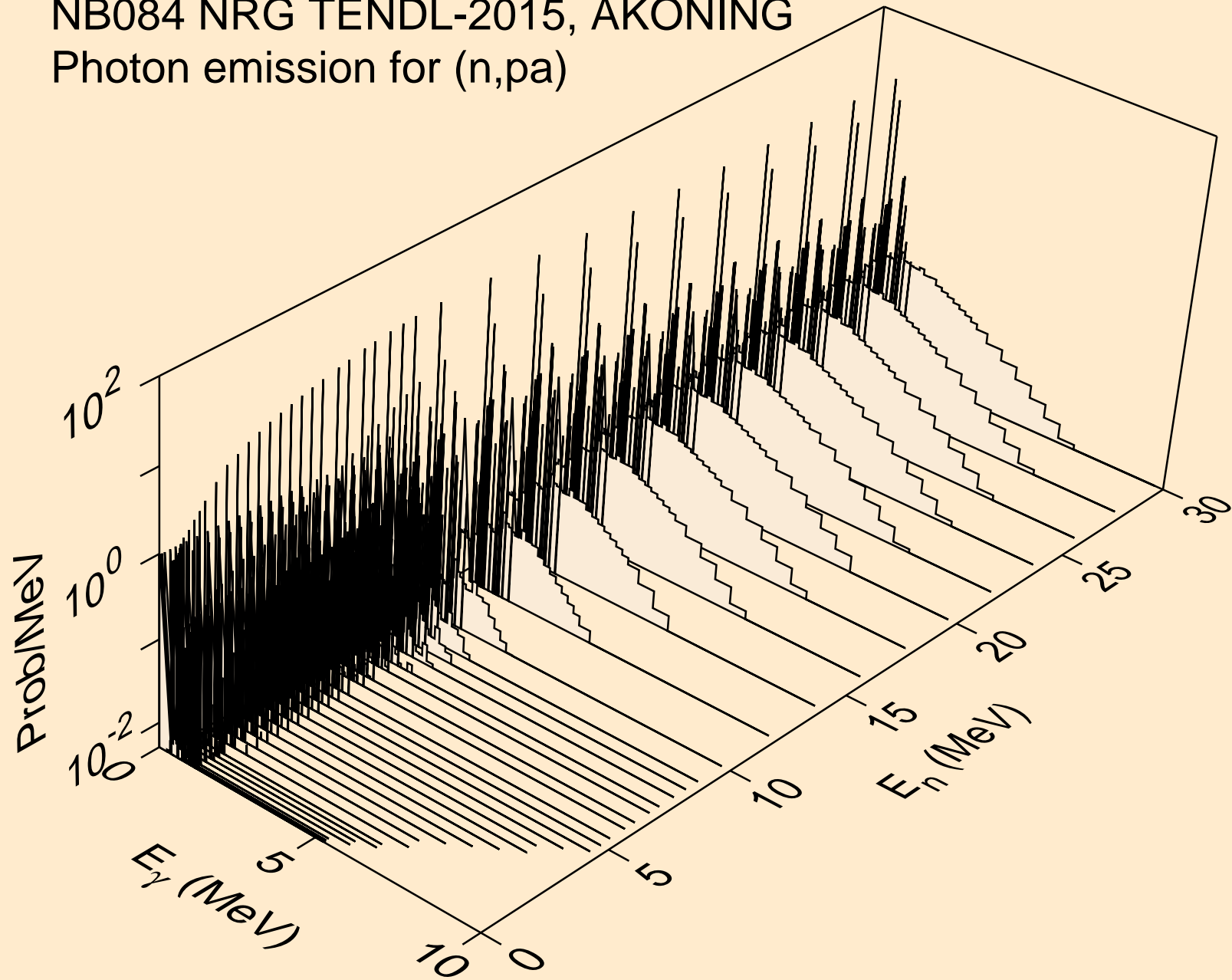

NB084 NRG TENDL-2015, AKONING
Photon emission for (n,d2a)

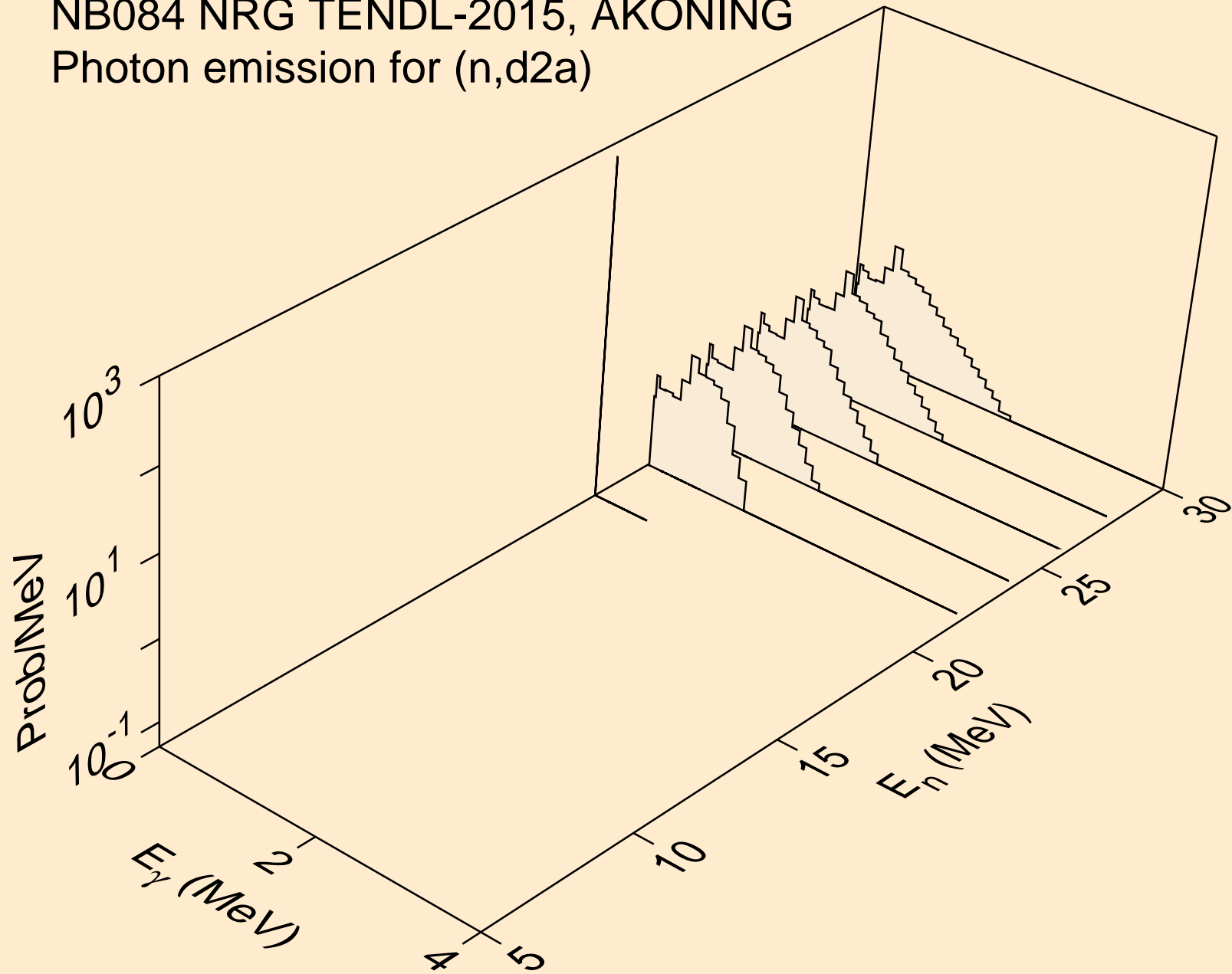

NB084 NRG TENDL-2015, AKONING
Photon emission for (n,pd)

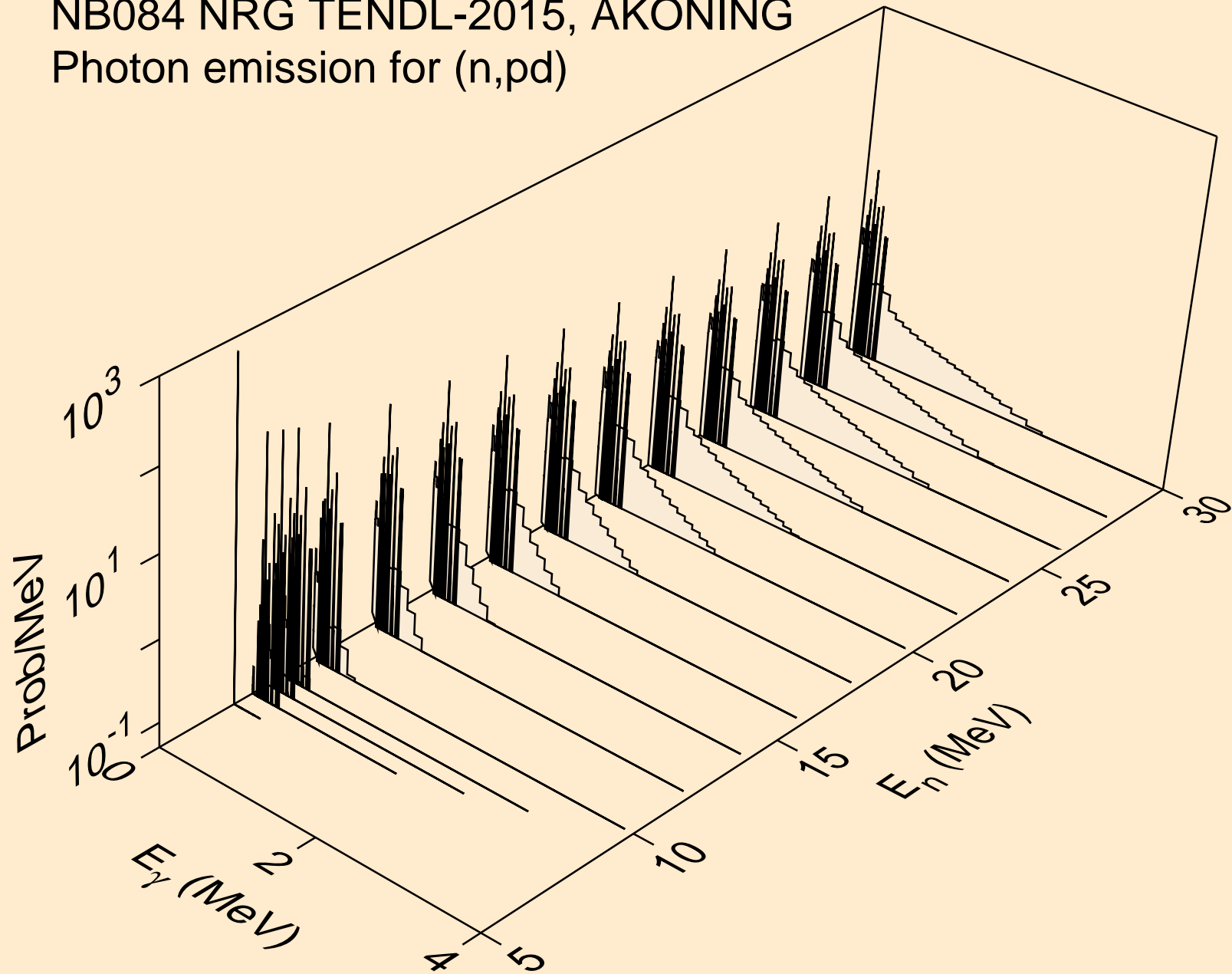

NB084 NRG TENDL-2015, AKONING
Photon emission for (n,pt)

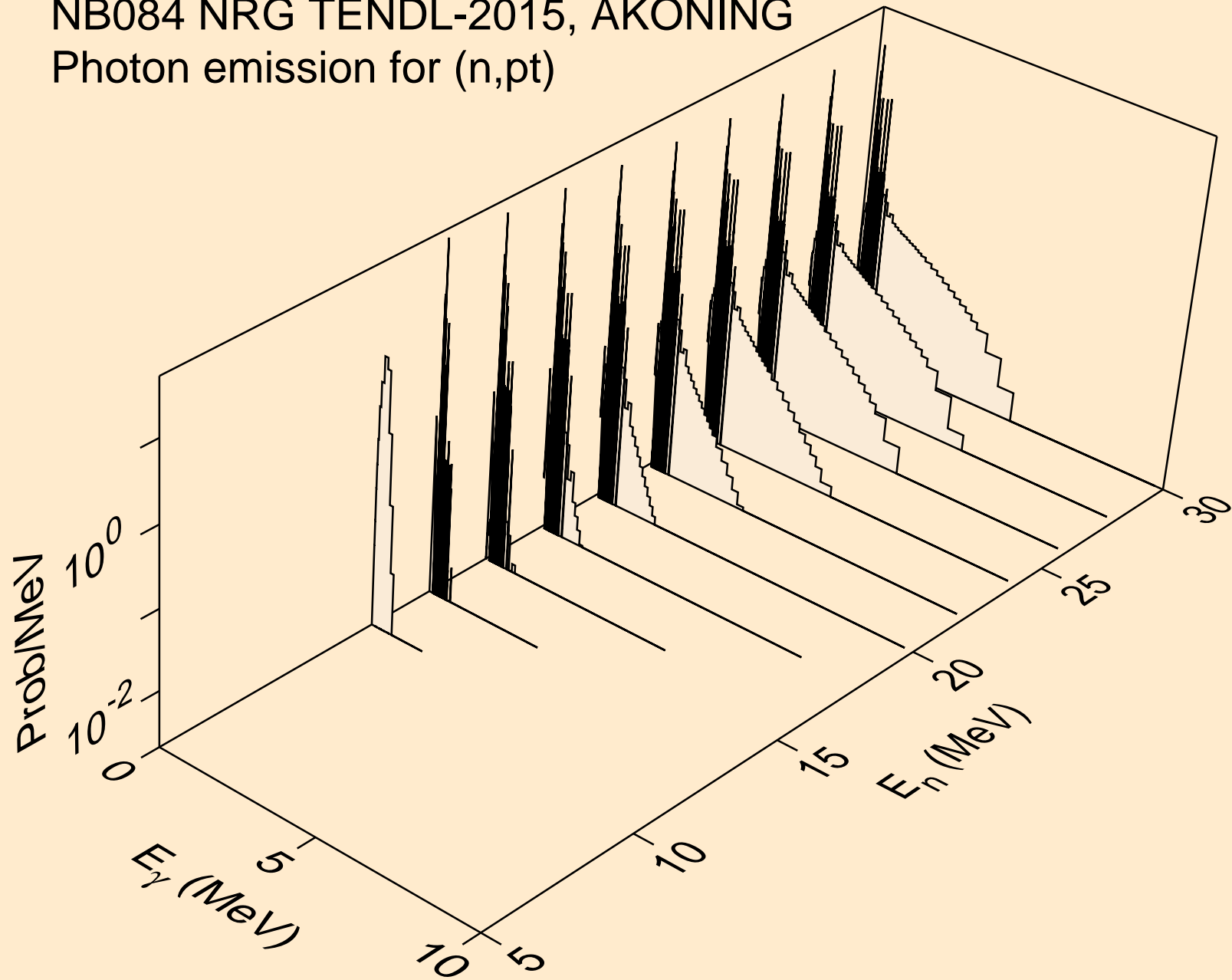

NB084 NRG TENDL-2015, AKONING
Photon emission for (n,da)

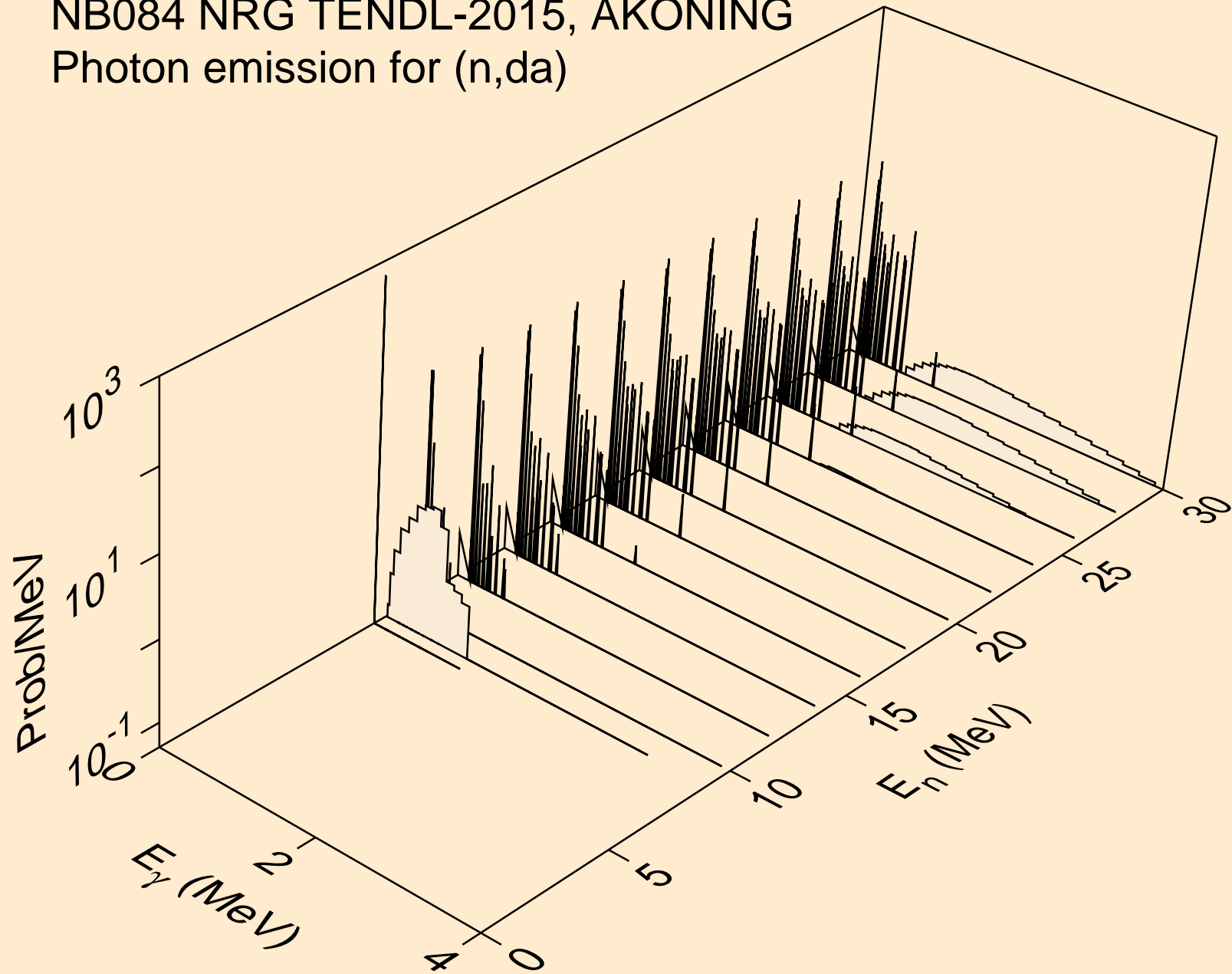

NB084 NRG TENDL-2015, AKONING
thermal capture photon spectrum

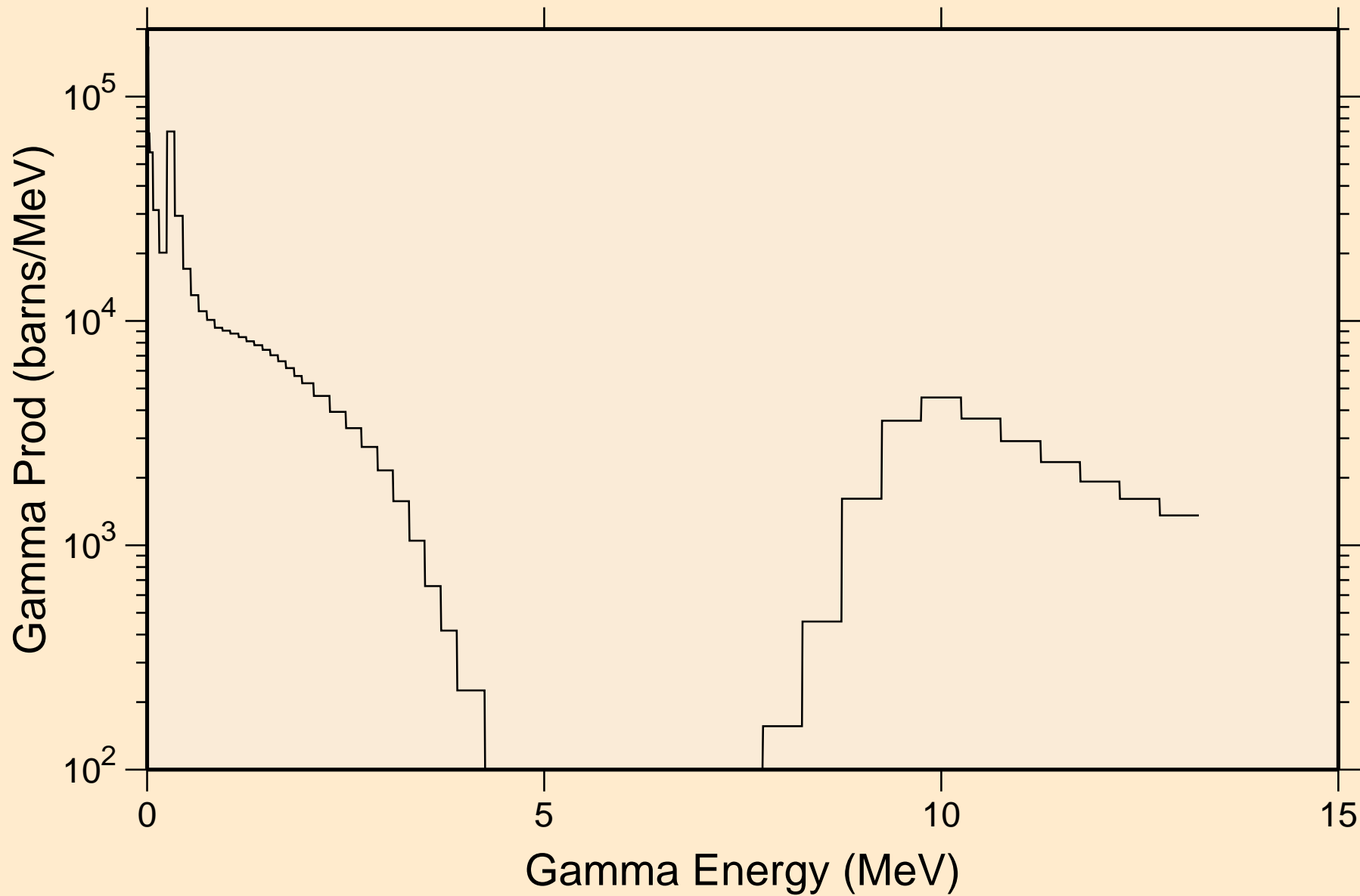

NB084 NRG TENDL-2015, AKONING
14 MeV photon spectrum

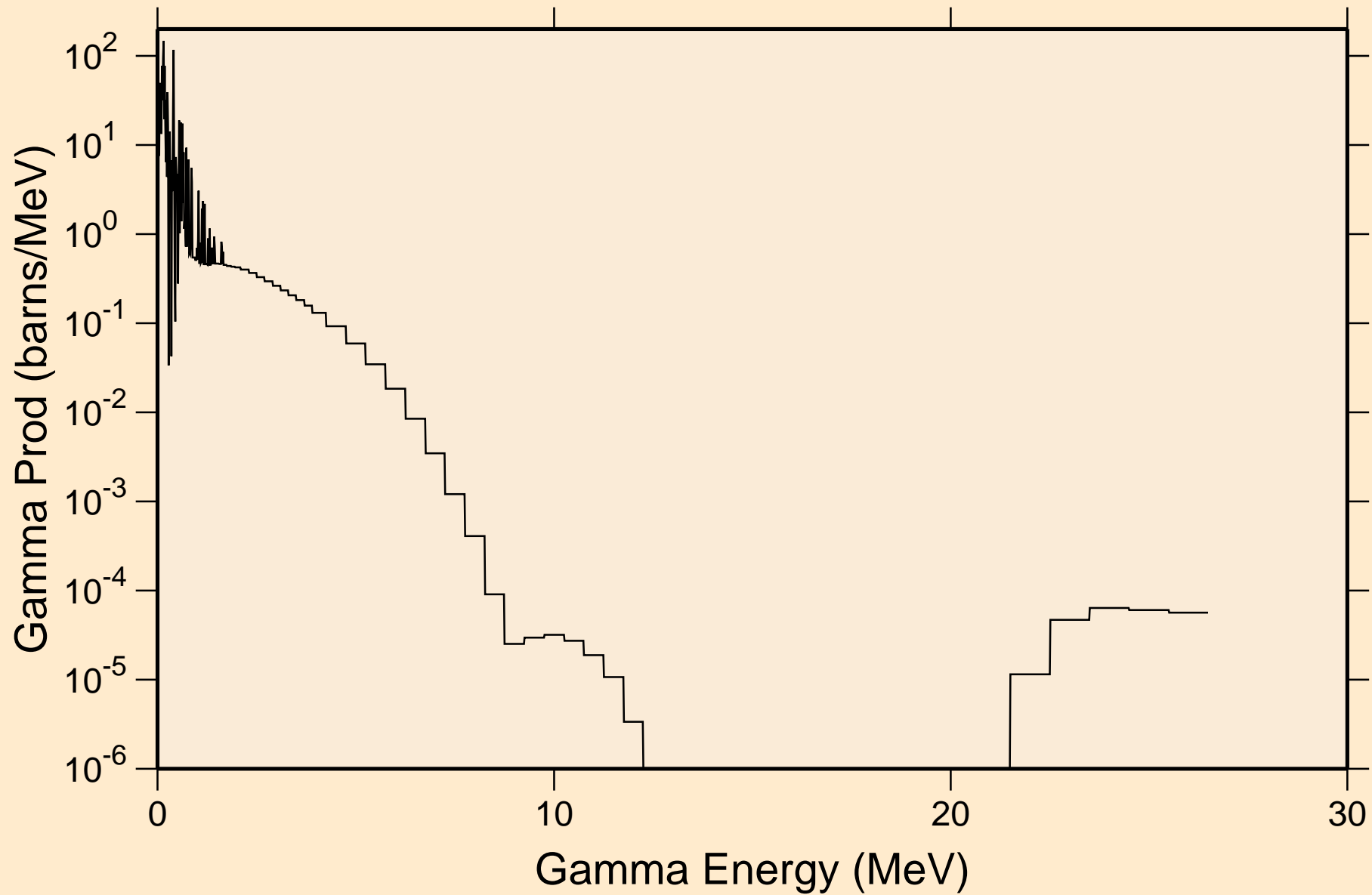

NB084 NRG TENDL-2015, AKONING

Particle heating contributions

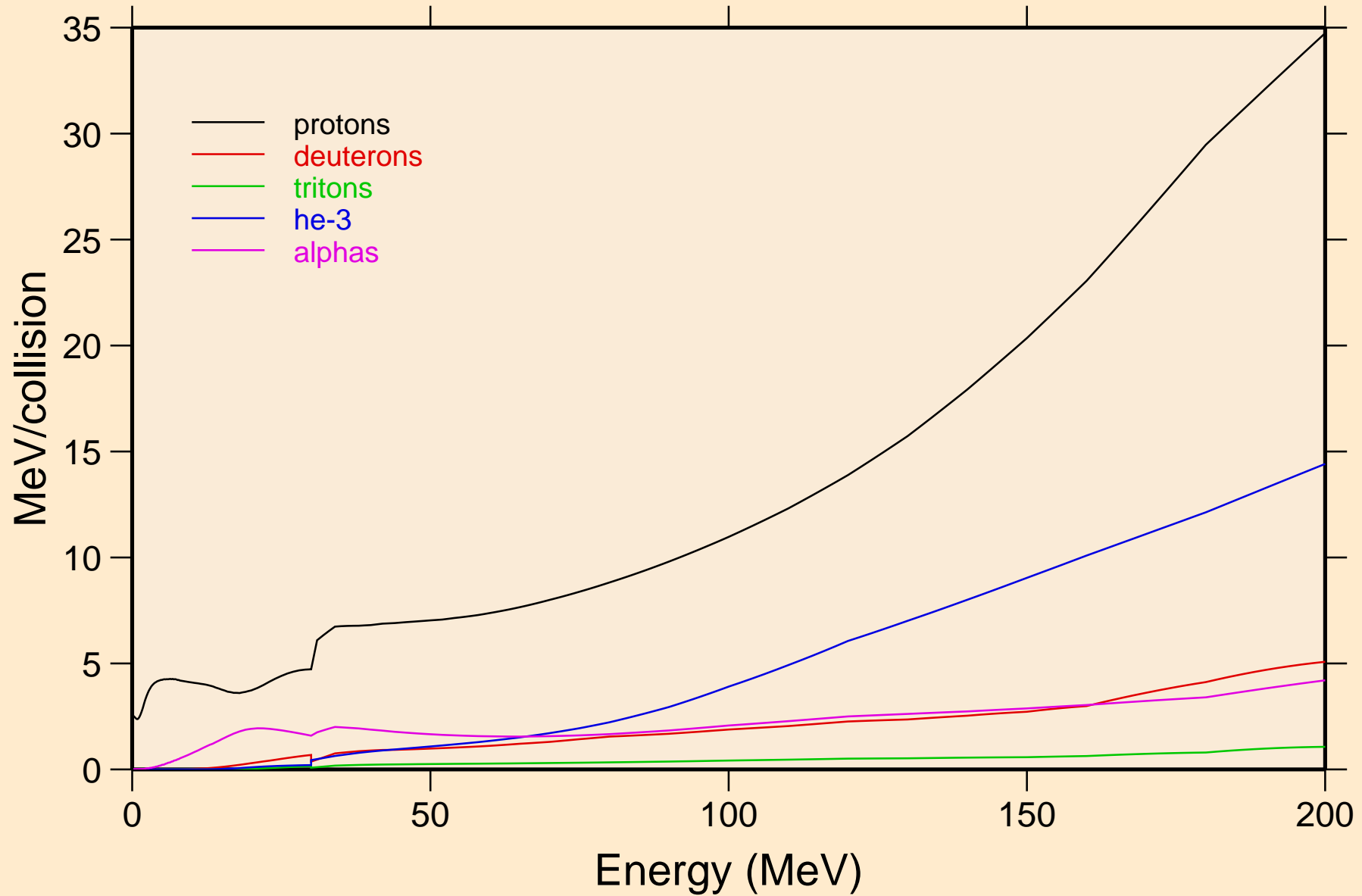

NB084 NRG TENDL-2015, AKONING

Recoil Heating

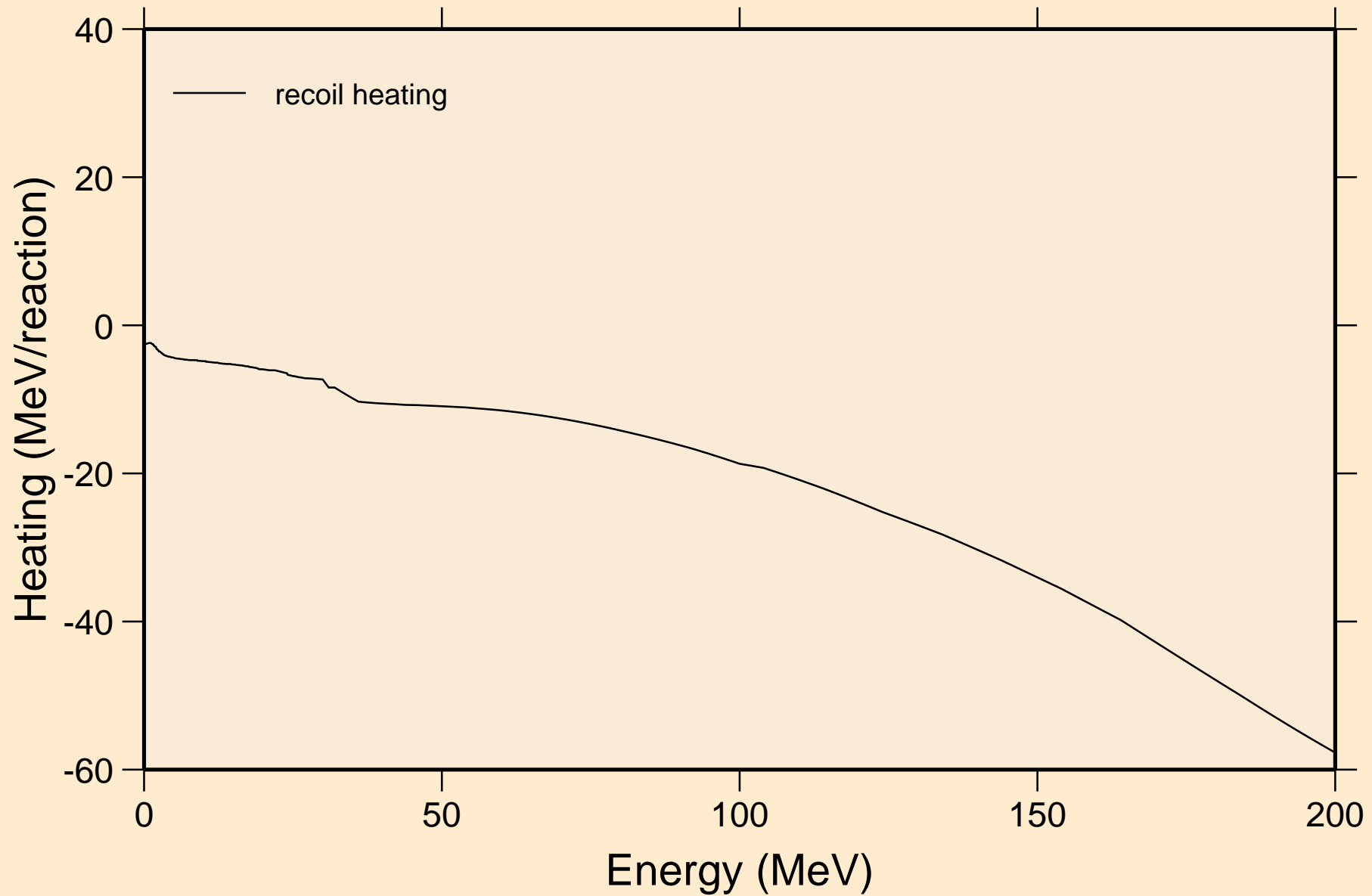

NB084 NRG TENDL-2015, AKONING

Particle production cross sections

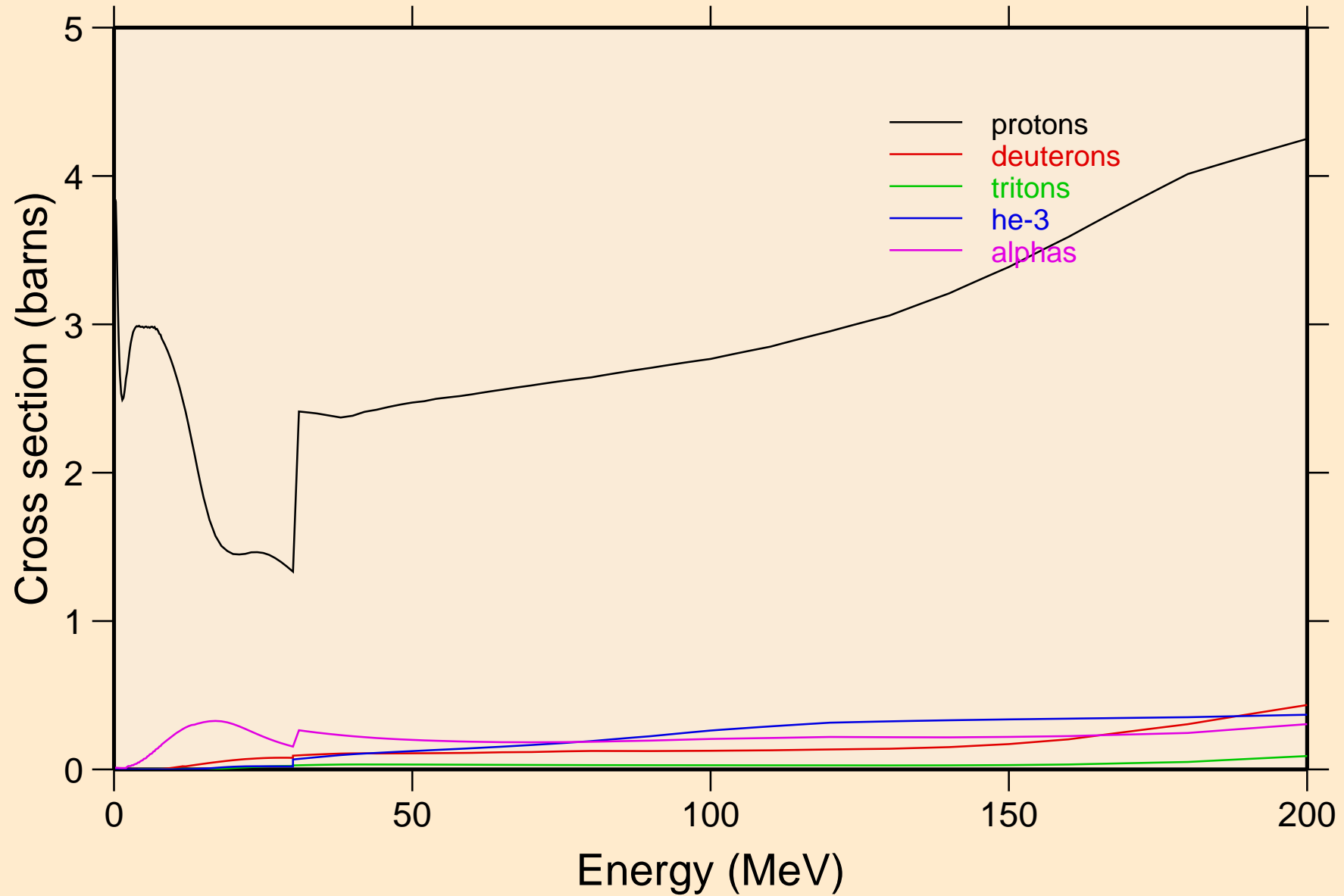

NB084 NRG TENDL-2015, AKONING
protons from (n,x)

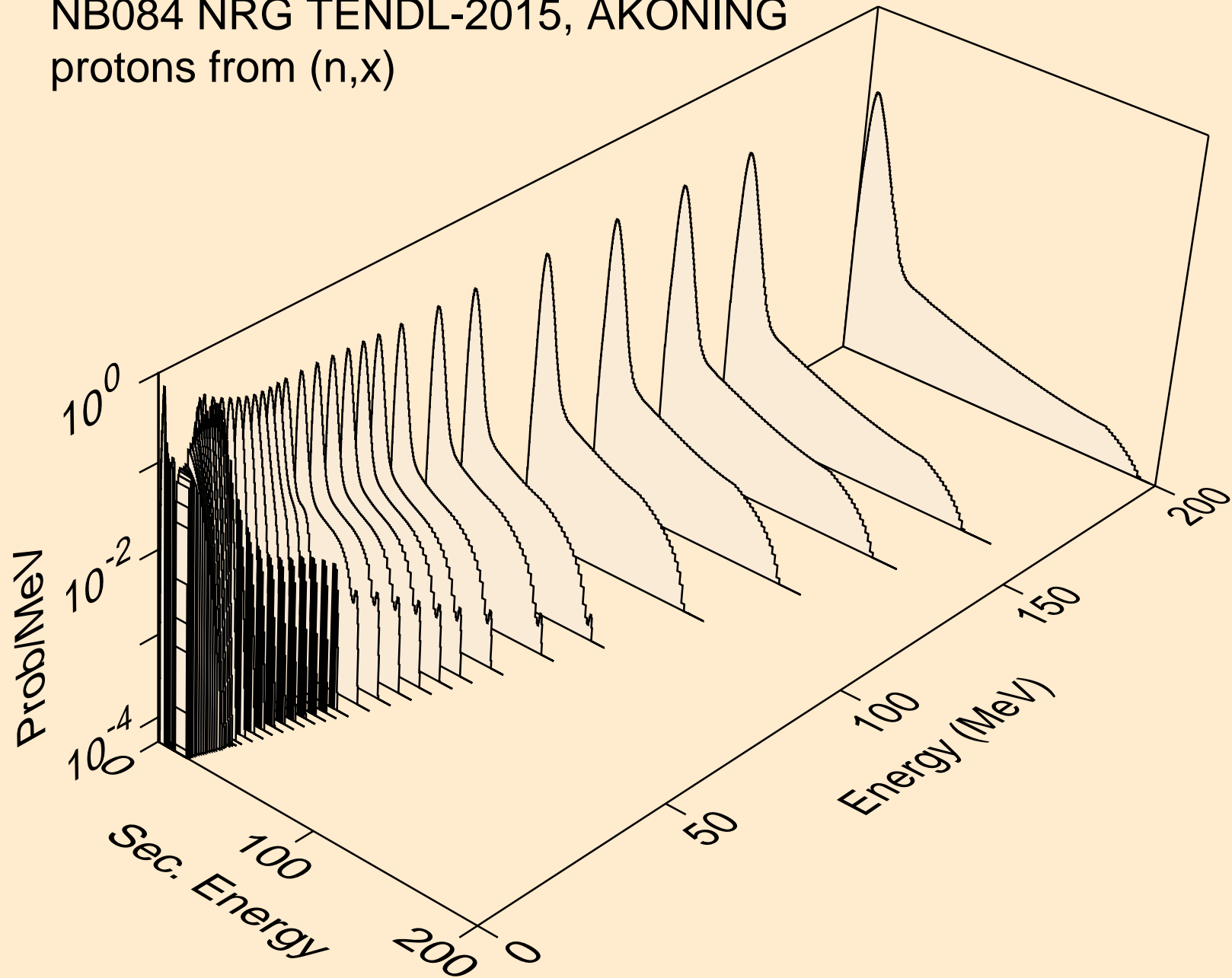

NB084 NRG TENDL-2015, AKONING
protons from (n,n*)p

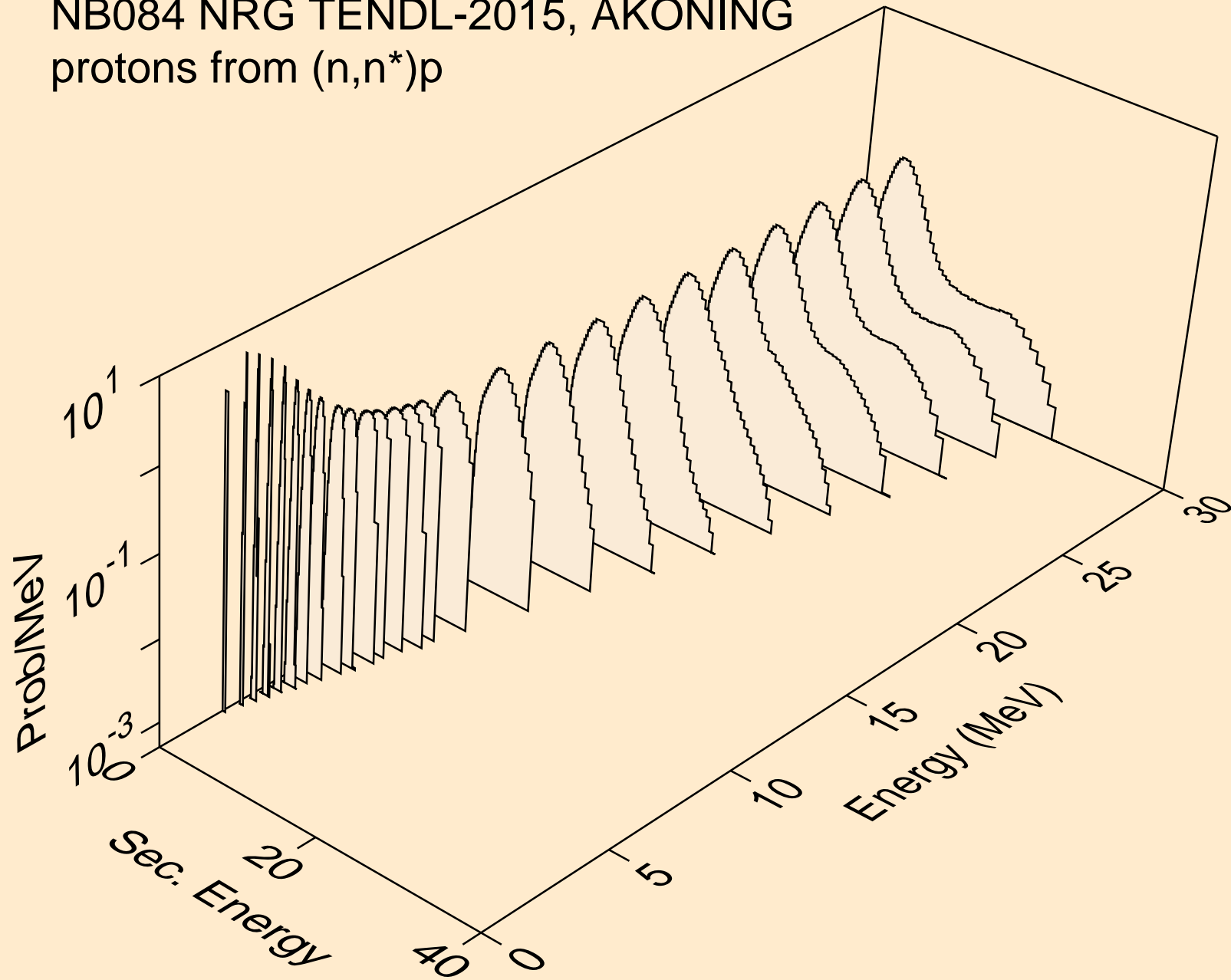

NB084 NRG TENDL-2015, AKONING
protons from (n,2np)

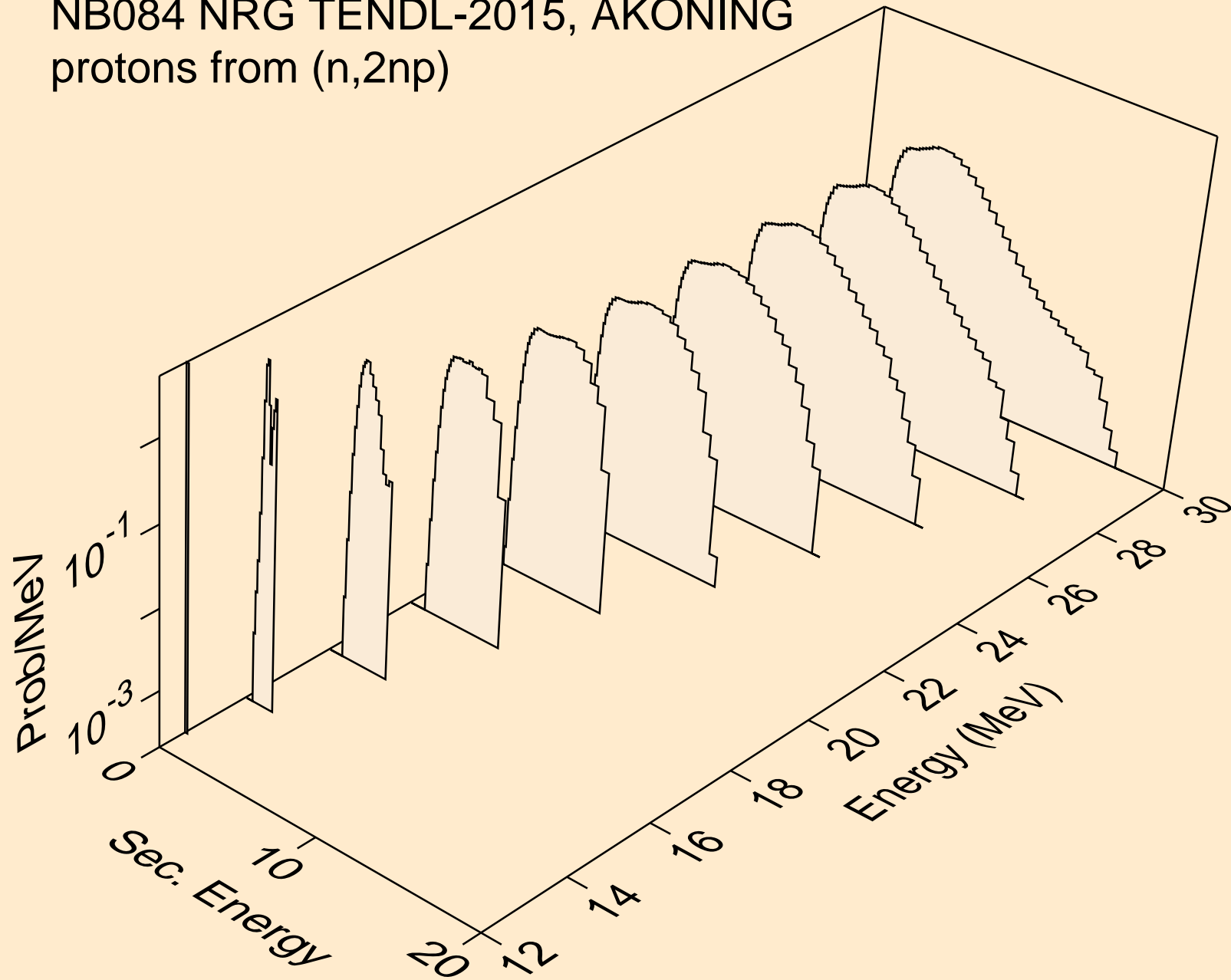

NB084 NRG TENDL-2015, AKONING
protons from (n,3np)

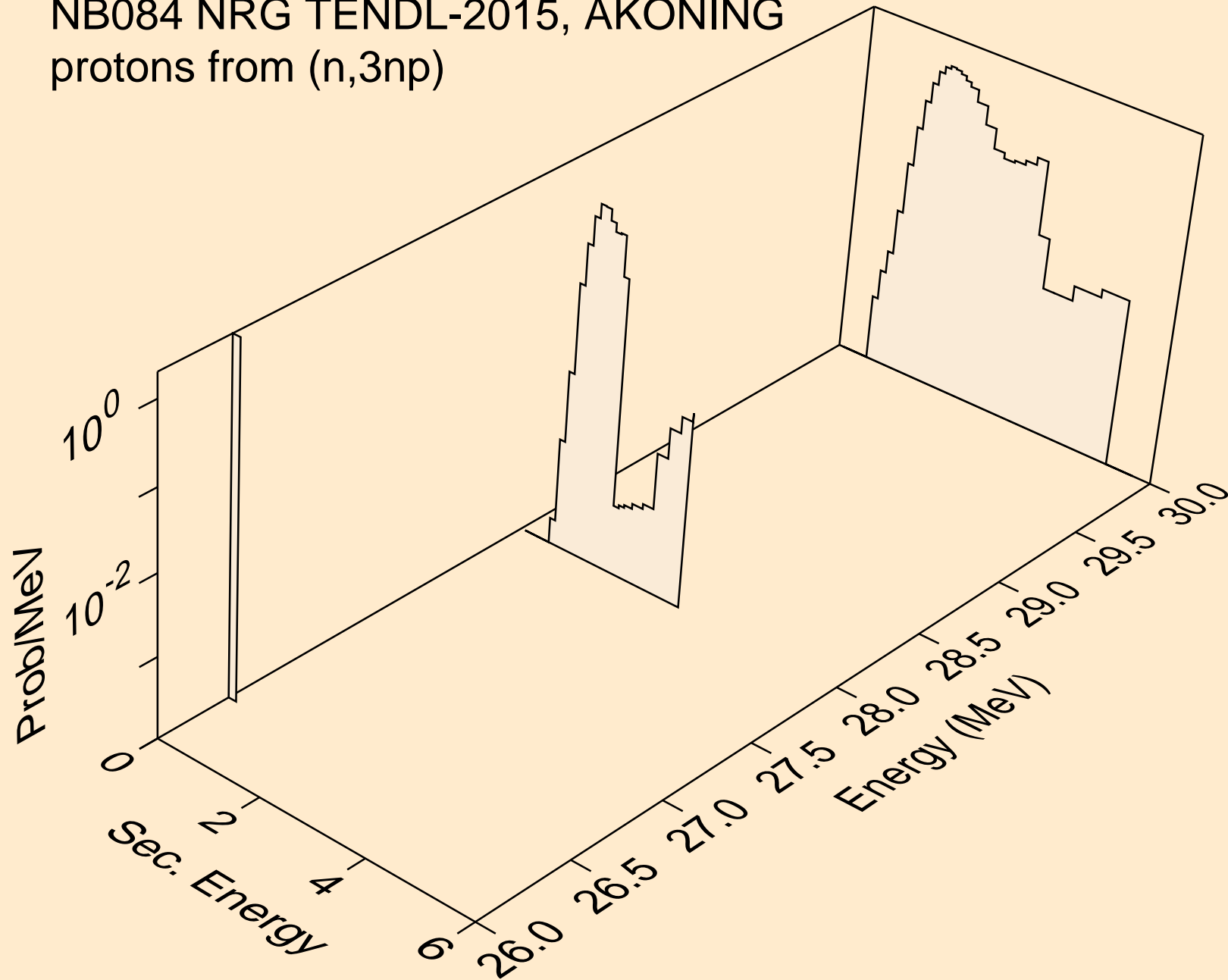

NB084 NRG TENDL-2015, AKONING
protons from (n,2np)

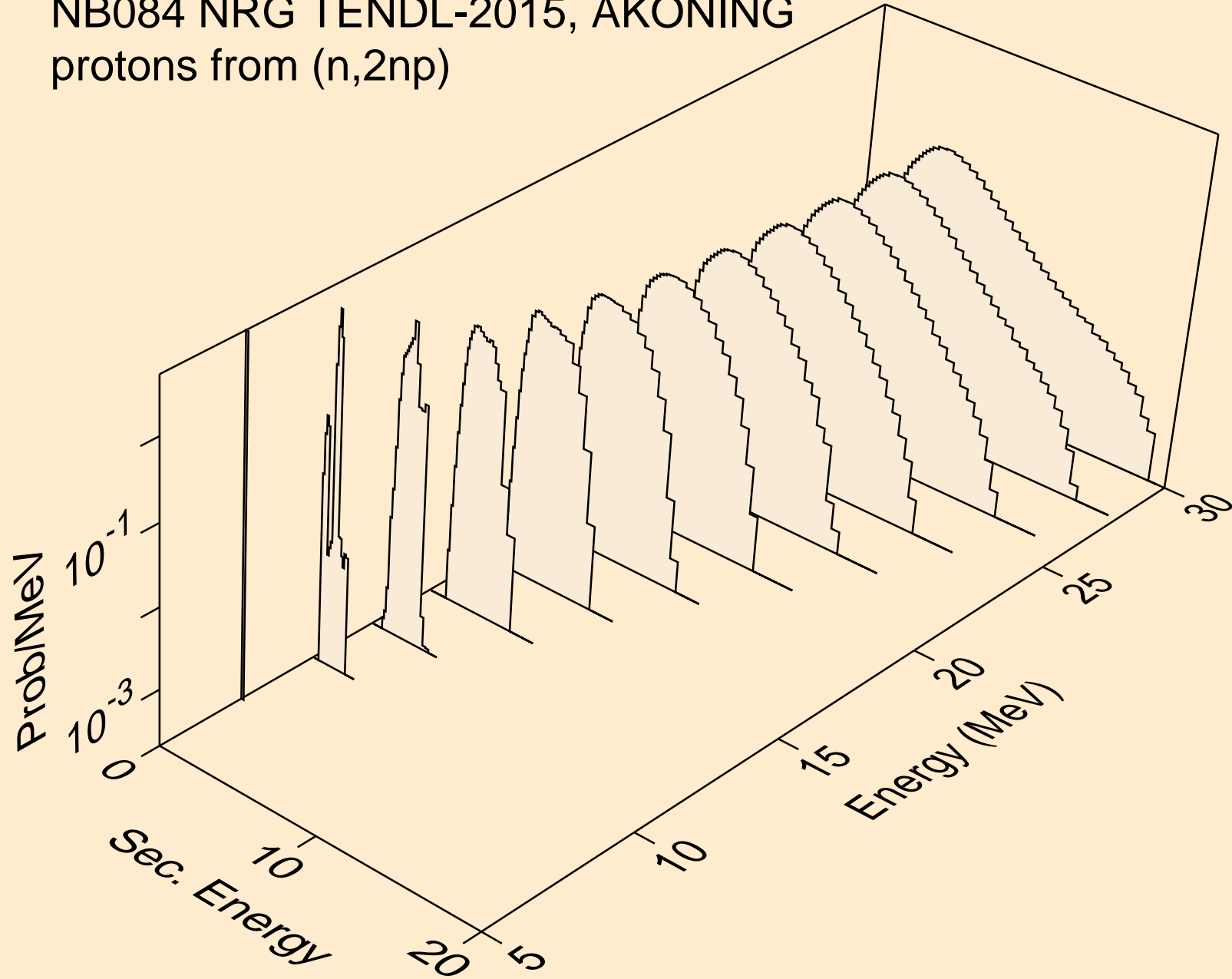

NB084 NRG TENDL-2015, AKONING
protons from (n,npa)

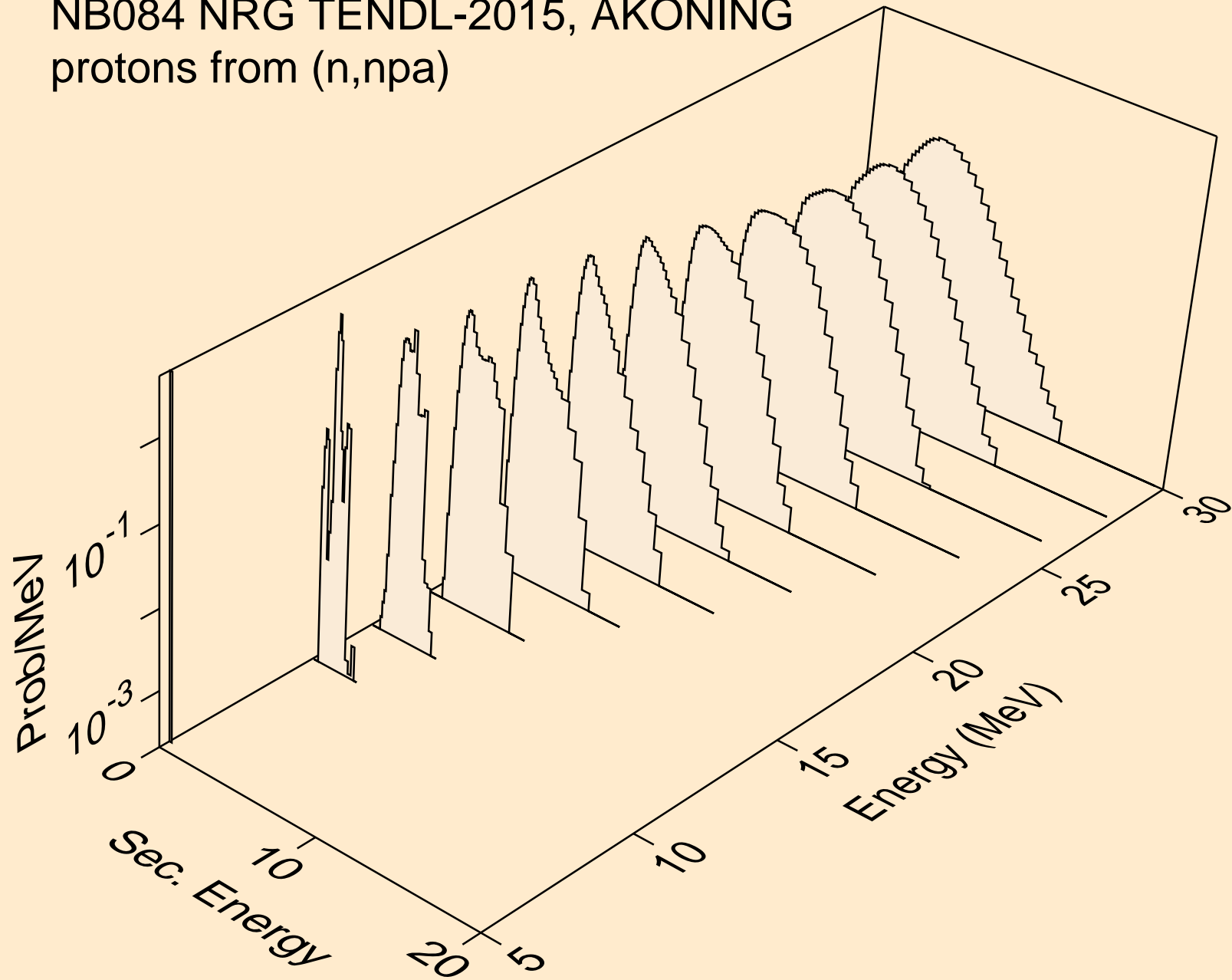

NB084 NRG TENDL-2015, AKONING
protons from (n,p)

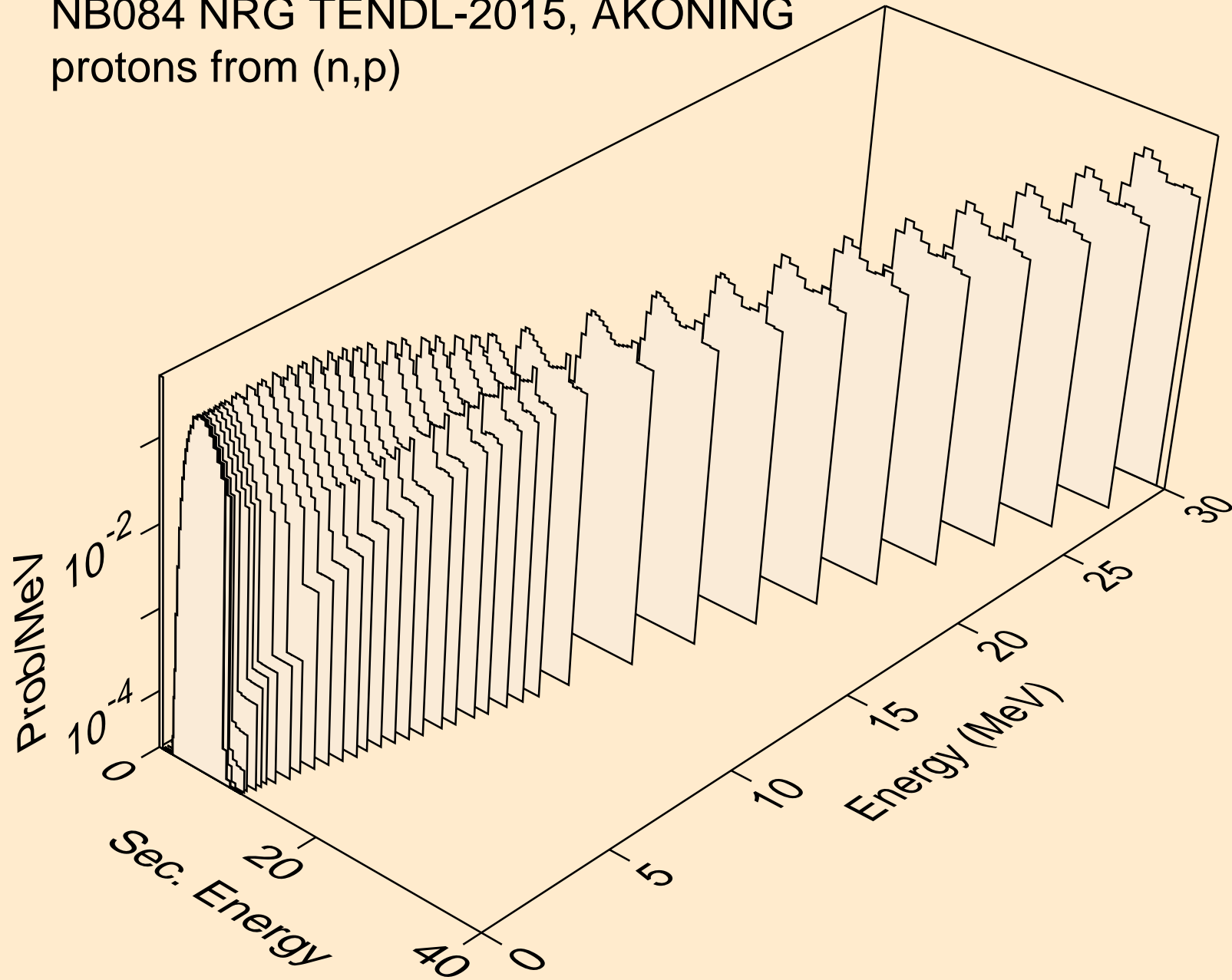

NB084 NRG TENDL-2015, AKONING
protons from (n,2p)

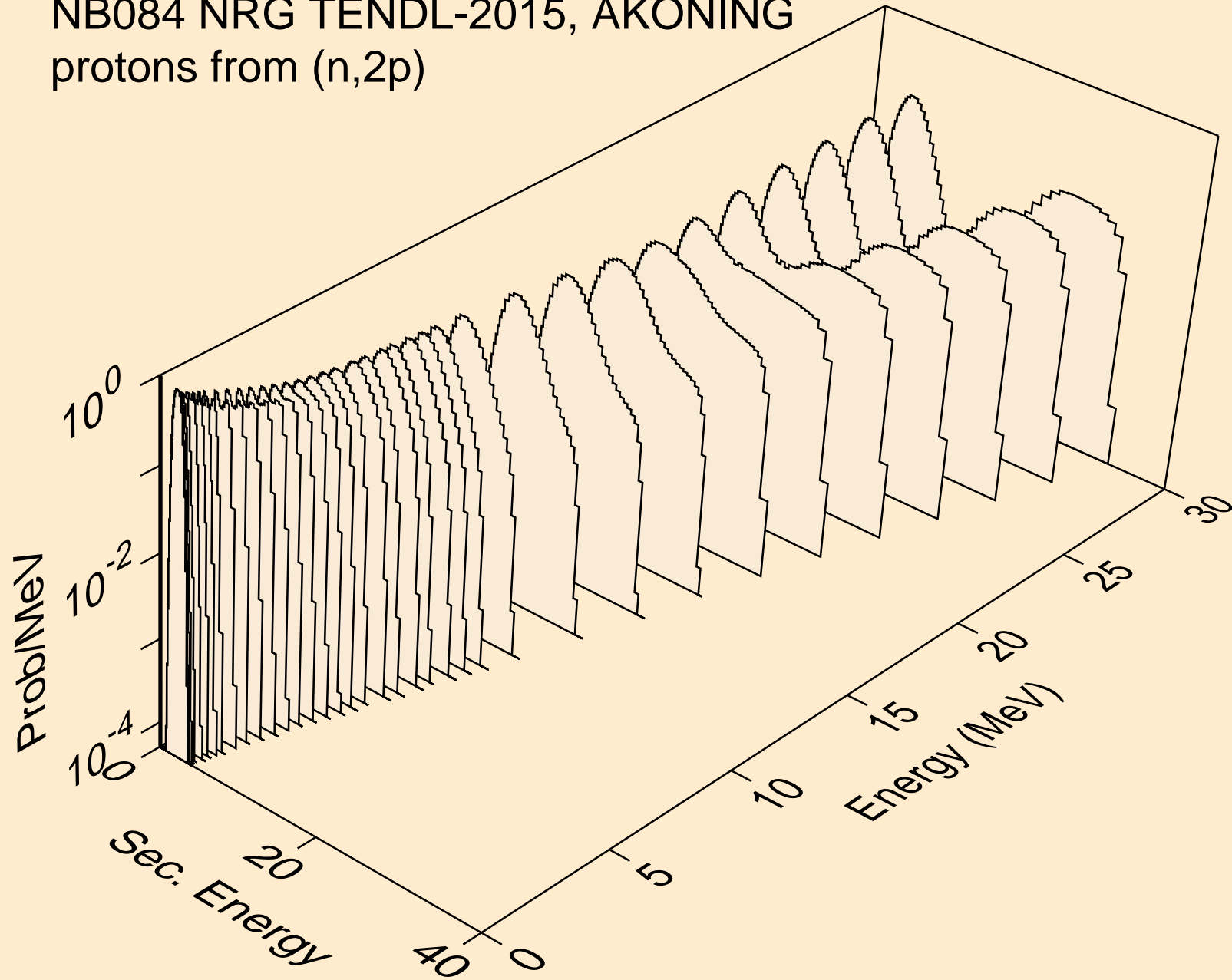

NB084 NRG TENDL-2015, AKONING
protons from (n,pa)

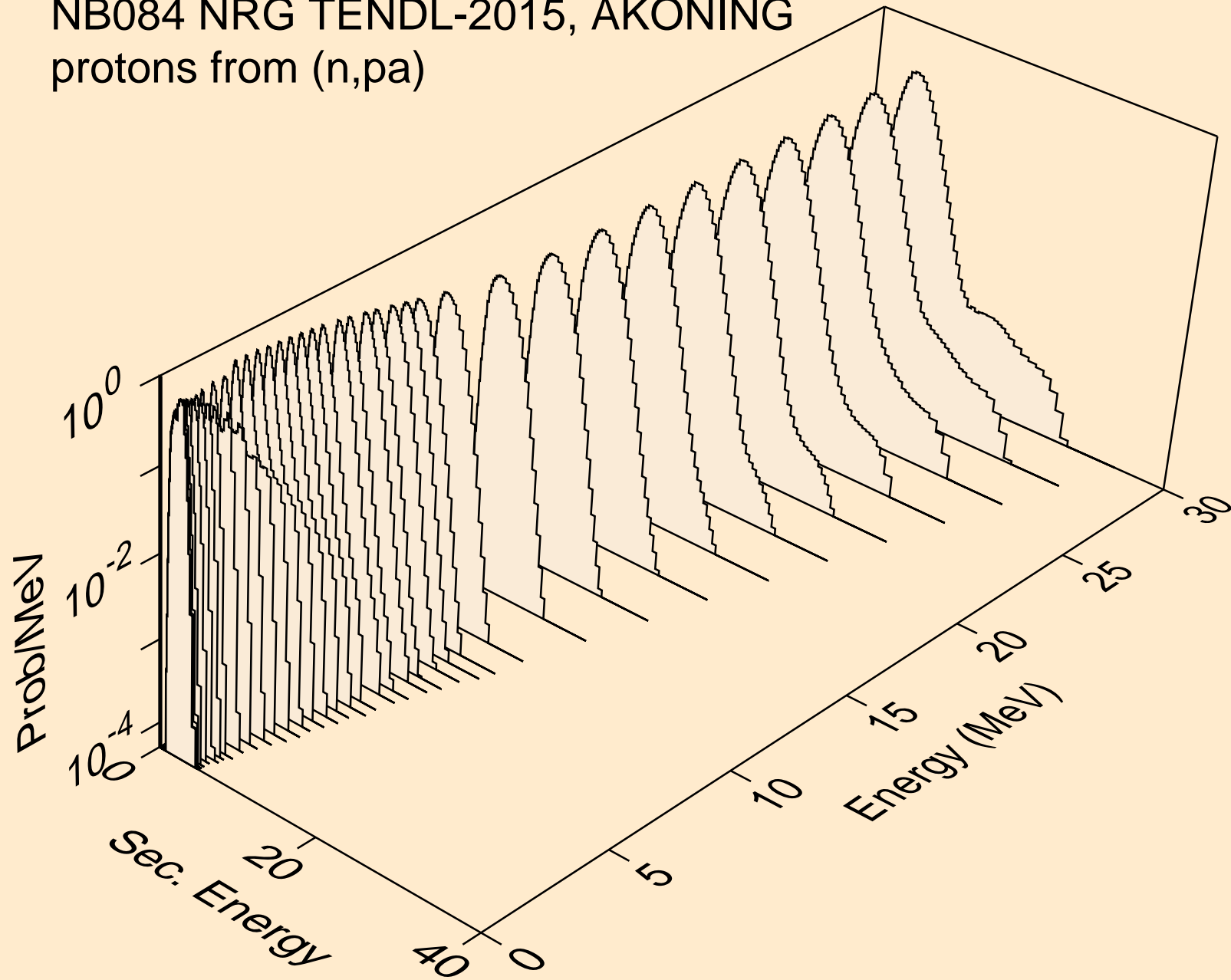

NB084 NRG TENDL-2015, AKONING
protons from (n,pd)

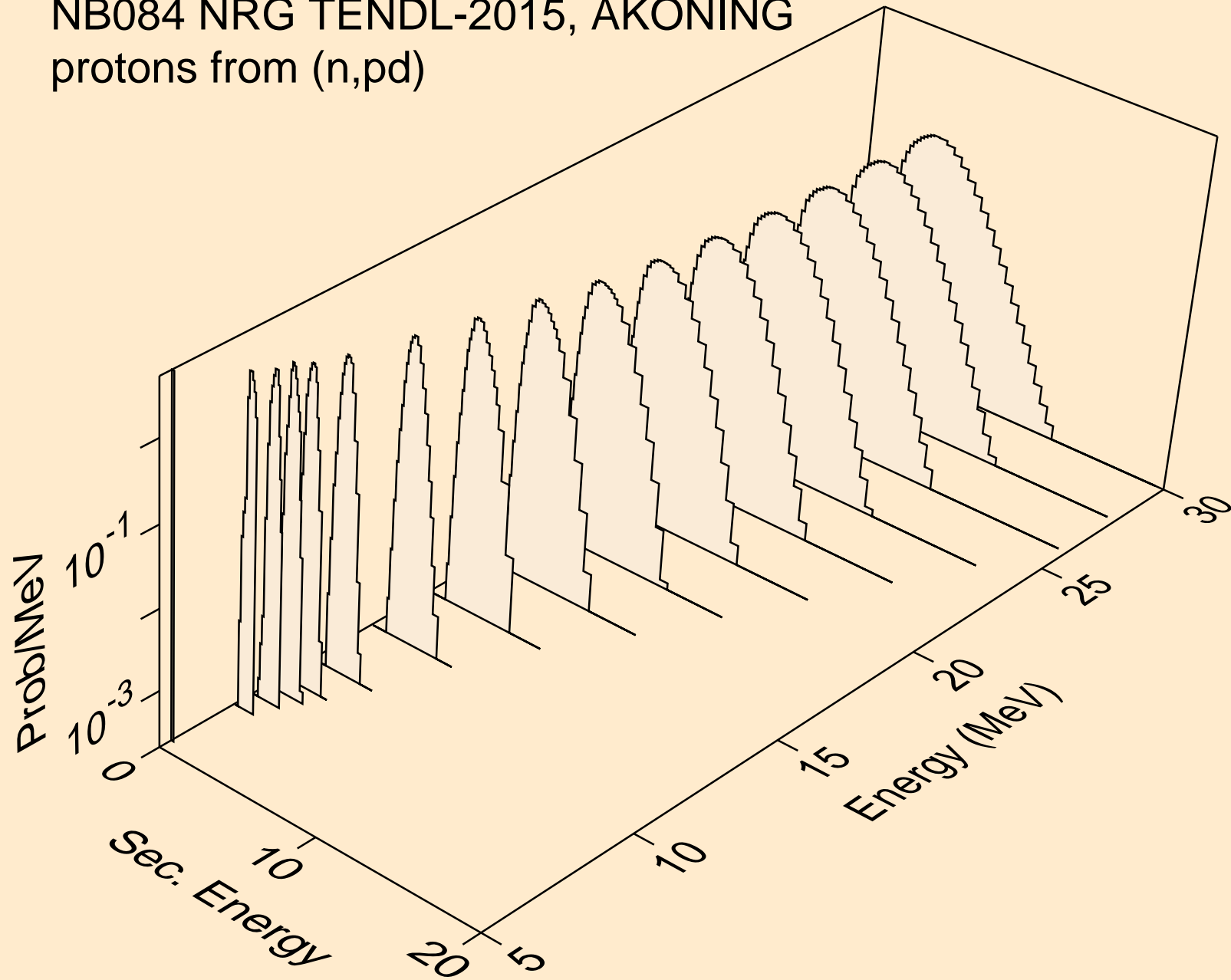

NB084 NRG TENDL-2015, AKONING
protons from (n,pt)

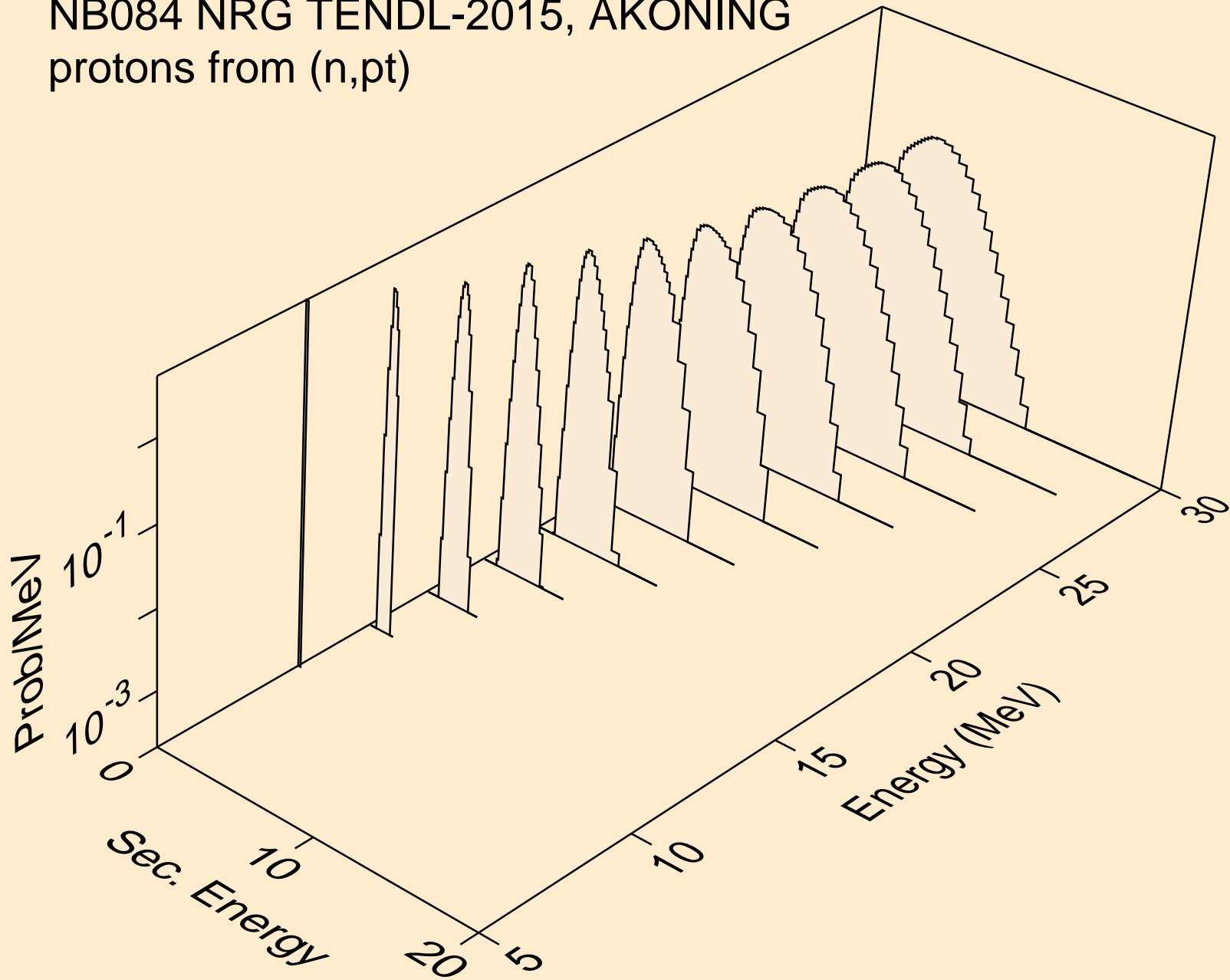

NB084 NRG TENDL-2015, AKONING
deuterons from (n,x)

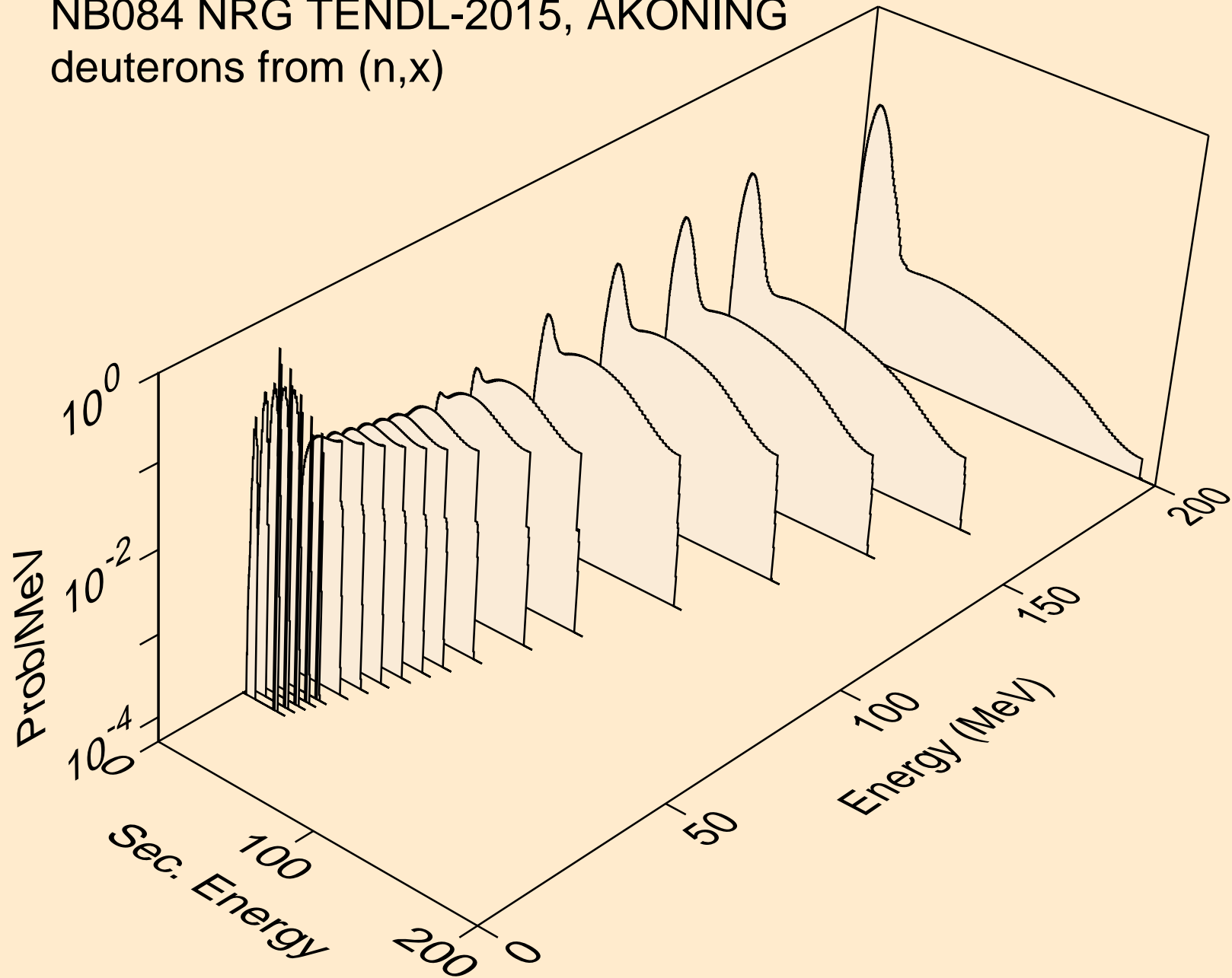

NB084 NRG TENDL-2015, AKONING
deuterons from (n,2nd)

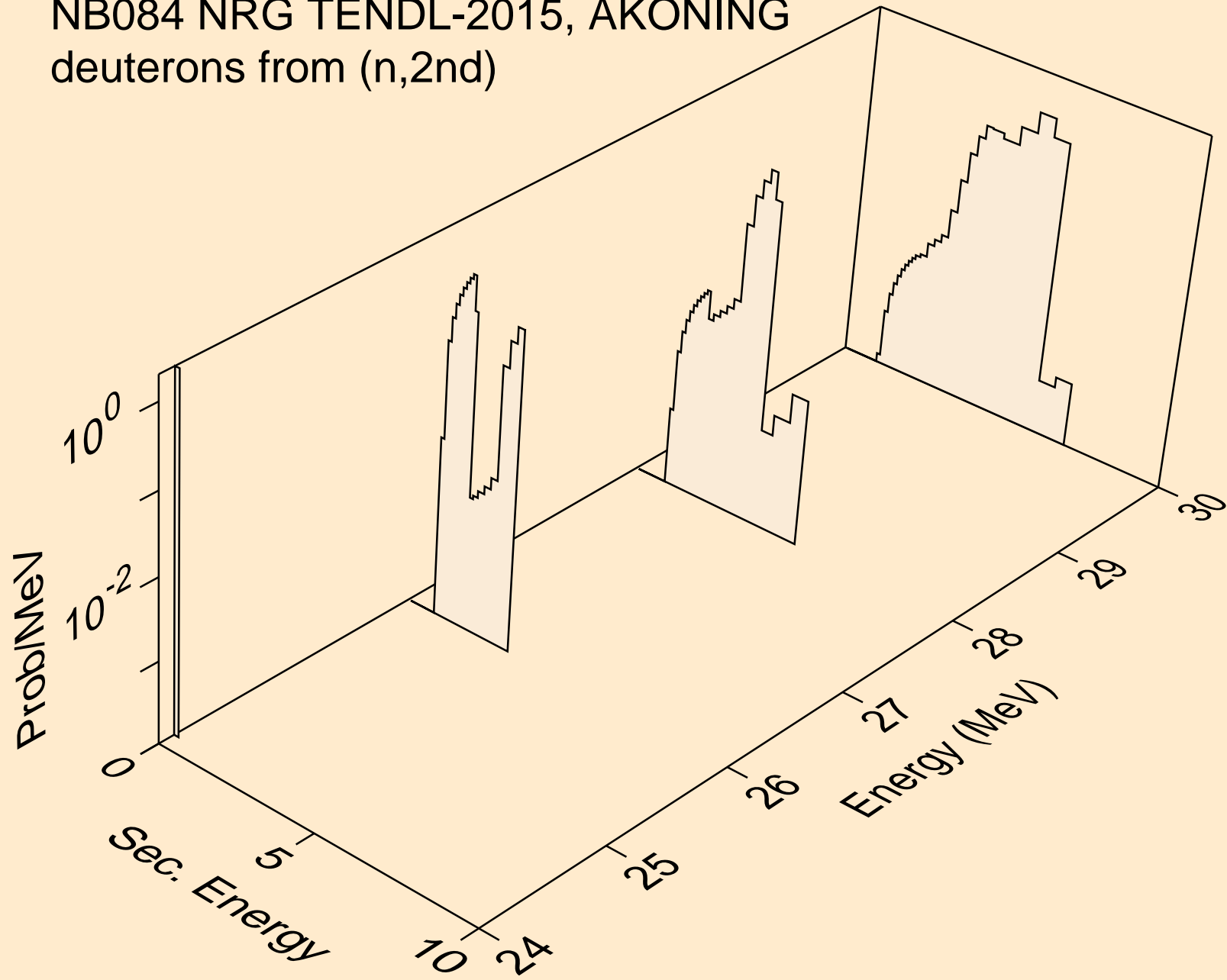

NB084 NRG TENDL-2015, AKONING
deuterons from (n,n*)d

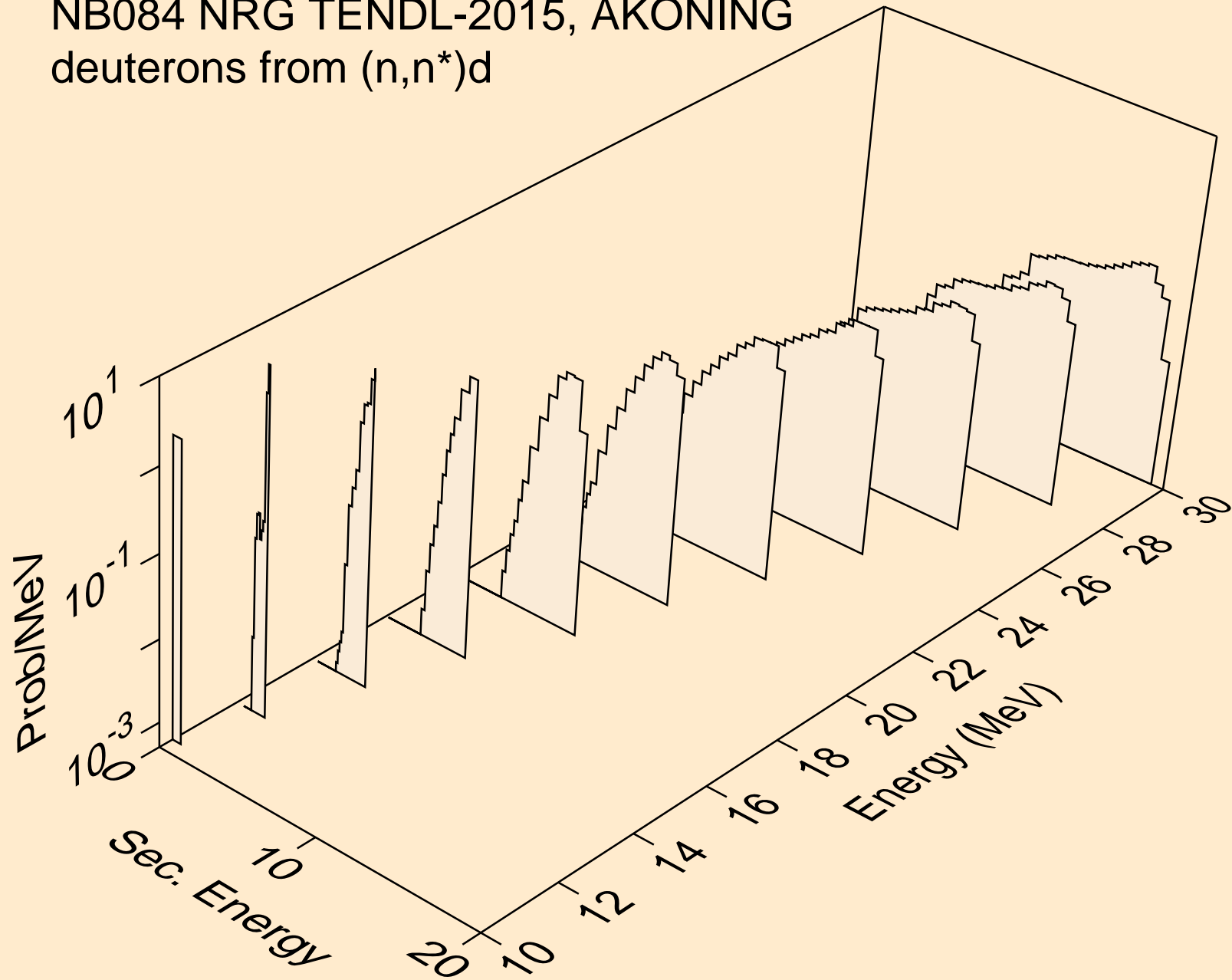

NB084 NRG TENDL-2015, AKONING
deuterons from (n,d)

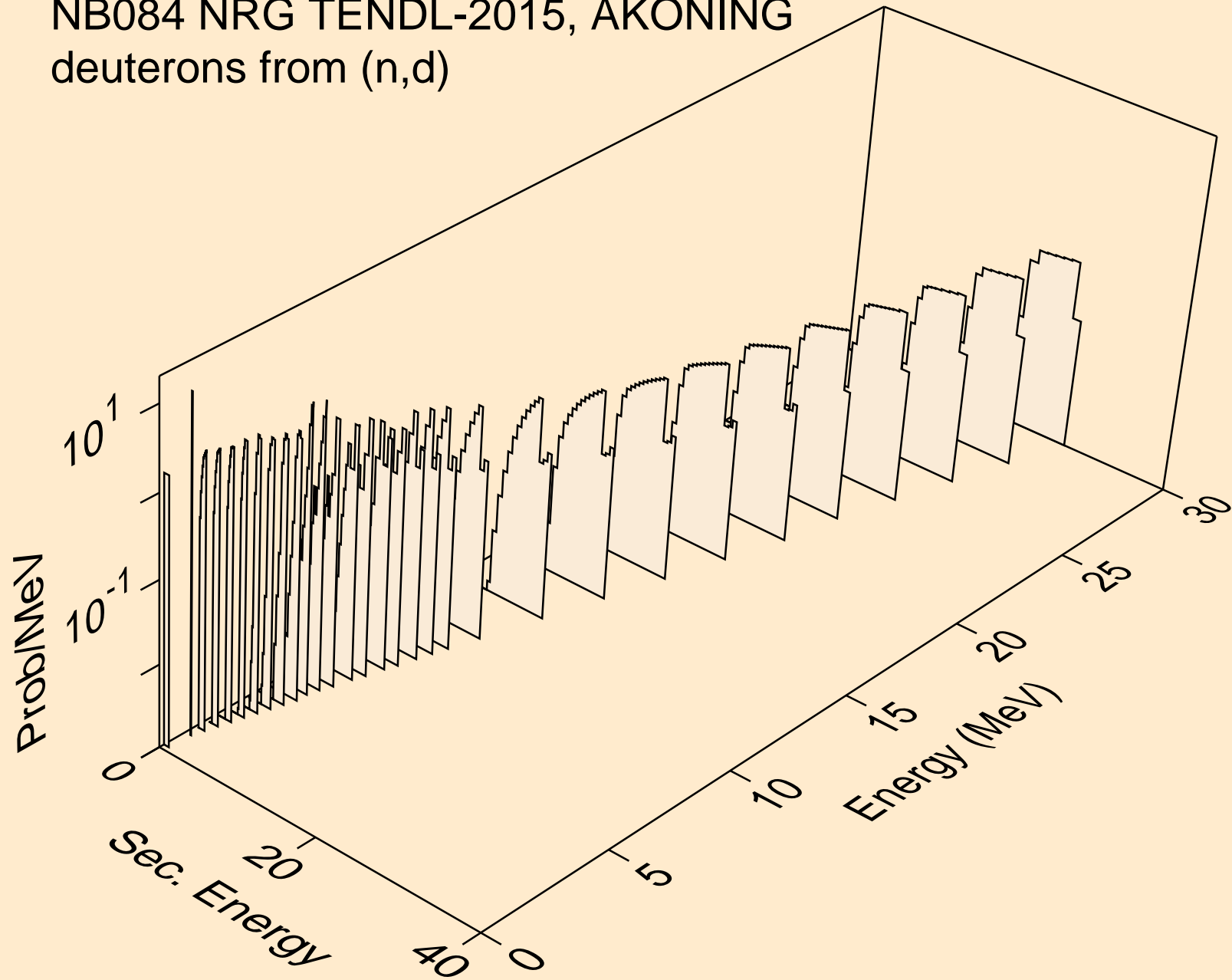

NB084 NRG TENDL-2015, AKONING
deuterons from (n,d2a)

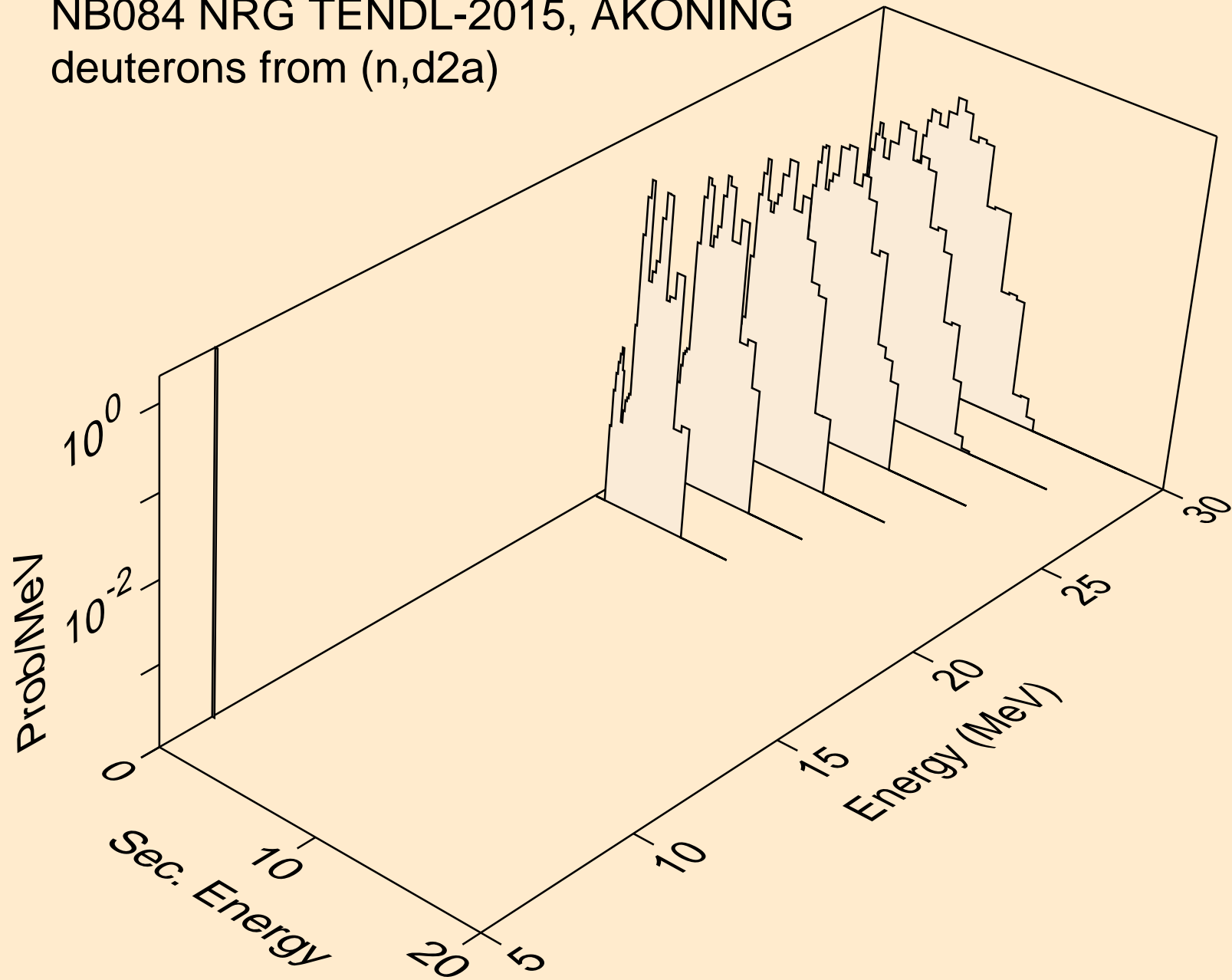

NB084 NRG TENDL-2015, AKONING
deuterons from (n,pd)

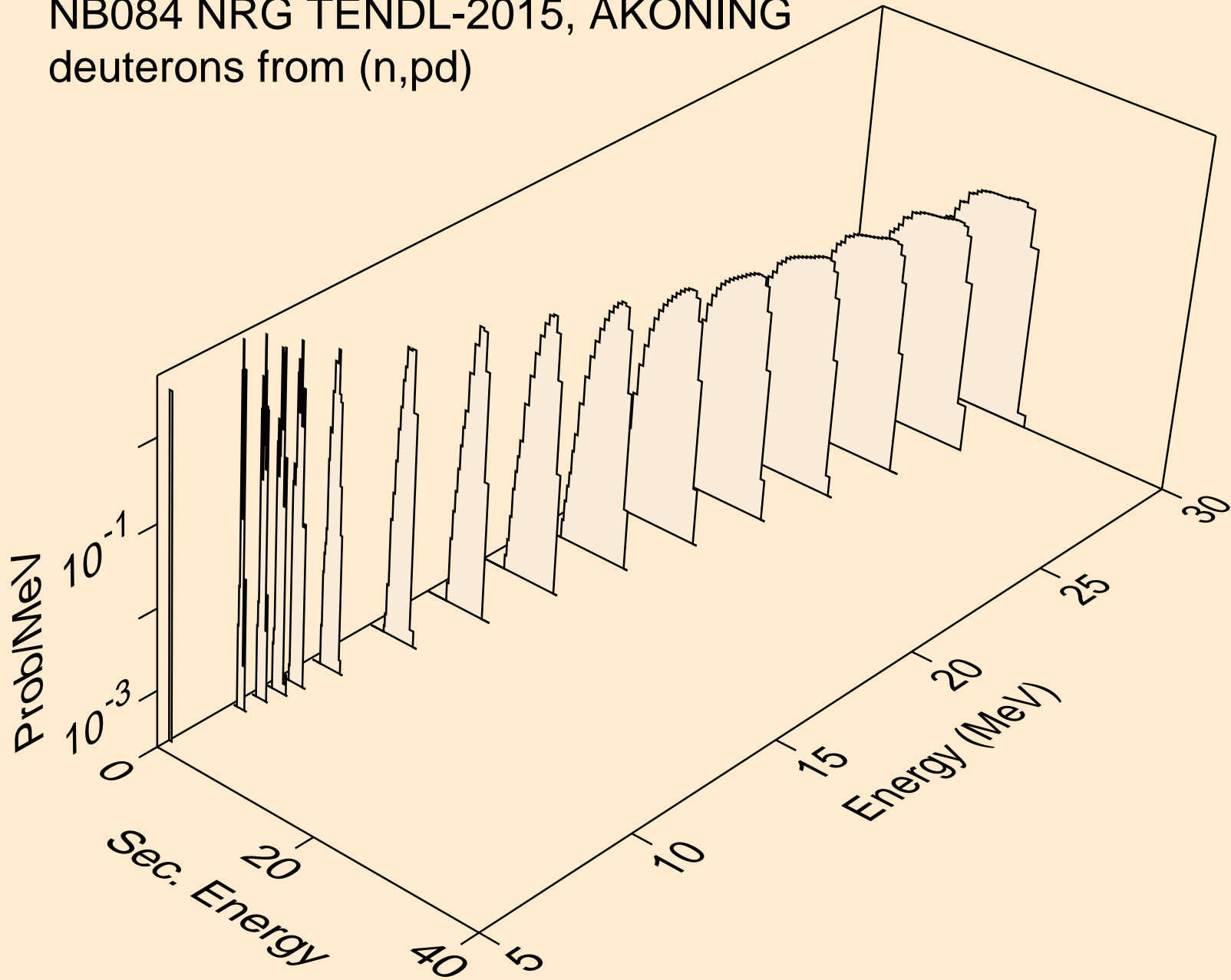

NB084 NRG TENDL-2015, AKONING
deuterons from (n,da)

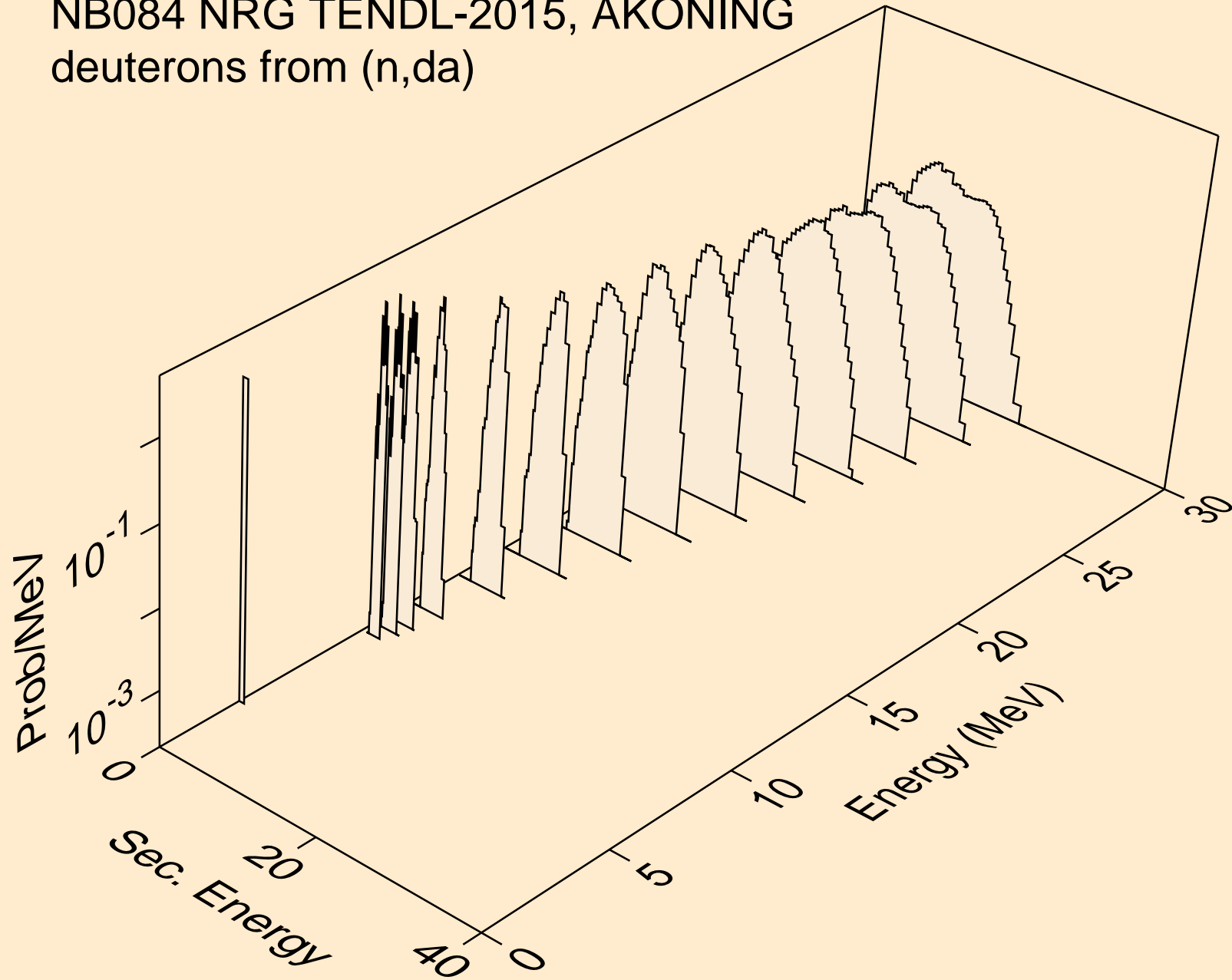

NB084 NRG TENDL-2015, AKONING
tritons from (n,x)

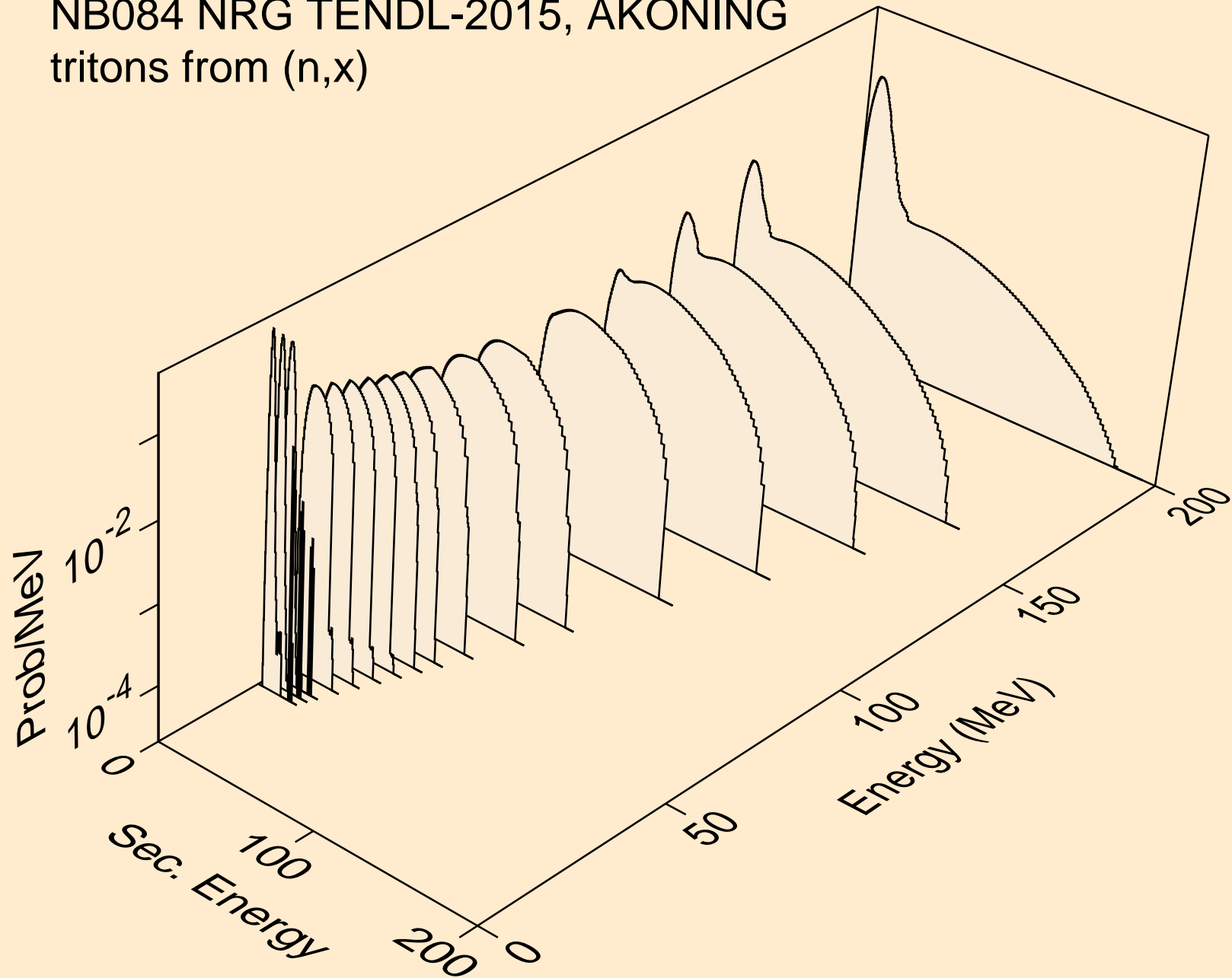

NB084 NRG TENDL-2015, AKONING
tritons from (n,n*)t

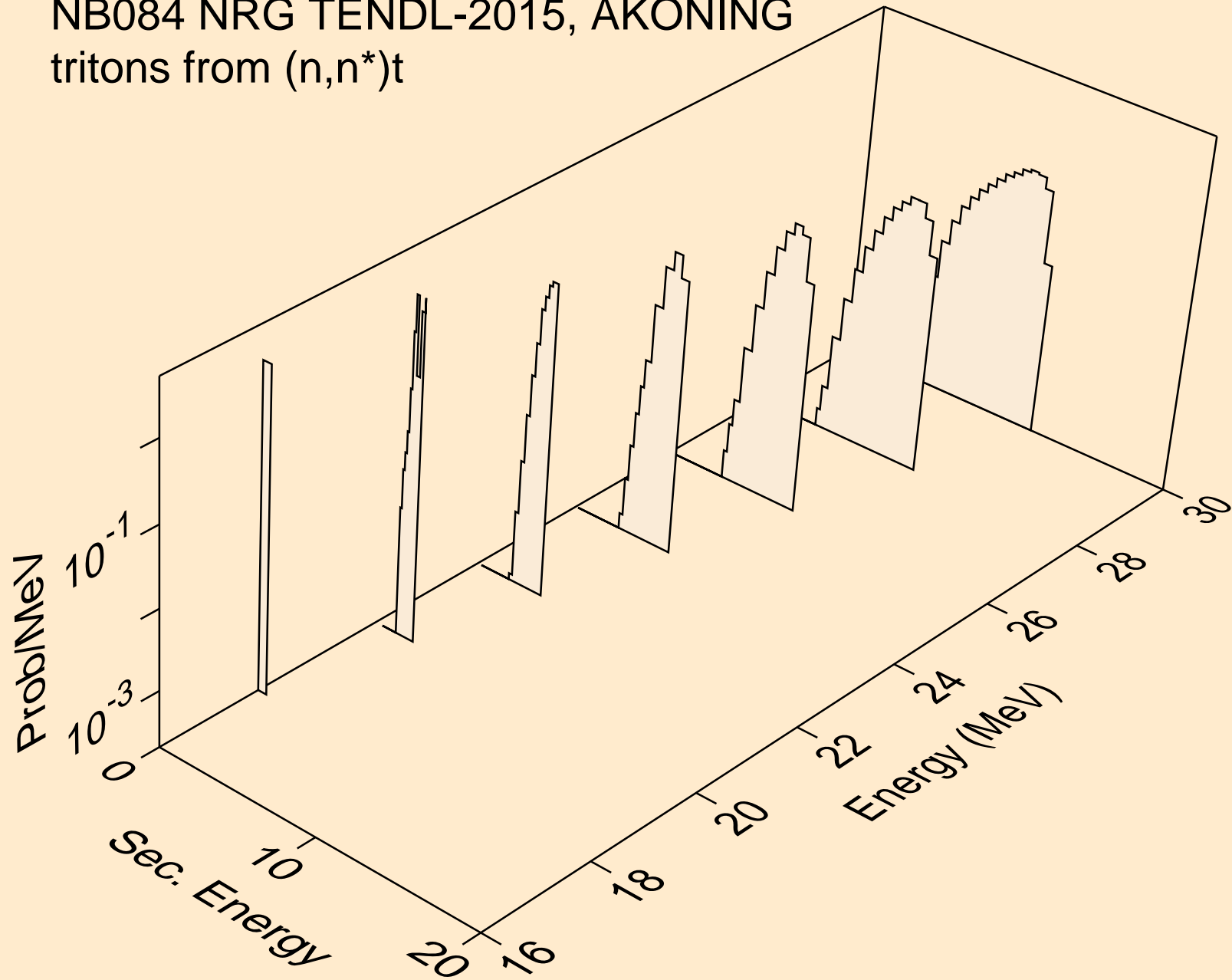

NB084 NRG TENDL-2015, AKONING
tritons from (n,t)

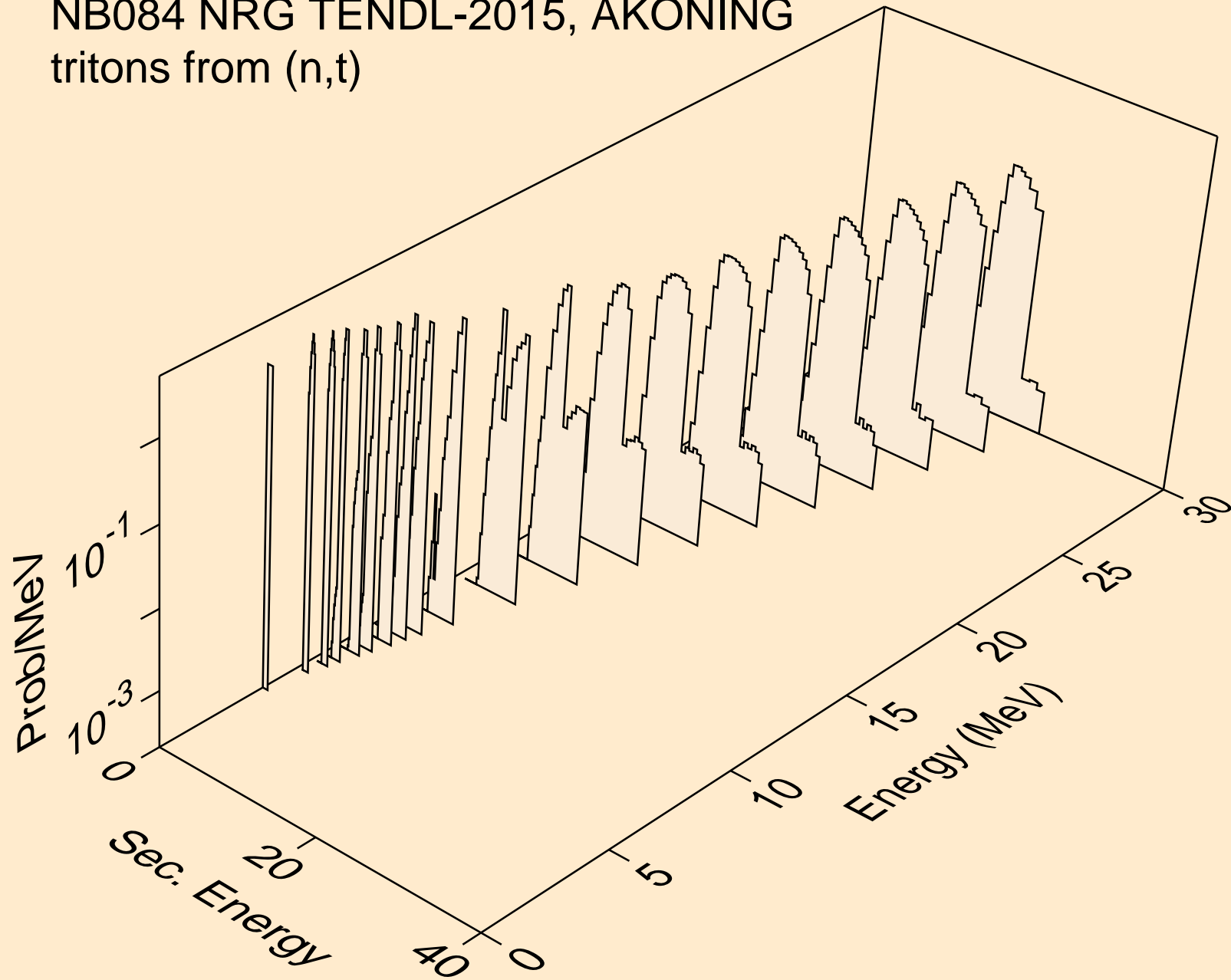

NB084 NRG TENDL-2015, AKONING
tritons from (n,pt)

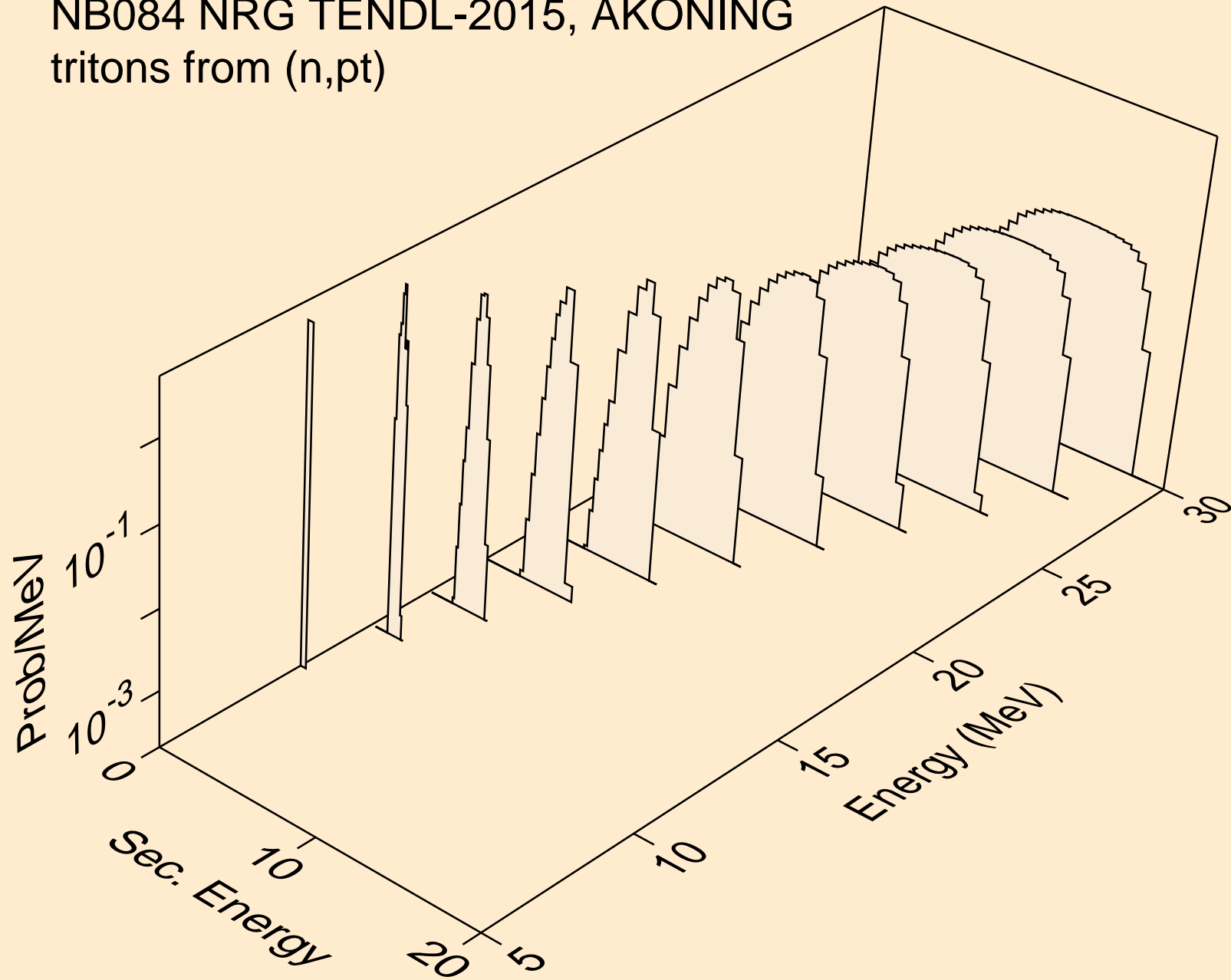

NB084 NRG TENDL-2015, AKONING
he3s from (n,x)

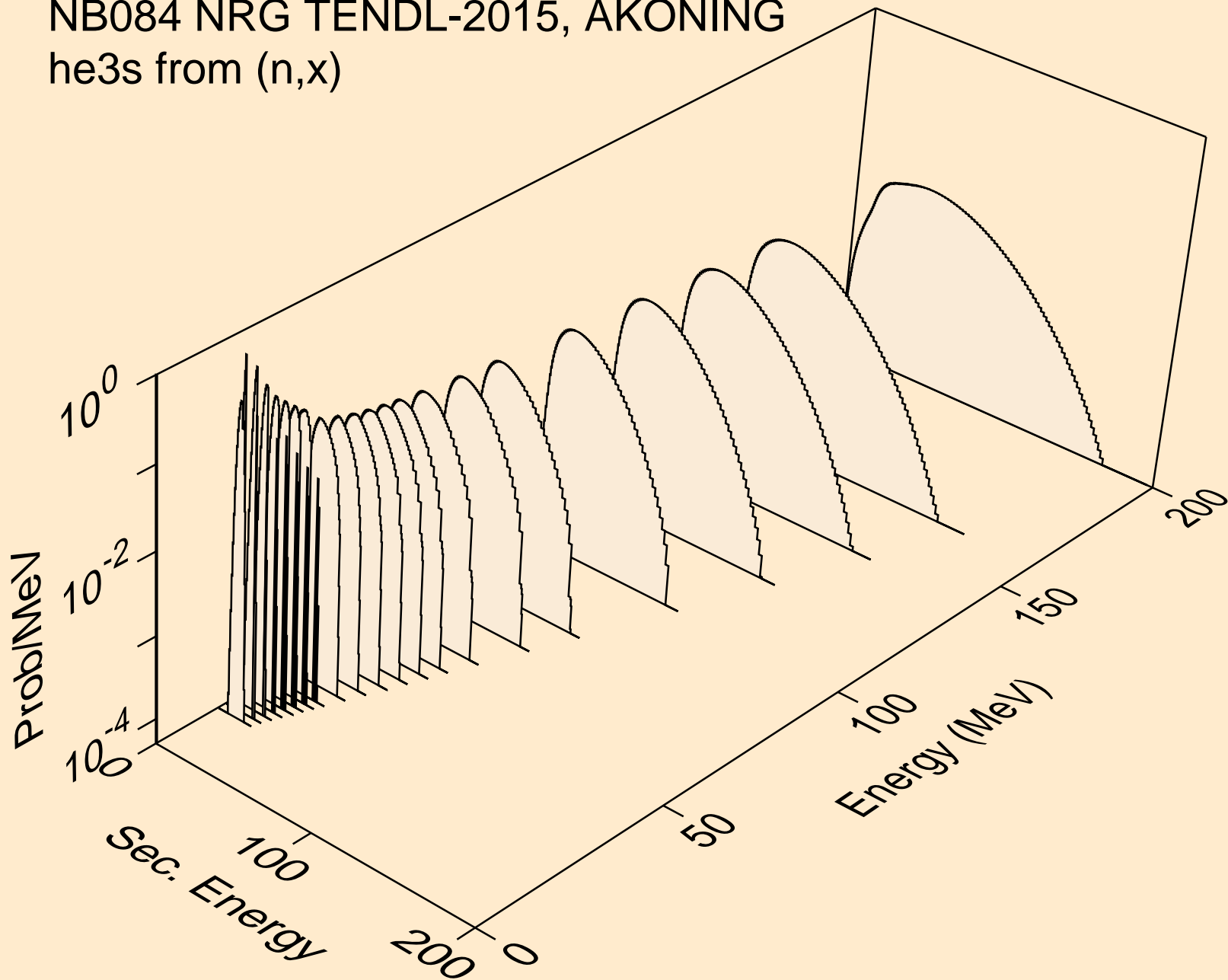

NB084 NRG TENDL-2015, AKONING
he3s from (n,n*)he3

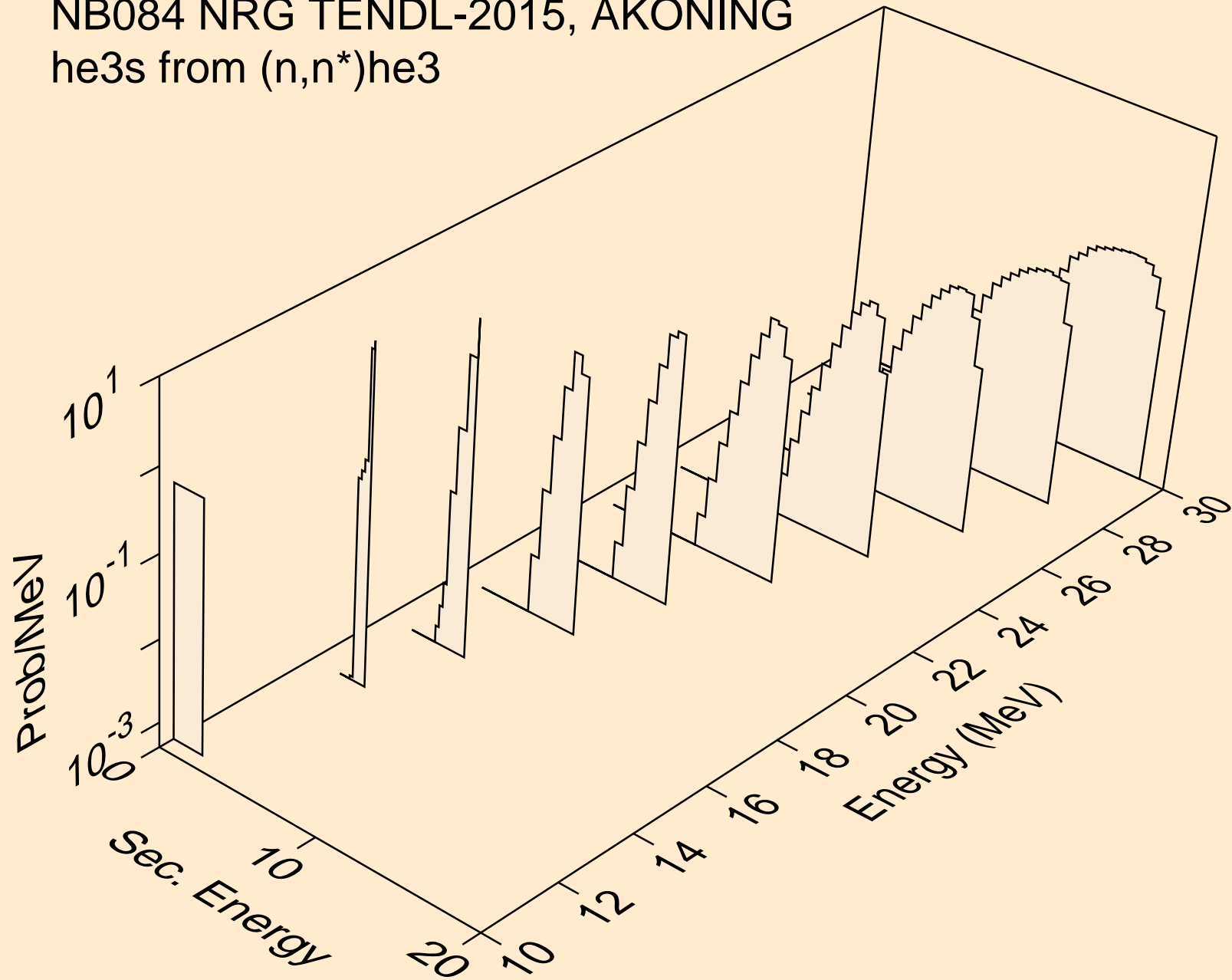

NB084 NRG TENDL-2015, AKONING
he3s from (n,he3)

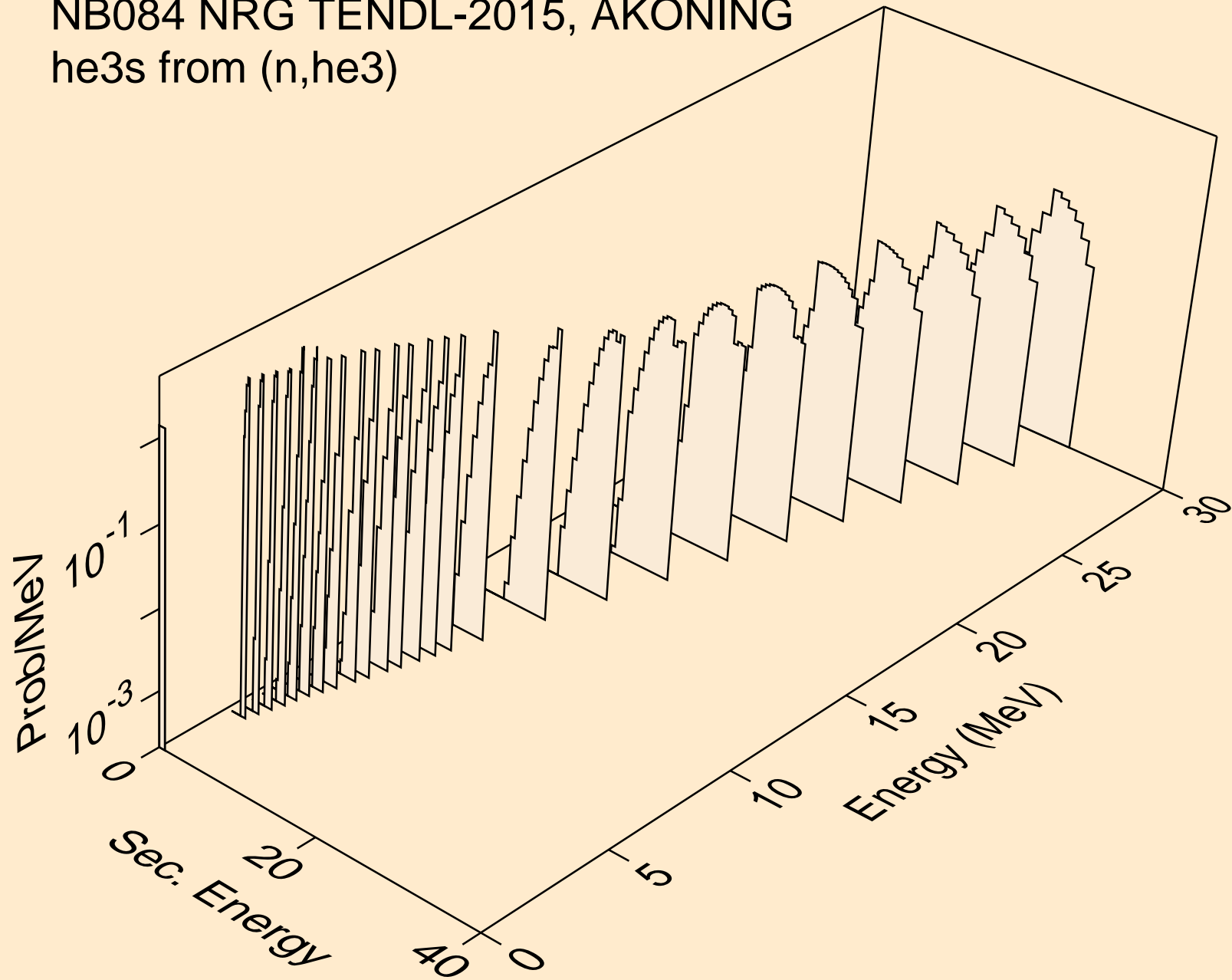

NB084 NRG TENDL-2015, AKONING
alphas from (n,x)

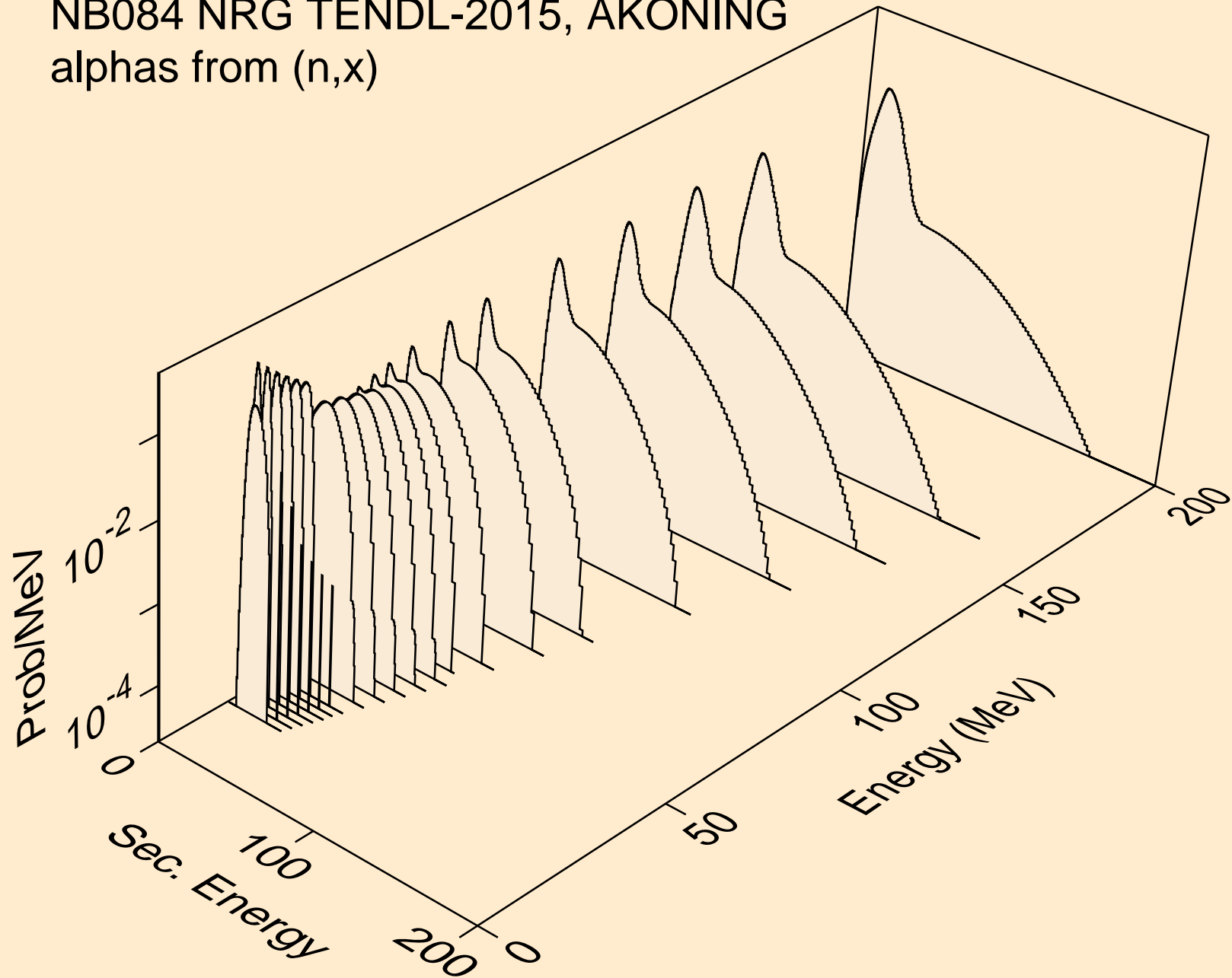

NB084 NRG TENDL-2015, AKONING
alphas from (n,n*)a

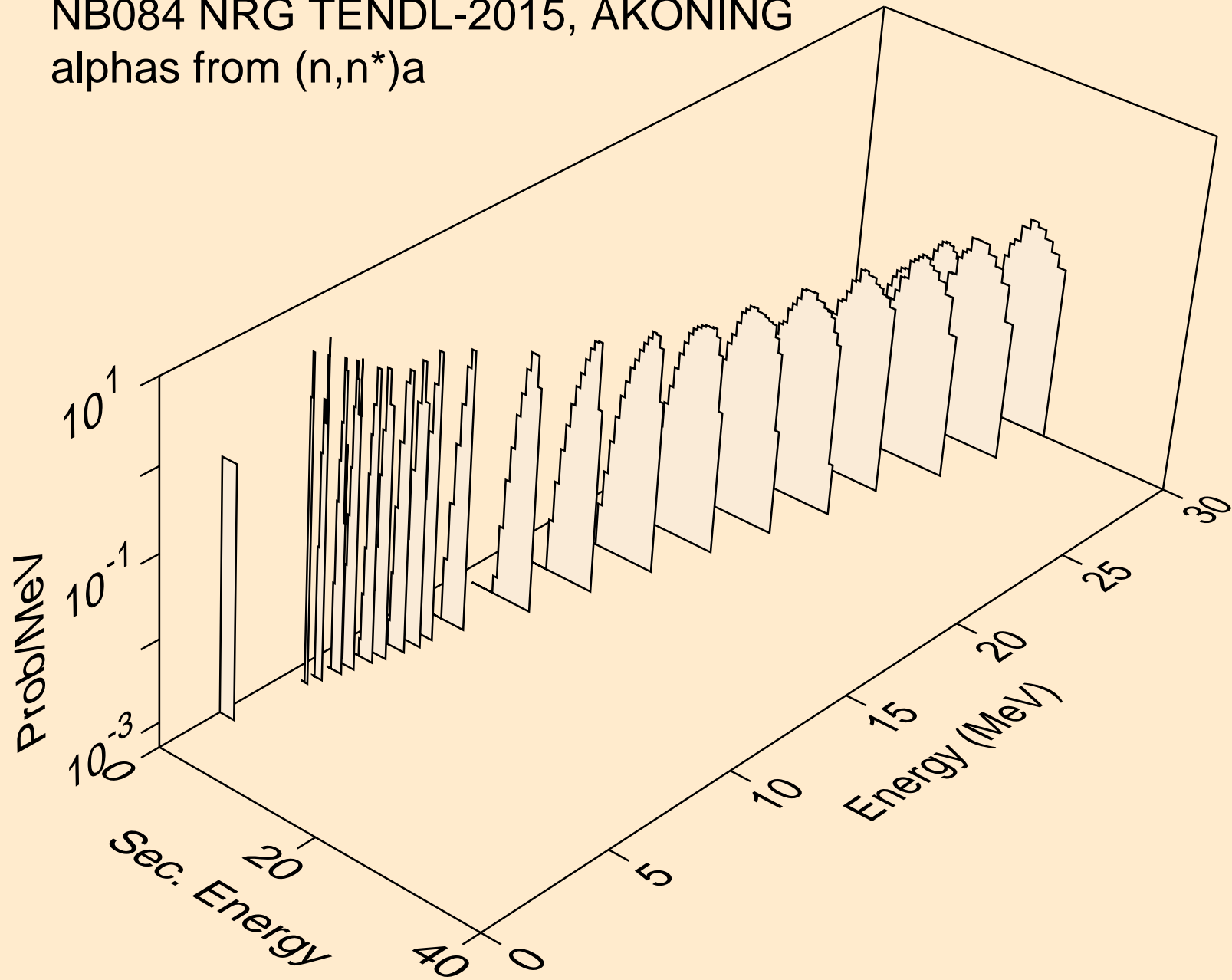

NB084 NRG TENDL-2015, AKONING
alphas from (n,2n)a

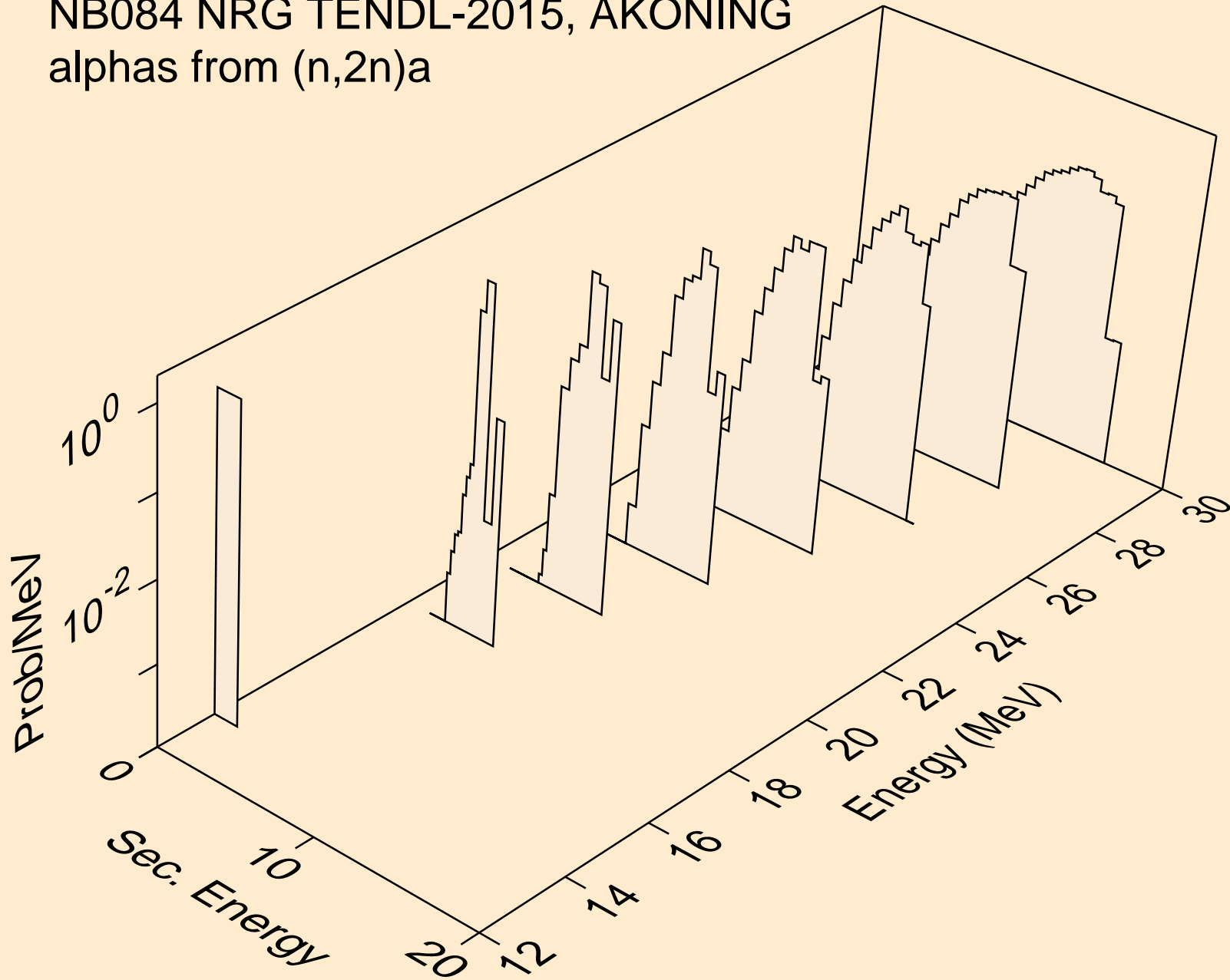

NB084 NRG TENDL-2015, AKONING
alphas from (n,n*)2a

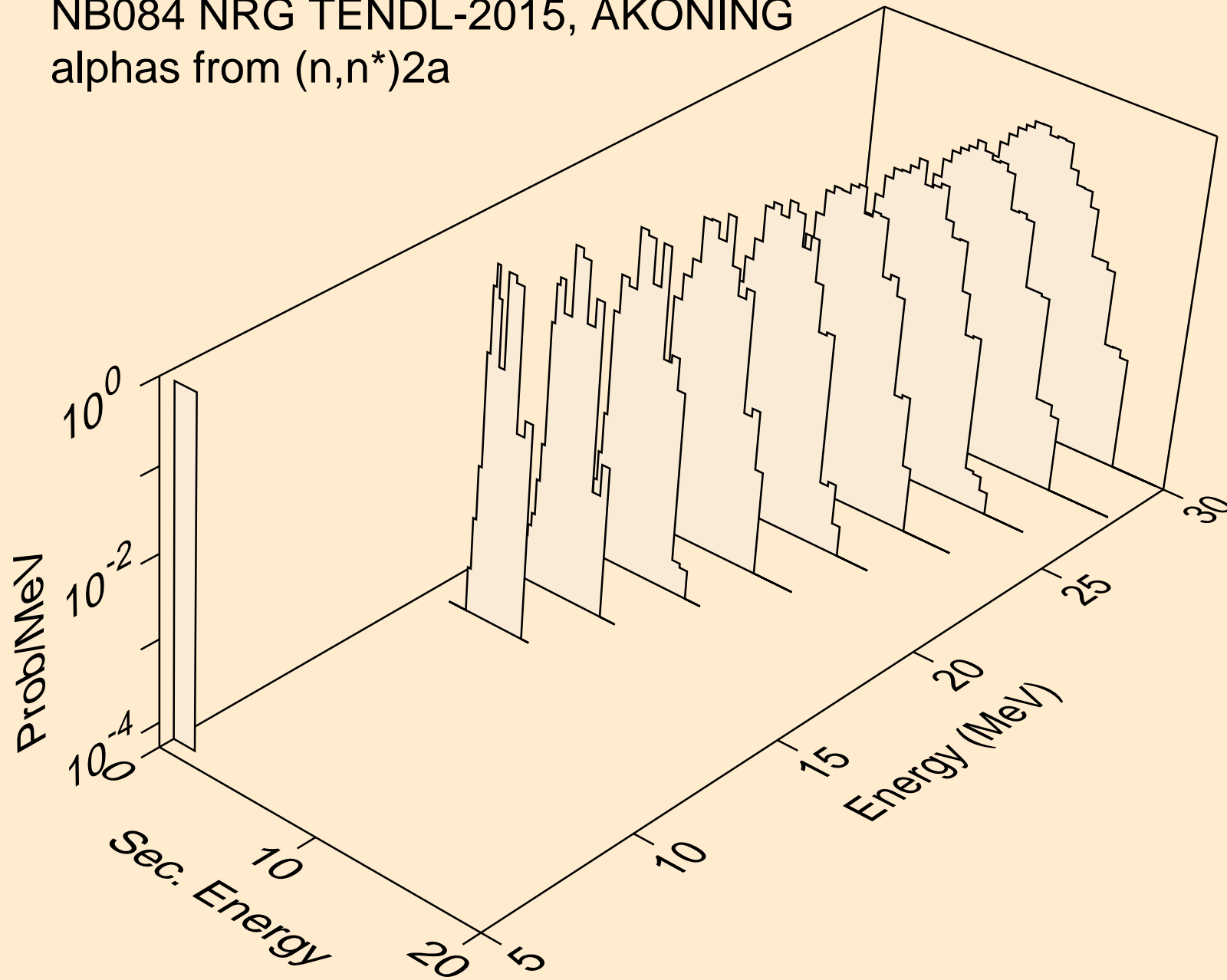

NB084 NRG TENDL-2015, AKONING
alphas from (n,npa)

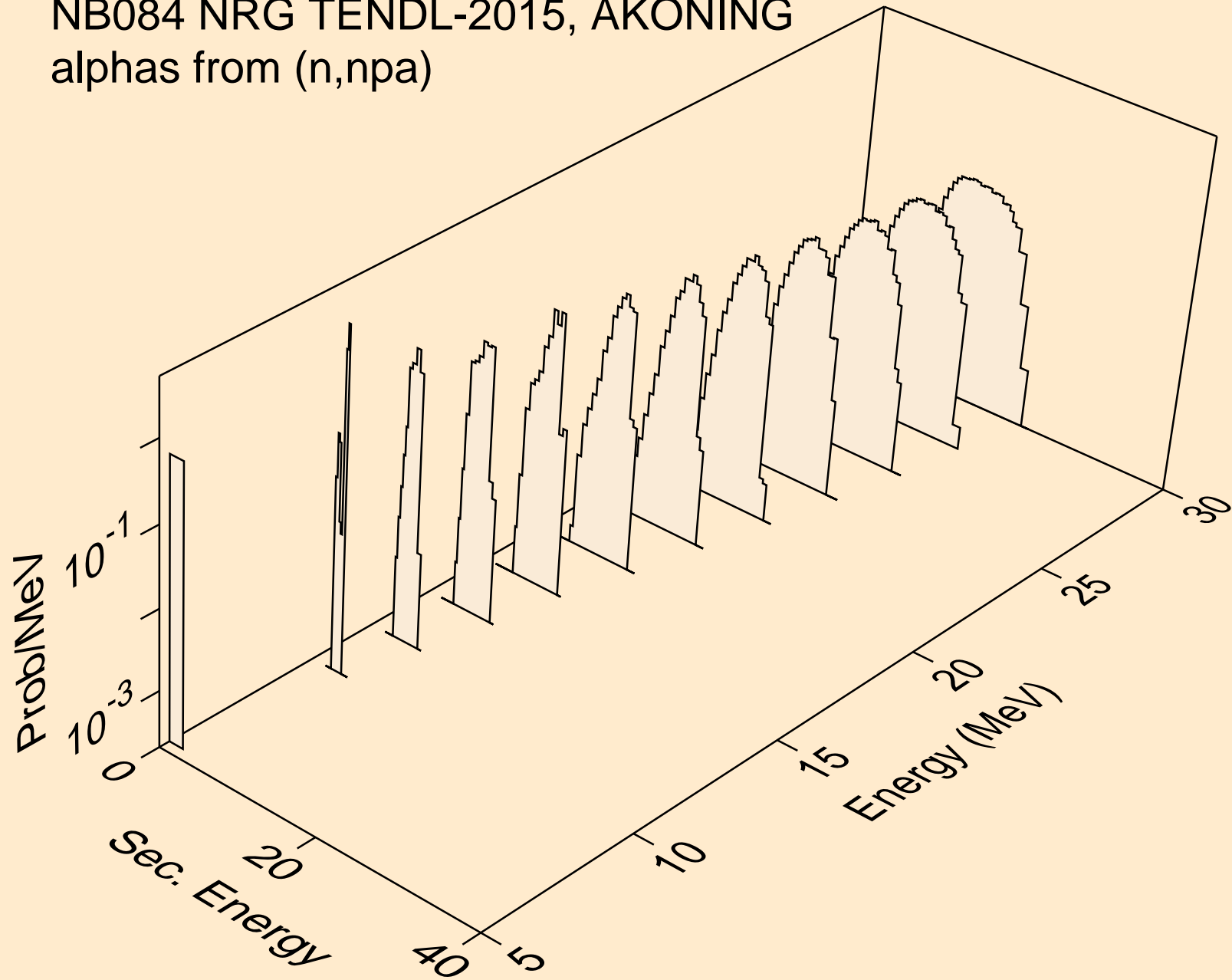

NB084 NRG TENDL-2015, AKONING
alphas from (n,a)

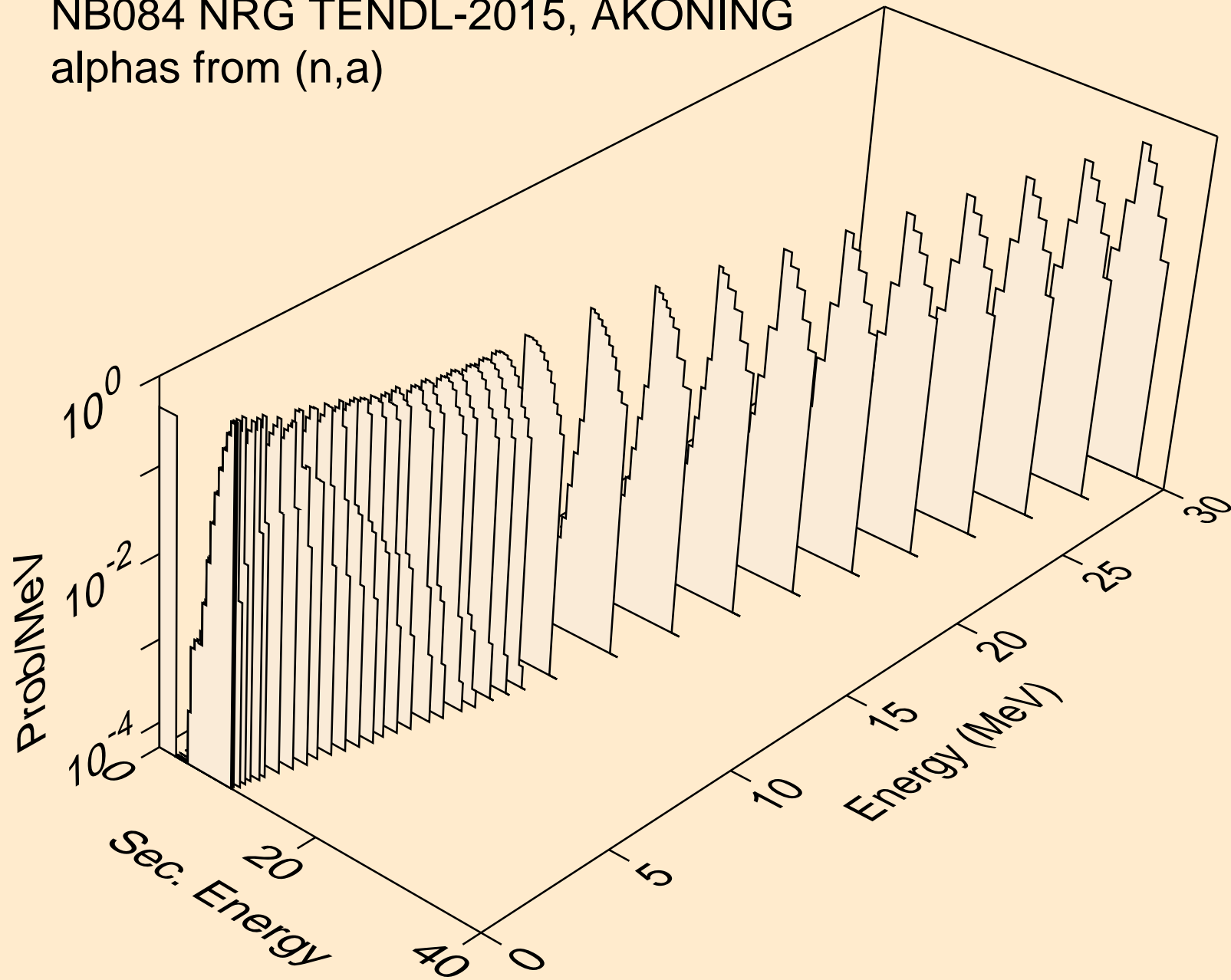

NB084 NRG TENDL-2015, AKONING
alphas from (n,2a)

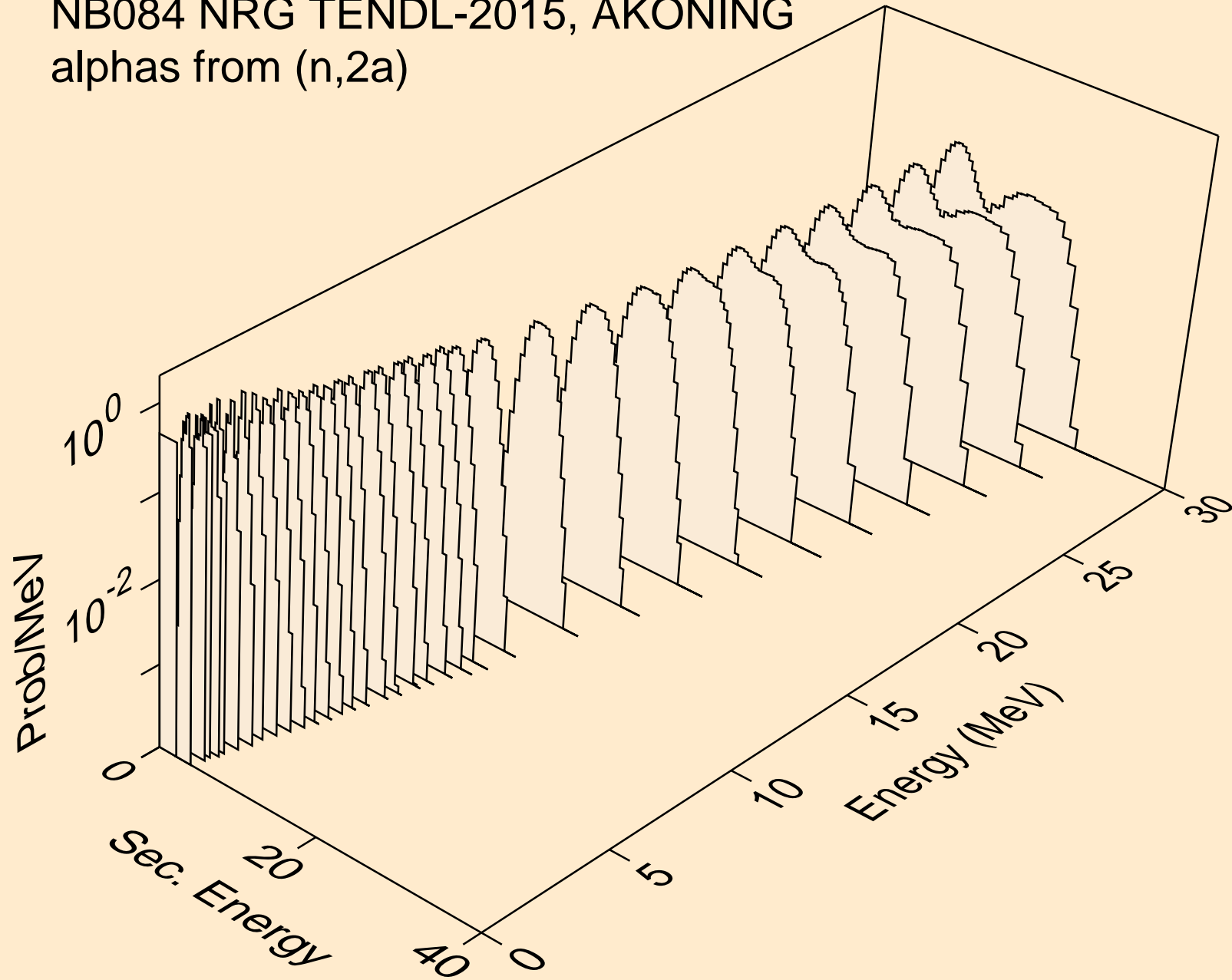

NB084 NRG TENDL-2015, AKONING
alphas from (n,3a)

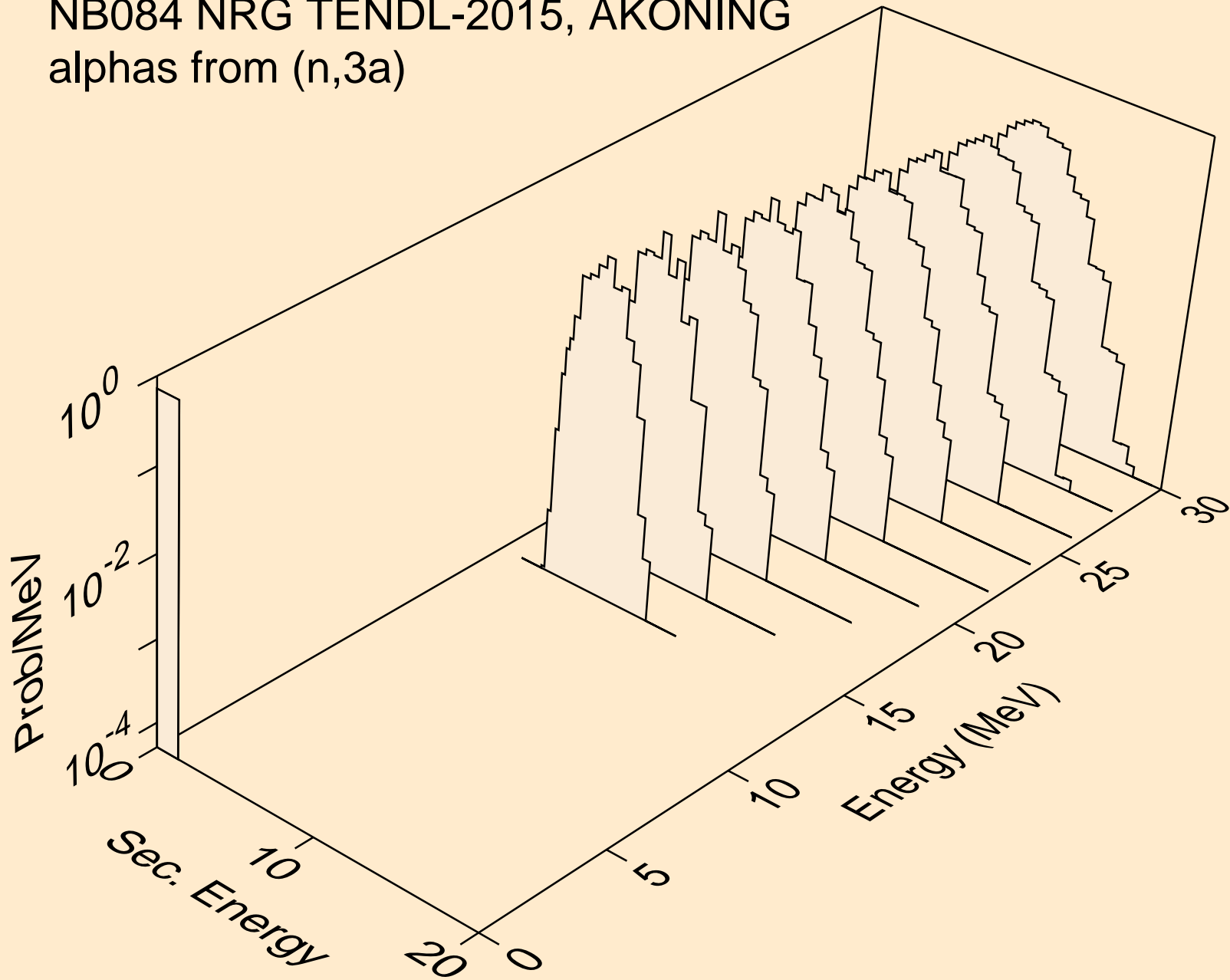

NB084 NRG TENDL-2015, AKONING
alphas from (n,pa)

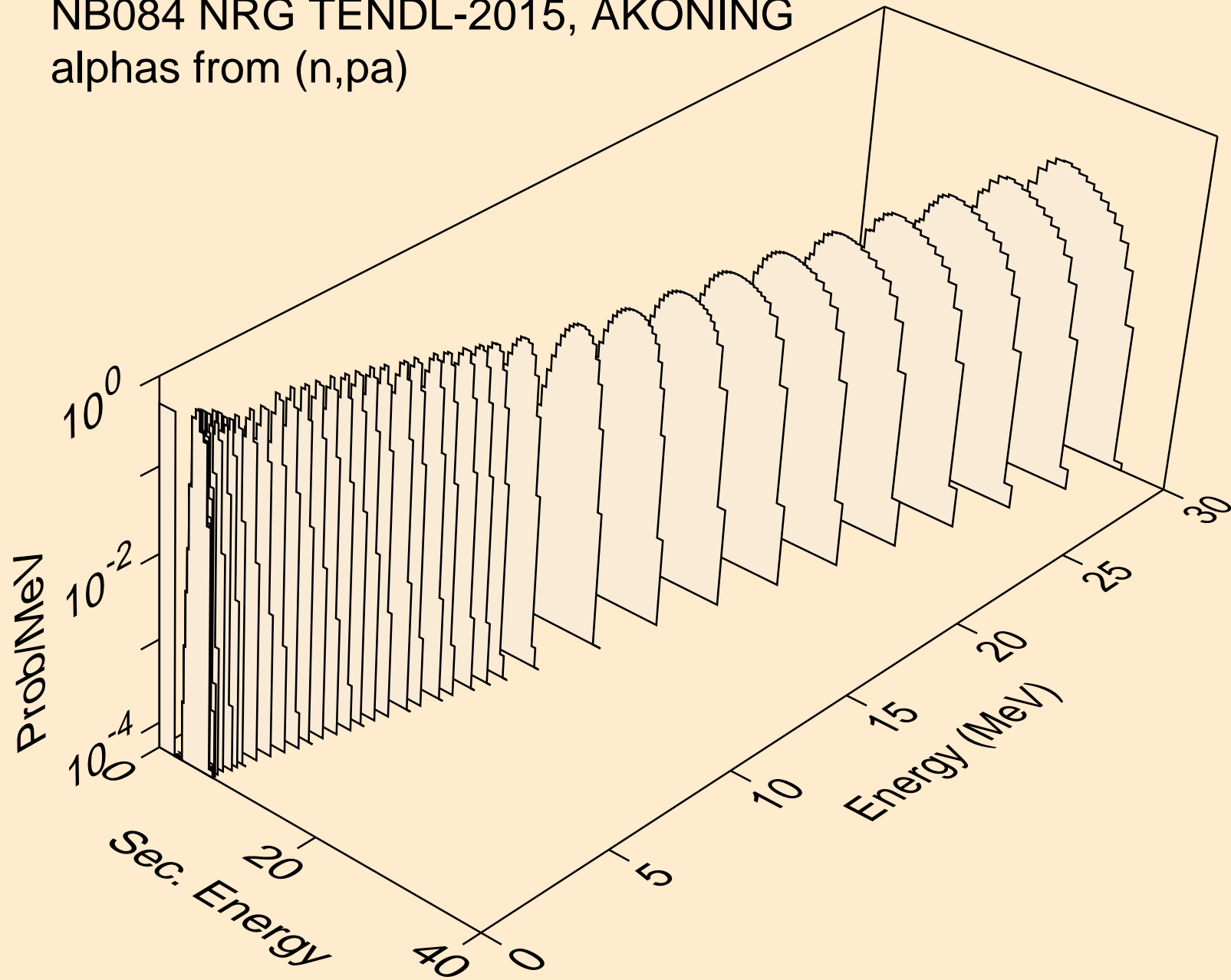

NB084 NRG TENDL-2015, AKONING
alphas from (n,d2a)

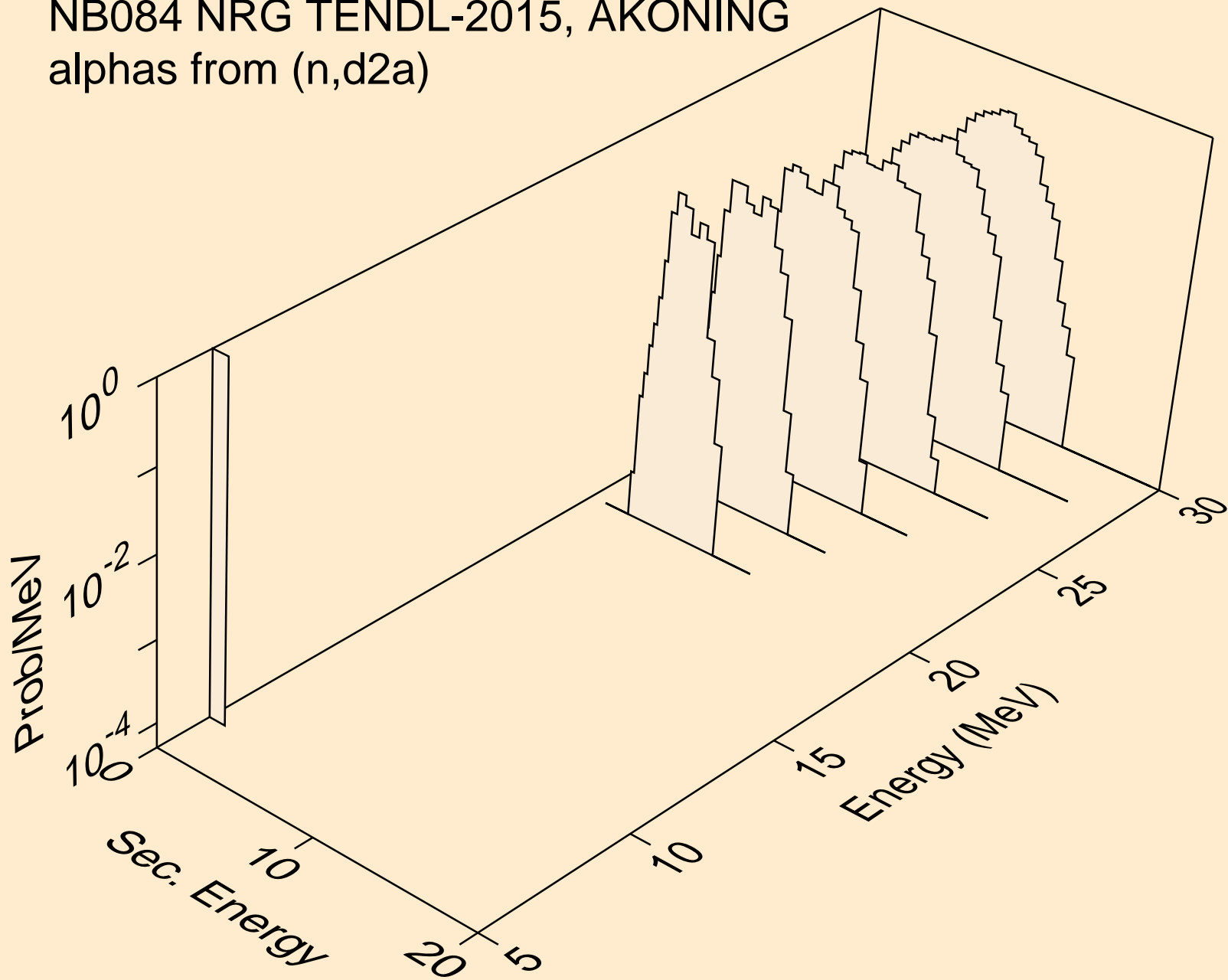

NB084 NRG TENDL-2015, AKONING
alphas from (n,da)

