

# ND126 NRG TENDL-2015, AKONING

## Principal cross sections

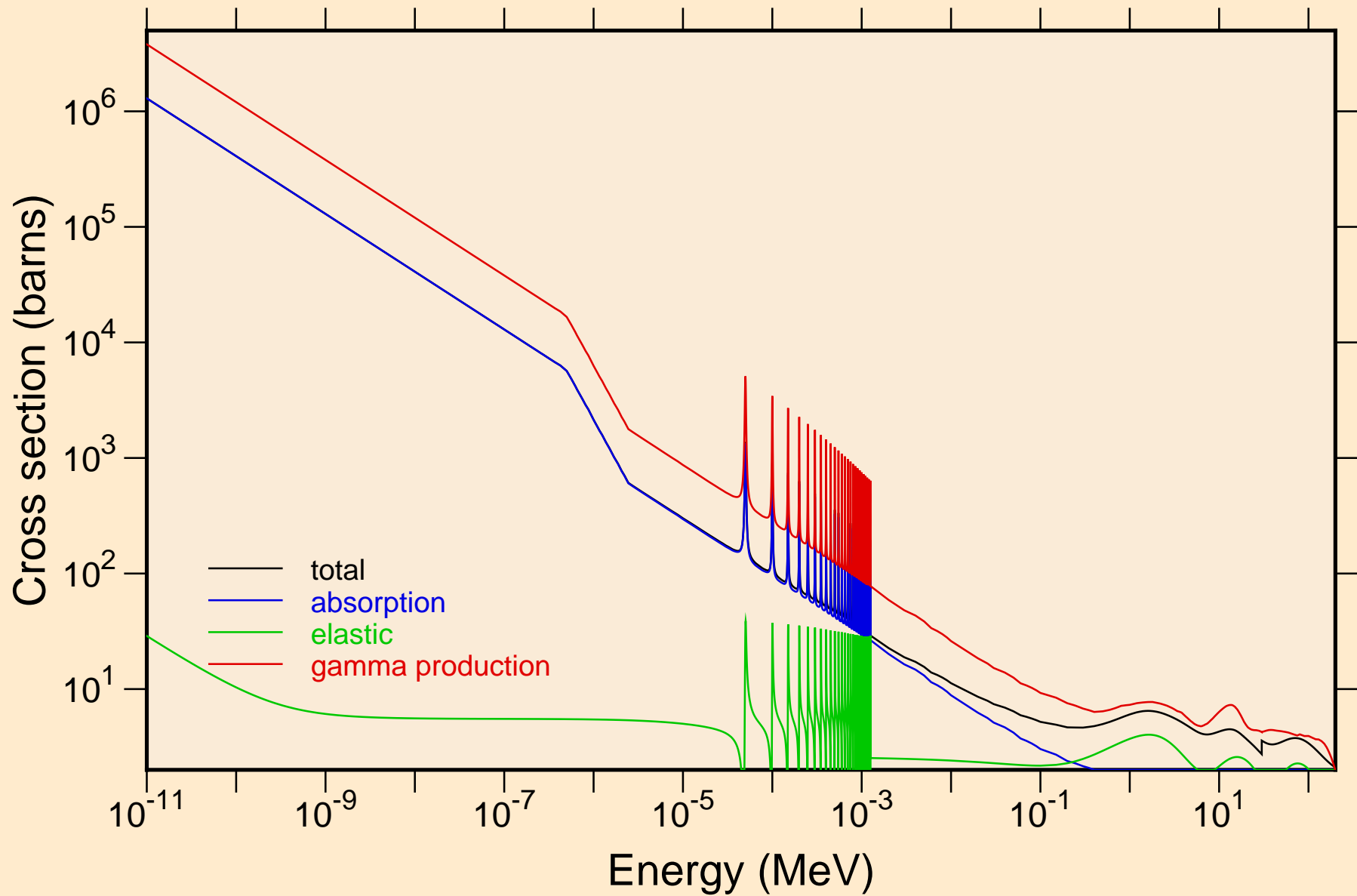

ND126 NRG TENDL-2015, AKONING  
resonance total cross section

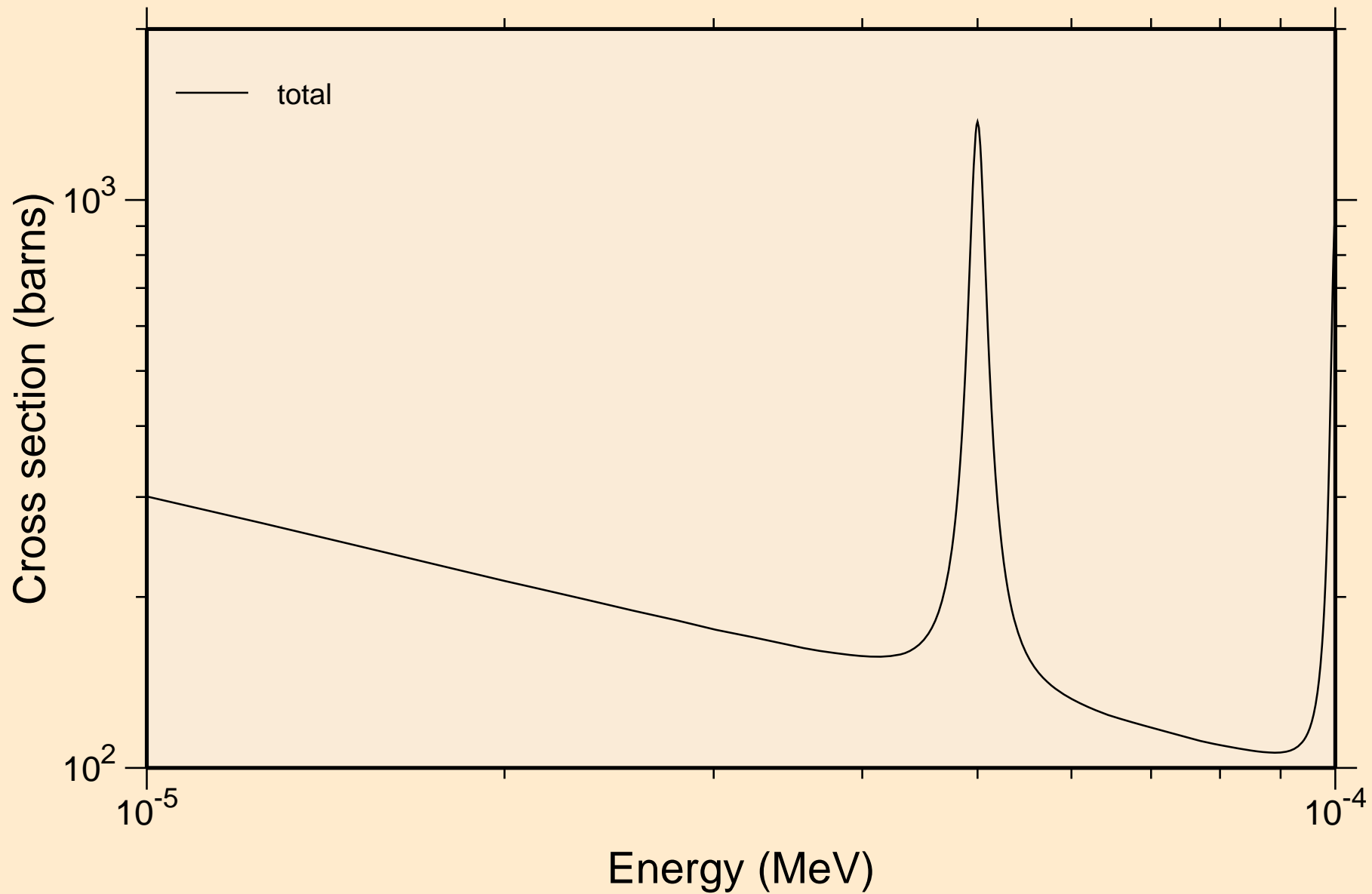

ND126 NRG TENDL-2015, AKONING  
resonance total cross section

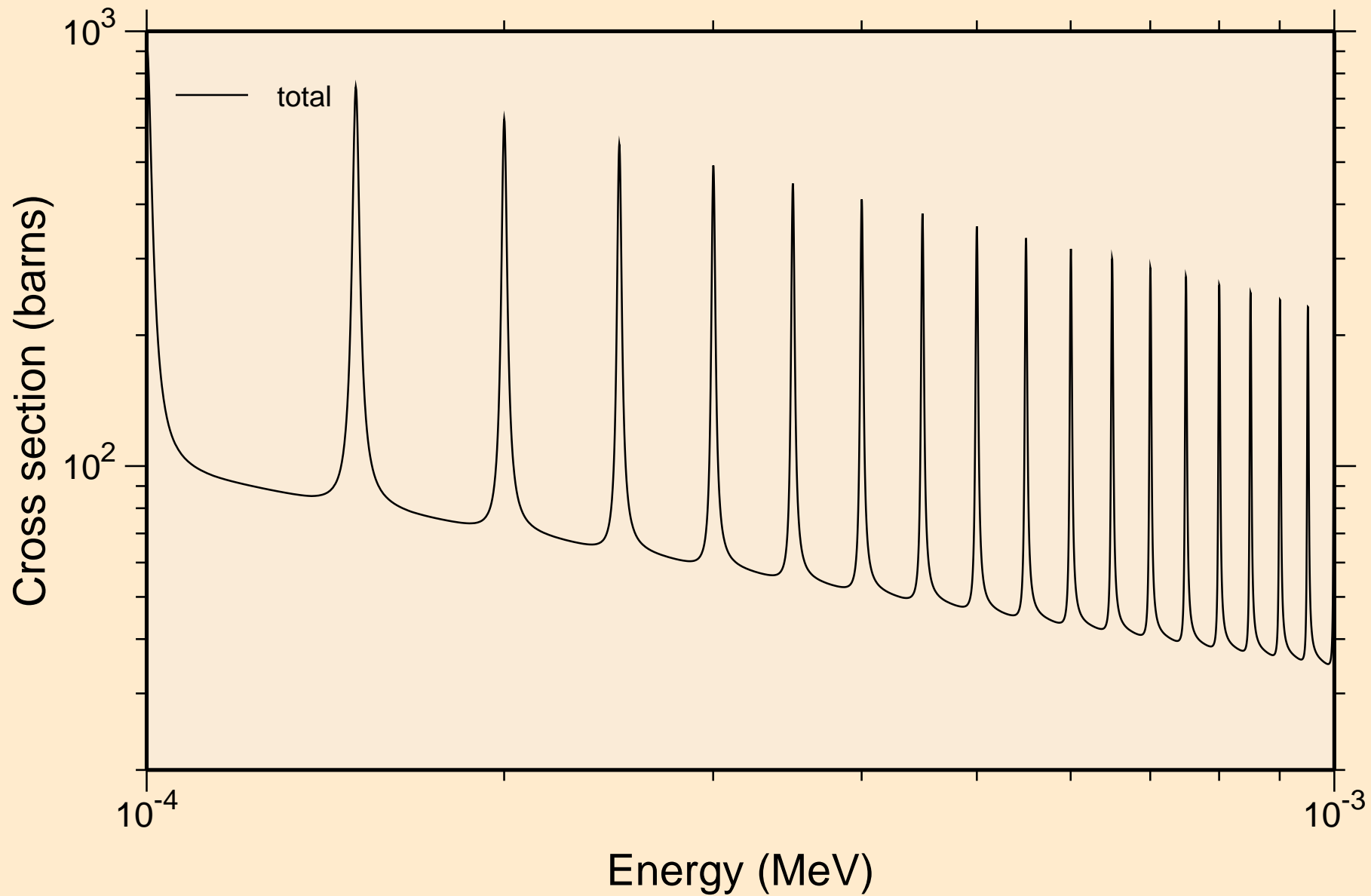

ND126 NRG TENDL-2015, AKONING  
resonance total cross section

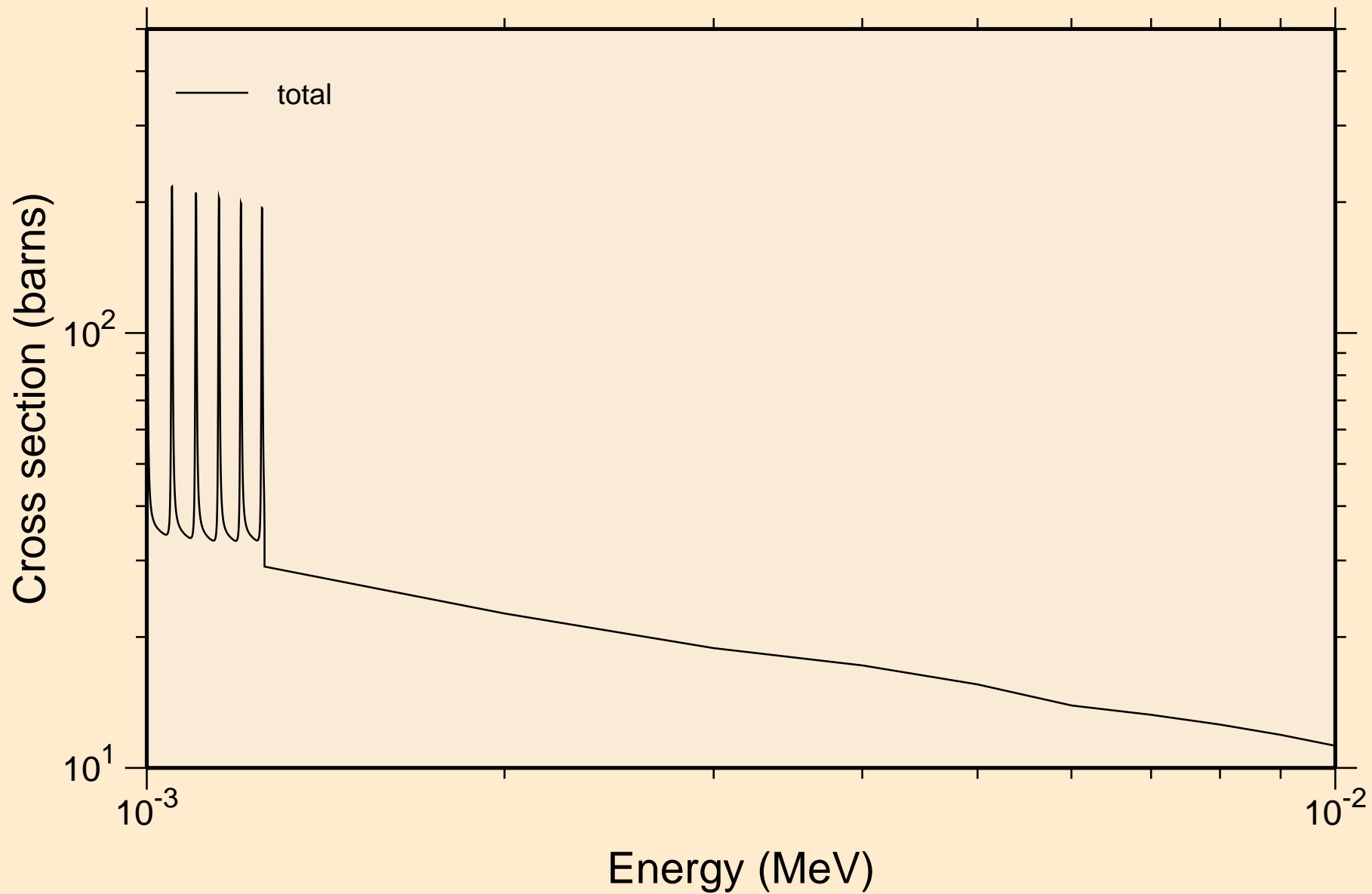

ND126 NRG TENDL-2015, AKONING  
resonance total cross section

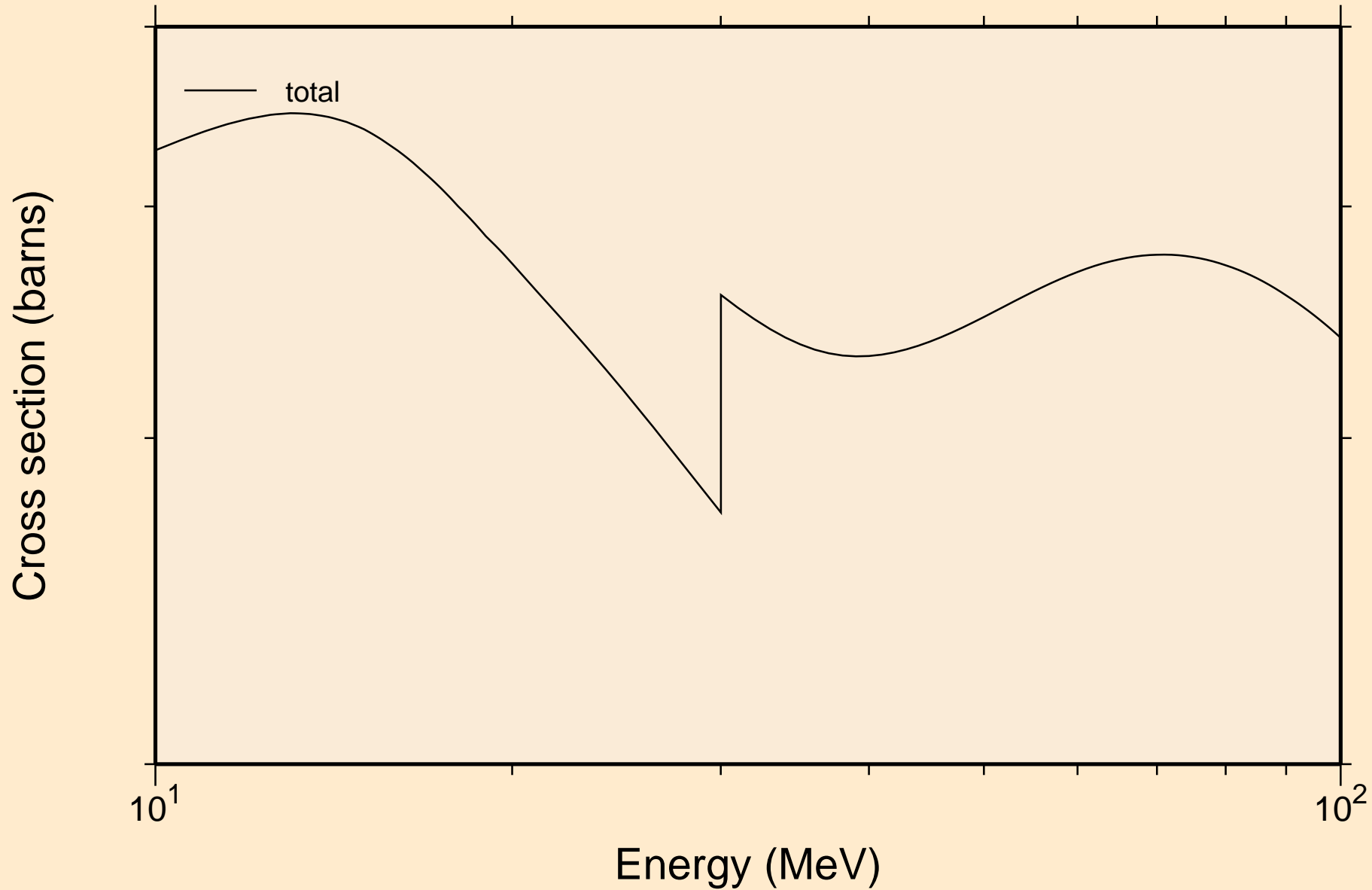

ND126 NRG TENDL-2015, AKONING  
resonance absorption cross sections

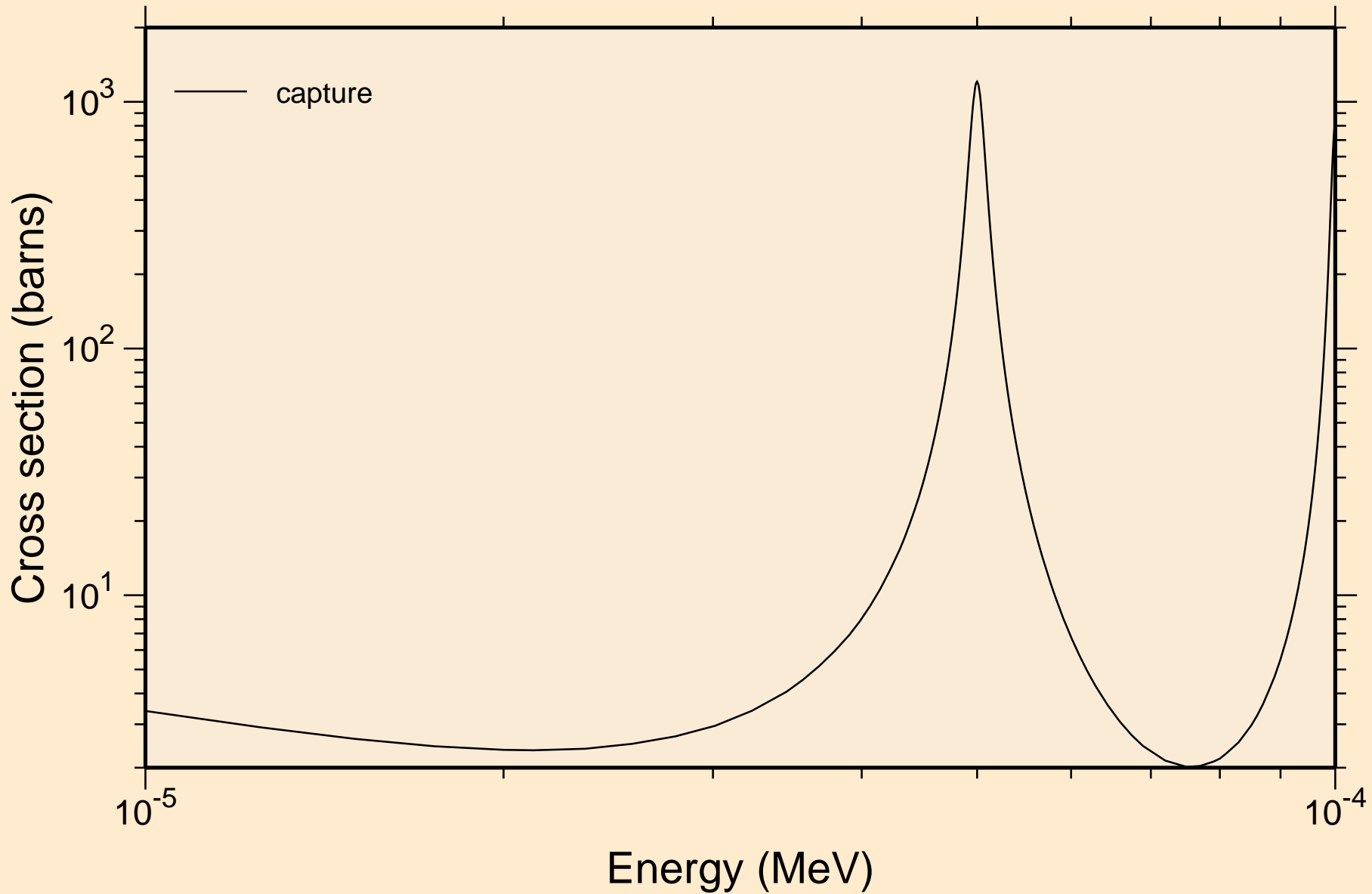

# ND126 NRG TENDL-2015, AKONING resonance absorption cross sections

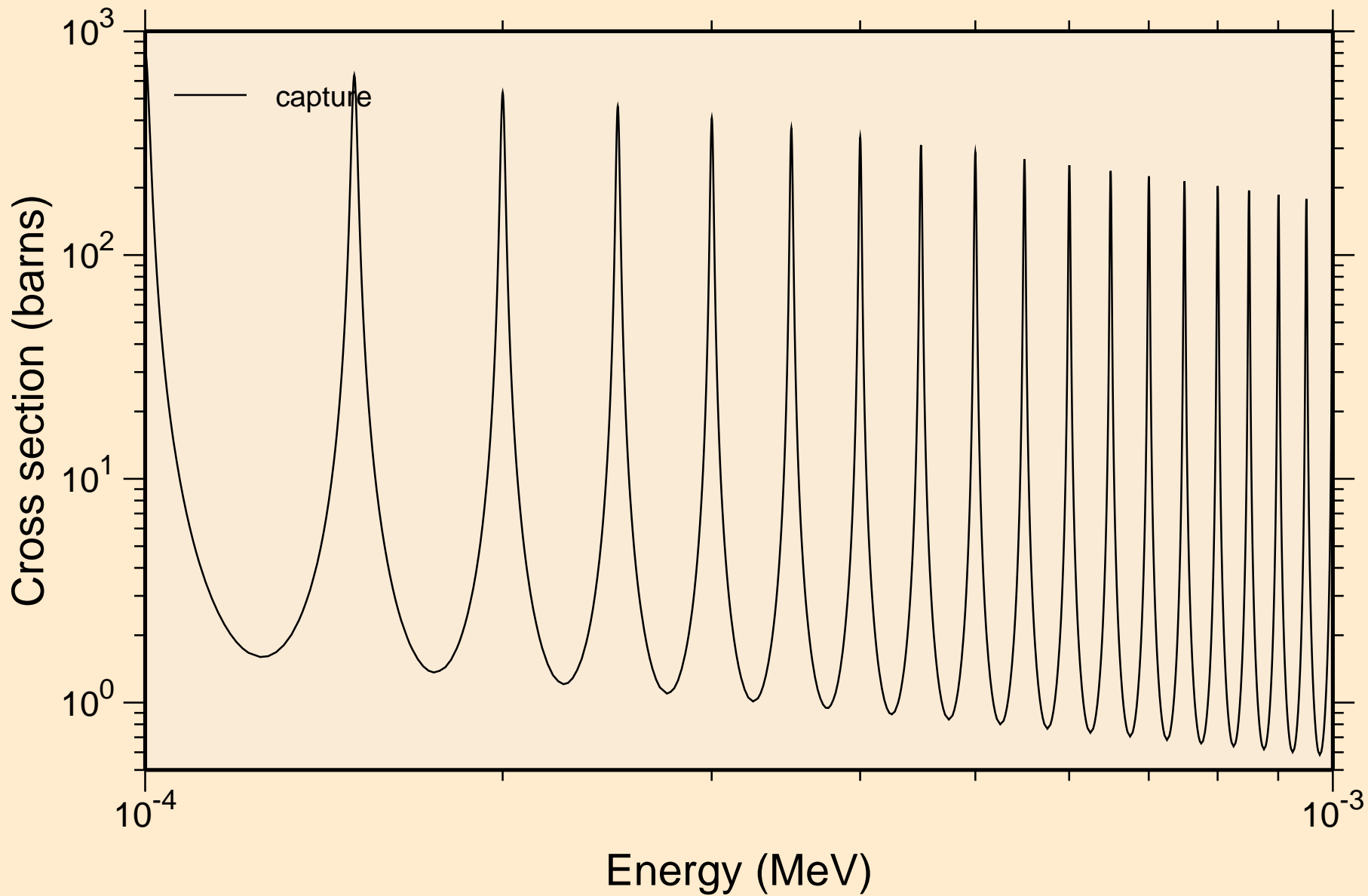

# ND126 NRG TENDL-2015, AKONING resonance absorption cross sections

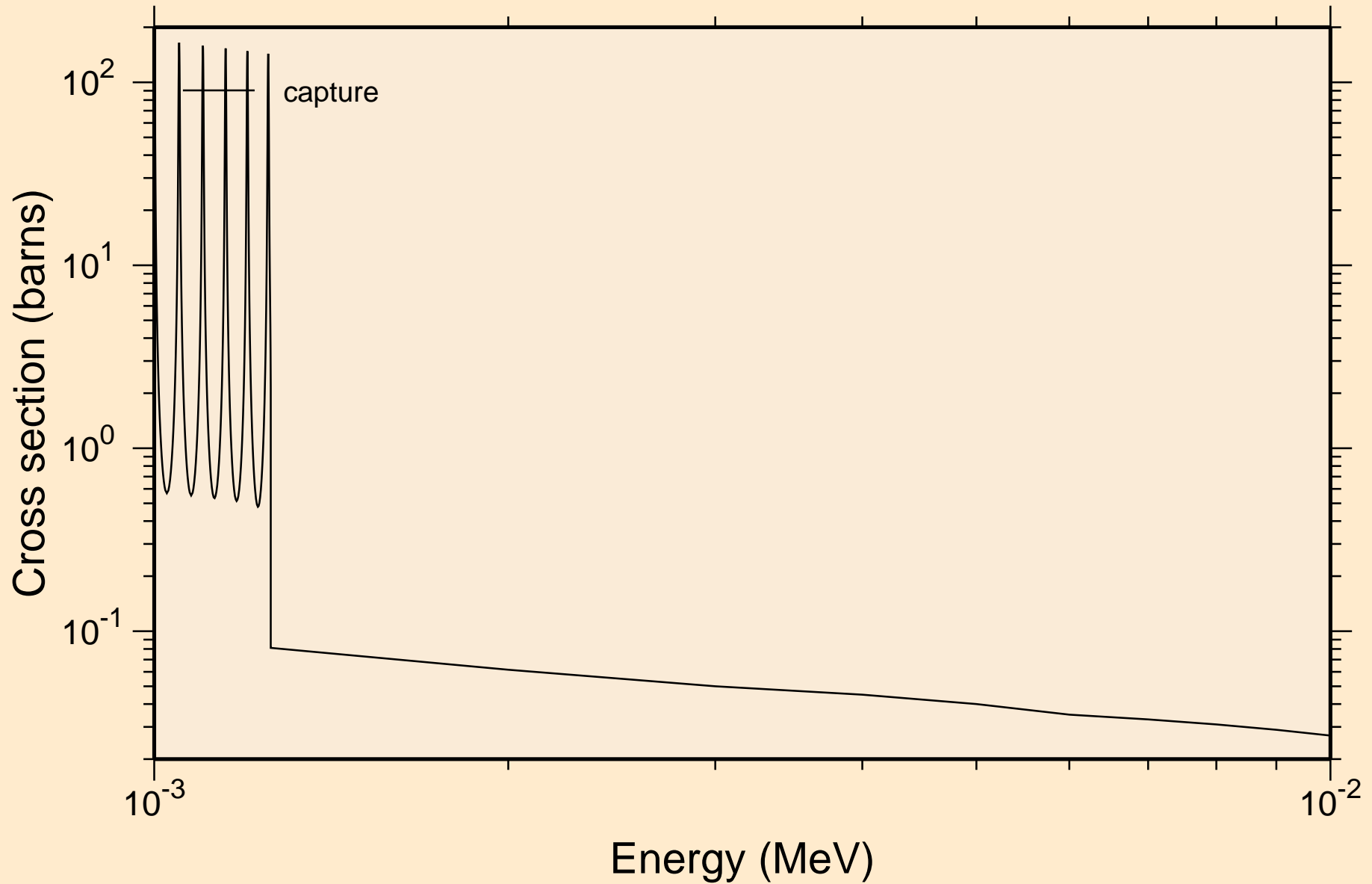



# ND126 NRG TENDL-2015, AKONING resonance absorption cross sections

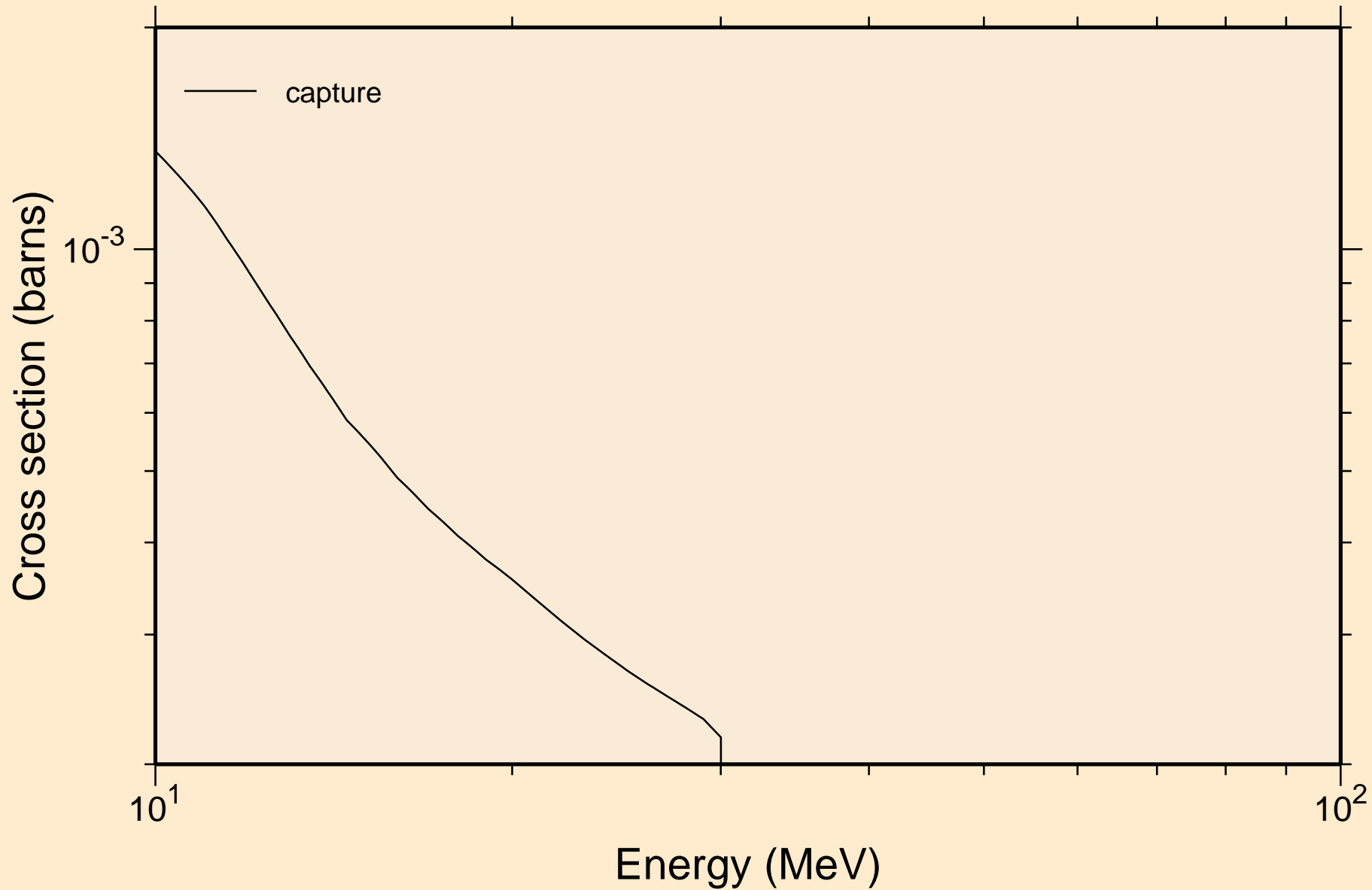

# ND126 NRG TENDL-2015, AKONING

## Non-threshold reactions

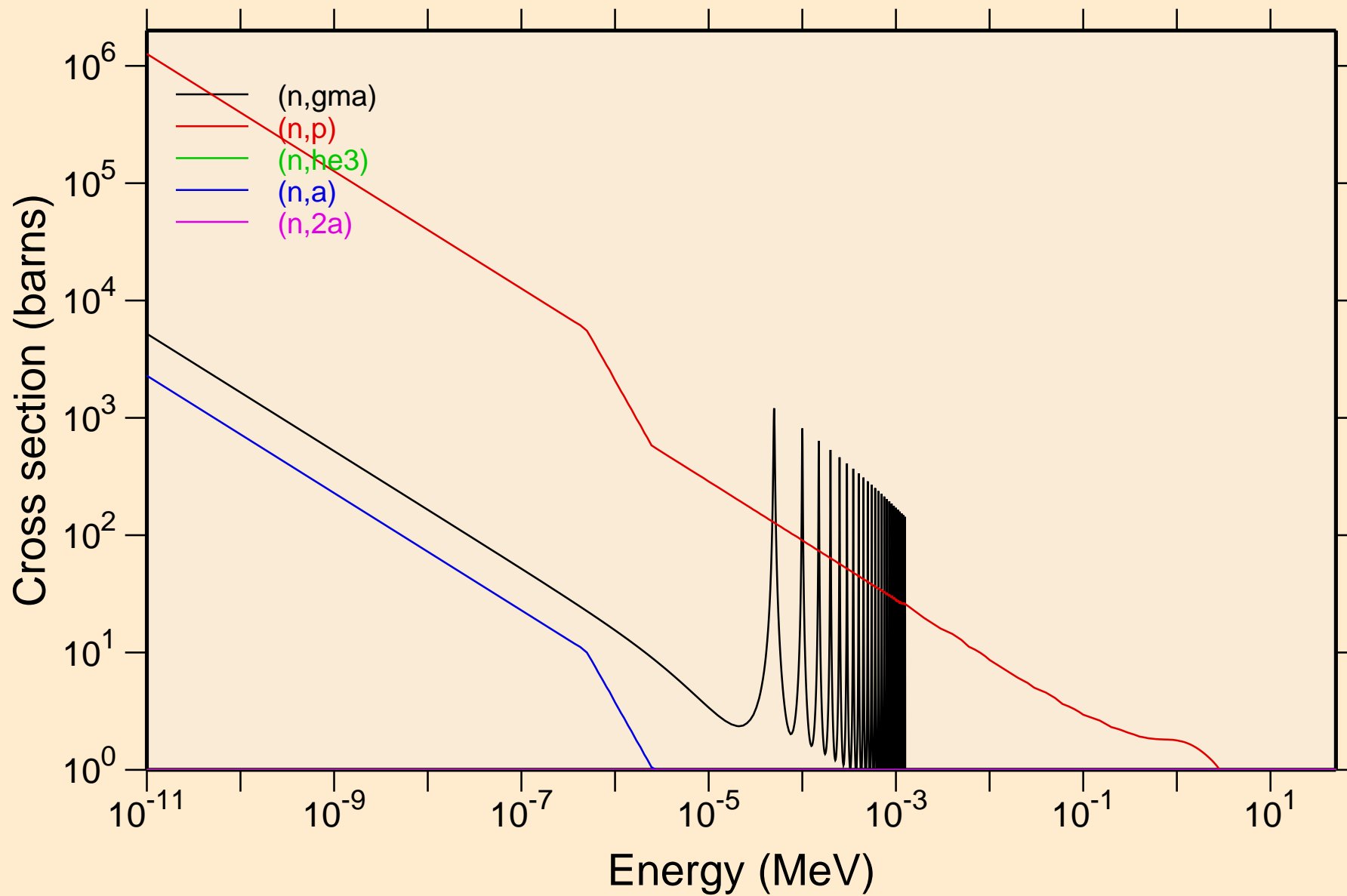

# ND126 NRG TENDL-2015, AKONING

## Non-threshold reactions

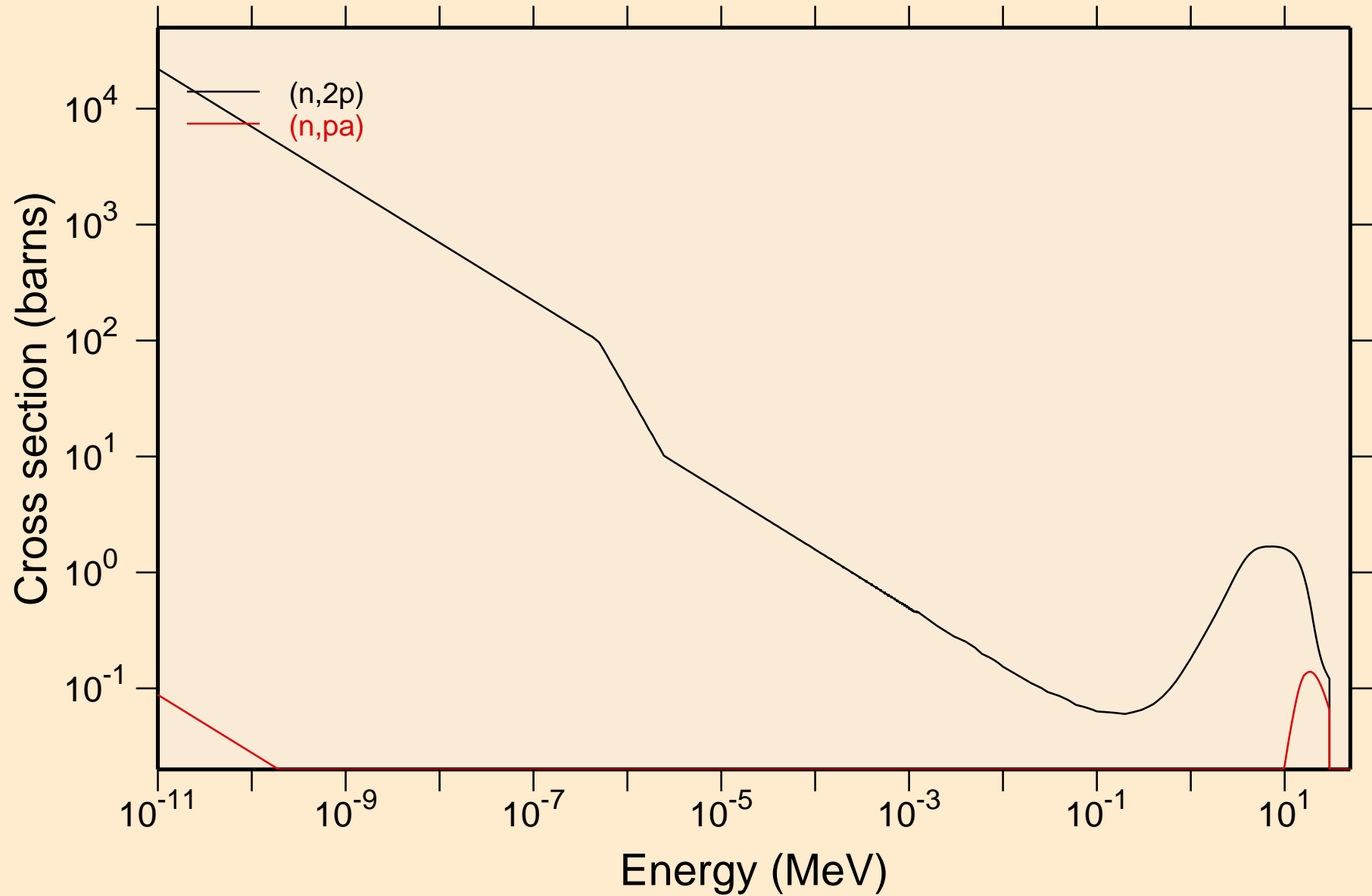

# ND126 NRG TENDL-2015, AKONING

## Principal cross sections

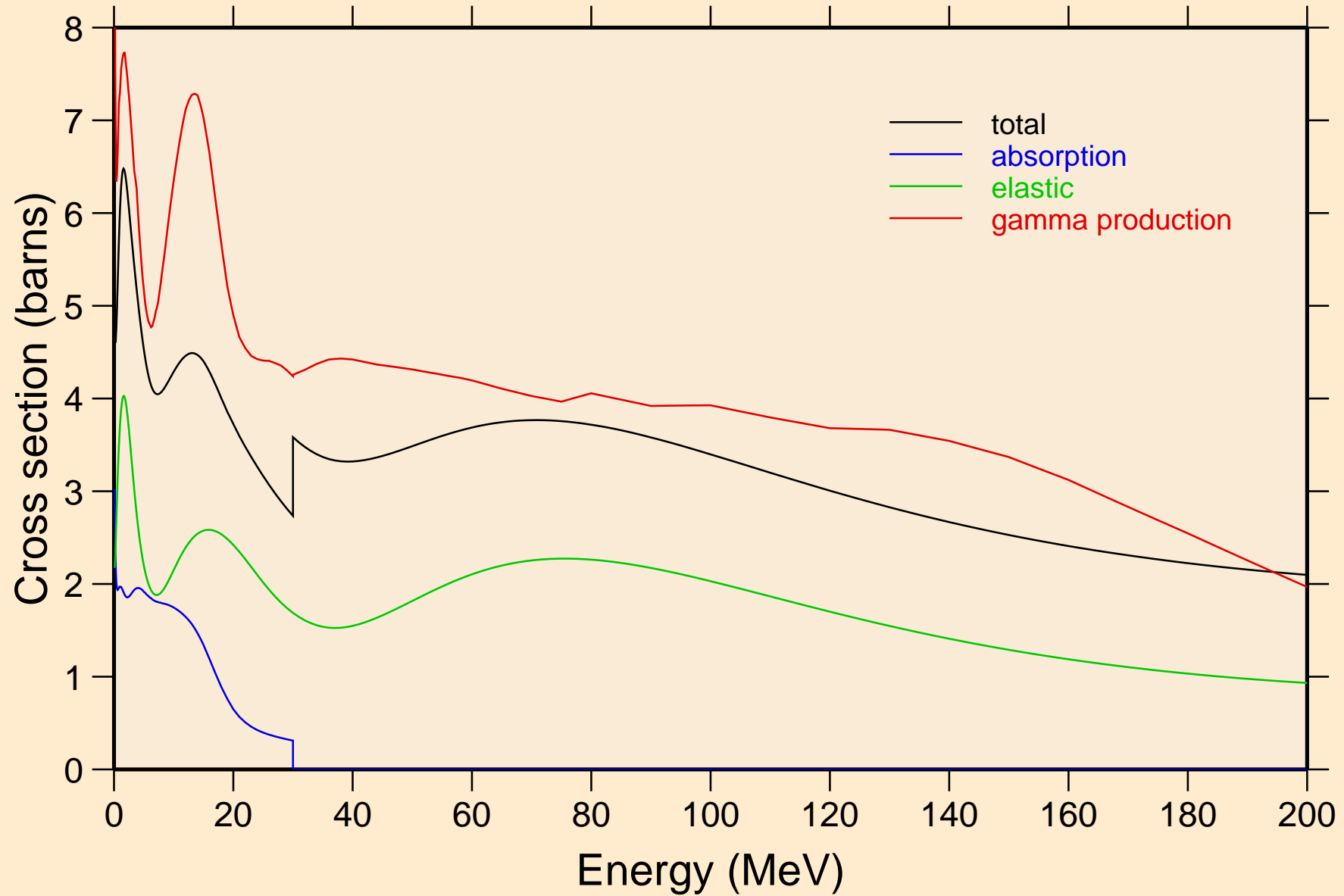

# ND126 NRG TENDL-2015, AKONING

## Non-threshold reactions

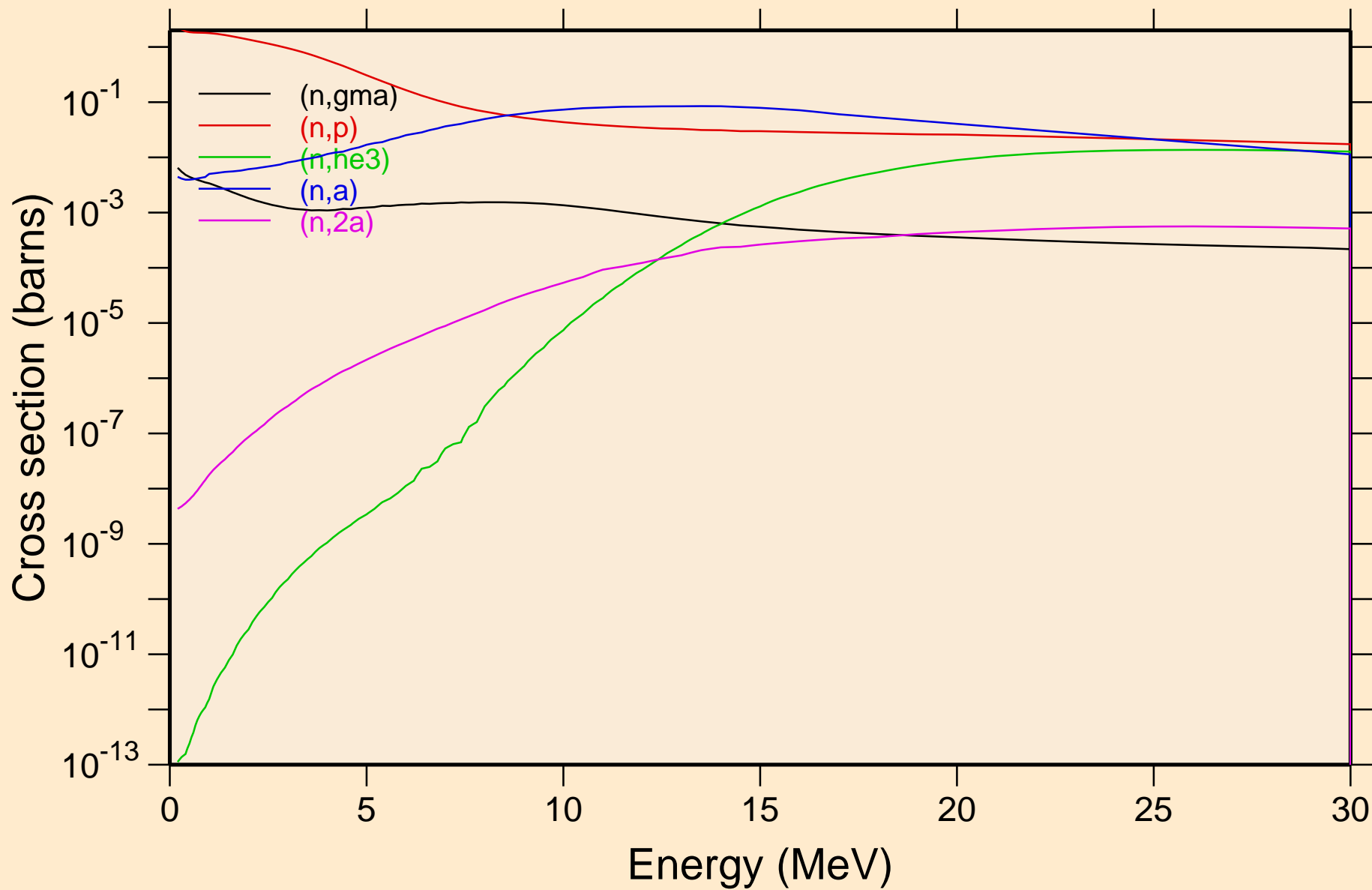

# ND126 NRG TENDL-2015, AKONING

## Non-threshold reactions

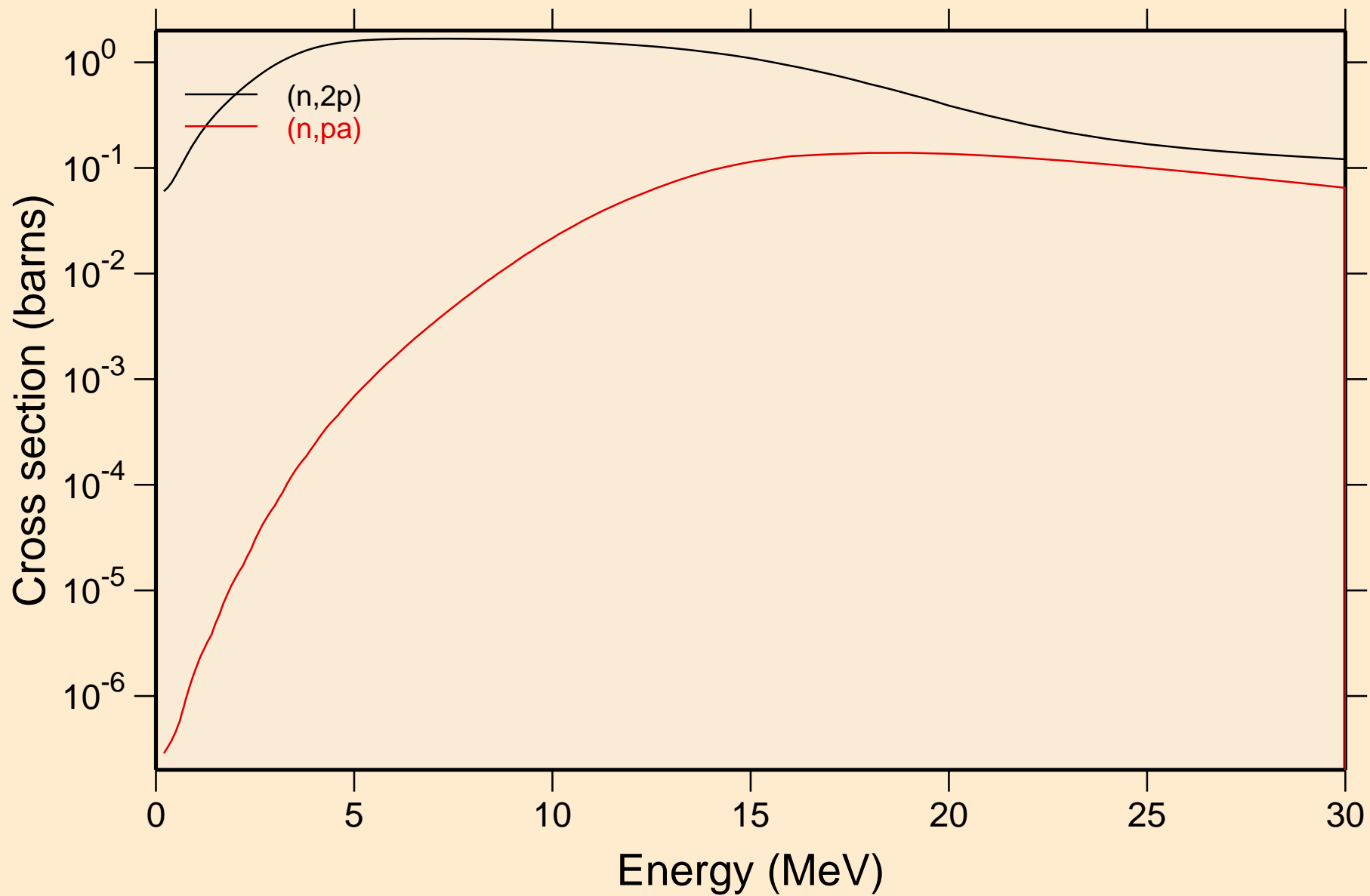

# ND126 NRG TENDL-2015, AKONING

## Inelastic levels

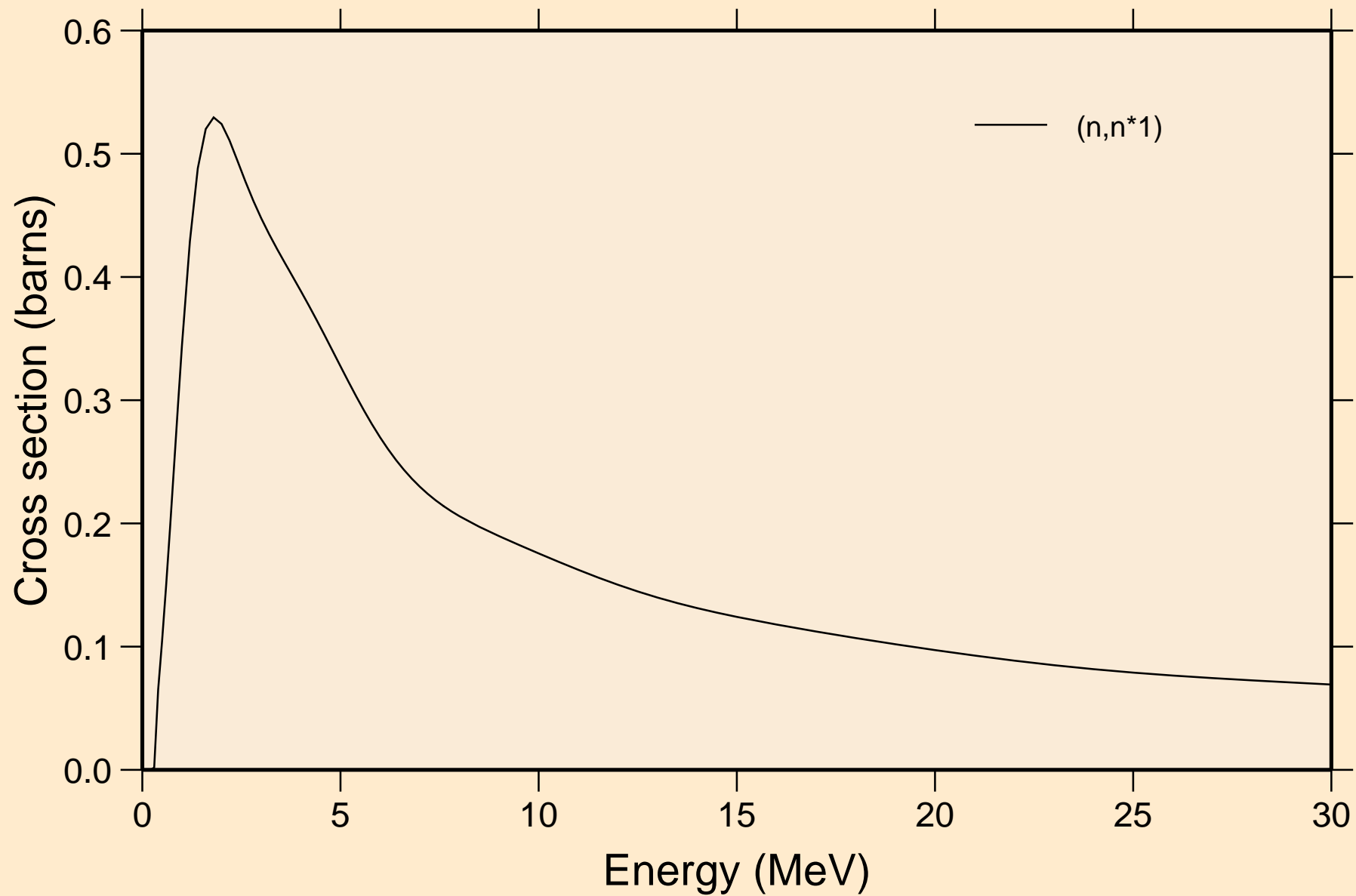

# ND126 NRG TENDL-2015, AKONING

## Threshold reactions

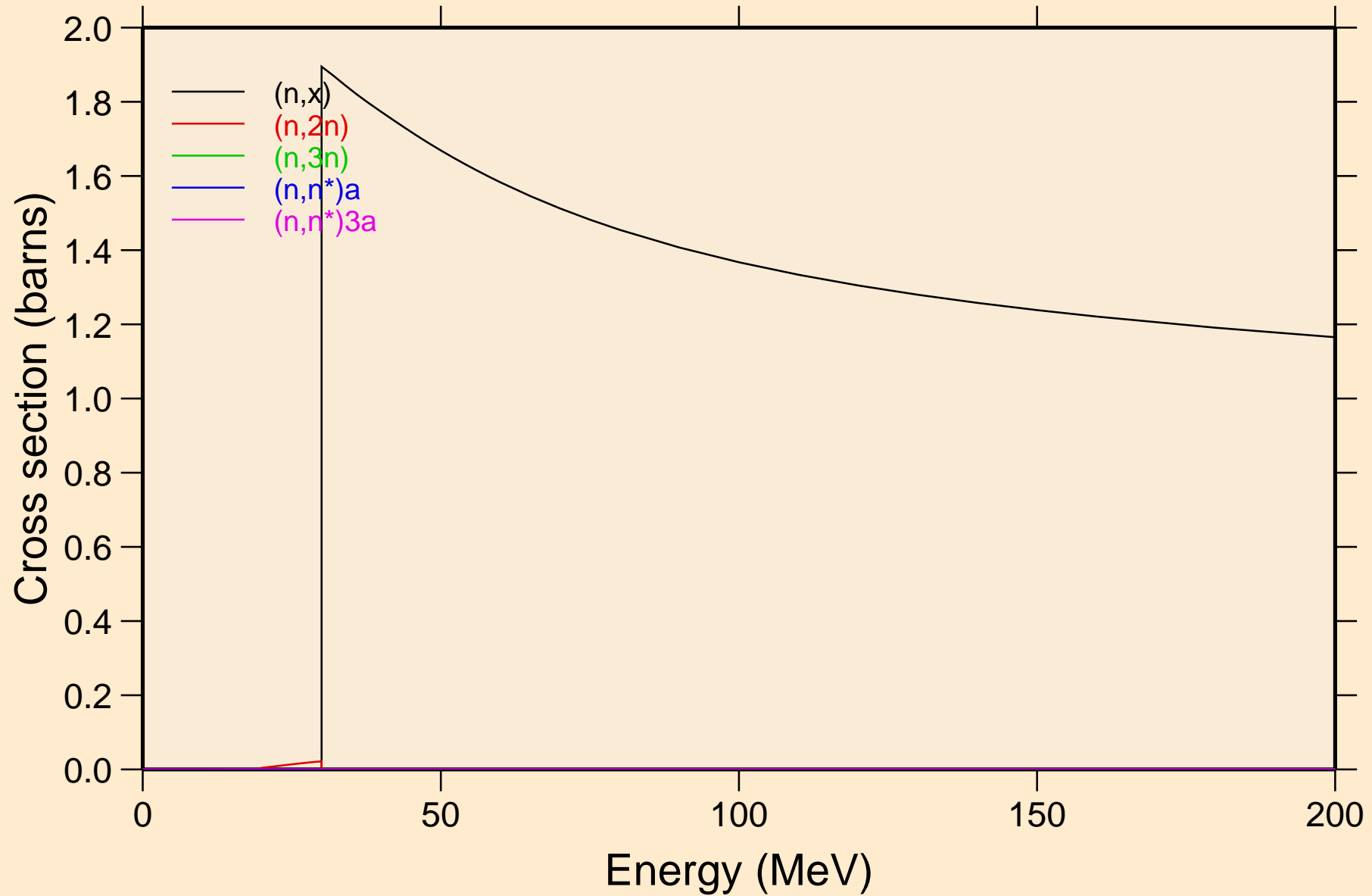



# ND126 NRG TENDL-2015, AKONING

## Threshold reactions

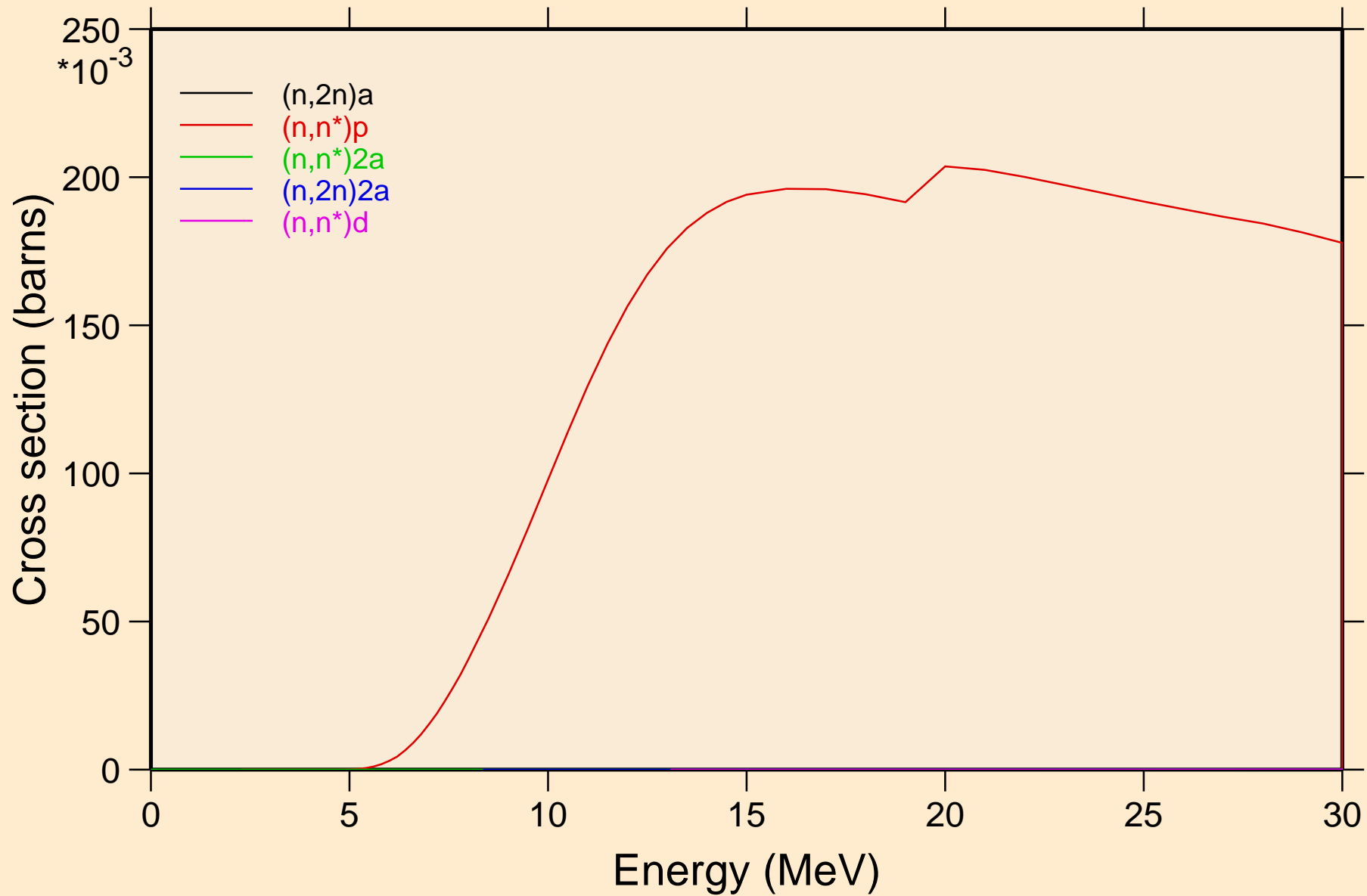

# ND126 NRG TENDL-2015, AKONING

## Threshold reactions

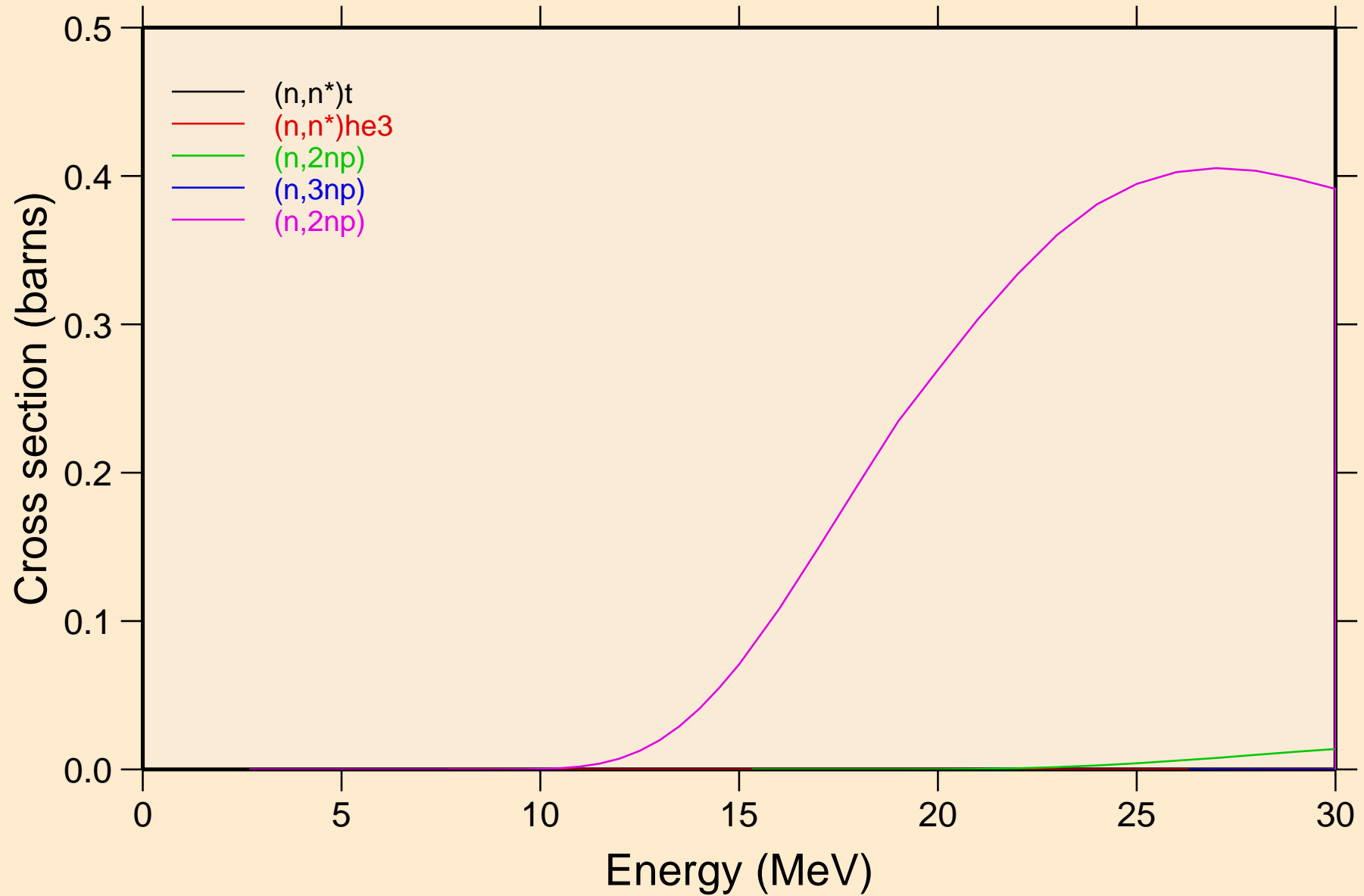

# ND126 NRG TENDL-2015, AKONING

## Threshold reactions

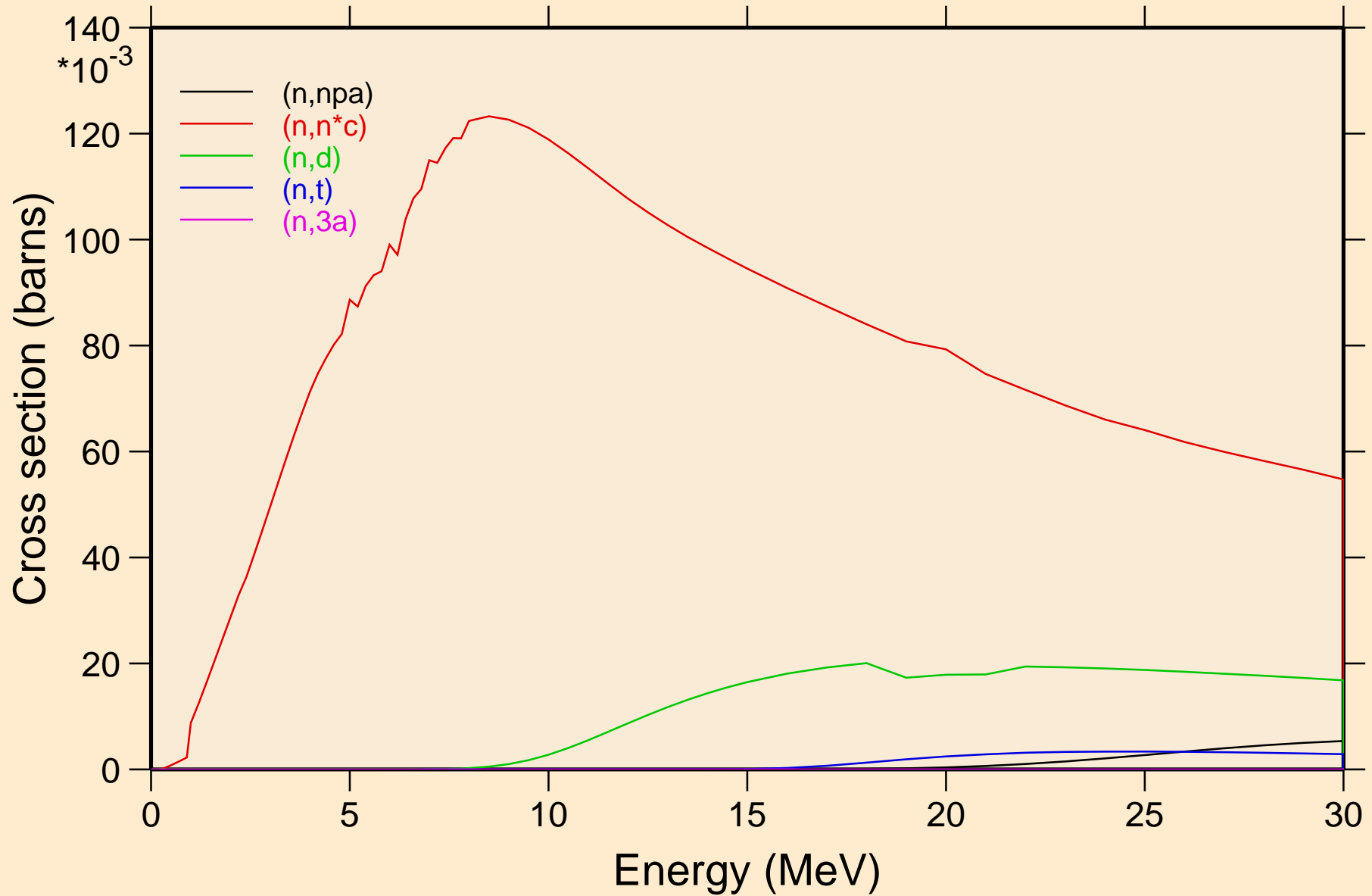

# ND126 NRG TENDL-2015, AKONING

## Threshold reactions

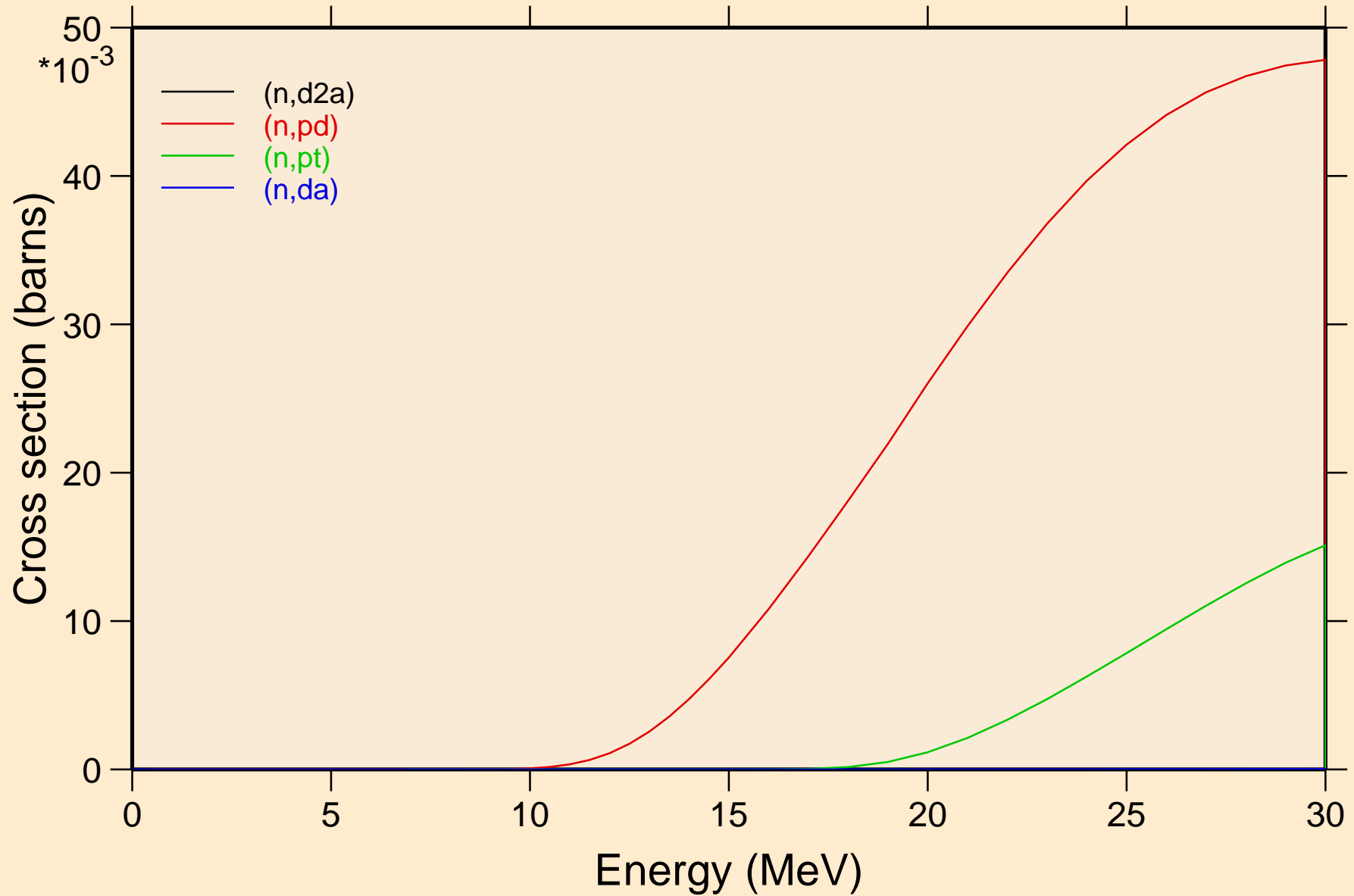

ND126 NRG TENDL-2015, AKONING  
angular distribution for elastic

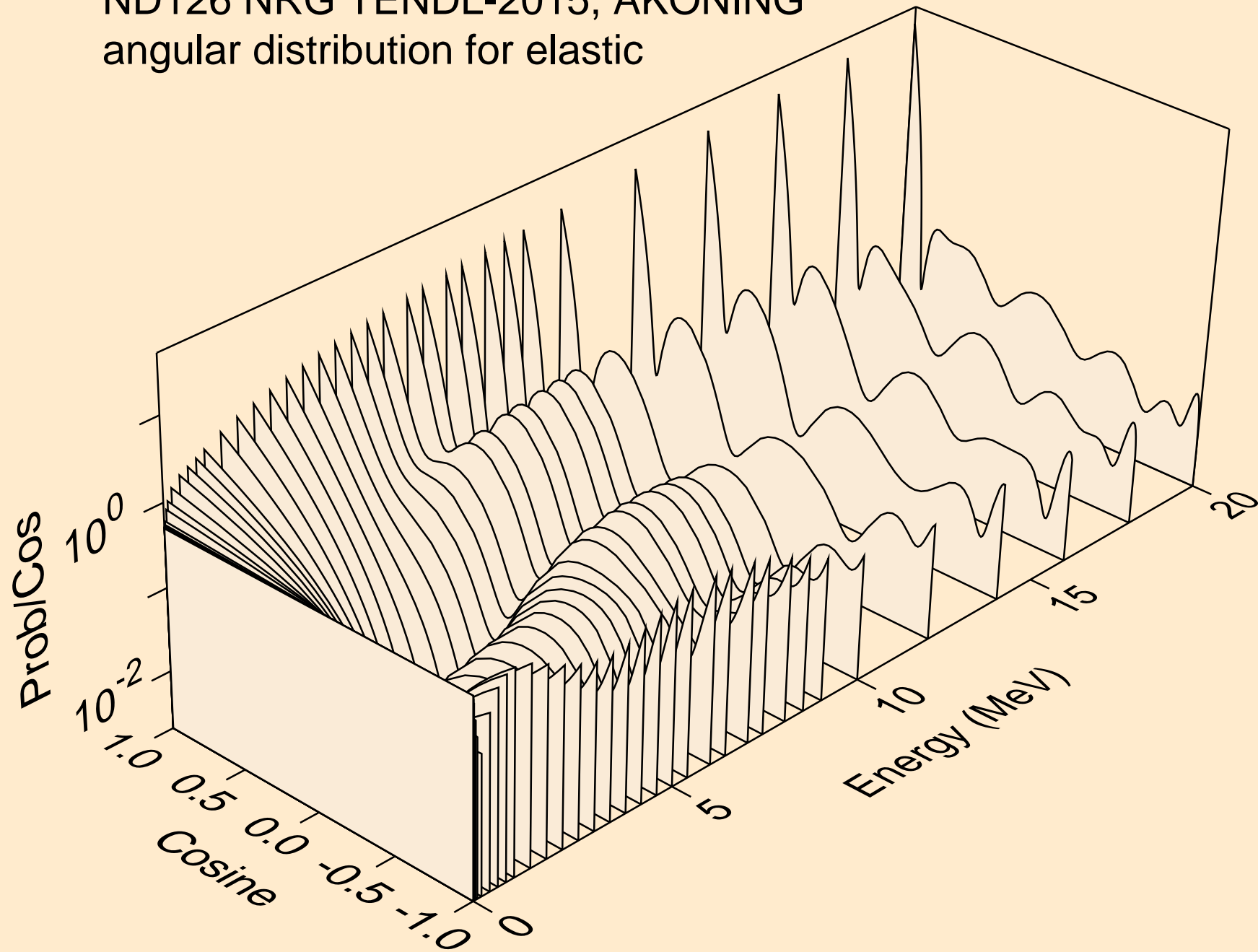

ND126 NRG TENDL-2015, AKONING  
angular distribution for elastic

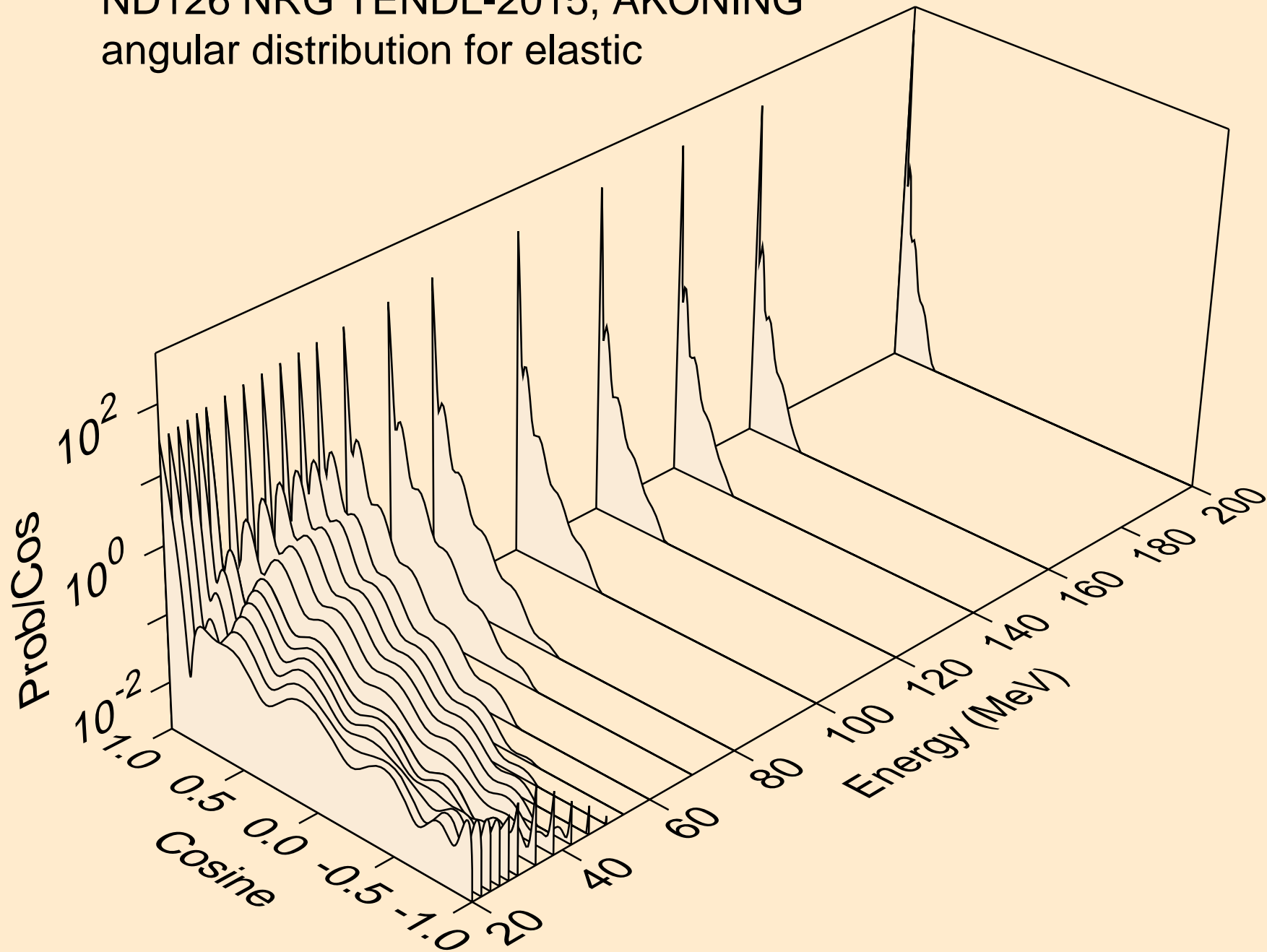

ND126 NRG TENDL-2015, AKONING  
angular distribution for (n,n\*1)

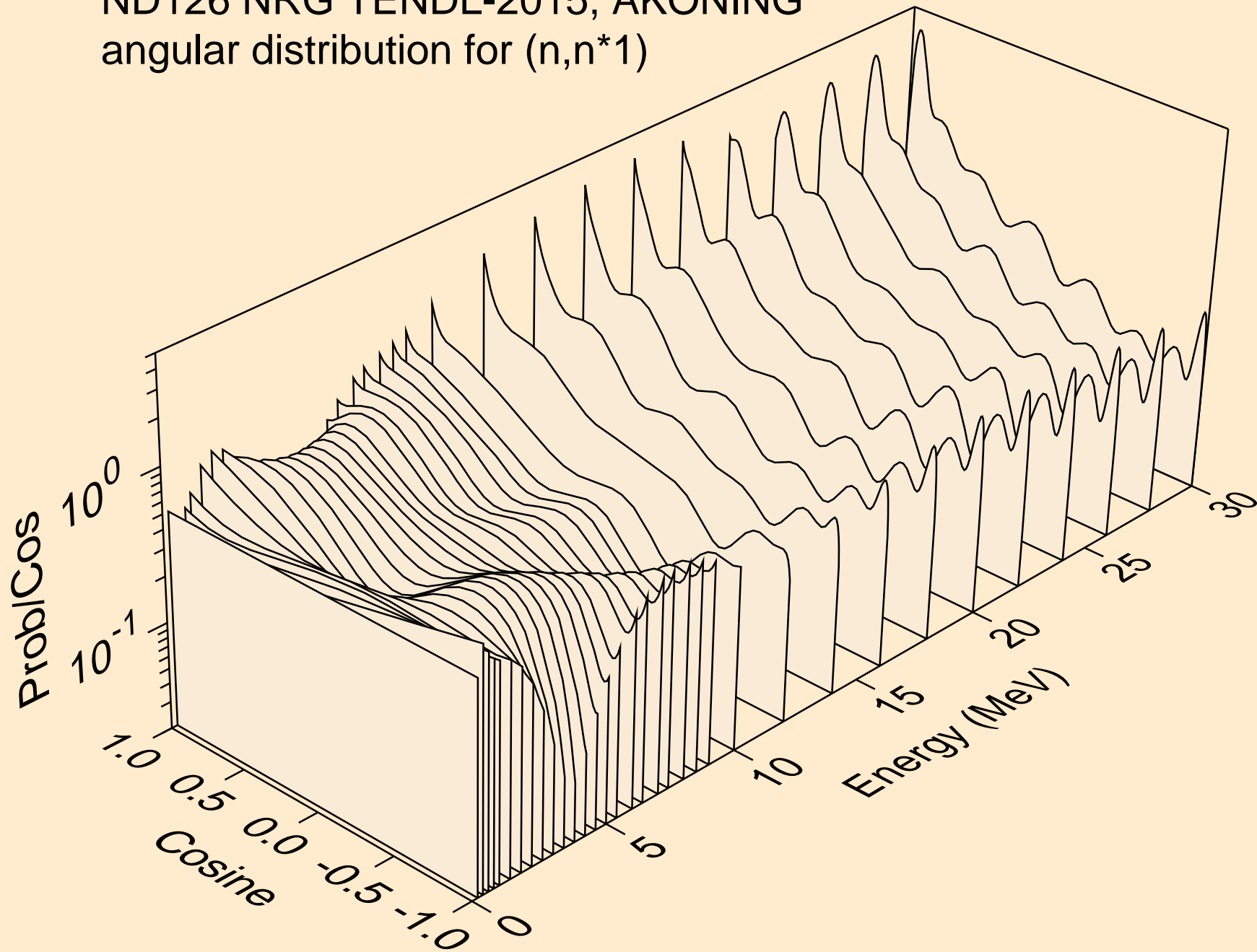

ND126 NRG TENDL-2015, AKONING  
Neutron emission for (n,x)

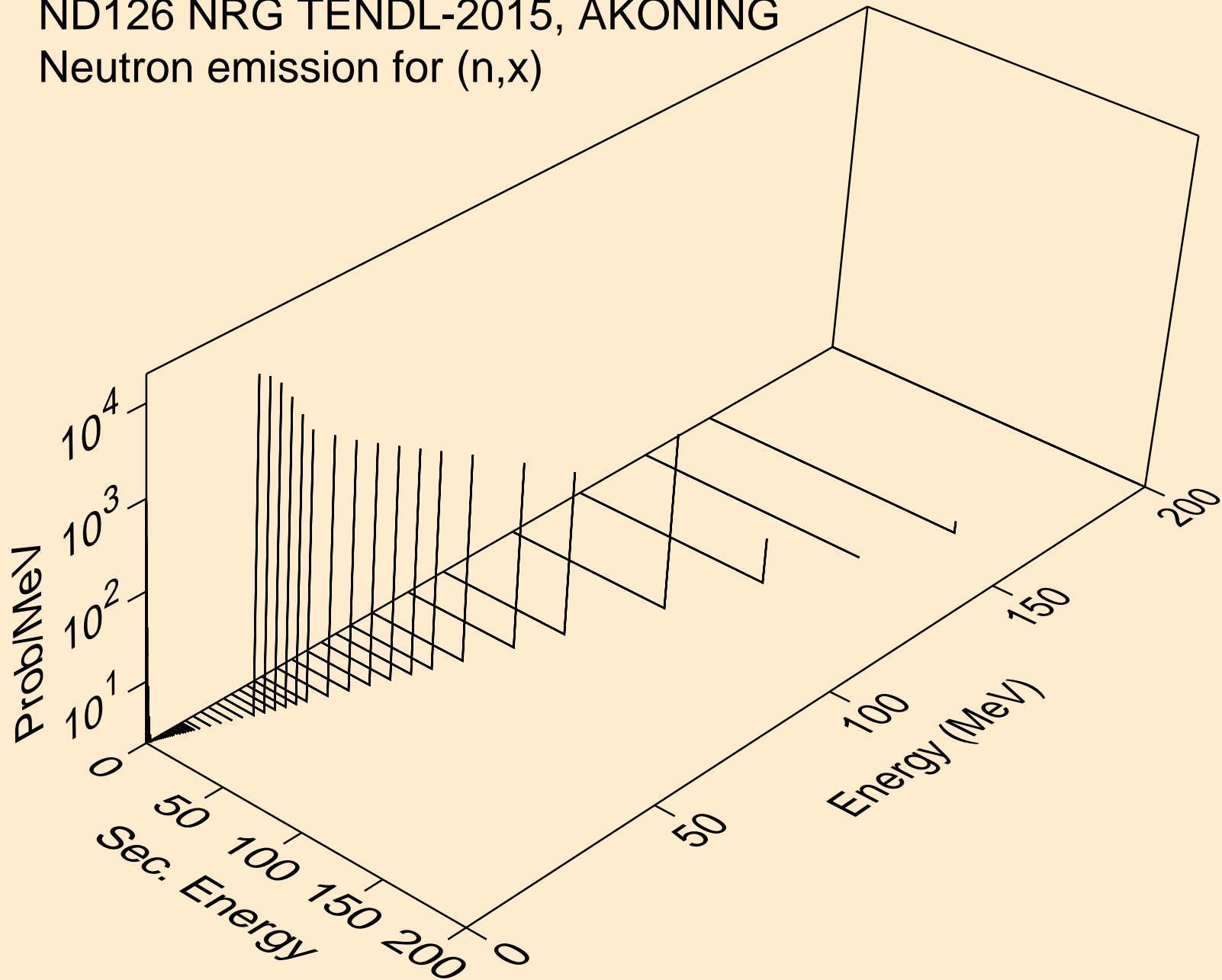



ND126 NRG TENDL-2015, AKONING  
Neutron emission for (n,2n)

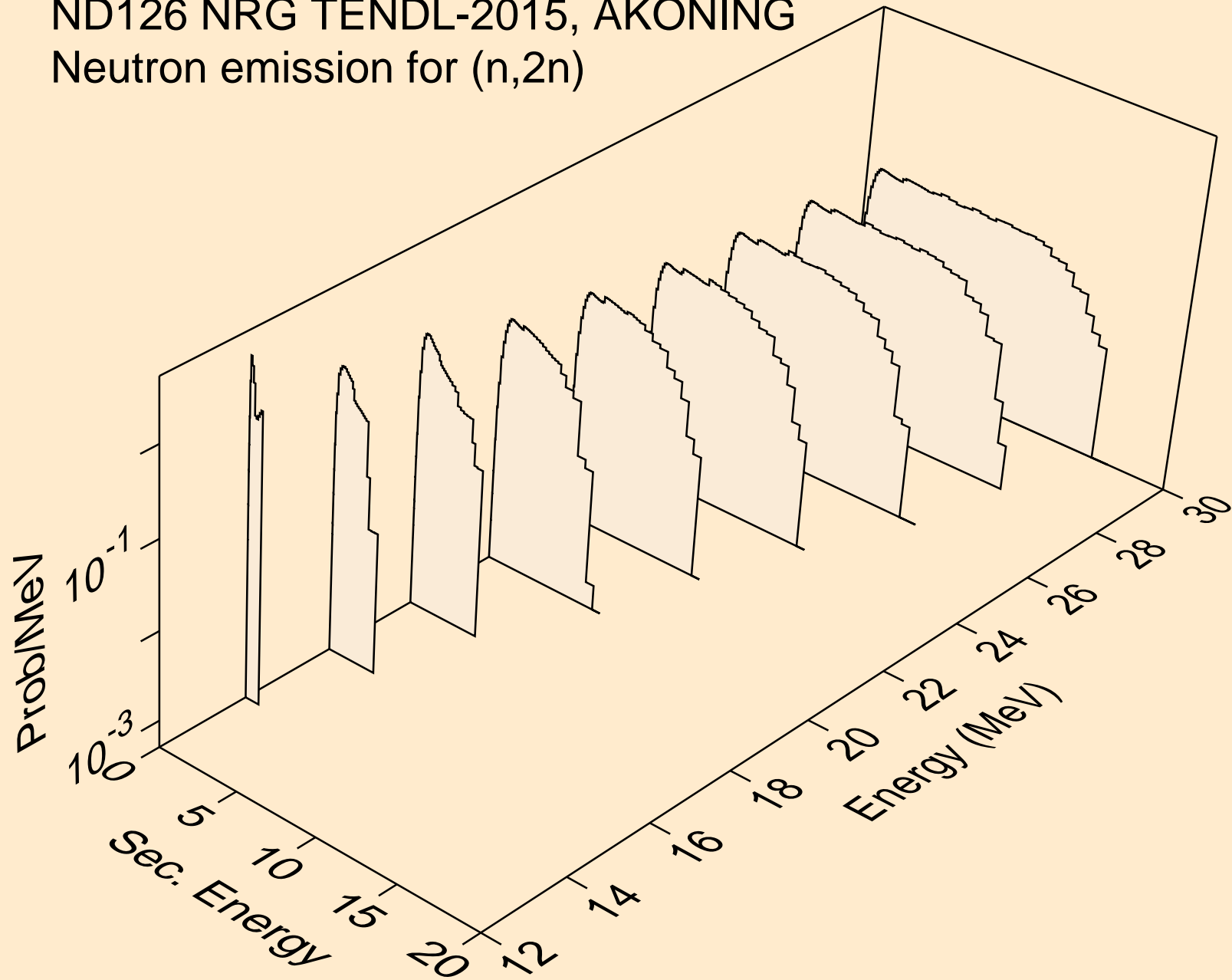

ND126 NRG TENDL-2015, AKONING  
Neutron emission for (n,3n)

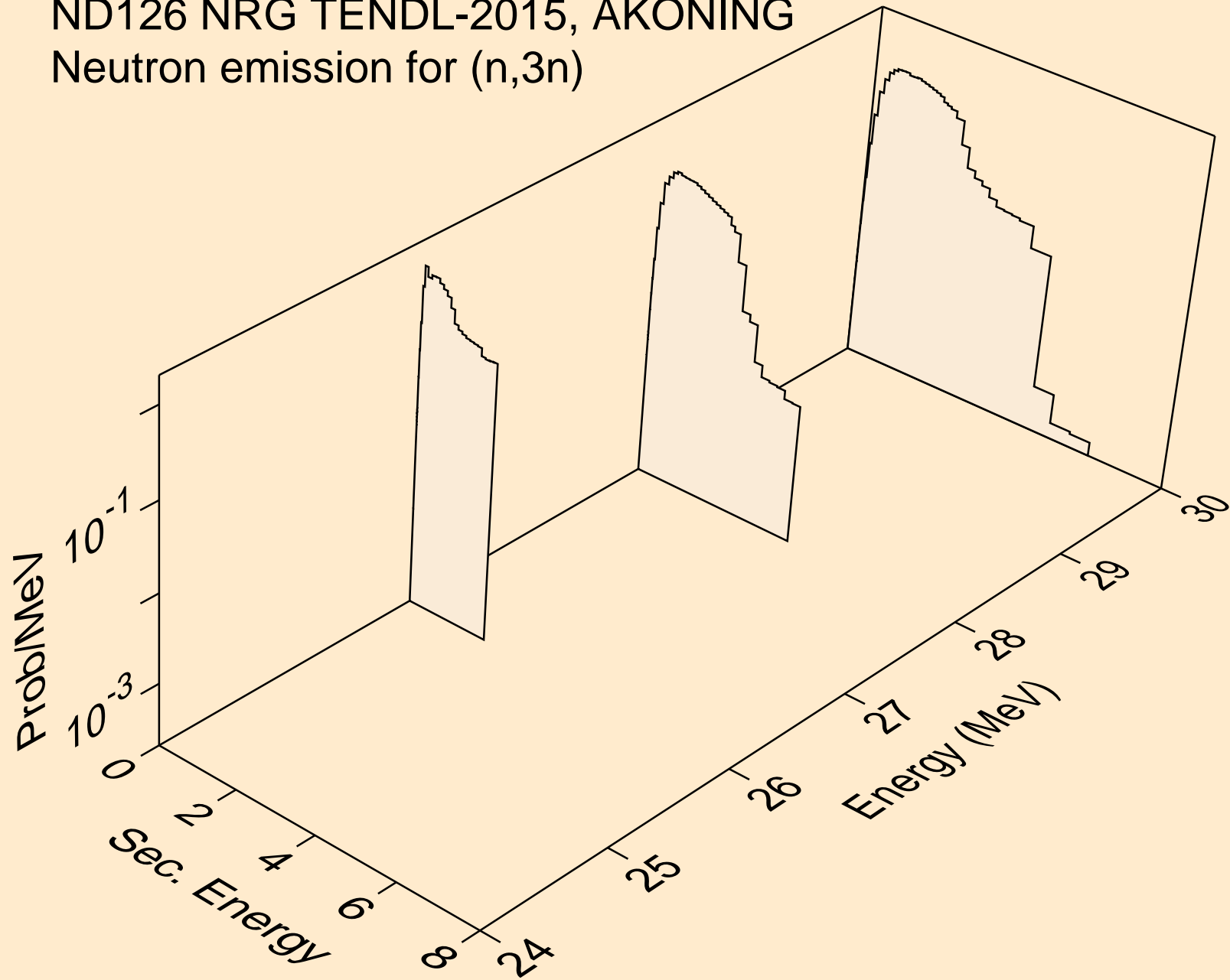

ND126 NRG TENDL-2015, AKONING  
Neutron emission for (n,n\*)a

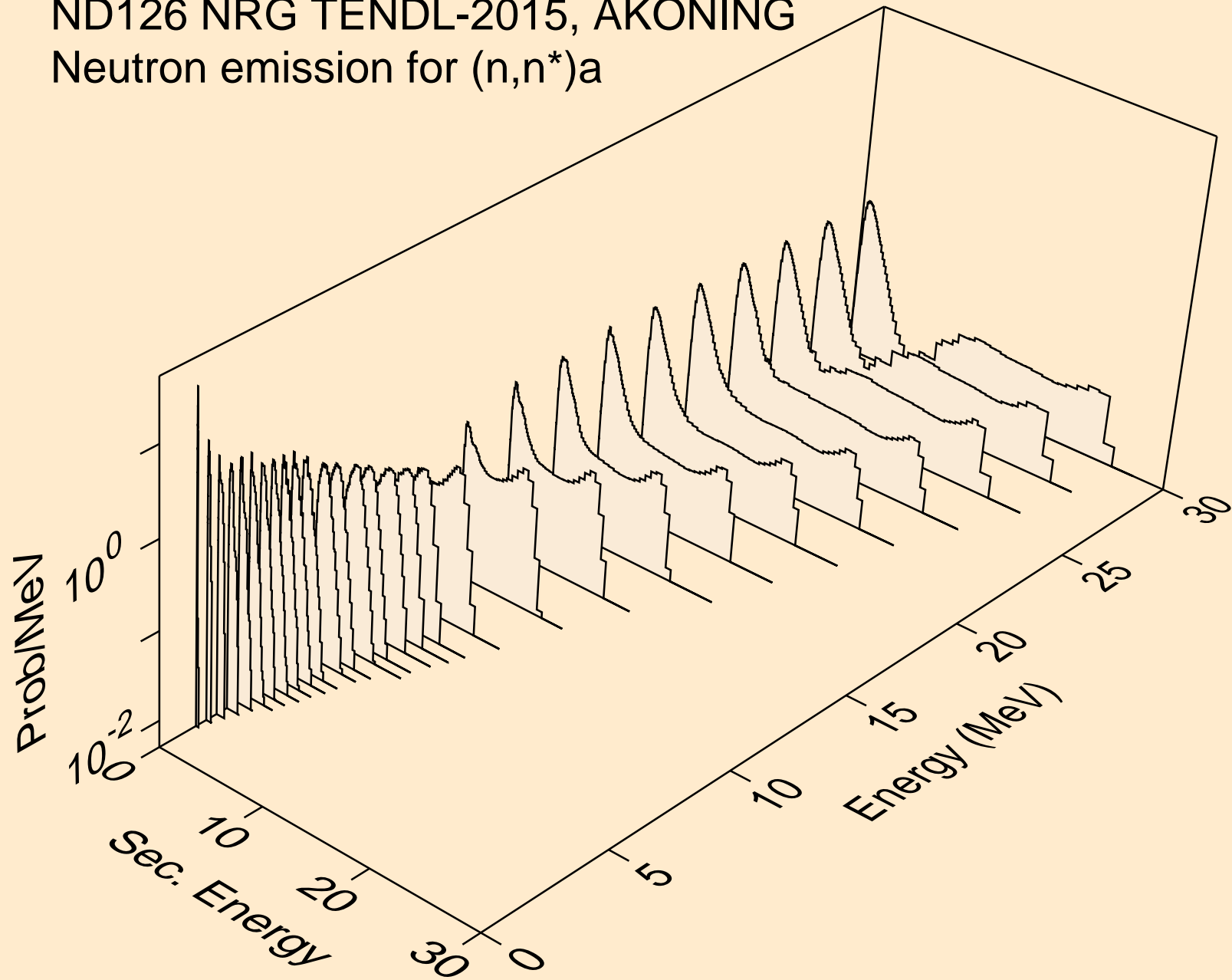

ND126 NRG TENDL-2015, AKONING  
Neutron emission for (n,n\*)3a

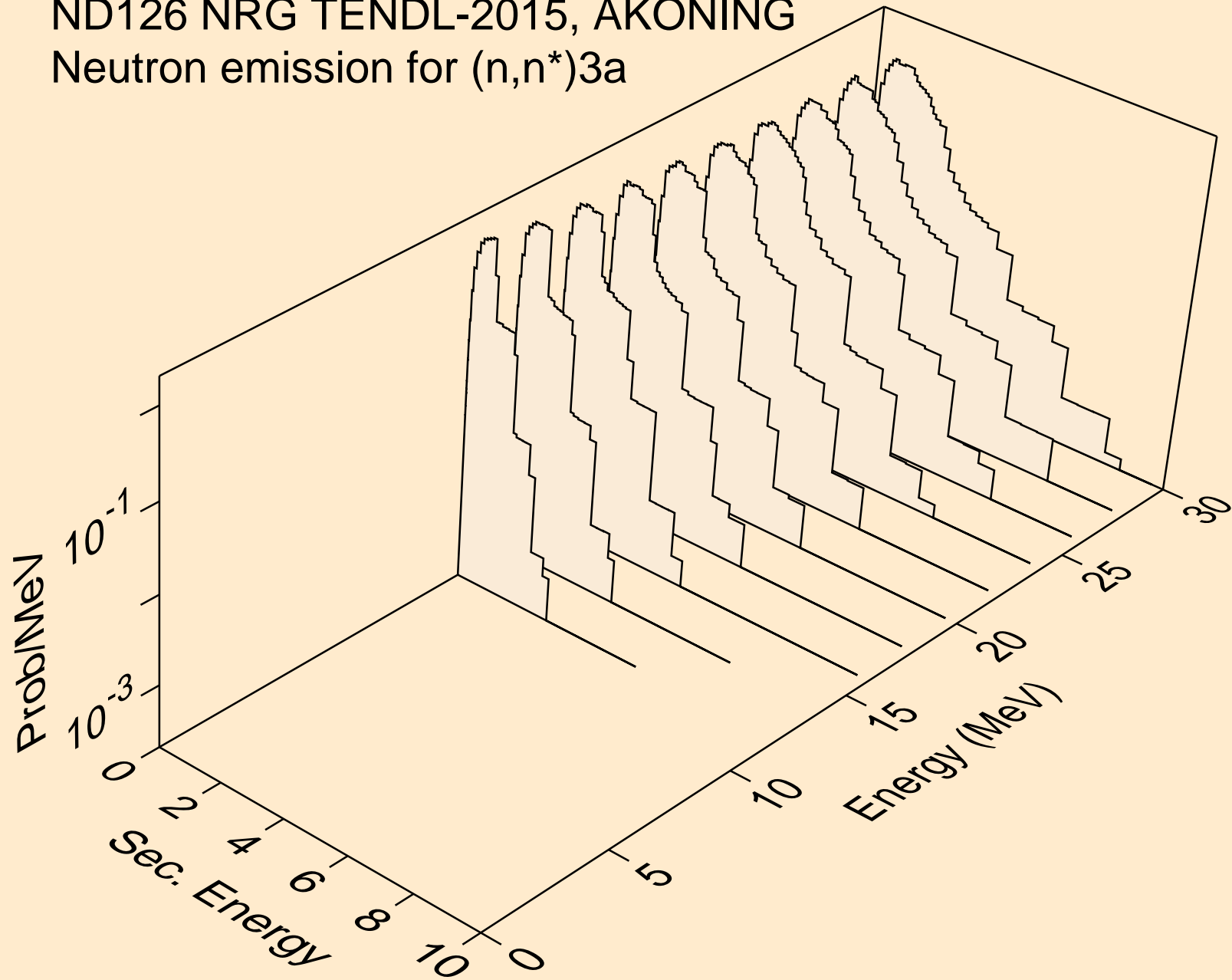

ND126 NRG TENDL-2015, AKONING  
Neutron emission for (n,2n)<sub>a</sub>

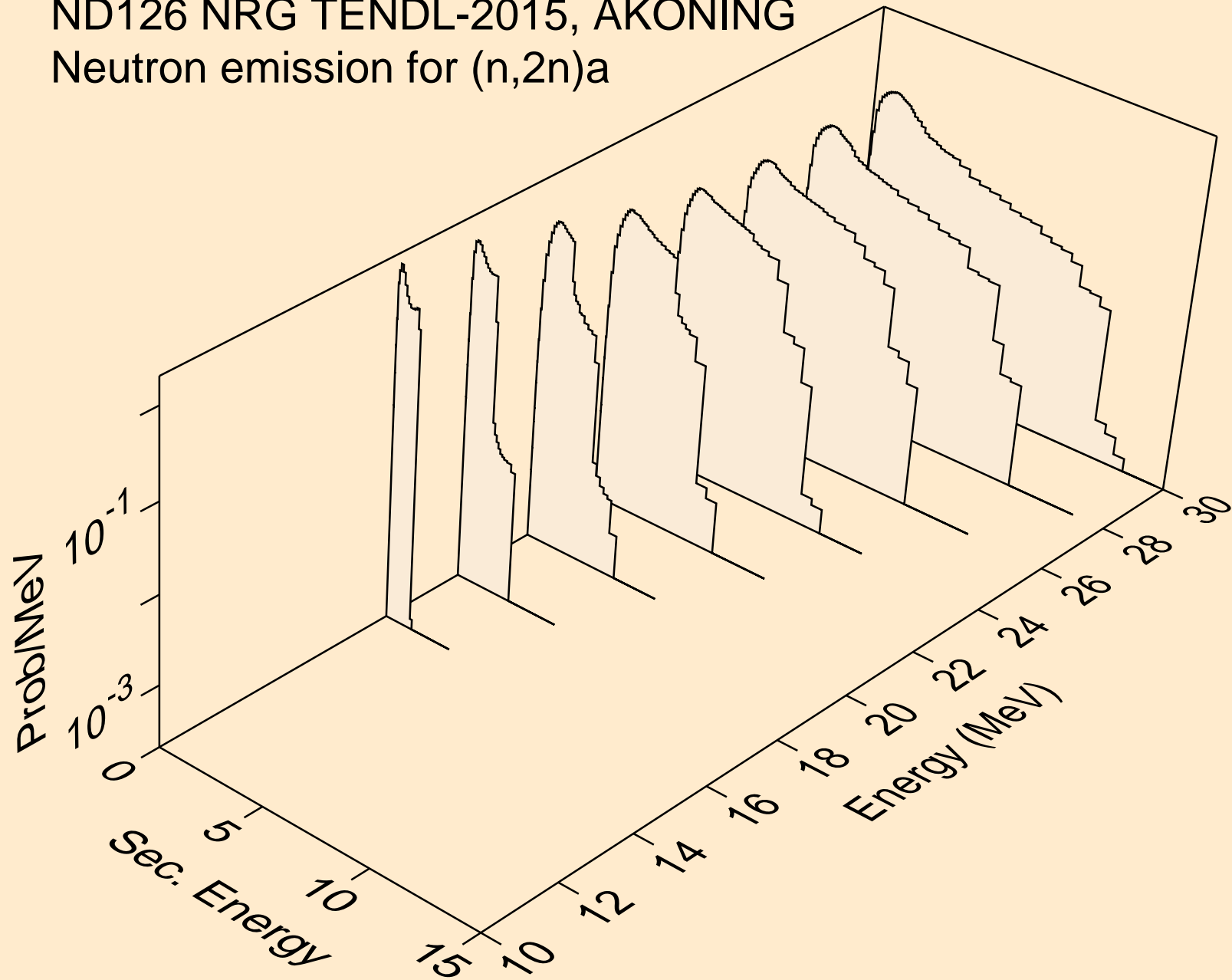

ND126 NRG TENDL-2015, AKONING  
Neutron emission for (n,n\*)p

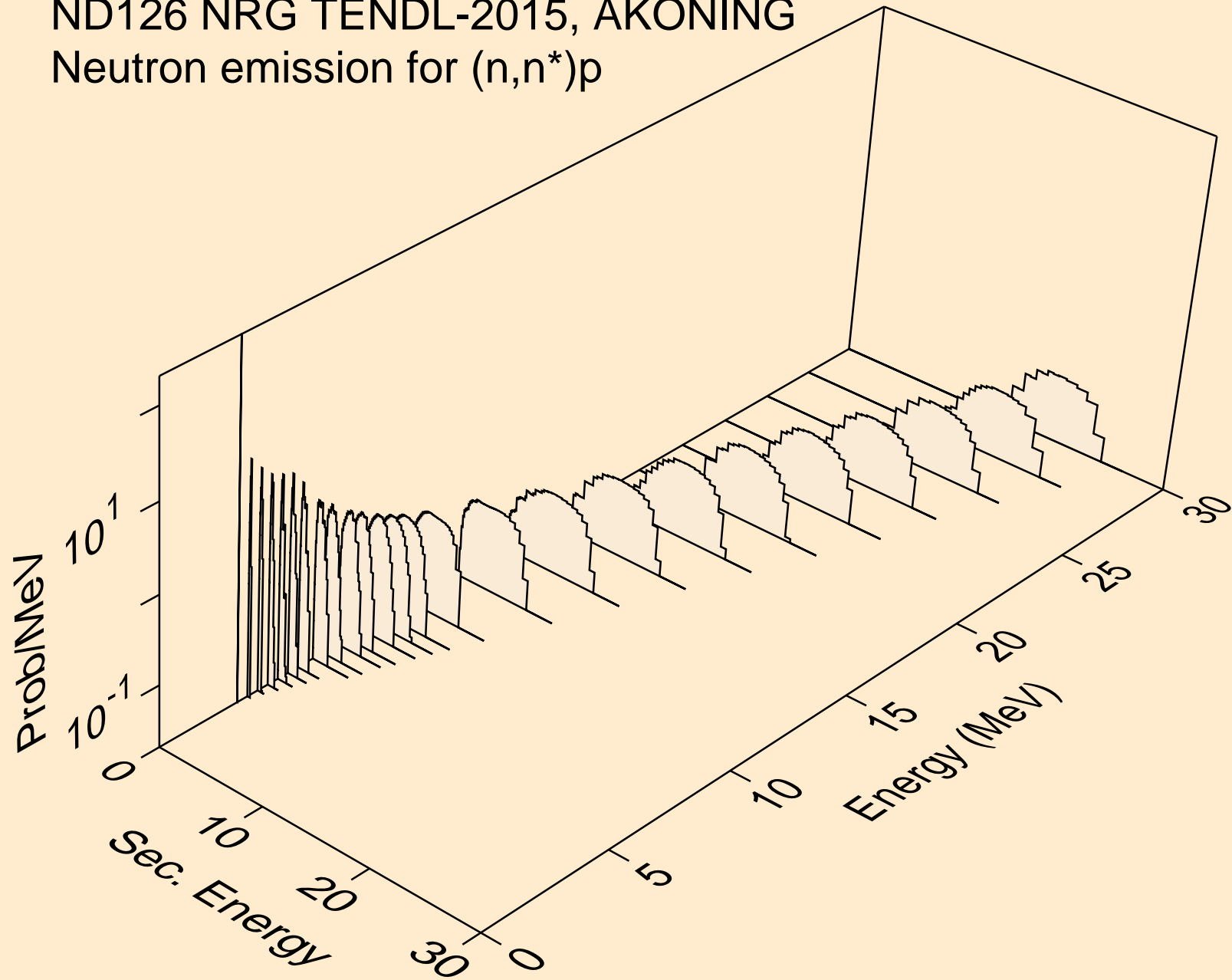

ND126 NRG TENDL-2015, AKONING  
Neutron emission for (n,n\*)2a

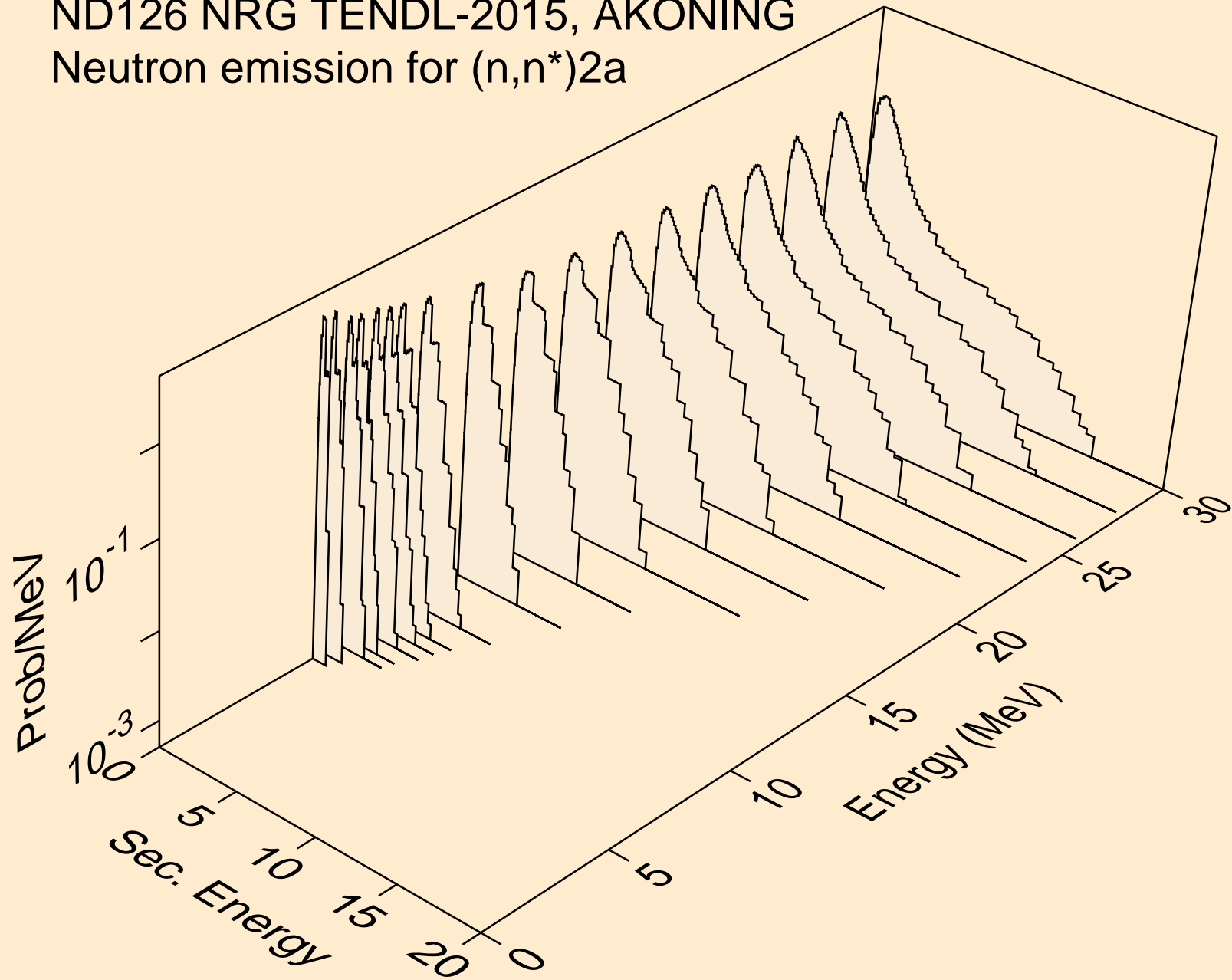

ND126 NRG TENDL-2015, AKONING  
Neutron emission for (n,2n)2a

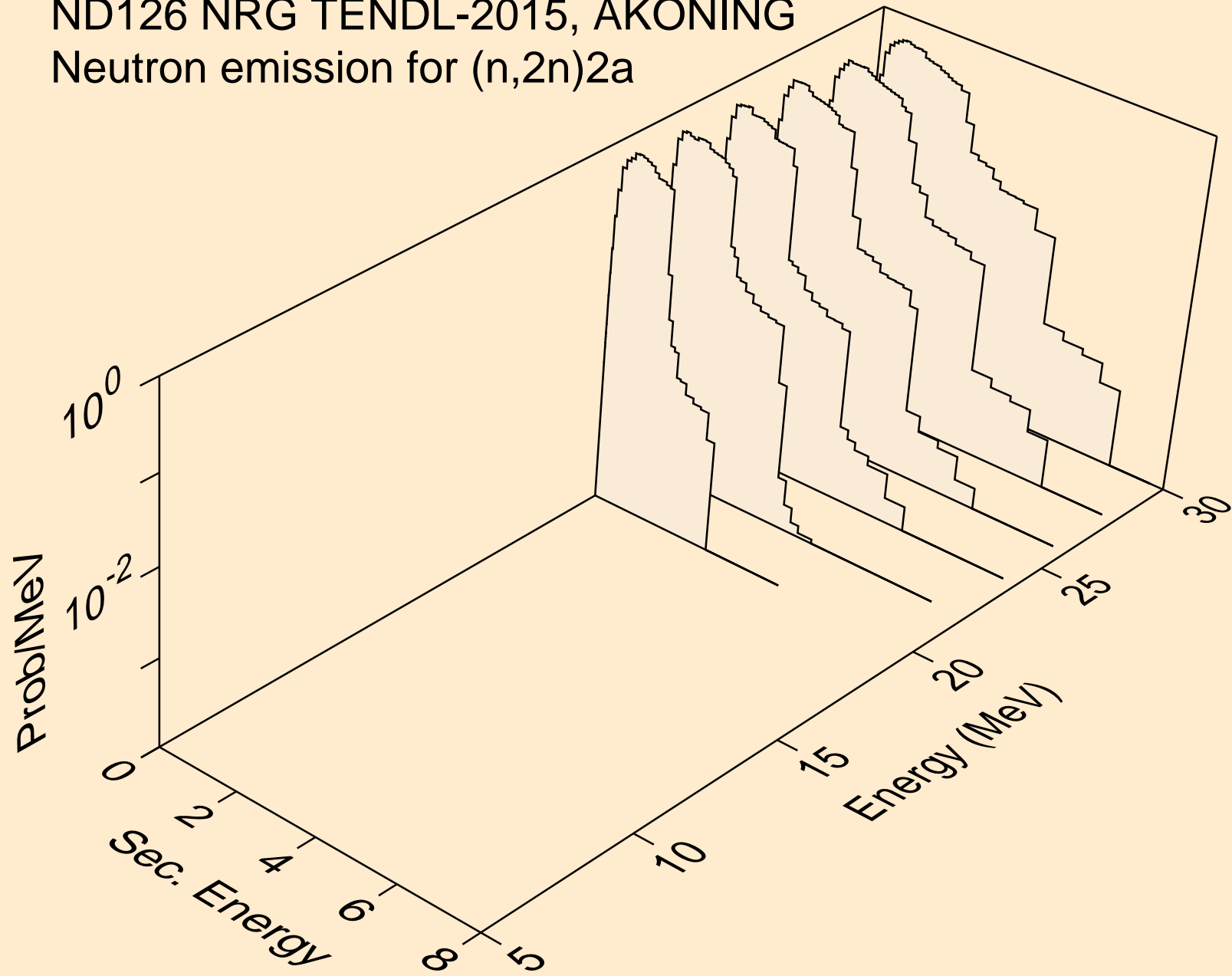



ND126 NRG TENDL-2015, AKONING  
Neutron emission for (n,n\*)d

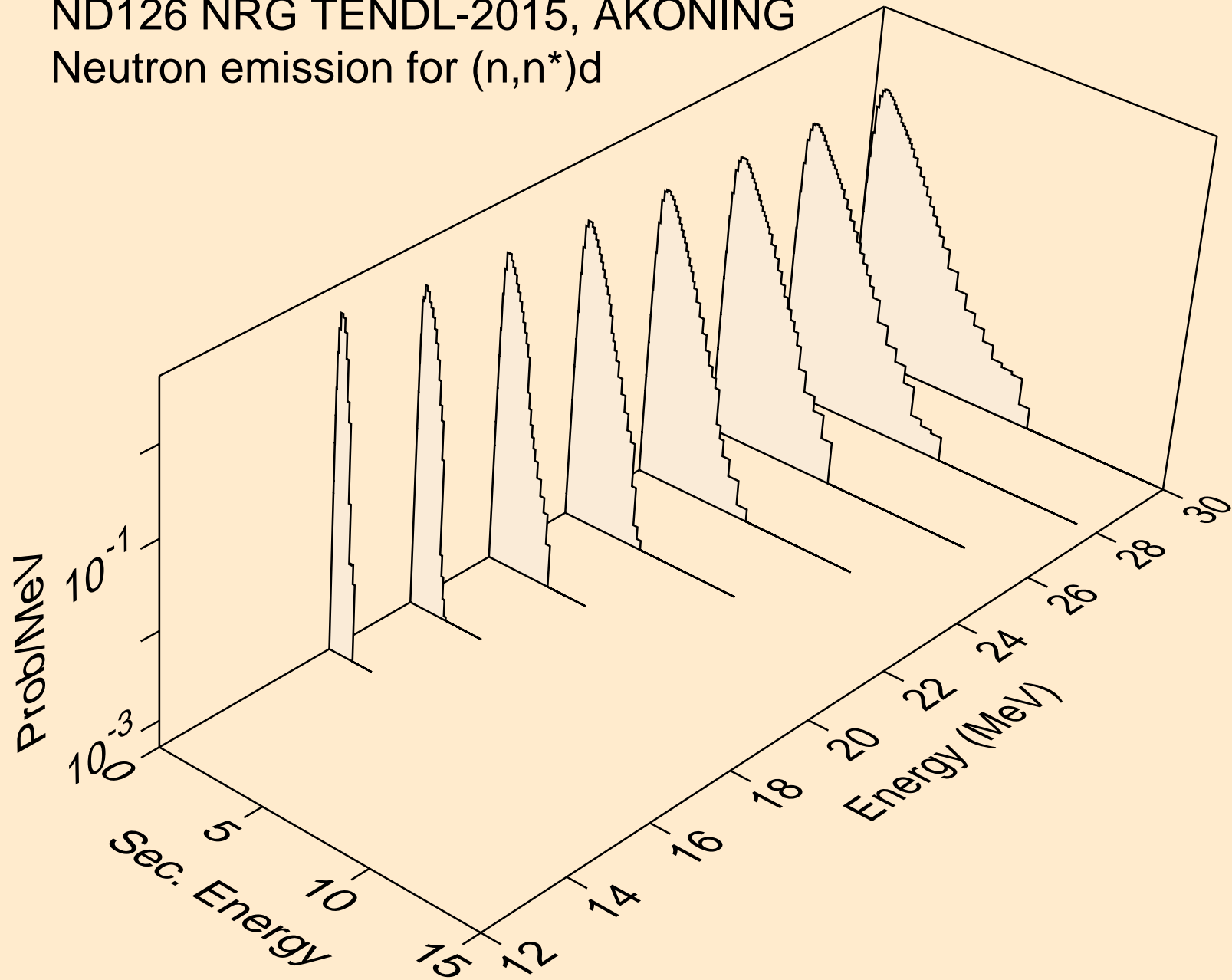

ND126 NRG TENDL-2015, AKONING  
Neutron emission for (n,n\*)t

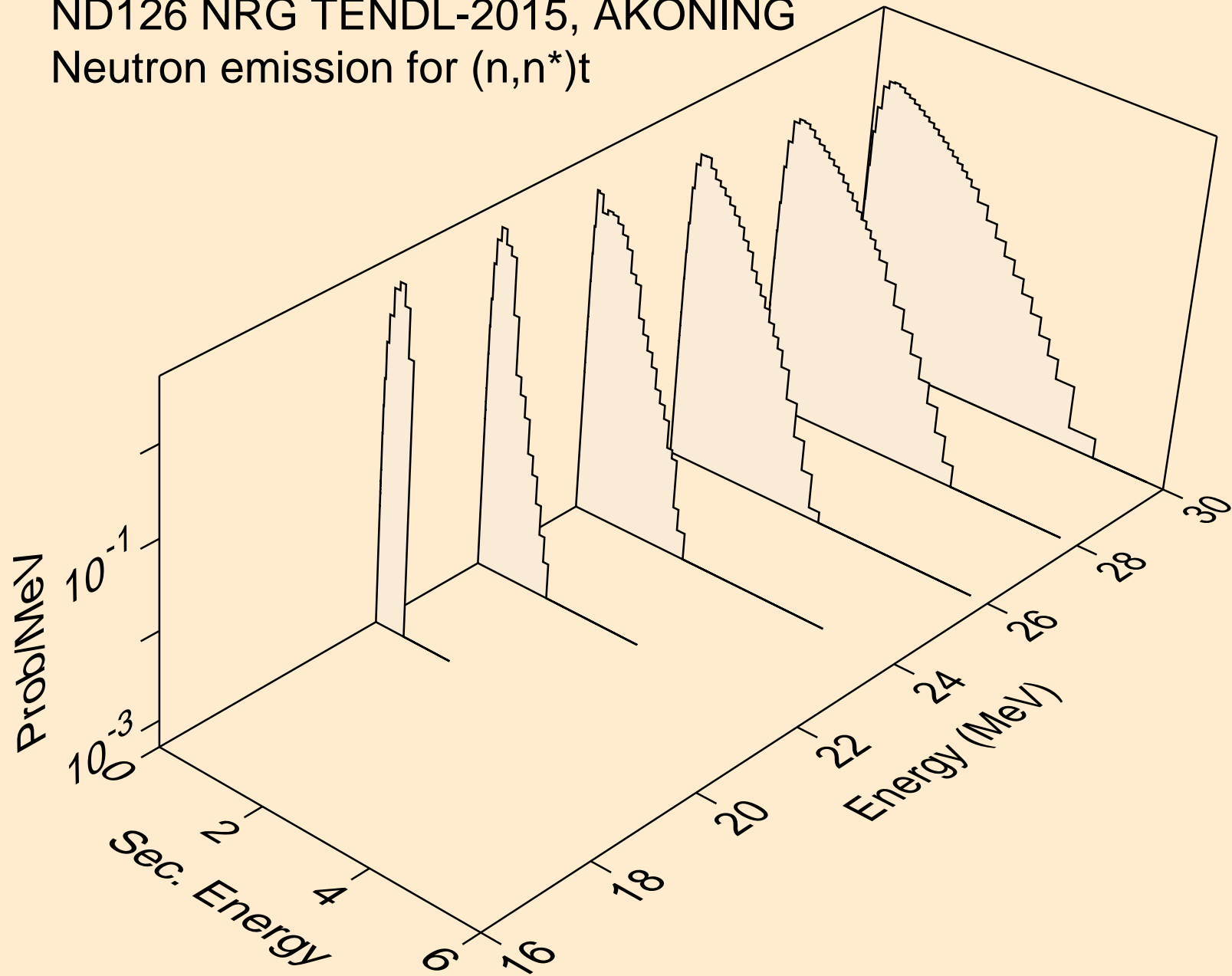

ND126 NRG TENDL-2015, AKONING  
Neutron emission for (n,n\*)he3

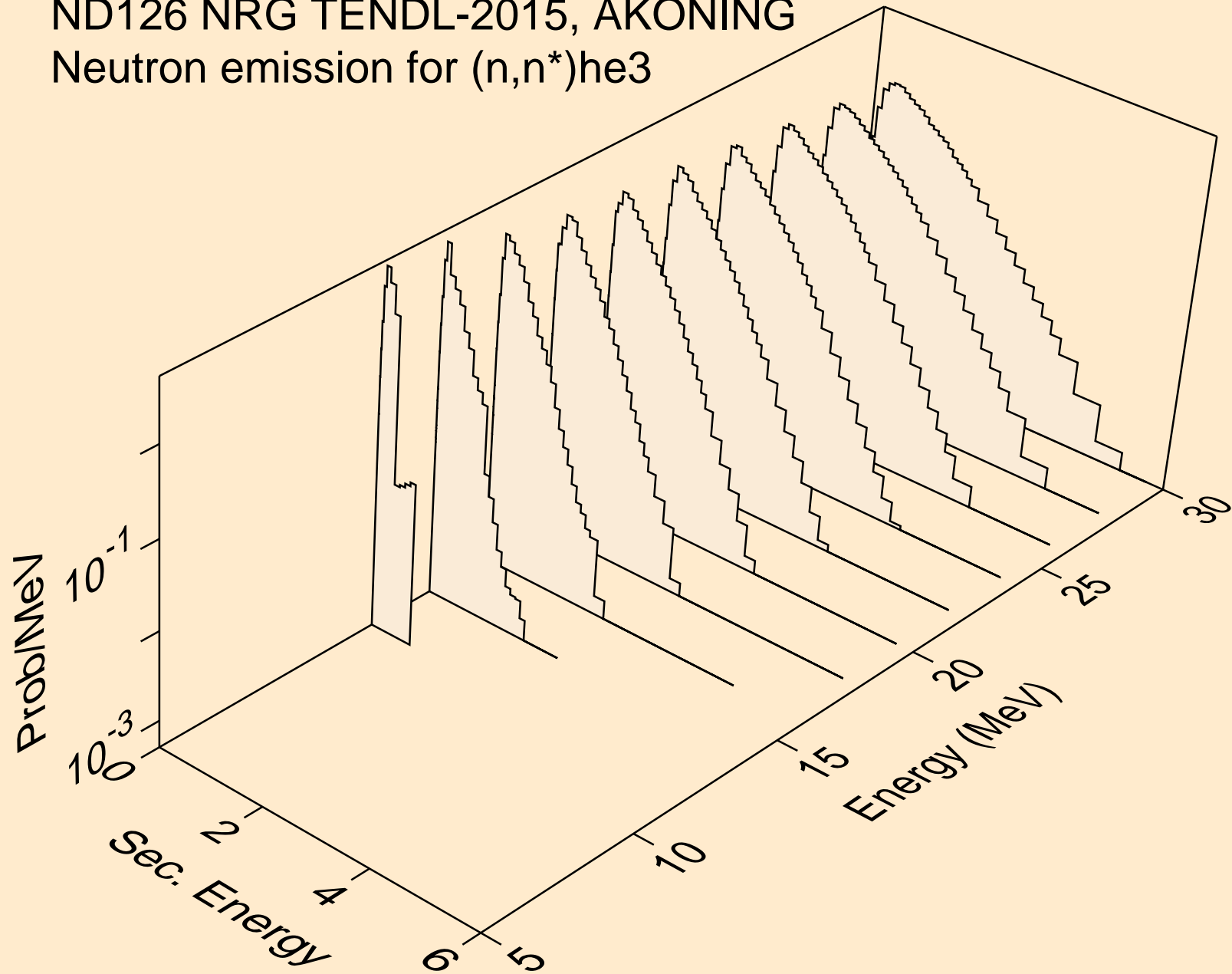

ND126 NRG TENDL-2015, AKONING  
Neutron emission for (n,2np)

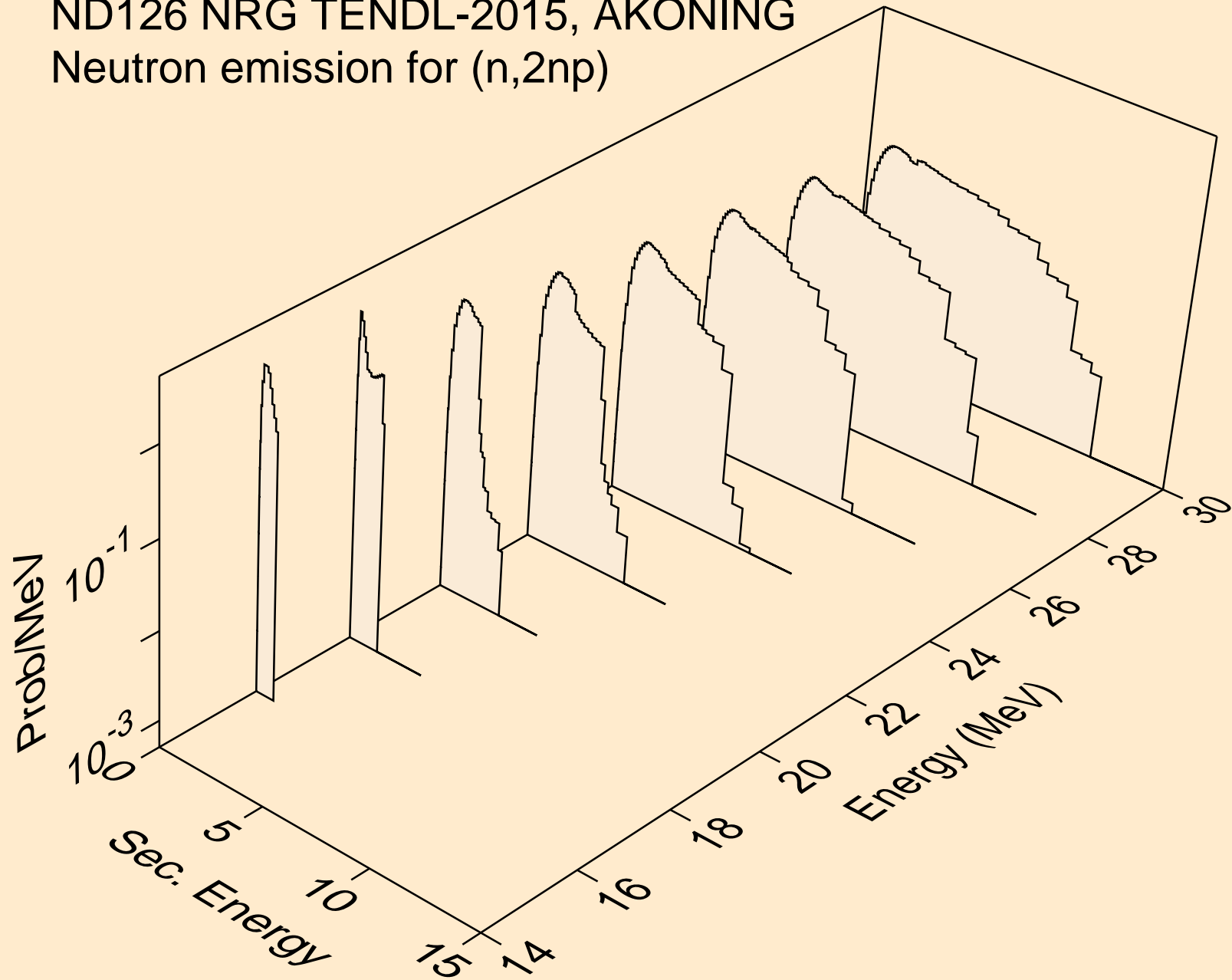

ND126 NRG TENDL-2015, AKONING  
Neutron emission for (n,3np)

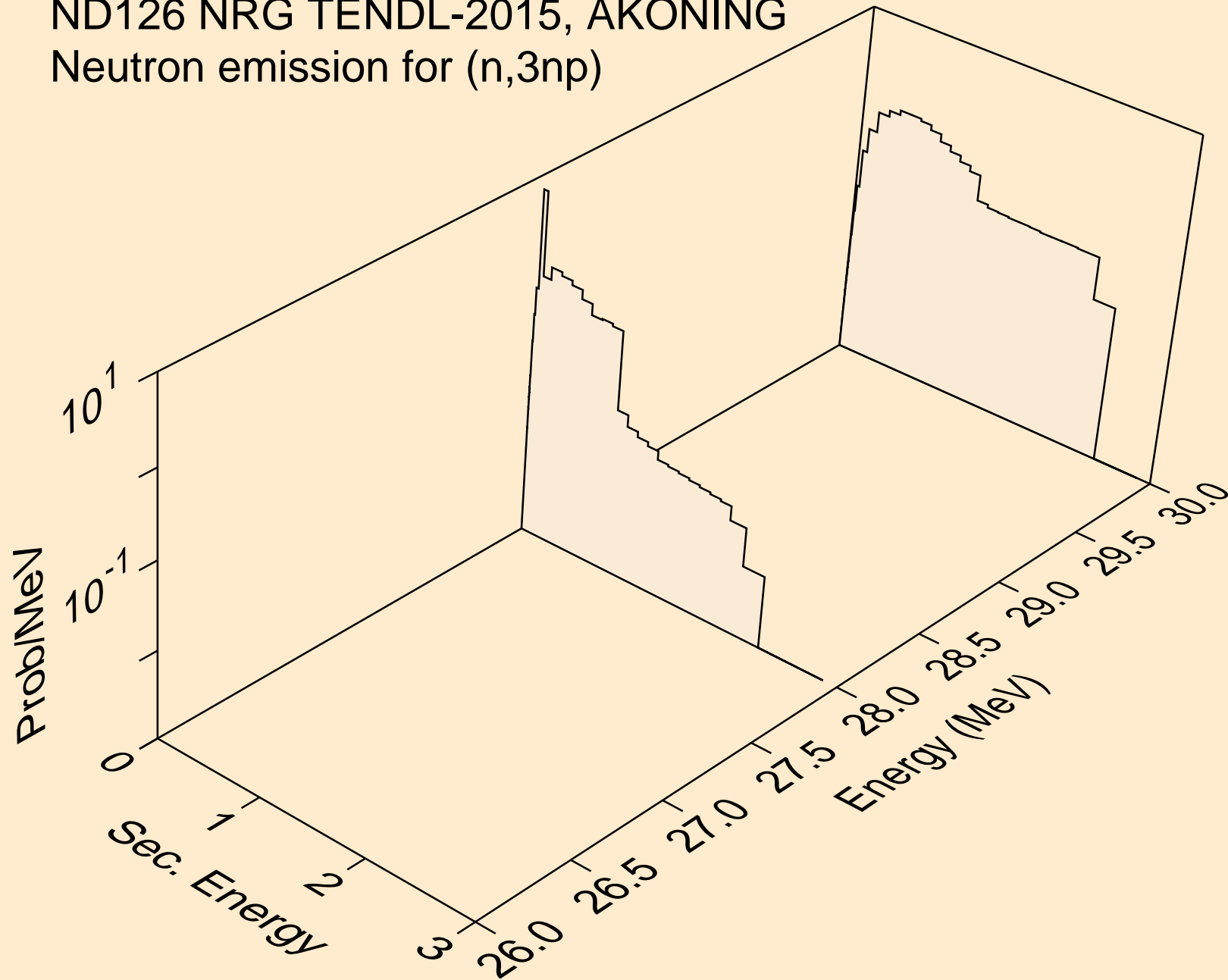

ND126 NRG TENDL-2015, AKONING  
Neutron emission for (n,2np)

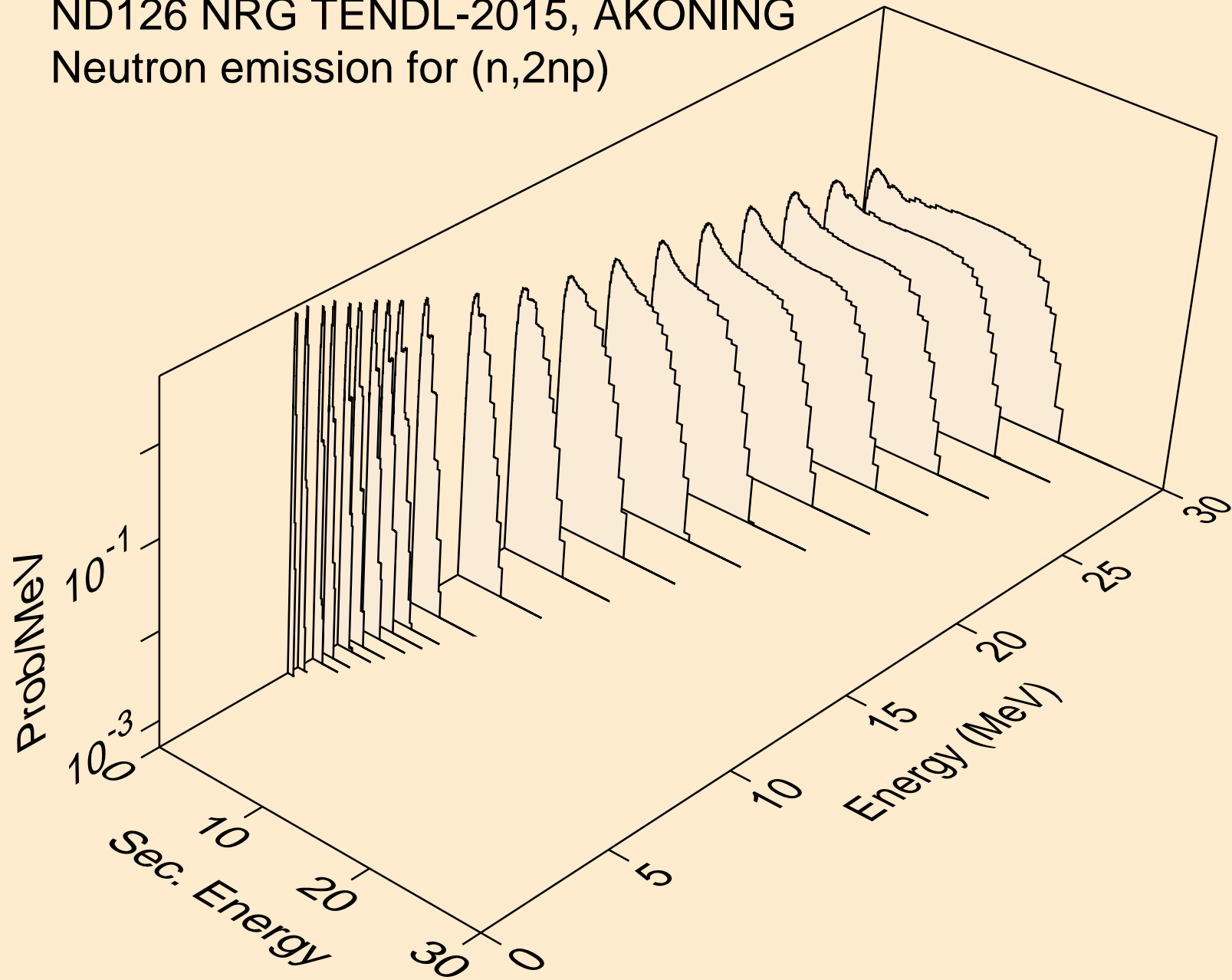

ND126 NRG TENDL-2015, AKONING  
Neutron emission for (n,npa)

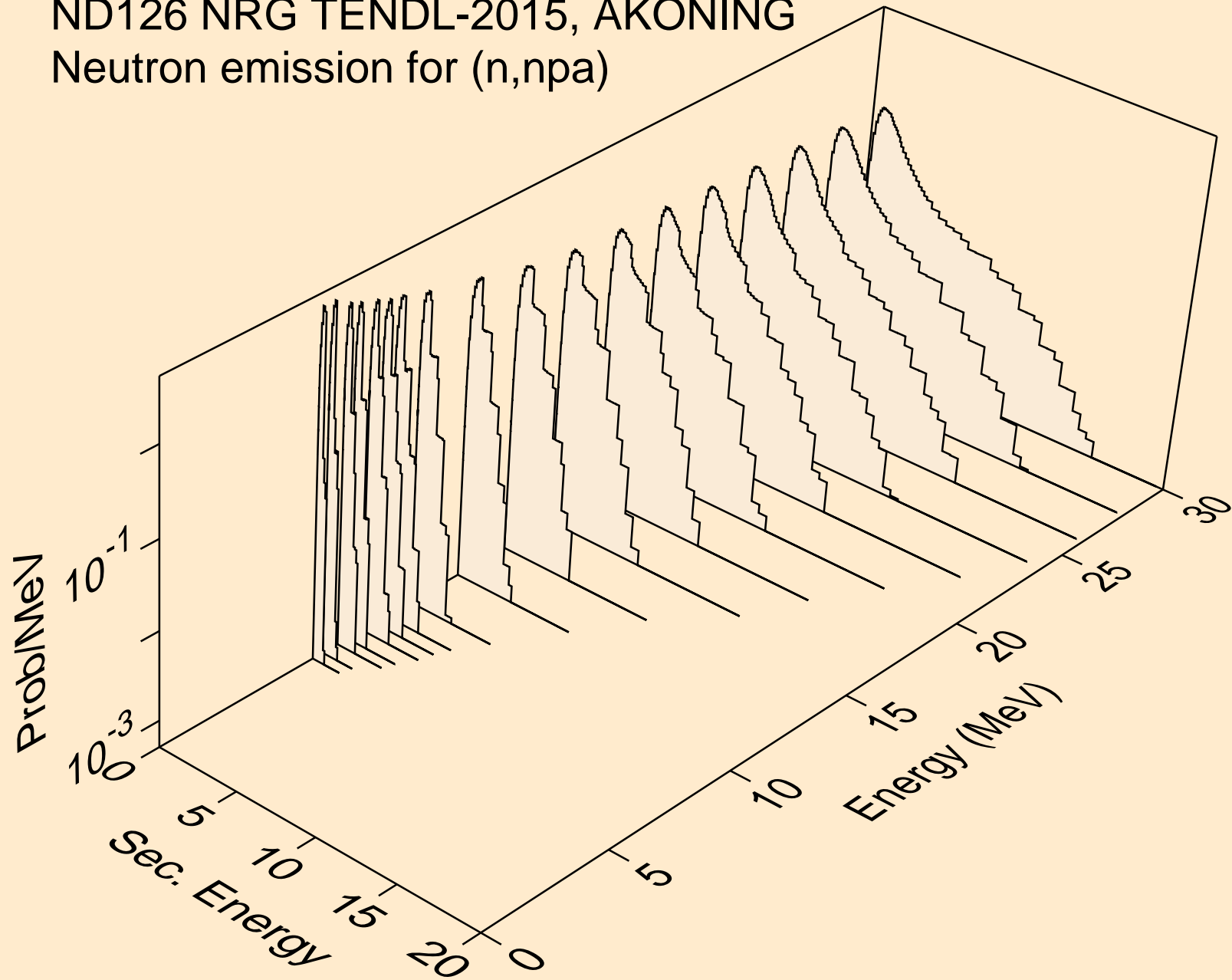

ND126 NRG TENDL-2015, AKONING  
Neutron emission for (n,n\*c)

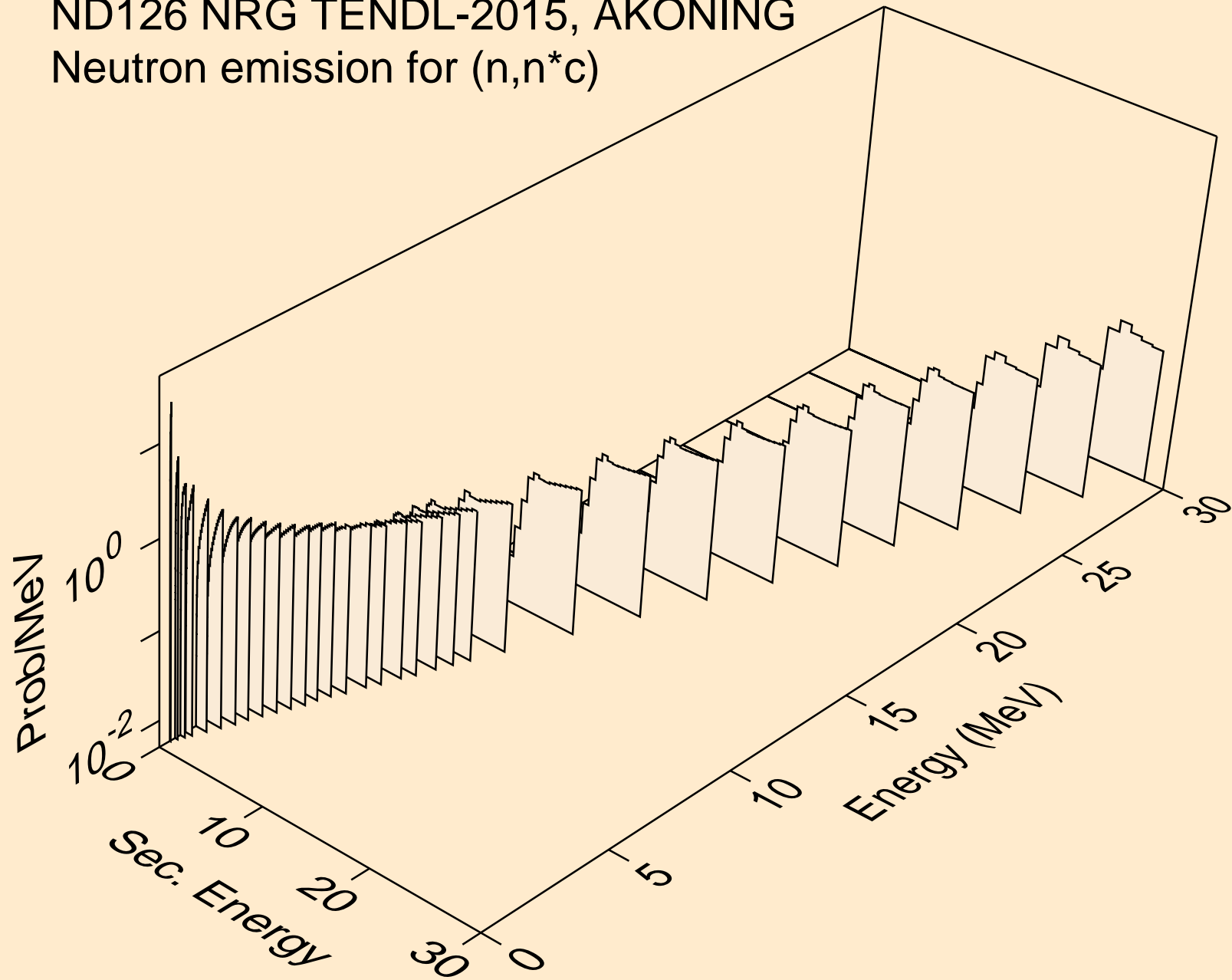



ND126 NRG TENDL-2015, AKONING  
Photon emission for (n,x)

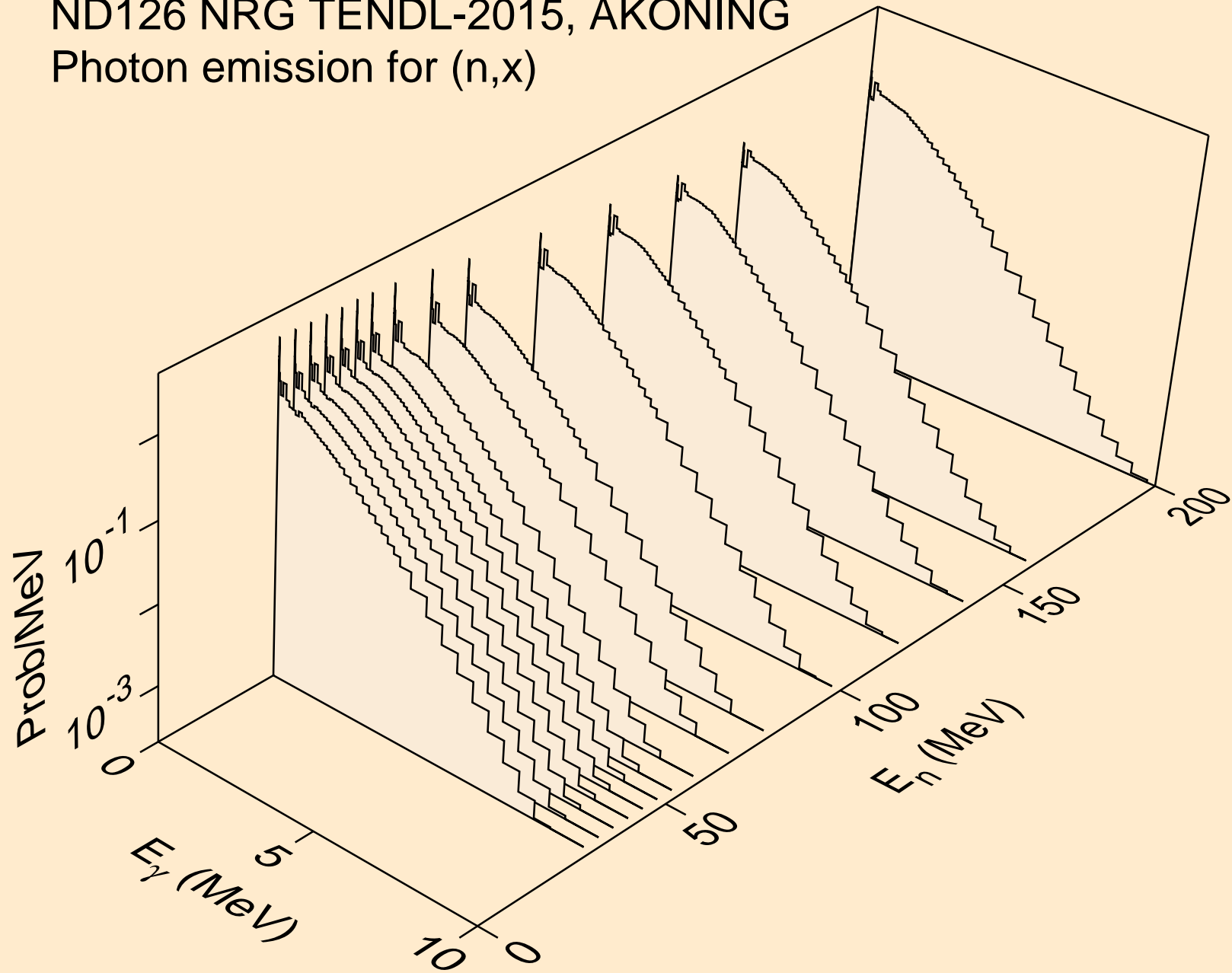

ND126 NRG TENDL-2015, AKONING  
Photon emission for (n,2n)

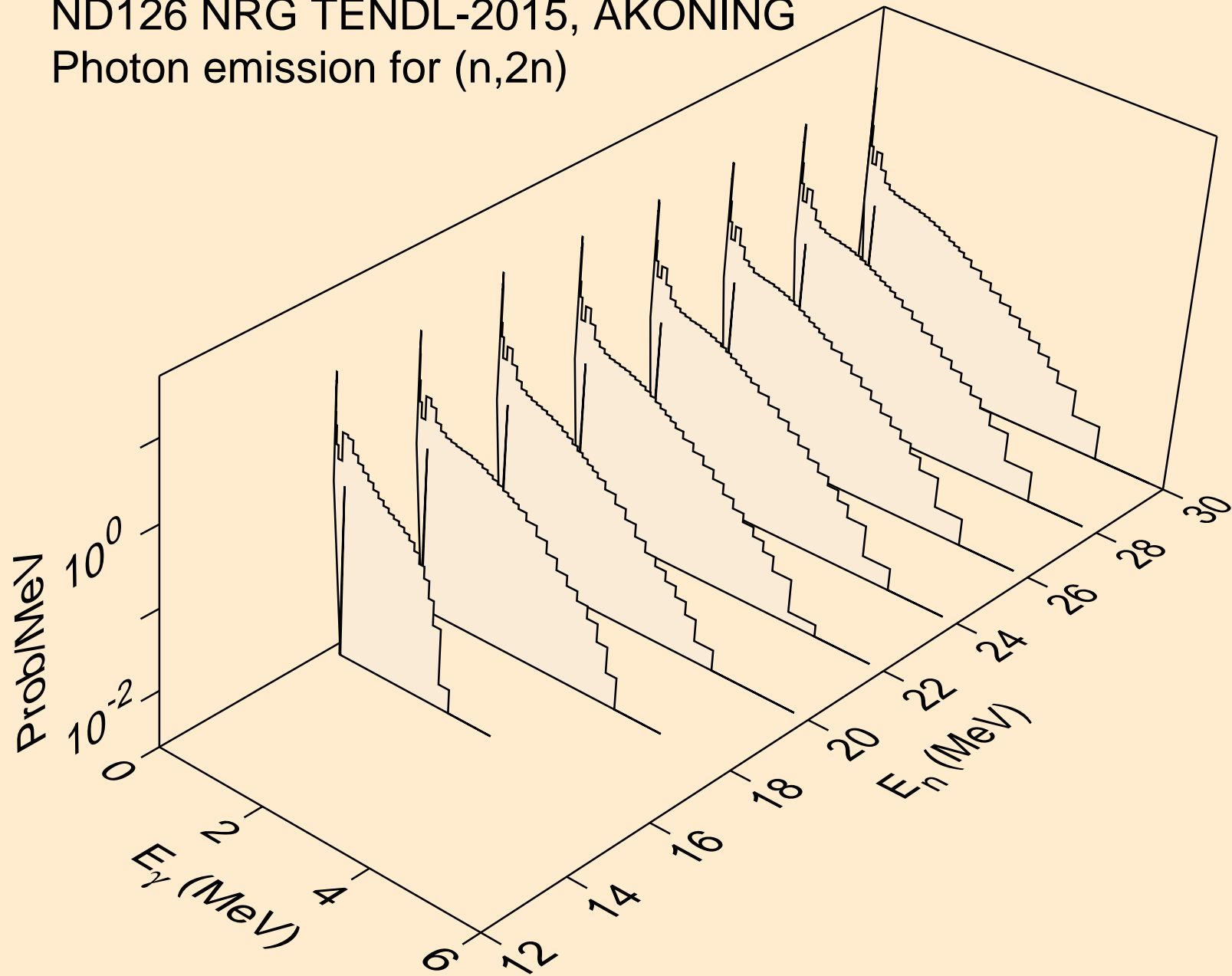

ND126 NRG TENDL-2015, AKONING  
Photon emission for (n,3n)

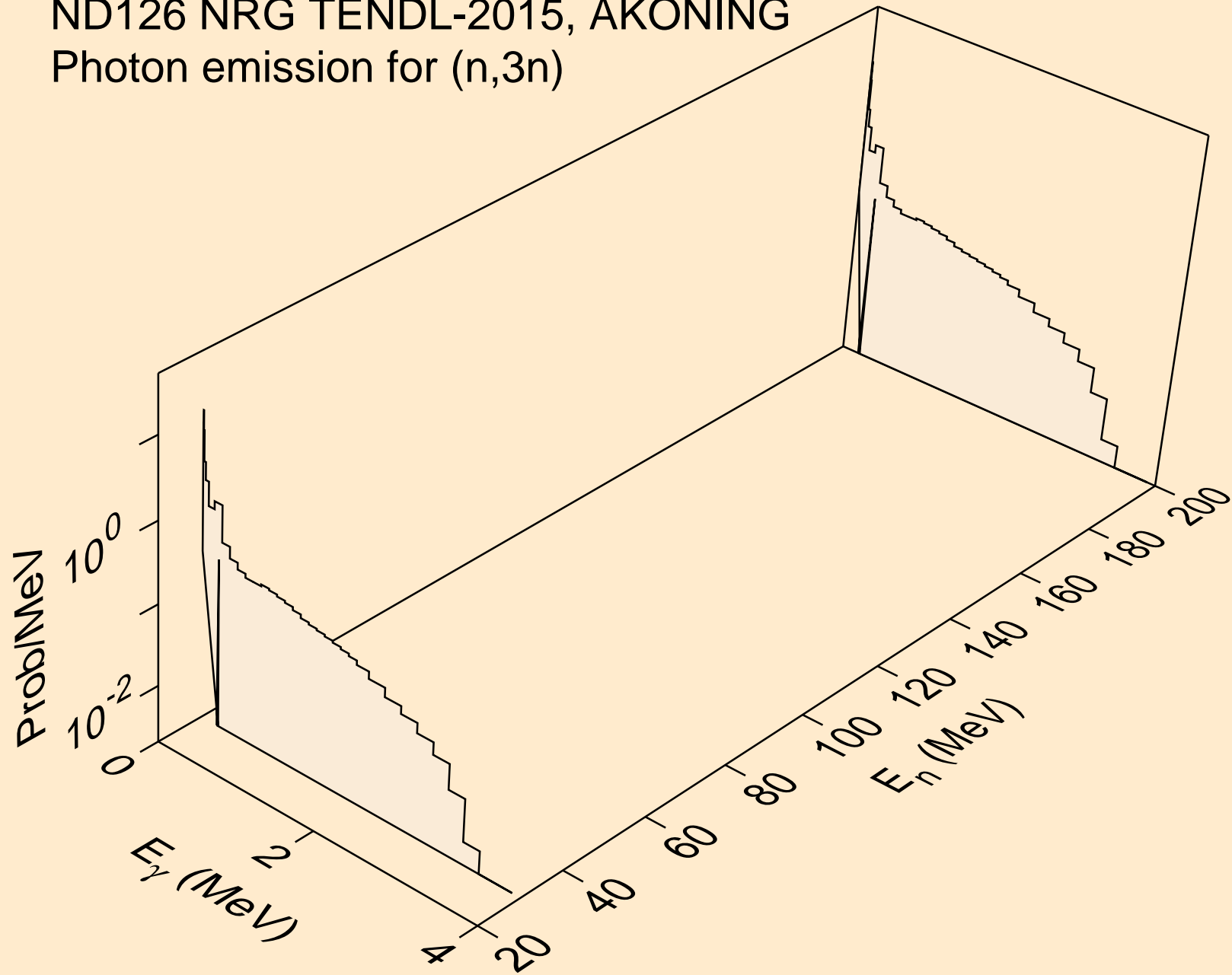

ND126 NRG TENDL-2015, AKONING  
Photon emission for (n,n\*)a

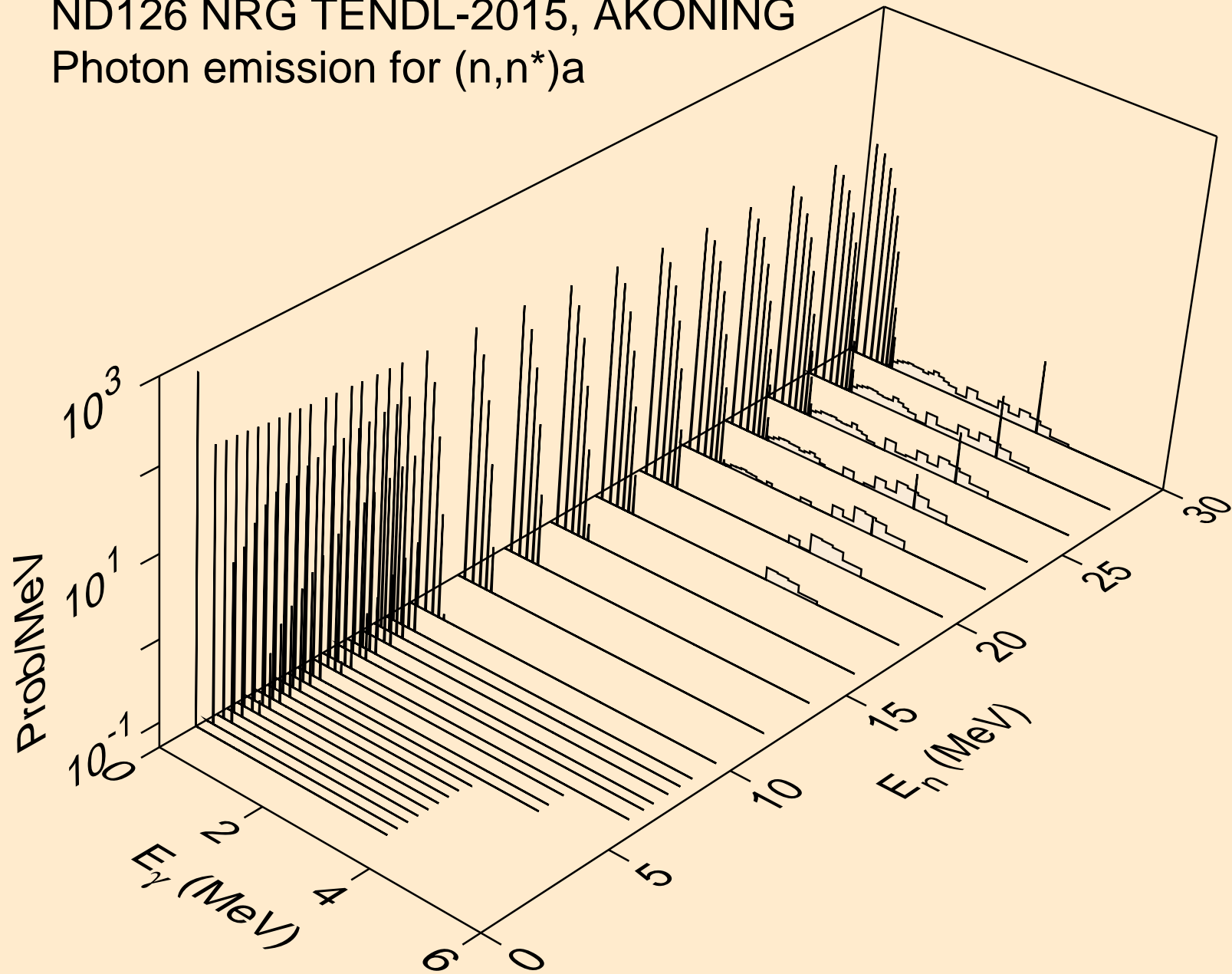

ND126 NRG TENDL-2015, AKONING  
Photon emission for (n,n\*)3a

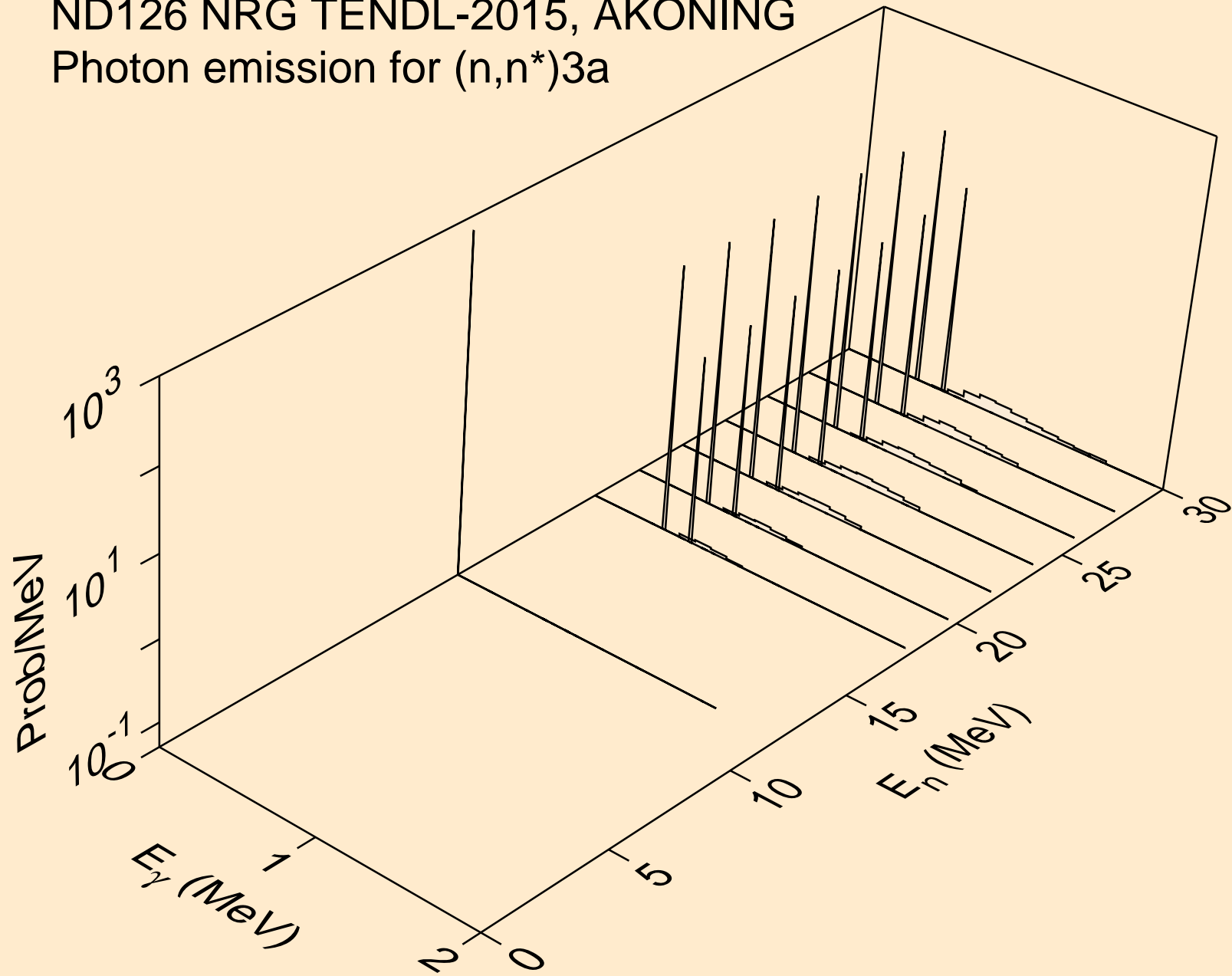

ND126 NRG TENDL-2015, AKONING  
Photon emission for (n,2n)a

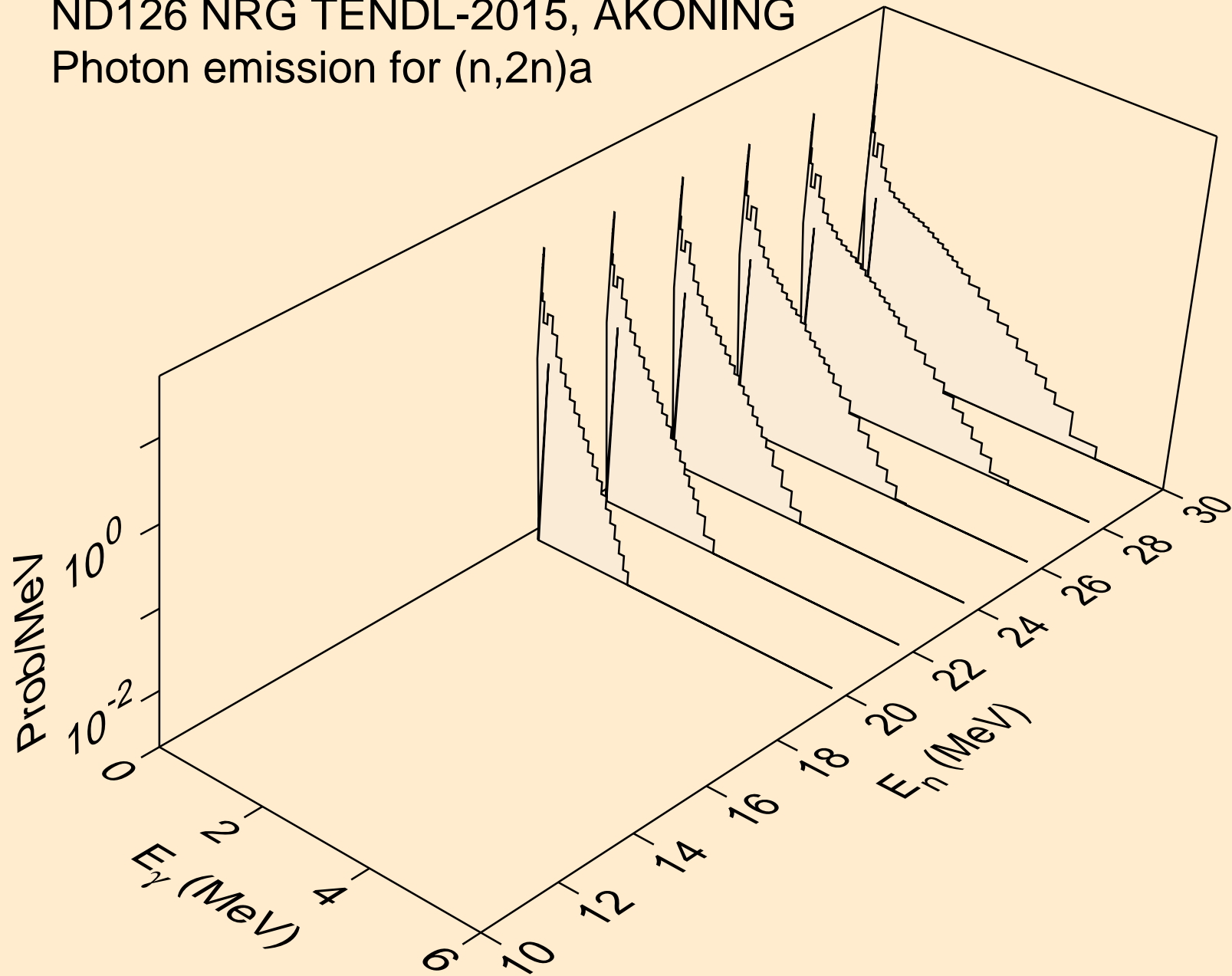

ND126 NRG TENDL-2015, AKONING  
Photon emission for (n,n\*)p

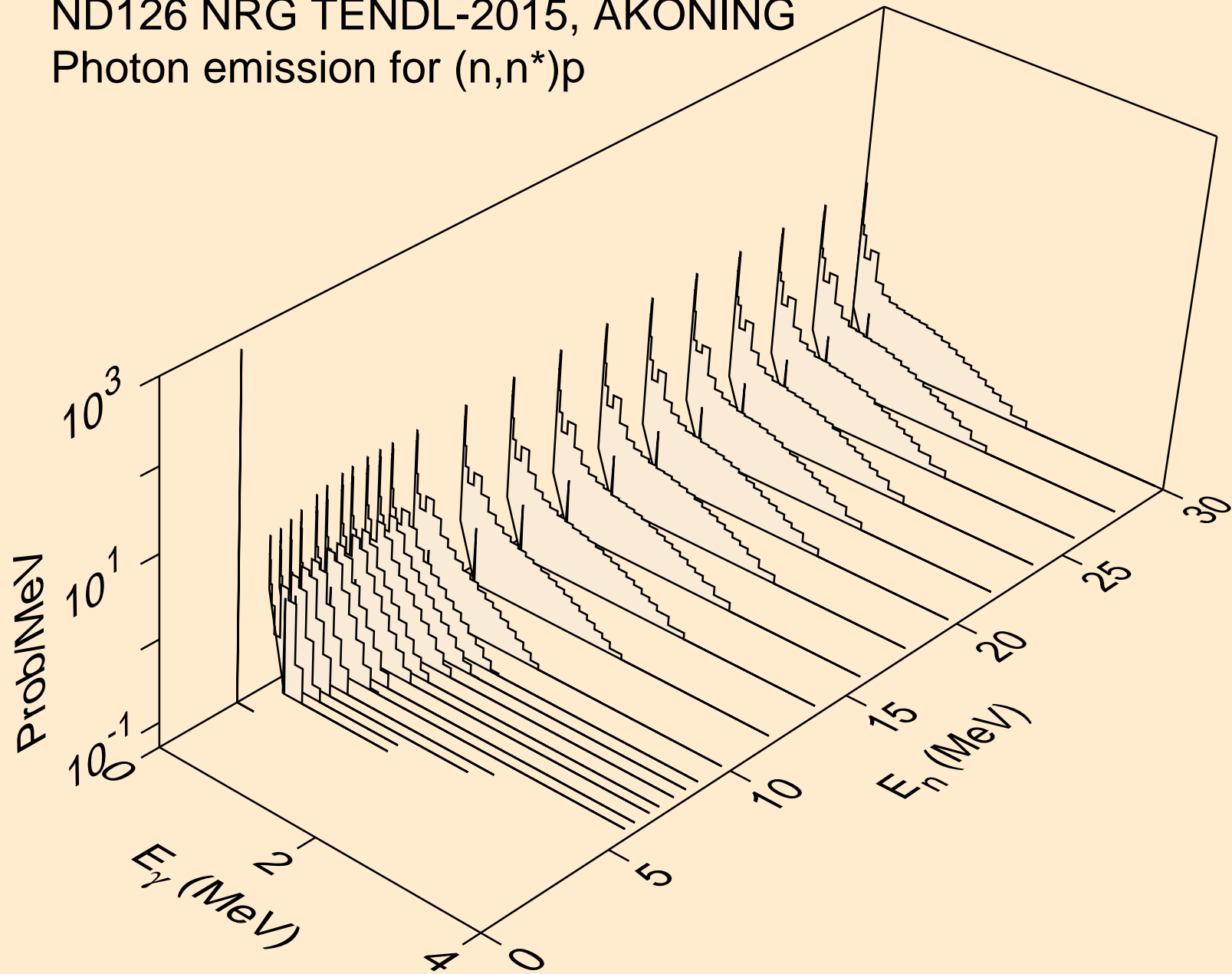

ND126 NRG TENDL-2015, AKONING  
Photon emission for (n,n\*)2a

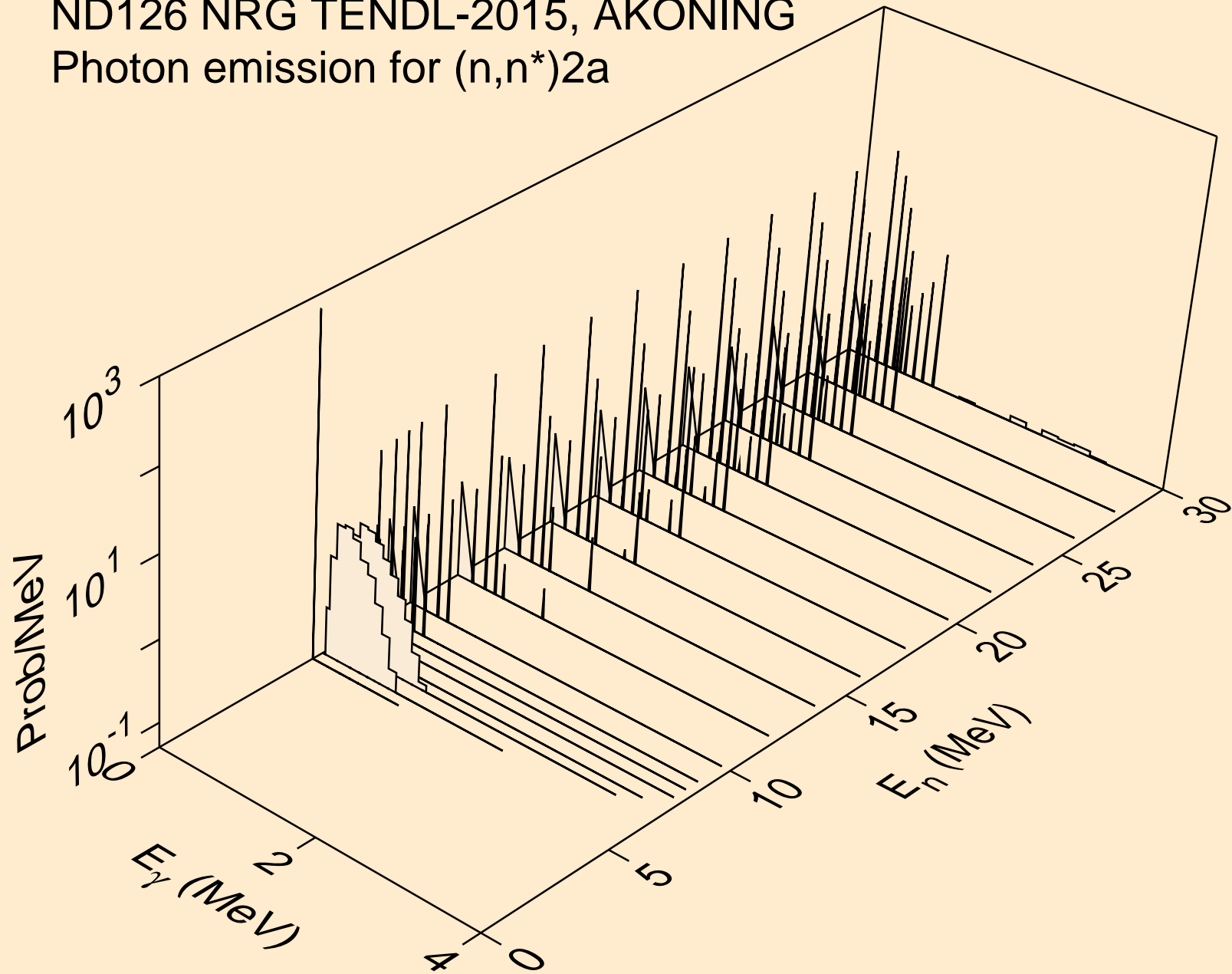



ND126 NRG TENDL-2015, AKONING  
Photon emission for (n,2n)2a

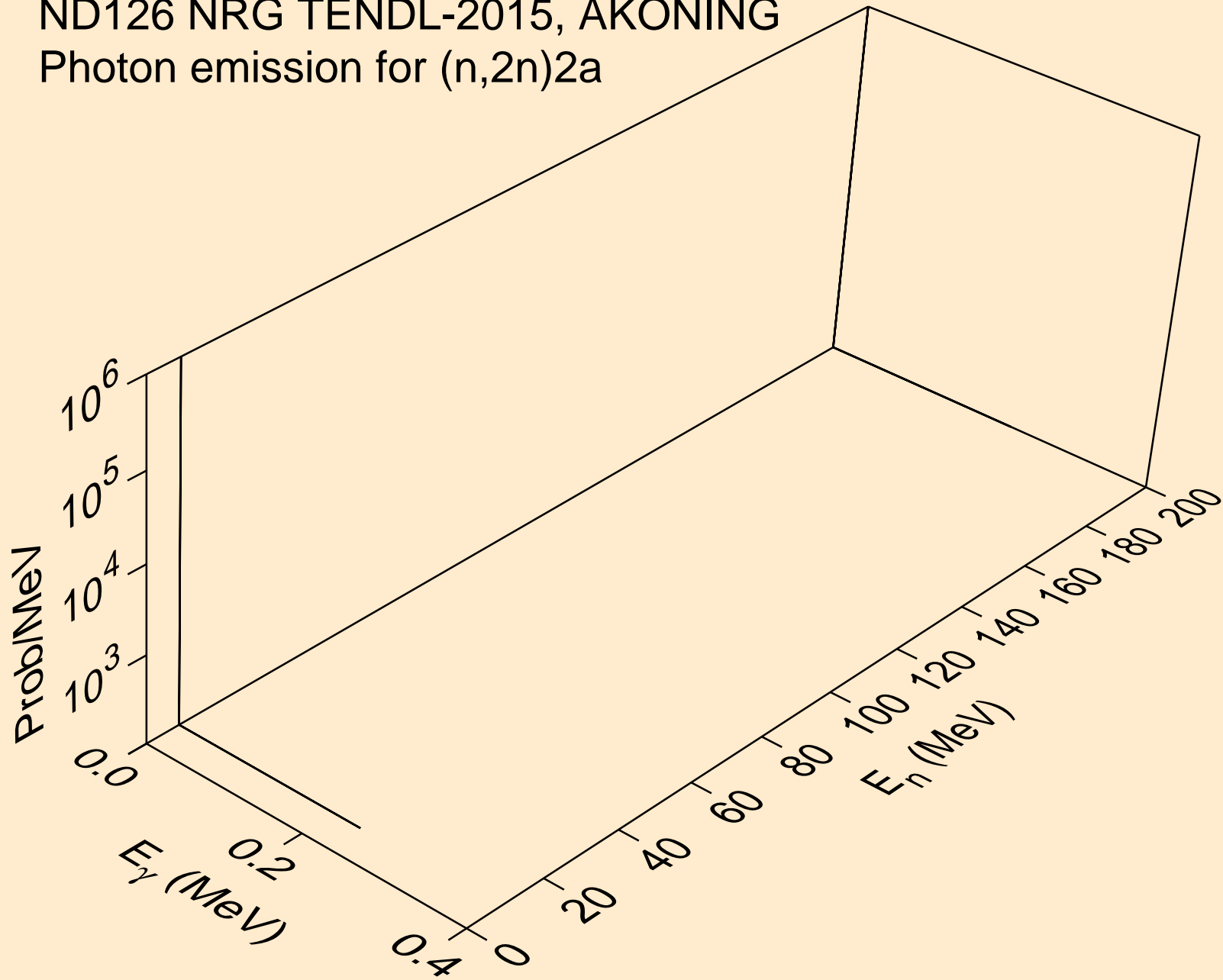

ND126 NRG TENDL-2015, AKONING  
Photon emission for (n,n\*)d

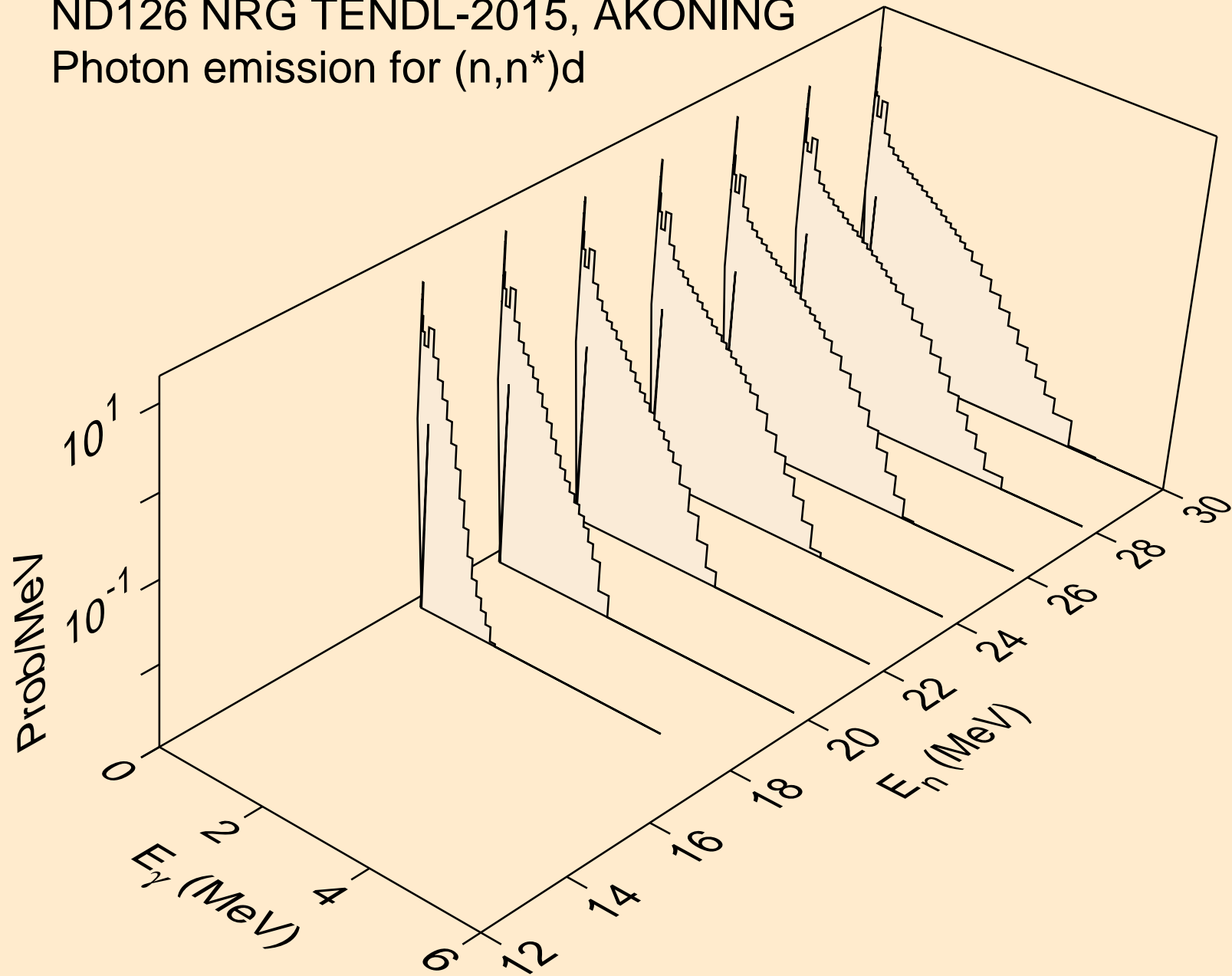

ND126 NRG TENDL-2015, AKONING  
Photon emission for (n,n\*)t

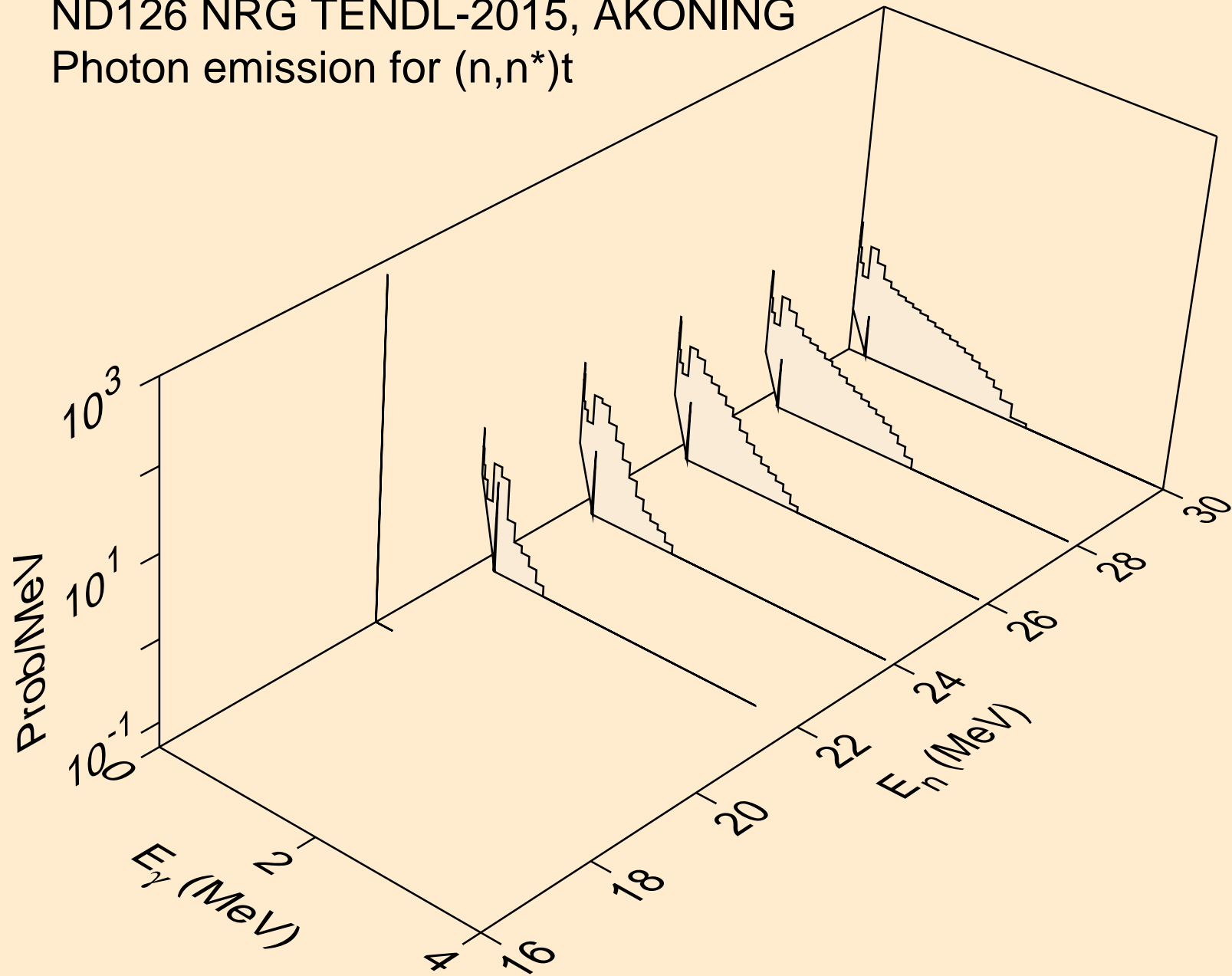

ND126 NRG TENDL-2015, AKONING  
Photon emission for (n,n\*)he3

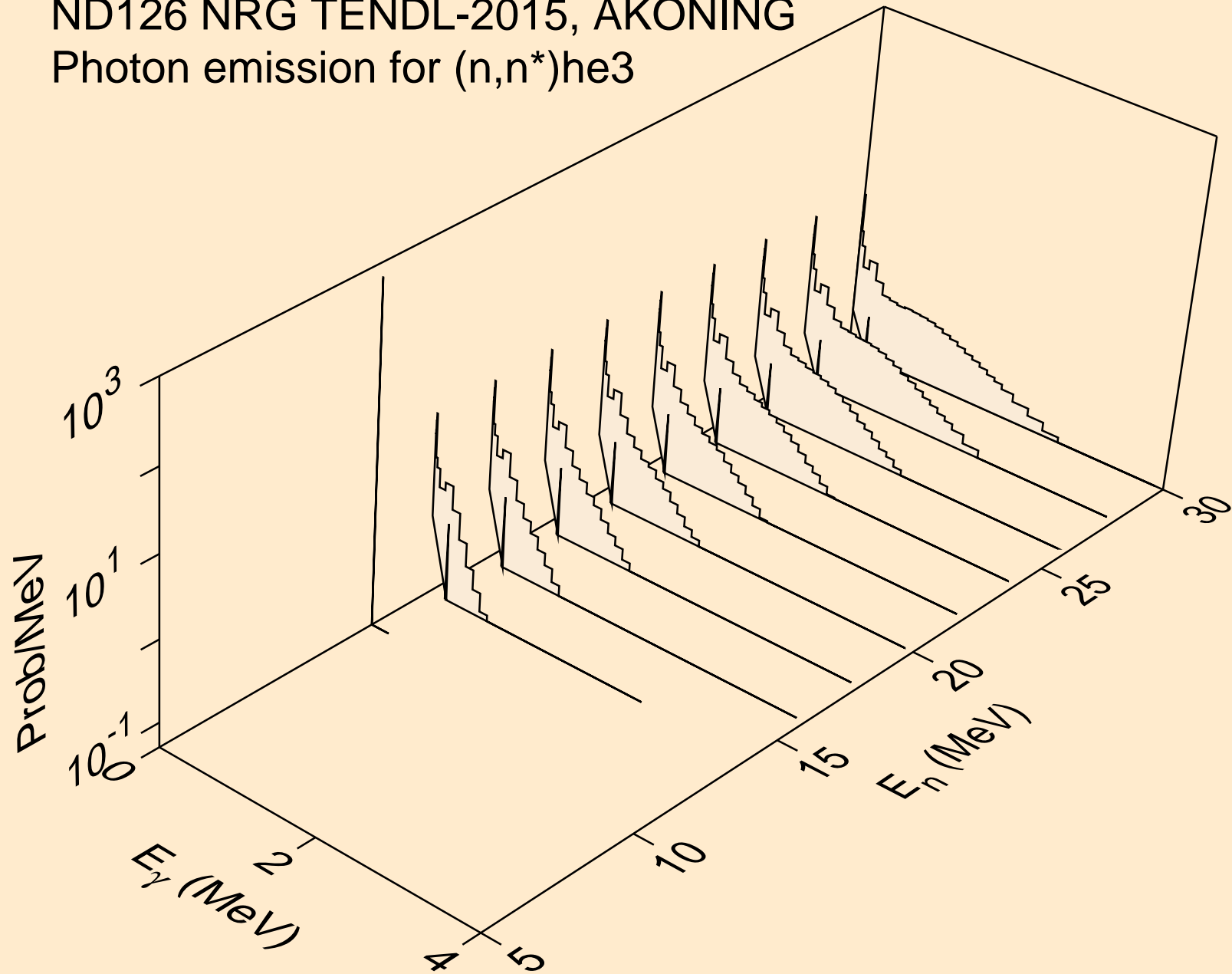

ND126 NRG TENDL-2015, AKONING  
Photon emission for (n,2np)

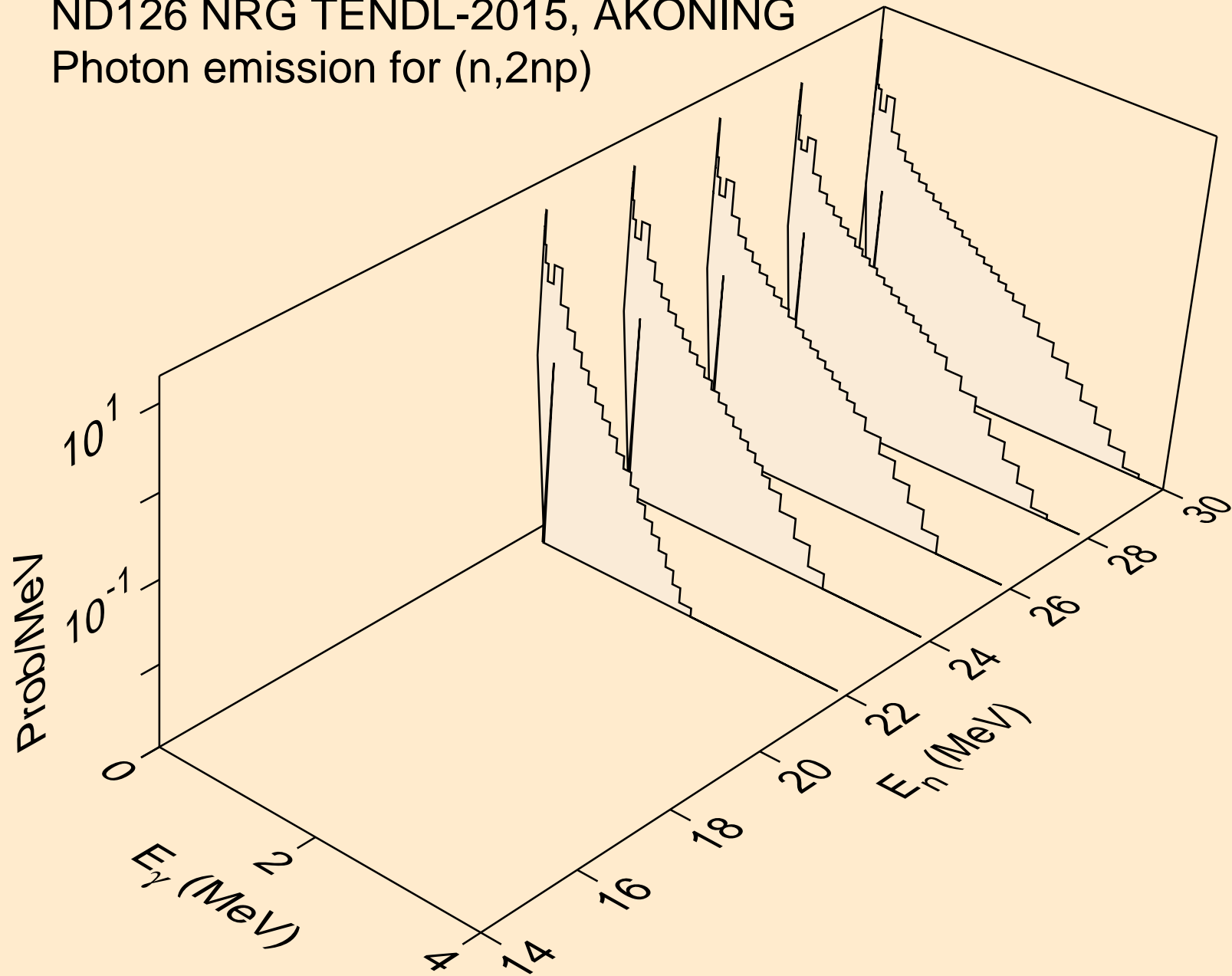

ND126 NRG TENDL-2015, AKONING  
Photon emission for (n,3np)

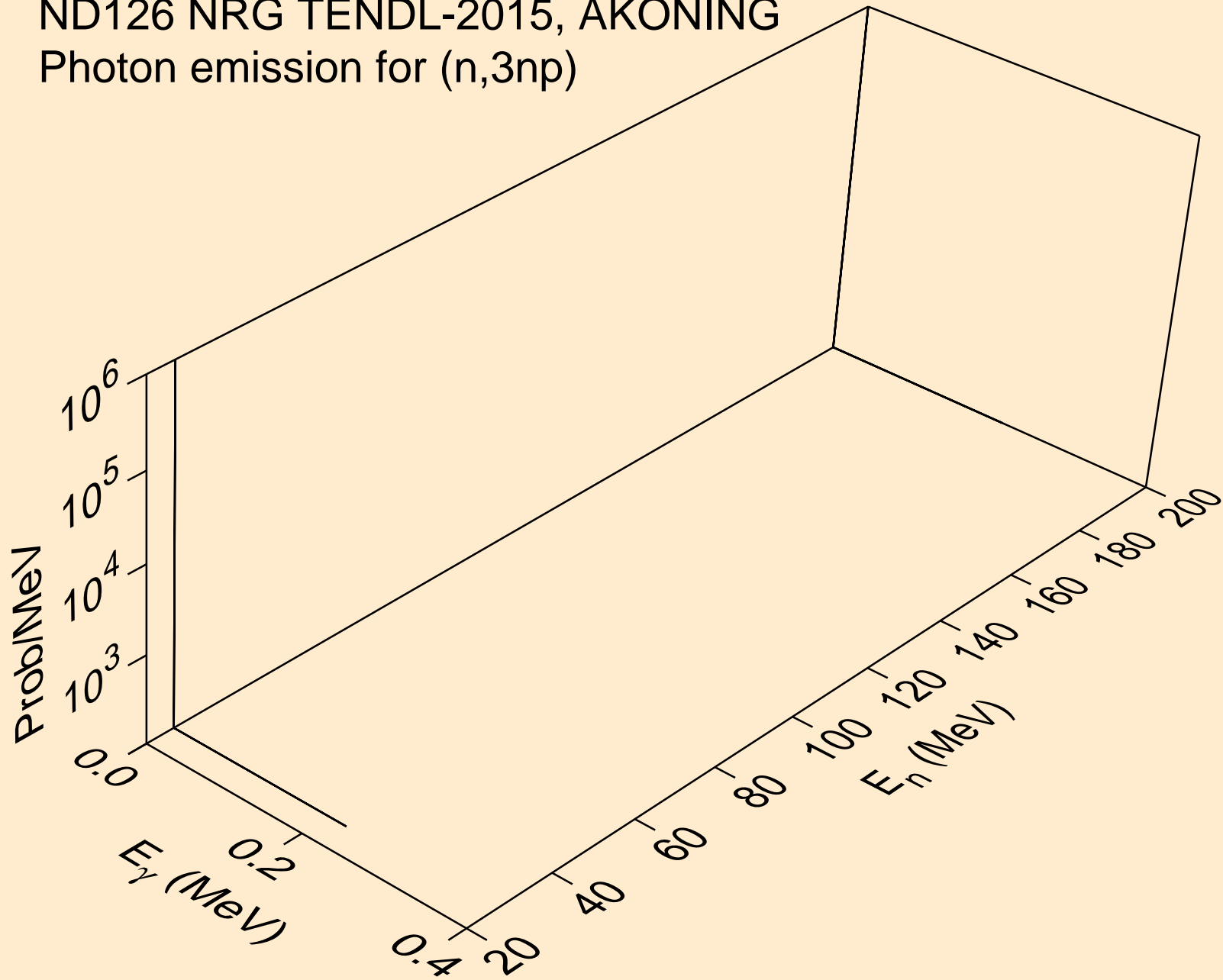

ND126 NRG TENDL-2015, AKONING  
Photon emission for (n,2np)

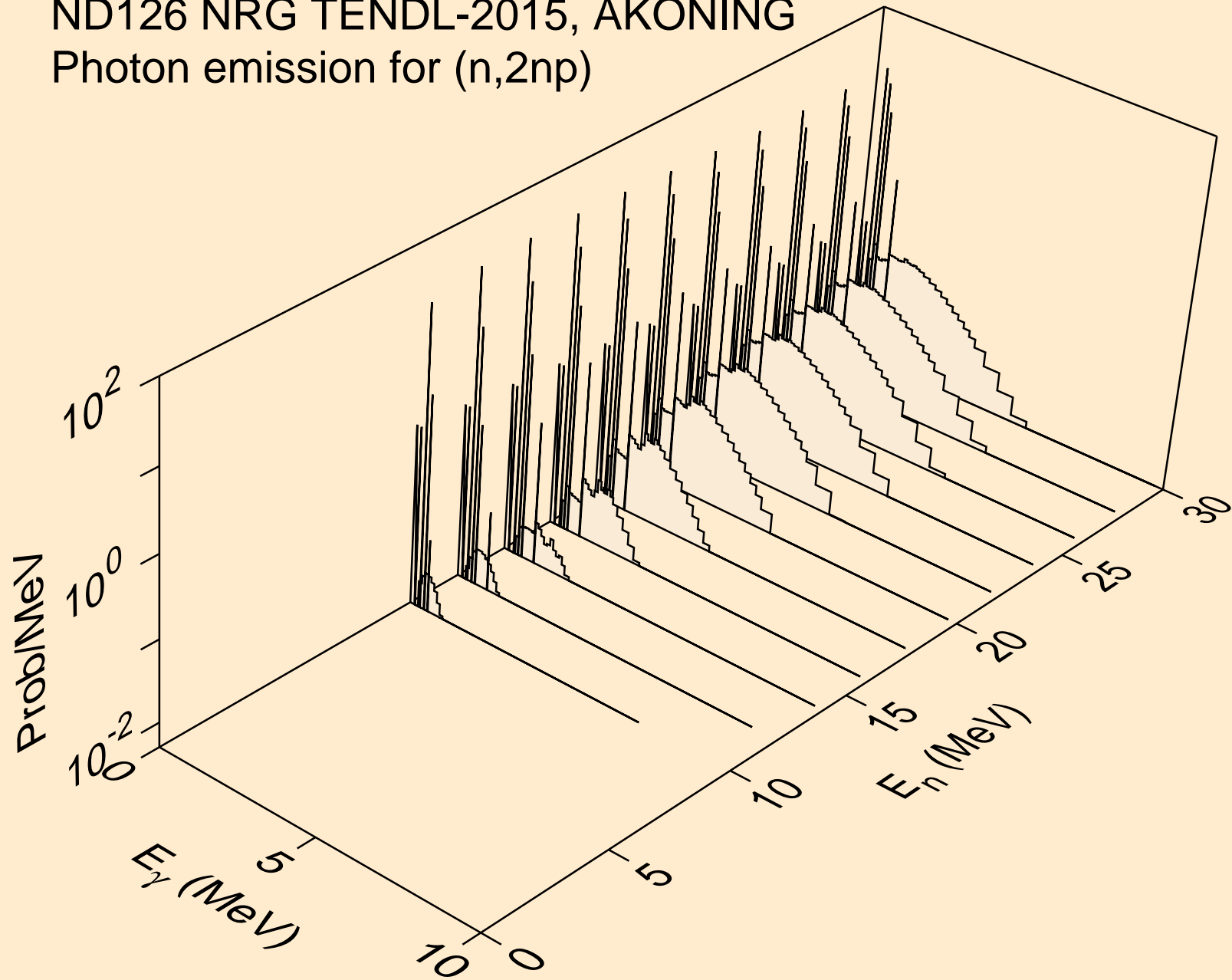

ND126 NRG TENDL-2015, AKONING  
Photon emission for (n,npa)

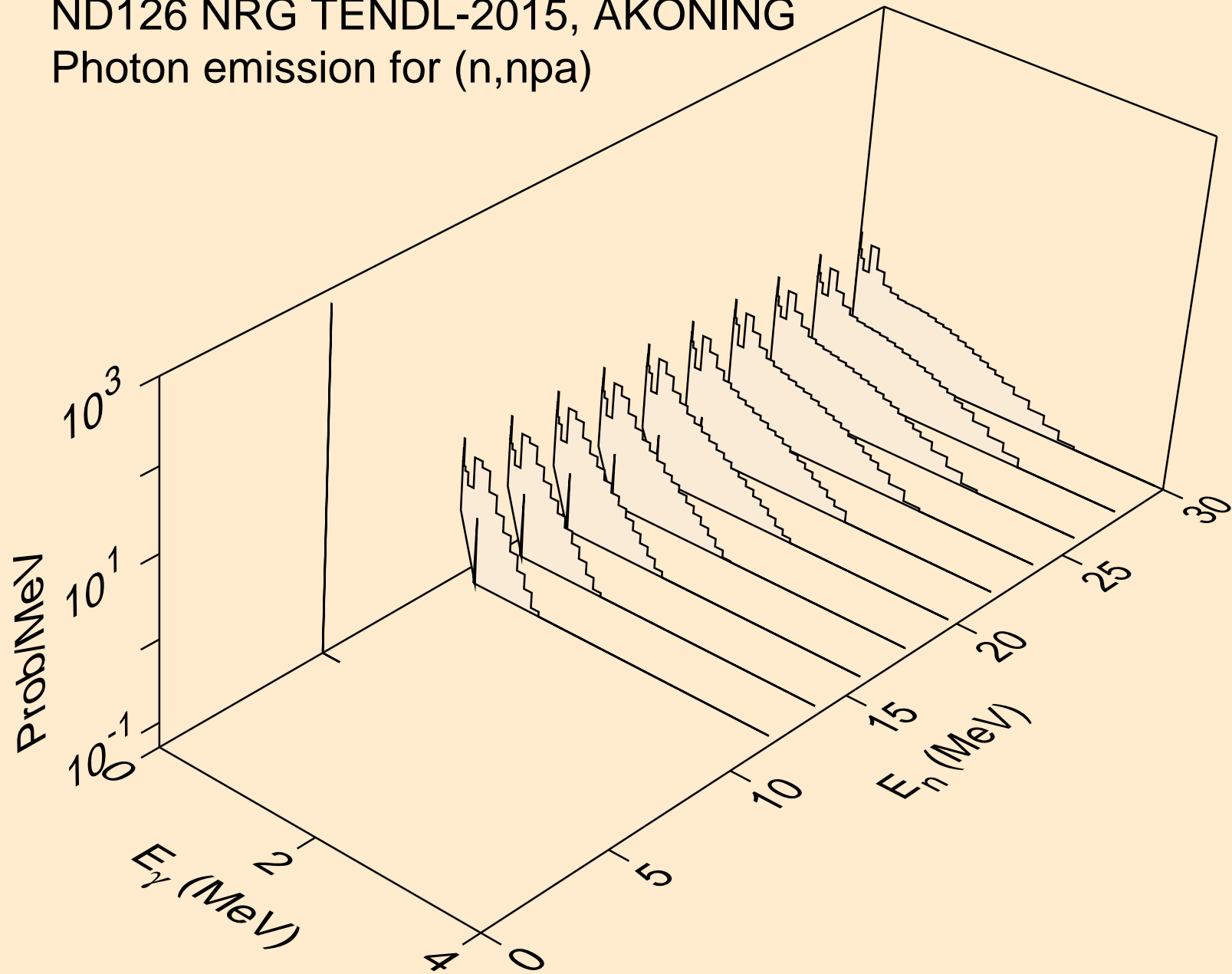



ND126 NRG TENDL-2015, AKONING  
Photon emission for (n,n\*c)

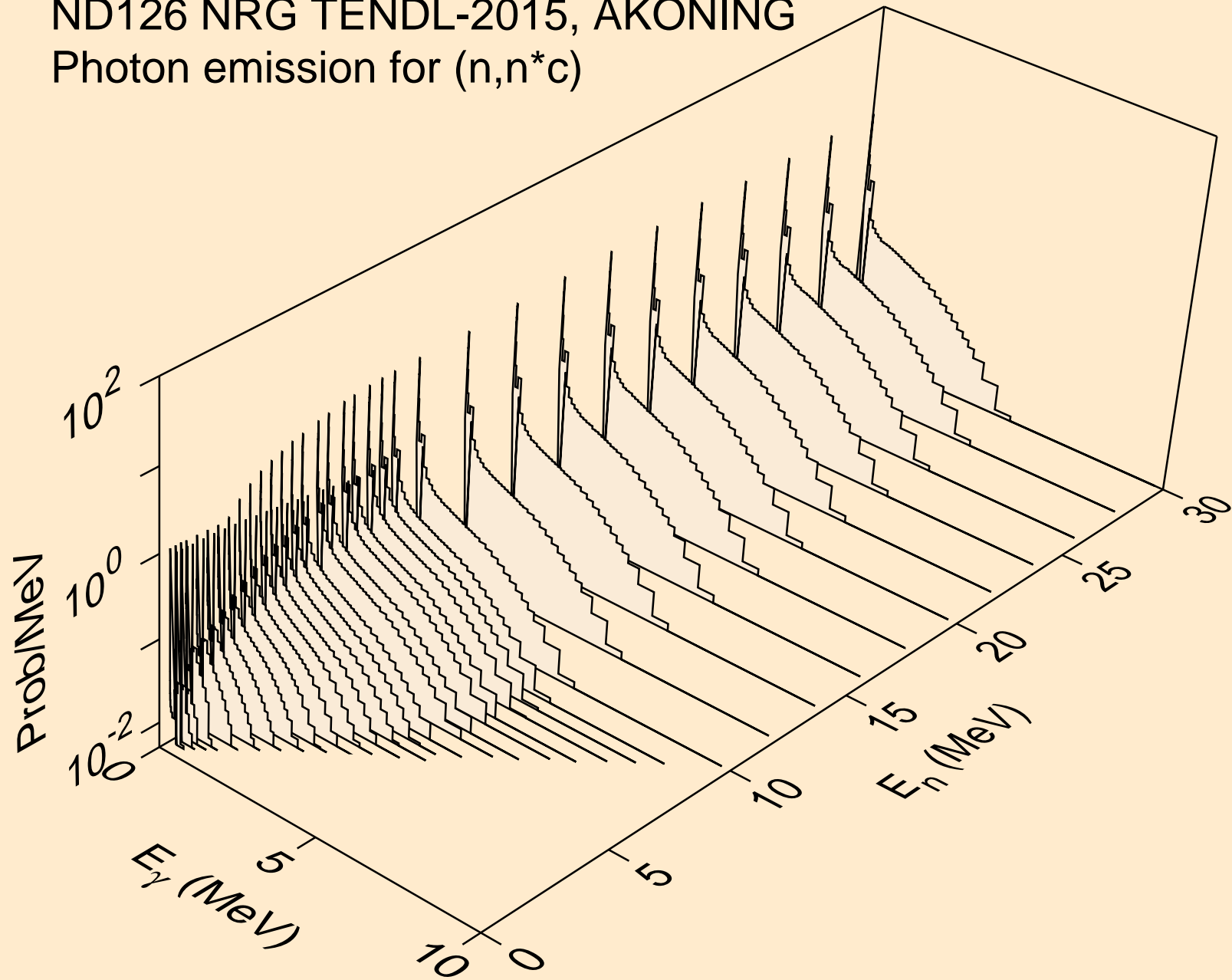

ND126 NRG TENDL-2015, AKONING  
Photon emission for (n,gma)

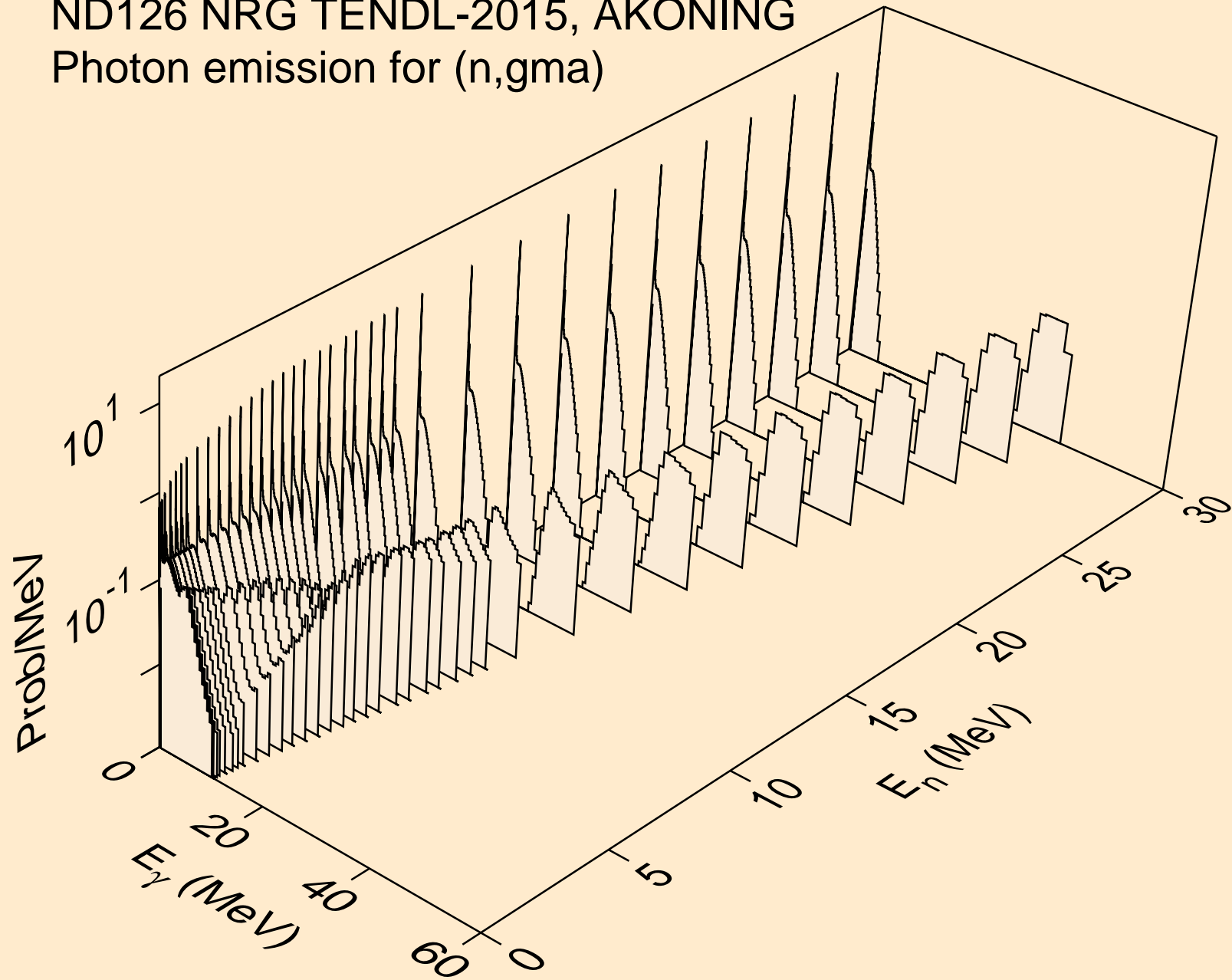

ND126 NRG TENDL-2015, AKONING  
Photon emission for (n,p)

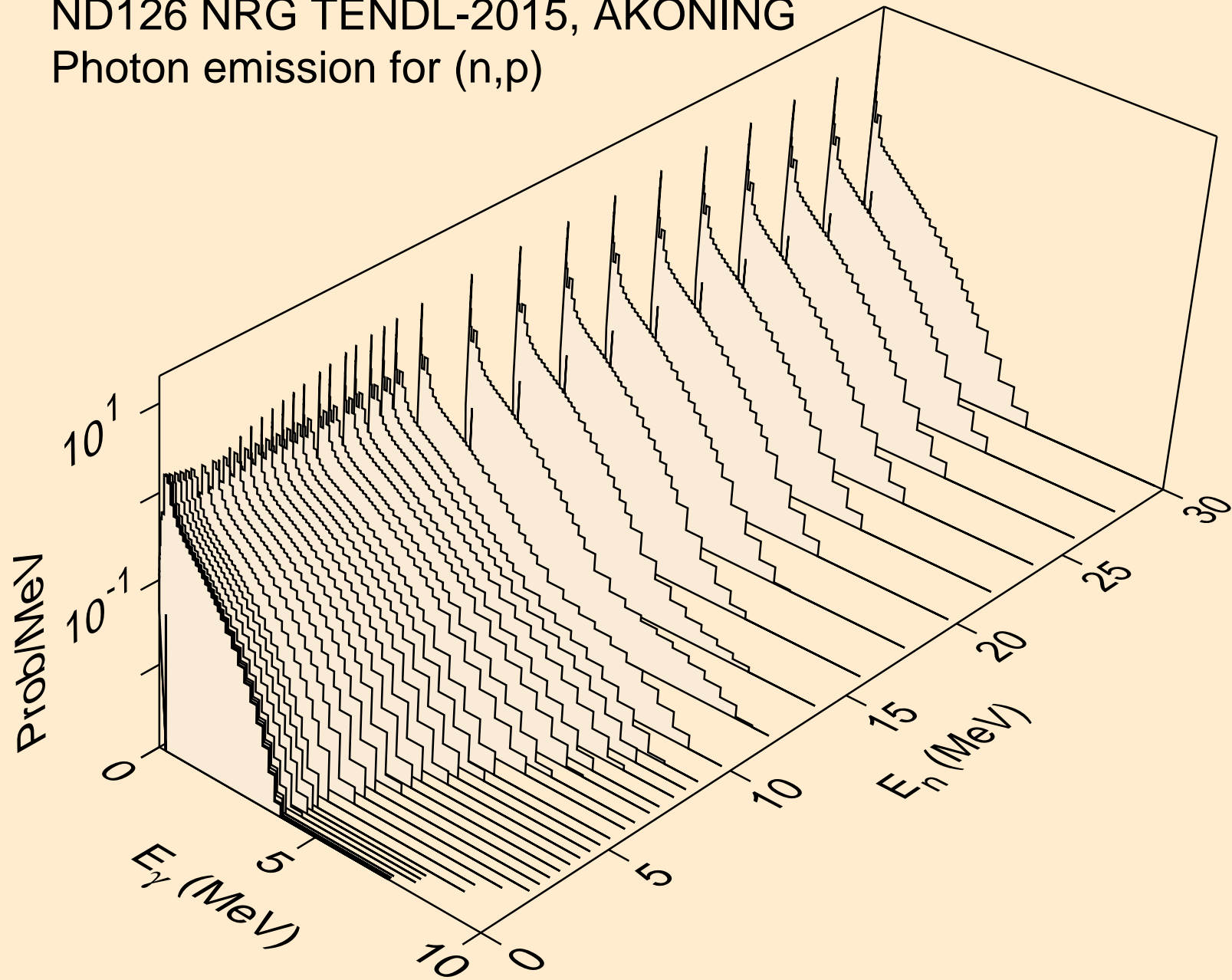

ND126 NRG TENDL-2015, AKONING  
Photon emission for (n,d)

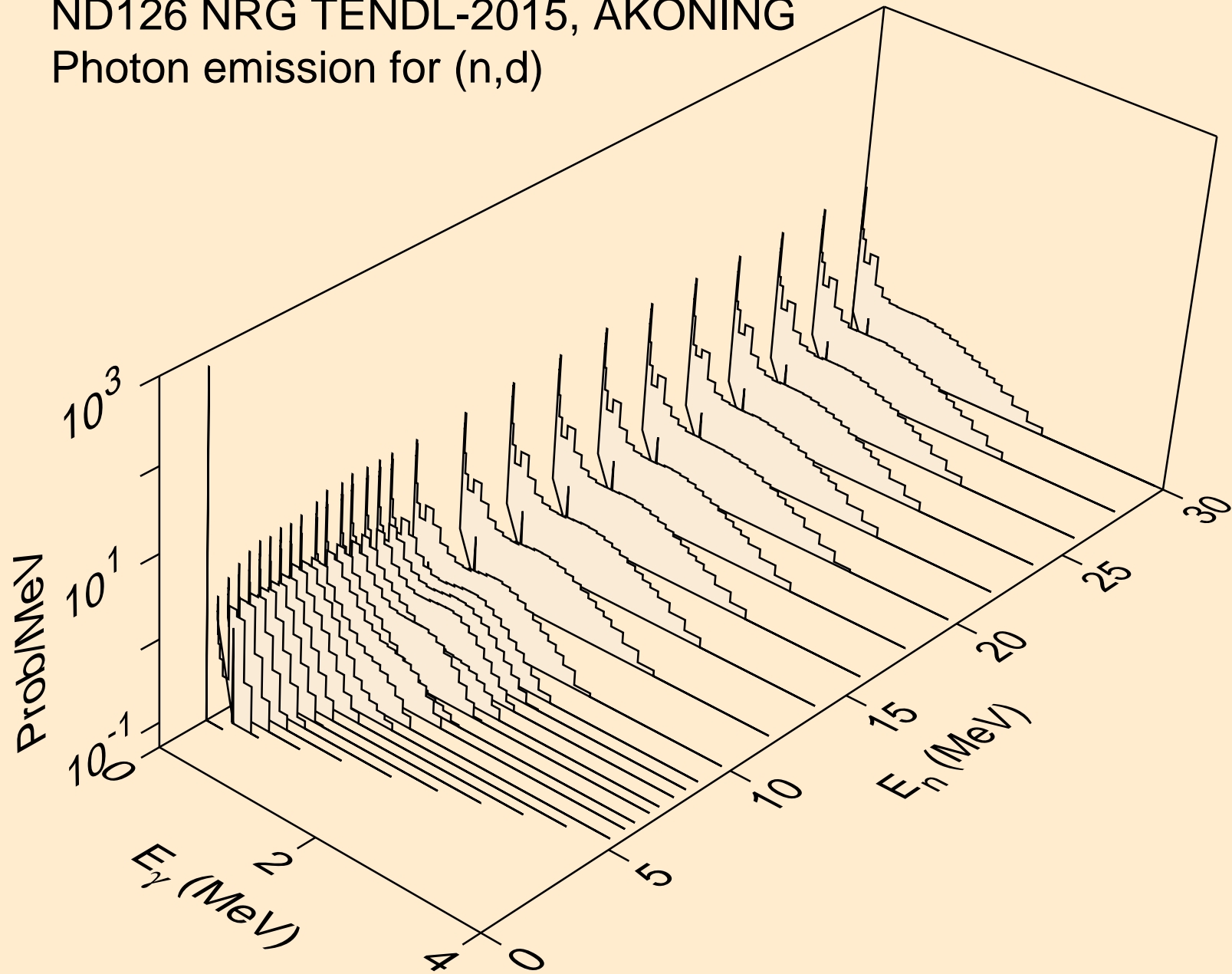

ND126 NRG TENDL-2015, AKONING  
Photon emission for (n,t)

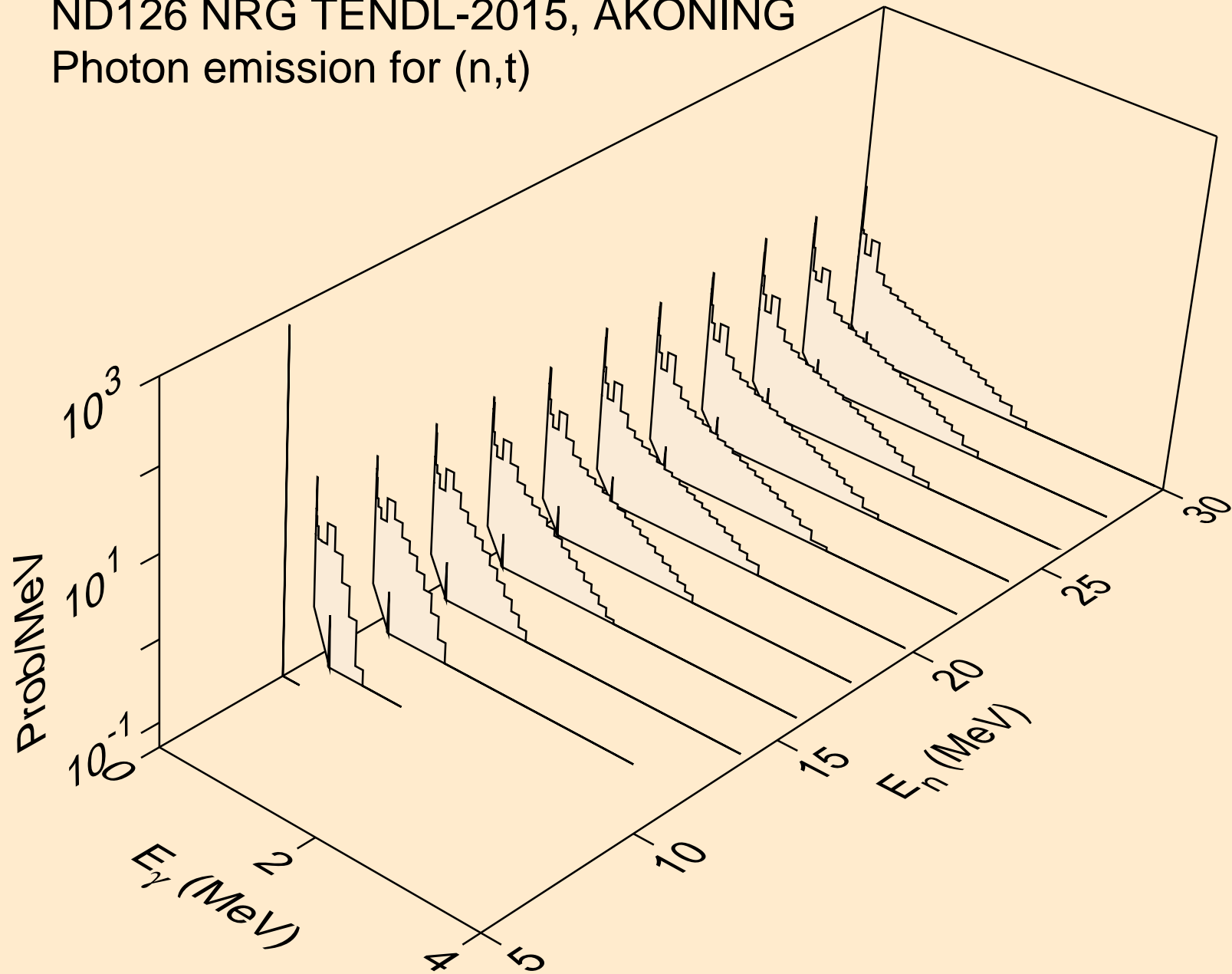

ND126 NRG TENDL-2015, AKONING  
Photon emission for (n,he3)

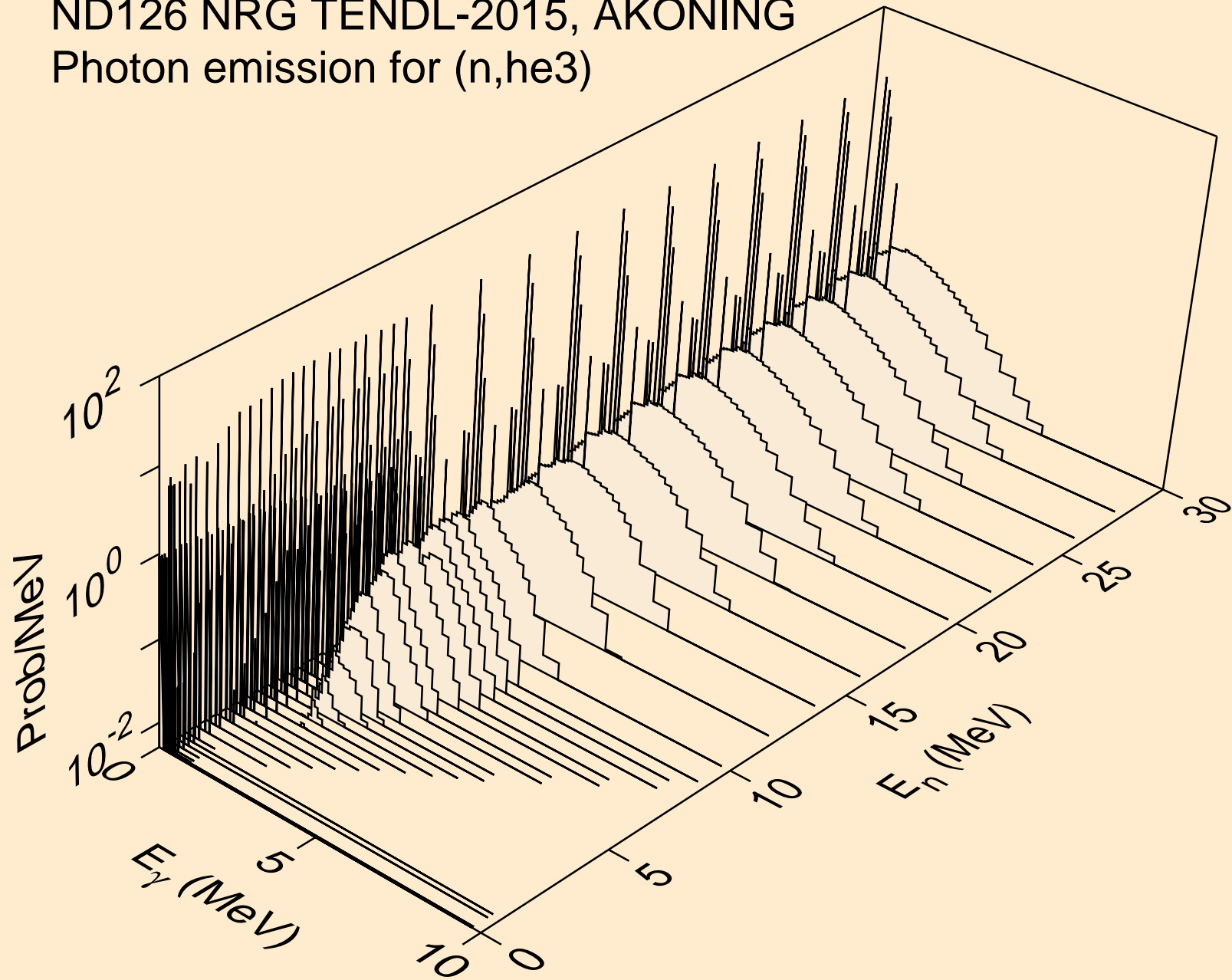

ND126 NRG TENDL-2015, AKONING  
Photon emission for (n,a)

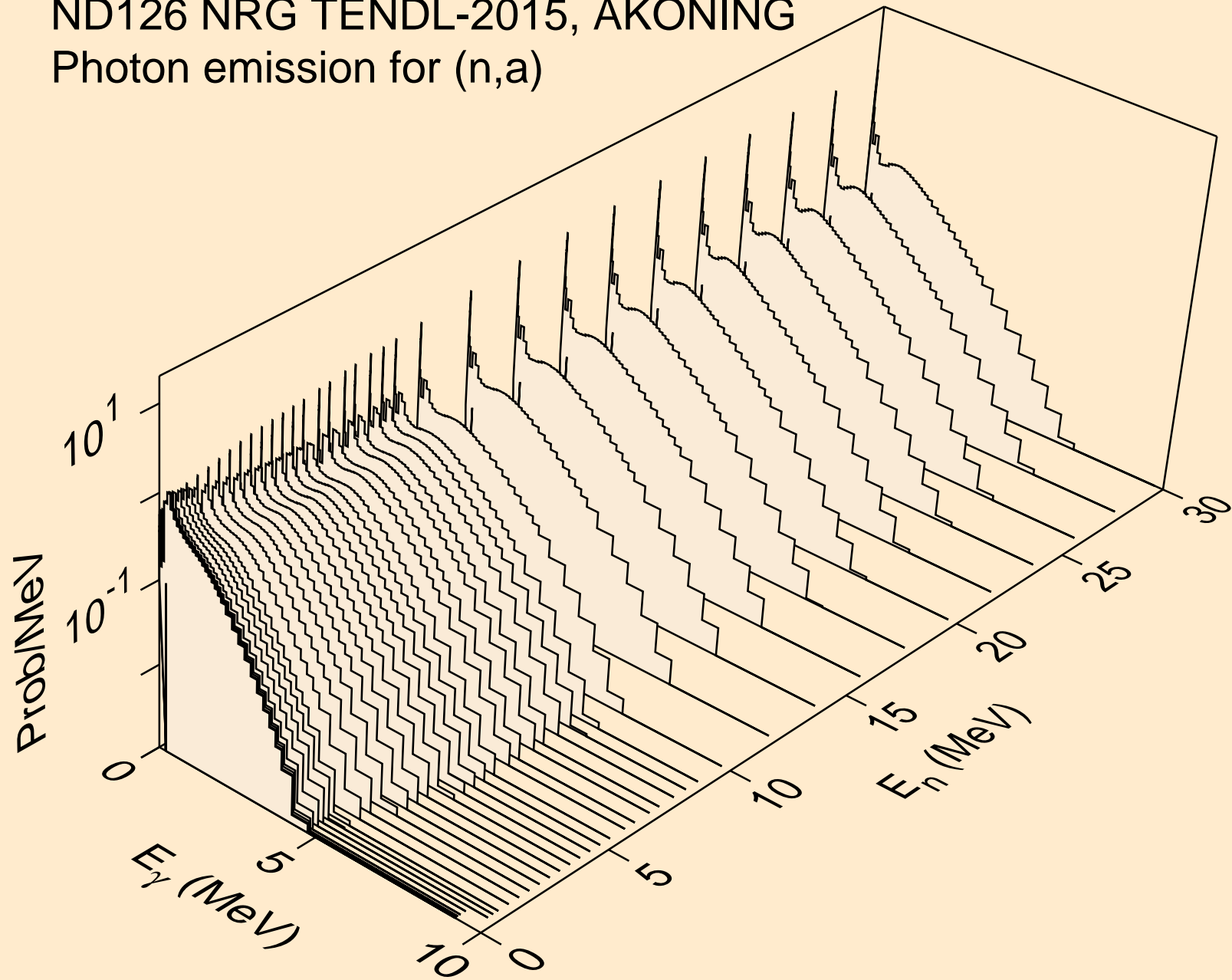

ND126 NRG TENDL-2015, AKONING  
Photon emission for (n,2a)

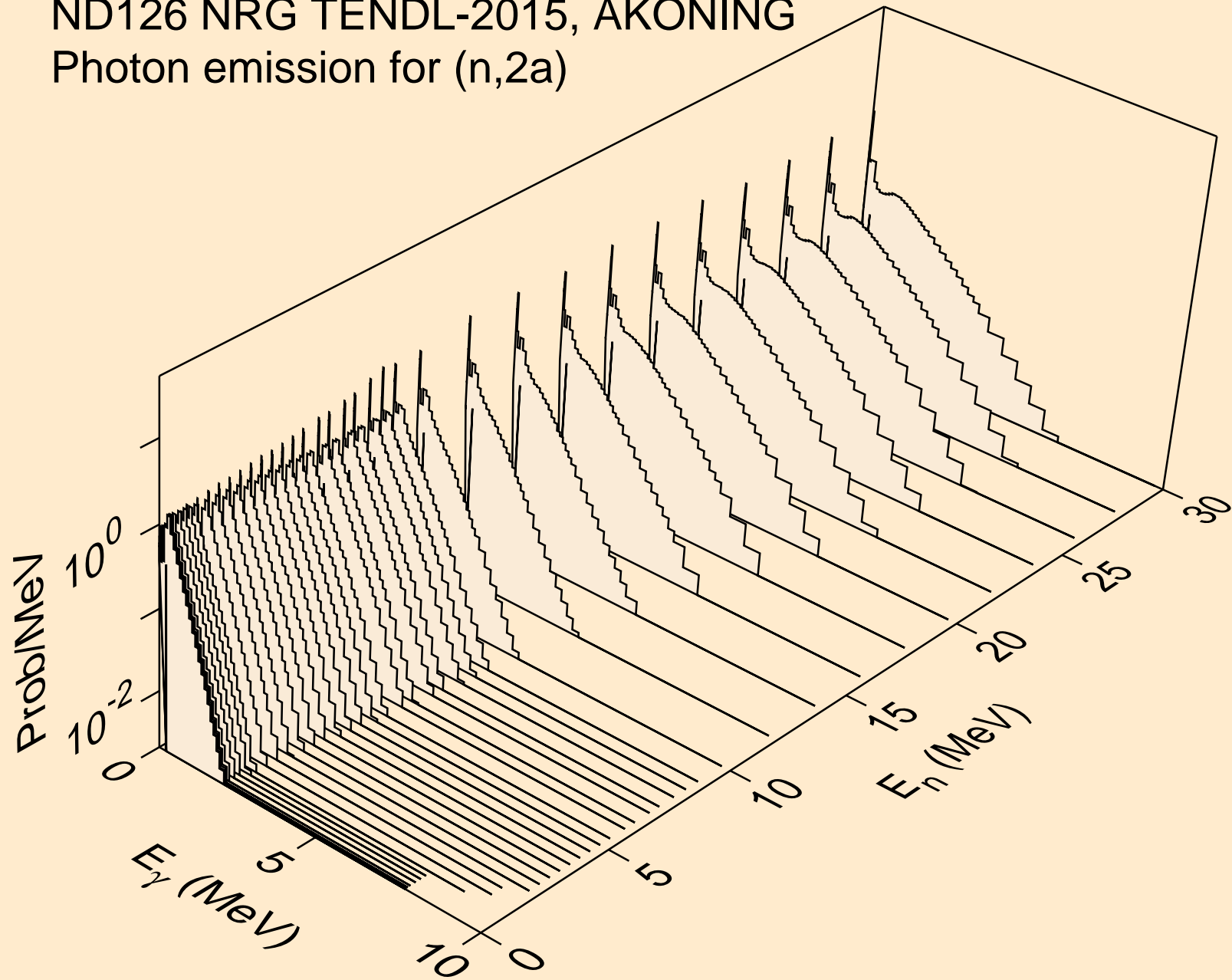



ND126 NRG TENDL-2015, AKONING  
Photon emission for (n,3a)

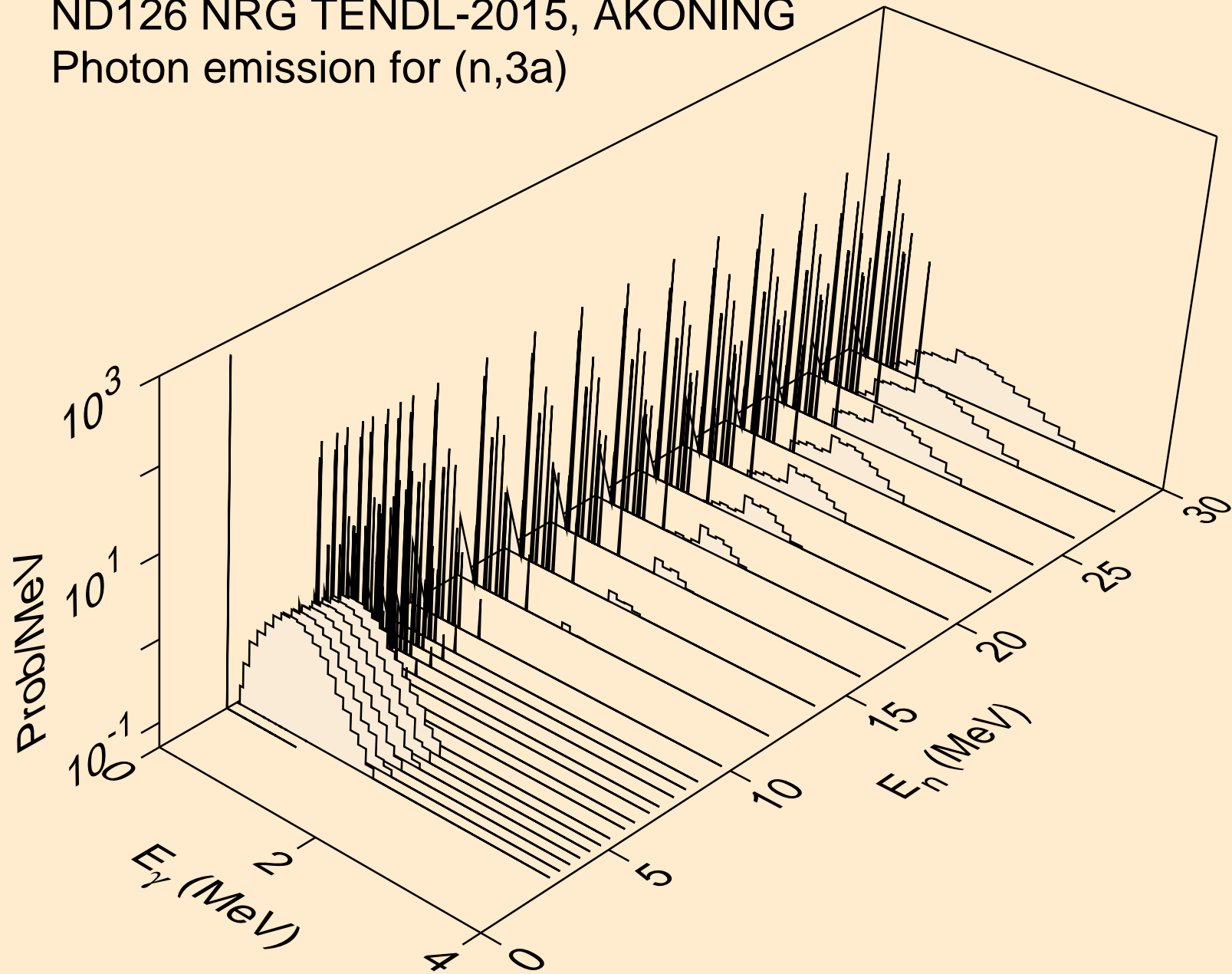

ND126 NRG TENDL-2015, AKONING  
Photon emission for (n,2p)

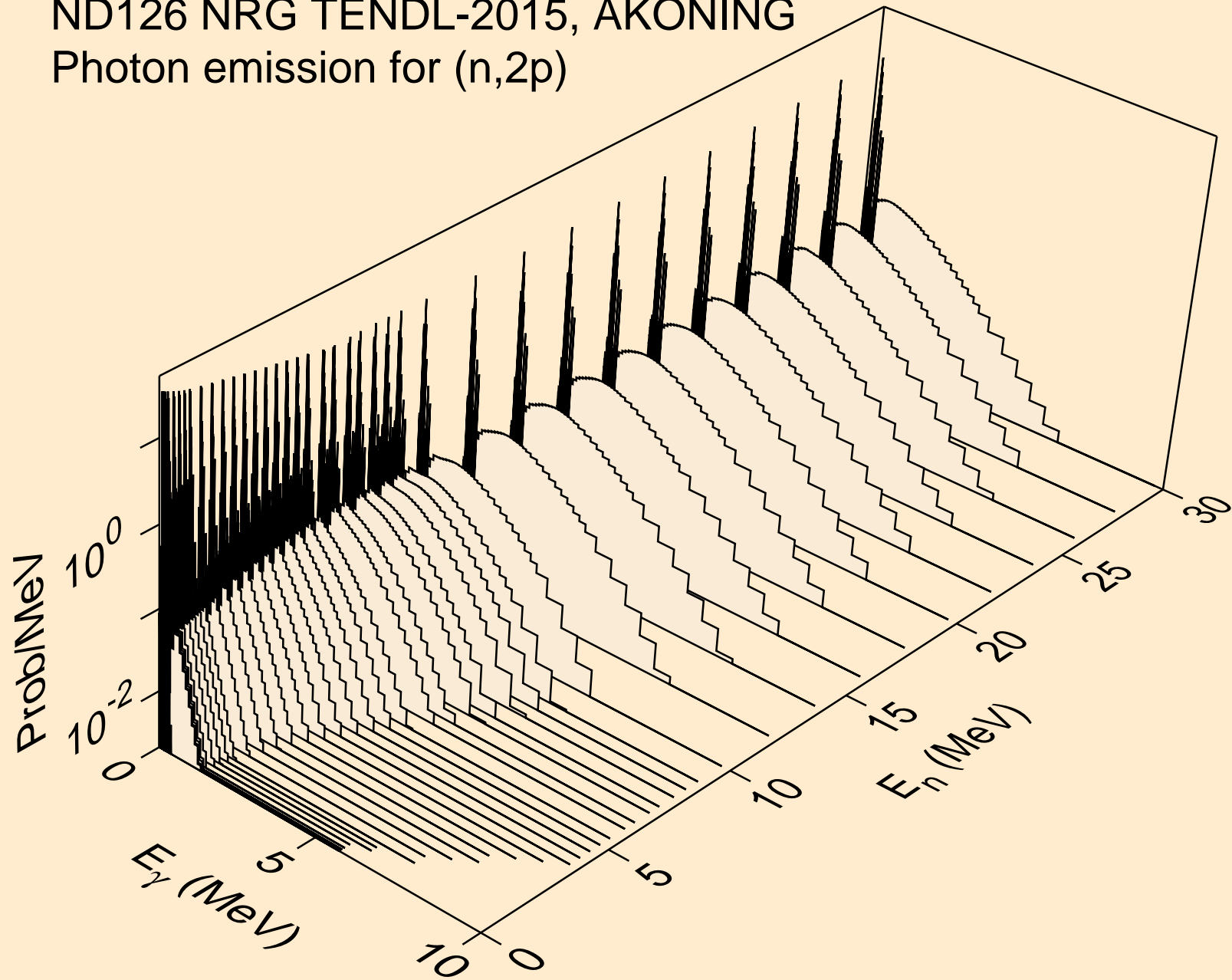

ND126 NRG TENDL-2015, AKONING  
Photon emission for (n,p $\alpha$ )

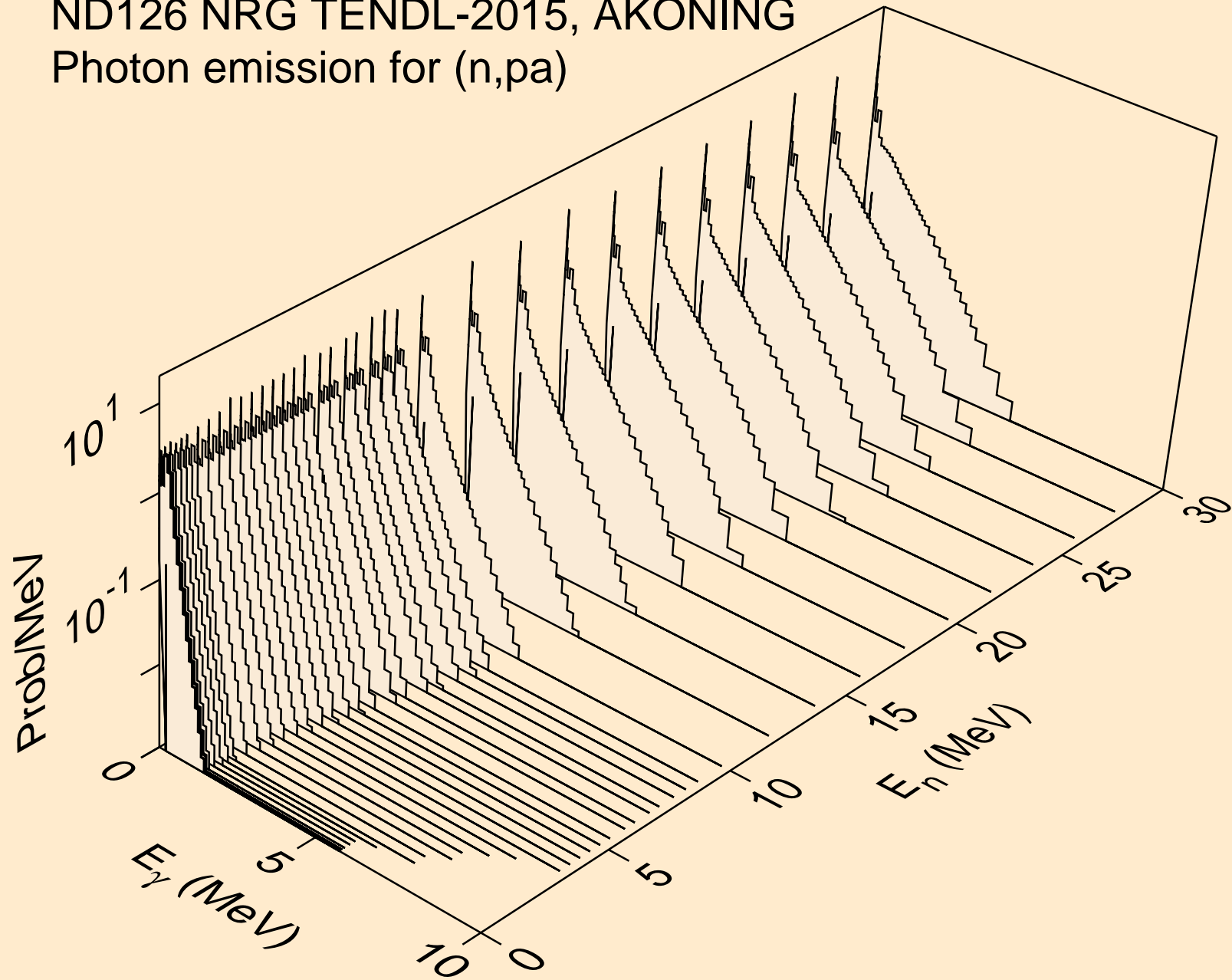

ND126 NRG TENDL-2015, AKONING  
Photon emission for (n,d2a)

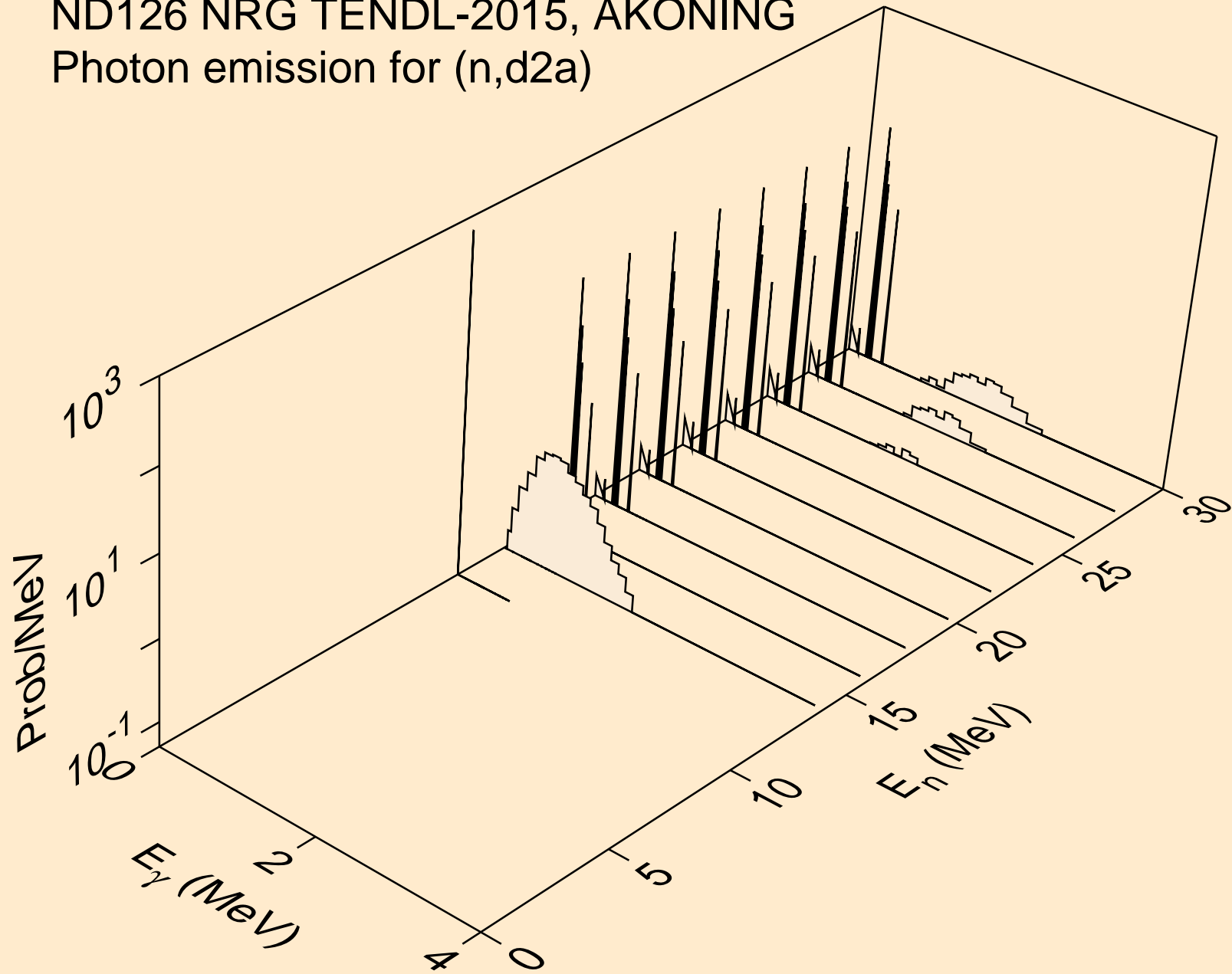

ND126 NRG TENDL-2015, AKONING  
Photon emission for (n,pd)

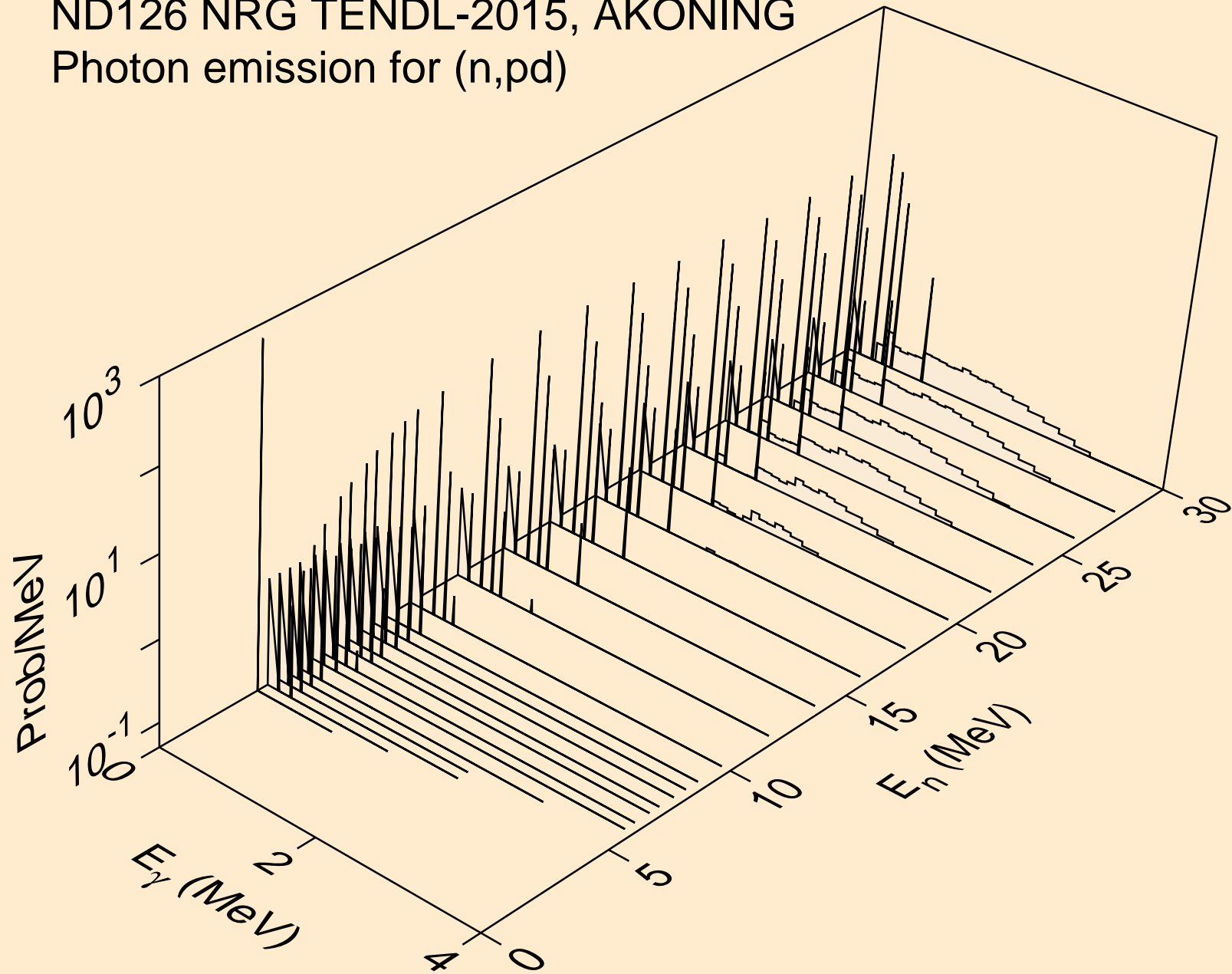

ND126 NRG TENDL-2015, AKONING  
Photon emission for (n,pt)

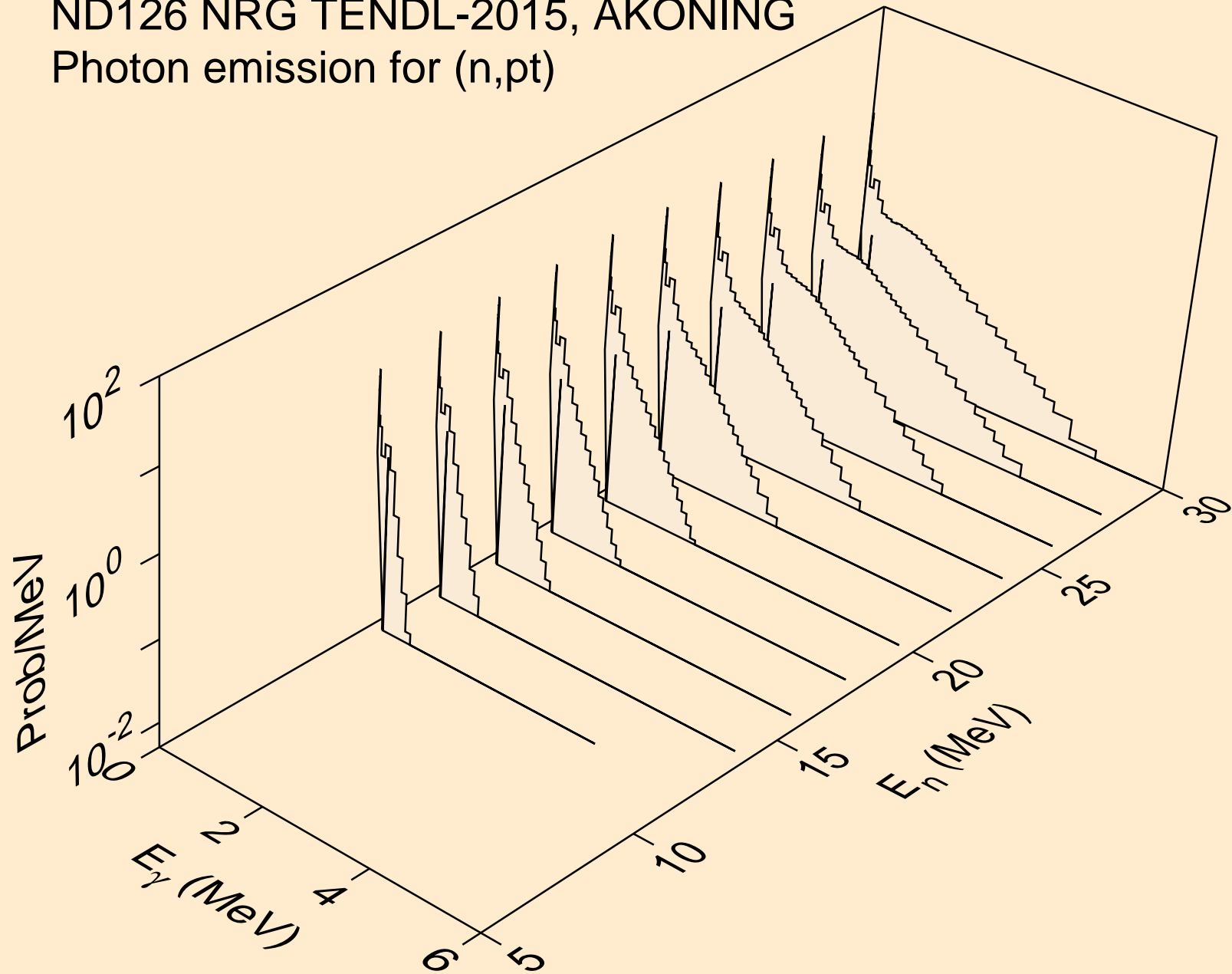

ND126 NRG TENDL-2015, AKONING  
Photon emission for (n,da)

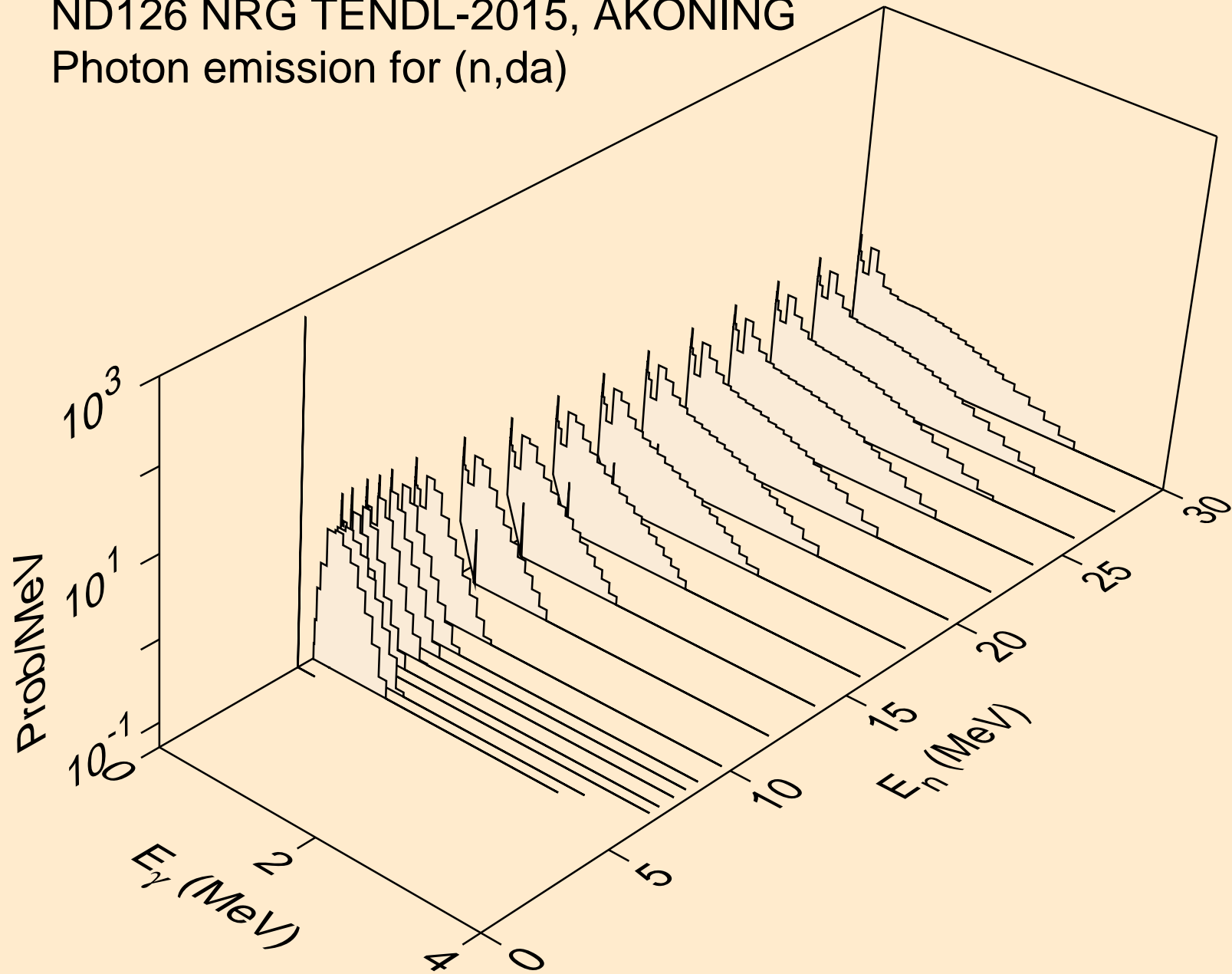

ND126 NRG TENDL-2015, AKONING  
thermal capture photon spectrum

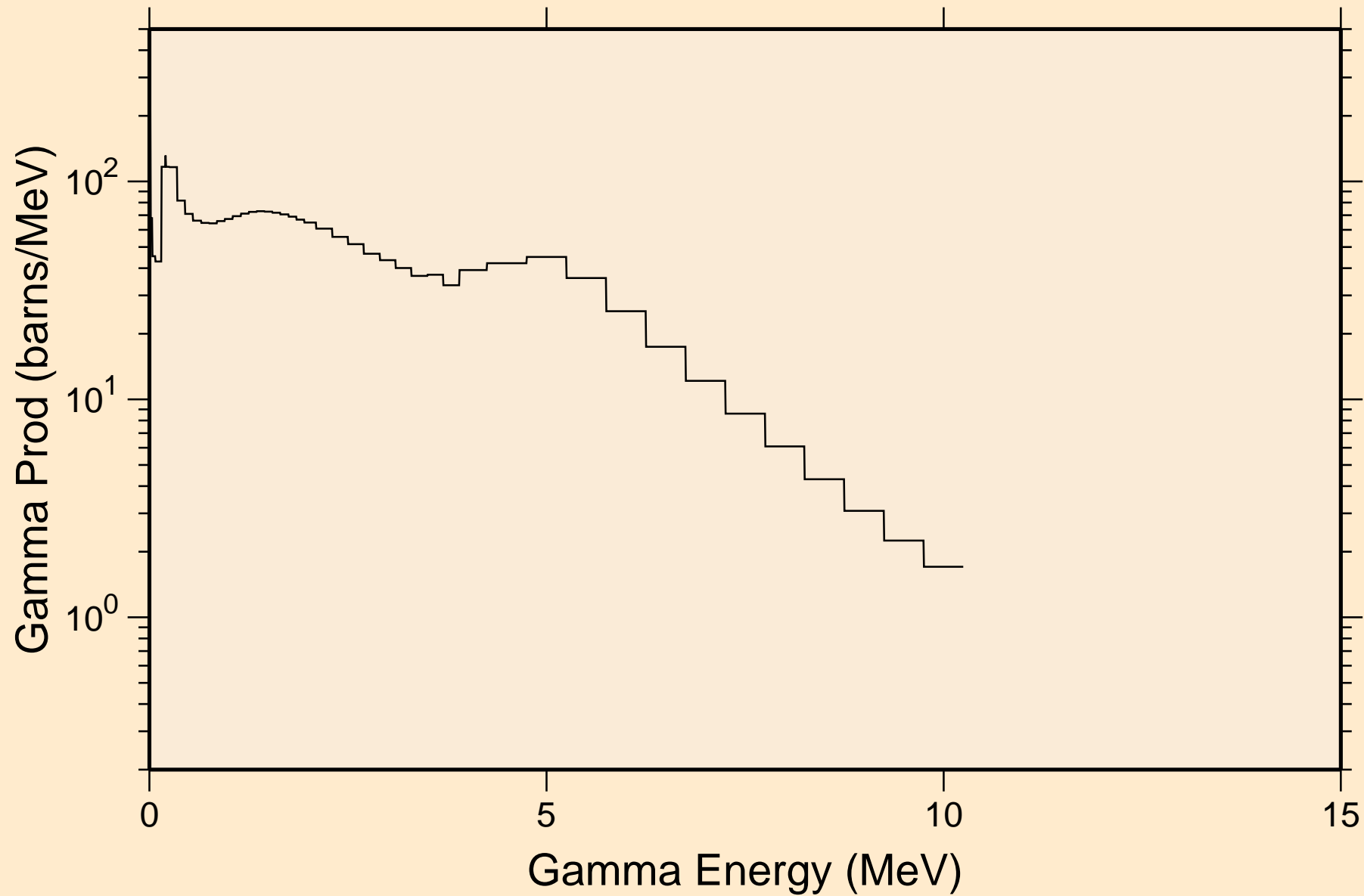



ND126 NRG TENDL-2015, AKONING  
14 MeV photon spectrum

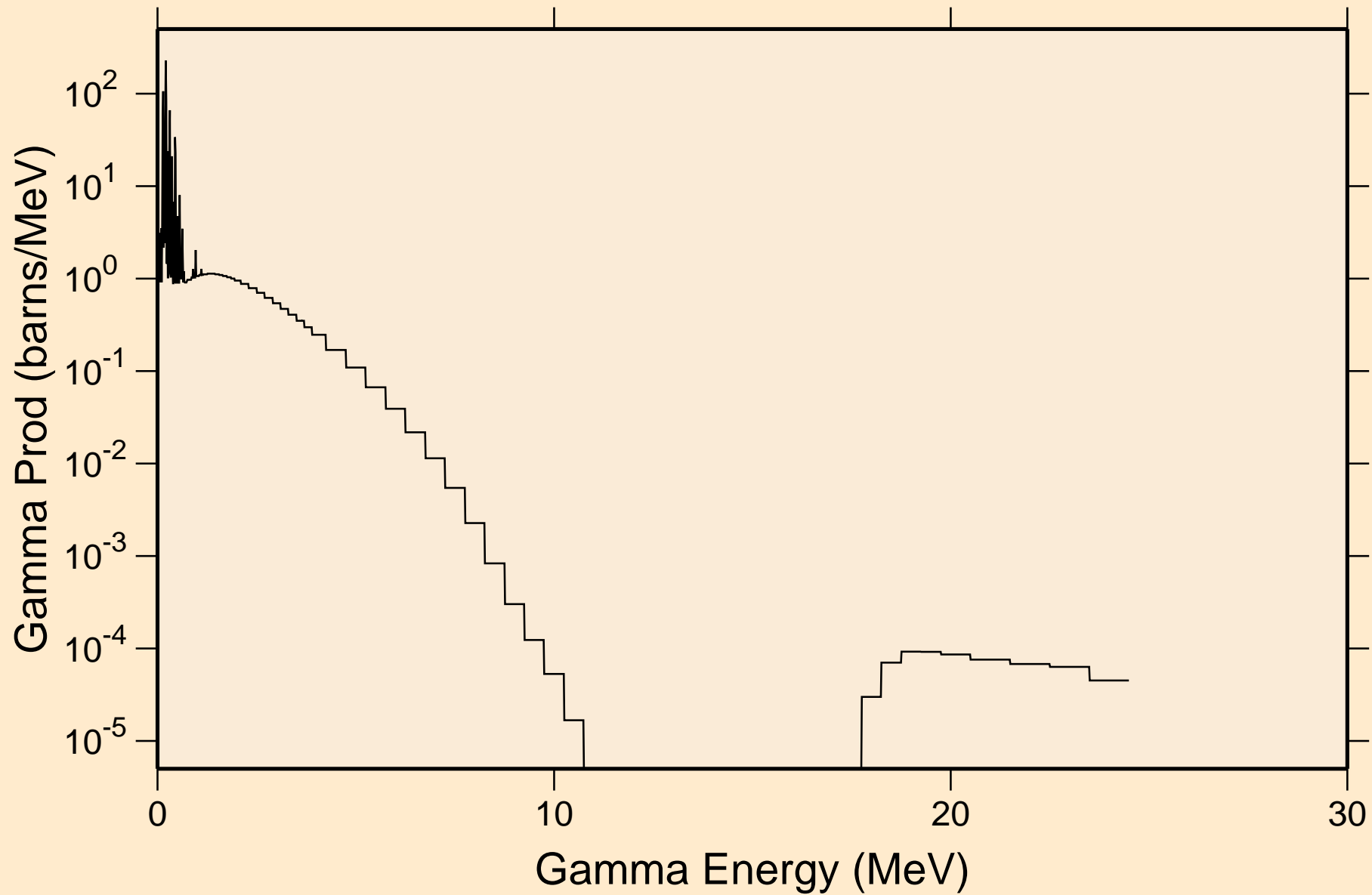

# ND126 NRG TENDL-2015, AKONING

## Particle heating contributions

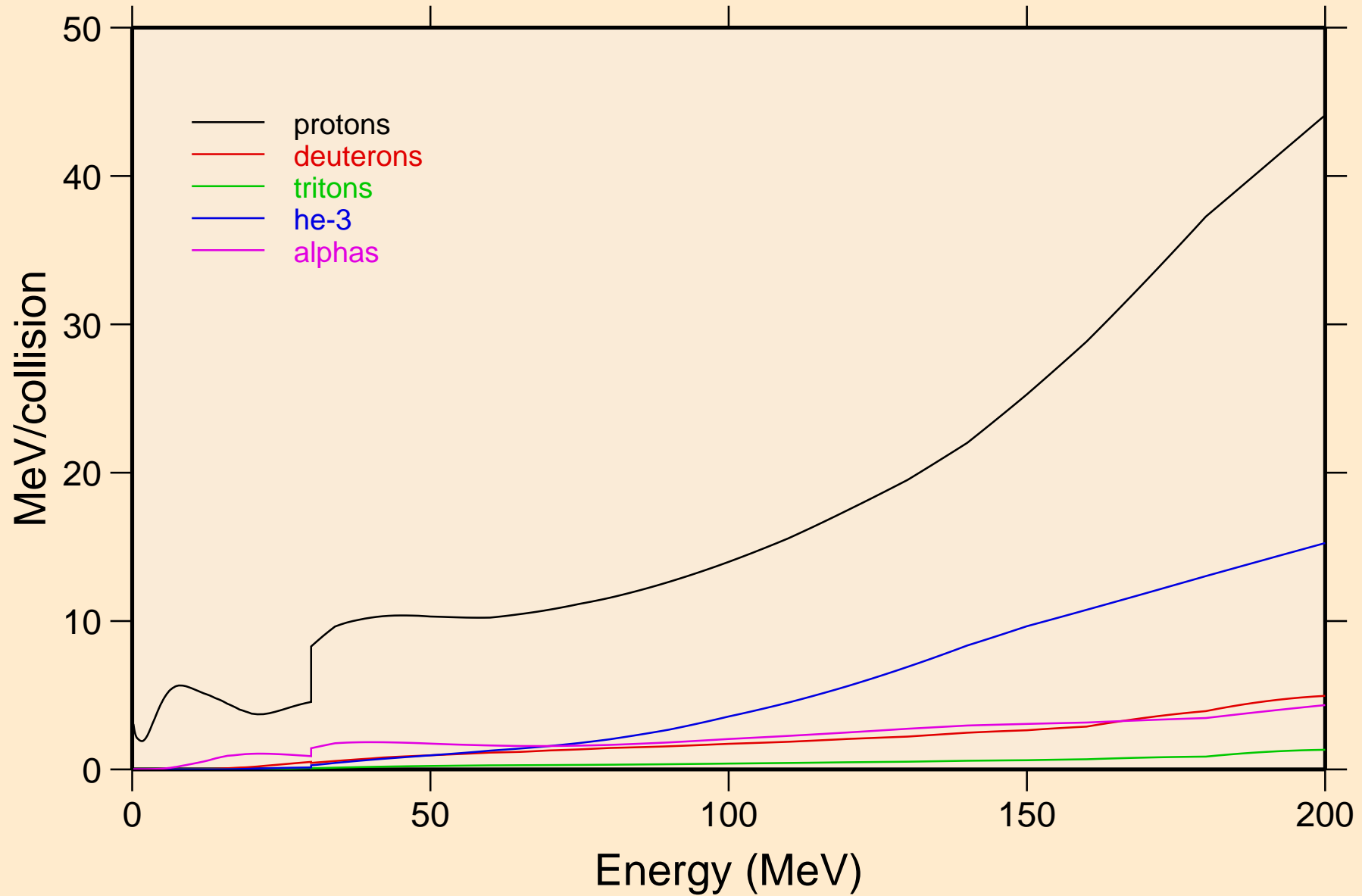

# ND126 NRG TENDL-2015, AKONING

## Recoil Heating

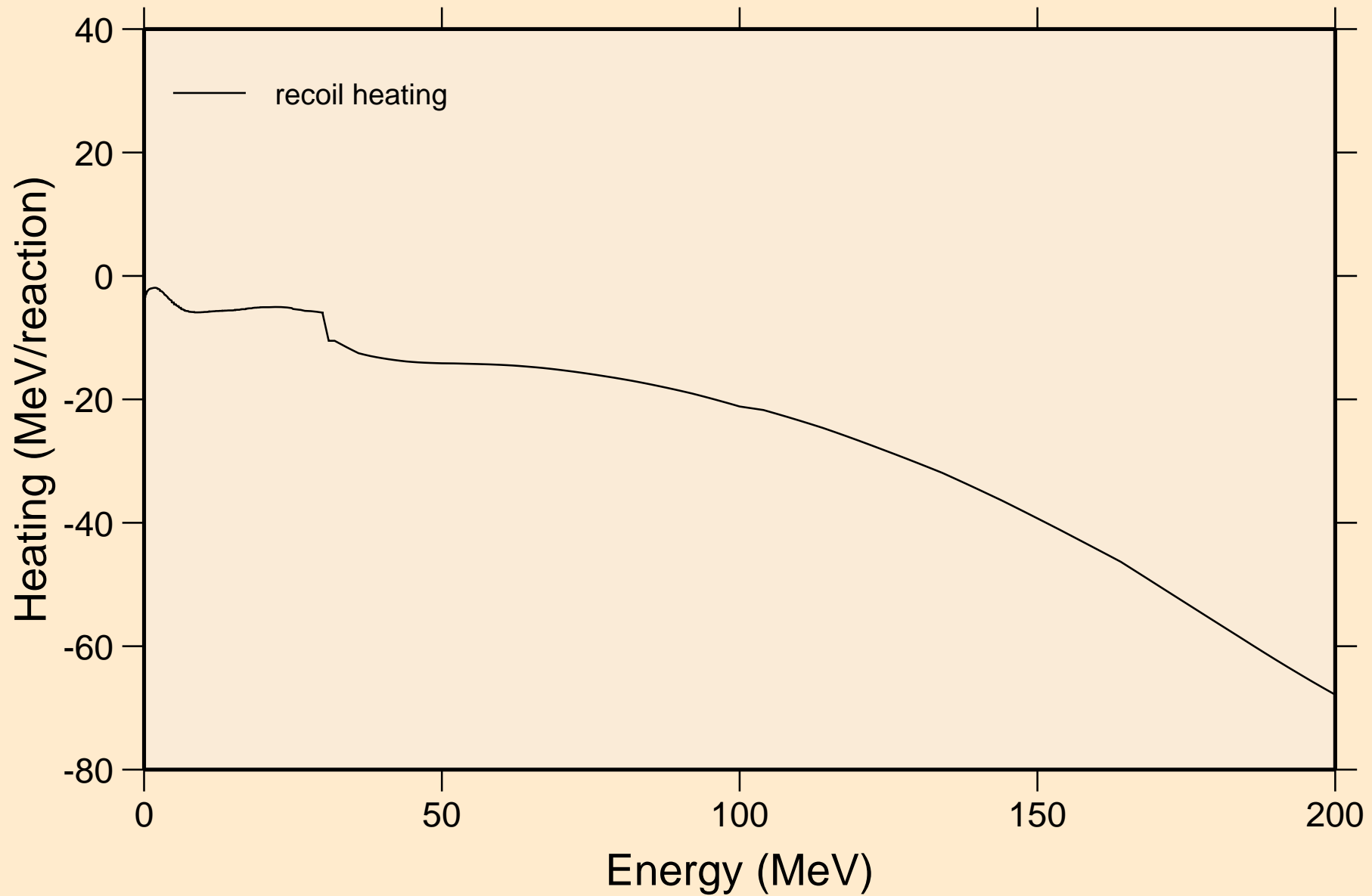

# ND126 NRG TENDL-2015, AKONING

## Particle production cross sections

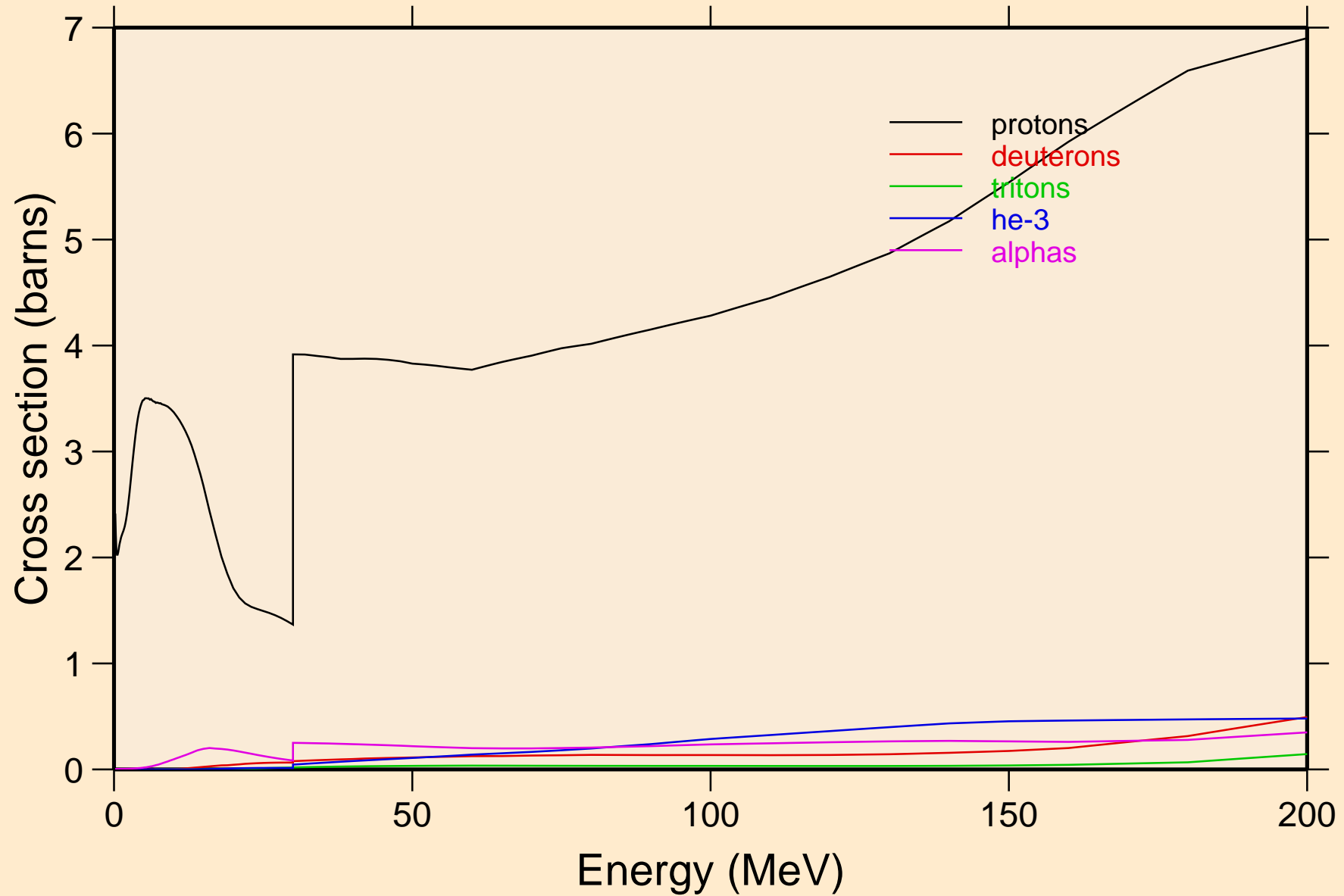

ND126 NRG TENDL-2015, AKONING  
protons from (n,x)

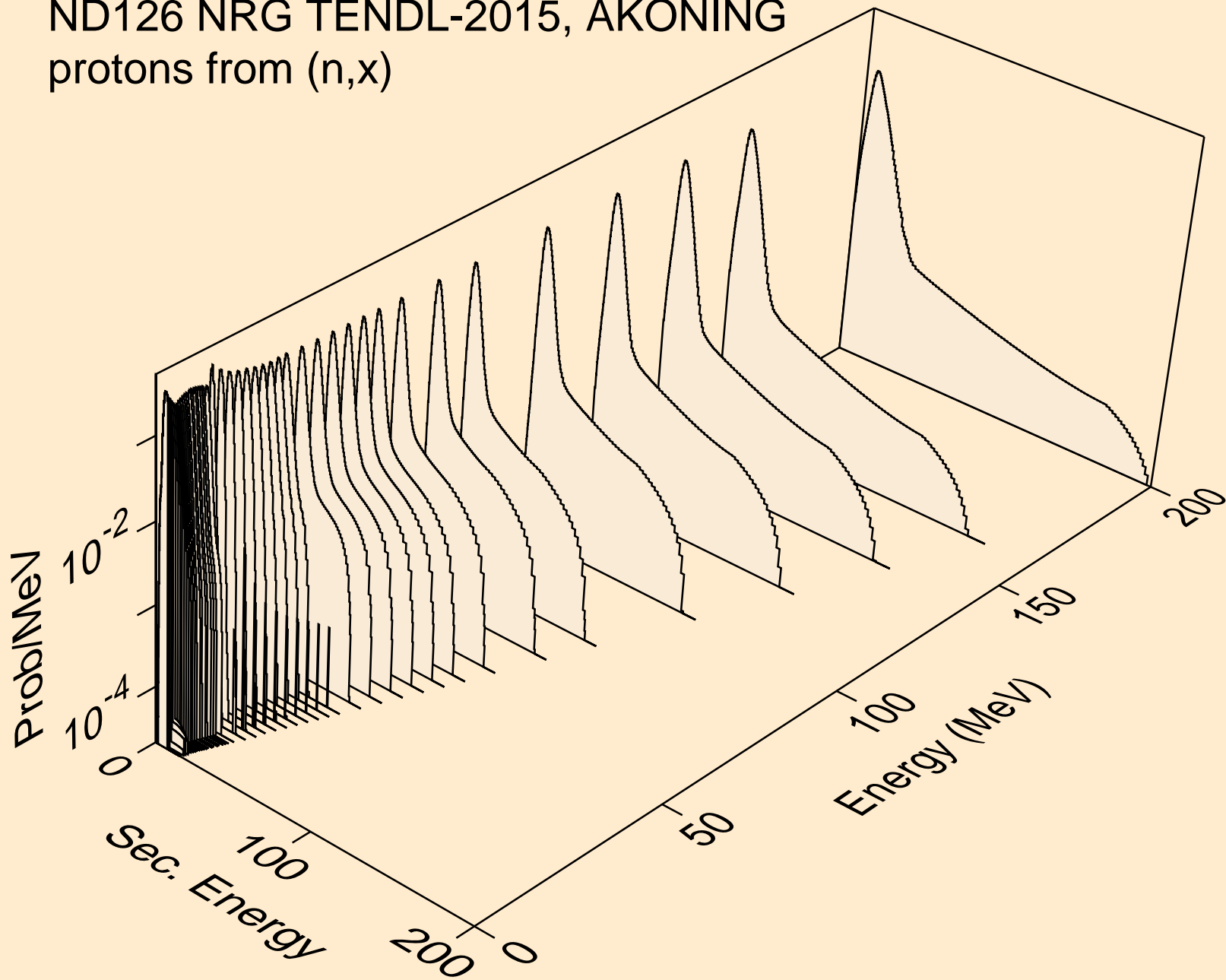

ND126 NRG TENDL-2015, AKONING  
protons from (n,n\*)p

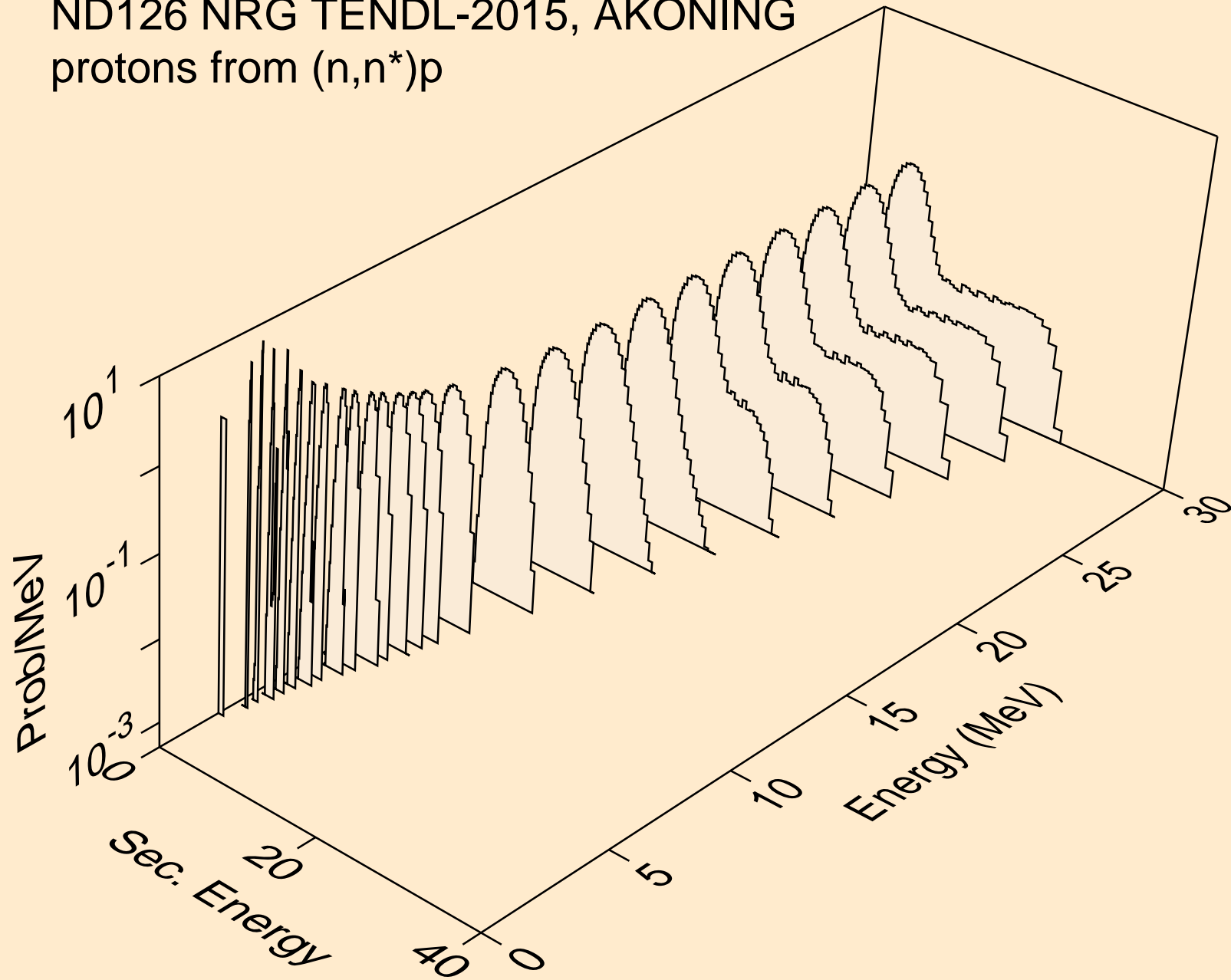

ND126 NRG TENDL-2015, AKONING  
protons from (n,2np)

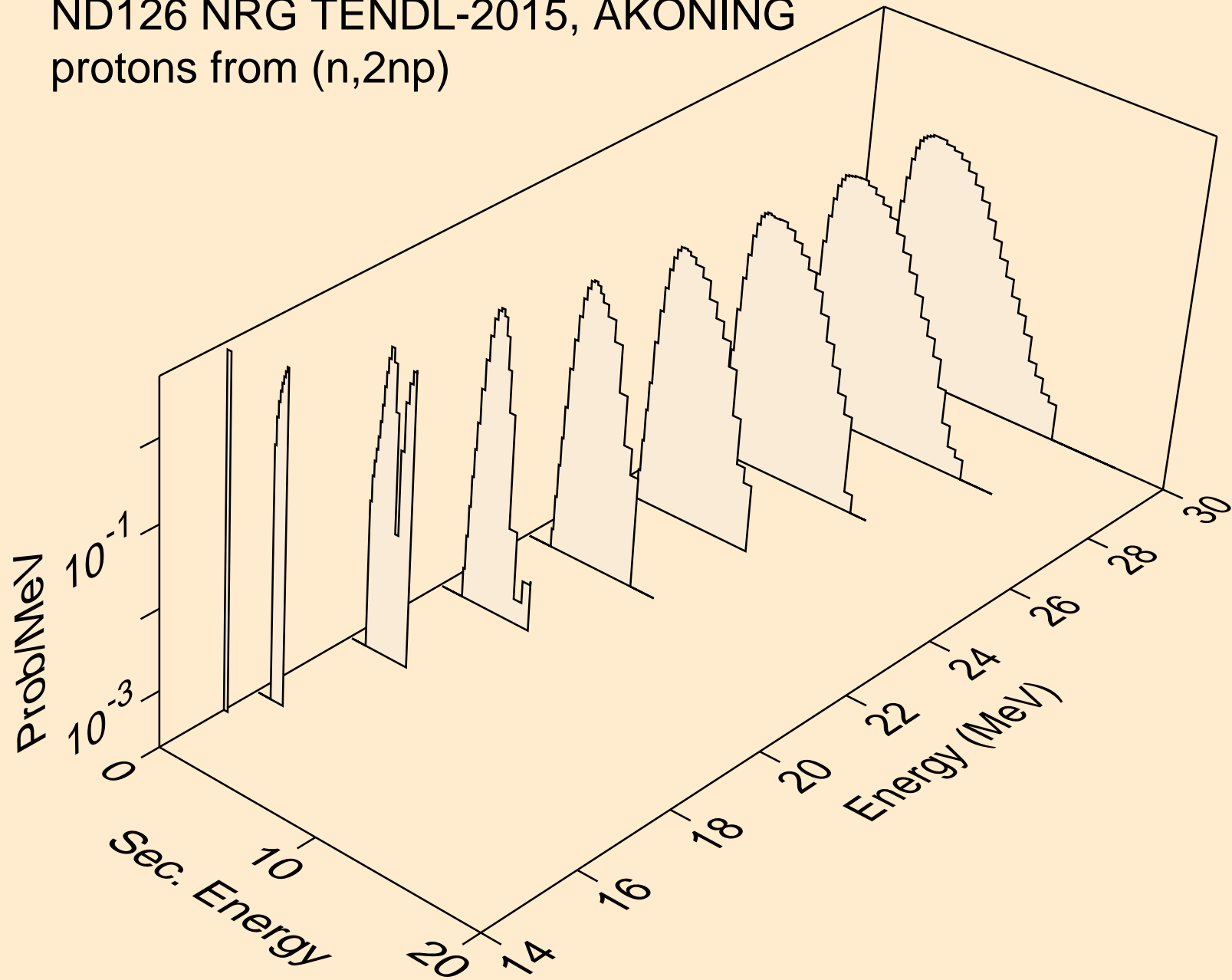

ND126 NRG TENDL-2015, AKONING  
protons from (n,3np)

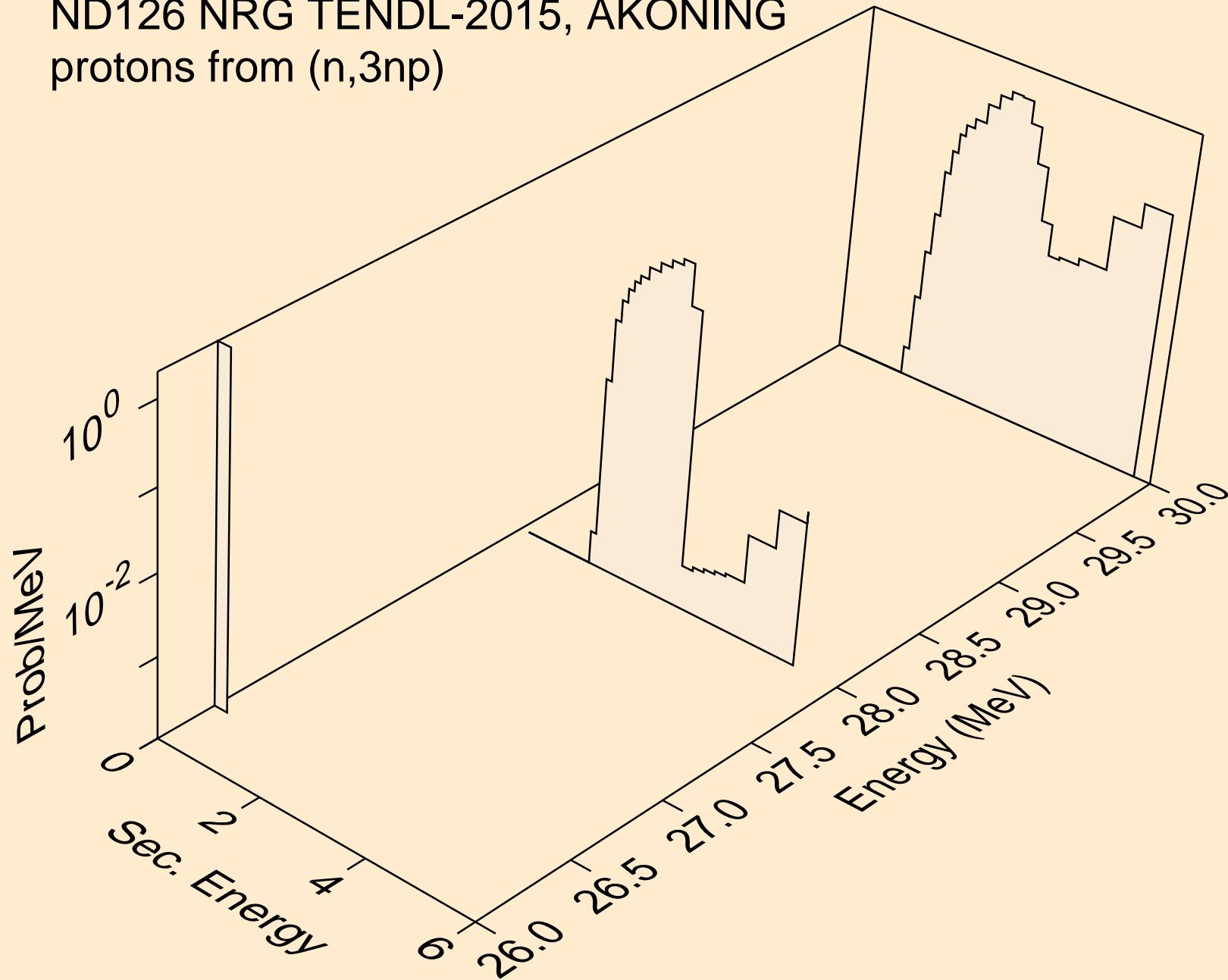



ND126 NRG TENDL-2015, AKONING  
protons from (n,2np)

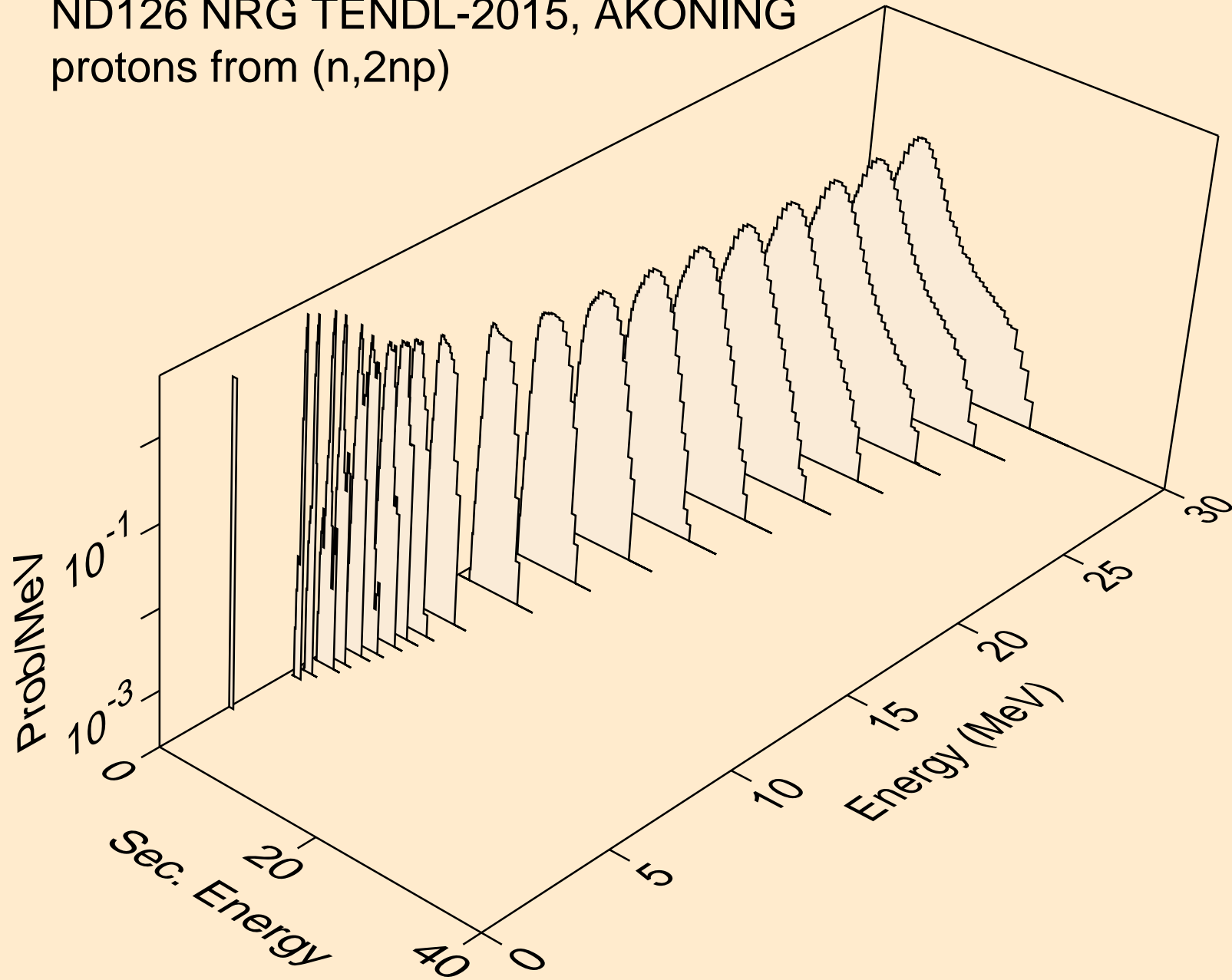

ND126 NRG TENDL-2015, AKONING  
protons from (n,npa)

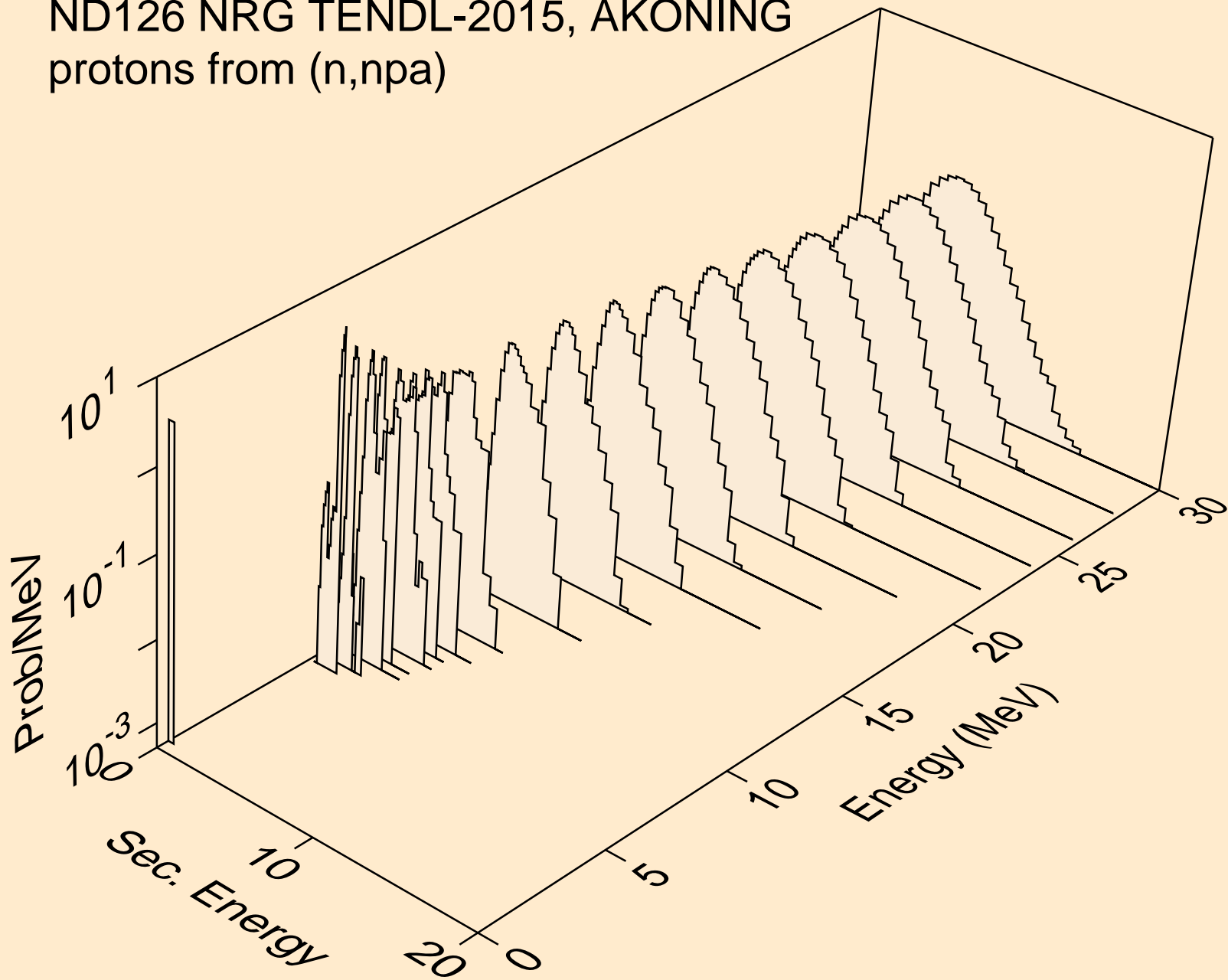

ND126 NRG TENDL-2015, AKONING  
protons from (n,p)

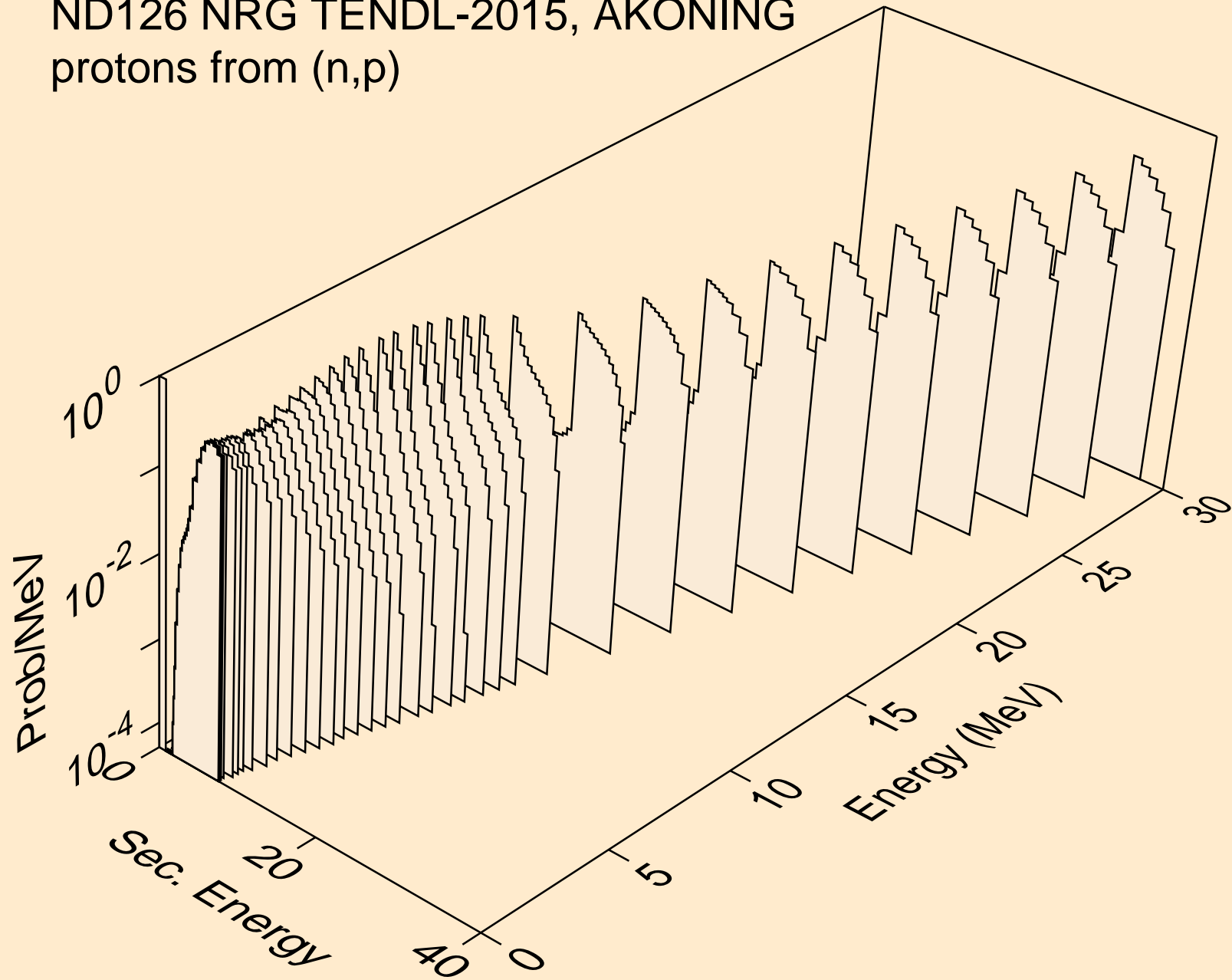

ND126 NRG TENDL-2015, AKONING  
protons from (n,2p)

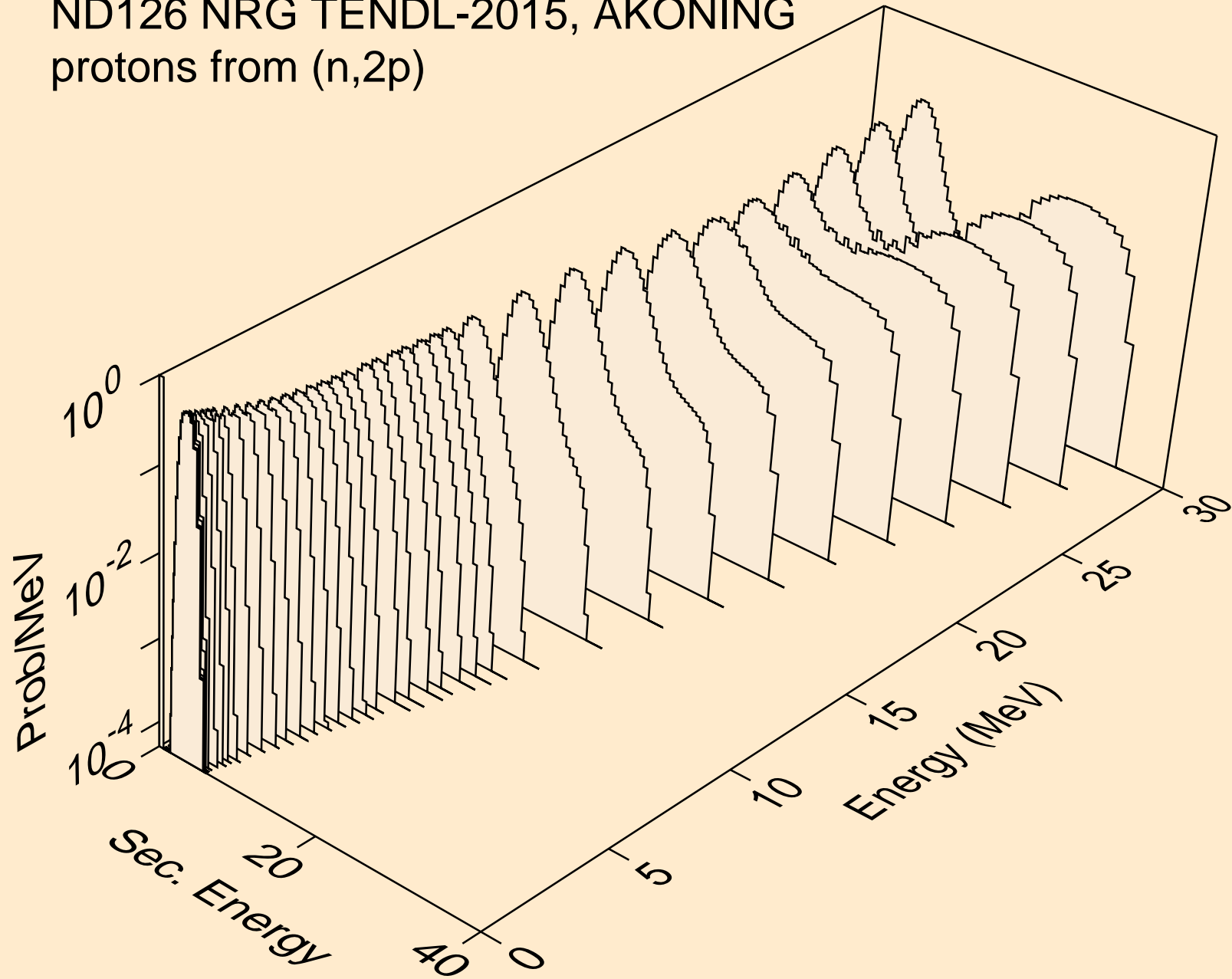

ND126 NRG TENDL-2015, AKONING  
protons from (n,pa)

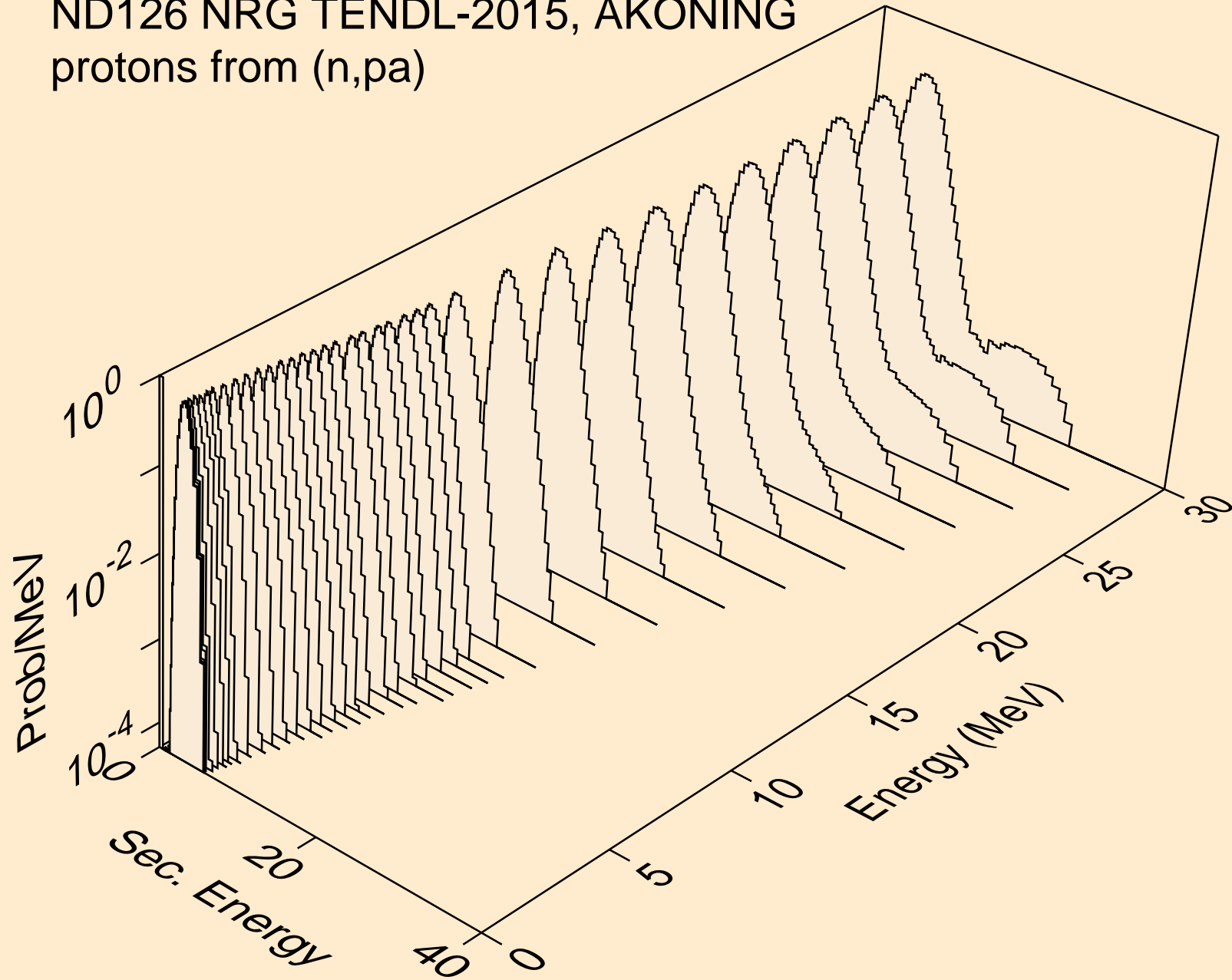

ND126 NRG TENDL-2015, AKONING  
protons from (n,pd)

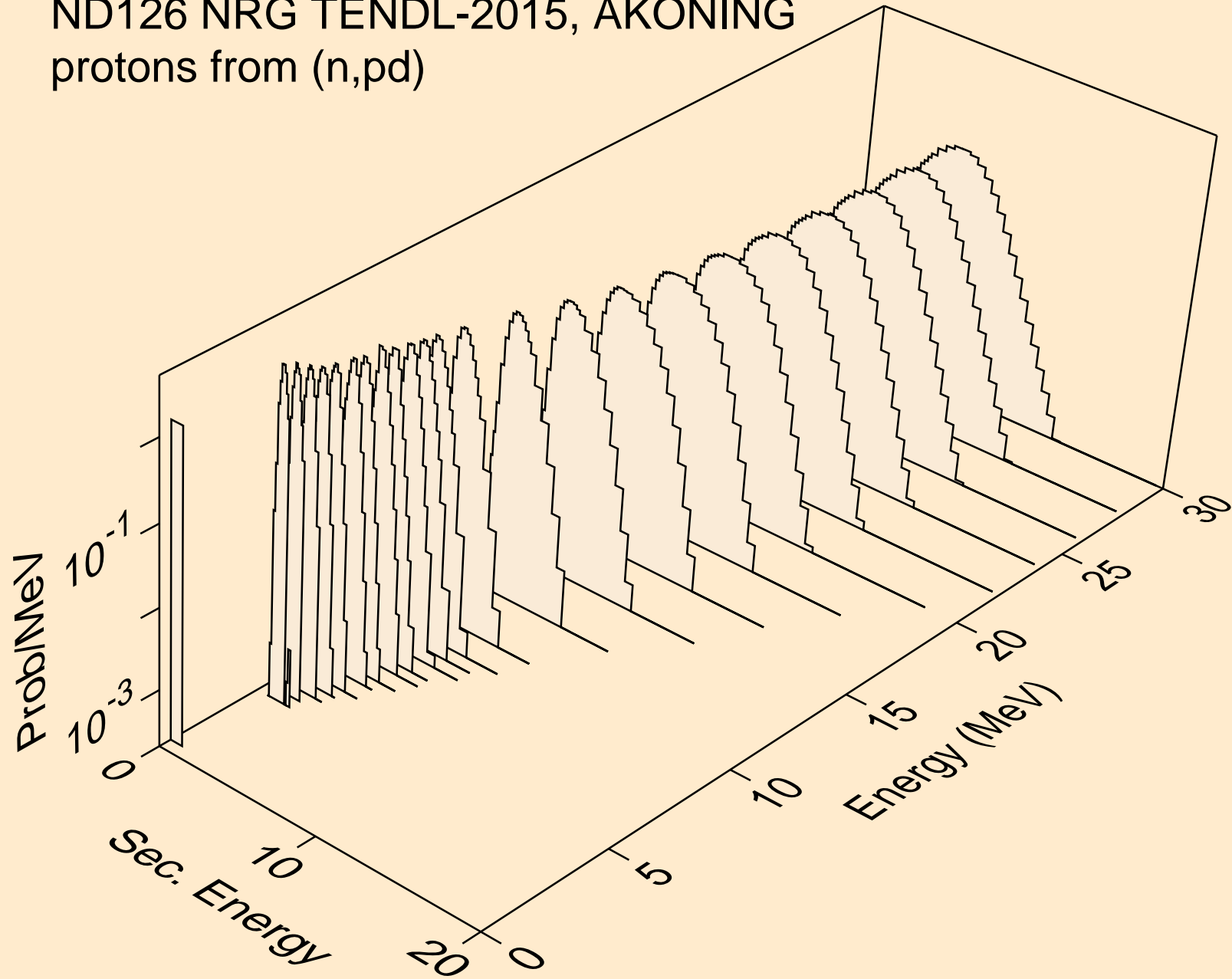

ND126 NRG TENDL-2015, AKONING  
protons from (n,pt)

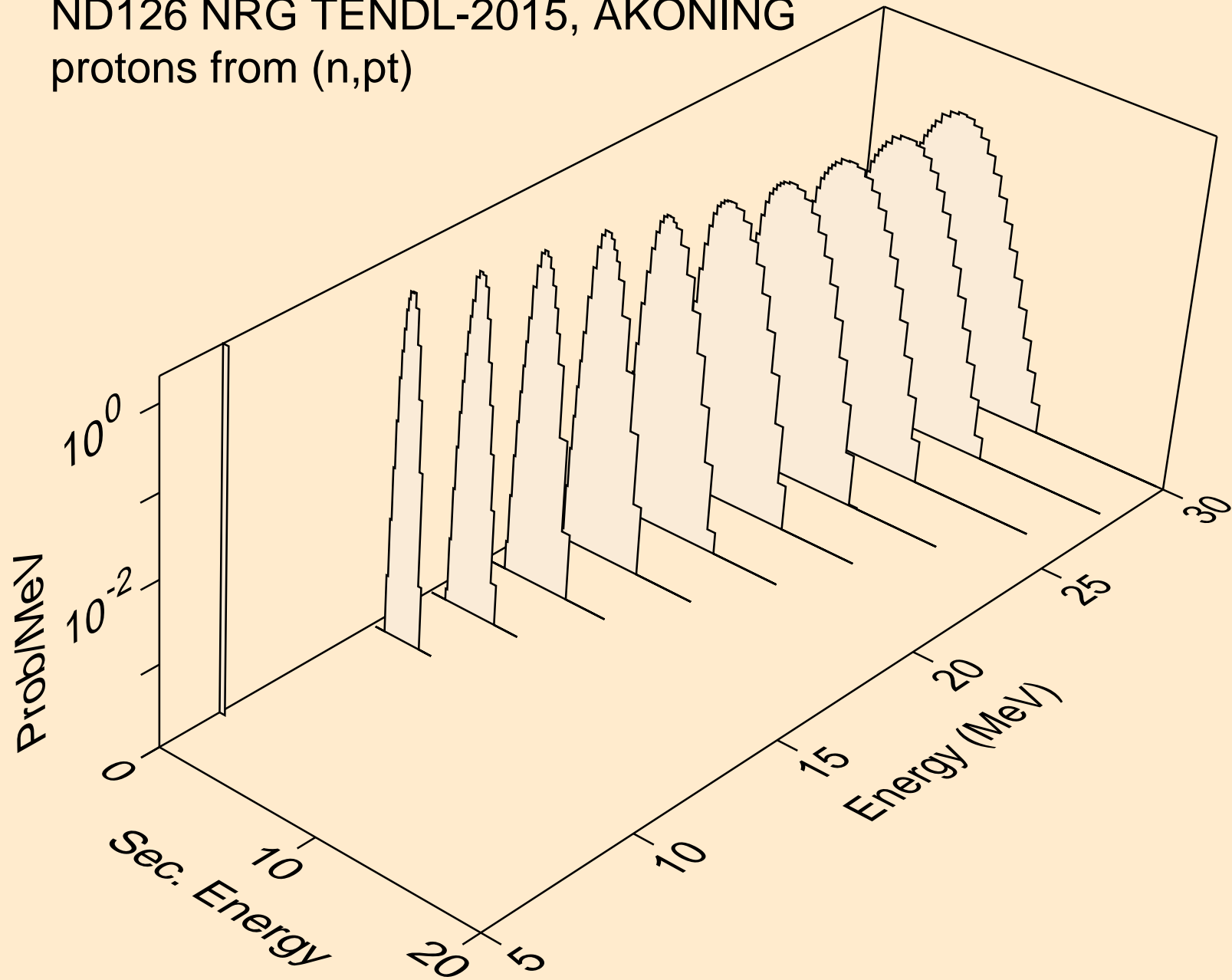

ND126 NRG TENDL-2015, AKONING  
deuterons from (n,x)

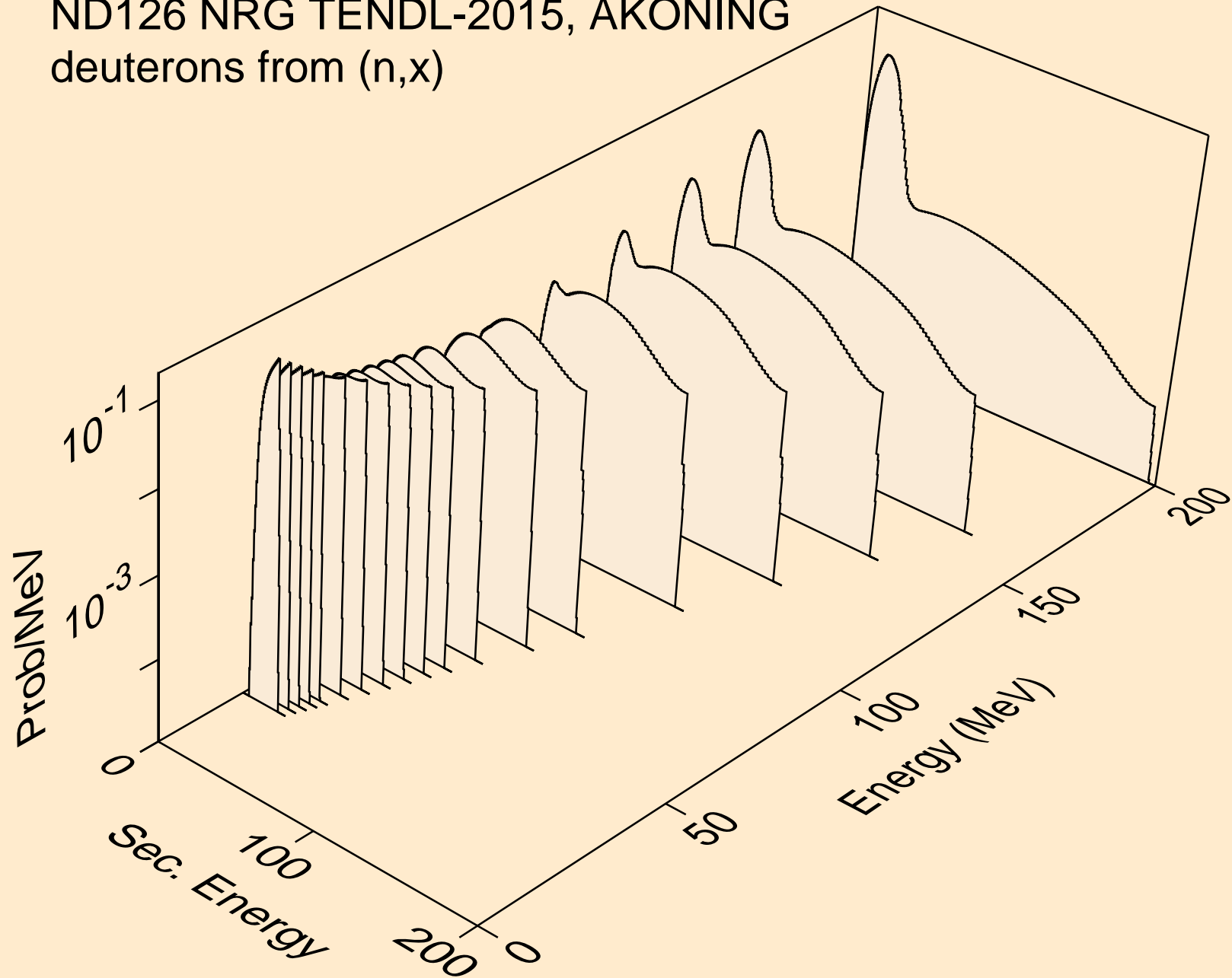



ND126 NRG TENDL-2015, AKONING  
deuterons from (n,n\*)d

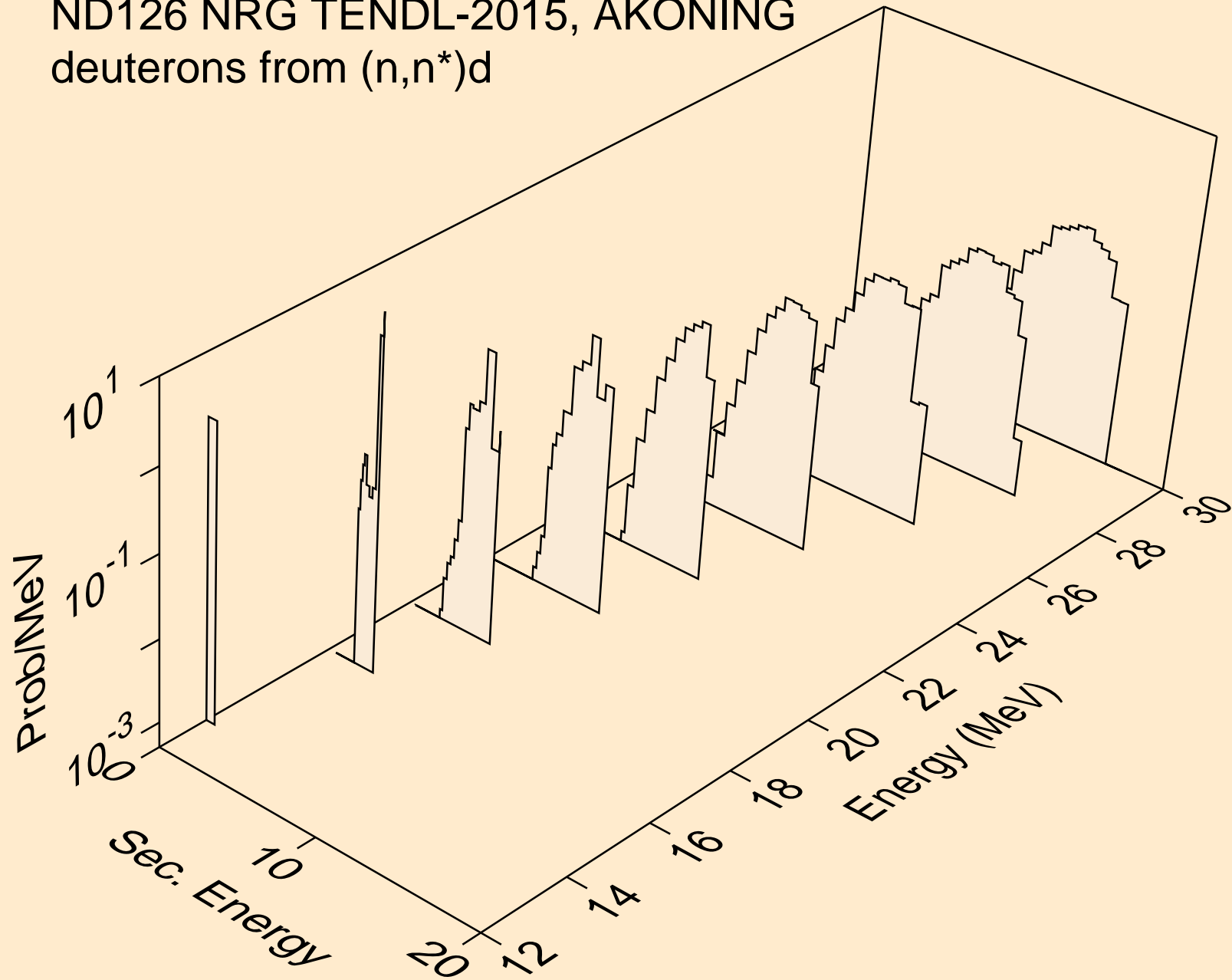

ND126 NRG TENDL-2015, AKONING  
deuterons from (n,d)

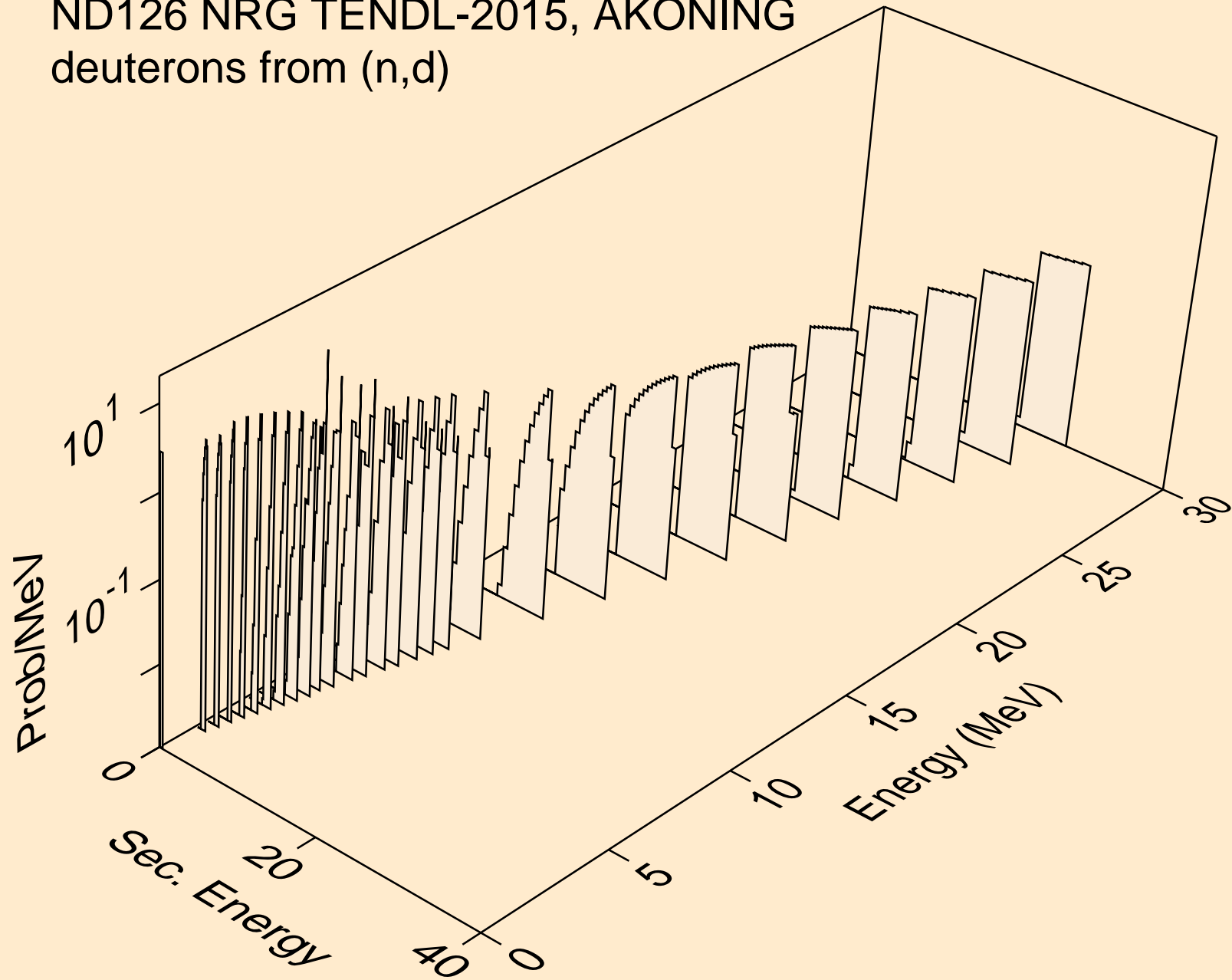

ND126 NRG TENDL-2015, AKONING  
deuterons from (n,d2a)

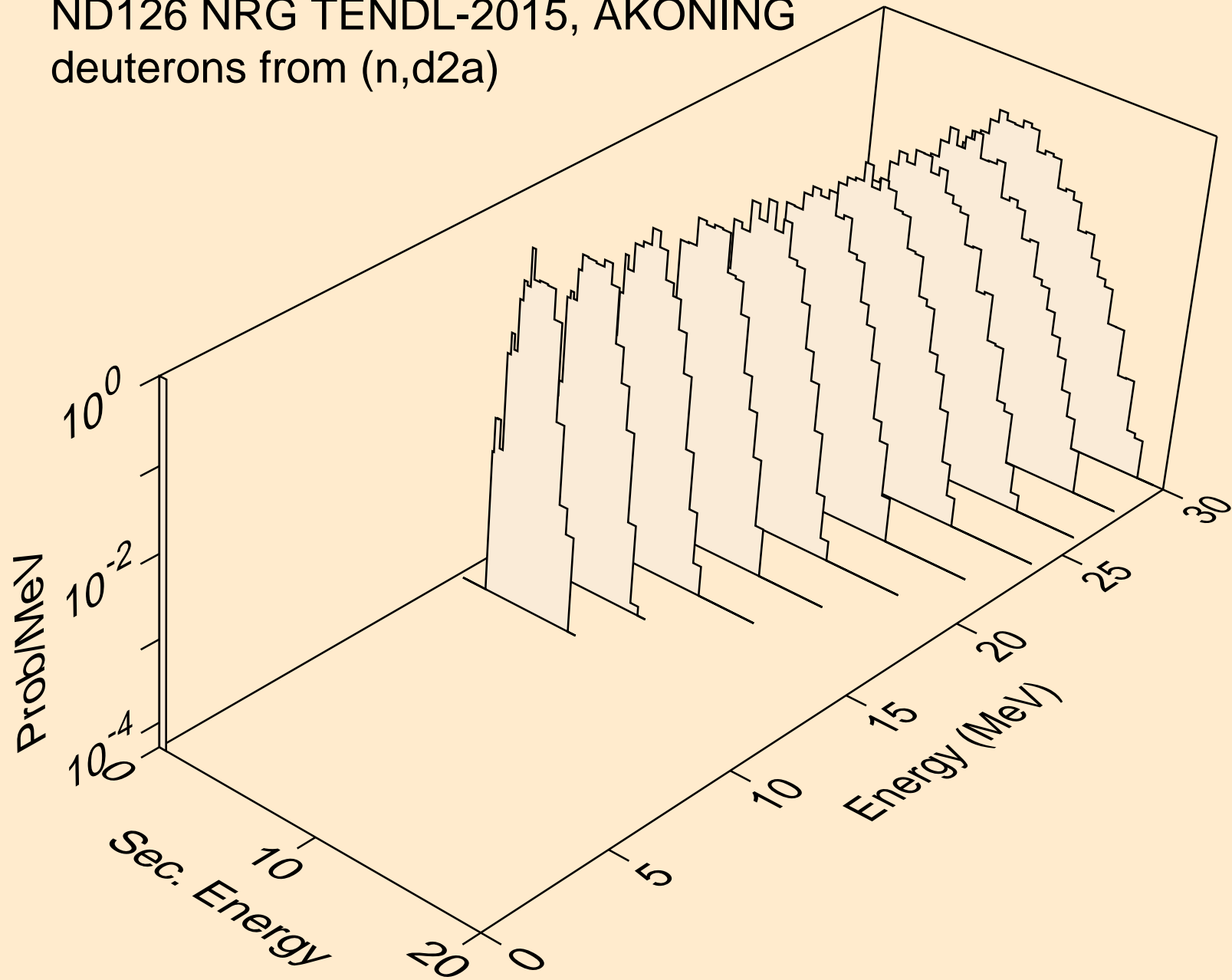

ND126 NRG TENDL-2015, AKONING  
deuterons from (n,pd)

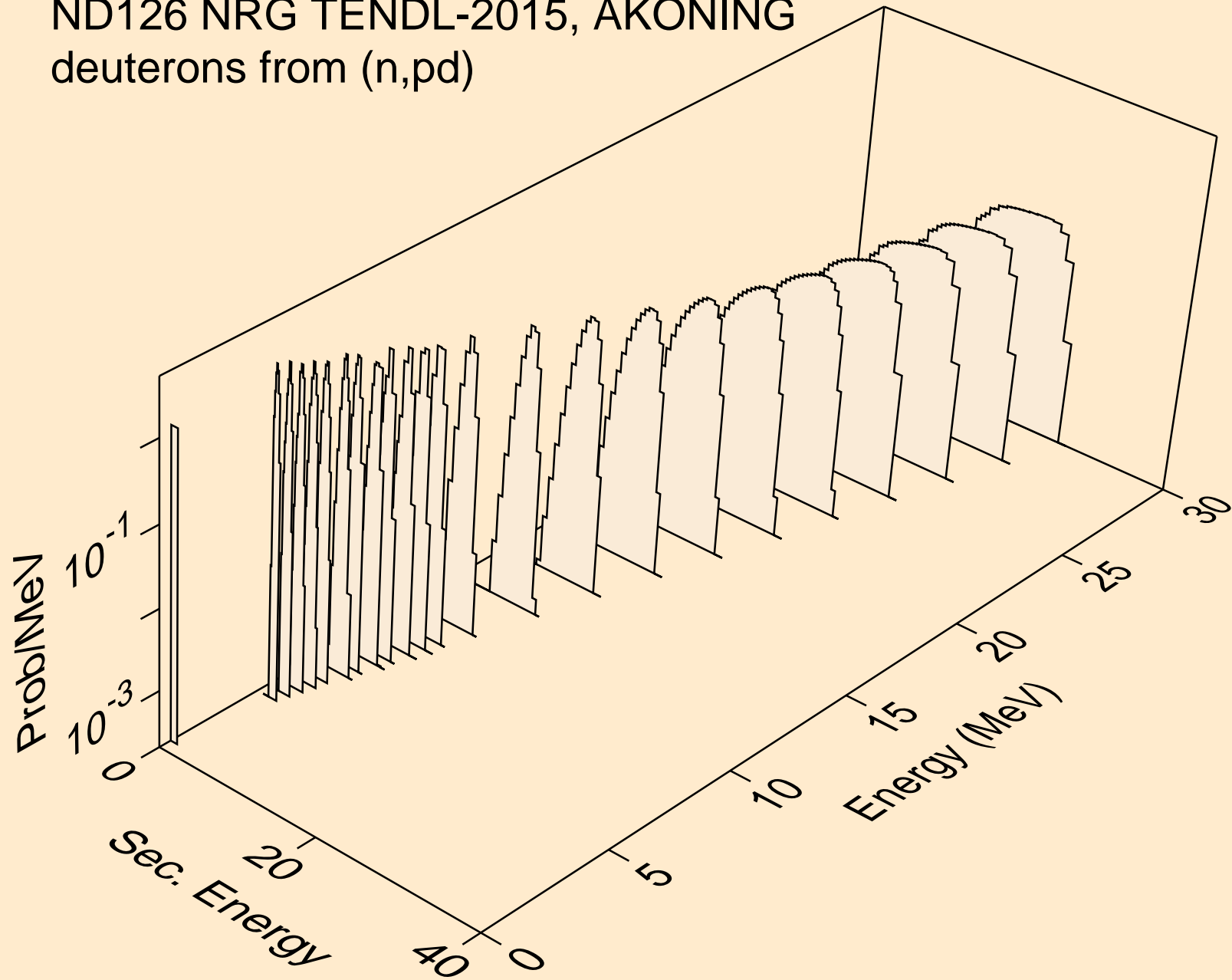

ND126 NRG TENDL-2015, AKONING  
deuterons from (n,da)

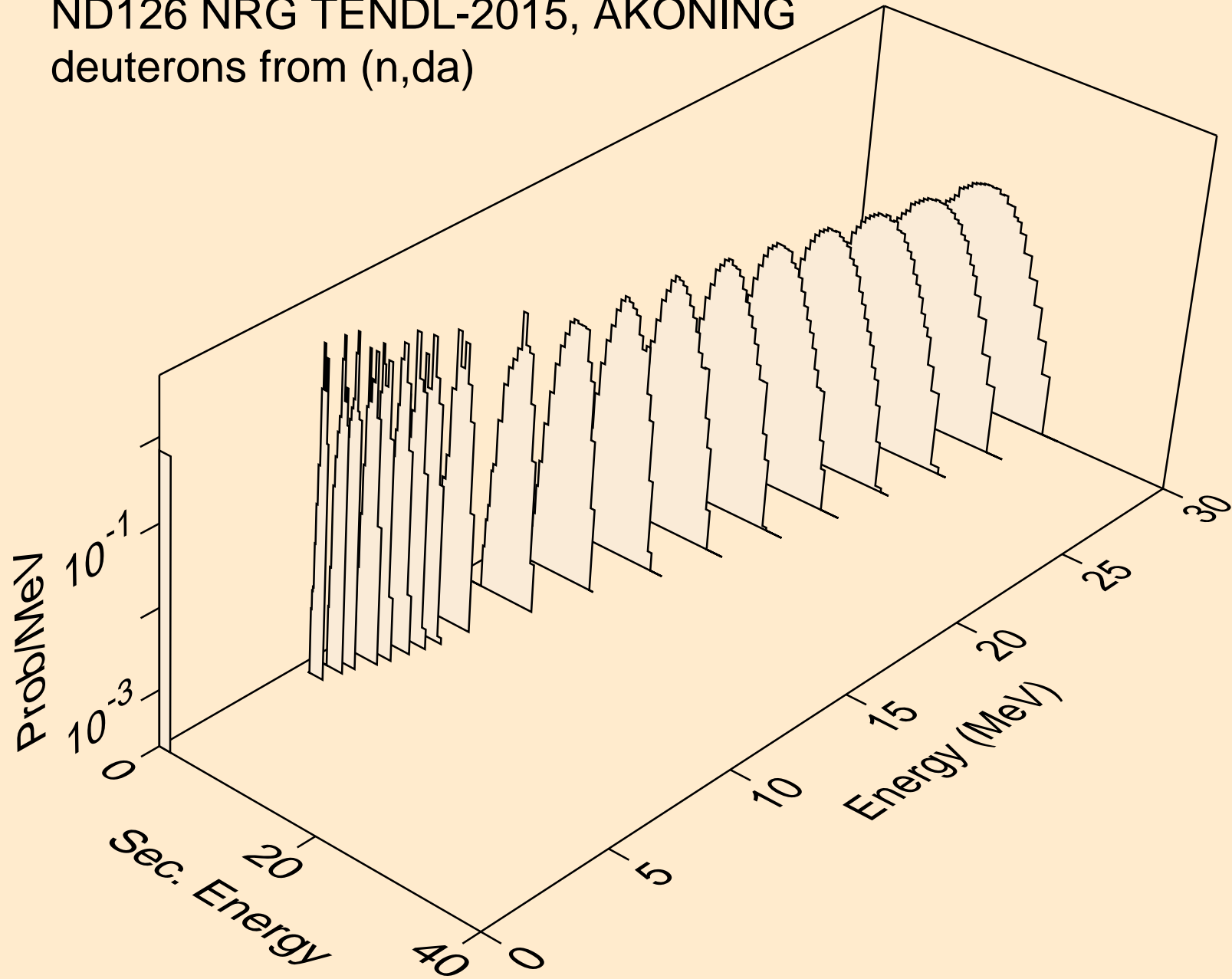

ND126 NRG TENDL-2015, AKONING  
tritons from (n,x)

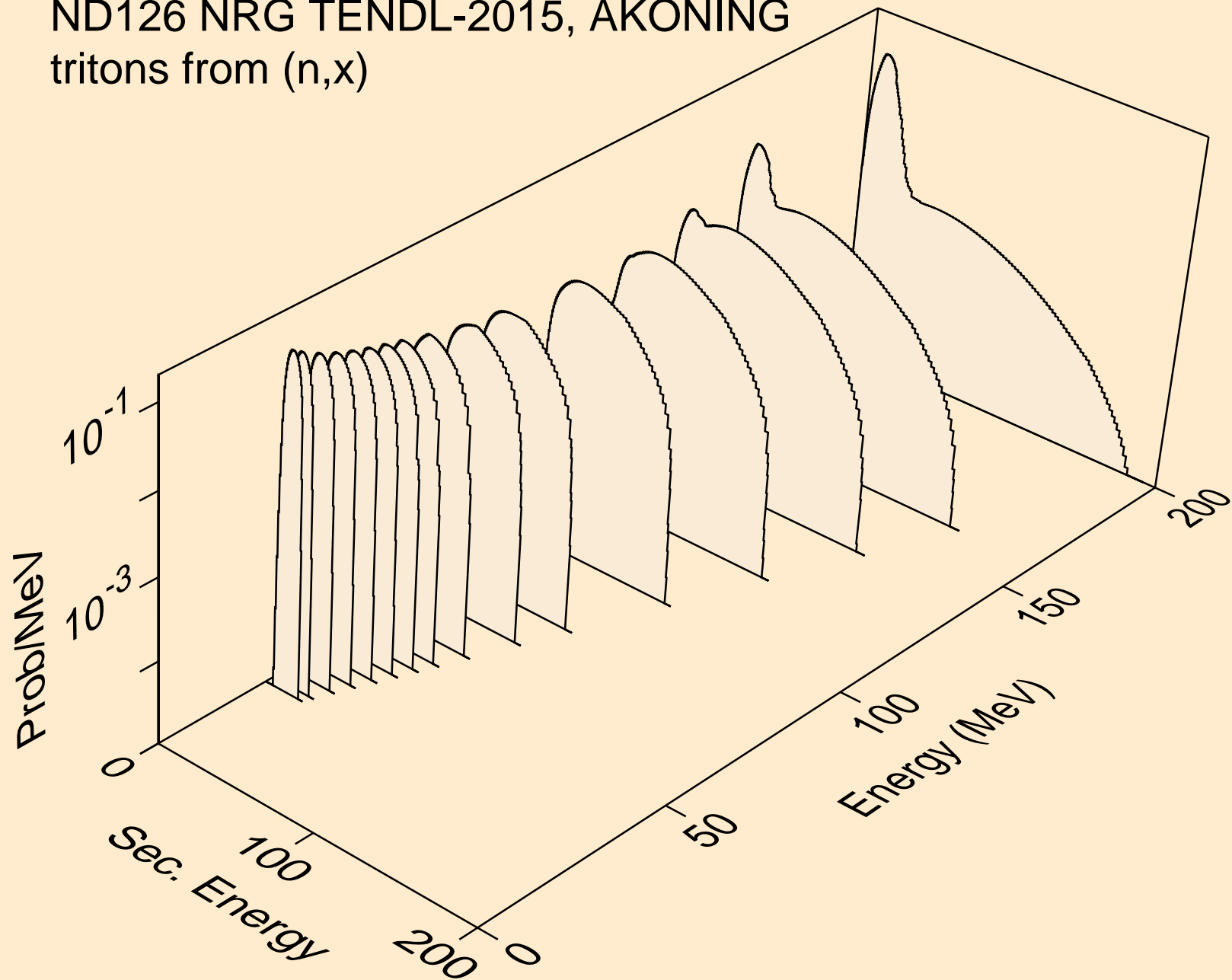

ND126 NRG TENDL-2015, AKONING  
tritons from (n,n\*)t

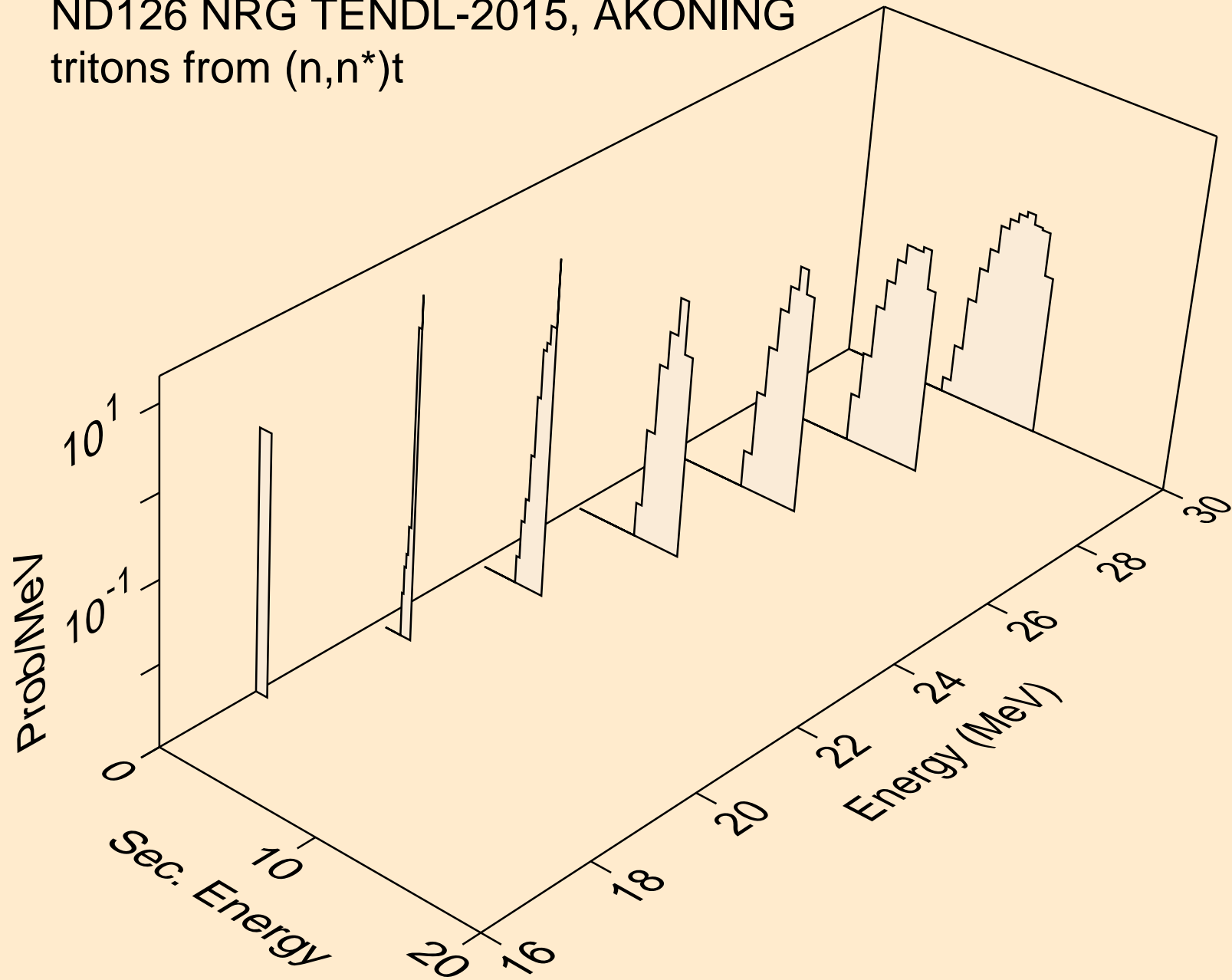

ND126 NRG TENDL-2015, AKONING  
tritons from (n,t)

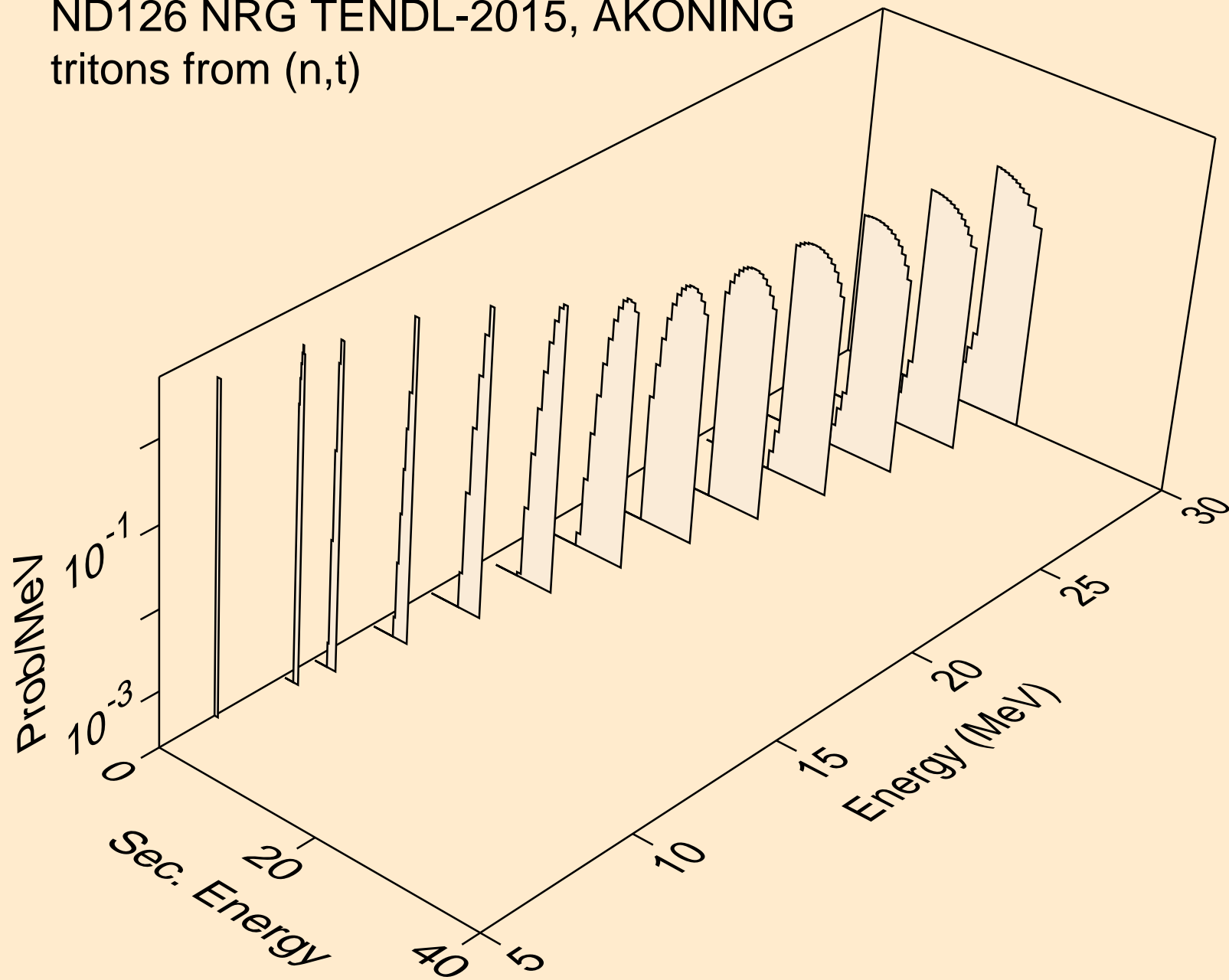



ND126 NRG TENDL-2015, AKONING  
tritons from (n,pt)

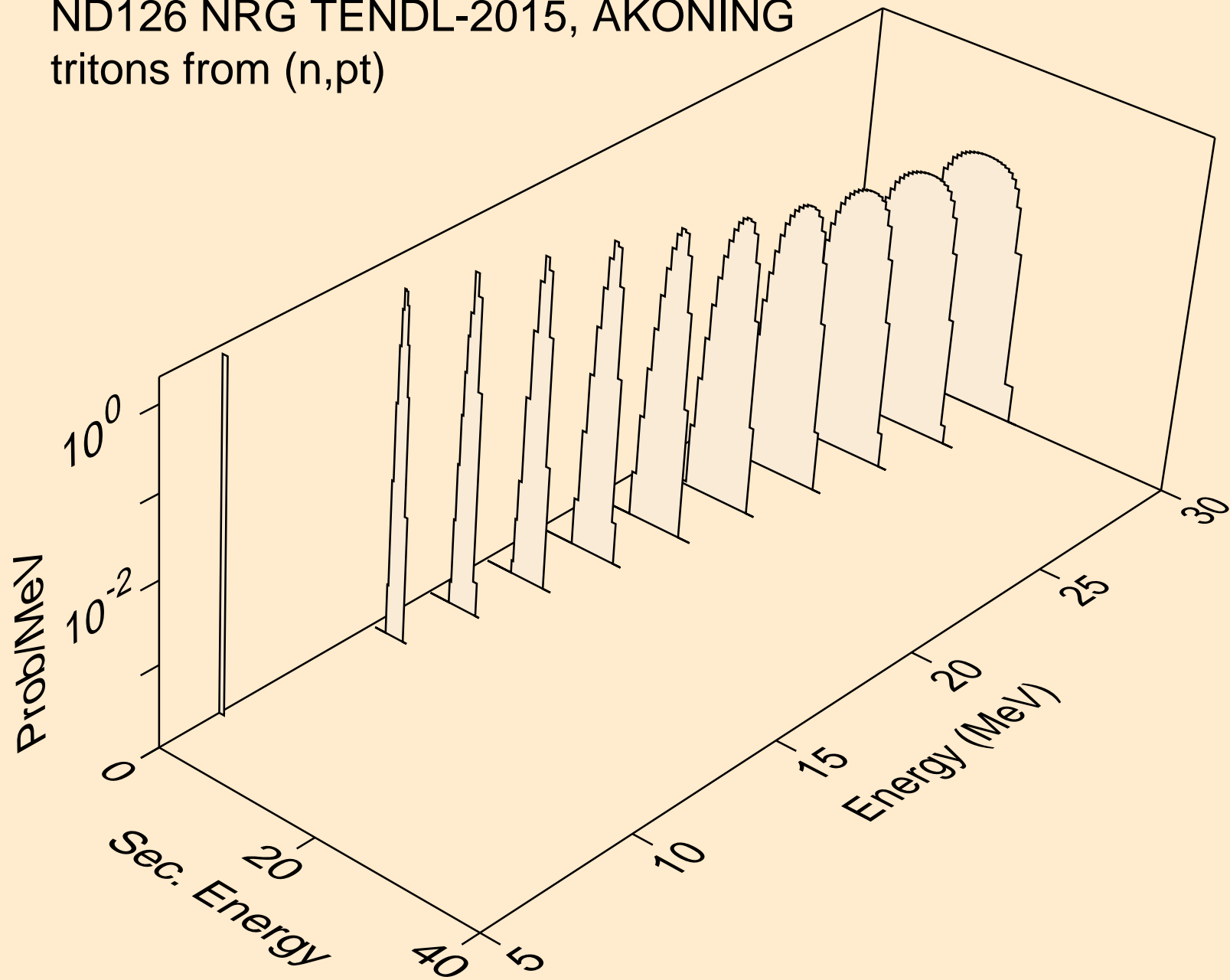

ND126 NRG TENDL-2015, AKONING  
he3s from (n,x)

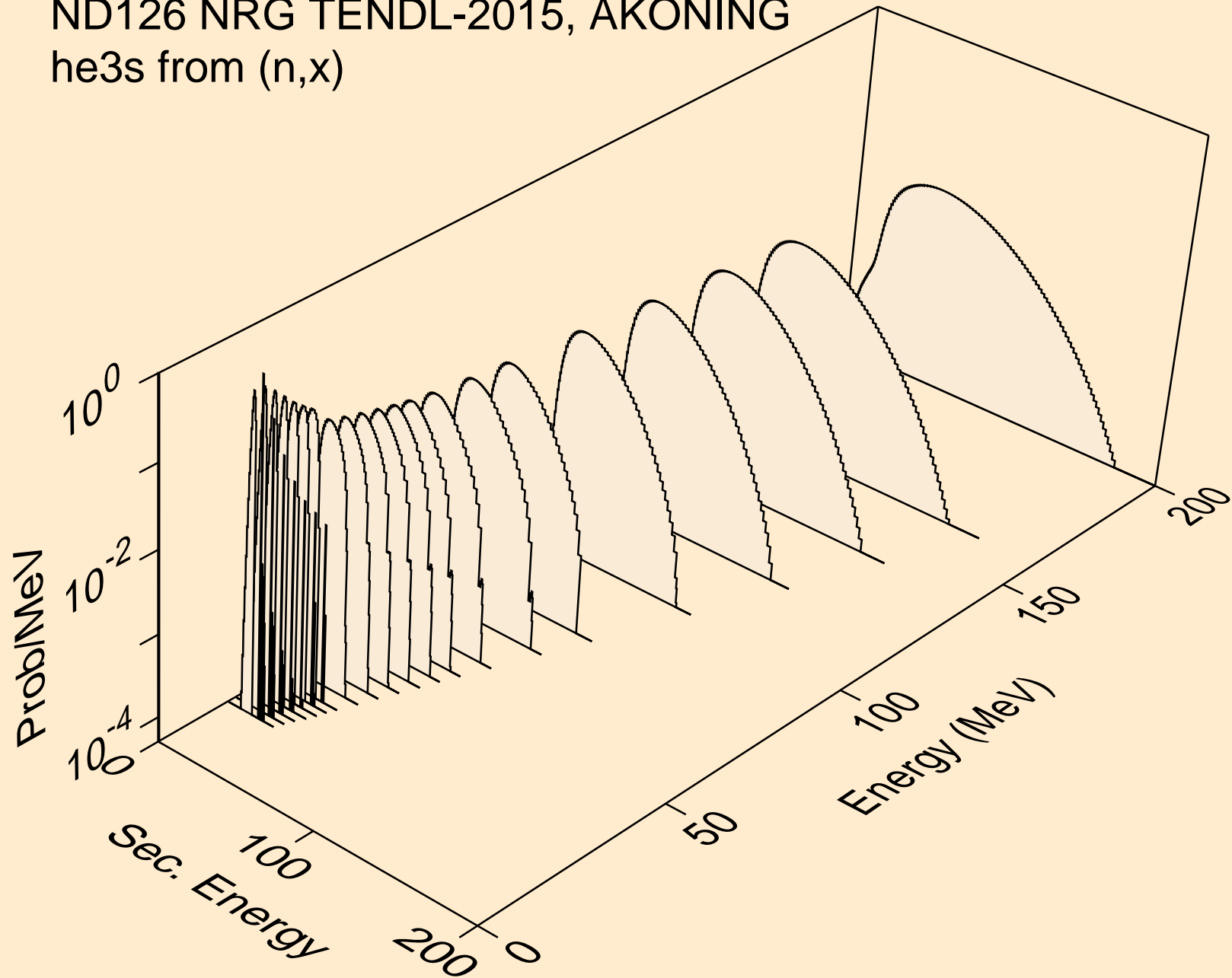

ND126 NRG TENDL-2015, AKONING  
he3s from (n,n\*)he3

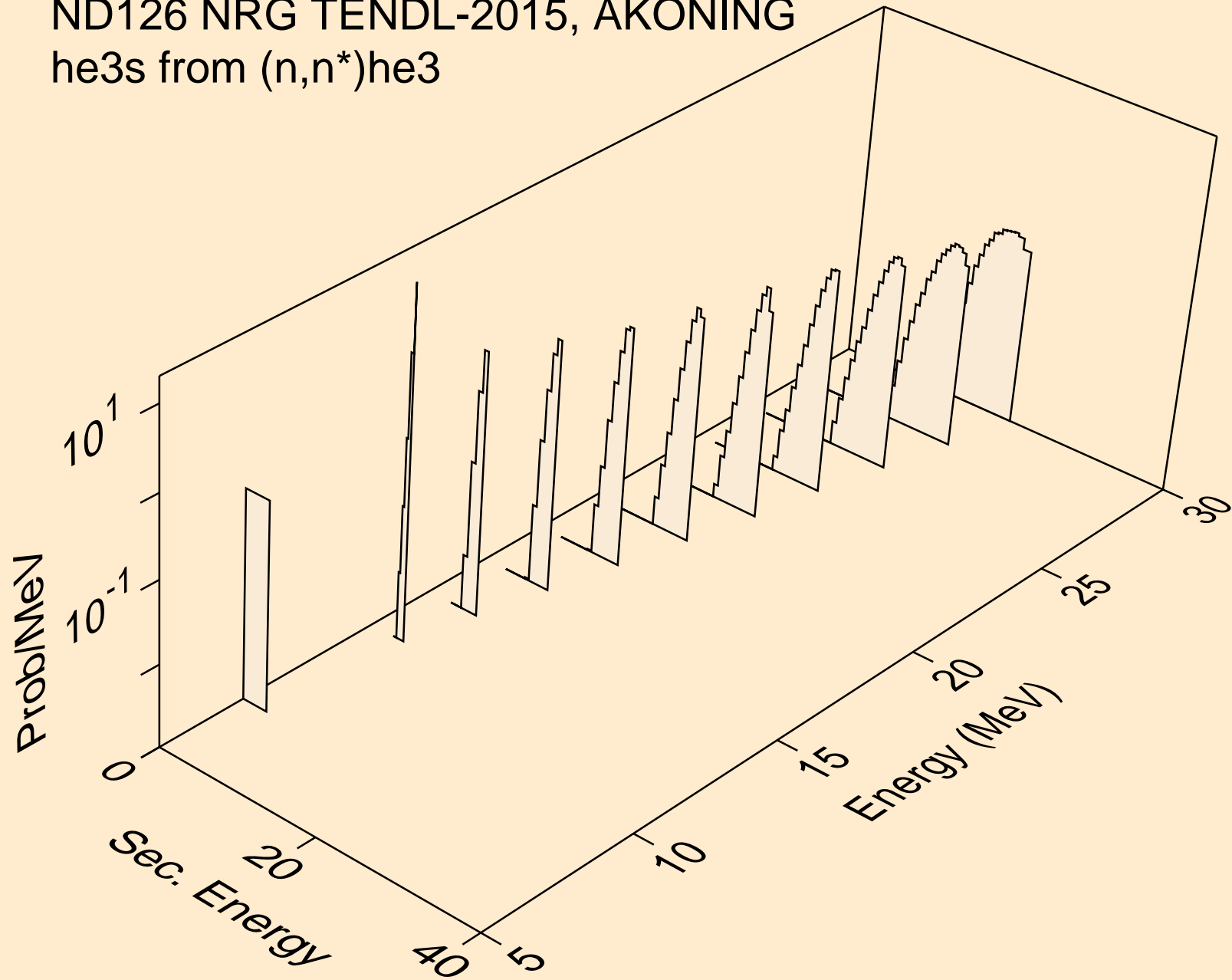

ND126 NRG TENDL-2015, AKONING  
he3s from (n,he3)

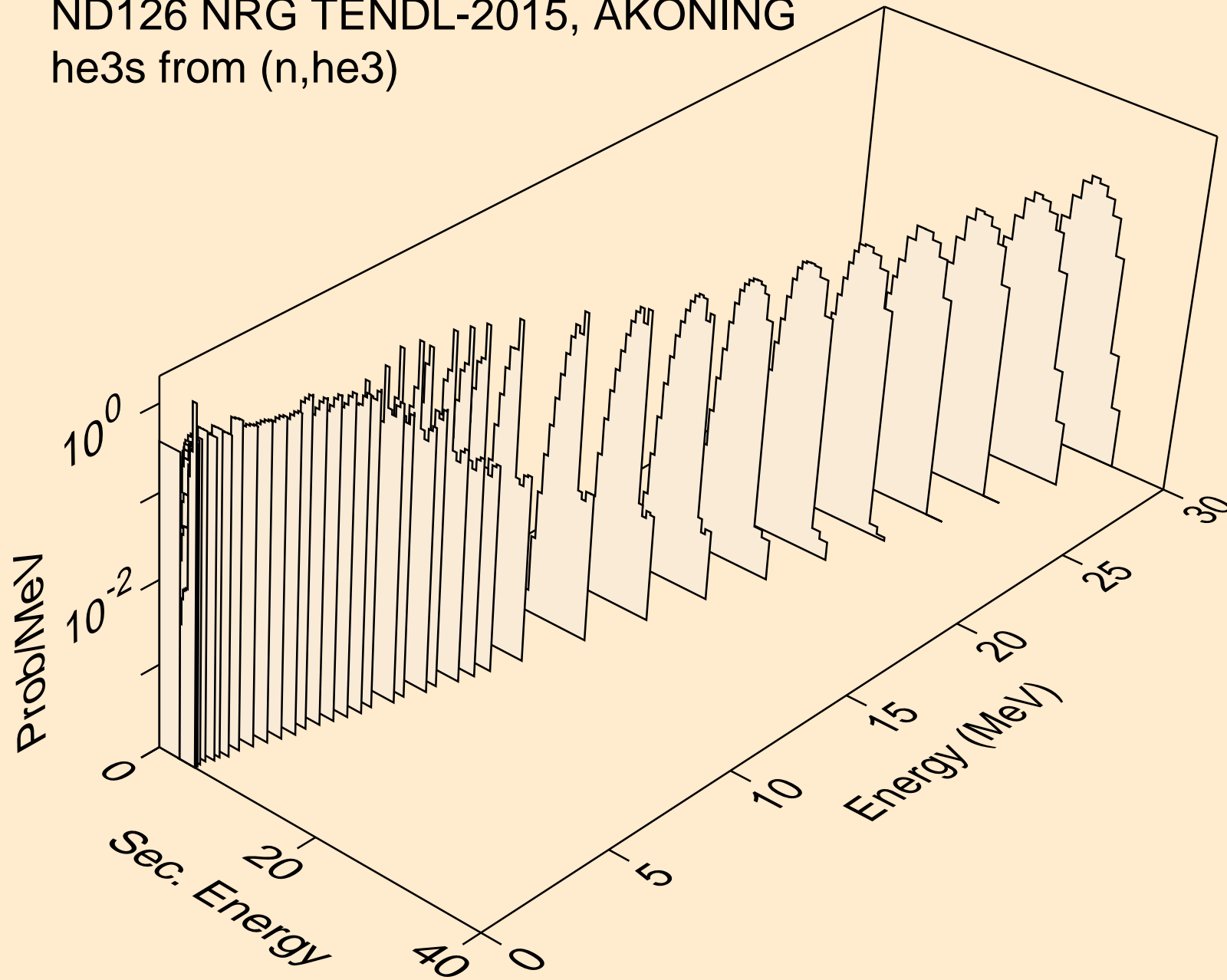

ND126 NRG TENDL-2015, AKONING  
alphas from (n,x)

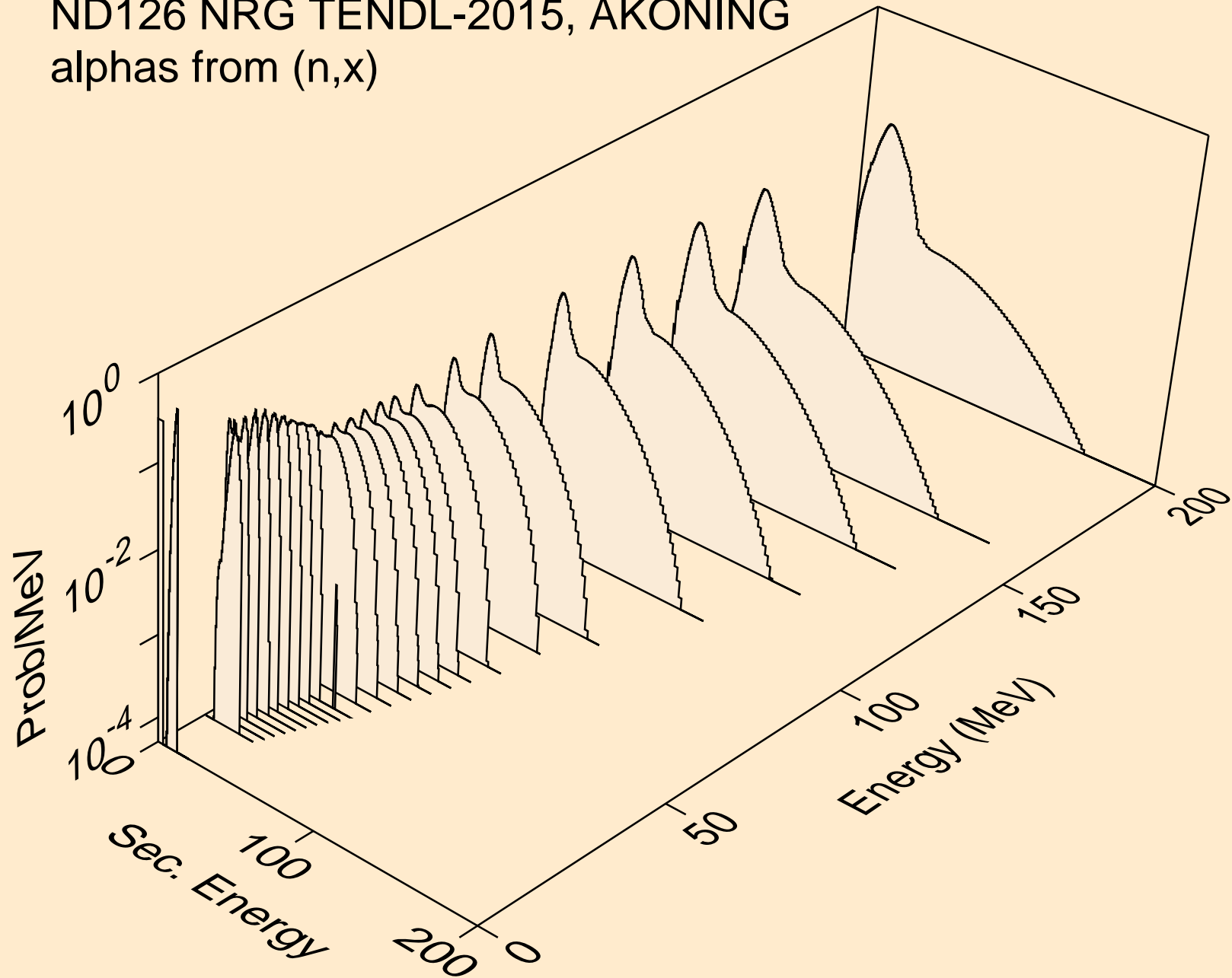

ND126 NRG TENDL-2015, AKONING  
alphas from (n,n\*)a

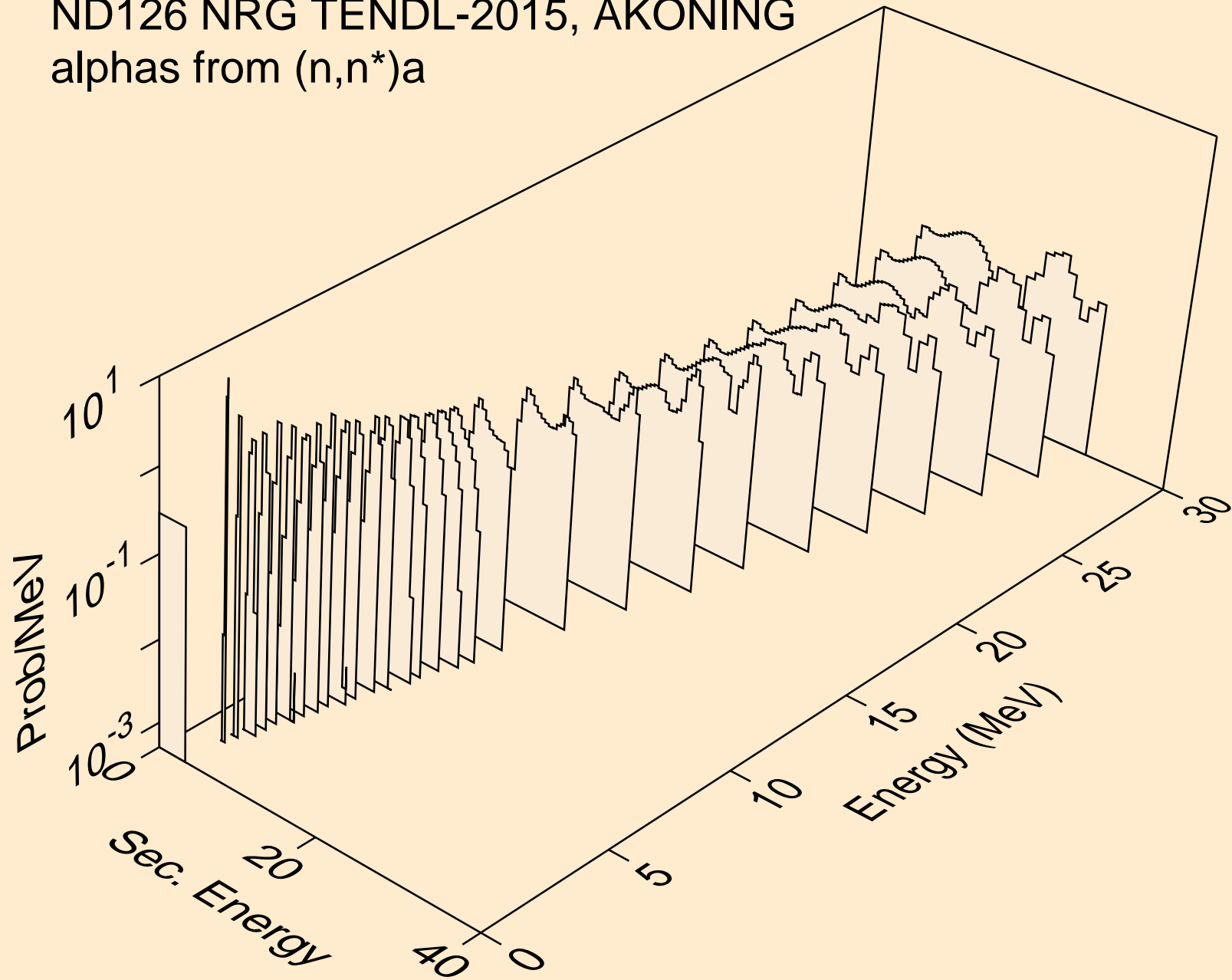

ND126 NRG TENDL-2015, AKONING  
alphas from (n,n\*)3a

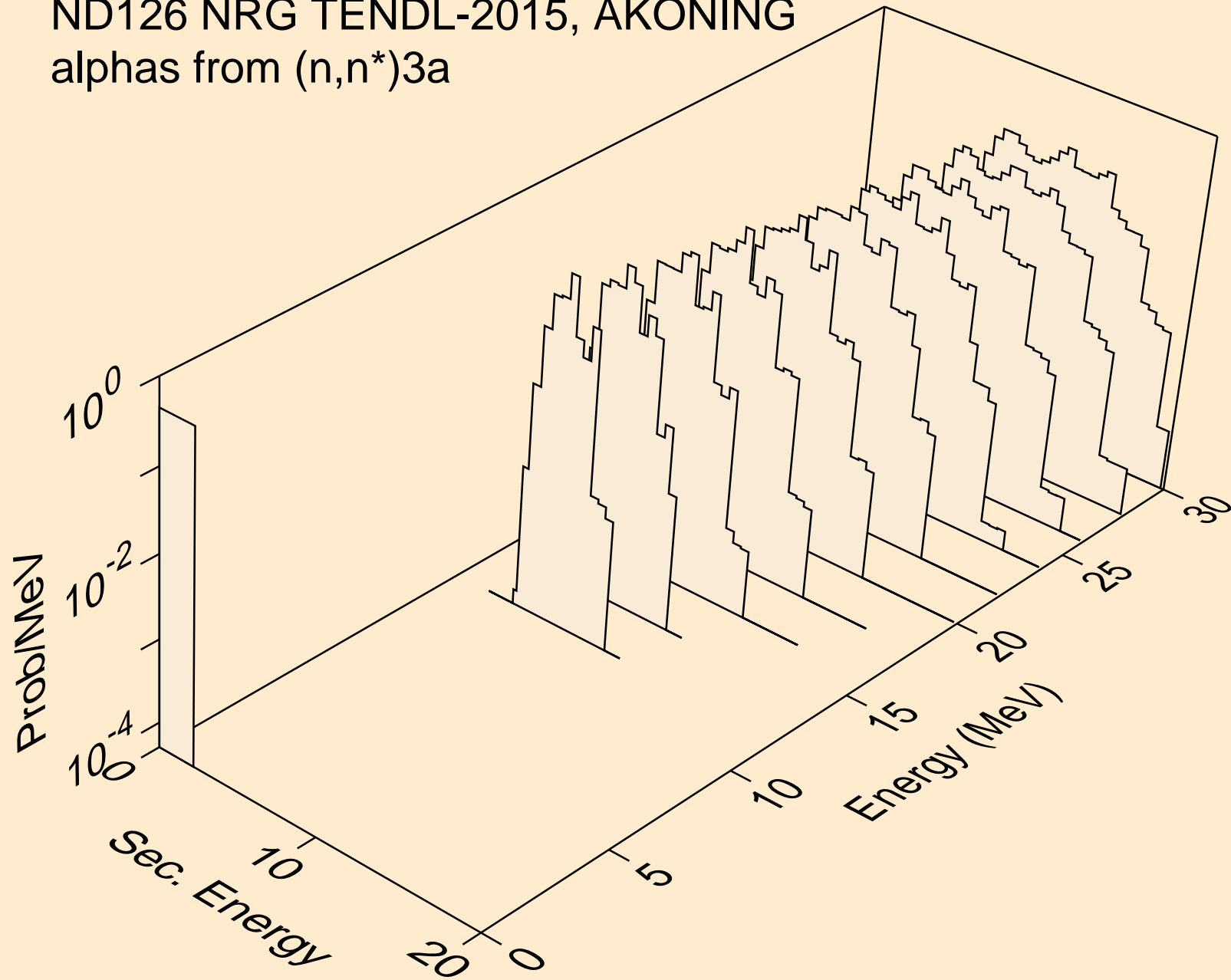

ND126 NRG TENDL-2015, AKONING  
alphas from (n,2n)a

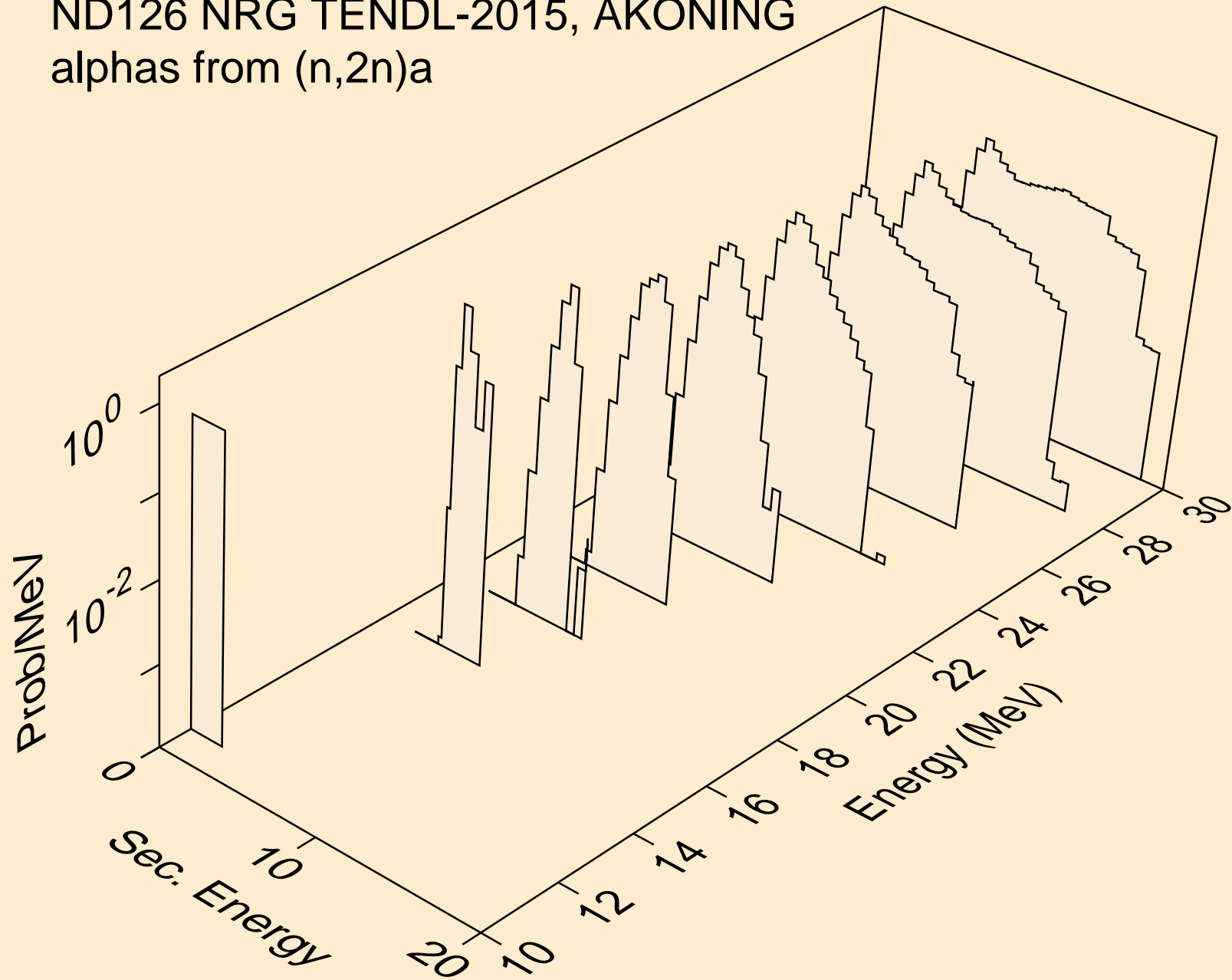



ND126 NRG TENDL-2015, AKONING  
alphas from (n,n\*)2a

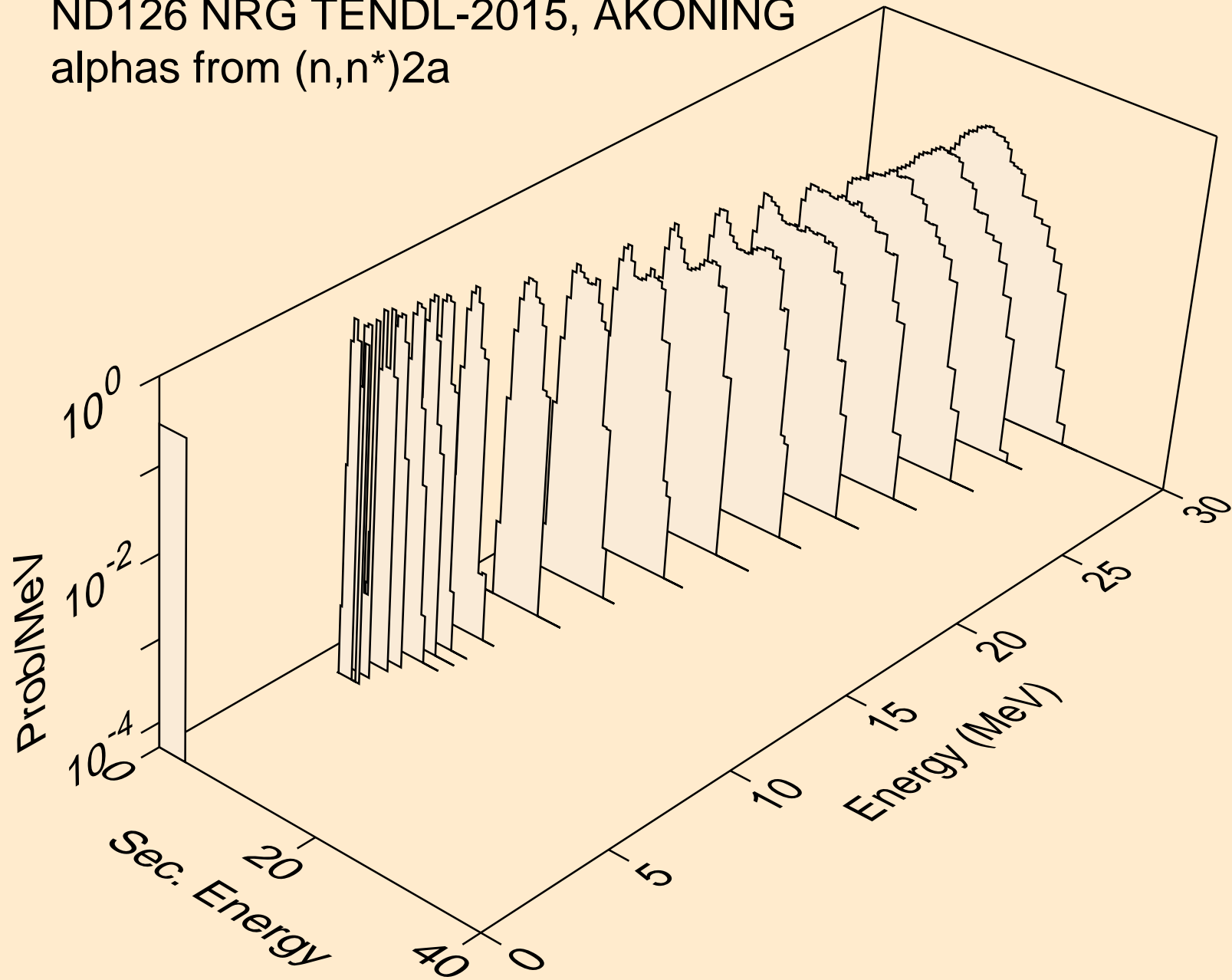

ND126 NRG TENDL-2015, AKONING  
alphas from (n,2n)2a

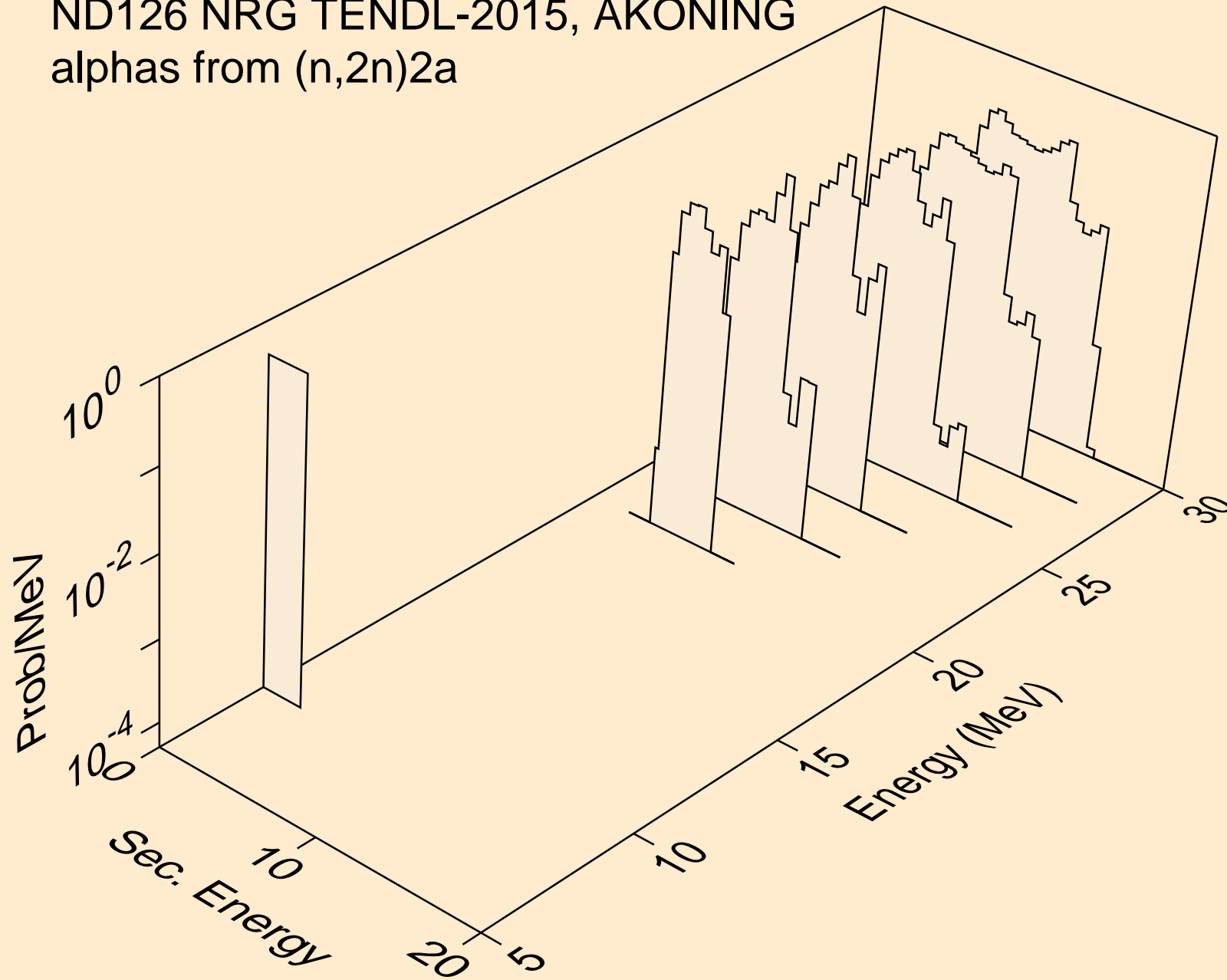

ND126 NRG TENDL-2015, AKONING  
alphas from (n,npa)

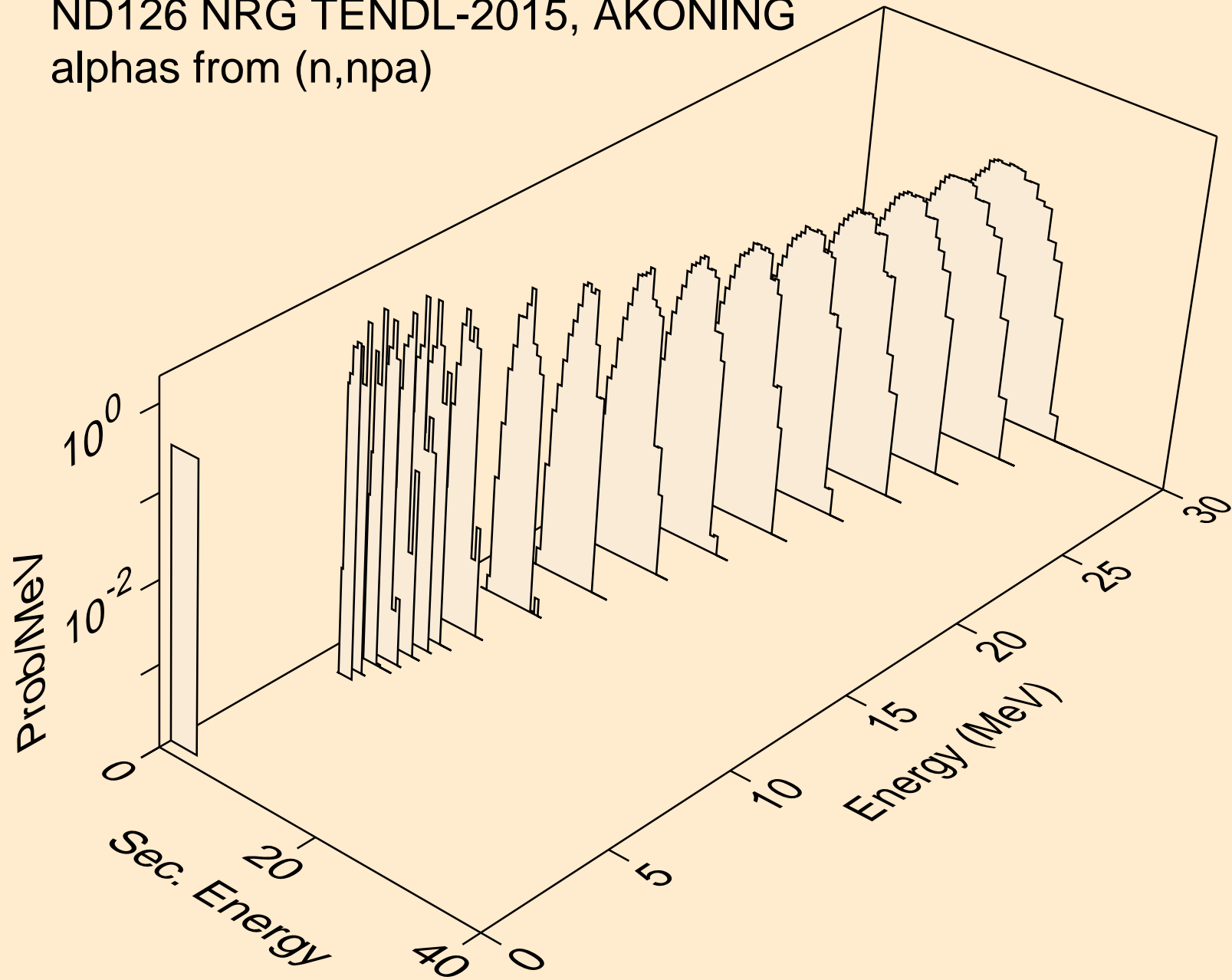

ND126 NRG TENDL-2015, AKONING  
alphas from (n,a)

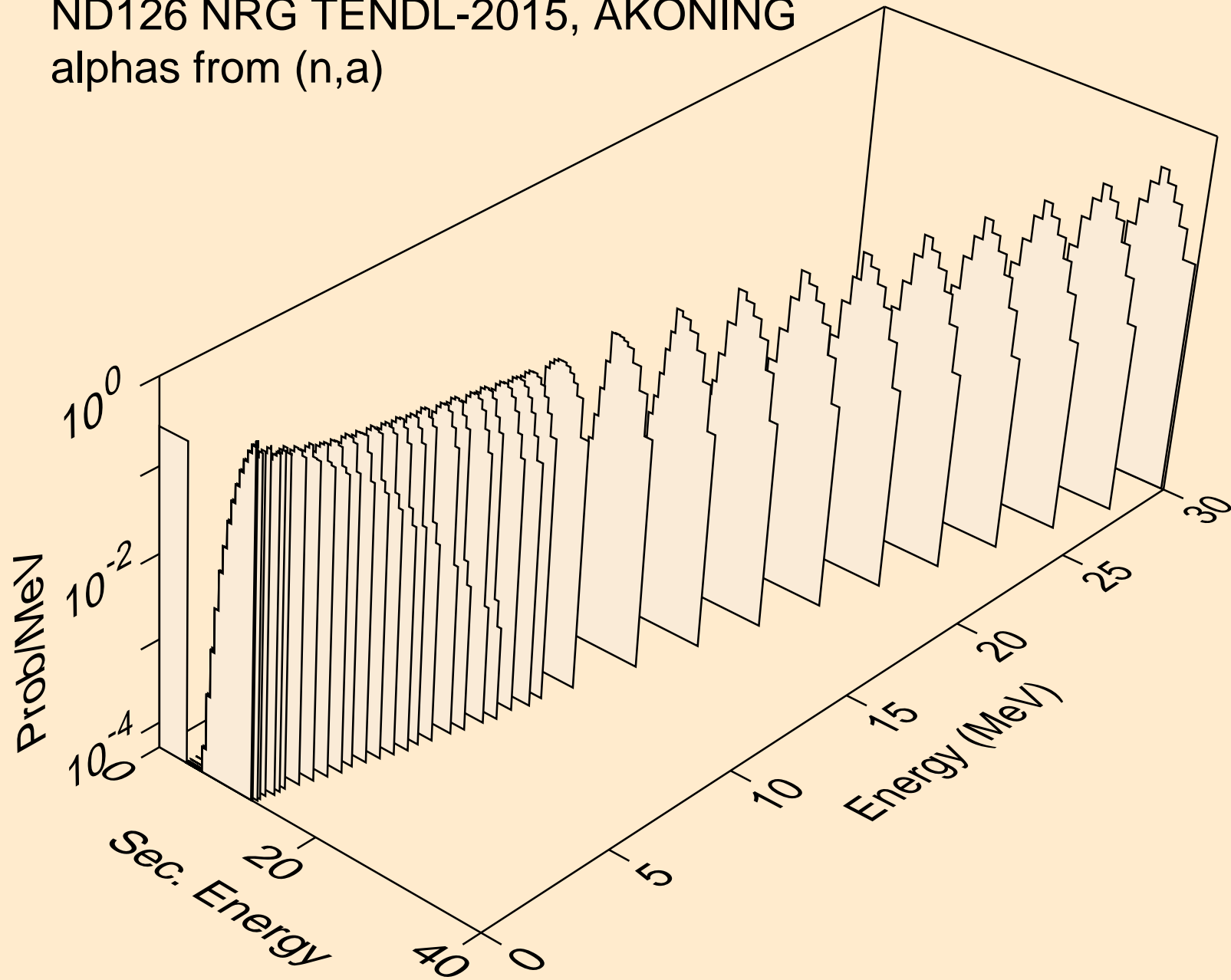

ND126 NRG TENDL-2015, AKONING  
alphas from (n,2a)

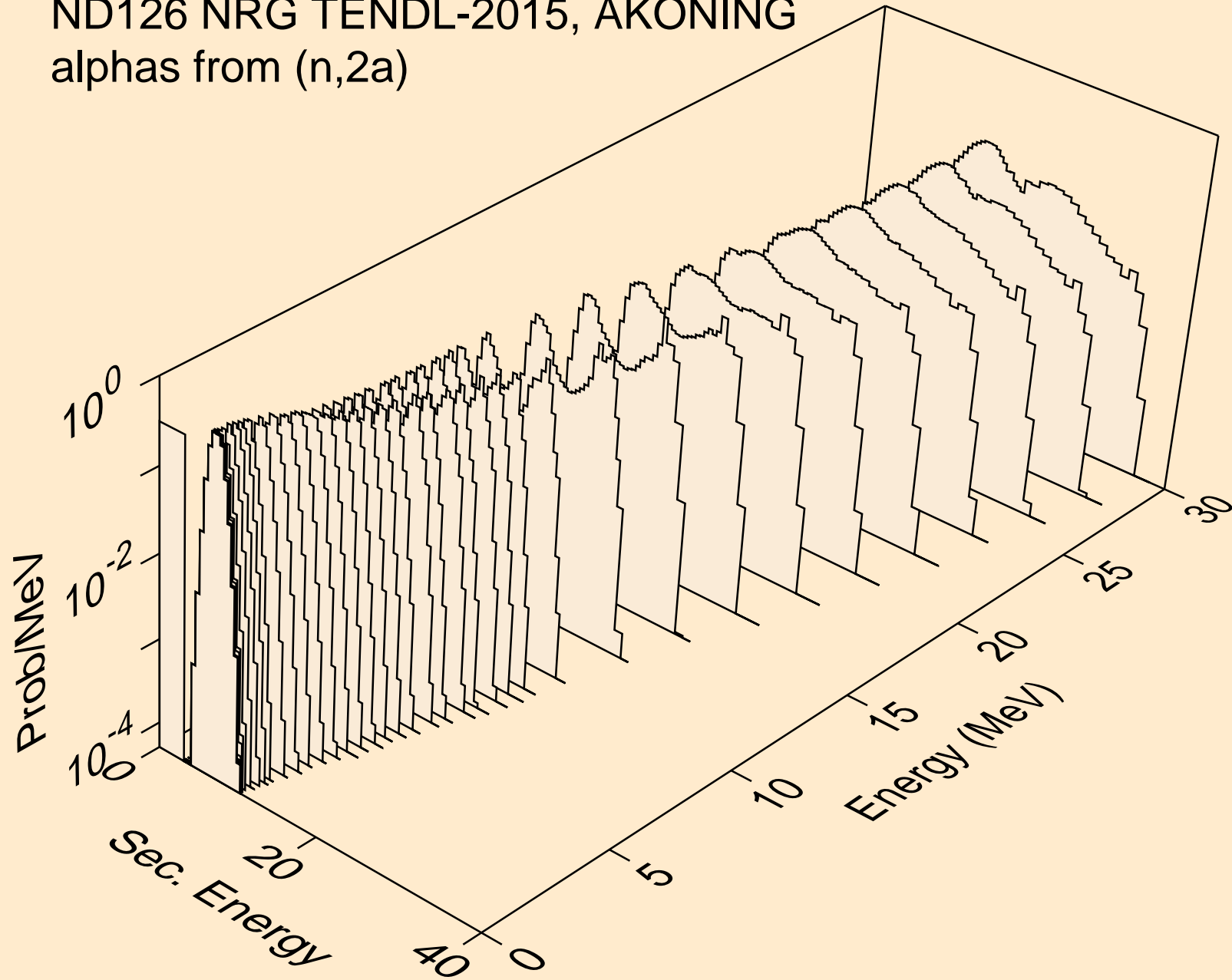

ND126 NRG TENDL-2015, AKONING  
alphas from (n,3a)

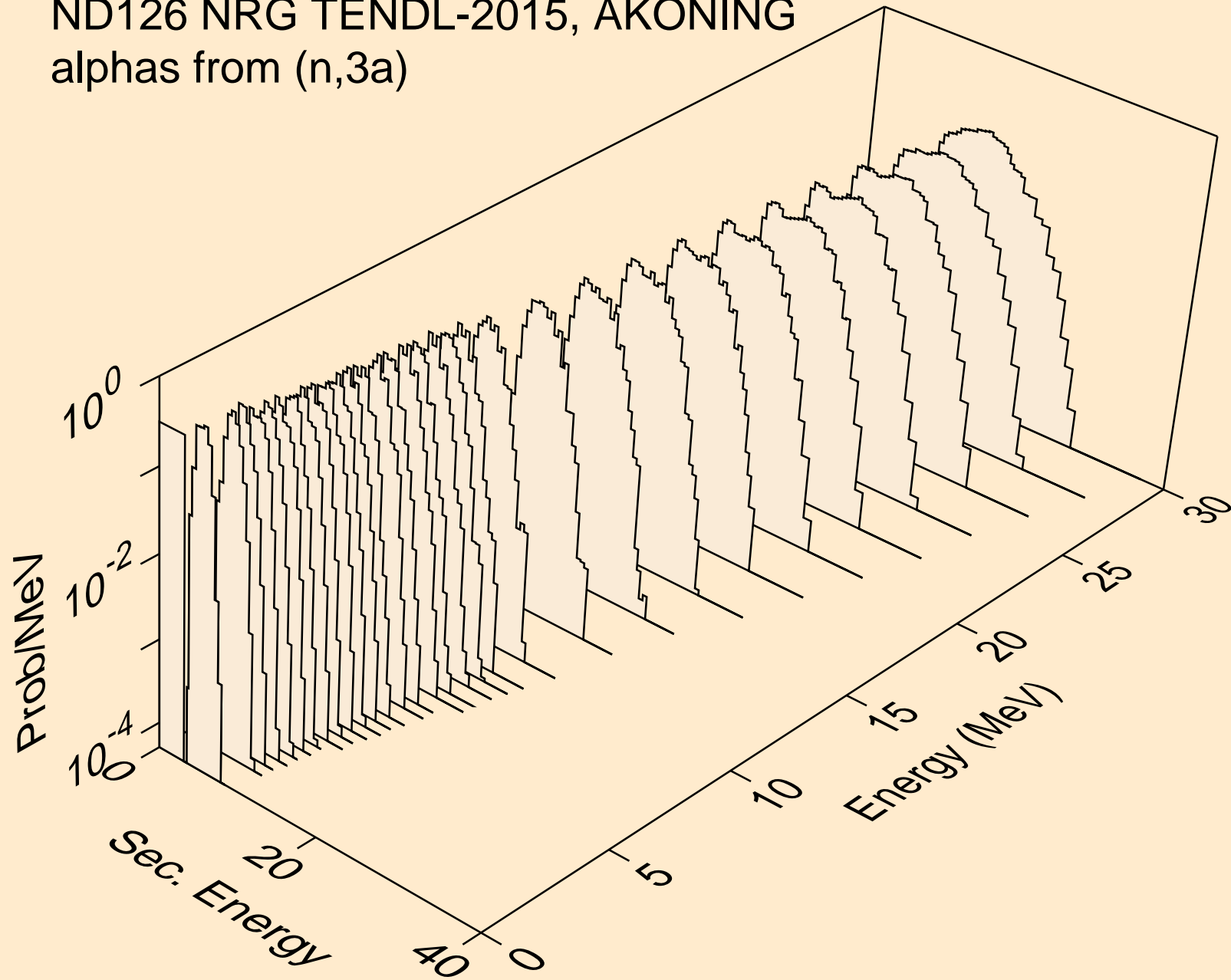

ND126 NRG TENDL-2015, AKONING  
alphas from (n,pa)

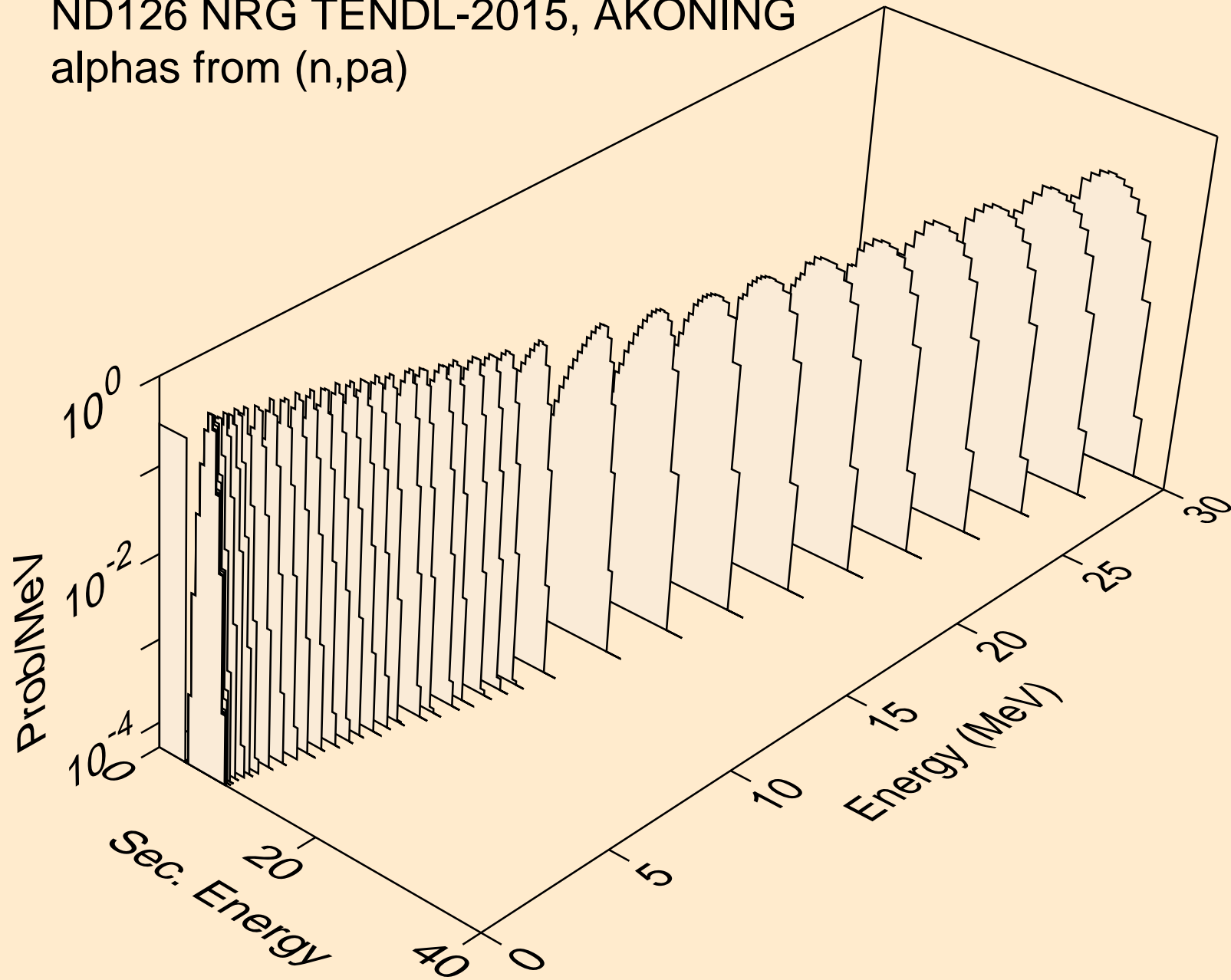

ND126 NRG TENDL-2015, AKONING  
alphas from (n,d2a)

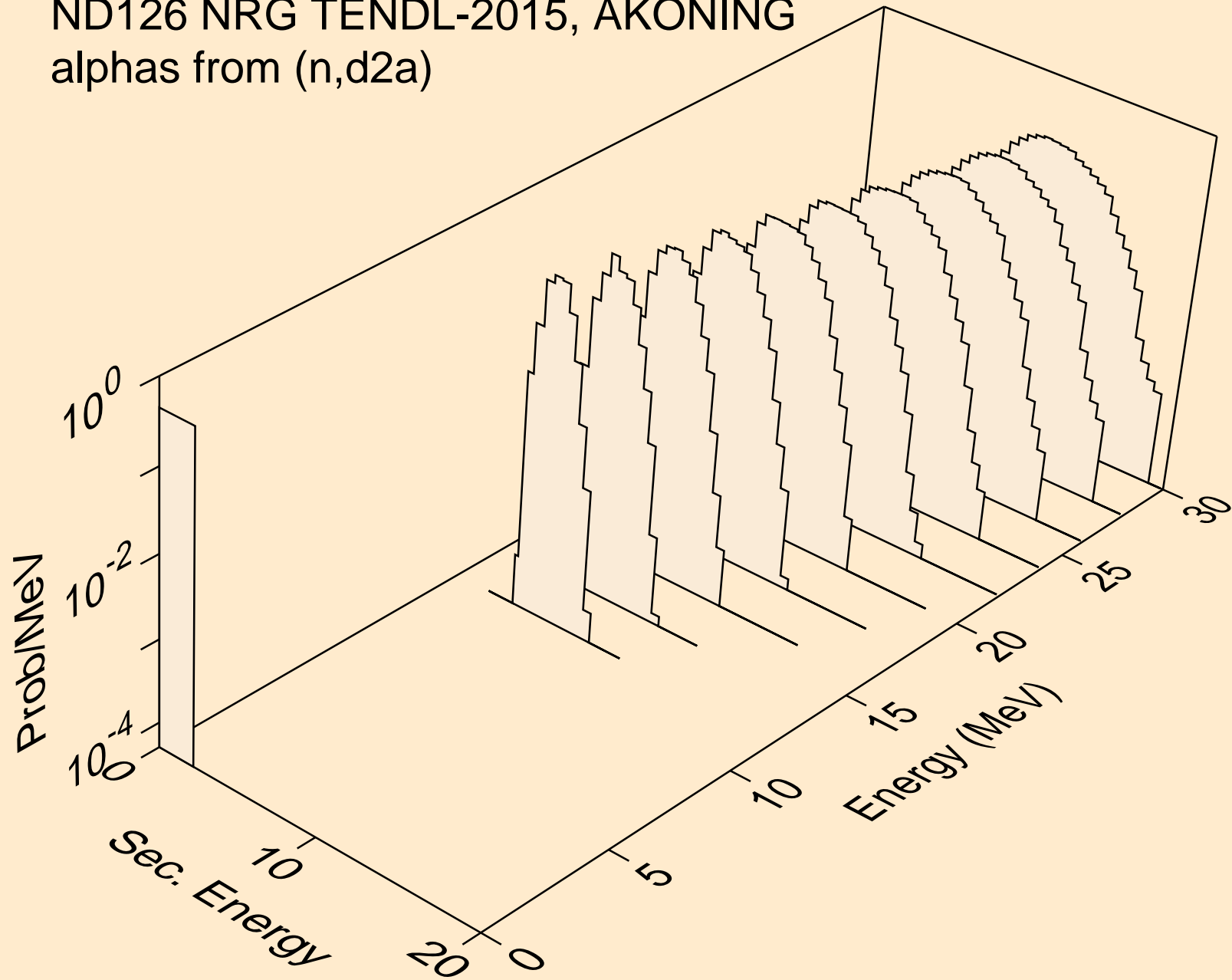



ND126 NRG TENDL-2015, AKONING  
alphas from (n,da)

