

ND127 NRG TENDL-2015, AKONING

Principal cross sections

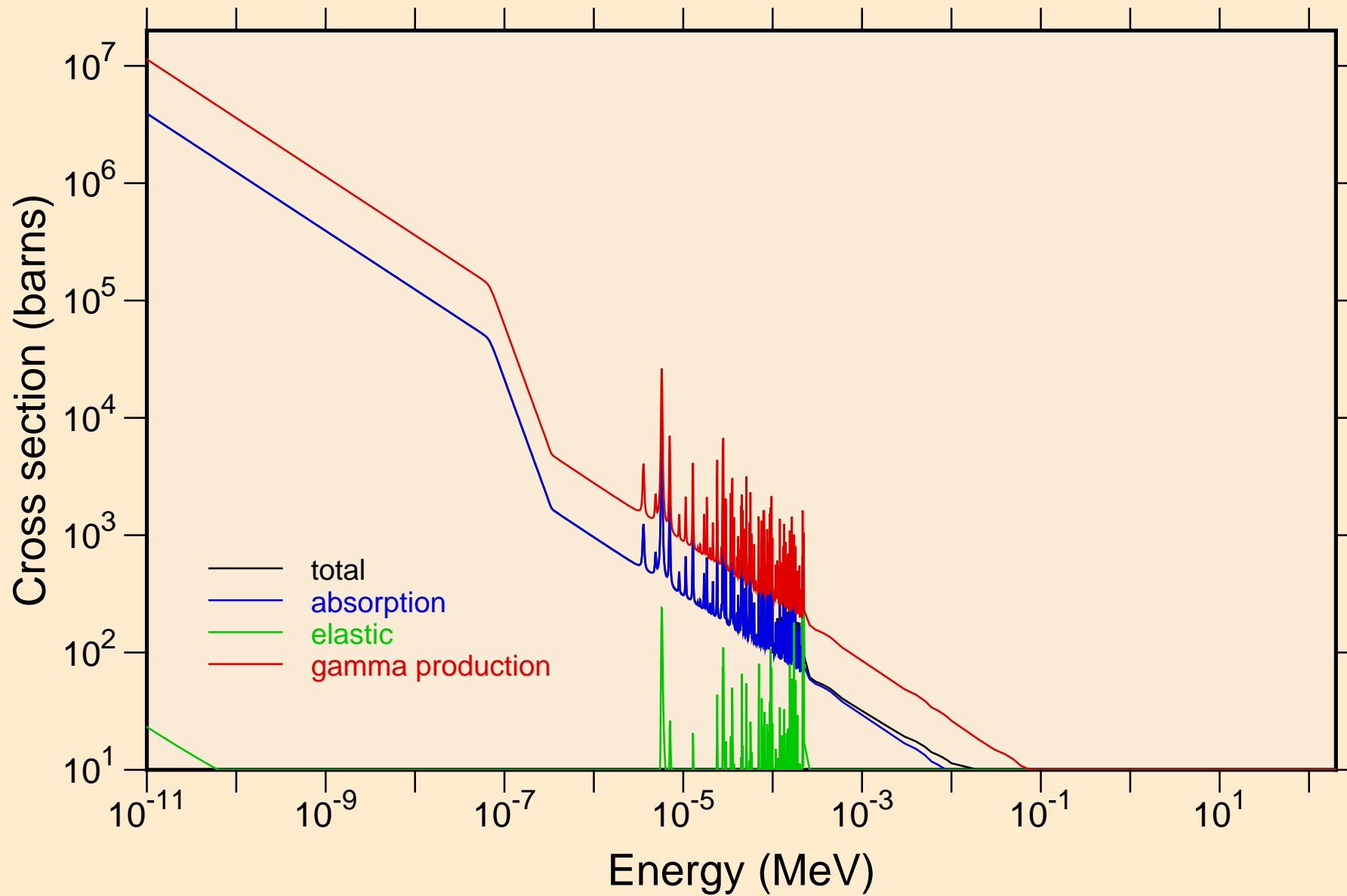

ND127 NRG TENDL-2015, AKONING
resonance total cross section

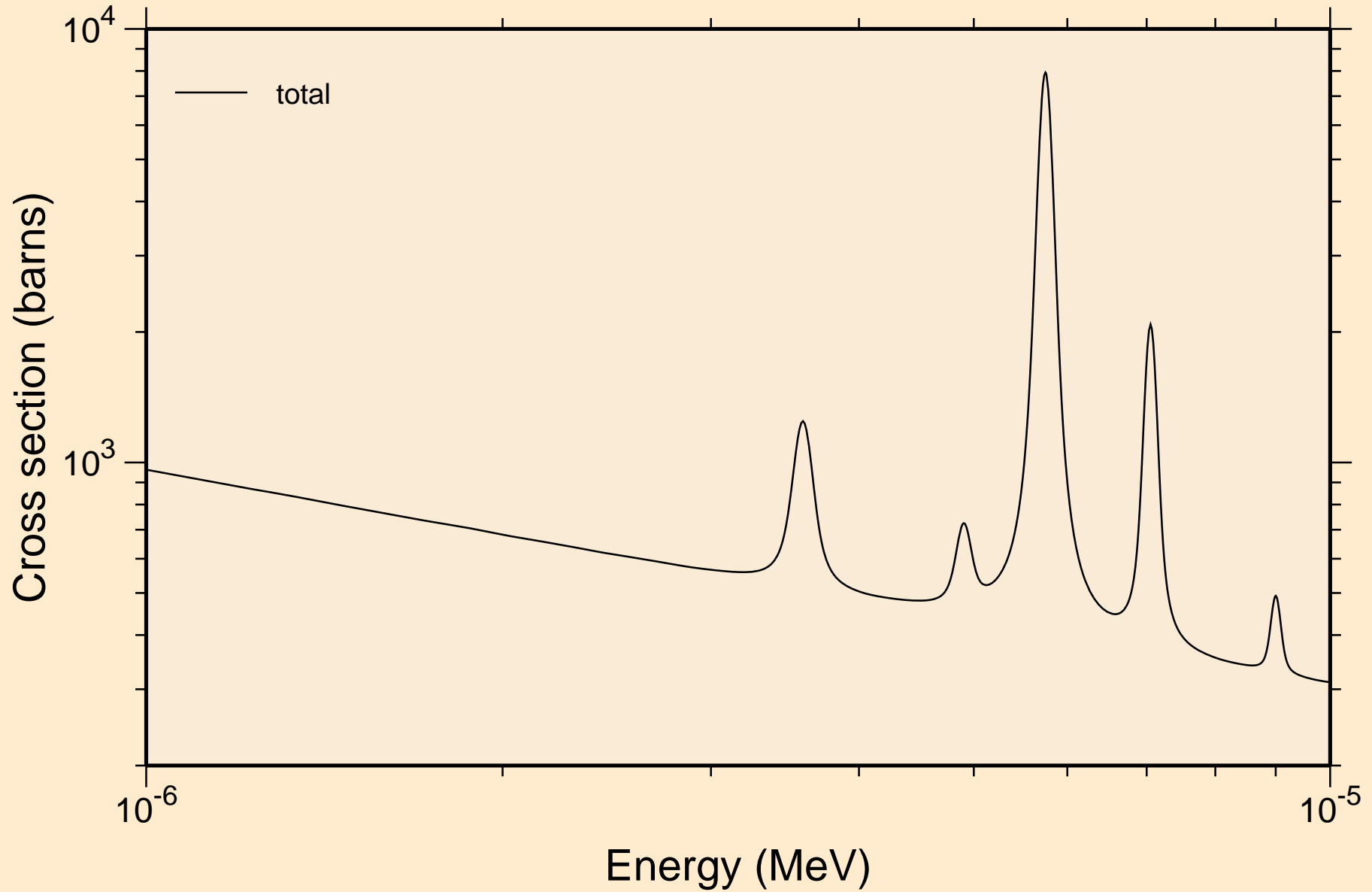

ND127 NRG TENDL-2015, AKONING
resonance total cross section

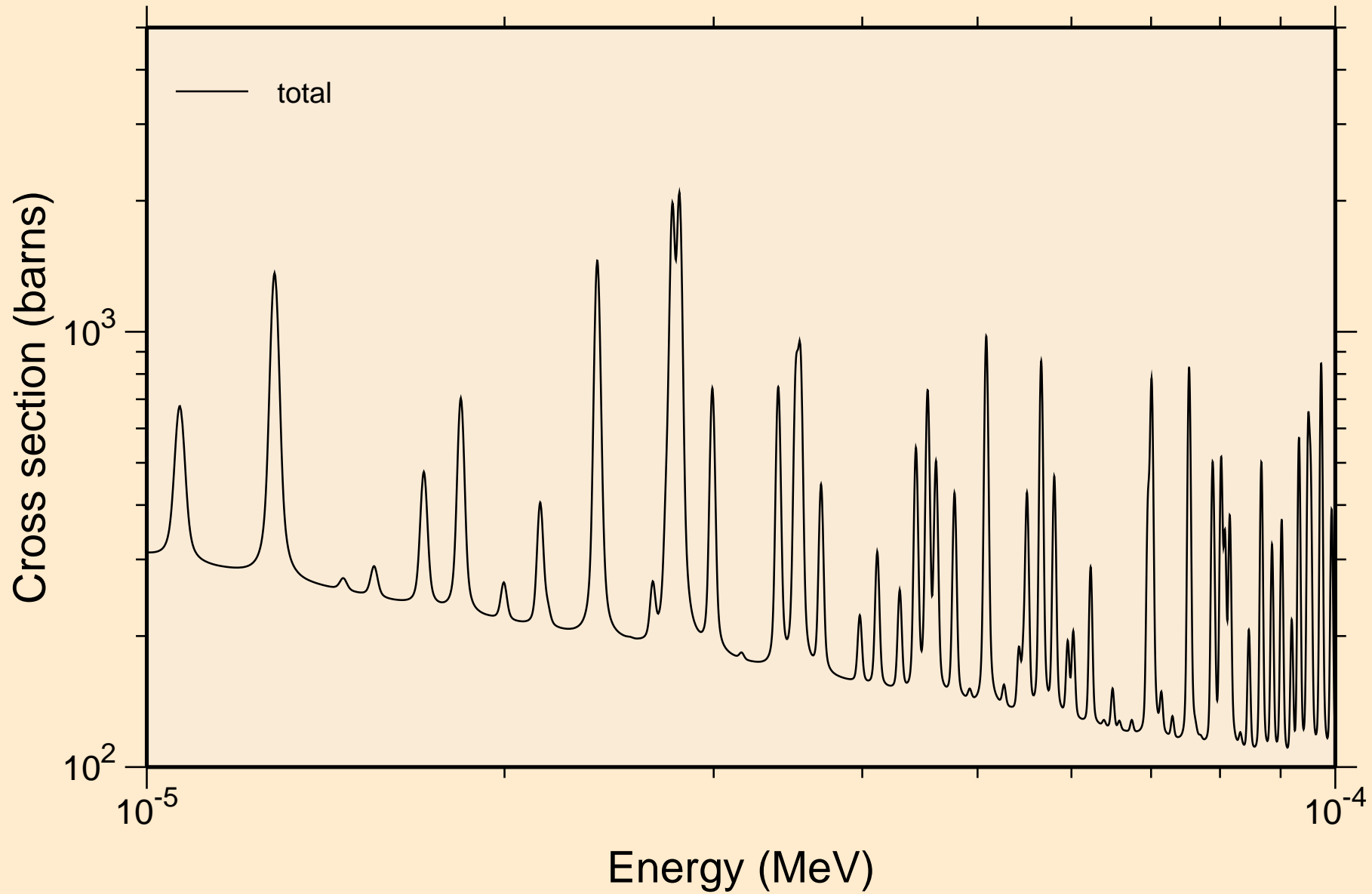

ND127 NRG TENDL-2015, AKONING
resonance total cross section

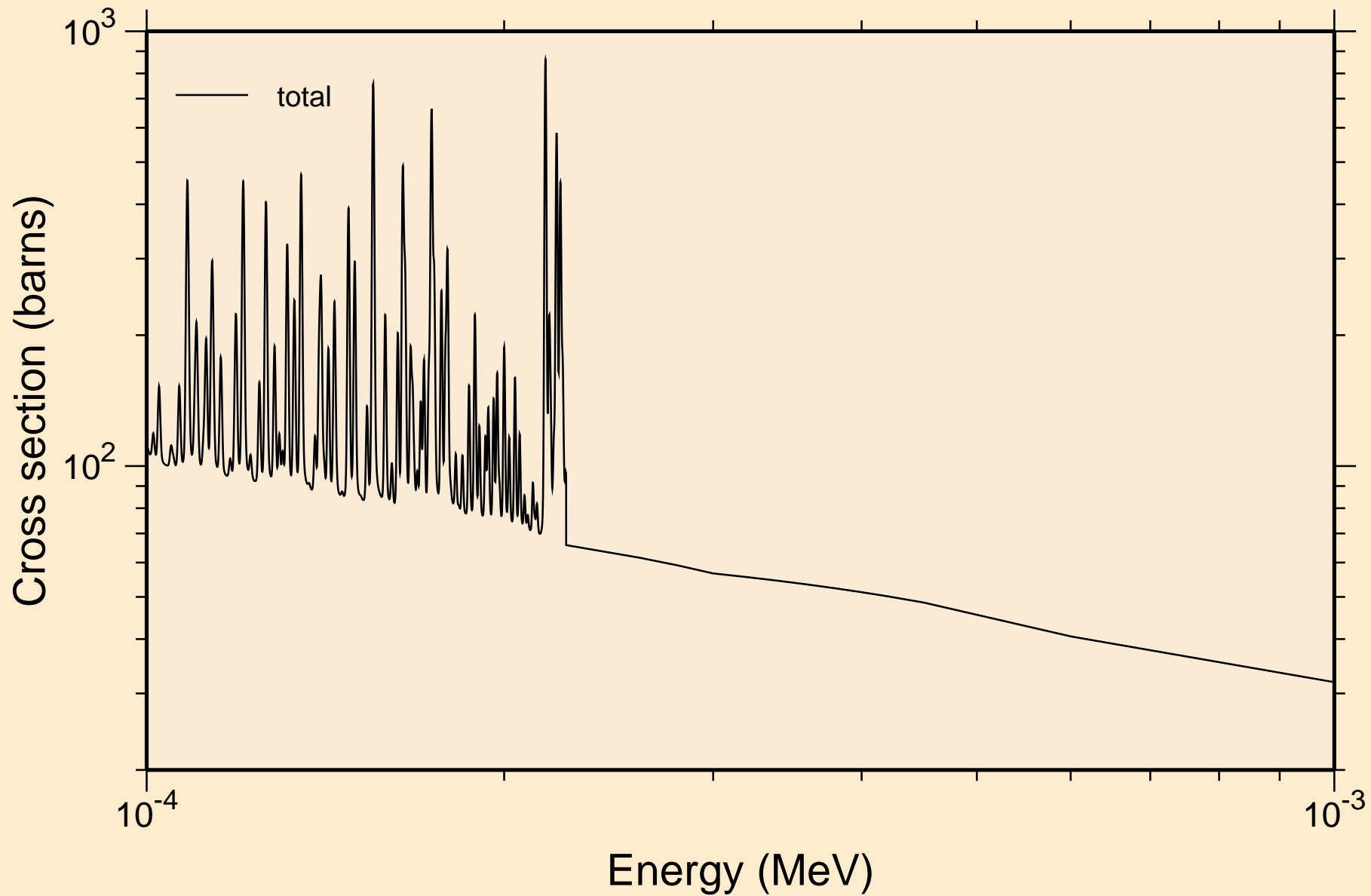

ND127 NRG TENDL-2015, AKONING
resonance total cross section

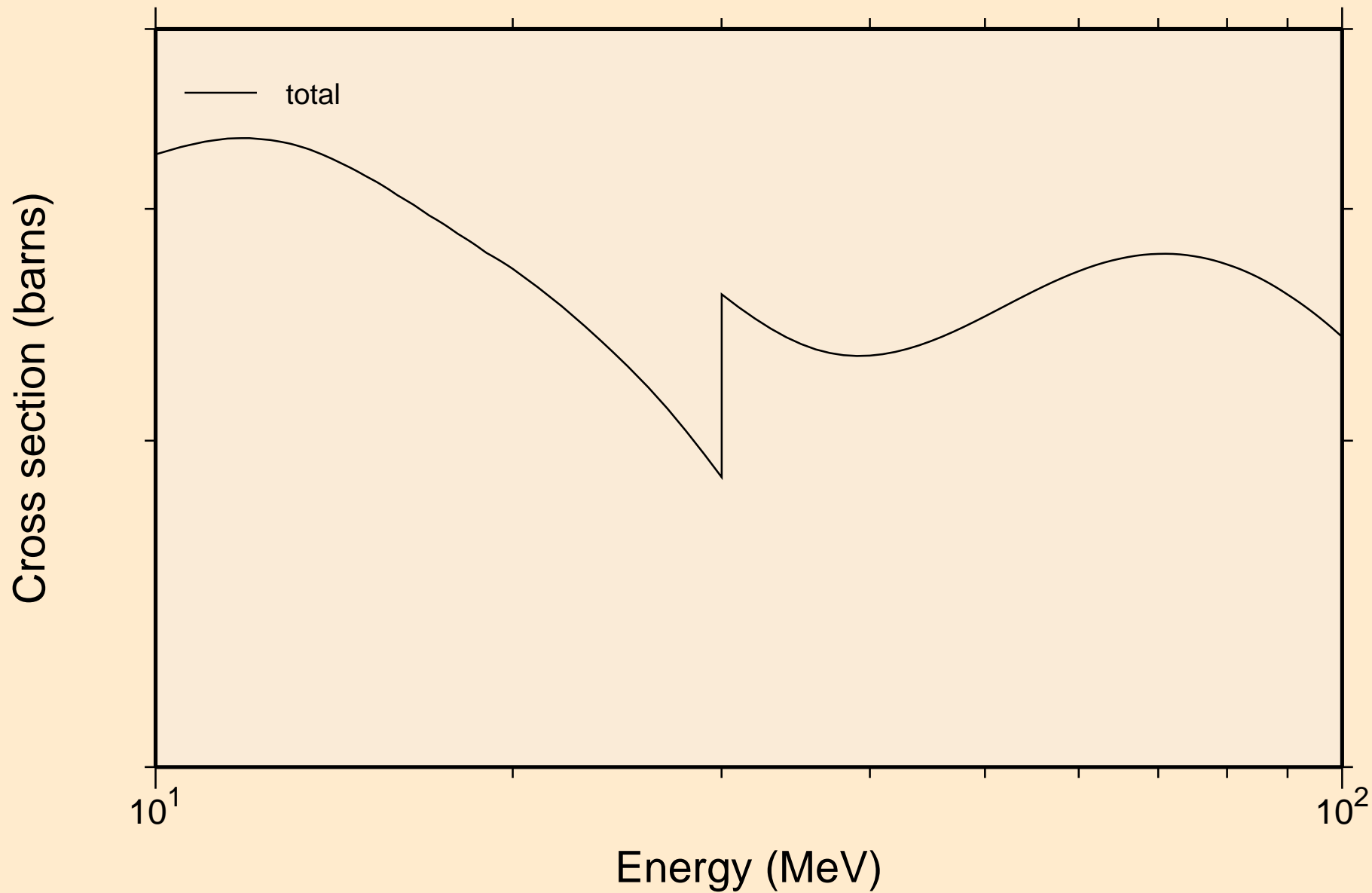

ND127 NRG TENDL-2015, AKONING resonance absorption cross sections

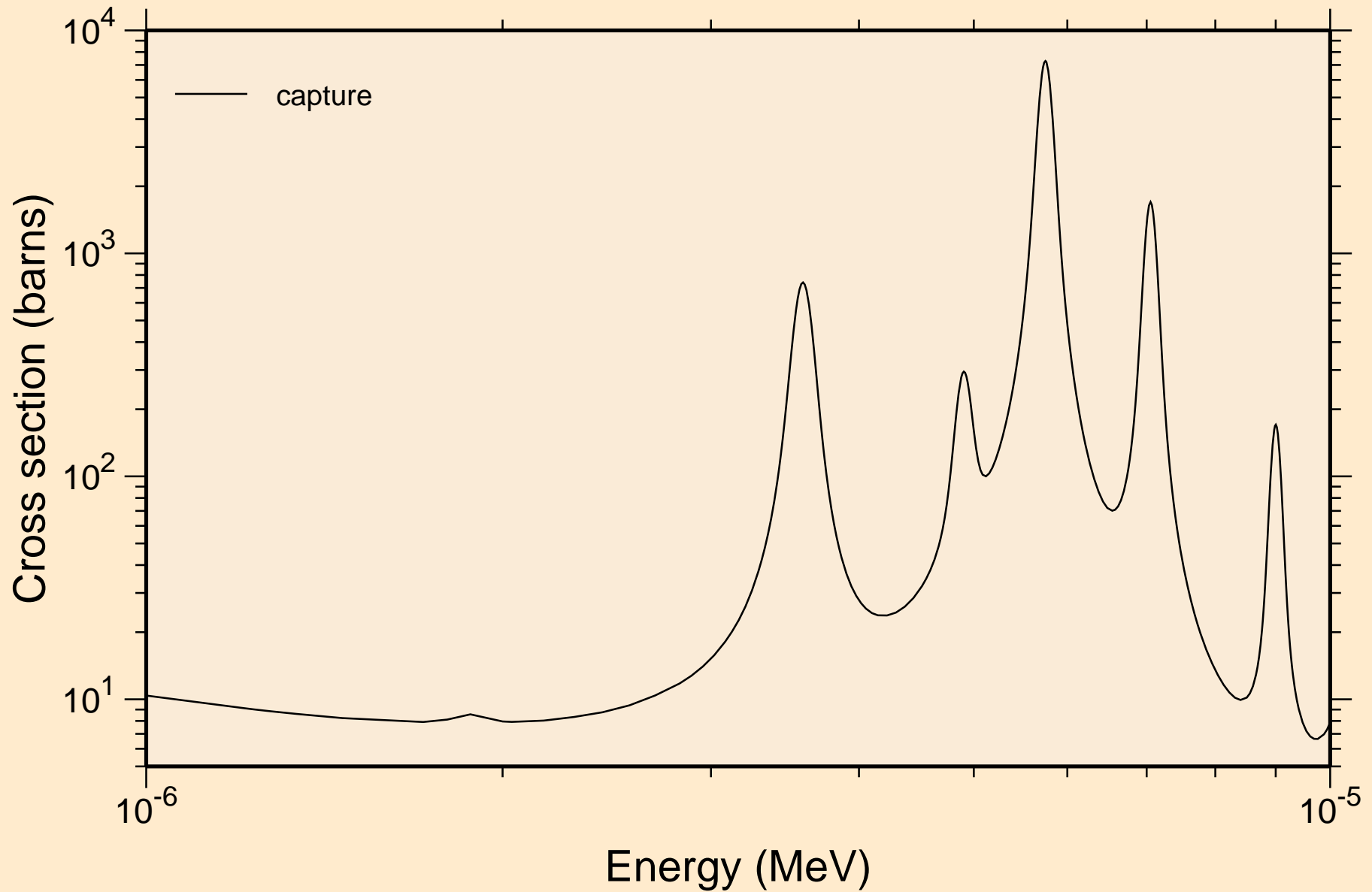

ND127 NRG TENDL-2015, AKONING resonance absorption cross sections

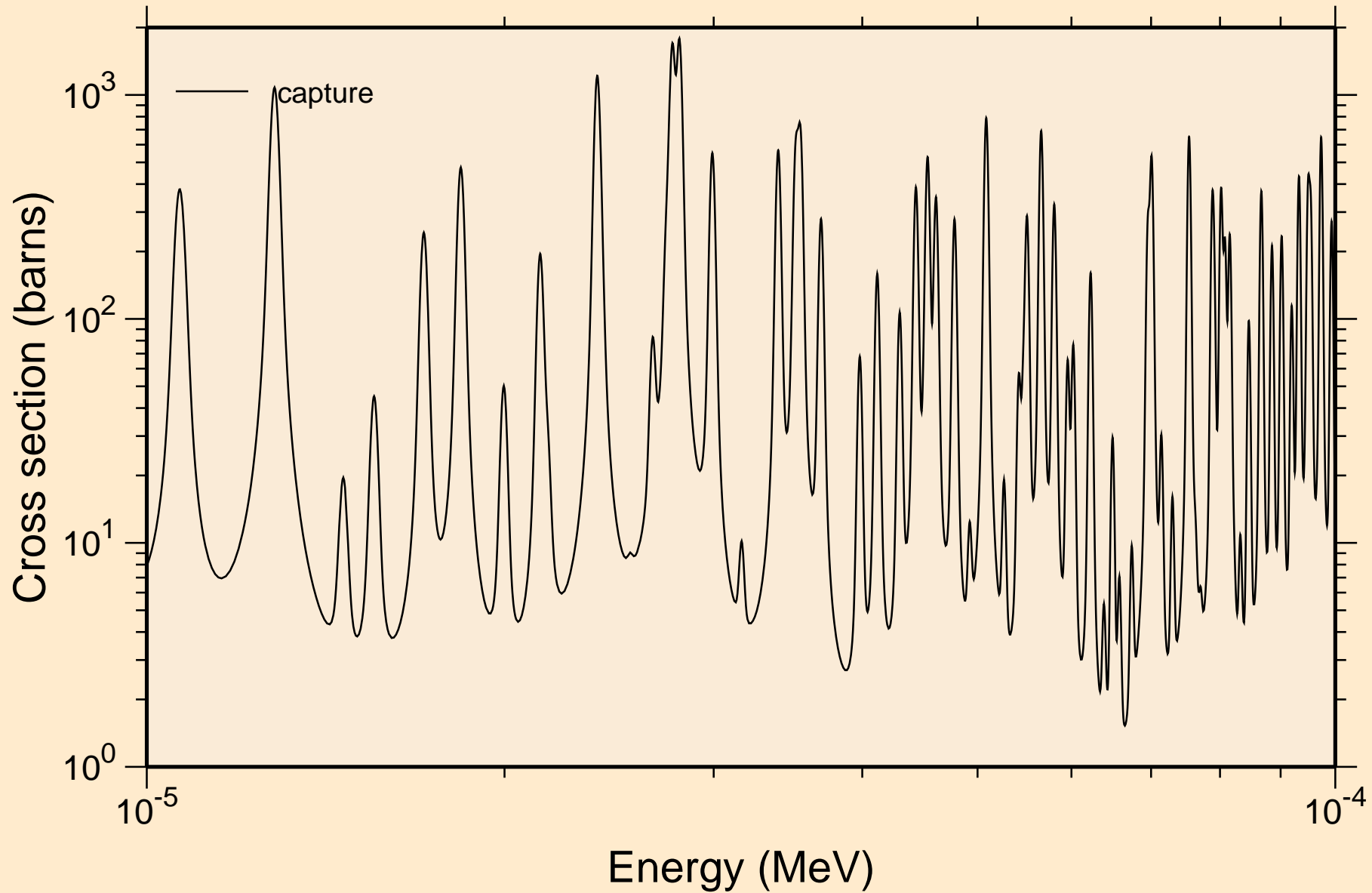

ND127 NRG TENDL-2015, AKONING resonance absorption cross sections

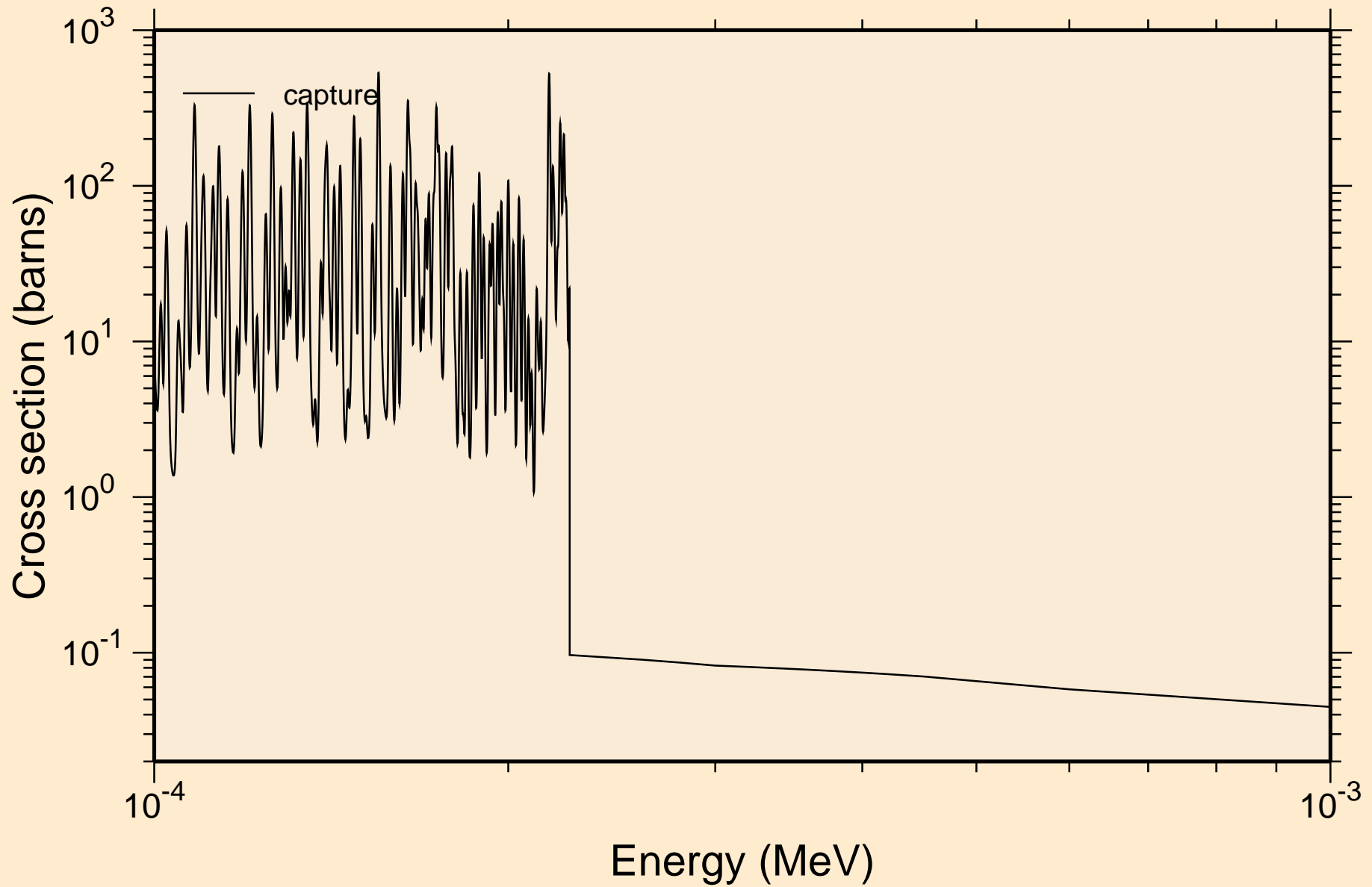

ND127 NRG TENDL-2015, AKONING
resonance absorption cross sections

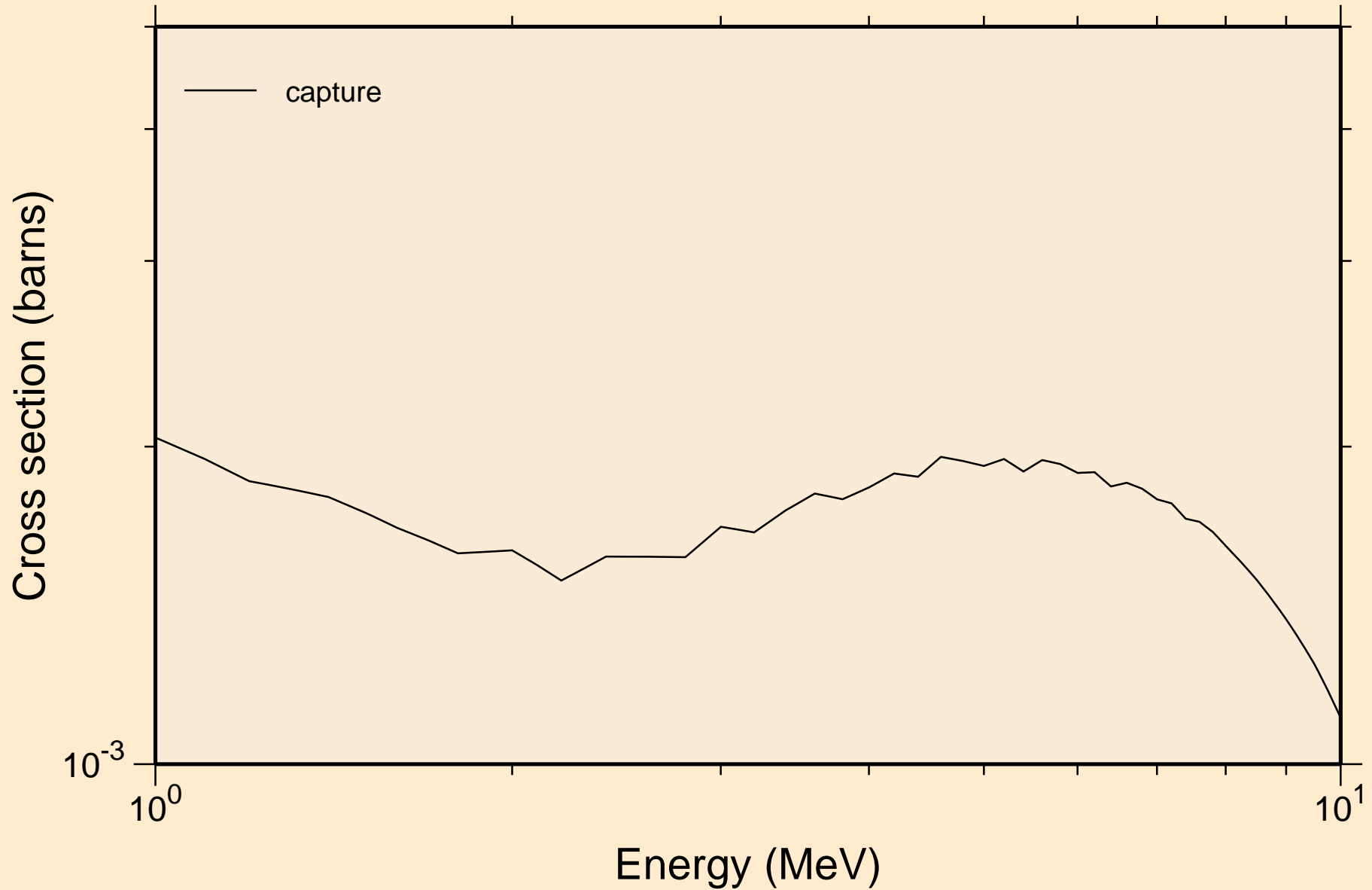

ND127 NRG TENDL-2015, AKONING

Non-threshold reactions

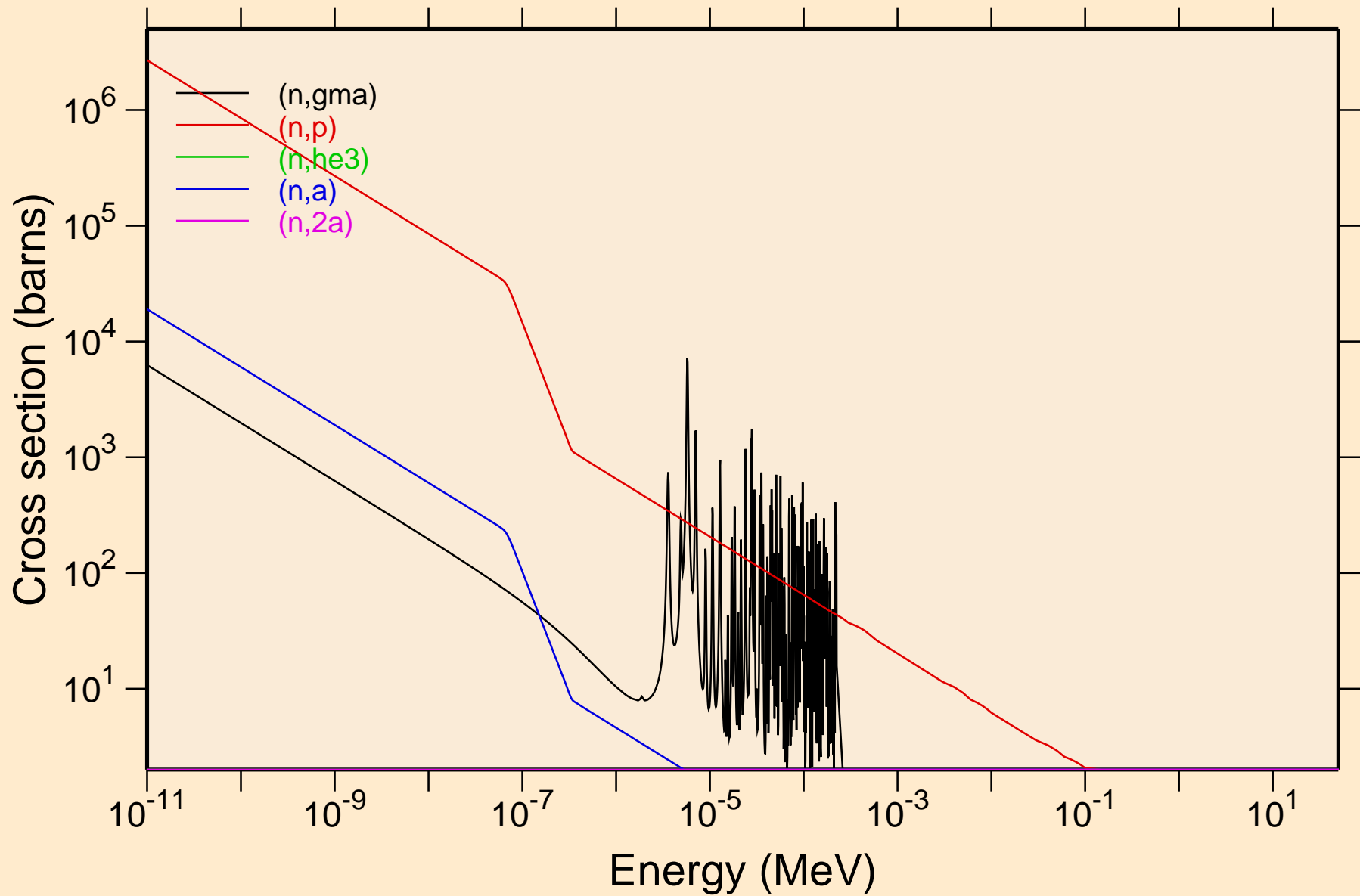

ND127 NRG TENDL-2015, AKONING

Non-threshold reactions

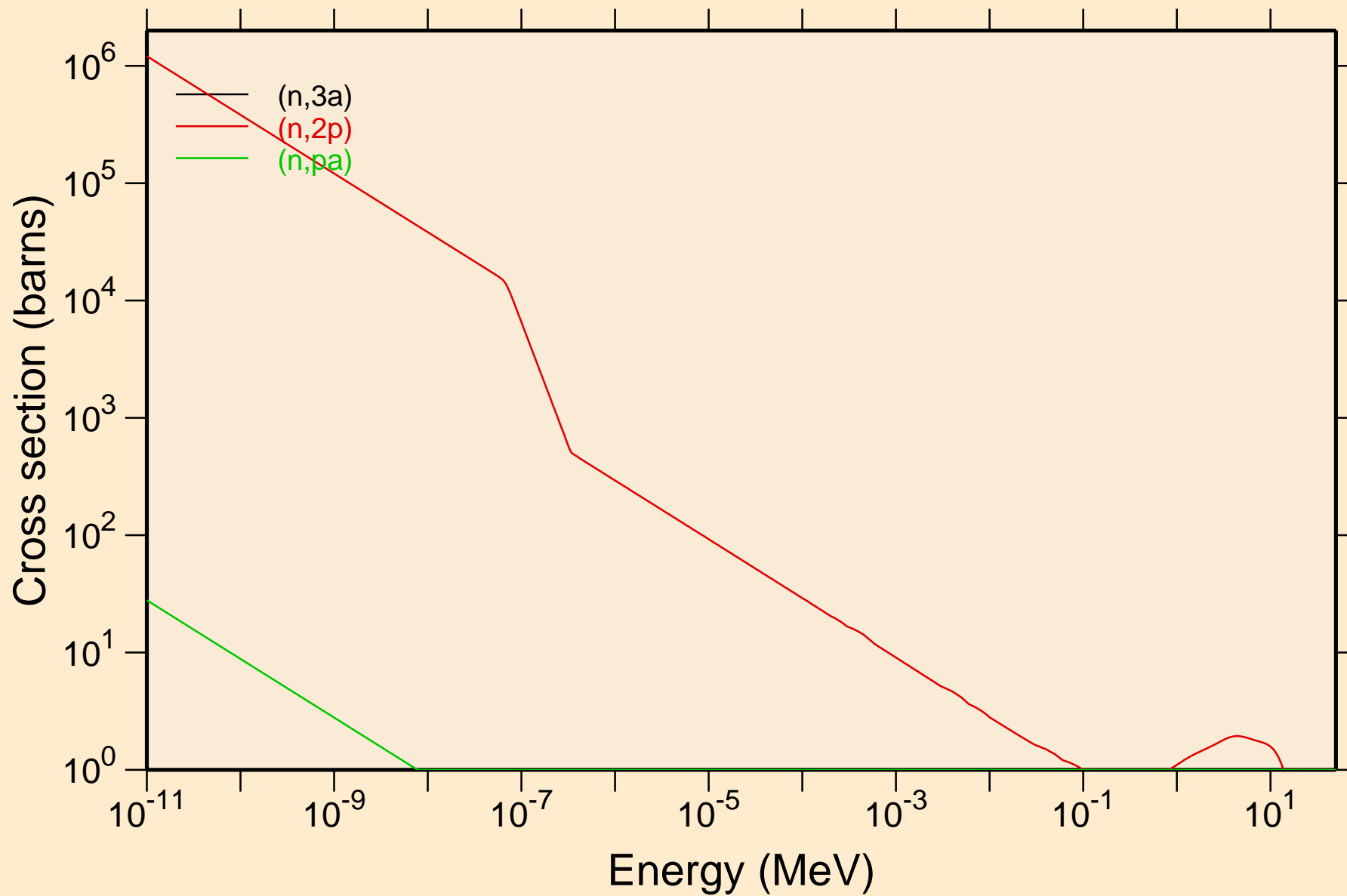

ND127 NRG TENDL-2015, AKONING

Principal cross sections

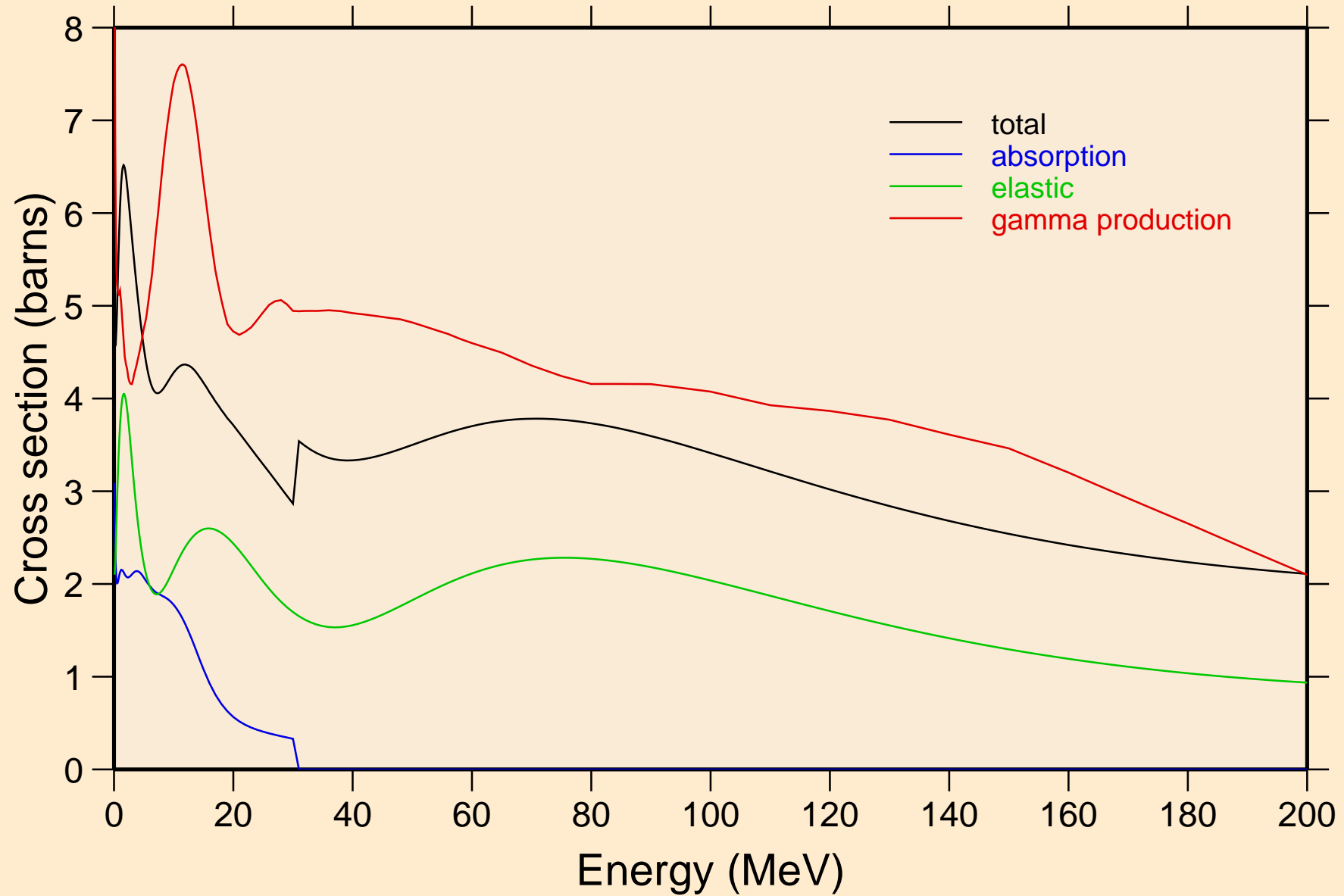

ND127 NRG TENDL-2015, AKONING

Non-threshold reactions

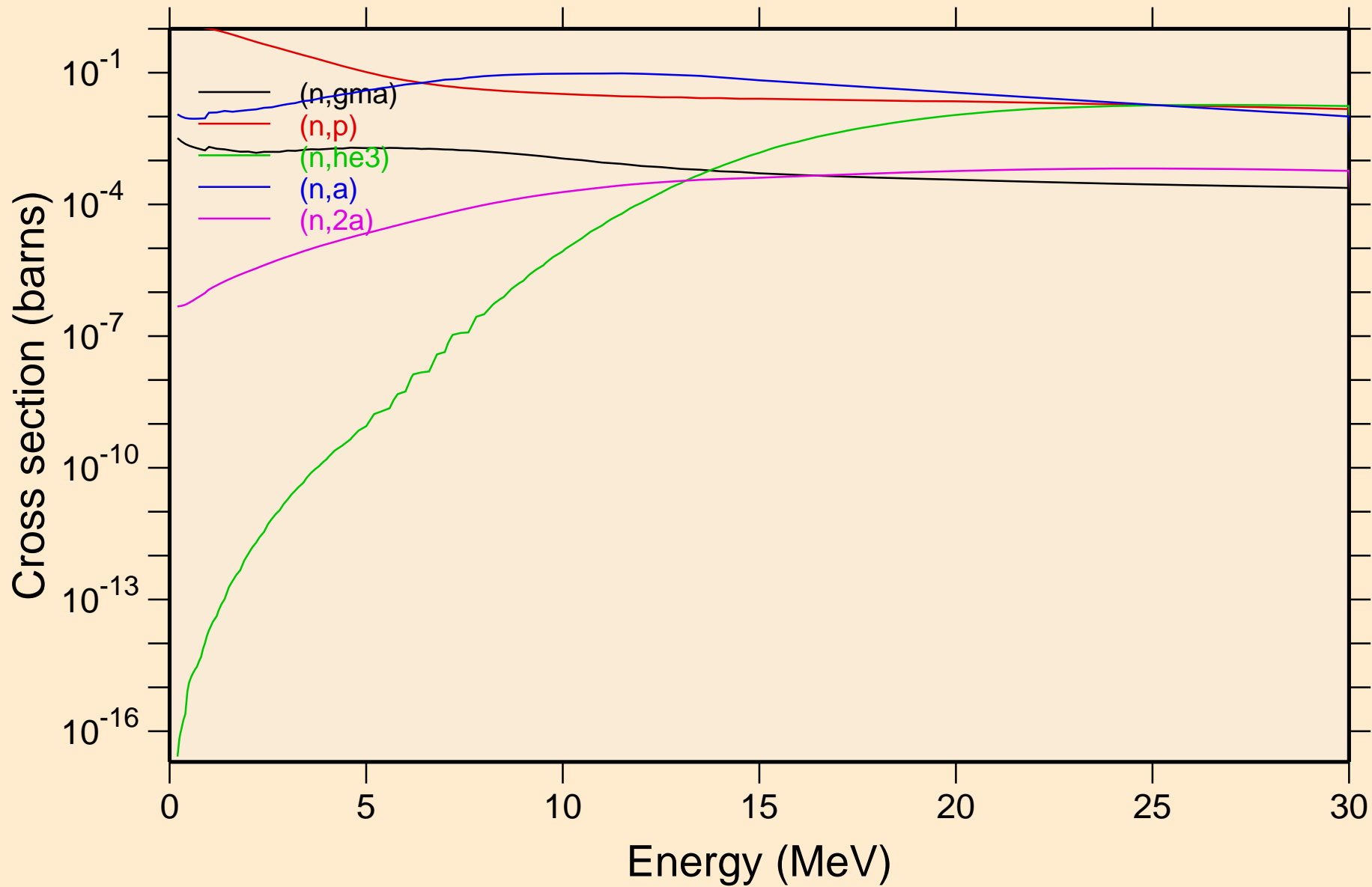

ND127 NRG TENDL-2015, AKONING

Non-threshold reactions

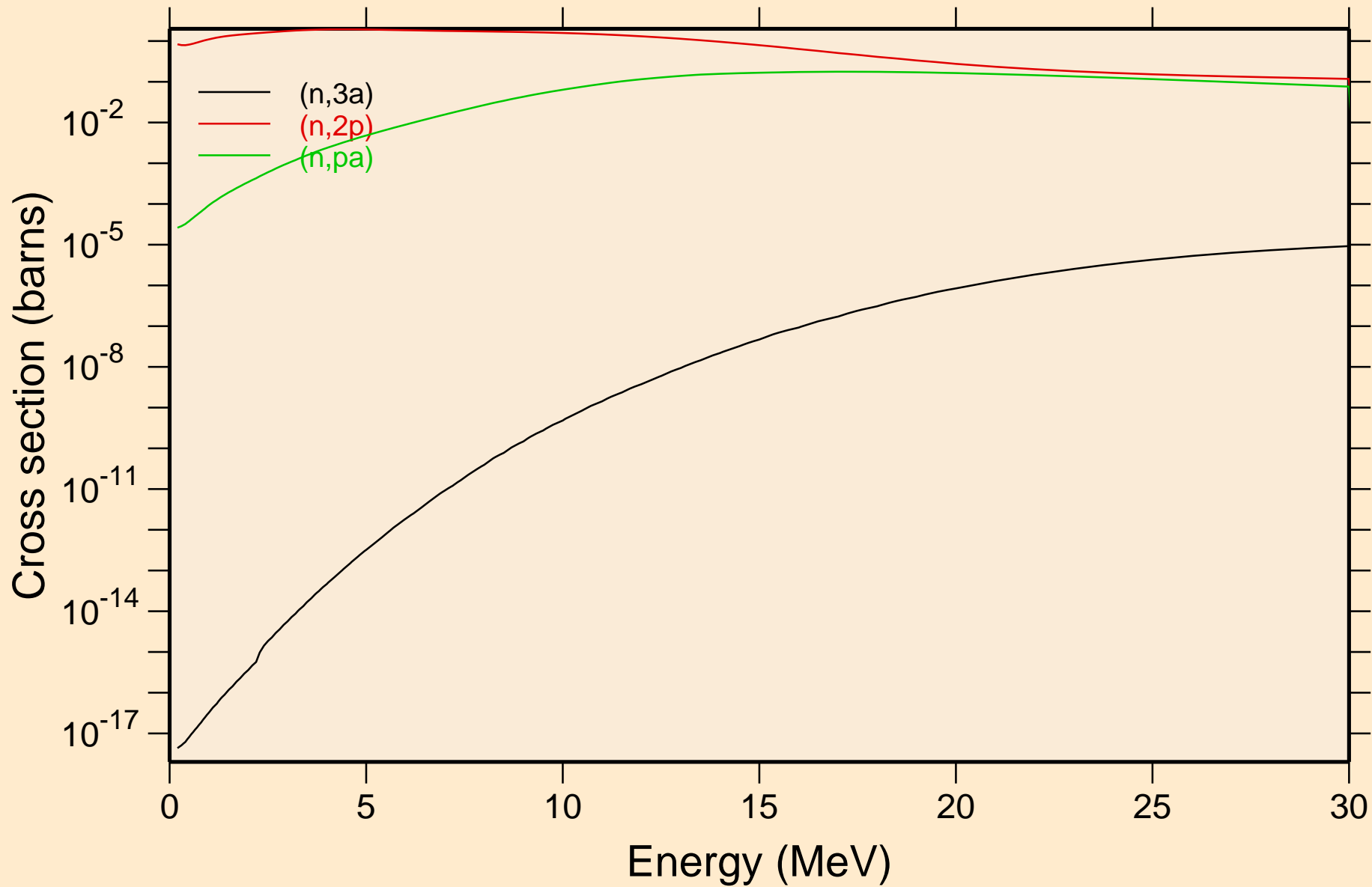

ND127 NRG TENDL-2015, AKONING

Inelastic levels

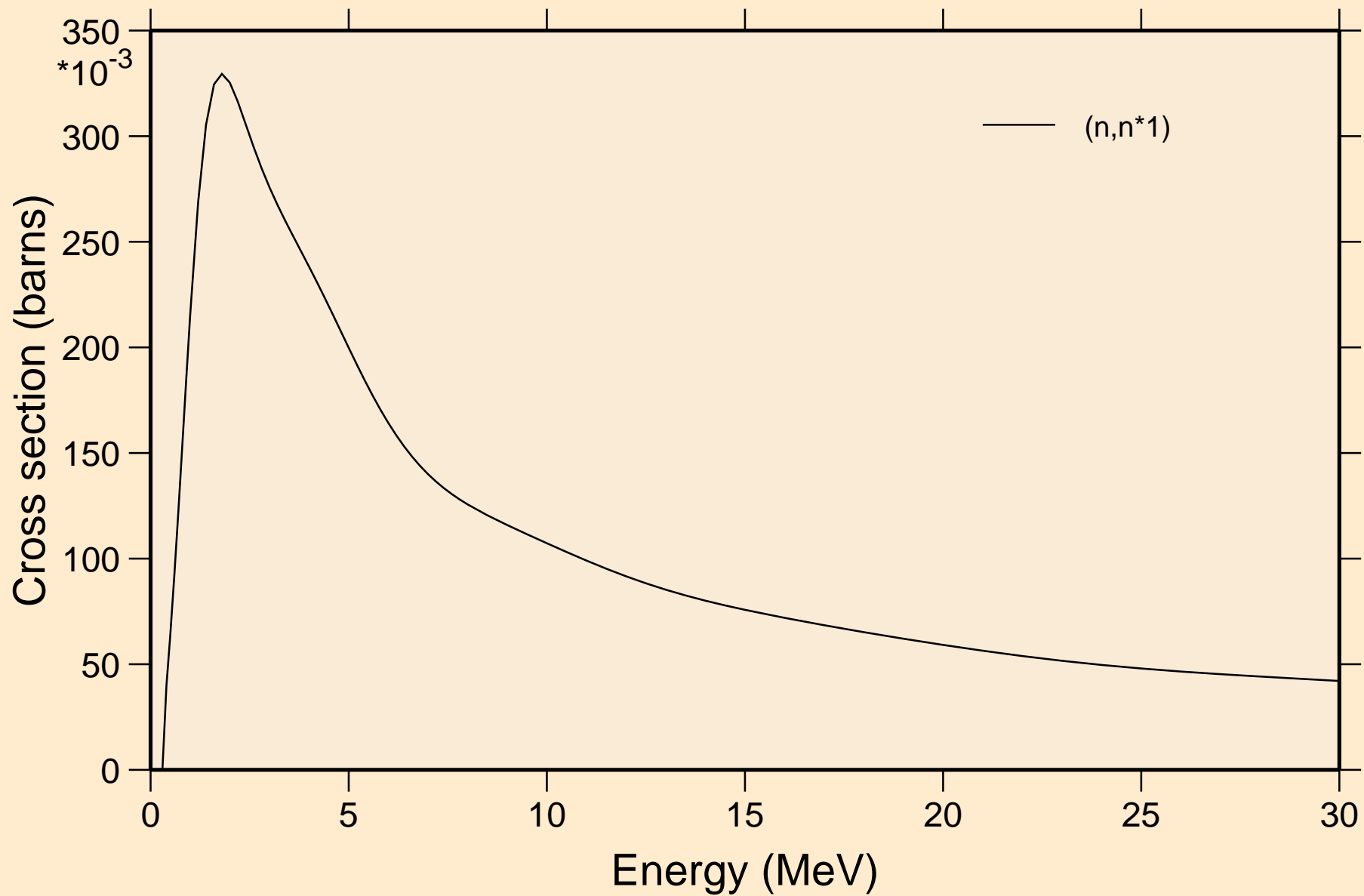

ND127 NRG TENDL-2015, AKONING

Threshold reactions

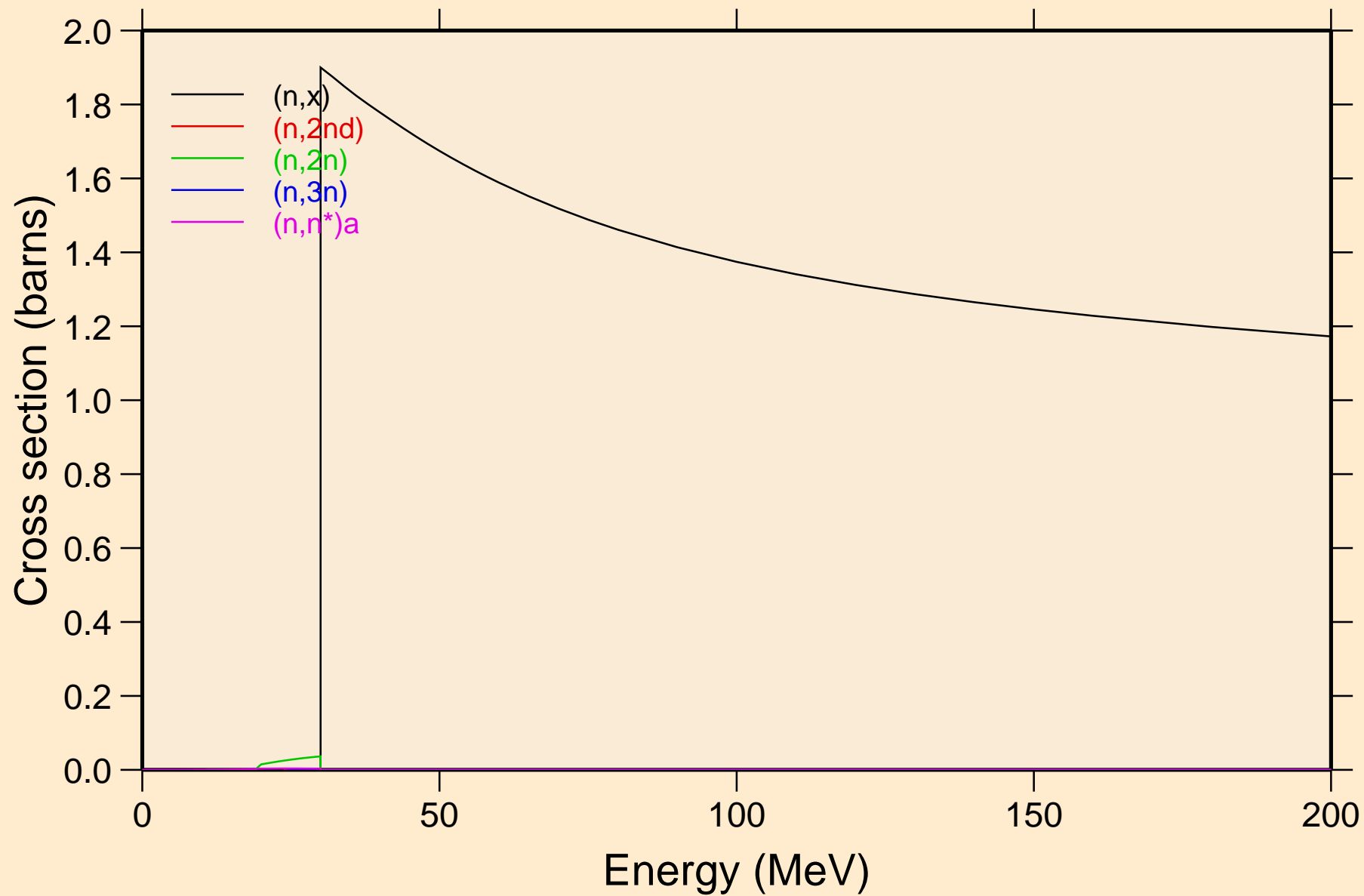

ND127 NRG TENDL-2015, AKONING

Threshold reactions

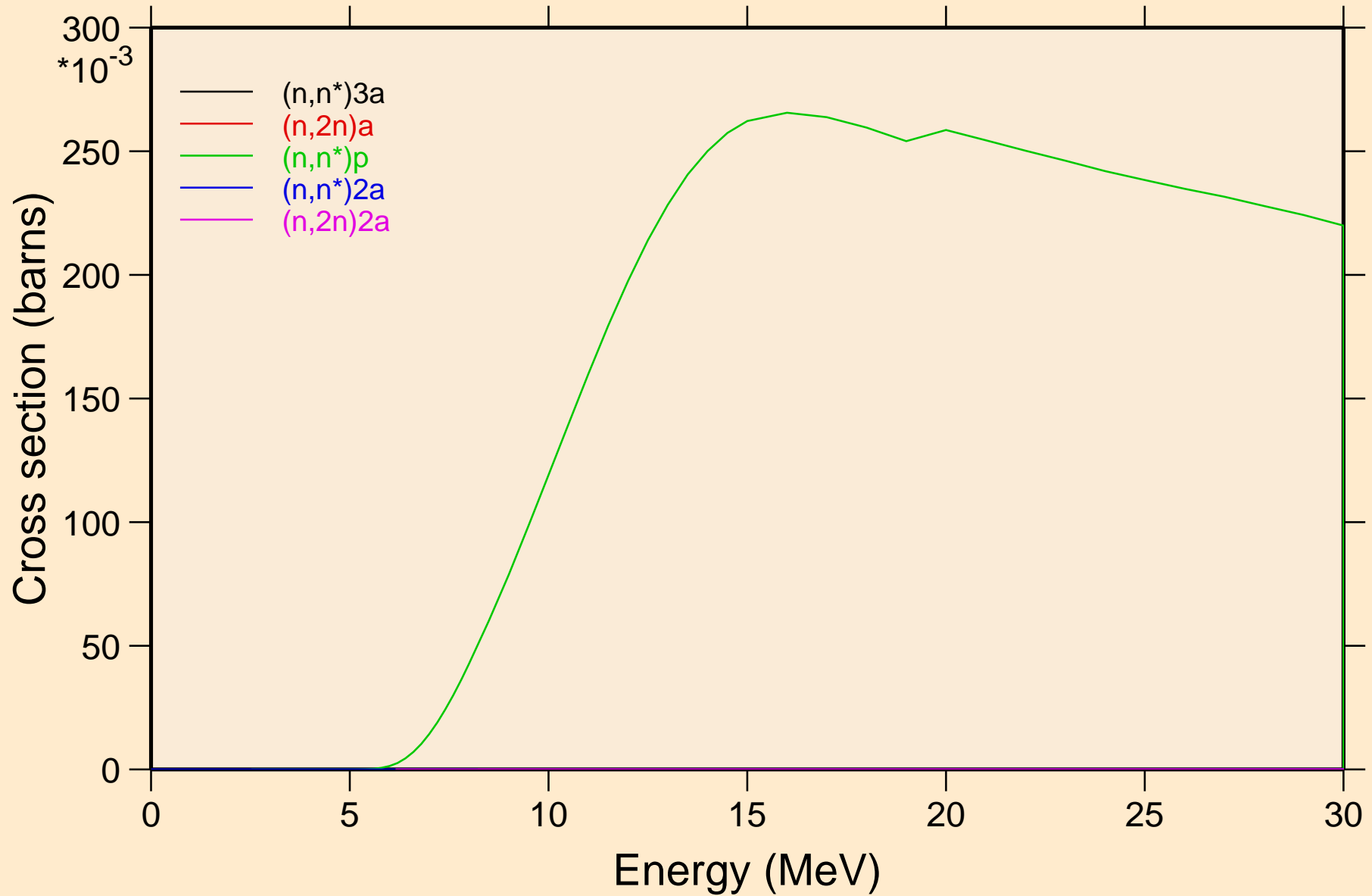

ND127 NRG TENDL-2015, AKONING

Threshold reactions

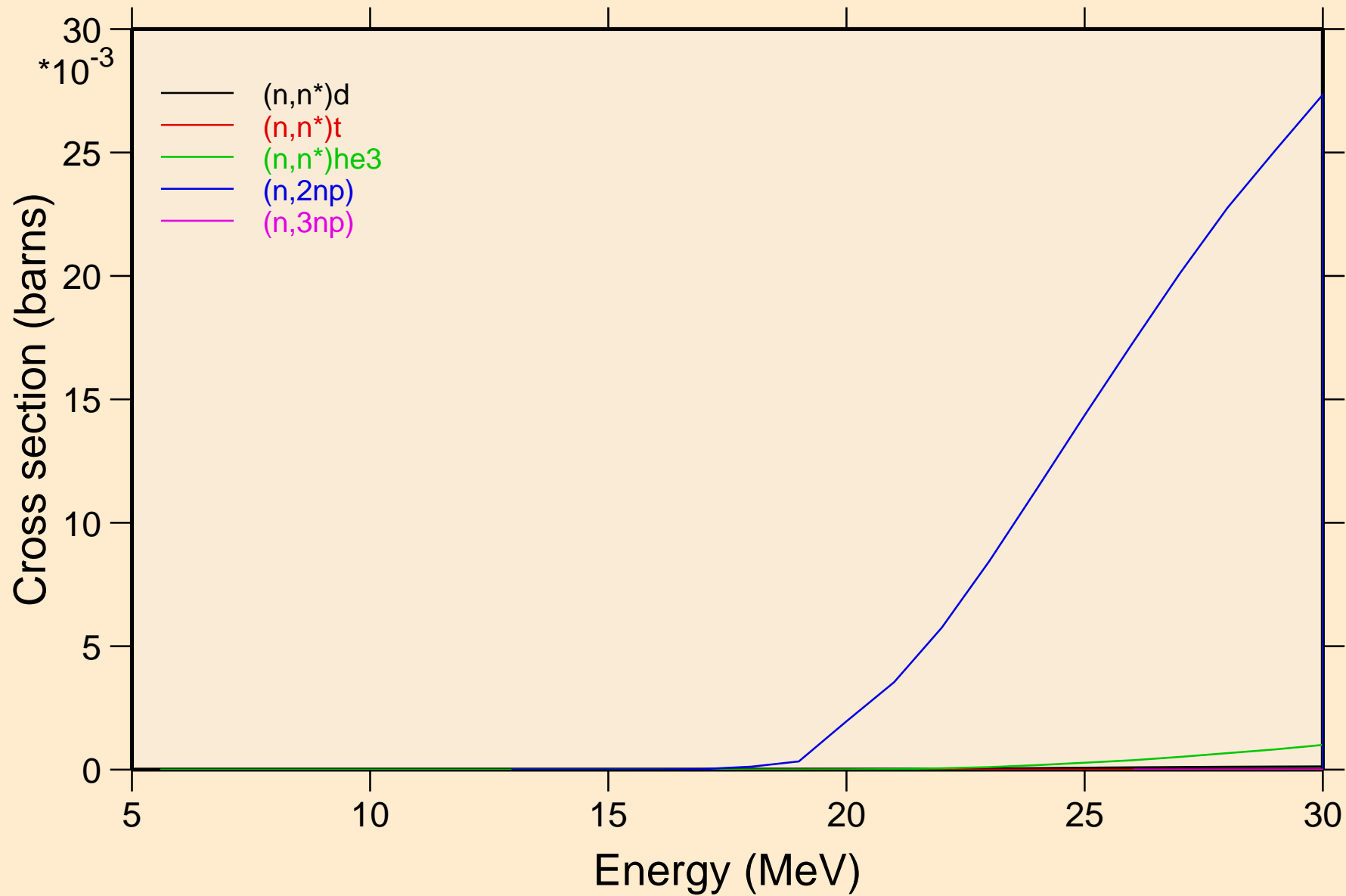

ND127 NRG TENDL-2015, AKONING

Threshold reactions

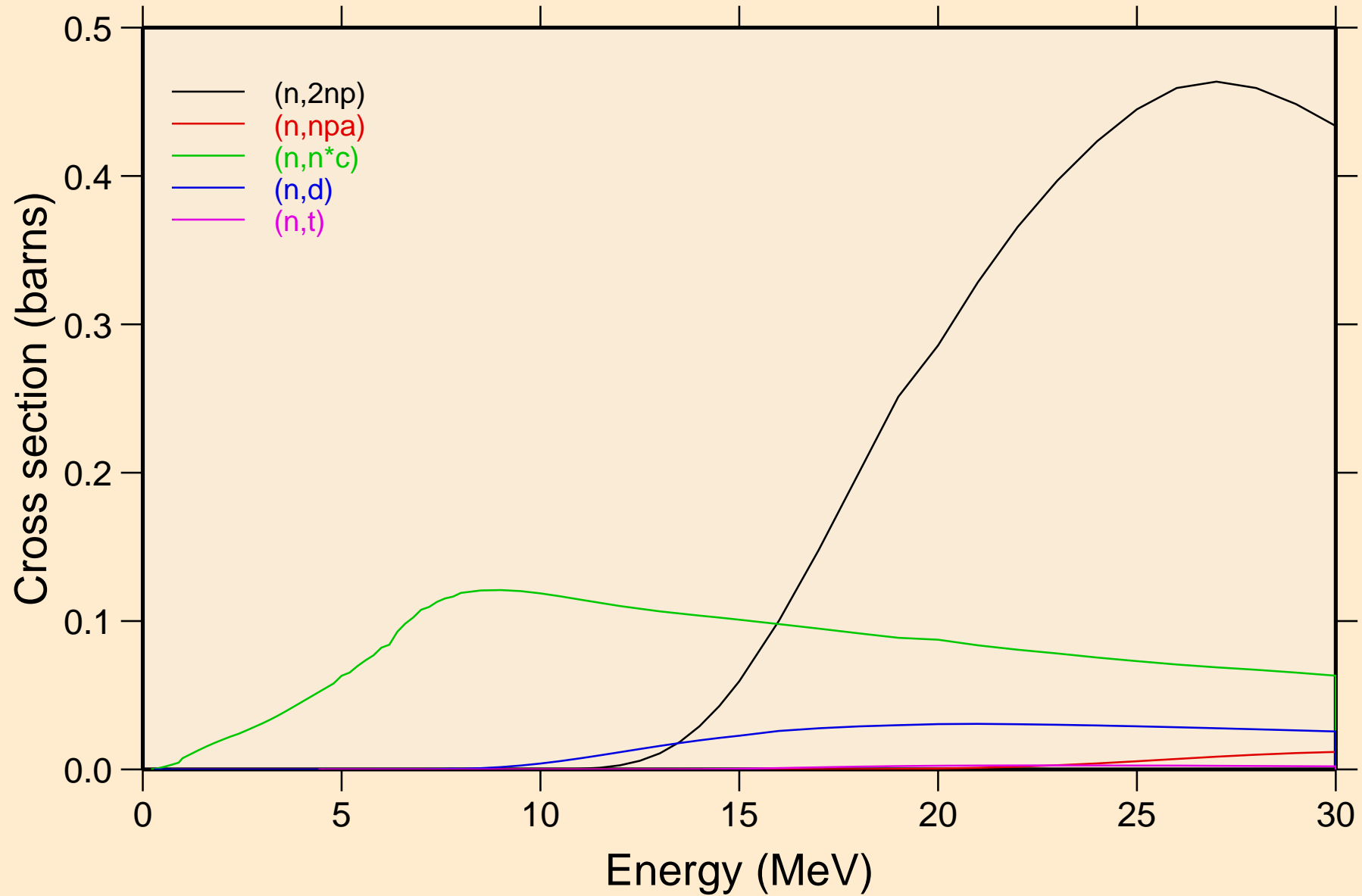

ND127 NRG TENDL-2015, AKONING

Threshold reactions

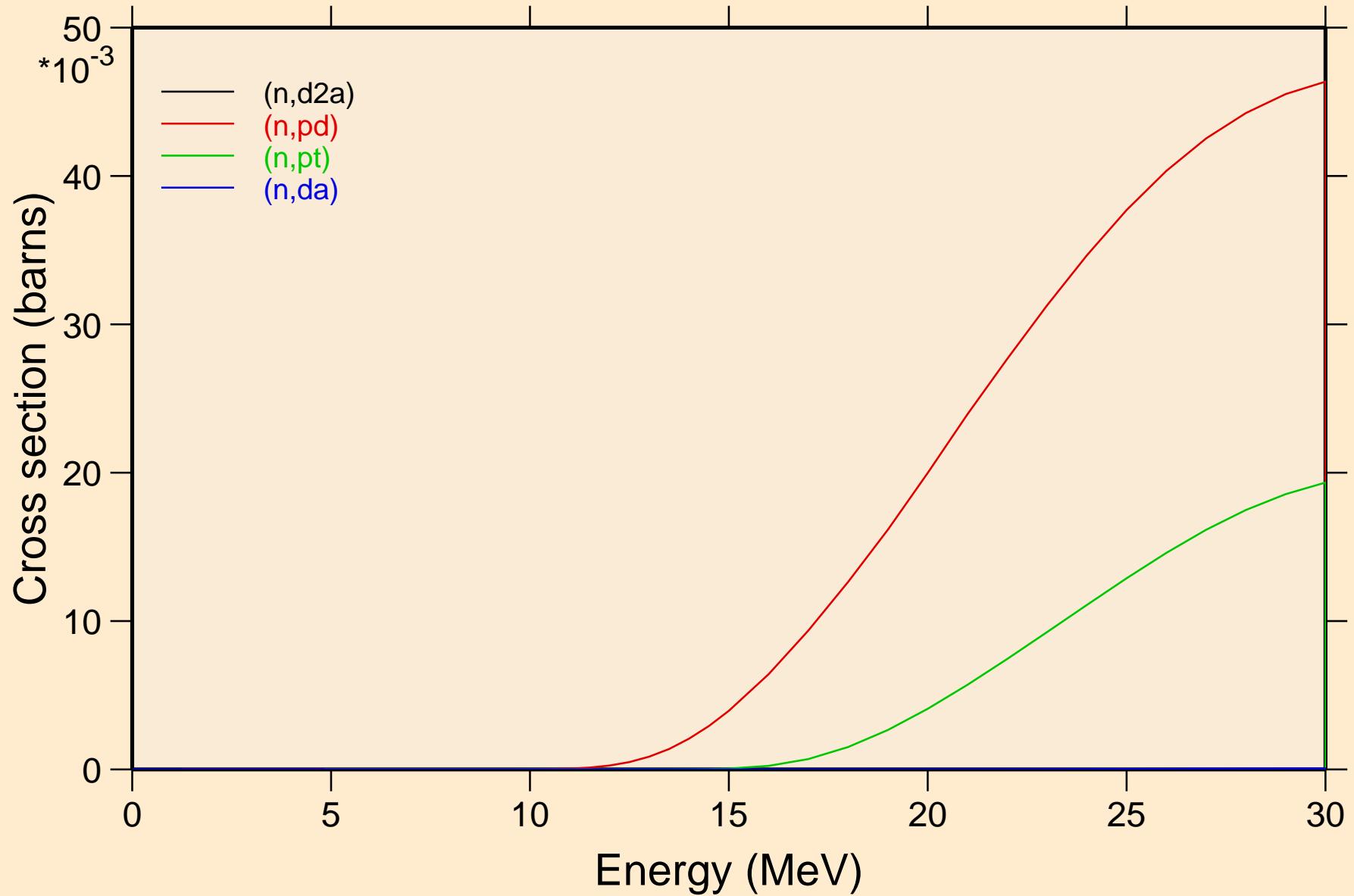

ND127 NRG TENDL-2015, AKONING
angular distribution for elastic

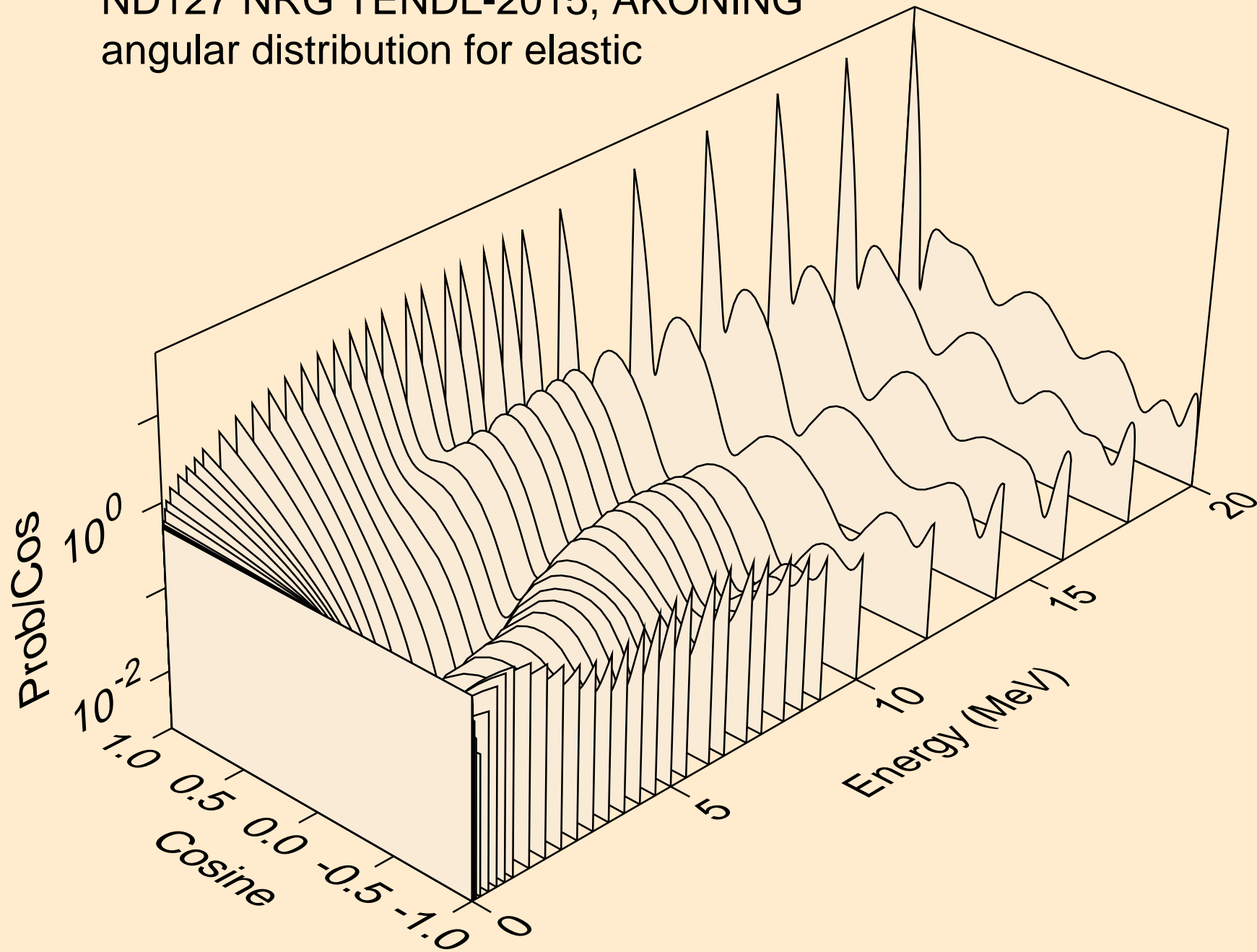

ND127 NRG TENDL-2015, AKONING
angular distribution for elastic

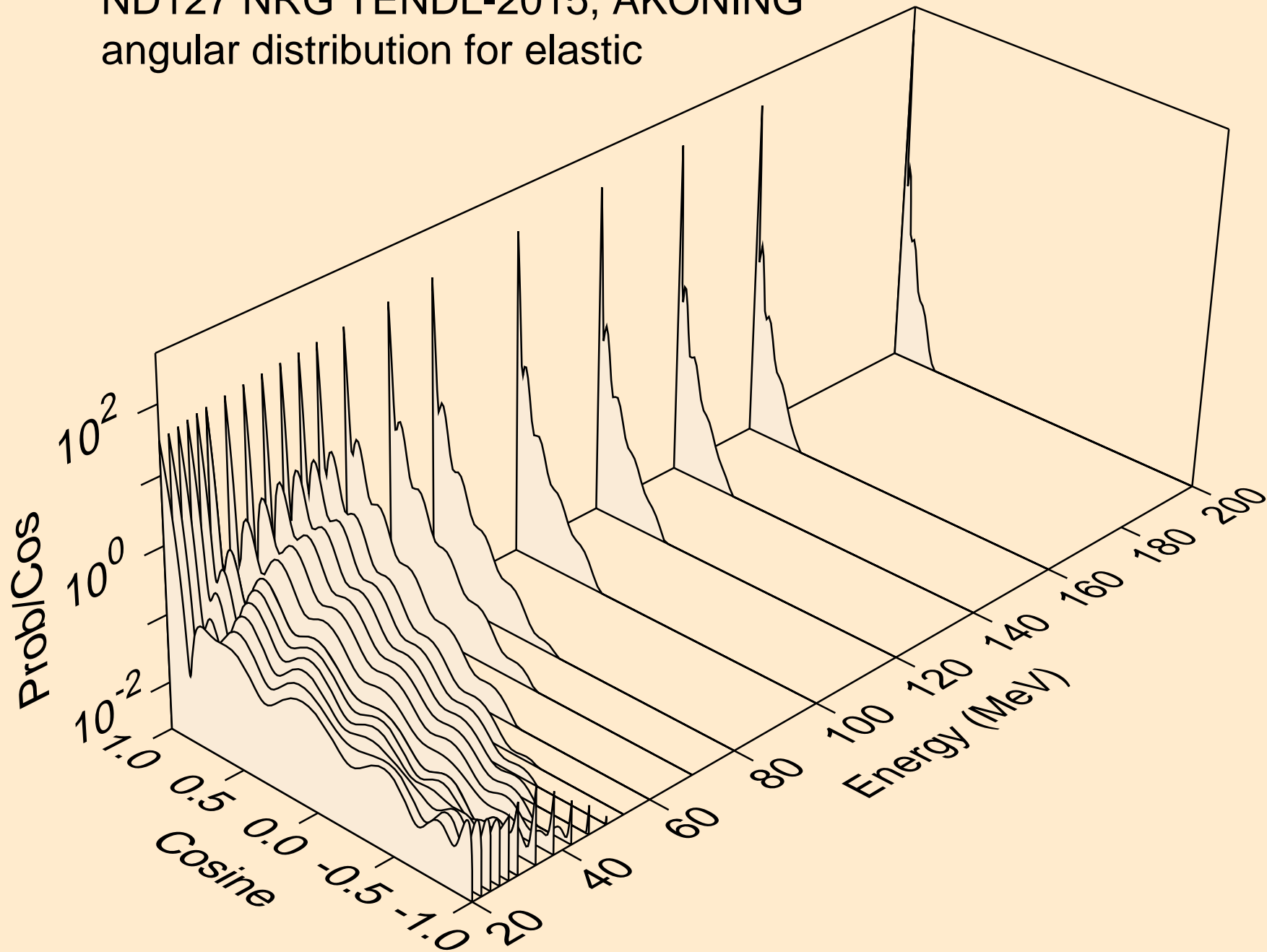

ND127 NRG TENDL-2015, AKONING
angular distribution for (n,n*1)

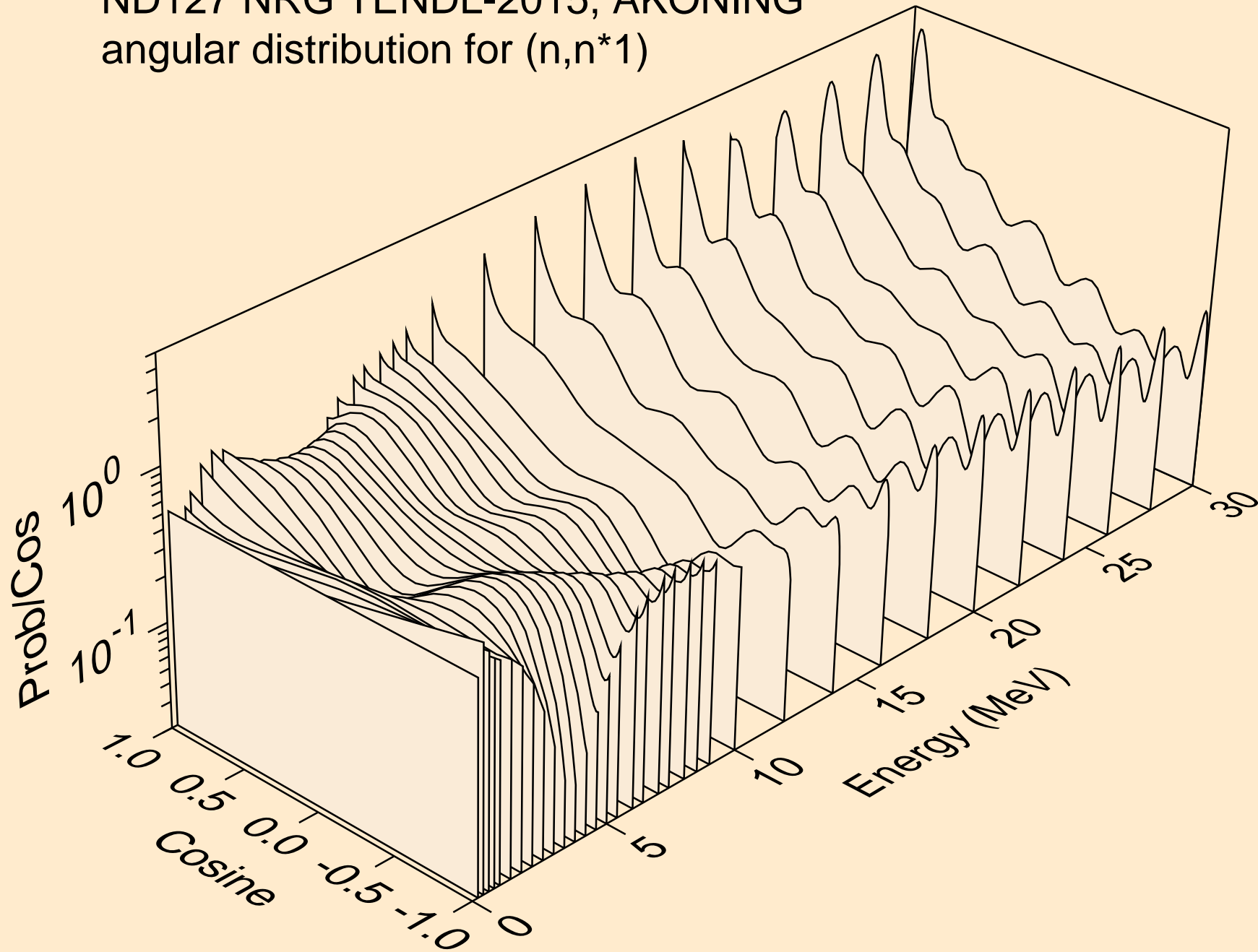

ND127 NRG TENDL-2015, AKONING
Neutron emission for (n,x)

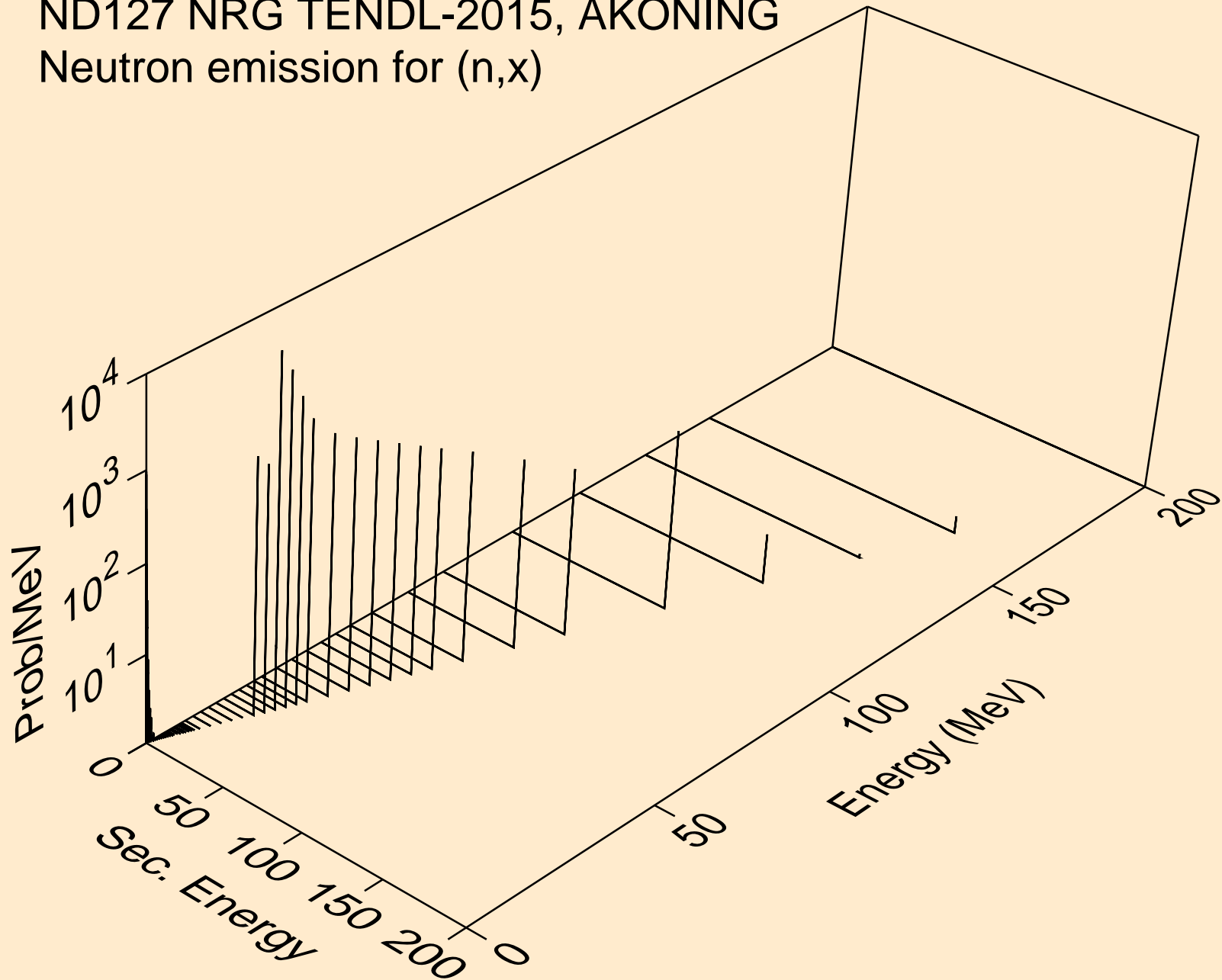

ND127 NRG TENDL-2015, AKONING
Neutron emission for (n,2nd)

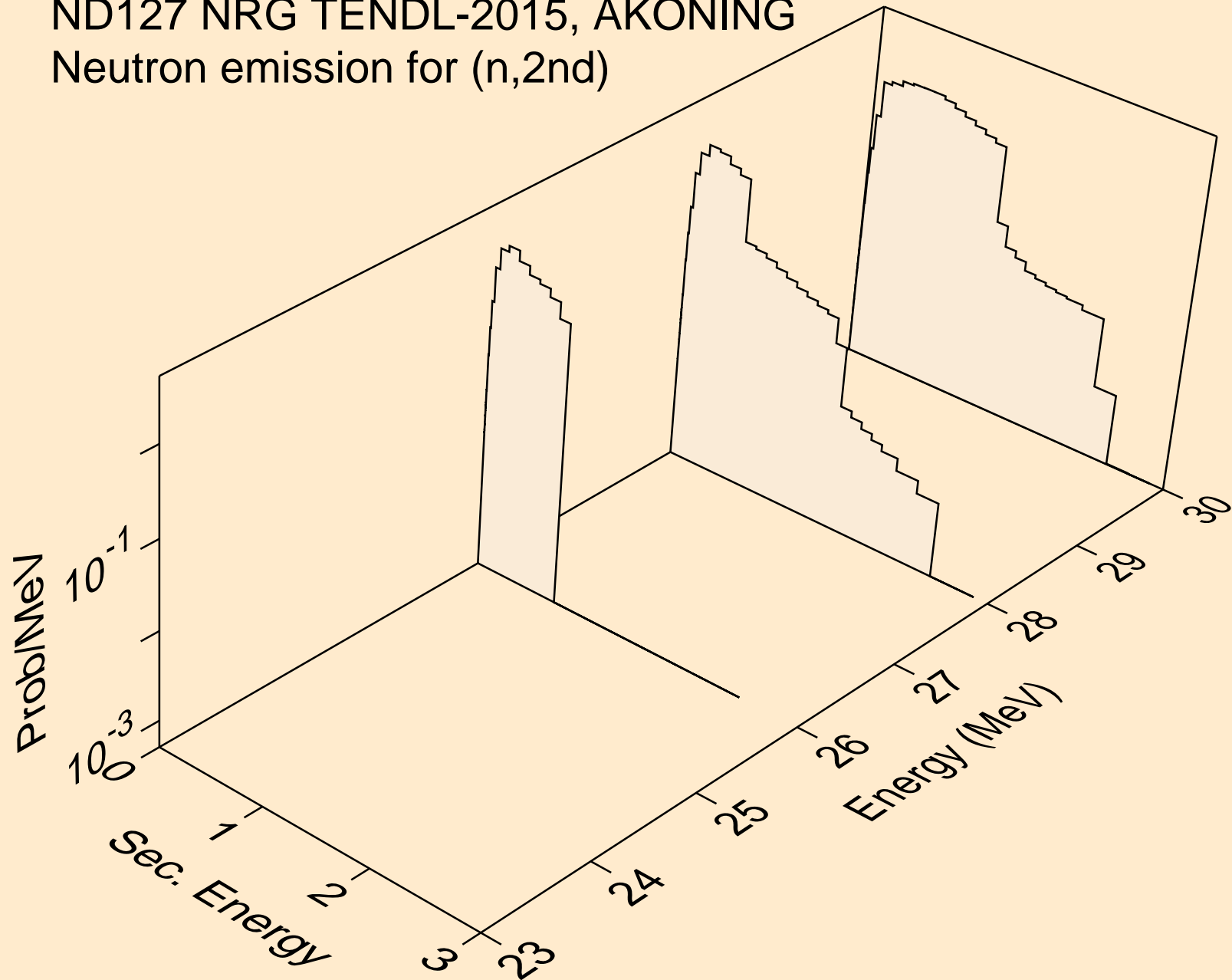

ND127 NRG TENDL-2015, AKONING
Neutron emission for (n,2n)

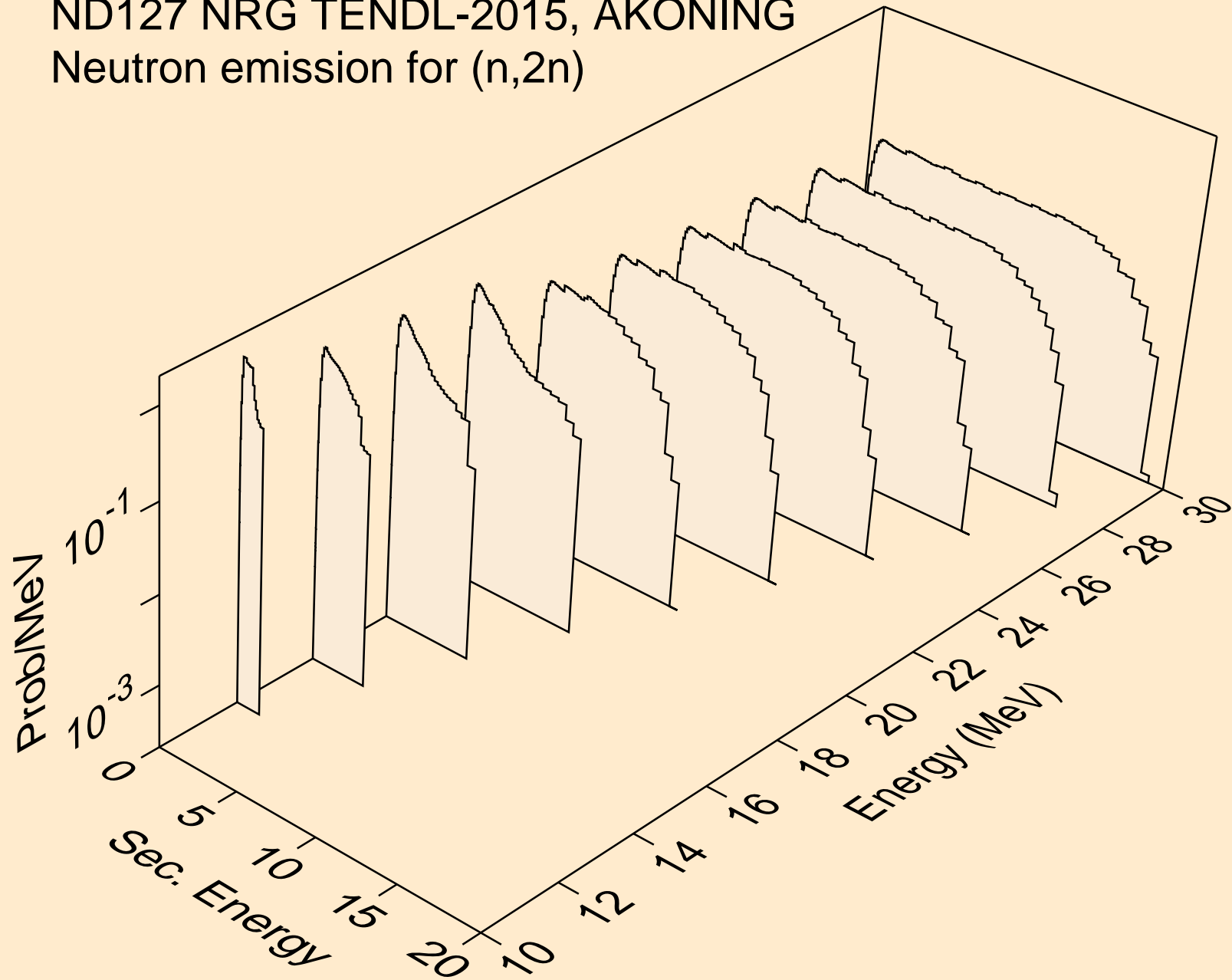

ND127 NRG TENDL-2015, AKONING
Neutron emission for (n,3n)

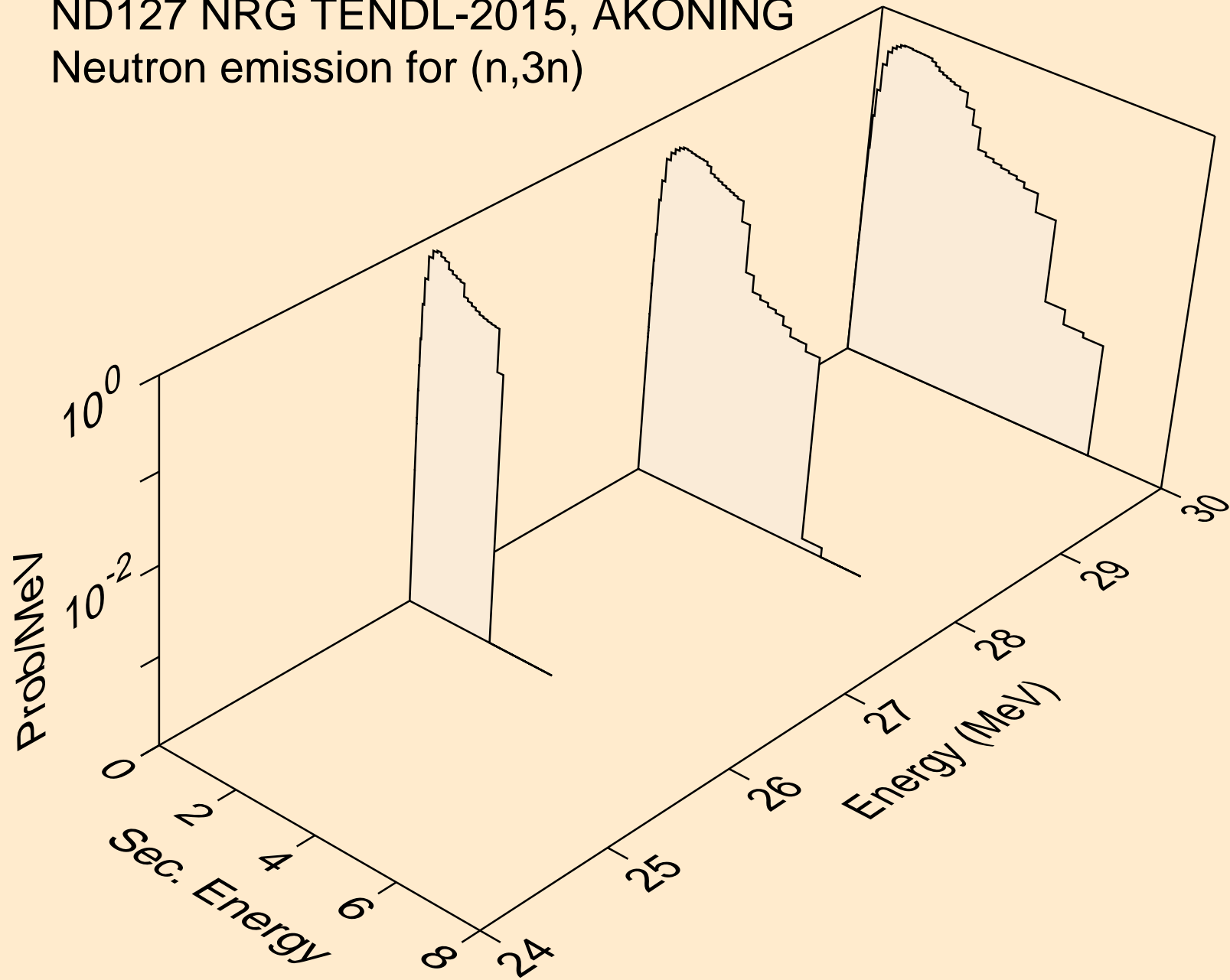

ND127 NRG TENDL-2015, AKONING
Neutron emission for (n,n*)a

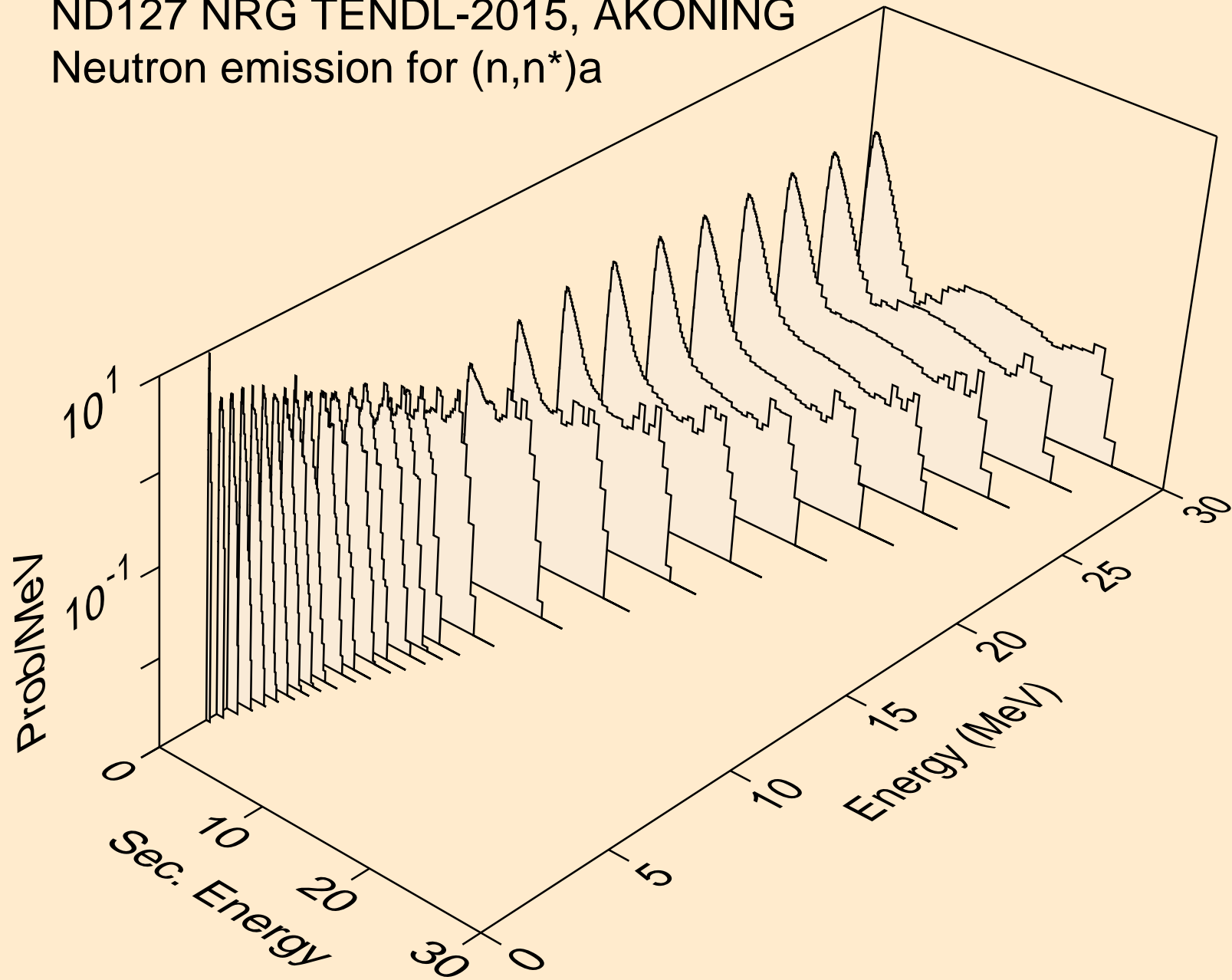

ND127 NRG TENDL-2015, AKONING
Neutron emission for (n,n*)3a

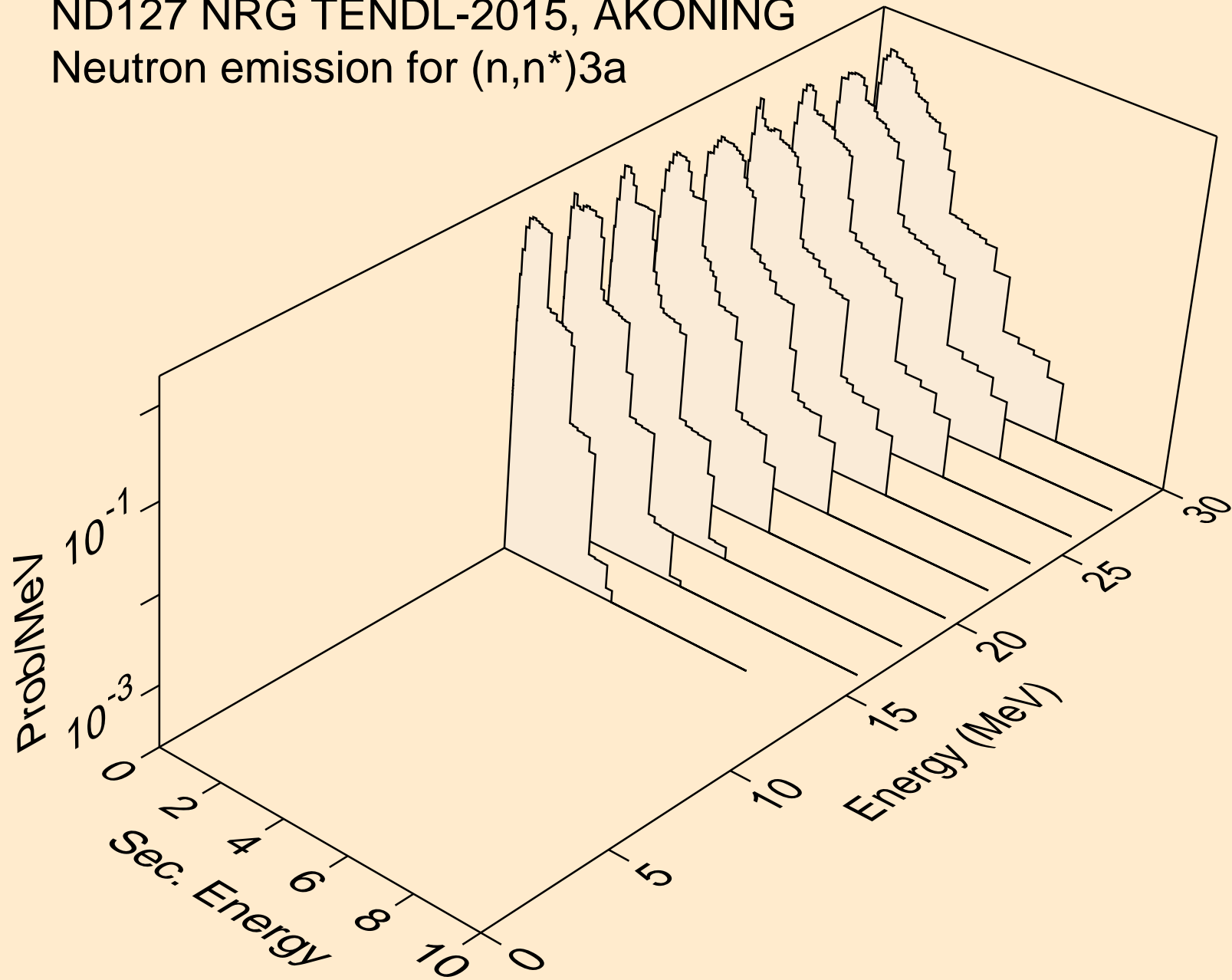

ND127 NRG TENDL-2015, AKONING
Neutron emission for (n,2n)a

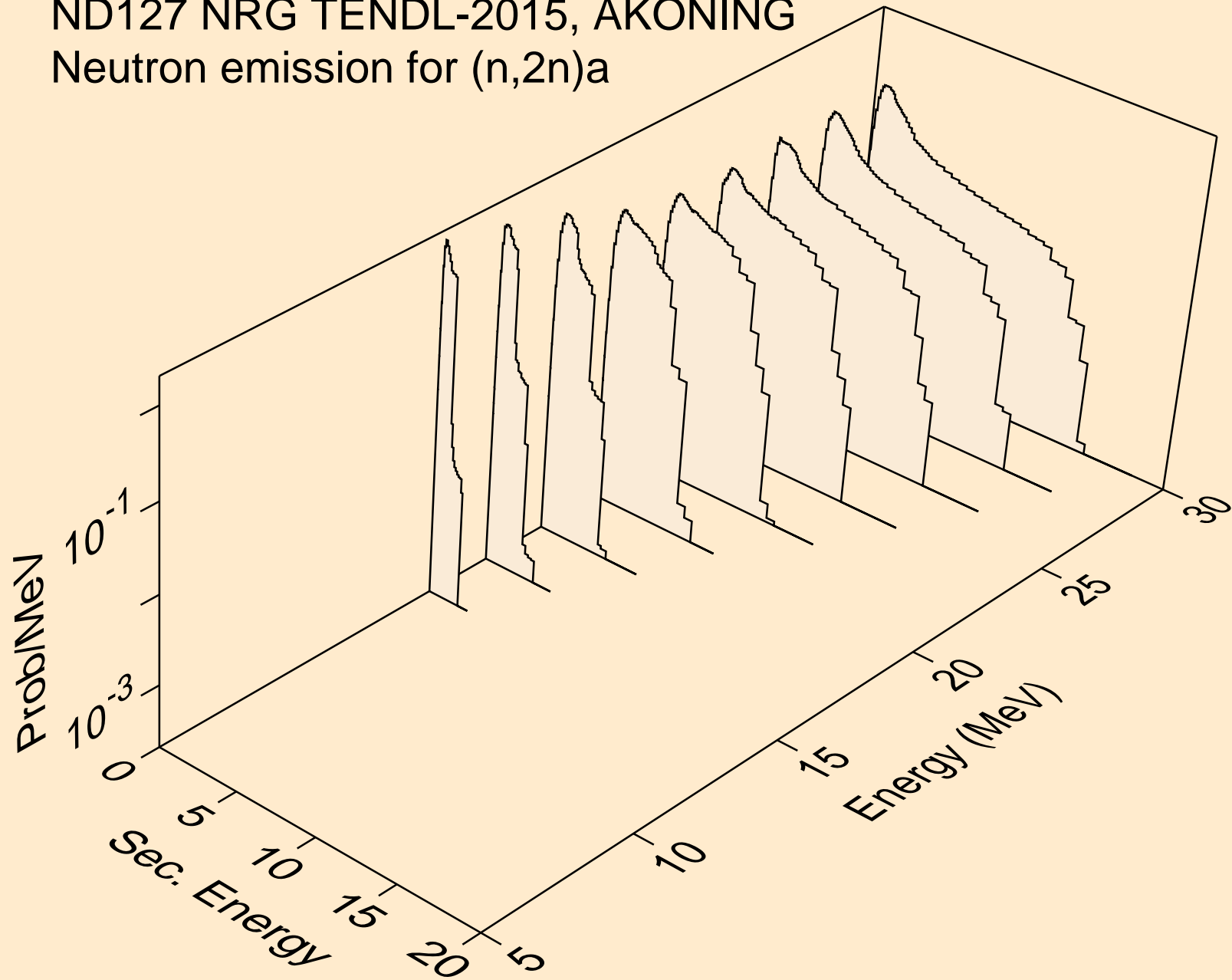

ND127 NRG TENDL-2015, AKONING
Neutron emission for (n,n*)p

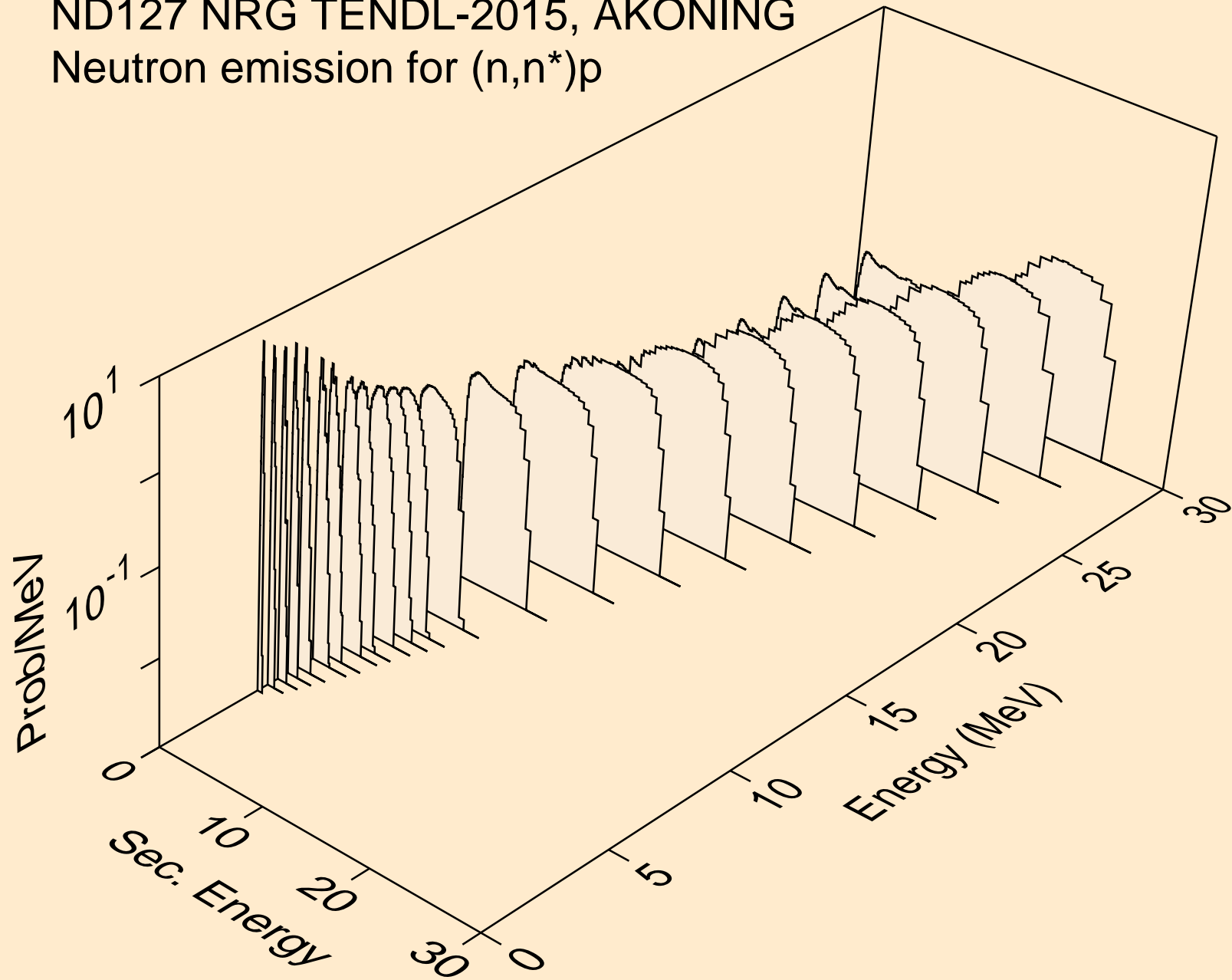

ND127 NRG TENDL-2015, AKONING
Neutron emission for (n,n*)2a

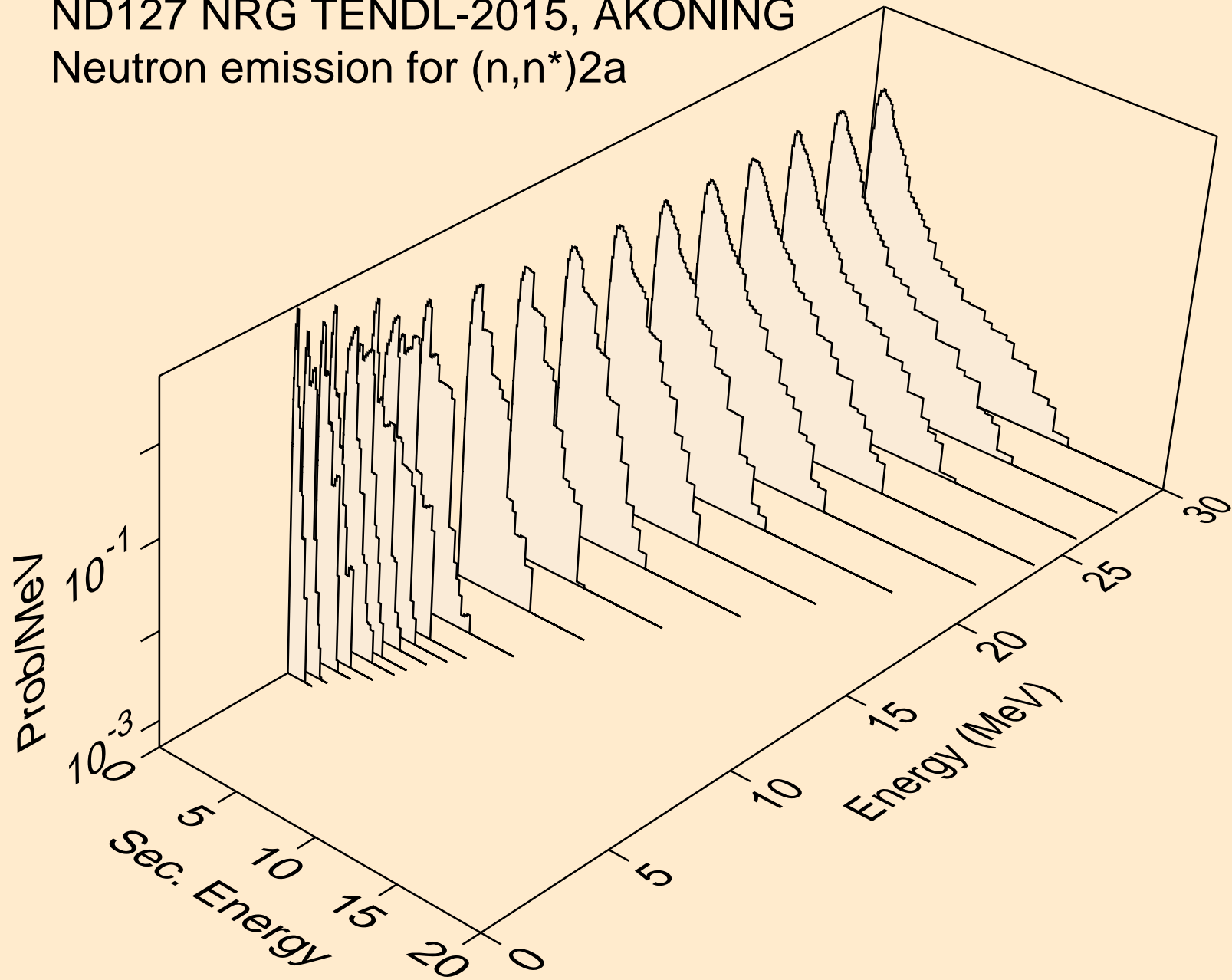

ND127 NRG TENDL-2015, AKONING
Neutron emission for (n,2n)2a

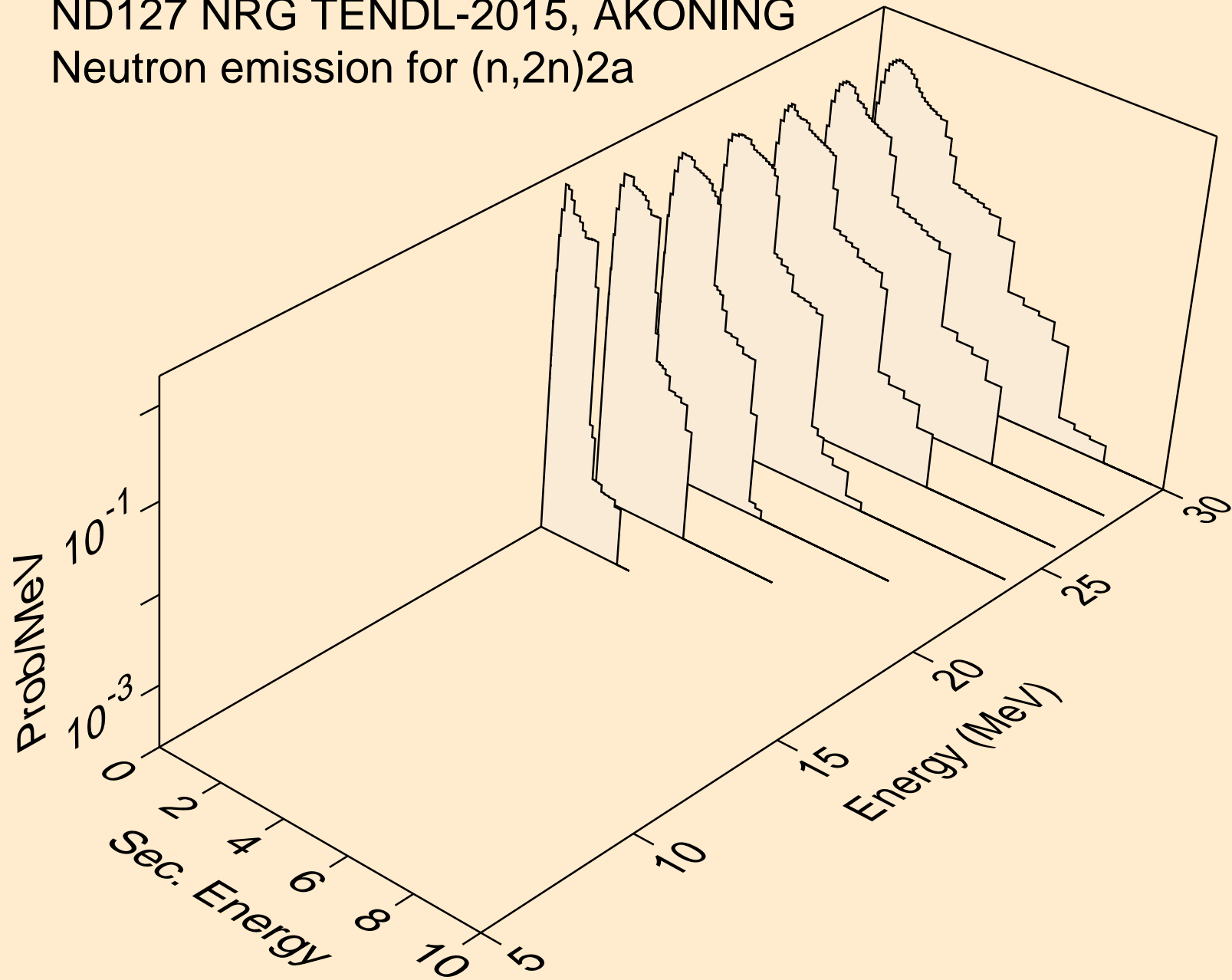

ND127 NRG TENDL-2015, AKONING
Neutron emission for (n,n*)d

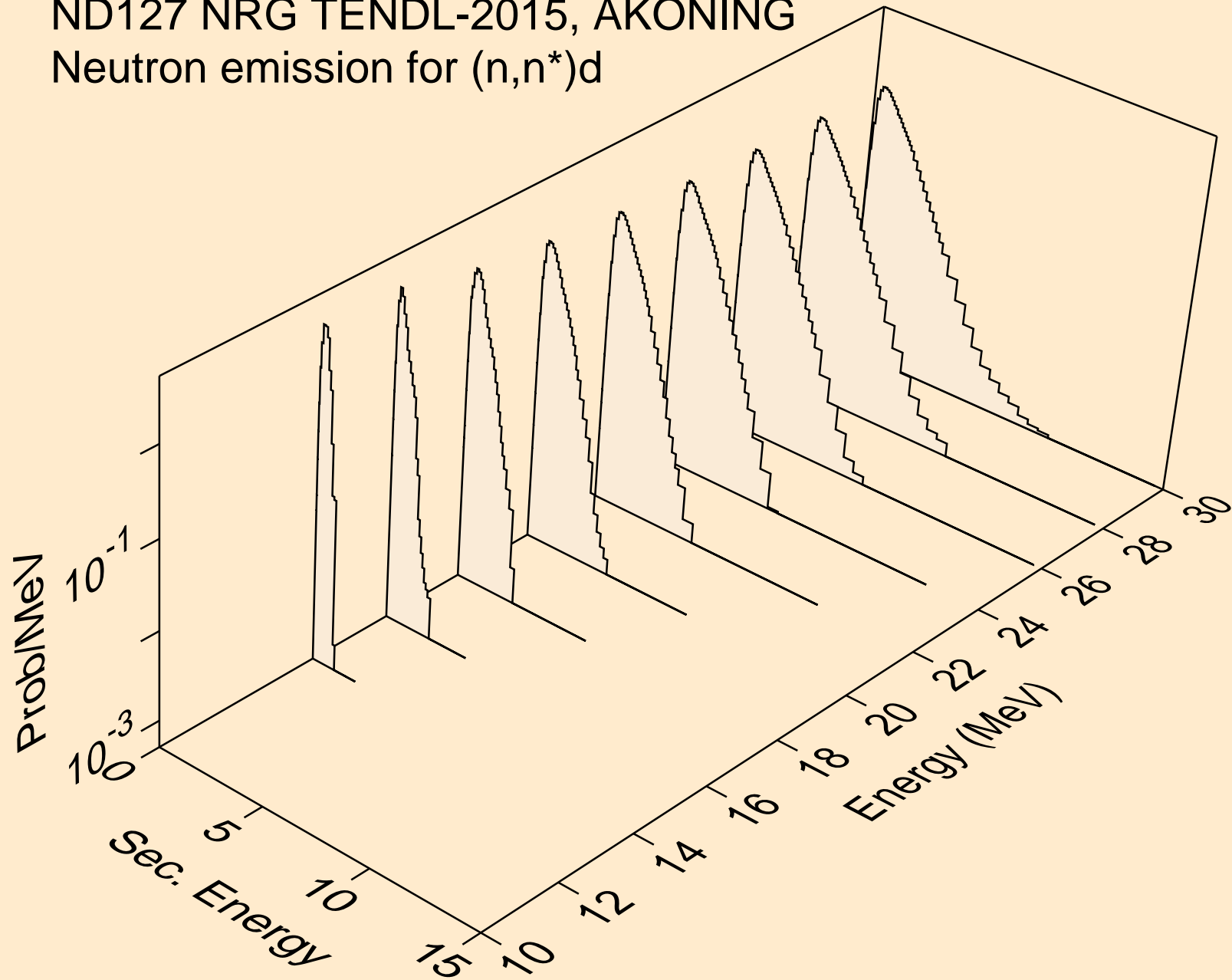

ND127 NRG TENDL-2015, AKONING
Neutron emission for (n,n*)t

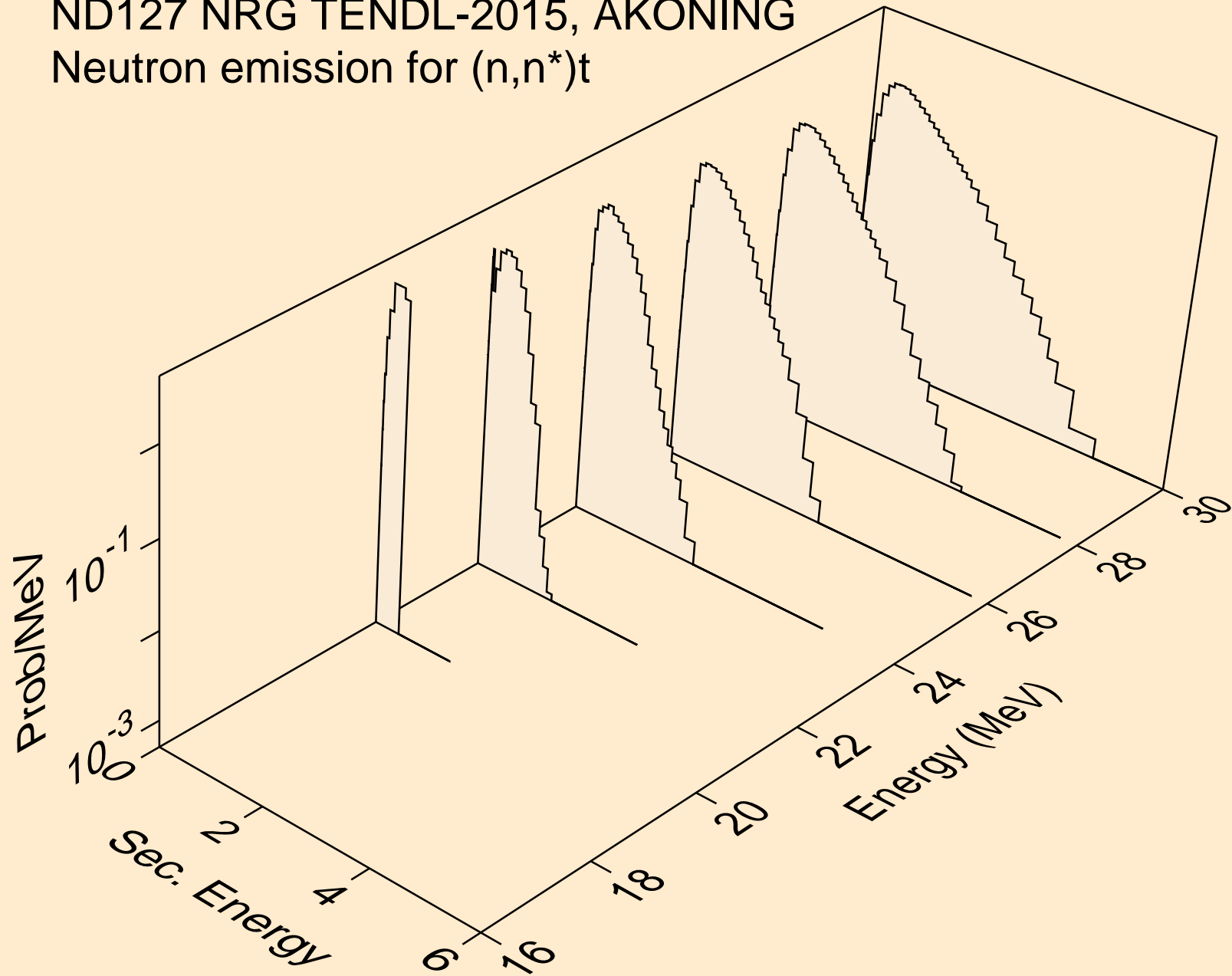

ND127 NRG TENDL-2015, AKONING
Neutron emission for (n,n*)he3

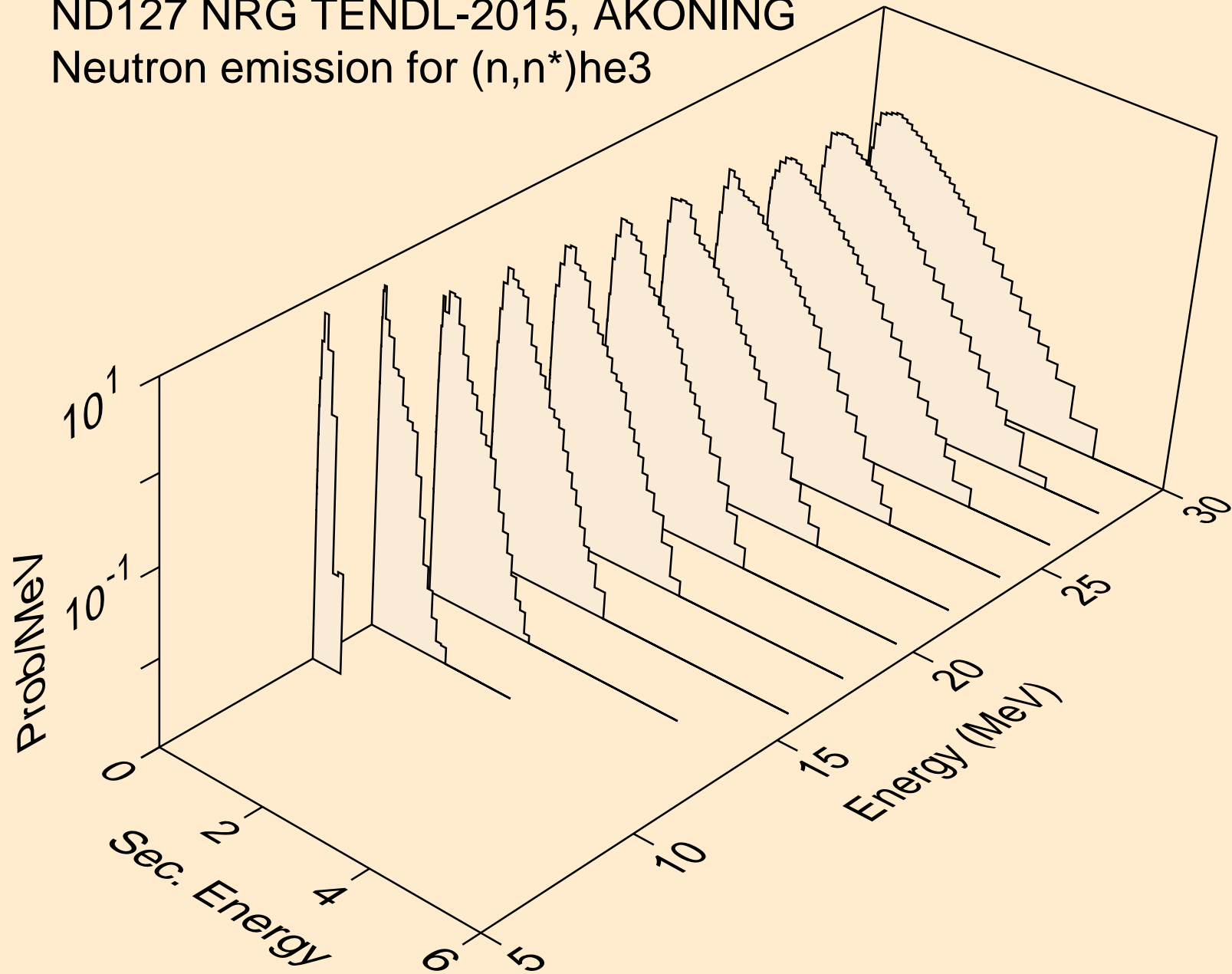

ND127 NRG TENDL-2015, AKONING
Neutron emission for (n,2np)

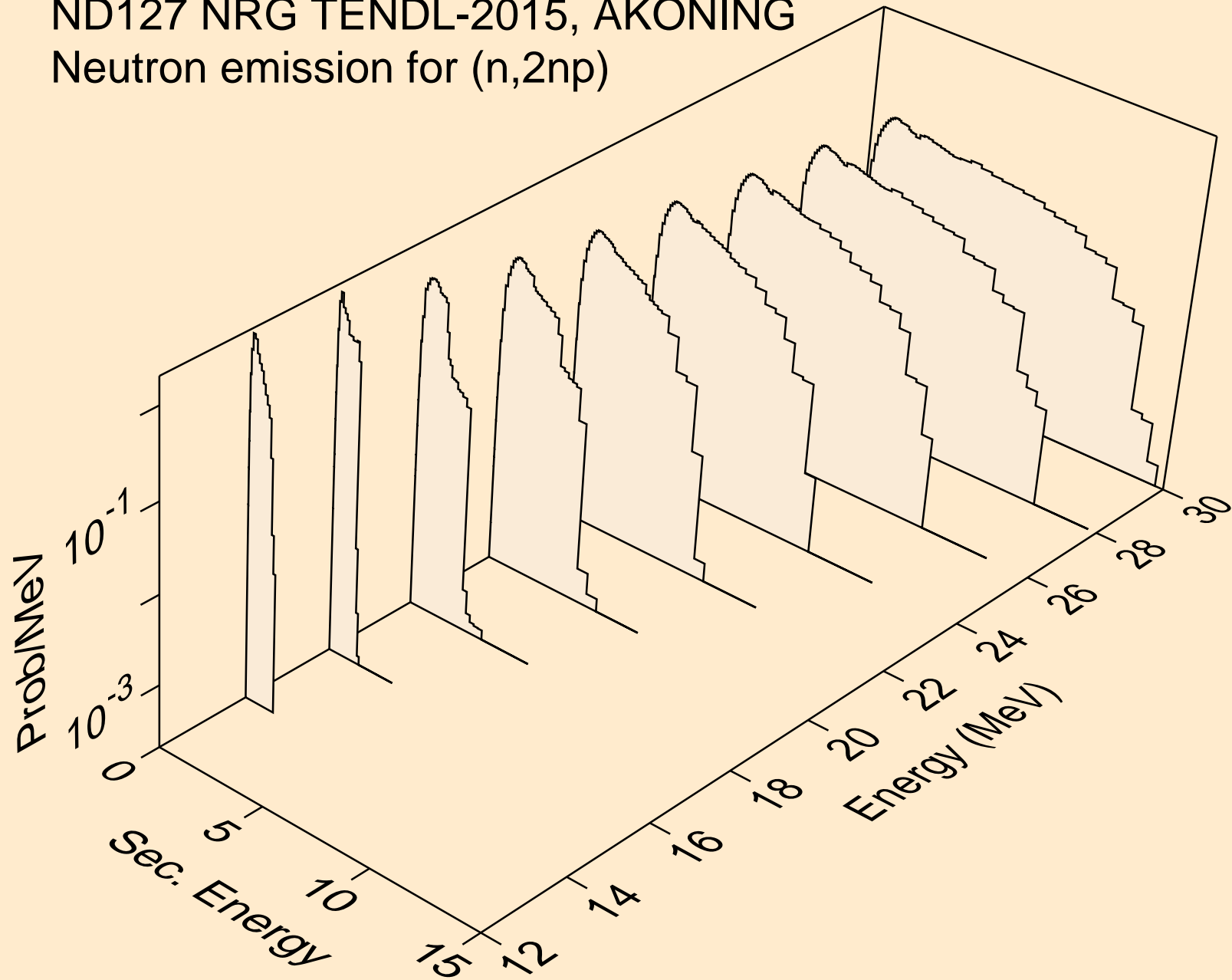

ND127 NRG TENDL-2015, AKONING
Neutron emission for (n,3np)

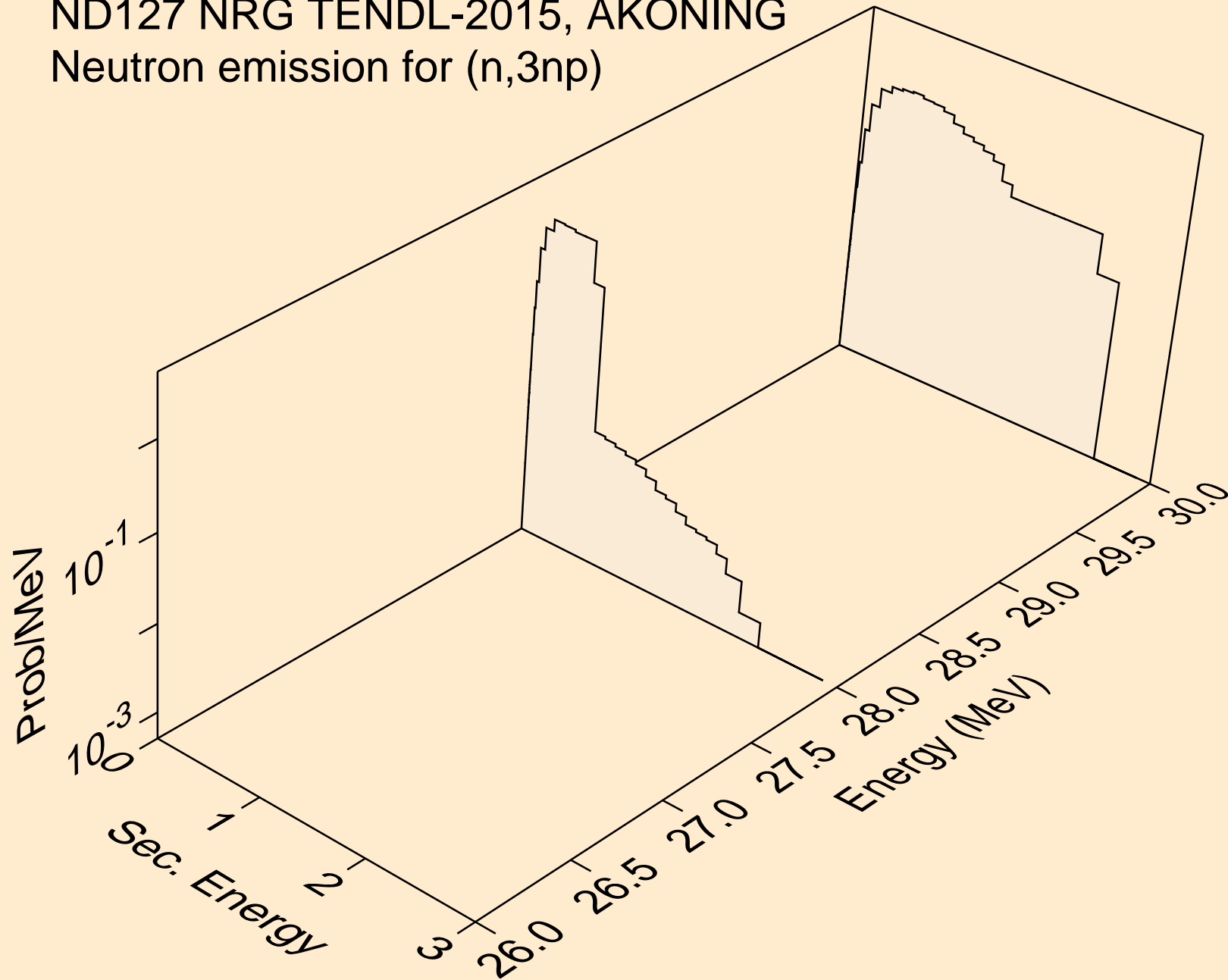

ND127 NRG TENDL-2015, AKONING
Neutron emission for (n,2np)

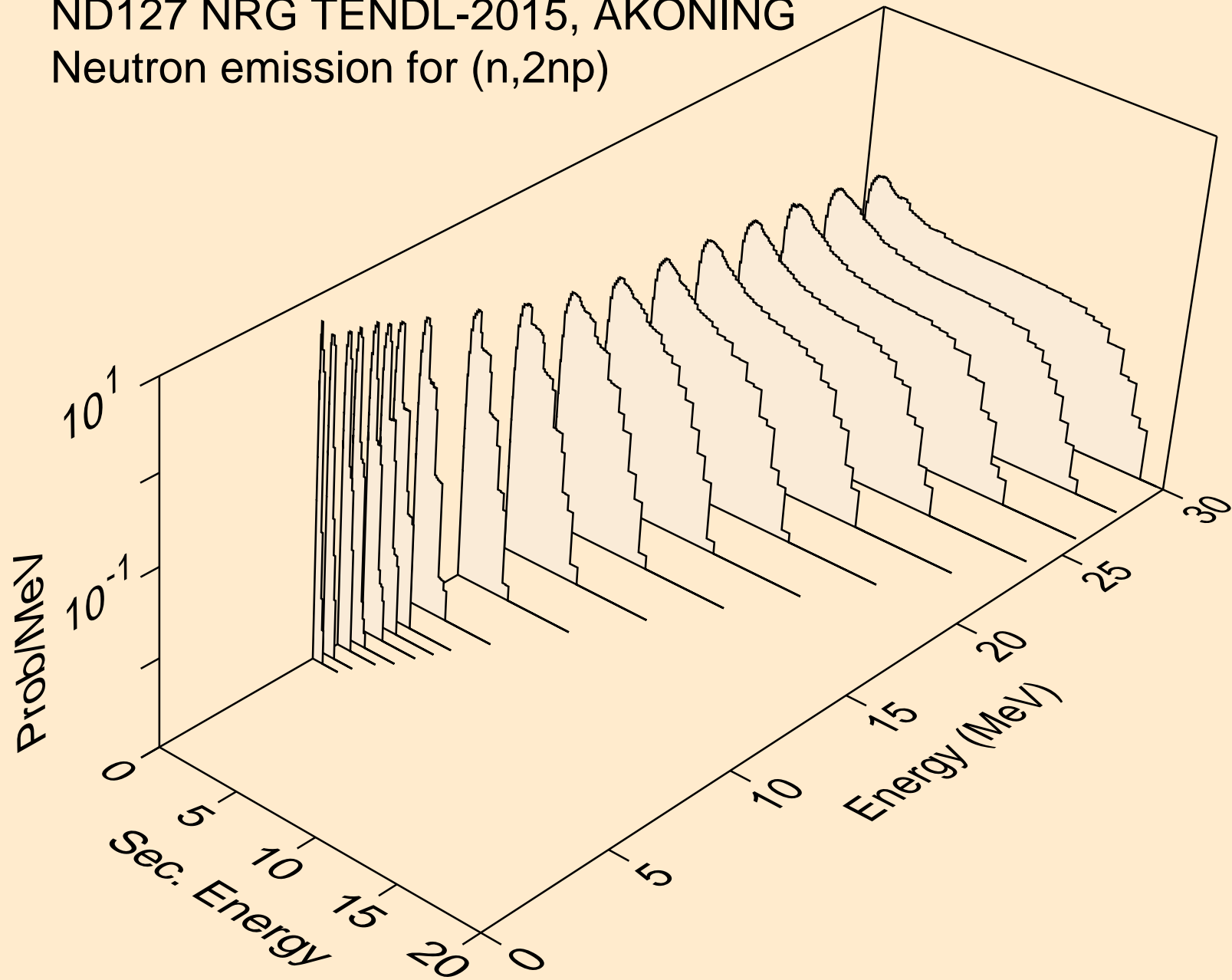

ND127 NRG TENDL-2015, AKONING
Neutron emission for (n,npa)

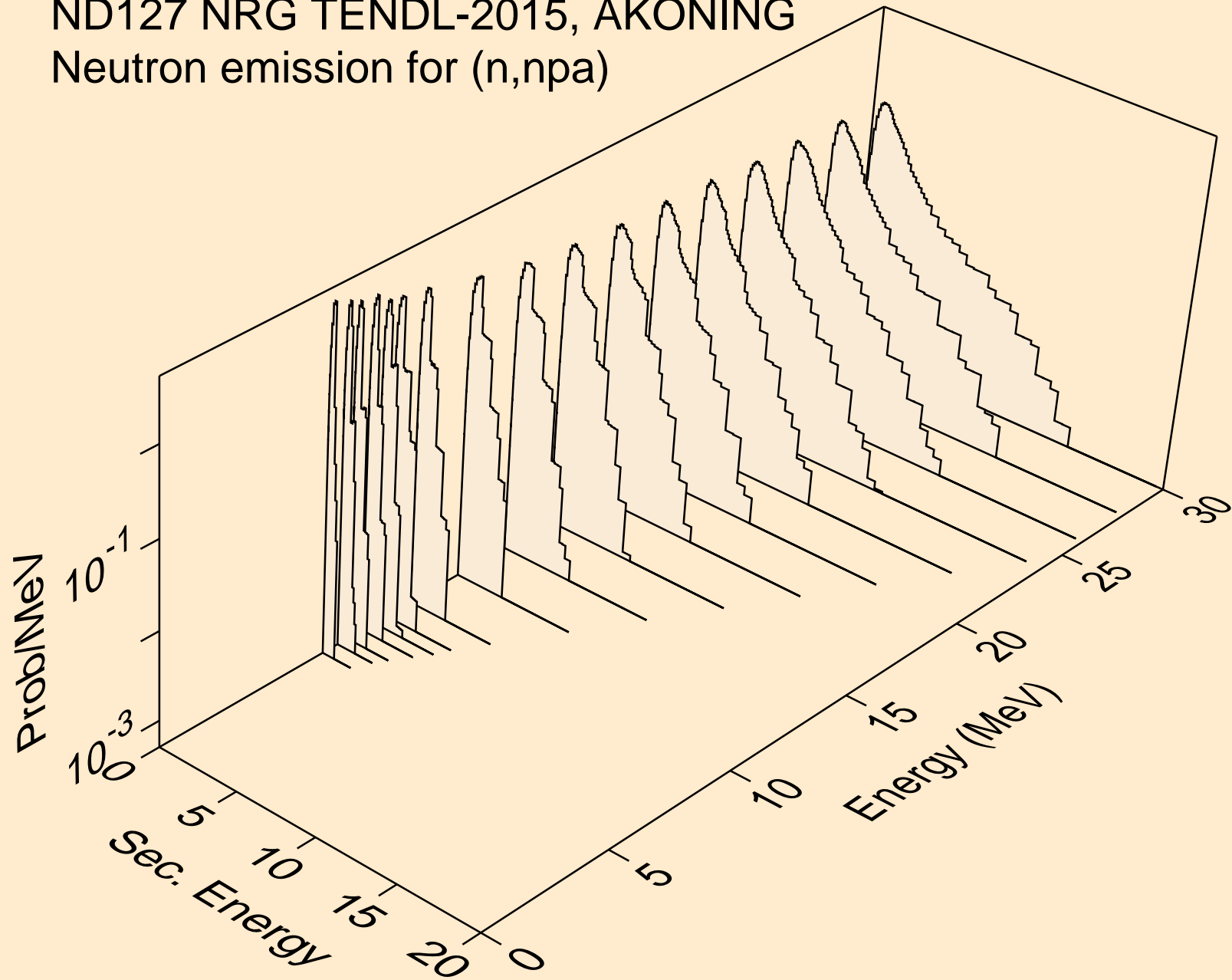

ND127 NRG TENDL-2015, AKONING
Neutron emission for (n,n*c)

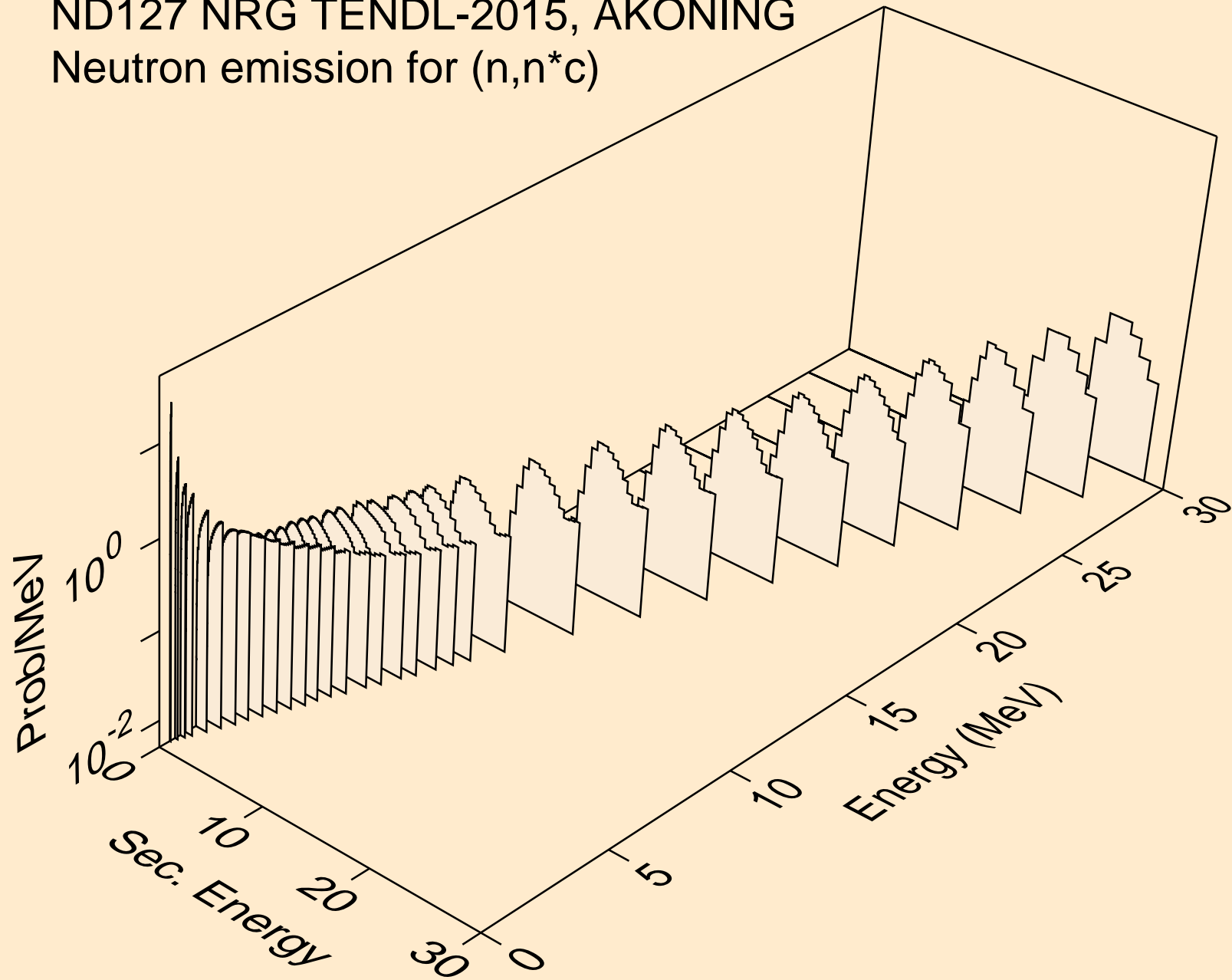

ND127 NRG TENDL-2015, AKONING
Photon emission for (n,x)

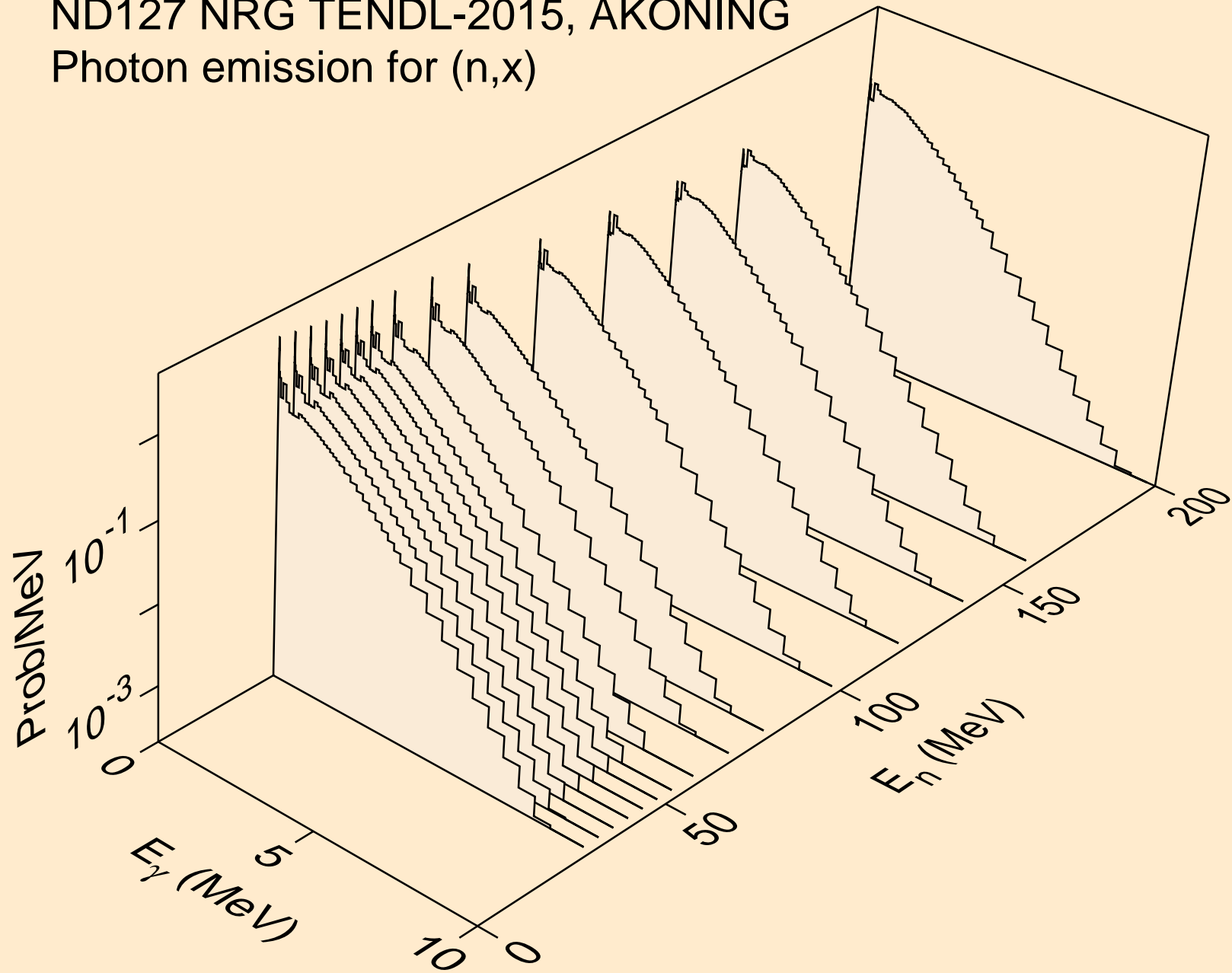

ND127 NRG TENDL-2015, AKONING
Photon emission for (n,2nd)

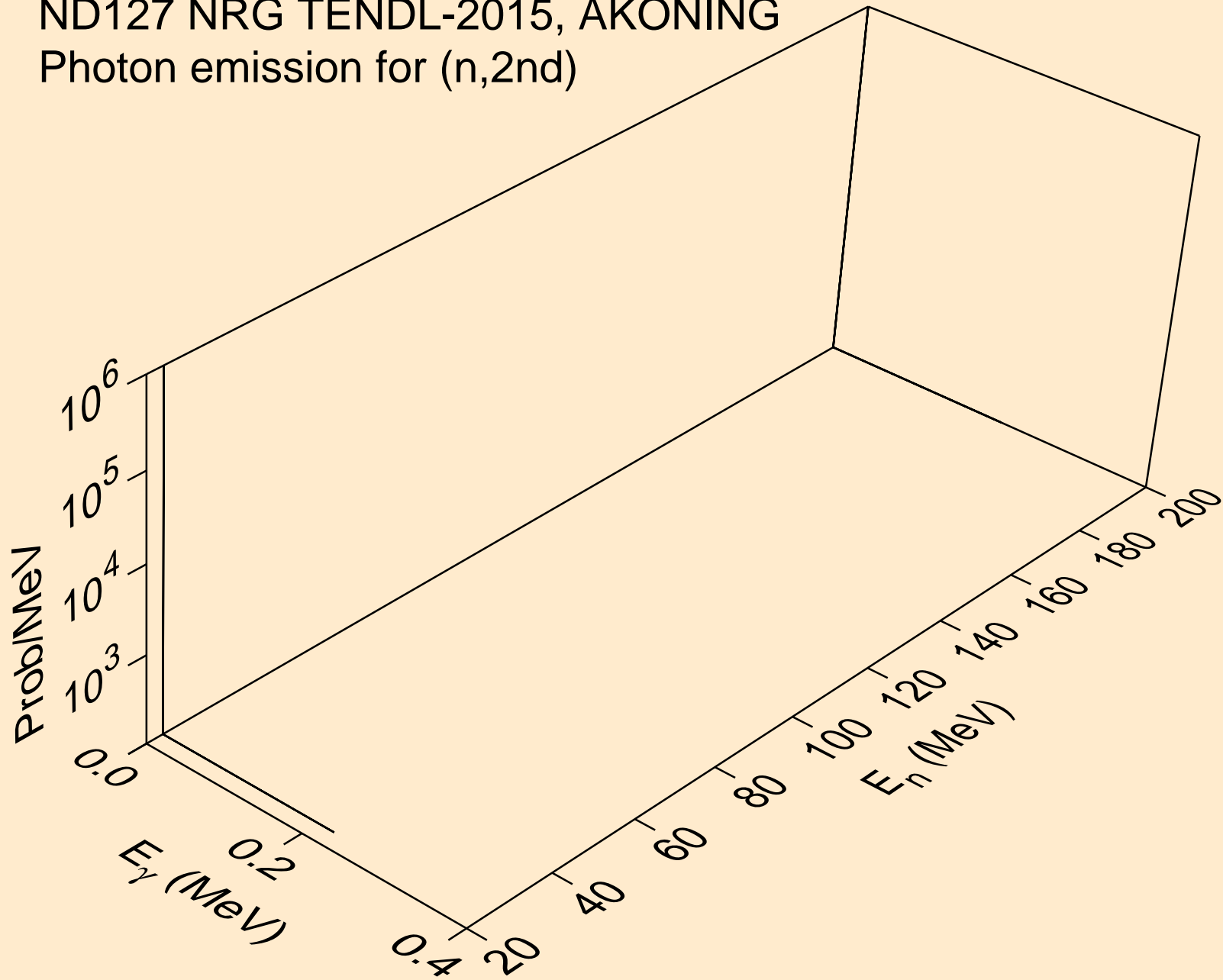

ND127 NRG TENDL-2015, AKONING
Photon emission for (n,2n)

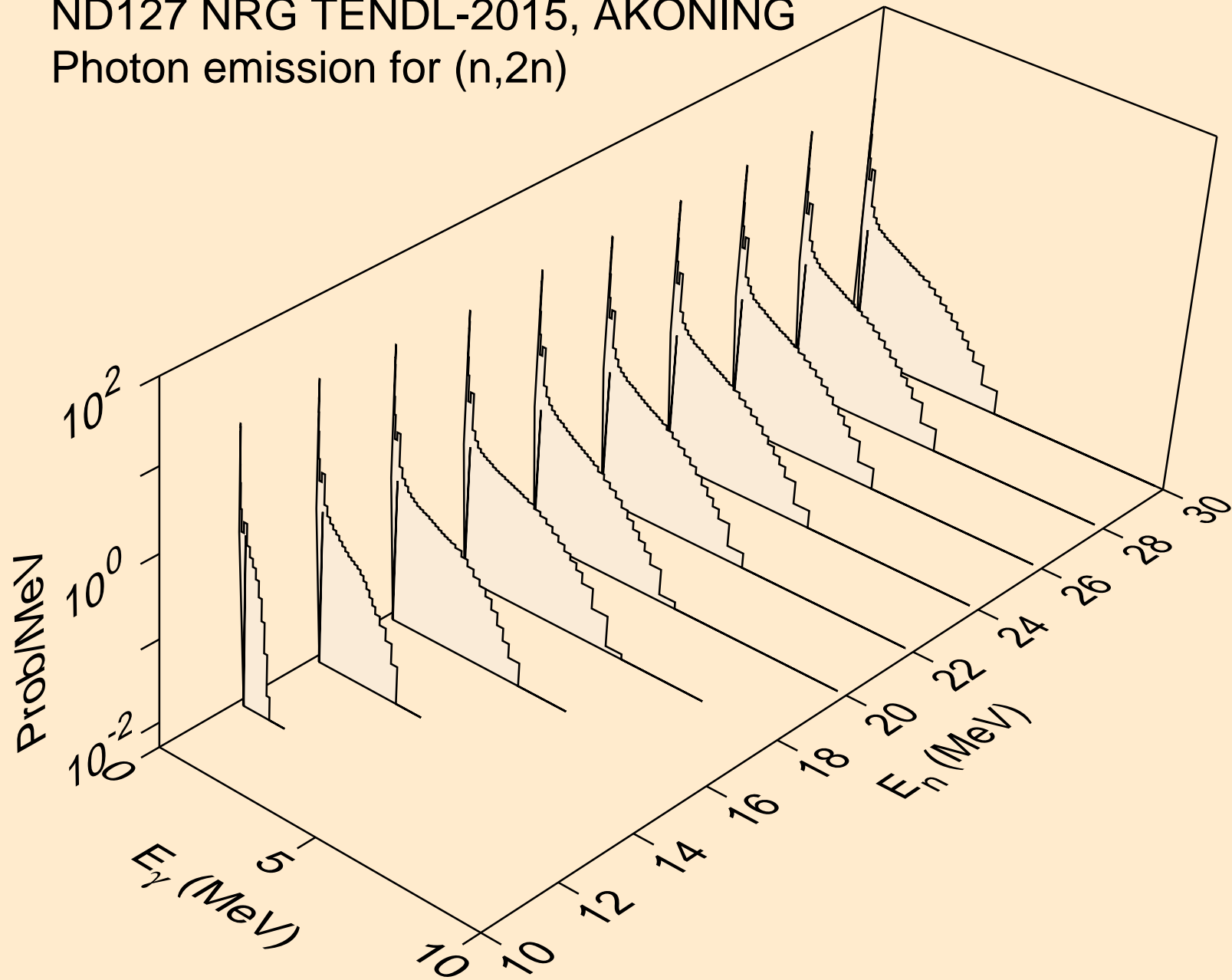

ND127 NRG TENDL-2015, AKONING
Photon emission for (n,3n)

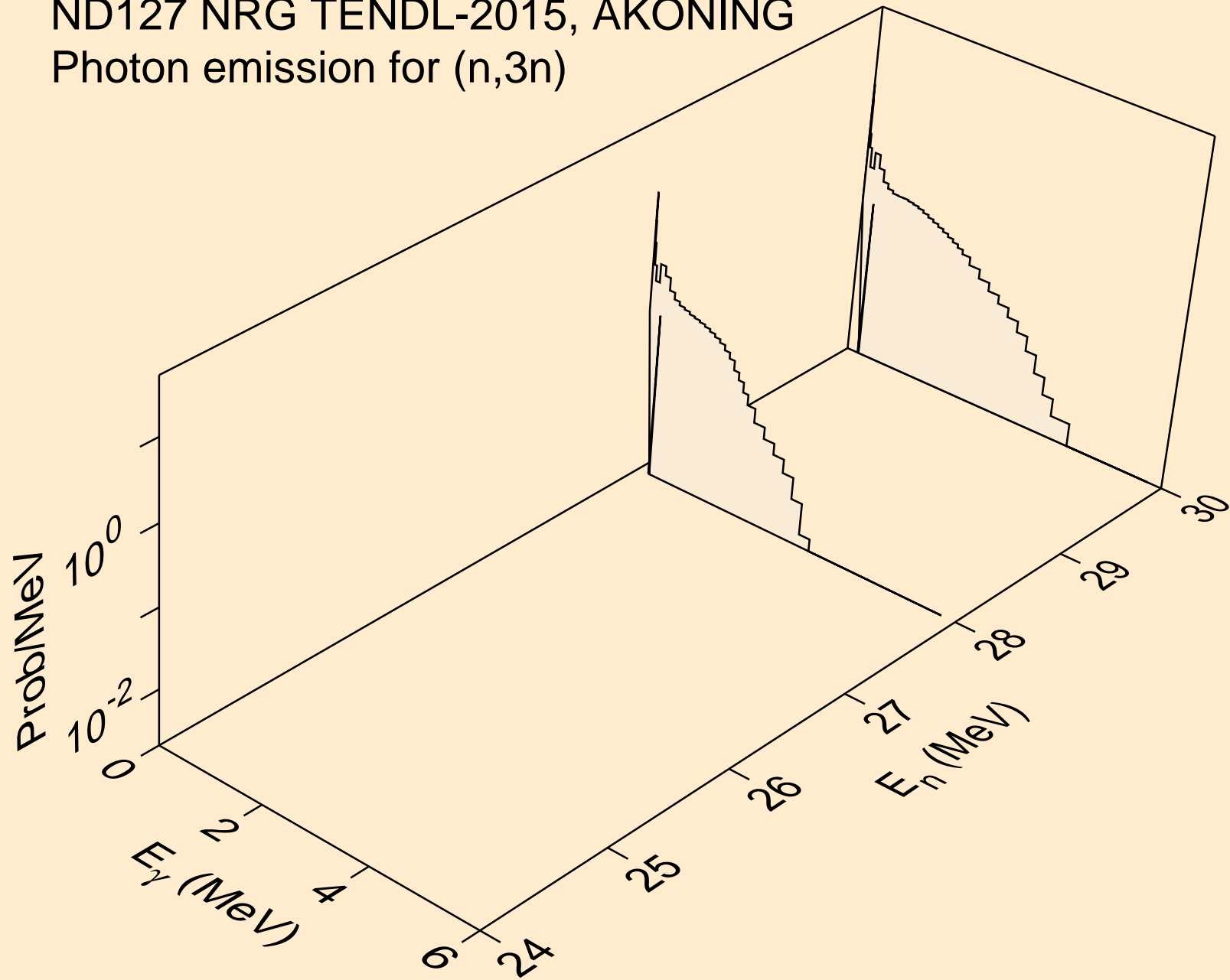

ND127 NRG TENDL-2015, AKONING
Photon emission for (n,n*)a

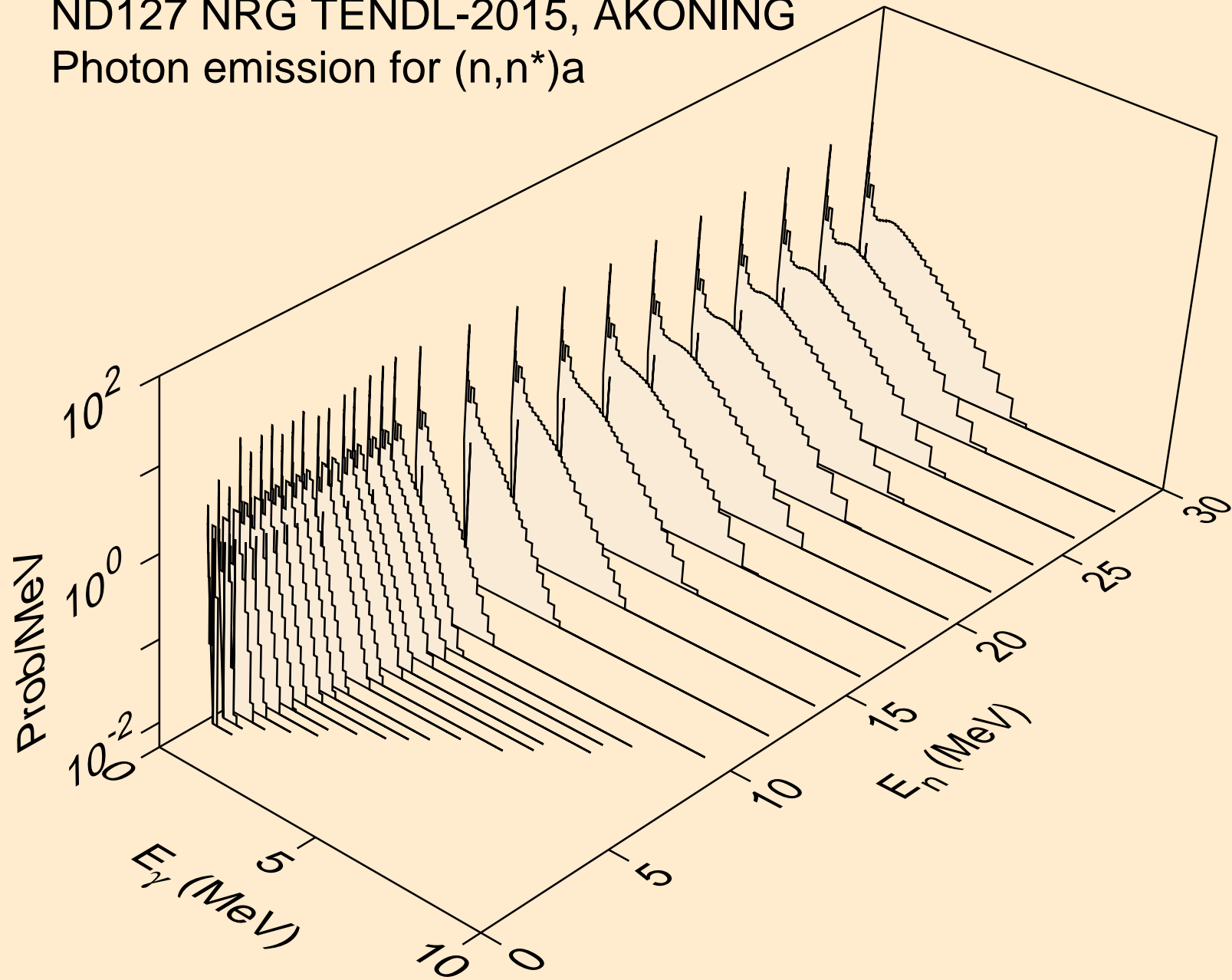

ND127 NRG TENDL-2015, AKONING
Photon emission for (n,n*)3a

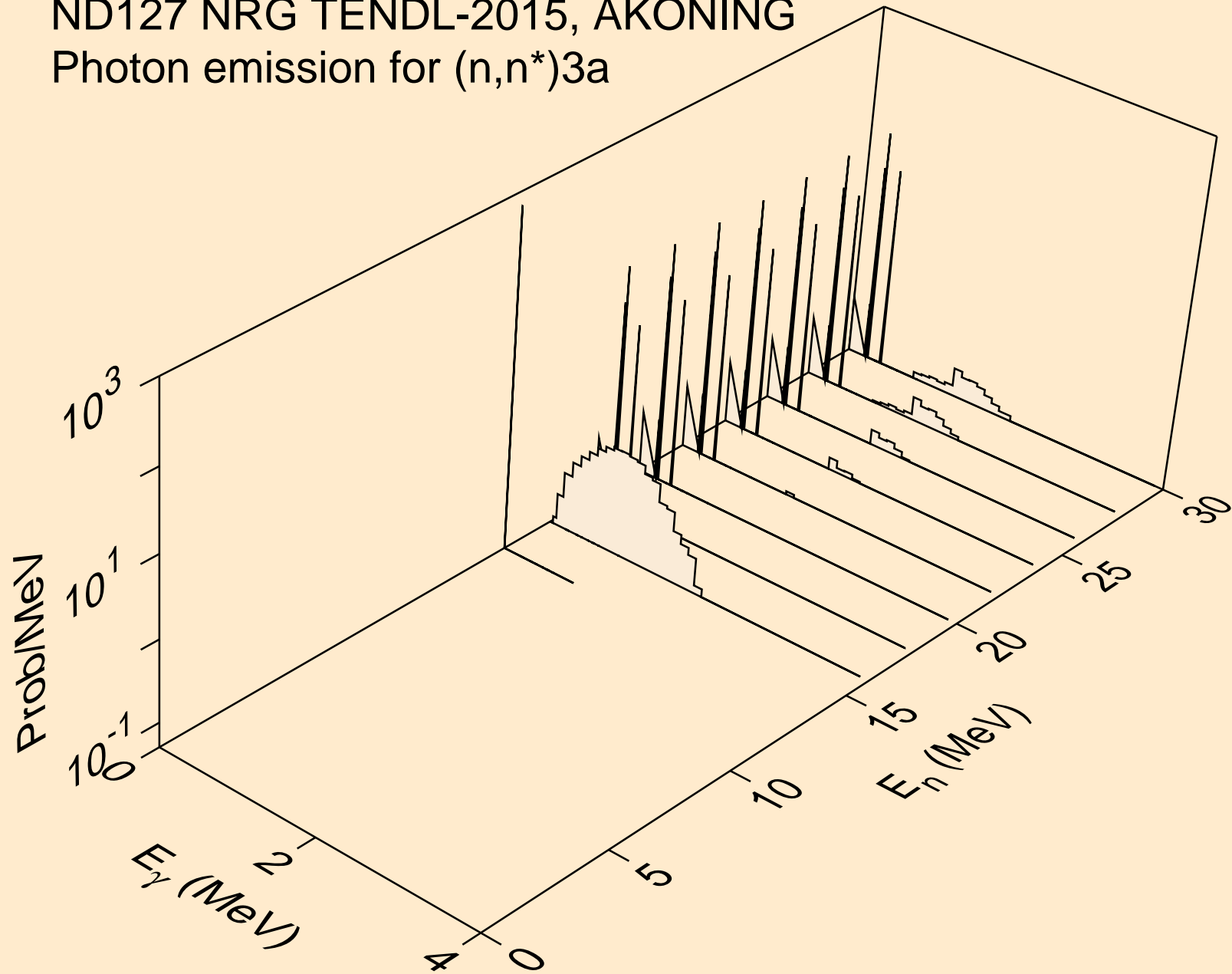

ND127 NRG TENDL-2015, AKONING
Photon emission for (n,2n)a

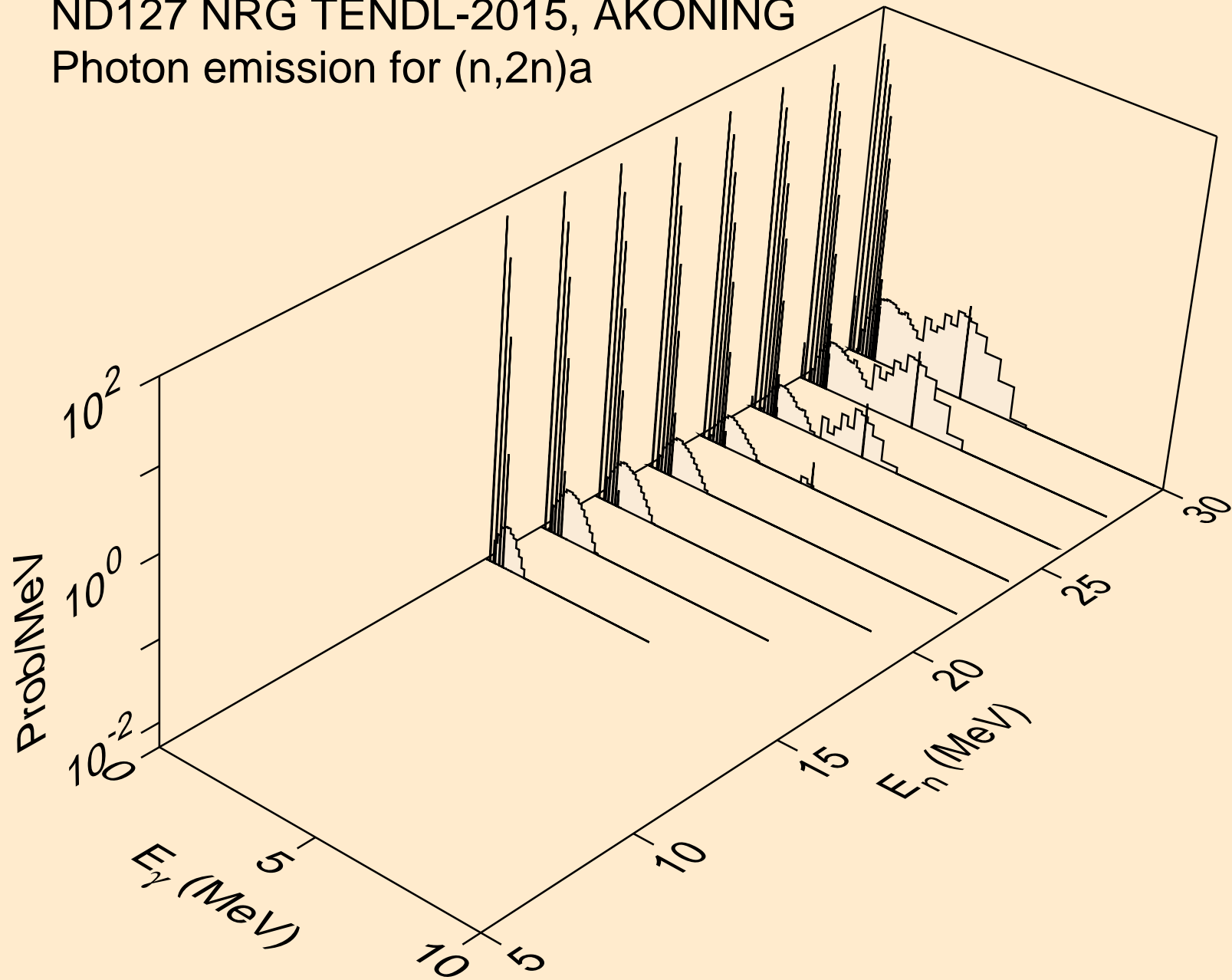

ND127 NRG TENDL-2015, AKONING
Photon emission for (n,n*)p

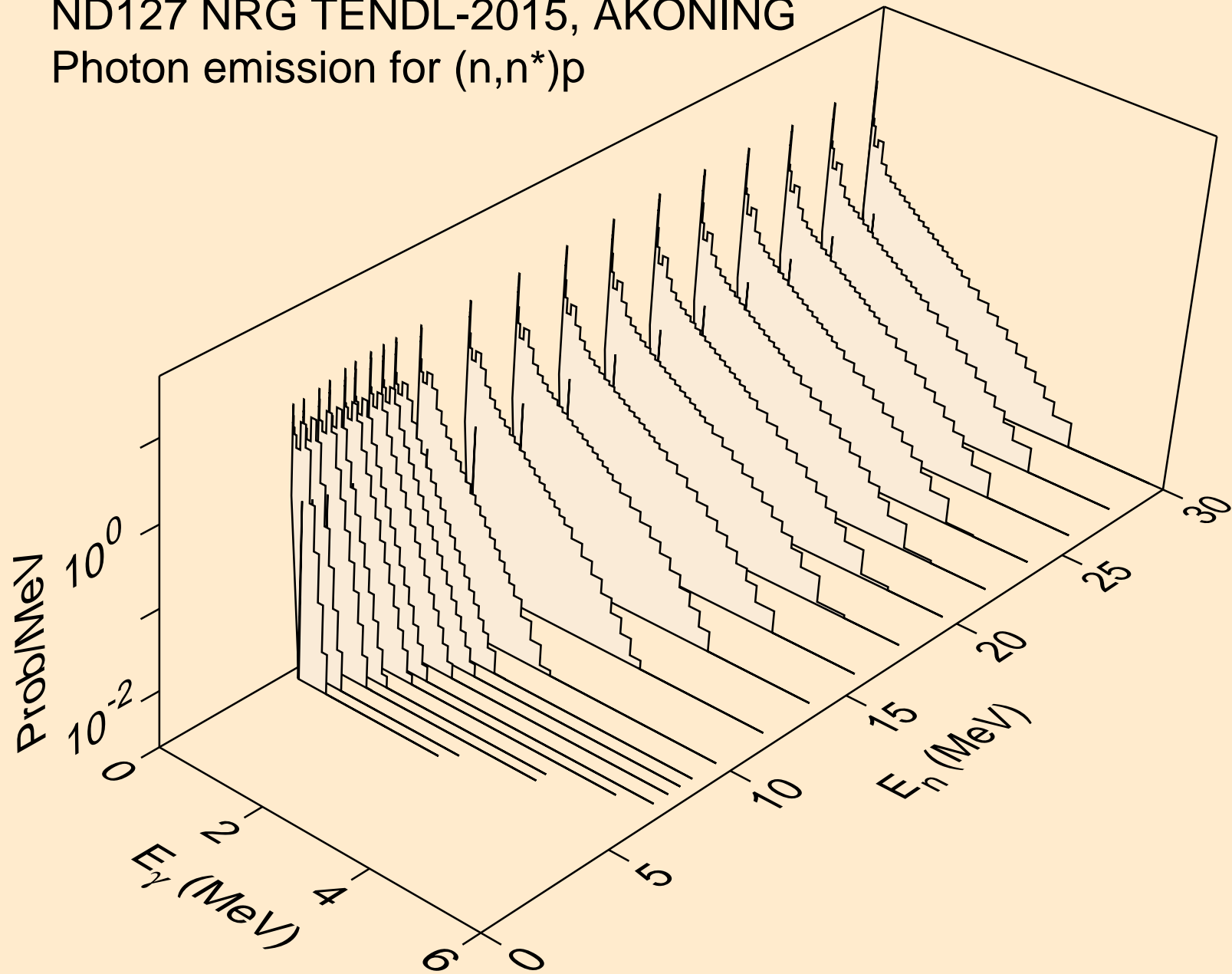

ND127 NRG TENDL-2015, AKONING
Photon emission for (n,n*)2a

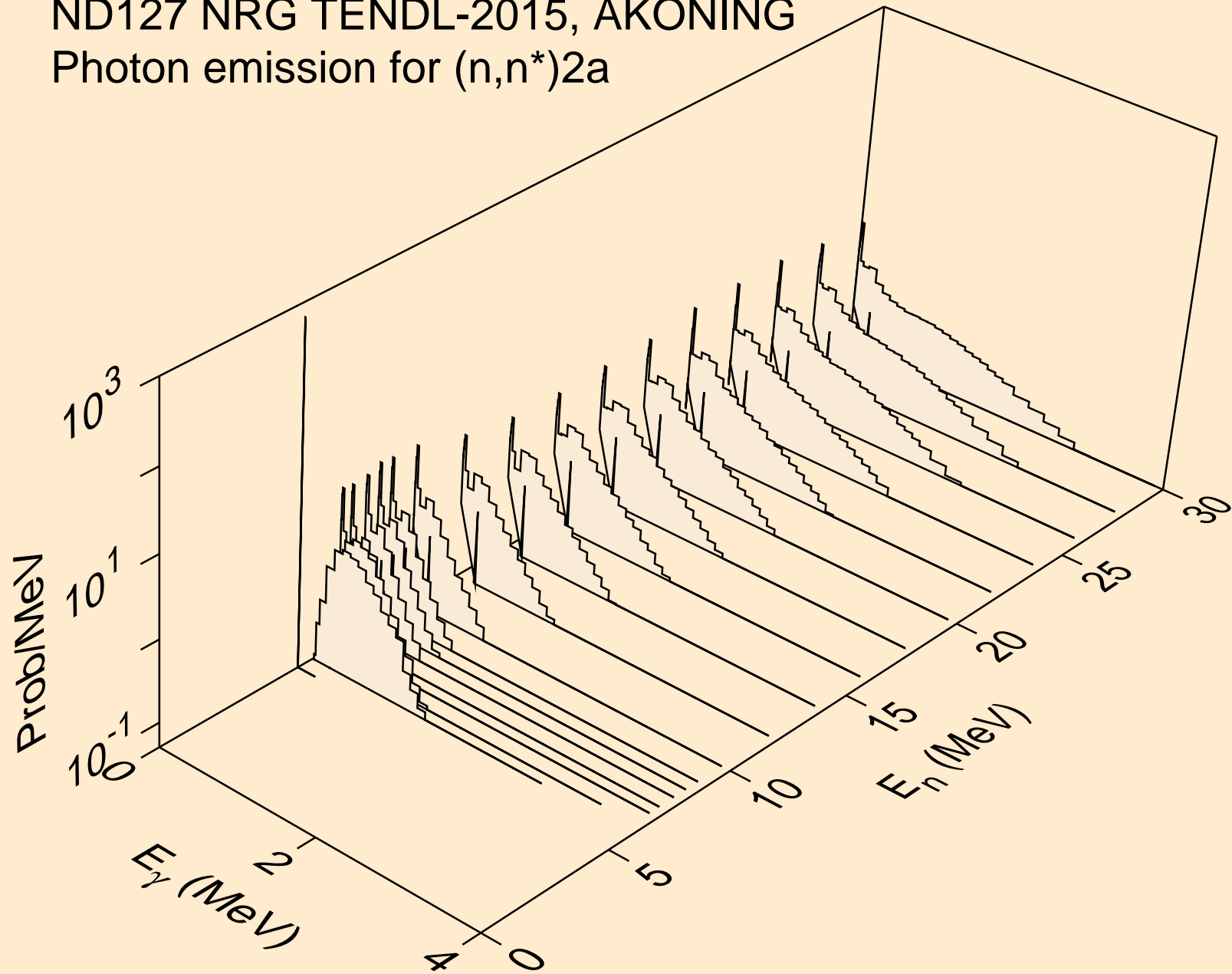

ND127 NRG TENDL-2015, AKONING
Photon emission for (n,2n)2a

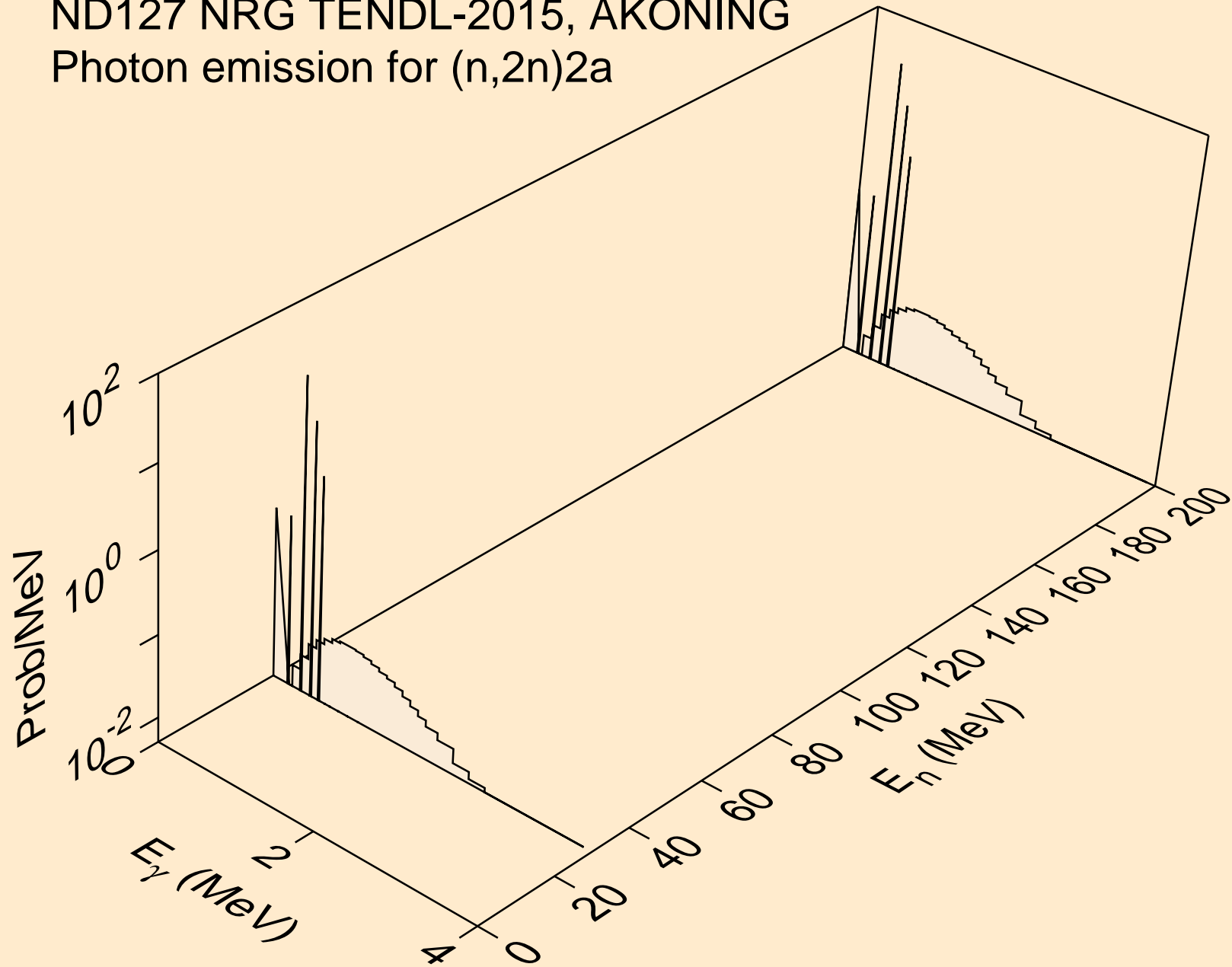

ND127 NRG TENDL-2015, AKONING
Photon emission for (n,n*)d

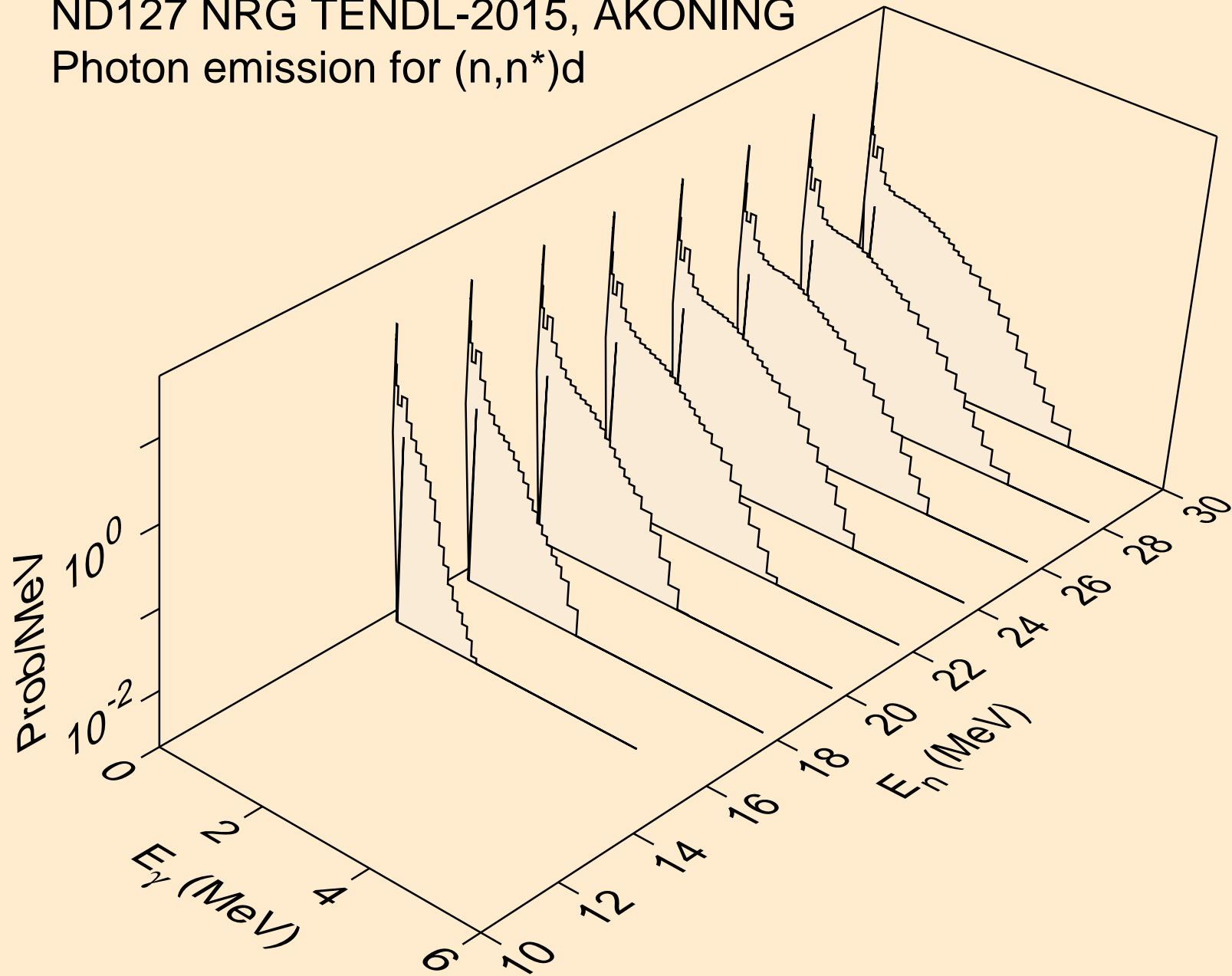

ND127 NRG TENDL-2015, AKONING
Photon emission for (n,n*)t

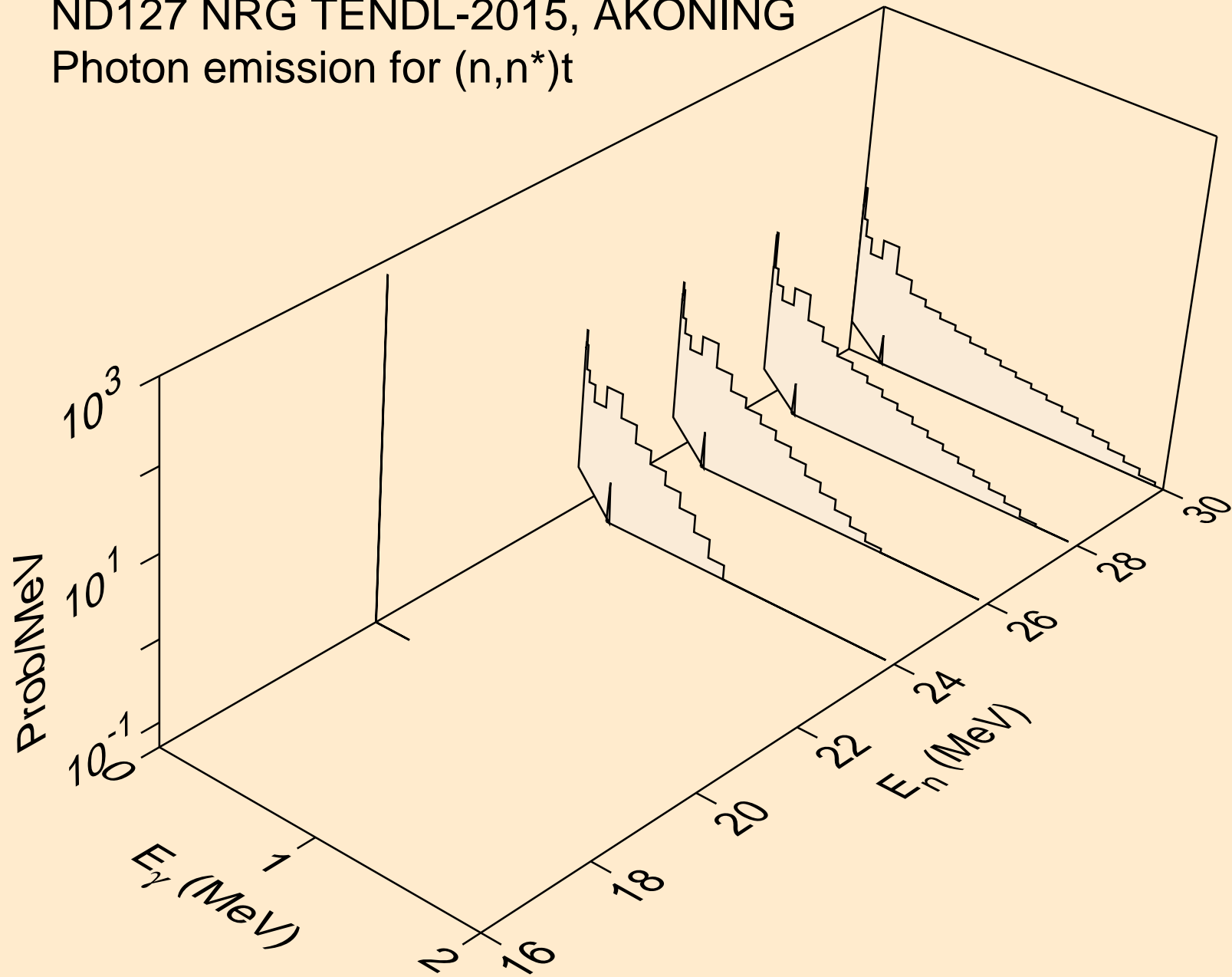

ND127 NRG TENDL-2015, AKONING
Photon emission for (n,n*)he3

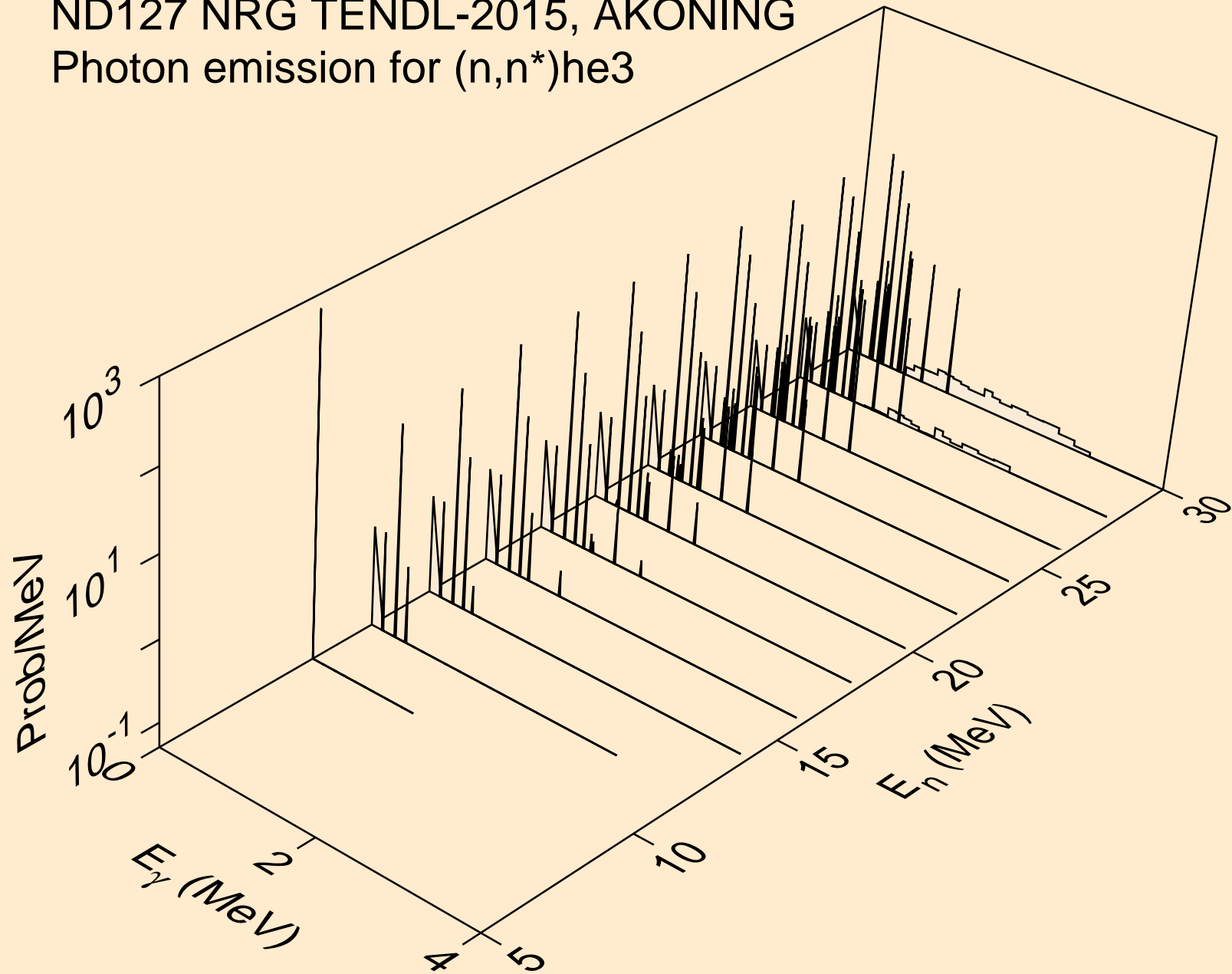

ND127 NRG TENDL-2015, AKONING
Photon emission for (n,2np)

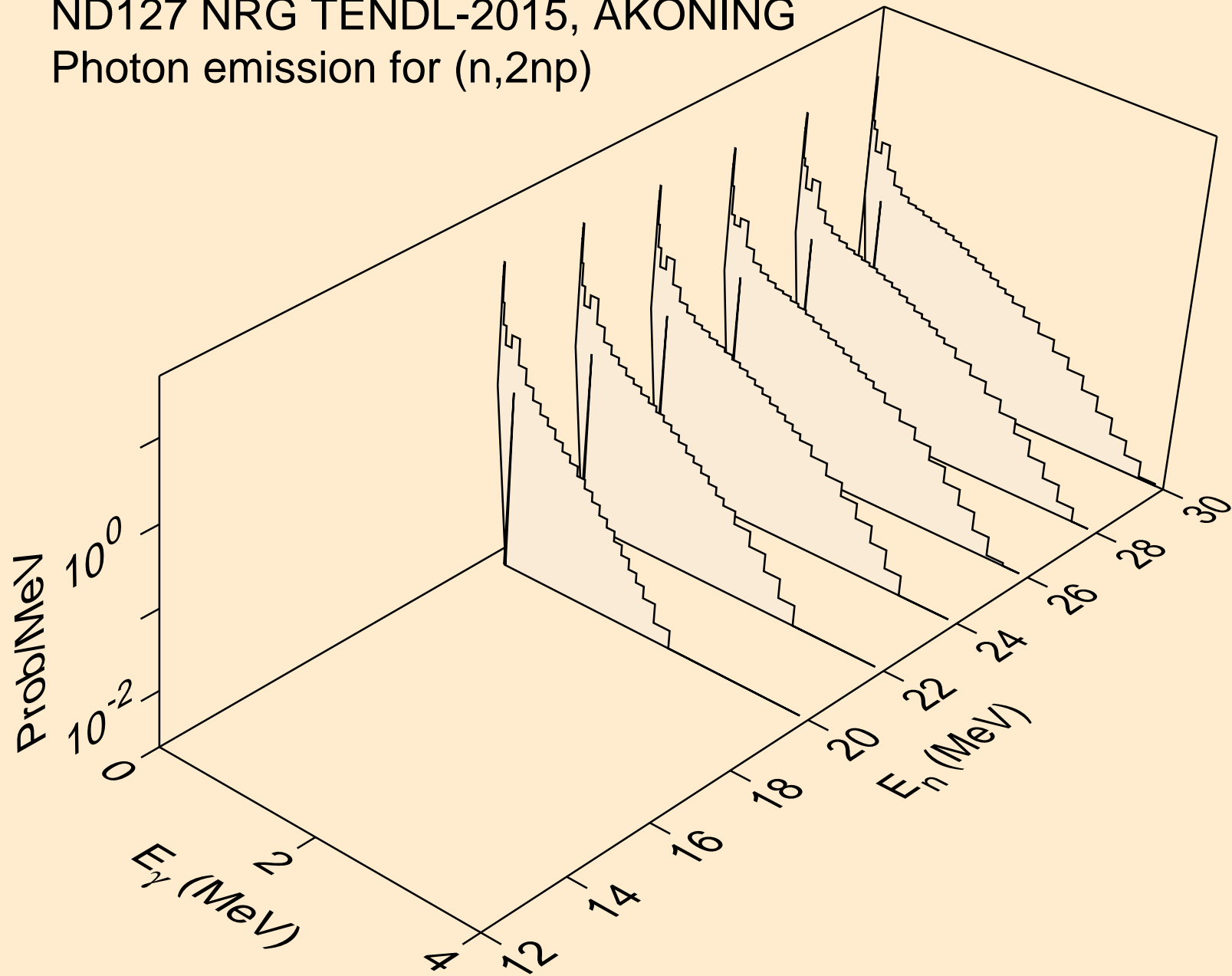

ND127 NRG TENDL-2015, AKONING
Photon emission for (n,3np)

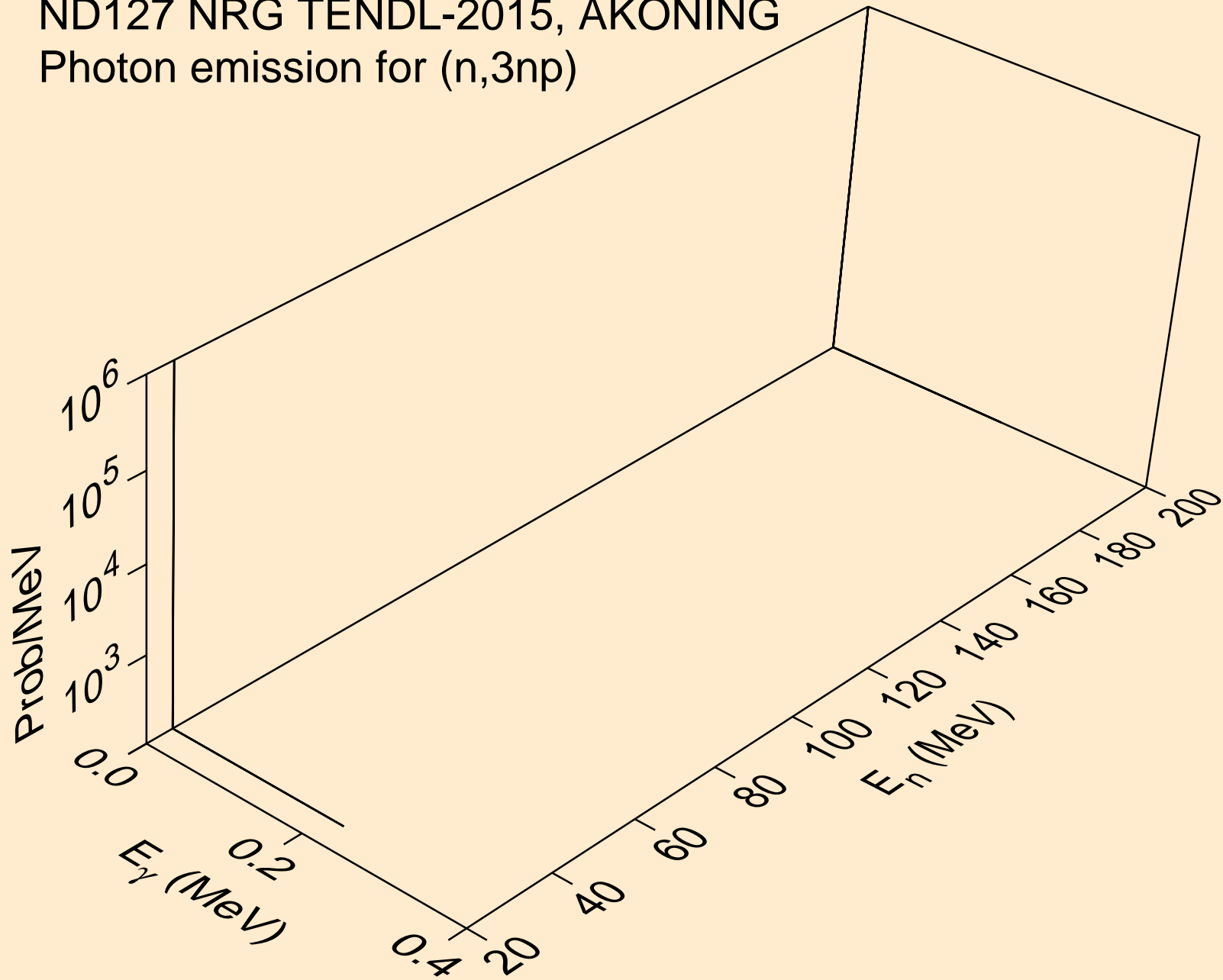

ND127 NRG TENDL-2015, AKONING
Photon emission for (n,2np)

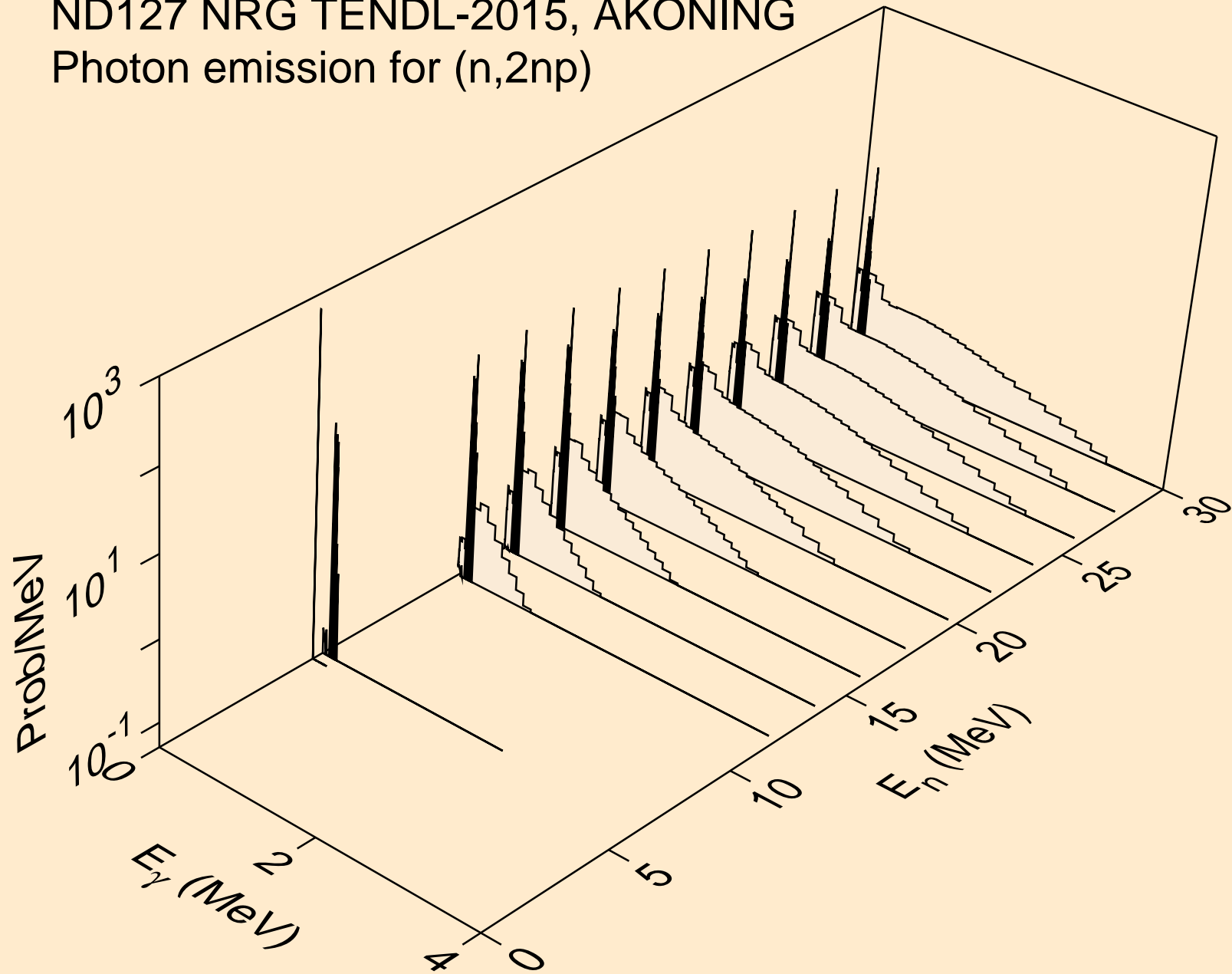

ND127 NRG TENDL-2015, AKONING
Photon emission for (n,npa)

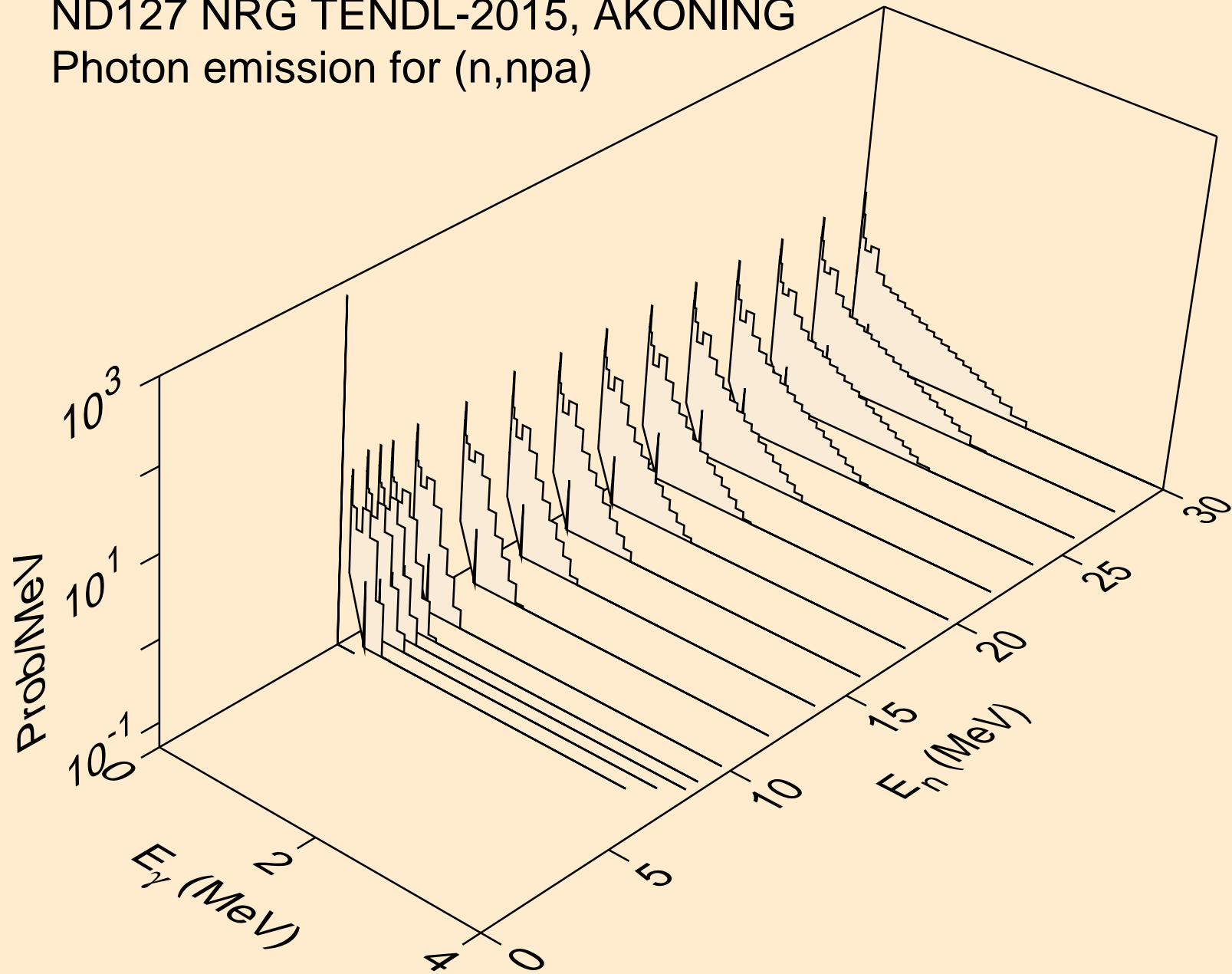

ND127 NRG TENDL-2015, AKONING
Photon emission for (n,n*c)

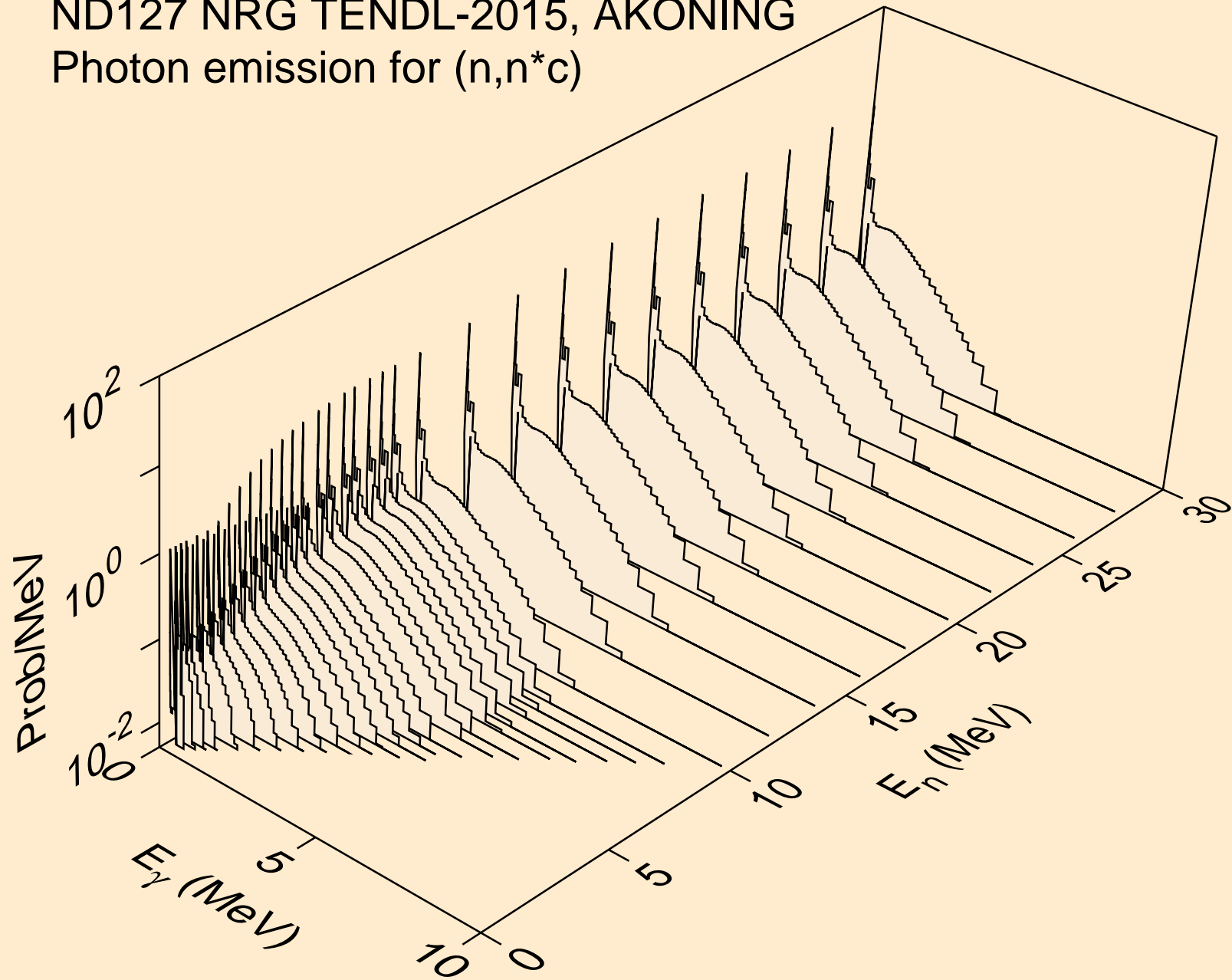

ND127 NRG TENDL-2015, AKONING
Photon emission for (n,gma)

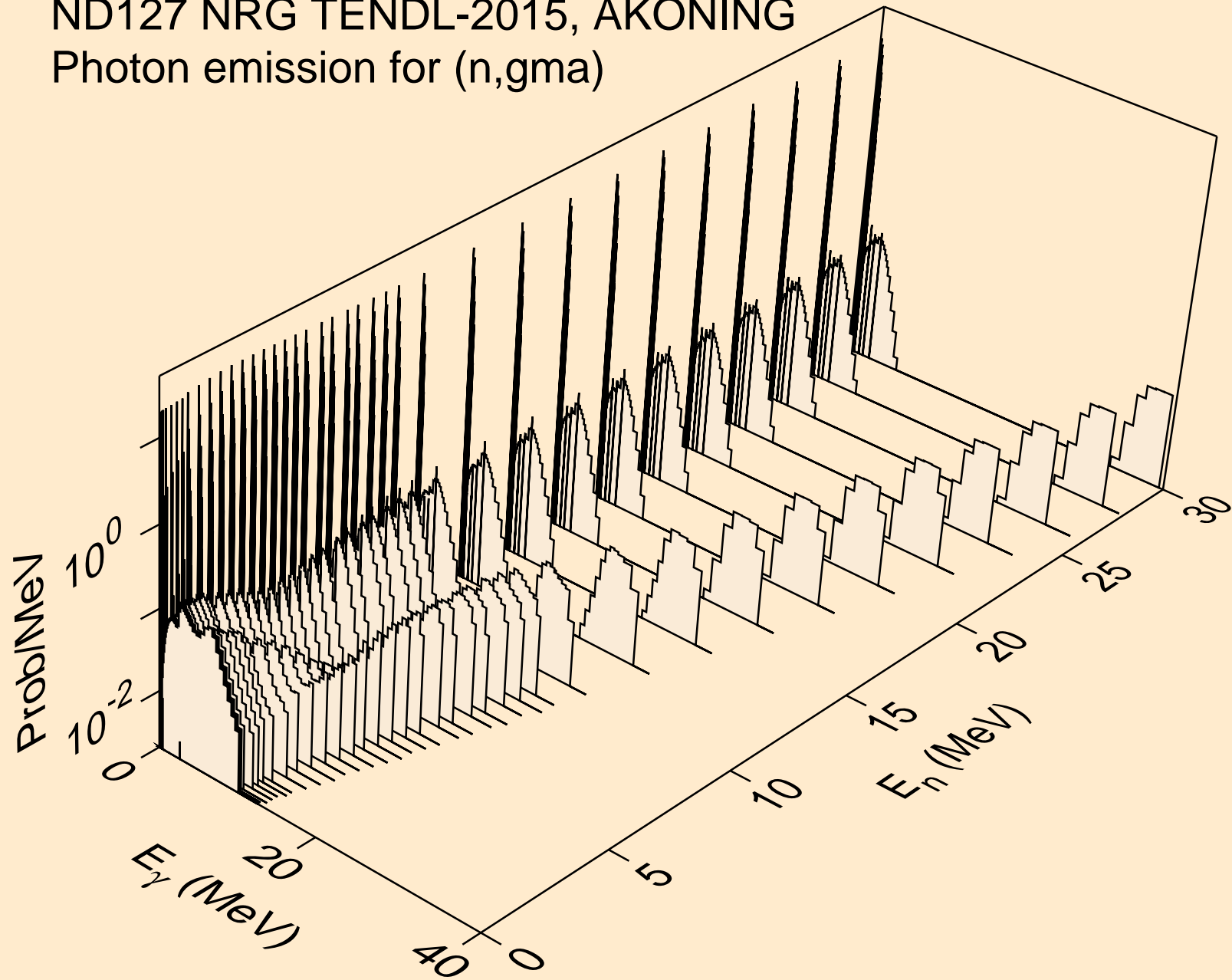

ND127 NRG TENDL-2015, AKONING
Photon emission for (n,p)

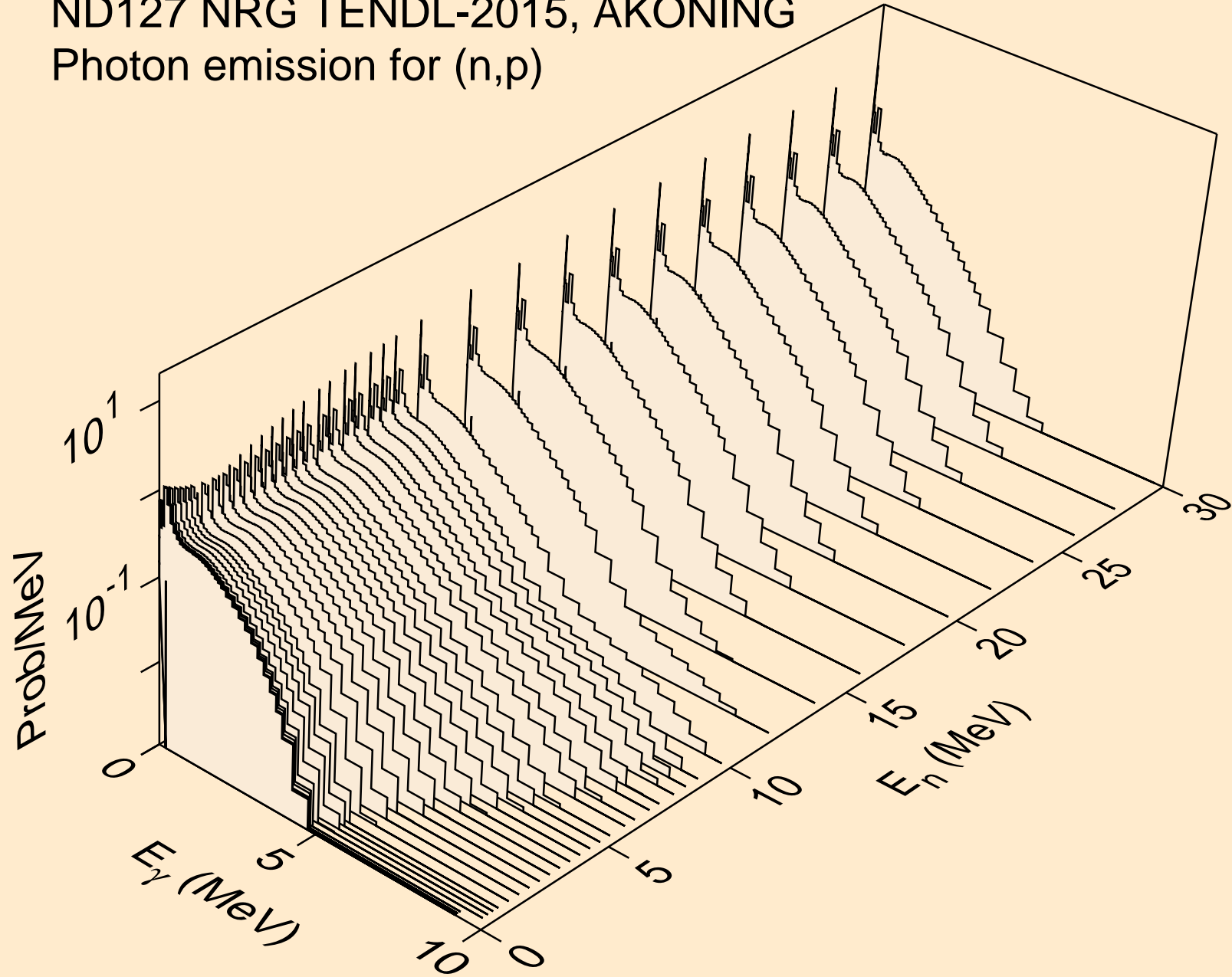

ND127 NRG TENDL-2015, AKONING
Photon emission for (n,d)

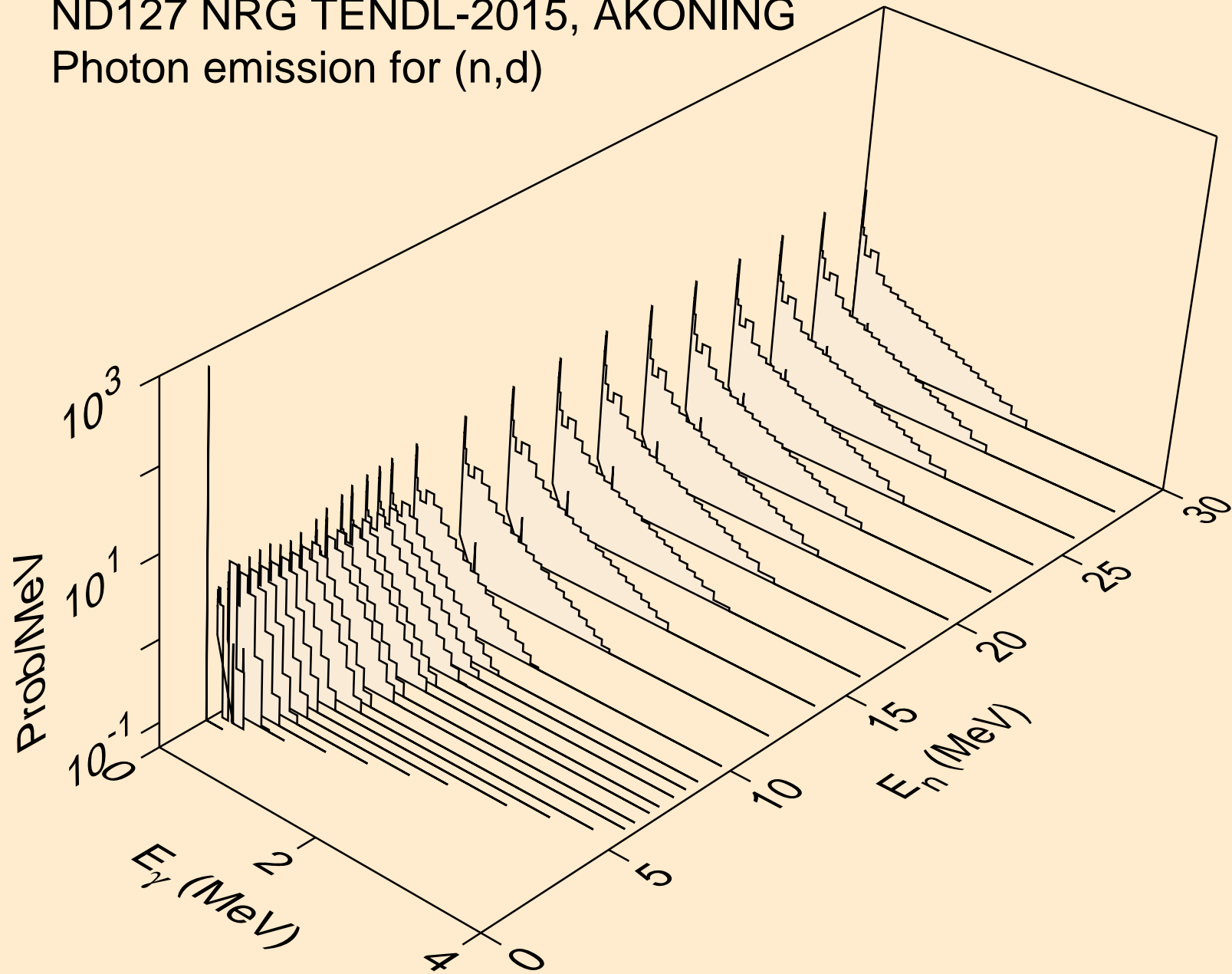

ND127 NRG TENDL-2015, AKONING
Photon emission for (n,t)

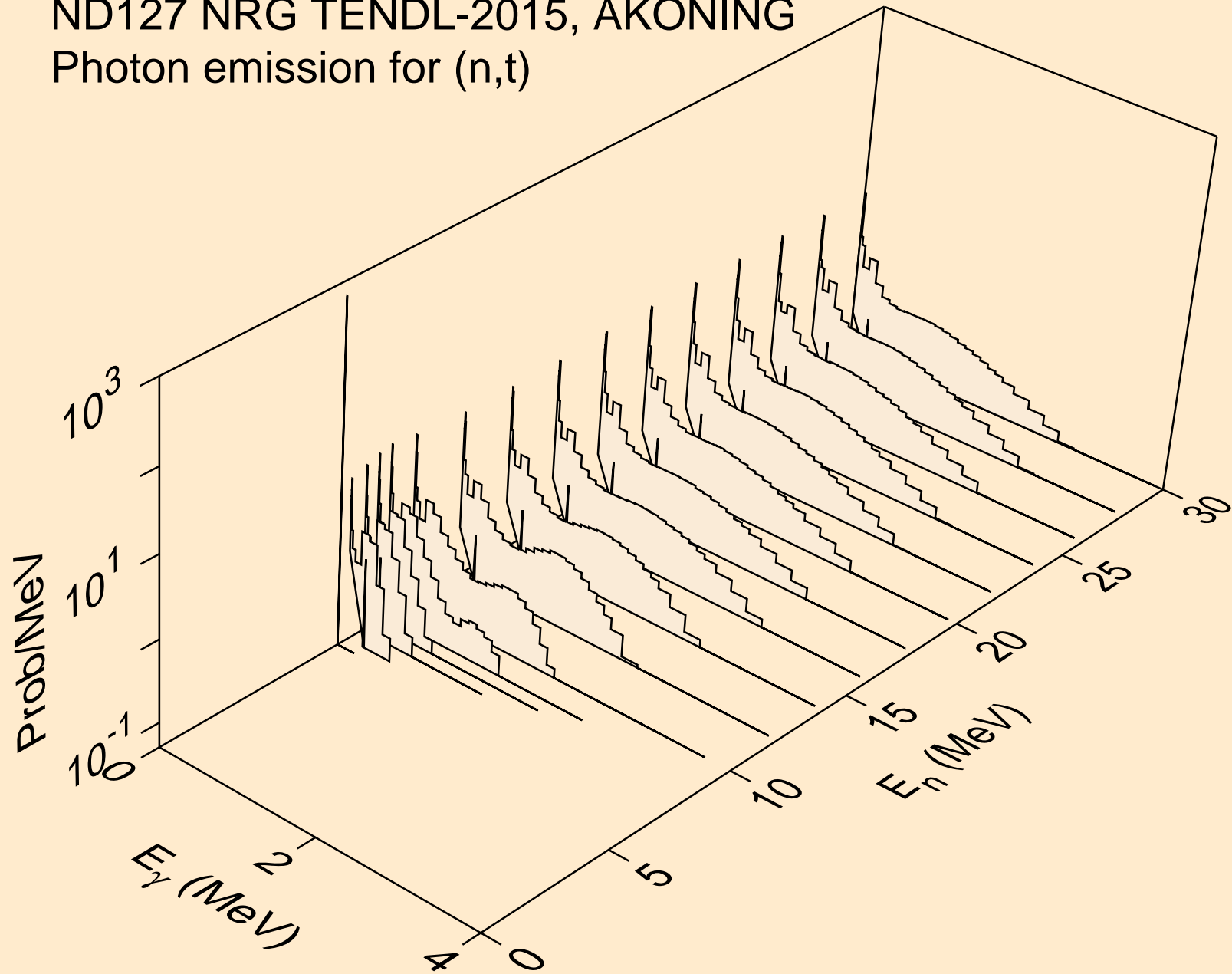

ND127 NRG TENDL-2015, AKONING
Photon emission for (n,he3)

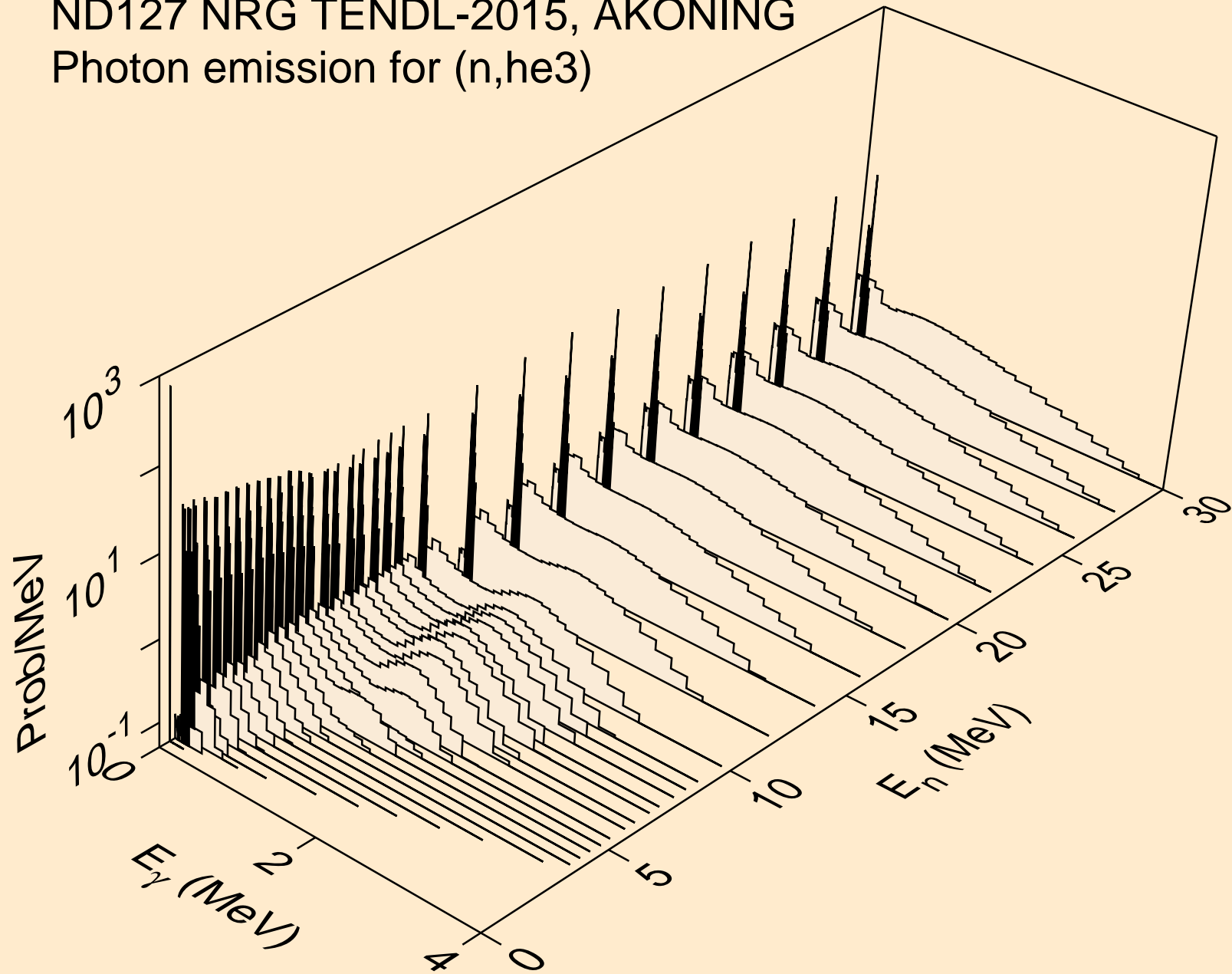

ND127 NRG TENDL-2015, AKONING
Photon emission for (n,a)

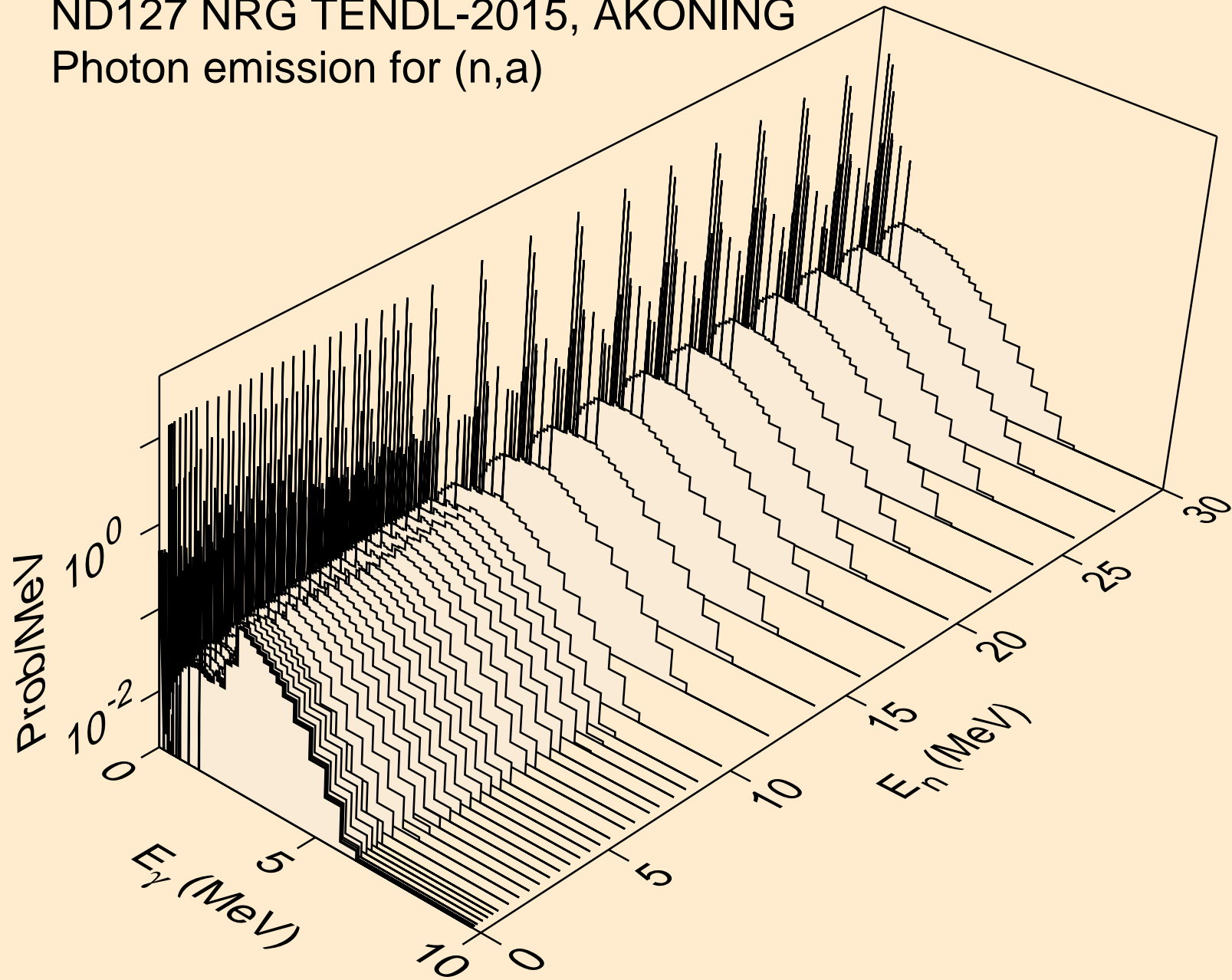

ND127 NRG TENDL-2015, AKONING
Photon emission for (n,2a)

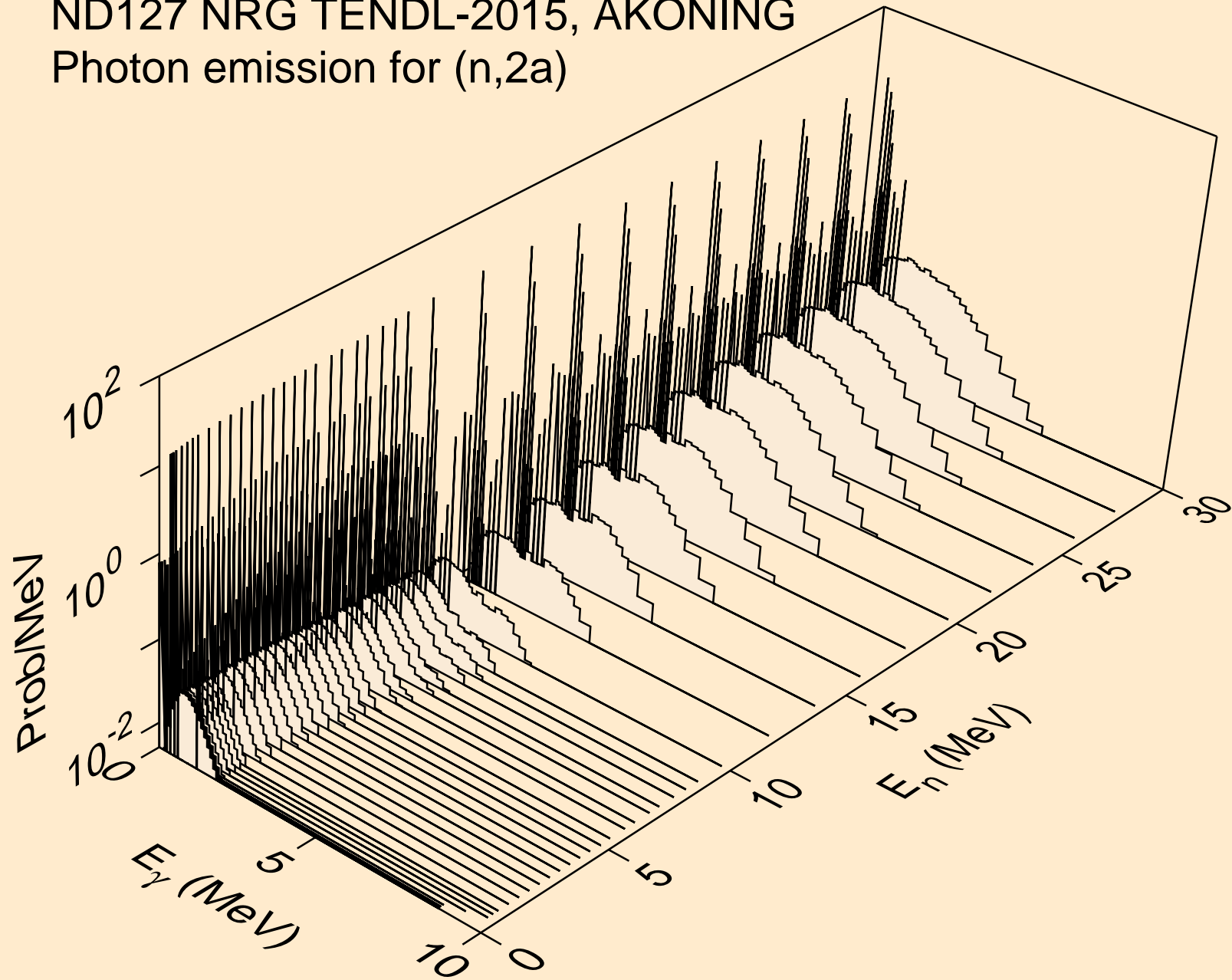

ND127 NRG TENDL-2015, AKONING
Photon emission for (n,3a)

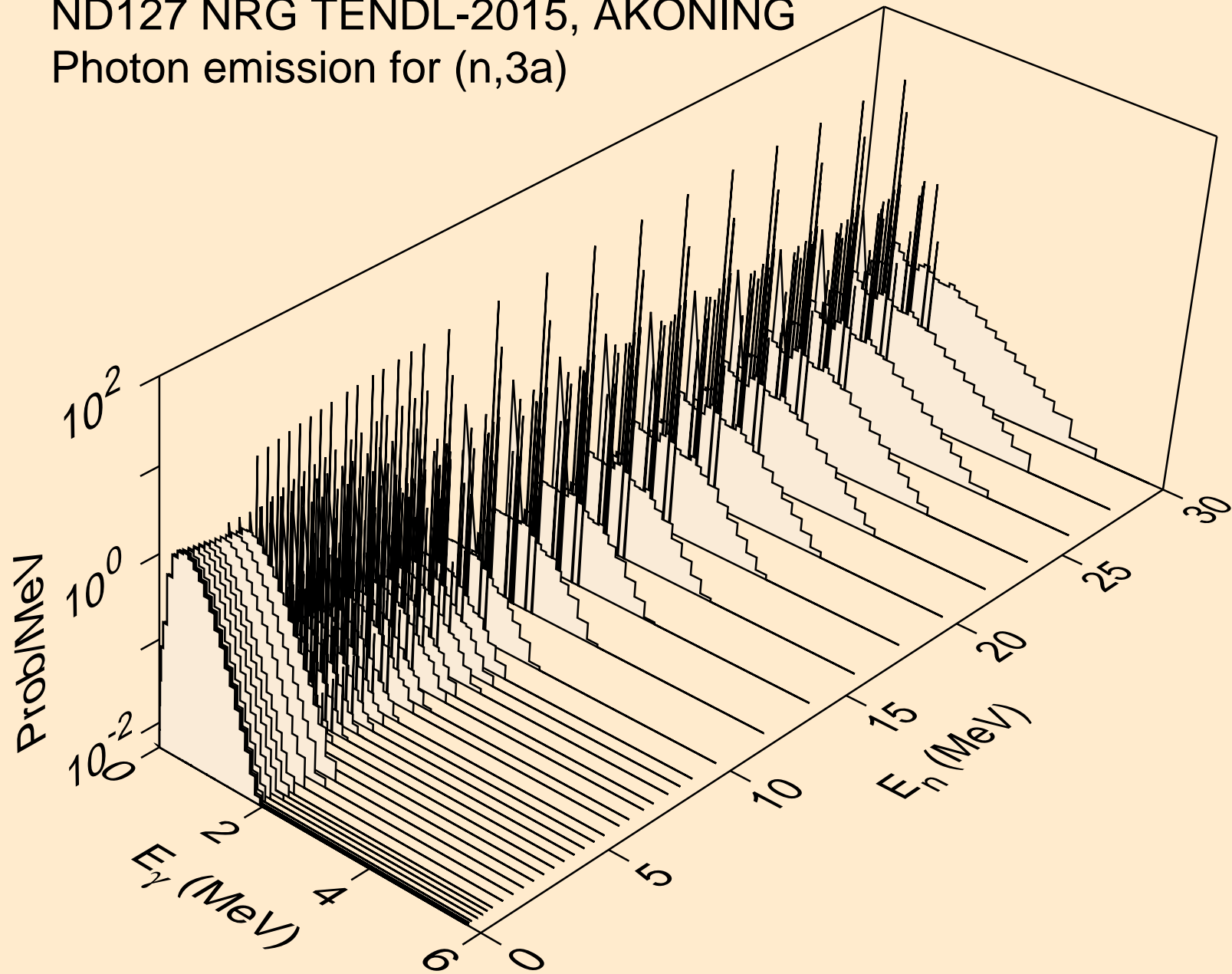

ND127 NRG TENDL-2015, AKONING
Photon emission for (n,2p)

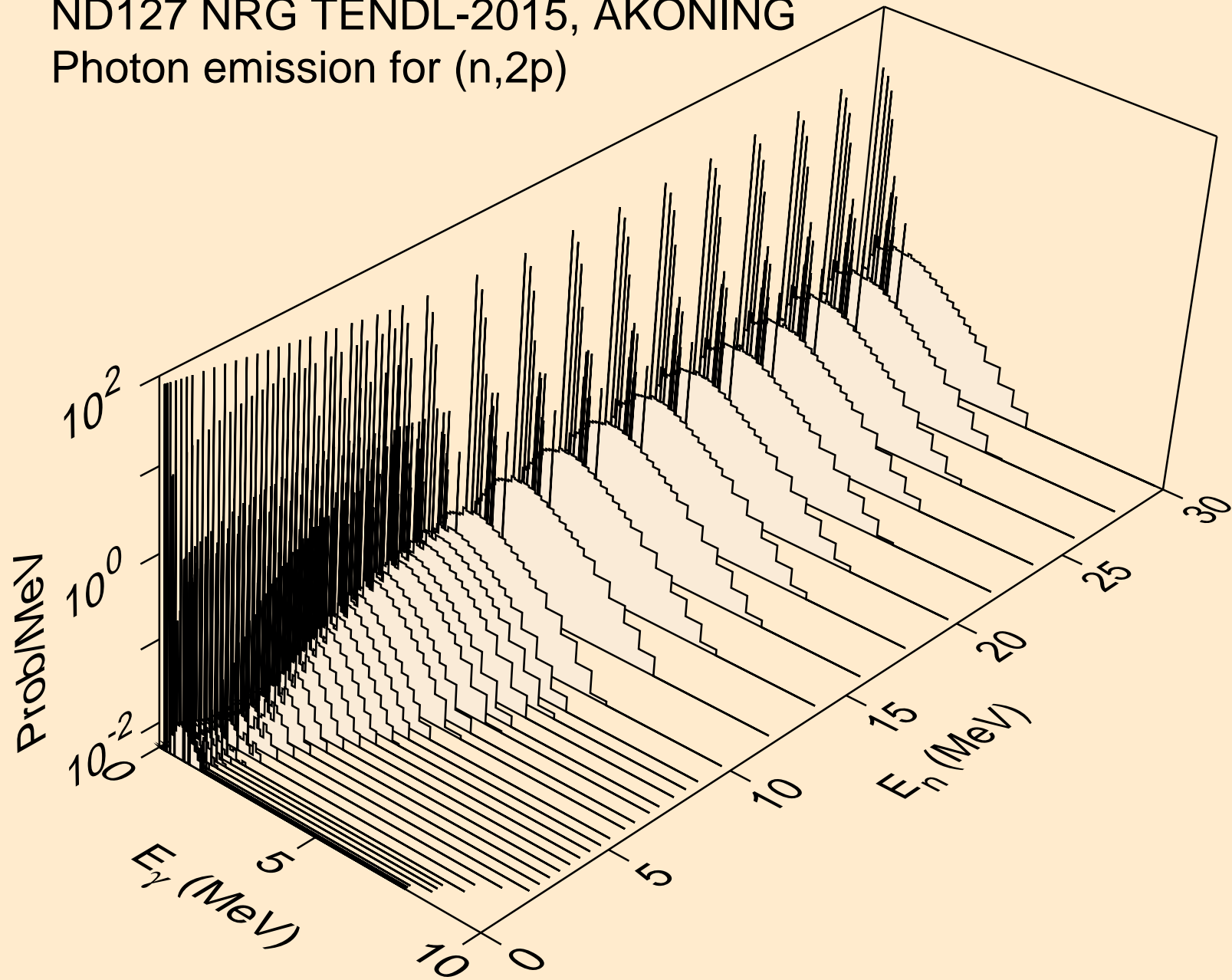

ND127 NRG TENDL-2015, AKONING
Photon emission for (n,p α)

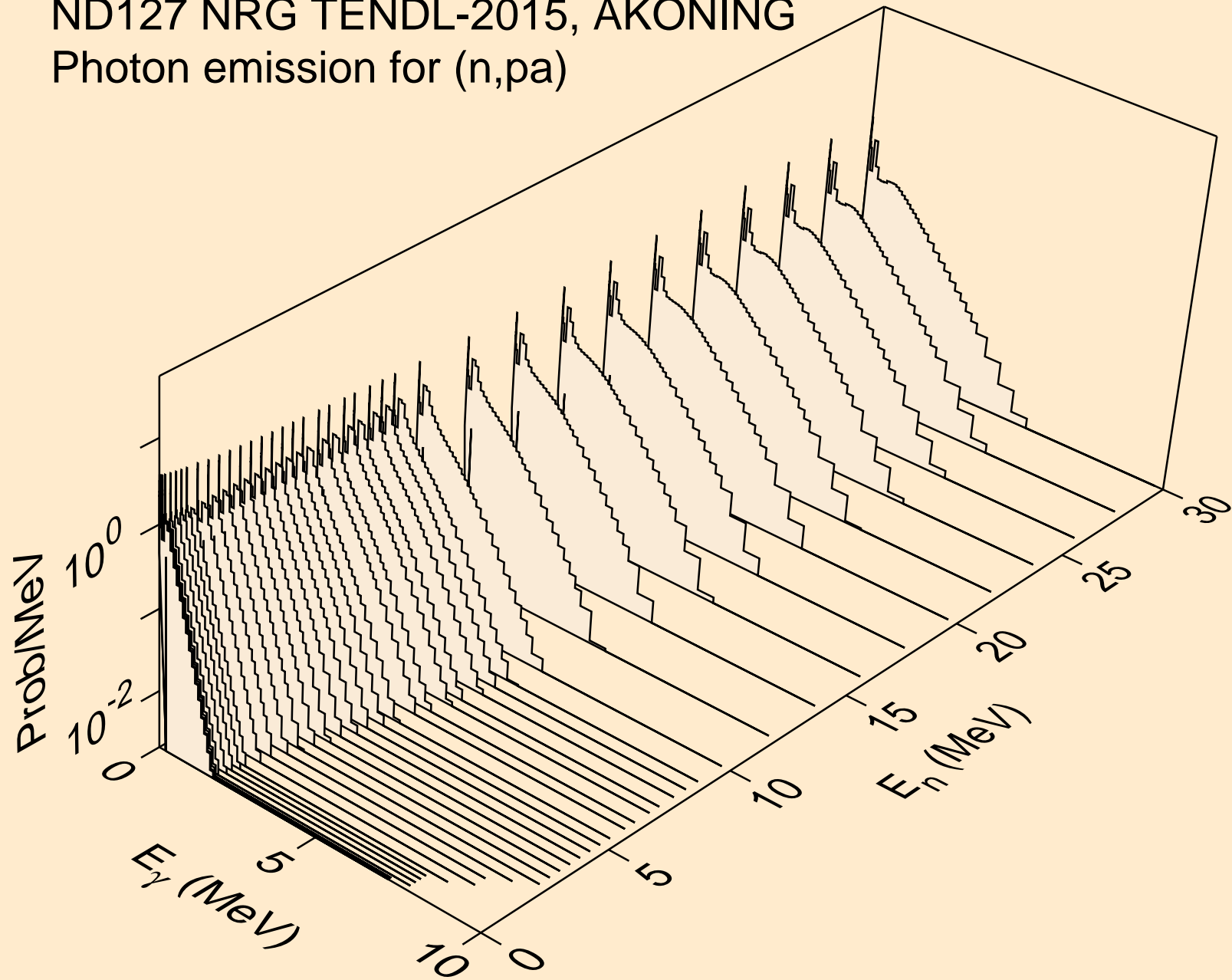

ND127 NRG TENDL-2015, AKONING
Photon emission for (n,d2a)

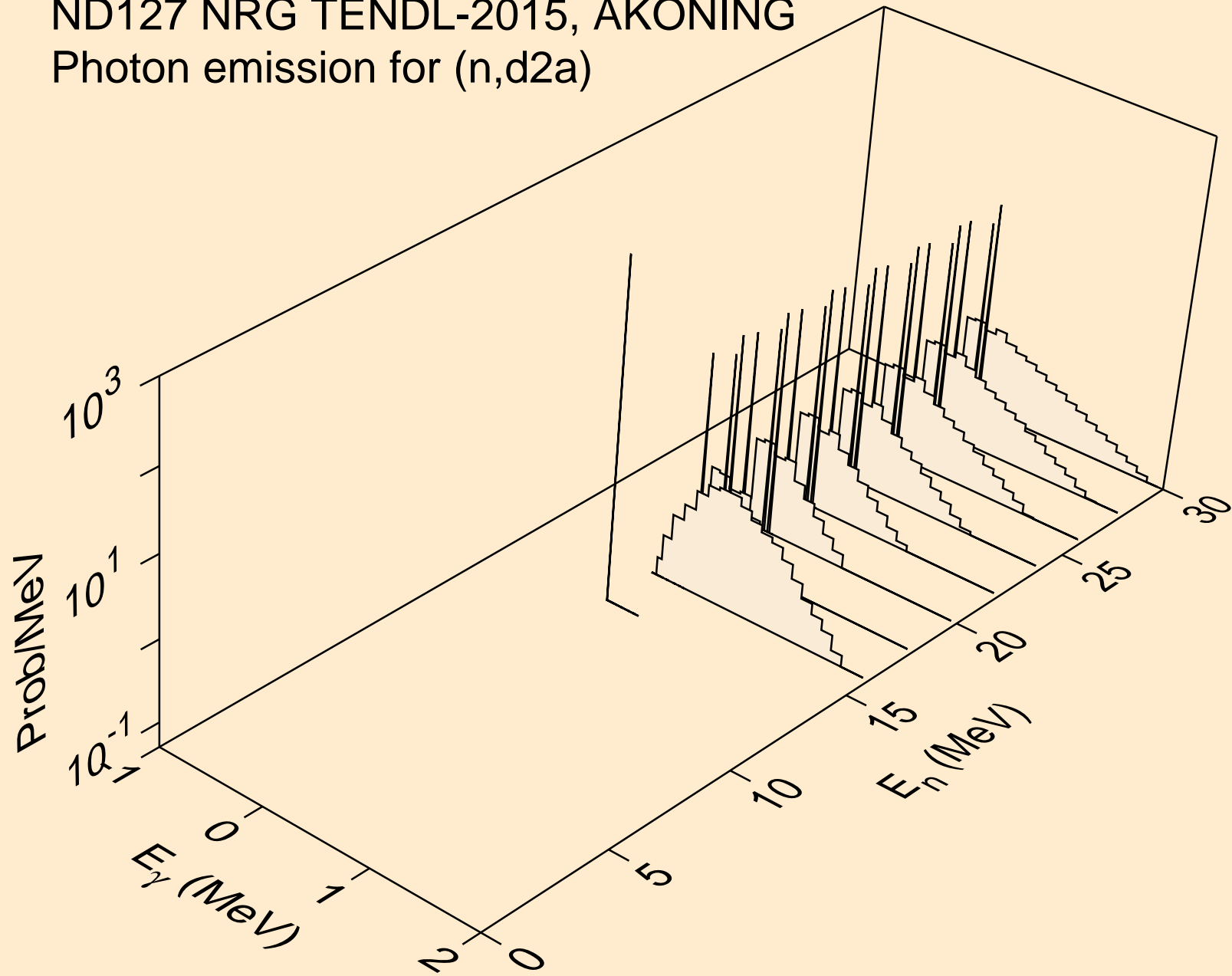

ND127 NRG TENDL-2015, AKONING
Photon emission for (n,pd)

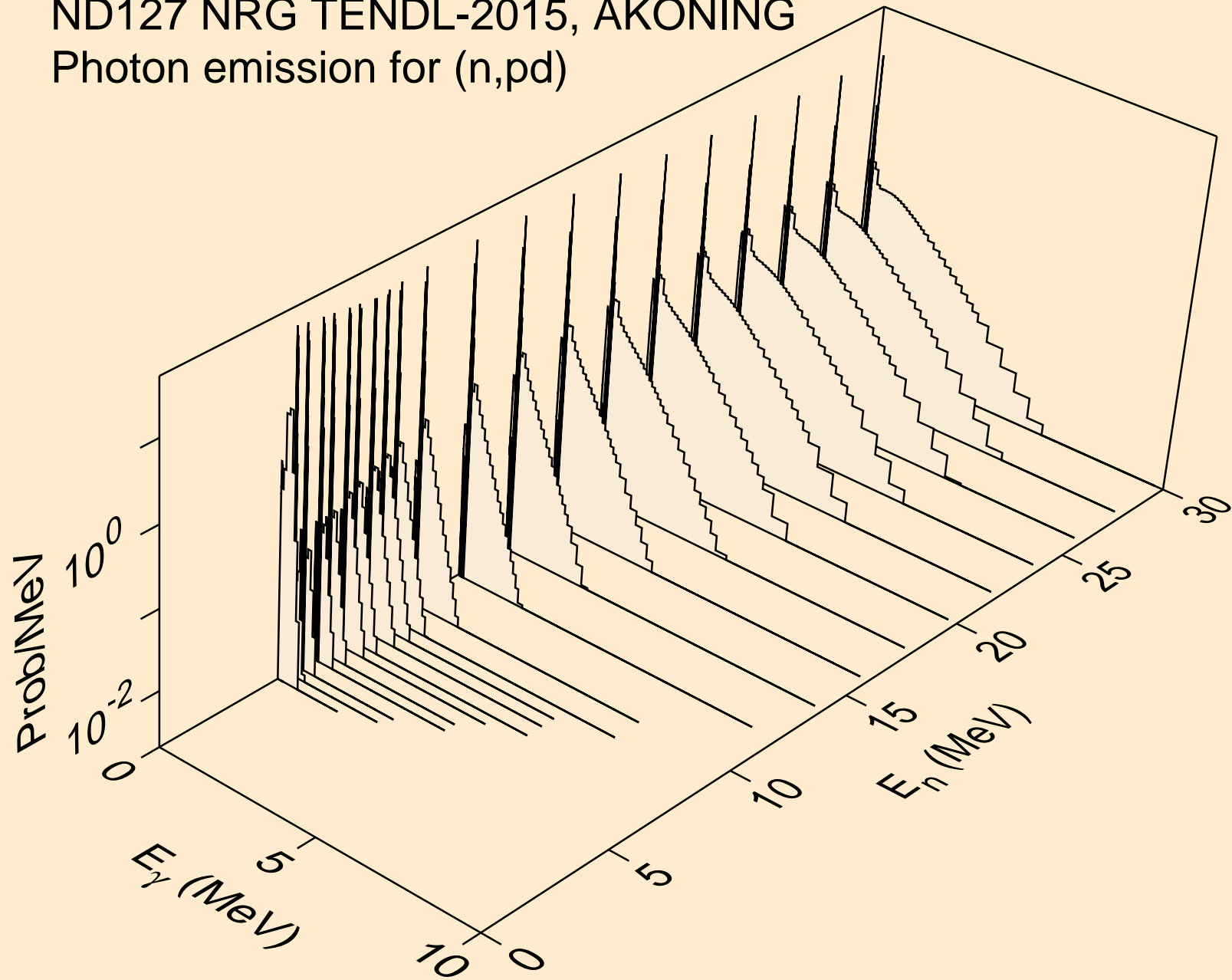

ND127 NRG TENDL-2015, AKONING
Photon emission for (n,pt)

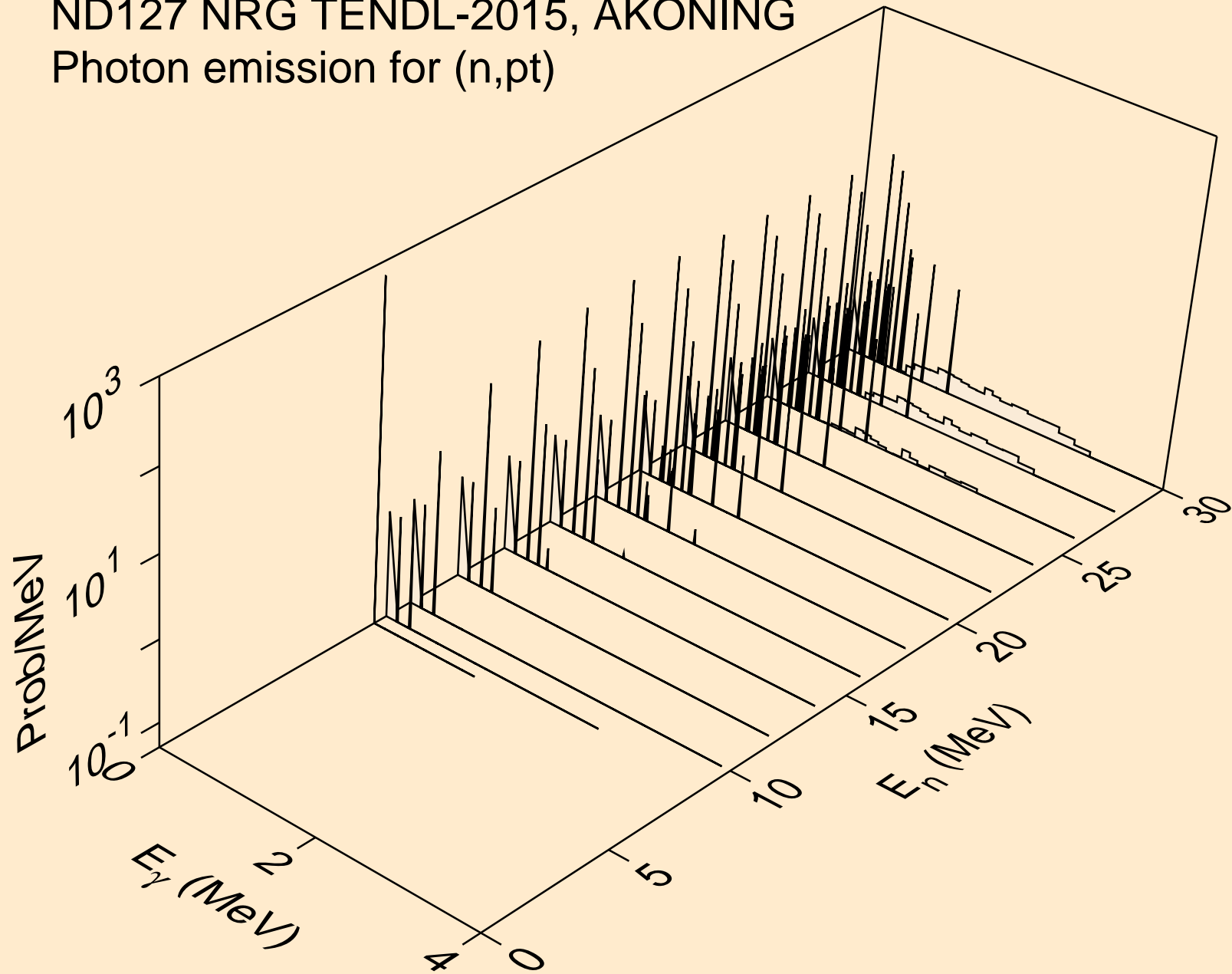

ND127 NRG TENDL-2015, AKONING
Photon emission for (n,da)

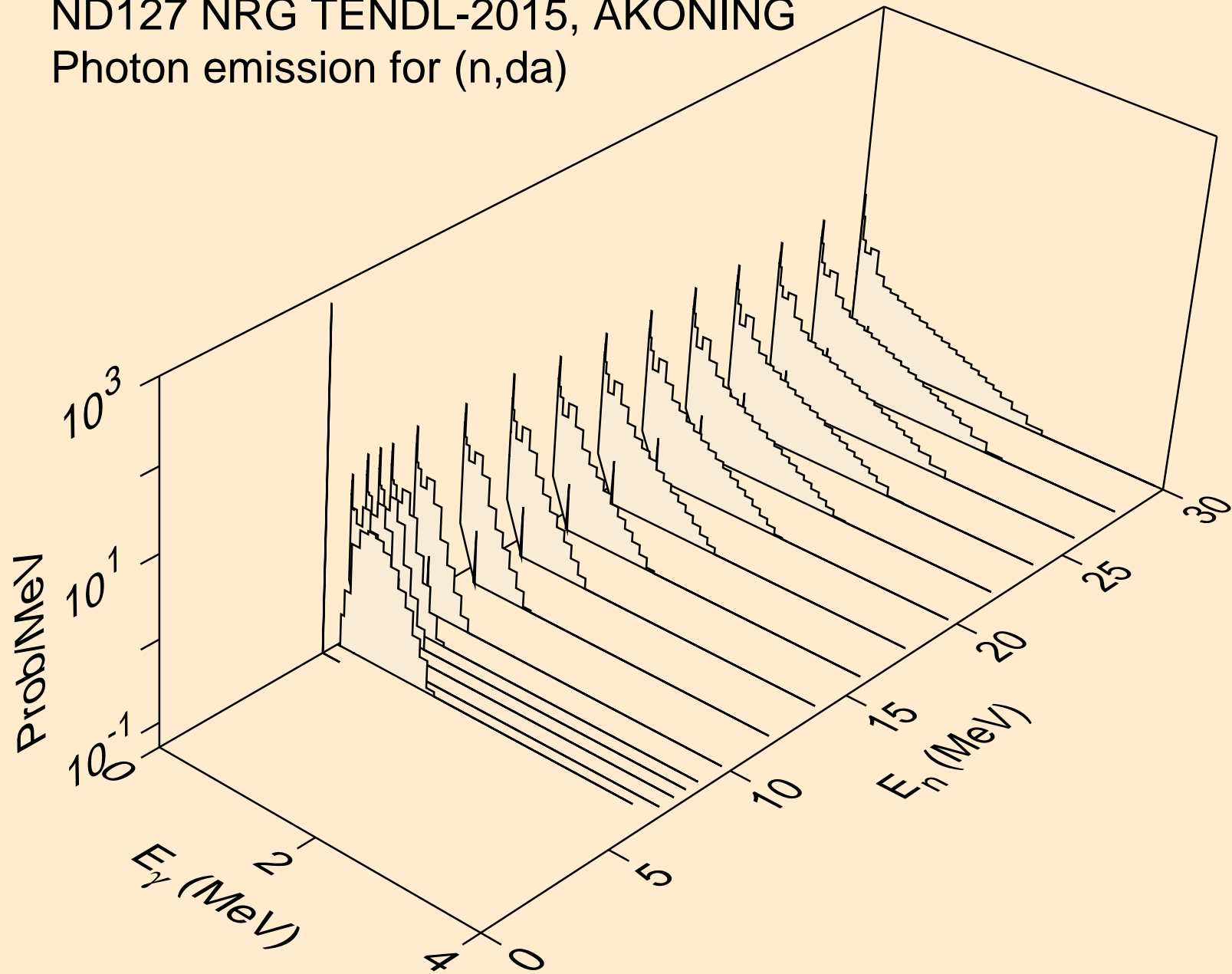

ND127 NRG TENDL-2015, AKONING
thermal capture photon spectrum

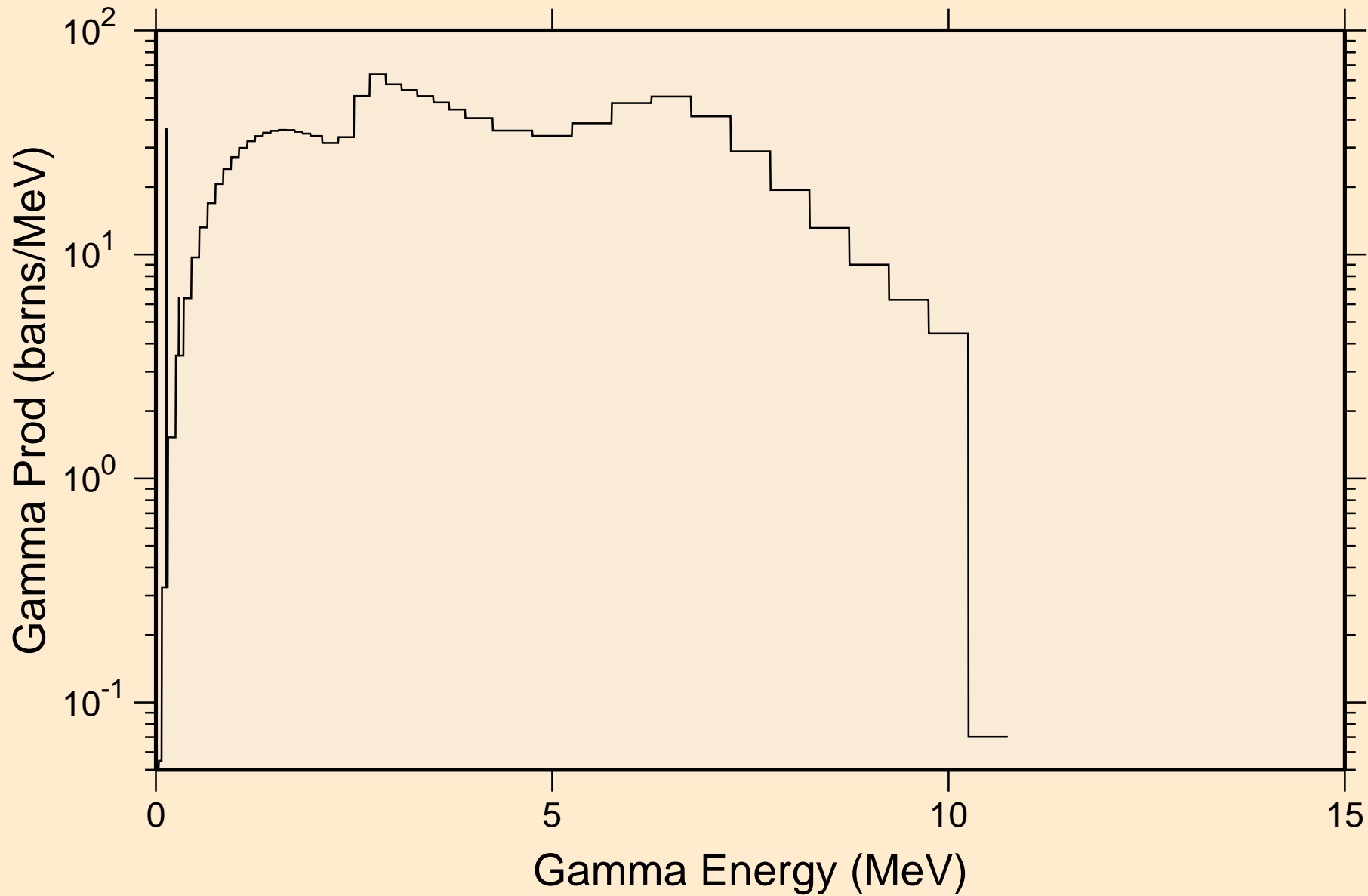

ND127 NRG TENDL-2015, AKONING
14 MeV photon spectrum

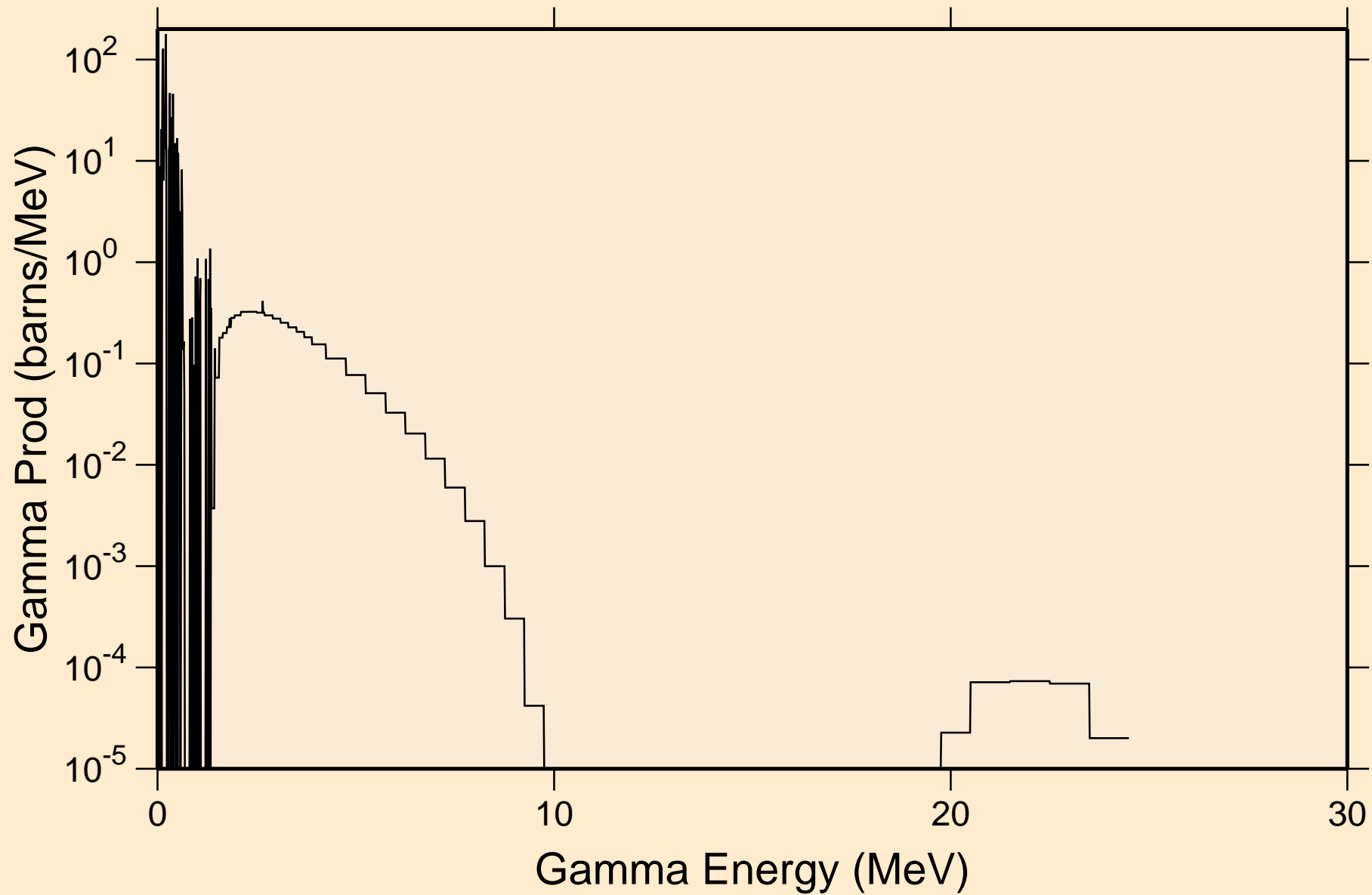

ND127 NRG TENDL-2015, AKONING

Particle heating contributions

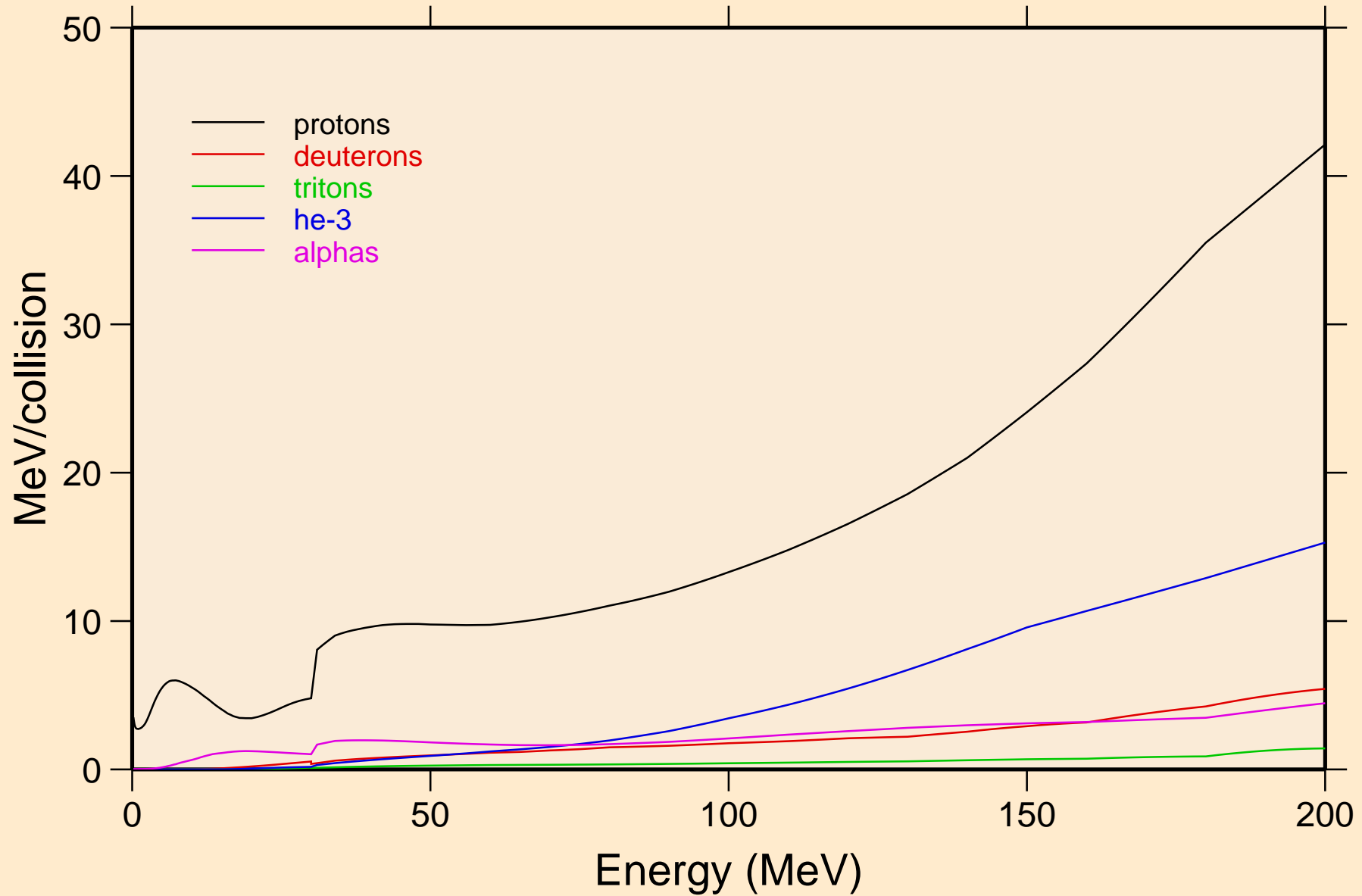

ND127 NRG TENDL-2015, AKONING

Recoil Heating

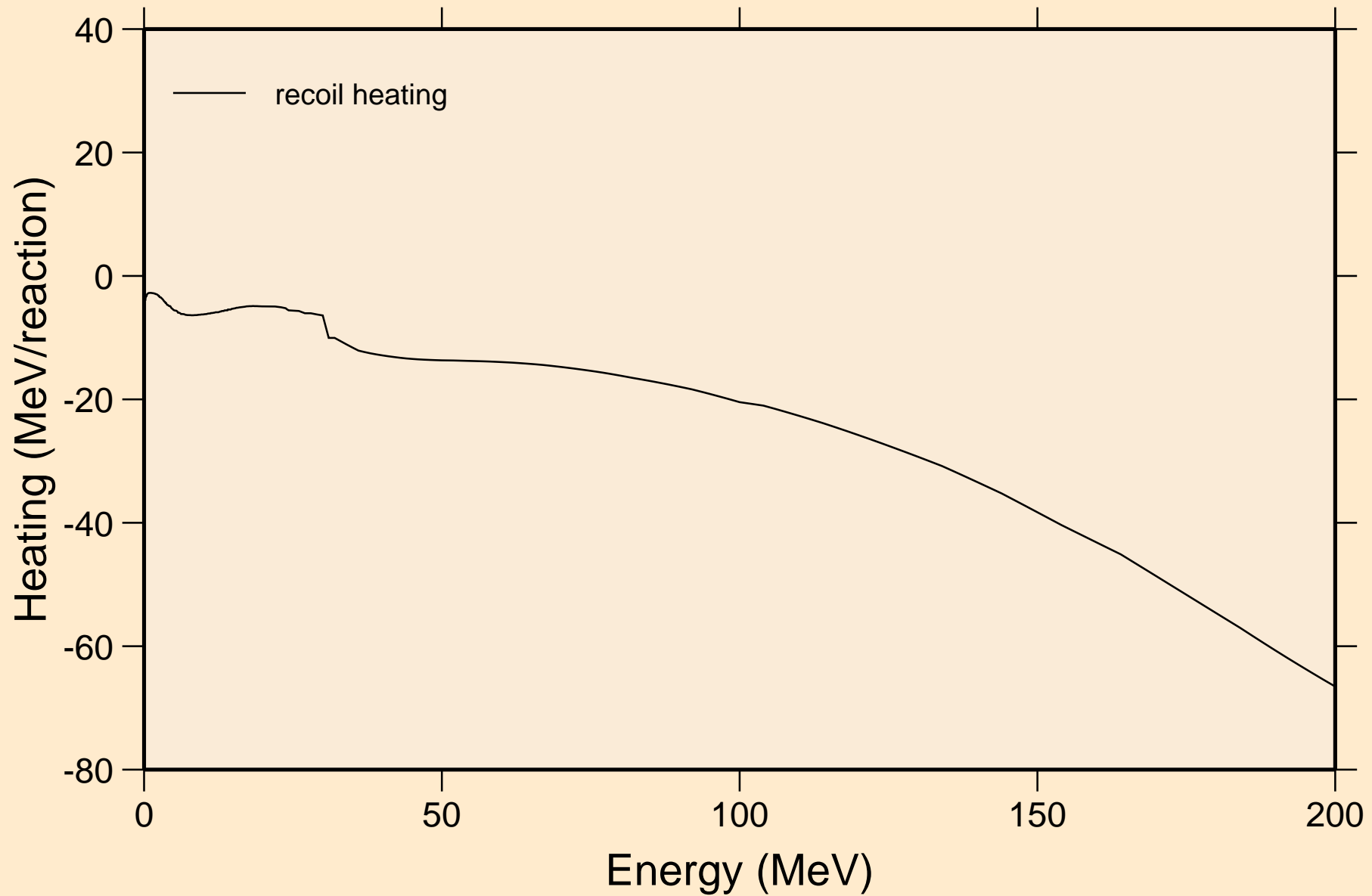

ND127 NRG TENDL-2015, AKONING

Particle production cross sections

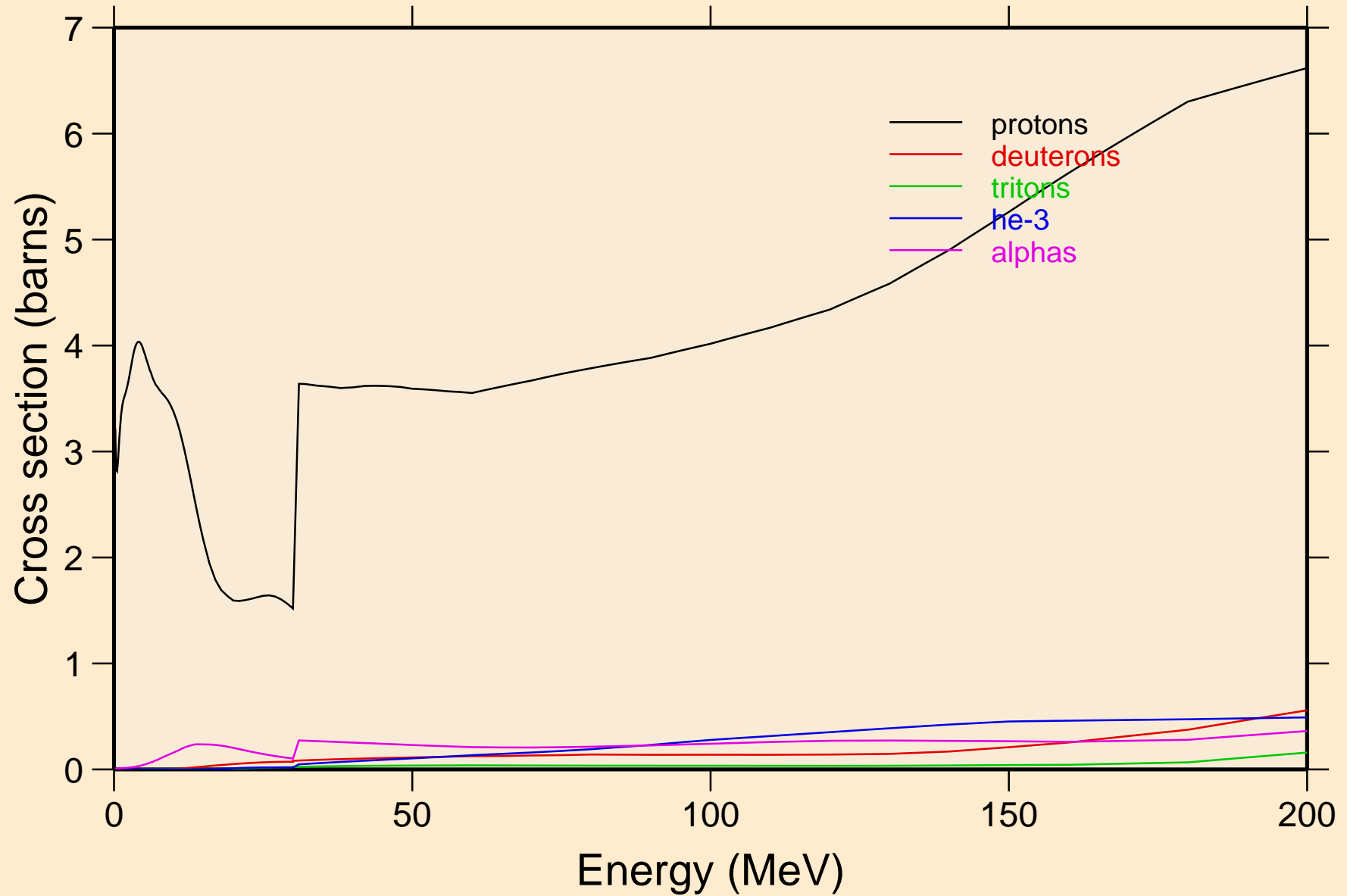

ND127 NRG TENDL-2015, AKONING
protons from (n,x)

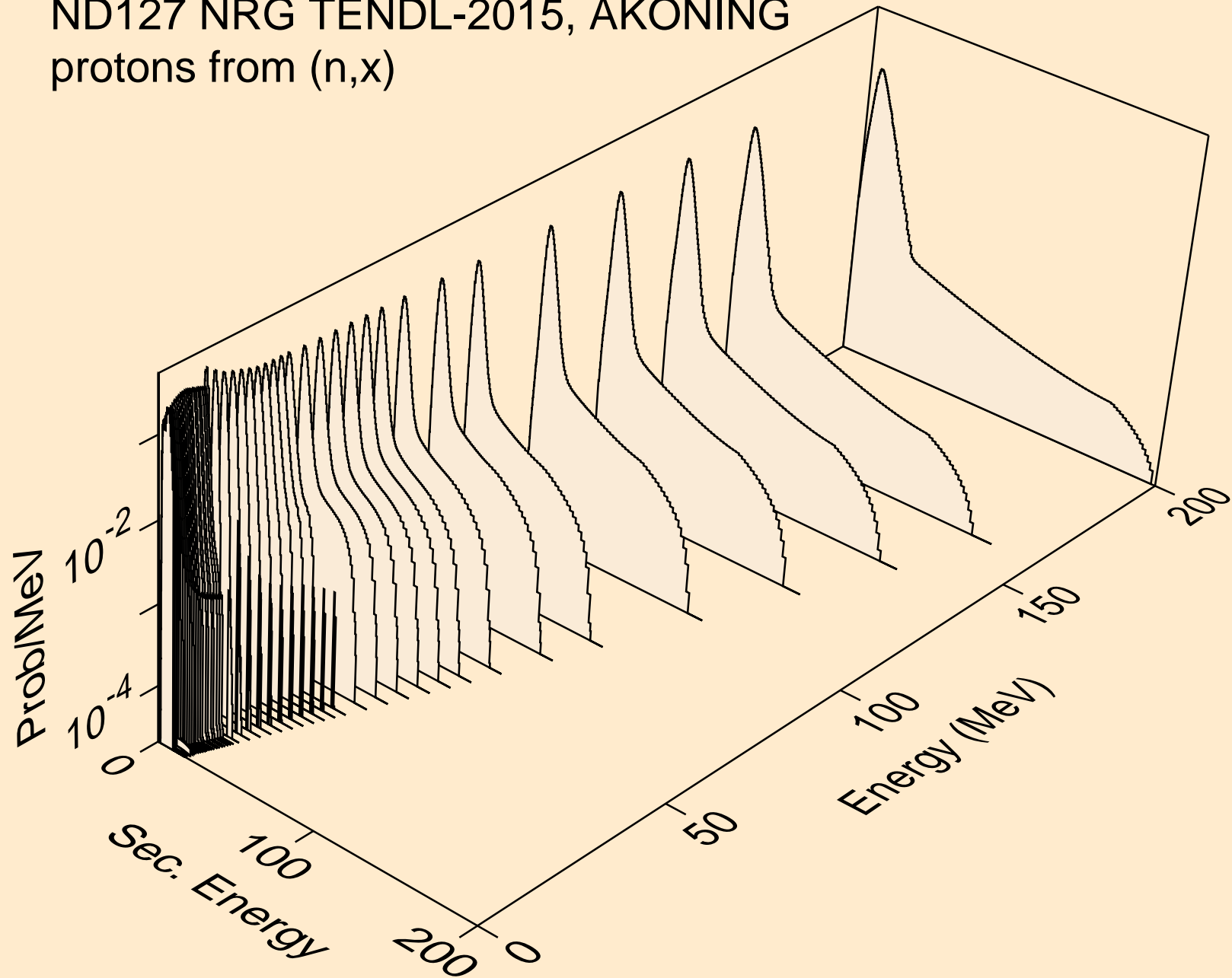

ND127 NRG TENDL-2015, AKONING
protons from (n,n*)p

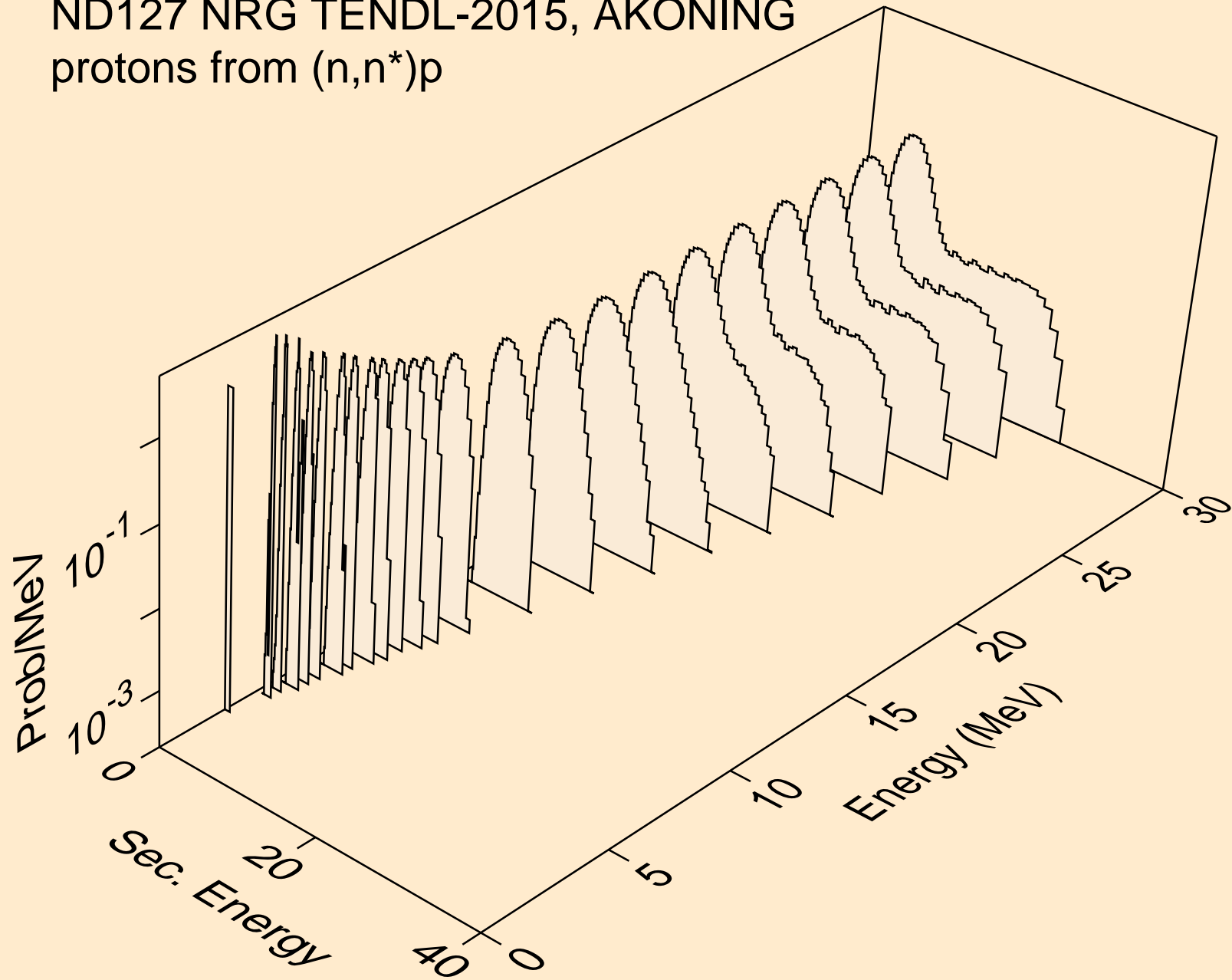

ND127 NRG TENDL-2015, AKONING
protons from (n,2np)

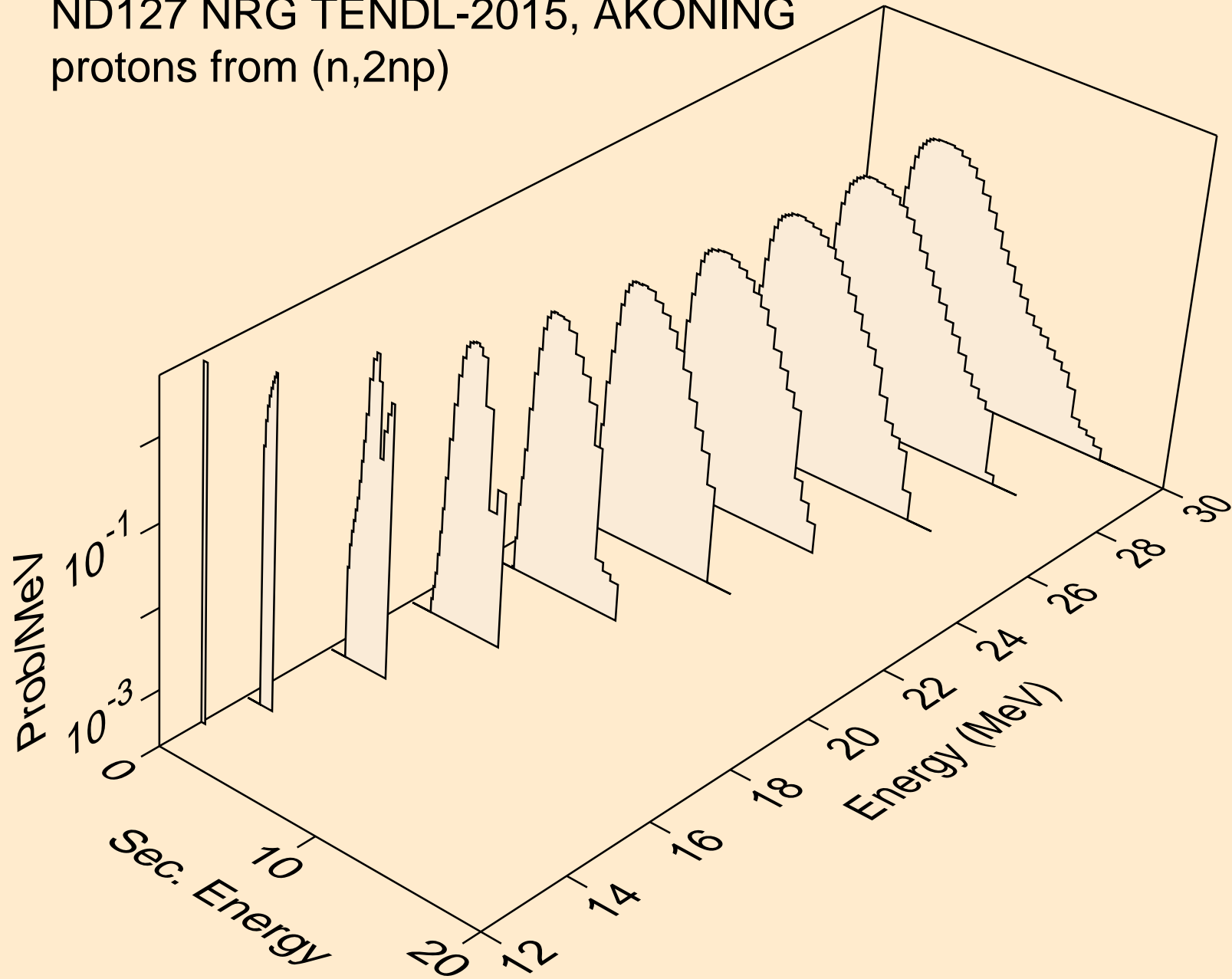

ND127 NRG TENDL-2015, AKONING
protons from (n,3np)

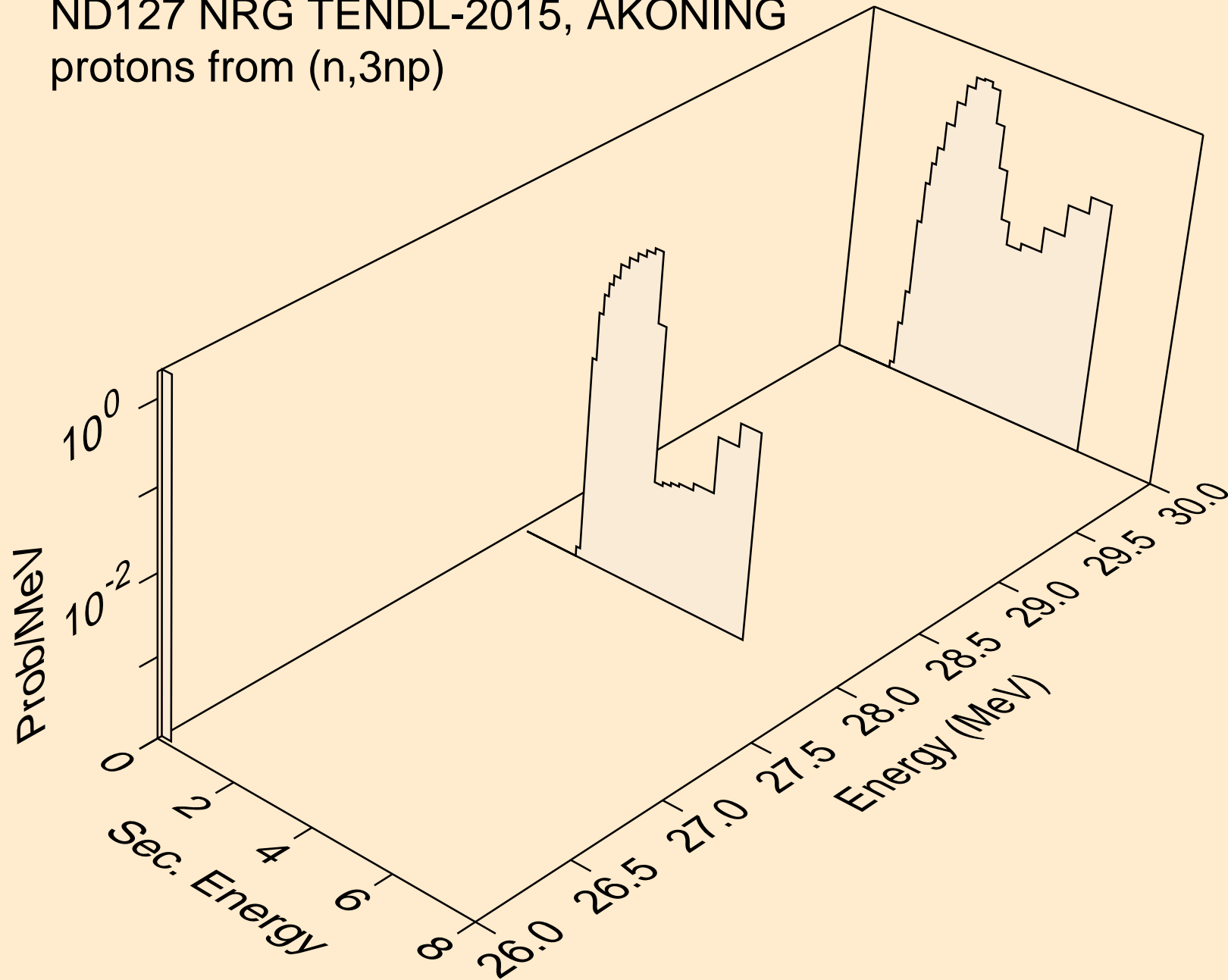

ND127 NRG TENDL-2015, AKONING
protons from (n,2np)

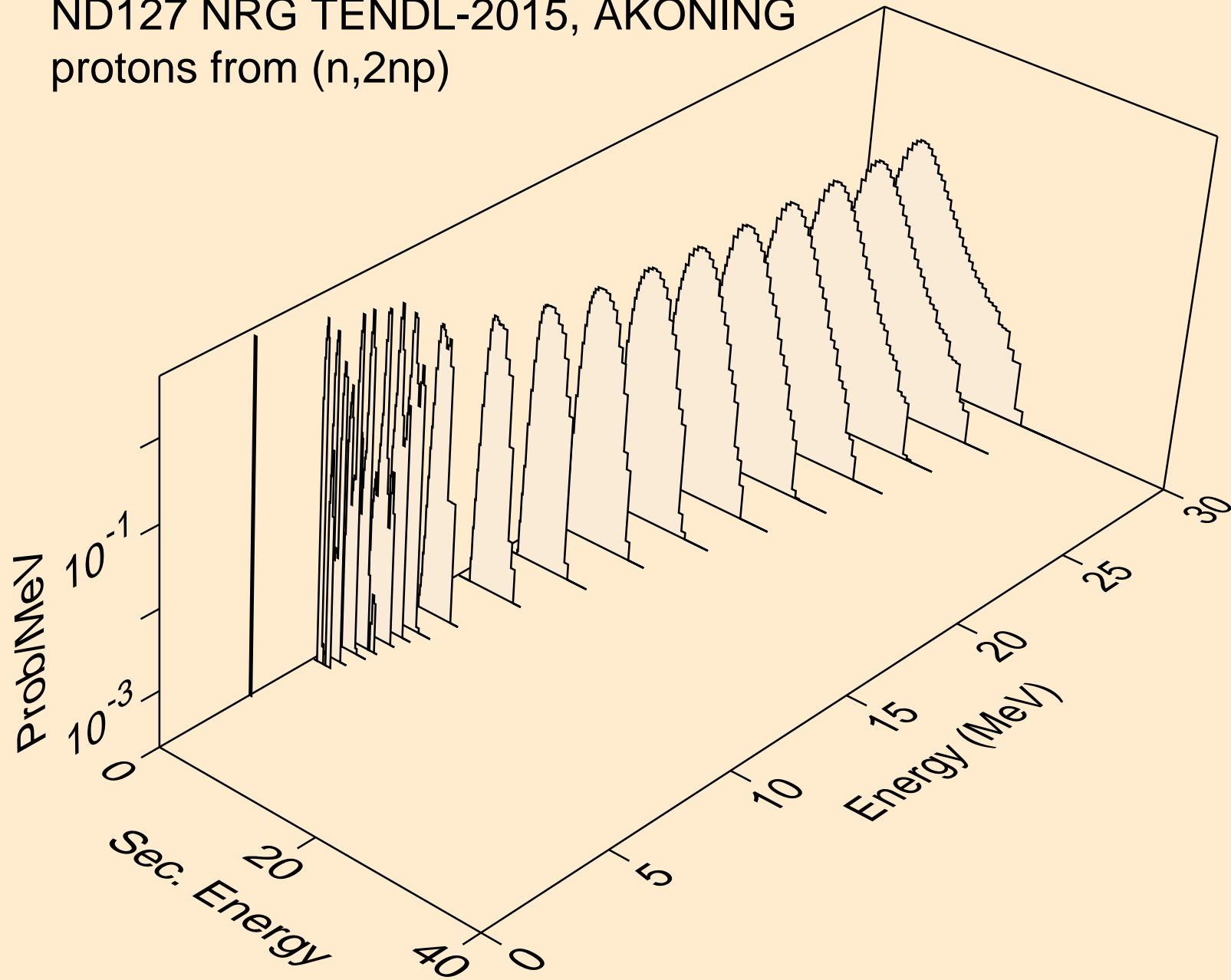

ND127 NRG TENDL-2015, AKONING
protons from (n,npa)

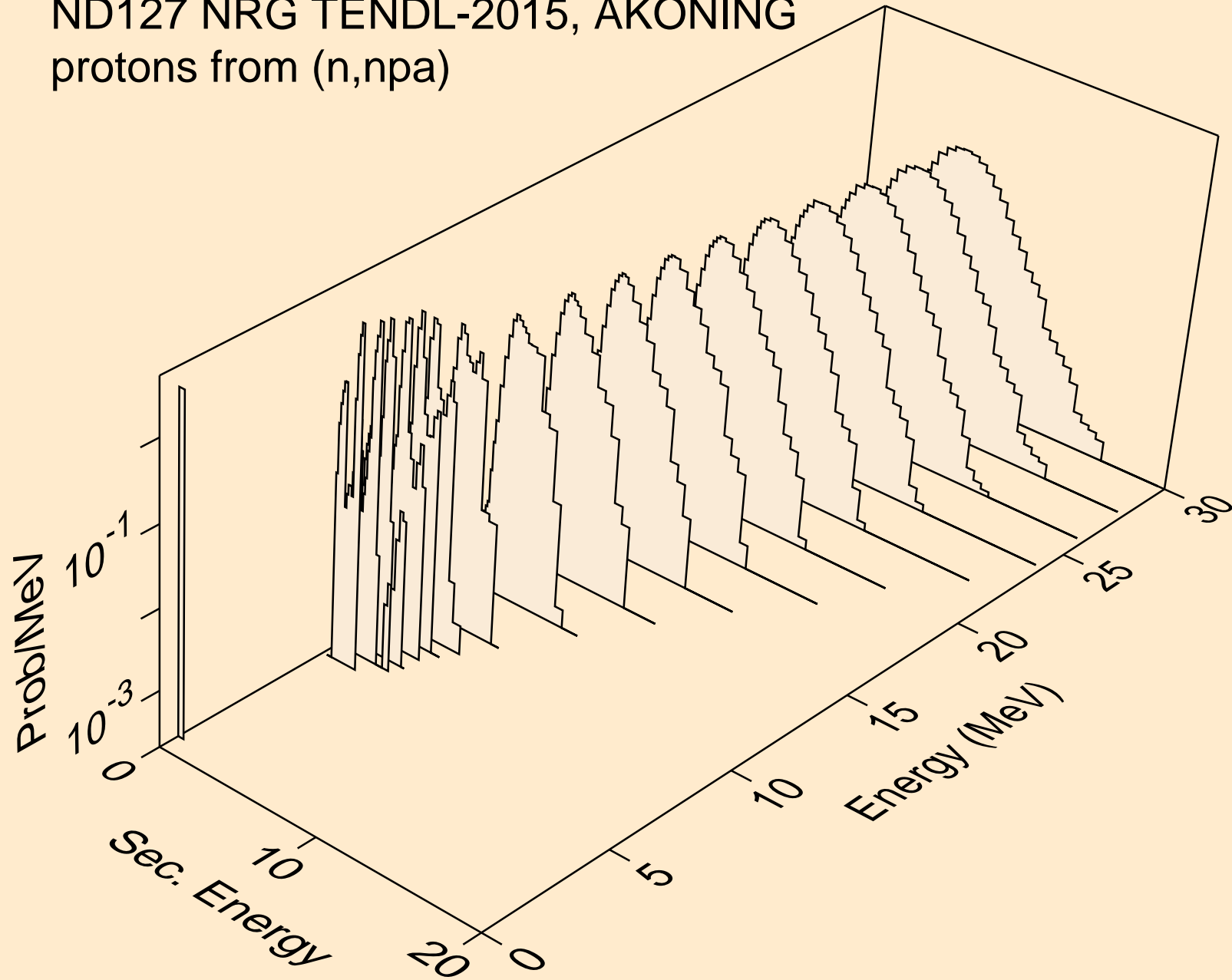

ND127 NRG TENDL-2015, AKONING
protons from (n,p)

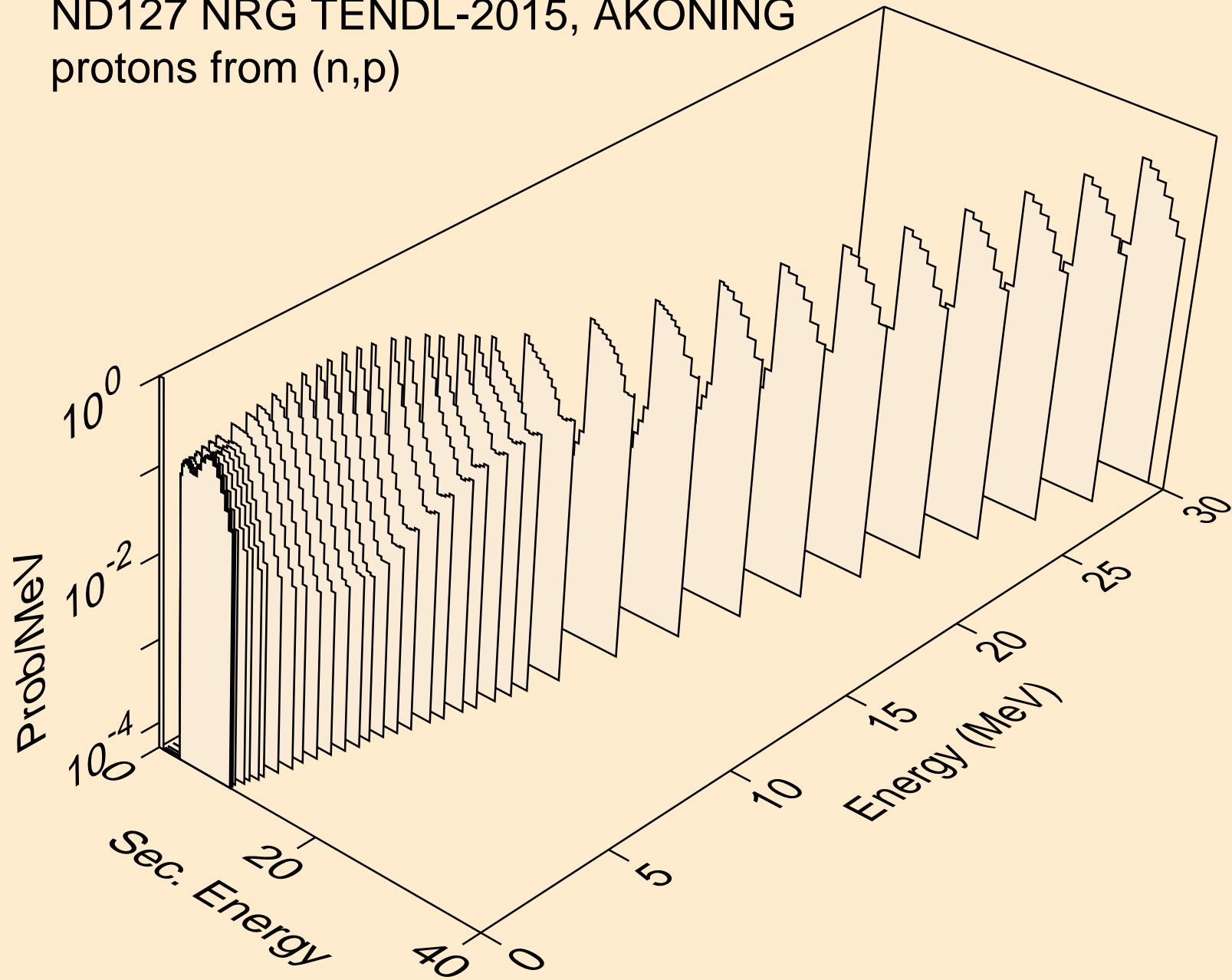

ND127 NRG TENDL-2015, AKONING
protons from (n,2p)

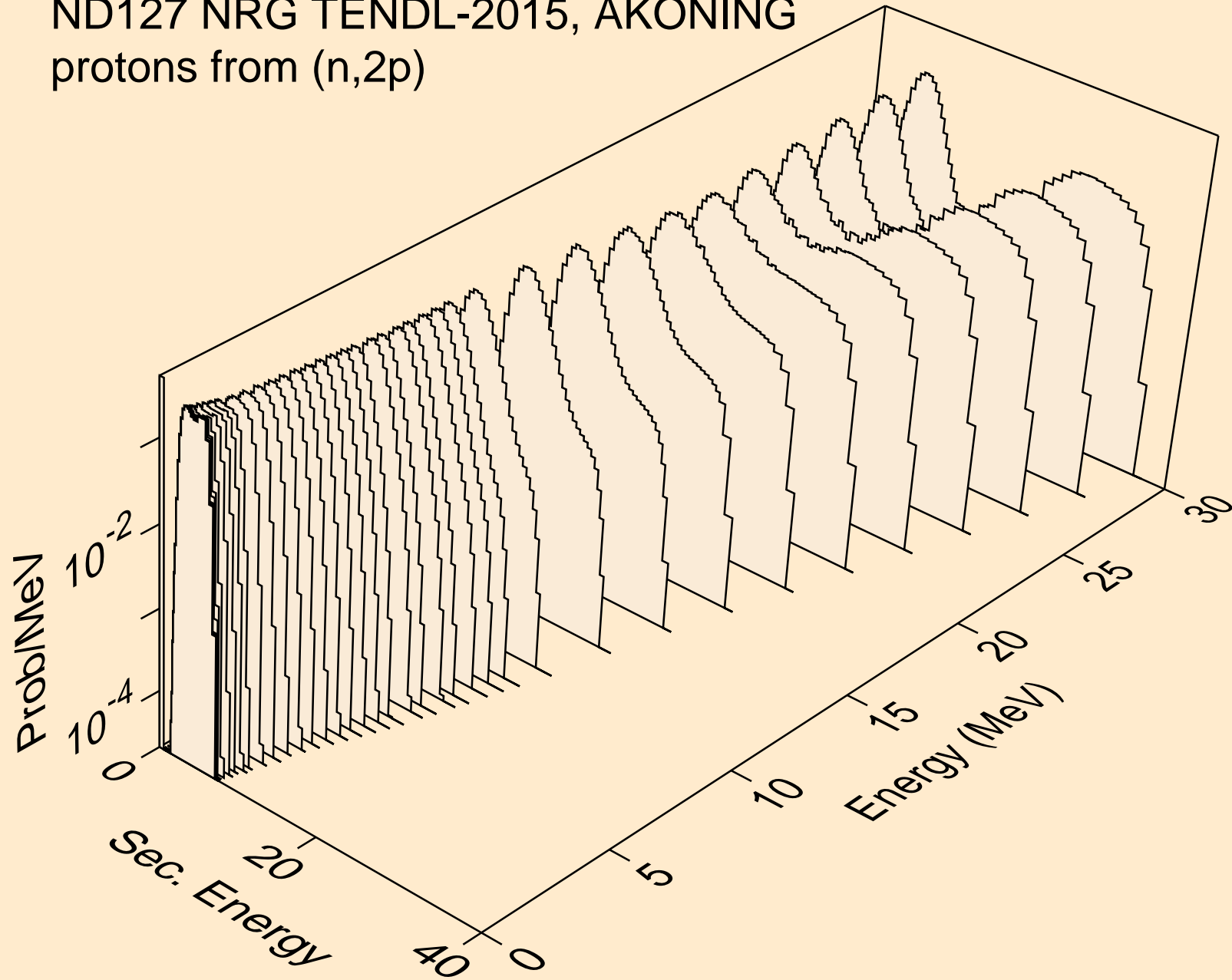

ND127 NRG TENDL-2015, AKONING
protons from (n,pa)

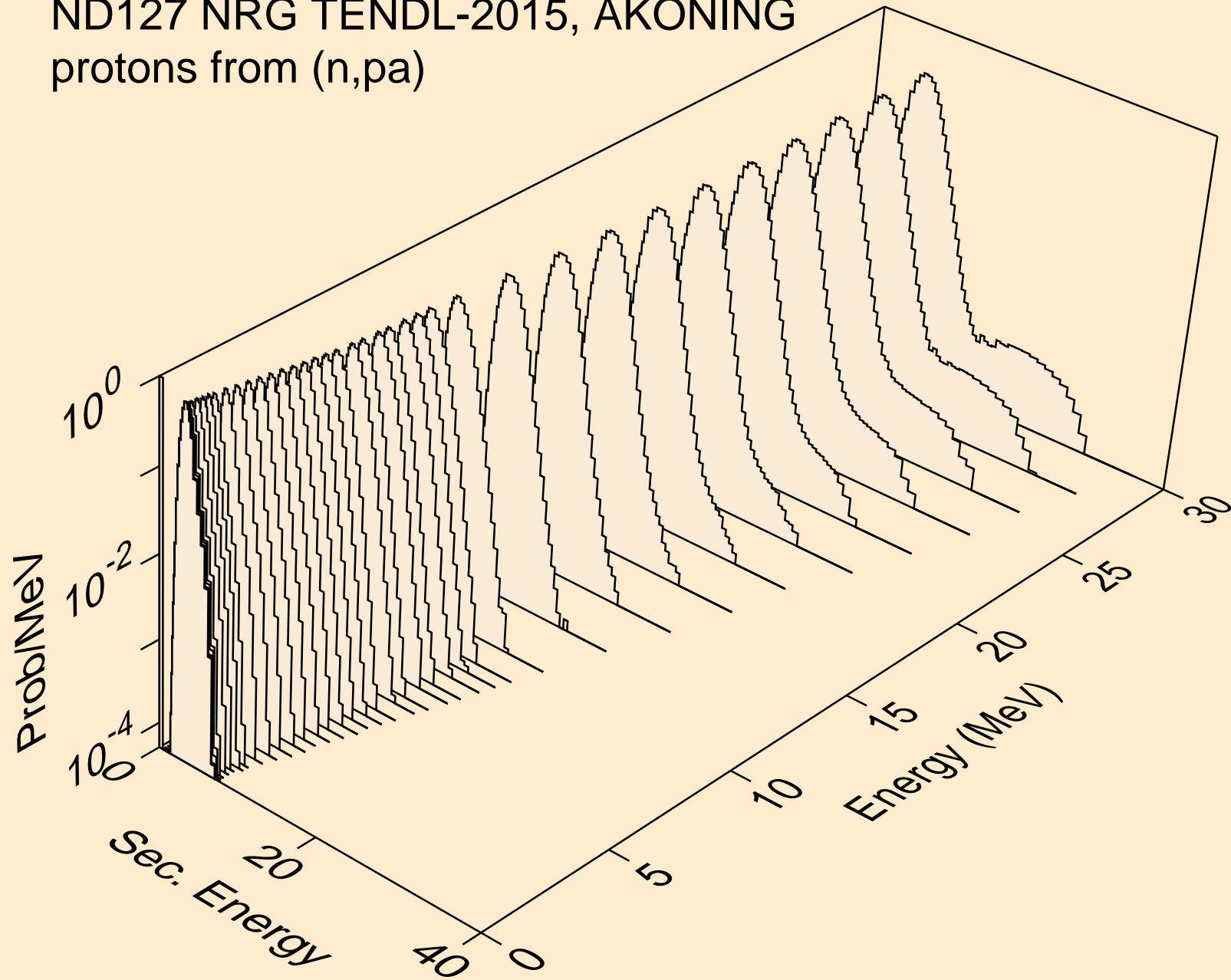

ND127 NRG TENDL-2015, AKONING
protons from (n,pd)

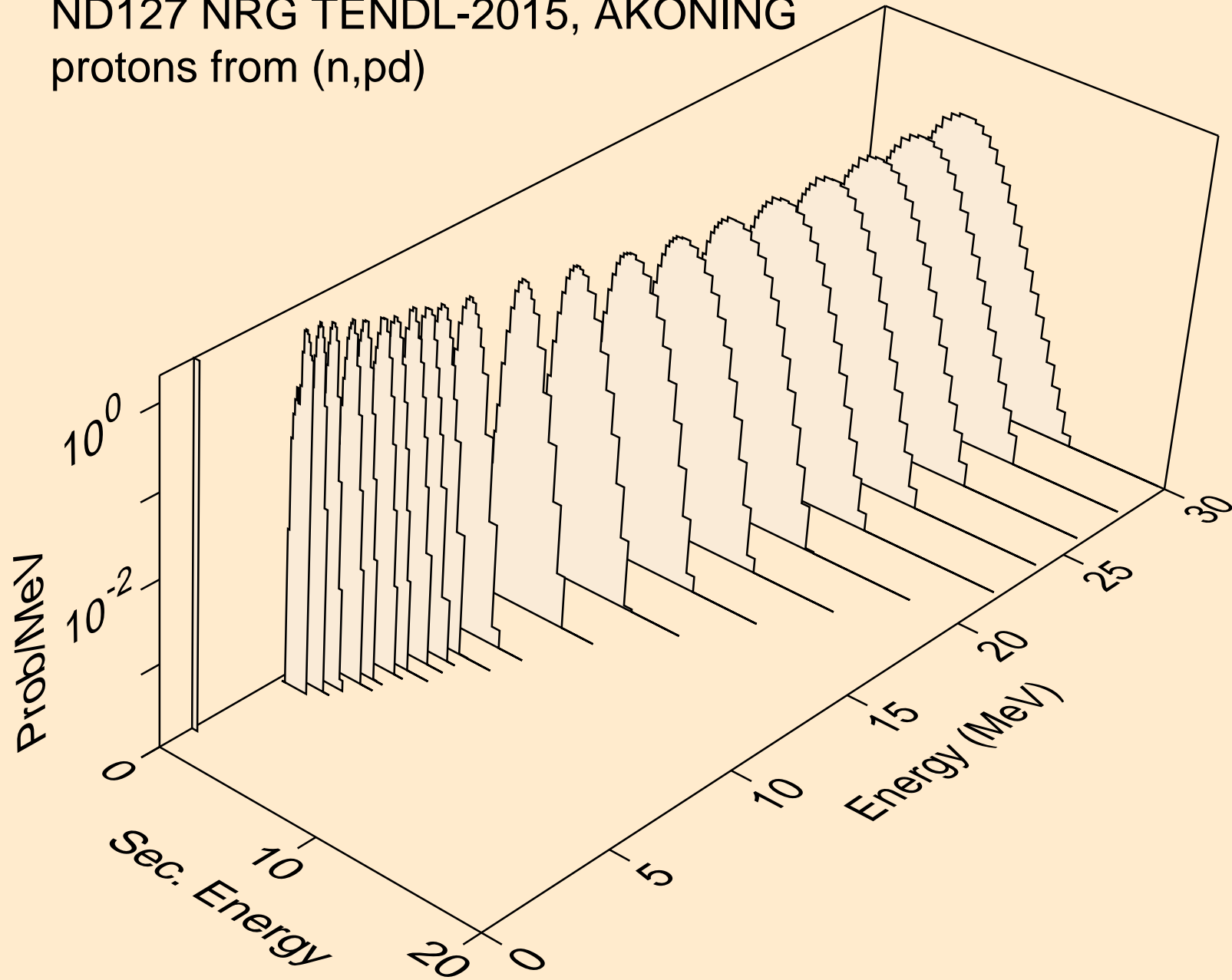

ND127 NRG TENDL-2015, AKONING
protons from (n,pt)

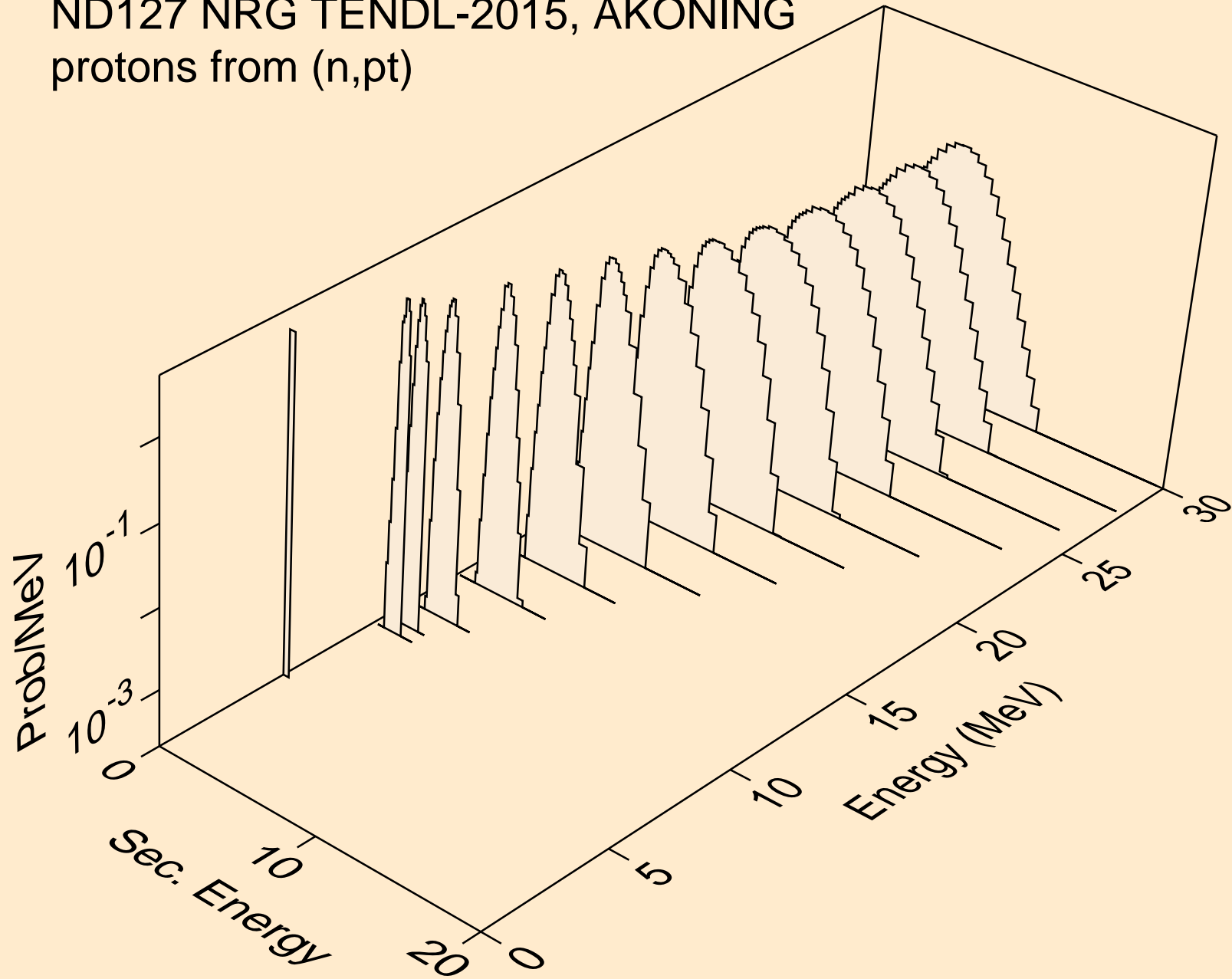

ND127 NRG TENDL-2015, AKONING
deuterons from (n,x)

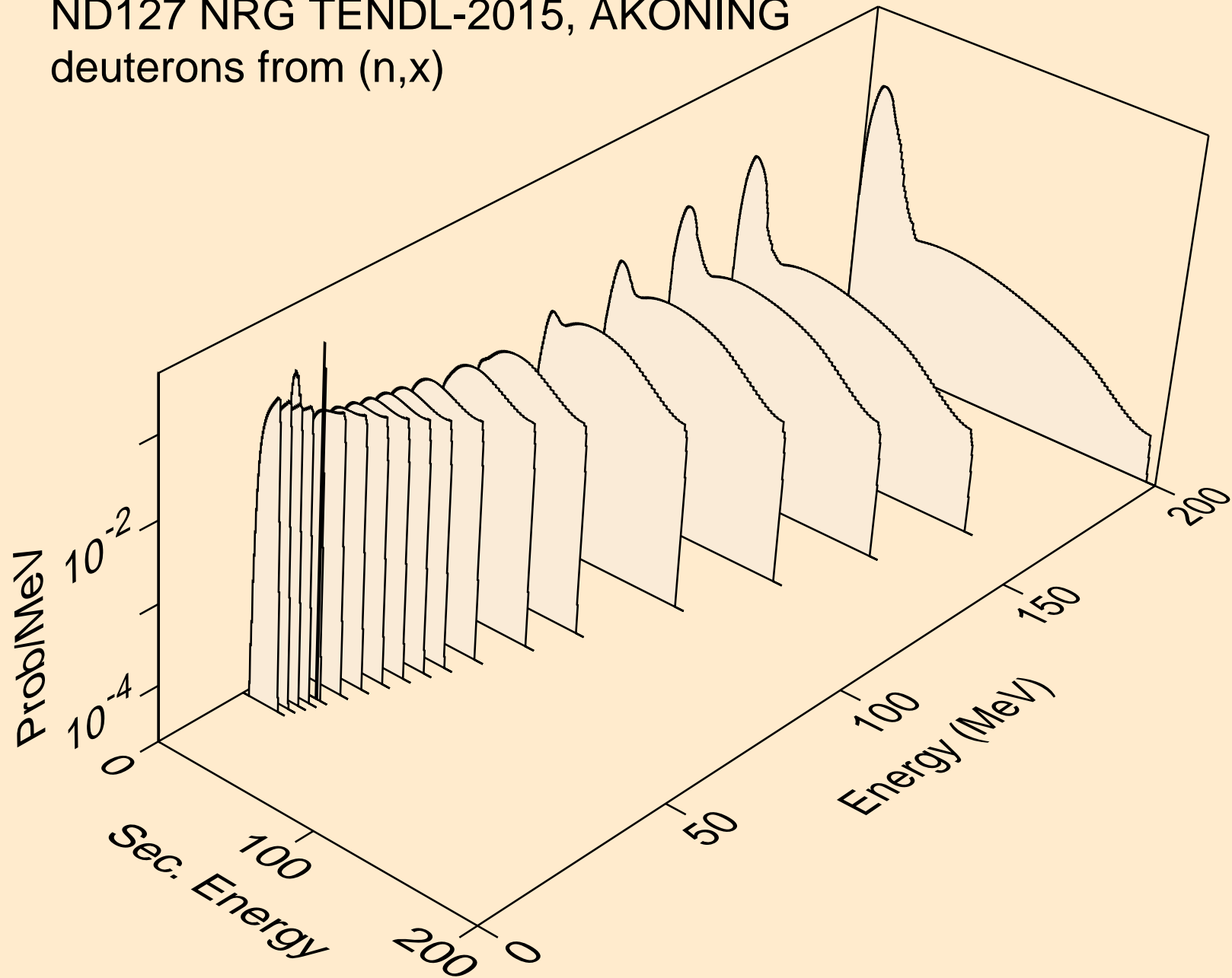

ND127 NRG TENDL-2015, AKONING
deuterons from (n,2nd)

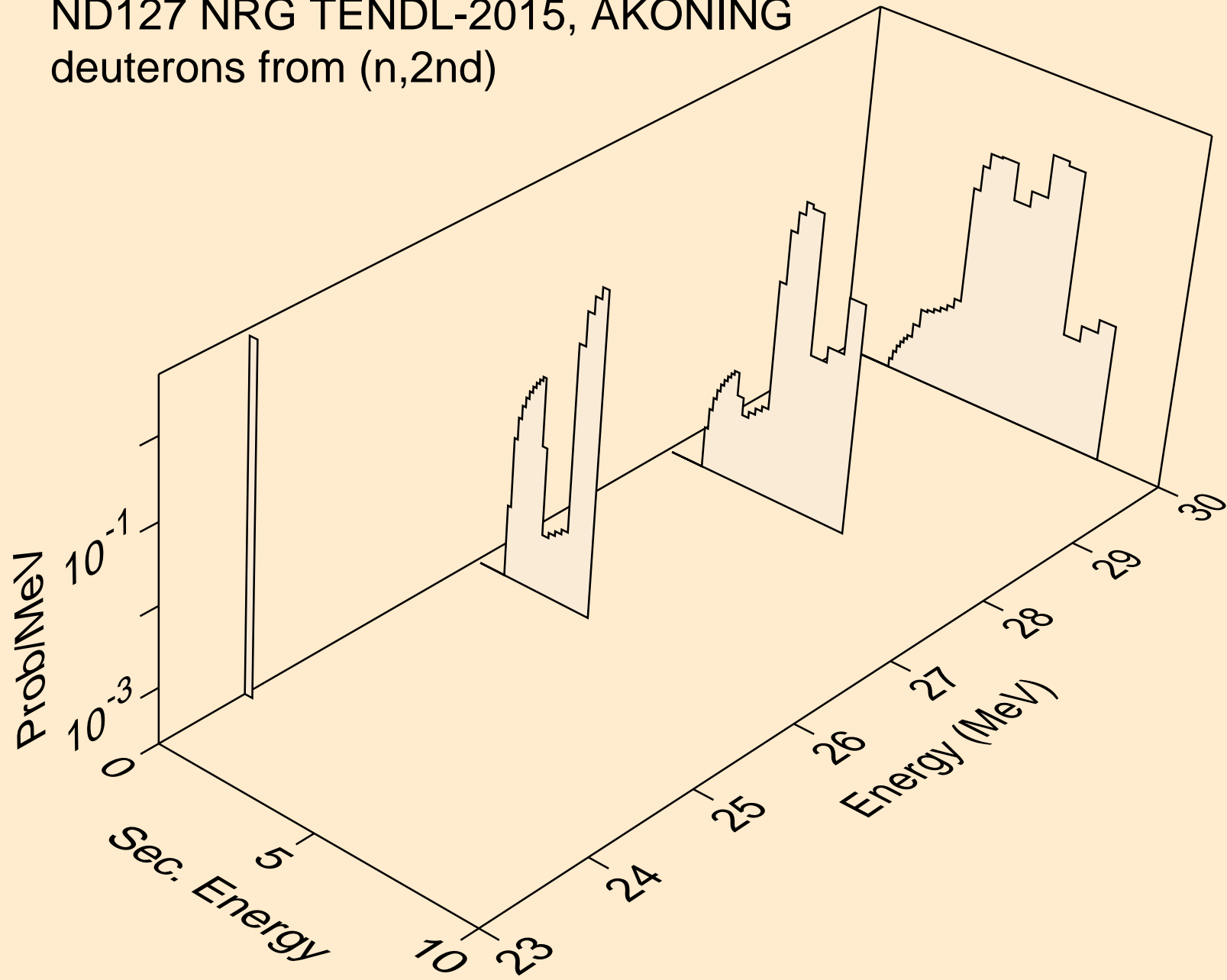

ND127 NRG TENDL-2015, AKONING
deuterons from (n,n*)d

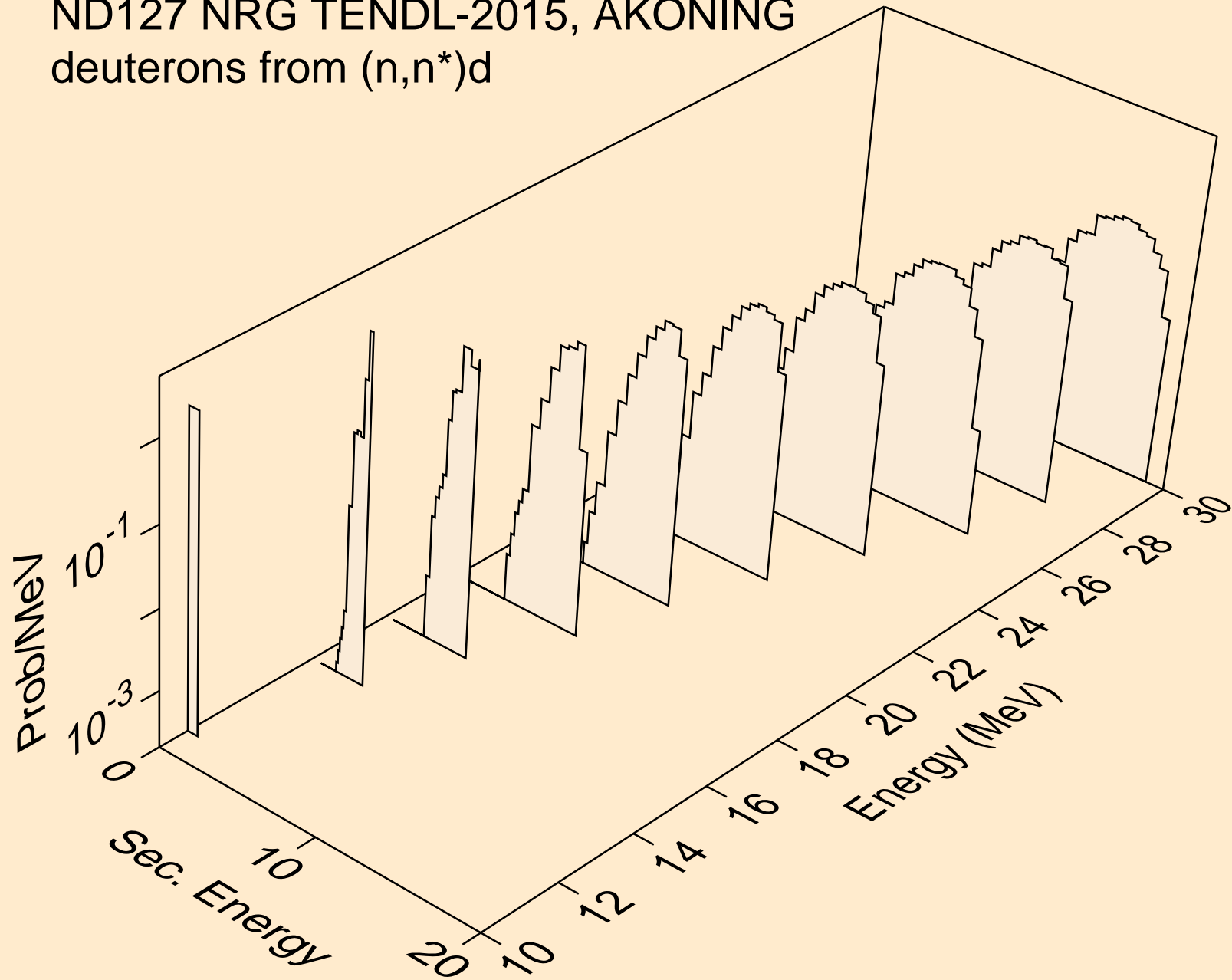

ND127 NRG TENDL-2015, AKONING
deuterons from (n,d)

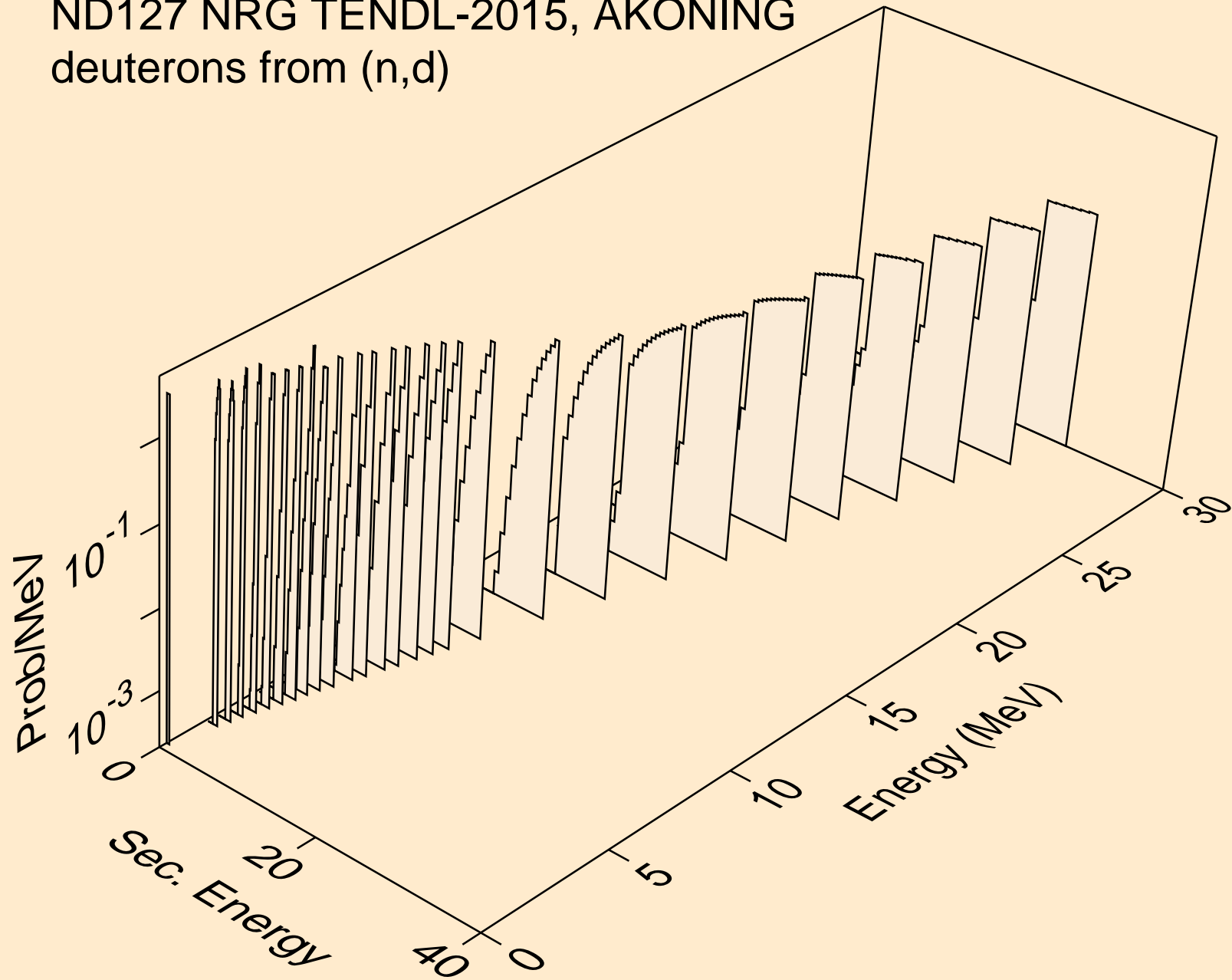

ND127 NRG TENDL-2015, AKONING
deuterons from (n,d2a)

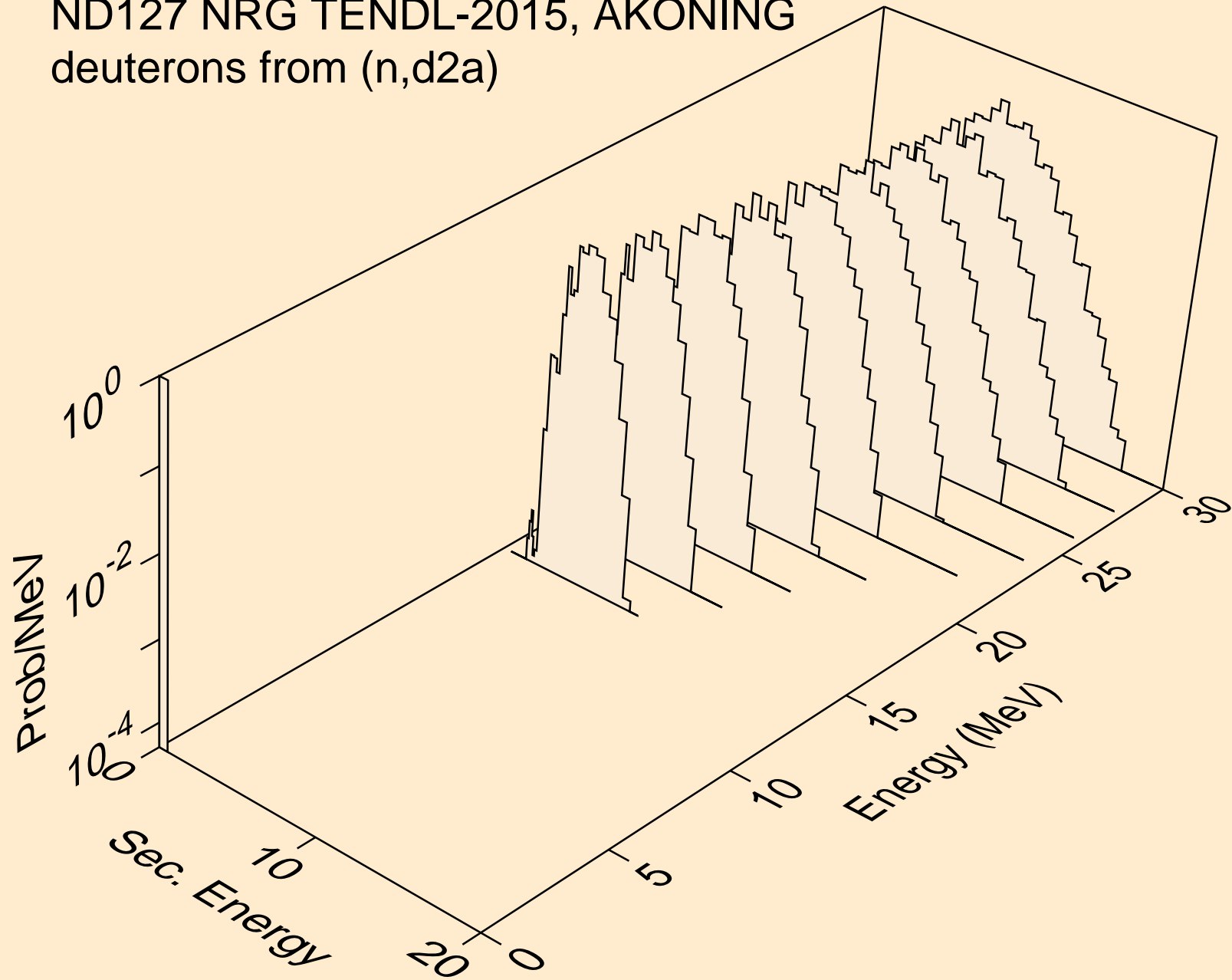

ND127 NRG TENDL-2015, AKONING
deuterons from (n,pd)

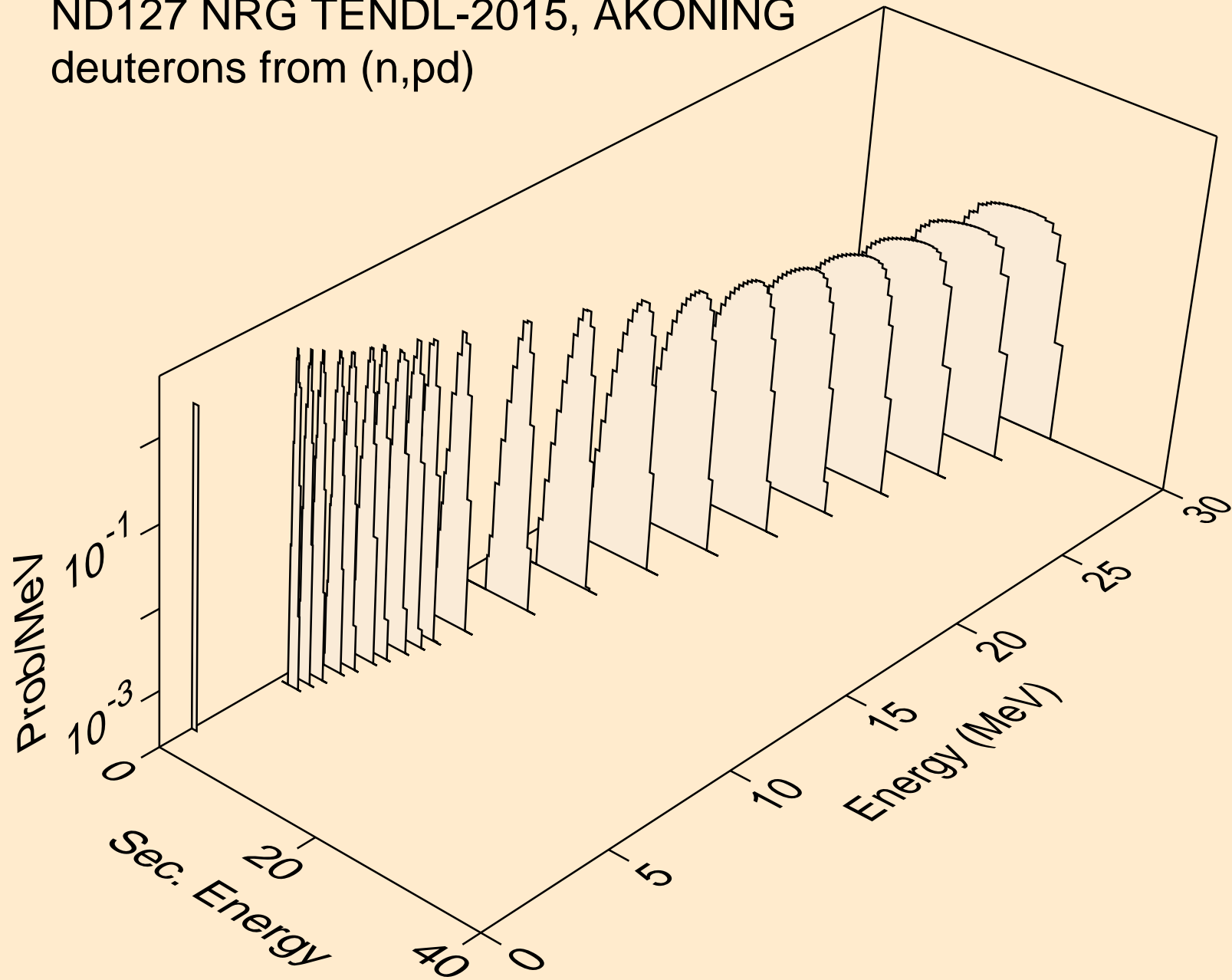

ND127 NRG TENDL-2015, AKONING
deuterons from (n,da)

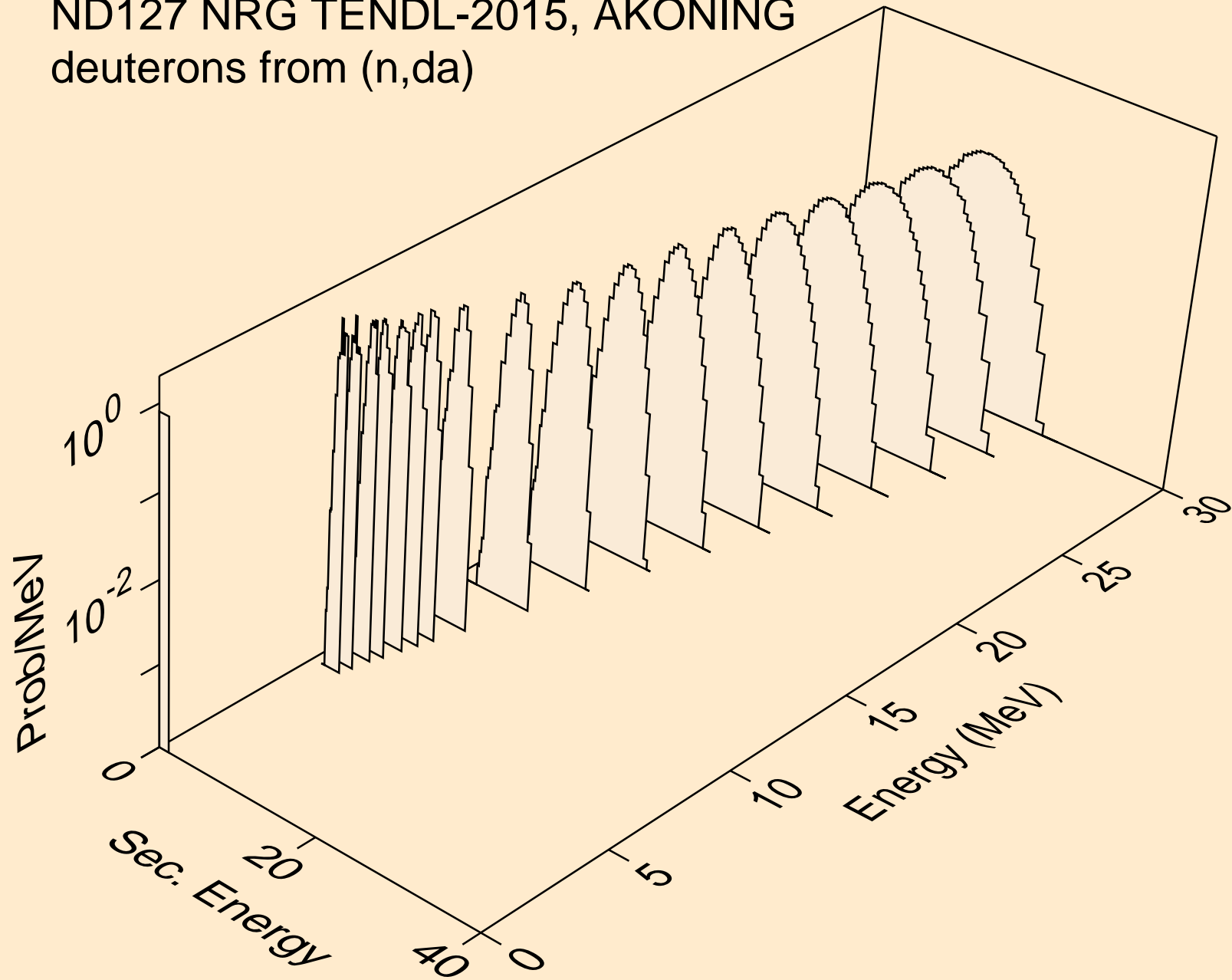

ND127 NRG TENDL-2015, AKONING
tritons from (n,x)

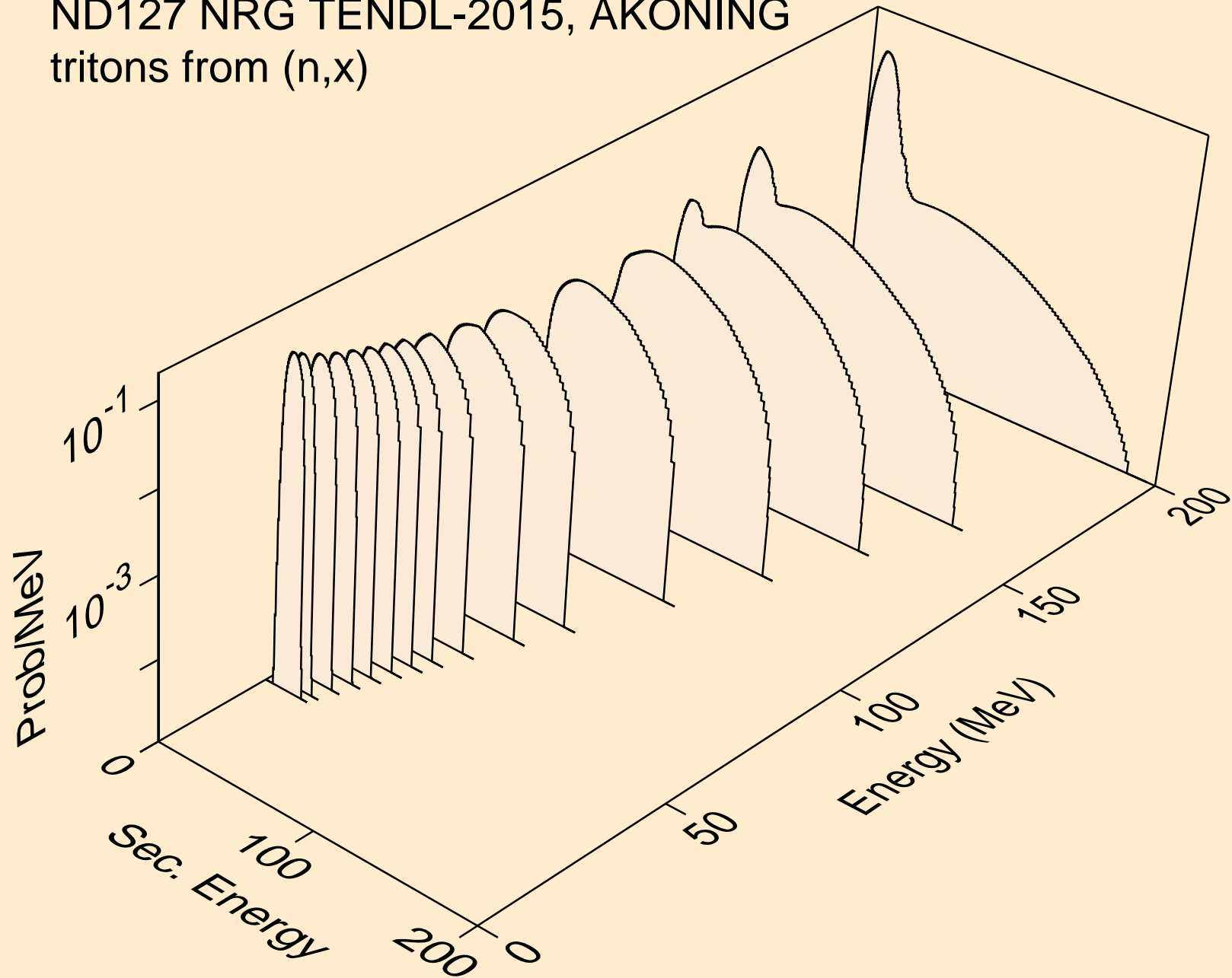

ND127 NRG TENDL-2015, AKONING
tritons from (n,n*)t

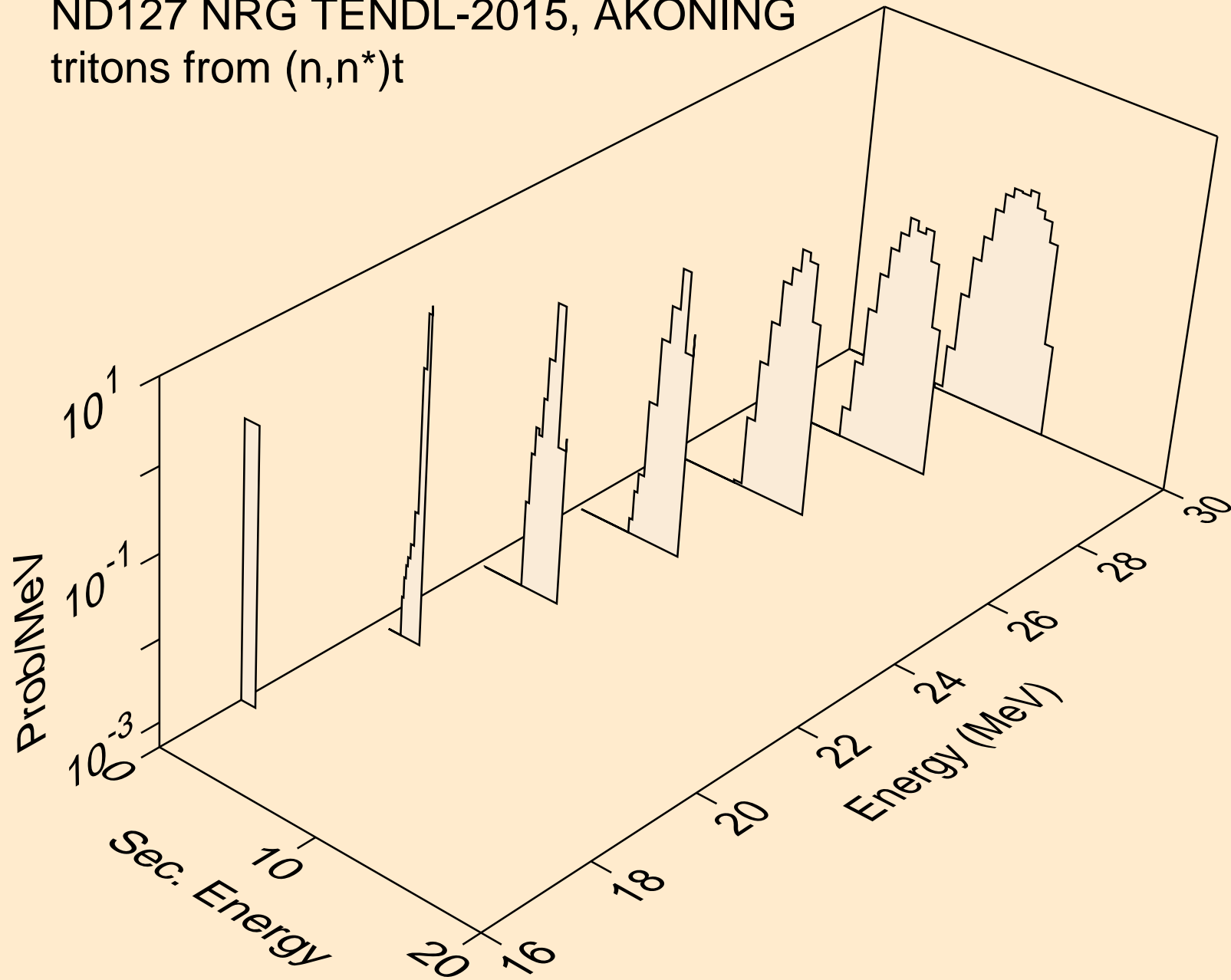

ND127 NRG TENDL-2015, AKONING
tritons from (n,t)

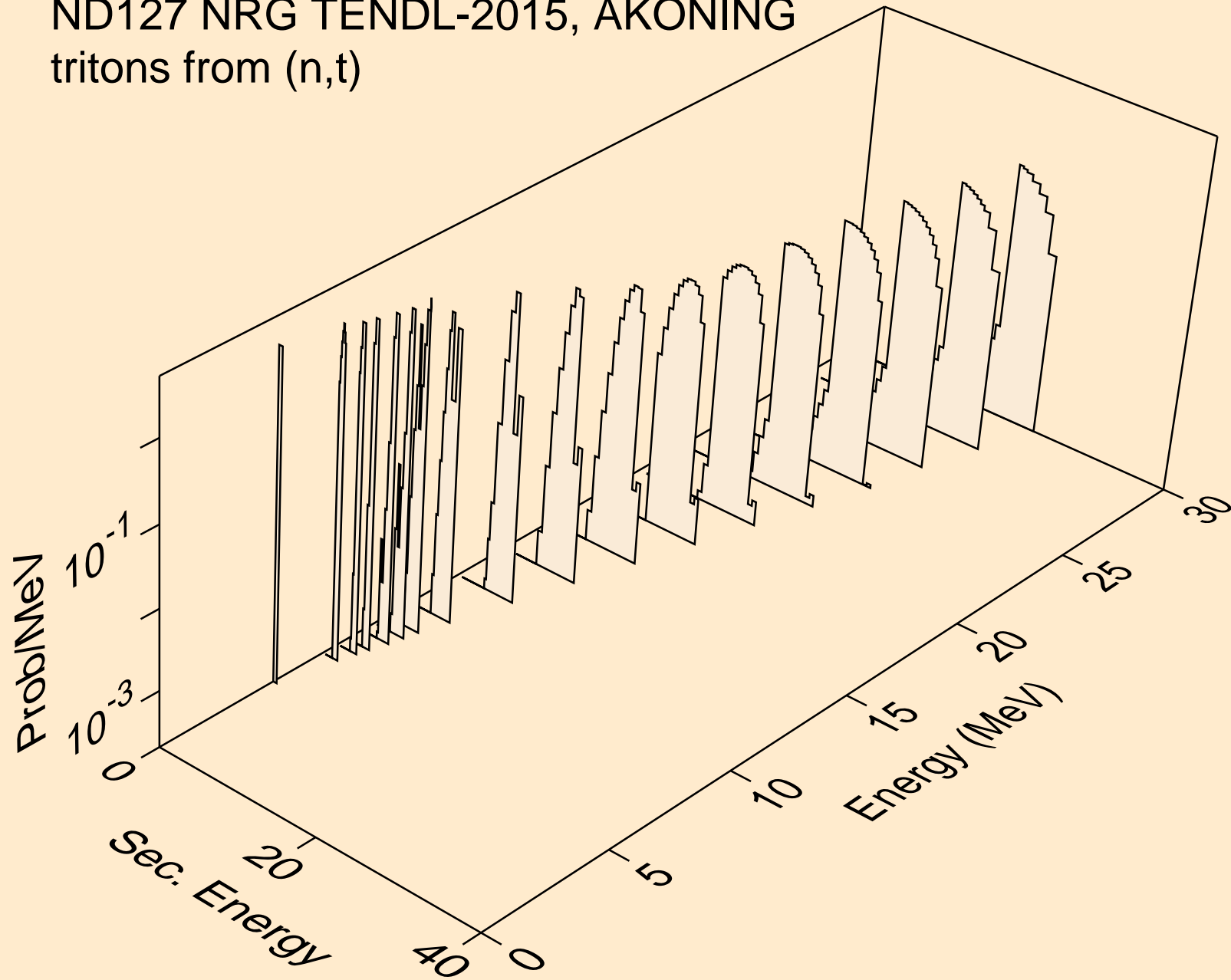

ND127 NRG TENDL-2015, AKONING
tritons from (n,pt)

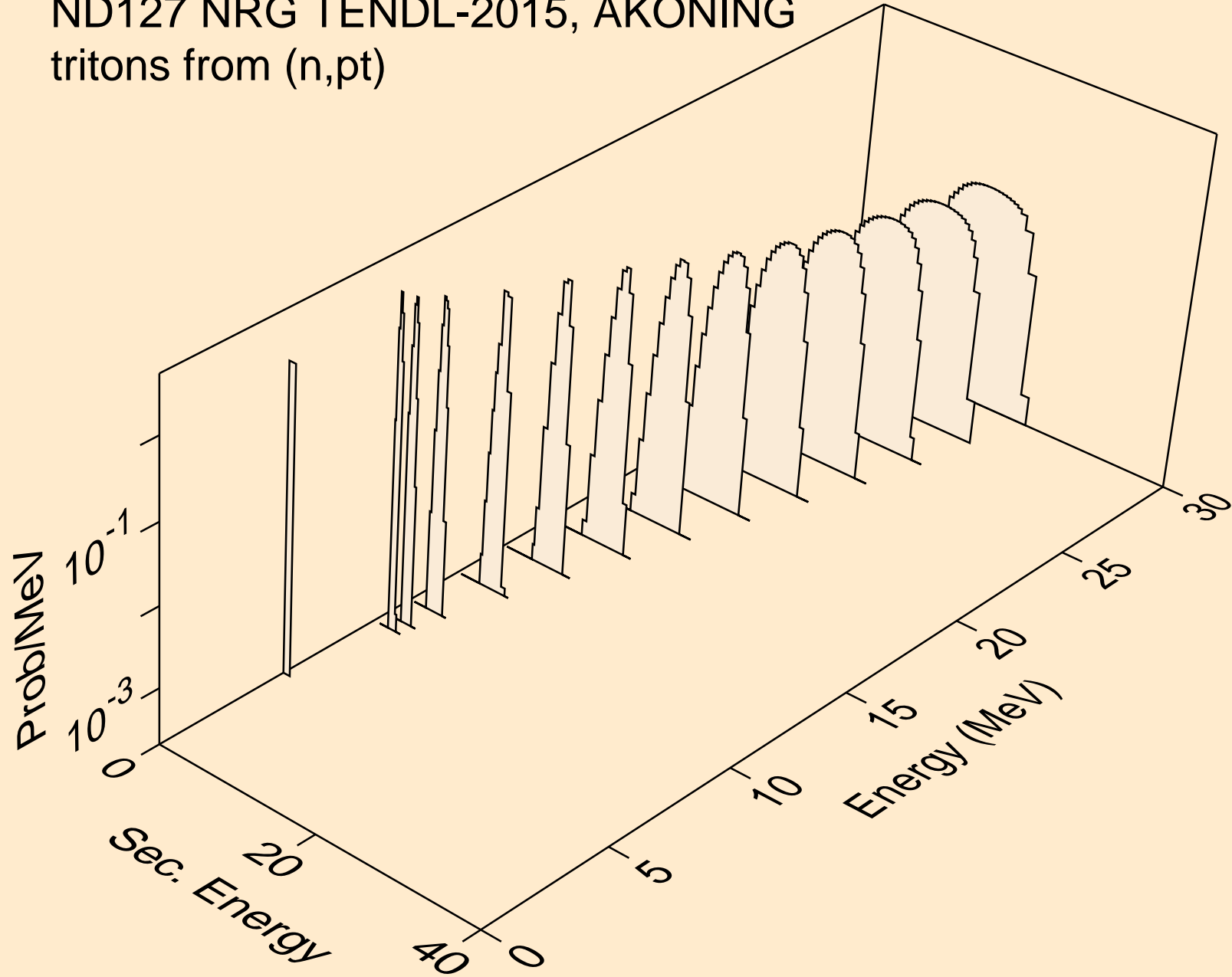

ND127 NRG TENDL-2015, AKONING
he3s from (n,x)

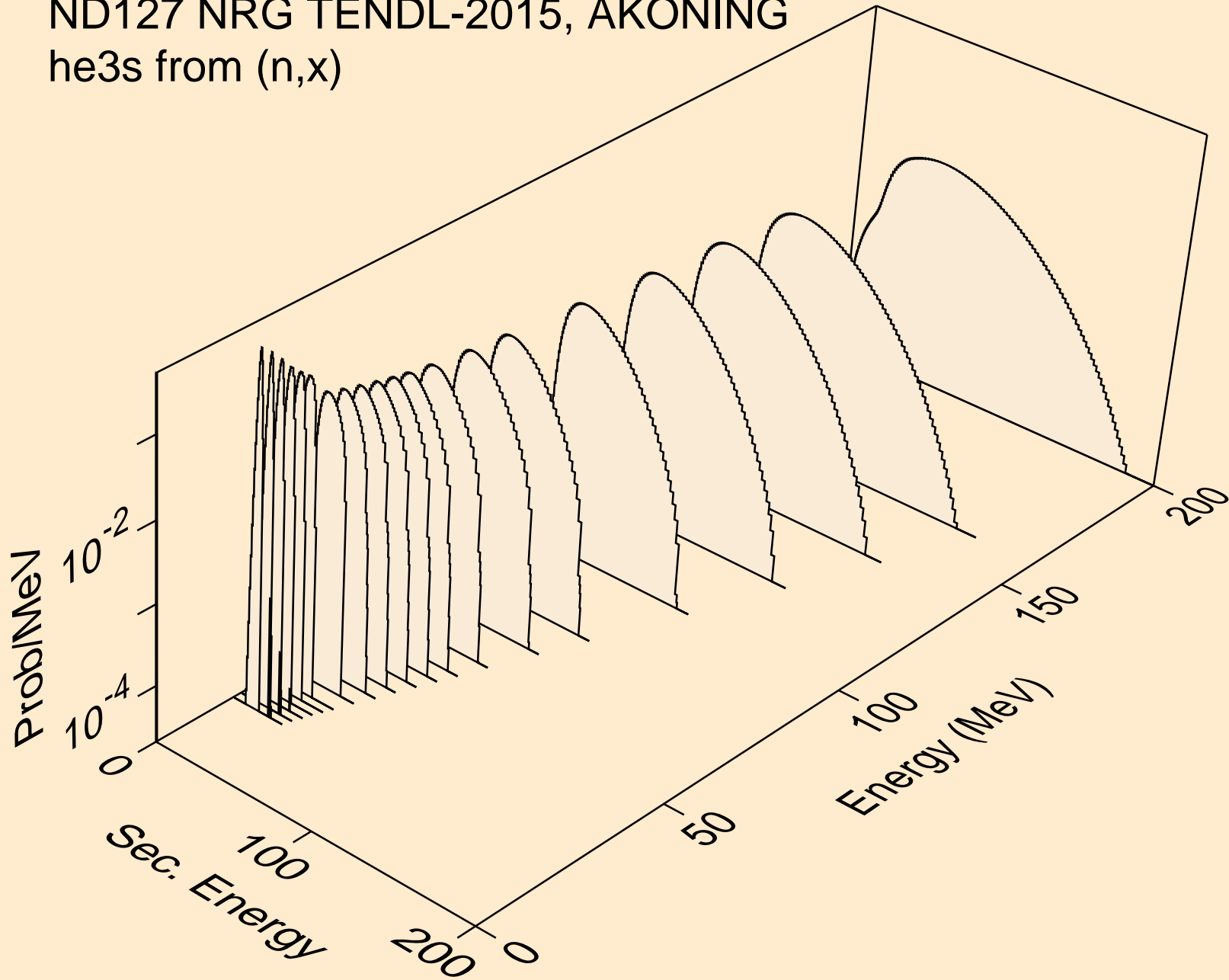

ND127 NRG TENDL-2015, AKONING
he3s from (n,n*)he3

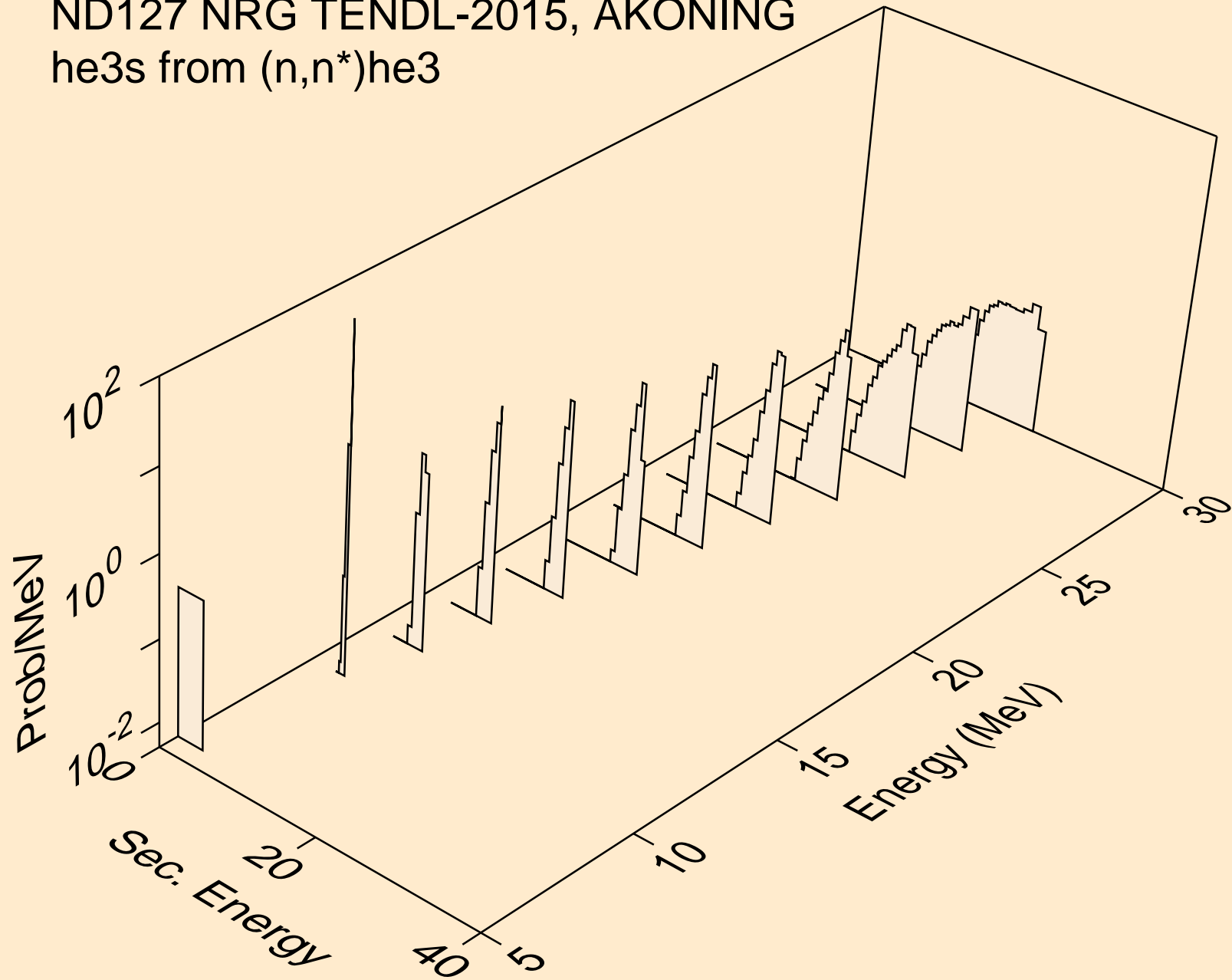

ND127 NRG TENDL-2015, AKONING
he3s from (n,he3)

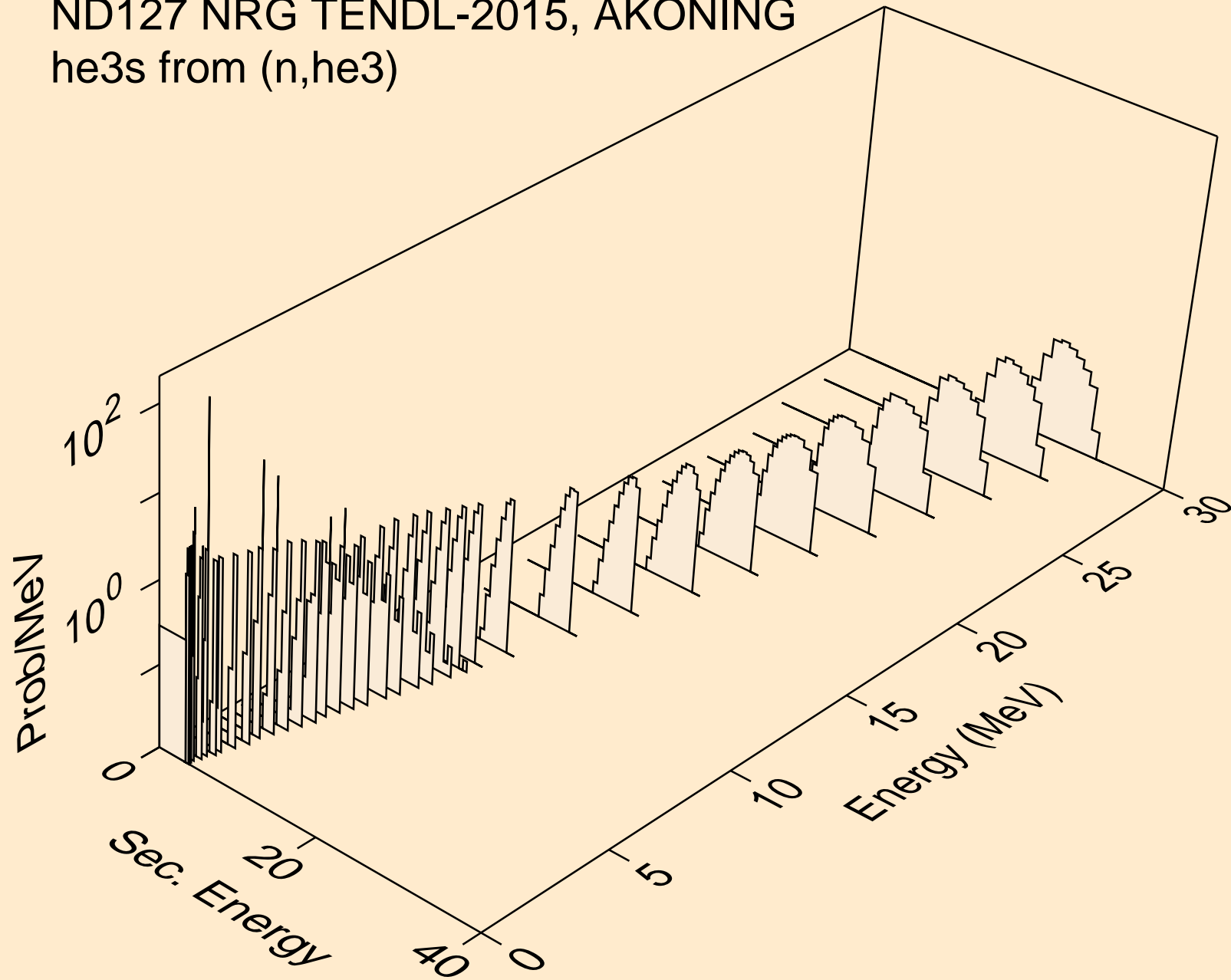

ND127 NRG TENDL-2015, AKONING
alphas from (n,x)

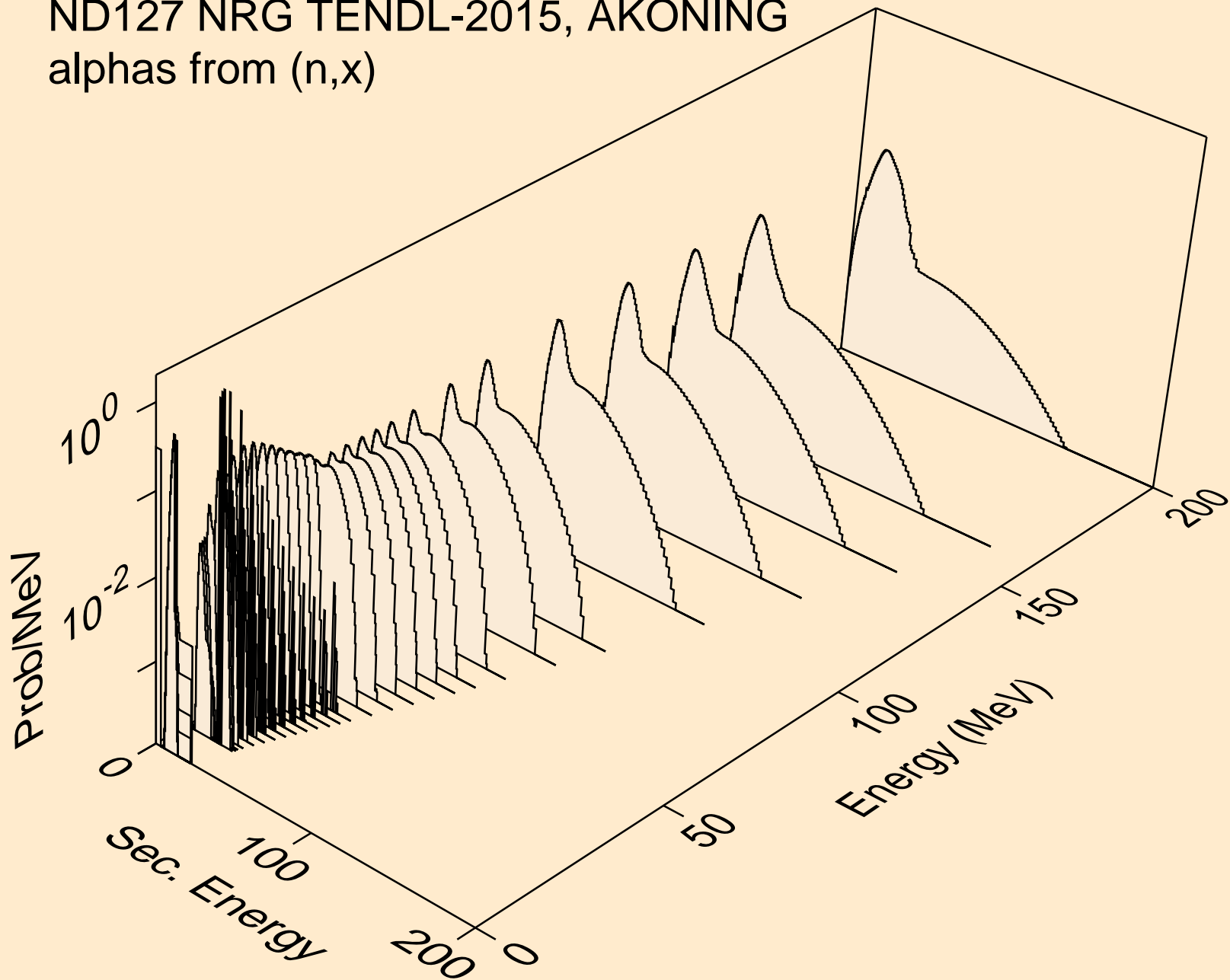

ND127 NRG TENDL-2015, AKONING
alphas from (n,n*)a

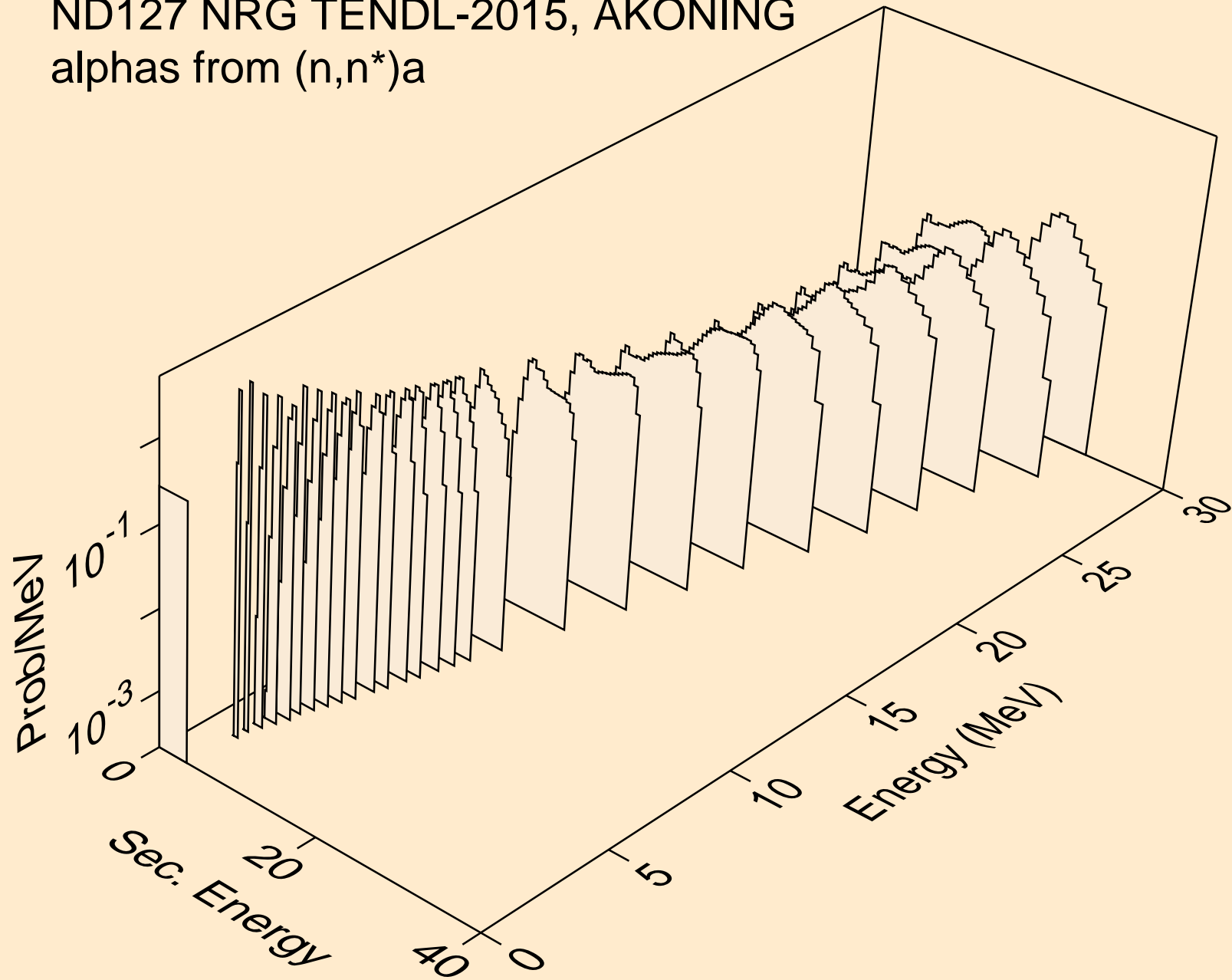

ND127 NRG TENDL-2015, AKONING
alphas from (n,n*)3a

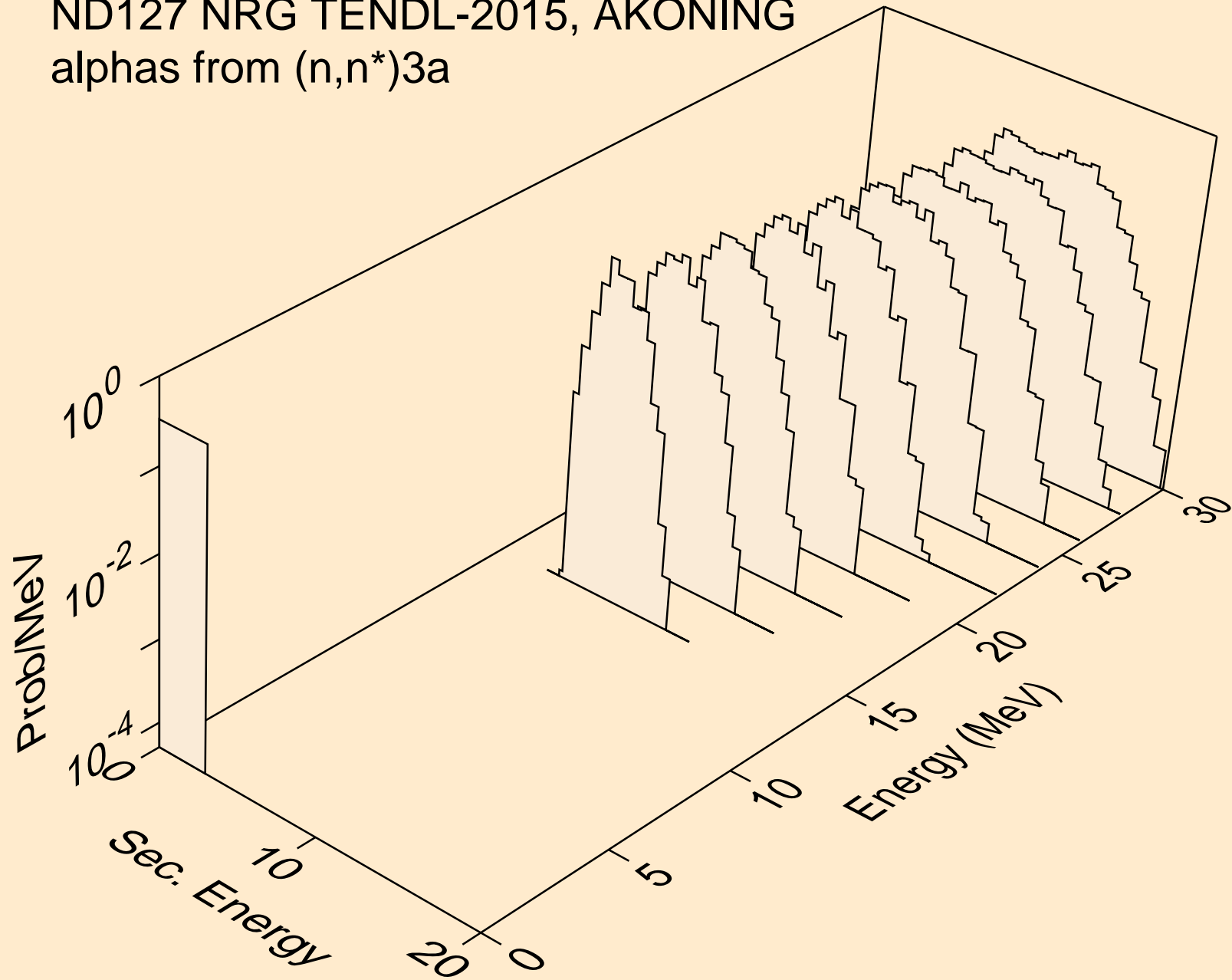

ND127 NRG TENDL-2015, AKONING
alphas from (n,2n)a

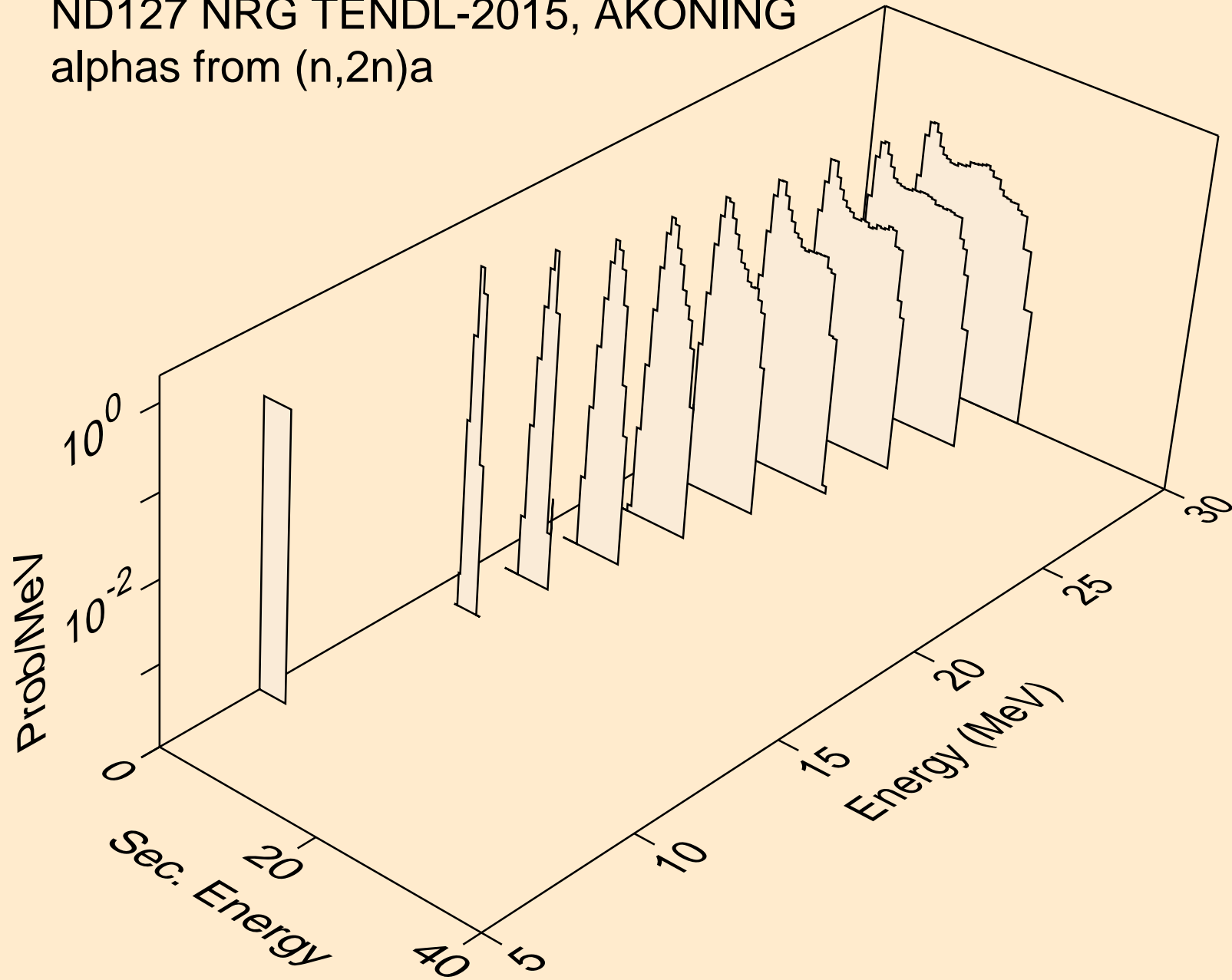

ND127 NRG TENDL-2015, AKONING
alphas from (n,n*)2a

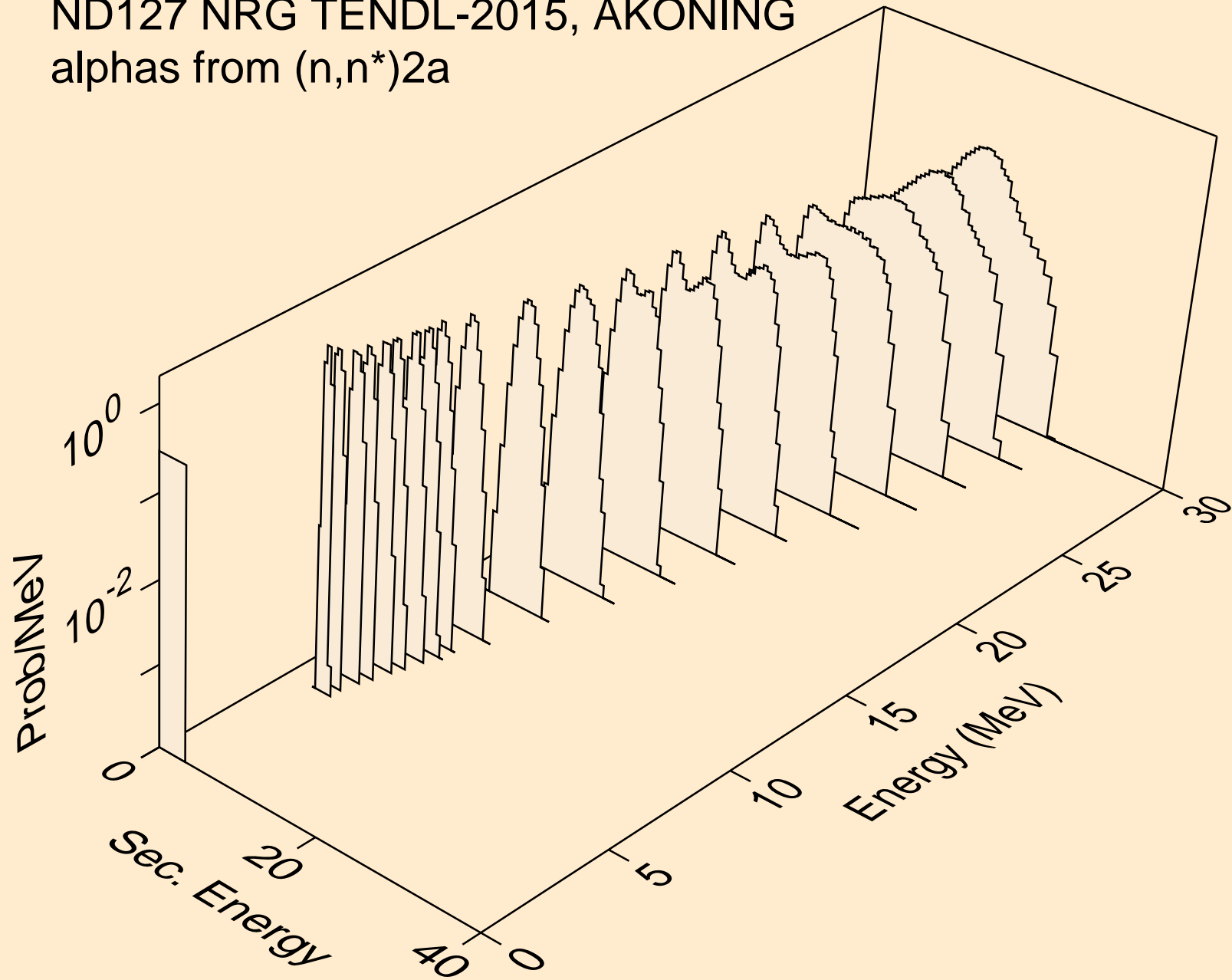

ND127 NRG TENDL-2015, AKONING
alphas from (n,2n)2a

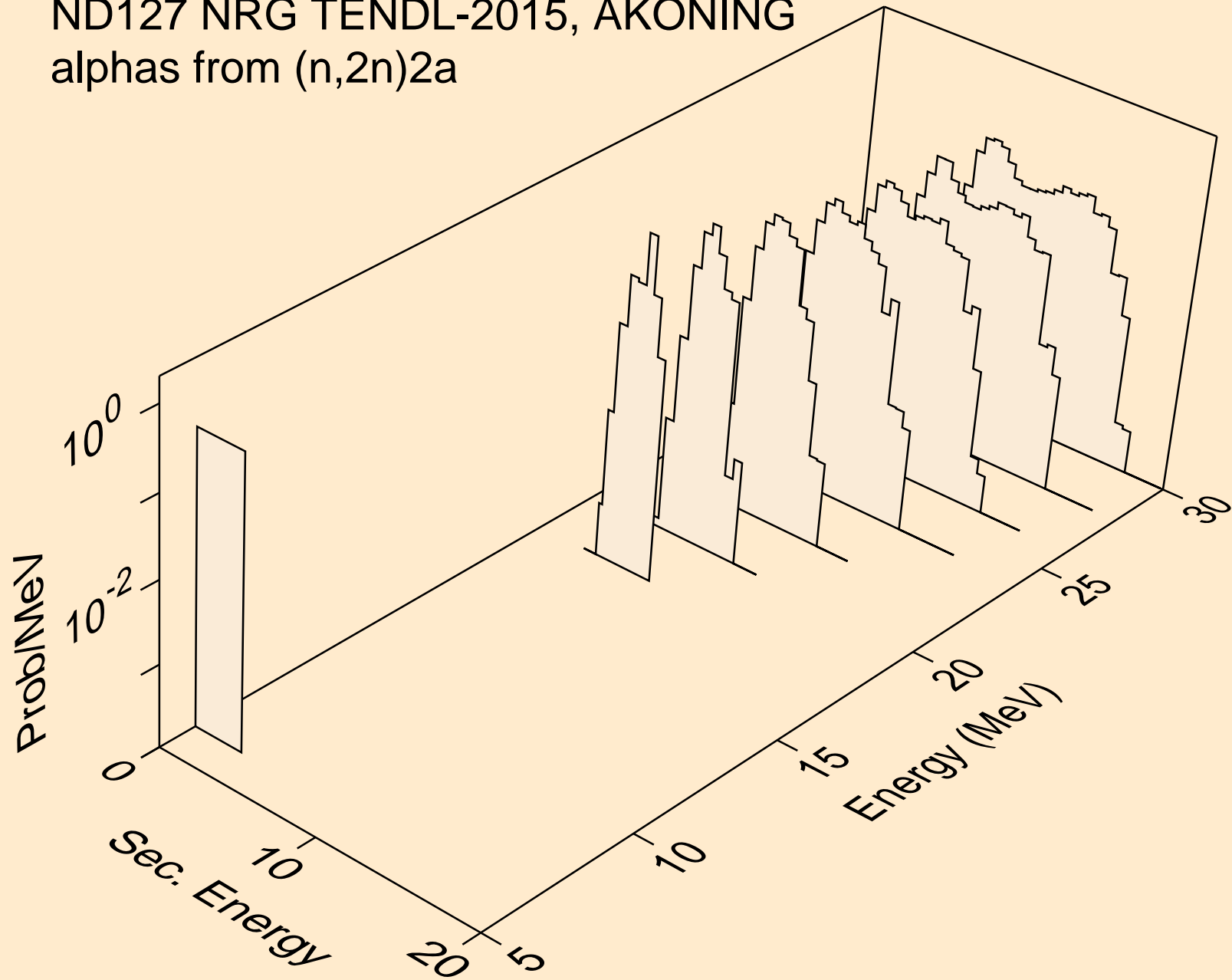

ND127 NRG TENDL-2015, AKONING
alphas from (n,npa)

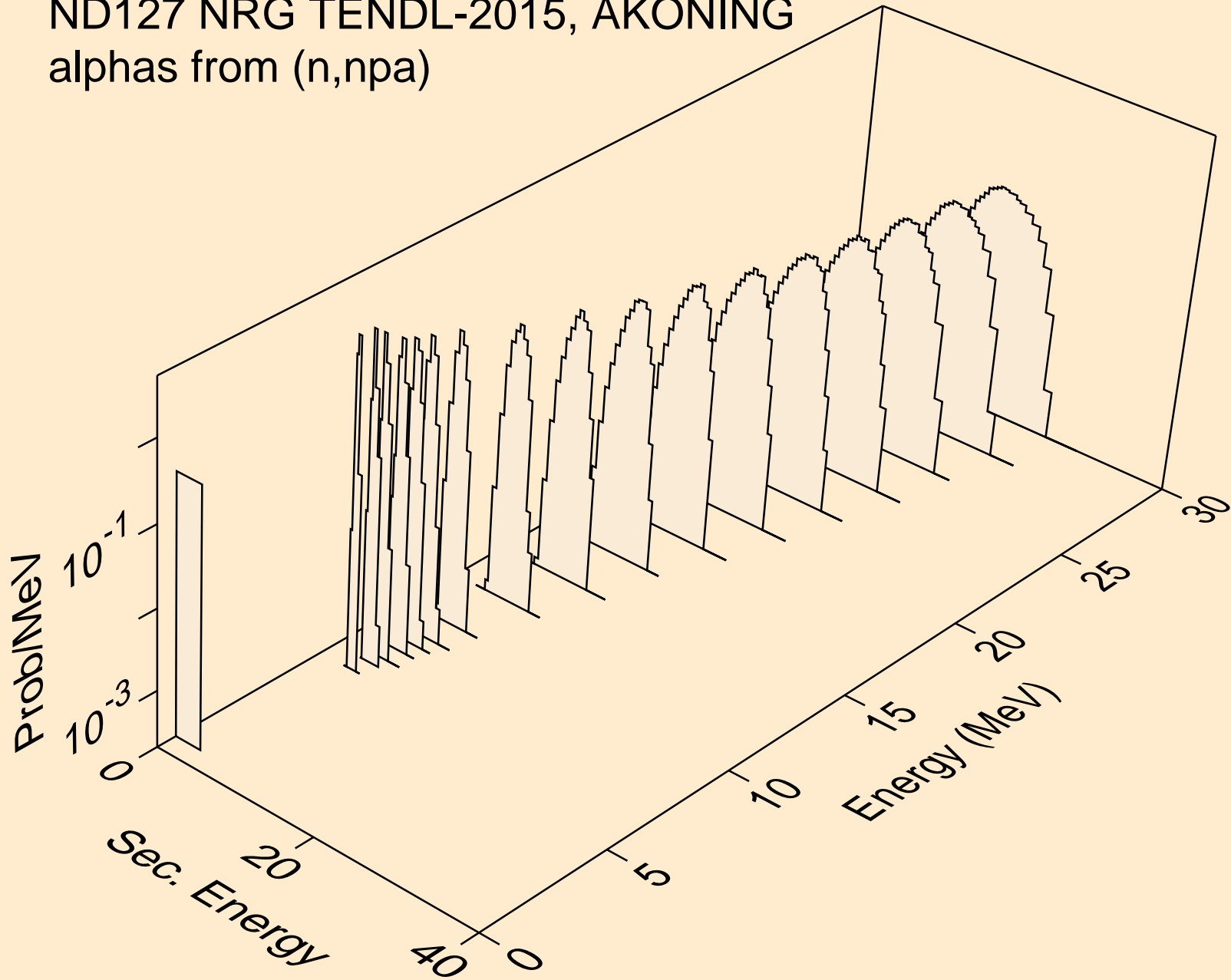

ND127 NRG TENDL-2015, AKONING
alphas from (n,a)

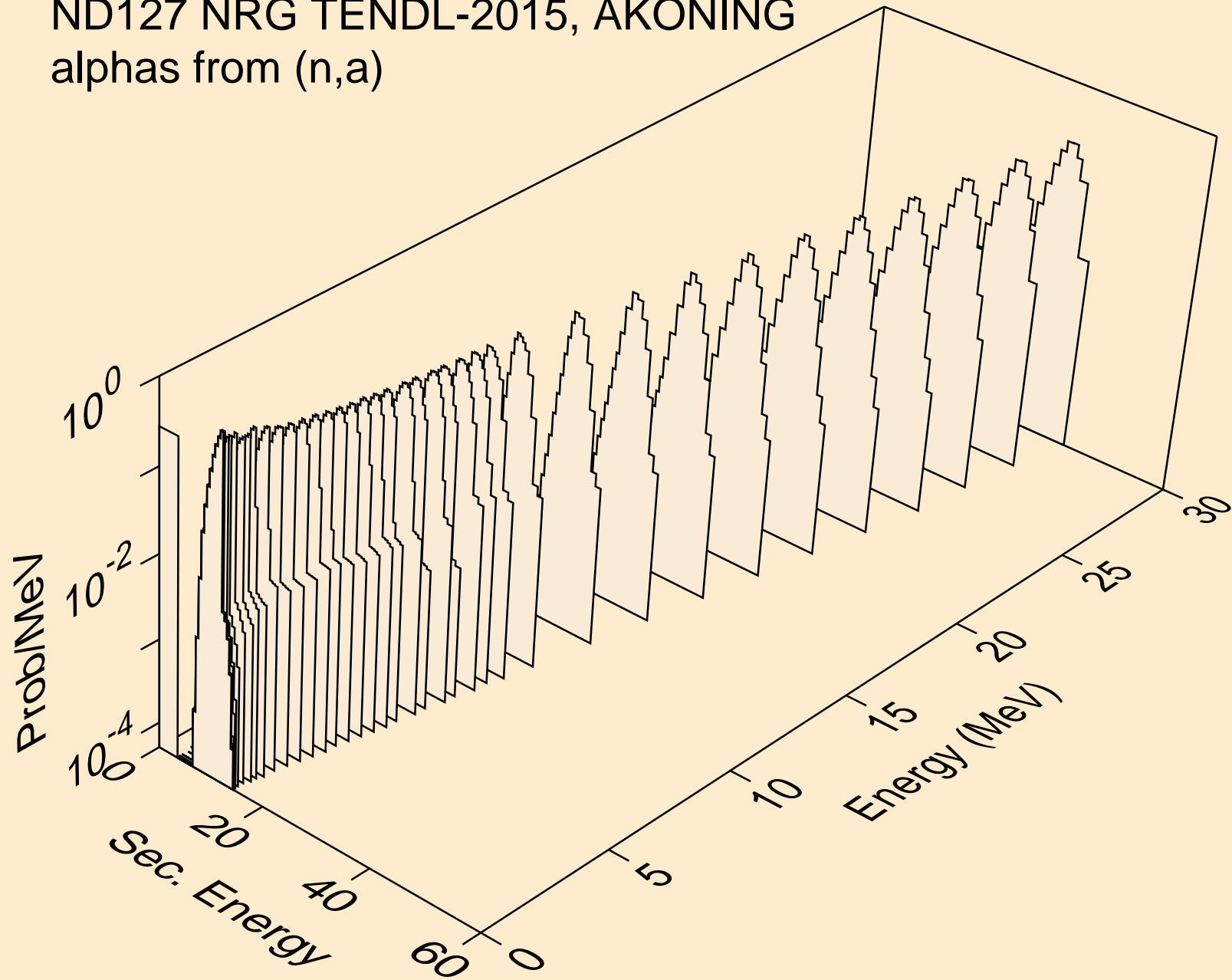

ND127 NRG TENDL-2015, AKONING
alphas from (n,2a)

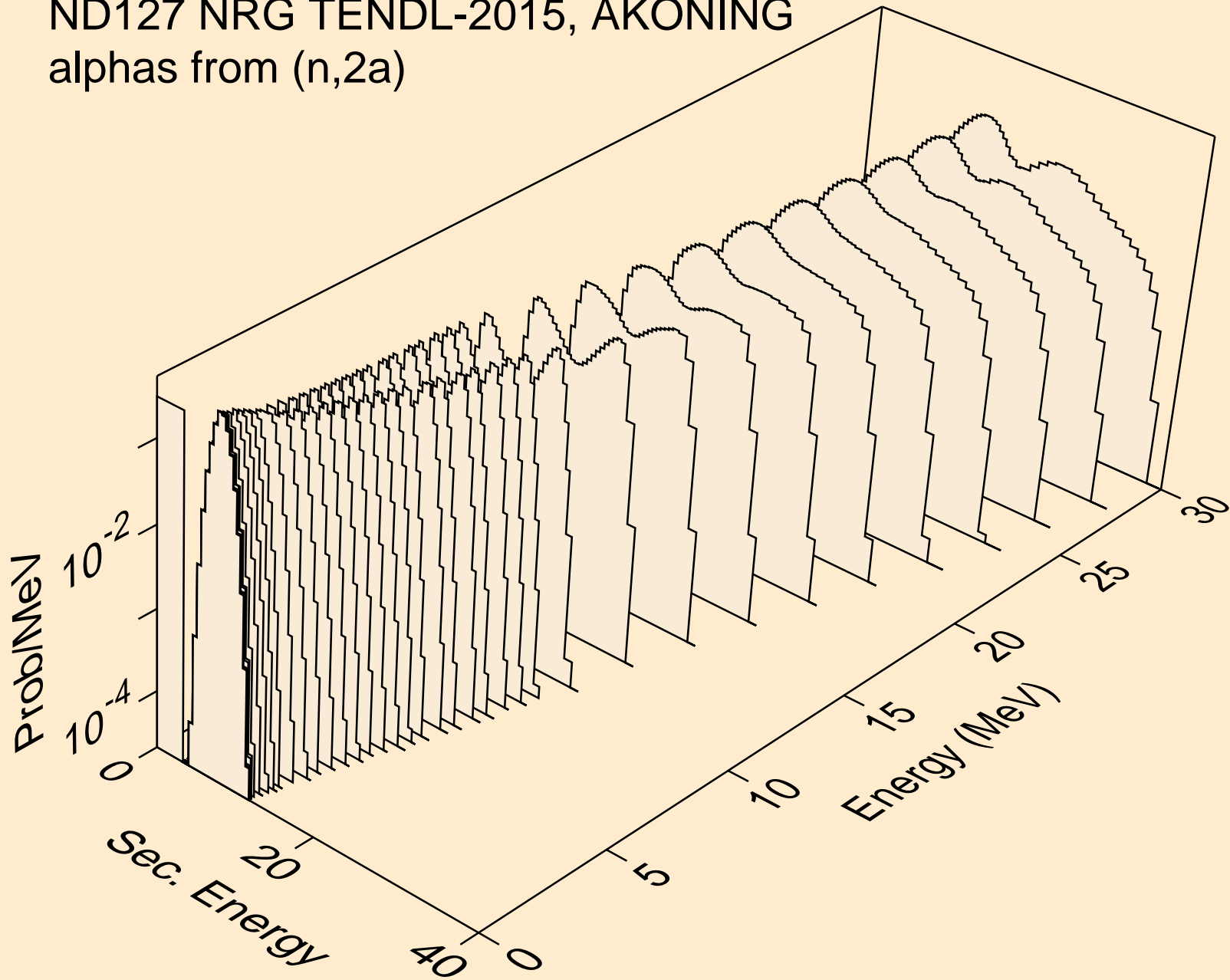

ND127 NRG TENDL-2015, AKONING
alphas from (n,3a)

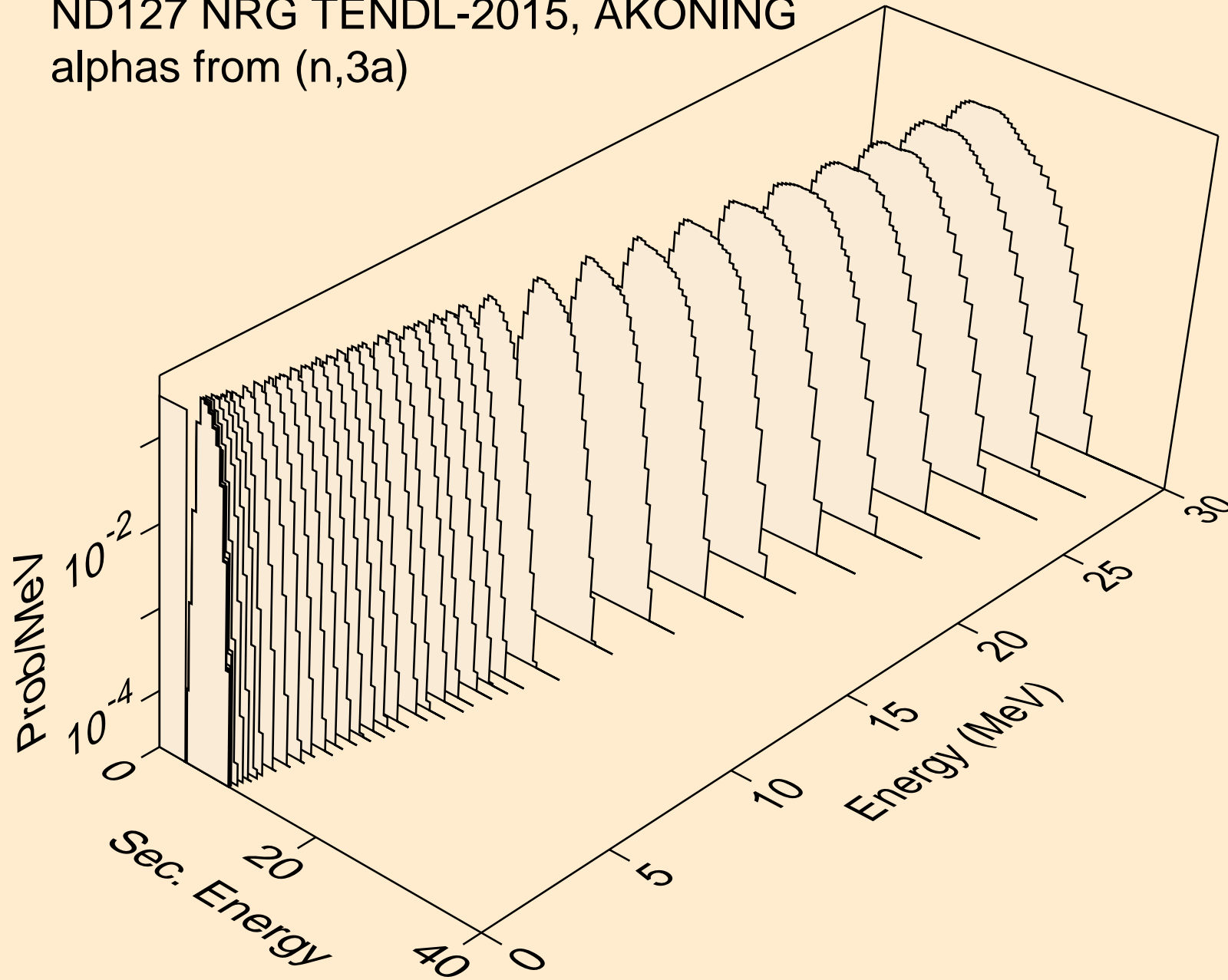

ND127 NRG TENDL-2015, AKONING
alphas from (n,pa)

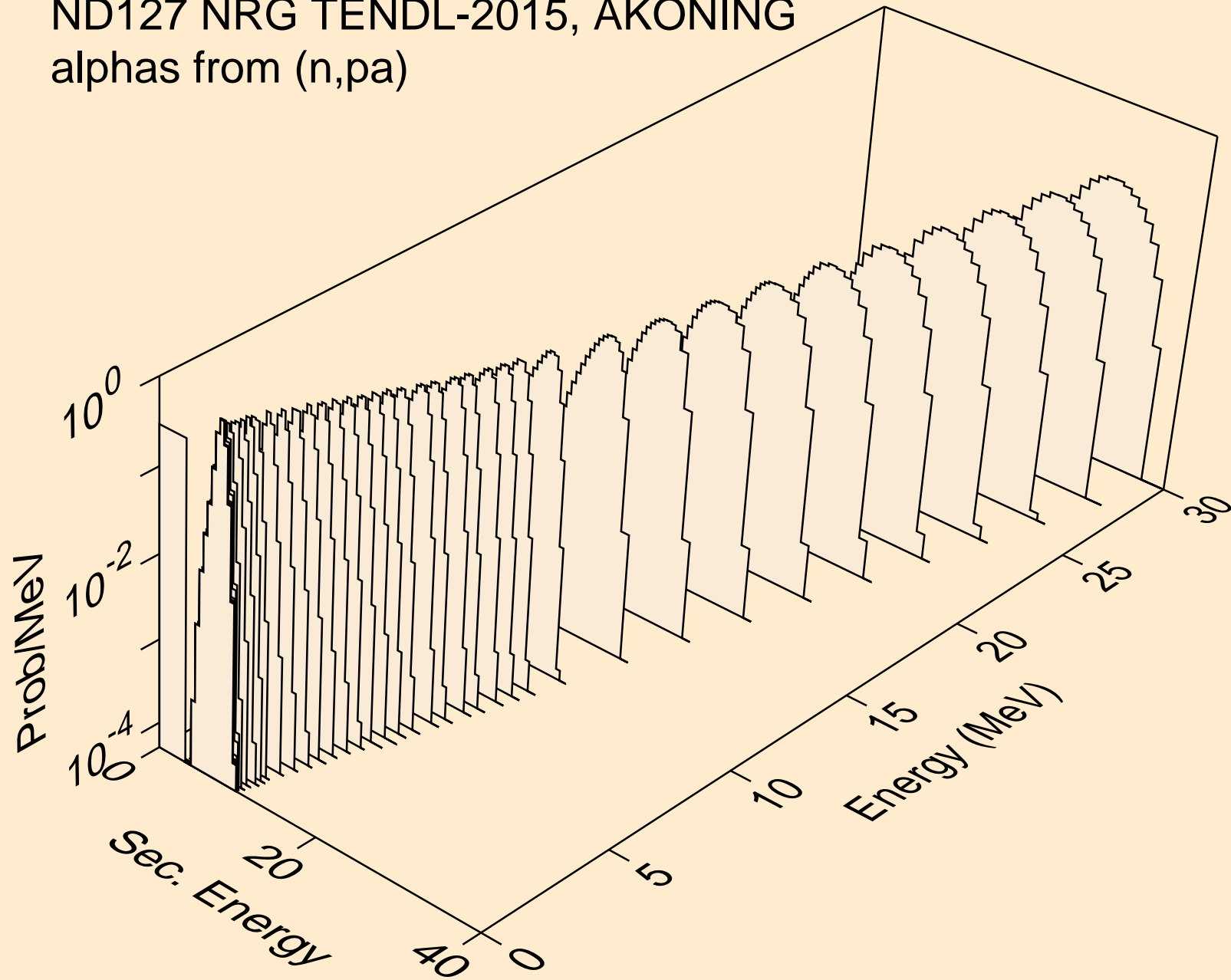

ND127 NRG TENDL-2015, AKONING
alphas from (n,d2a)

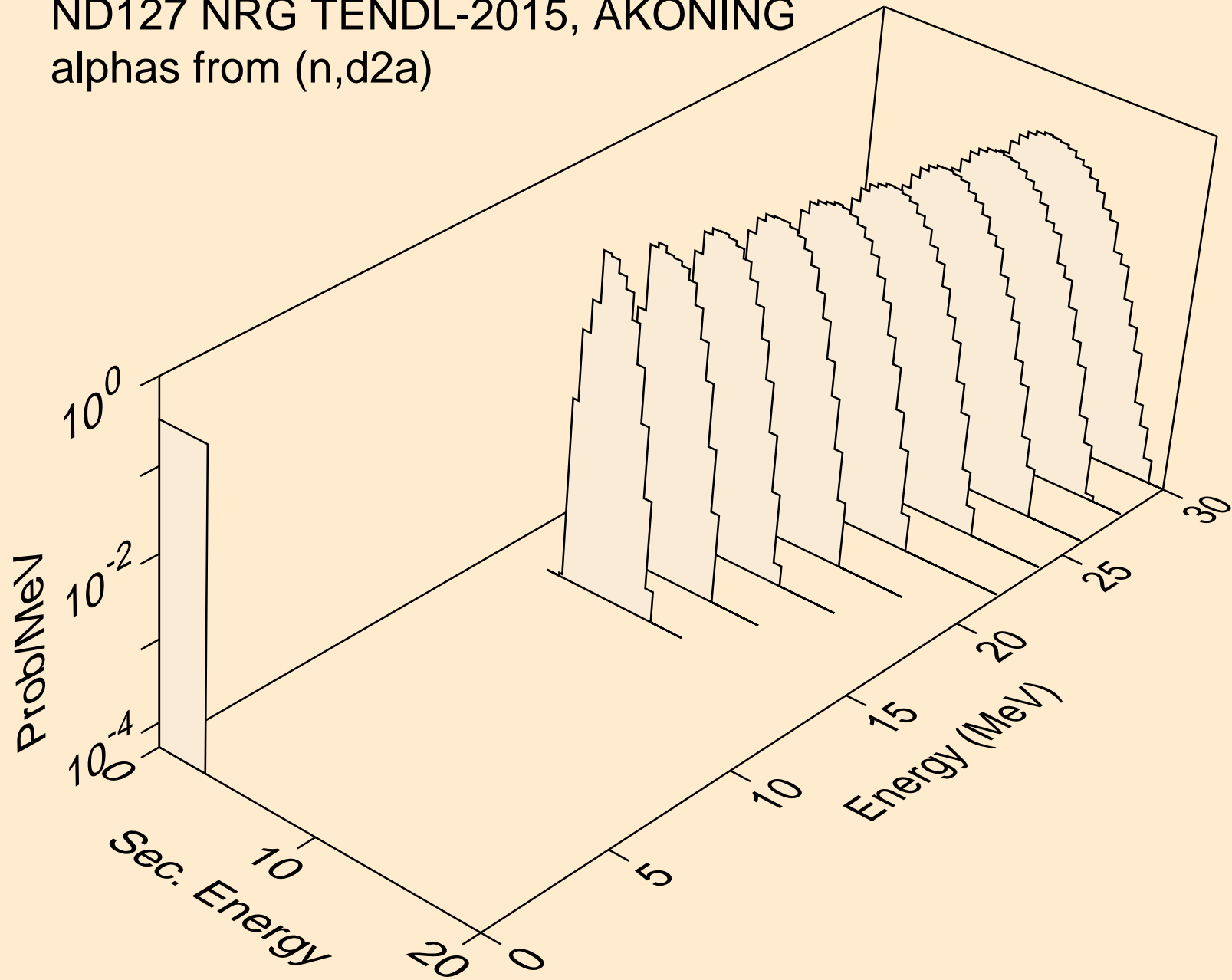

ND127 NRG TENDL-2015, AKONING
alphas from (n,da)

