

NP243 NRG TENDL-2015, AKONING

Principal cross sections

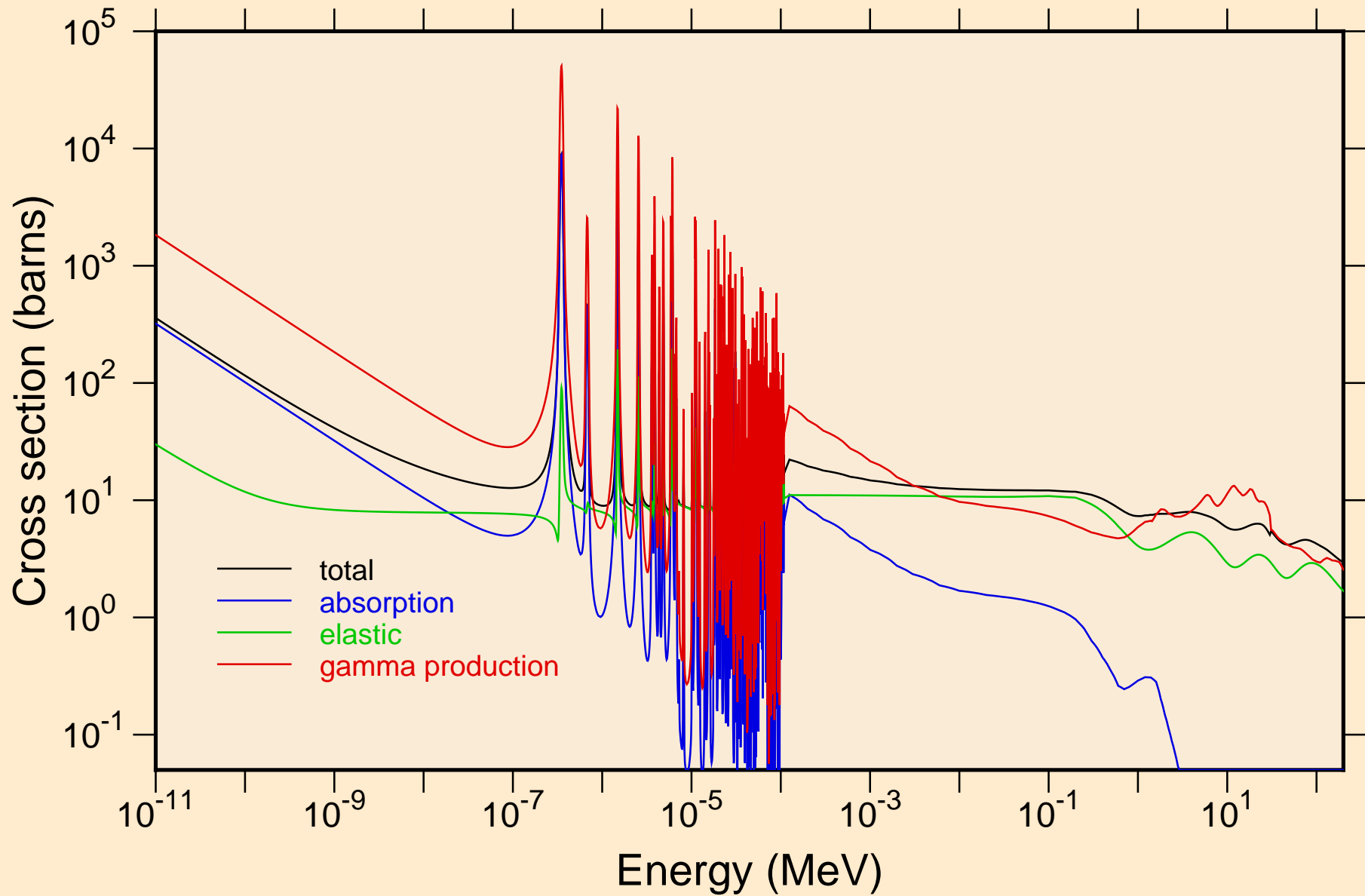

NP243 NRG TENDL-2015, AKONING
resonance total cross section

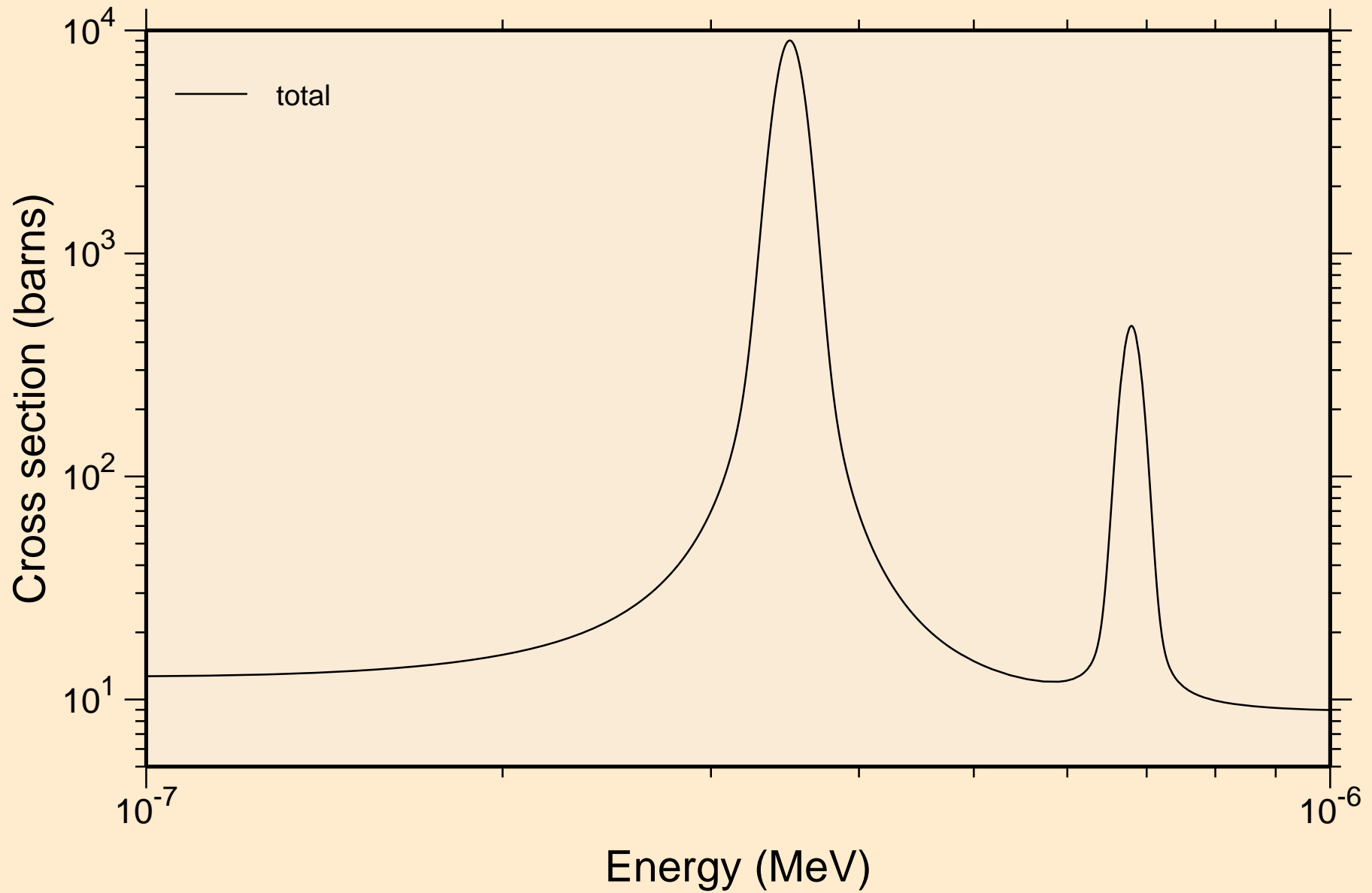

NP243 NRG TENDL-2015, AKONING
resonance total cross section

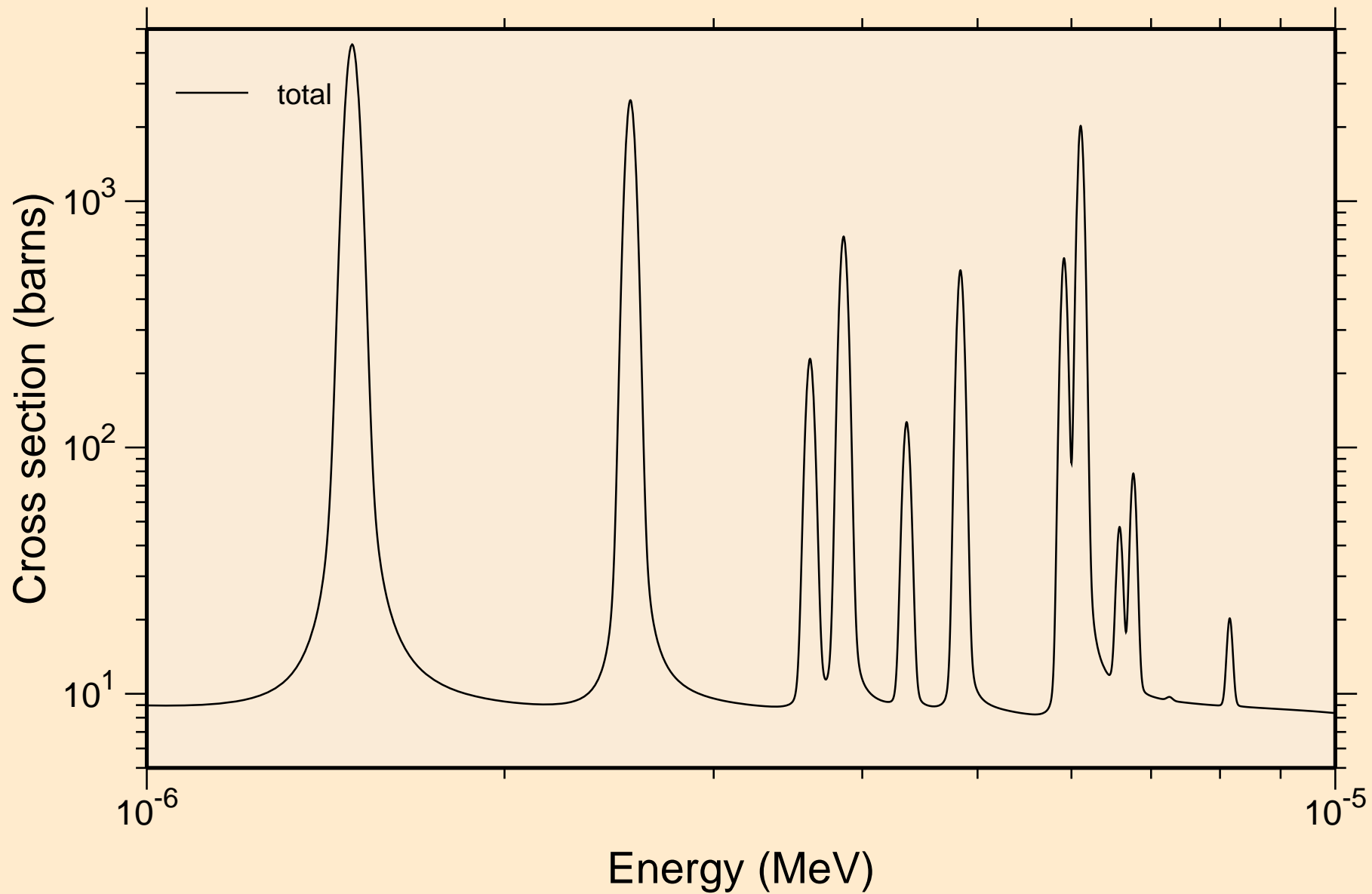

NP243 NRG TENDL-2015, AKONING
resonance total cross section

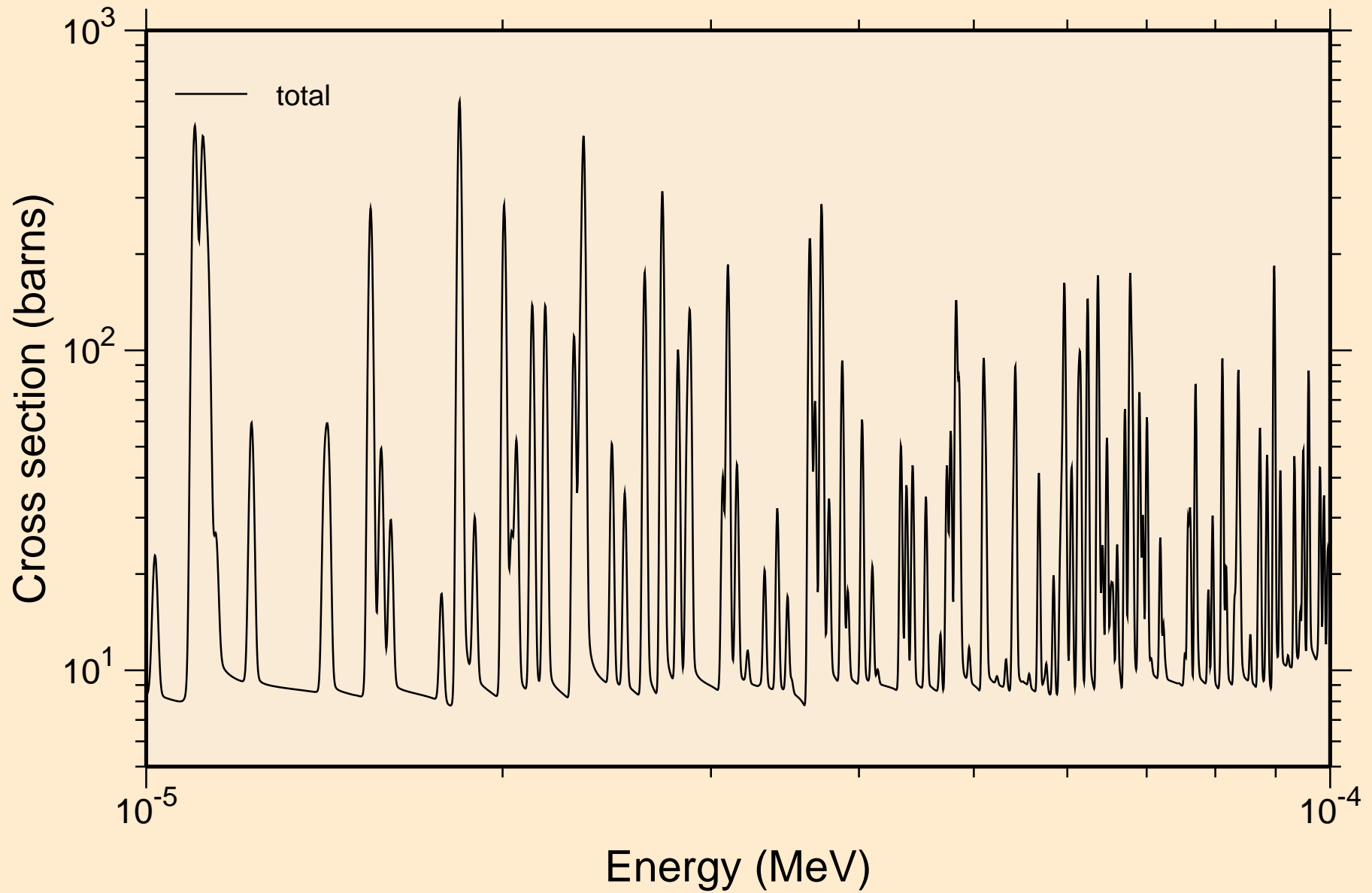

NP243 NRG TENDL-2015, AKONING
resonance total cross section

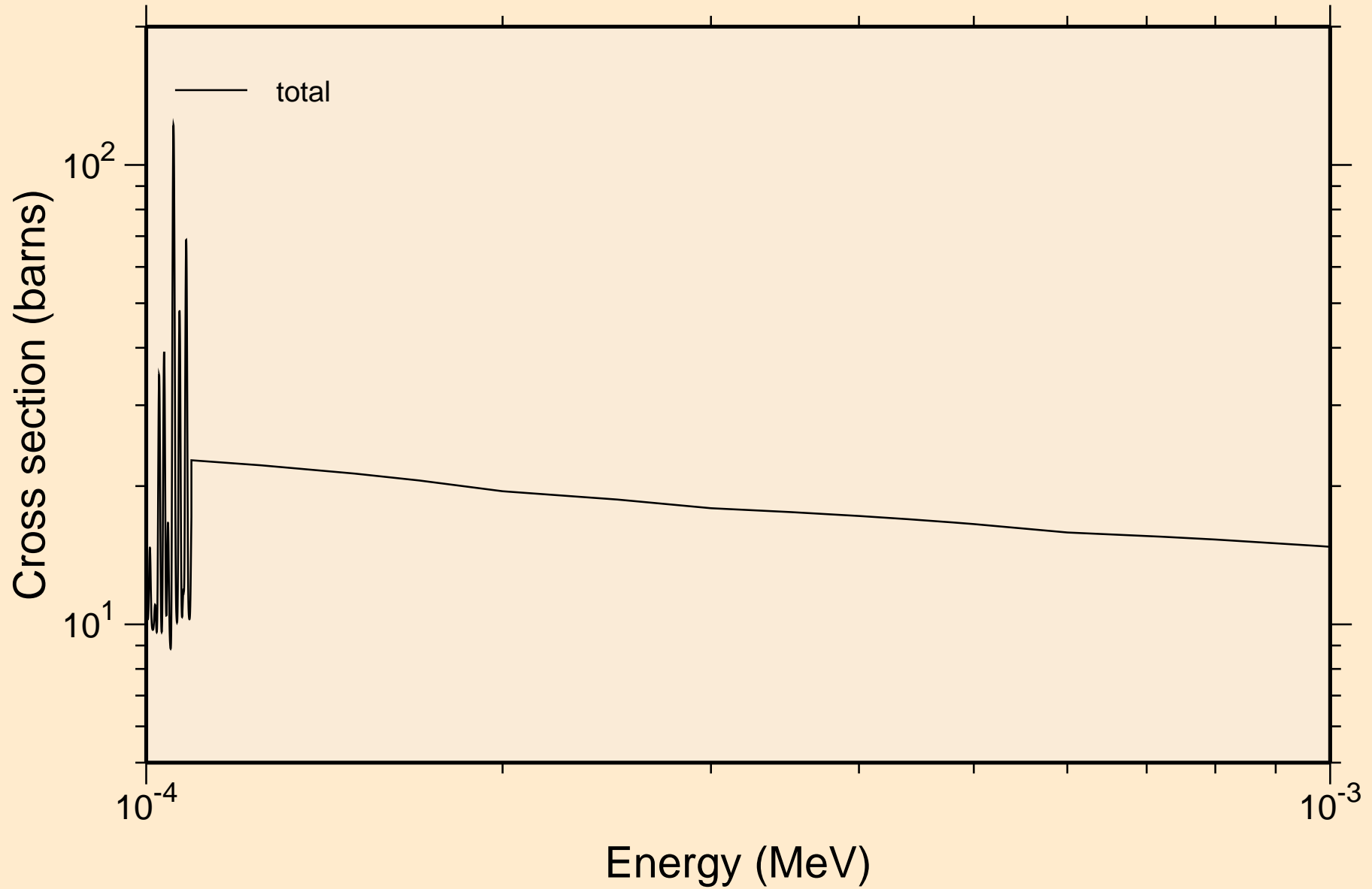

NP243 NRG TENDL-2015, AKONING
resonance total cross section

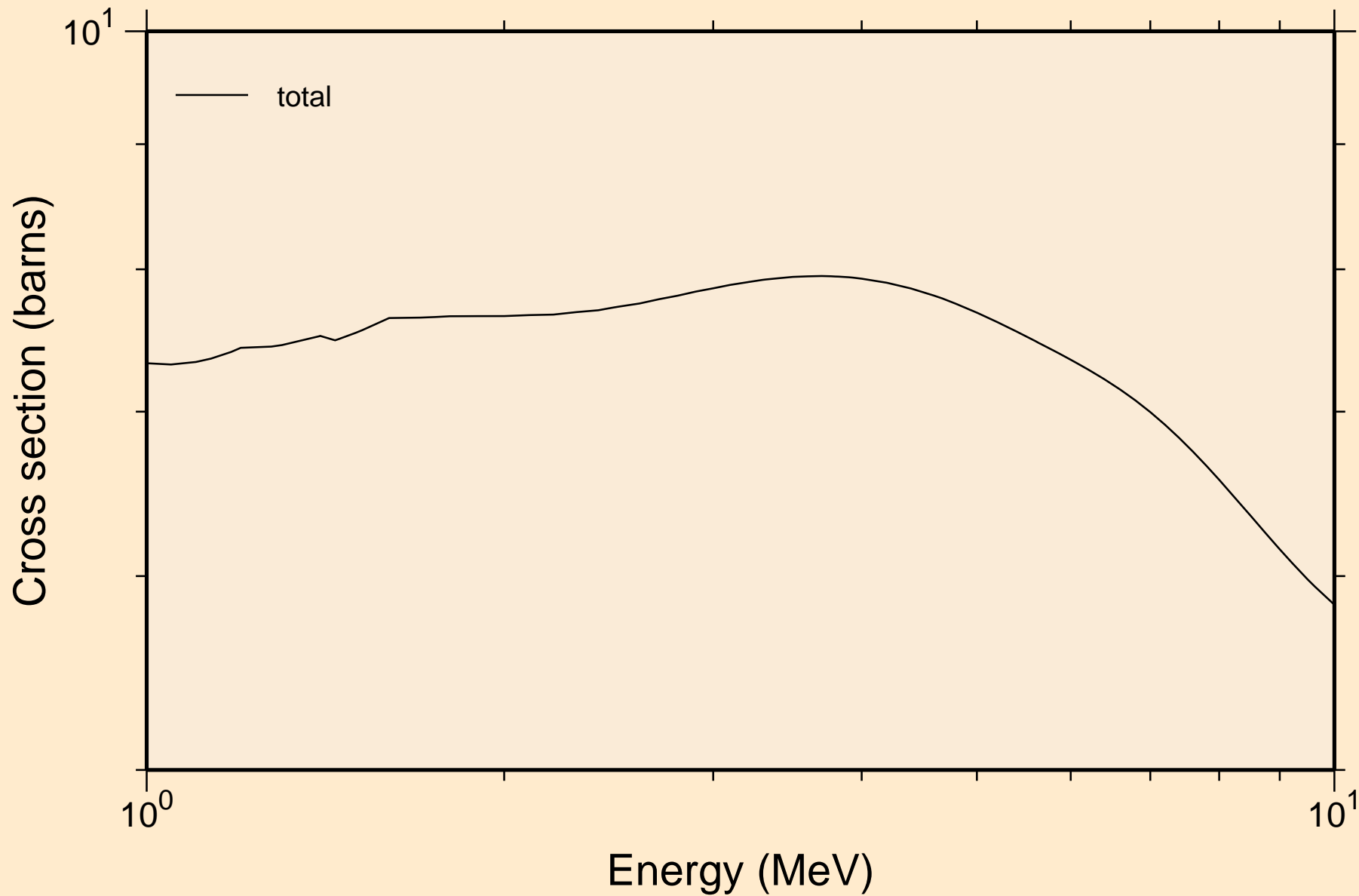

NP243 NRG TENDL-2015, AKONING

resonance absorption cross sections

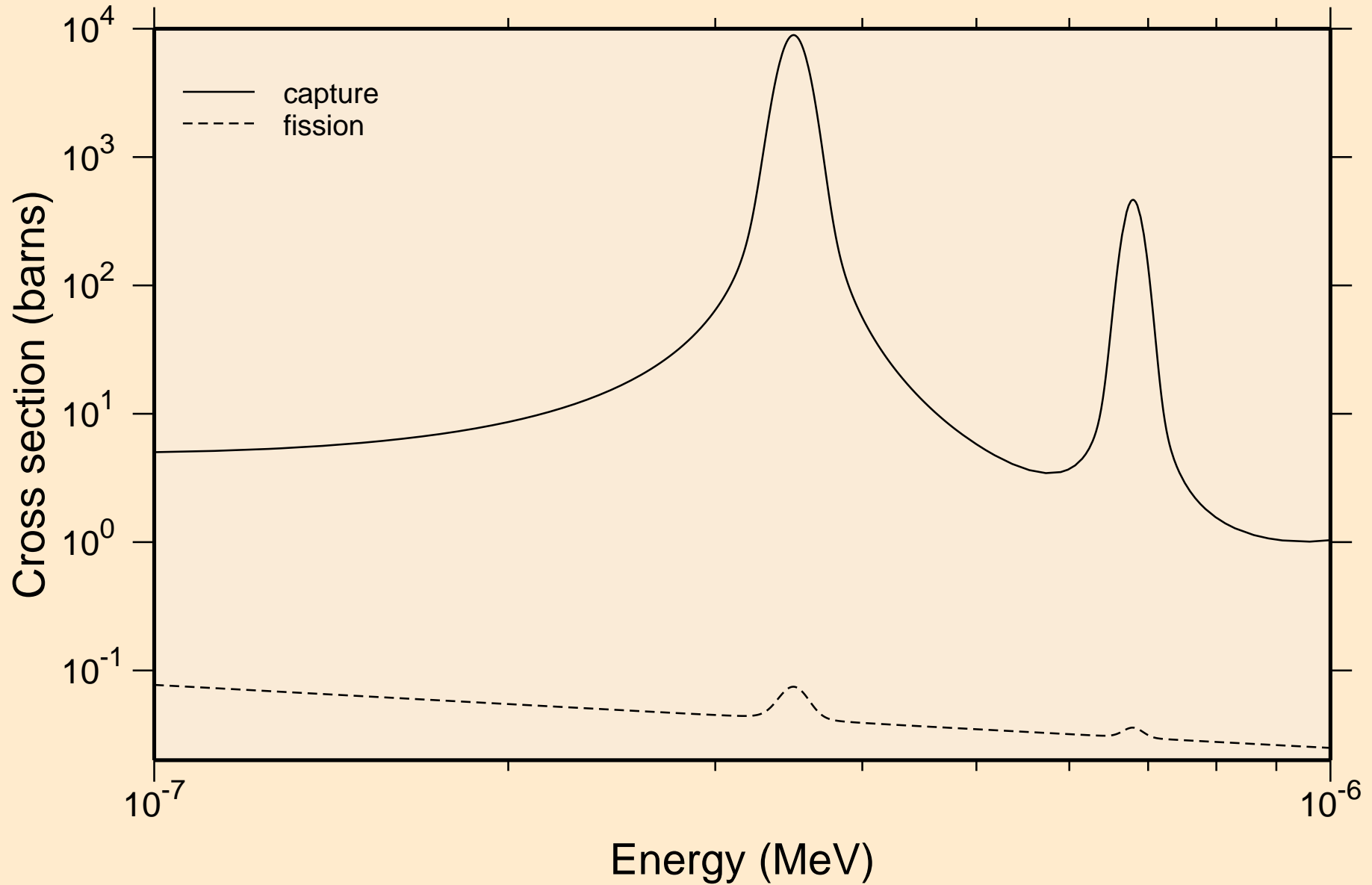

NP243 NRG TENDL-2015, AKONING

resonance absorption cross sections

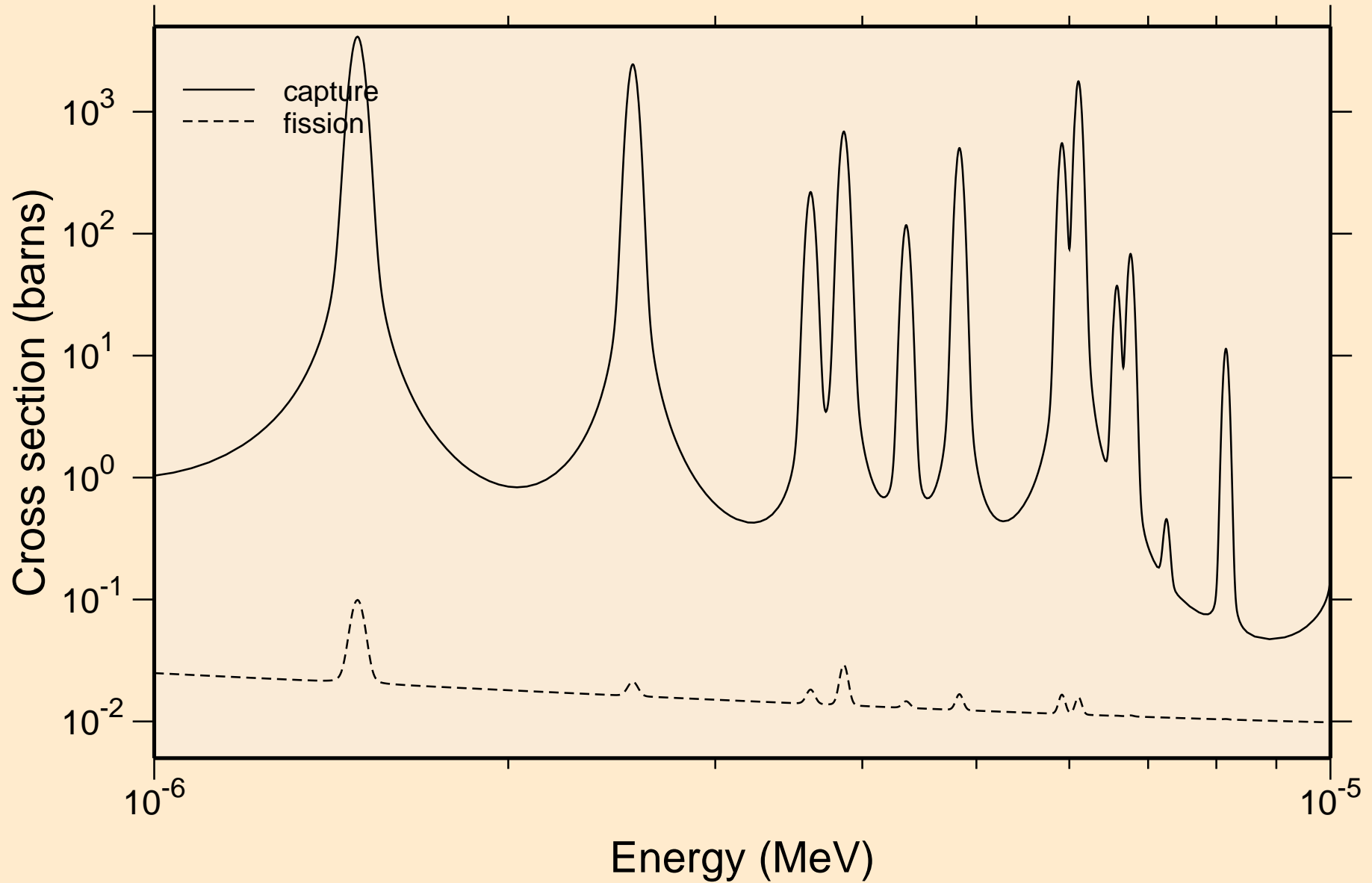

NP243 NRG TENDL-2015, AKONING

resonance absorption cross sections

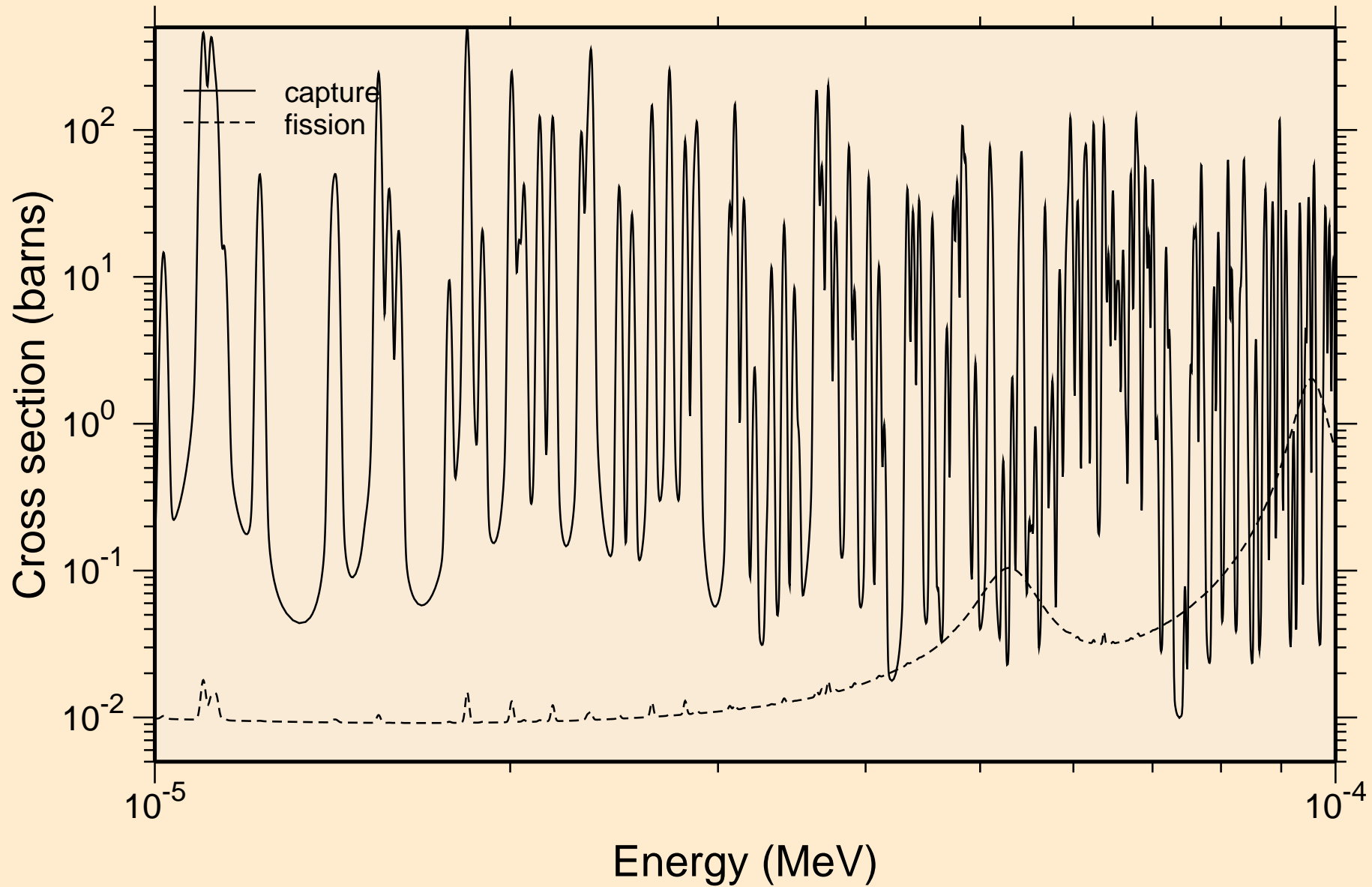

NP243 NRG TENDL-2015, AKONING

resonance absorption cross sections

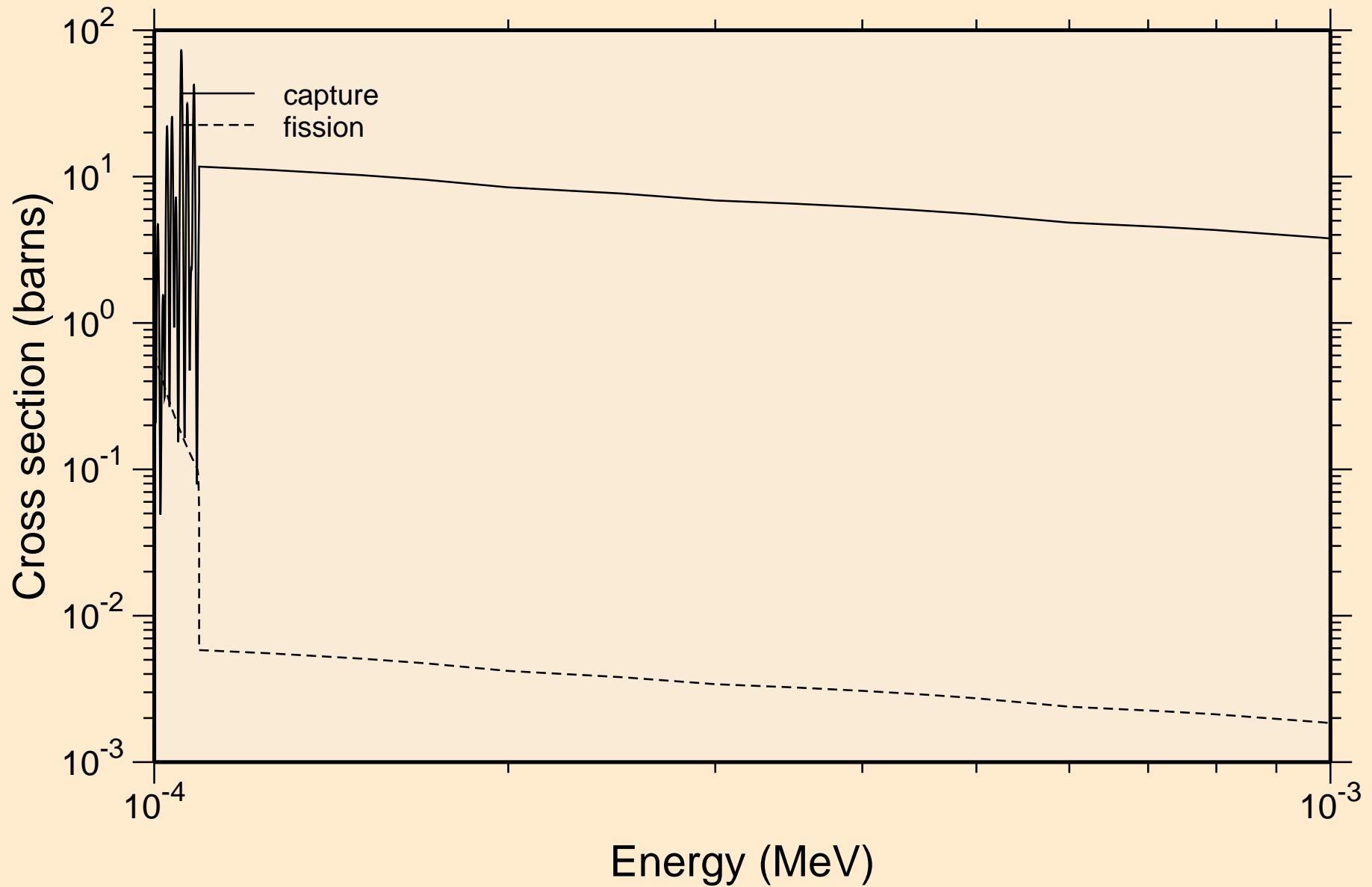

NP243 NRG TENDL-2015, AKONING

resonance absorption cross sections

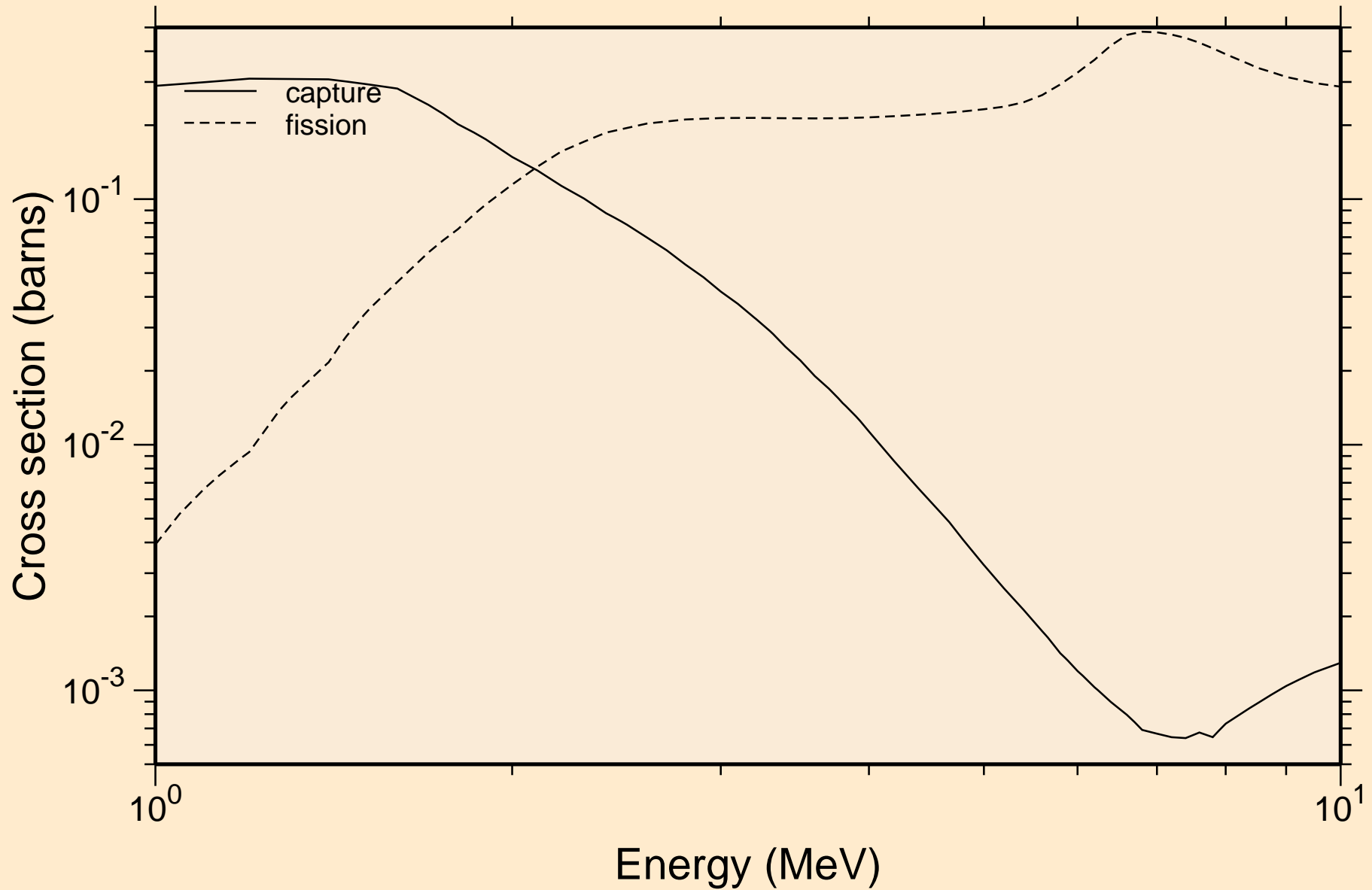

NP243 NRG TENDL-2015, AKONING

Non-threshold reactions

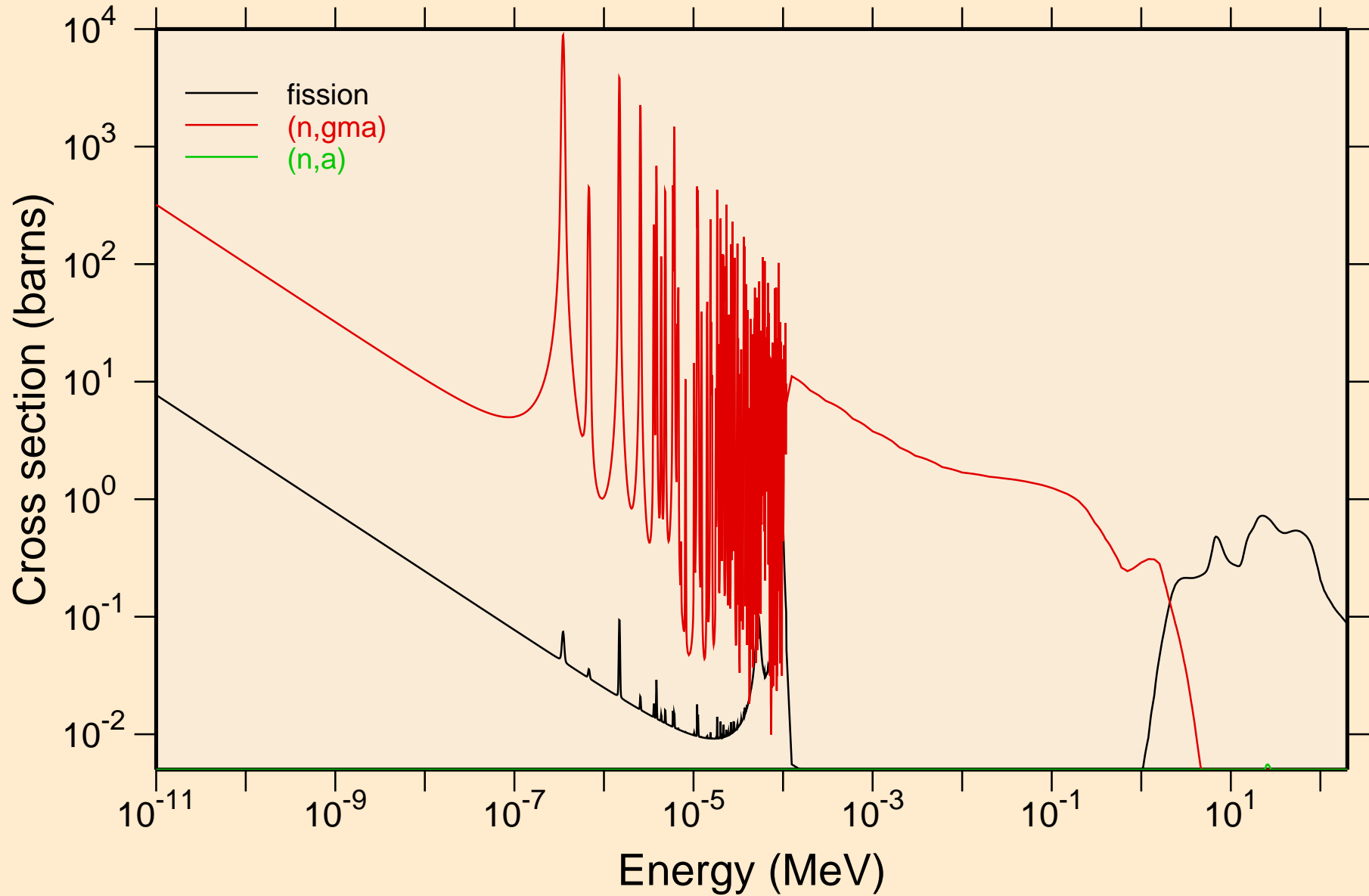

NP243 NRG TENDL-2015, AKONING

Principal cross sections

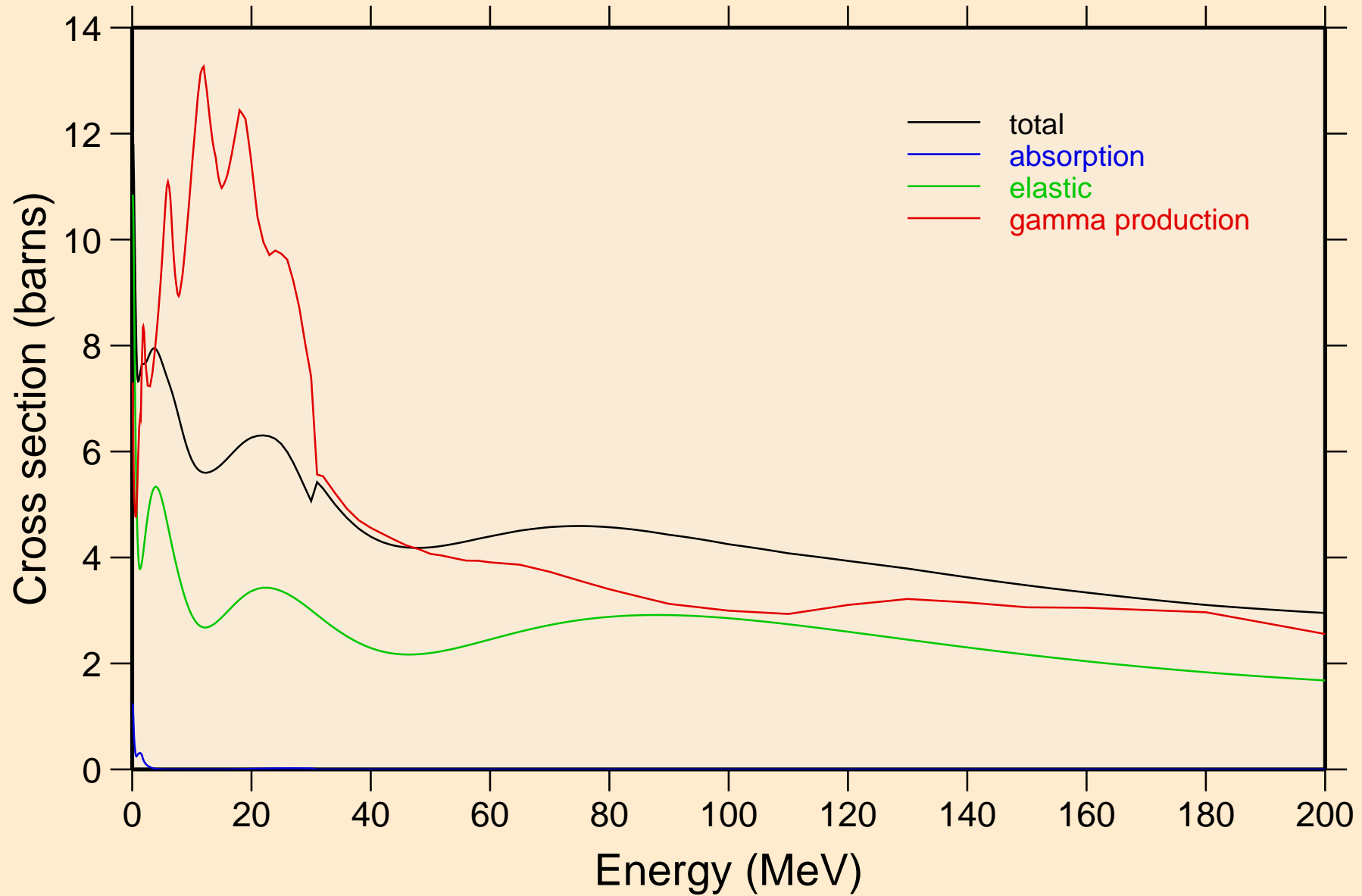

NP243 NRG TENDL-2015, AKONING

Non-threshold reactions

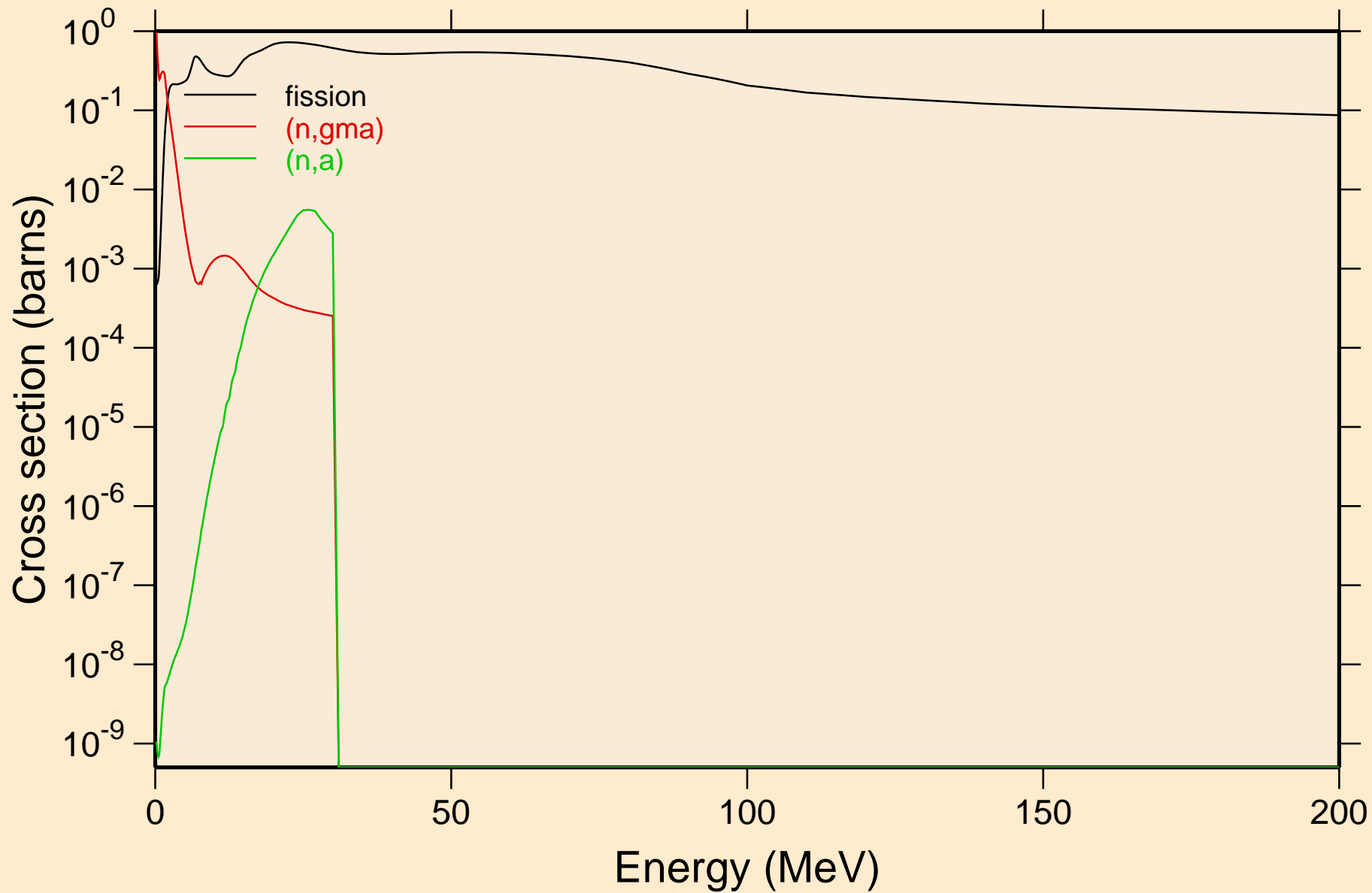

NP243 NRG TENDL-2015, AKONING

Inelastic levels

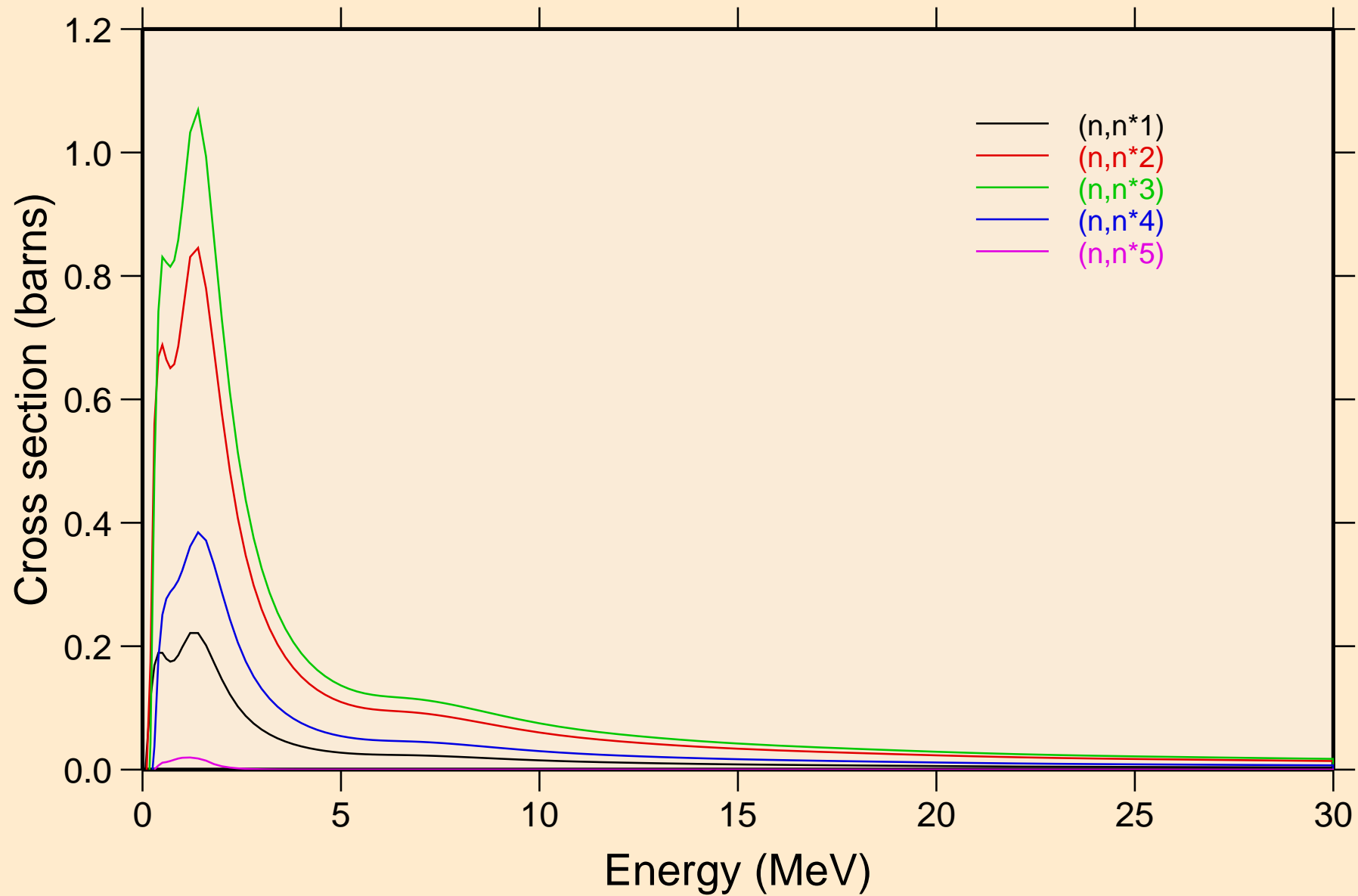

NP243 NRG TENDL-2015, AKONING

Inelastic levels

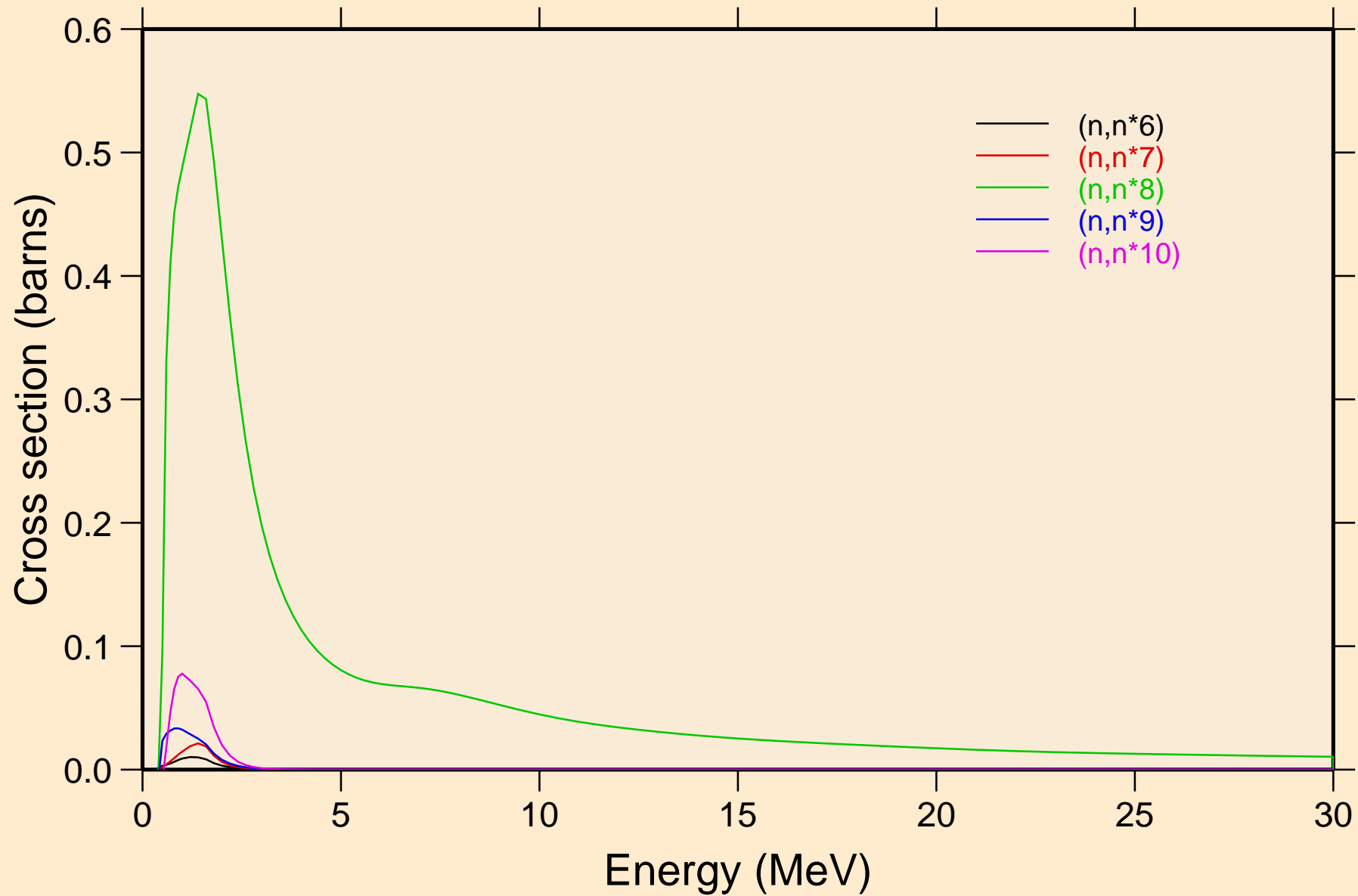

NP243 NRG TENDL-2015, AKONING

Inelastic levels

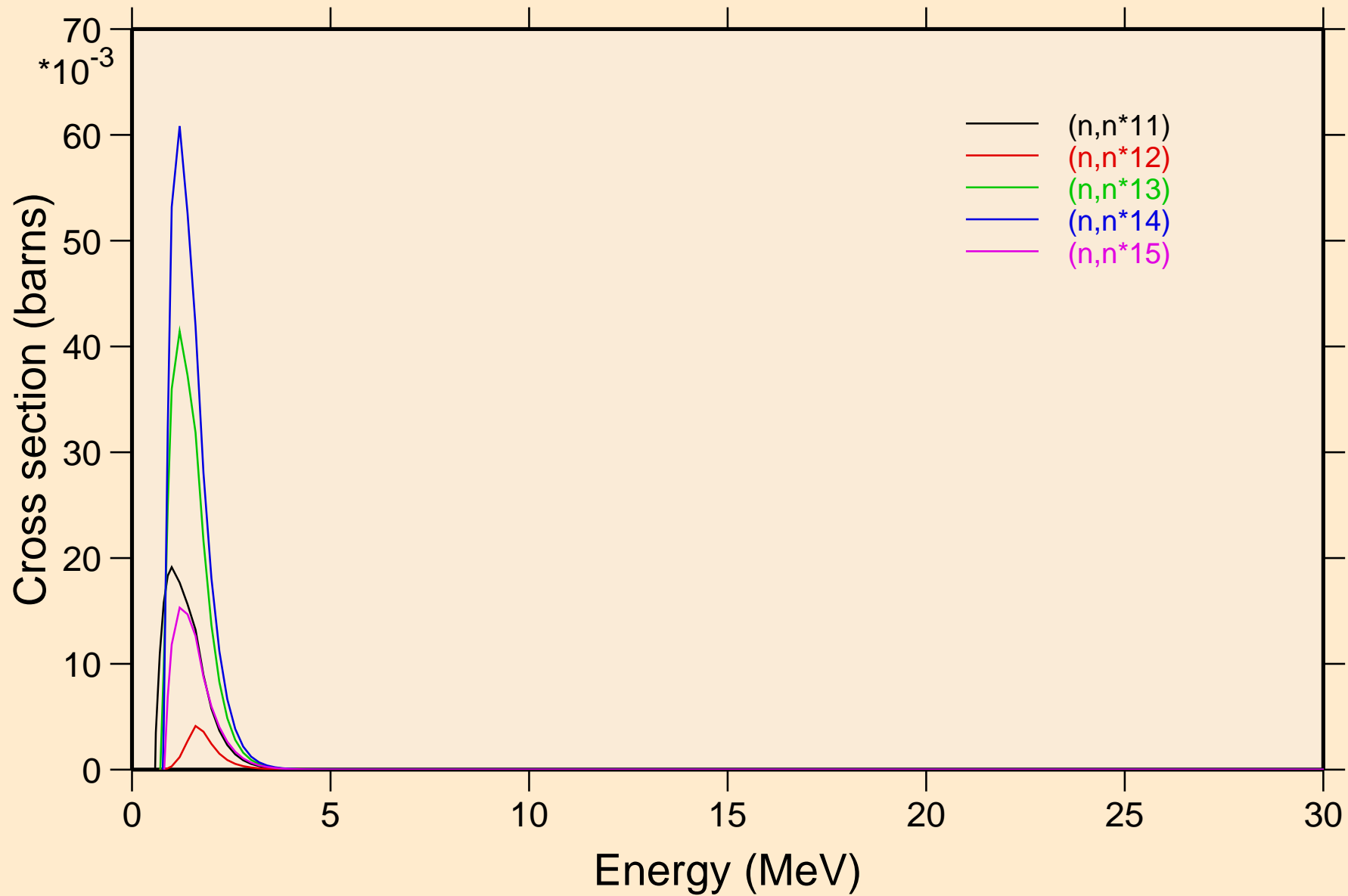

NP243 NRG TENDL-2015, AKONING

Inelastic levels

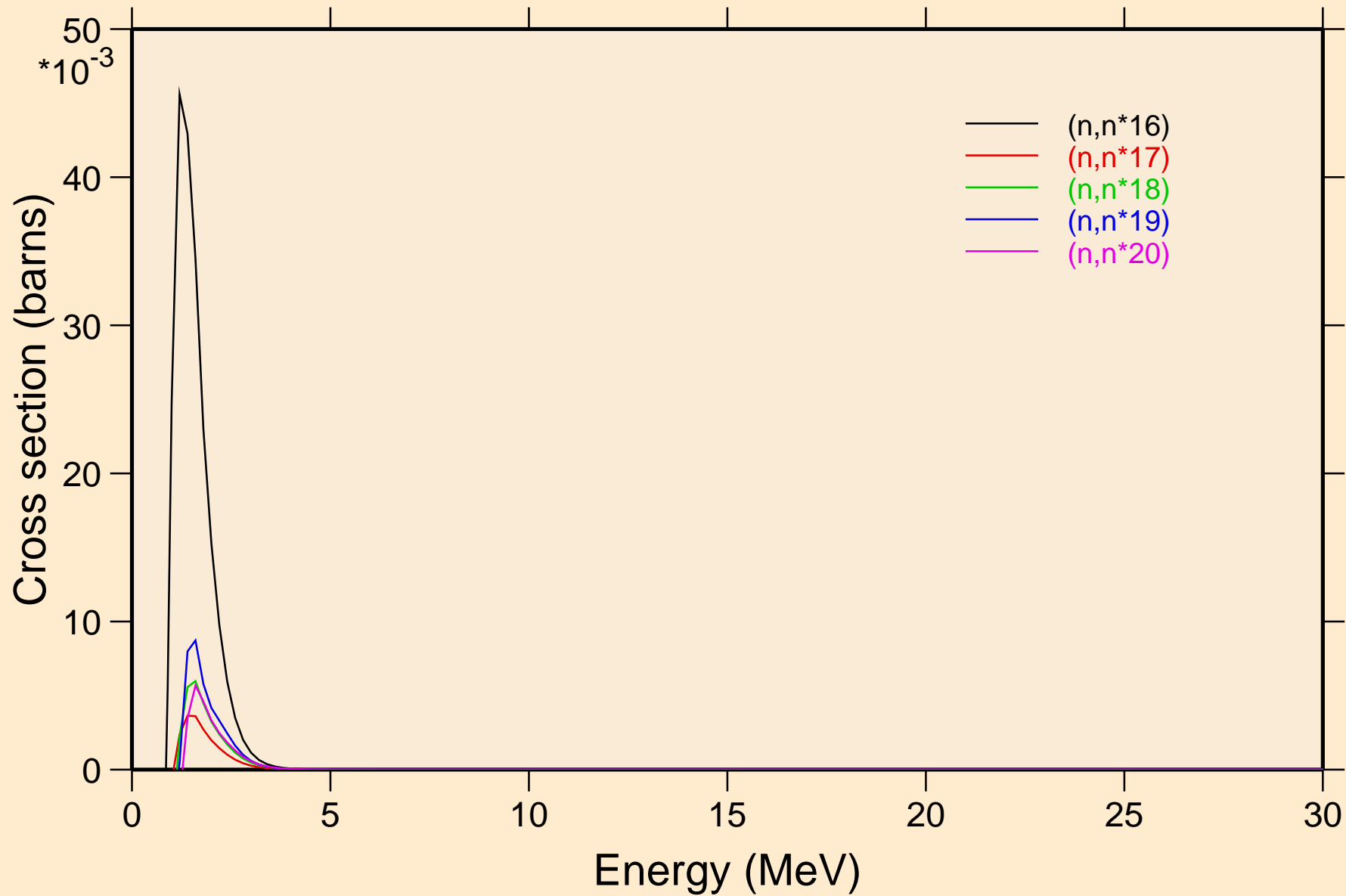

NP243 NRG TENDL-2015, AKONING

Inelastic levels

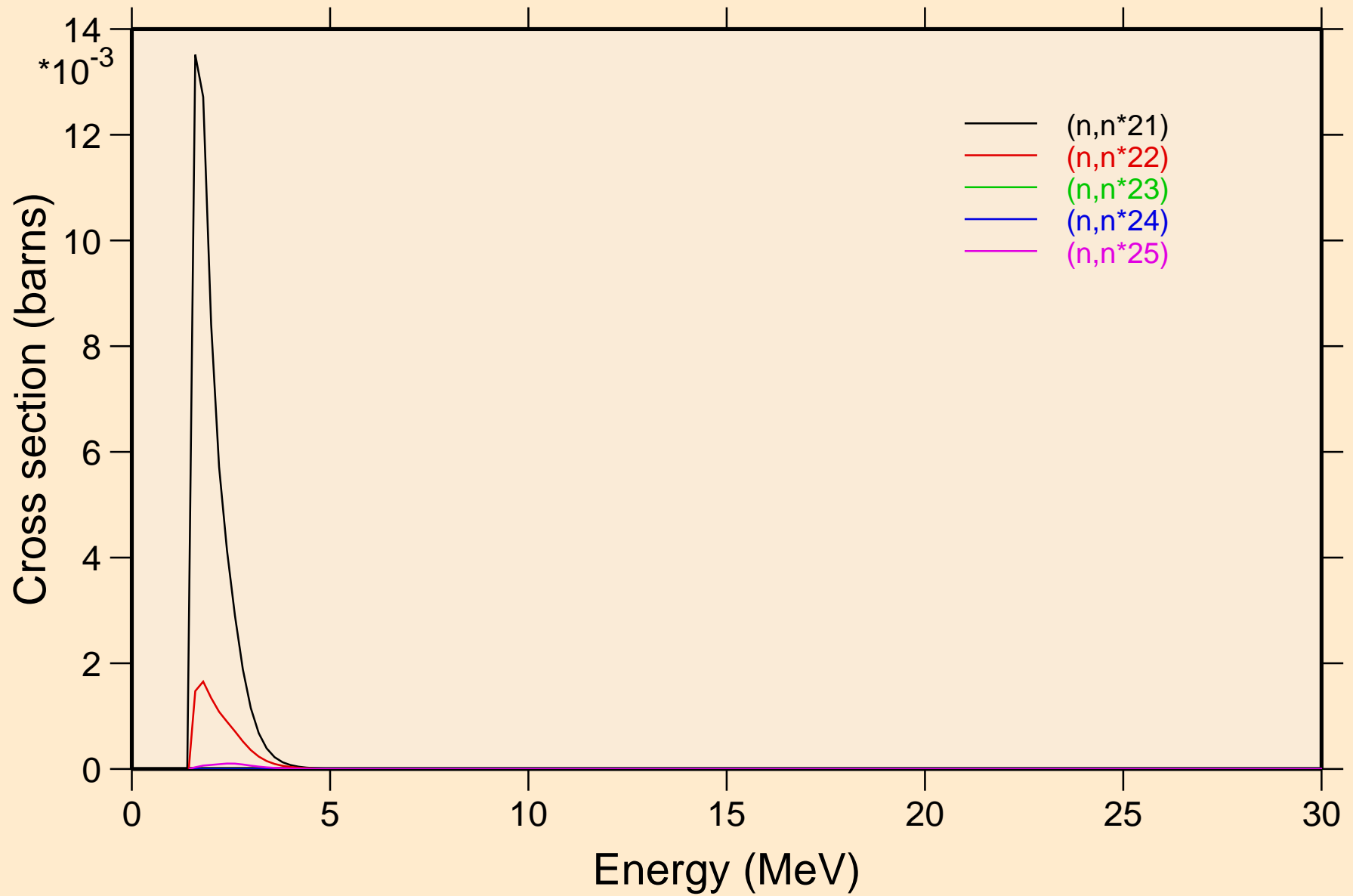

NP243 NRG TENDL-2015, AKONING
Inelastic levels

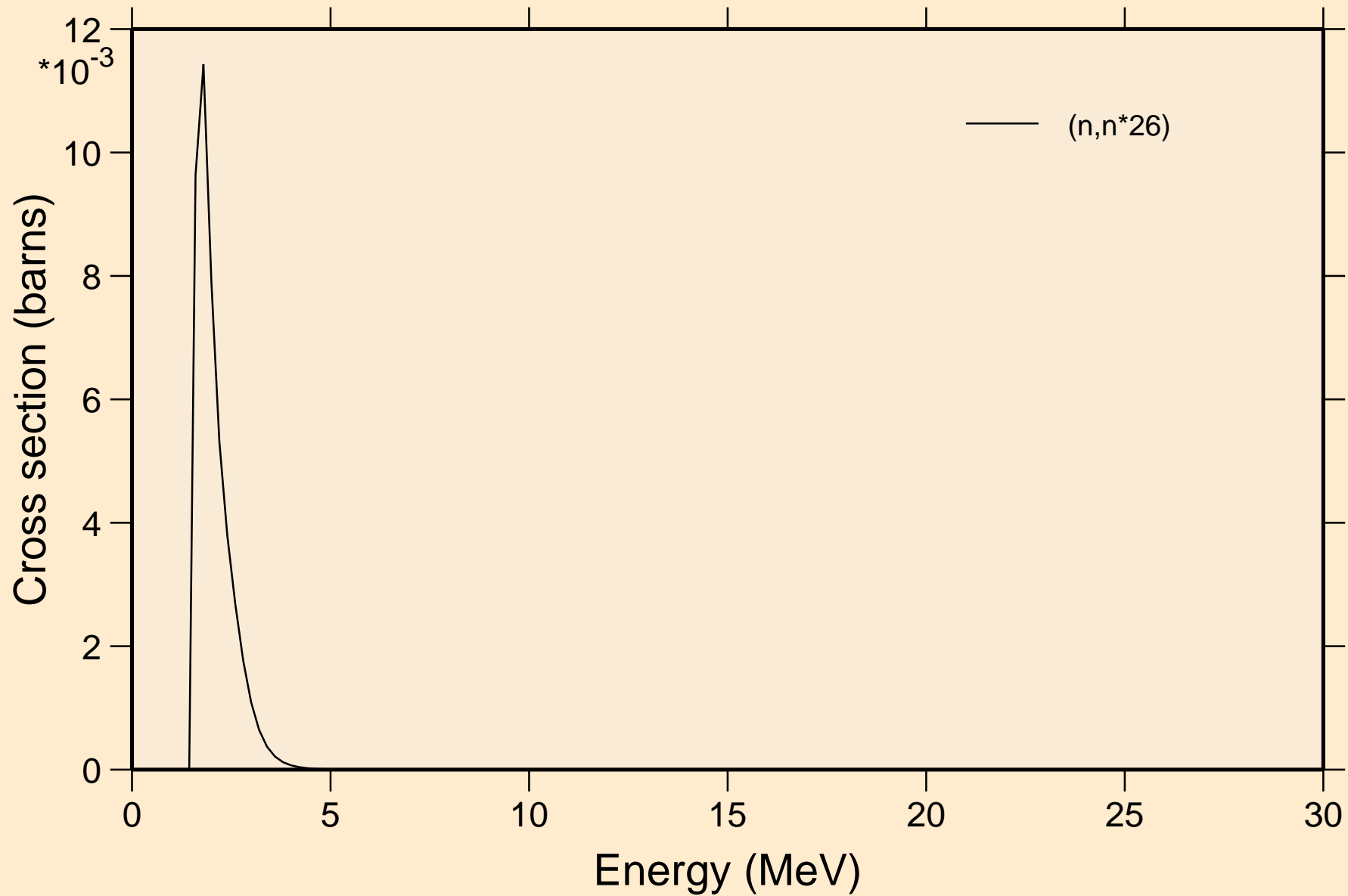

NP243 NRG TENDL-2015, AKONING

Threshold reactions

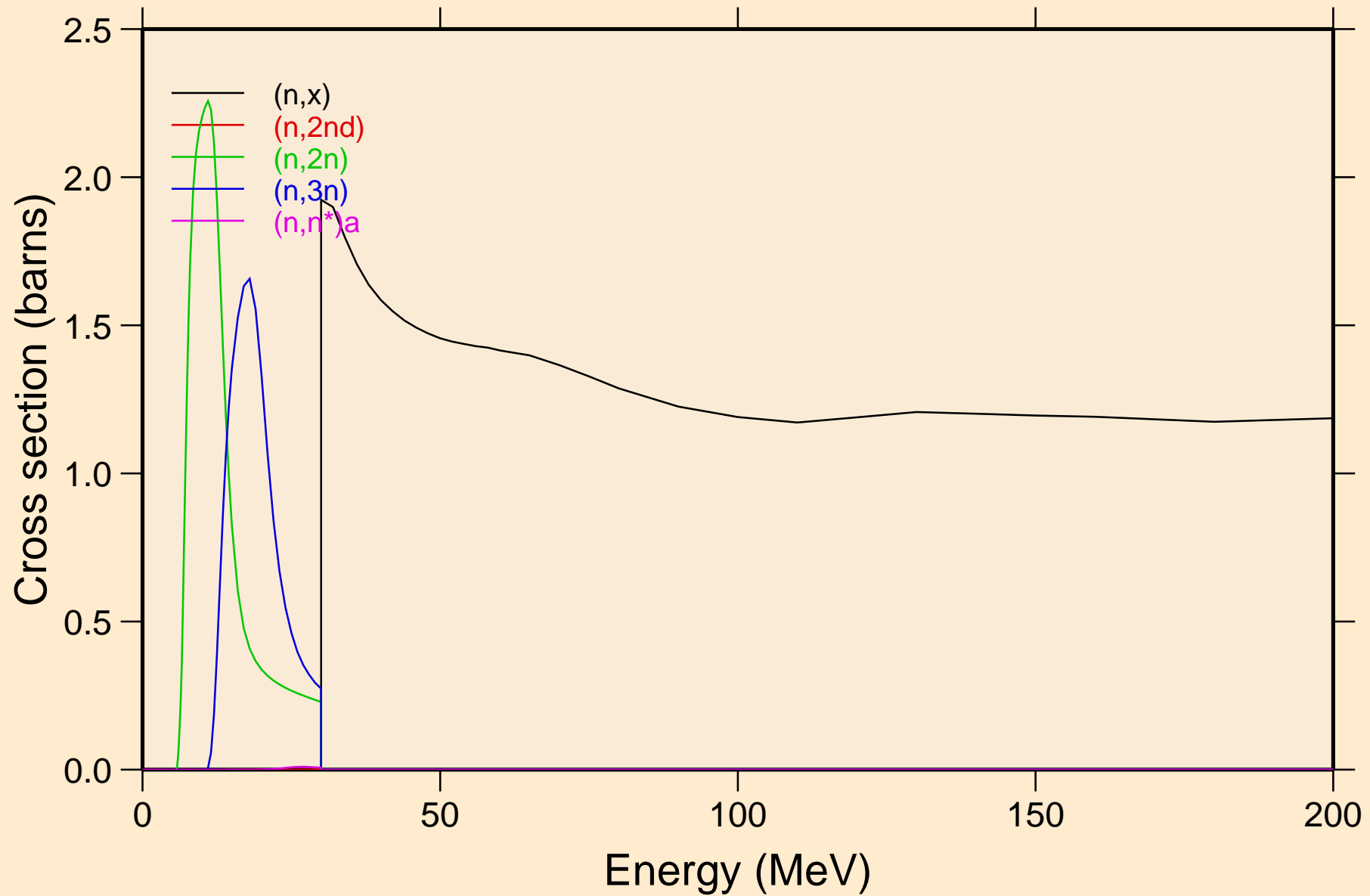

NP243 NRG TENDL-2015, AKONING

Threshold reactions

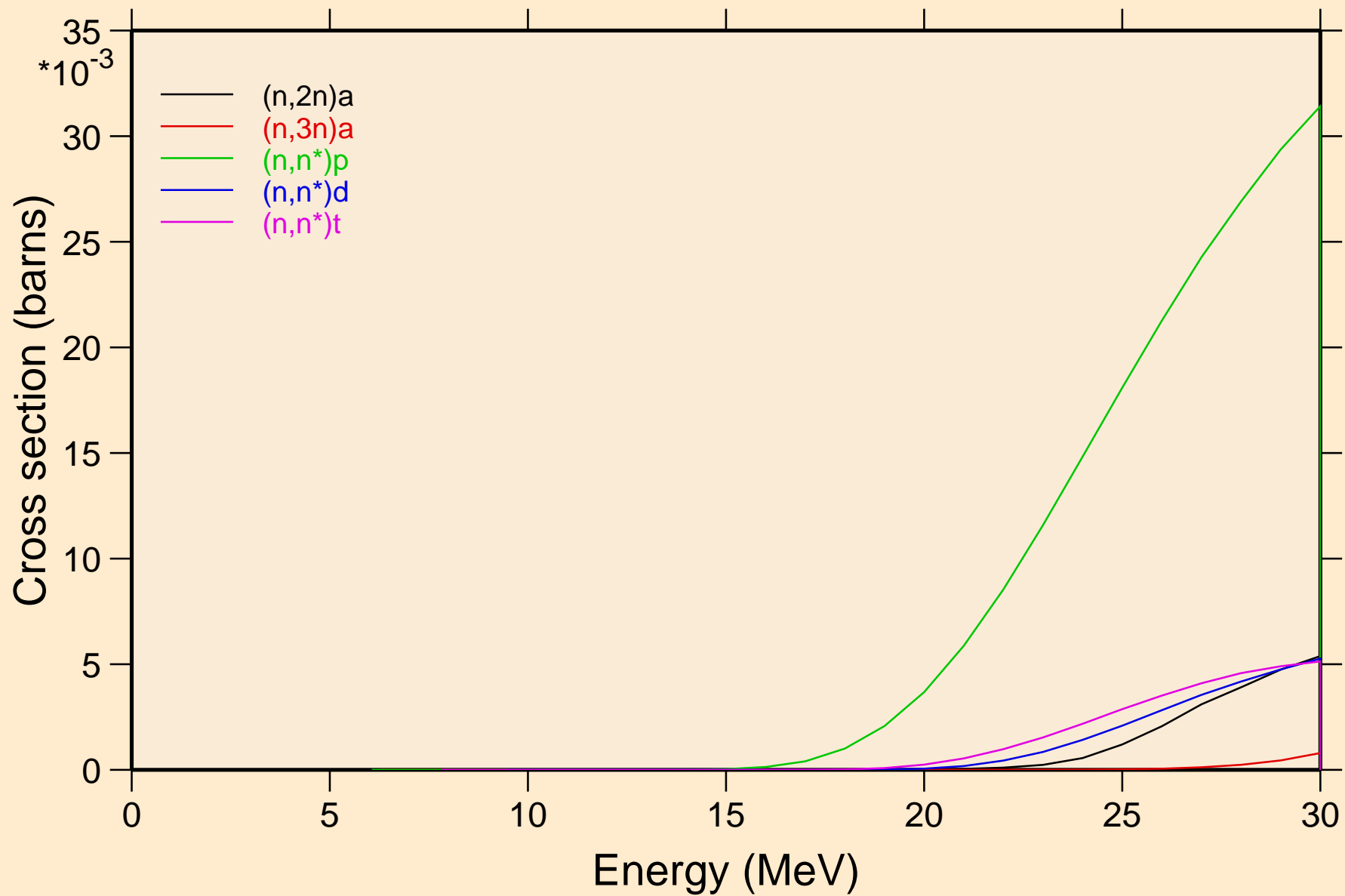

NP243 NRG TENDL-2015, AKONING

Threshold reactions

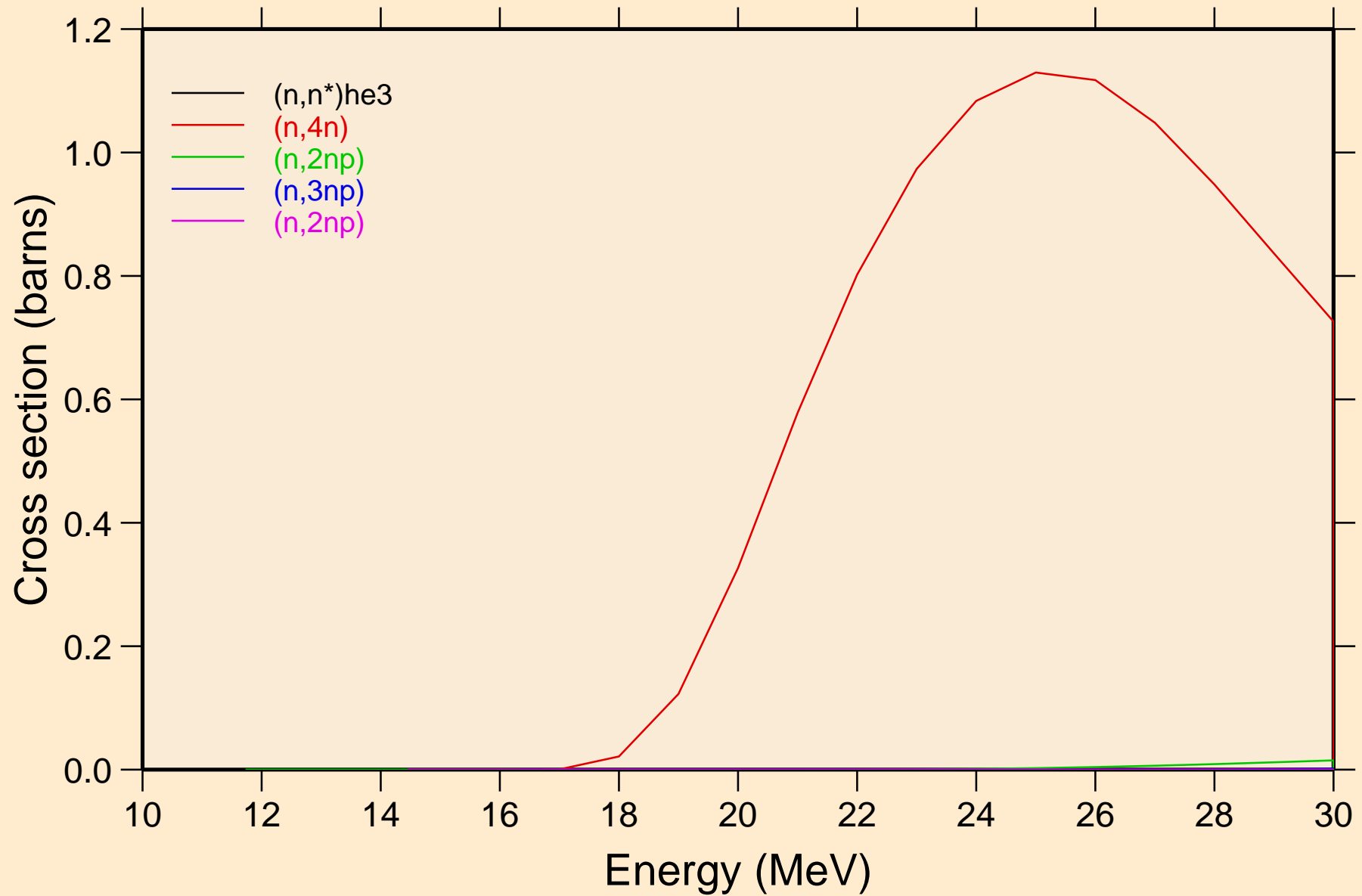

NP243 NRG TENDL-2015, AKONING

Threshold reactions

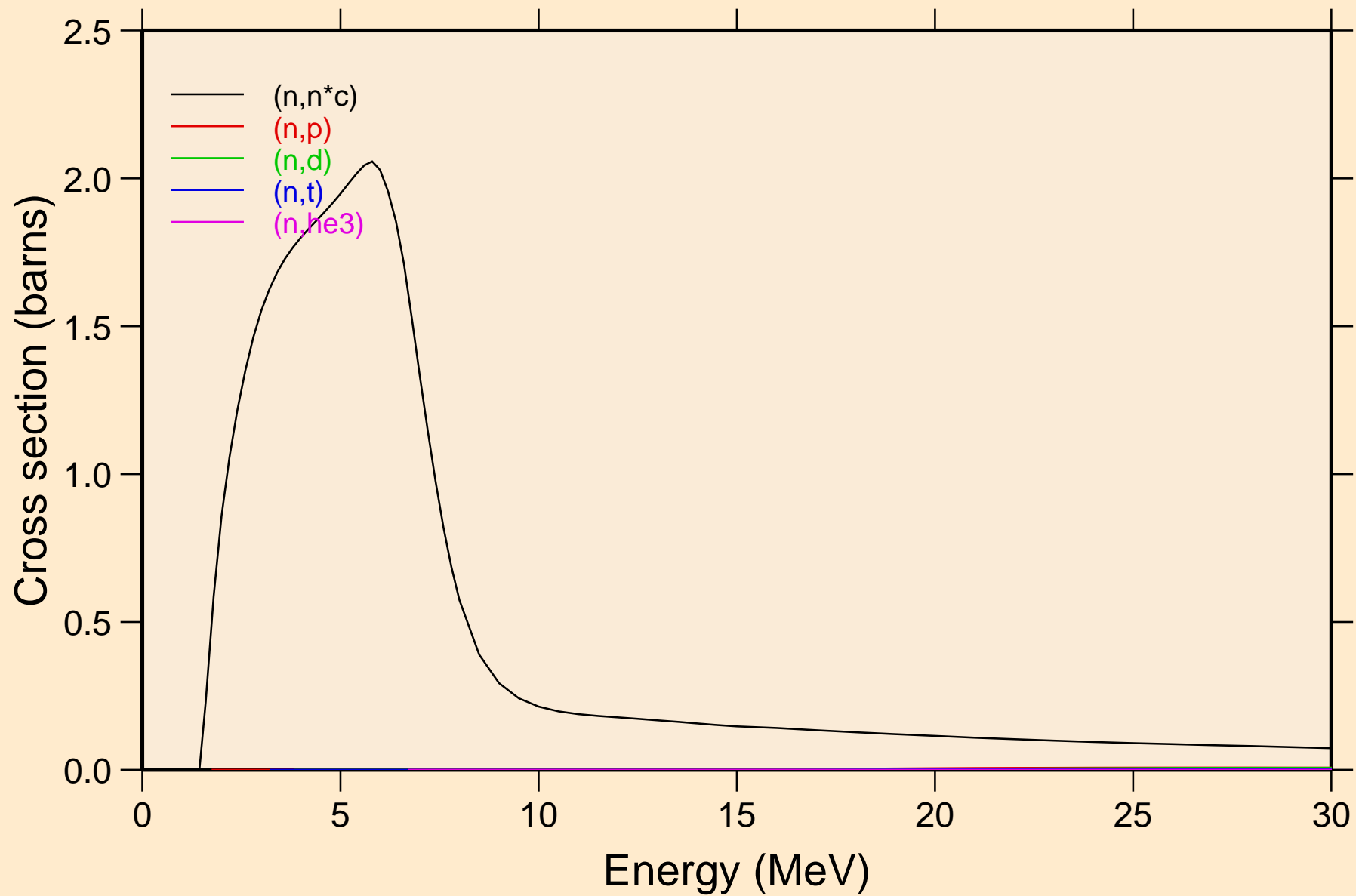

NP243 NRG TENDL-2015, AKONING

Threshold reactions

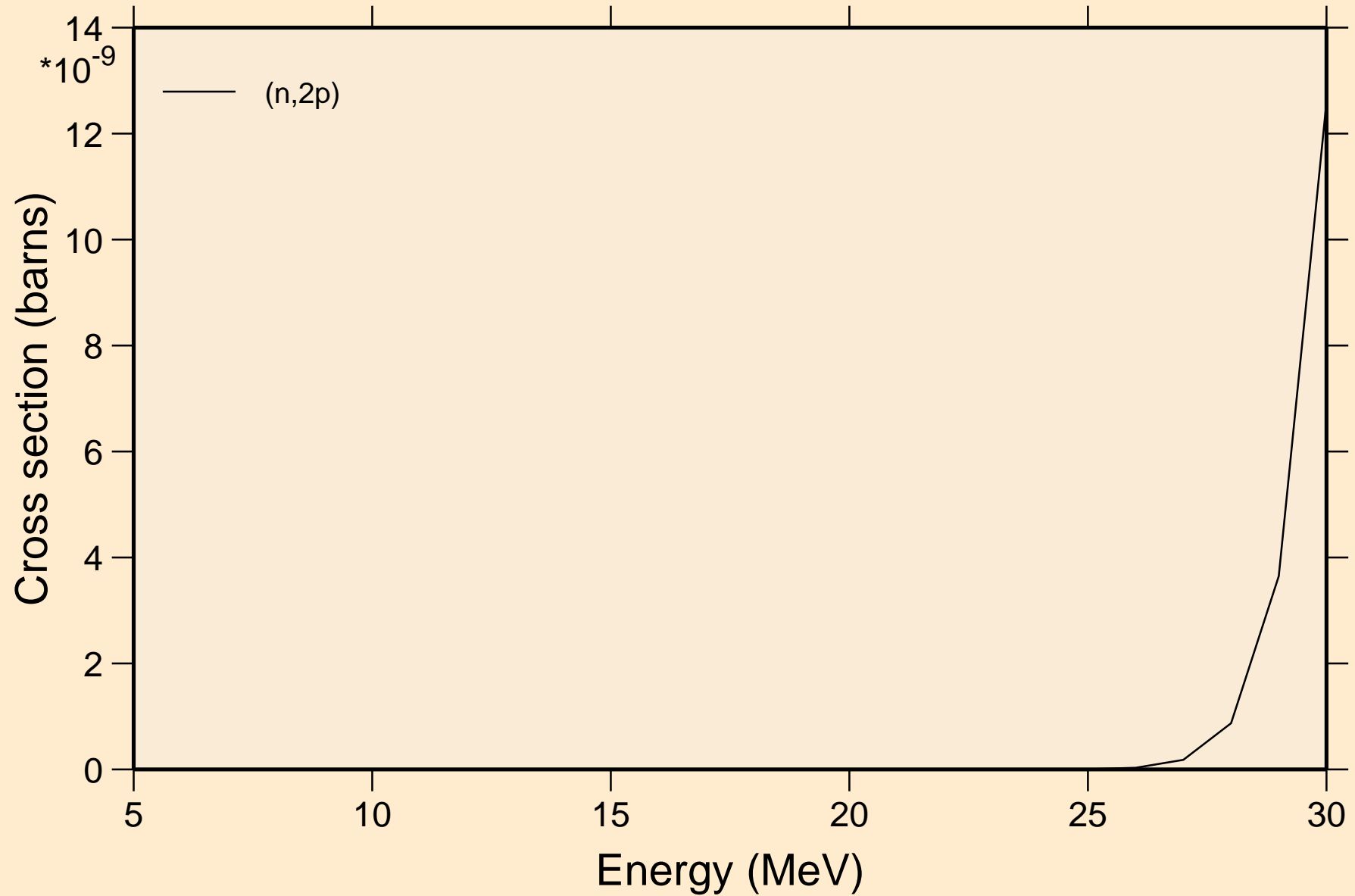

NP243 NRG TENDL-2015, AKONING
angular distribution for elastic

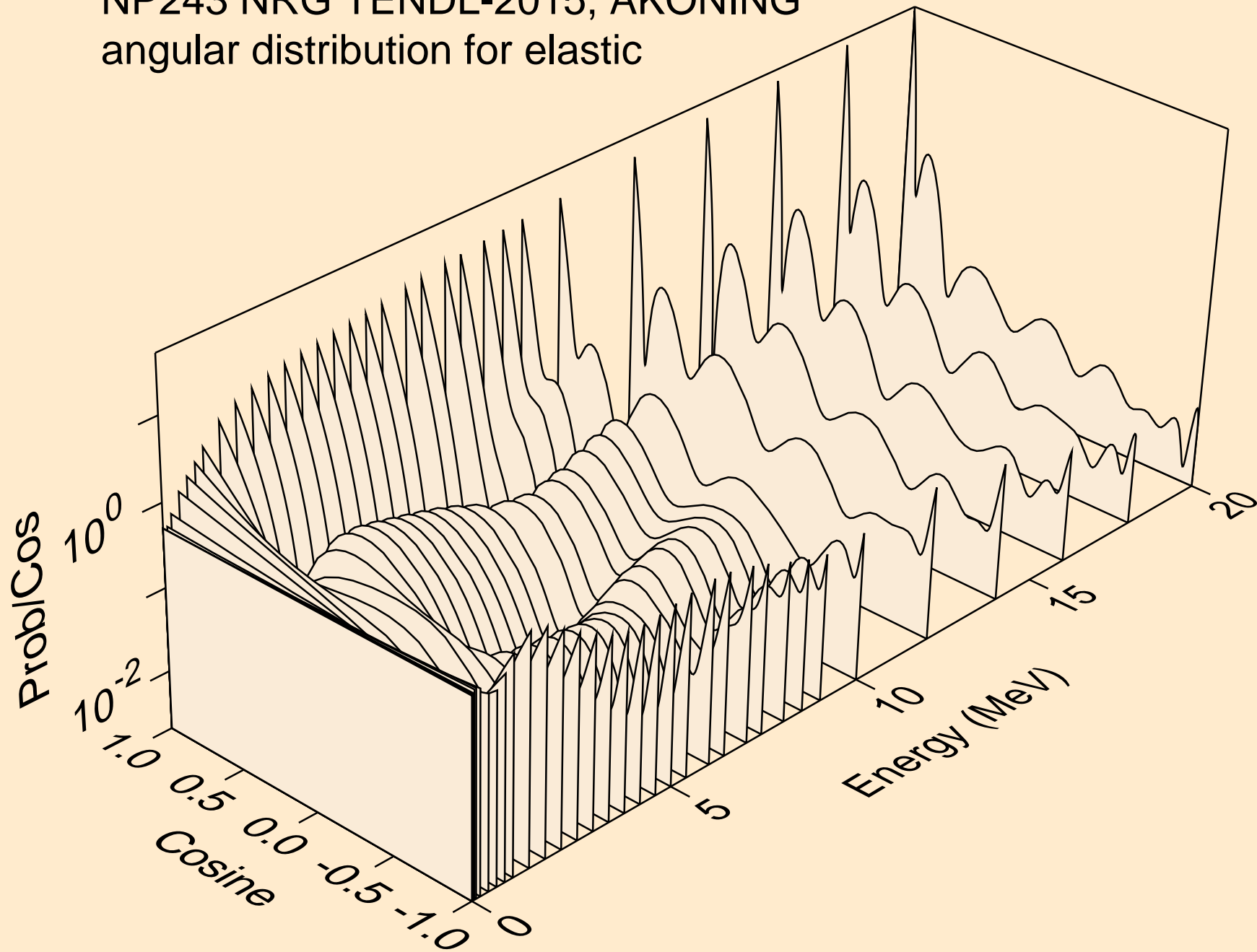

NP243 NRG TENDL-2015, AKONING
angular distribution for elastic

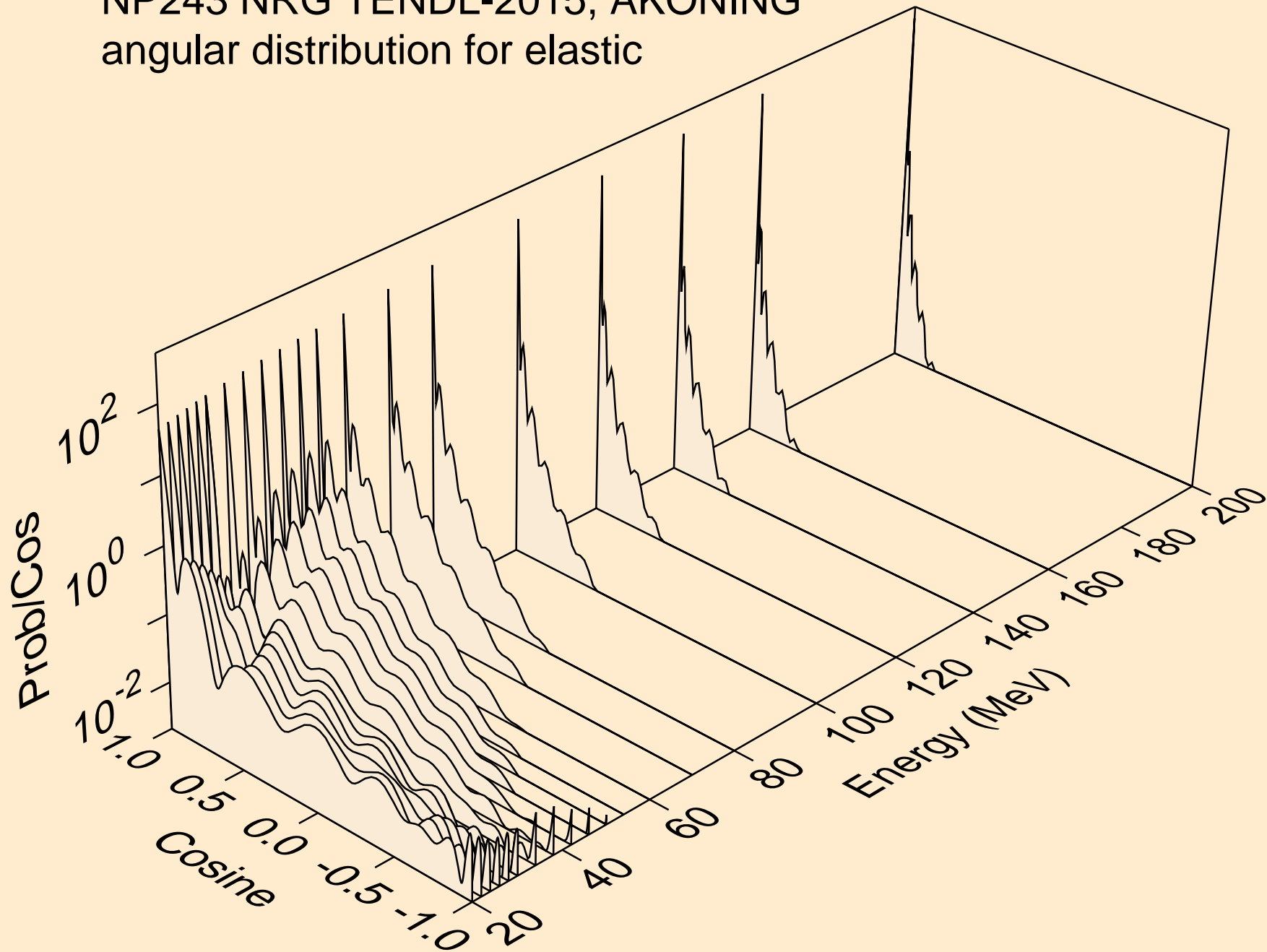

NP243 NRG TENDL-2015, AKONING
angular distribution for (n,n*1)

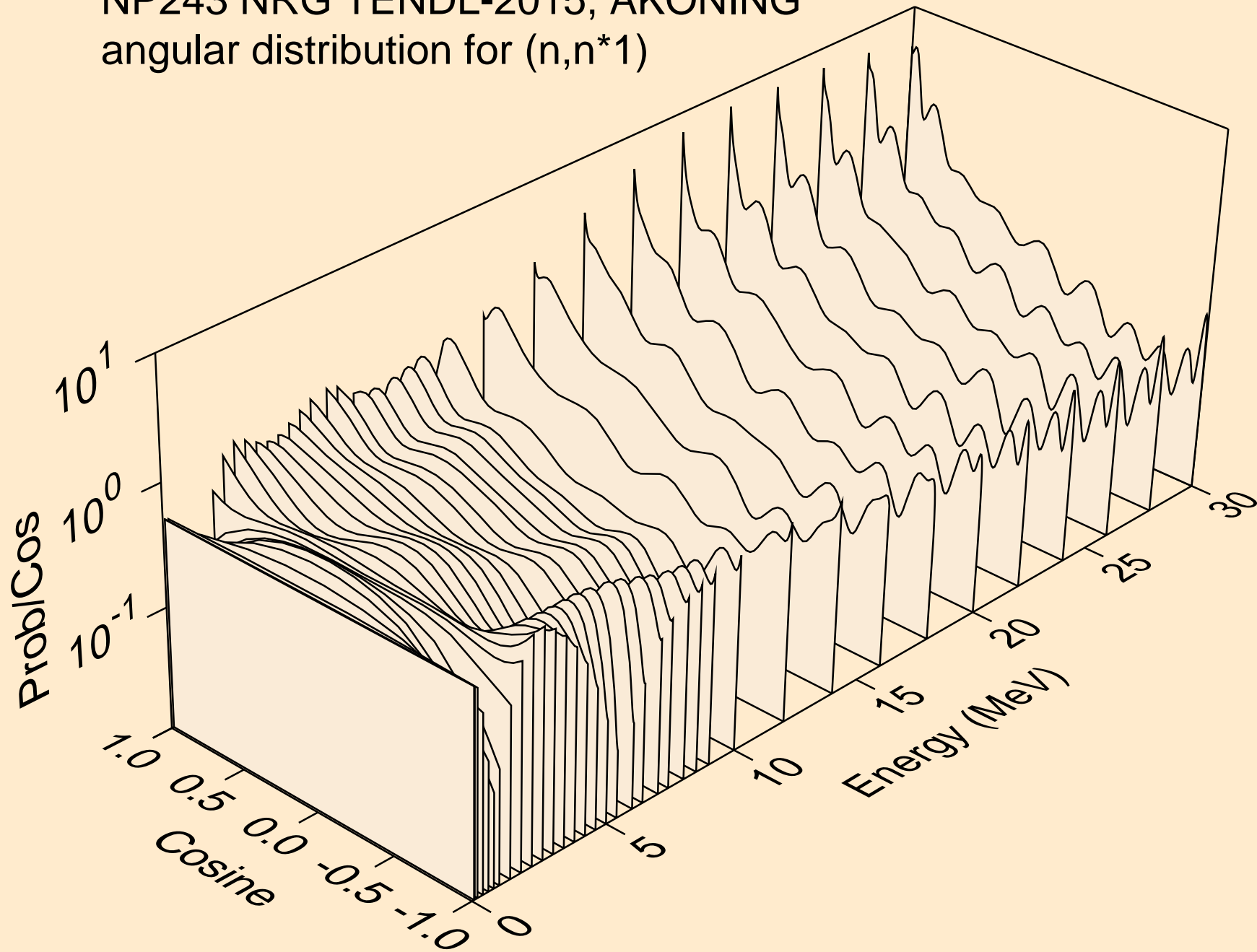

NP243 NRG TENDL-2015, AKONING
angular distribution for (n,n*2)

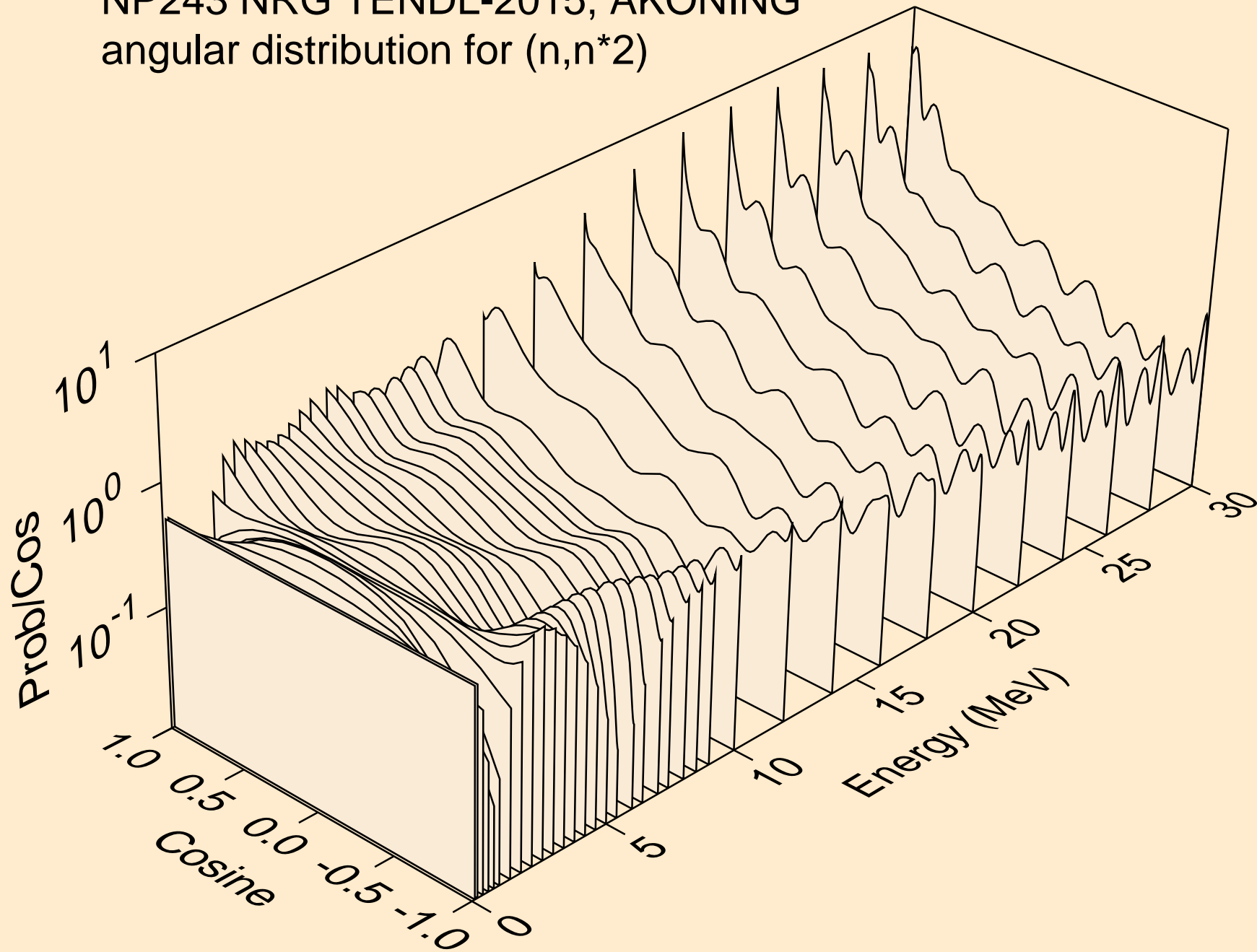

NP243 NRG TENDL-2015, AKONING
angular distribution for (n,n*3)

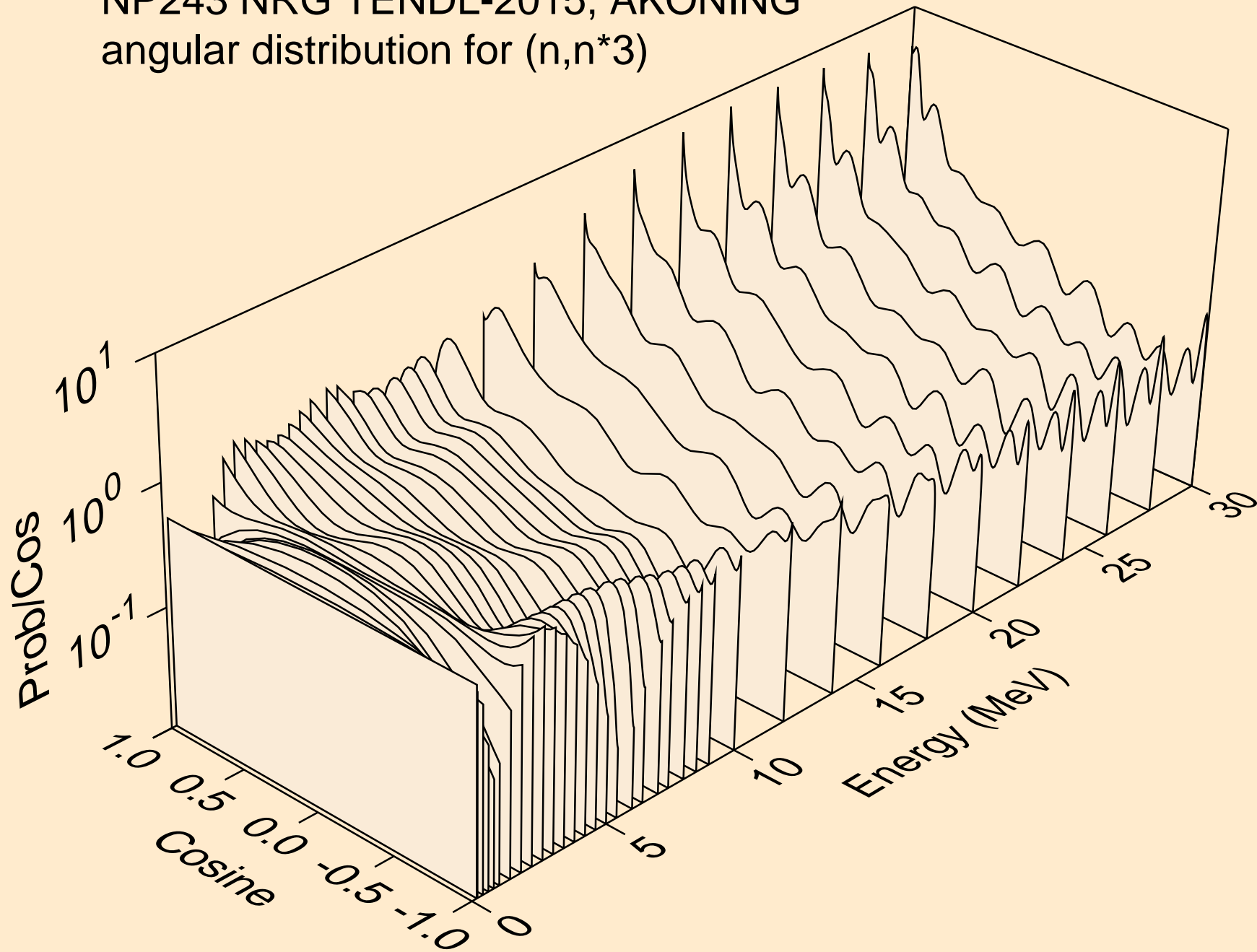

NP243 NRG TENDL-2015, AKONING
angular distribution for (n,n*4)

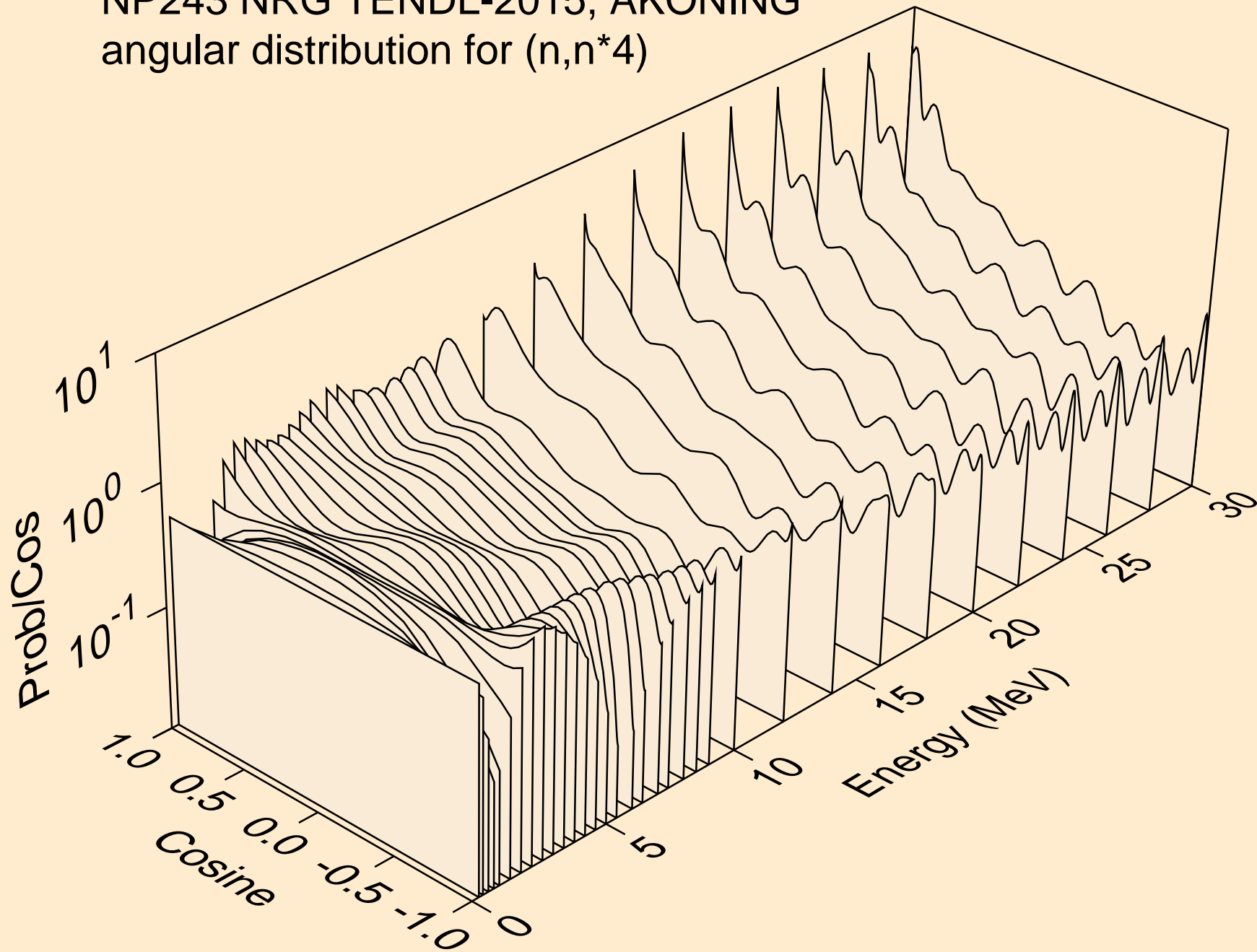

NP243 NRG TENDL-2015, AKONING
angular distribution for (n,n*5)

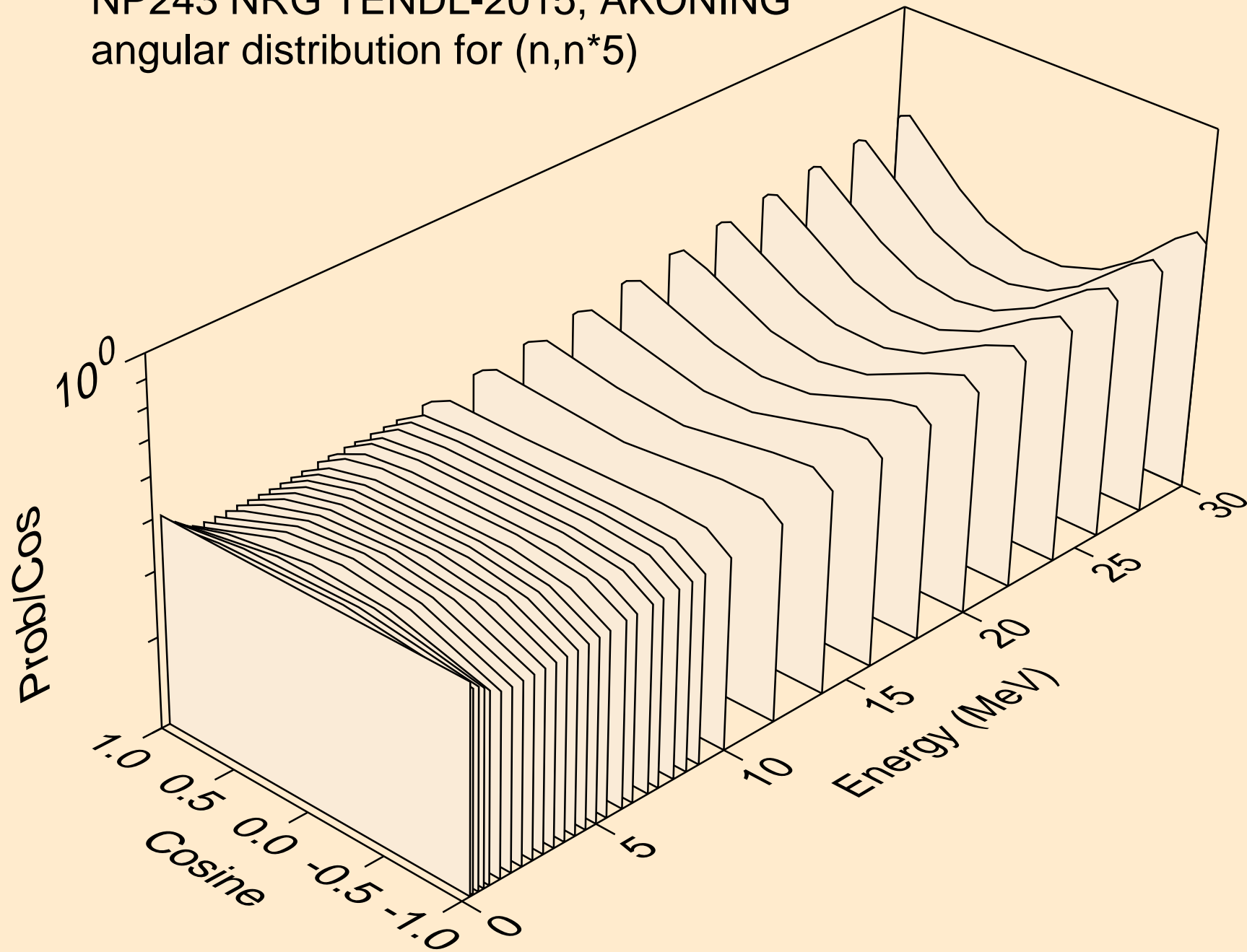

NP243 NRG TENDL-2015, AKONING
angular distribution for (n,n*6)

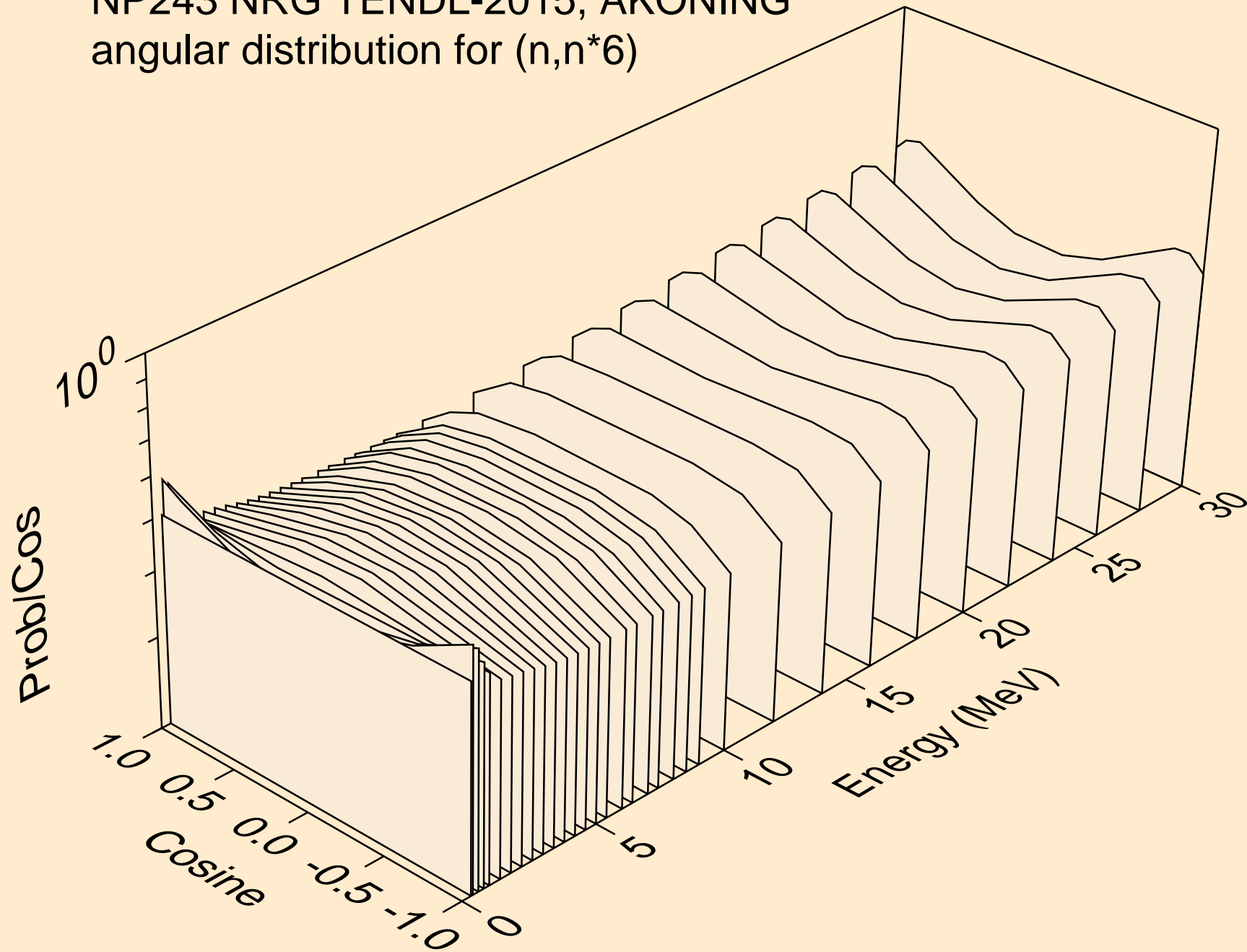

NP243 NRG TENDL-2015, AKONING
angular distribution for (n,n*7)

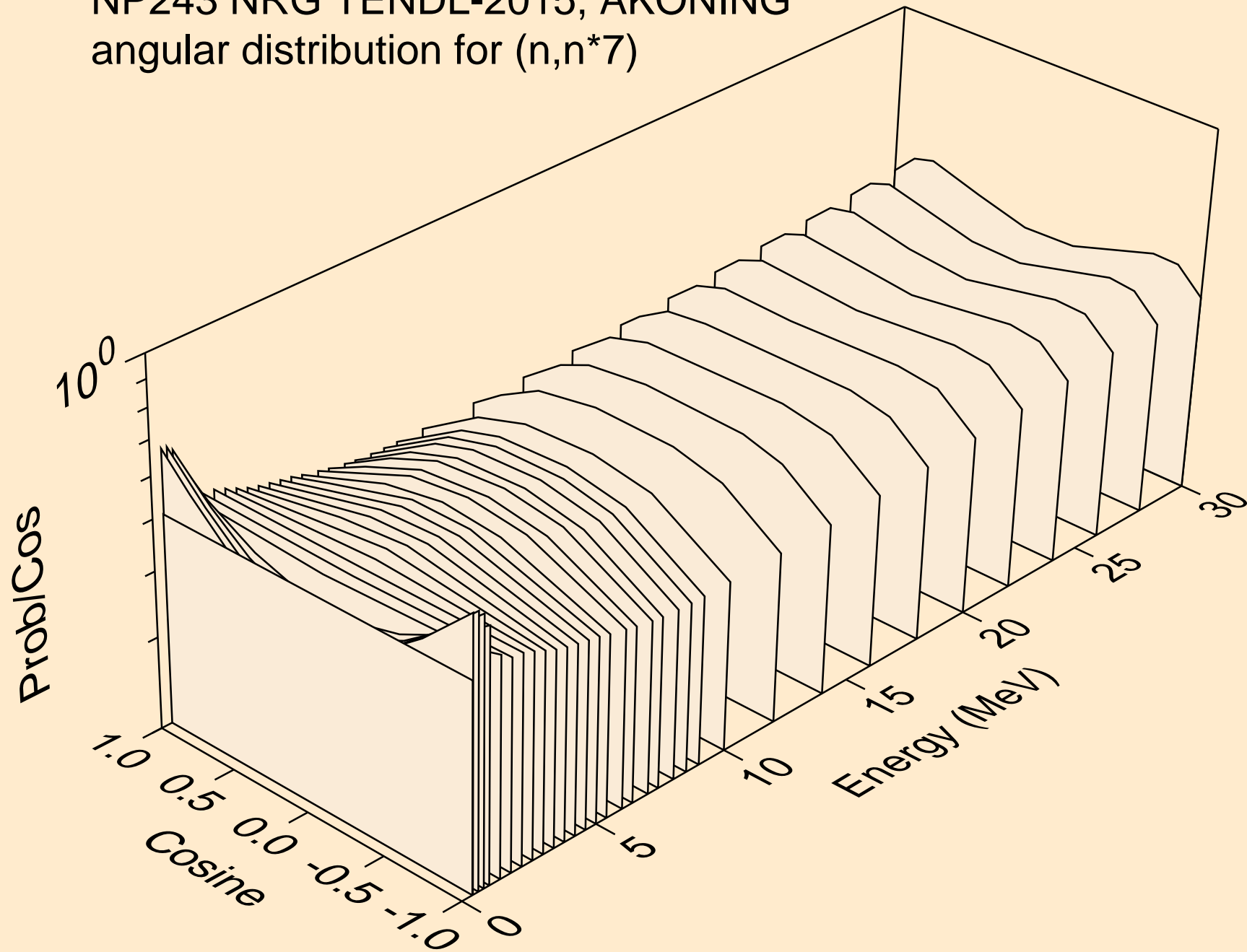

NP243 NRG TENDL-2015, AKONING
angular distribution for (n,n*8)

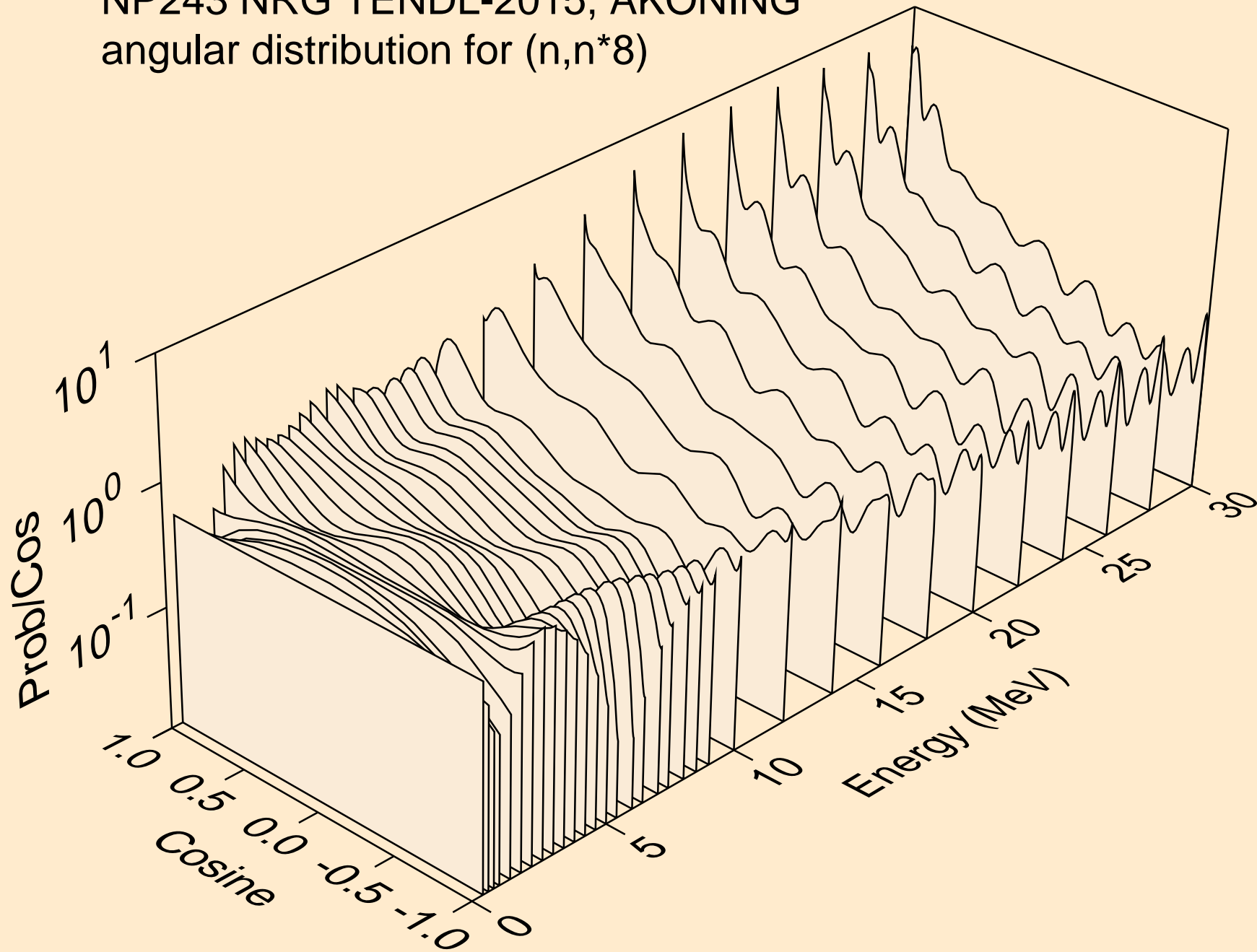

NP243 NRG TENDL-2015, AKONING
angular distribution for (n,n*9)

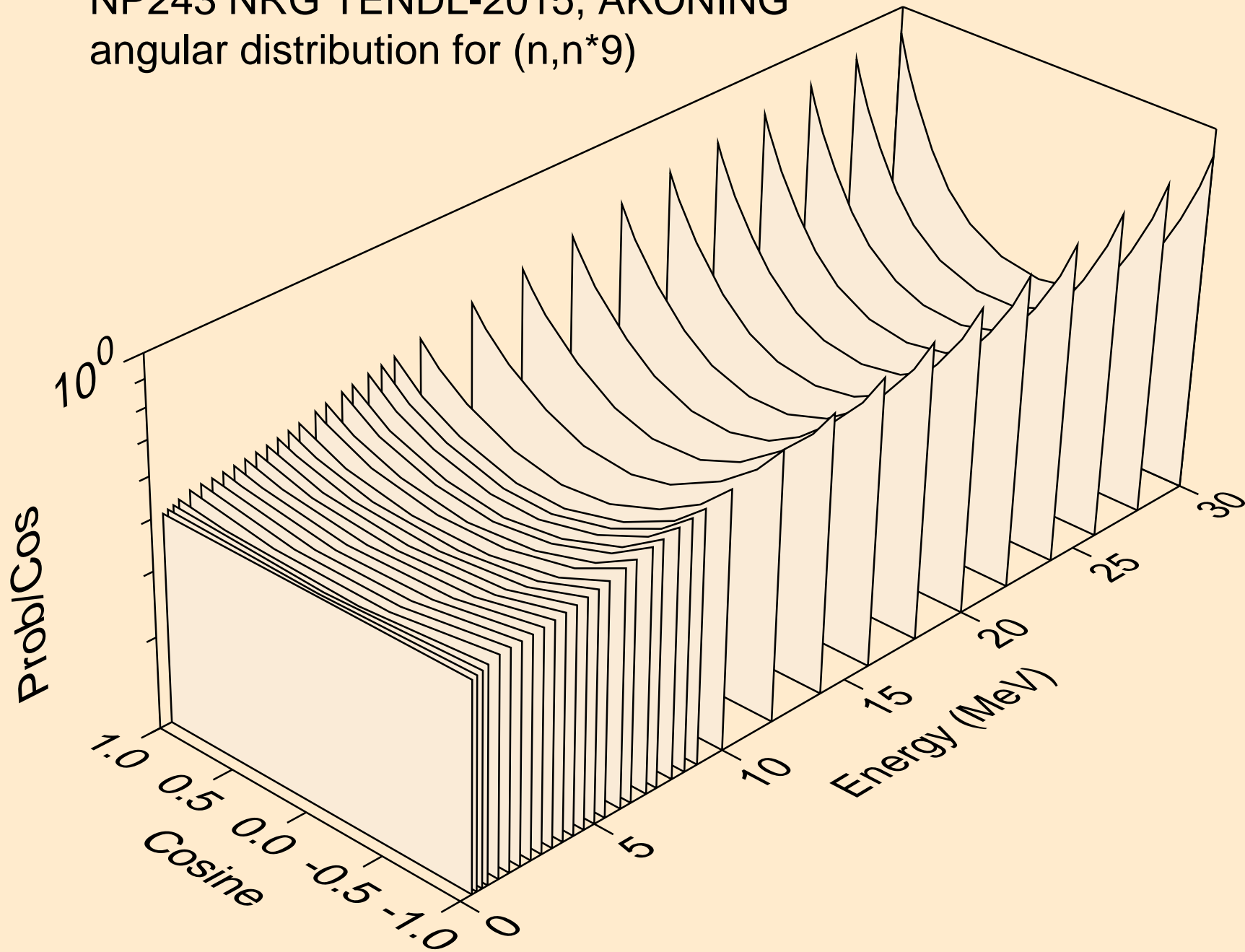

NP243 NRG TENDL-2015, AKONING
angular distribution for (n,n*10)

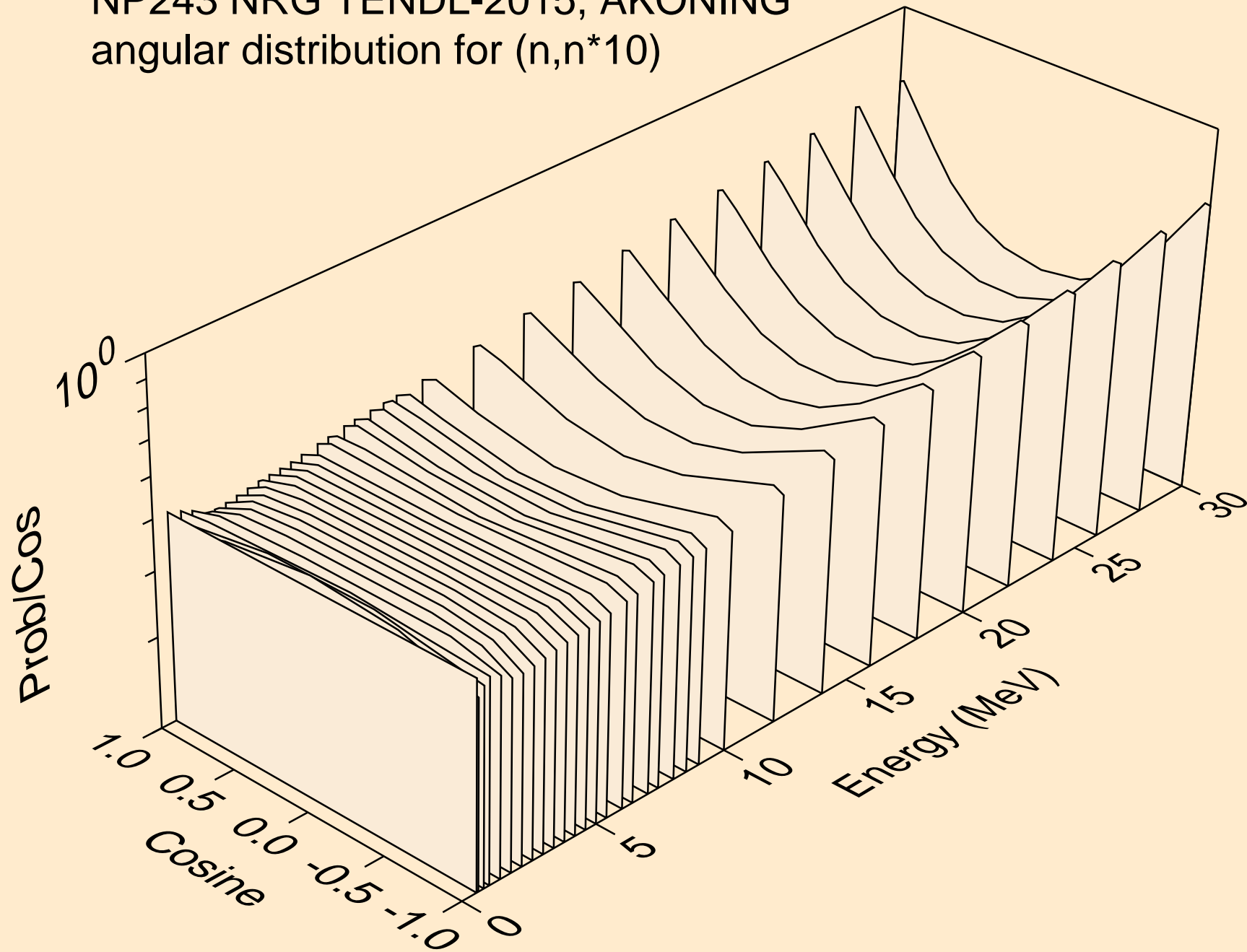

NP243 NRG TENDL-2015, AKONING
angular distribution for (n,n*11)

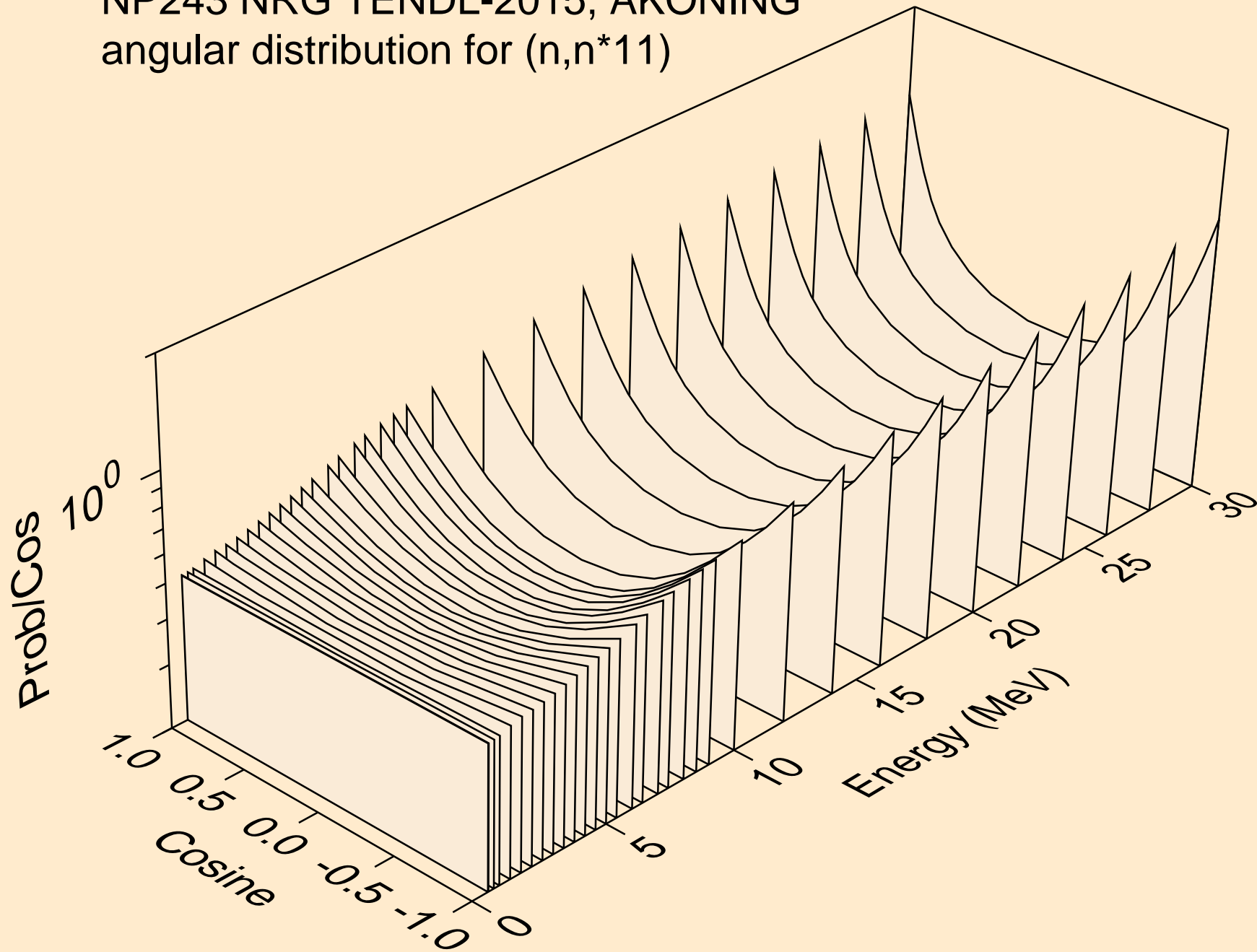

NP243 NRG TENDL-2015, AKONING
angular distribution for (n,n*12)

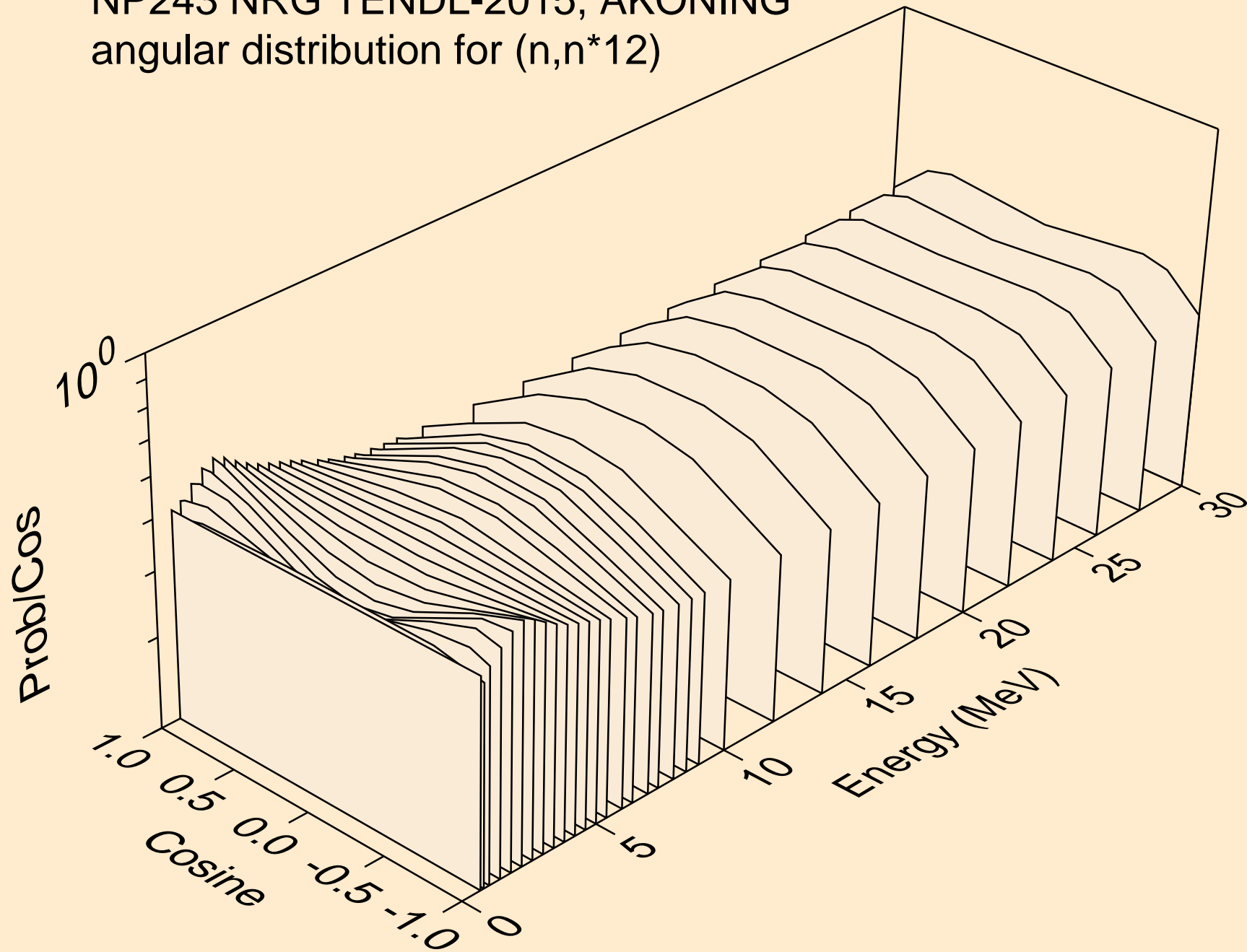

NP243 NRG TENDL-2015, AKONING
angular distribution for (n,n*13)

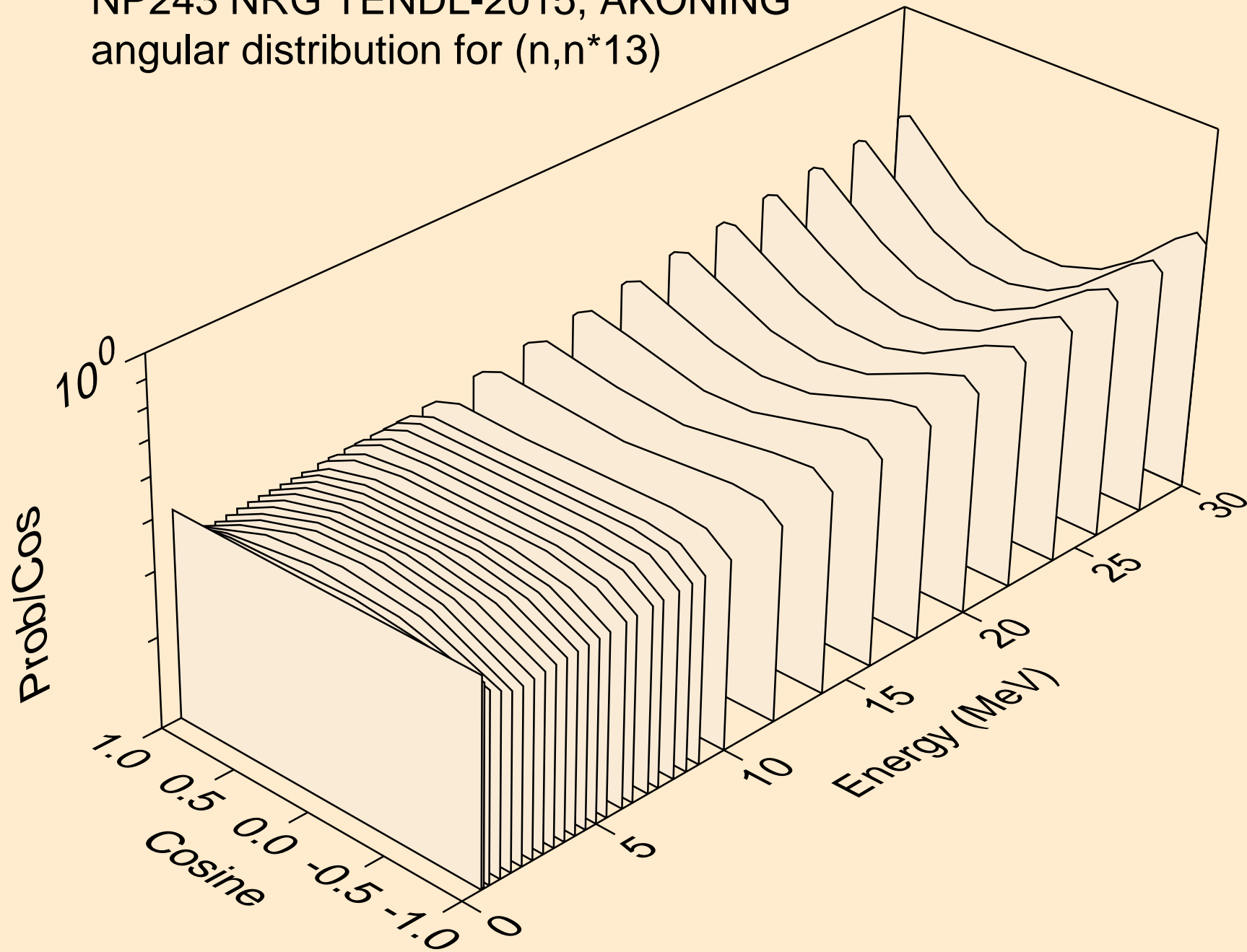

NP243 NRG TENDL-2015, AKONING
angular distribution for (n,n*14)

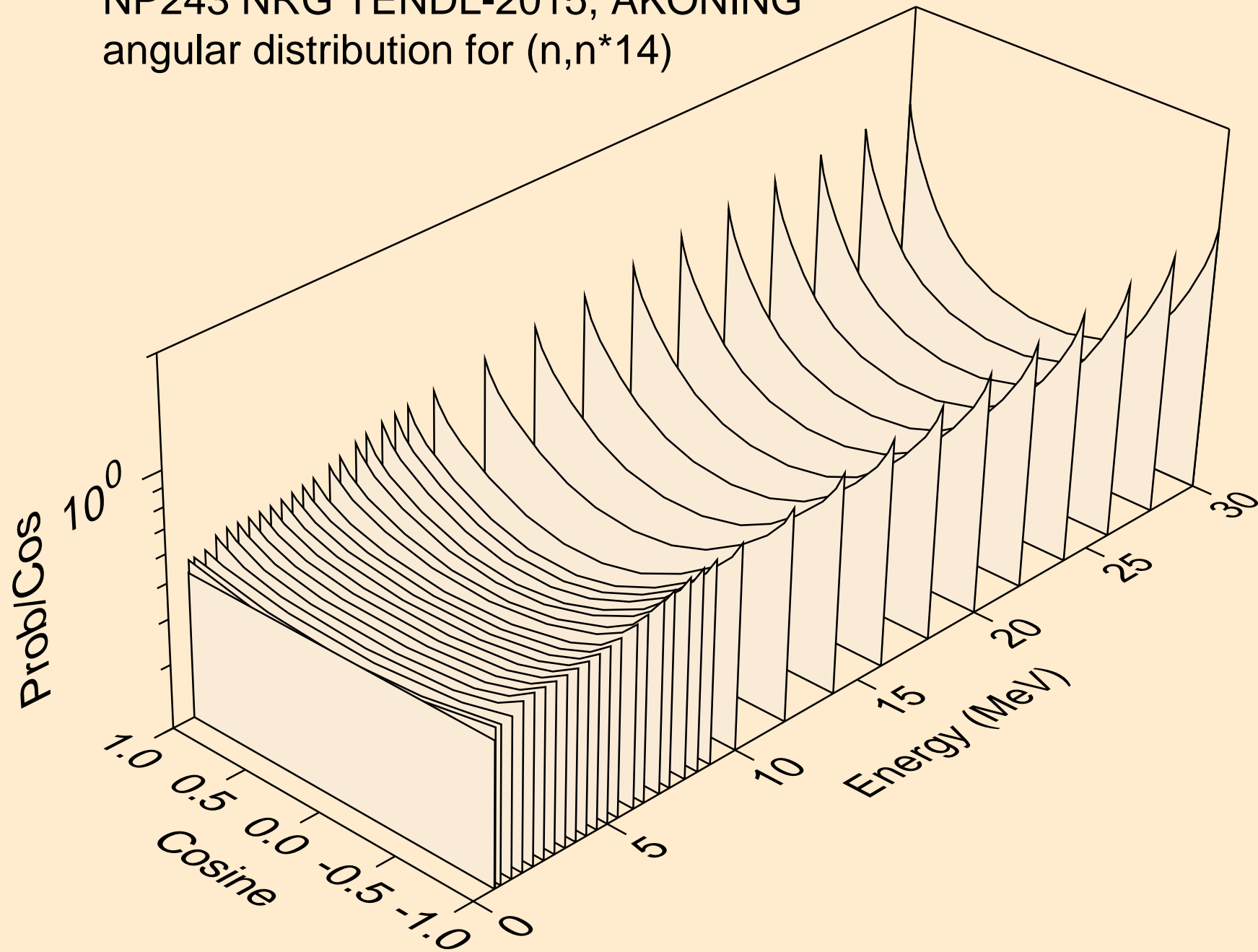

NP243 NRG TENDL-2015, AKONING
angular distribution for (n,n*15)

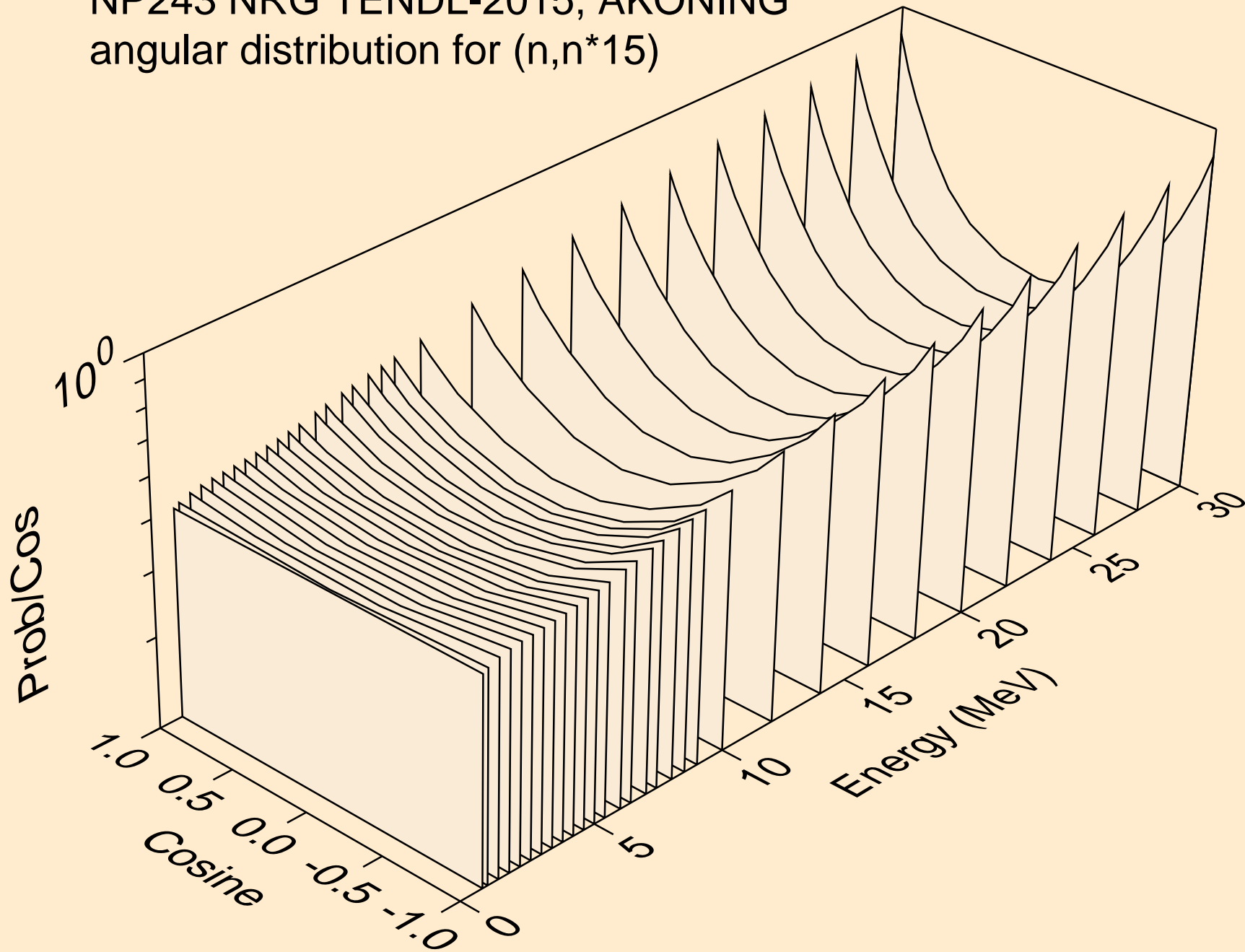

NP243 NRG TENDL-2015, AKONING
angular distribution for (n,n*16)

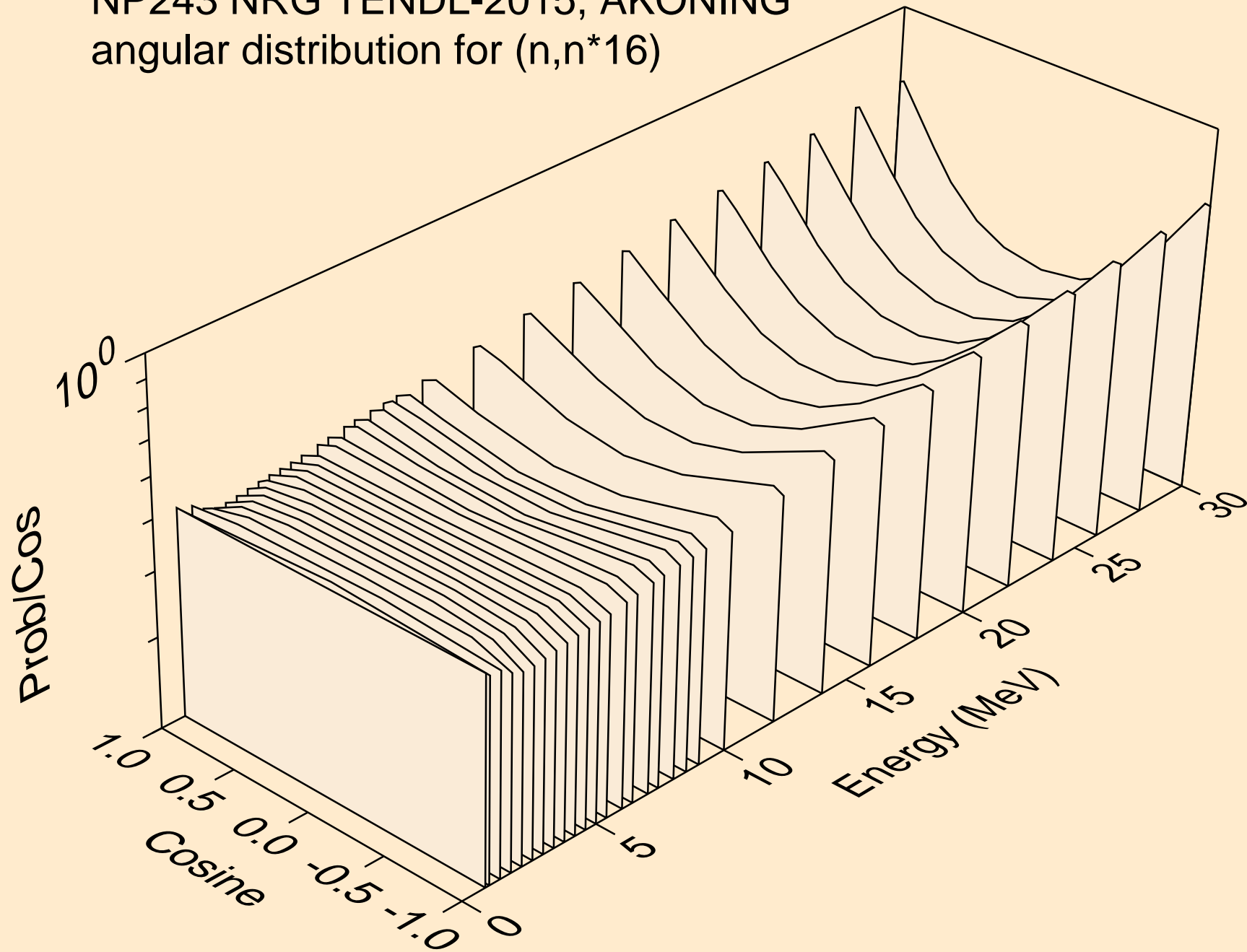

NP243 NRG TENDL-2015, AKONING
angular distribution for (n,n*17)

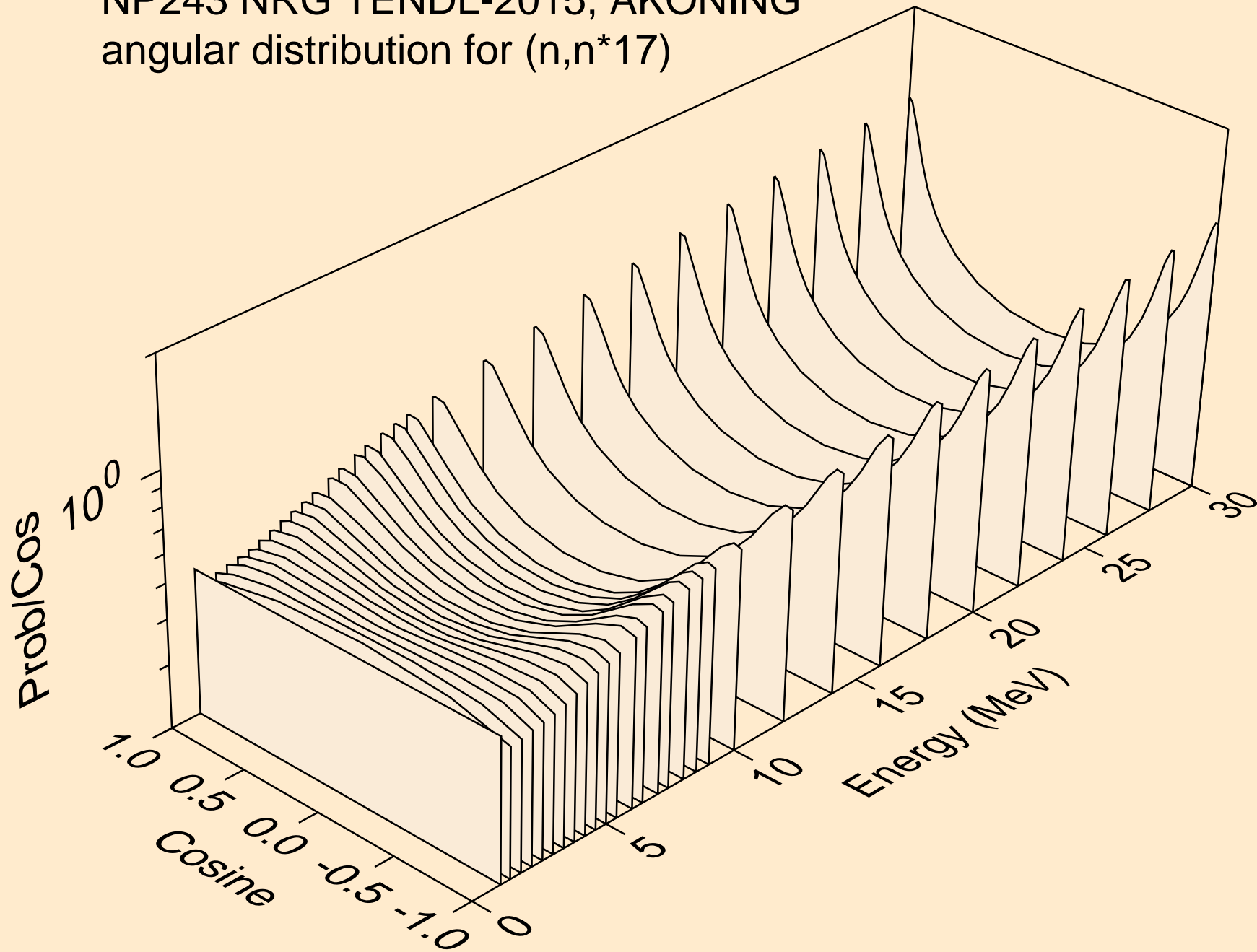

NP243 NRG TENDL-2015, AKONING
angular distribution for (n,n*18)

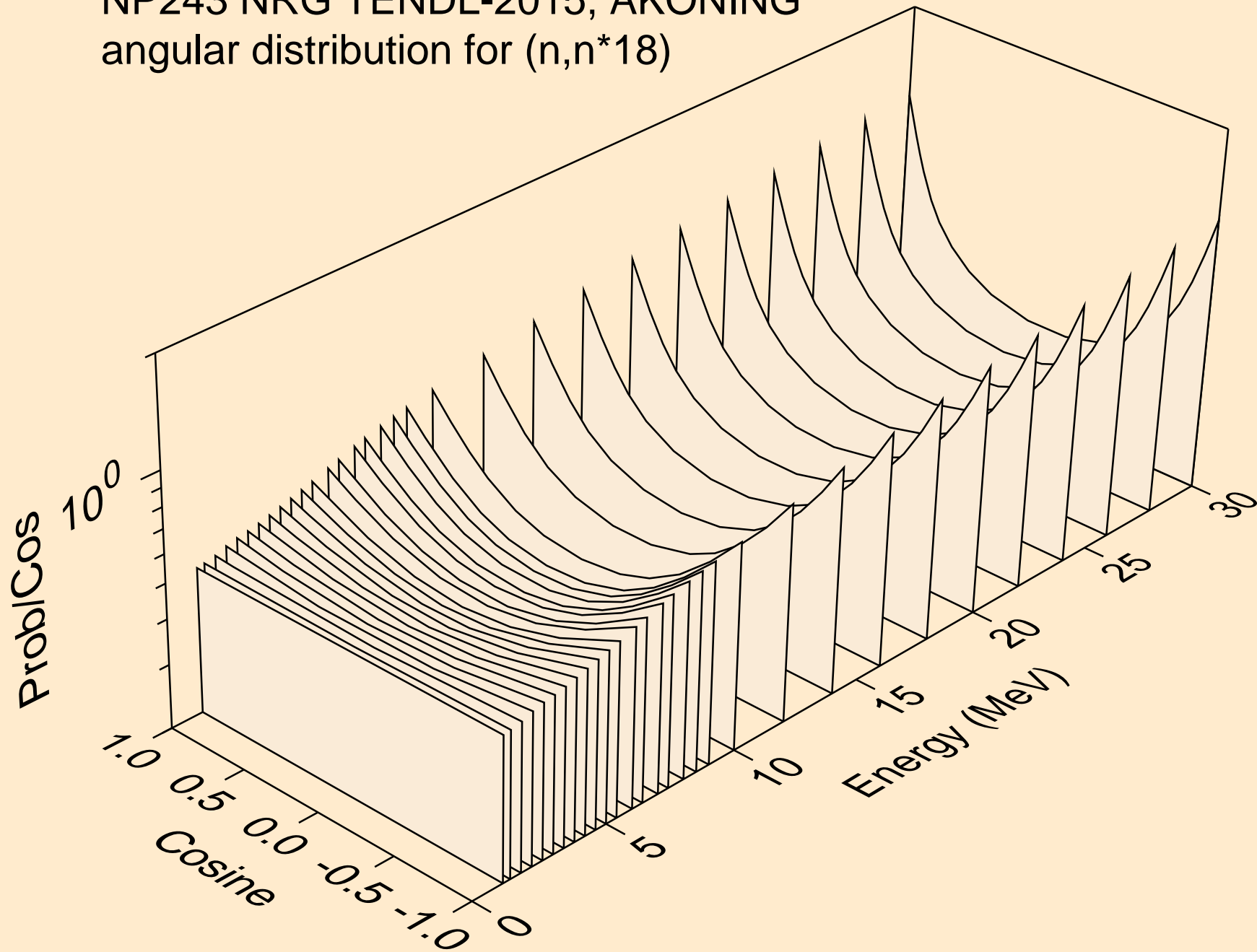

NP243 NRG TENDL-2015, AKONING
angular distribution for (n,n*19)

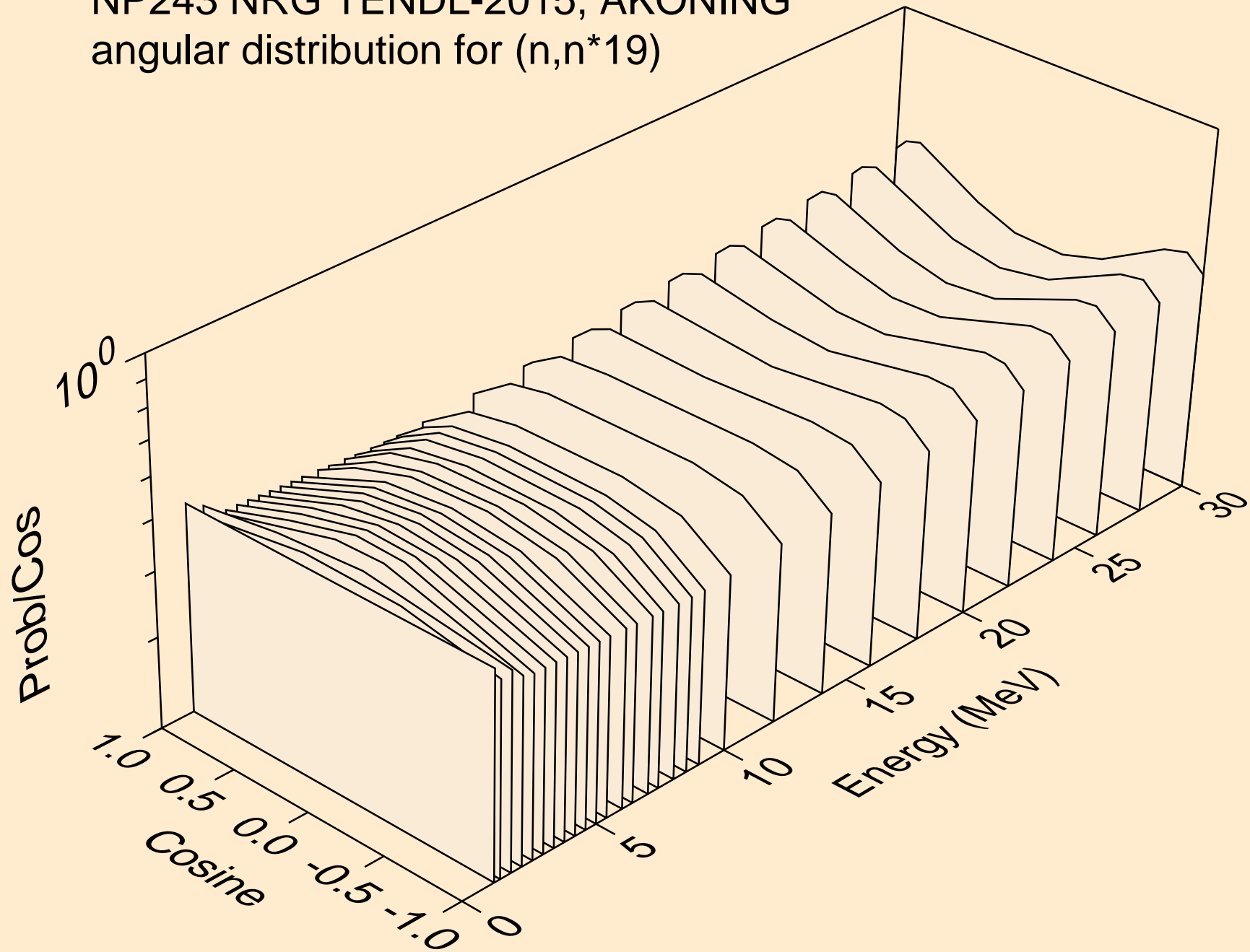

NP243 NRG TENDL-2015, AKONING
angular distribution for (n,n*20)

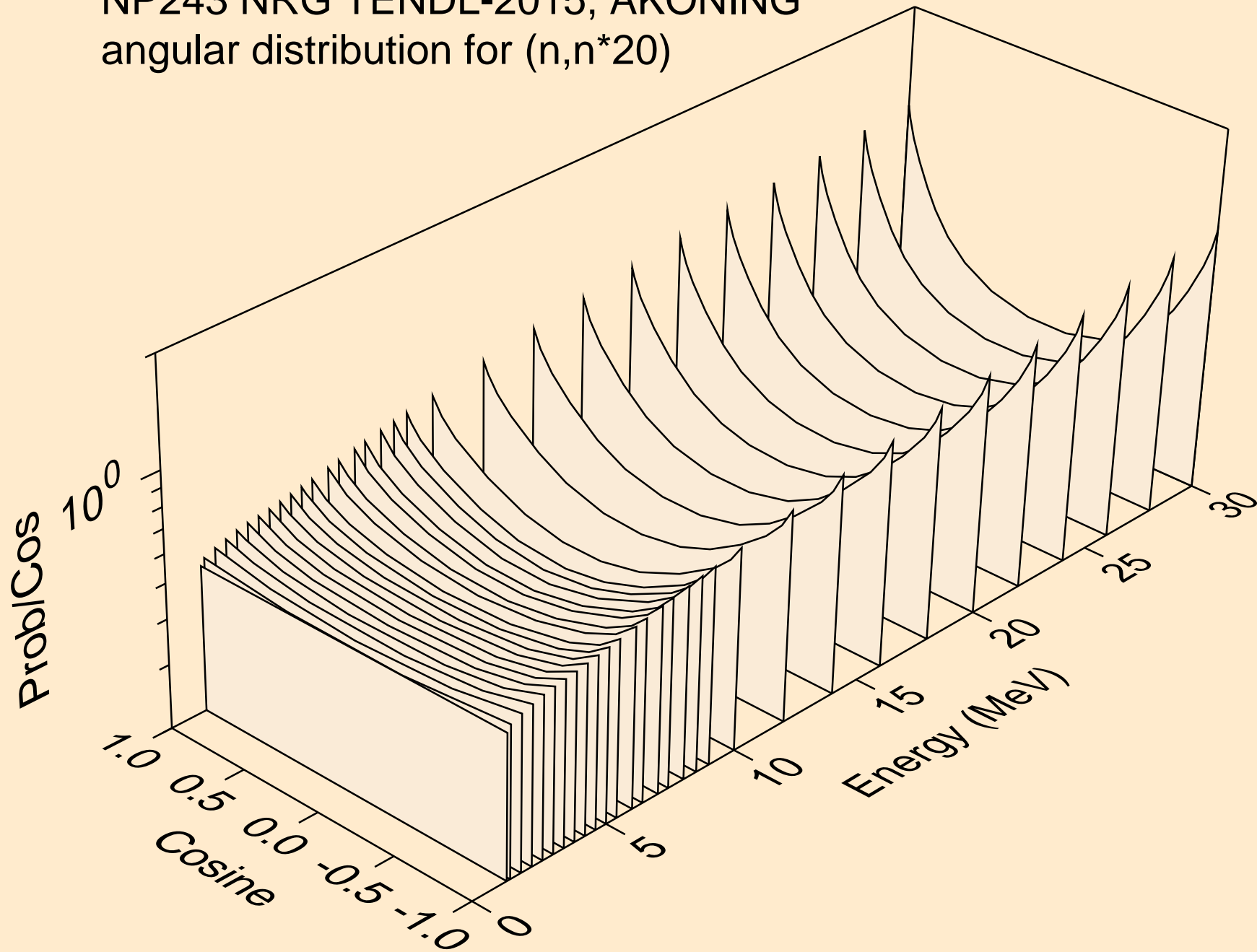

NP243 NRG TENDL-2015, AKONING
angular distribution for (n,n*21)

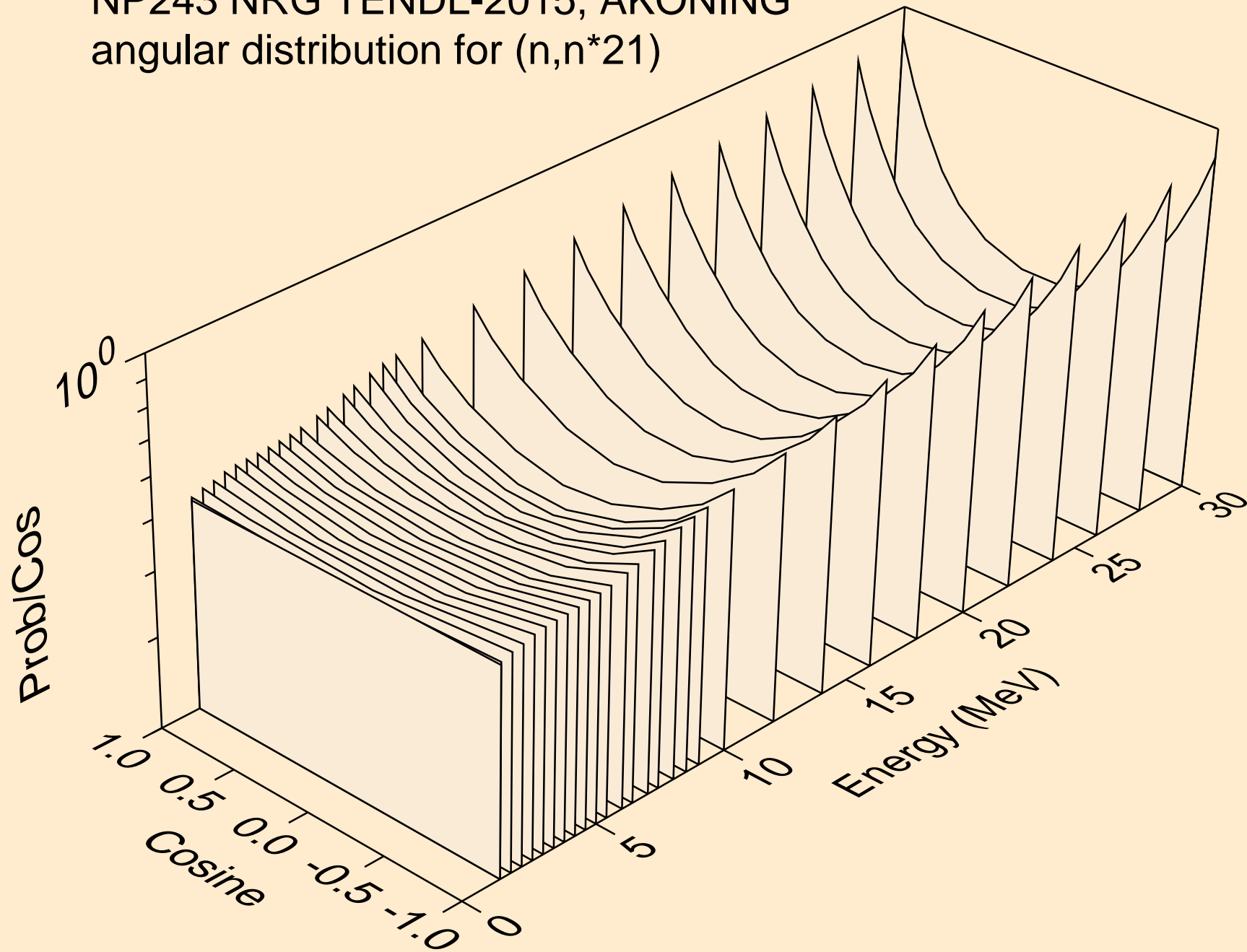

NP243 NRG TENDL-2015, AKONING
angular distribution for (n,n*22)

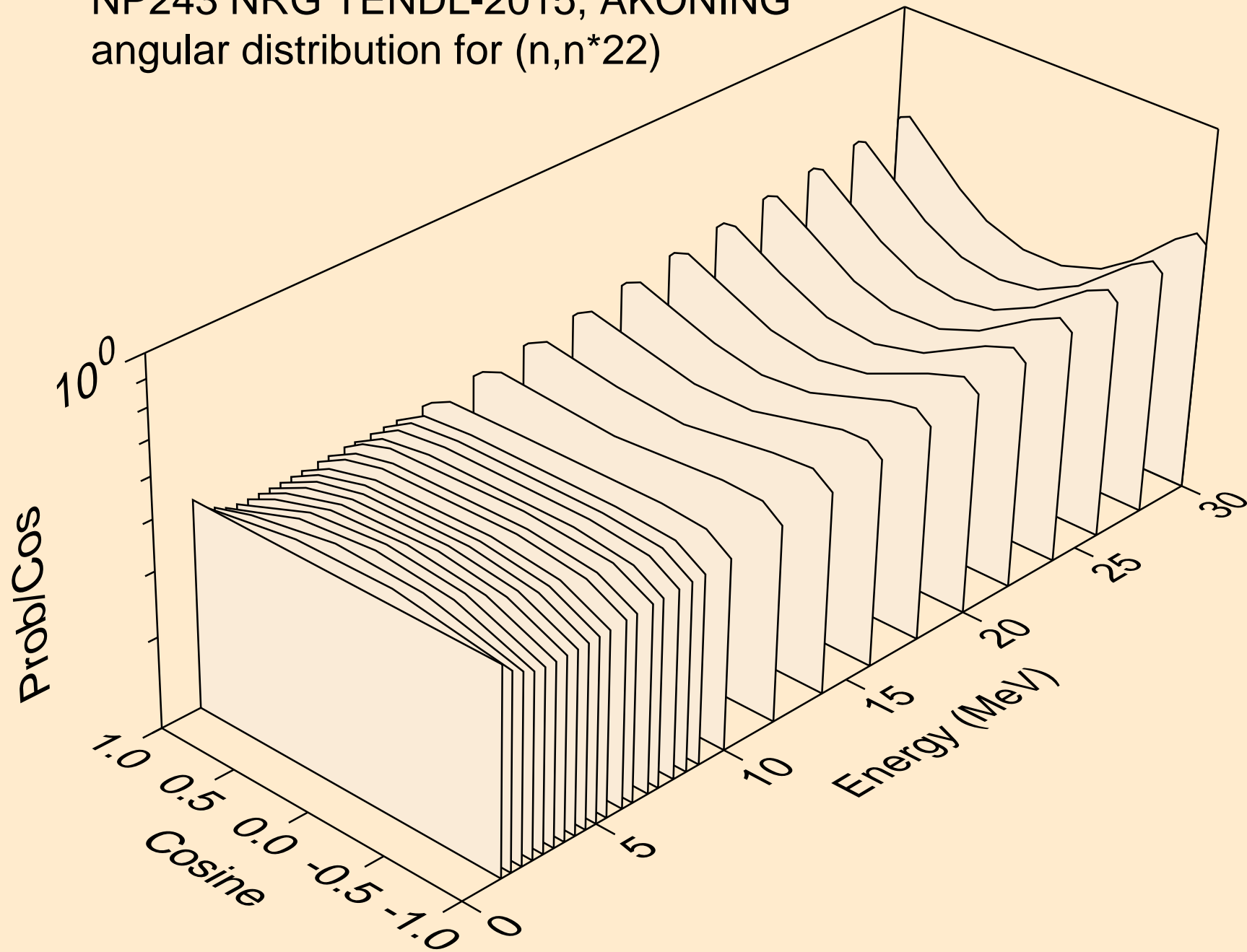

NP243 NRG TENDL-2015, AKONING
angular distribution for (n,n*23)

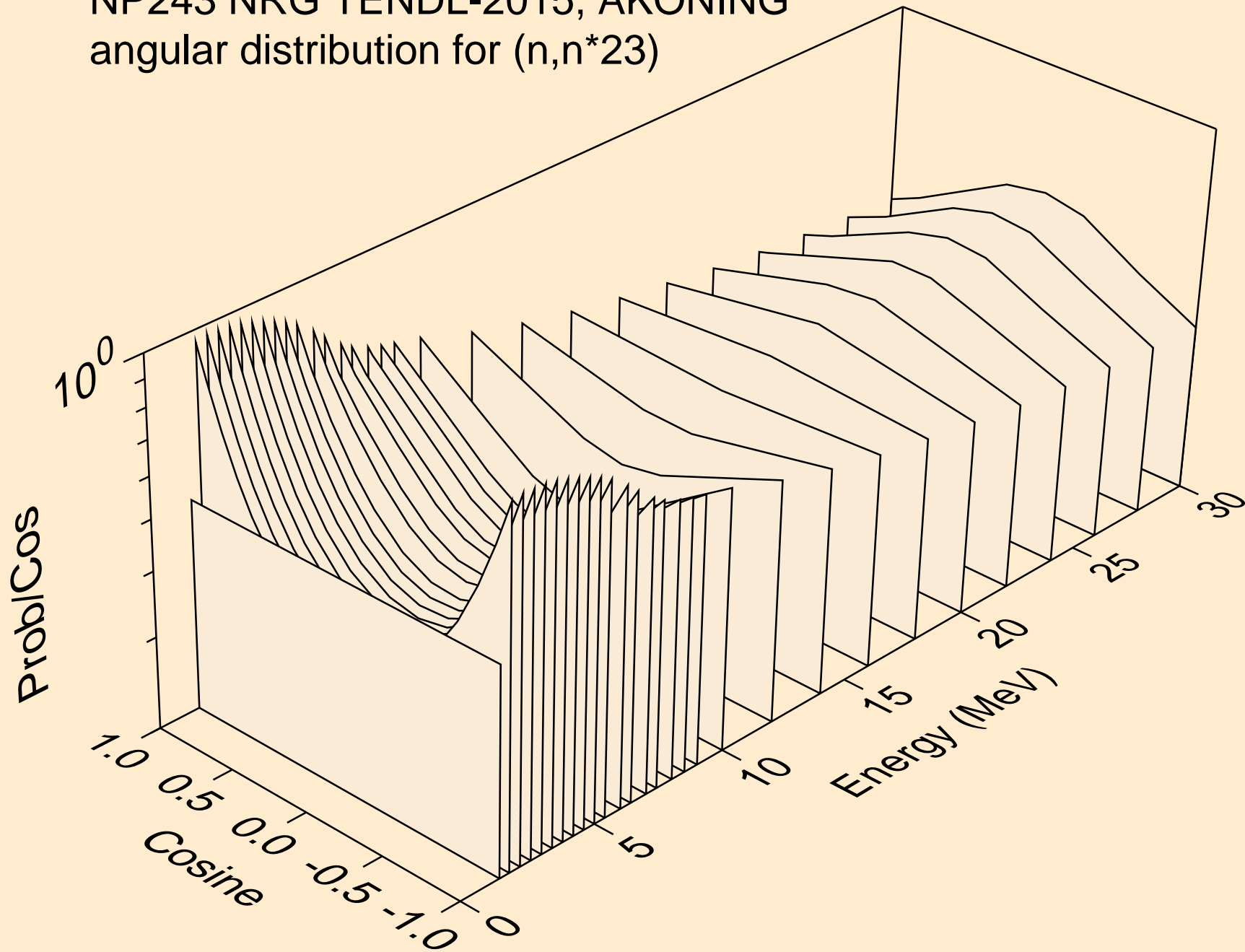

NP243 NRG TENDL-2015, AKONING
angular distribution for (n,n*24)

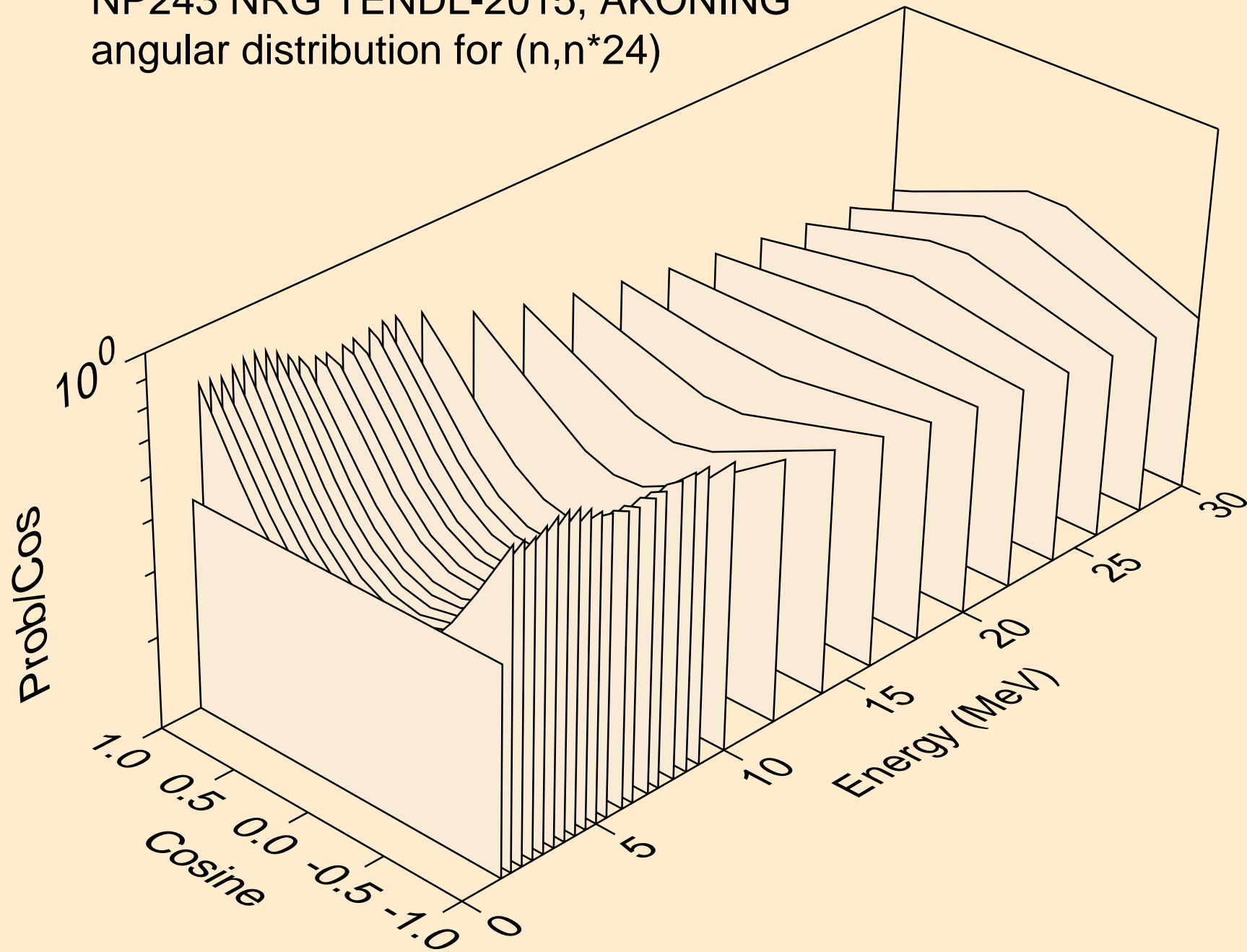

NP243 NRG TENDL-2015, AKONING
angular distribution for (n,n*25)

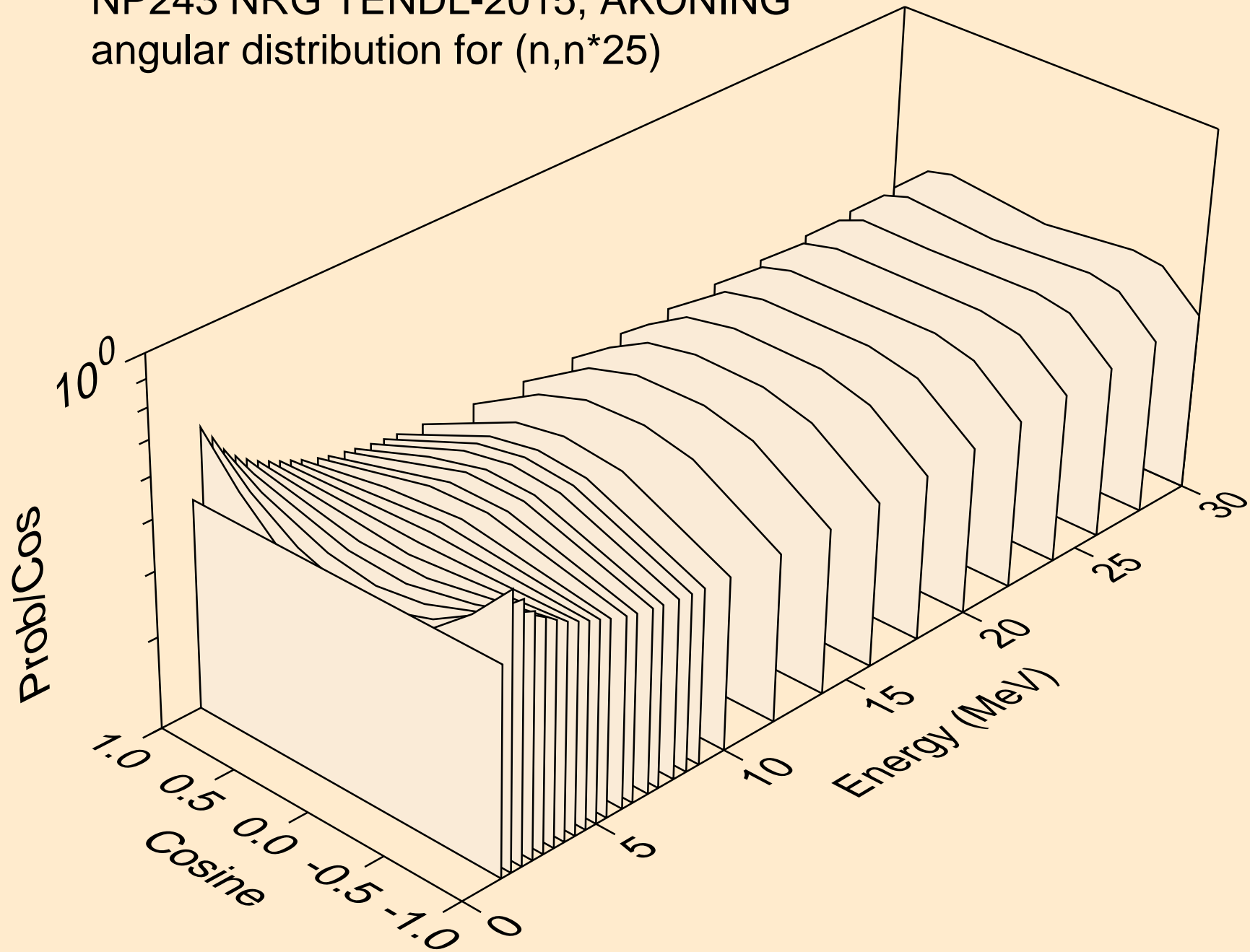

NP243 NRG TENDL-2015, AKONING
angular distribution for (n,n*26)

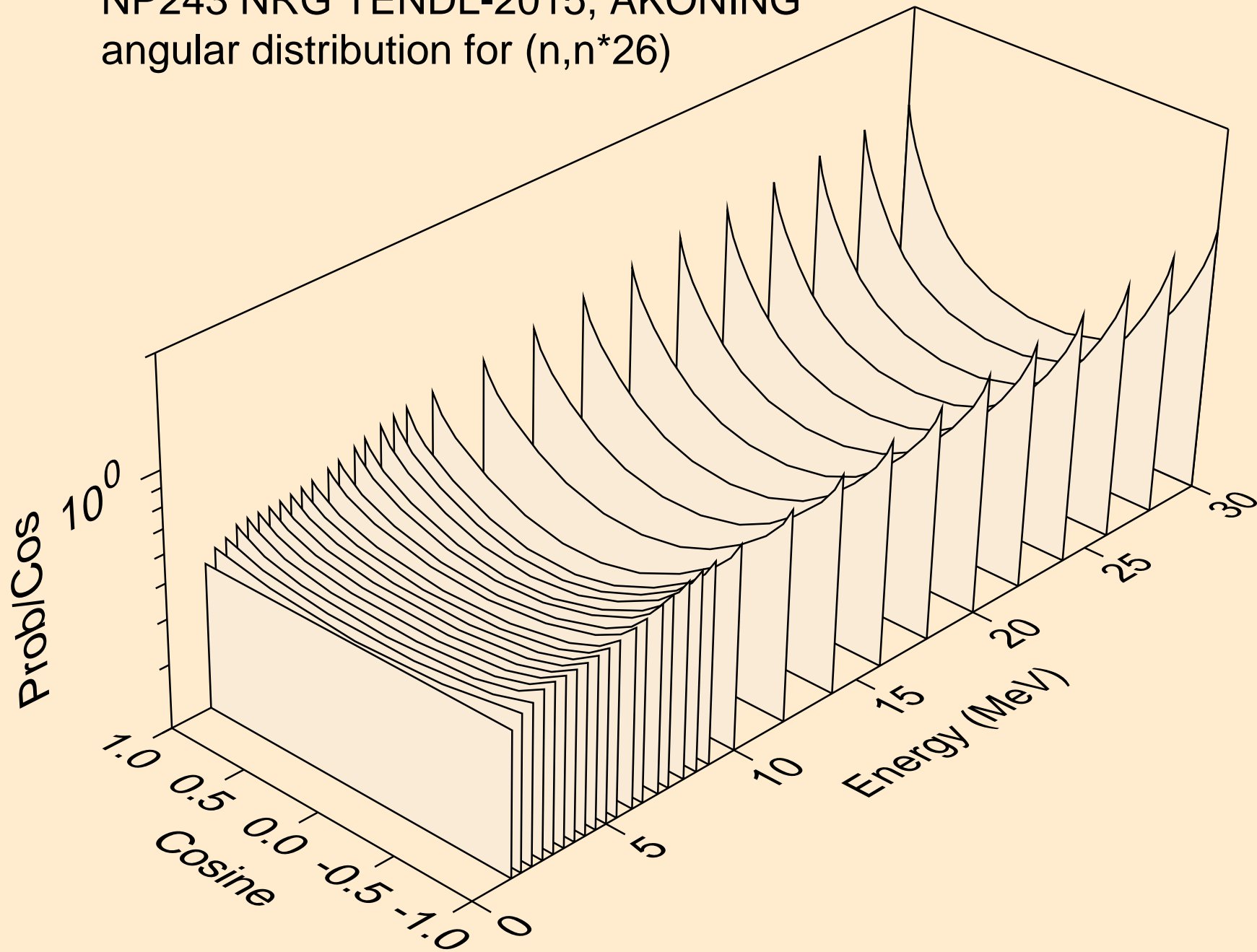

NP243 NRG TENDL-2015, AKONING

Total fission nubar

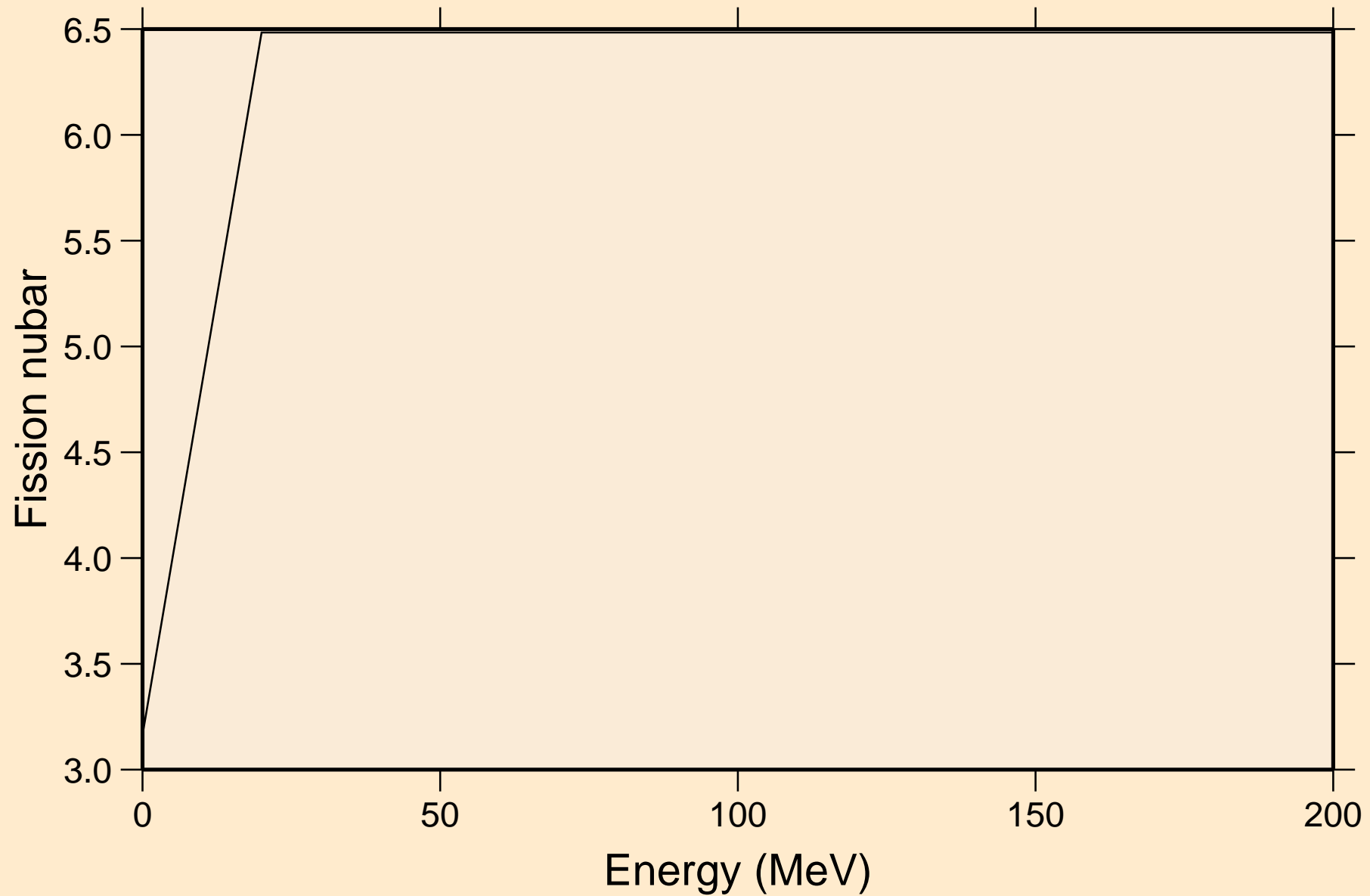

NP243 NRG TENDL-2015, AKONING
Neutron emission for (n,x)

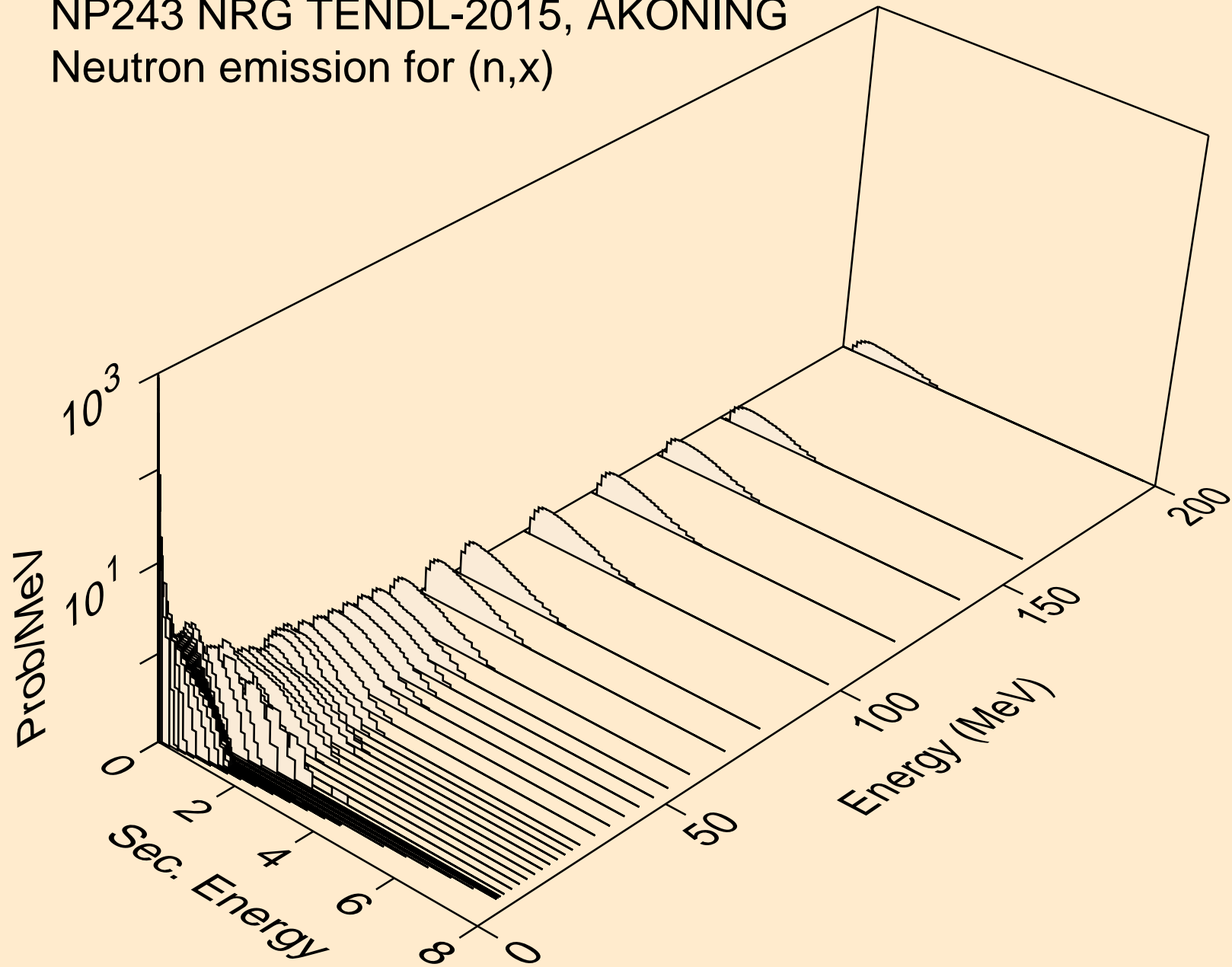

NP243 NRG TENDL-2015, AKONING
Neutron emission for (n,2nd)

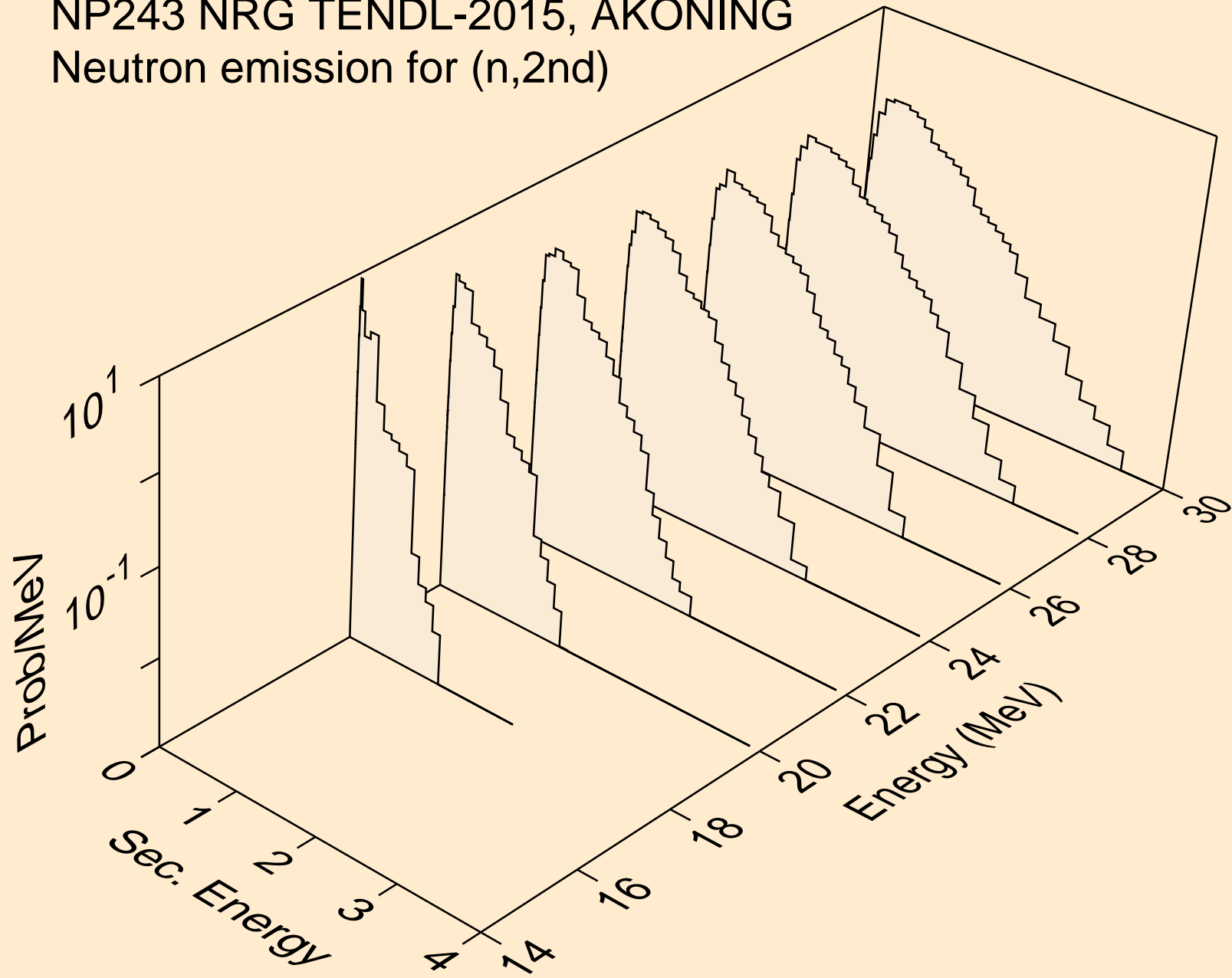

NP243 NRG TENDL-2015, AKONING
Neutron emission for (n,2n)

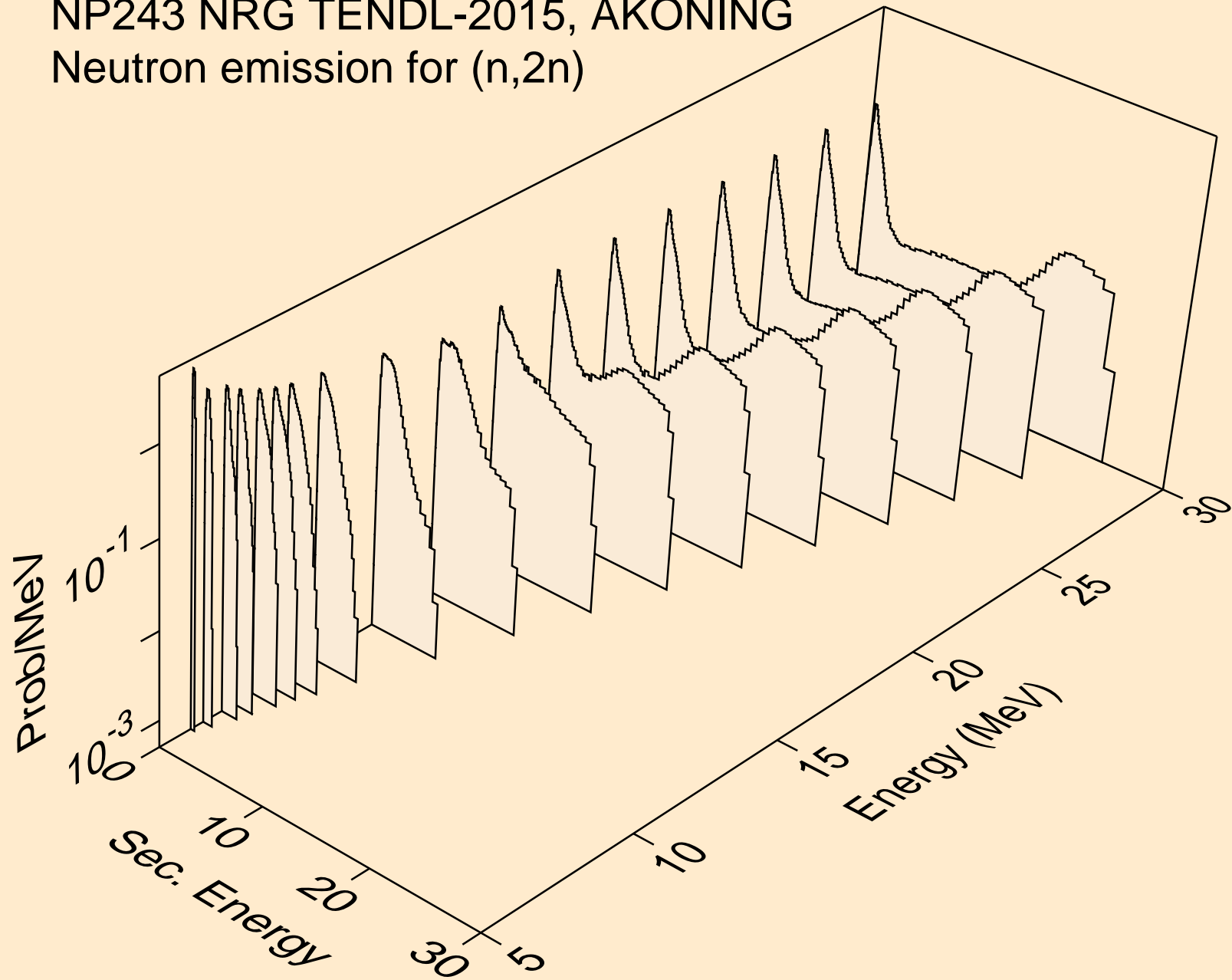

NP243 NRG TENDL-2015, AKONING
Neutron emission for (n,3n)

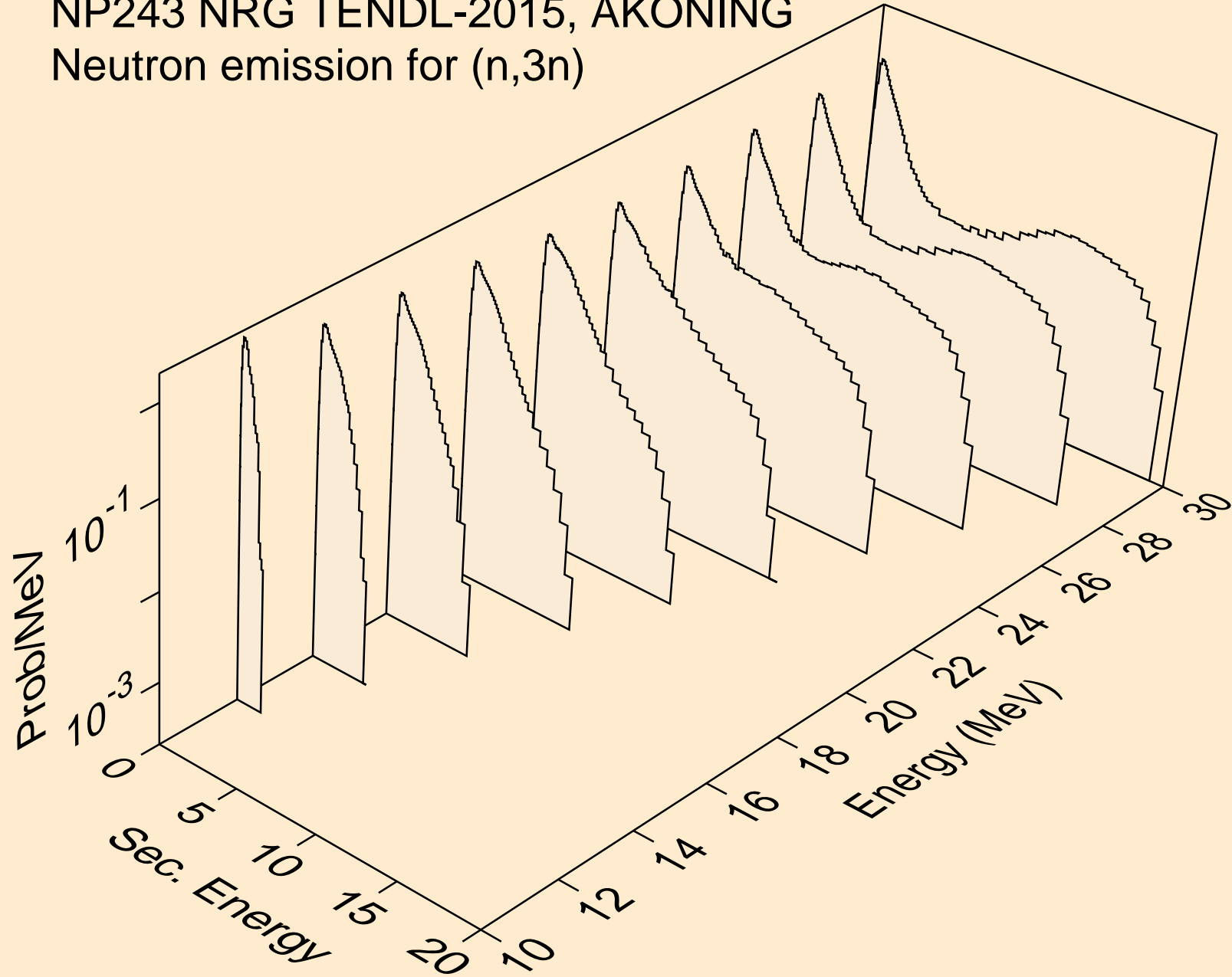

NP243 NRG TENDL-2015, AKONING
Neutron emission for fission

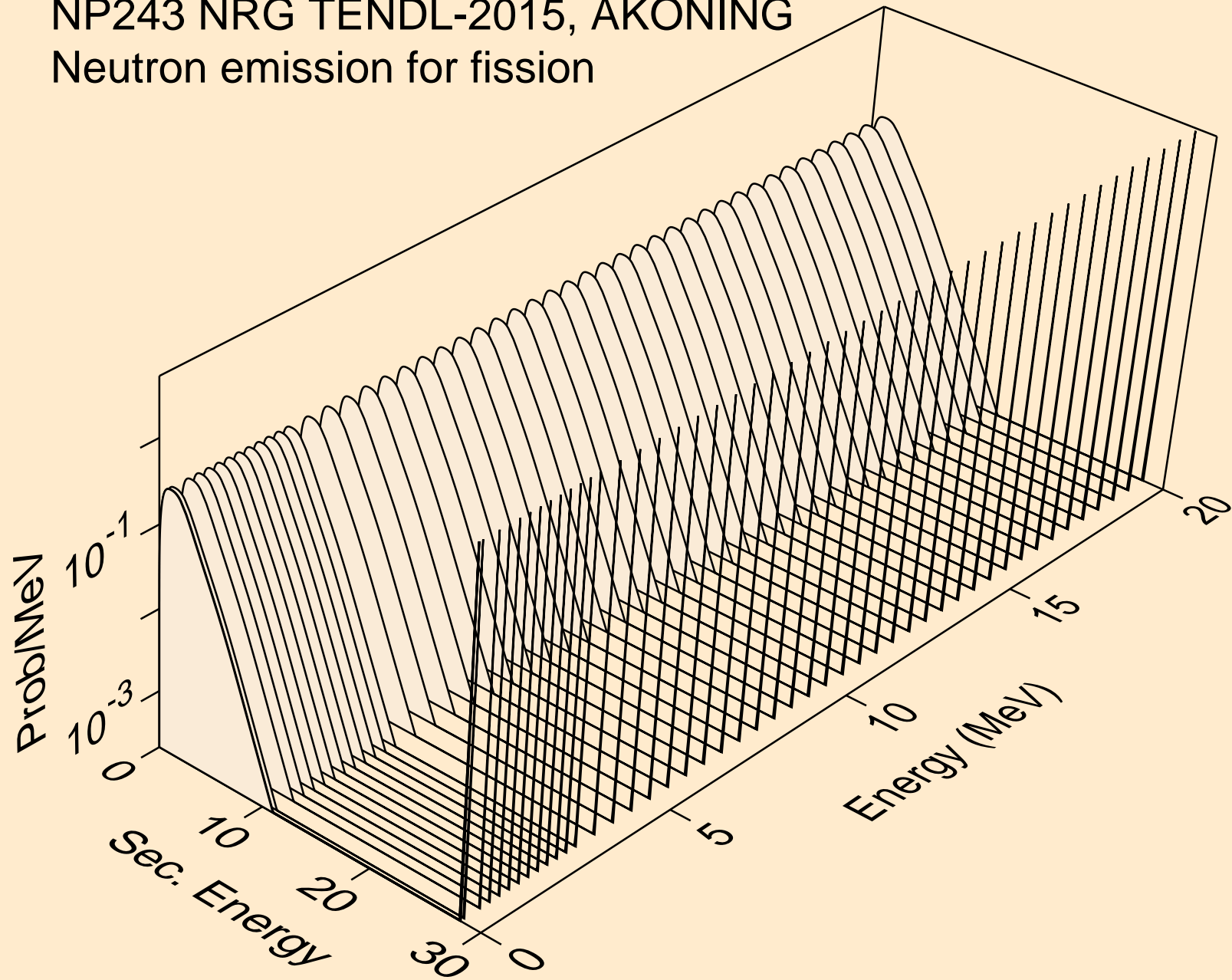

NP243 NRG TENDL-2015, AKONING
Neutron emission for (n,n*)a

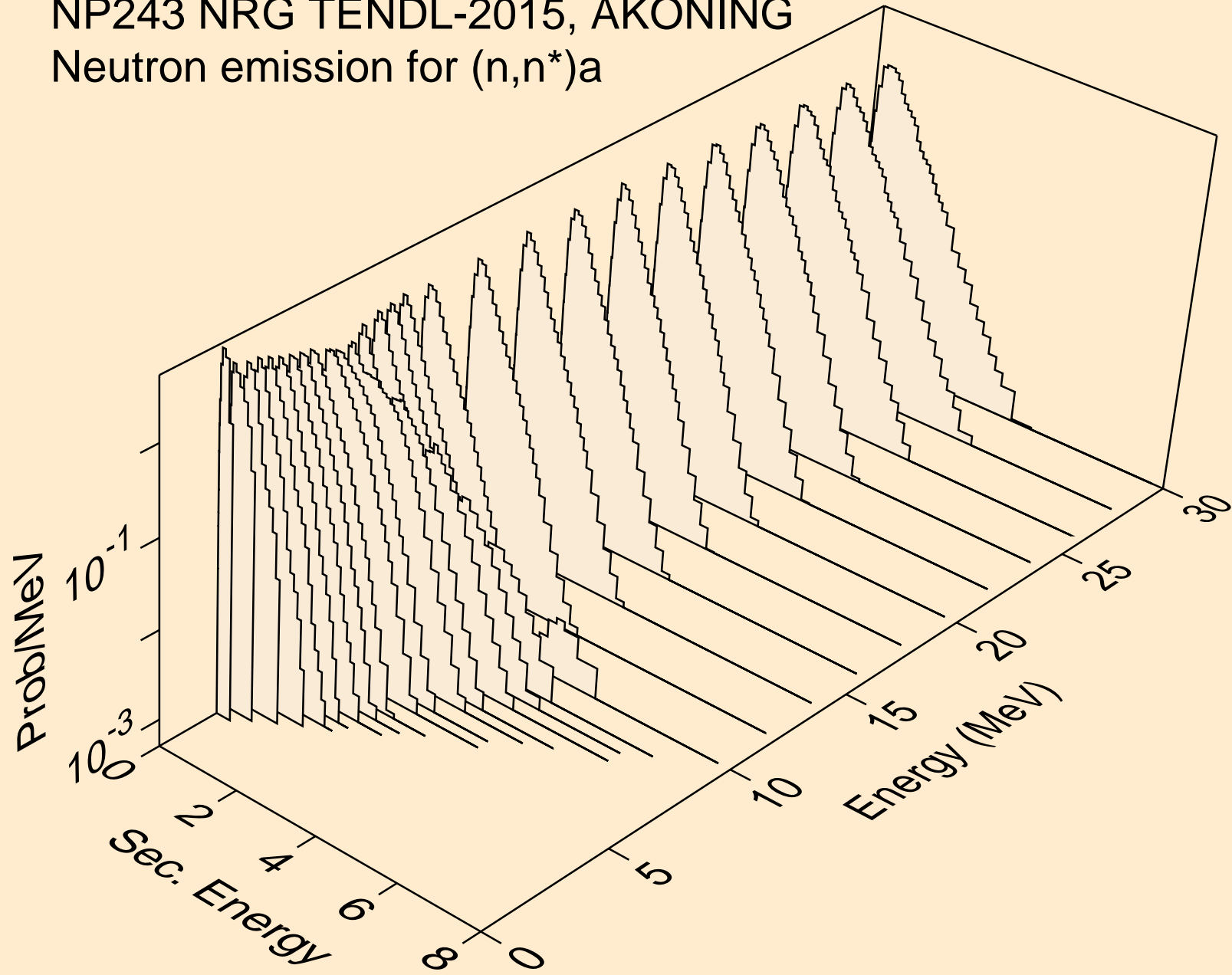

NP243 NRG TENDL-2015, AKONING
Neutron emission for (n,2n)a

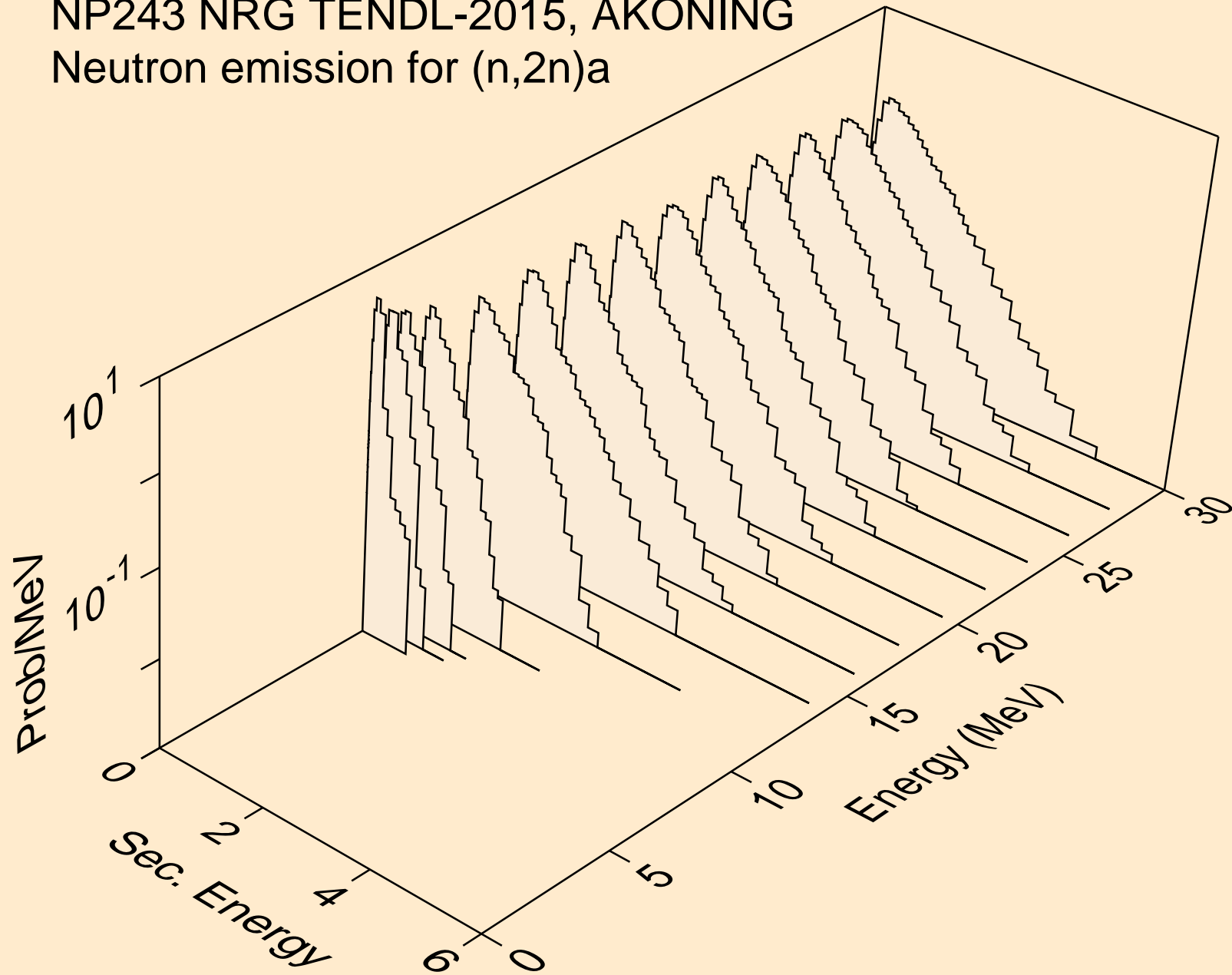

NP243 NRG TENDL-2015, AKONING
Neutron emission for (n,3n)a

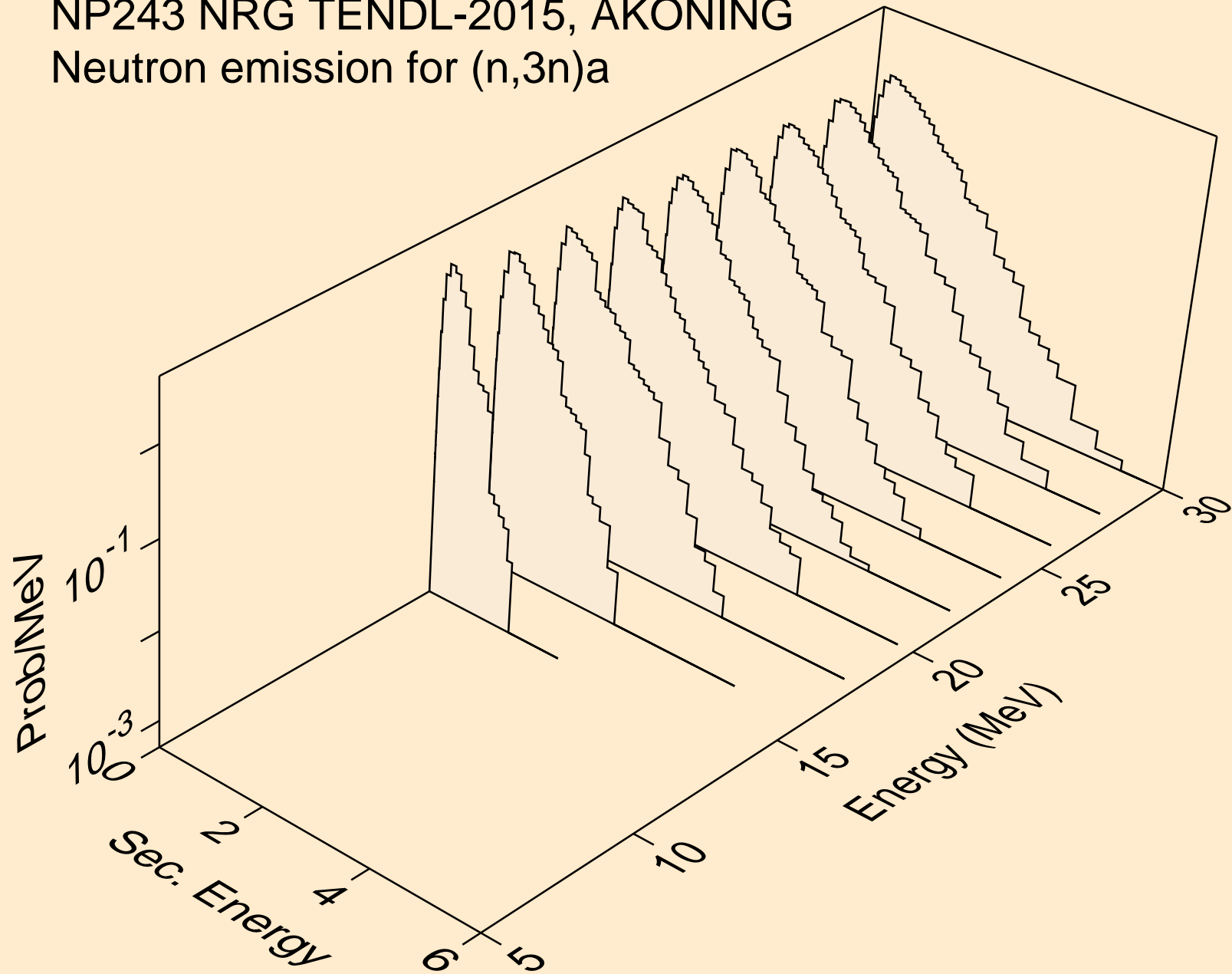

NP243 NRG TENDL-2015, AKONING
Neutron emission for (n,n*)p

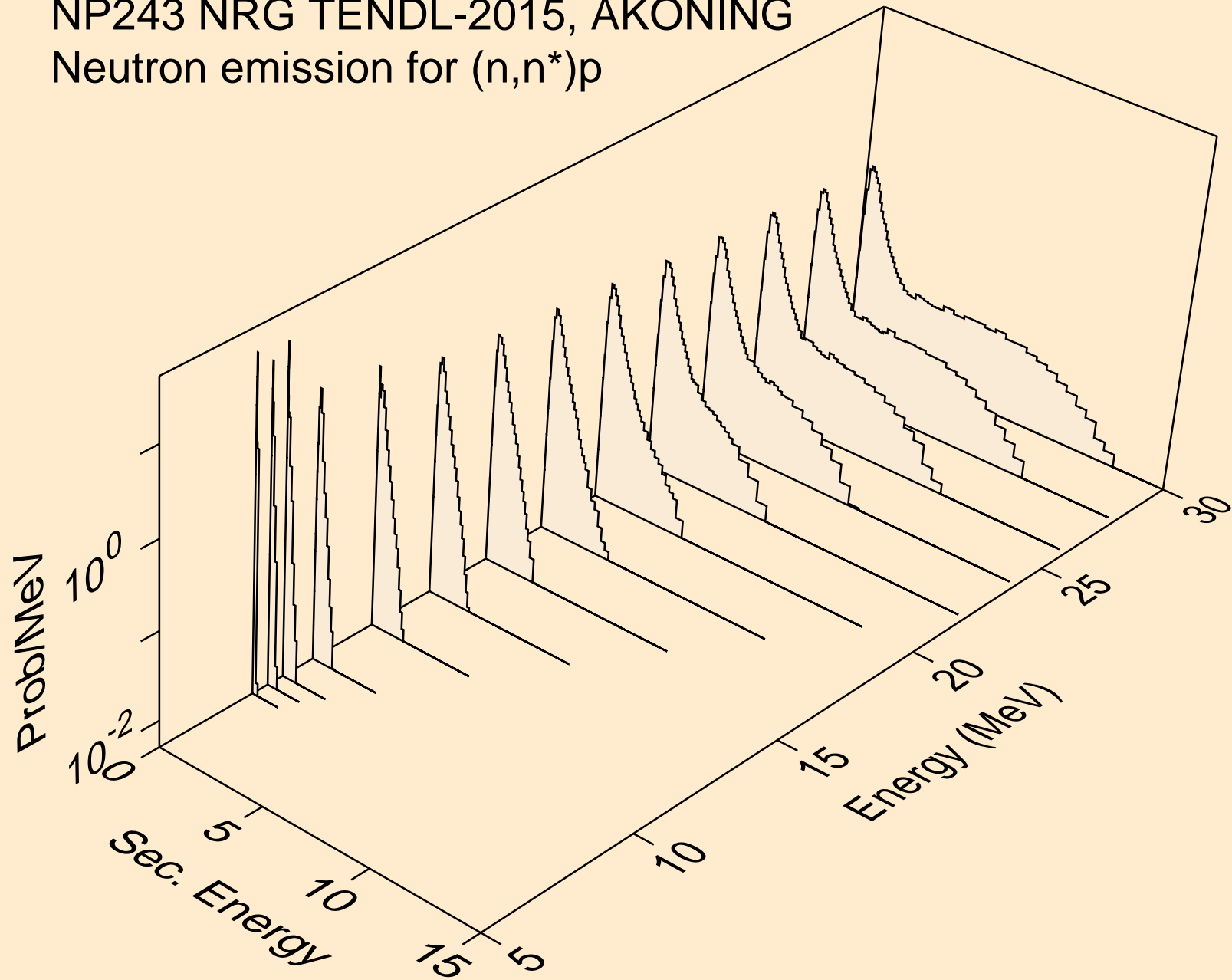

NP243 NRG TENDL-2015, AKONING
Neutron emission for (n,n*)d

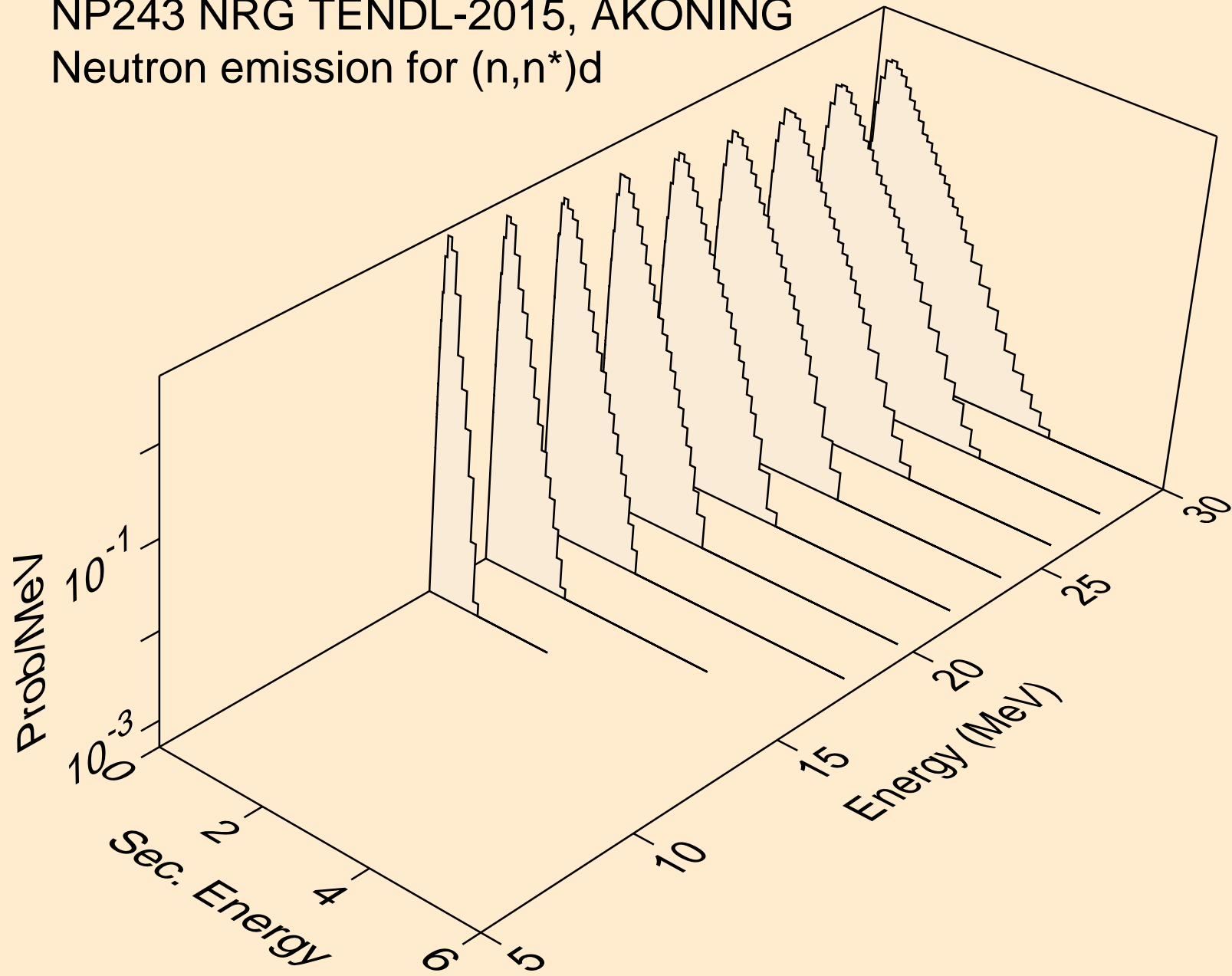

NP243 NRG TENDL-2015, AKONING
Neutron emission for (n,n*)t

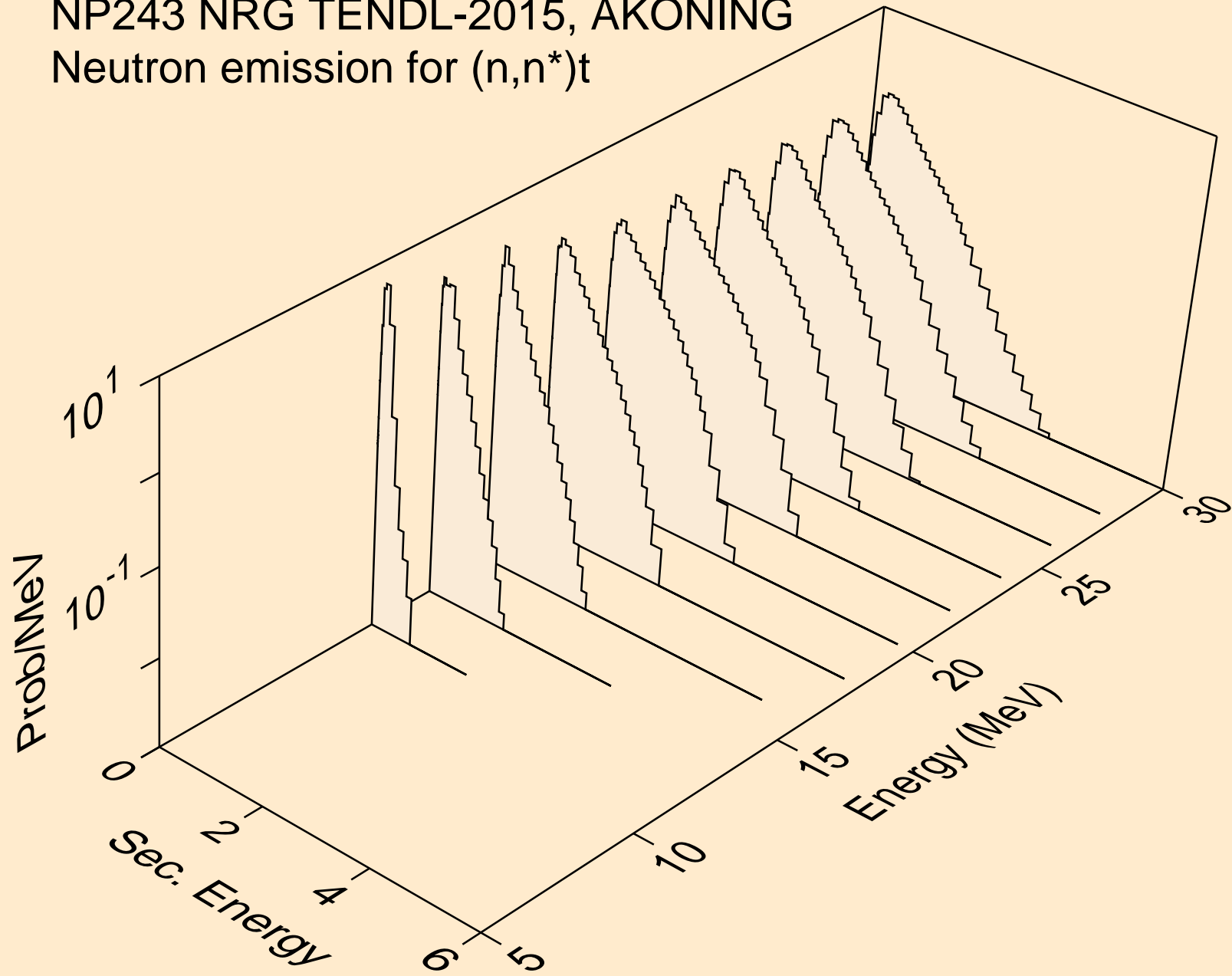

NP243 NRG TENDL-2015, AKONING
Neutron emission for (n,n*)he3

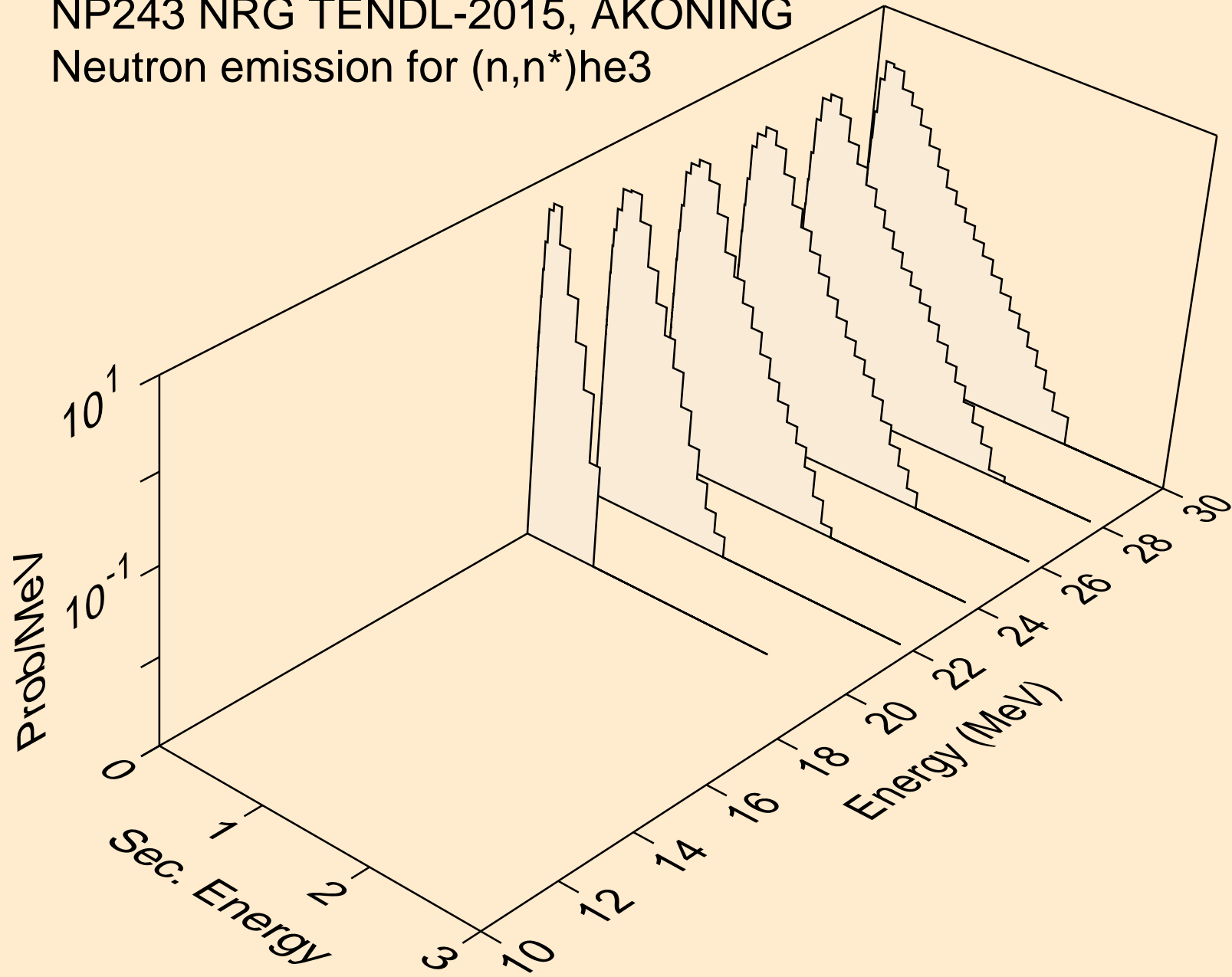

NP243 NRG TENDL-2015, AKONING
Neutron emission for (n,4n)

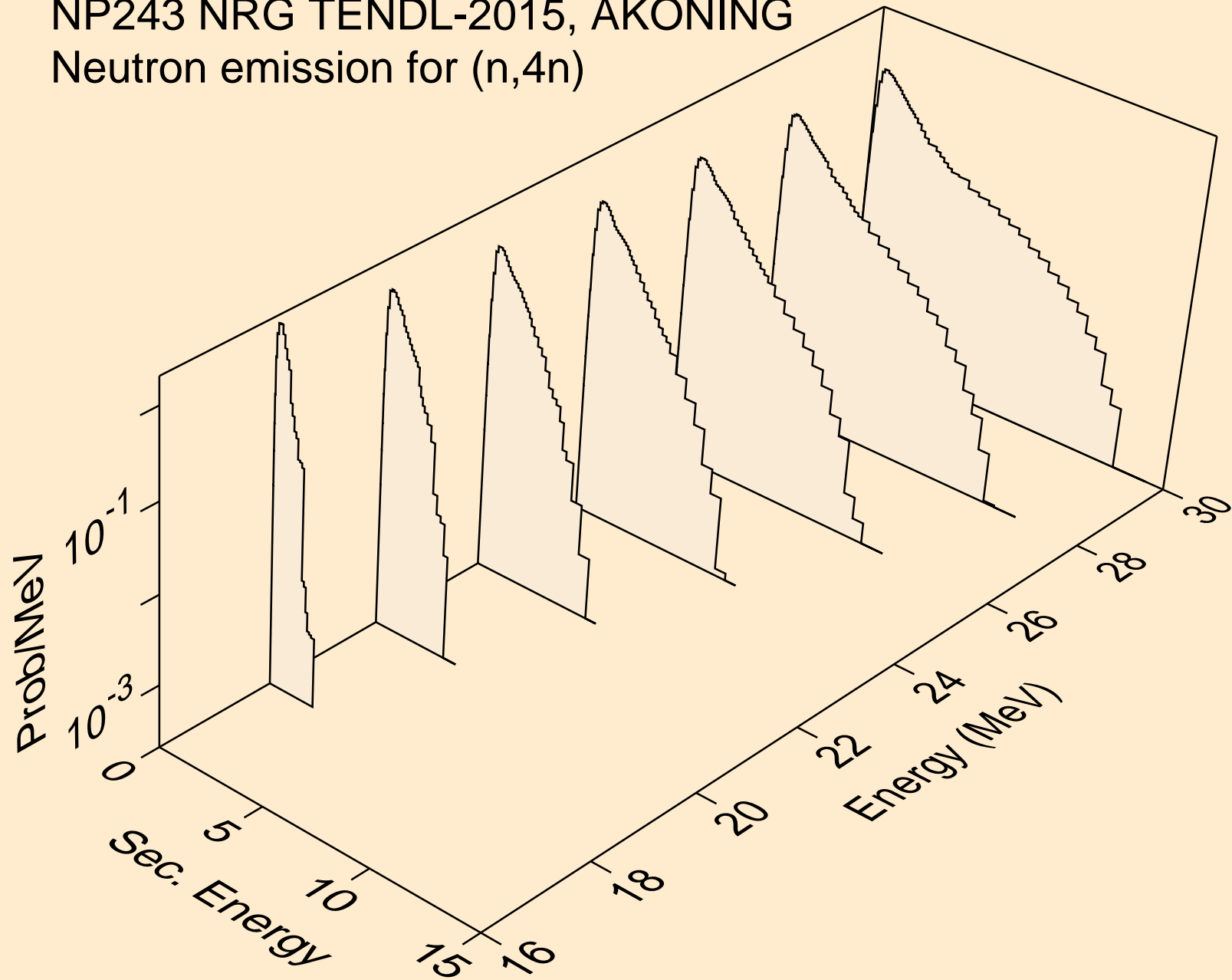

NP243 NRG TENDL-2015, AKONING
Neutron emission for (n,2np)

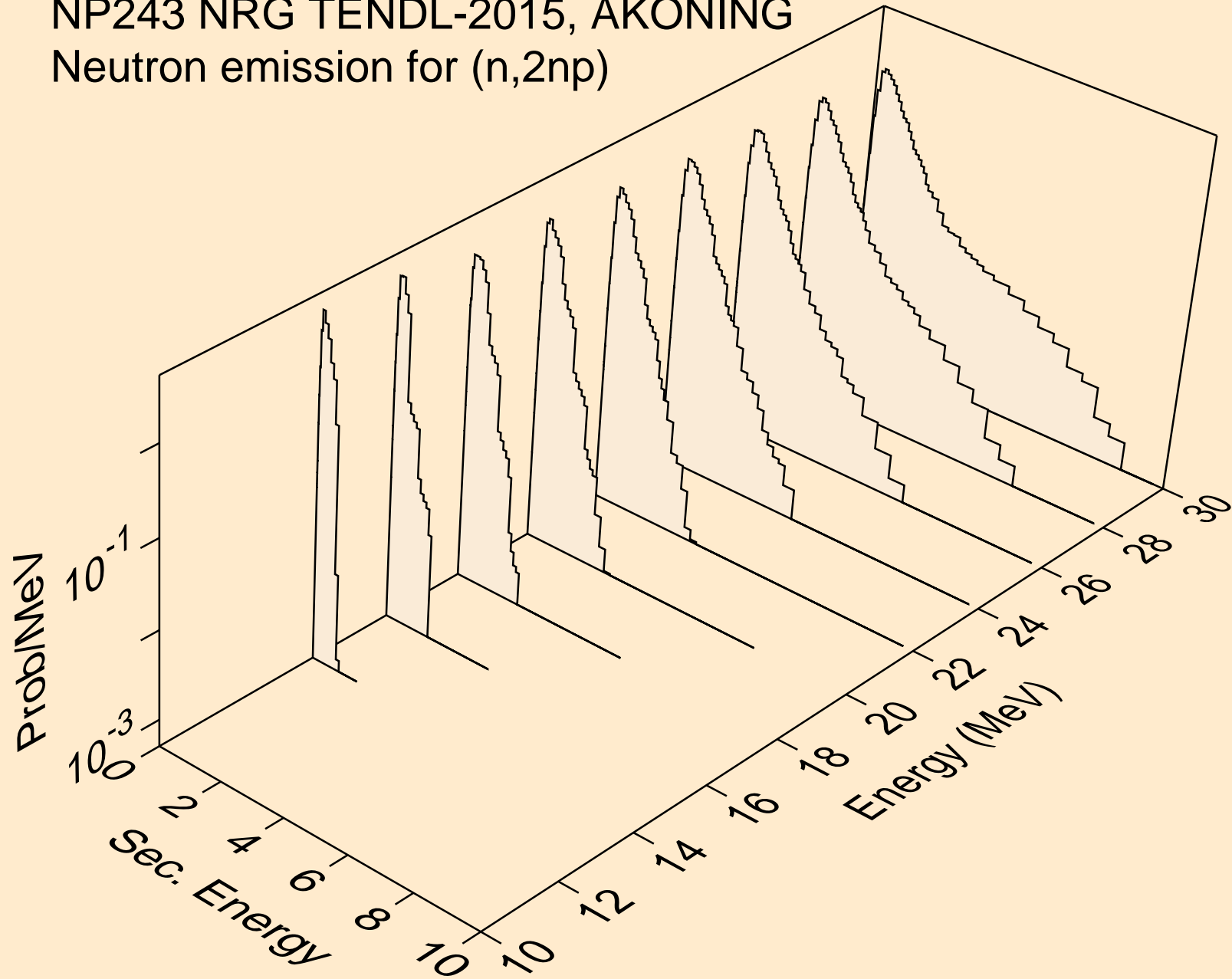

NP243 NRG TENDL-2015, AKONING
Neutron emission for (n,3np)

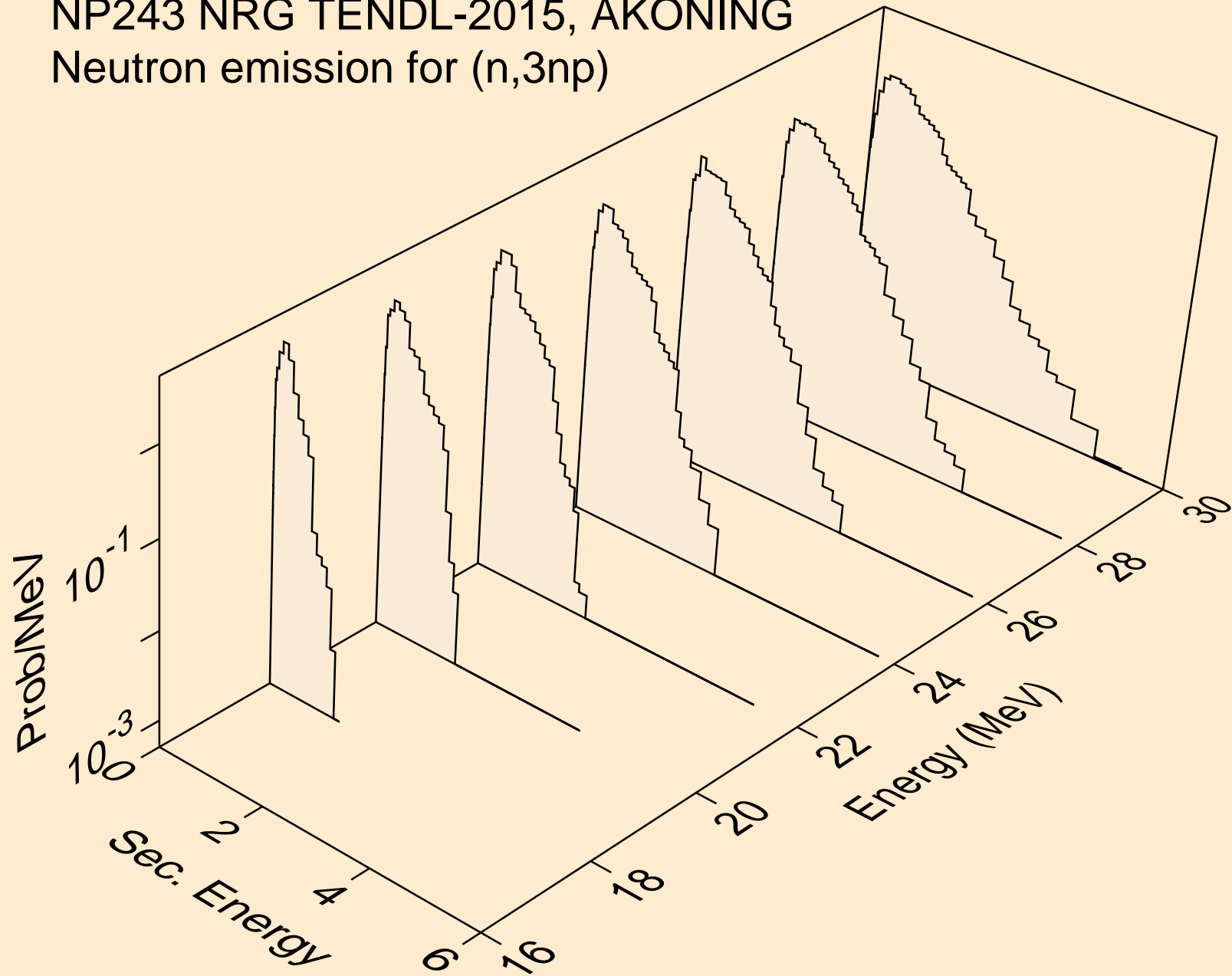

NP243 NRG TENDL-2015, AKONING
Neutron emission for (n,2np)

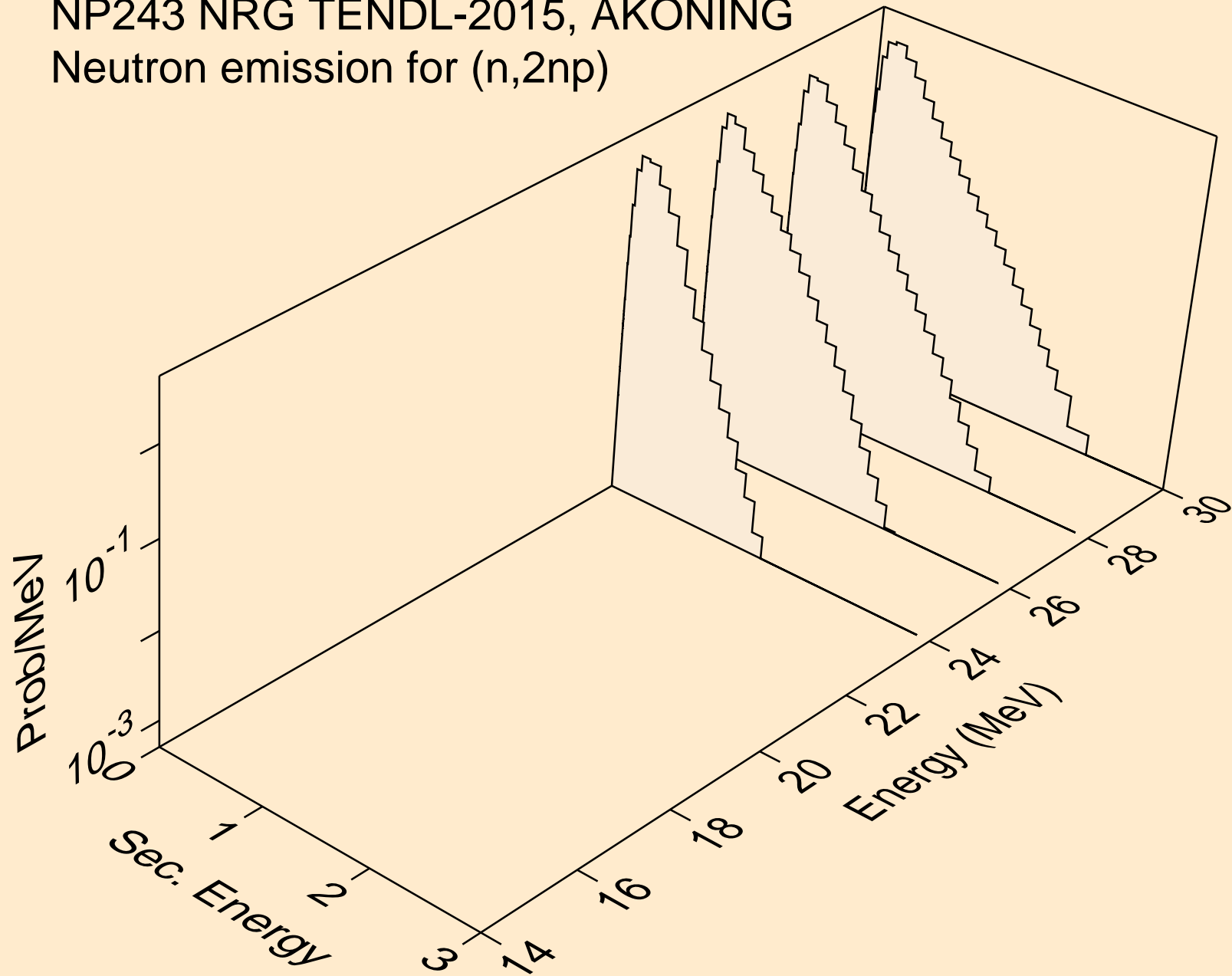

NP243 NRG TENDL-2015, AKONING
Neutron emission for (n,n*c)

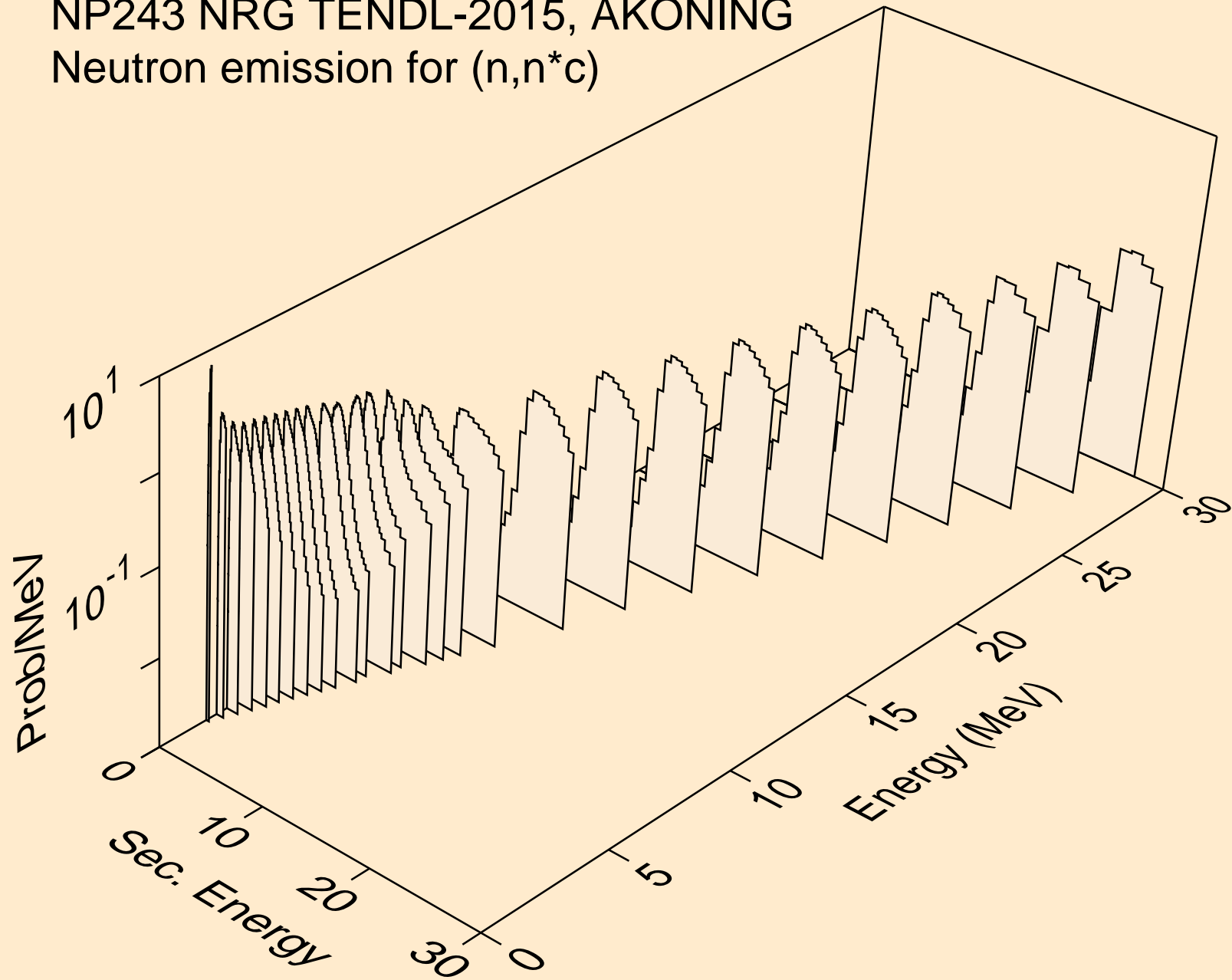

NP243 NRG TENDL-2015, AKONING

Delayed nubar

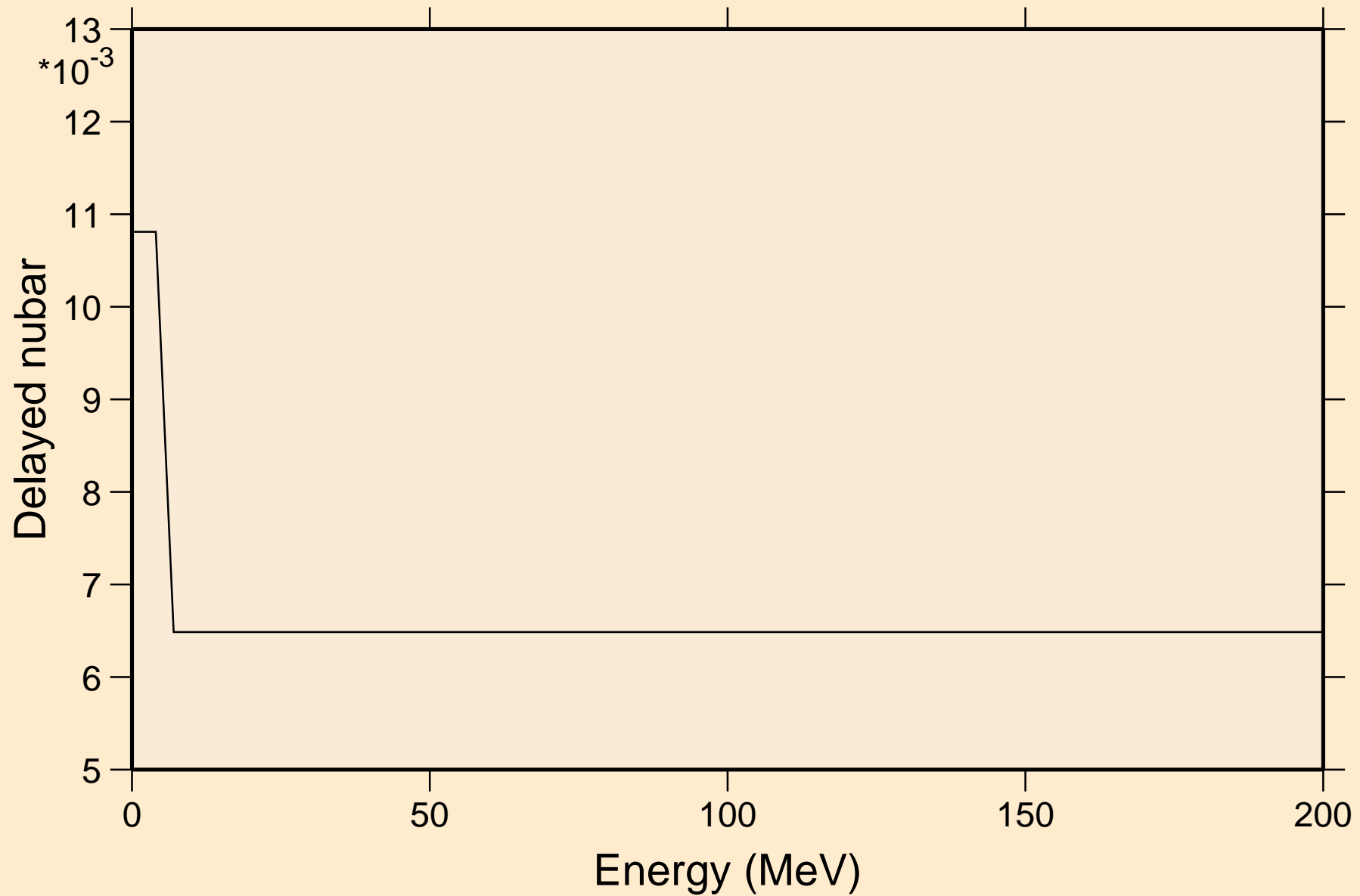

NP243 NRG TENDL-2015, AKONING

Delayed neutron spectra

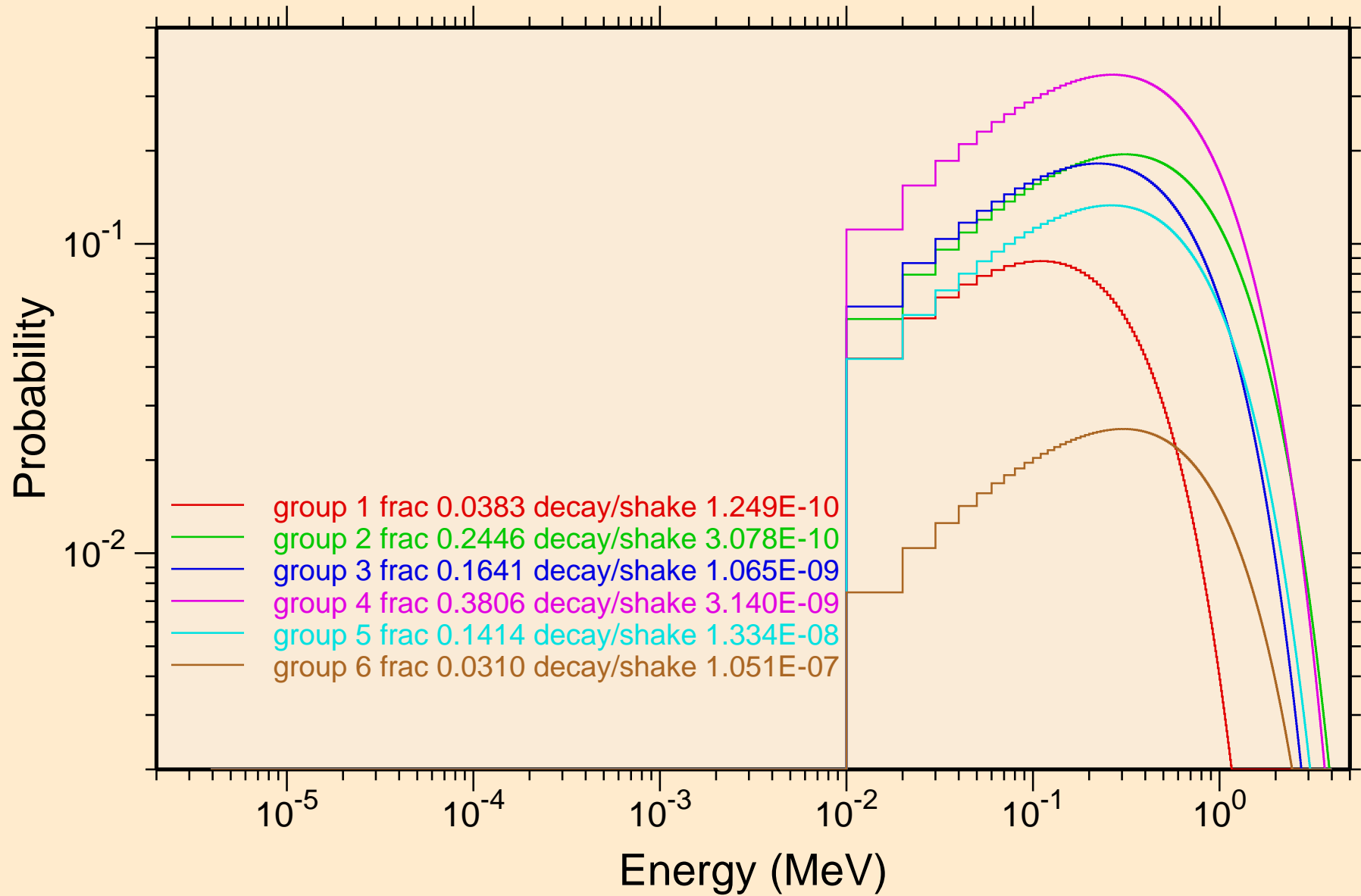

NP243 NRG TENDL-2015, AKONING
Photon emission for (n,x)

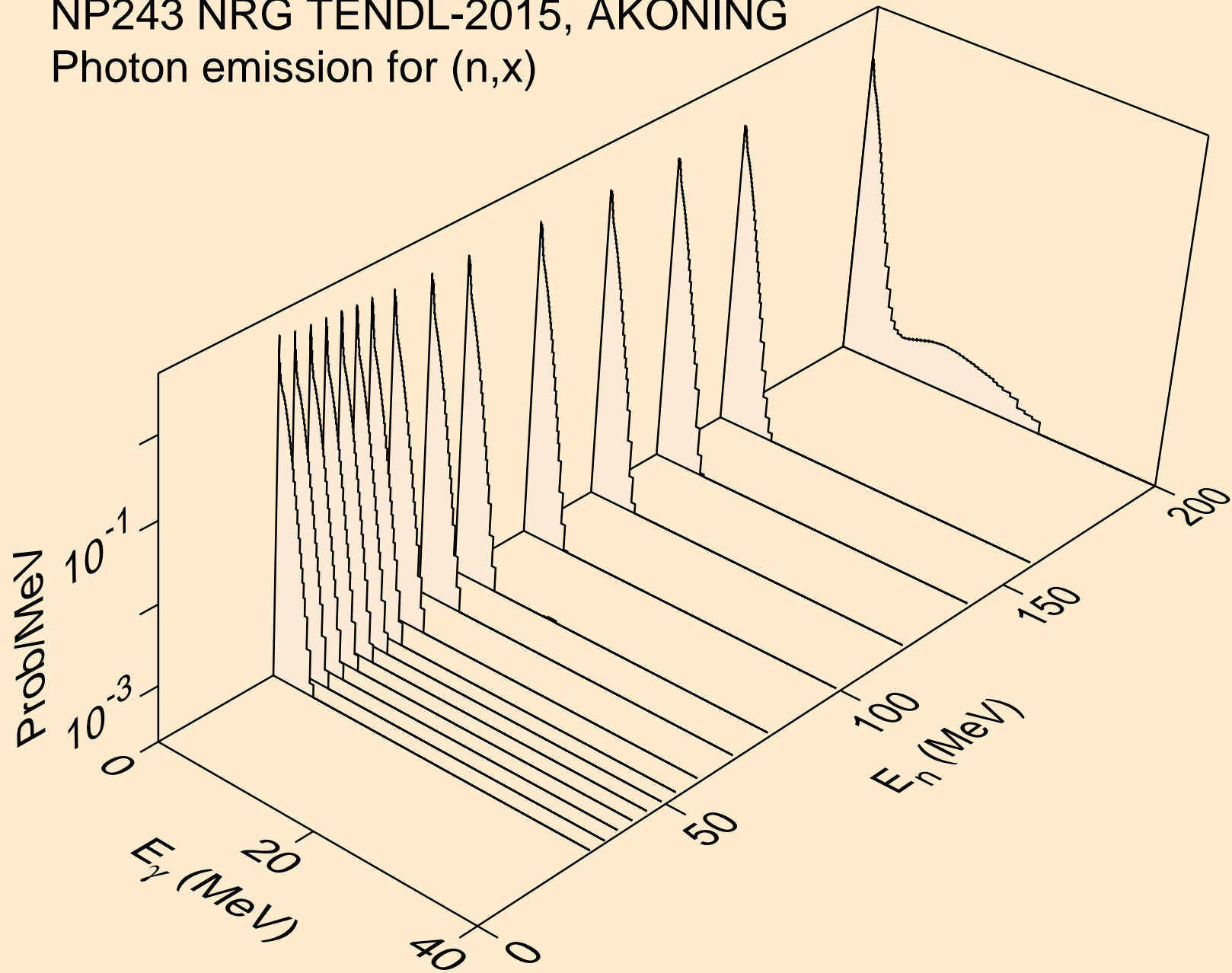

NP243 NRG TENDL-2015, AKONING
Photon emission for (n,2nd)

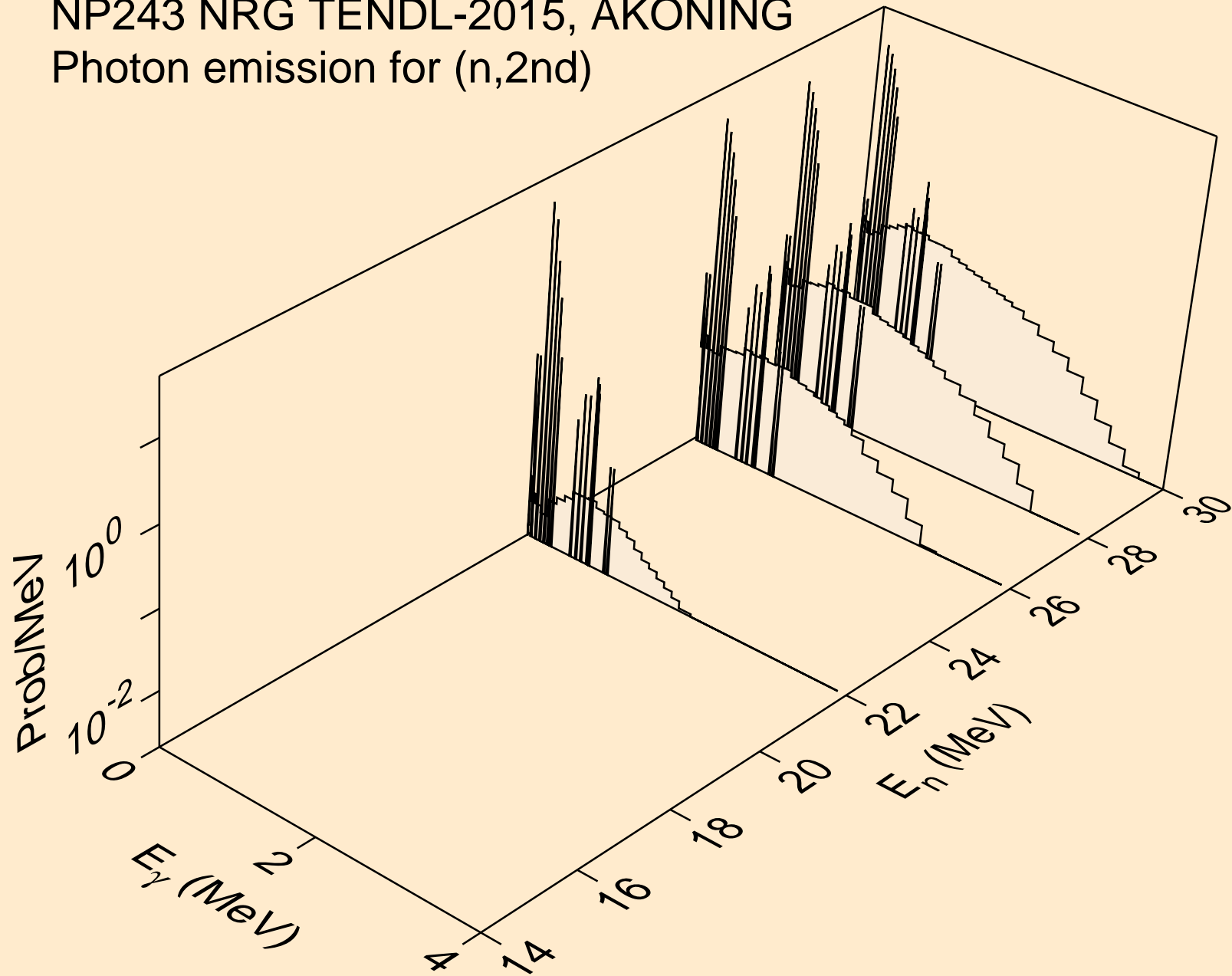

NP243 NRG TENDL-2015, AKONING
Photon emission for (n,2n)

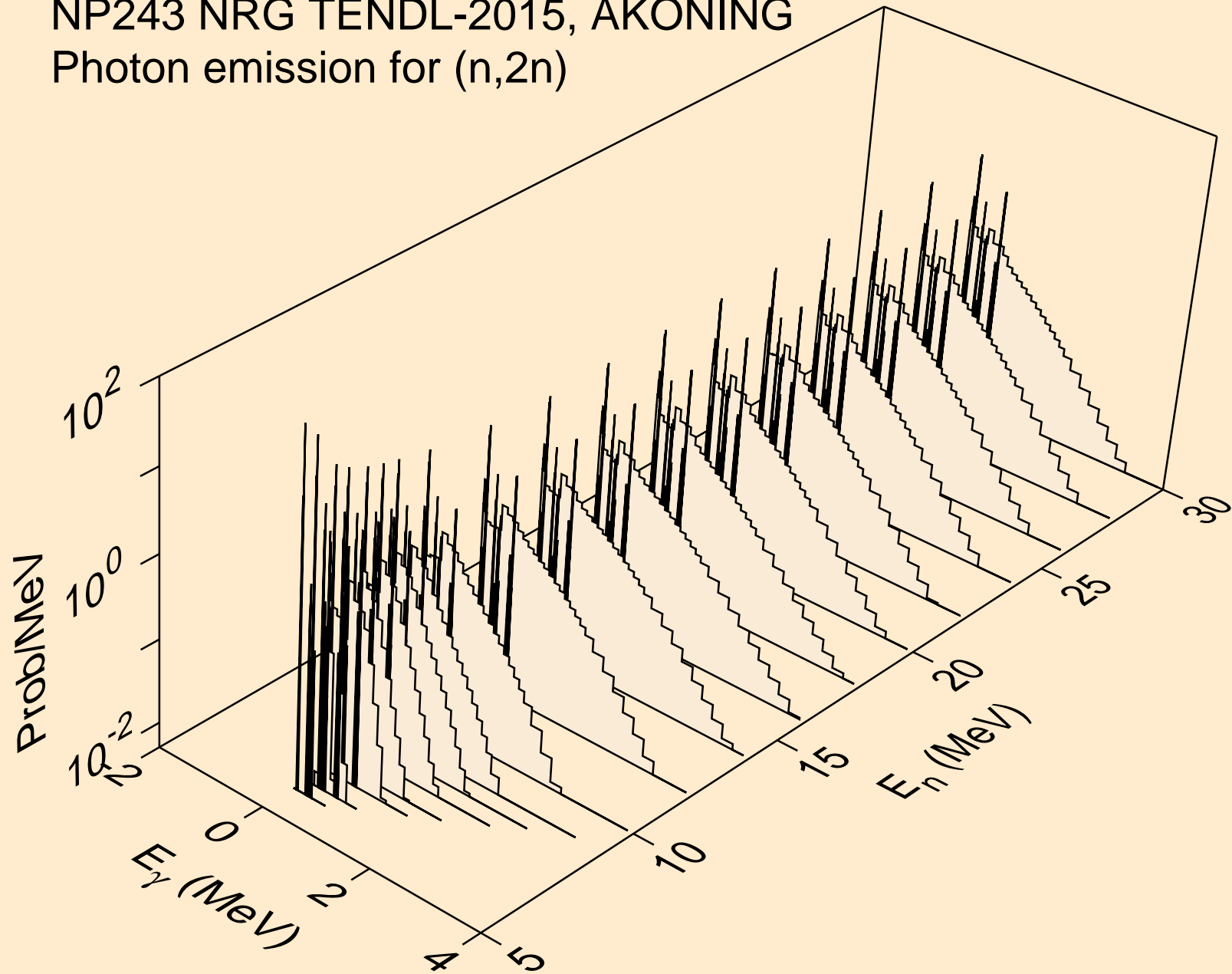

NP243 NRG TENDL-2015, AKONING
Photon emission for (n,3n)

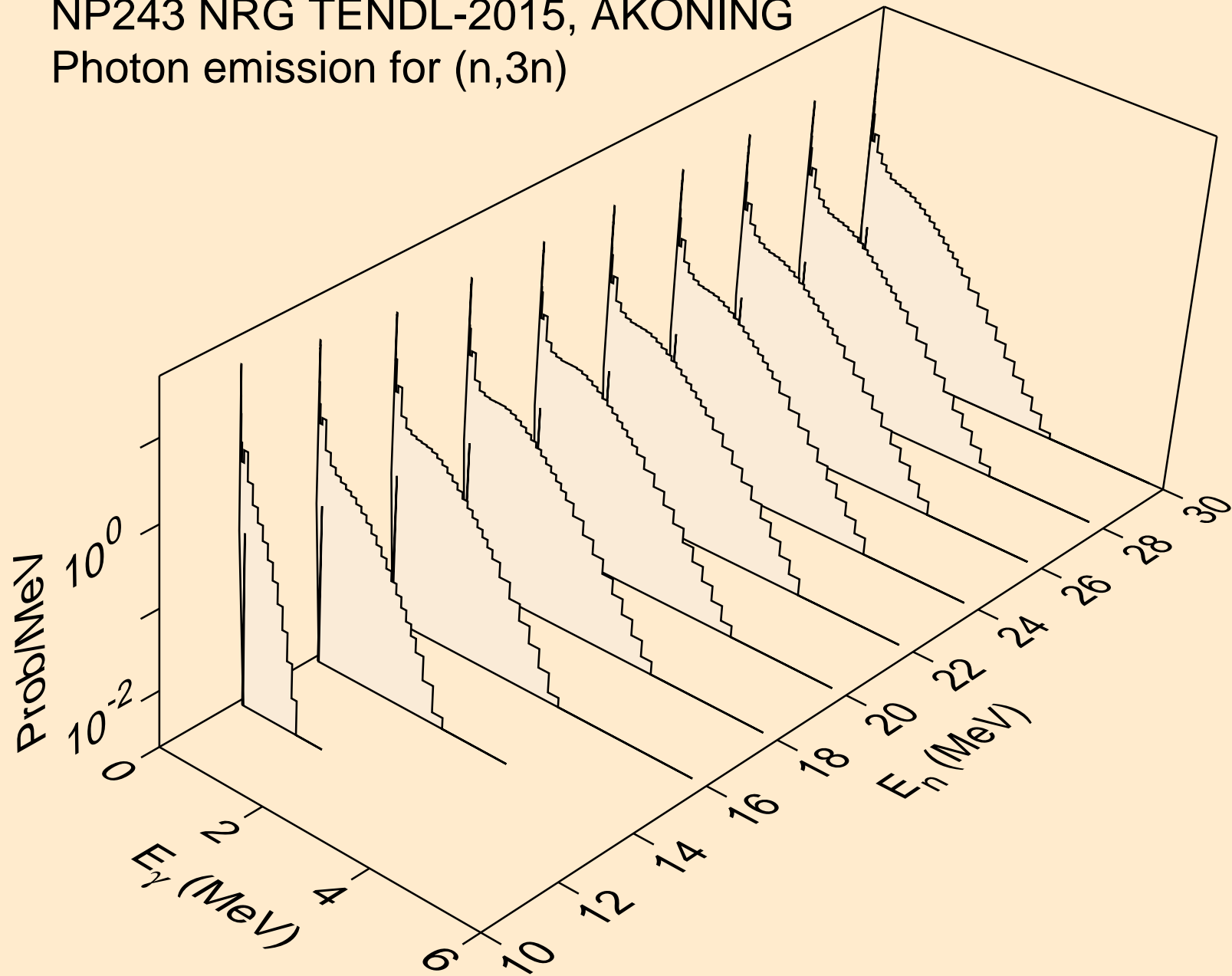

NP243 NRG TENDL-2015, AKONING
Photon emission for (n,n*)a

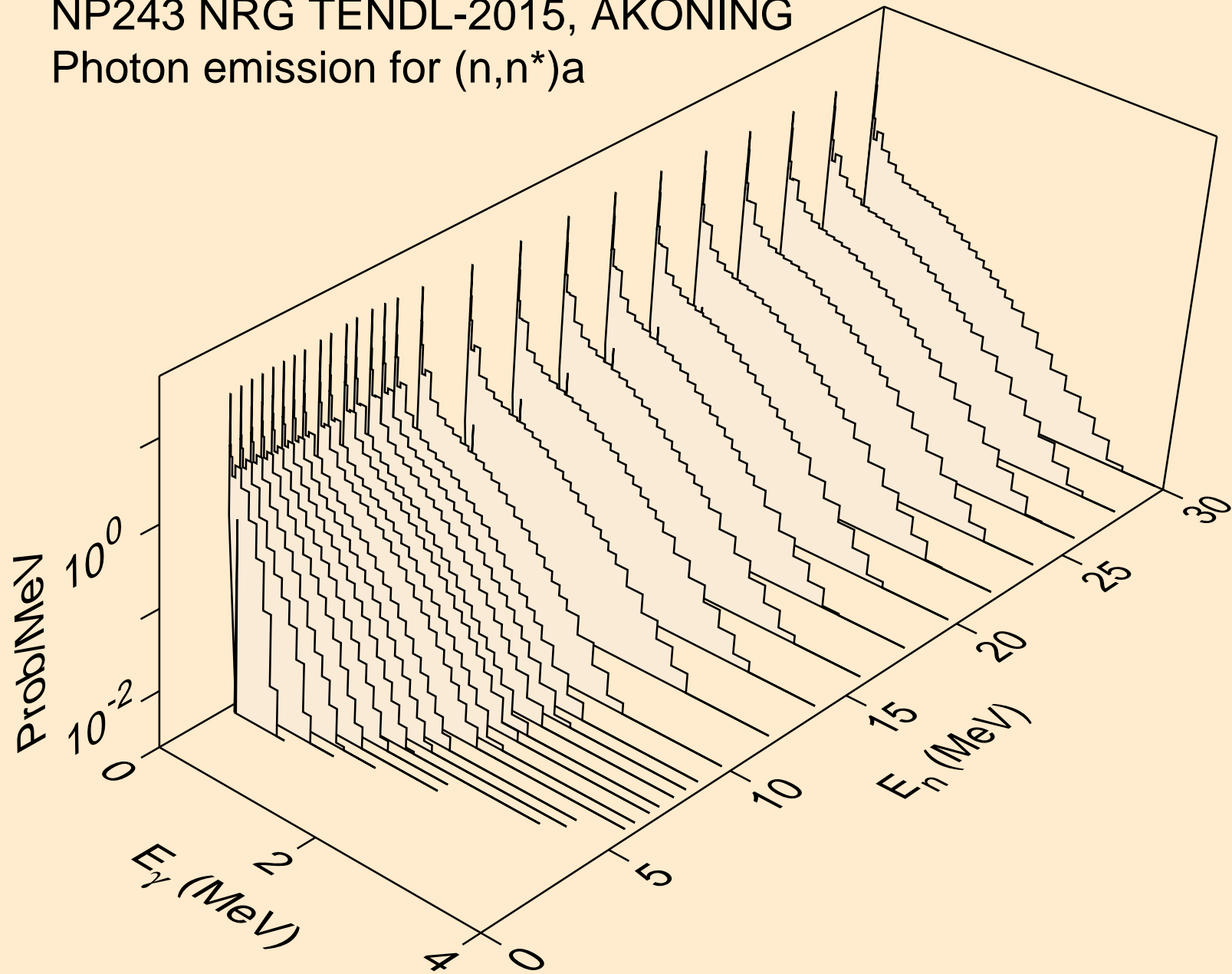

NP243 NRG TENDL-2015, AKONING
Photon emission for (n,2n)a

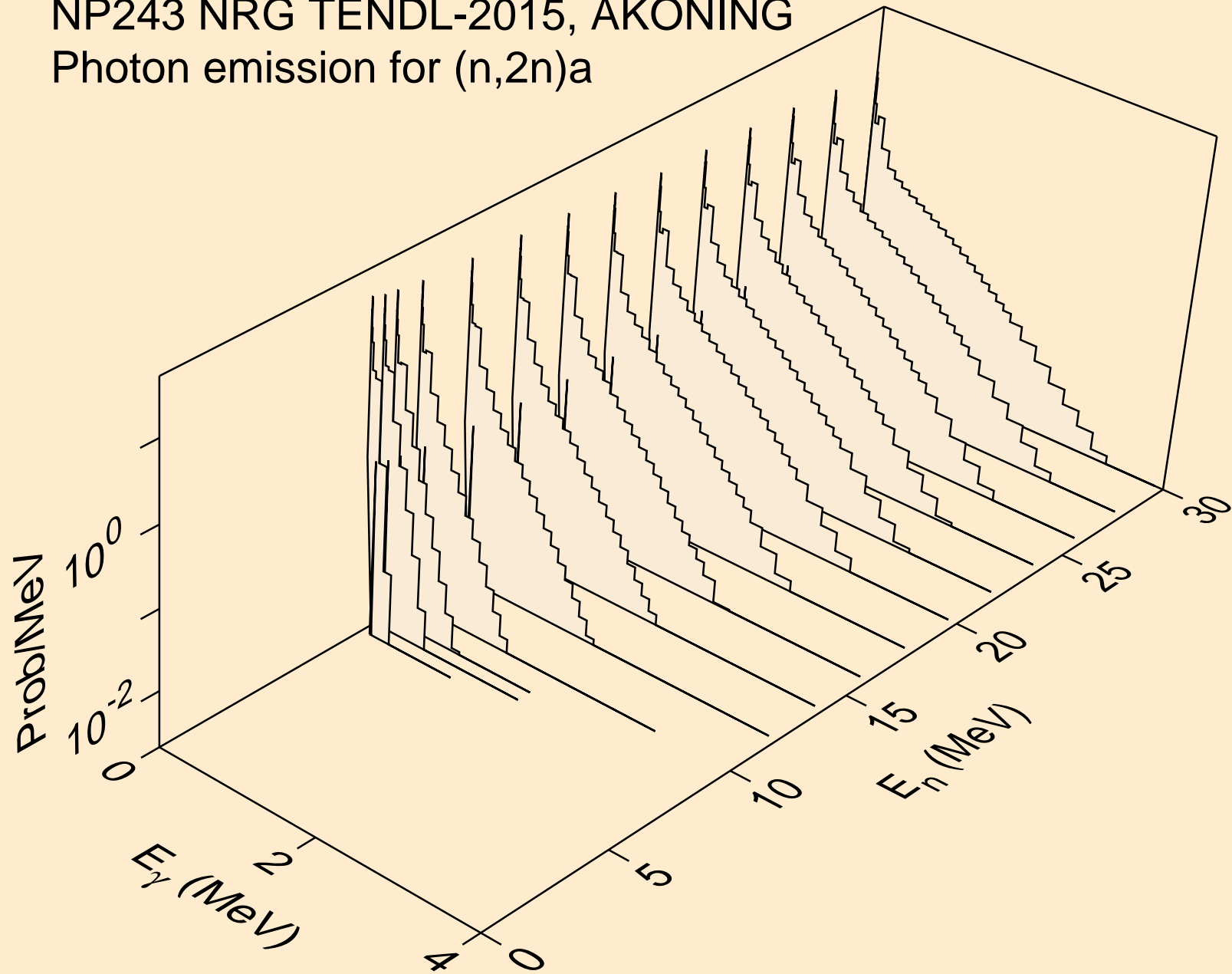

NP243 NRG TENDL-2015, AKONING
Photon emission for (n,3n)a

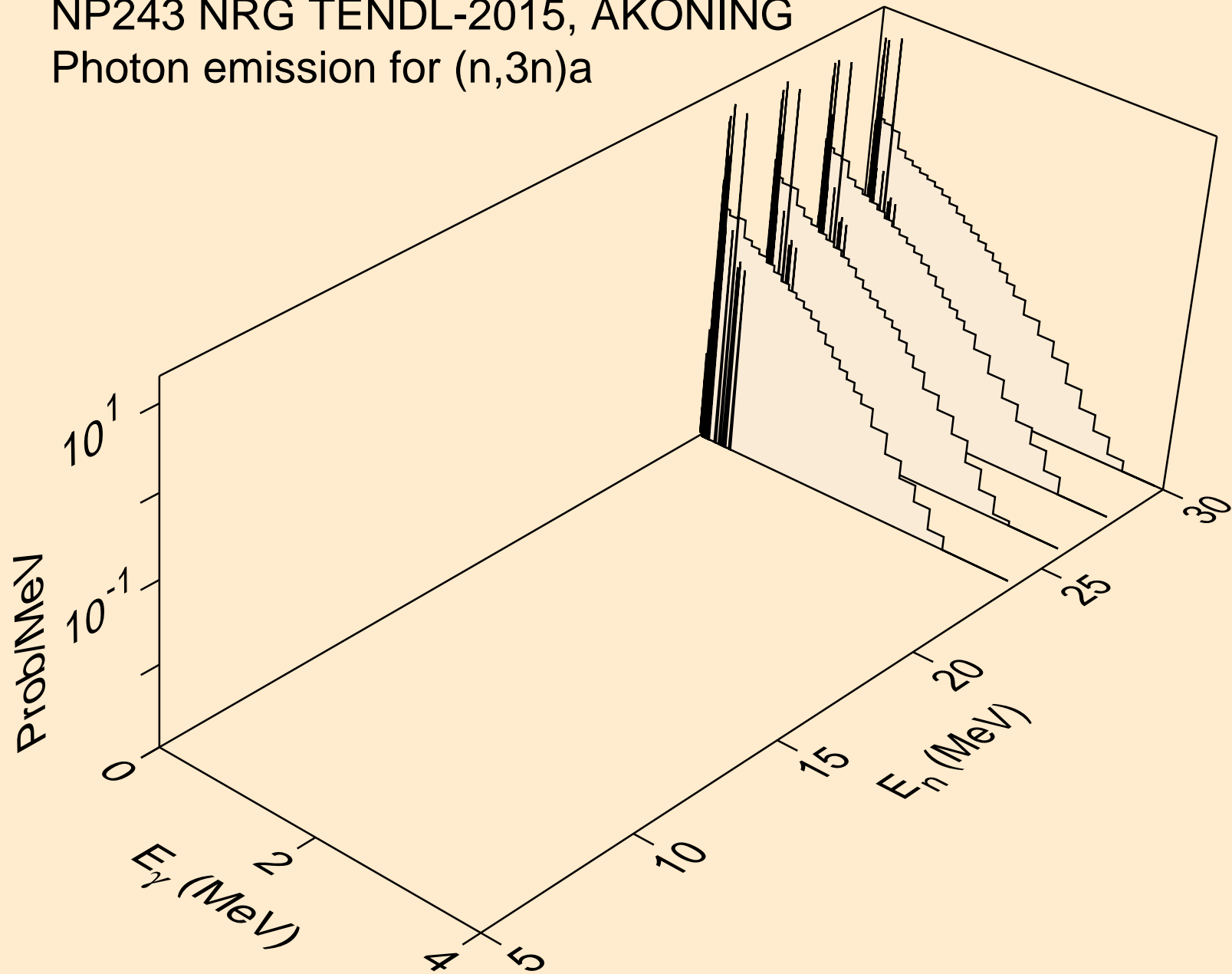

NP243 NRG TENDL-2015, AKONING
Photon emission for (n,n*)p

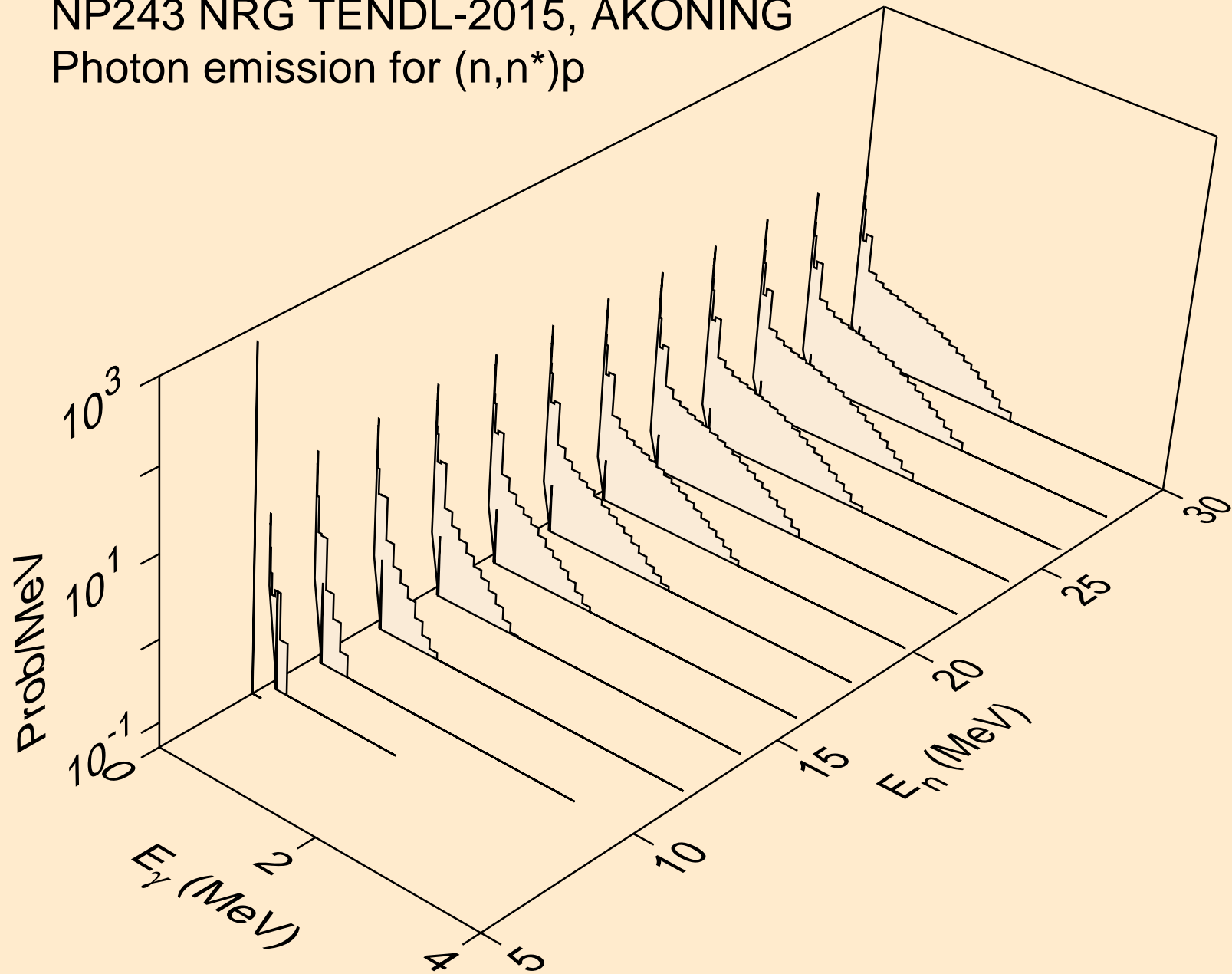

NP243 NRG TENDL-2015, AKONING
Photon emission for (n,n*)d

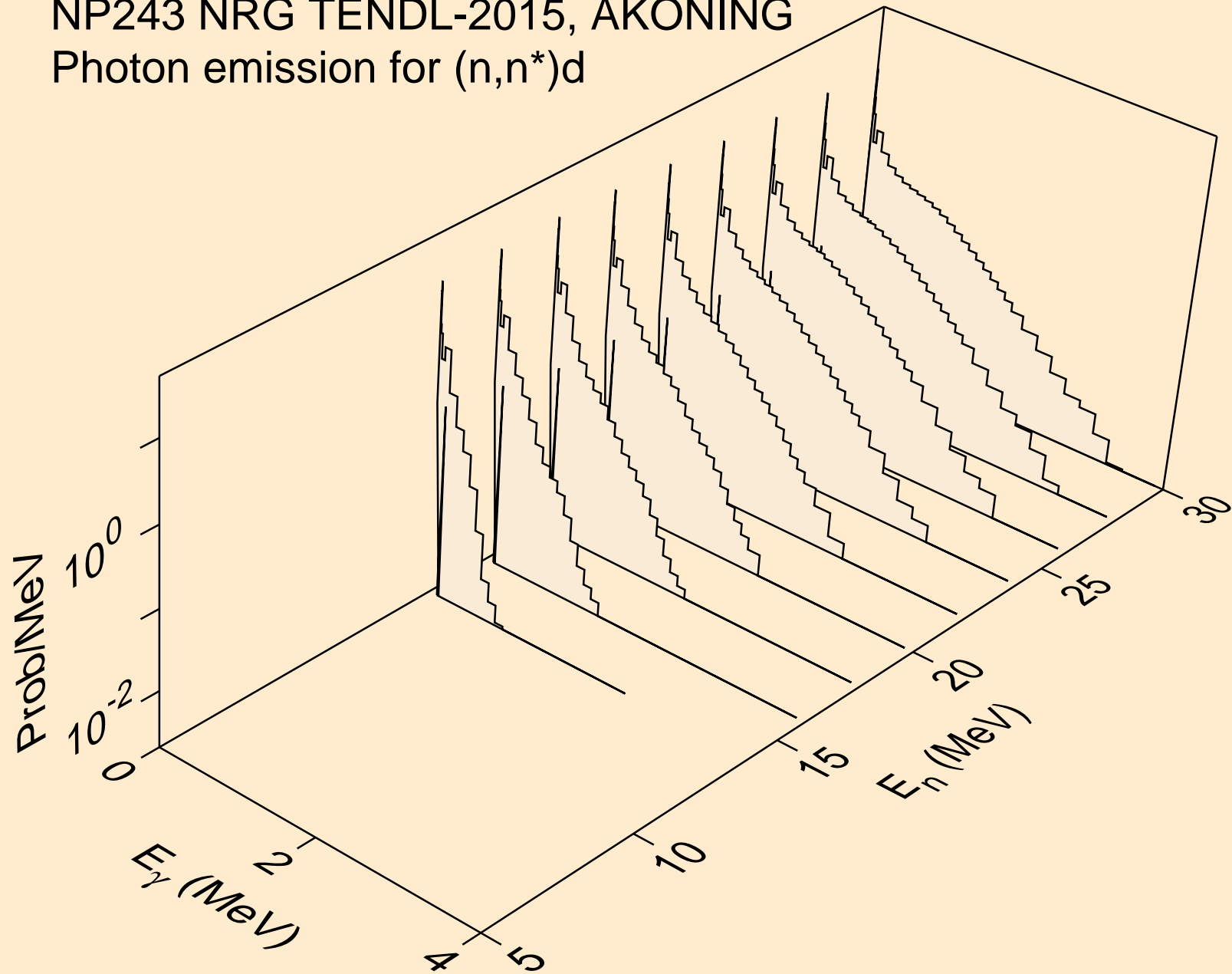

NP243 NRG TENDL-2015, AKONING
Photon emission for (n,n*)t

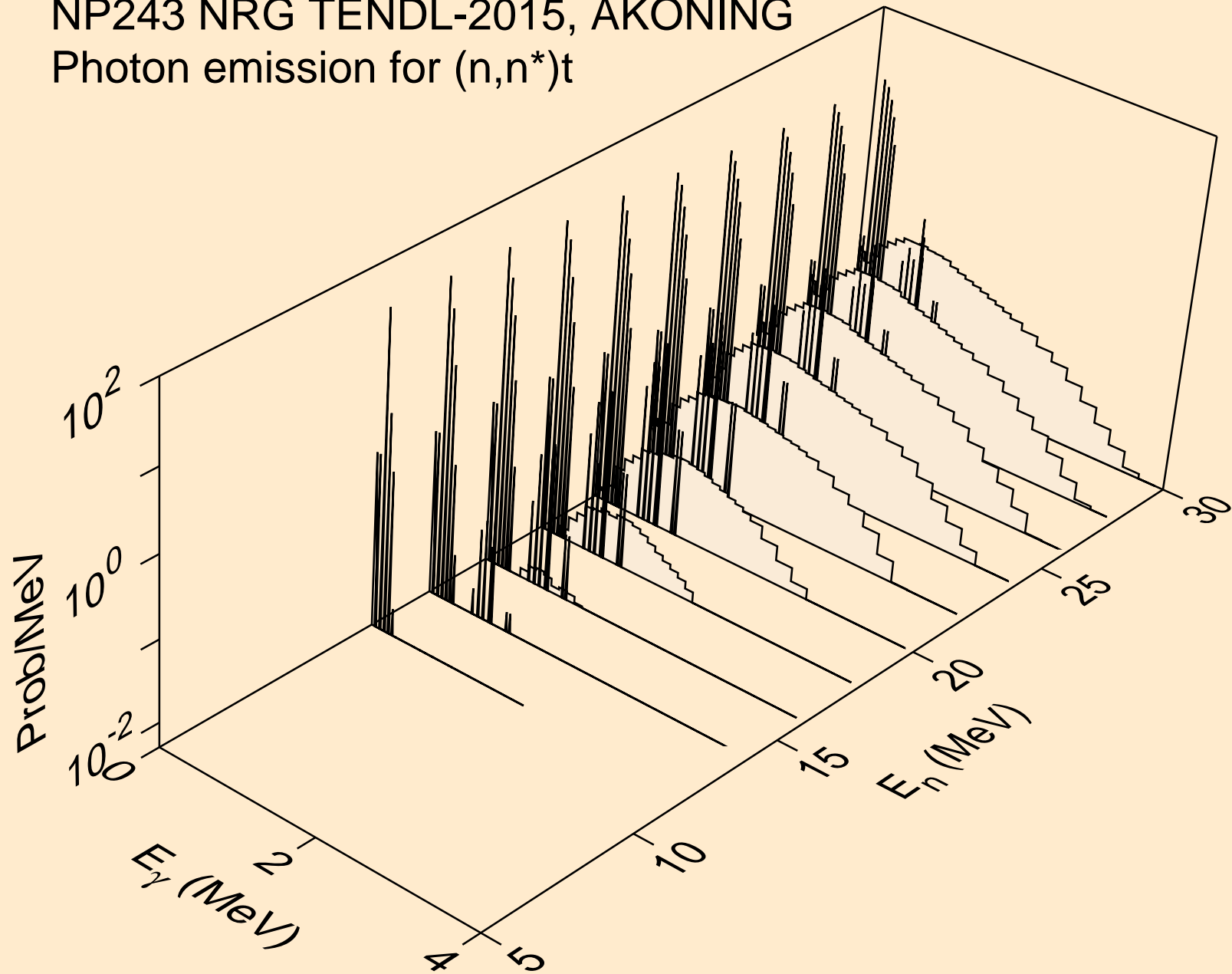

NP243 NRG TENDL-2015, AKONING
Photon emission for (n,n*)he3

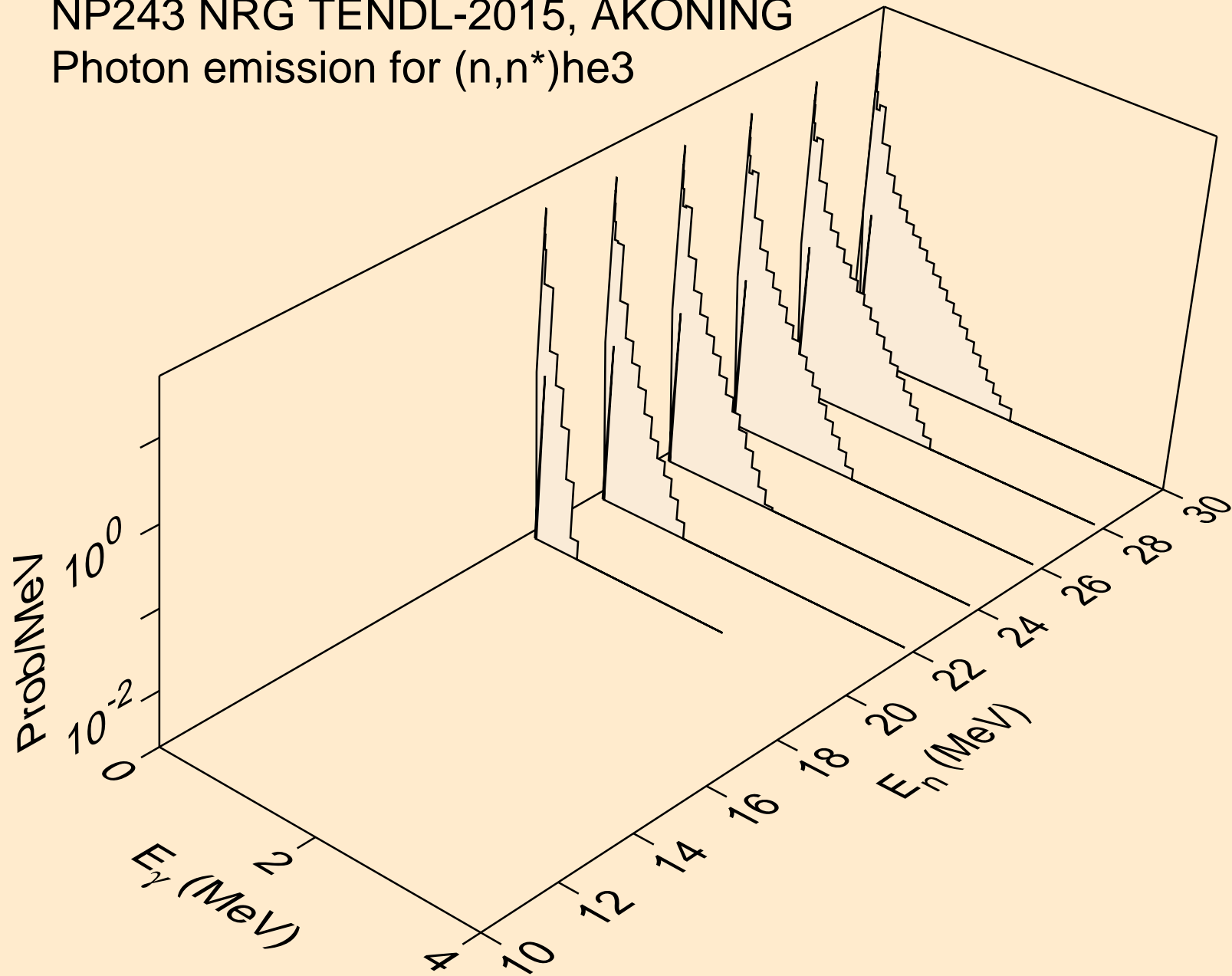

NP243 NRG TENDL-2015, AKONING
Photon emission for (n,4n)

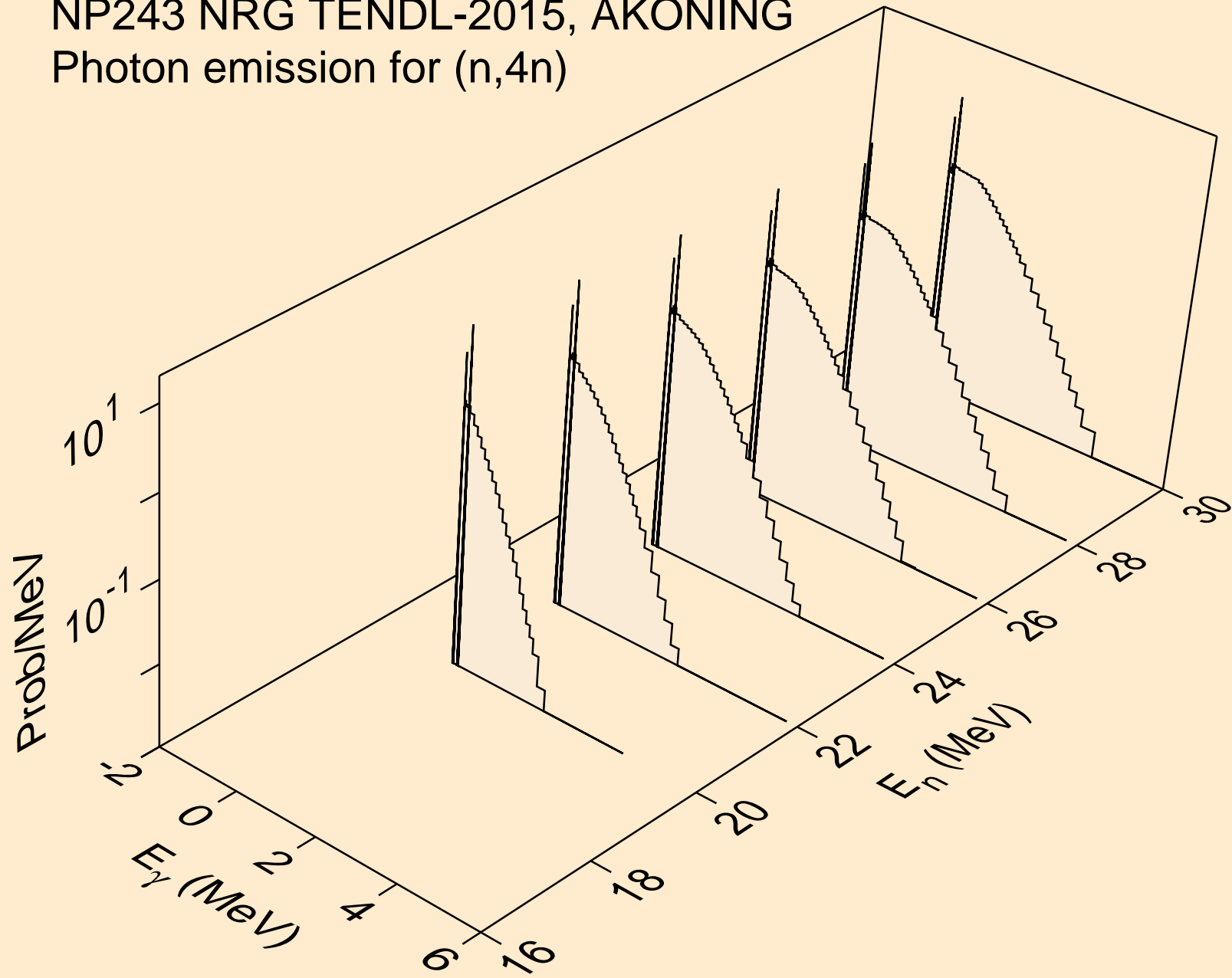

NP243 NRG TENDL-2015, AKONING
Photon emission for (n,2np)

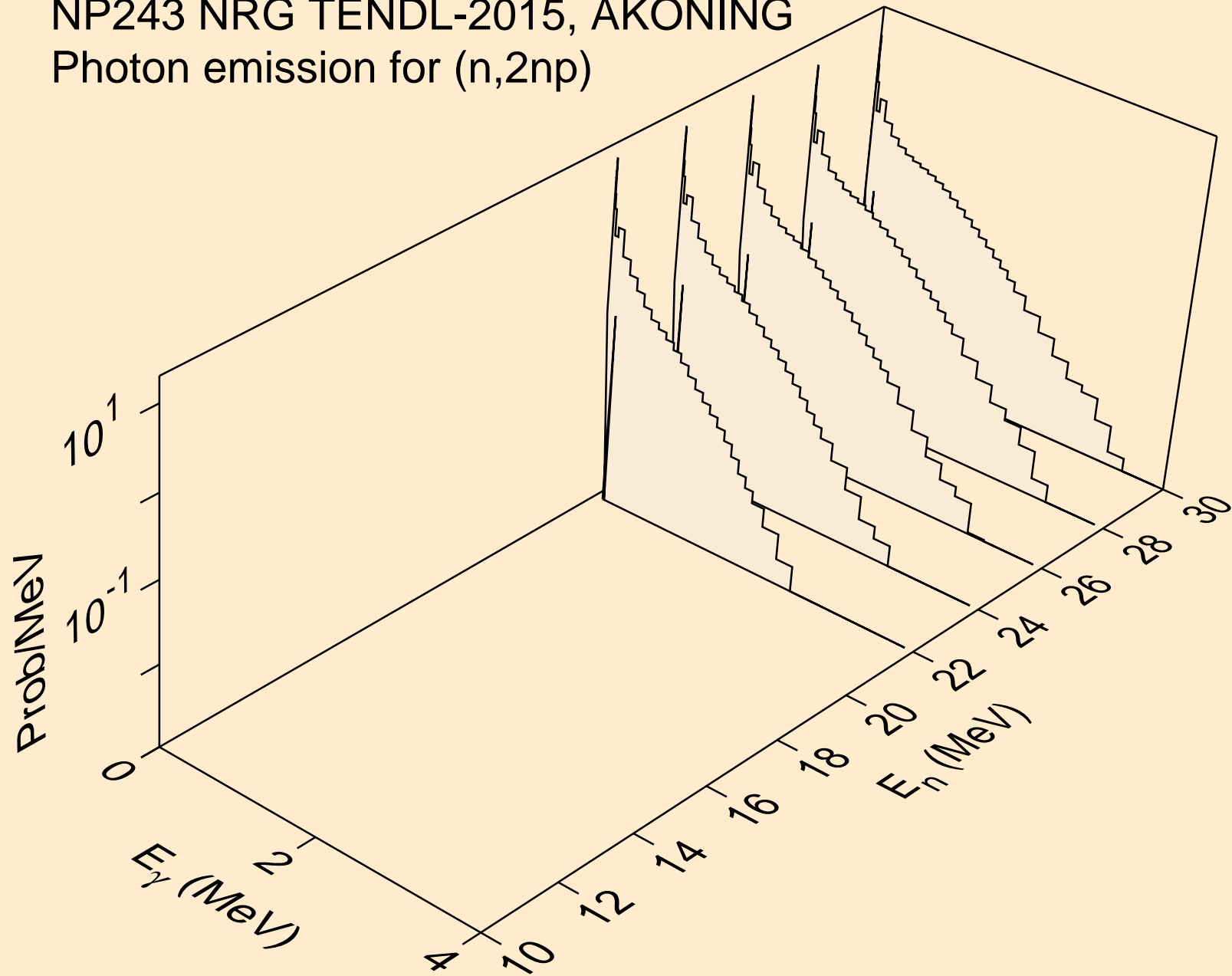

NP243 NRG TENDL-2015, AKONING
Photon emission for (n,3np)

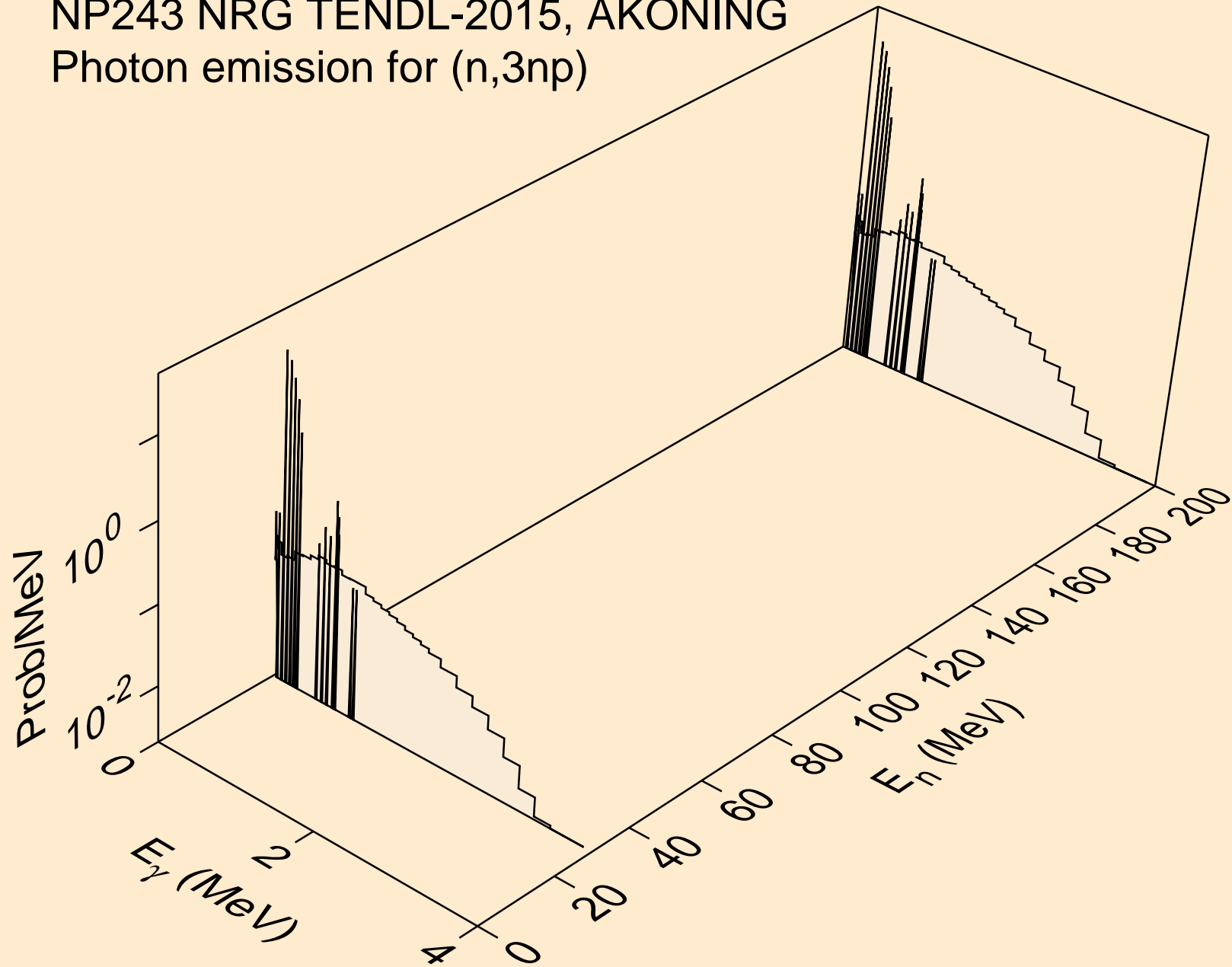

NP243 NRG TENDL-2015, AKONING
Photon emission for (n,2np)

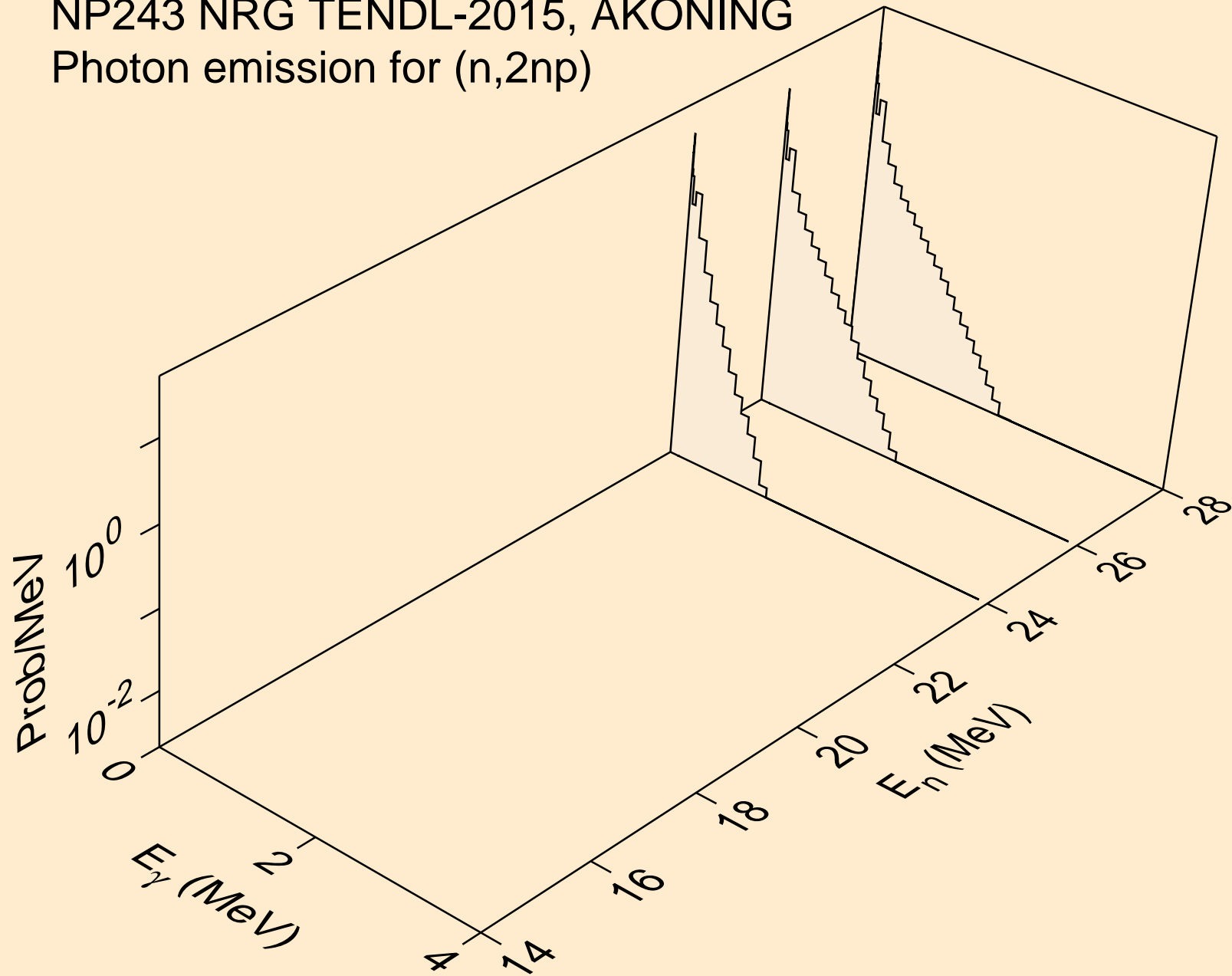

NP243 NRG TENDL-2015, AKONING
Photon emission for (n,n*c)

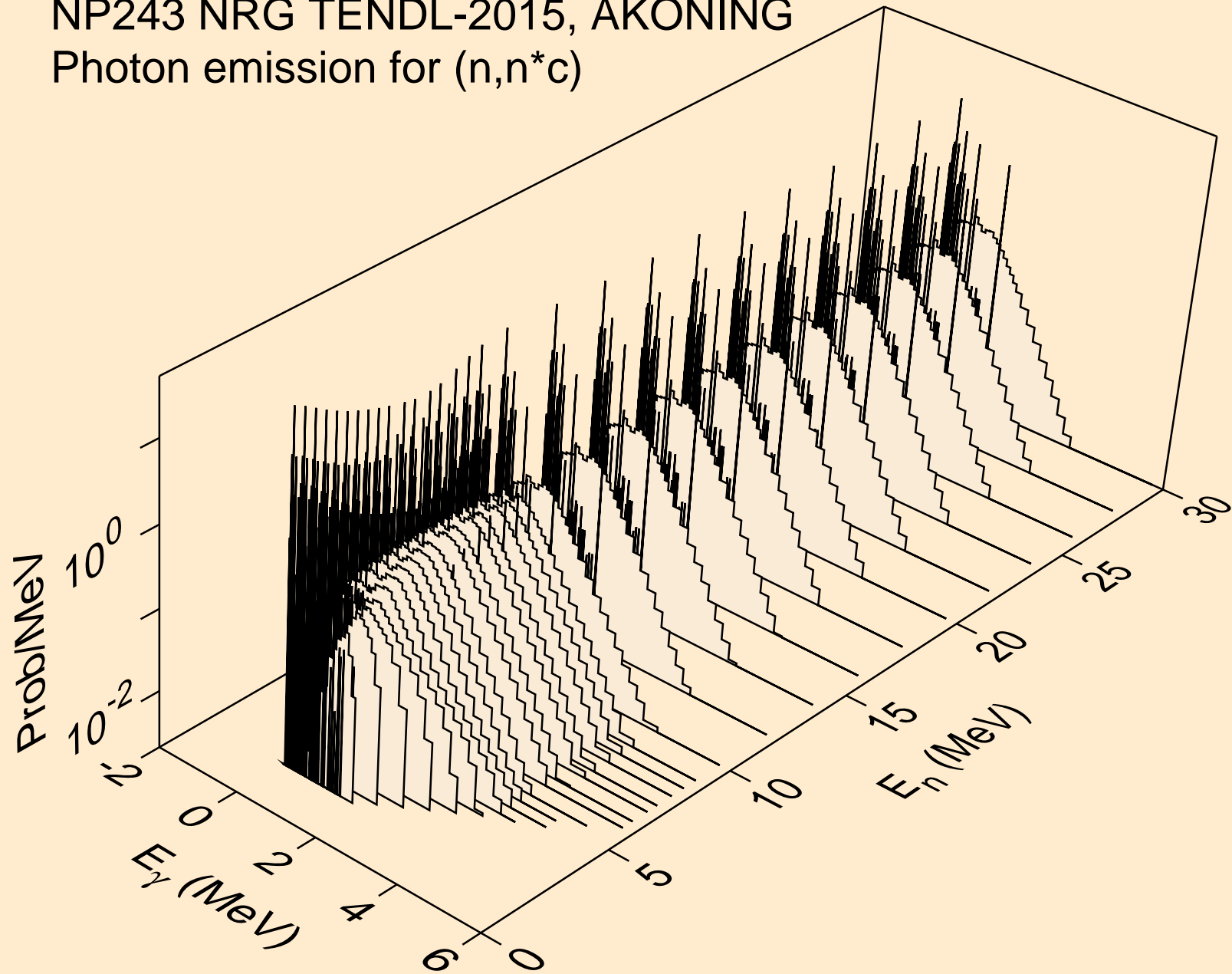

NP243 NRG TENDL-2015, AKONING
Photon emission for (n,gma)

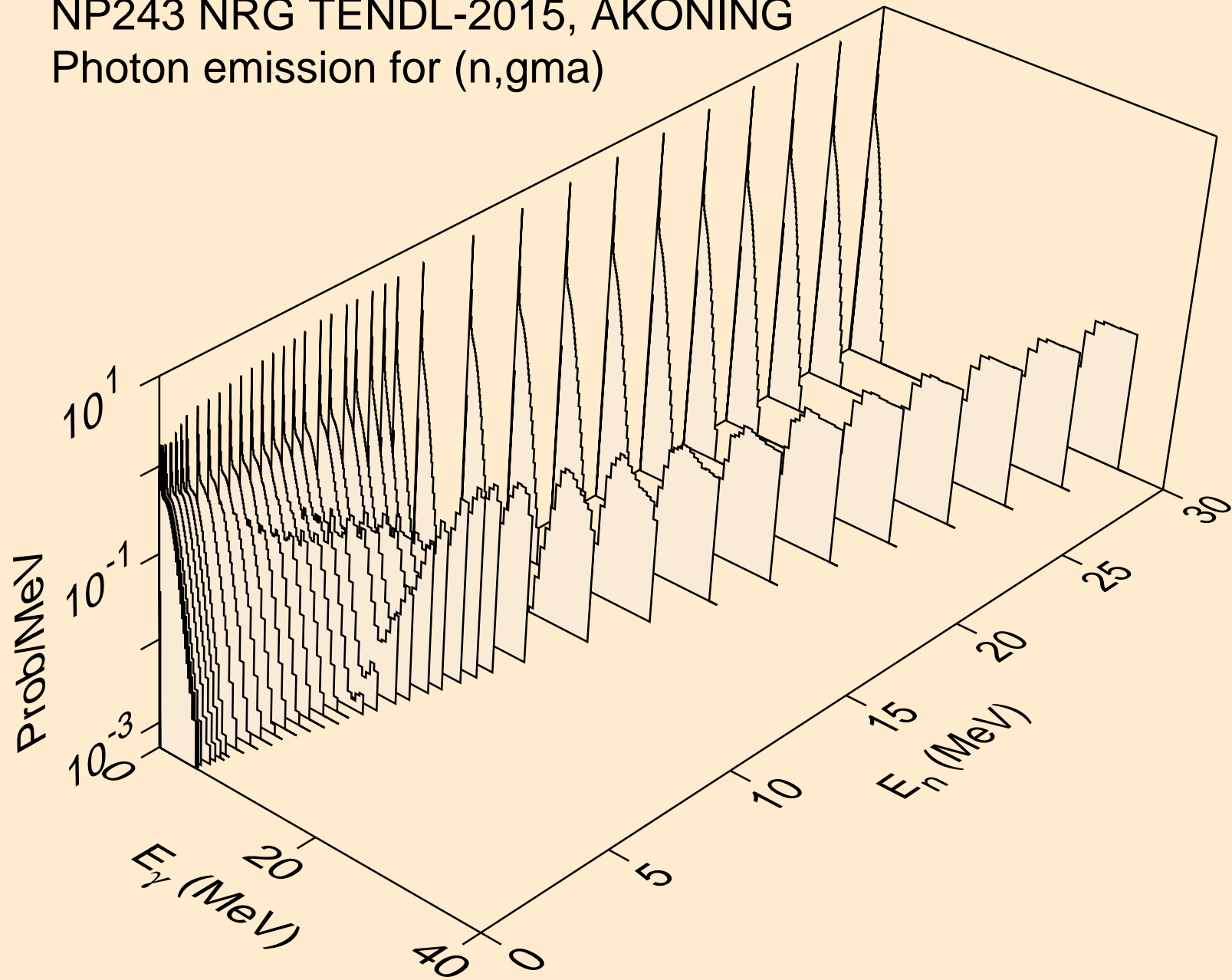

NP243 NRG TENDL-2015, AKONING
Photon emission for (n,p)

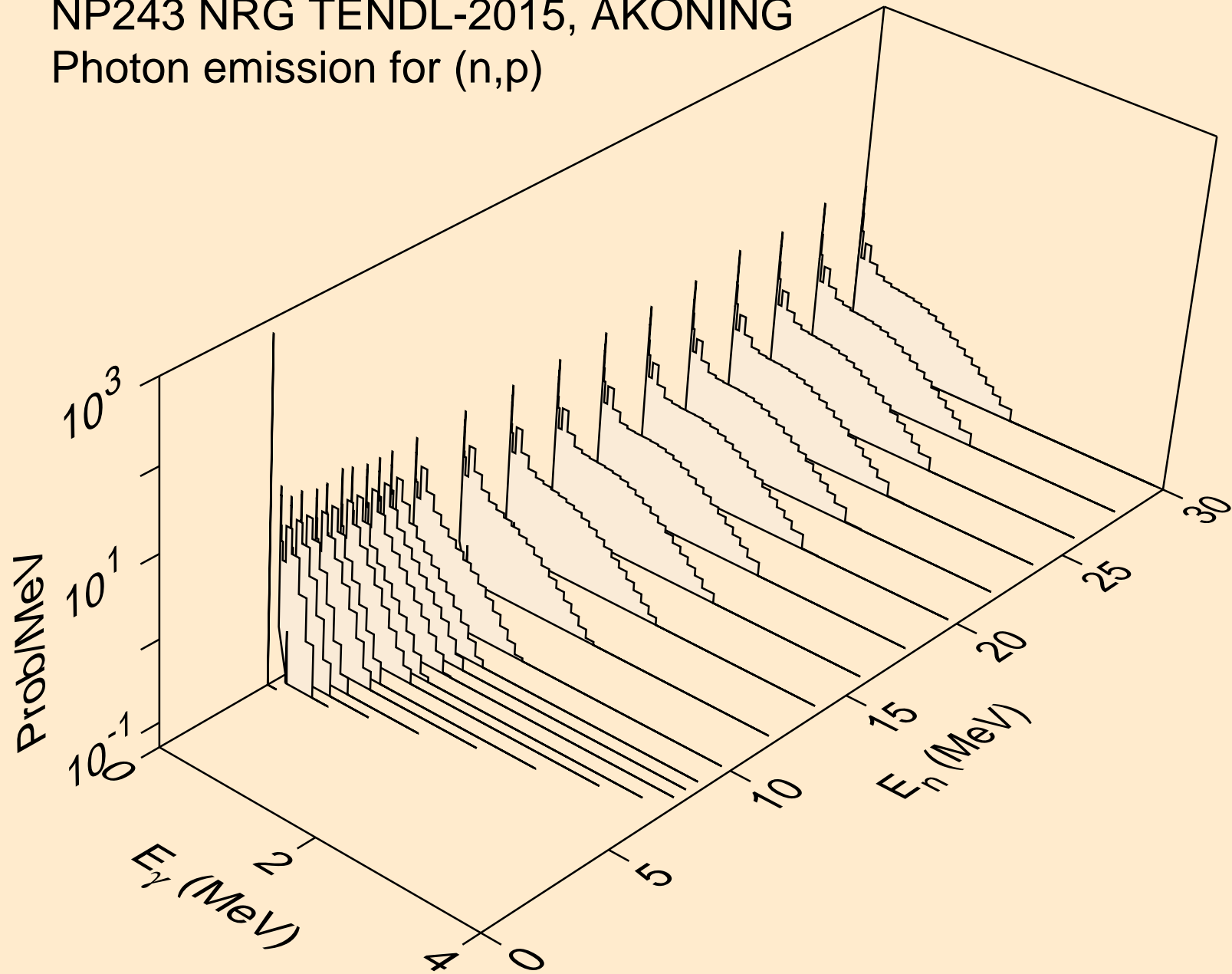

NP243 NRG TENDL-2015, AKONING
Photon emission for (n,d)

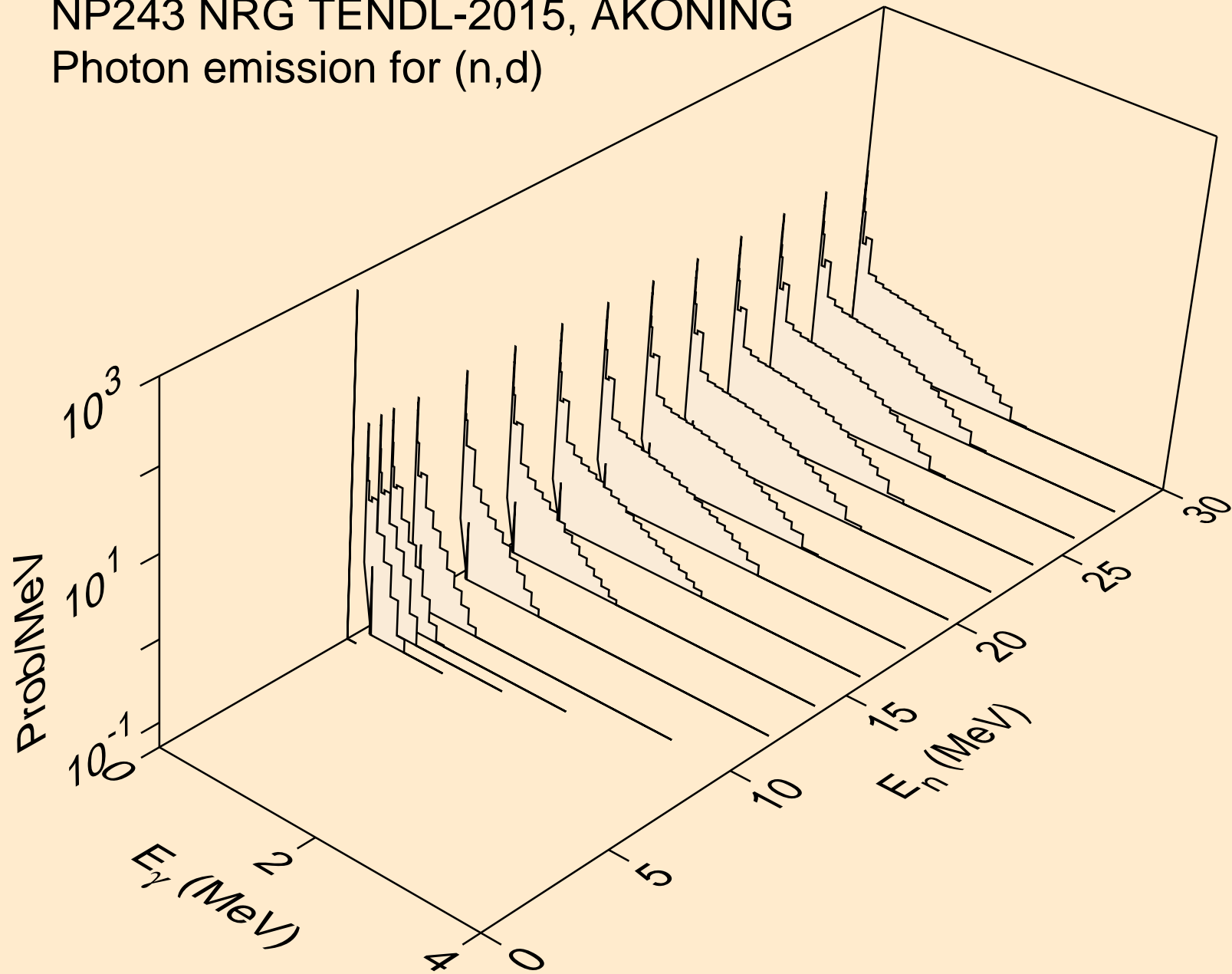

NP243 NRG TENDL-2015, AKONING
Photon emission for (n,t)

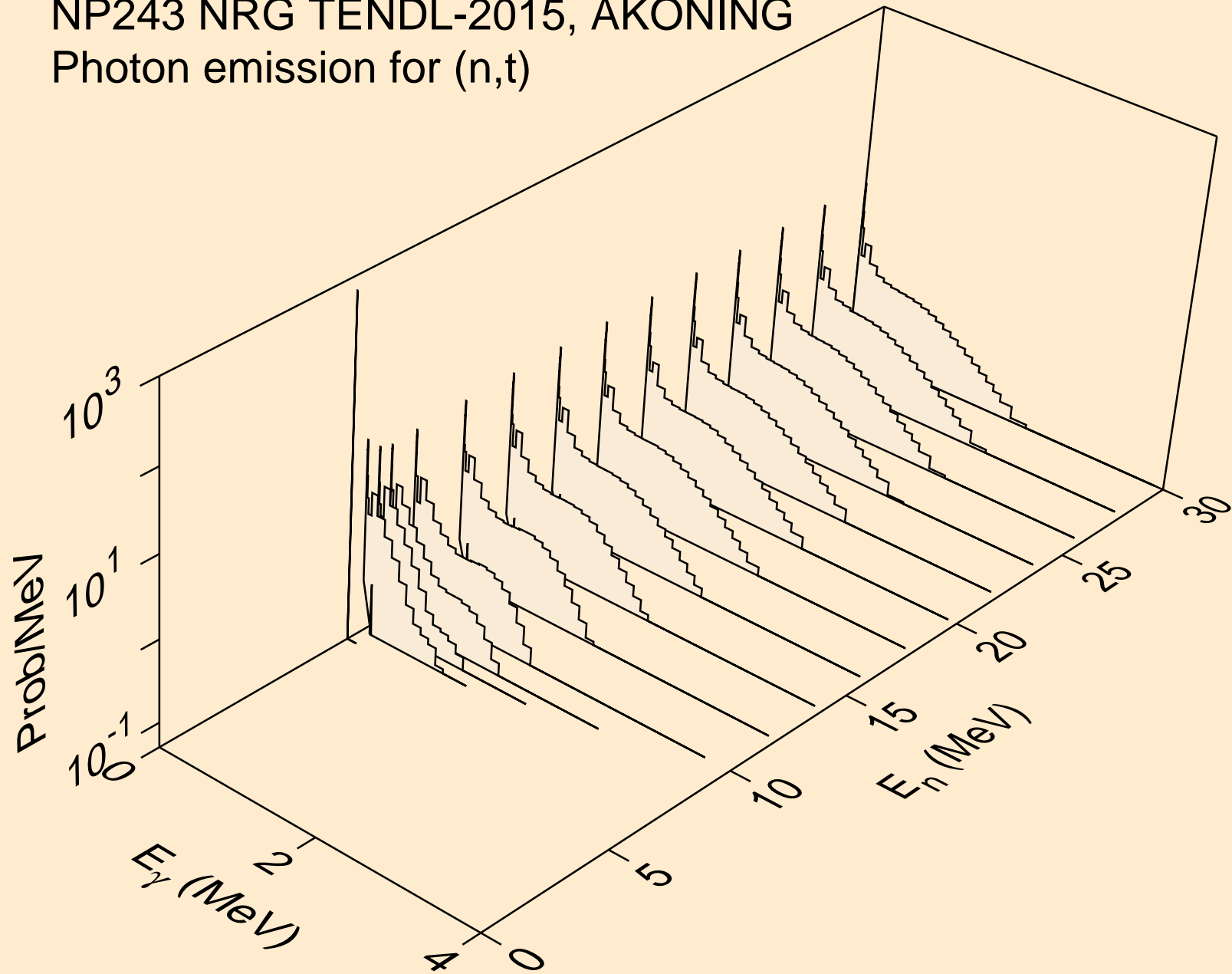

NP243 NRG TENDL-2015, AKONING
Photon emission for (n,he3)

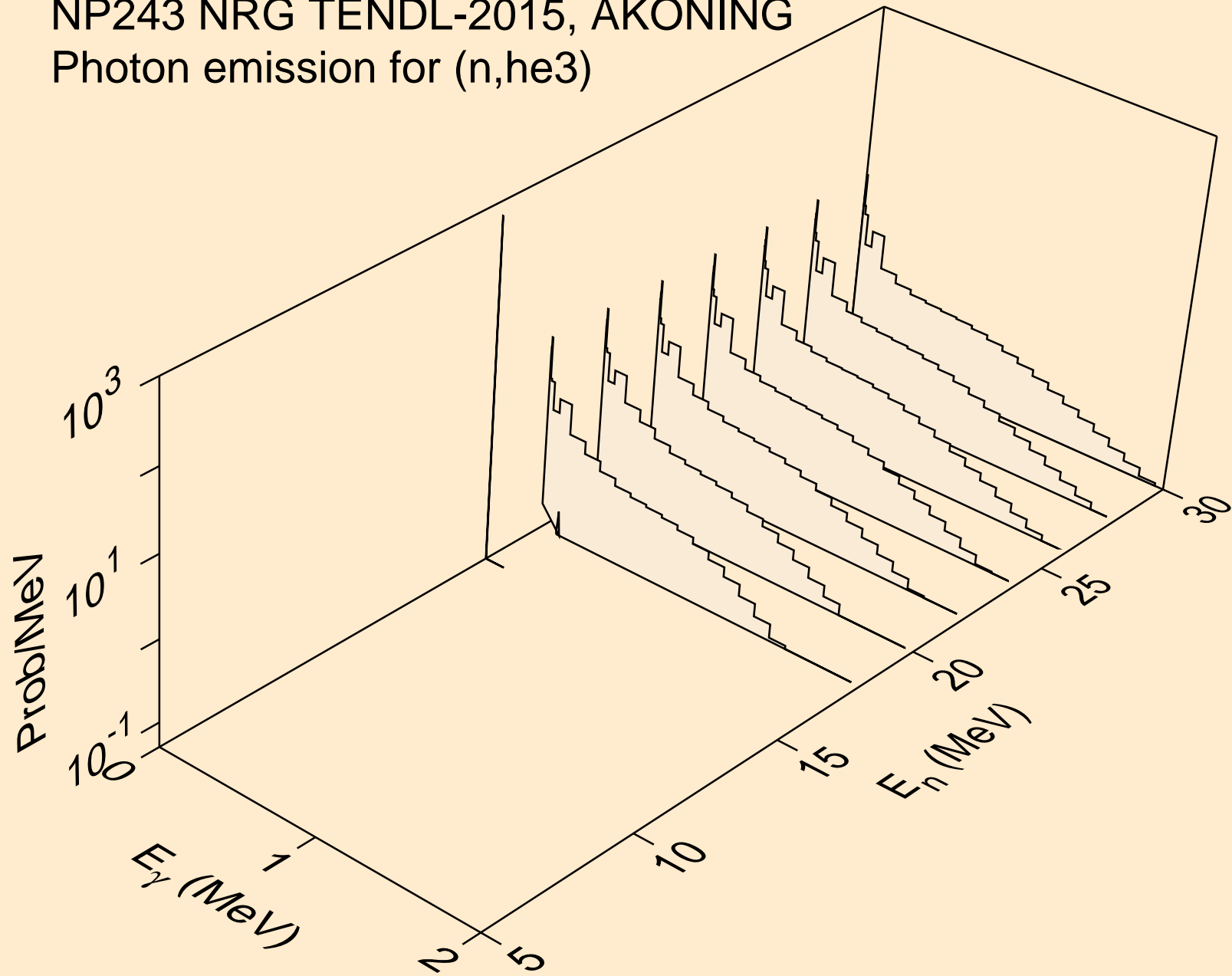

NP243 NRG TENDL-2015, AKONING
Photon emission for (n,a)

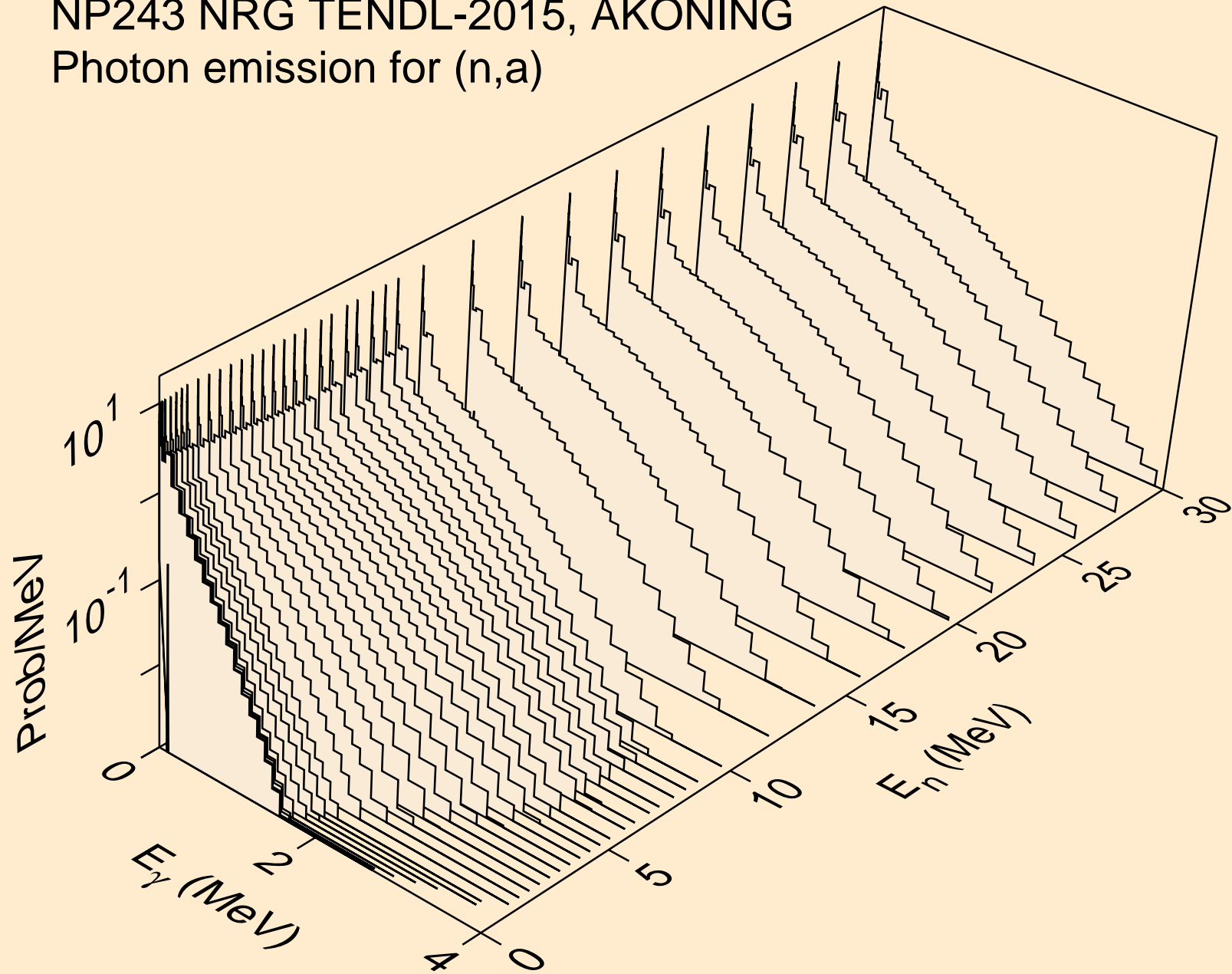

NP243 NRG TENDL-2015, AKONING
Photon emission for (n,2p)

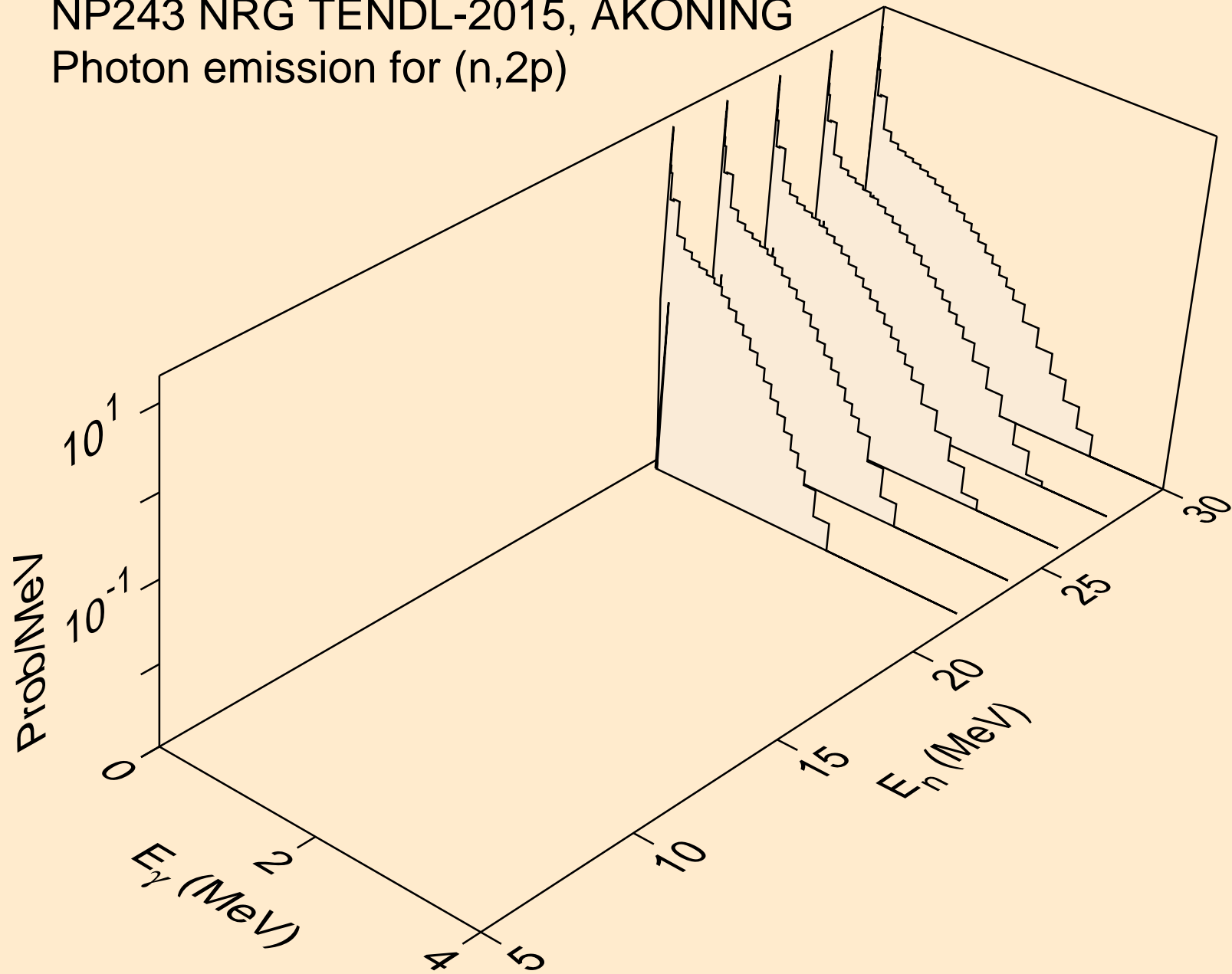

NP243 NRG TENDL-2015, AKONING
thermal capture photon spectrum

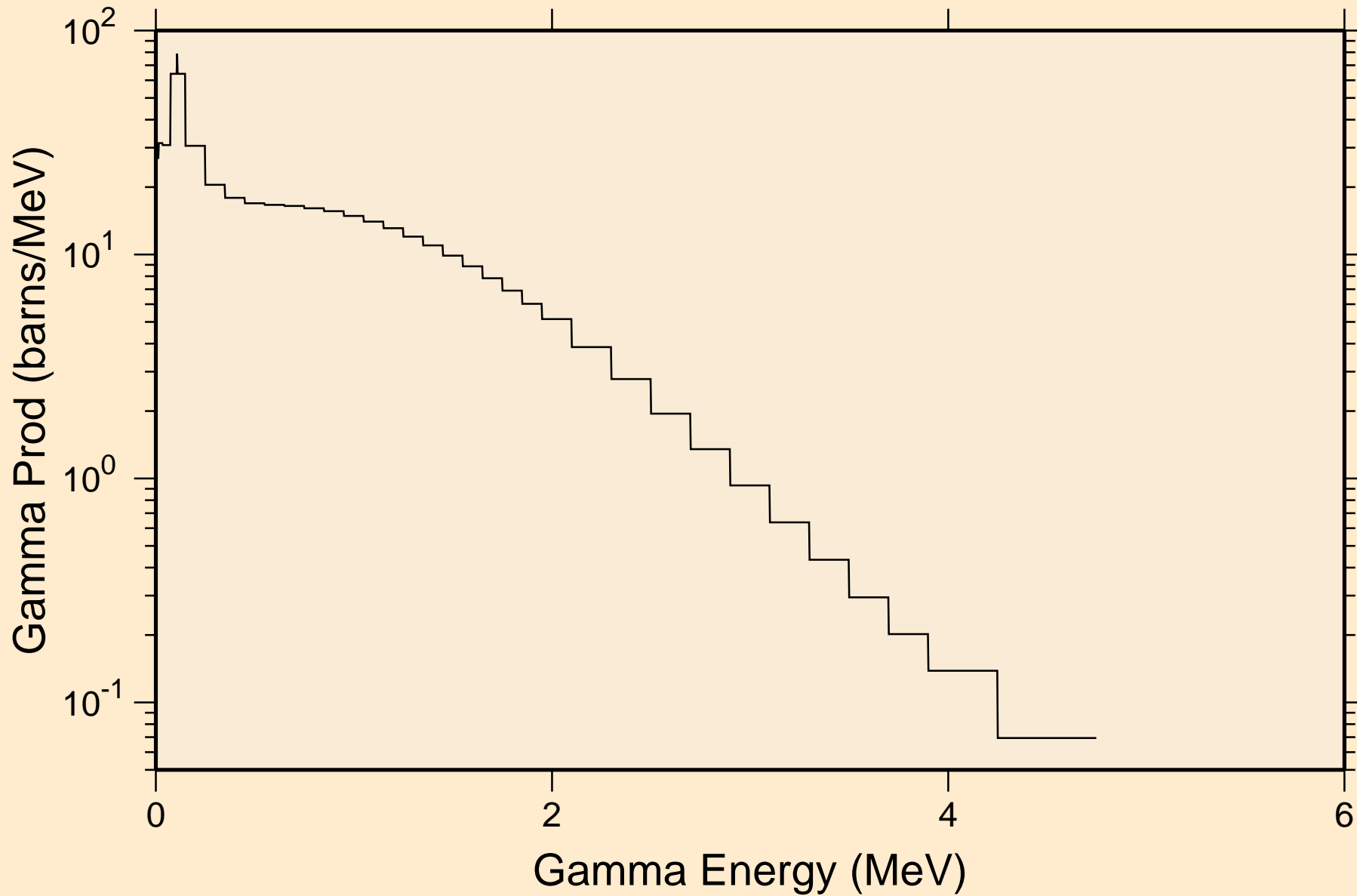

NP243 NRG TENDL-2015, AKONING
14 MeV photon spectrum

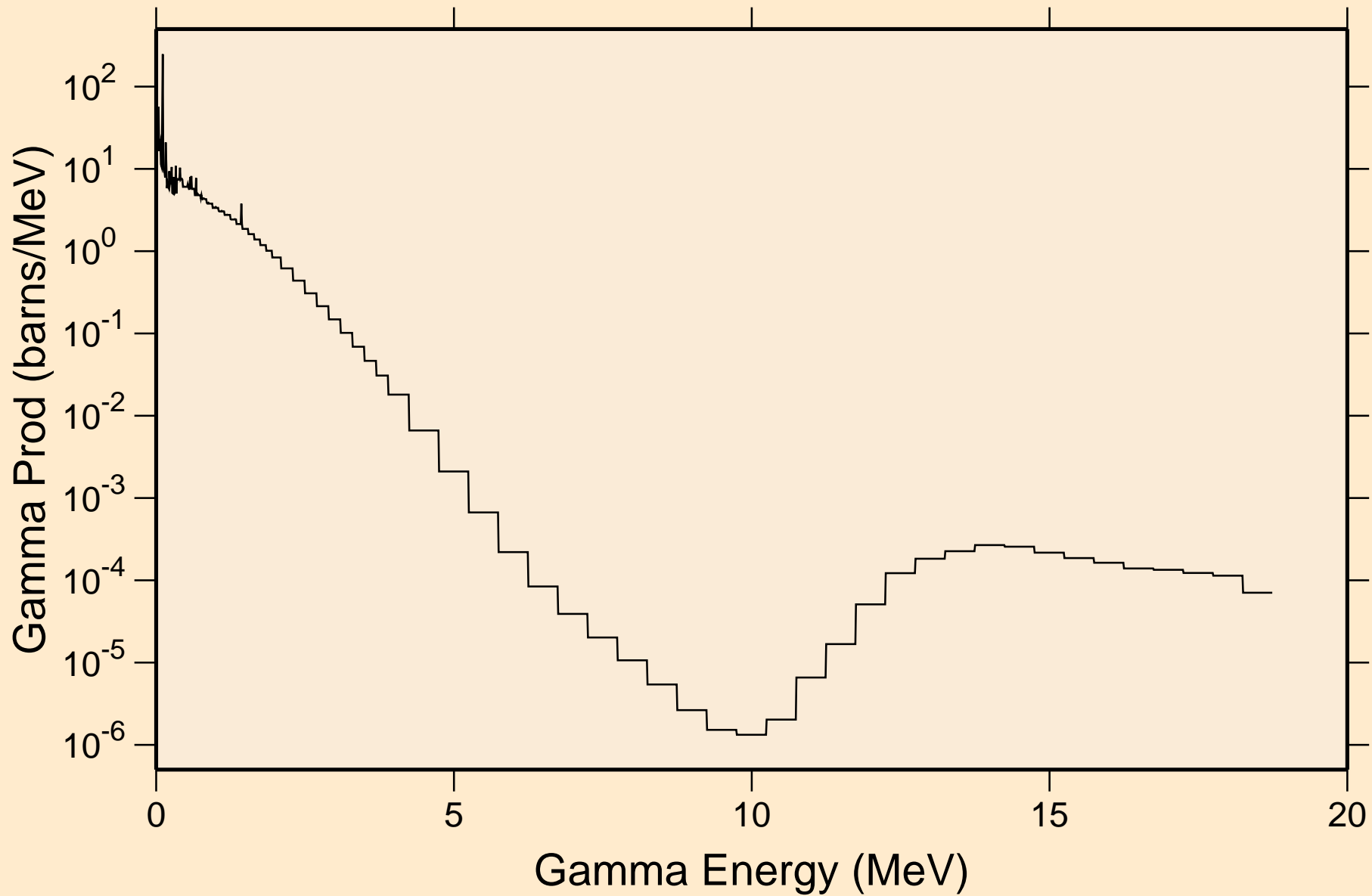

NP243 NRG TENDL-2015, AKONING

Particle heating contributions

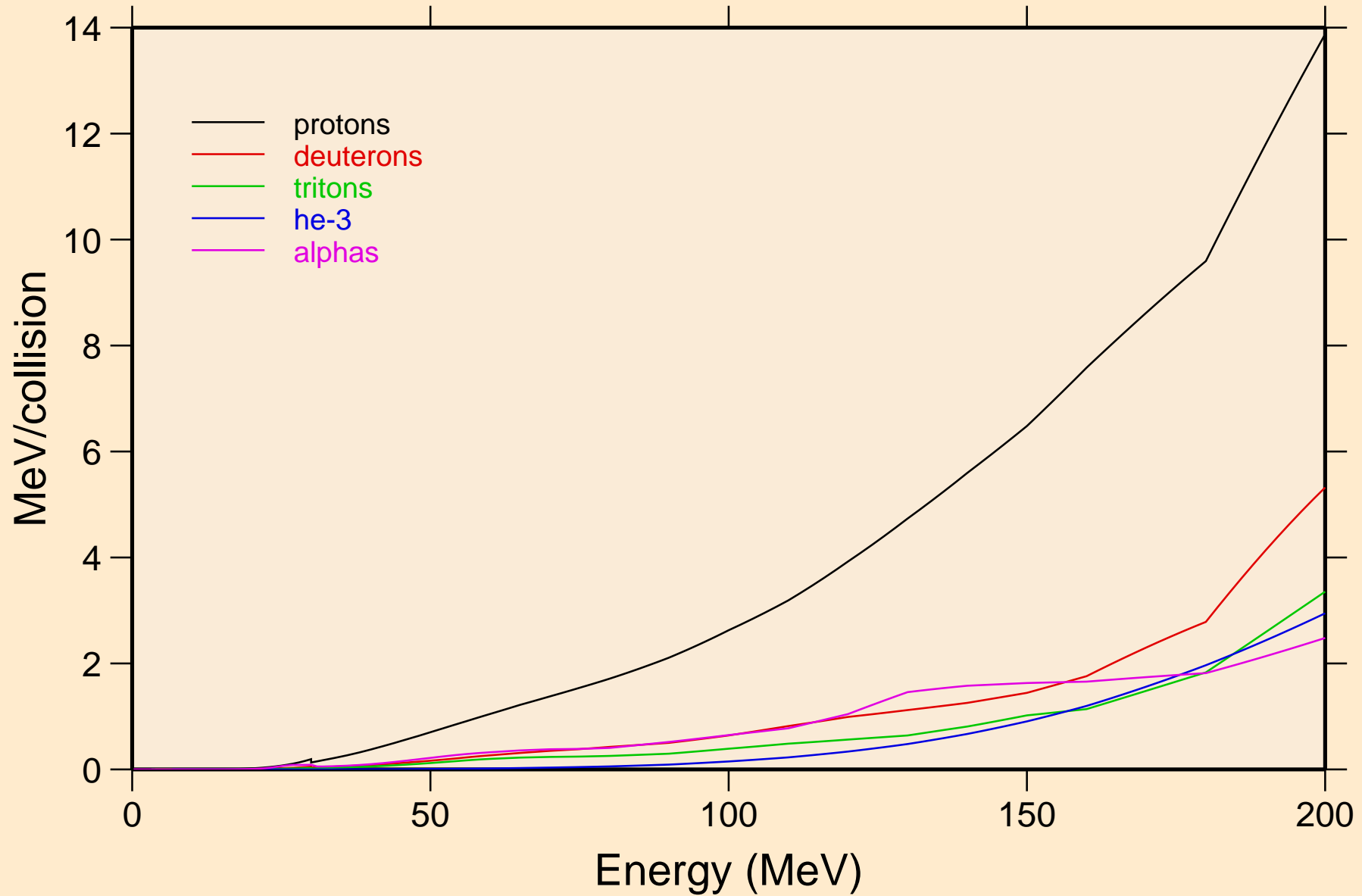

NP243 NRG TENDL-2015, AKONING

Recoil Heating

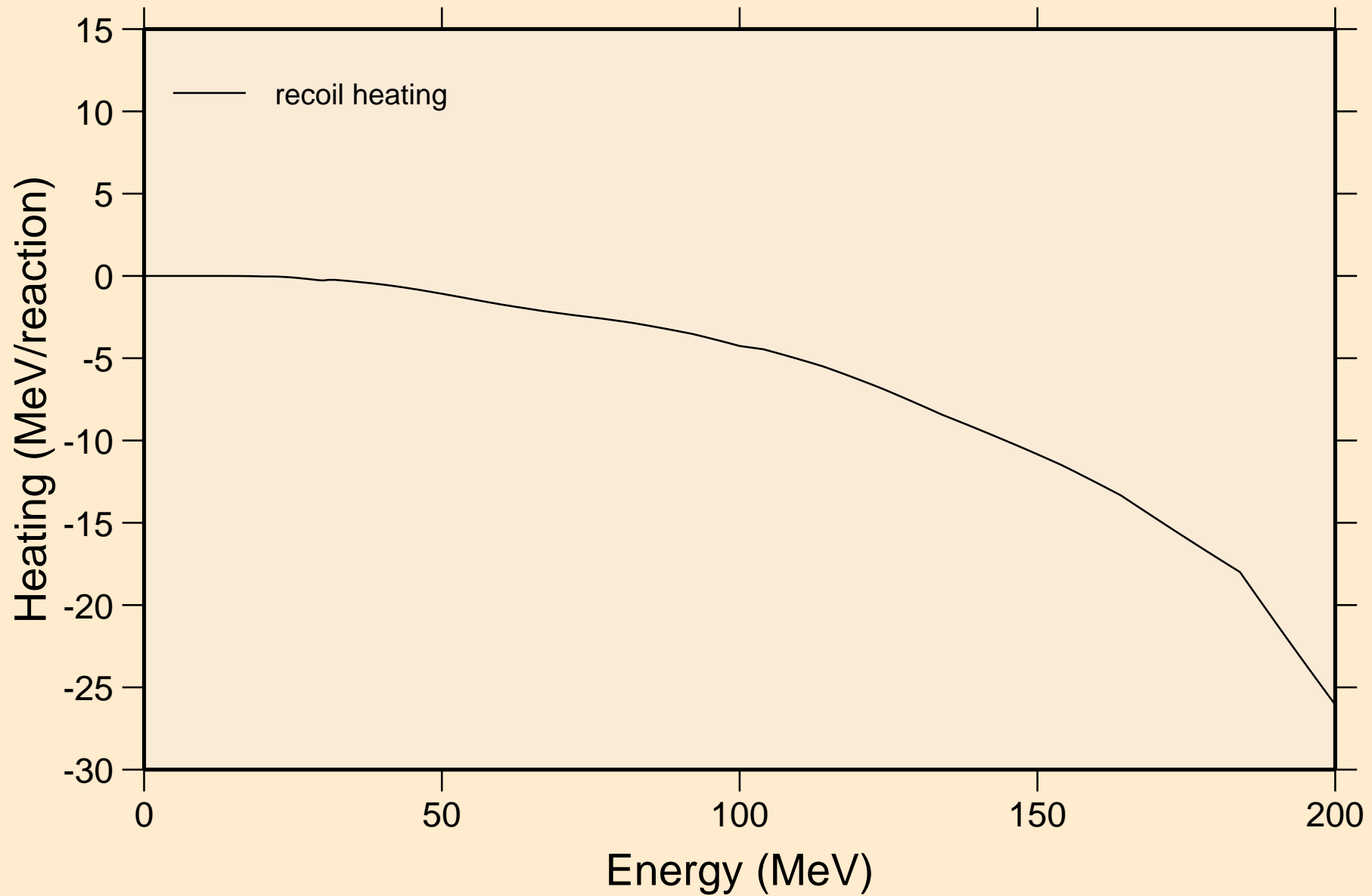

NP243 NRG TENDL-2015, AKONING

Particle production cross sections

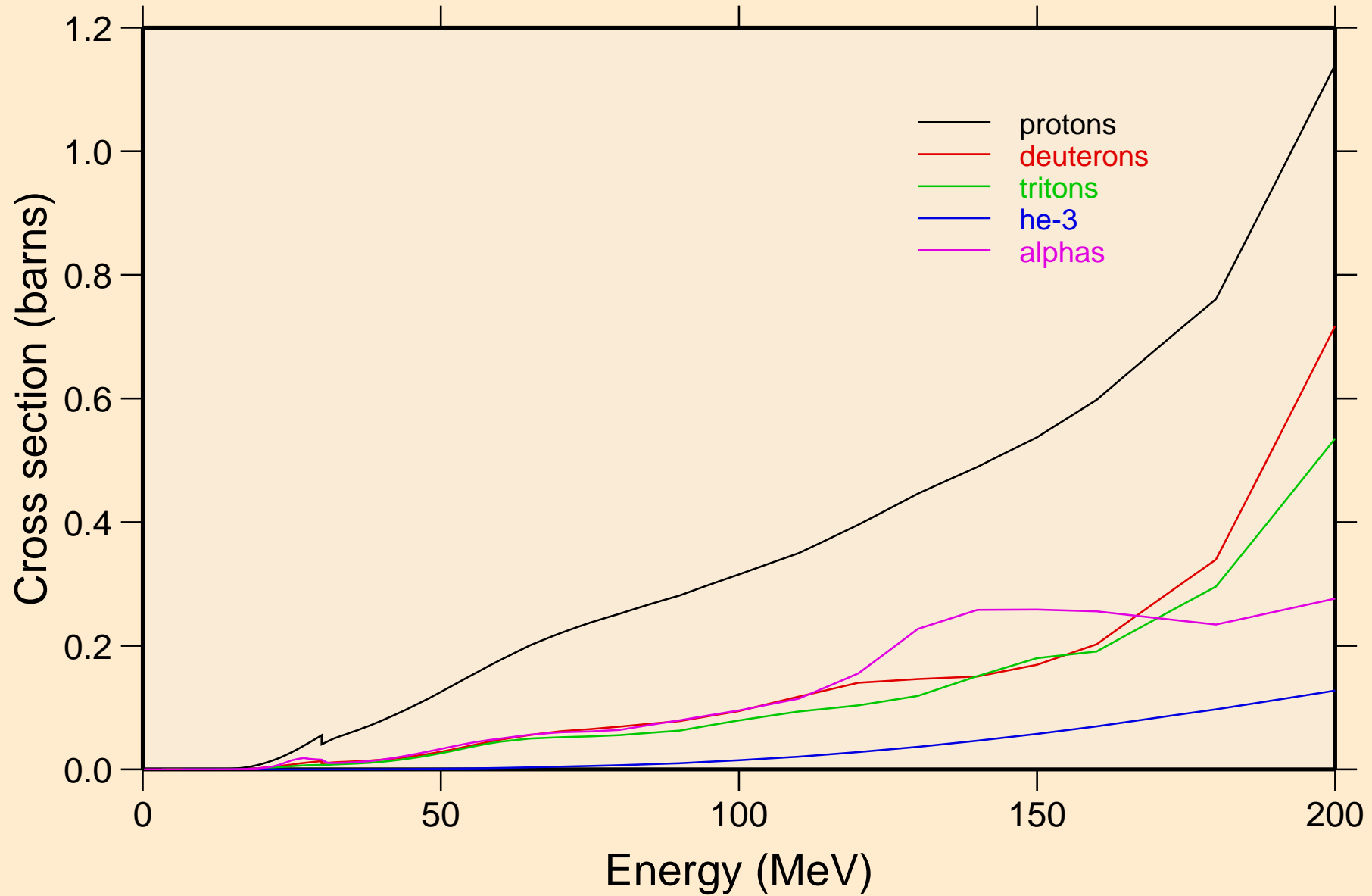

NP243 NRG TENDL-2015, AKONING
protons from (n,x)

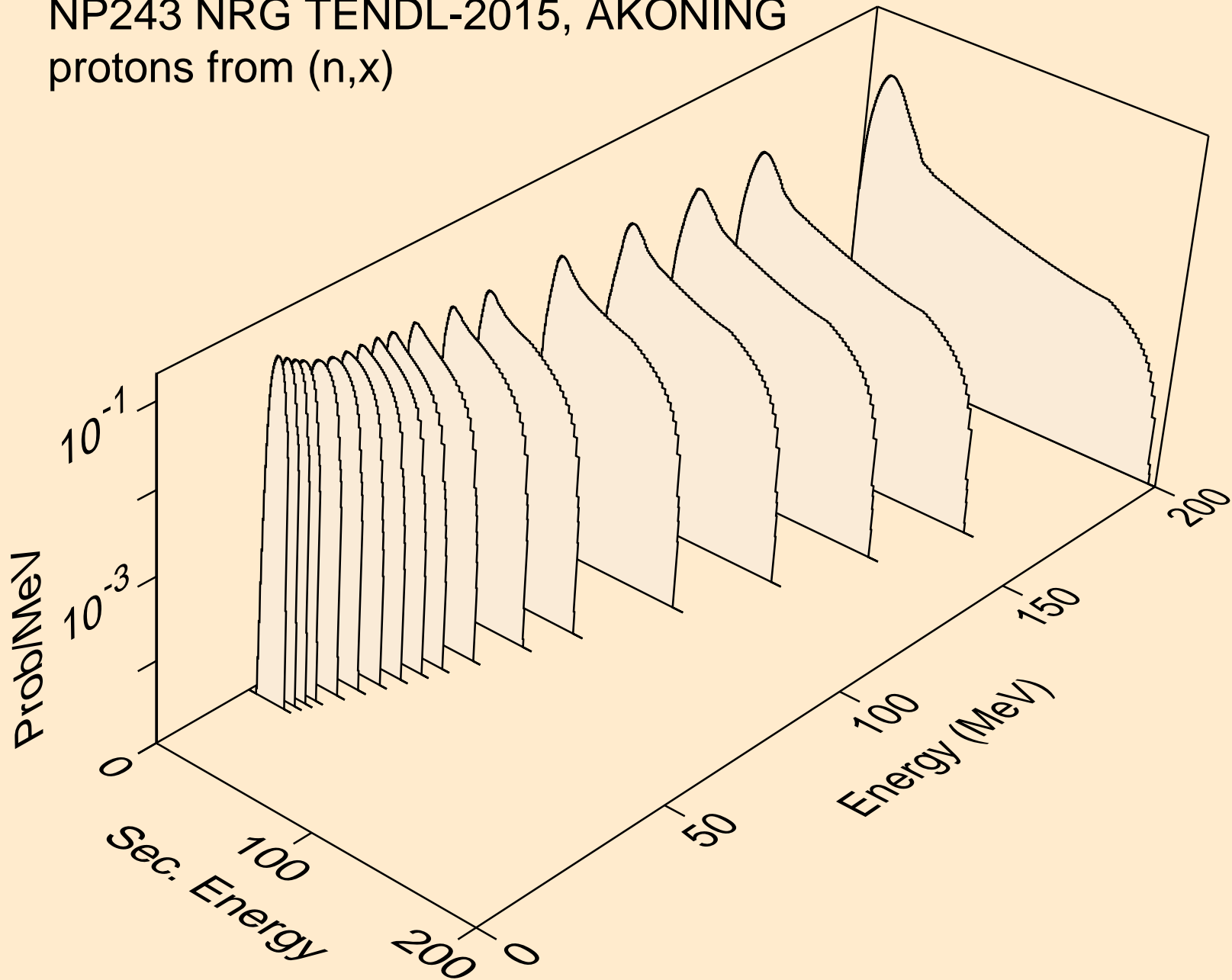

NP243 NRG TENDL-2015, AKONING
protons from (n,n*)p

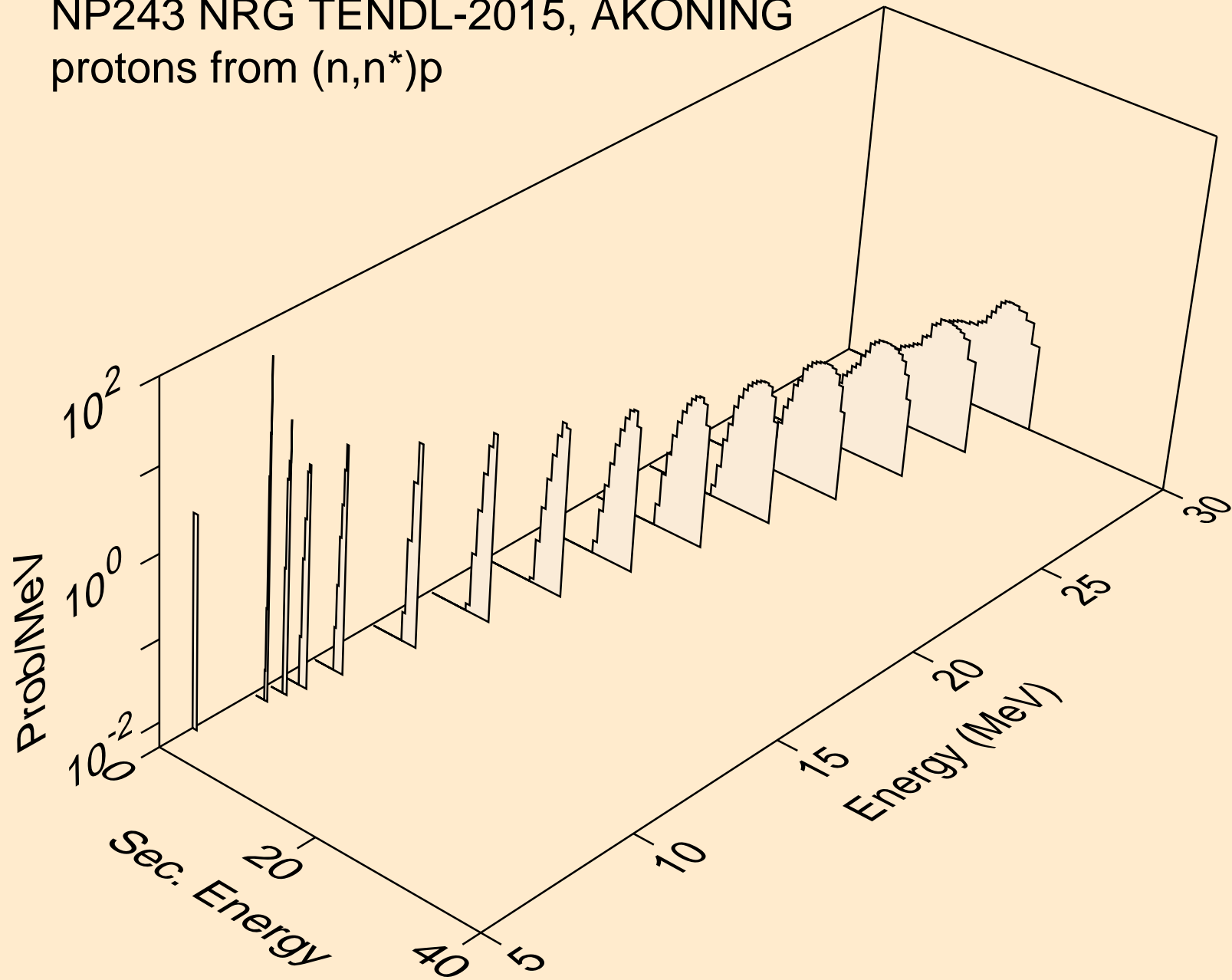

NP243 NRG TENDL-2015, AKONING
protons from (n,2np)

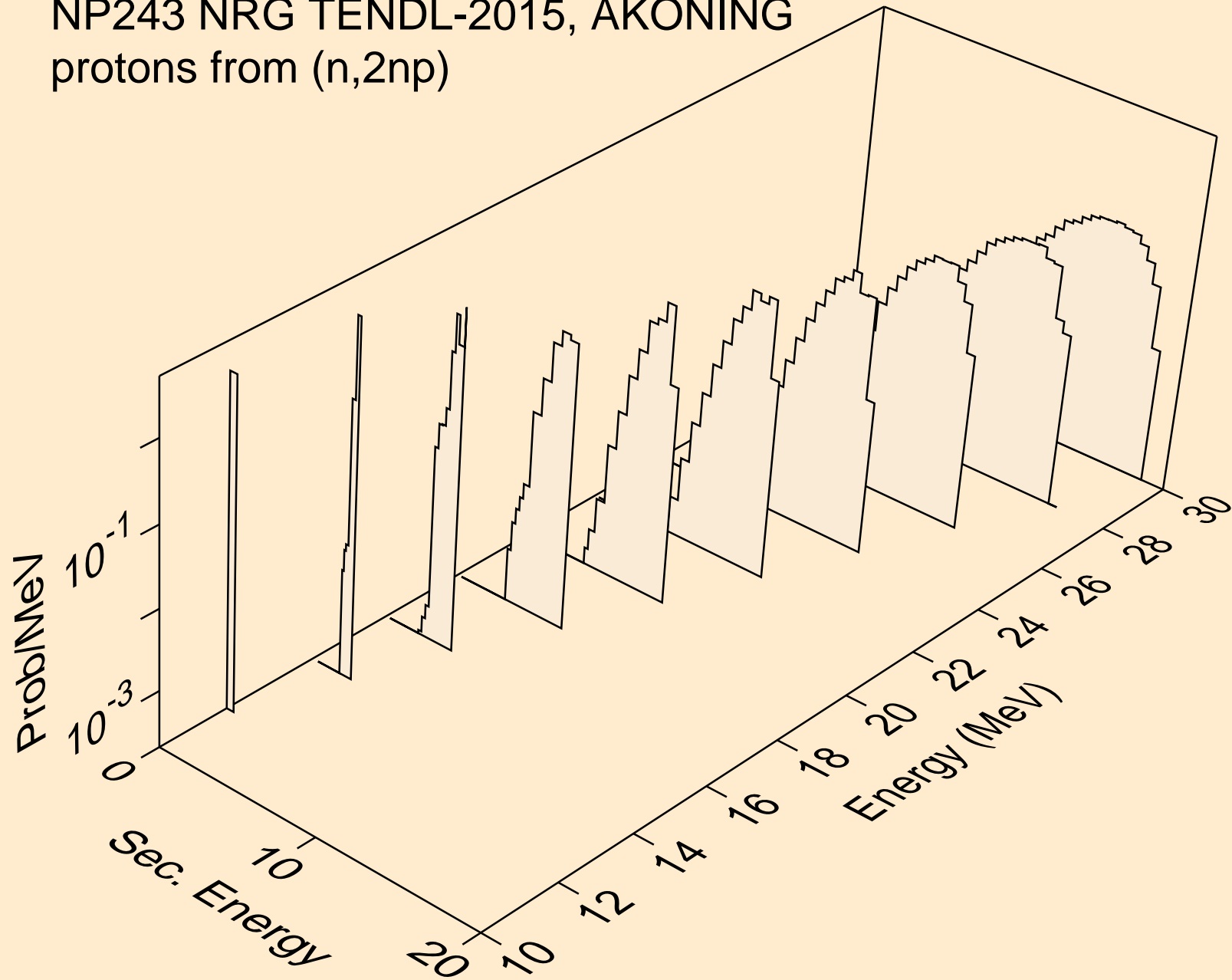

NP243 NRG TENDL-2015, AKONING
protons from (n,3np)

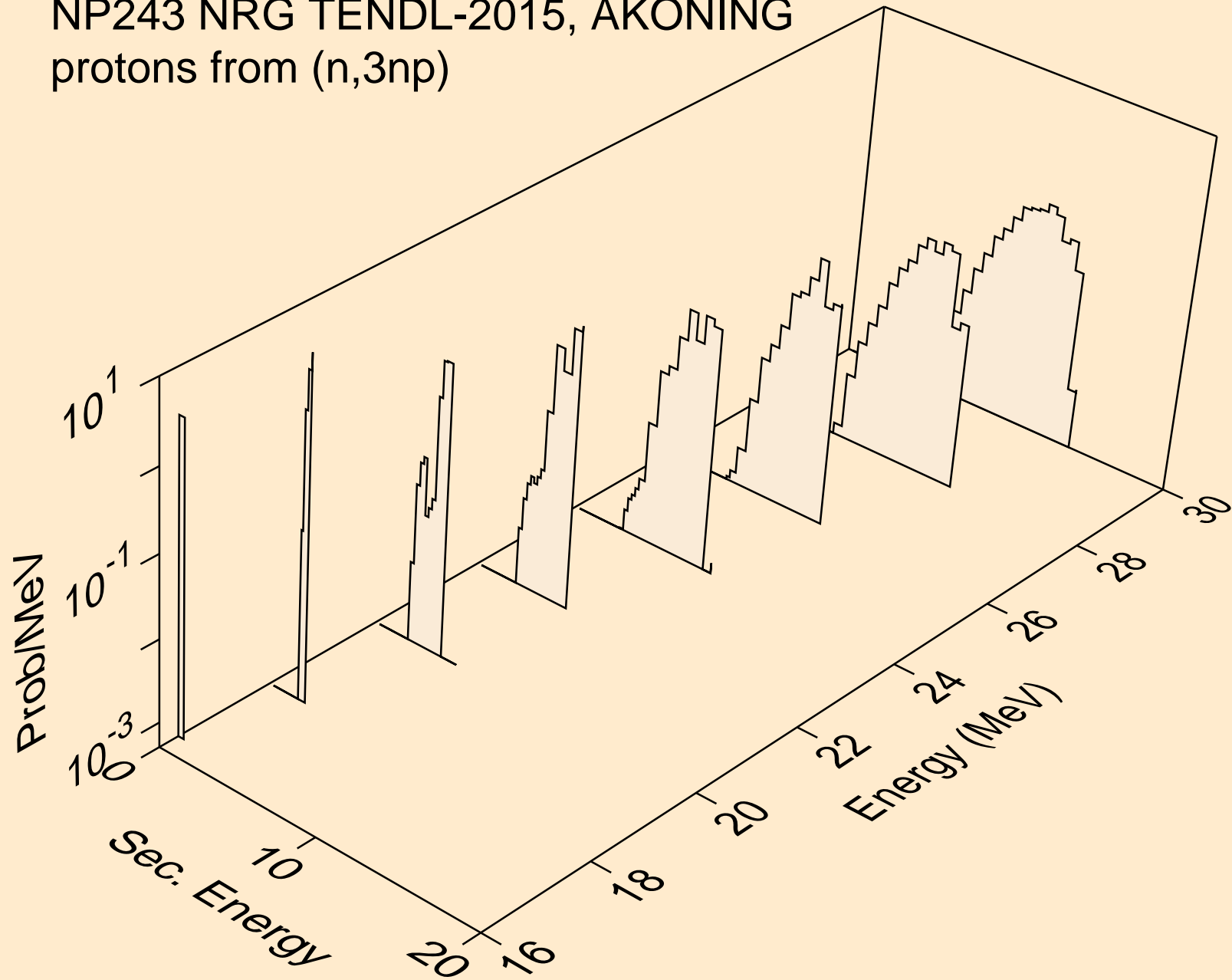

NP243 NRG TENDL-2015, AKONING
protons from (n,2np)

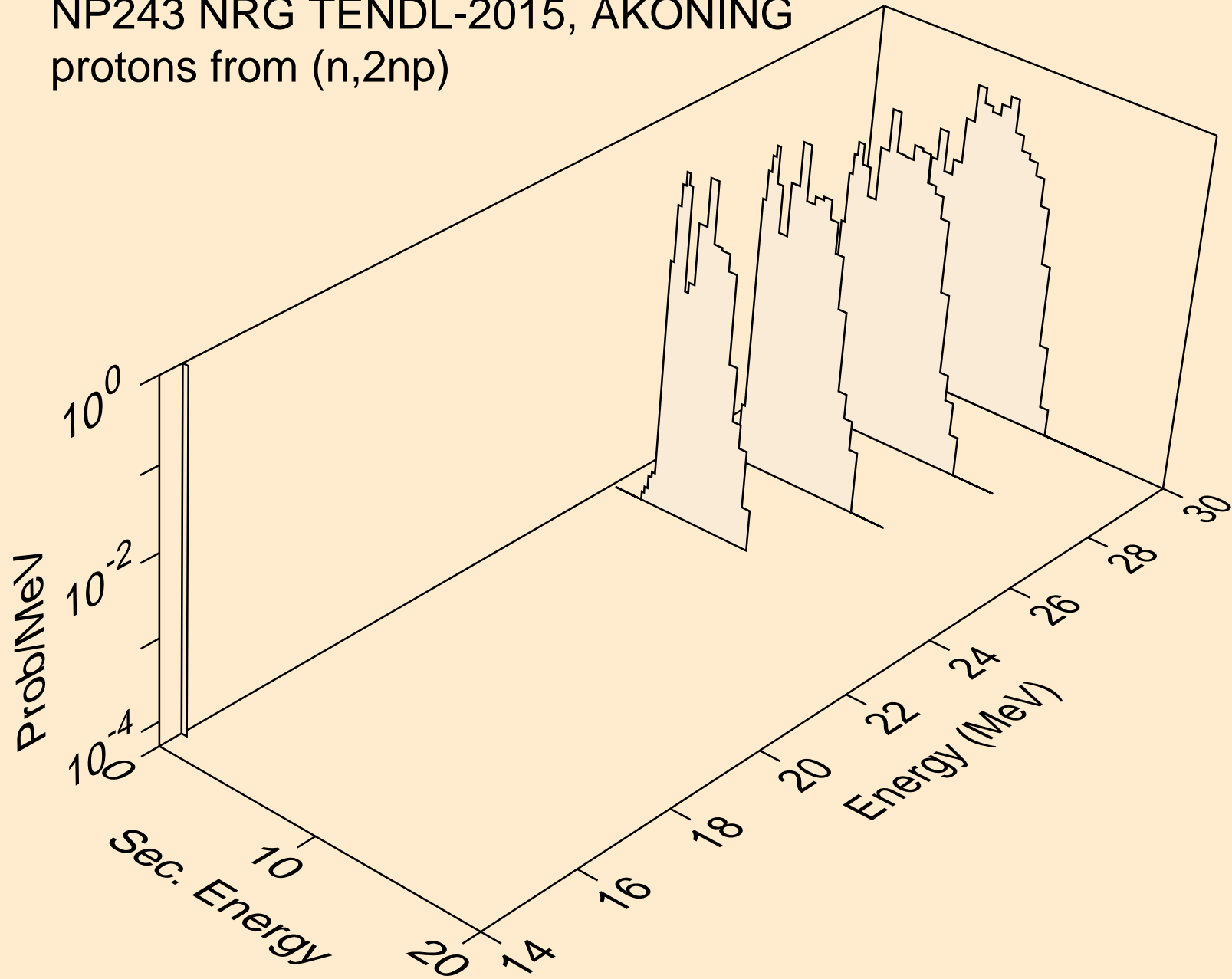

NP243 NRG TENDL-2015, AKONING
protons from (n,p)

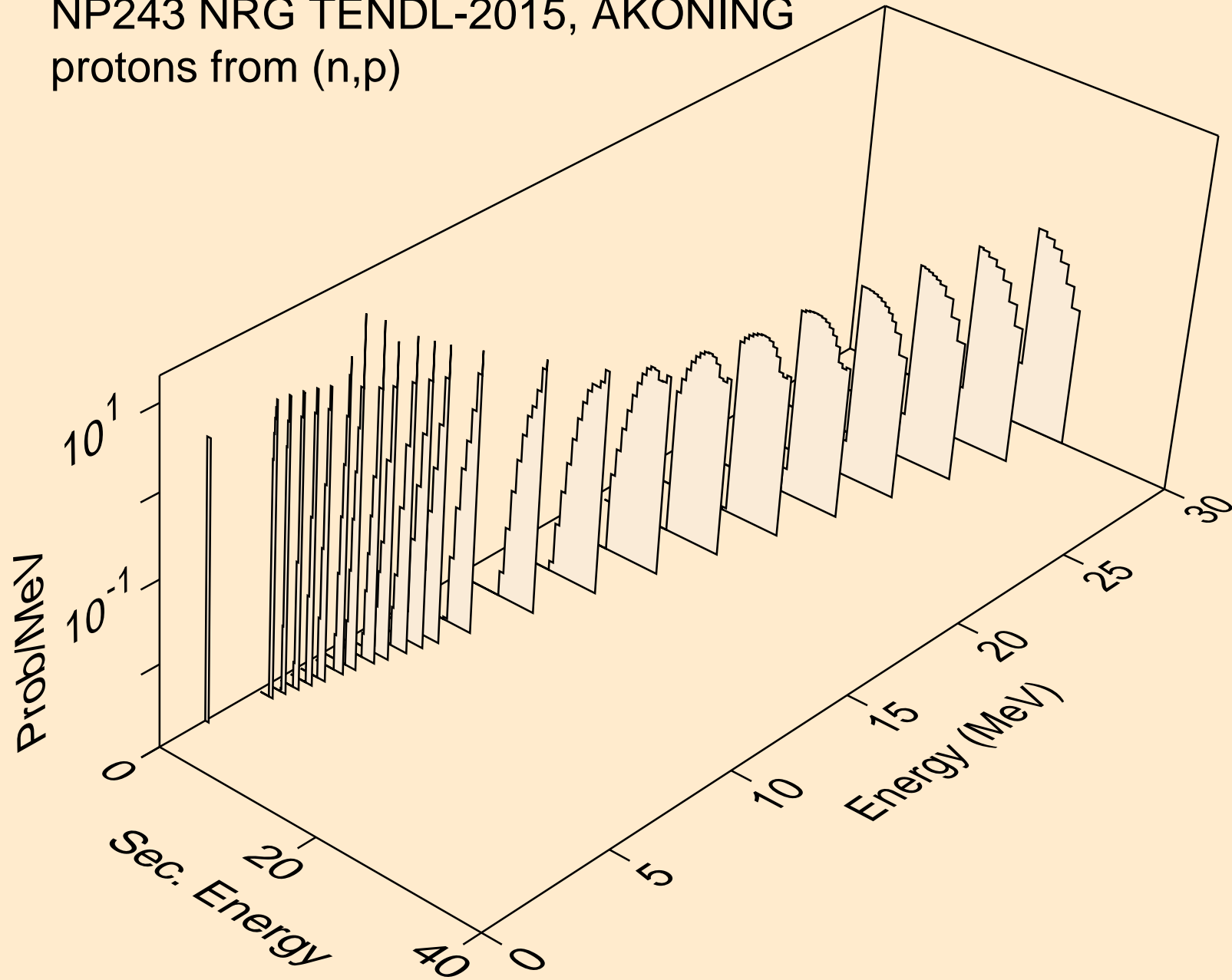

NP243 NRG TENDL-2015, AKONING
protons from (n,2p)

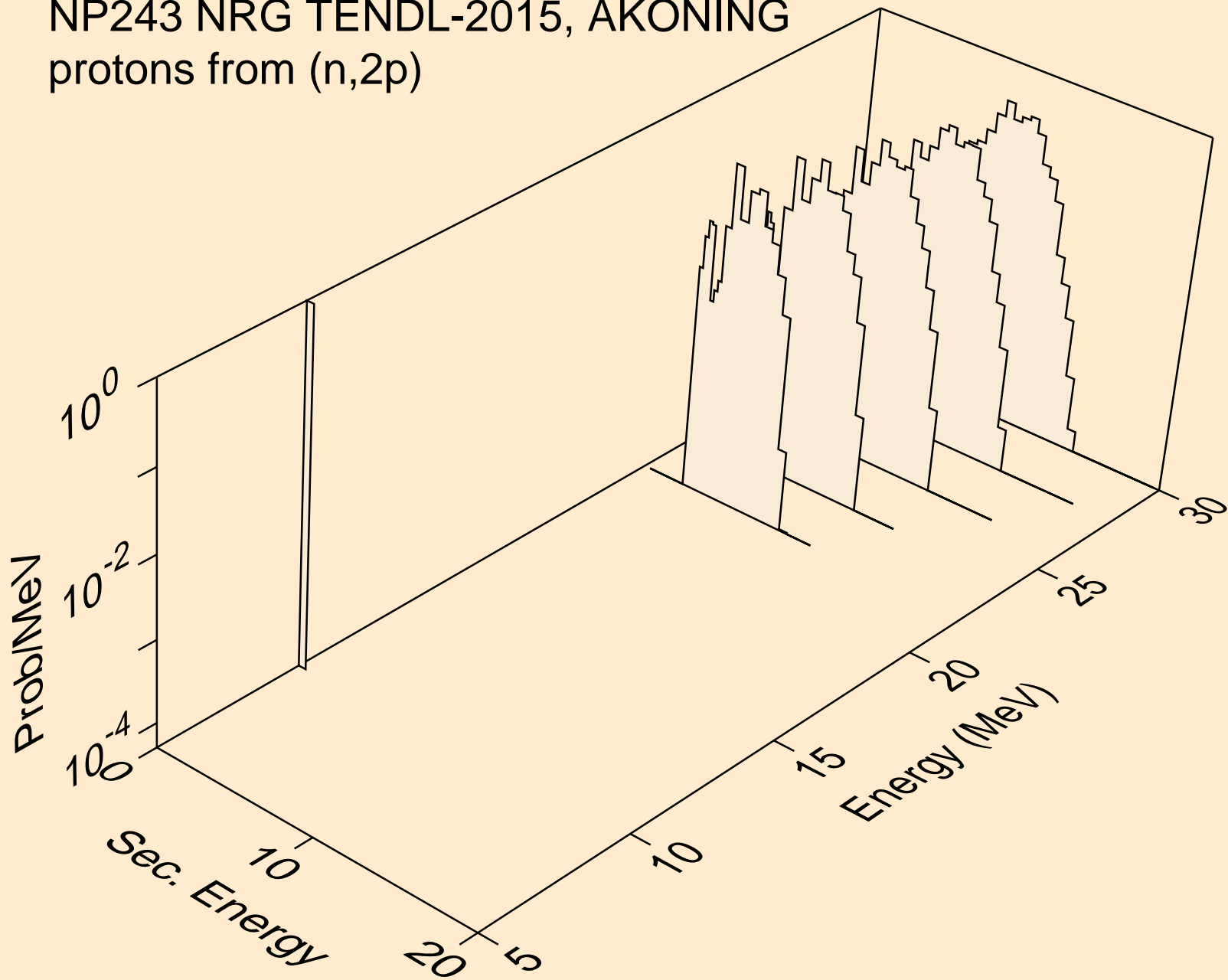

NP243 NRG TENDL-2015, AKONING
deuterons from (n,x)

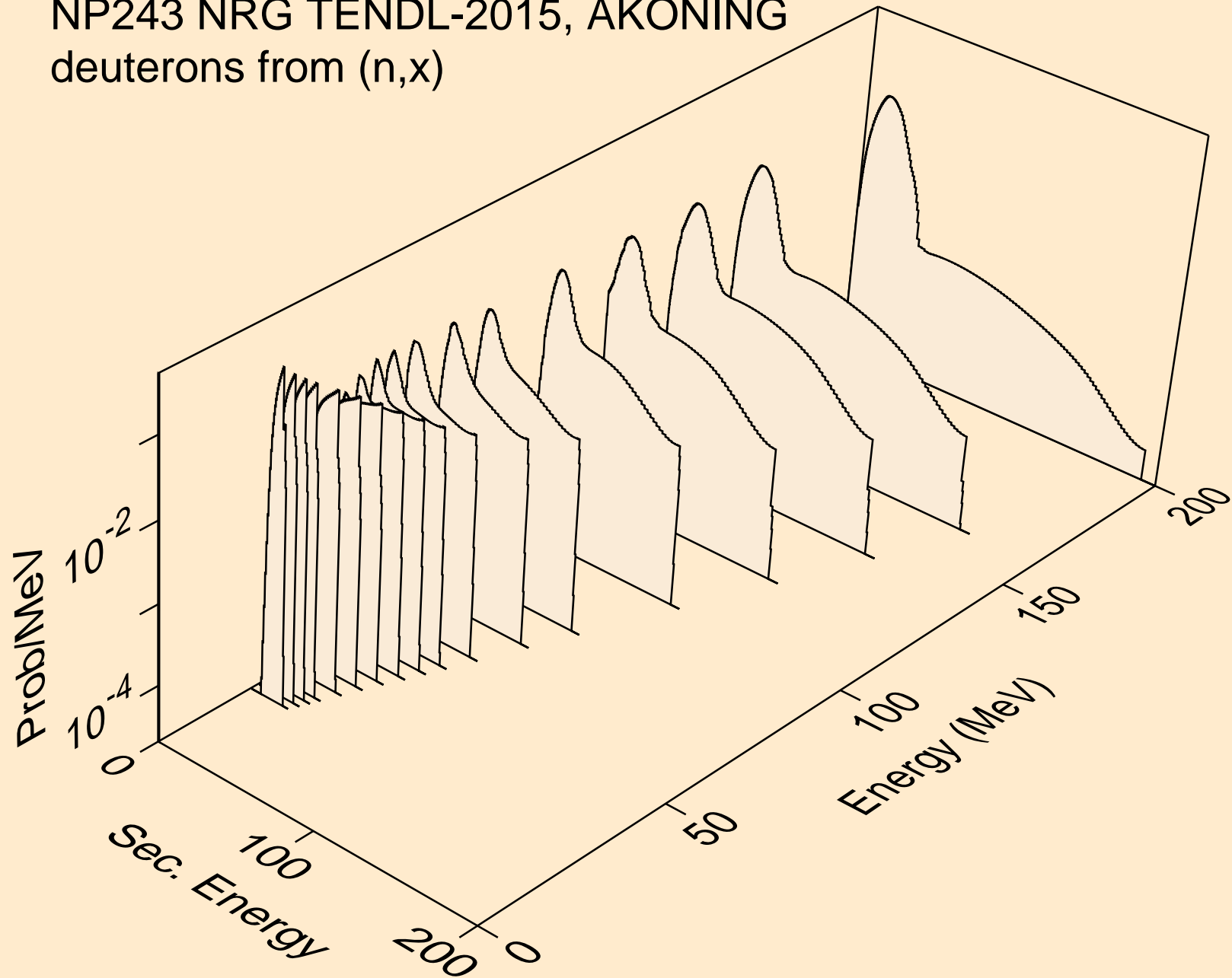

NP243 NRG TENDL-2015, AKONING
deuterons from (n,2nd)

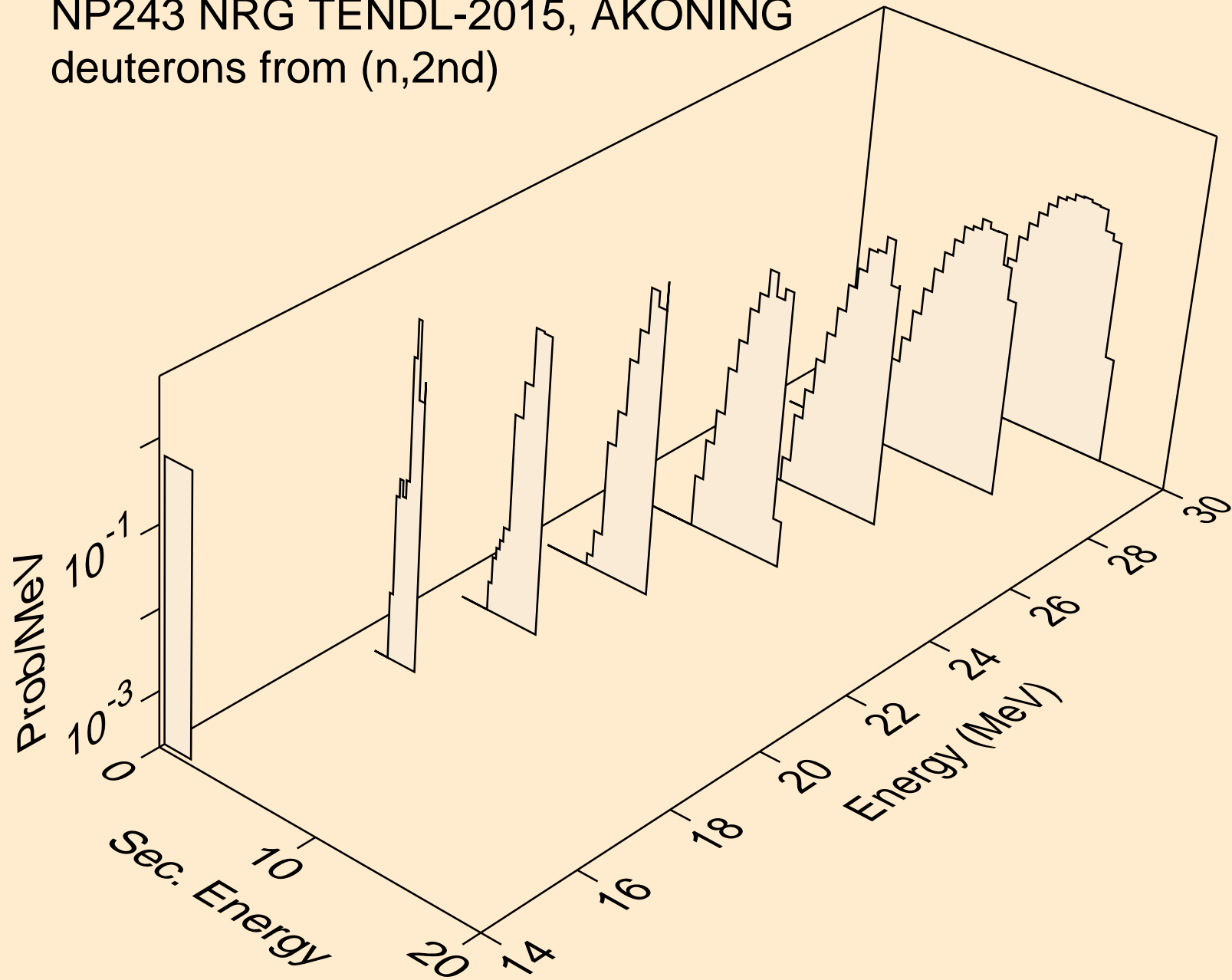

NP243 NRG TENDL-2015, AKONING
deuterons from (n,n*)d

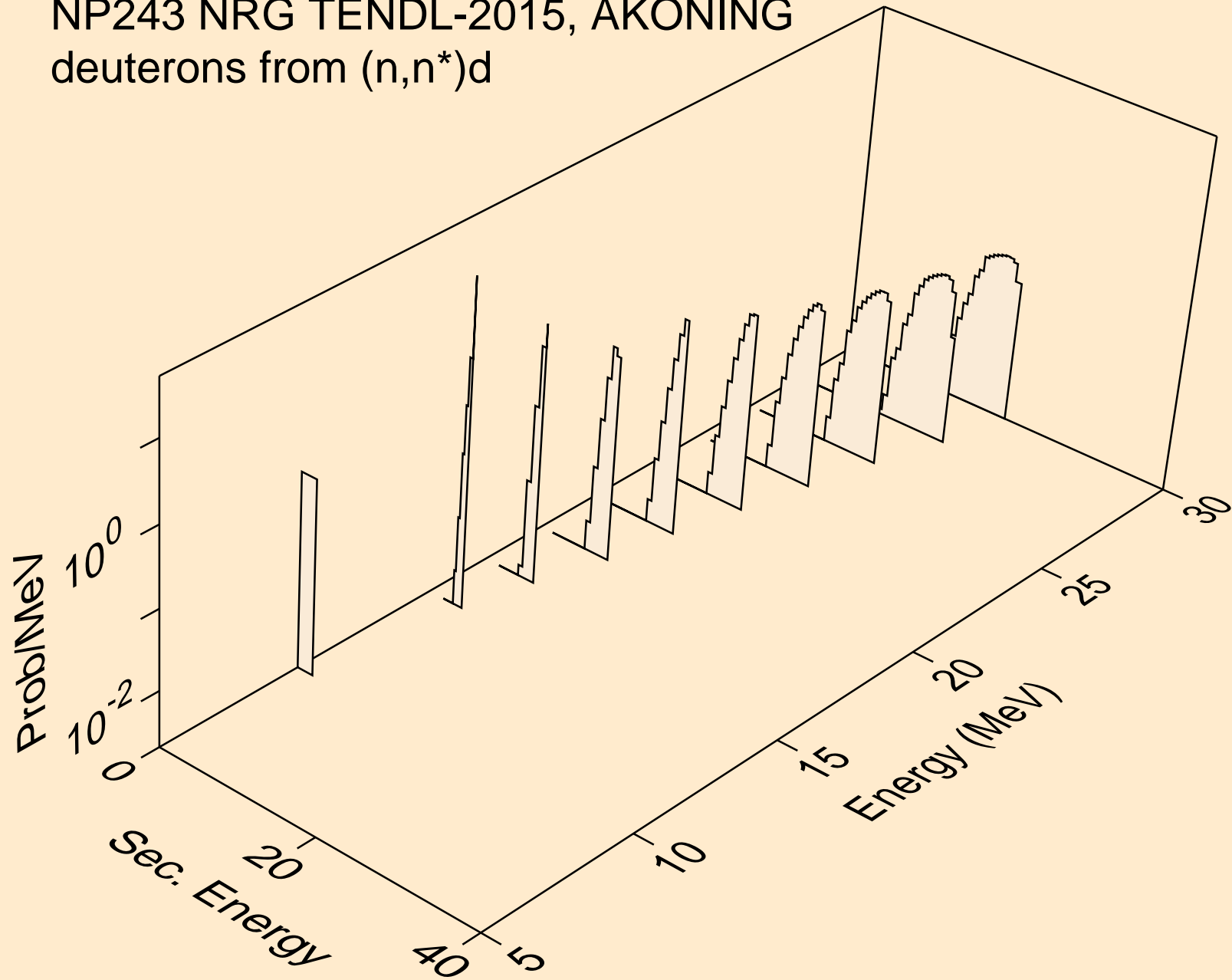

NP243 NRG TENDL-2015, AKONING
deuterons from (n,d)

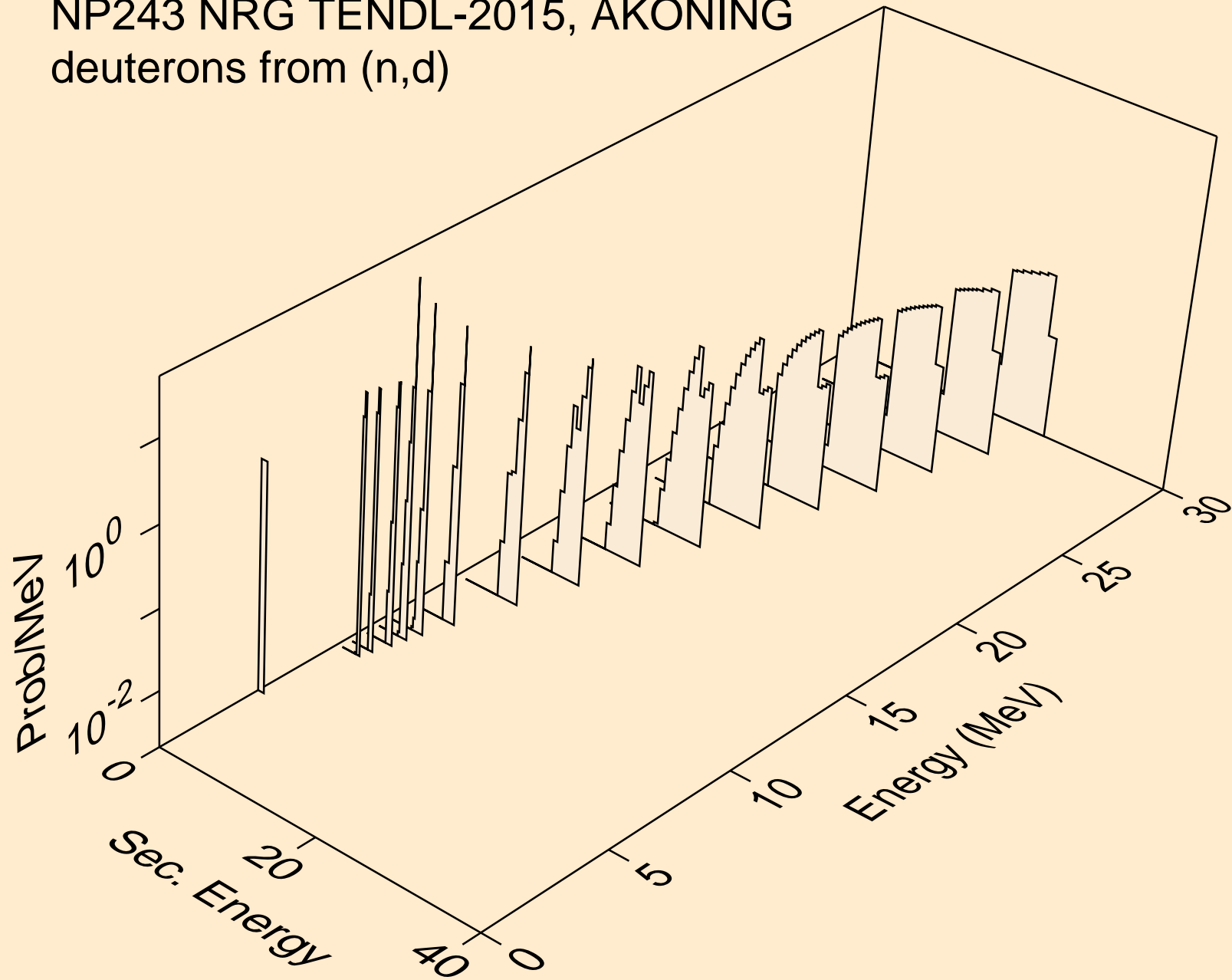

NP243 NRG TENDL-2015, AKONING
tritons from (n,x)

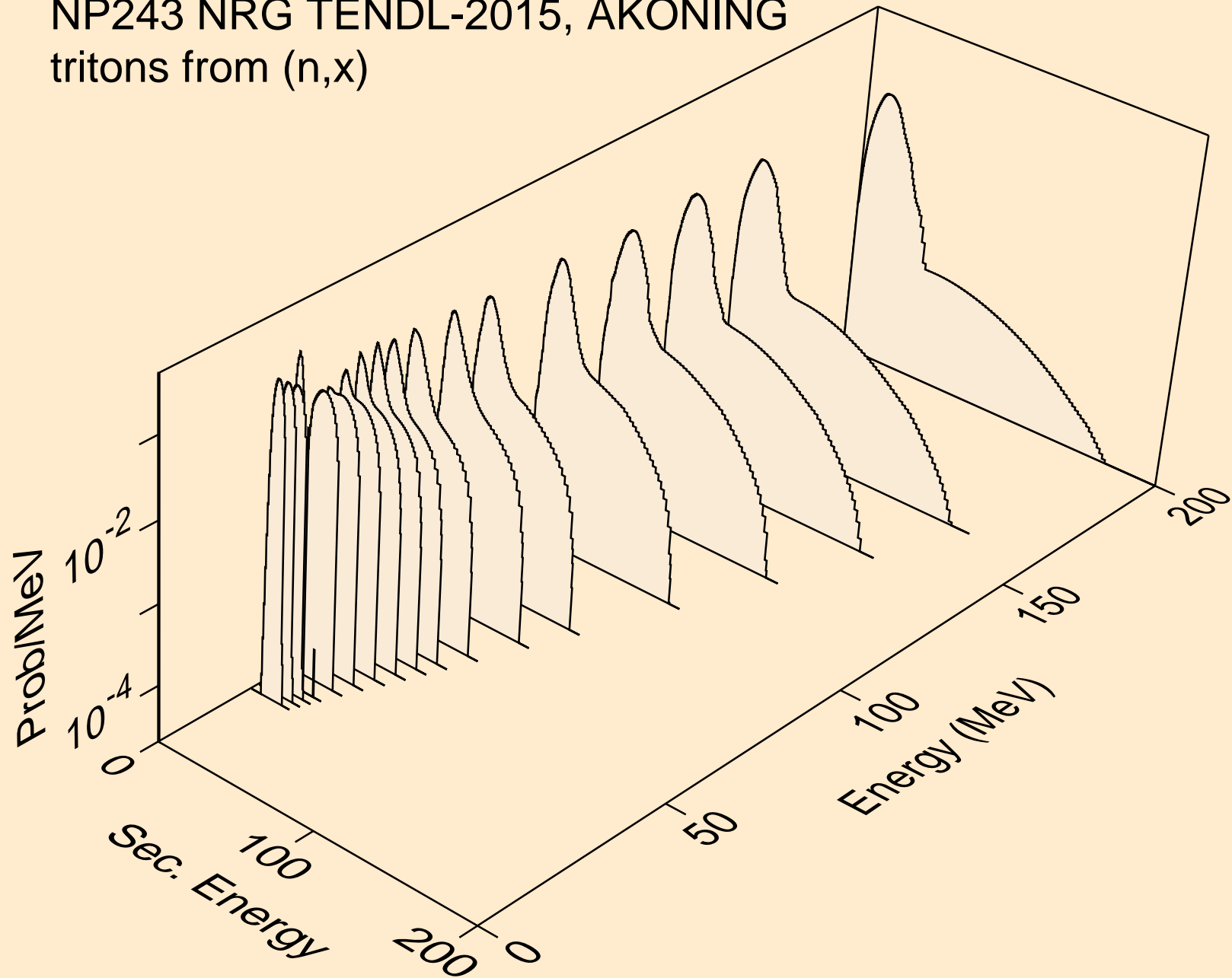

NP243 NRG TENDL-2015, AKONING
tritons from (n,n*)t

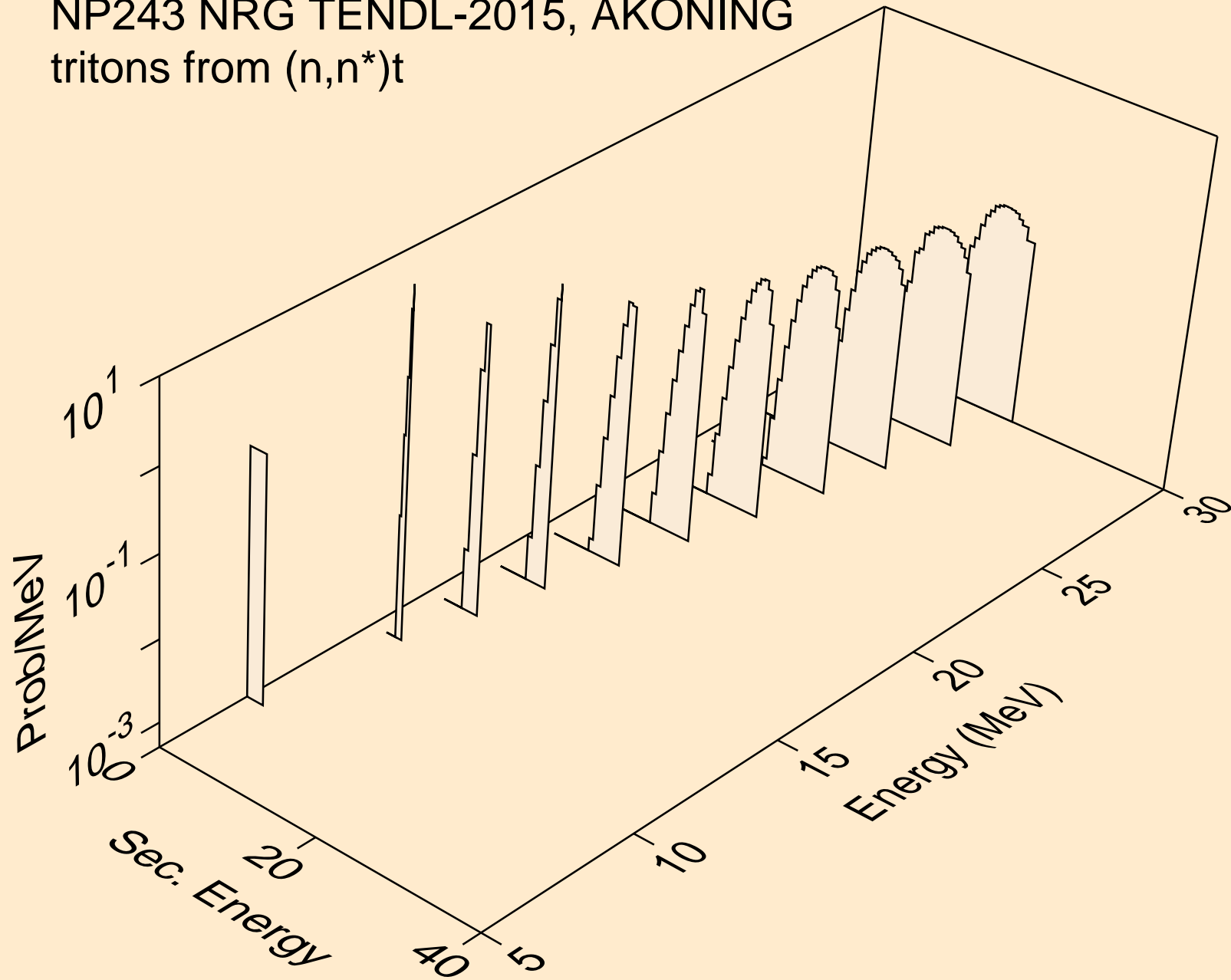

NP243 NRG TENDL-2015, AKONING
tritons from (n,t)

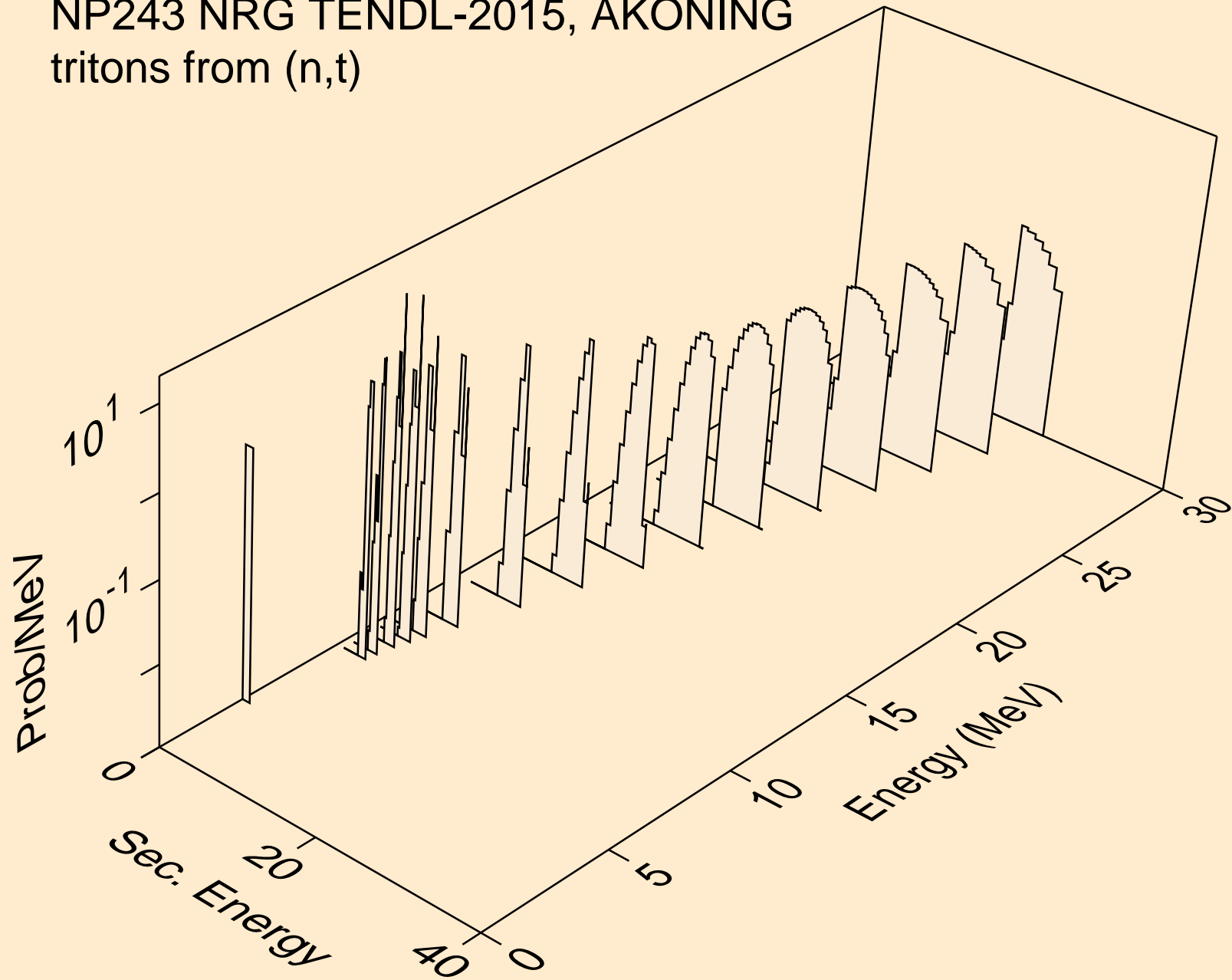

NP243 NRG TENDL-2015, AKONING
he3s from (n,x)

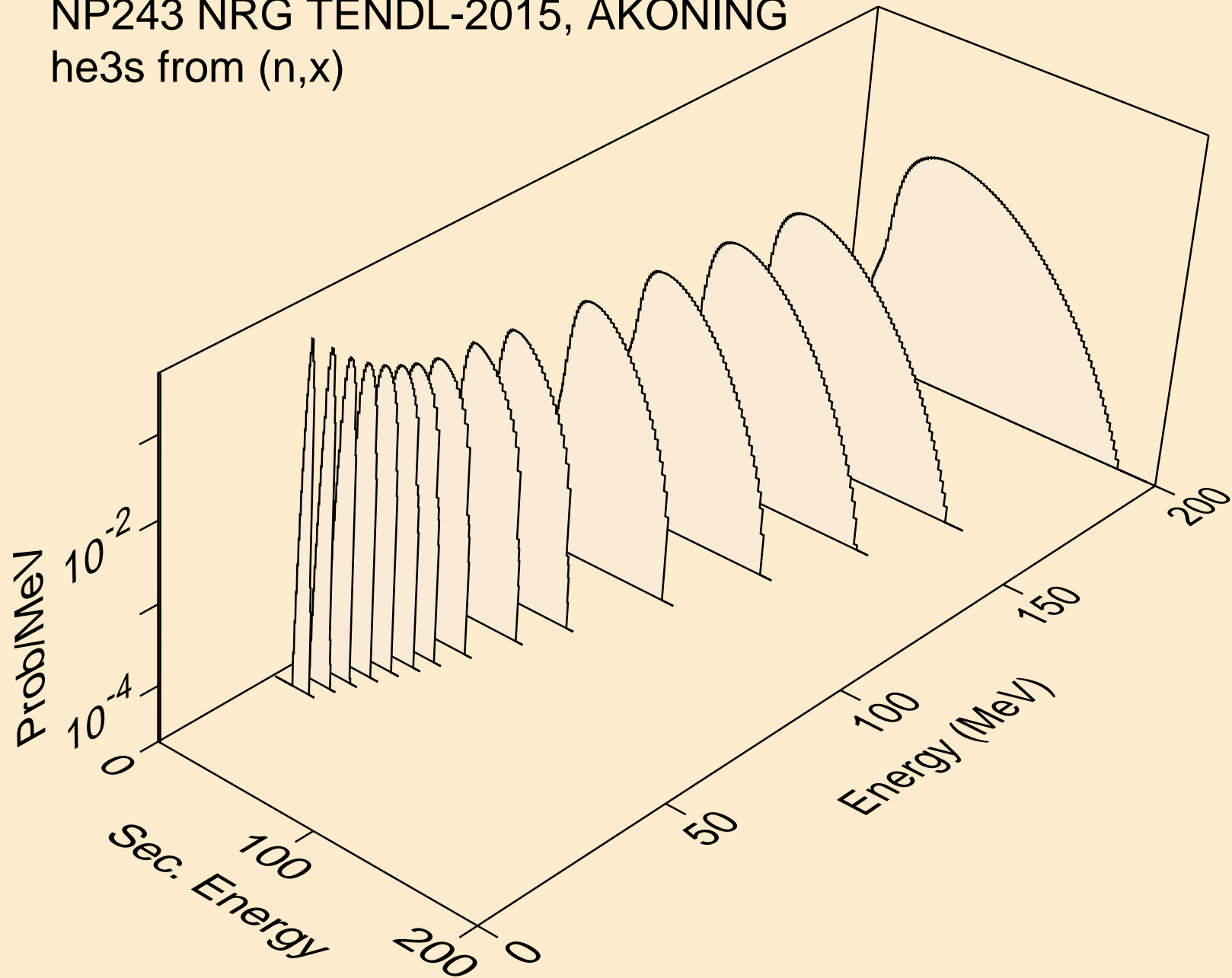

NP243 NRG TENDL-2015, AKONING
he3s from (n,n*)he3

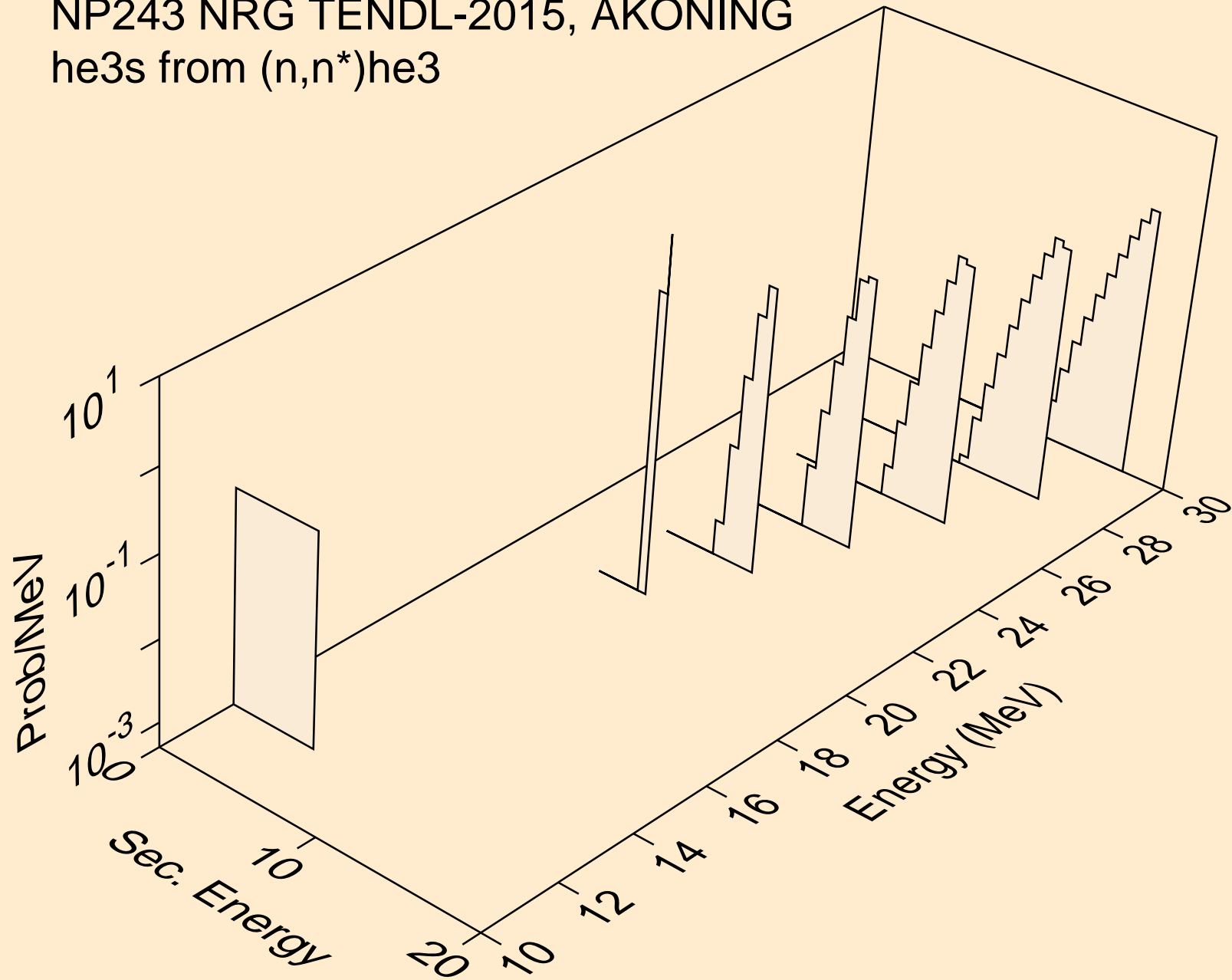

NP243 NRG TENDL-2015, AKONING
he3s from (n,he3)

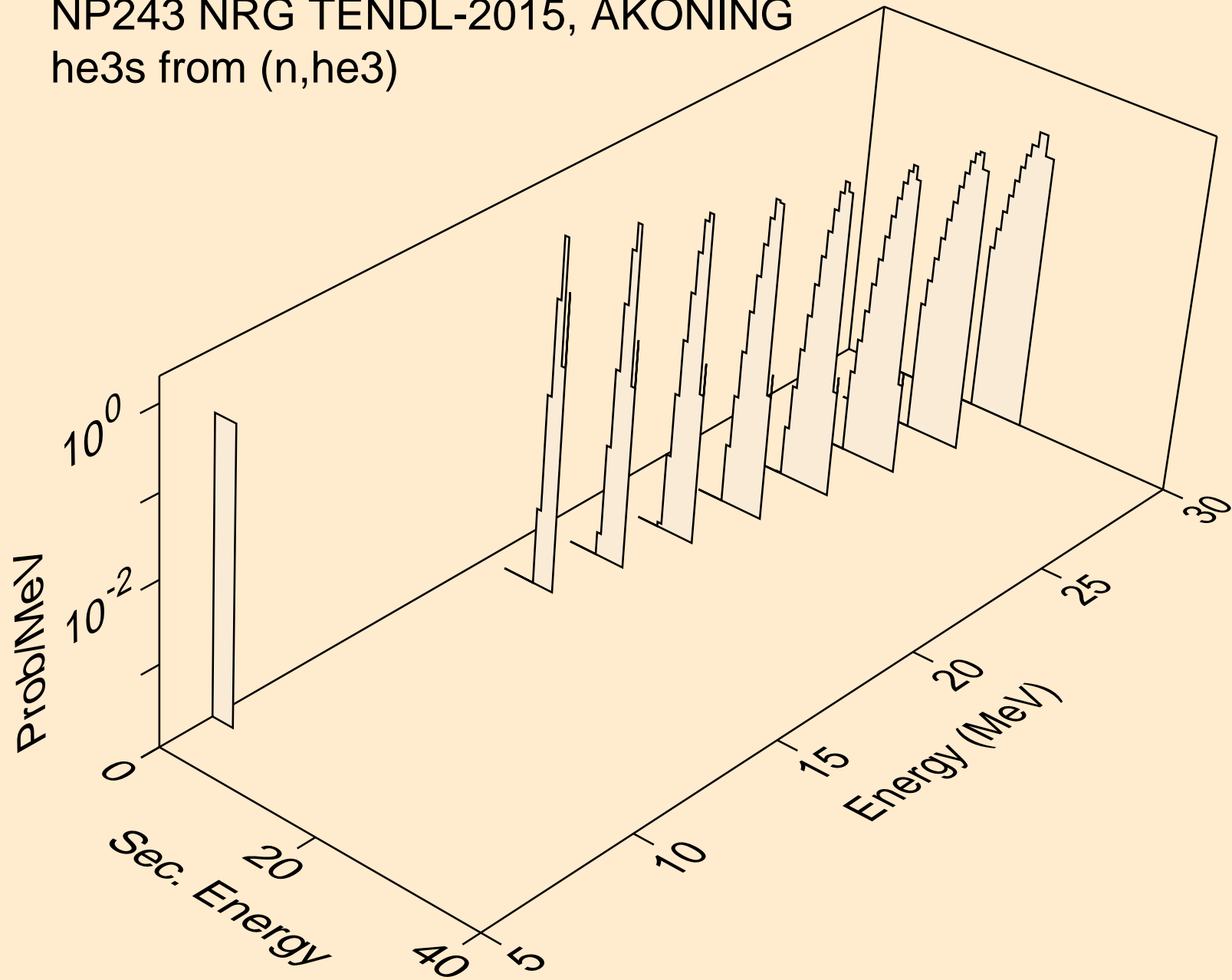

NP243 NRG TENDL-2015, AKONING
alphas from (n,x)

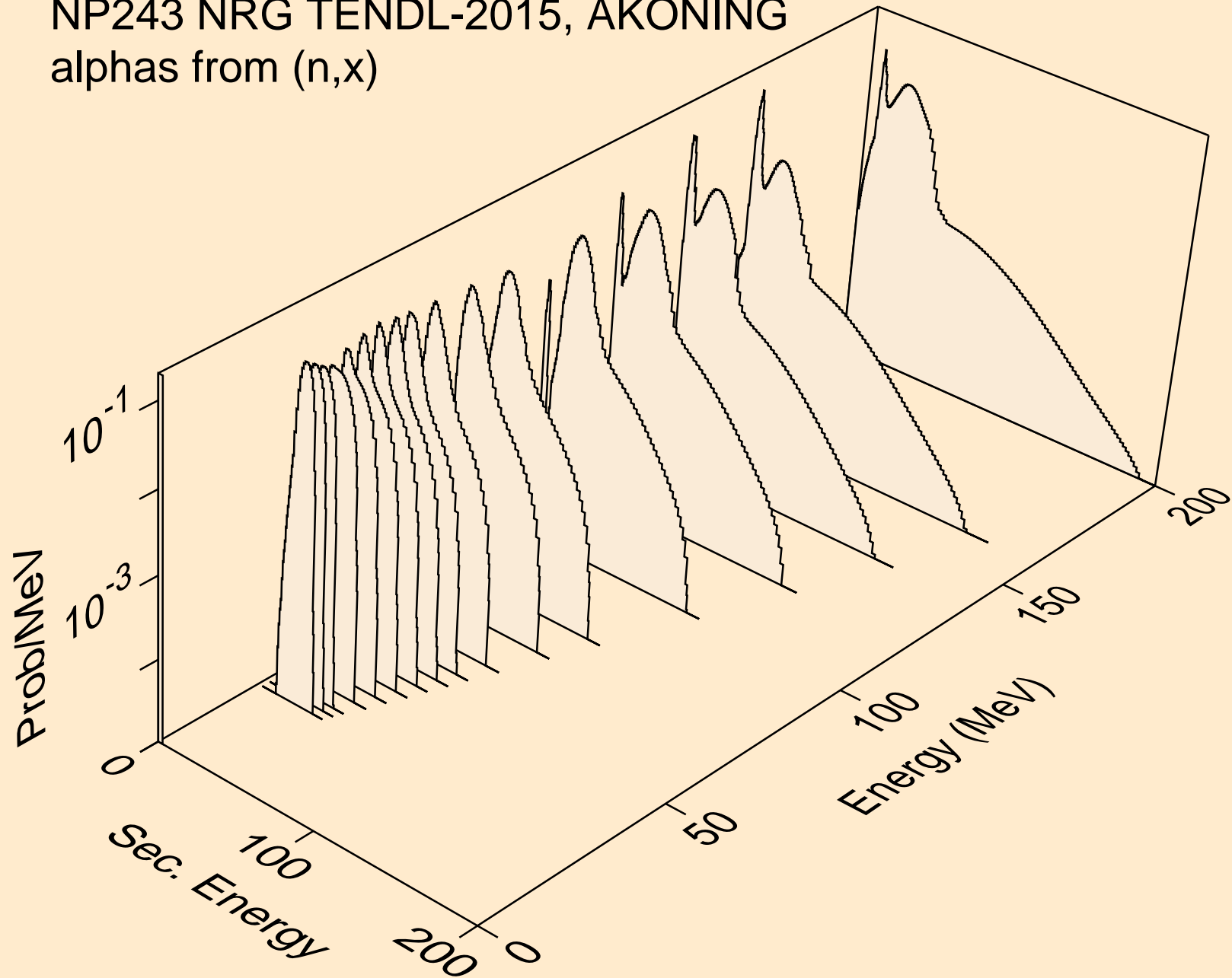

NP243 NRG TENDL-2015, AKONING
alphas from (n,n*)a

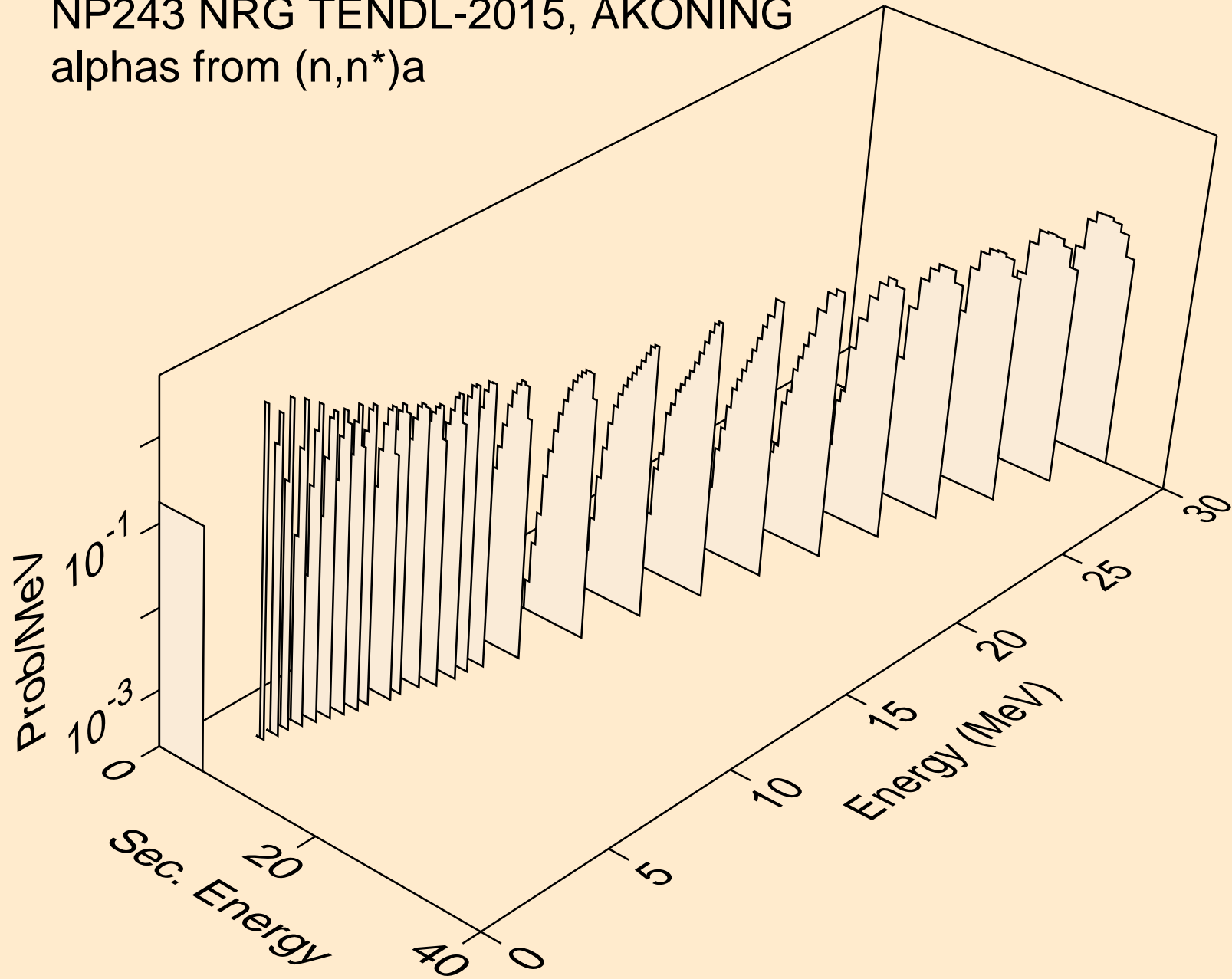

NP243 NRG TENDL-2015, AKONING
alphas from (n,2n)a

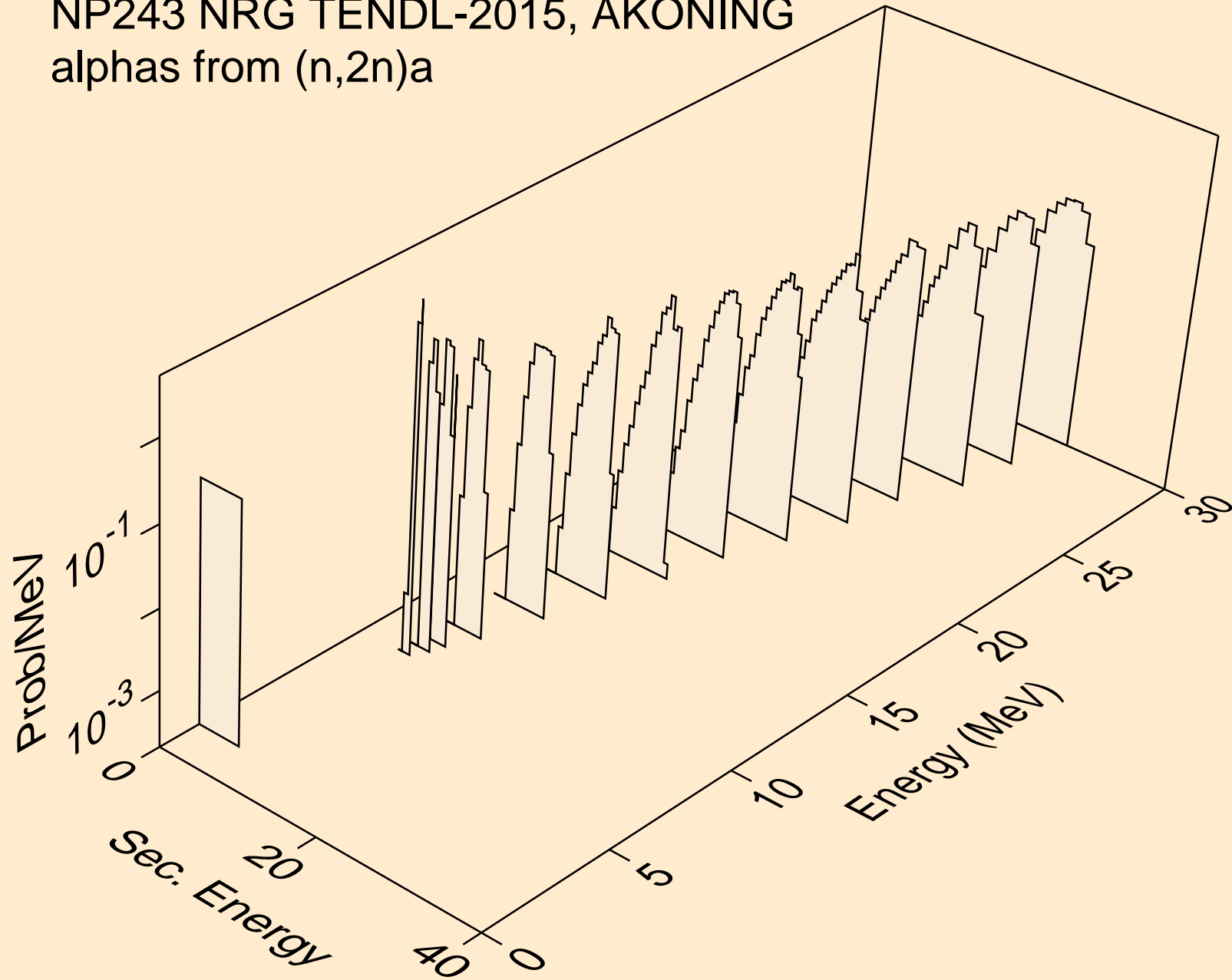

NP243 NRG TENDL-2015, AKONING
alphas from (n,3n)a

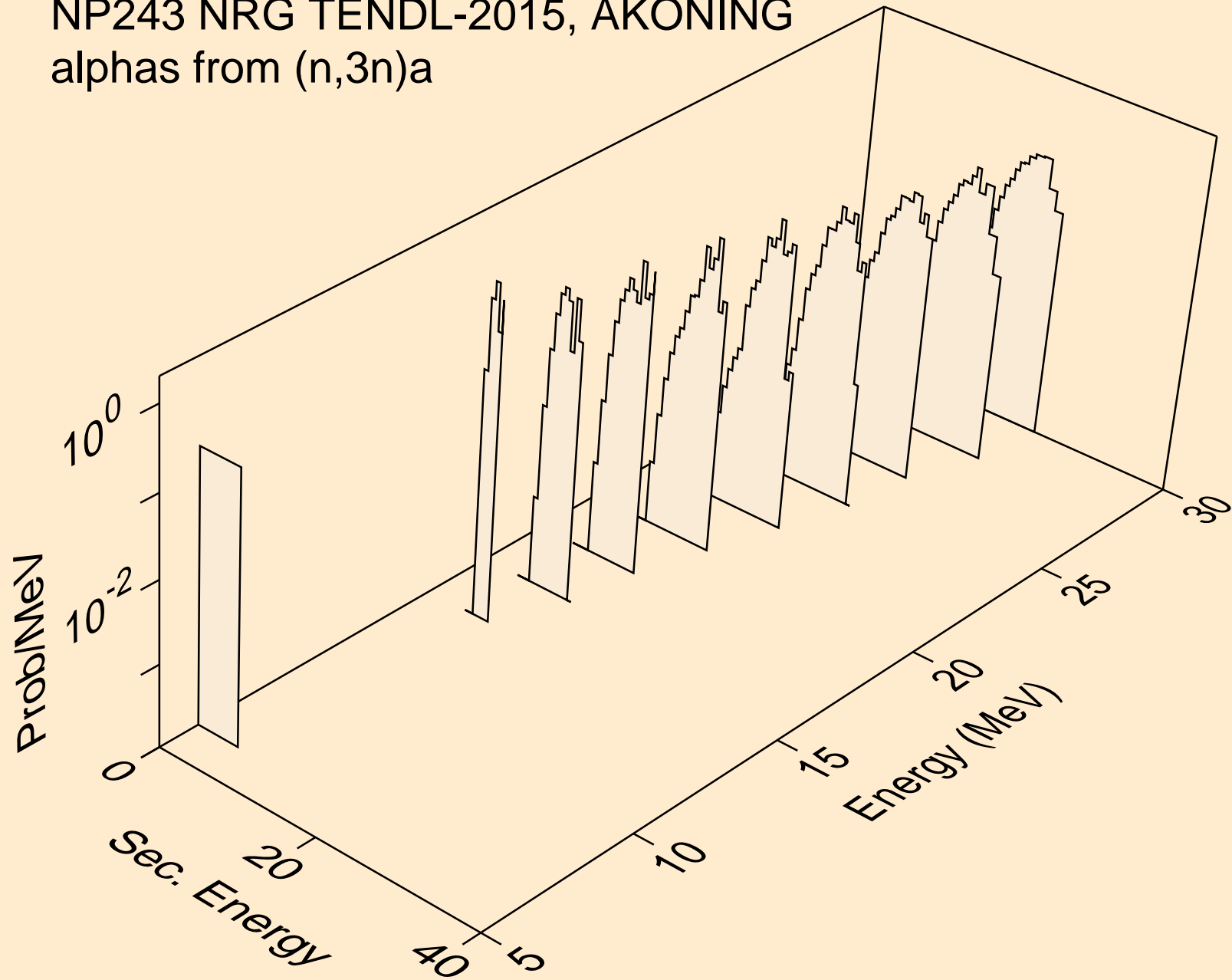

NP243 NRG TENDL-2015, AKONING
alphas from (n,a)

