

NP245 NRG TENDL-2015, AKONING

Principal cross sections

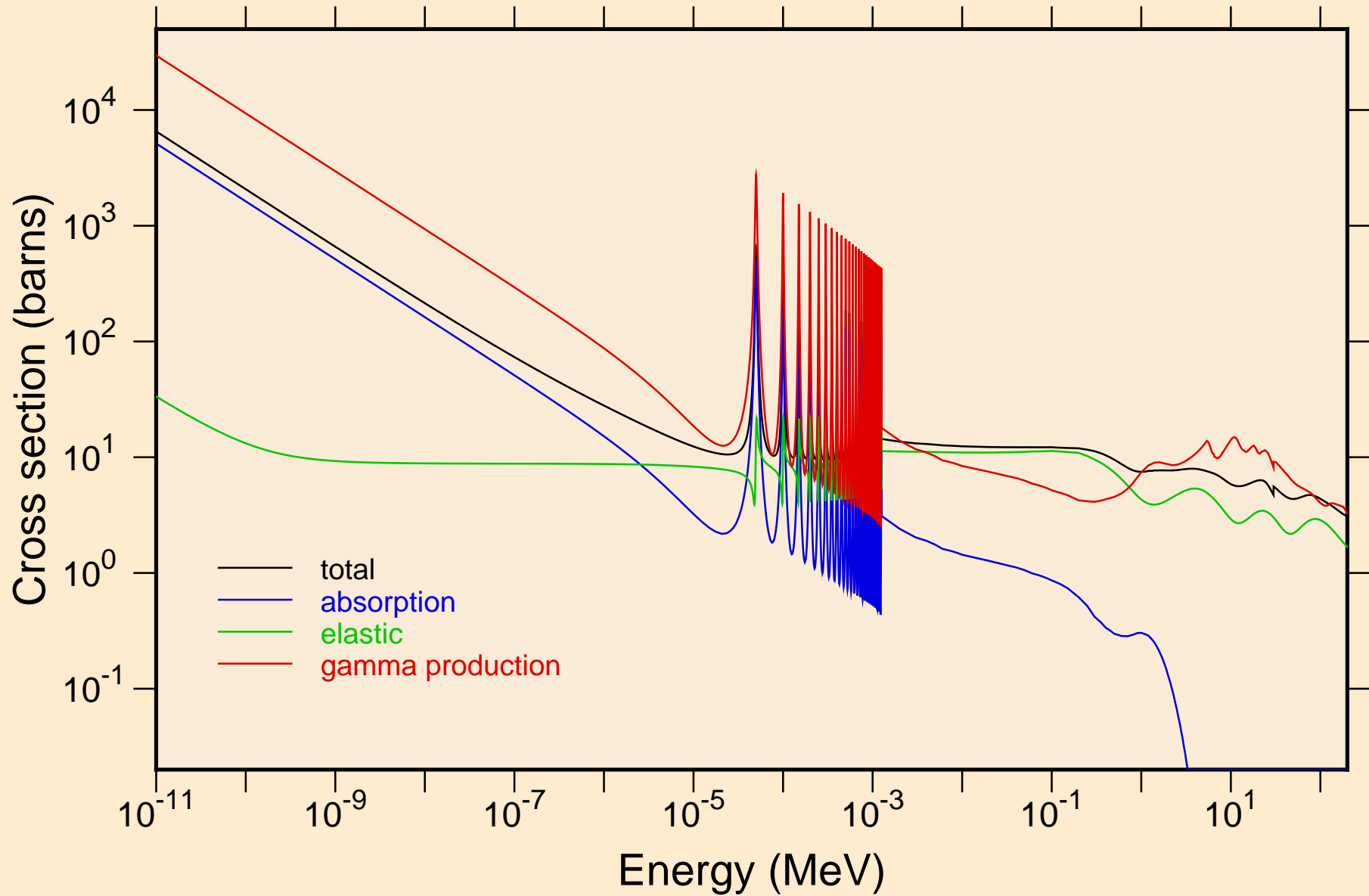

NP245 NRG TENDL-2015, AKONING
resonance total cross section

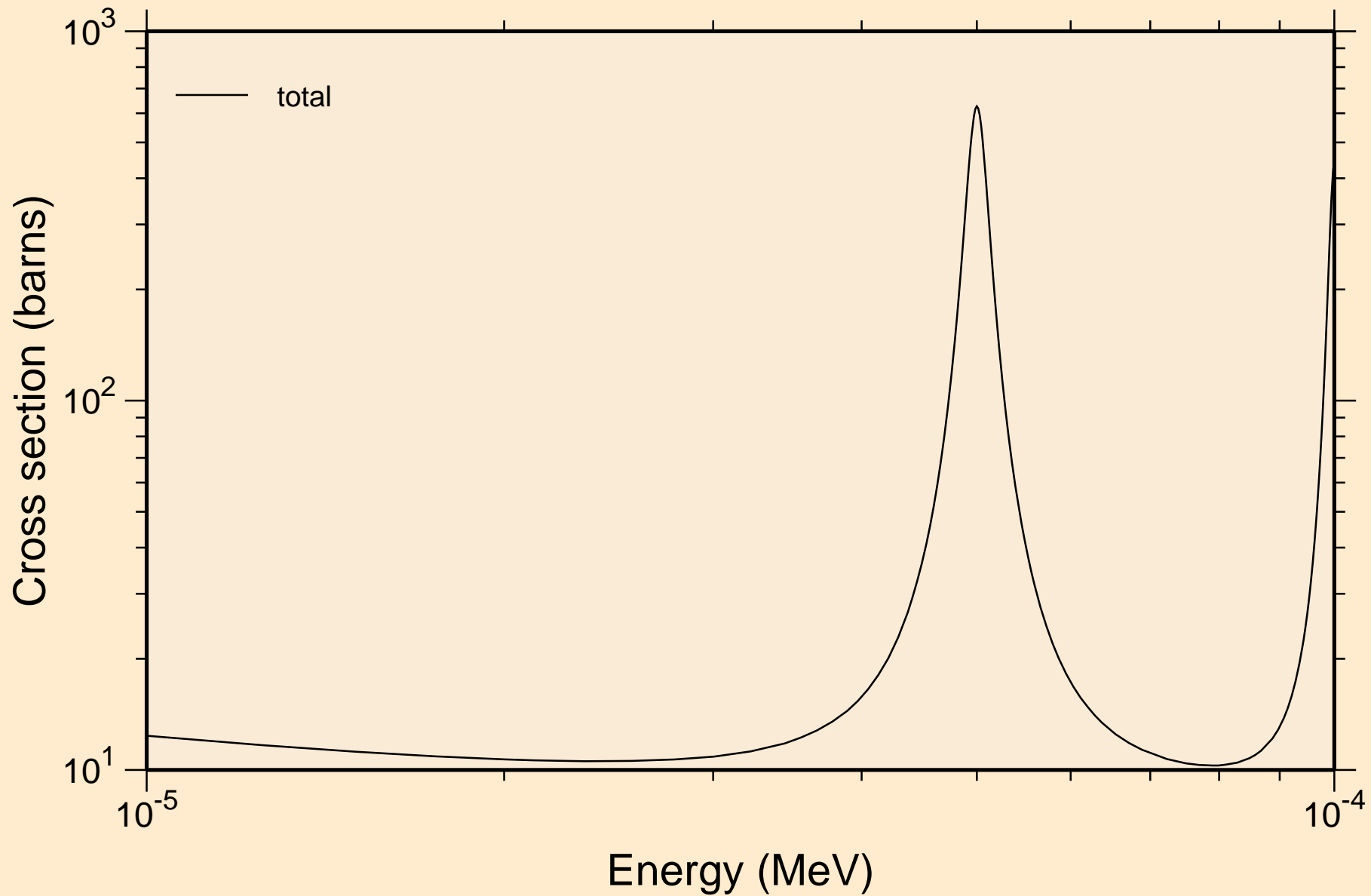

NP245 NRG TENDL-2015, AKONING
resonance total cross section

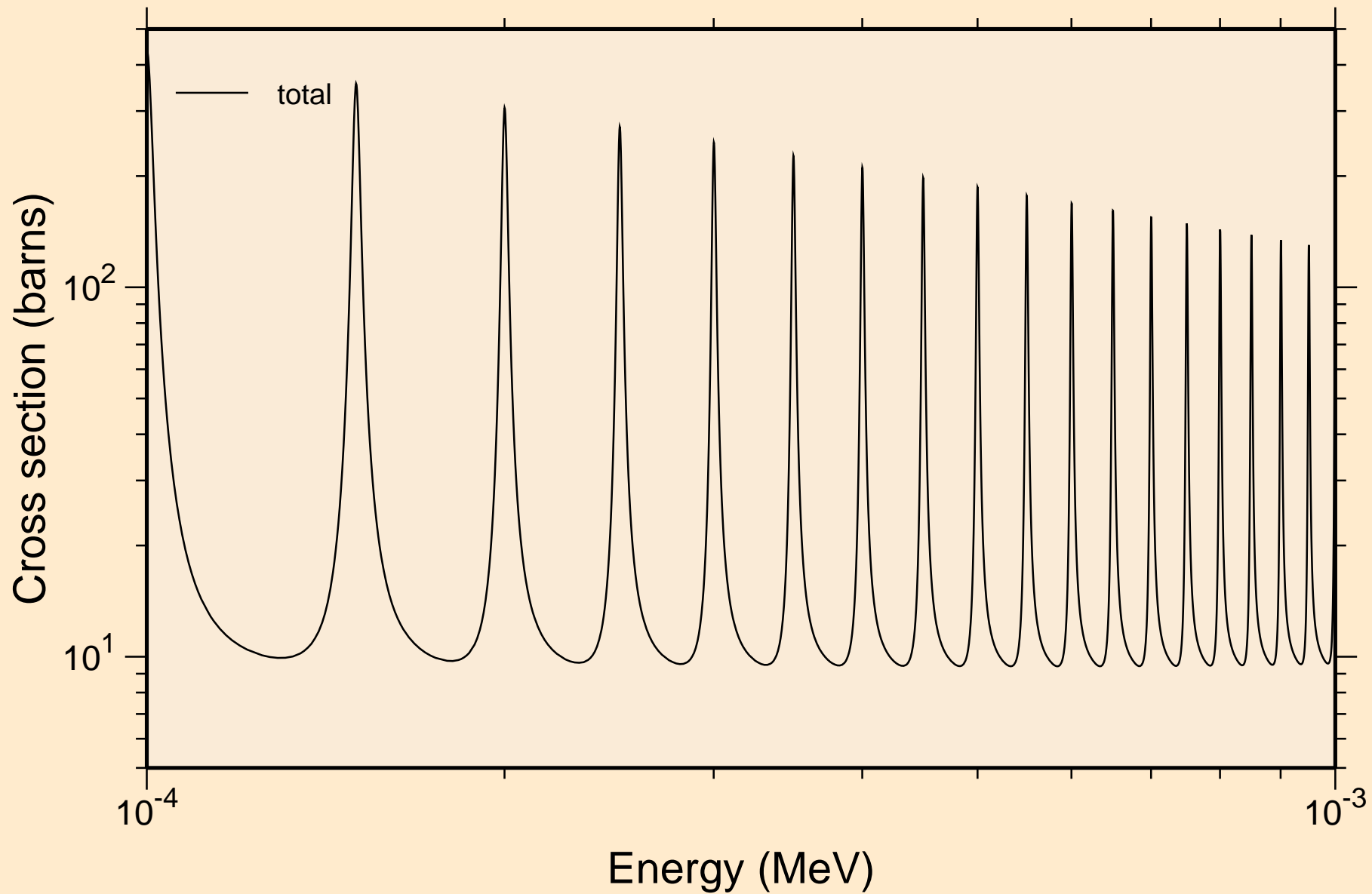

NP245 NRG TENDL-2015, AKONING
resonance total cross section

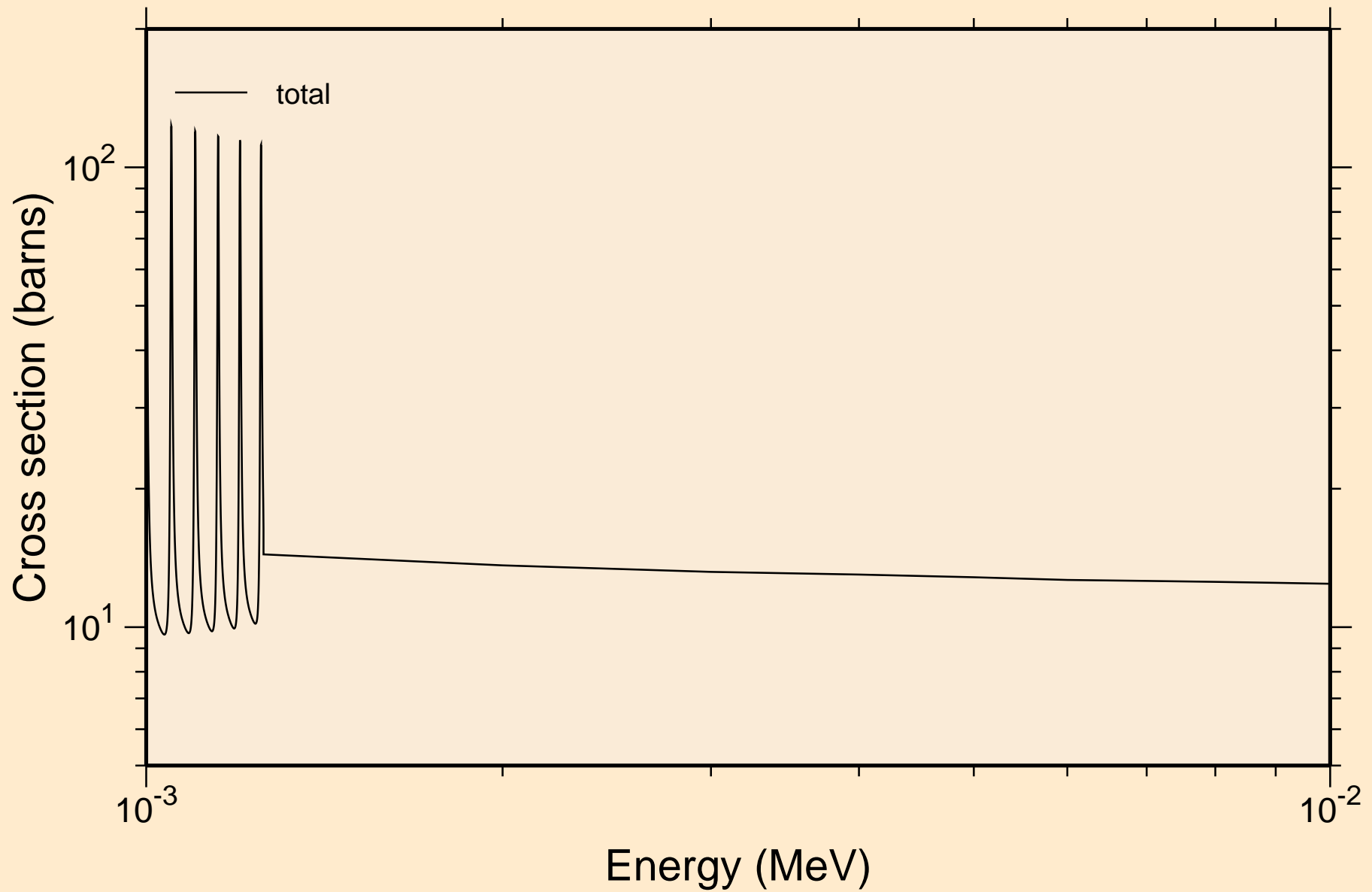

NP245 NRG TENDL-2015, AKONING
resonance total cross section

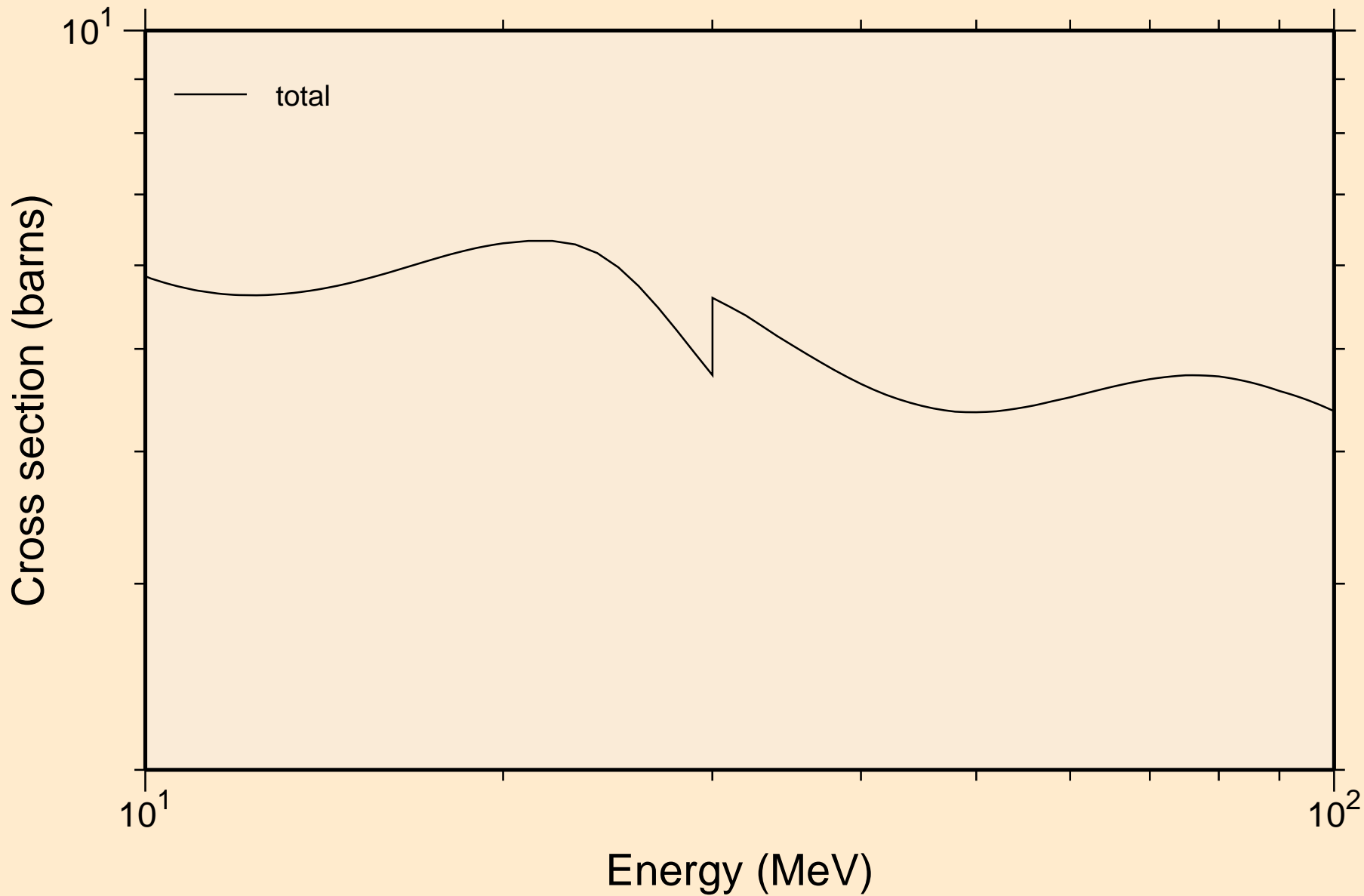

NP245 NRG TENDL-2015, AKONING
resonance absorption cross sections

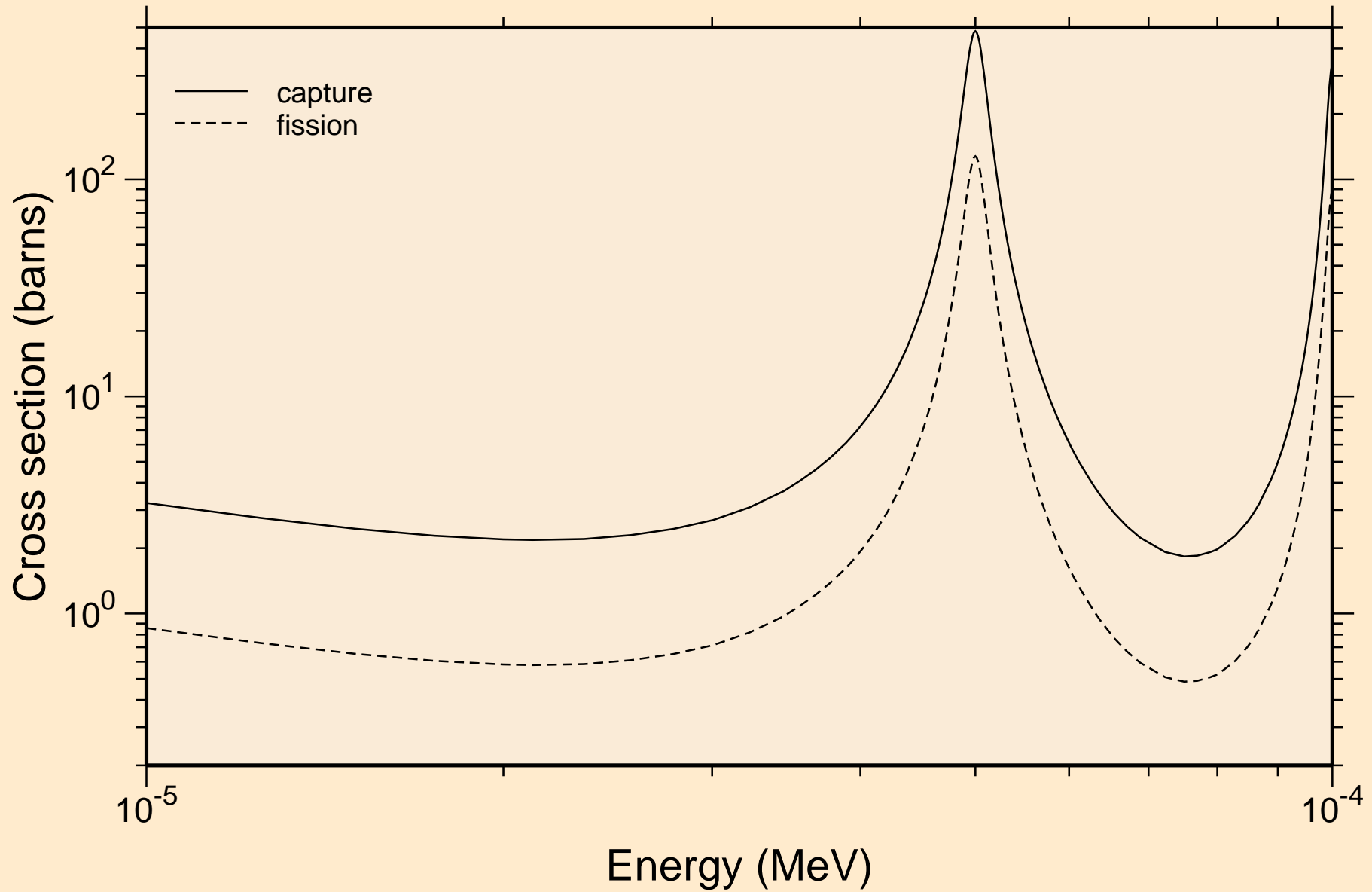

NP245 NRG TENDL-2015, AKONING

resonance absorption cross sections

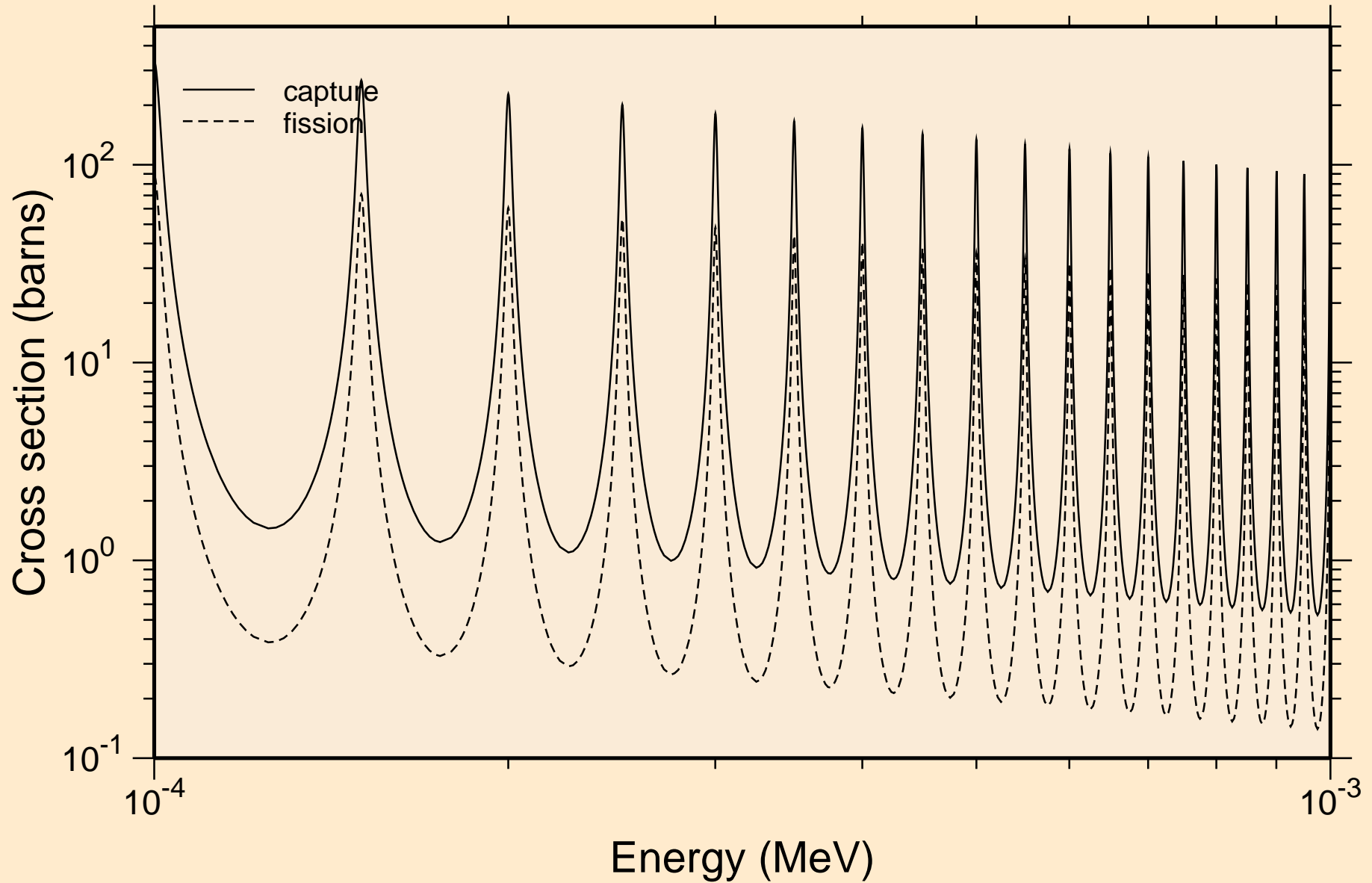

NP245 NRG TENDL-2015, AKONING
resonance absorption cross sections

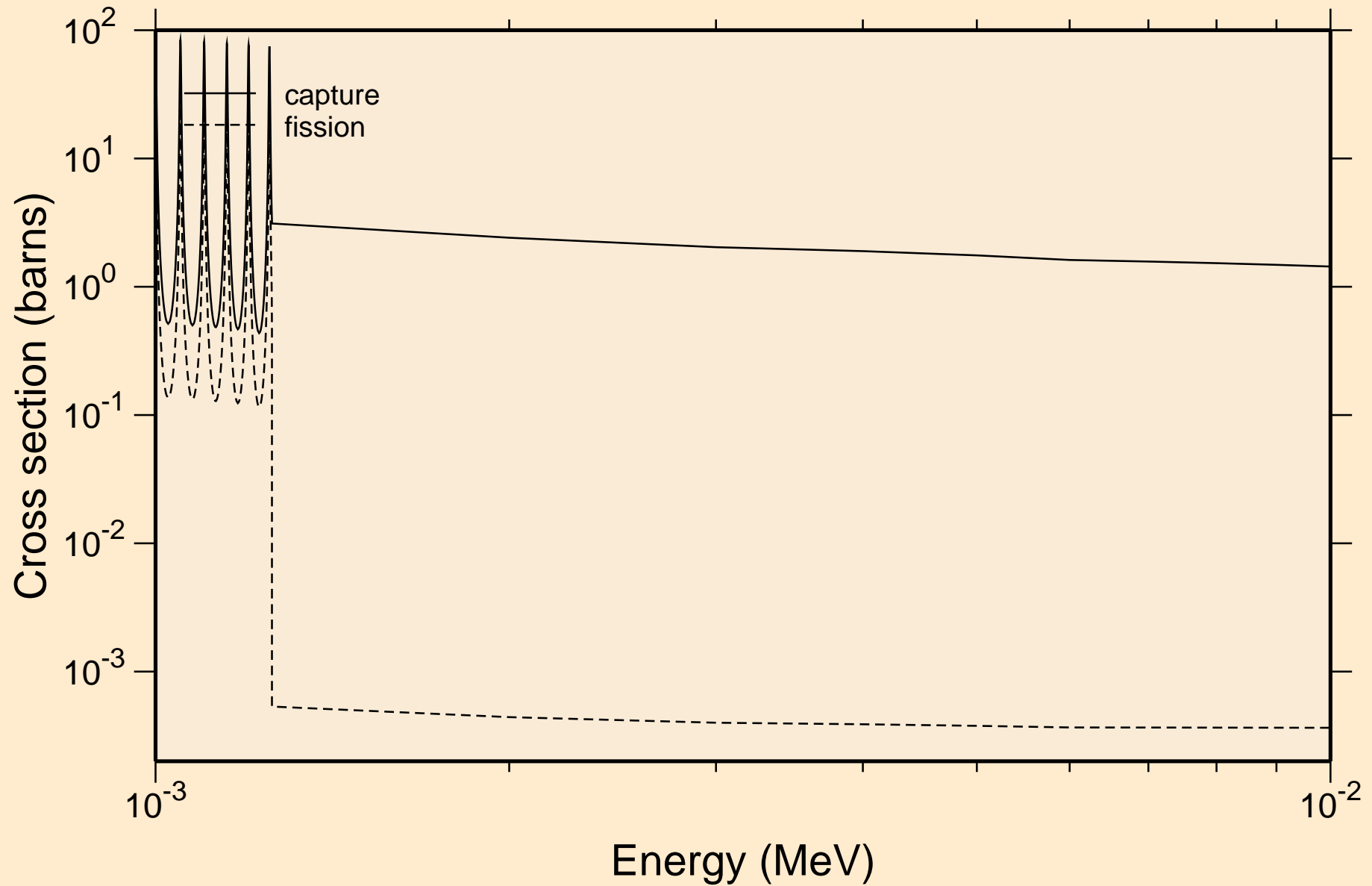

NP245 NRG TENDL-2015, AKONING

resonance absorption cross sections

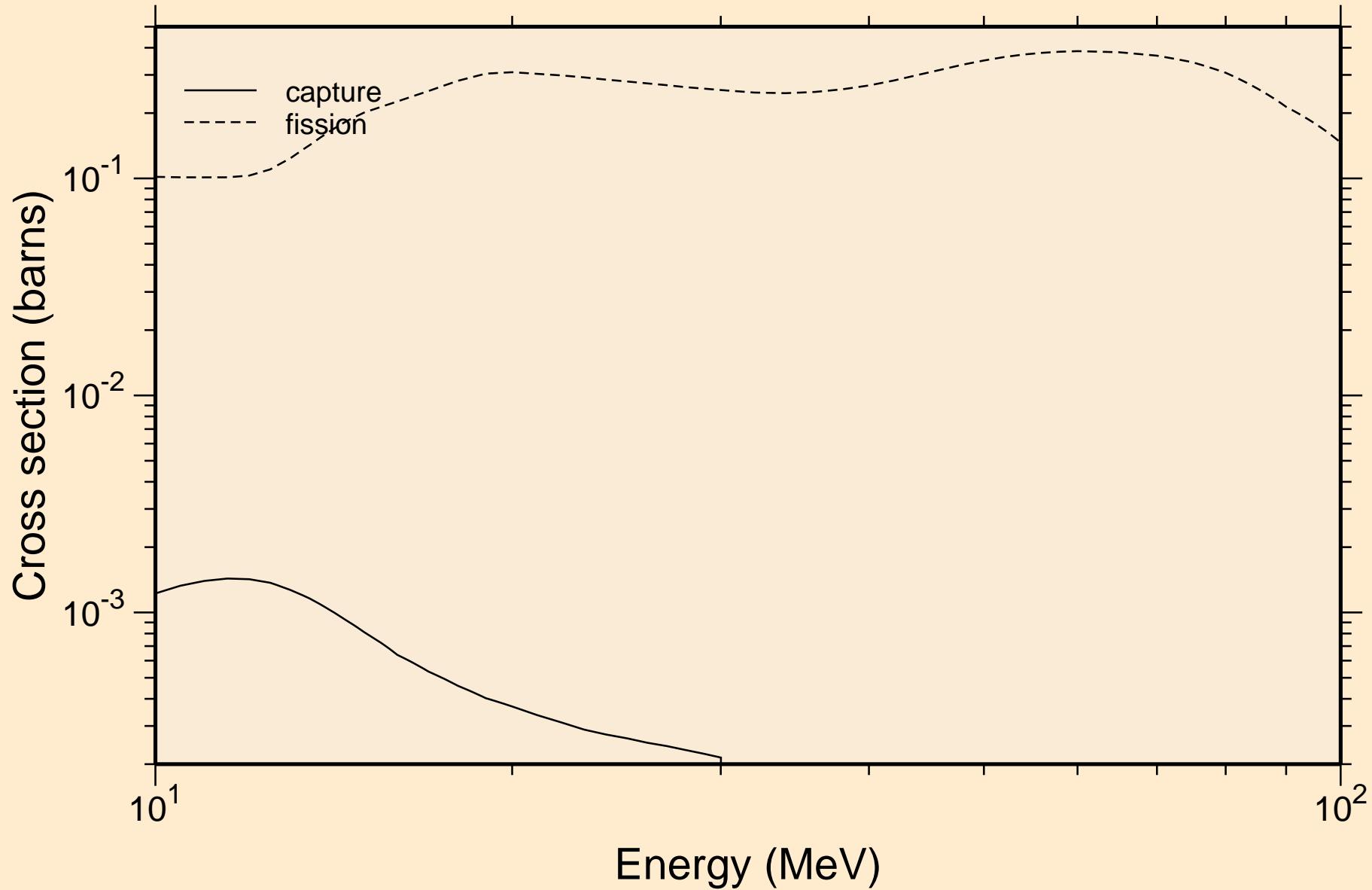

NP245 NRG TENDL-2015, AKONING

Non-threshold reactions

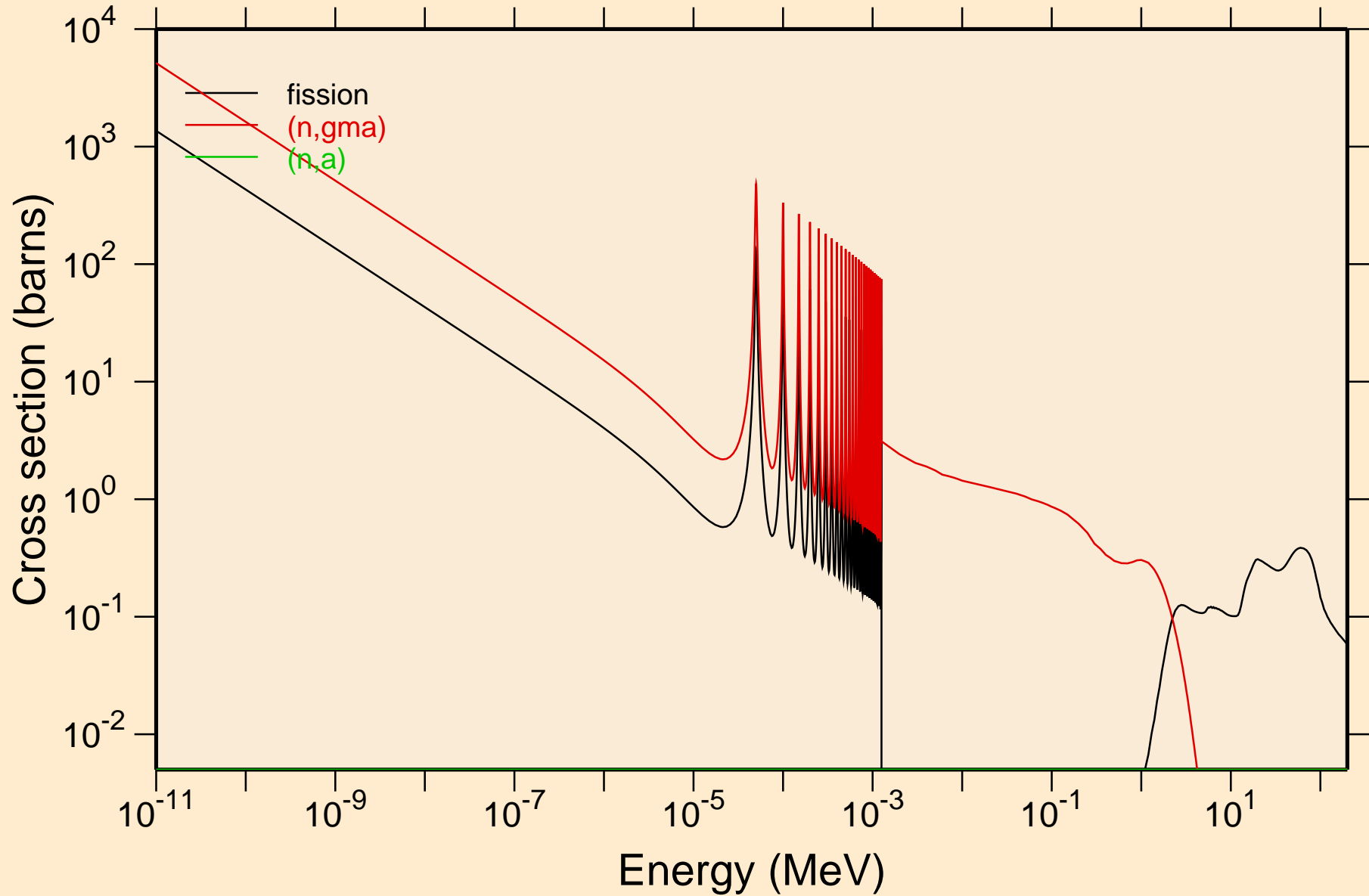

NP245 NRG TENDL-2015, AKONING

Principal cross sections

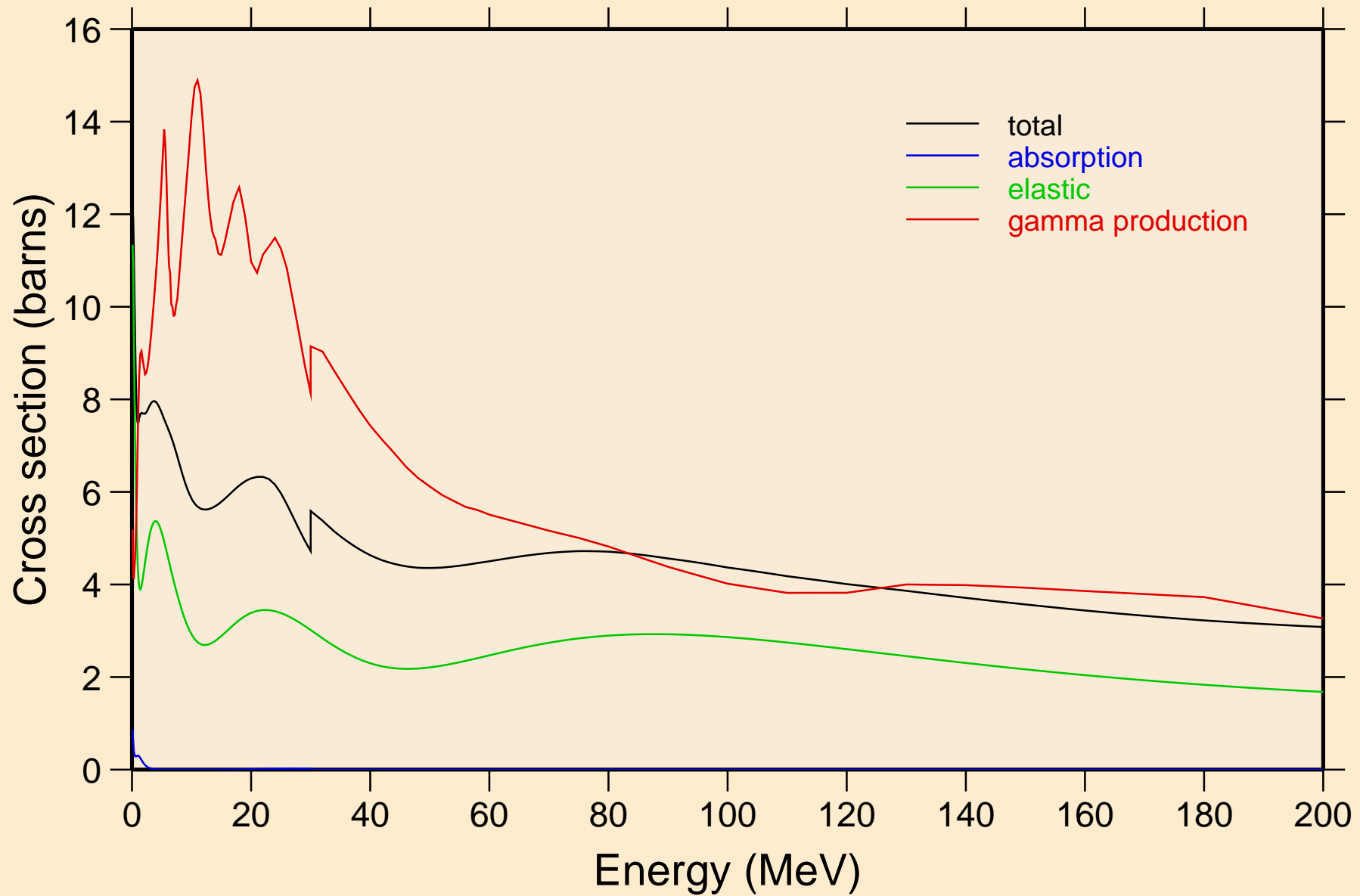

NP245 NRG TENDL-2015, AKONING

Non-threshold reactions

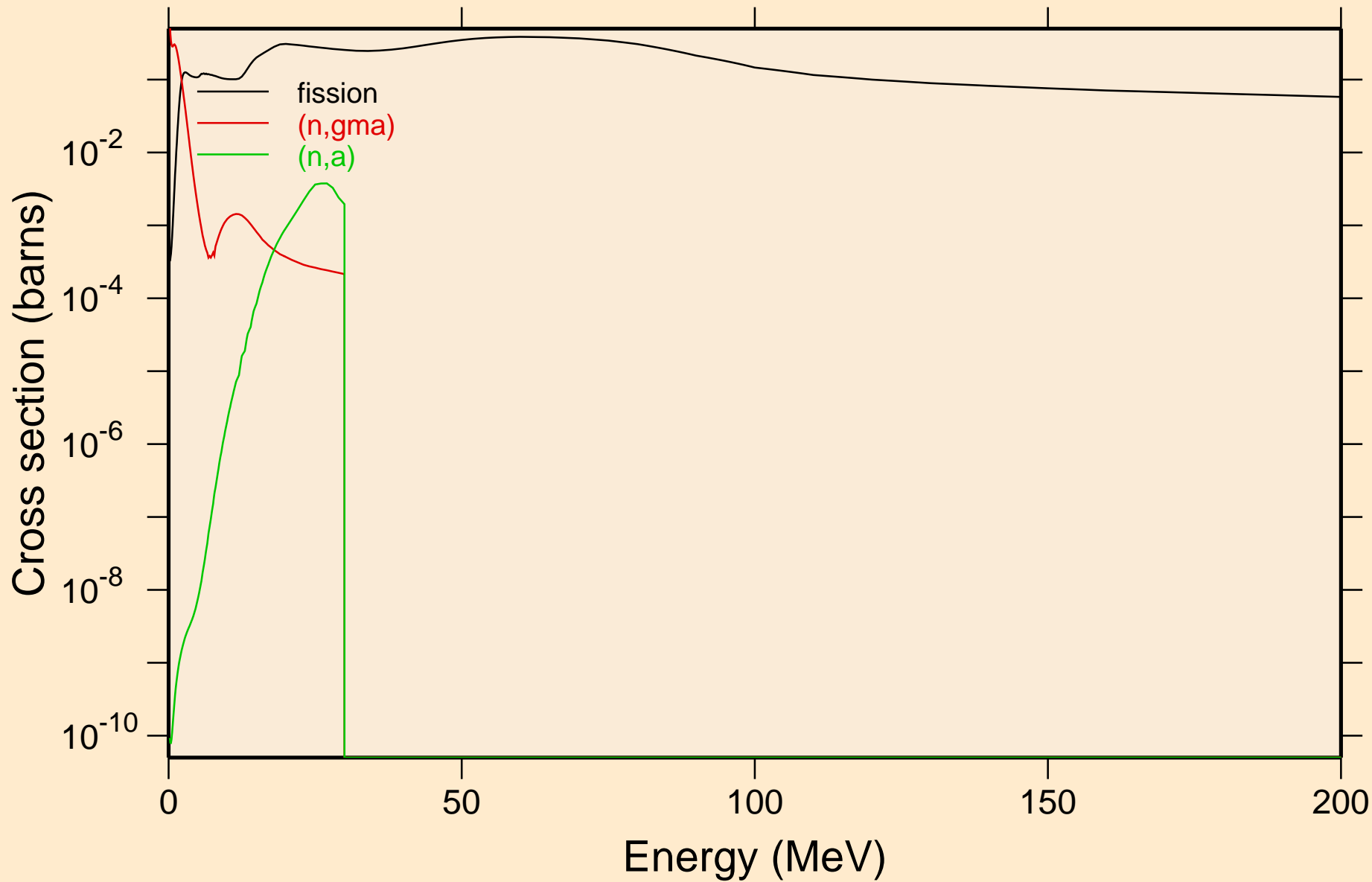

NP245 NRG TENDL-2015, AKONING
Inelastic levels

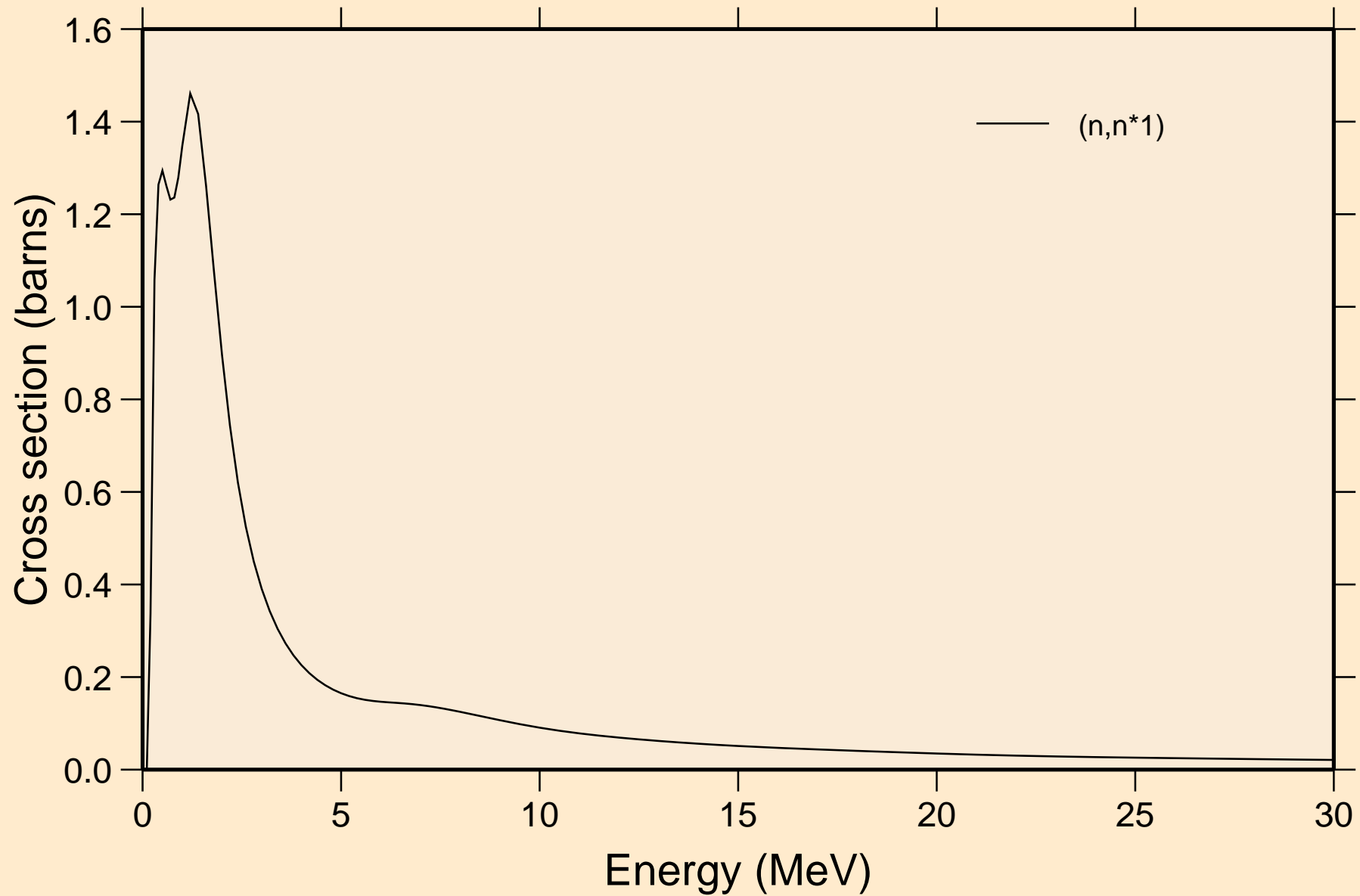

NP245 NRG TENDL-2015, AKONING

Threshold reactions

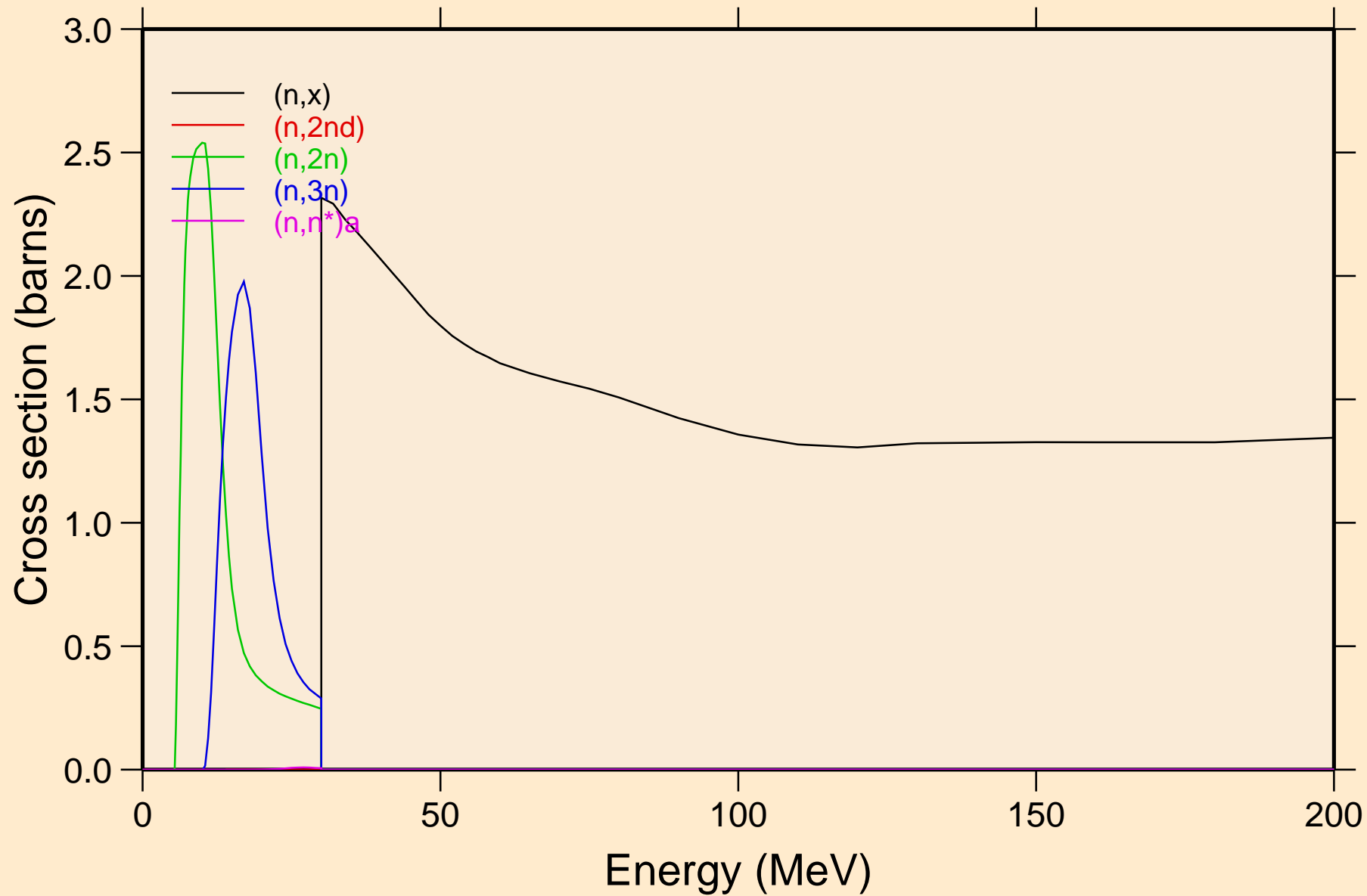

NP245 NRG TENDL-2015, AKONING

Threshold reactions

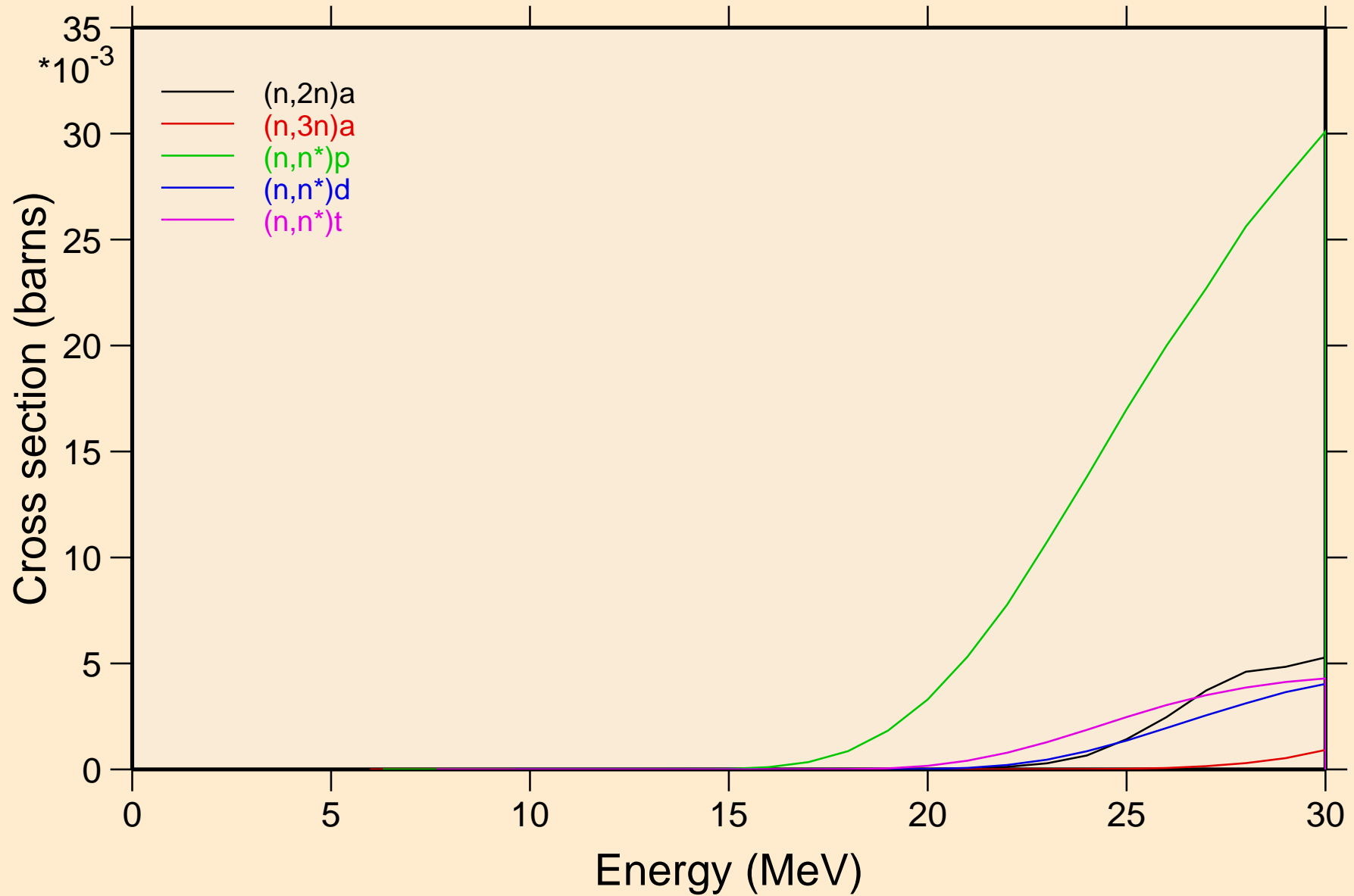

NP245 NRG TENDL-2015, AKONING

Threshold reactions

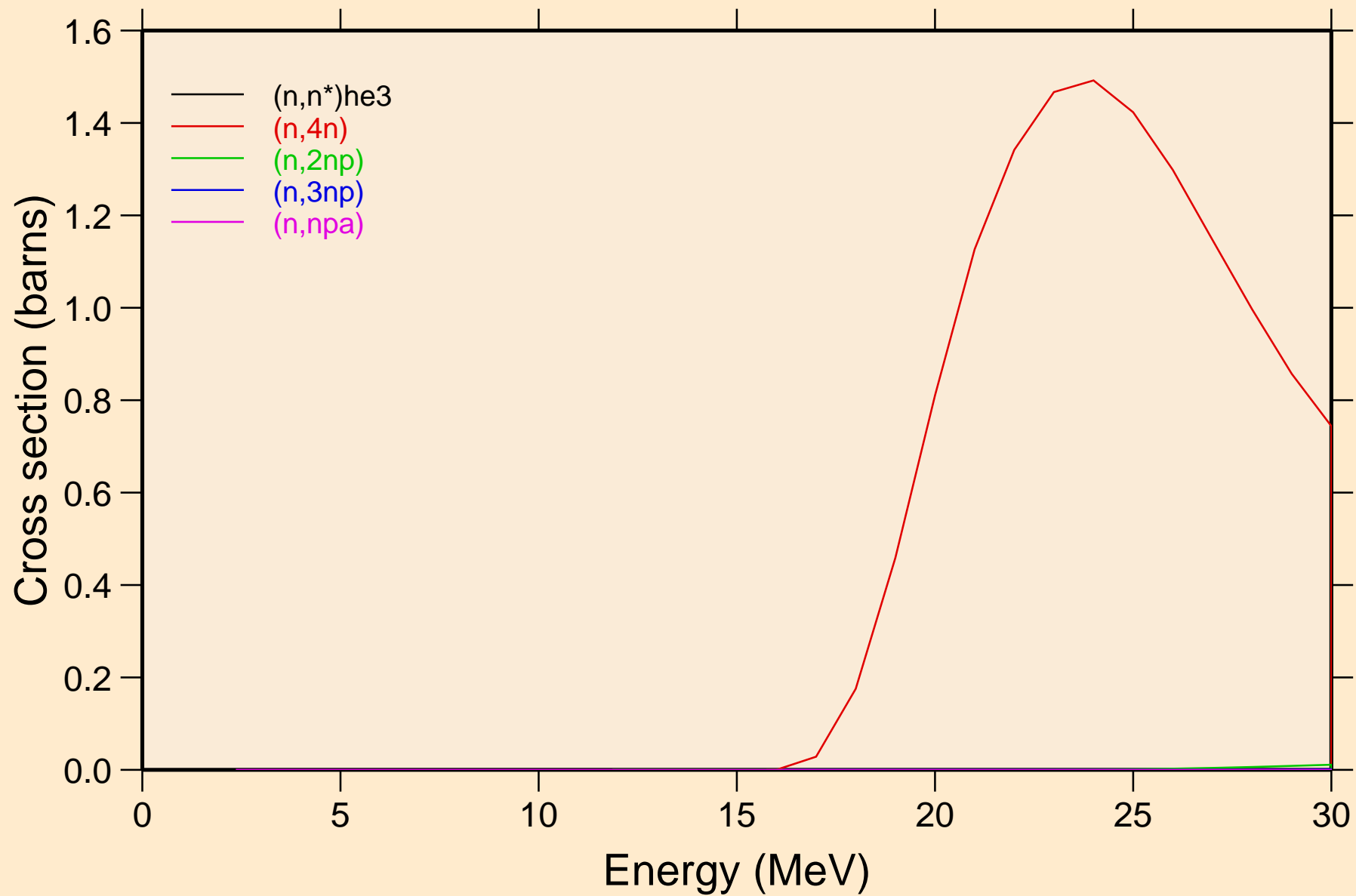

NP245 NRG TENDL-2015, AKONING

Threshold reactions

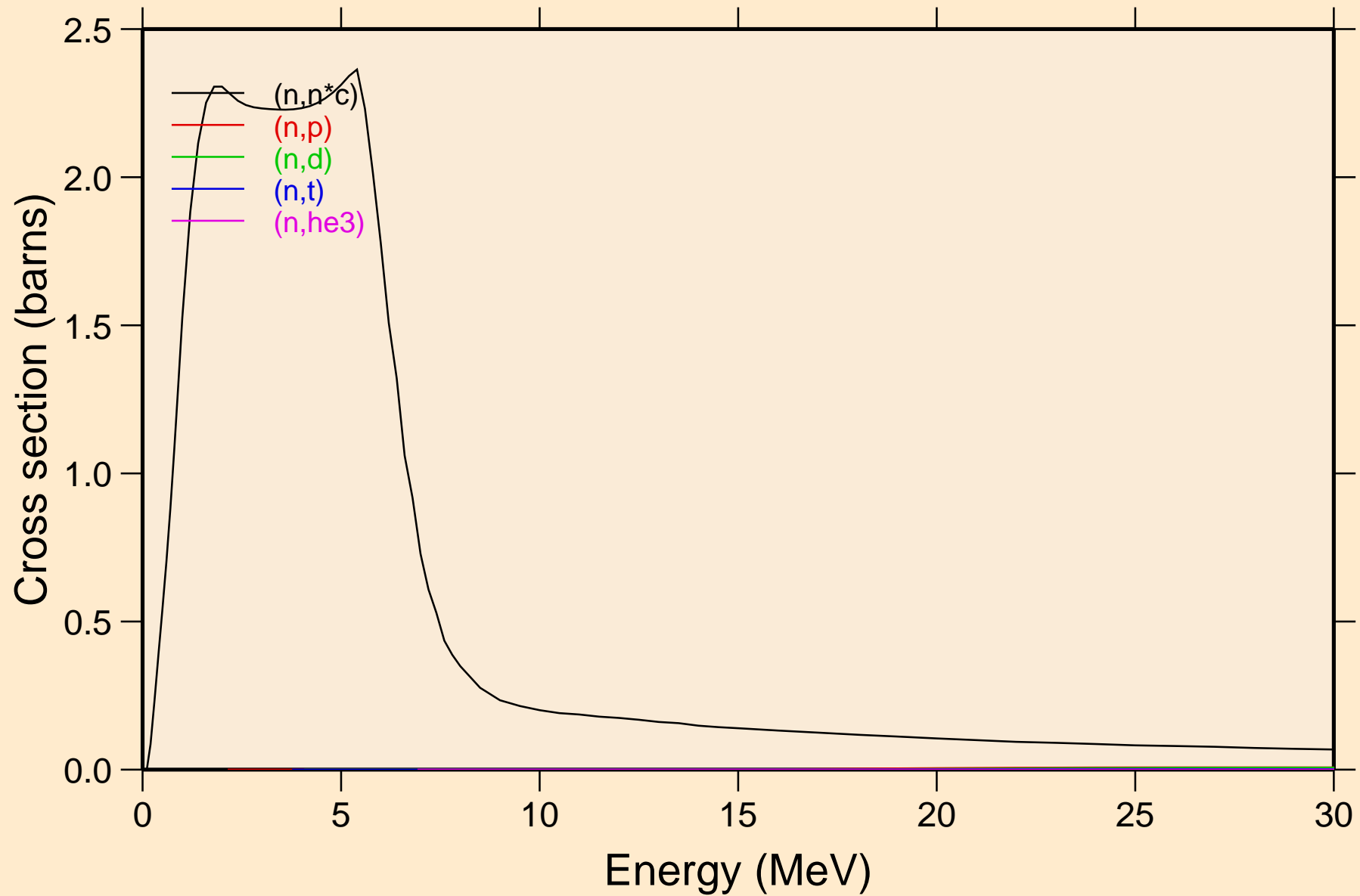

NP245 NRG TENDL-2015, AKONING

Threshold reactions

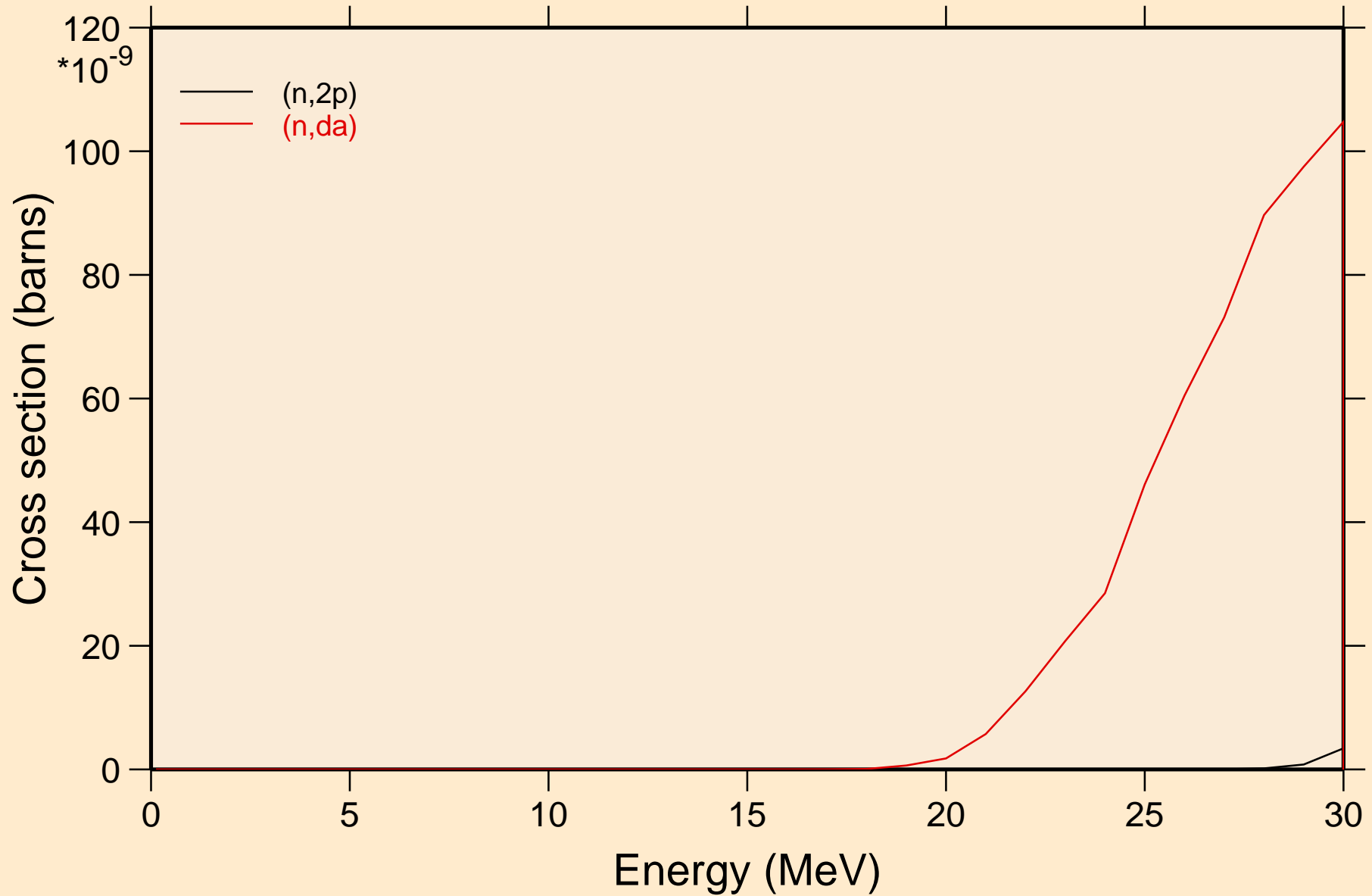

NP245 NRG TENDL-2015, AKONING
angular distribution for elastic

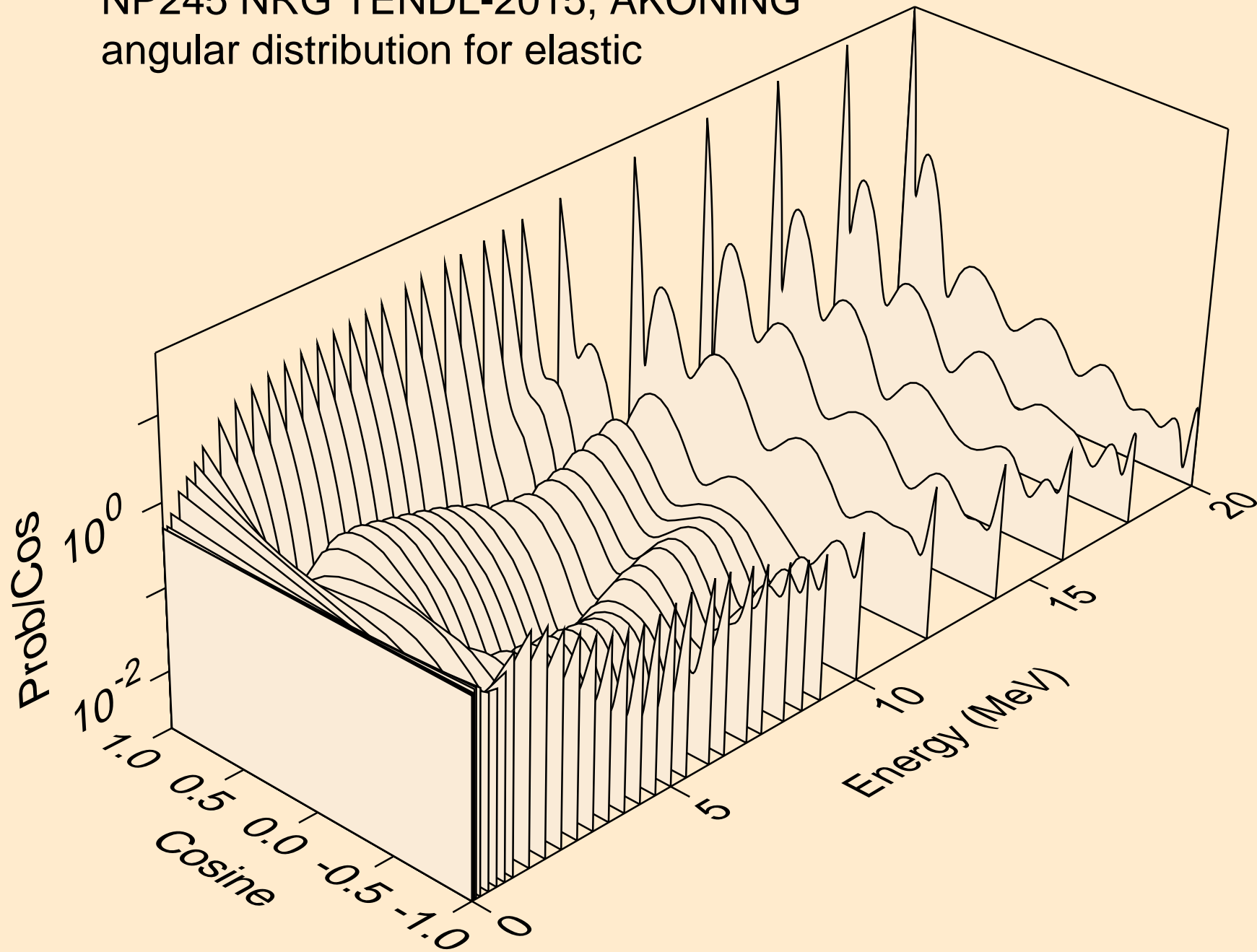

NP245 NRG TENDL-2015, AKONING
angular distribution for elastic

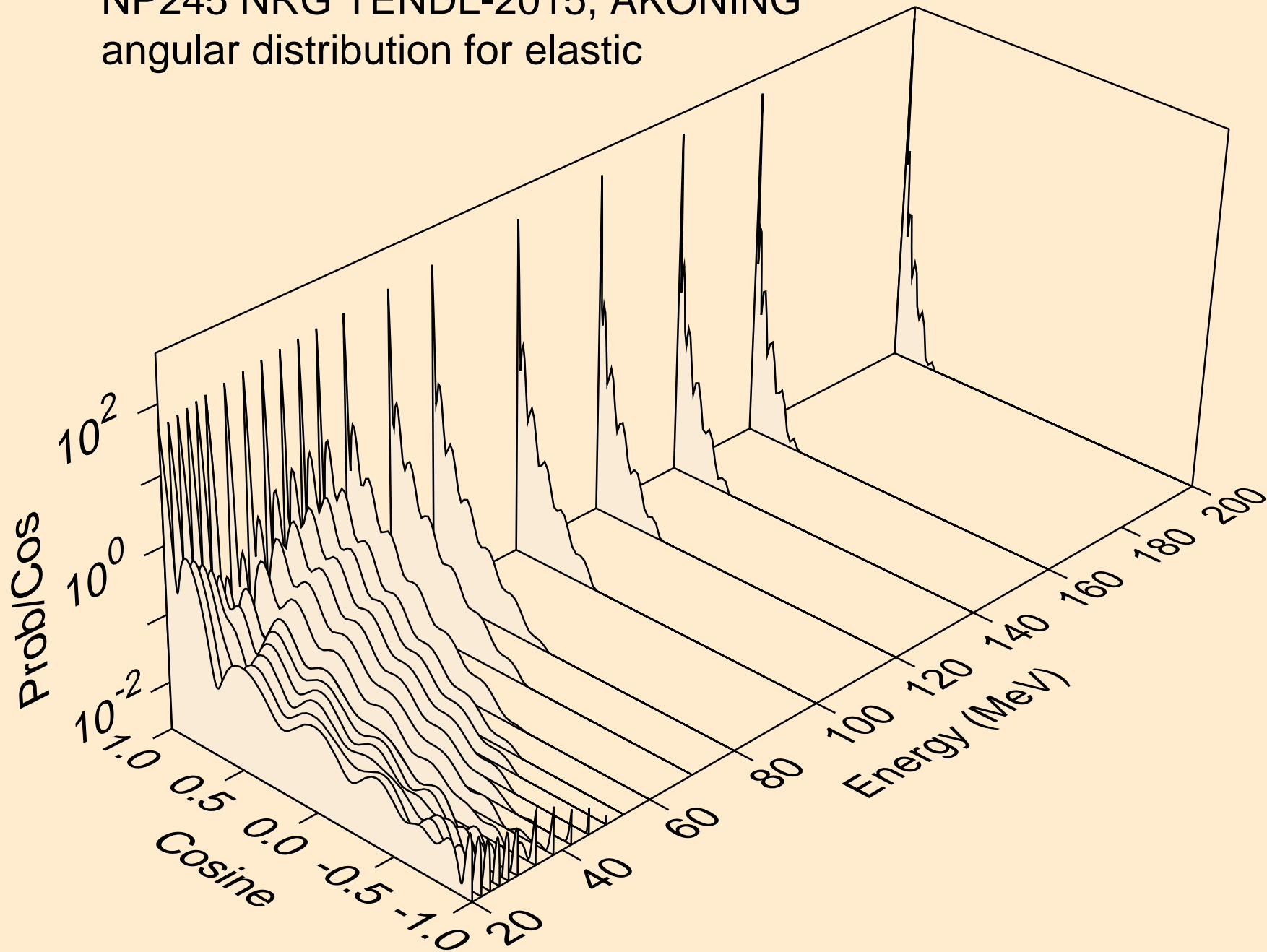

NP245 NRG TENDL-2015, AKONING
angular distribution for (n,n*1)

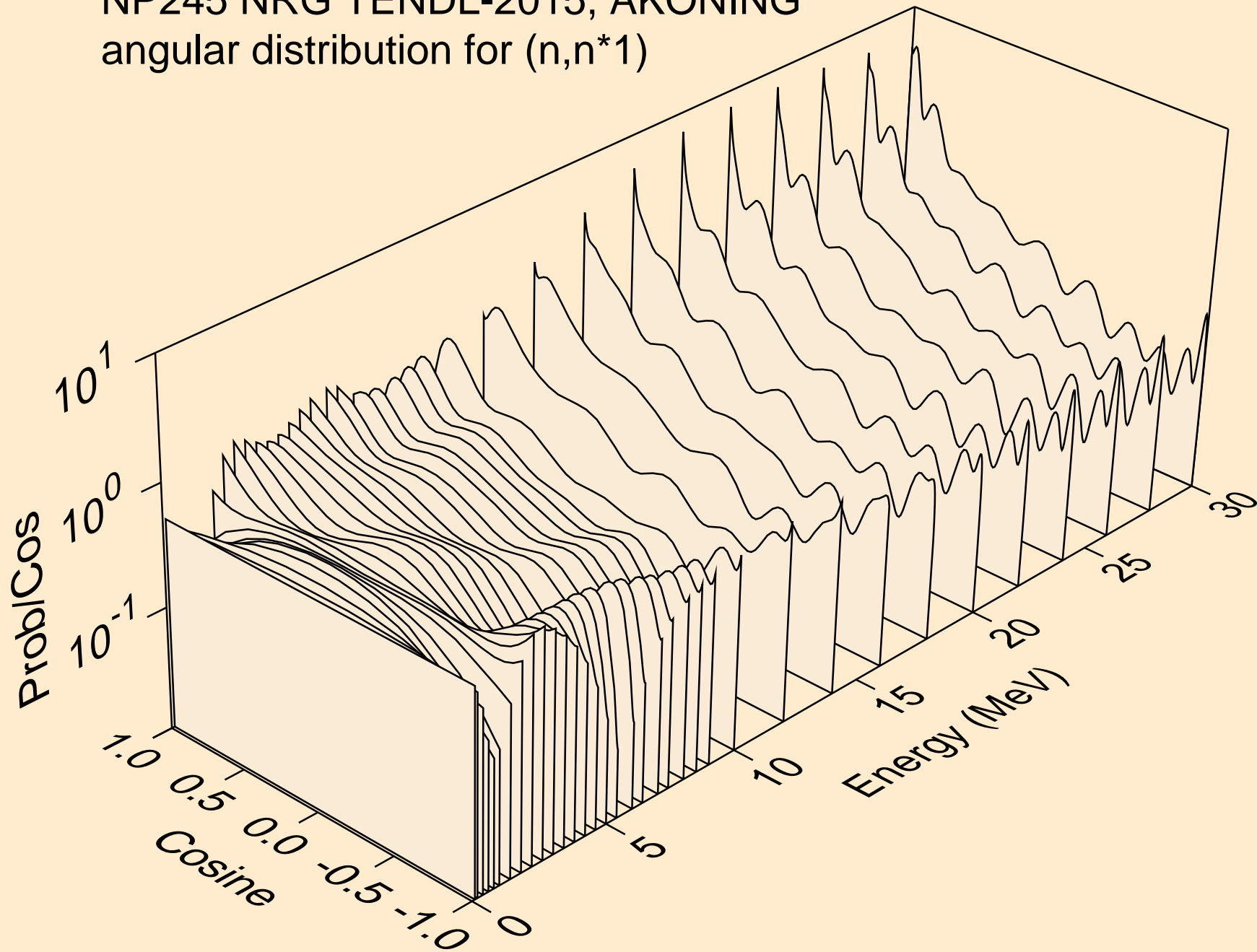

NP245 NRG TENDL-2015, AKONING

Total fission nubar

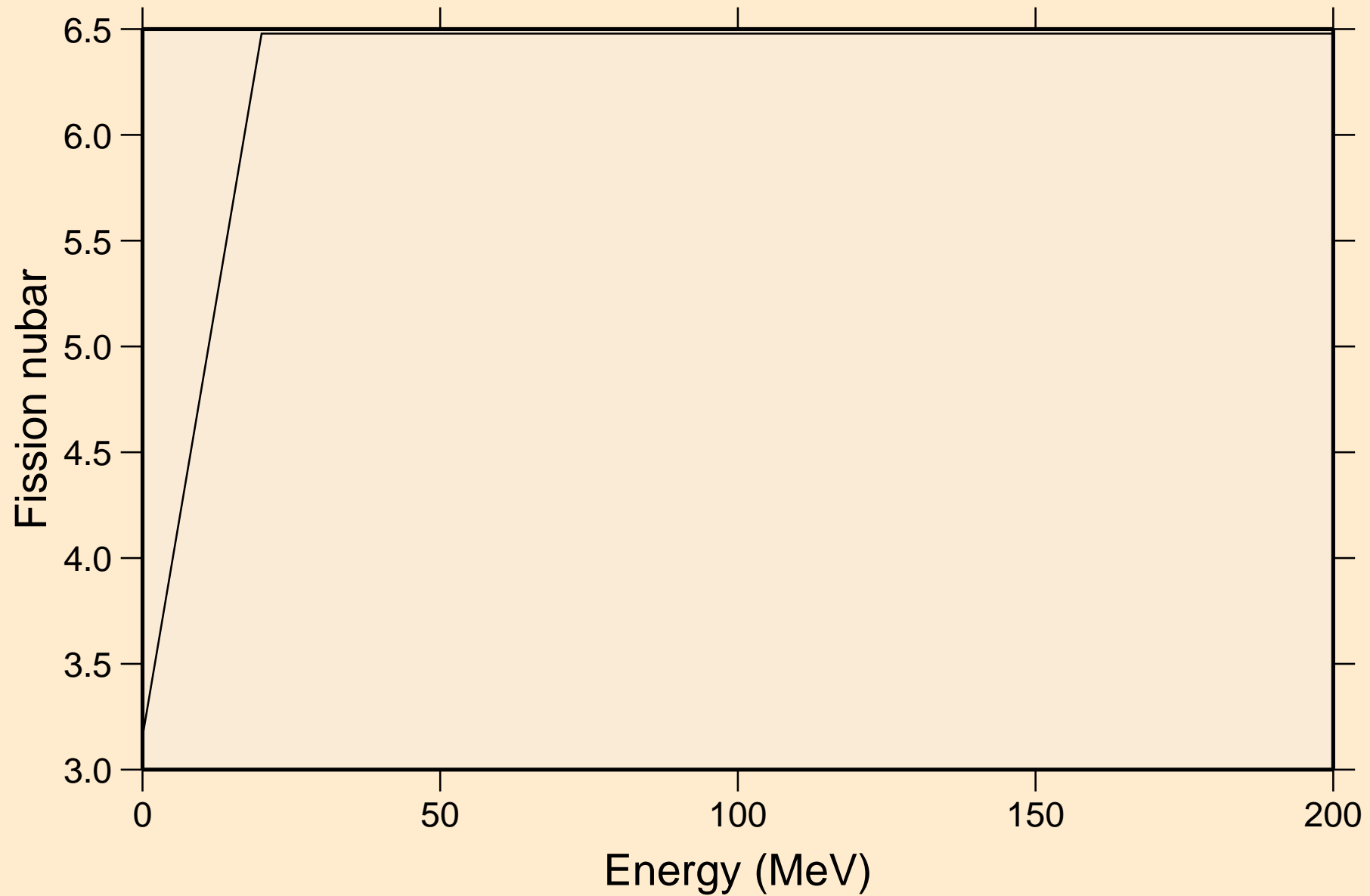

NP245 NRG TENDL-2015, AKONING
Neutron emission for (n,x)

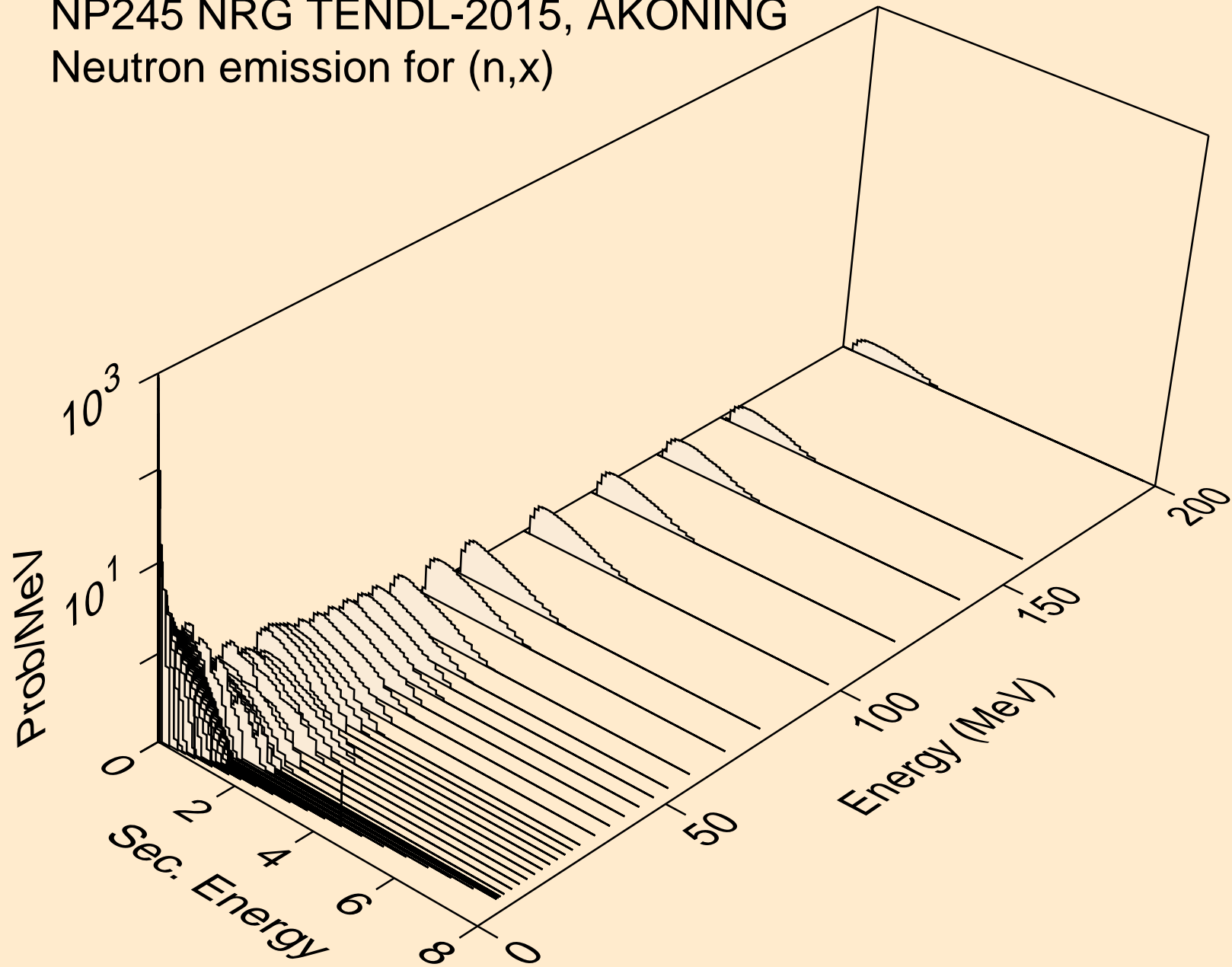

NP245 NRG TENDL-2015, AKONING
Neutron emission for (n,2nd)

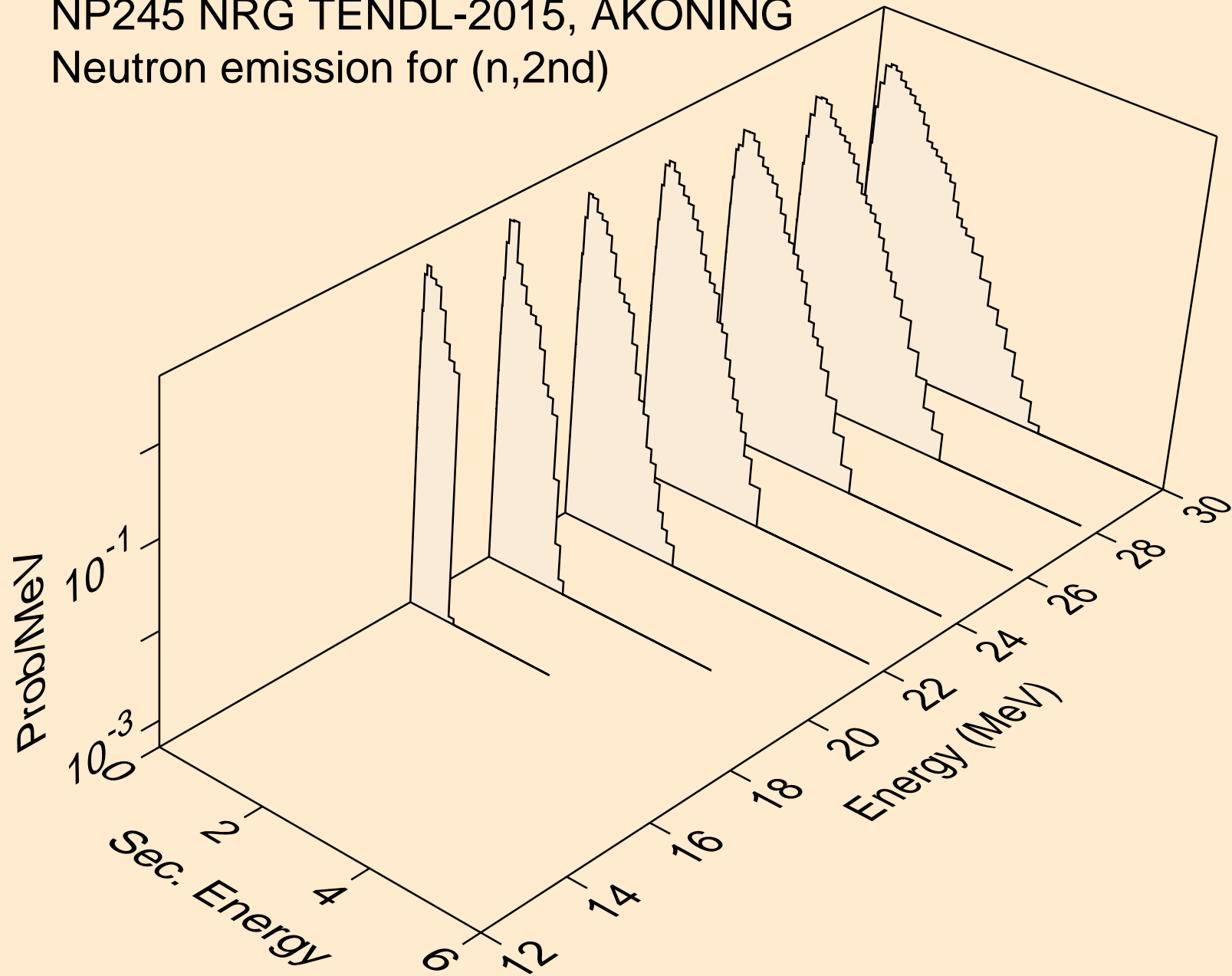

NP245 NRG TENDL-2015, AKONING
Neutron emission for (n,2n)

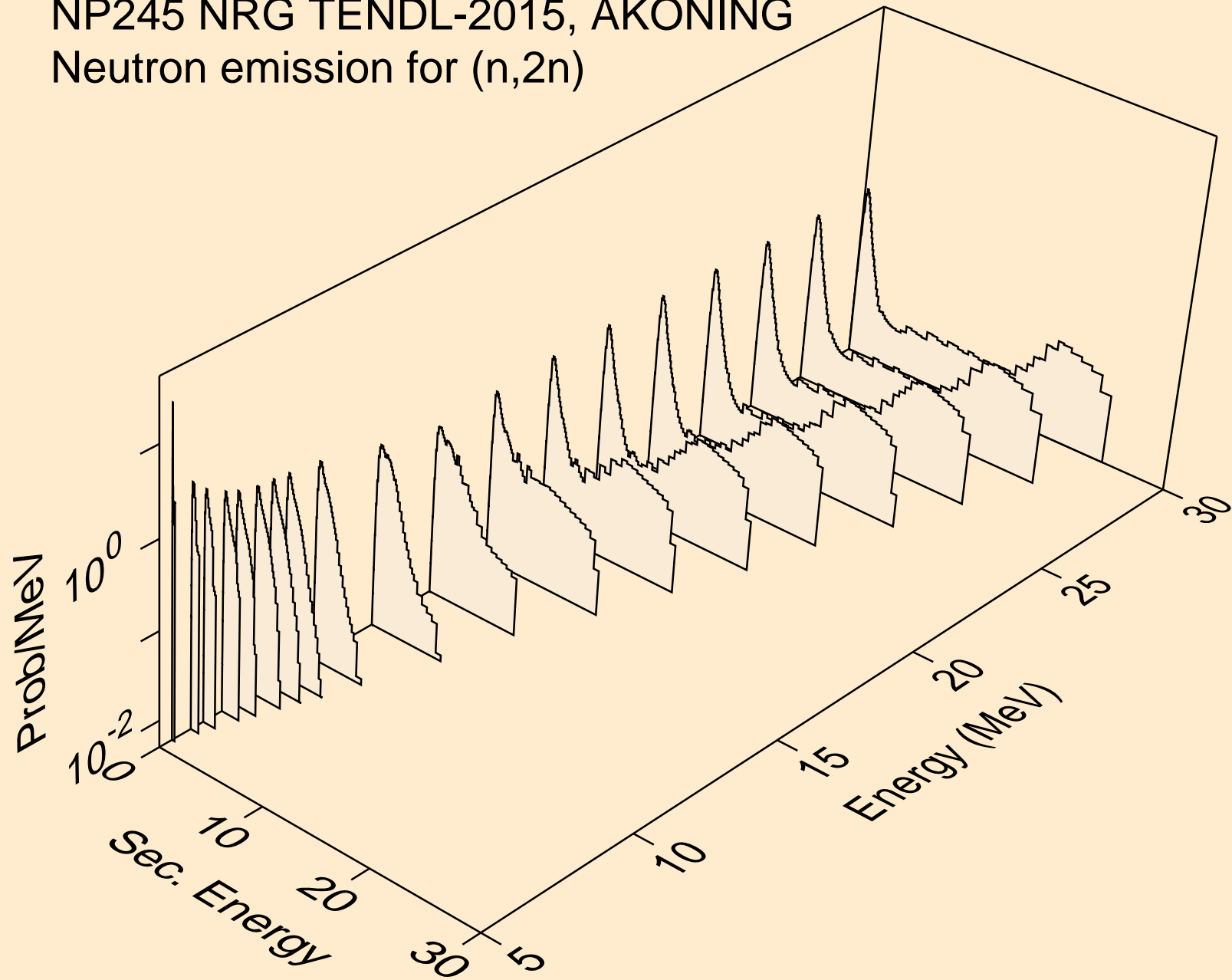

NP245 NRG TENDL-2015, AKONING
Neutron emission for (n,3n)

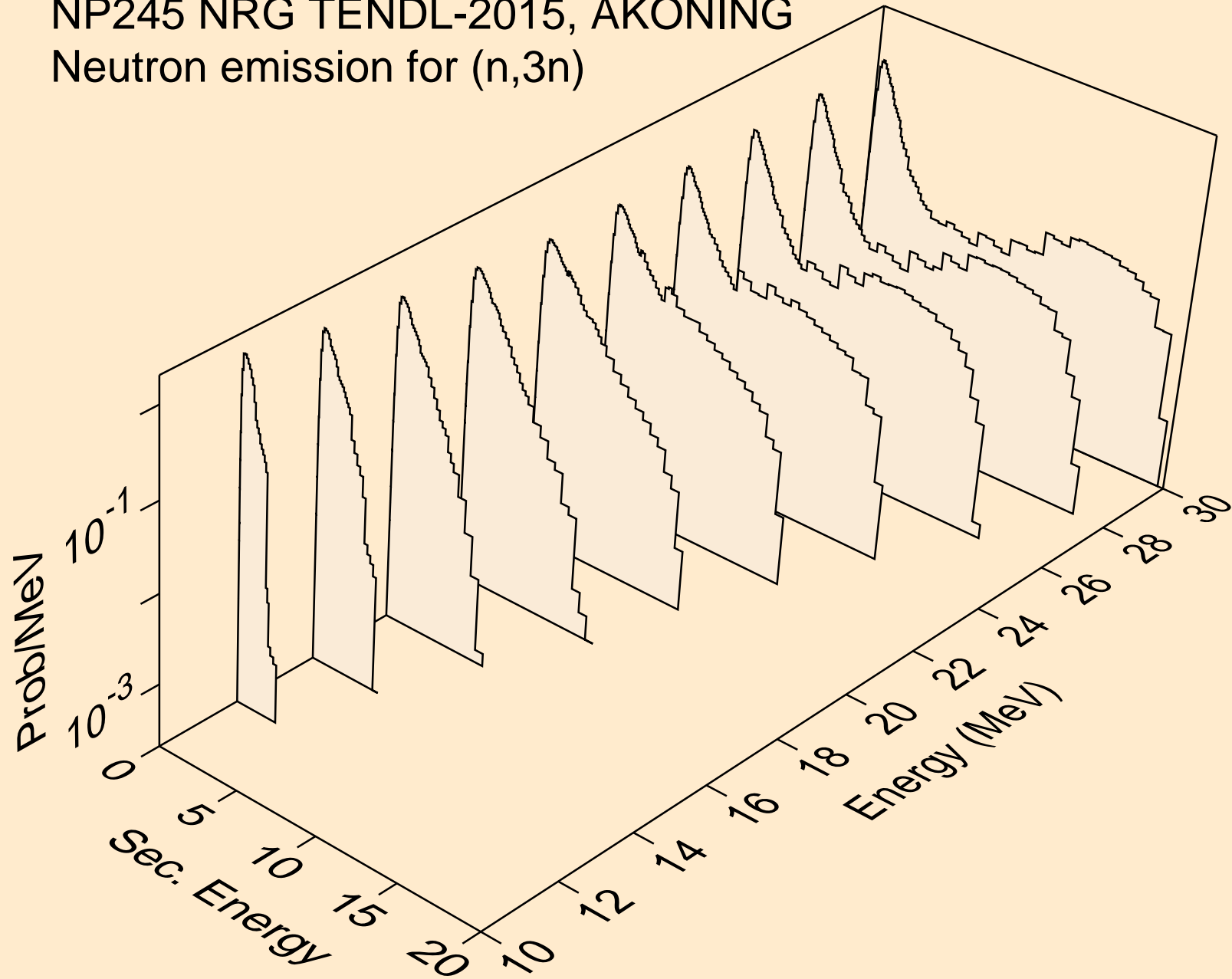

NP245 NRG TENDL-2015, AKONING
Neutron emission for fission

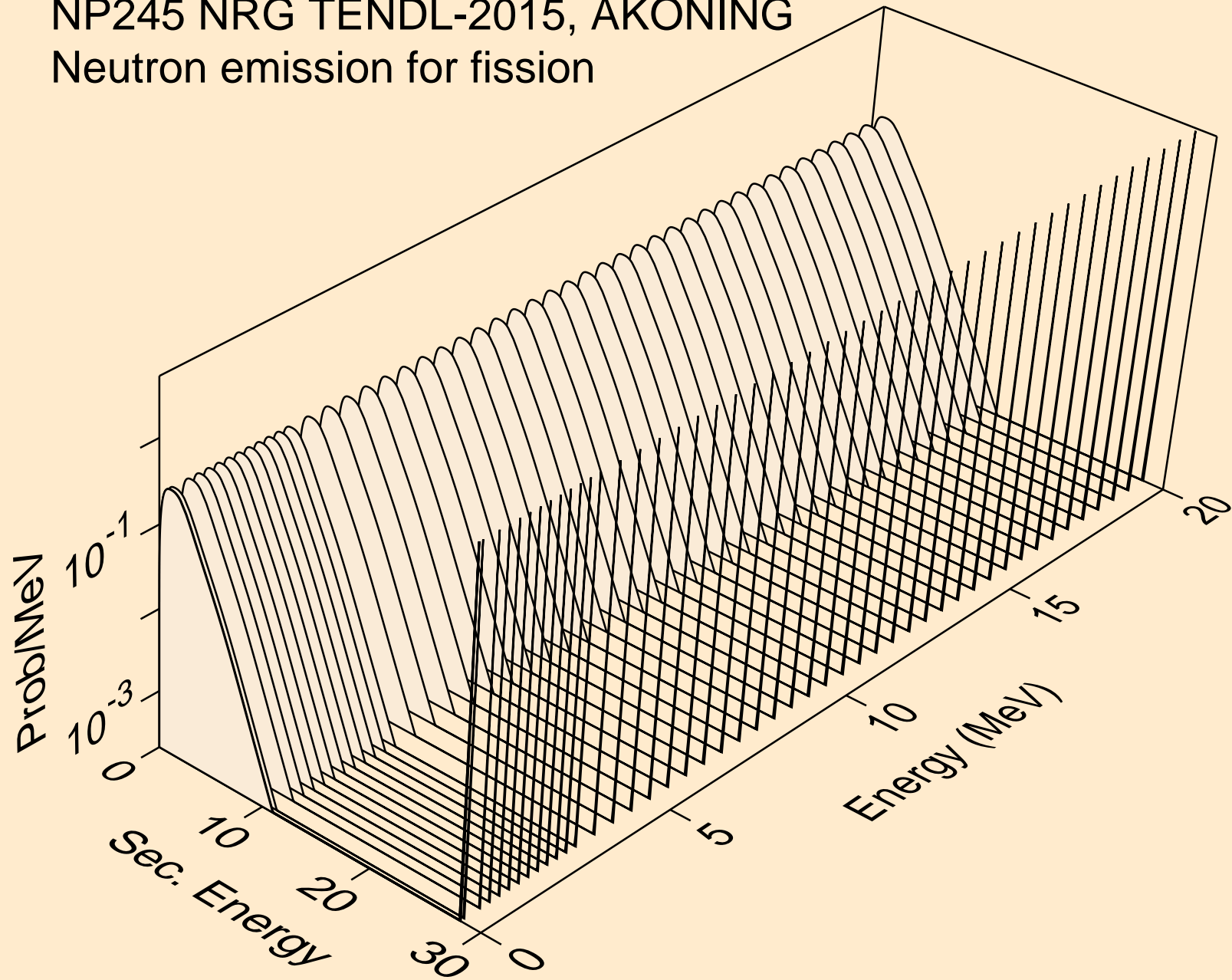

NP245 NRG TENDL-2015, AKONING
Neutron emission for (n,n*)a

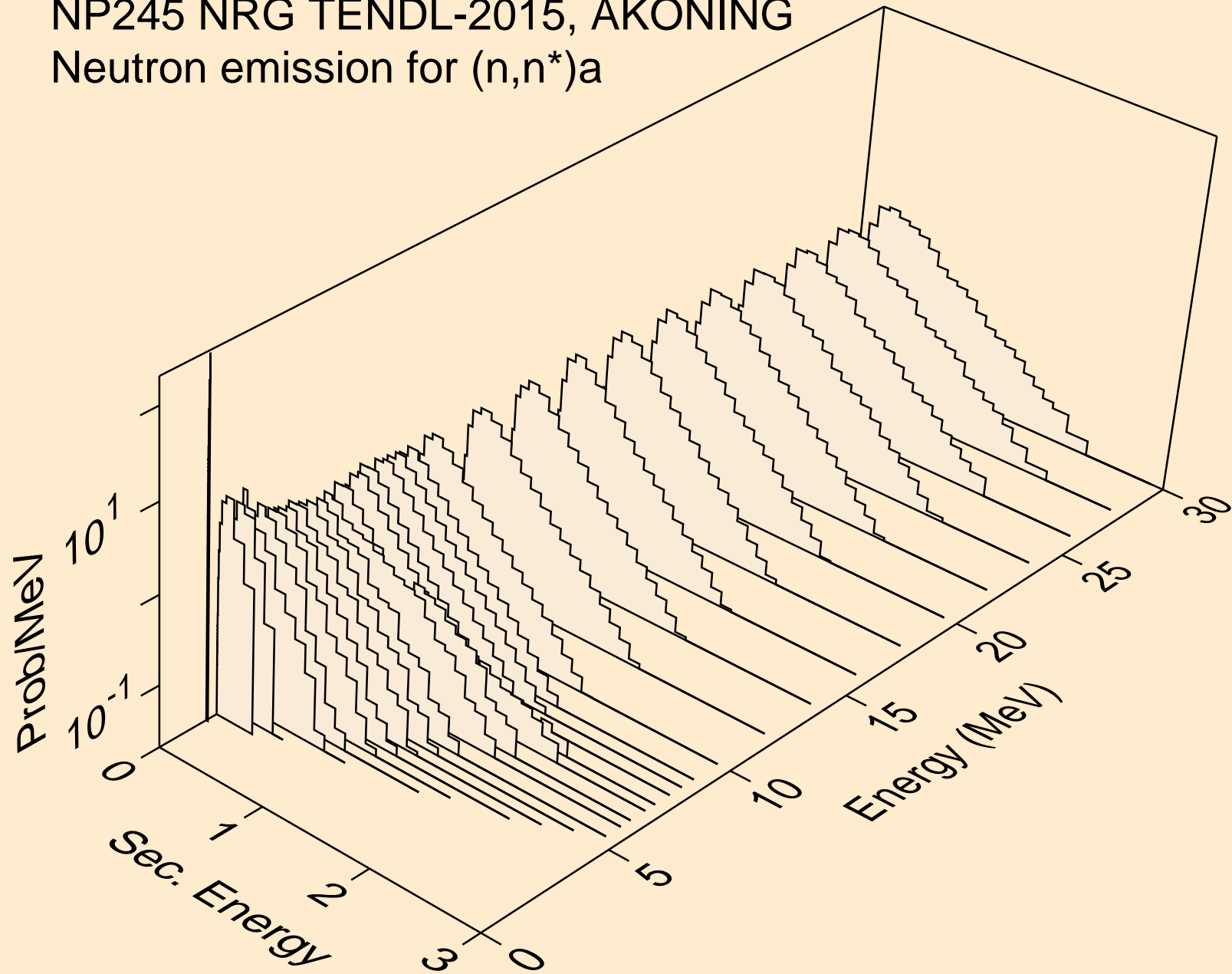

NP245 NRG TENDL-2015, AKONING
Neutron emission for (n,2n)a

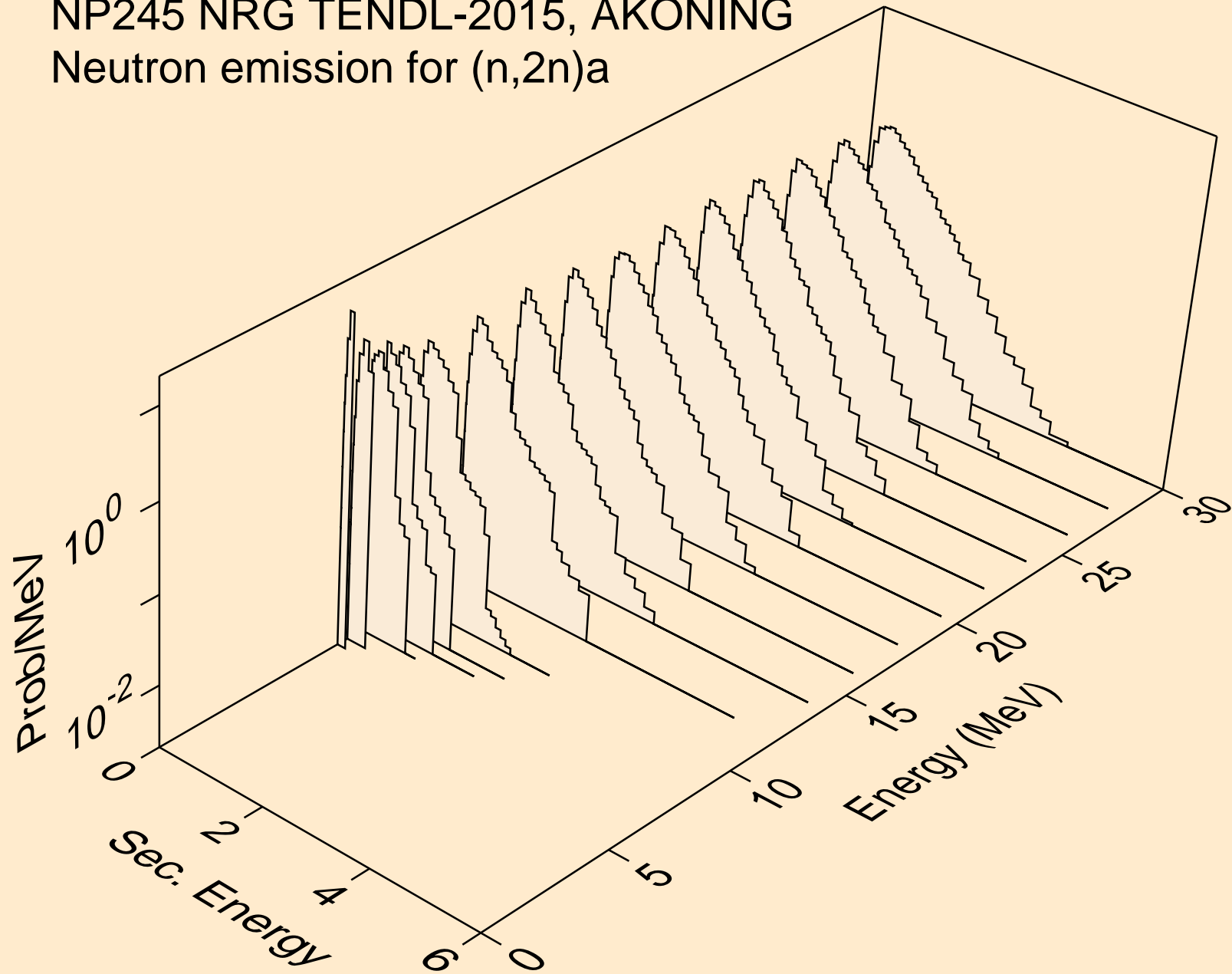

NP245 NRG TENDL-2015, AKONING
Neutron emission for (n,3n)a

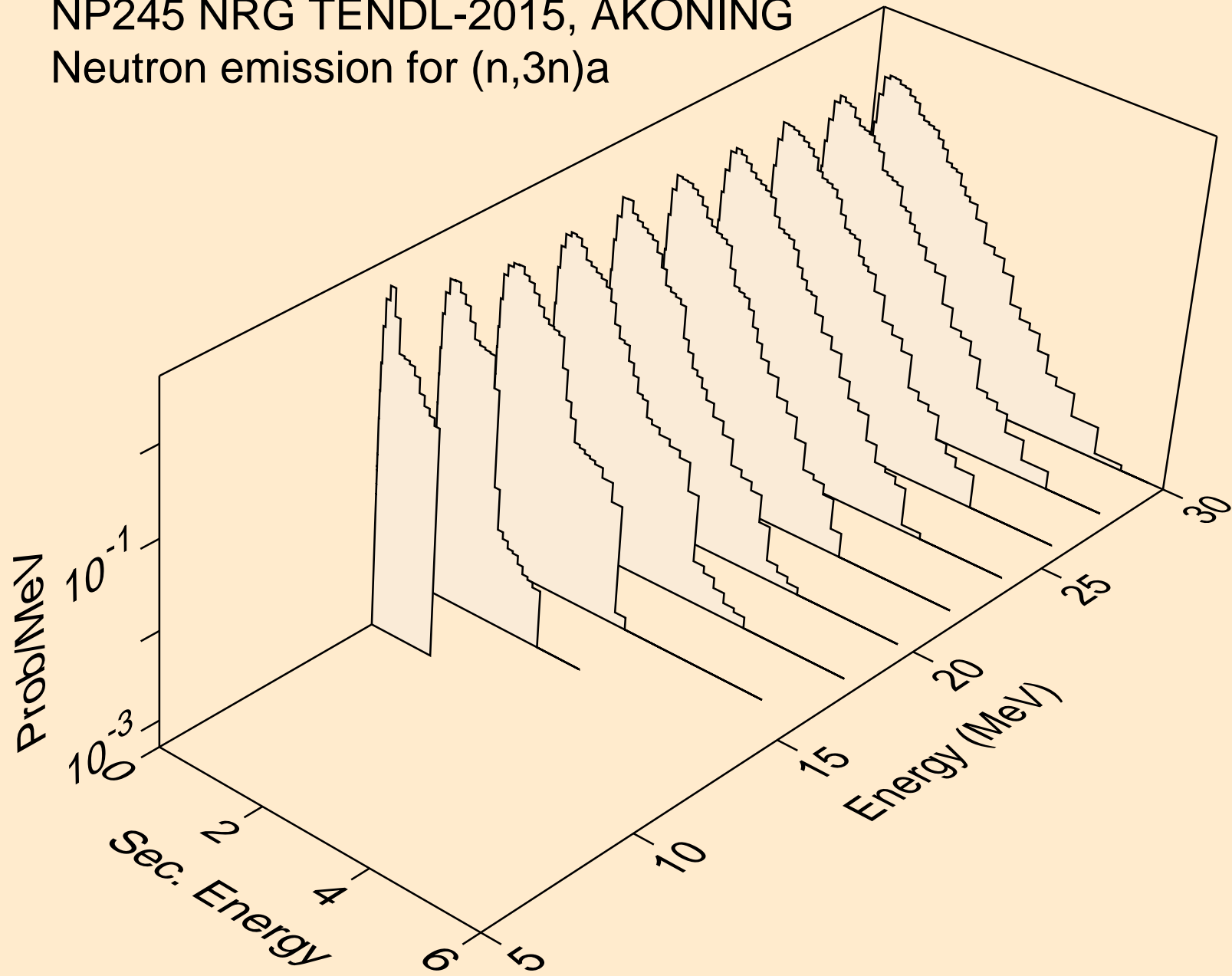

NP245 NRG TENDL-2015, AKONING
Neutron emission for (n,n*)p

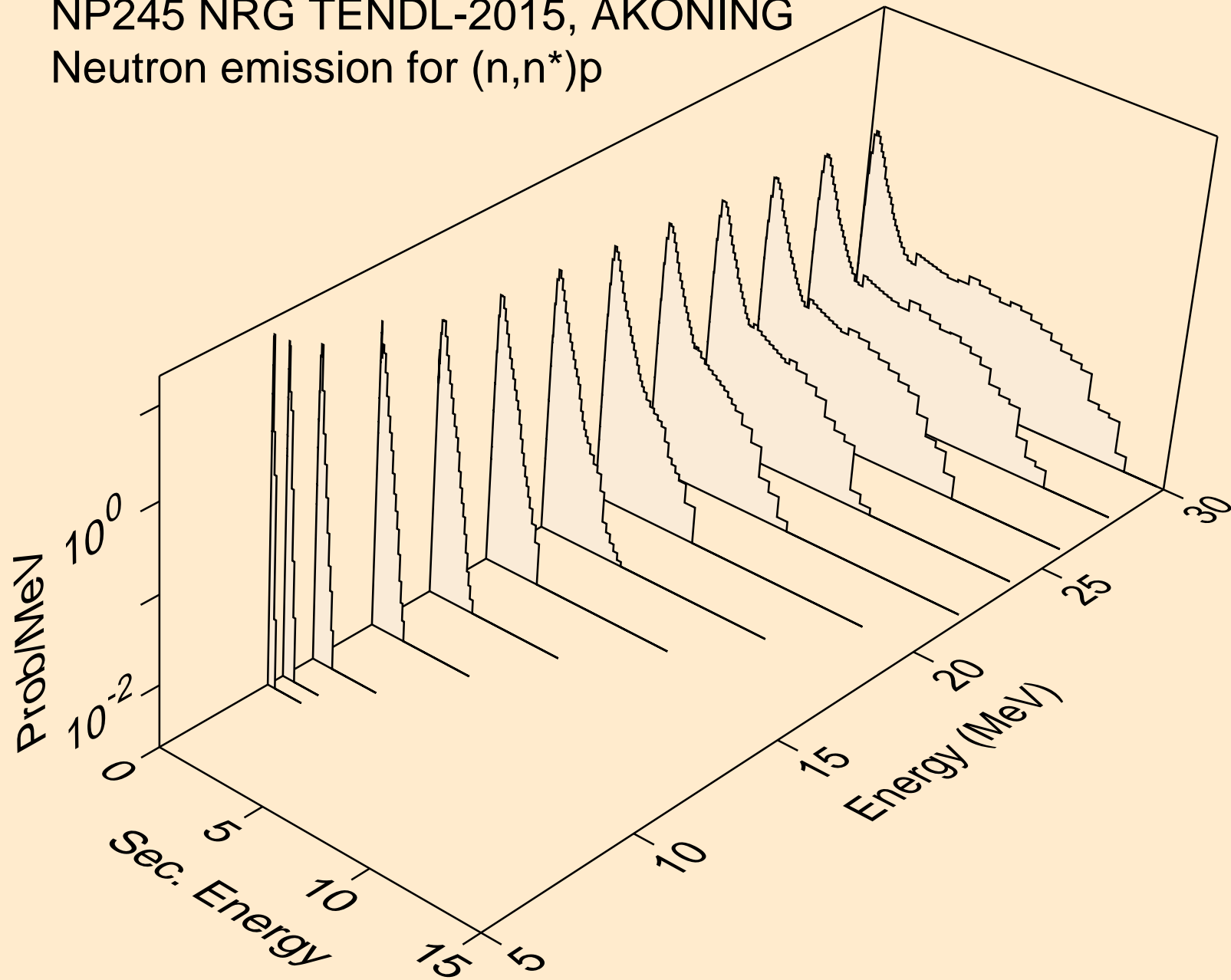

NP245 NRG TENDL-2015, AKONING
Neutron emission for (n,n*)d

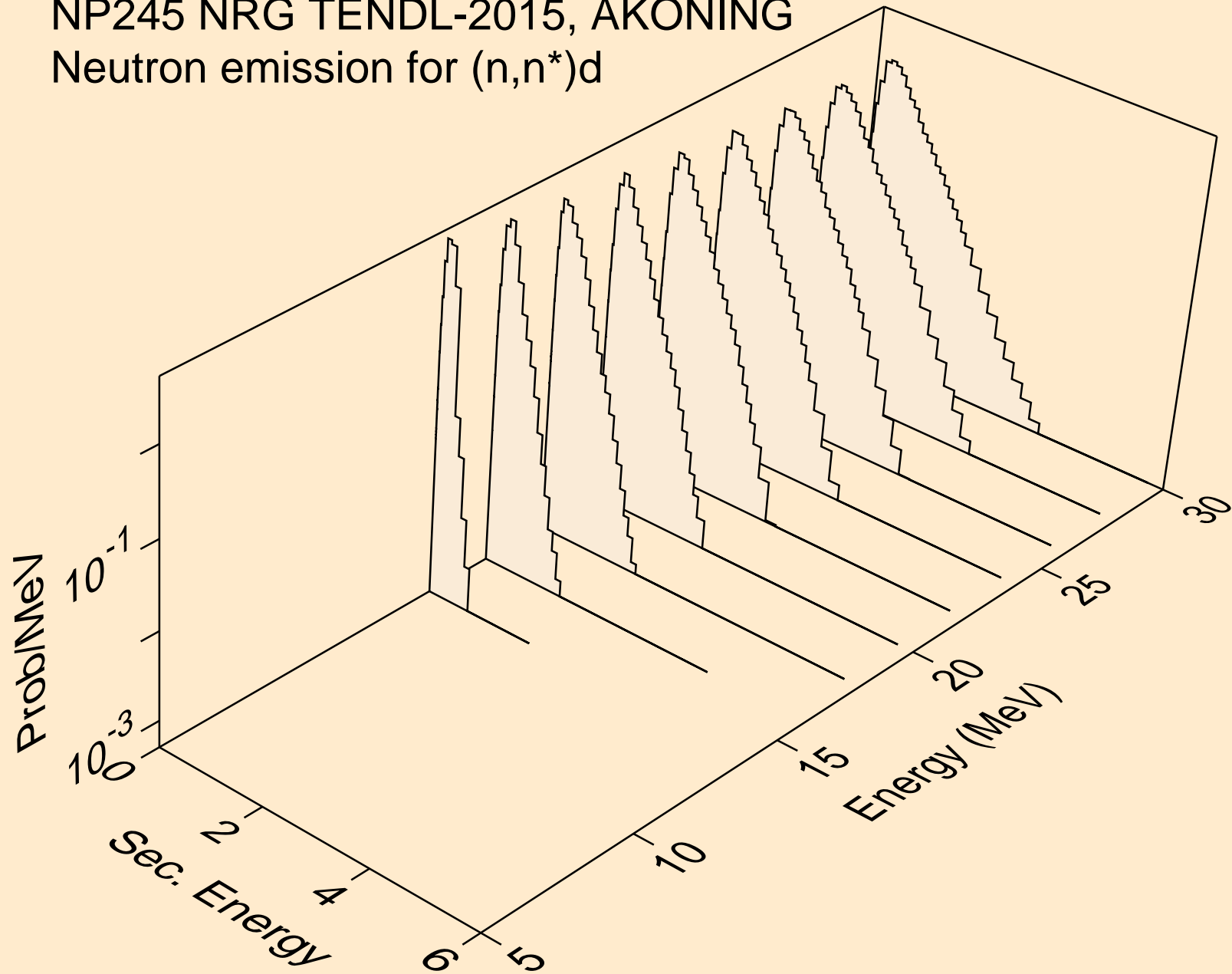

NP245 NRG TENDL-2015, AKONING
Neutron emission for (n,n*)t

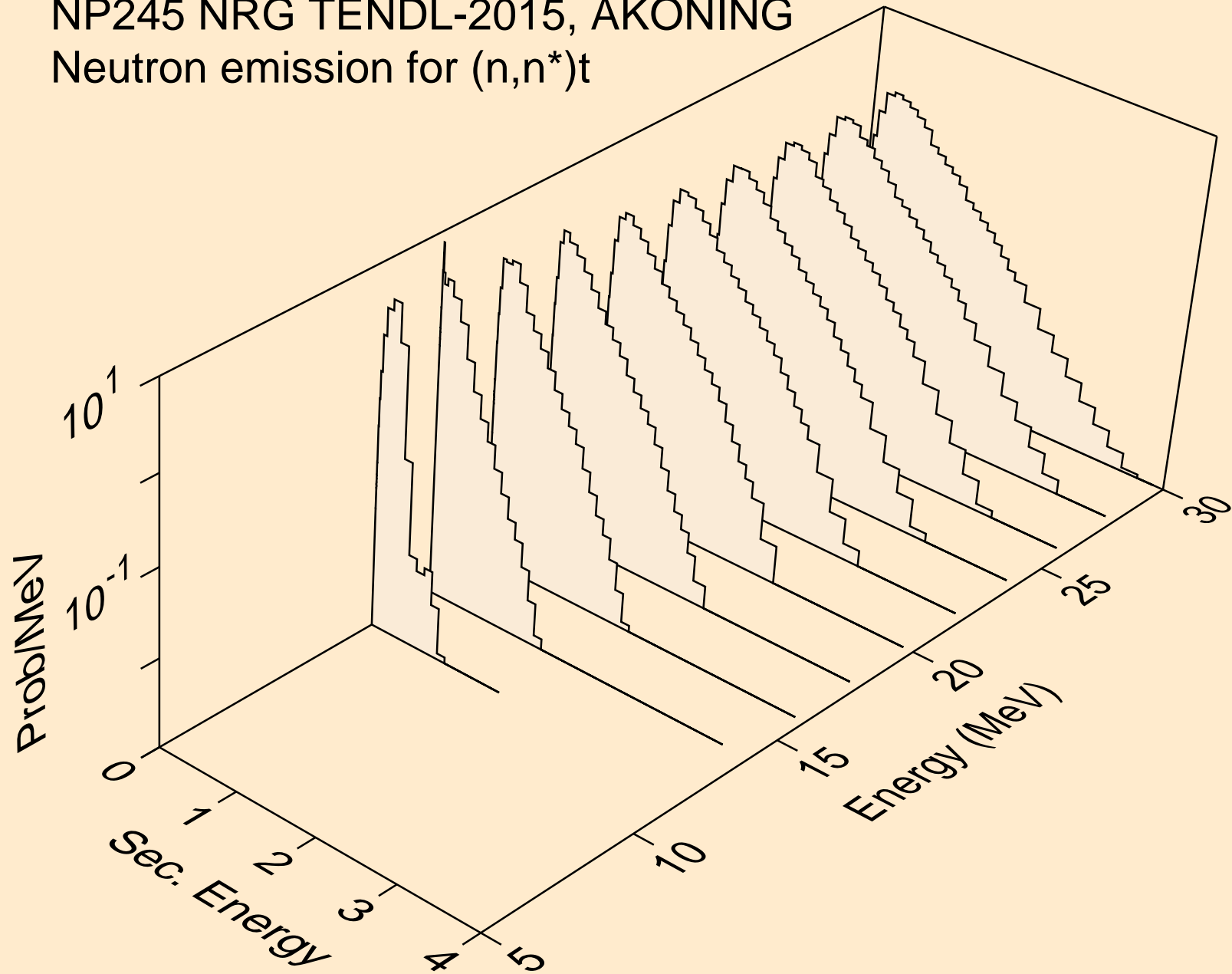

NP245 NRG TENDL-2015, AKONING
Neutron emission for (n,n*)he3

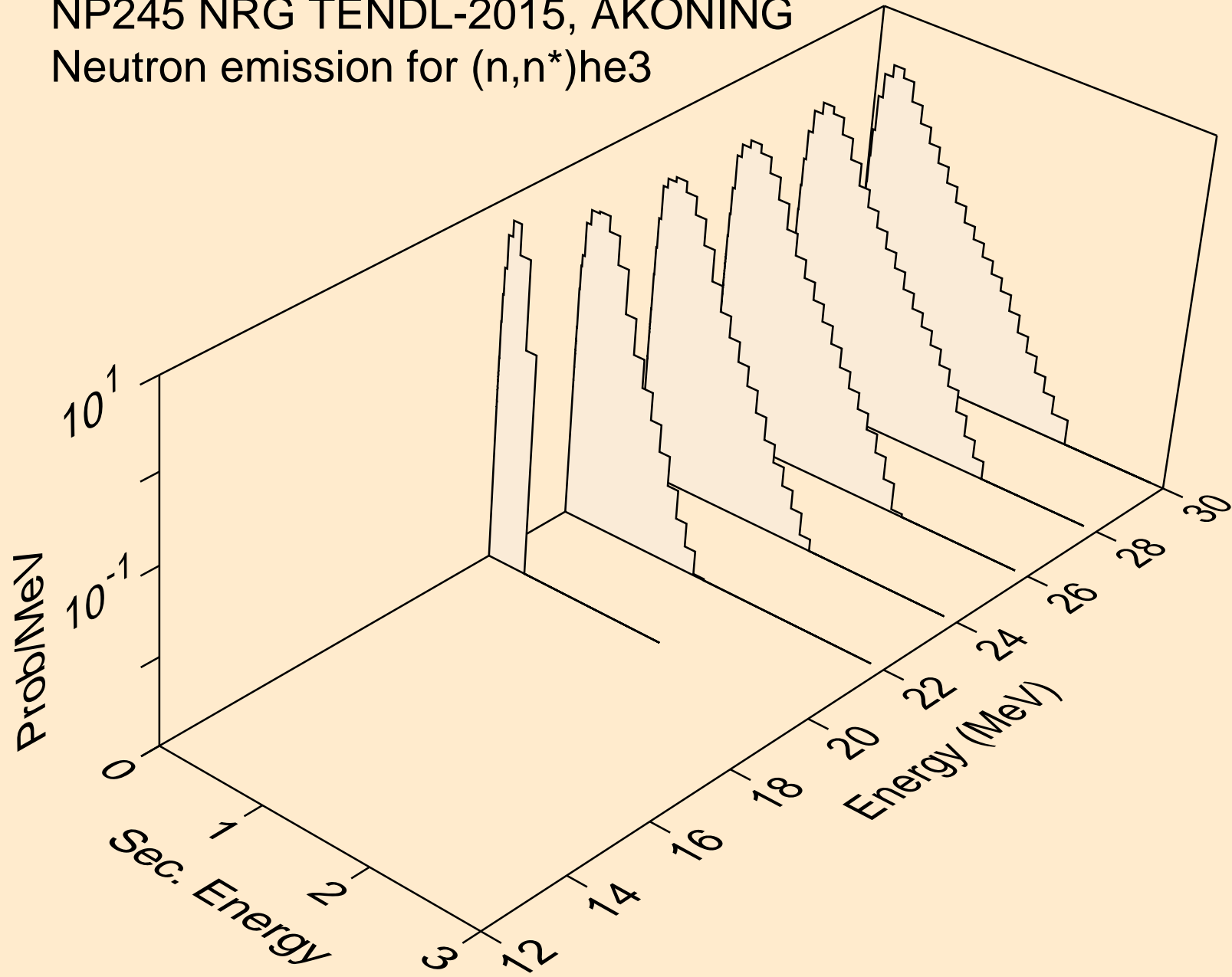

NP245 NRG TENDL-2015, AKONING
Neutron emission for (n,4n)

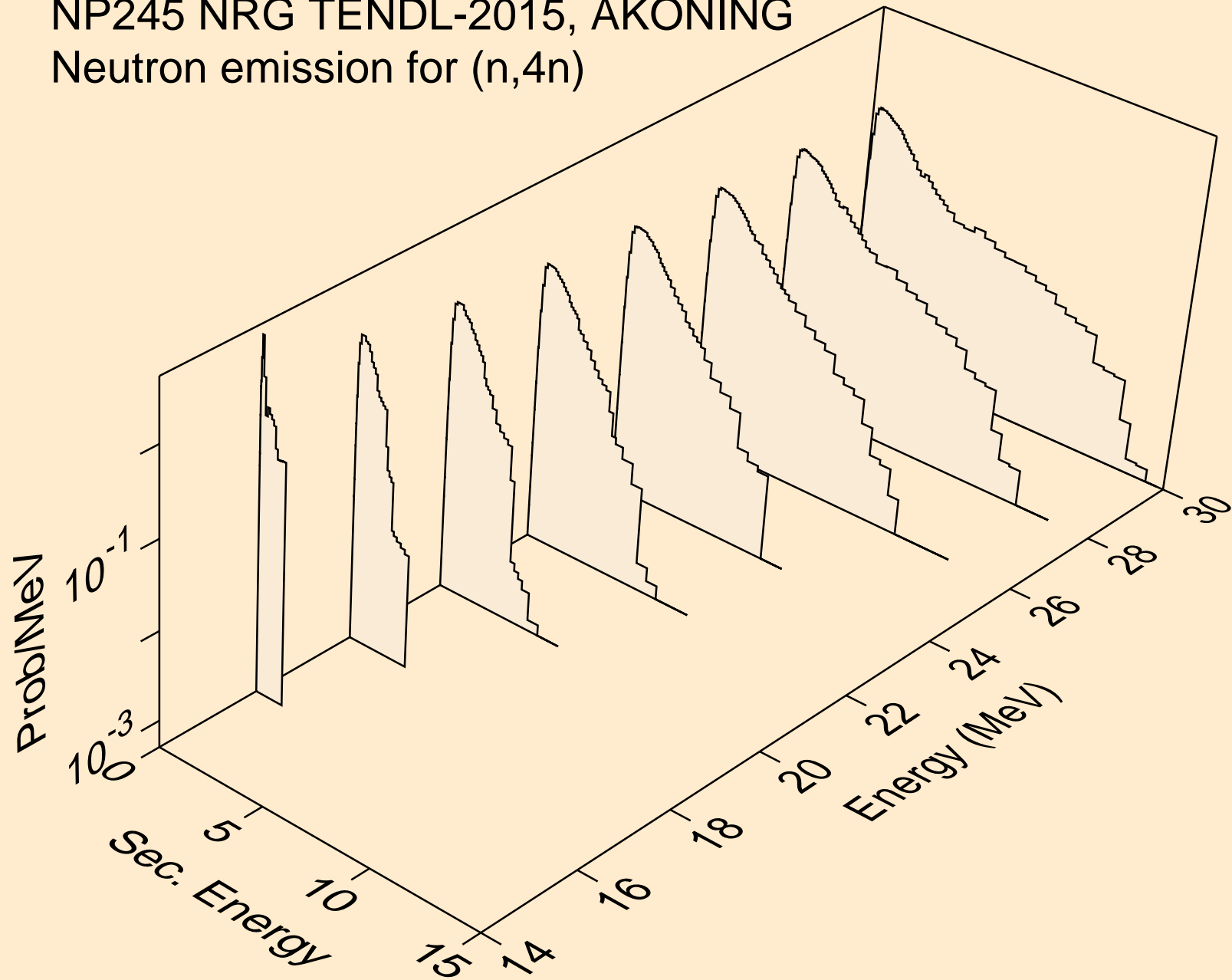

NP245 NRG TENDL-2015, AKONING
Neutron emission for (n,2np)

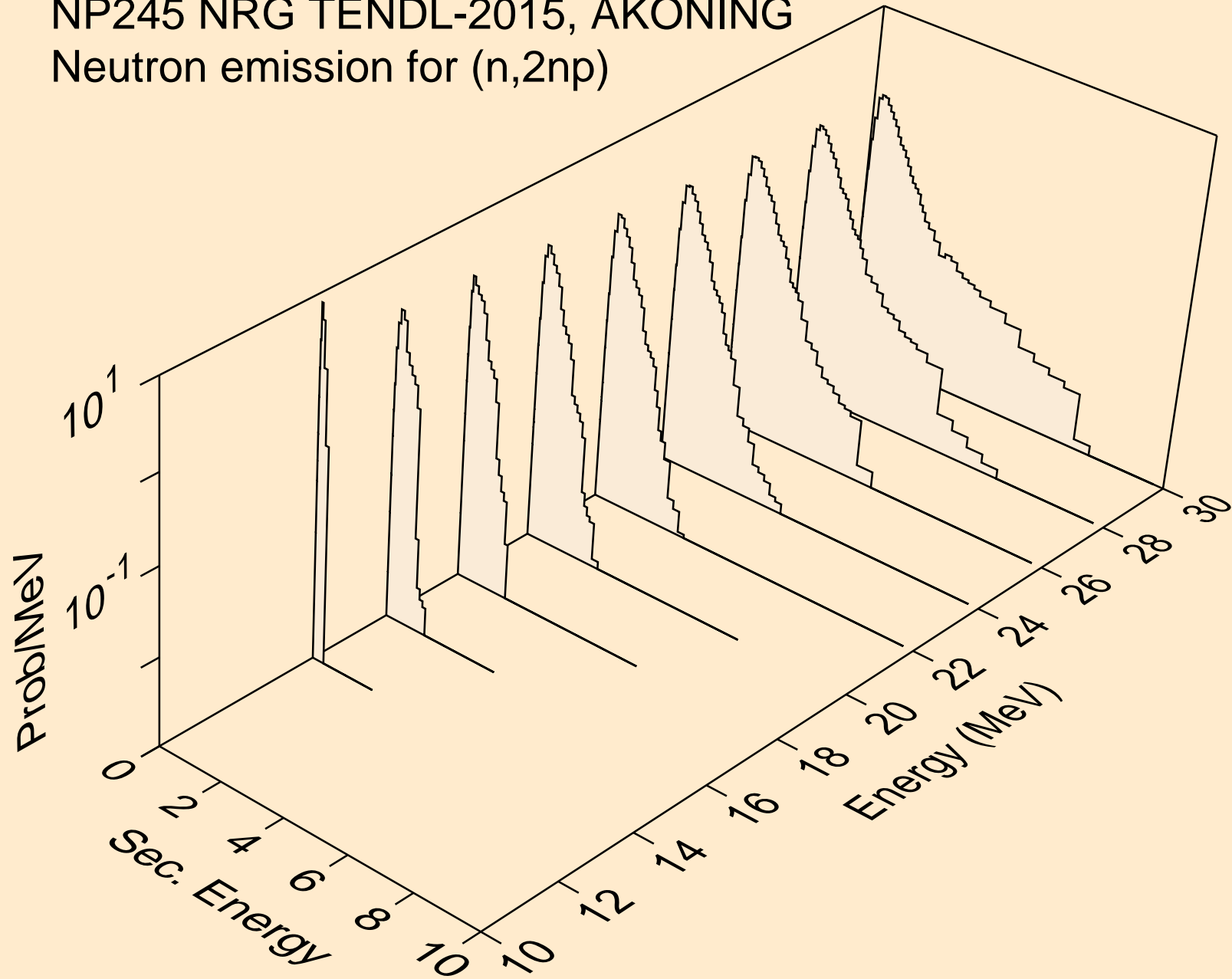

NP245 NRG TENDL-2015, AKONING
Neutron emission for (n,3np)

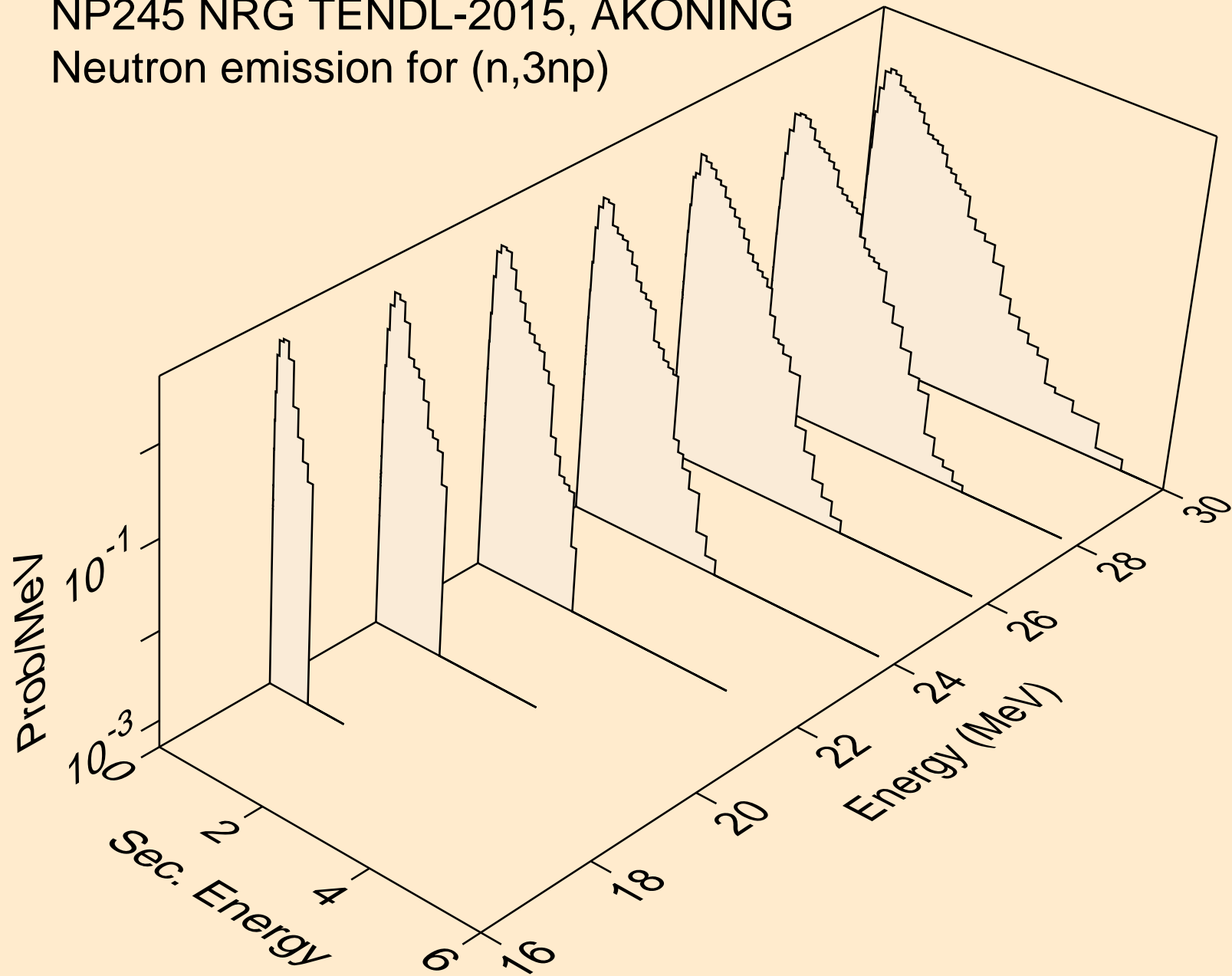

NP245 NRG TENDL-2015, AKONING
Neutron emission for (n,npa)

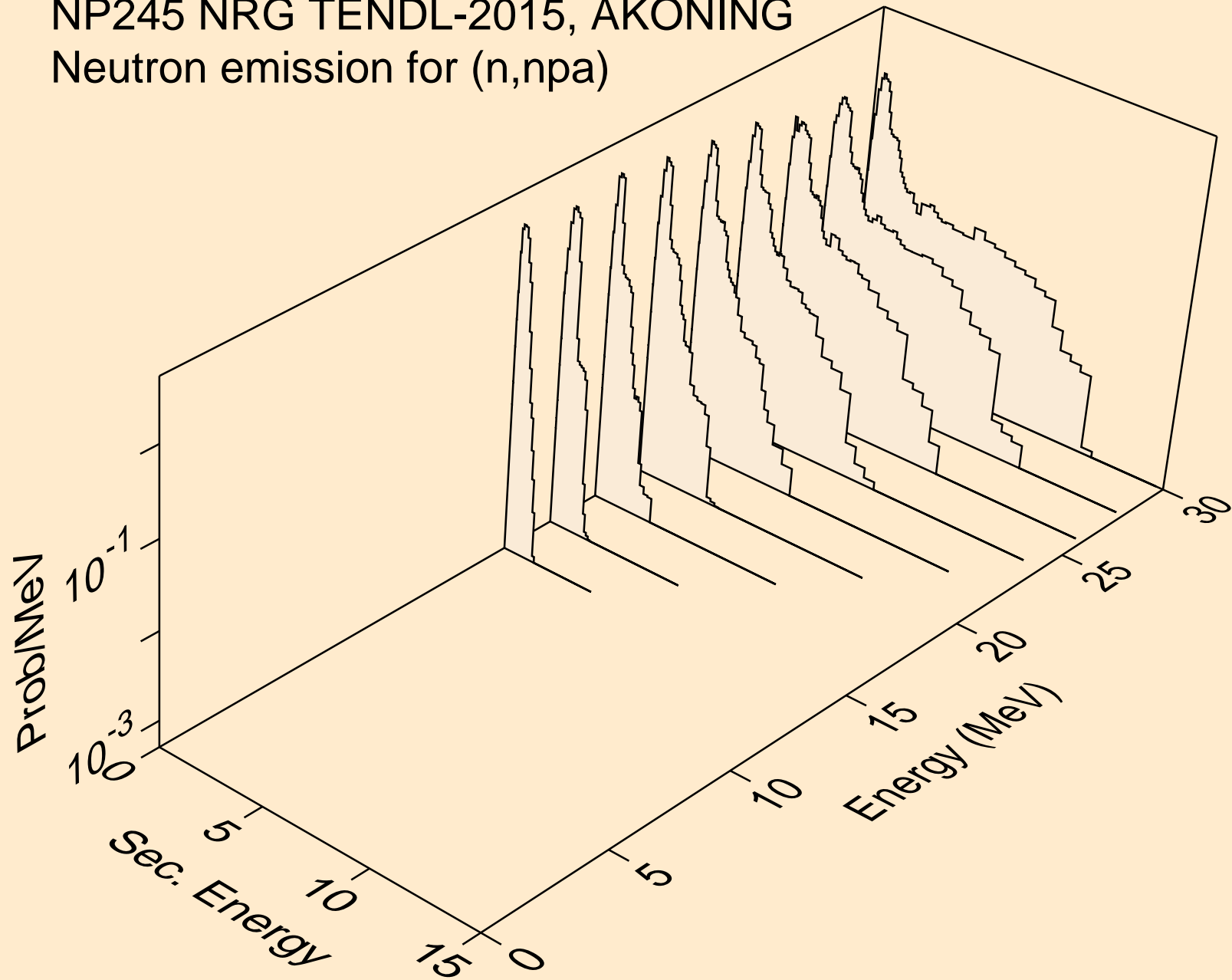

NP245 NRG TENDL-2015, AKONING
Neutron emission for (n,n*c)

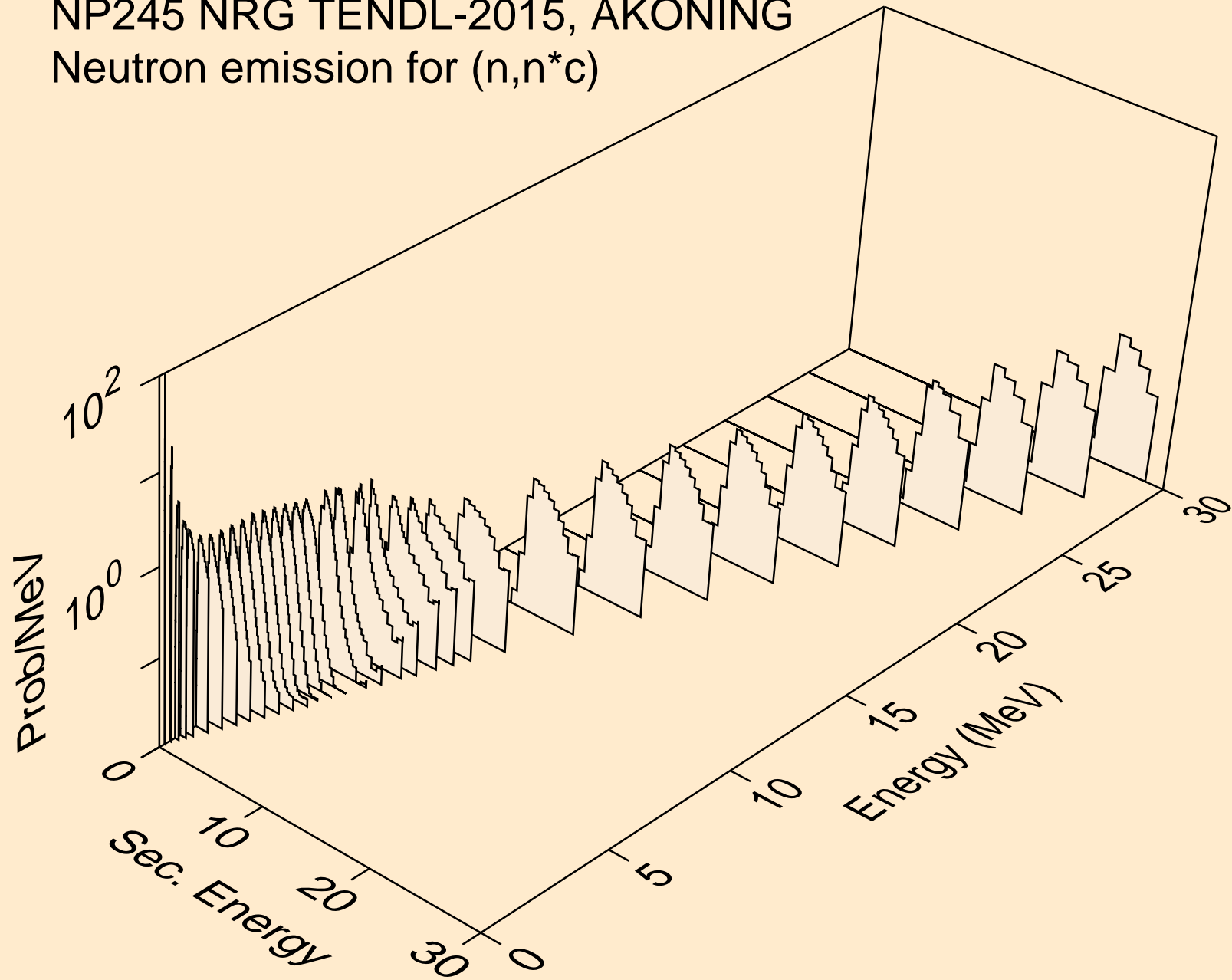

NP245 NRG TENDL-2015, AKONING

Delayed nubar

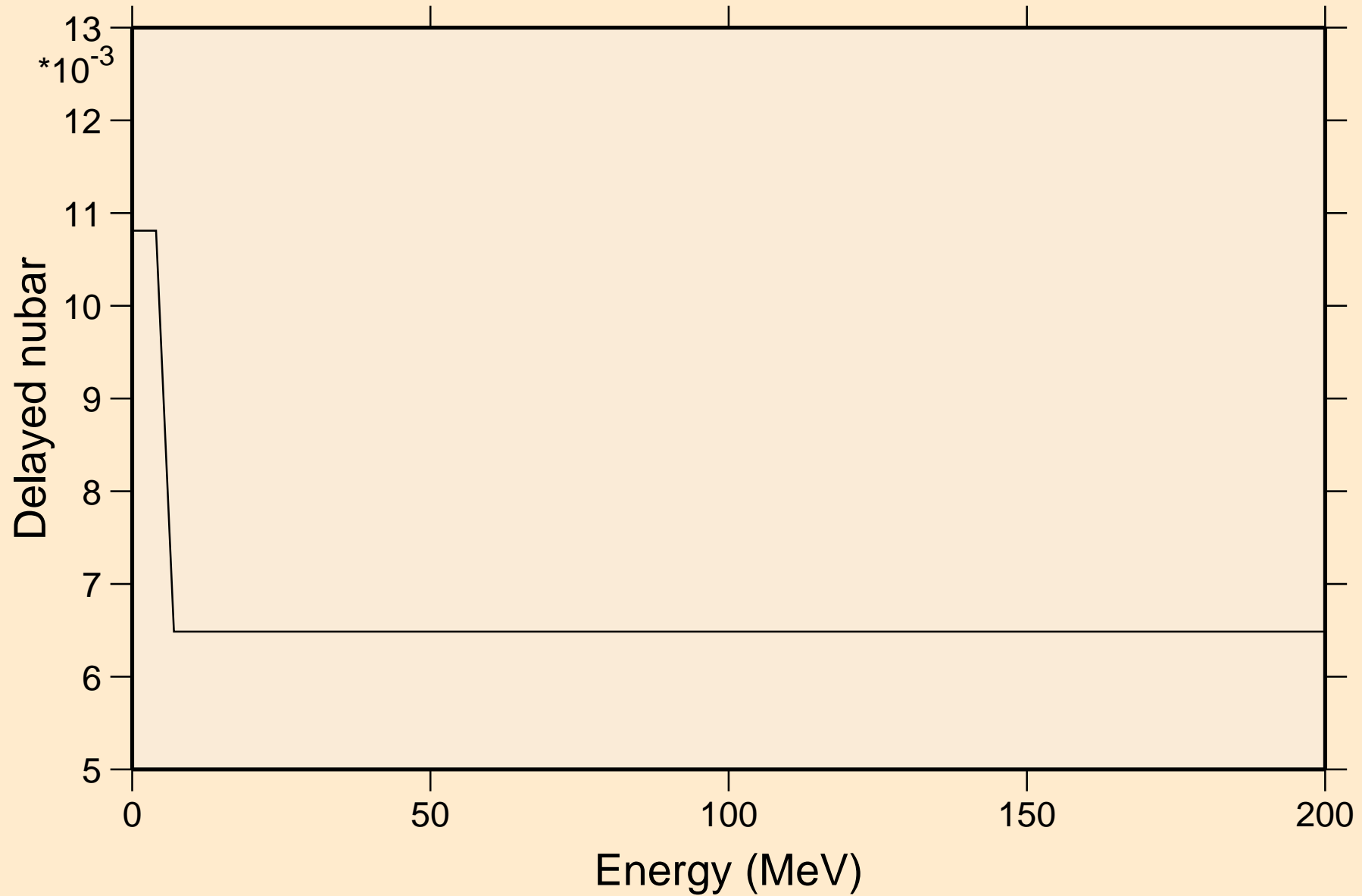

NP245 NRG TENDL-2015, AKONING

Delayed neutron spectra

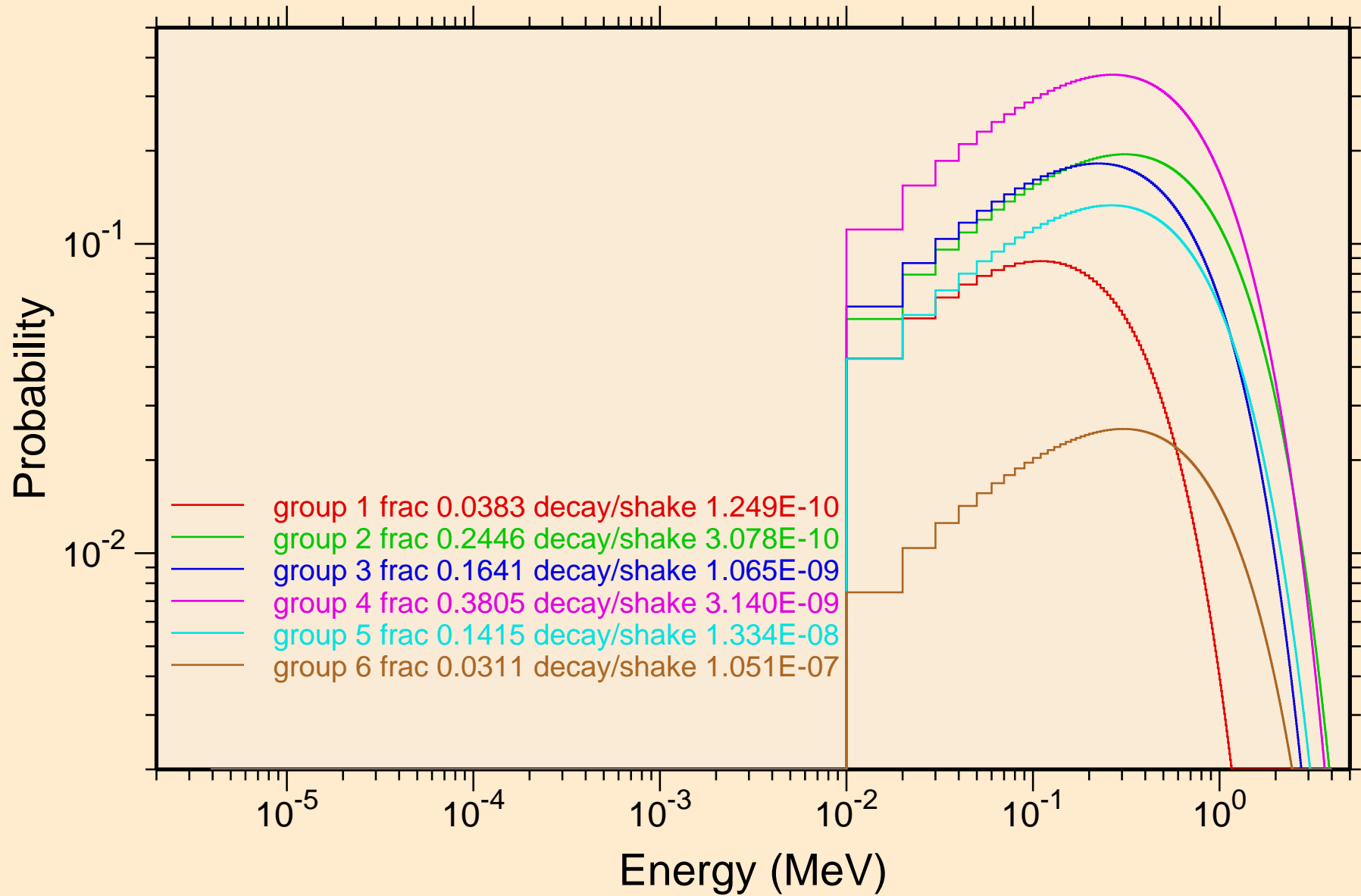

NP245 NRG TENDL-2015, AKONING
Photon emission for (n,x)

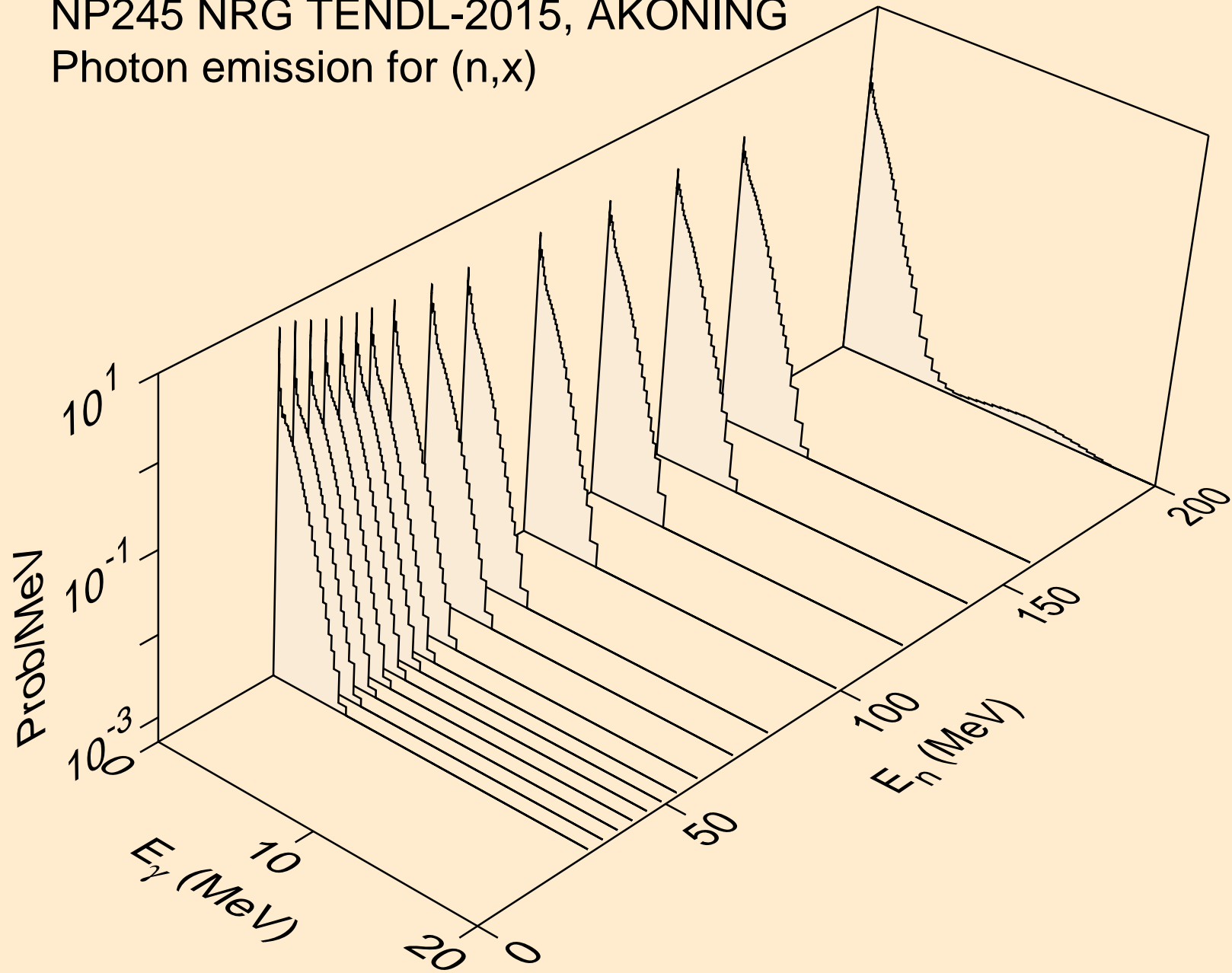

NP245 NRG TENDL-2015, AKONING
Photon emission for (n,2nd)

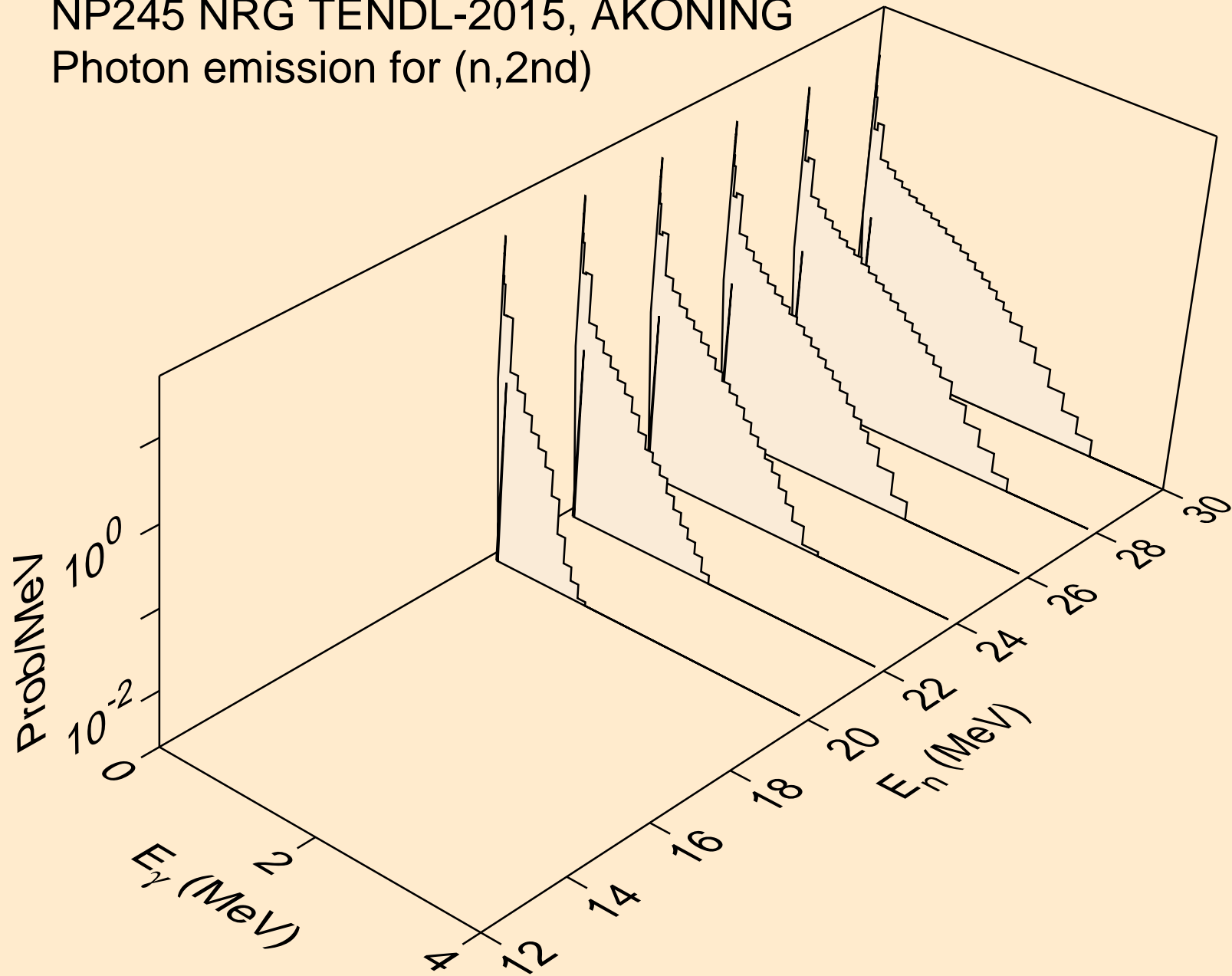

NP245 NRG TENDL-2015, AKONING
Photon emission for (n,2n)

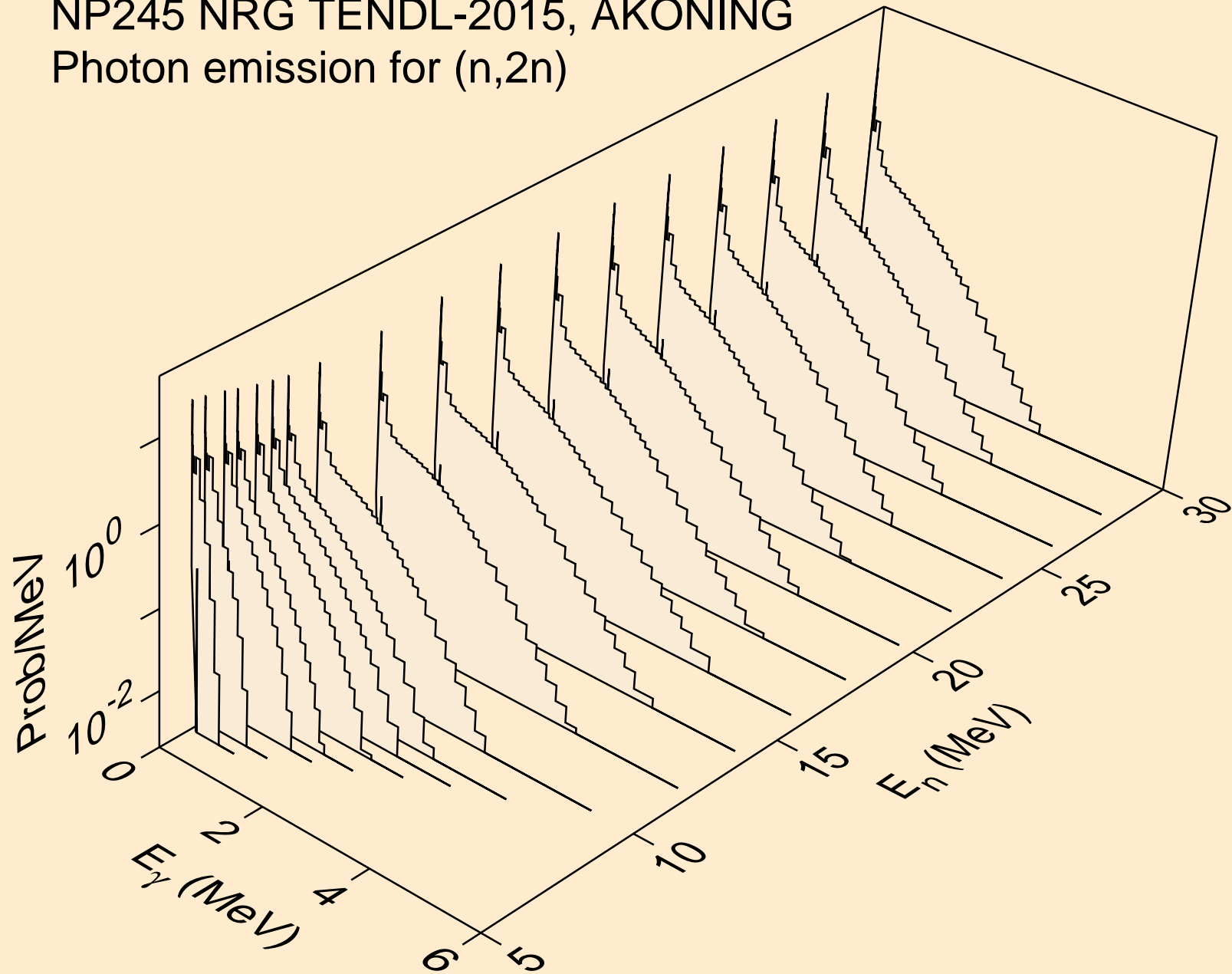

NP245 NRG TENDL-2015, AKONING
Photon emission for (n,3n)

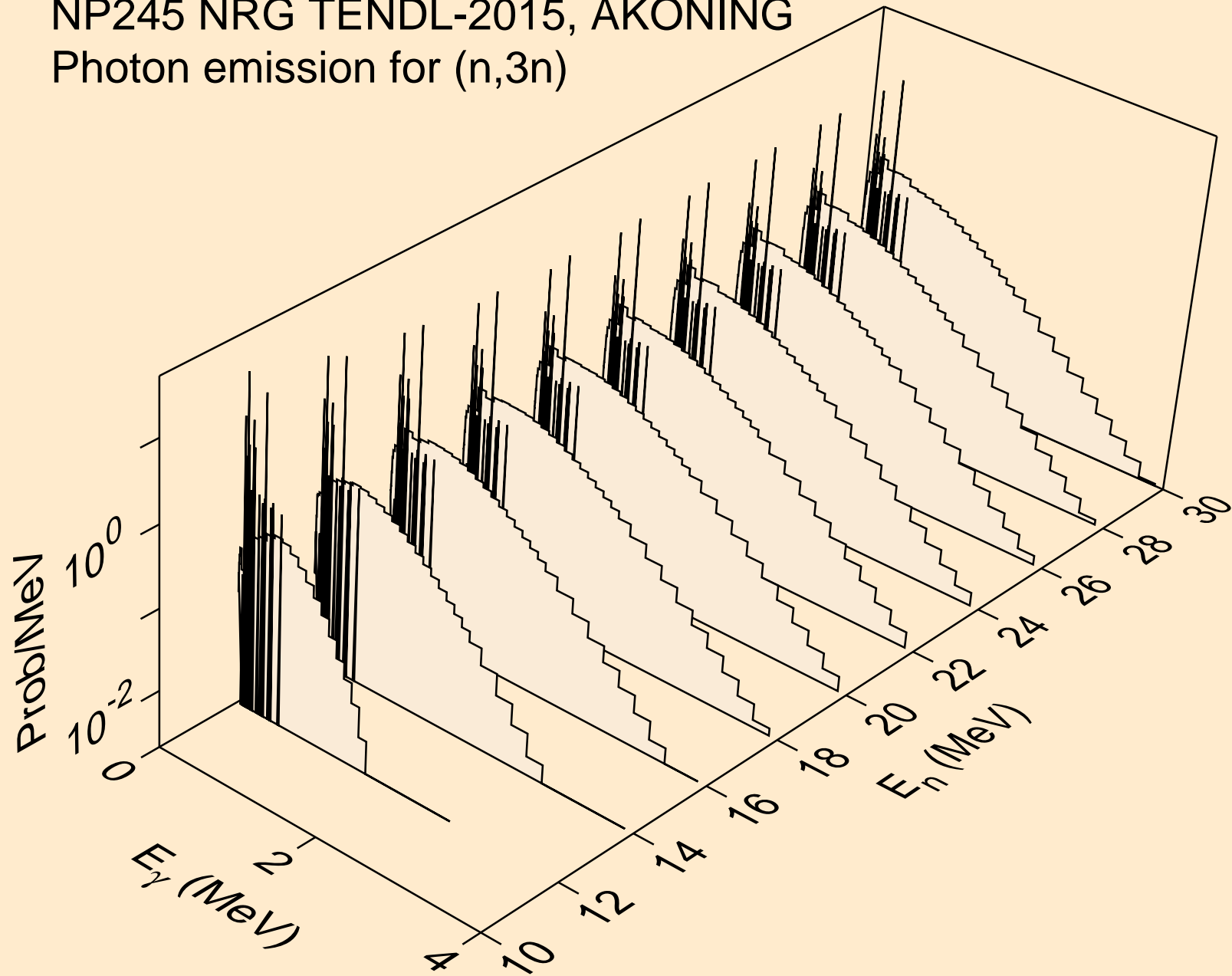

NP245 NRG TENDL-2015, AKONING
Photon emission for (n,n*)a

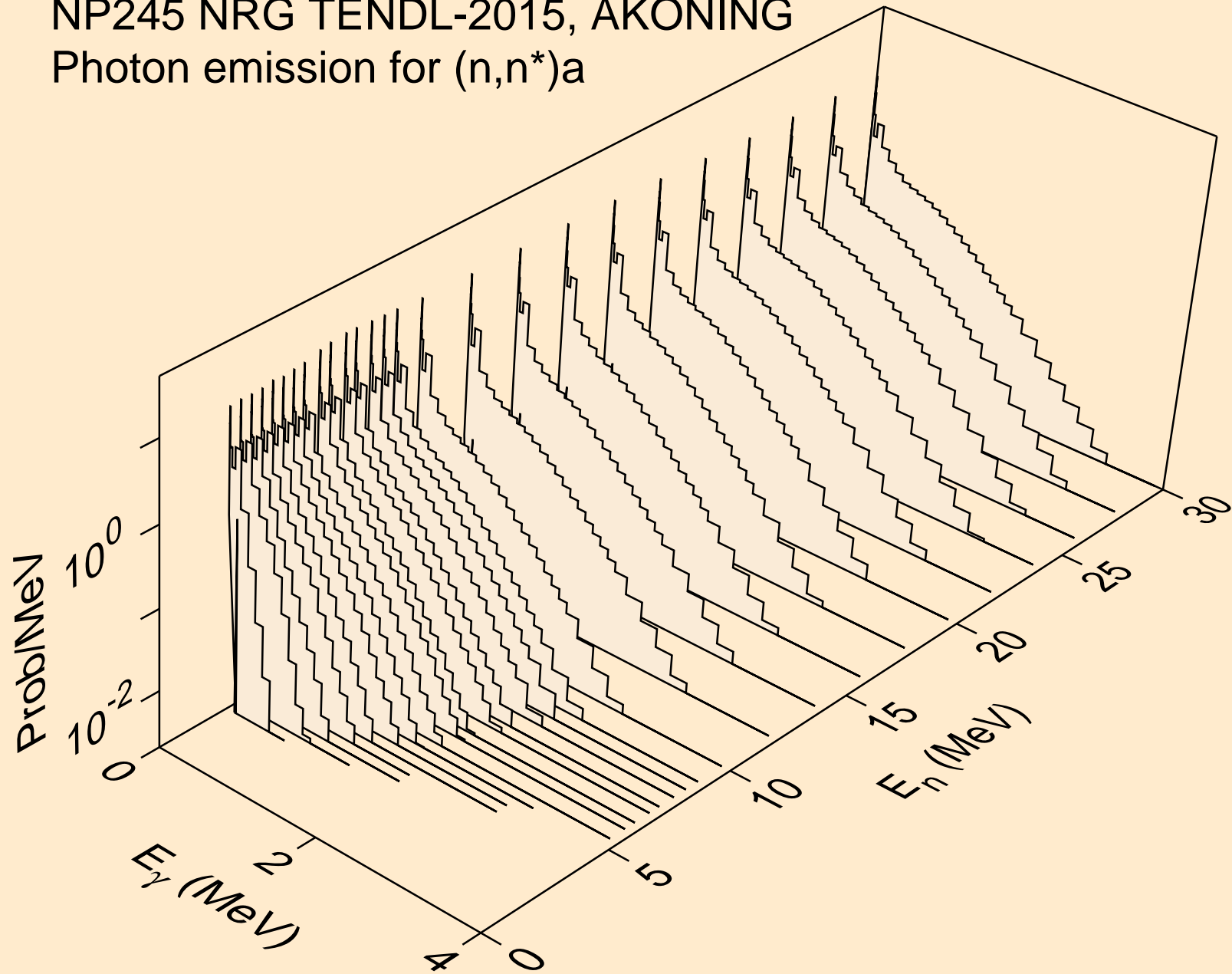

NP245 NRG TENDL-2015, AKONING
Photon emission for (n,2n)a

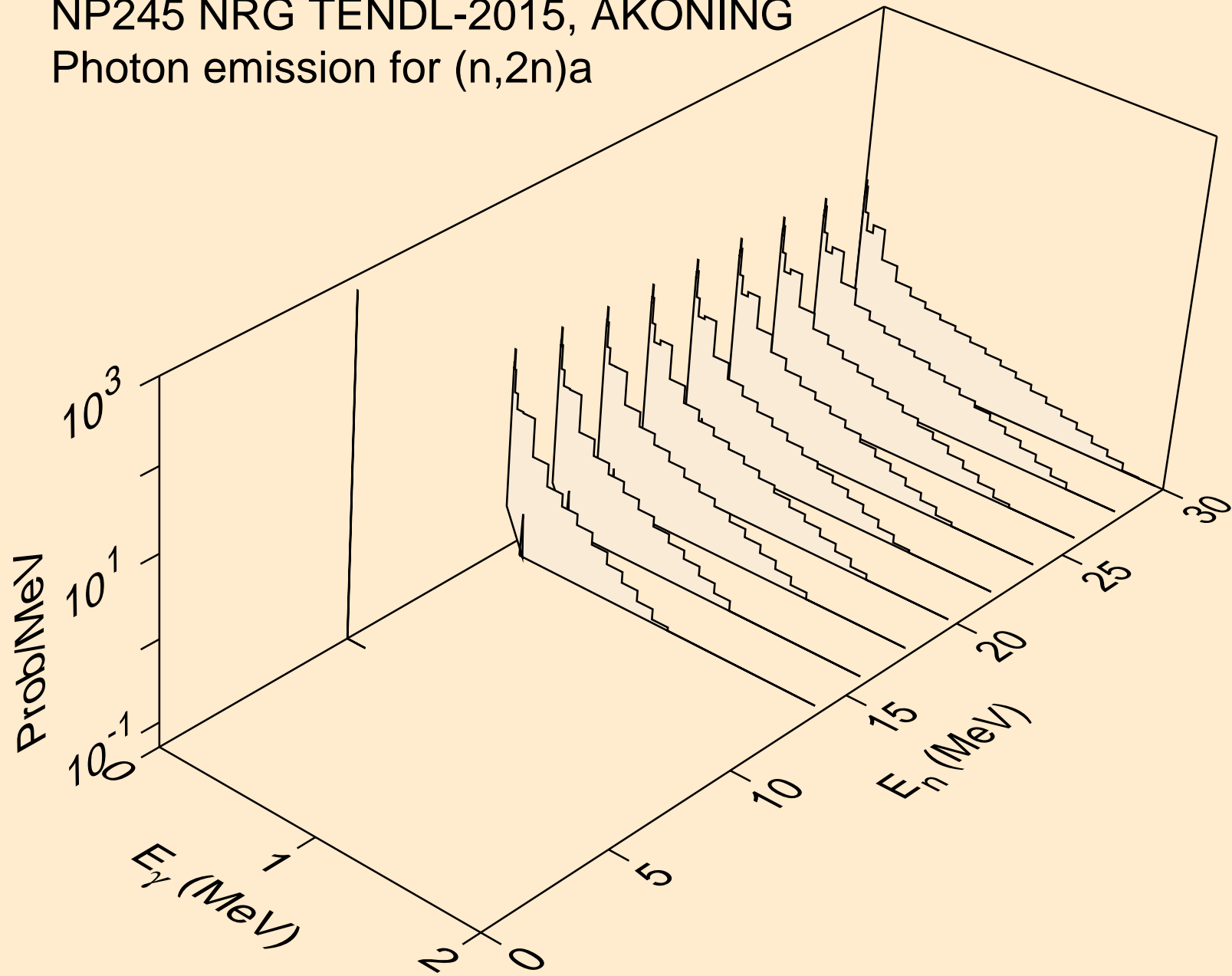

NP245 NRG TENDL-2015, AKONING
Photon emission for (n,3n)a

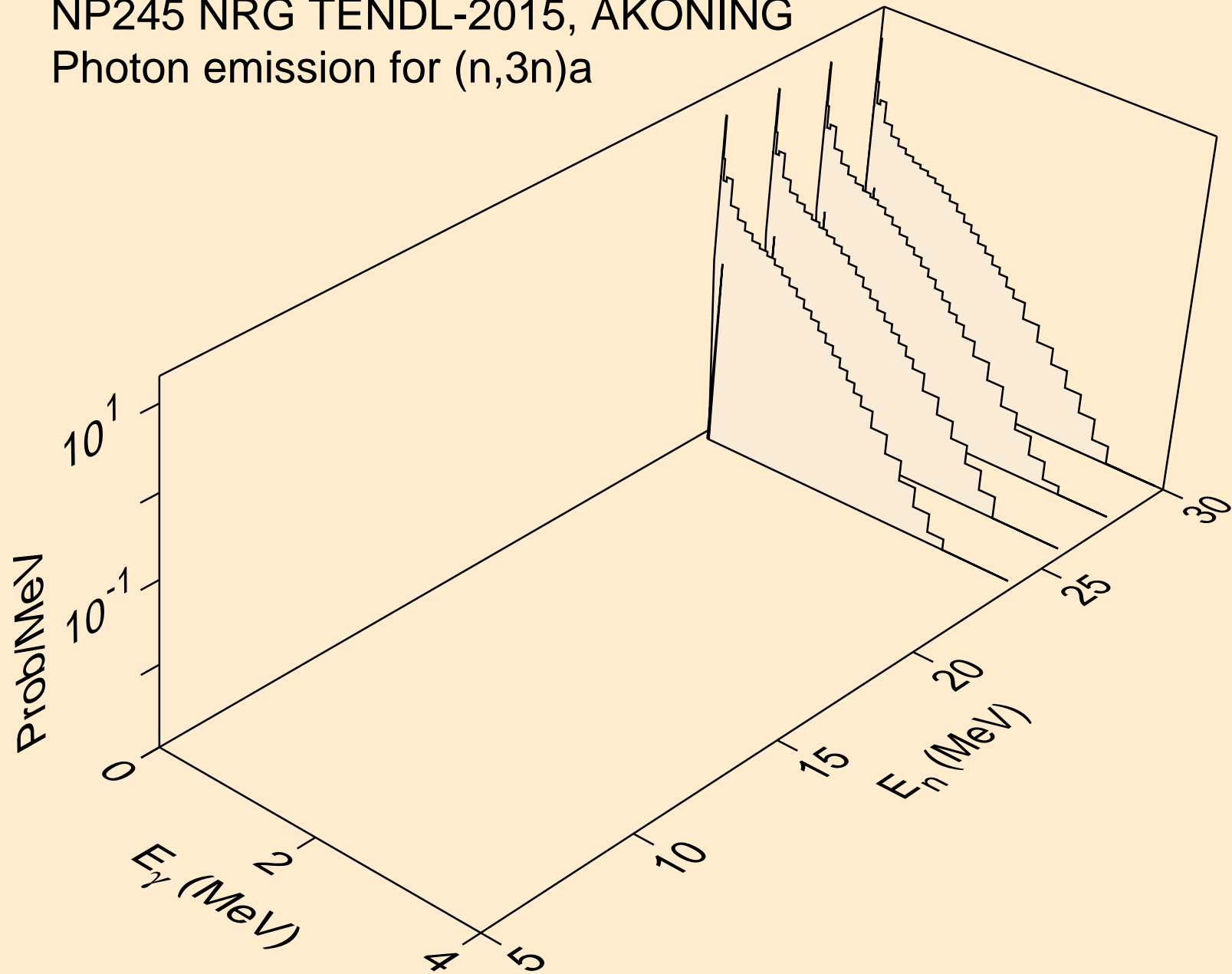

NP245 NRG TENDL-2015, AKONING

Photon emission for (n,n*)p

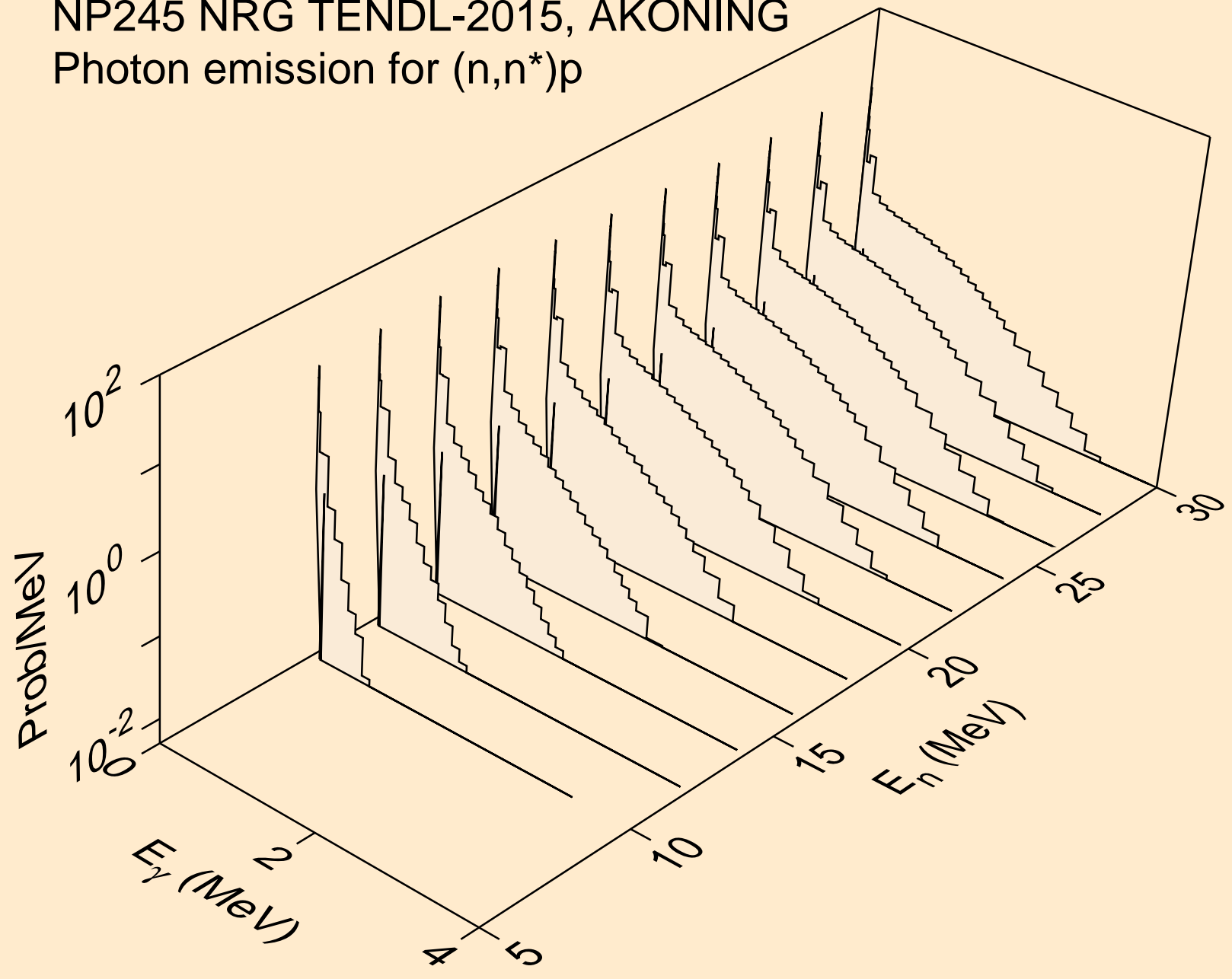

NP245 NRG TENDL-2015, AKONING
Photon emission for (n,n*)d

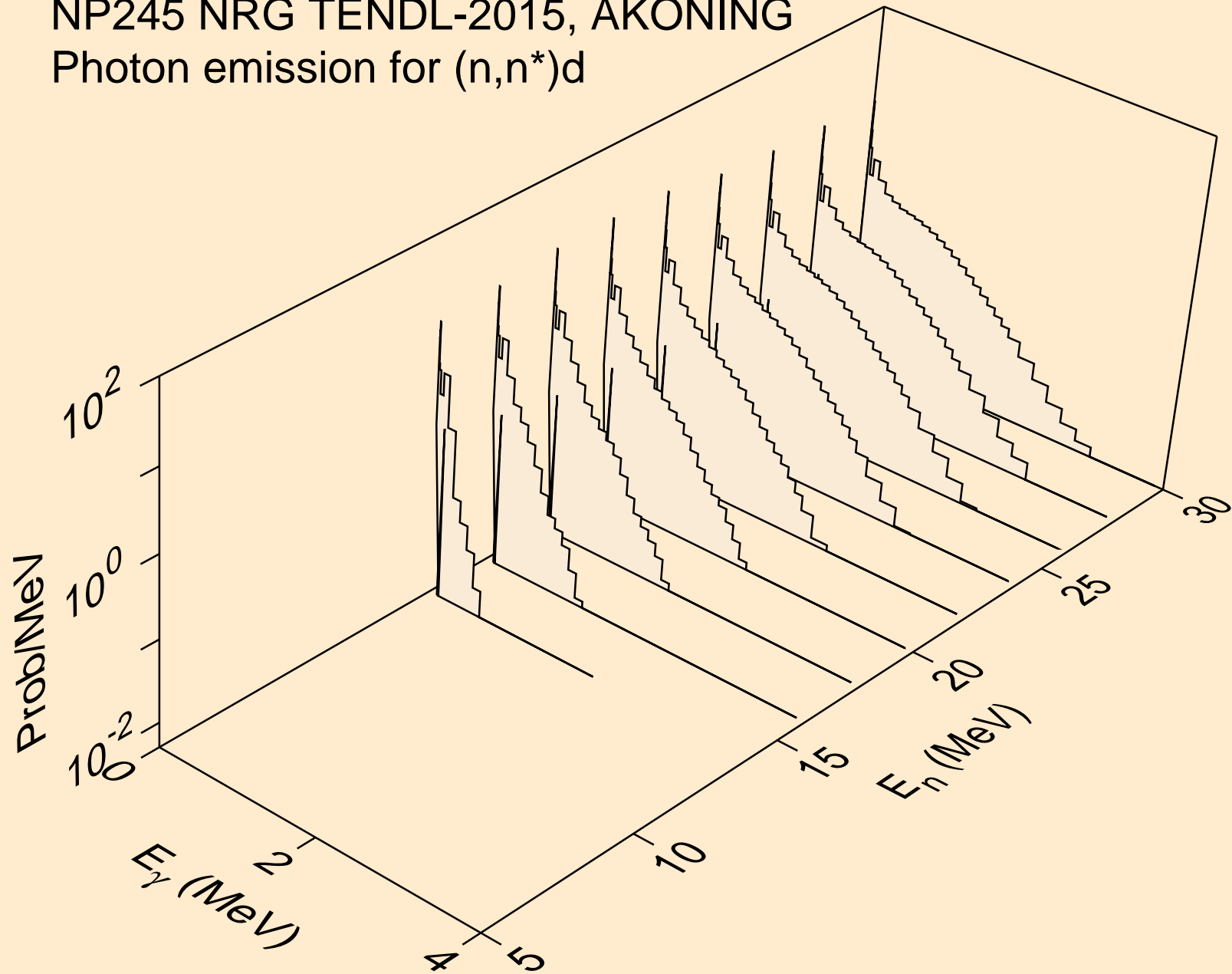

NP245 NRG TENDL-2015, AKONING
Photon emission for (n,n*)t

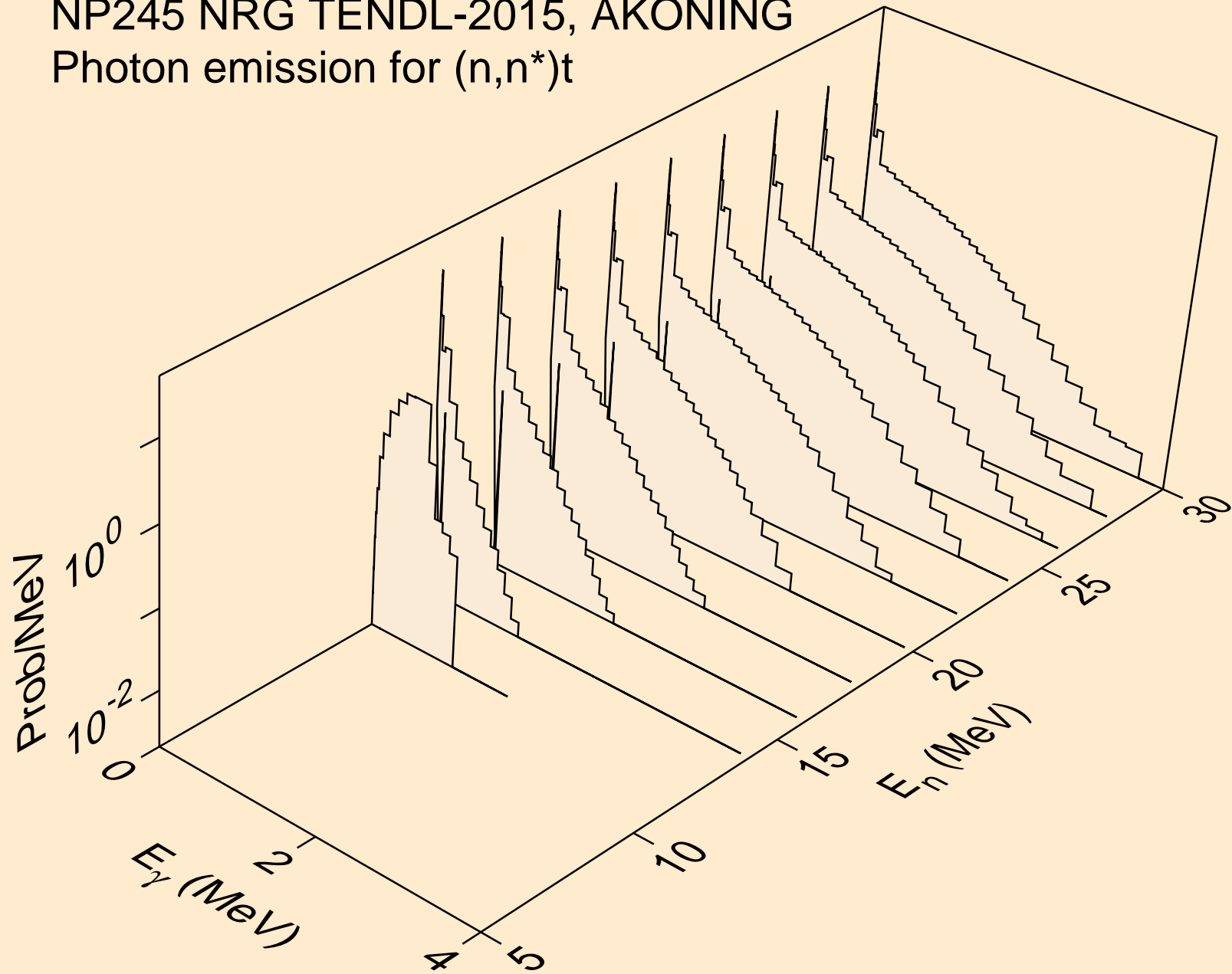

NP245 NRG TENDL-2015, AKONING
Photon emission for (n,n*)he3

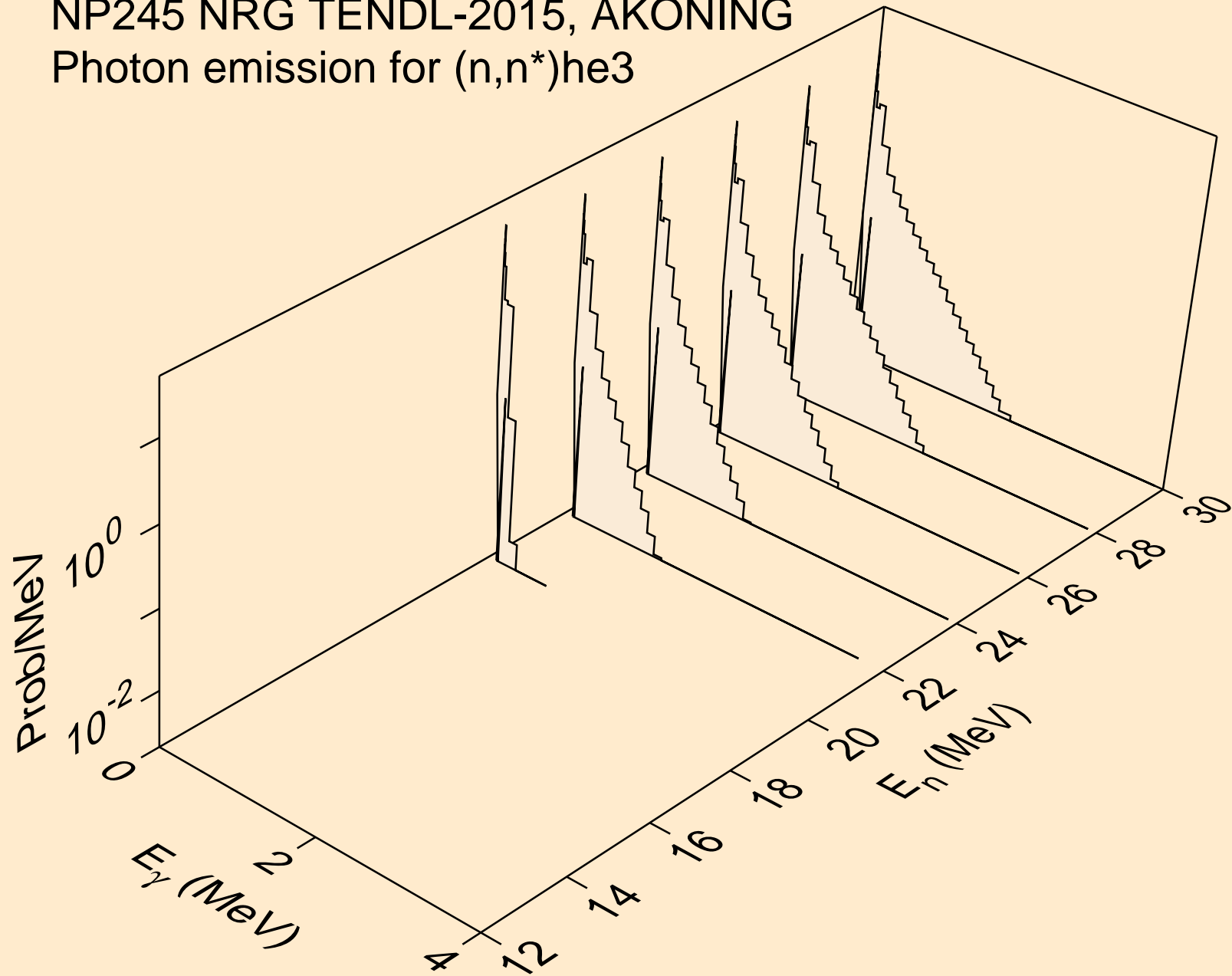

NP245 NRG TENDL-2015, AKONING
Photon emission for (n,4n)

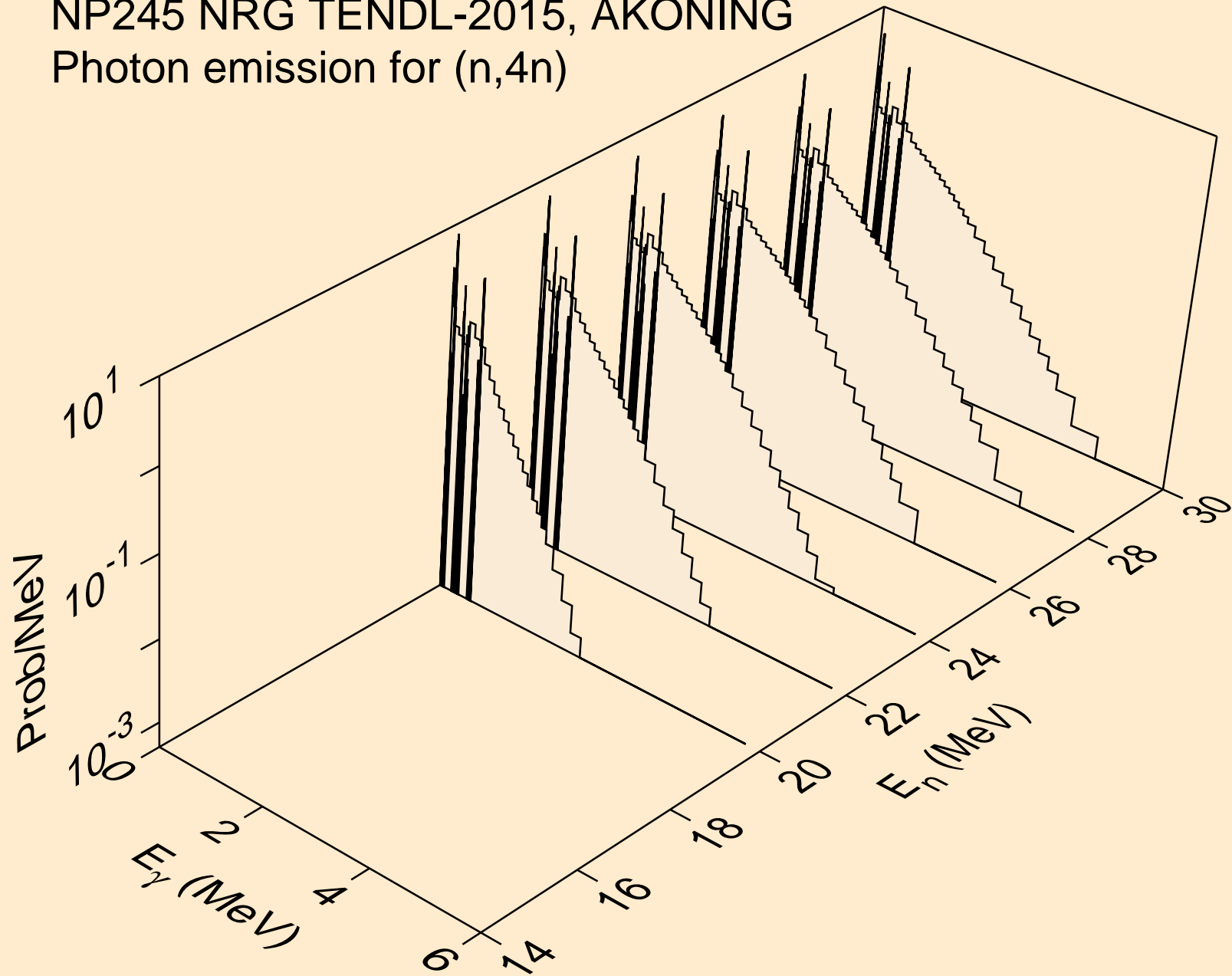

NP245 NRG TENDL-2015, AKONING
Photon emission for (n,2np)

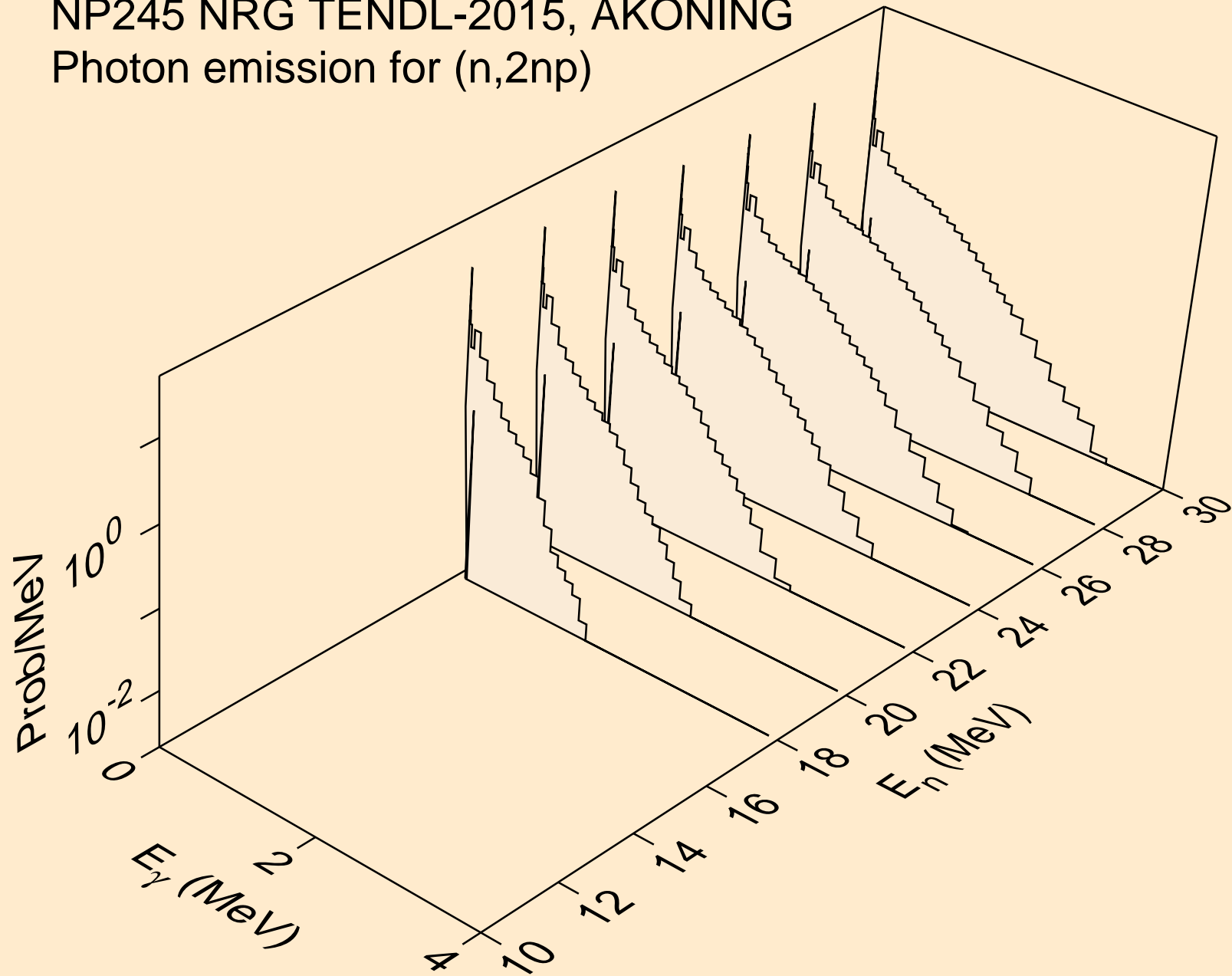

NP245 NRG TENDL-2015, AKONING
Photon emission for (n,3np)

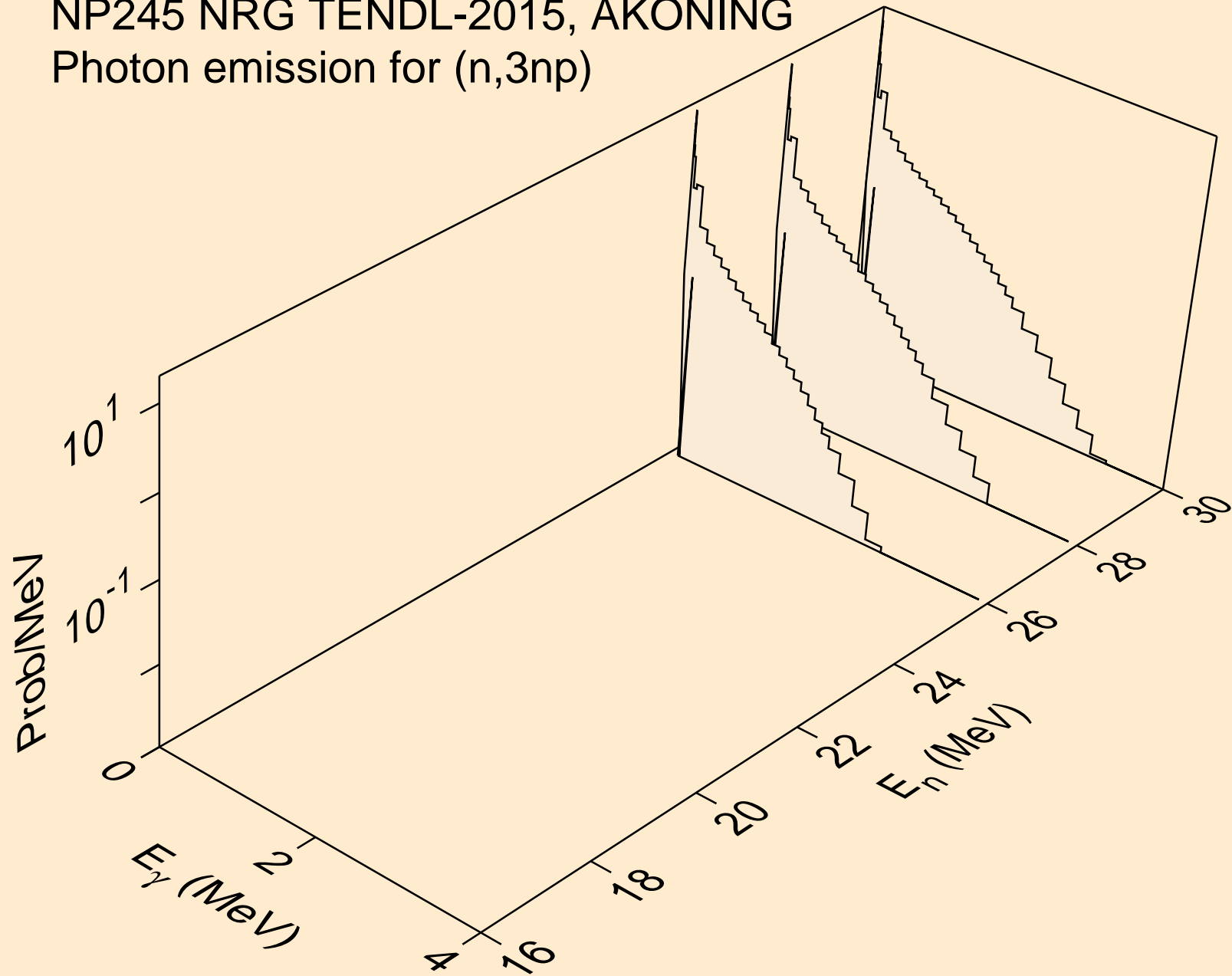

NP245 NRG TENDL-2015, AKONING
Photon emission for (n,npa)

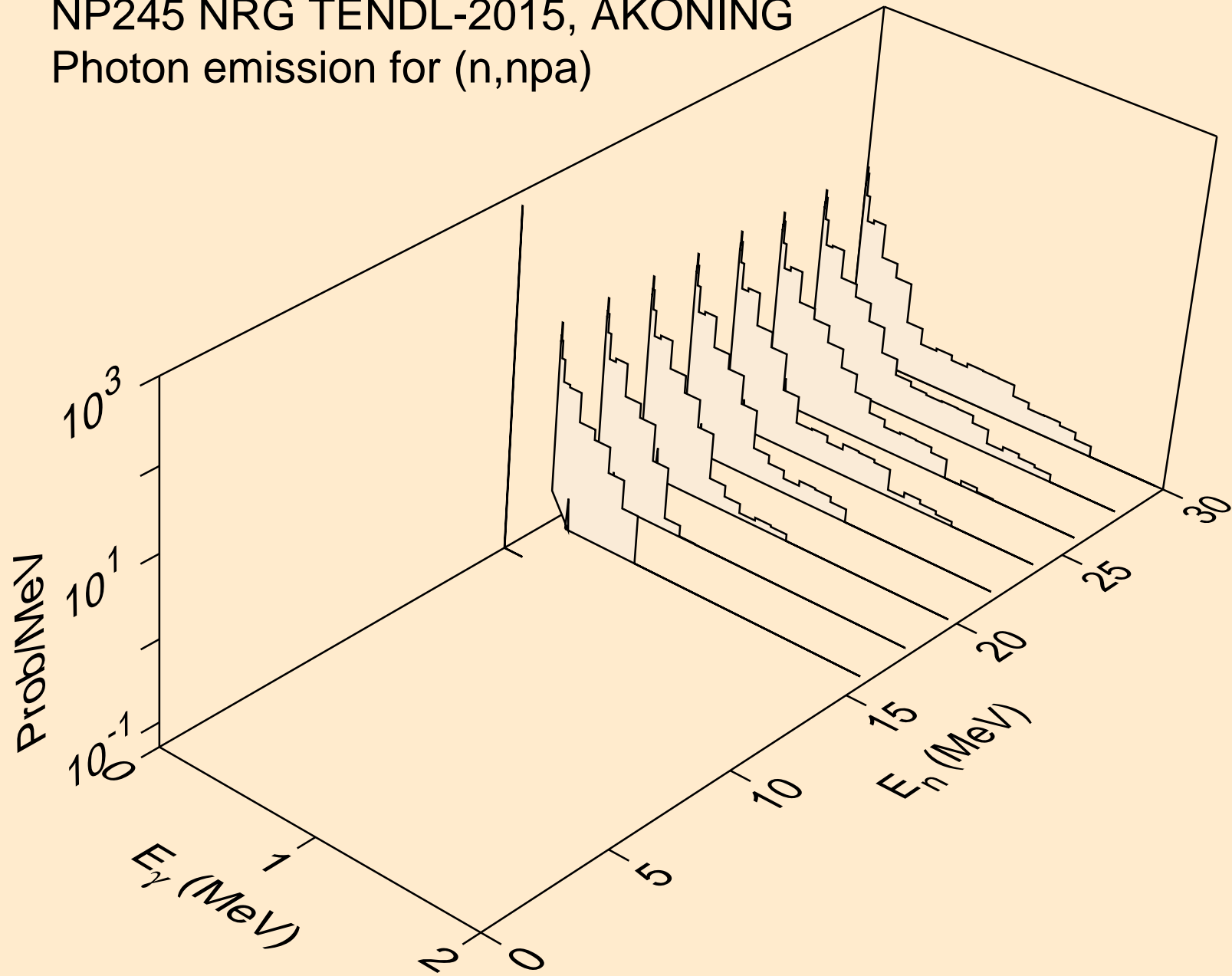

NP245 NRG TENDL-2015, AKONING
Photon emission for (n,n*c)

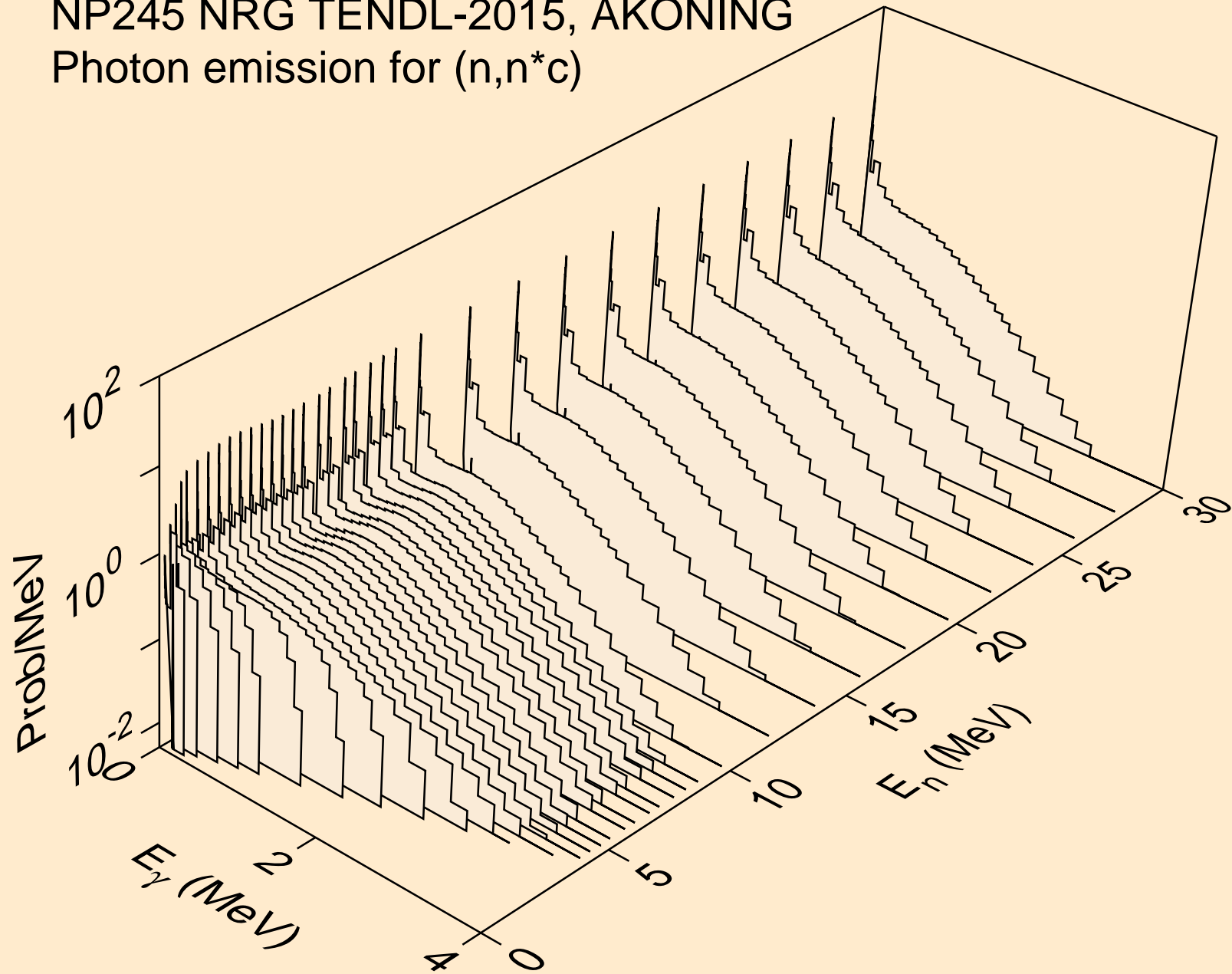

NP245 NRG TENDL-2015, AKONING
Photon emission for (n,gma)

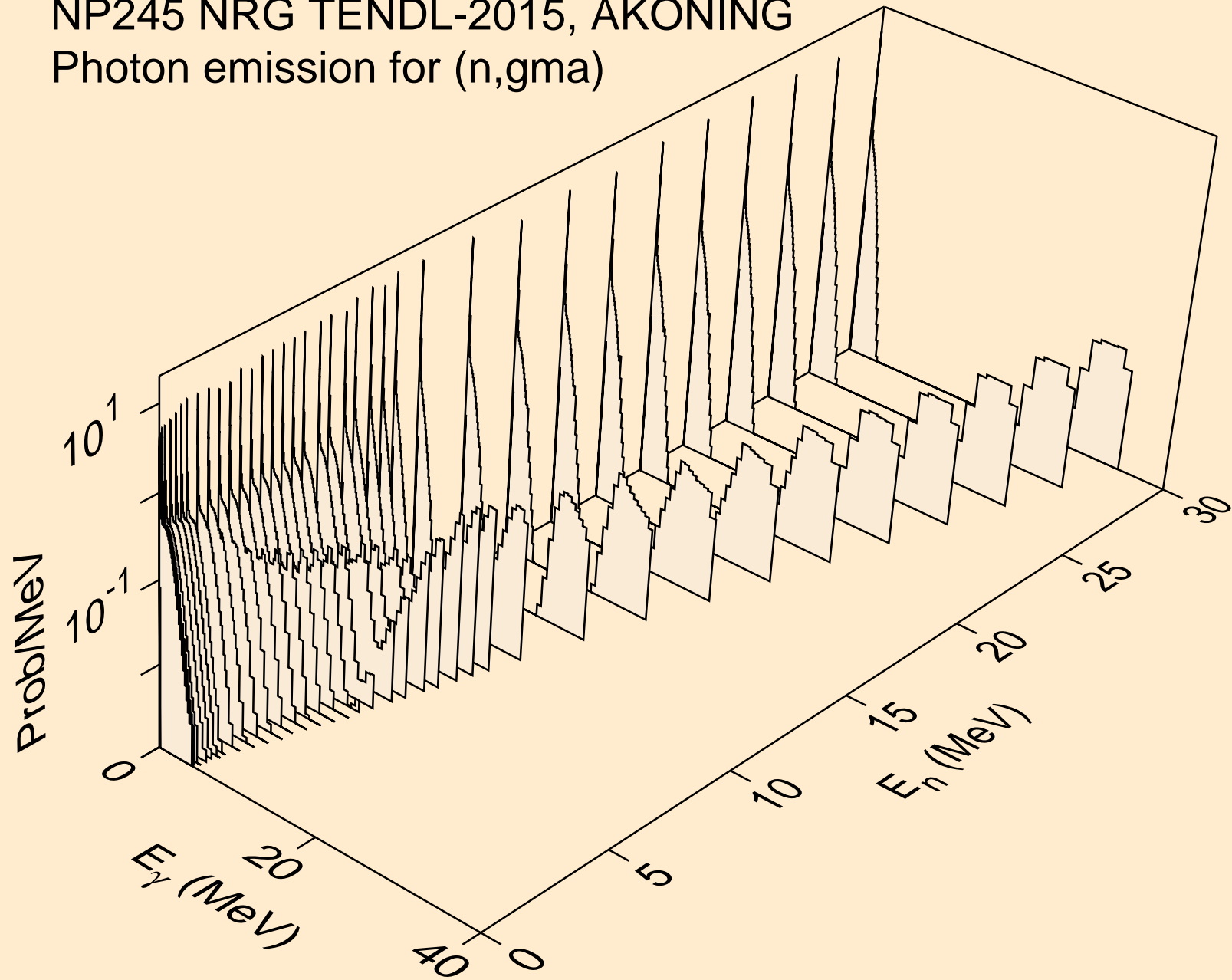

NP245 NRG TENDL-2015, AKONING
Photon emission for (n,p)

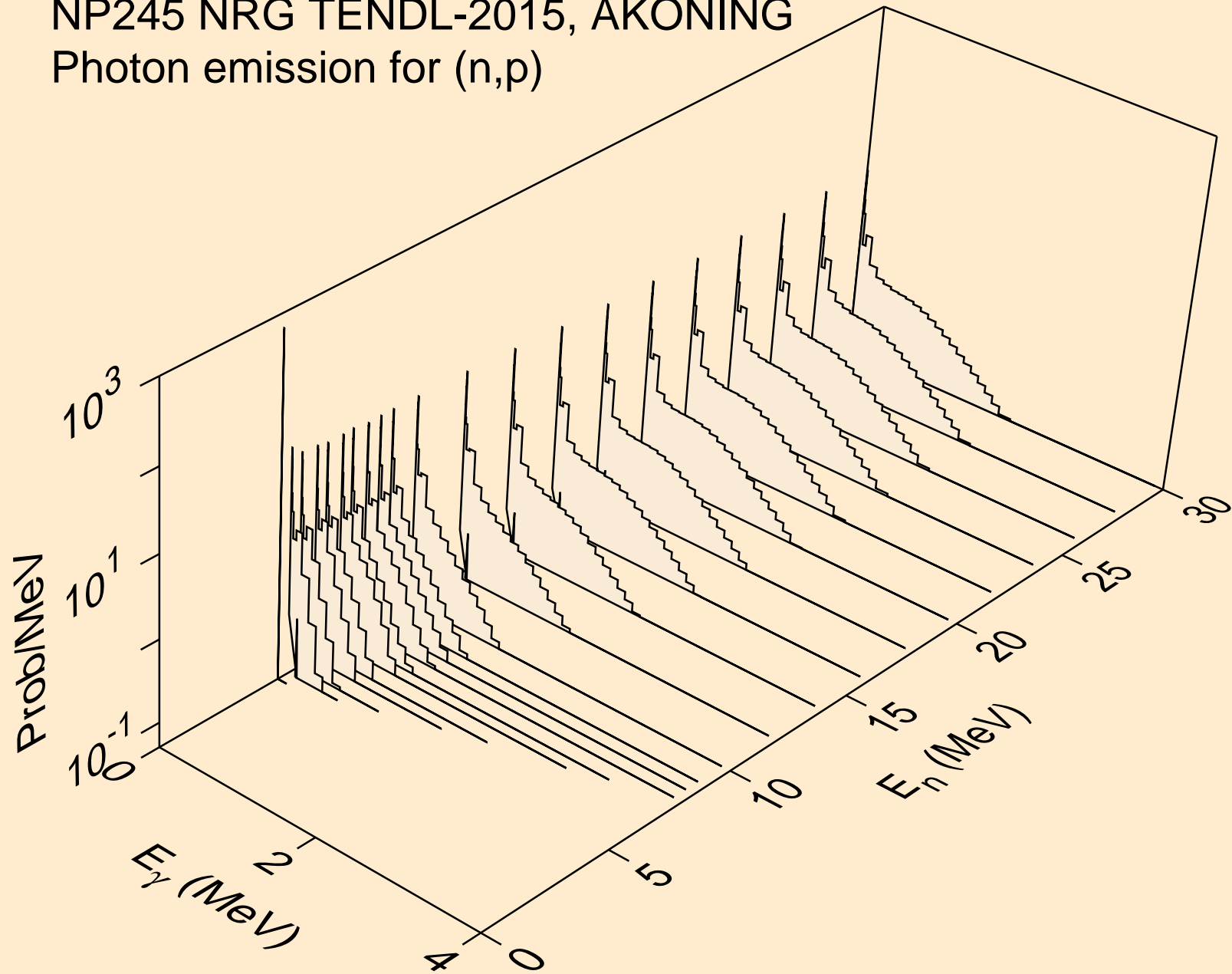

NP245 NRG TENDL-2015, AKONING
Photon emission for (n,d)

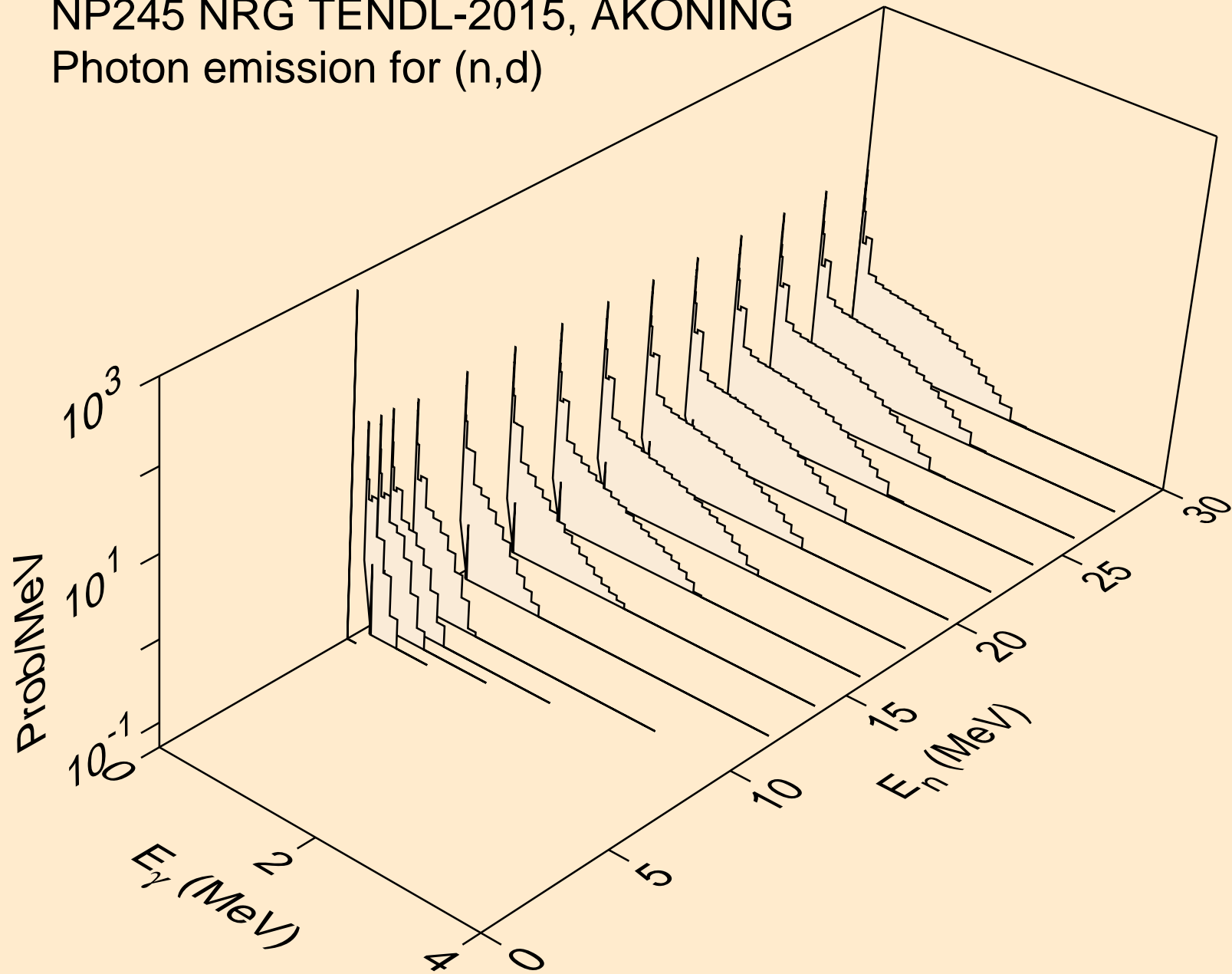

NP245 NRG TENDL-2015, AKONING
Photon emission for (n,t)

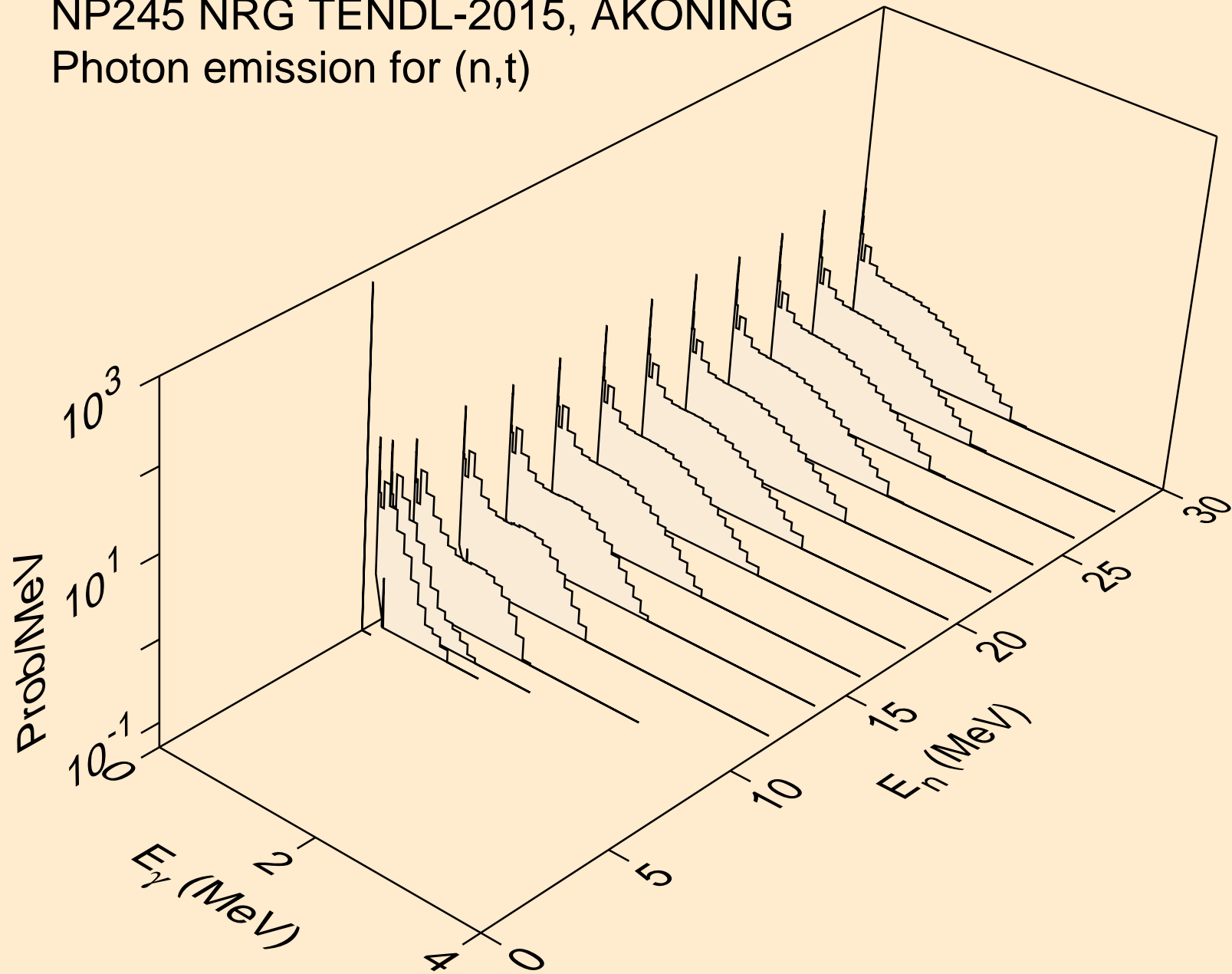

NP245 NRG TENDL-2015, AKONING
Photon emission for (n,he3)

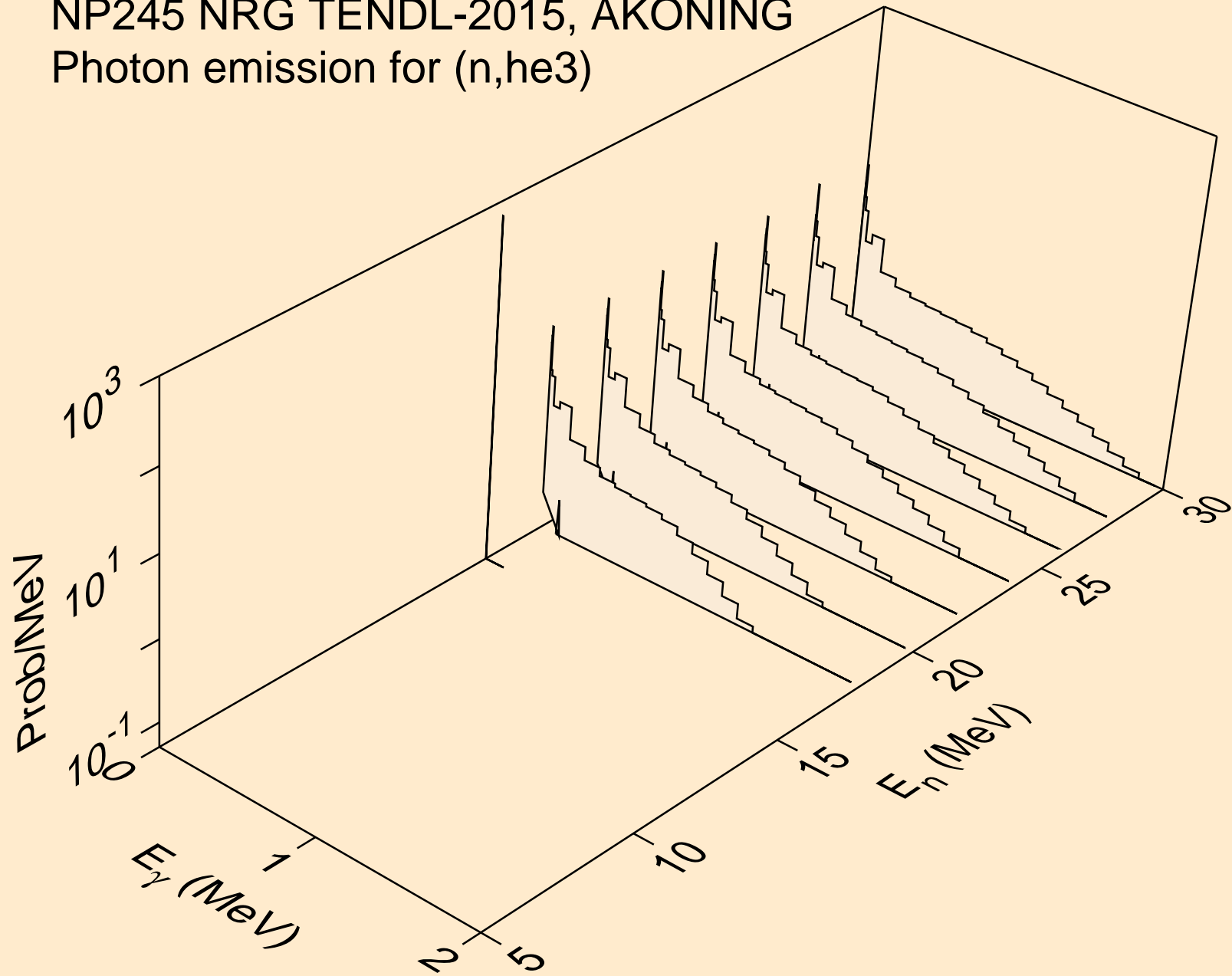

NP245 NRG TENDL-2015, AKONING
Photon emission for (n,a)

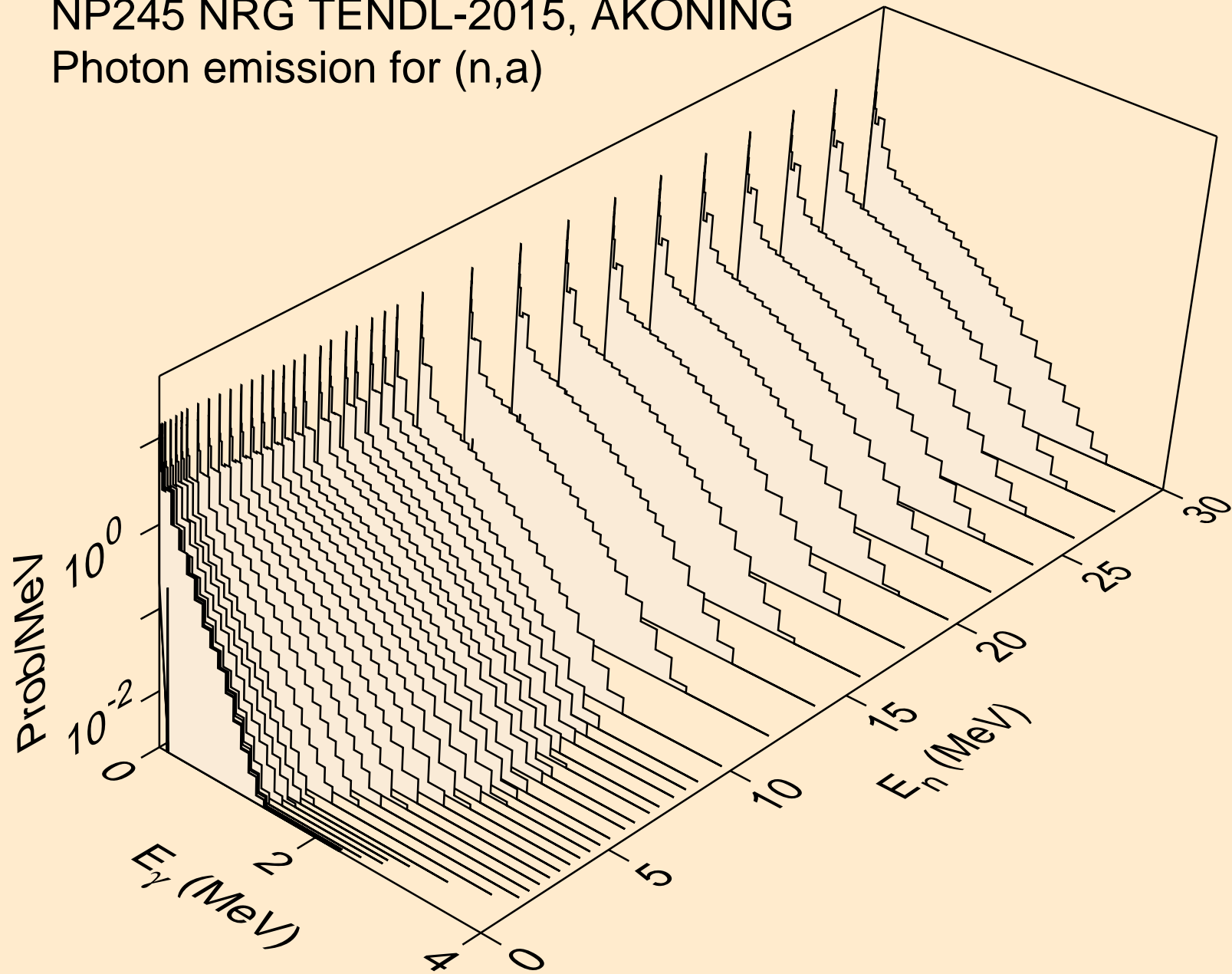

NP245 NRG TENDL-2015, AKONING
Photon emission for (n,2p)

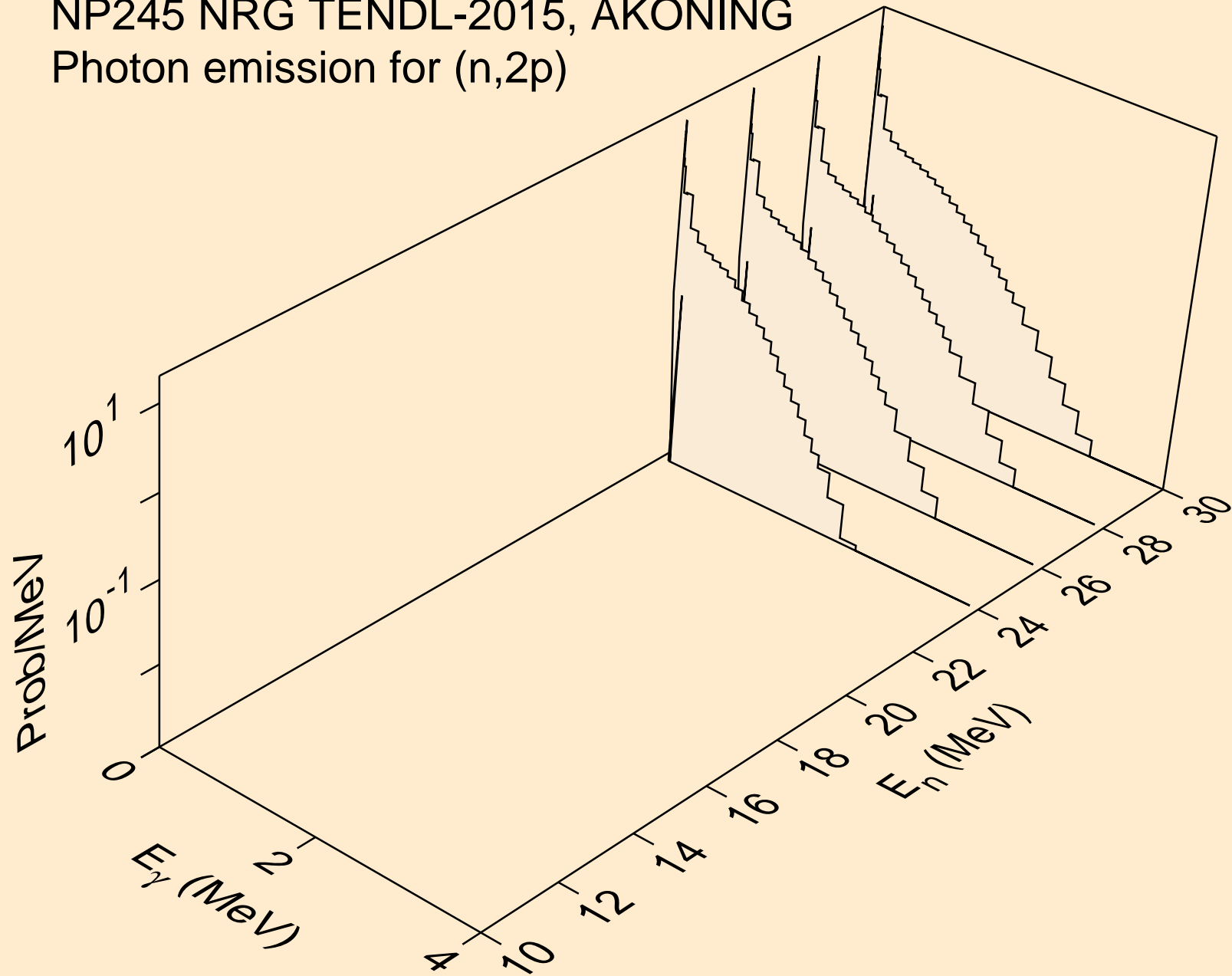

NP245 NRG TENDL-2015, AKONING
Photon emission for (n,da)

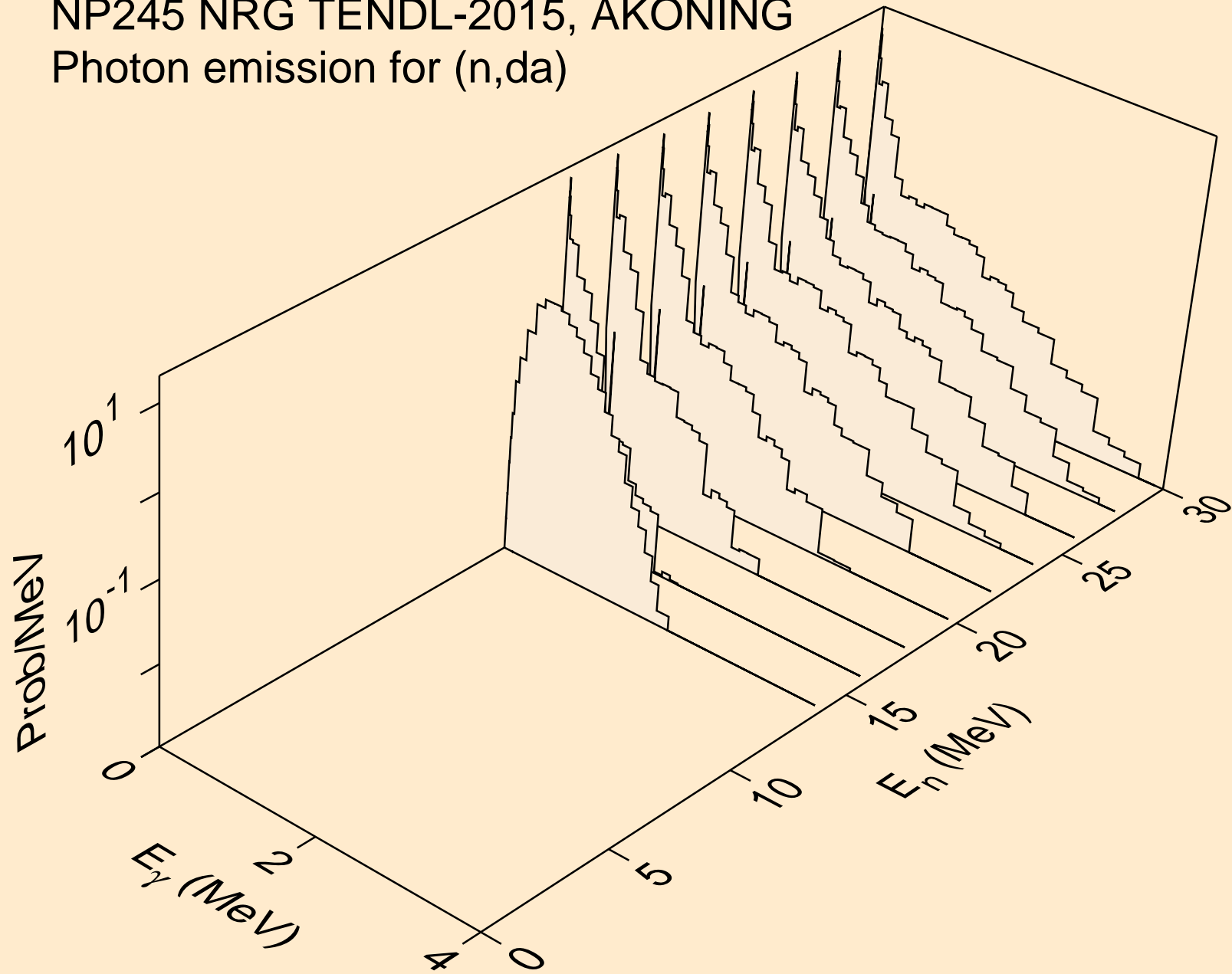

NP245 NRG TENDL-2015, AKONING
thermal capture photon spectrum

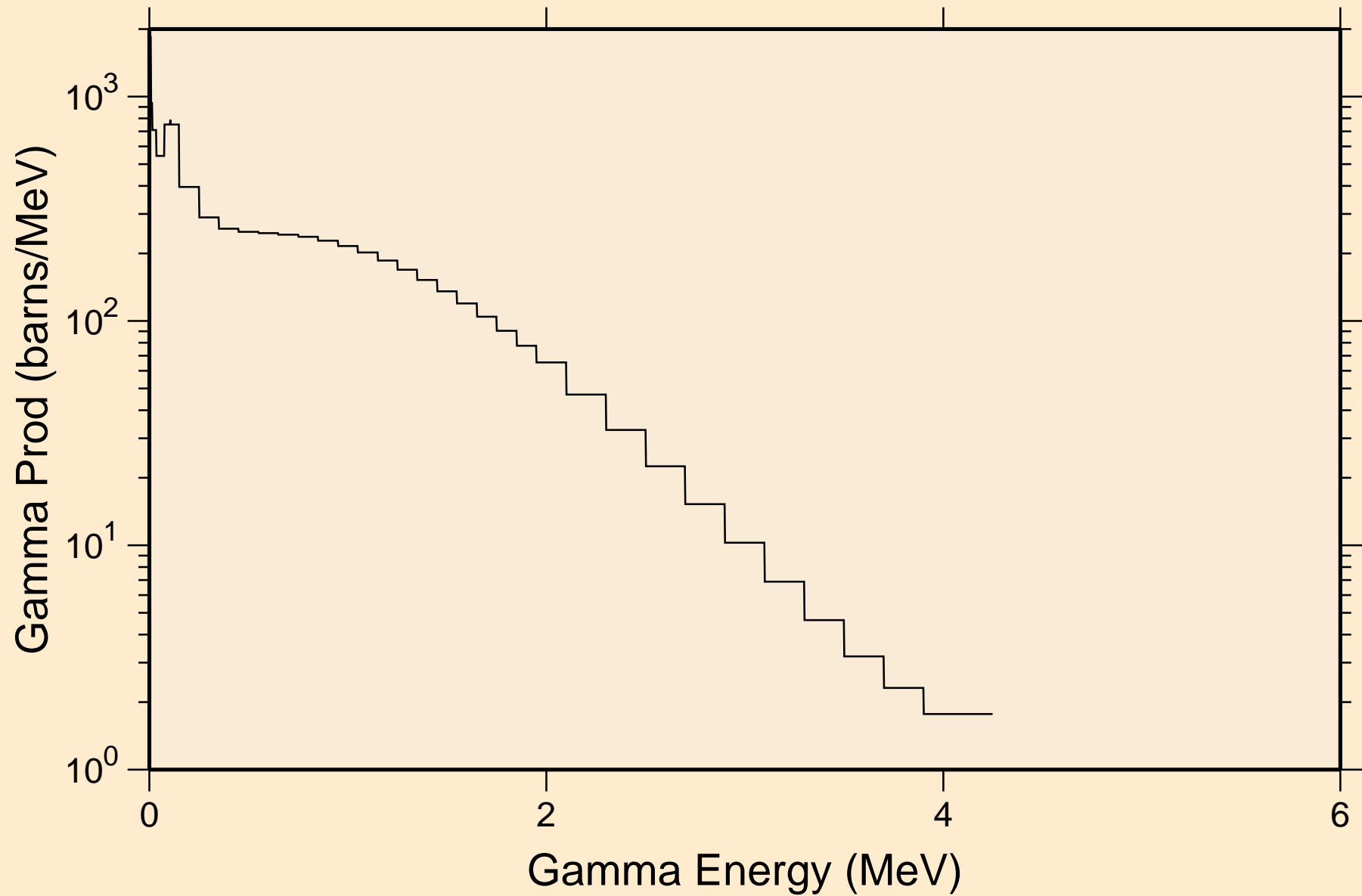

NP245 NRG TENDL-2015, AKONING
14 MeV photon spectrum

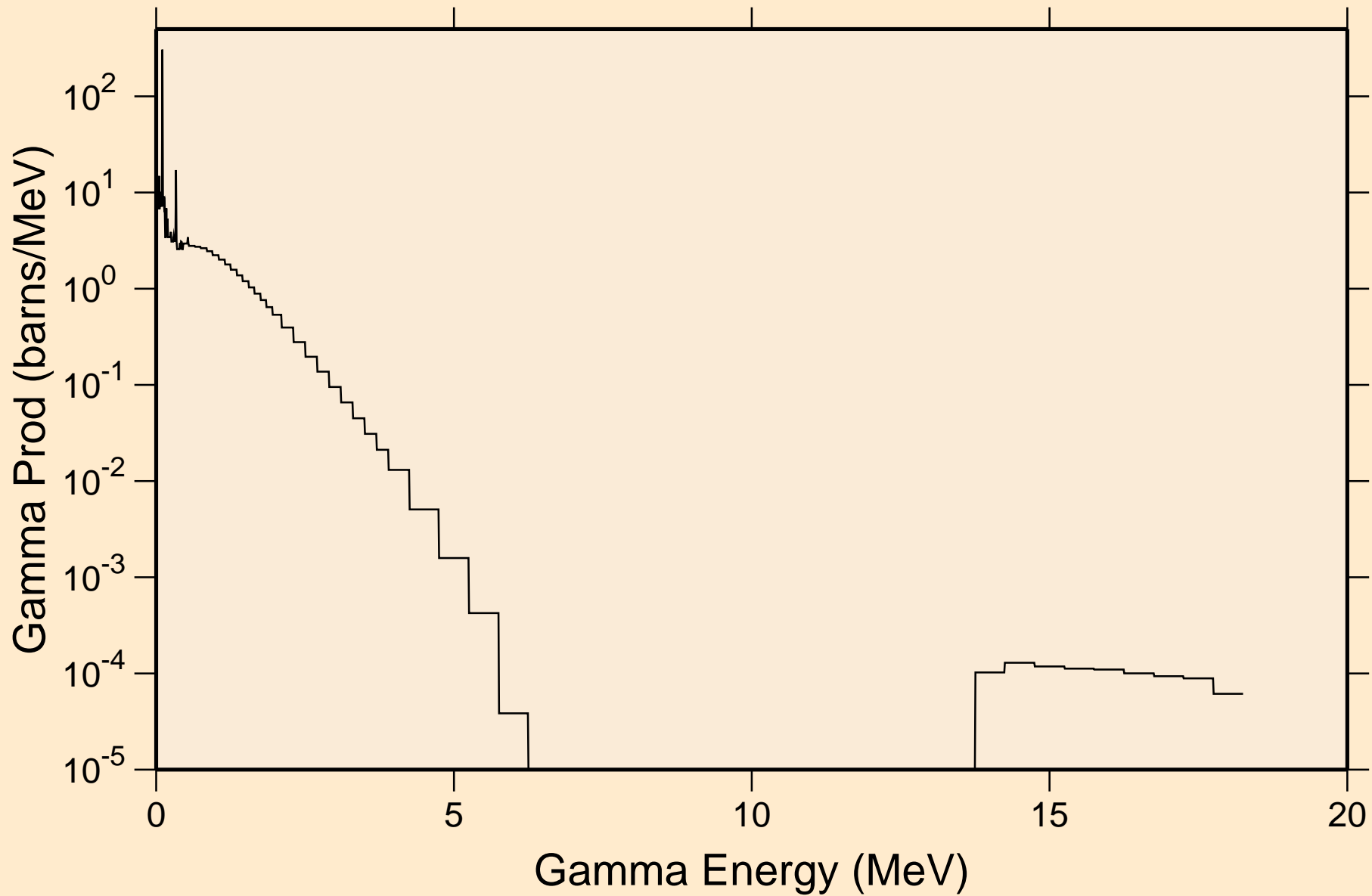

NP245 NRG TENDL-2015, AKONING

Particle heating contributions

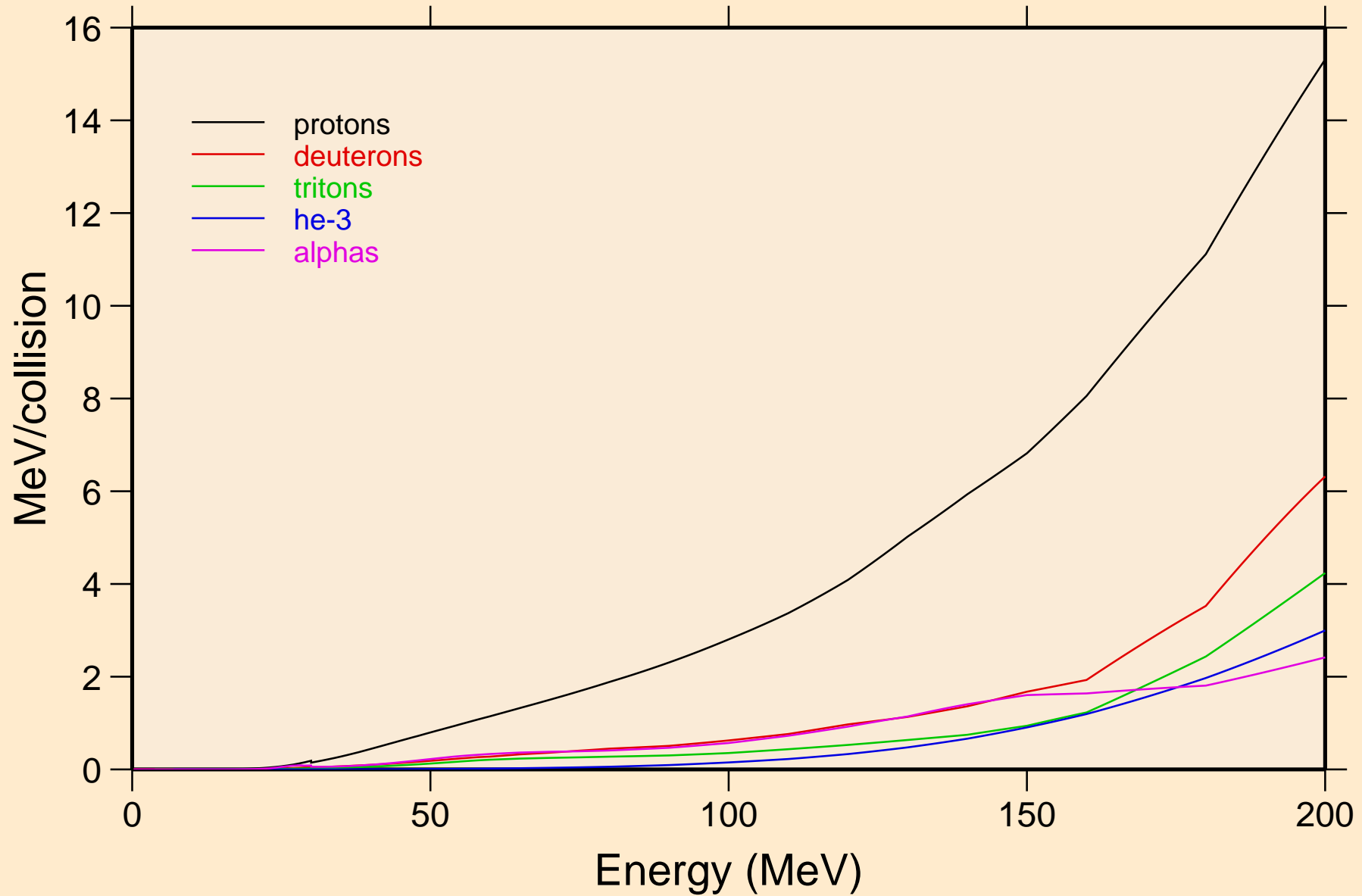

NP245 NRG TENDL-2015, AKONING

Recoil Heating

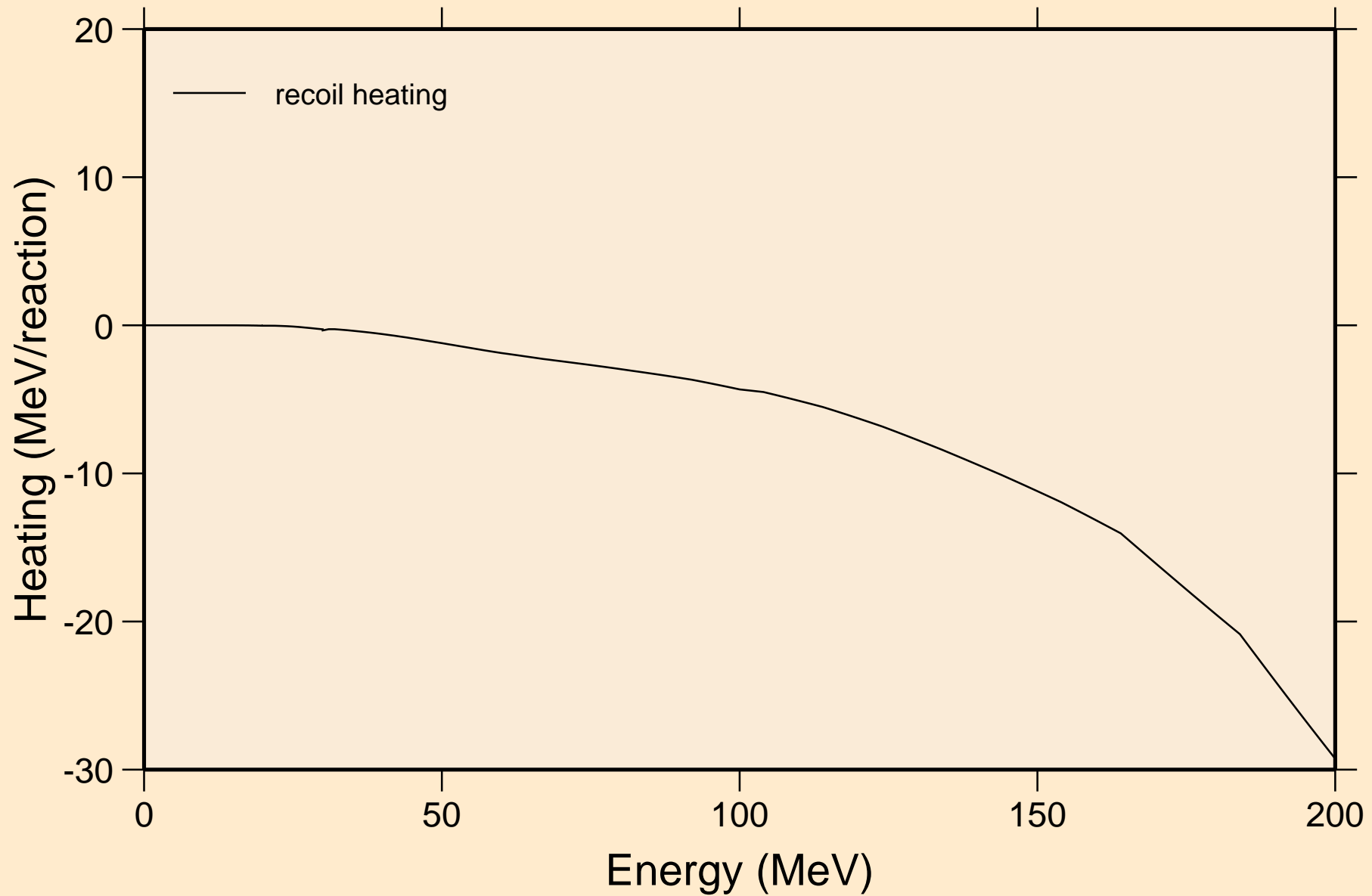

NP245 NRG TENDL-2015, AKONING

Particle production cross sections

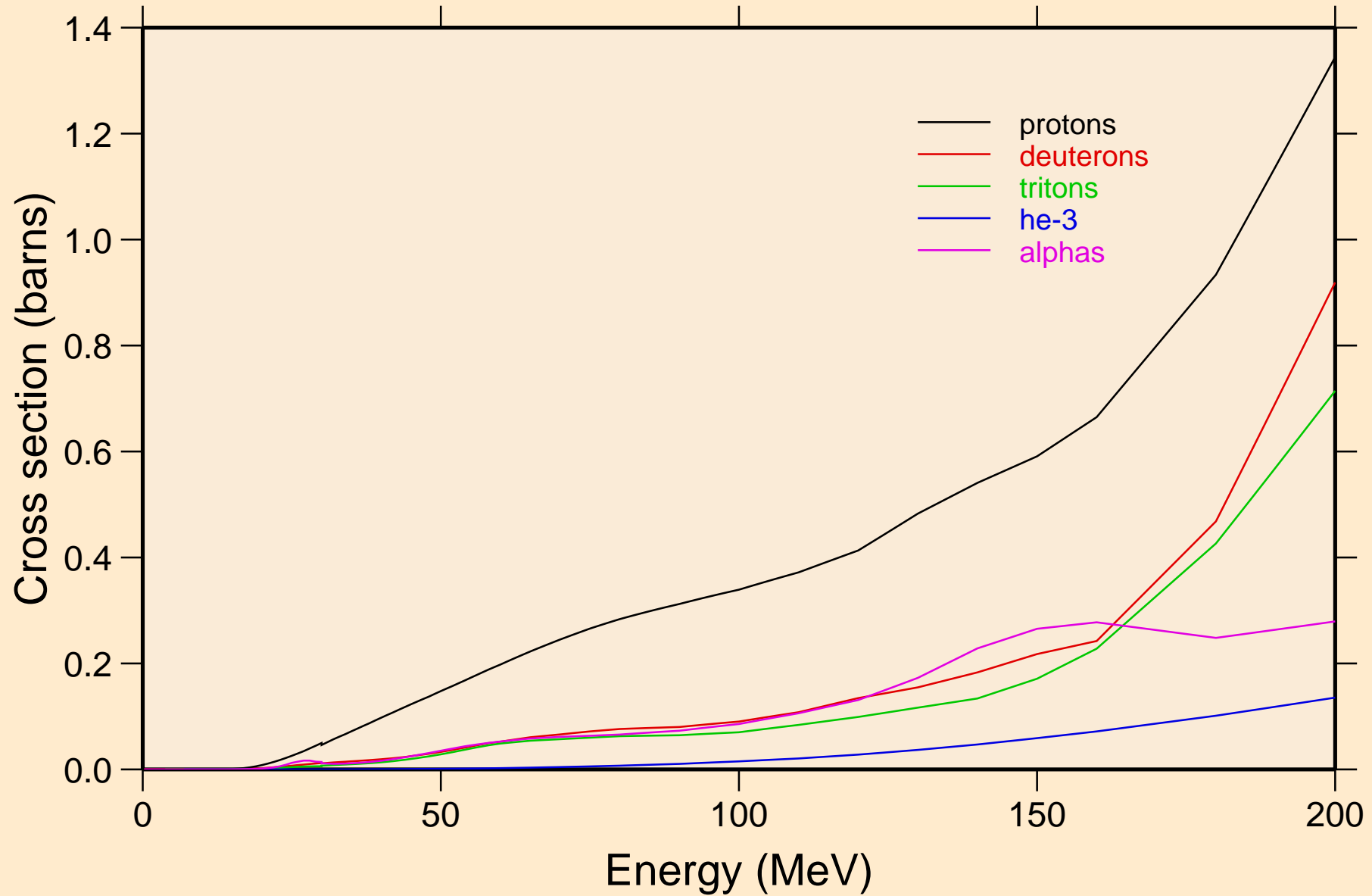

NP245 NRG TENDL-2015, AKONING
protons from (n,x)

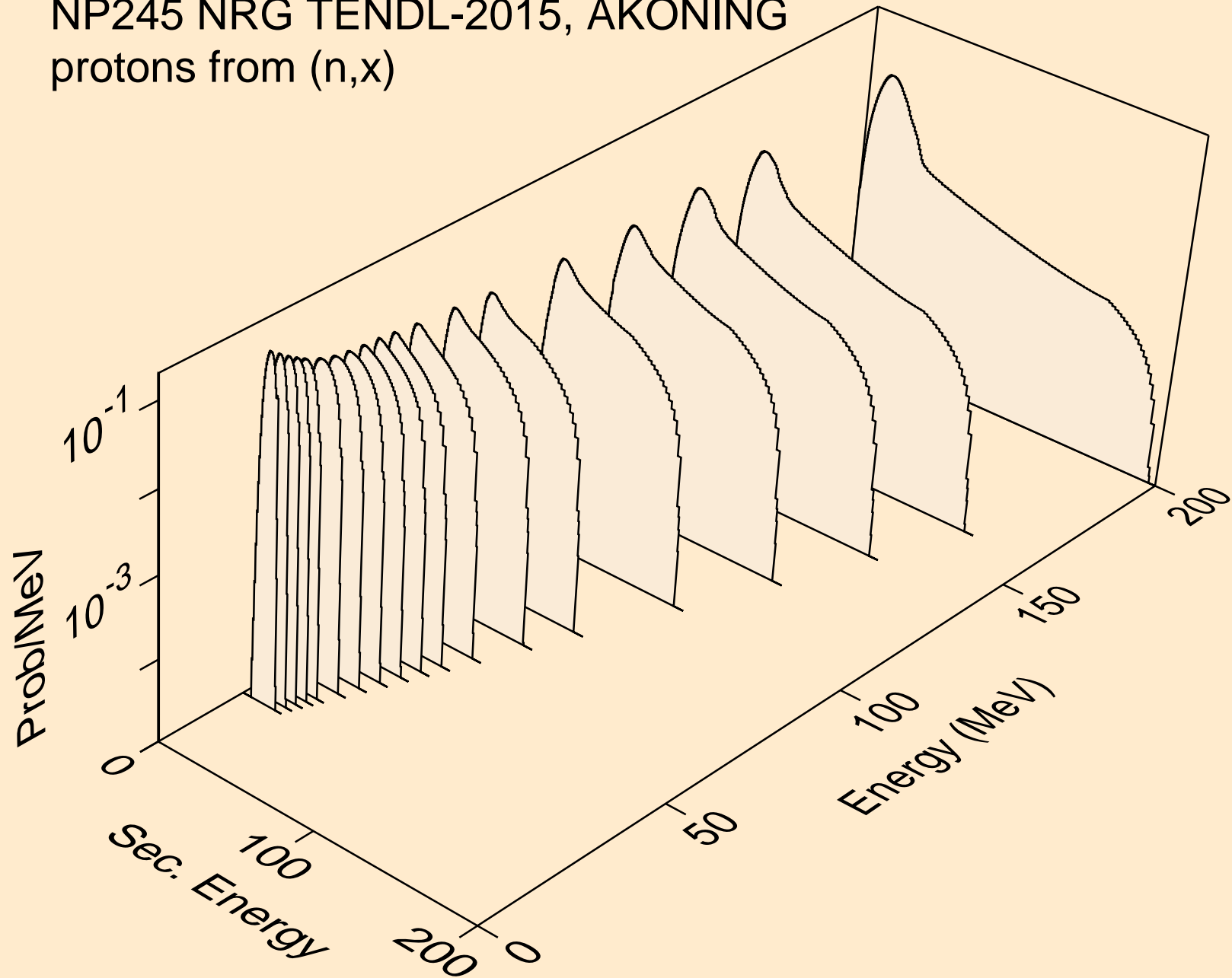

NP245 NRG TENDL-2015, AKONING
protons from (n,n*)p

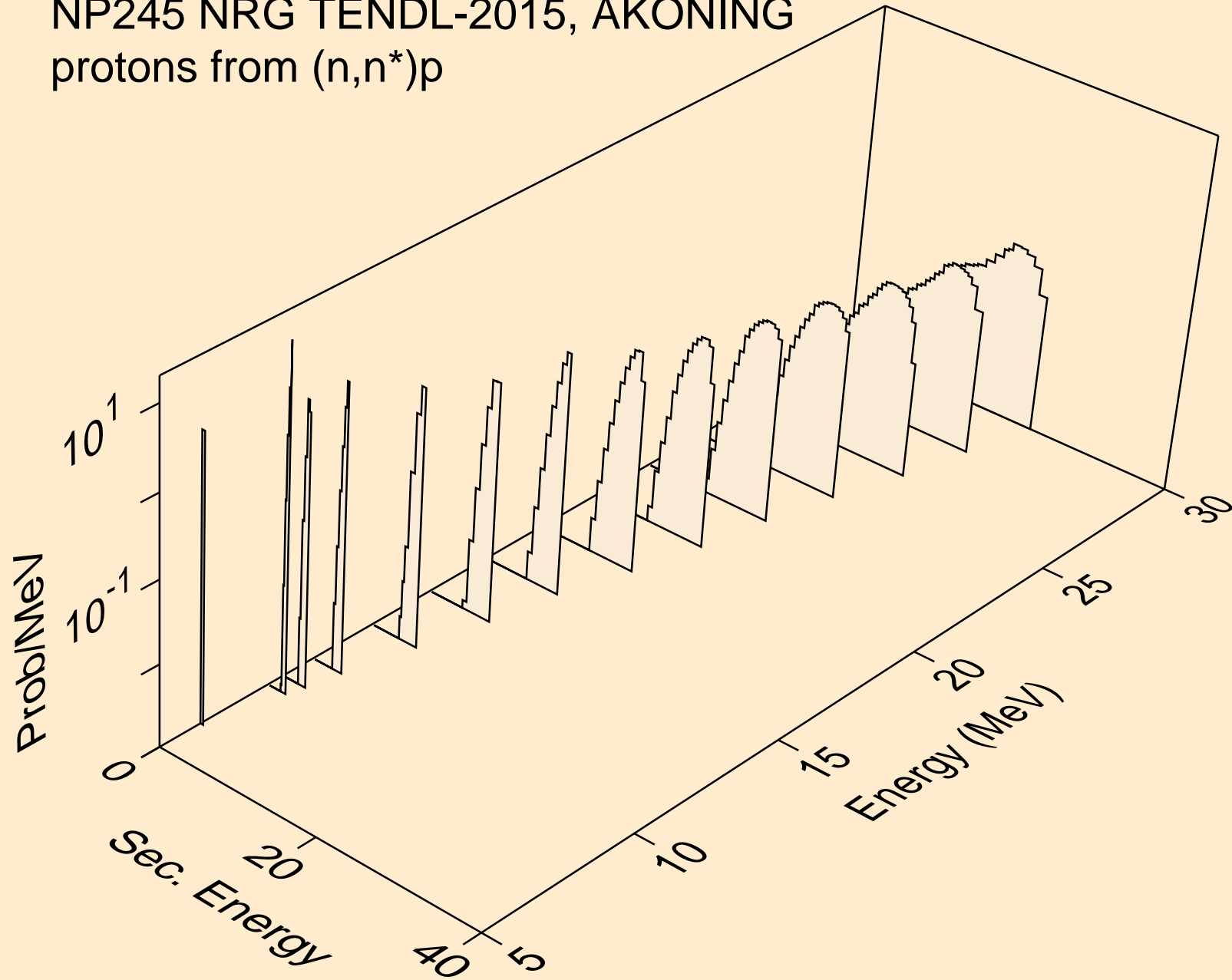

NP245 NRG TENDL-2015, AKONING
protons from (n,2np)

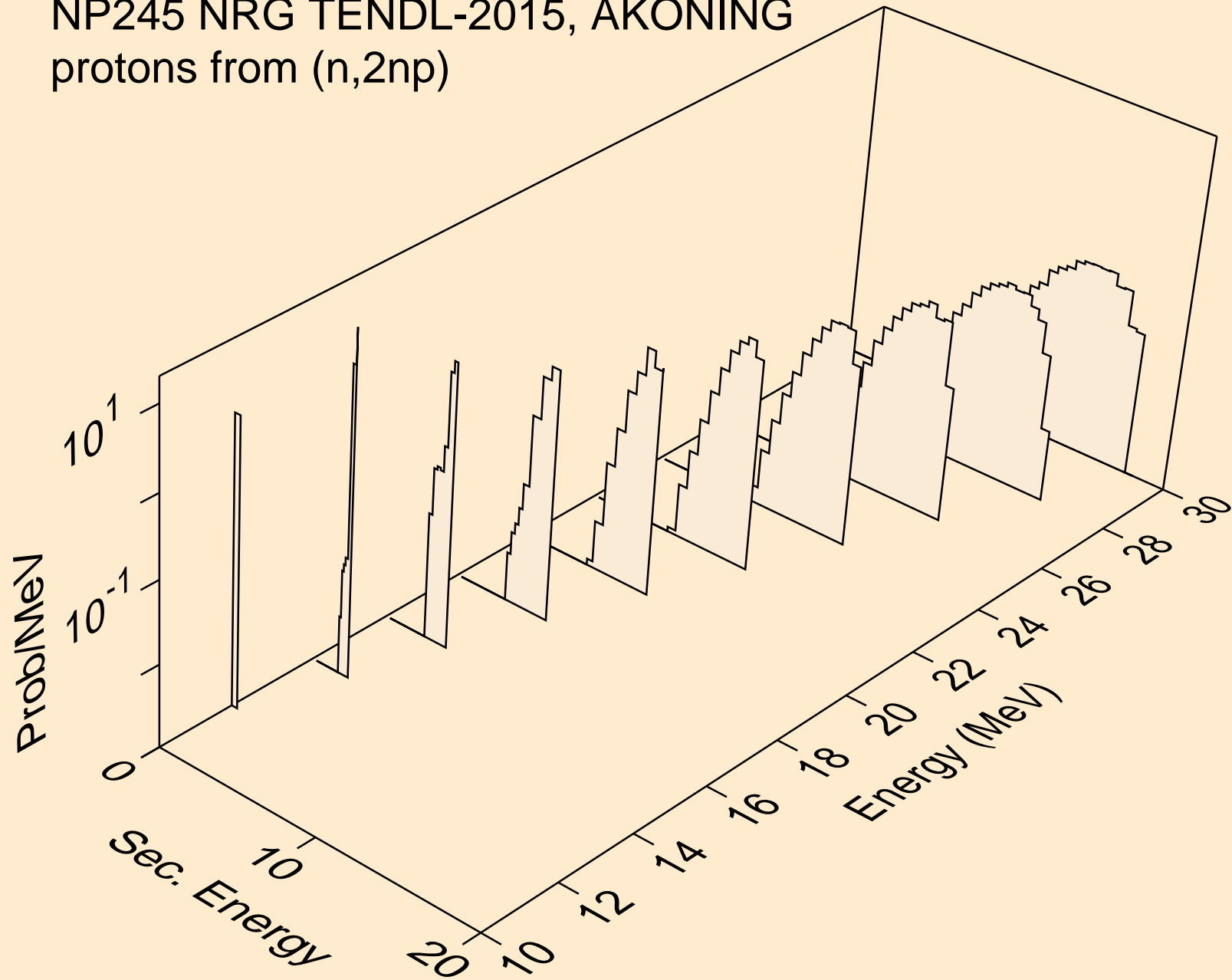

NP245 NRG TENDL-2015, AKONING
protons from (n,3np)

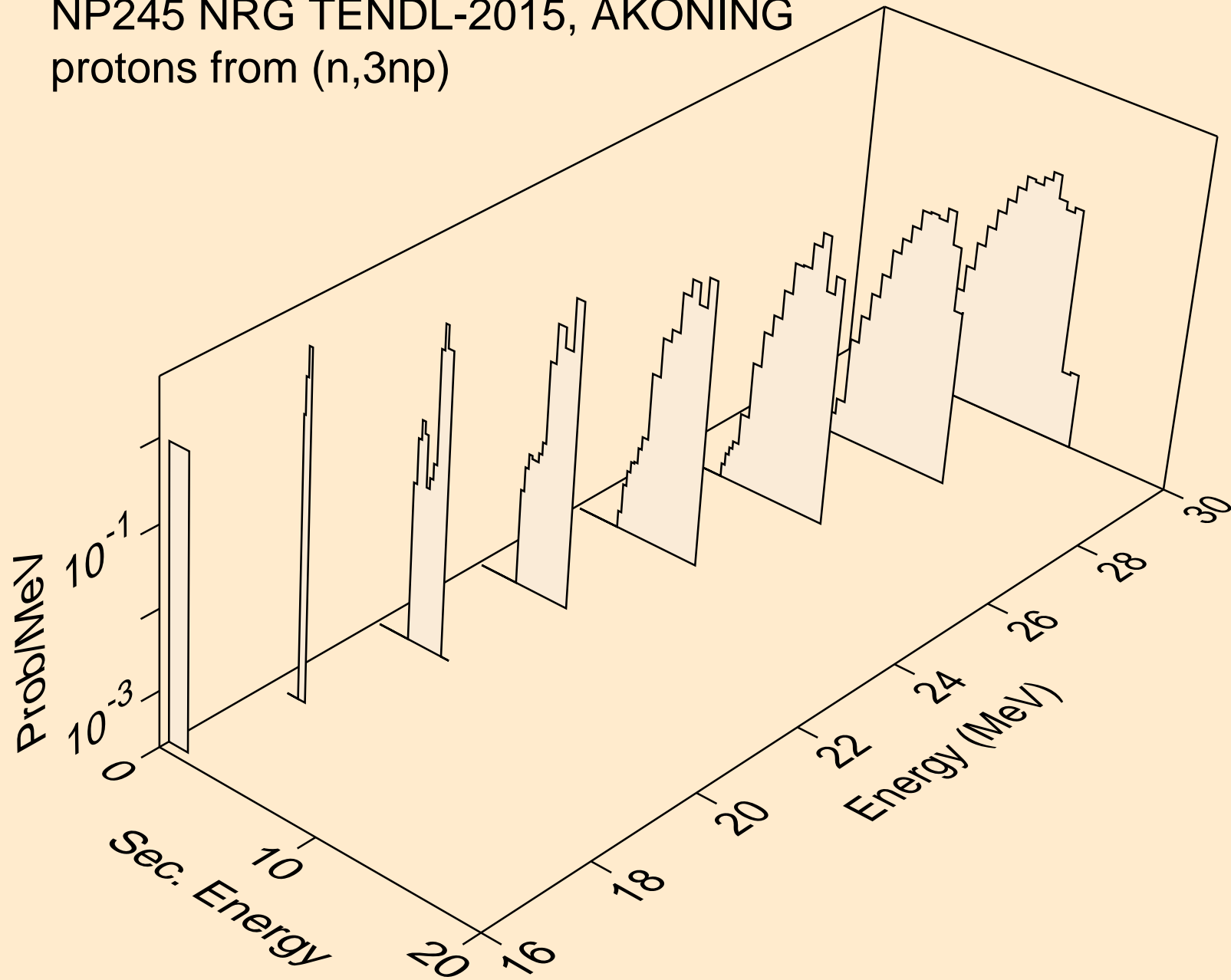

NP245 NRG TENDL-2015, AKONING
protons from (n,npa)

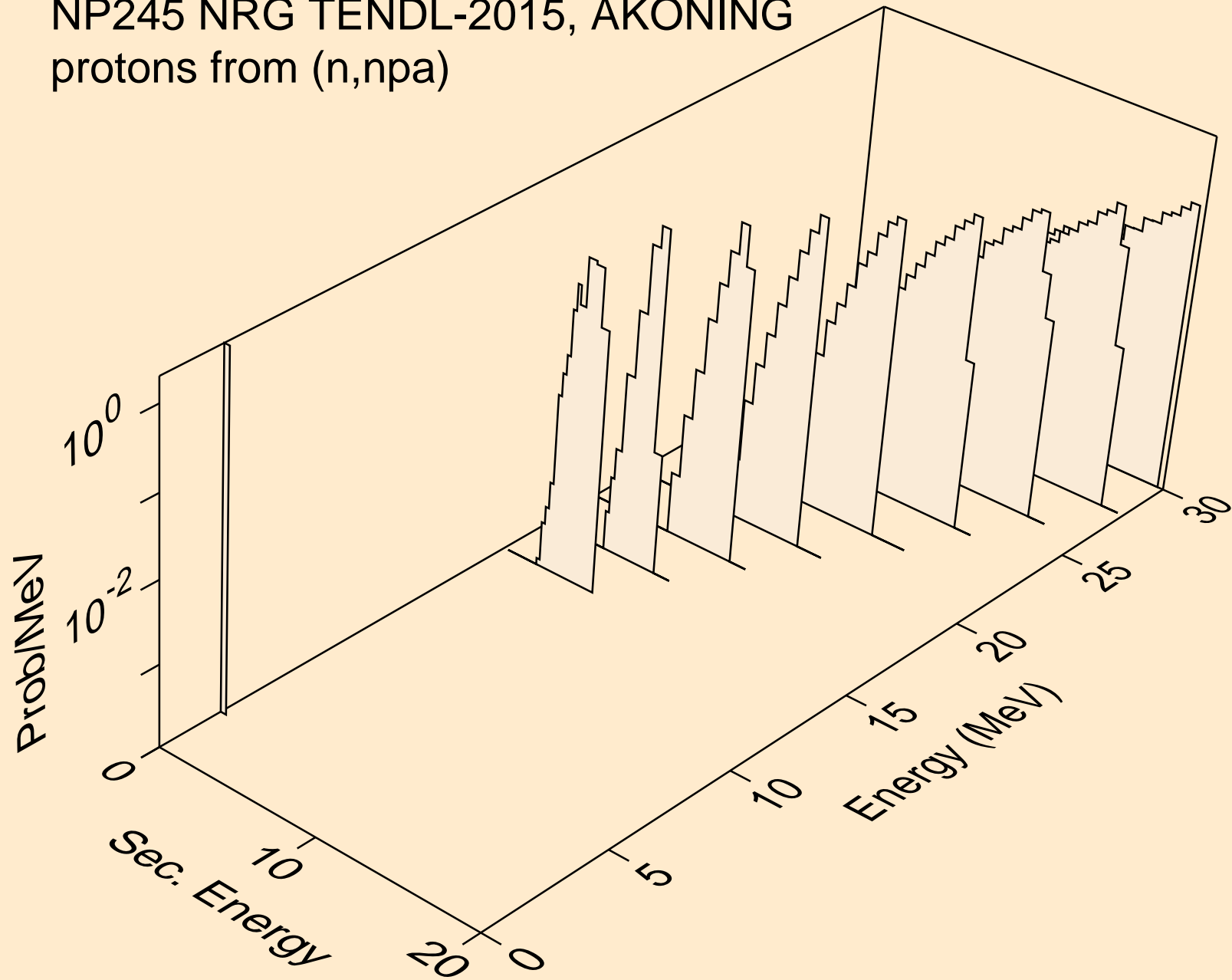

NP245 NRG TENDL-2015, AKONING
protons from (n,p)

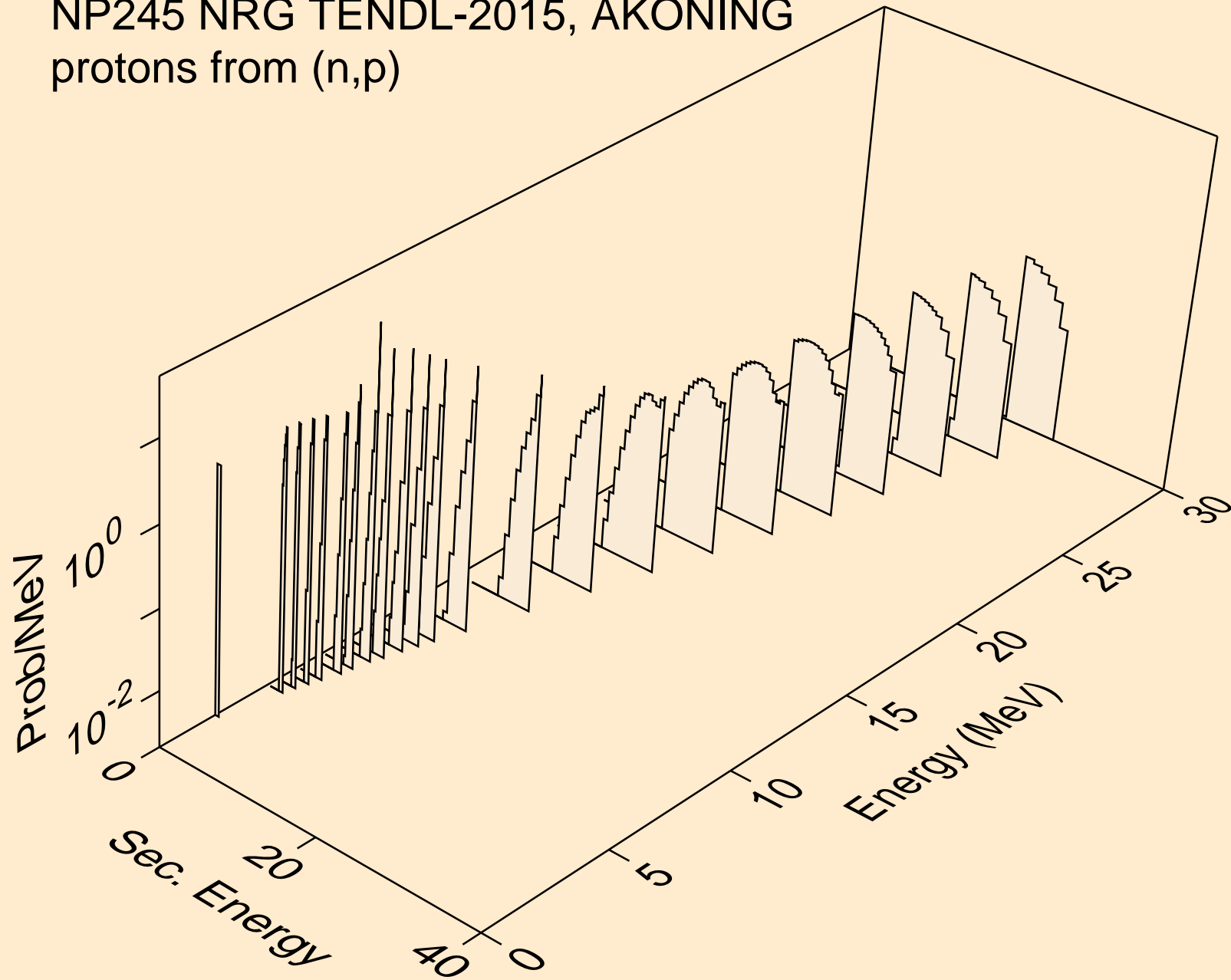

NP245 NRG TENDL-2015, AKONING
protons from (n,2p)

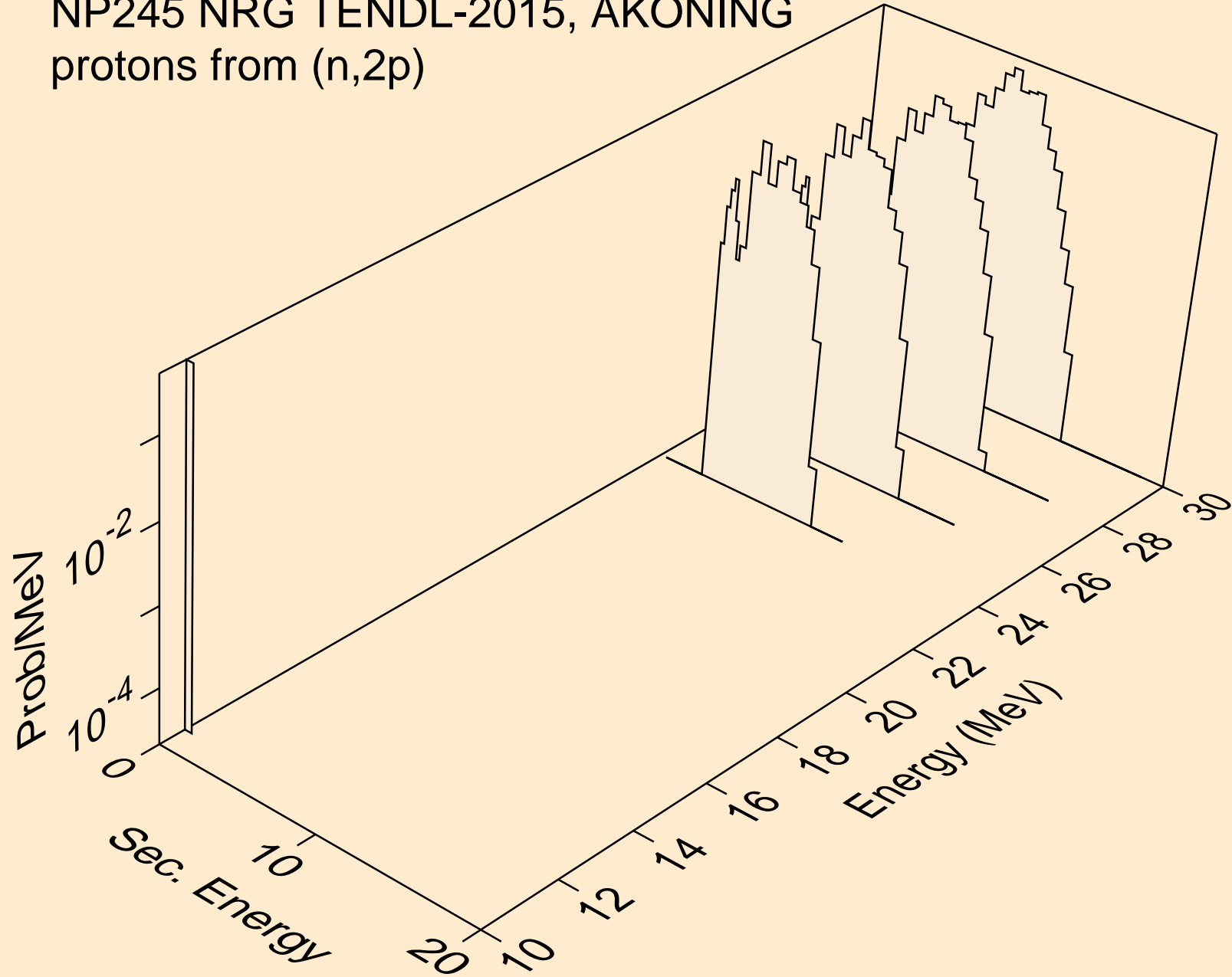

NP245 NRG TENDL-2015, AKONING
deuterons from (n,x)

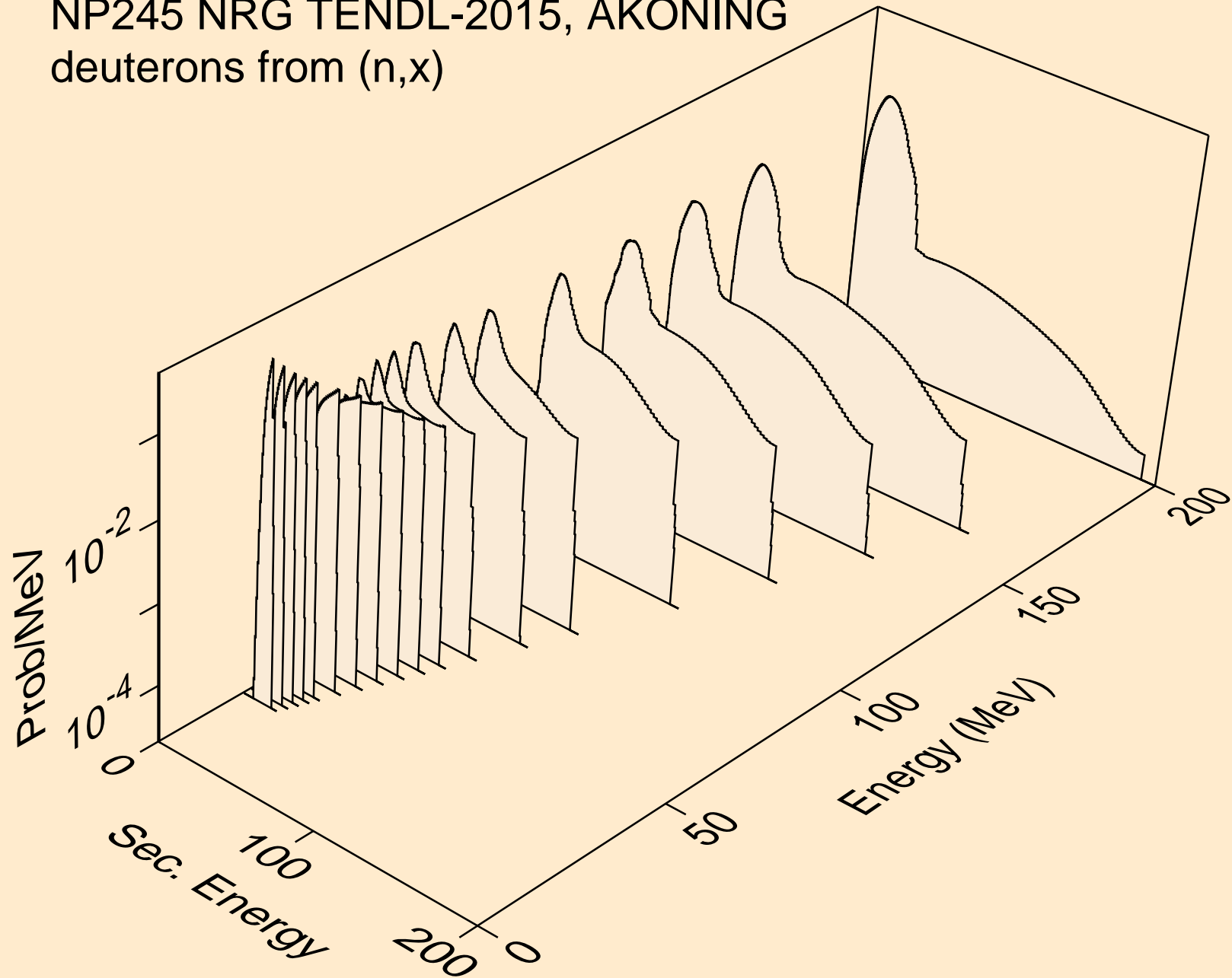

NP245 NRG TENDL-2015, AKONING
deuterons from (n,2nd)

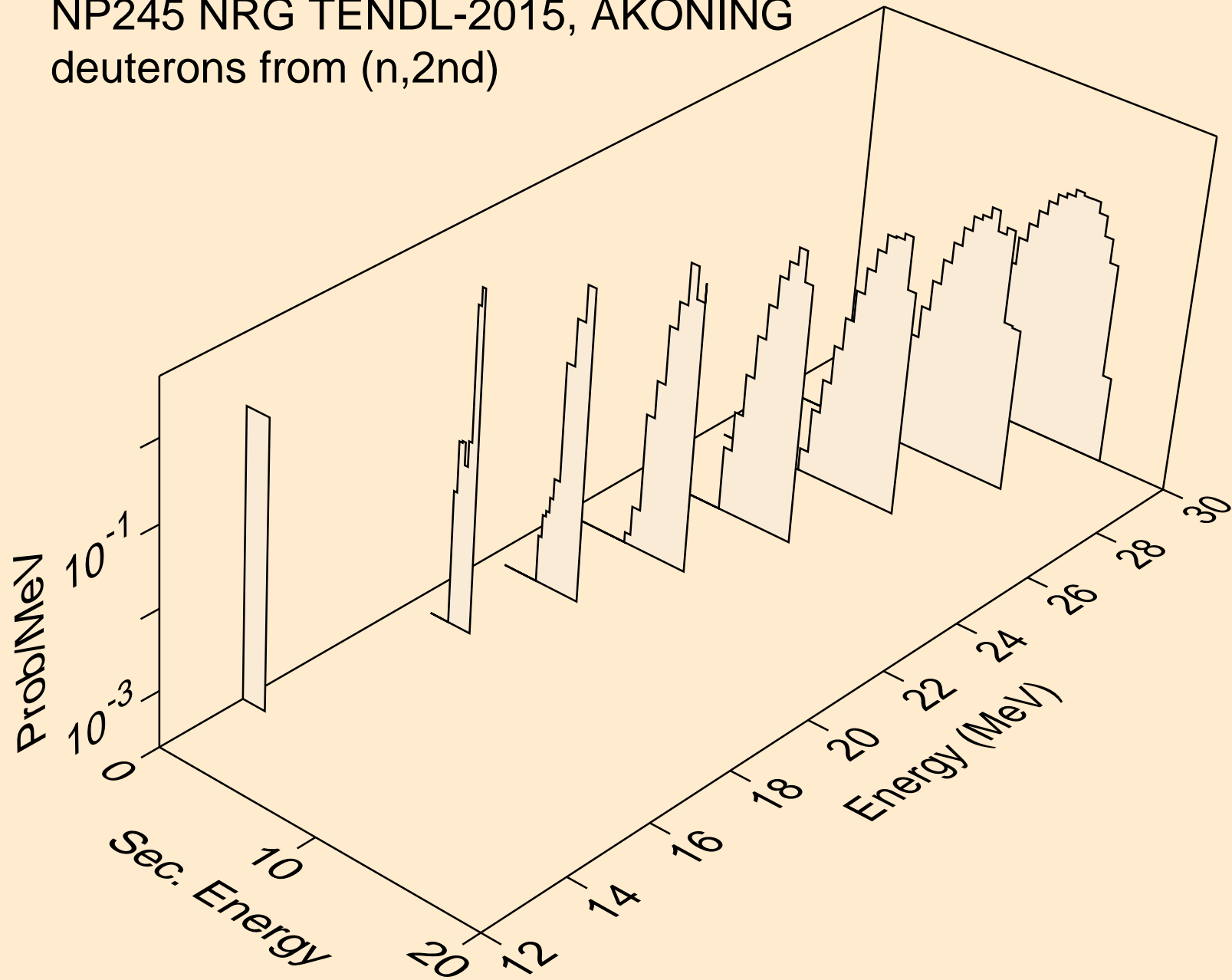

NP245 NRG TENDL-2015, AKONING
deuterons from (n,n*)d

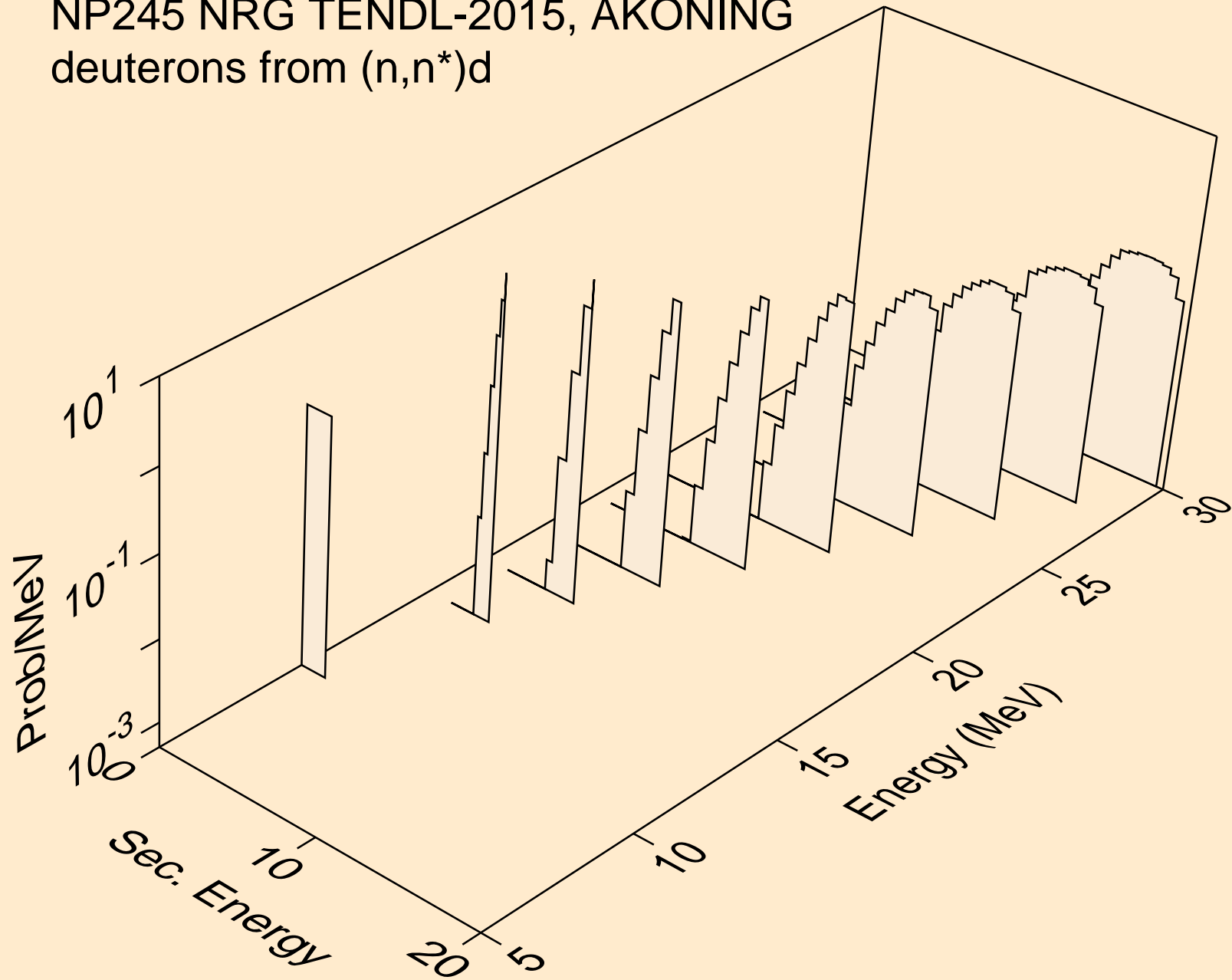

NP245 NRG TENDL-2015, AKONING
deuterons from (n,d)

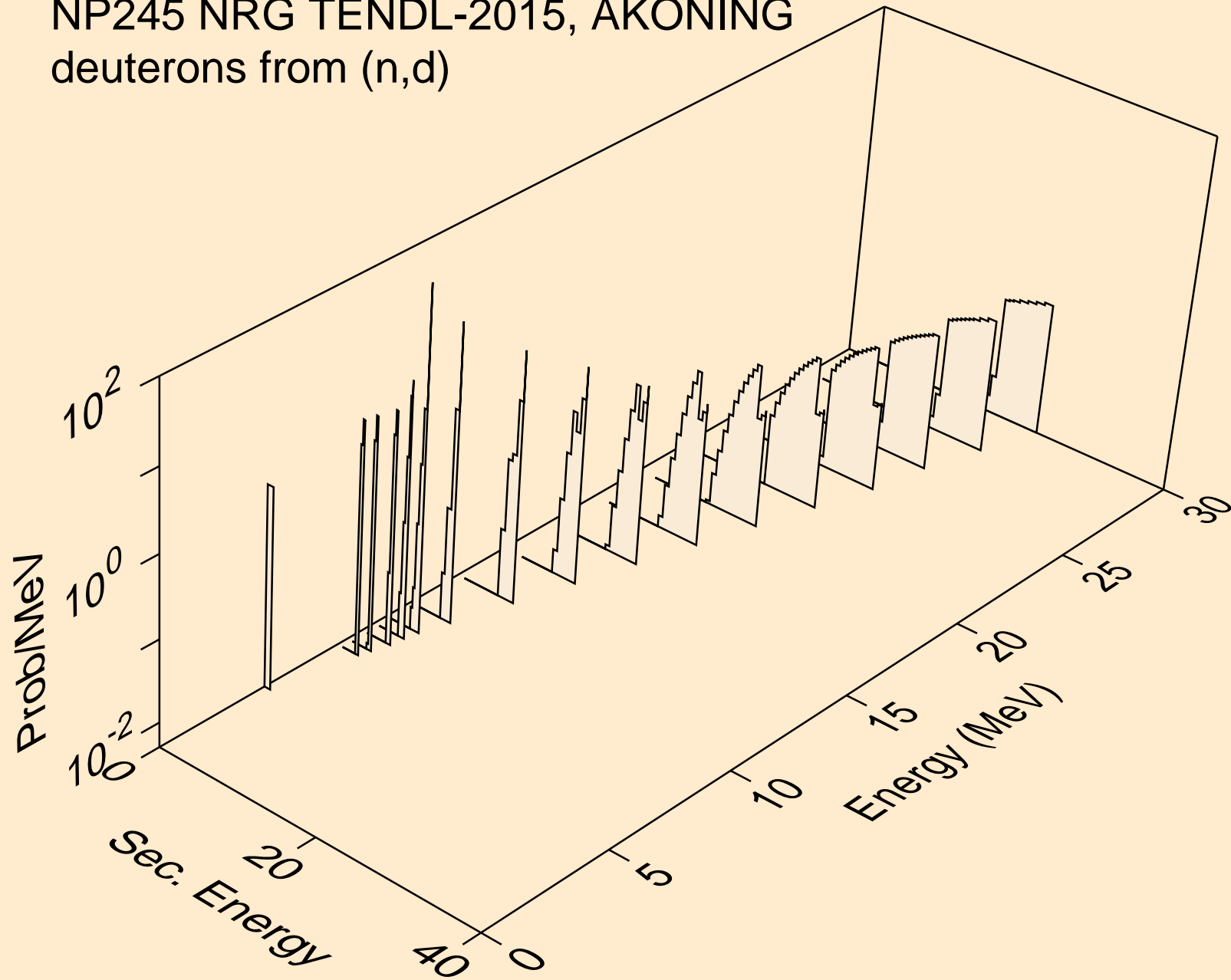

NP245 NRG TENDL-2015, AKONING
deuterons from (n,da)

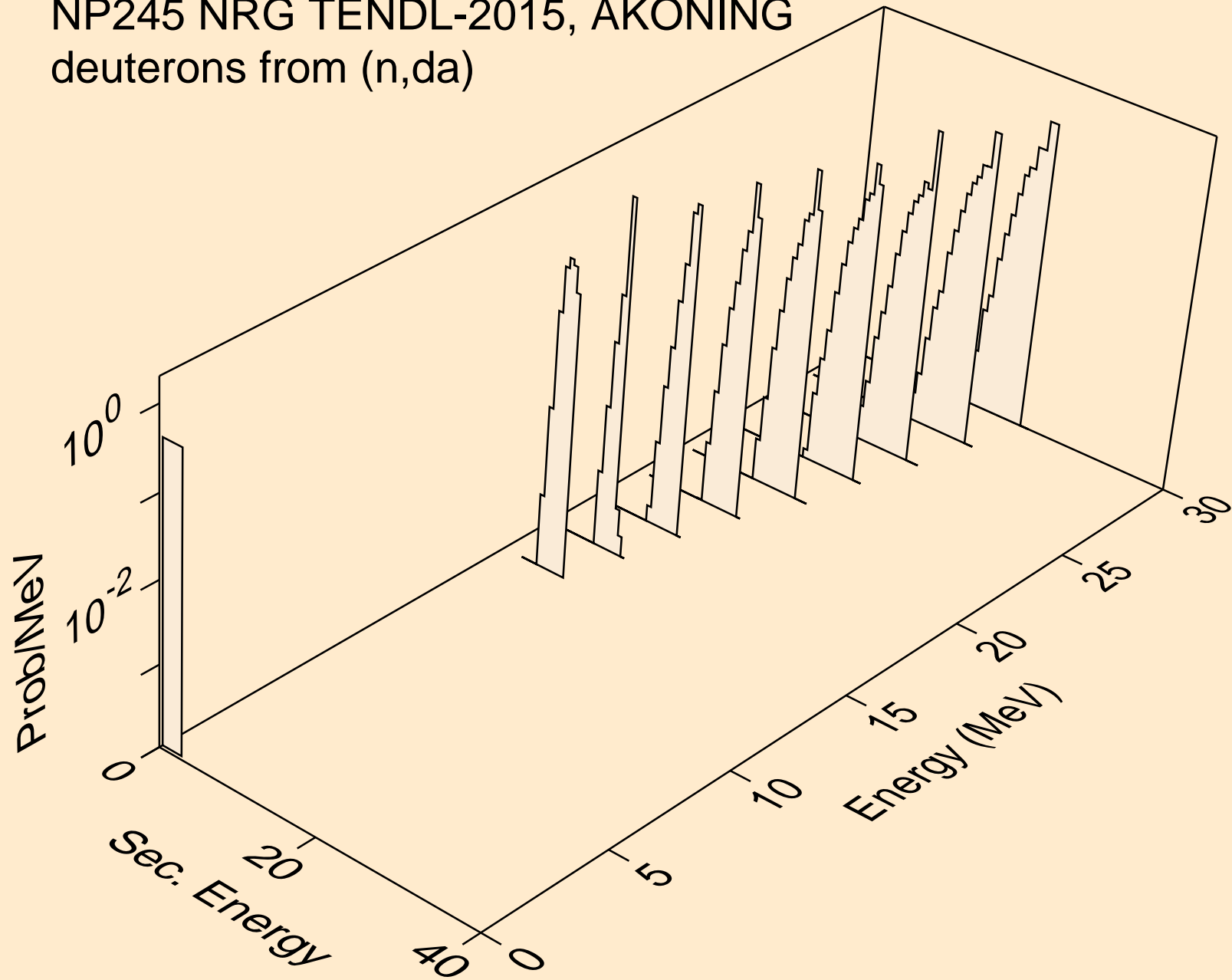

NP245 NRG TENDL-2015, AKONING
tritons from (n,x)

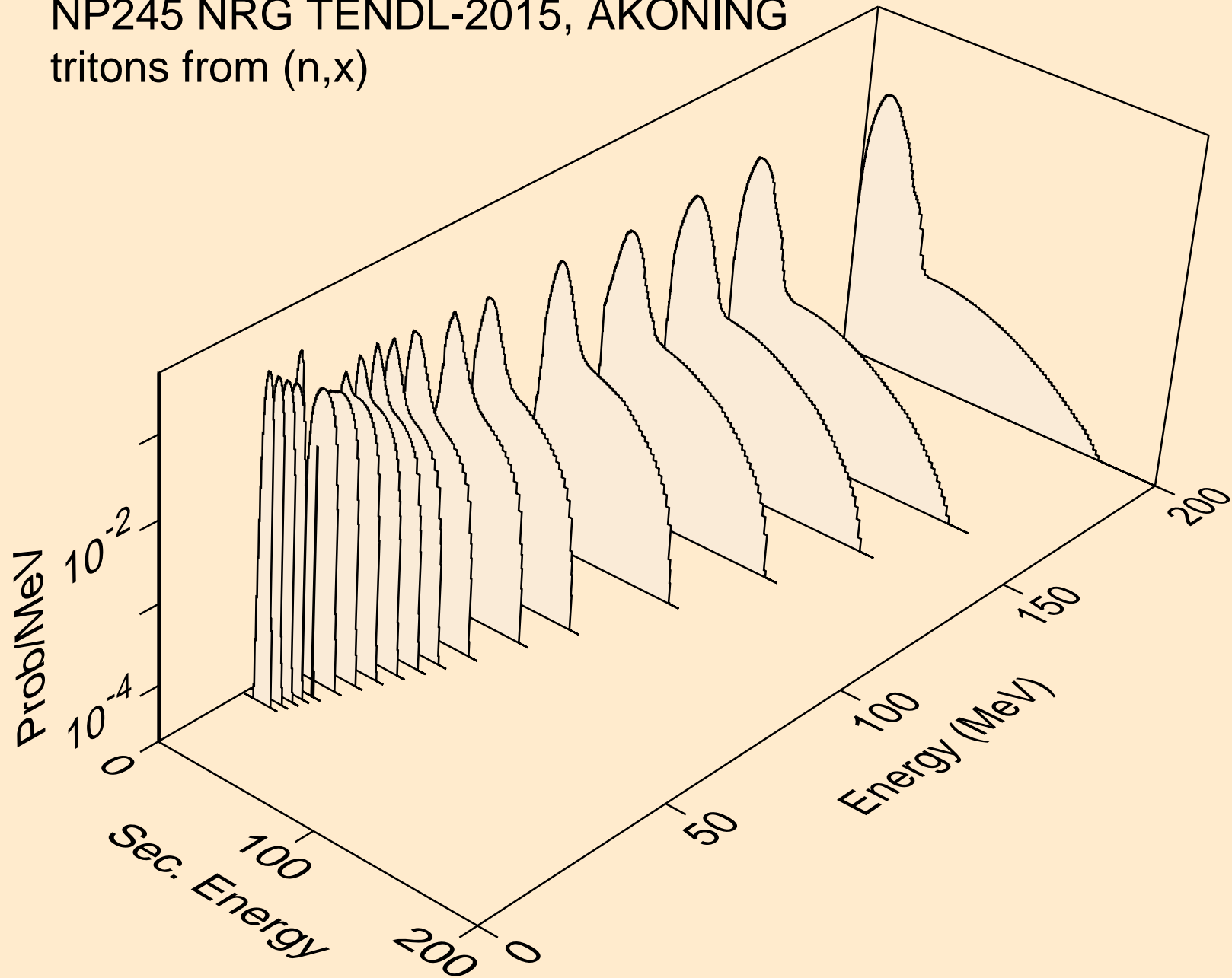

NP245 NRG TENDL-2015, AKONING
tritons from (n,n*)t

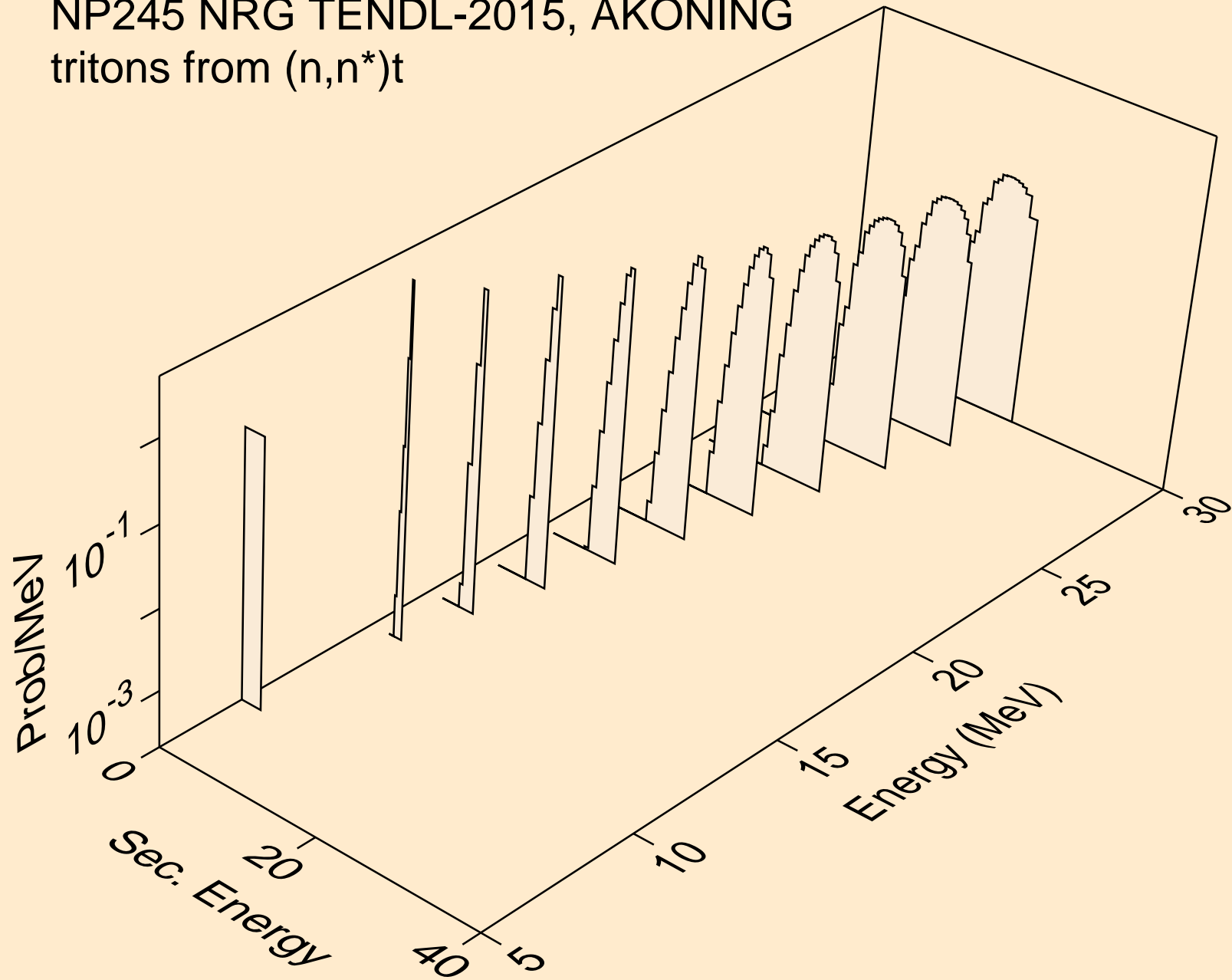

NP245 NRG TENDL-2015, AKONING
tritons from (n,t)

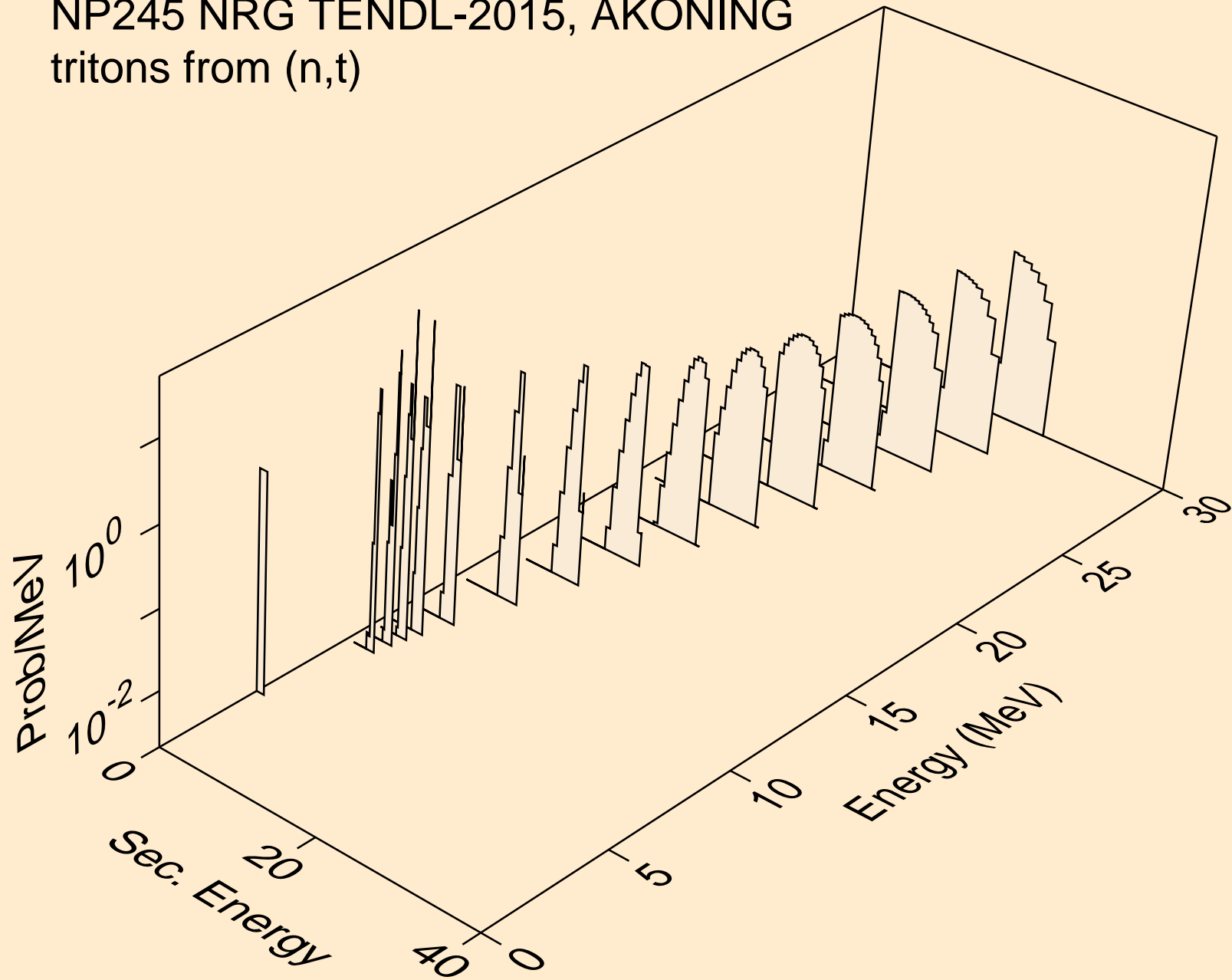

NP245 NRG TENDL-2015, AKONING
he3s from (n,x)

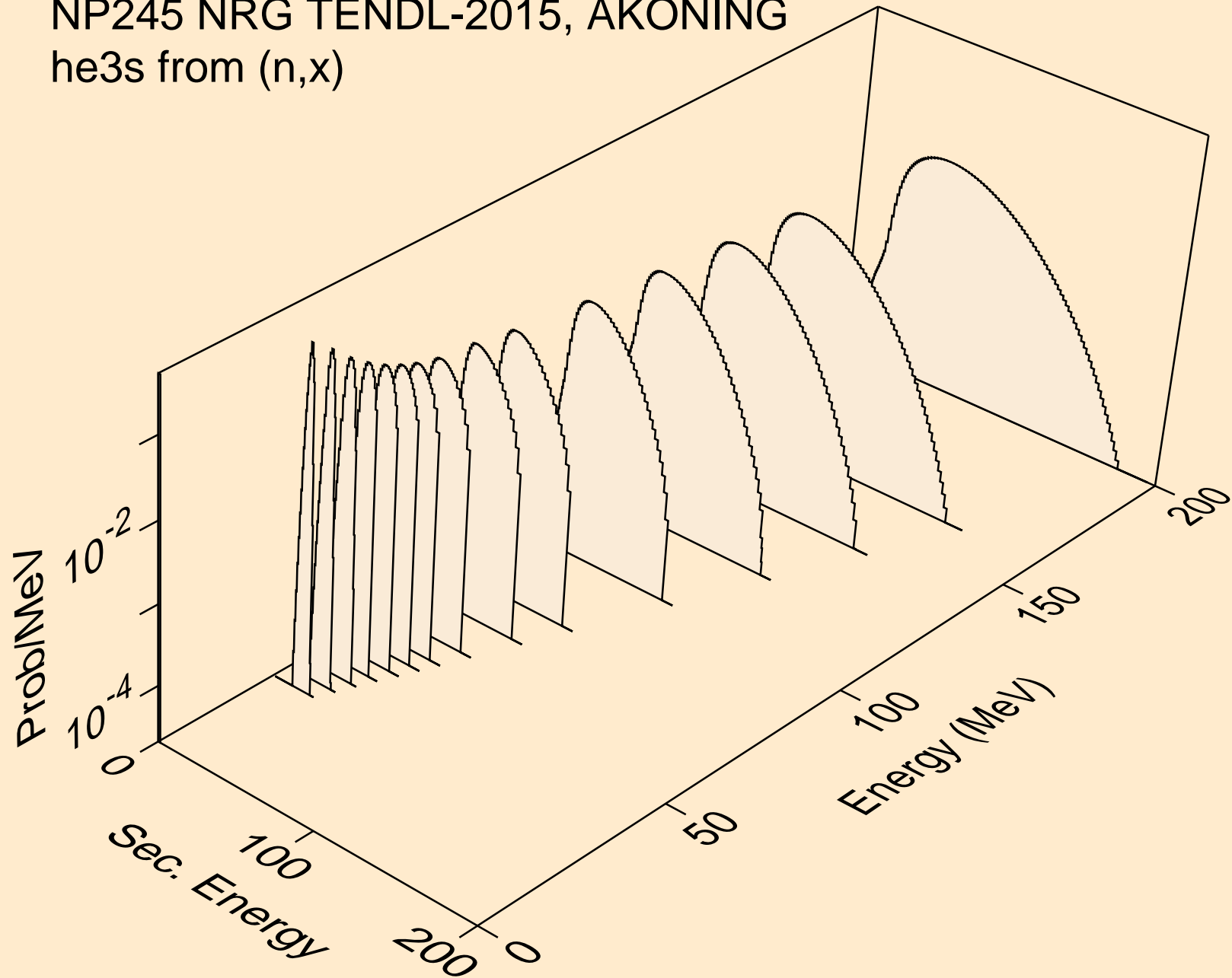

NP245 NRG TENDL-2015, AKONING
he3s from (n,n*)he3

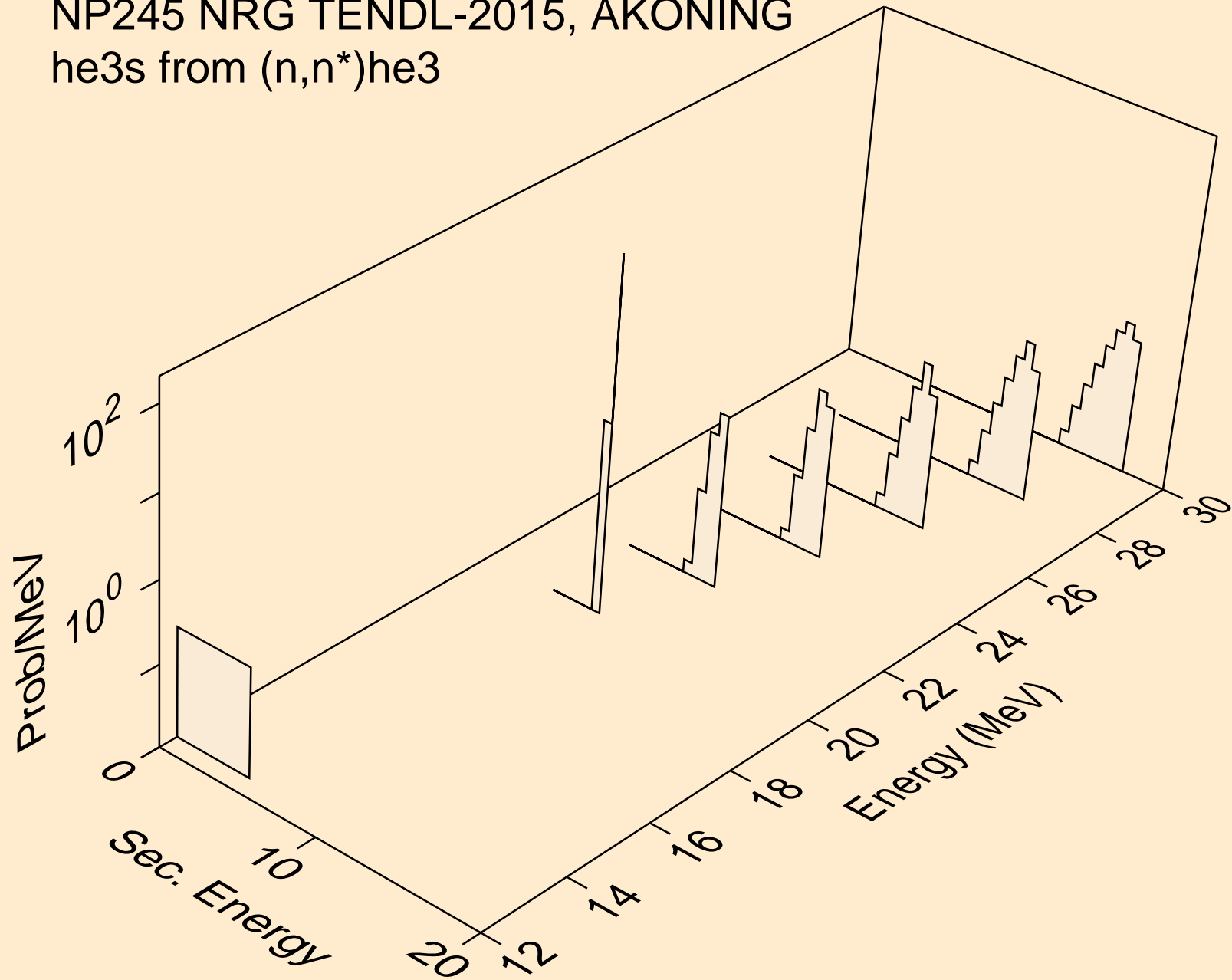

NP245 NRG TENDL-2015, AKONING
he3s from (n,he3)

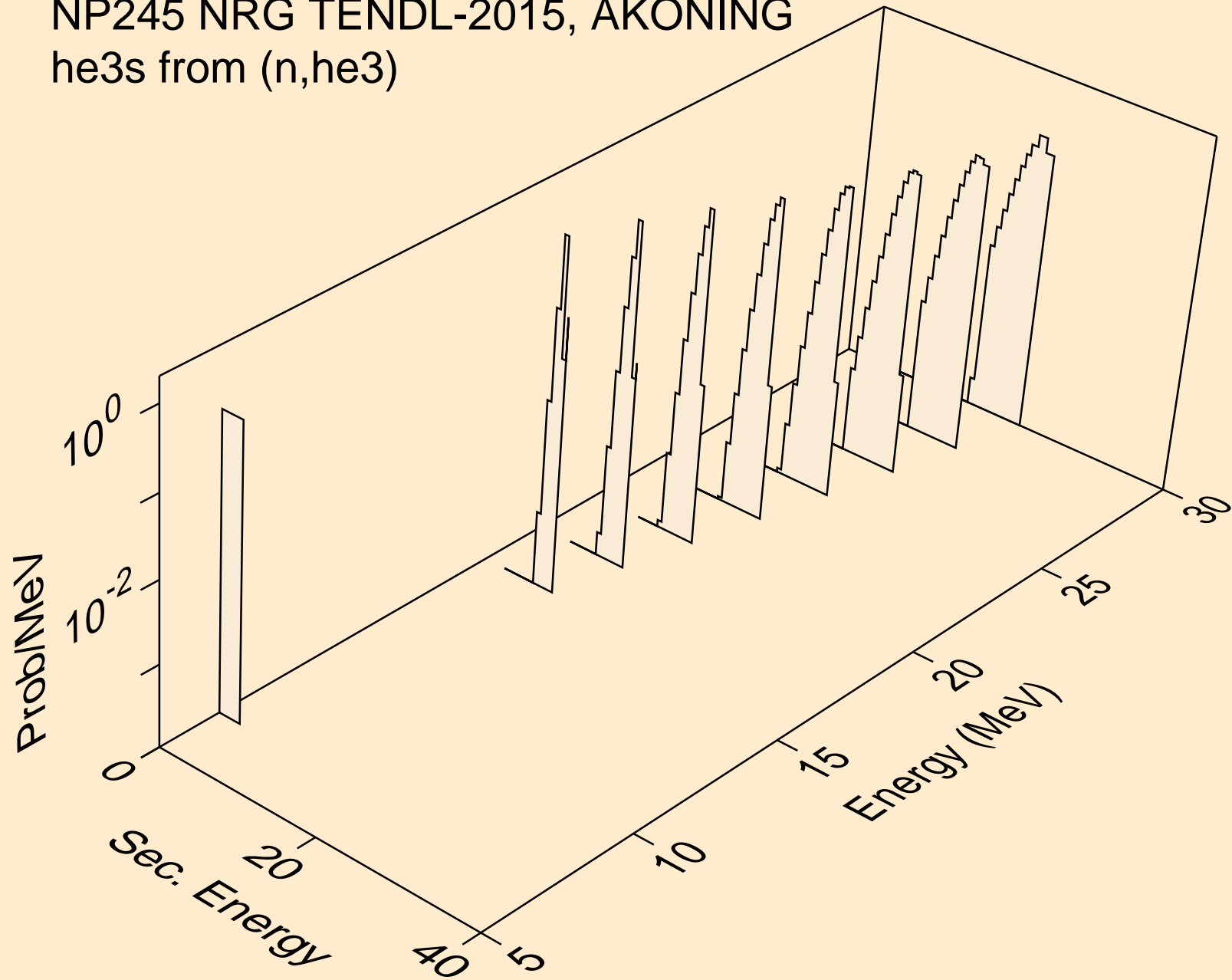

NP245 NRG TENDL-2015, AKONING
alphas from (n,x)

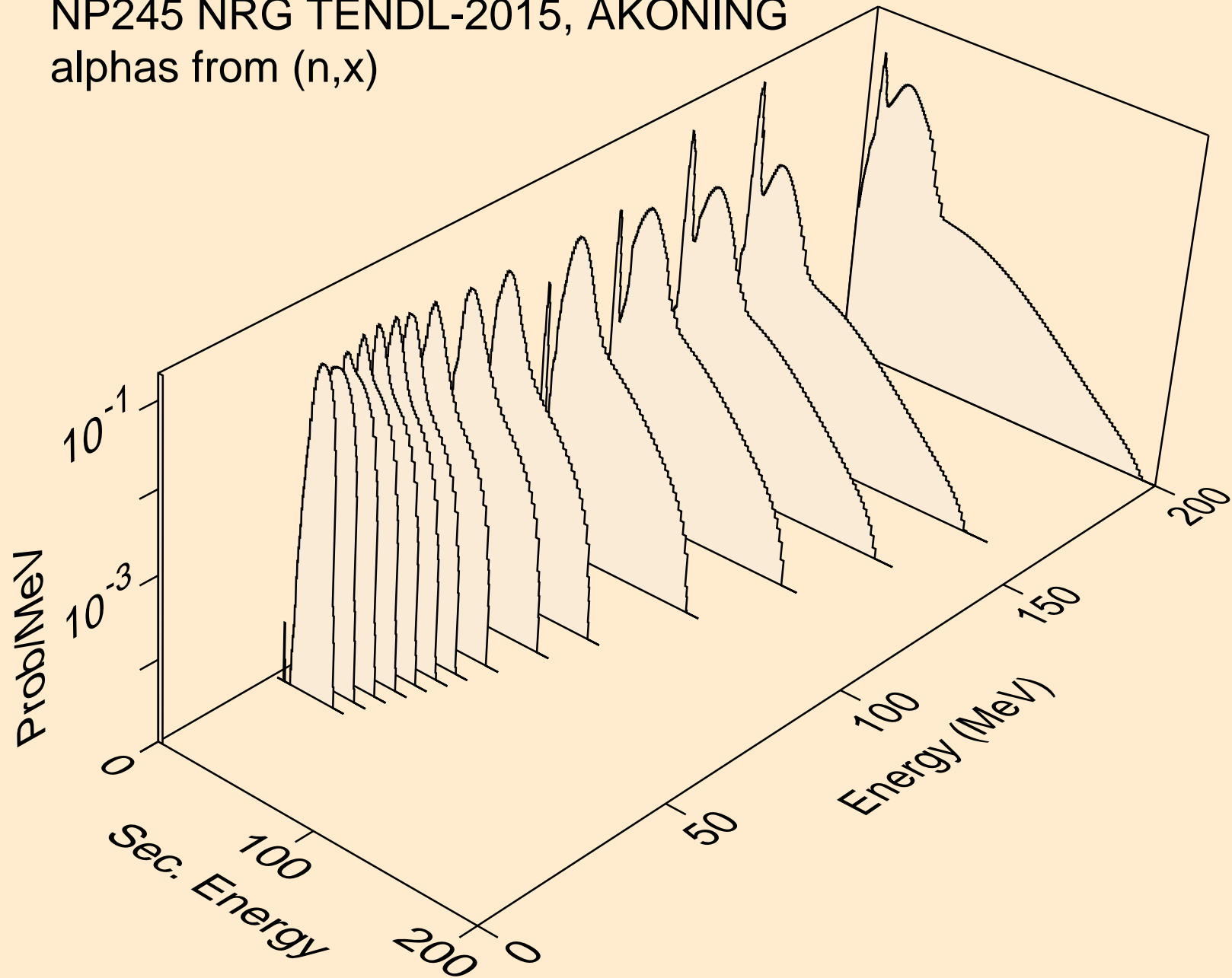

NP245 NRG TENDL-2015, AKONING
alphas from (n,n*)a

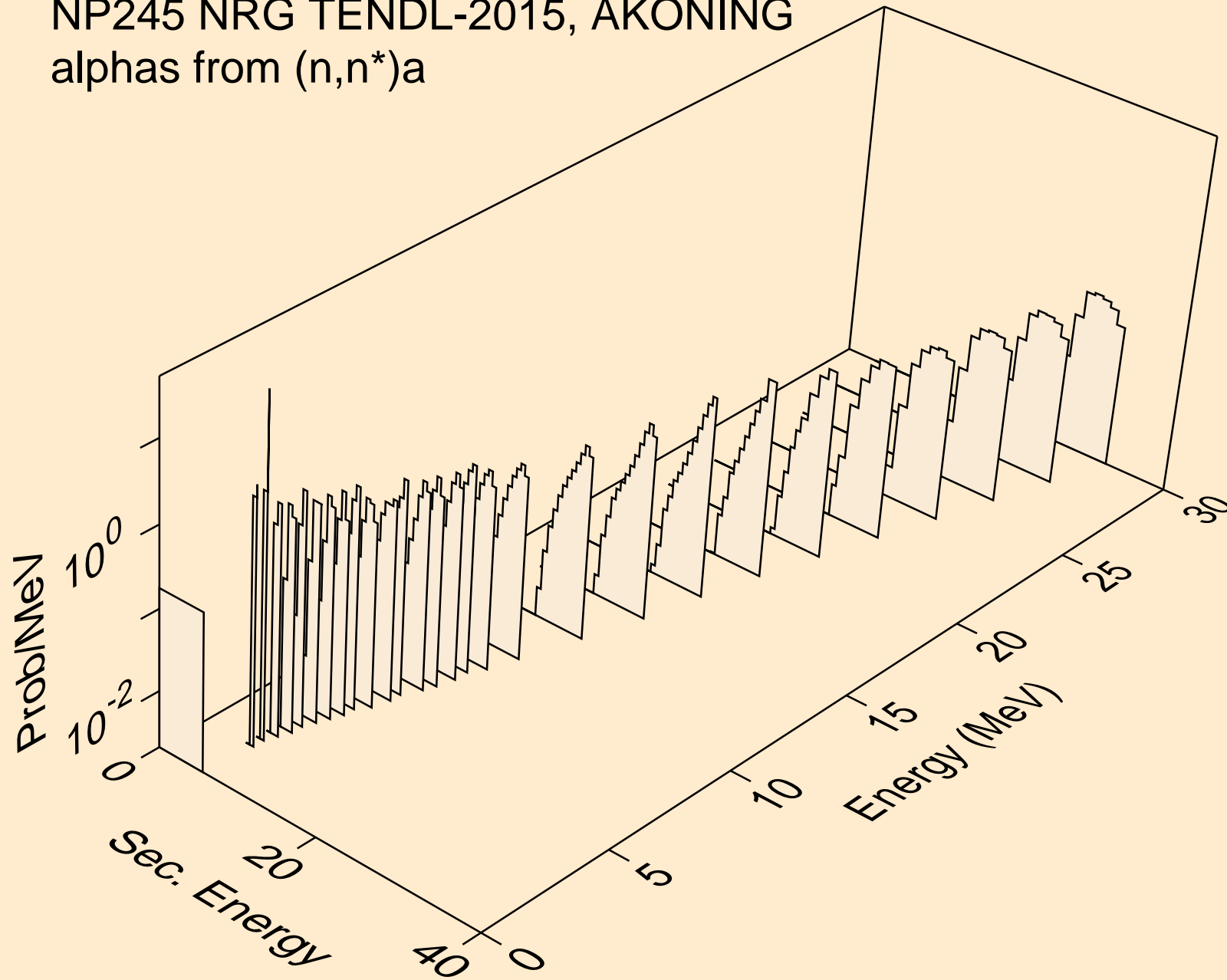

NP245 NRG TENDL-2015, AKONING
alphas from (n,2n)a

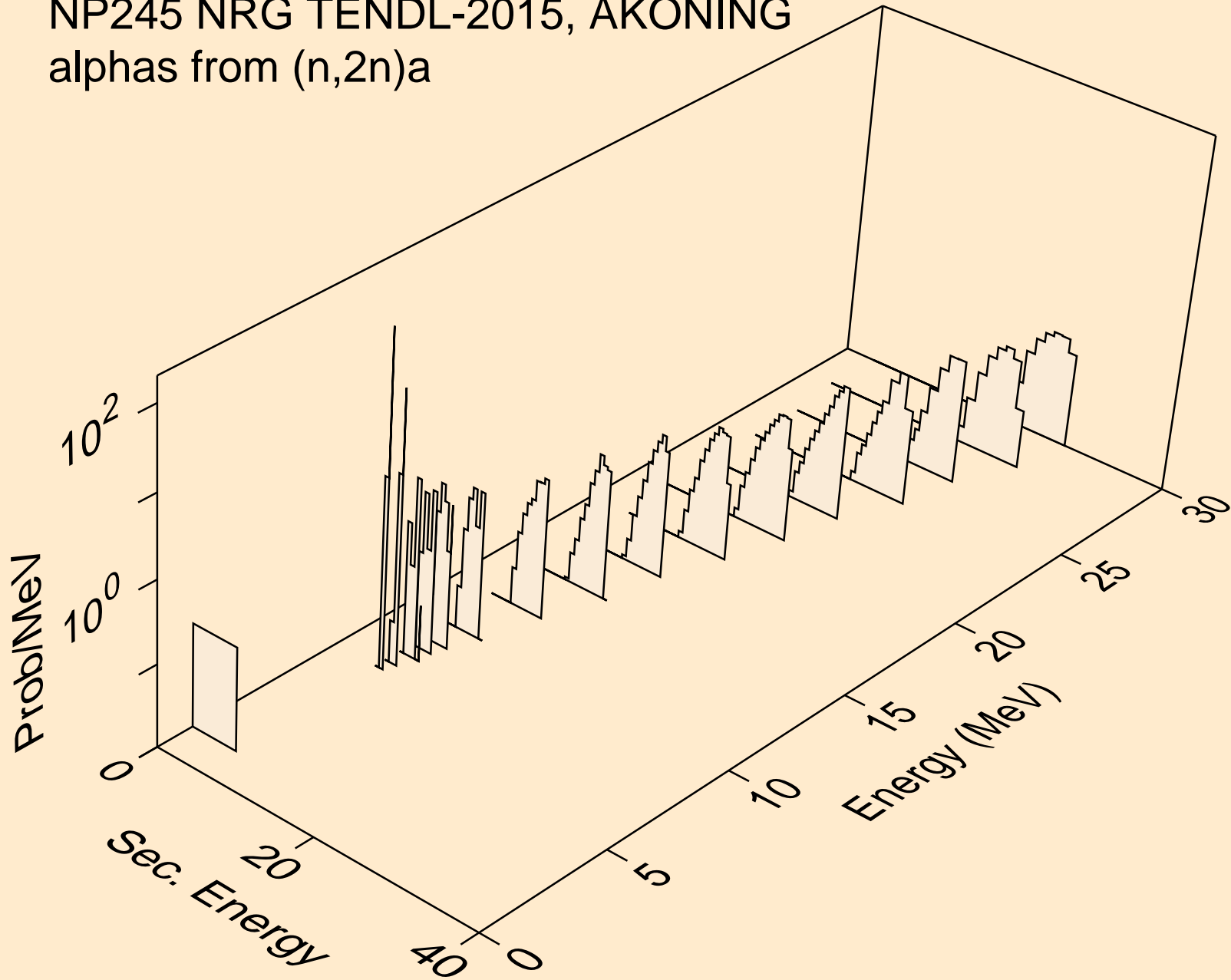

NP245 NRG TENDL-2015, AKONING
alphas from (n,3n)a

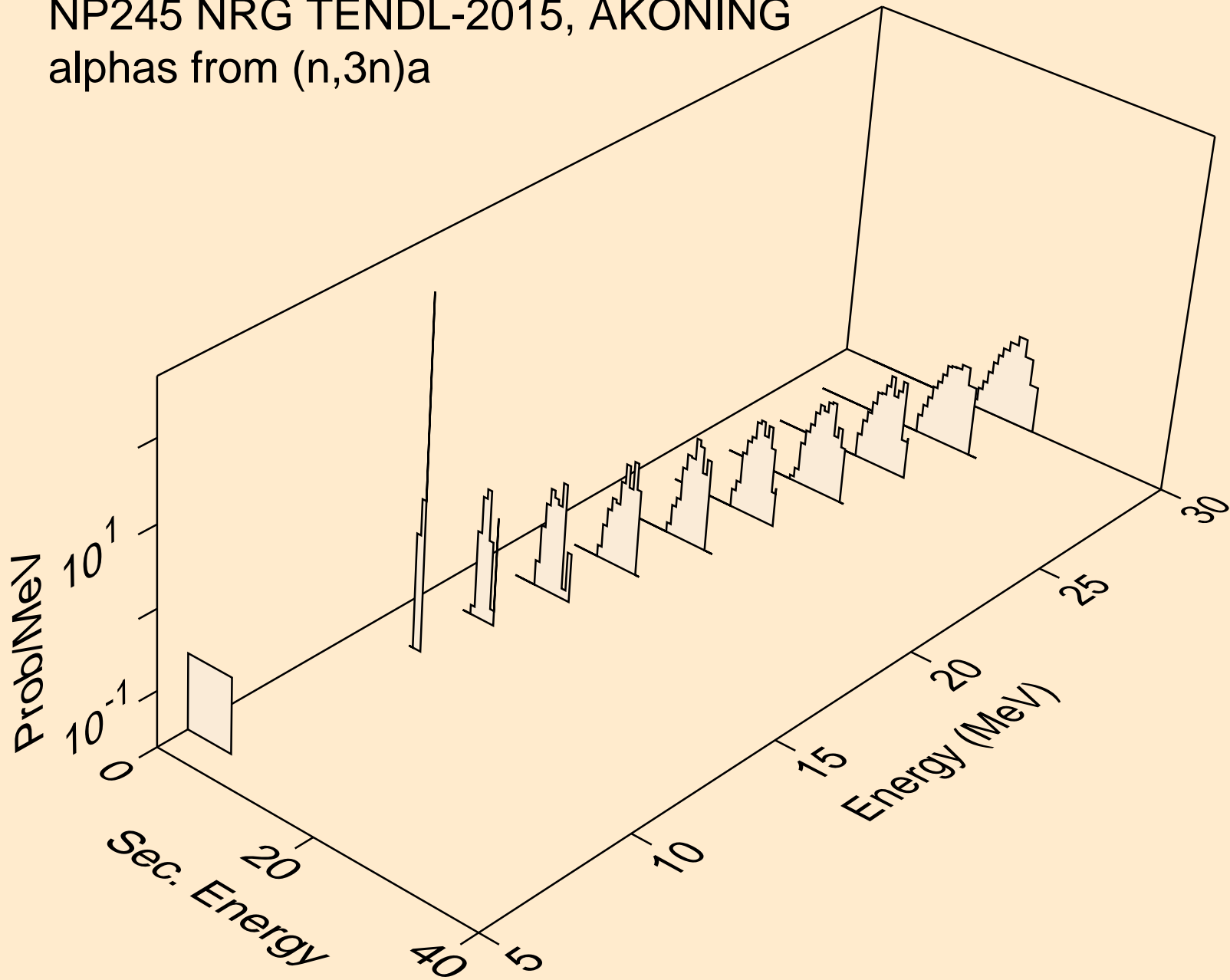

NP245 NRG TENDL-2015, AKONING
alphas from (n,npa)

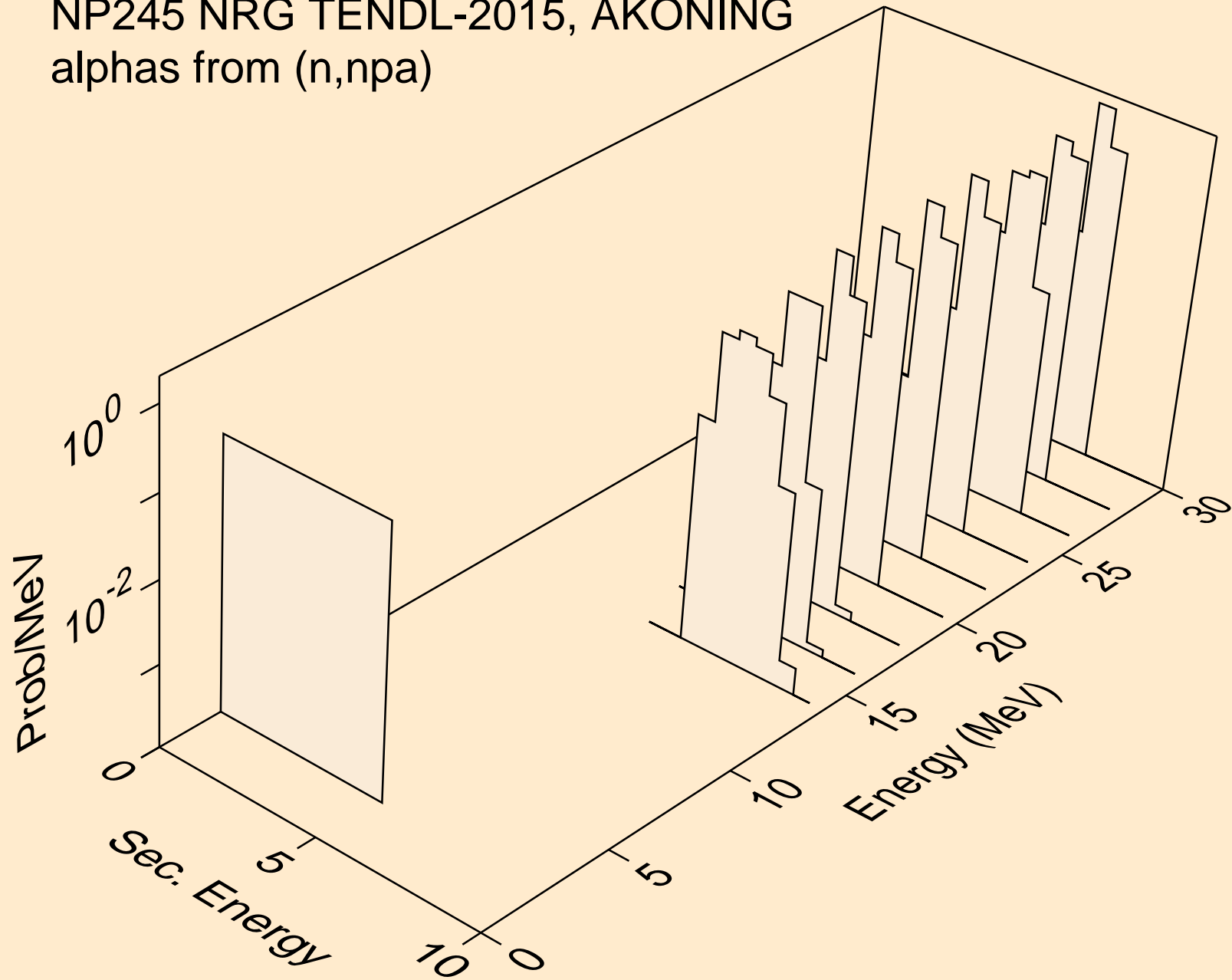

NP245 NRG TENDL-2015, AKONING
alphas from (n,a)

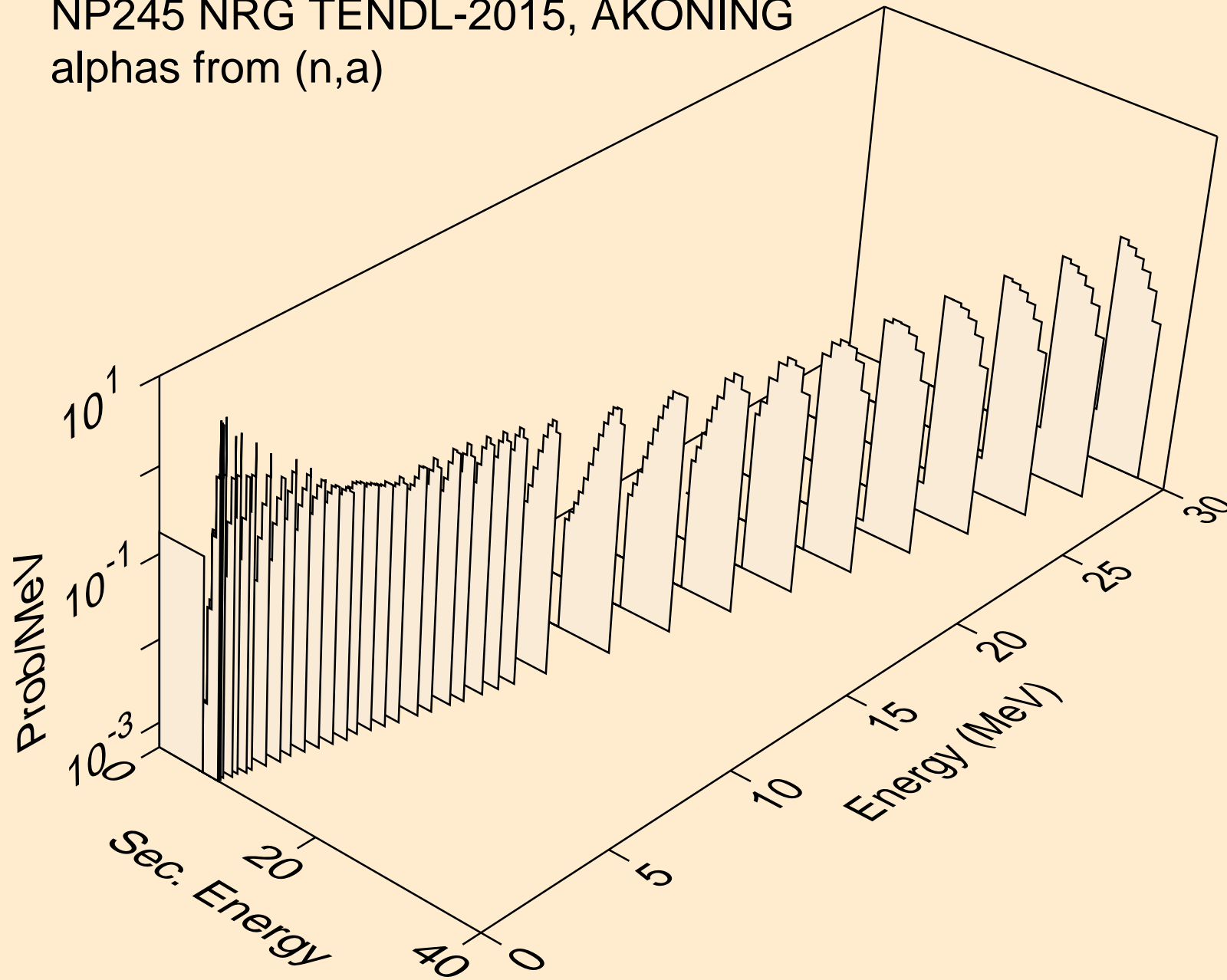

NP245 NRG TENDL-2015, AKONING
alphas from (n,da)

