

OS168 NRG TENDL-2015, AKONING

Principal cross sections

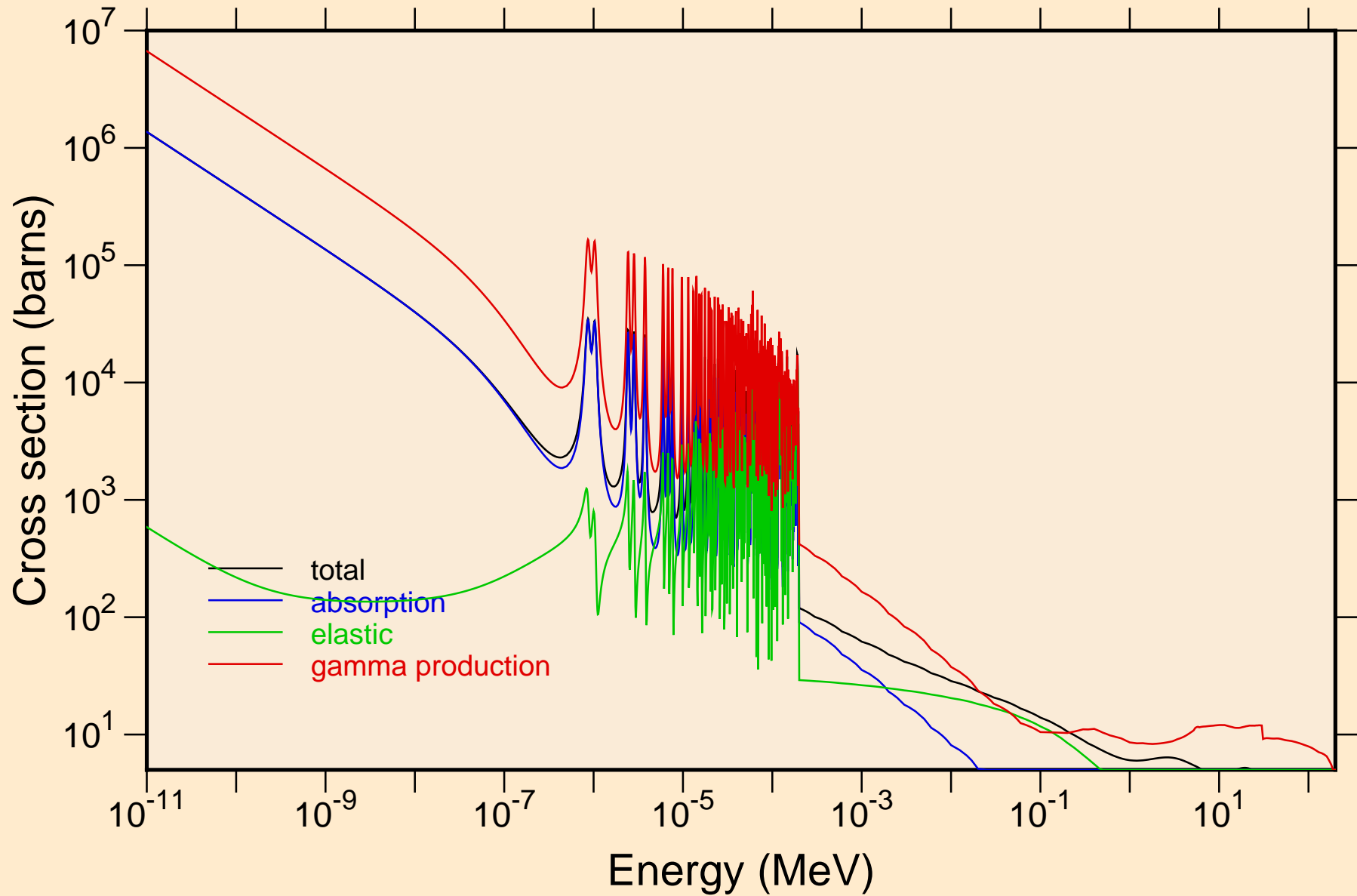

OS168 NRG TENDL-2015, AKONING
resonance total cross section

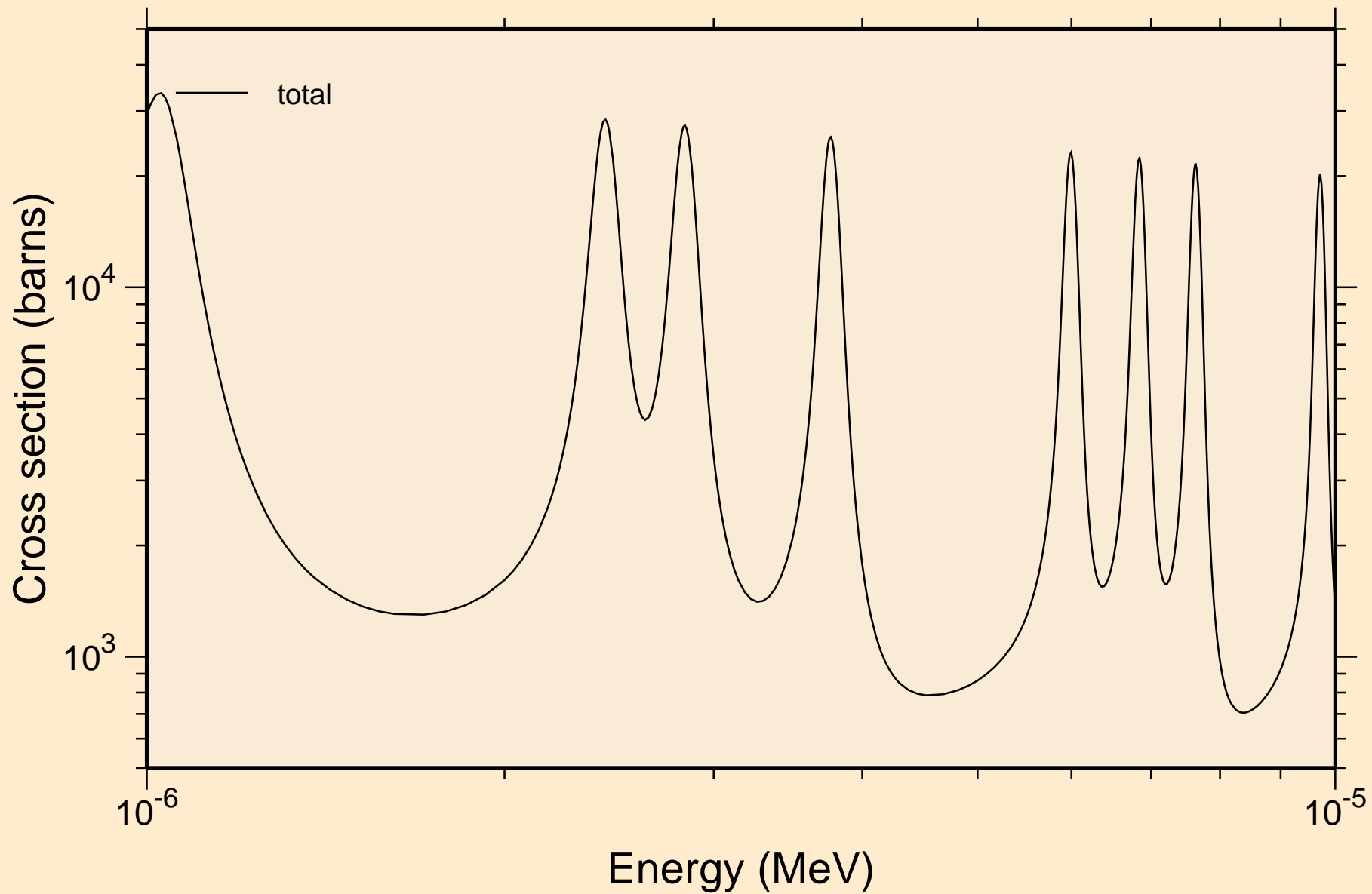

OS168 NRG TENDL-2015, AKONING
resonance total cross section

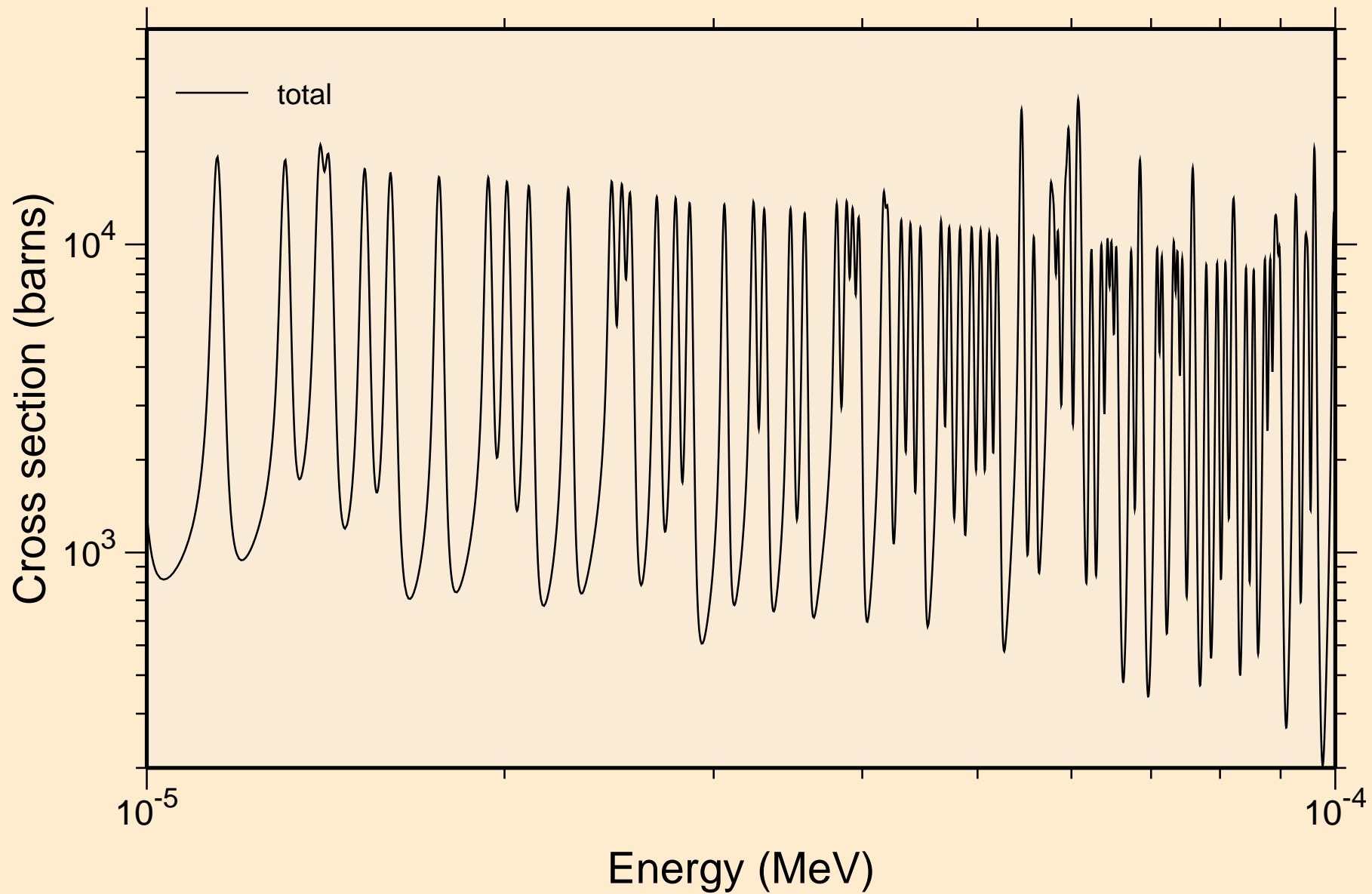

OS168 NRG TENDL-2015, AKONING
resonance total cross section

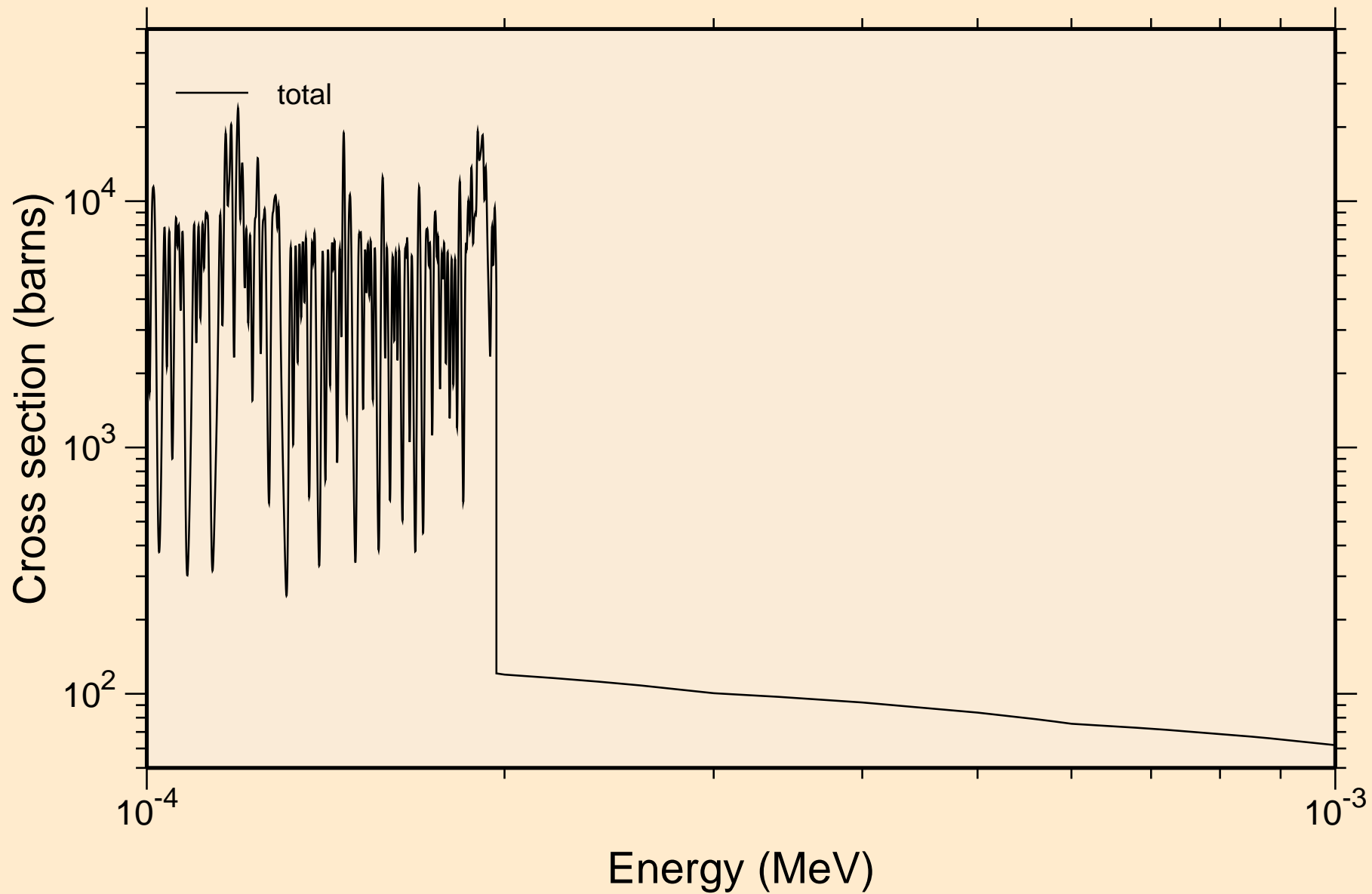

OS168 NRG TENDL-2015, AKONING
resonance total cross section

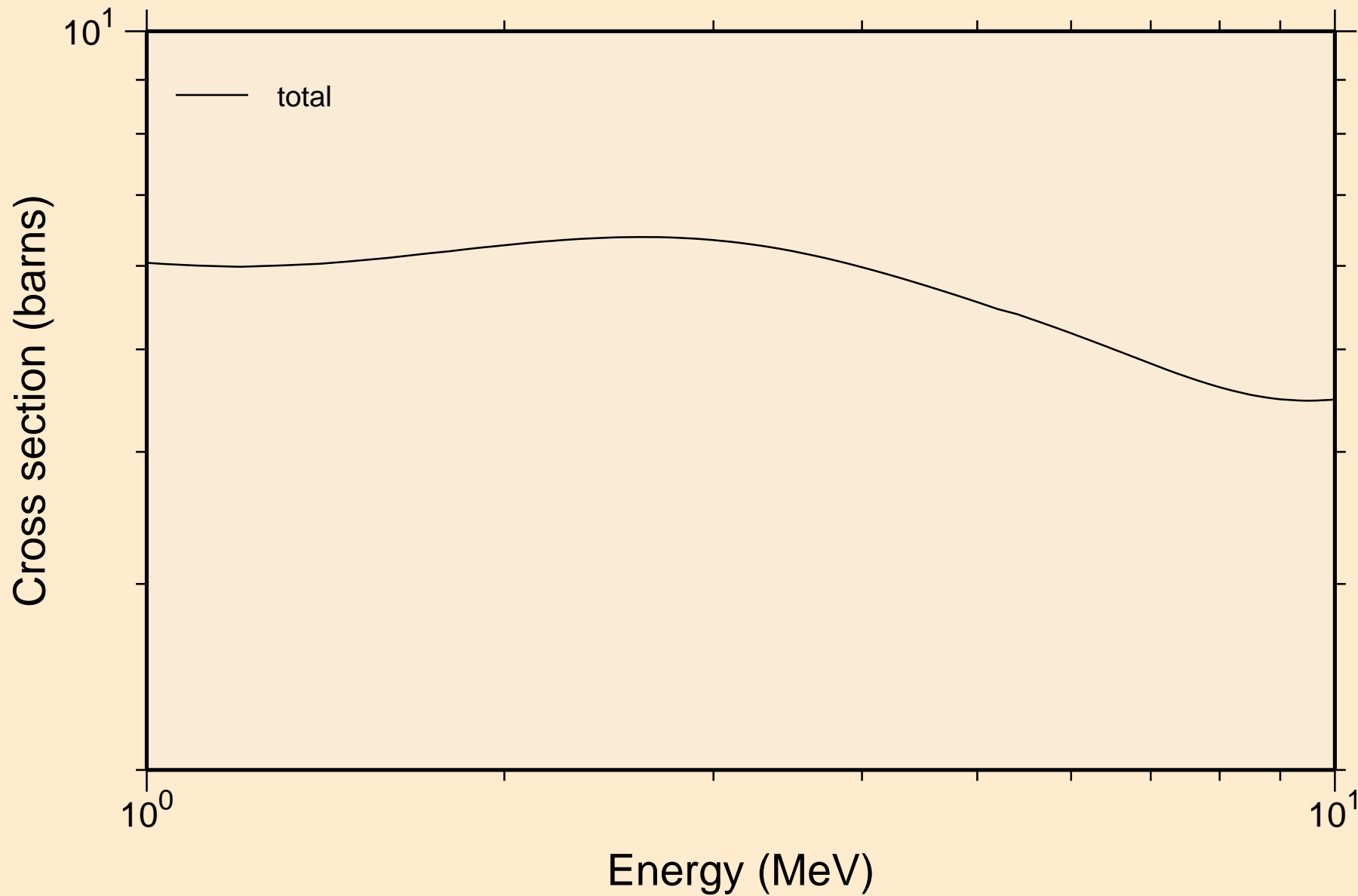

OS168 NRG TENDL-2015, AKONING
resonance absorption cross sections

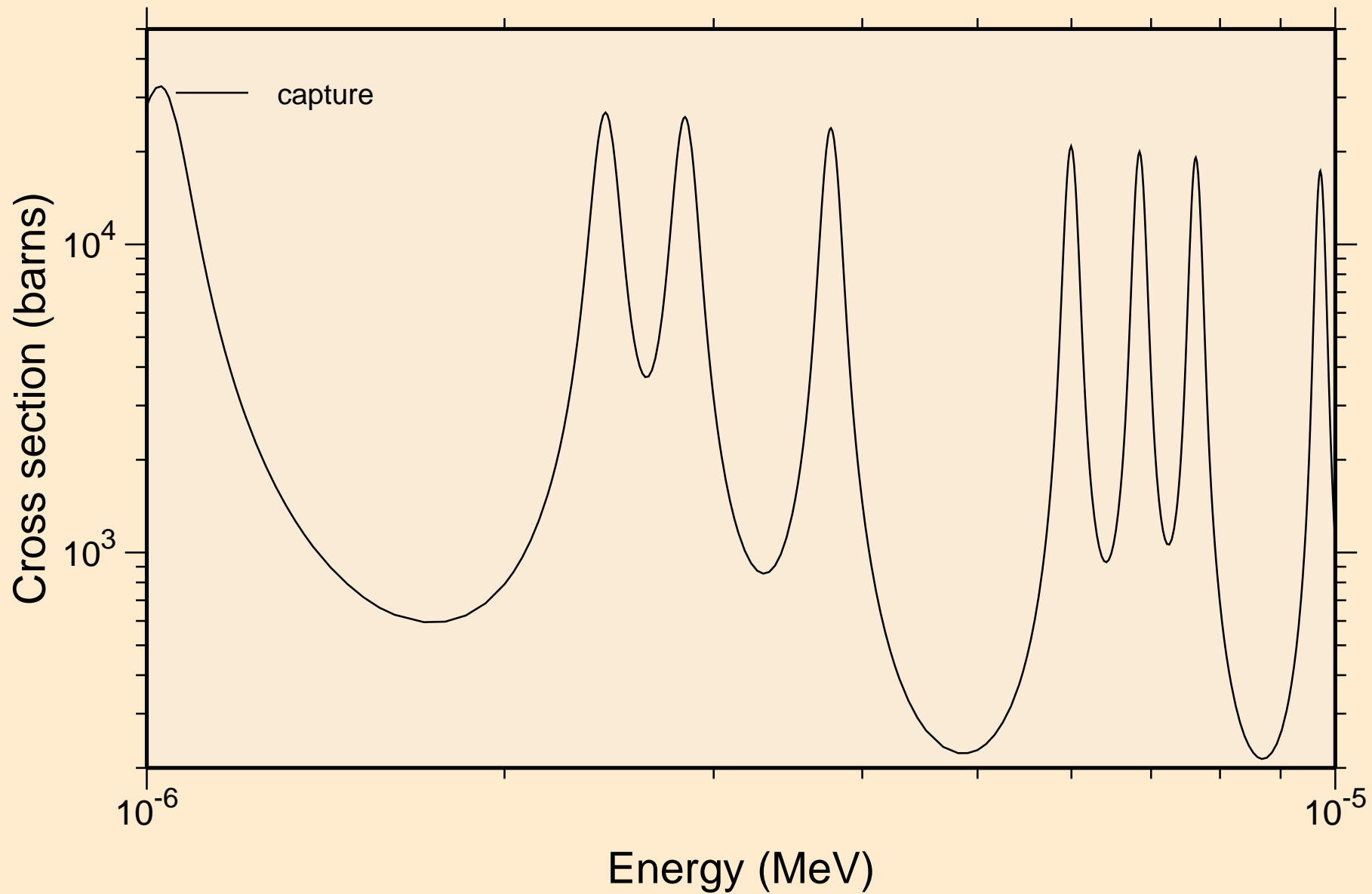

OS168 NRG TENDL-2015, AKONING
resonance absorption cross sections

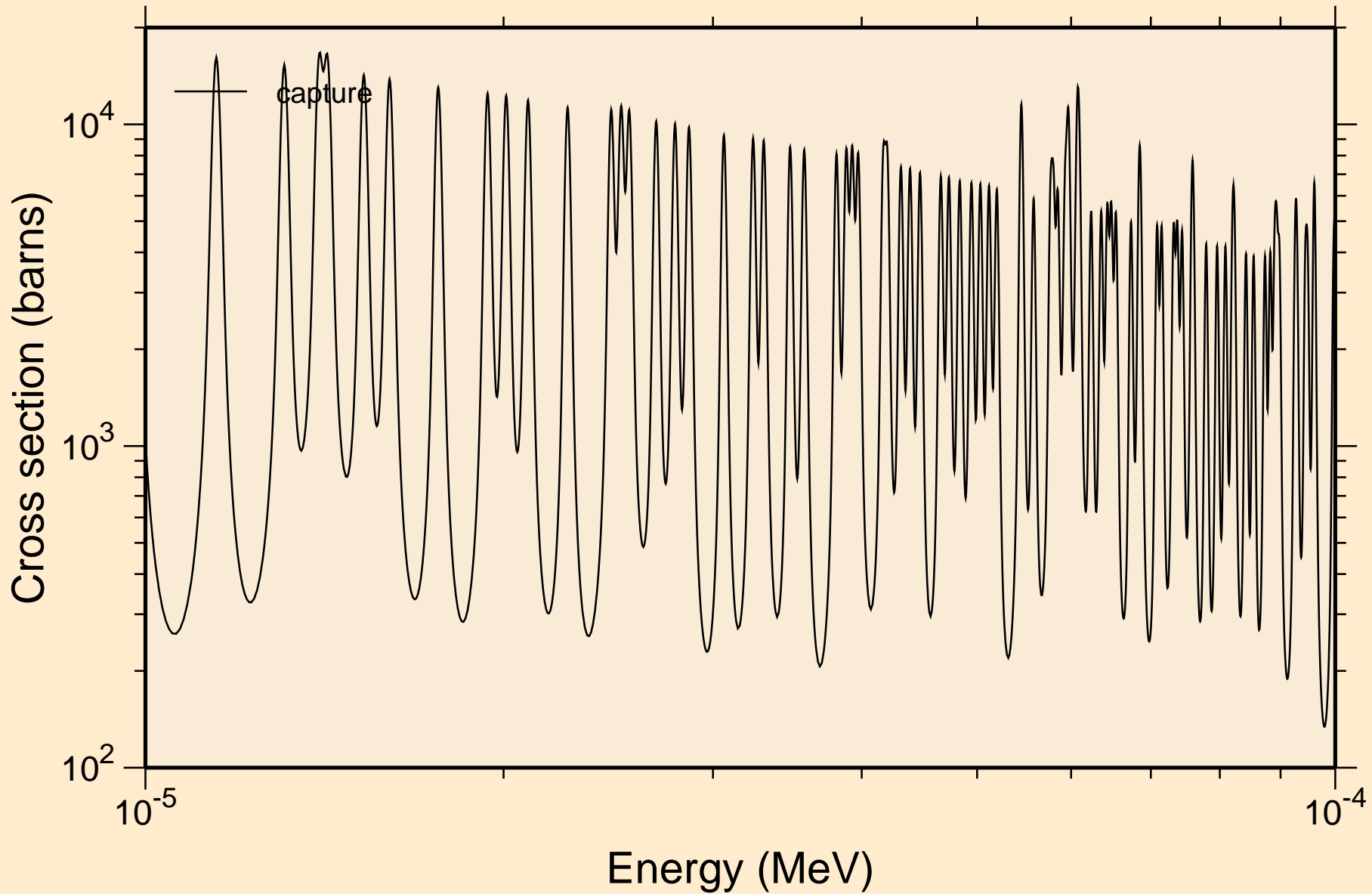

OS168 NRG TENDL-2015, AKONING
resonance absorption cross sections

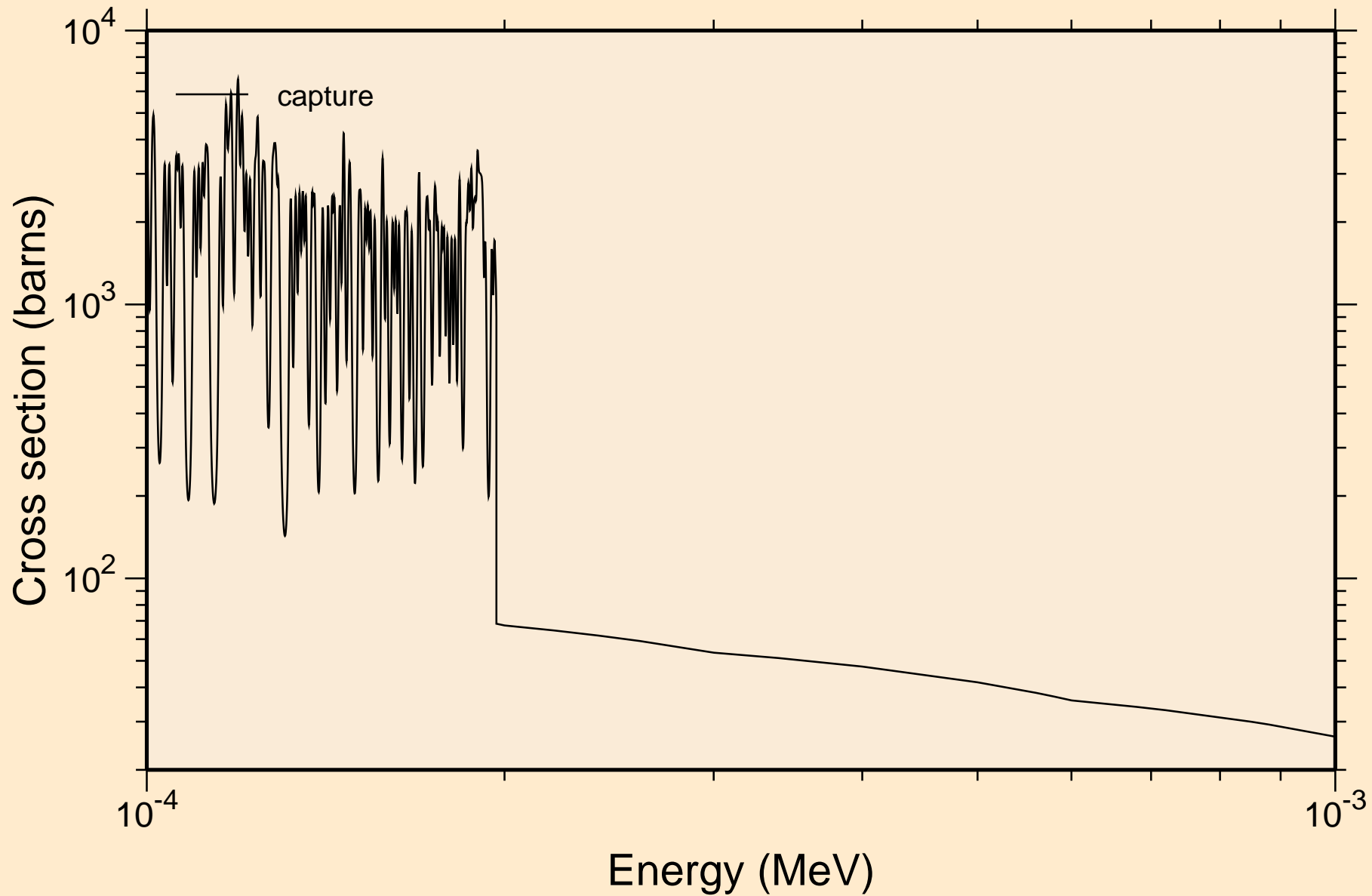

OS168 NRG TENDL-2015, AKONING
resonance absorption cross sections

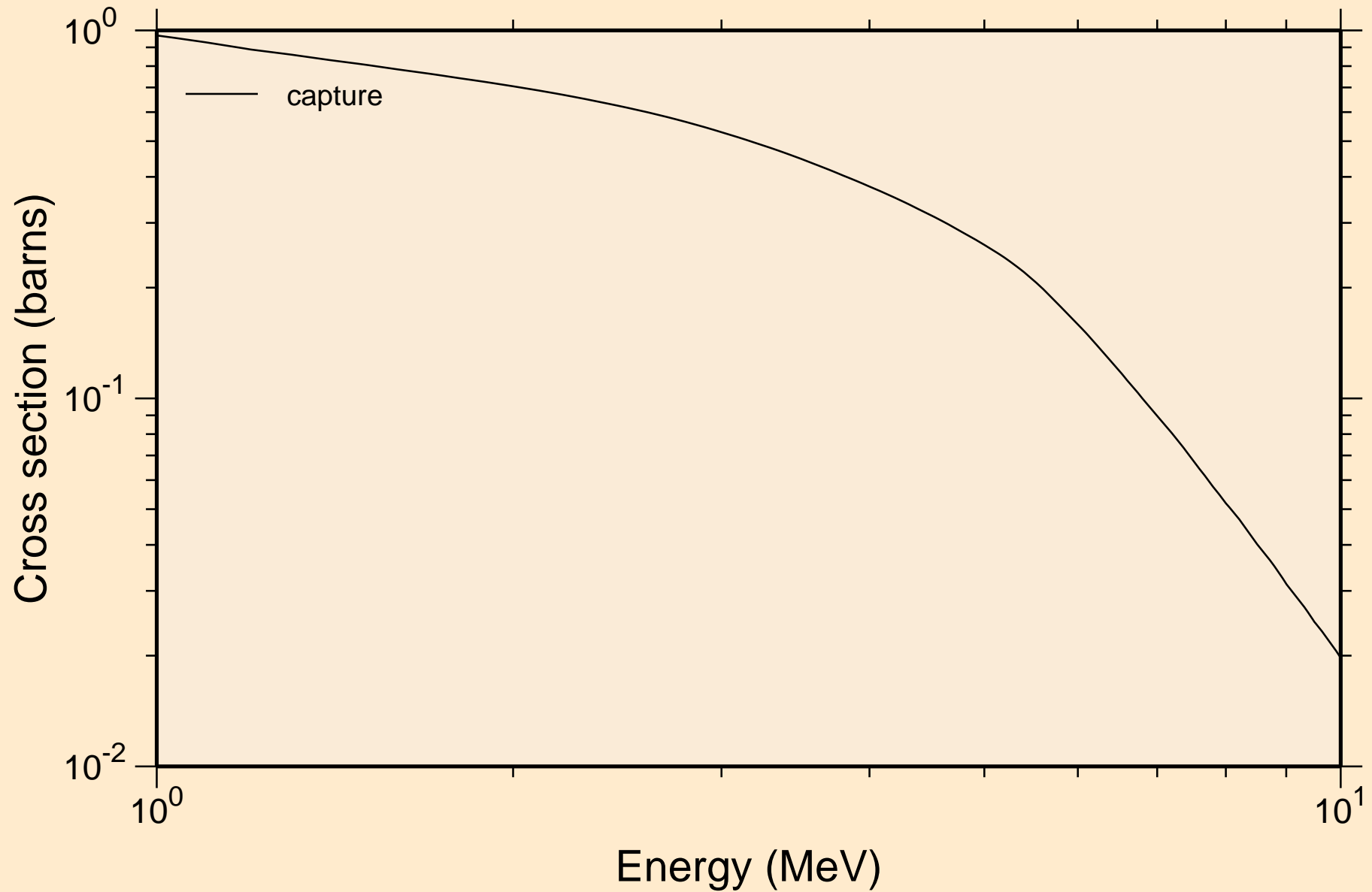

OS168 NRG TENDL-2015, AKONING

Non-threshold reactions

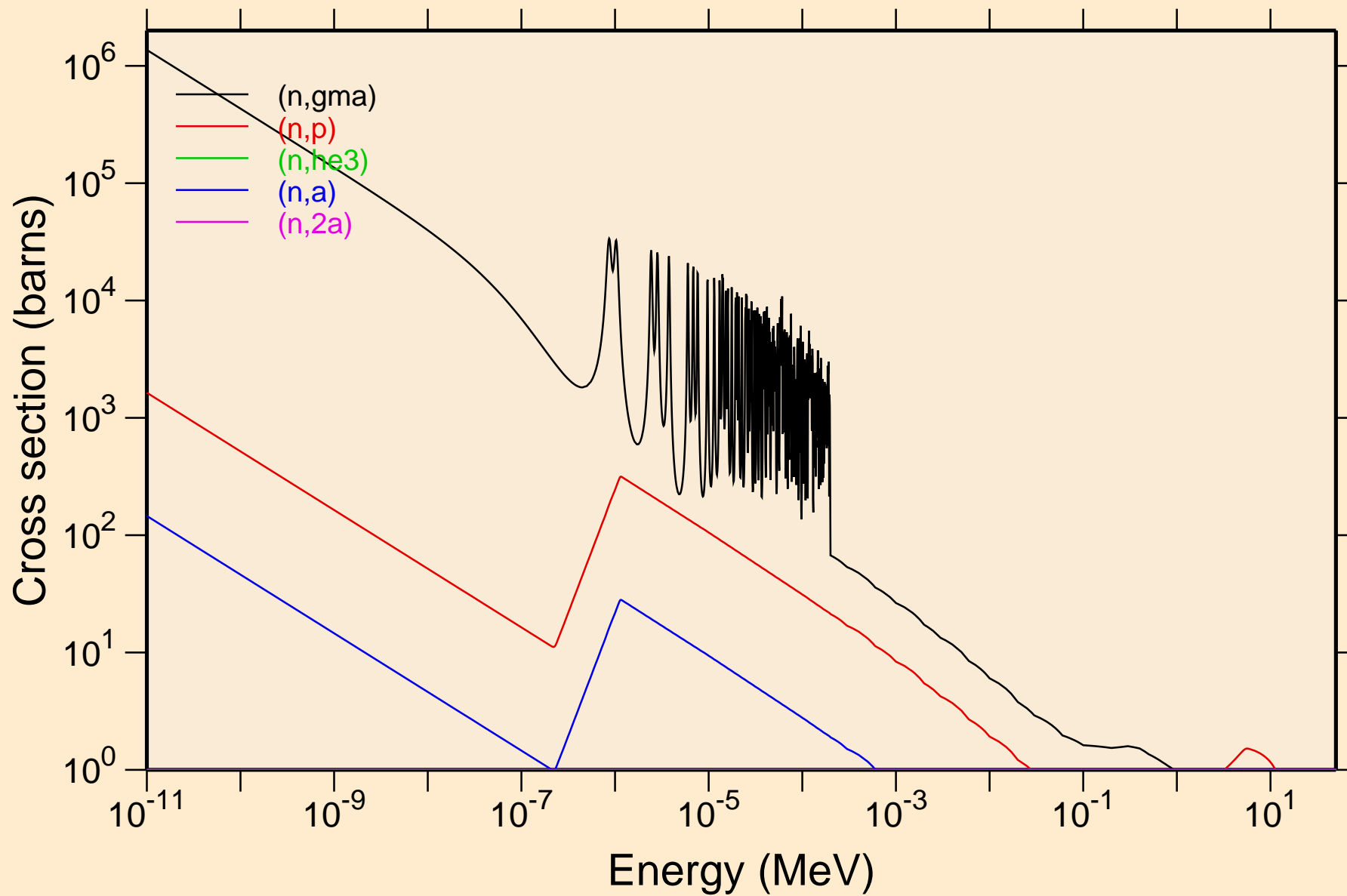

OS168 NRG TENDL-2015, AKONING

Non-threshold reactions

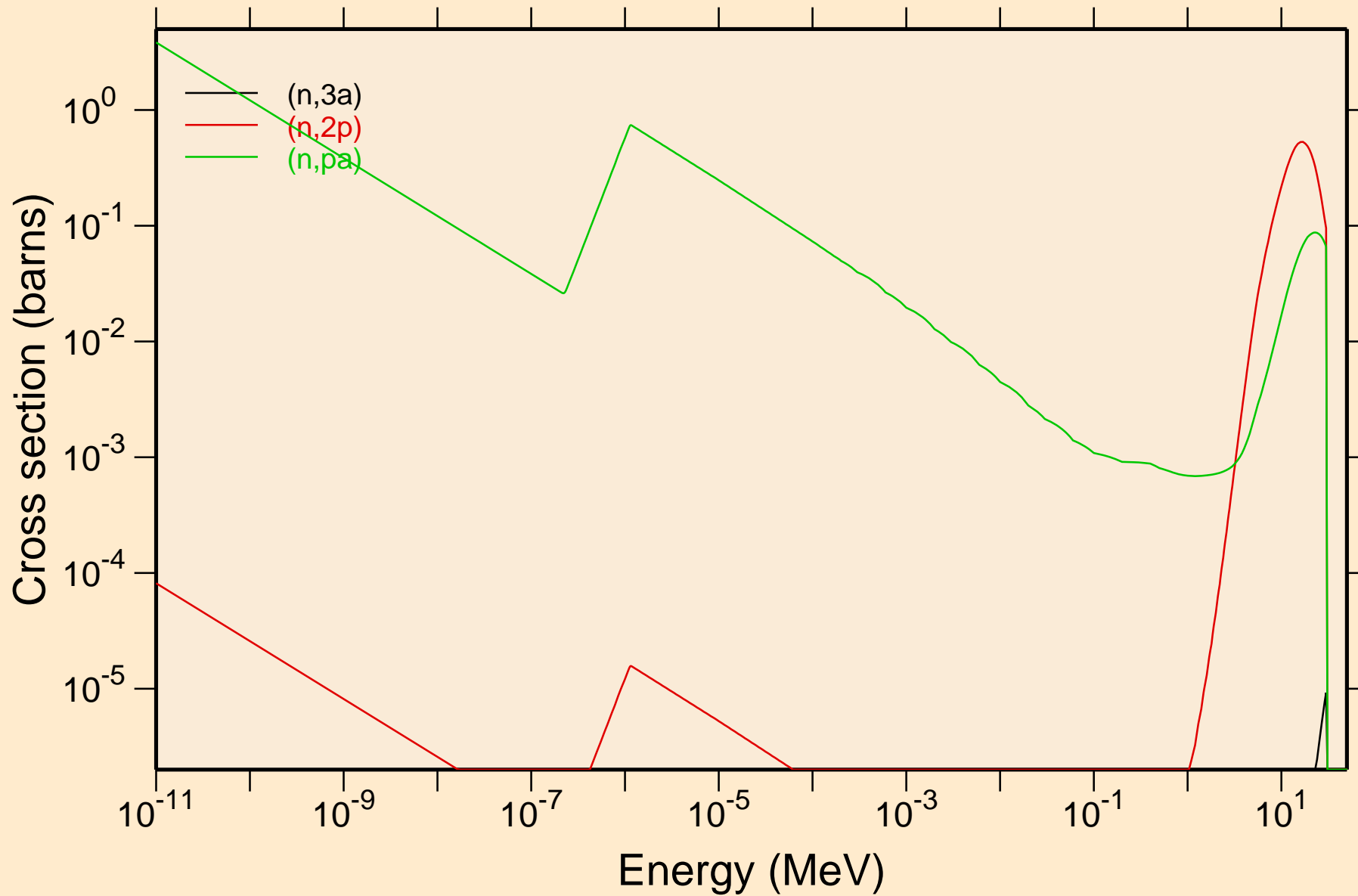

OS168 NRG TENDL-2015, AKONING

Principal cross sections

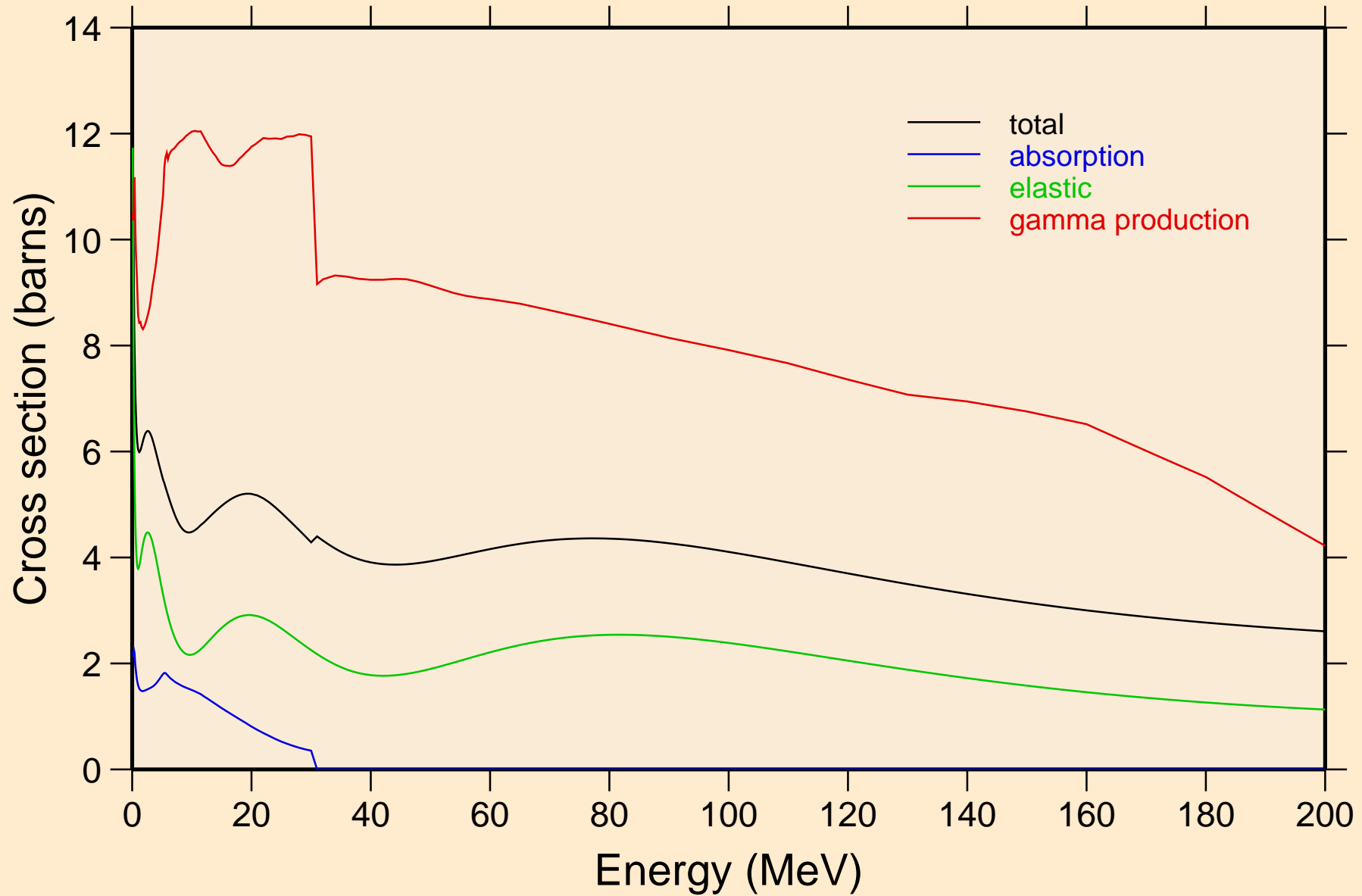

OS168 NRG TENDL-2015, AKONING

Non-threshold reactions

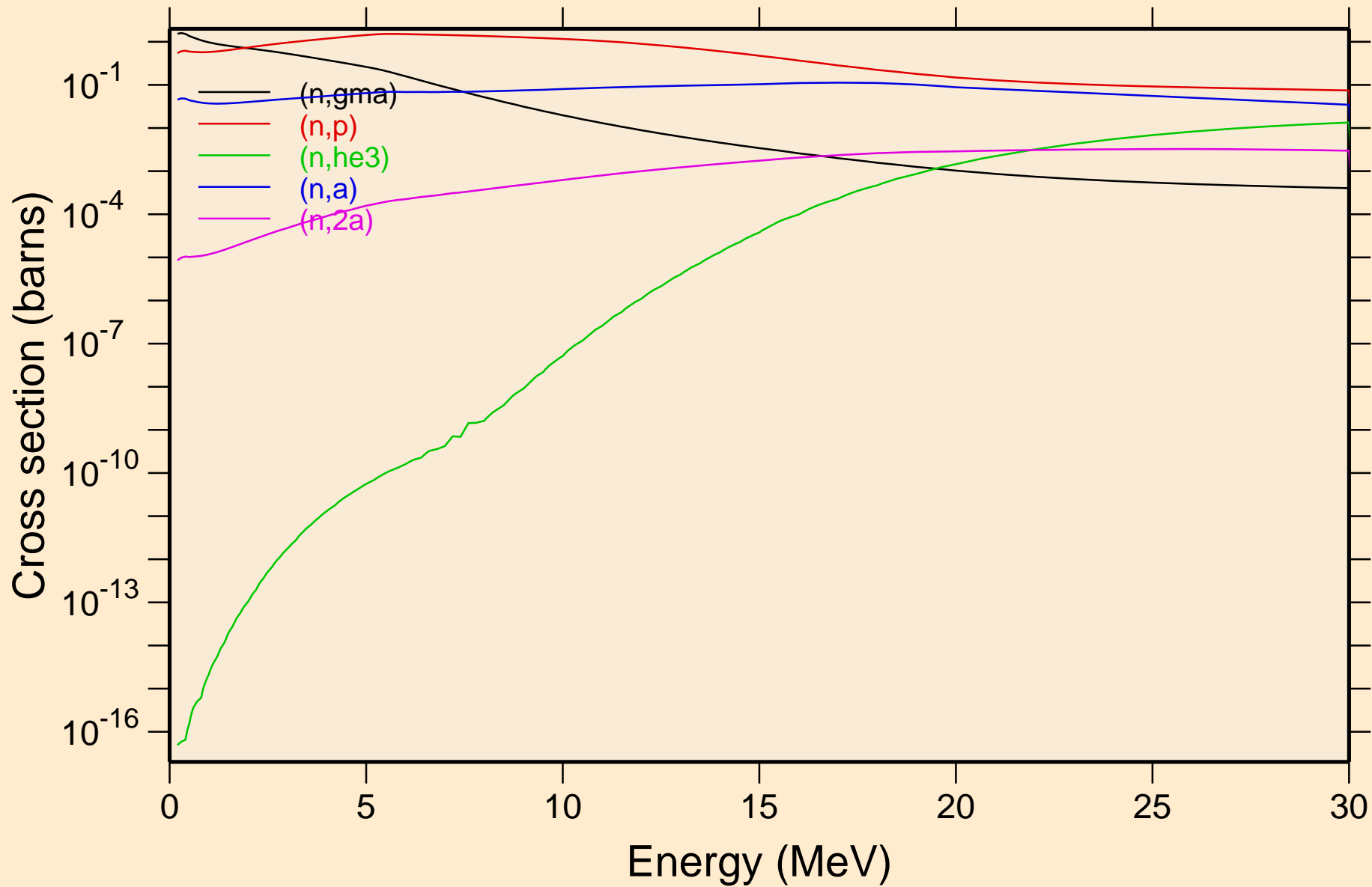

OS168 NRG TENDL-2015, AKONING

Non-threshold reactions

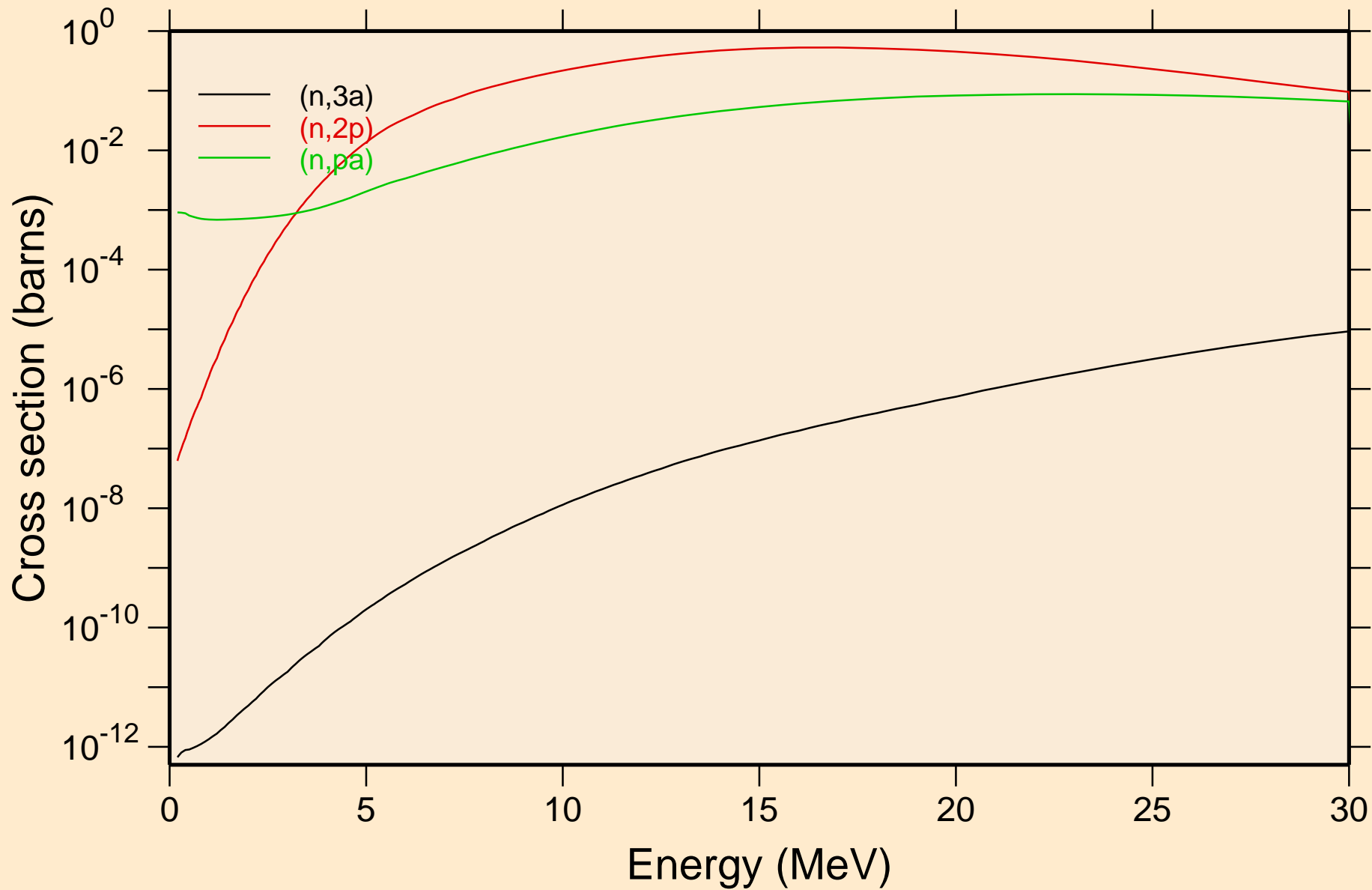

OS168 NRG TENDL-2015, AKONING

Inelastic levels

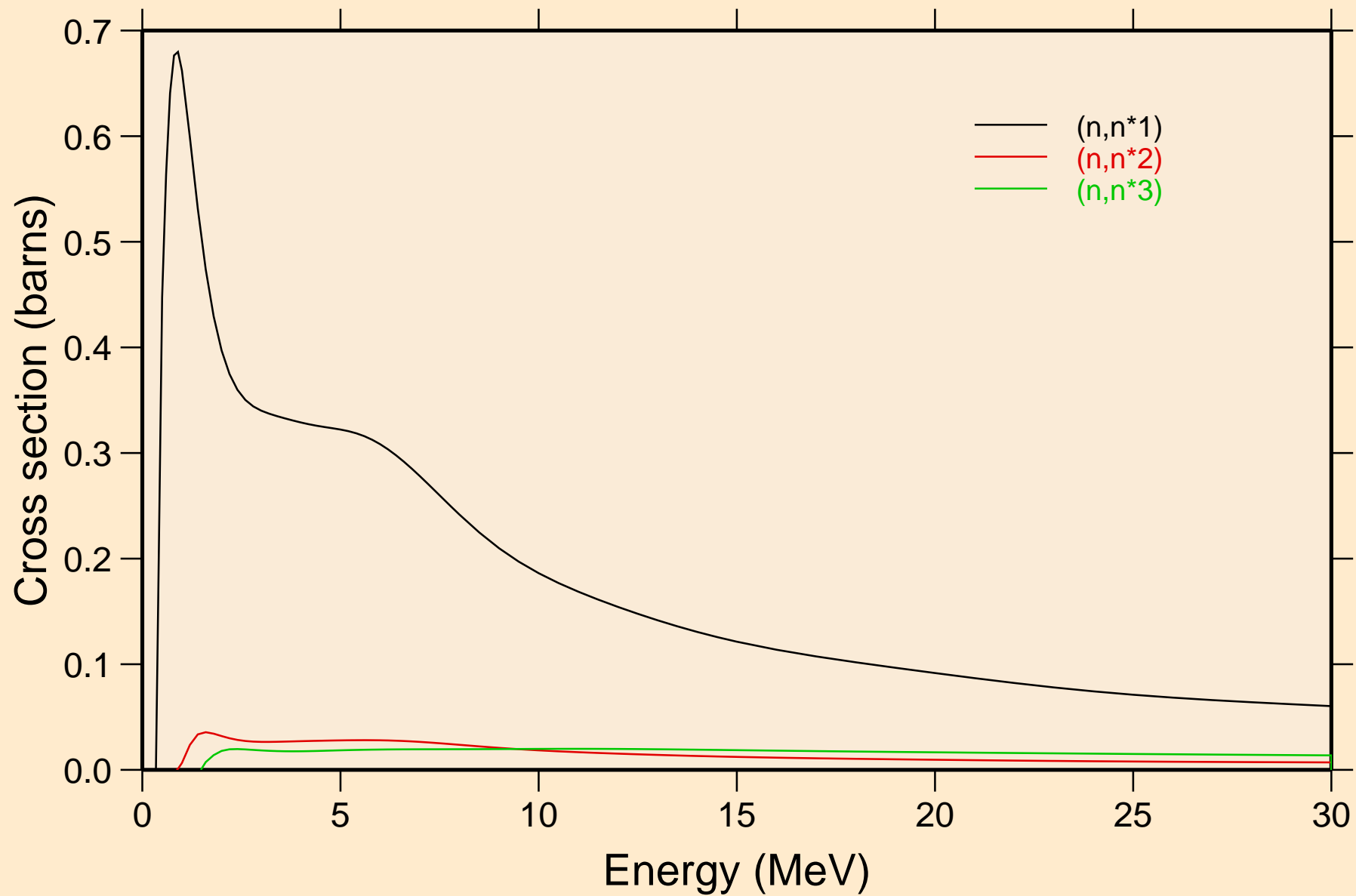

OS168 NRG TENDL-2015, AKONING

Threshold reactions

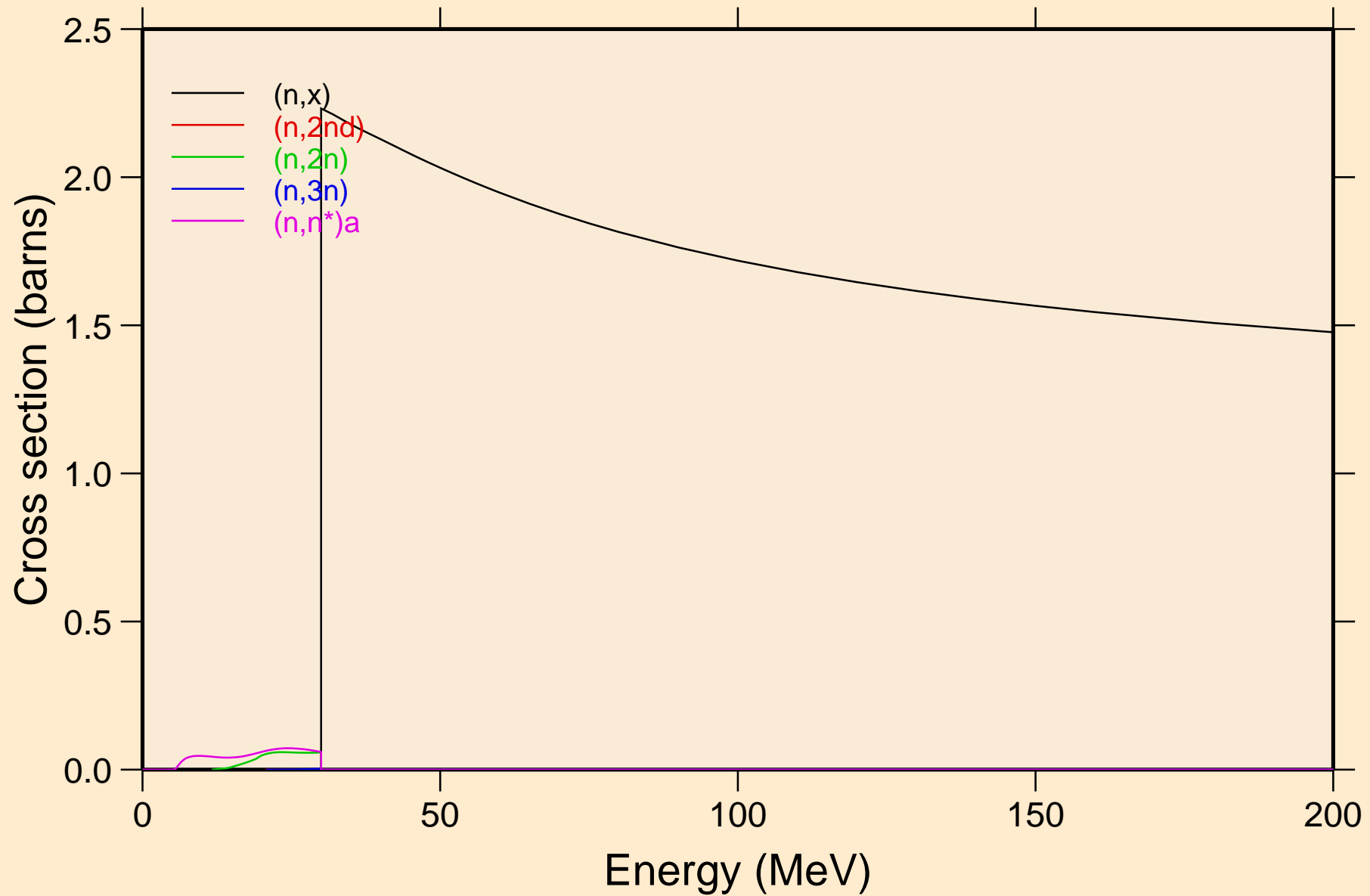

OS168 NRG TENDL-2015, AKONING

Threshold reactions

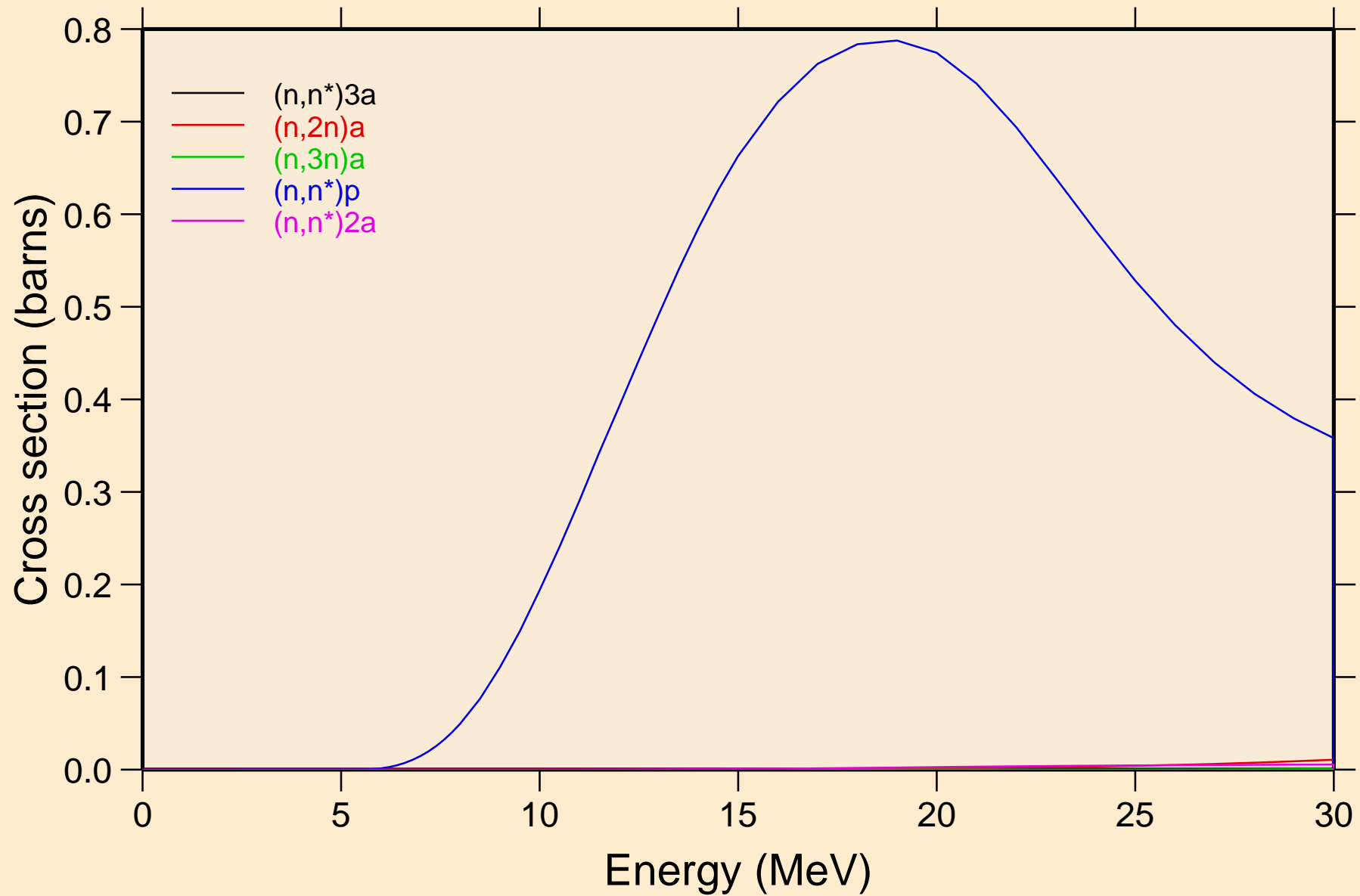

OS168 NRG TENDL-2015, AKONING

Threshold reactions

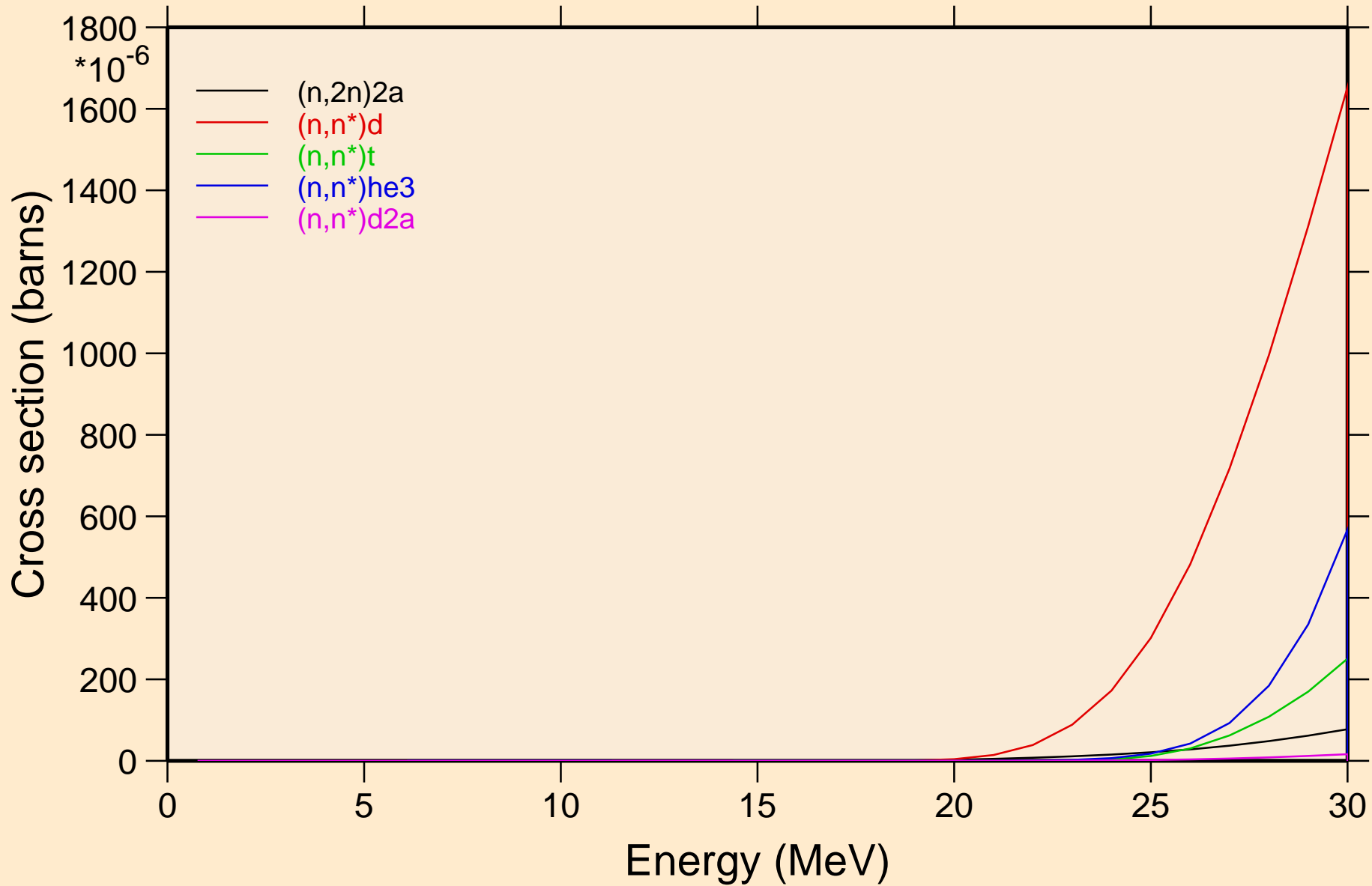

OS168 NRG TENDL-2015, AKONING

Threshold reactions

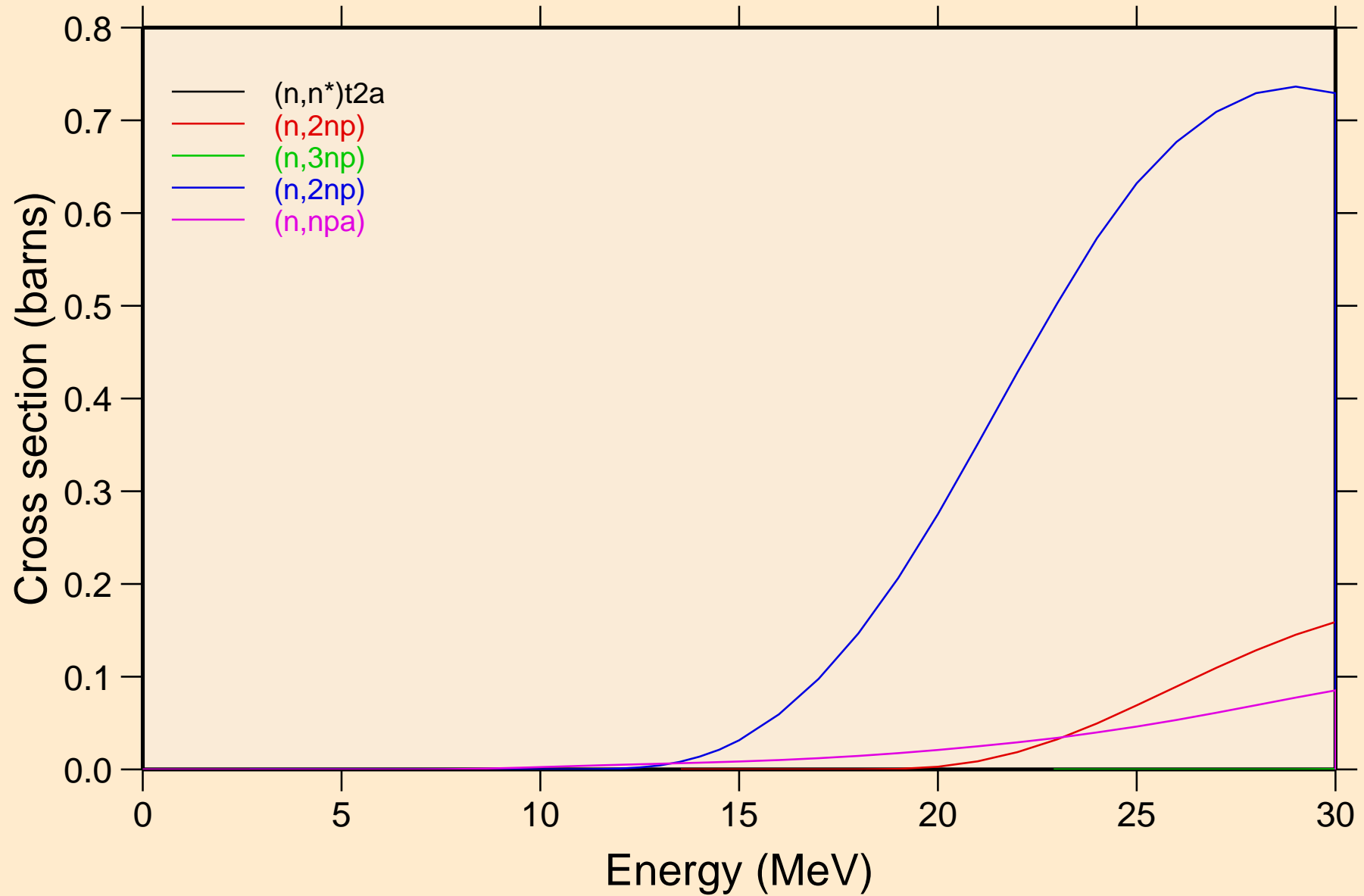

OS168 NRG TENDL-2015, AKONING

Threshold reactions

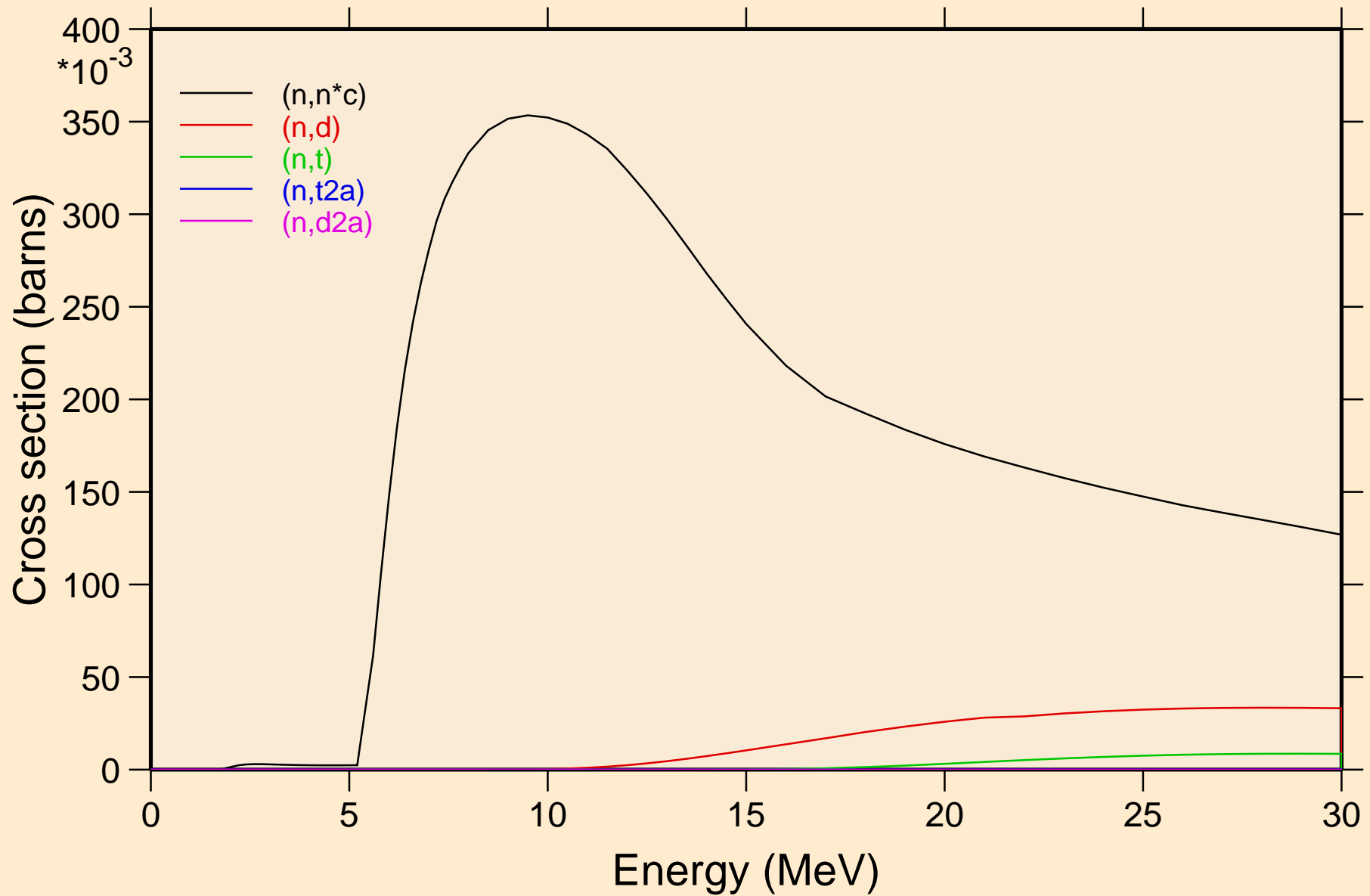

OS168 NRG TENDL-2015, AKONING

Threshold reactions

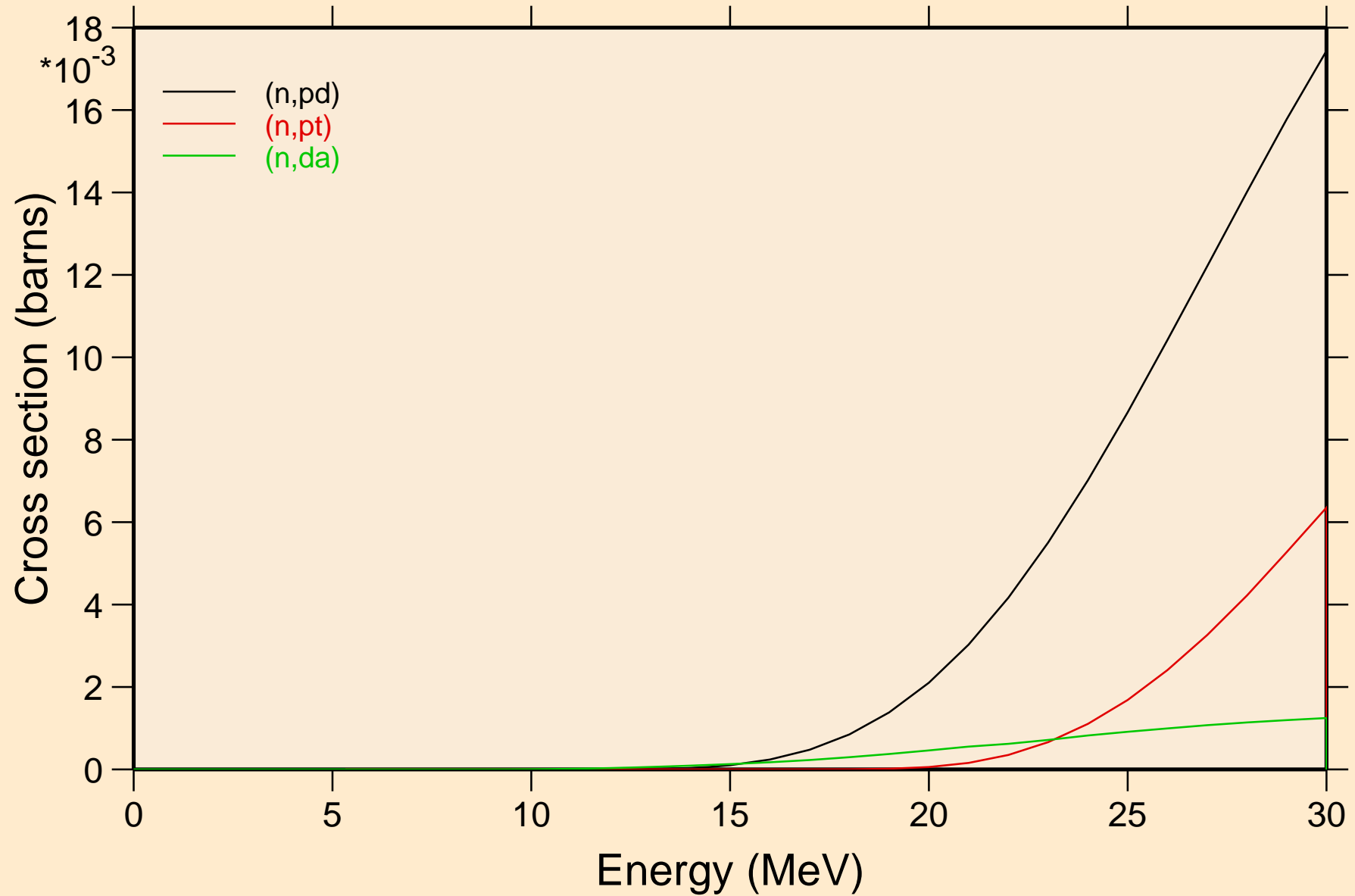

OS168 NRG TENDL-2015, AKONING
angular distribution for elastic

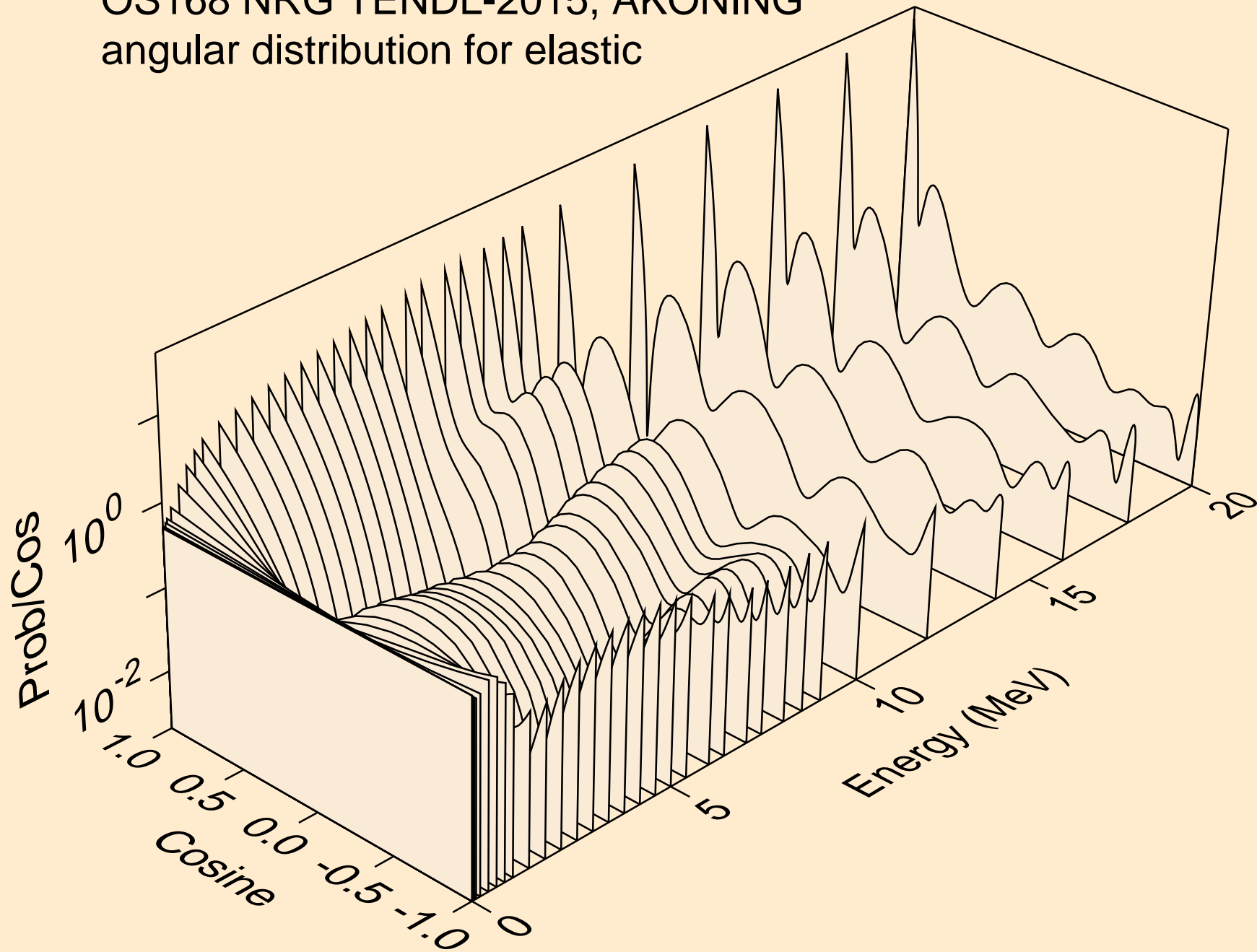

OS168 NRG TENDL-2015, AKONING
angular distribution for elastic

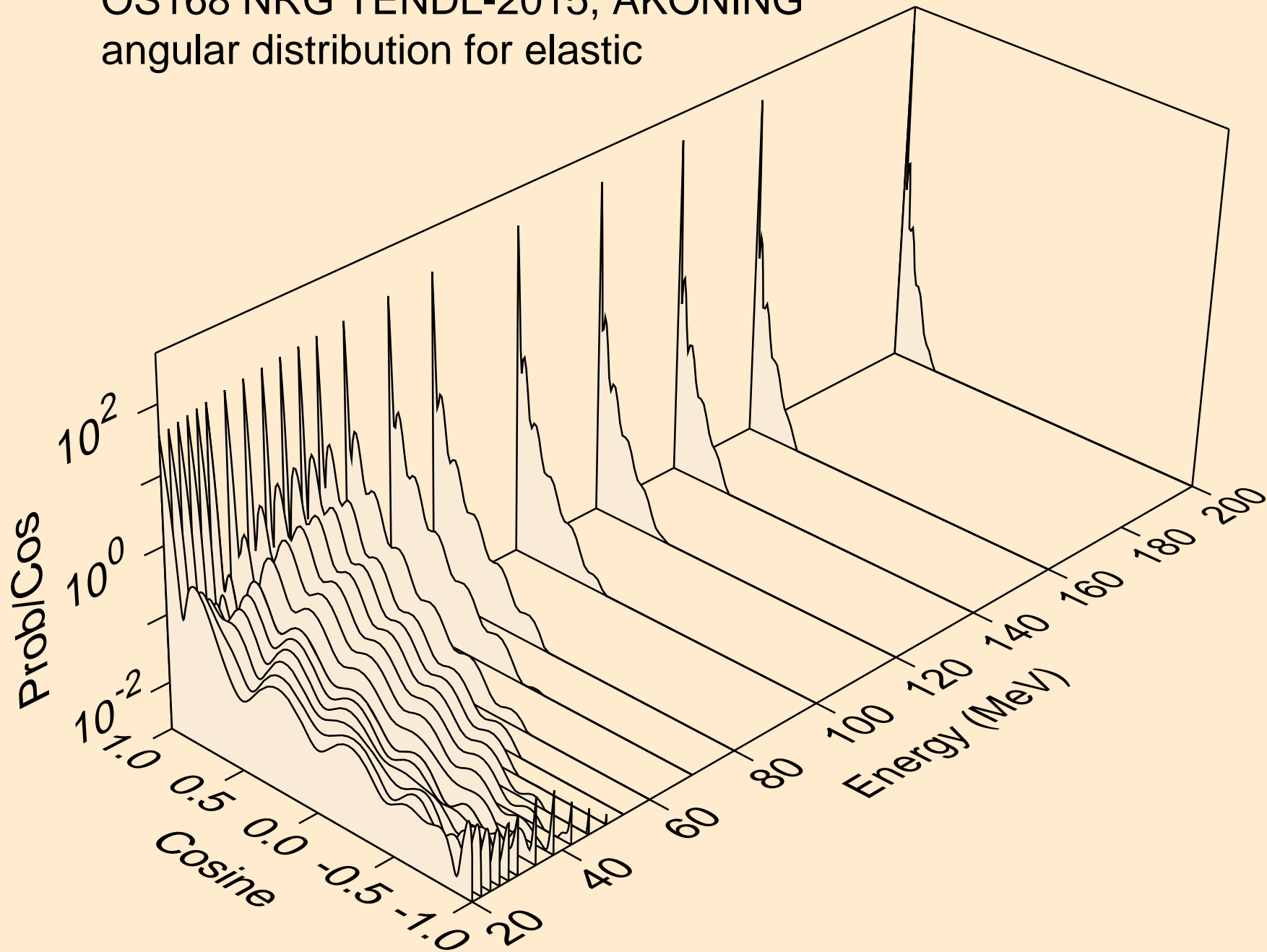

OS168 NRG TENDL-2015, AKONING
angular distribution for (n,n*1)

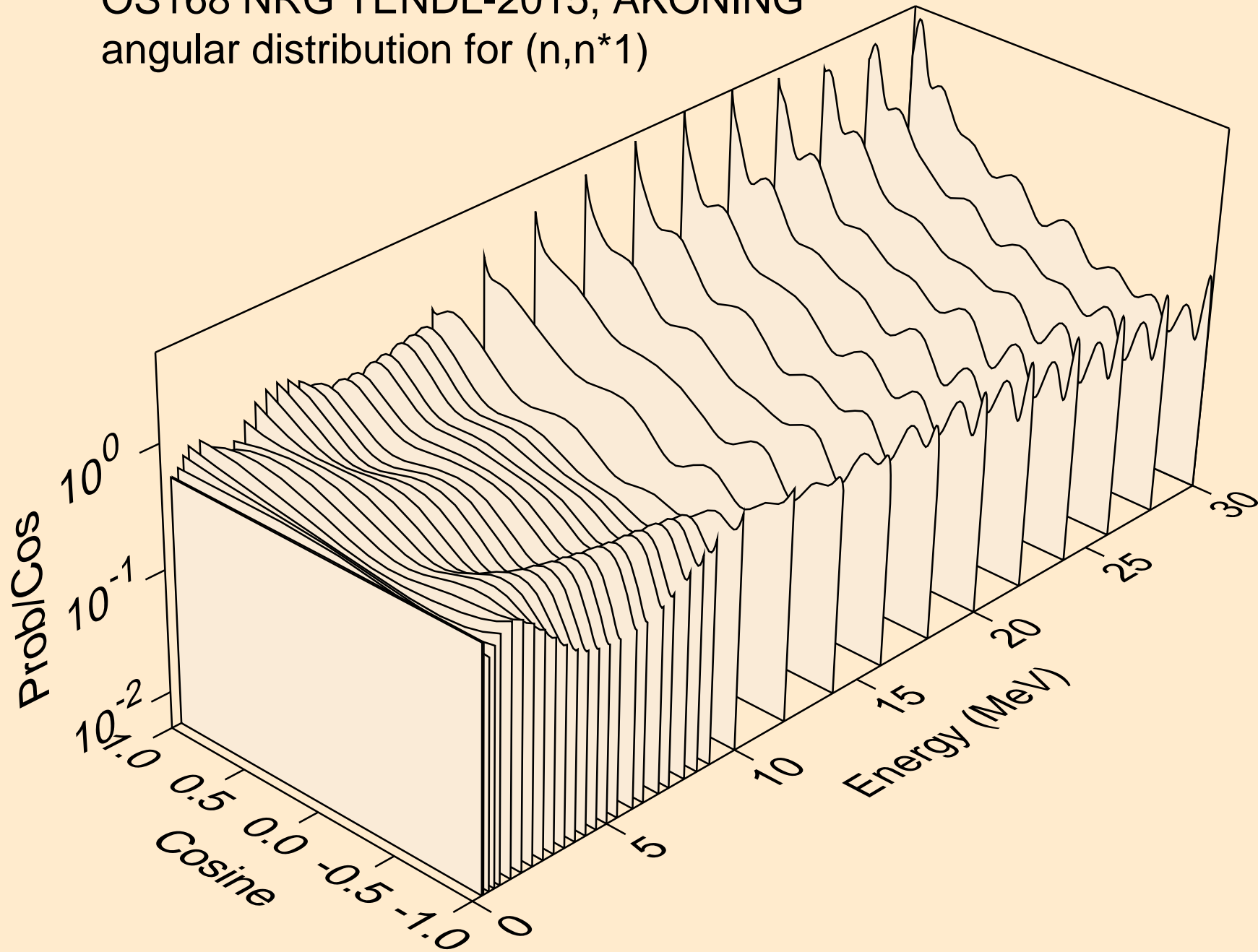

OS168 NRG TENDL-2015, AKONING
angular distribution for (n,n*2)

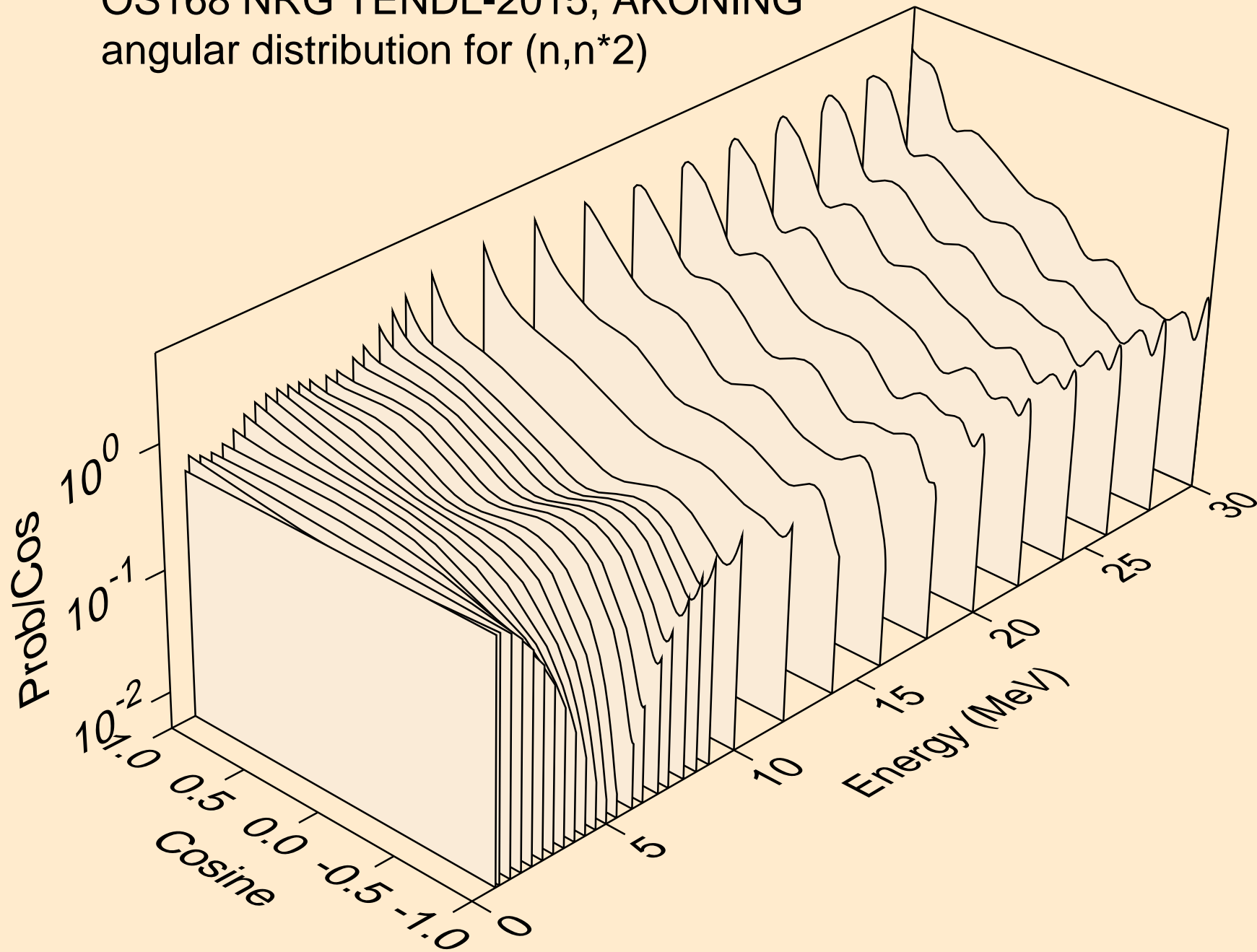

OS168 NRG TENDL-2015, AKONING
angular distribution for (n,n*3)

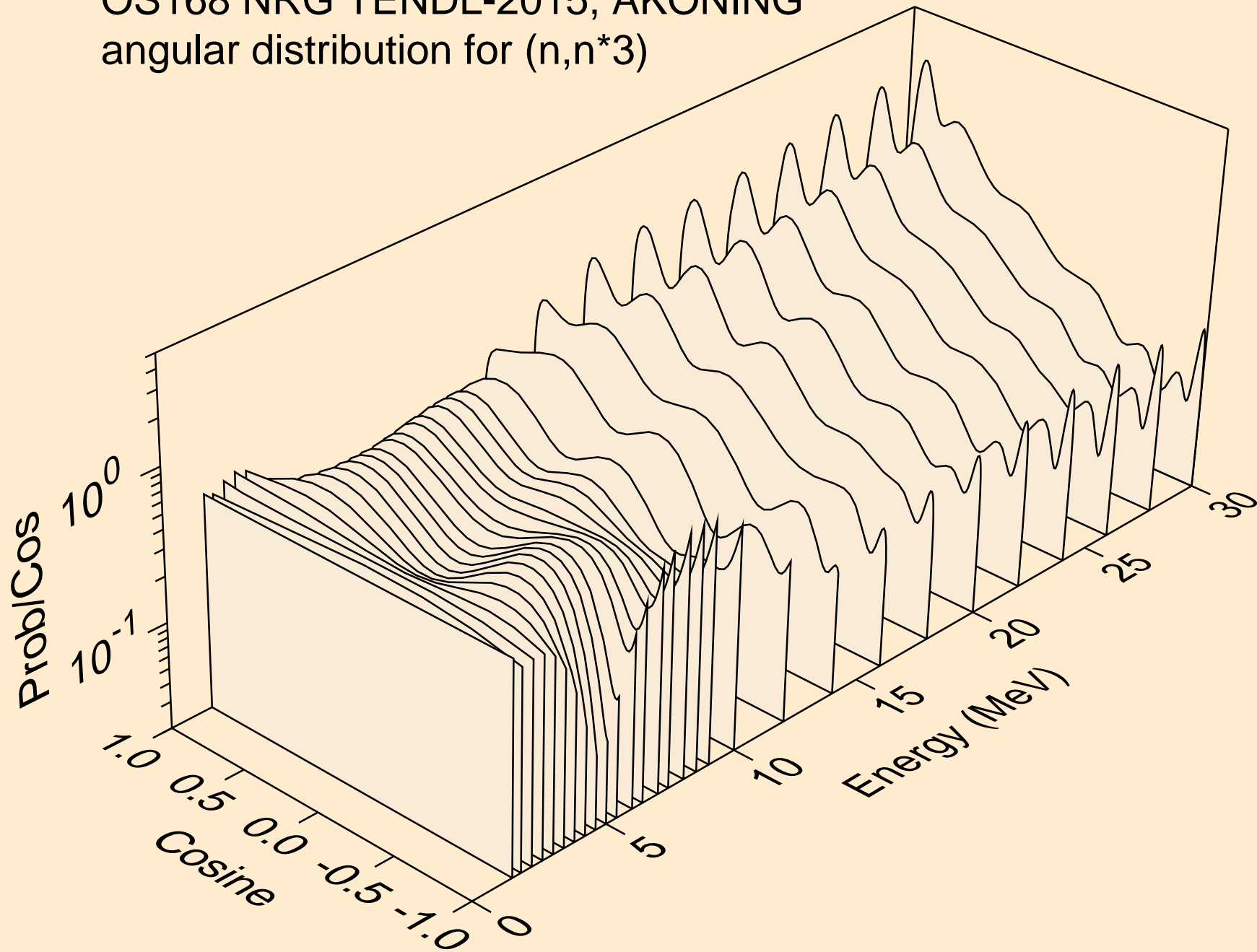

OS168 NRG TENDL-2015, AKONING
Neutron emission for (n,x)

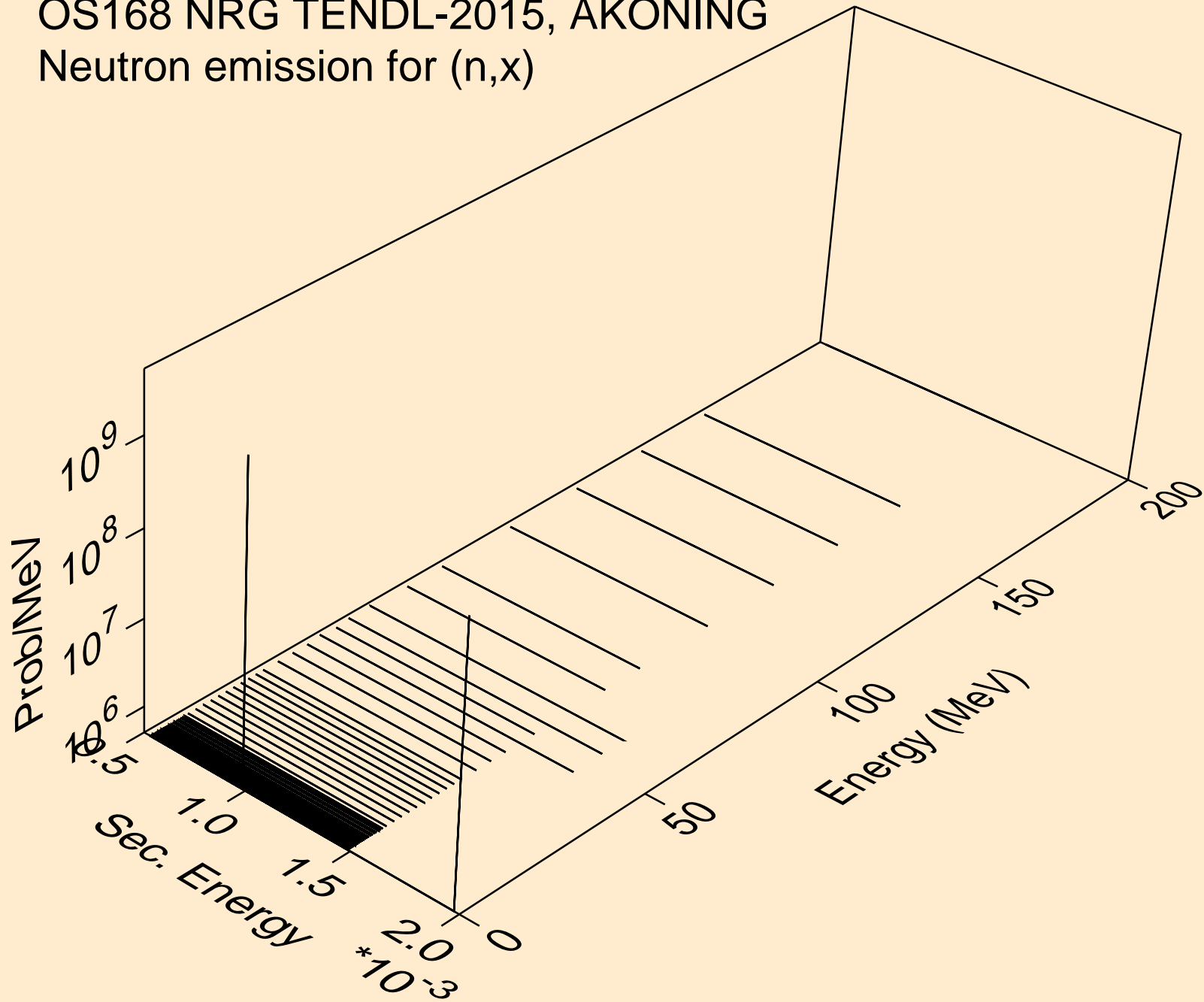

OS168 NRG TENDL-2015, AKONING
Neutron emission for (n,2nd)

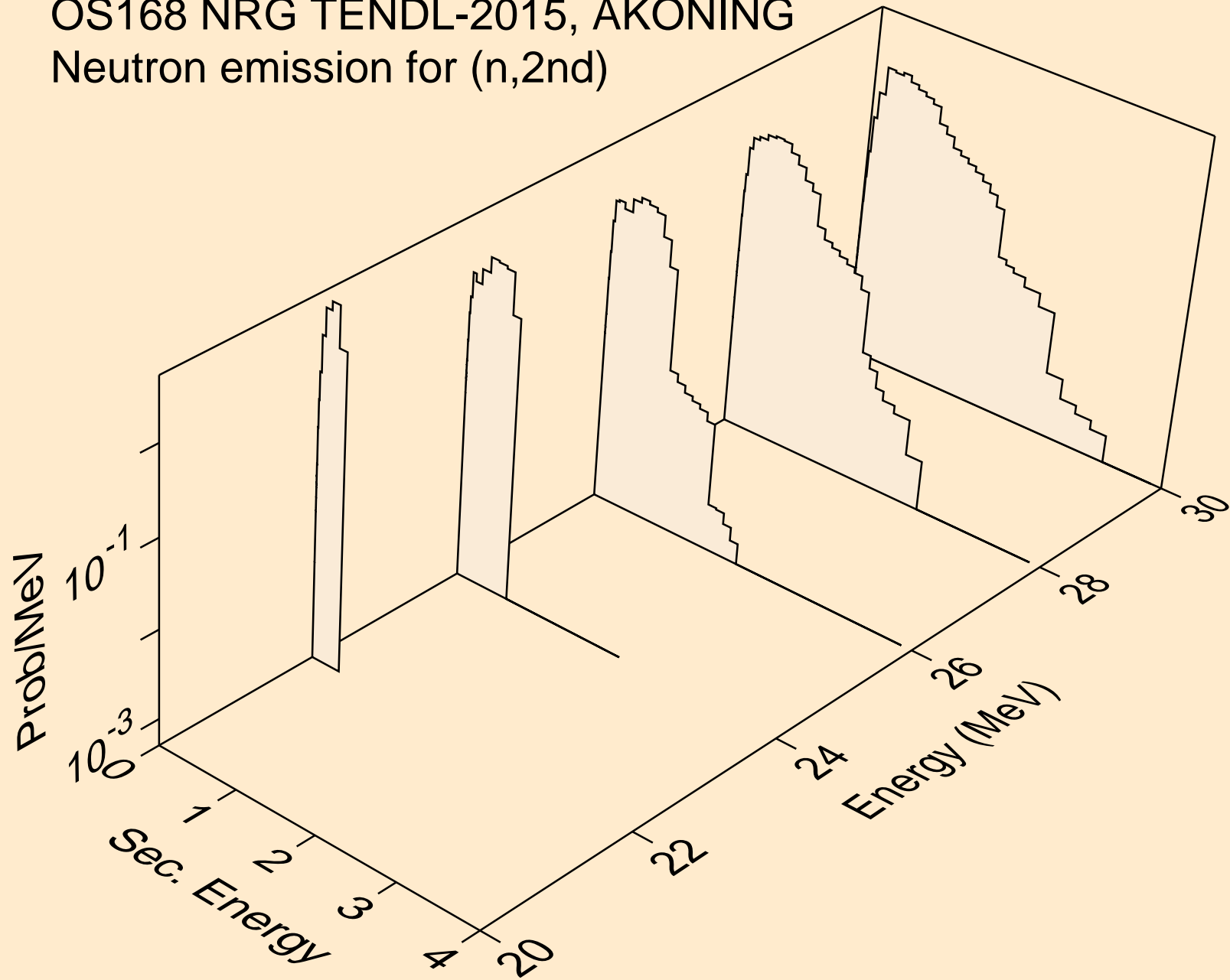

OS168 NRG TENDL-2015, AKONING
Neutron emission for (n,2n)

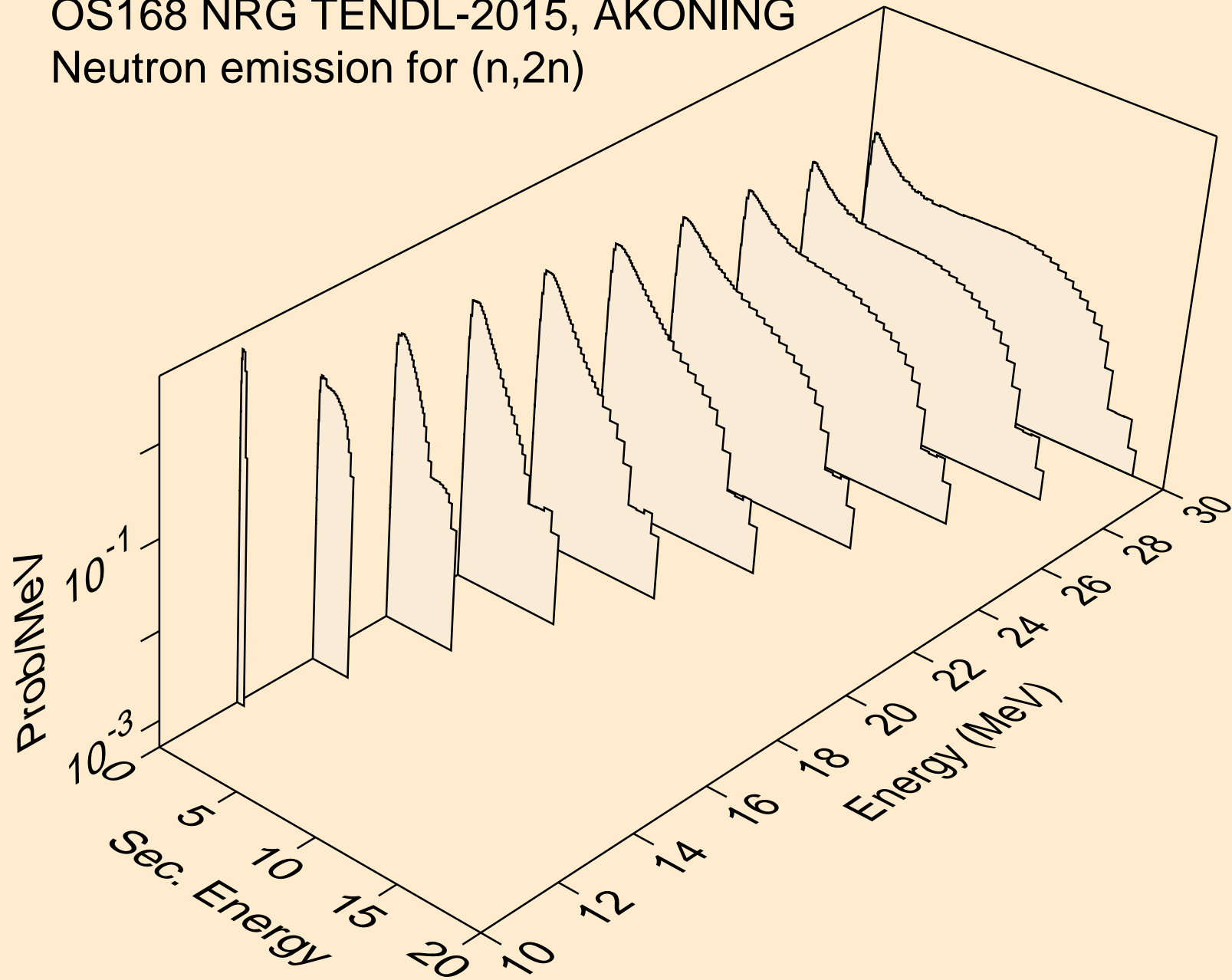

OS168 NRG TENDL-2015, AKONING
Neutron emission for (n,3n)

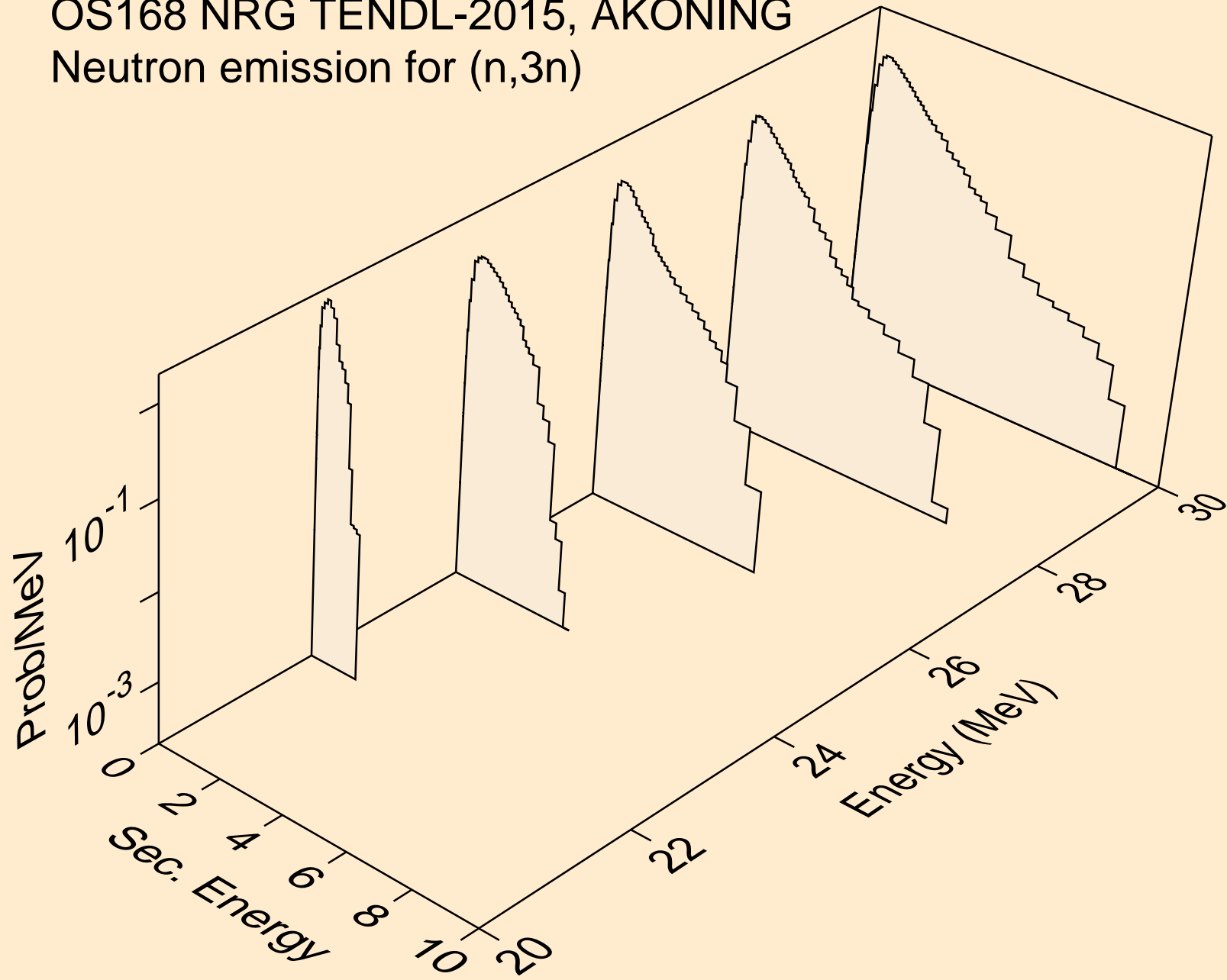

OS168 NRG TENDL-2015, AKONING
Neutron emission for (n,n*)a

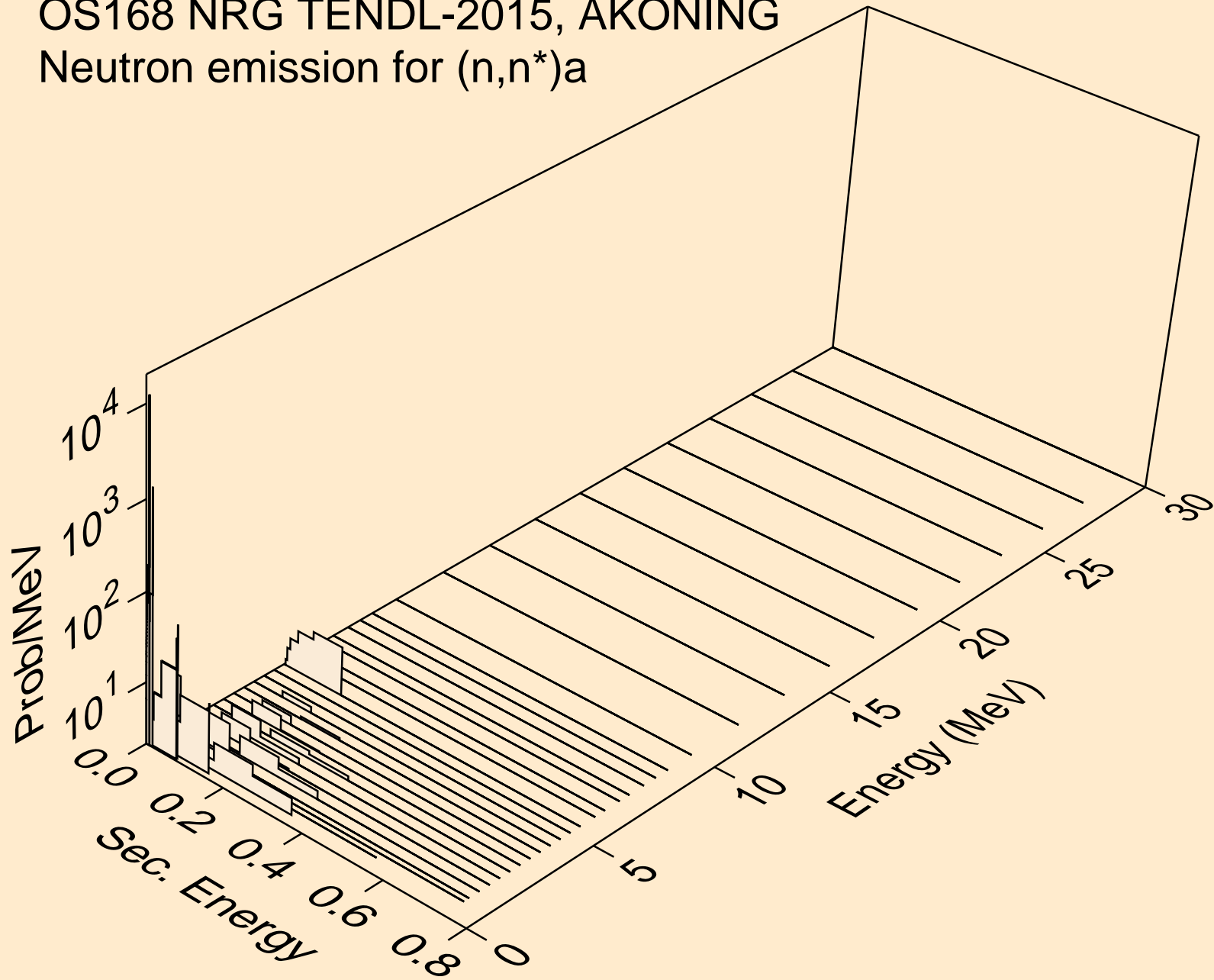

OS168 NRG TENDL-2015, AKONING
Neutron emission for (n,n*)3a

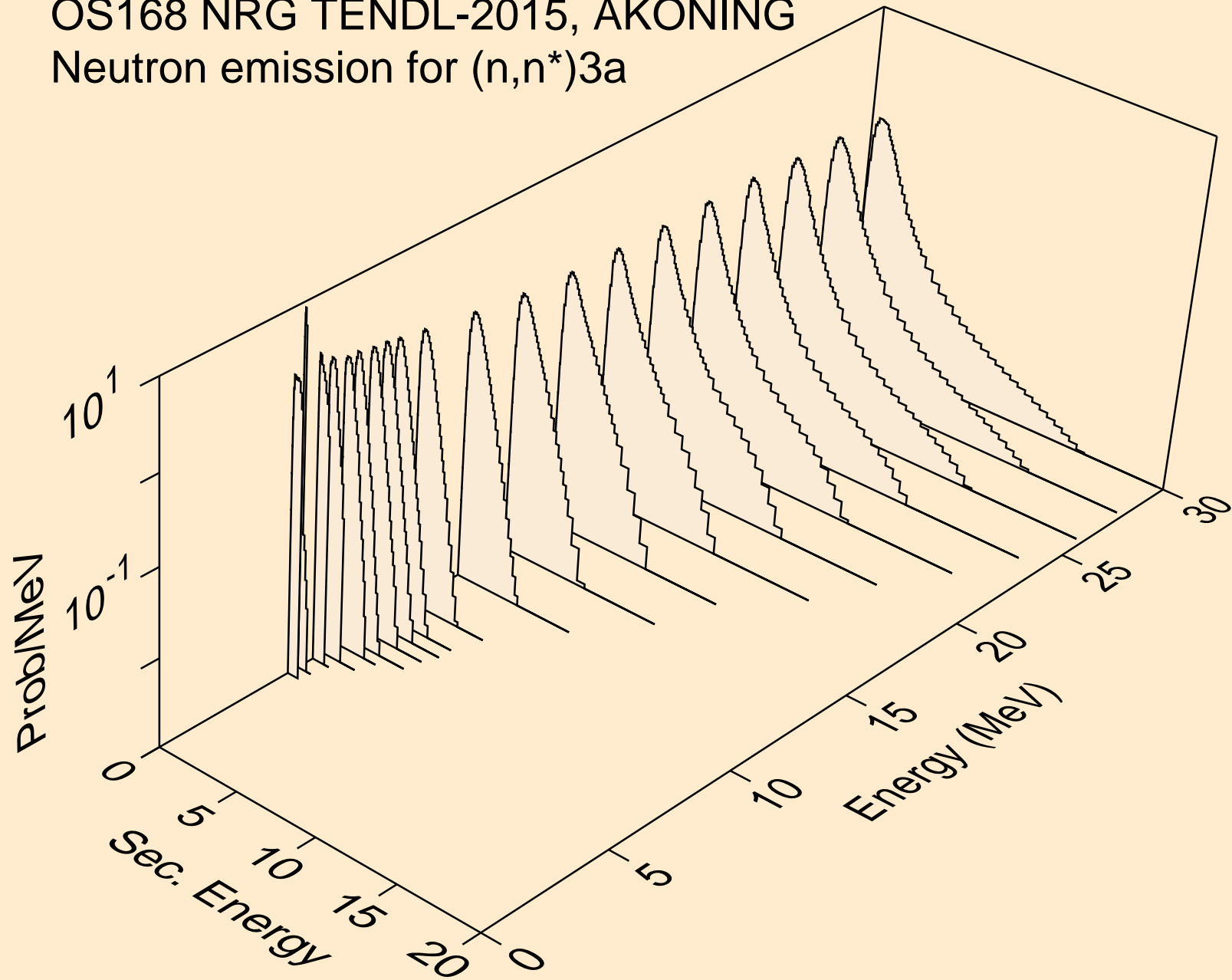

OS168 NRG TENDL-2015, AKONING
Neutron emission for (n,2n)a

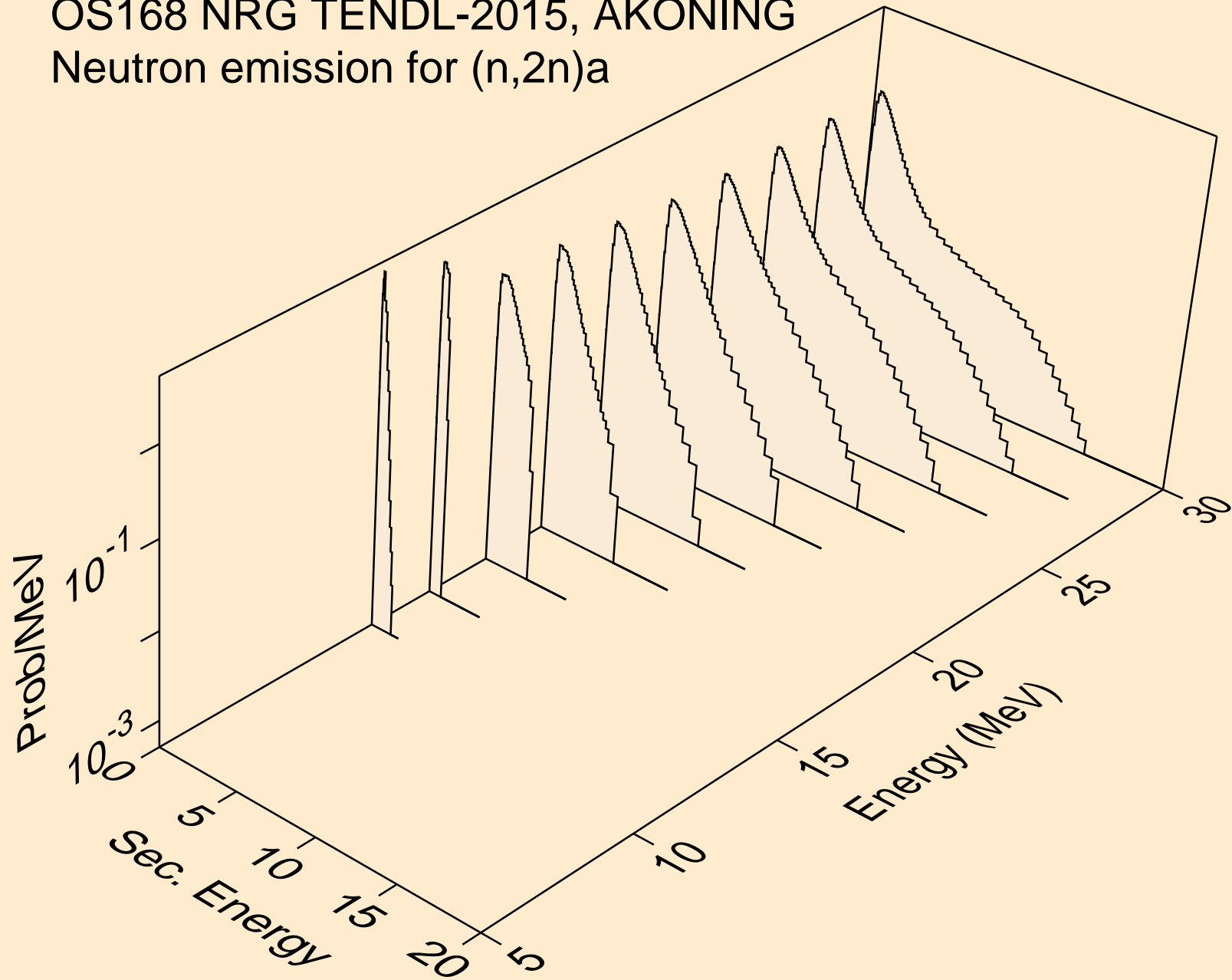

OS168 NRG TENDL-2015, AKONING
Neutron emission for (n,3n)a

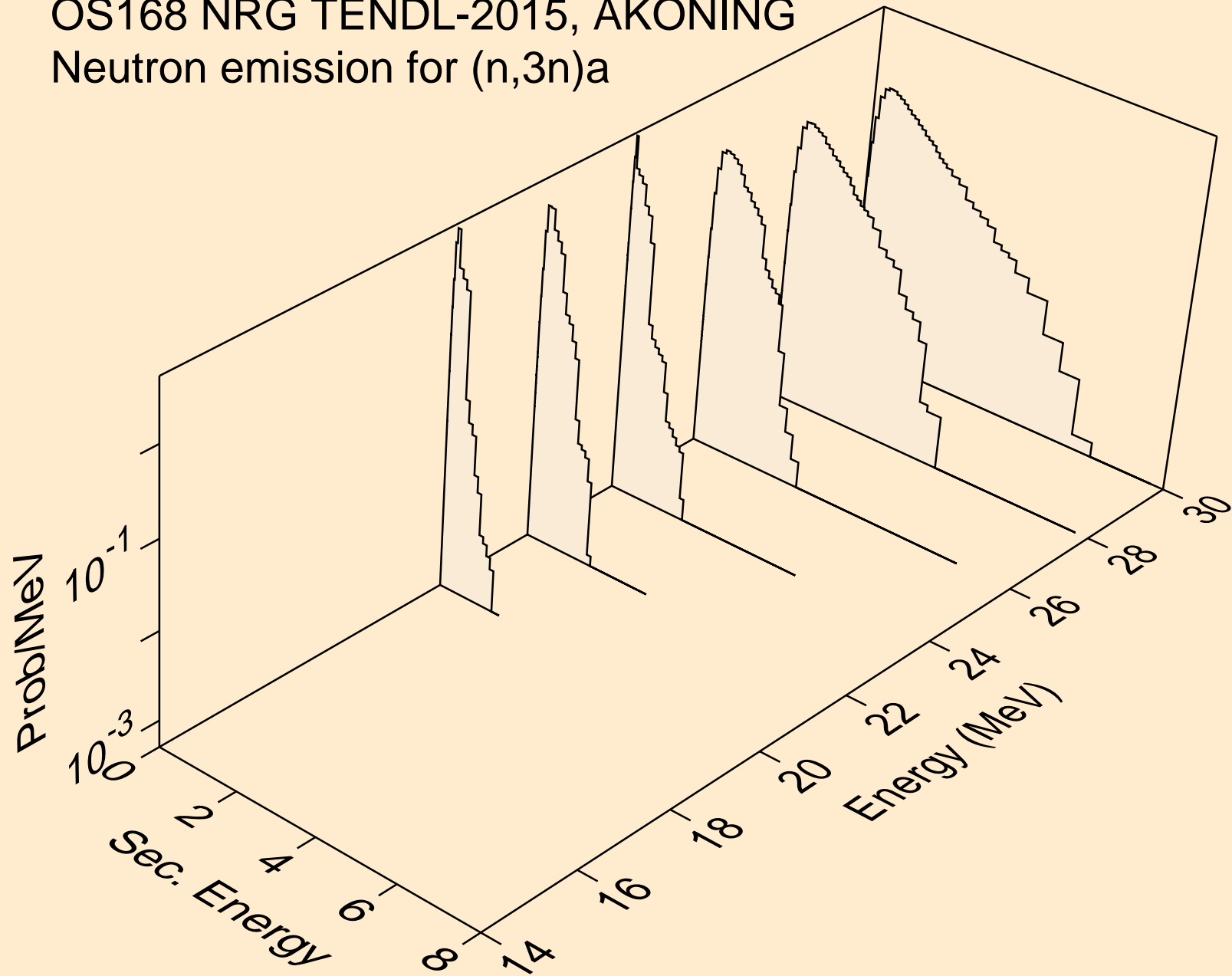

OS168 NRG TENDL-2015, AKONING
Neutron emission for (n,n*)p

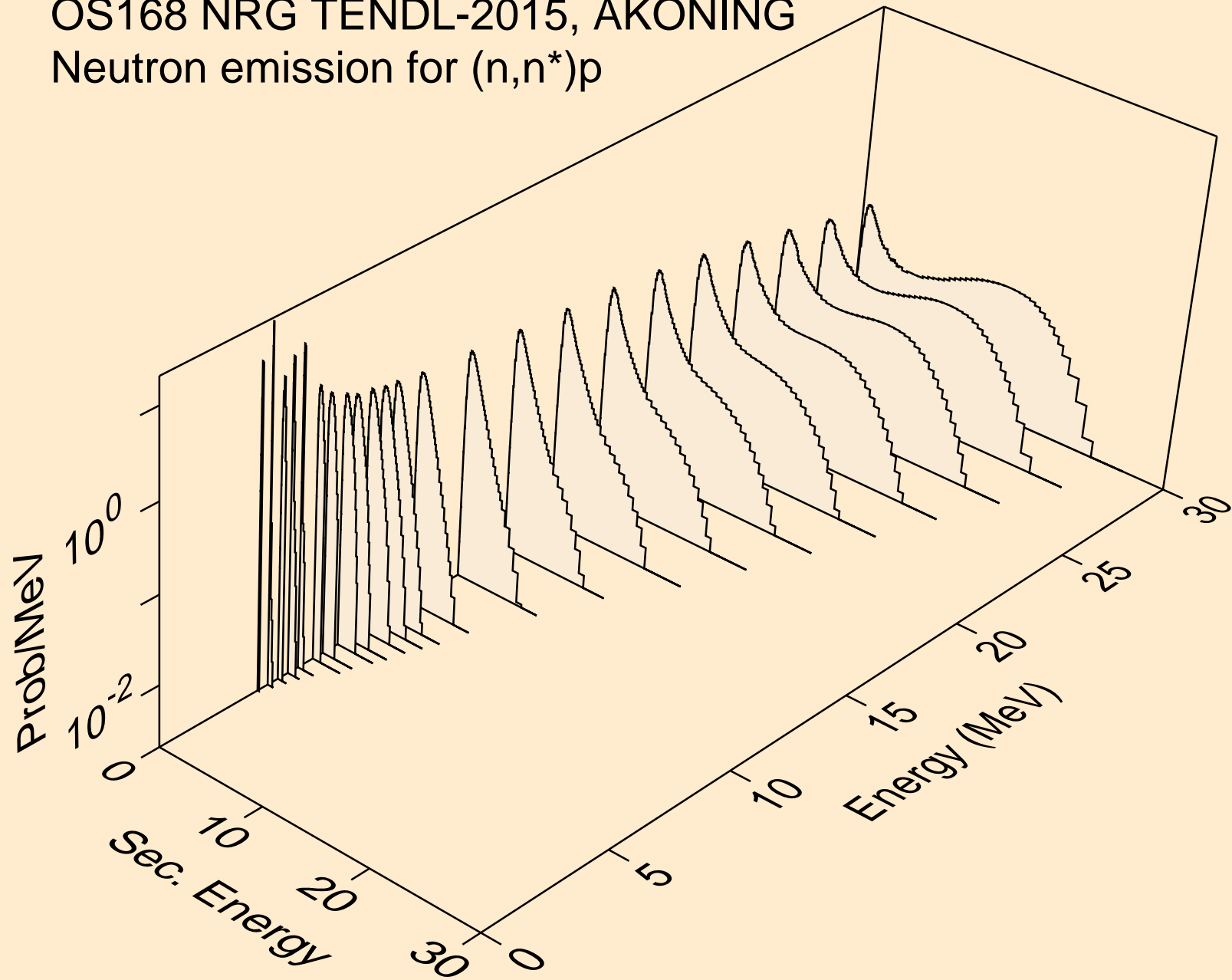

OS168 NRG TENDL-2015, AKONING
Neutron emission for (n,n*)2a

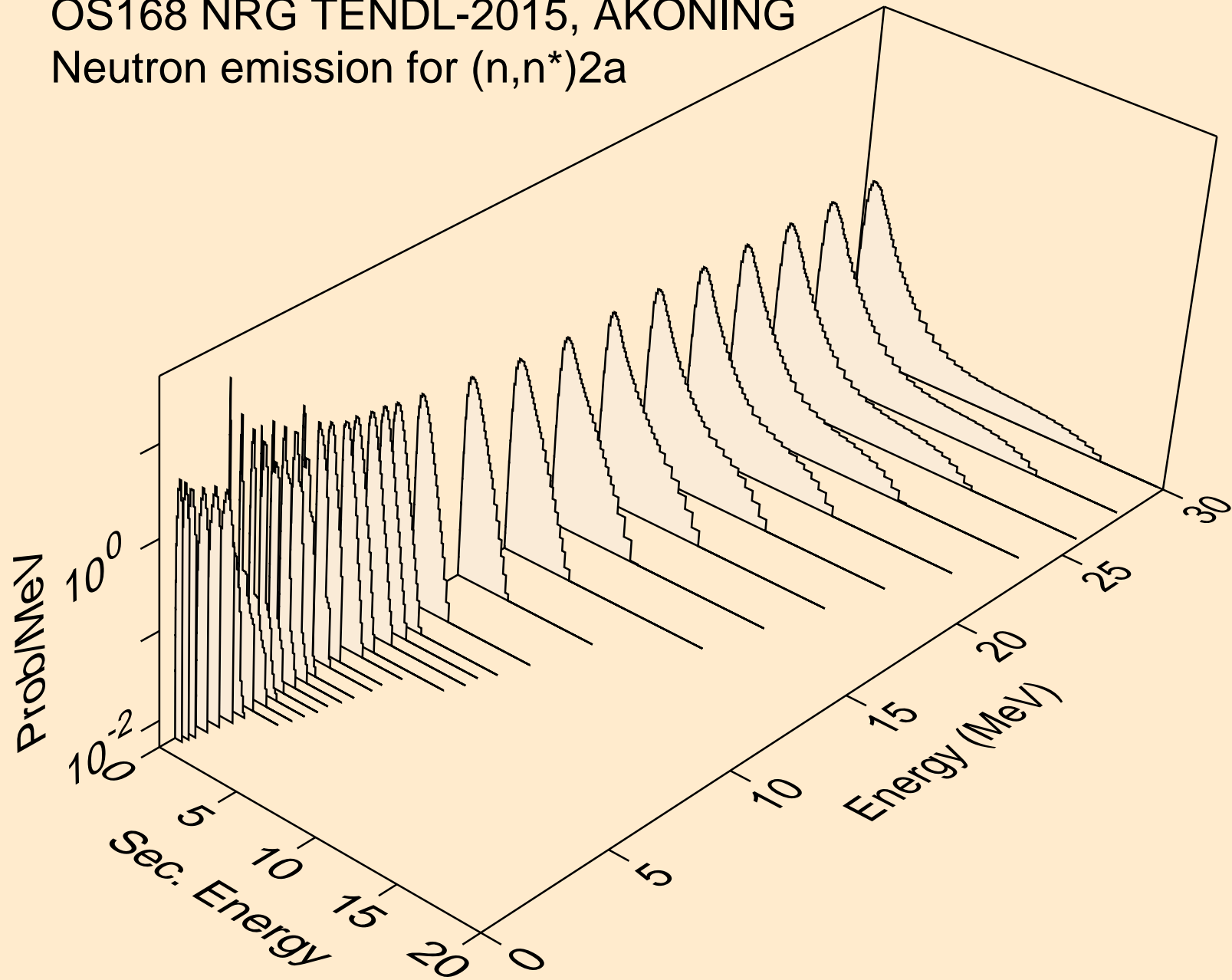

OS168 NRG TENDL-2015, AKONING
Neutron emission for (n,2n)2a

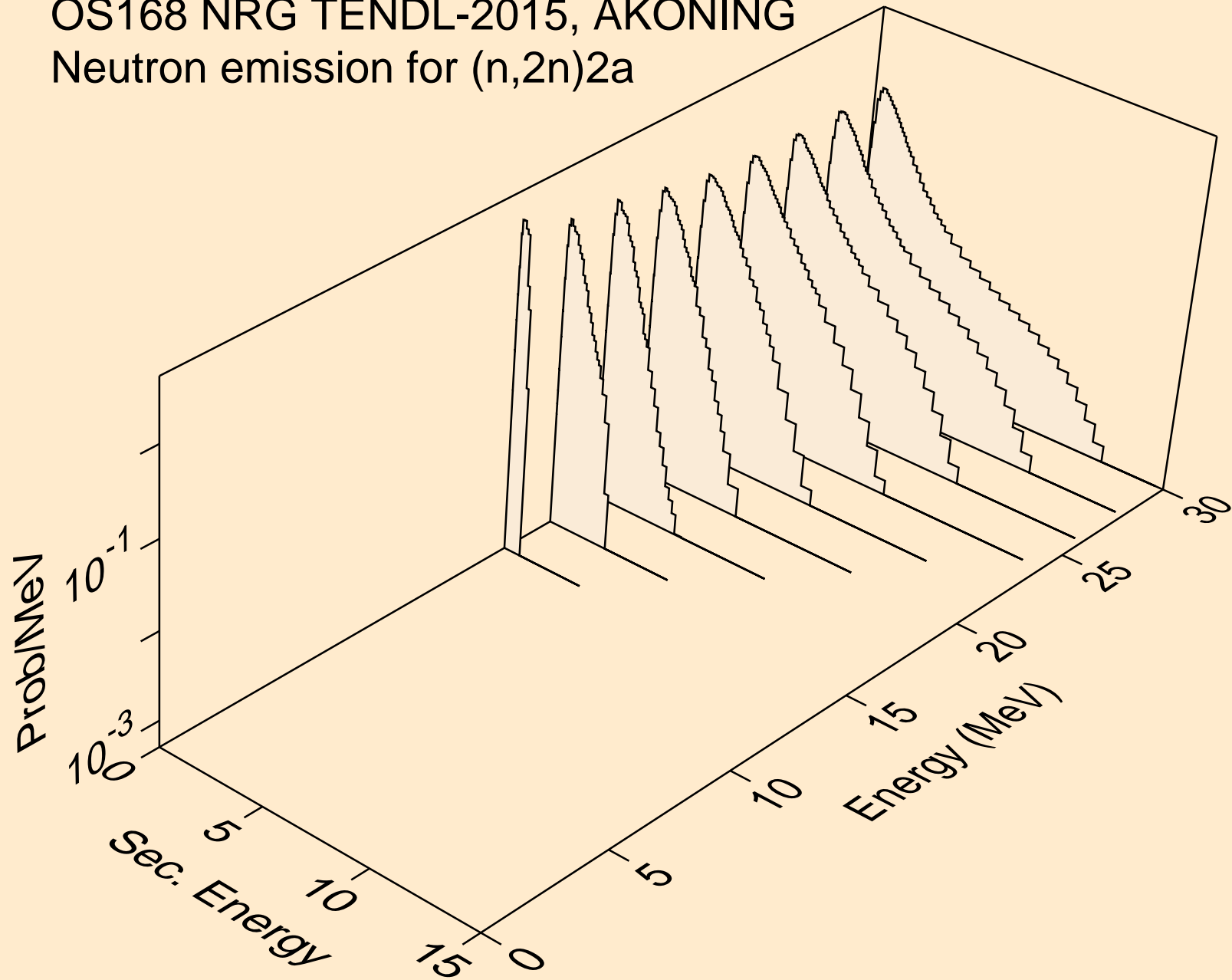

OS168 NRG TENDL-2015, AKONING
Neutron emission for (n,n*)d

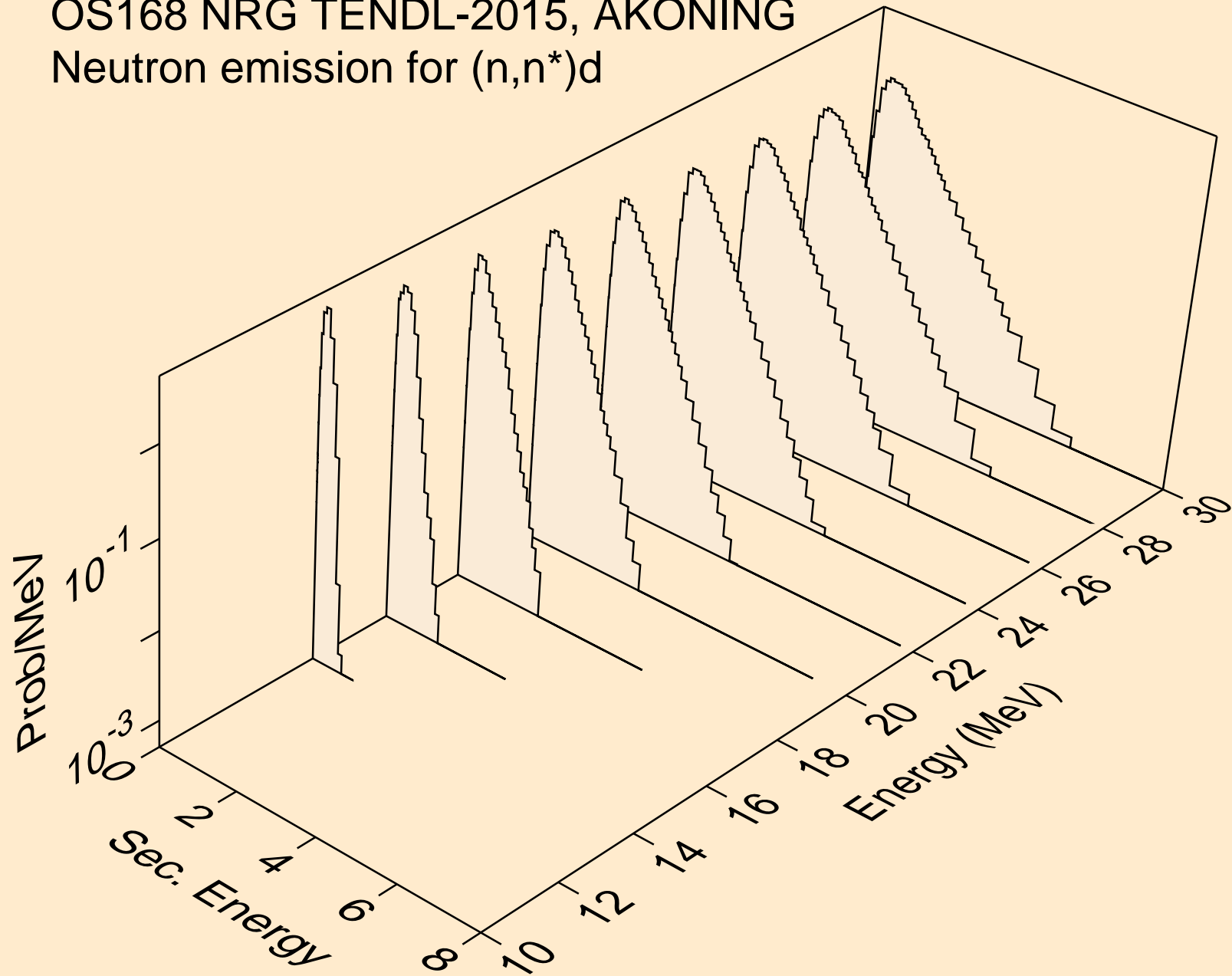

OS168 NRG TENDL-2015, AKONING
Neutron emission for (n,n*)t

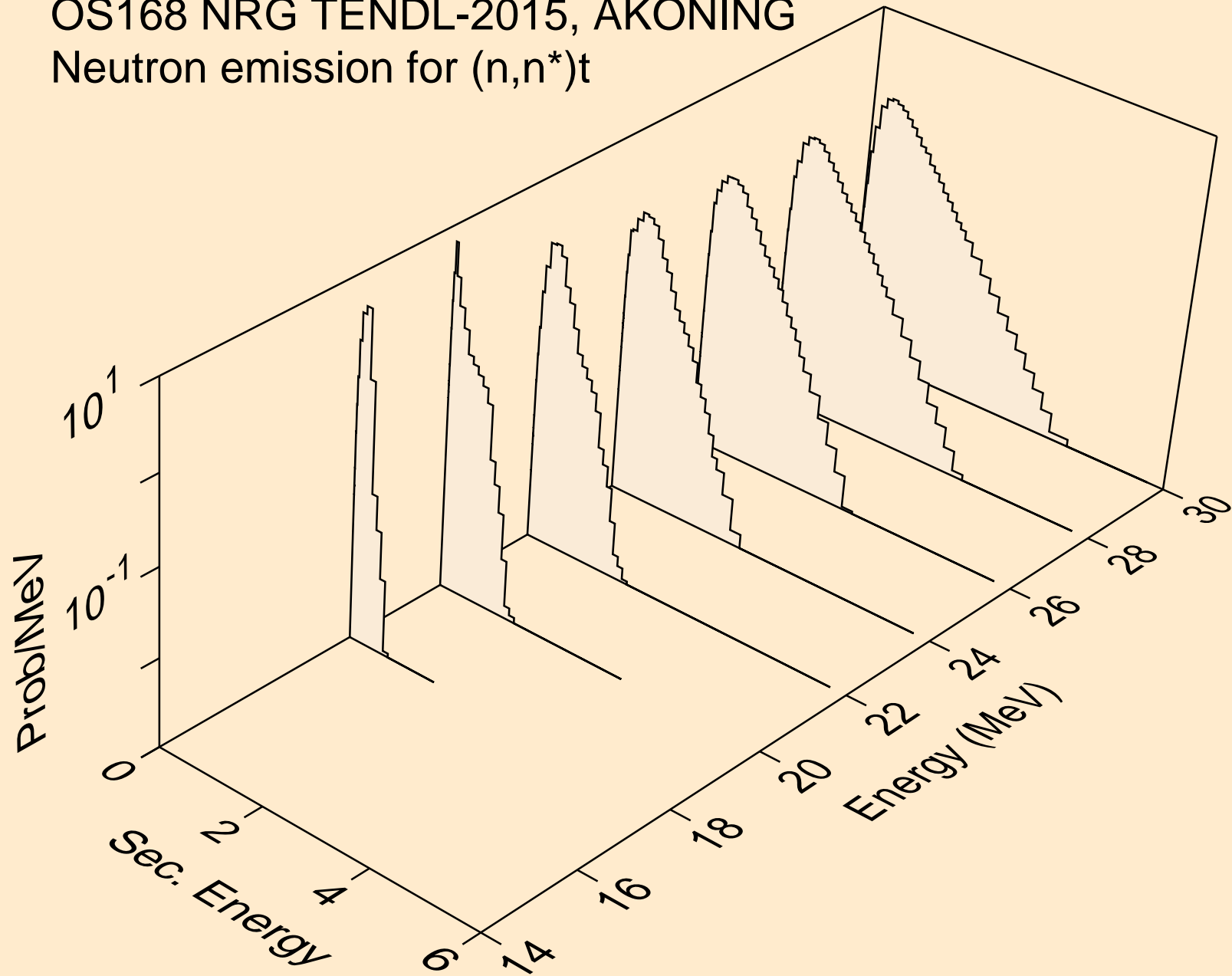

OS168 NRG TENDL-2015, AKONING
Neutron emission for (n,n*)he3

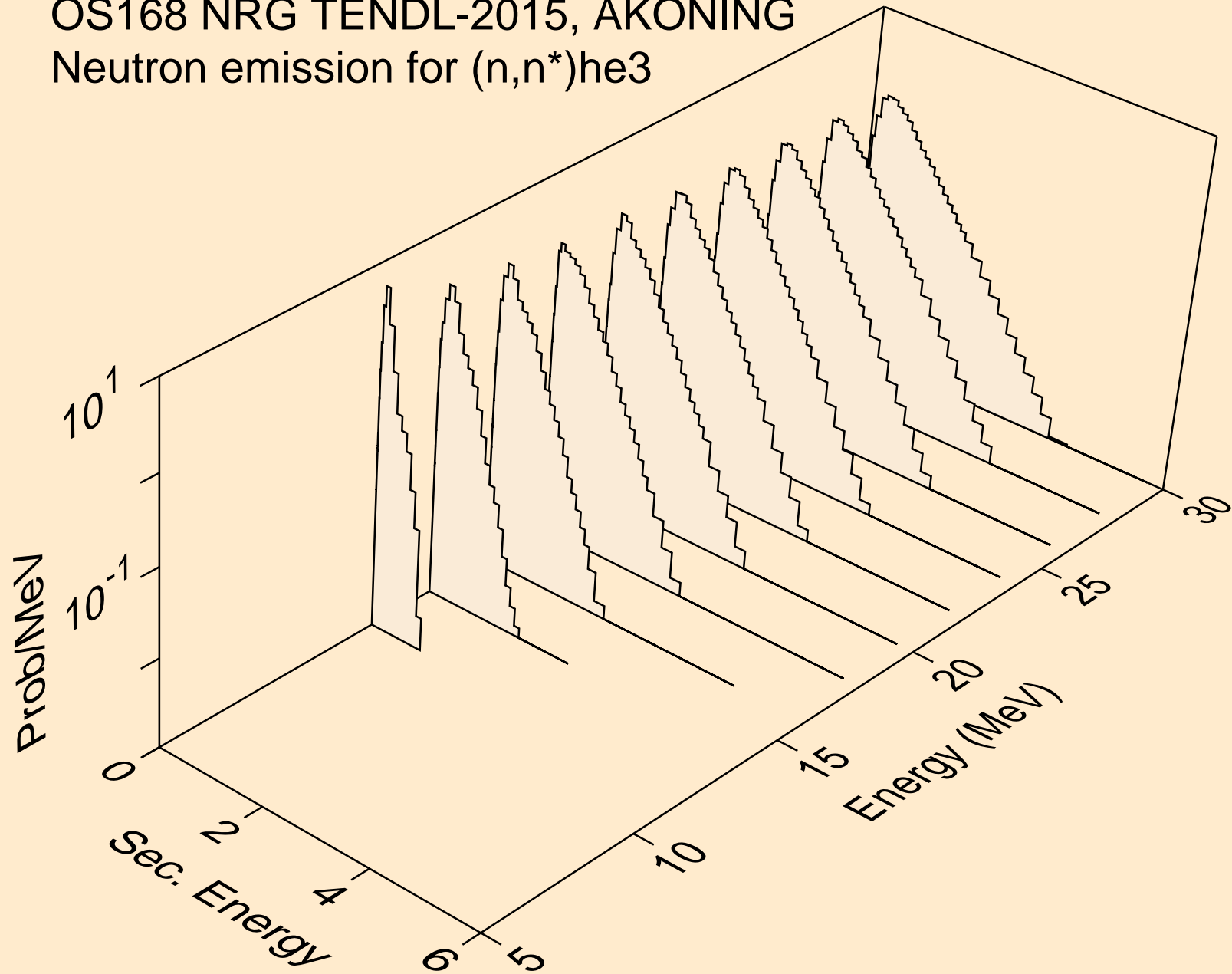

OS168 NRG TENDL-2015, AKONING
Neutron emission for (n,n*)d2a

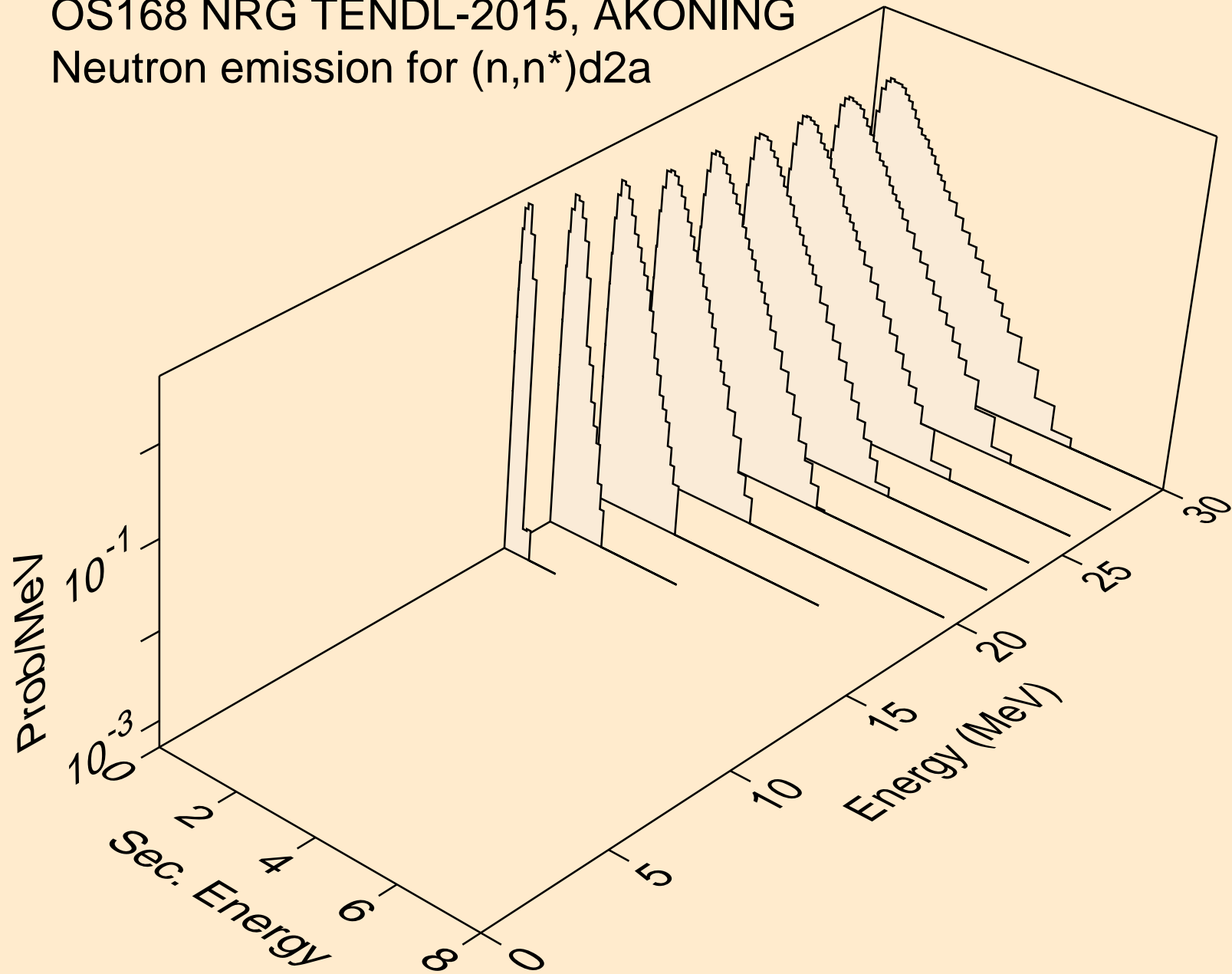

OS168 NRG TENDL-2015, AKONING
Neutron emission for (n,n*)t2a

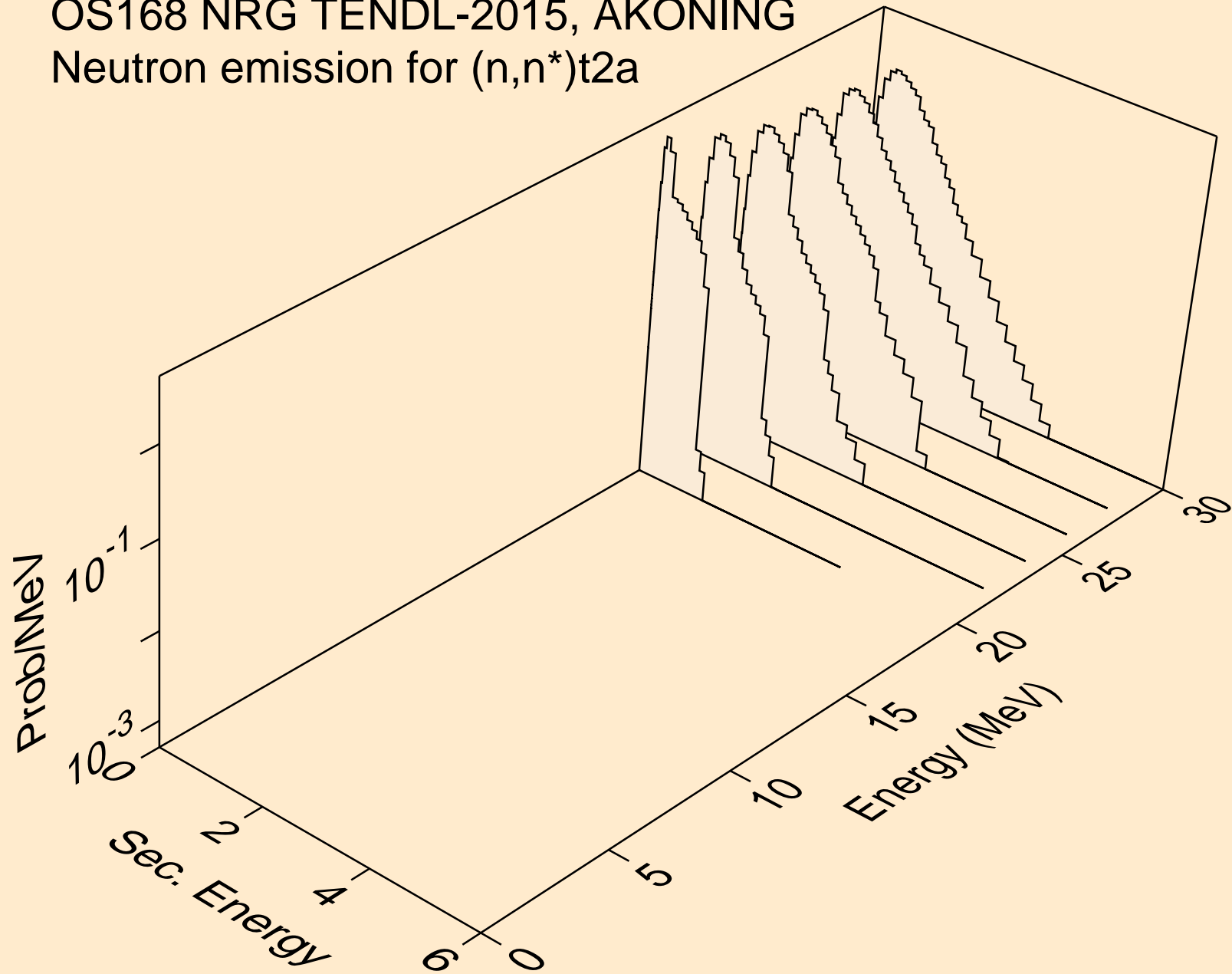

OS168 NRG TENDL-2015, AKONING
Neutron emission for (n,2np)

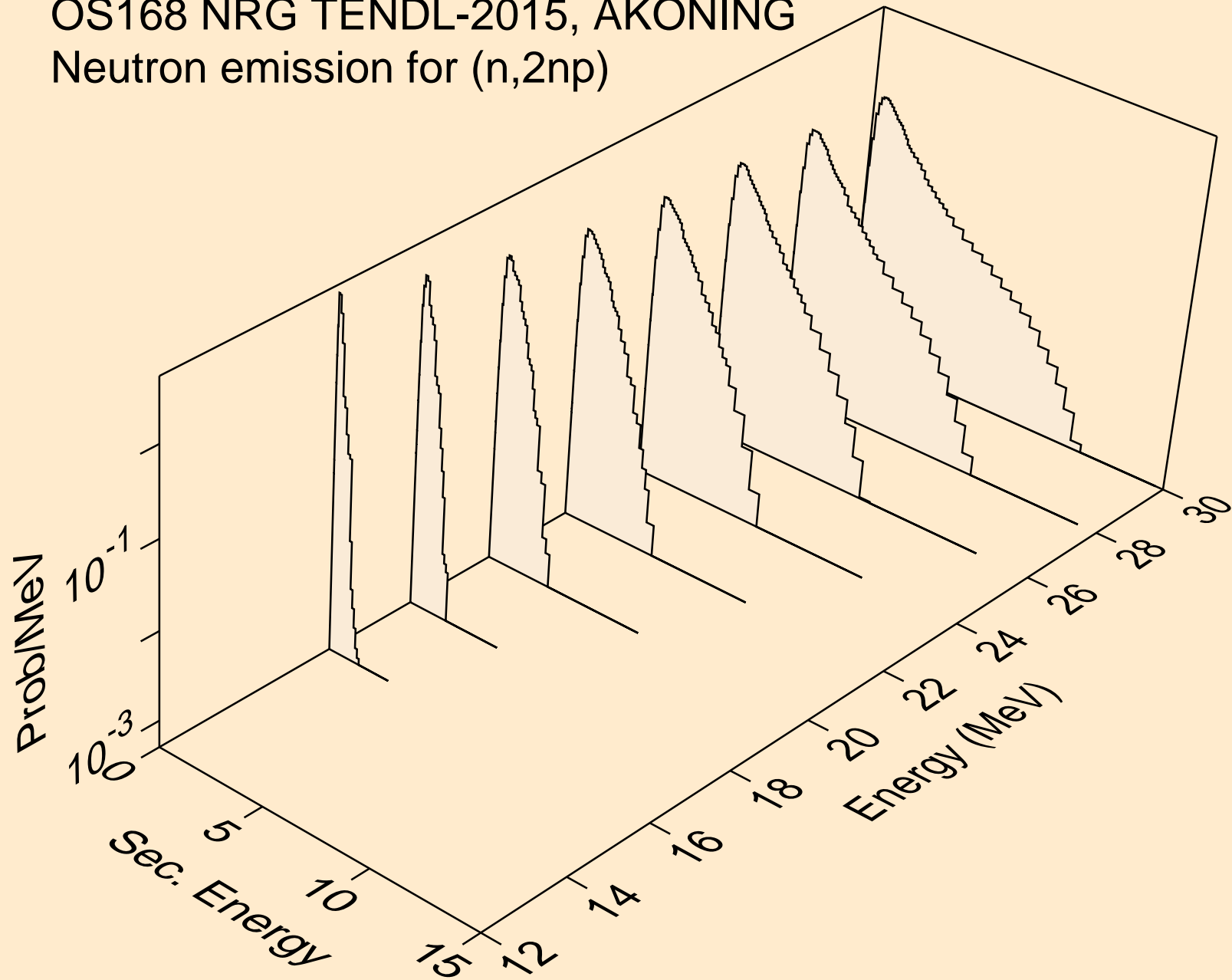

OS168 NRG TENDL-2015, AKONING
Neutron emission for (n,3np)

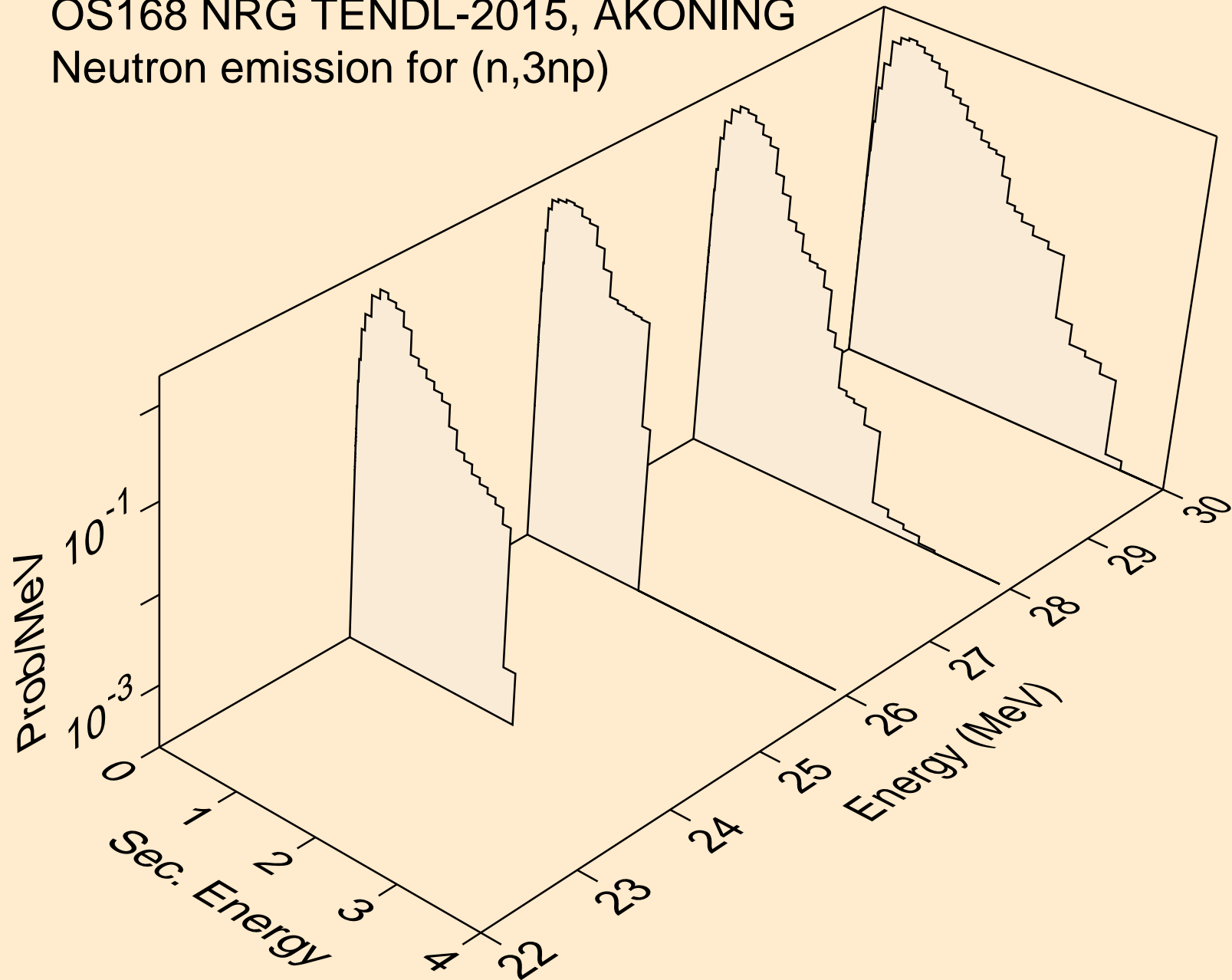

OS168 NRG TENDL-2015, AKONING
Neutron emission for (n,2np)

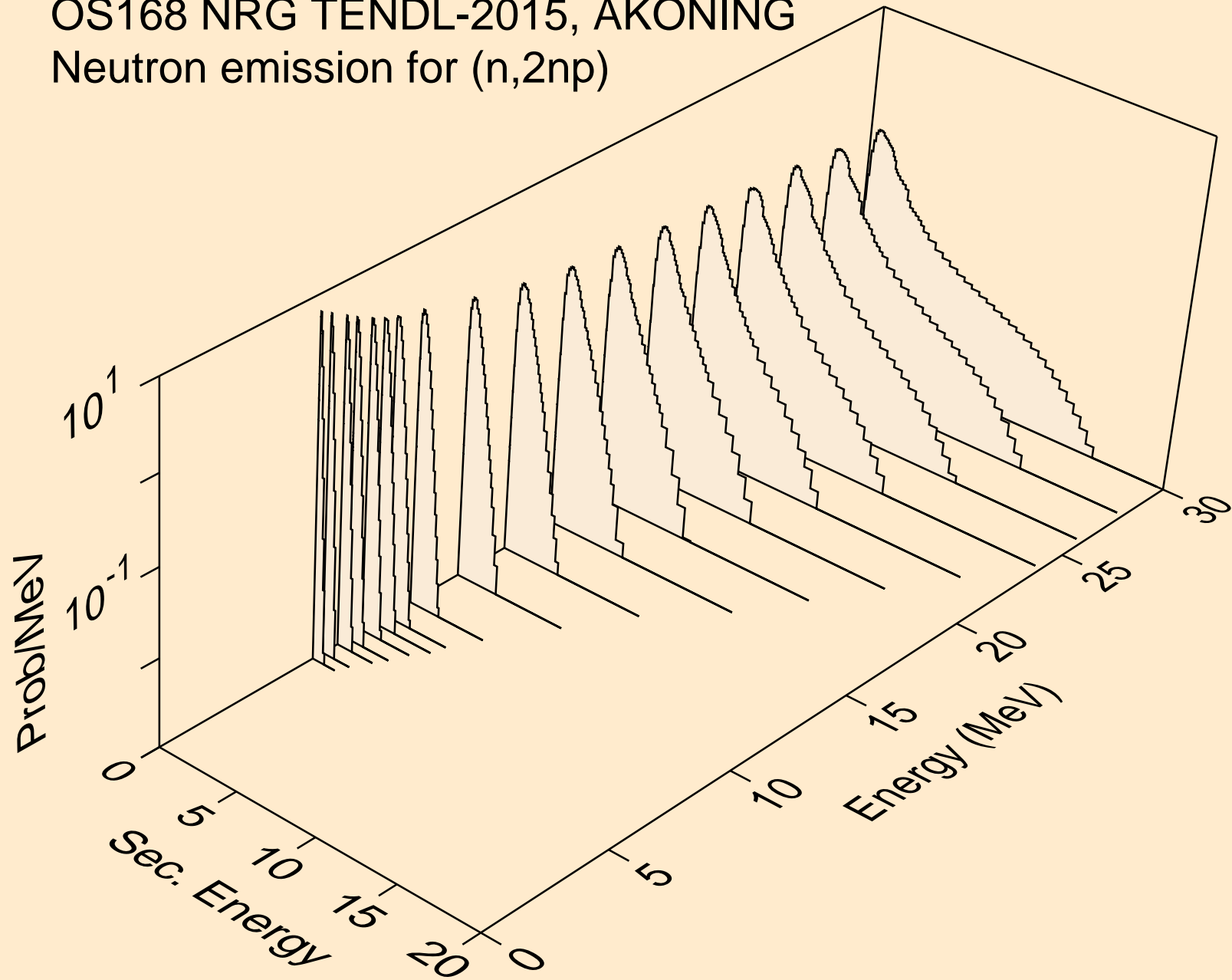

OS168 NRG TENDL-2015, AKONING
Neutron emission for (n,npa)

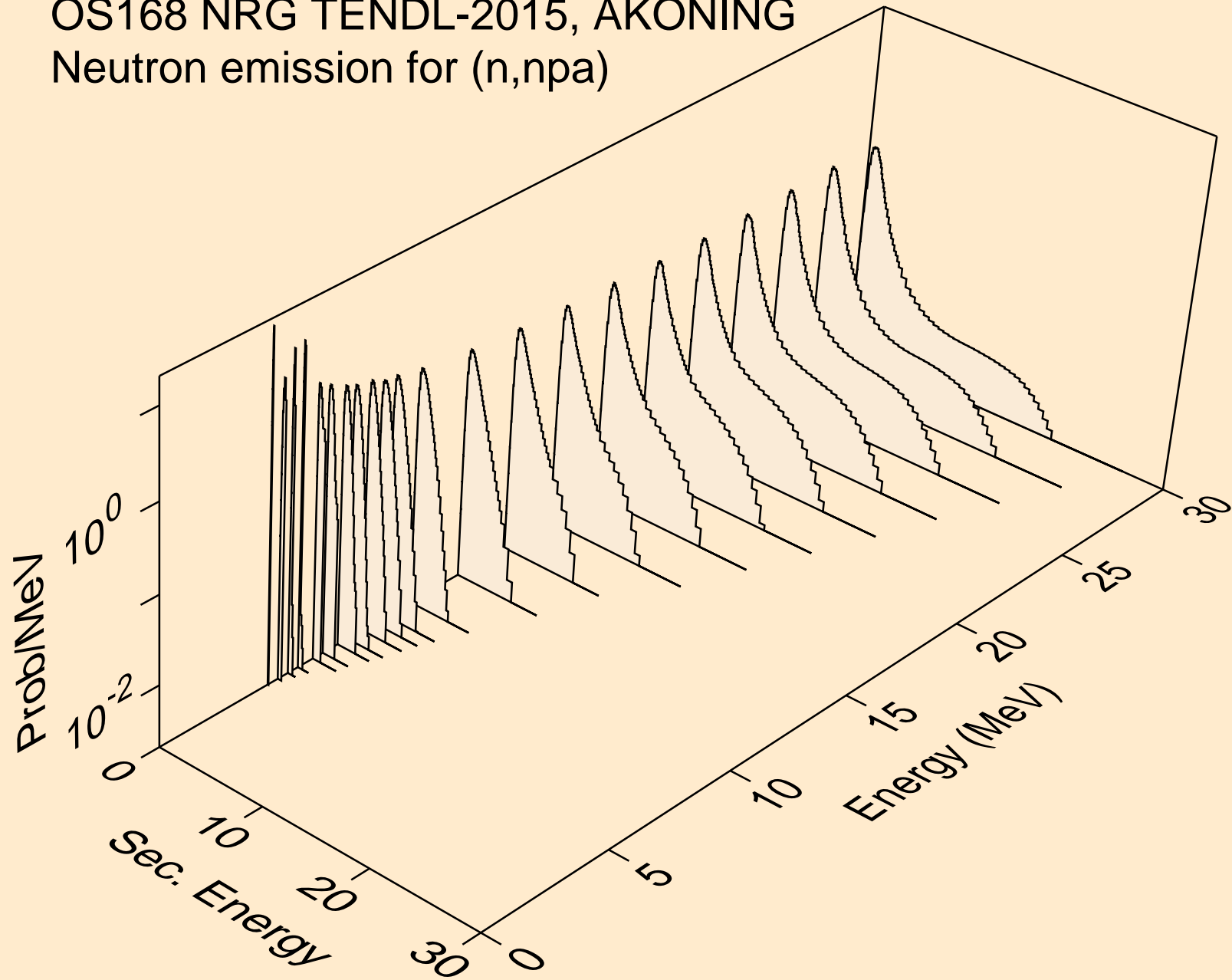

OS168 NRG TENDL-2015, AKONING
Neutron emission for (n,n*c)

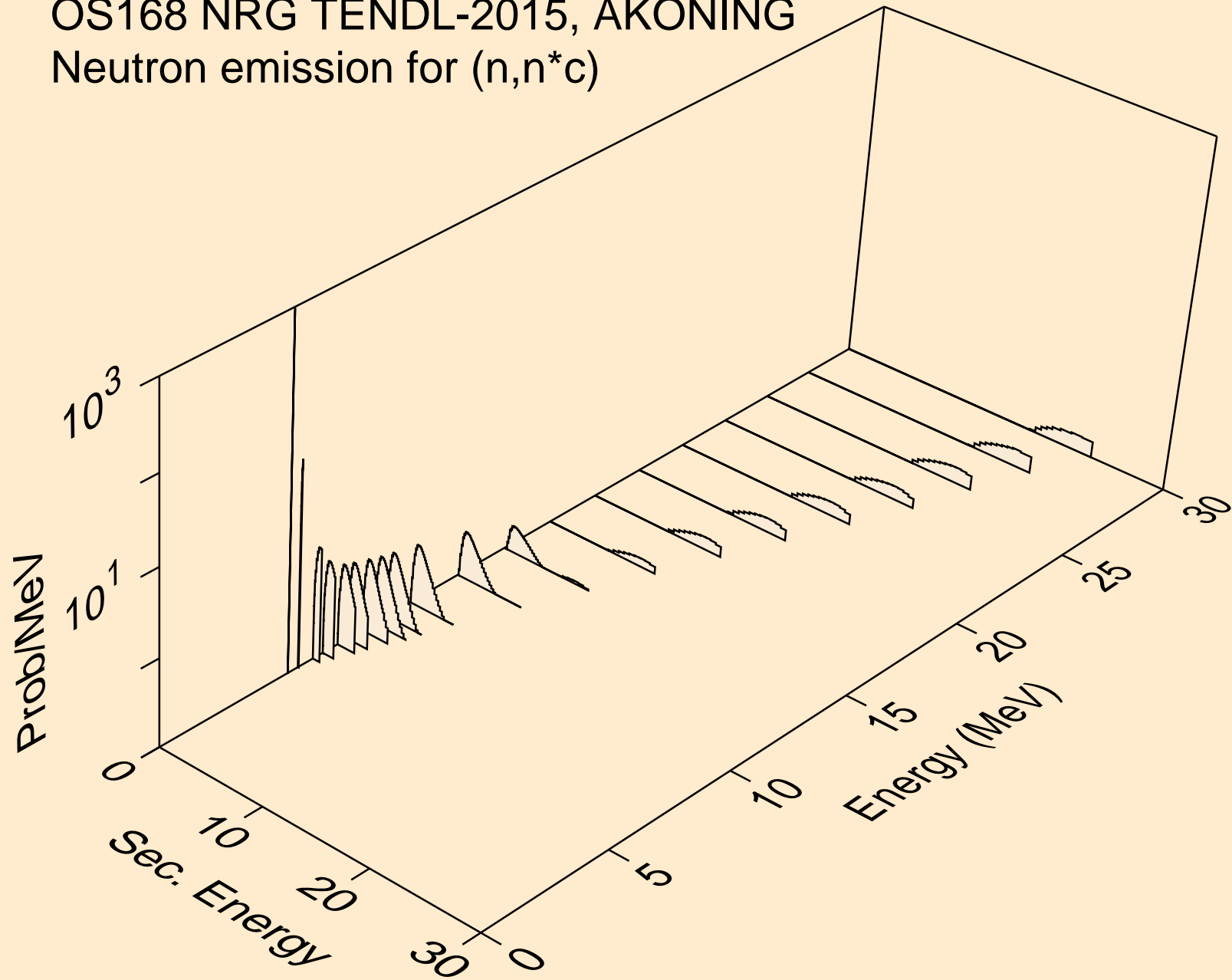

OS168 NRG TENDL-2015, AKONING
Photon emission for (n,x)

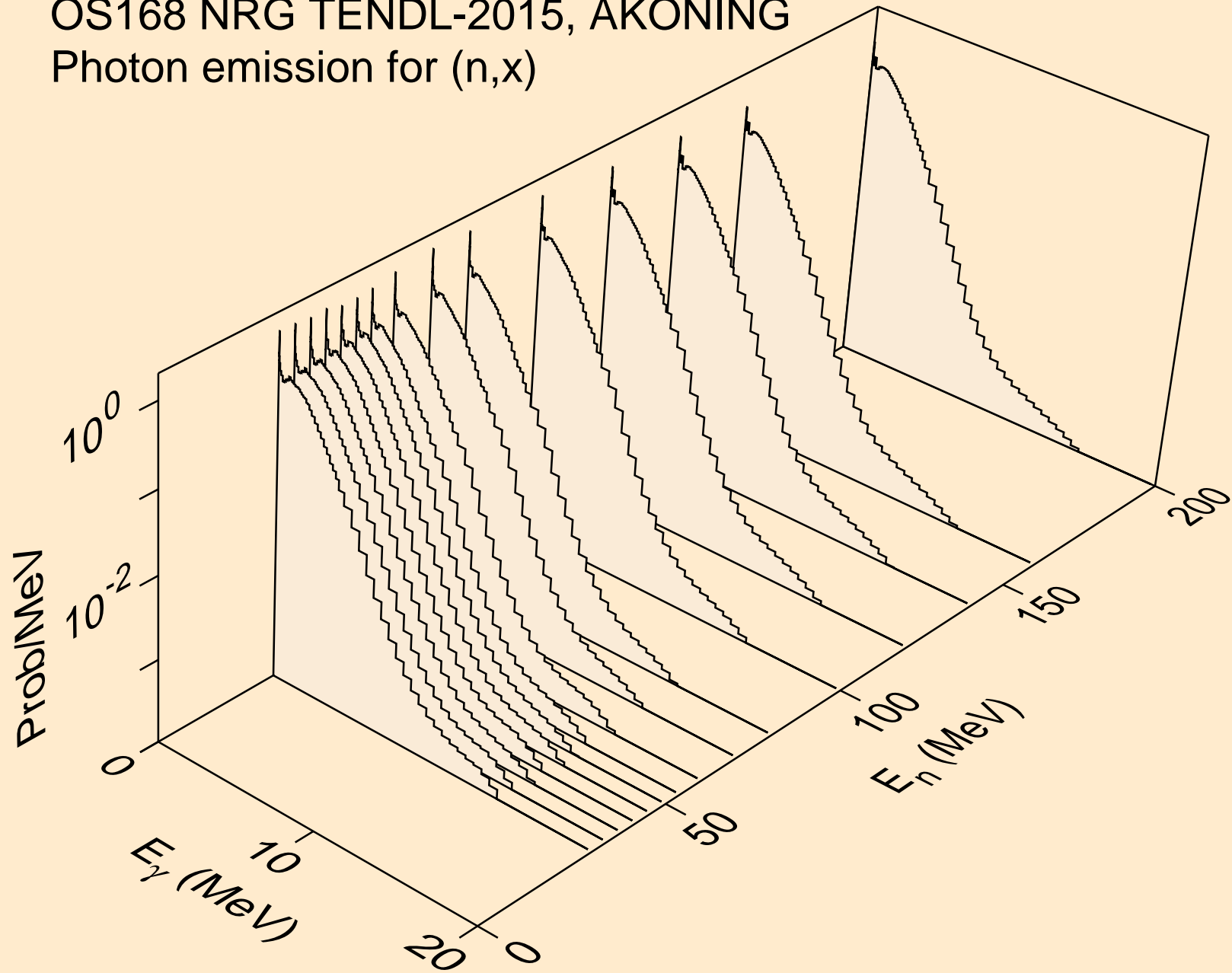

OS168 NRG TENDL-2015, AKONING
Photon emission for (n,2nd)

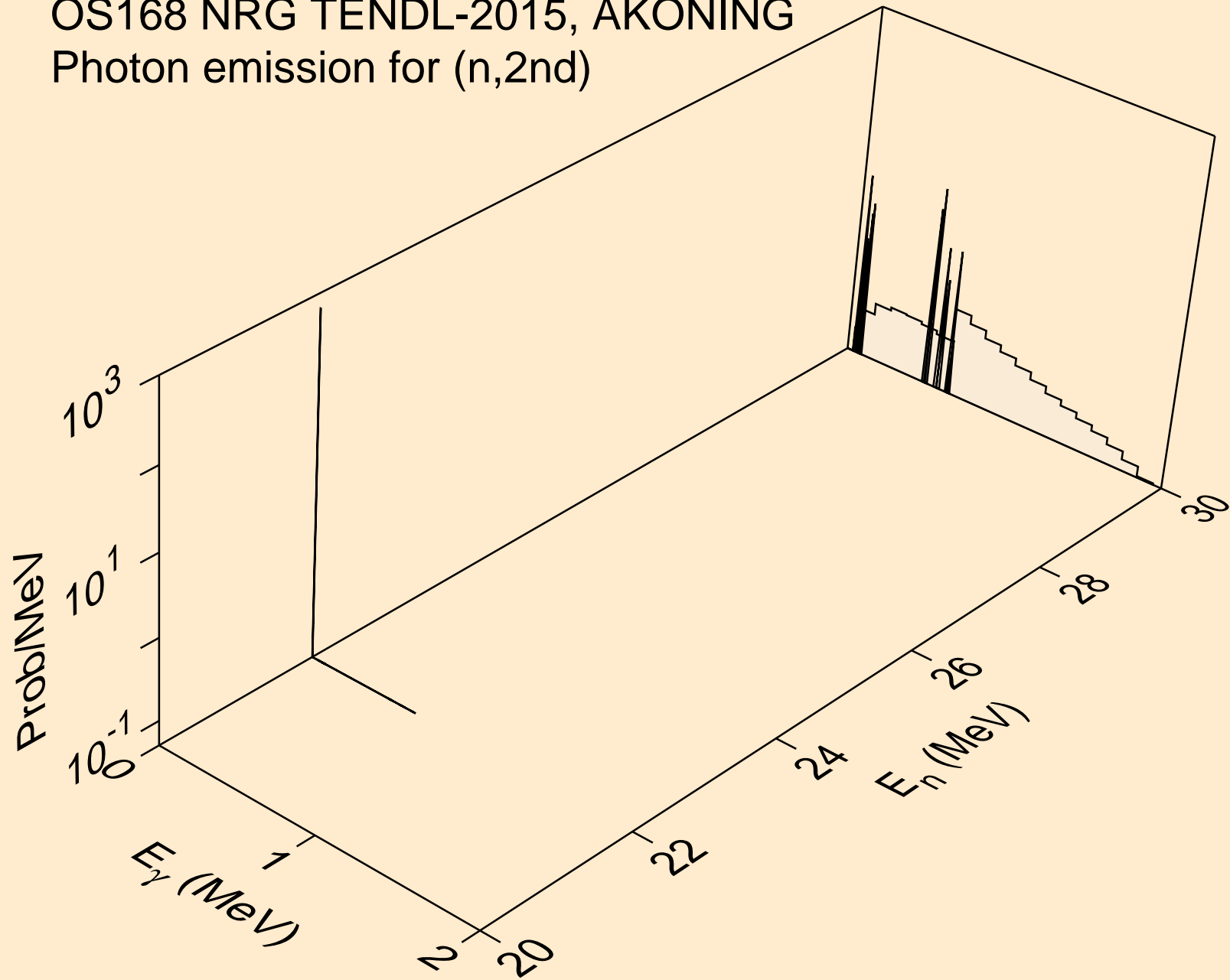

OS168 NRG TENDL-2015, AKONING
Photon emission for (n,2n)

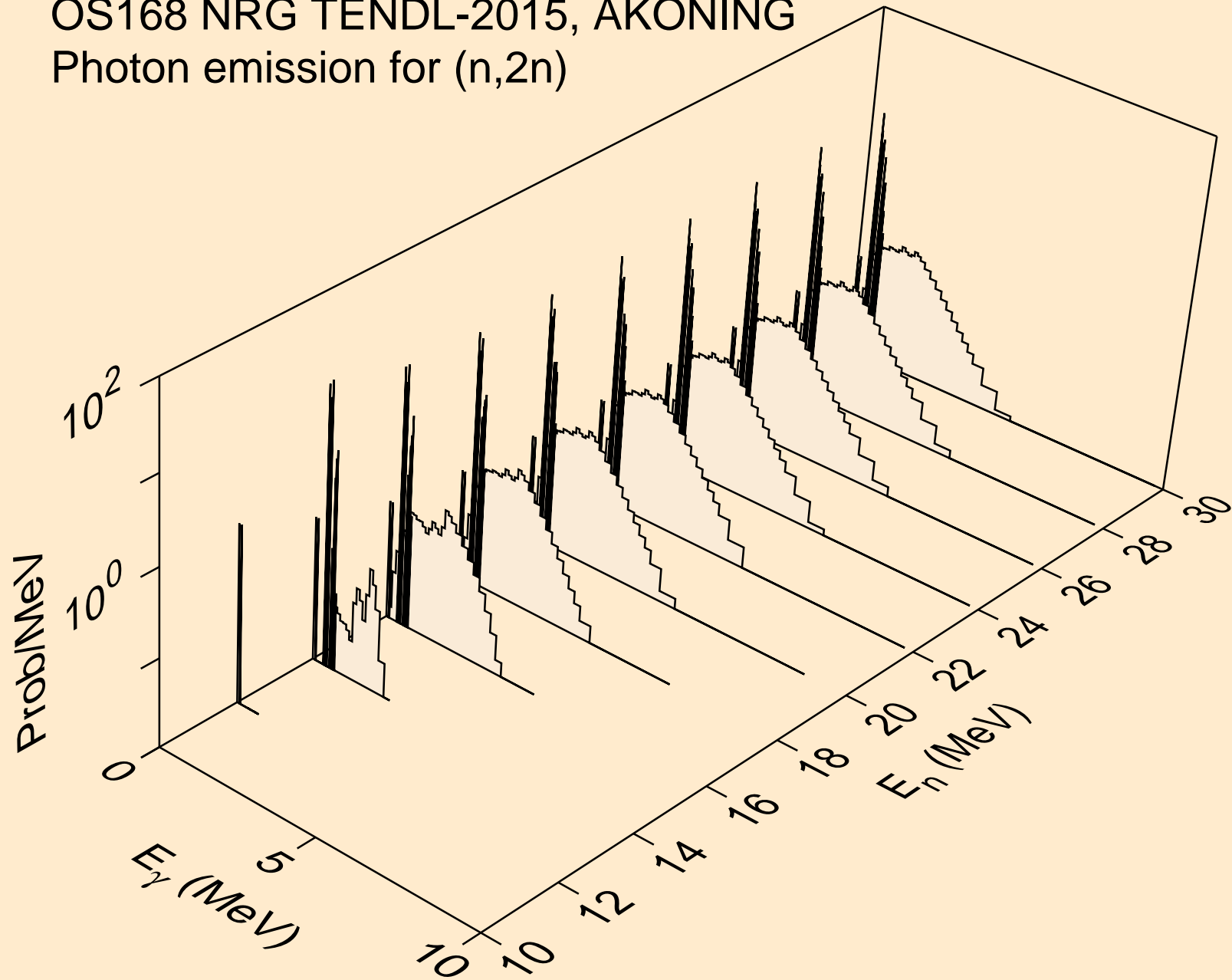

OS168 NRG TENDL-2015, AKONING
Photon emission for (n,3n)

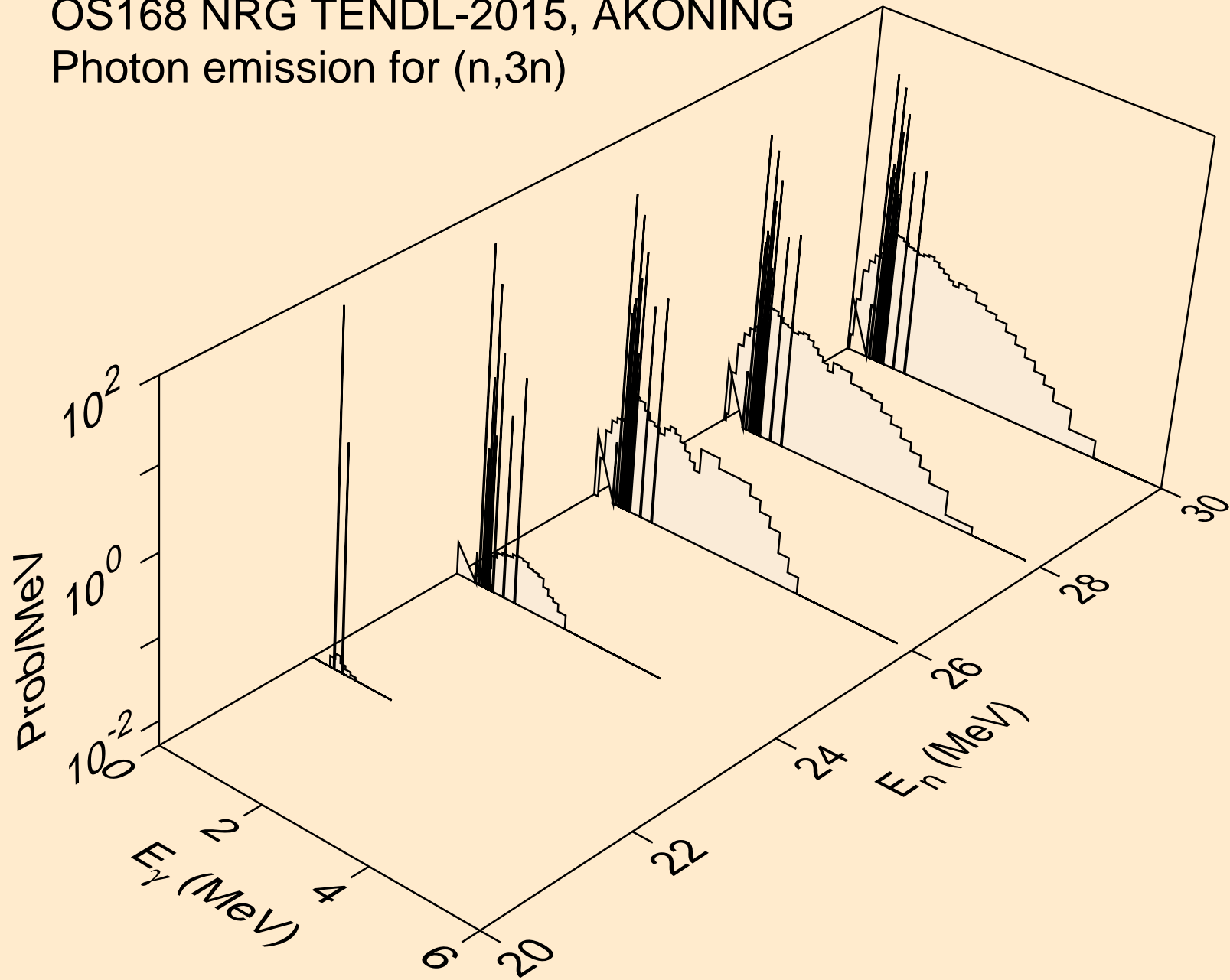

OS168 NRG TENDL-2015, AKONING
Photon emission for (n,n*)a

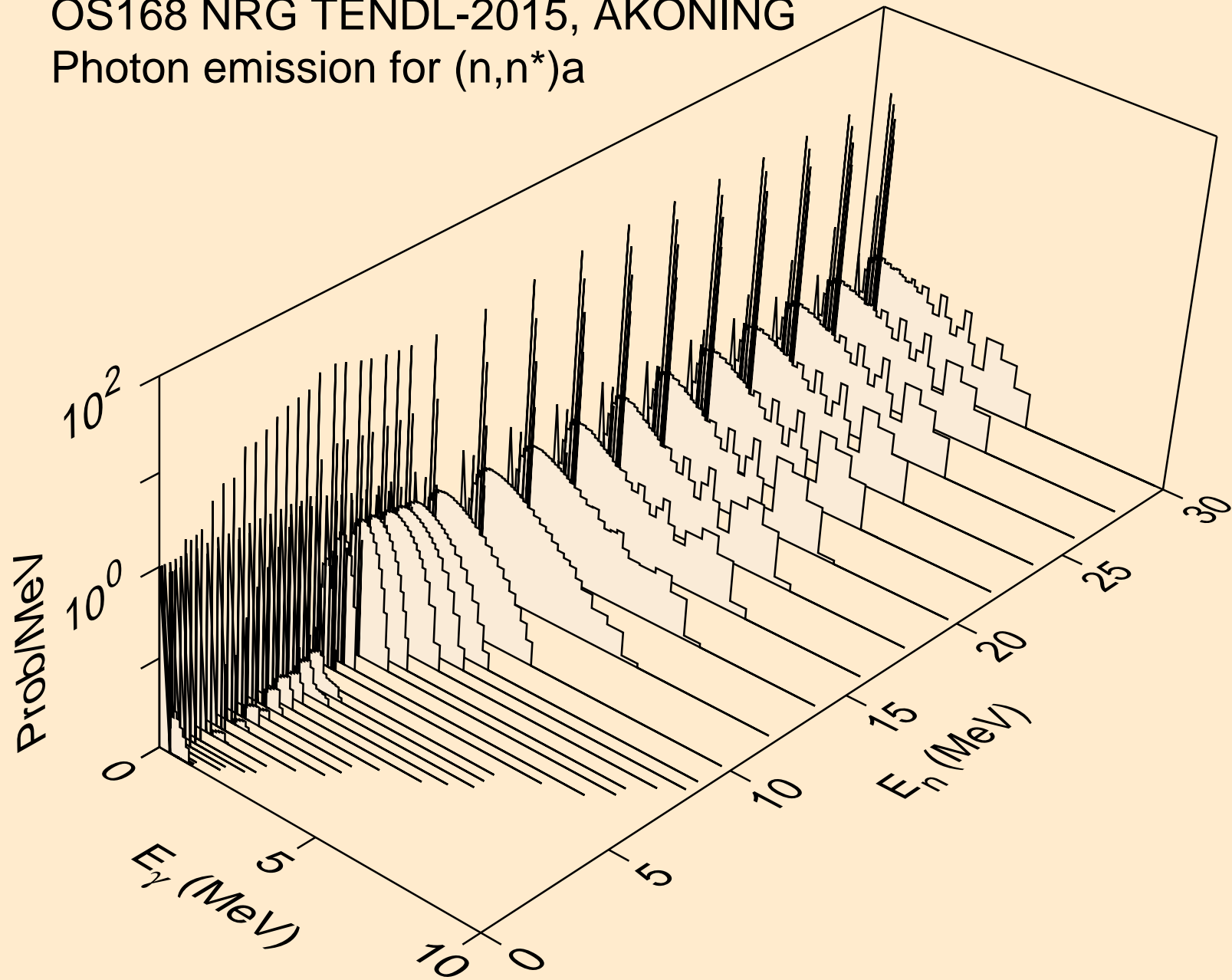

OS168 NRG TENDL-2015, AKONING
Photon emission for (n,n*)3a

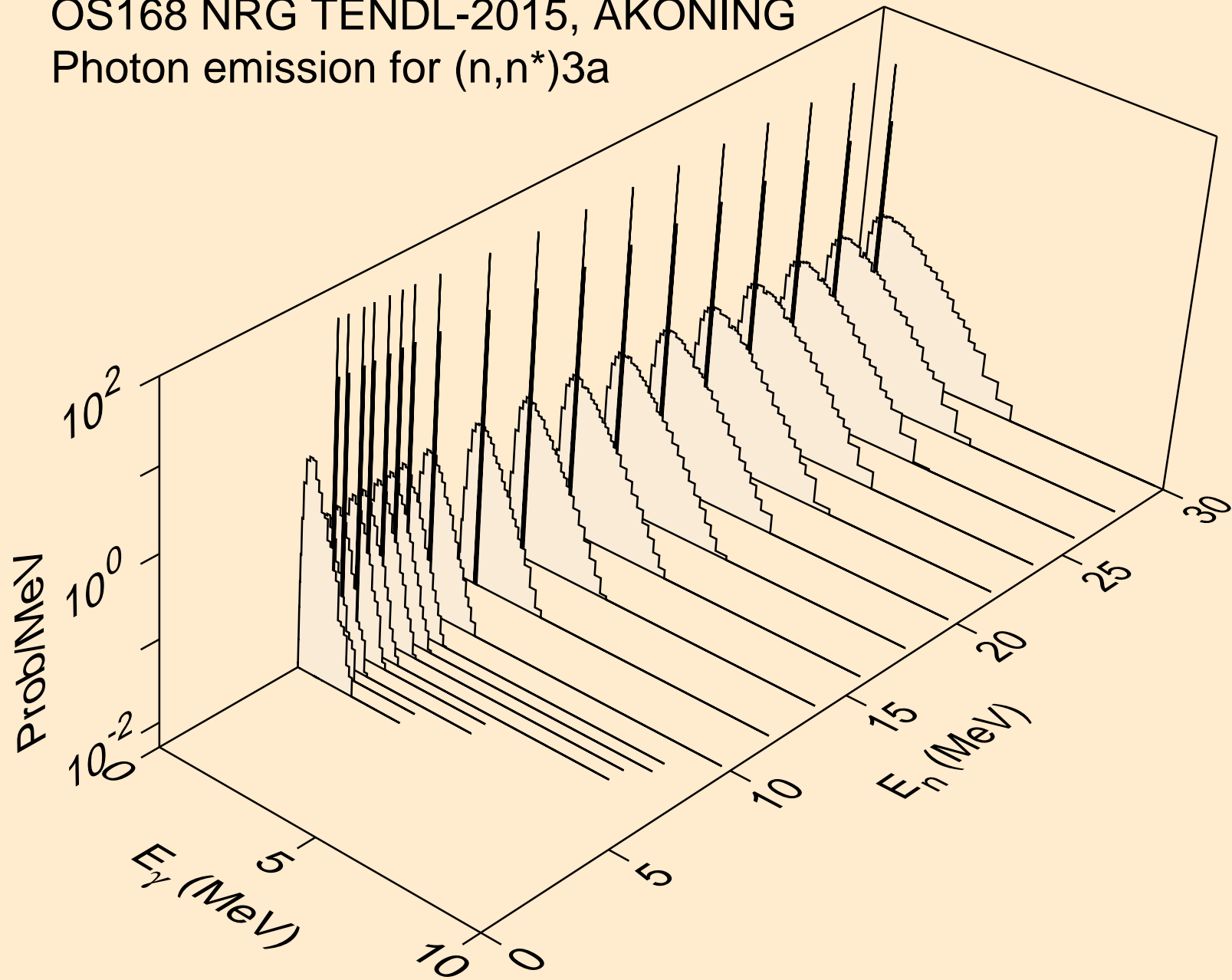

OS168 NRG TENDL-2015, AKONING
Photon emission for (n,2n)a

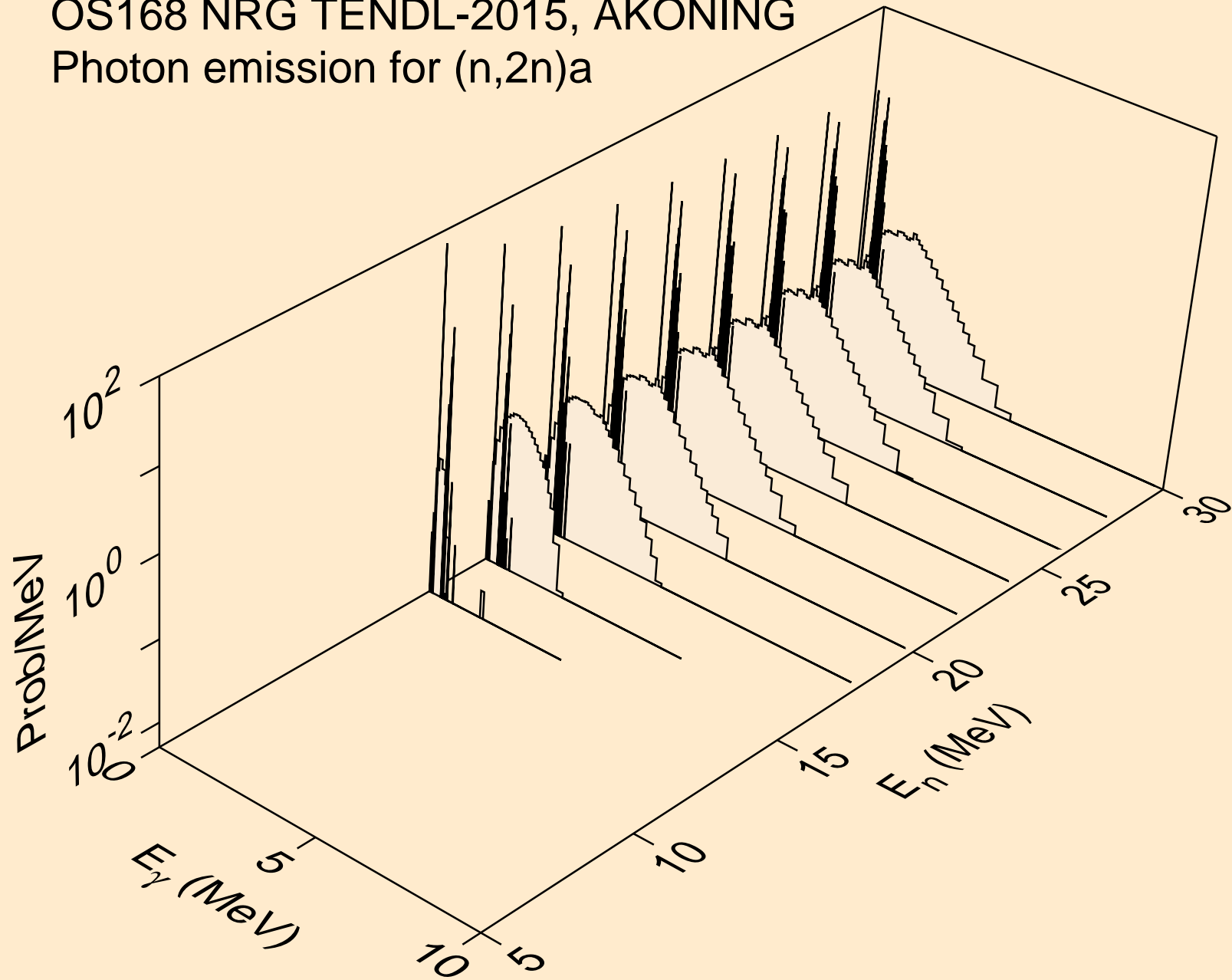

OS168 NRG TENDL-2015, AKONING
Photon emission for (n,3n)a

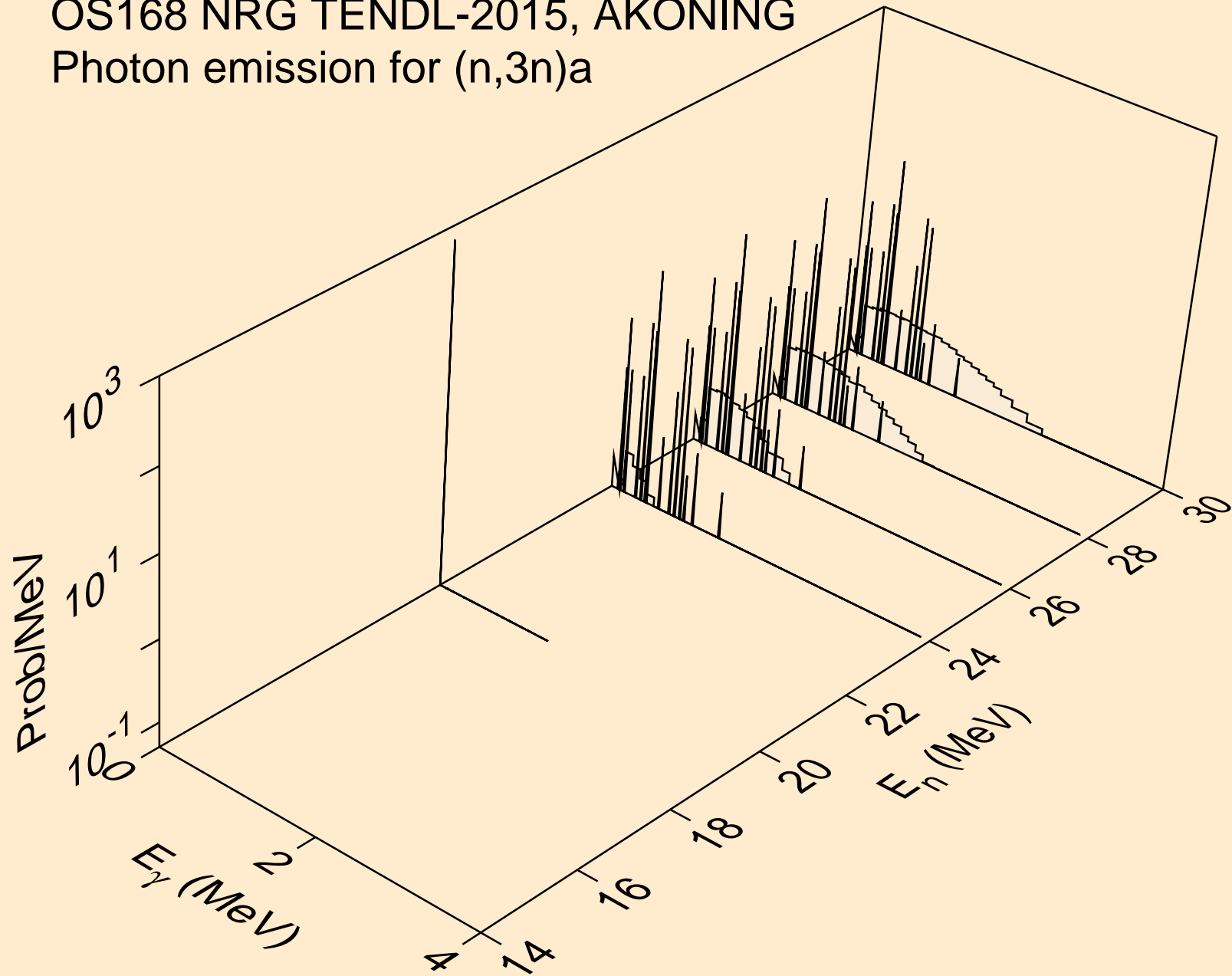

OS168 NRG TENDL-2015, AKONING
Photon emission for (n,n*)p

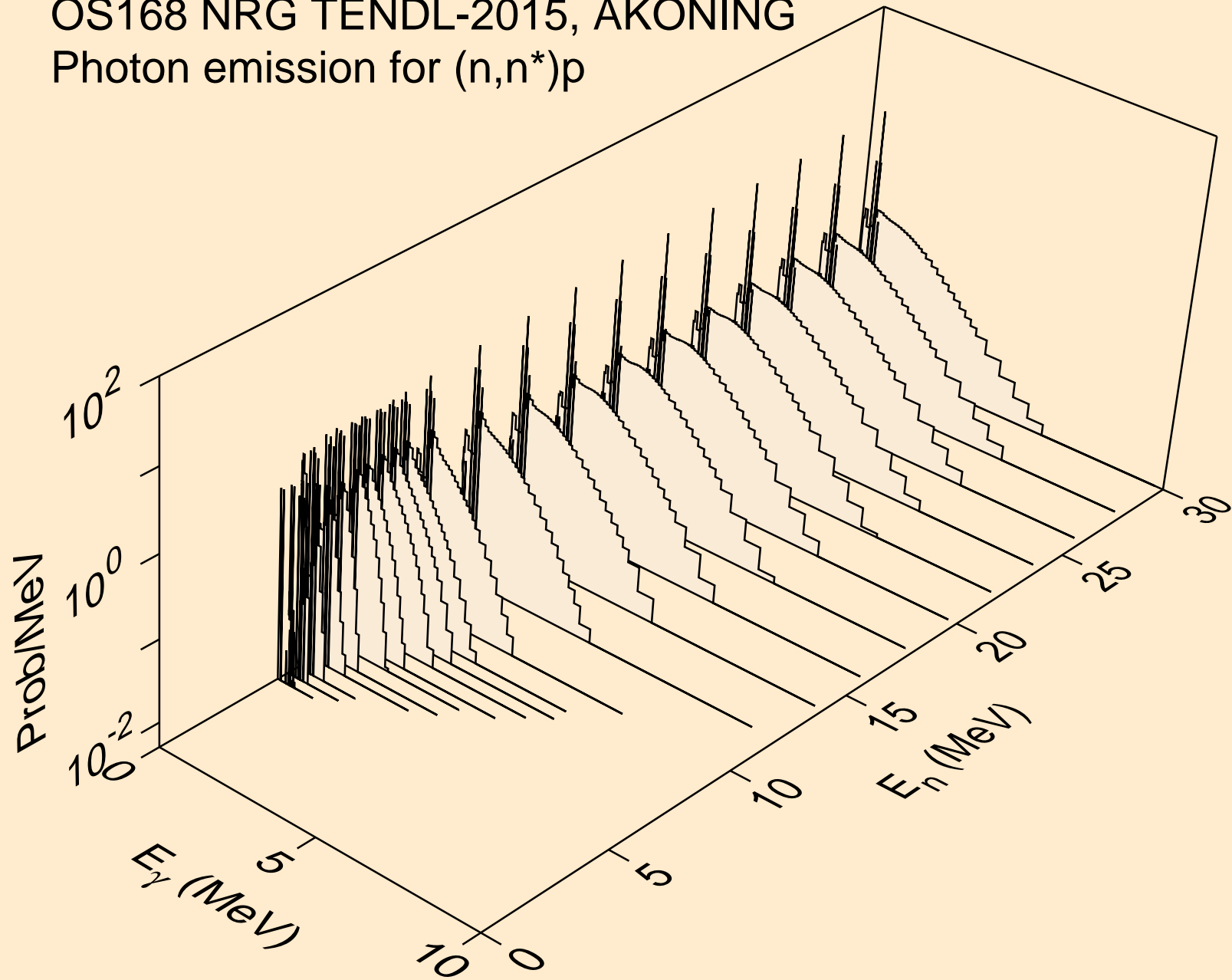

OS168 NRG TENDL-2015, AKONING
Photon emission for (n,n*)2a

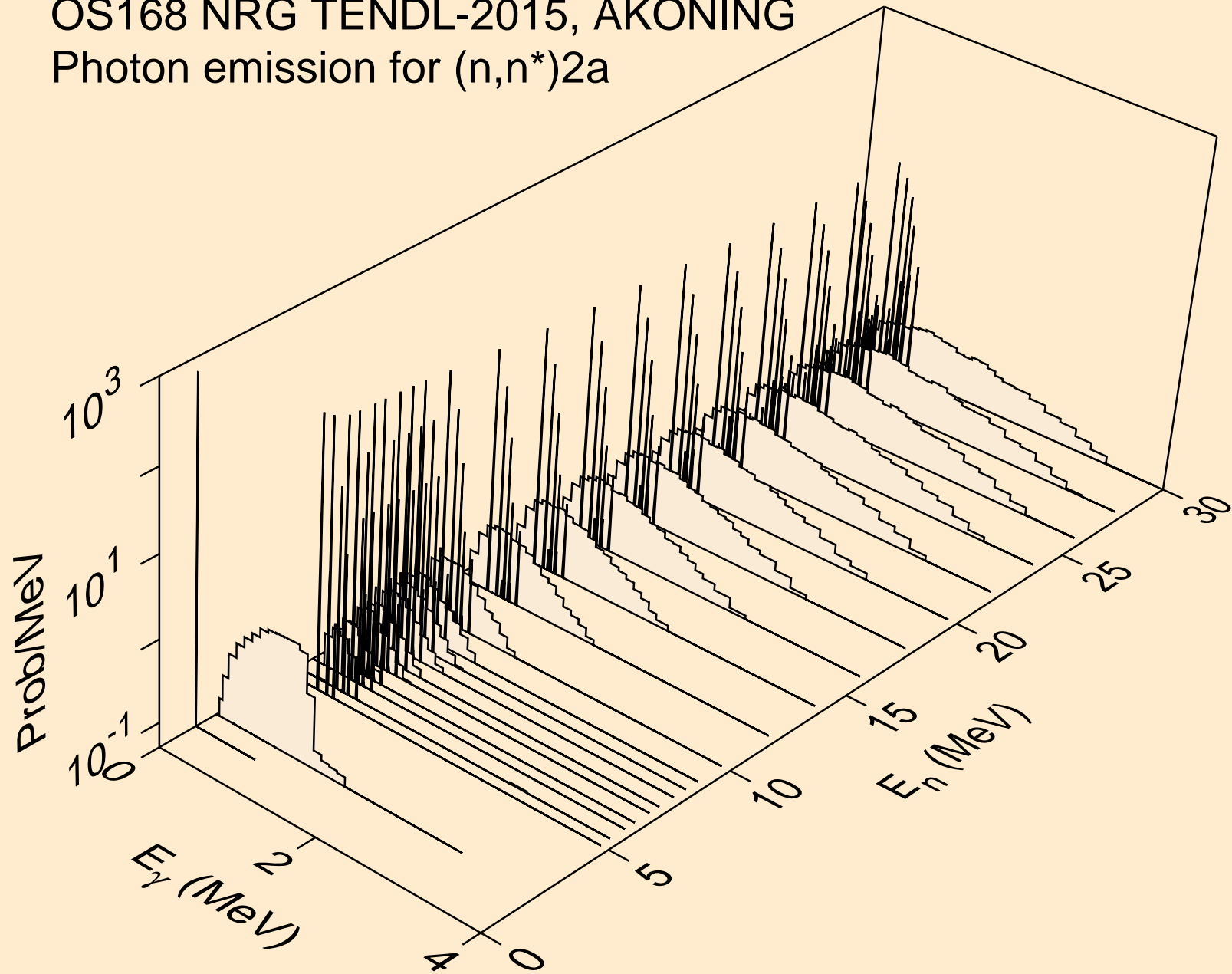

OS168 NRG TENDL-2015, AKONING
Photon emission for (n,2n)2a

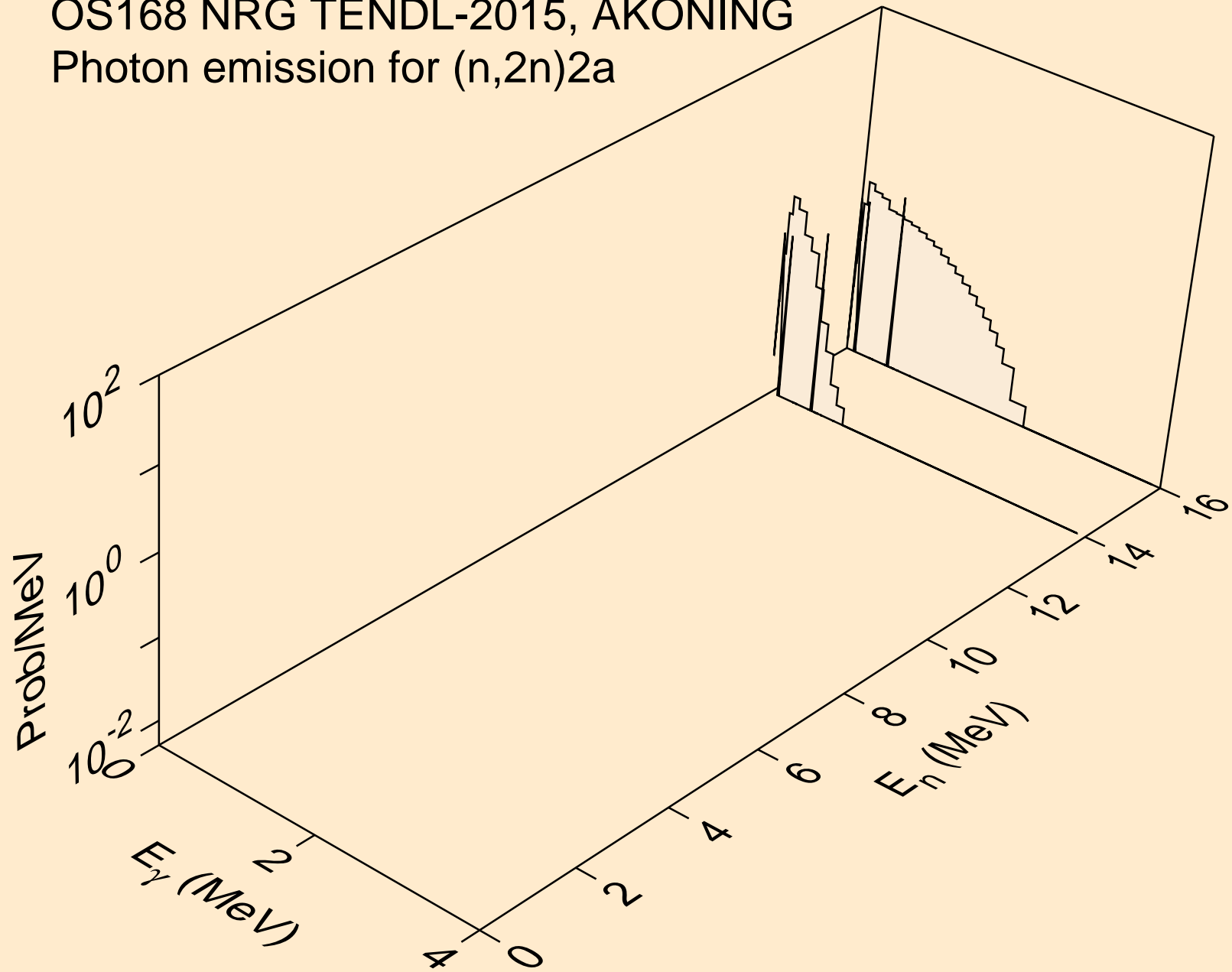

OS168 NRG TENDL-2015, AKONING
Photon emission for (n,n*)d

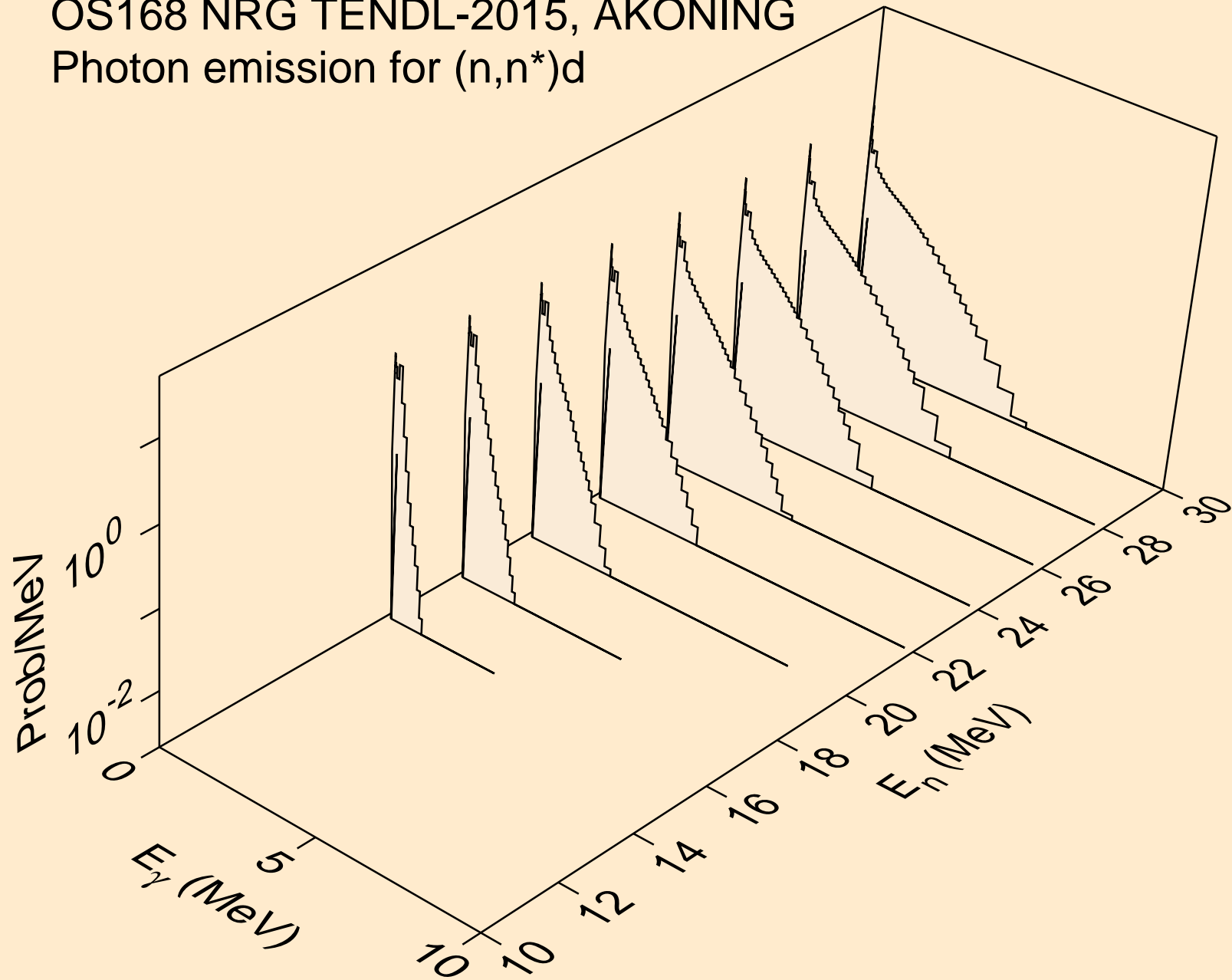

OS168 NRG TENDL-2015, AKONING
Photon emission for (n,n*)t

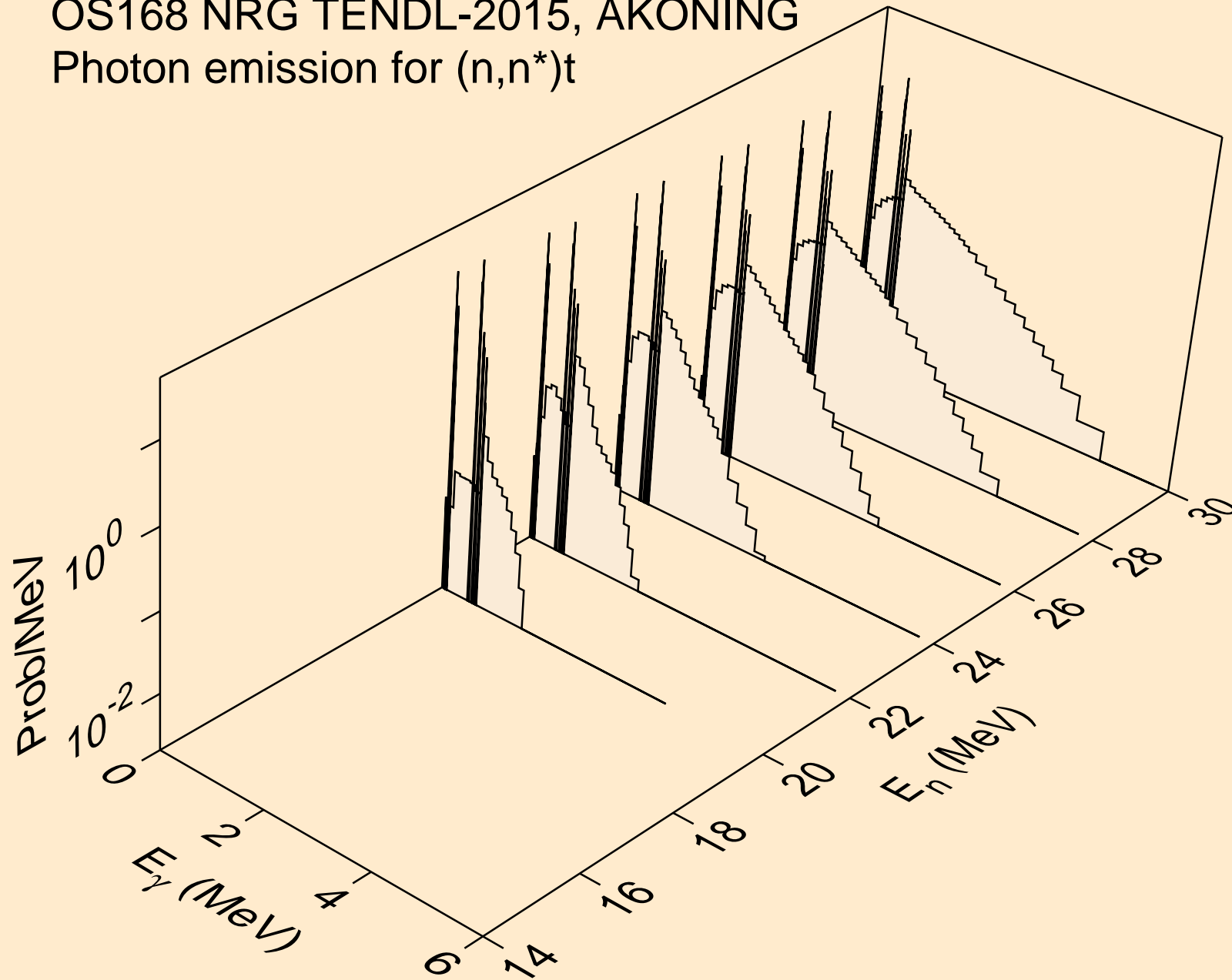

OS168 NRG TENDL-2015, AKONING
Photon emission for (n,n*)he3

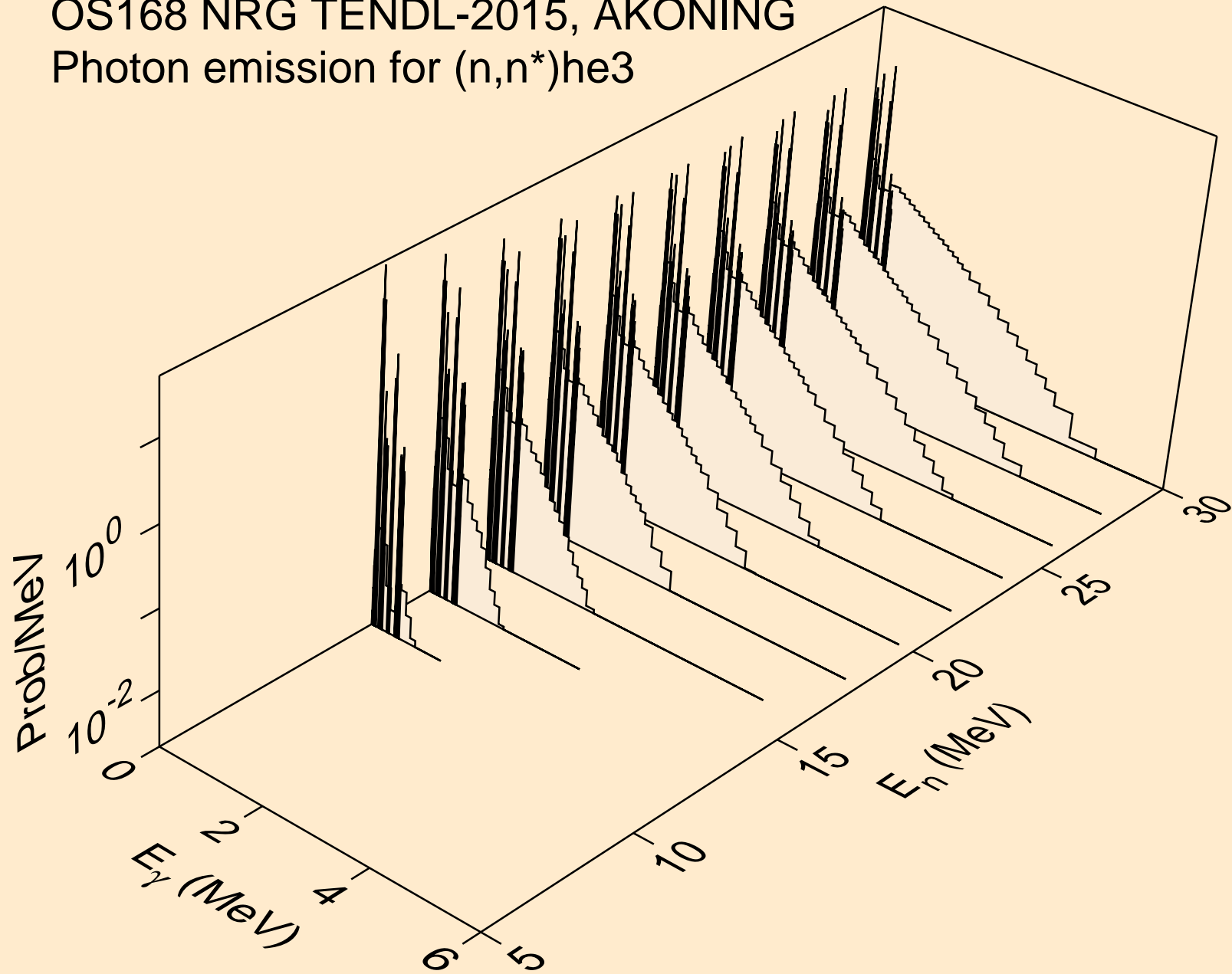

OS168 NRG TENDL-2015, AKONING
Photon emission for (n,n*)d2a

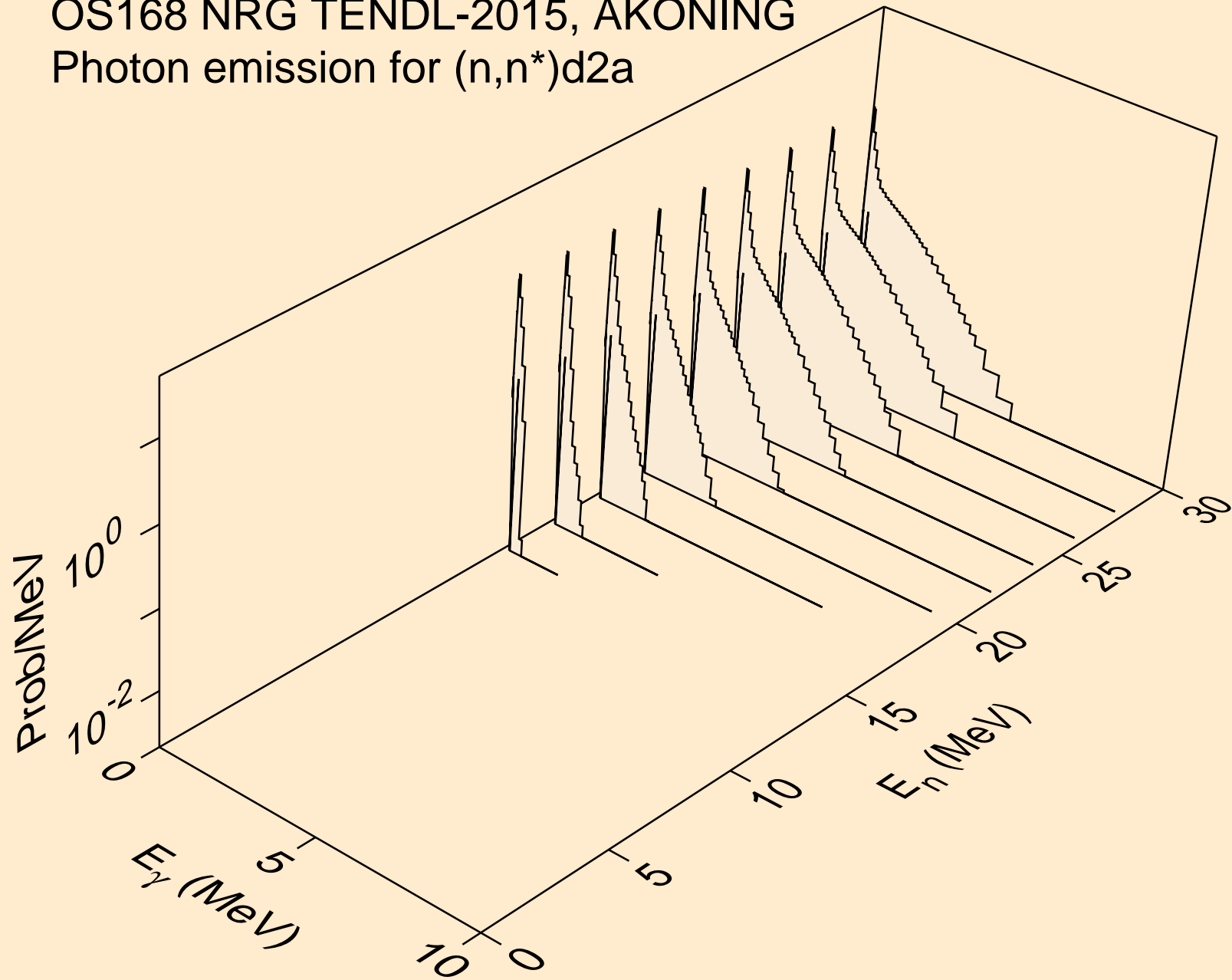

OS168 NRG TENDL-2015, AKONING
Photon emission for (n,n*)t2a

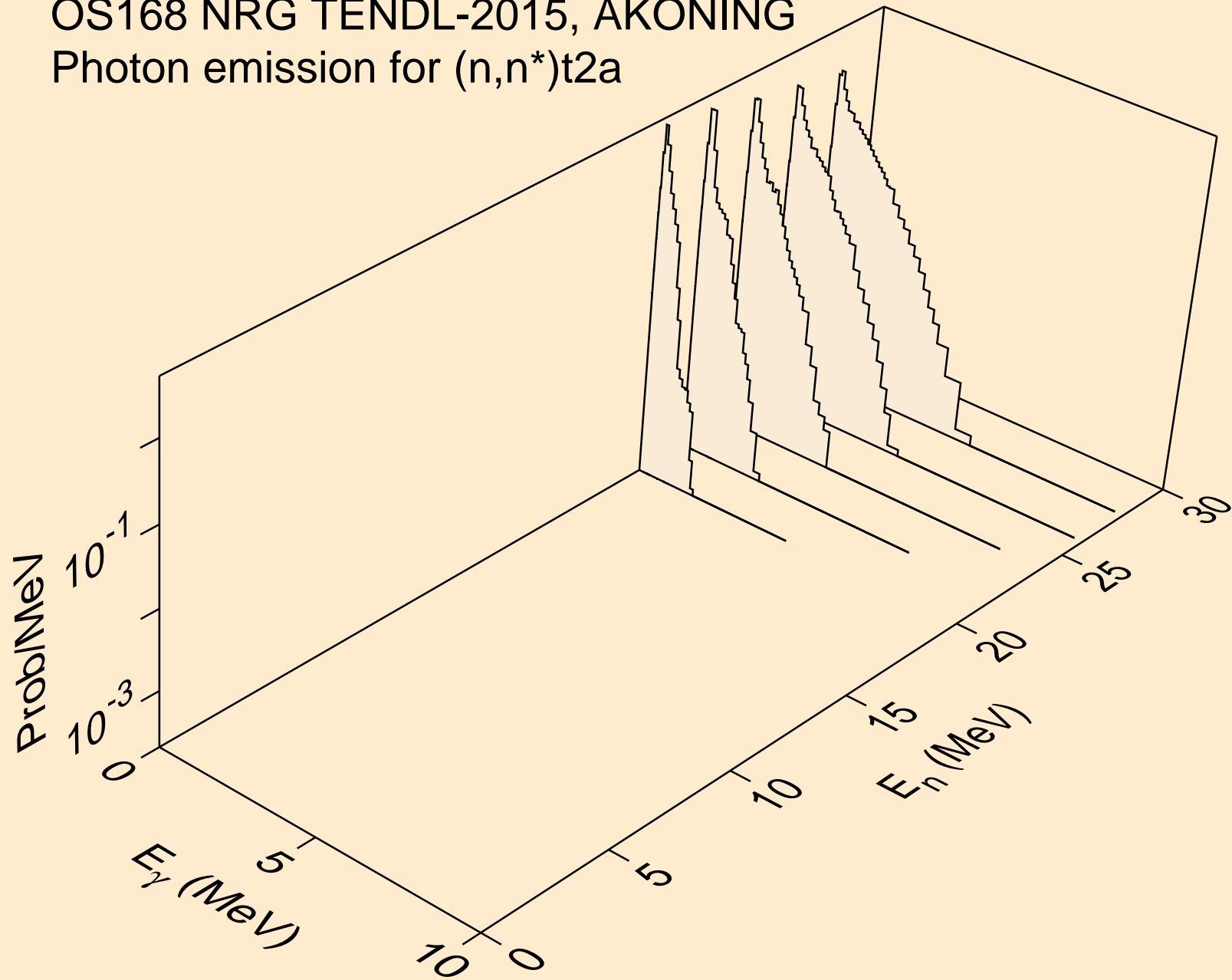

OS168 NRG TENDL-2015, AKONING
Photon emission for (n,2np)

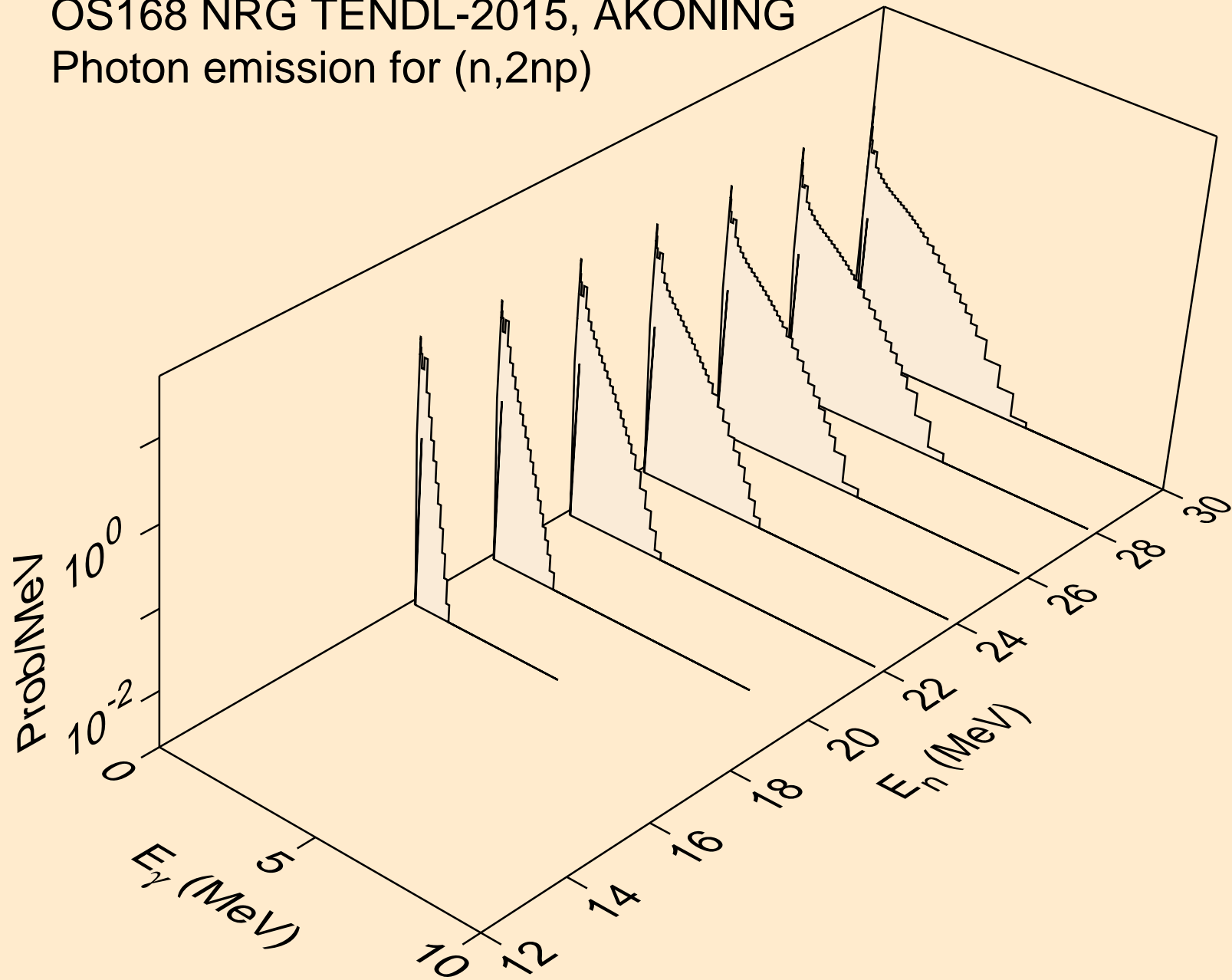

OS168 NRG TENDL-2015, AKONING
Photon emission for (n,3np)

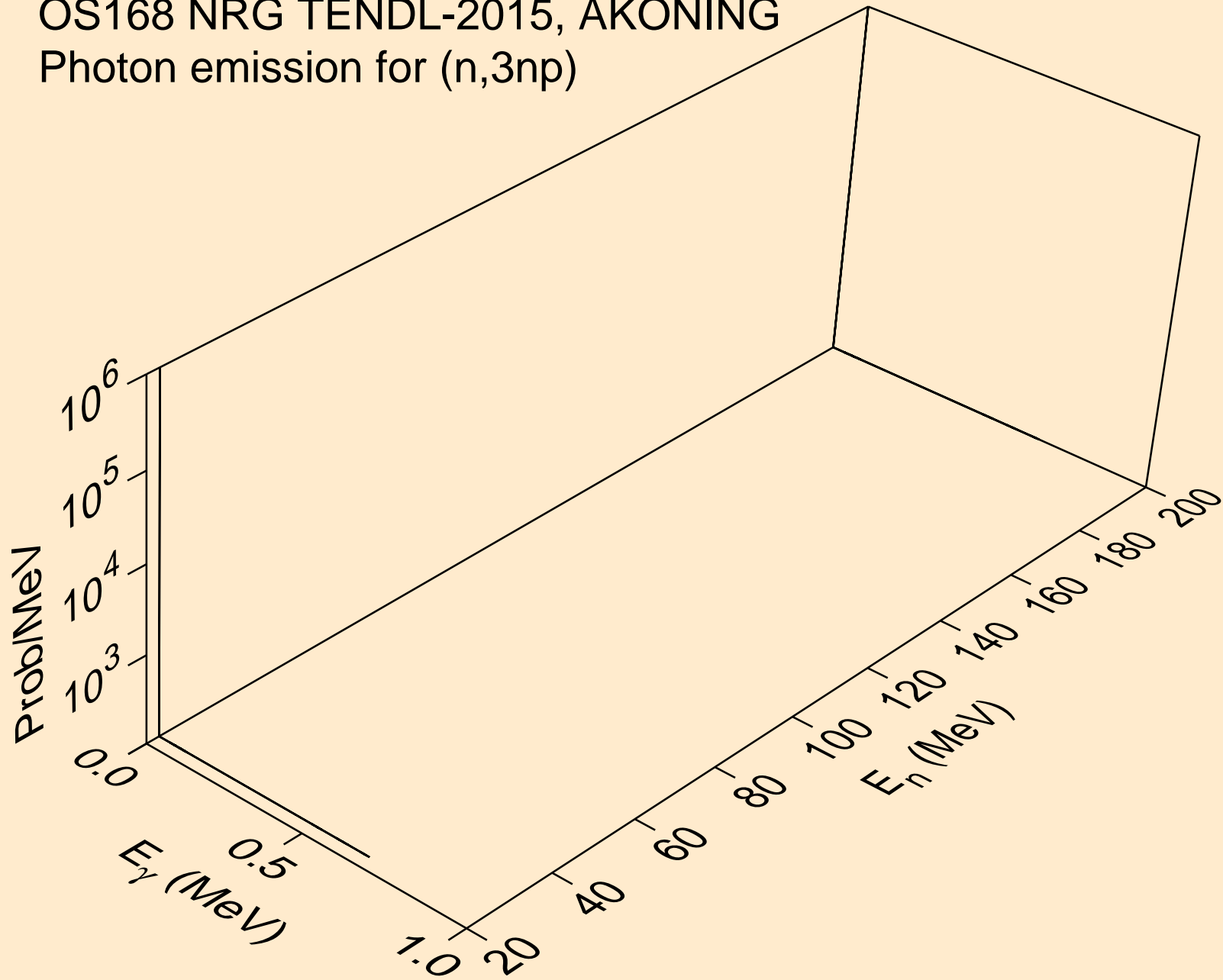

OS168 NRG TENDL-2015, AKONING
Photon emission for (n,2np)

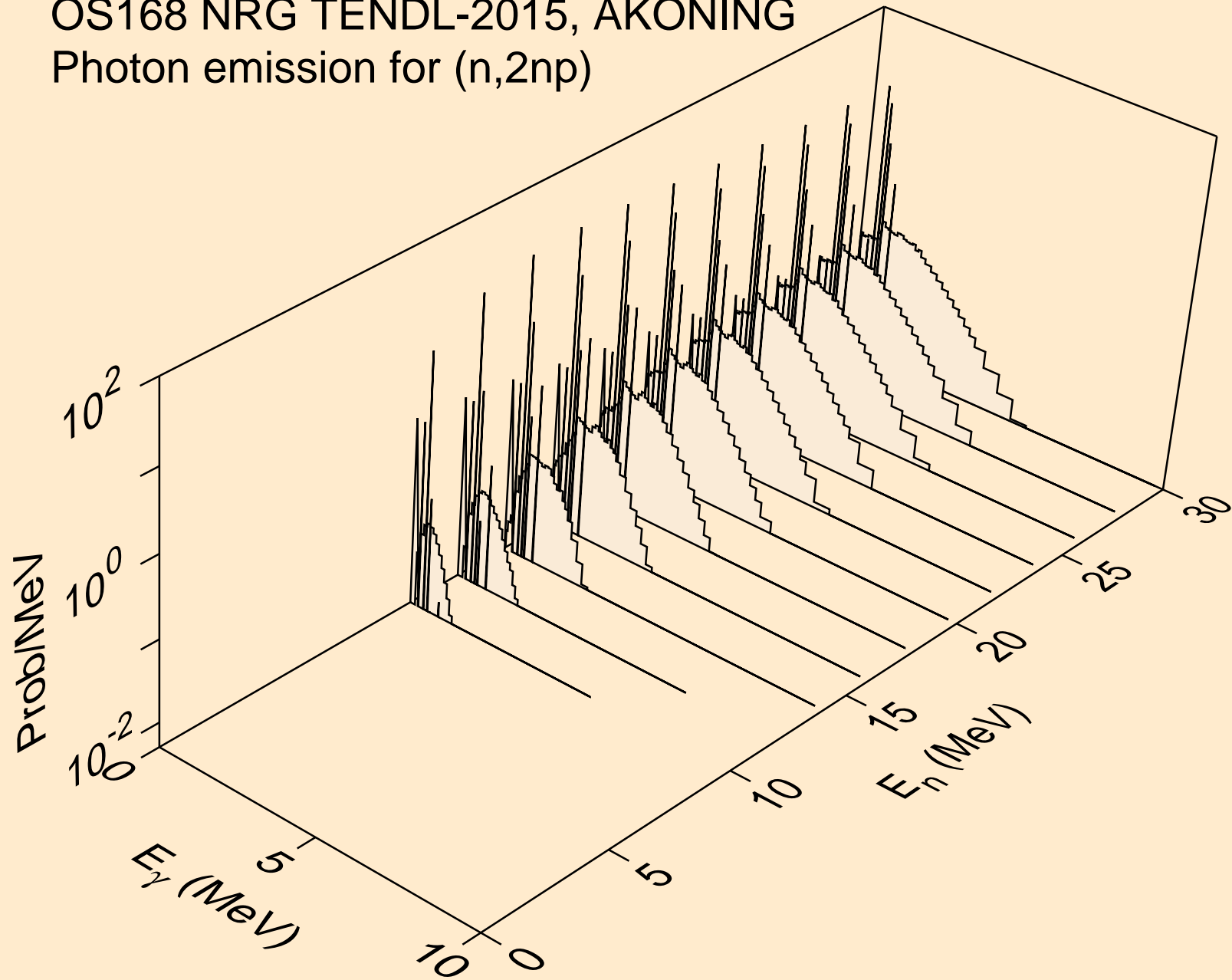

OS168 NRG TENDL-2015, AKONING
Photon emission for (n,npa)

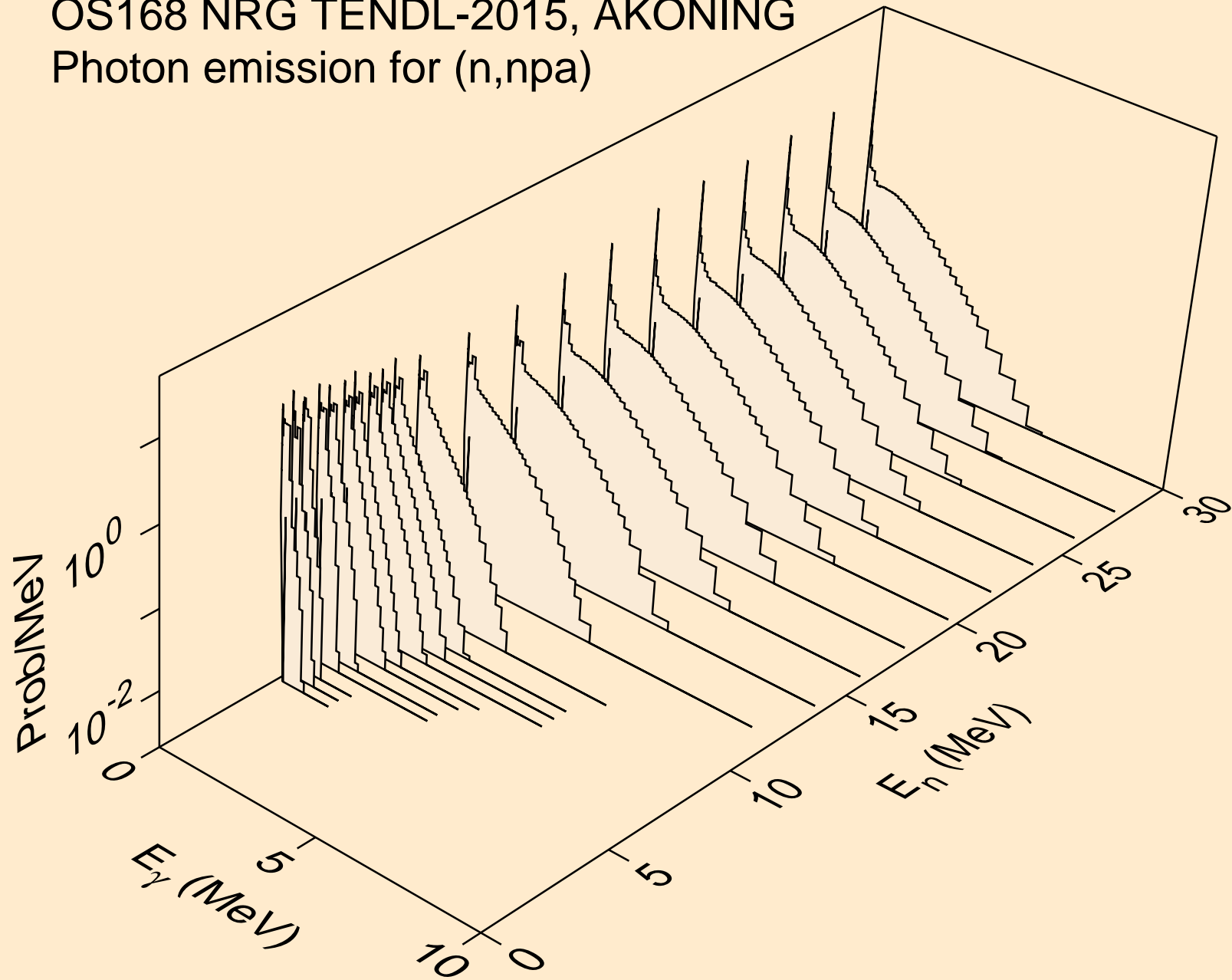

OS168 NRG TENDL-2015, AKONING
Photon emission for (n,n*c)

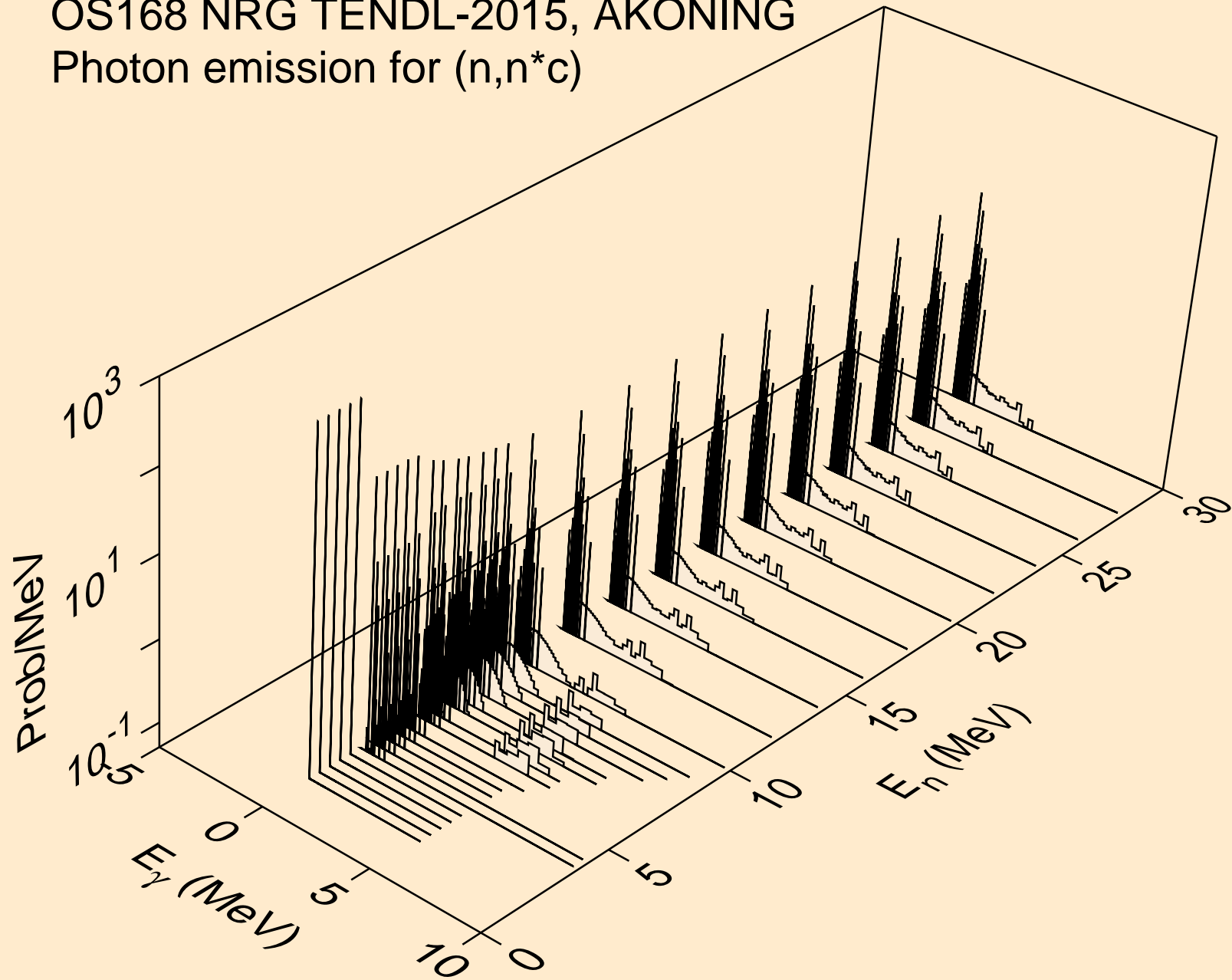

OS168 NRG TENDL-2015, AKONING
Photon emission for (n,gma)

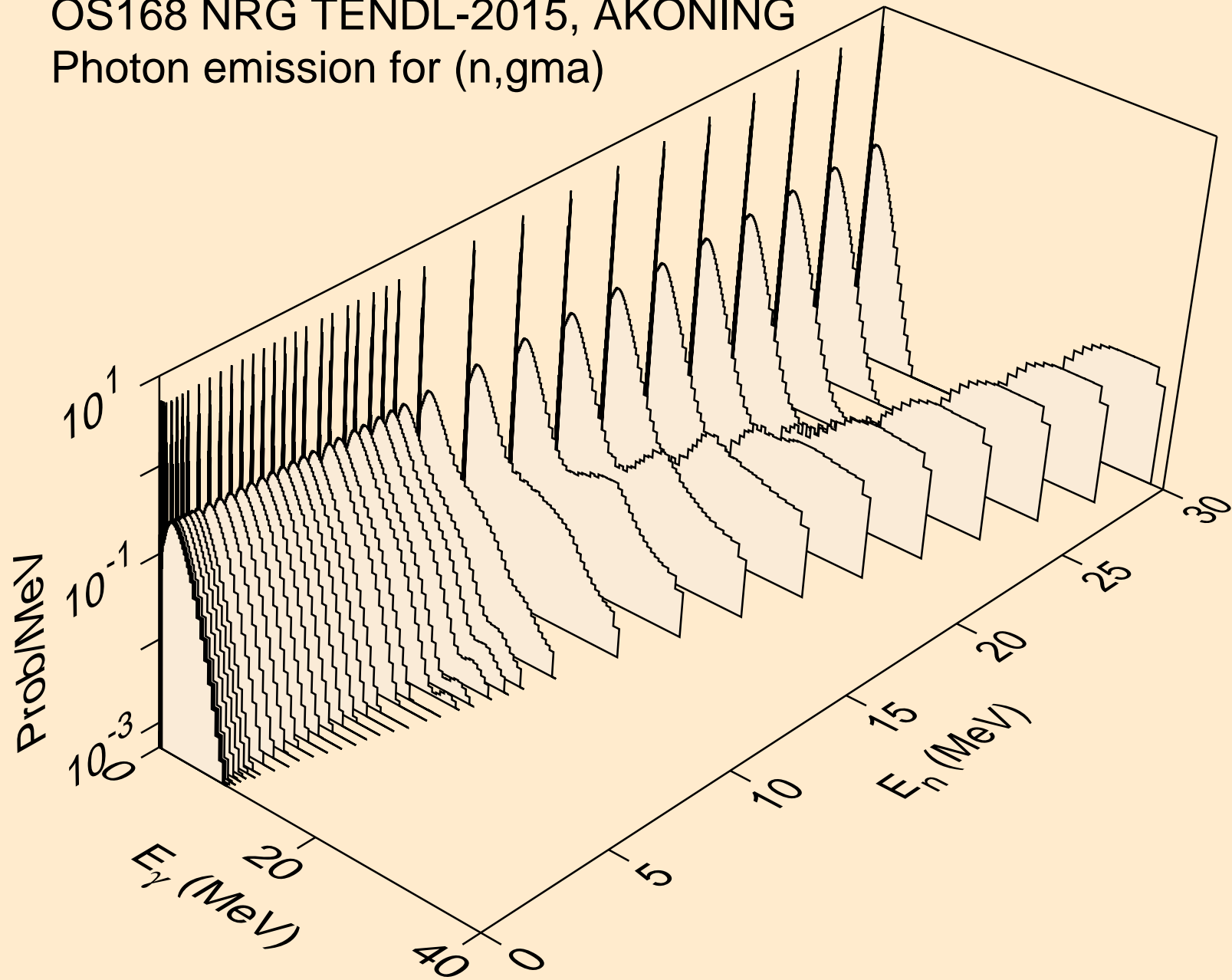

OS168 NRG TENDL-2015, AKONING
Photon emission for (n,p)

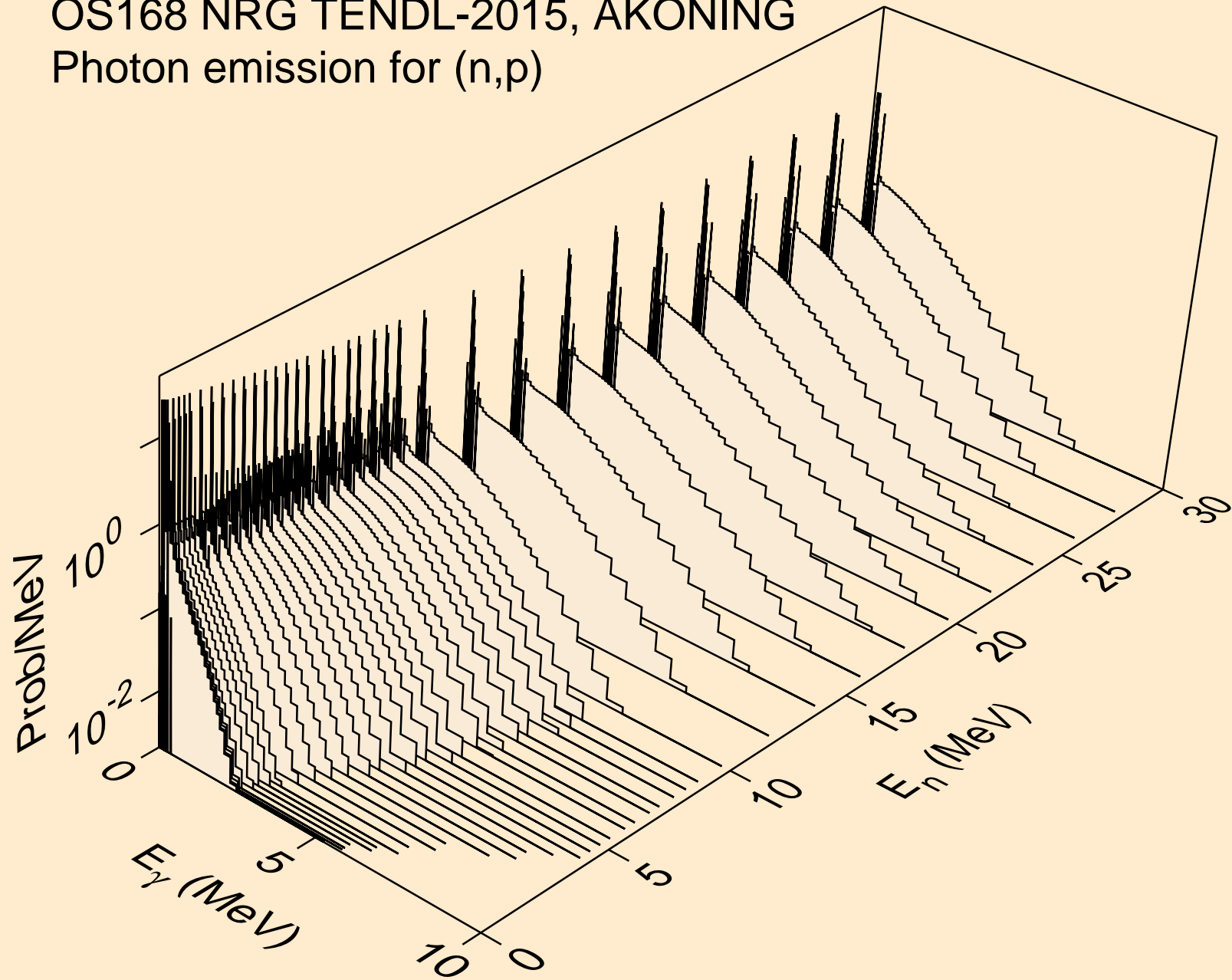

OS168 NRG TENDL-2015, AKONING
Photon emission for (n,d)

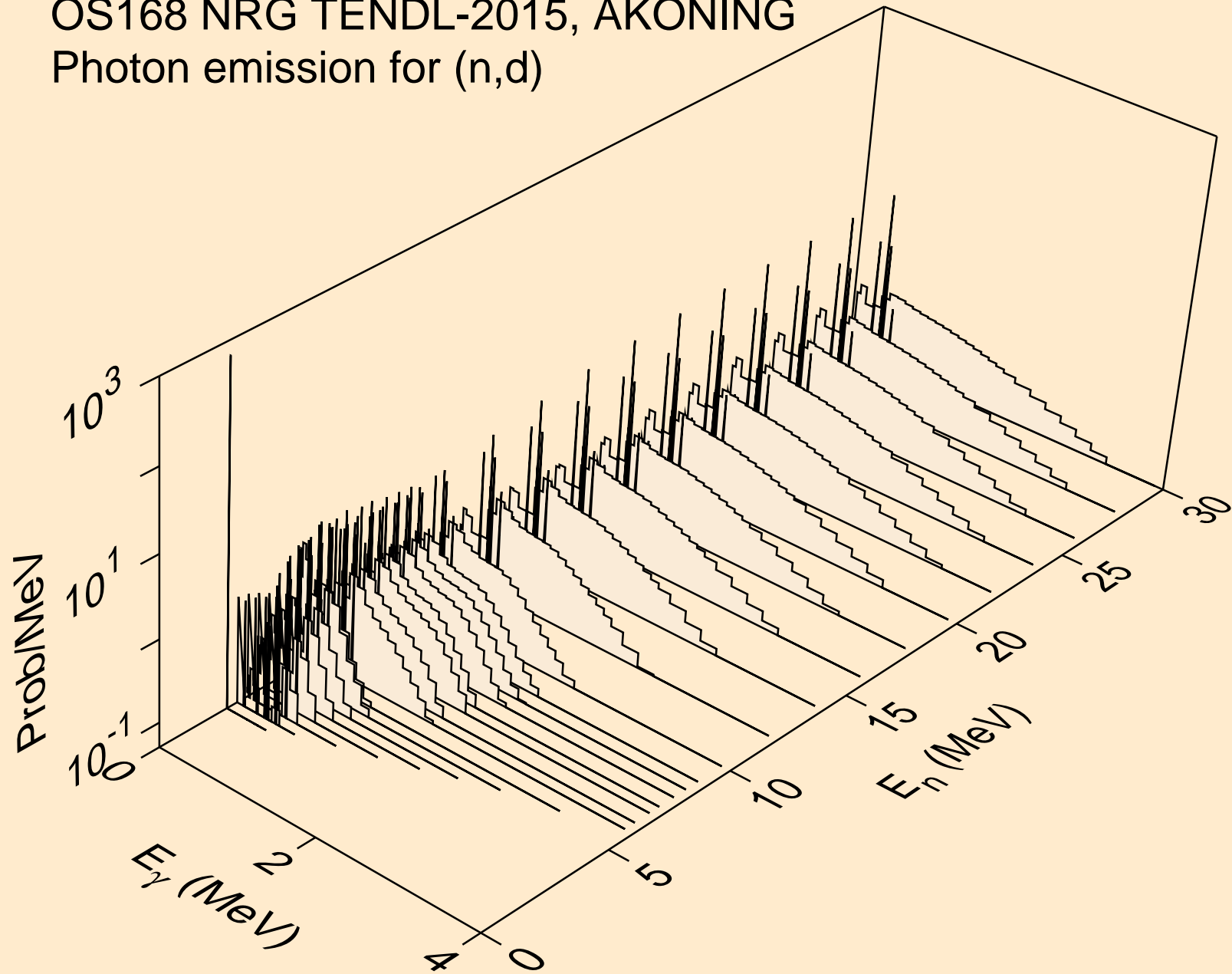

OS168 NRG TENDL-2015, AKONING
Photon emission for (n,t)

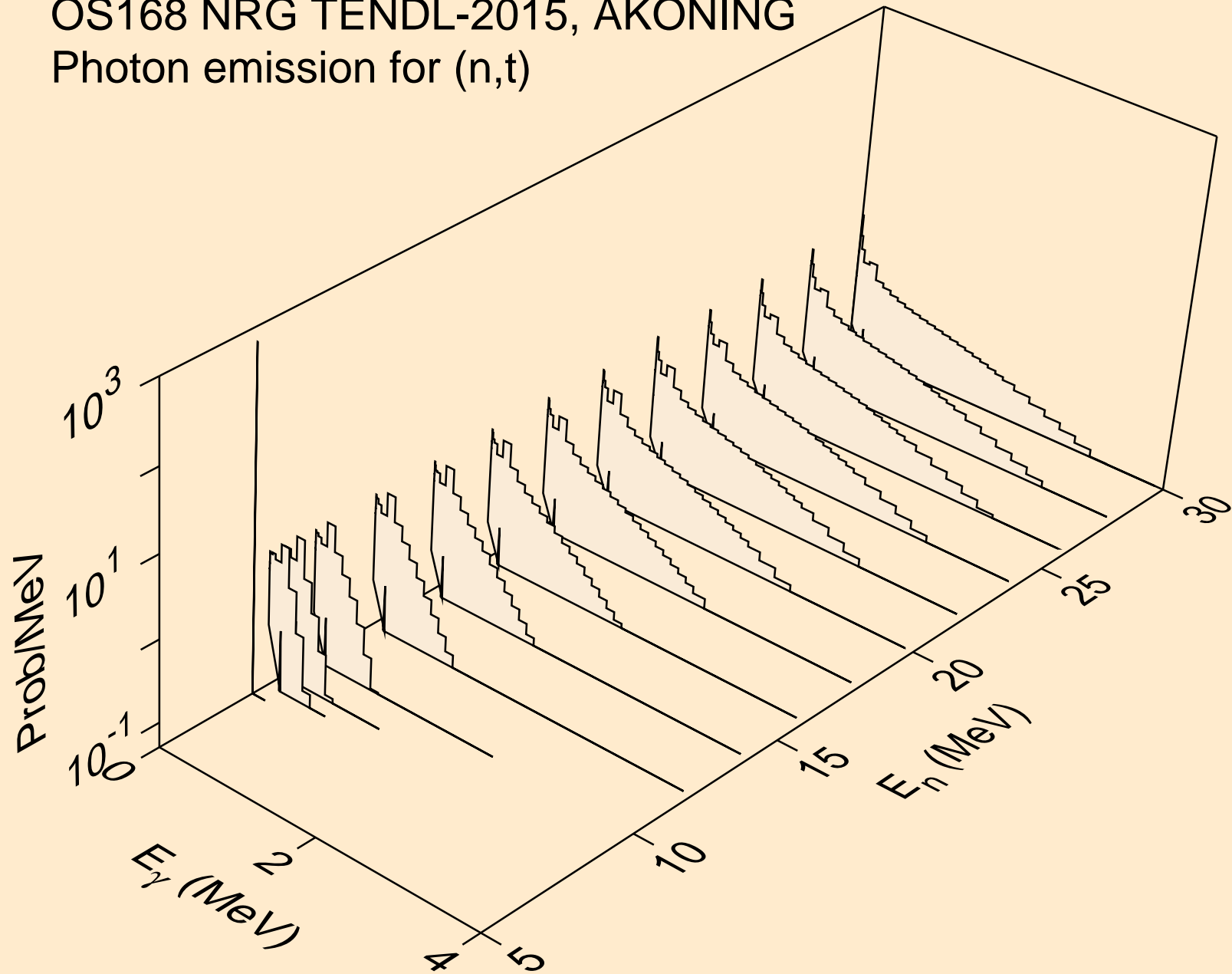

OS168 NRG TENDL-2015, AKONING
Photon emission for (n,he3)

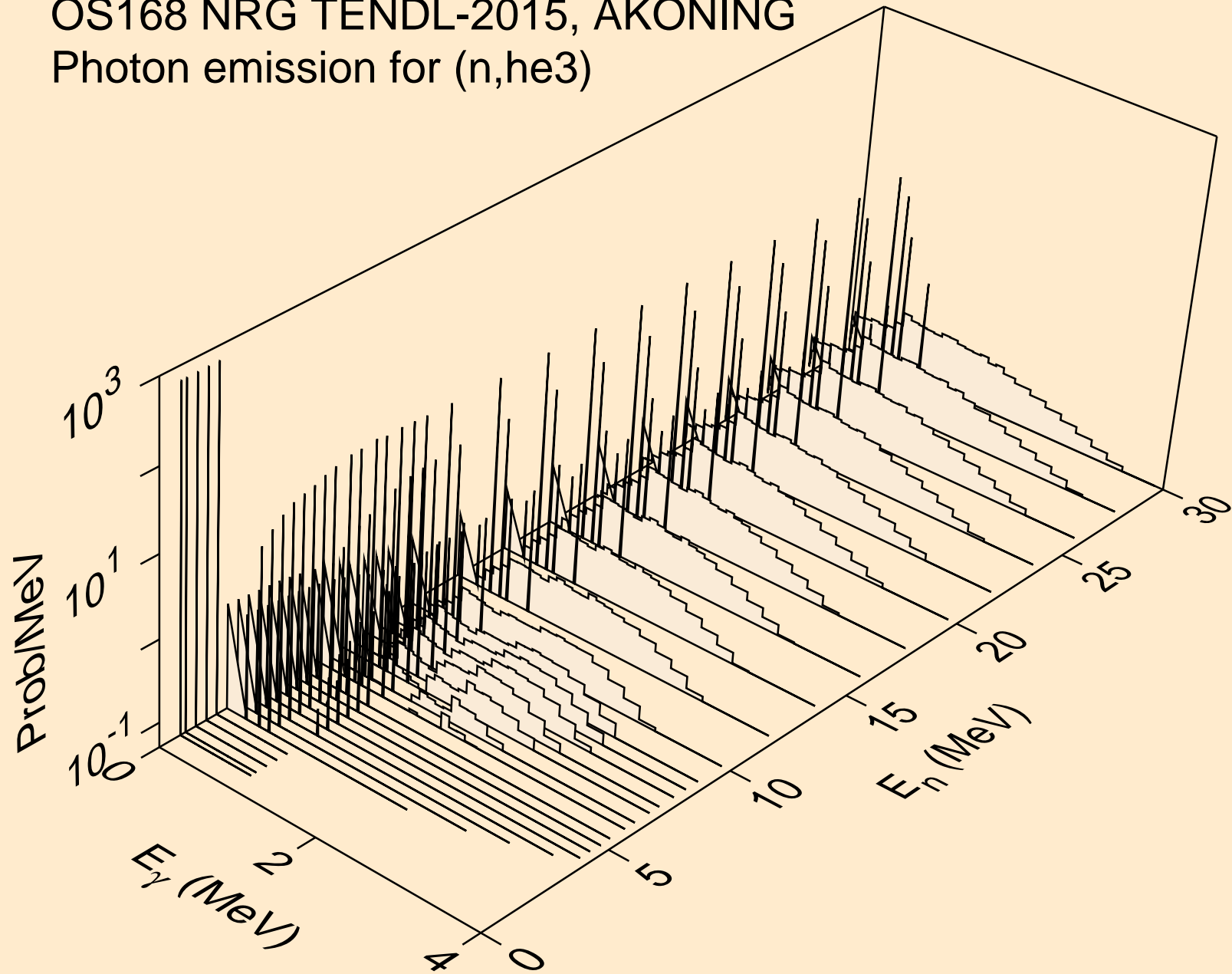

OS168 NRG TENDL-2015, AKONING
Photon emission for (n,a)

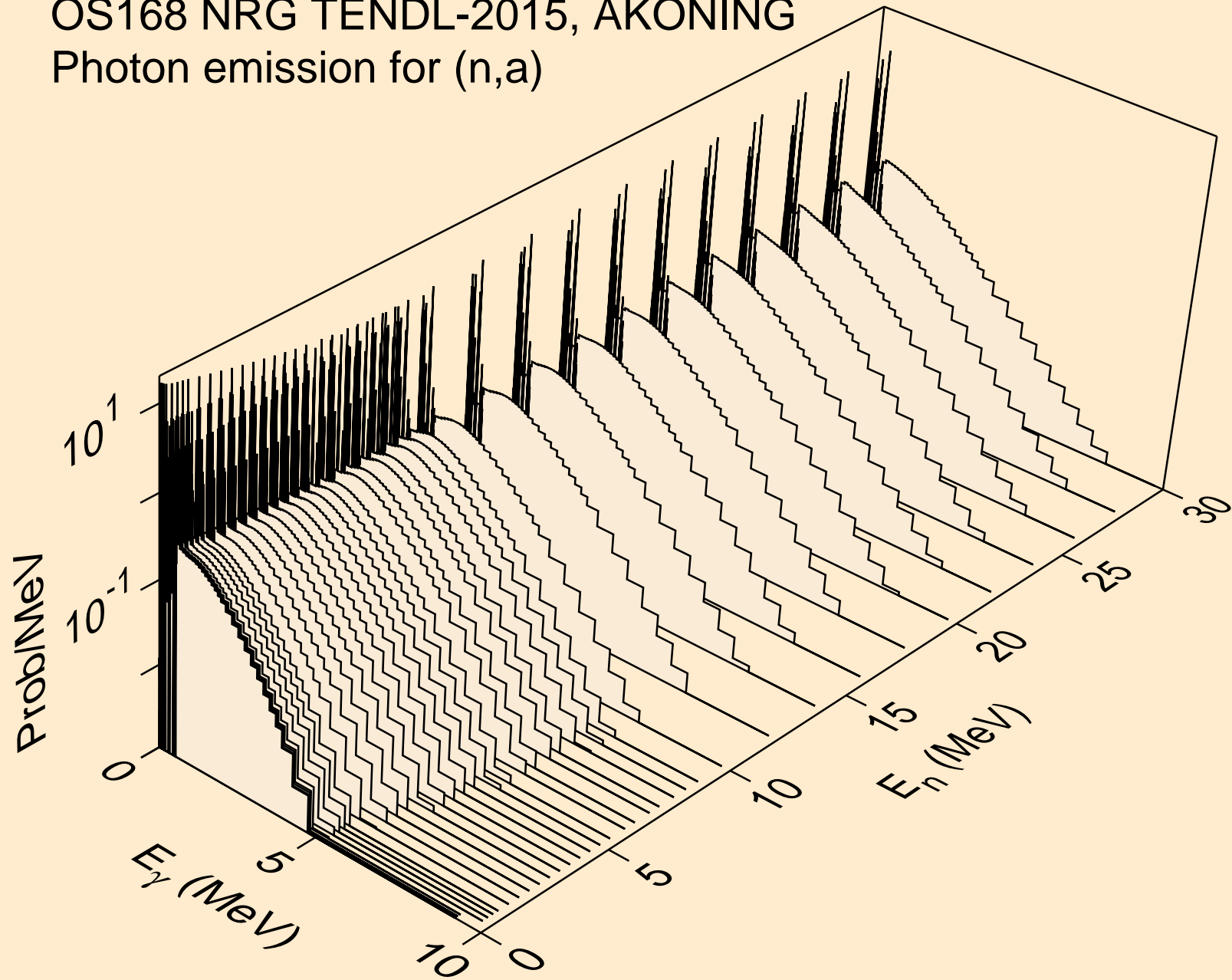

OS168 NRG TENDL-2015, AKONING
Photon emission for (n,2a)

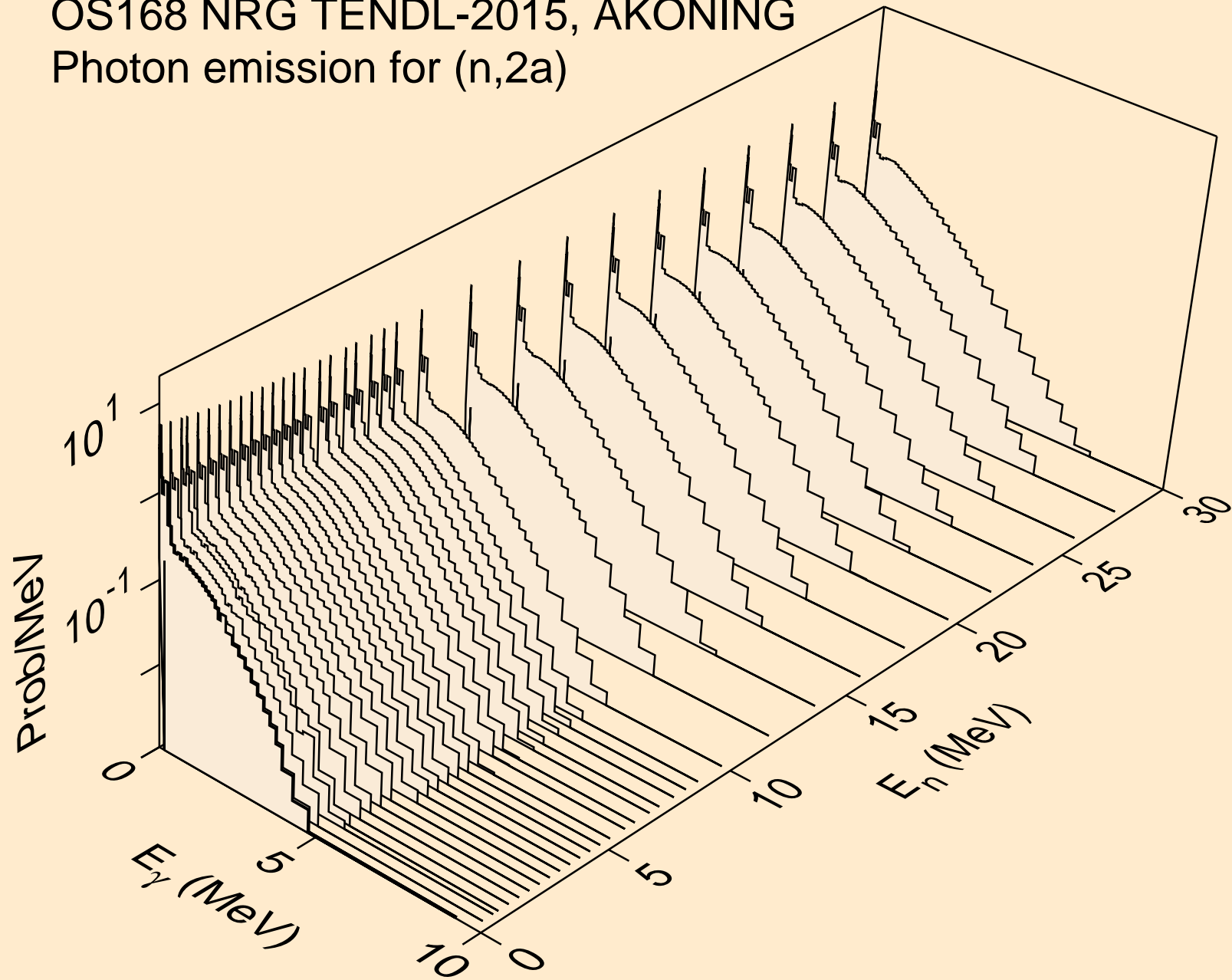

OS168 NRG TENDL-2015, AKONING
Photon emission for (n,3a)

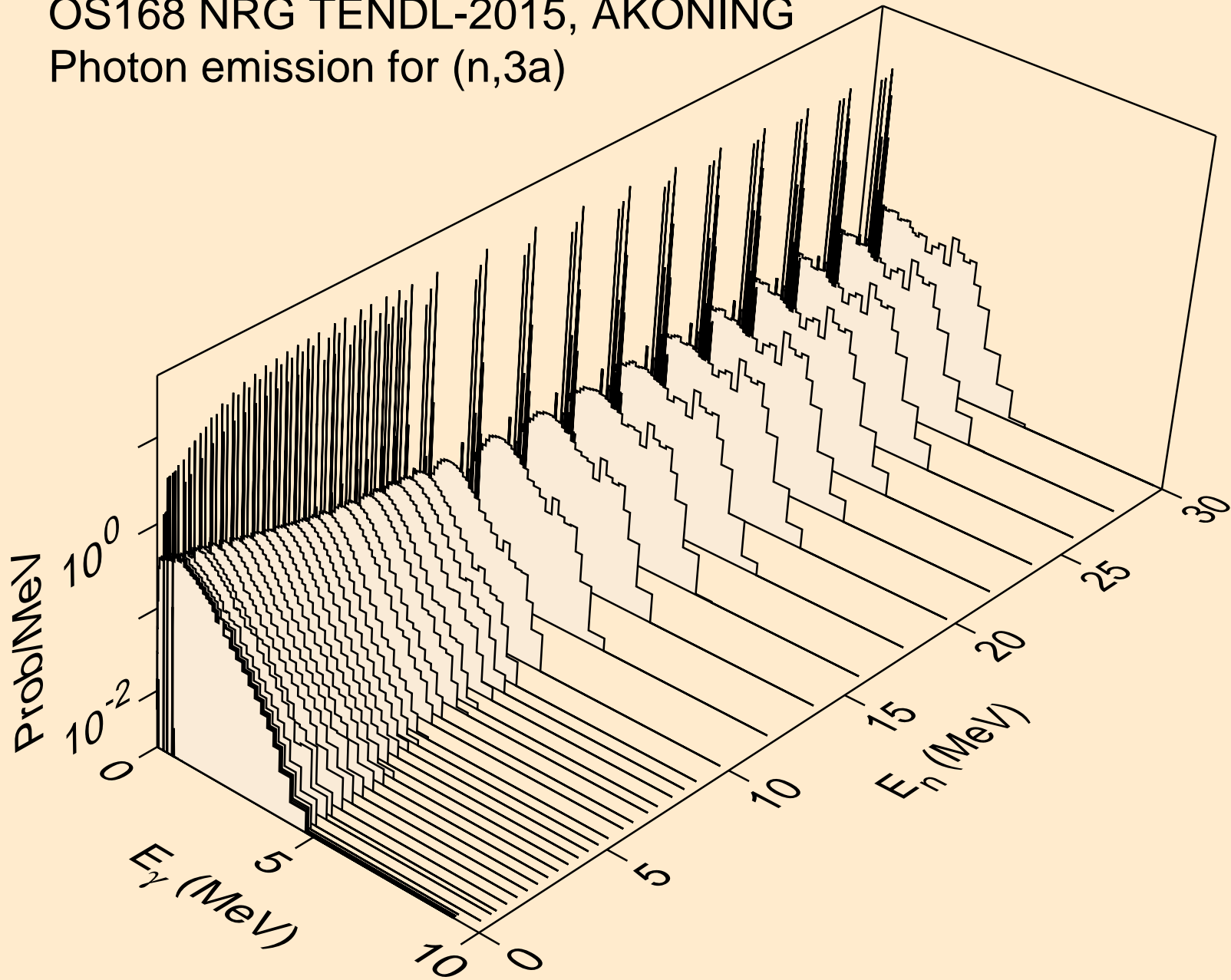

OS168 NRG TENDL-2015, AKONING
Photon emission for (n,2p)

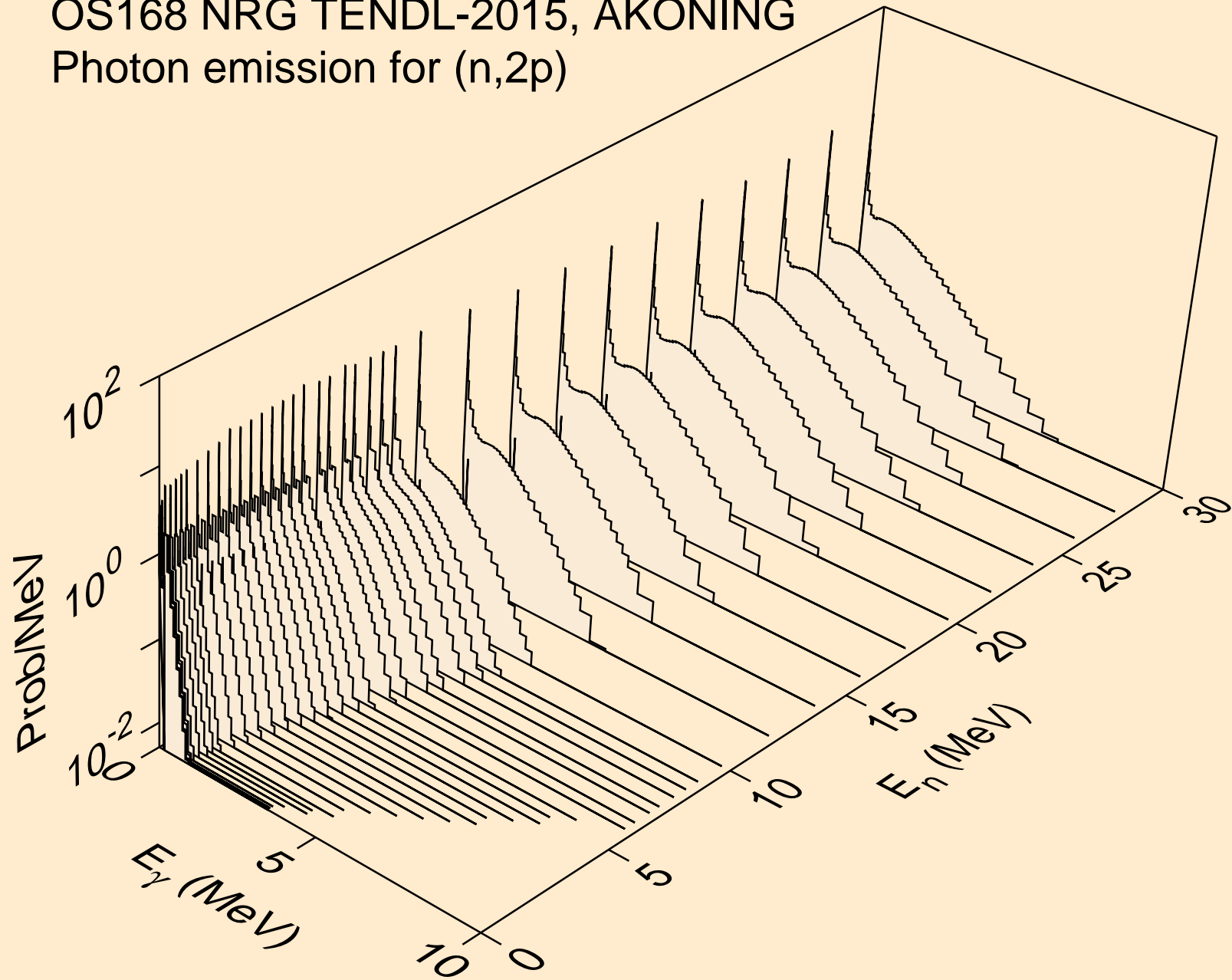

OS168 NRG TENDL-2015, AKONING
Photon emission for (n,p α)

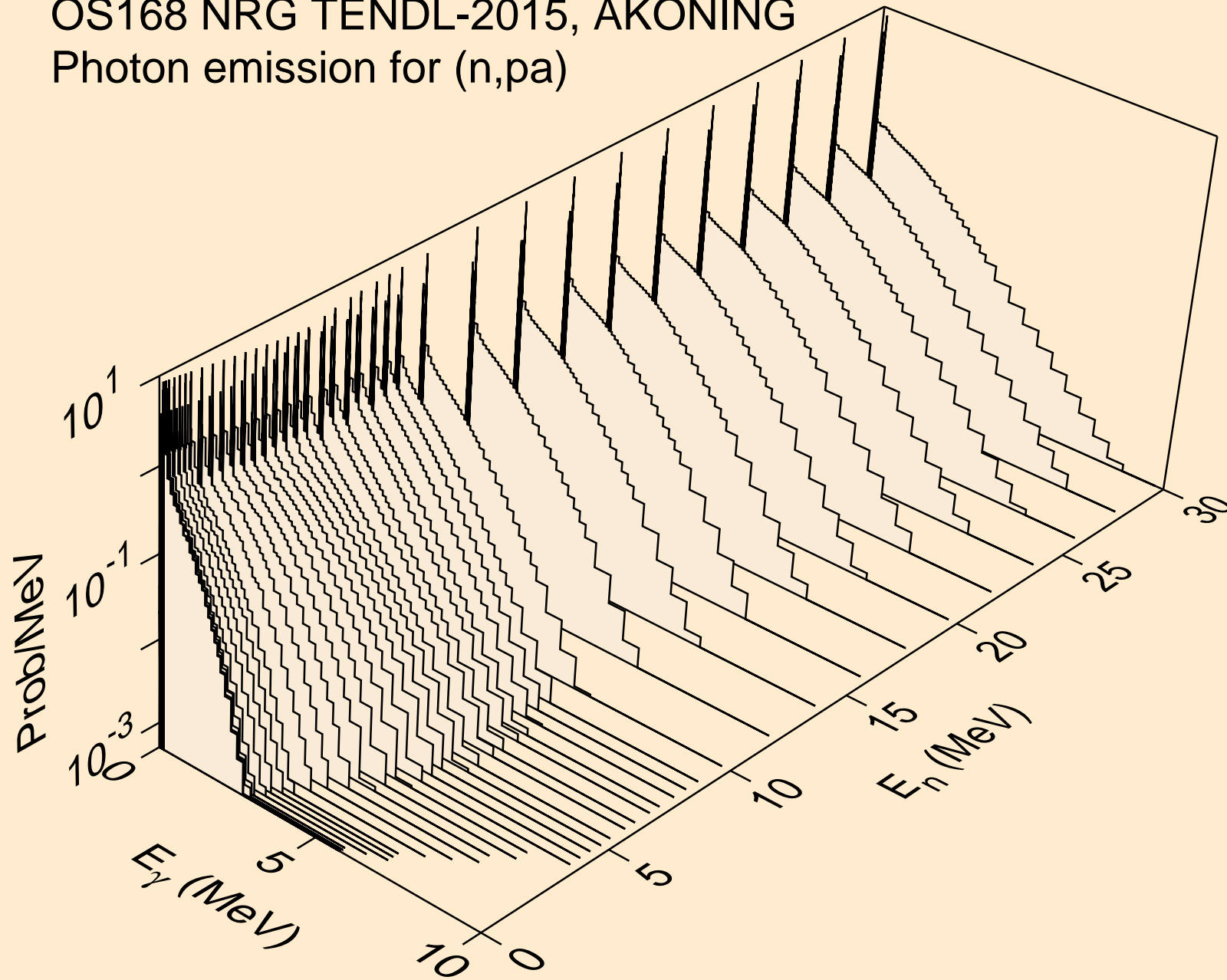

OS168 NRG TENDL-2015, AKONING
Photon emission for (n,t2a)

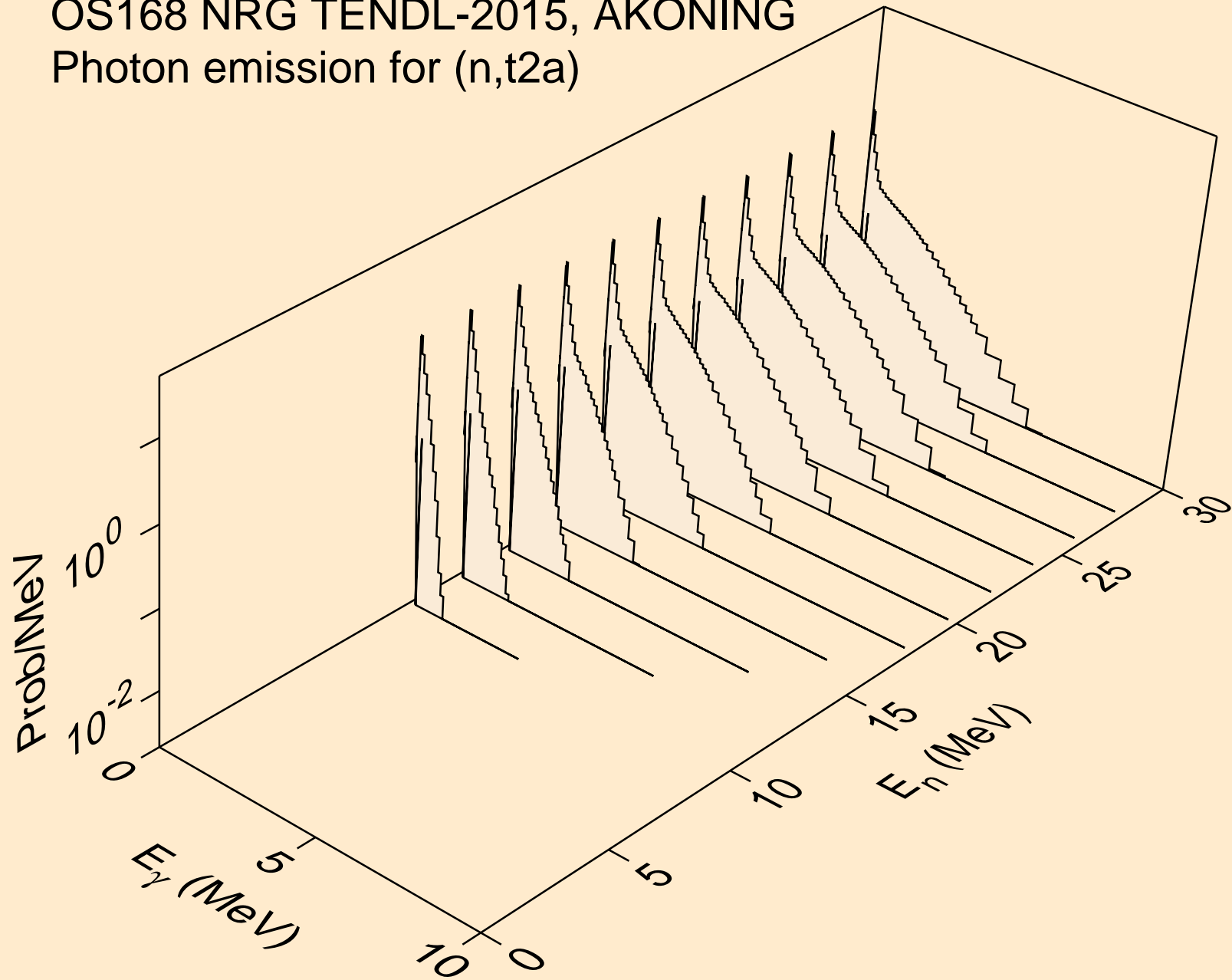

OS168 NRG TENDL-2015, AKONING
Photon emission for (n,d2a)

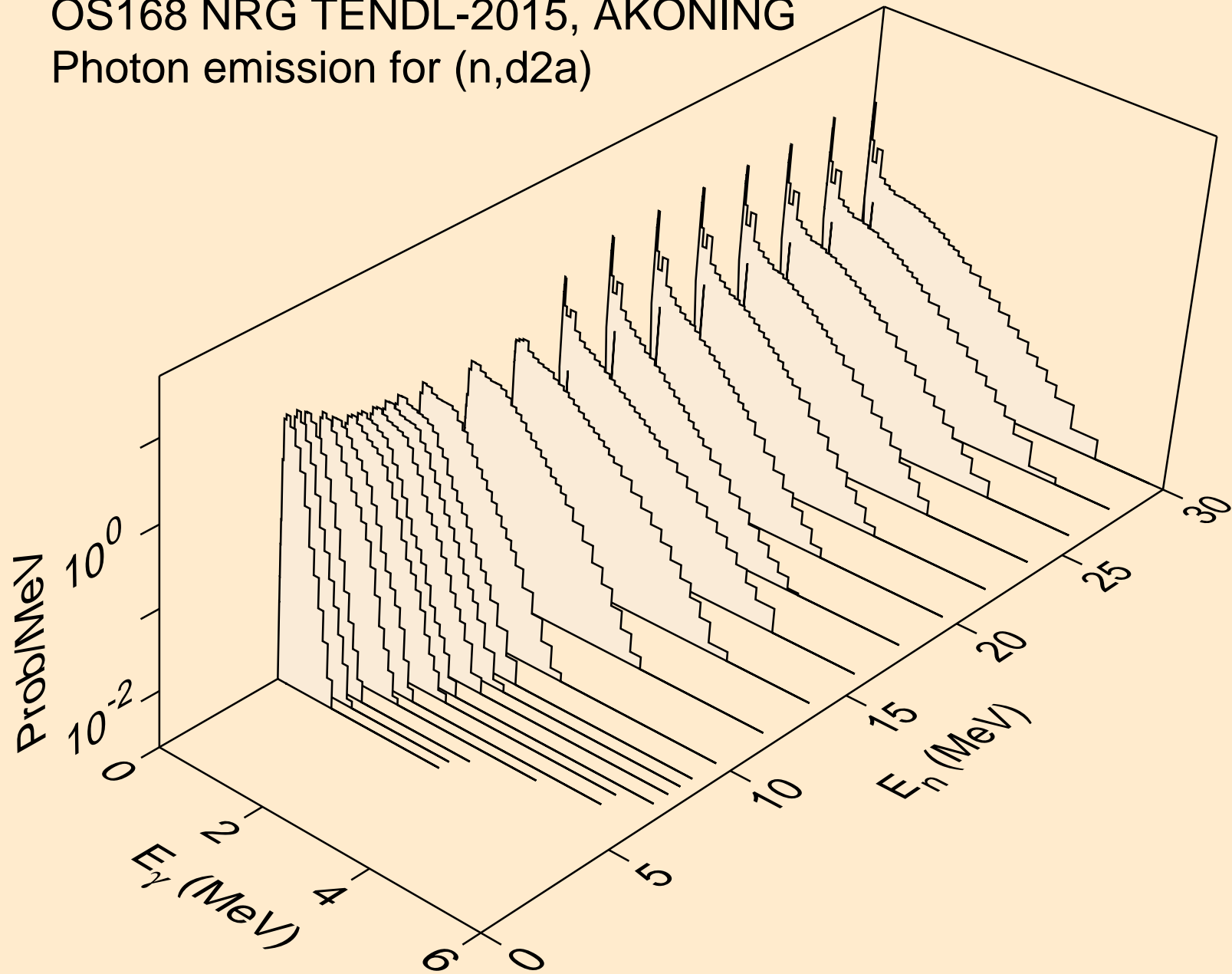

OS168 NRG TENDL-2015, AKONING
Photon emission for (n,pd)

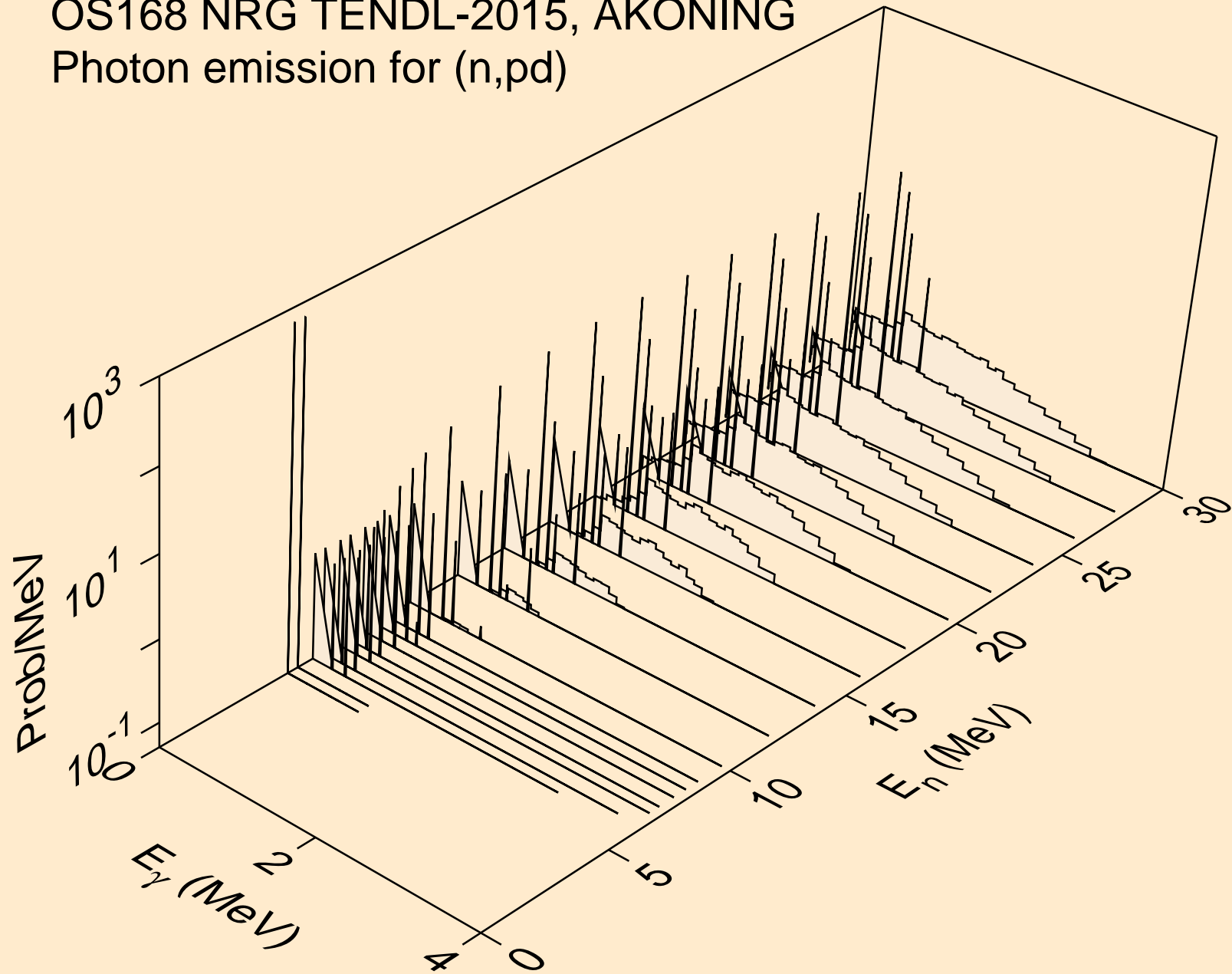

OS168 NRG TENDL-2015, AKONING
Photon emission for (n,pt)

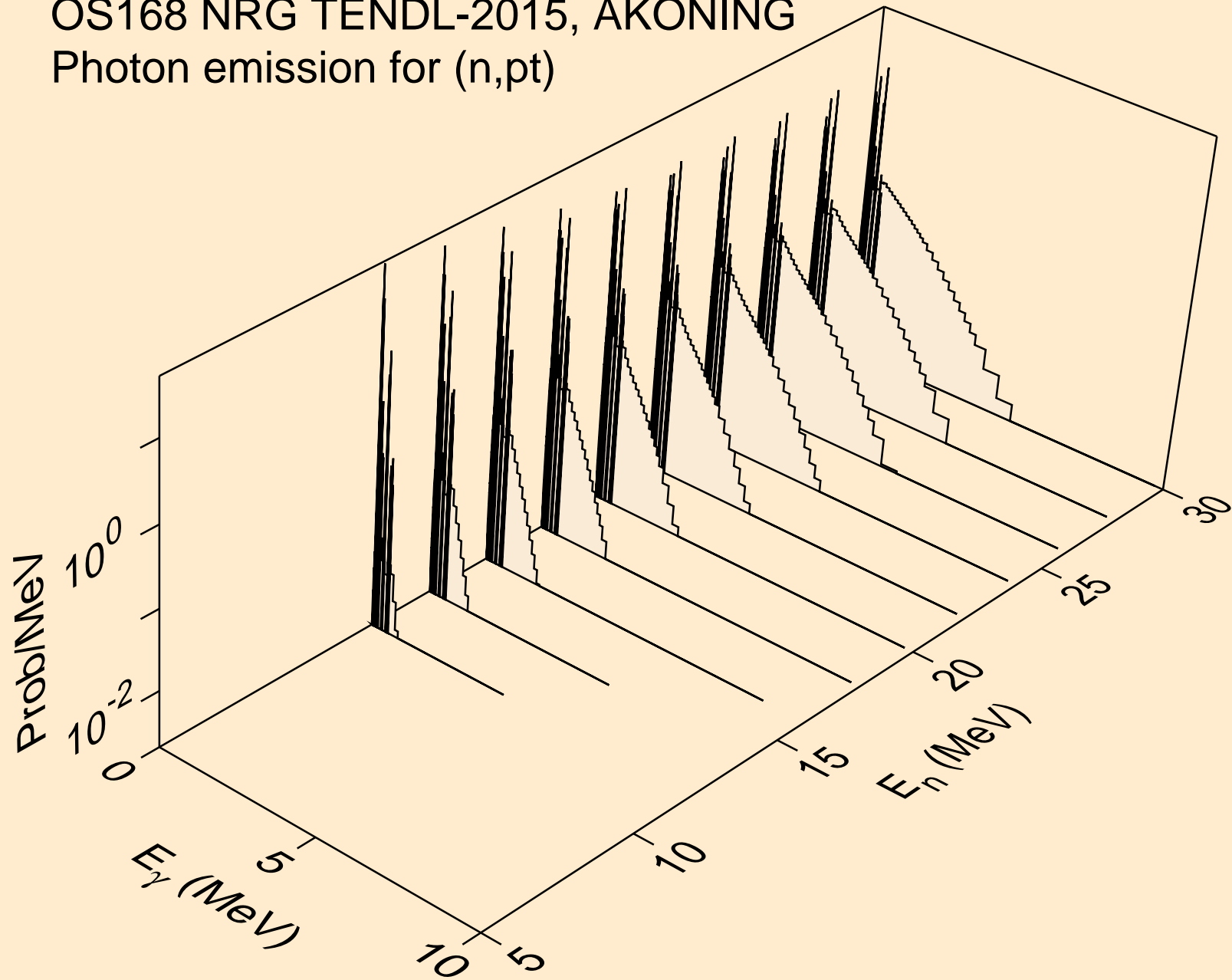

OS168 NRG TENDL-2015, AKONING
Photon emission for (n,da)

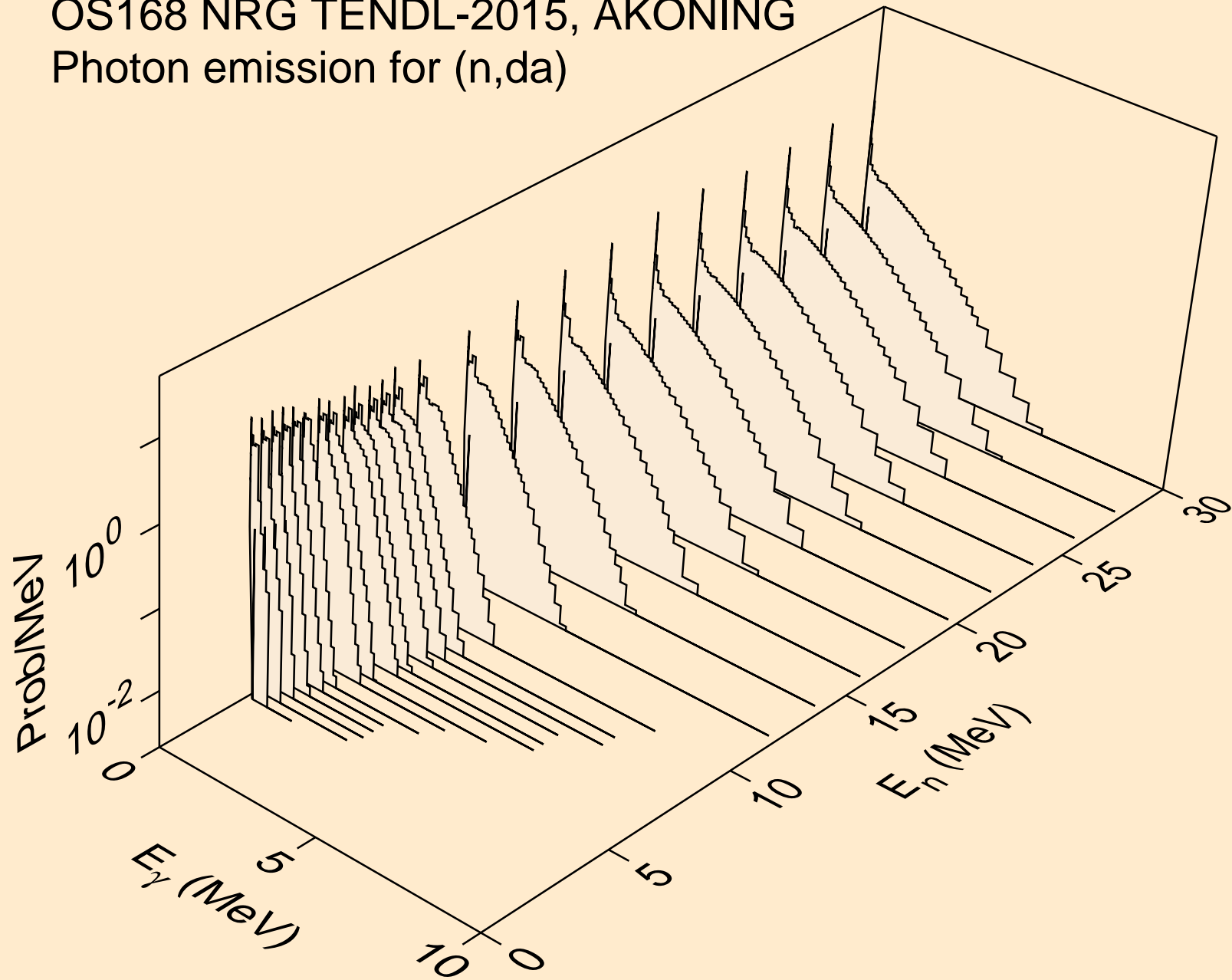

OS168 NRG TENDL-2015, AKONING
thermal capture photon spectrum

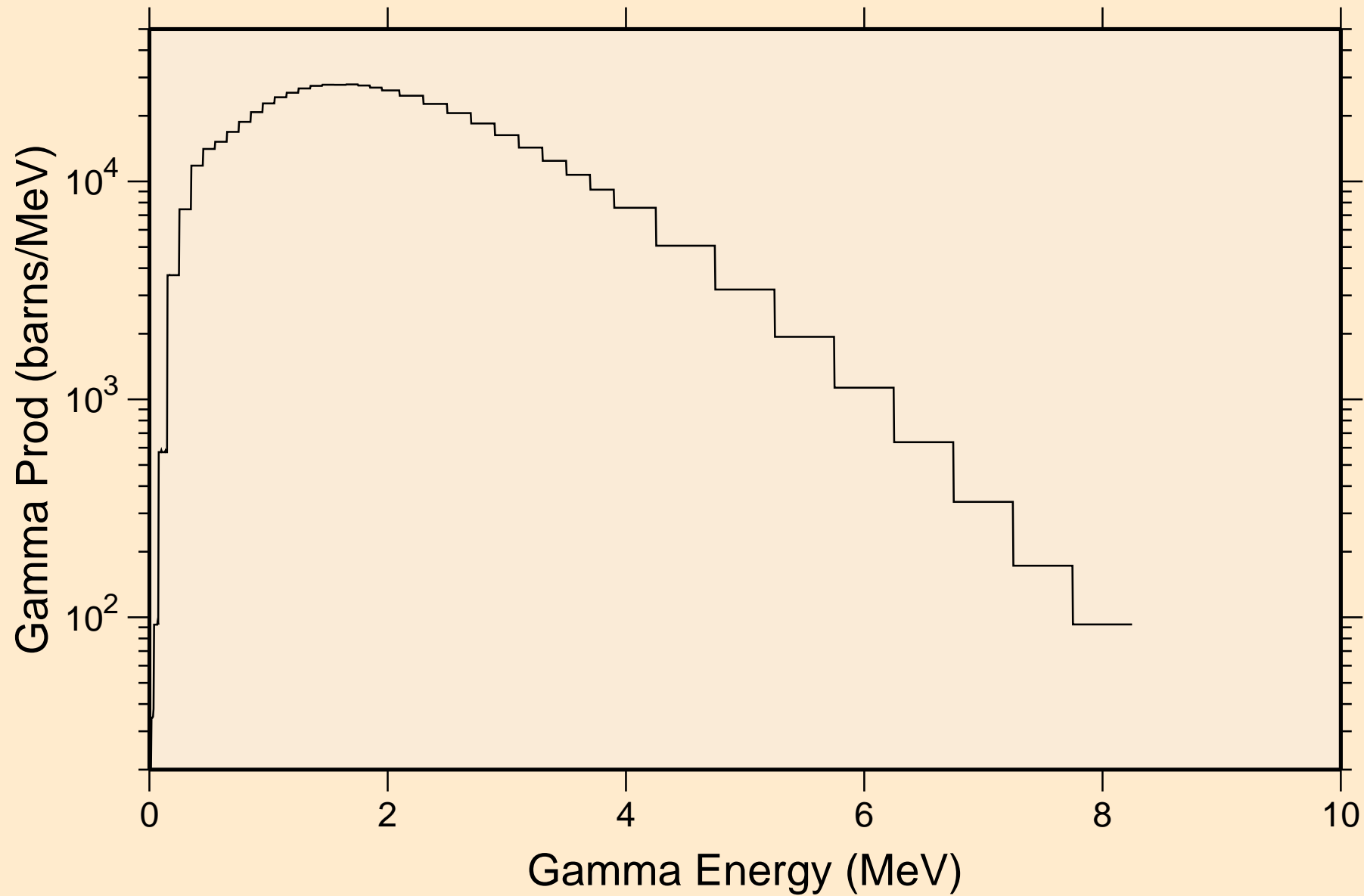

OS168 NRG TENDL-2015, AKONING
14 MeV photon spectrum

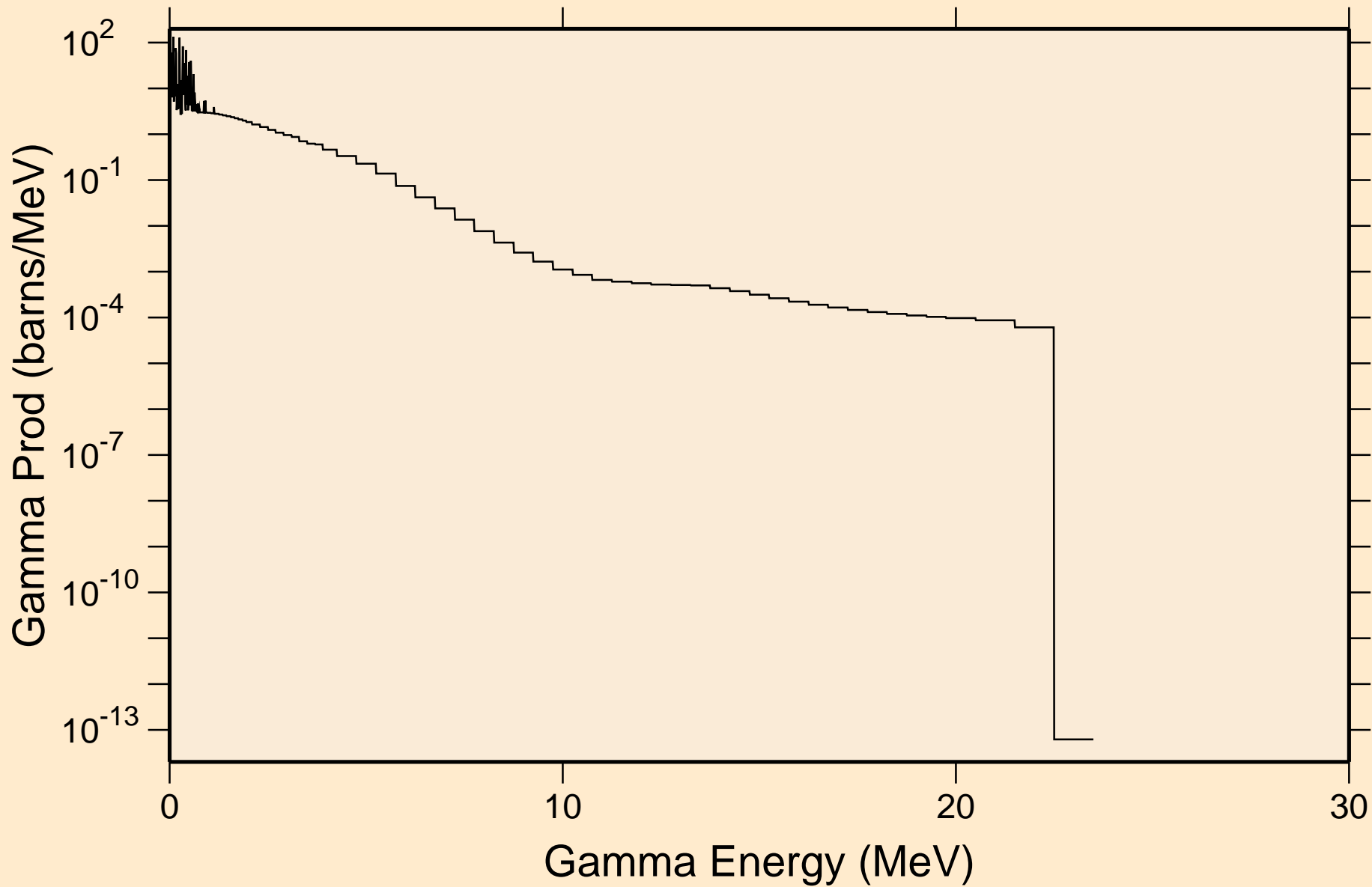

OS168 NRG TENDL-2015, AKONING

Particle heating contributions

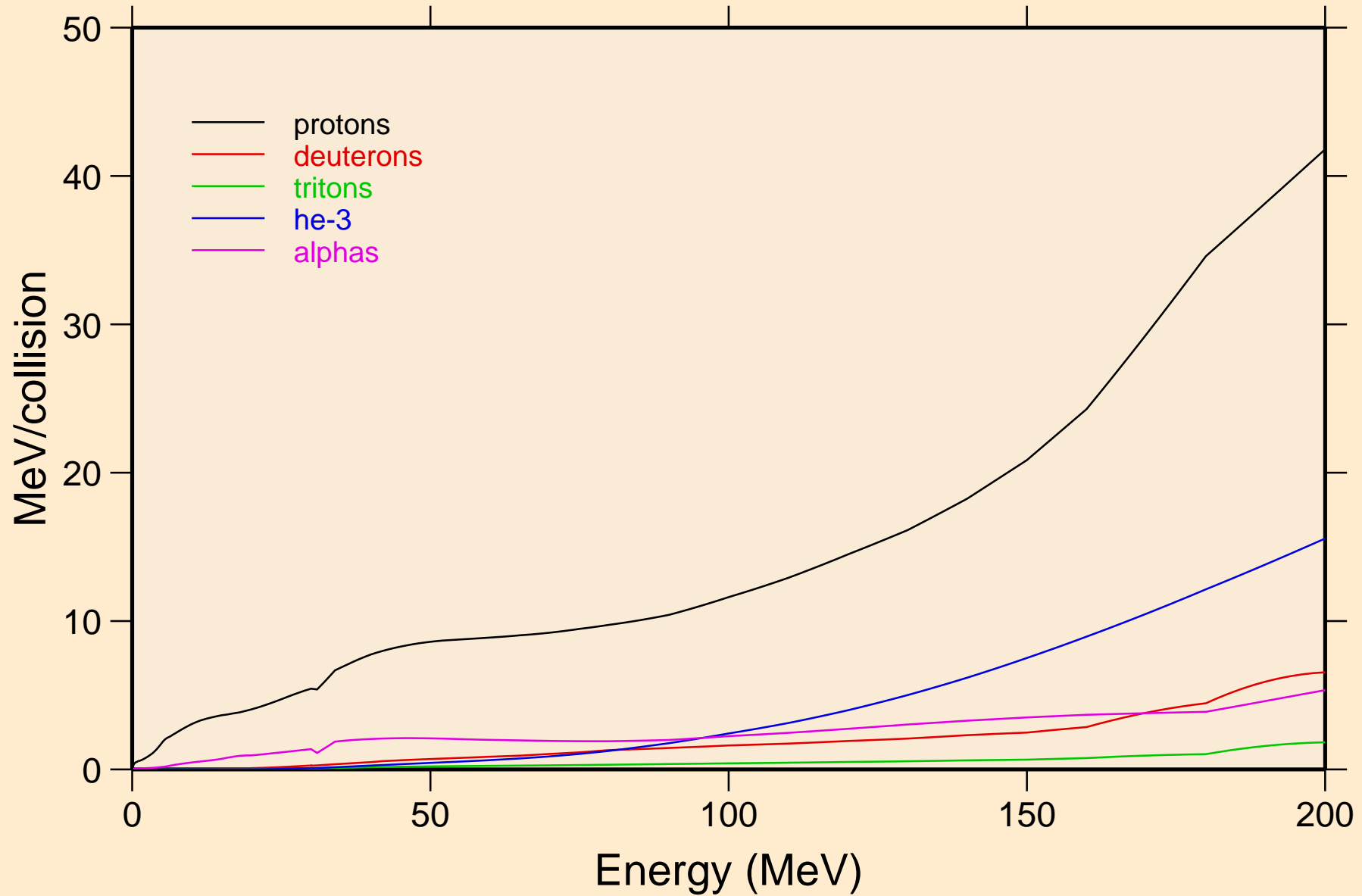

OS168 NRG TENDL-2015, AKONING

Recoil Heating

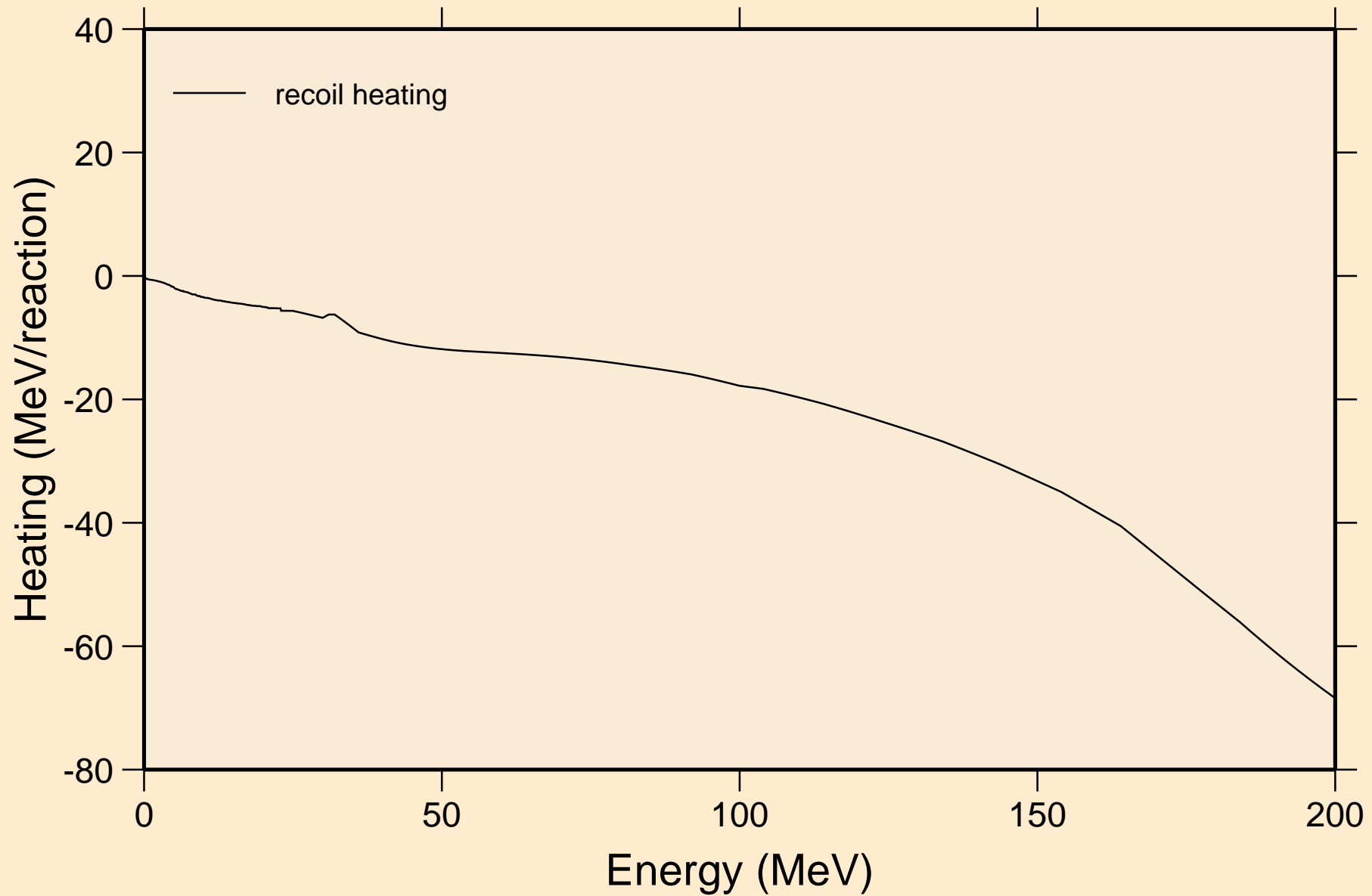

OS168 NRG TENDL-2015, AKONING

Particle production cross sections

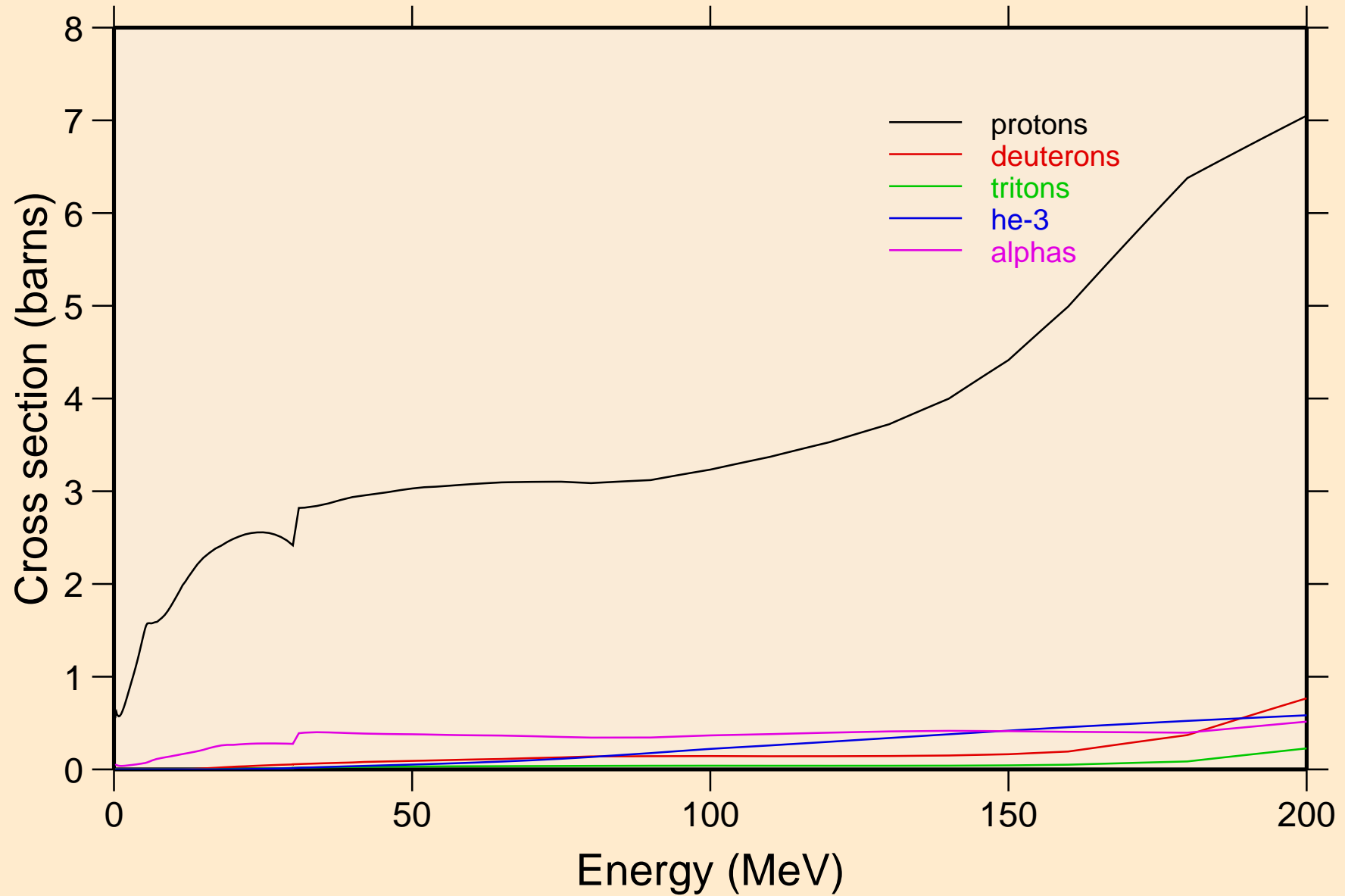

OS168 NRG TENDL-2015, AKONING
protons from (n,x)

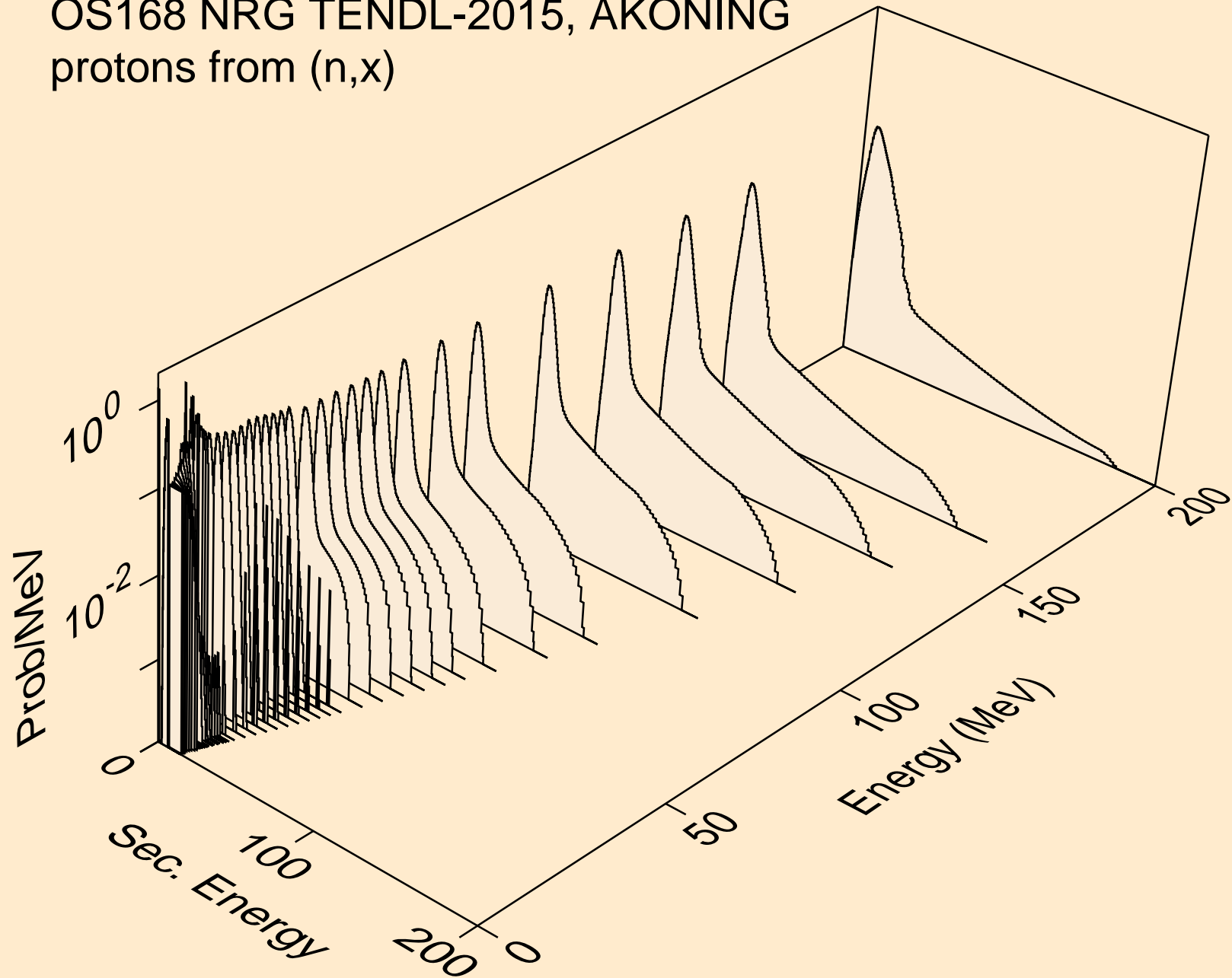

OS168 NRG TENDL-2015, AKONING
protons from (n,n*)p

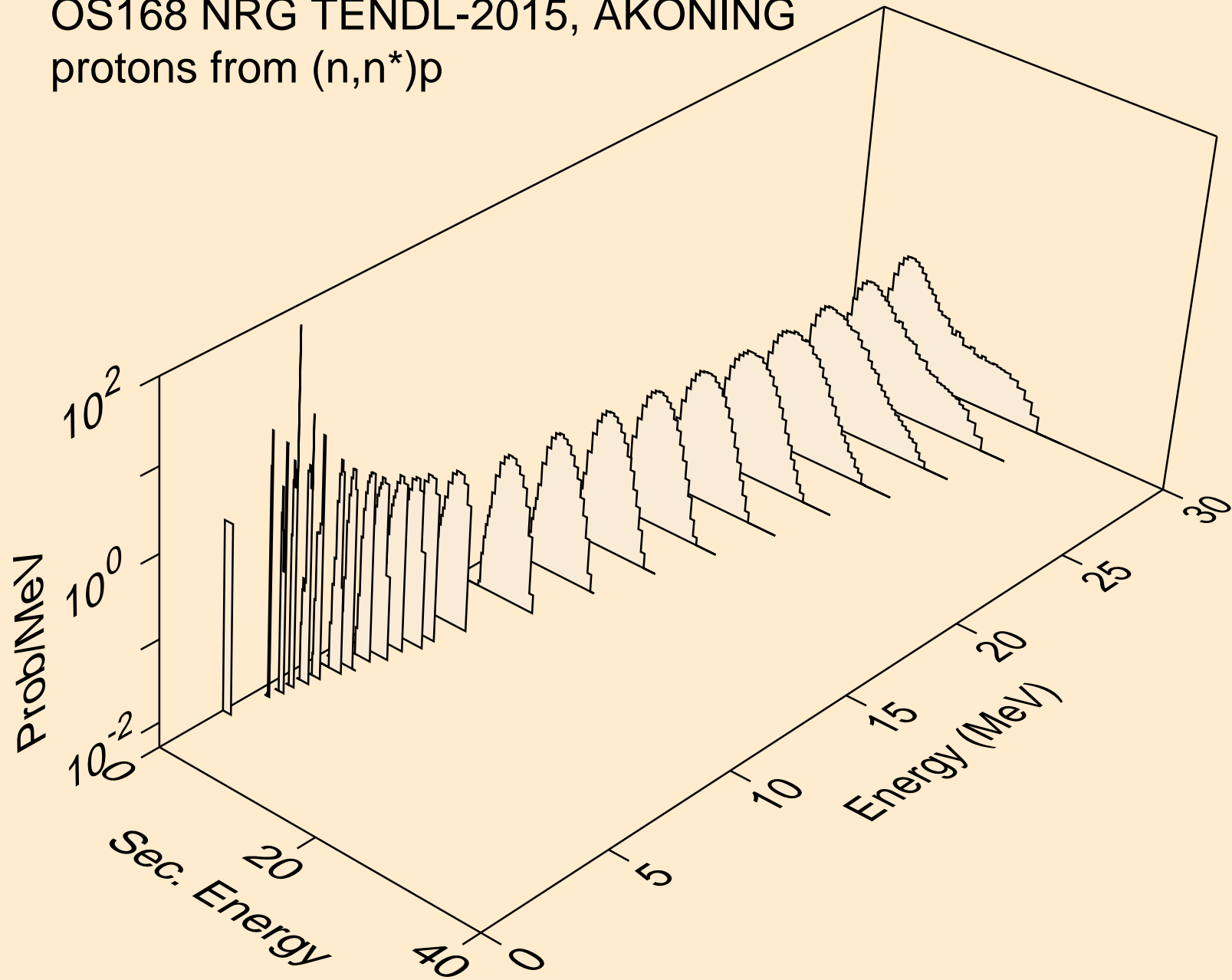

OS168 NRG TENDL-2015, AKONING
protons from (n,2np)

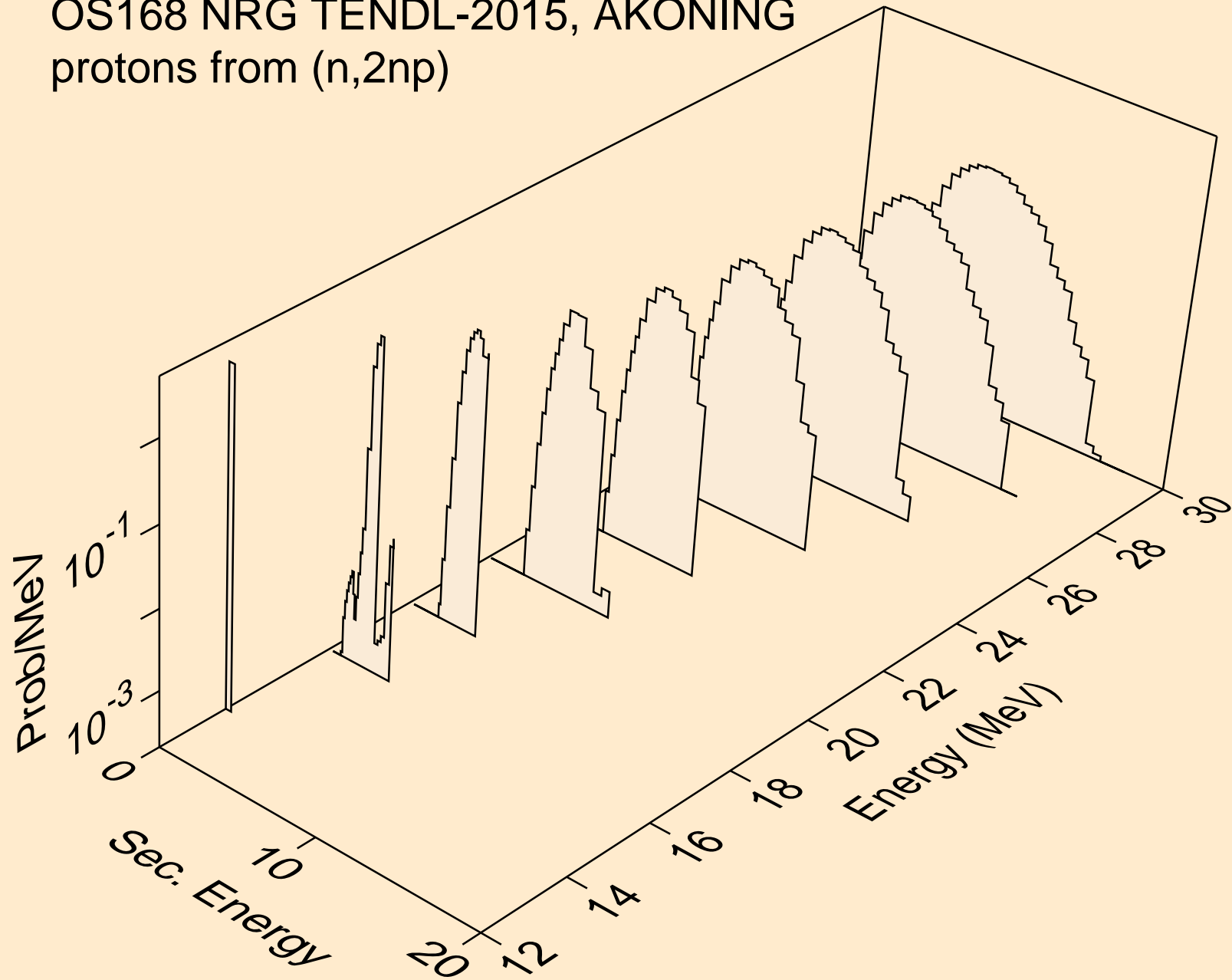

OS168 NRG TENDL-2015, AKONING
protons from (n,3np)

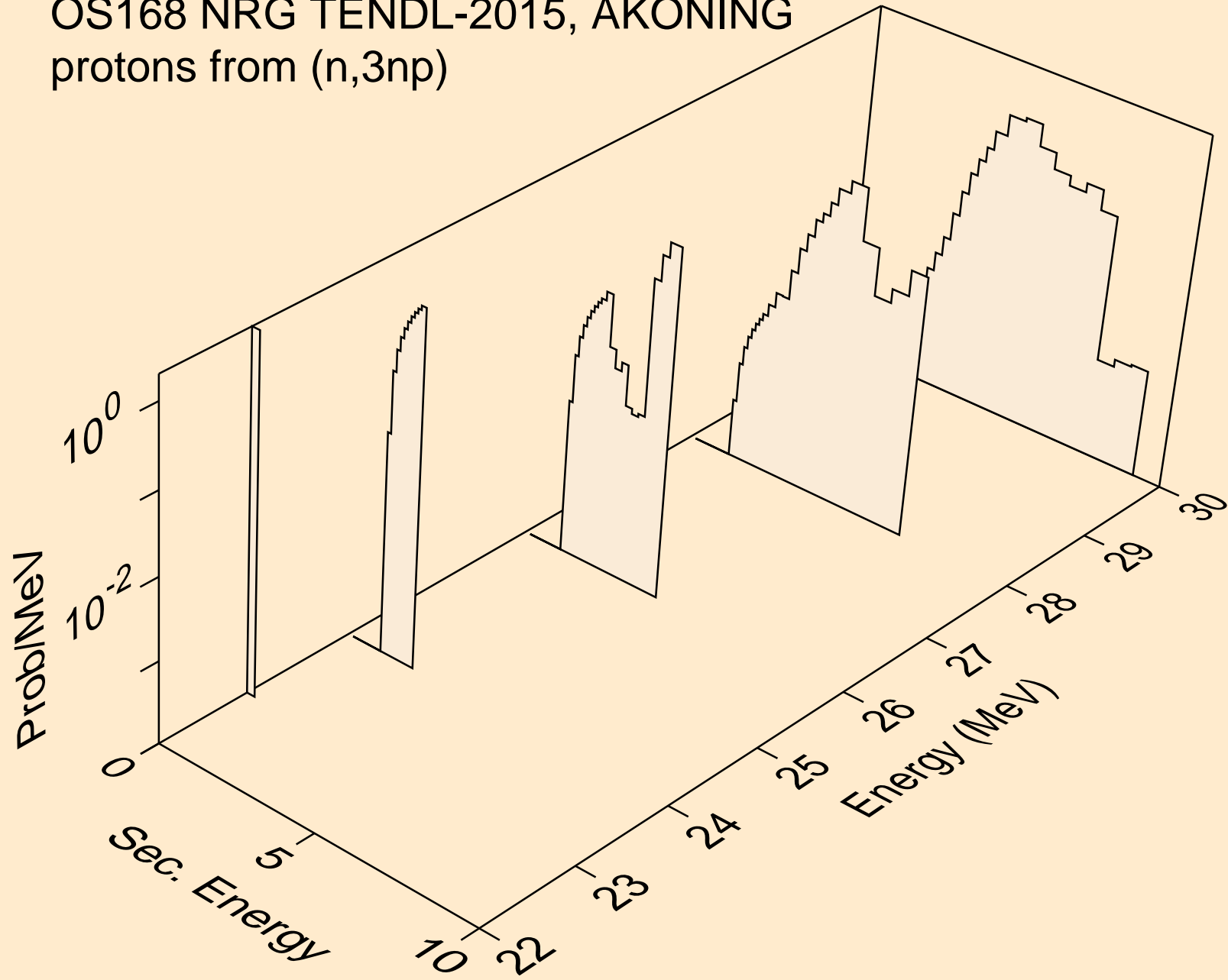

OS168 NRG TENDL-2015, AKONING
protons from (n,2np)

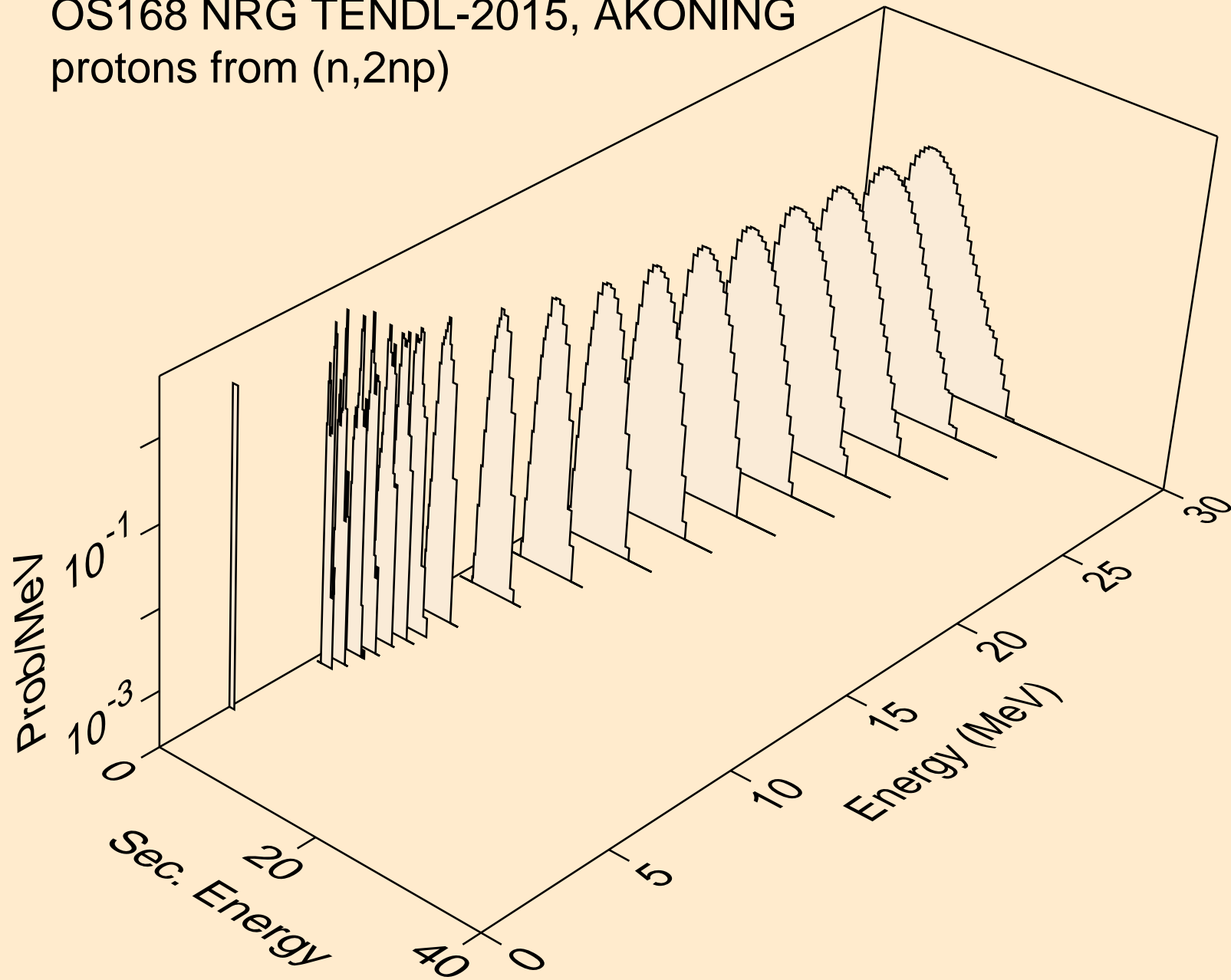

OS168 NRG TENDL-2015, AKONING
protons from (n,npa)

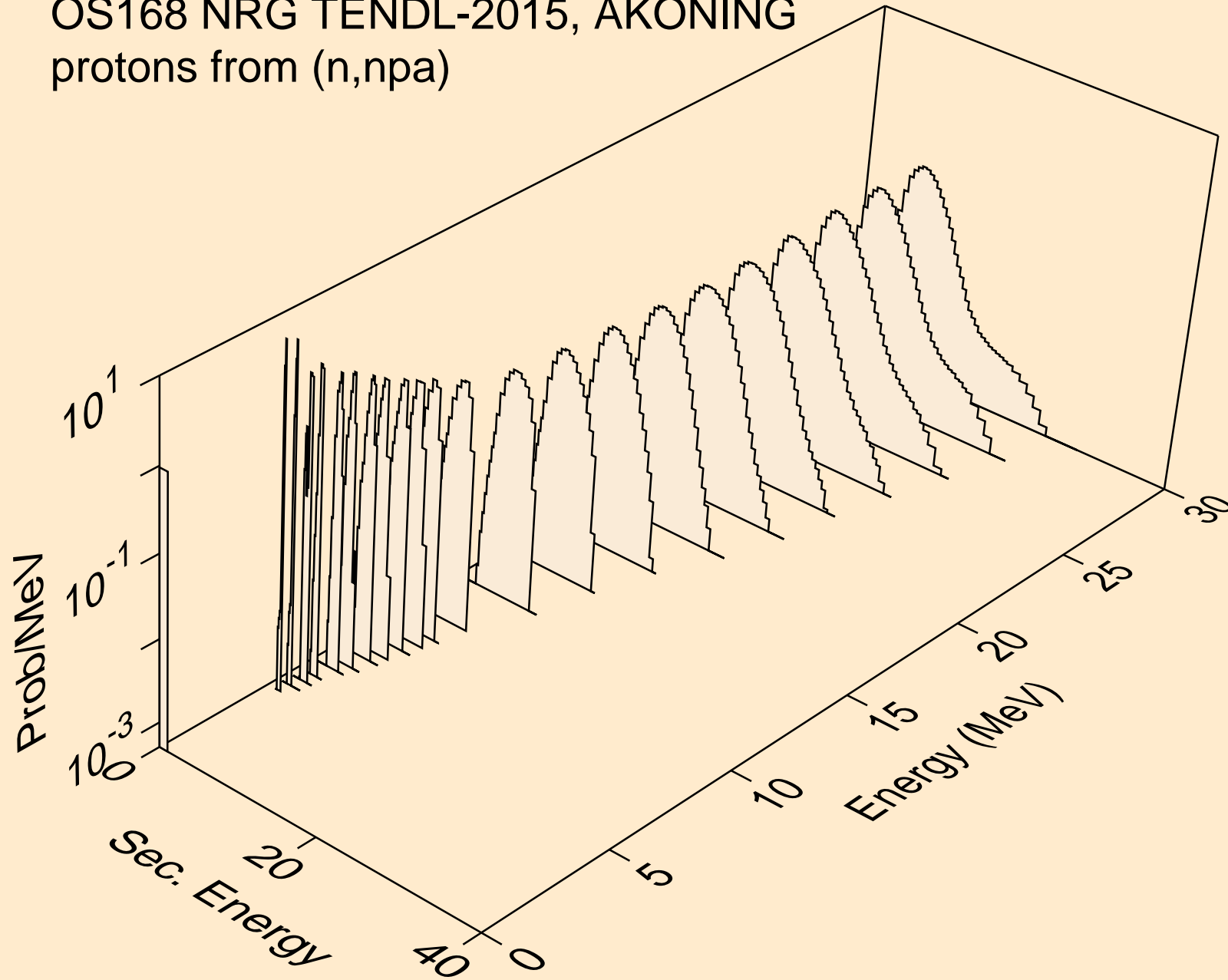

OS168 NRG TENDL-2015, AKONING
protons from (n,p)

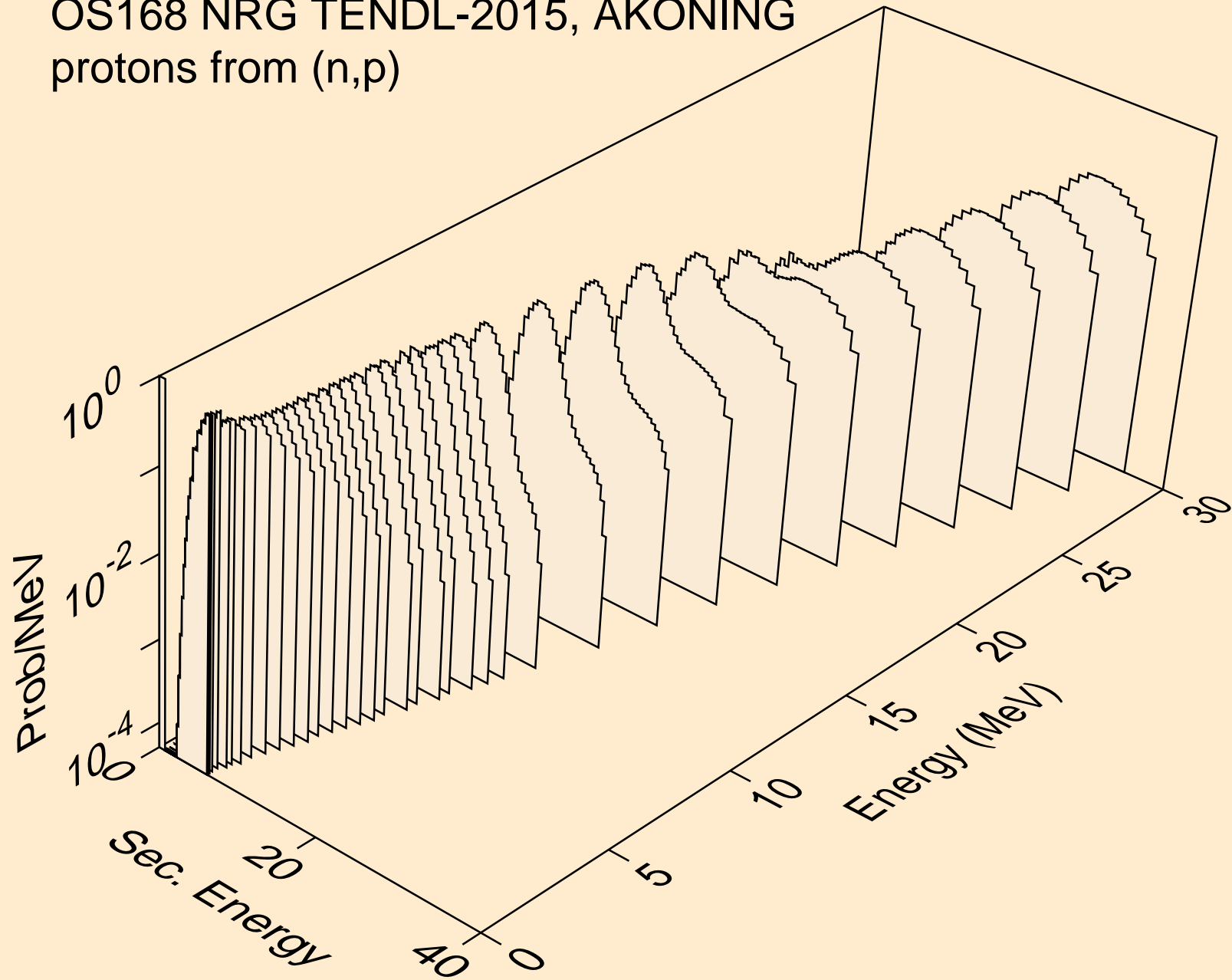

OS168 NRG TENDL-2015, AKONING
protons from (n,2p)

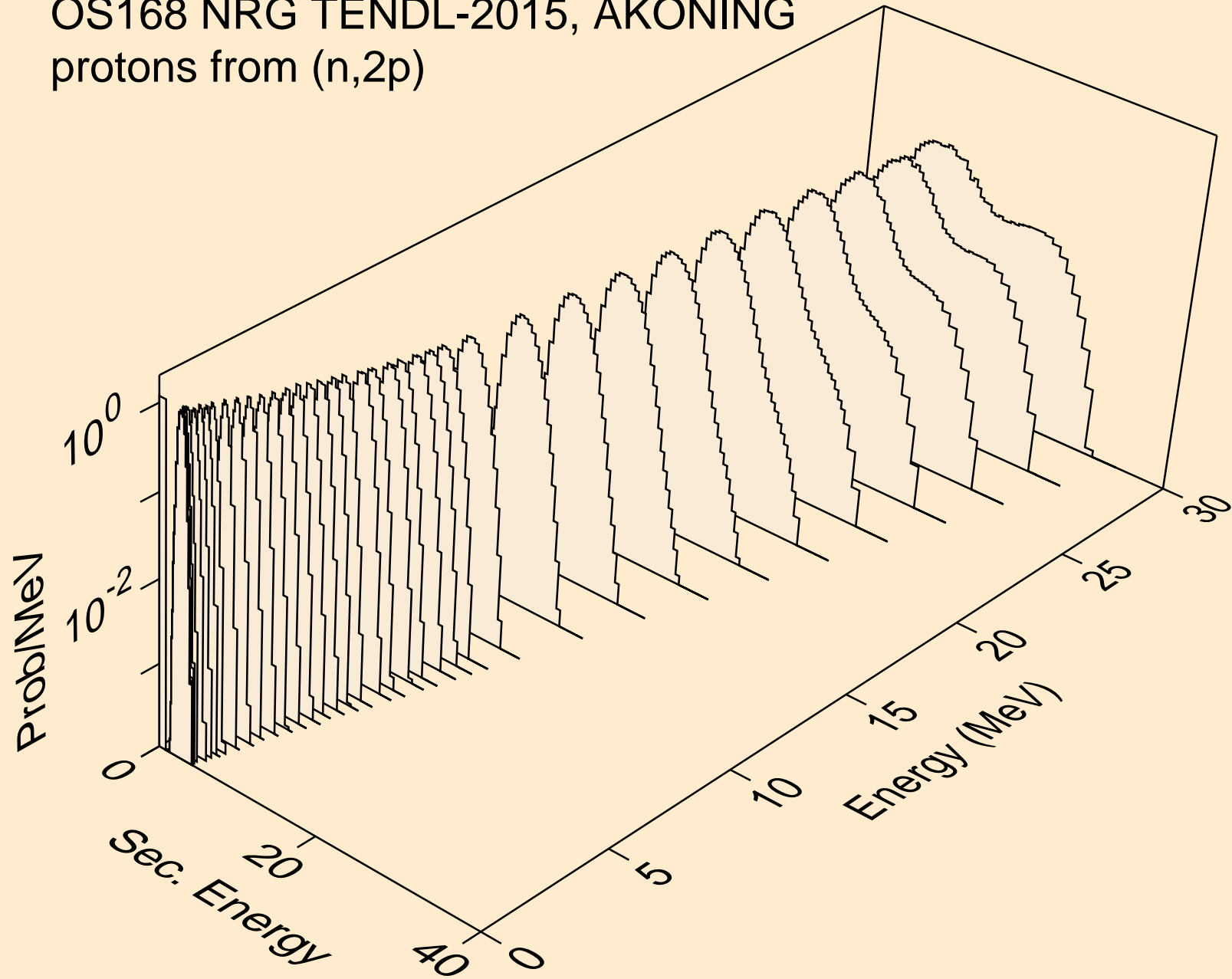

OS168 NRG TENDL-2015, AKONING
protons from (n,pa)

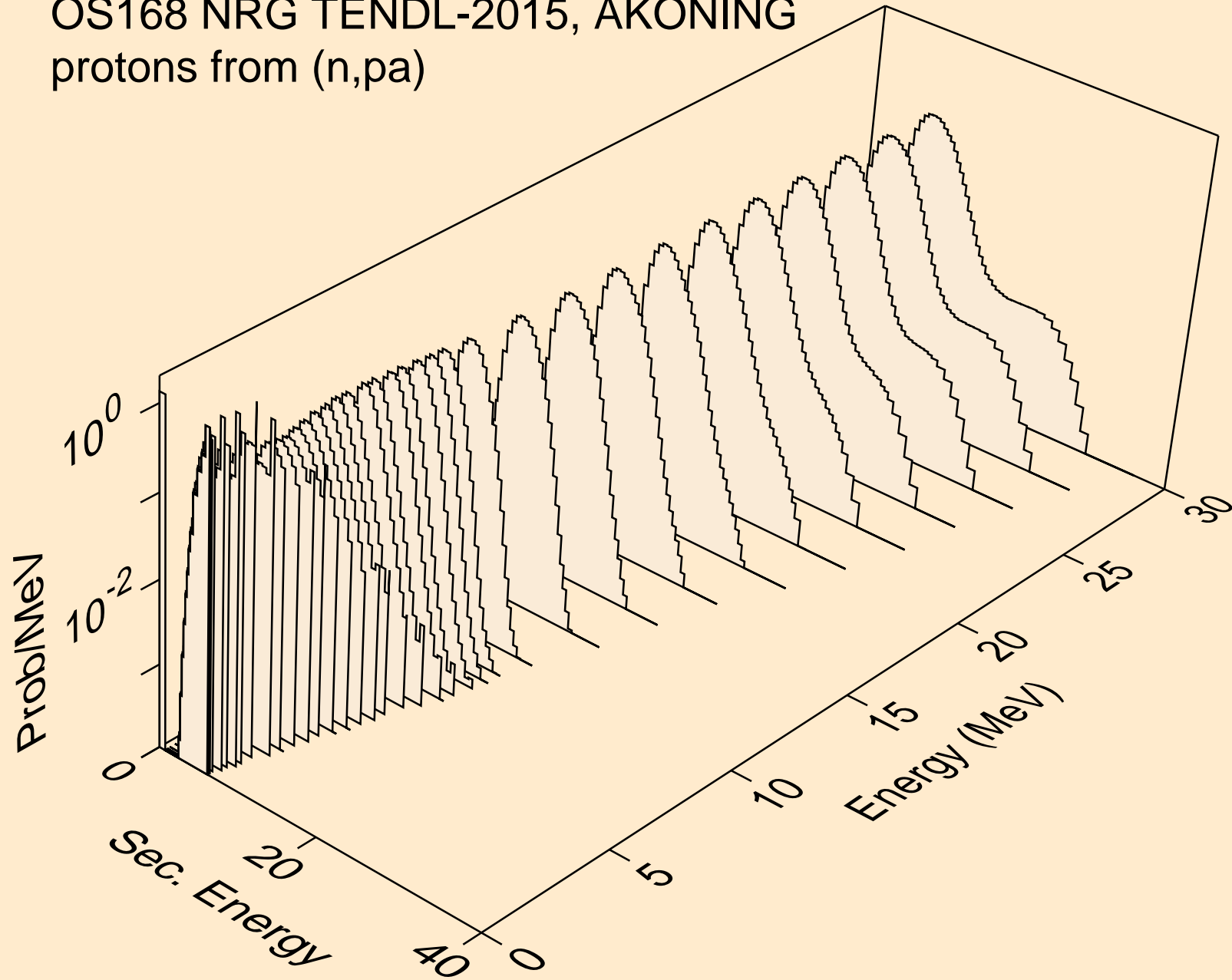

OS168 NRG TENDL-2015, AKONING
protons from (n,pd)

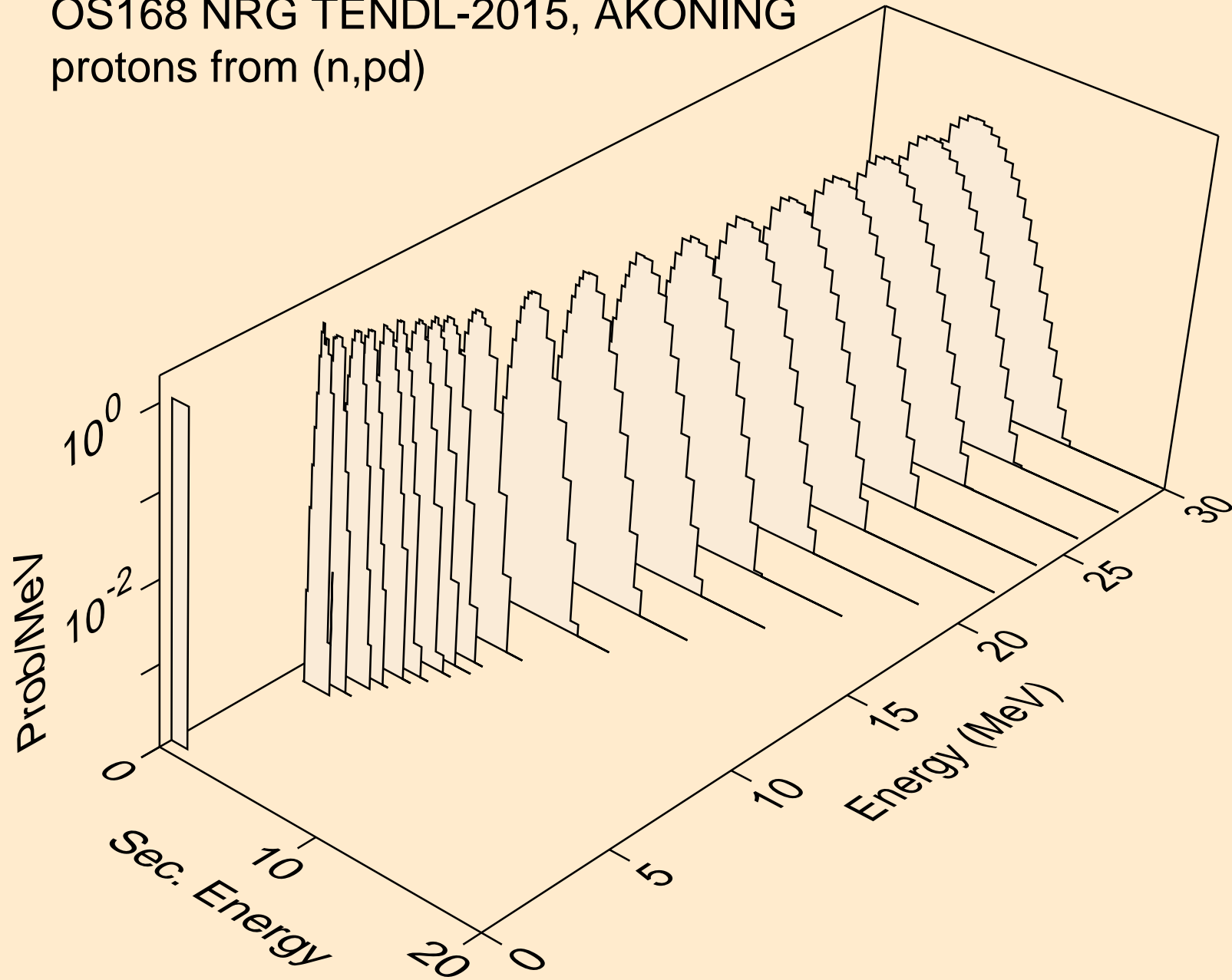

OS168 NRG TENDL-2015, AKONING
protons from (n,pt)

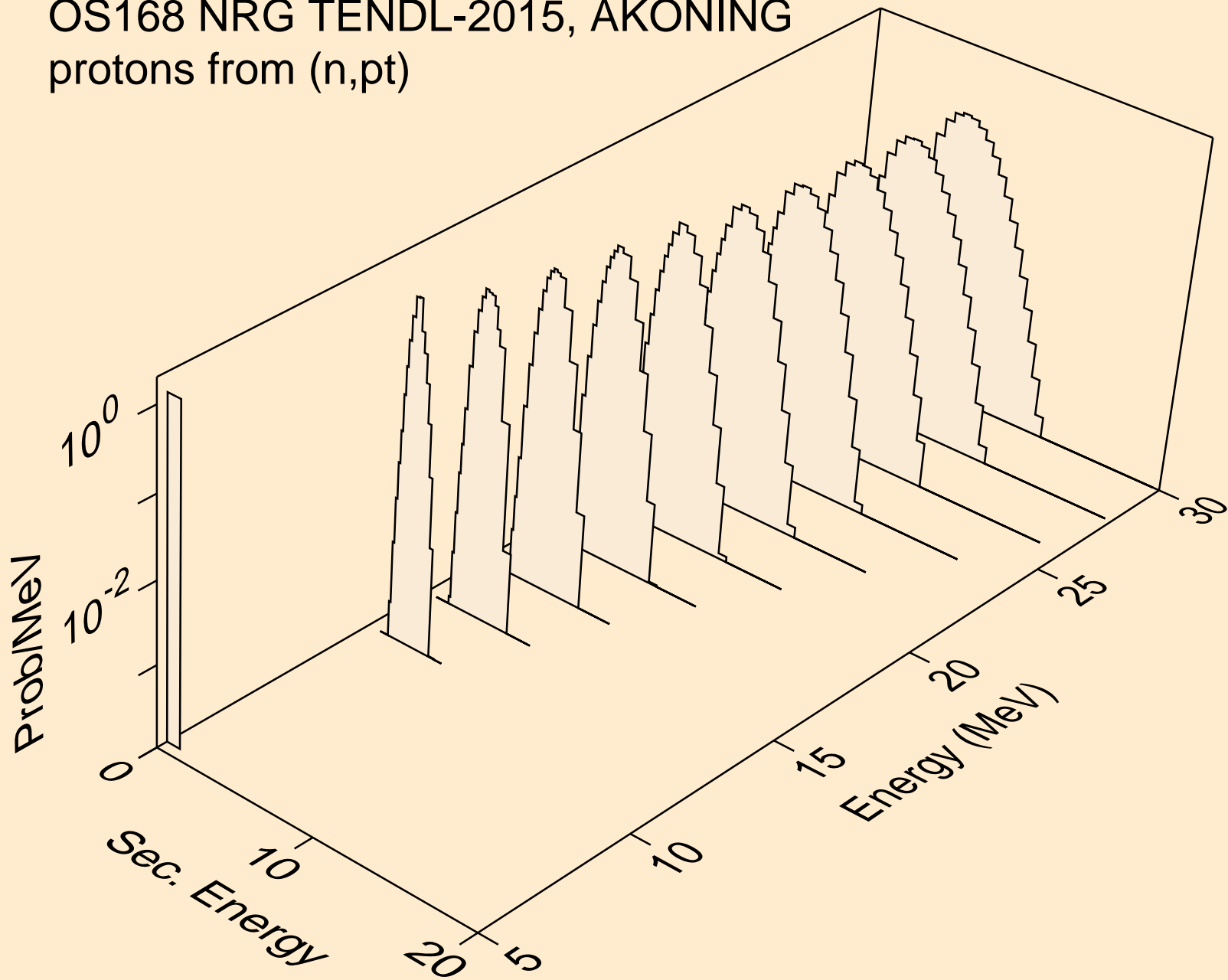

OS168 NRG TENDL-2015, AKONING
deuterons from (n,x)

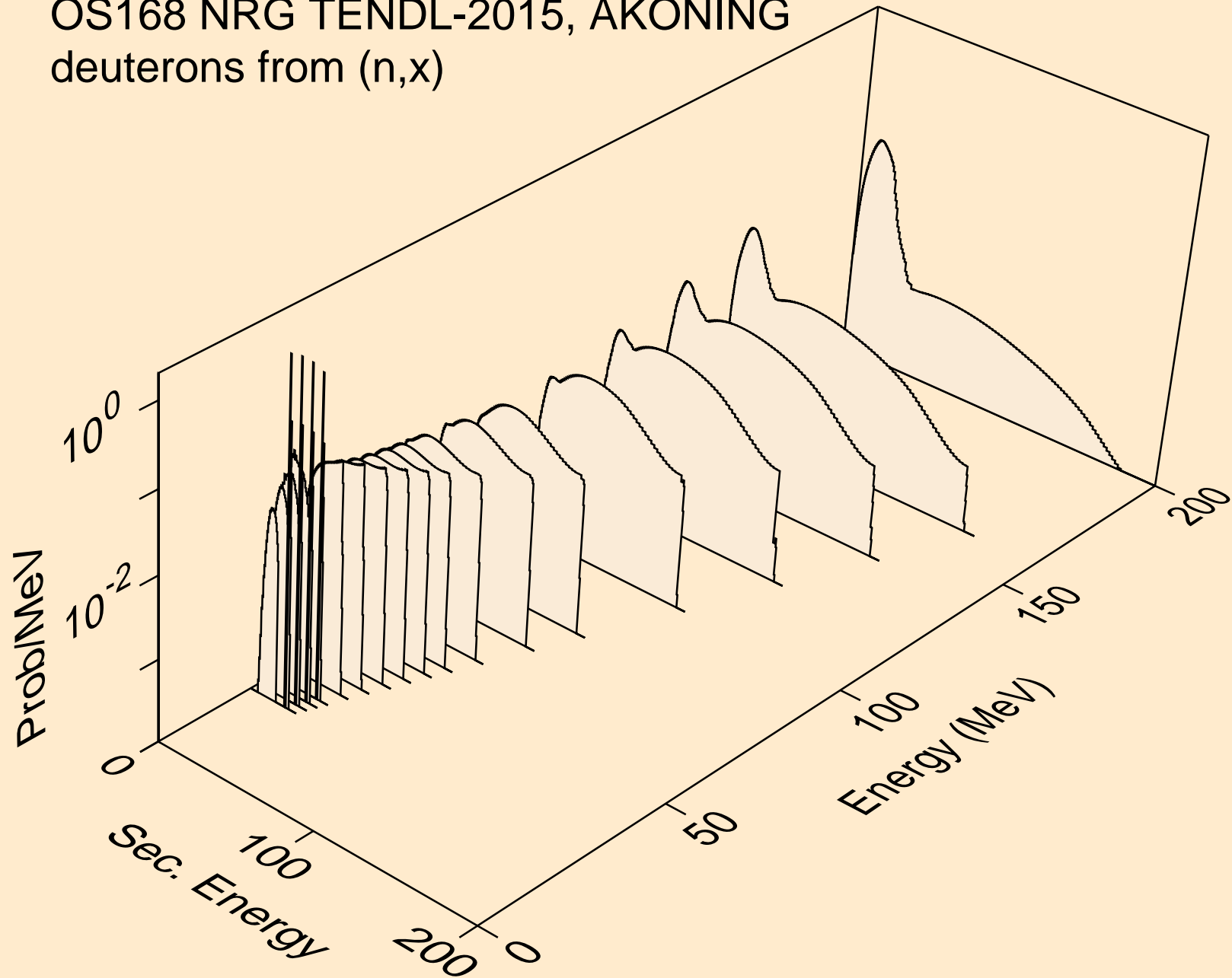

OS168 NRG TENDL-2015, AKONING
deuterons from (n,2nd)

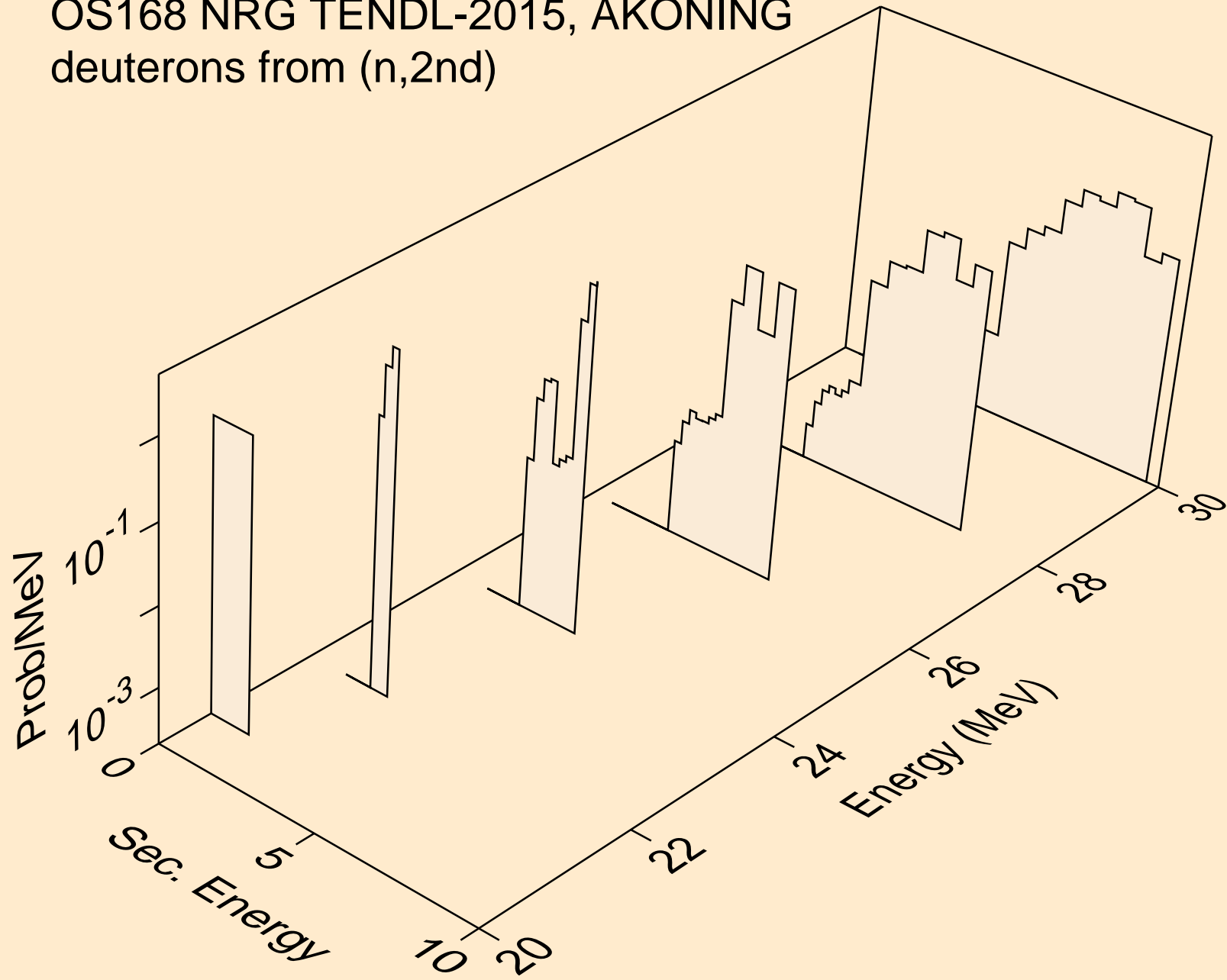

OS168 NRG TENDL-2015, AKONING
deuterons from (n,n*)d

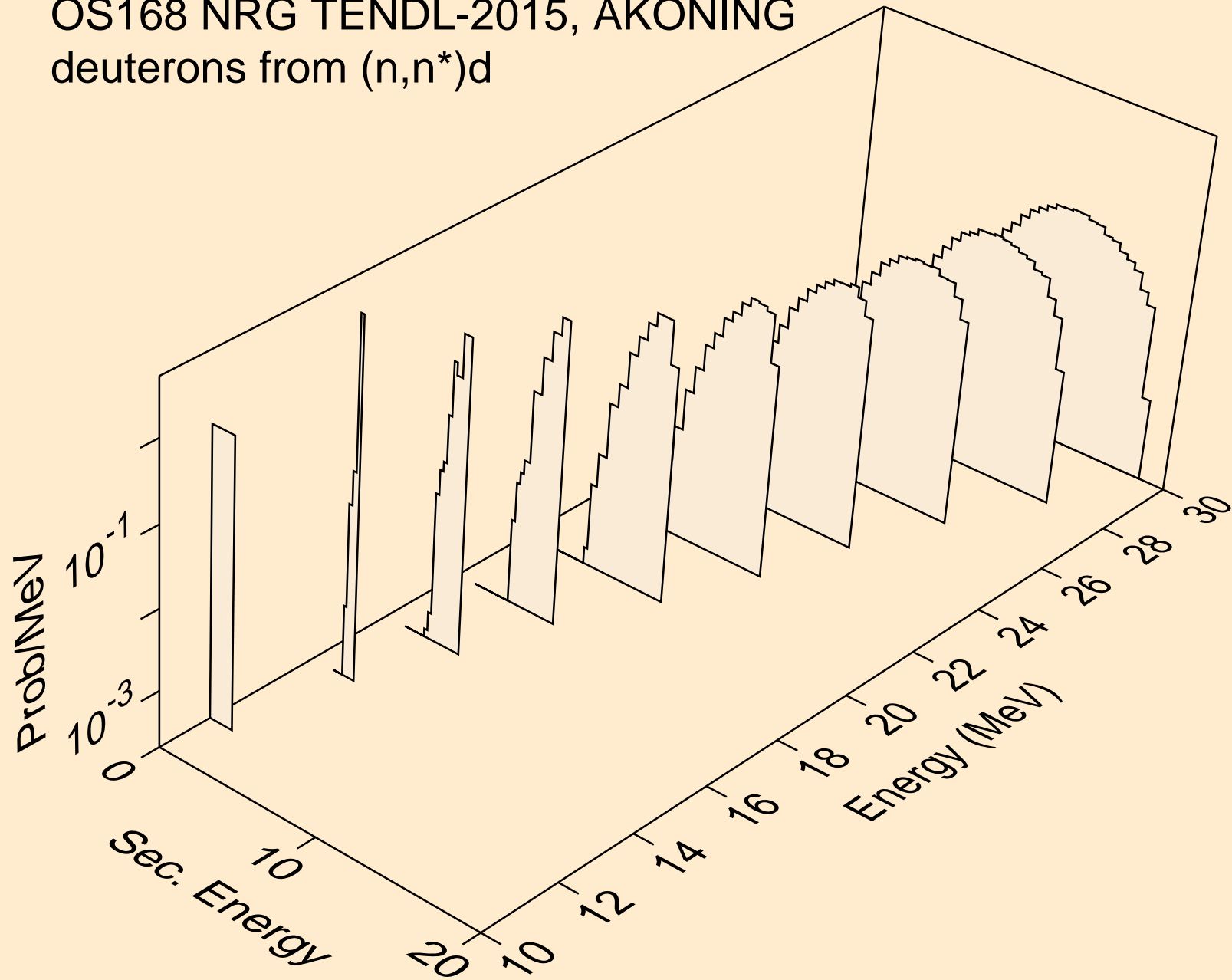

OS168 NRG TENDL-2015, AKONING
deuterons from (n,n*)d2a

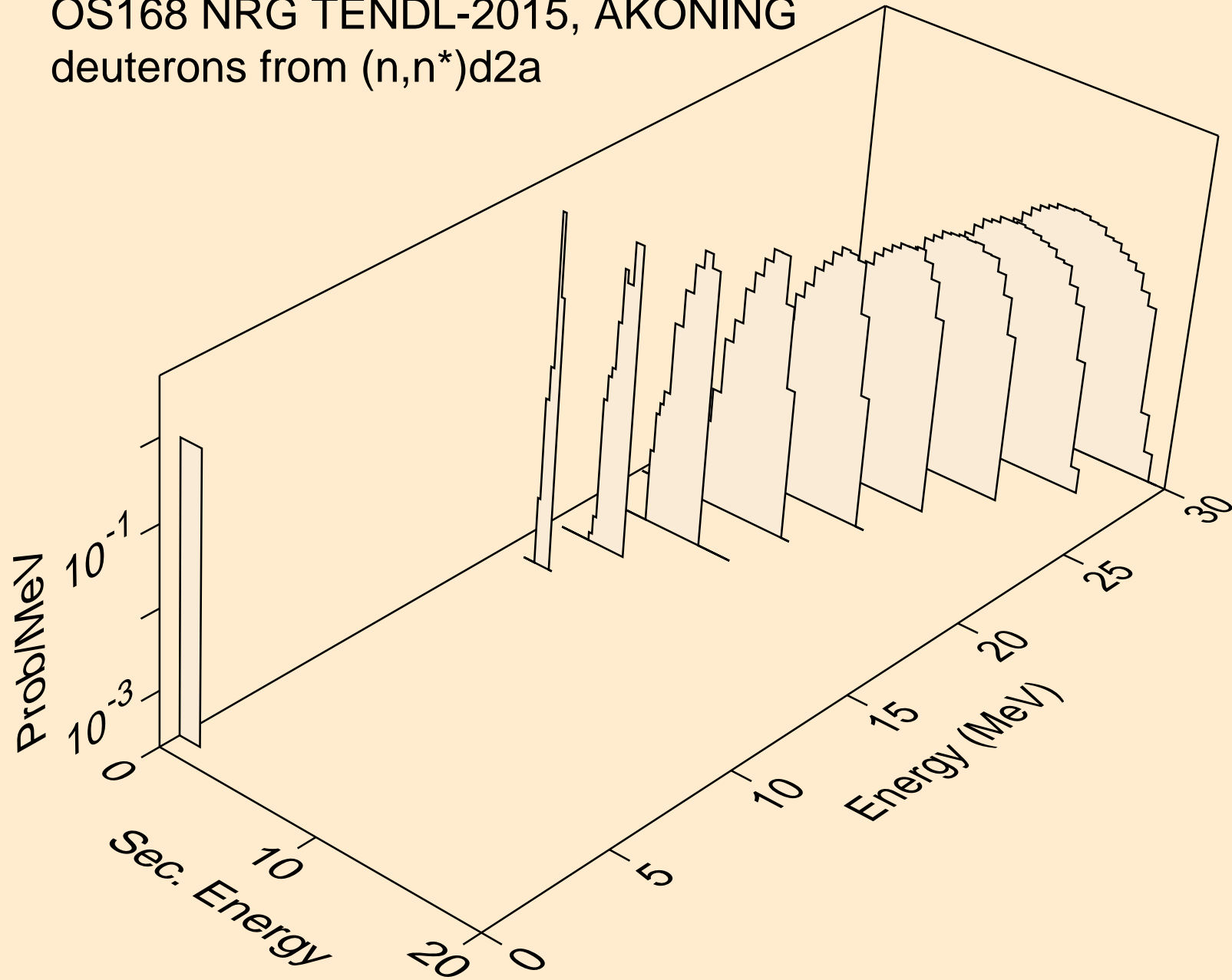

OS168 NRG TENDL-2015, AKONING
deuterons from (n,d)

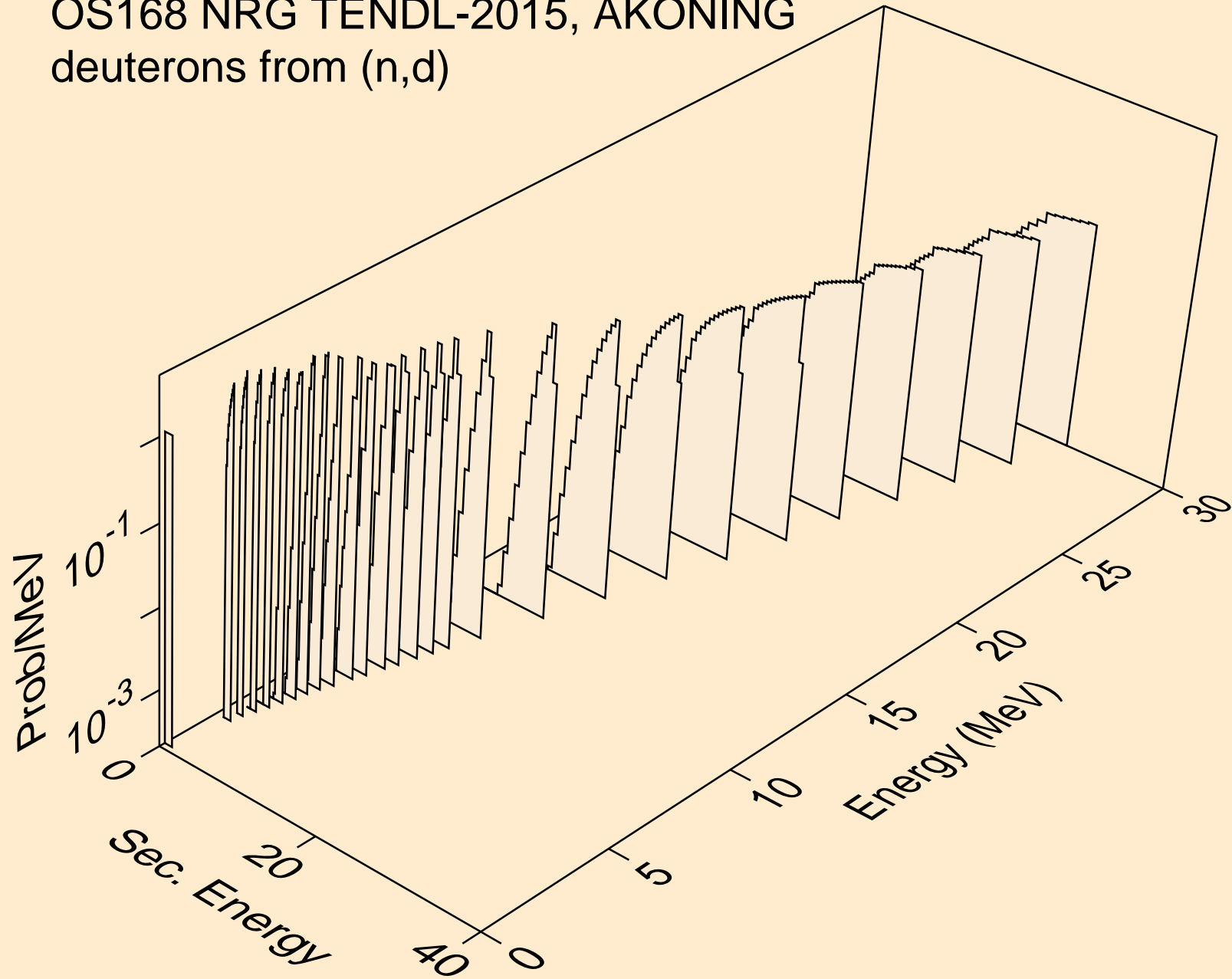

OS168 NRG TENDL-2015, AKONING
deuterons from (n,d2a)

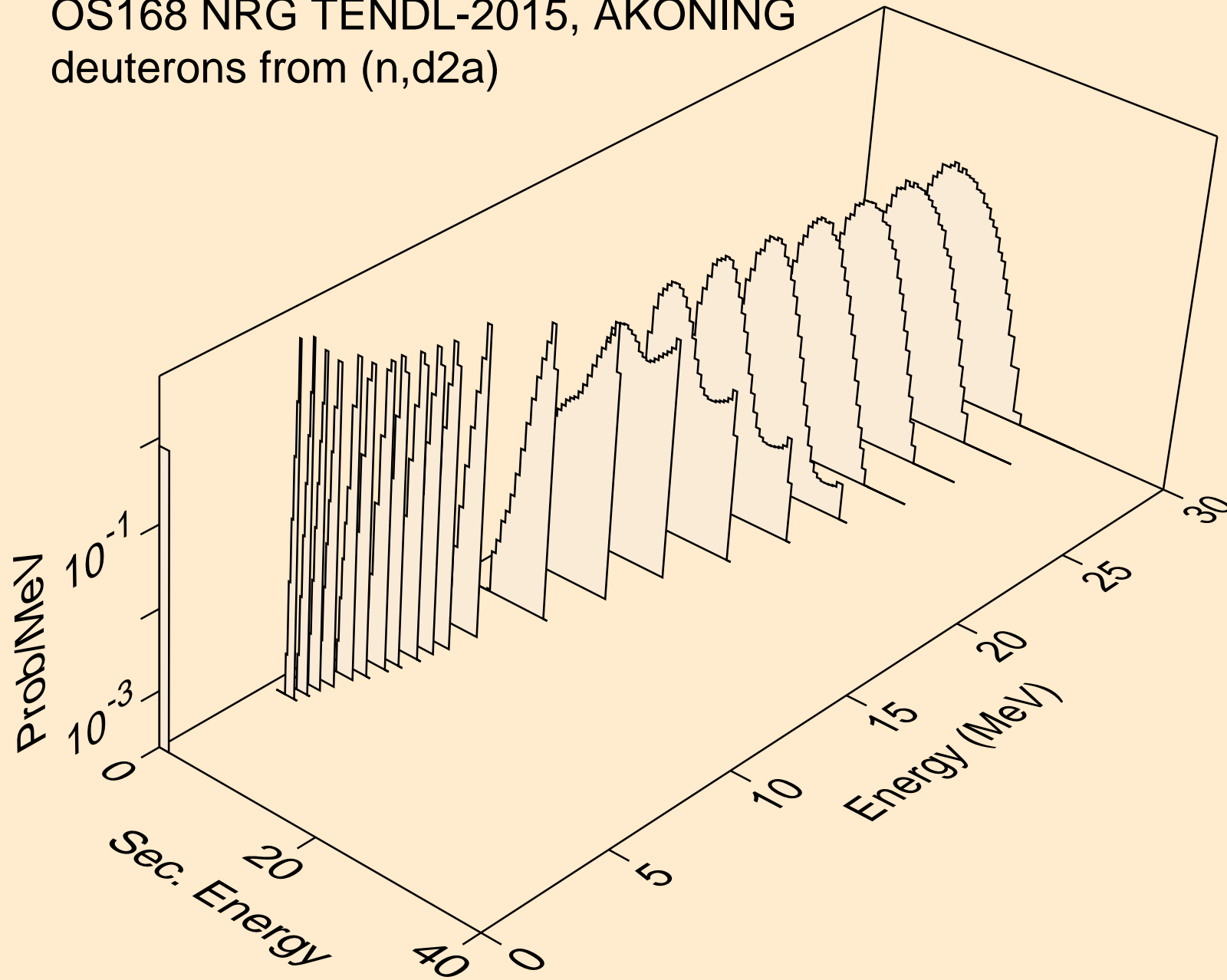

OS168 NRG TENDL-2015, AKONING
deuterons from (n,pd)

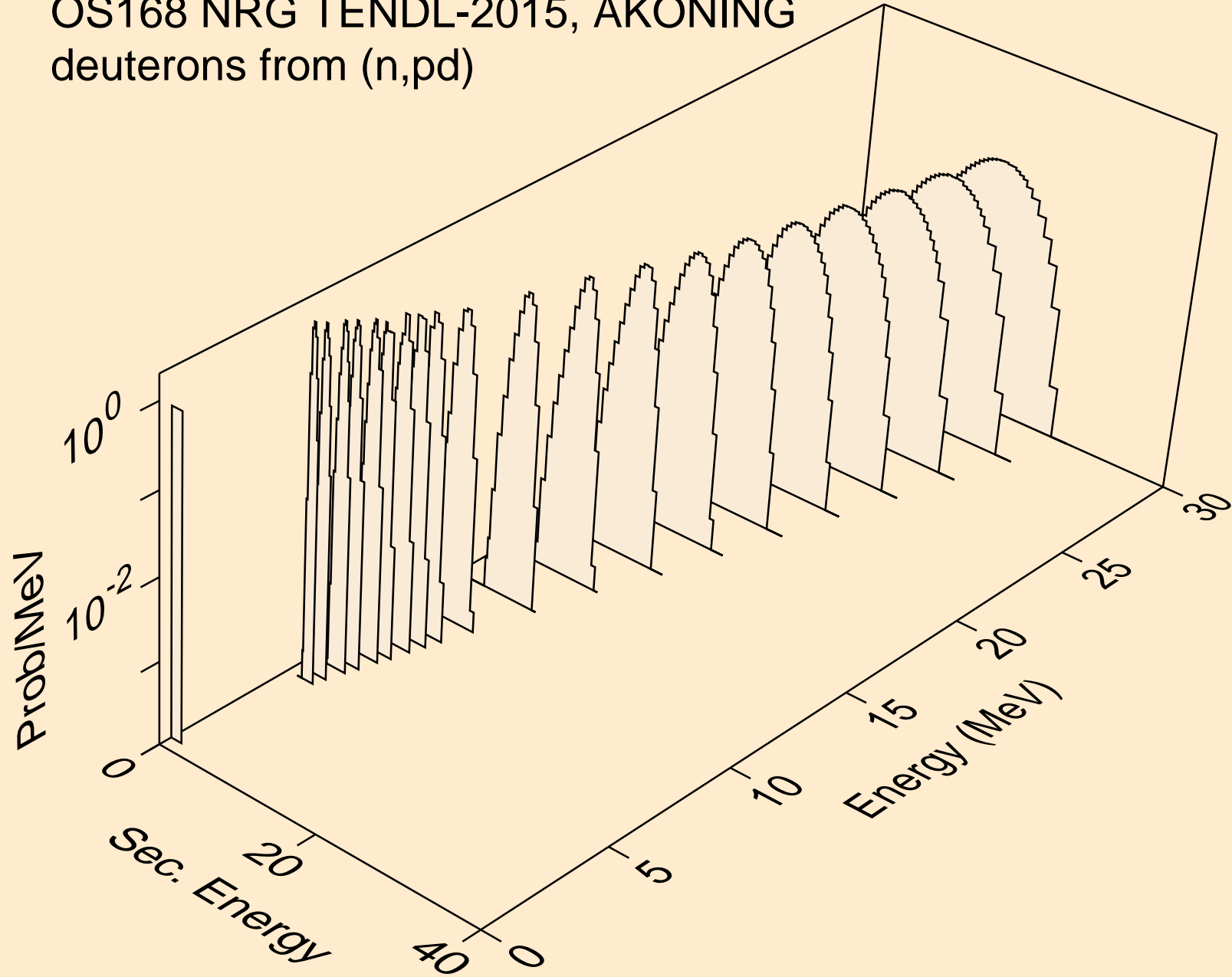

OS168 NRG TENDL-2015, AKONING
deuterons from (n,da)

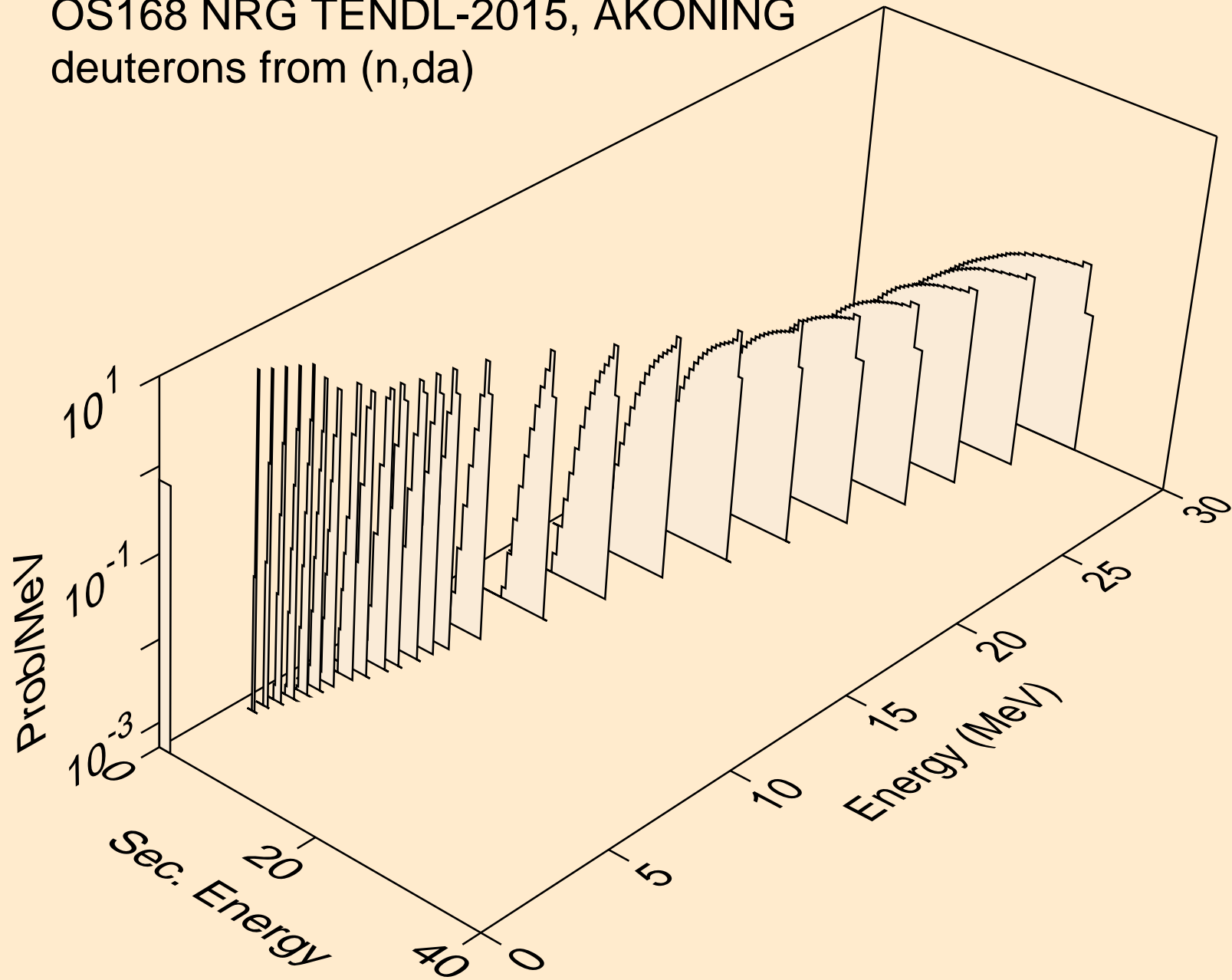

OS168 NRG TENDL-2015, AKONING
tritons from (n,x)

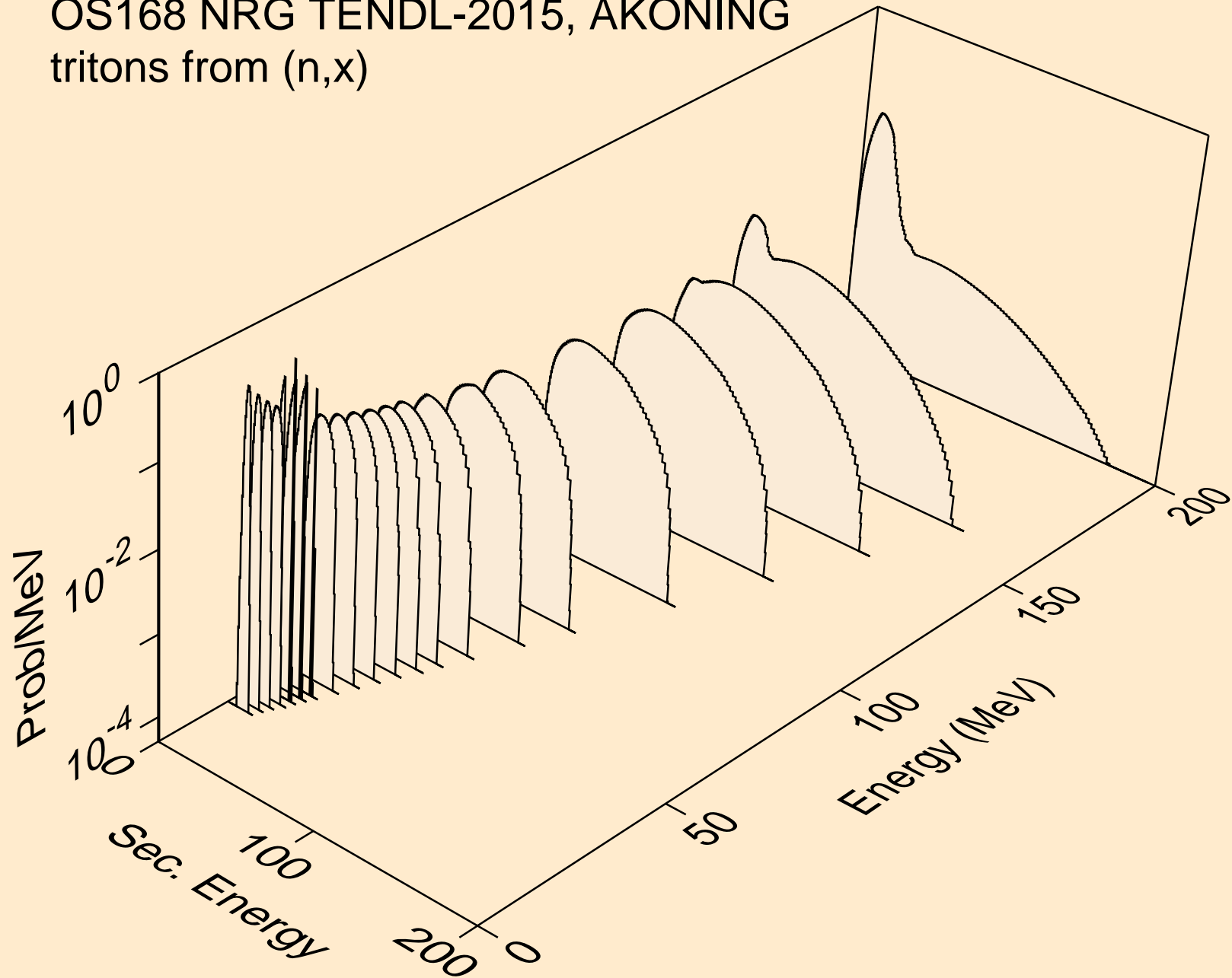

OS168 NRG TENDL-2015, AKONING
tritons from (n,n*)t

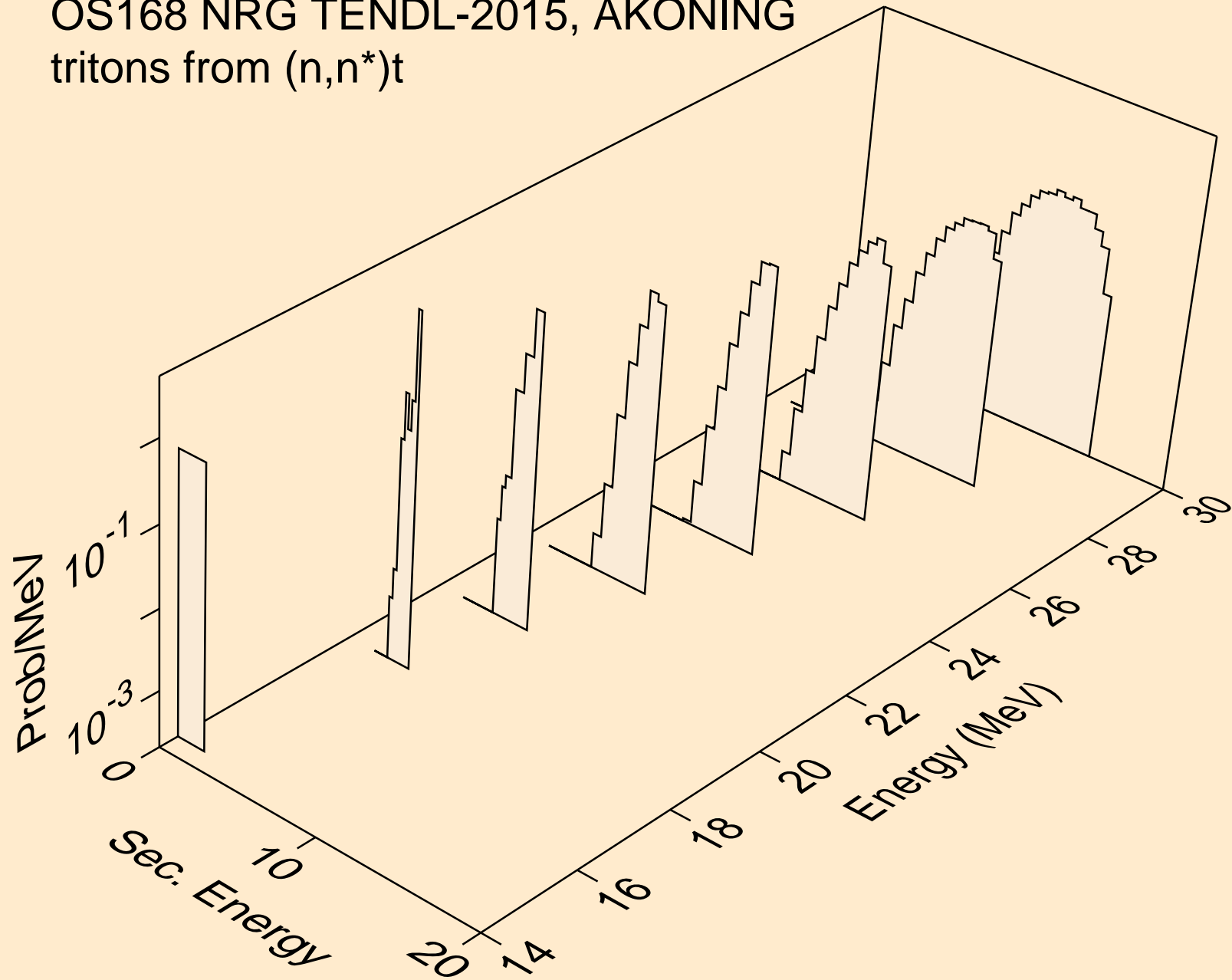

OS168 NRG TENDL-2015, AKONING
tritons from (n,n*)t2a

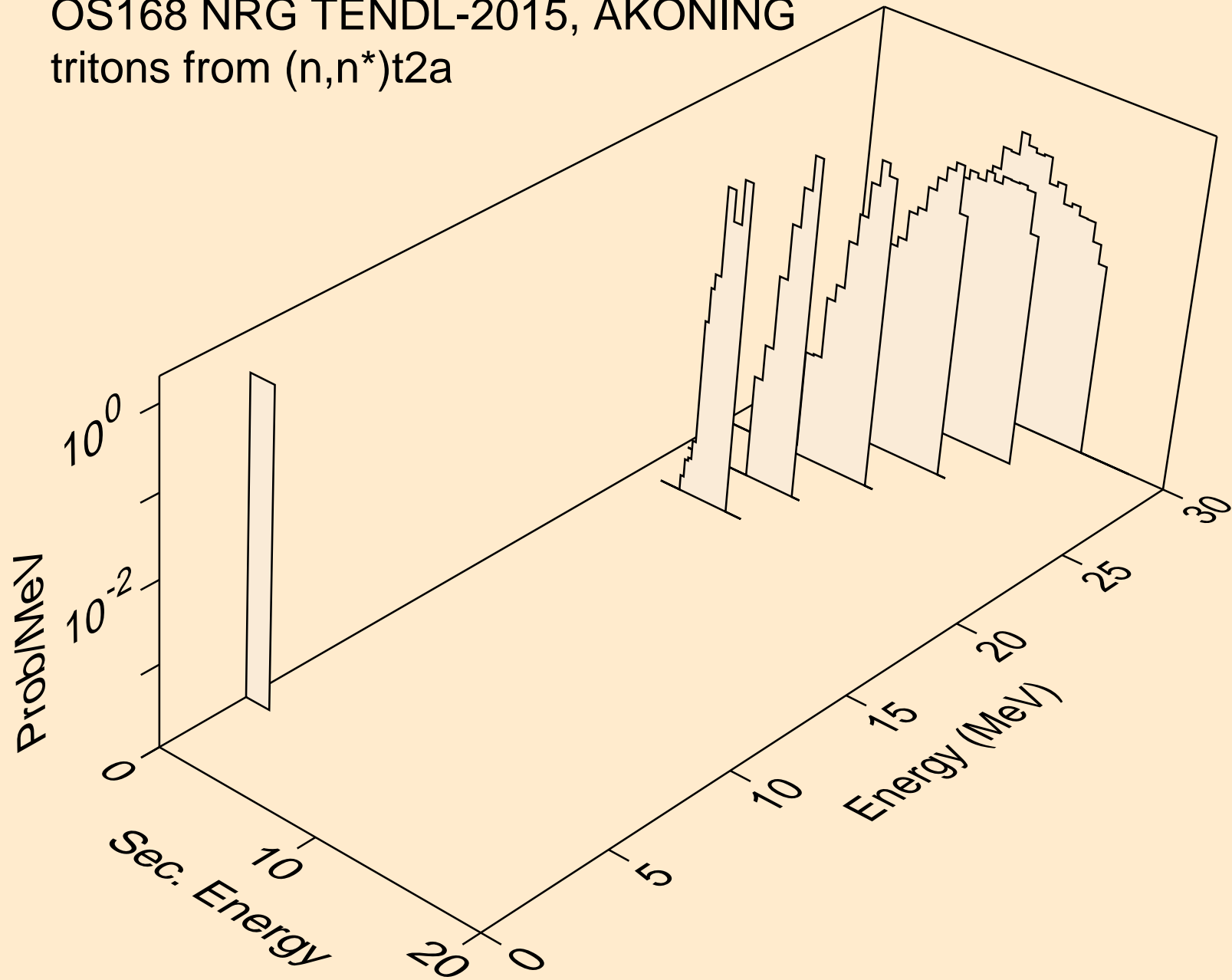

OS168 NRG TENDL-2015, AKONING
tritons from (n,t)

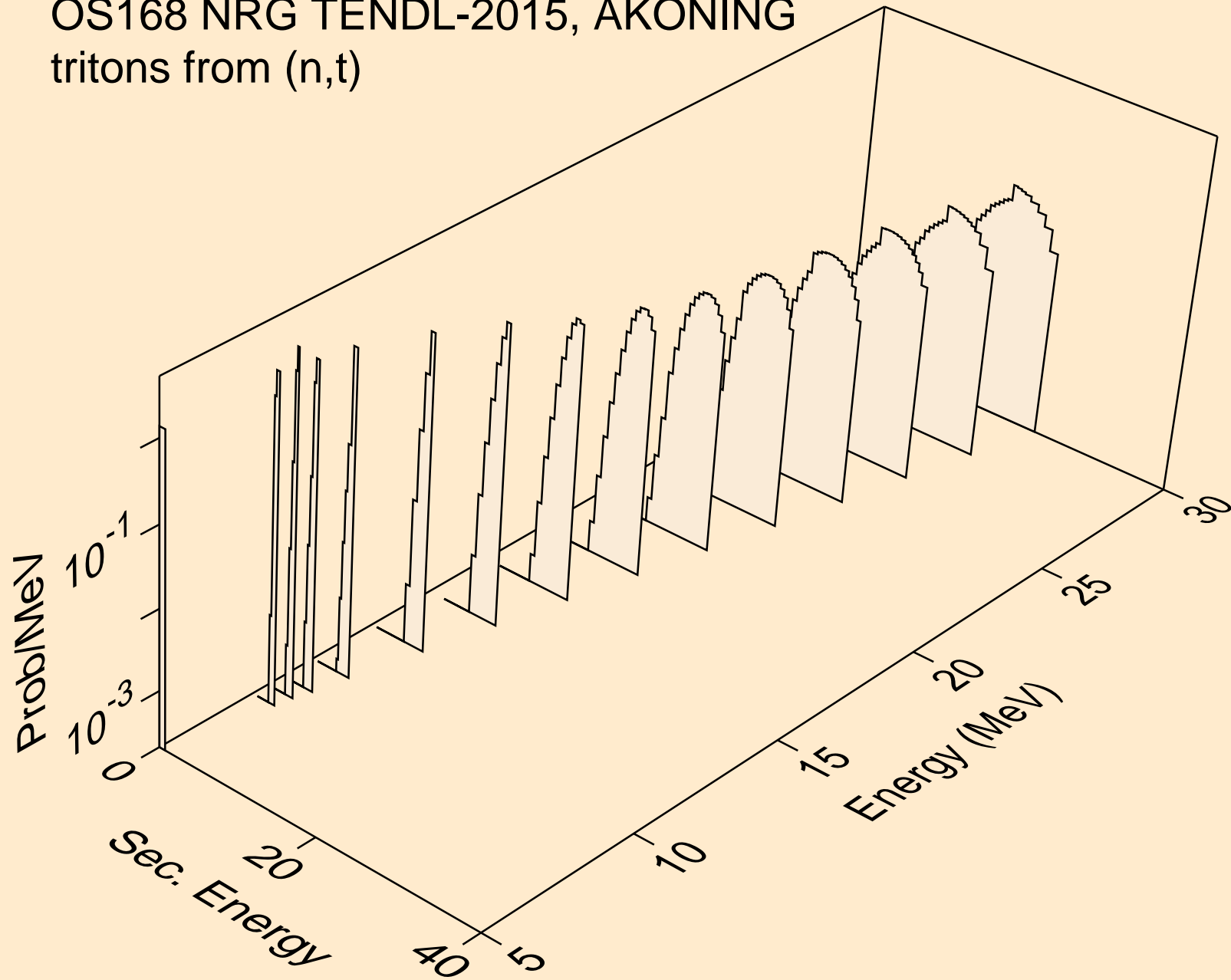

OS168 NRG TENDL-2015, AKONING
tritons from (n,t2a)

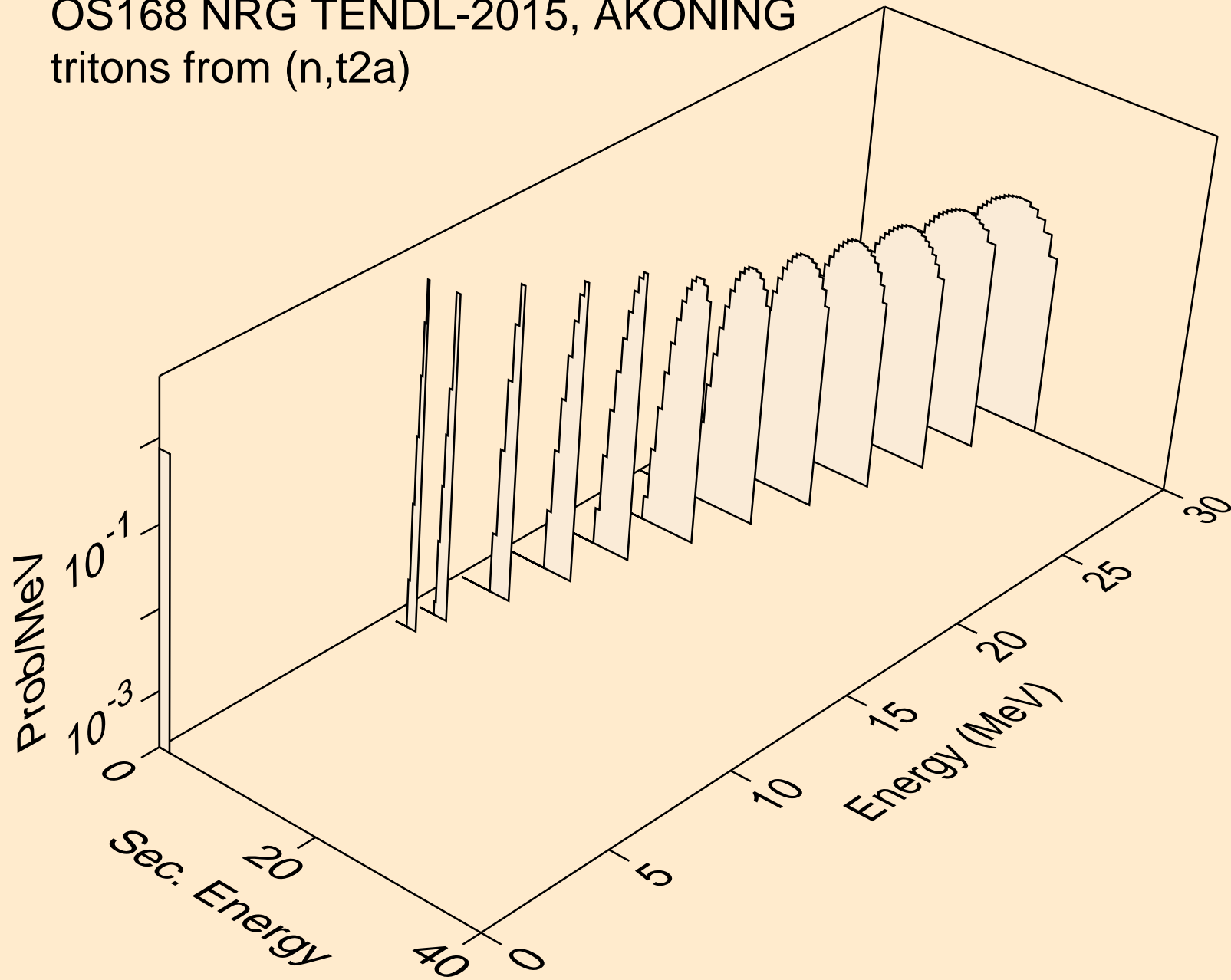

OS168 NRG TENDL-2015, AKONING
tritons from (n,pt)

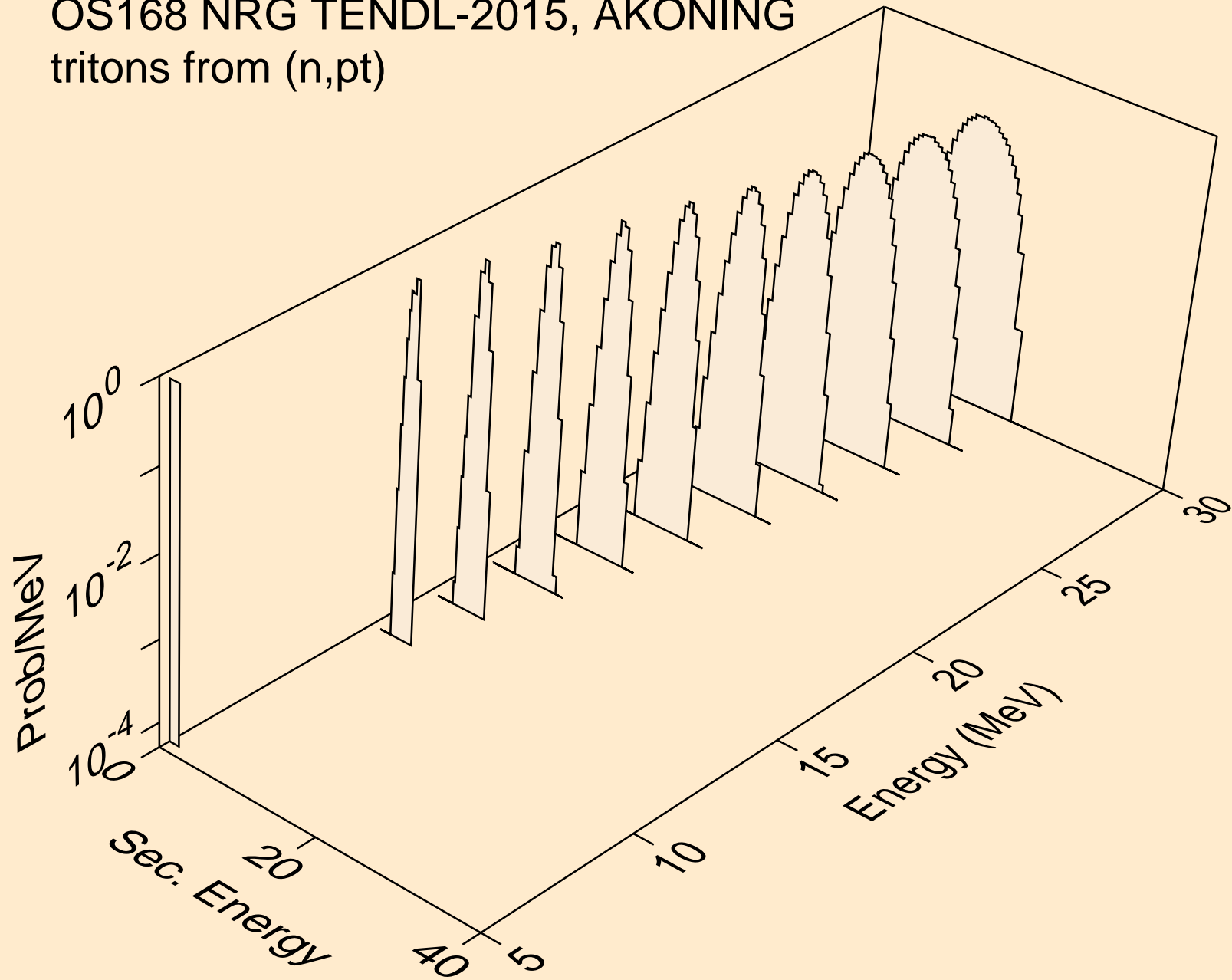

OS168 NRG TENDL-2015, AKONING
he3s from (n,x)

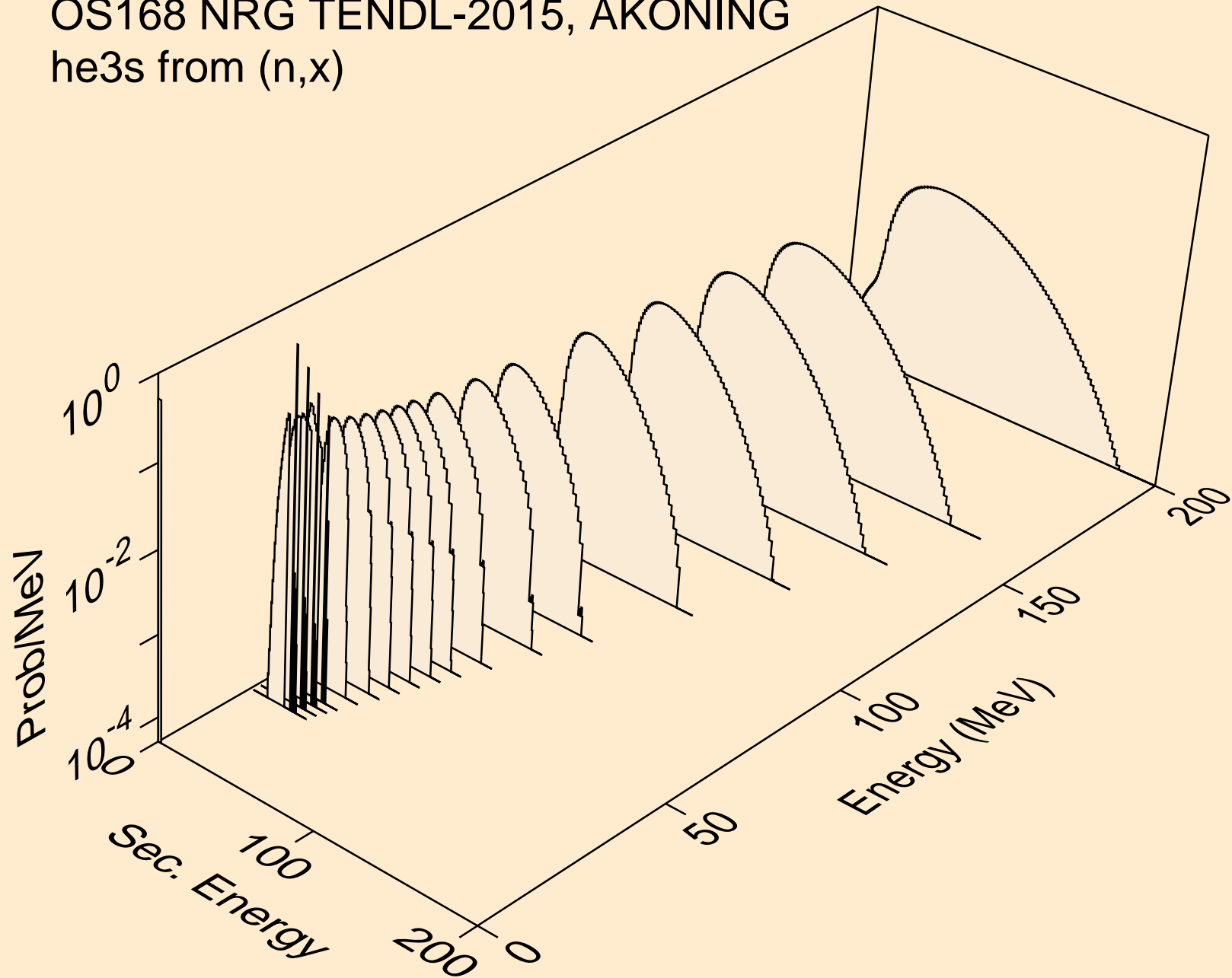

OS168 NRG TENDL-2015, AKONING
he3s from (n,n*)he3

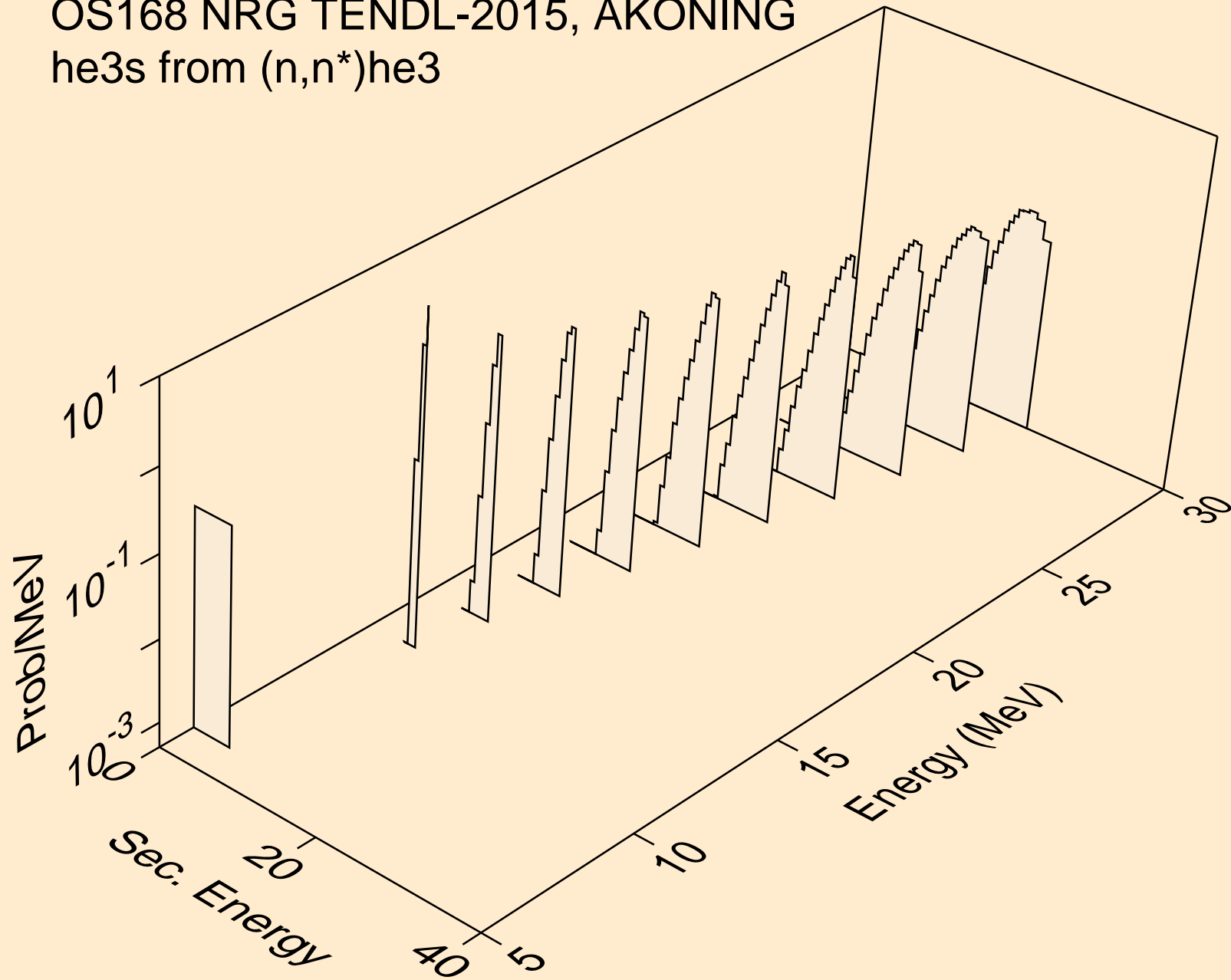

OS168 NRG TENDL-2015, AKONING
he3s from (n,he3)

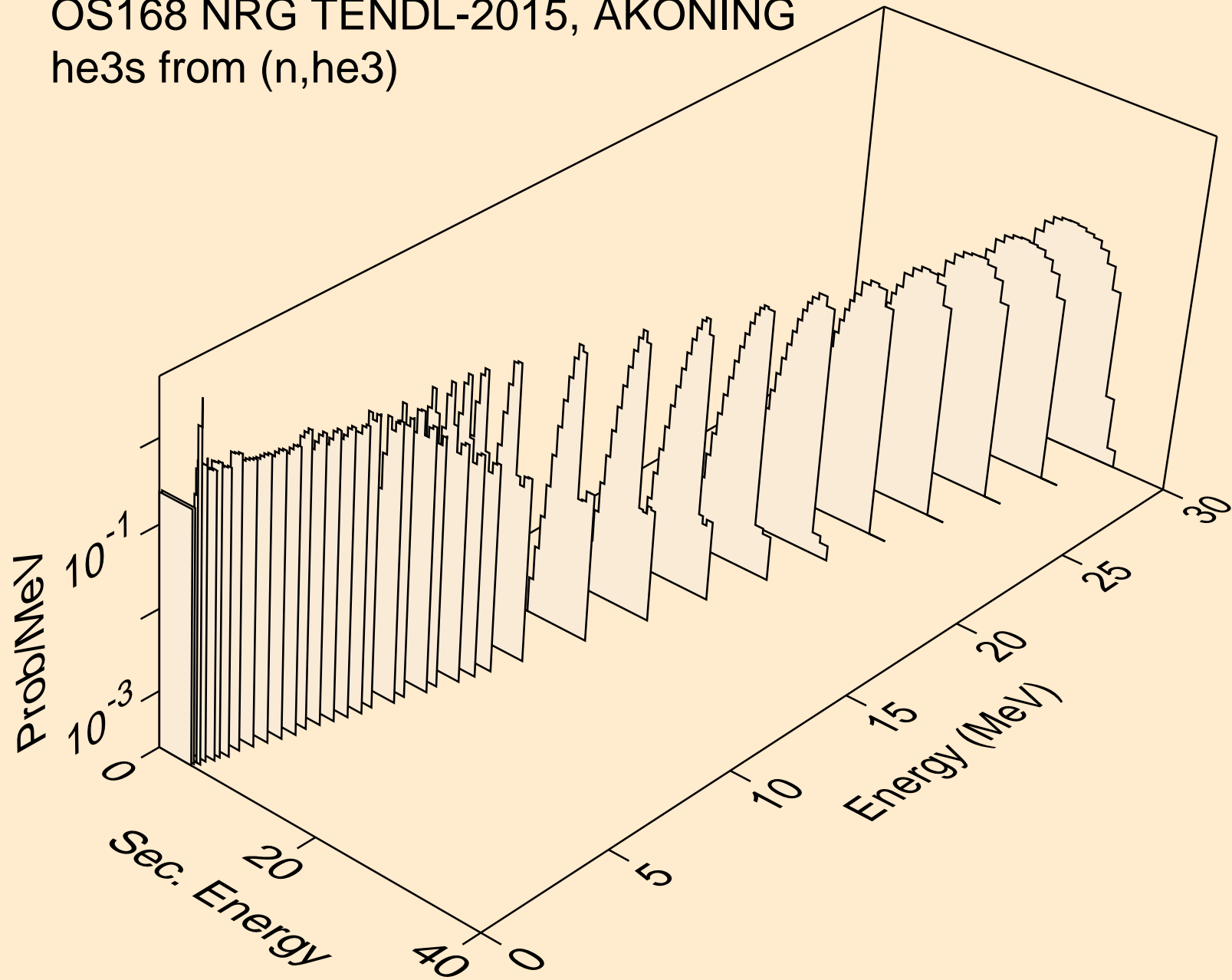

OS168 NRG TENDL-2015, AKONING
alphas from (n,x)

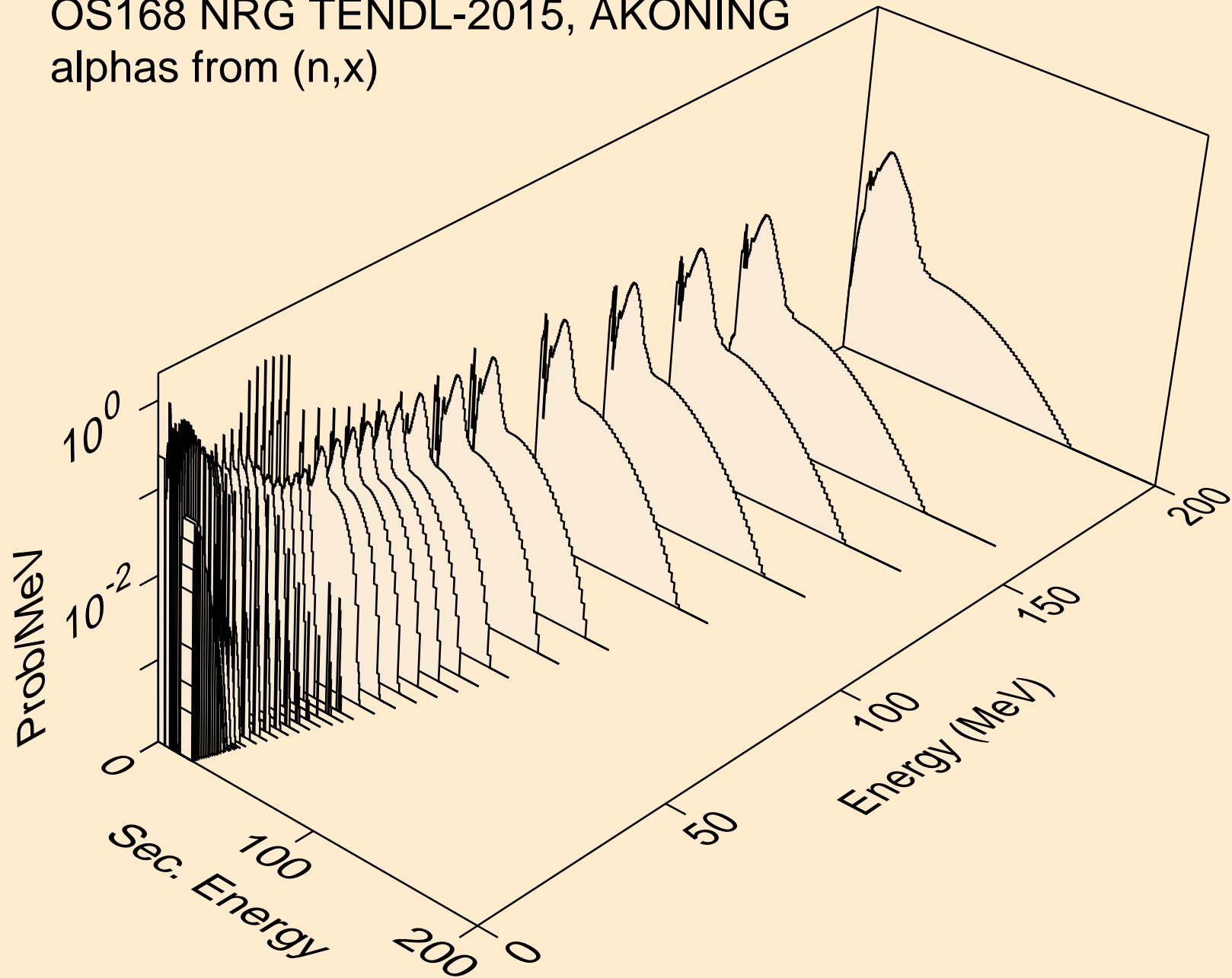

OS168 NRG TENDL-2015, AKONING
alphas from (n,n*)a

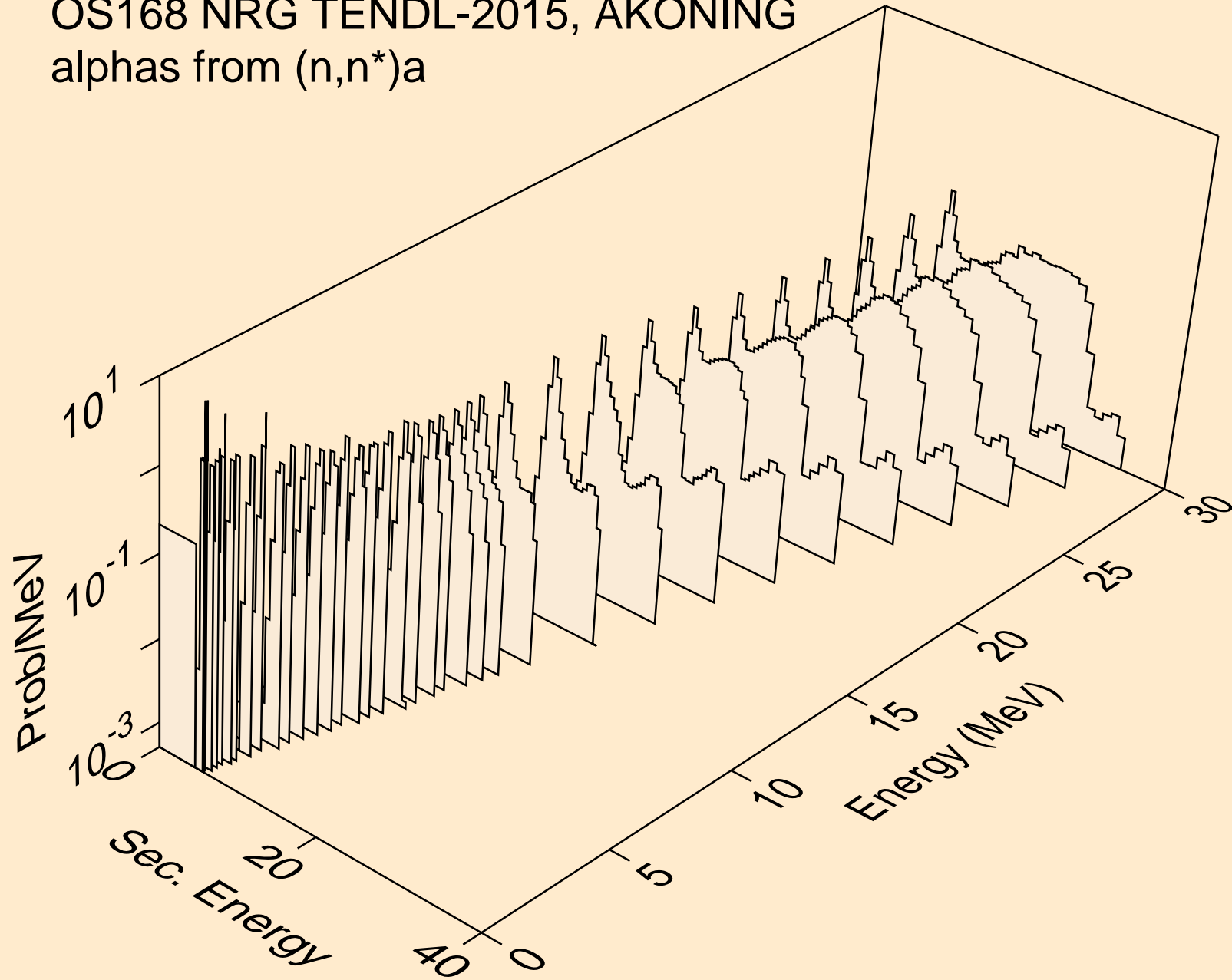

OS168 NRG TENDL-2015, AKONING
alphas from (n,n*)3a

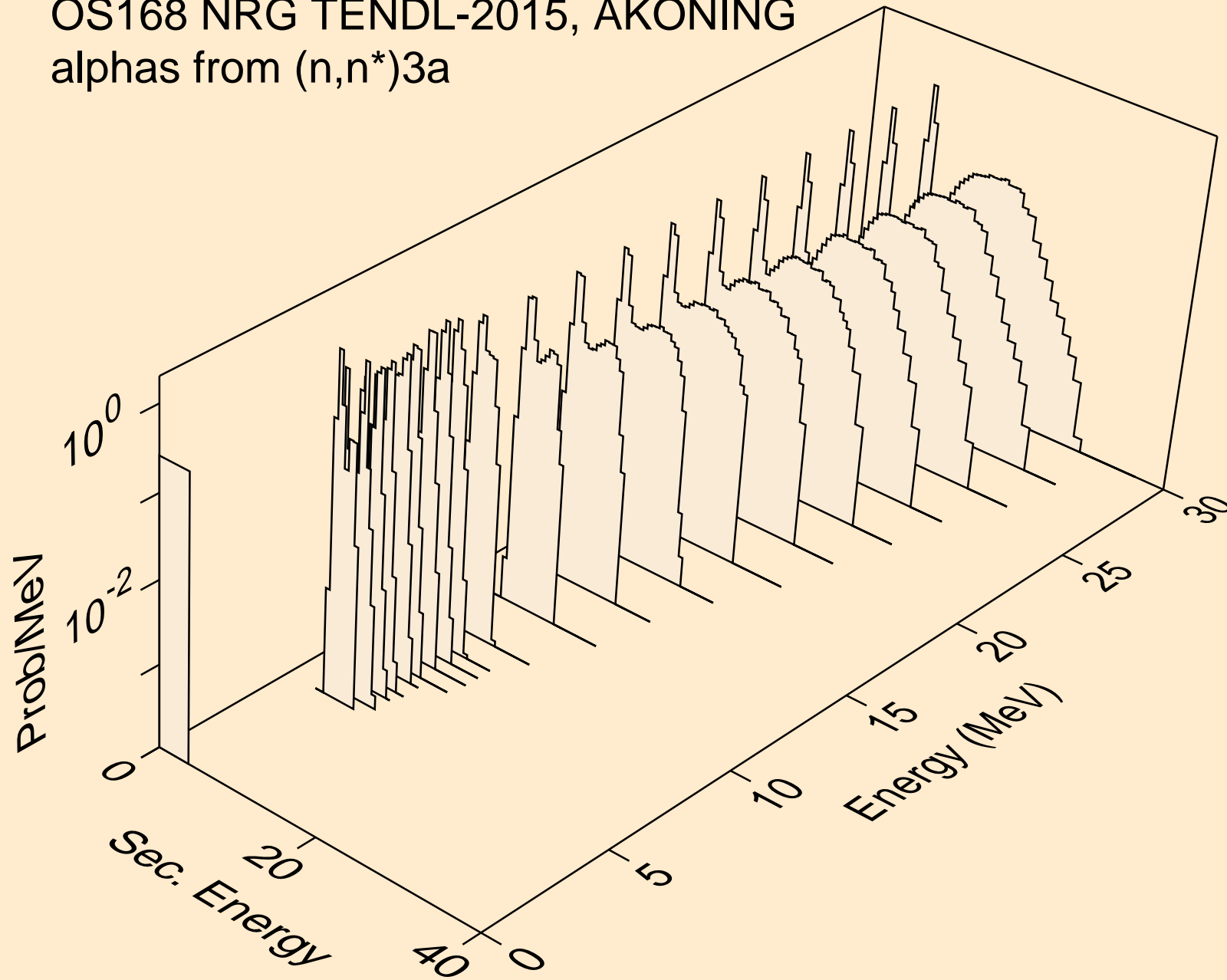

OS168 NRG TENDL-2015, AKONING
alphas from (n,2n)a

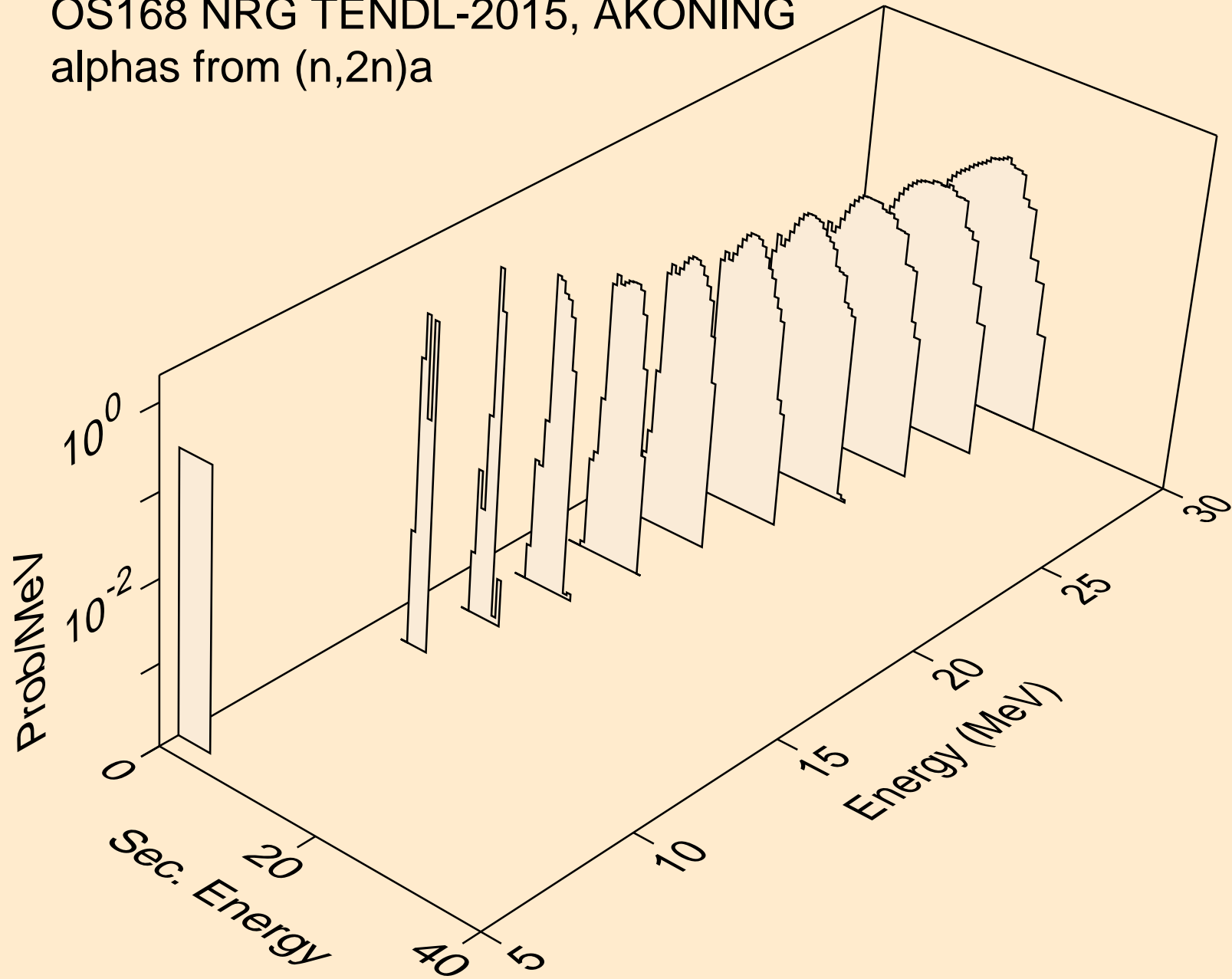

OS168 NRG TENDL-2015, AKONING
alphas from (n,3n)a

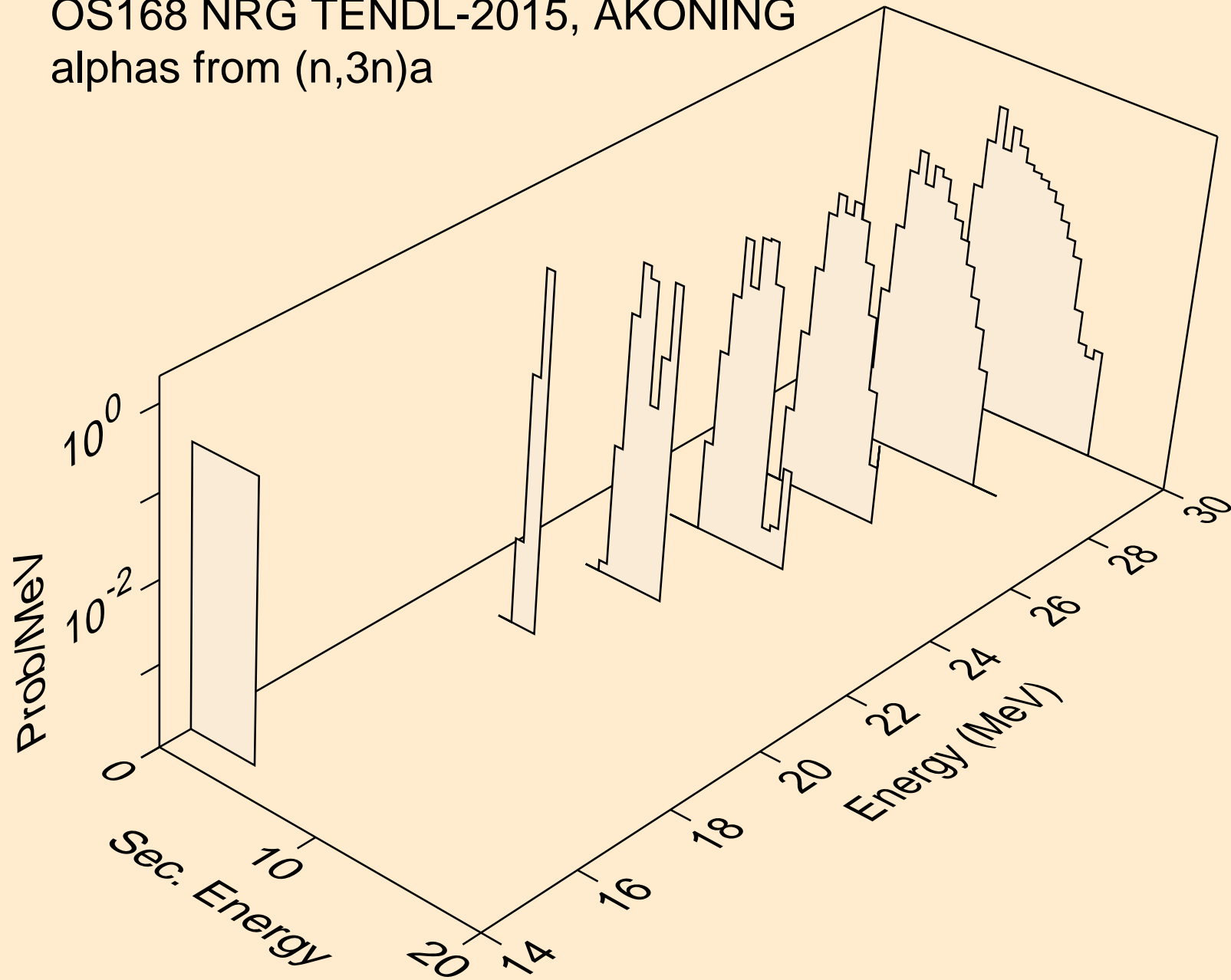

OS168 NRG TENDL-2015, AKONING
alphas from (n,n*)2a

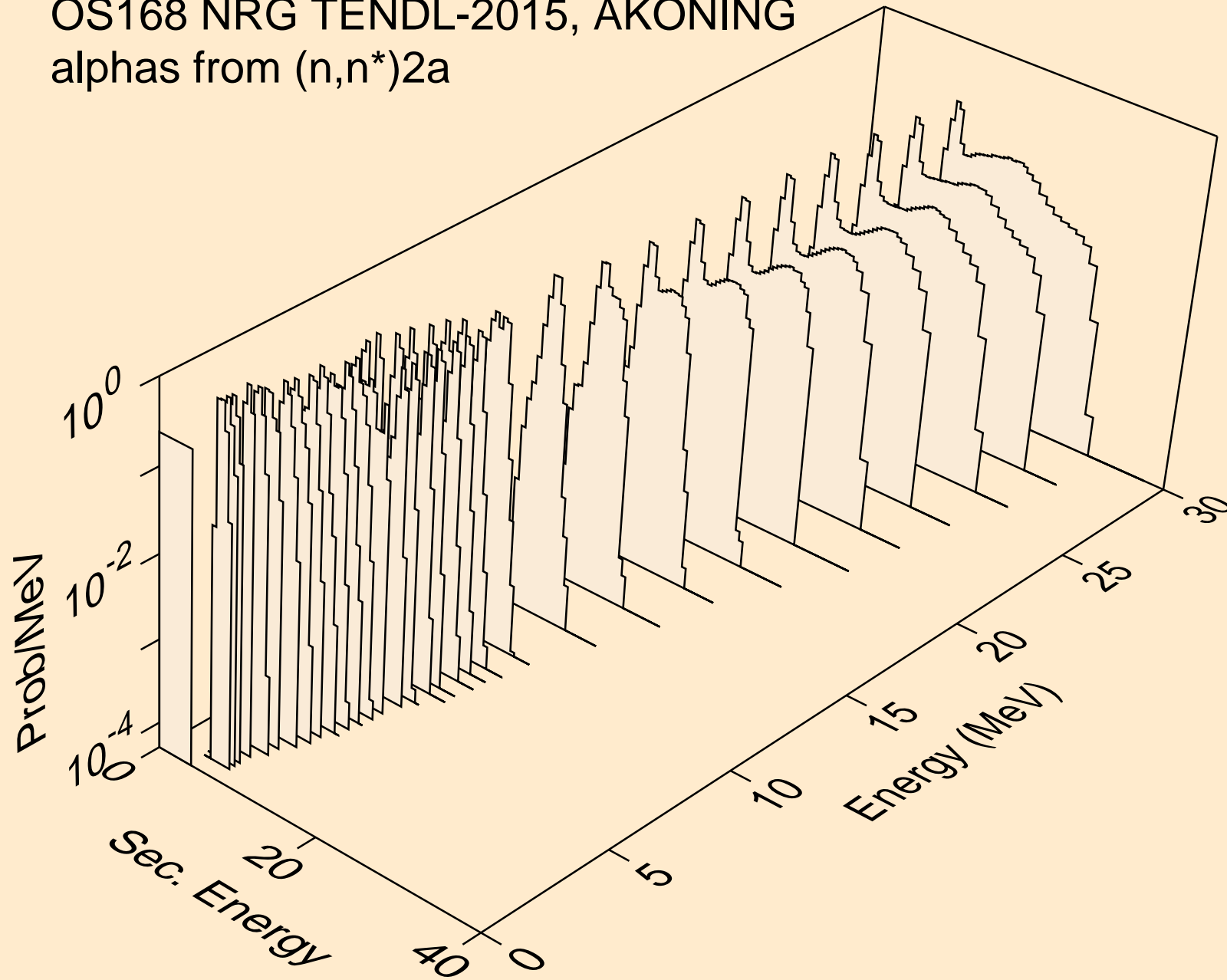

OS168 NRG TENDL-2015, AKONING
alphas from (n,2n)2a

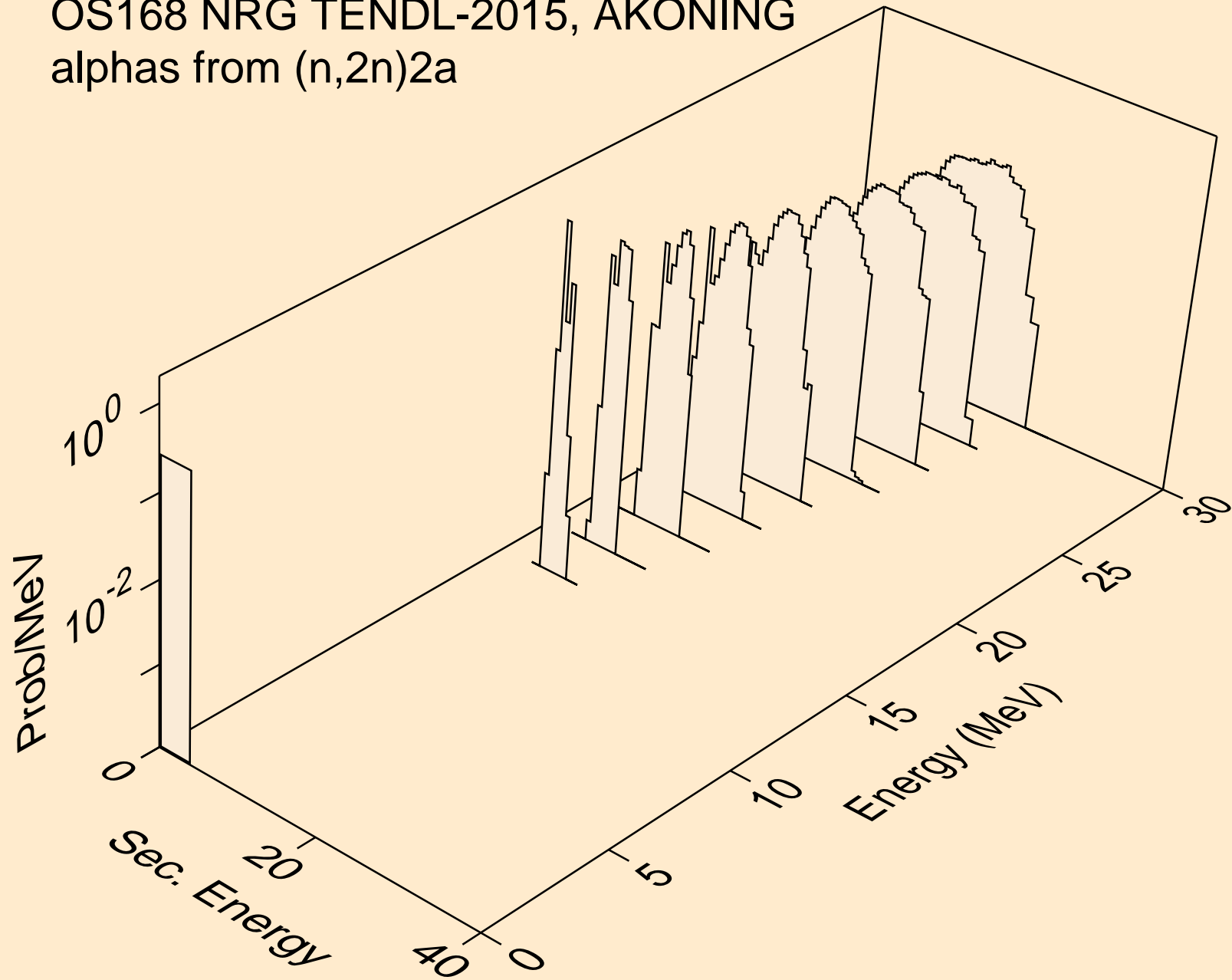

OS168 NRG TENDL-2015, AKONING
alphas from (n,n*)d2a

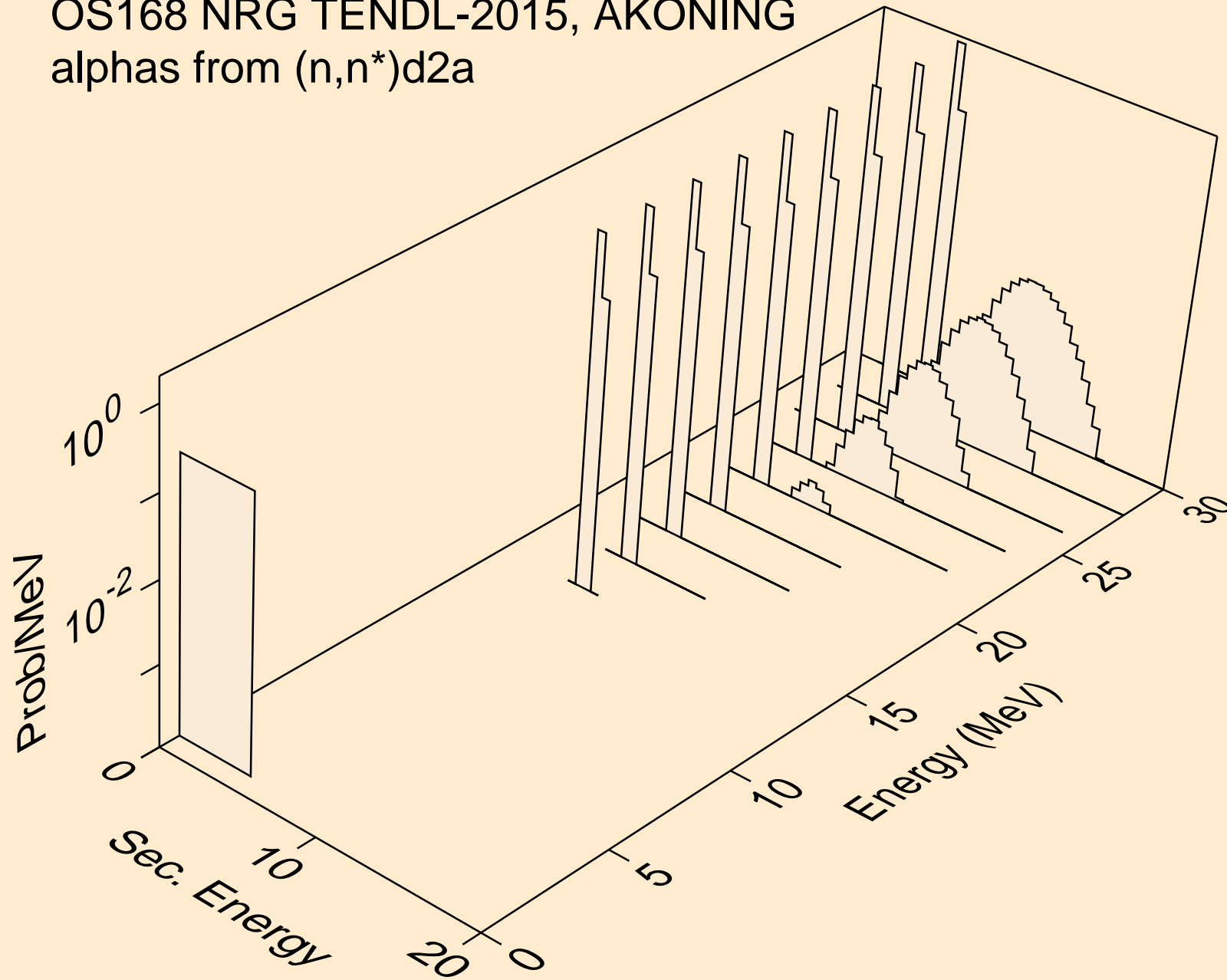

OS168 NRG TENDL-2015, AKONING
alphas from (n,n*)t2a

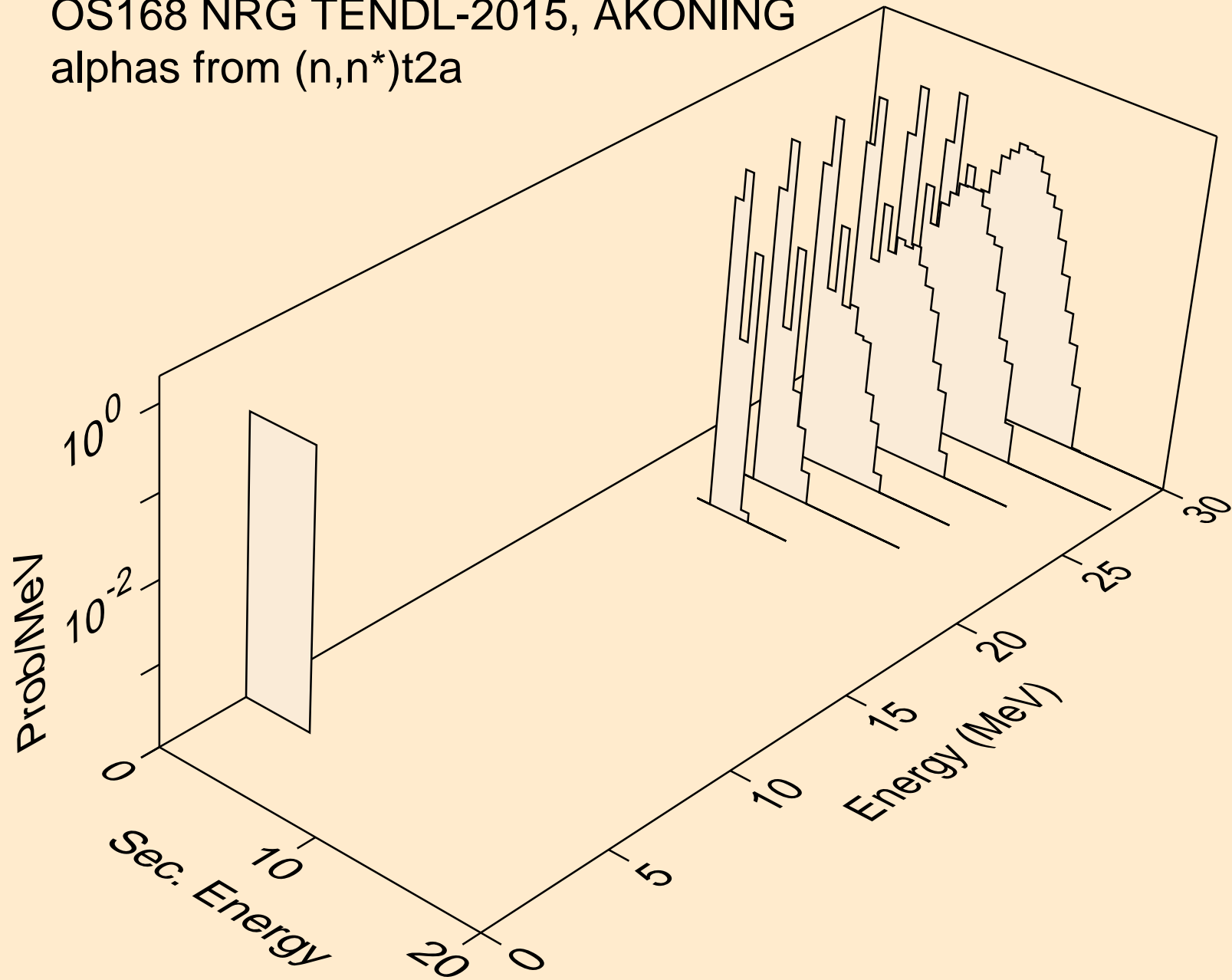

OS168 NRG TENDL-2015, AKONING
alphas from (n,npa)

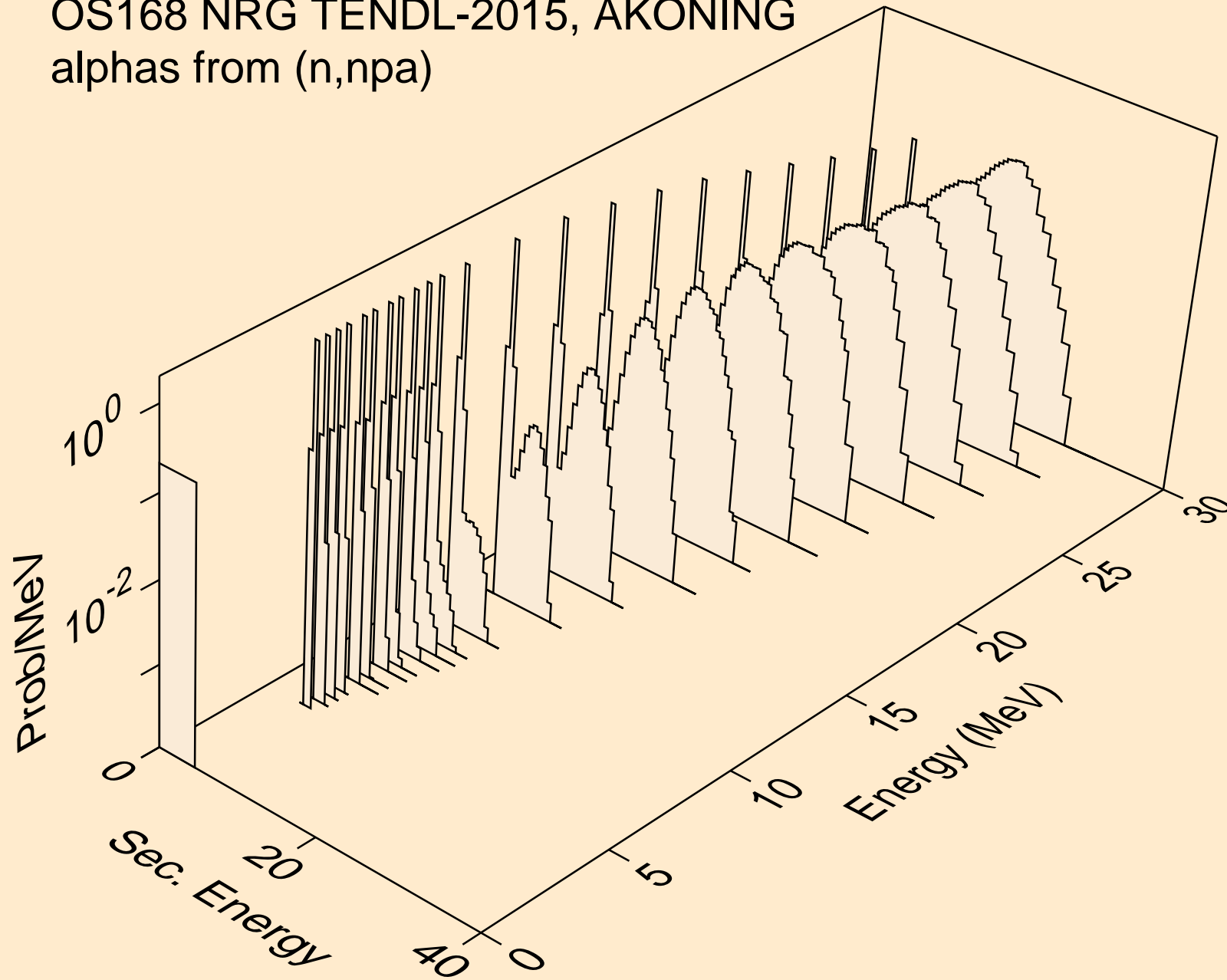

OS168 NRG TENDL-2015, AKONING
alphas from (n,a)

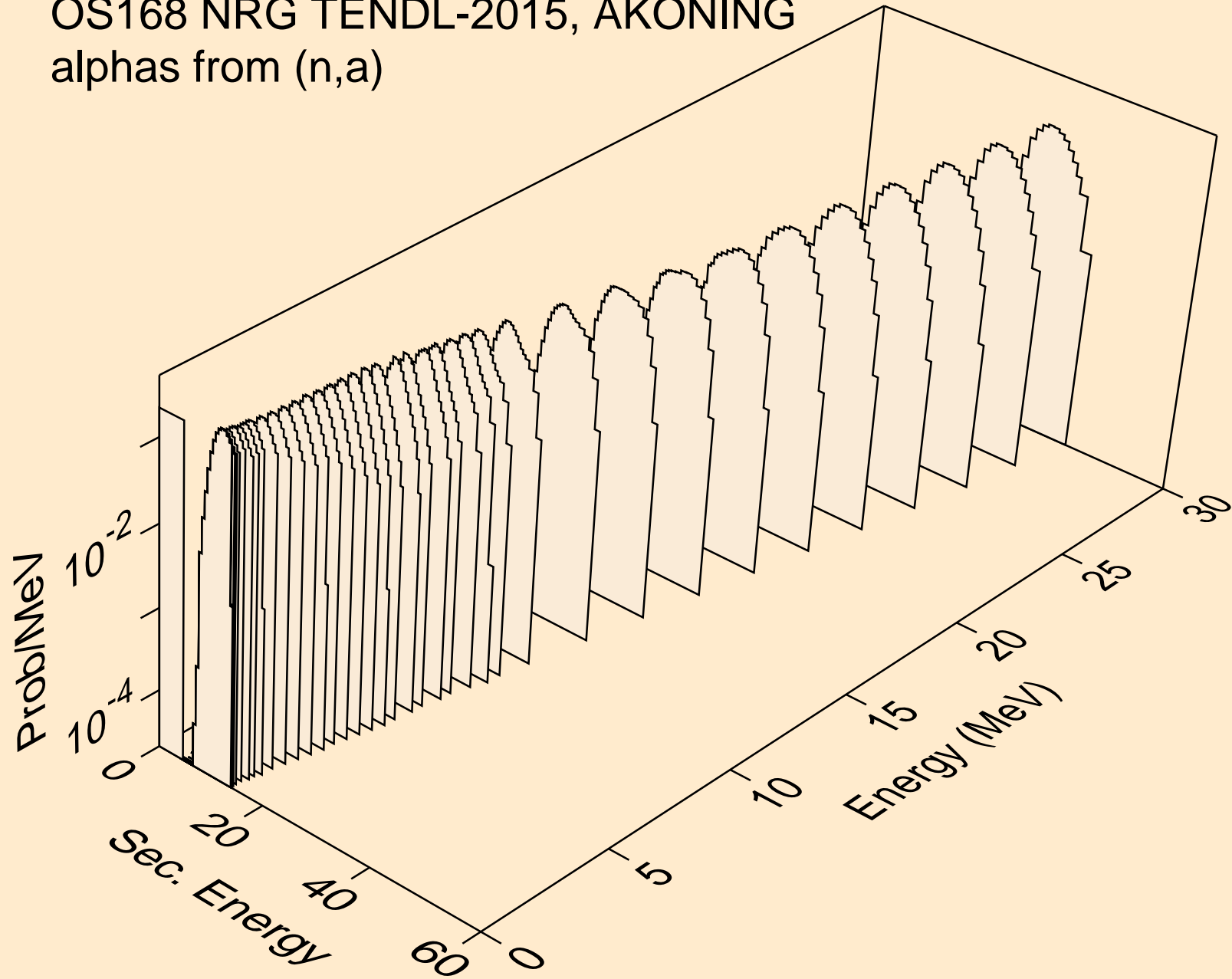

OS168 NRG TENDL-2015, AKONING
alphas from (n,2a)

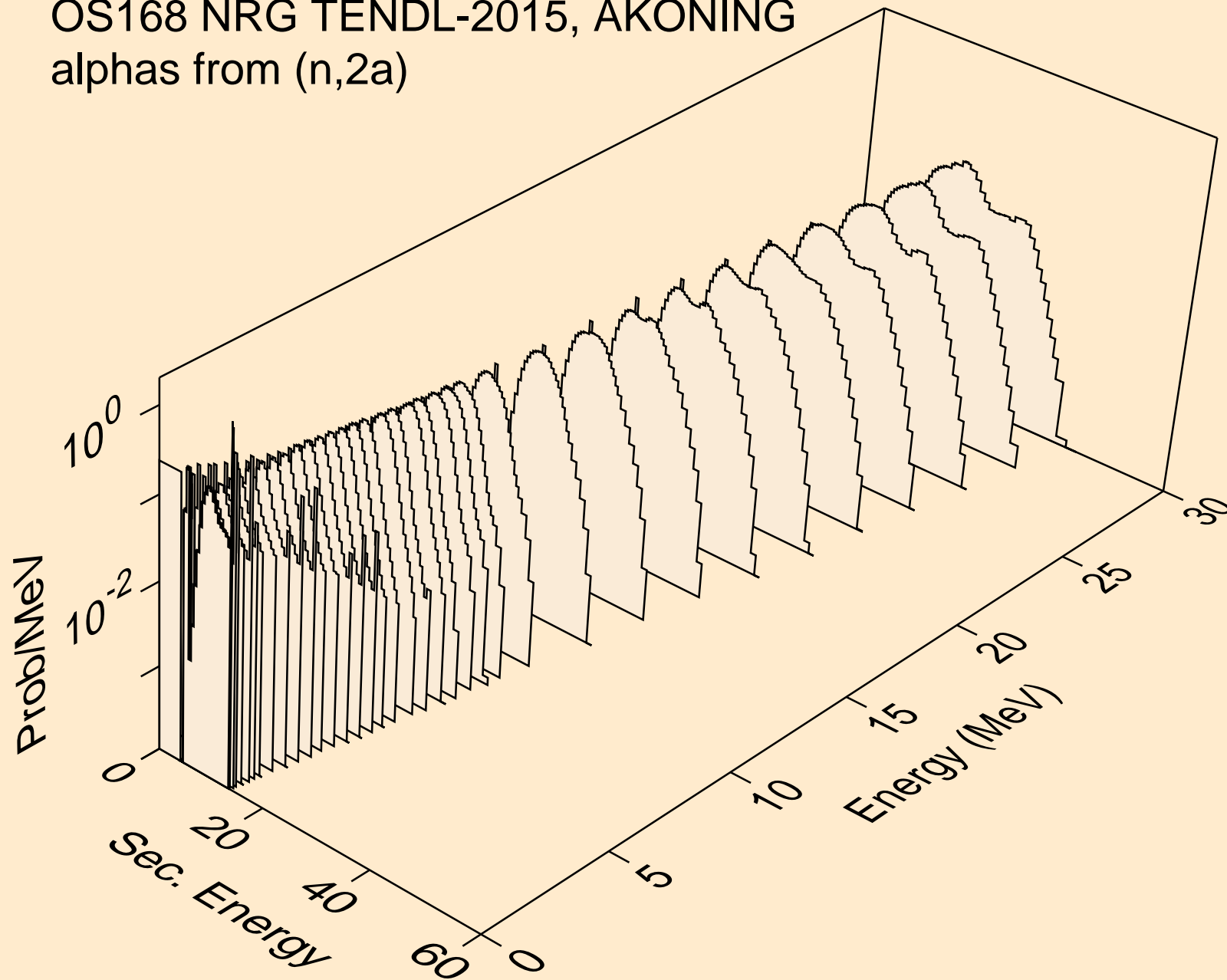

OS168 NRG TENDL-2015, AKONING
alphas from (n,3a)

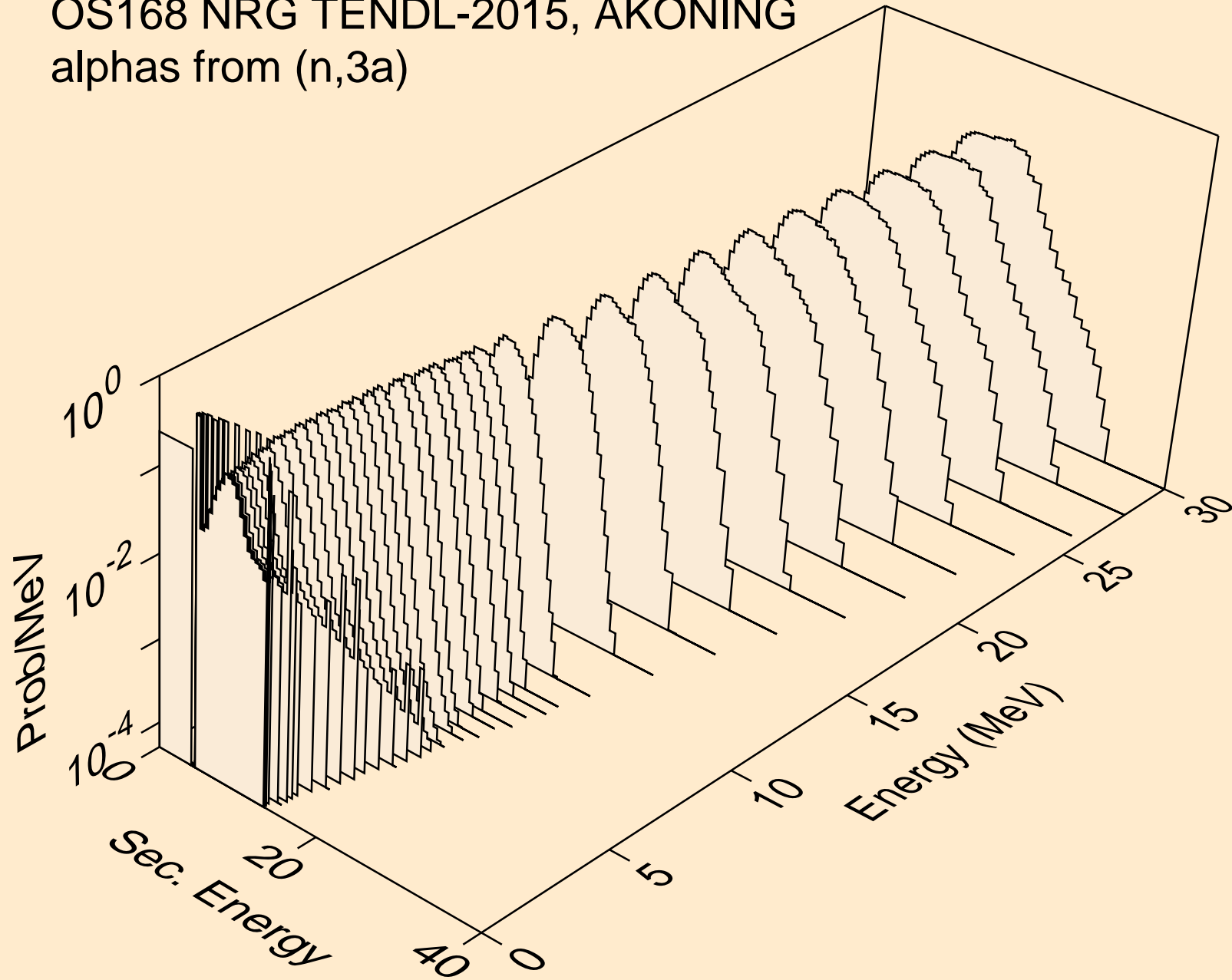

OS168 NRG TENDL-2015, AKONING
alphas from (n,pa)

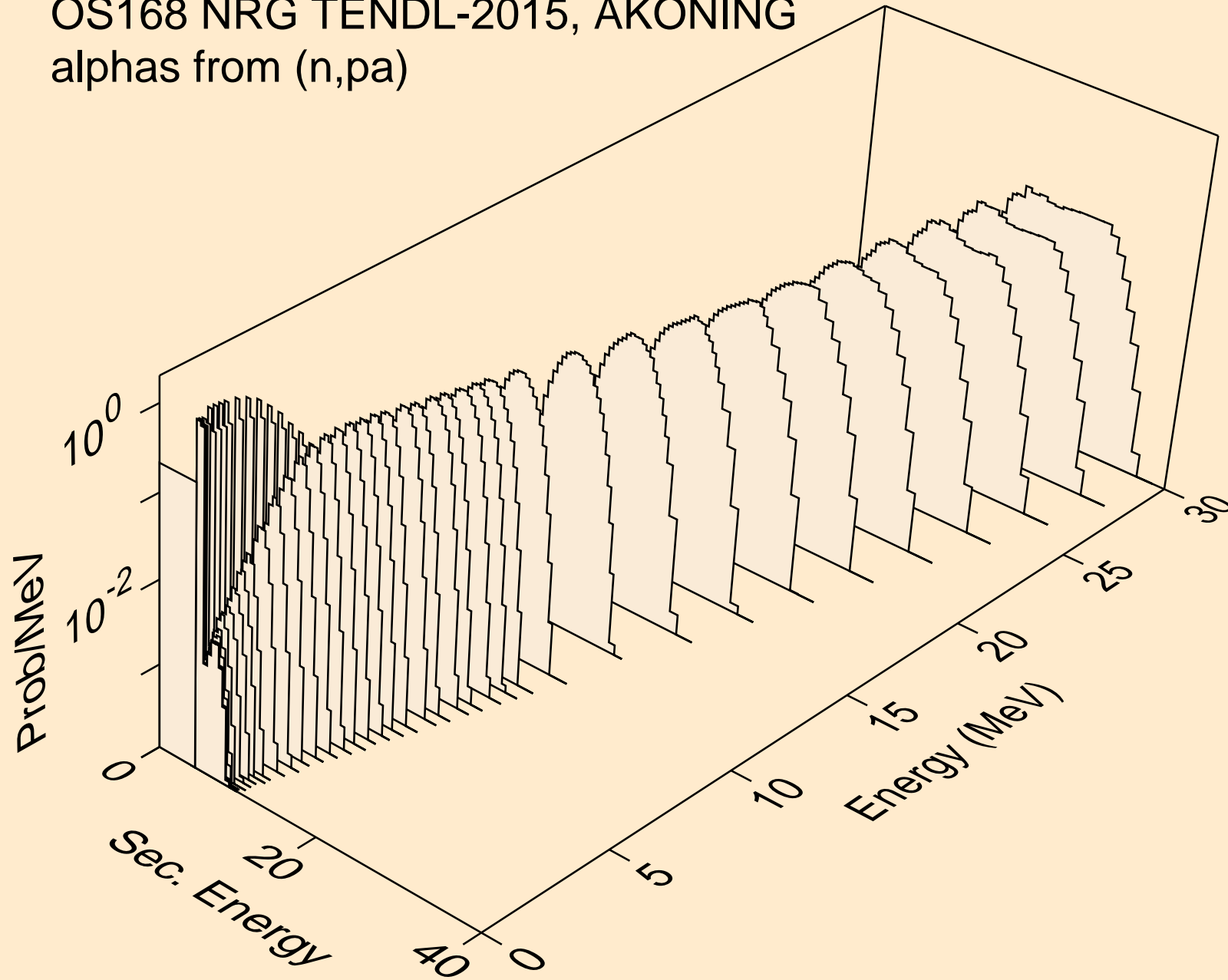

OS168 NRG TENDL-2015, AKONING
alphas from (n,t2a)

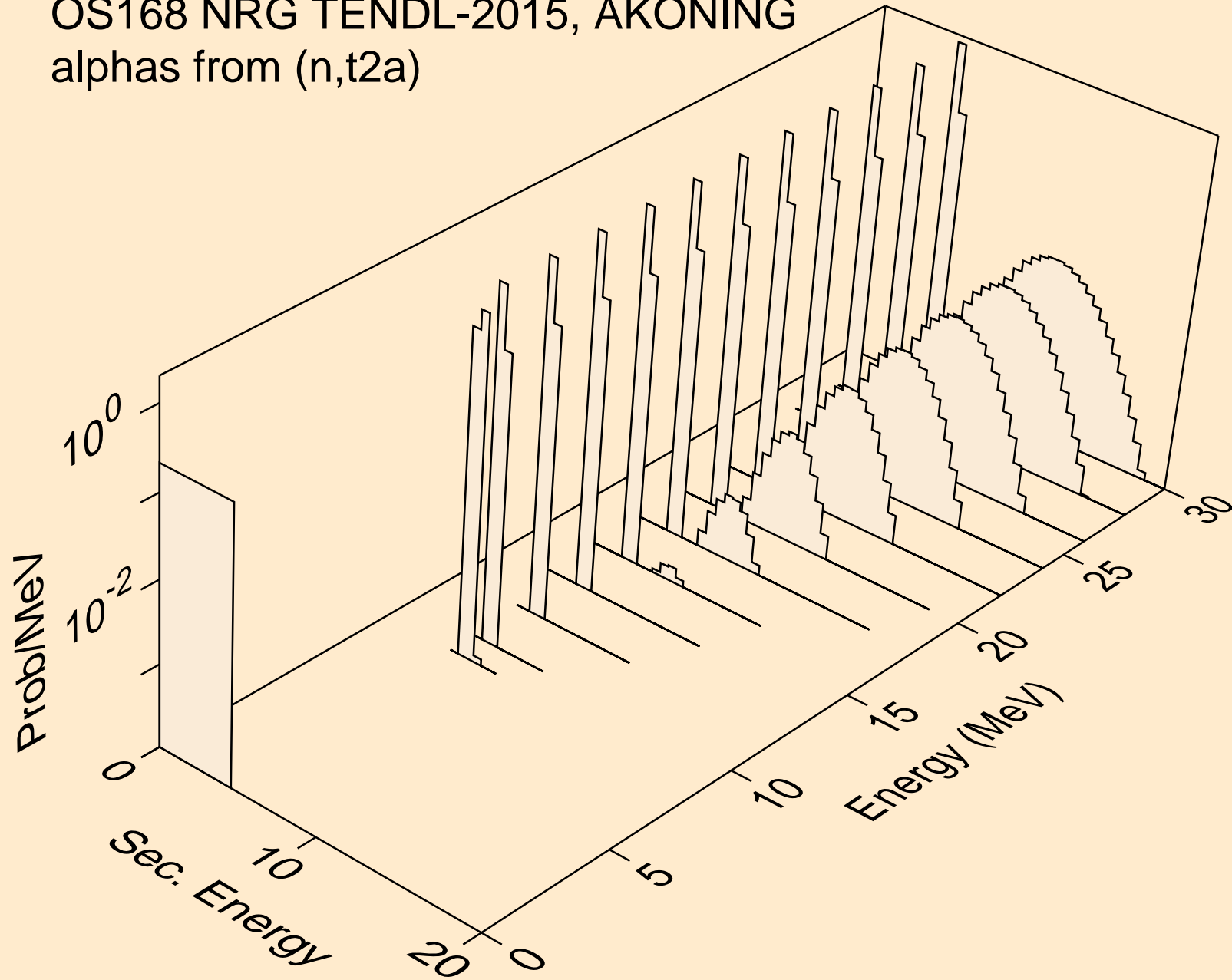

OS168 NRG TENDL-2015, AKONING
alphas from (n,d2a)

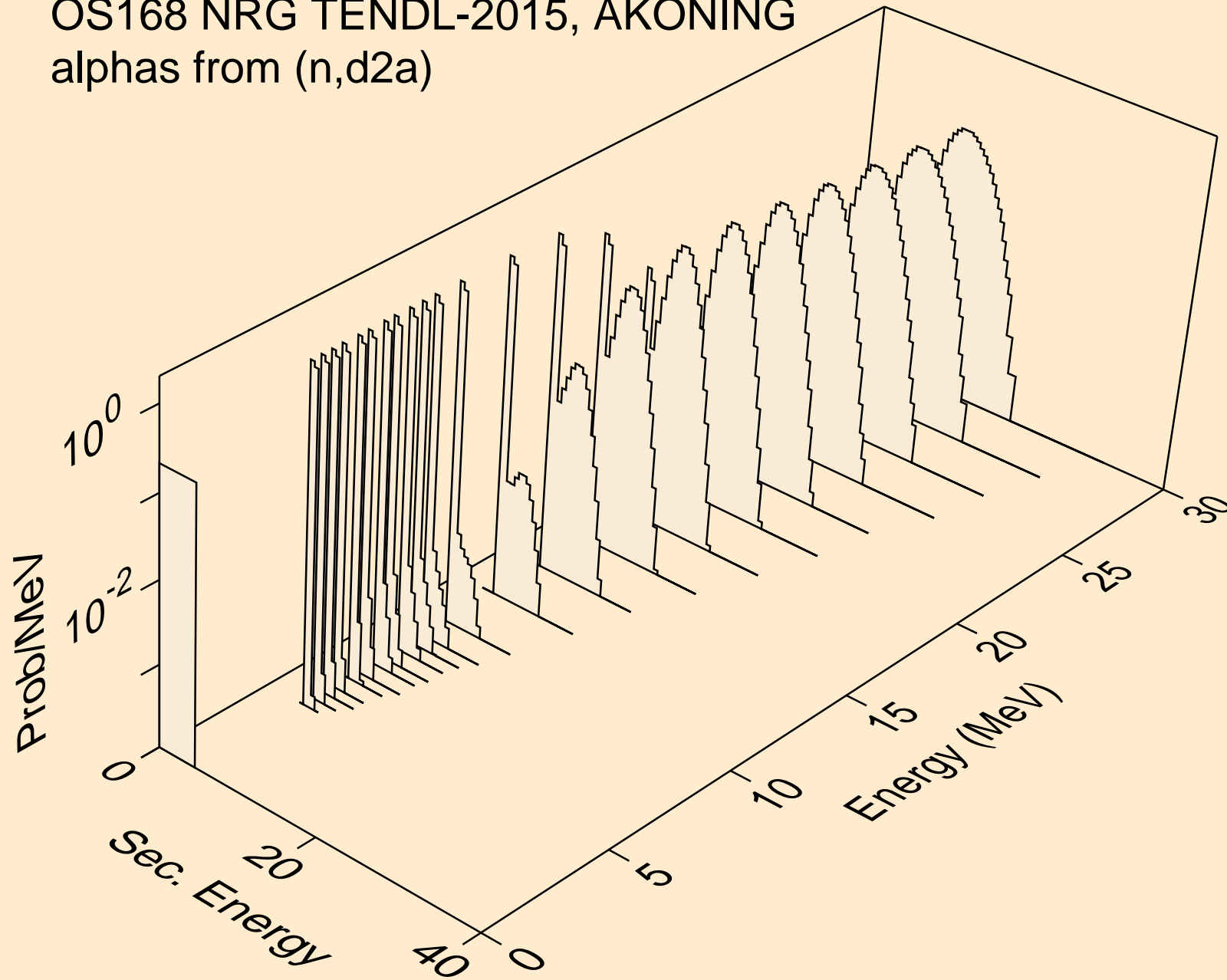

OS168 NRG TENDL-2015, AKONING
alphas from (n,da)

