

PA226 NRG TENDL-2015, AKONING
Principal cross sections

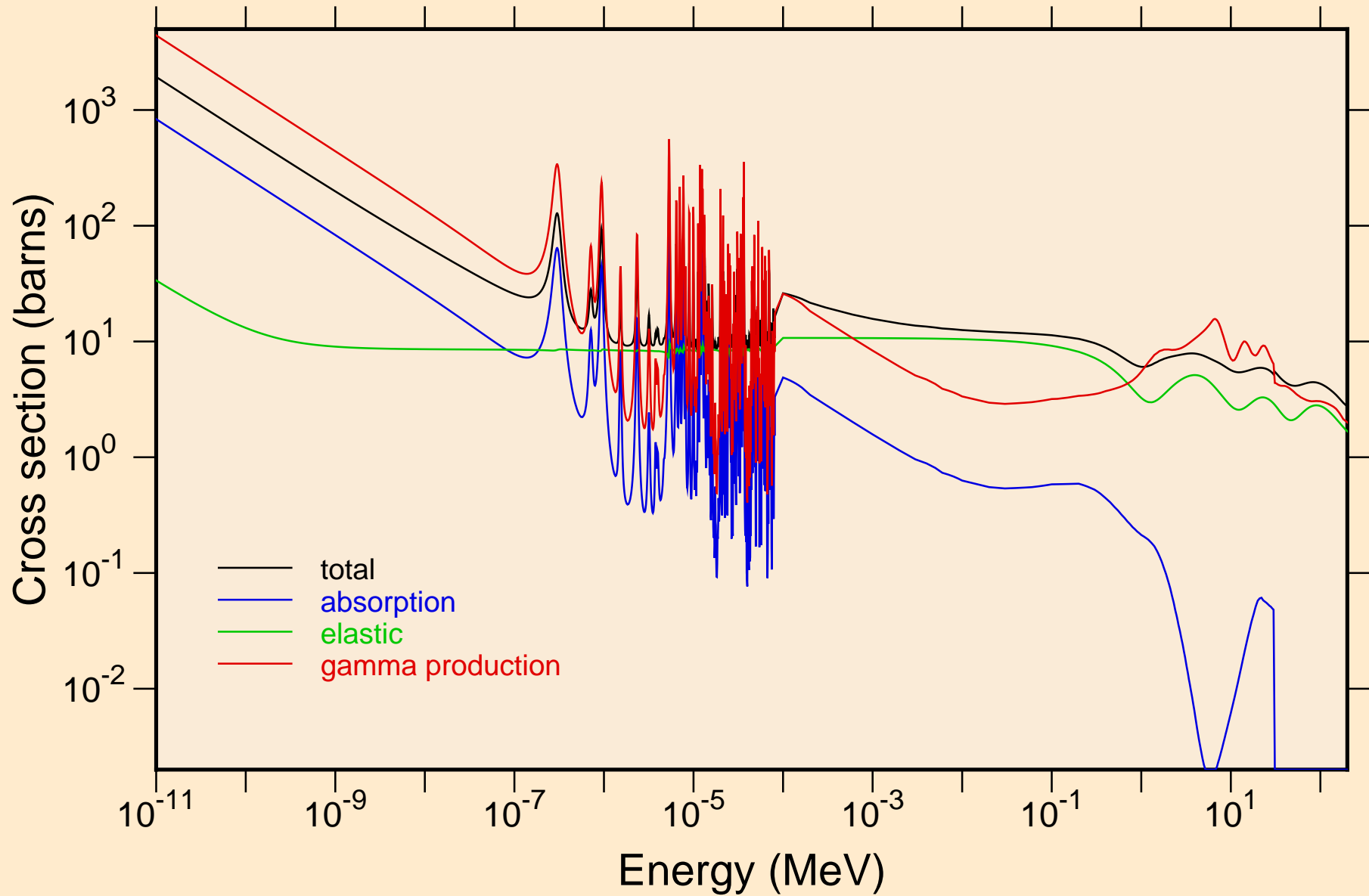

PA226 NRG TENDL-2015, AKONING
resonance total cross section

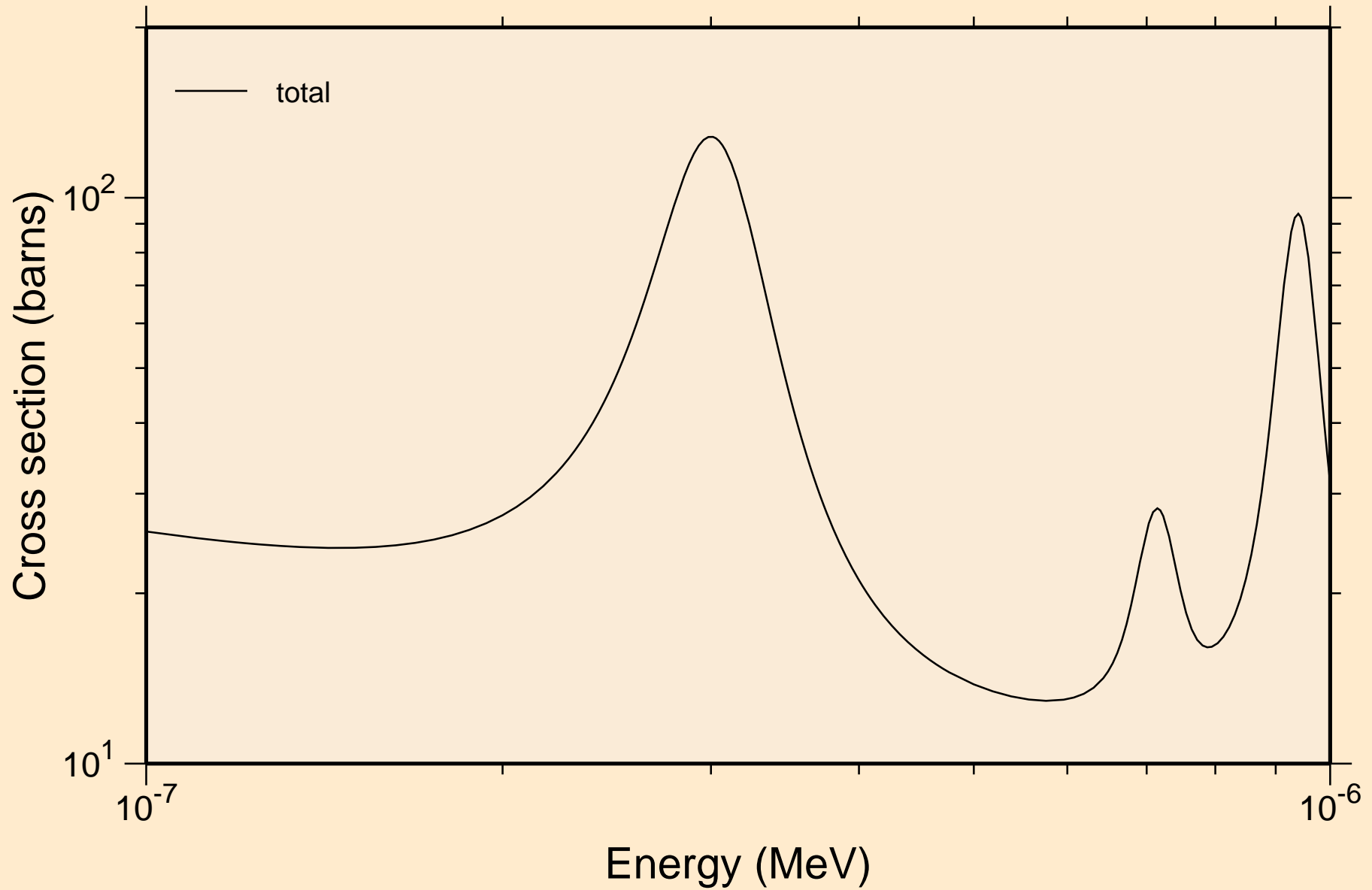

PA226 NRG TENDL-2015, AKONING
resonance total cross section

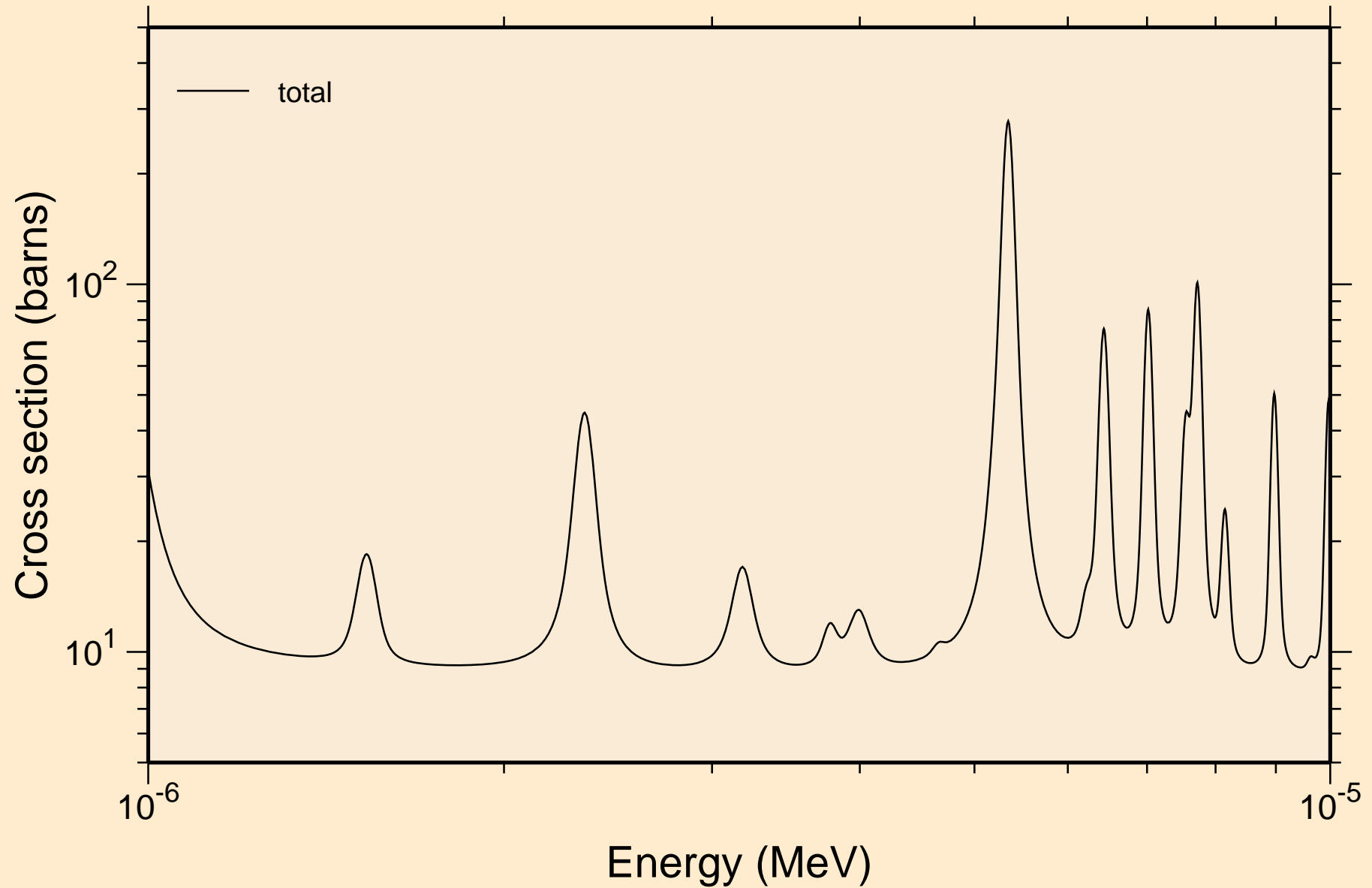

PA226 NRG TENDL-2015, AKONING
resonance total cross section

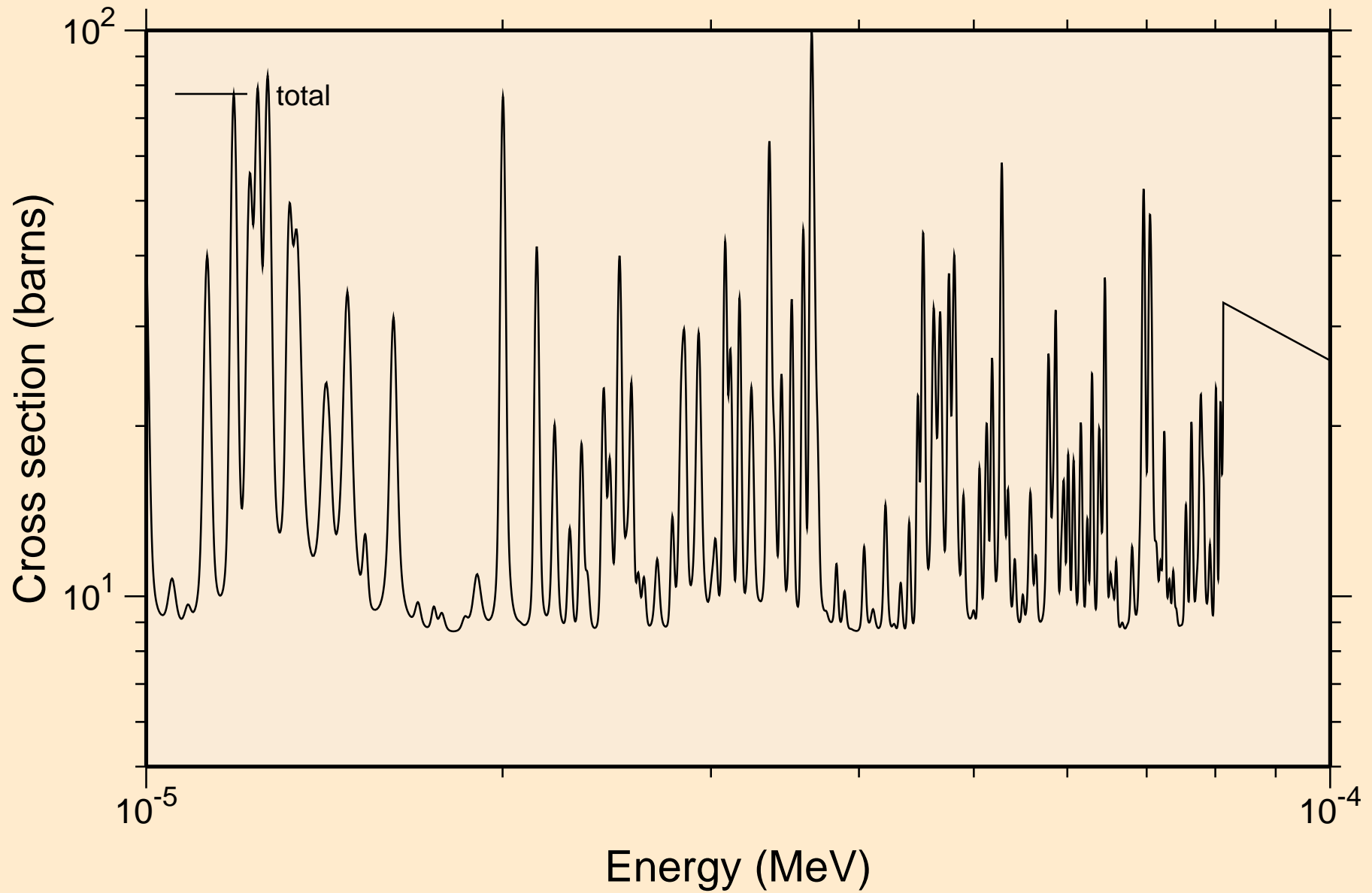

PA226 NRG TENDL-2015, AKONING
resonance total cross section

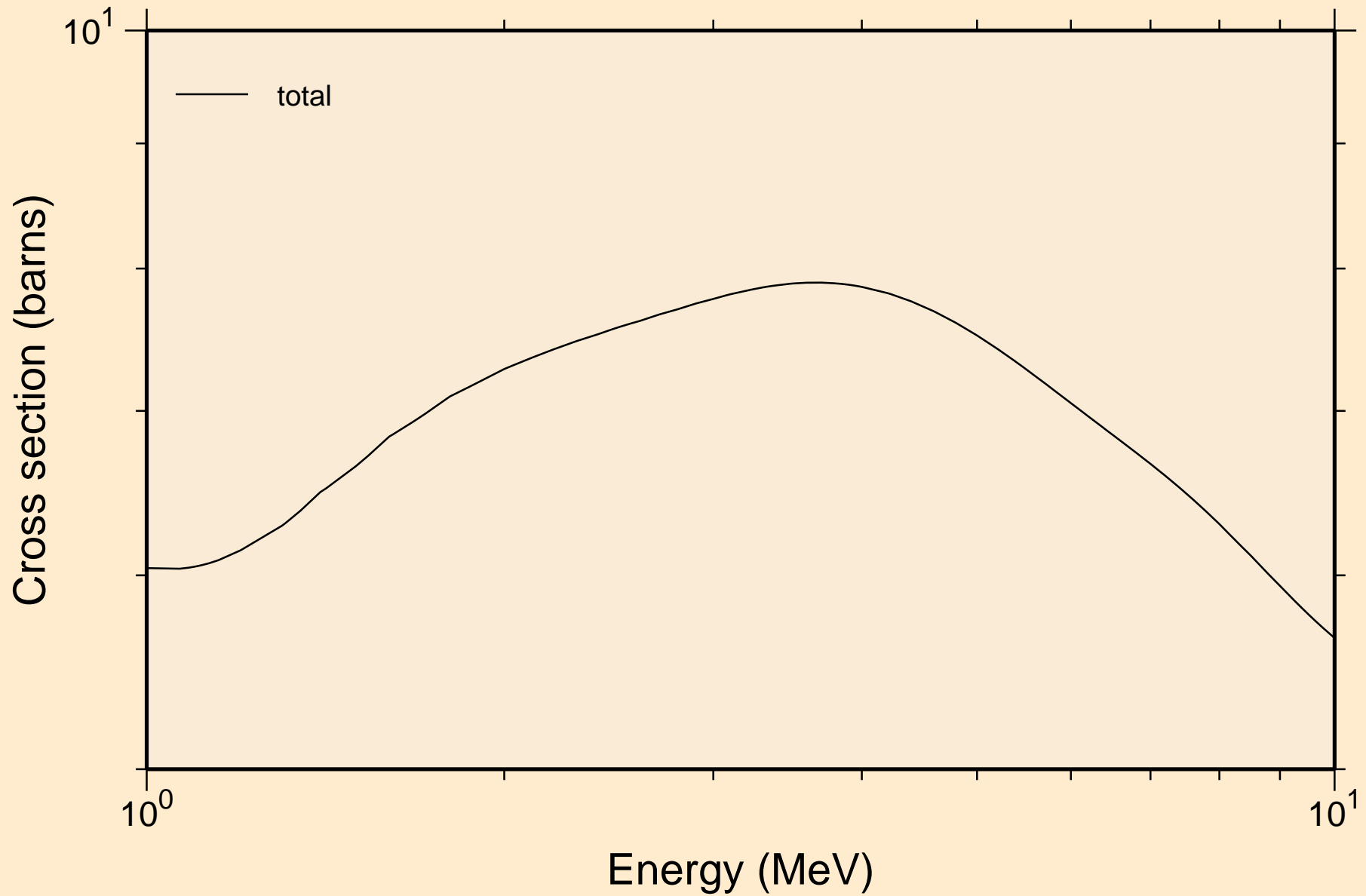

PA226 NRG TENDL-2015, AKONING
resonance absorption cross sections

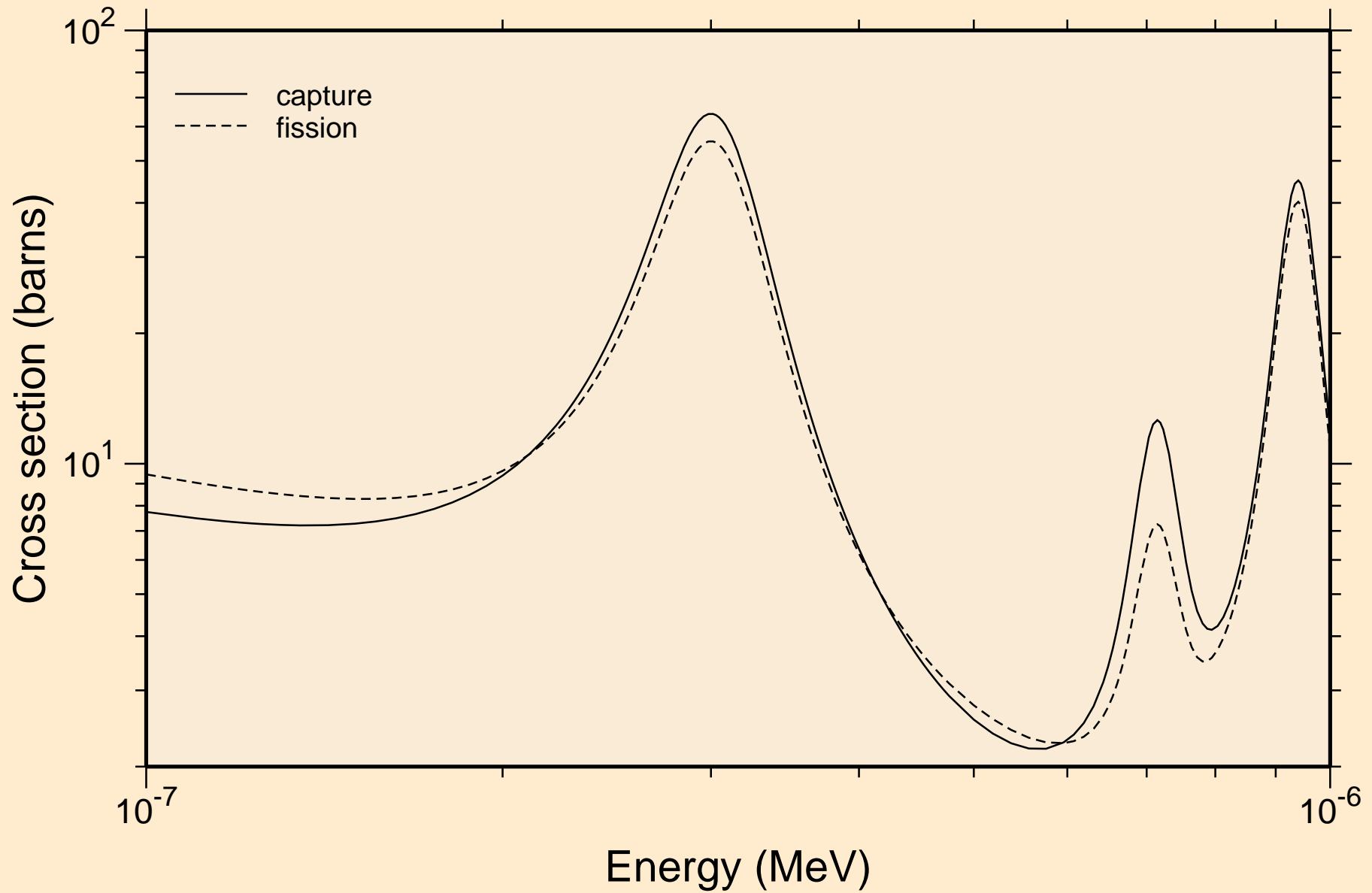

PA226 NRG TENDL-2015, AKONING
resonance absorption cross sections

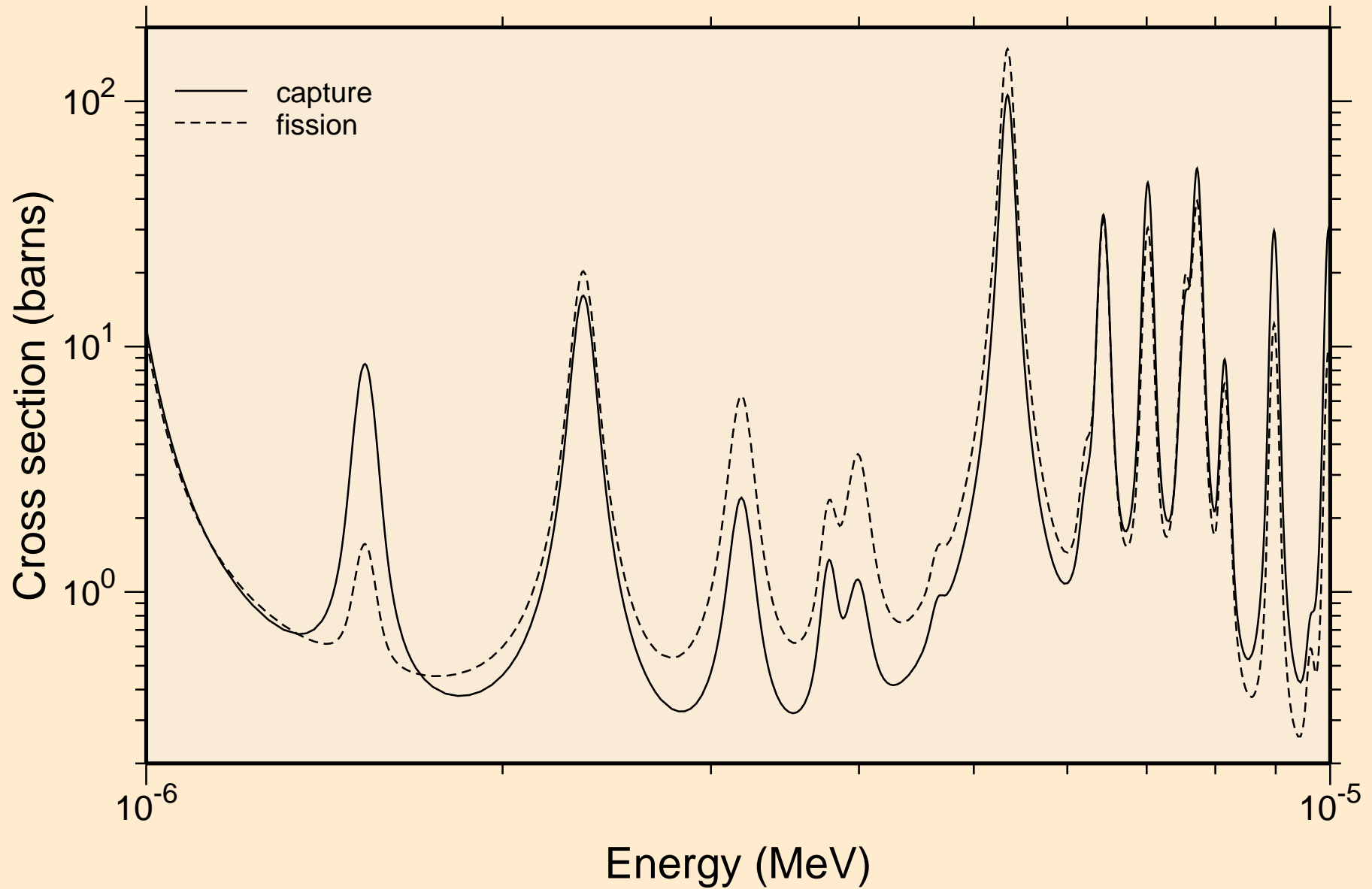

PA226 NRG TENDL-2015, AKONING
resonance absorption cross sections

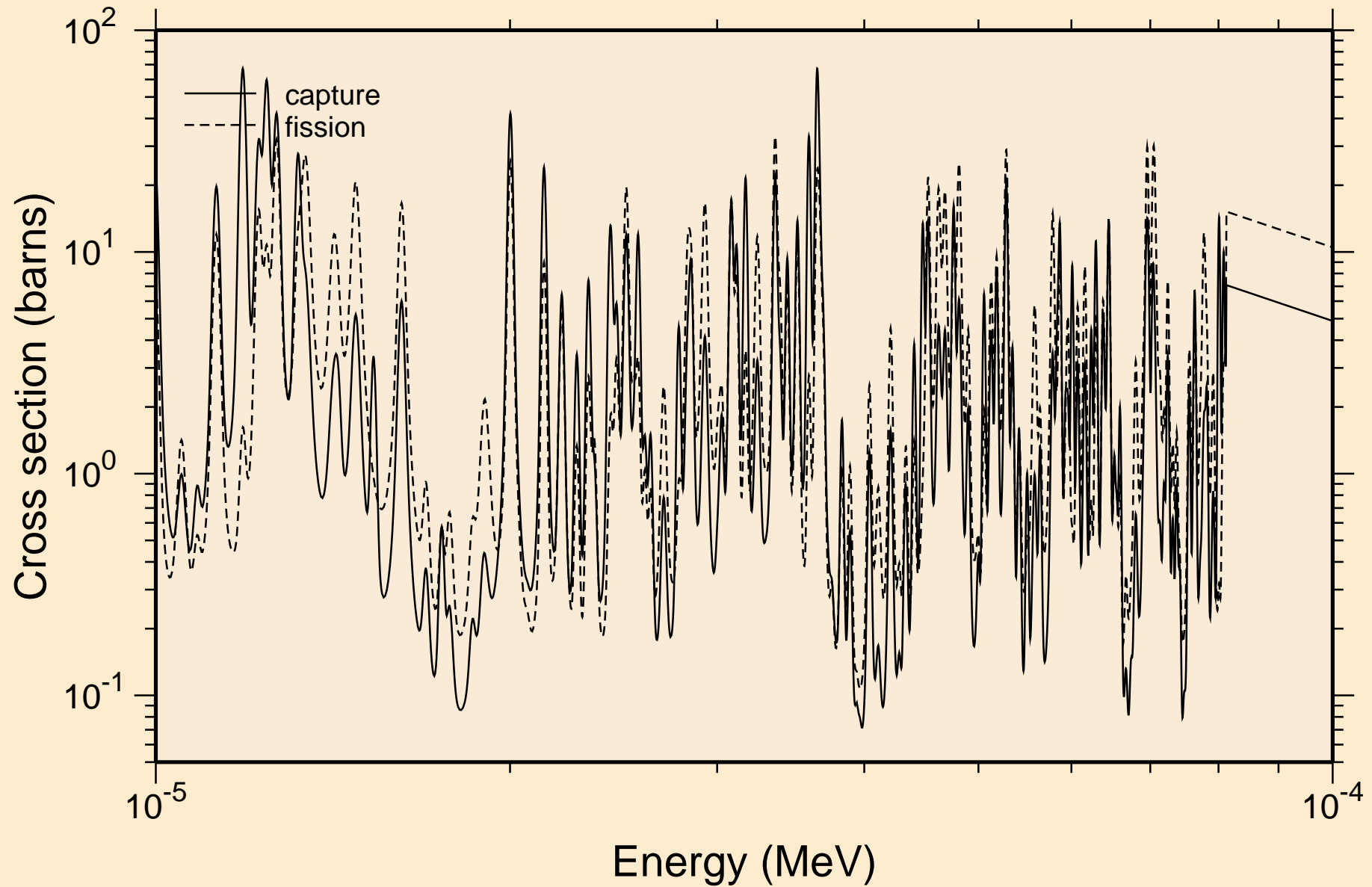

PA226 NRG TENDL-2015, AKONING
resonance absorption cross sections

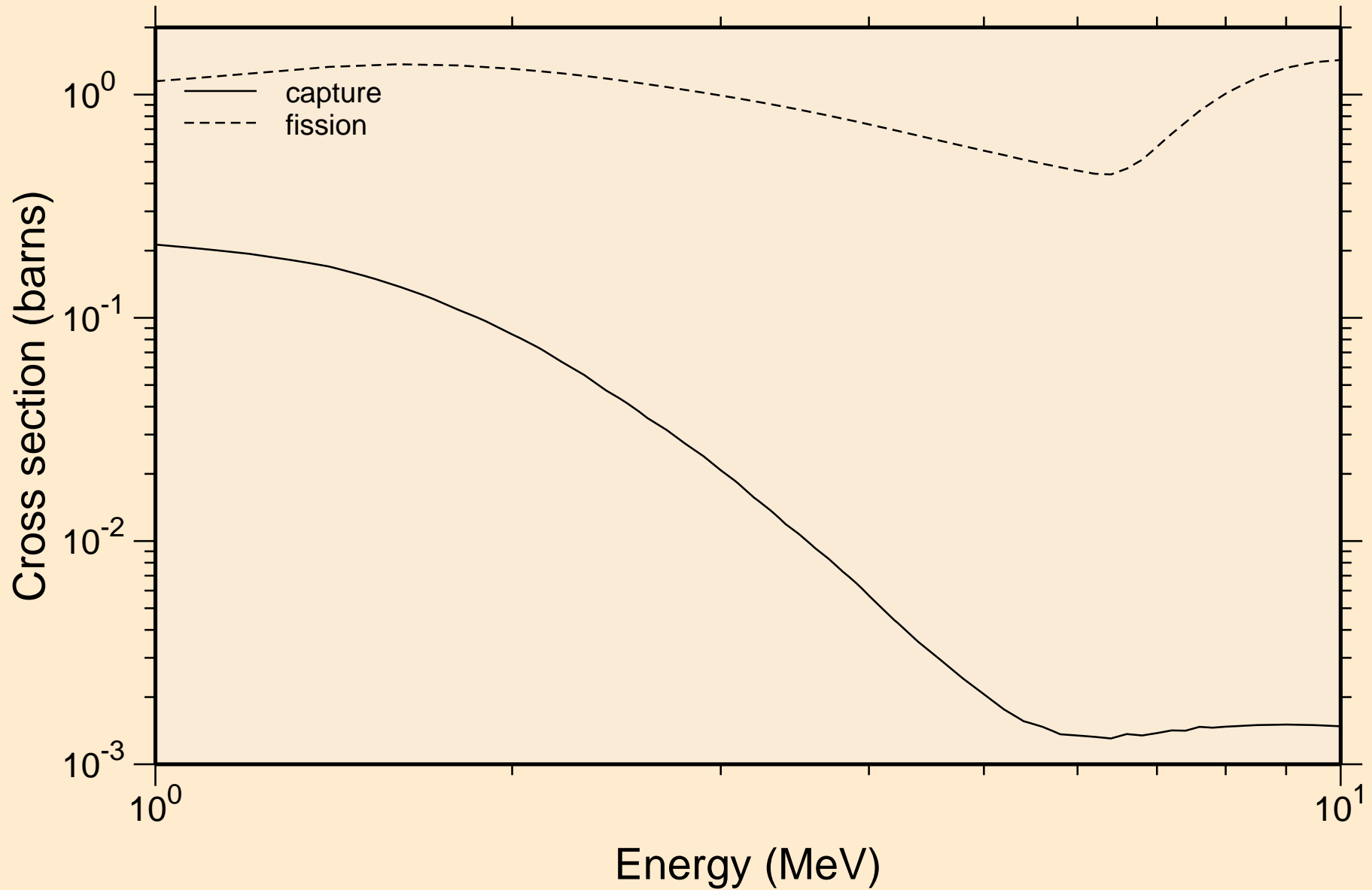

PA226 NRG TENDL-2015, AKONING

Non-threshold reactions

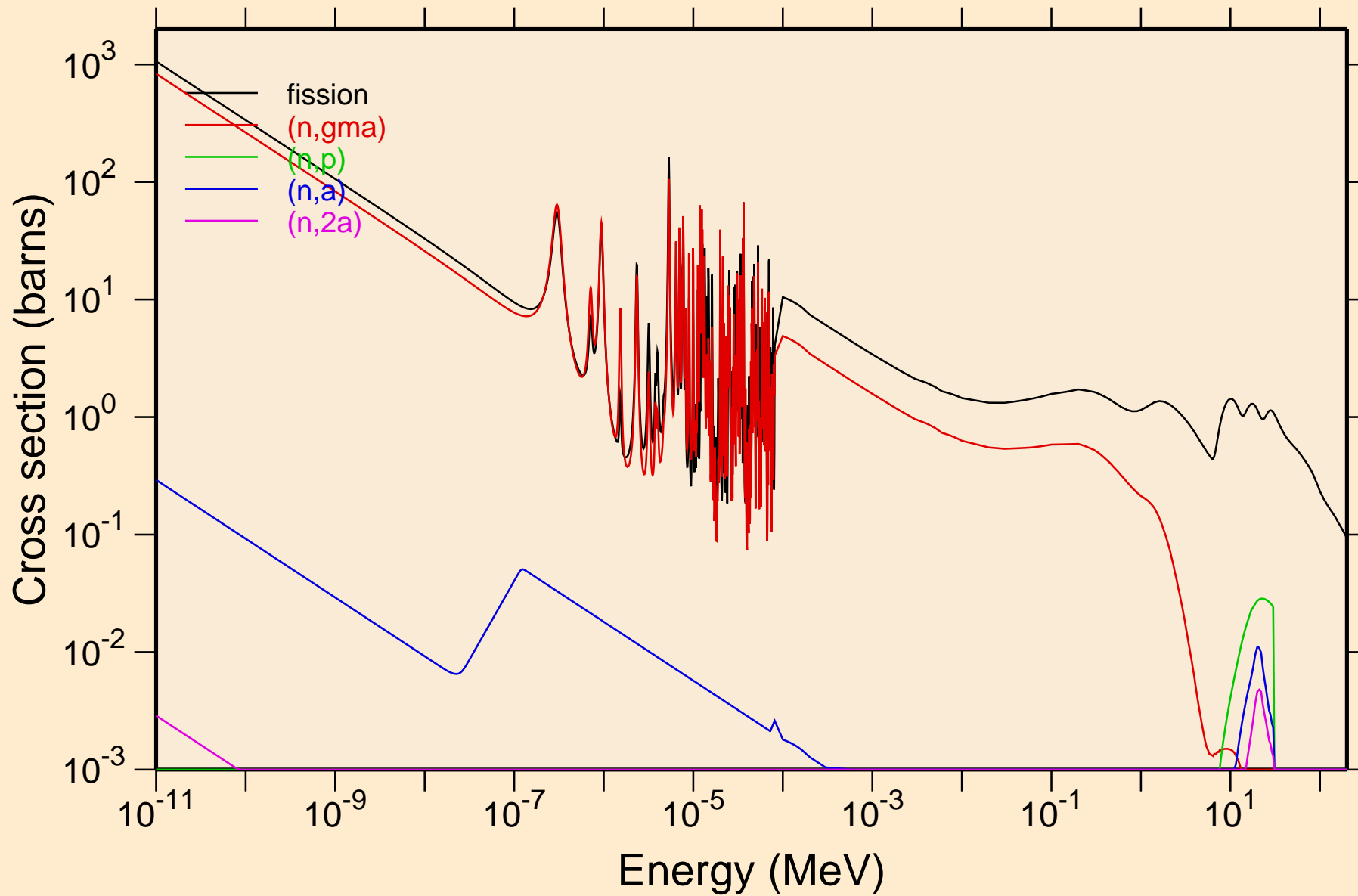

PA226 NRG TENDL-2015, AKONING
Non-threshold reactions

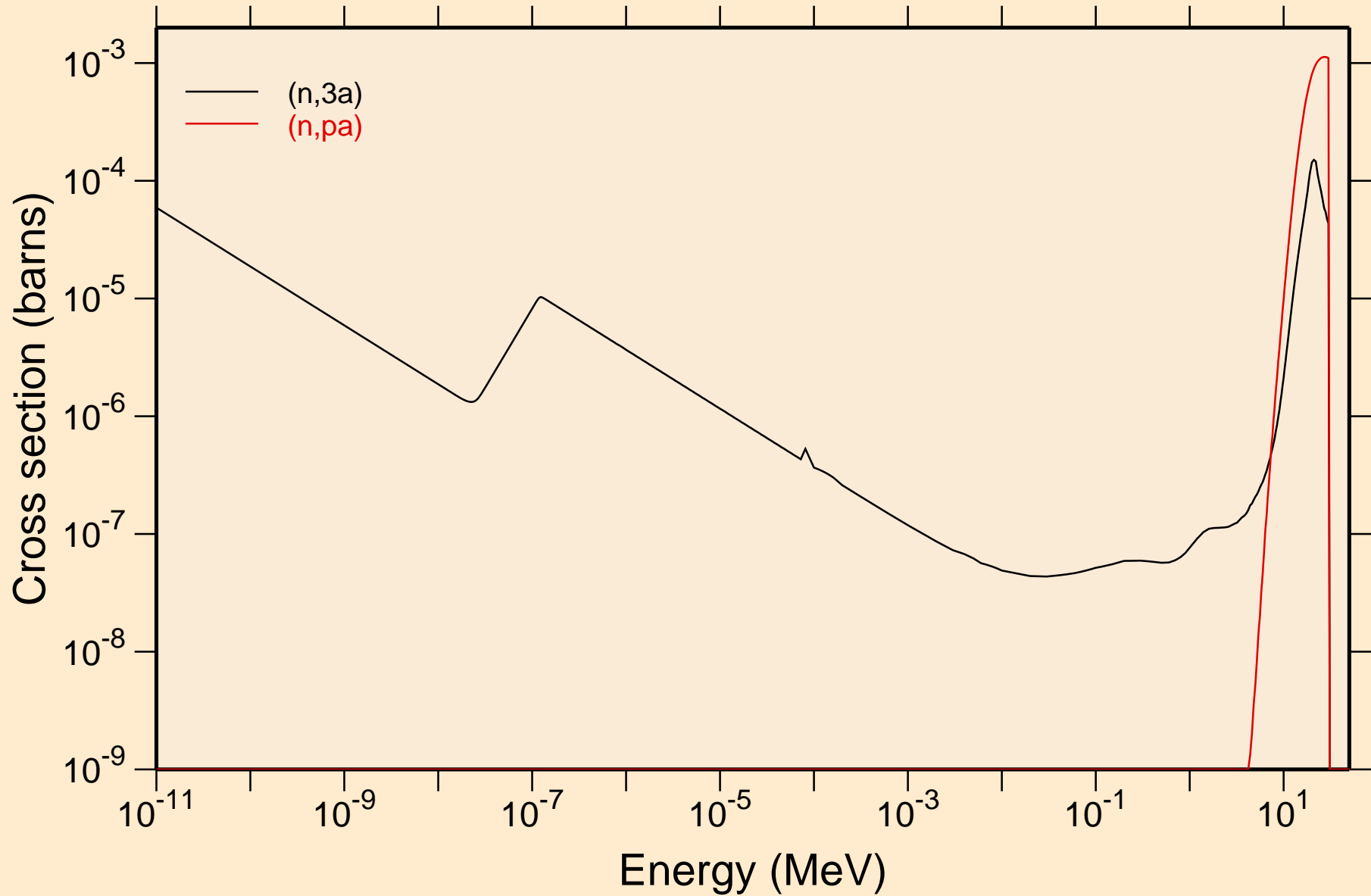

PA226 NRG TENDL-2015, AKONING

Principal cross sections

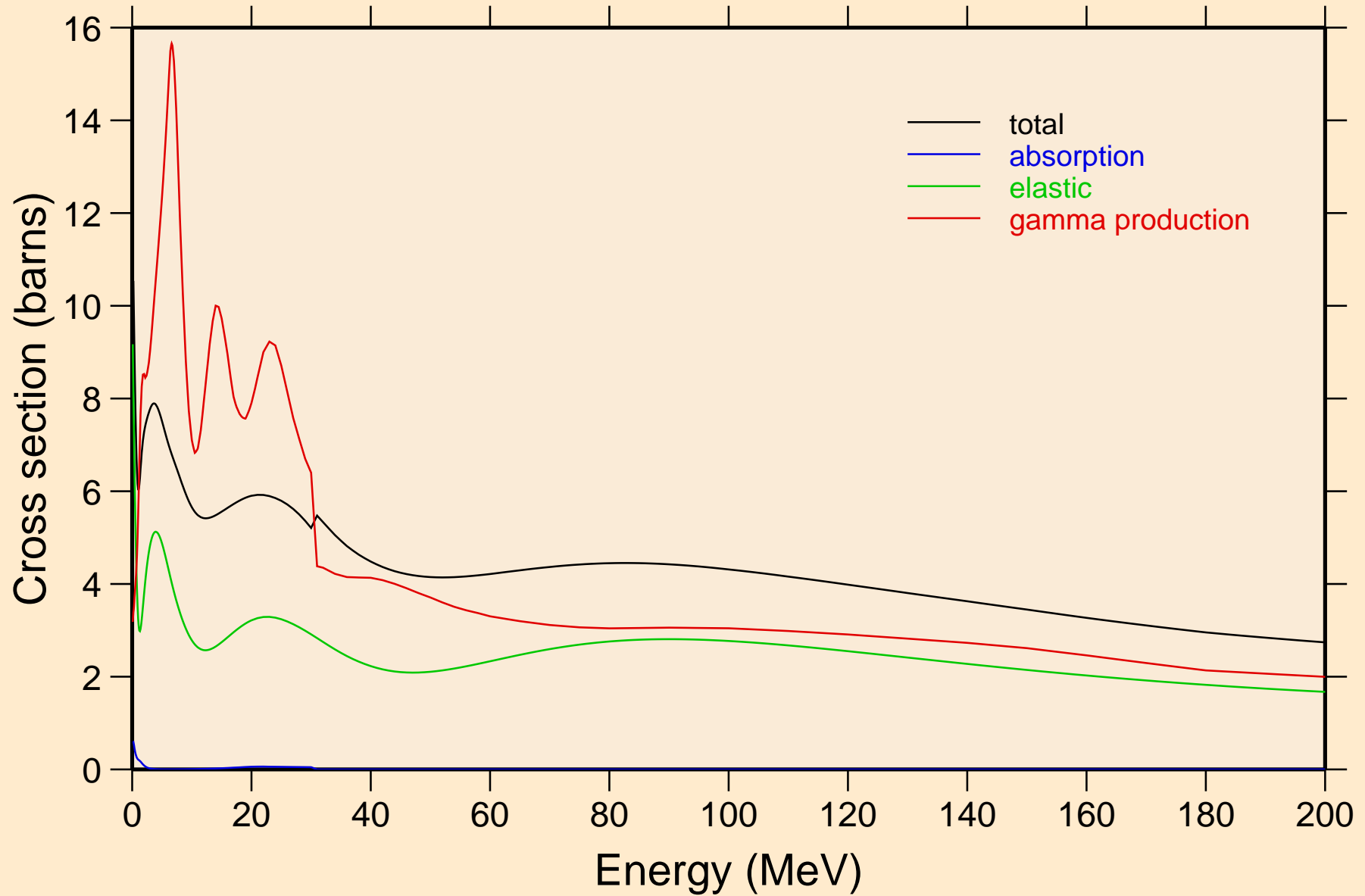

PA226 NRG TENDL-2015, AKONING

Non-threshold reactions

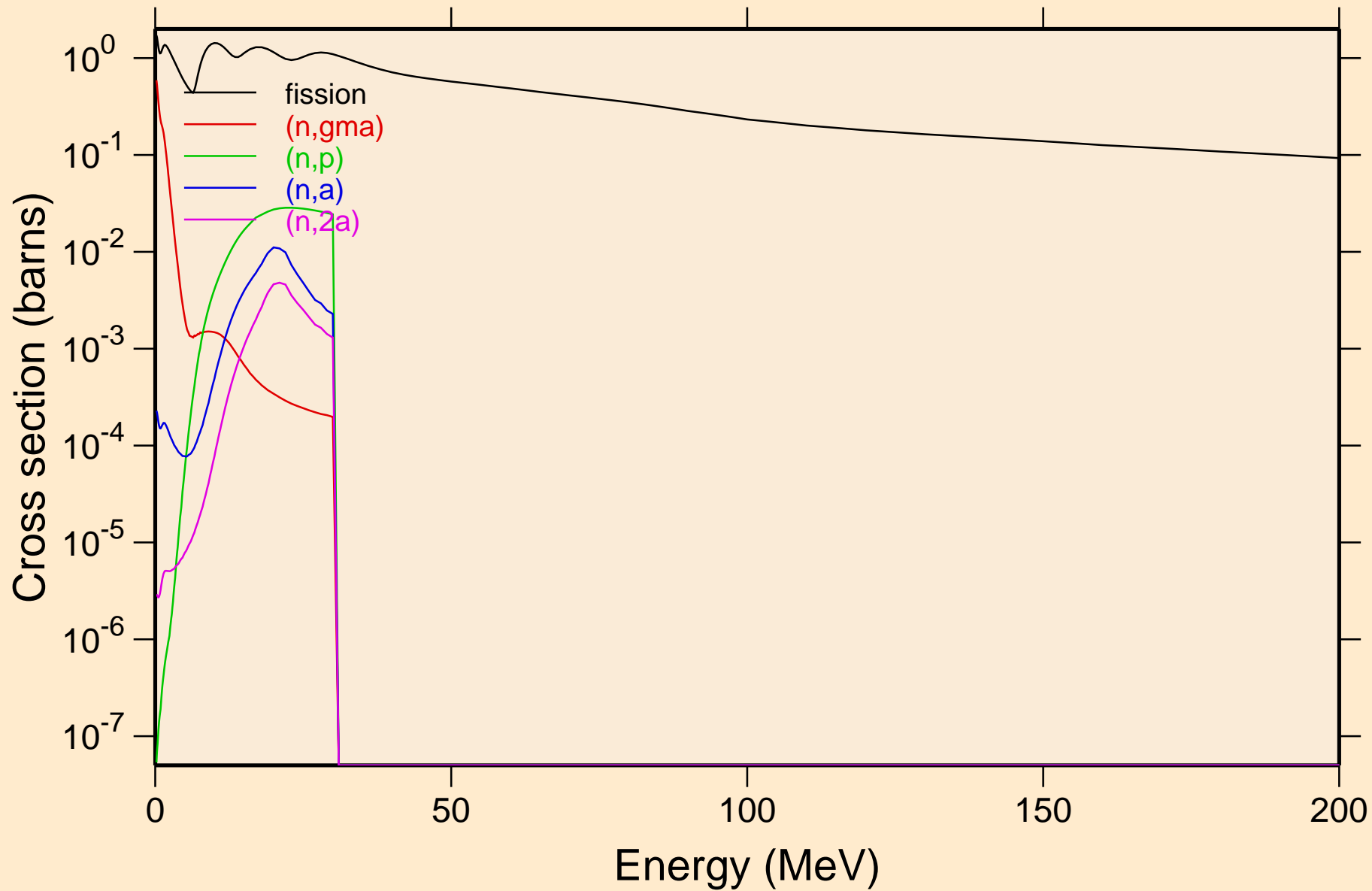

PA226 NRG TENDL-2015, AKONING
Non-threshold reactions

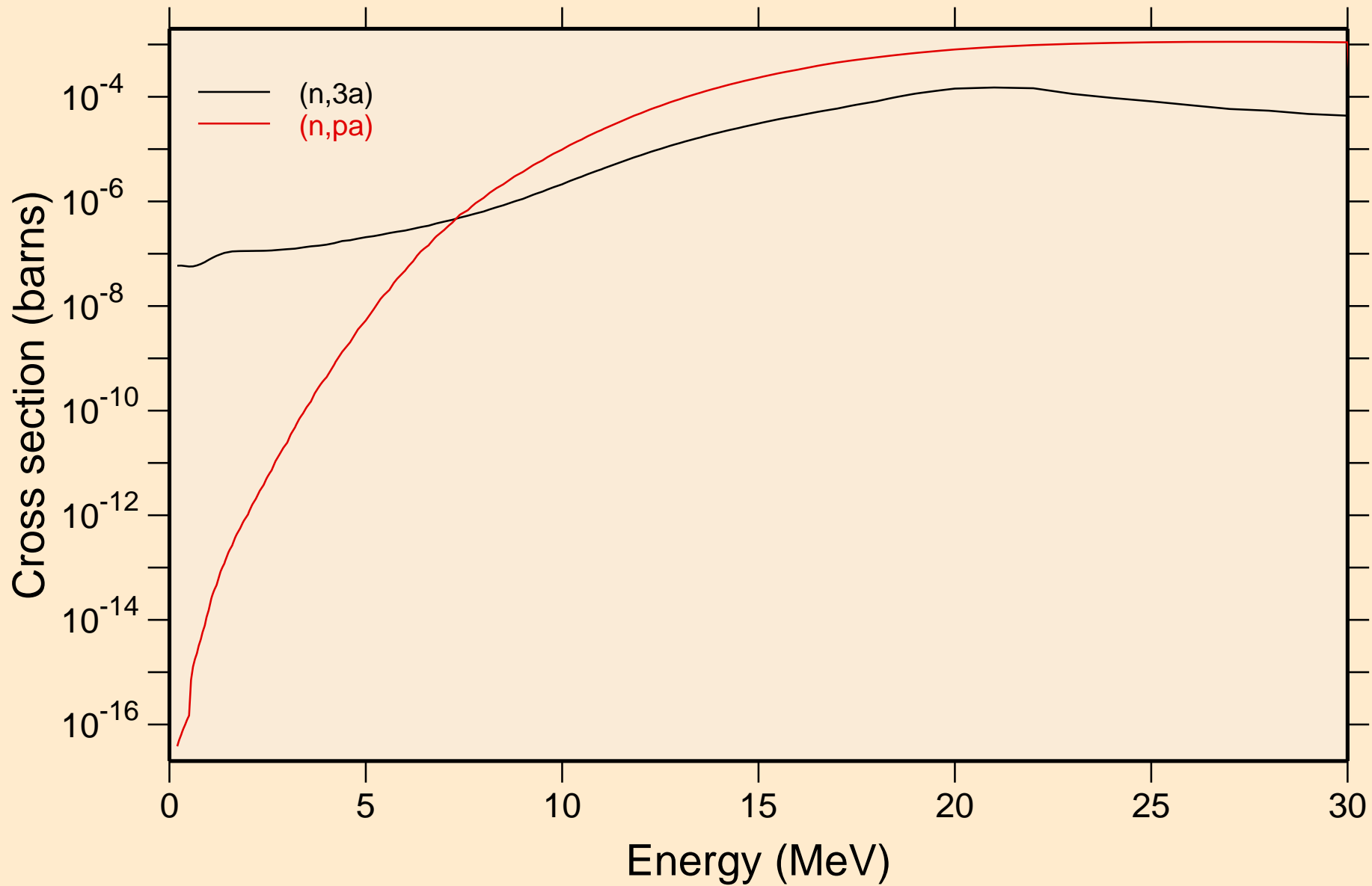

PA226 NRG TENDL-2015, AKONING
Inelastic levels

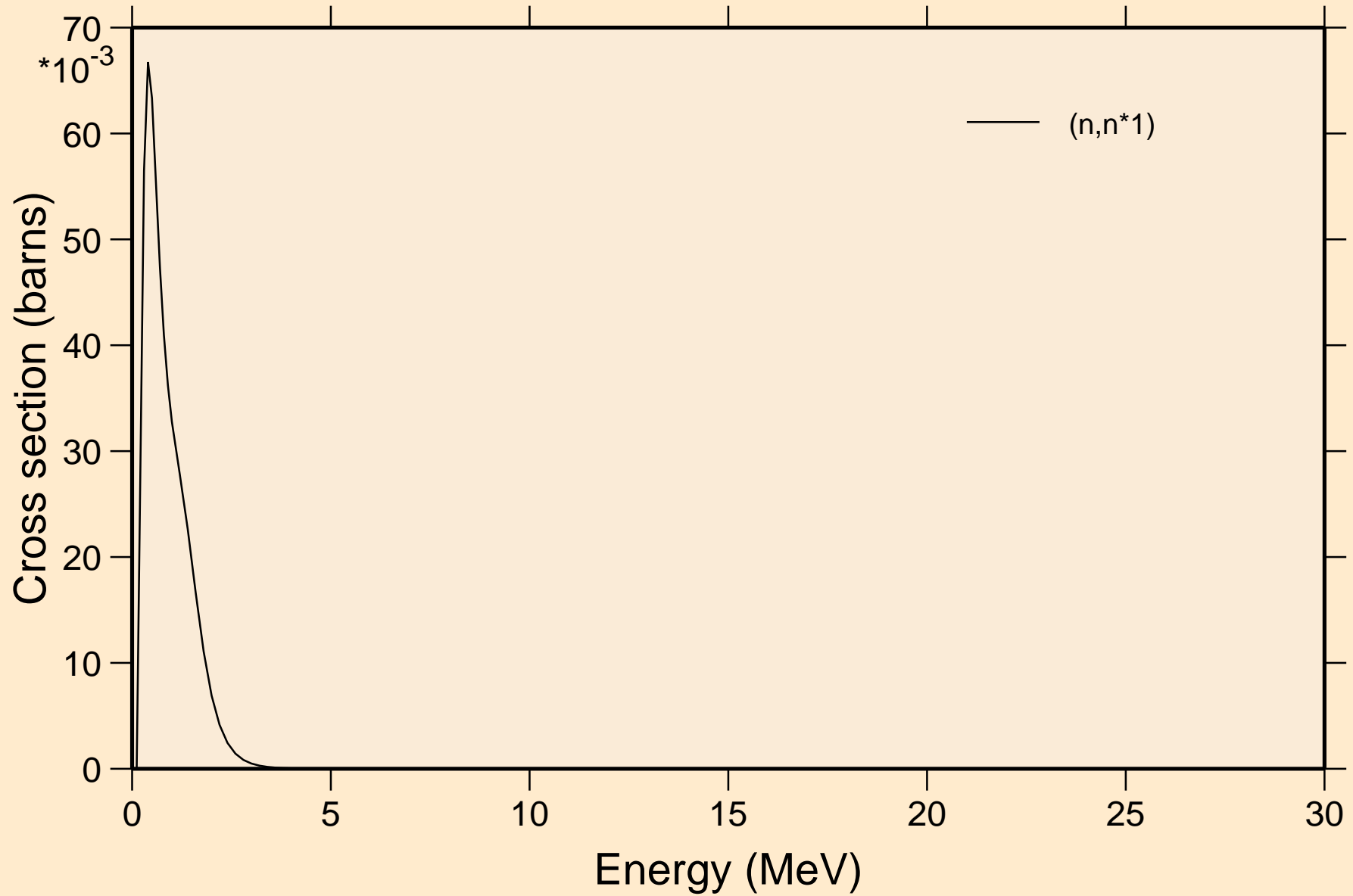

PA226 NRG TENDL-2015, AKONING

Threshold reactions

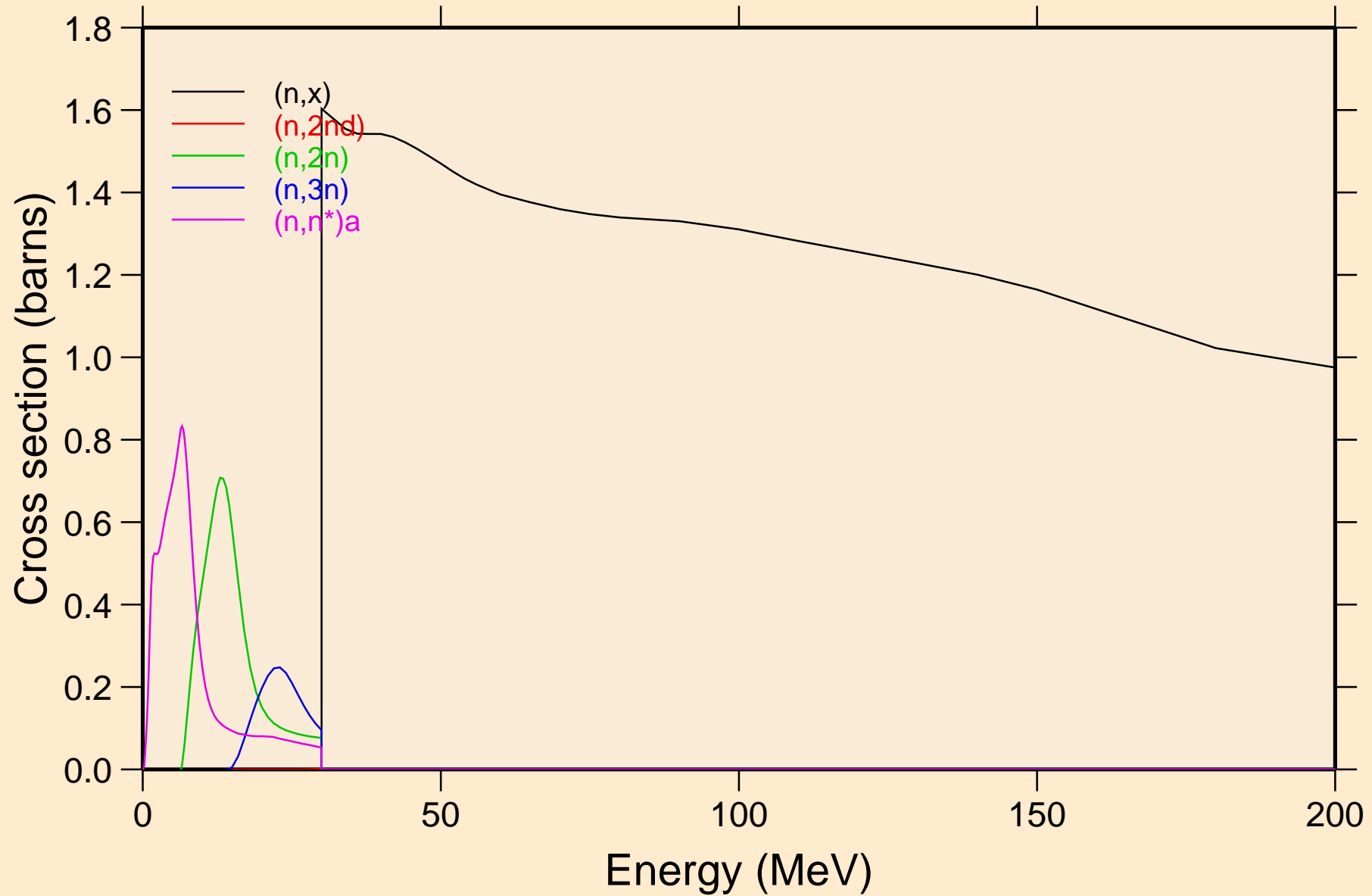

PA226 NRG TENDL-2015, AKONING
Threshold reactions

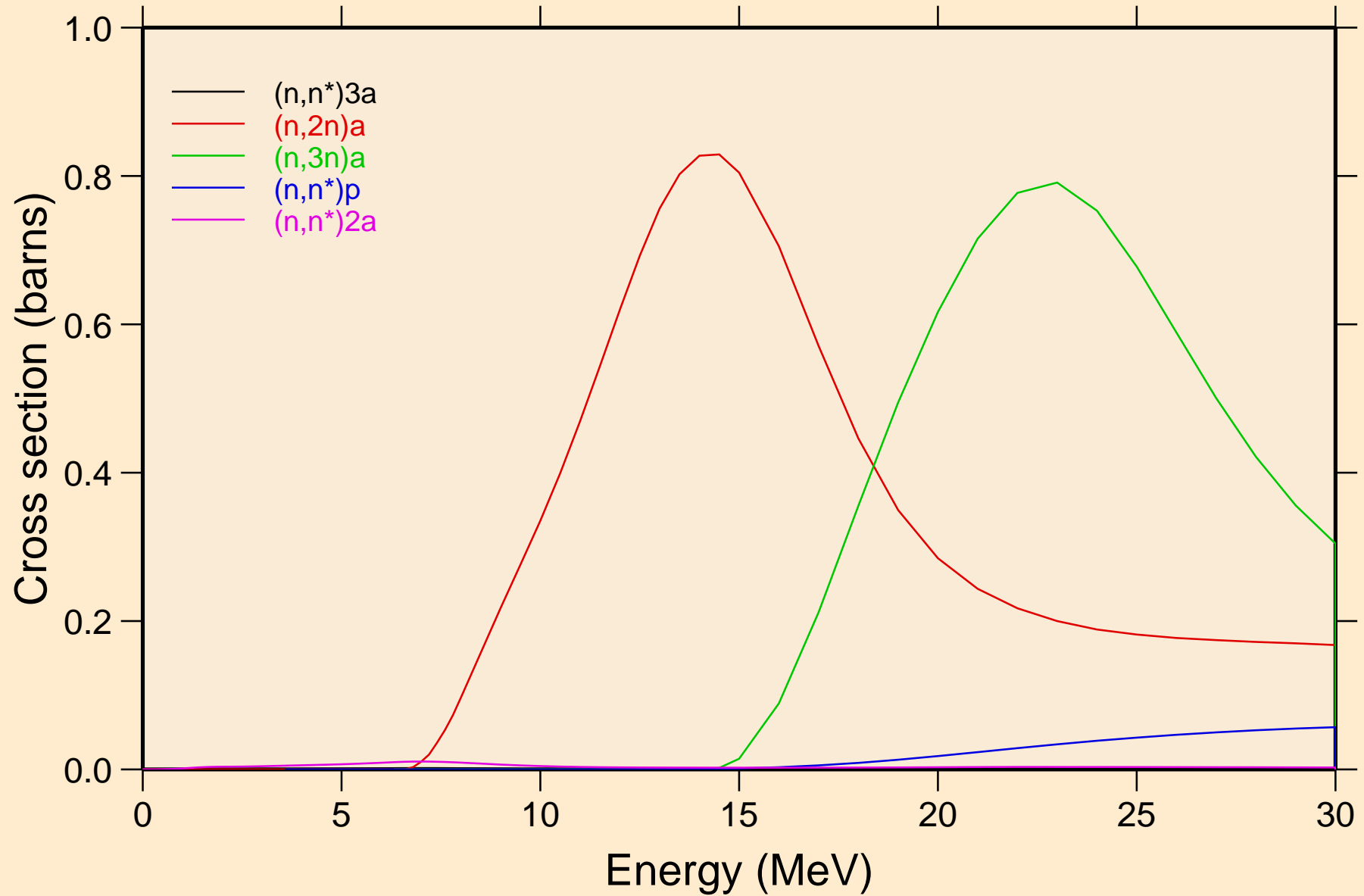

PA226 NRG TENDL-2015, AKONING

Threshold reactions

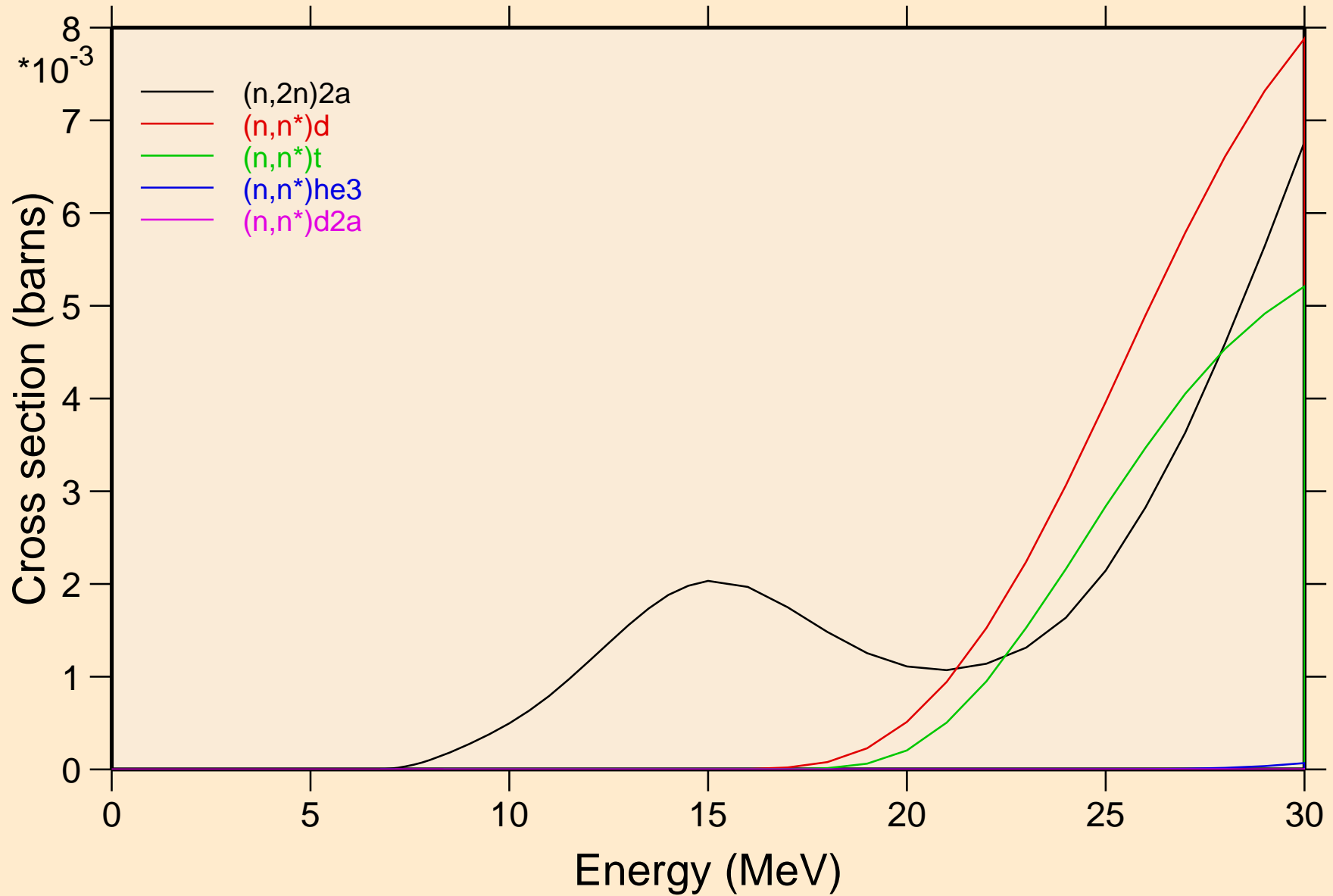

PA226 NRG TENDL-2015, AKONING

Threshold reactions

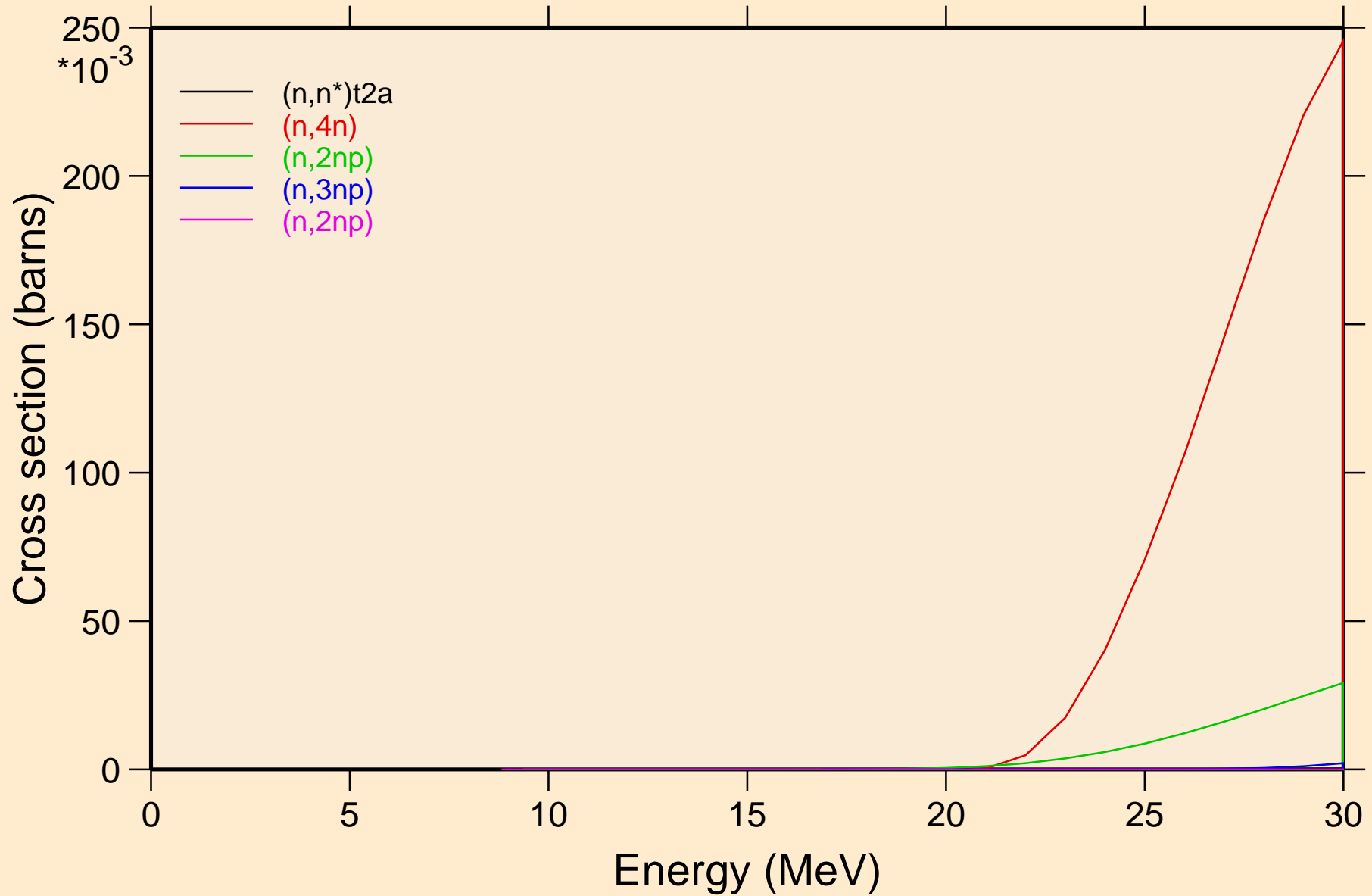

PA226 NRG TENDL-2015, AKONING

Threshold reactions

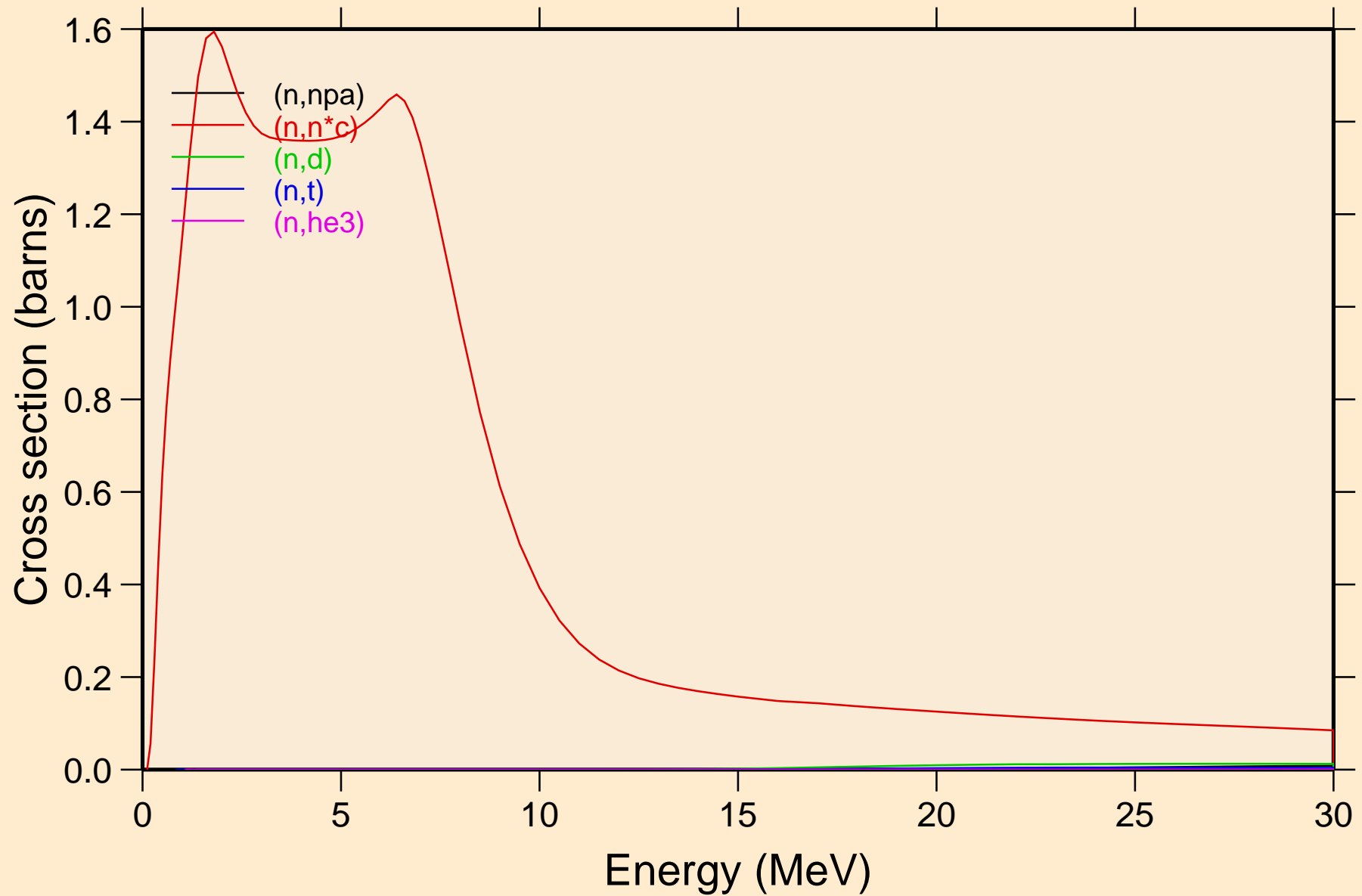

PA226 NRG TENDL-2015, AKONING

Threshold reactions

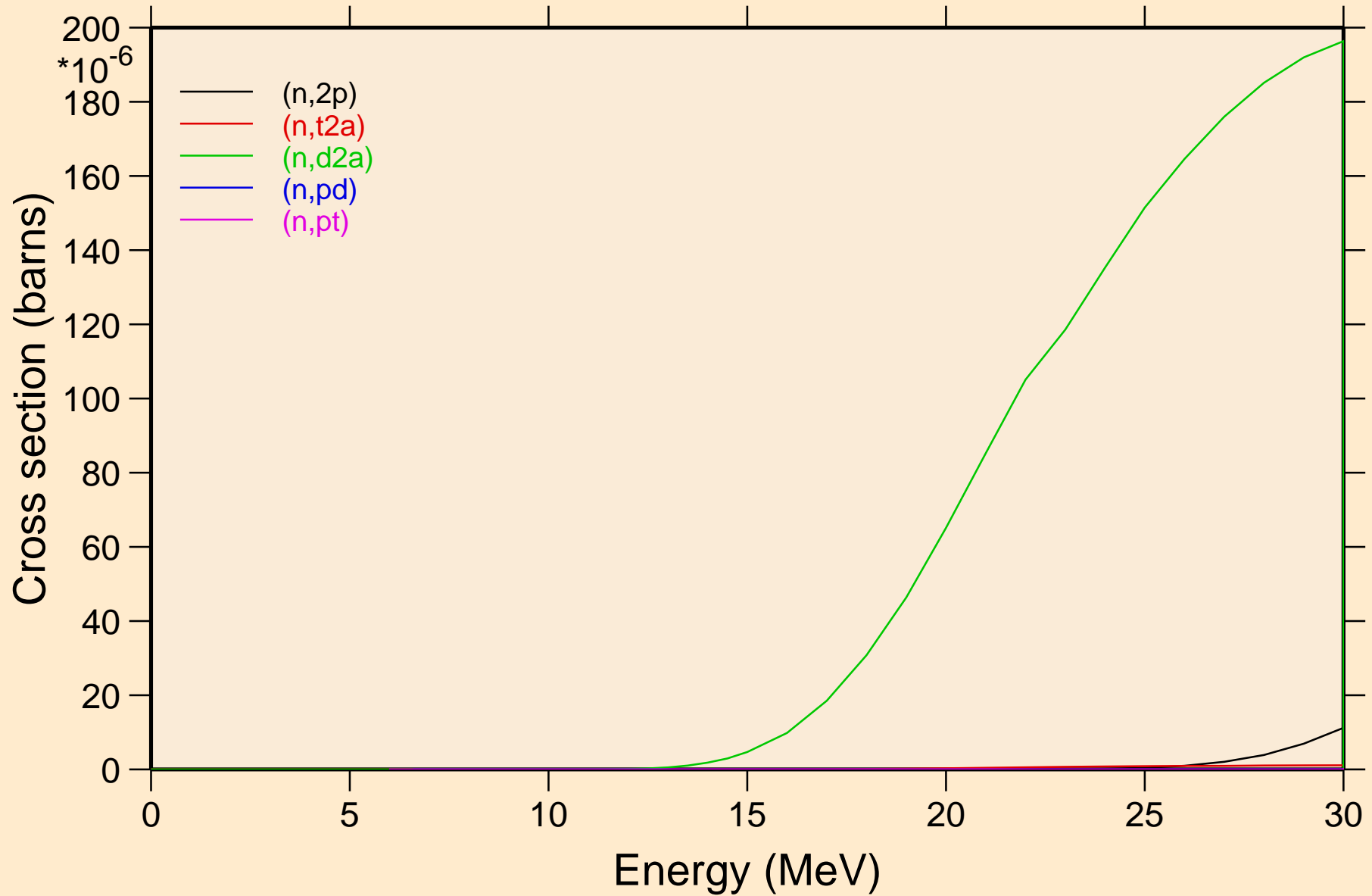

PA226 NRG TENDL-2015, AKONING

Threshold reactions

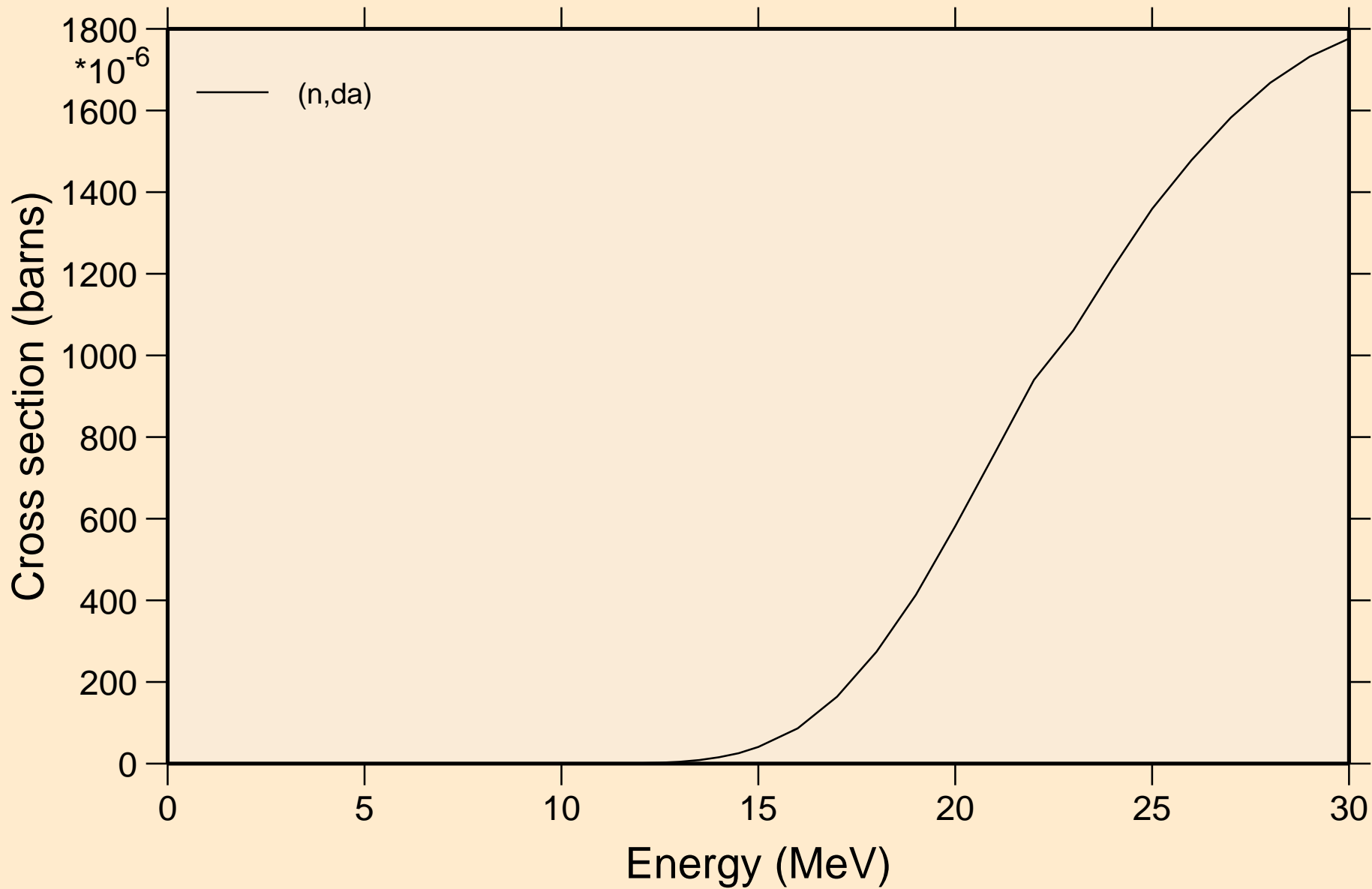

PA226 NRG TENDL-2015, AKONING
angular distribution for elastic

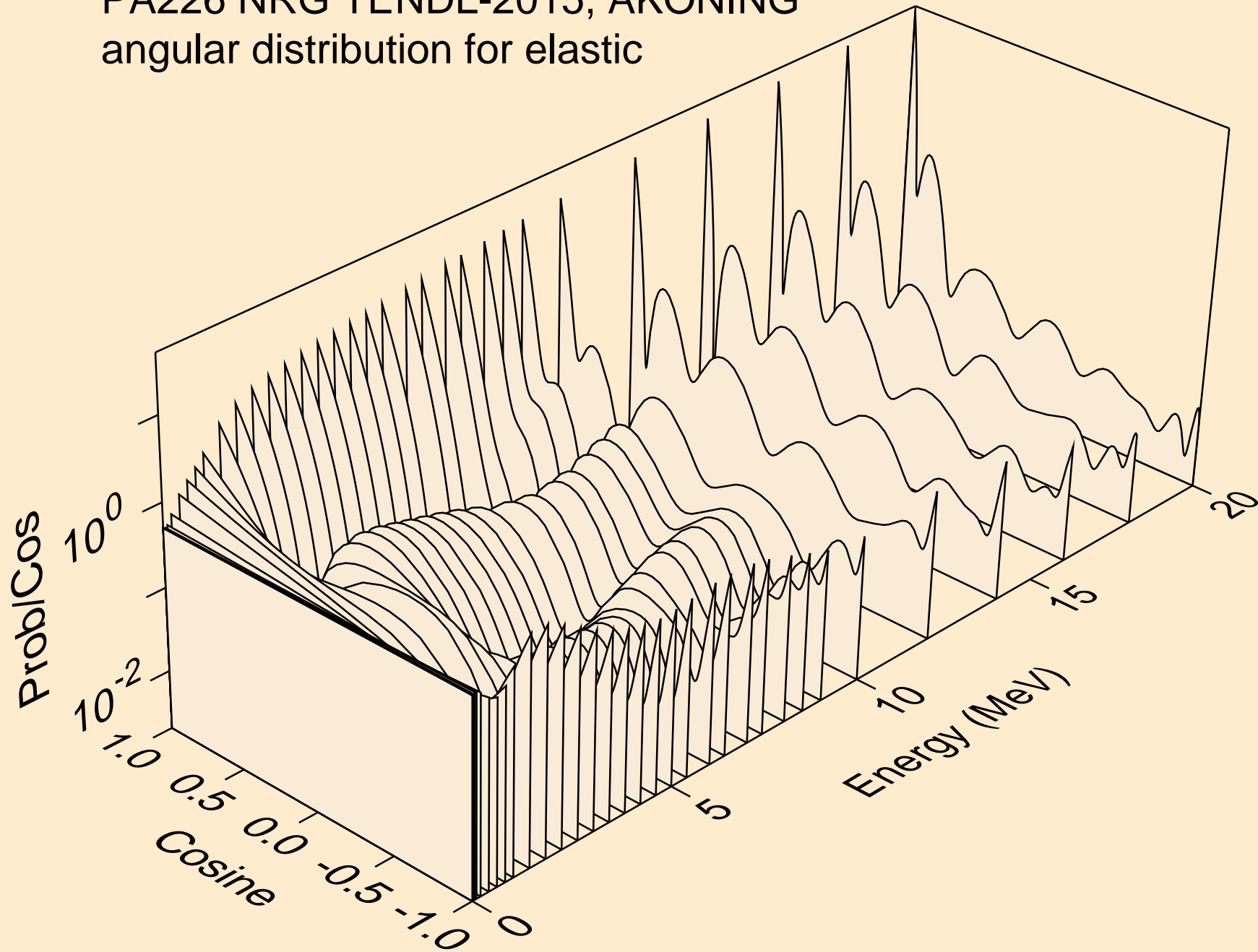

PA226 NRG TENDL-2015, AKONING
angular distribution for elastic

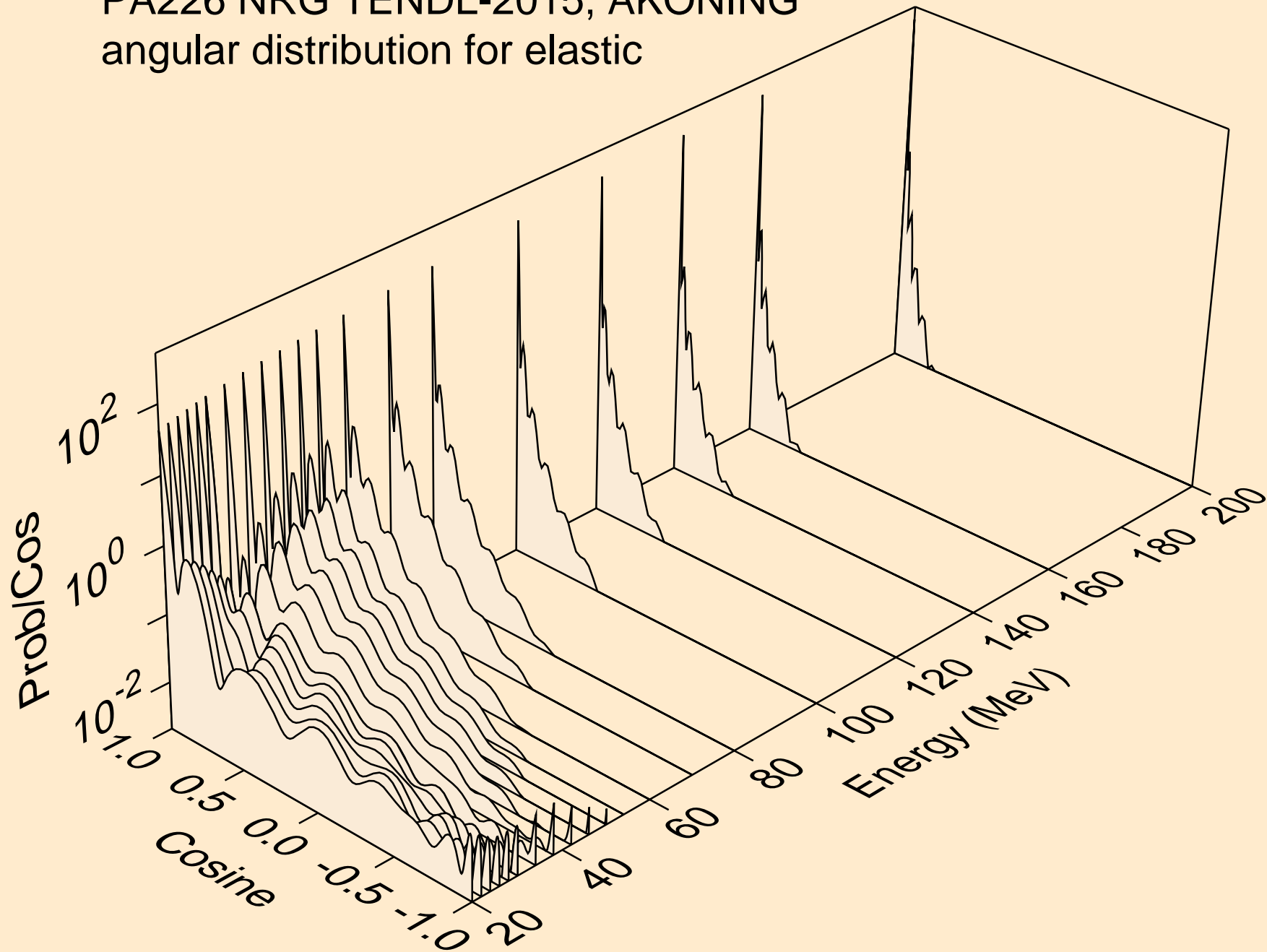

PA226 NRG TENDL-2015, AKONING
angular distribution for (n,n*1)

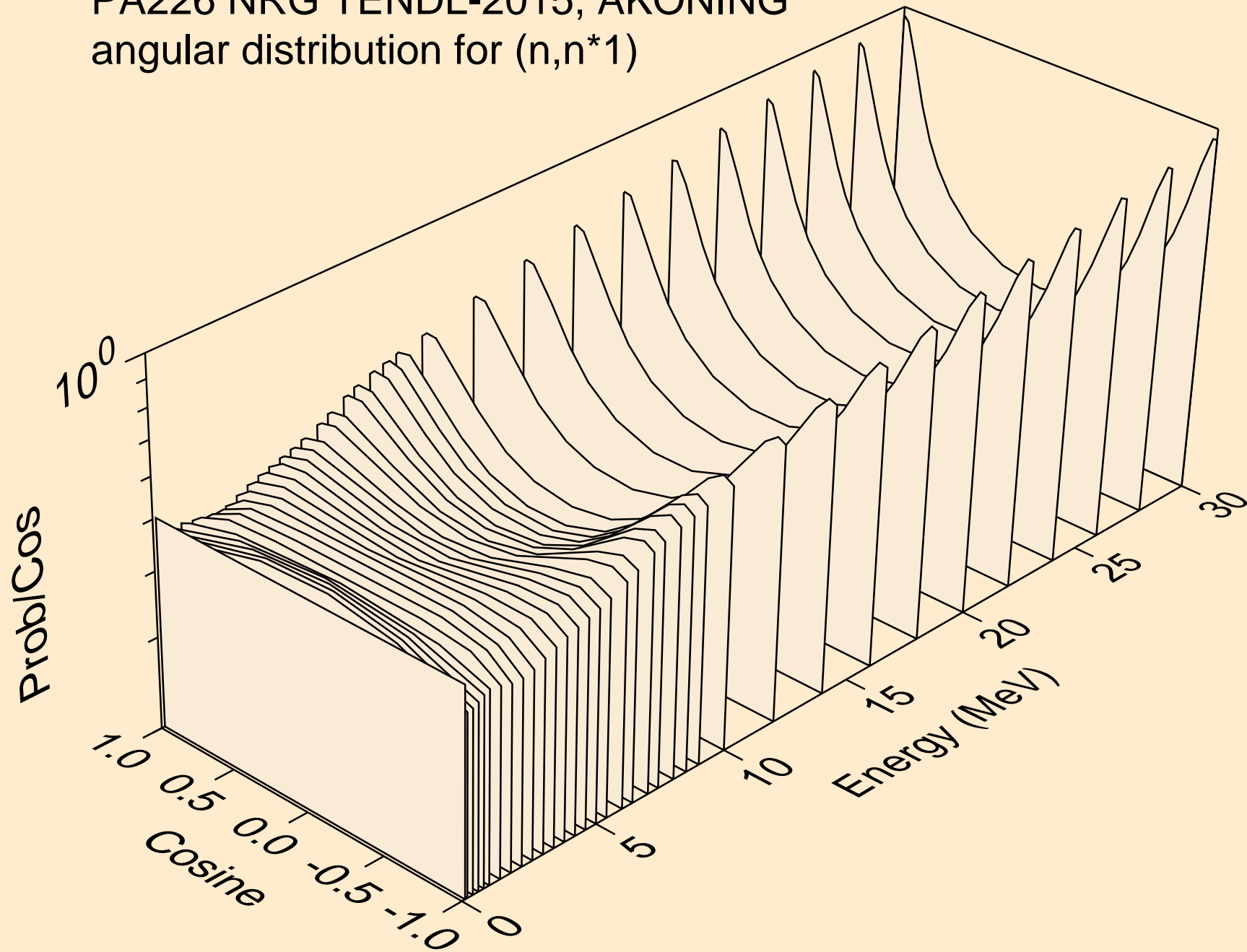

PA226 NRG TENDL-2015, AKONING

Total fission nubar

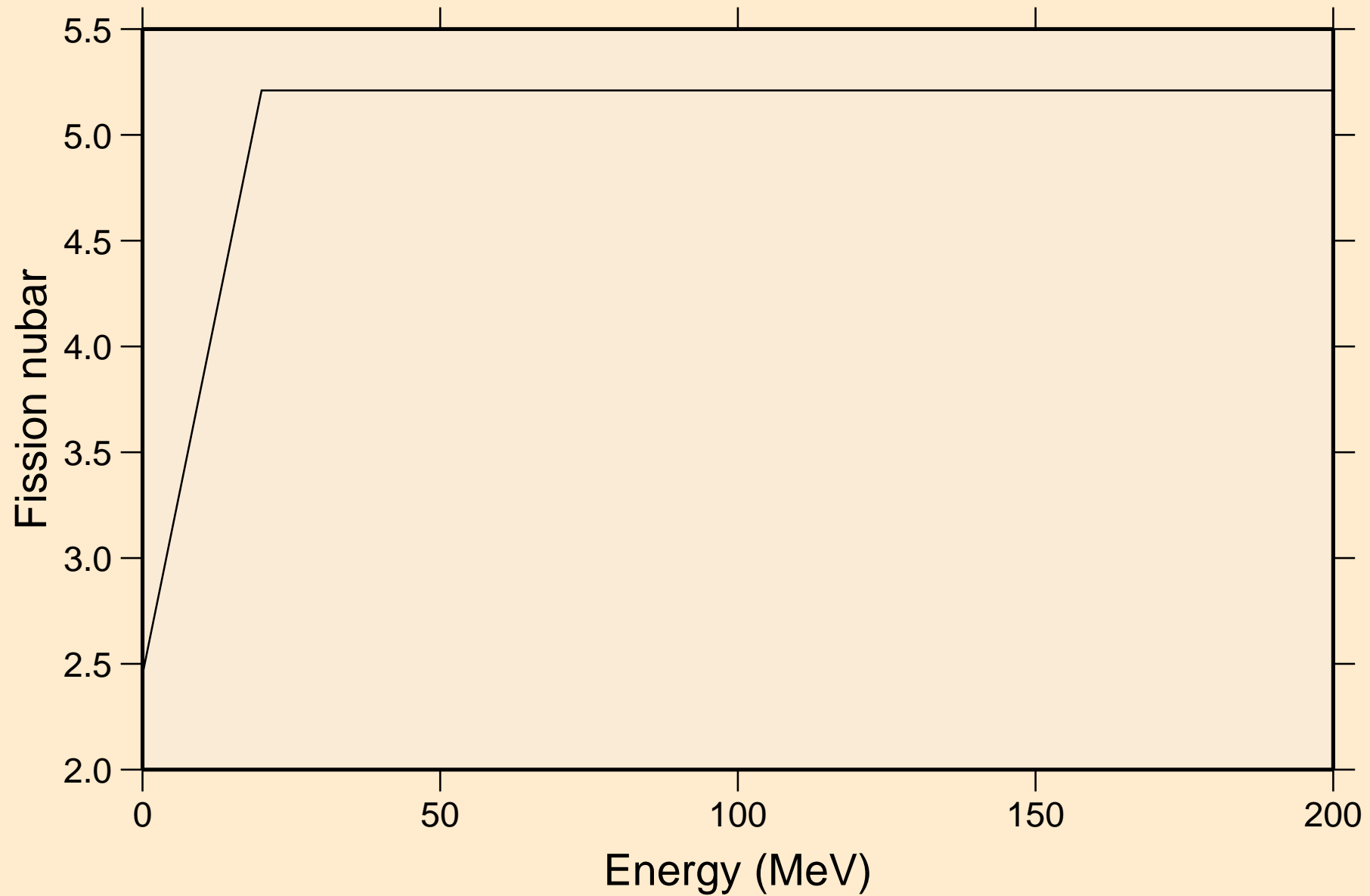

PA226 NRG TENDL-2015, AKONING
Neutron emission for (n,x)

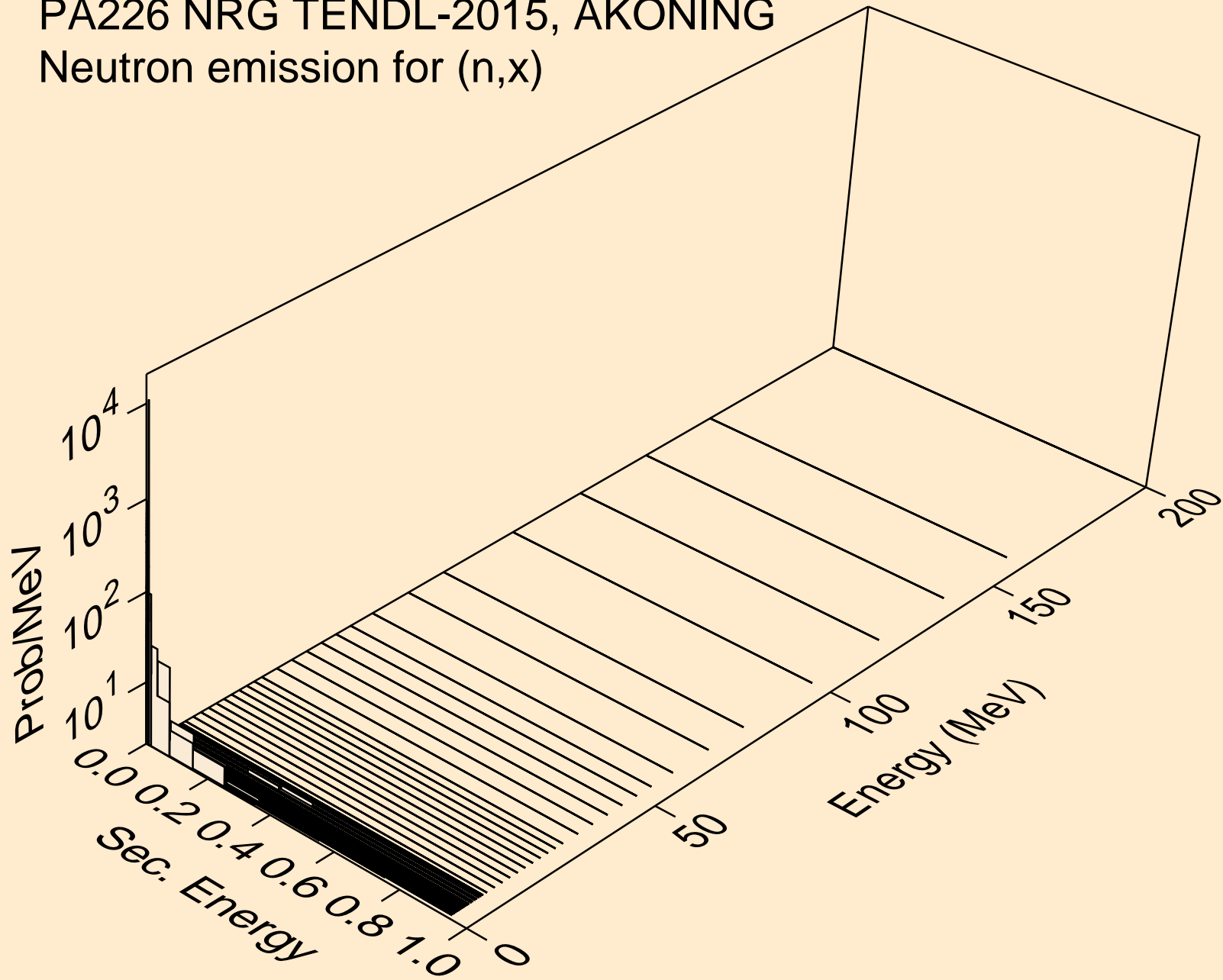

PA226 NRG TENDL-2015, AKONING
Neutron emission for (n,2nd)

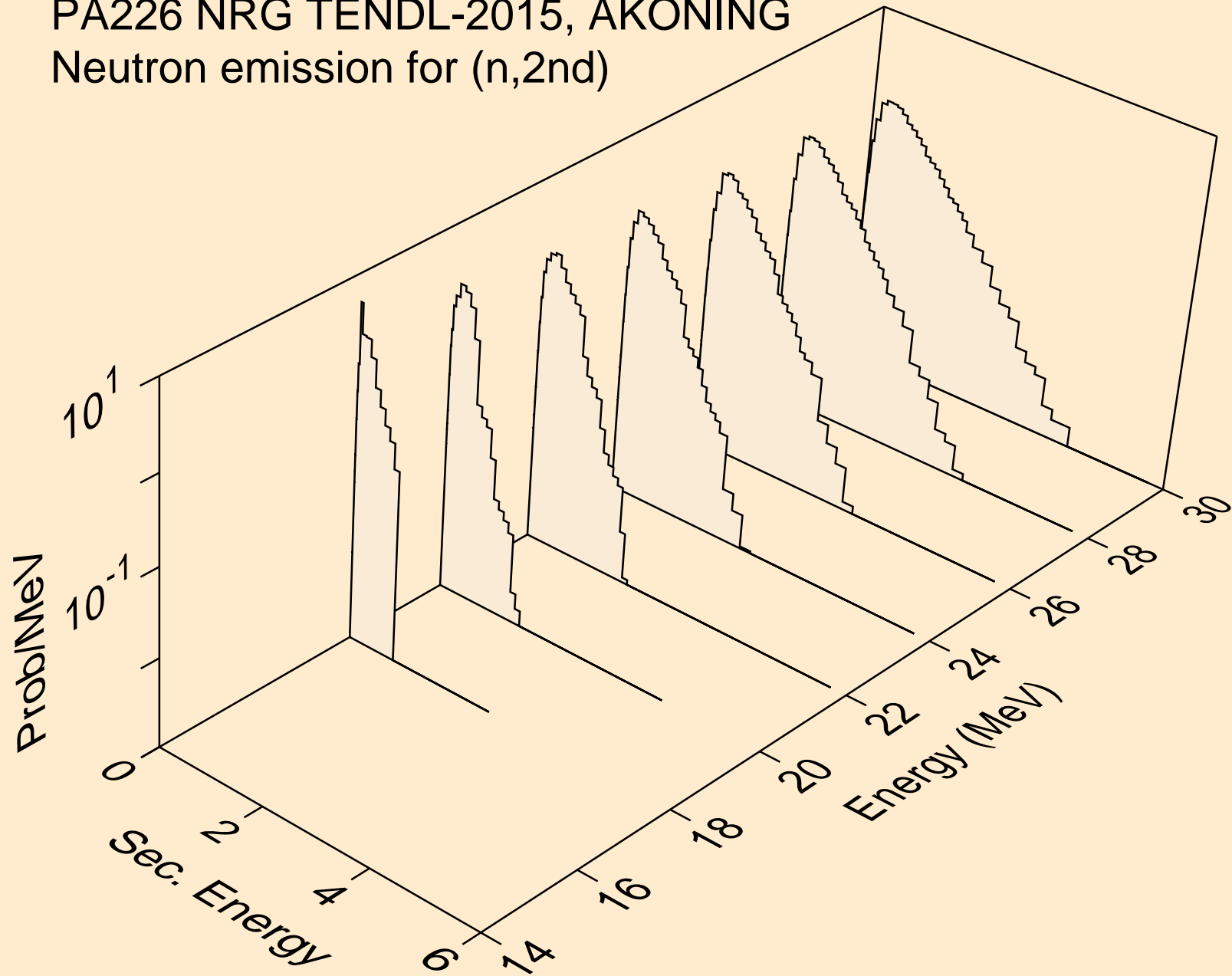

PA226 NRG TENDL-2015, AKONING
Neutron emission for (n,2n)

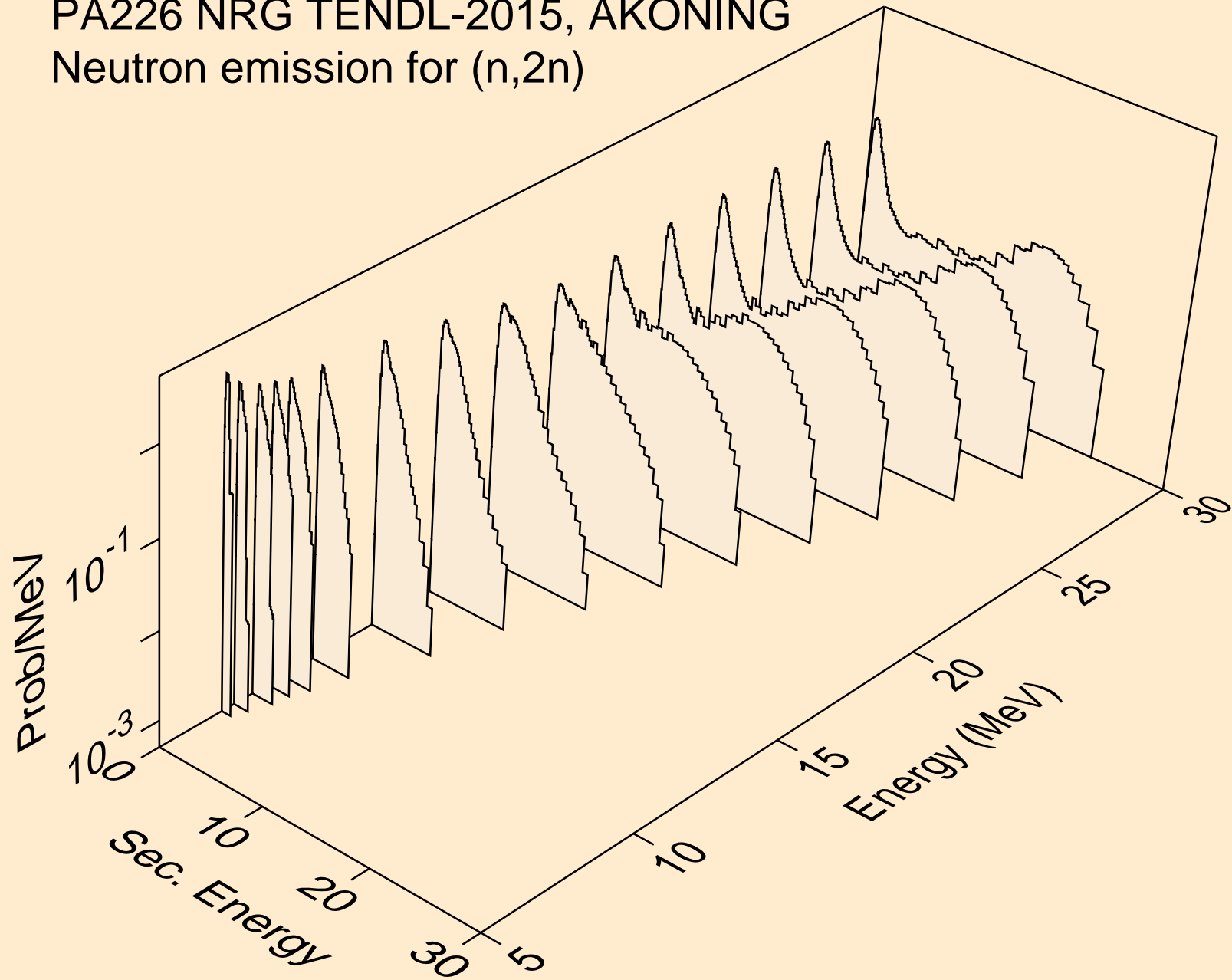

PA226 NRG TENDL-2015, AKONING
Neutron emission for (n,3n)

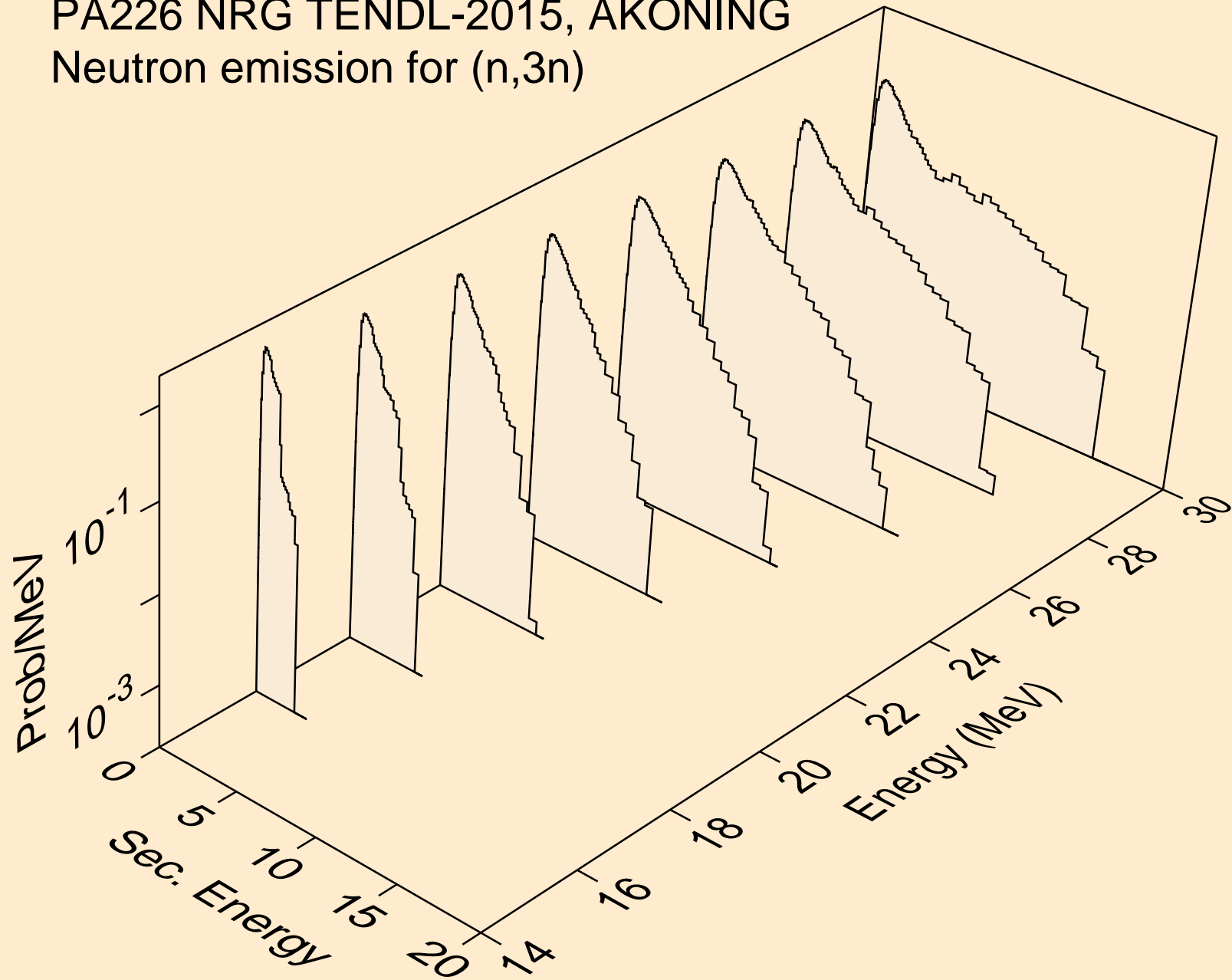

PA226 NRG TENDL-2015, AKONING
Neutron emission for fission

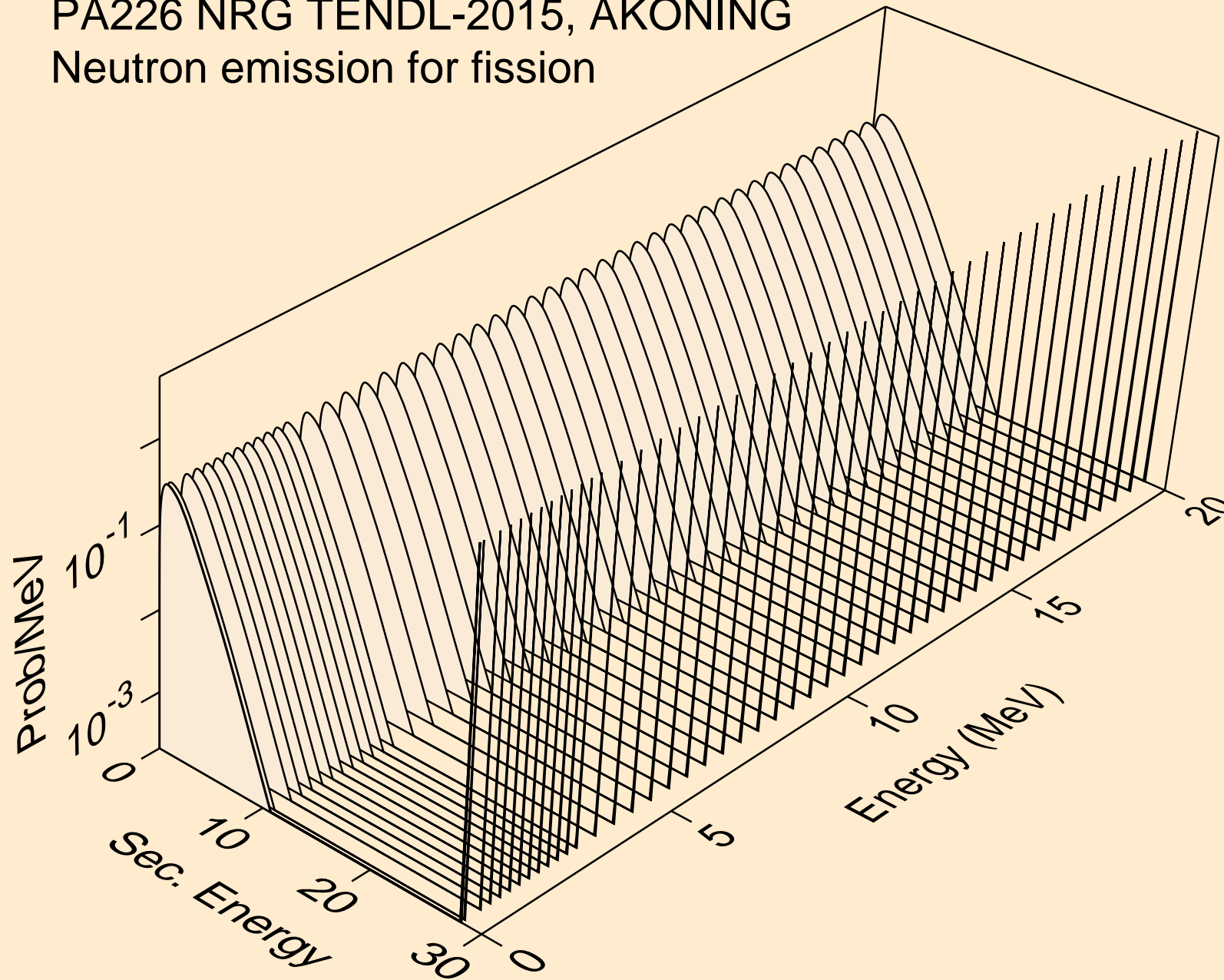

PA226 NRG TENDL-2015, AKONING
Neutron emission for (n,n*)a

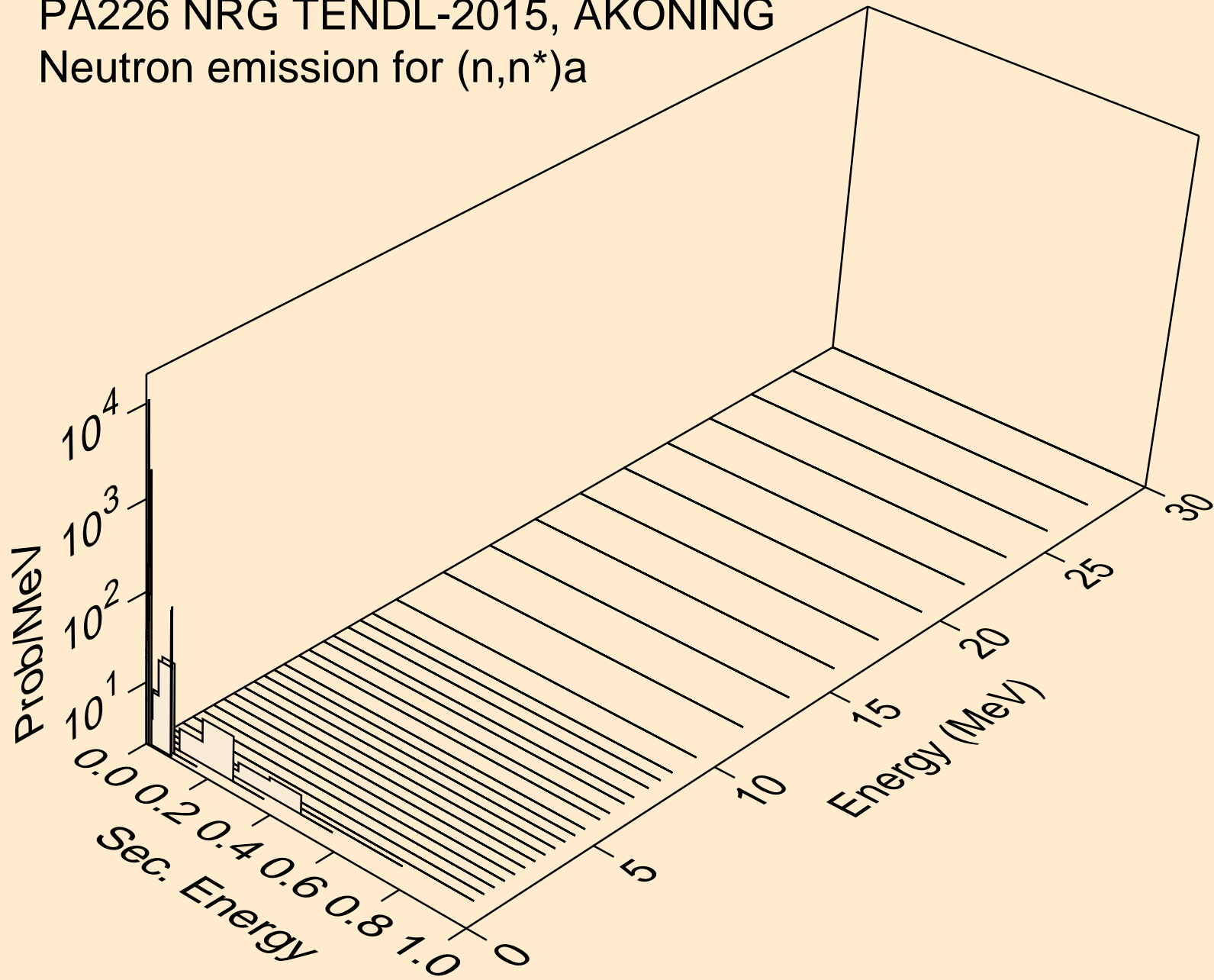

PA226 NRG TENDL-2015, AKONING
Neutron emission for (n,n*)3a

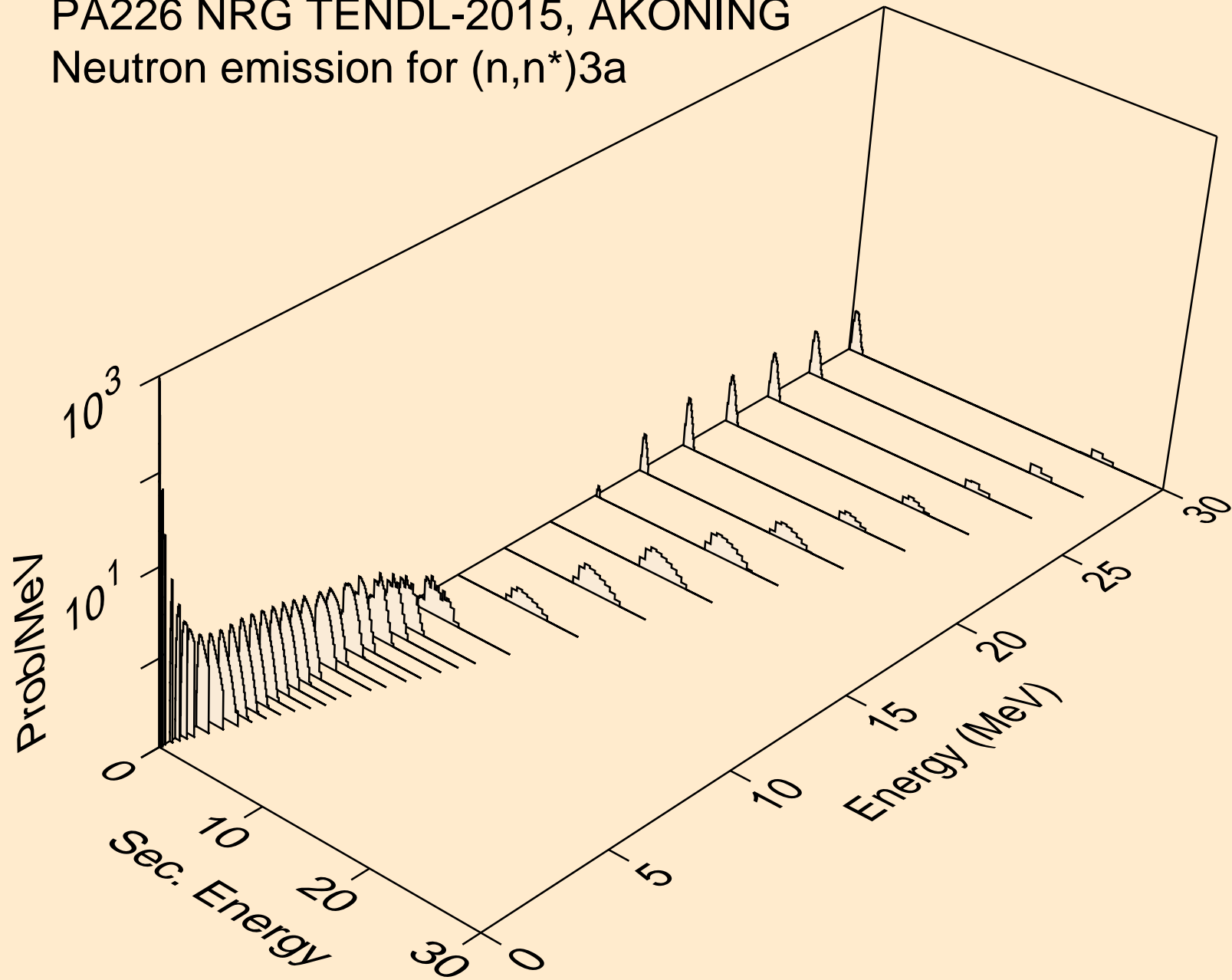

PA226 NRG TENDL-2015, AKONING
Neutron emission for (n,2n)a

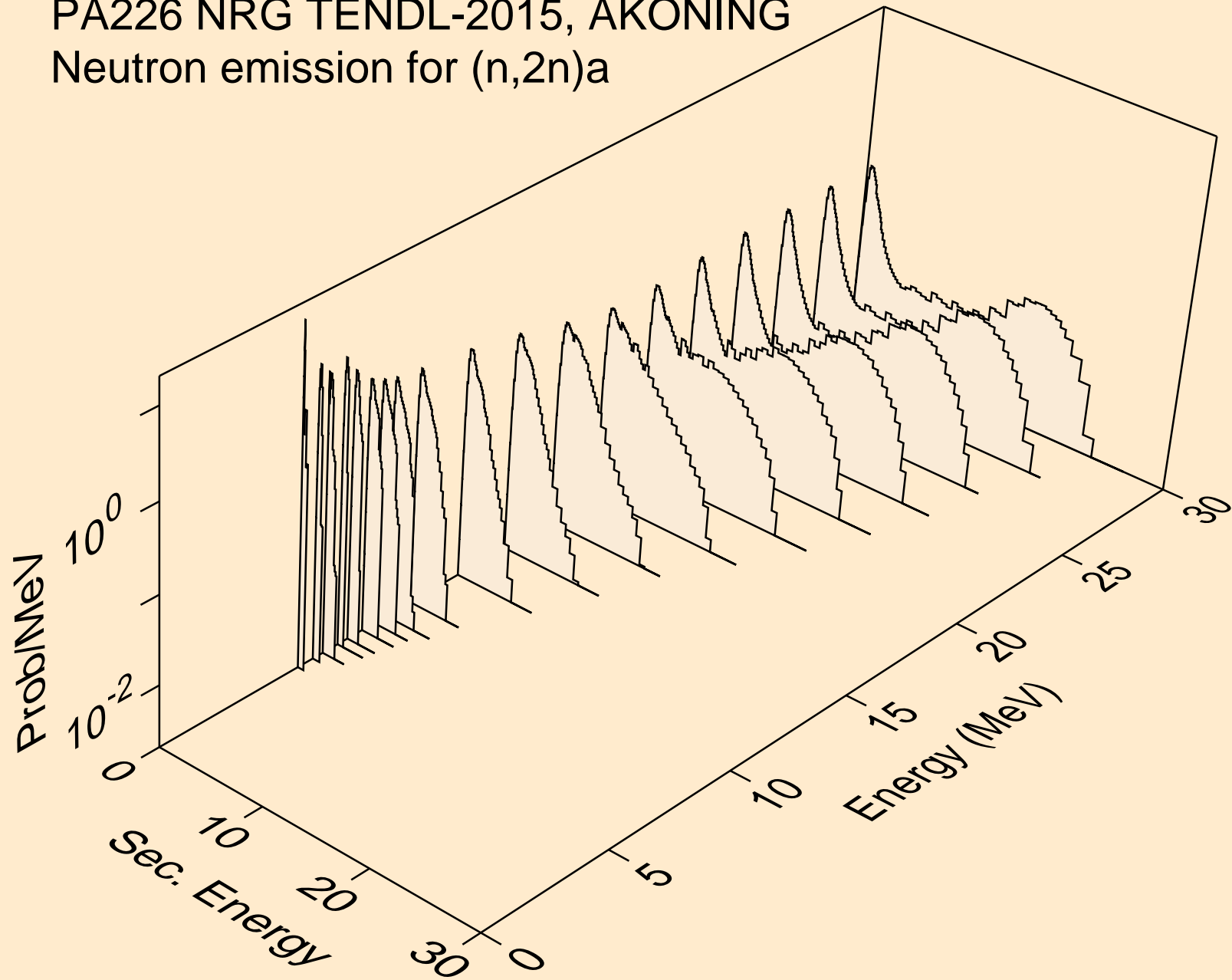

PA226 NRG TENDL-2015, AKONING
Neutron emission for (n,3n)a

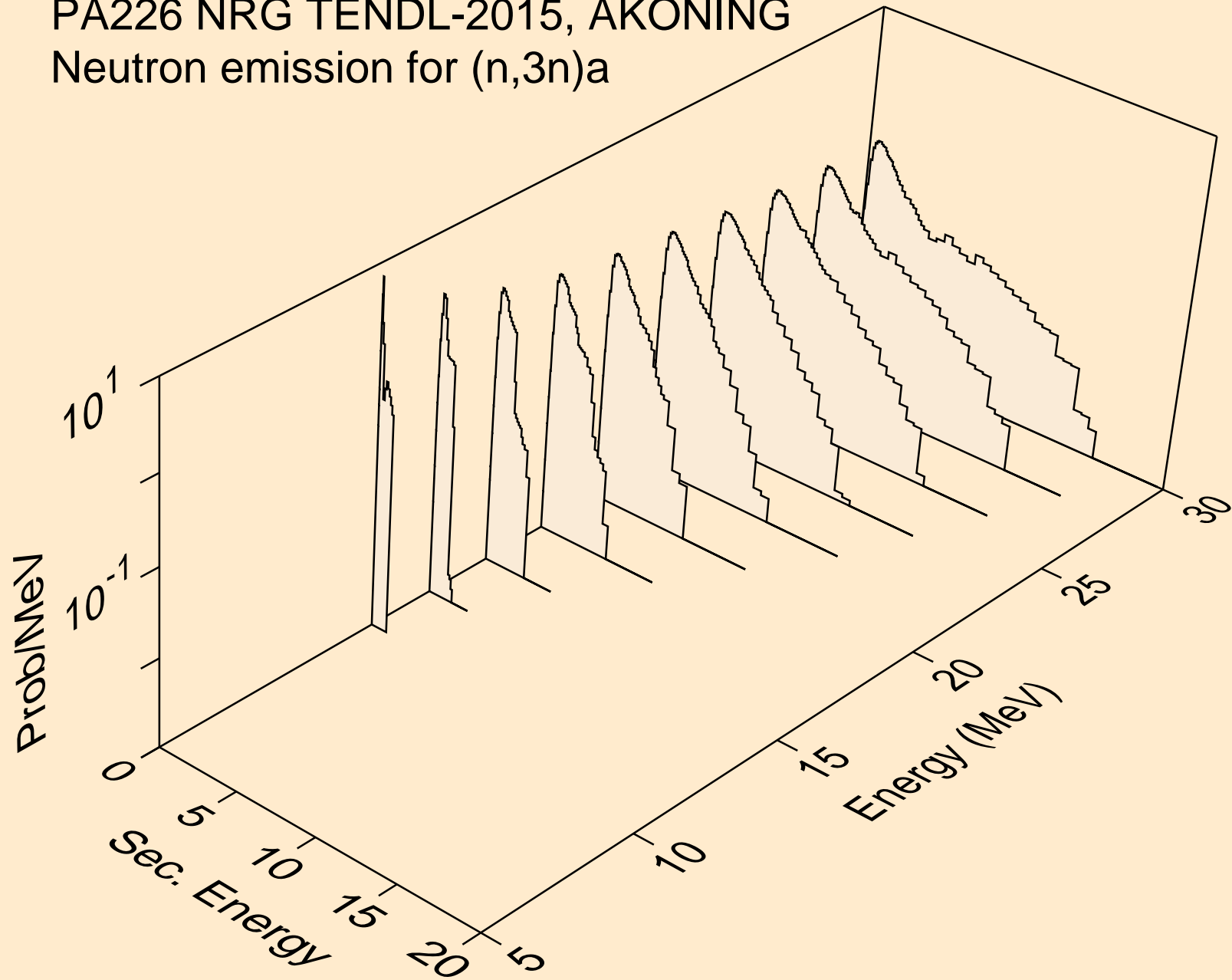

PA226 NRG TENDL-2015, AKONING
Neutron emission for (n,n*)p

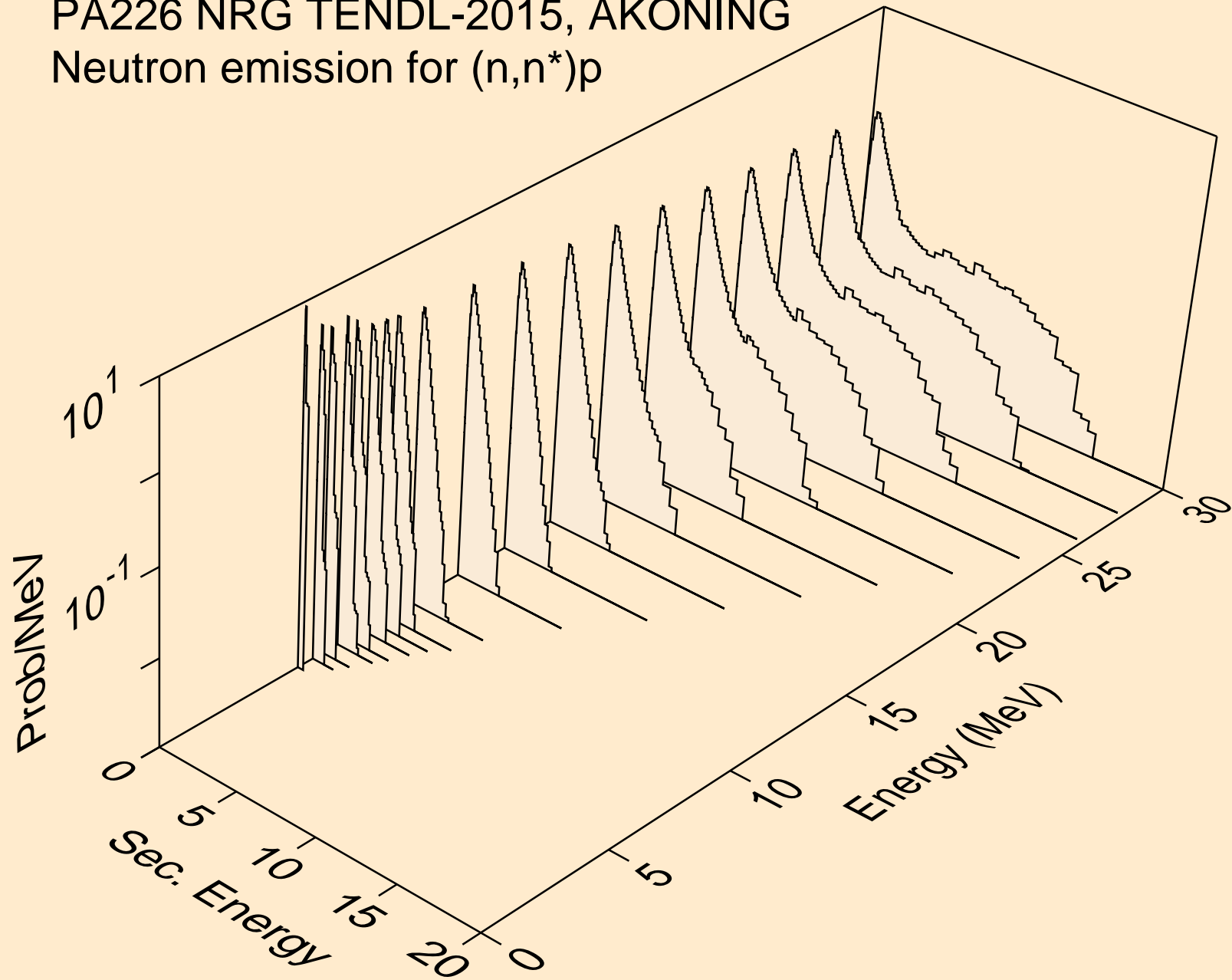

PA226 NRG TENDL-2015, AKONING
Neutron emission for (n,n*)2a

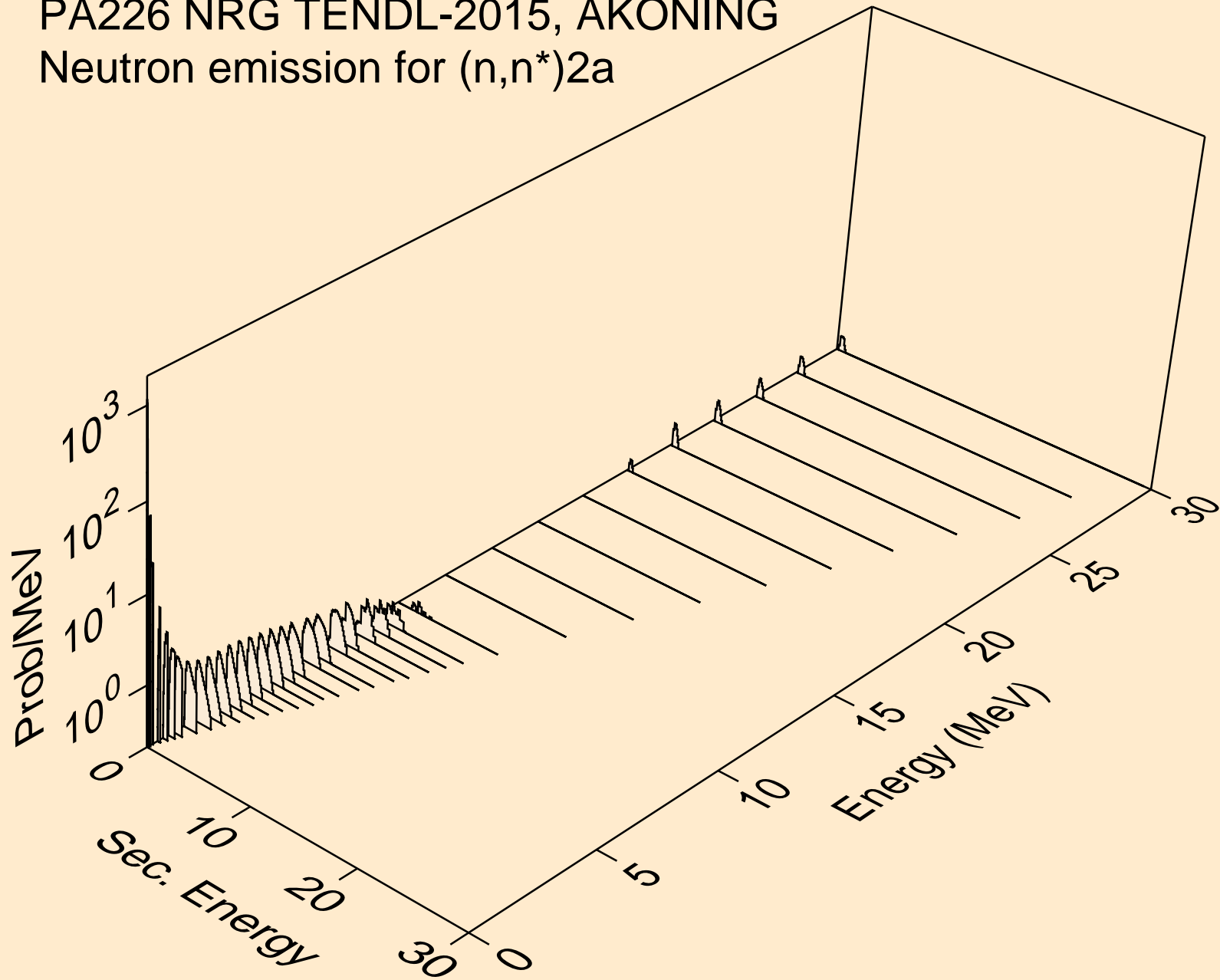

PA226 NRG TENDL-2015, AKONING
Neutron emission for (n,2n)2a

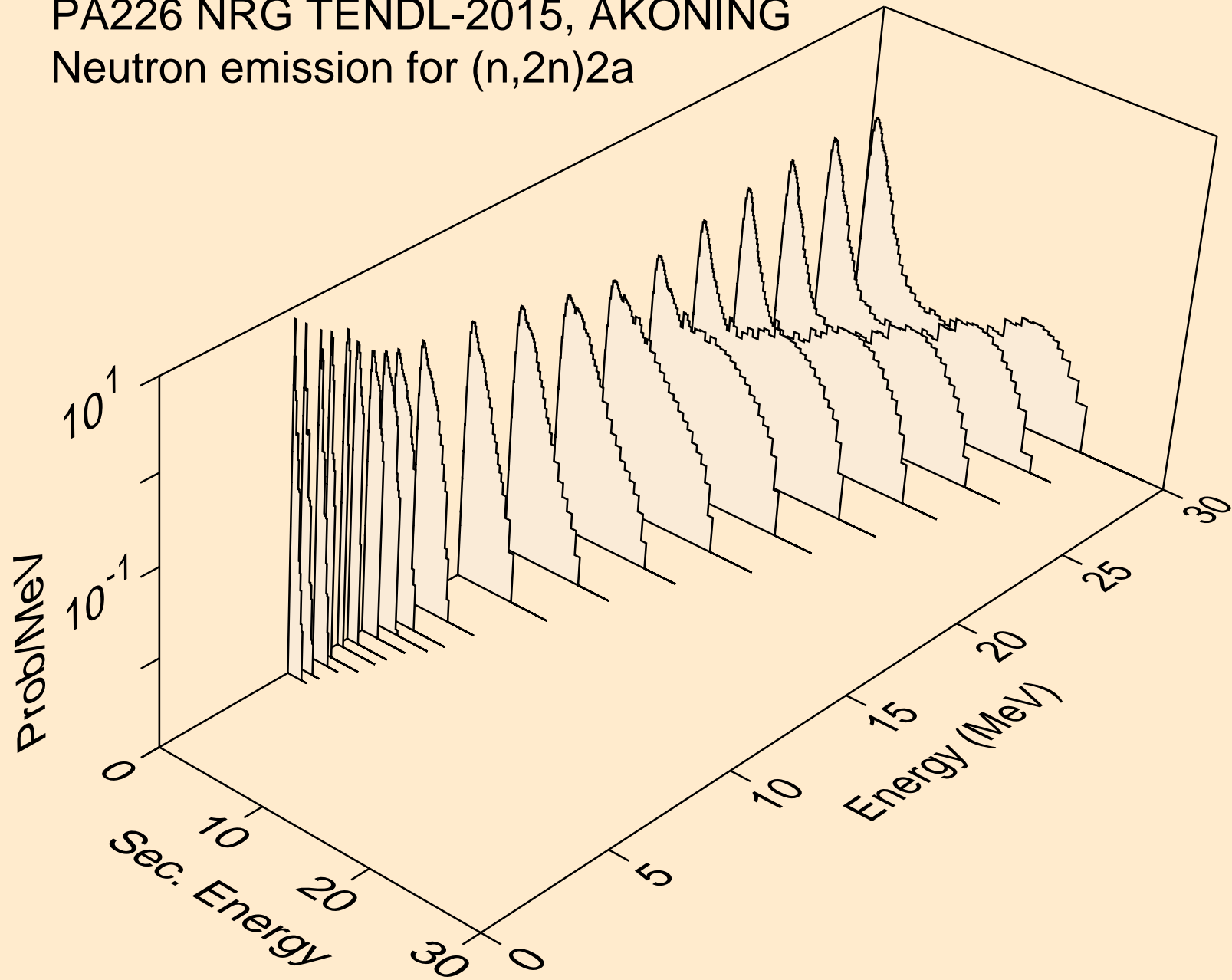

PA226 NRG TENDL-2015, AKONING
Neutron emission for (n,n*)d

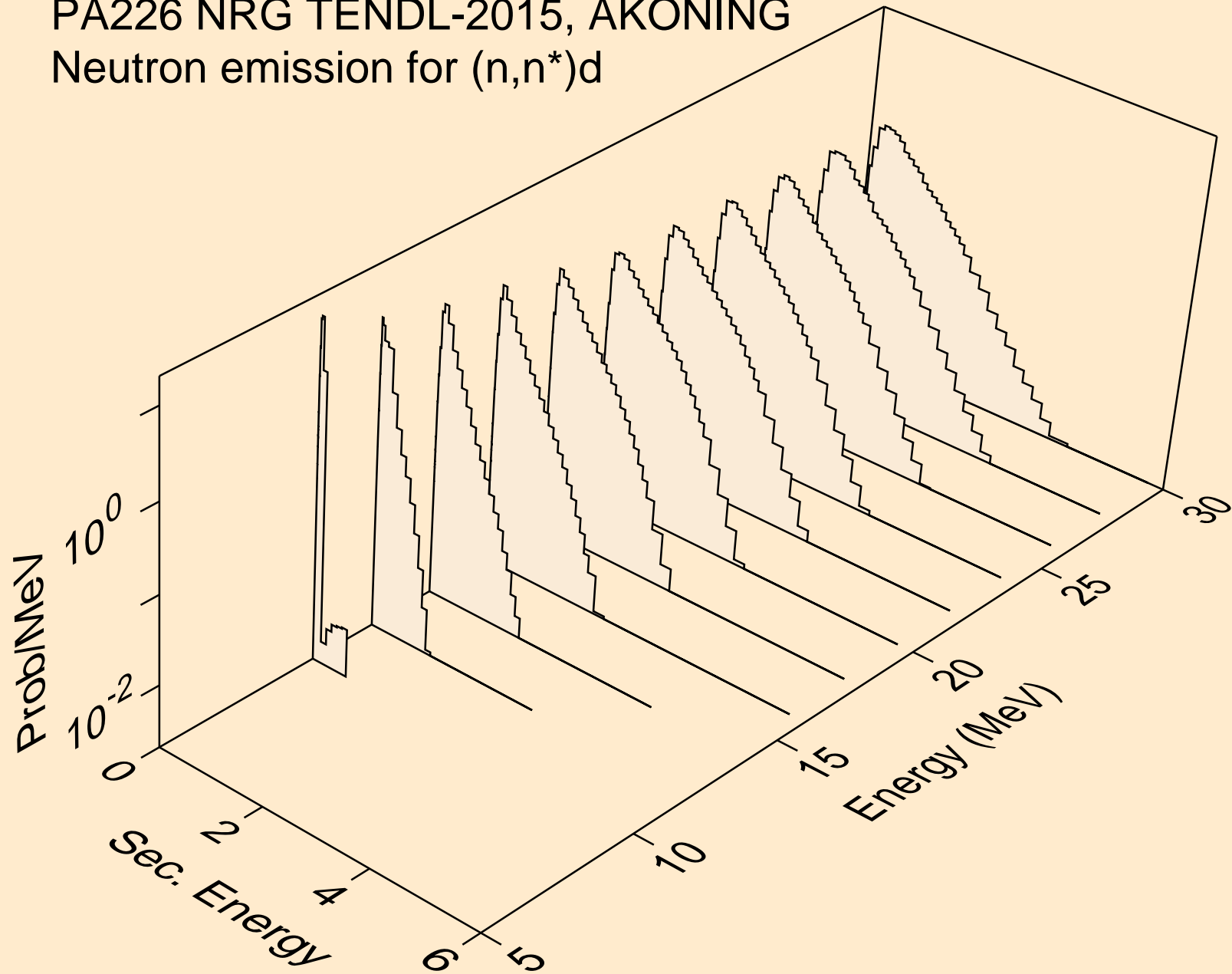

PA226 NRG TENDL-2015, AKONING
Neutron emission for (n,n*)t

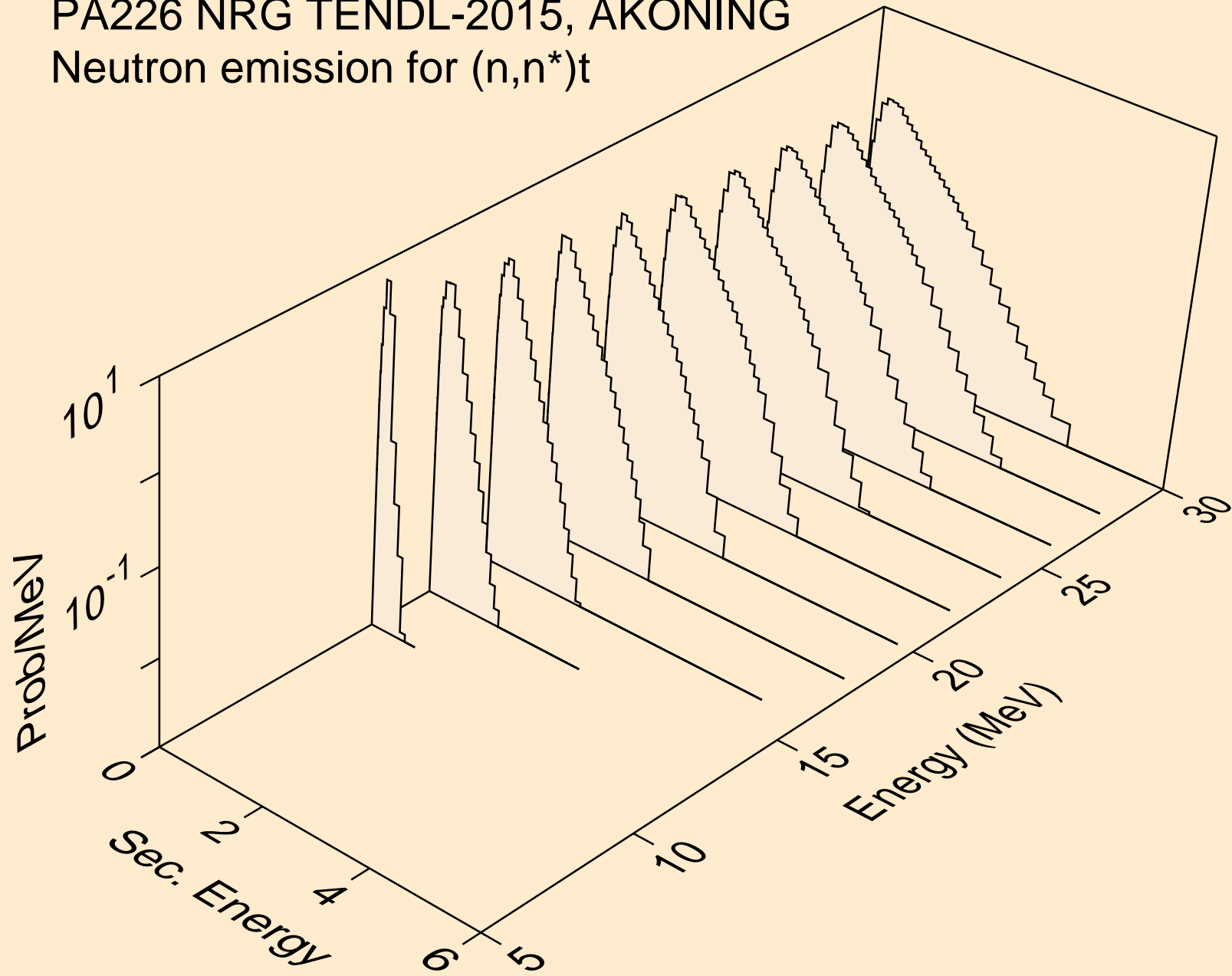

PA226 NRG TENDL-2015, AKONING
Neutron emission for (n,n*)he3

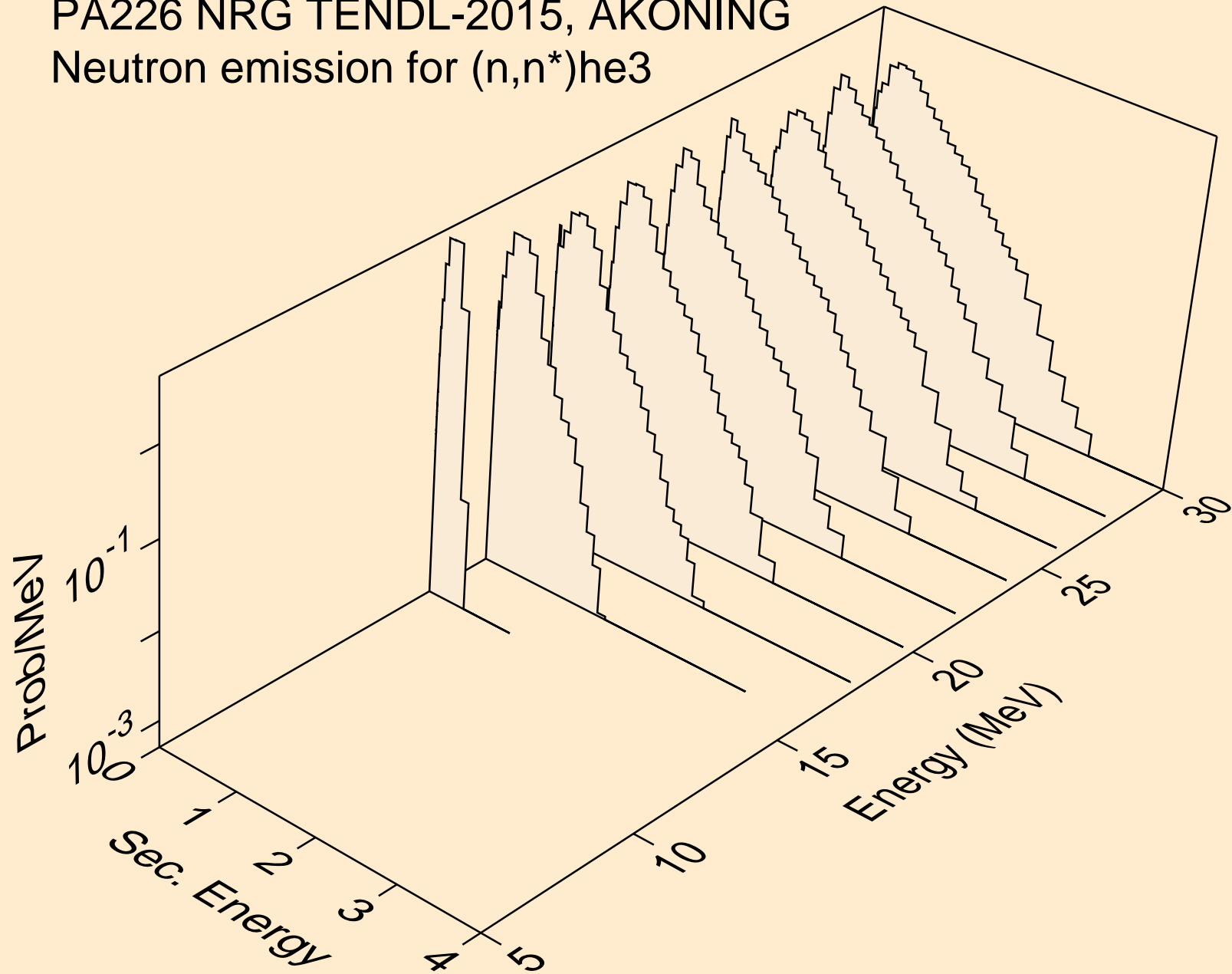

PA226 NRG TENDL-2015, AKONING
Neutron emission for (n,n*)d2a

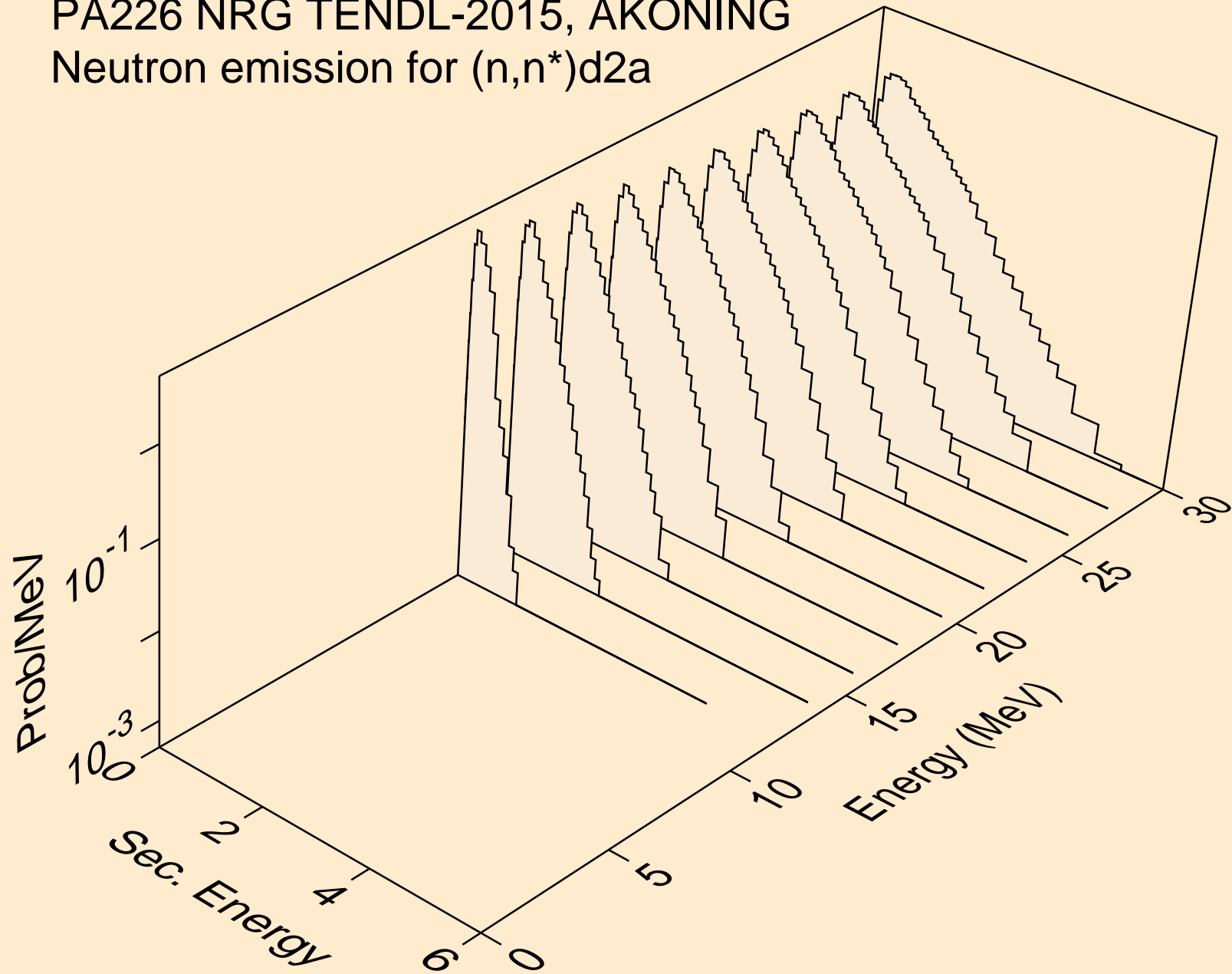

PA226 NRG TENDL-2015, AKONING
Neutron emission for (n,n*)t2a

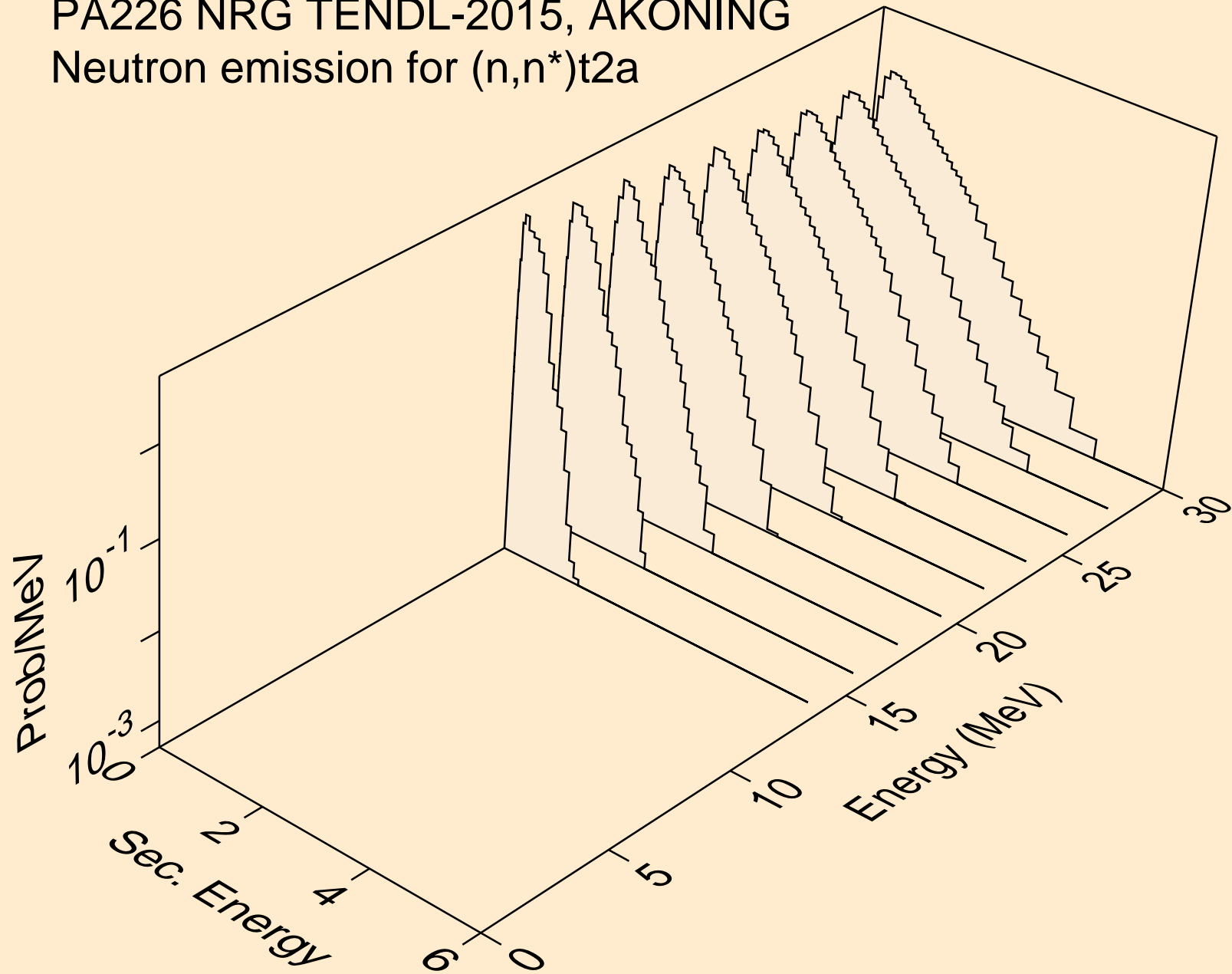

PA226 NRG TENDL-2015, AKONING
Neutron emission for (n,4n)

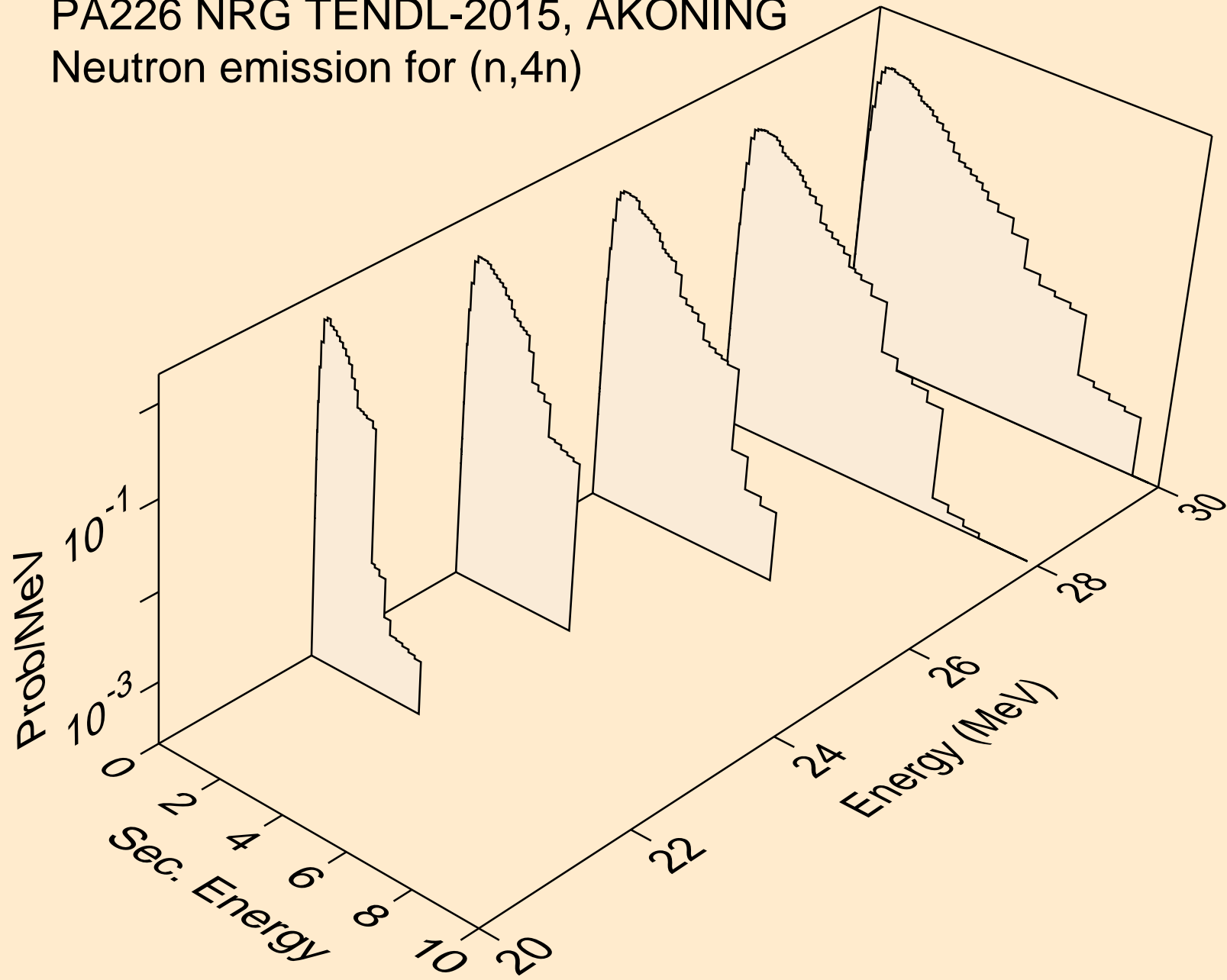

PA226 NRG TENDL-2015, AKONING
Neutron emission for (n,2np)

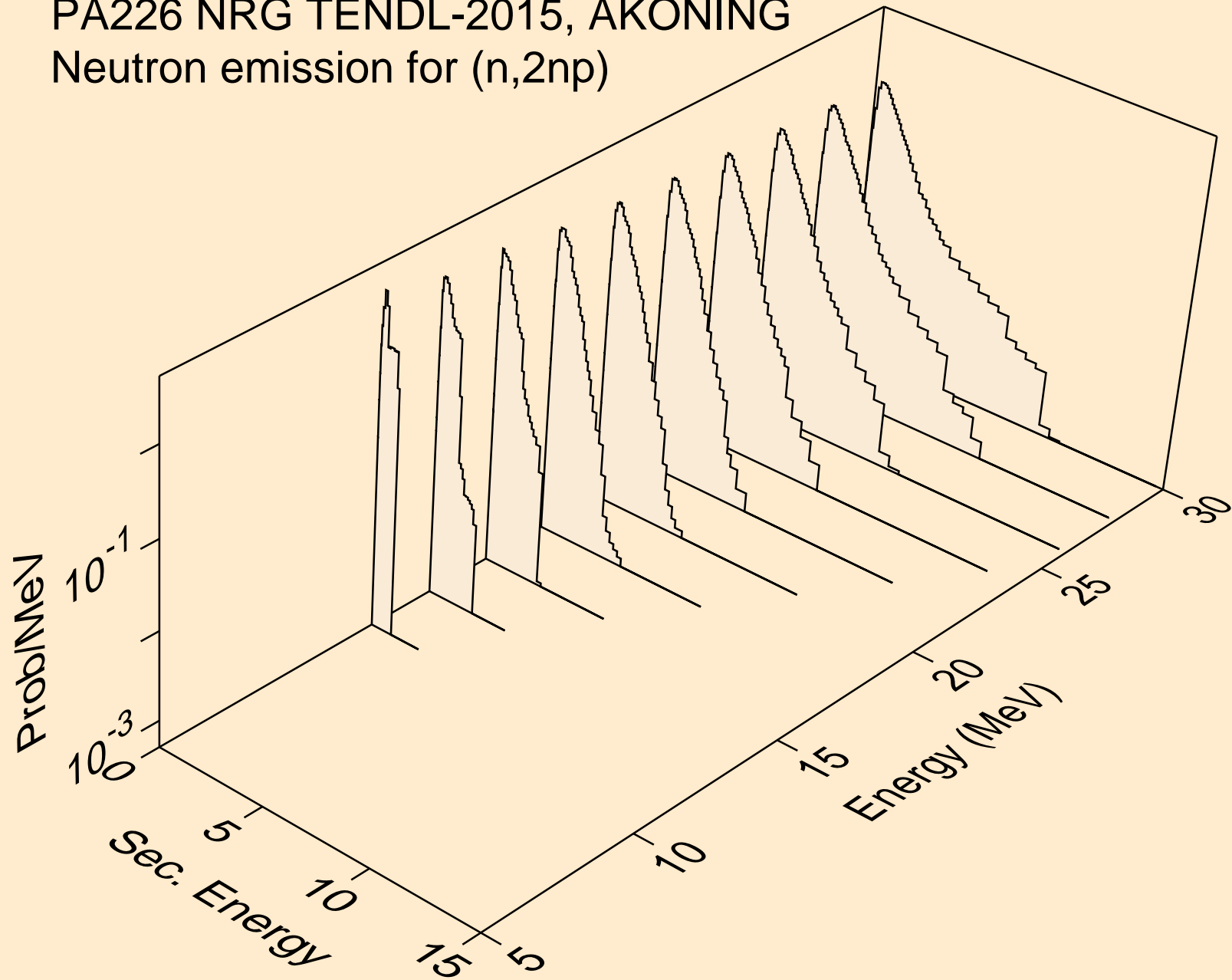

PA226 NRG TENDL-2015, AKONING
Neutron emission for (n,3np)

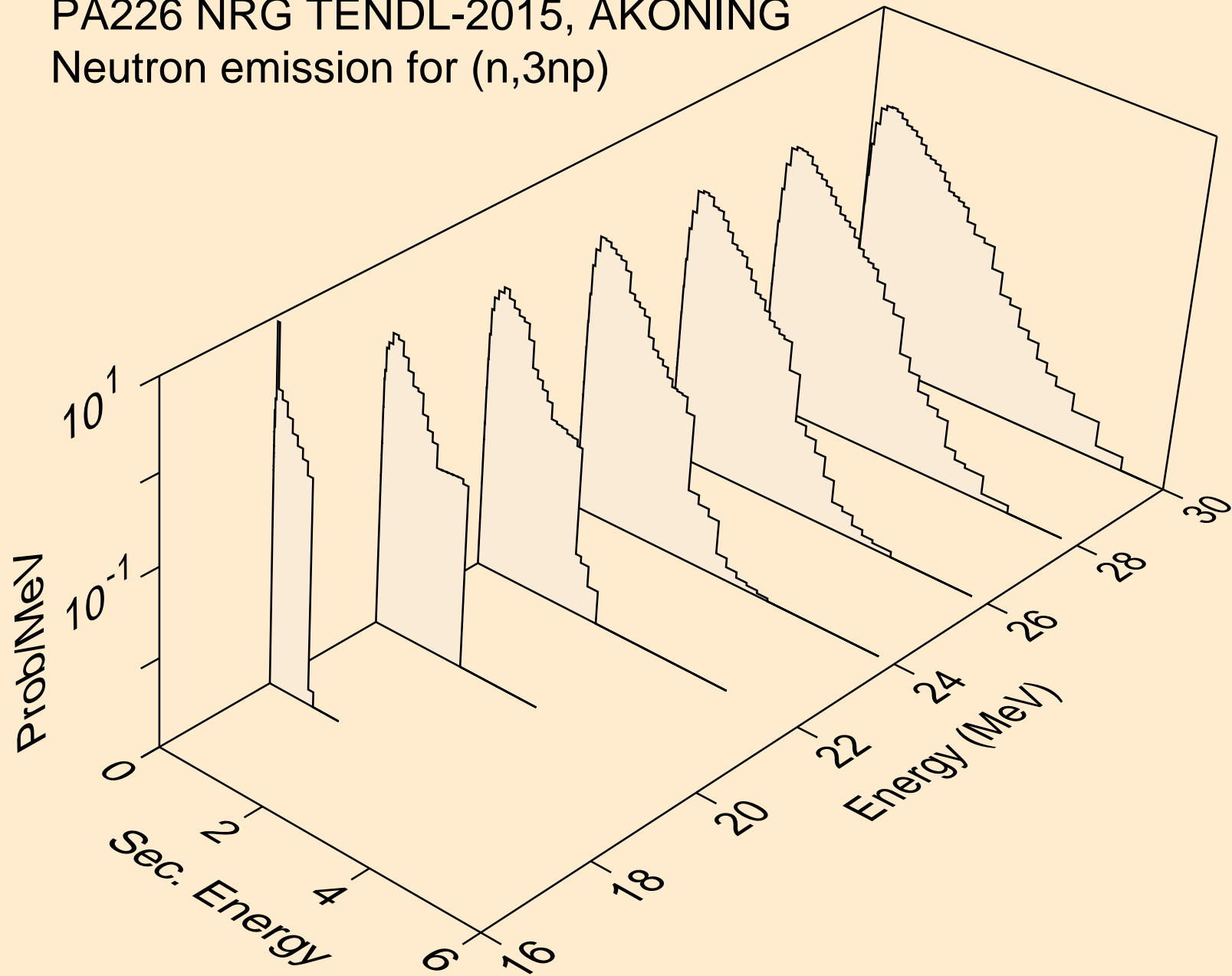

PA226 NRG TENDL-2015, AKONING
Neutron emission for (n,2np)

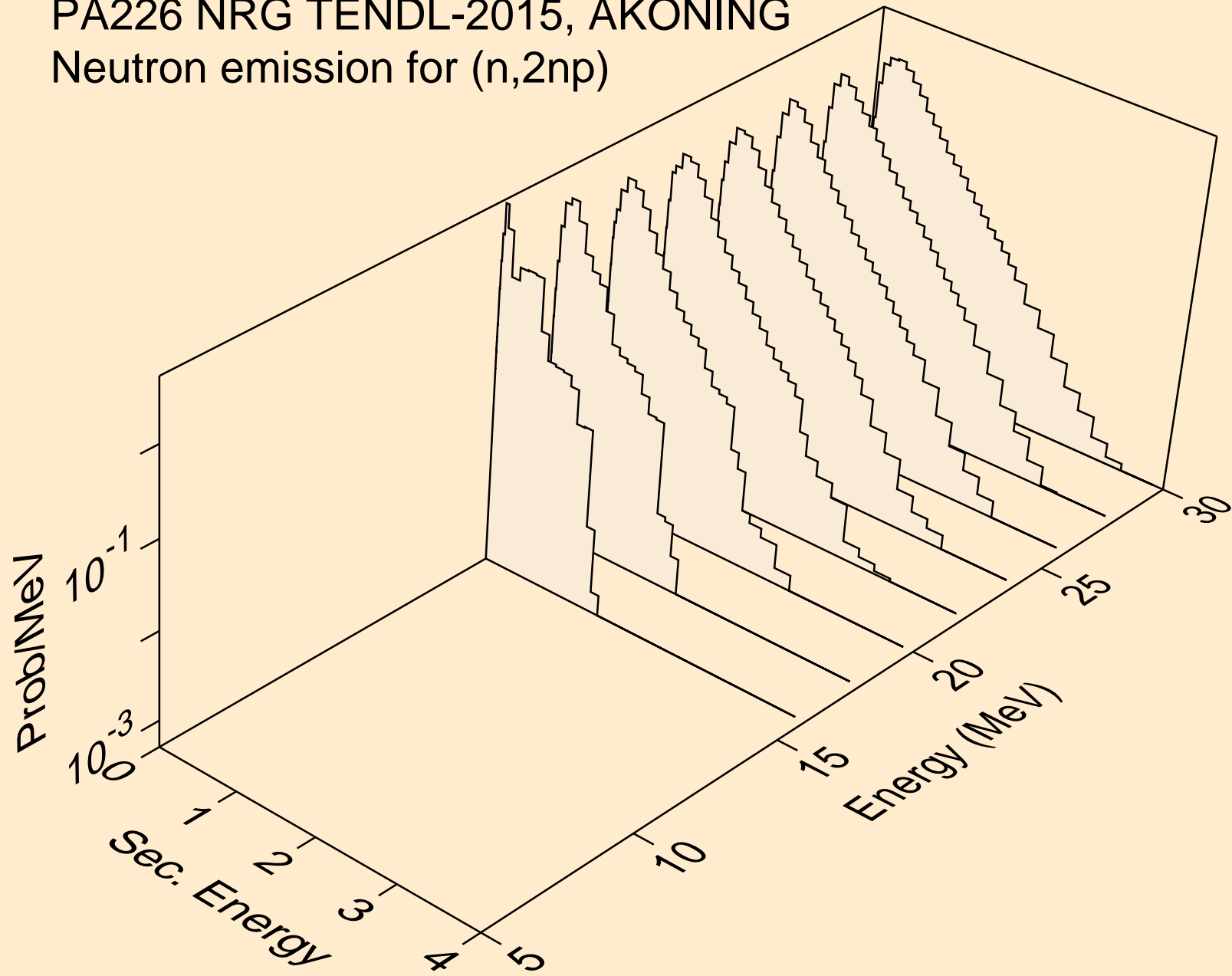

PA226 NRG TENDL-2015, AKONING
Neutron emission for (n,npa)

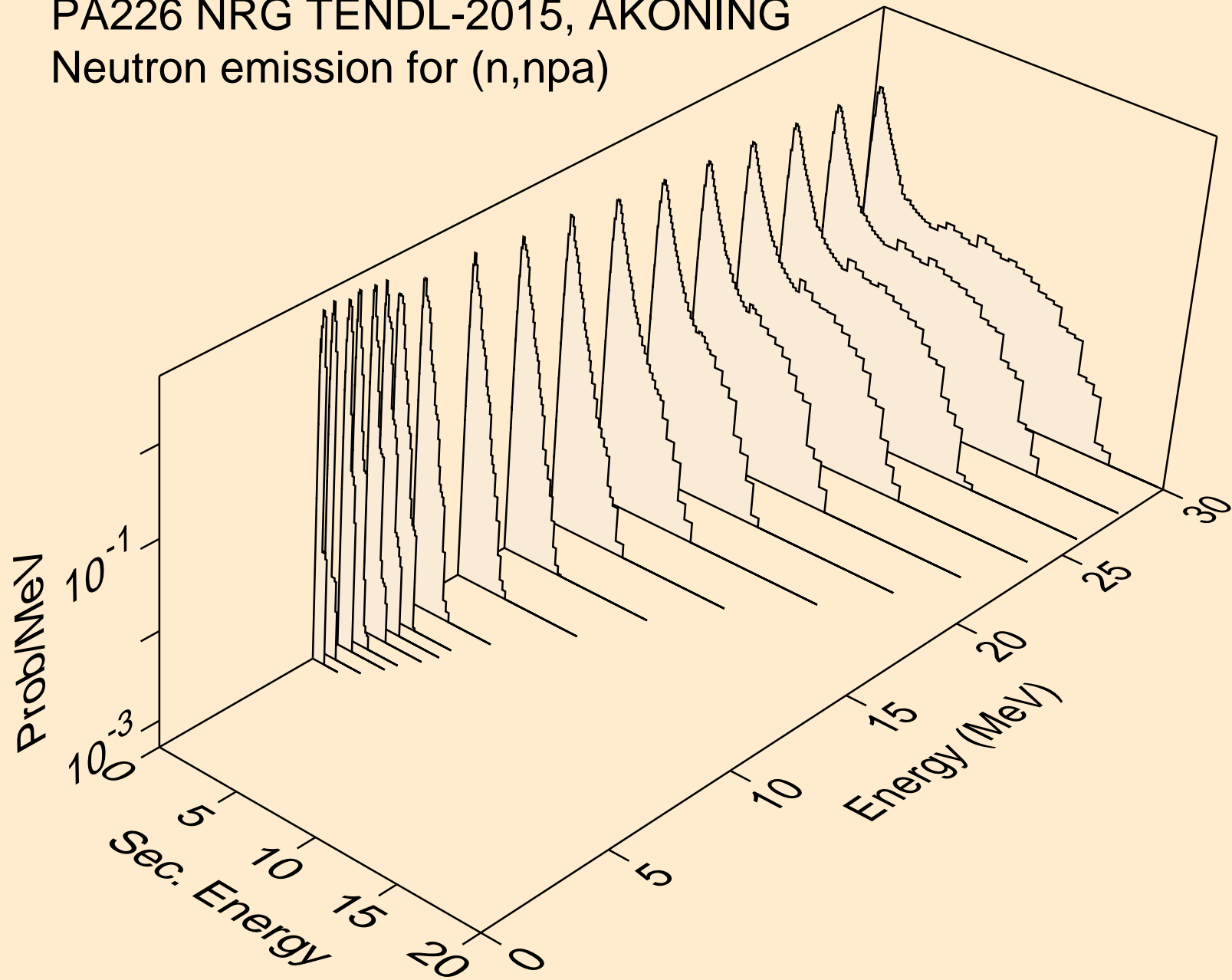

PA226 NRG TENDL-2015, AKONING
Neutron emission for (n,n*c)

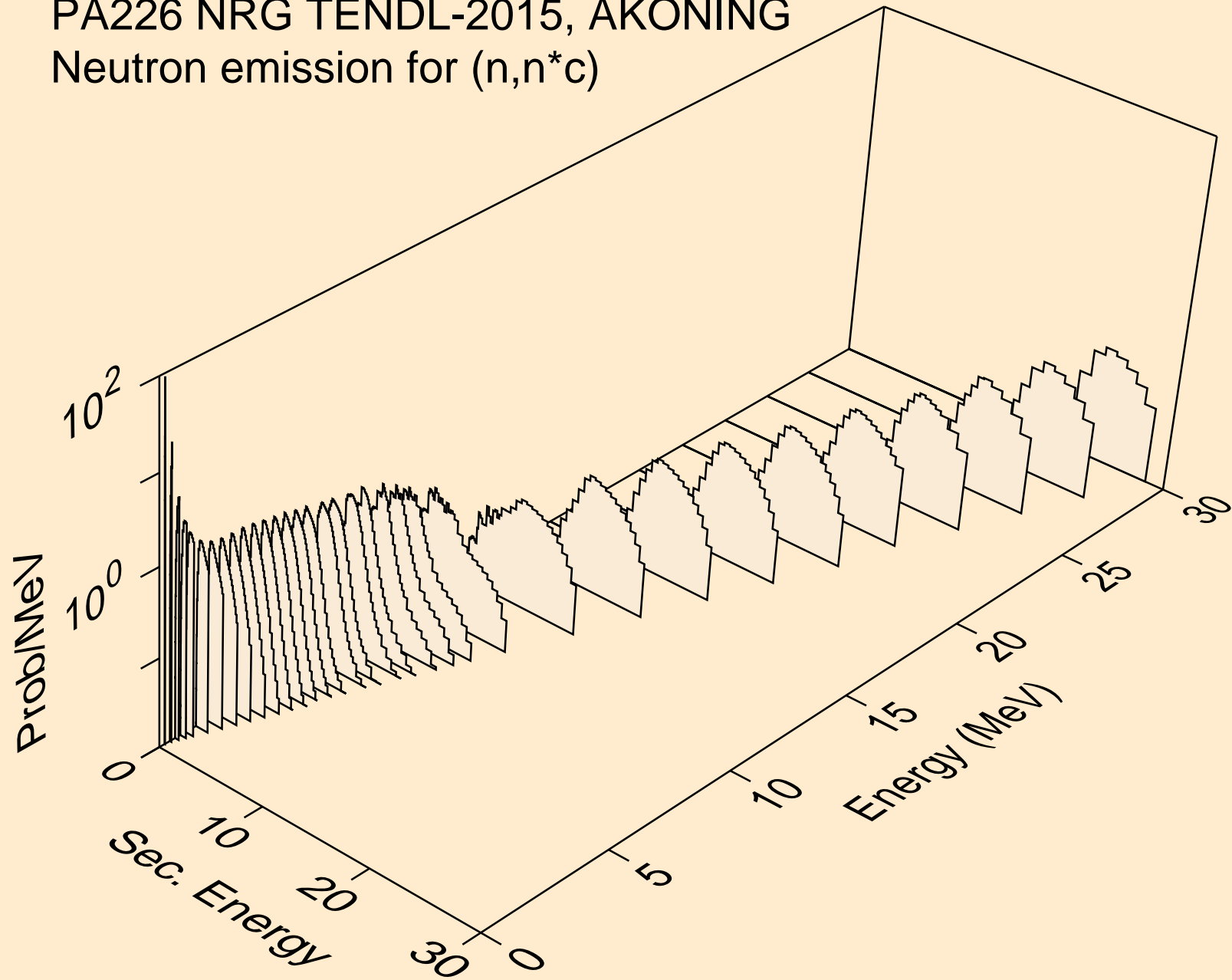

PA226 NRG TENDL-2015, AKONING

Delayed nubar

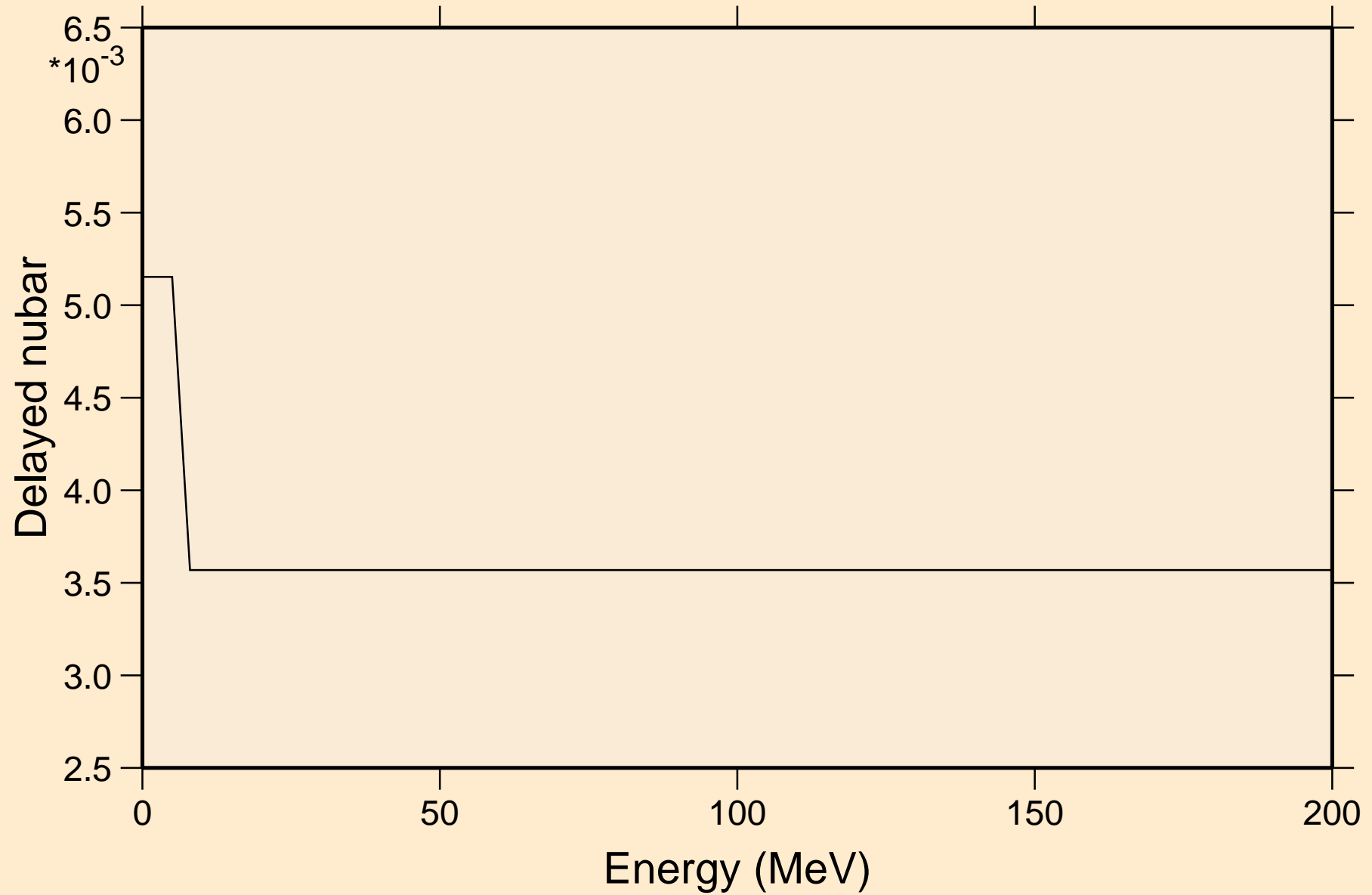

PA226 NRG TENDL-2015, AKONING

Delayed neutron spectra

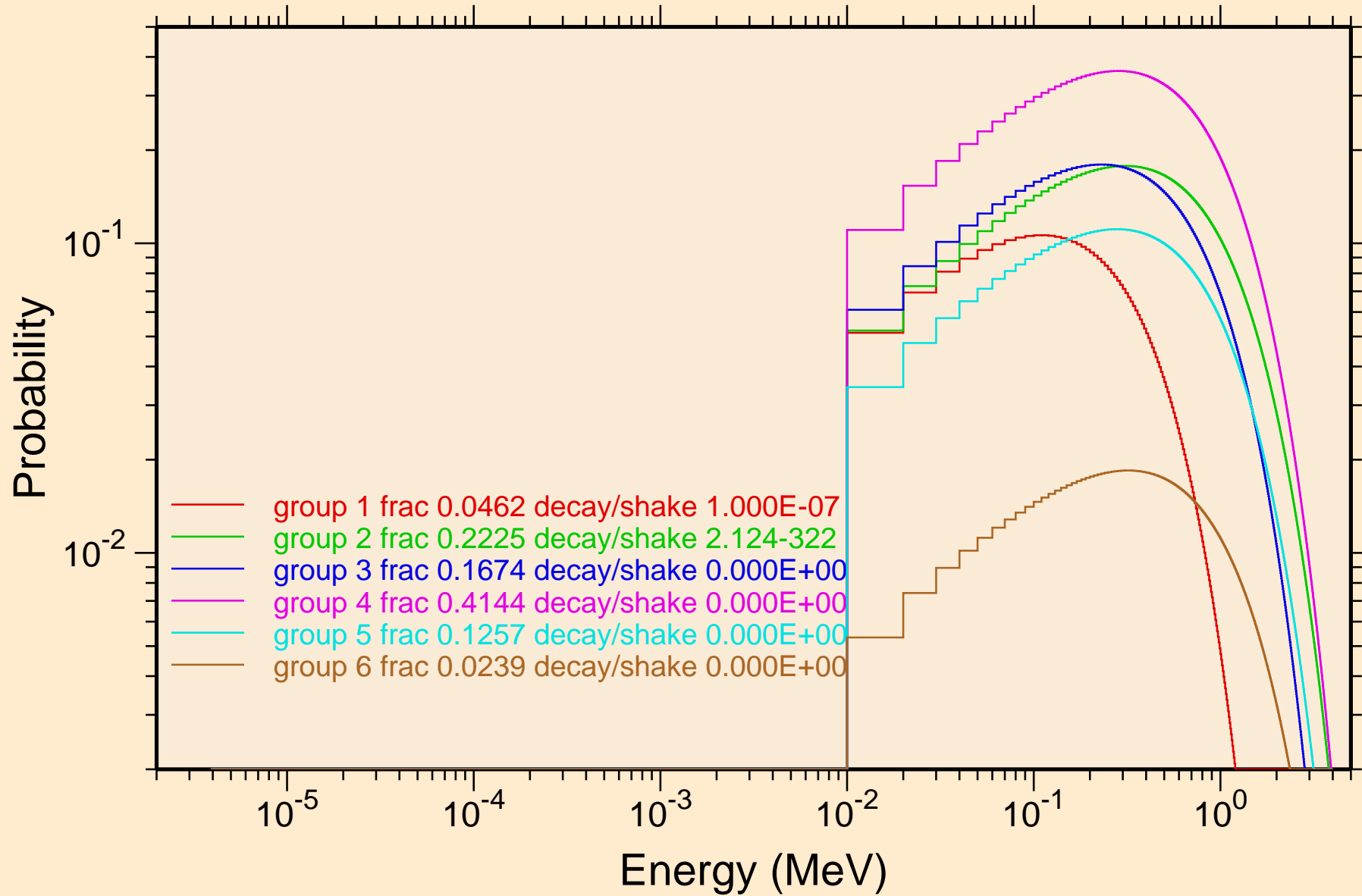

PA226 NRG TENDL-2015, AKONING
Photon emission for (n,x)

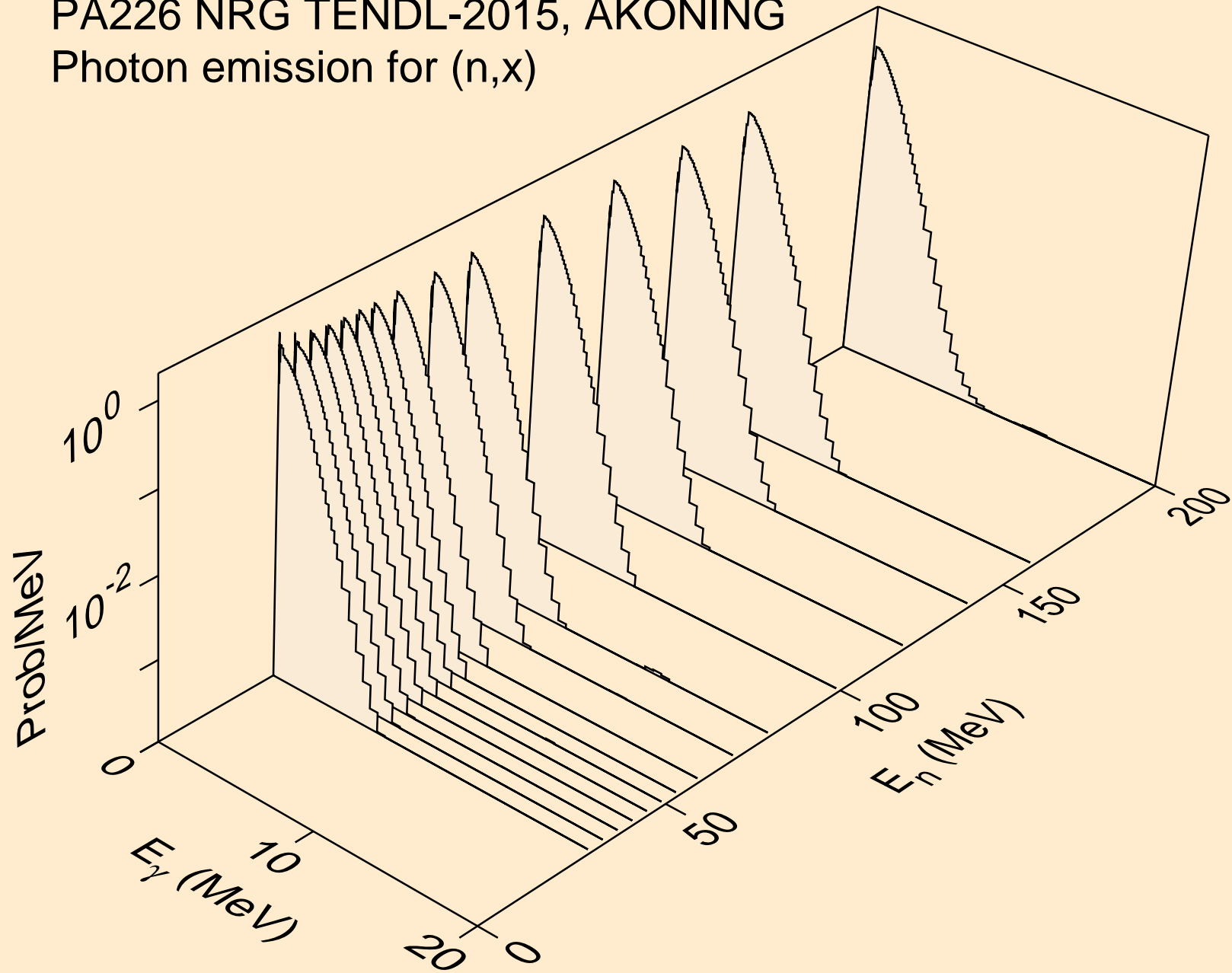

PA226 NRG TENDL-2015, AKONING
Photon emission for (n,2nd)

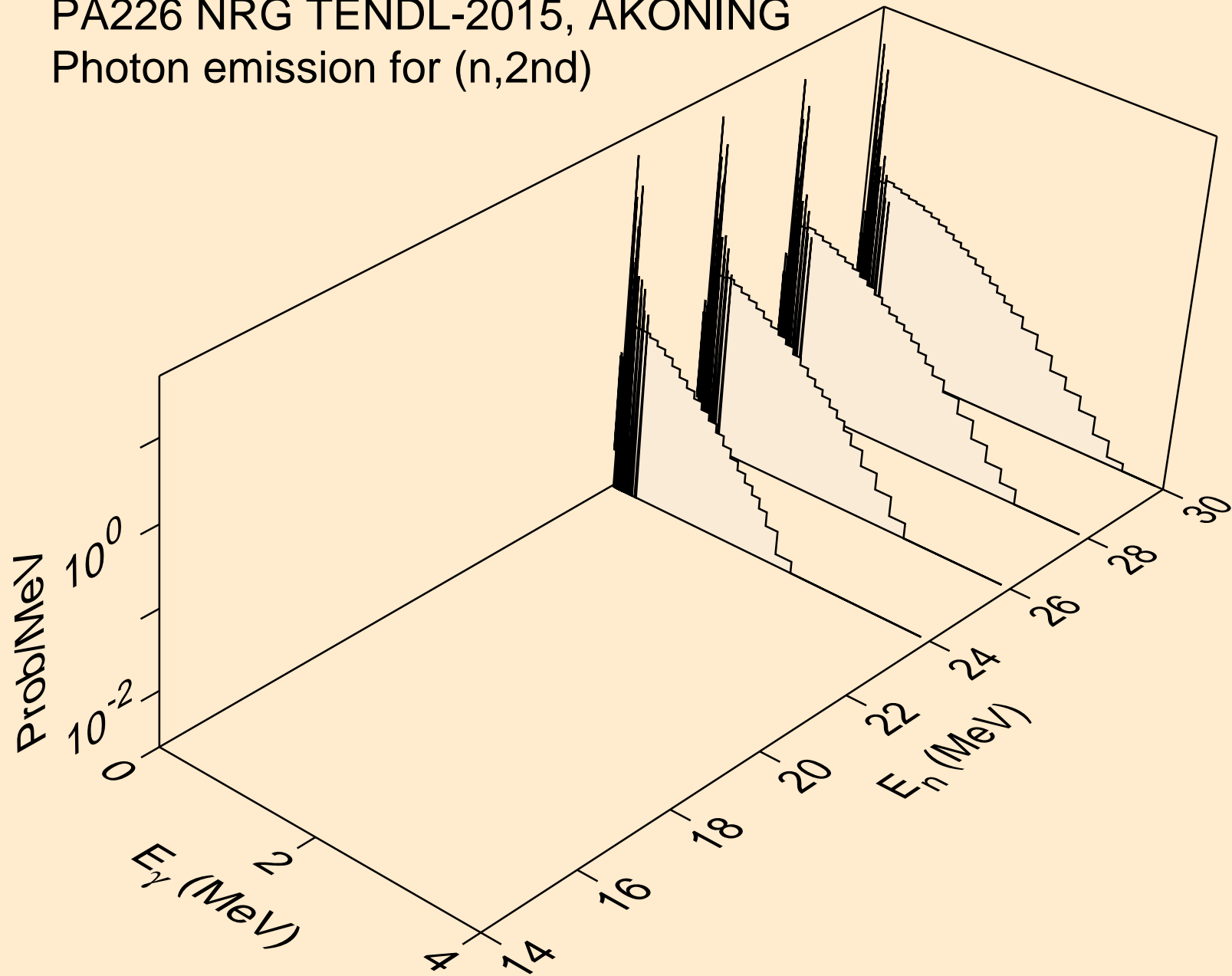

PA226 NRG TENDL-2015, AKONING
Photon emission for (n,2n)

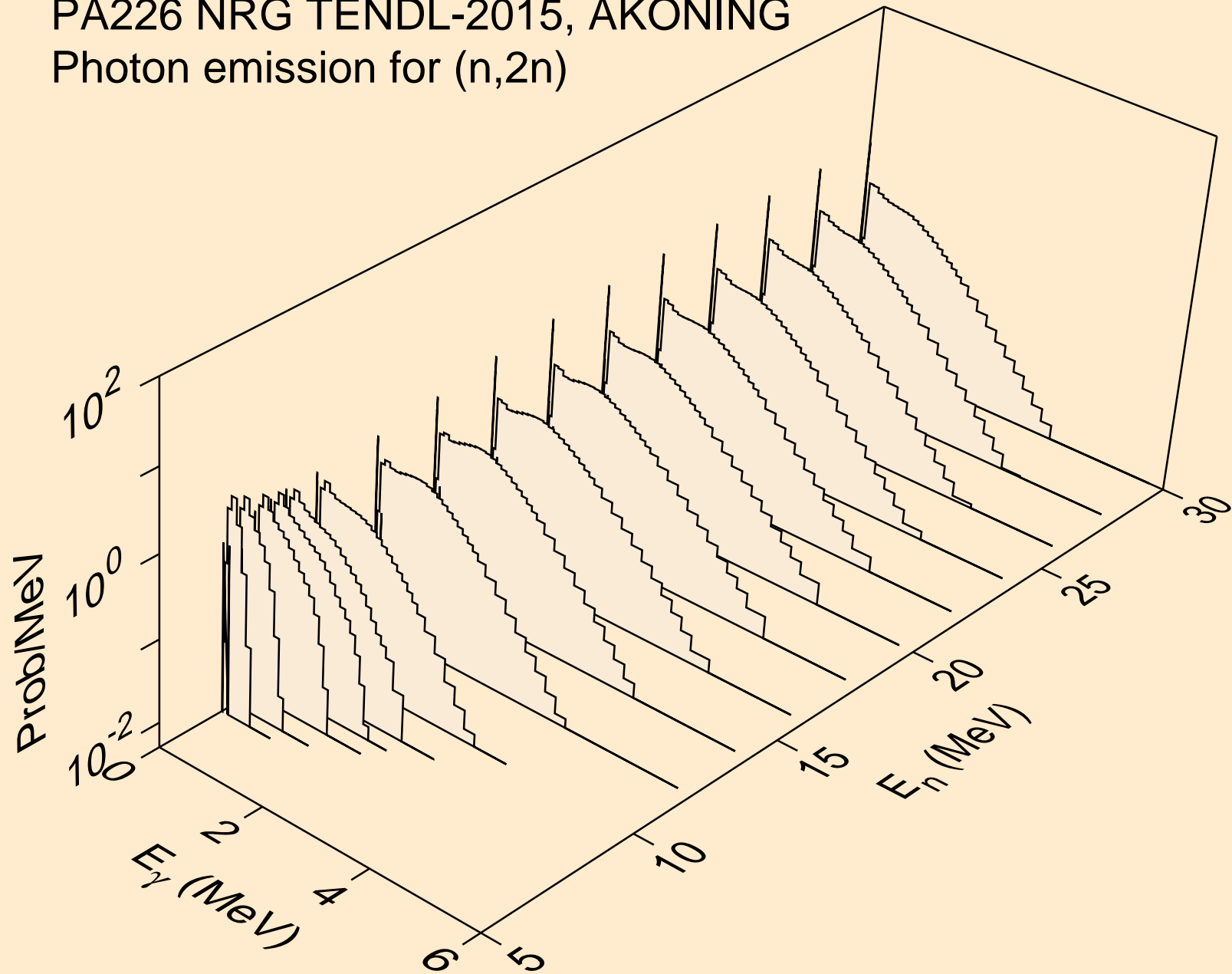

PA226 NRG TENDL-2015, AKONING
Photon emission for (n,3n)

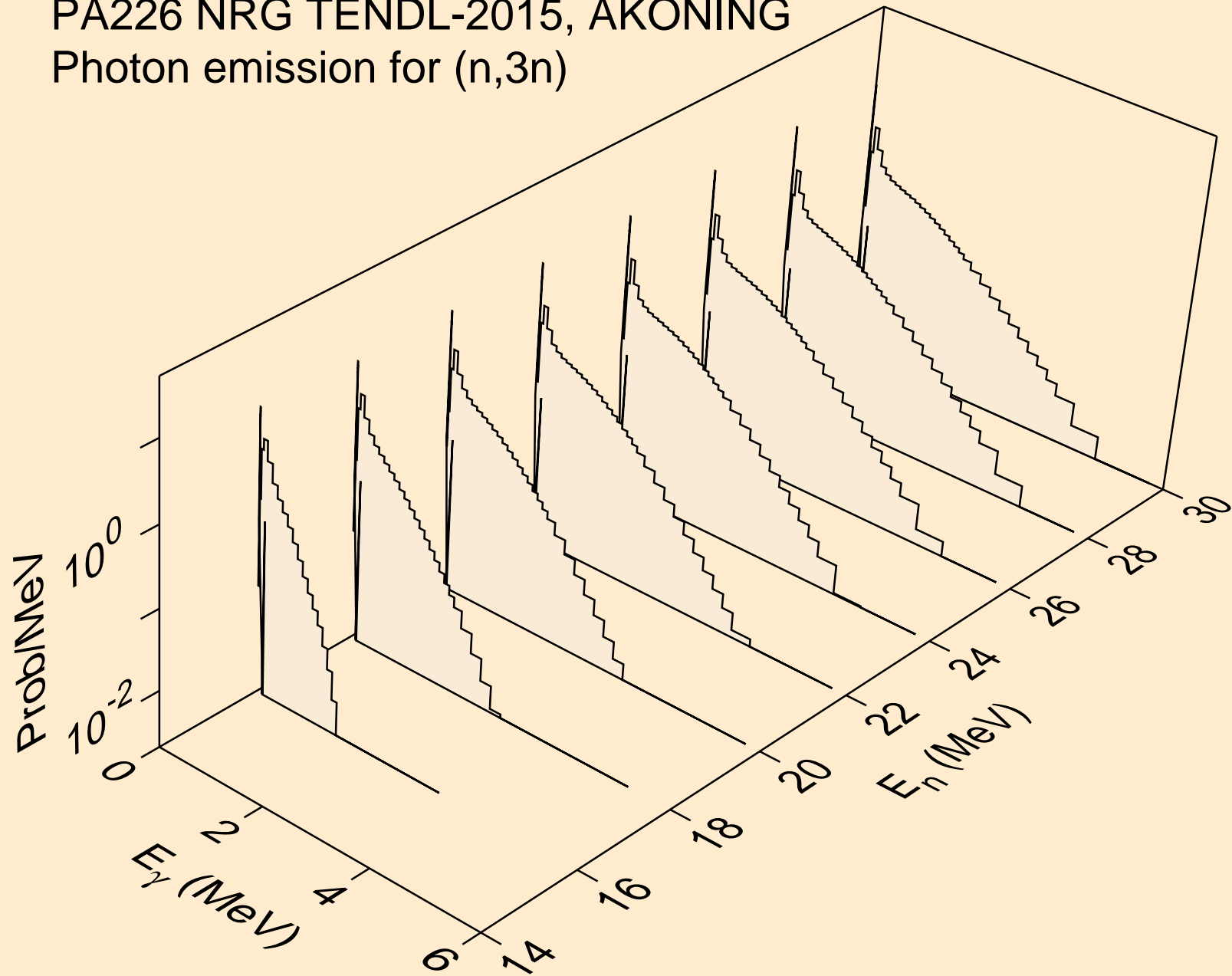

PA226 NRG TENDL-2015, AKONING
Photon emission for (n,n*)a

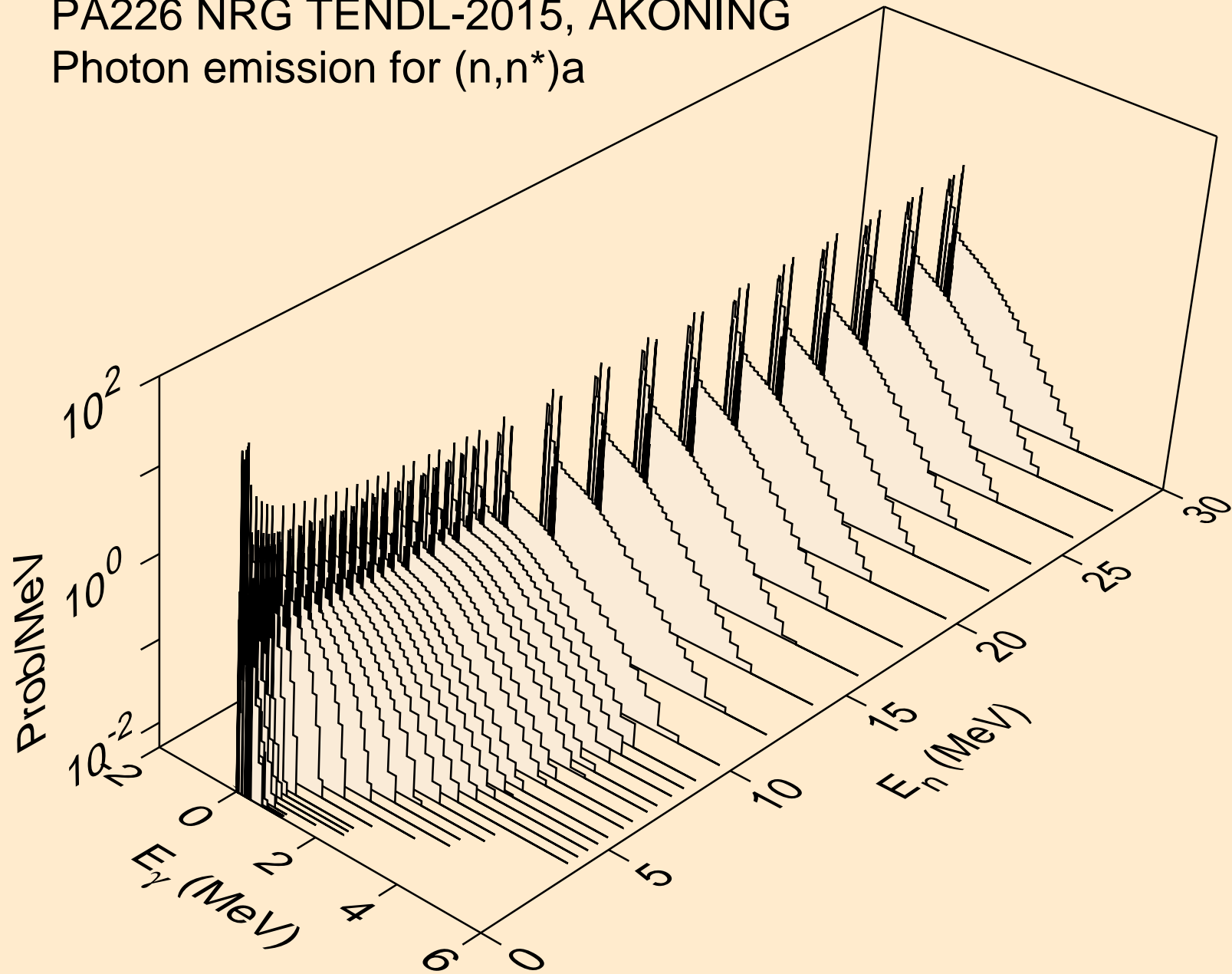

PA226 NRG TENDL-2015, AKONING
Photon emission for (n,n*)3a

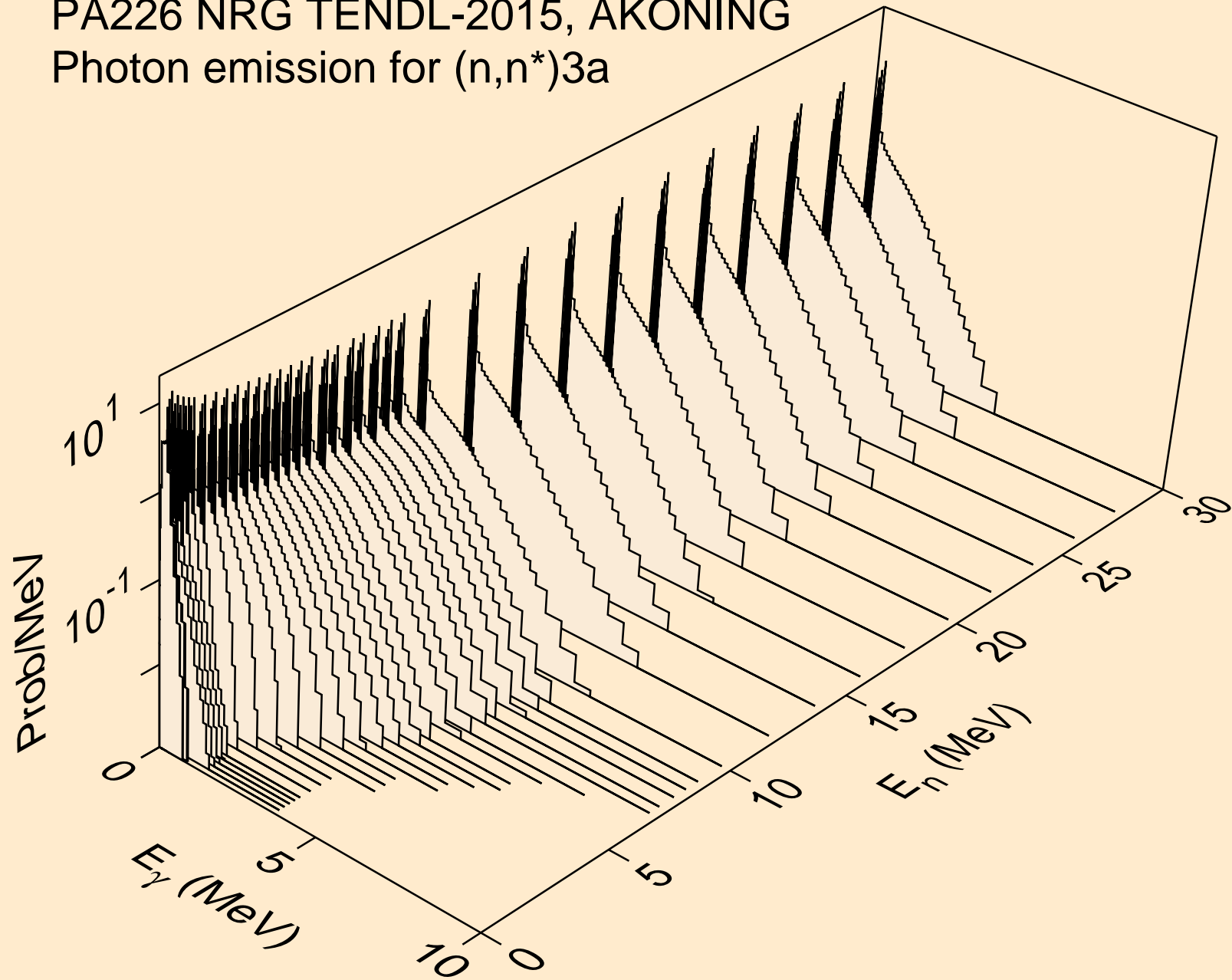

PA226 NRG TENDL-2015, AKONING
Photon emission for (n,2n)a

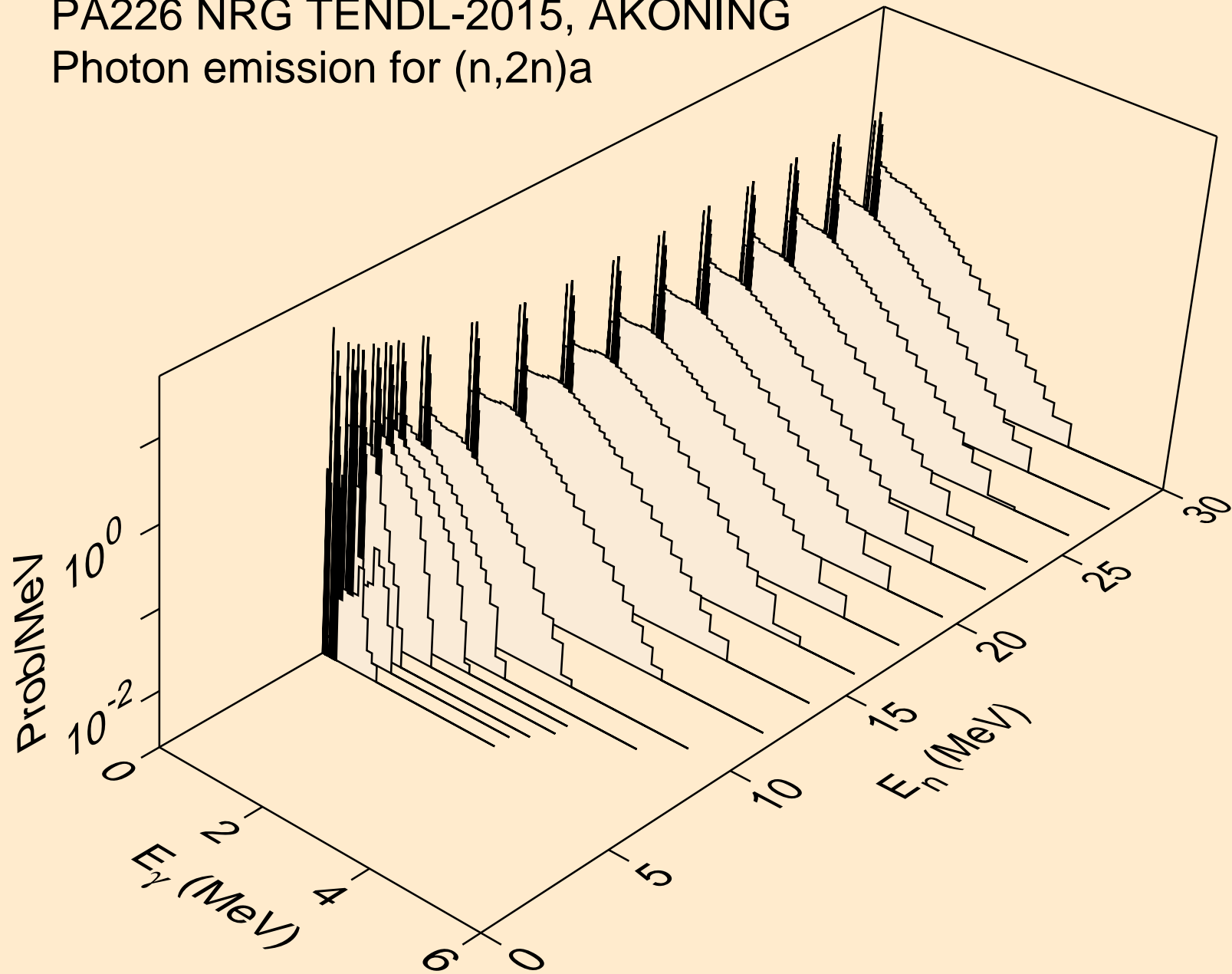

PA226 NRG TENDL-2015, AKONING
Photon emission for (n,3n)a

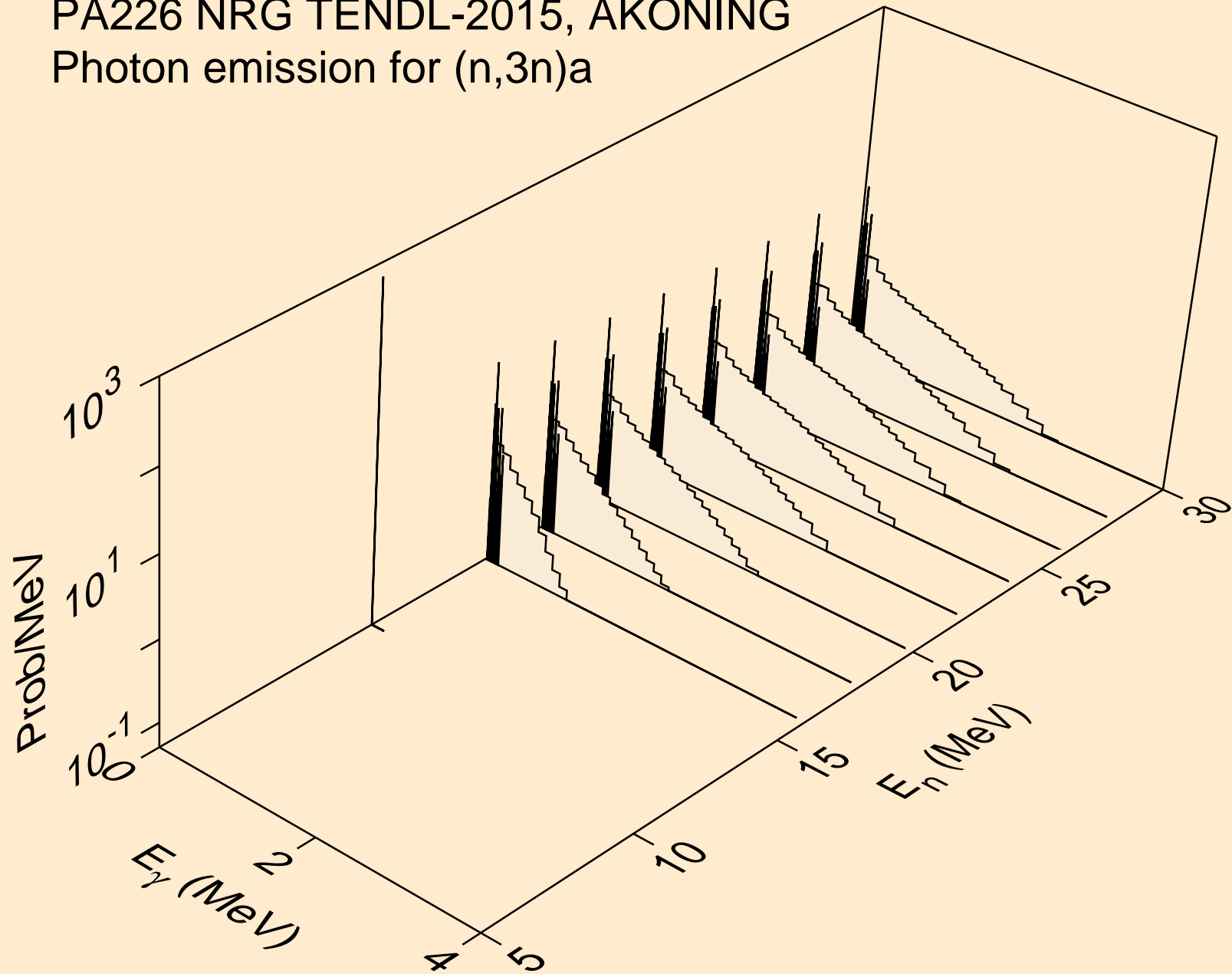

PA226 NRG TENDL-2015, AKONING
Photon emission for (n,n*)p

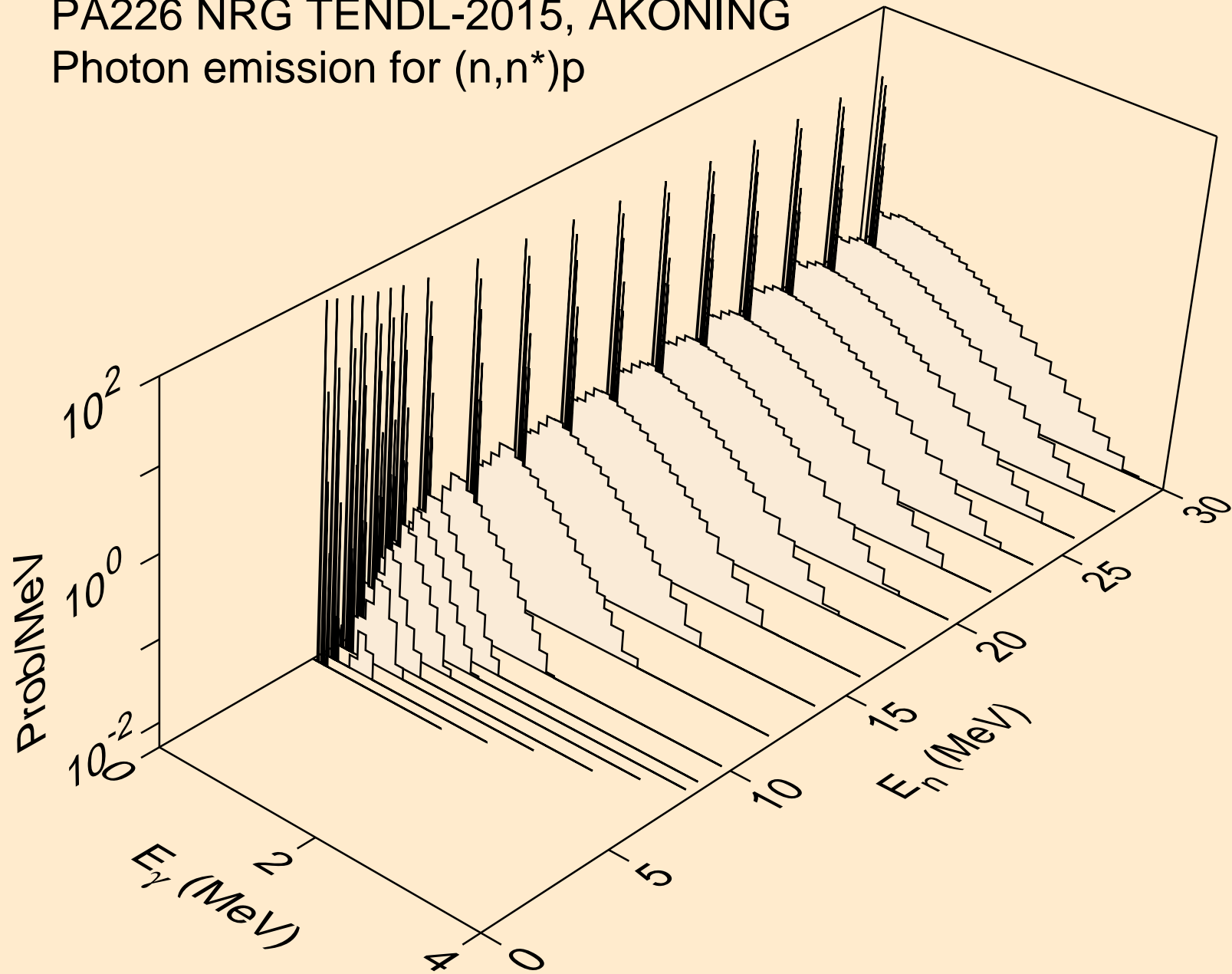

PA226 NRG TENDL-2015, AKONING
Photon emission for (n,n*)2a

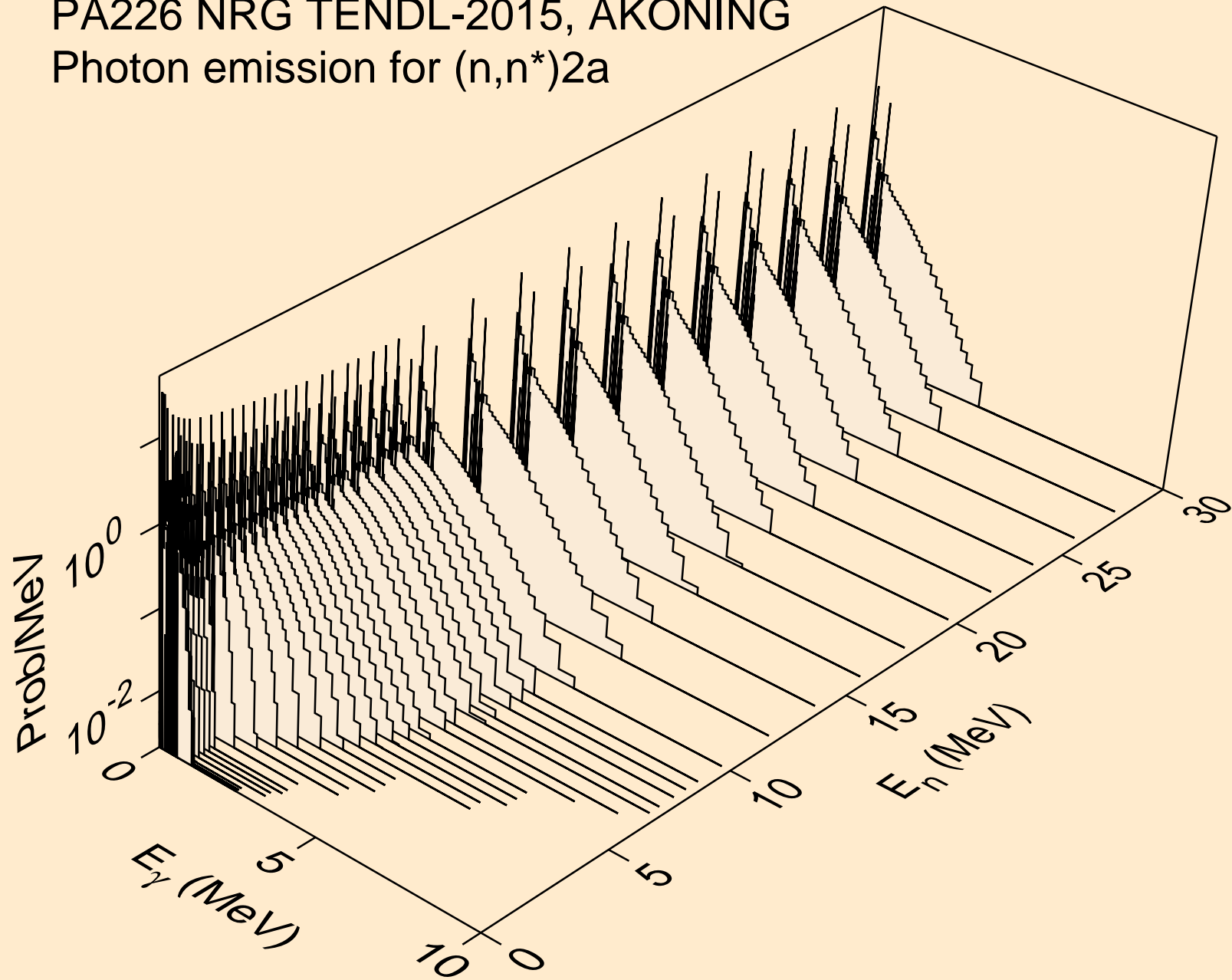

PA226 NRG TENDL-2015, AKONING
Photon emission for (n,2n)2a

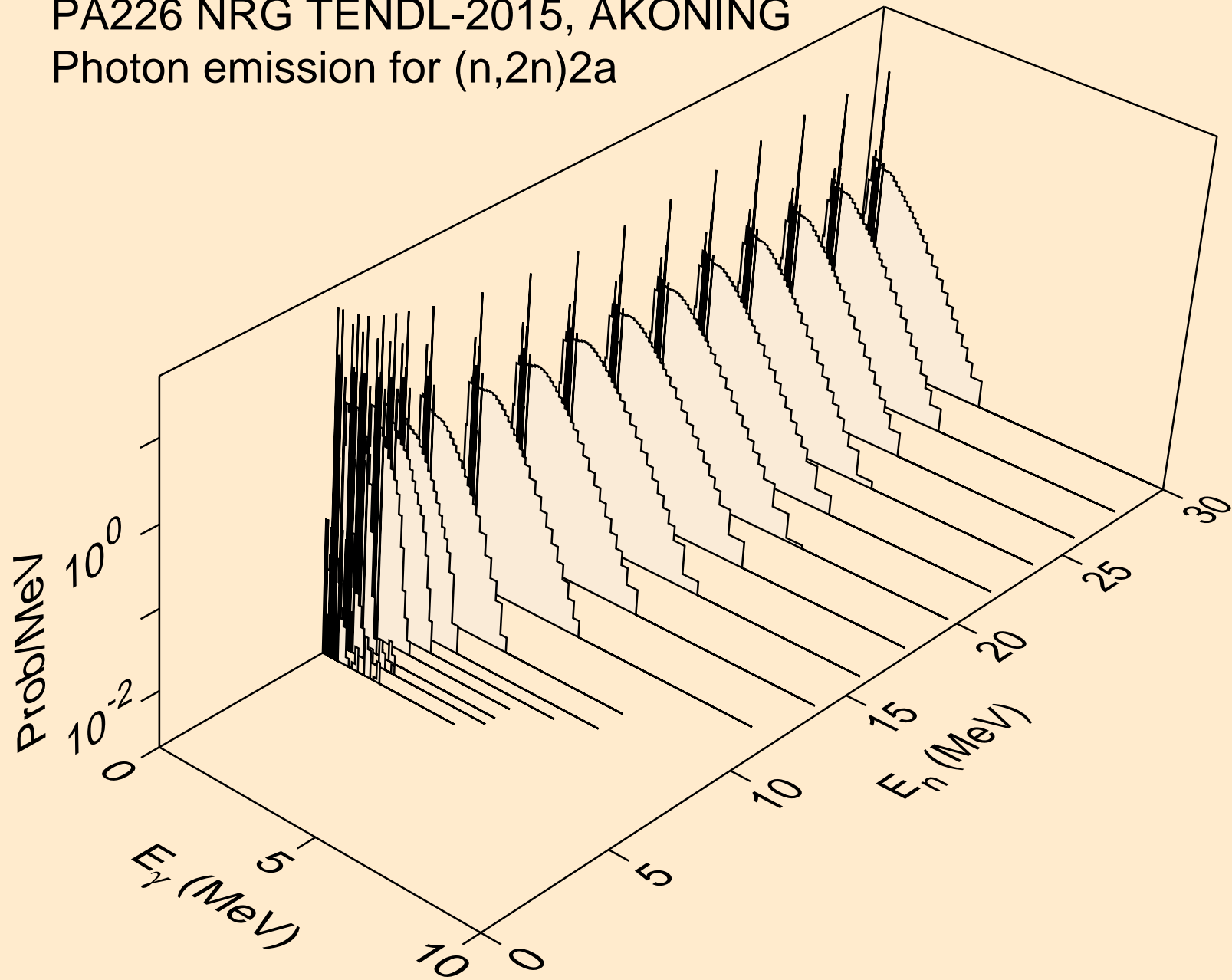

PA226 NRG TENDL-2015, AKONING
Photon emission for (n,n*)d

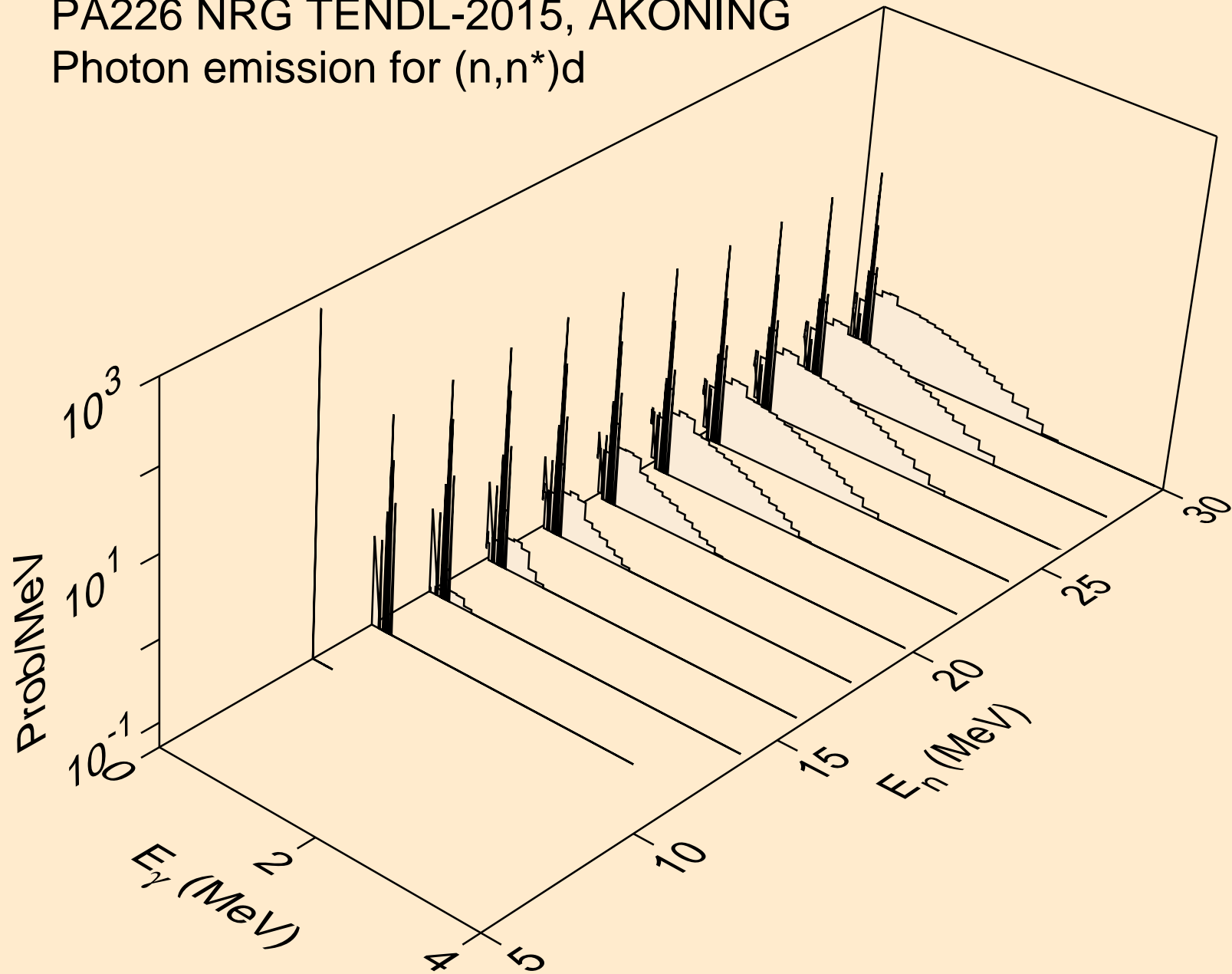

PA226 NRG TENDL-2015, AKONING
Photon emission for (n,n*)t

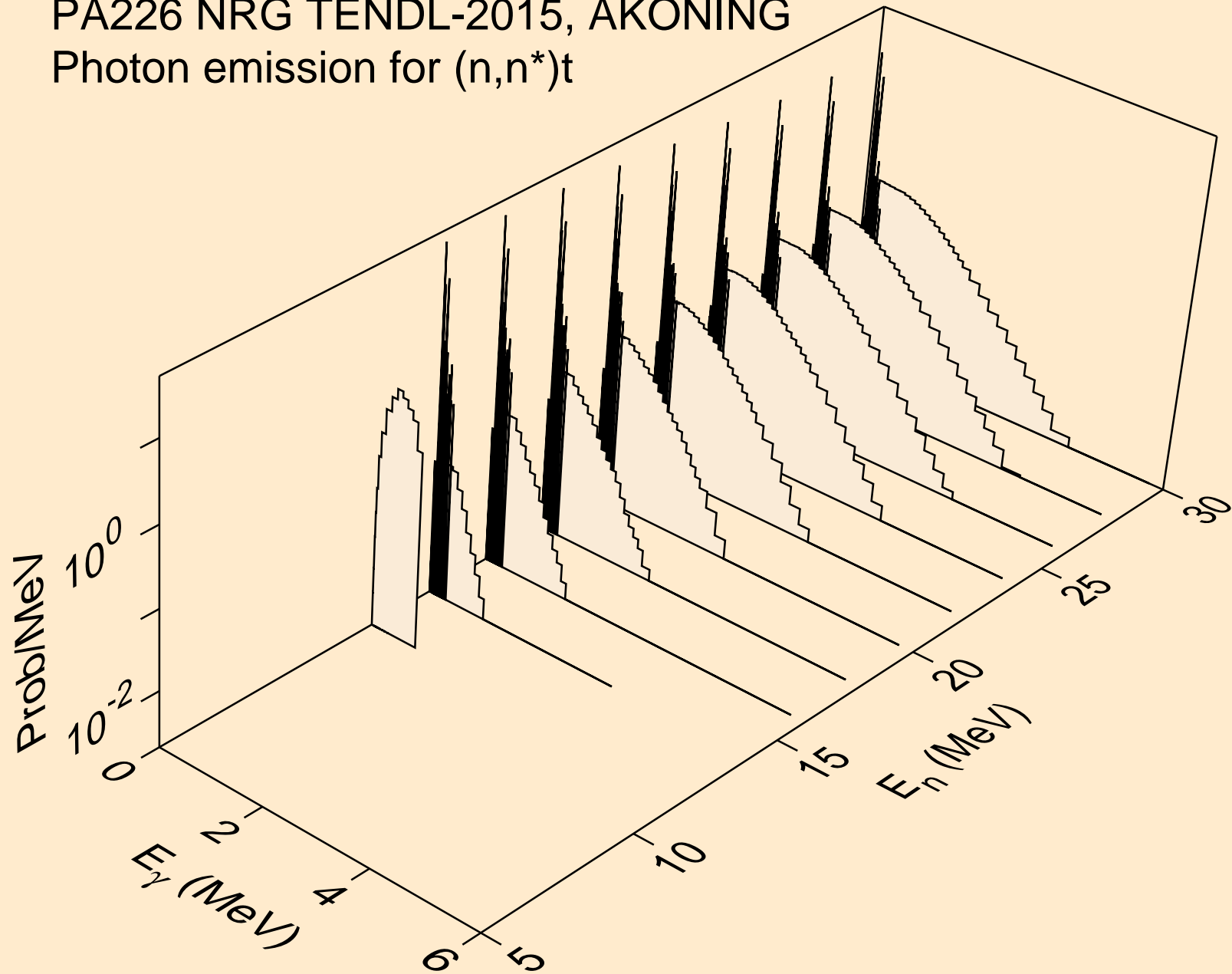

PA226 NRG TENDL-2015, AKONING
Photon emission for (n,n*)he3

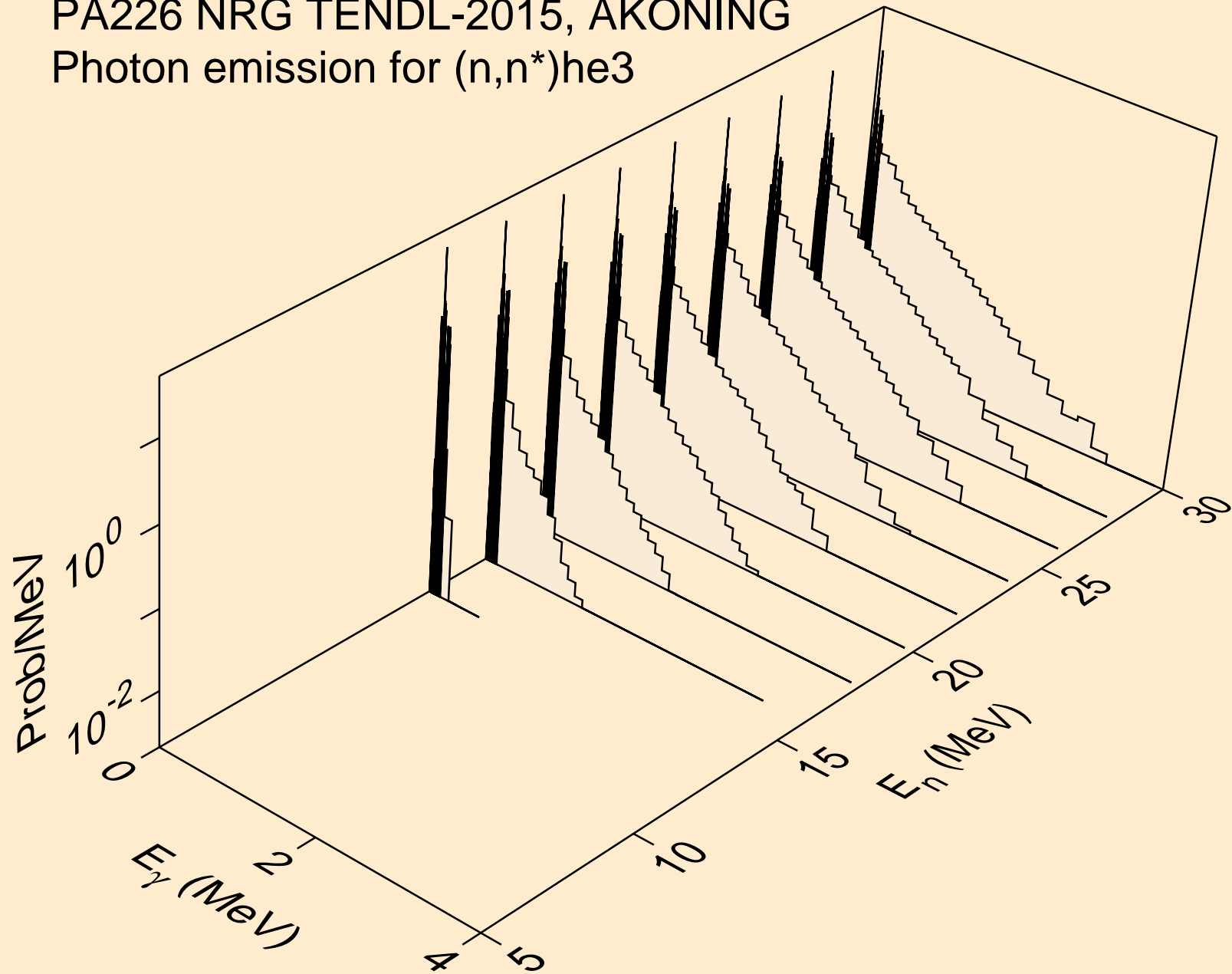

PA226 NRG TENDL-2015, AKONING
Photon emission for (n,n*)d2a

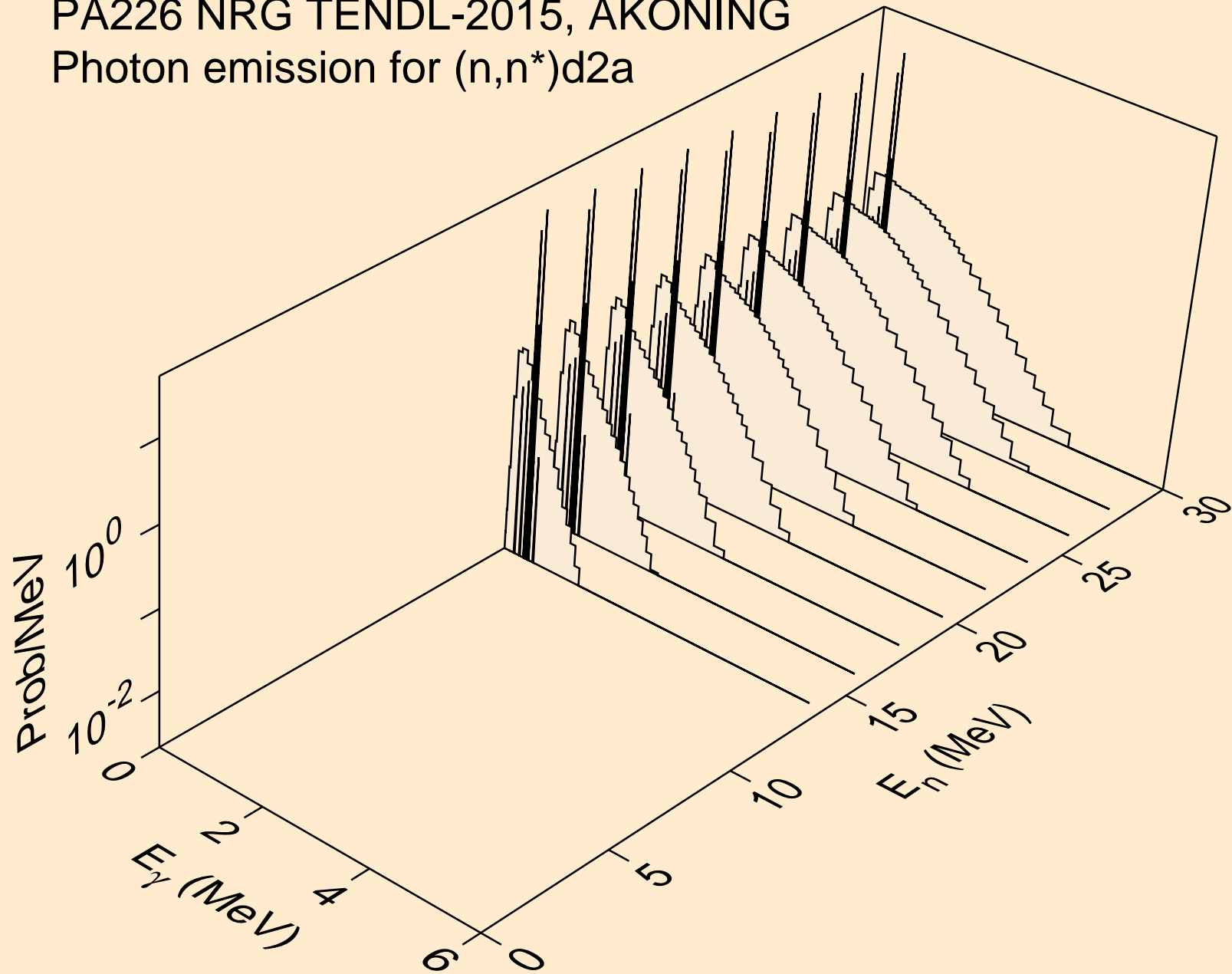

PA226 NRG TENDL-2015, AKONING
Photon emission for (n,n*)t2a

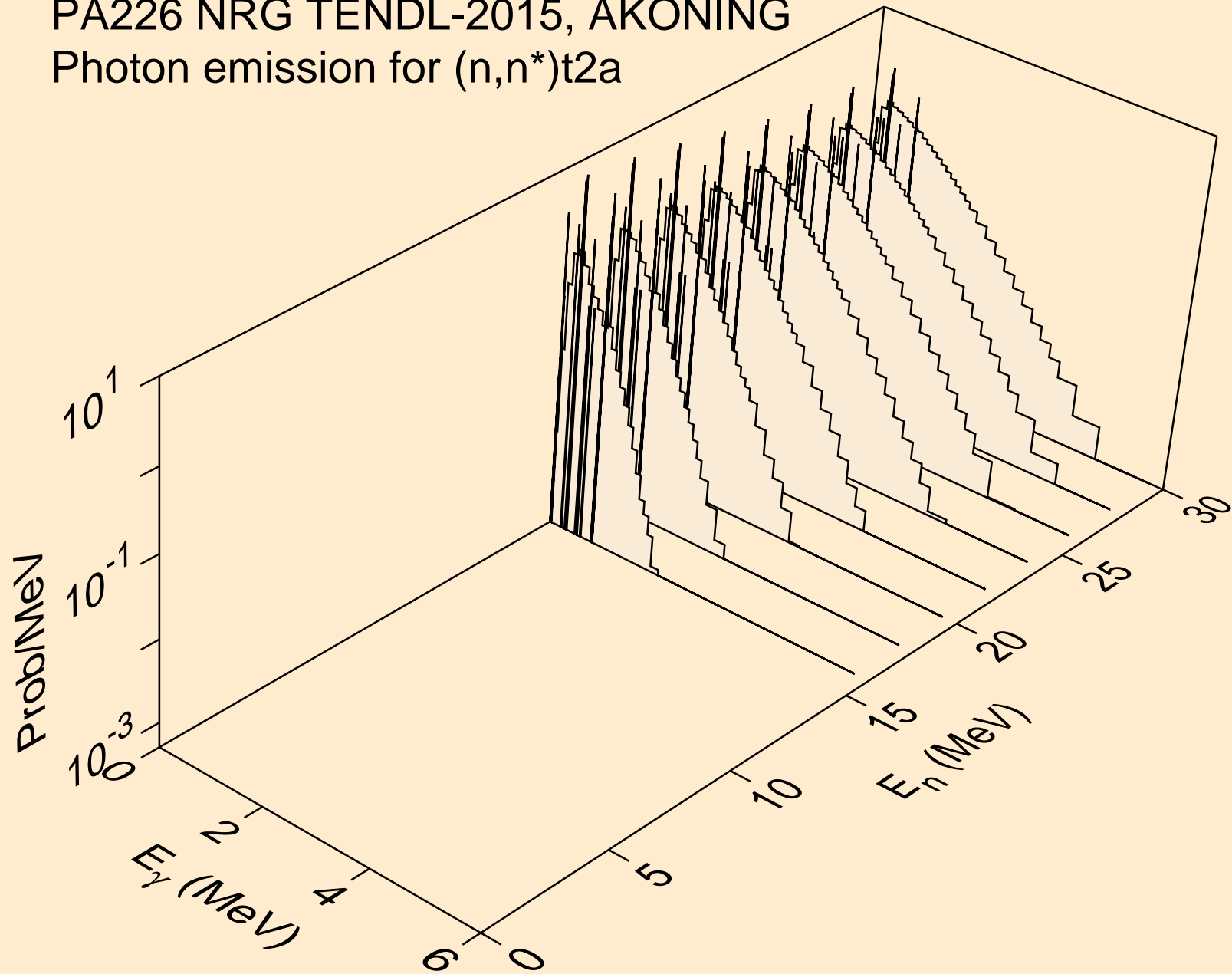

PA226 NRG TENDL-2015, AKONING
Photon emission for (n,4n)

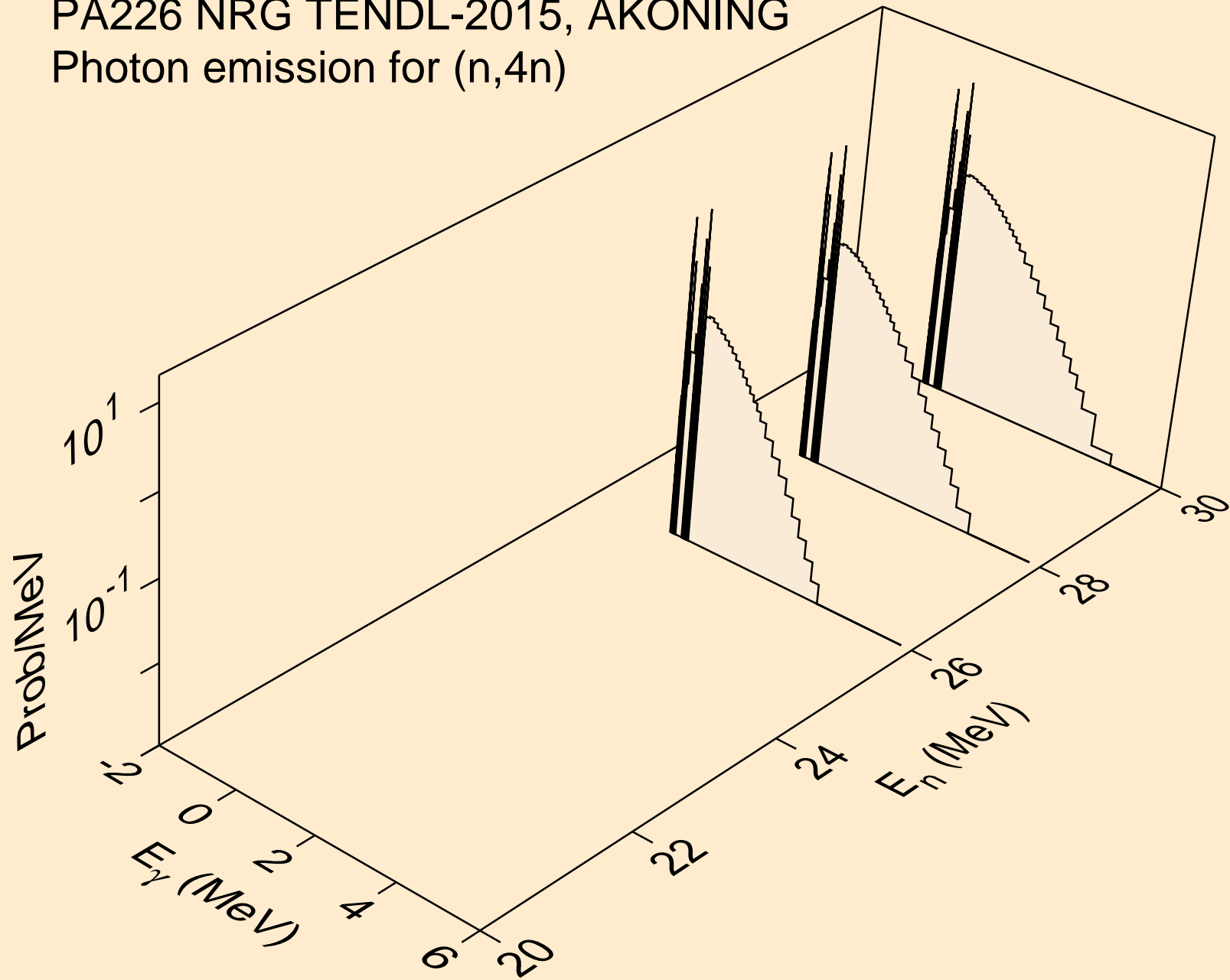

PA226 NRG TENDL-2015, AKONING
Photon emission for (n,2np)

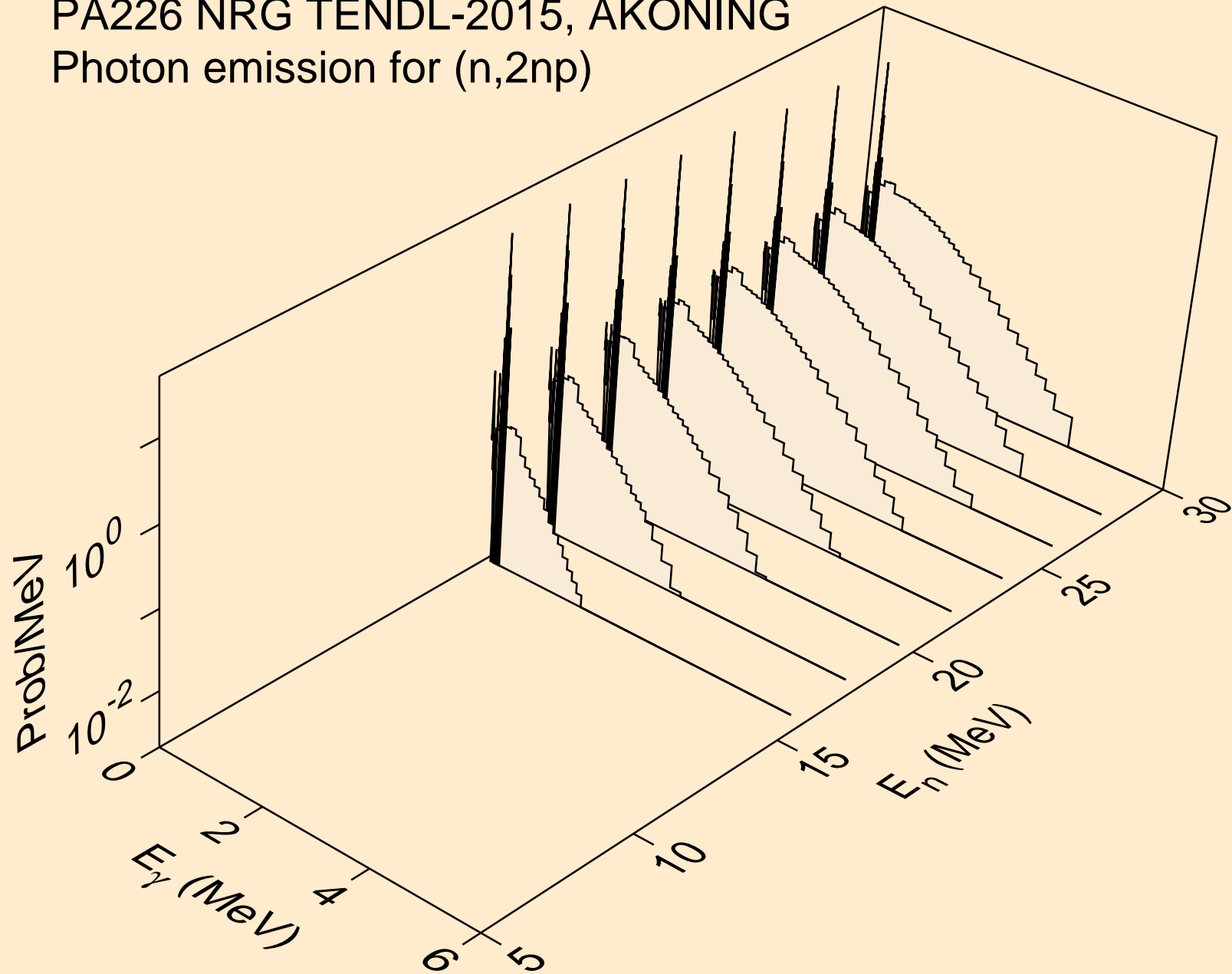

PA226 NRG TENDL-2015, AKONING
Photon emission for (n,3np)

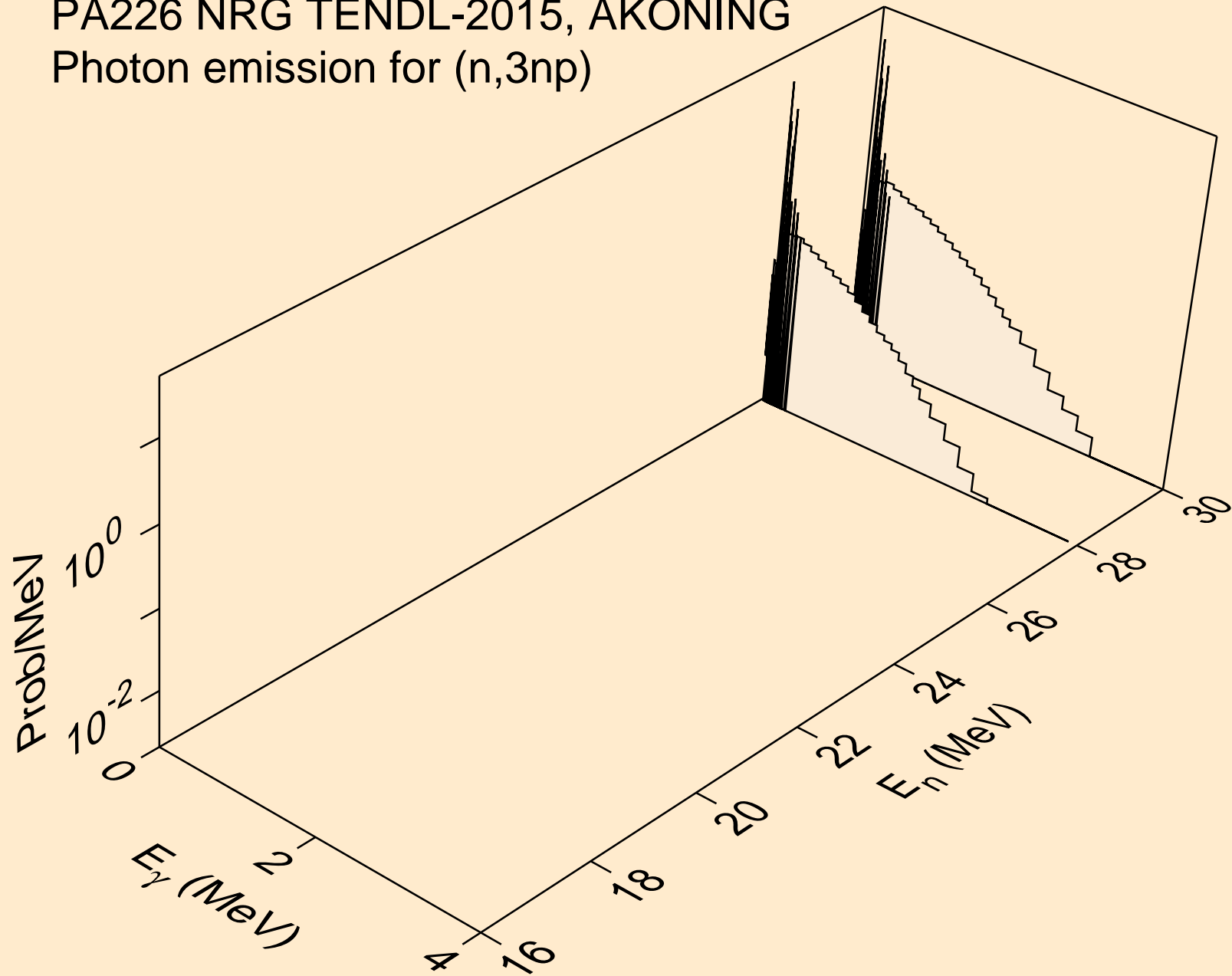

PA226 NRG TENDL-2015, AKONING
Photon emission for (n,2np)

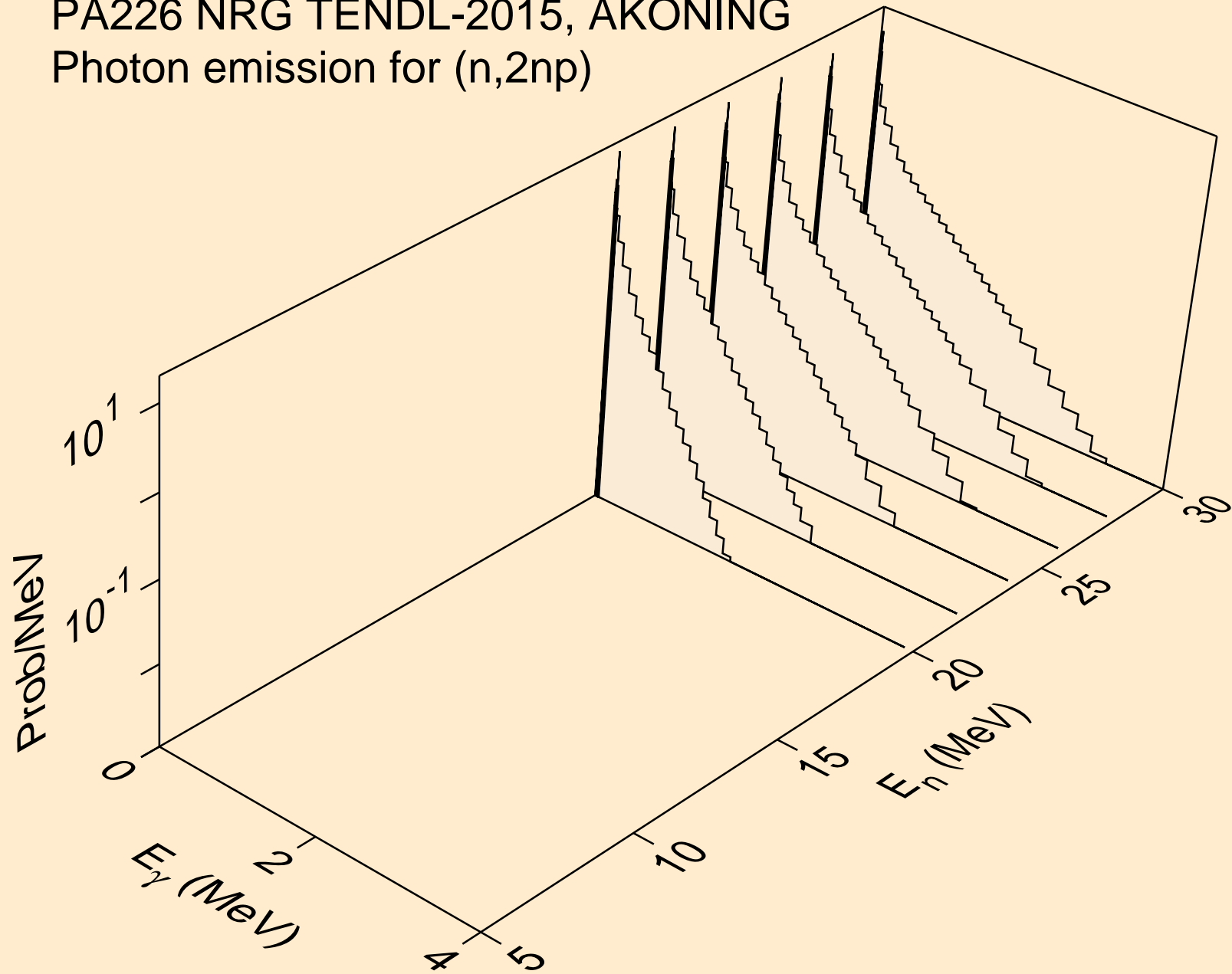

PA226 NRG TENDL-2015, AKONING
Photon emission for (n,npa)

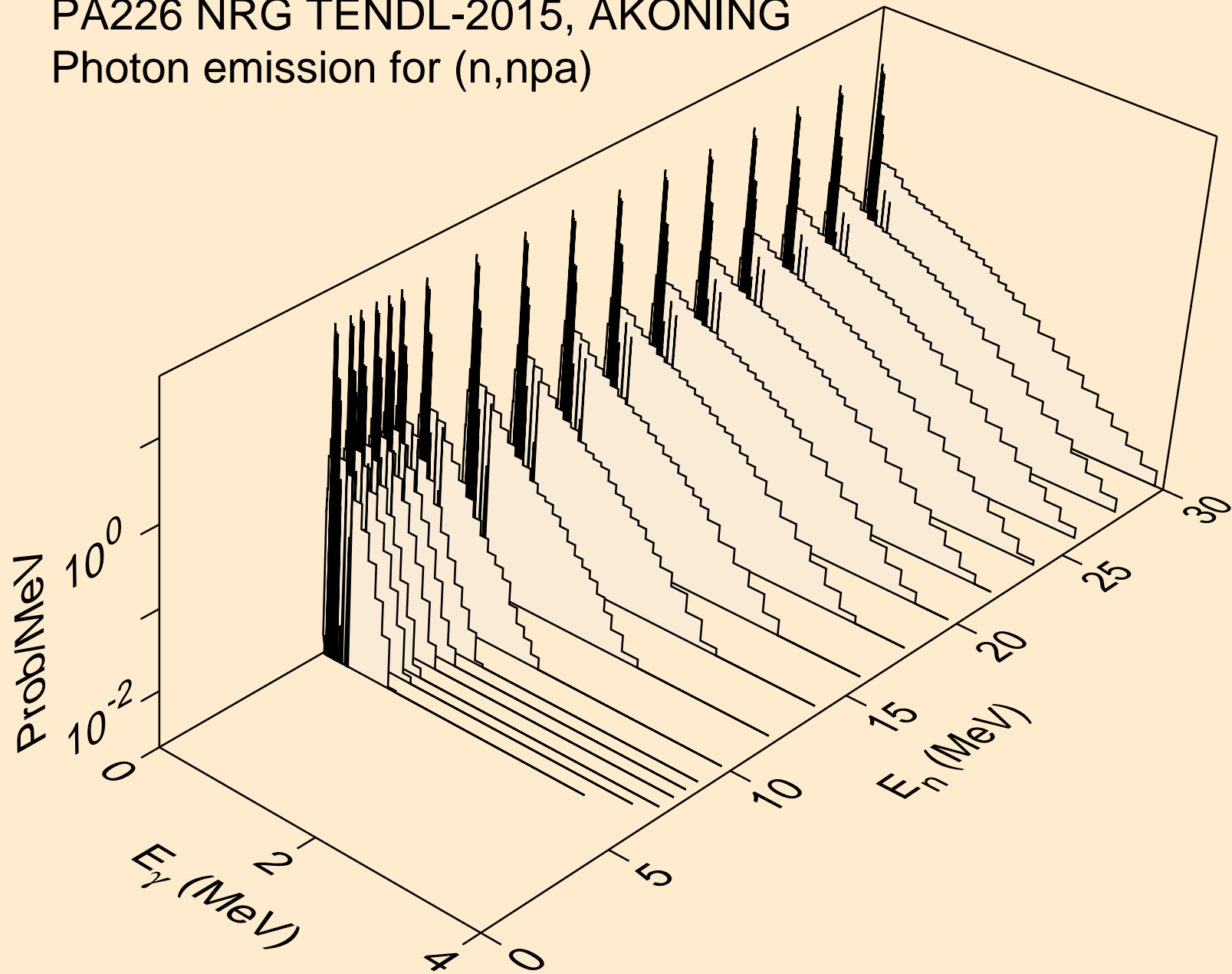

PA226 NRG TENDL-2015, AKONING
Photon emission for (n,n*c)

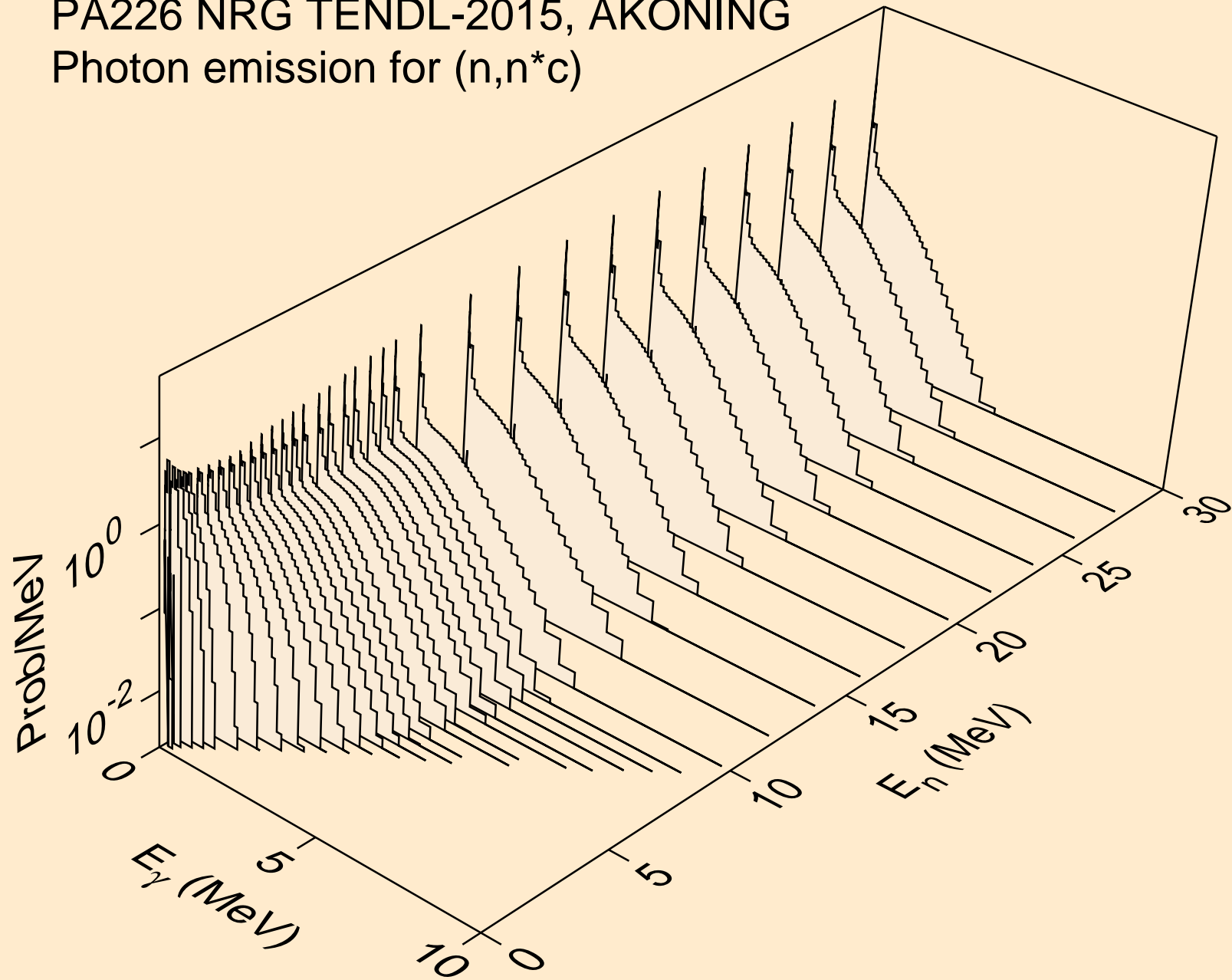

PA226 NRG TENDL-2015, AKONING
Photon emission for (n,gma)

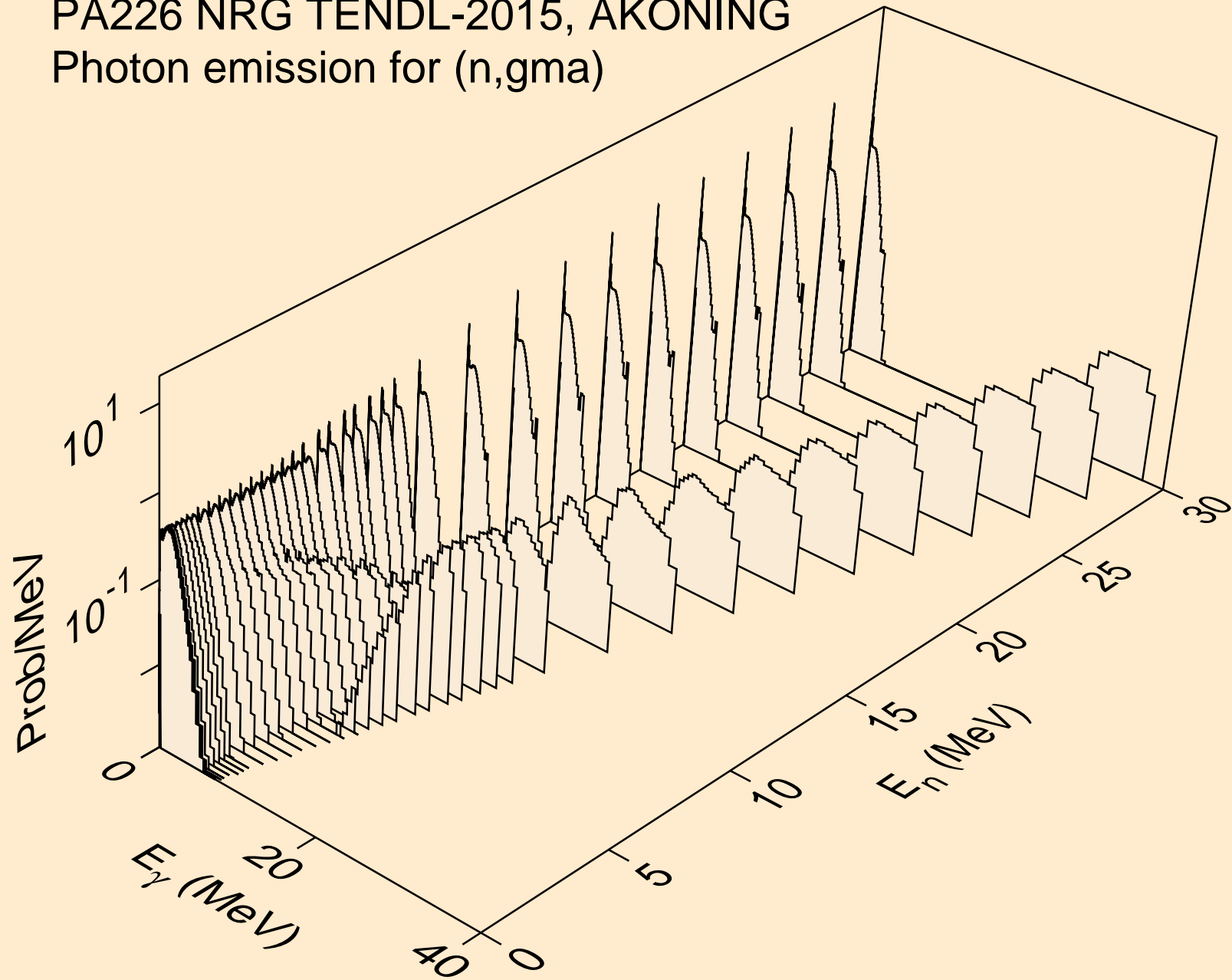

PA226 NRG TENDL-2015, AKONING
Photon emission for (n,p)

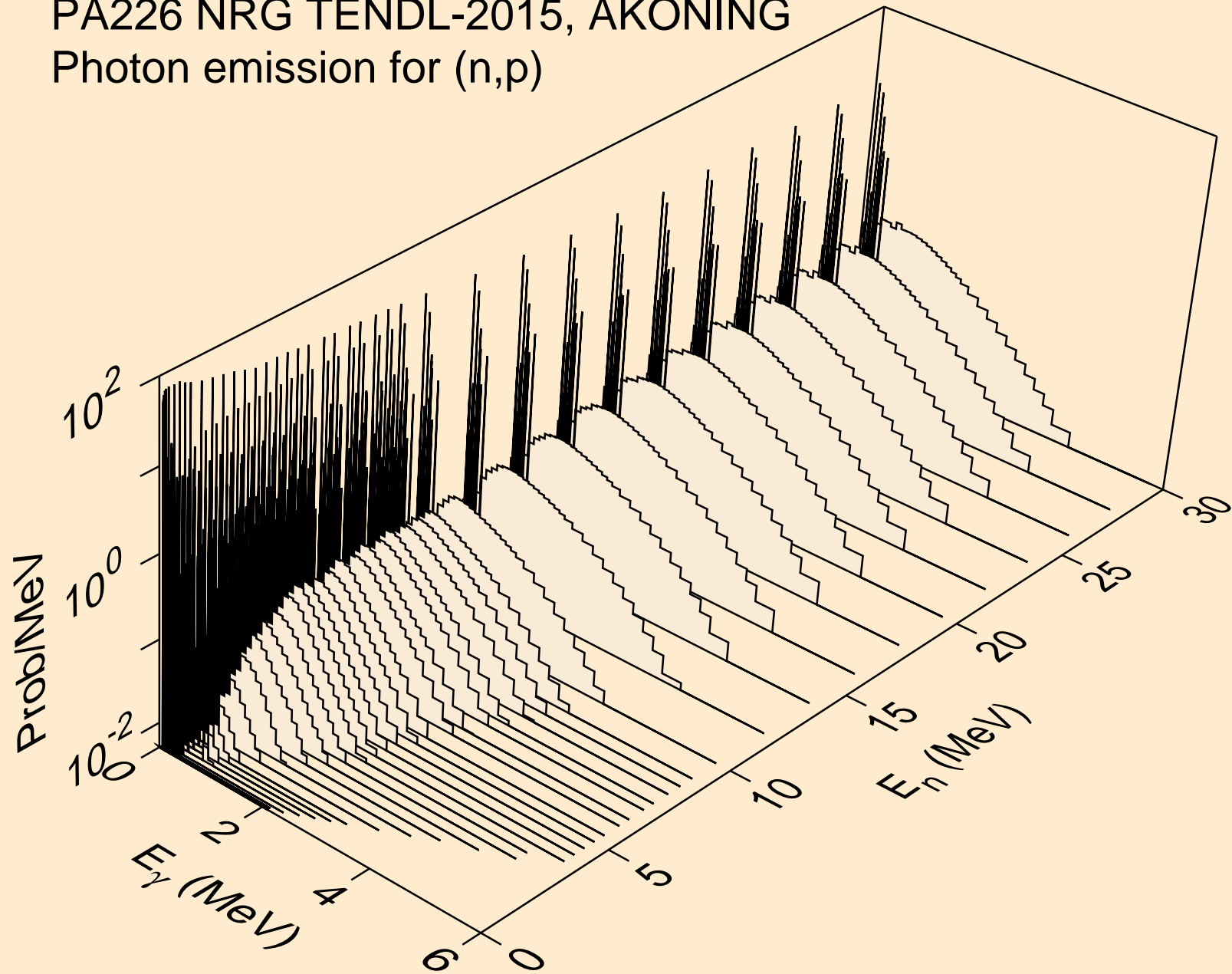

PA226 NRG TENDL-2015, AKONING
Photon emission for (n,d)

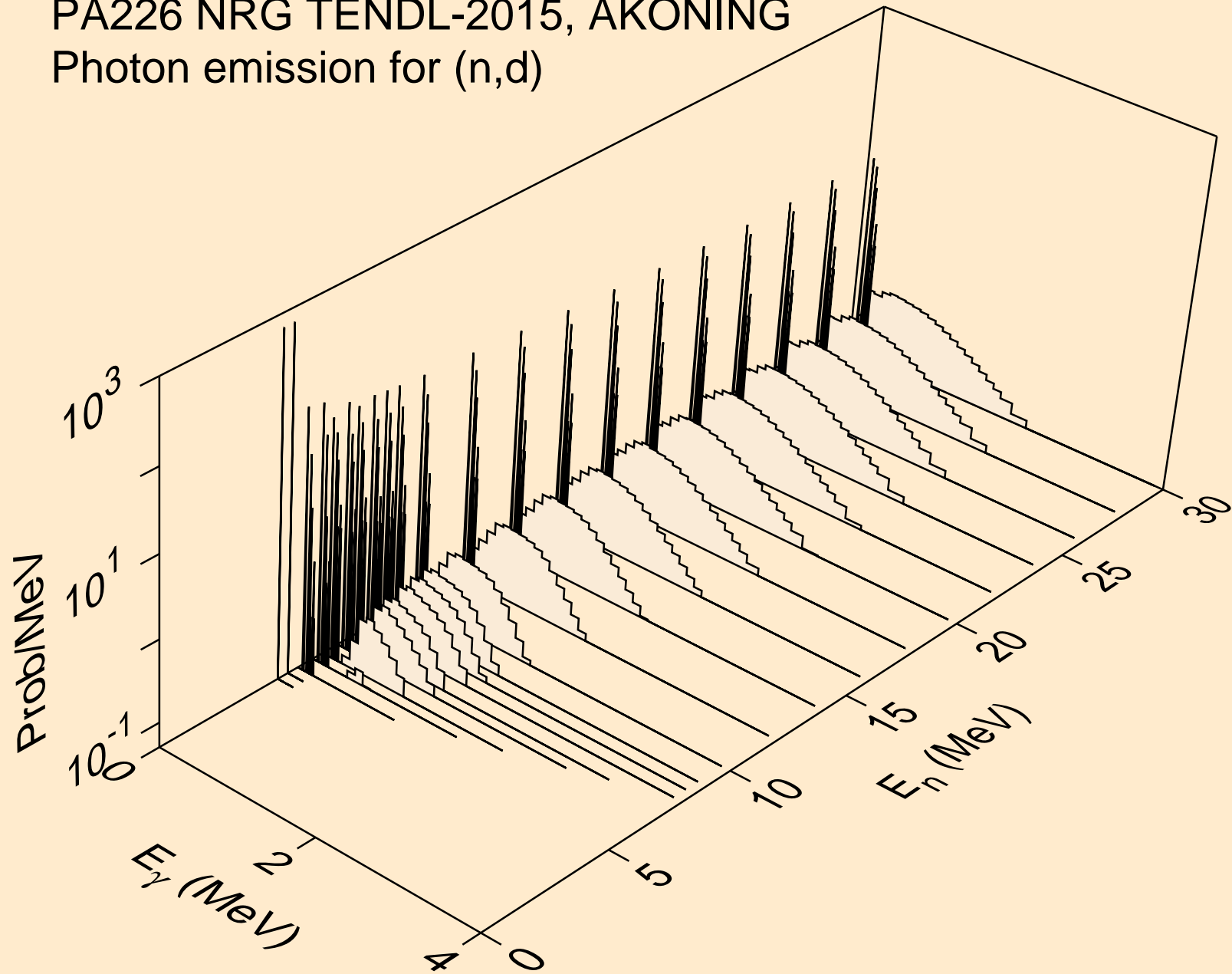

PA226 NRG TENDL-2015, AKONING
Photon emission for (n,t)

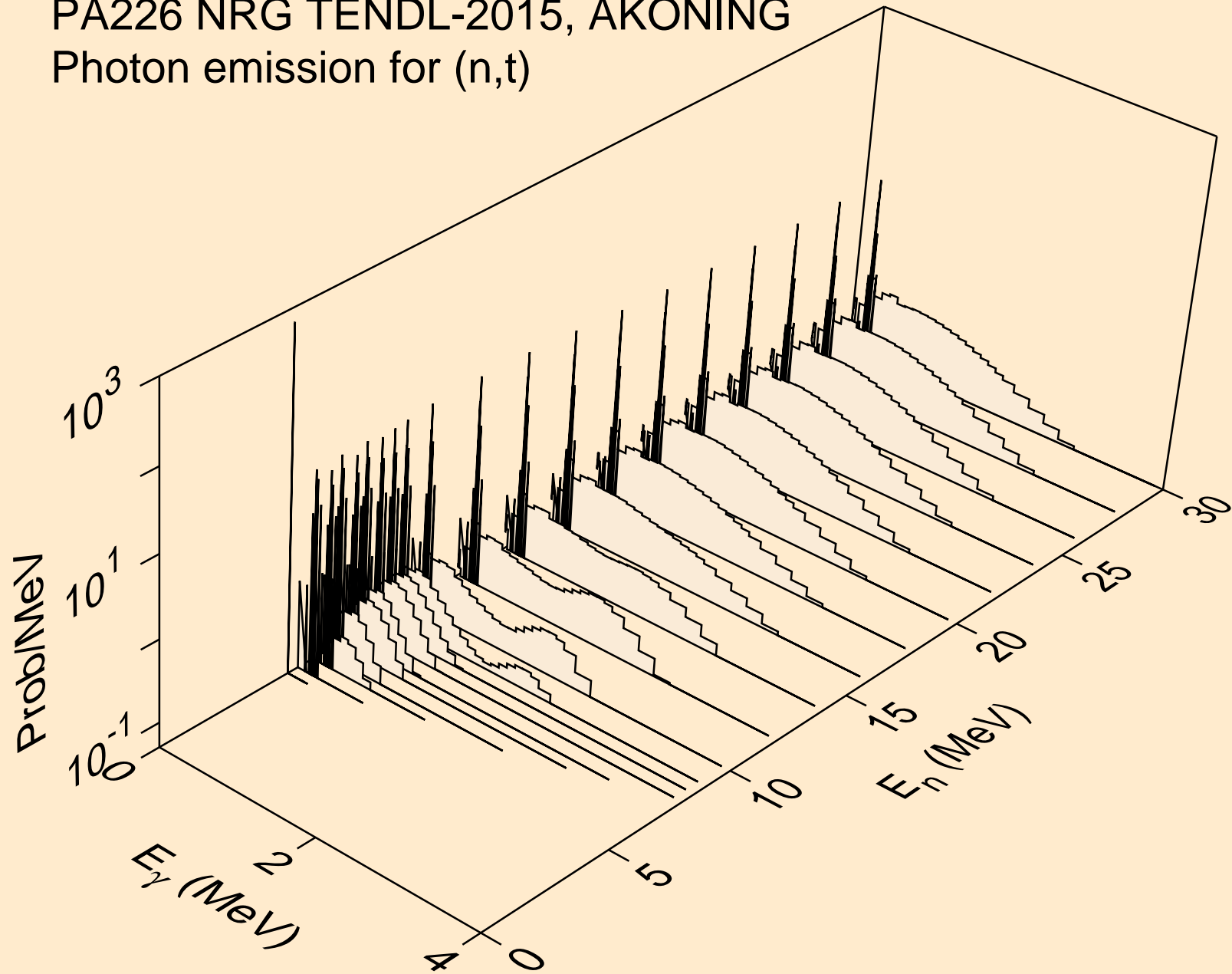

PA226 NRG TENDL-2015, AKONING
Photon emission for (n,he3)

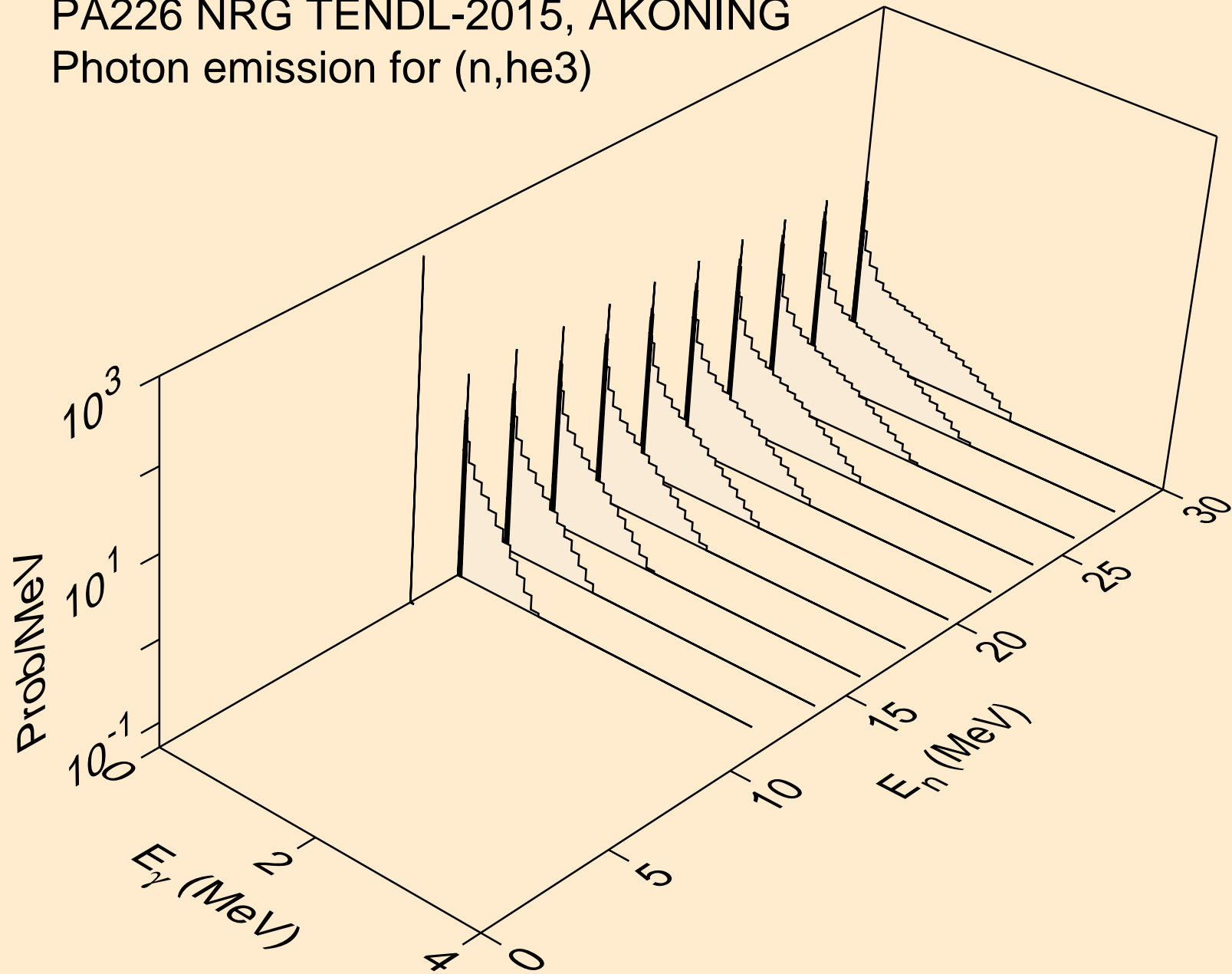

PA226 NRG TENDL-2015, AKONING
Photon emission for (n,a)

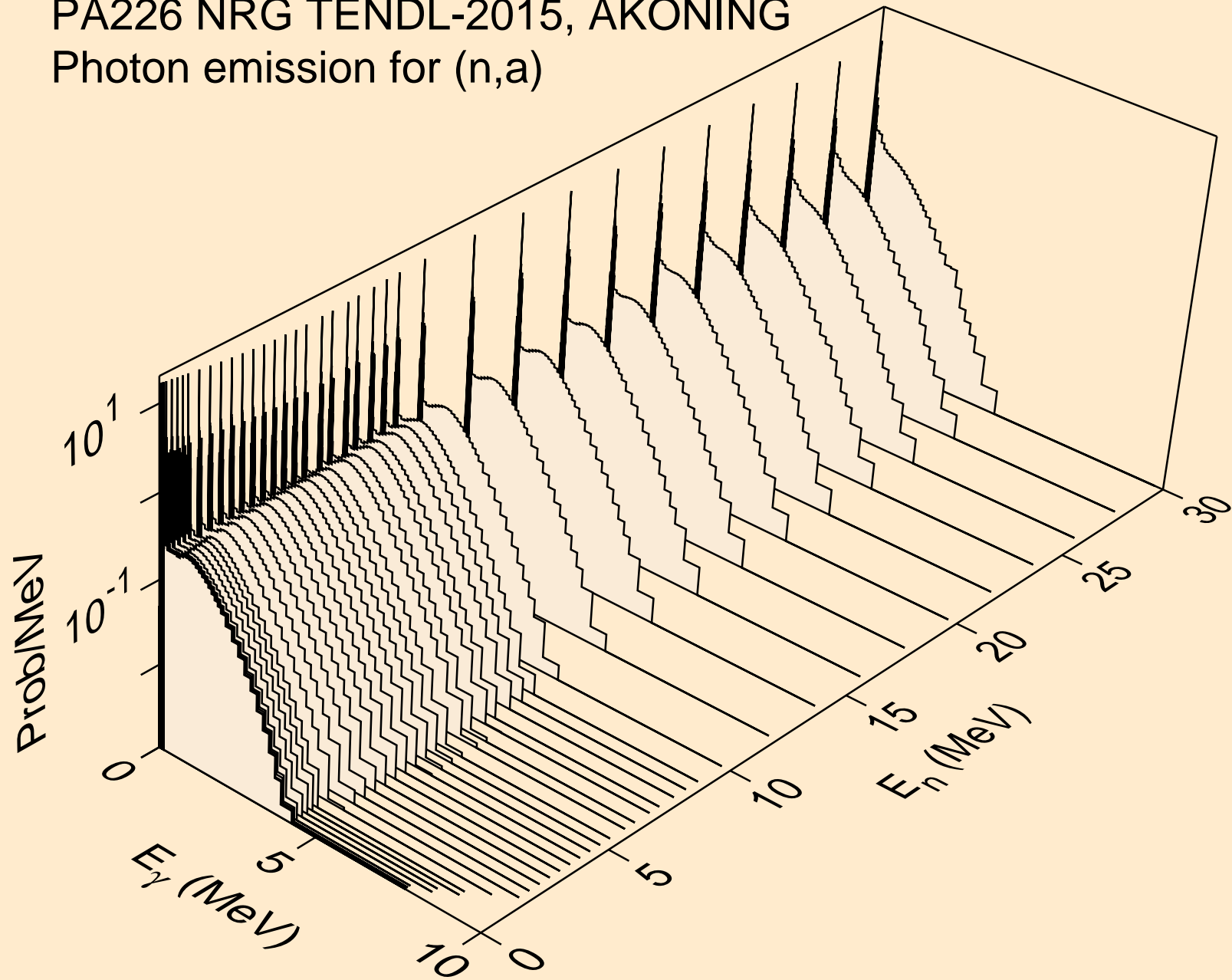

PA226 NRG TENDL-2015, AKONING
Photon emission for (n,2a)

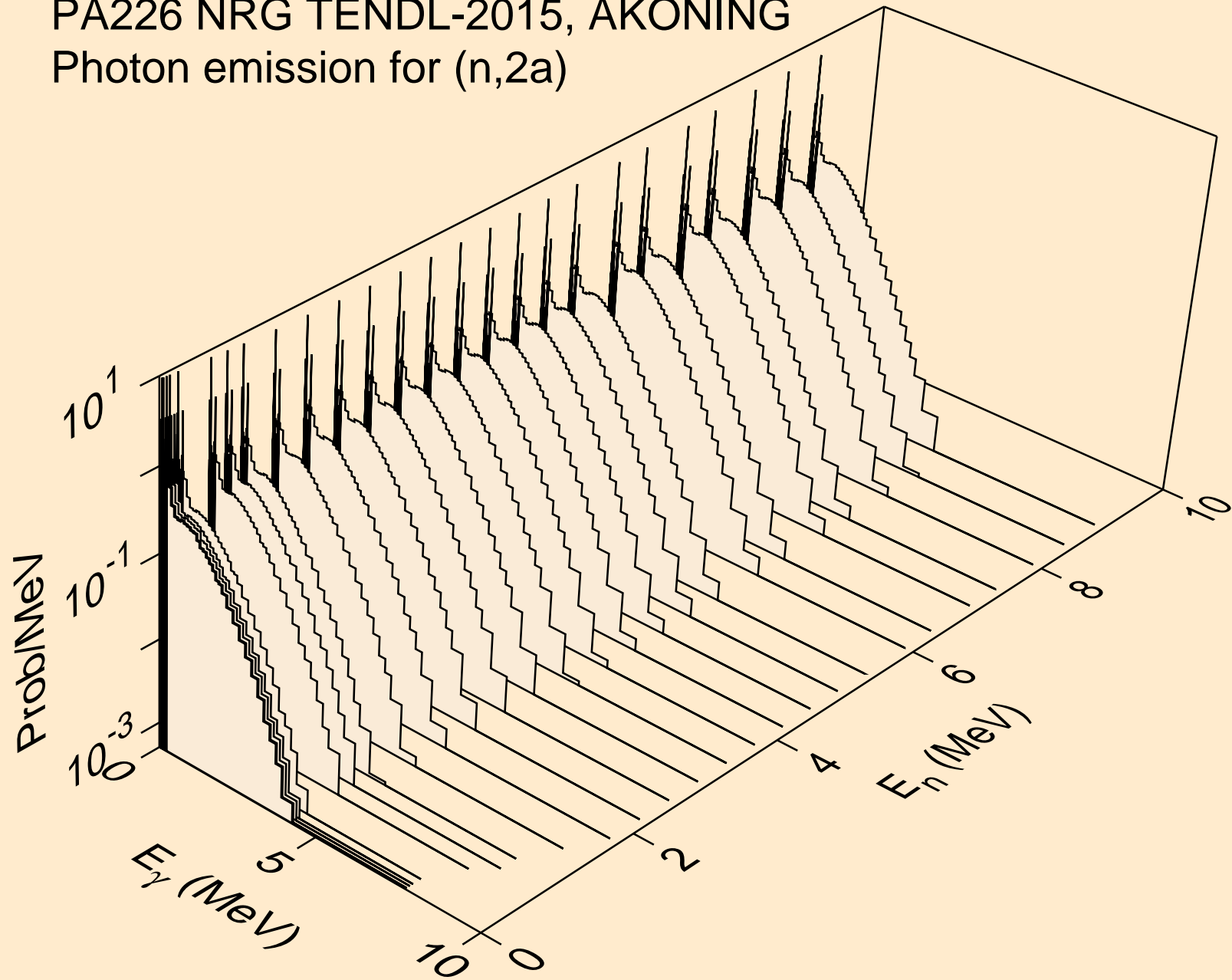

PA226 NRG TENDL-2015, AKONING
Photon emission for (n,3a)

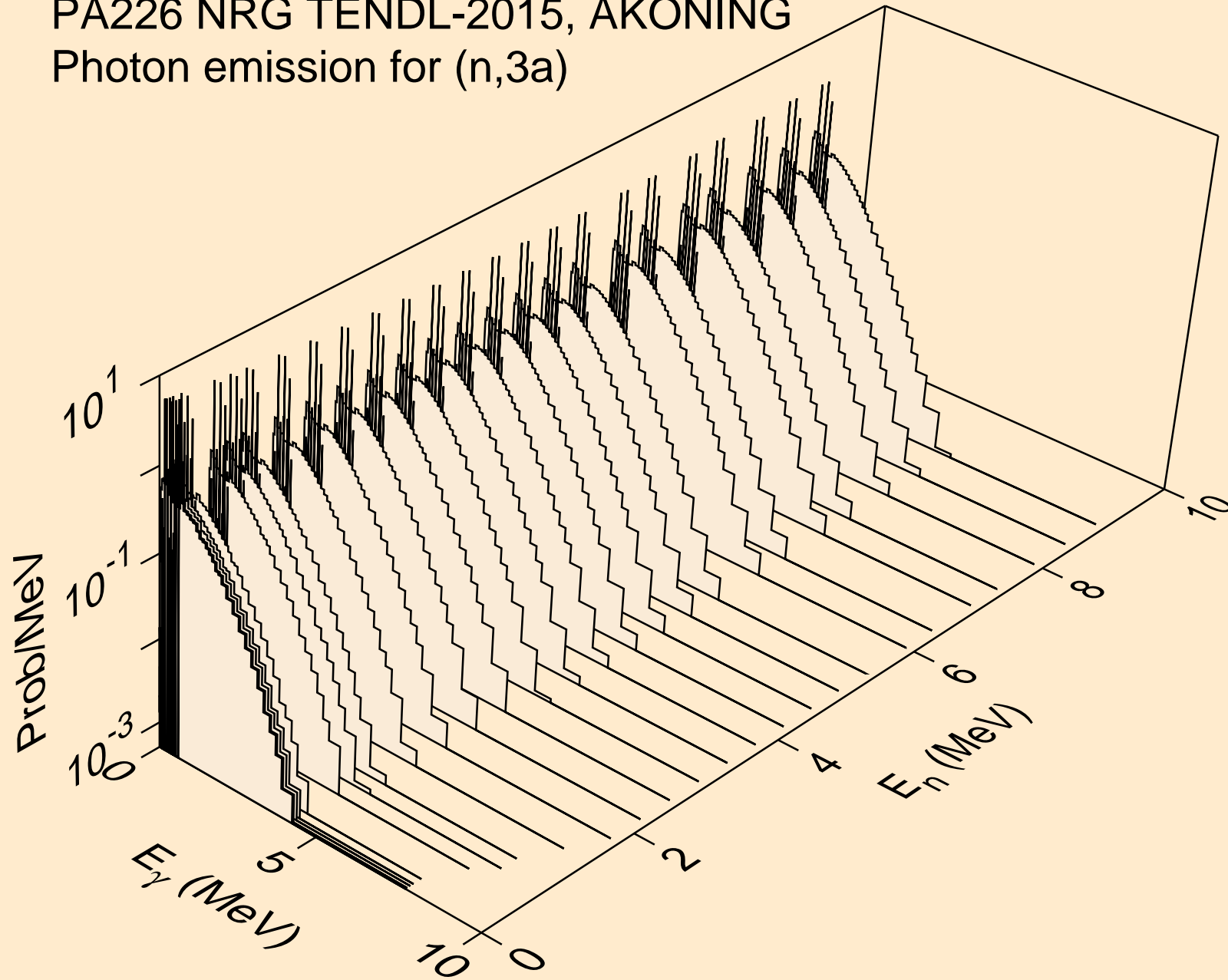

PA226 NRG TENDL-2015, AKONING
Photon emission for (n,2p)

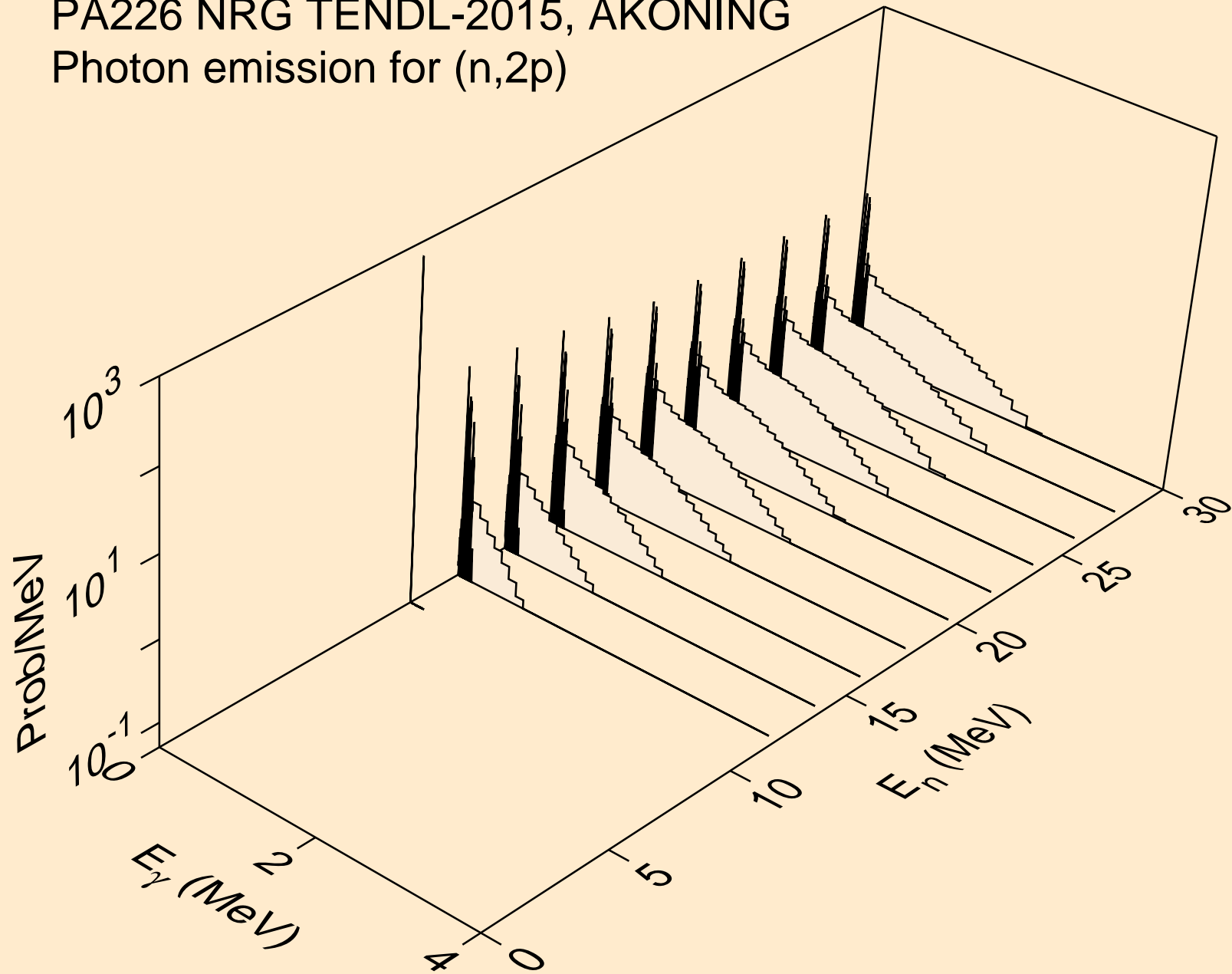

PA226 NRG TENDL-2015, AKONING
Photon emission for (n,pa)

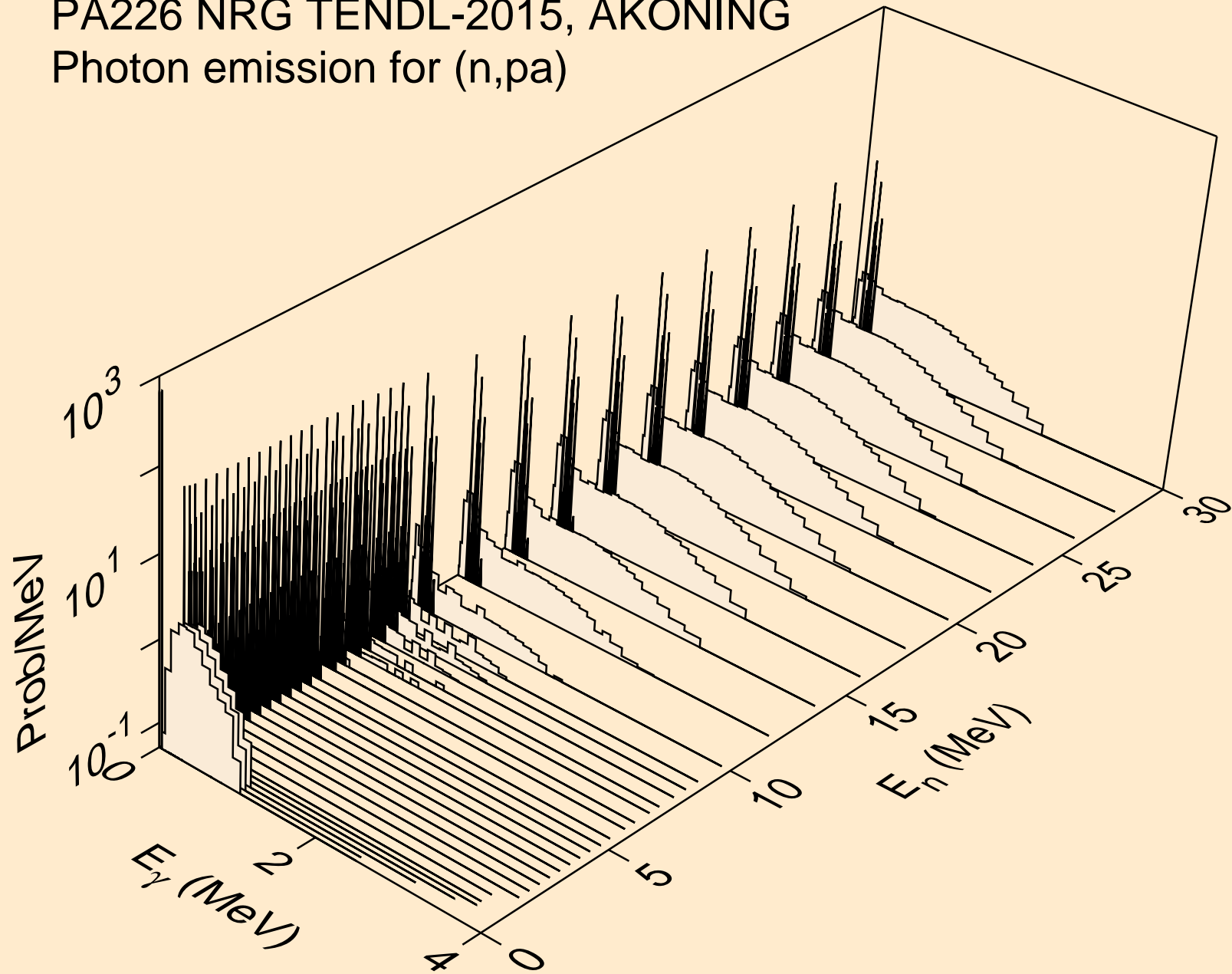

PA226 NRG TENDL-2015, AKONING
Photon emission for (n,t2a)

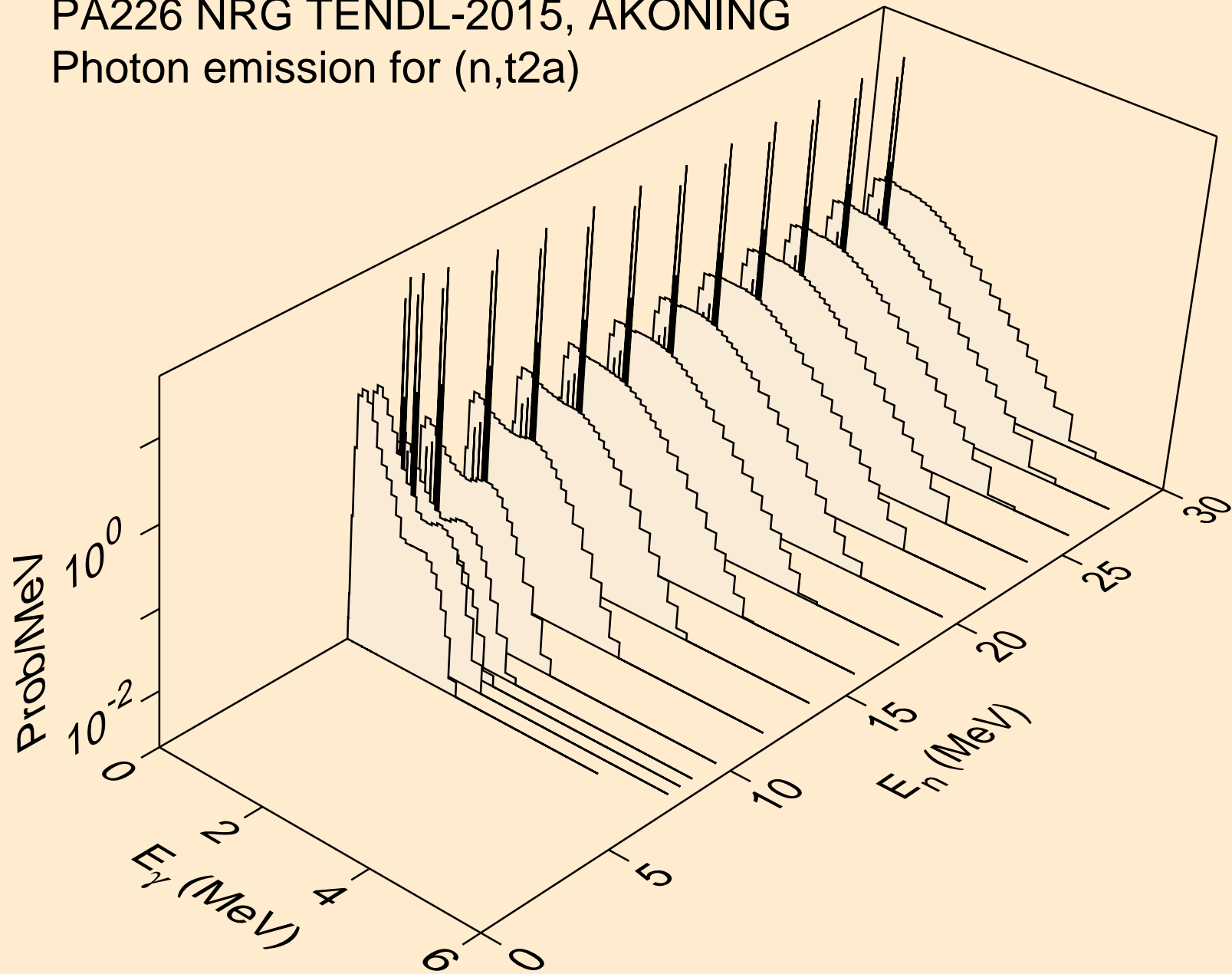

PA226 NRG TENDL-2015, AKONING
Photon emission for (n,d2a)

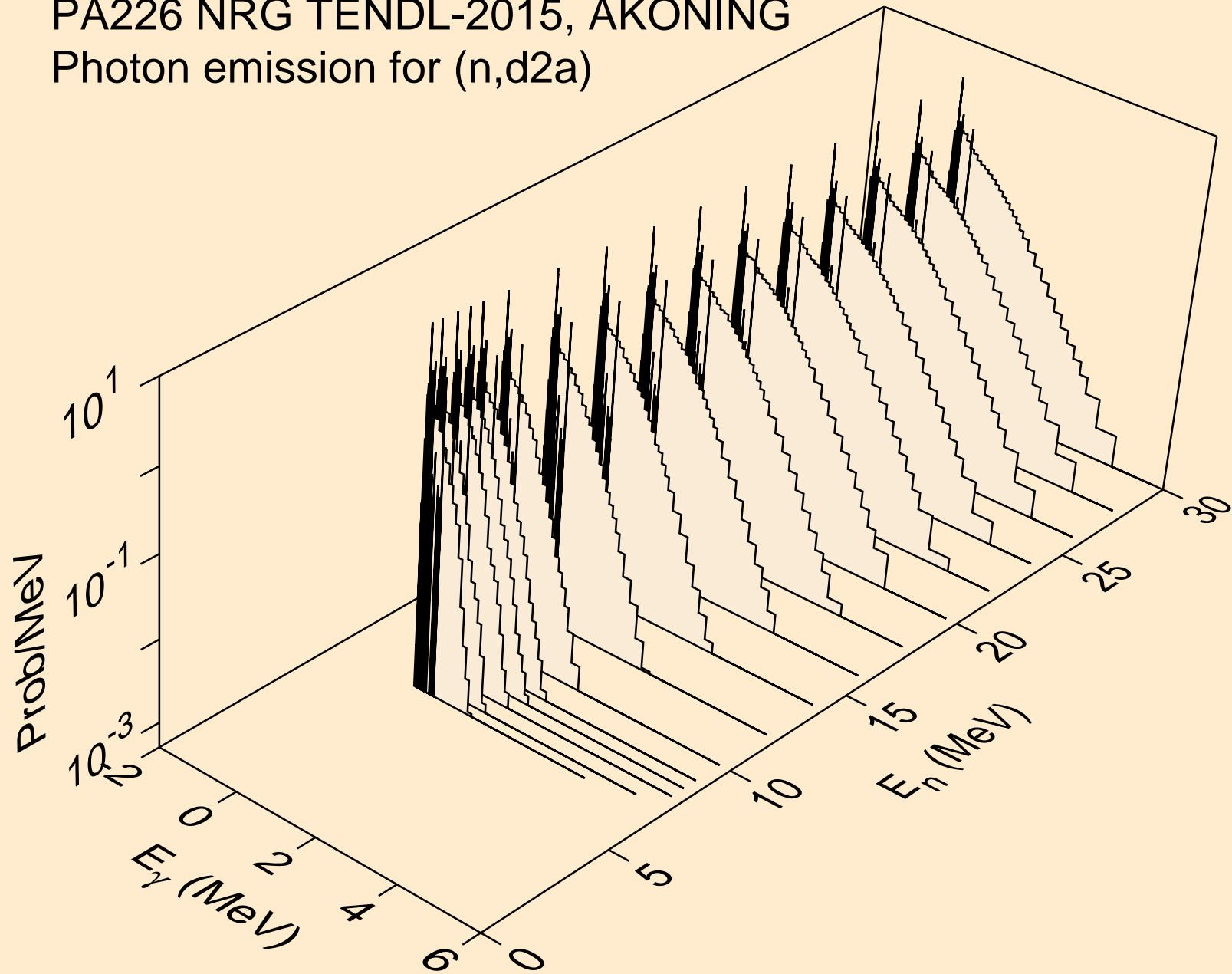

PA226 NRG TENDL-2015, AKONING
Photon emission for (n,pd)

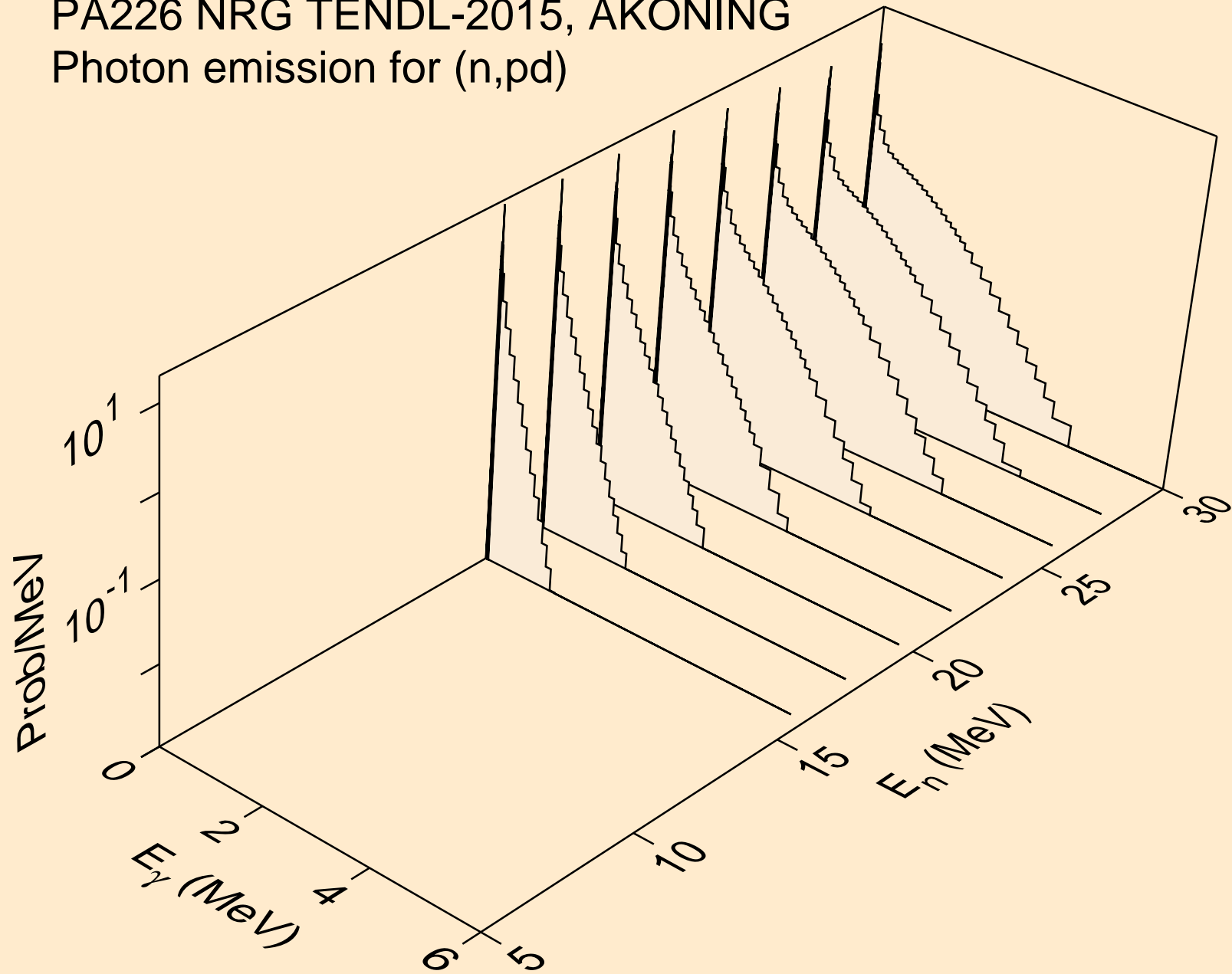

PA226 NRG TENDL-2015, AKONING
Photon emission for (n,pt)

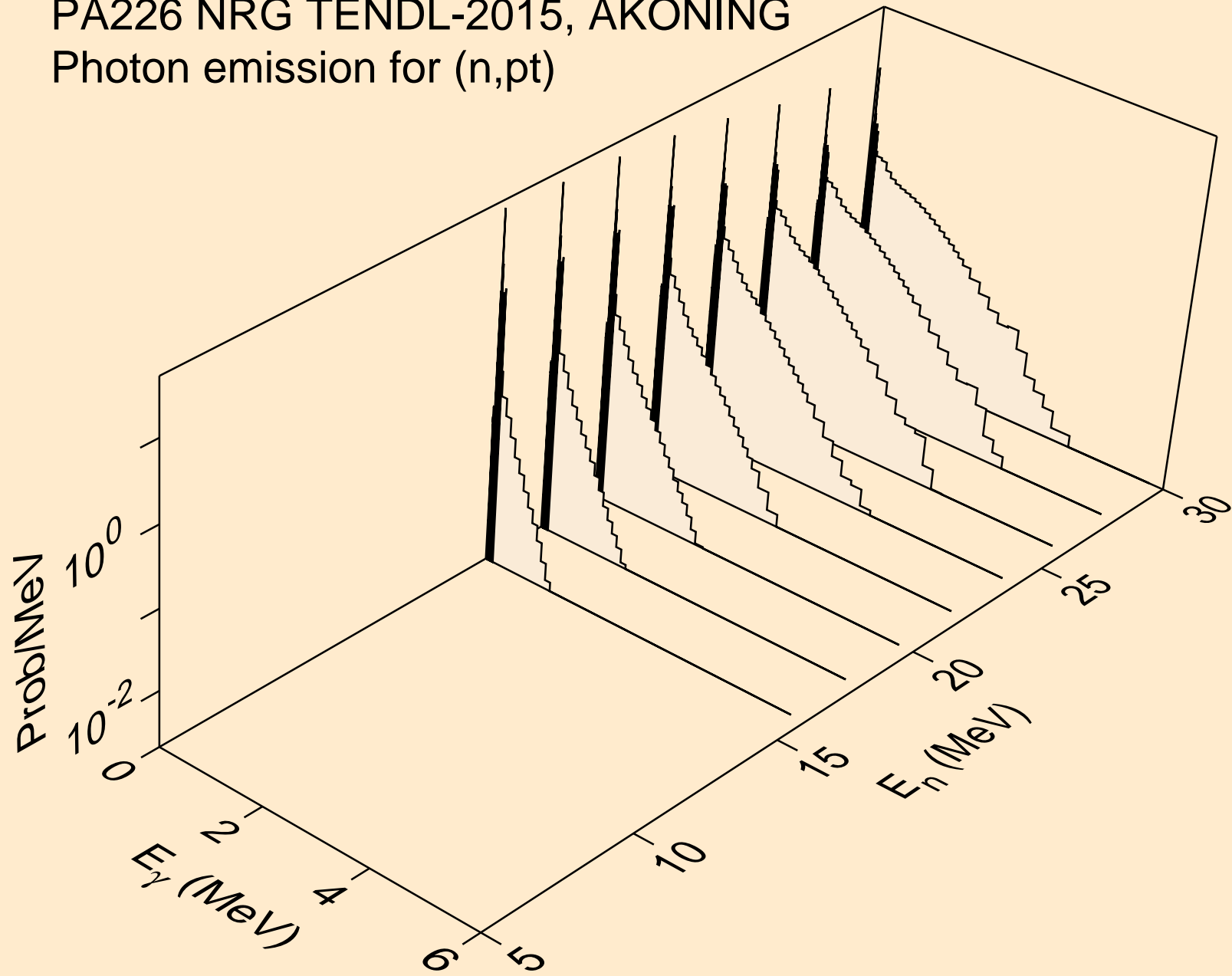

PA226 NRG TENDL-2015, AKONING
Photon emission for (n,da)

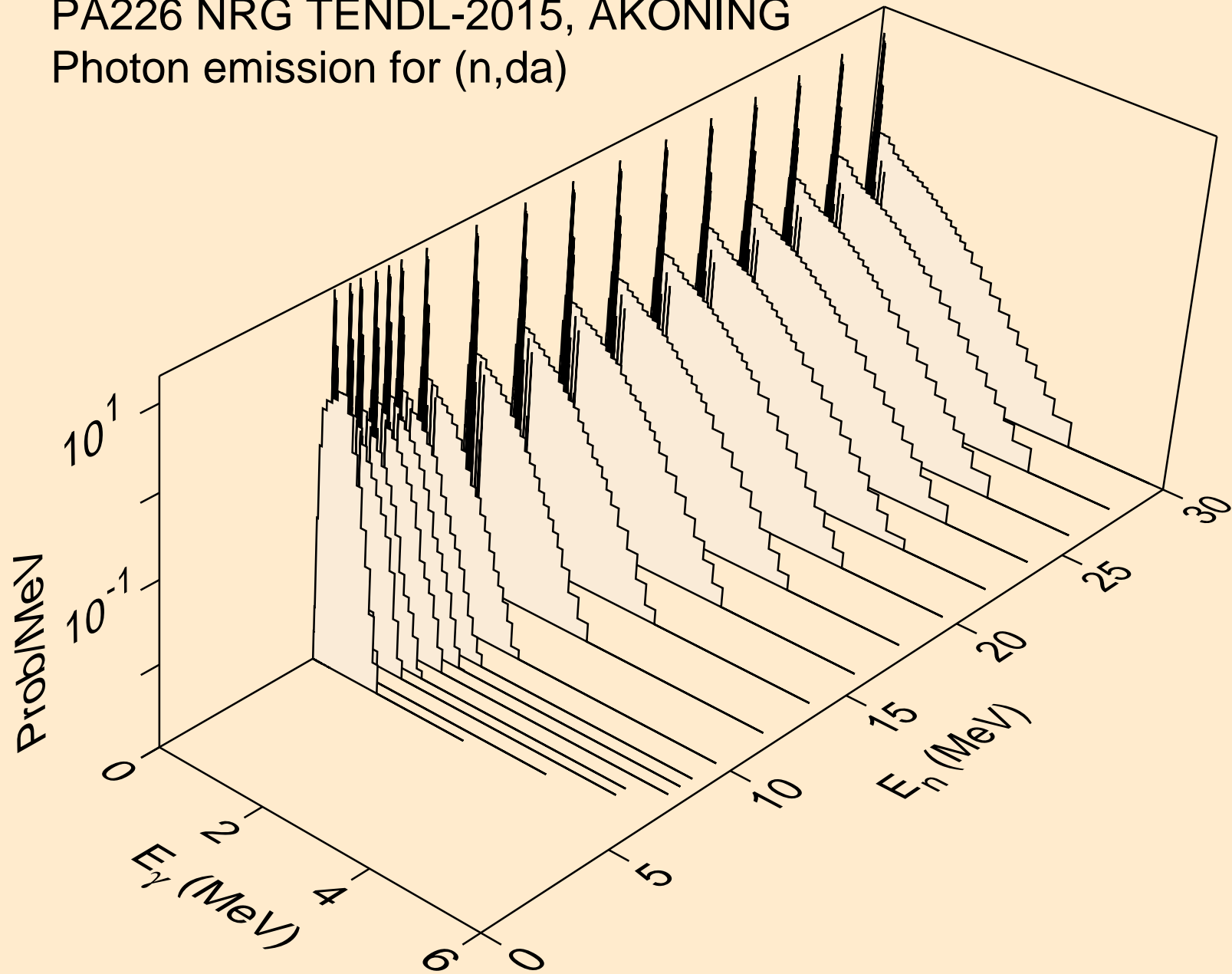

PA226 NRG TENDL-2015, AKONING
thermal capture photon spectrum

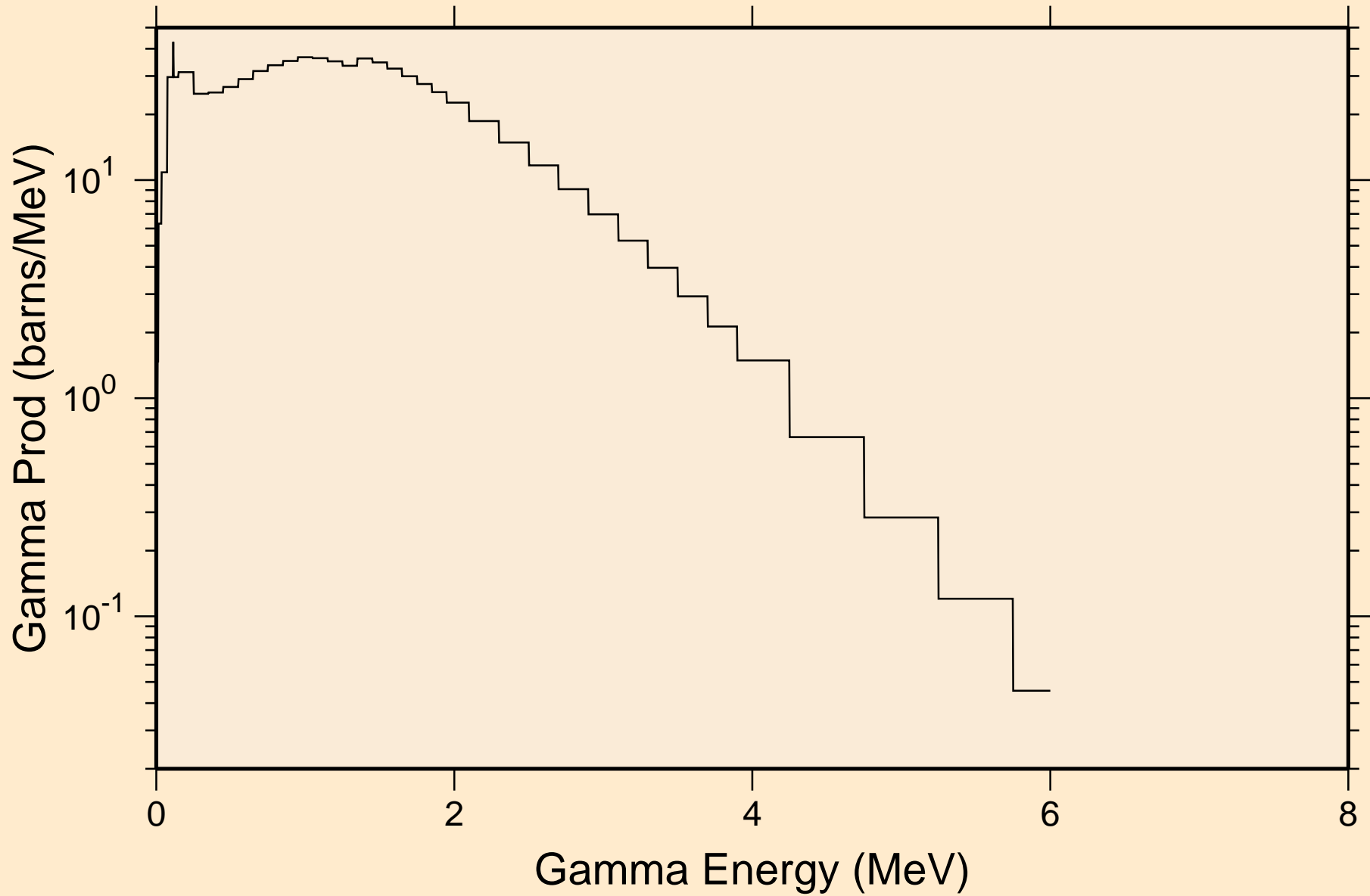

PA226 NRG TENDL-2015, AKONING
14 MeV photon spectrum

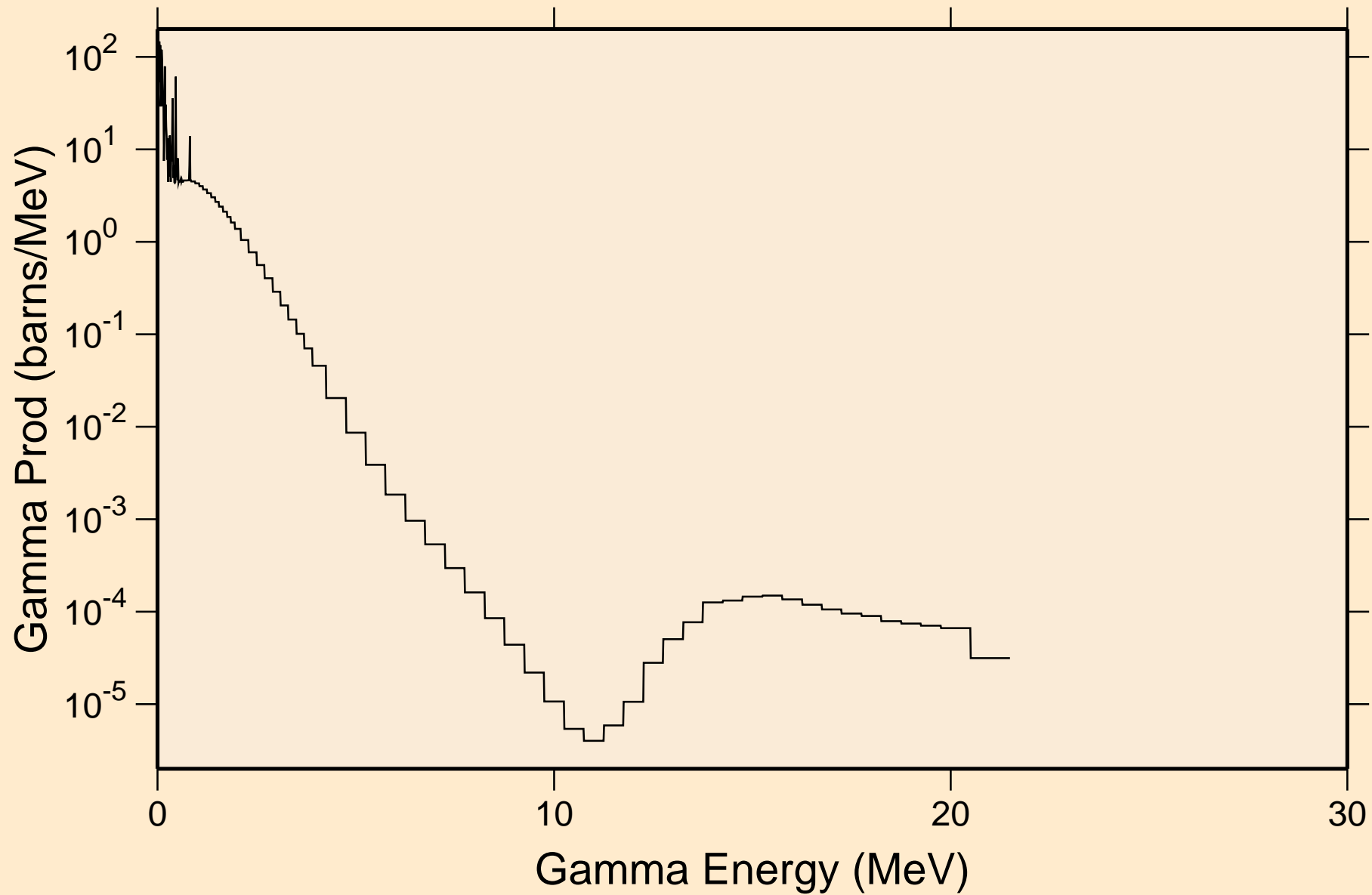

PA226 NRG TENDL-2015, AKONING

Particle heating contributions

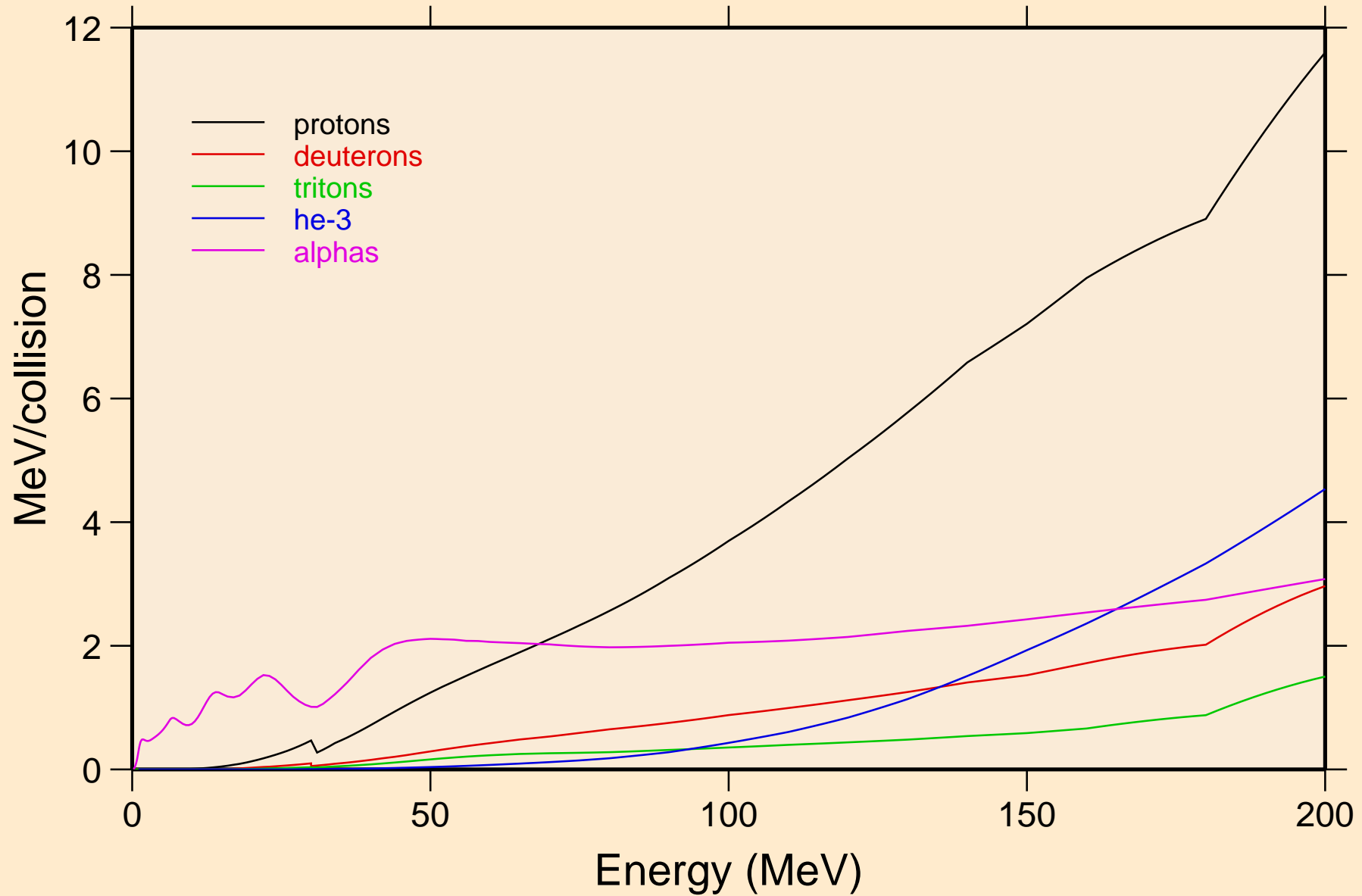

PA226 NRG TENDL-2015, AKONING

Recoil Heating

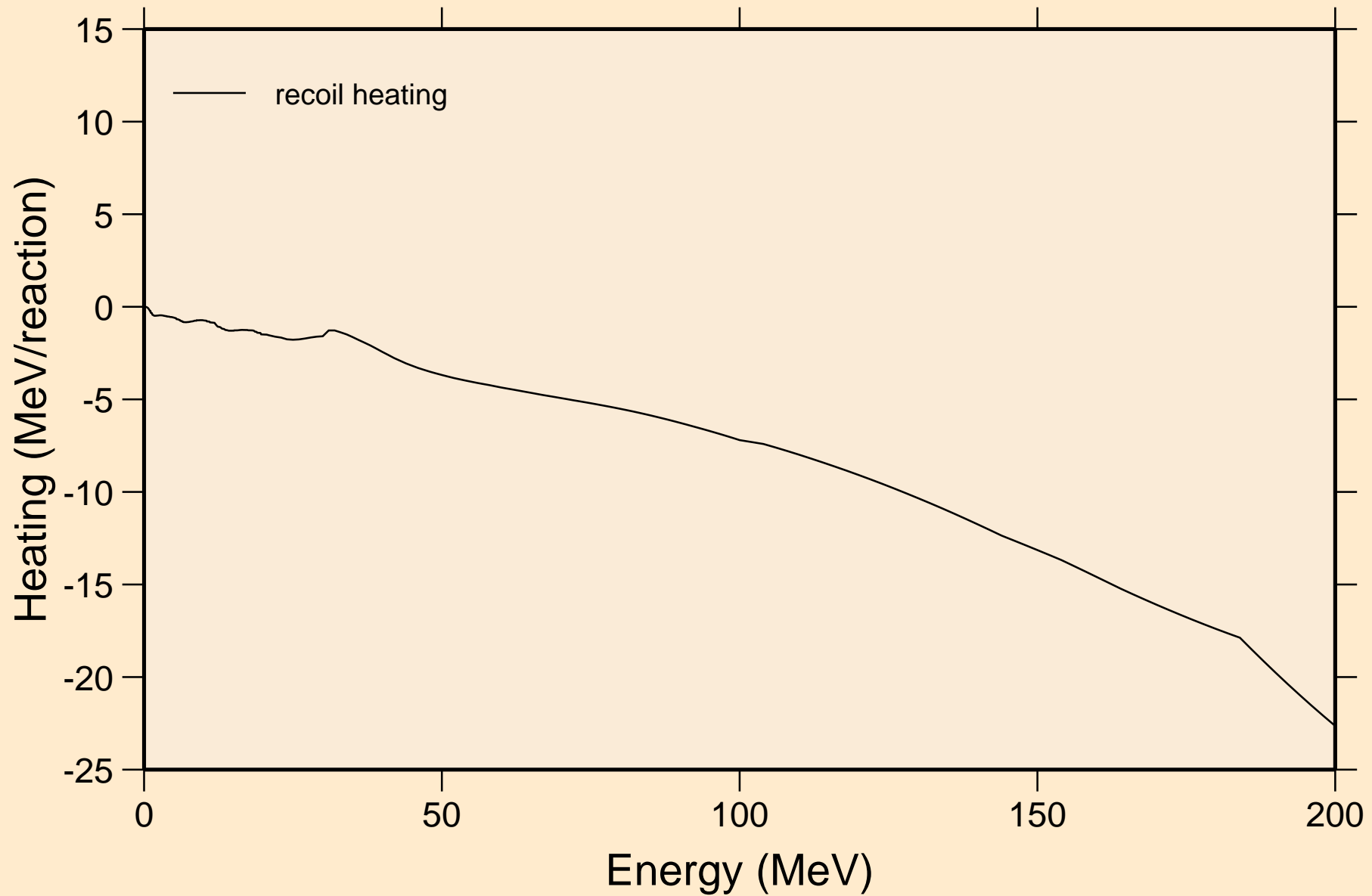

PA226 NRG TENDL-2015, AKONING

Particle production cross sections

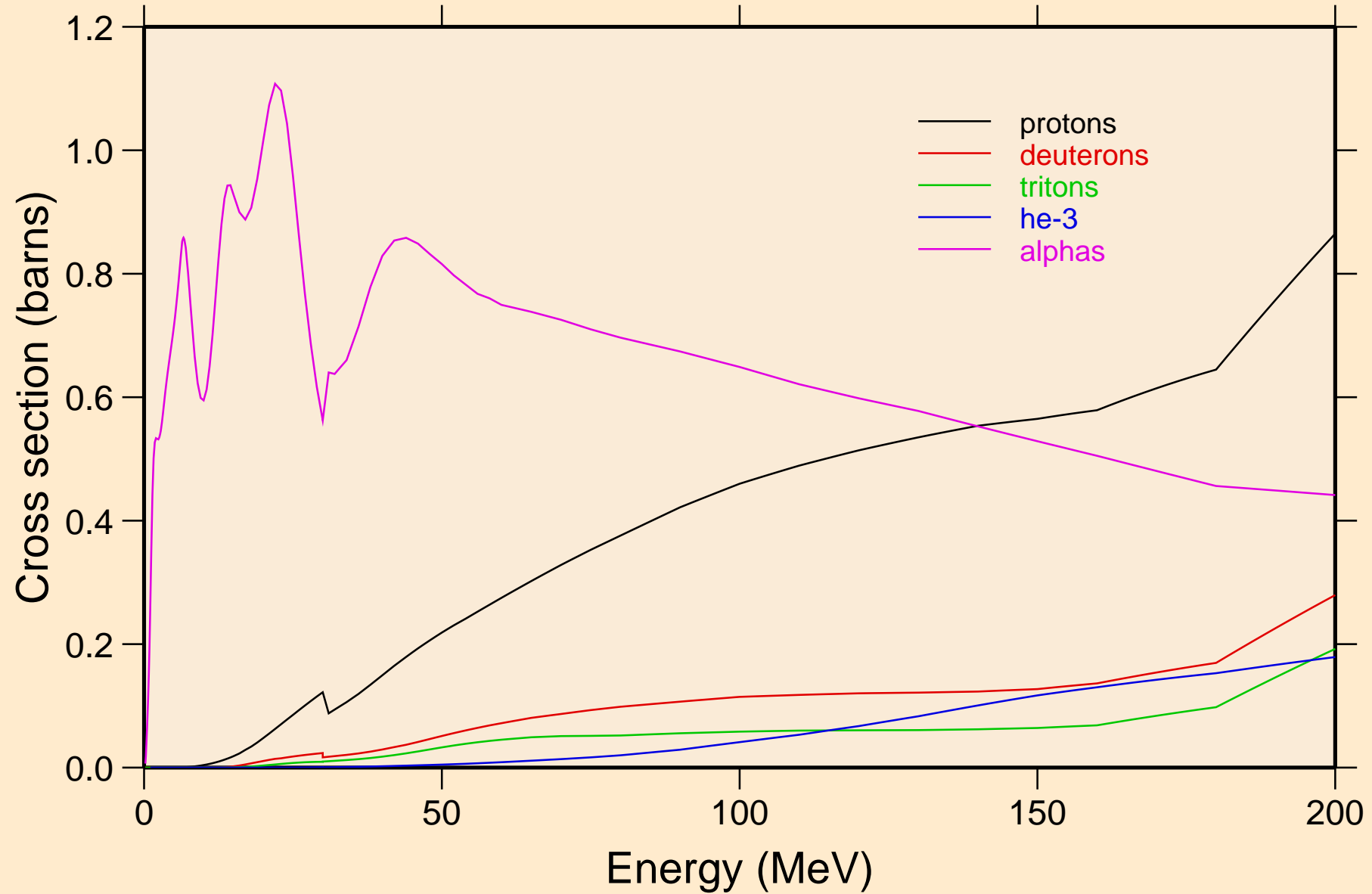

PA226 NRG TENDL-2015, AKONING
protons from (n,x)

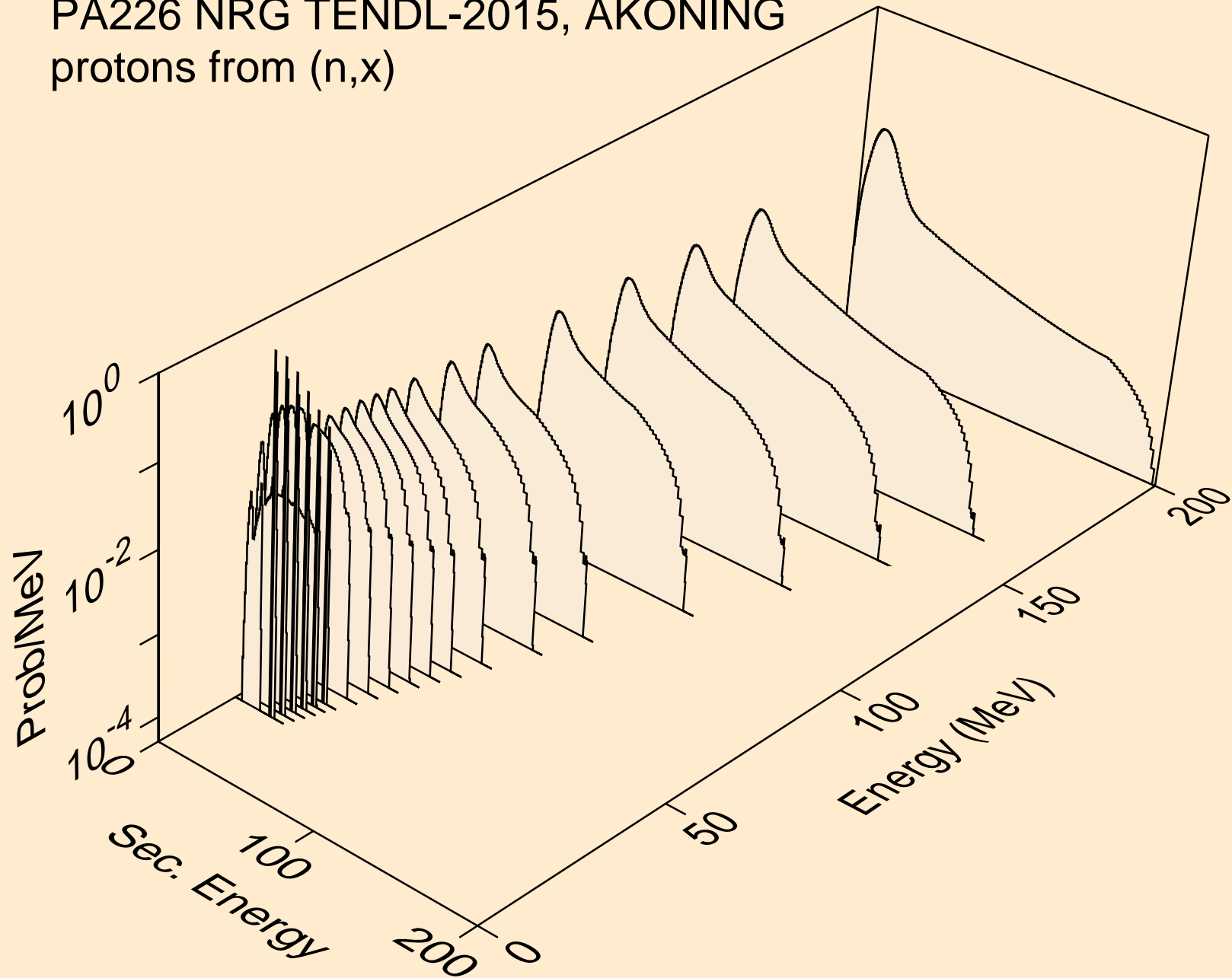

PA226 NRG TENDL-2015, AKONING
protons from (n,n*)p

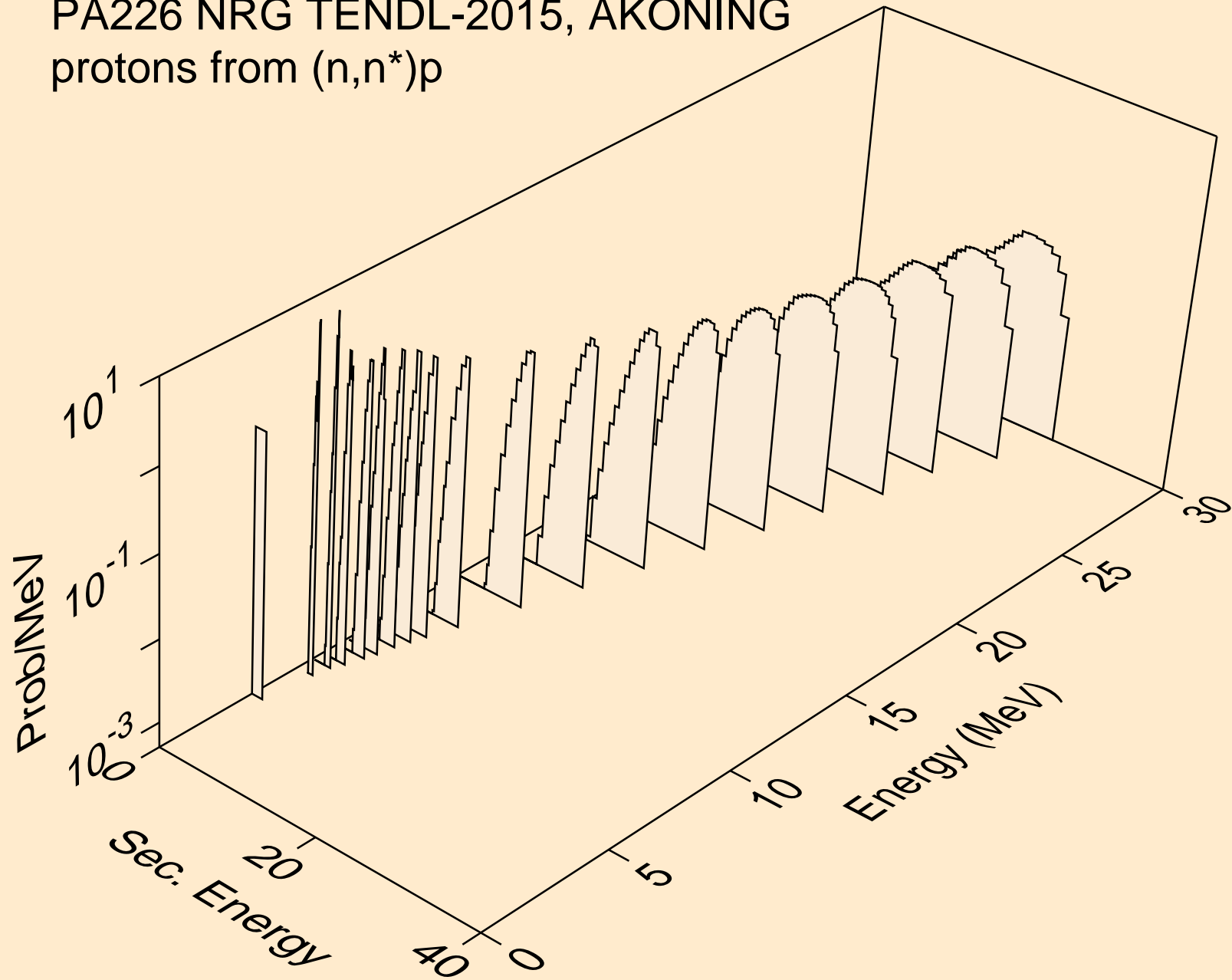

PA226 NRG TENDL-2015, AKONING
protons from (n,2np)

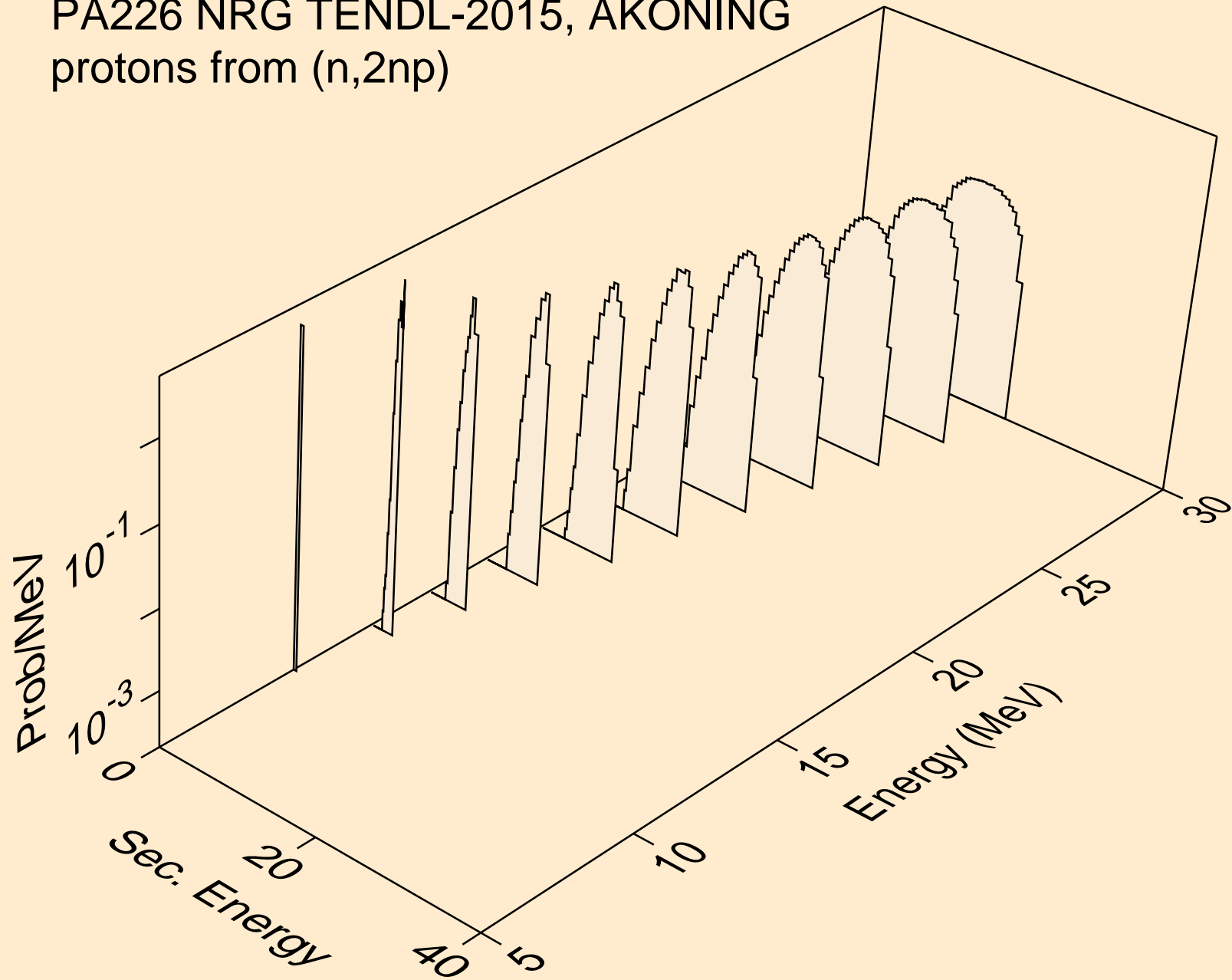

PA226 NRG TENDL-2015, AKONING
protons from (n,3np)

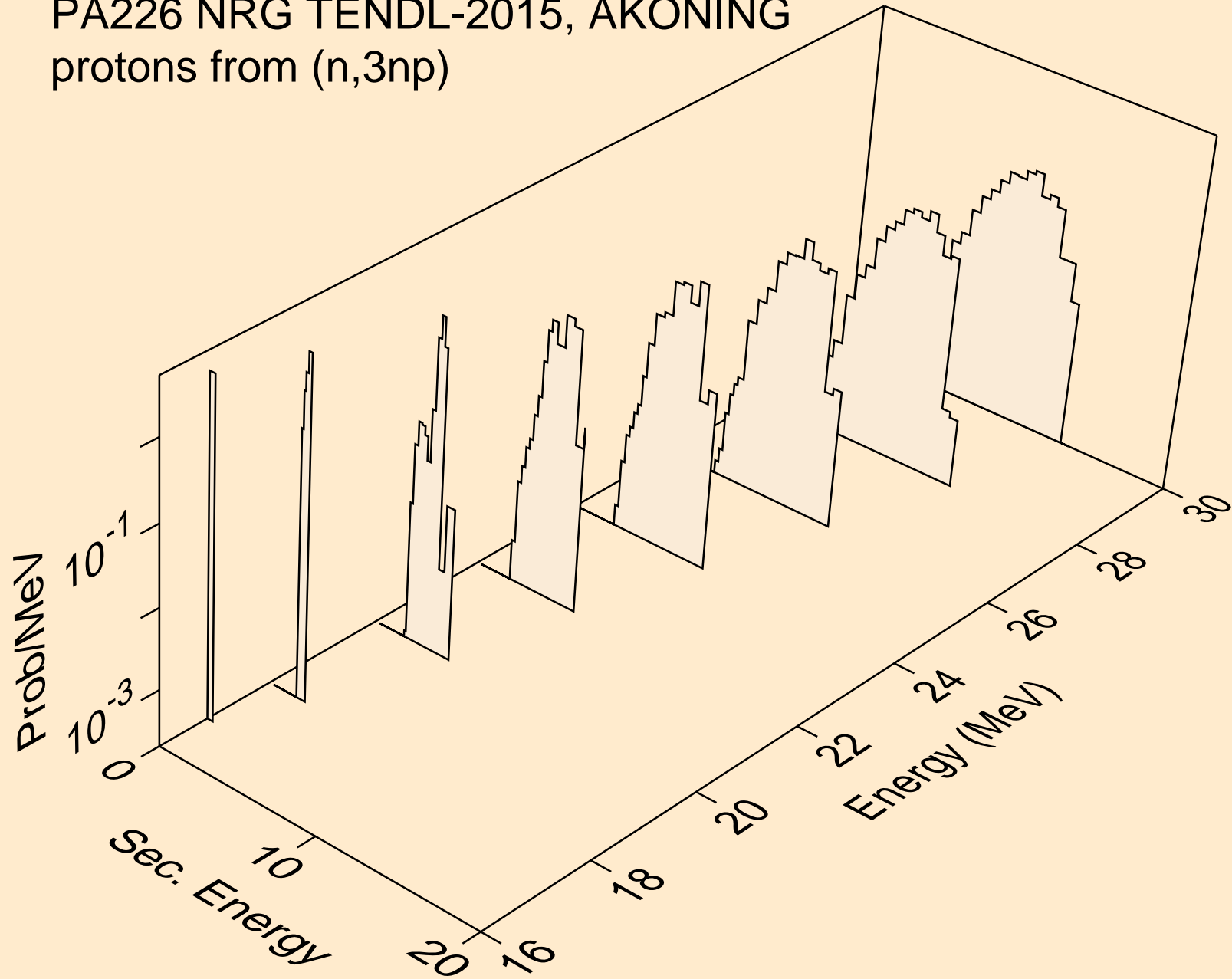

PA226 NRG TENDL-2015, AKONING
protons from (n,2np)

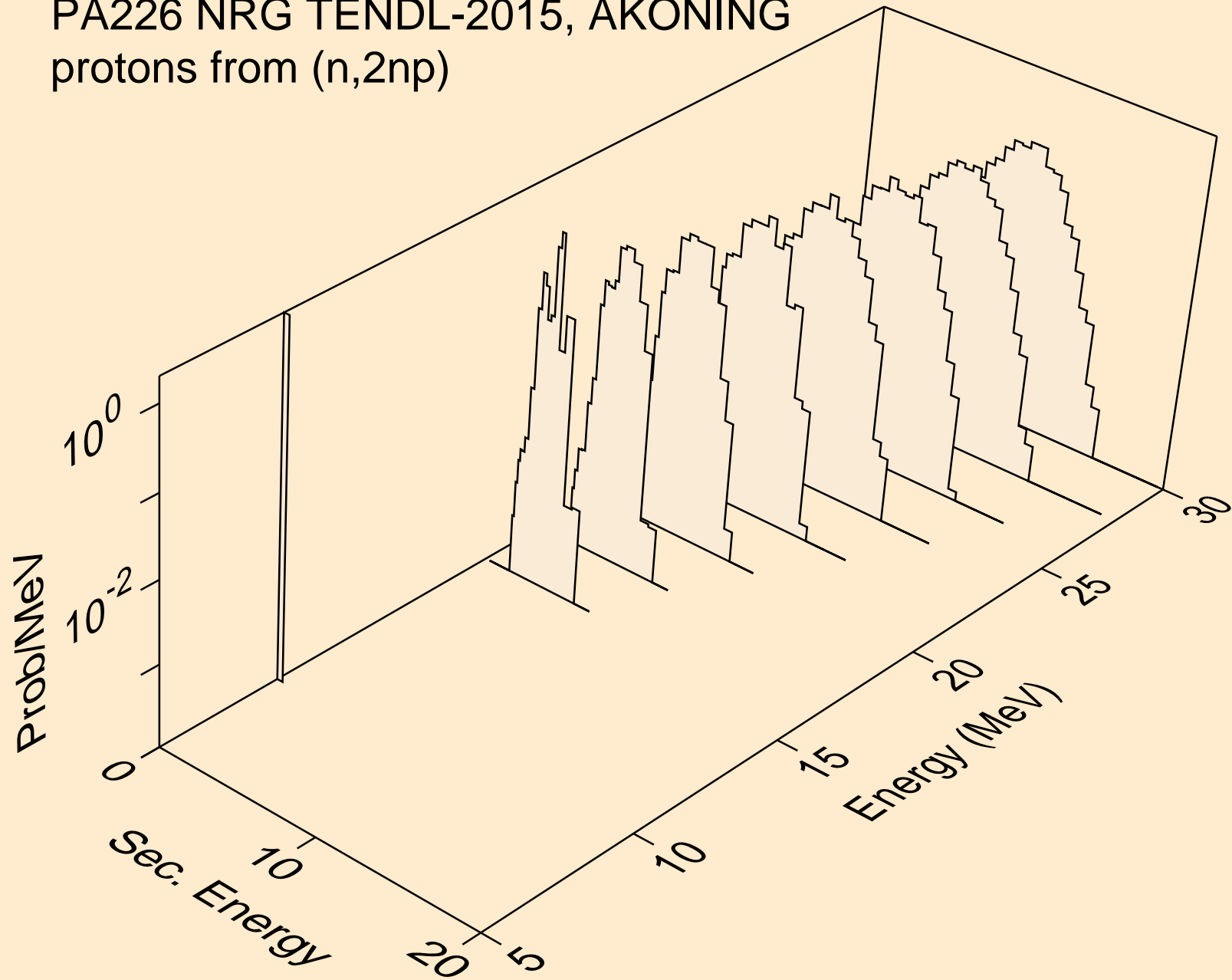

PA226 NRG TENDL-2015, AKONING
protons from (n,npa)

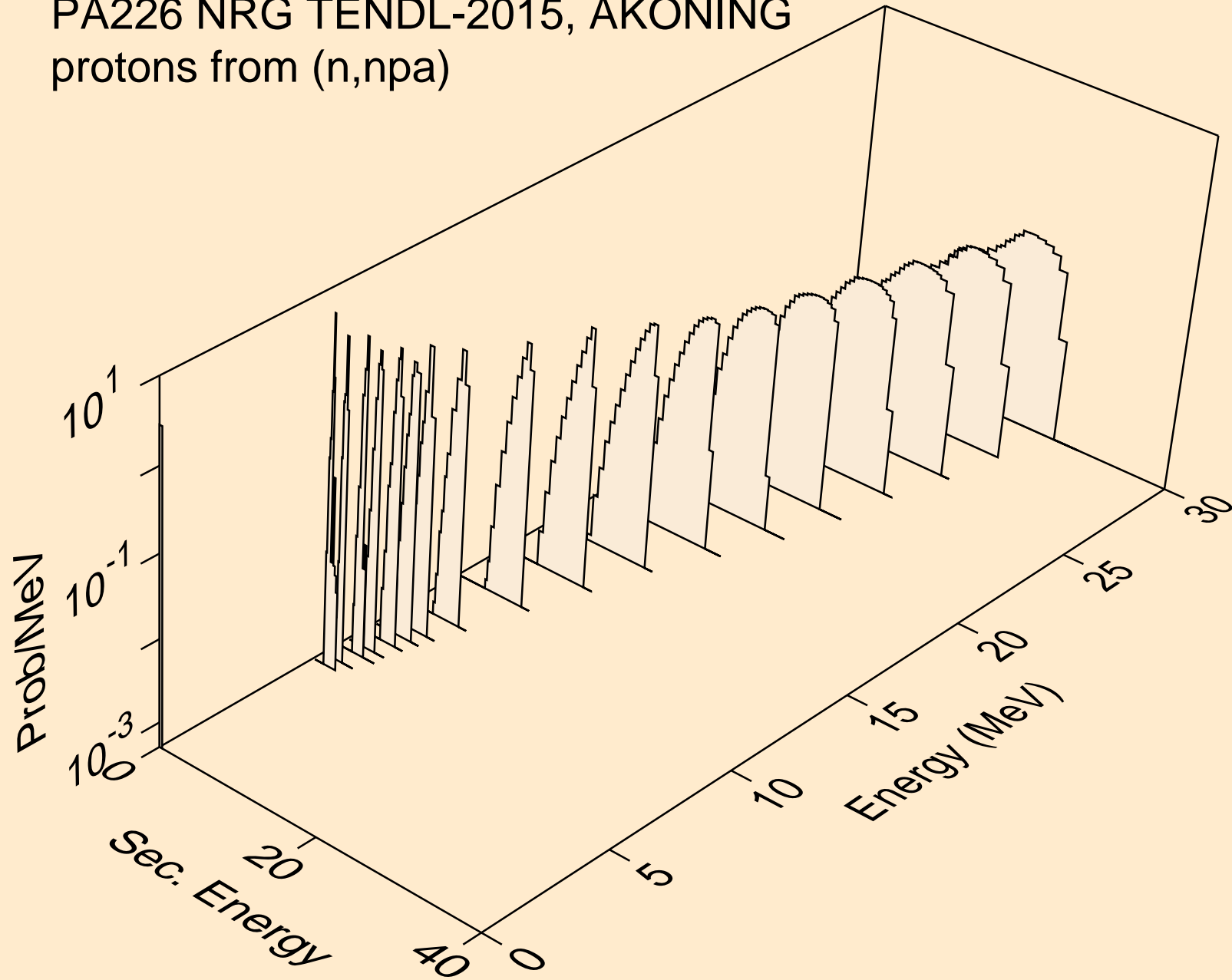

PA226 NRG TENDL-2015, AKONING
protons from (n,p)

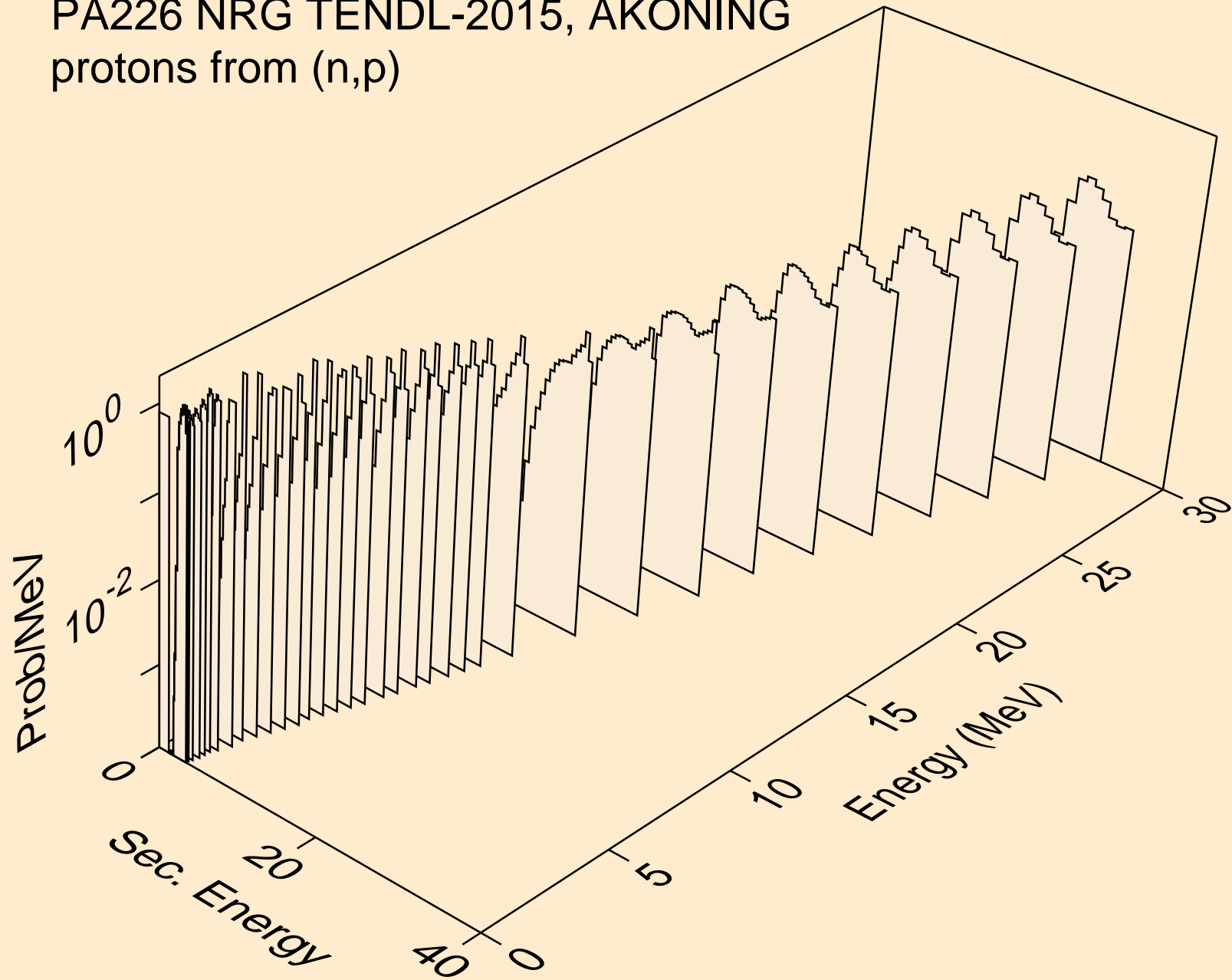

PA226 NRG TENDL-2015, AKONING
protons from (n,2p)

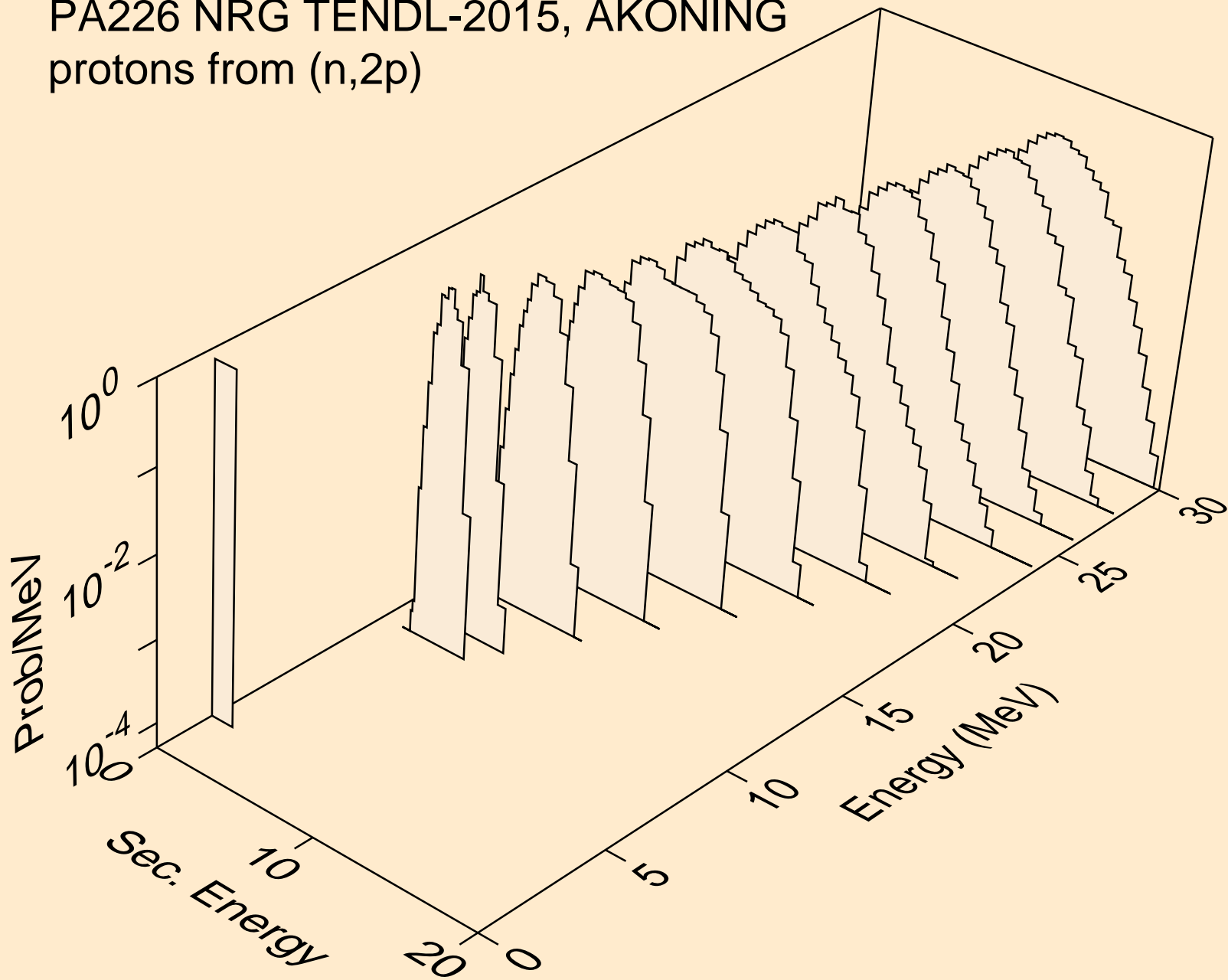

PA226 NRG TENDL-2015, AKONING
protons from (n,pa)

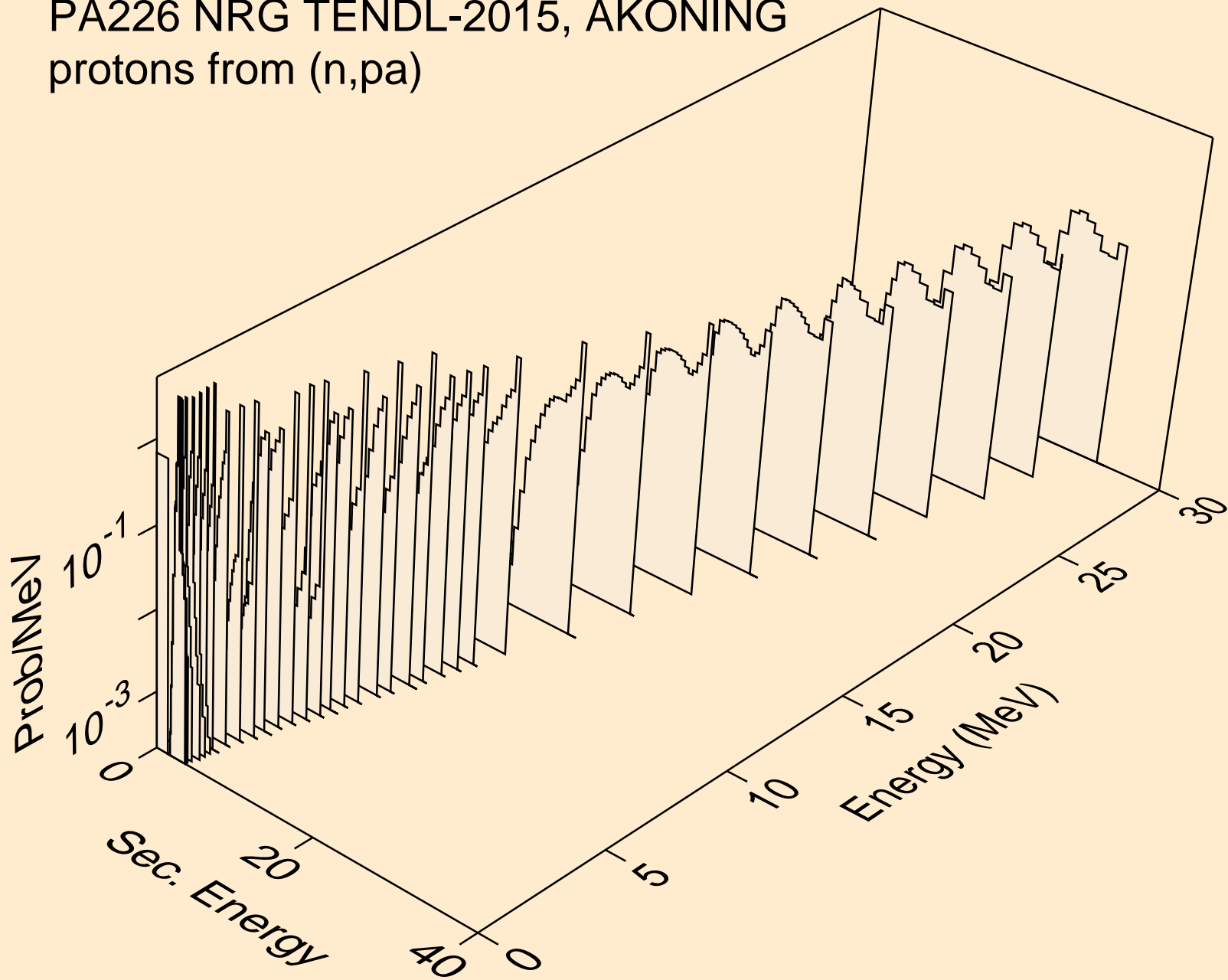

PA226 NRG TENDL-2015, AKONING
protons from (n,pd)

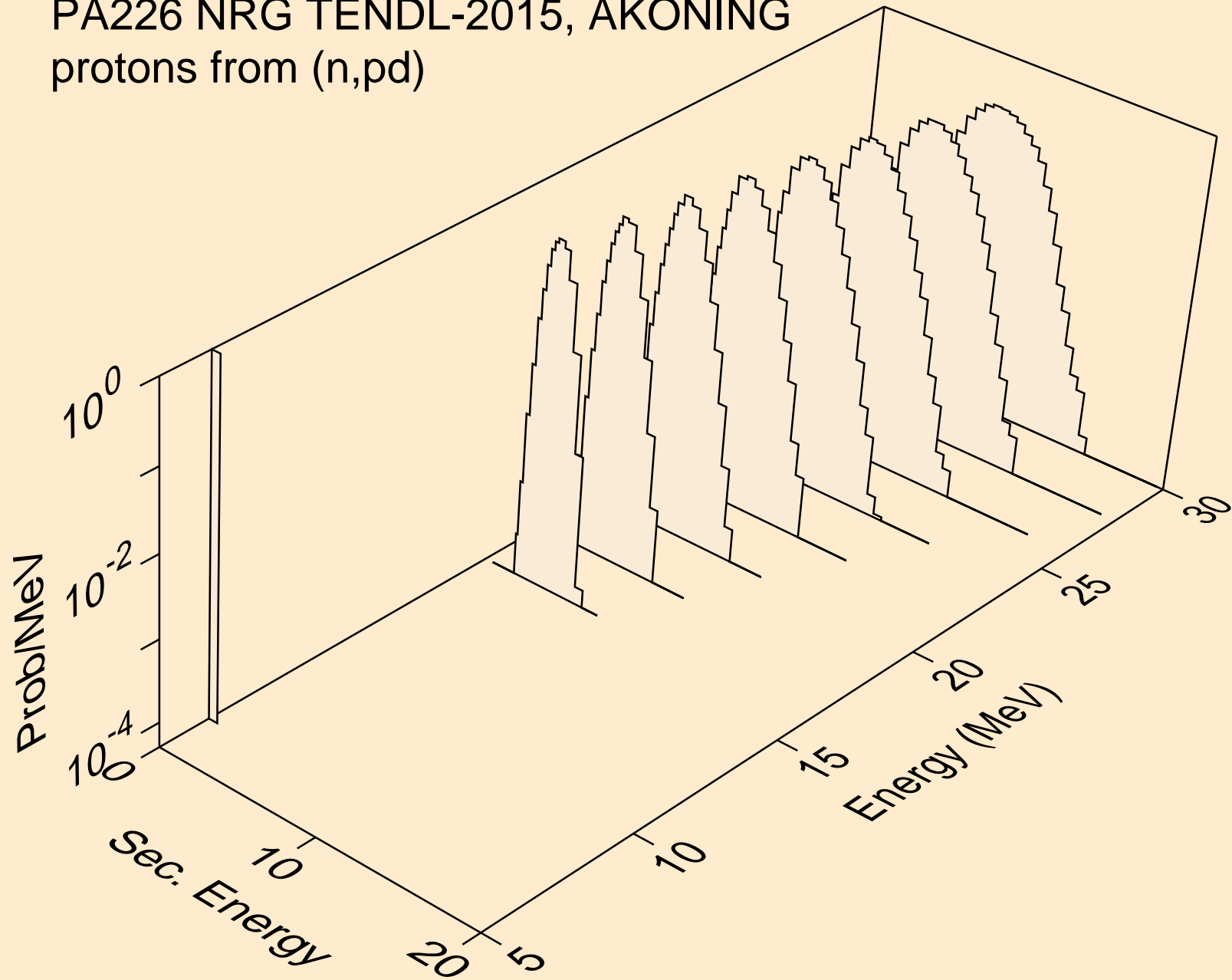

PA226 NRG TENDL-2015, AKONING
protons from (n,pt)

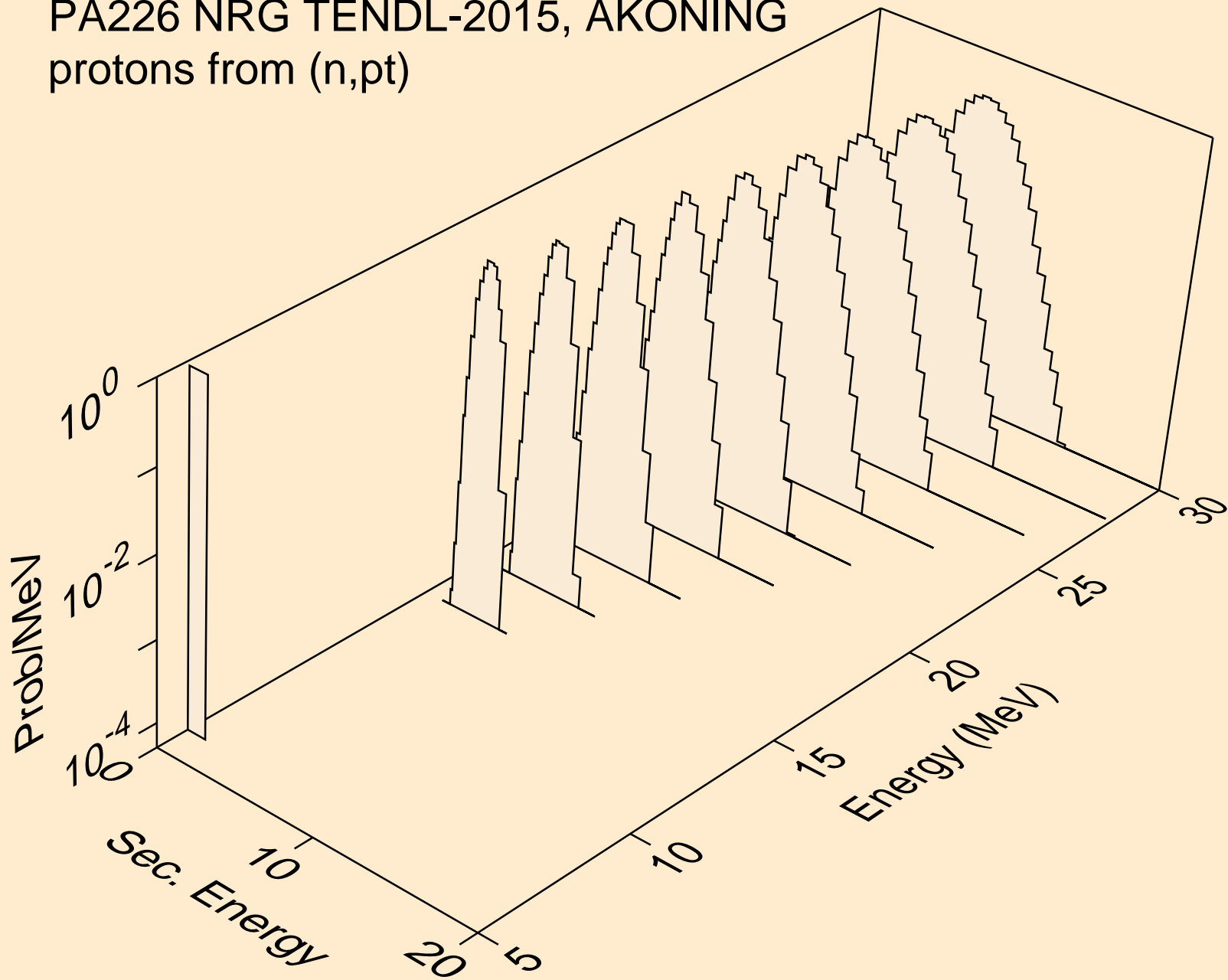

PA226 NRG TENDL-2015, AKONING
deuterons from (n,x)

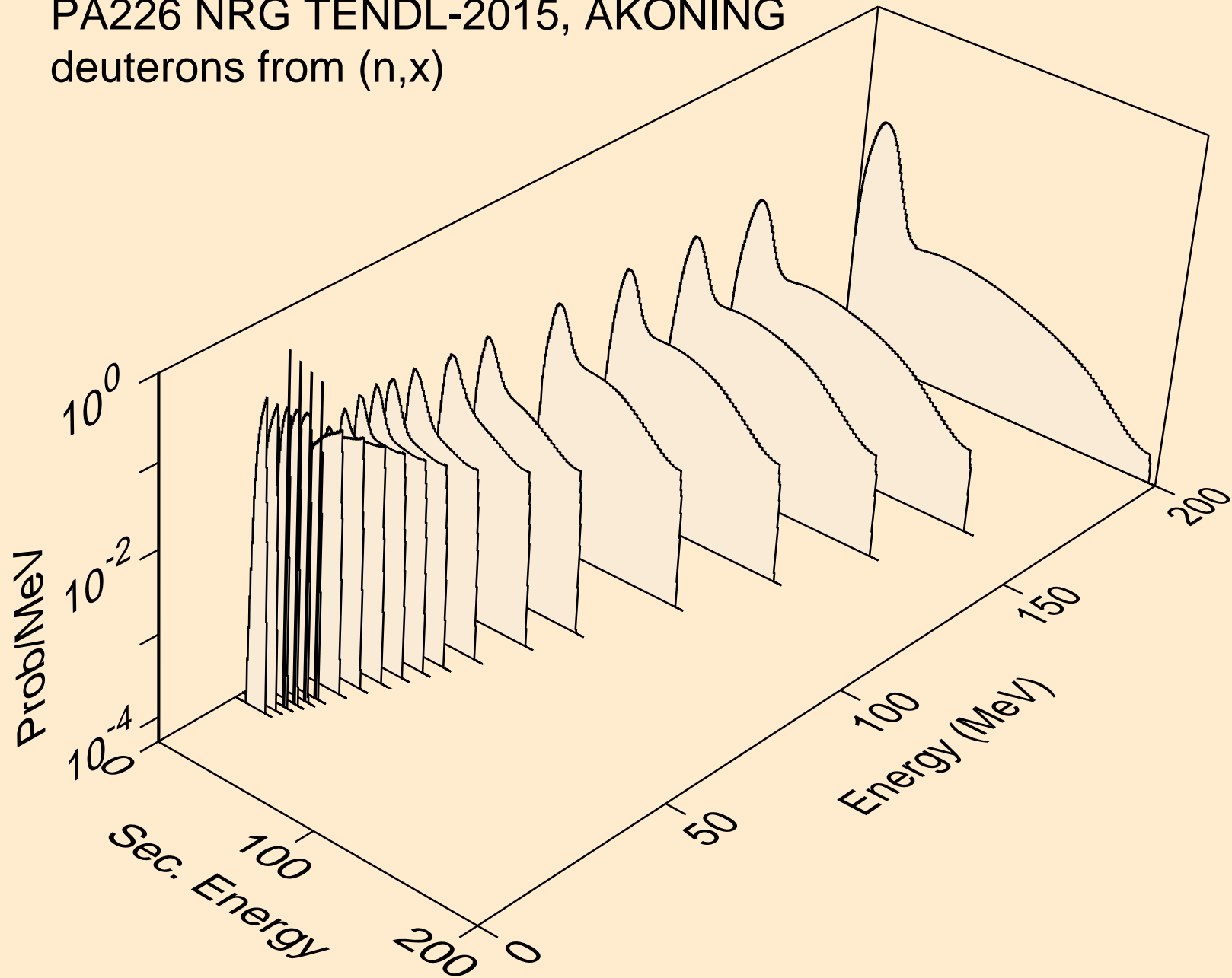

PA226 NRG TENDL-2015, AKONING
deuterons from (n,2nd)

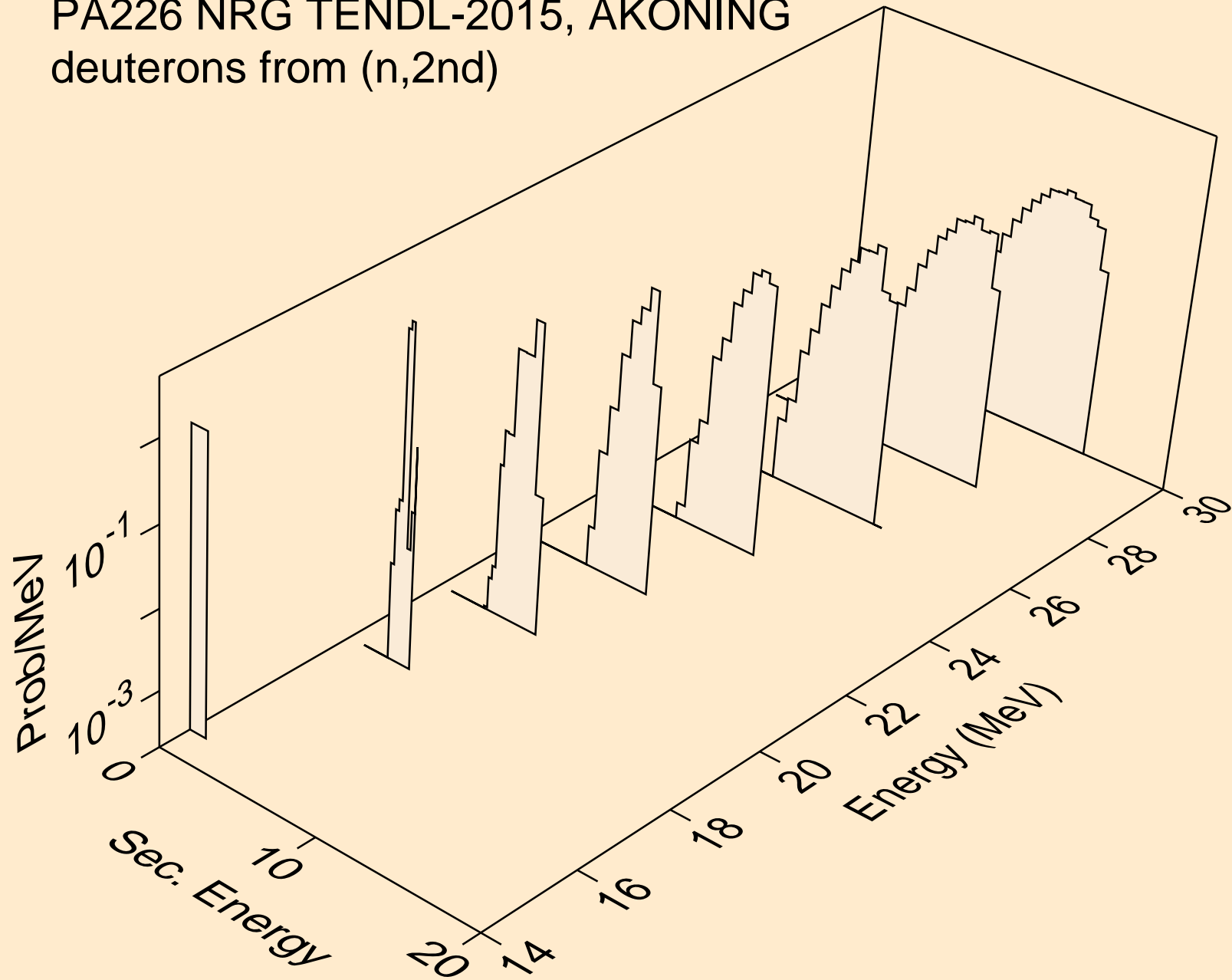

PA226 NRG TENDL-2015, AKONING
deuterons from (n,n*)d

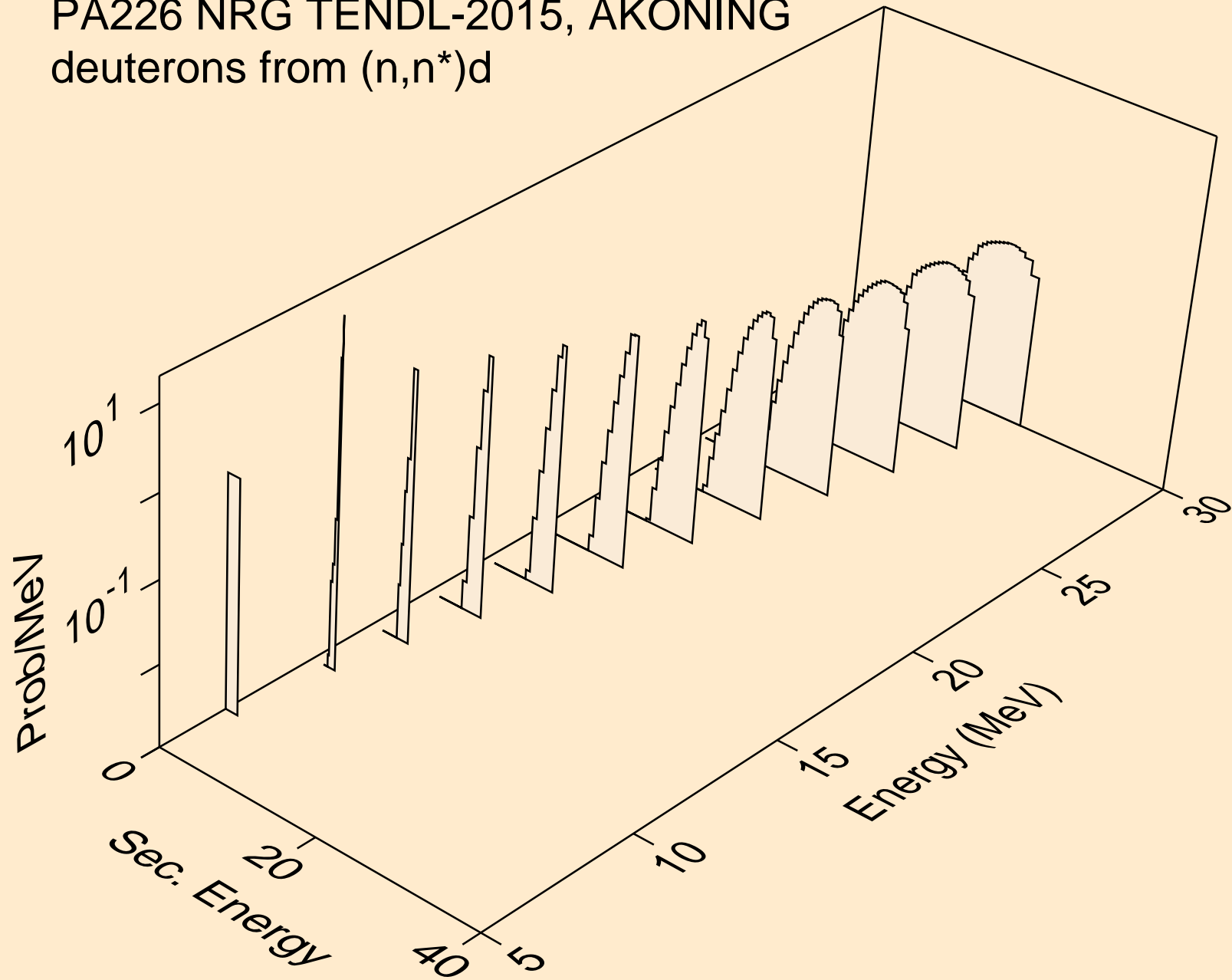

PA226 NRG TENDL-2015, AKONING
deuterons from (n,n*)d2a

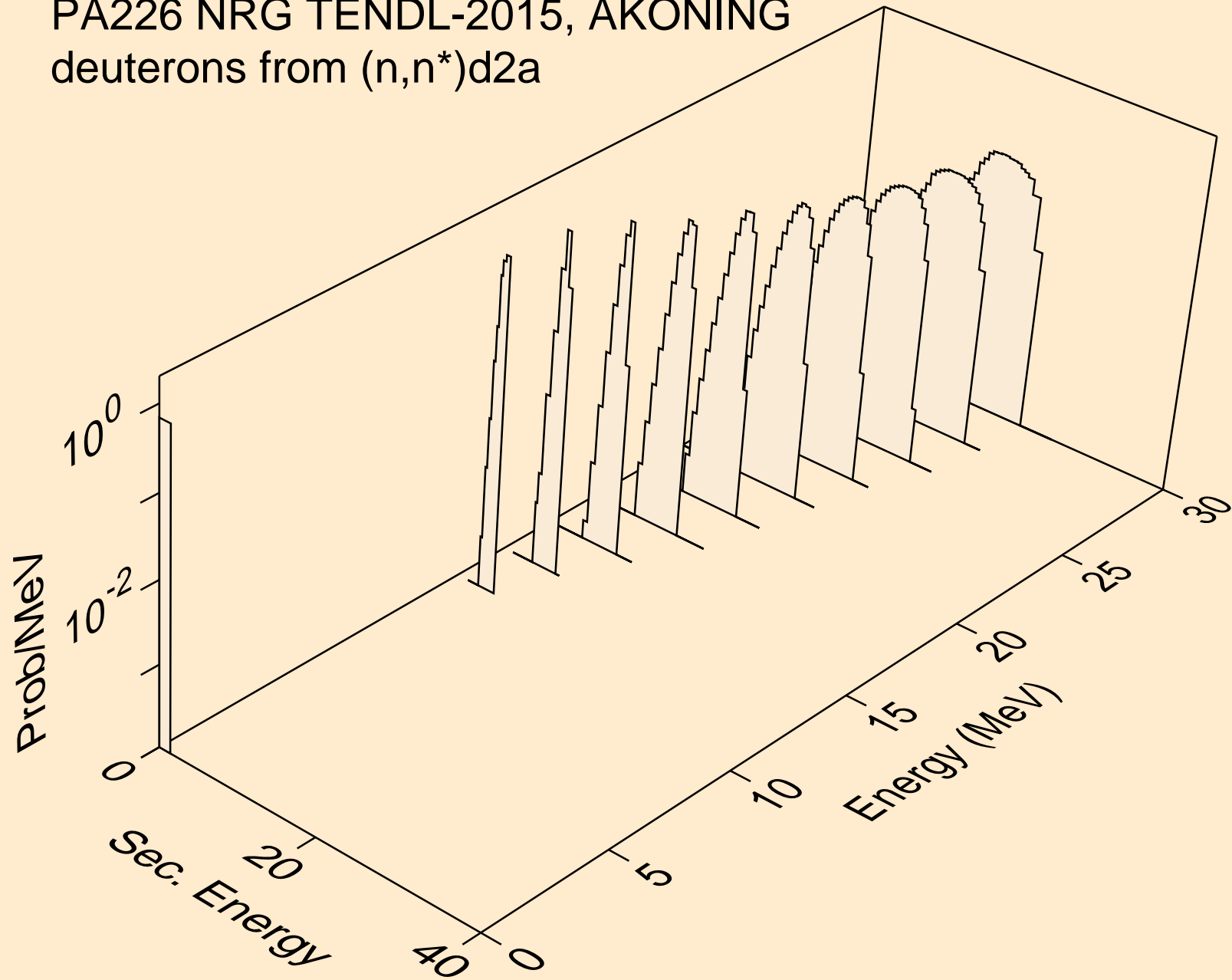

PA226 NRG TENDL-2015, AKONING
deuterons from (n,d)

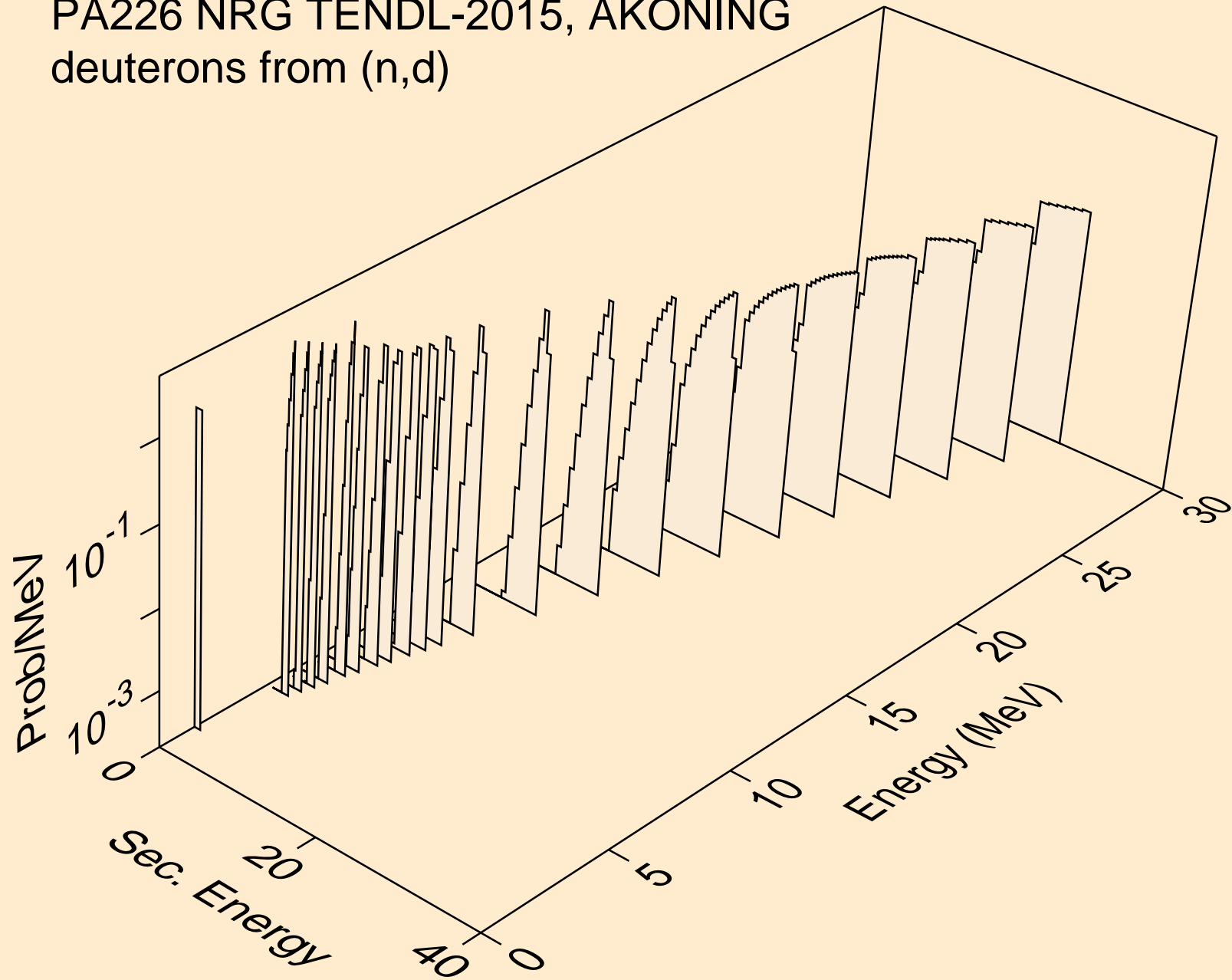

PA226 NRG TENDL-2015, AKONING
deuterons from (n,d2a)

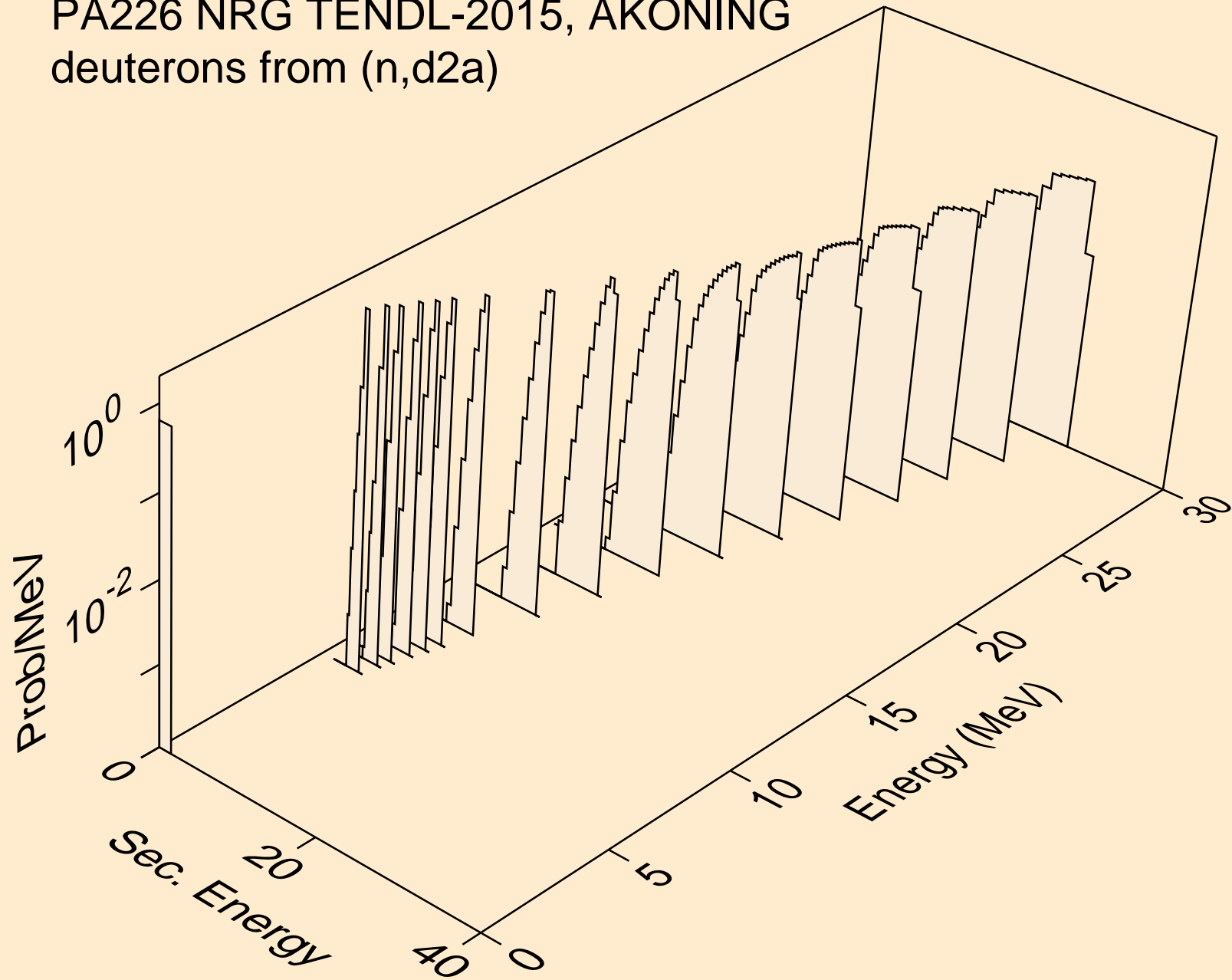

PA226 NRG TENDL-2015, AKONING
deuterons from (n,pd)

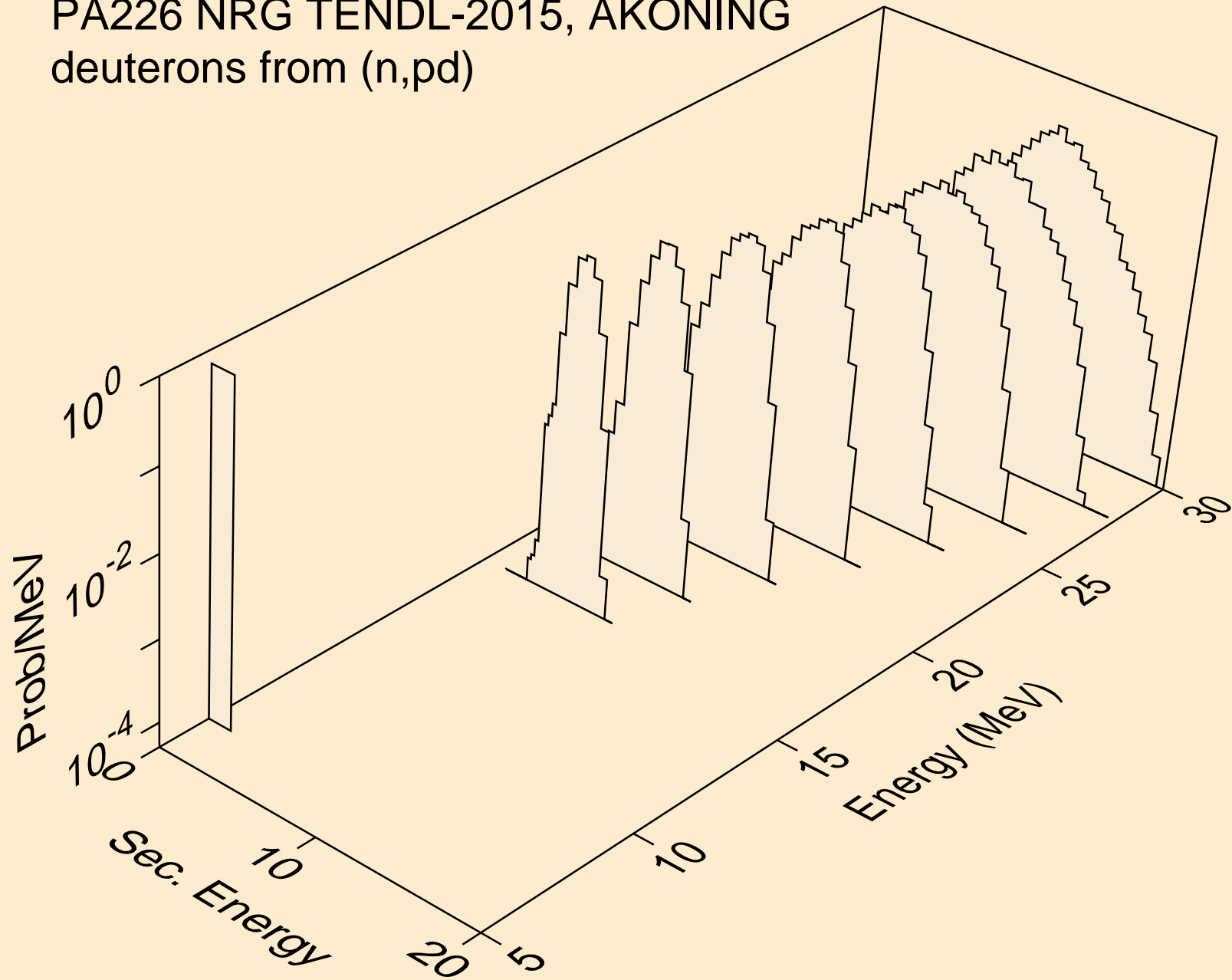

PA226 NRG TENDL-2015, AKONING
deuterons from (n,da)

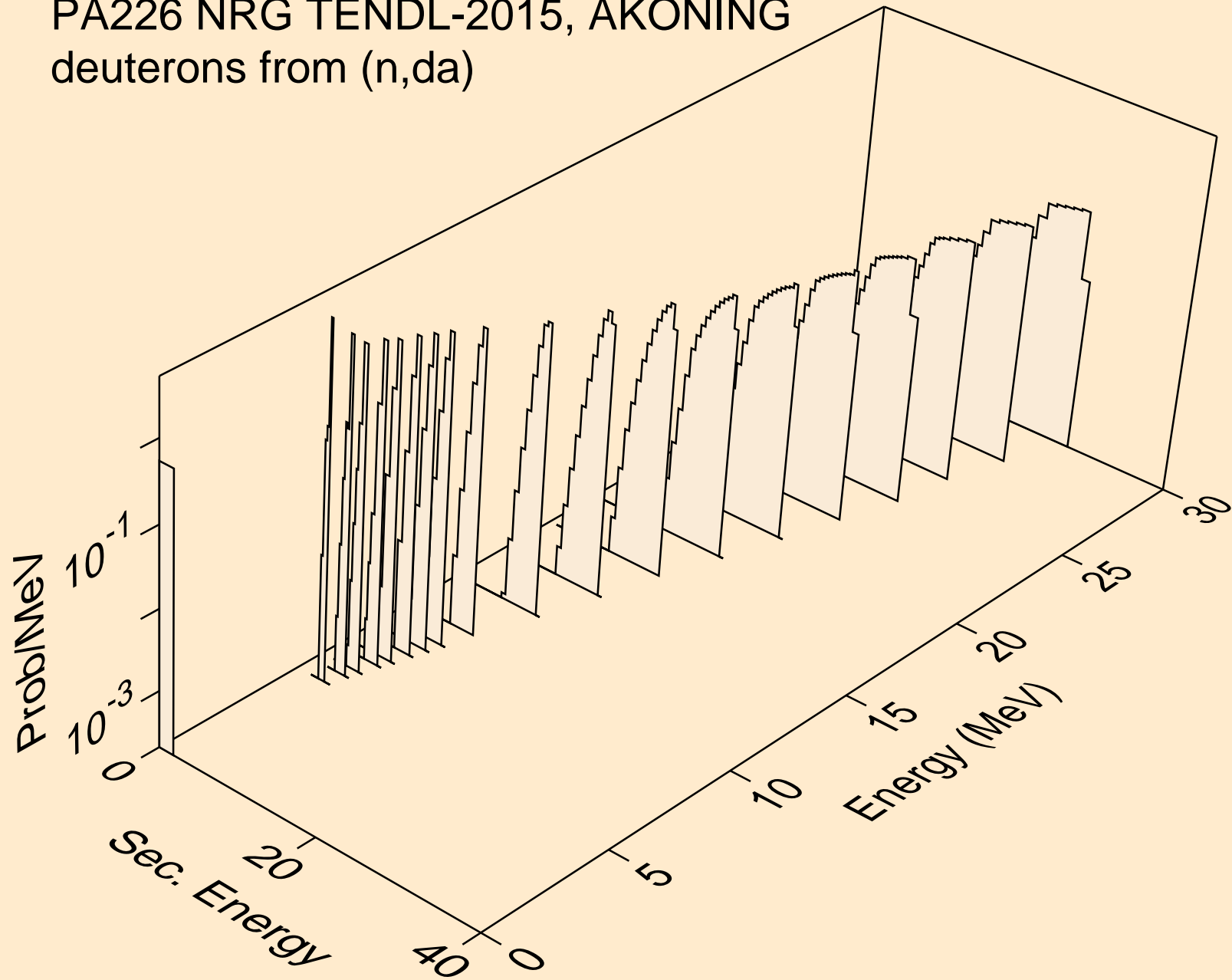

PA226 NRG TENDL-2015, AKONING
tritons from (n,x)

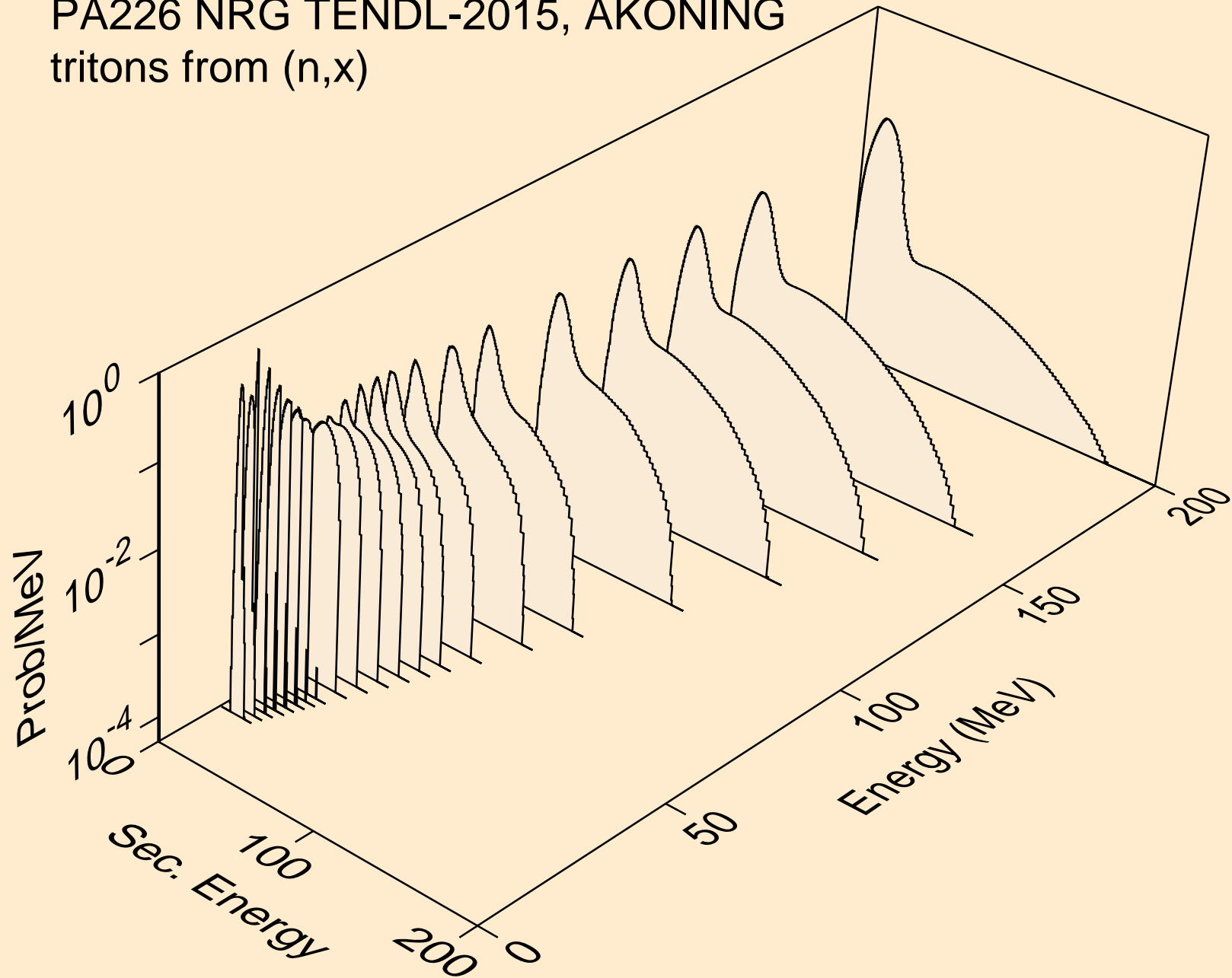

PA226 NRG TENDL-2015, AKONING
tritons from (n,n*)t

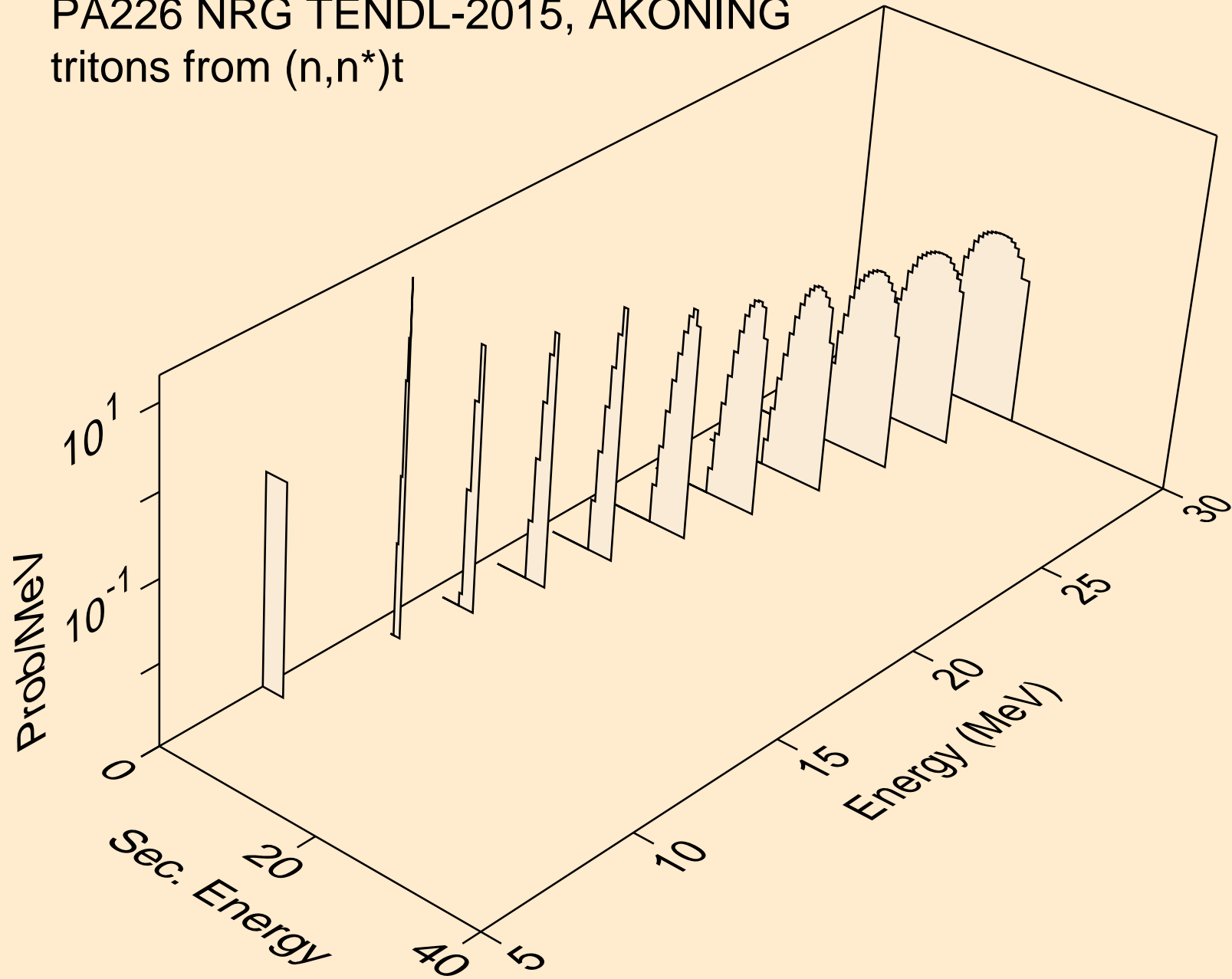

PA226 NRG TENDL-2015, AKONING
tritons from (n,n*)t2a

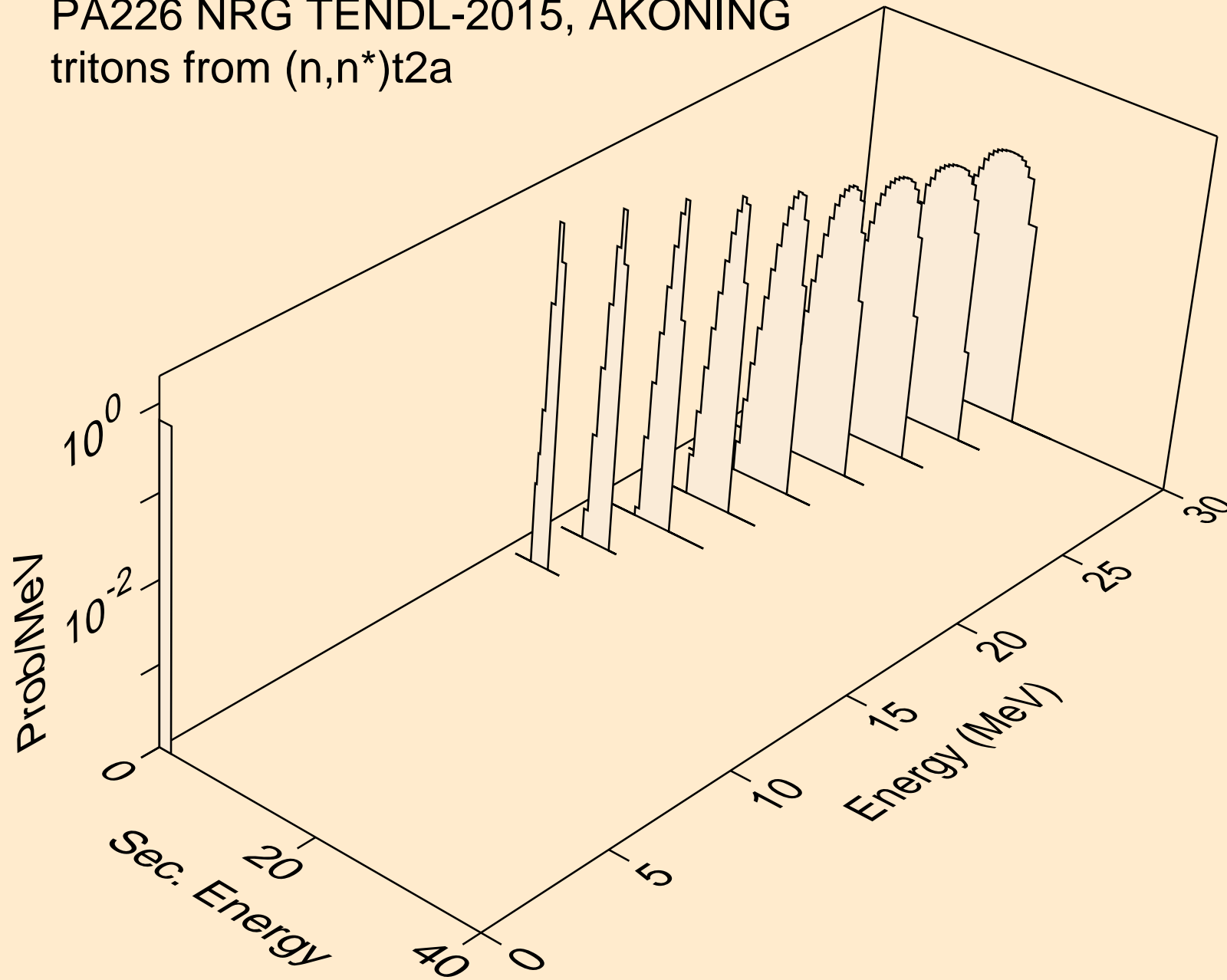

PA226 NRG TENDL-2015, AKONING
tritons from (n,t)

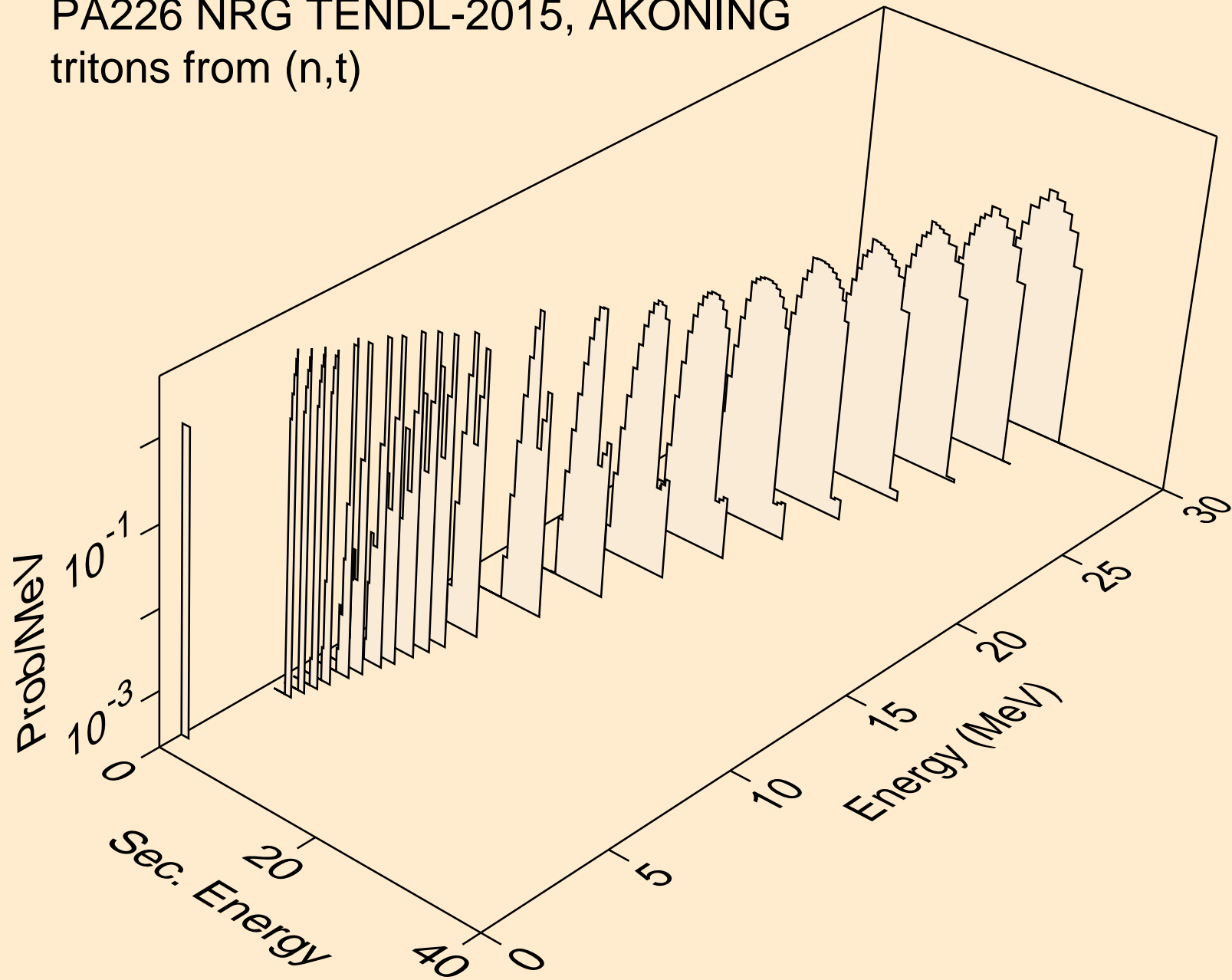

PA226 NRG TENDL-2015, AKONING
tritons from (n,t2a)

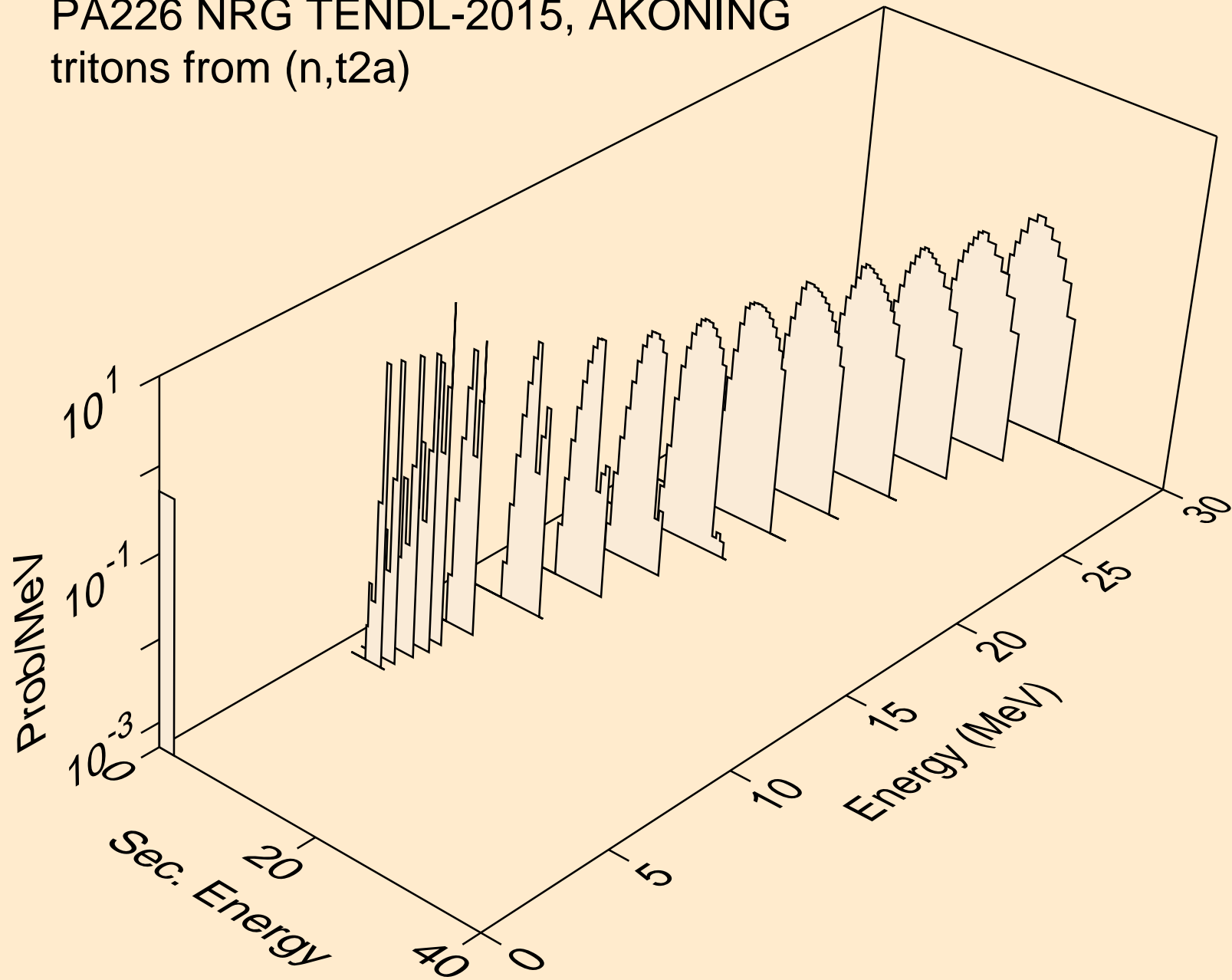

PA226 NRG TENDL-2015, AKONING
tritons from (n,pt)

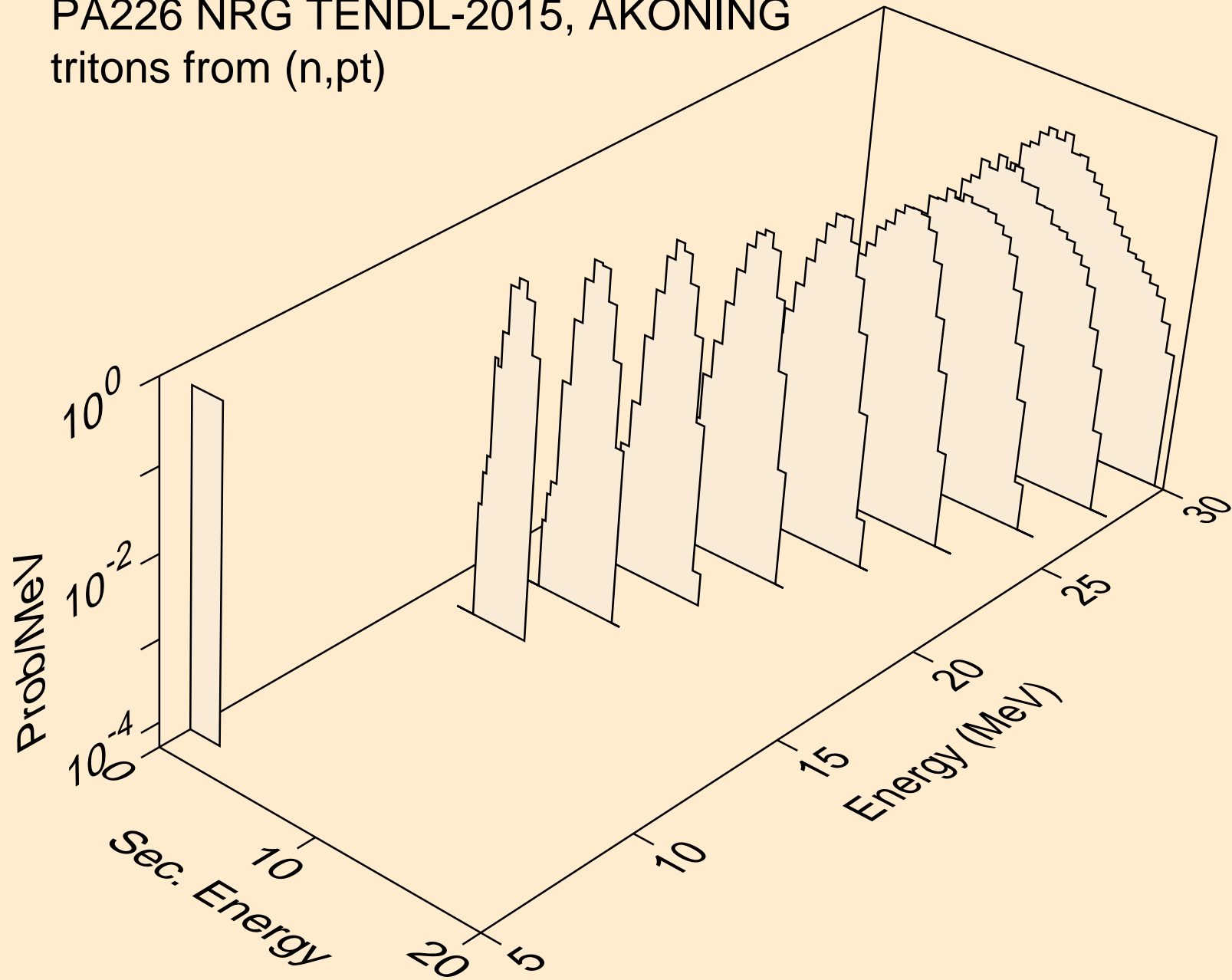

PA226 NRG TENDL-2015, AKONING
he3s from (n,x)

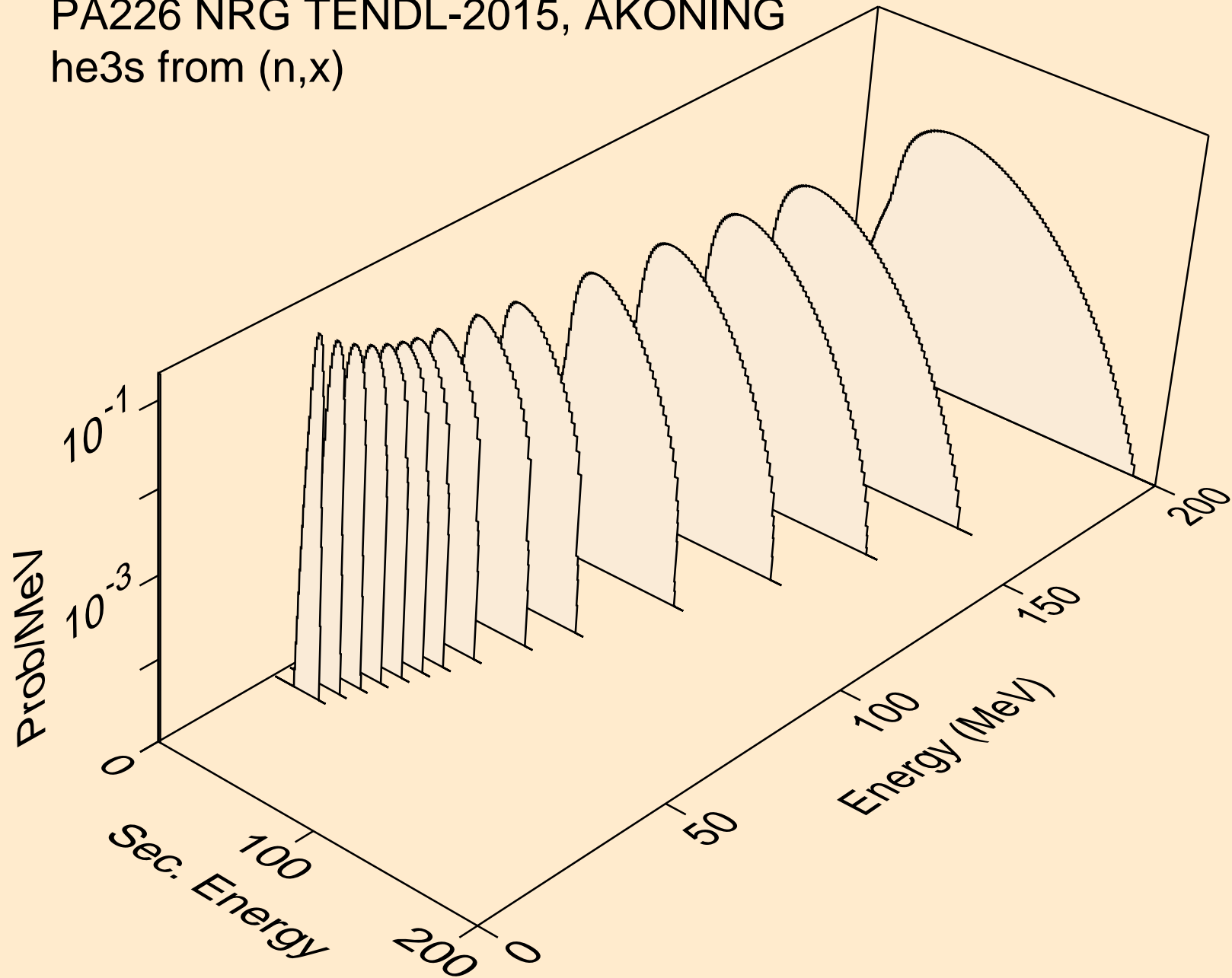

PA226 NRG TENDL-2015, AKONING
he3s from (n,n*)he3

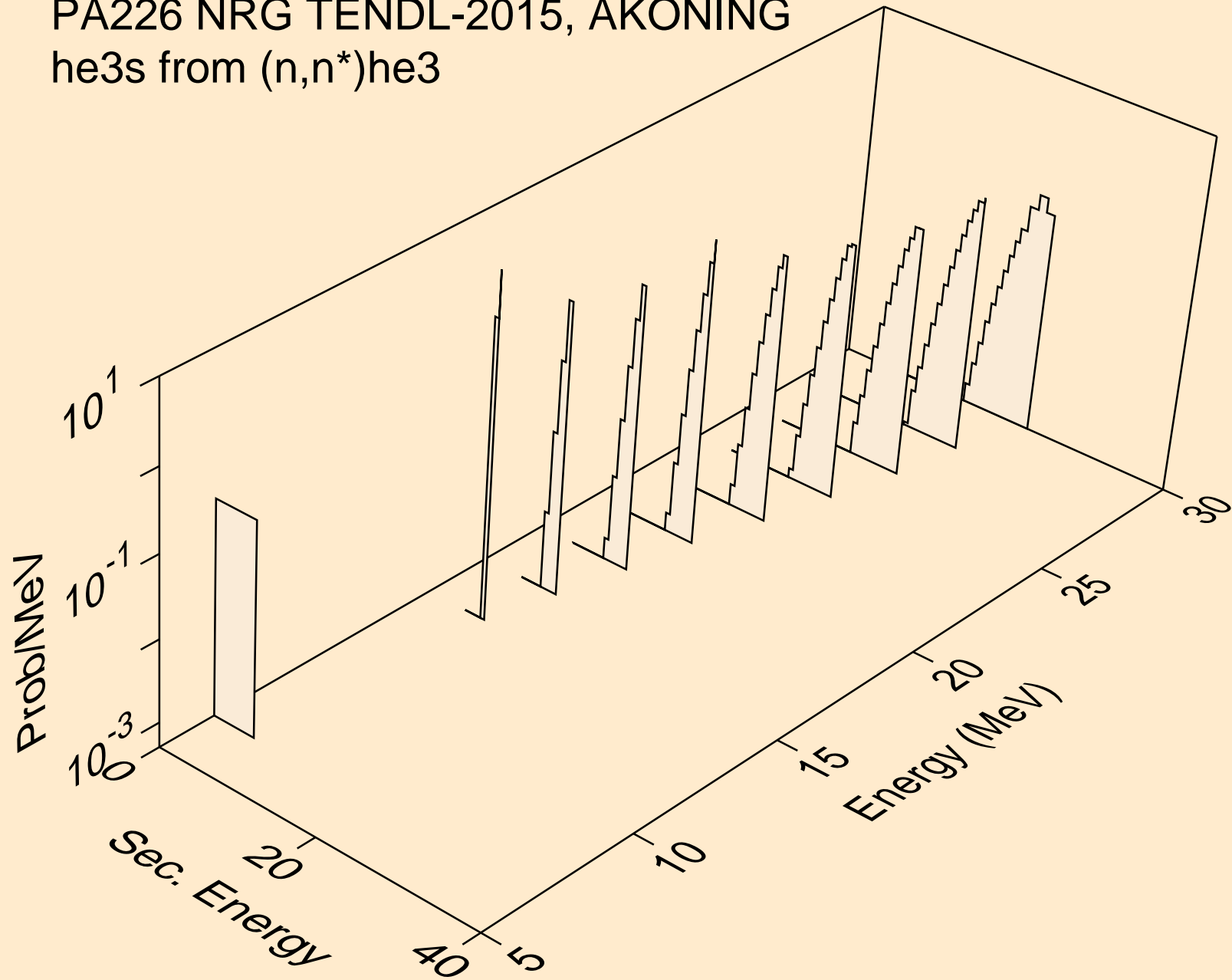

PA226 NRG TENDL-2015, AKONING
he3s from (n,he3)

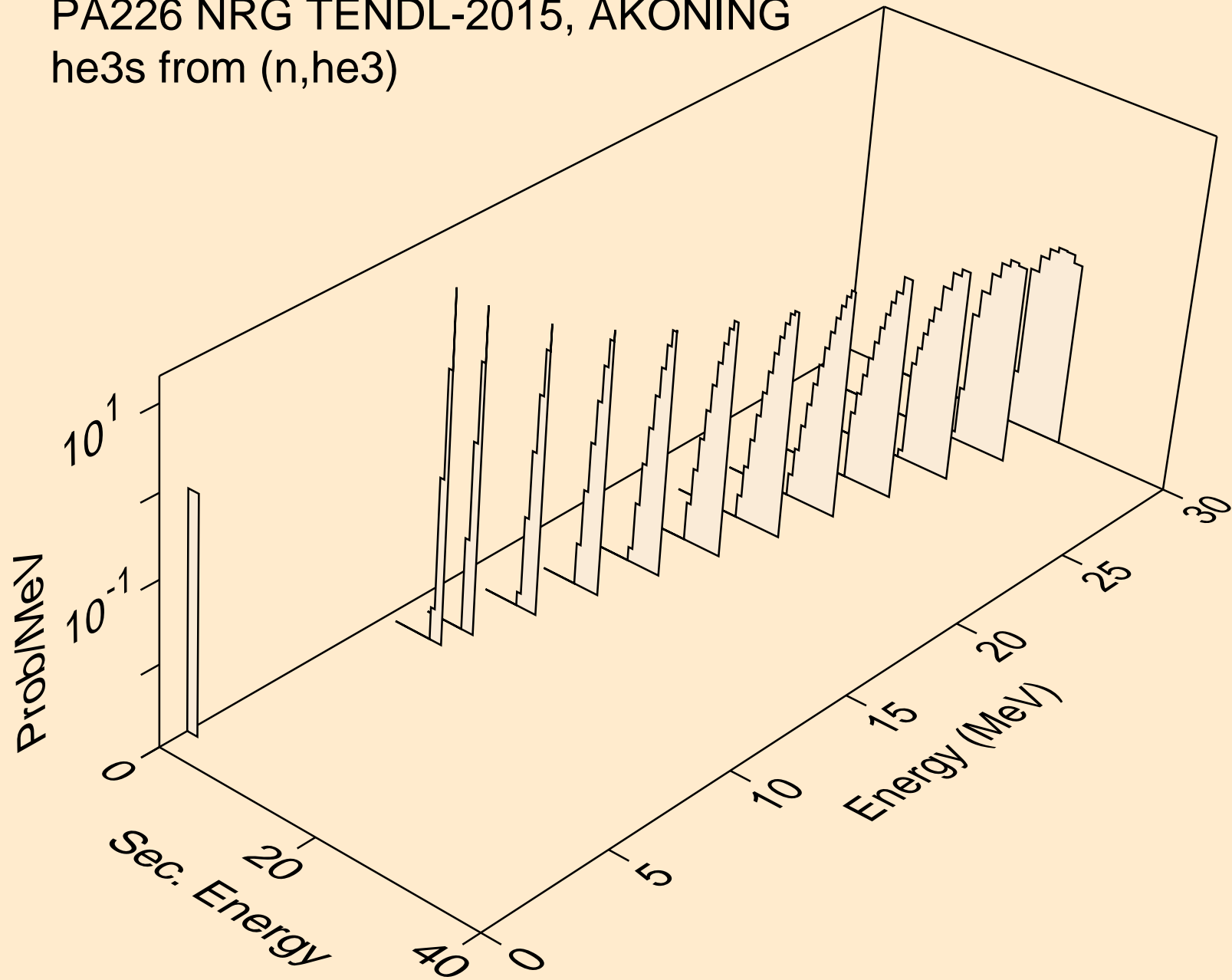

PA226 NRG TENDL-2015, AKONING
alphas from (n,x)

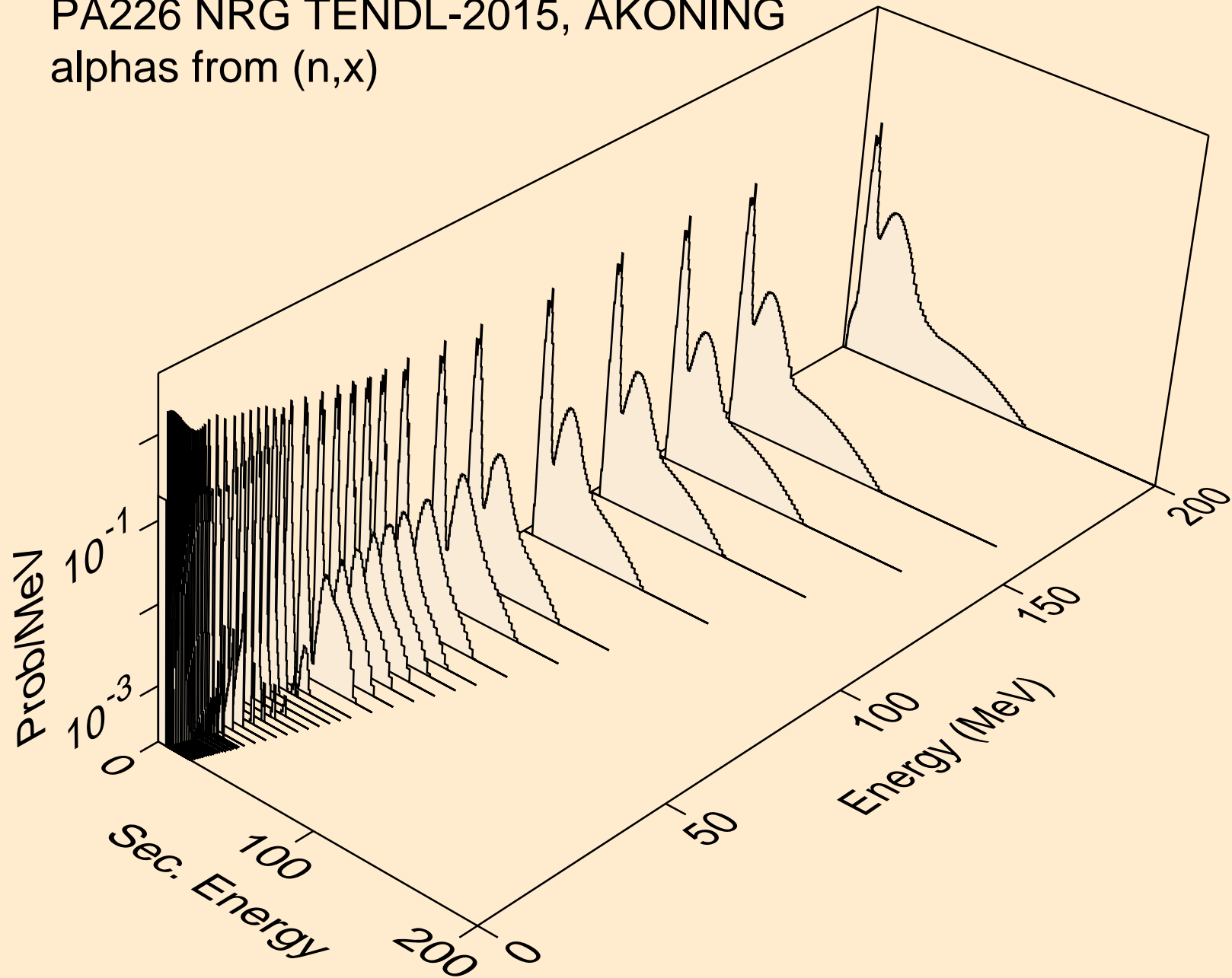

PA226 NRG TENDL-2015, AKONING
alphas from (n,n*)a

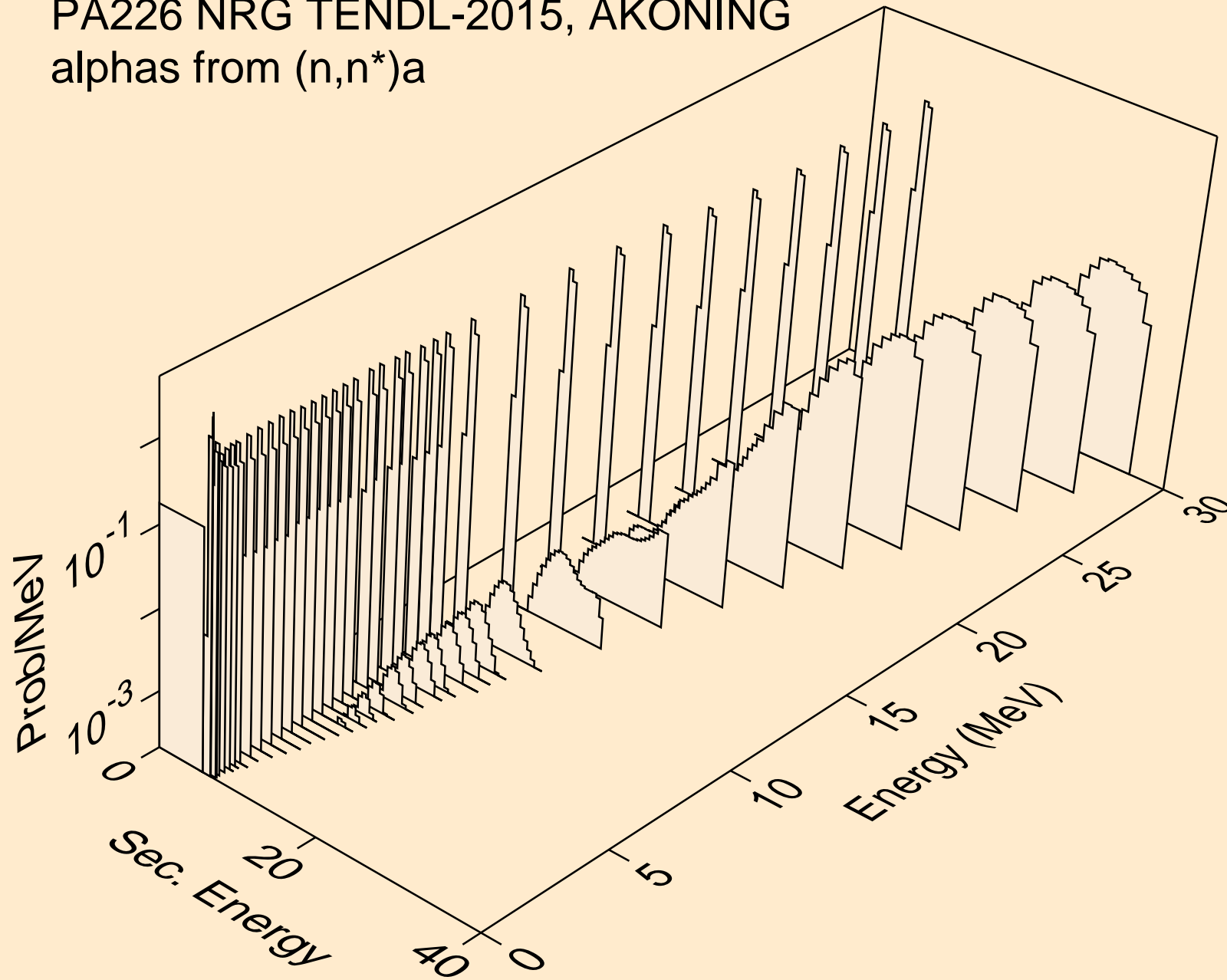

PA226 NRG TENDL-2015, AKONING
alphas from (n,n*)3a

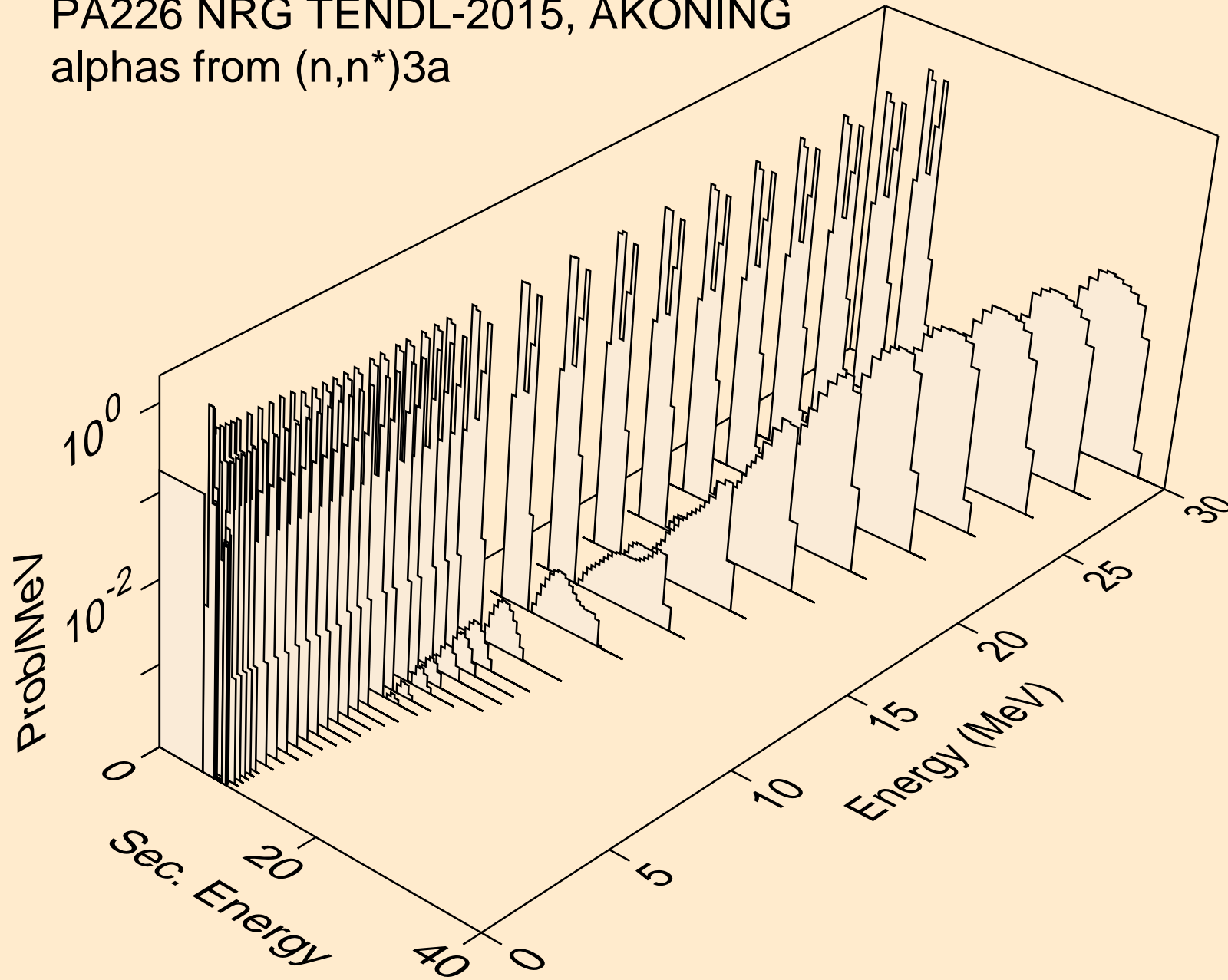

PA226 NRG TENDL-2015, AKONING
alphas from (n,2n)a

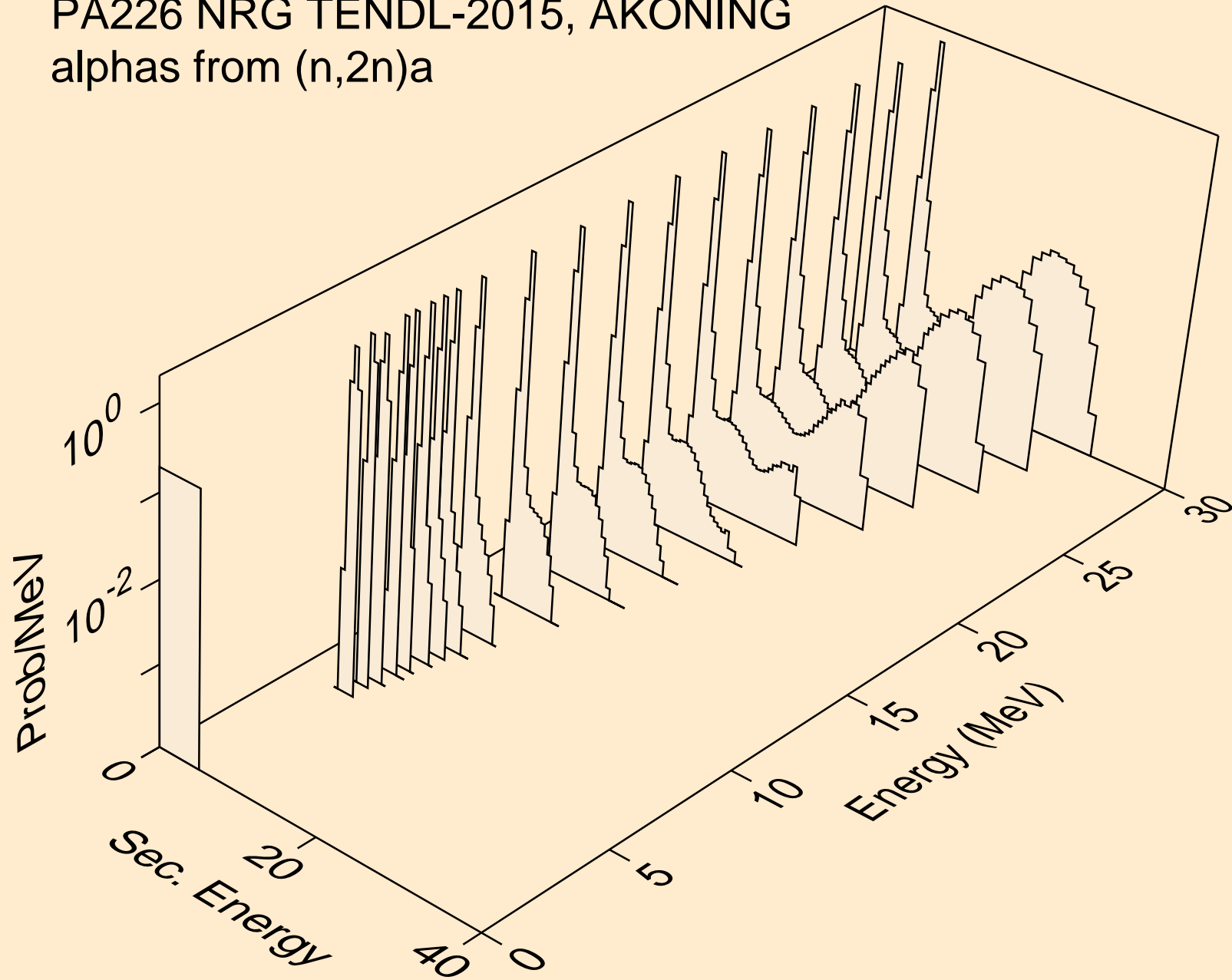

PA226 NRG TENDL-2015, AKONING
alphas from (n,3n)a

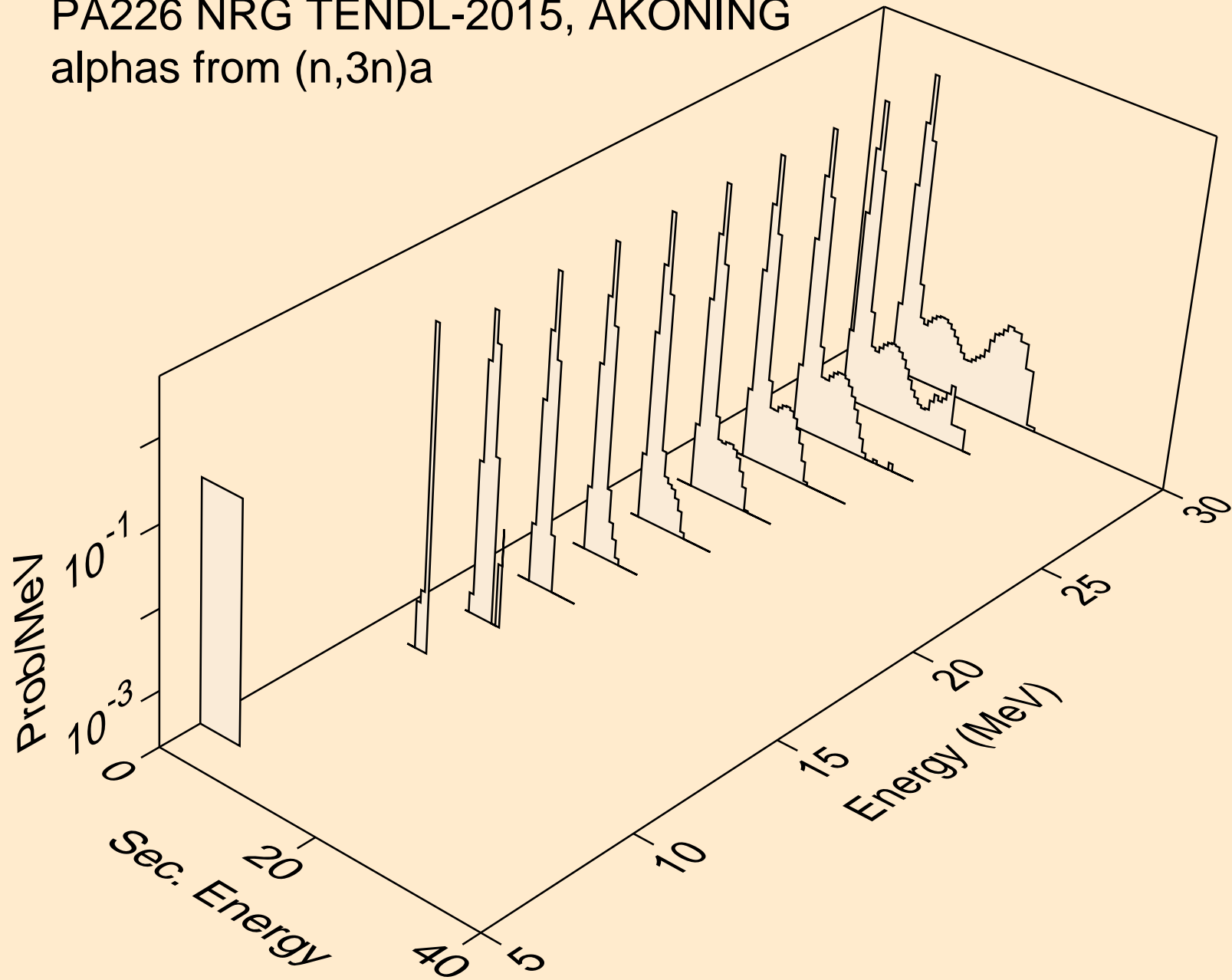

PA226 NRG TENDL-2015, AKONING
alphas from (n,n*)2a

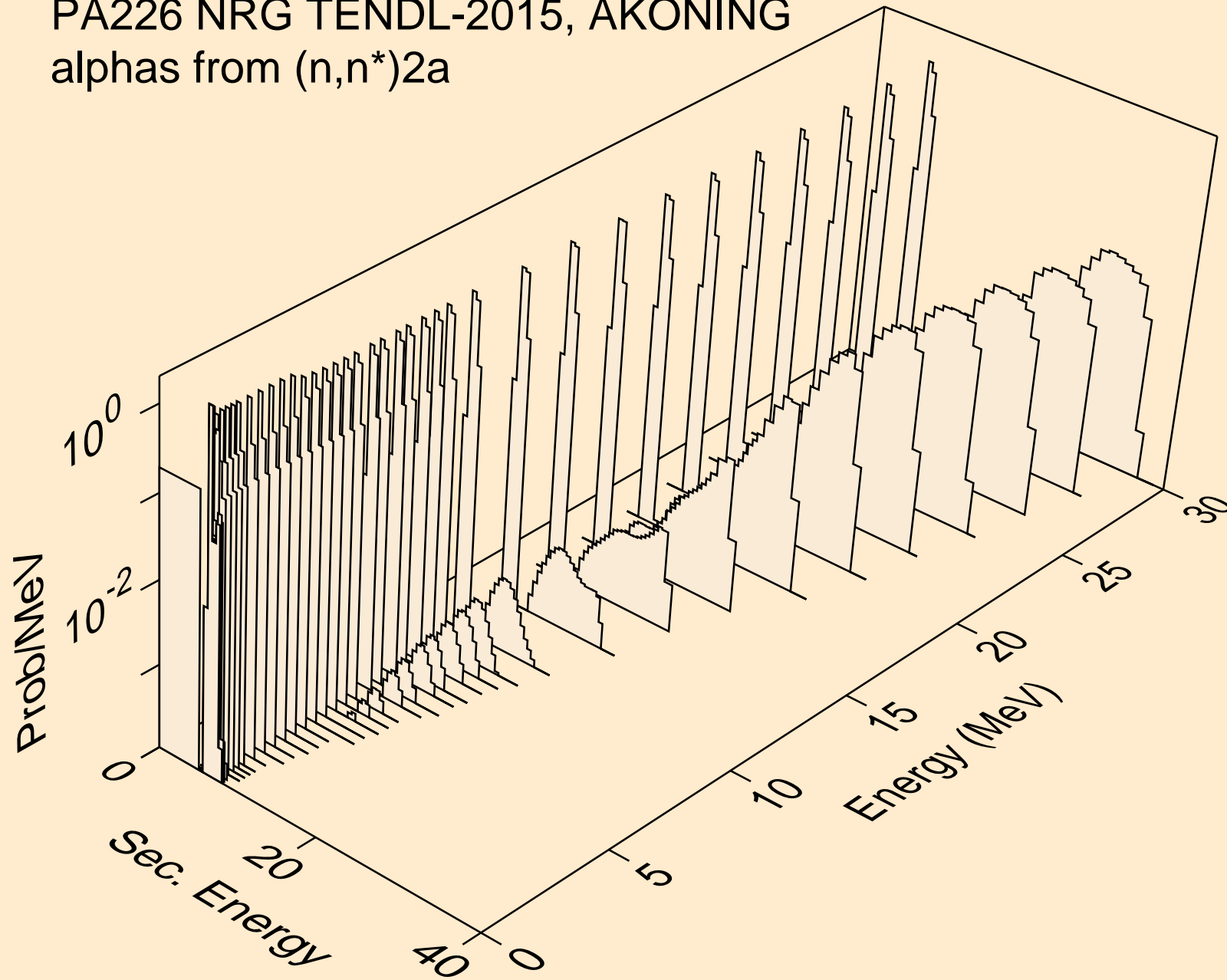

PA226 NRG TENDL-2015, AKONING
alphas from (n,2n)2a

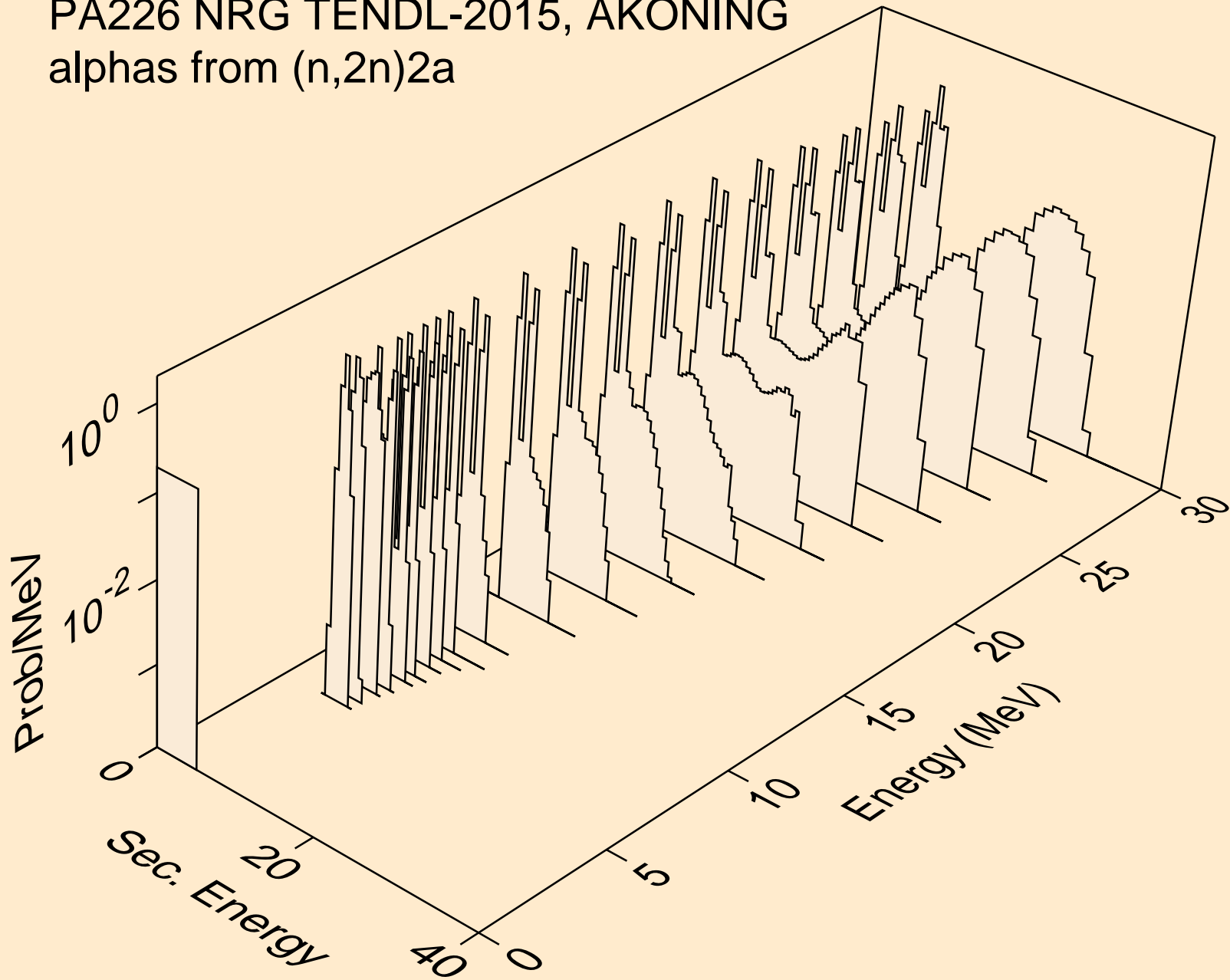

PA226 NRG TENDL-2015, AKONING
alphas from (n,n*)d2a

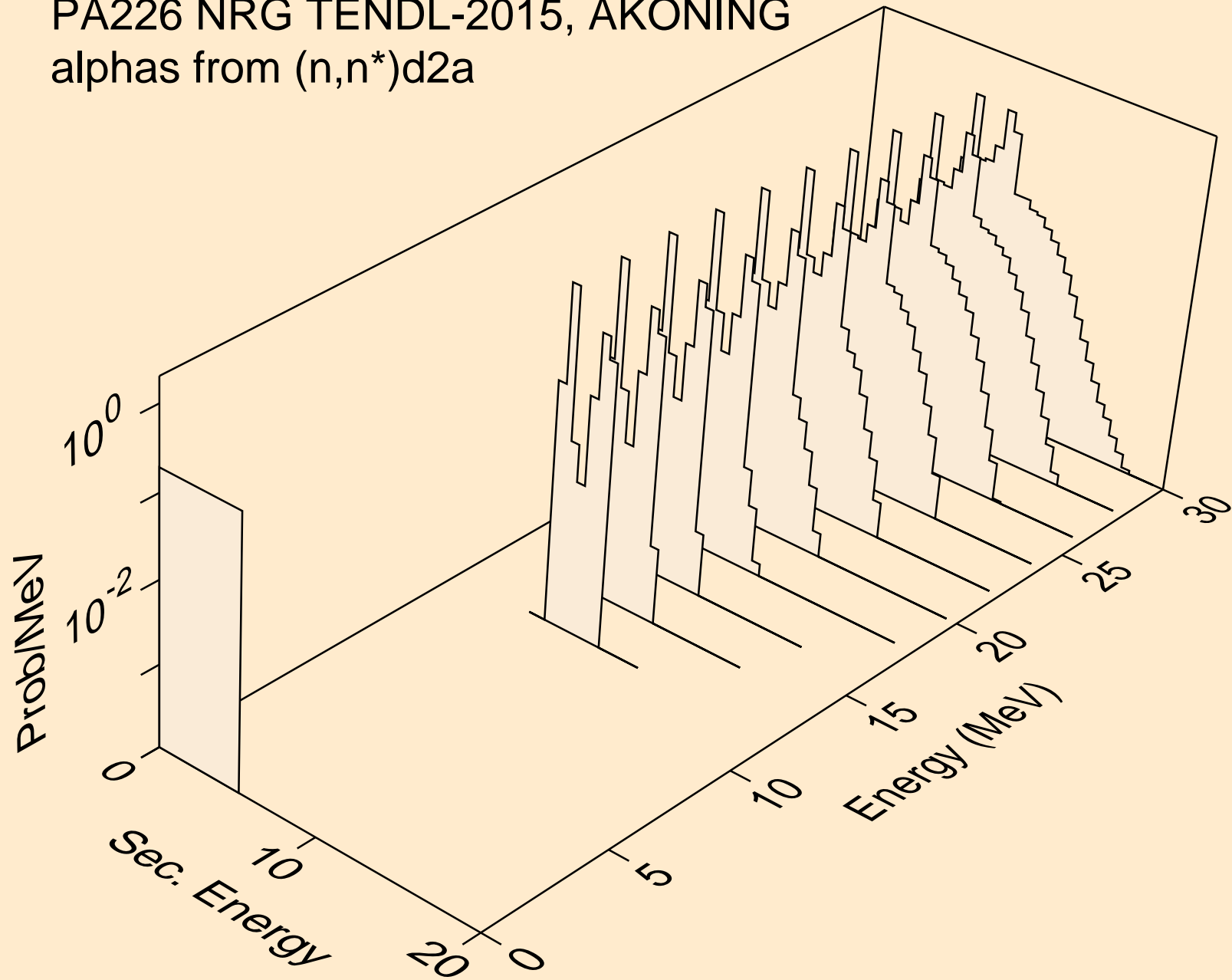

PA226 NRG TENDL-2015, AKONING
alphas from (n,n*)t2a

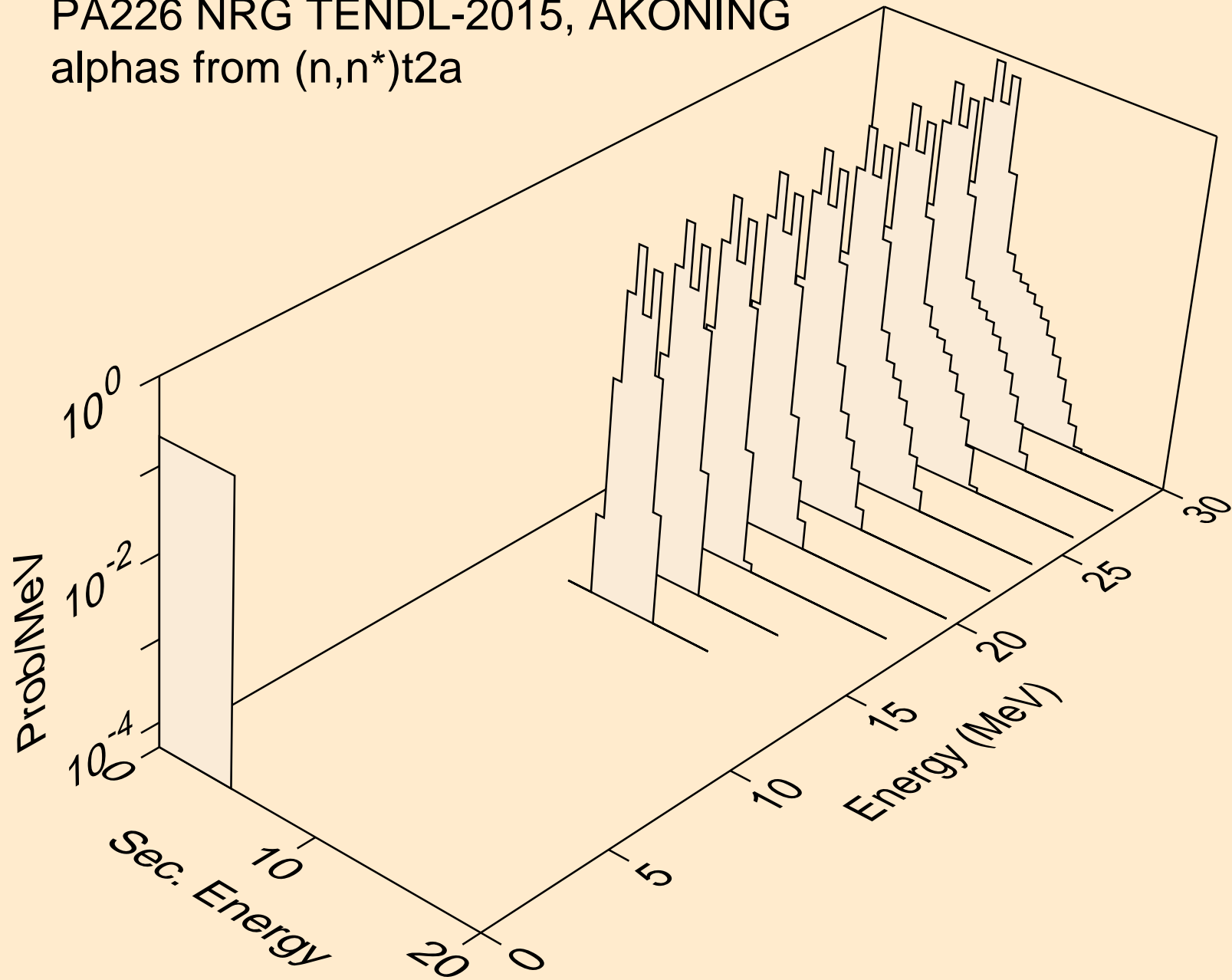

PA226 NRG TENDL-2015, AKONING
alphas from (n,npa)

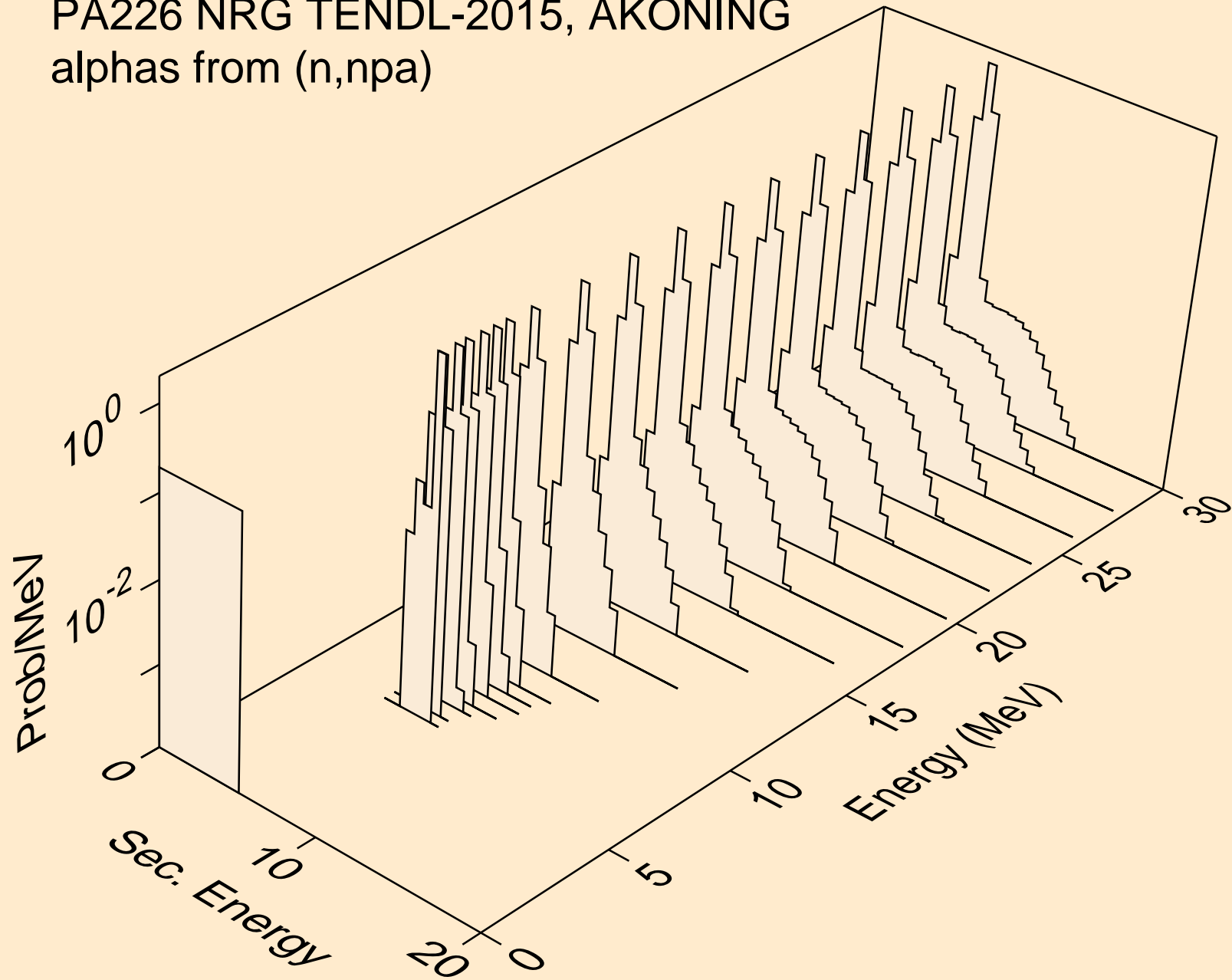

PA226 NRG TENDL-2015, AKONING
alphas from (n,a)

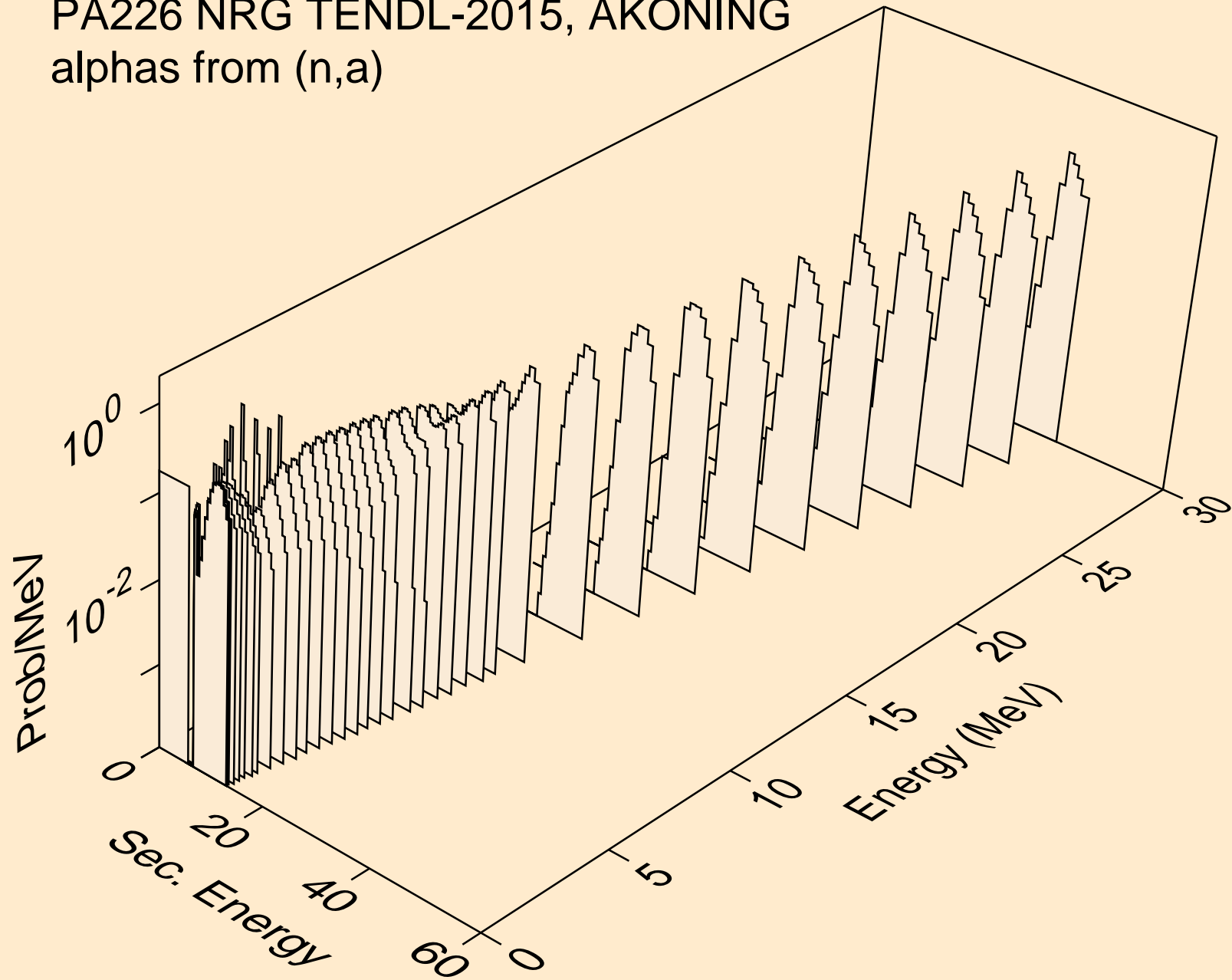

PA226 NRG TENDL-2015, AKONING
alphas from (n,2a)

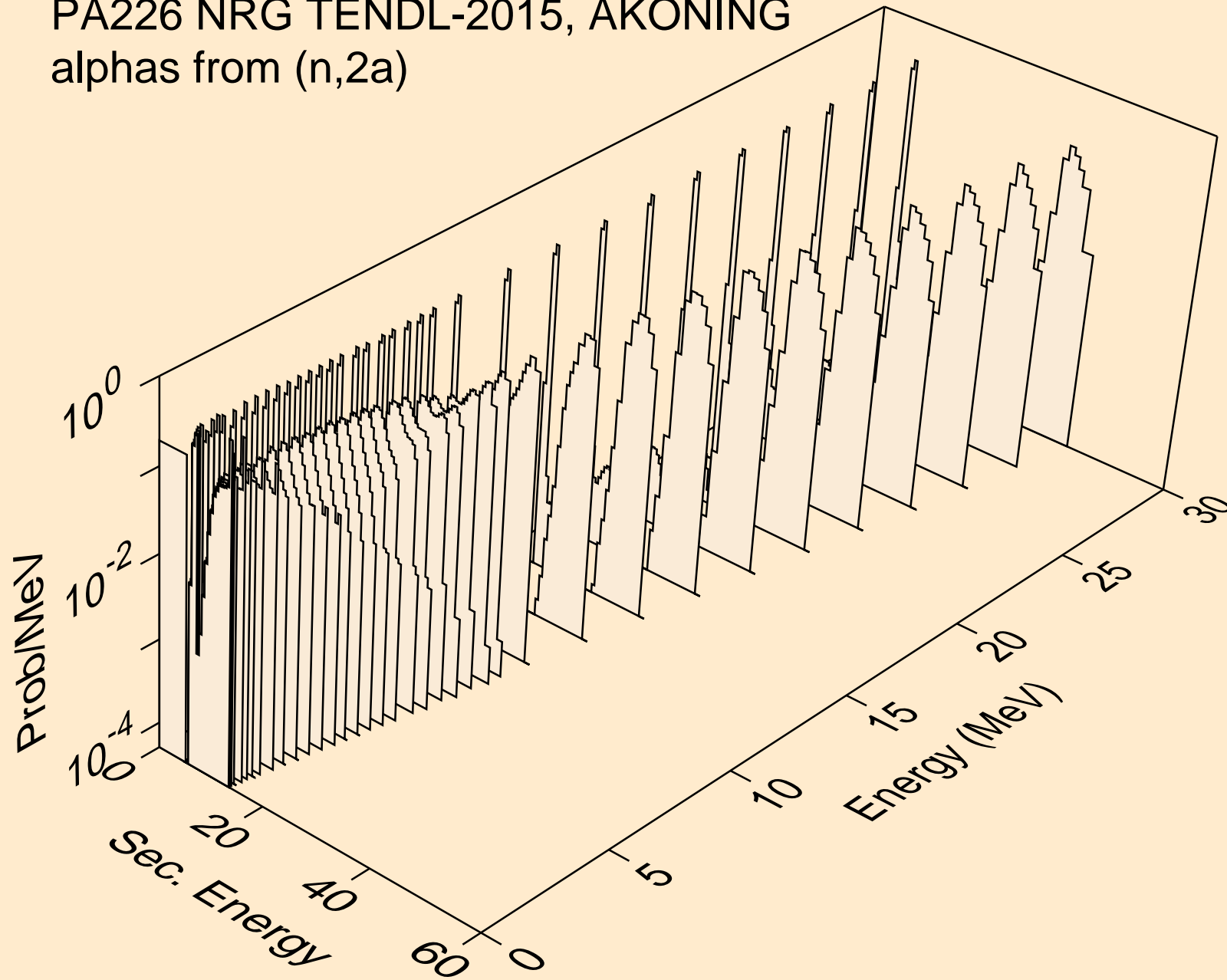

PA226 NRG TENDL-2015, AKONING
alphas from (n,3a)

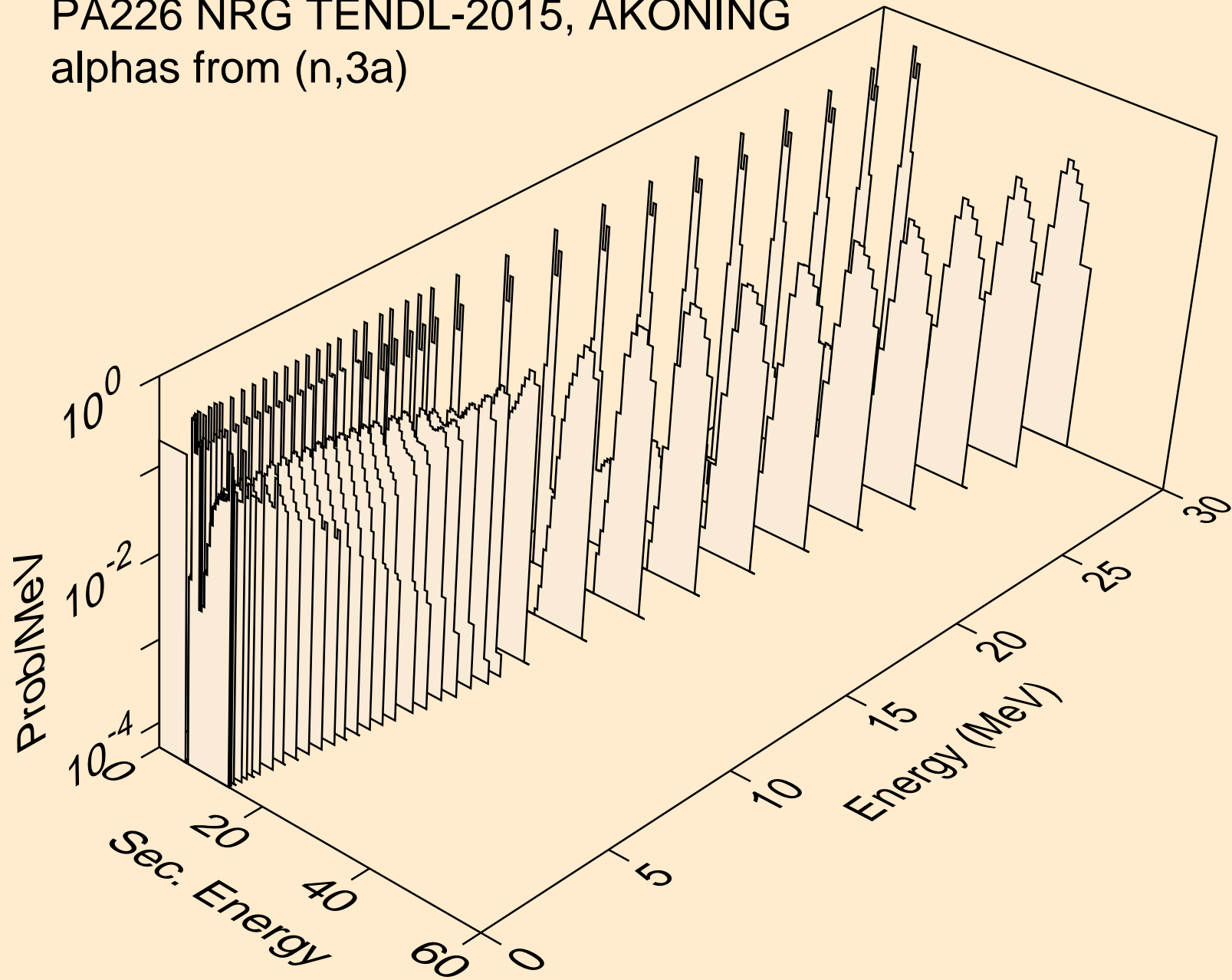

PA226 NRG TENDL-2015, AKONING
alphas from (n,pa)

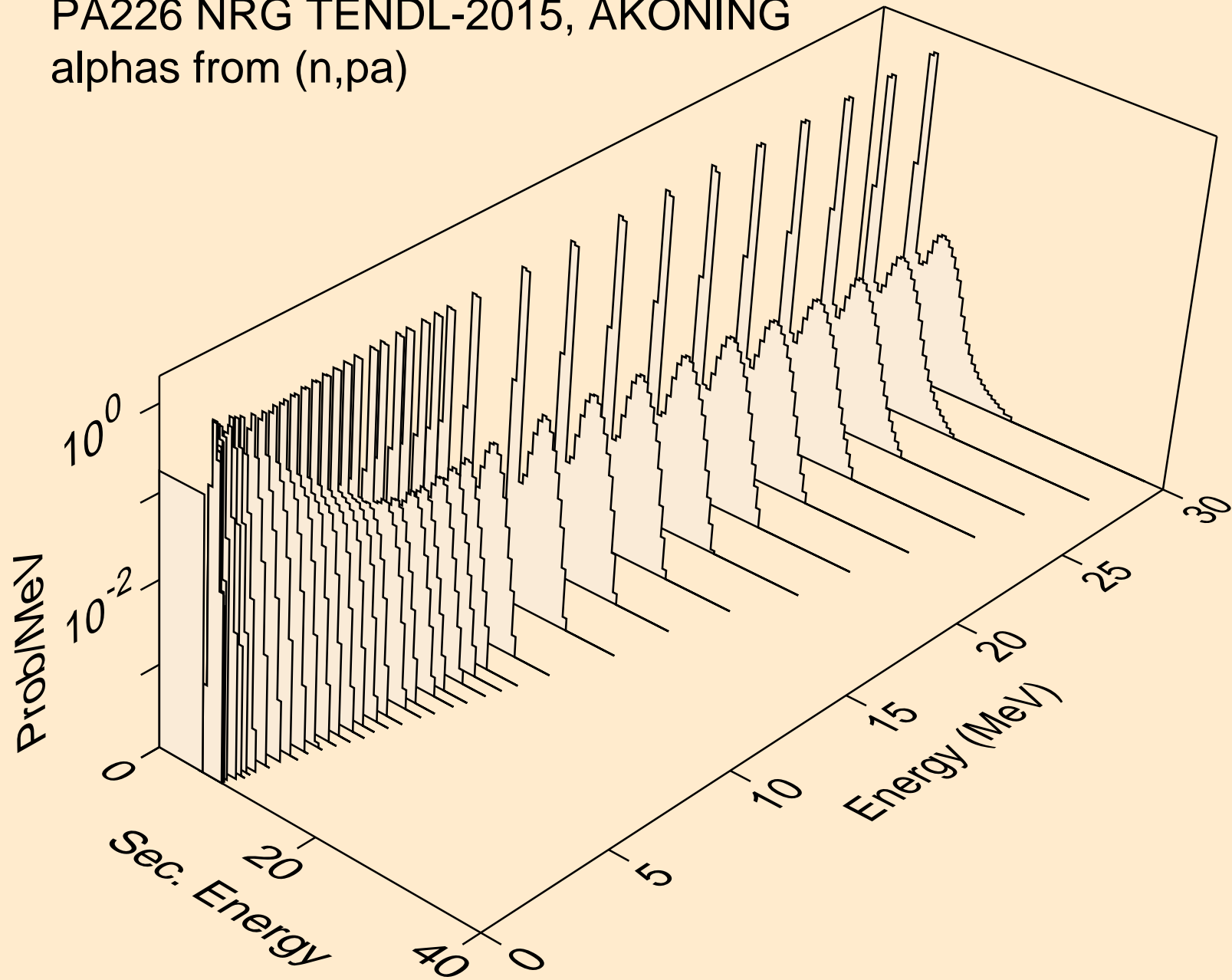

PA226 NRG TENDL-2015, AKONING
alphas from (n,t2a)

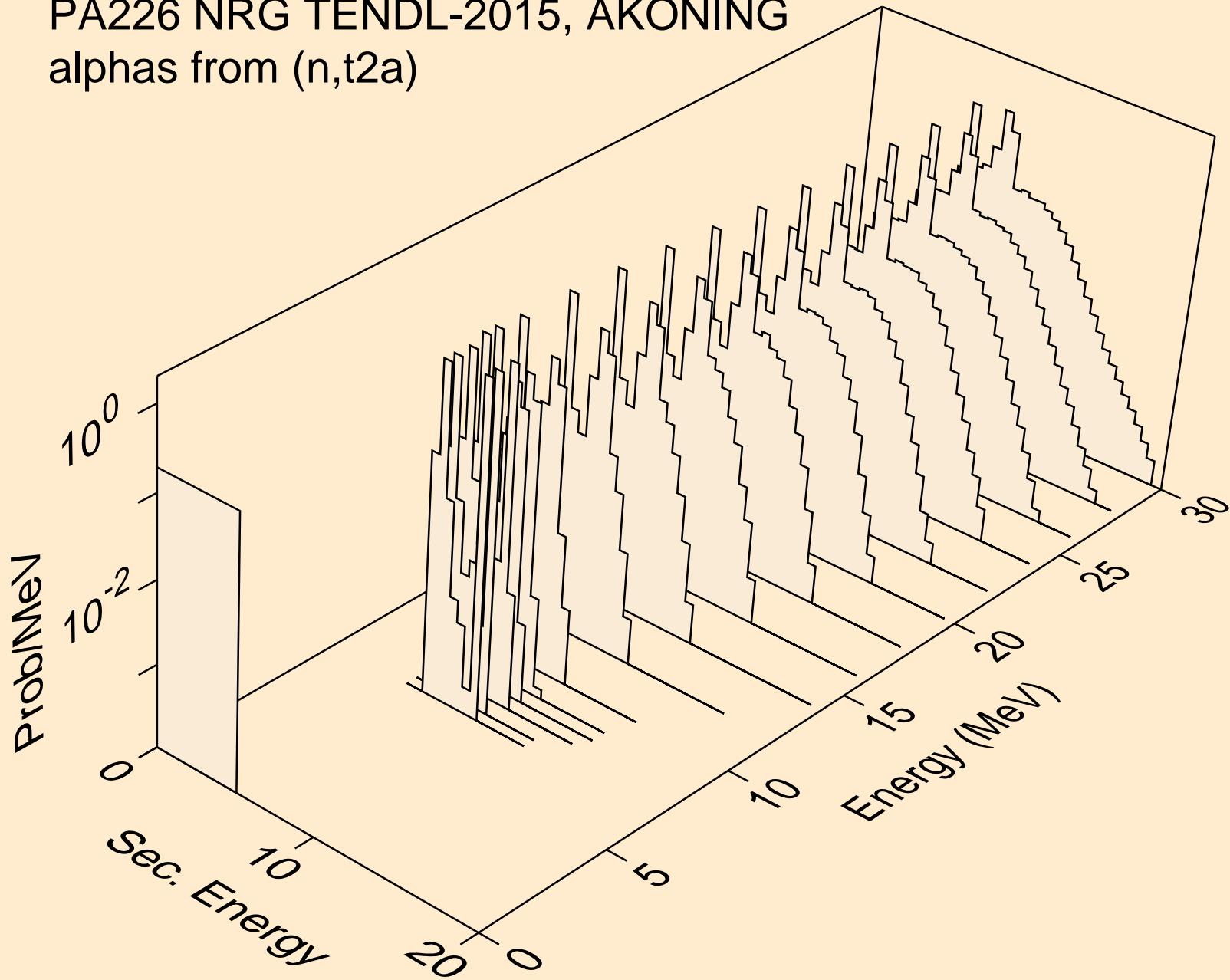

PA226 NRG TENDL-2015, AKONING
alphas from (n,d2a)

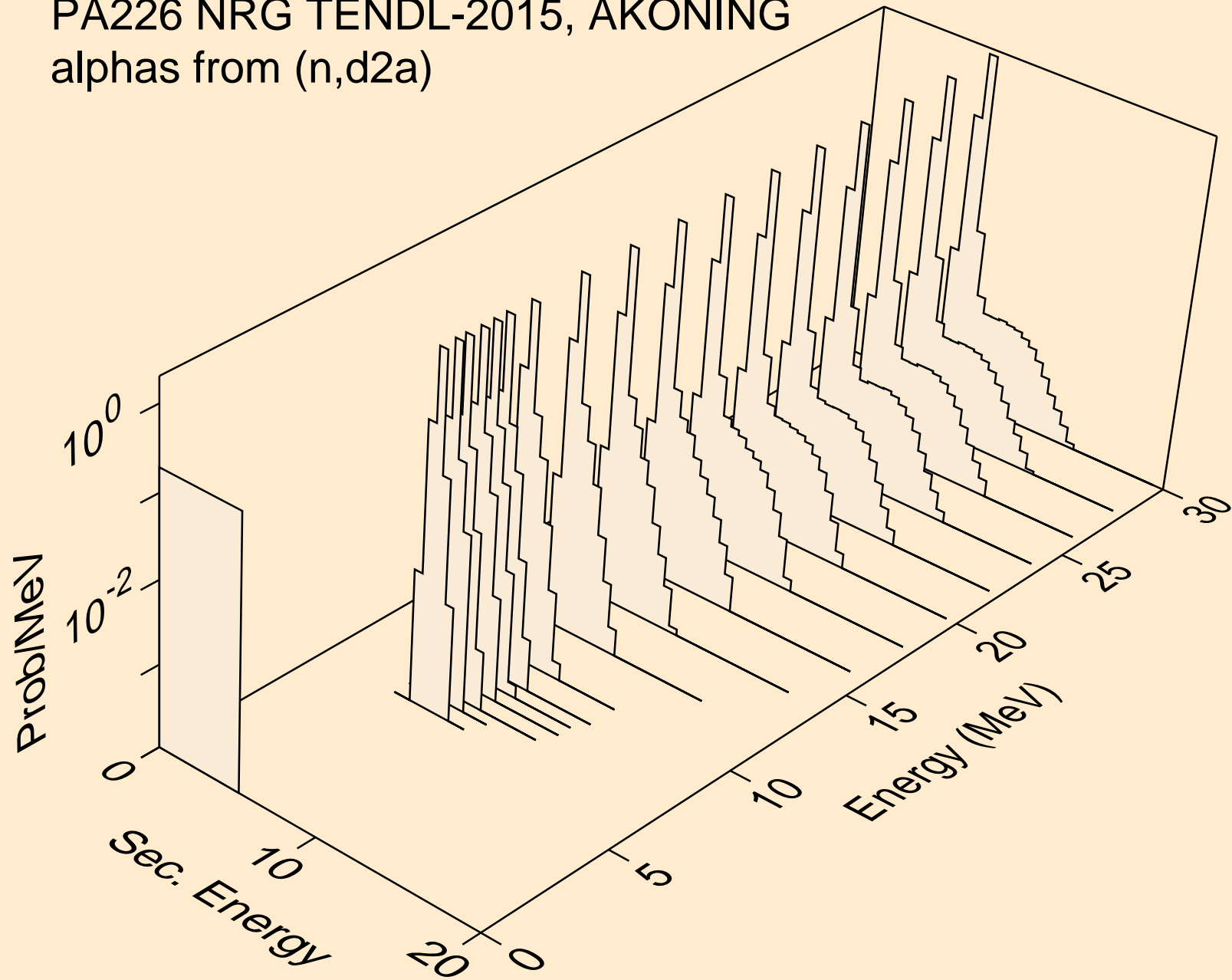

PA226 NRG TENDL-2015, AKONING
alphas from (n,da)

