

PA237 NRG TENDL-2015, AKONING

Principal cross sections

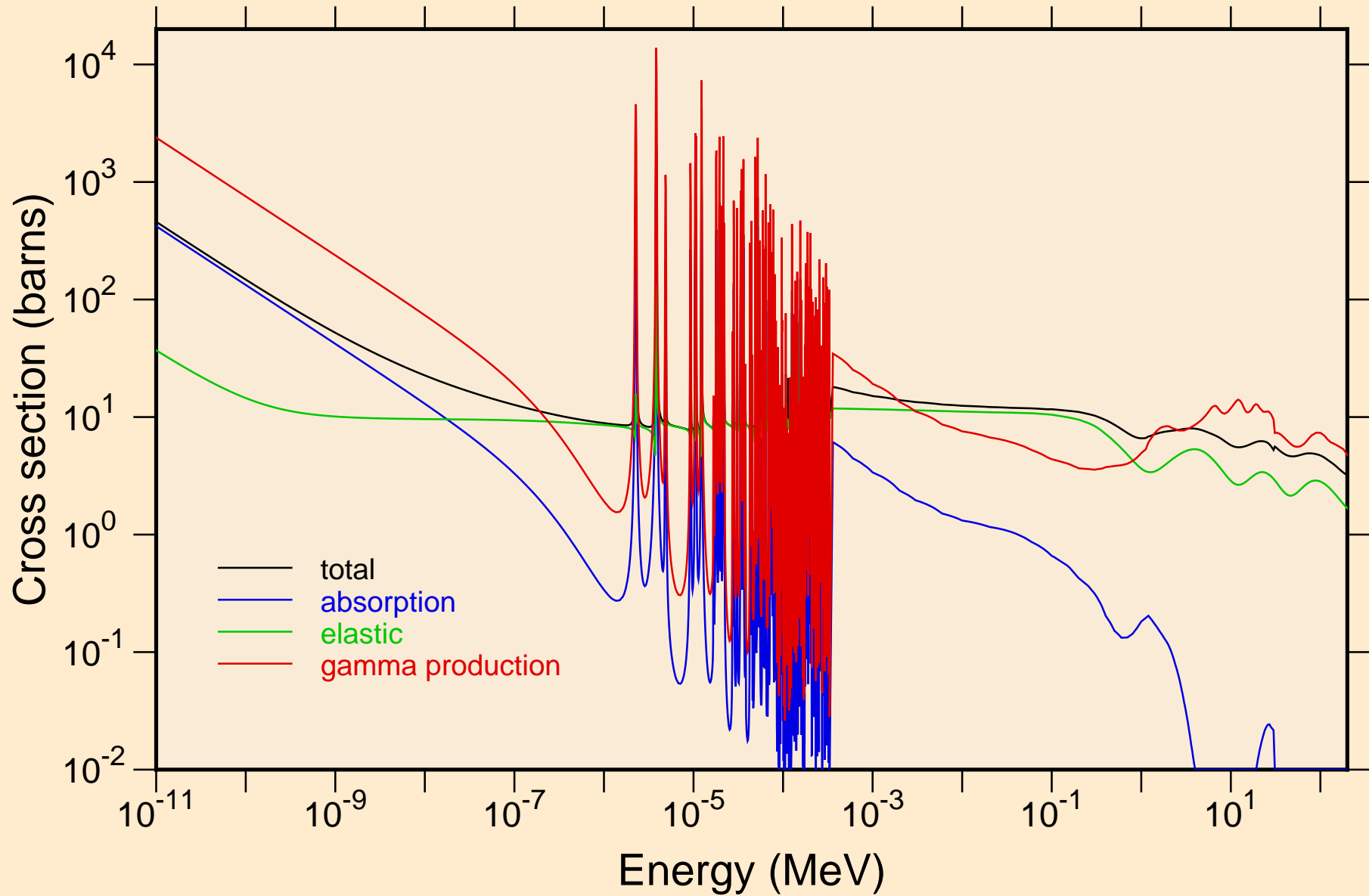

PA237 NRG TENDL-2015, AKONING
resonance total cross section

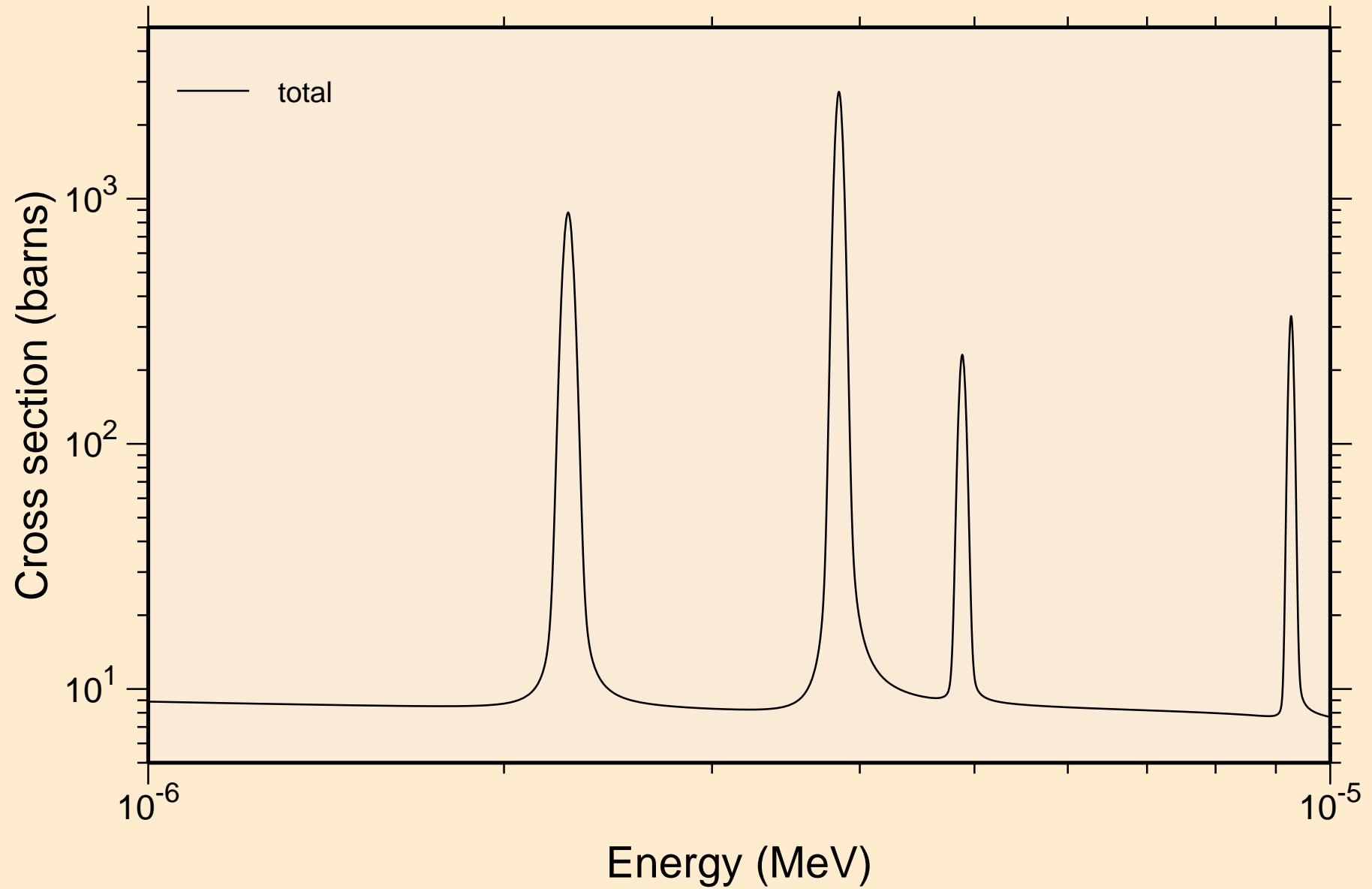

PA237 NRG TENDL-2015, AKONING
resonance total cross section

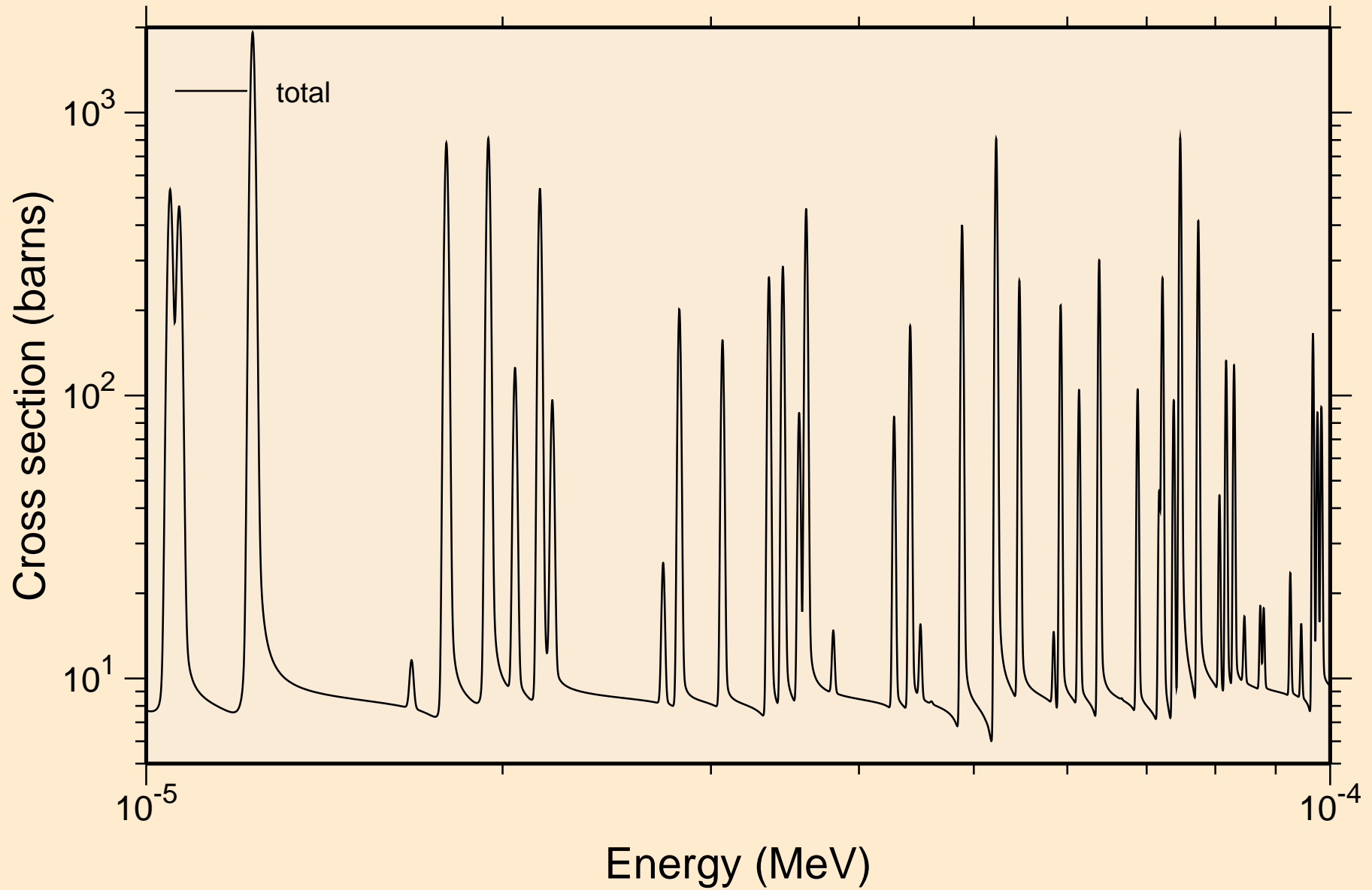

PA237 NRG TENDL-2015, AKONING
resonance total cross section

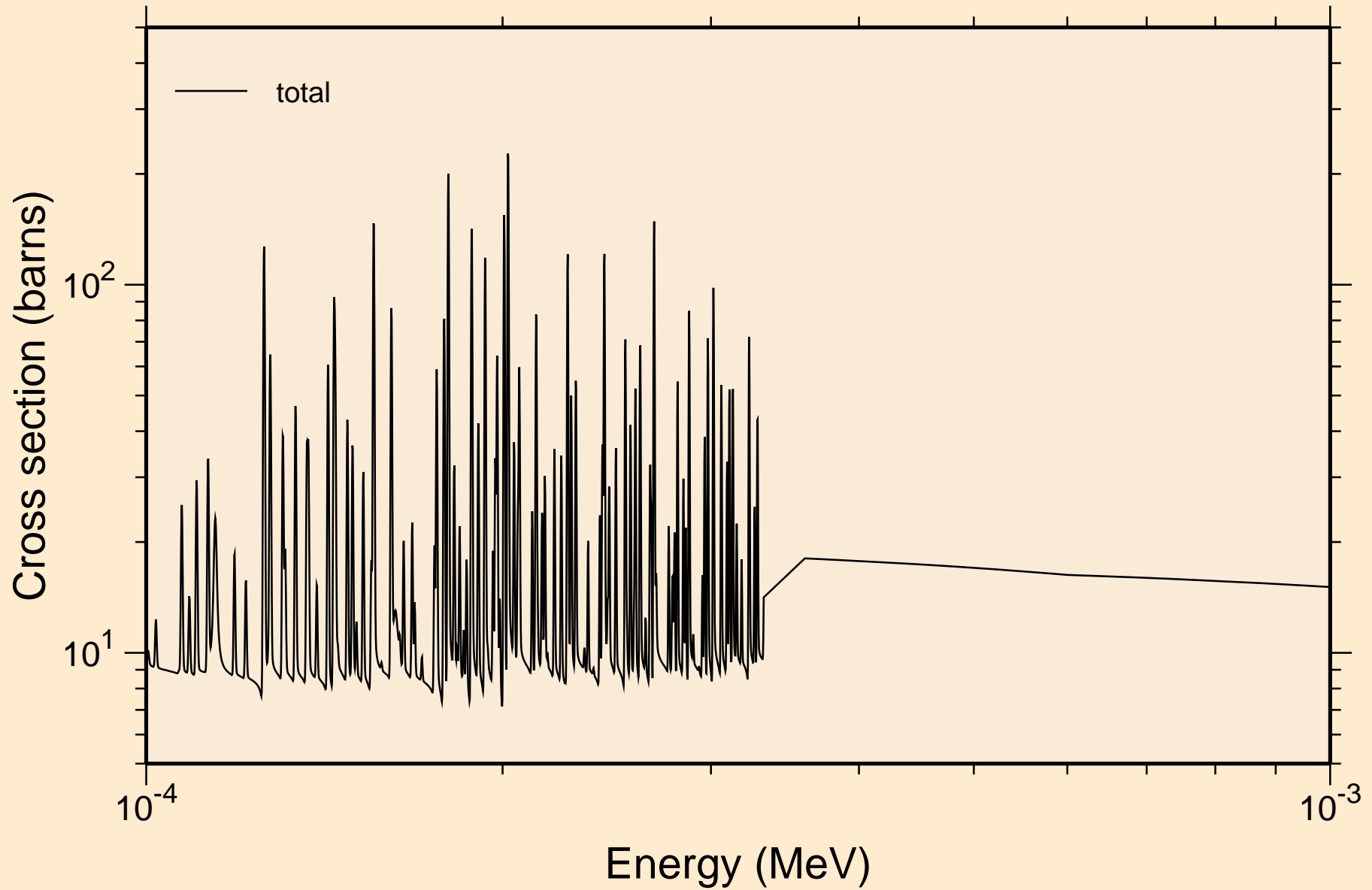

PA237 NRG TENDL-2015, AKONING
resonance total cross section

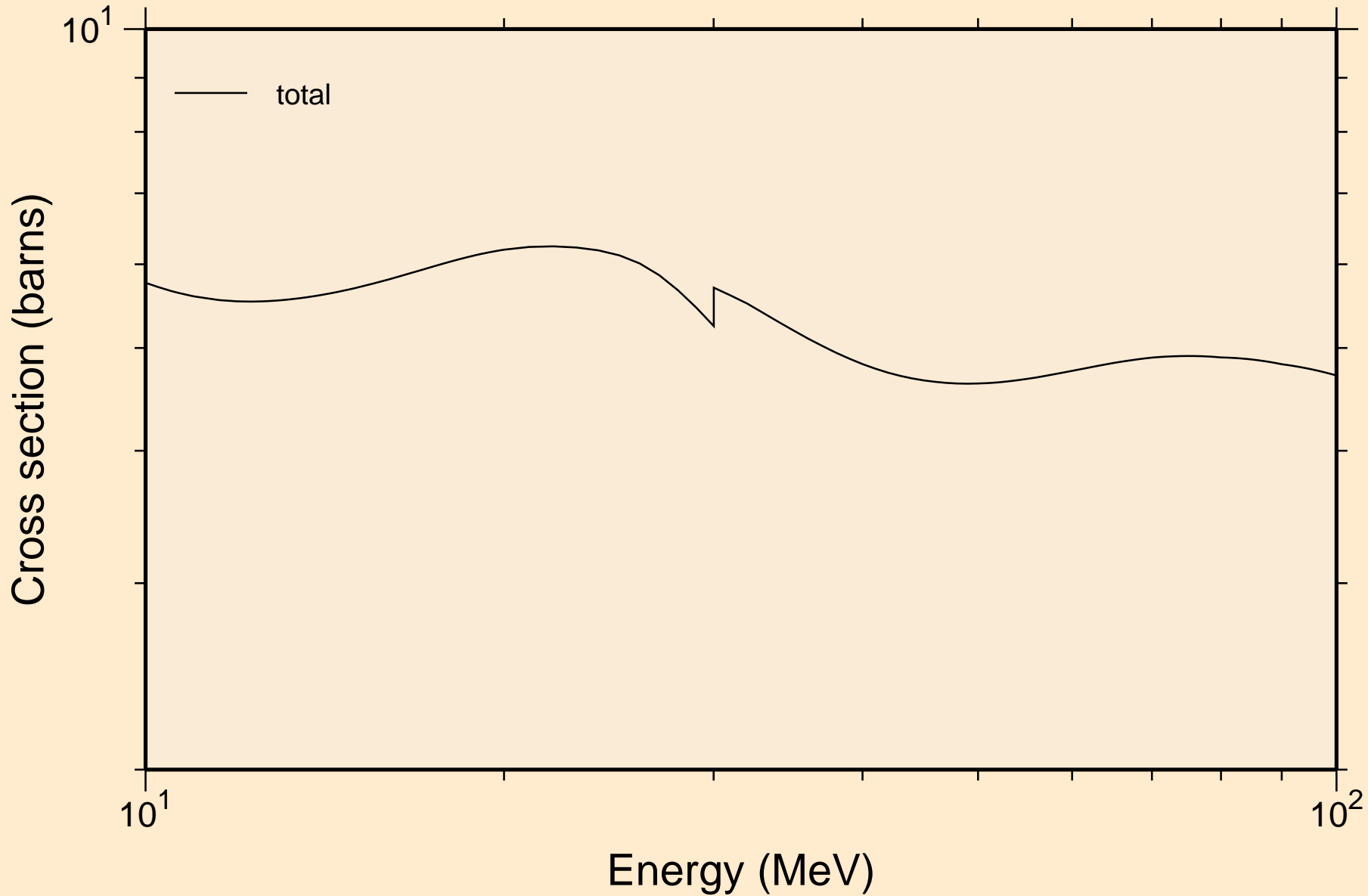

PA237 NRG TENDL-2015, AKONING
resonance absorption cross sections

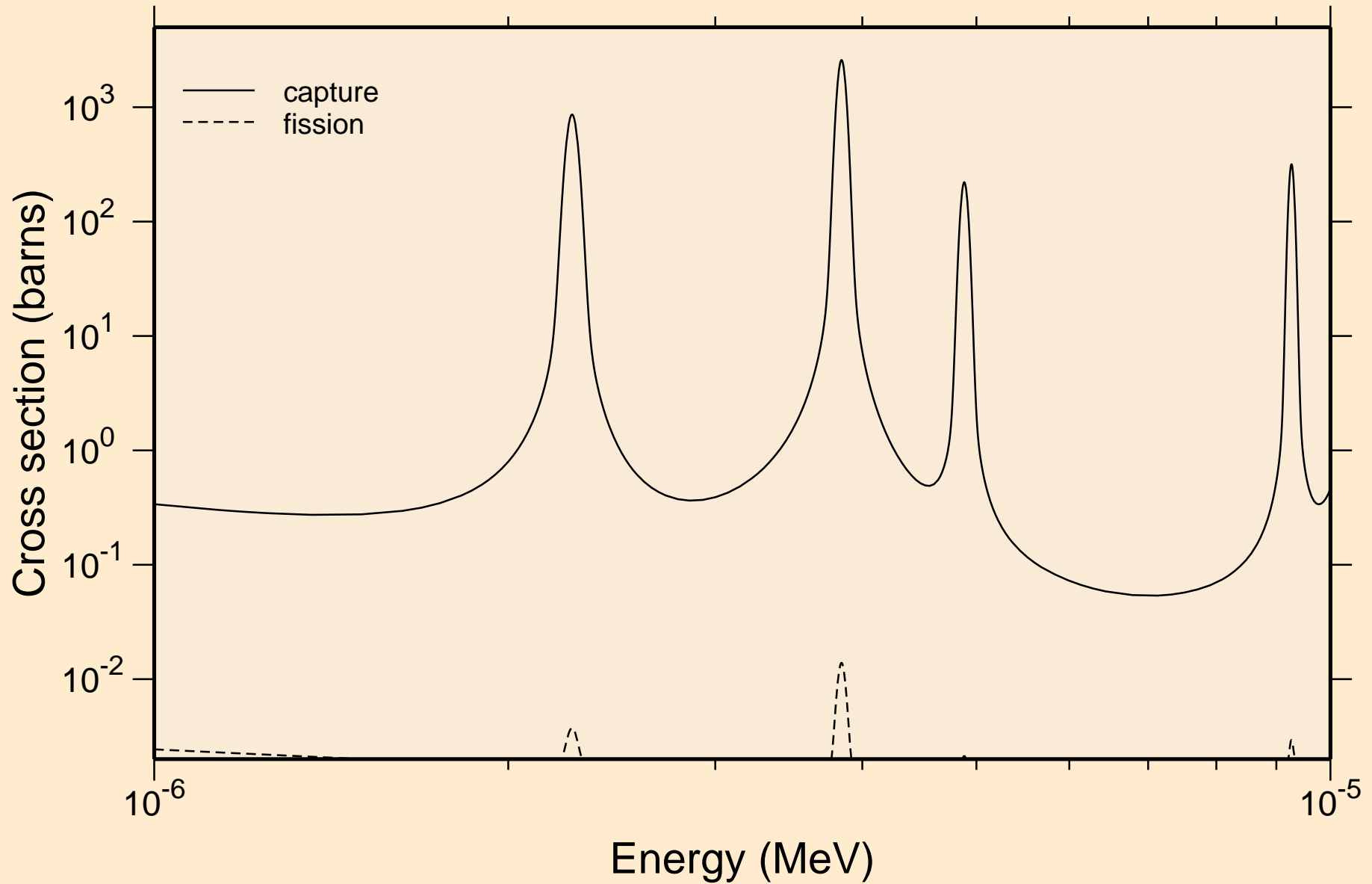

PA237 NRG TENDL-2015, AKONING

resonance absorption cross sections

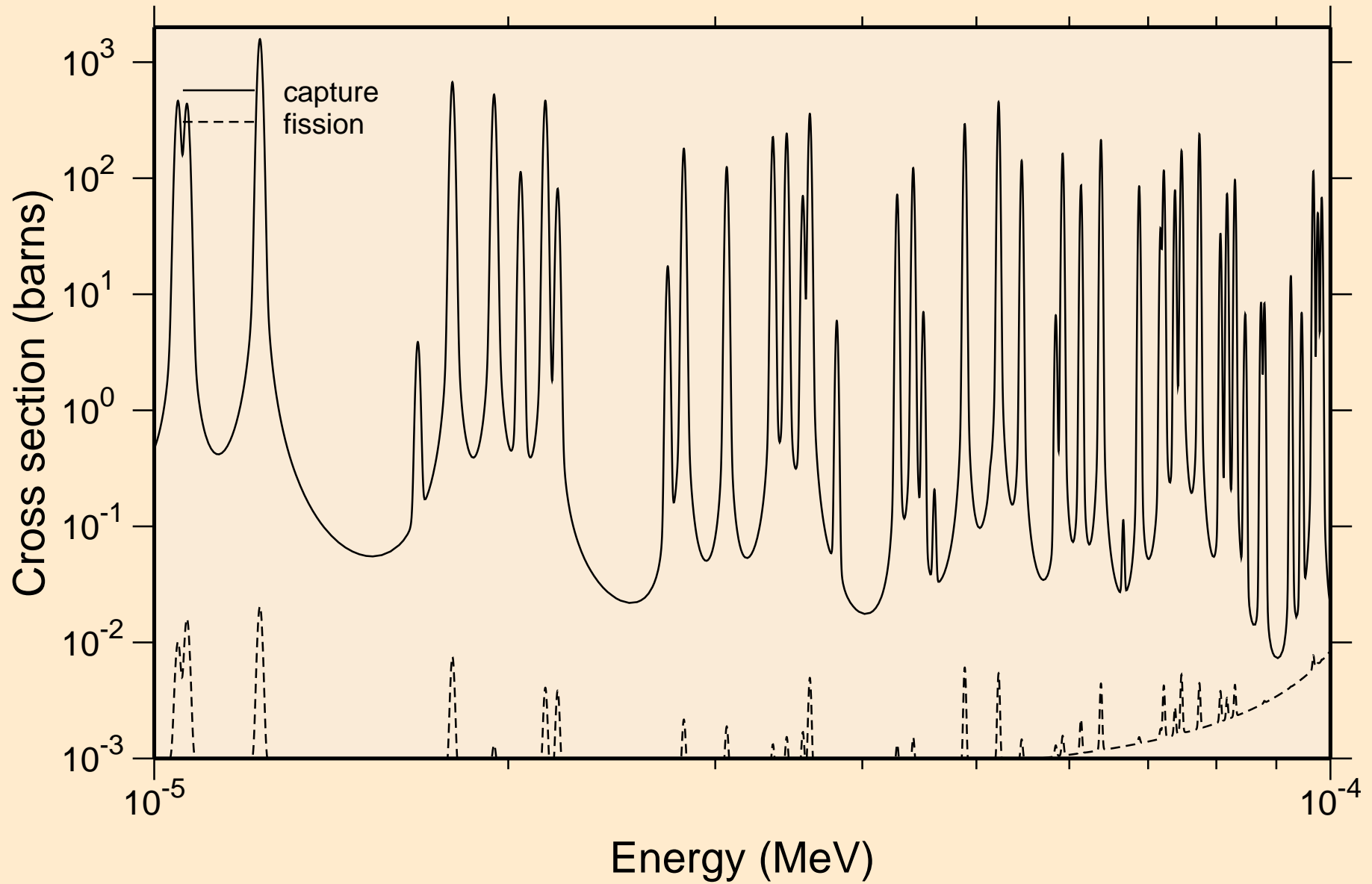

PA237 NRG TENDL-2015, AKONING
resonance absorption cross sections

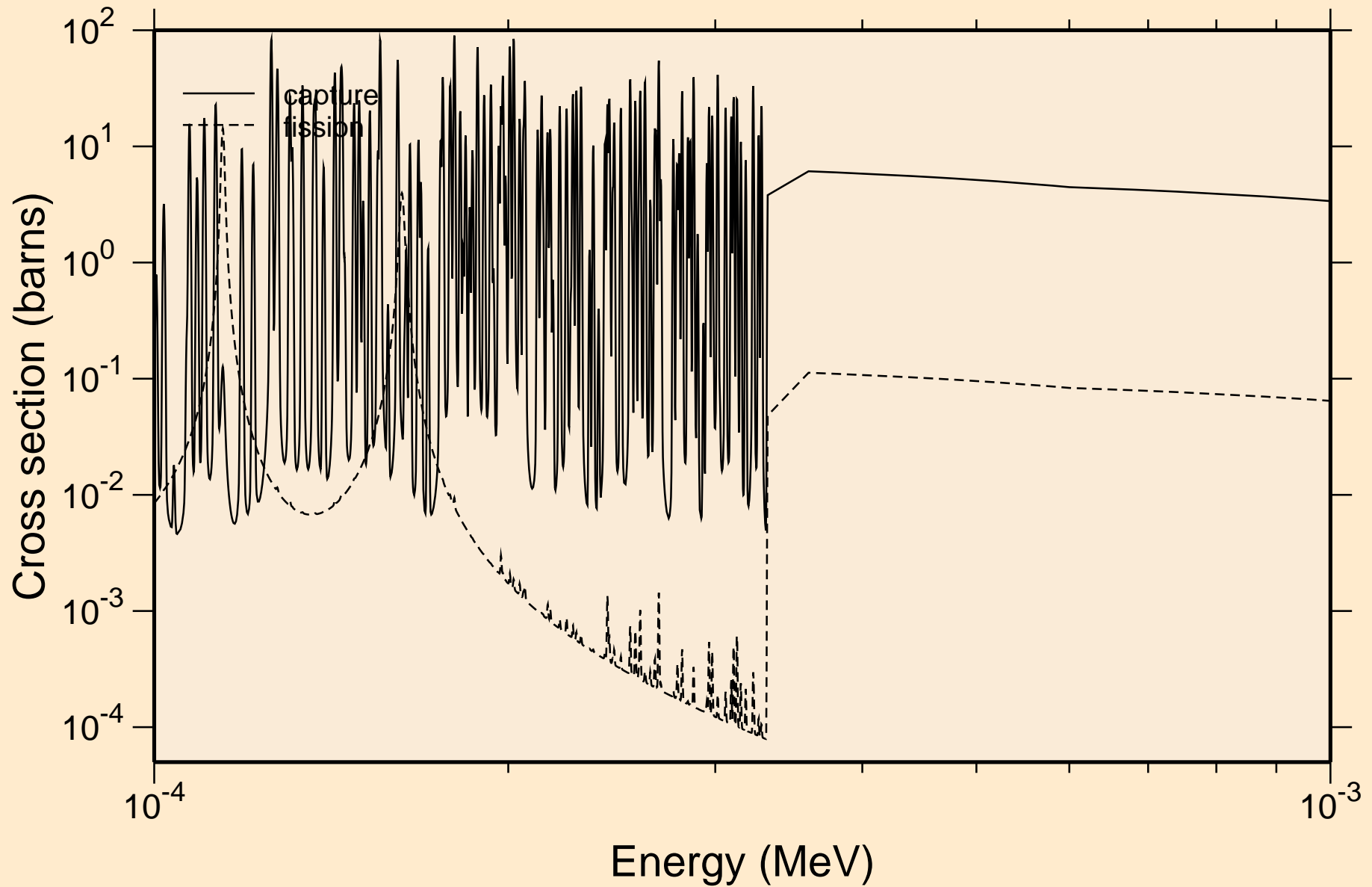

PA237 NRG TENDL-2015, AKONING
resonance absorption cross sections

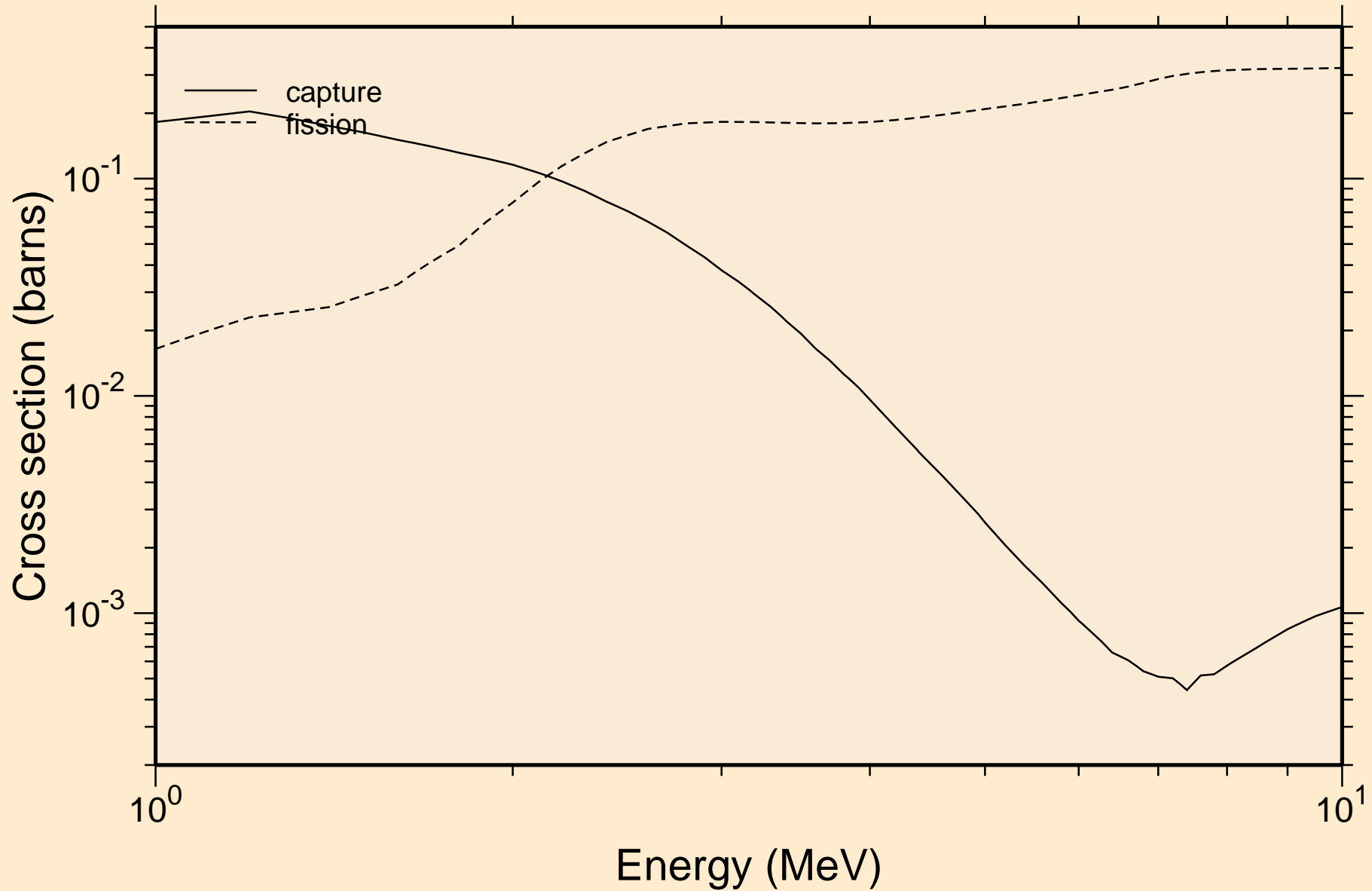

PA237 NRG TENDL-2015, AKONING

Non-threshold reactions

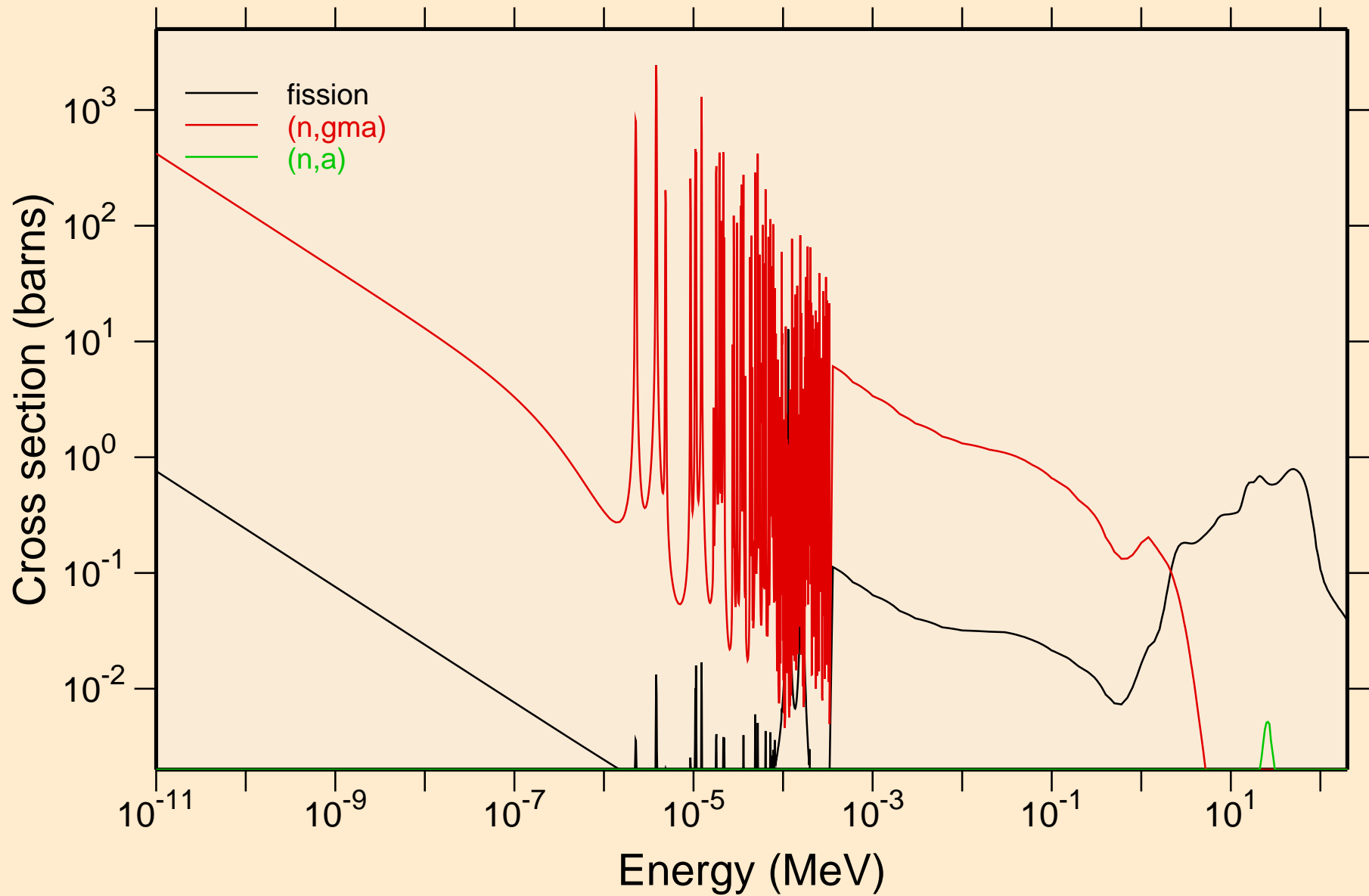

PA237 NRG TENDL-2015, AKONING

Principal cross sections

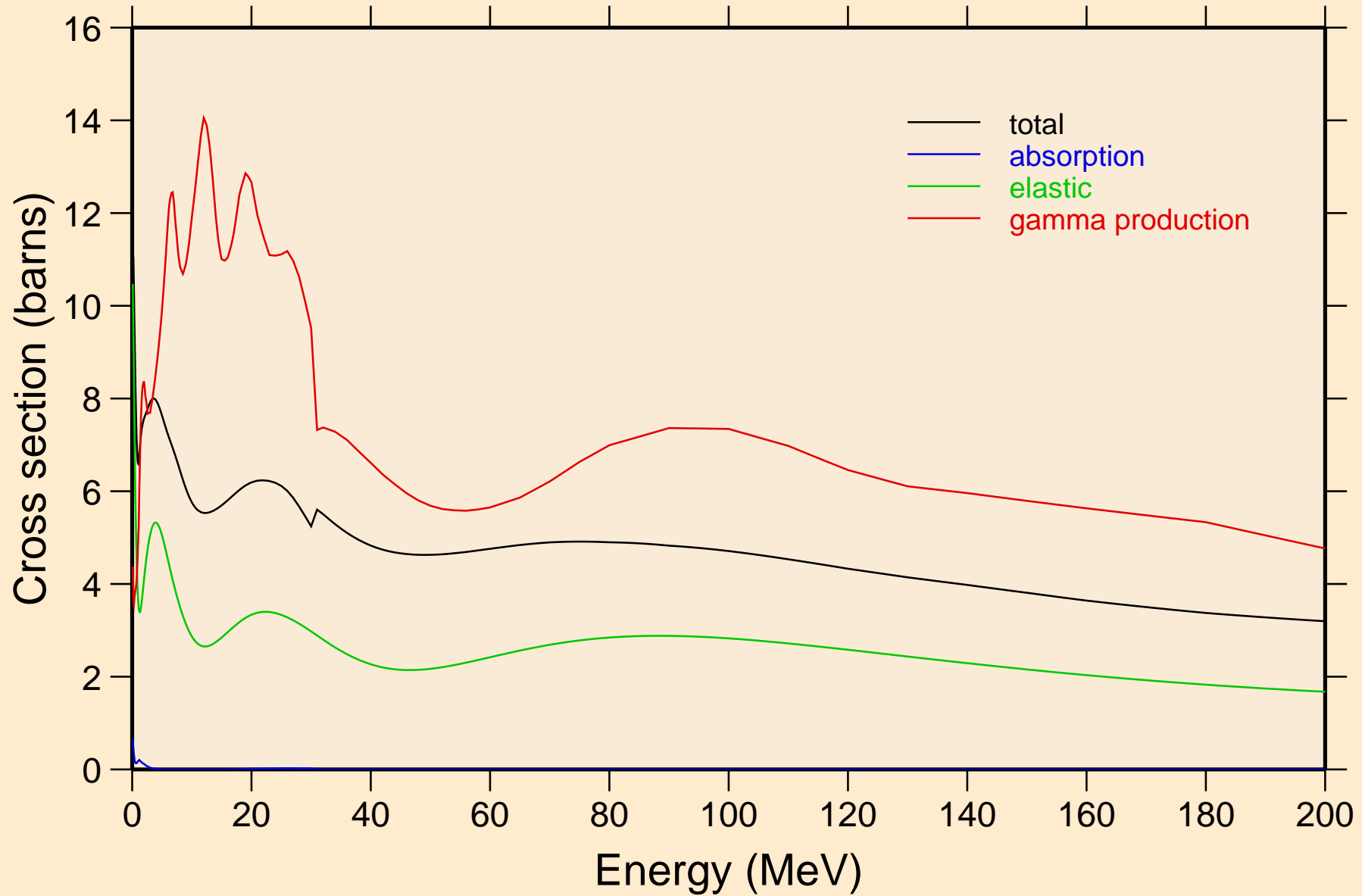

PA237 NRG TENDL-2015, AKONING

Non-threshold reactions

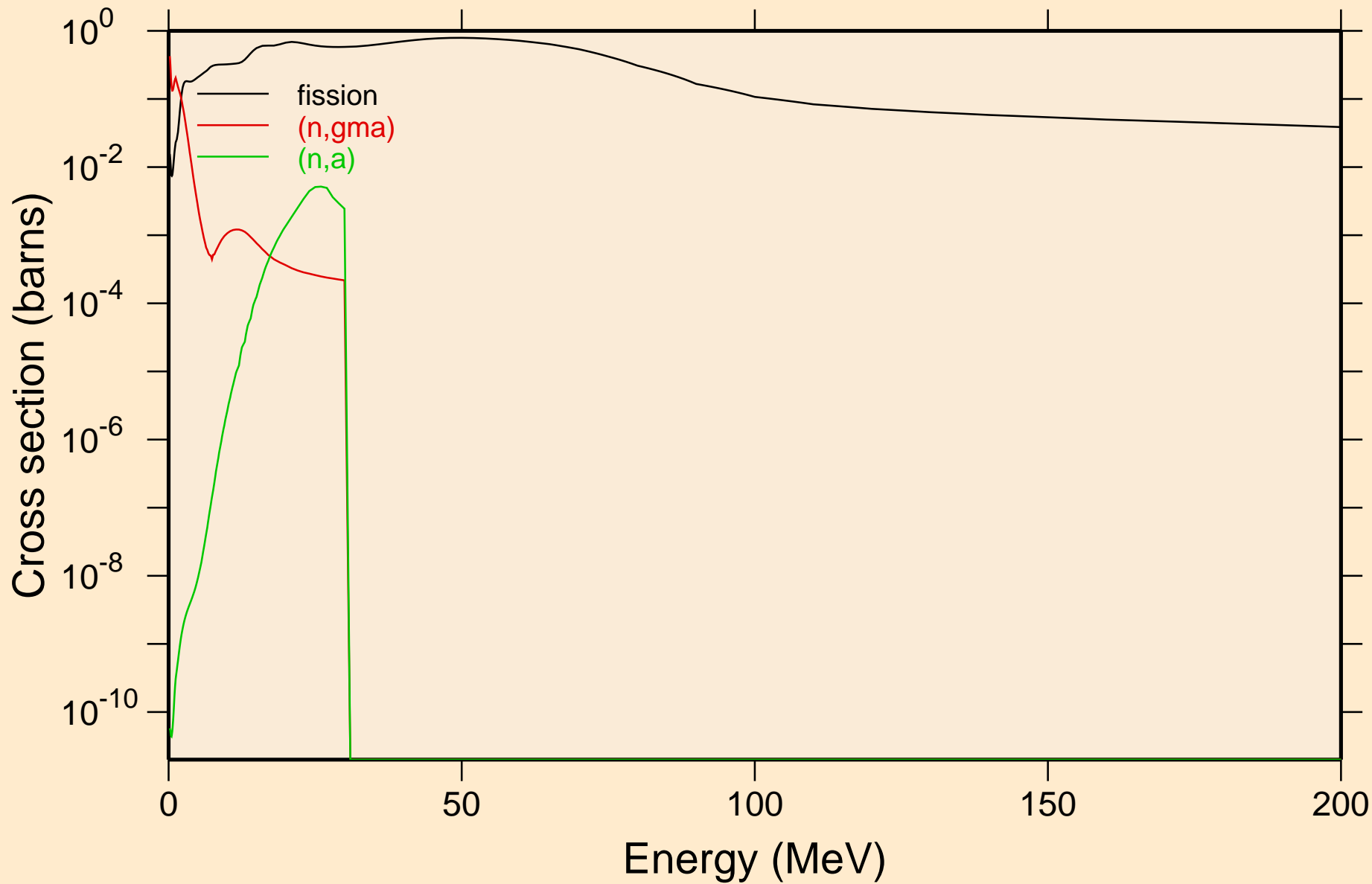

PA237 NRG TENDL-2015, AKONING
Inelastic levels

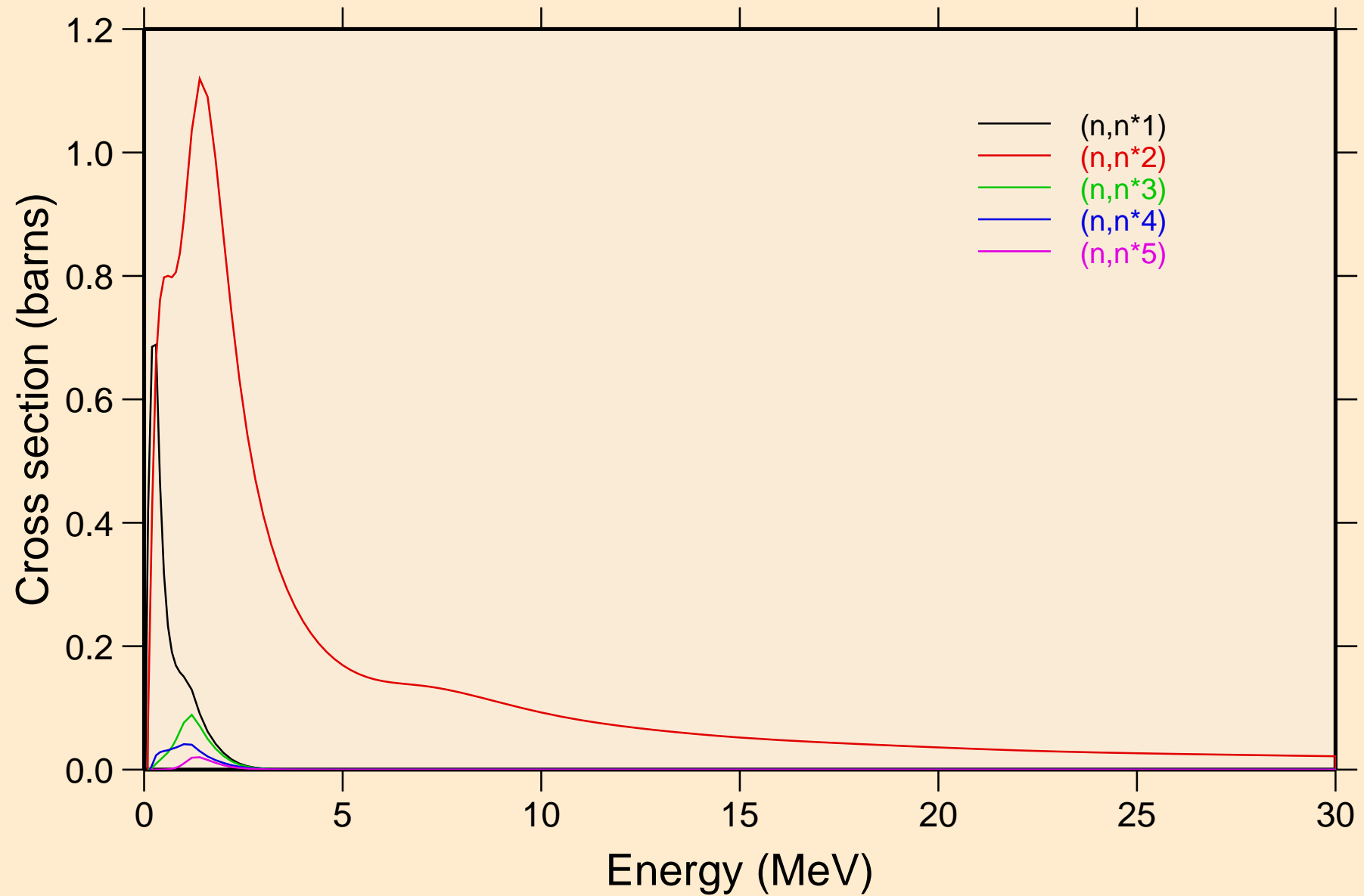

PA237 NRG TENDL-2015, AKONING

Inelastic levels

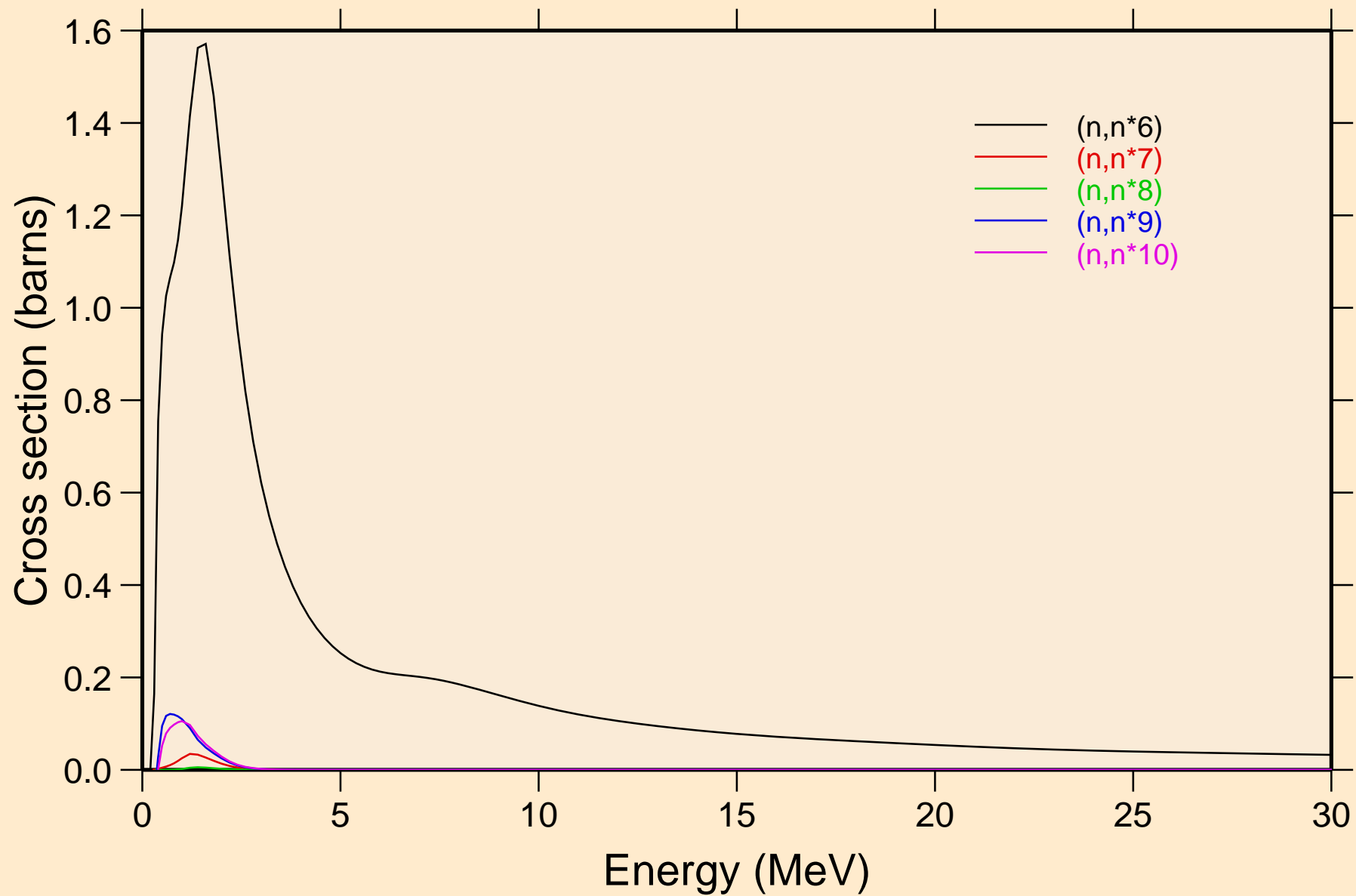

PA237 NRG TENDL-2015, AKONING

Inelastic levels

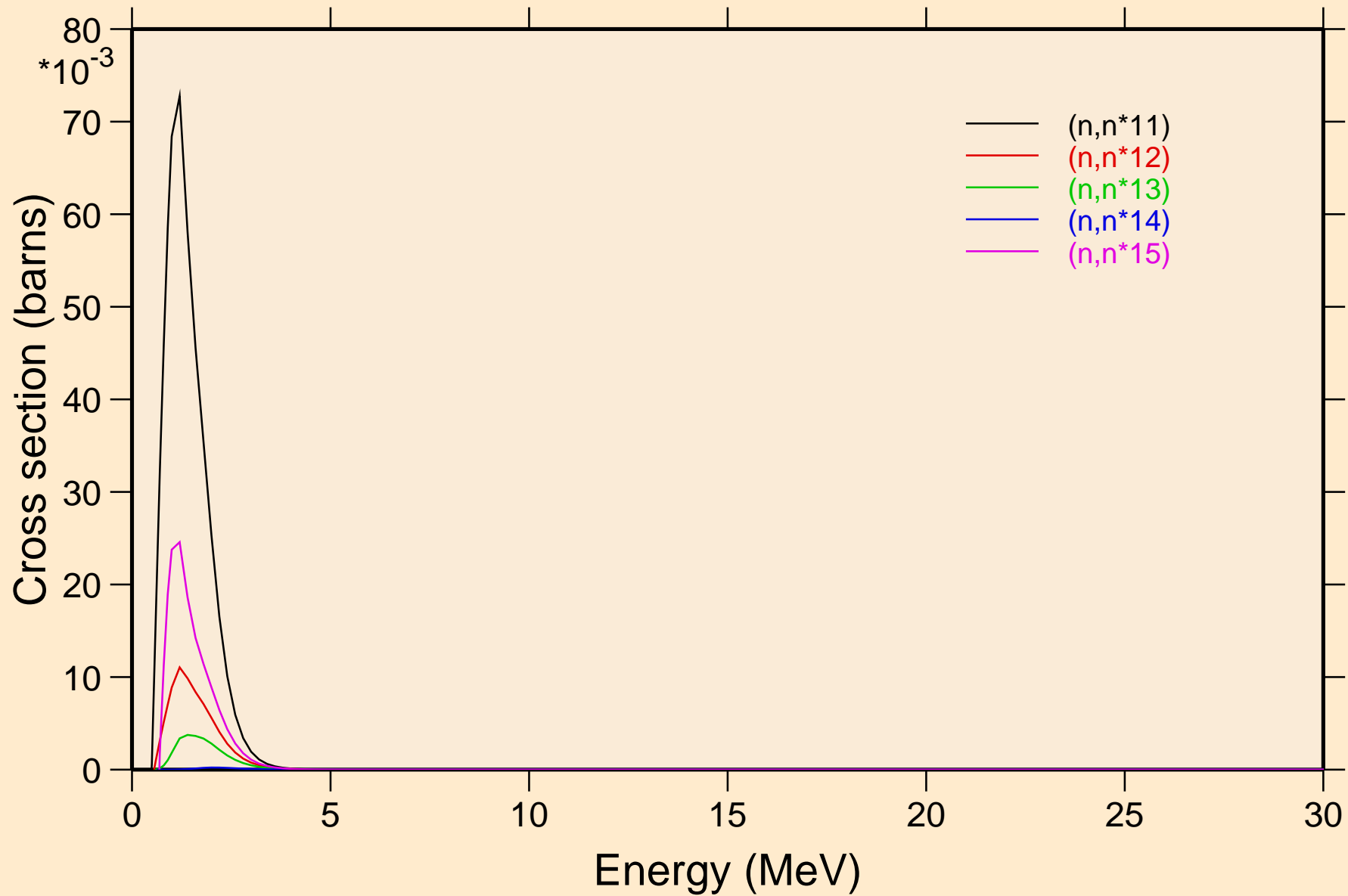

PA237 NRG TENDL-2015, AKONING

Inelastic levels

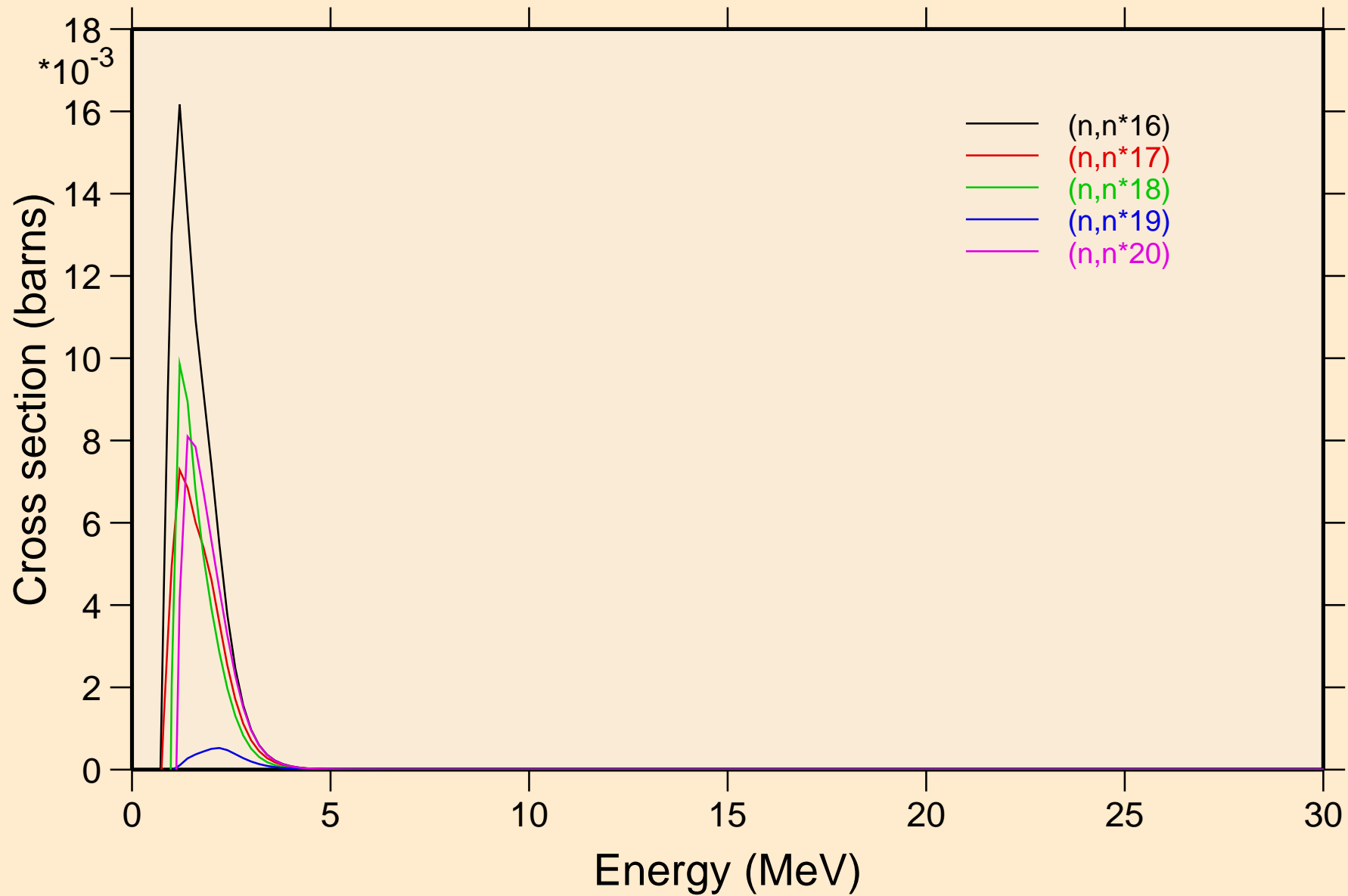

PA237 NRG TENDL-2015, AKONING
Inelastic levels

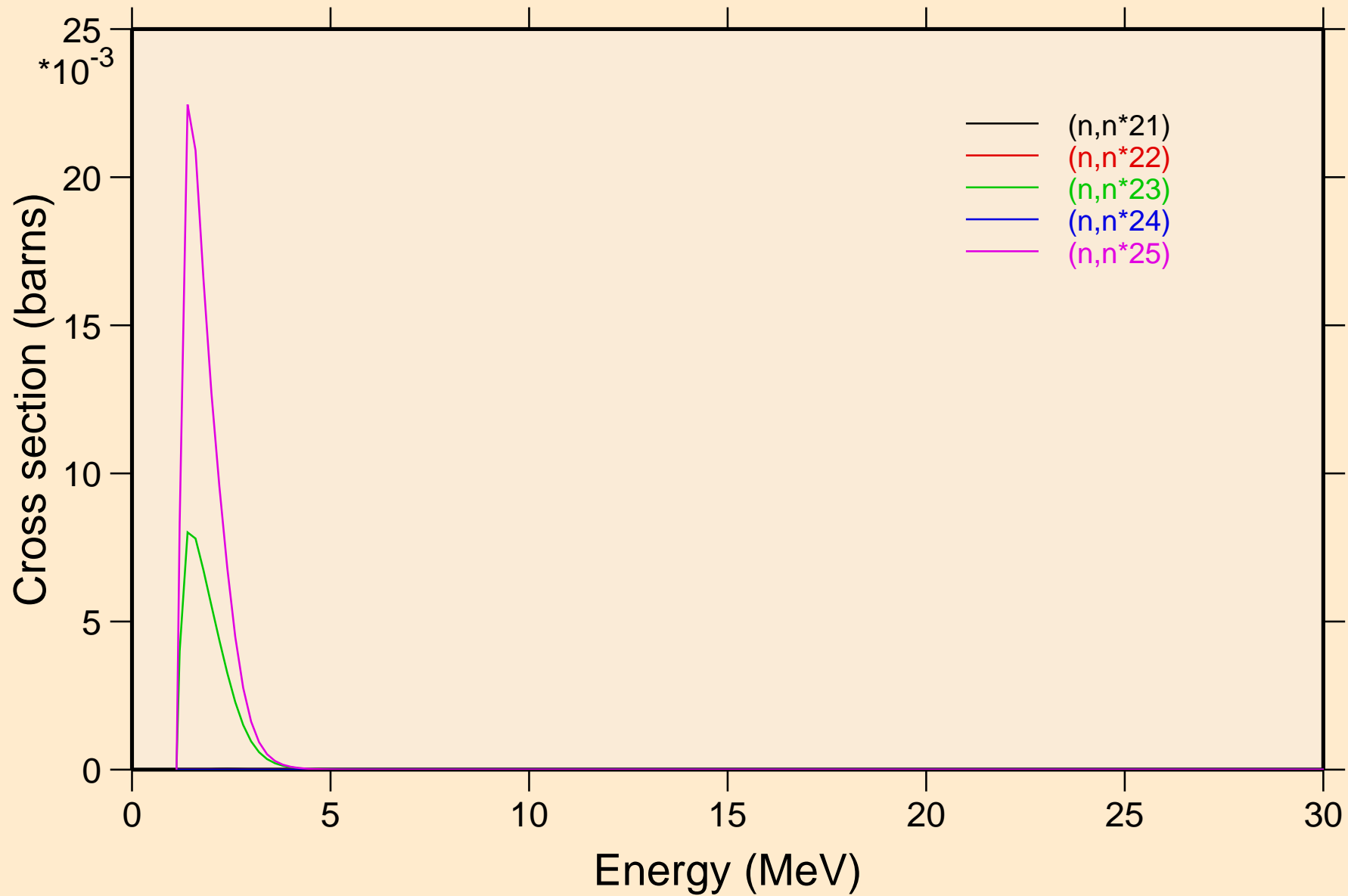

PA237 NRG TENDL-2015, AKONING

Inelastic levels

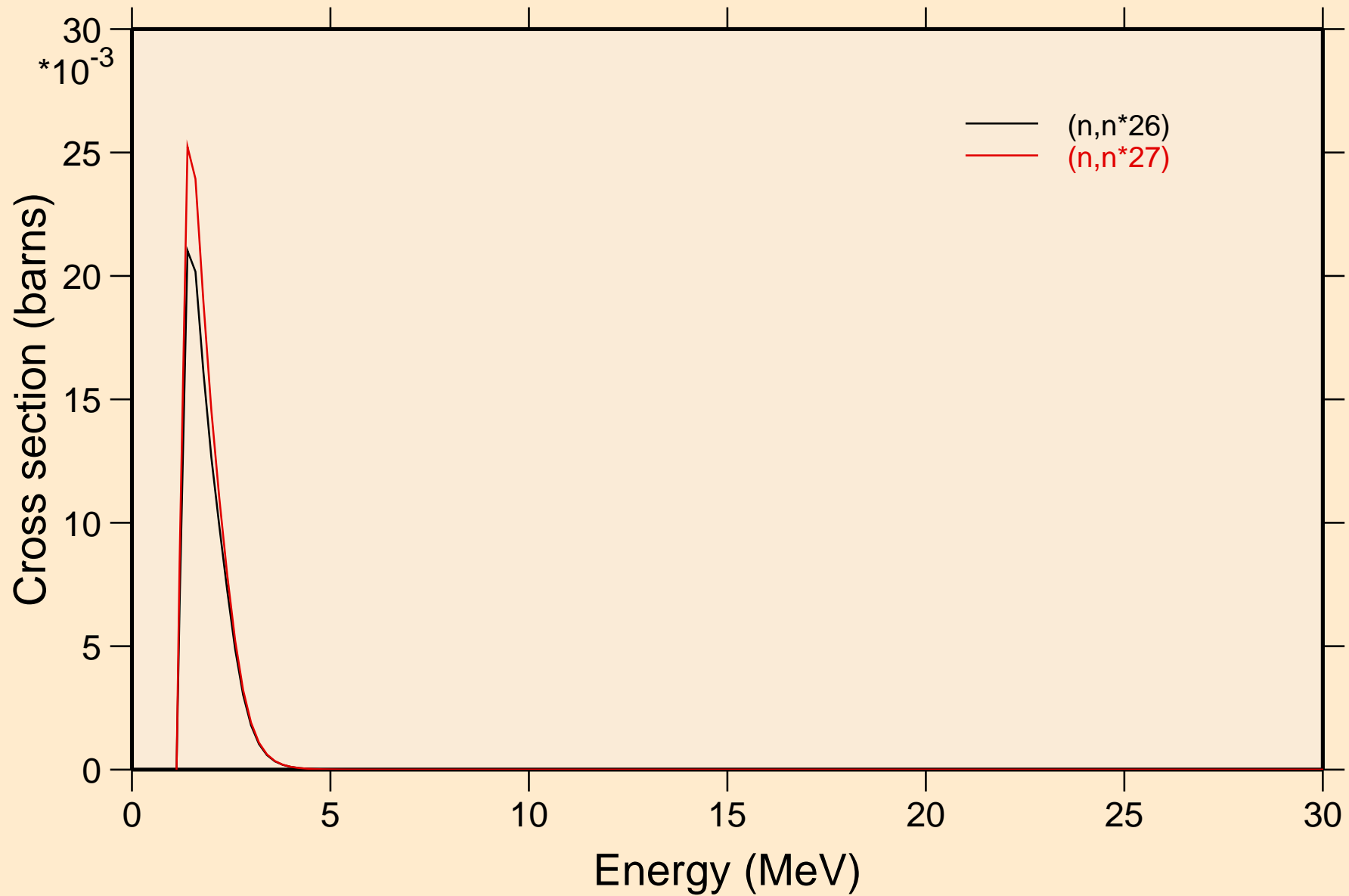

PA237 NRG TENDL-2015, AKONING

Threshold reactions

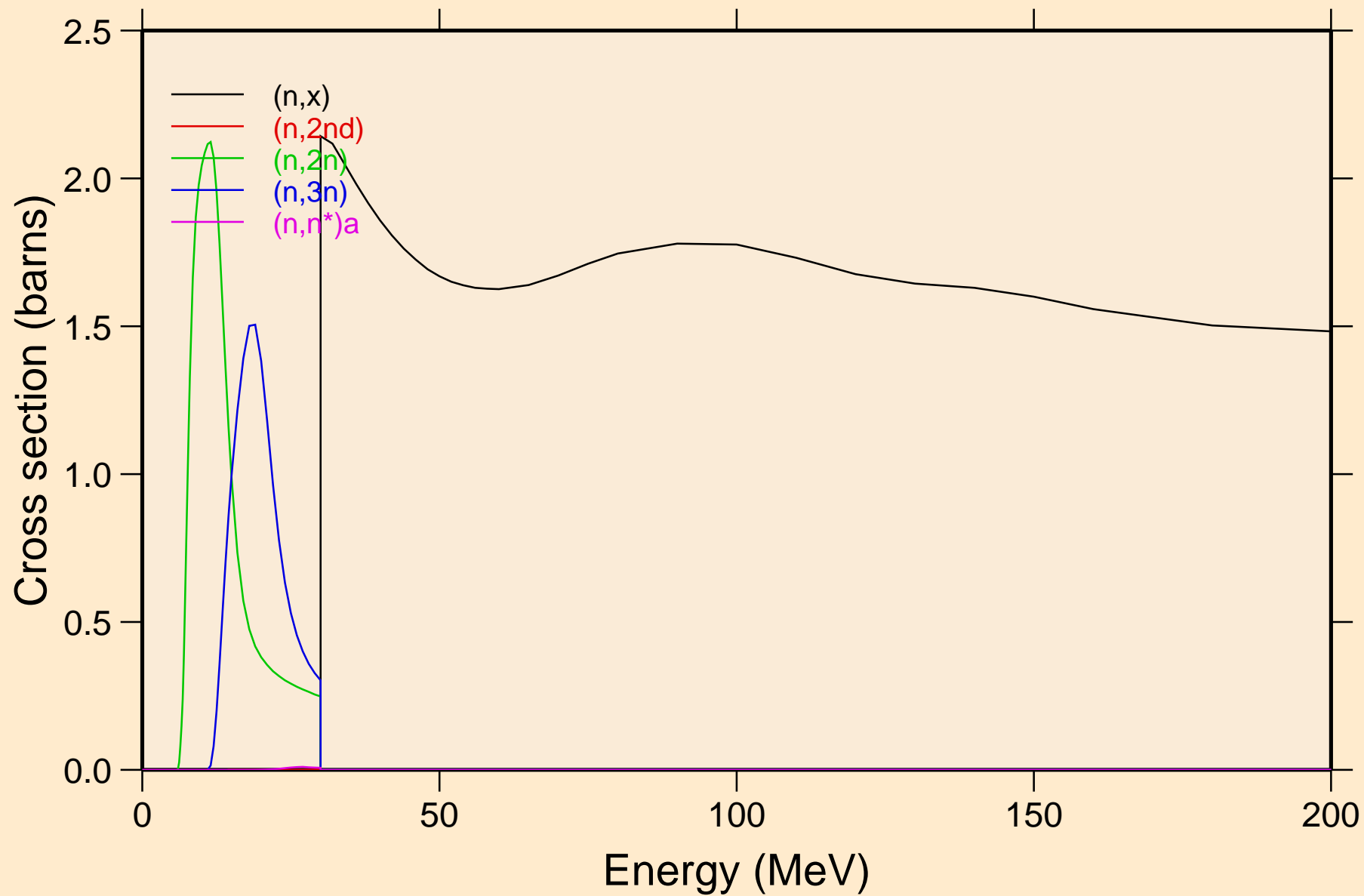

PA237 NRG TENDL-2015, AKONING

Threshold reactions

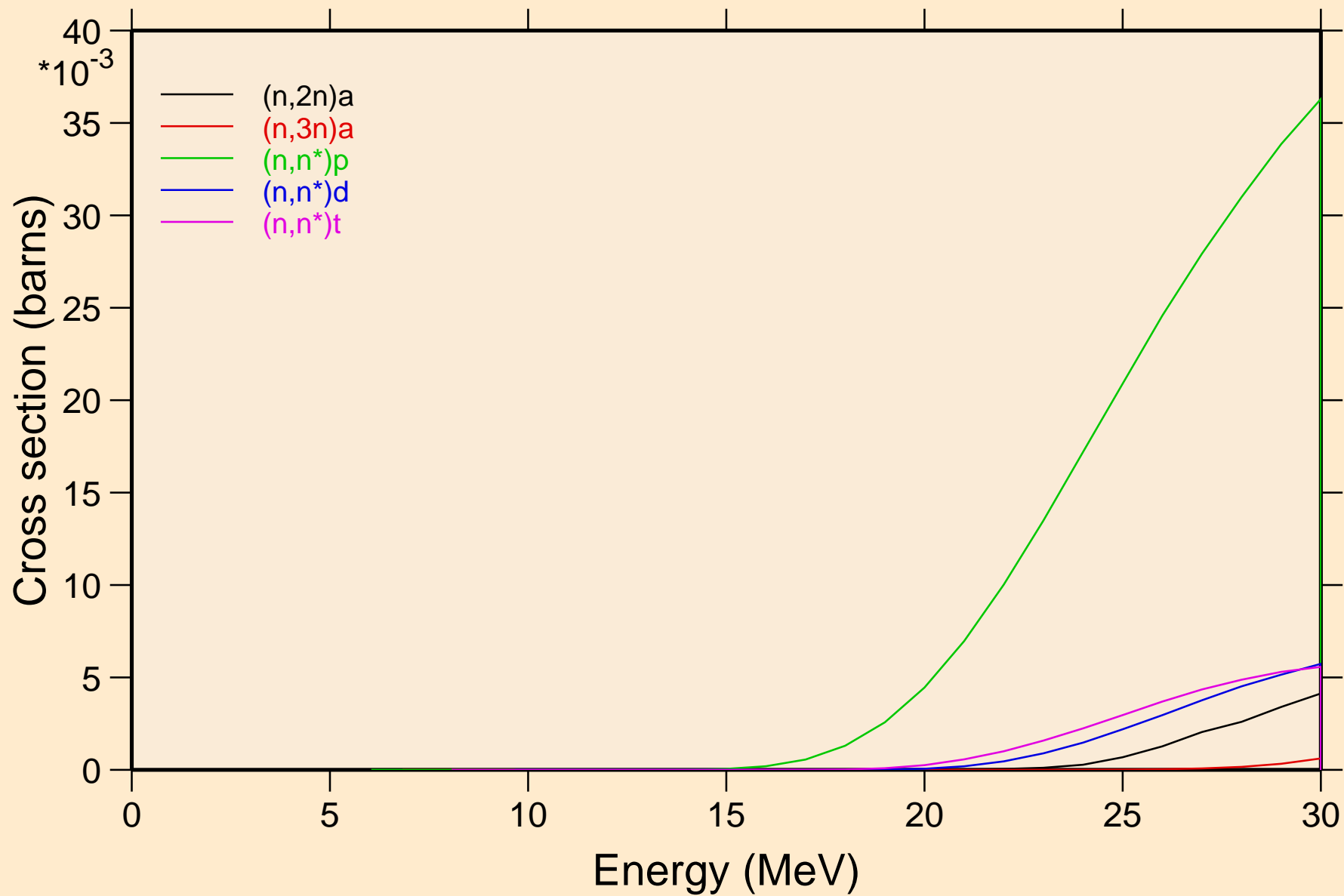

PA237 NRG TENDL-2015, AKONING

Threshold reactions

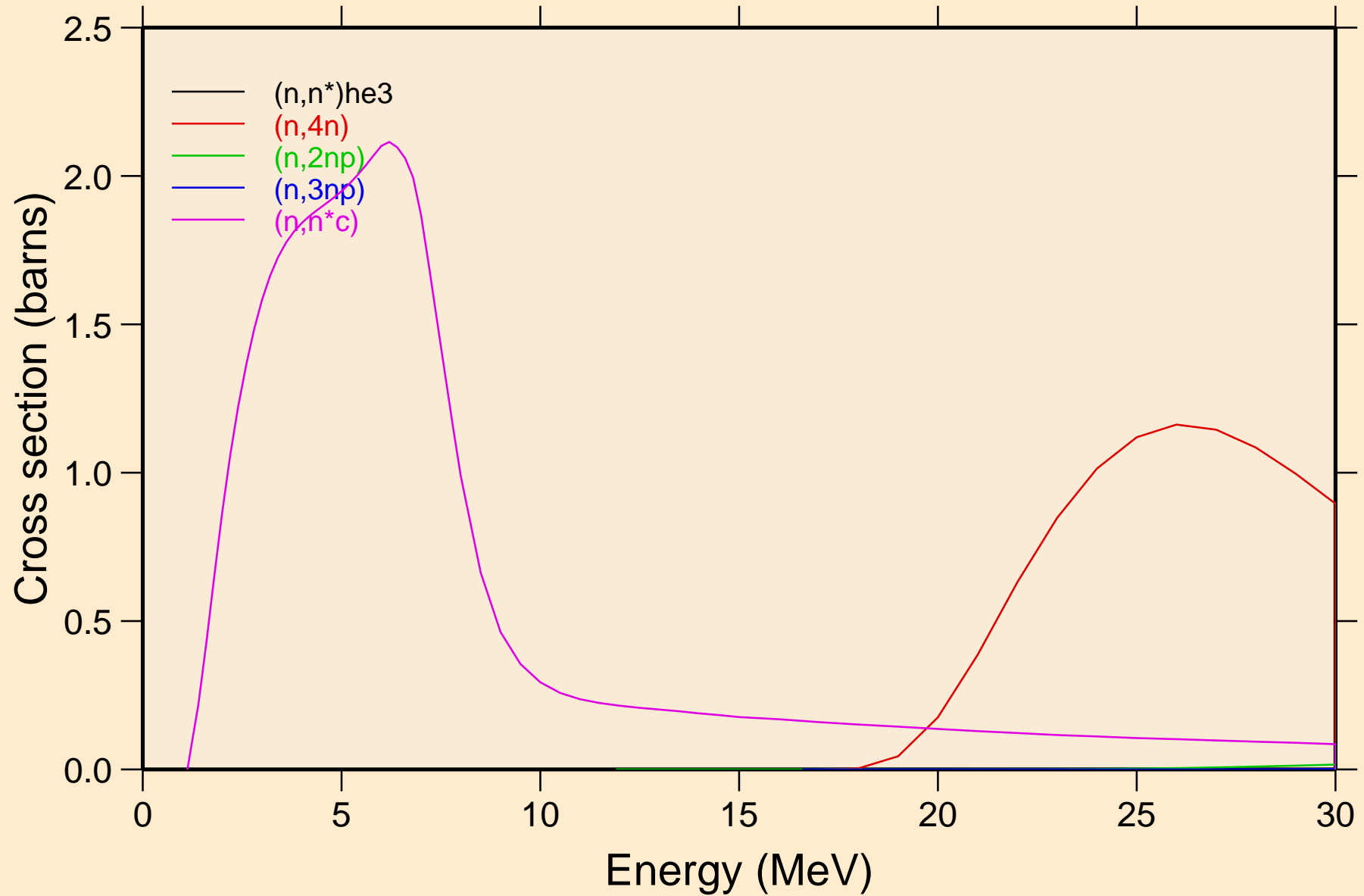

PA237 NRG TENDL-2015, AKONING

Threshold reactions

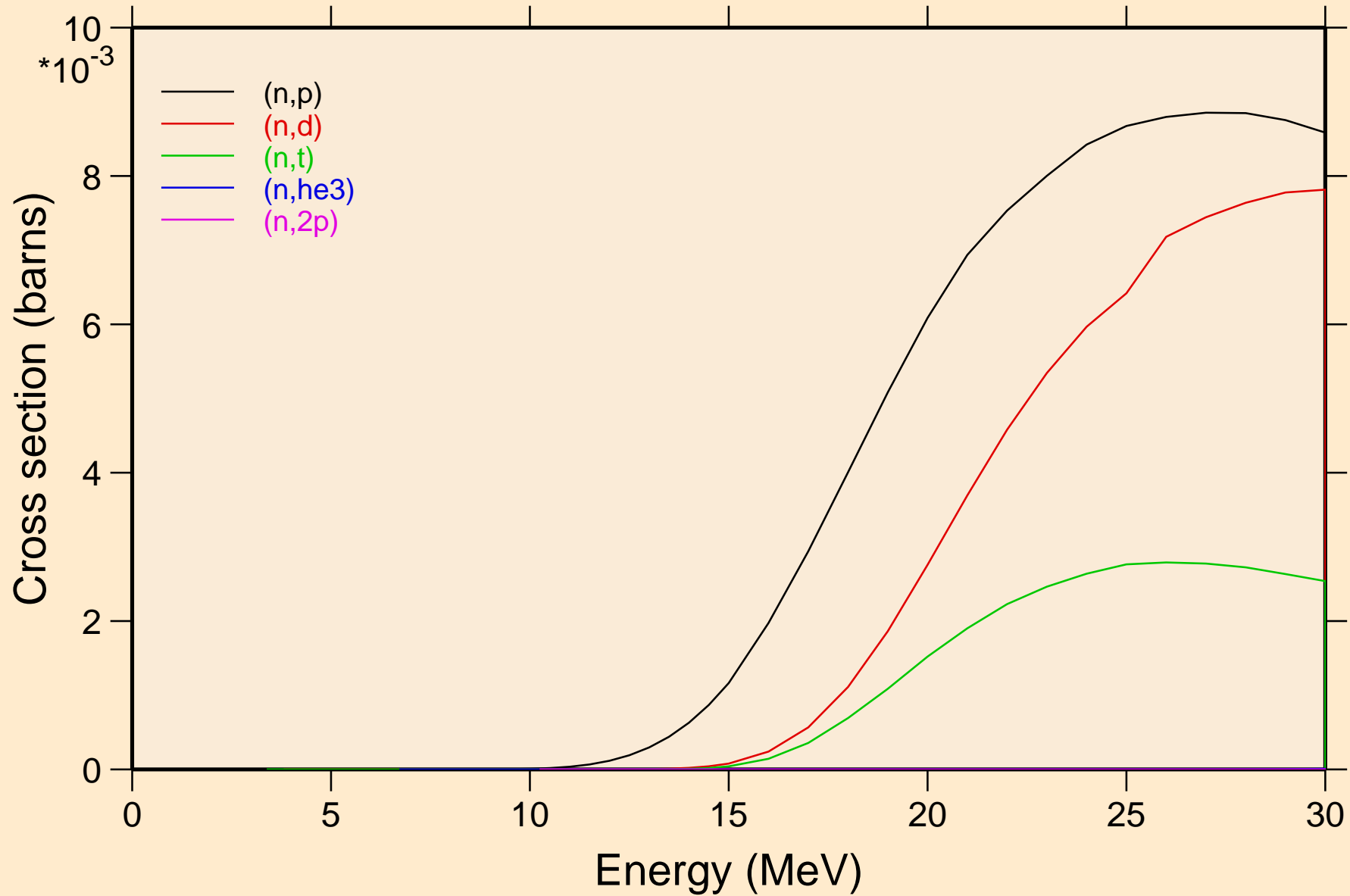

PA237 NRG TENDL-2015, AKONING
angular distribution for elastic

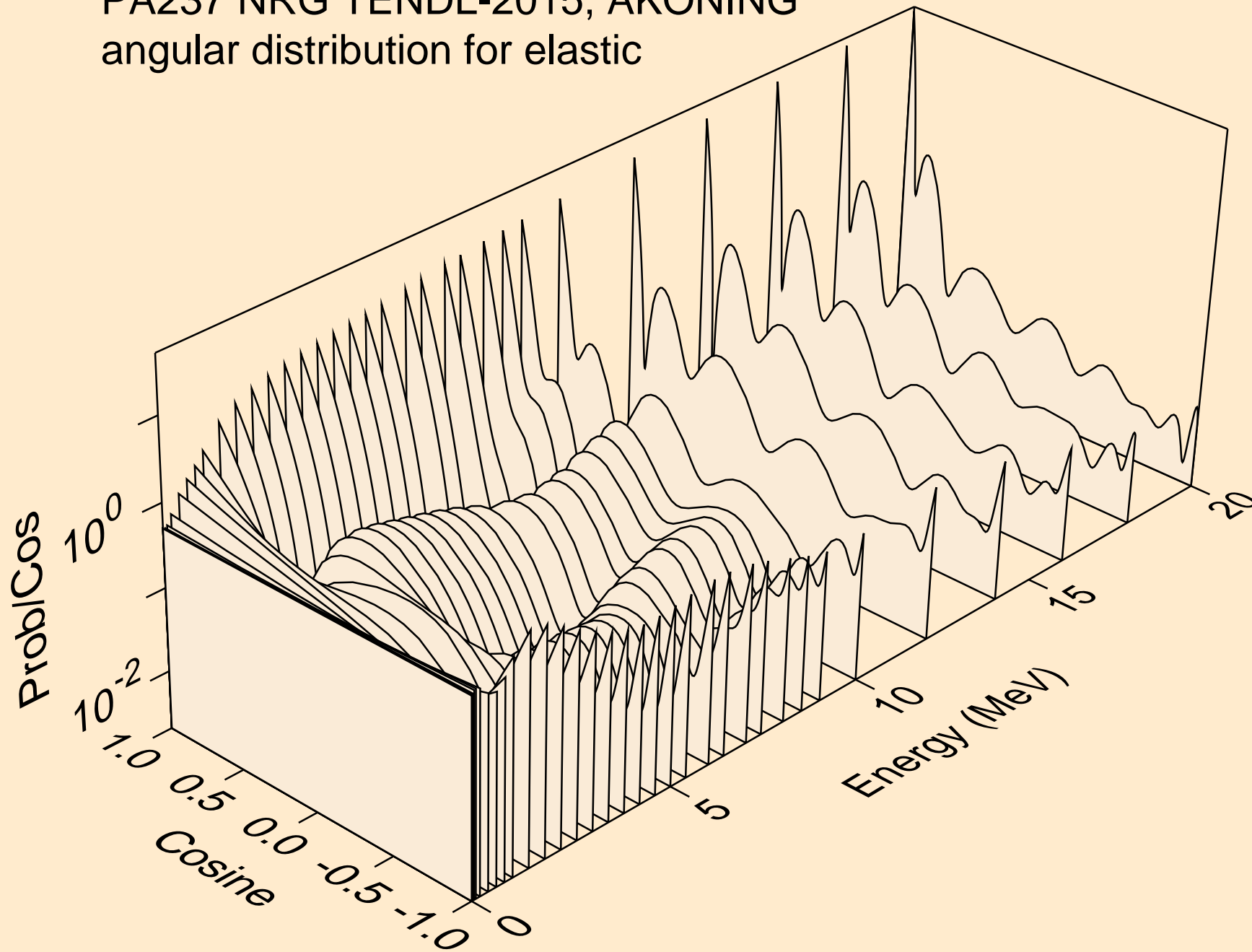

PA237 NRG TENDL-2015, AKONING
angular distribution for elastic

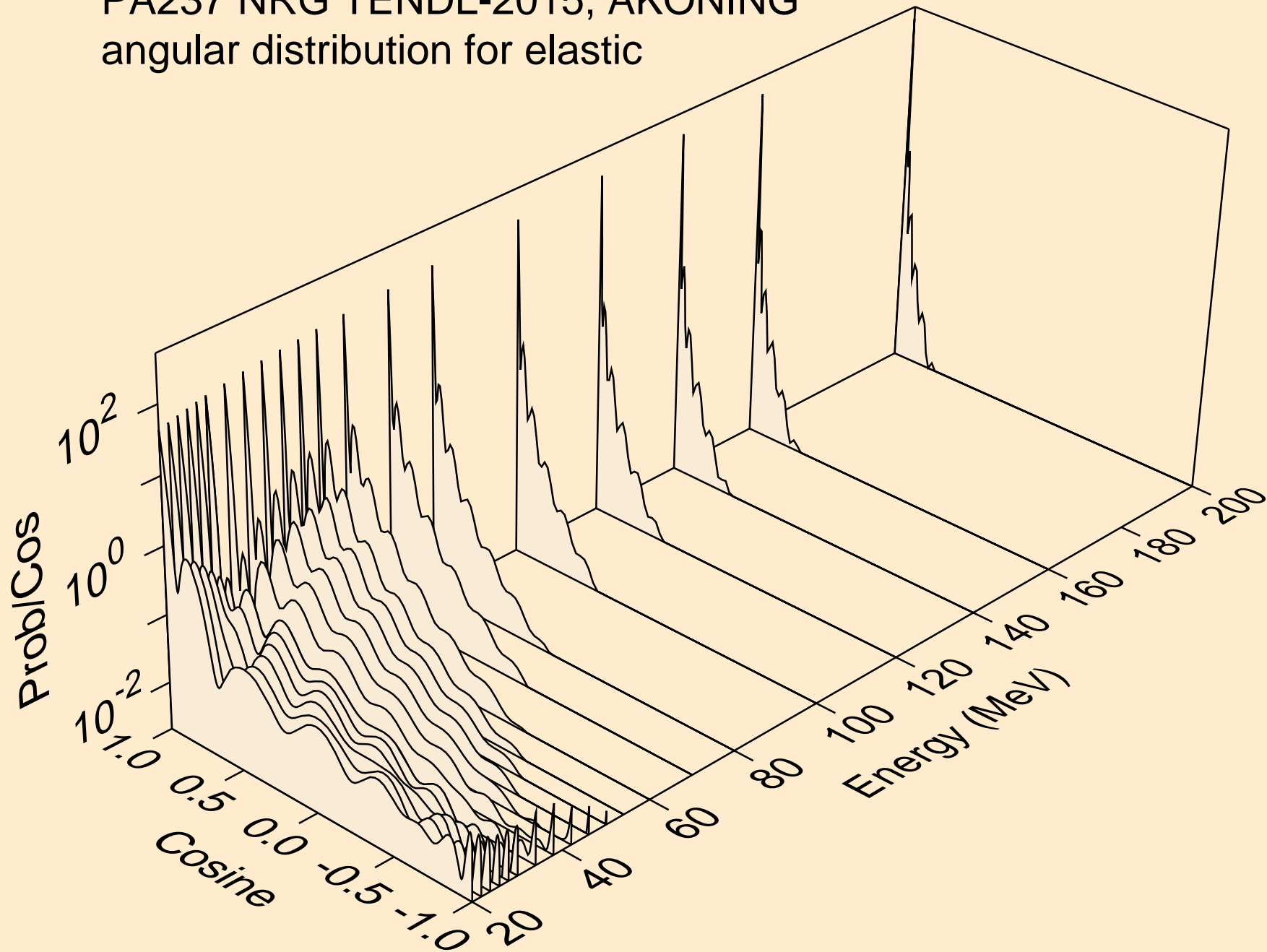

PA237 NRG TENDL-2015, AKONING
angular distribution for (n,n*1)

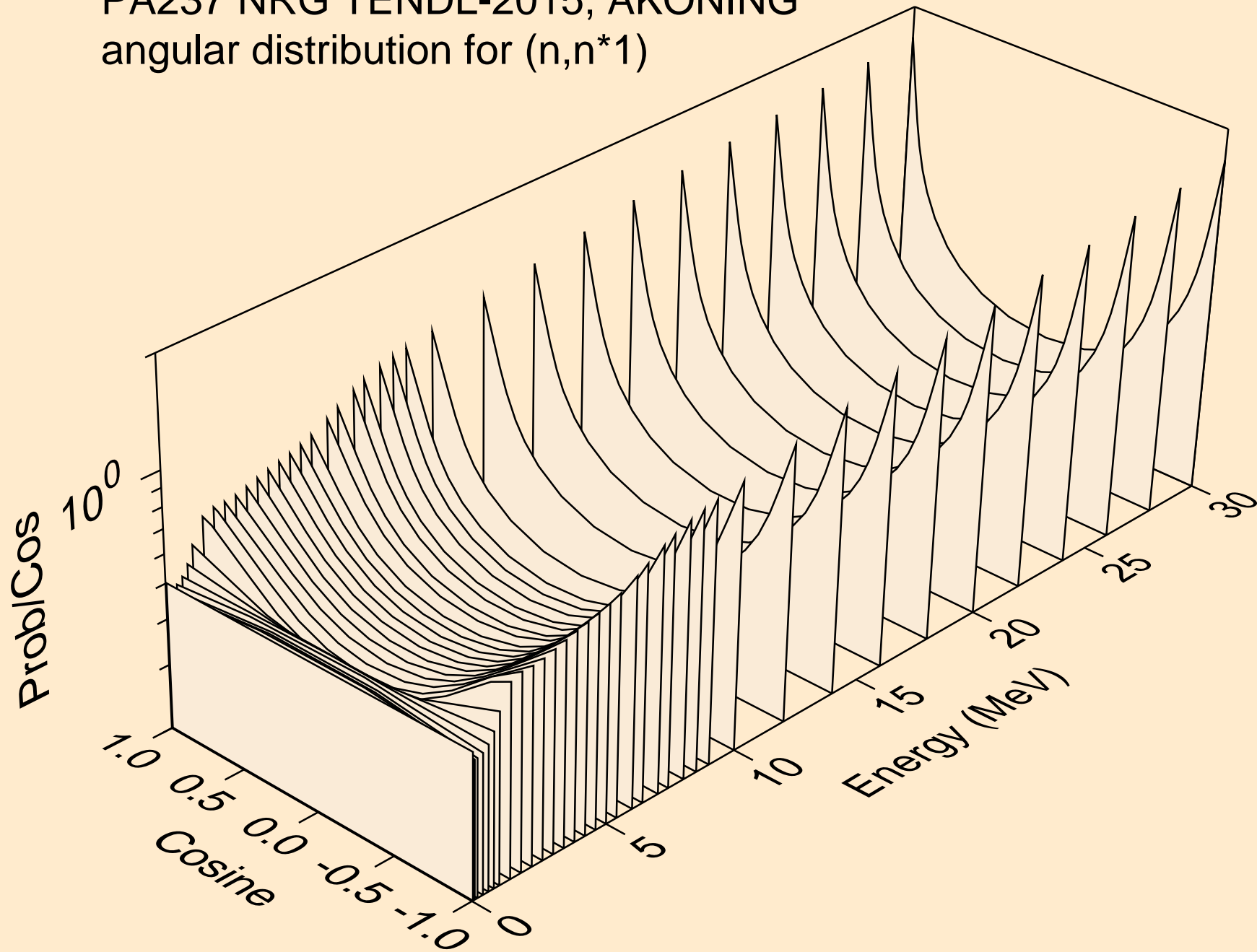

PA237 NRG TENDL-2015, AKONING
angular distribution for (n,n*2)

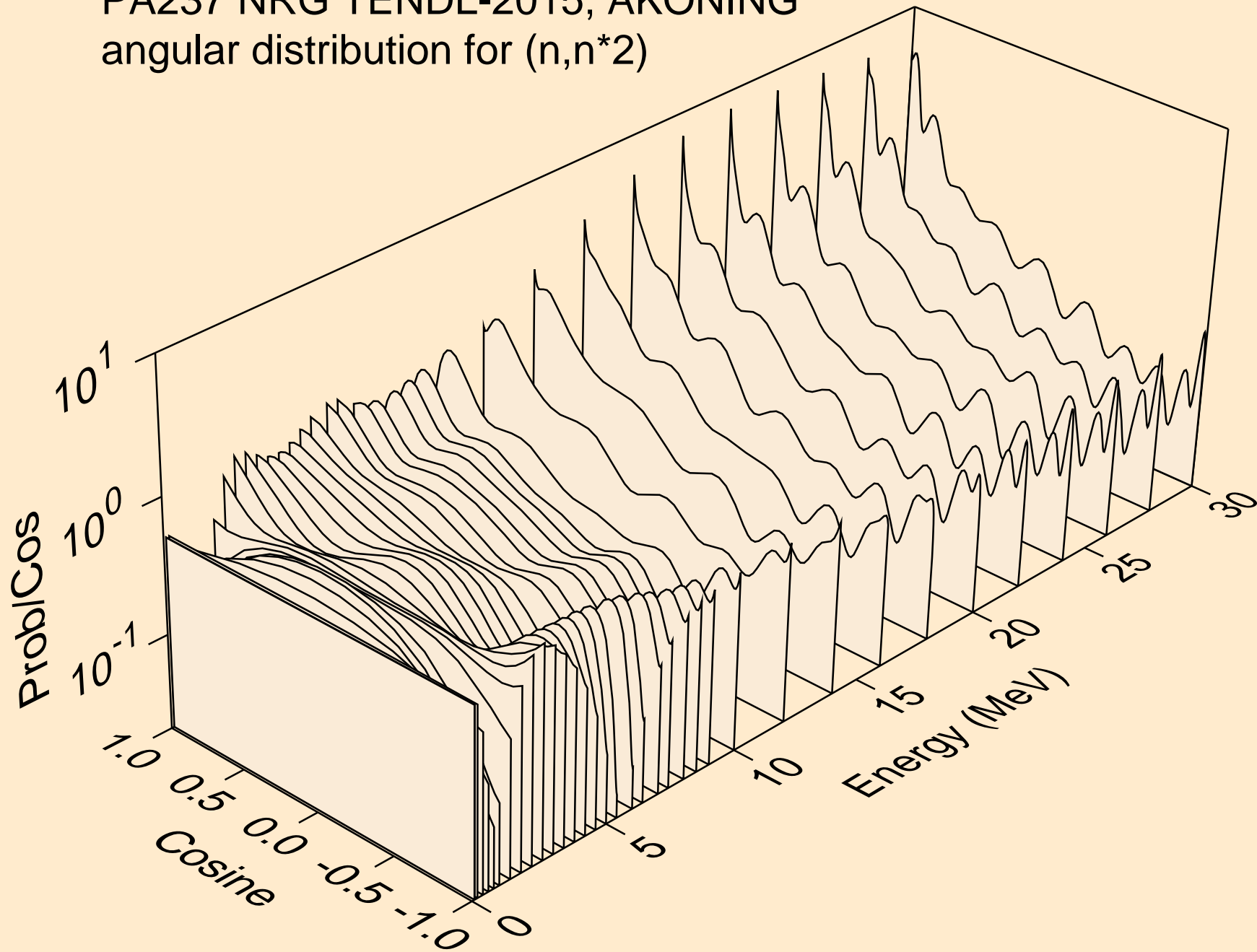

PA237 NRG TENDL-2015, AKONING
angular distribution for (n,n*3)

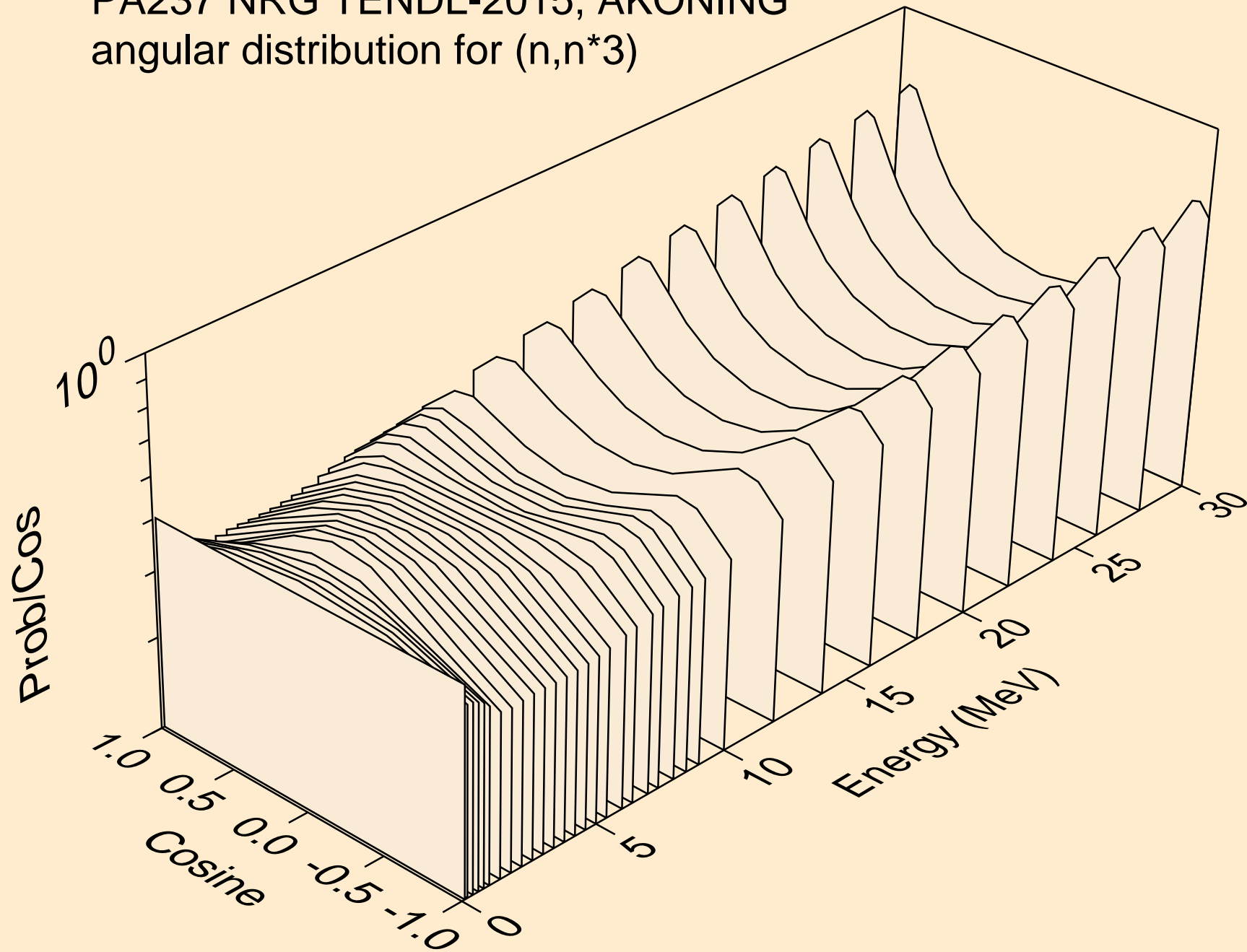

PA237 NRG TENDL-2015, AKONING
angular distribution for (n,n*4)

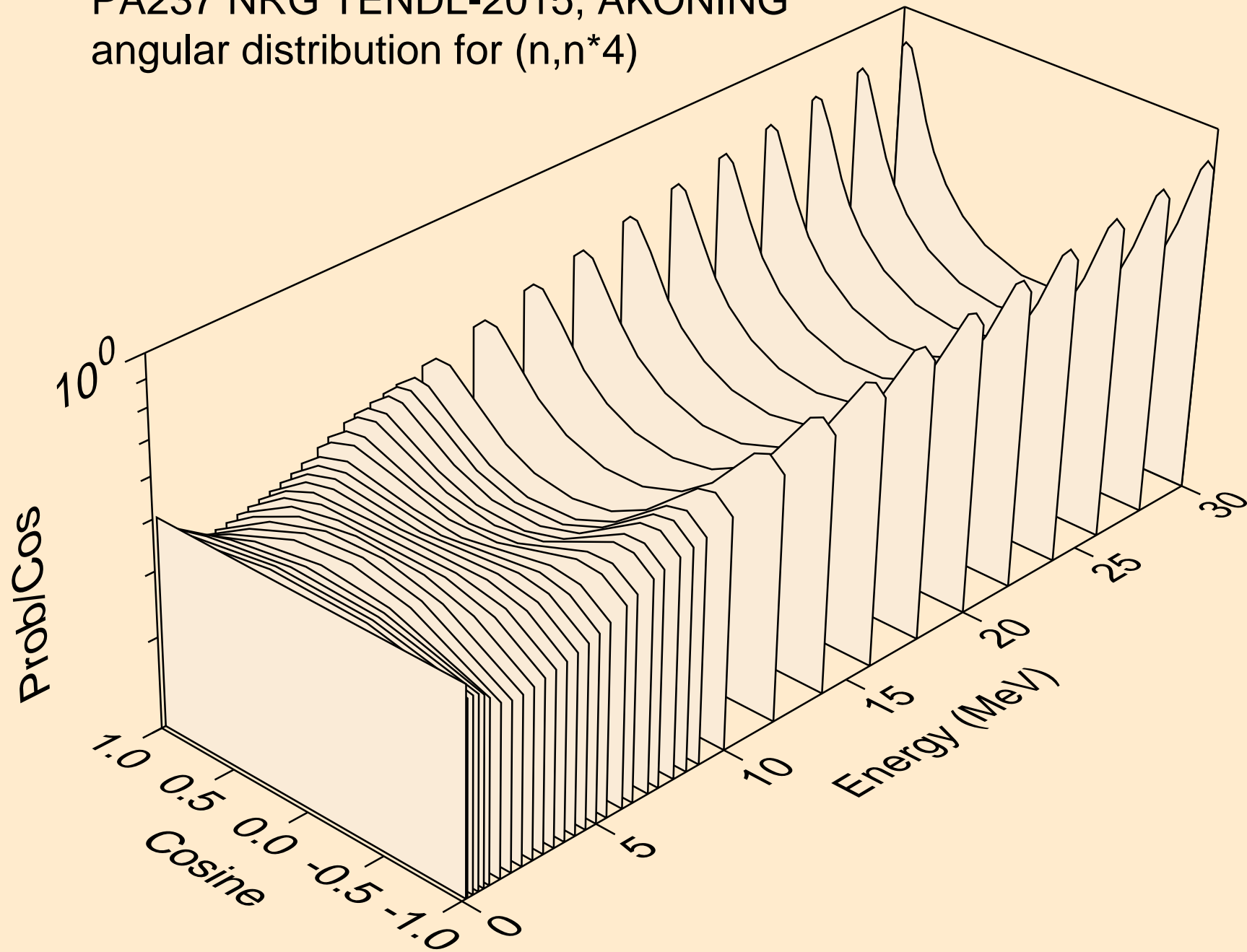

PA237 NRG TENDL-2015, AKONING
angular distribution for (n,n*5)

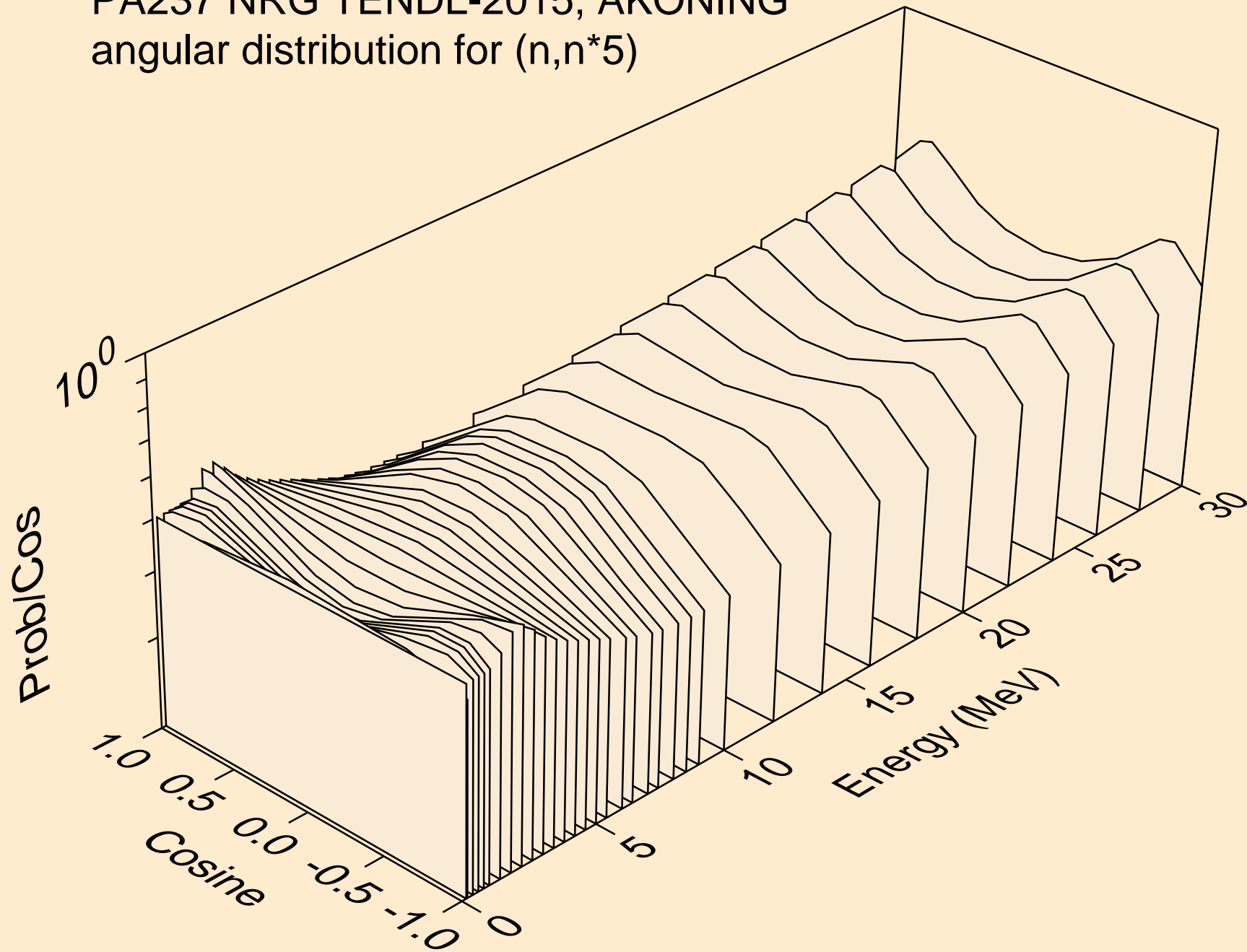

PA237 NRG TENDL-2015, AKONING
angular distribution for (n,n*6)

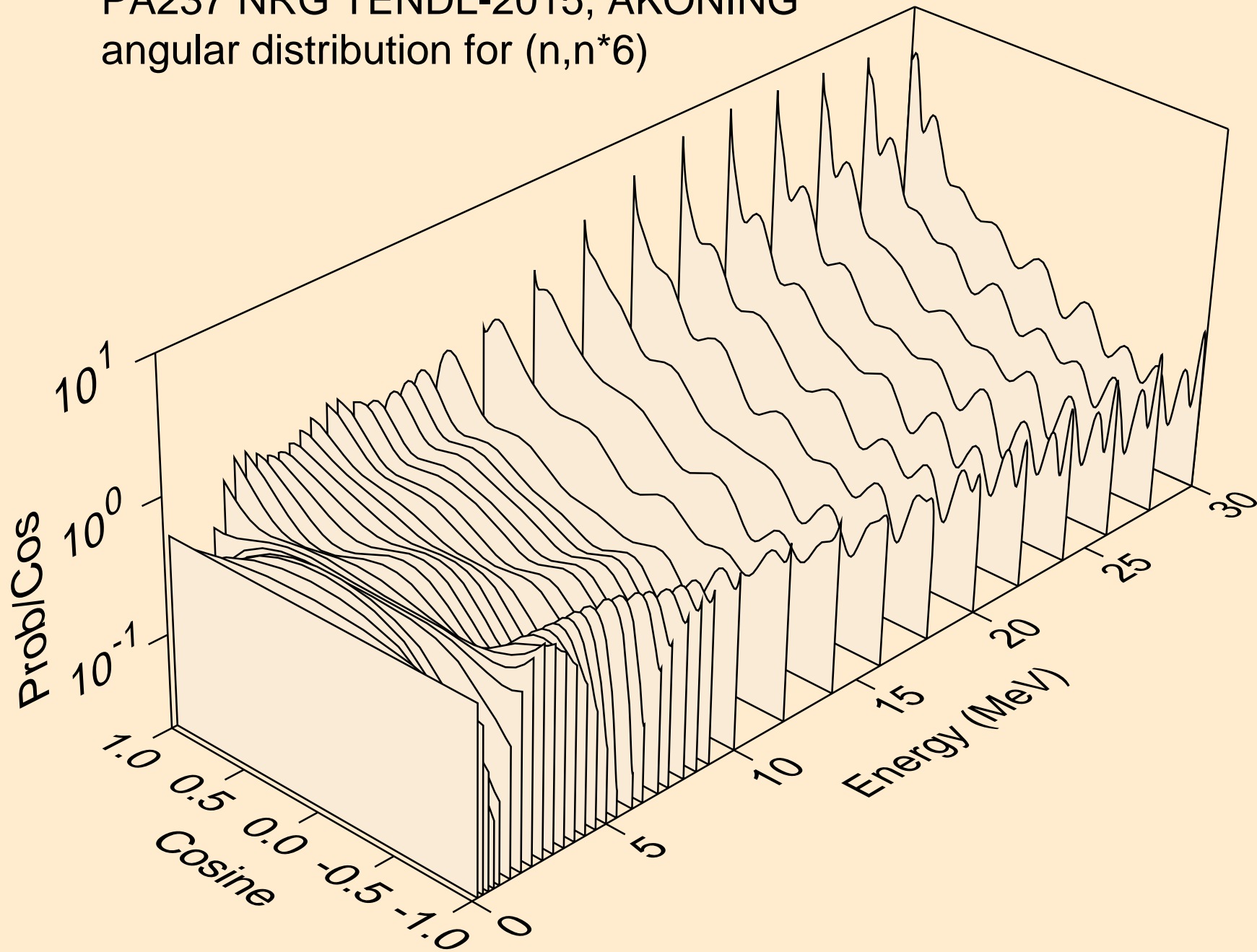

PA237 NRG TENDL-2015, AKONING
angular distribution for (n,n*7)

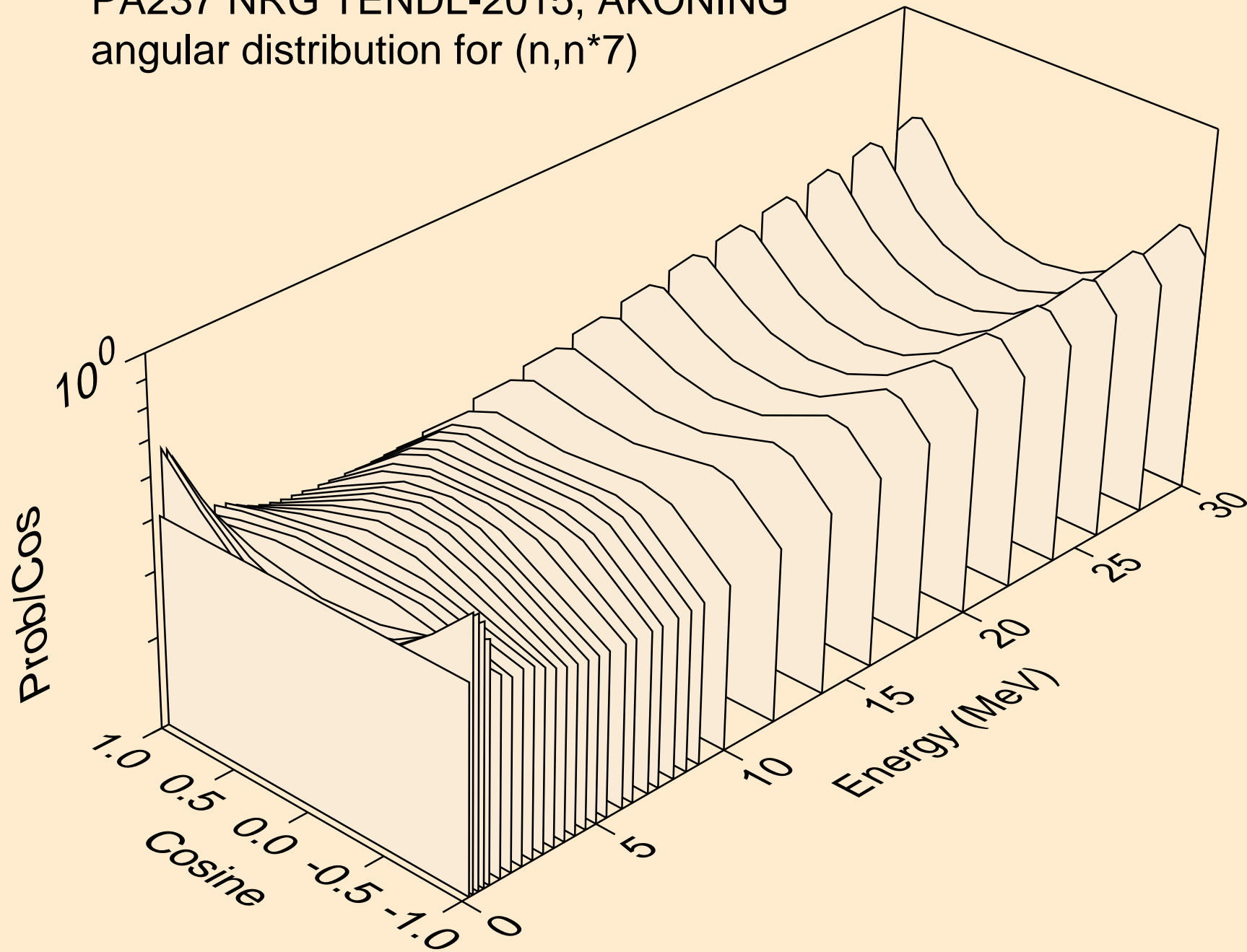

PA237 NRG TENDL-2015, AKONING
angular distribution for (n,n*8)

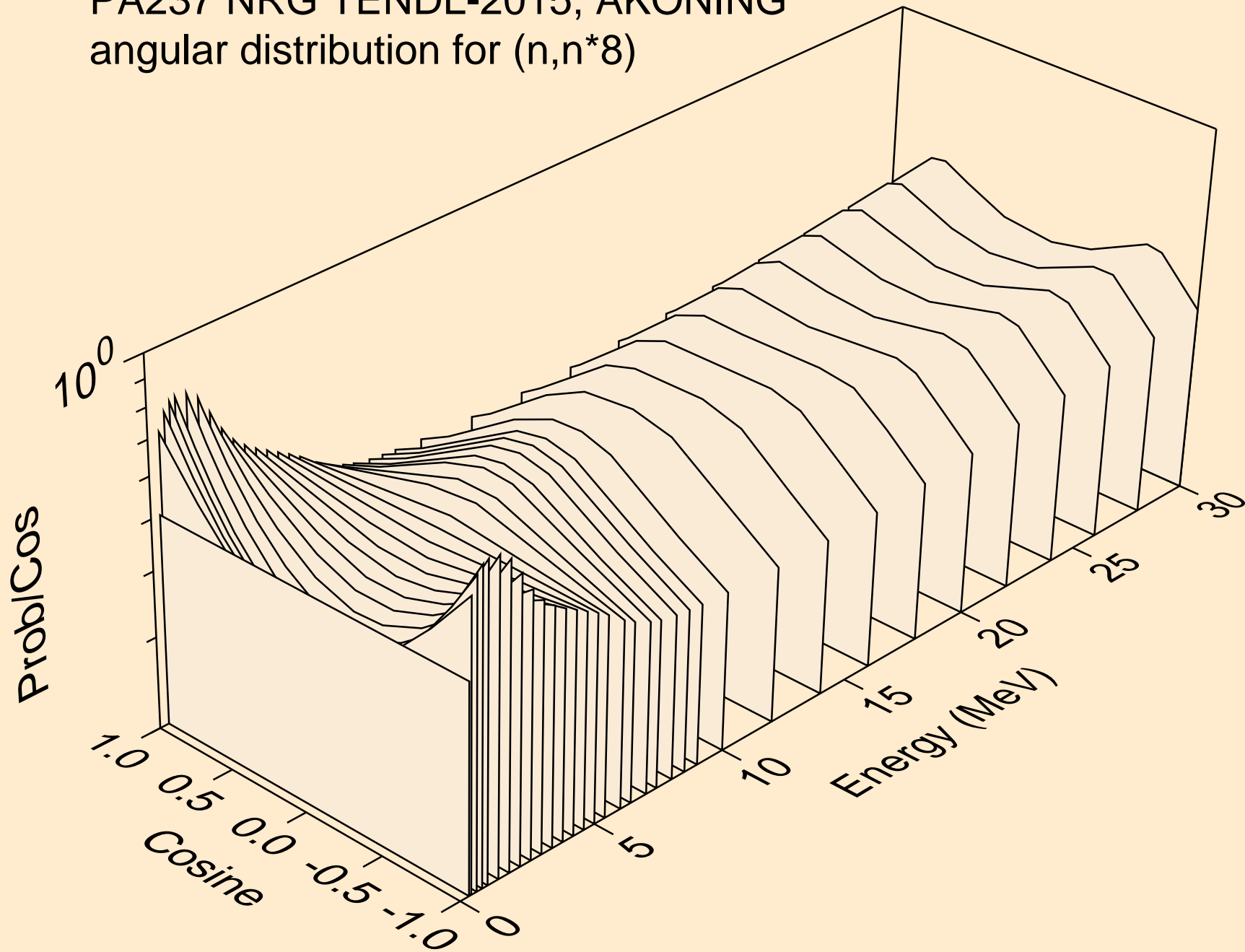

PA237 NRG TENDL-2015, AKONING
angular distribution for (n,n*9)

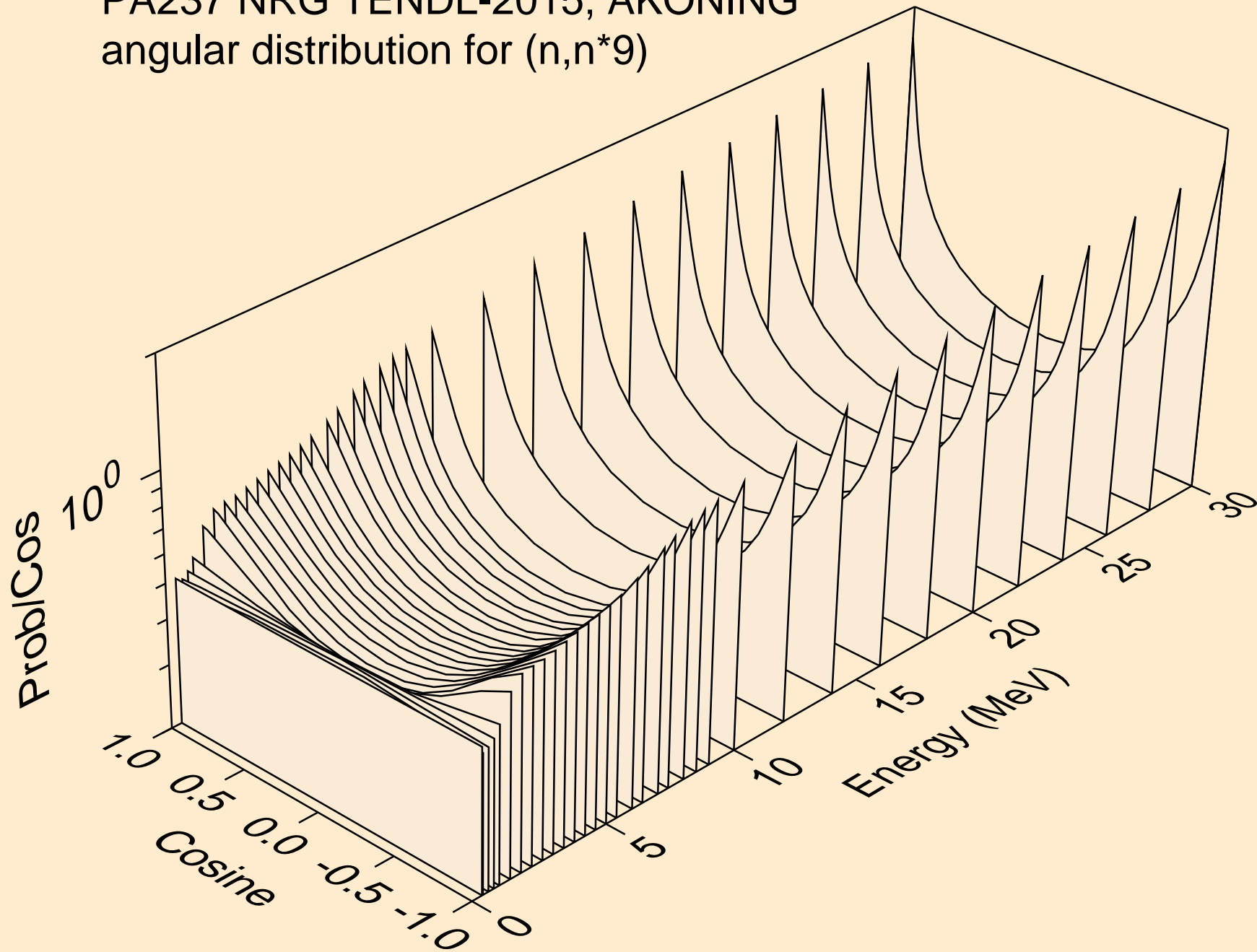

PA237 NRG TENDL-2015, AKONING
angular distribution for (n,n*10)

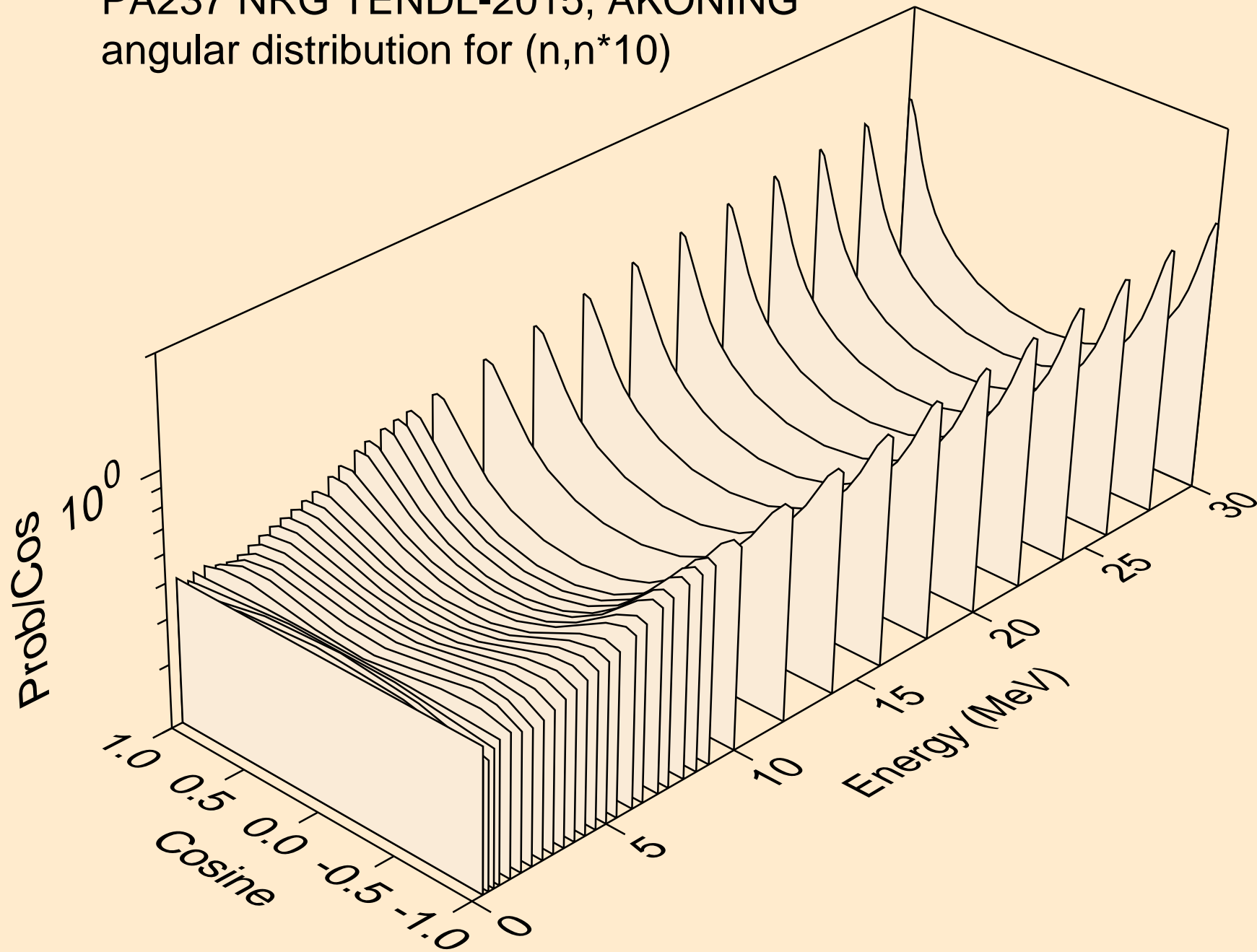

PA237 NRG TENDL-2015, AKONING
angular distribution for (n,n*11)

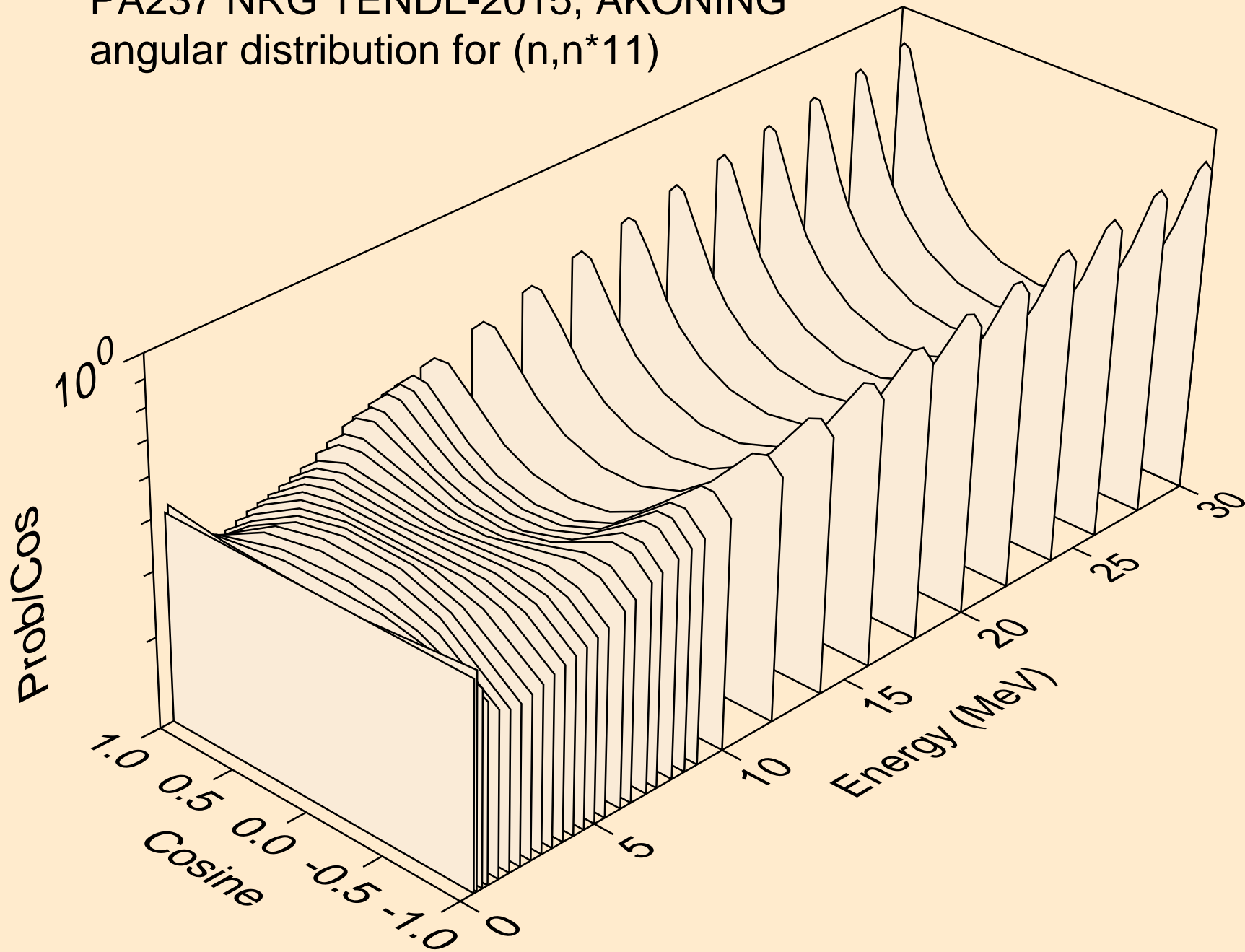

PA237 NRG TENDL-2015, AKONING
angular distribution for (n,n*12)

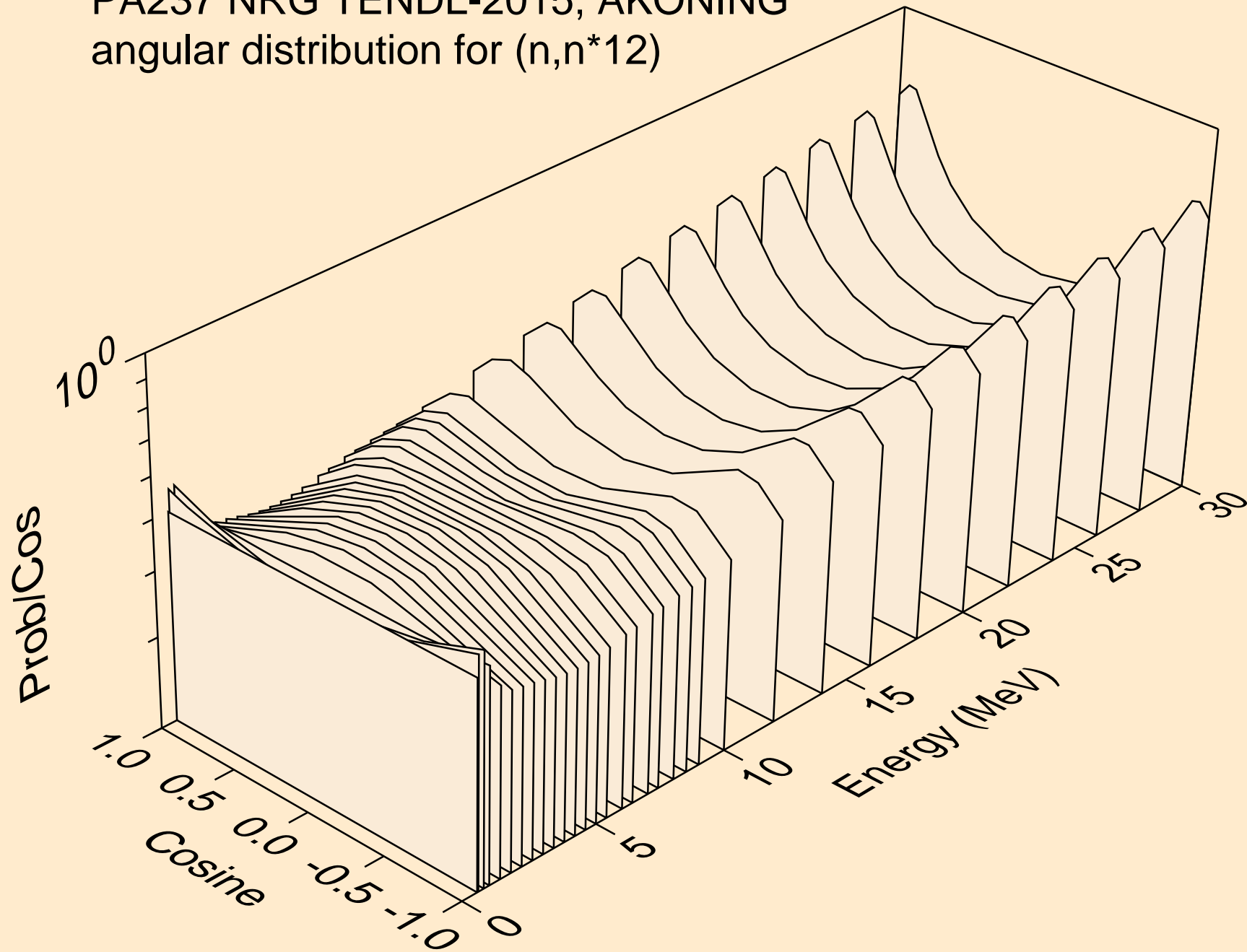

PA237 NRG TENDL-2015, AKONING
angular distribution for (n,n*13)

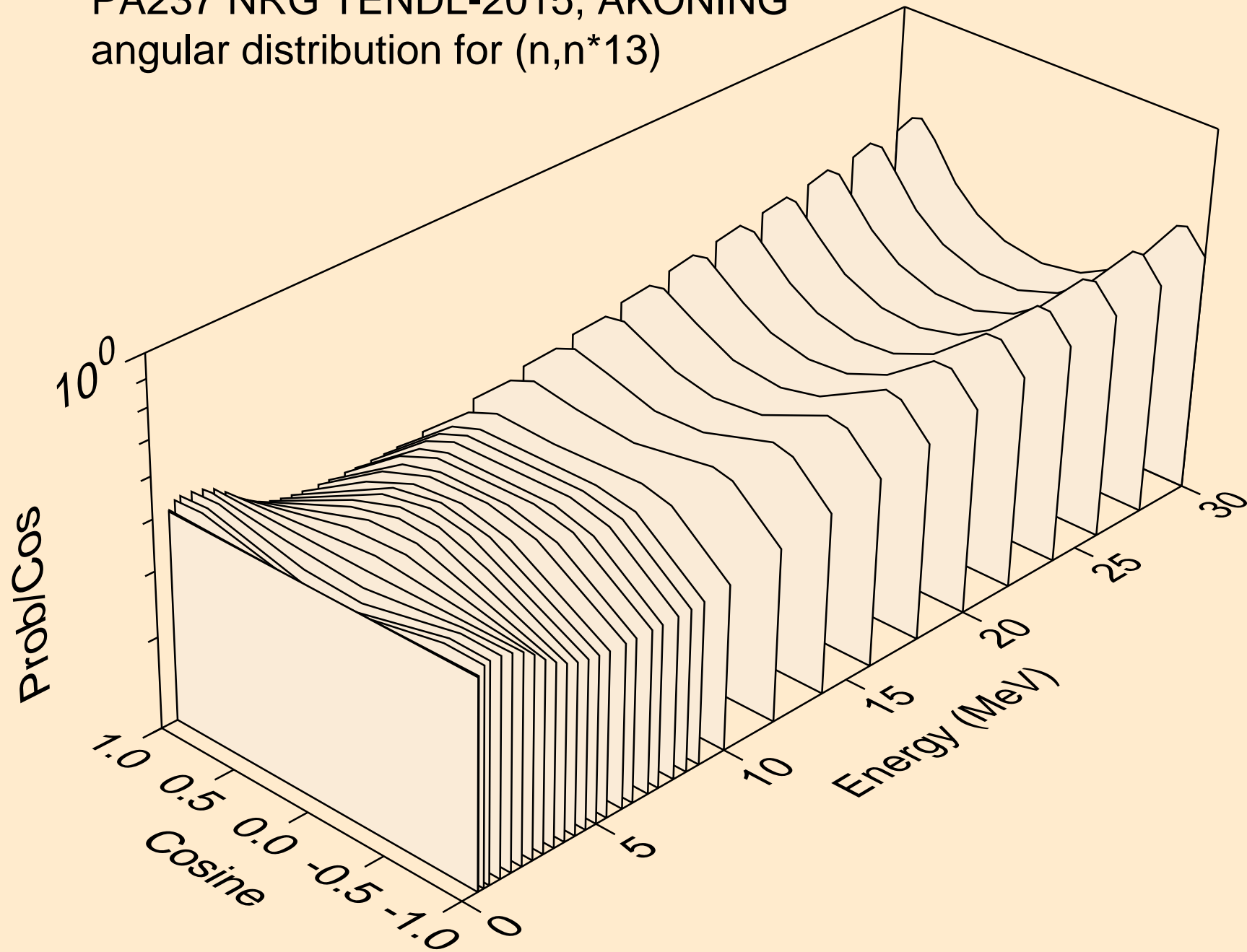

PA237 NRG TENDL-2015, AKONING
angular distribution for (n,n*14)

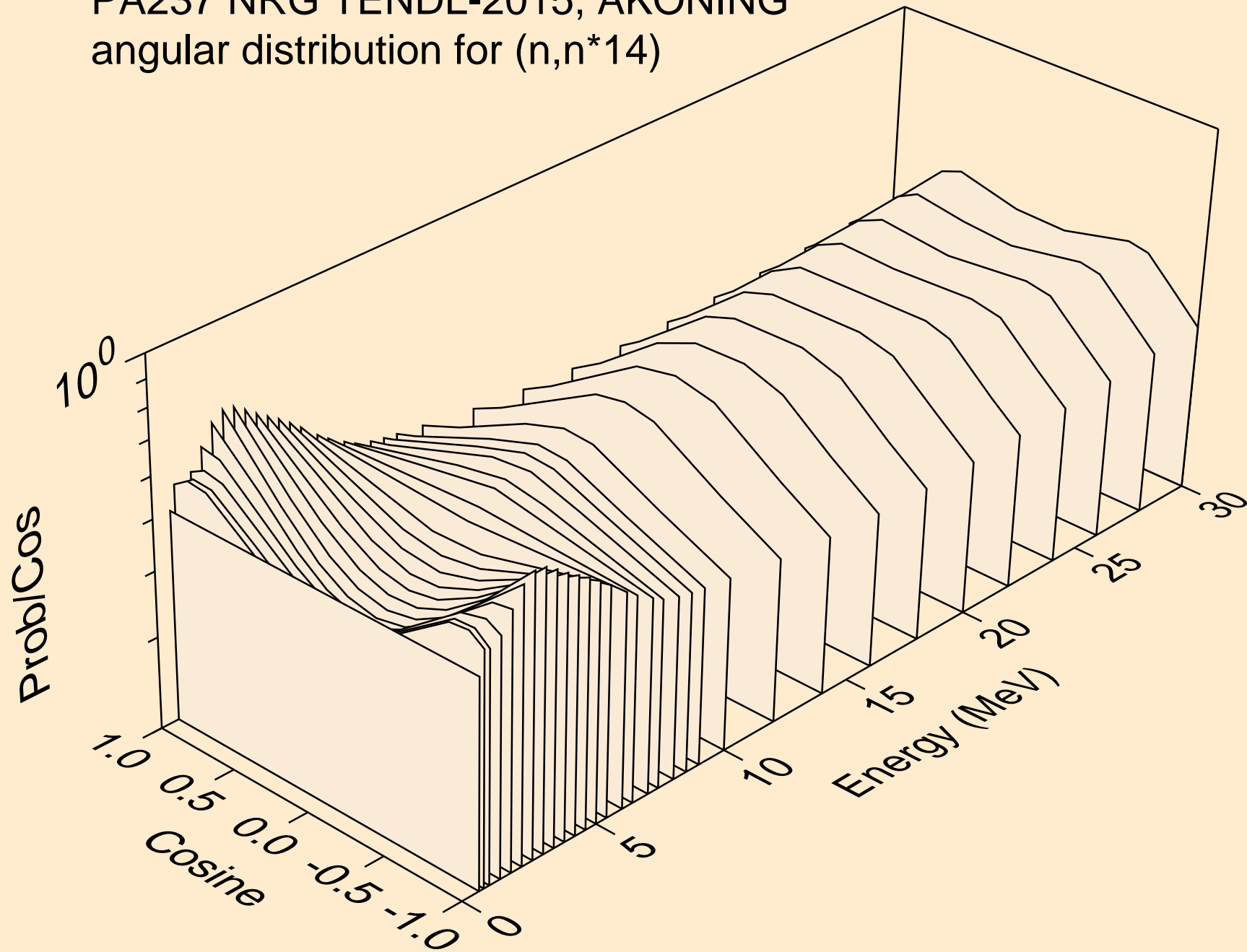

PA237 NRG TENDL-2015, AKONING
angular distribution for (n,n*15)

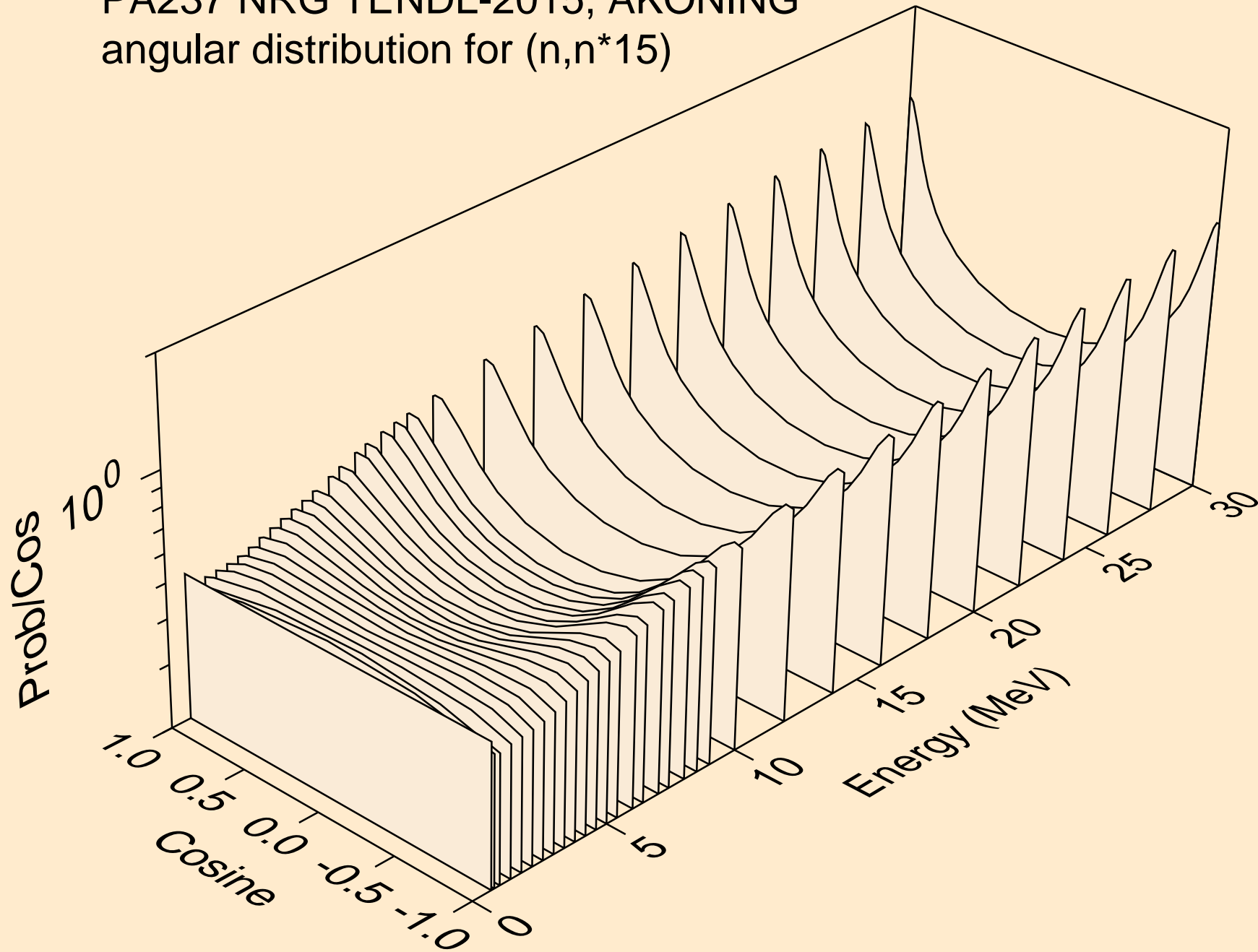

PA237 NRG TENDL-2015, AKONING
angular distribution for (n,n*16)

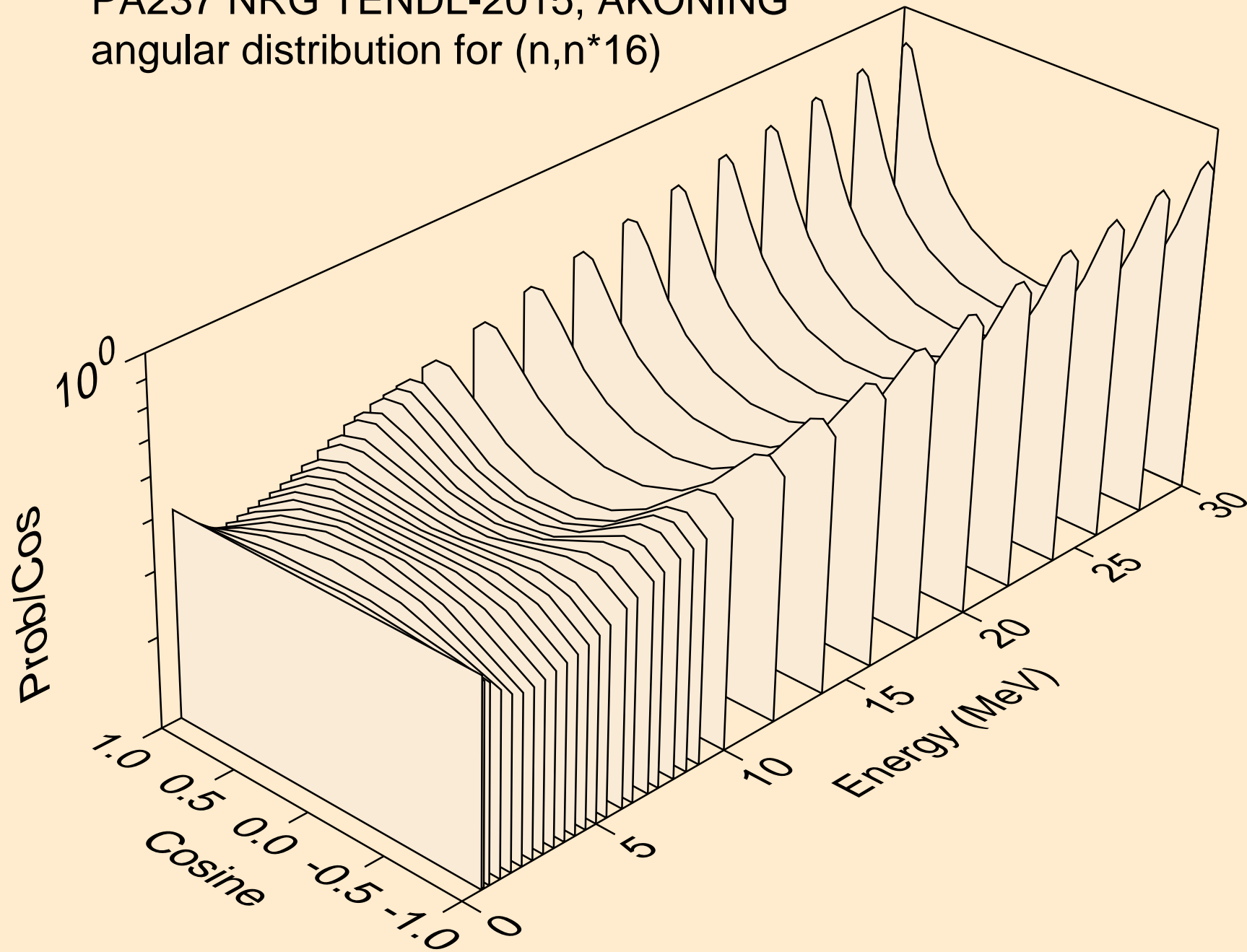

PA237 NRG TENDL-2015, AKONING
angular distribution for (n,n*17)

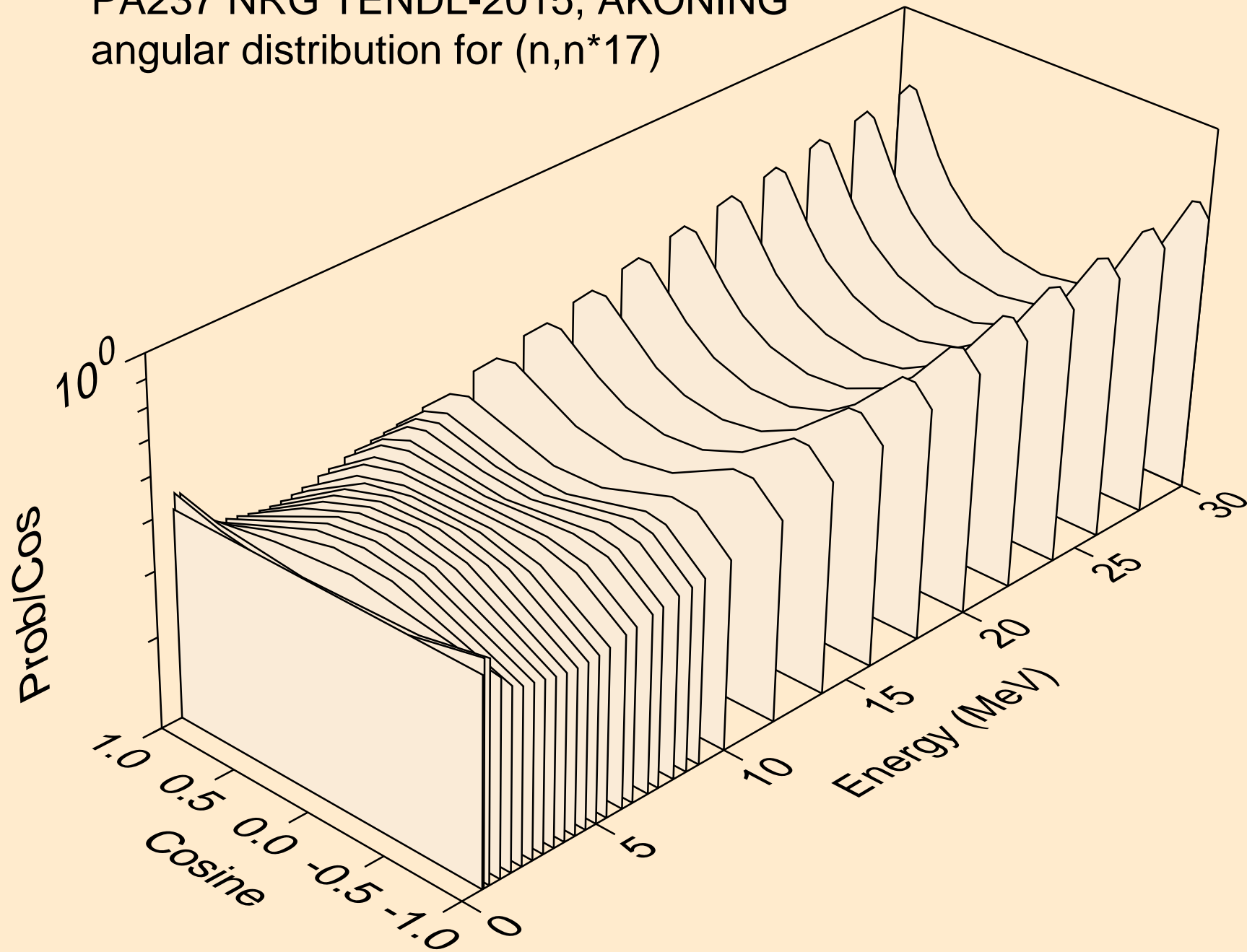

PA237 NRG TENDL-2015, AKONING
angular distribution for (n,n*18)

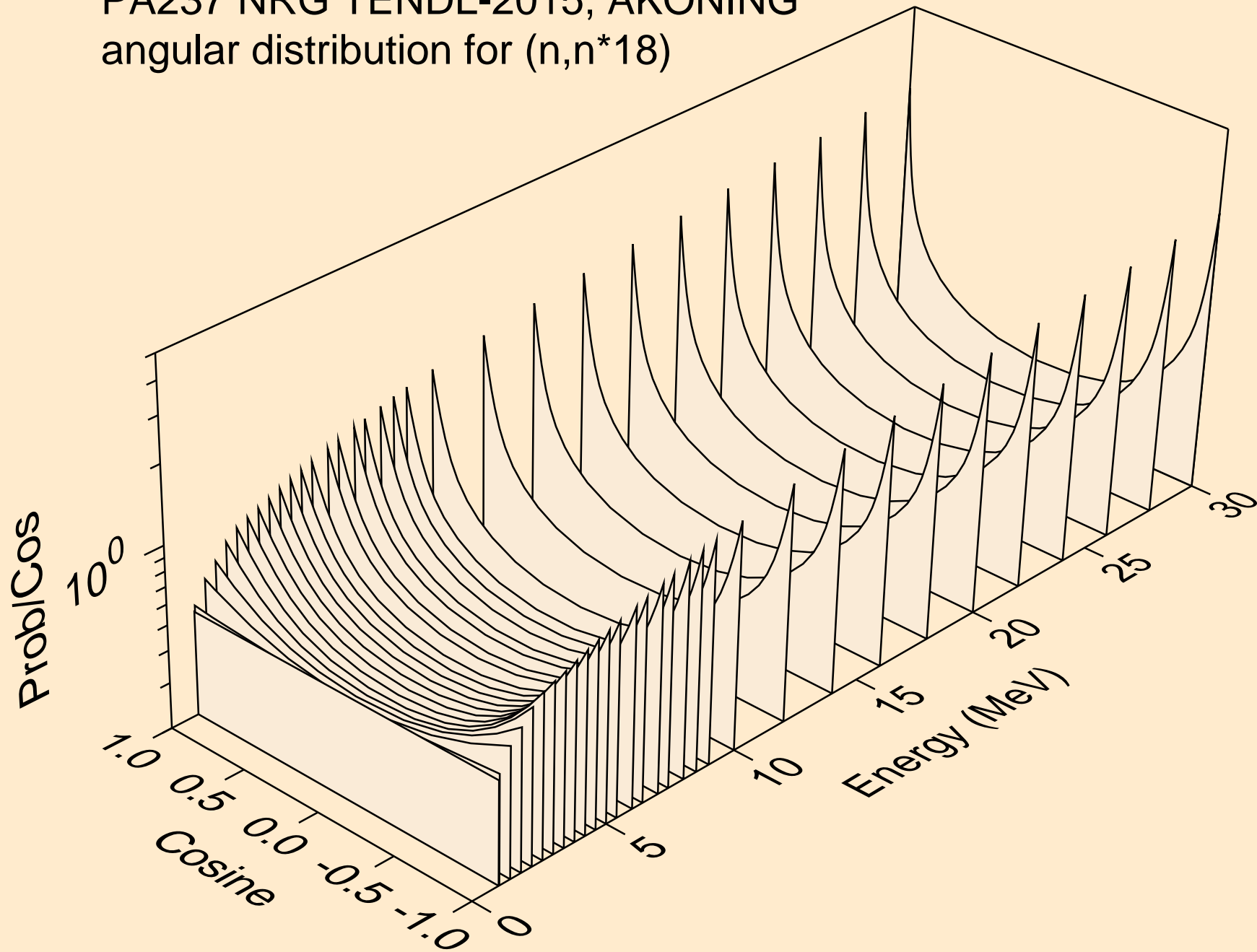

PA237 NRG TENDL-2015, AKONING
angular distribution for (n,n*19)

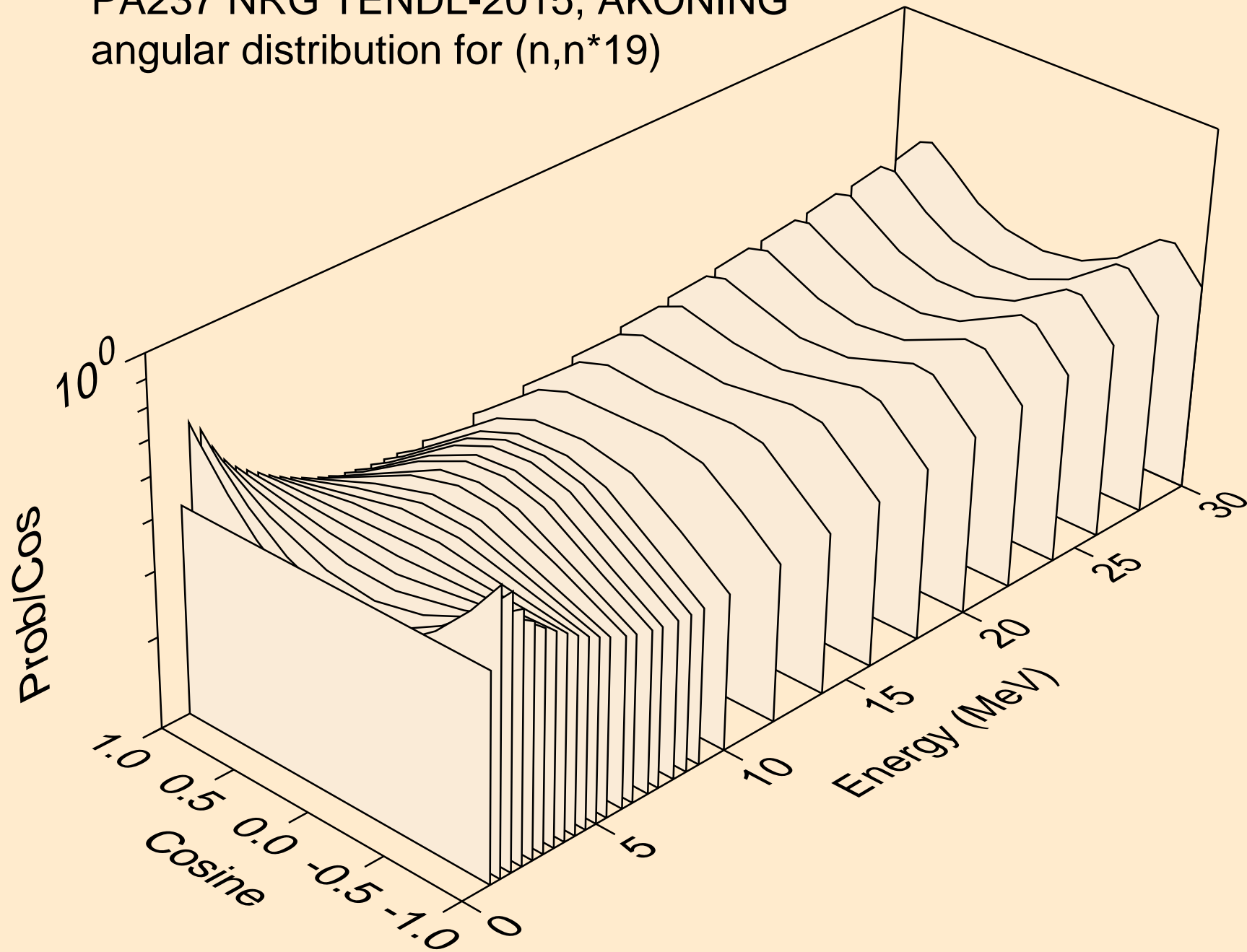

PA237 NRG TENDL-2015, AKONING
angular distribution for (n,n*20)

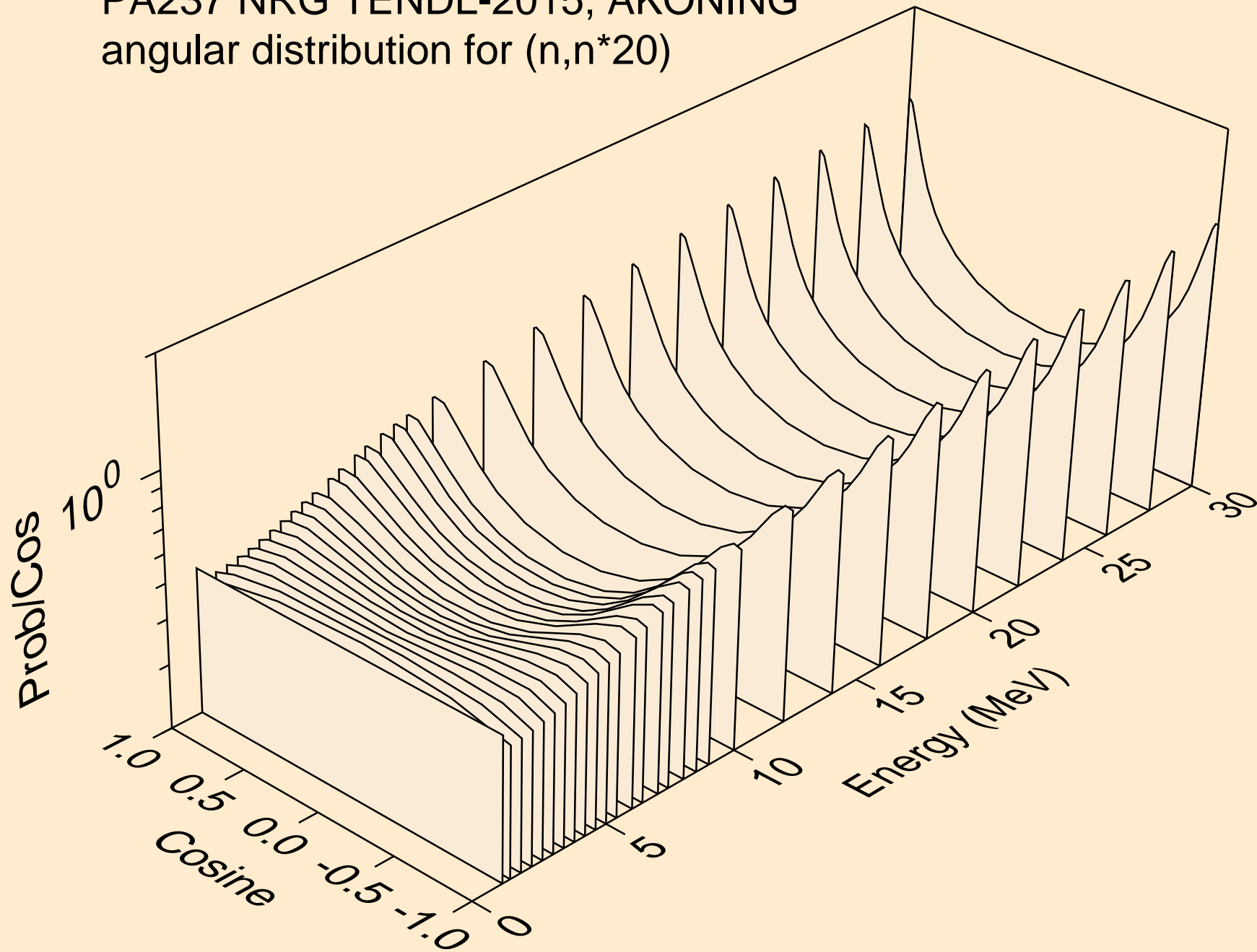

PA237 NRG TENDL-2015, AKONING
angular distribution for (n,n*21)

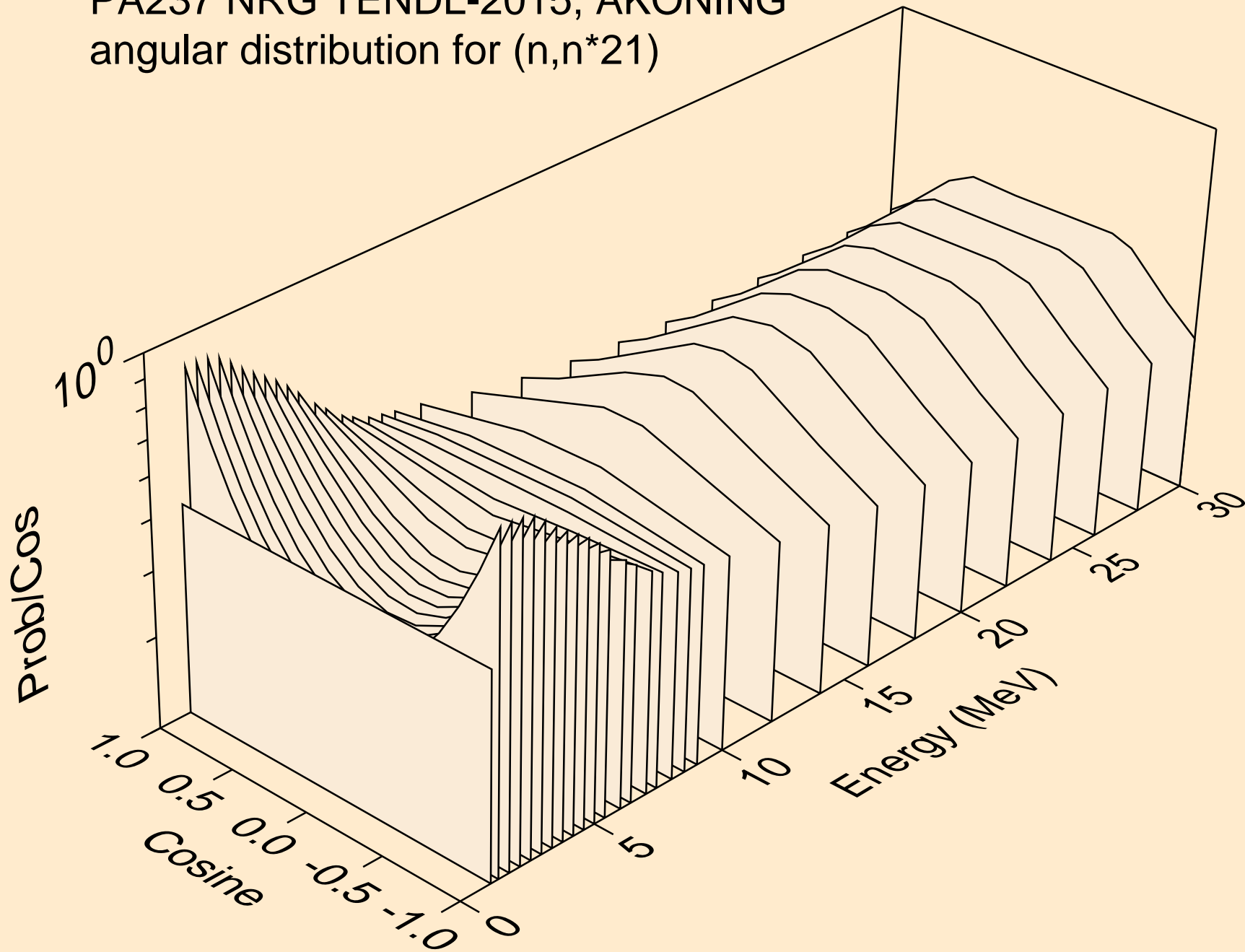

PA237 NRG TENDL-2015, AKONING
angular distribution for (n,n*22)

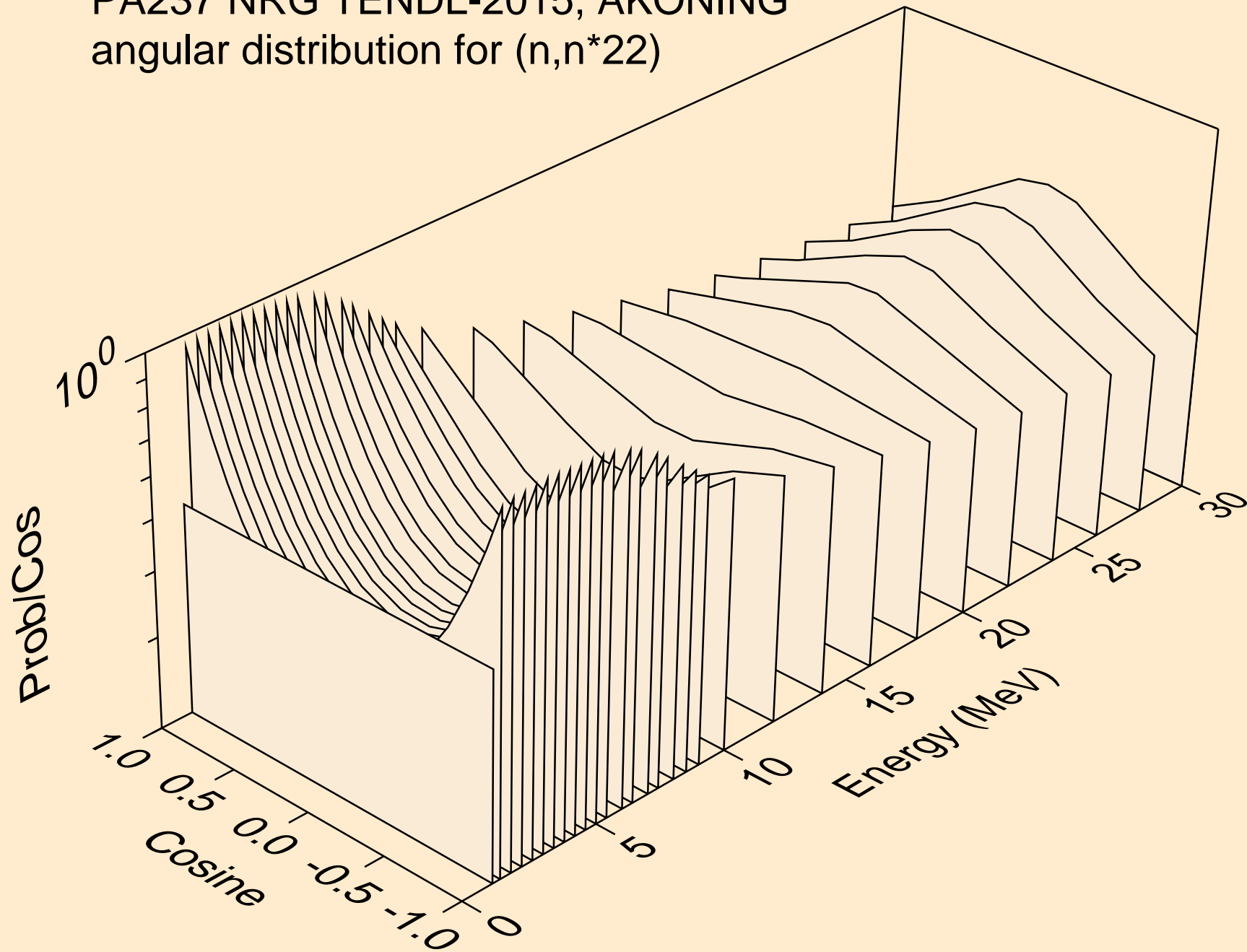

PA237 NRG TENDL-2015, AKONING
angular distribution for (n,n*23)

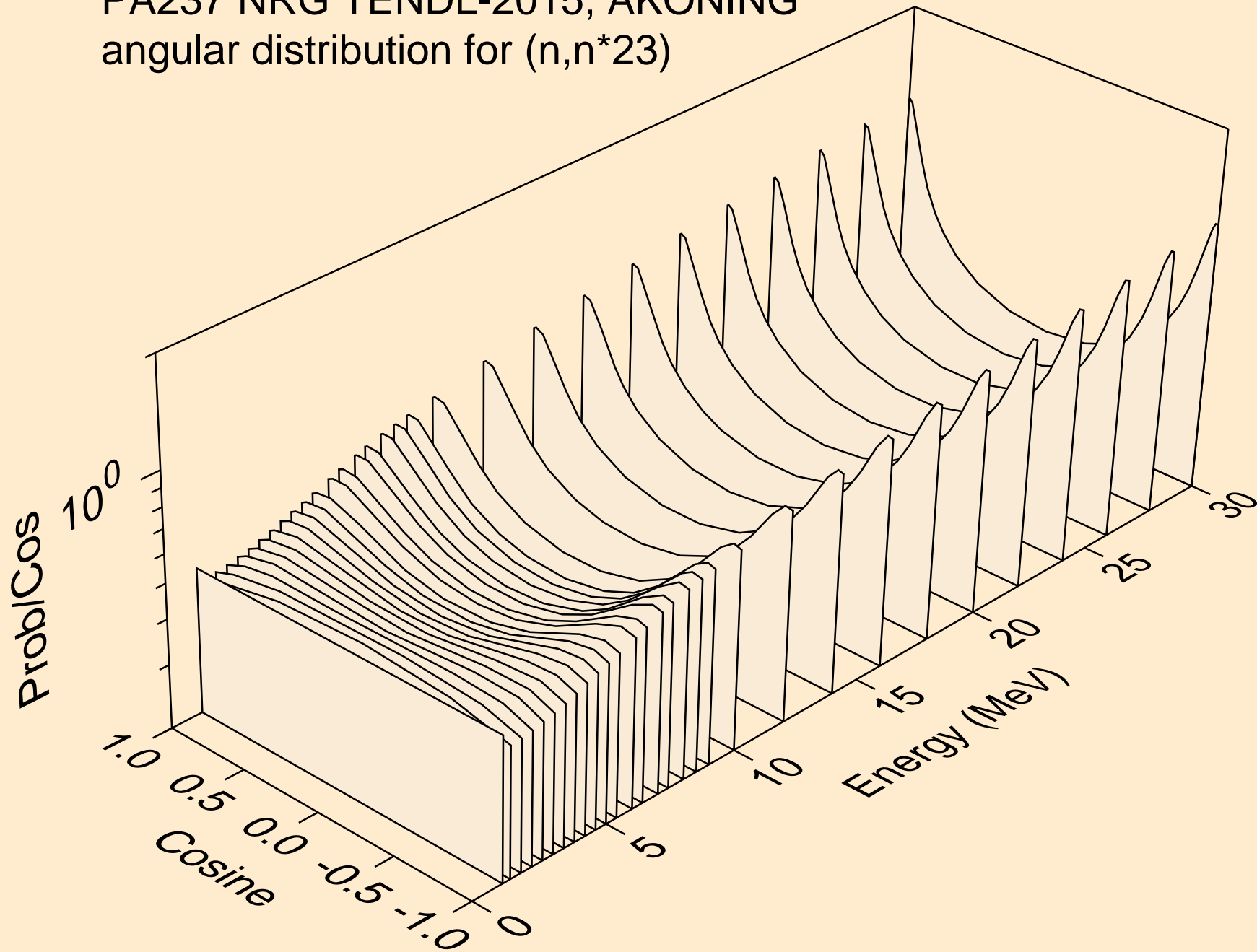

PA237 NRG TENDL-2015, AKONING
angular distribution for (n,n*24)

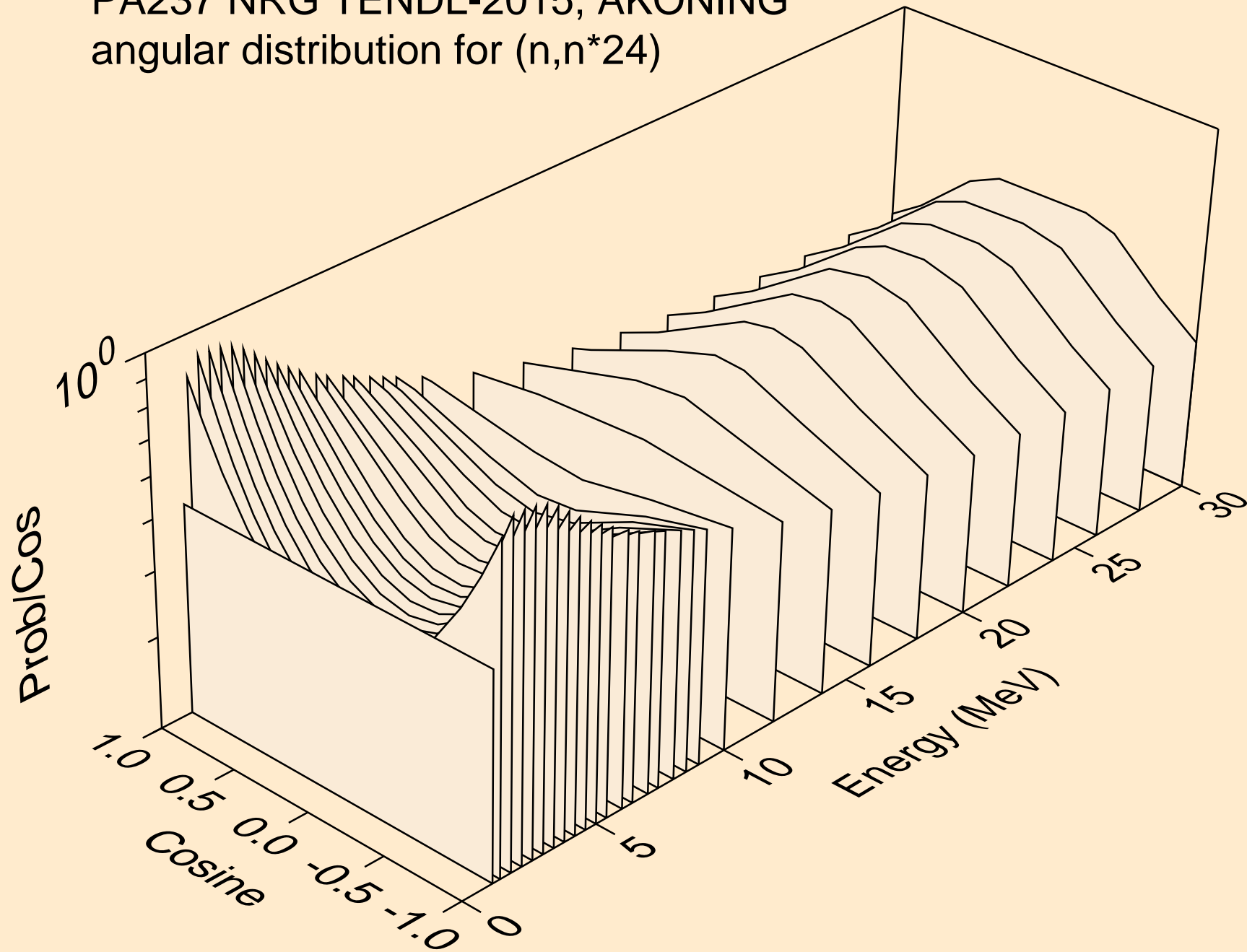

PA237 NRG TENDL-2015, AKONING
angular distribution for (n,n*25)

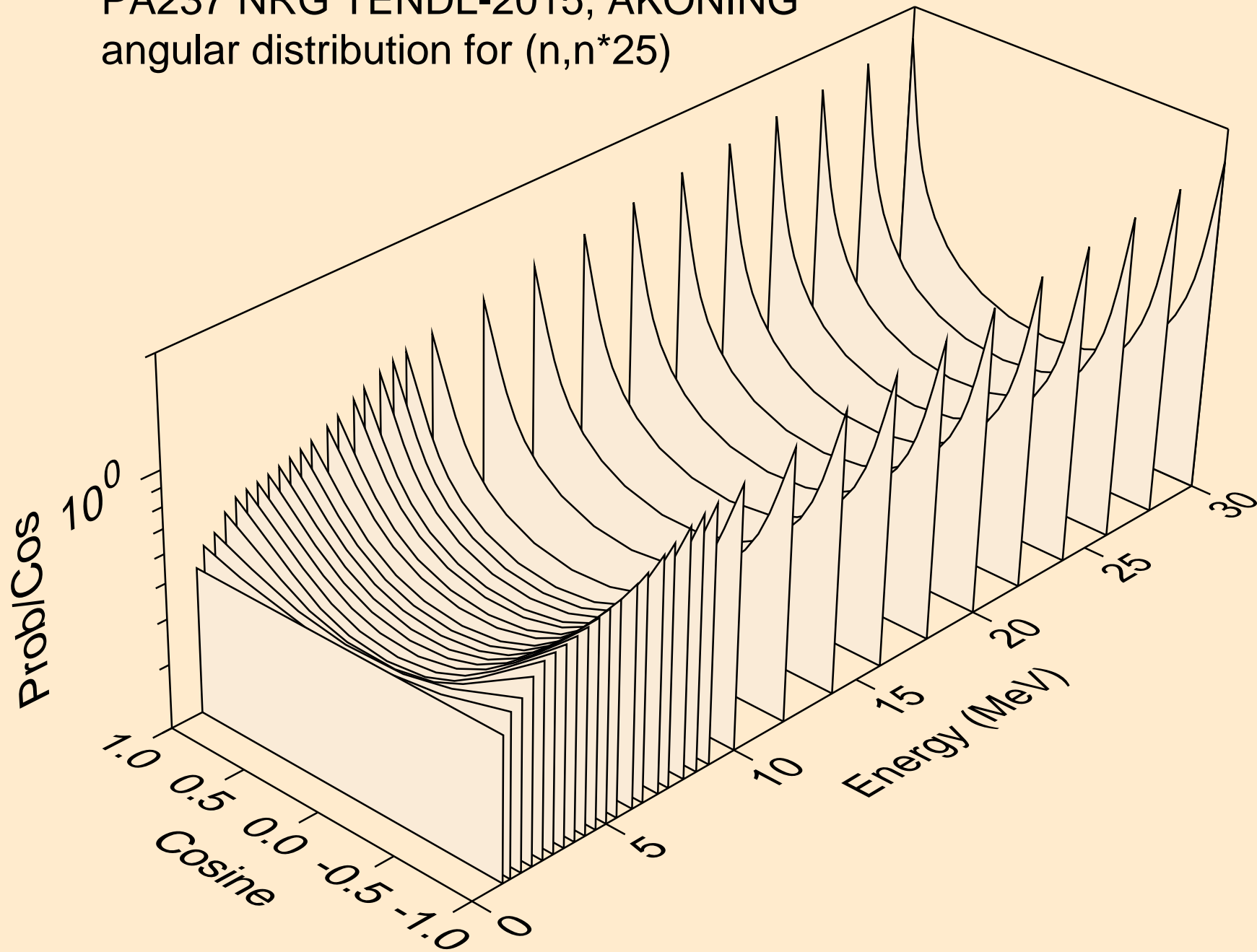

PA237 NRG TENDL-2015, AKONING
angular distribution for (n,n*26)

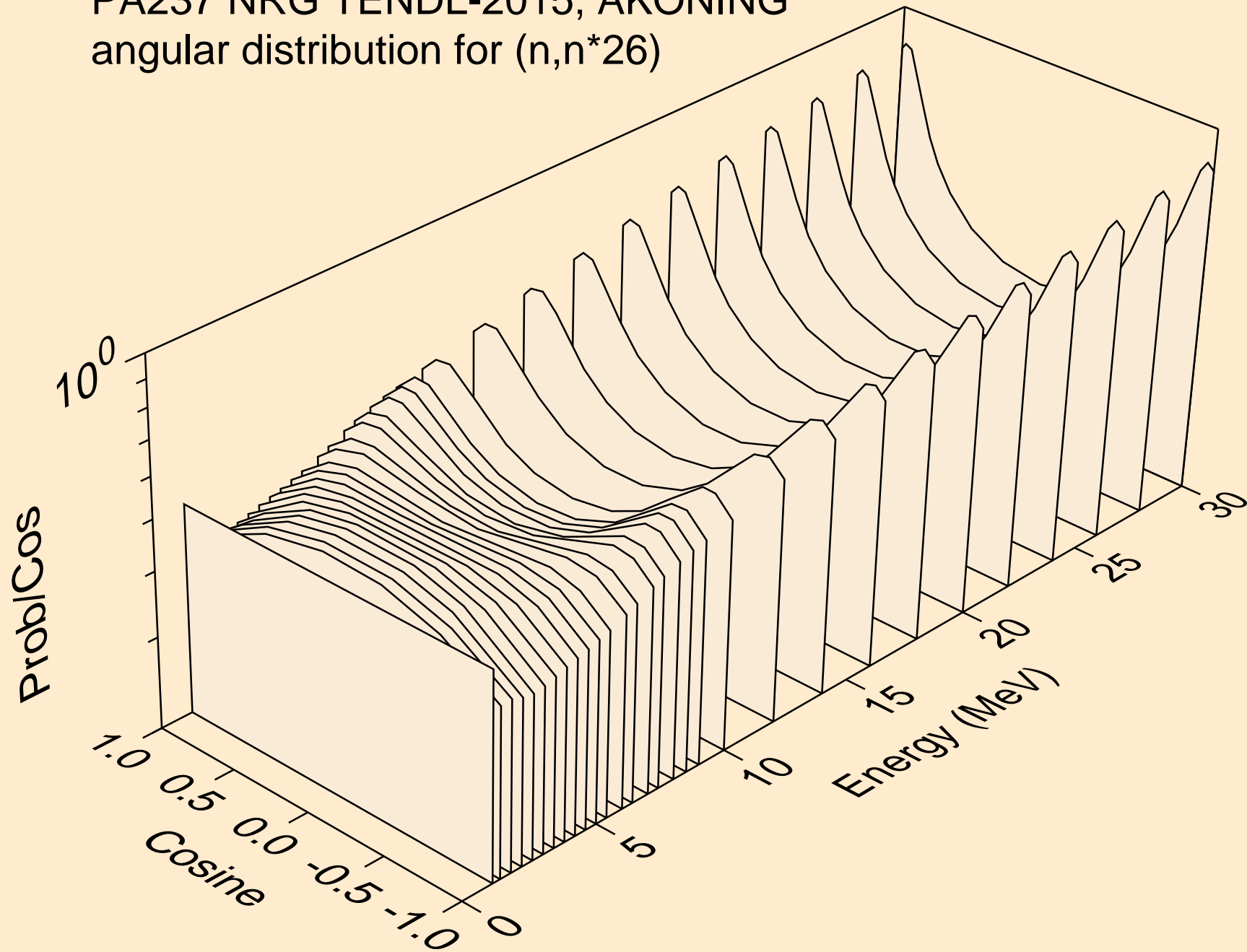

PA237 NRG TENDL-2015, AKONING
angular distribution for (n,n*27)

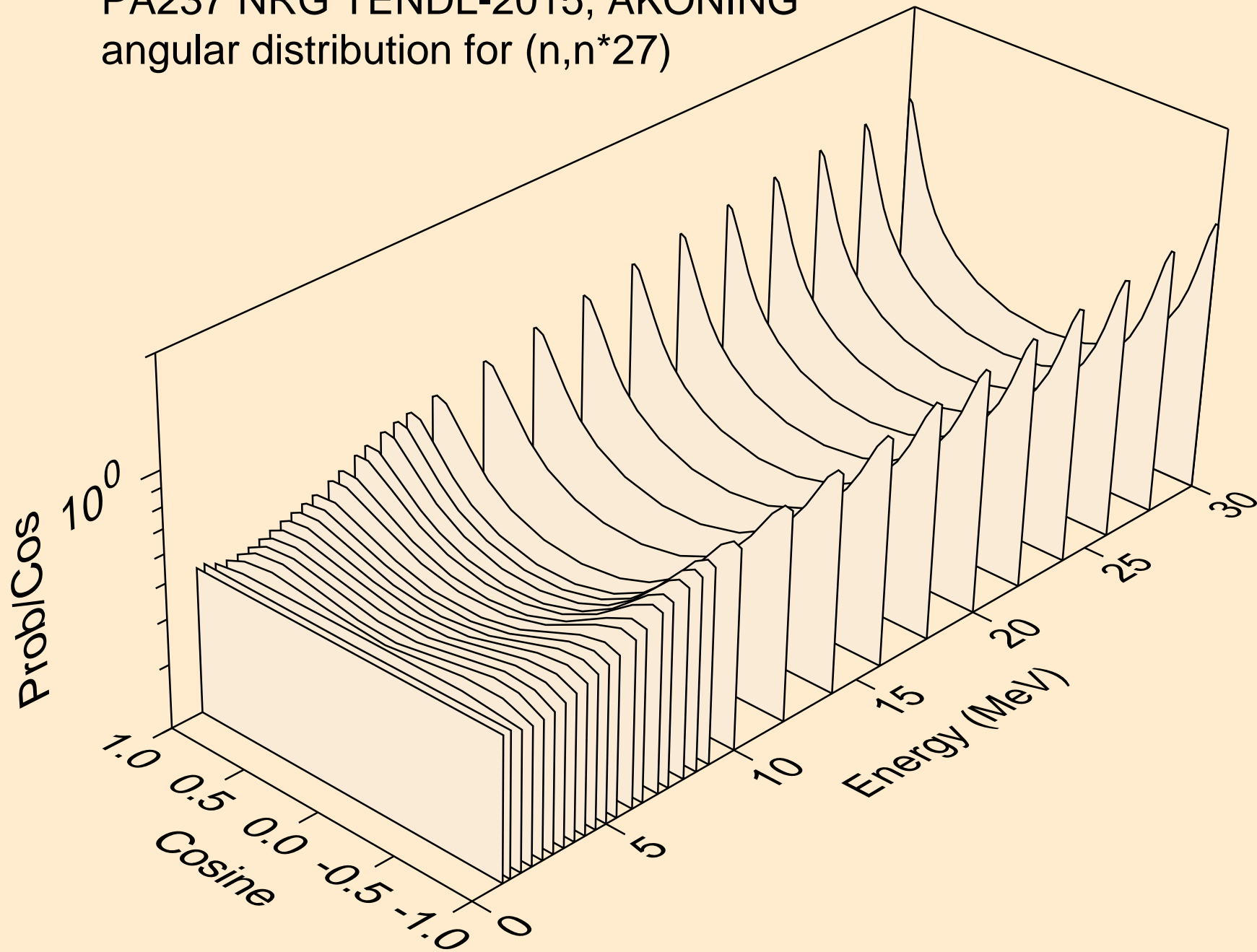

PA237 NRG TENDL-2015, AKONING

Total fission nubar

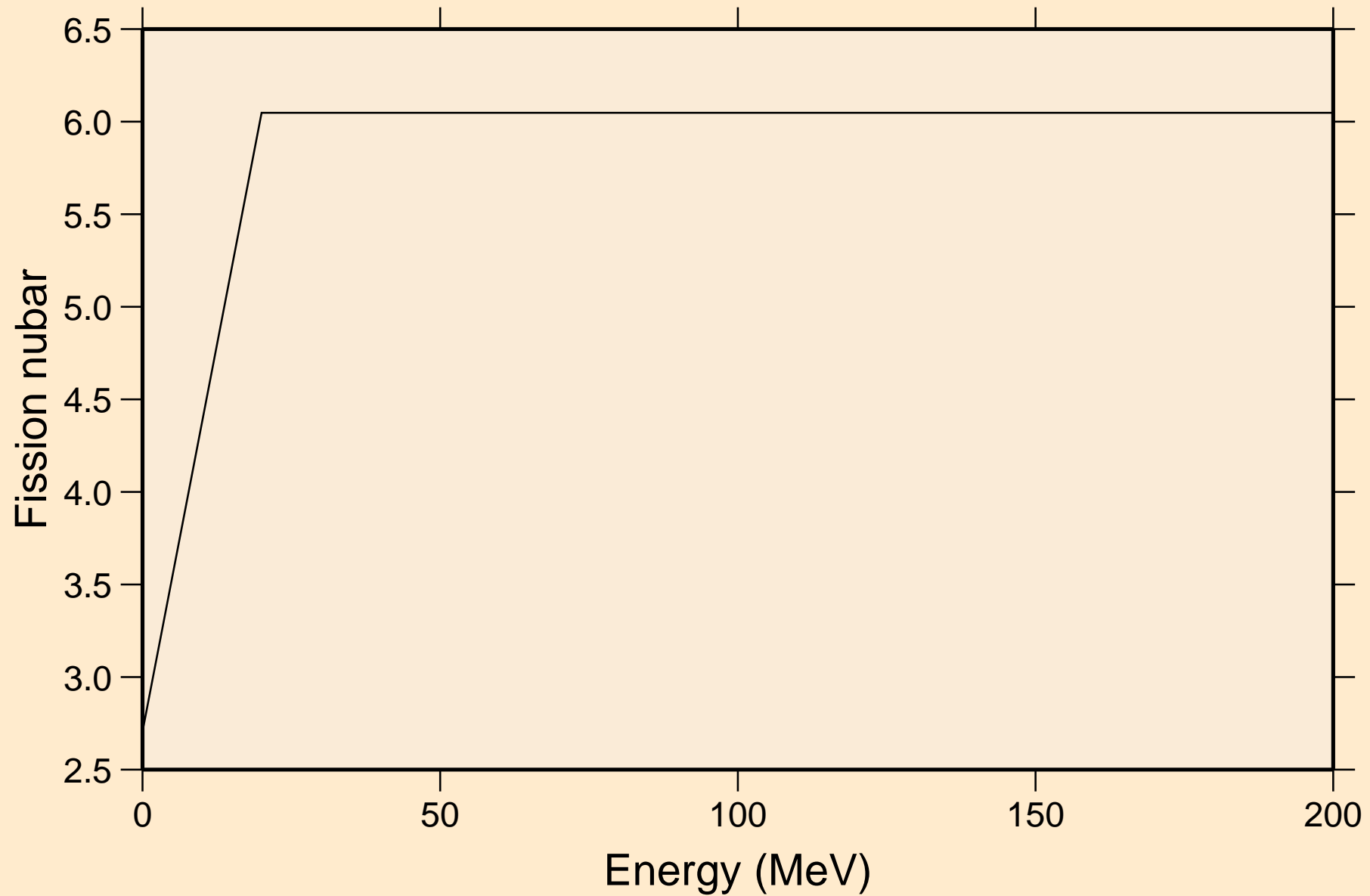

PA237 NRG TENDL-2015, AKONING
Neutron emission for (n,x)

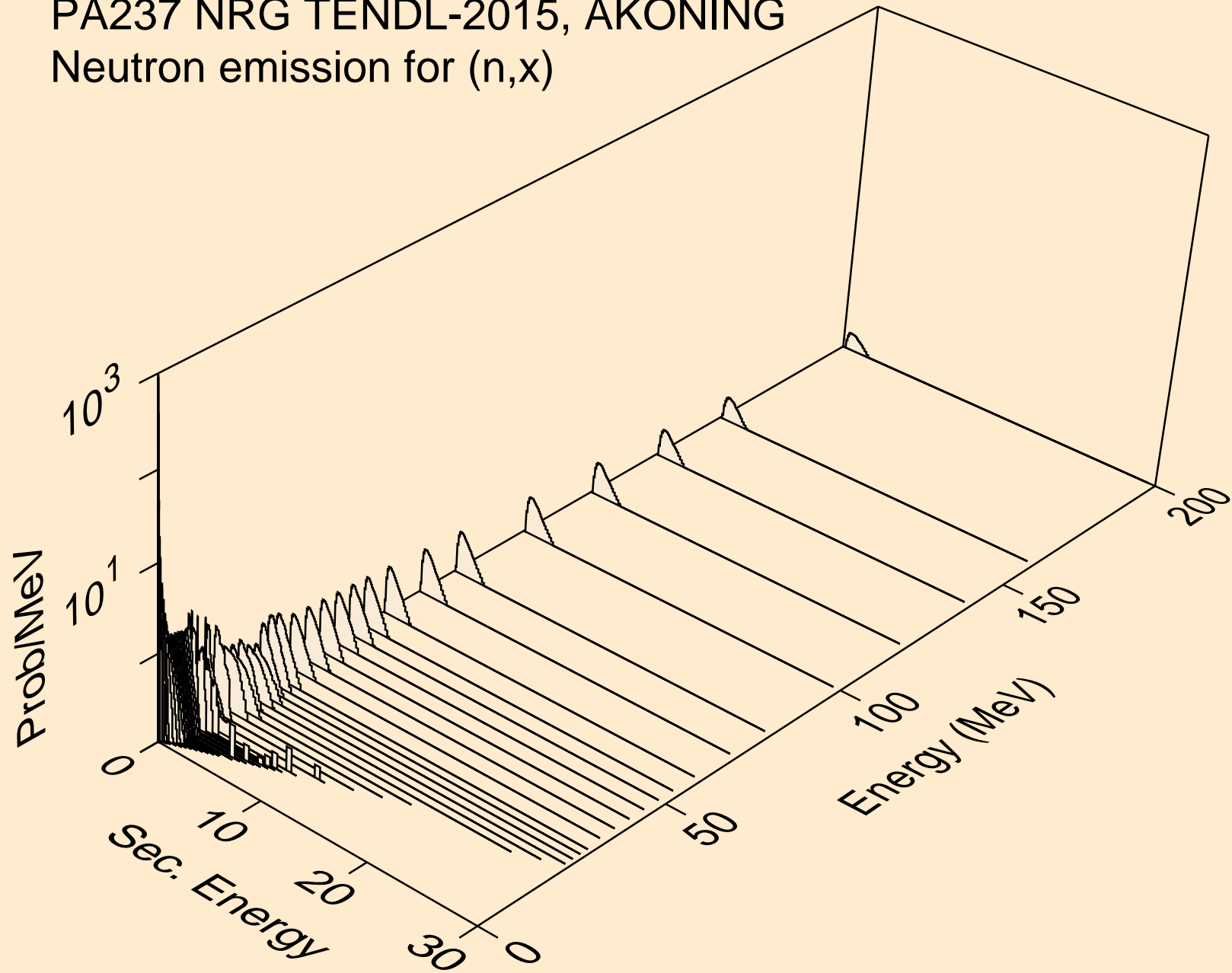

PA237 NRG TENDL-2015, AKONING
Neutron emission for (n,2nd)

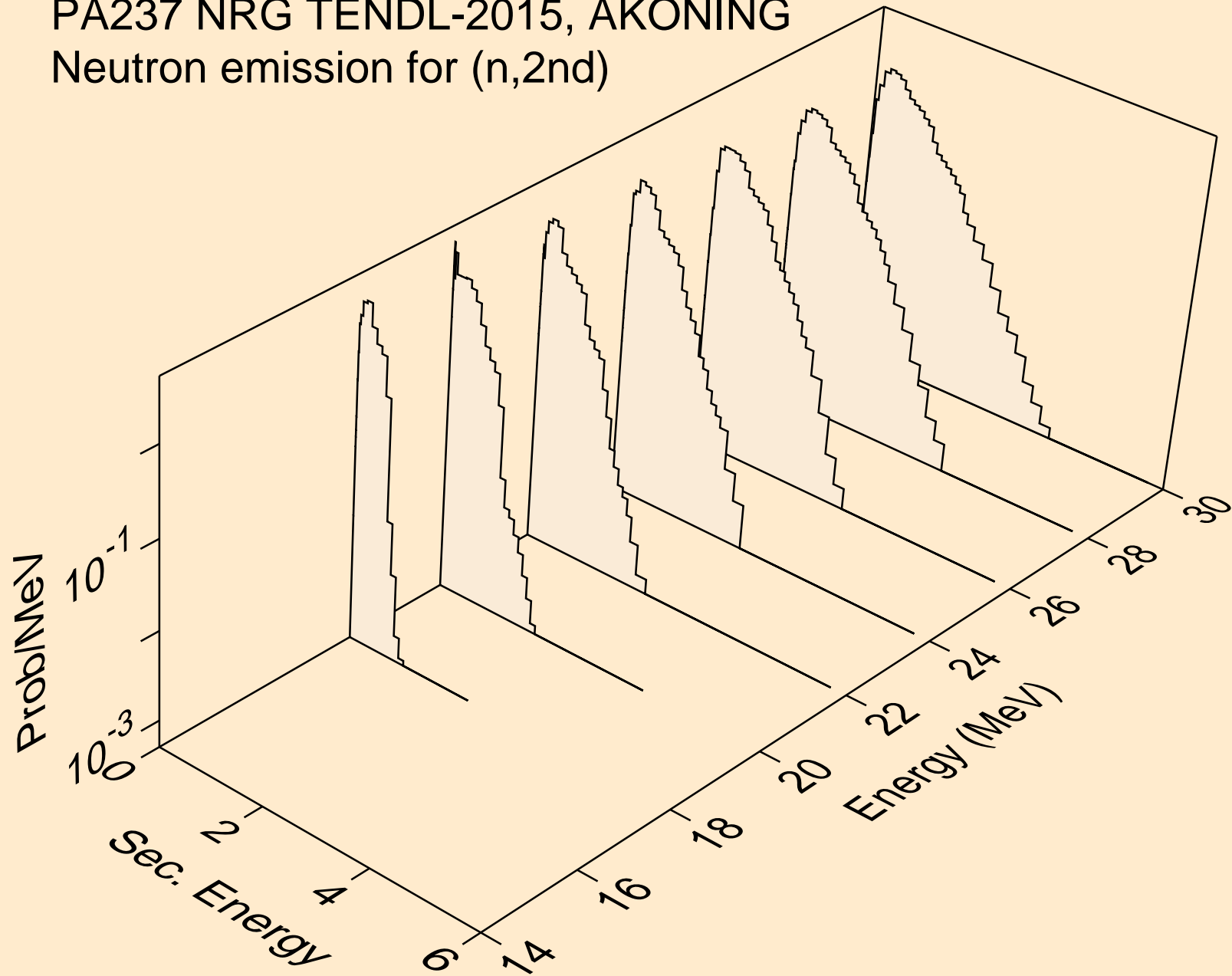

PA237 NRG TENDL-2015, AKONING
Neutron emission for (n,2n)

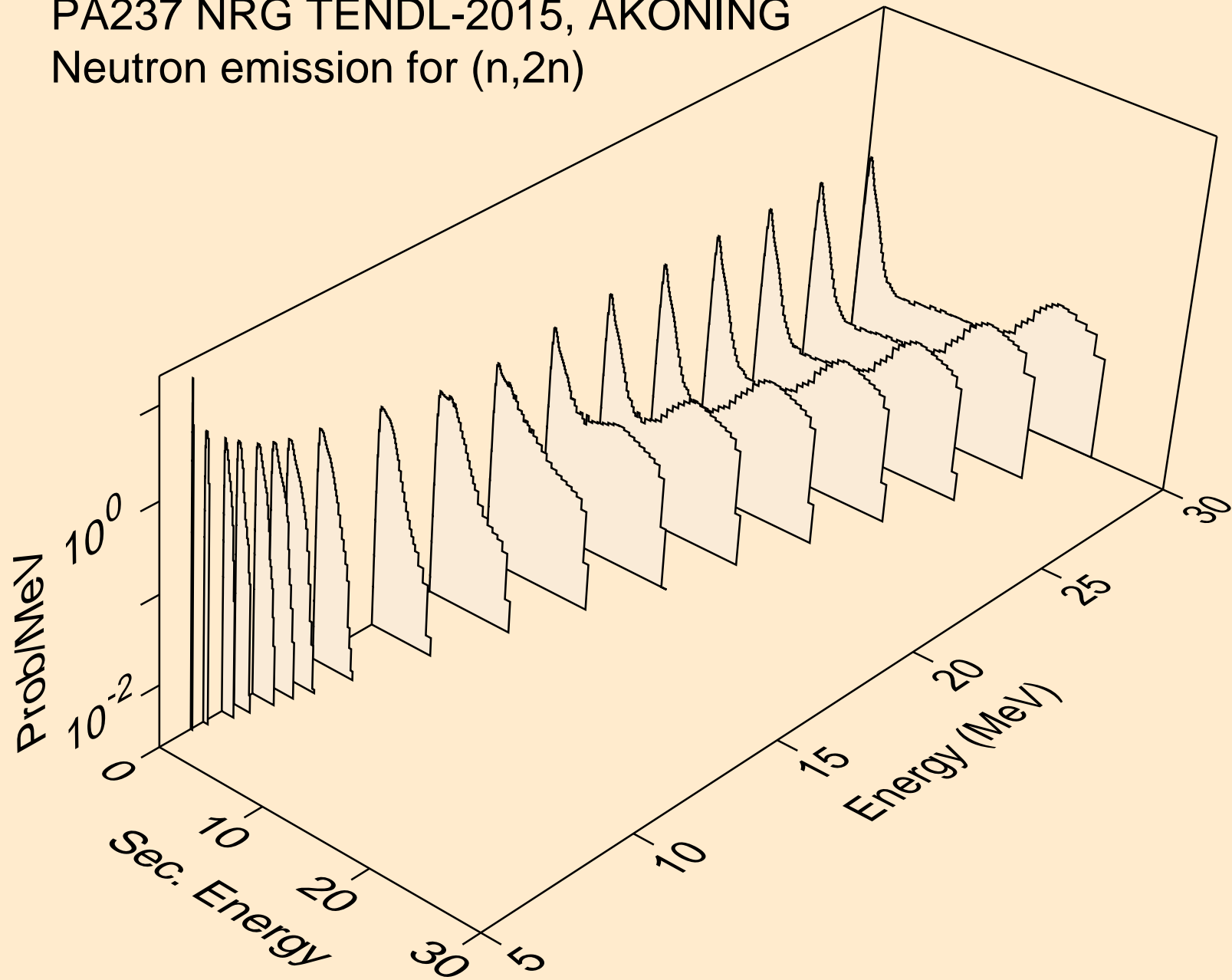

PA237 NRG TENDL-2015, AKONING
Neutron emission for (n,3n)

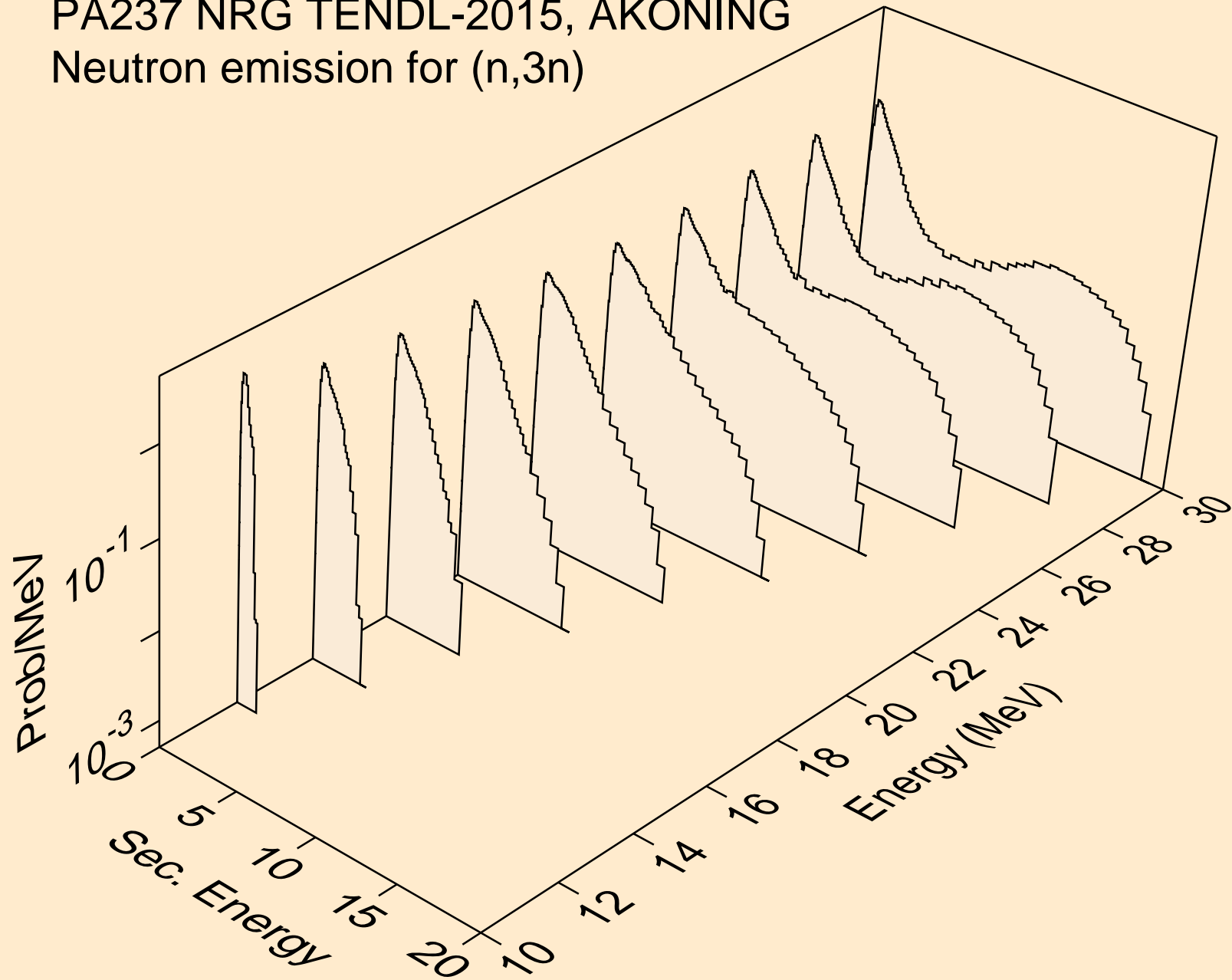

PA237 NRG TENDL-2015, AKONING
Neutron emission for fission

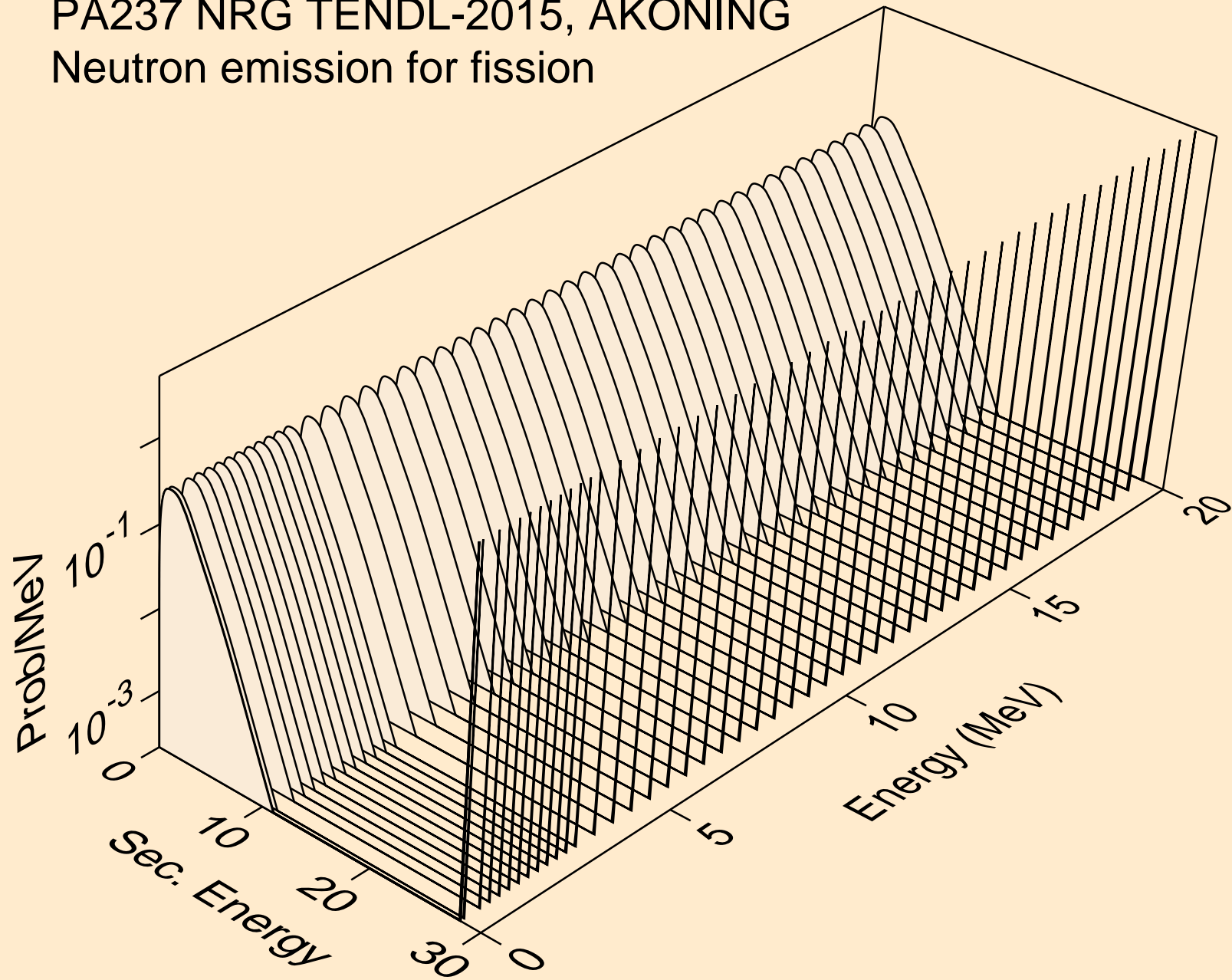

PA237 NRG TENDL-2015, AKONING
Neutron emission for (n,n*)a

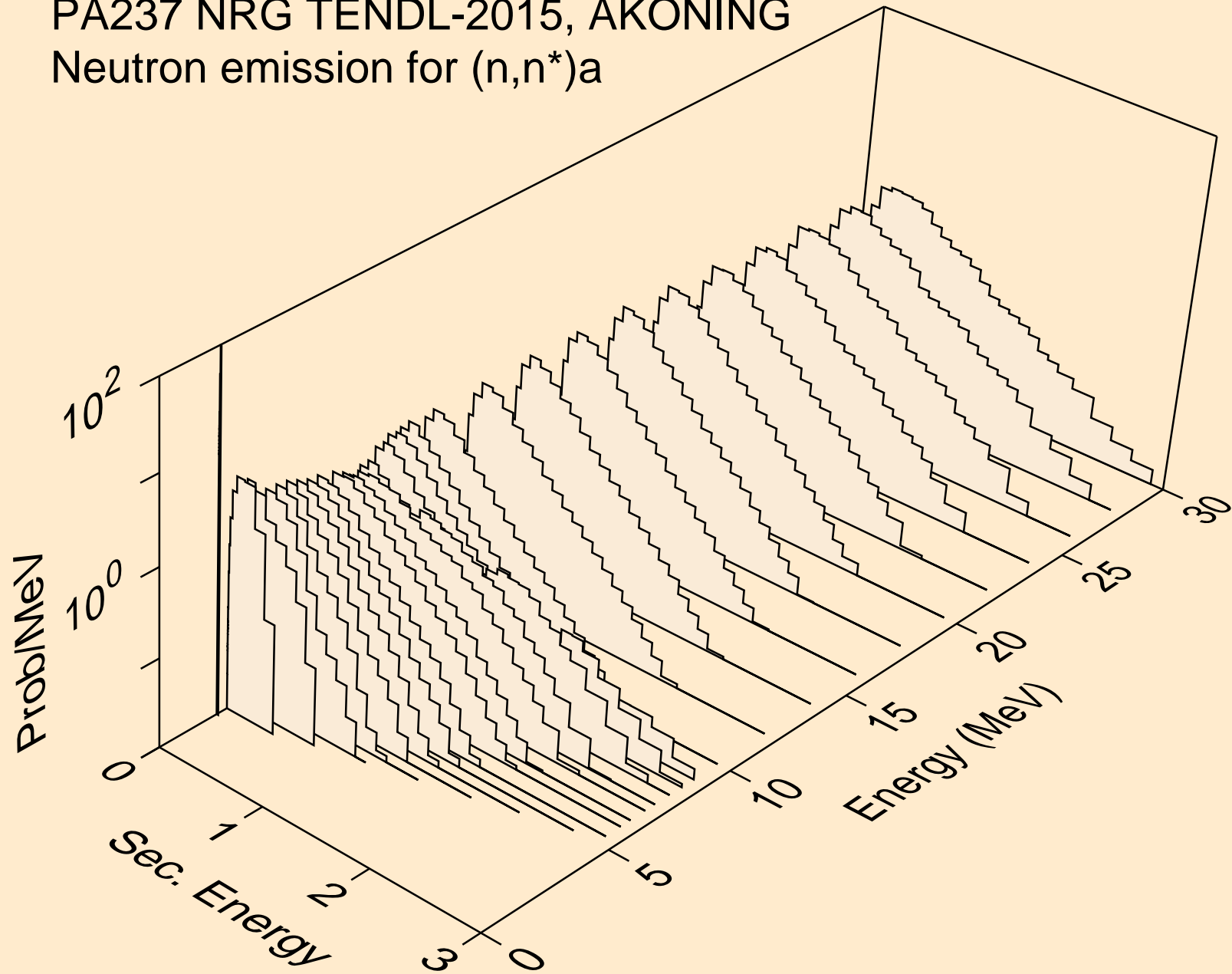

PA237 NRG TENDL-2015, AKONING
Neutron emission for (n,2n)a

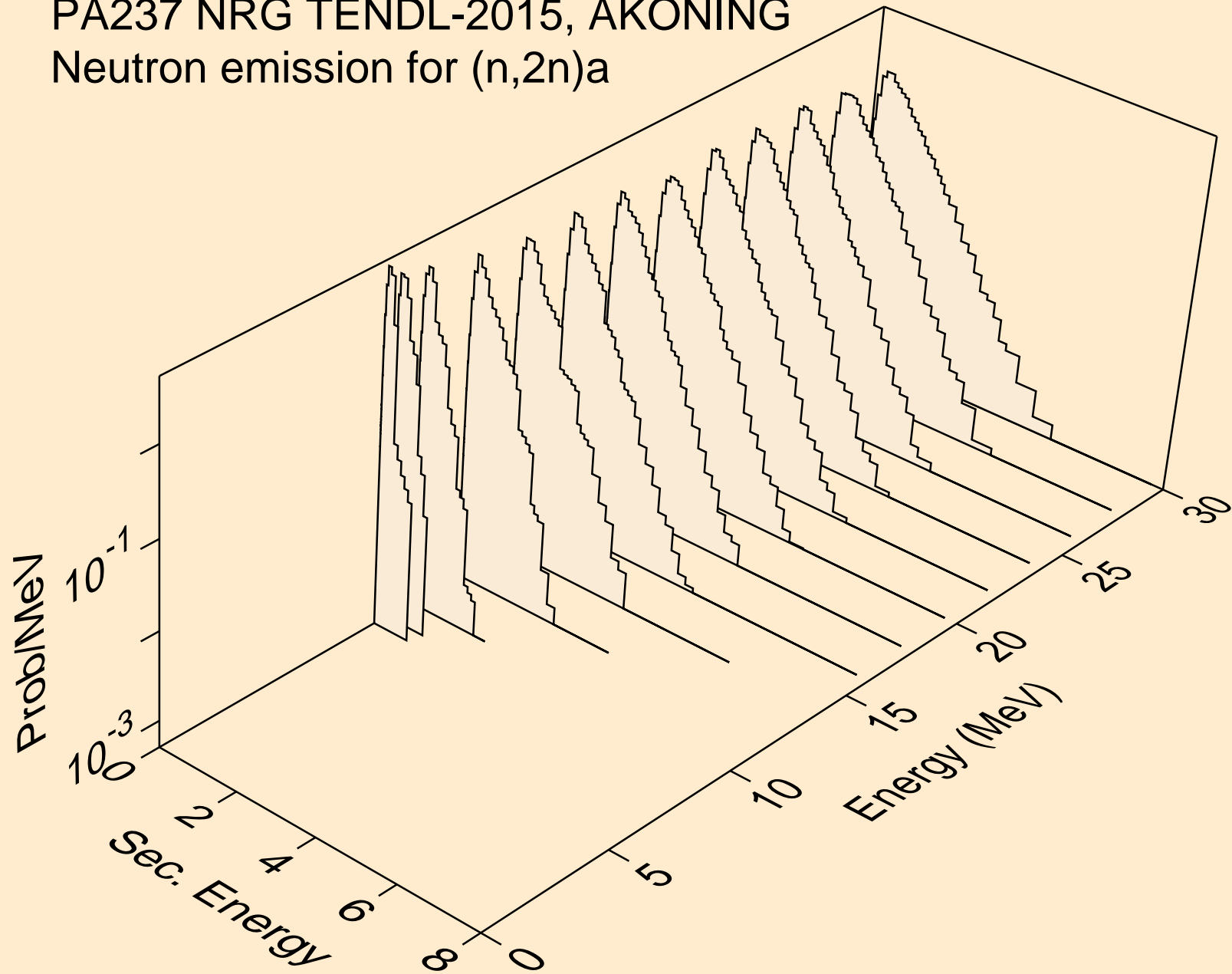

PA237 NRG TENDL-2015, AKONING
Neutron emission for (n,3n)a

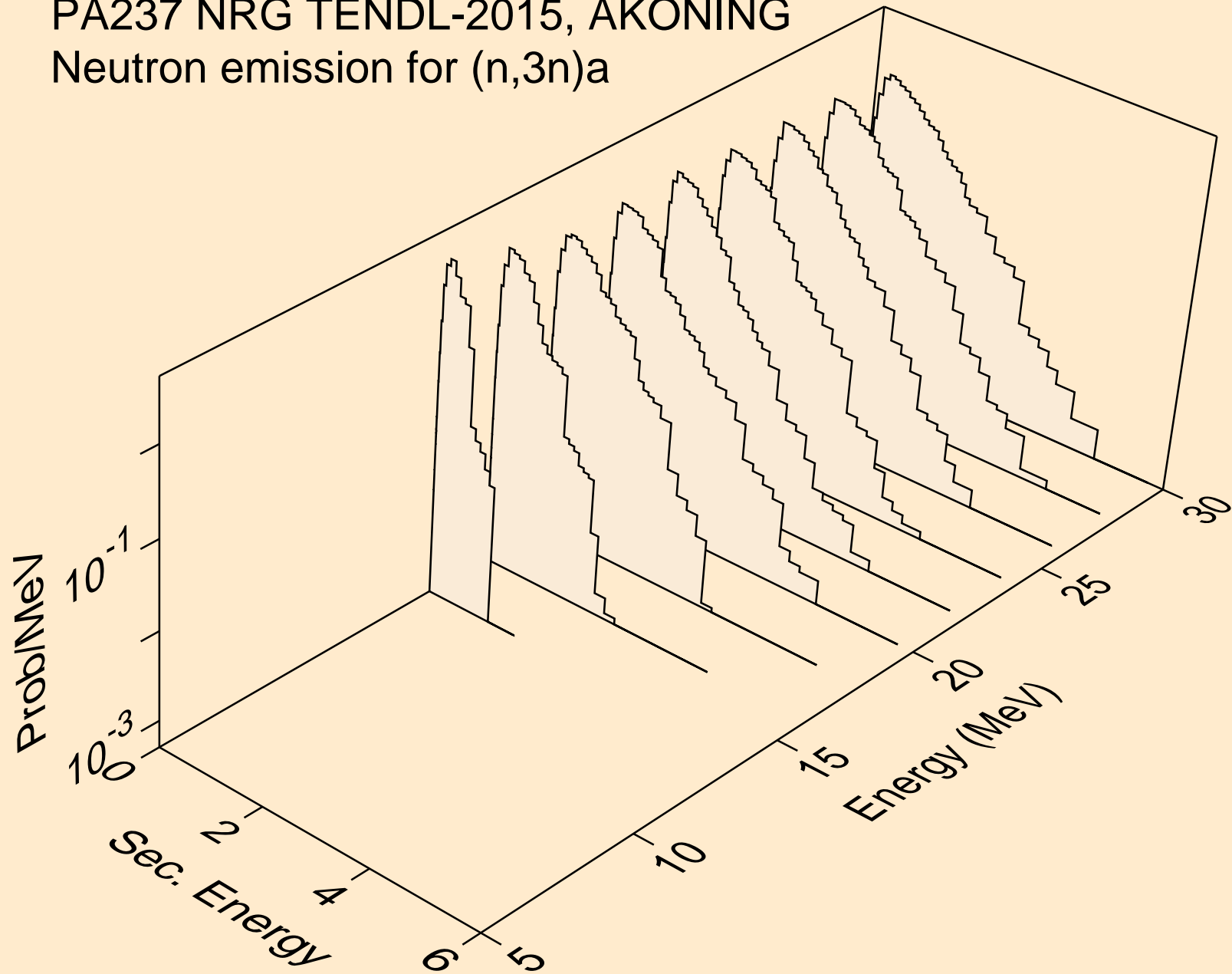

PA237 NRG TENDL-2015, AKONING
Neutron emission for (n,n*)p

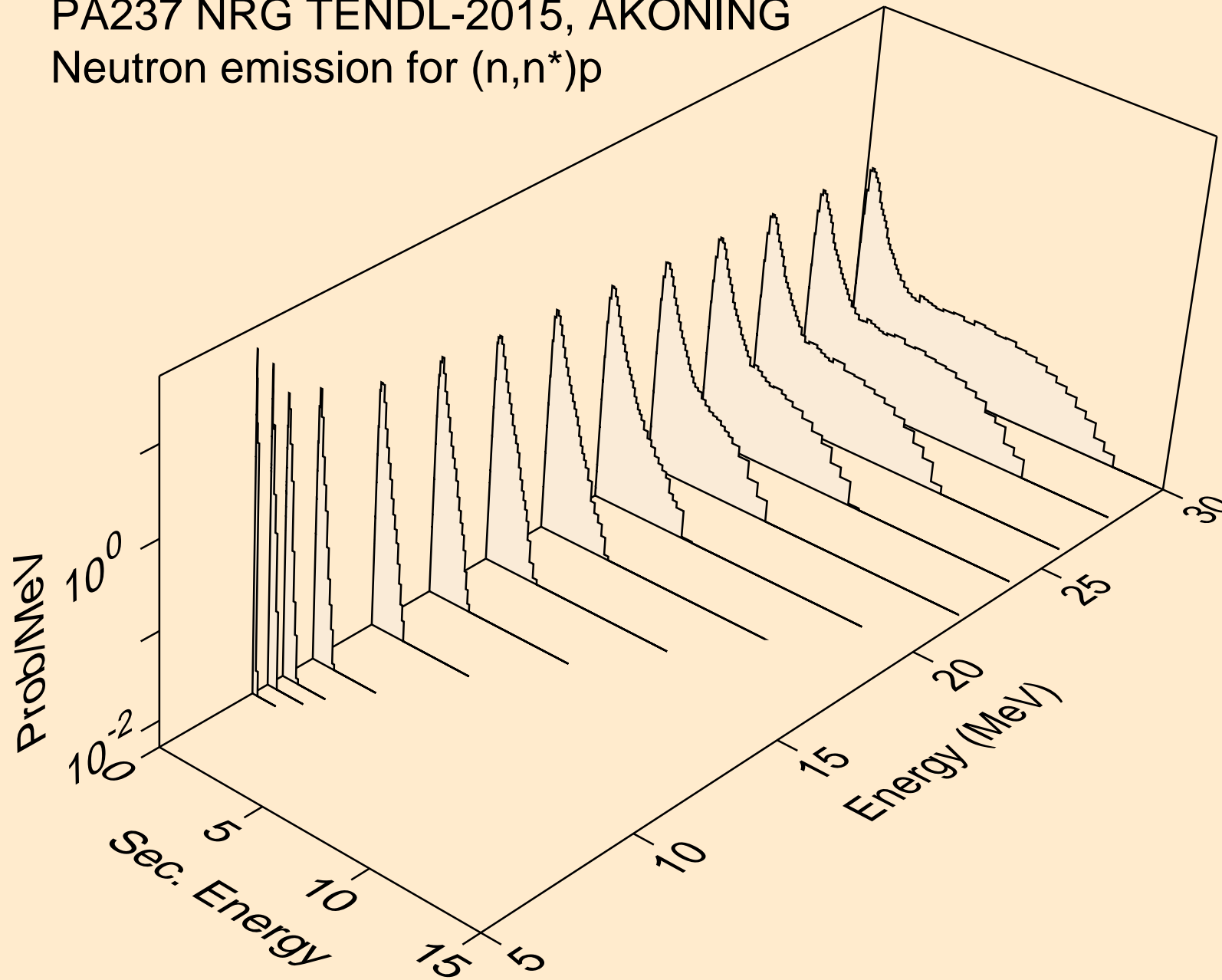

PA237 NRG TENDL-2015, AKONING
Neutron emission for (n,n*)d

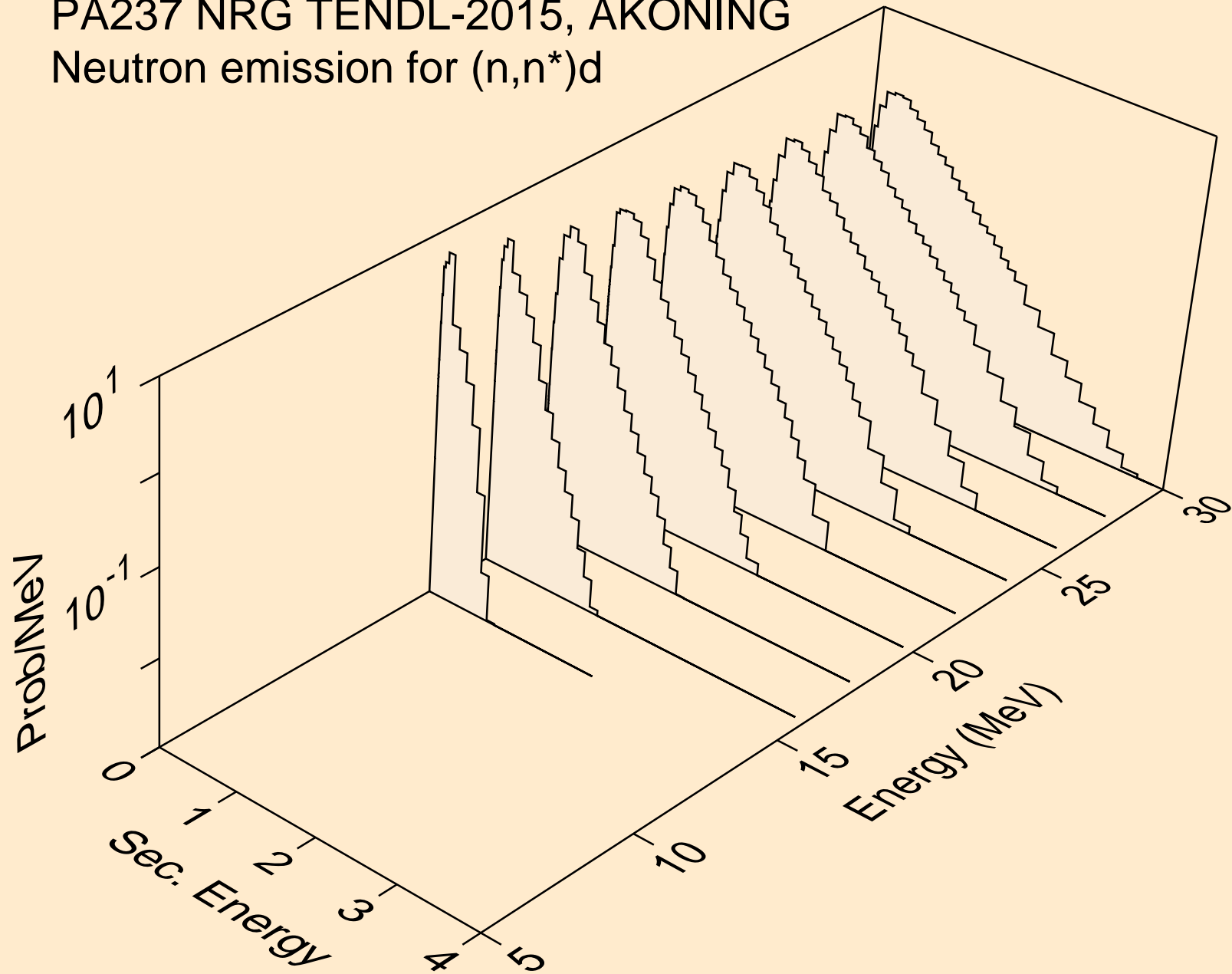

PA237 NRG TENDL-2015, AKONING
Neutron emission for (n,n*)t

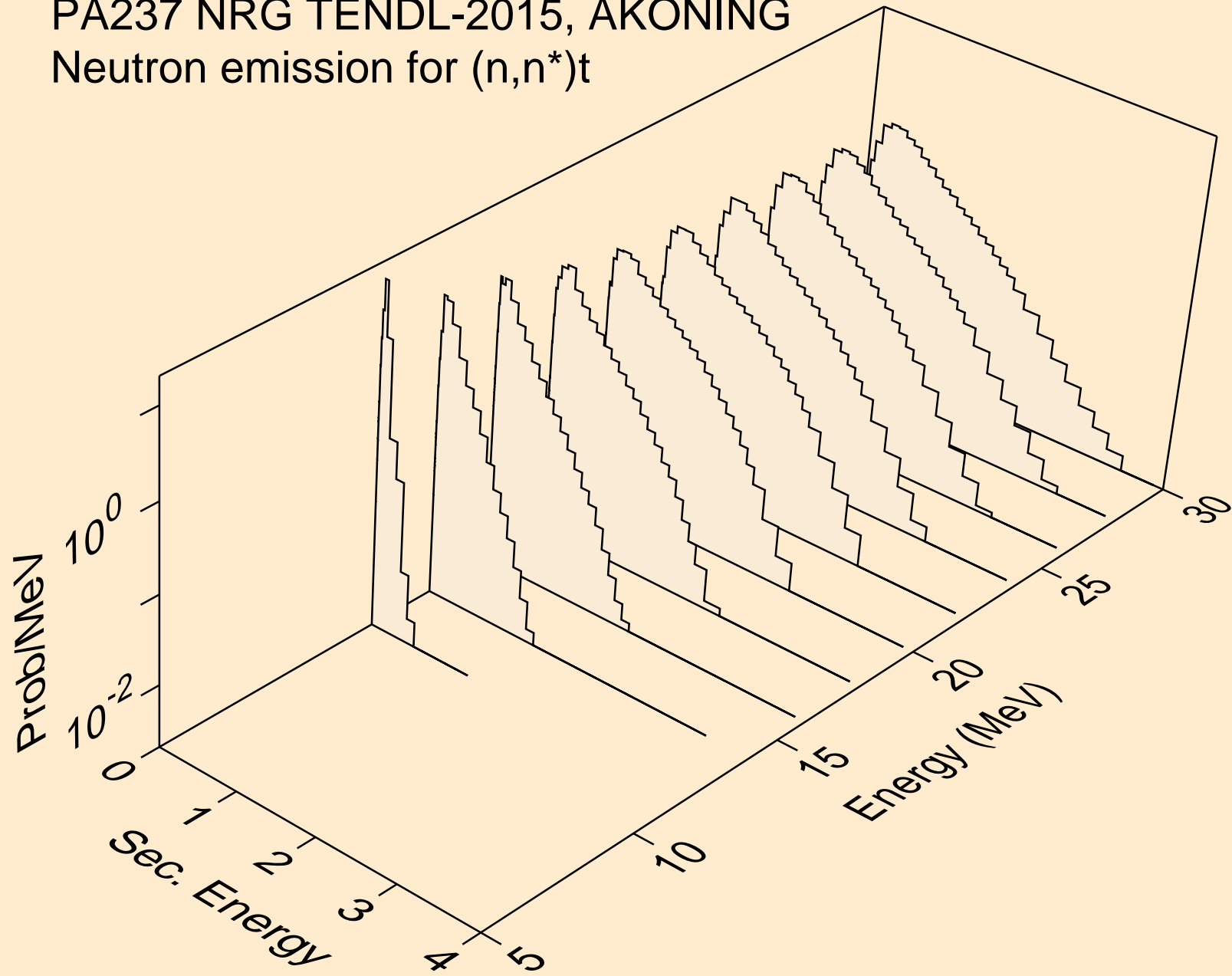

PA237 NRG TENDL-2015, AKONING
Neutron emission for (n,n*)he3

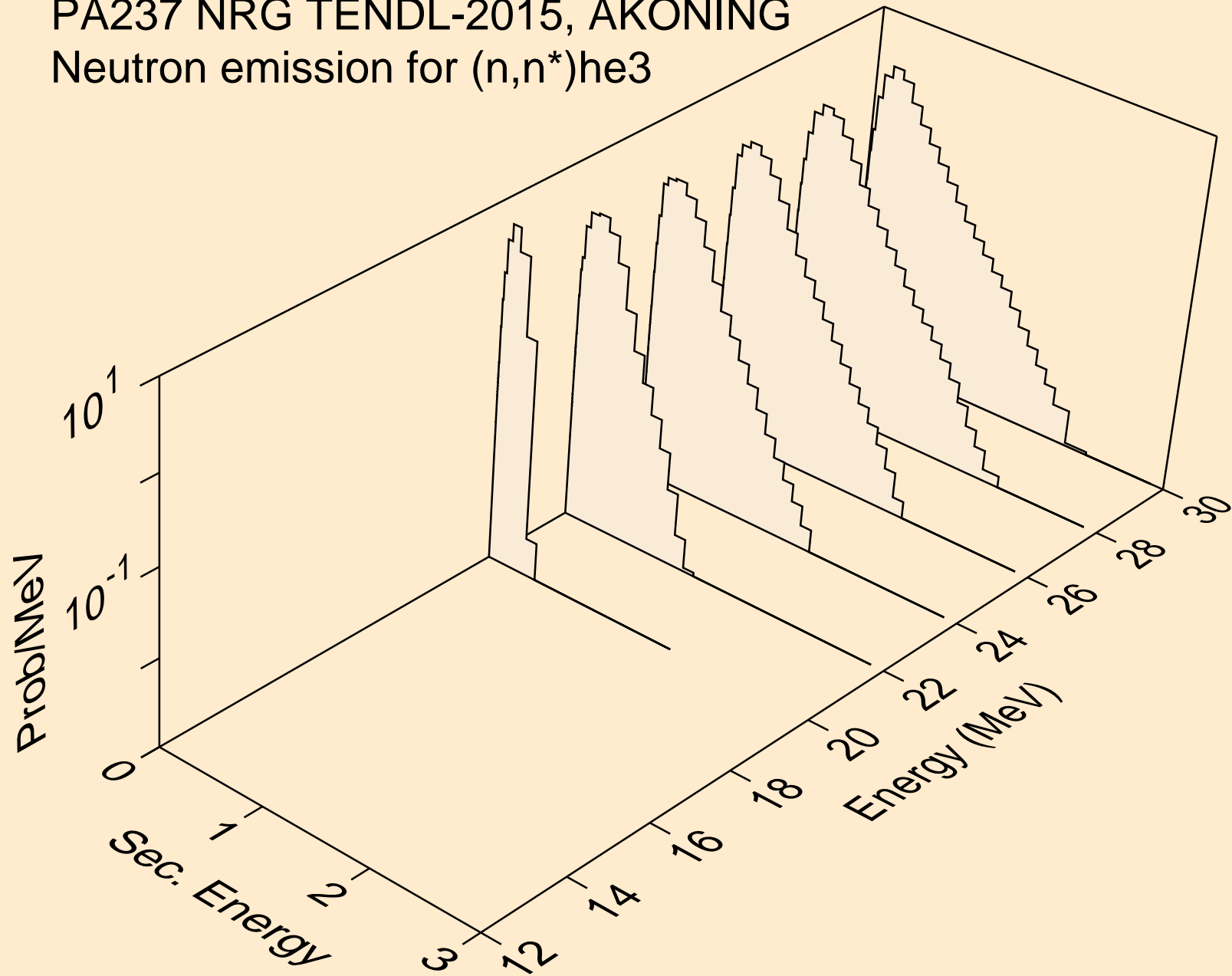

PA237 NRG TENDL-2015, AKONING
Neutron emission for (n,4n)

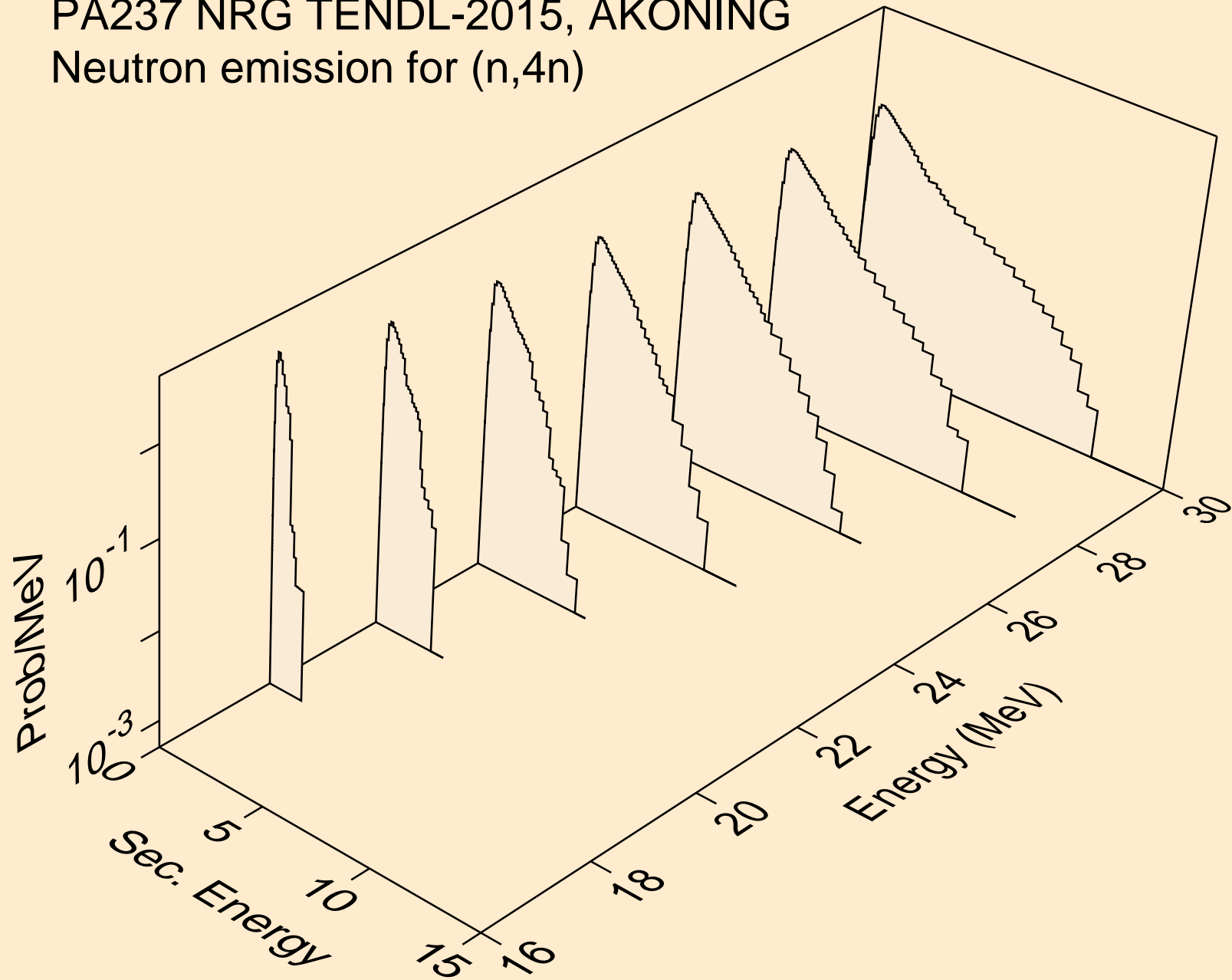

PA237 NRG TENDL-2015, AKONING
Neutron emission for (n,2np)

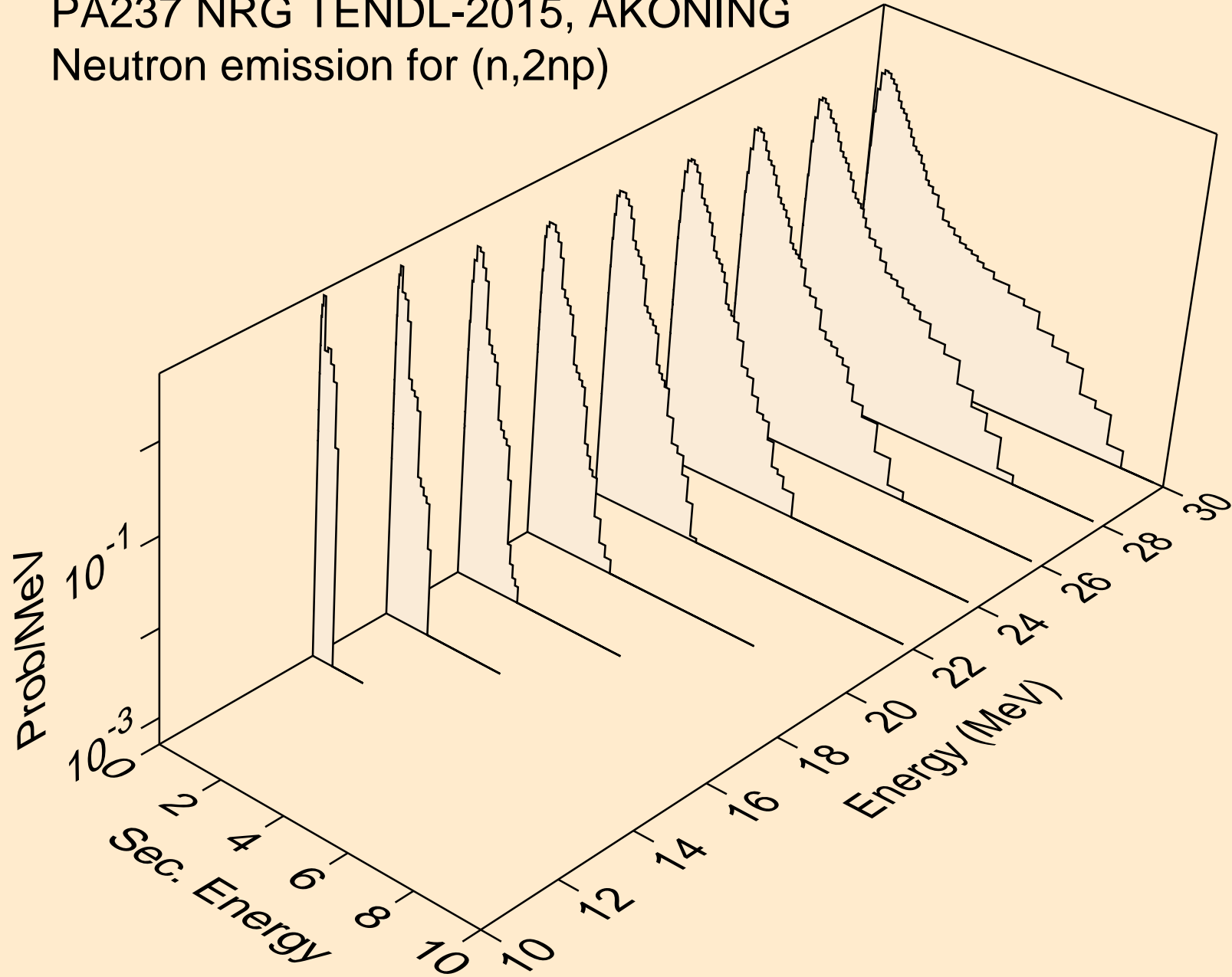

PA237 NRG TENDL-2015, AKONING
Neutron emission for (n,3np)

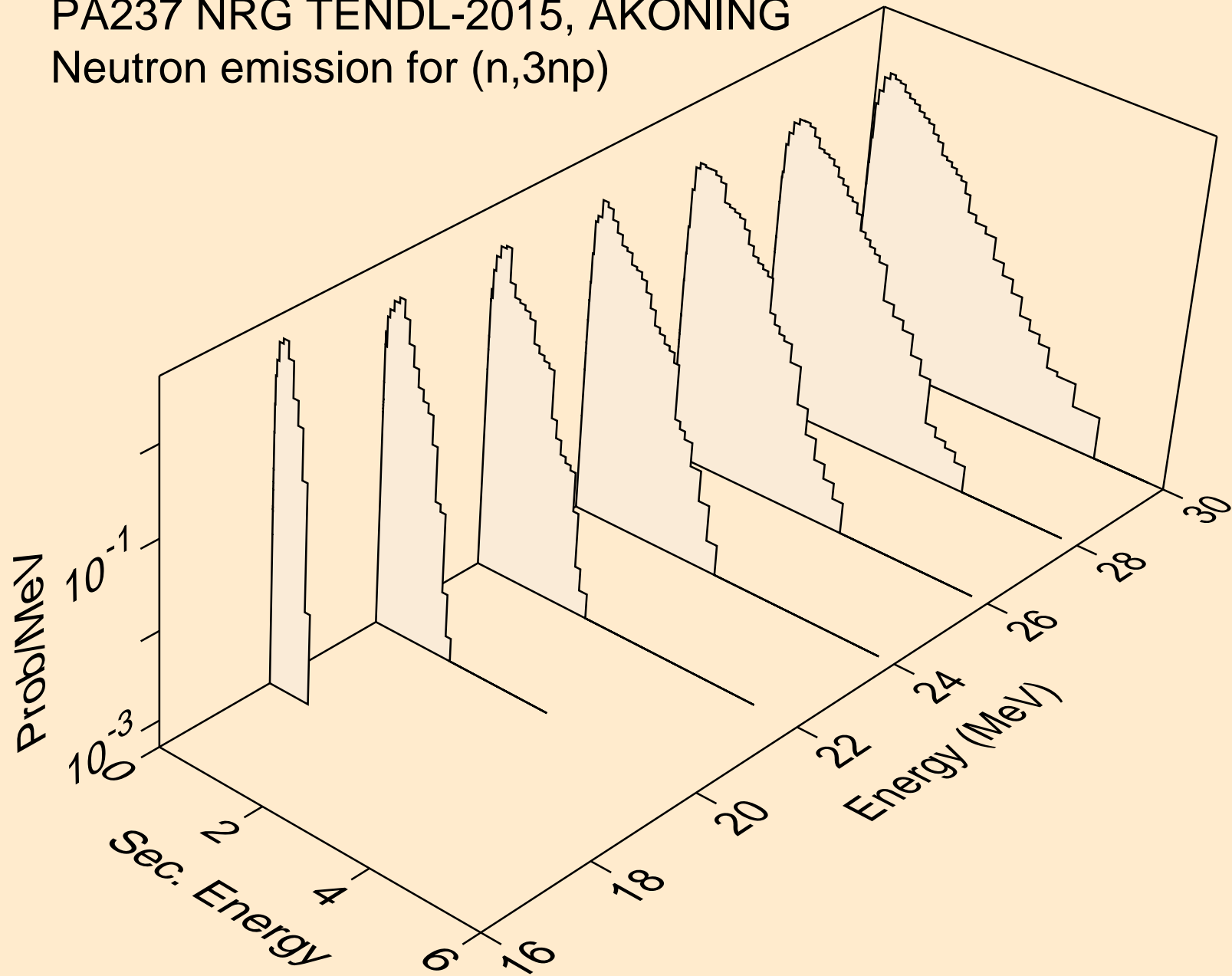

PA237 NRG TENDL-2015, AKONING
Neutron emission for (n,n*c)

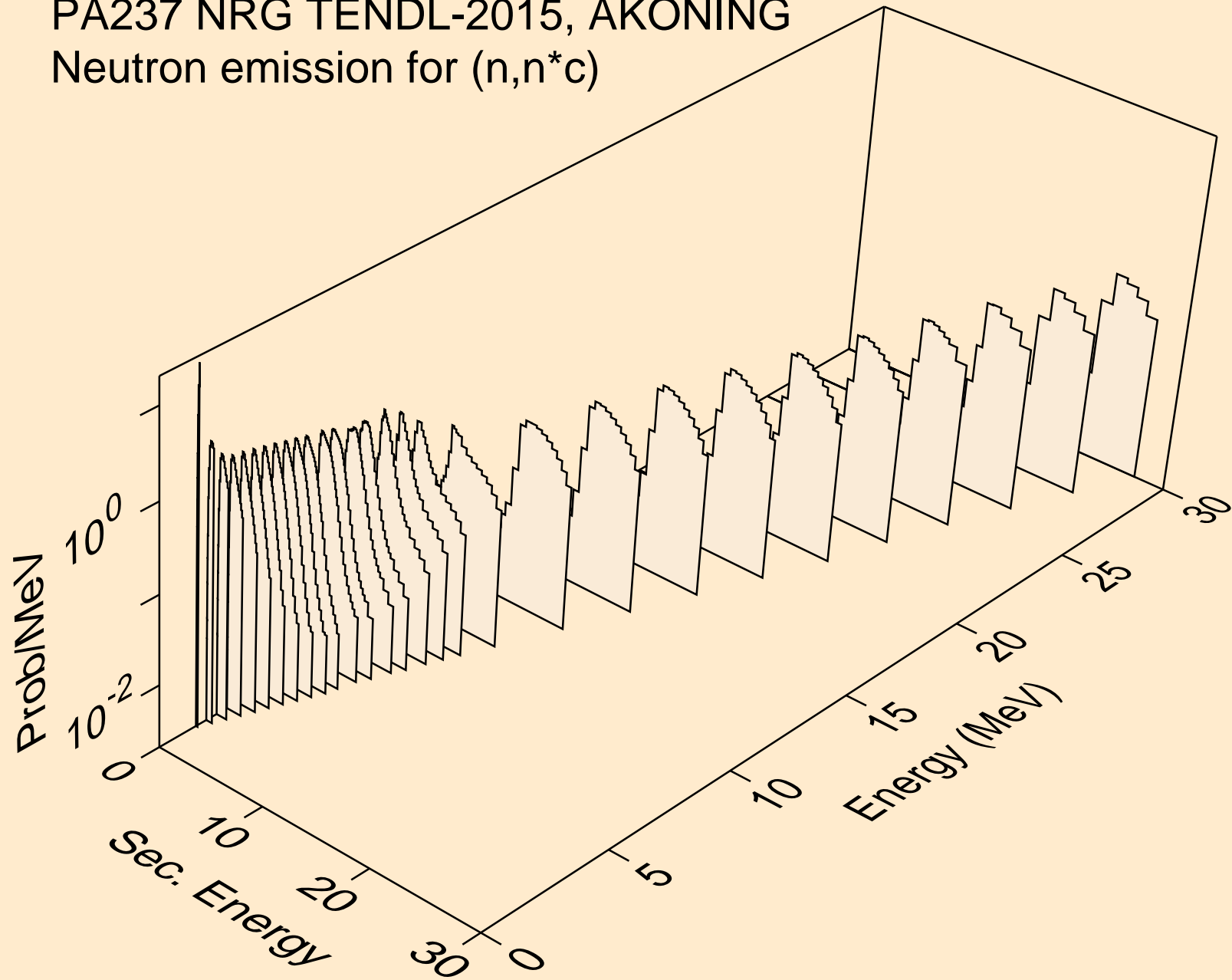

PA237 NRG TENDL-2015, AKONING

Delayed nubar

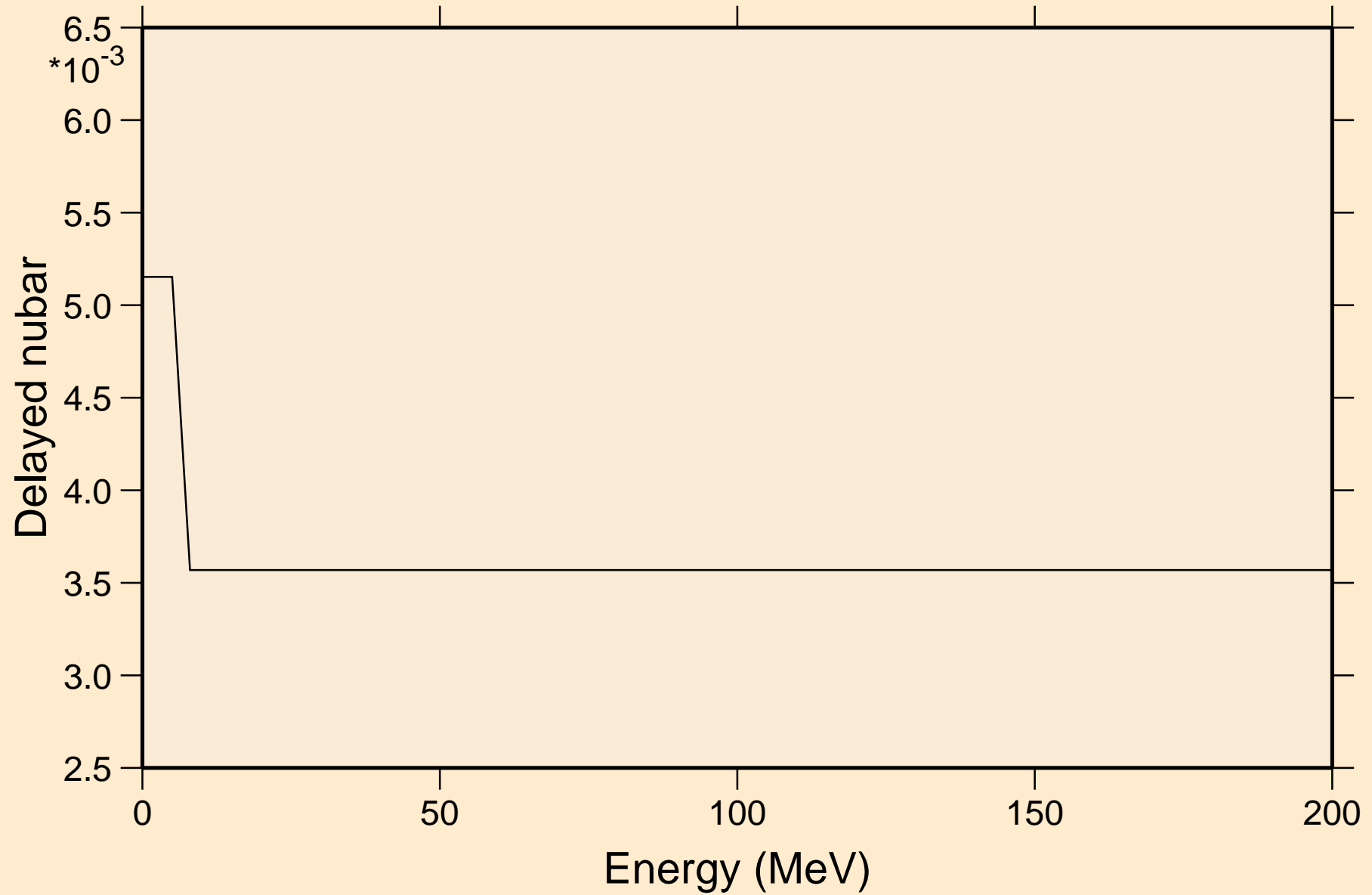

PA237 NRG TENDL-2015, AKONING

Delayed neutron spectra

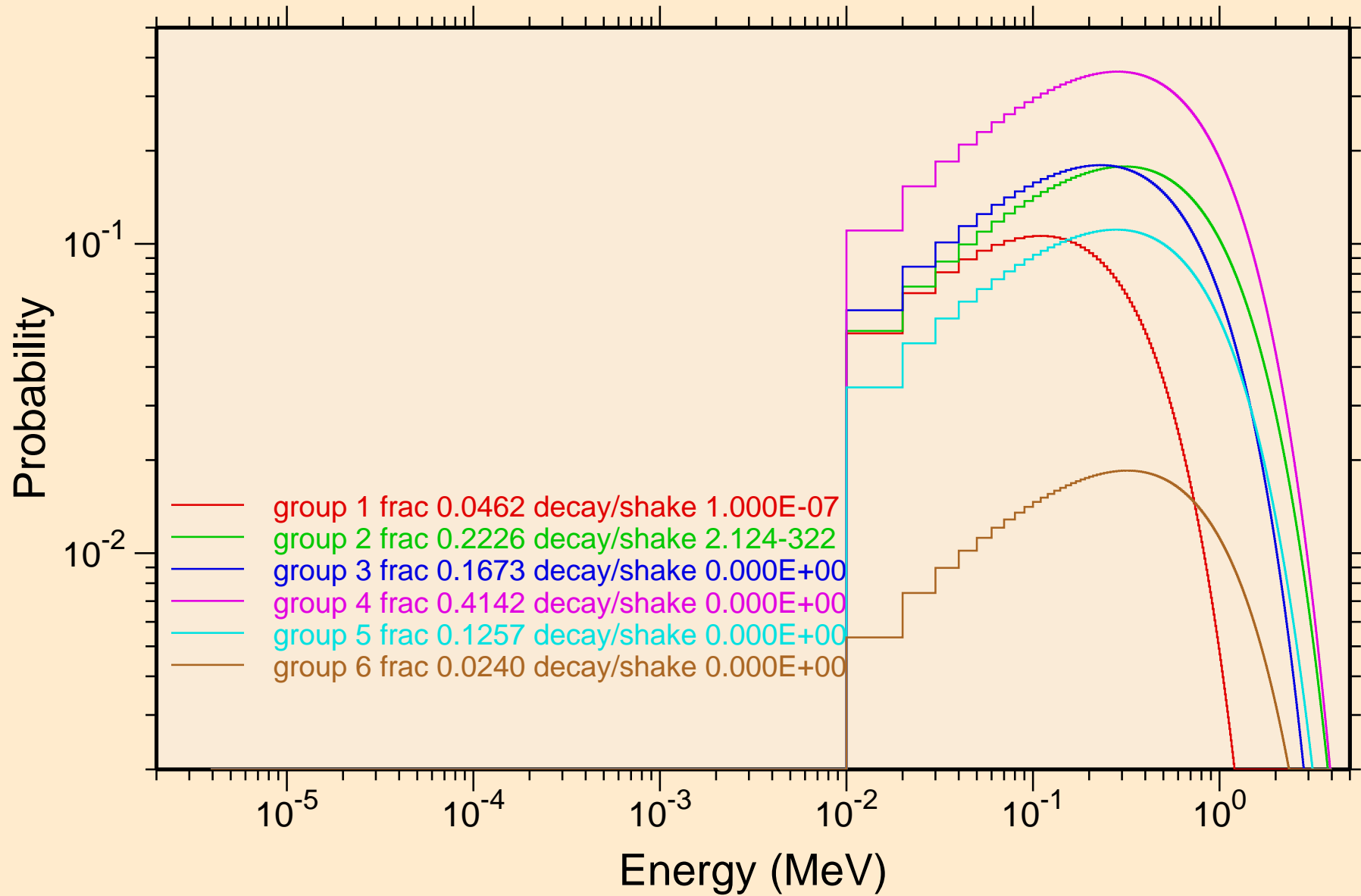

PA237 NRG TENDL-2015, AKONING
Photon emission for (n,x)

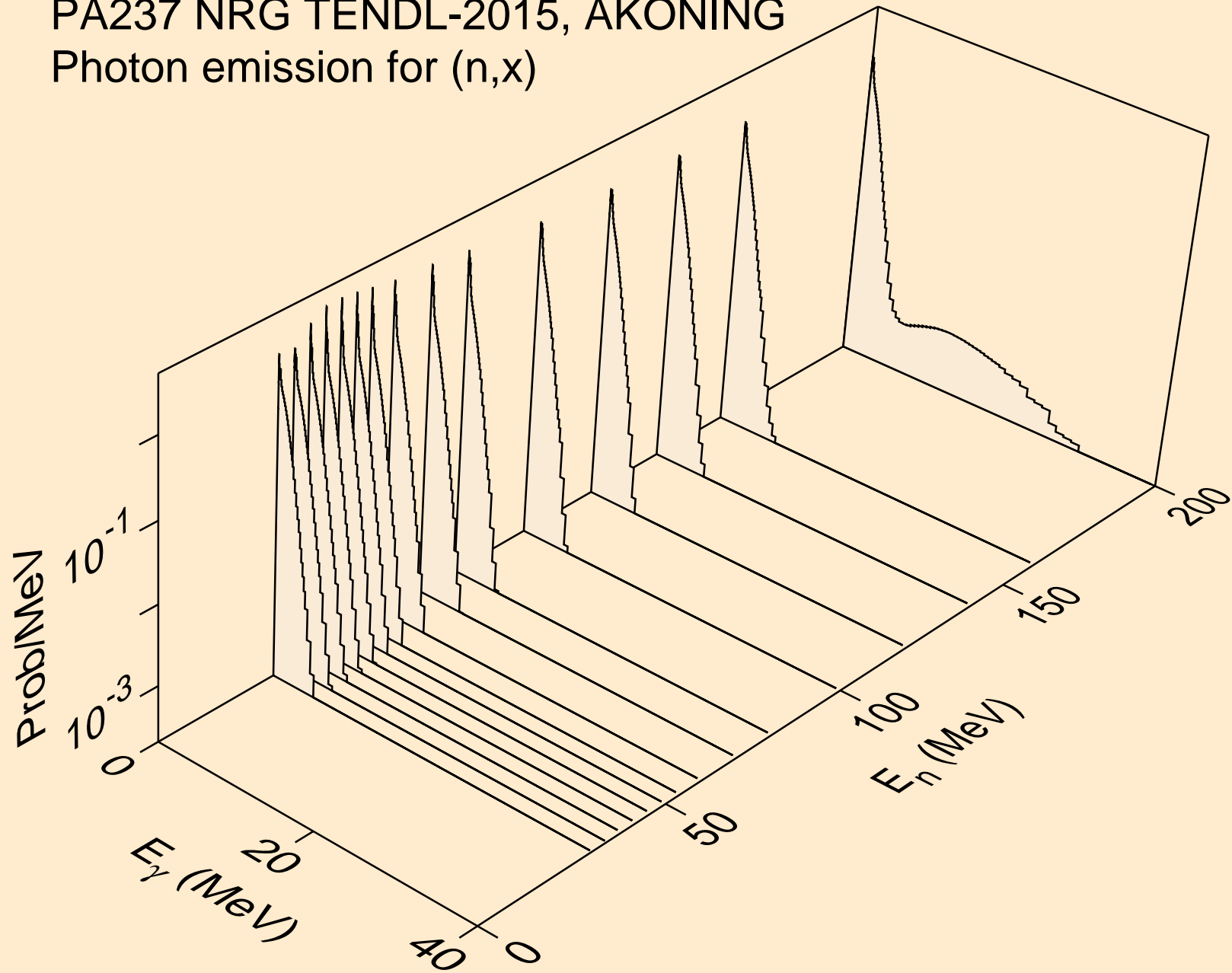

PA237 NRG TENDL-2015, AKONING
Photon emission for (n,2nd)

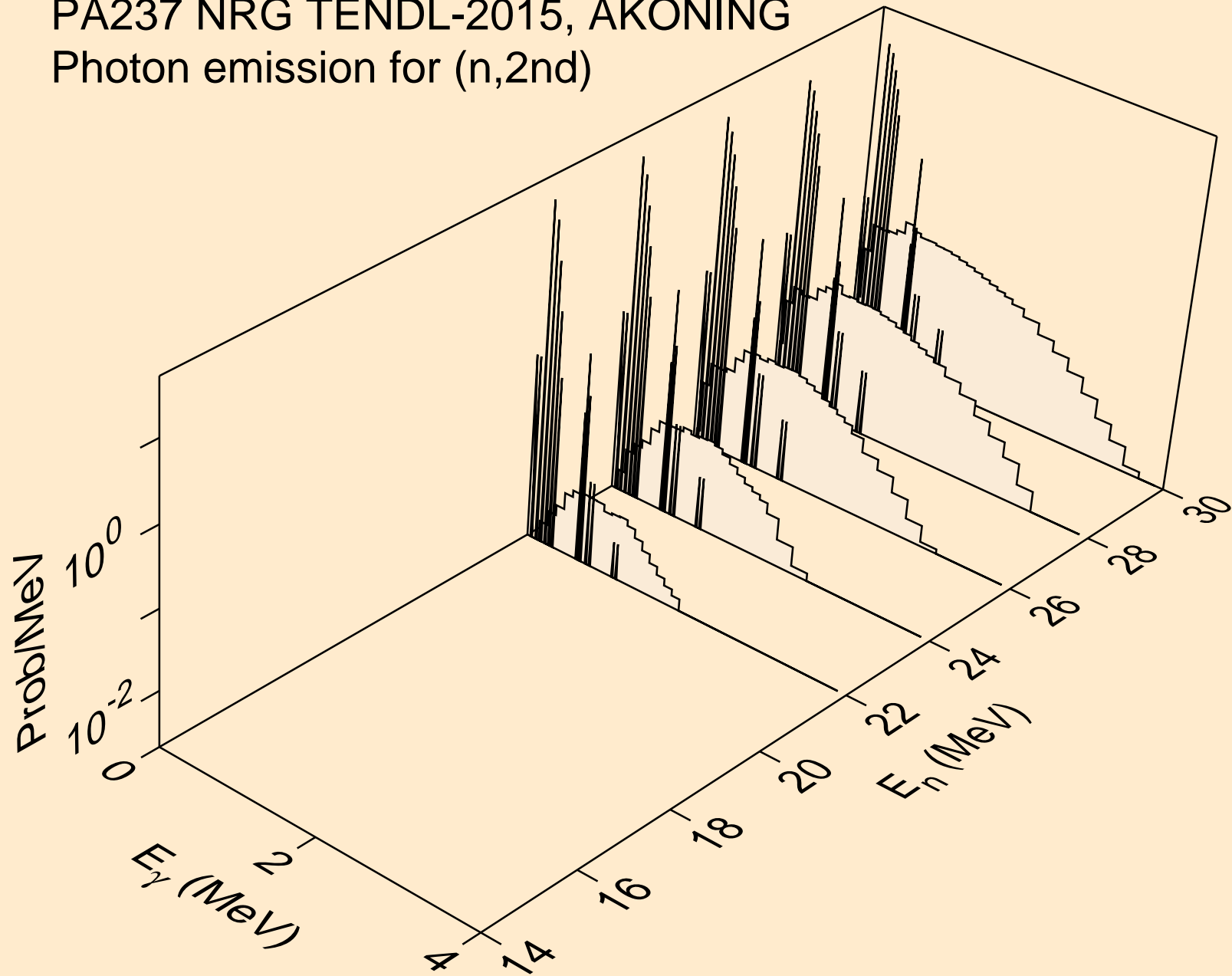

PA237 NRG TENDL-2015, AKONING
Photon emission for (n,2n)

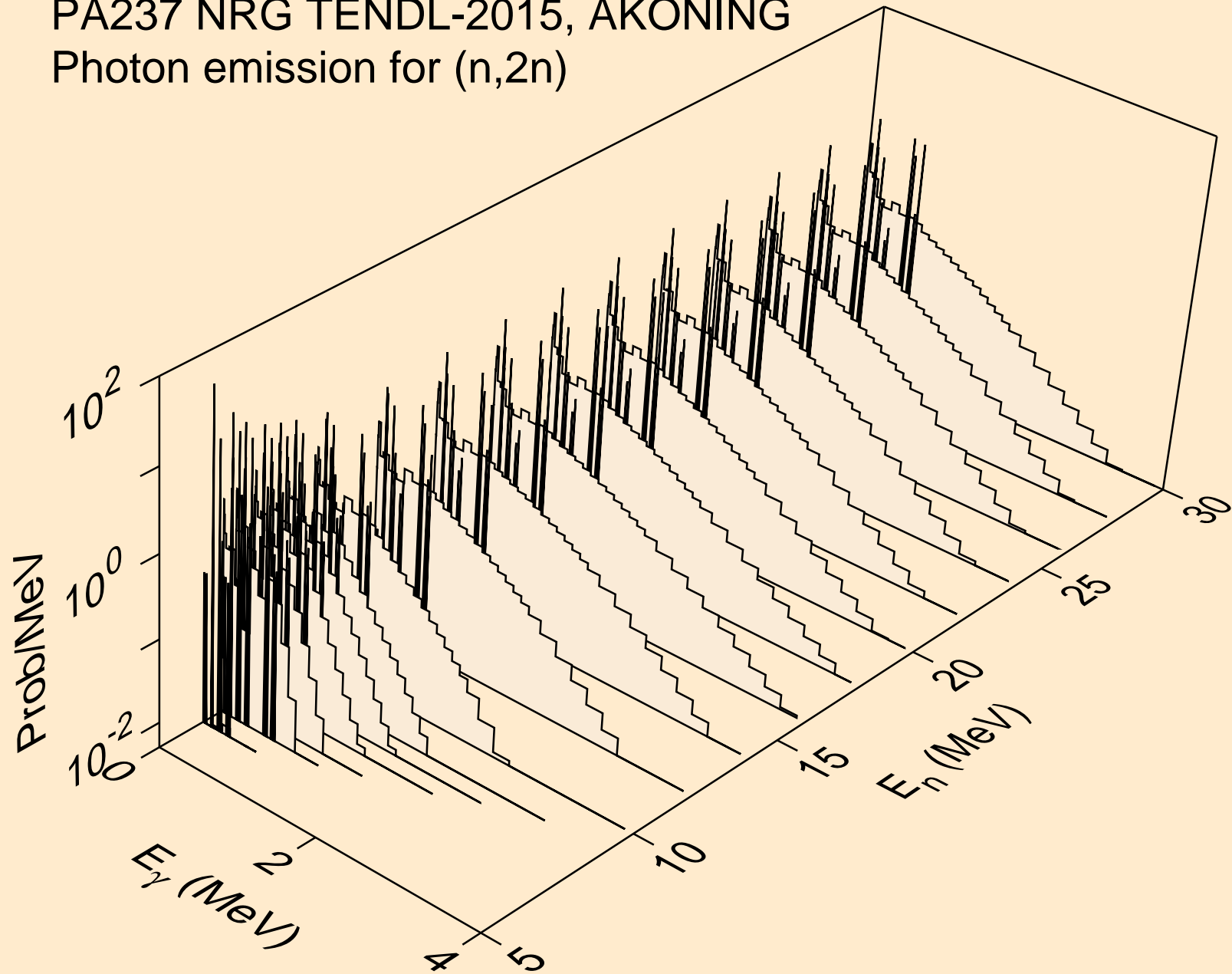

PA237 NRG TENDL-2015, AKONING
Photon emission for (n,3n)

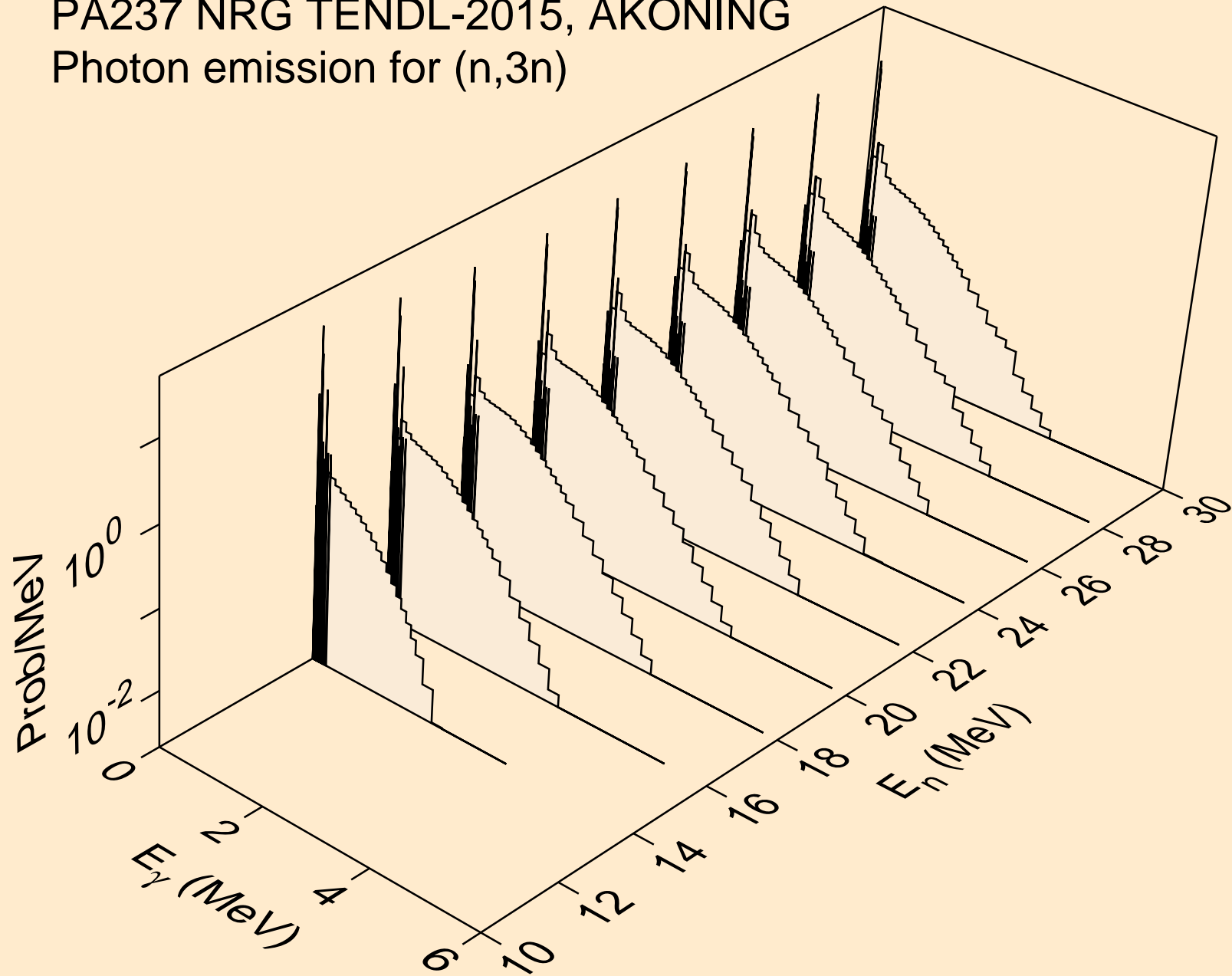

PA237 NRG TENDL-2015, AKONING
Photon emission for (n,n*)a

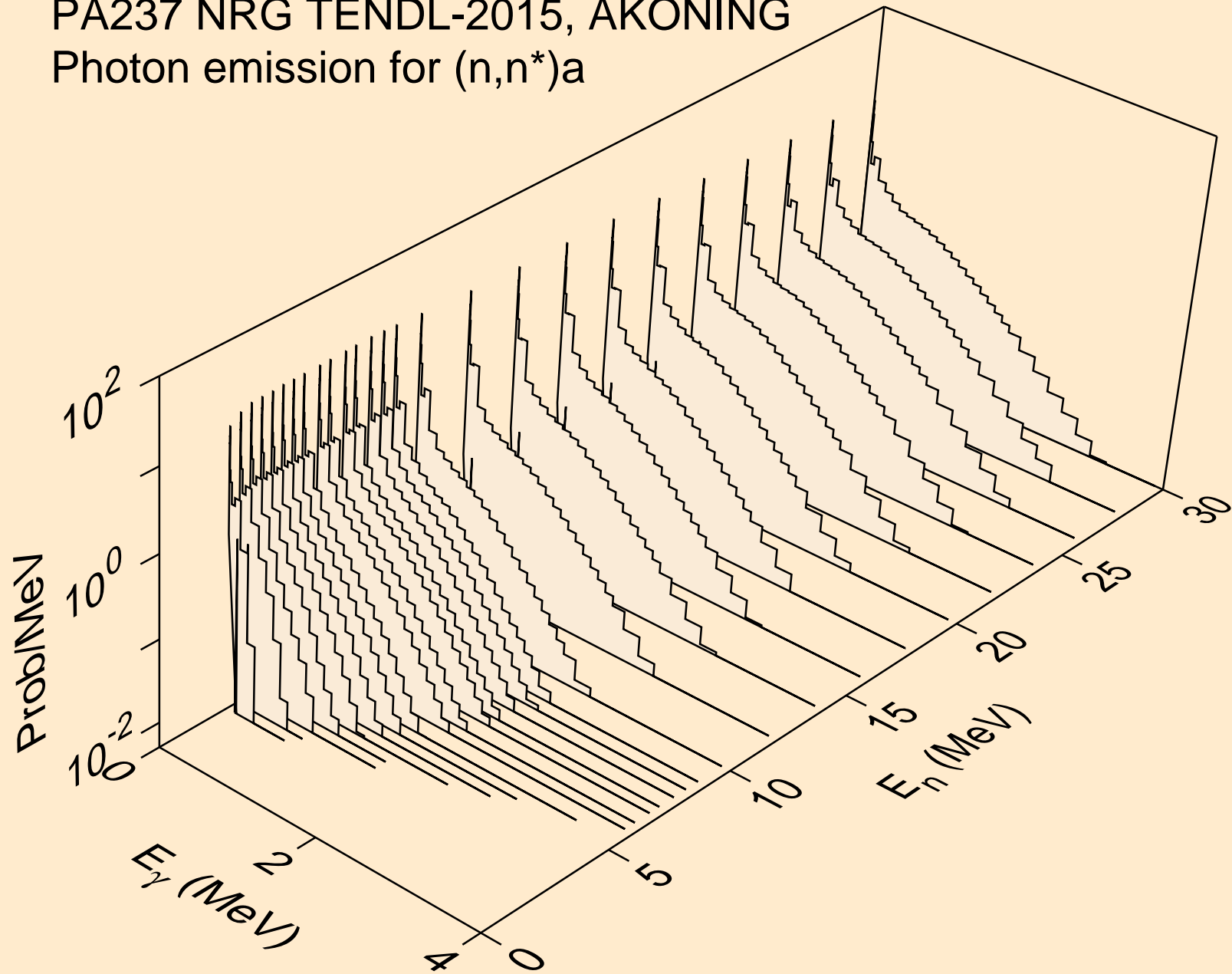

PA237 NRG TENDL-2015, AKONING
Photon emission for (n,2n)a

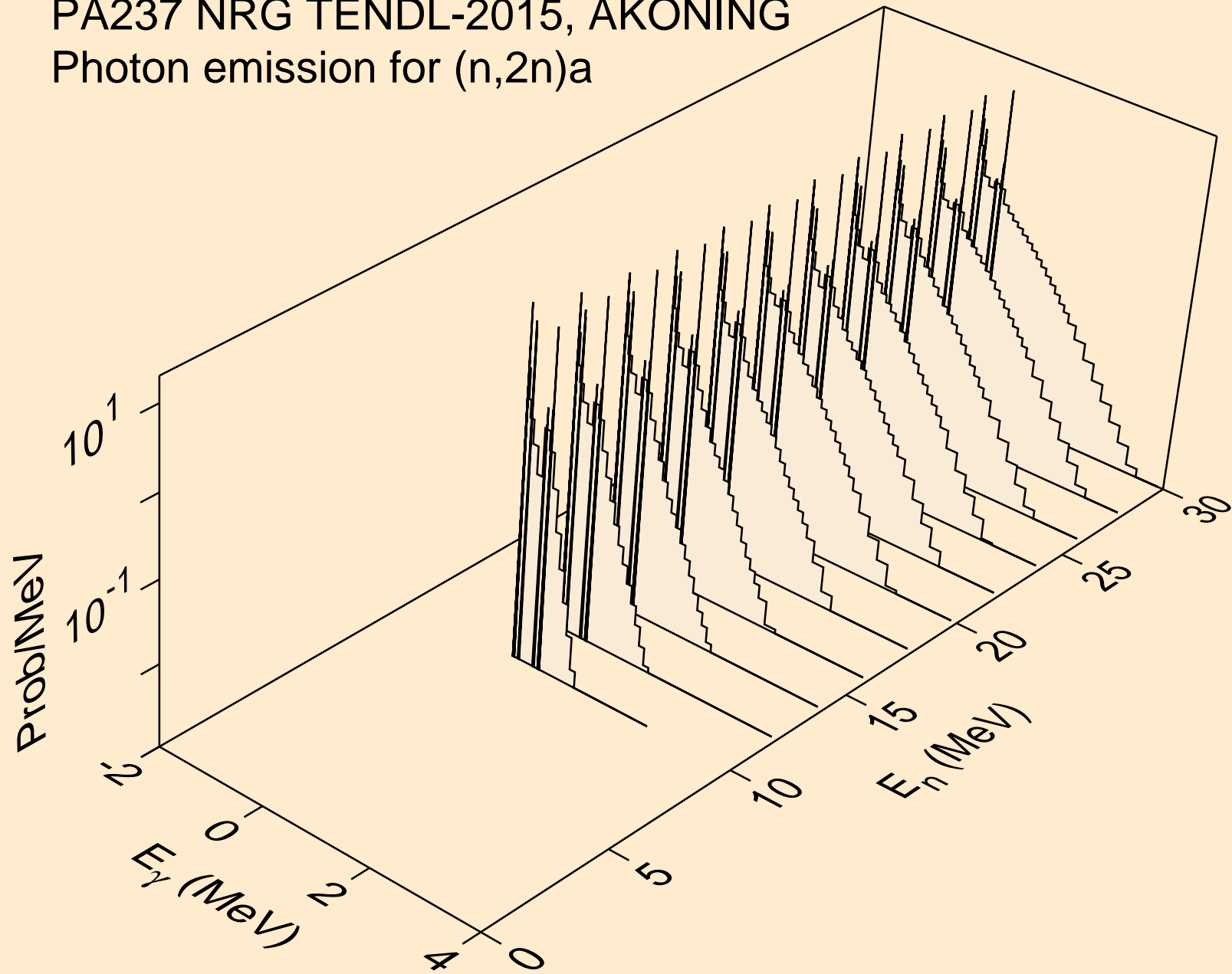

PA237 NRG TENDL-2015, AKONING
Photon emission for (n,3n)a

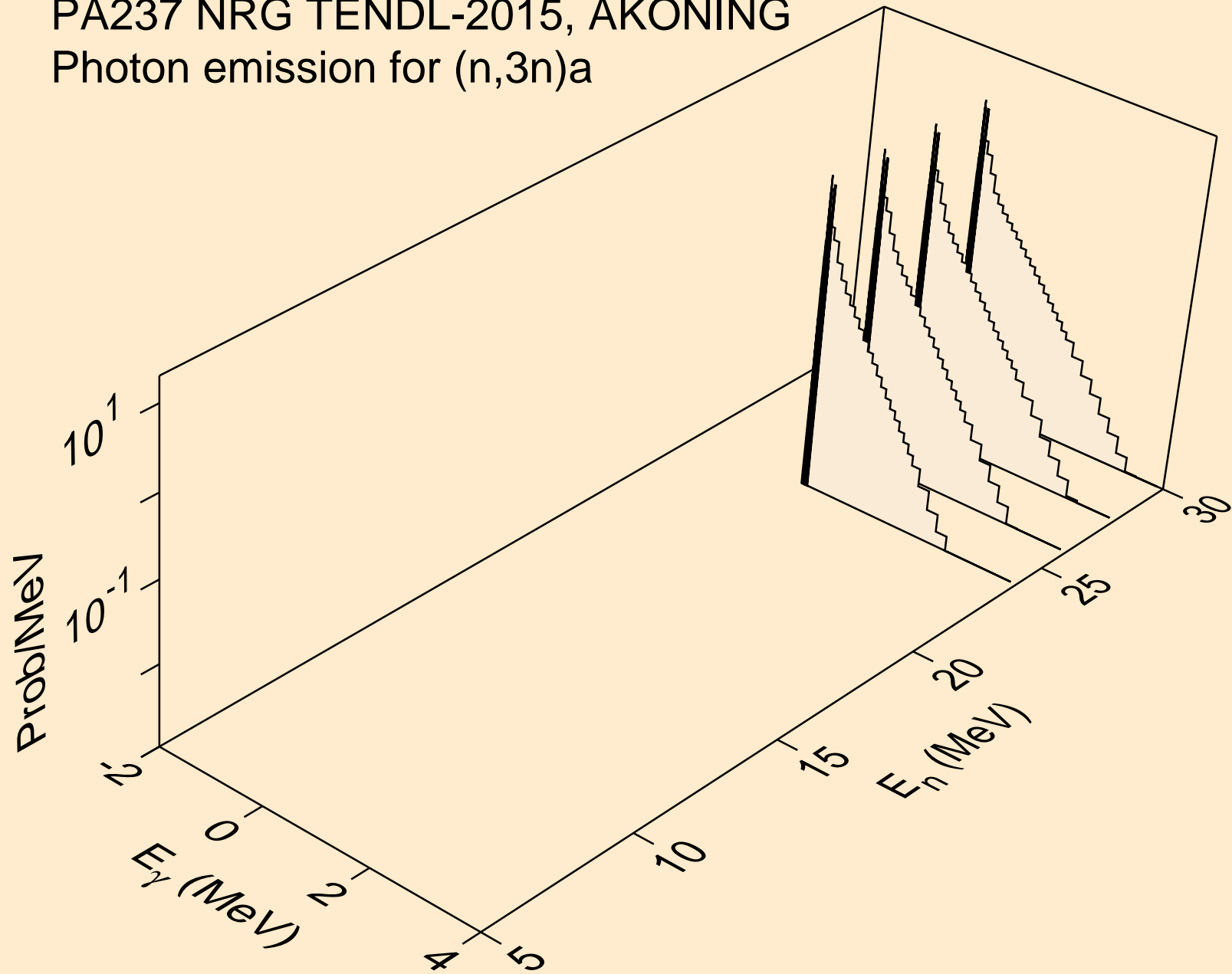

PA237 NRG TENDL-2015, AKONING
Photon emission for (n,n*)p

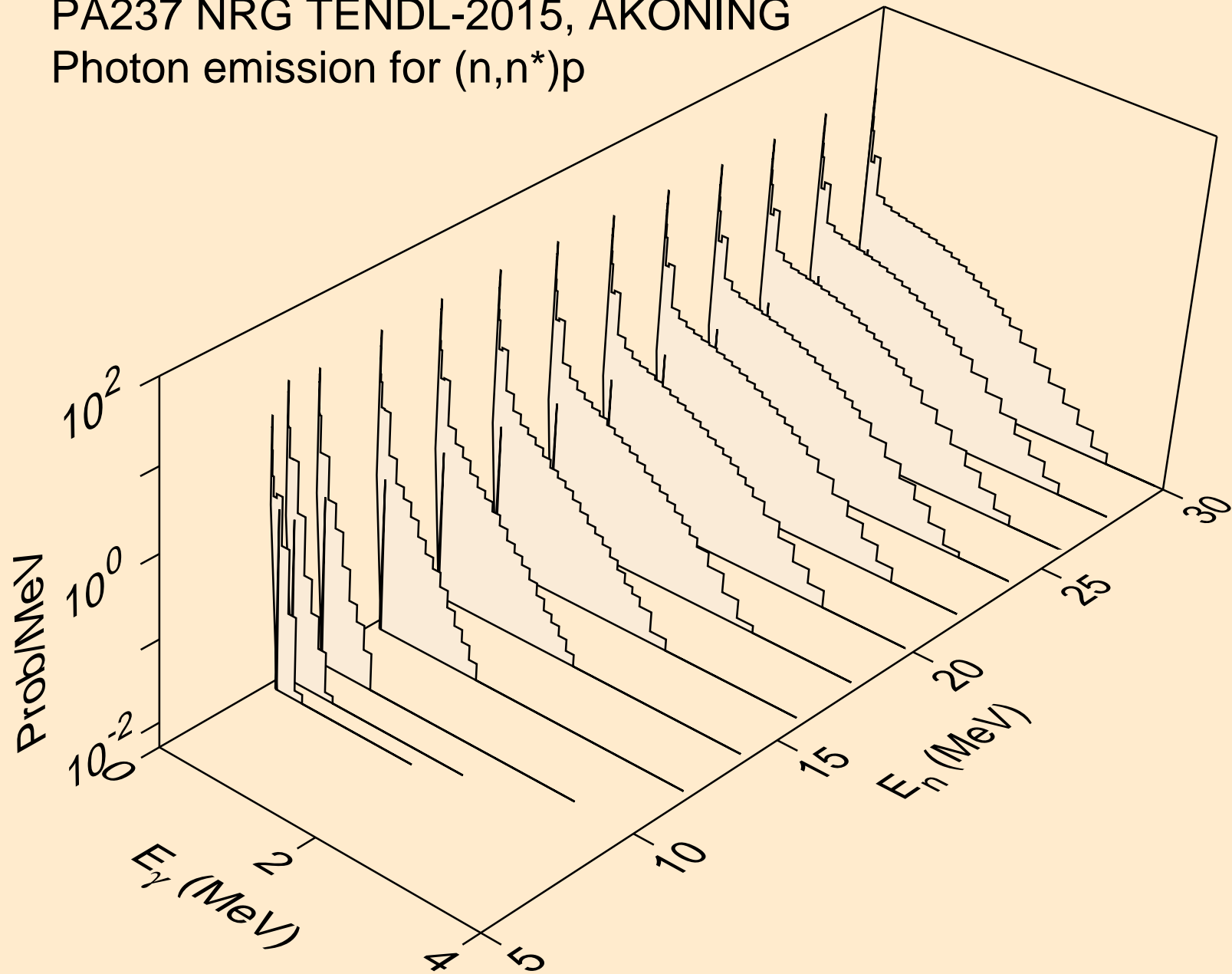

PA237 NRG TENDL-2015, AKONING
Photon emission for (n,n*)d

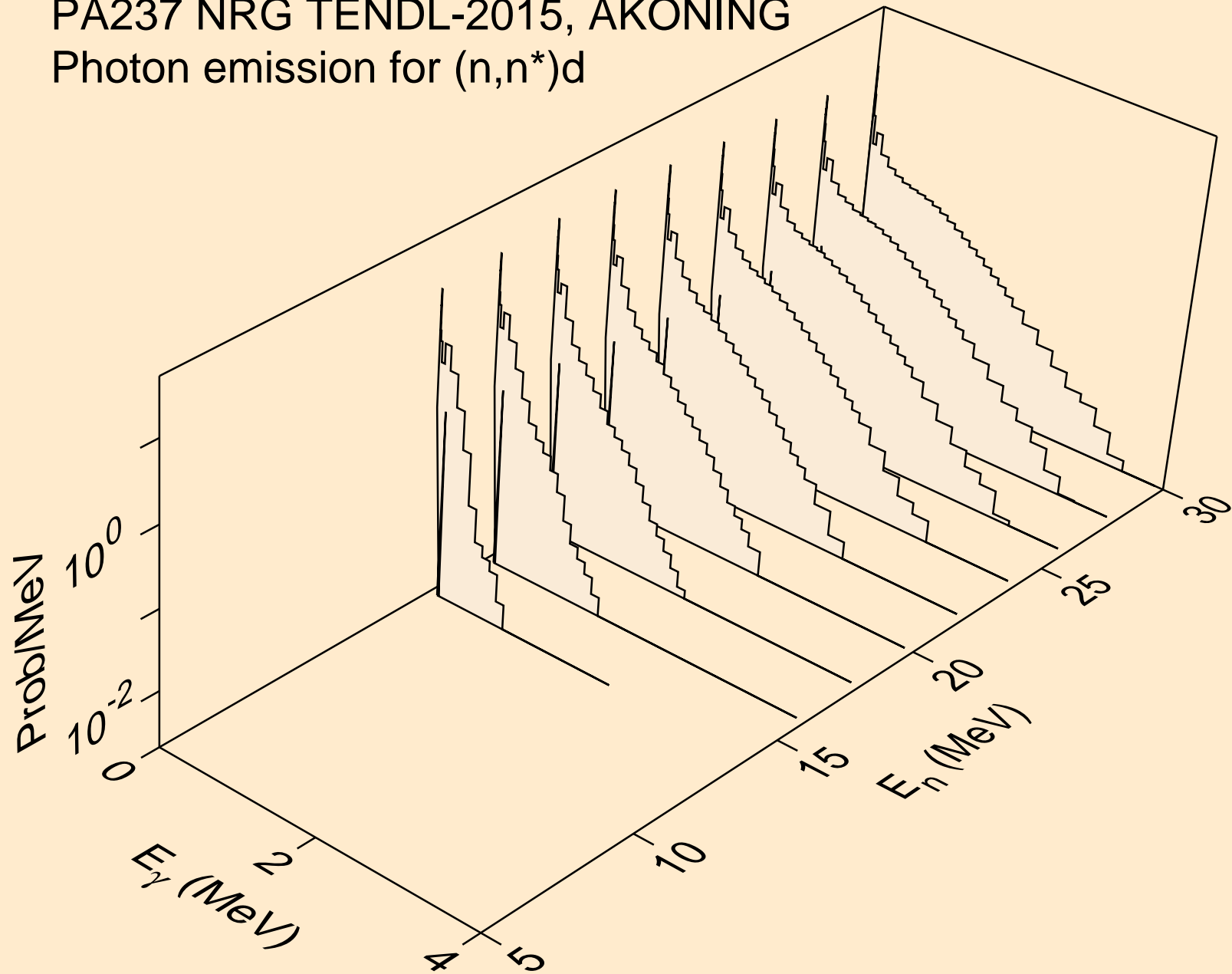

PA237 NRG TENDL-2015, AKONING
Photon emission for (n,n*)t

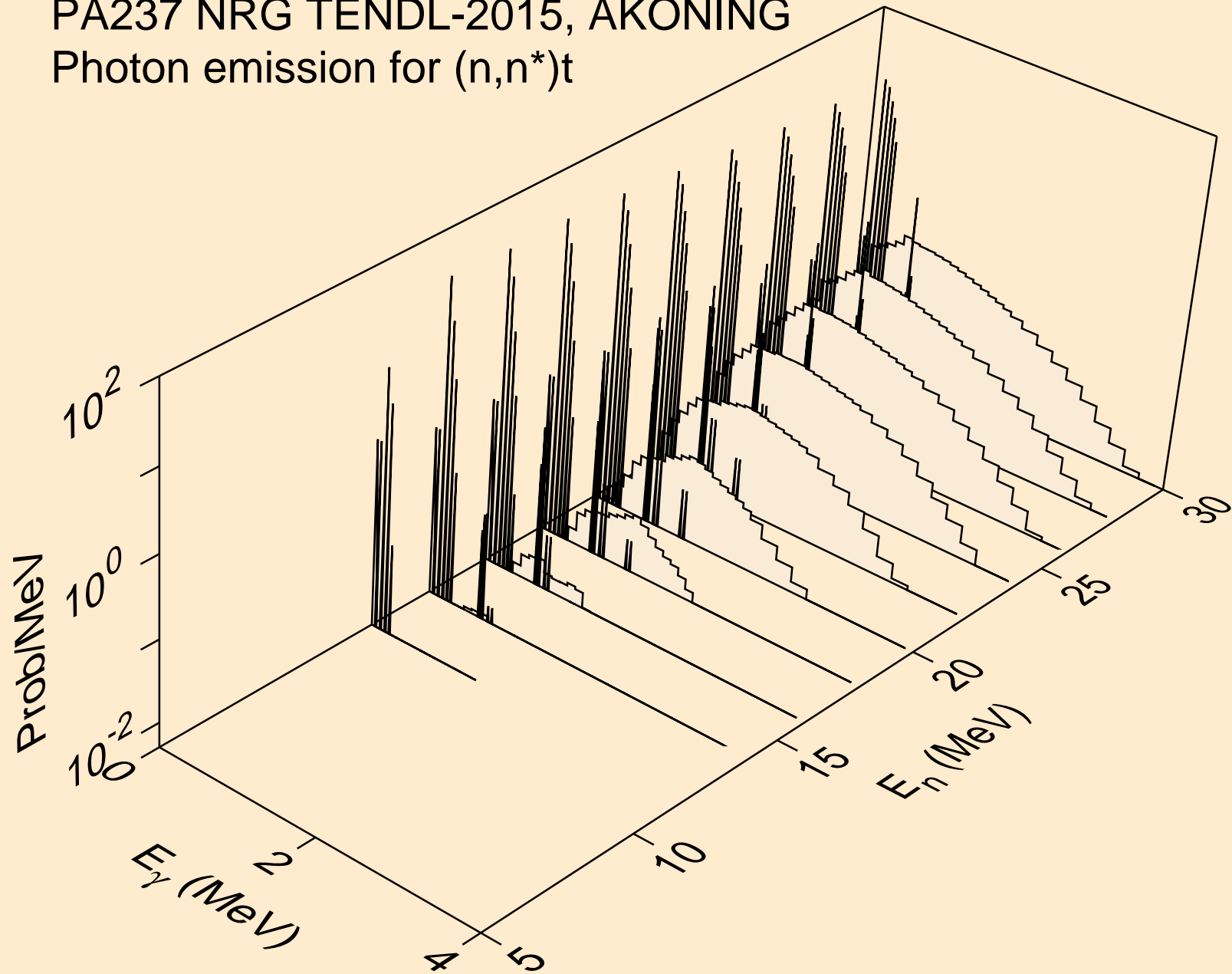

PA237 NRG TENDL-2015, AKONING
Photon emission for (n,n*)he3

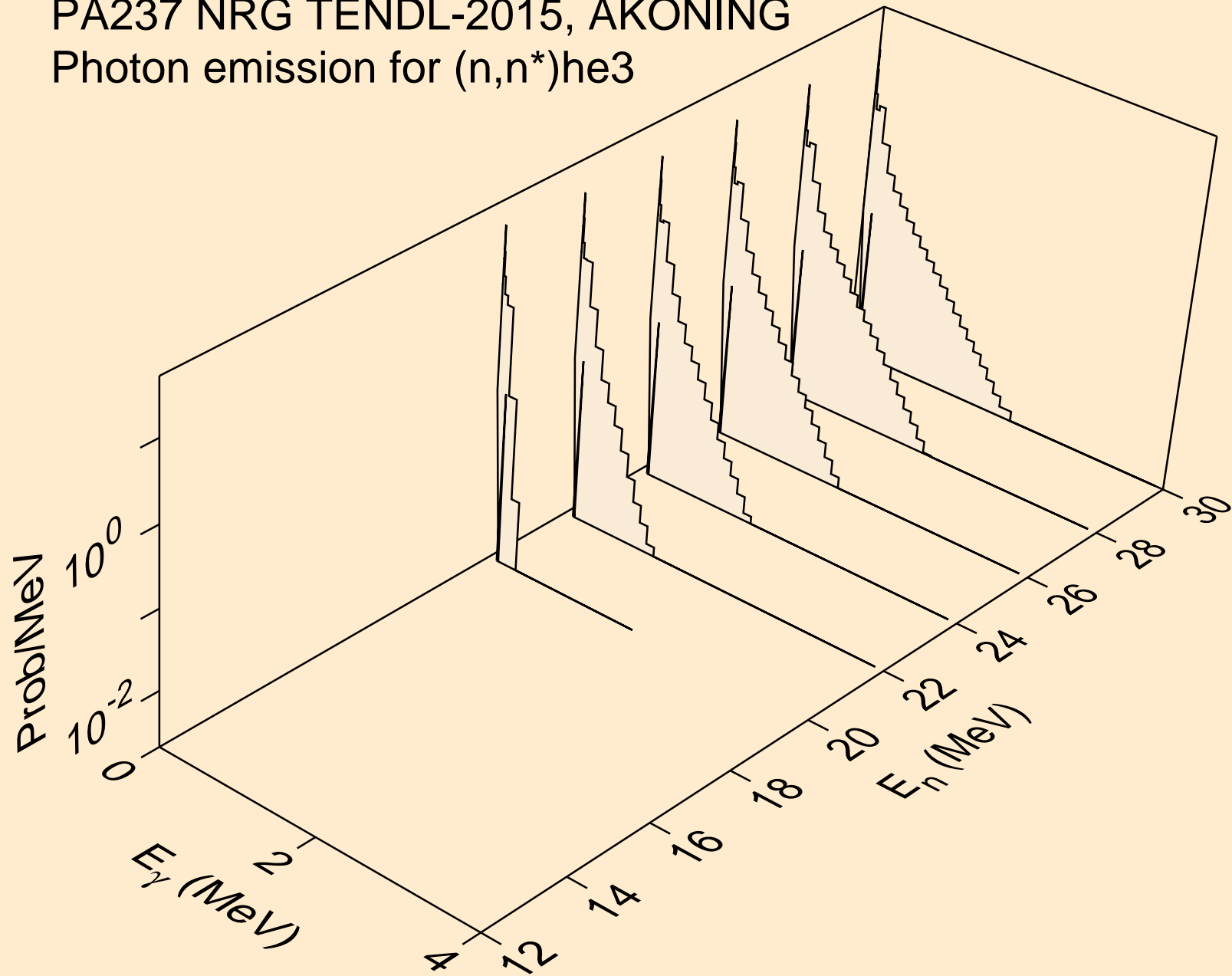

PA237 NRG TENDL-2015, AKONING
Photon emission for (n,4n)

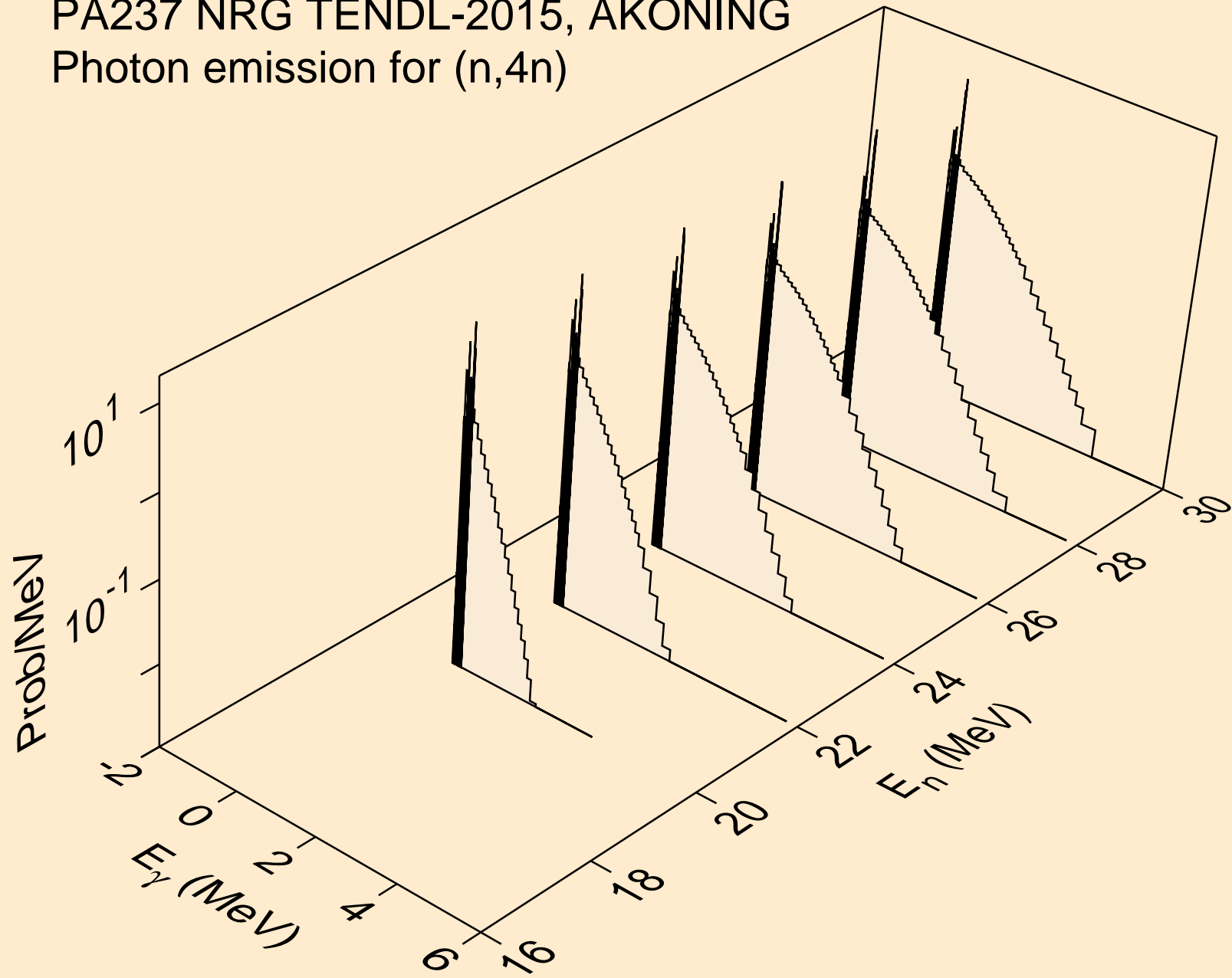

PA237 NRG TENDL-2015, AKONING
Photon emission for (n,2np)

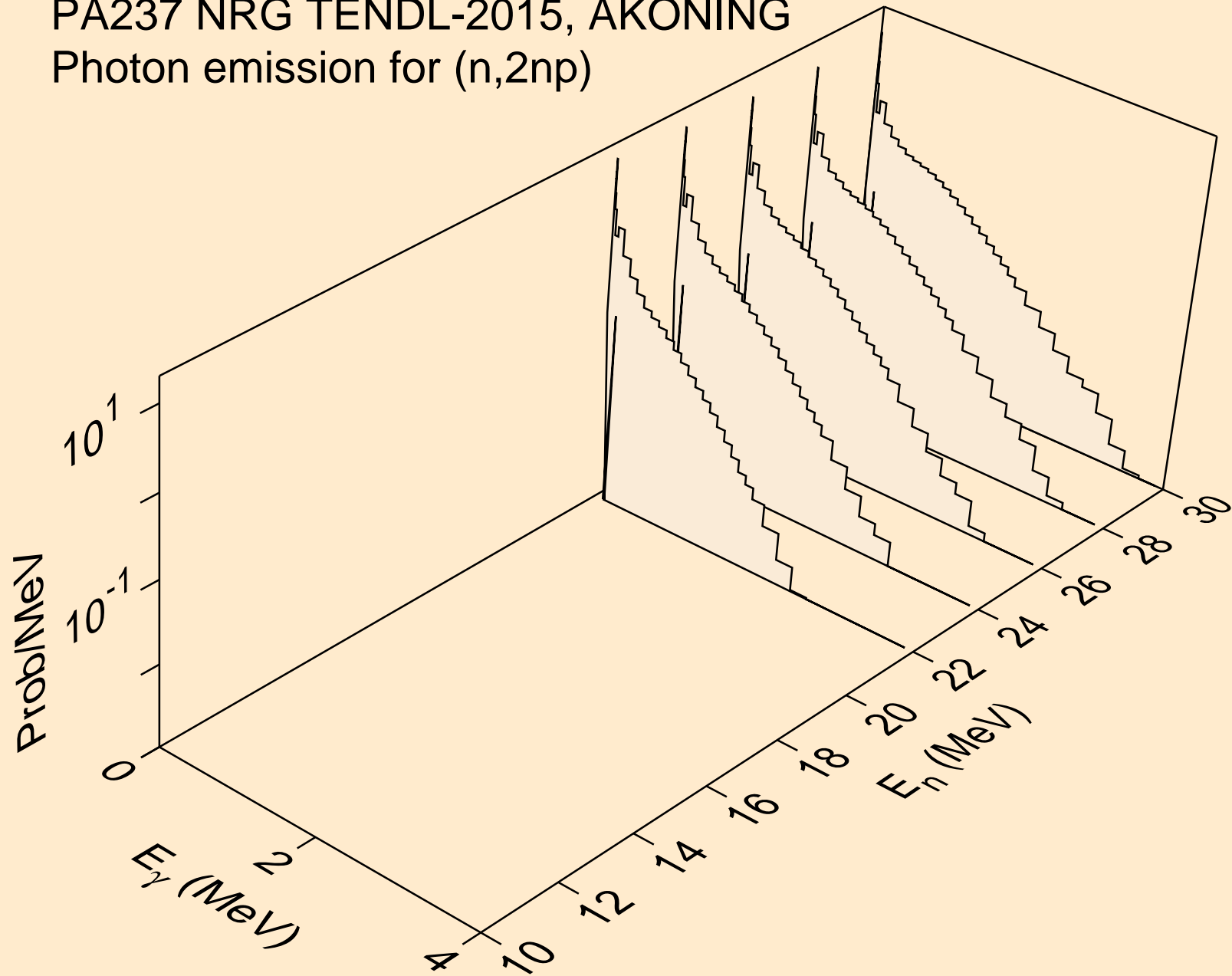

PA237 NRG TENDL-2015, AKONING
Photon emission for (n,3np)

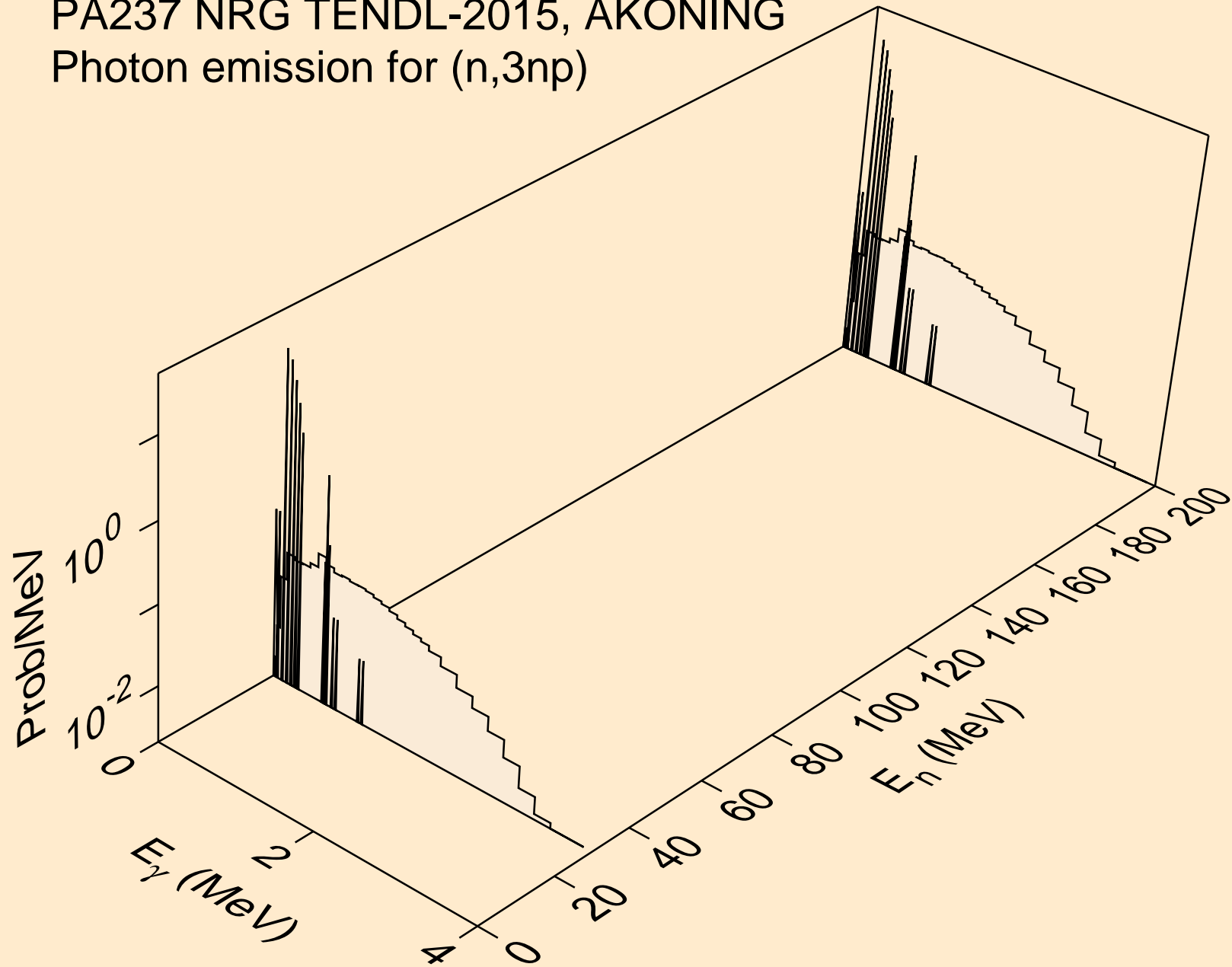

PA237 NRG TENDL-2015, AKONING
Photon emission for (n,n*c)

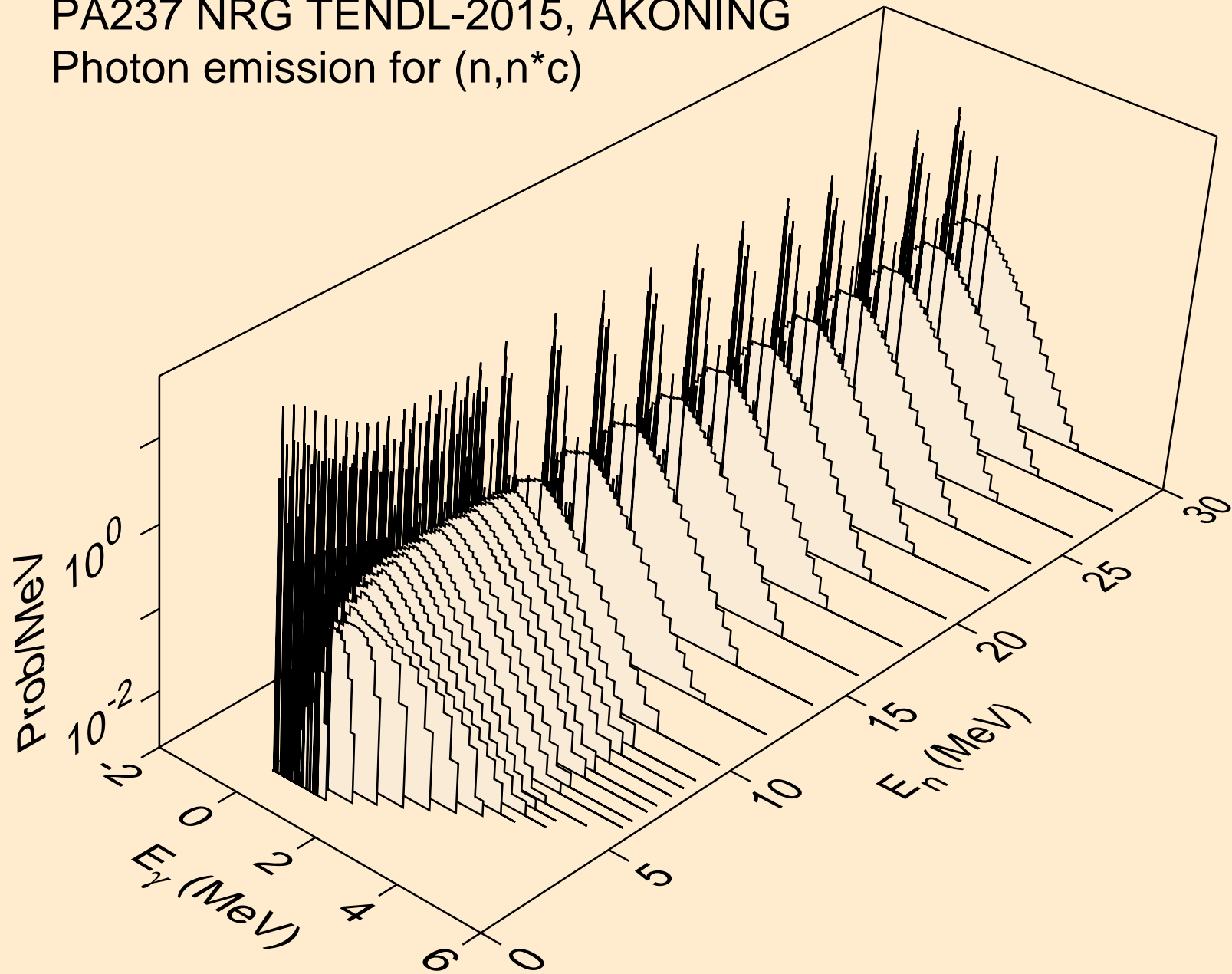

PA237 NRG TENDL-2015, AKONING
Photon emission for (n,gma)

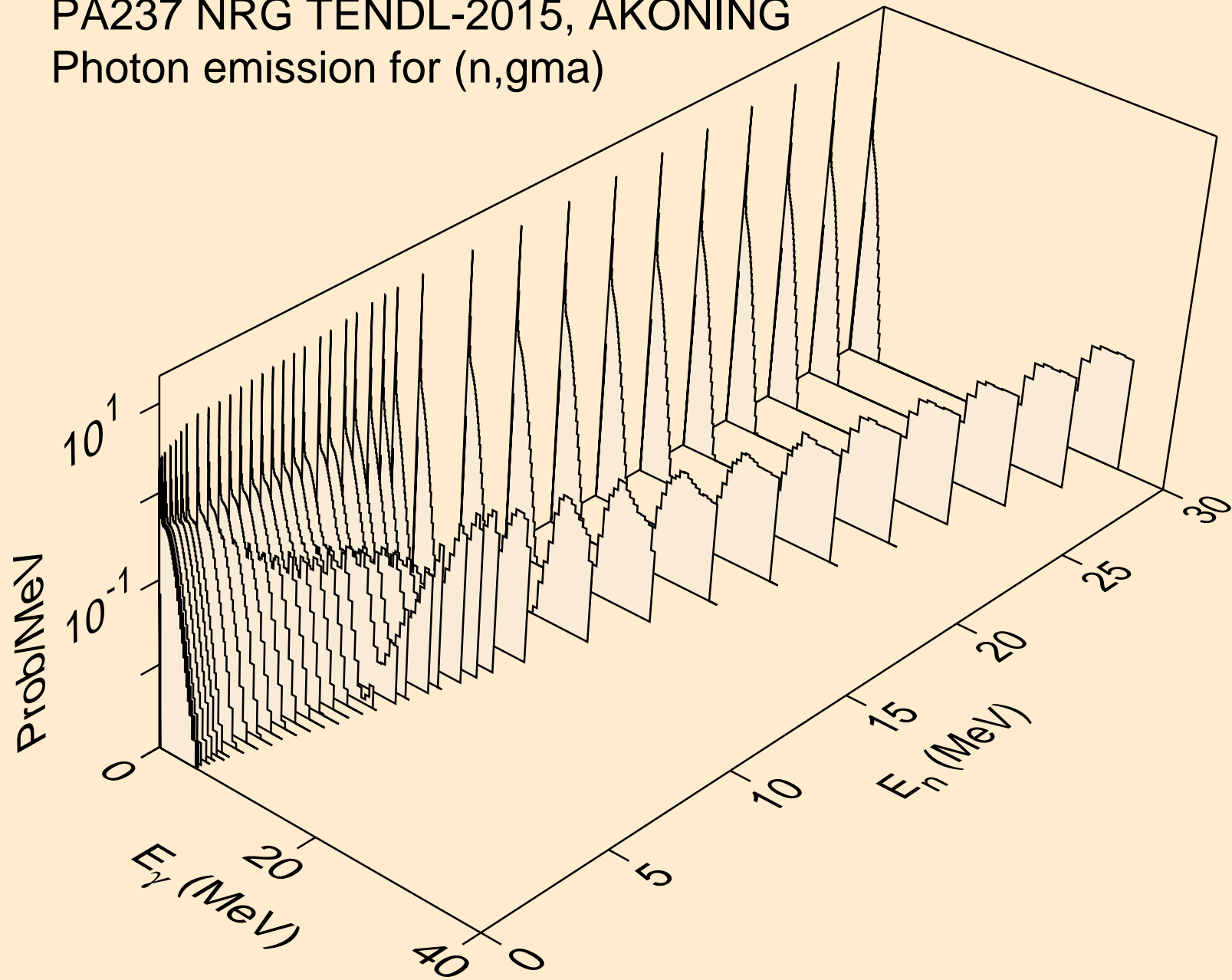

PA237 NRG TENDL-2015, AKONING
Photon emission for (n,p)

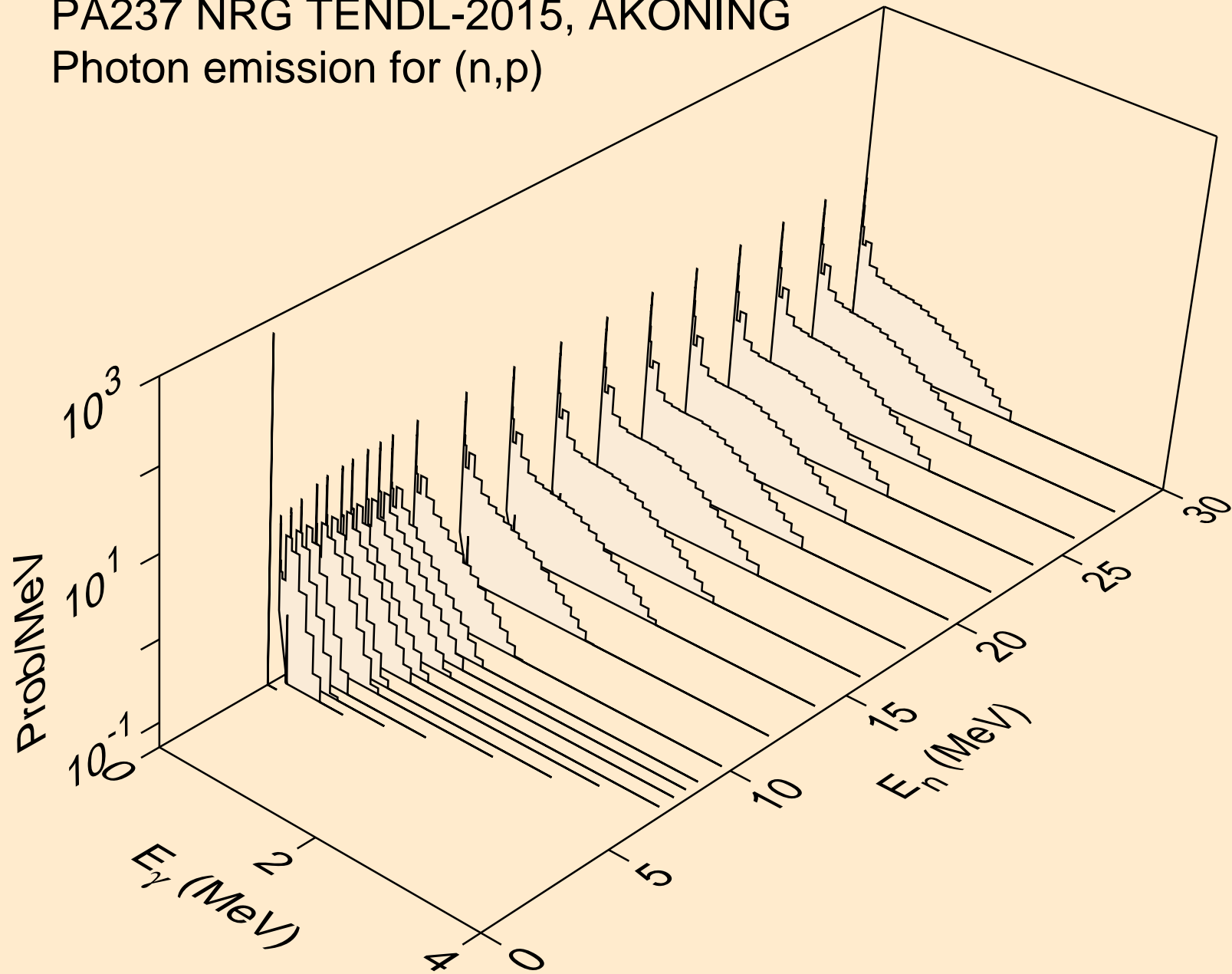

PA237 NRG TENDL-2015, AKONING
Photon emission for (n,d)

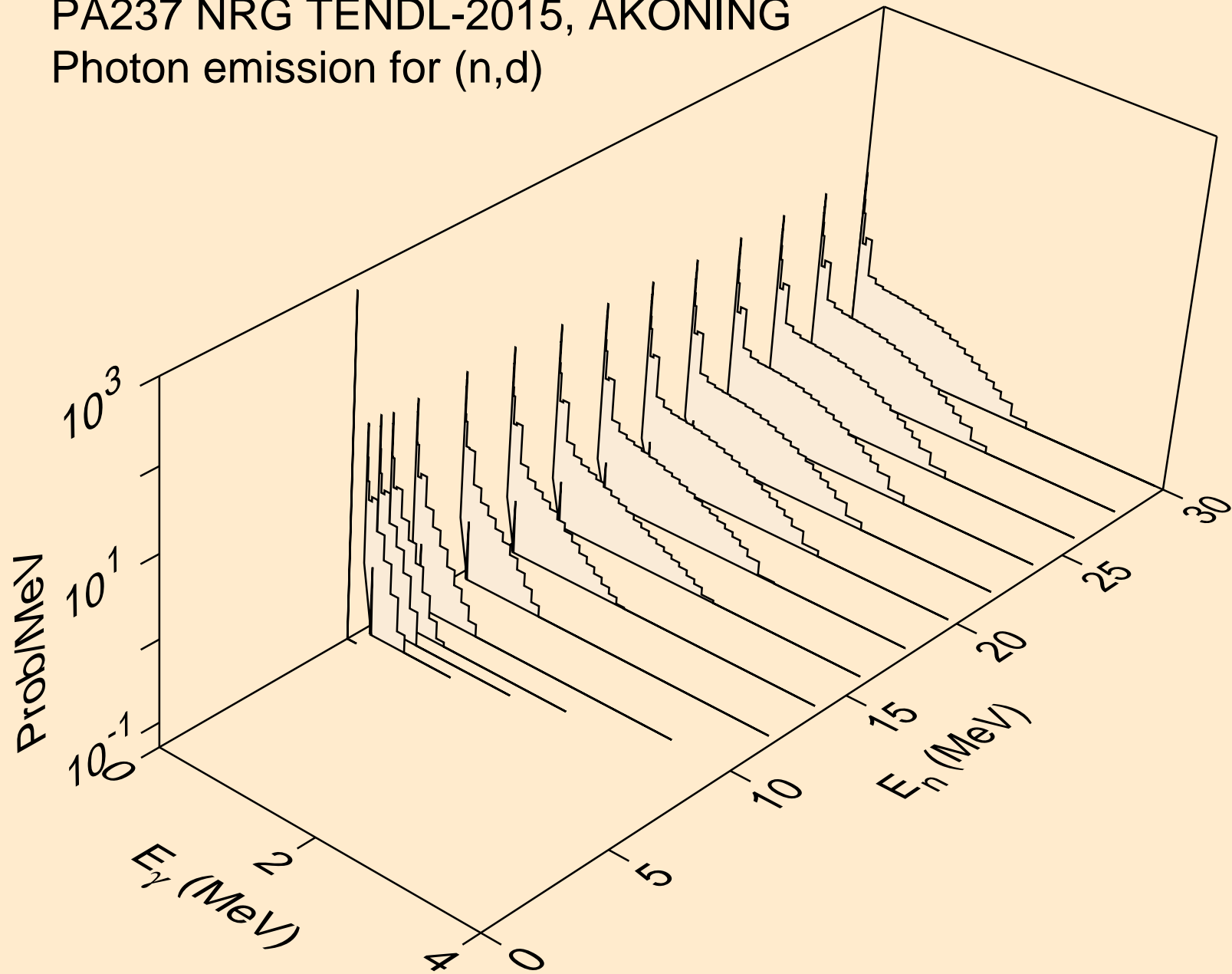

PA237 NRG TENDL-2015, AKONING
Photon emission for (n,t)

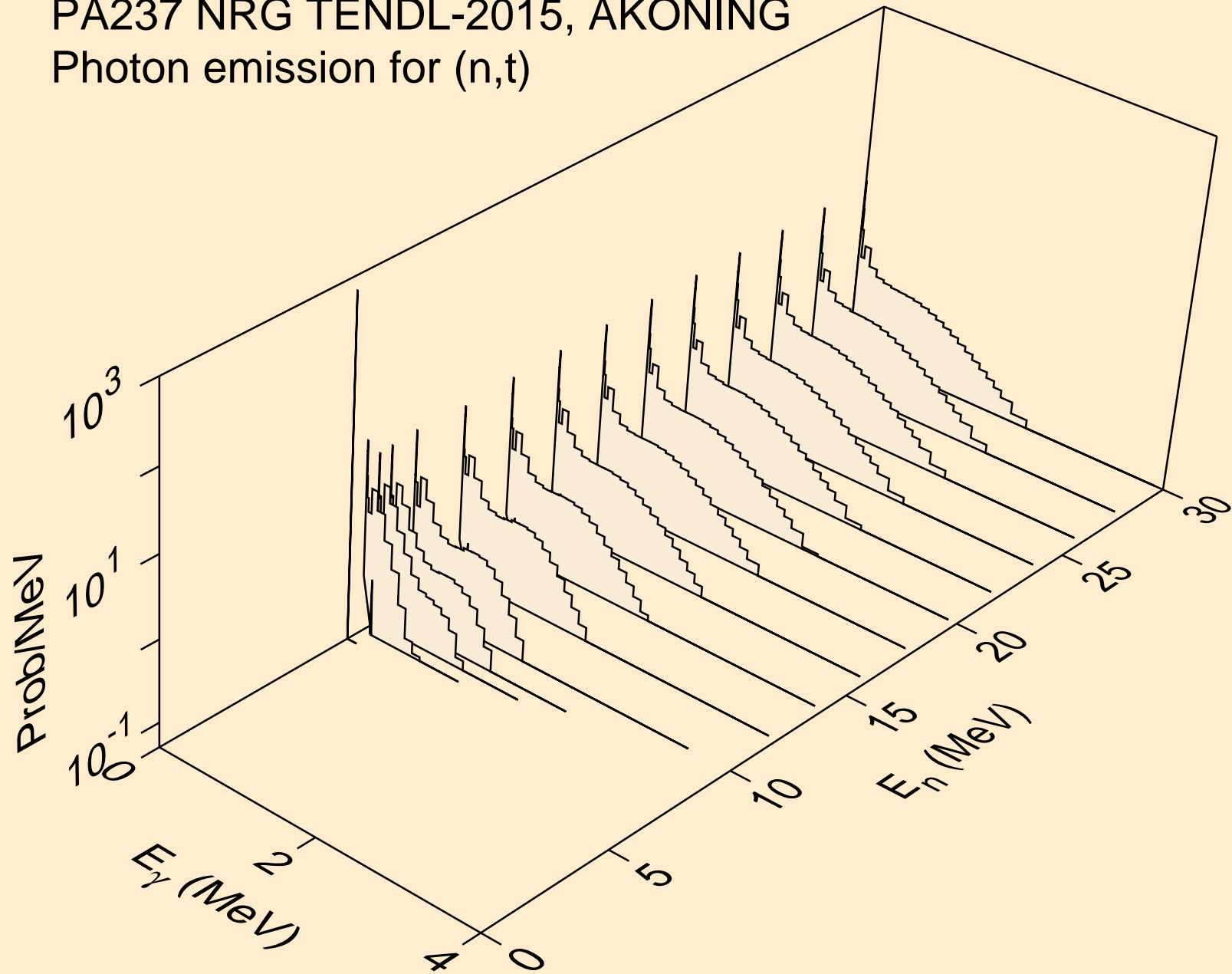

PA237 NRG TENDL-2015, AKONING
Photon emission for (n,he3)

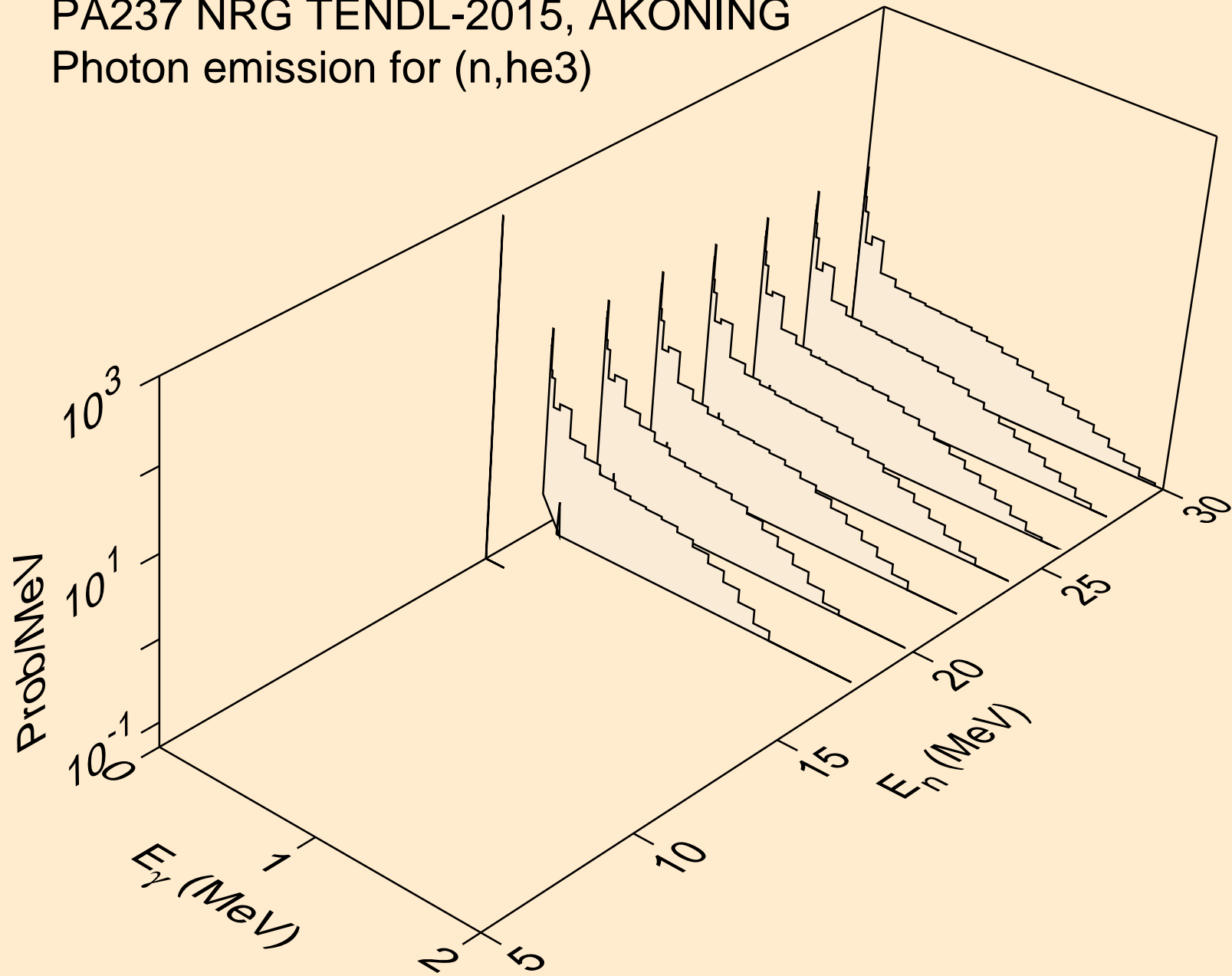

PA237 NRG TENDL-2015, AKONING
Photon emission for (n,a)

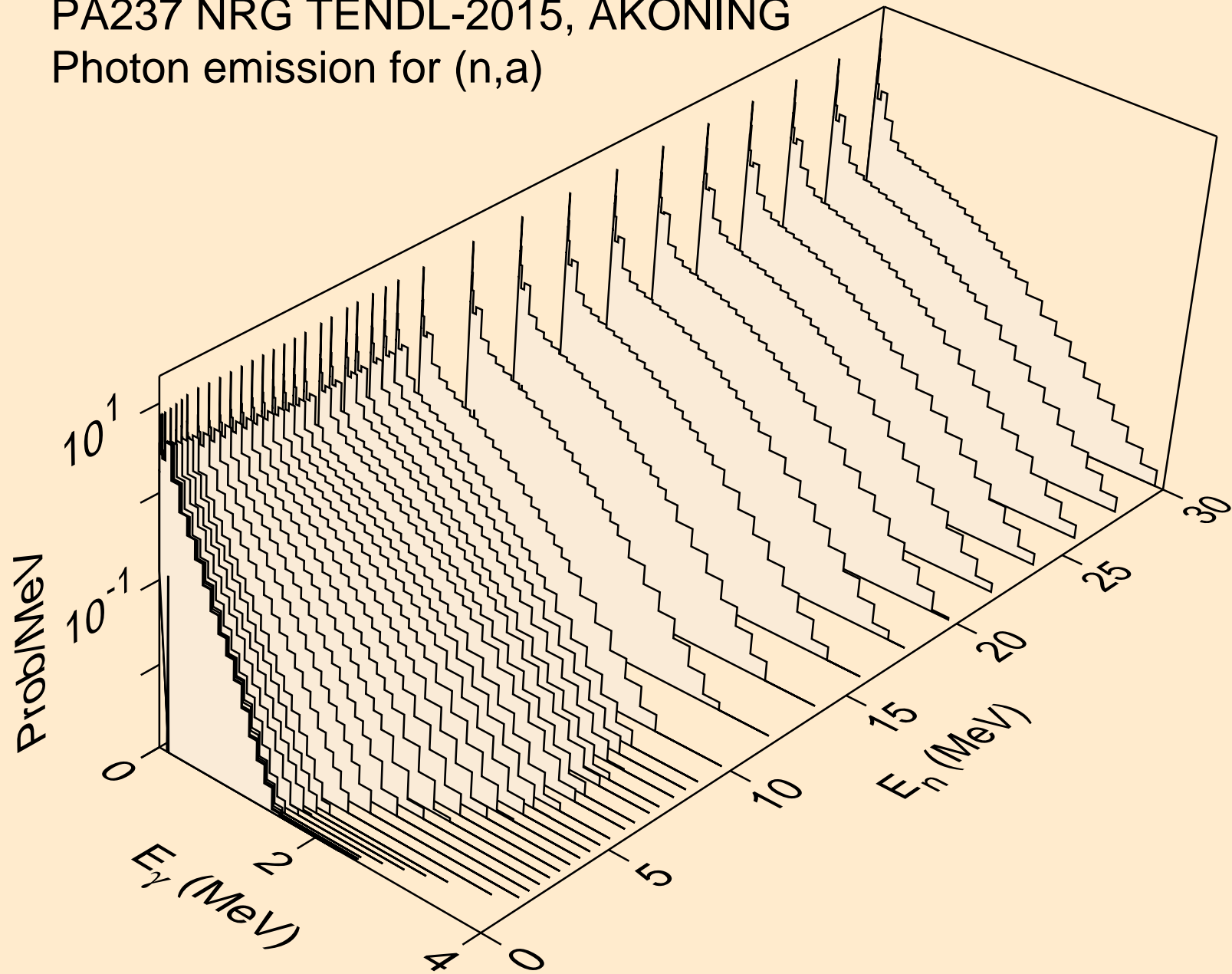

PA237 NRG TENDL-2015, AKONING
Photon emission for (n,2p)

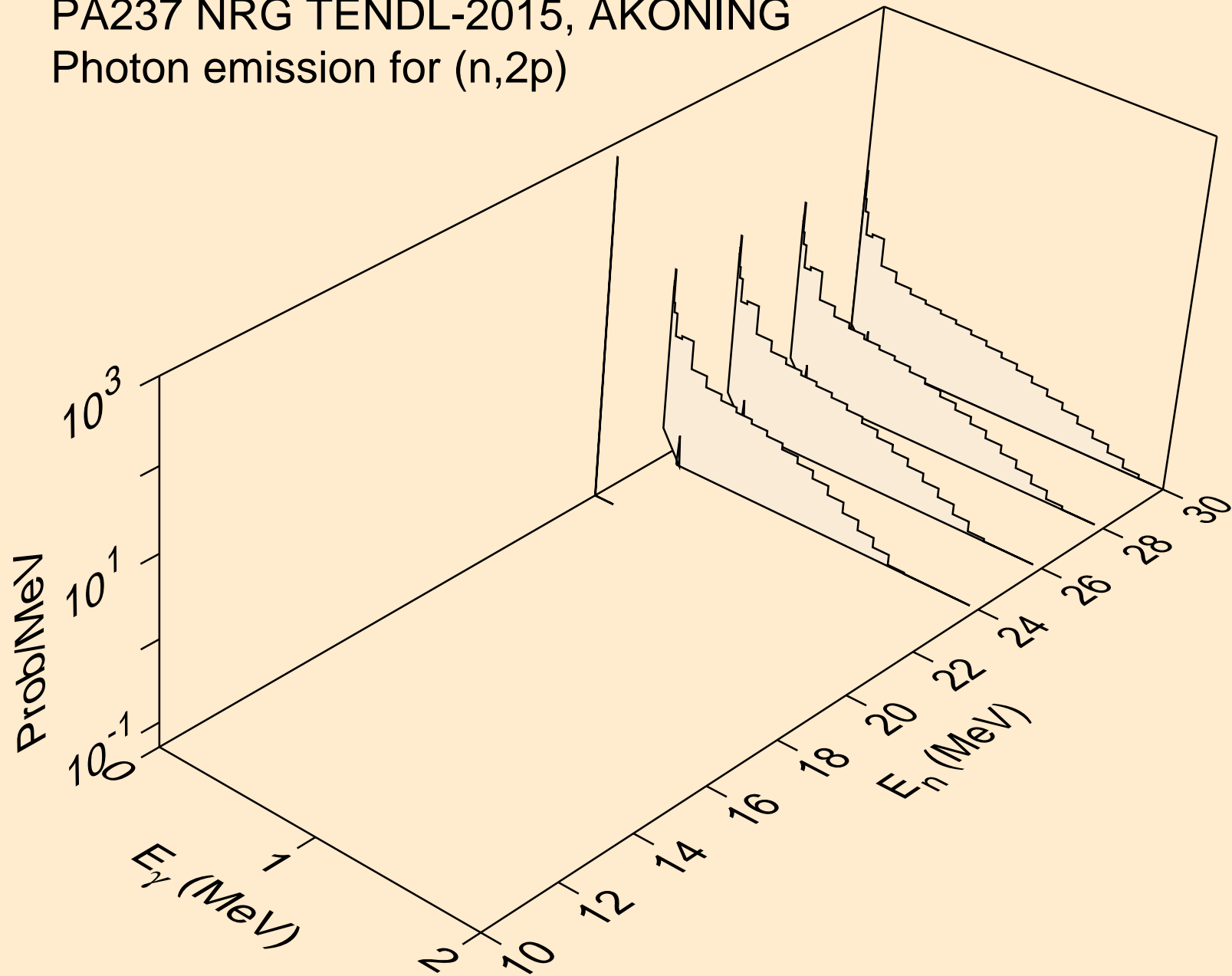

PA237 NRG TENDL-2015, AKONING
thermal capture photon spectrum

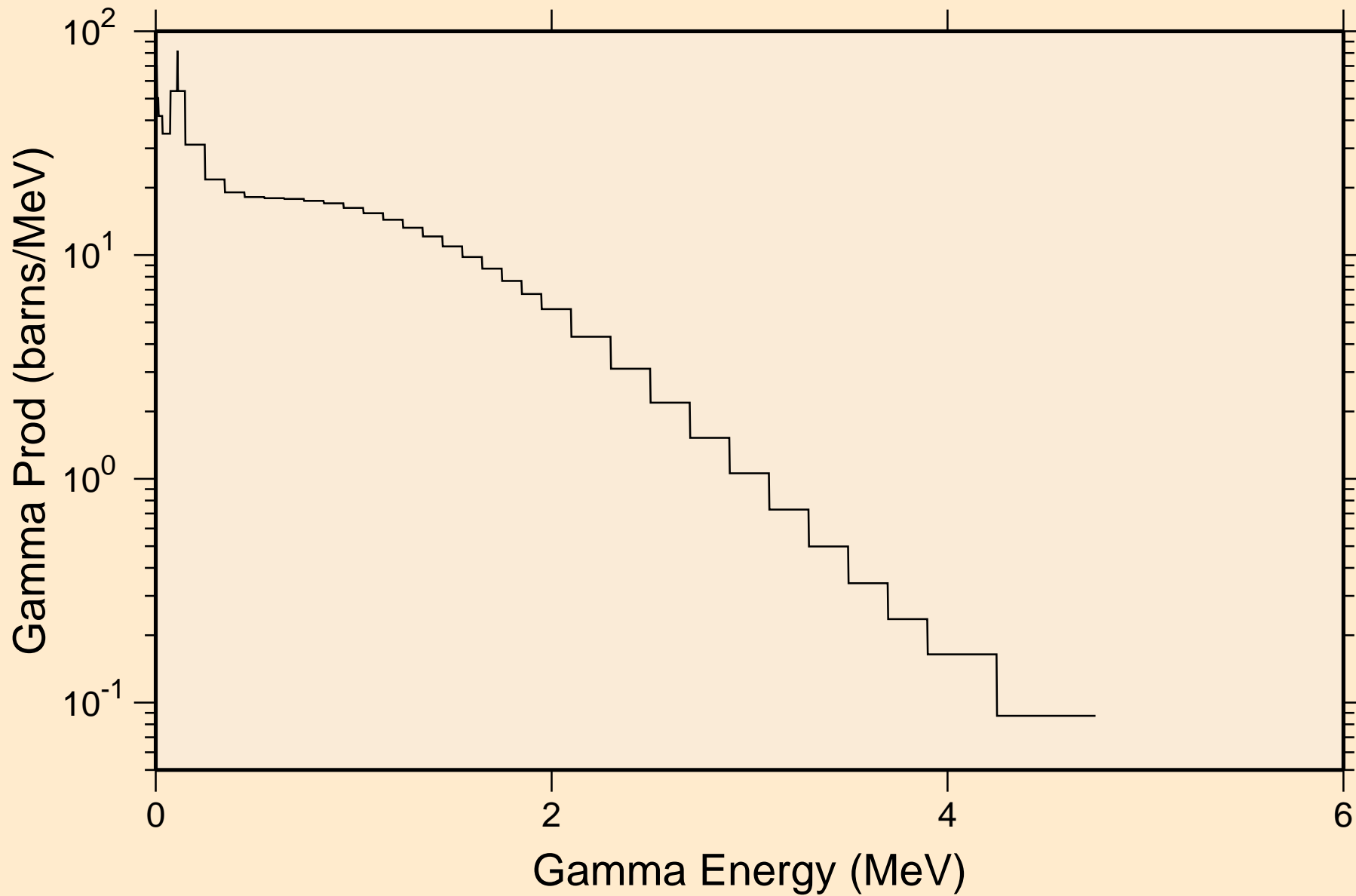

PA237 NRG TENDL-2015, AKONING
14 MeV photon spectrum

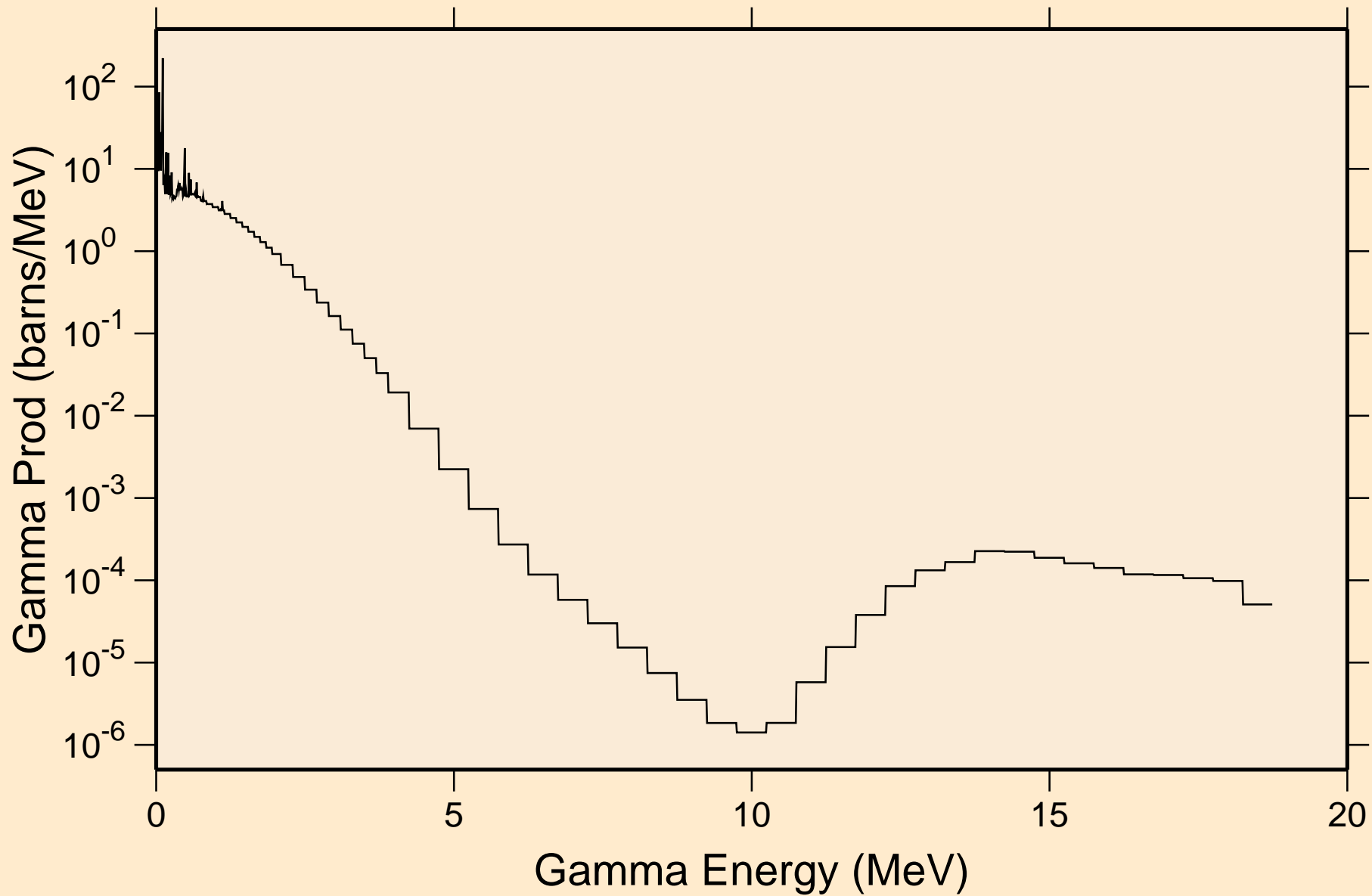

PA237 NRG TENDL-2015, AKONING

Particle heating contributions

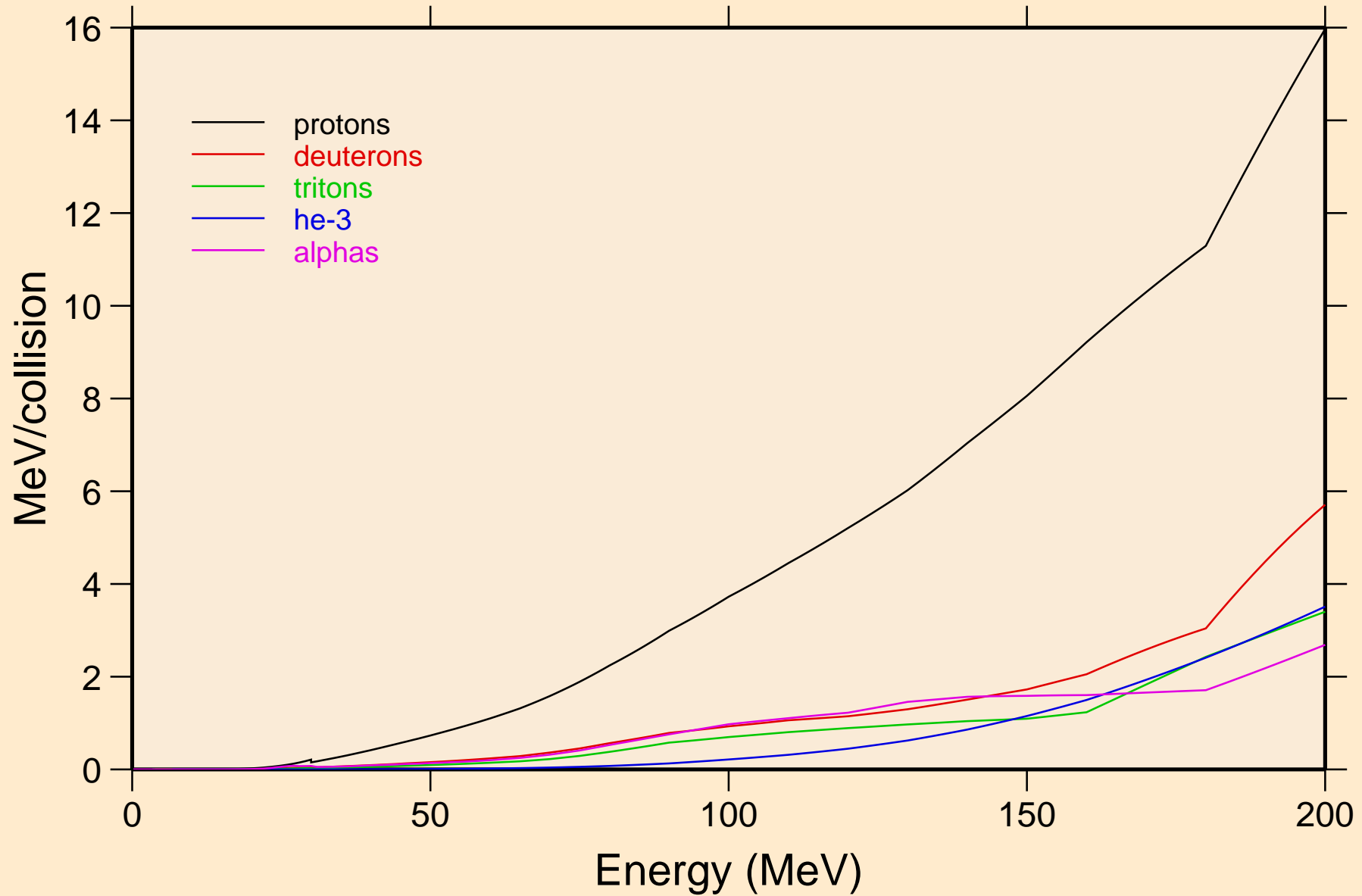

PA237 NRG TENDL-2015, AKONING
Recoil Heating

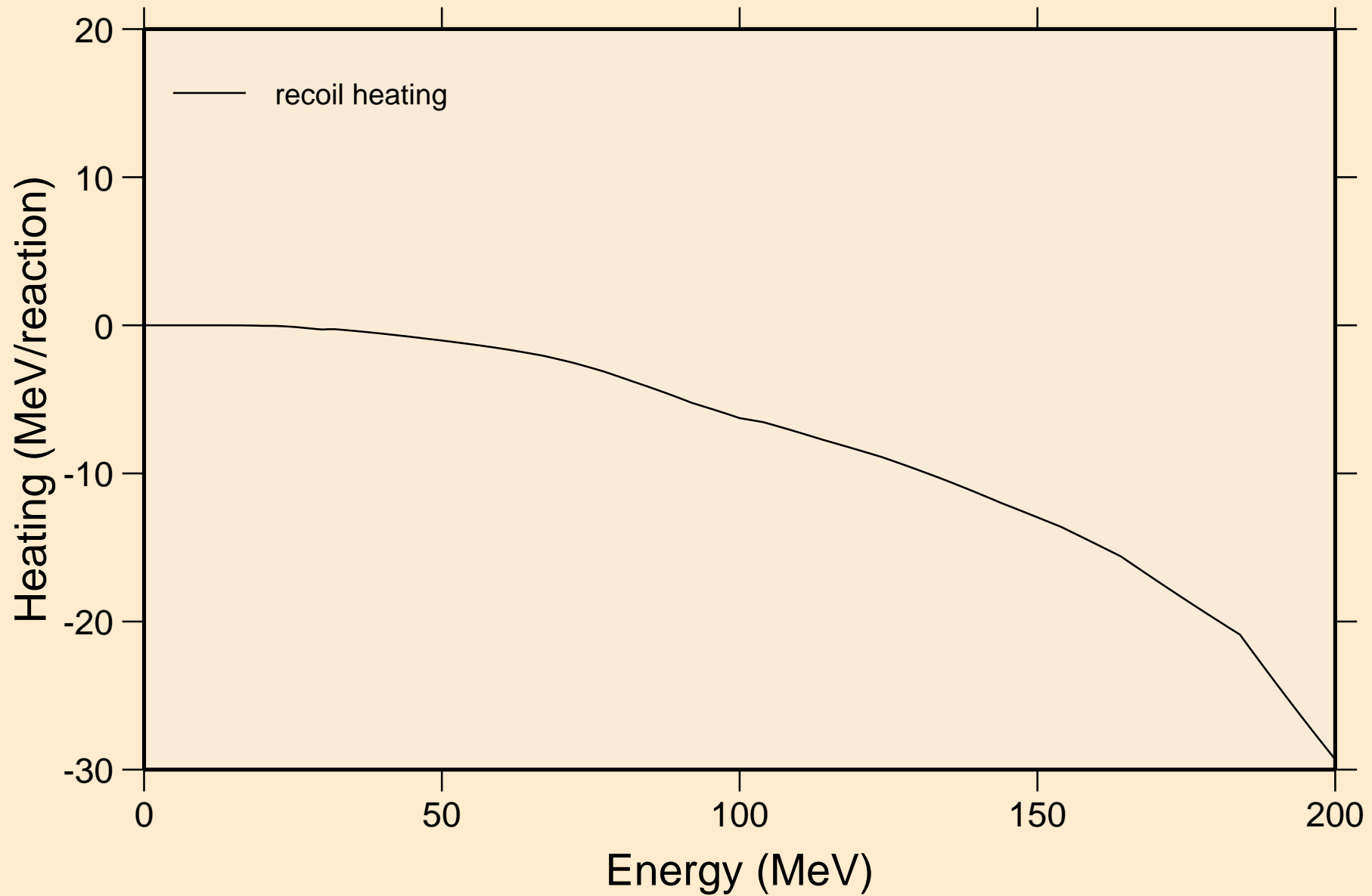

PA237 NRG TENDL-2015, AKONING

Particle production cross sections

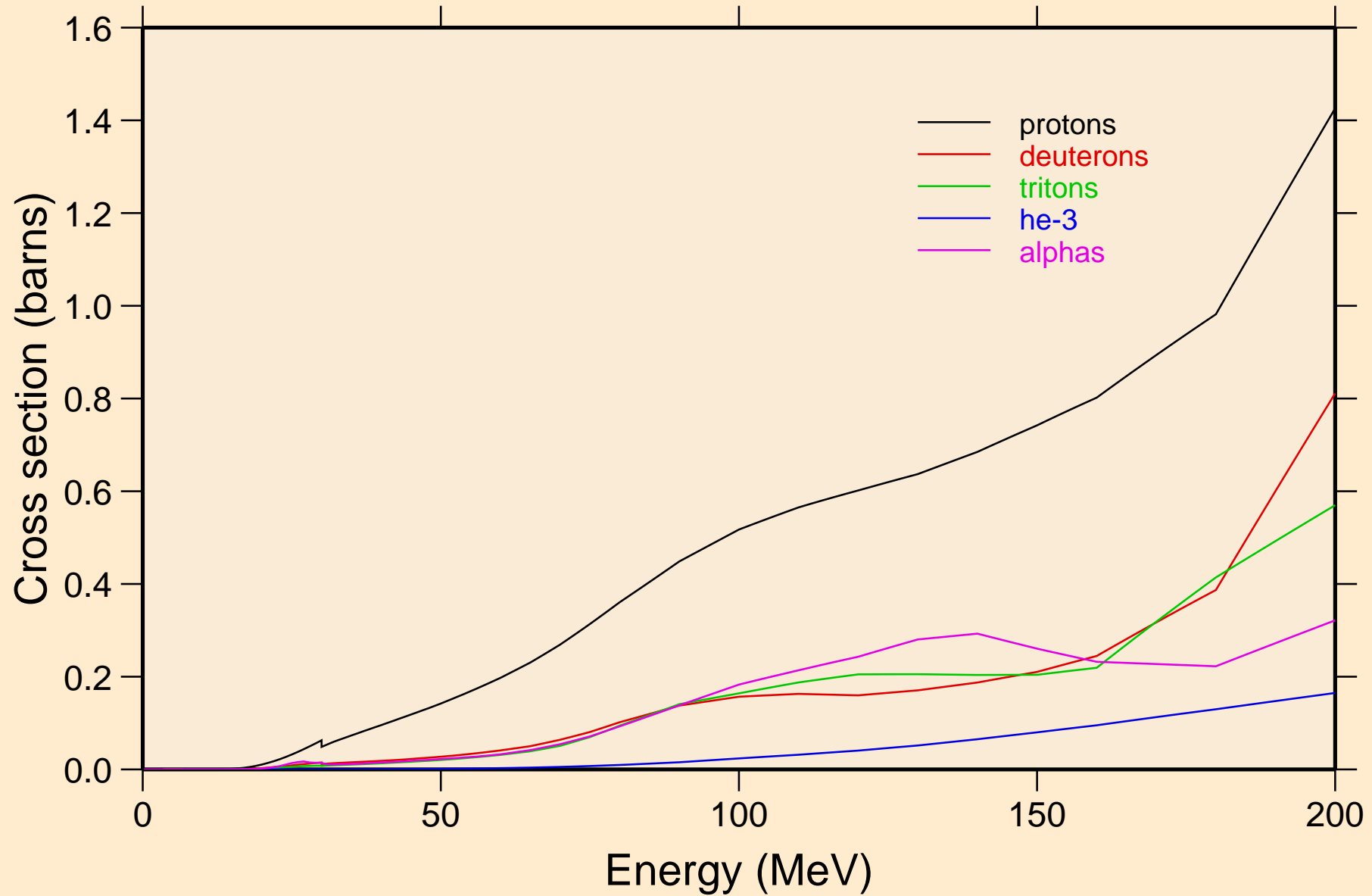

PA237 NRG TENDL-2015, AKONING
protons from (n,x)

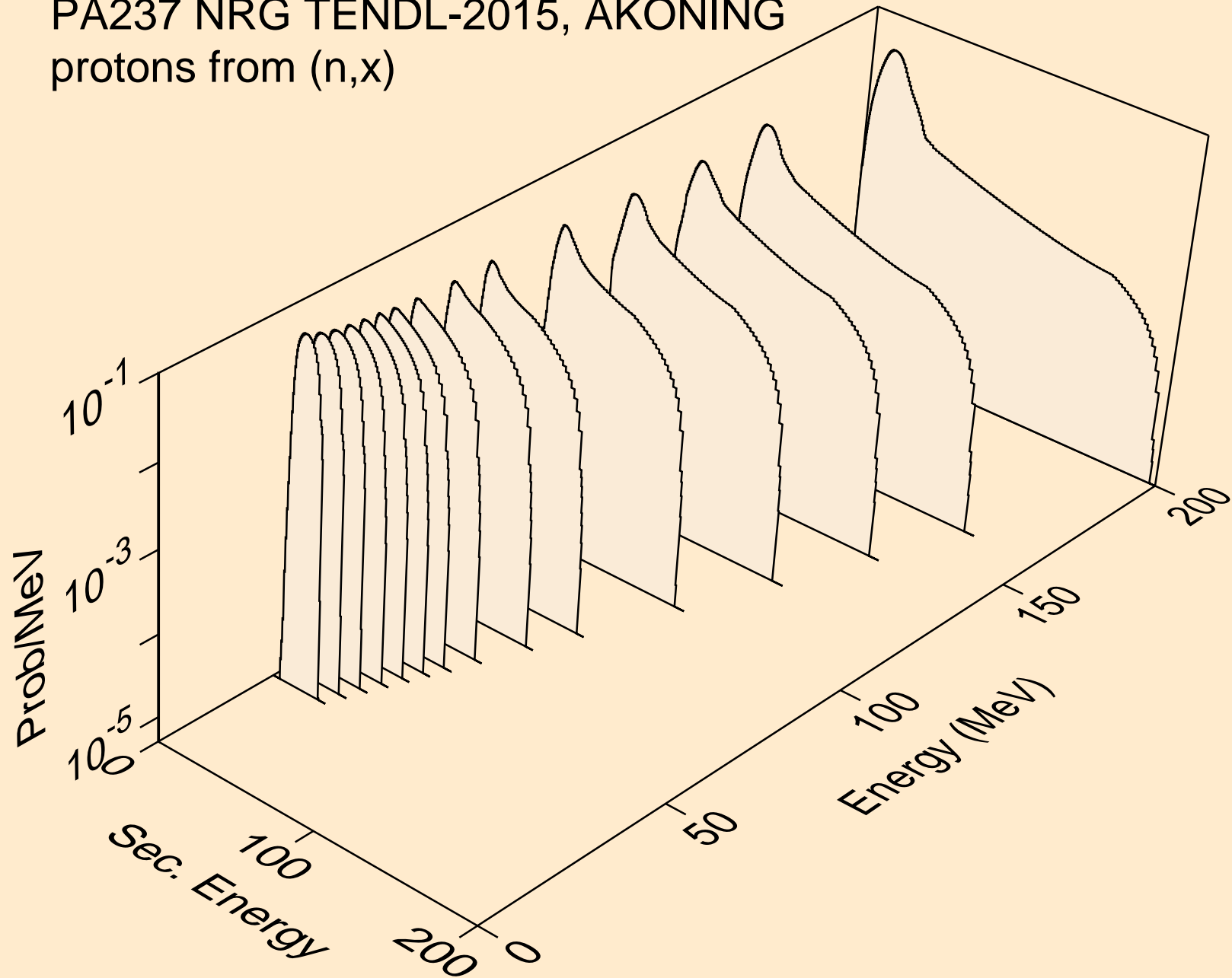

PA237 NRG TENDL-2015, AKONING
protons from (n,n*)p

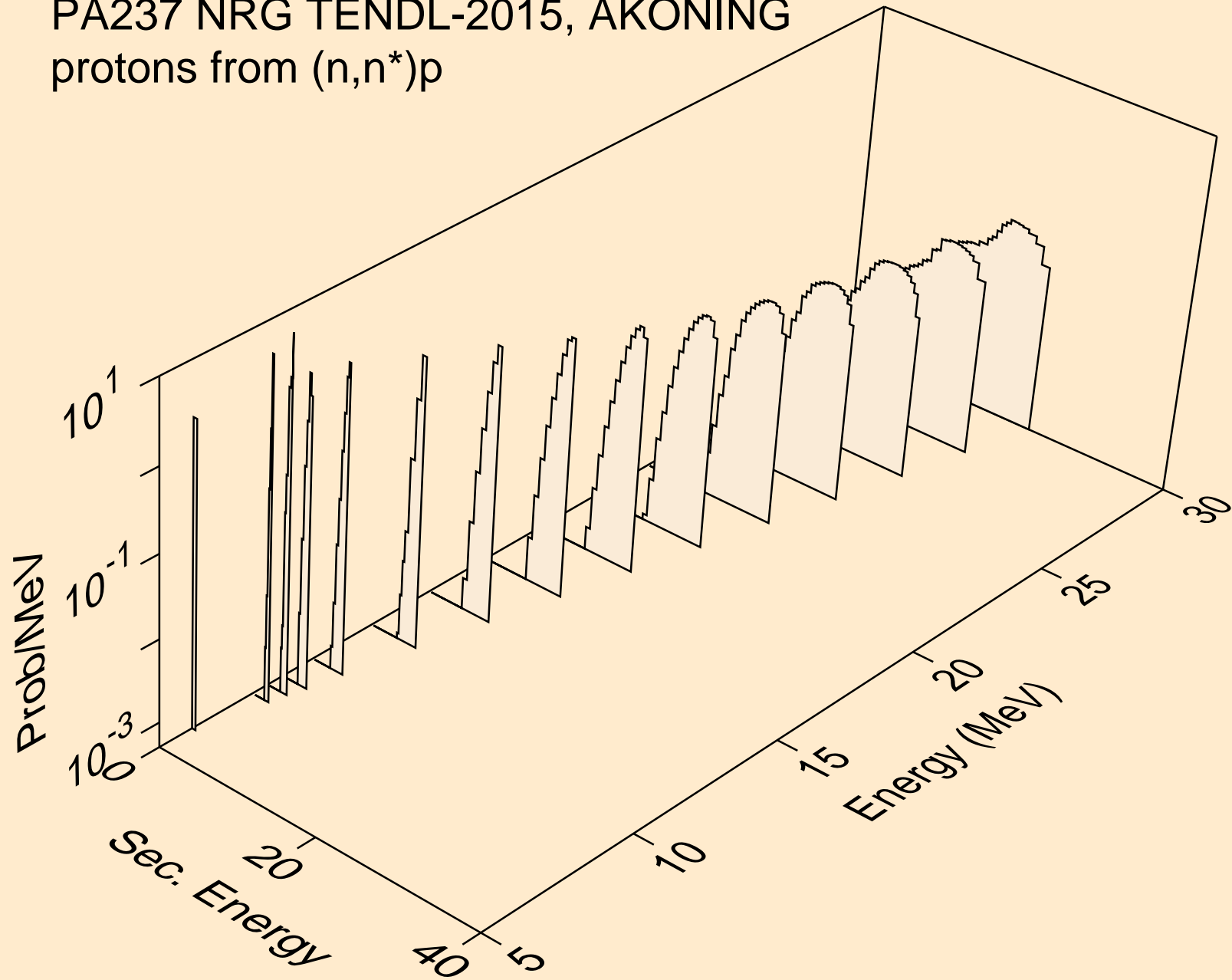

PA237 NRG TENDL-2015, AKONING
protons from (n,2np)

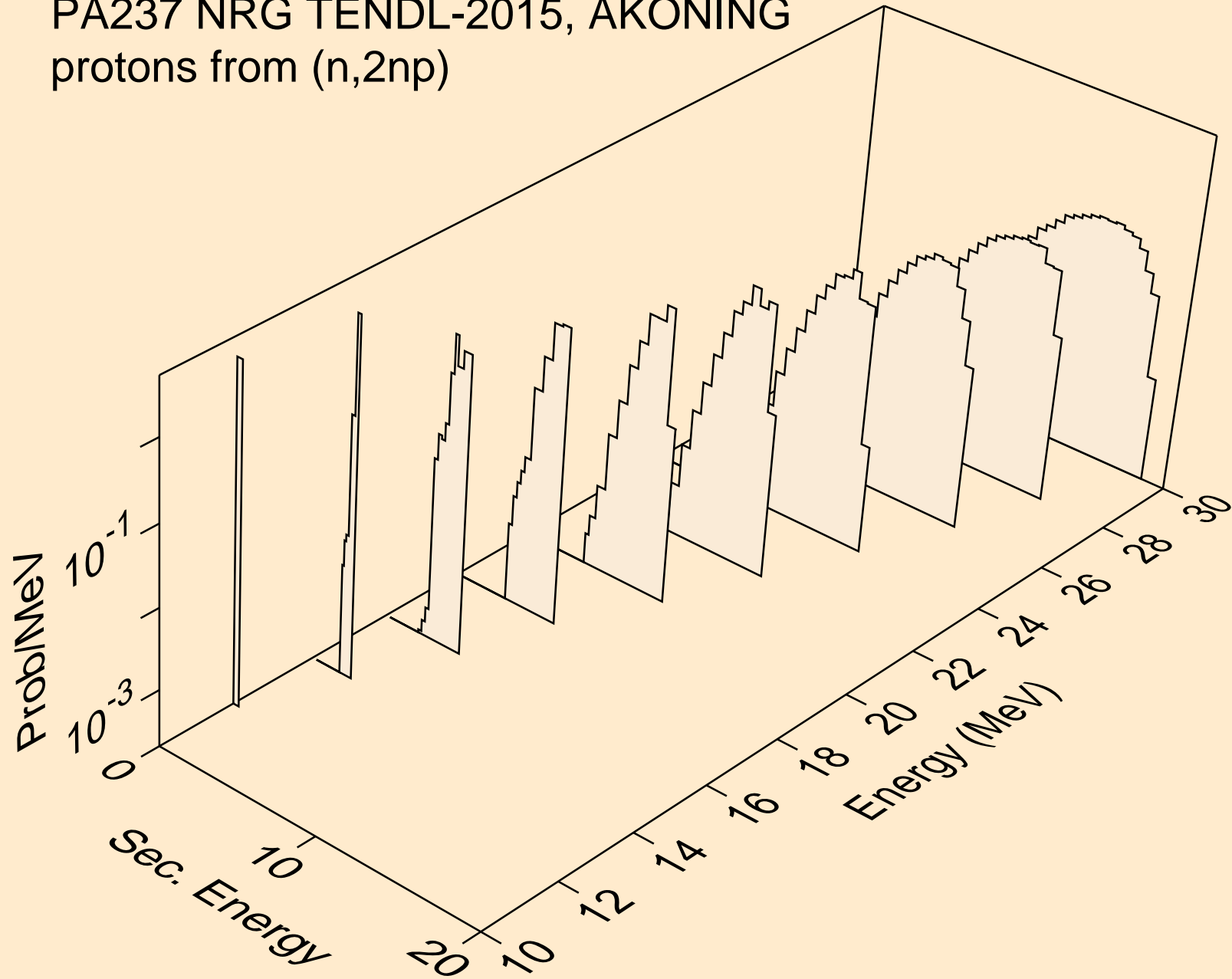

PA237 NRG TENDL-2015, AKONING
protons from (n,3np)

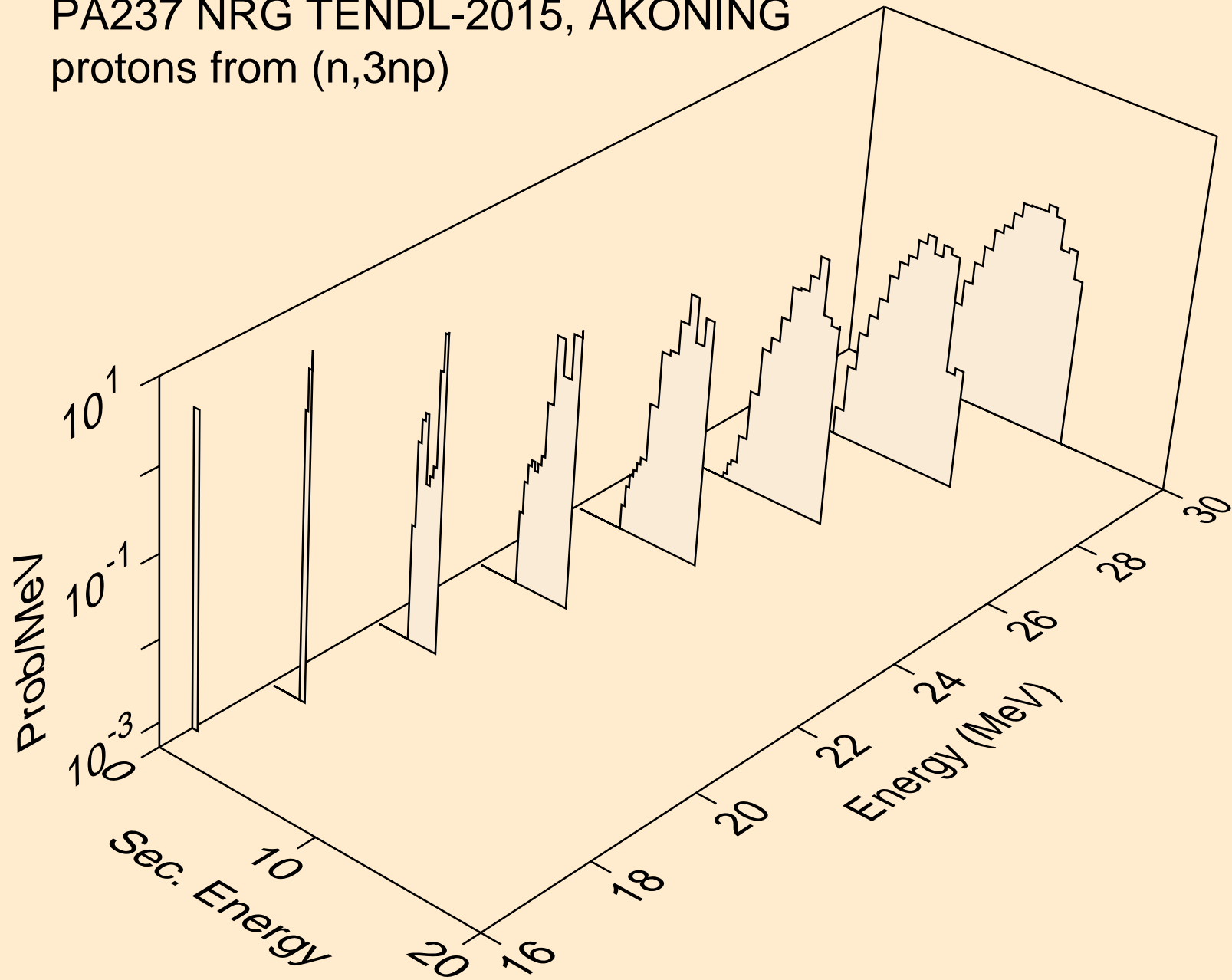

PA237 NRG TENDL-2015, AKONING
protons from (n,p)

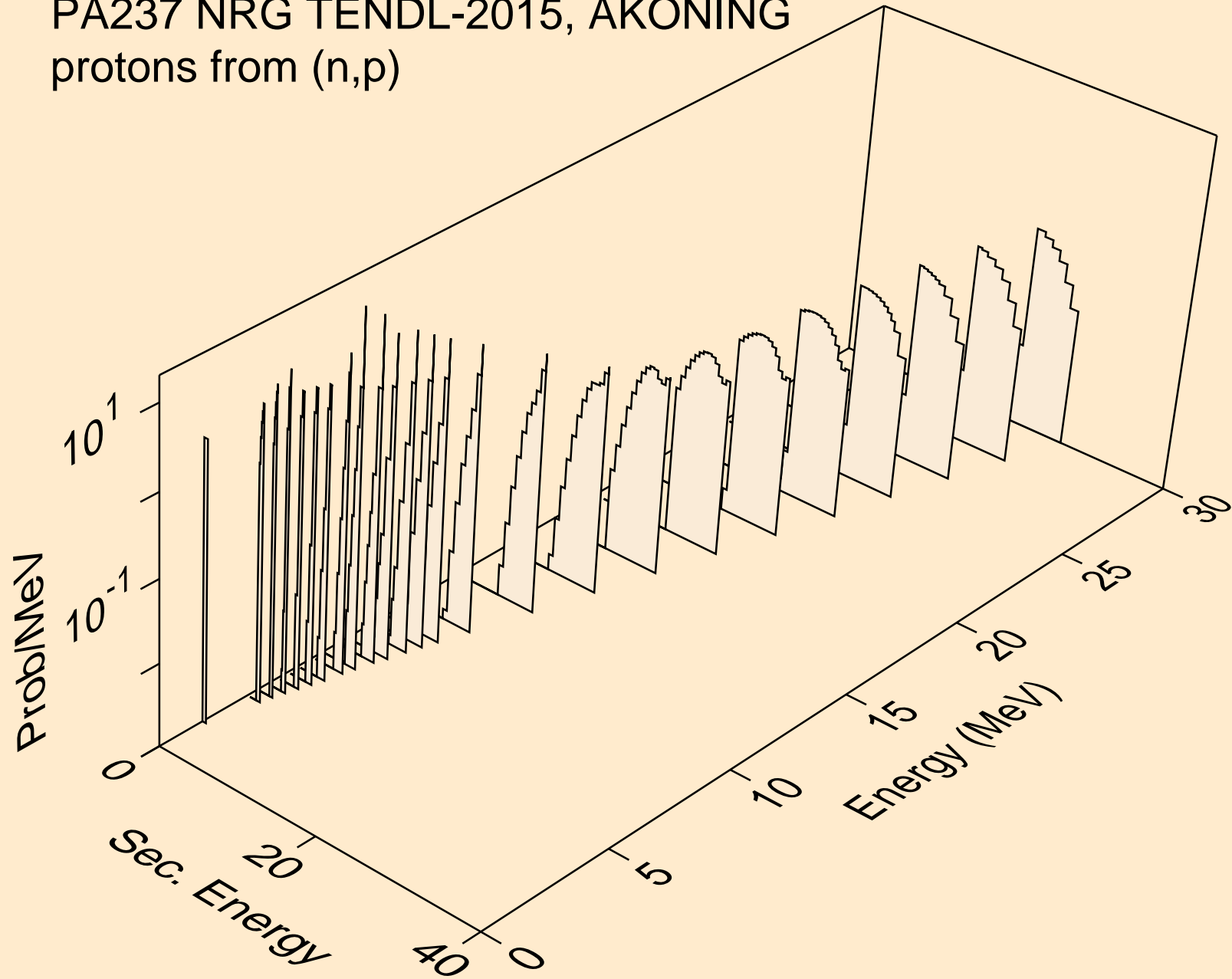

PA237 NRG TENDL-2015, AKONING
protons from (n,2p)

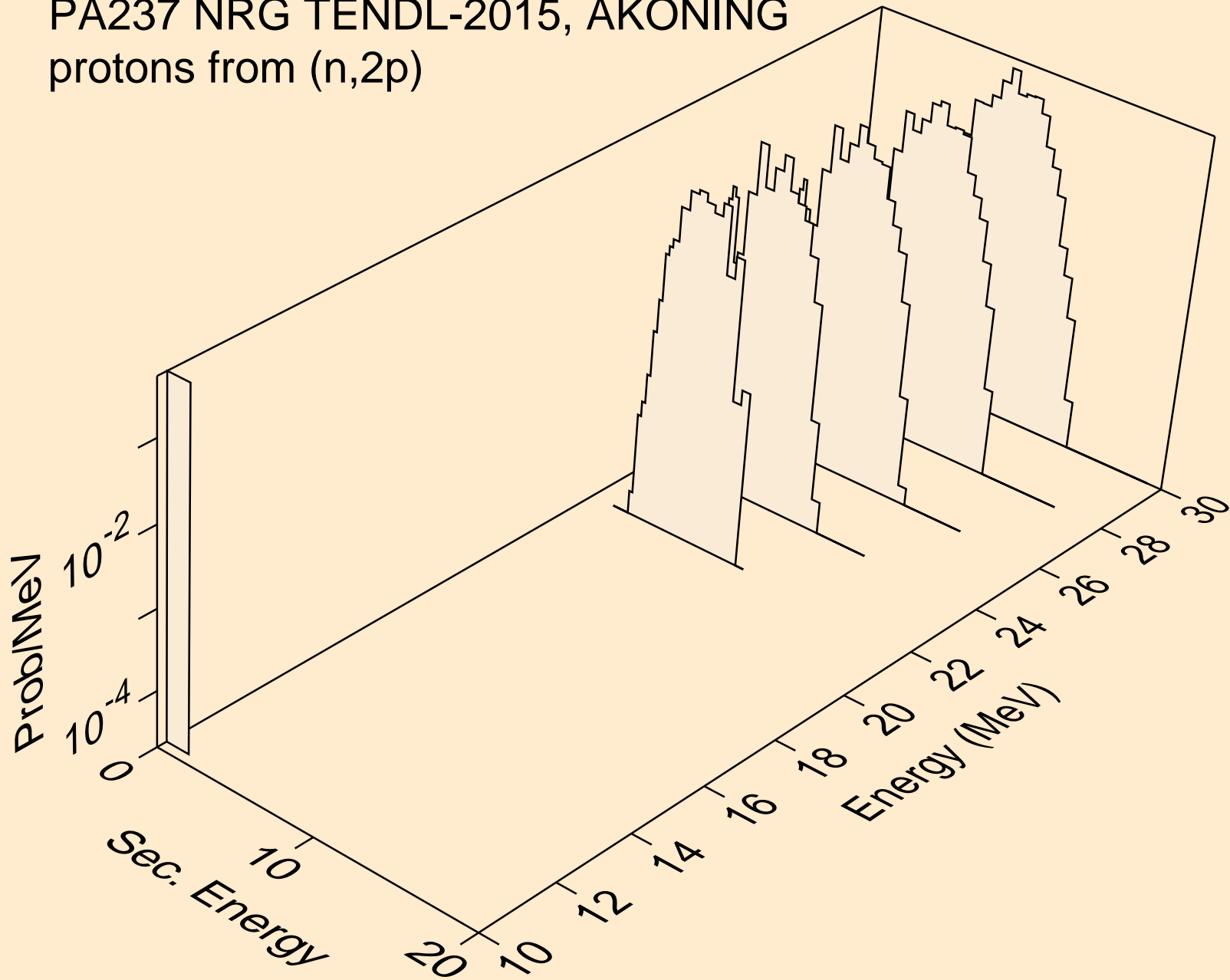

PA237 NRG TENDL-2015, AKONING
deuterons from (n,x)

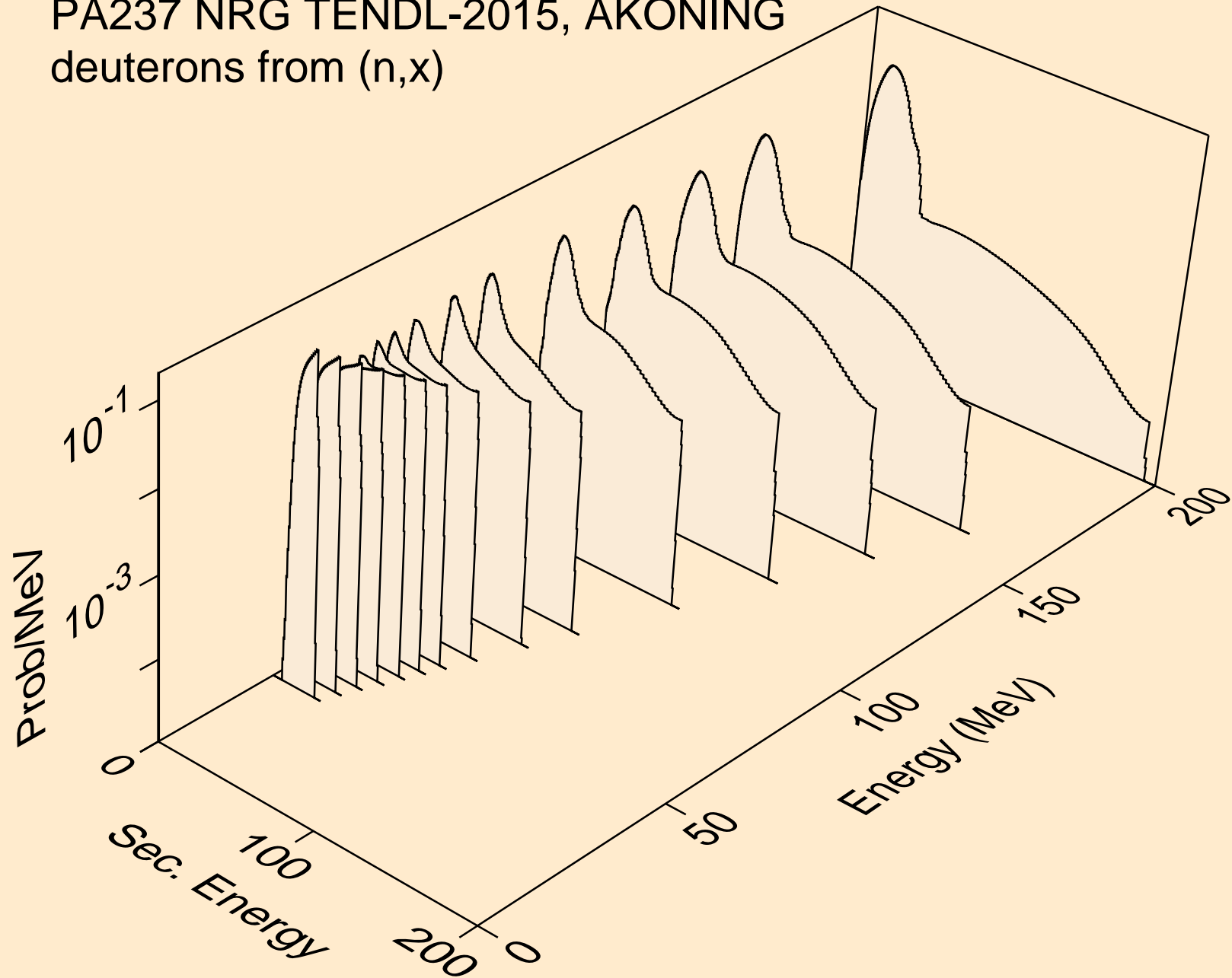

PA237 NRG TENDL-2015, AKONING
deuterons from (n,2nd)

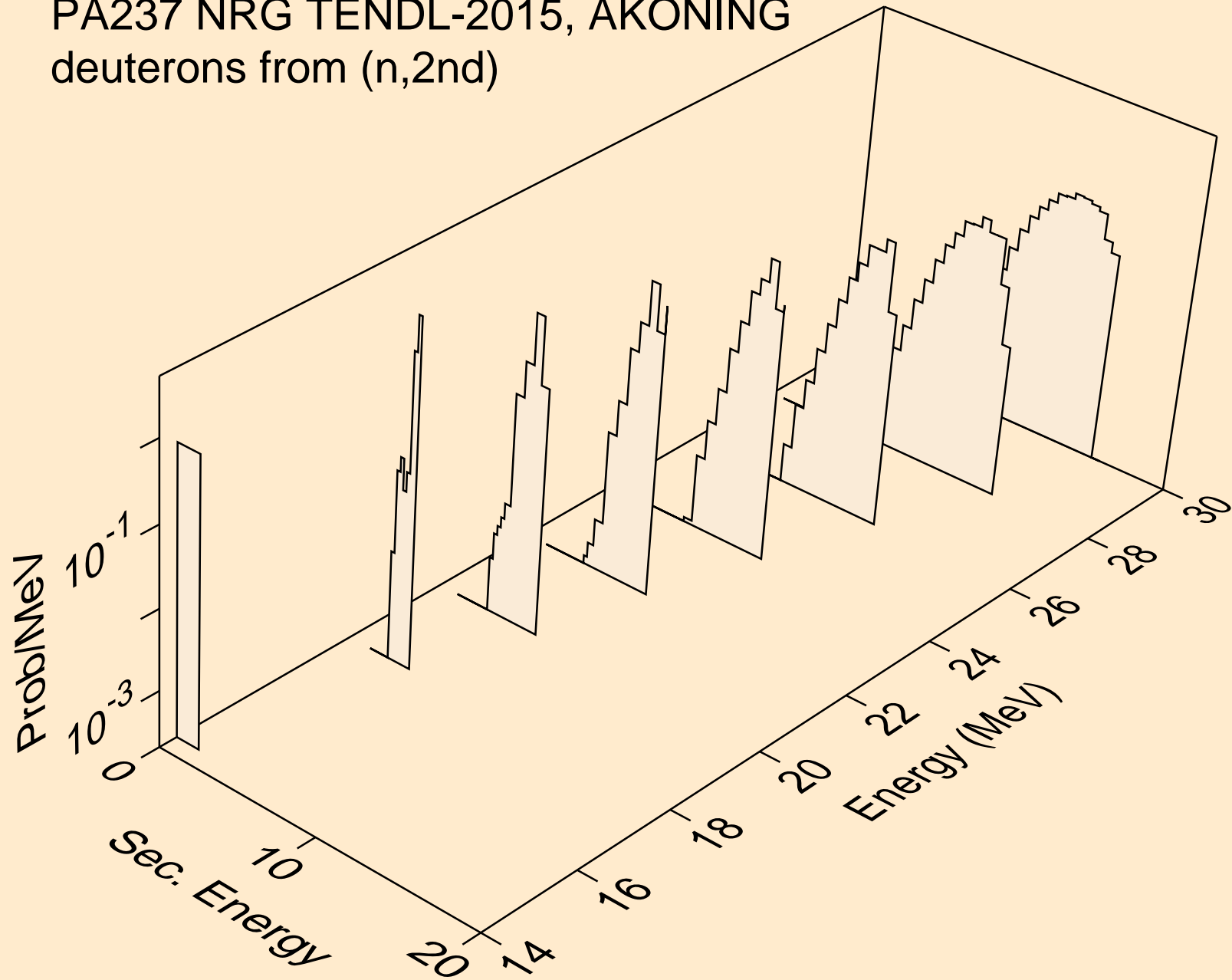

PA237 NRG TENDL-2015, AKONING
deuterons from (n,n*)d

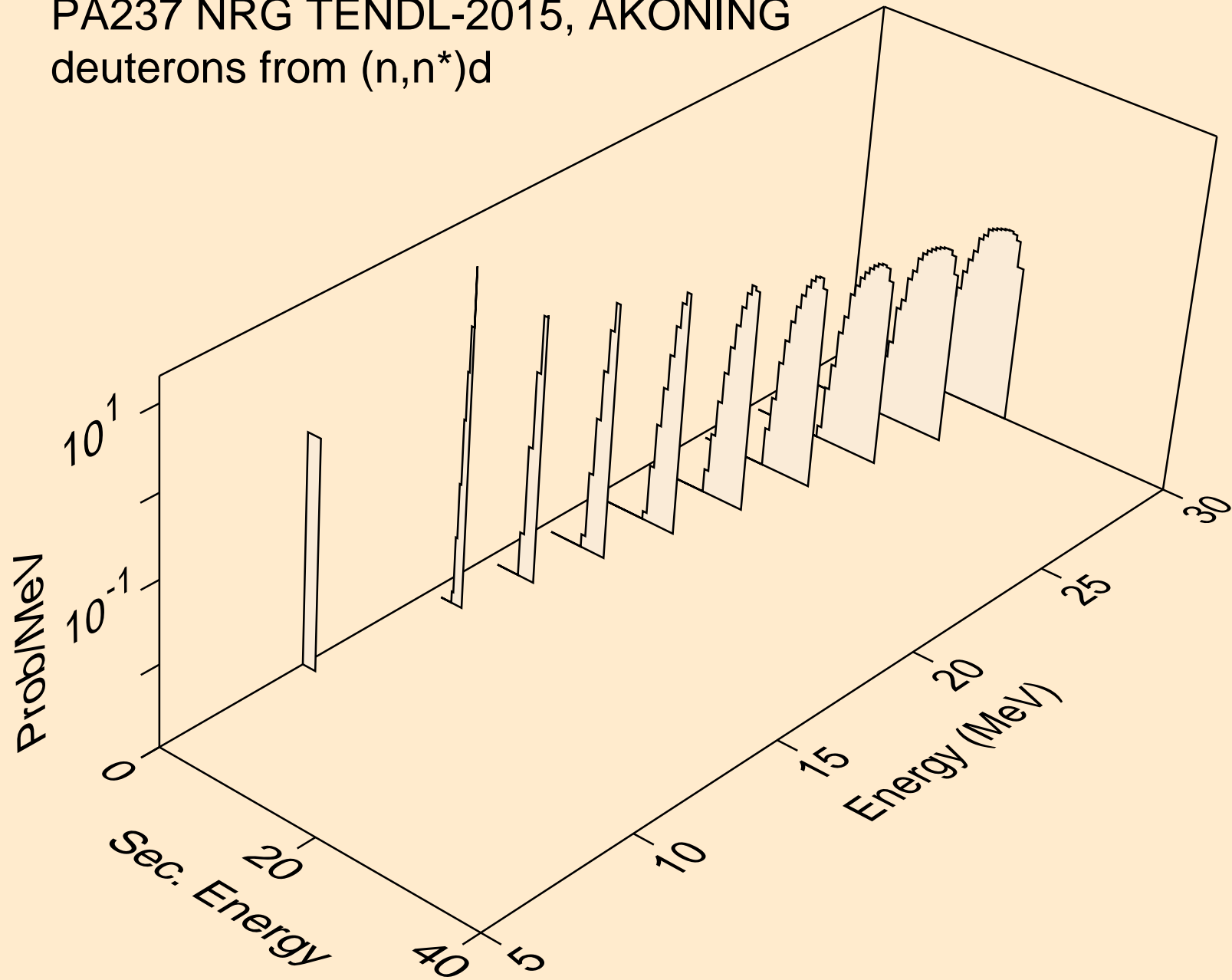

PA237 NRG TENDL-2015, AKONING
deuterons from (n,d)

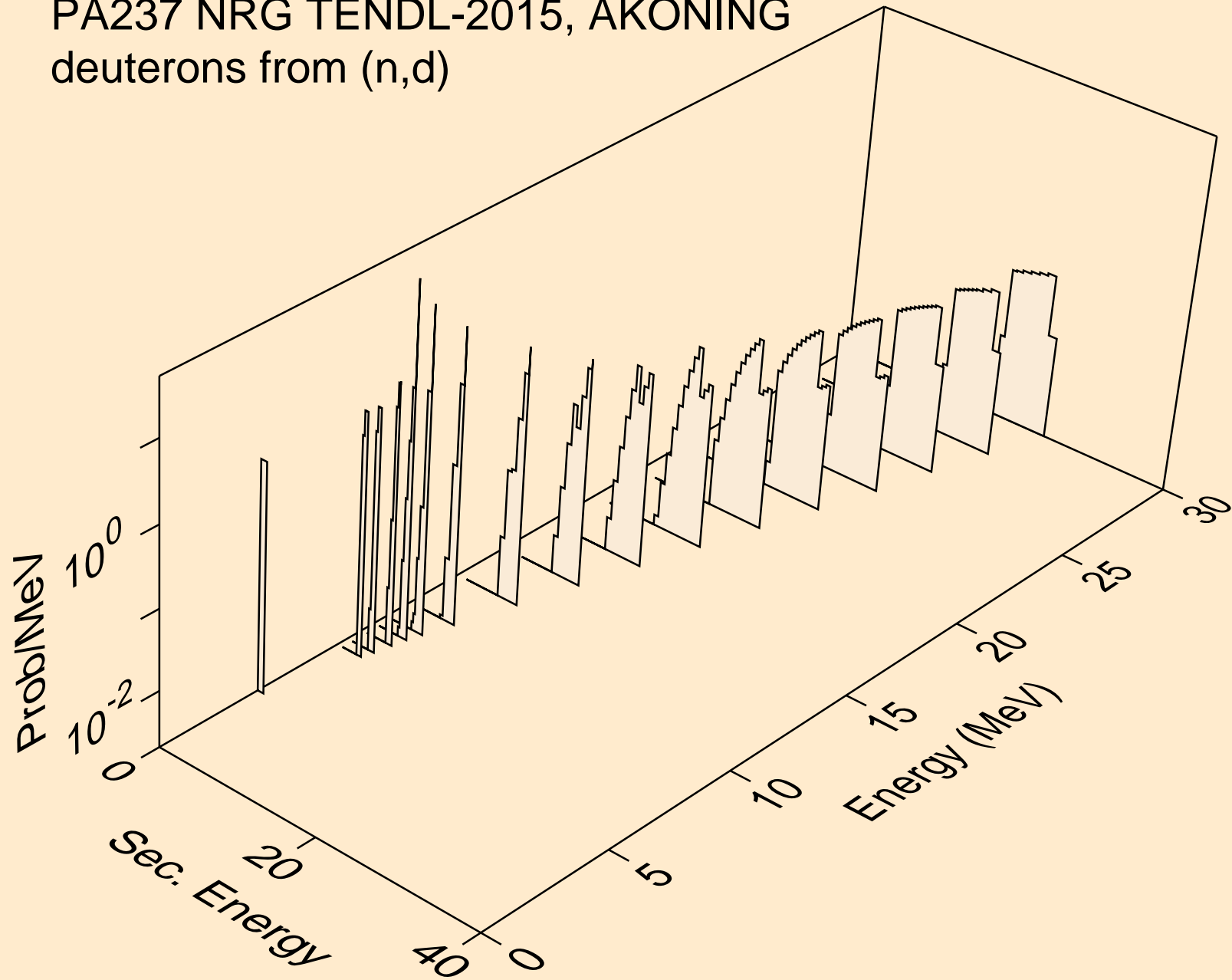

PA237 NRG TENDL-2015, AKONING
tritons from (n,x)

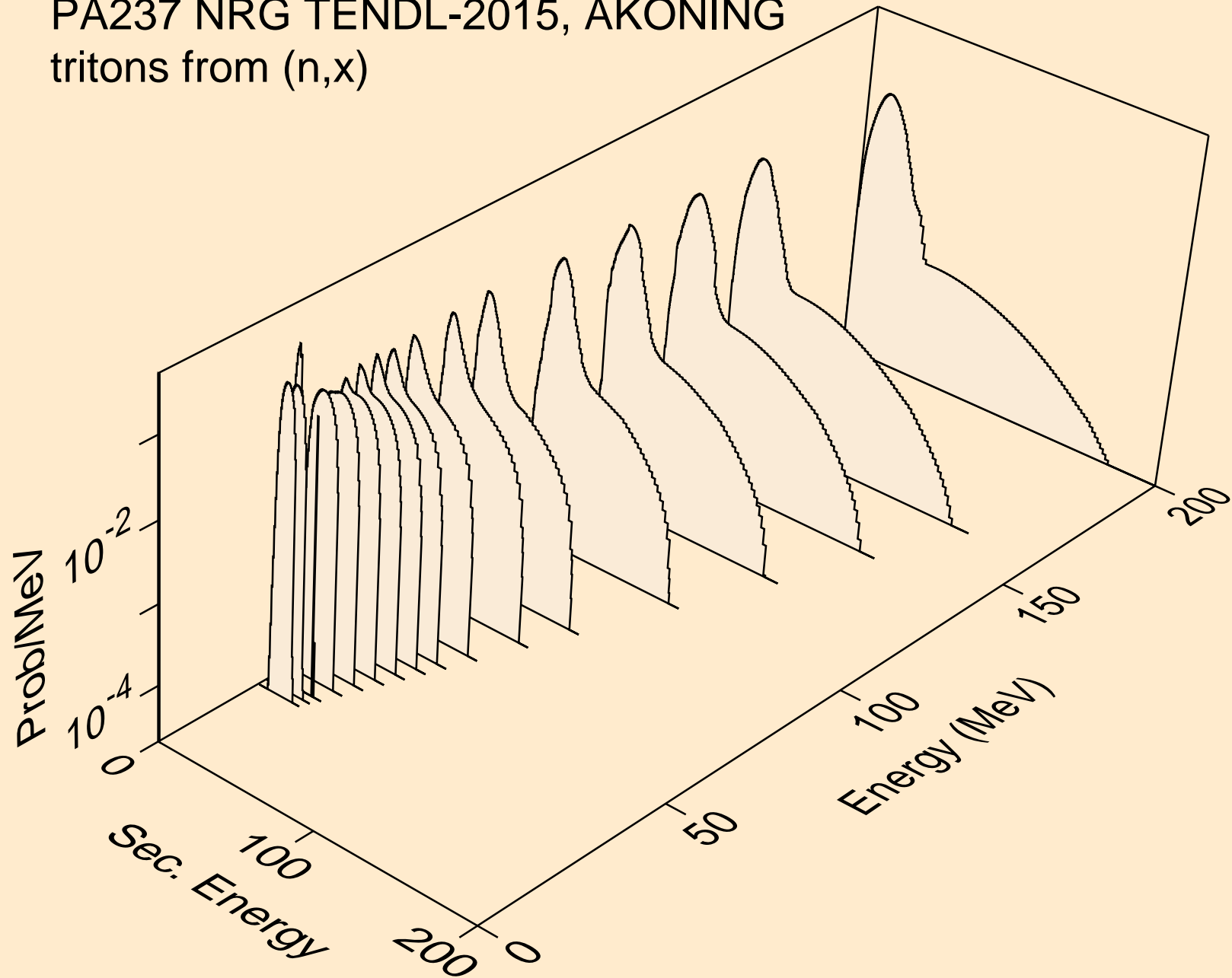

PA237 NRG TENDL-2015, AKONING
tritons from (n,n*)t

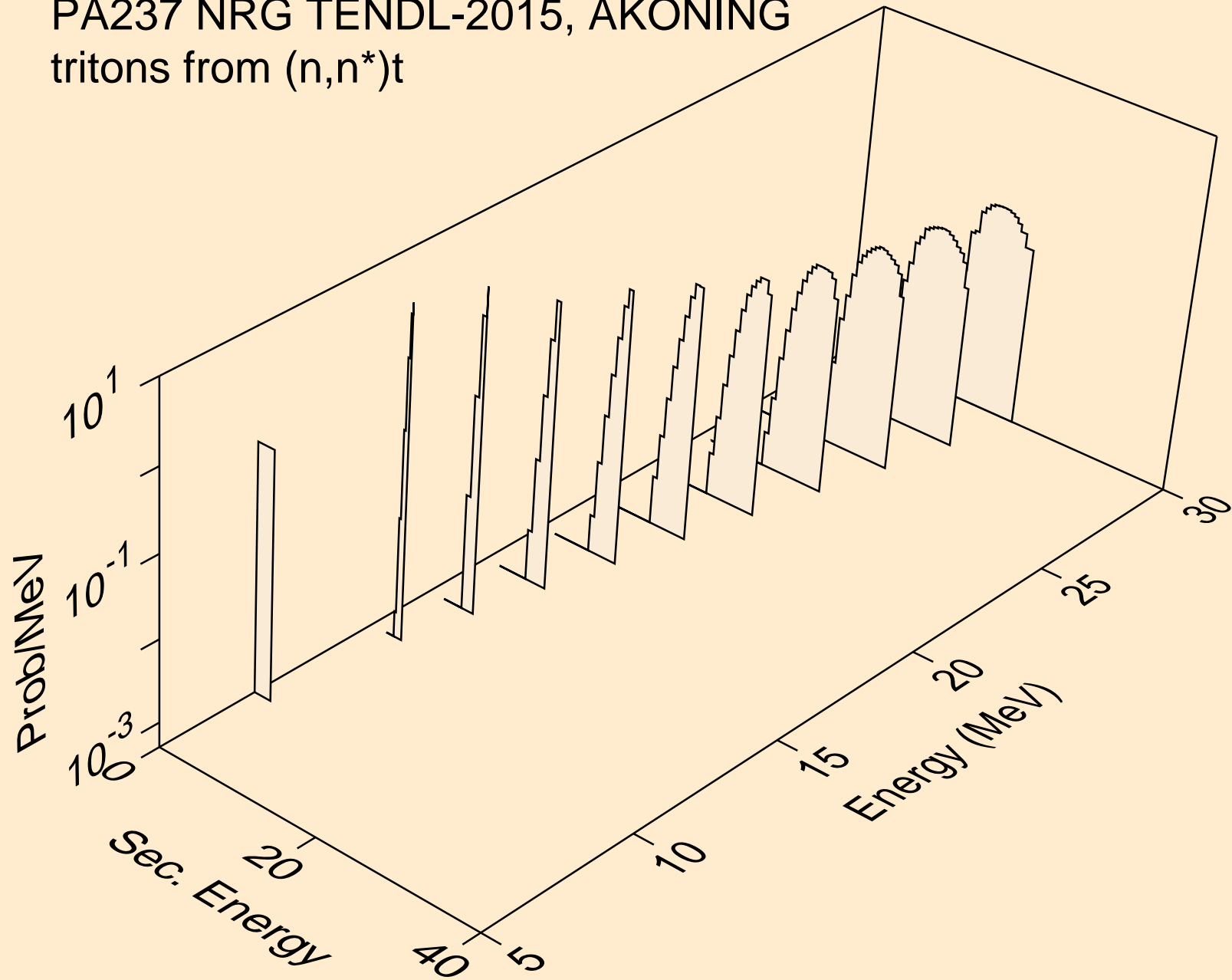

PA237 NRG TENDL-2015, AKONING
tritons from (n,t)

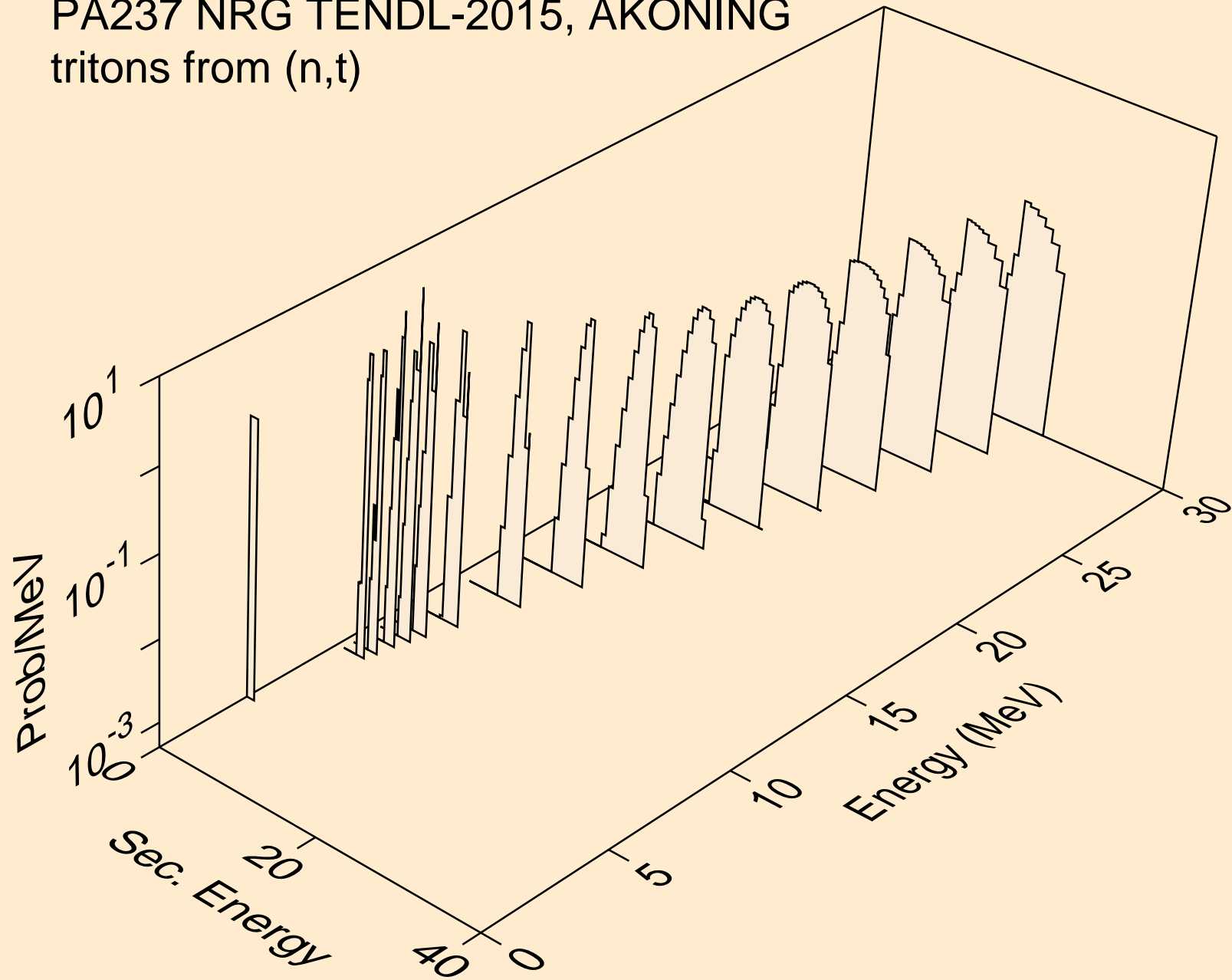

PA237 NRG TENDL-2015, AKONING
he3s from (n,x)

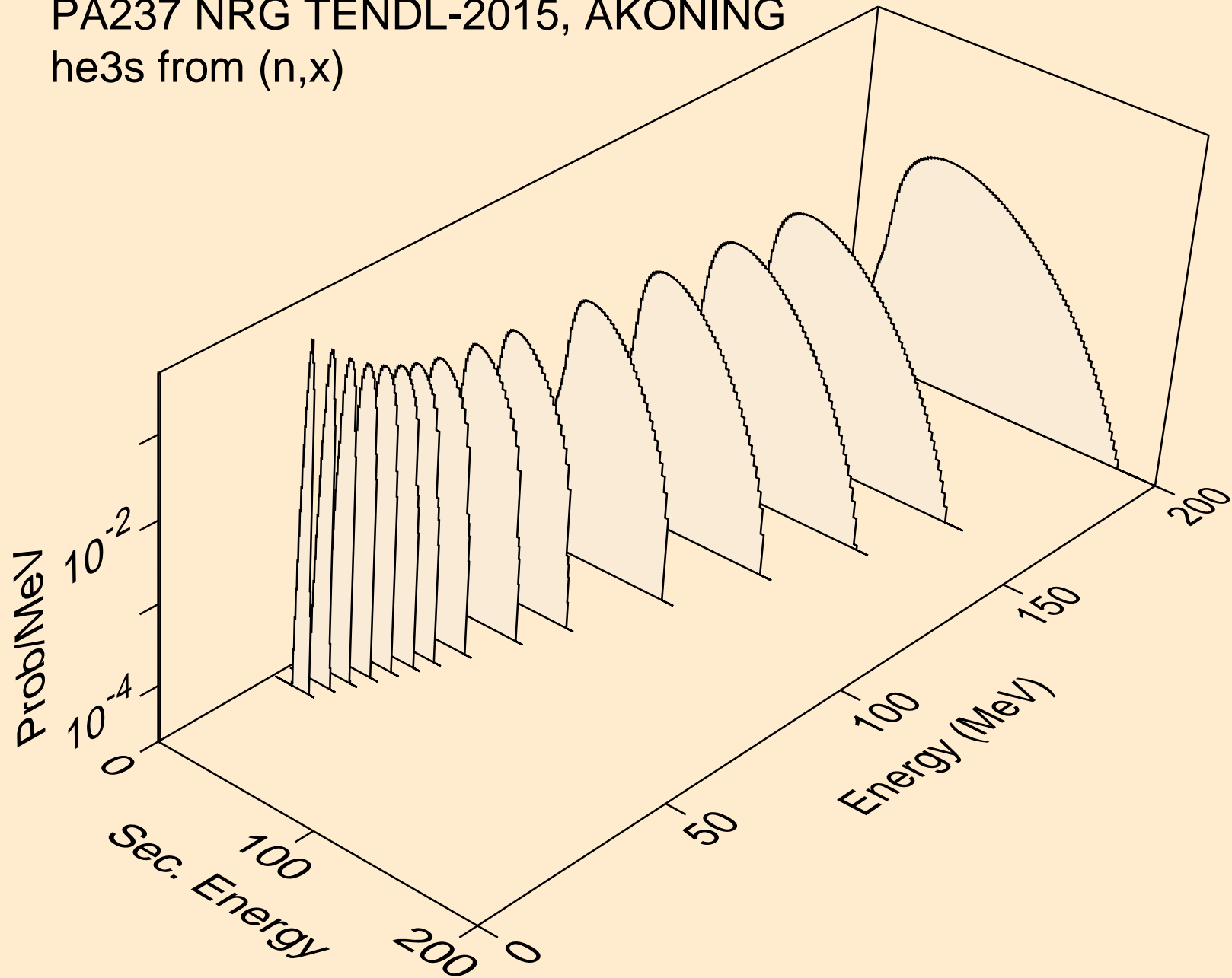

PA237 NRG TENDL-2015, AKONING
he3s from (n,n*)he3

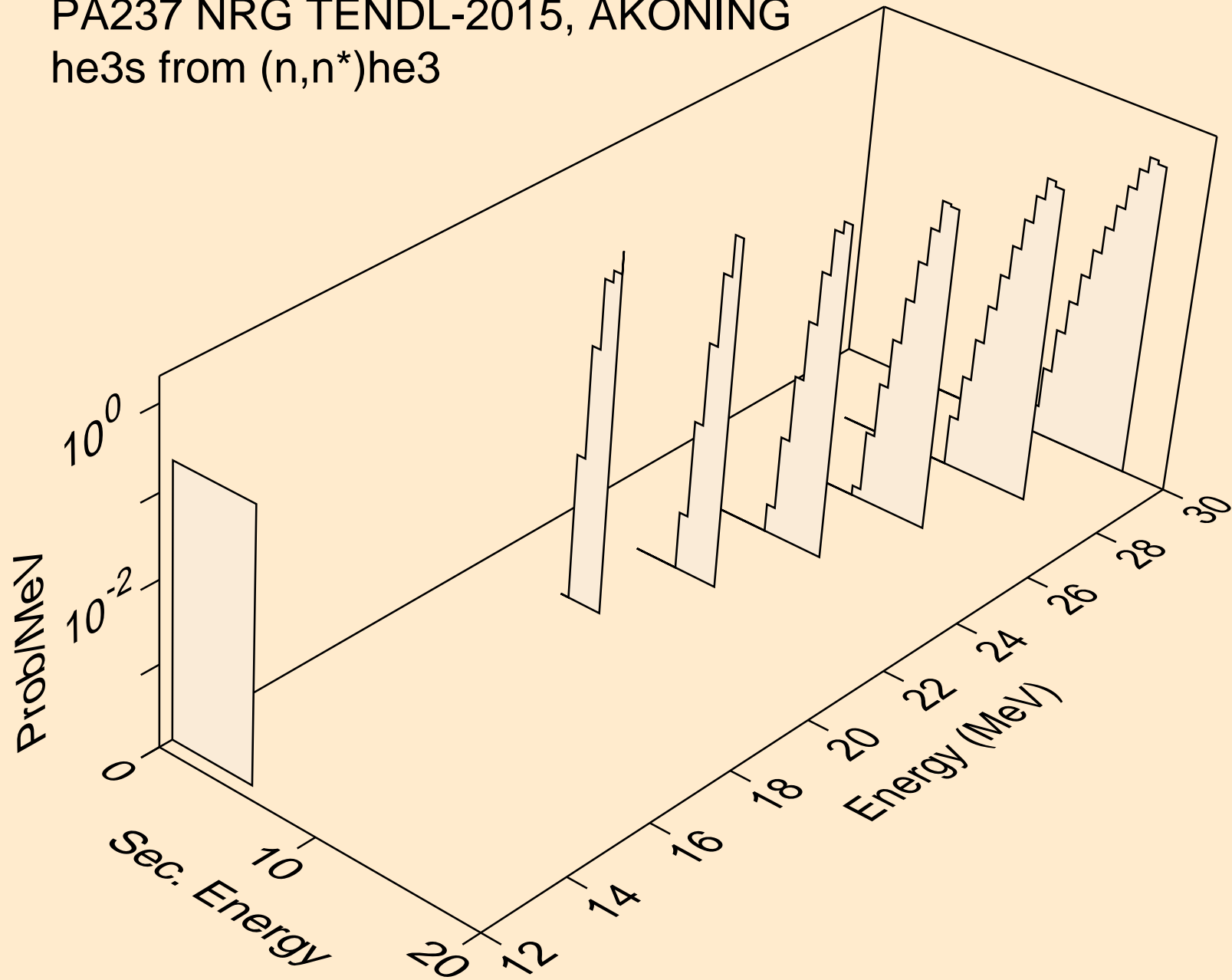

PA237 NRG TENDL-2015, AKONING
he3s from (n,he3)

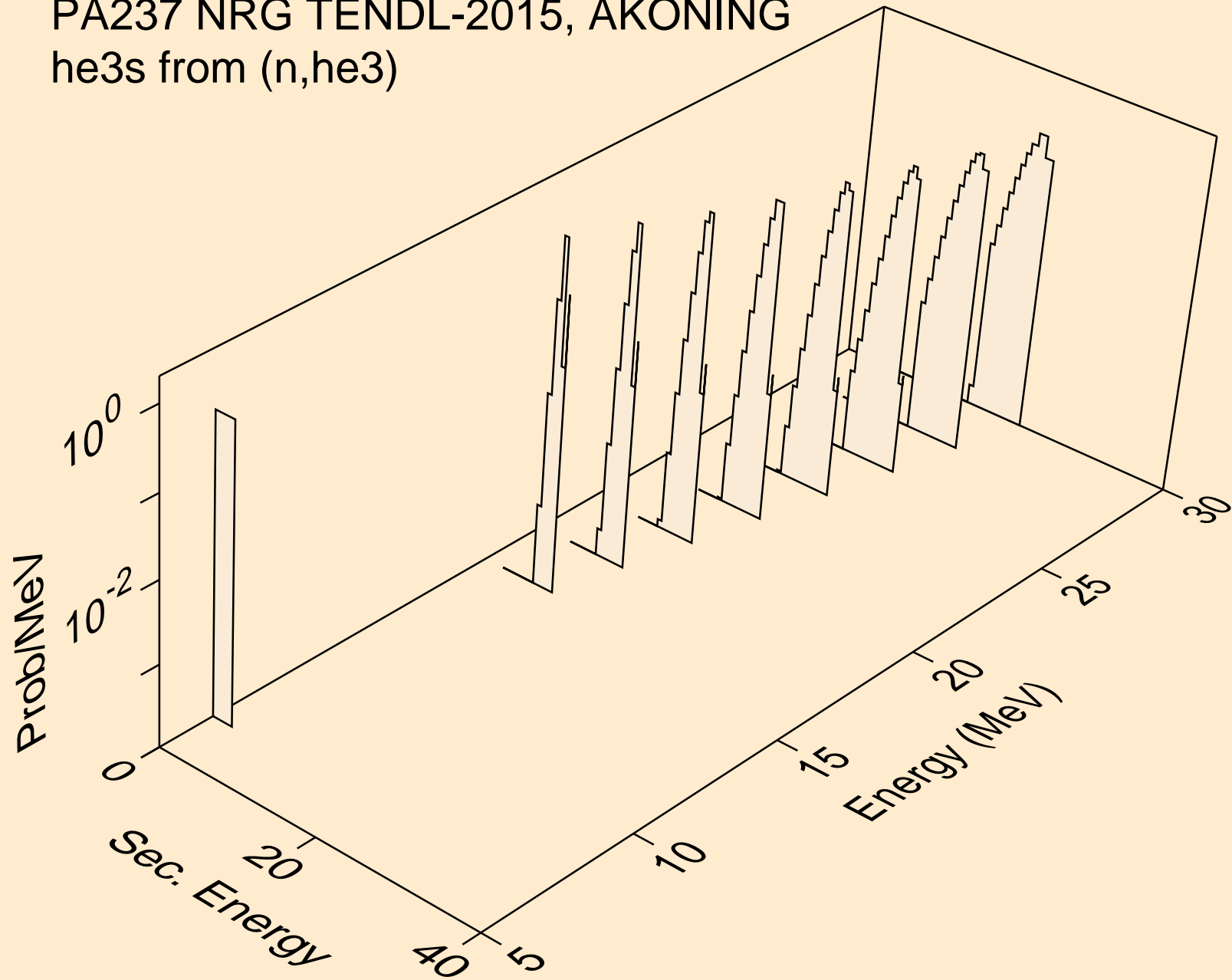

PA237 NRG TENDL-2015, AKONING
alphas from (n,x)

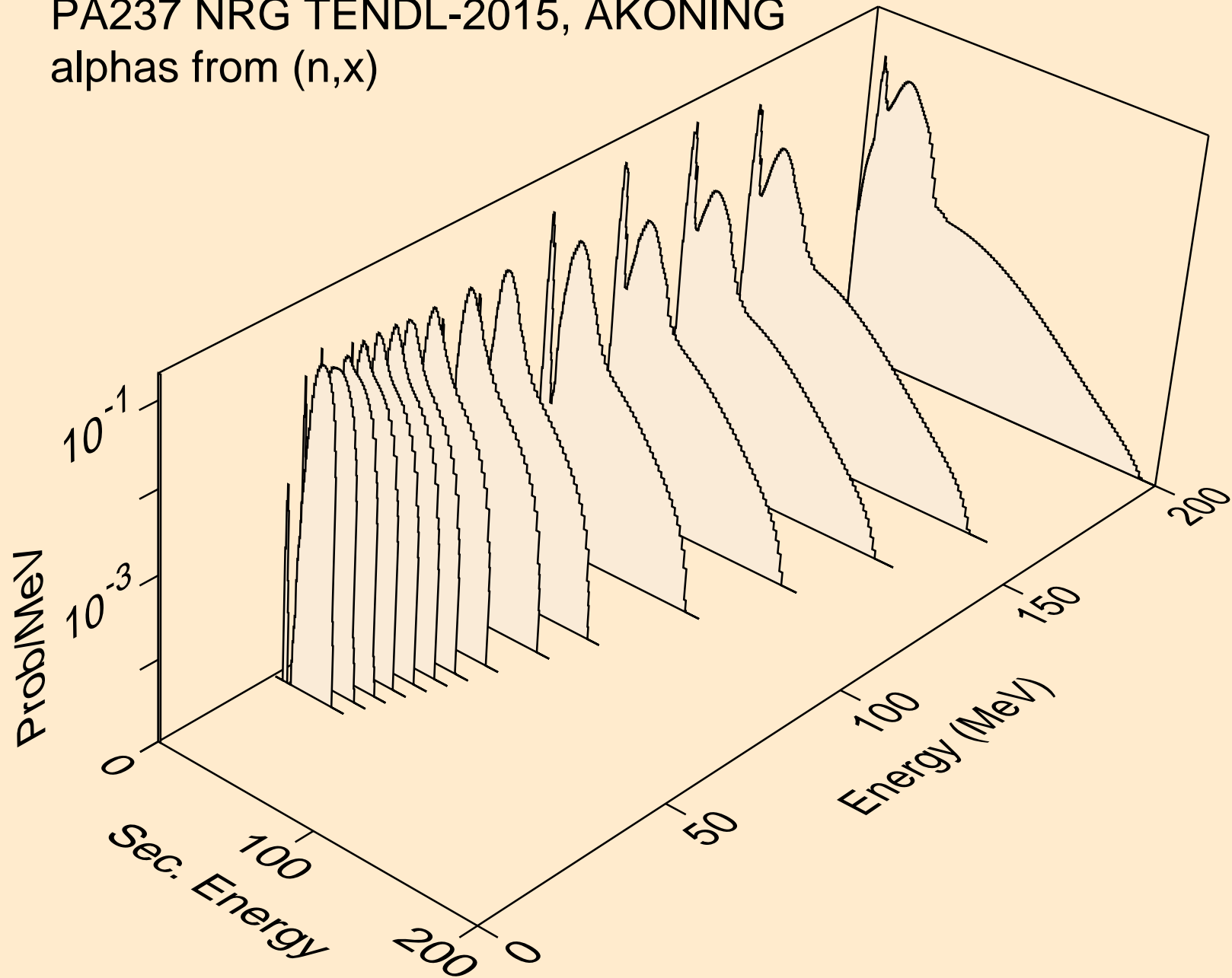

PA237 NRG TENDL-2015, AKONING
alphas from (n,n*)a

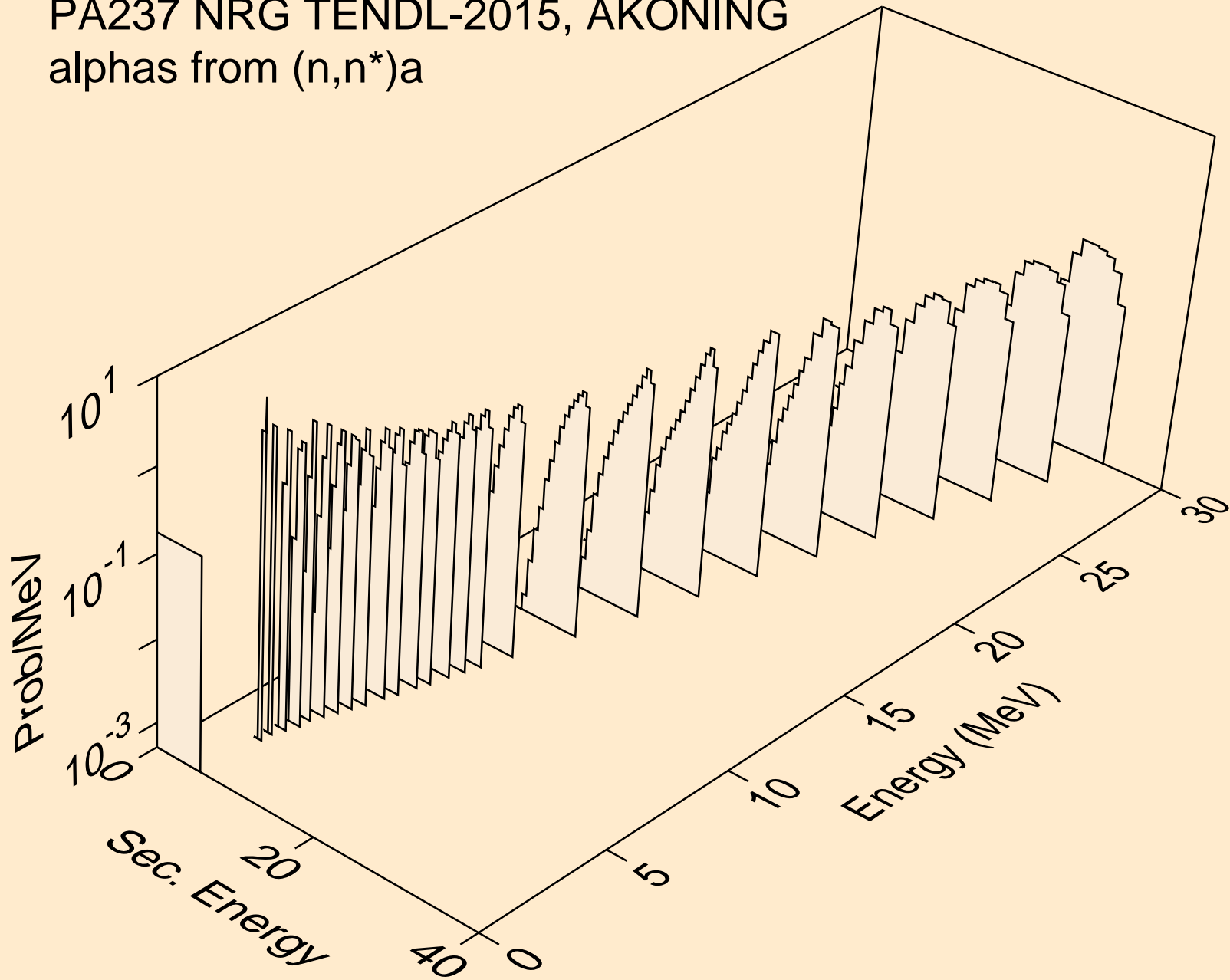

PA237 NRG TENDL-2015, AKONING
alphas from (n,2n)a

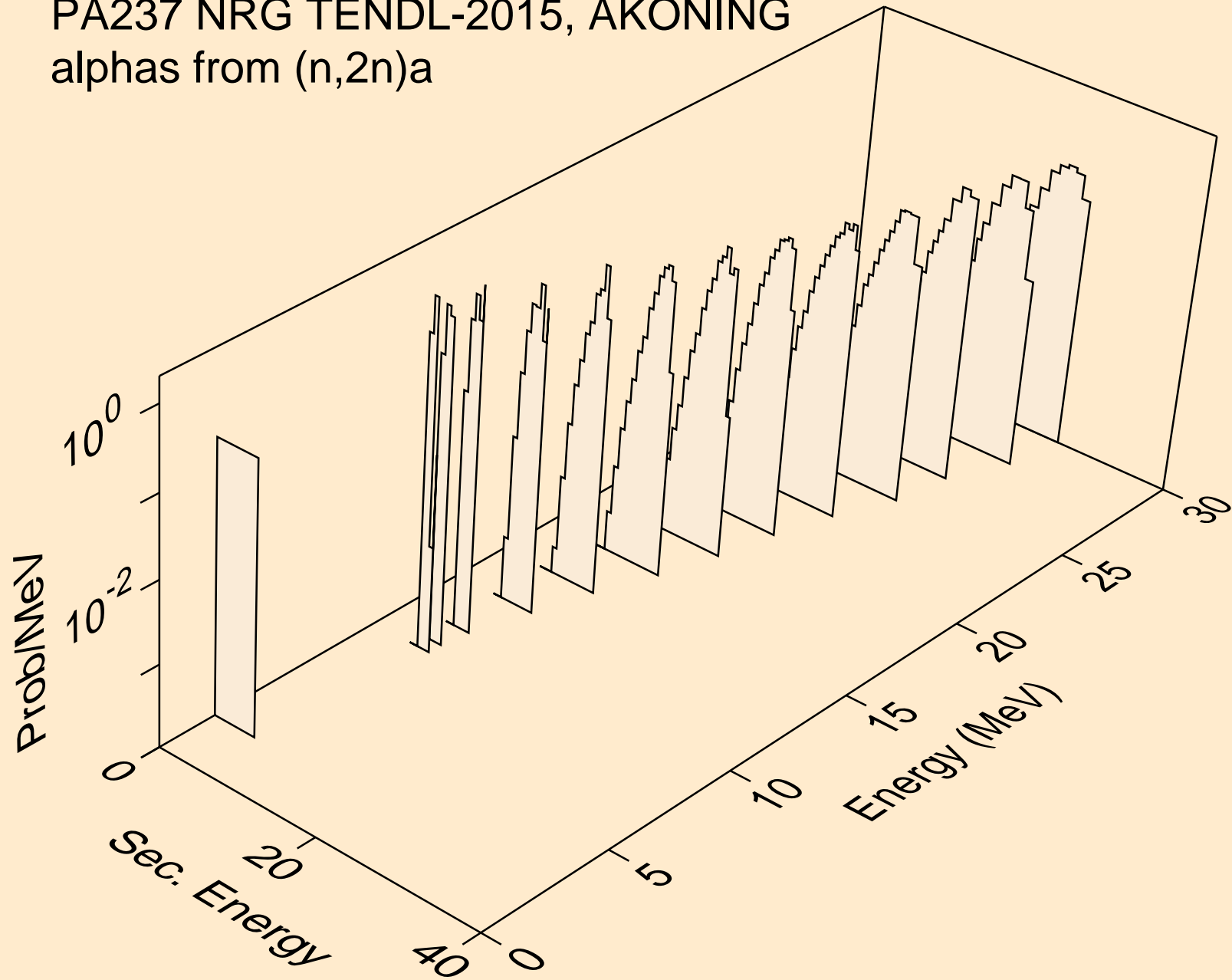

PA237 NRG TENDL-2015, AKONING
alphas from (n,3n)a

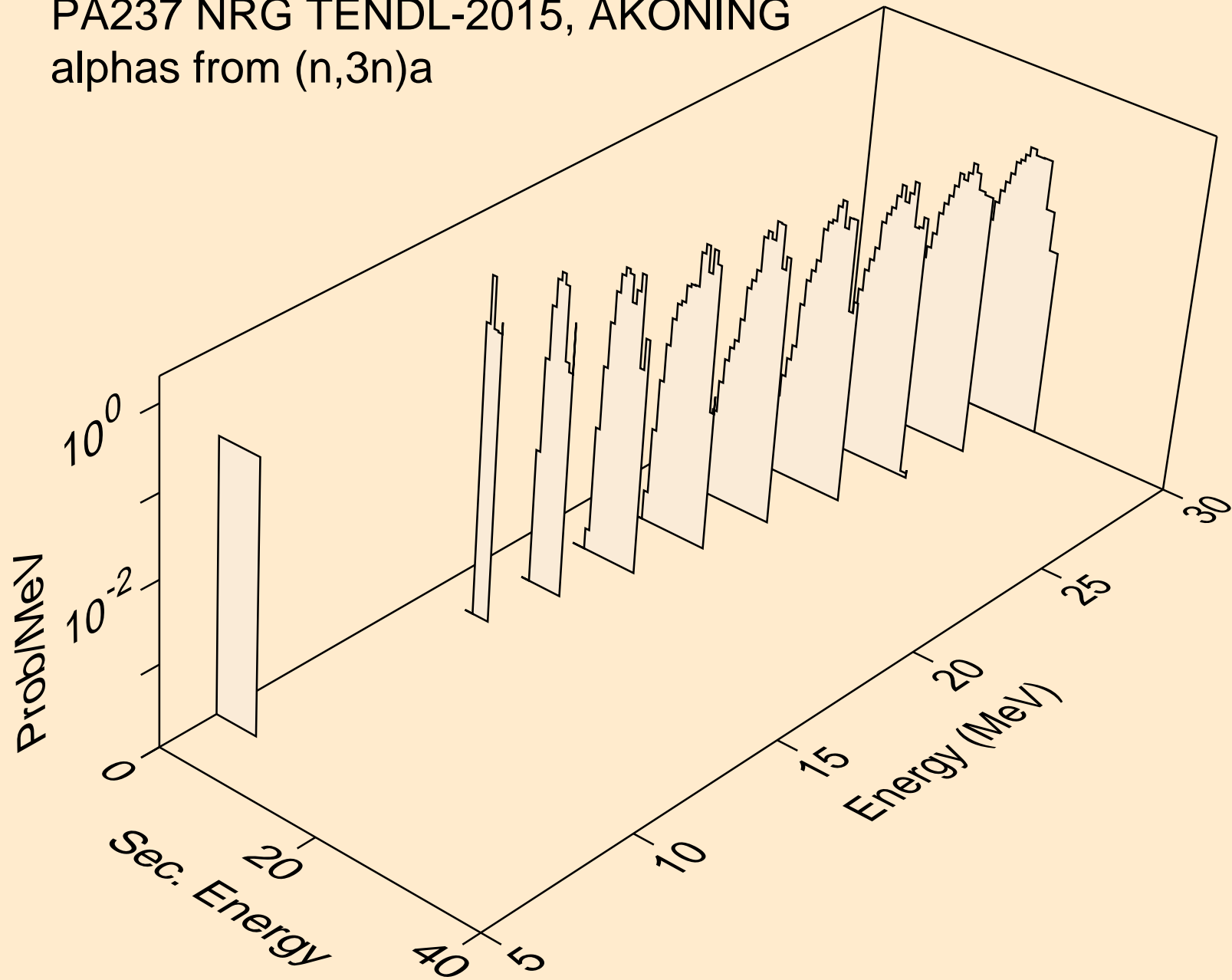

PA237 NRG TENDL-2015, AKONING
alphas from (n,a)

