

# PB191 NRG TENDL-2015, AKONING

## Principal cross sections

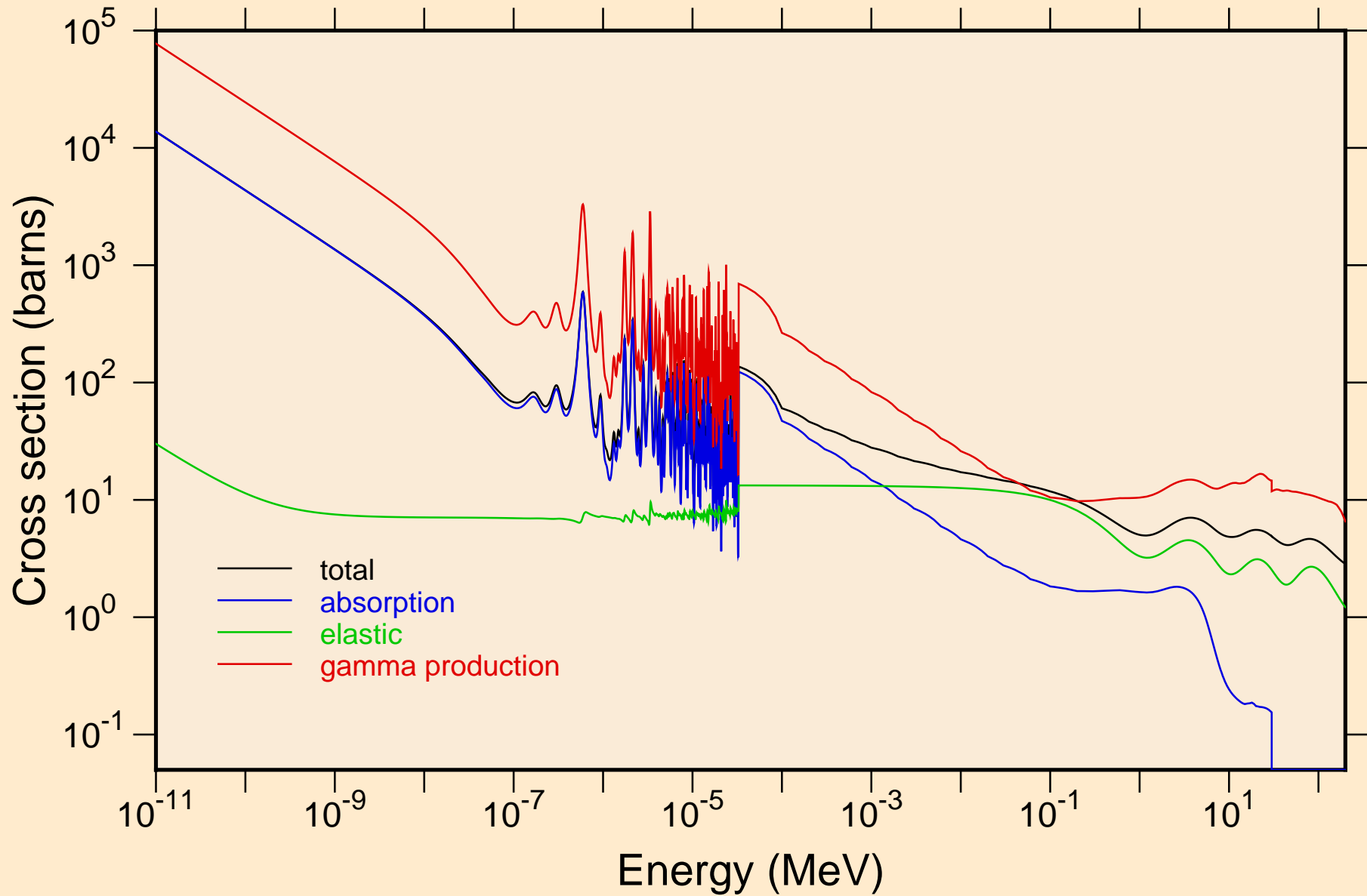

PB191 NRG TENDL-2015, AKONING  
resonance total cross section

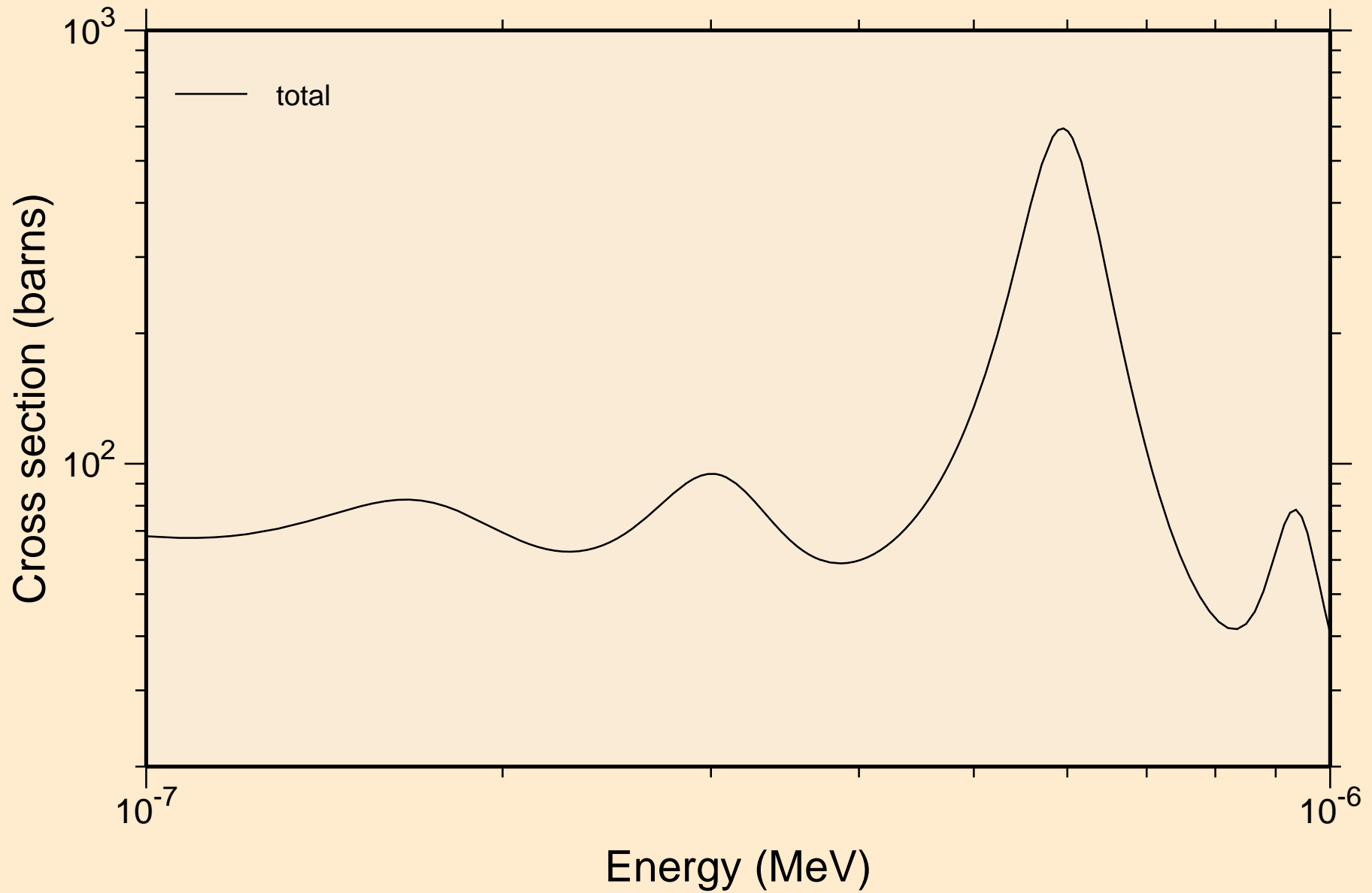

PB191 NRG TENDL-2015, AKONING  
resonance total cross section

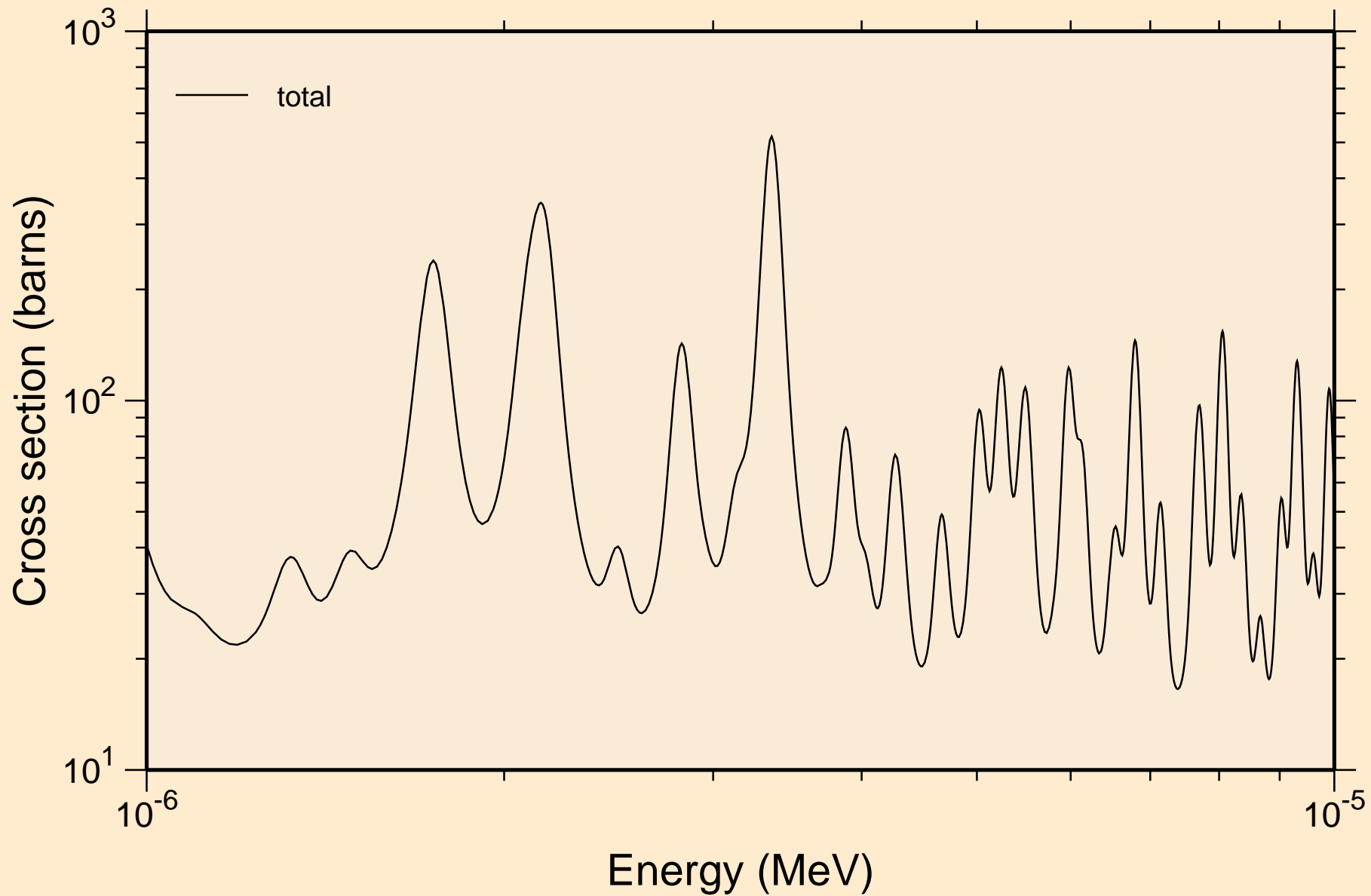

PB191 NRG TENDL-2015, AKONING  
resonance total cross section

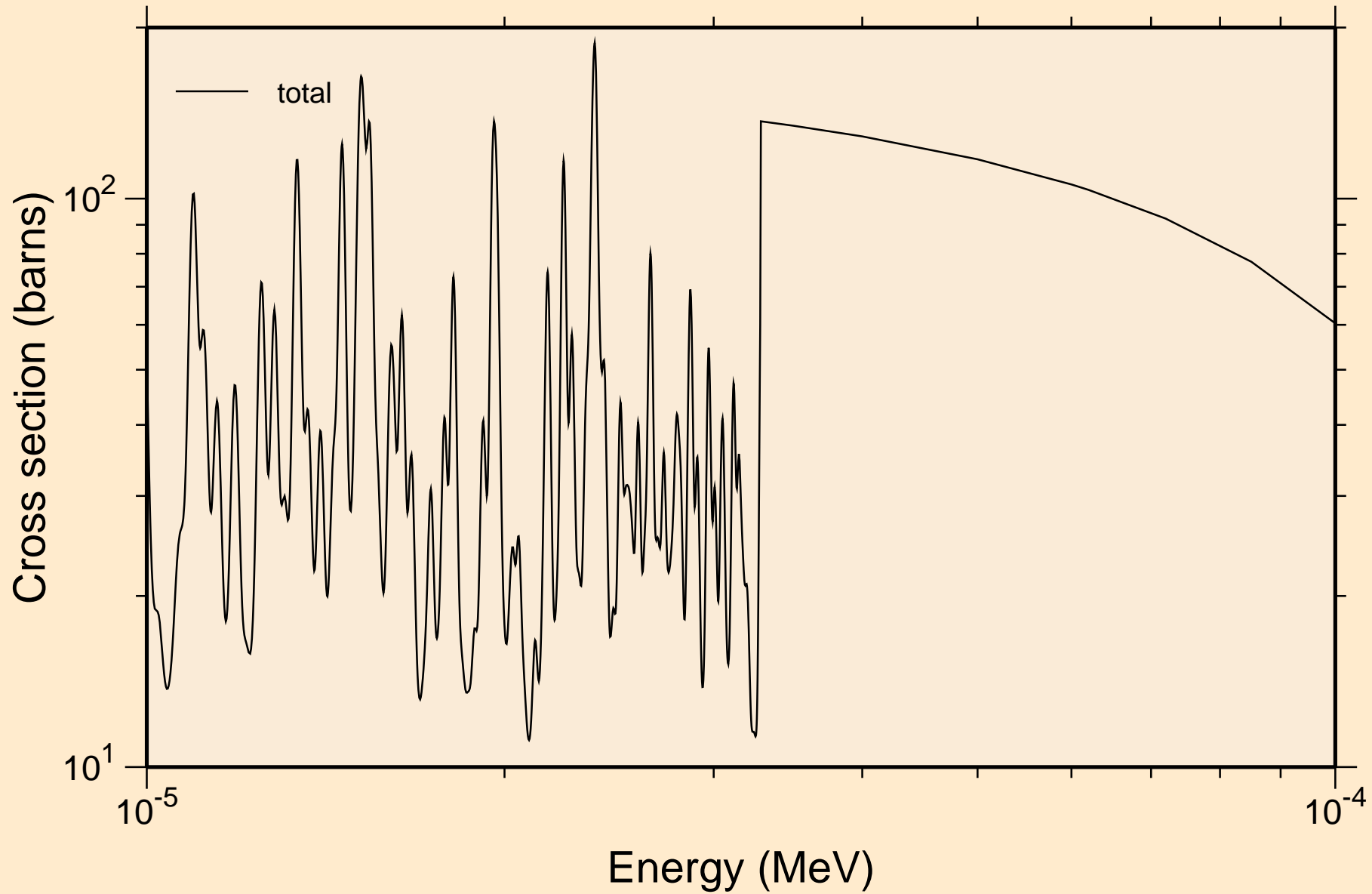

PB191 NRG TENDL-2015, AKONING  
resonance total cross section

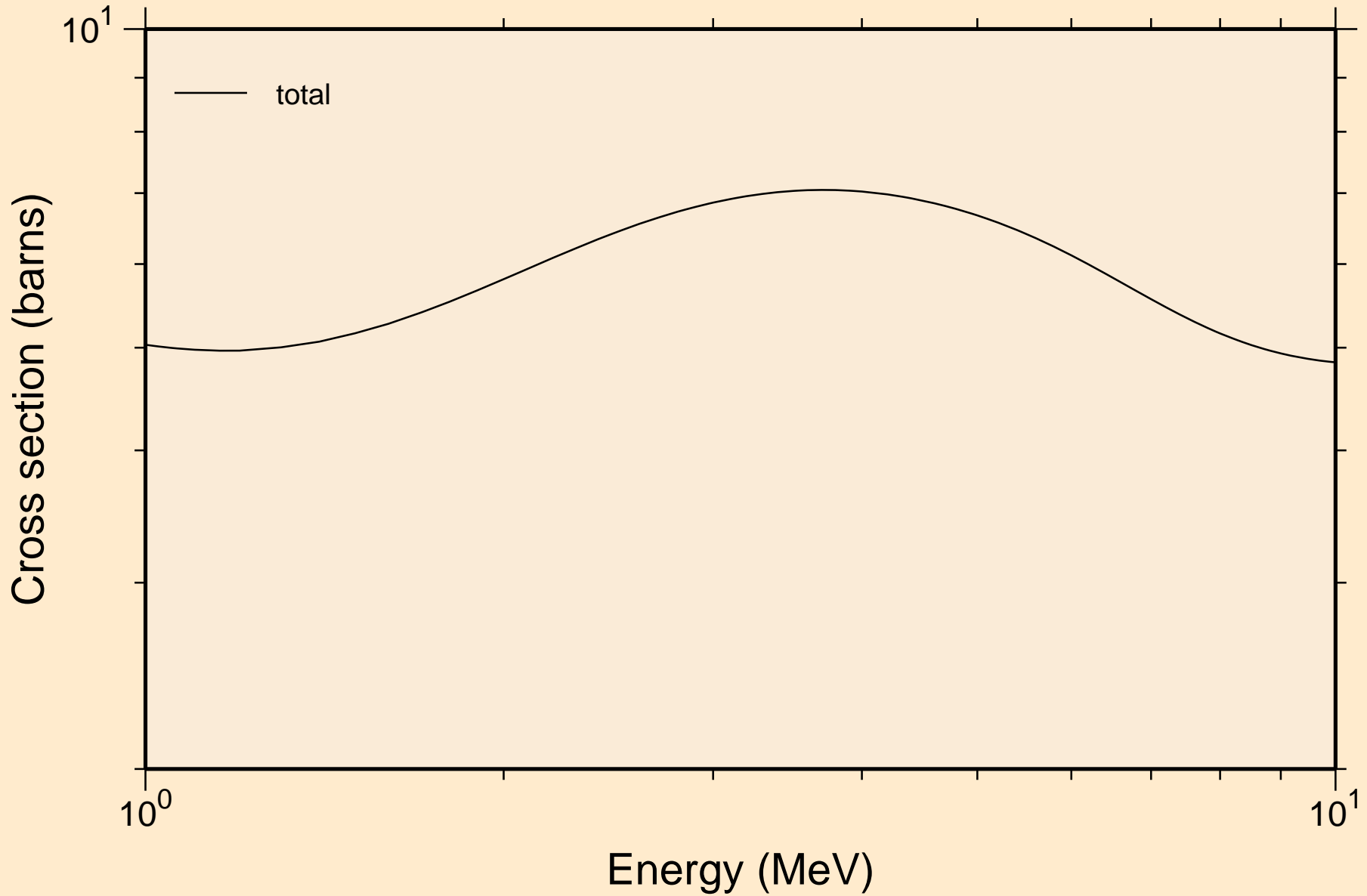

PB191 NRG TENDL-2015, AKONING  
resonance absorption cross sections

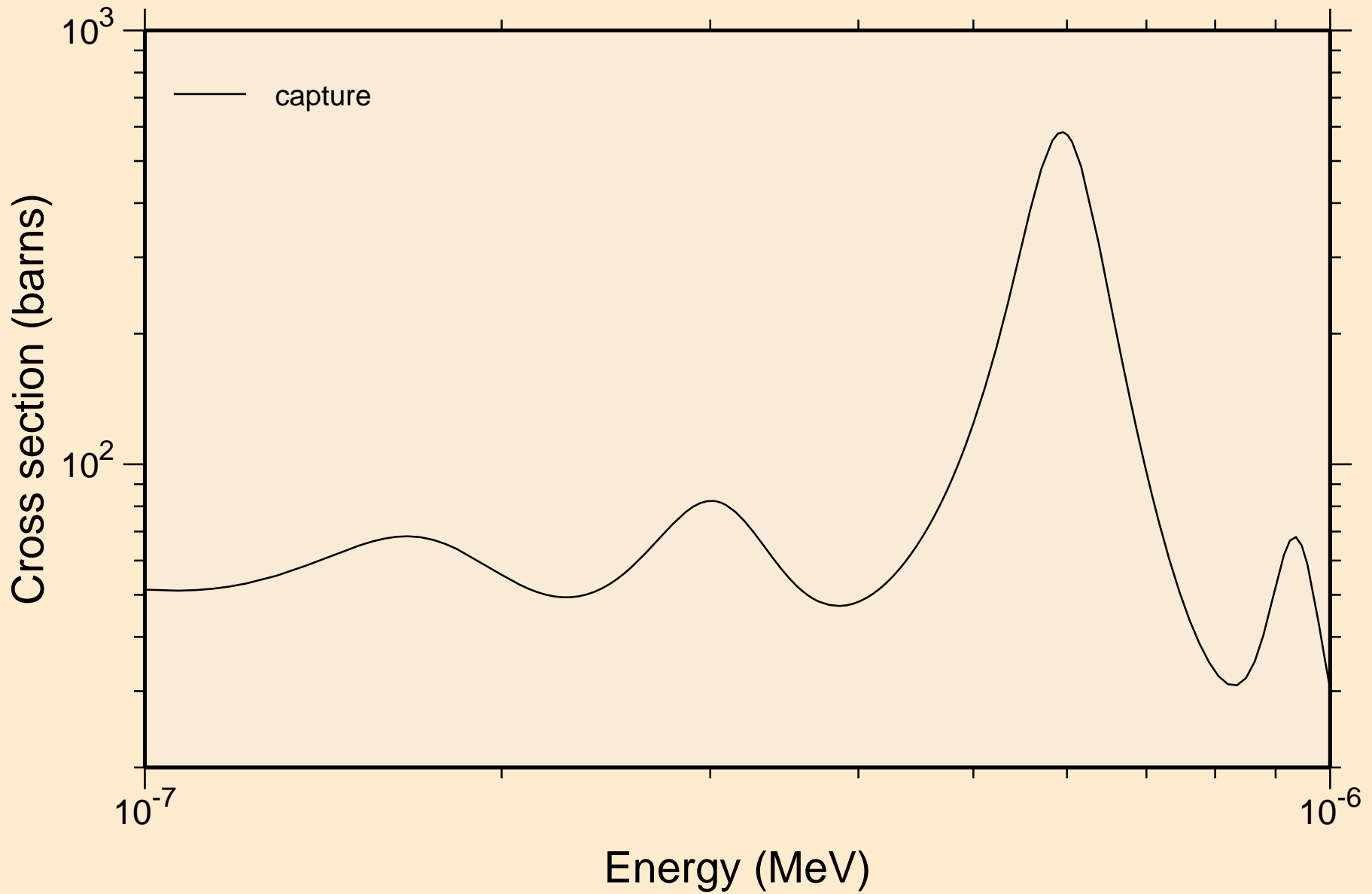

PB191 NRG TENDL-2015, AKONING  
resonance absorption cross sections

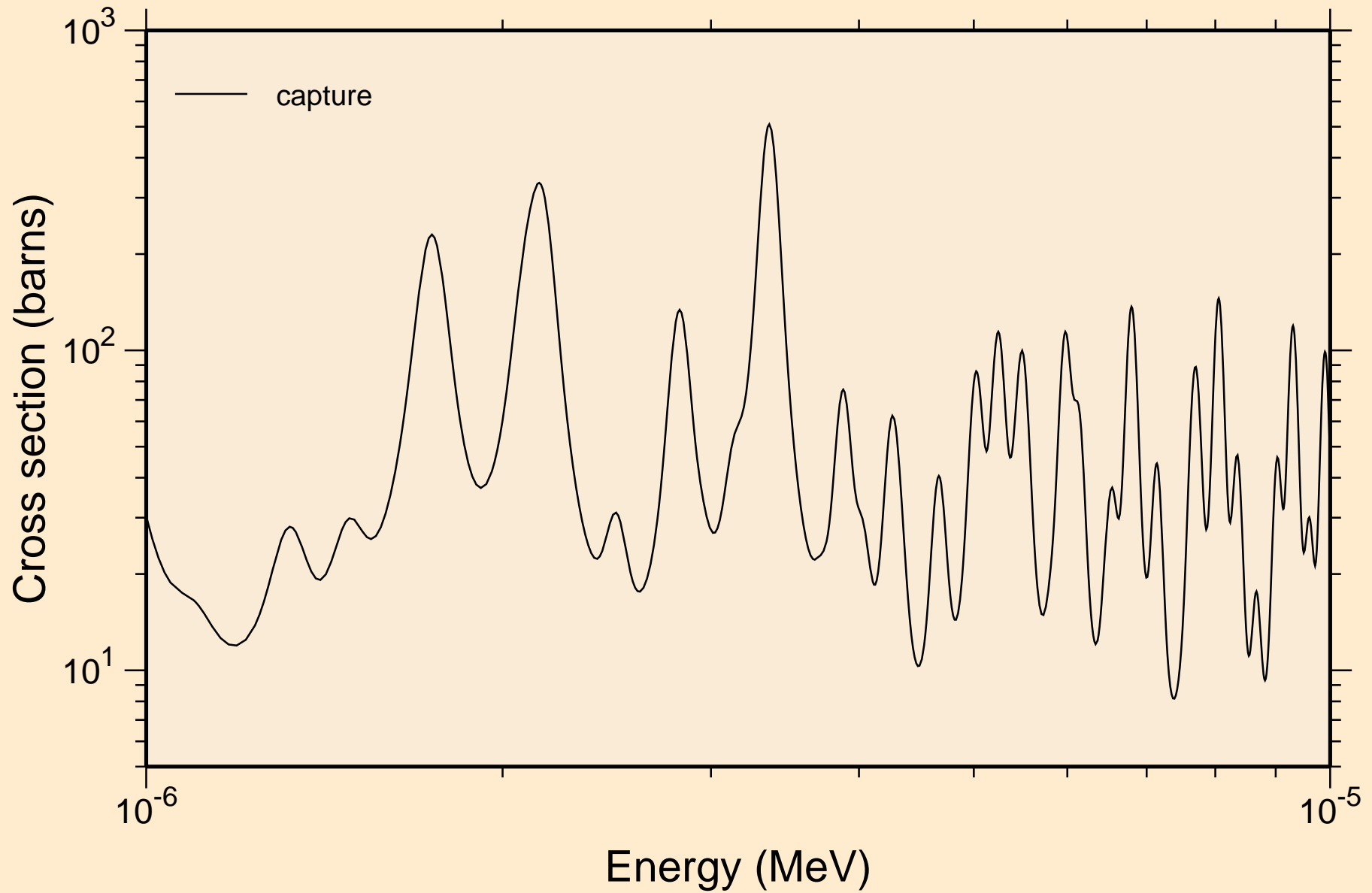

PB191 NRG TENDL-2015, AKONING  
resonance absorption cross sections

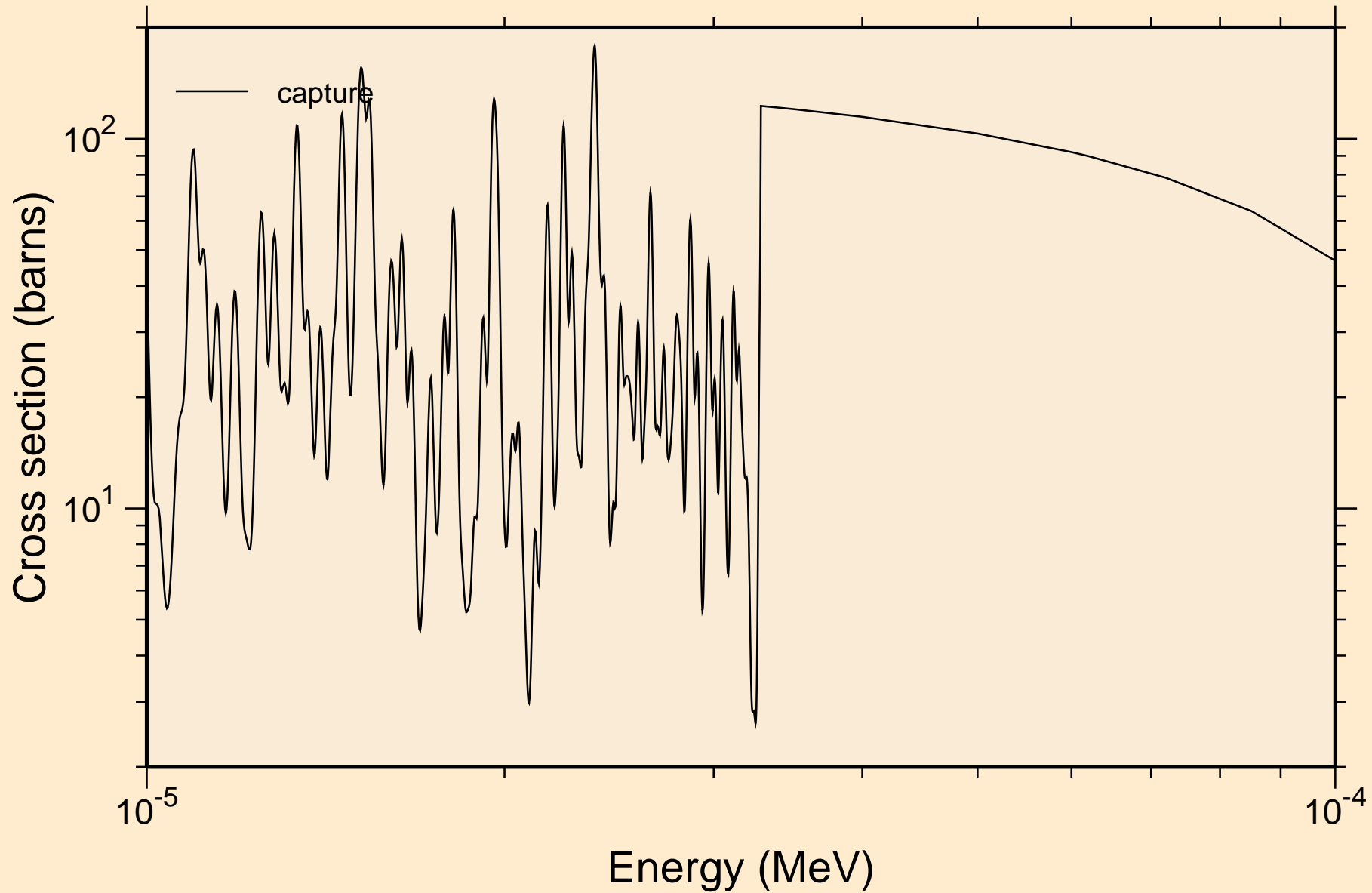



PB191 NRG TENDL-2015, AKONING  
resonance absorption cross sections

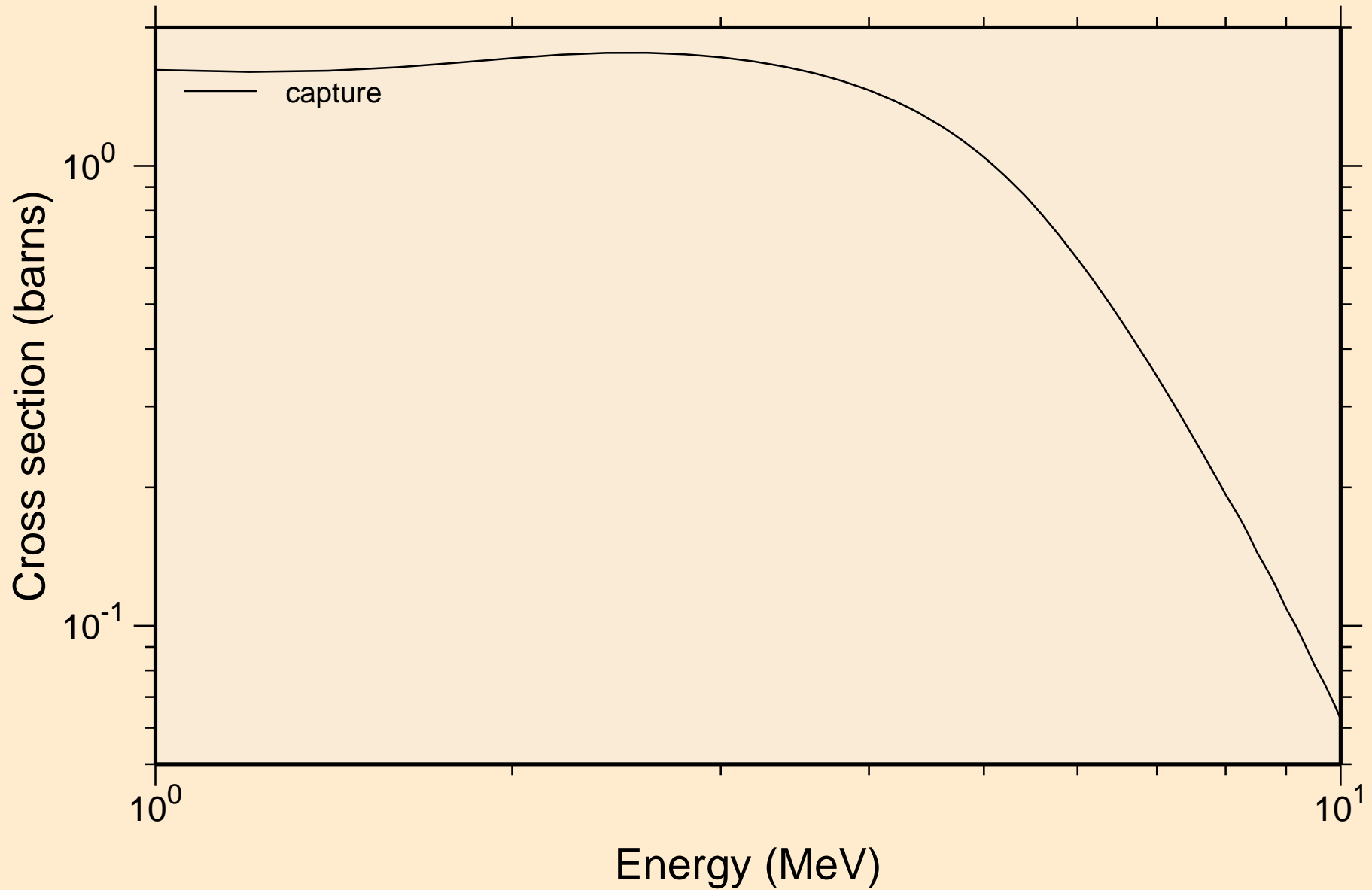

PB191 NRG TENDL-2015, AKONING  
Non-threshold reactions

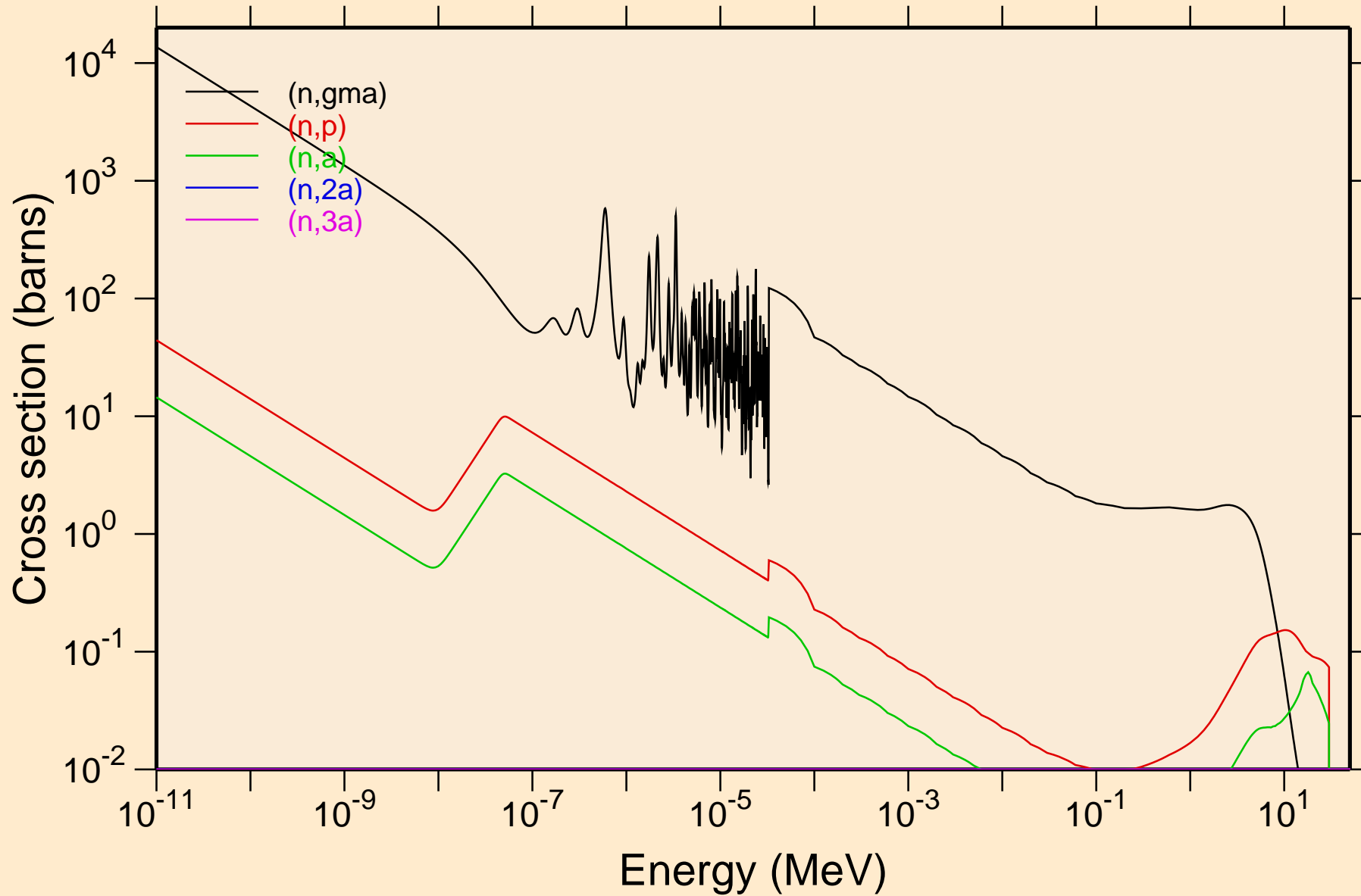

PB191 NRG TENDL-2015, AKONING  
Non-threshold reactions

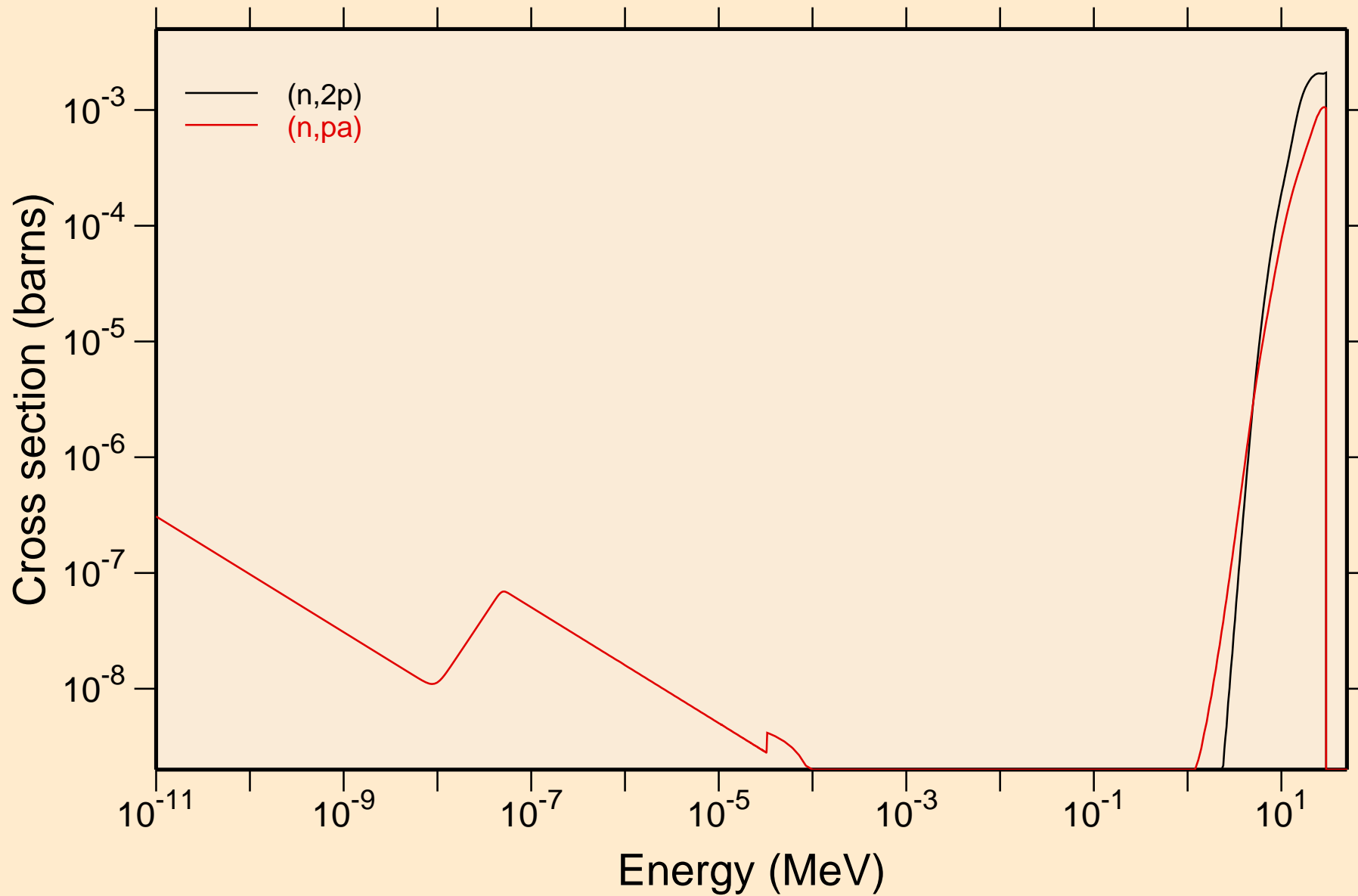

# PB191 NRG TENDL-2015, AKONING

## Principal cross sections

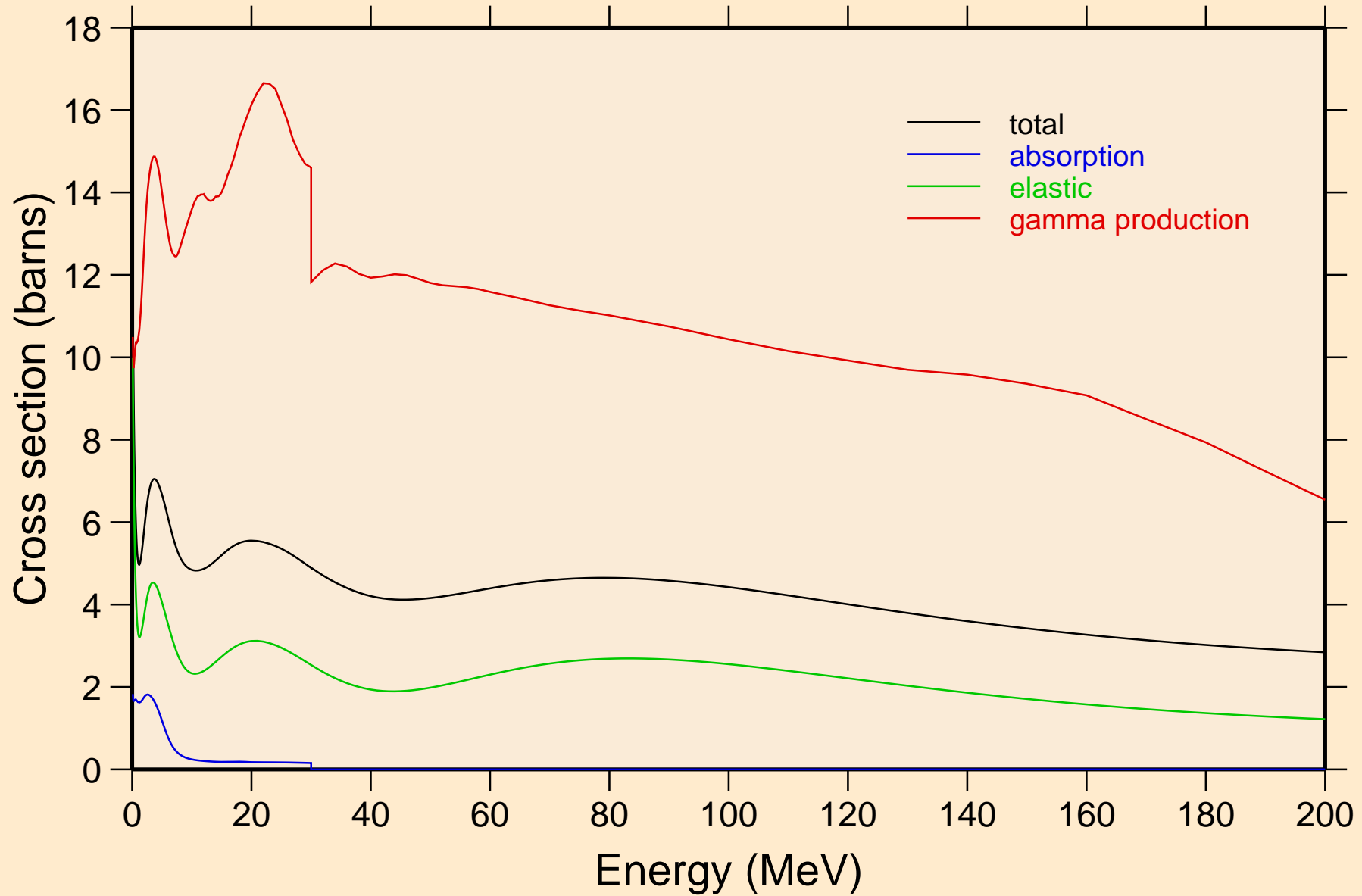

# PB191 NRG TENDL-2015, AKONING

## Non-threshold reactions

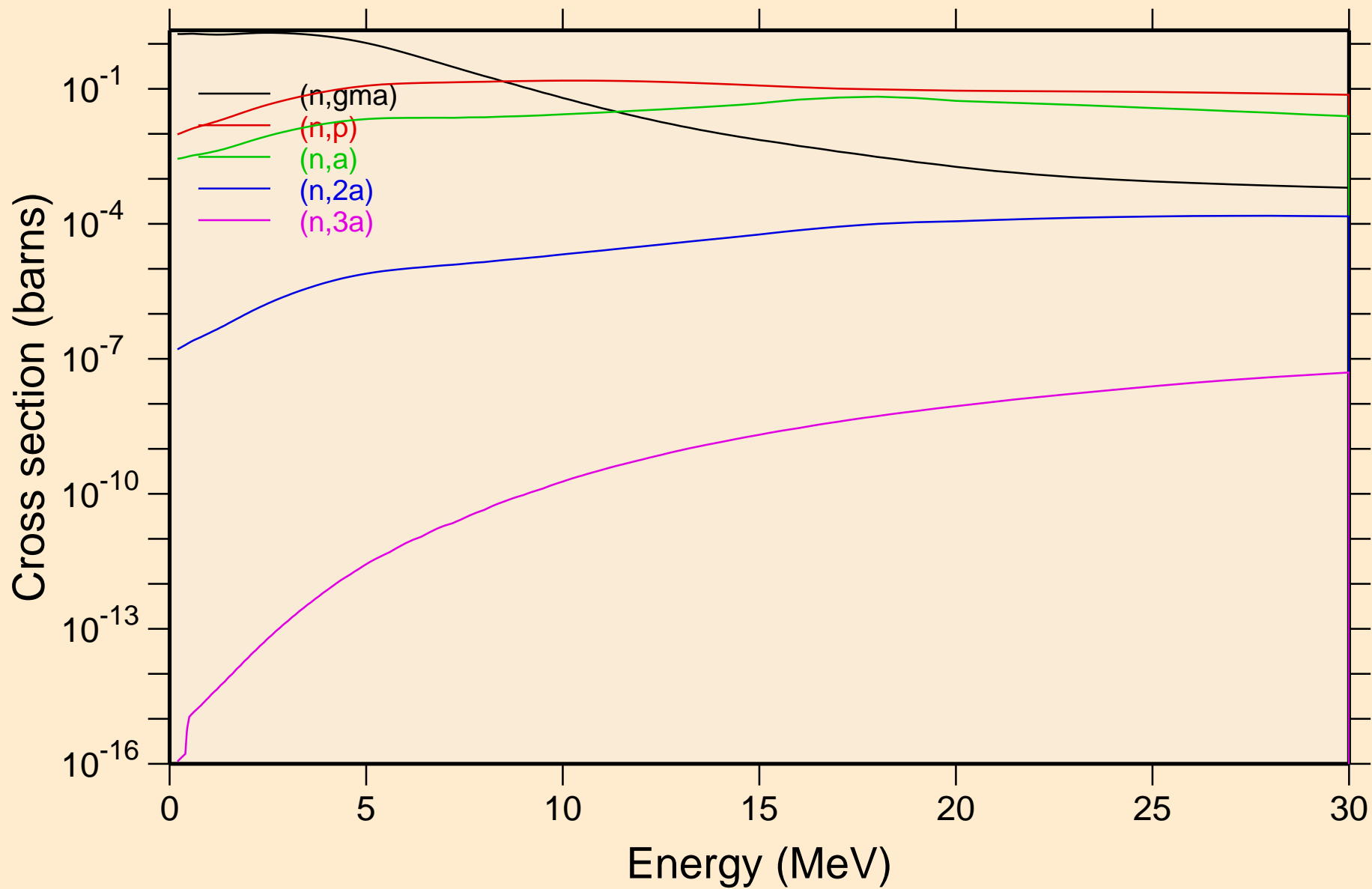

PB191 NRG TENDL-2015, AKONING  
Non-threshold reactions

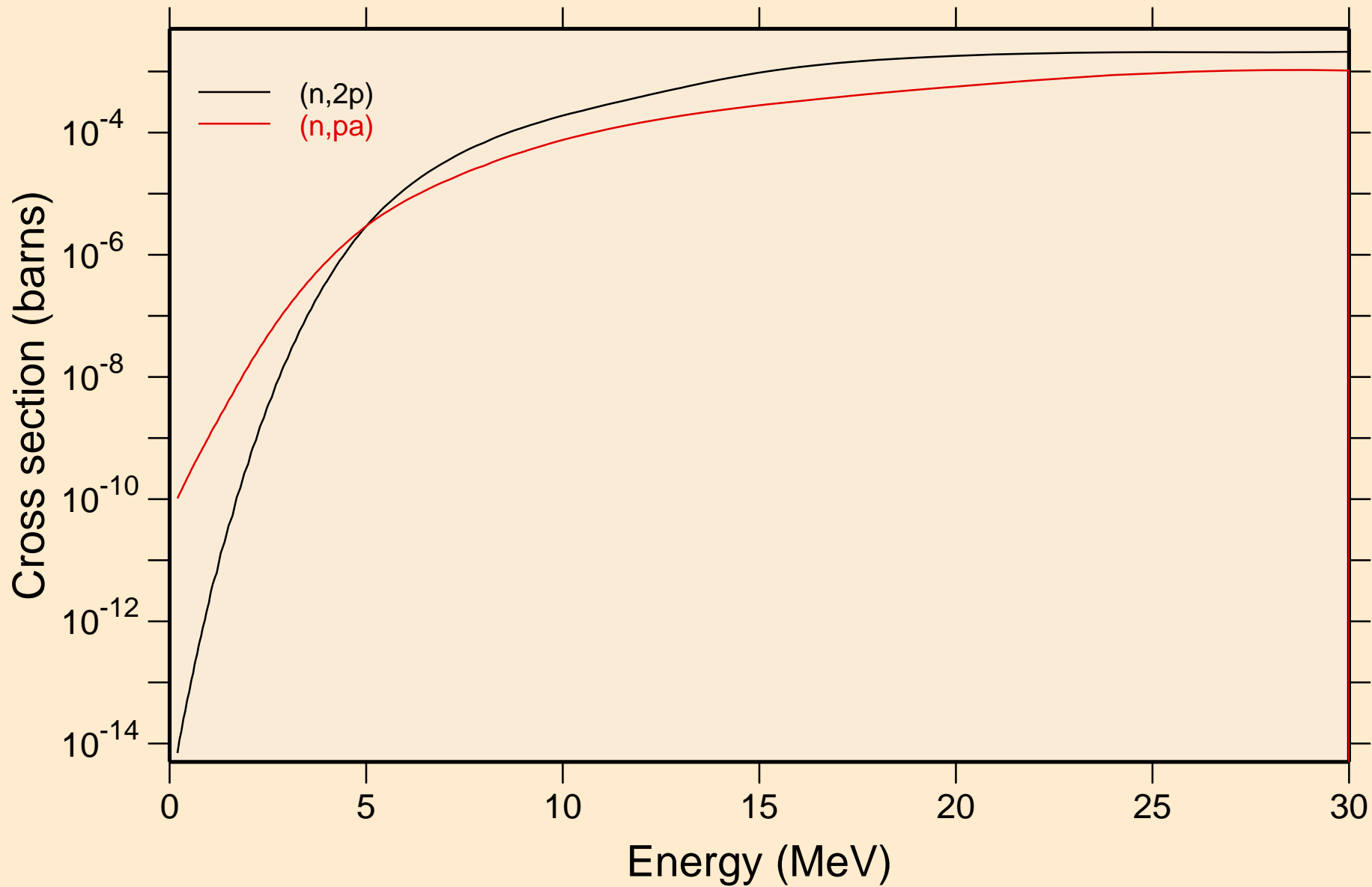

PB191 NRG TENDL-2015, AKONING  
Inelastic levels

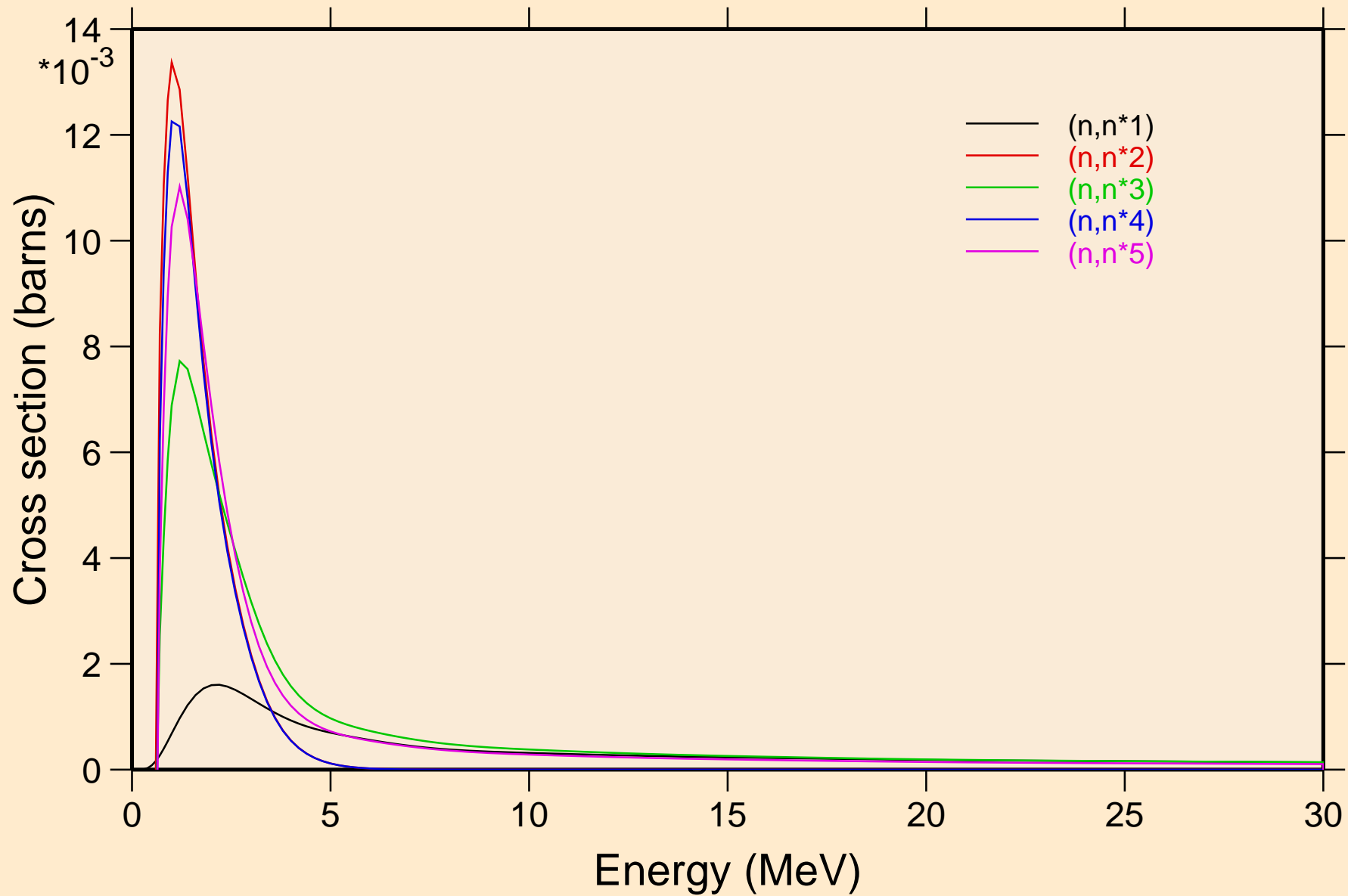

PB191 NRG TENDL-2015, AKONING  
Inelastic levels

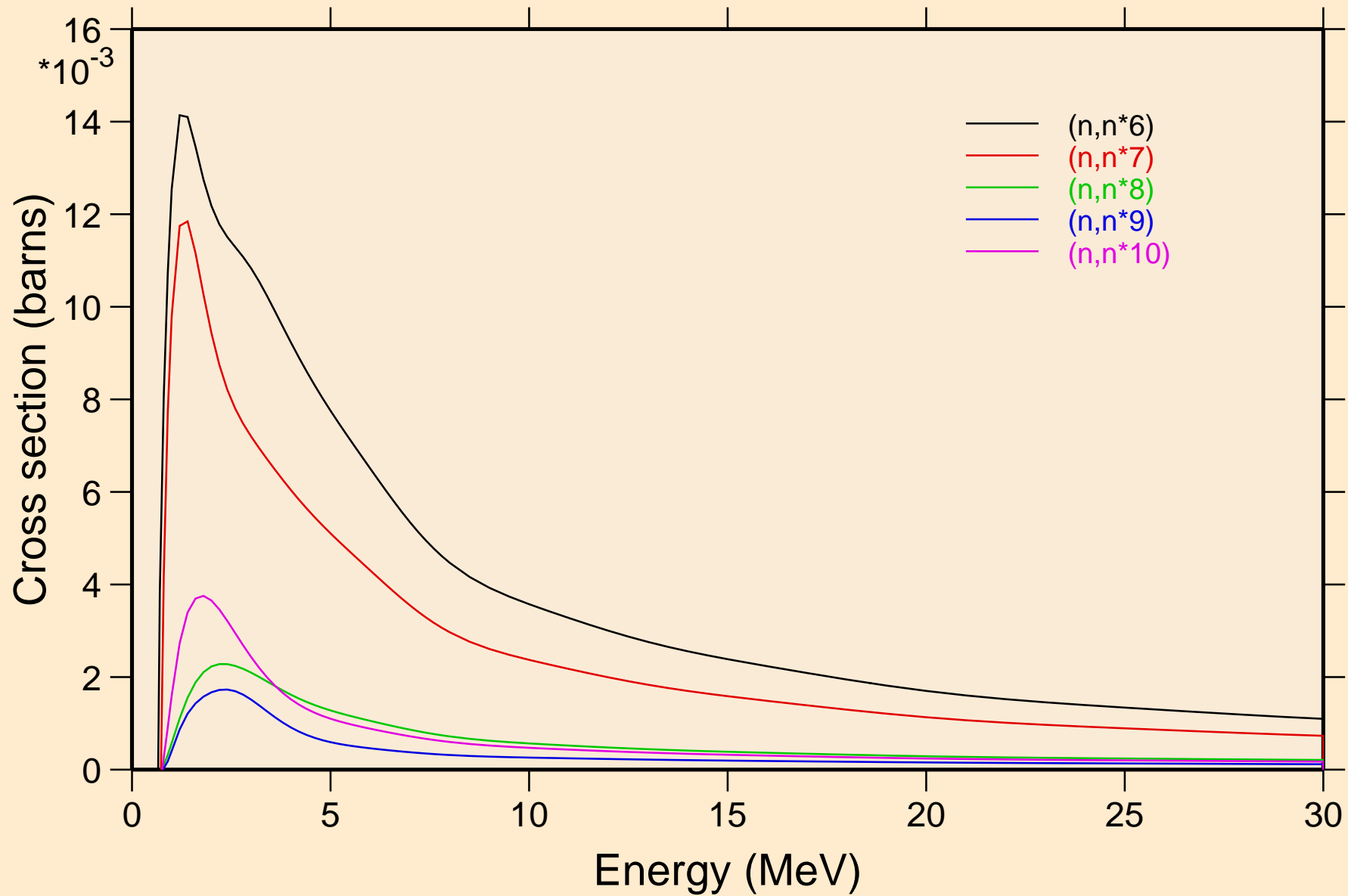



PB191 NRG TENDL-2015, AKONING  
Inelastic levels

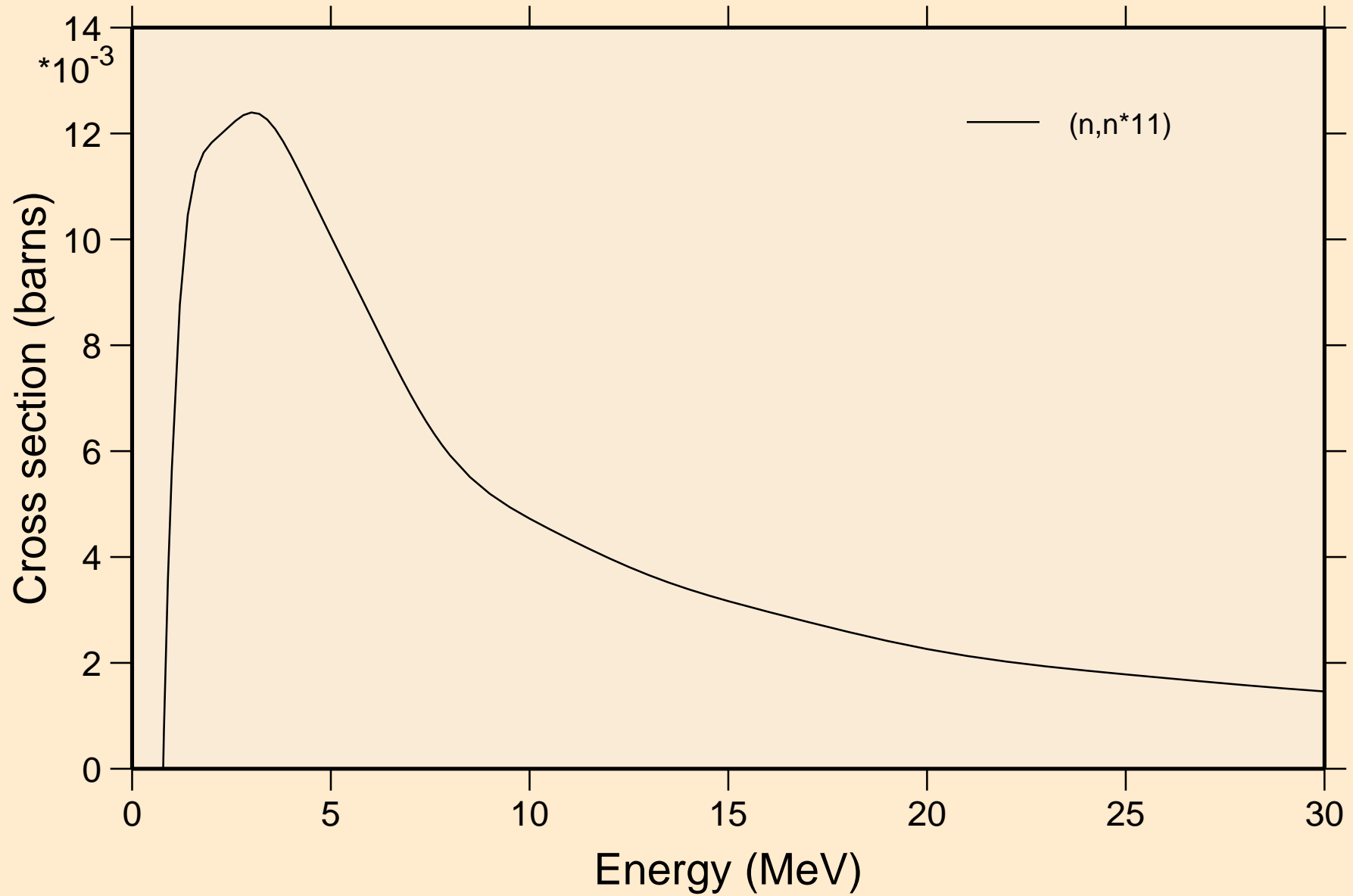

# PB191 NRG TENDL-2015, AKONING

## Threshold reactions

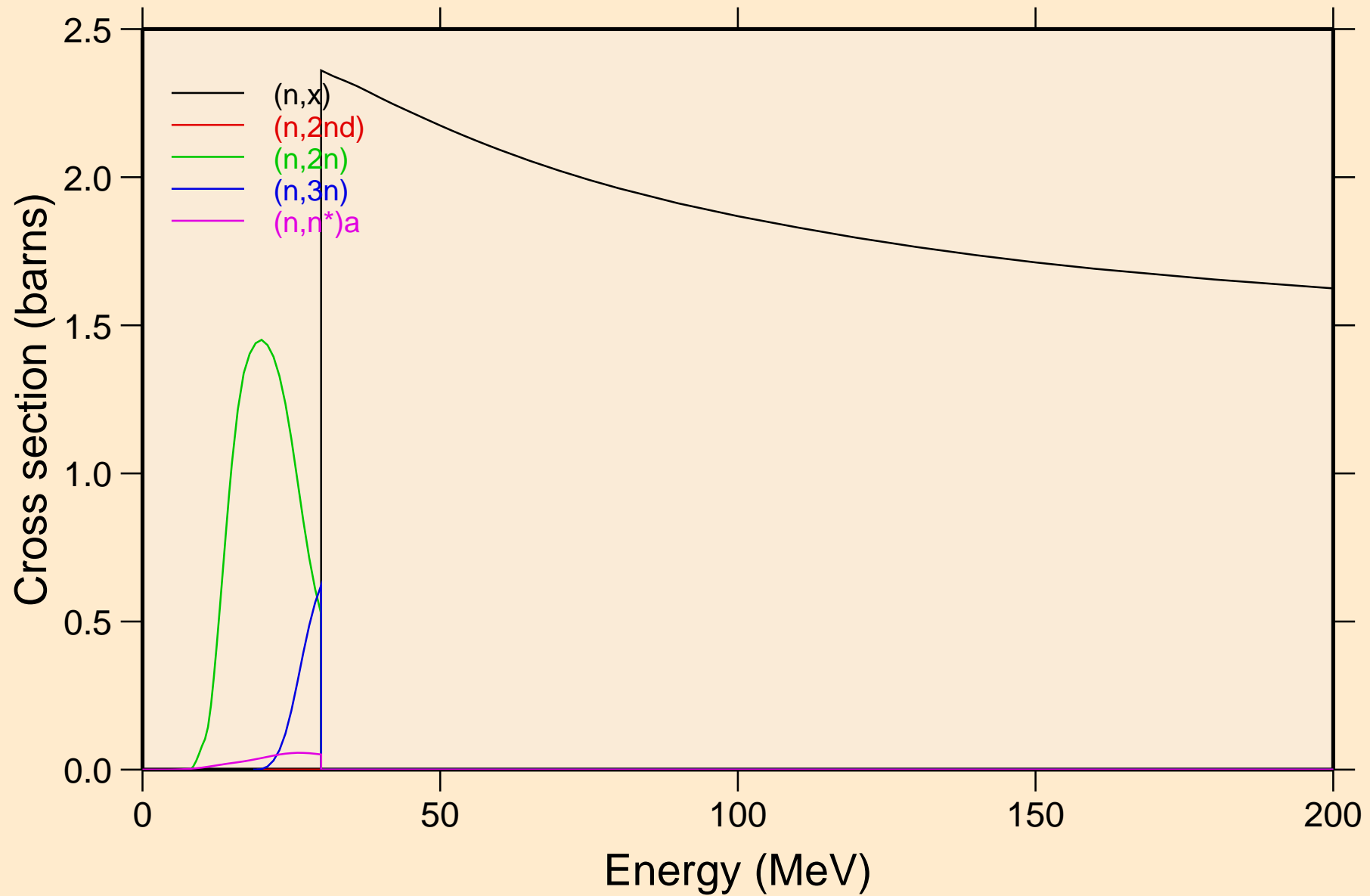

# PB191 NRG TENDL-2015, AKONING

## Threshold reactions

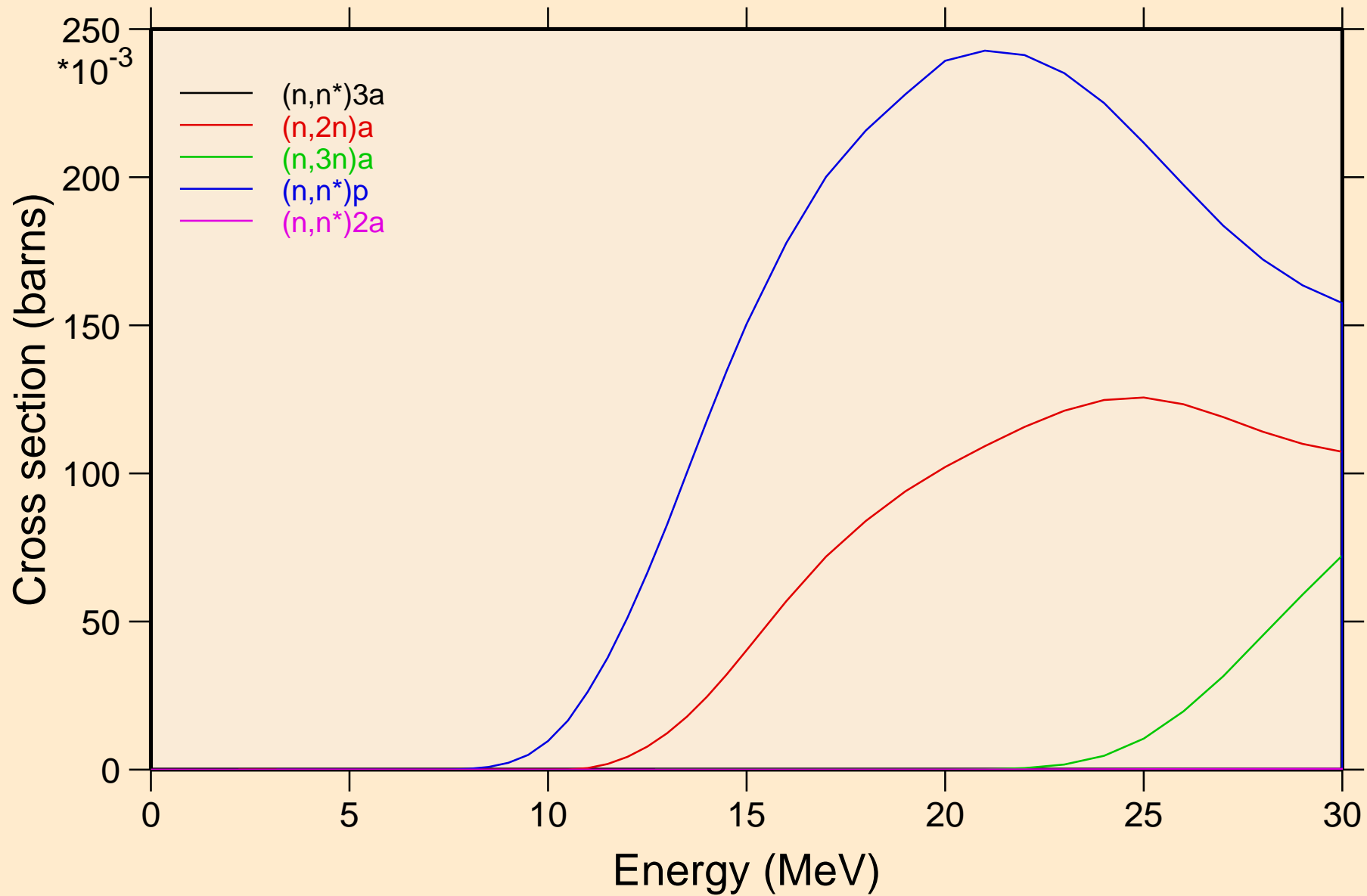

# PB191 NRG TENDL-2015, AKONING

## Threshold reactions

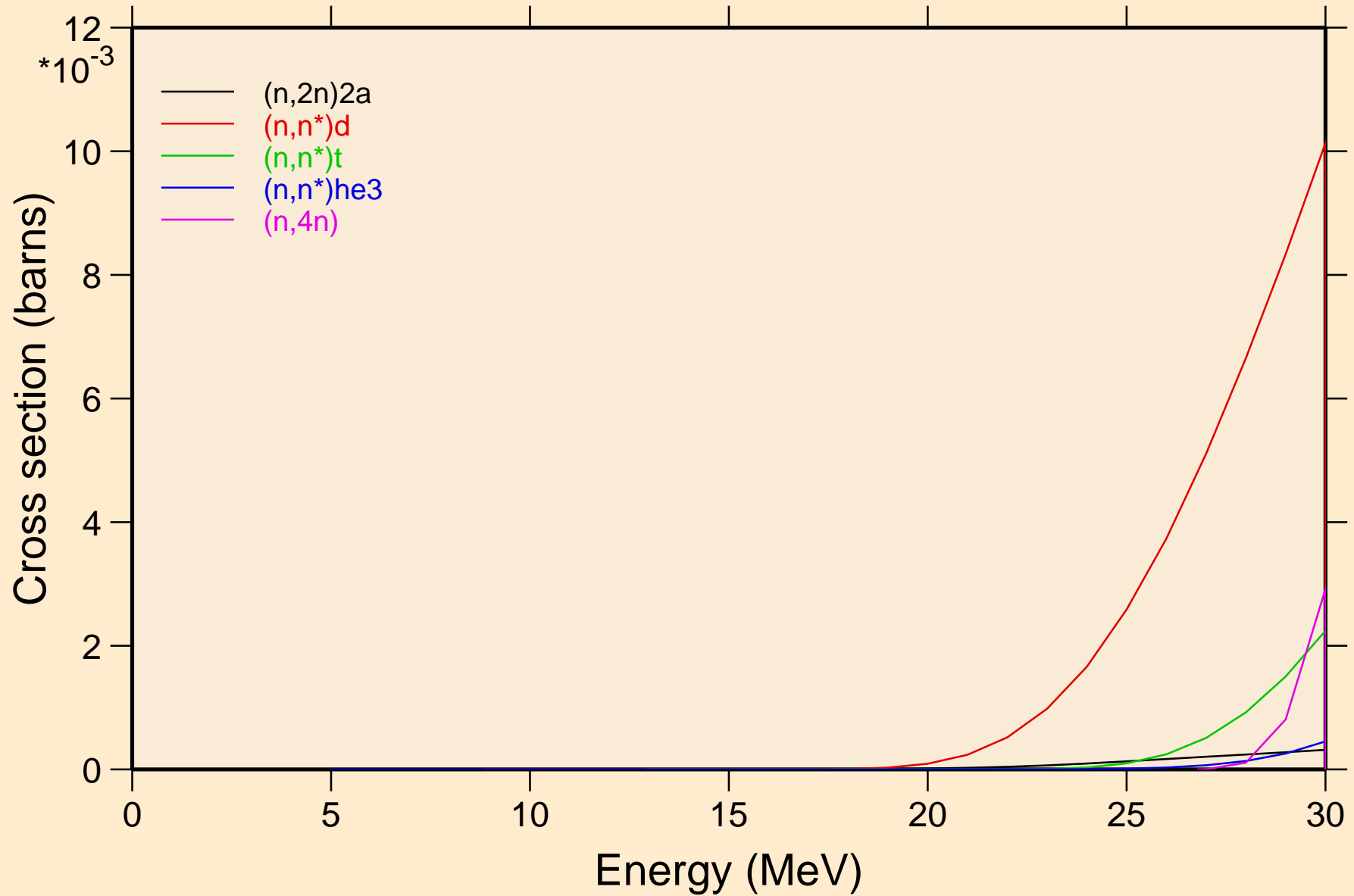

# PB191 NRG TENDL-2015, AKONING

## Threshold reactions

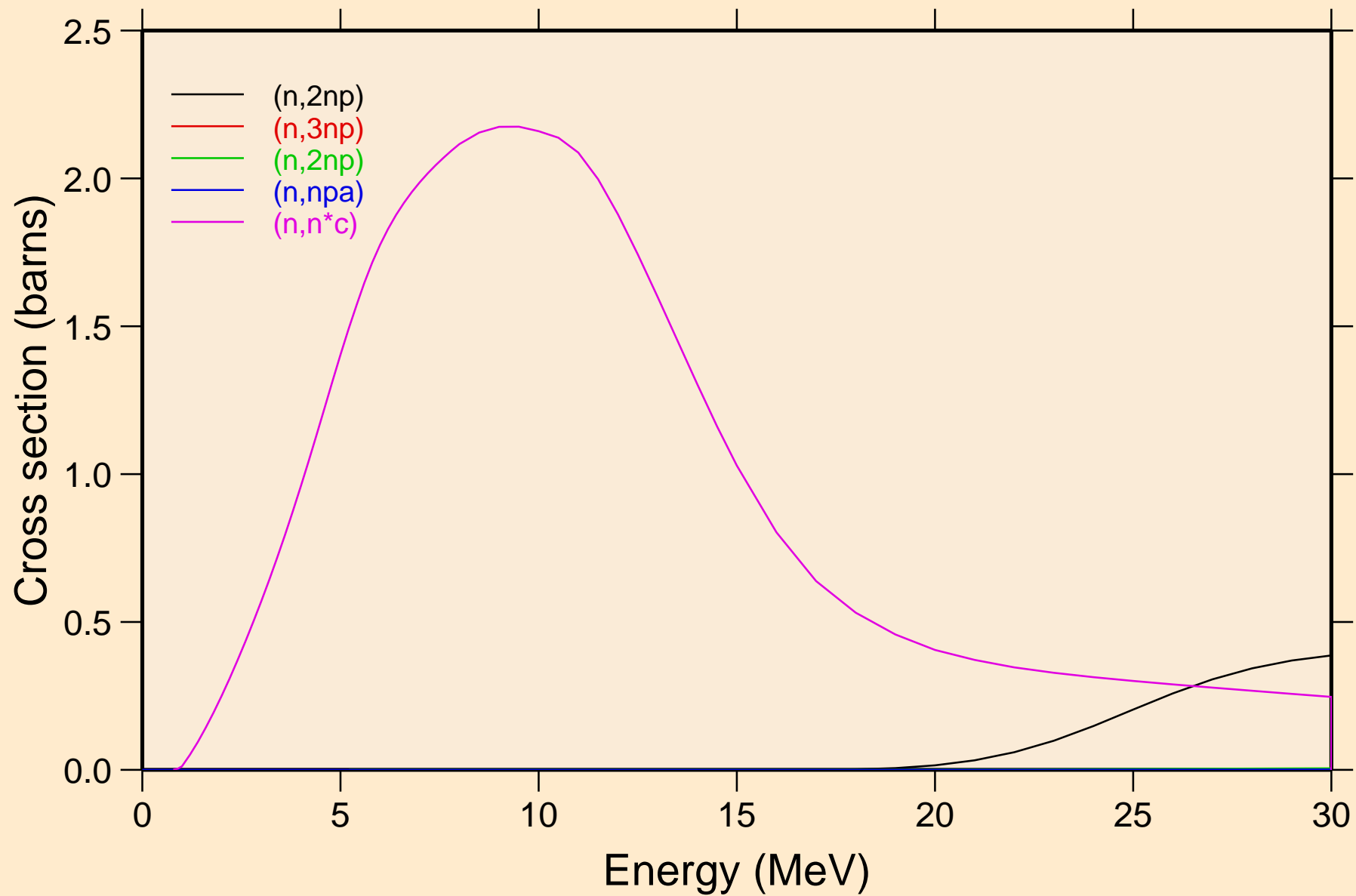

# PB191 NRG TENDL-2015, AKONING

## Threshold reactions

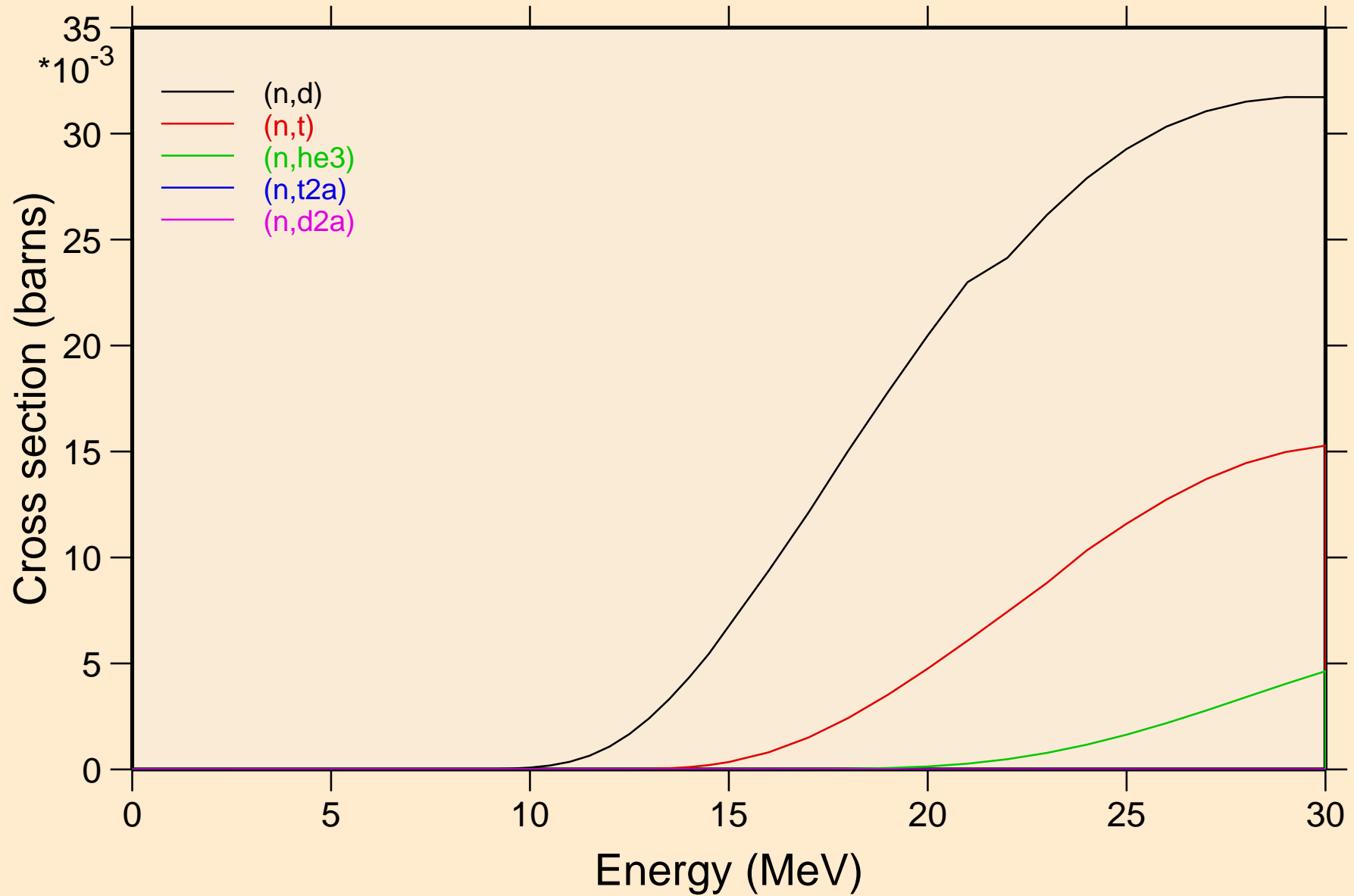

# PB191 NRG TENDL-2015, AKONING

## Threshold reactions

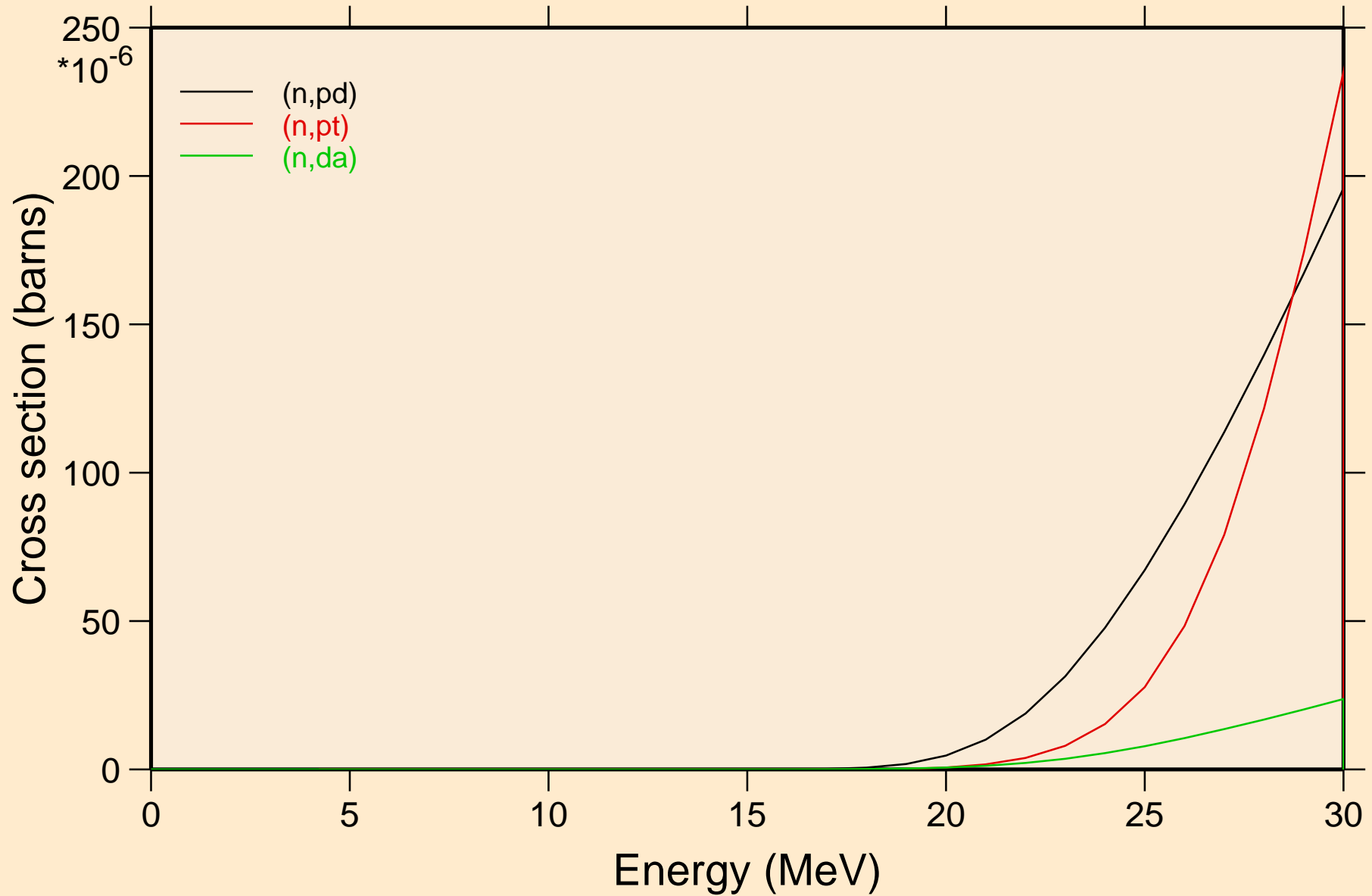

PB191 NRG TENDL-2015, AKONING  
angular distribution for elastic

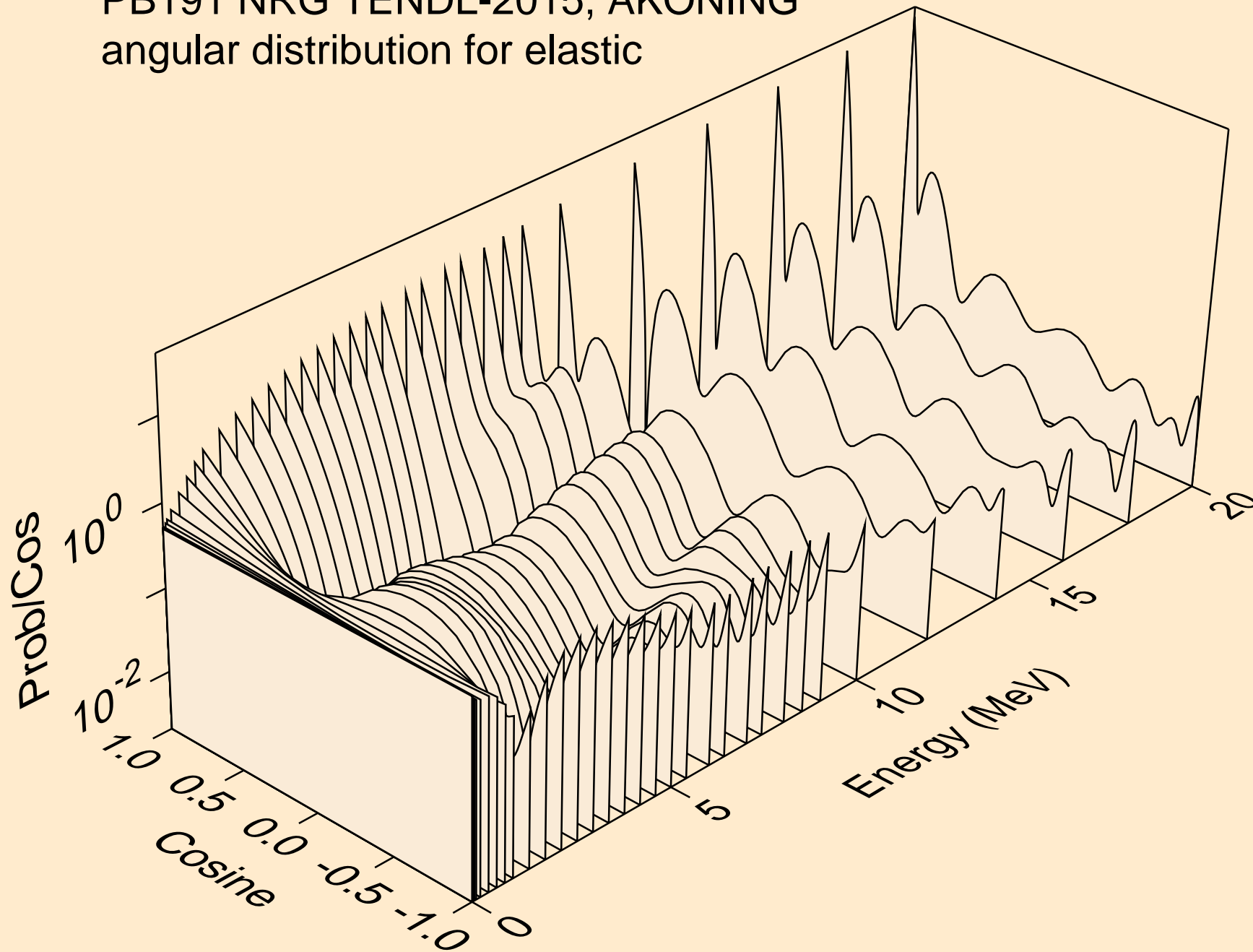



PB191 NRG TENDL-2015, AKONING  
angular distribution for elastic

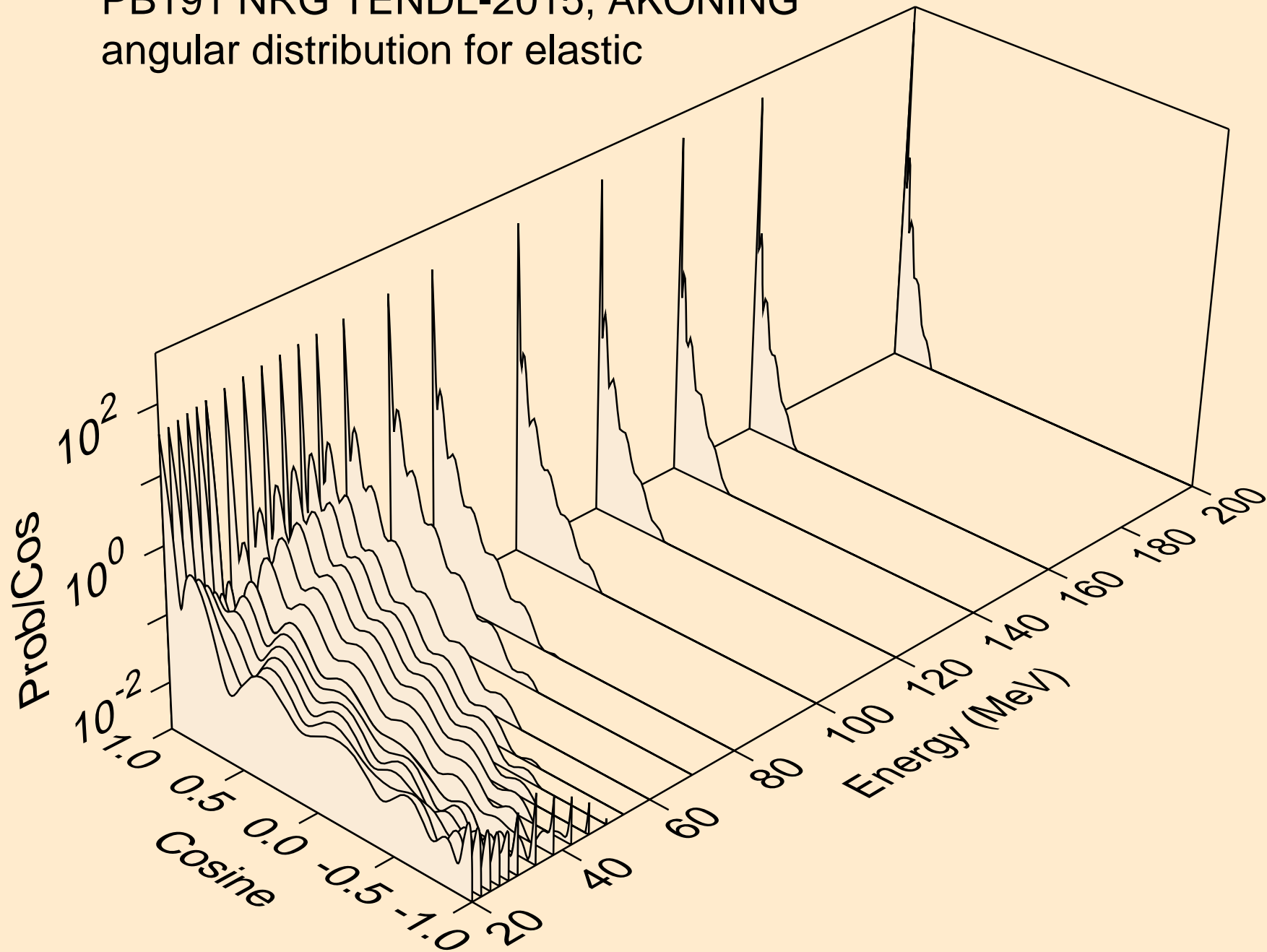

PB191 NRG TENDL-2015, AKONING  
angular distribution for (n,n\*1)

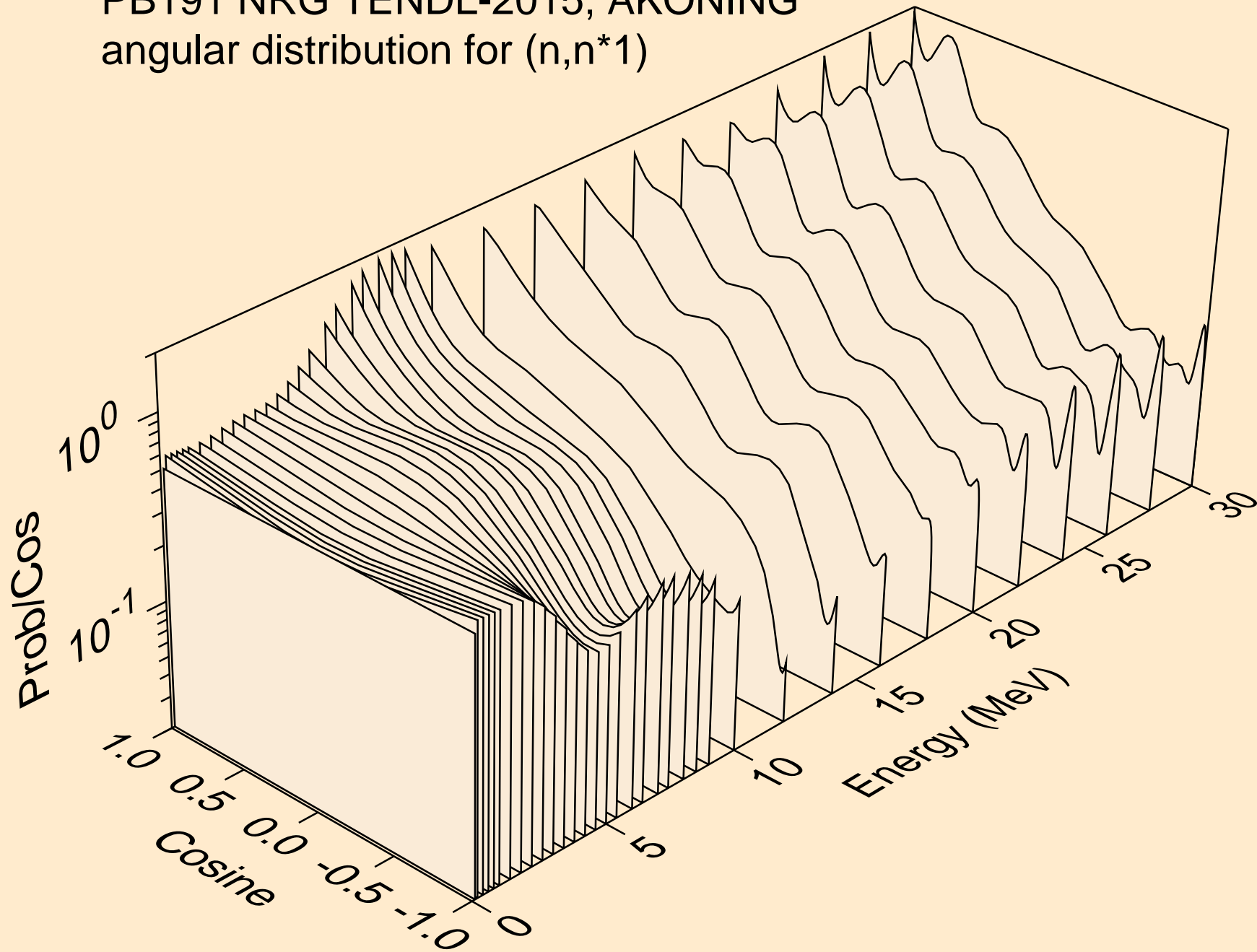

PB191 NRG TENDL-2015, AKONING  
angular distribution for (n,n\*2)

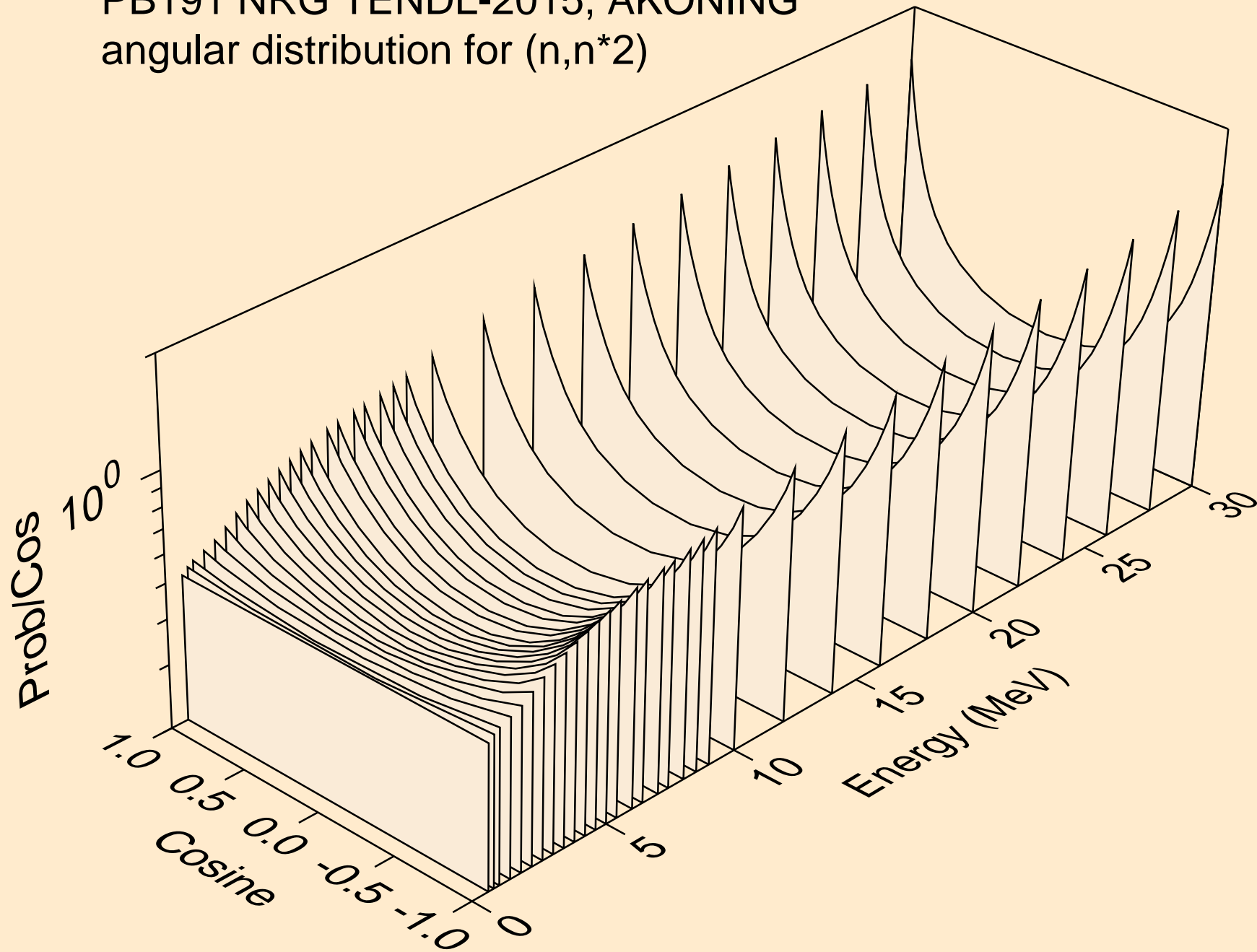

PB191 NRG TENDL-2015, AKONING  
angular distribution for (n,n\*3)

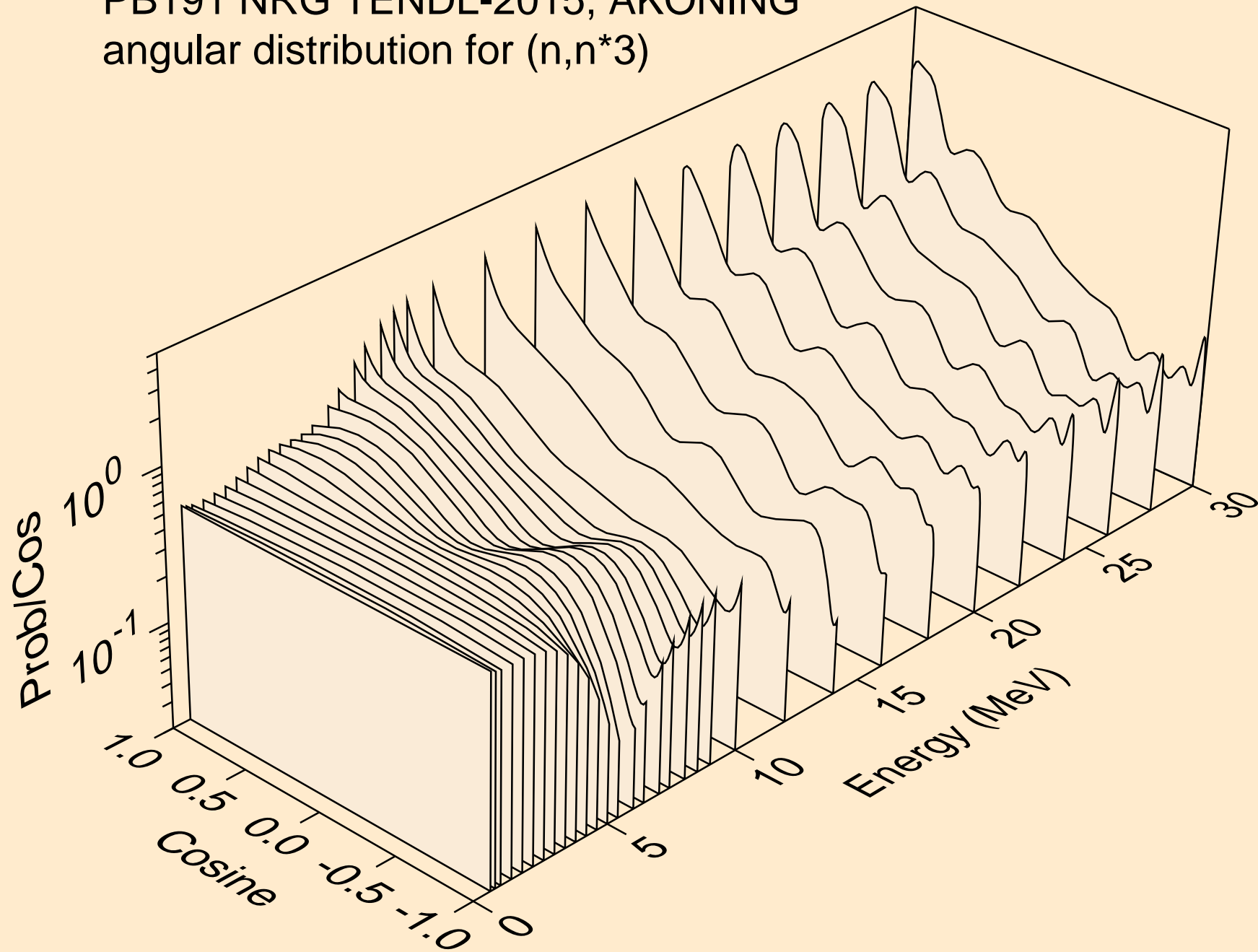

PB191 NRG TENDL-2015, AKONING  
angular distribution for (n,n\*4)

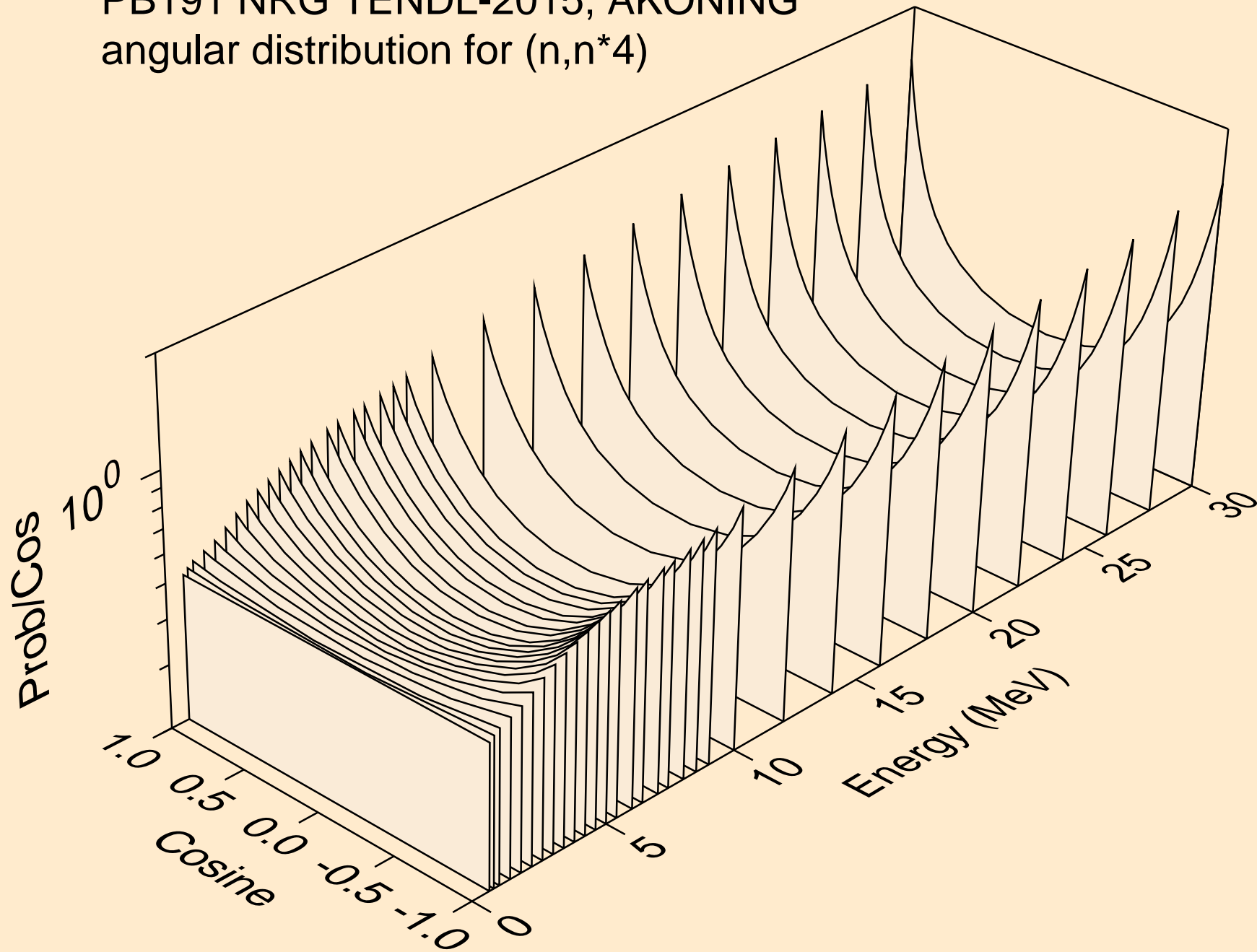

PB191 NRG TENDL-2015, AKONING  
angular distribution for (n,n\*5)

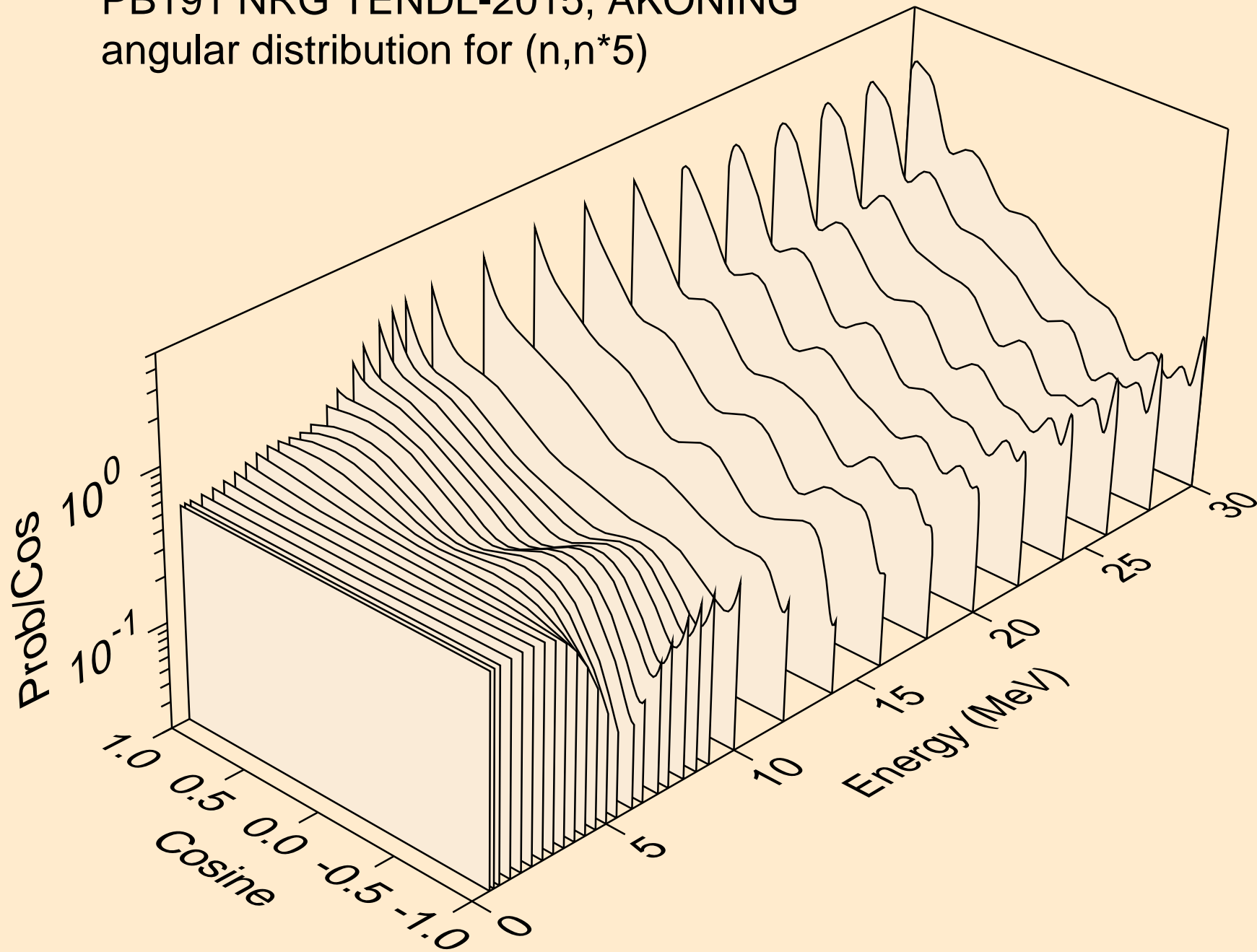

PB191 NRG TENDL-2015, AKONING  
angular distribution for (n,n\*6)

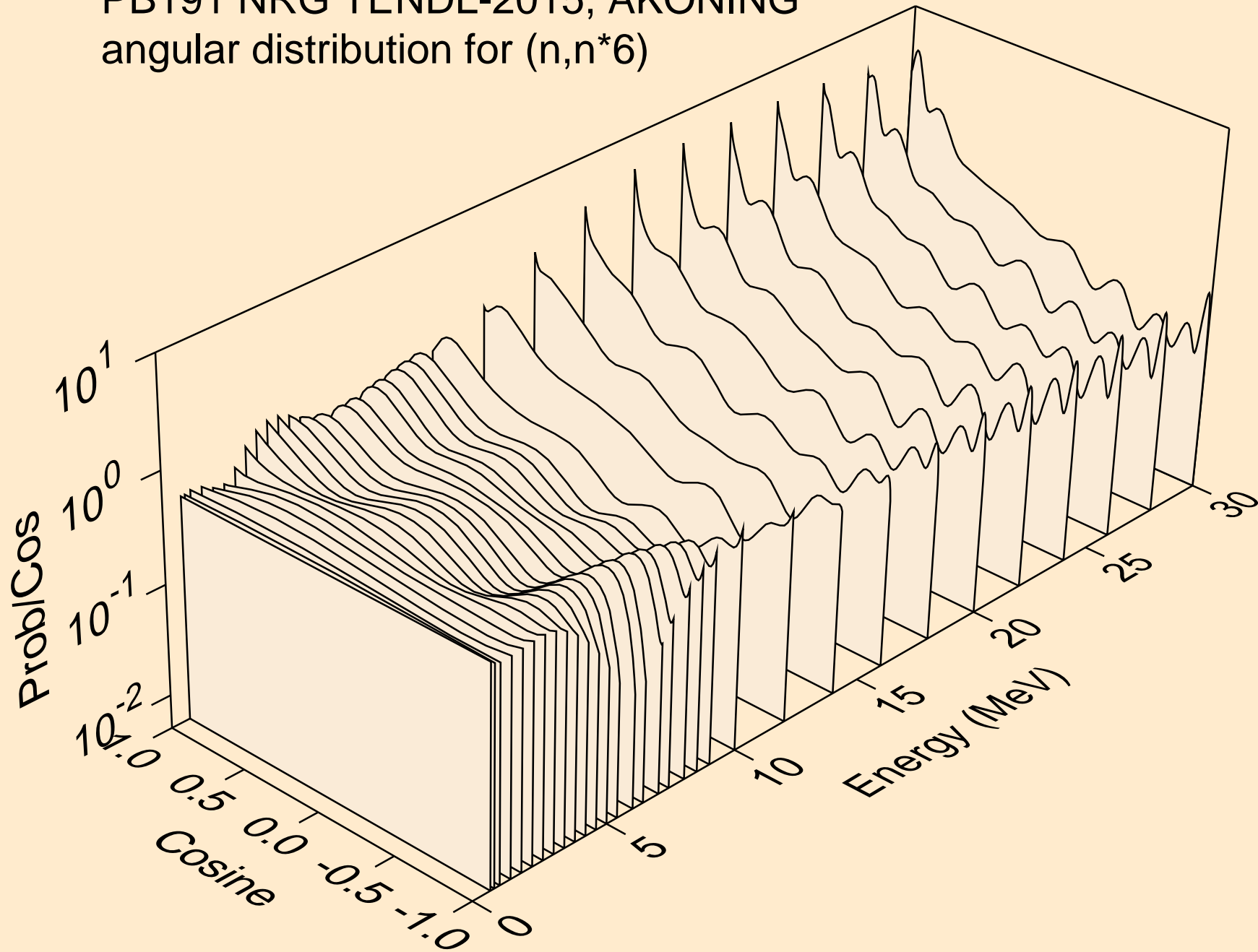

PB191 NRG TENDL-2015, AKONING  
angular distribution for (n,n\*7)

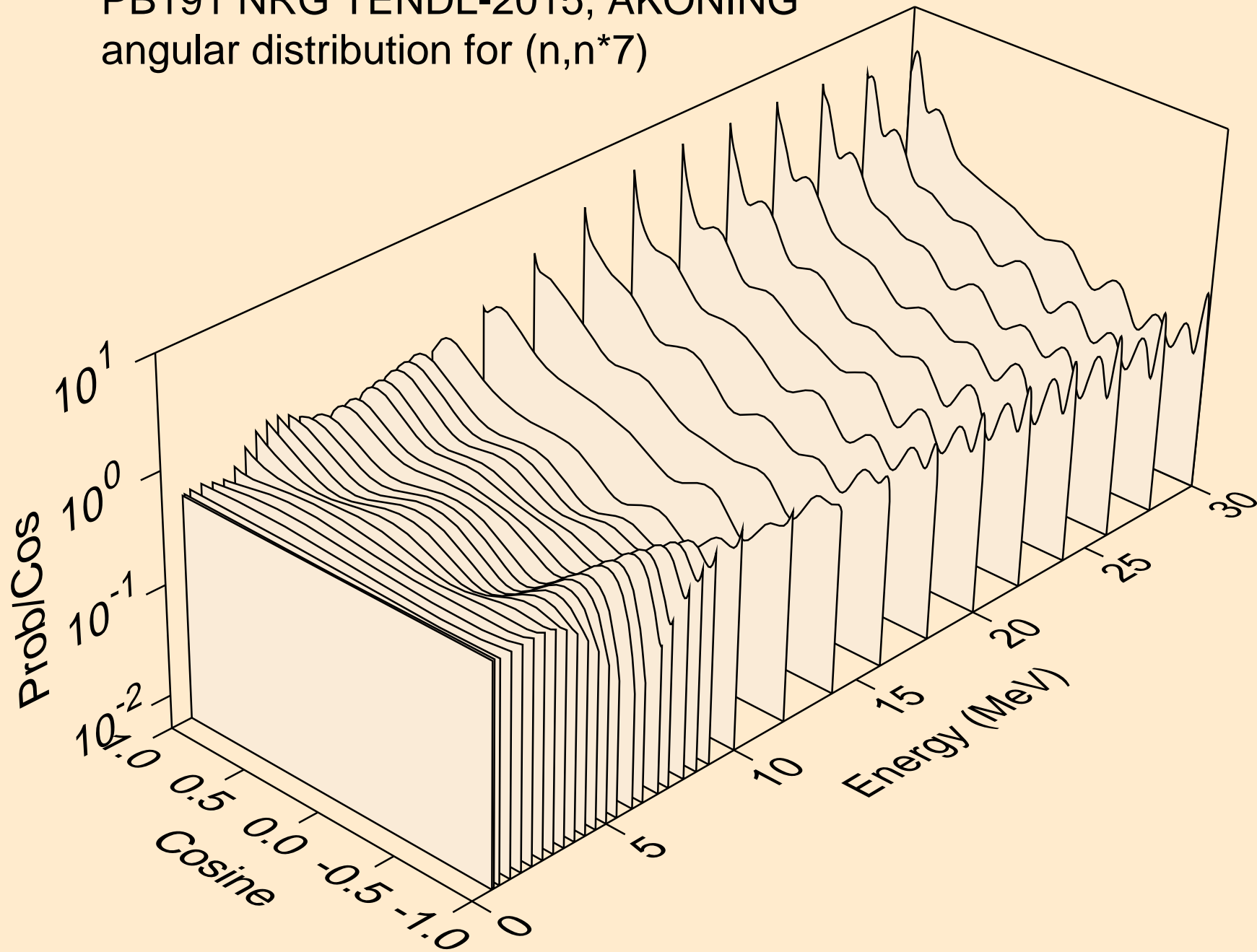



PB191 NRG TENDL-2015, AKONING  
angular distribution for (n,n\*8)

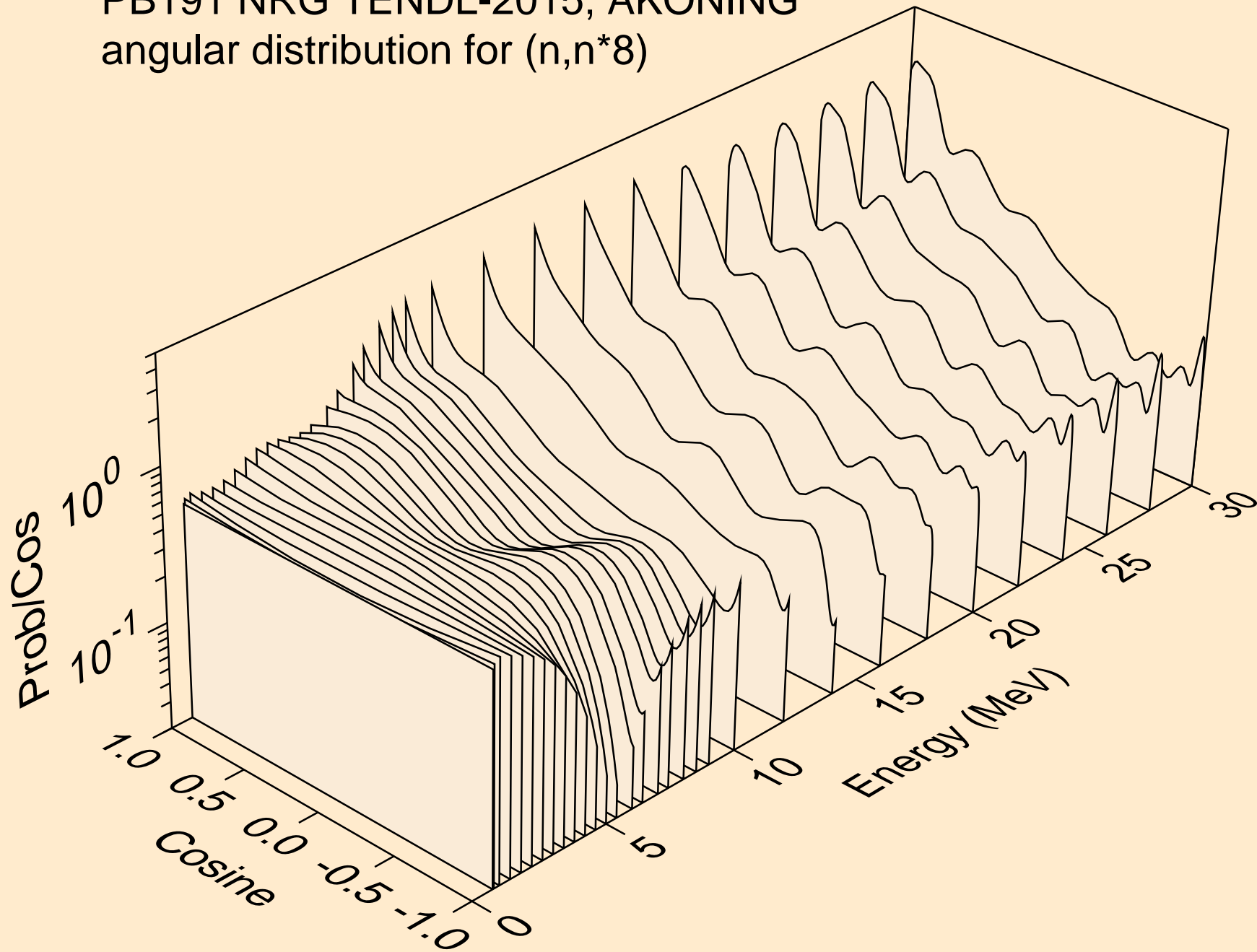

PB191 NRG TENDL-2015, AKONING  
angular distribution for (n,n\*9)

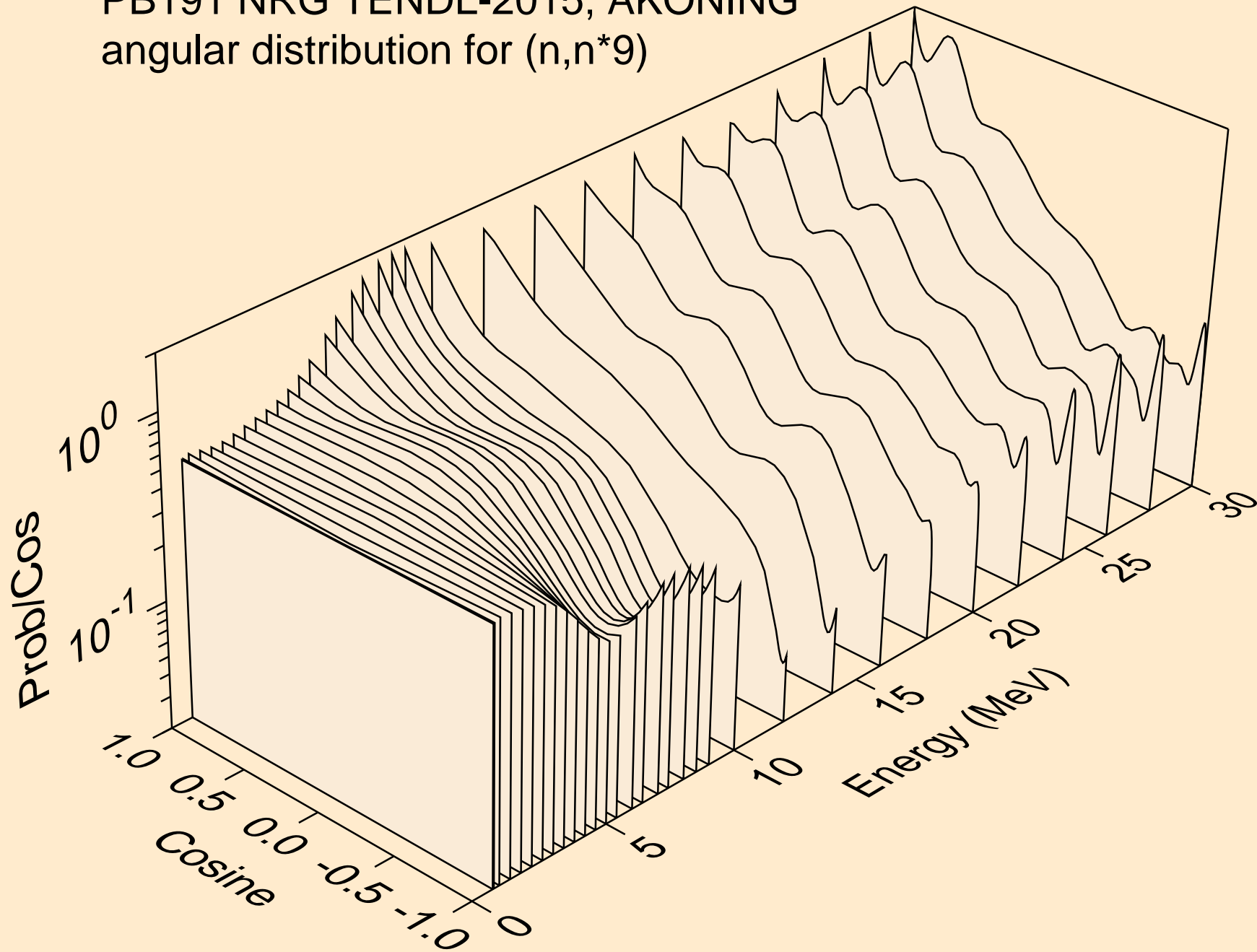

PB191 NRG TENDL-2015, AKONING  
angular distribution for (n,n\*10)

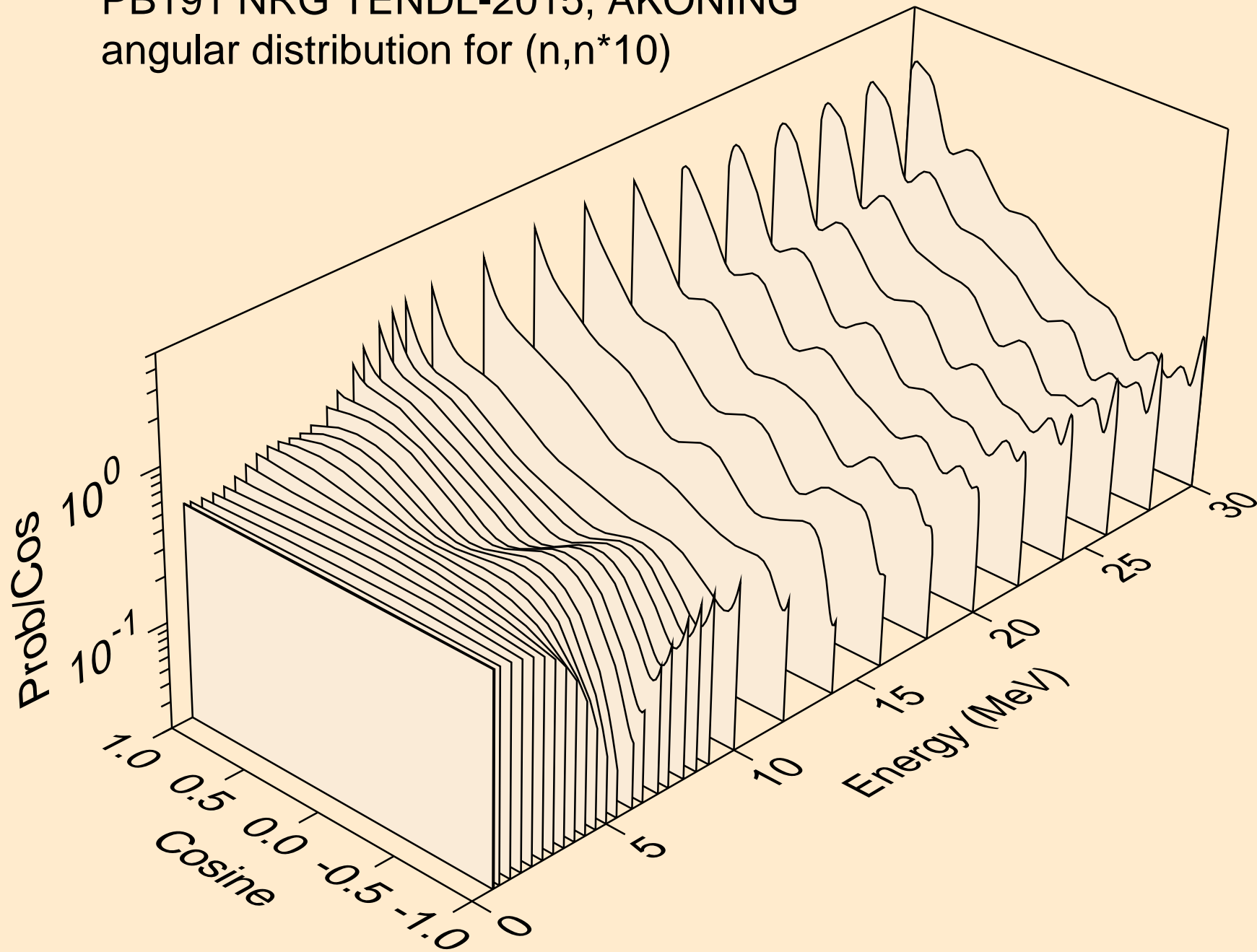

PB191 NRG TENDL-2015, AKONING  
angular distribution for (n,n\*11)

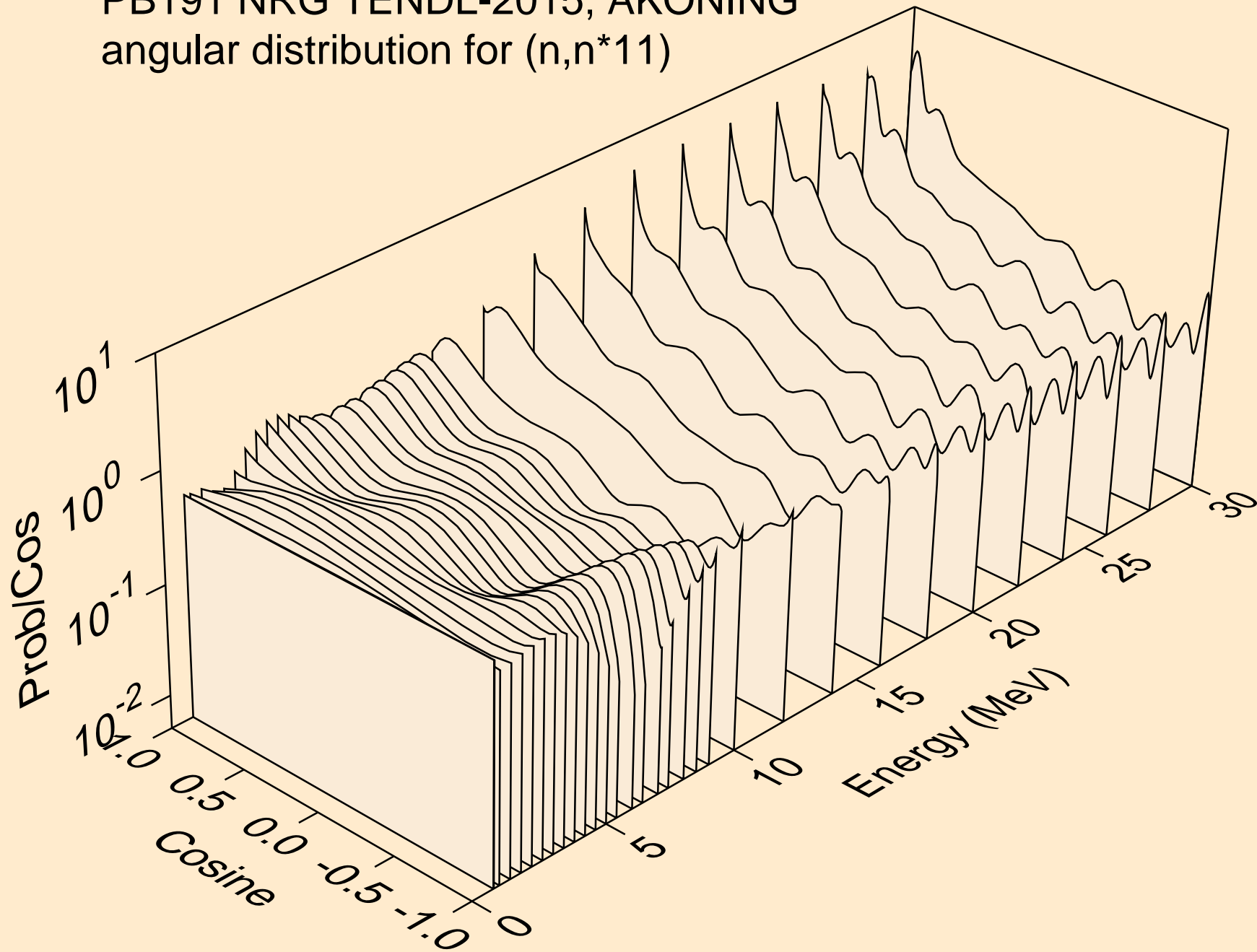

PB191 NRG TENDL-2015, AKONING  
Neutron emission for (n,x)

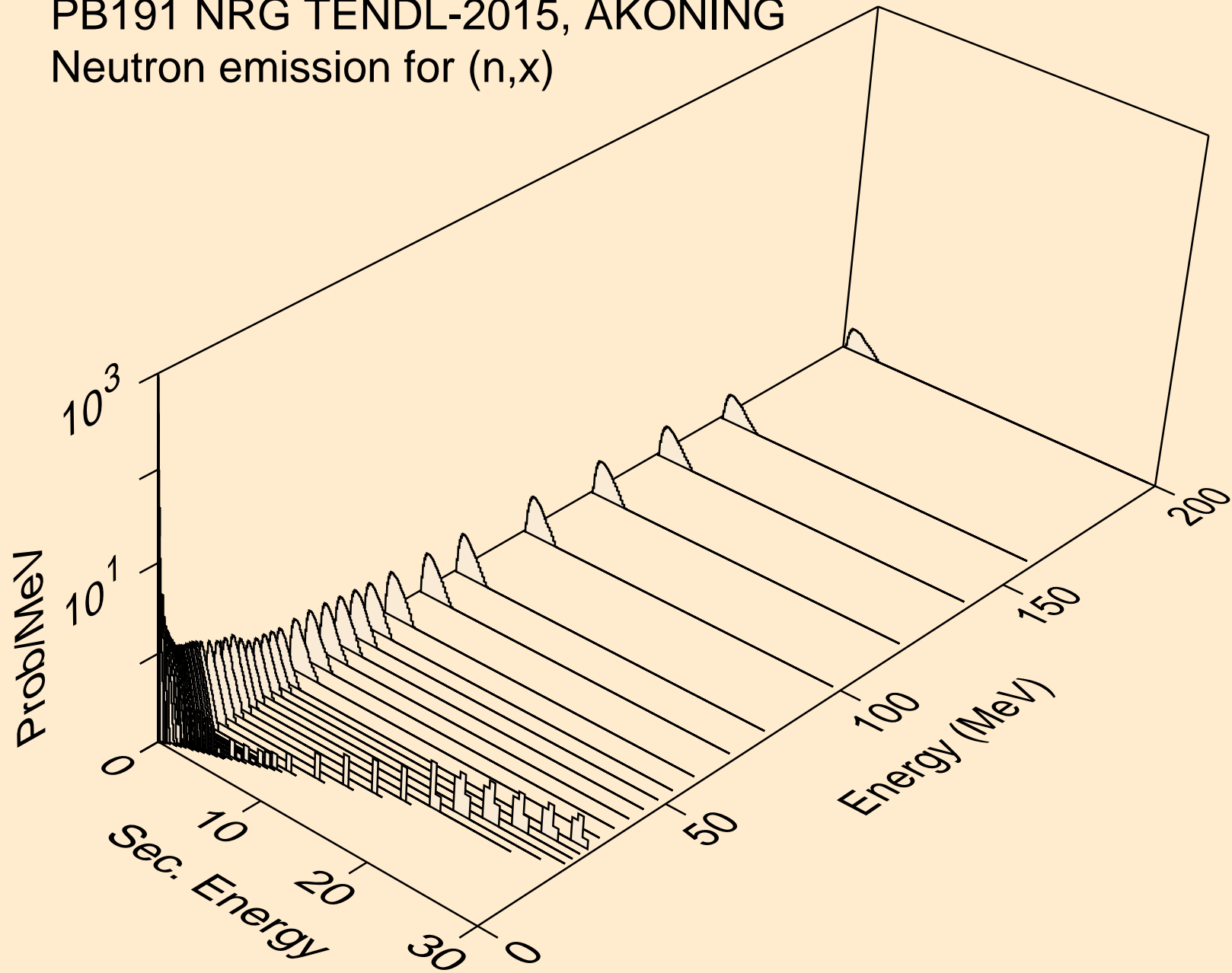

PB191 NRG TENDL-2015, AKONING  
Neutron emission for (n,2nd)

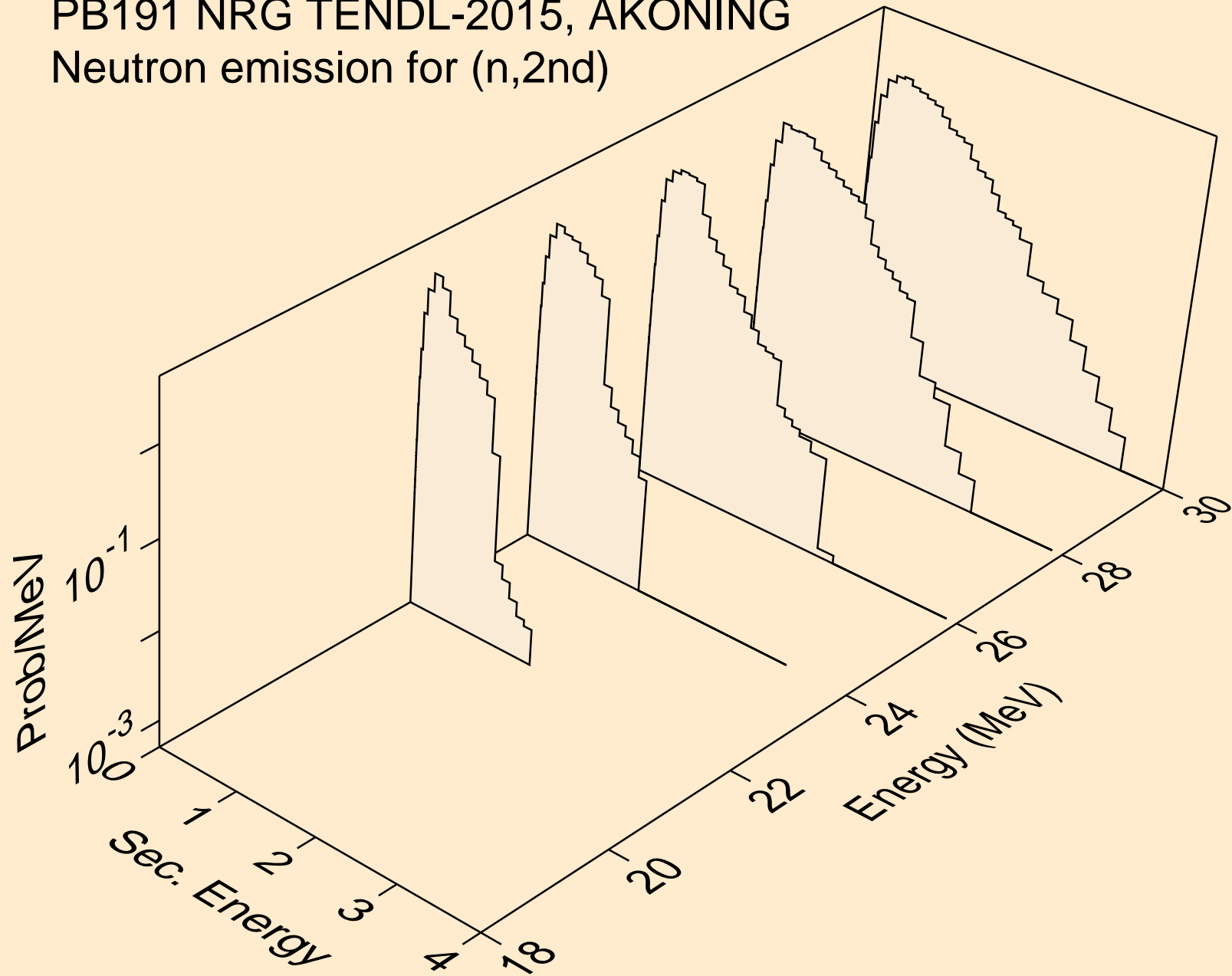

PB191 NRG TENDL-2015, AKONING  
Neutron emission for (n,2n)

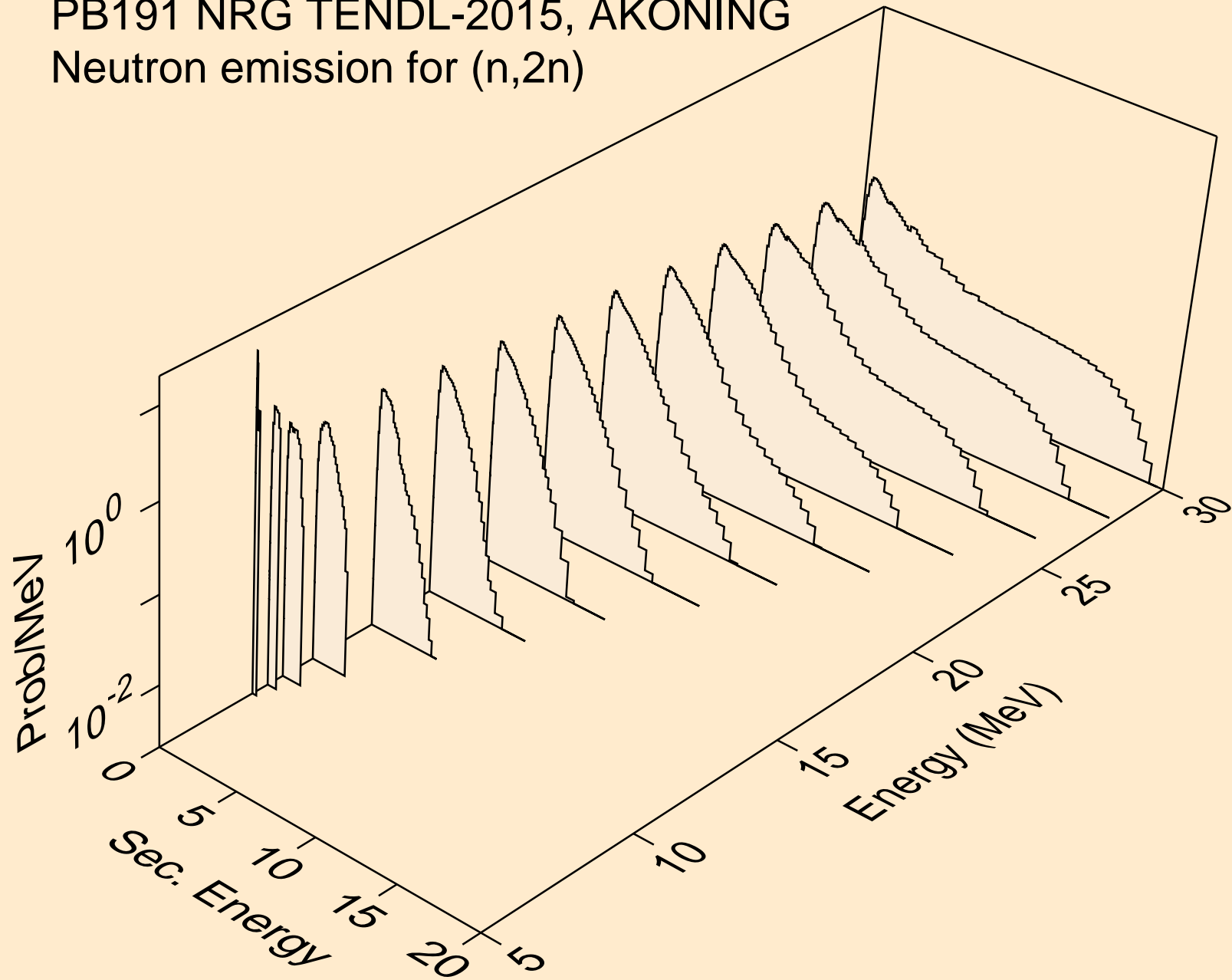

PB191 NRG TENDL-2015, AKONING  
Neutron emission for (n,3n)

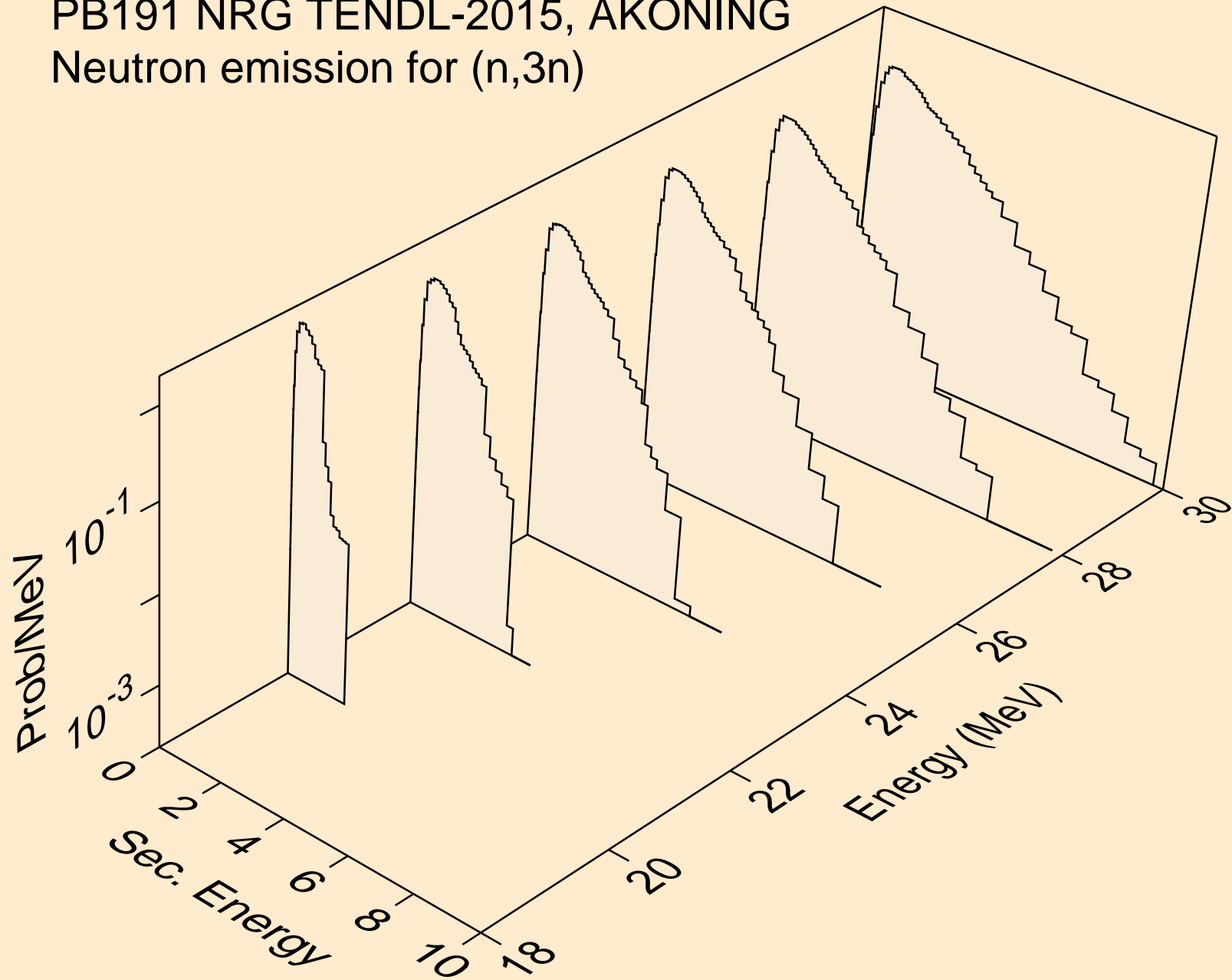



PB191 NRG TENDL-2015, AKONING  
Neutron emission for (n,n\*)a

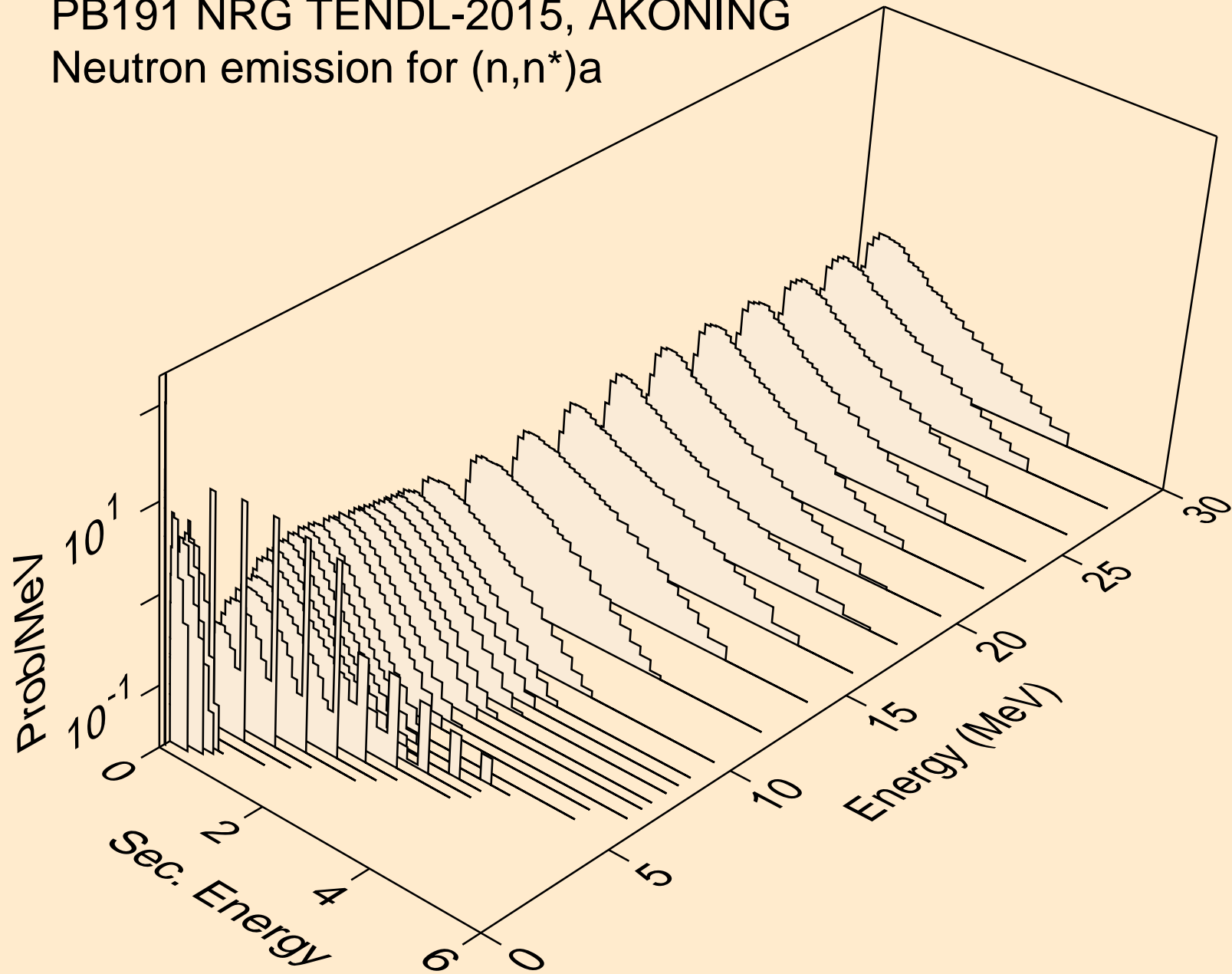

PB191 NRG TENDL-2015, AKONING  
Neutron emission for (n,n\*)3a

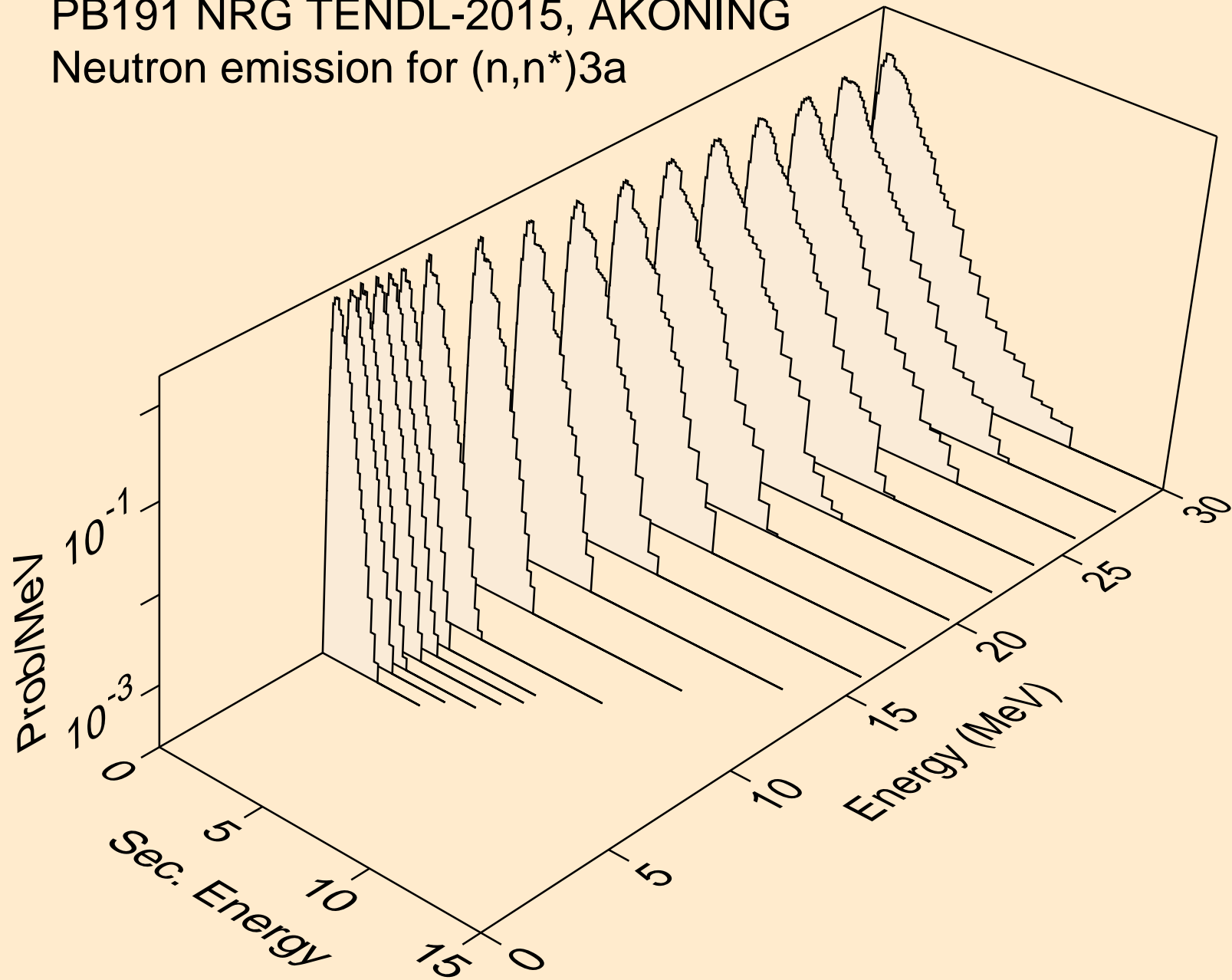

PB191 NRG TENDL-2015, AKONING  
Neutron emission for (n,2n)a

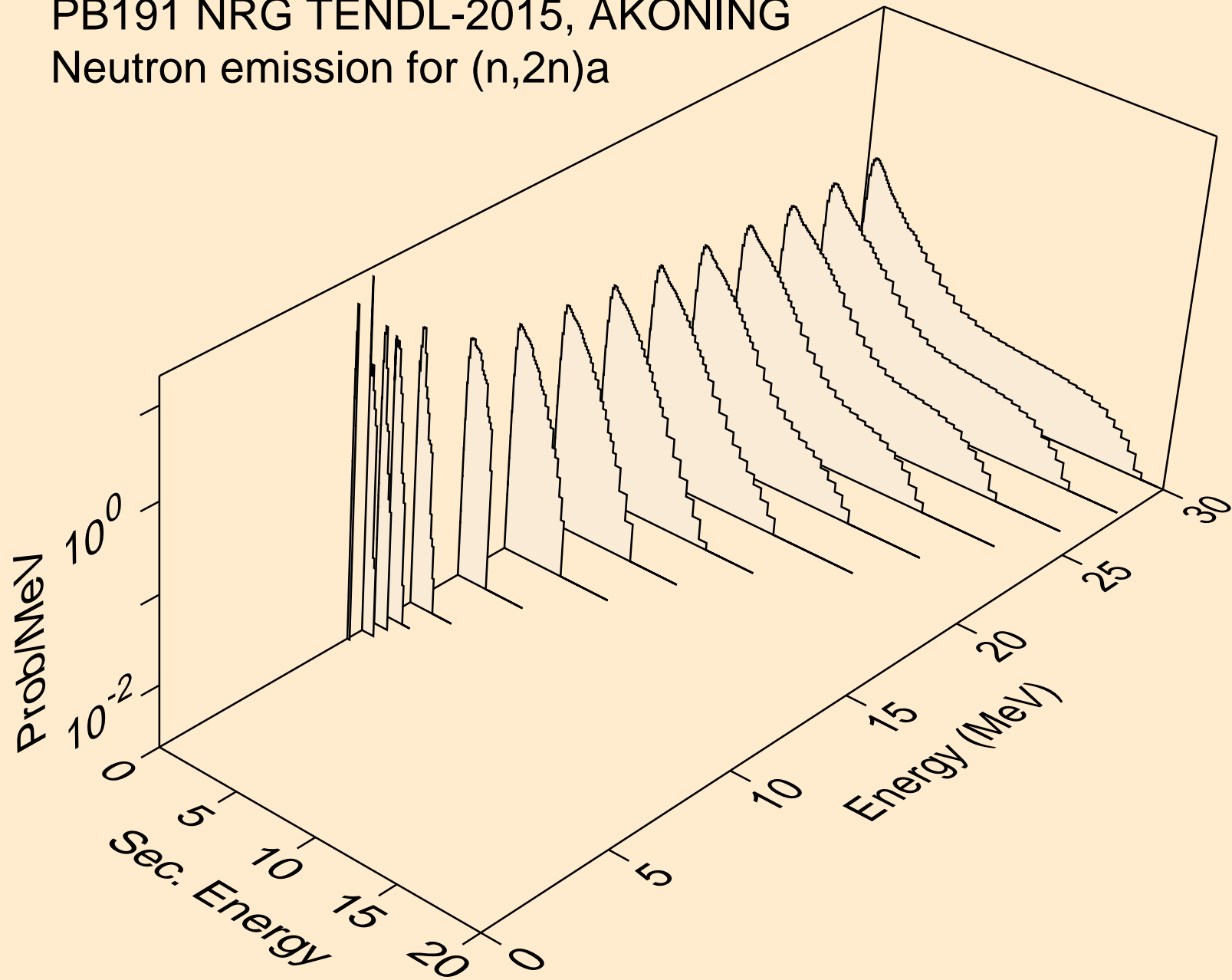

PB191 NRG TENDL-2015, AKONING  
Neutron emission for (n,3n)a

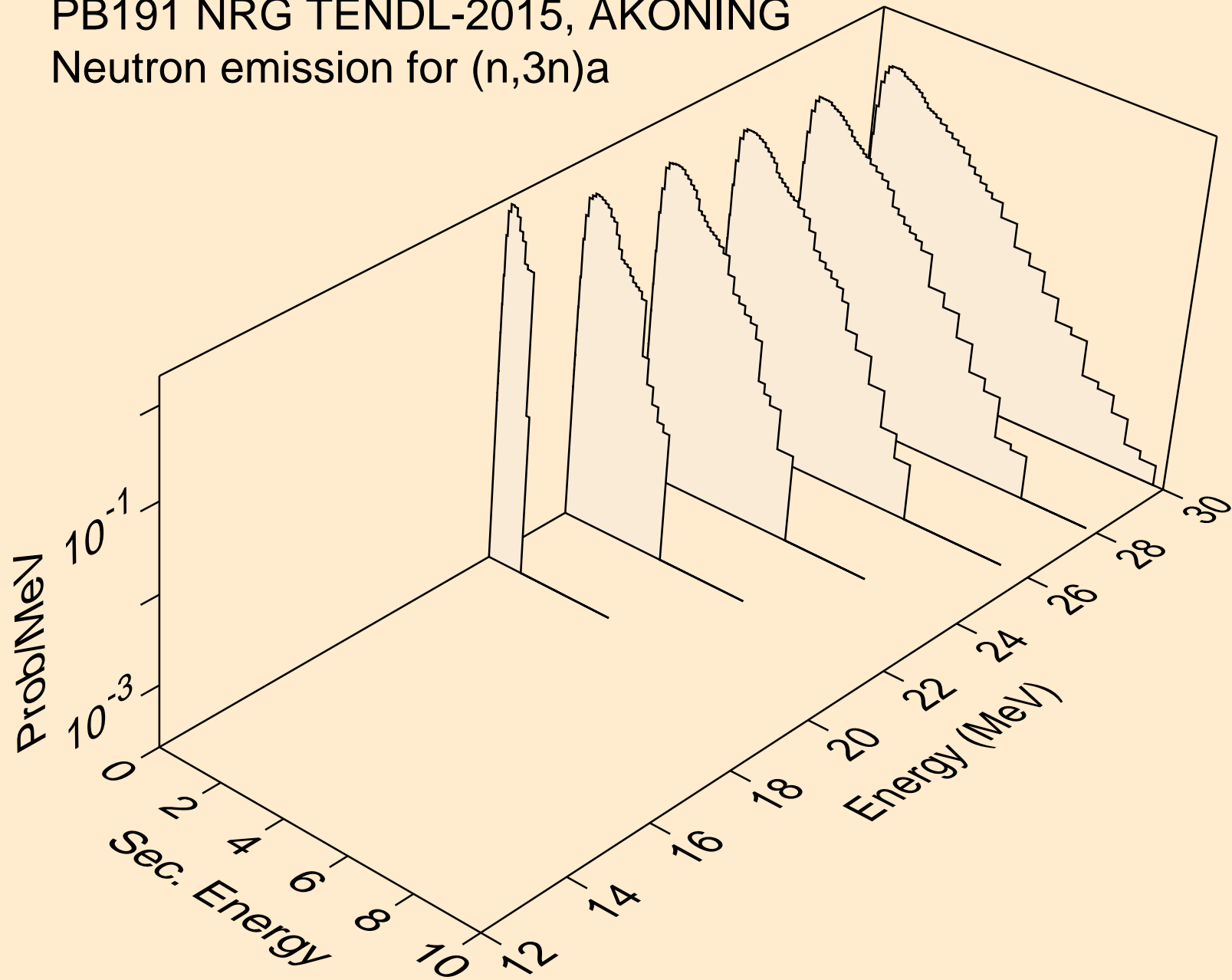

PB191 NRG TENDL-2015, AKONING  
Neutron emission for (n,n\*)p

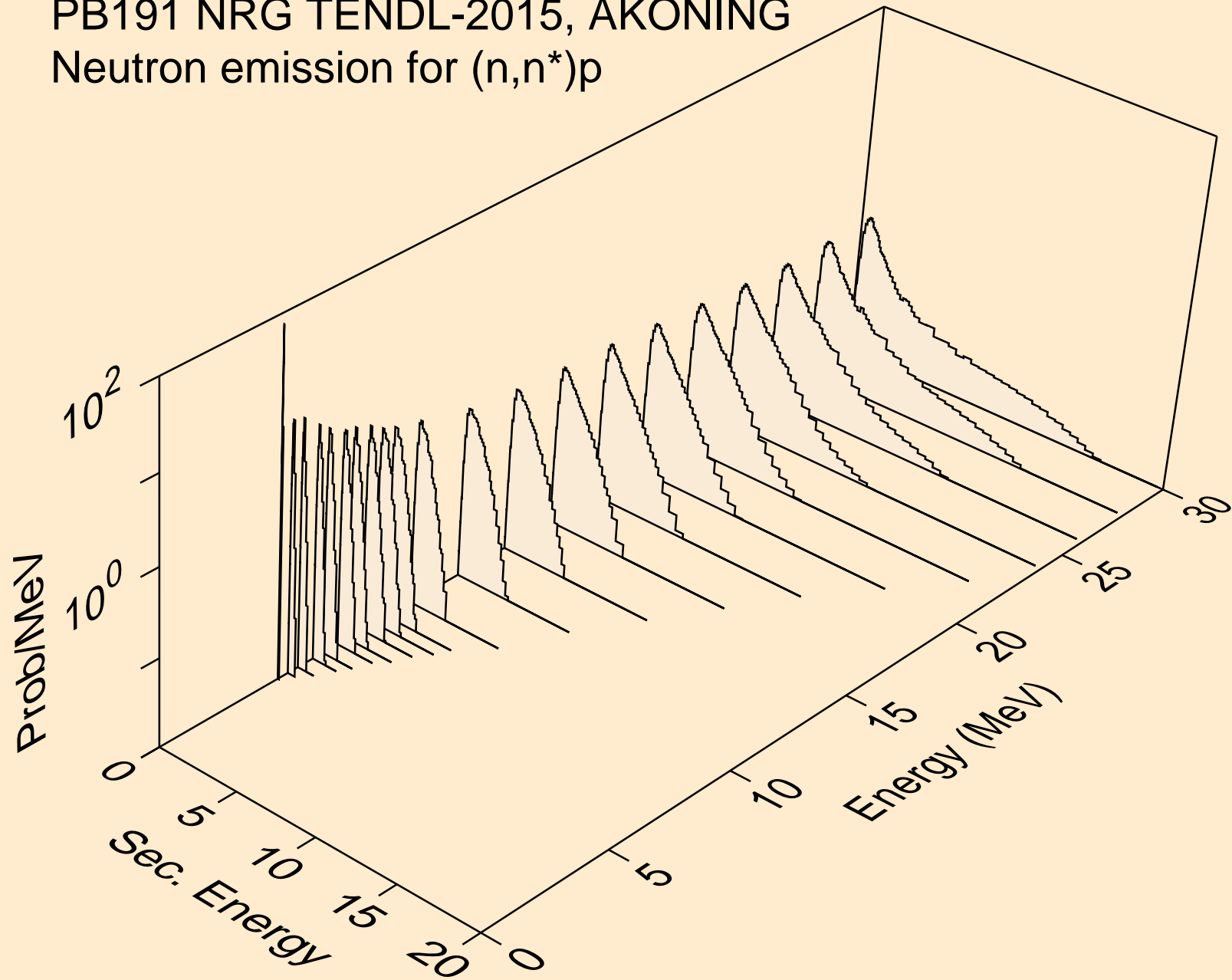

PB191 NRG TENDL-2015, AKONING  
Neutron emission for (n,n\*)2a

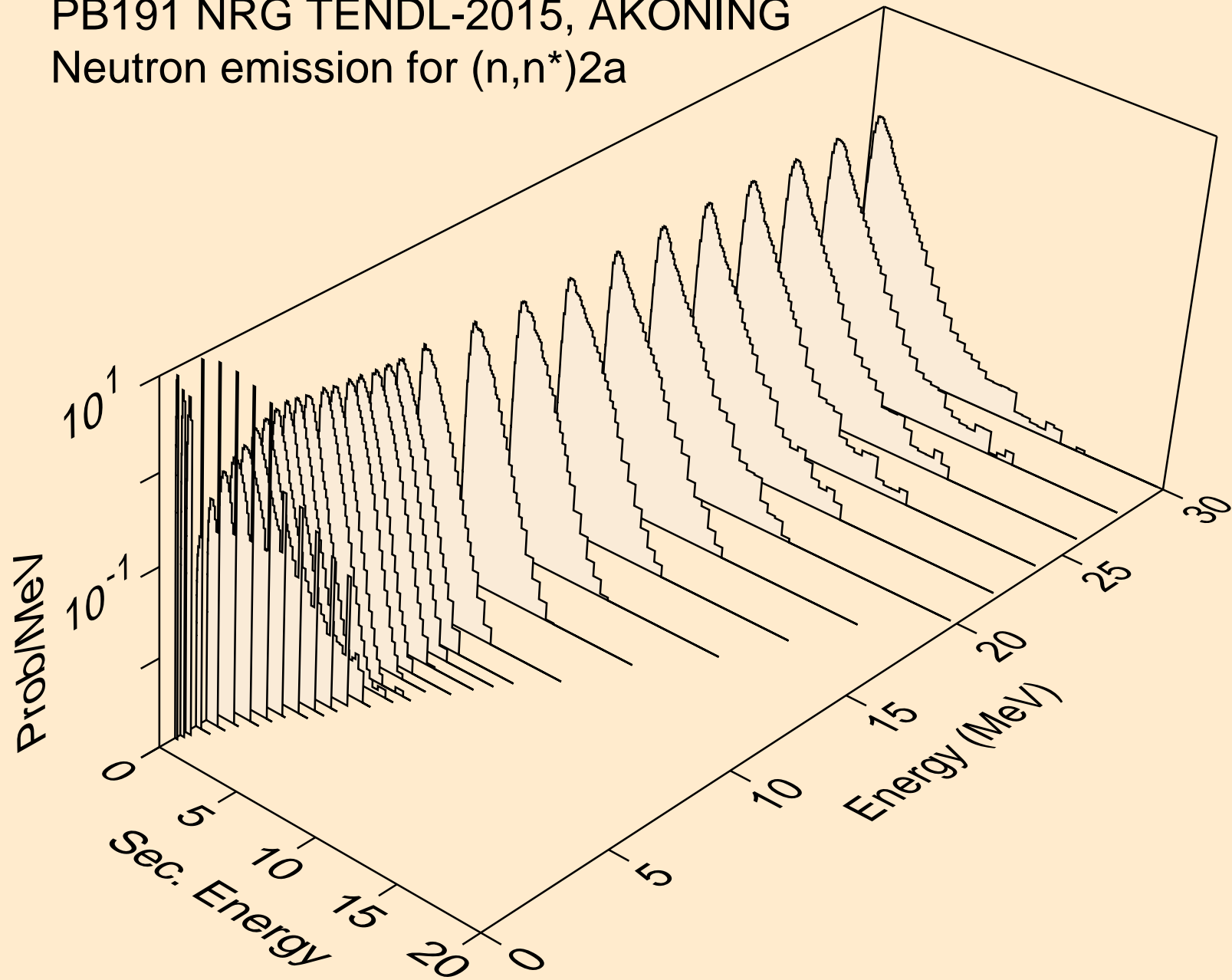

PB191 NRG TENDL-2015, AKONING  
Neutron emission for (n,2n)2a

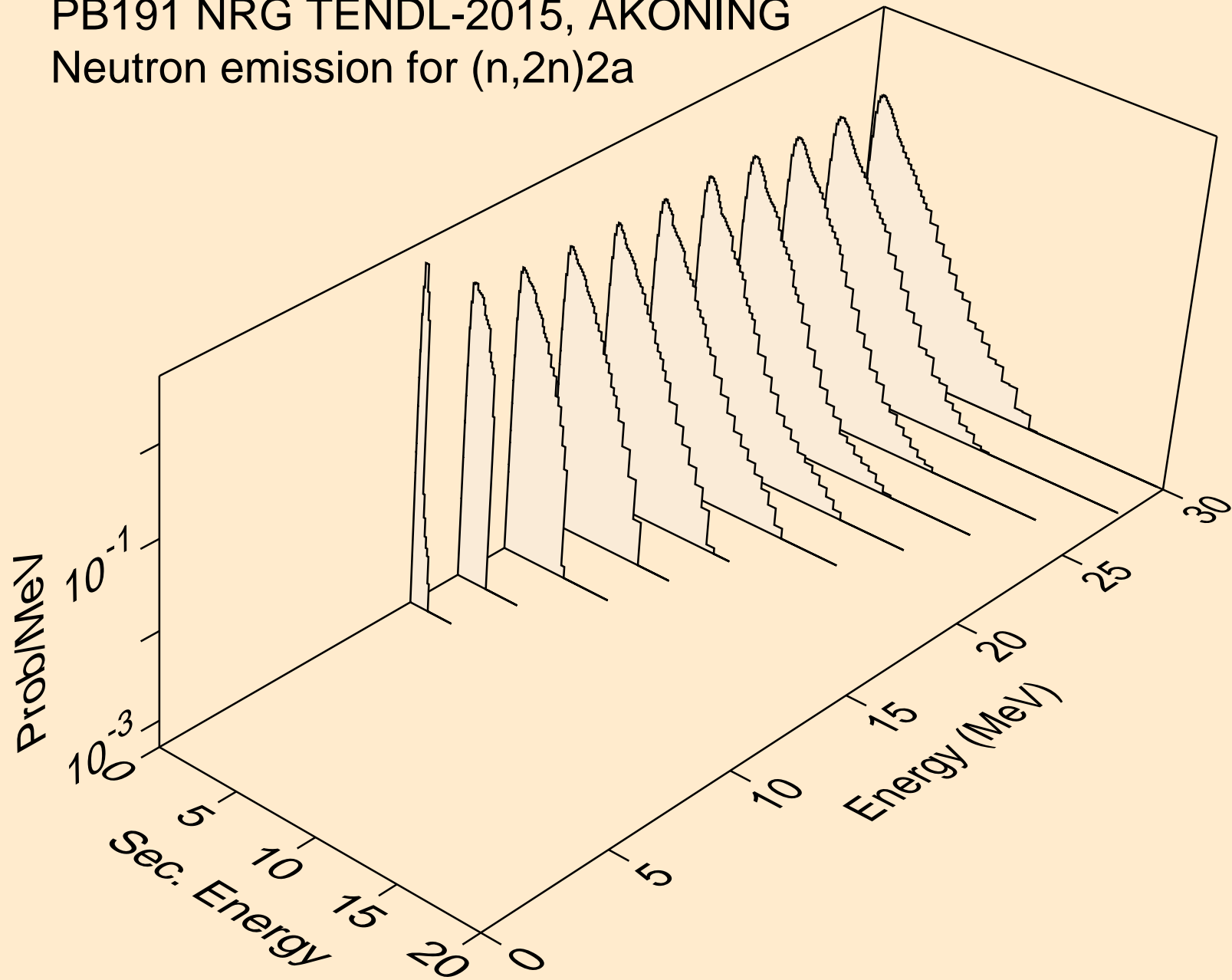

PB191 NRG TENDL-2015, AKONING  
Neutron emission for (n,n\*)d

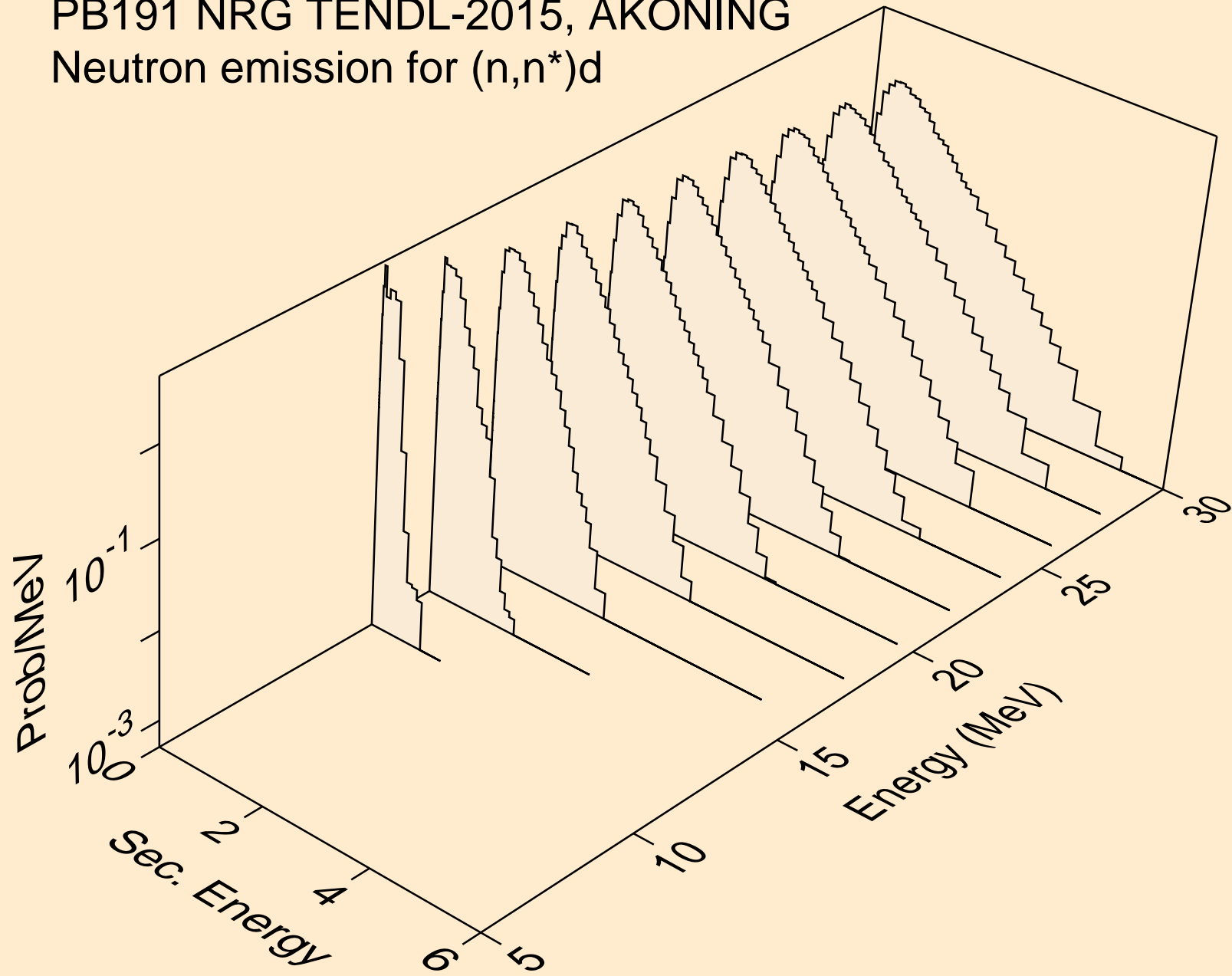



PB191 NRG TENDL-2015, AKONING  
Neutron emission for (n,n\*)t

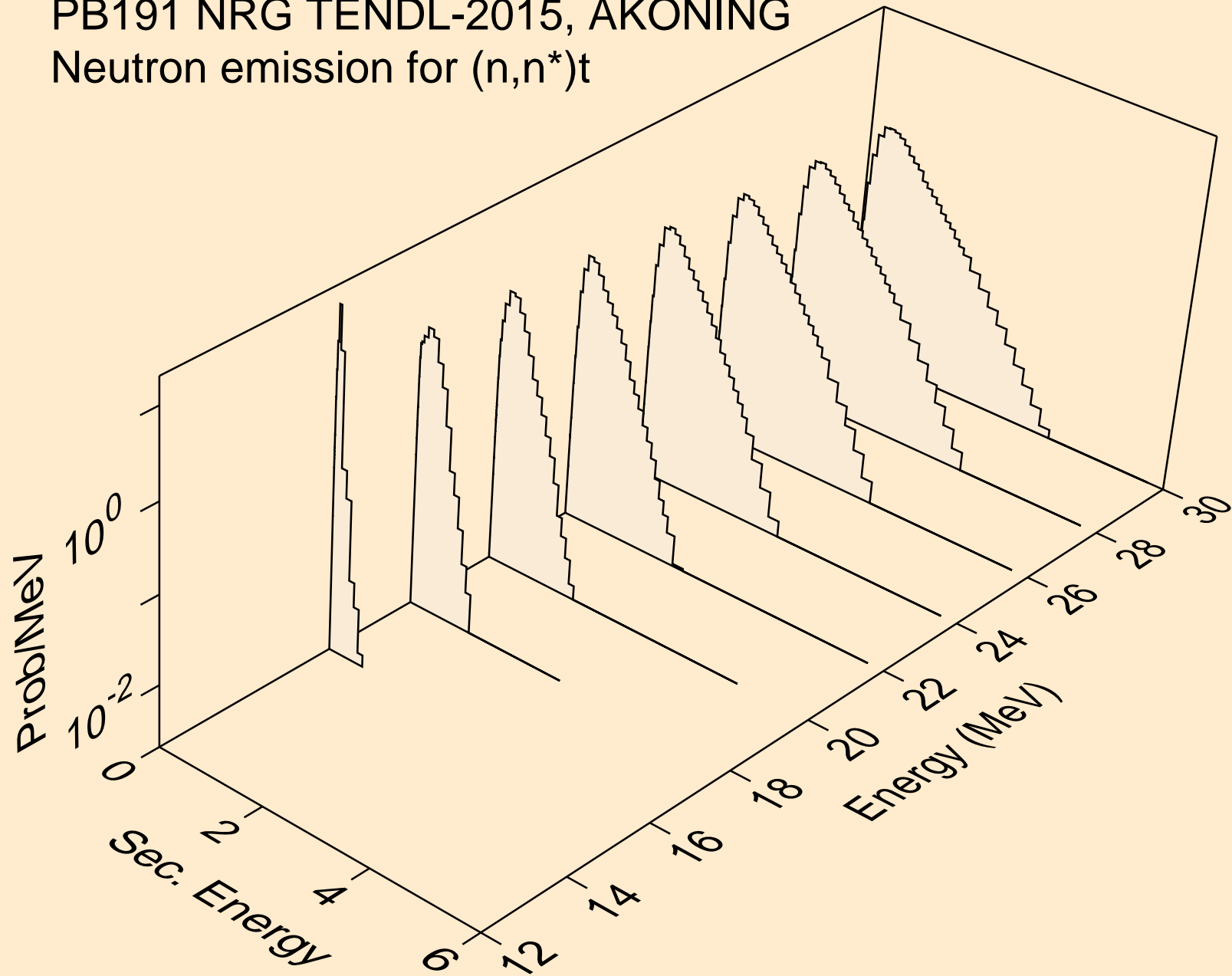

PB191 NRG TENDL-2015, AKONING  
Neutron emission for (n,n\*)he3

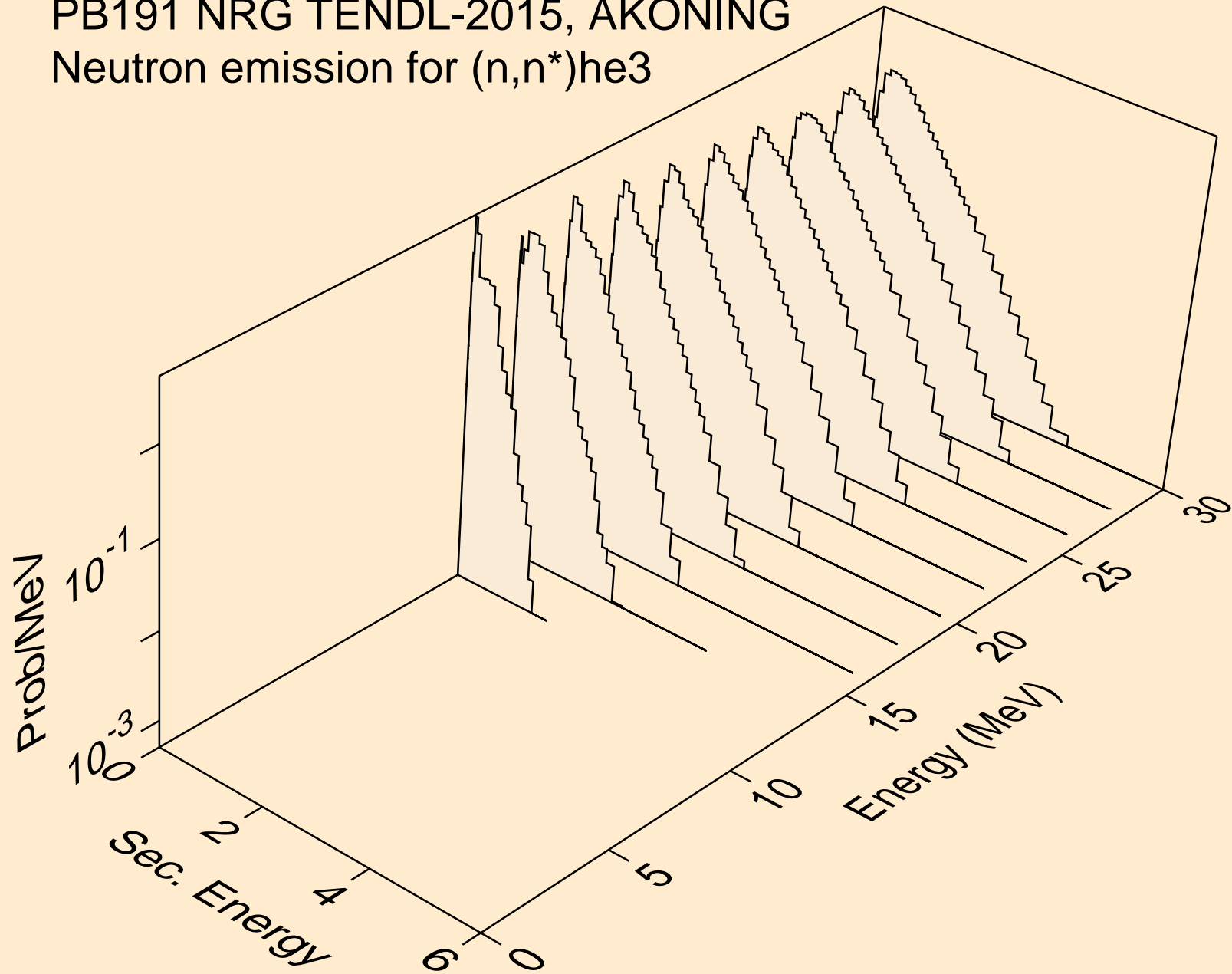

PB191 NRG TENDL-2015, AKONING  
Neutron emission for (n,4n)

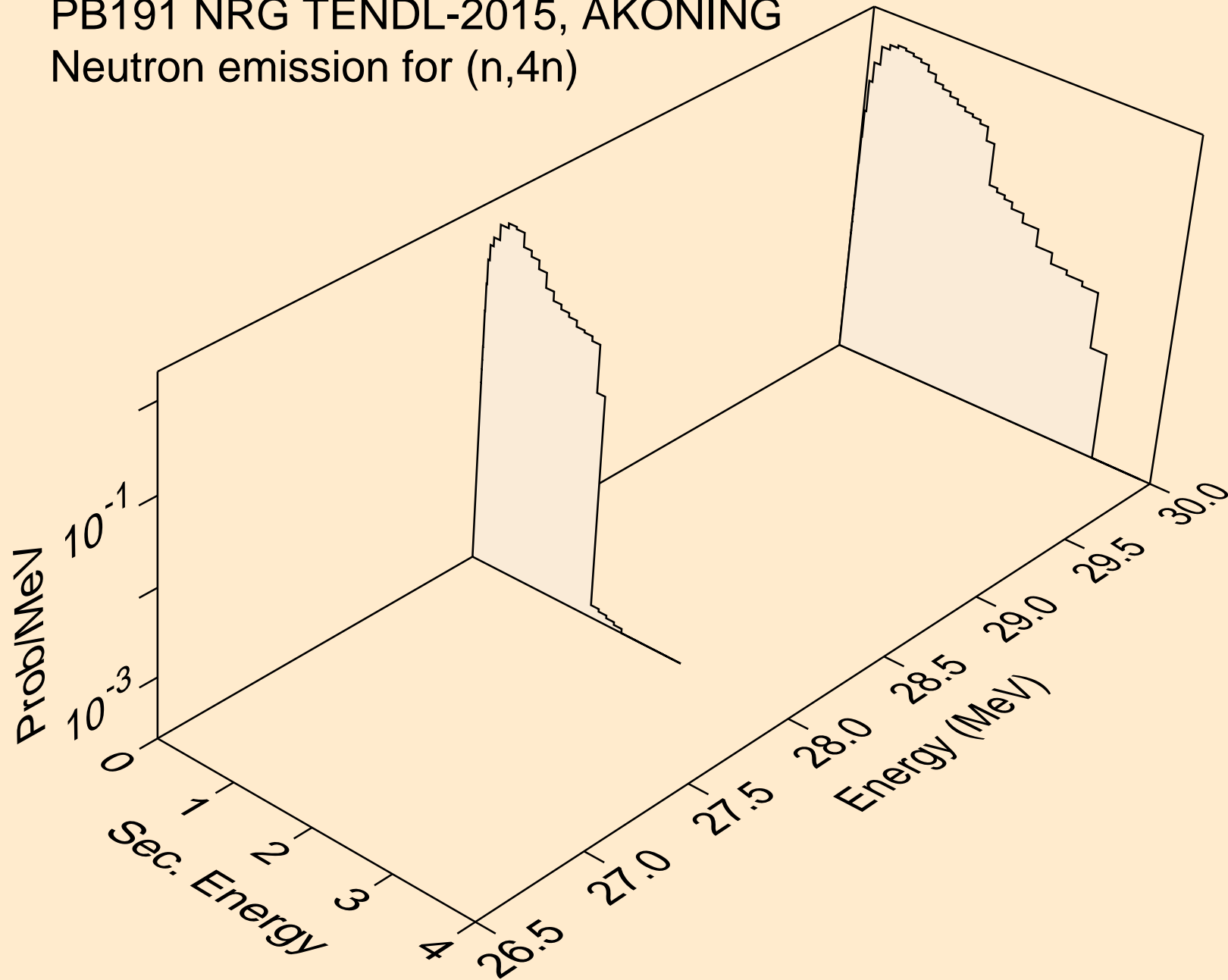

PB191 NRG TENDL-2015, AKONING  
Neutron emission for (n,2np)

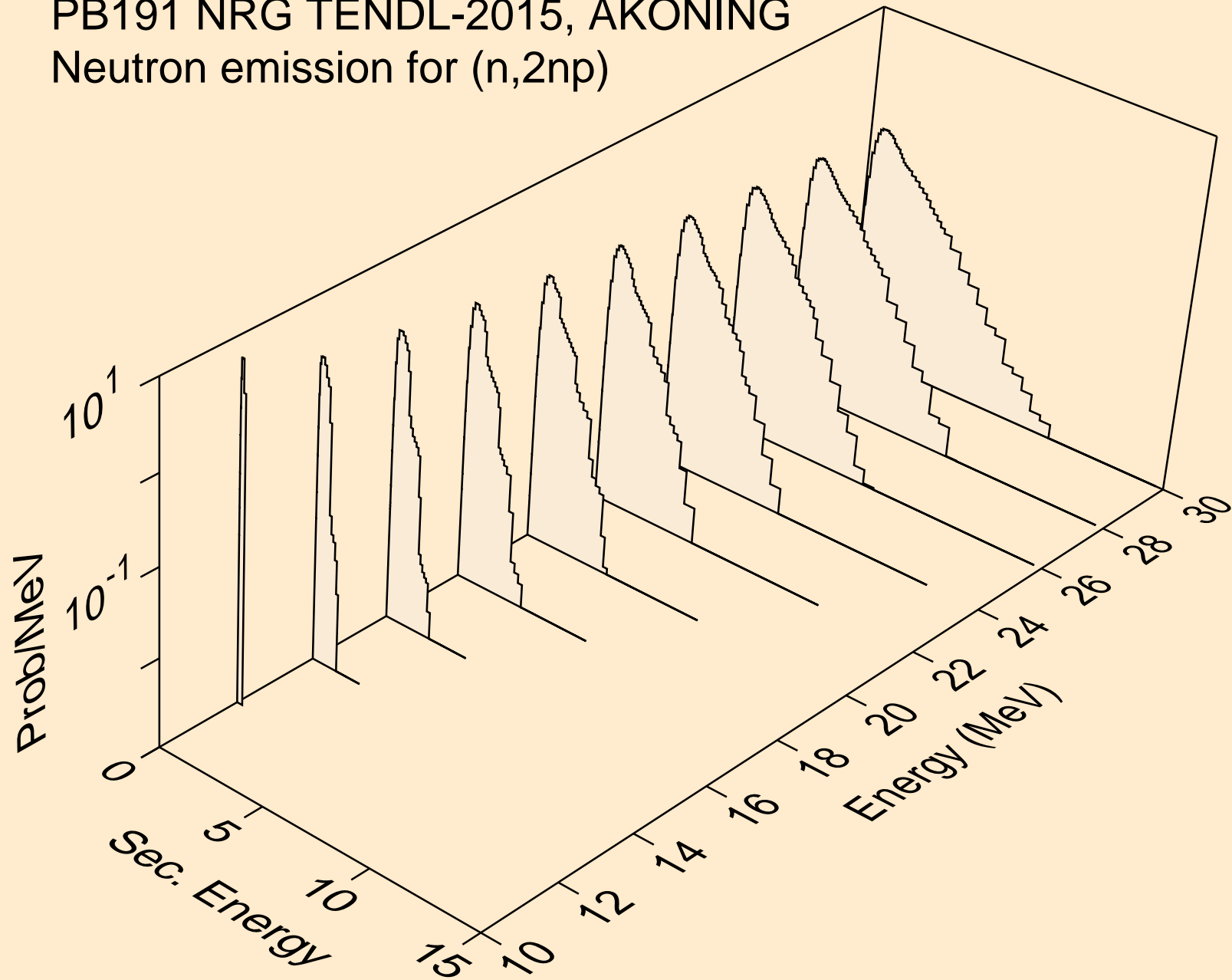

PB191 NRG TENDL-2015, AKONING  
Neutron emission for (n,3np)

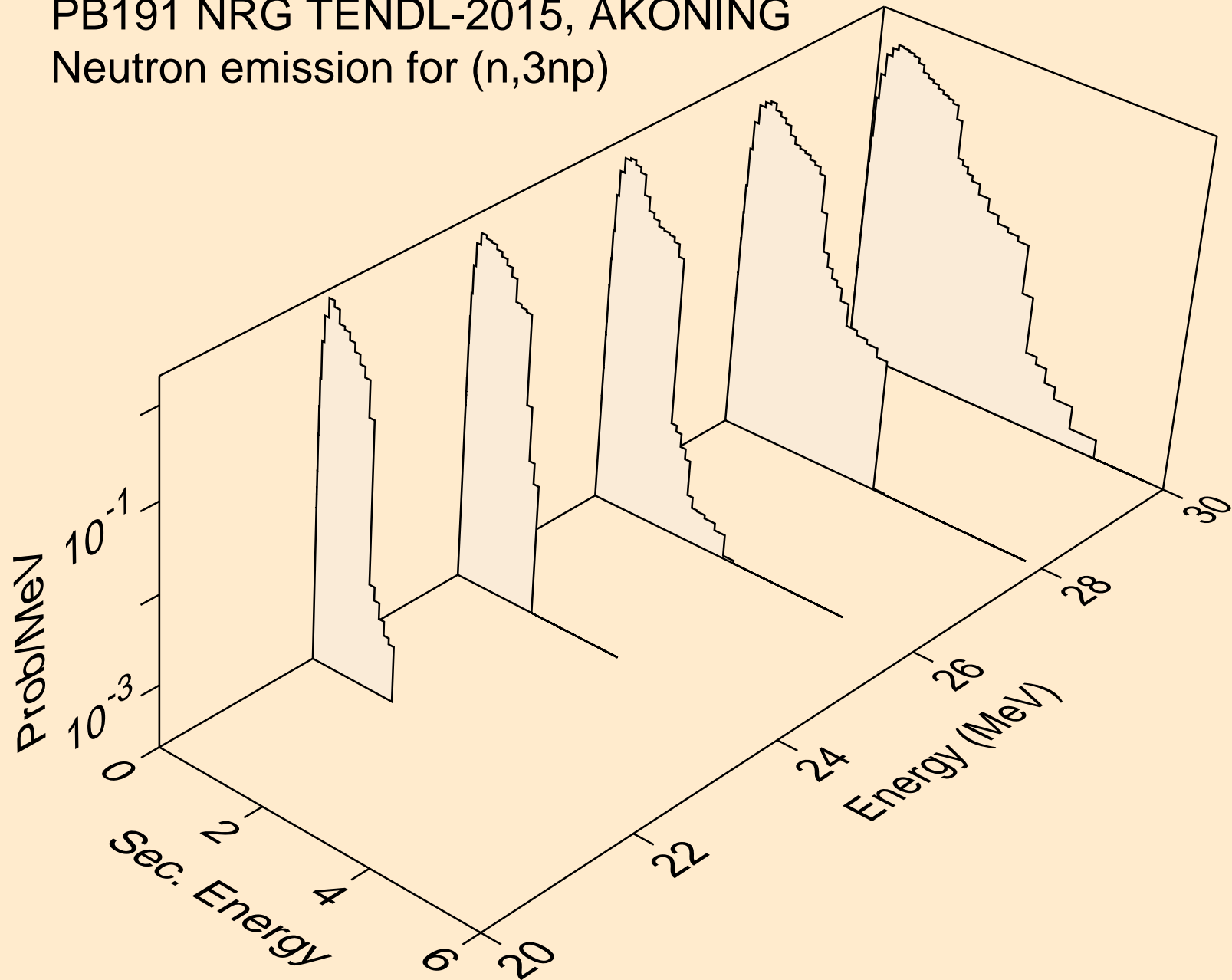

PB191 NRG TENDL-2015, AKONING  
Neutron emission for (n,2np)

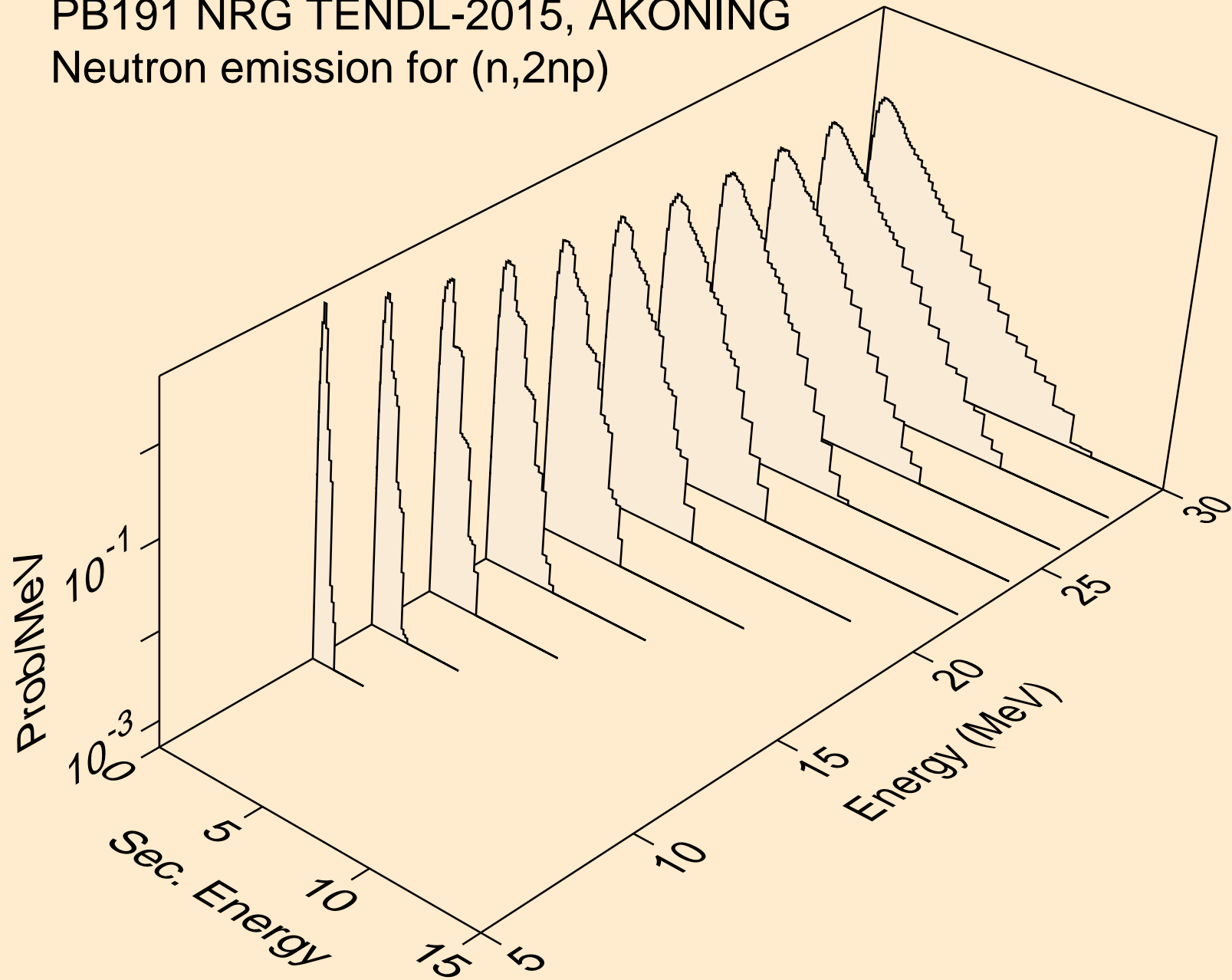

PB191 NRG TENDL-2015, AKONING  
Neutron emission for (n,npa)

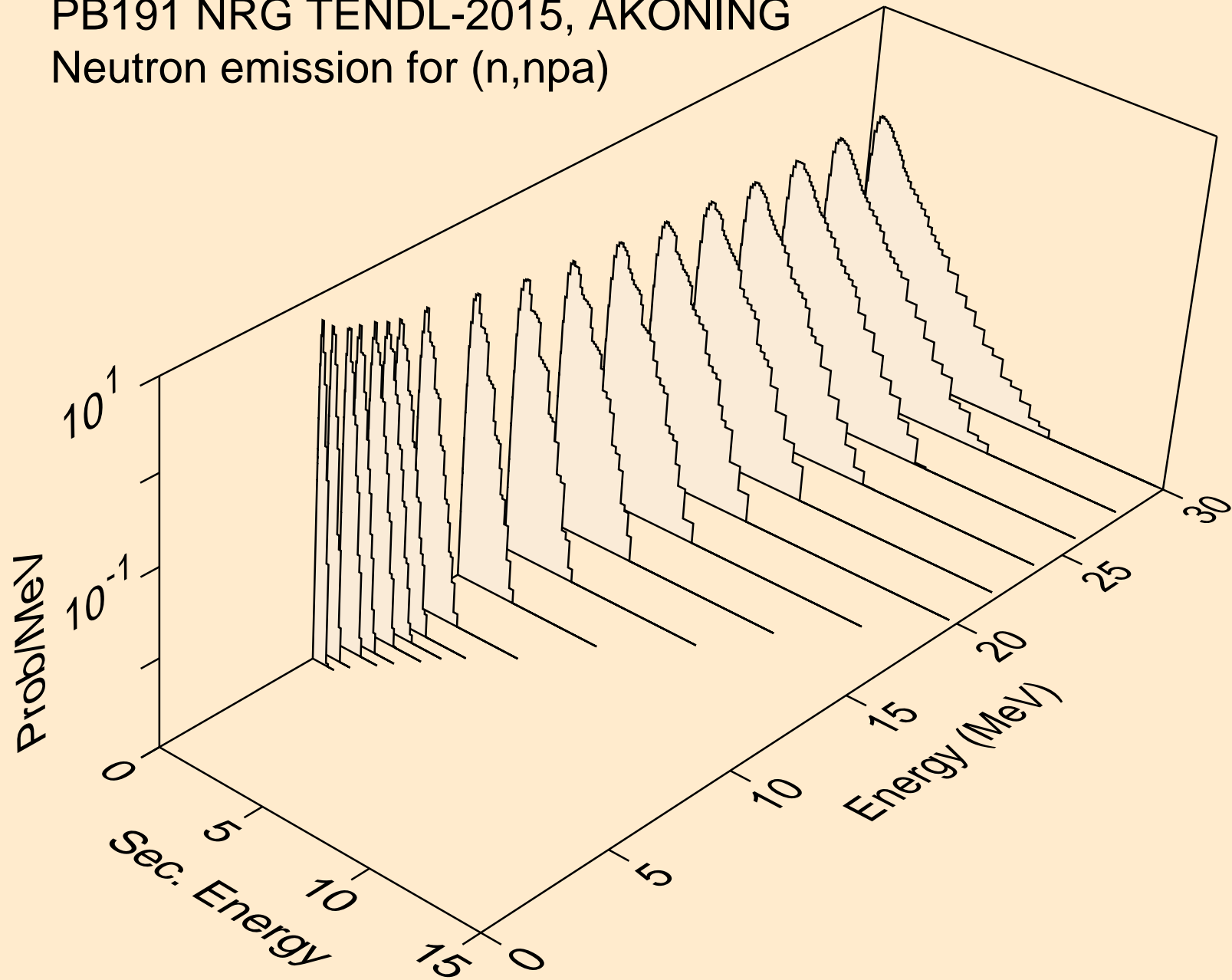

PB191 NRG TENDL-2015, AKONING  
Neutron emission for (n,n\*c)

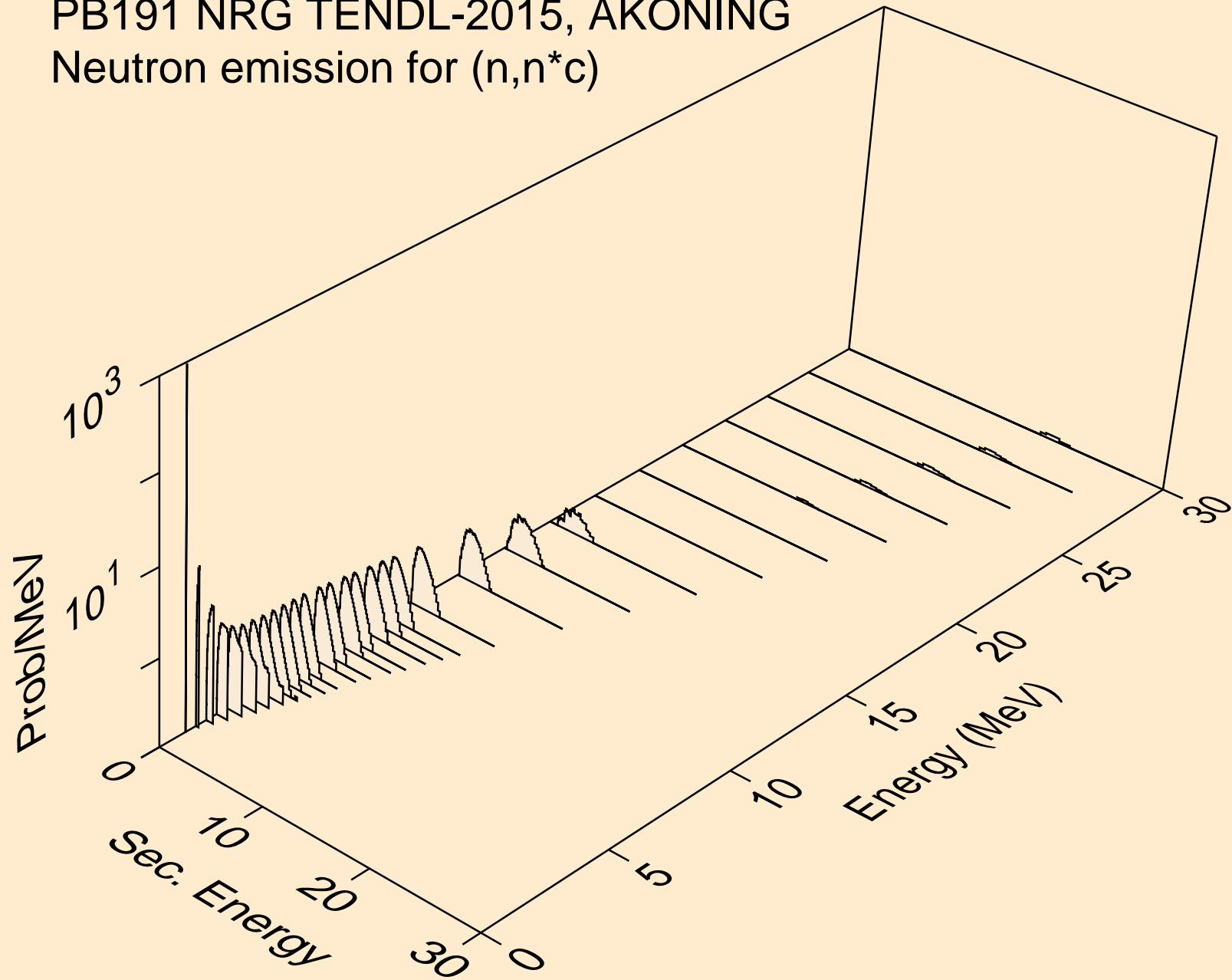



PB191 NRG TENDL-2015, AKONING  
Photon emission for (n,x)

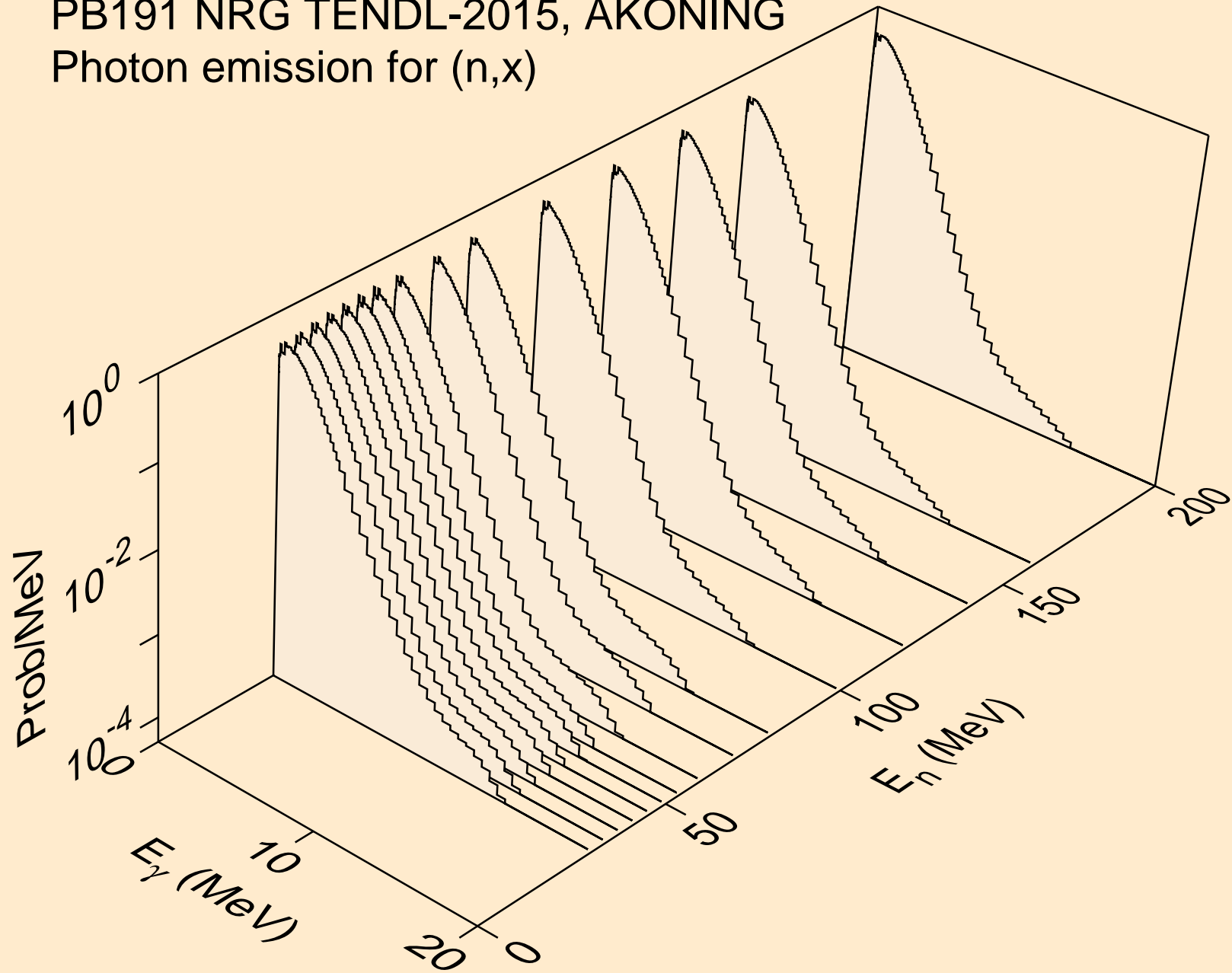

PB191 NRG TENDL-2015, AKONING  
Photon emission for (n,2nd)

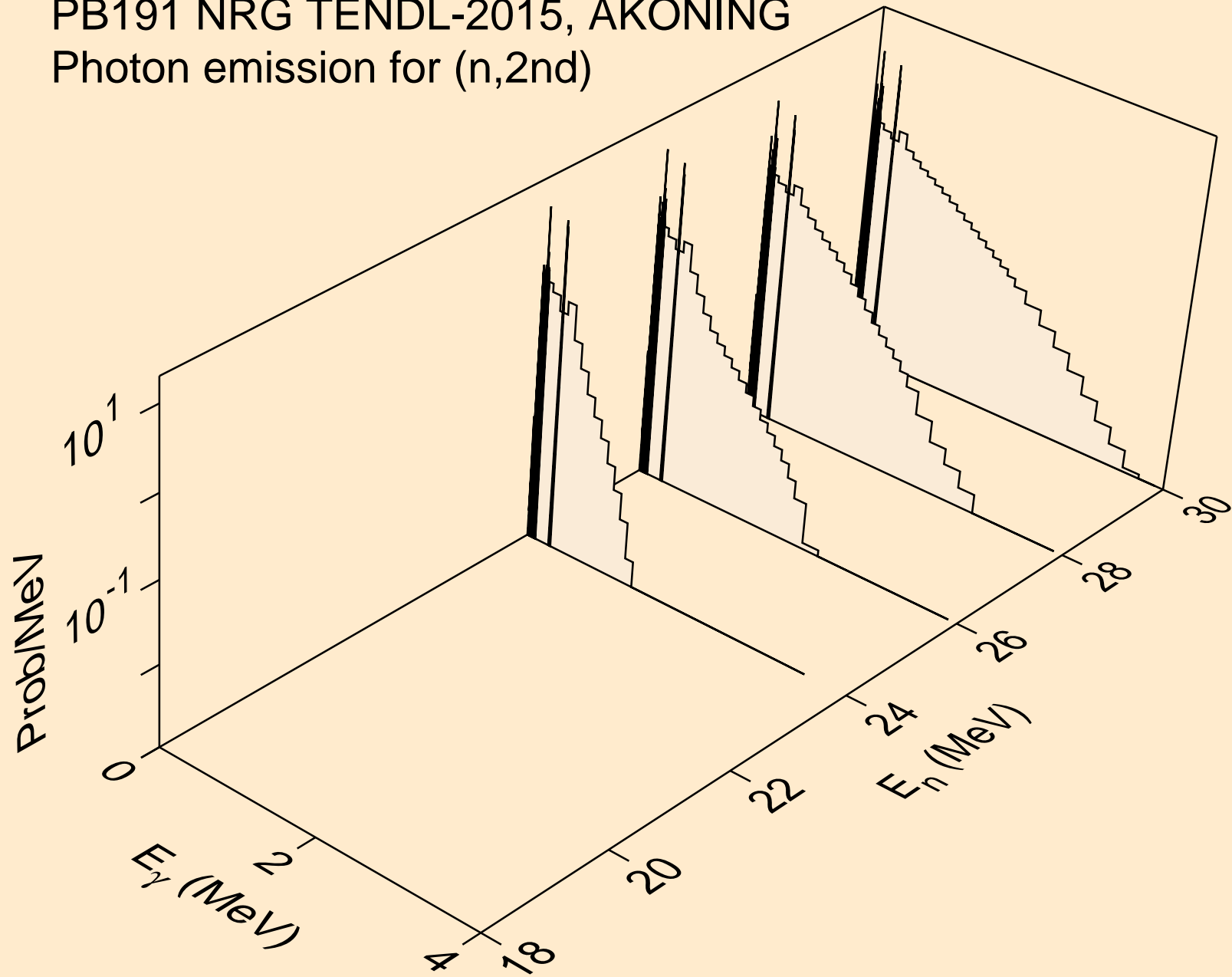

PB191 NRG TENDL-2015, AKONING  
Photon emission for (n,2n)

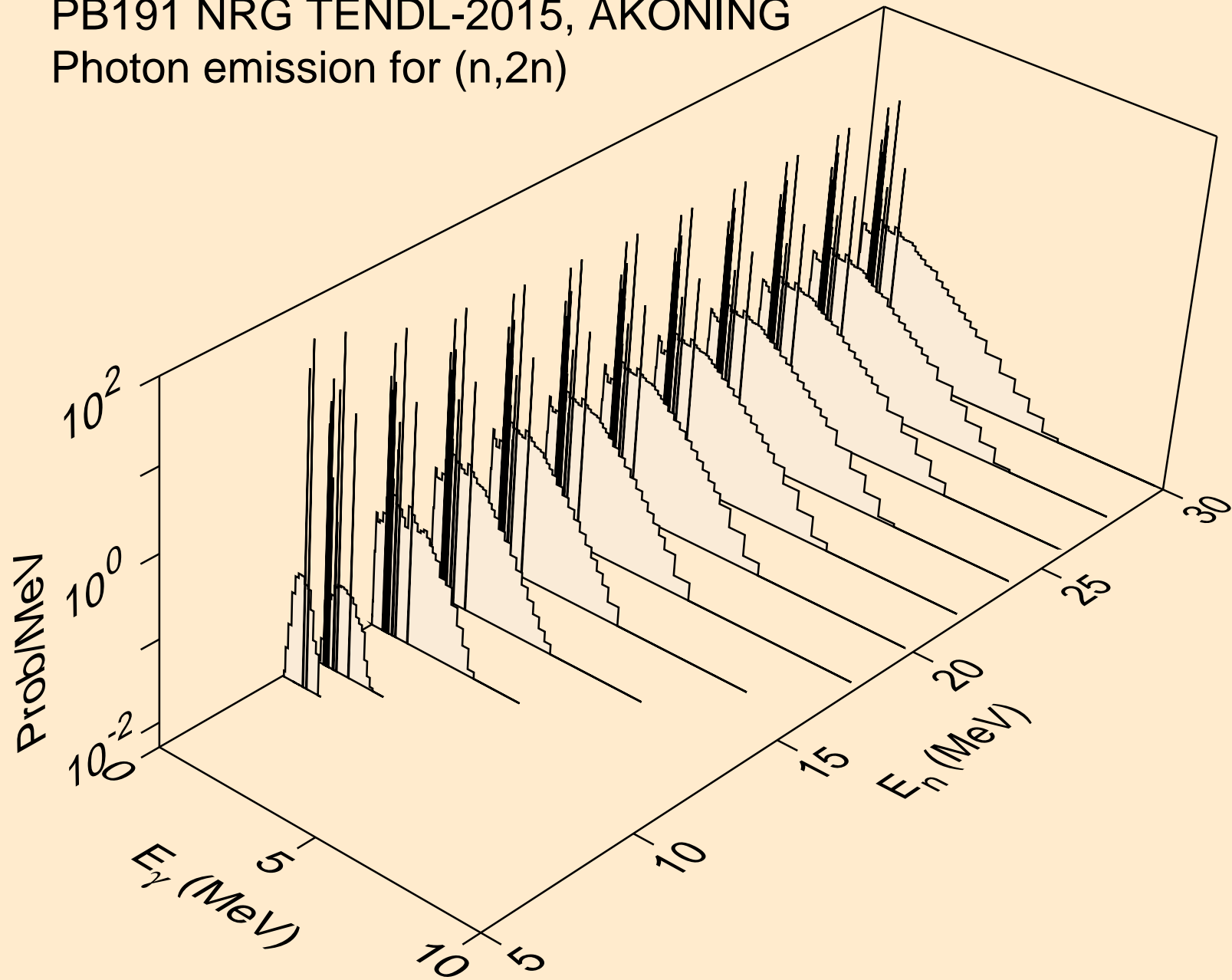

PB191 NRG TENDL-2015, AKONING  
Photon emission for (n,3n)

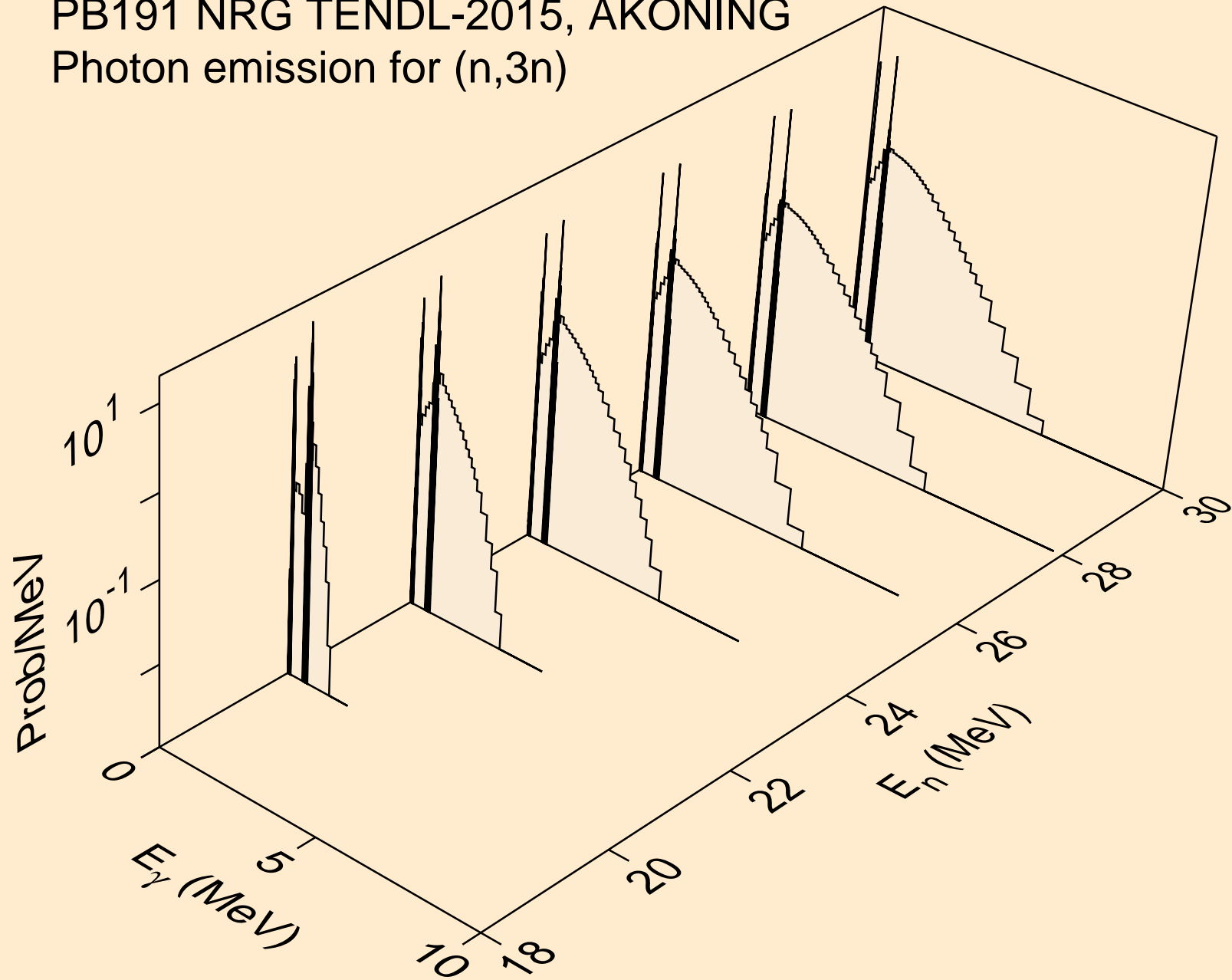

PB191 NRG TENDL-2015, AKONING  
Photon emission for (n,n\*)a

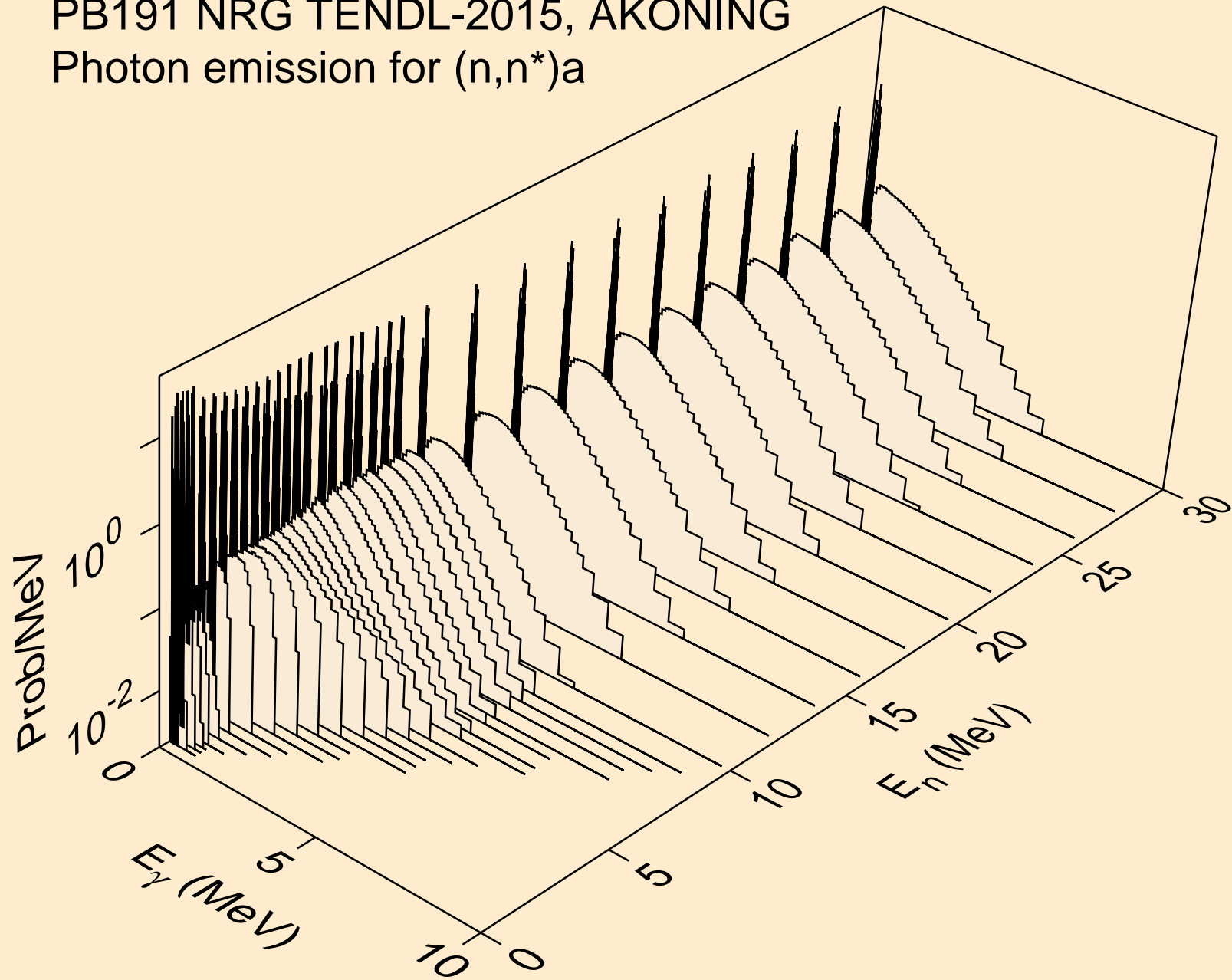

PB191 NRG TENDL-2015, AKONING  
Photon emission for (n,n\*)3a

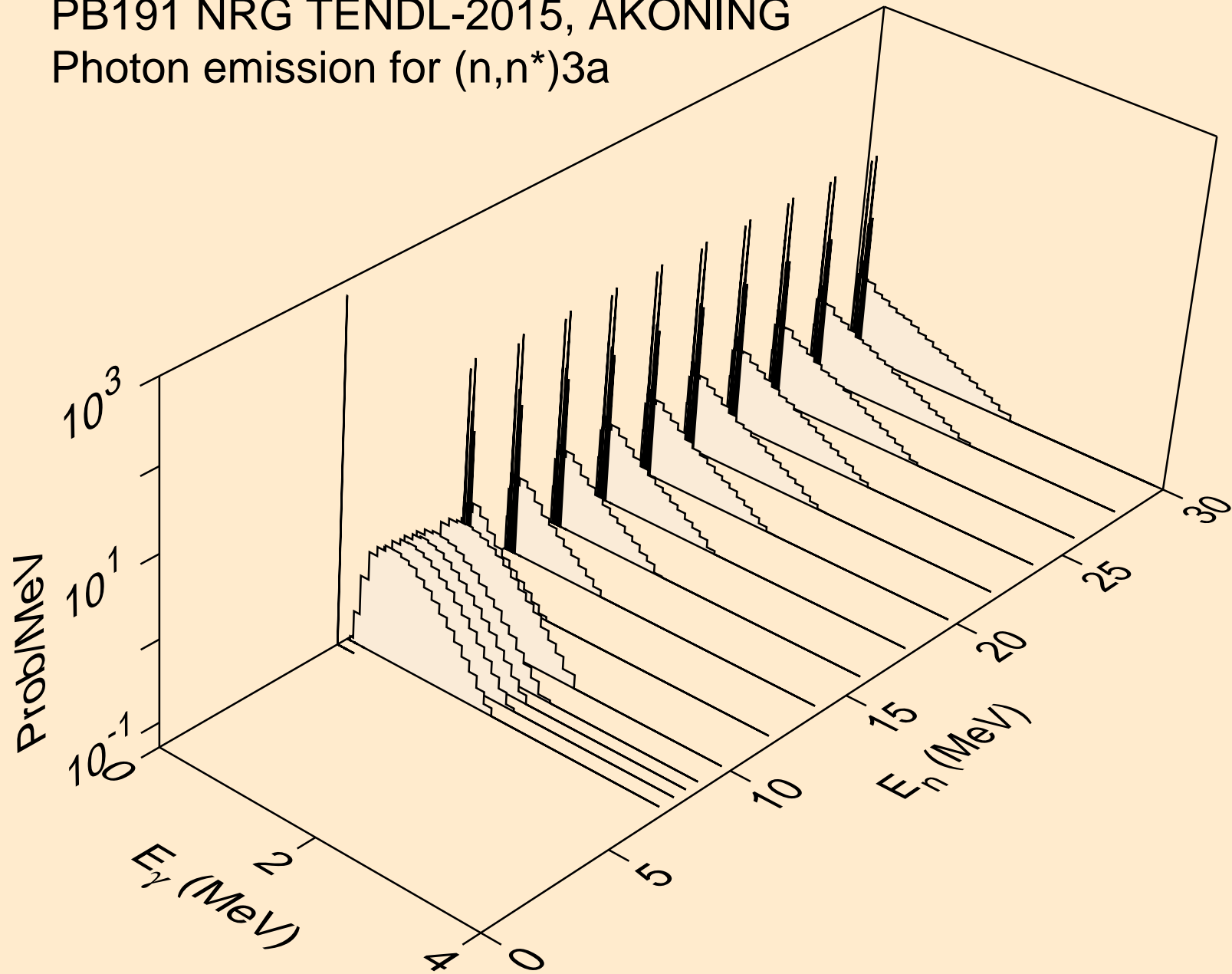

PB191 NRG TENDL-2015, AKONING  
Photon emission for (n,2n)a

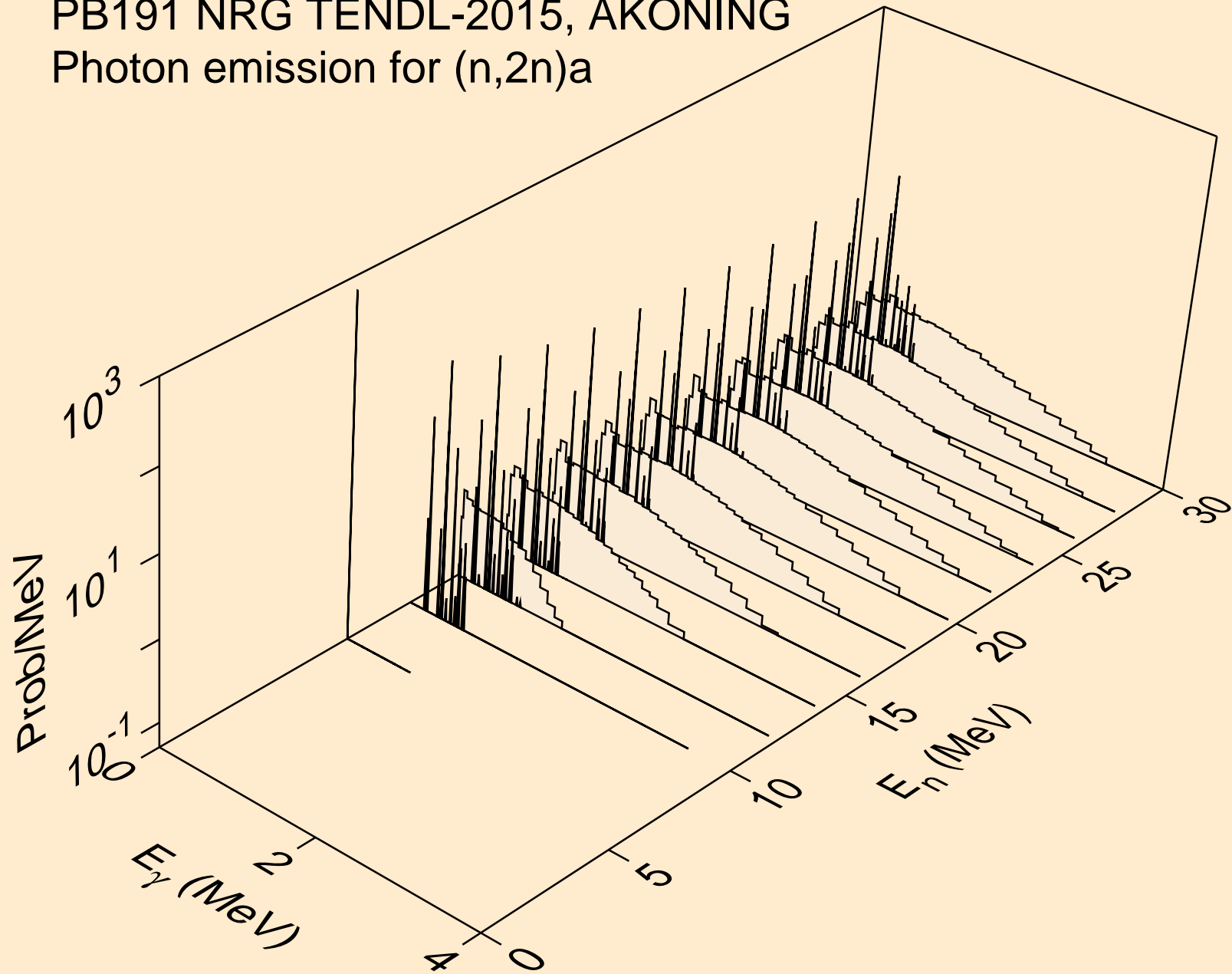

PB191 NRG TENDL-2015, AKONING  
Photon emission for (n,3n) $\alpha$

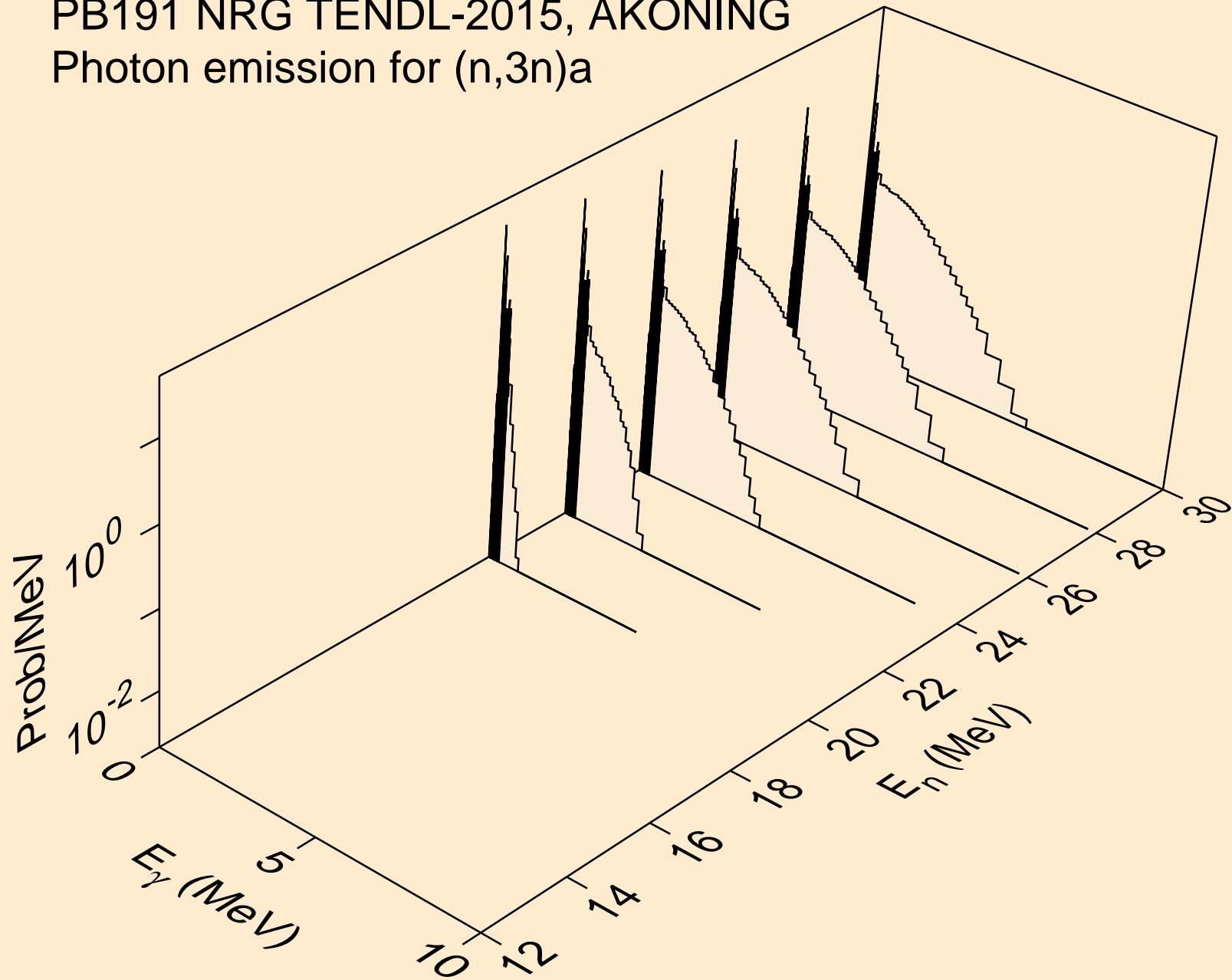



PB191 NRG TENDL-2015, AKONING  
Photon emission for (n,n\*)p

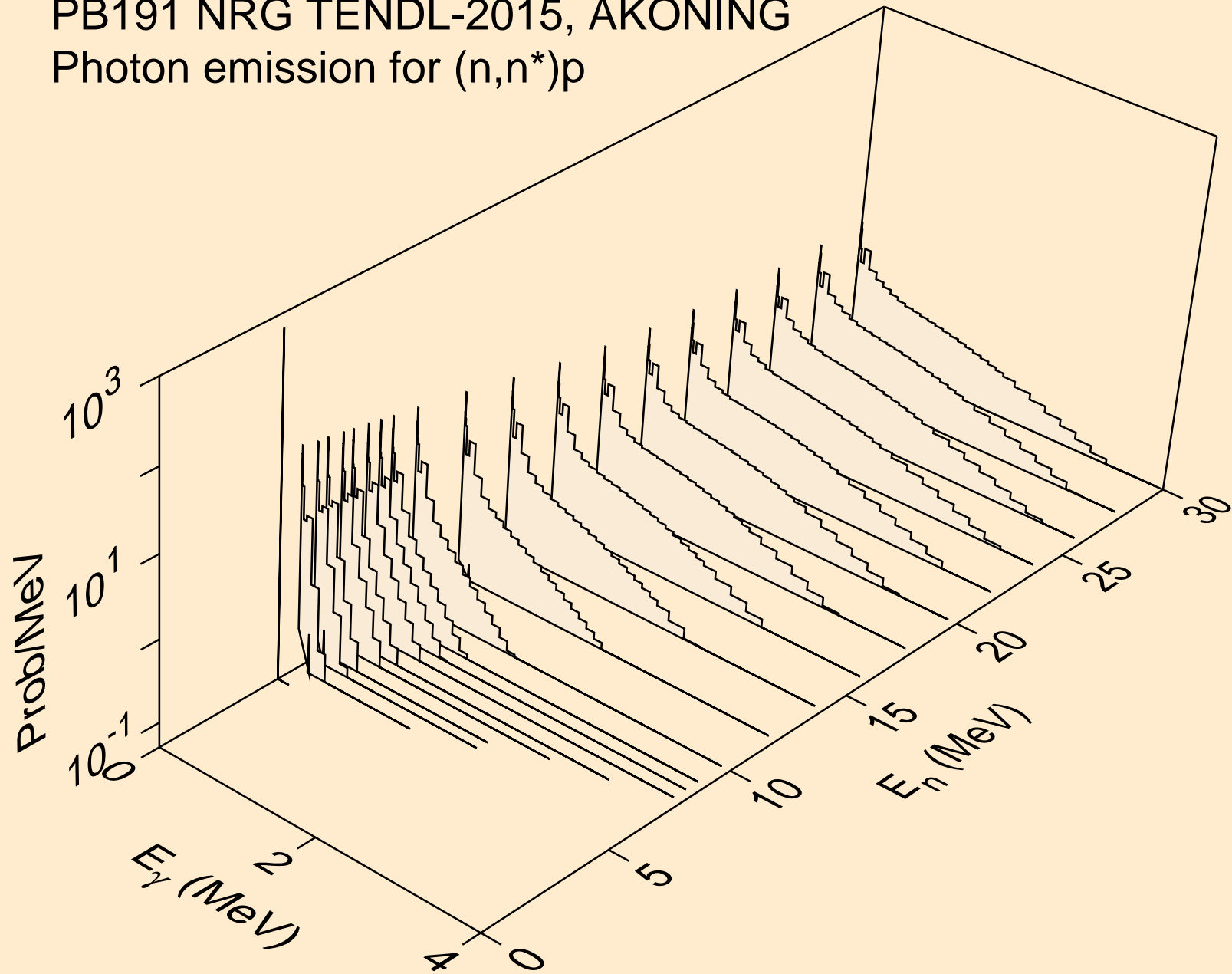

PB191 NRG TENDL-2015, AKONING  
Photon emission for (n,n\*)2a

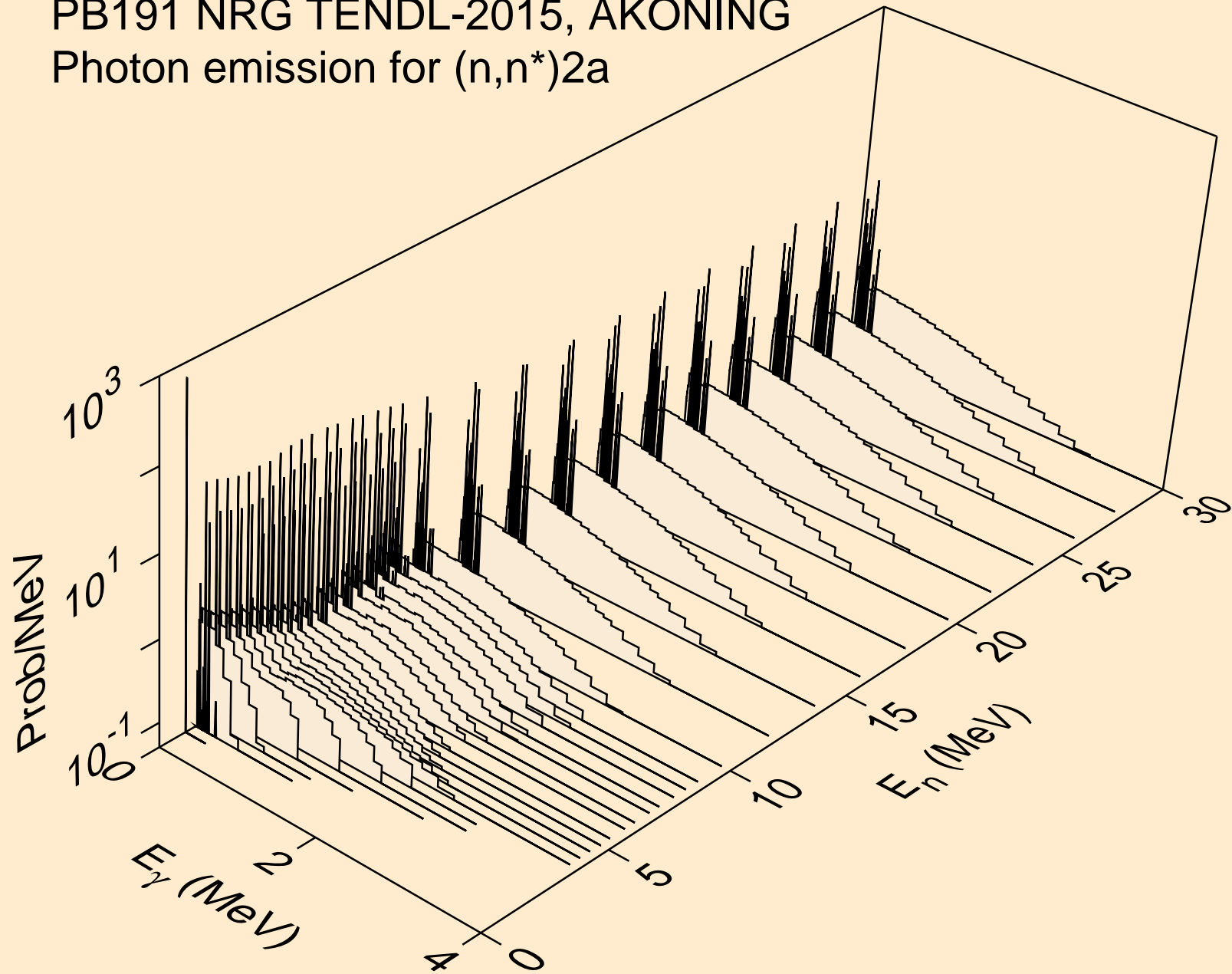

PB191 NRG TENDL-2015, AKONING  
Photon emission for (n,2n)2a

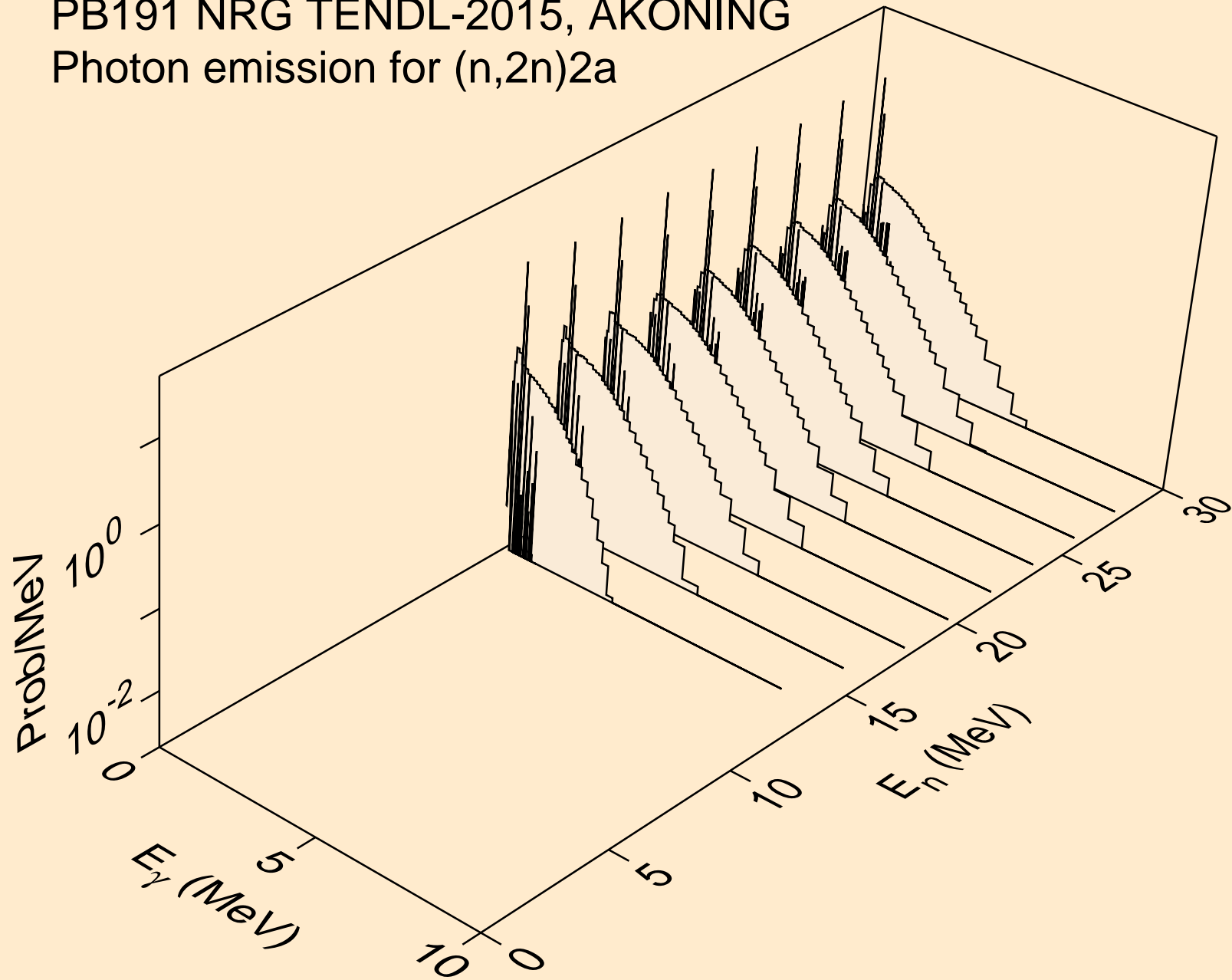

PB191 NRG TENDL-2015, AKONING  
Photon emission for (n,n\*)d

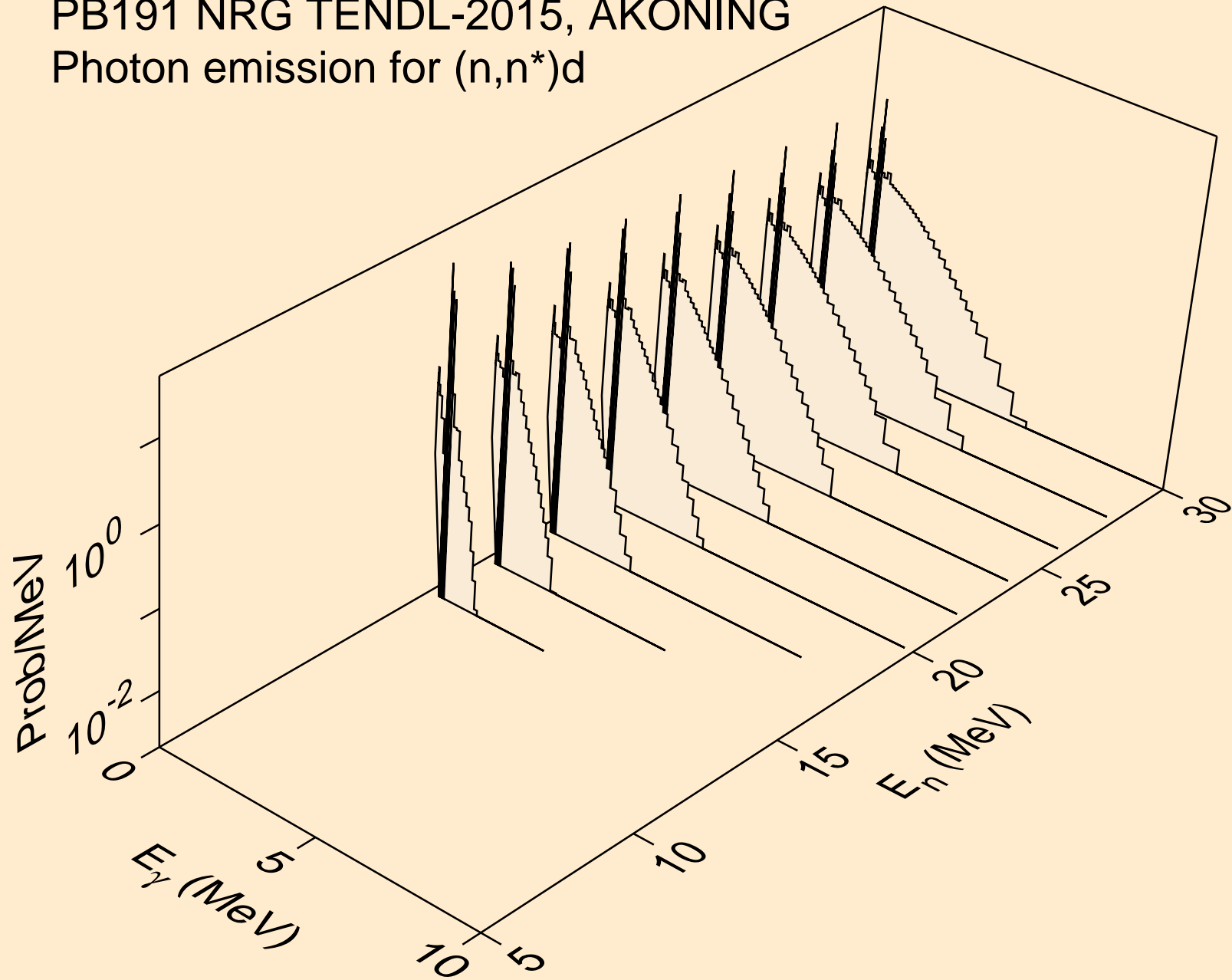

PB191 NRG TENDL-2015, AKONING  
Photon emission for (n,n\*)t

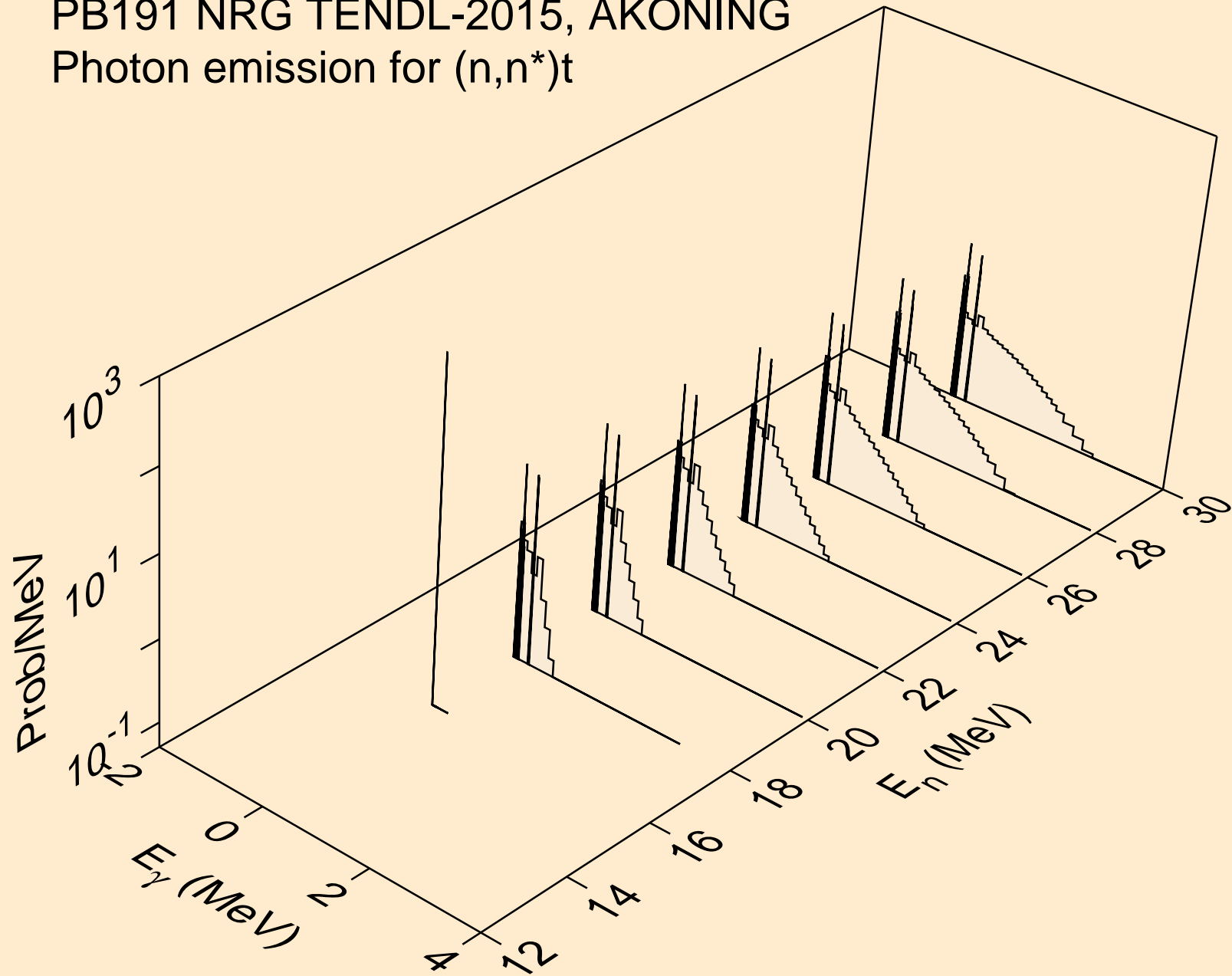

PB191 NRG TENDL-2015, AKONING  
Photon emission for (n,n\*)he3

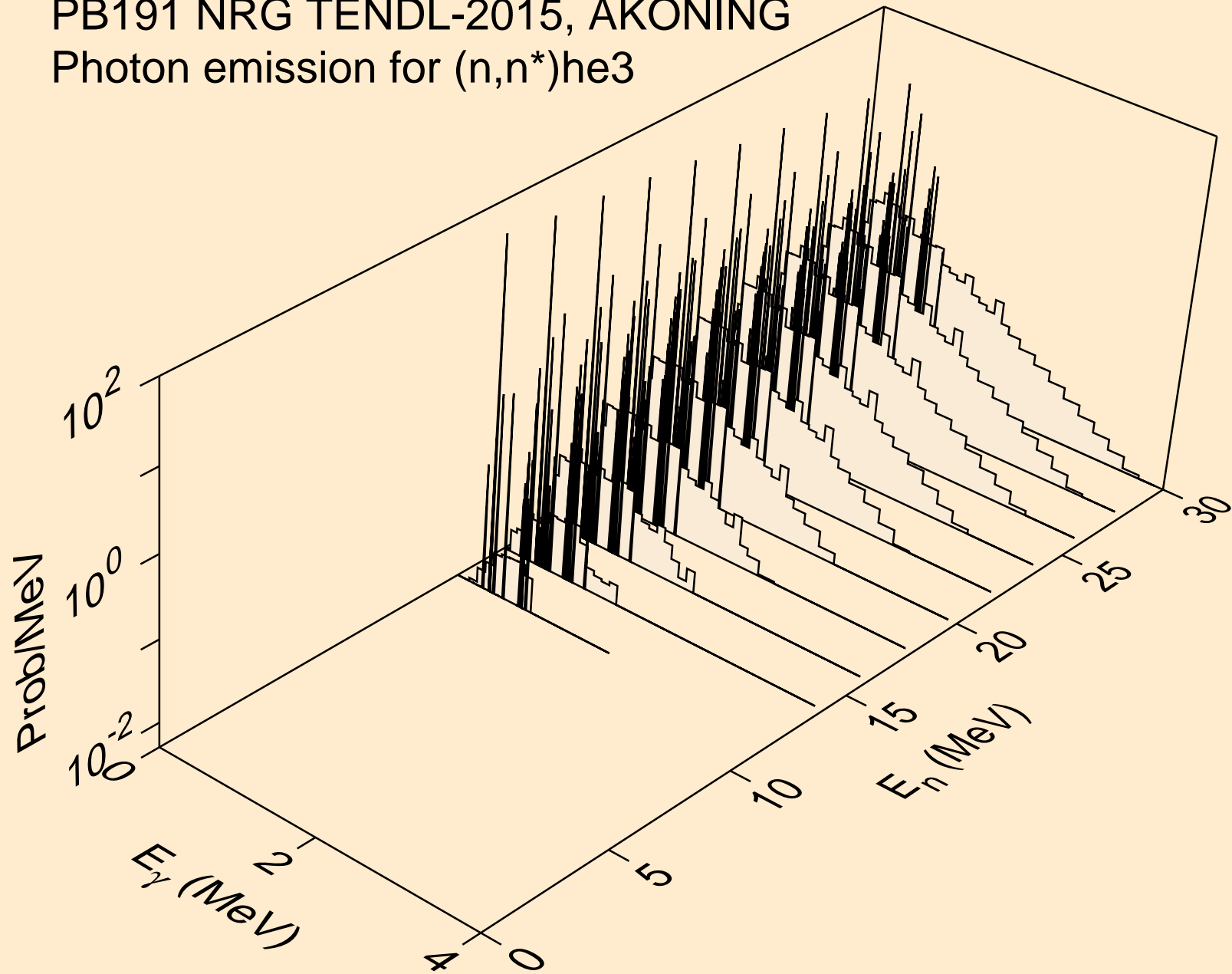

PB191 NRG TENDL-2015, AKONING  
Photon emission for (n,4n)

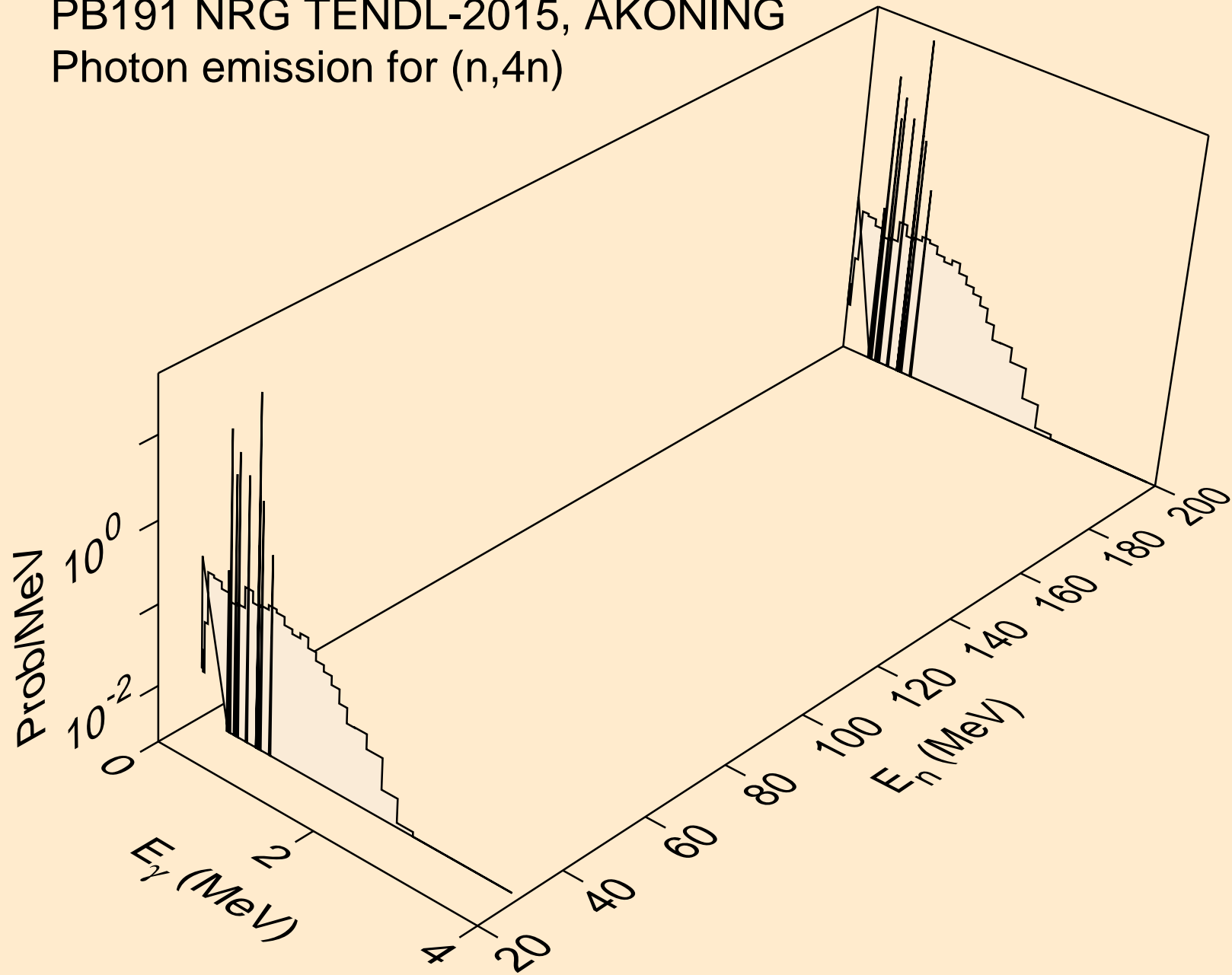

PB191 NRG TENDL-2015, AKONING  
Photon emission for (n,2np)

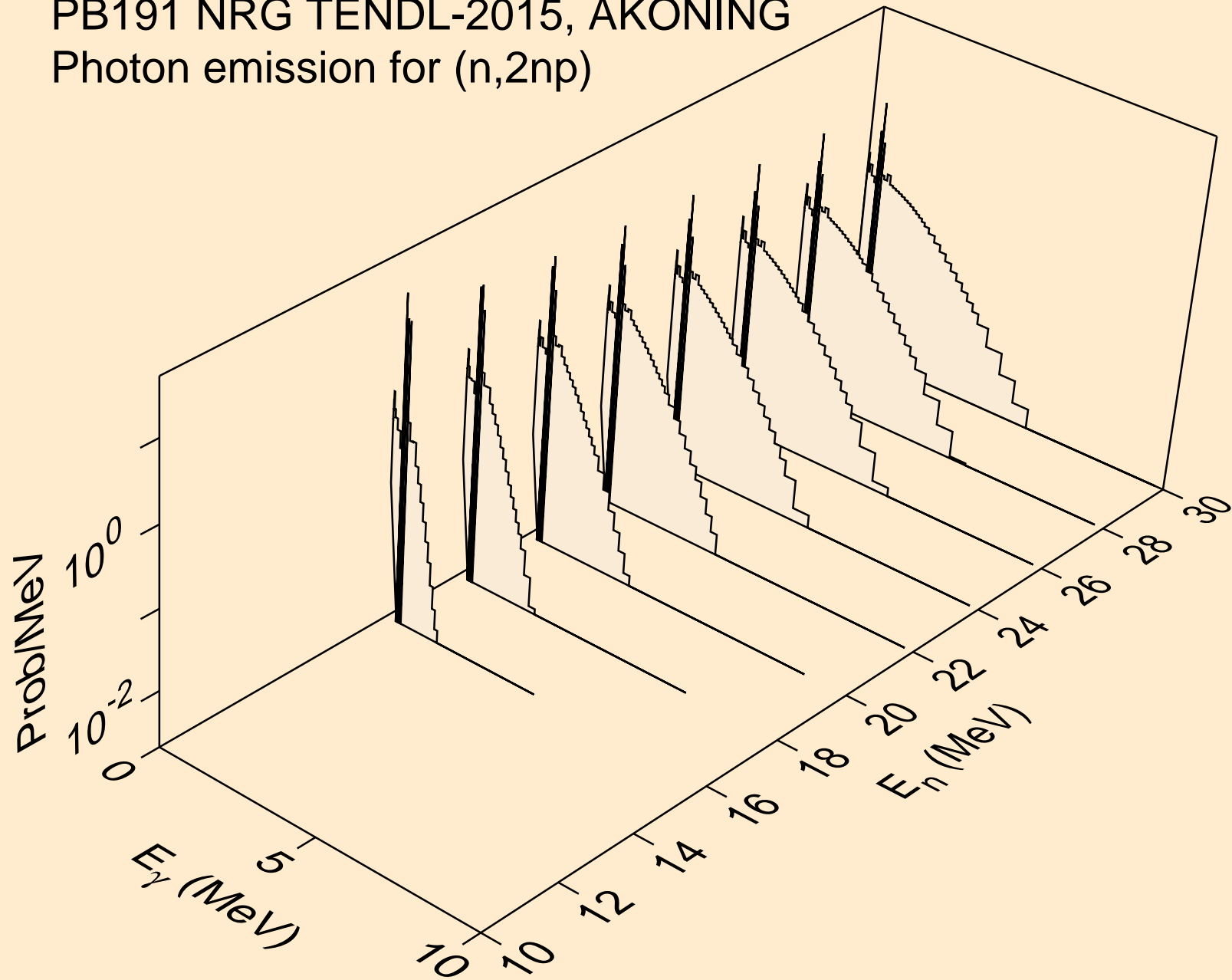



PB191 NRG TENDL-2015, AKONING  
Photon emission for (n,3np)

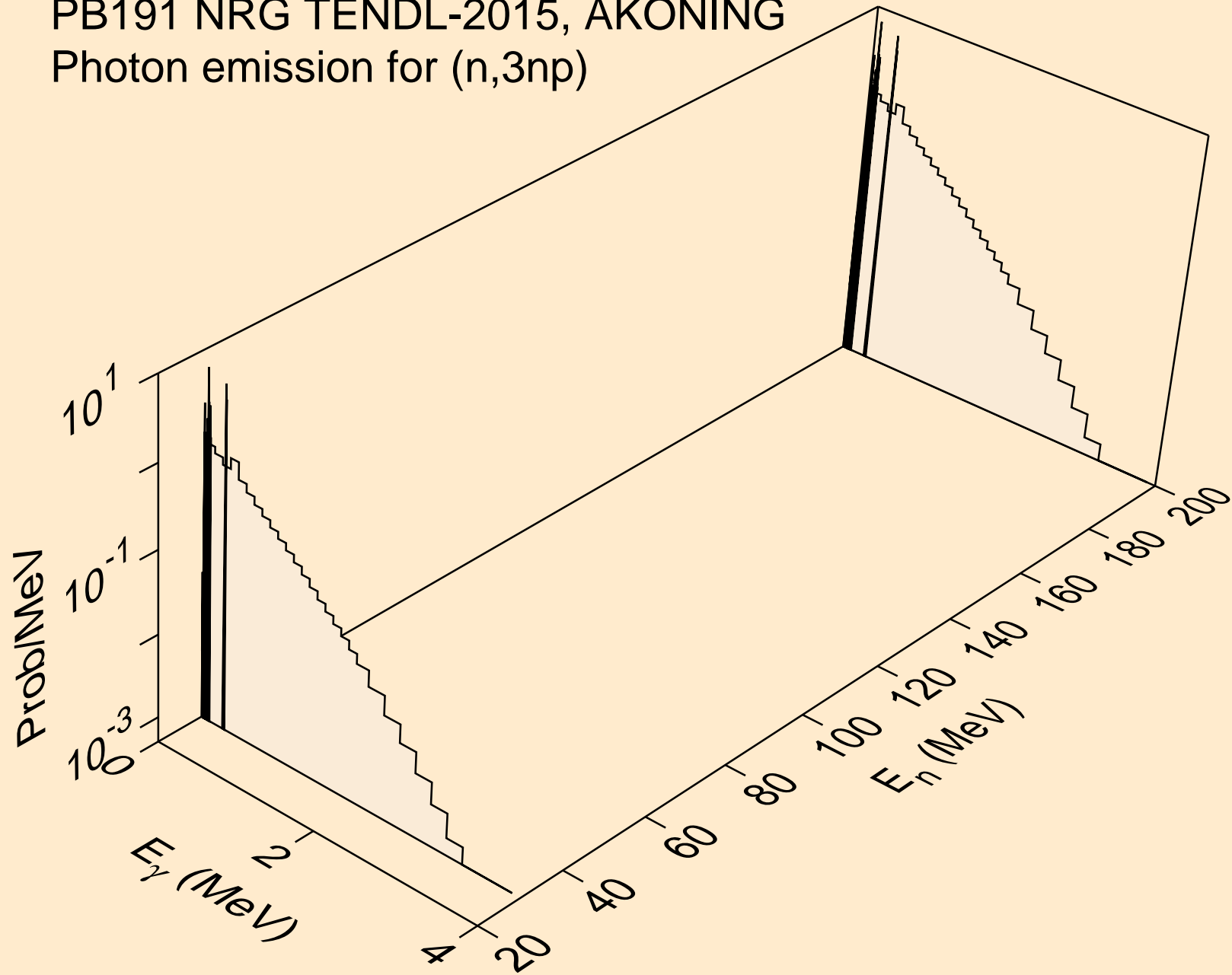

PB191 NRG TENDL-2015, AKONING  
Photon emission for (n,2np)

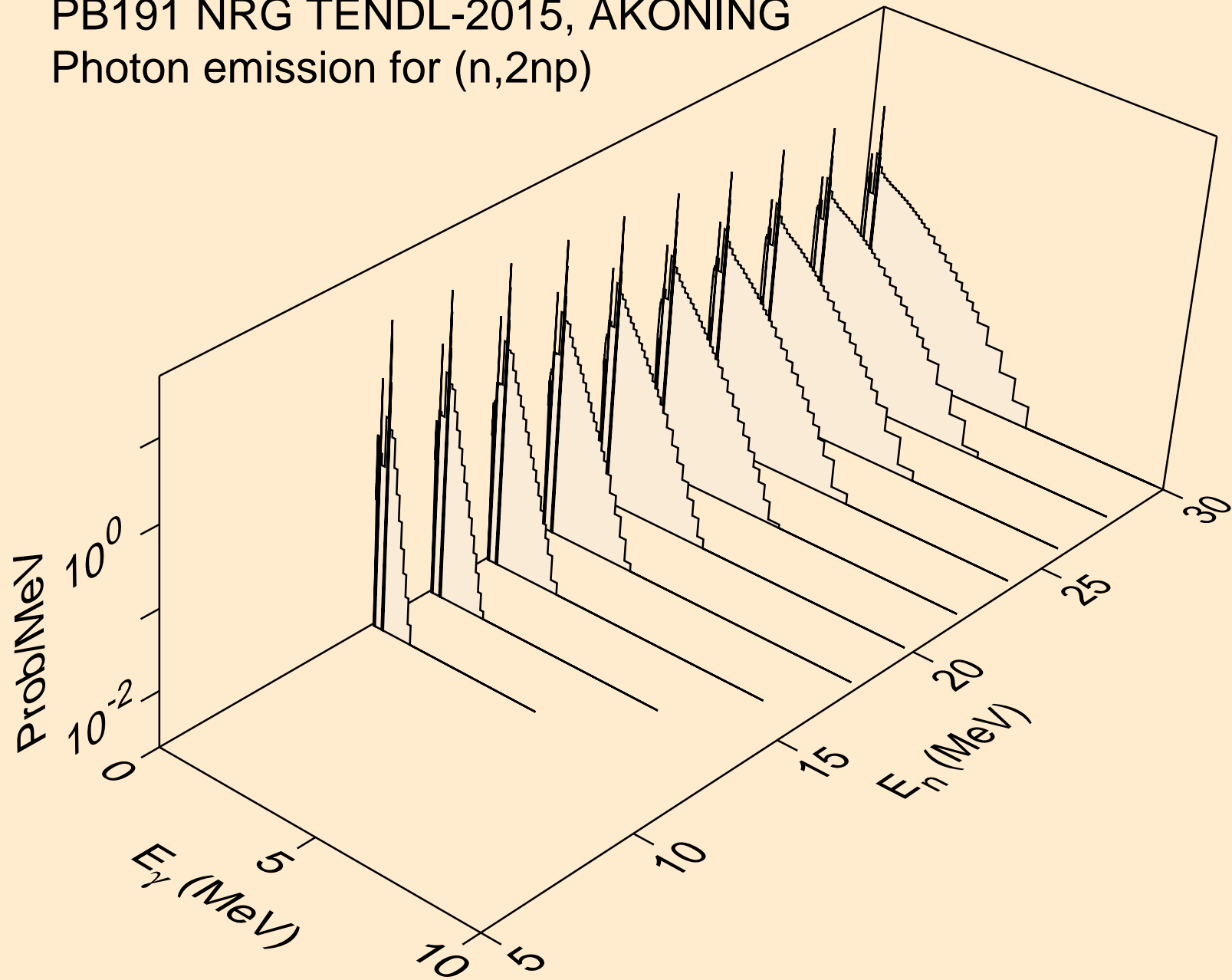

PB191 NRG TENDL-2015, AKONING  
Photon emission for (n,npa)

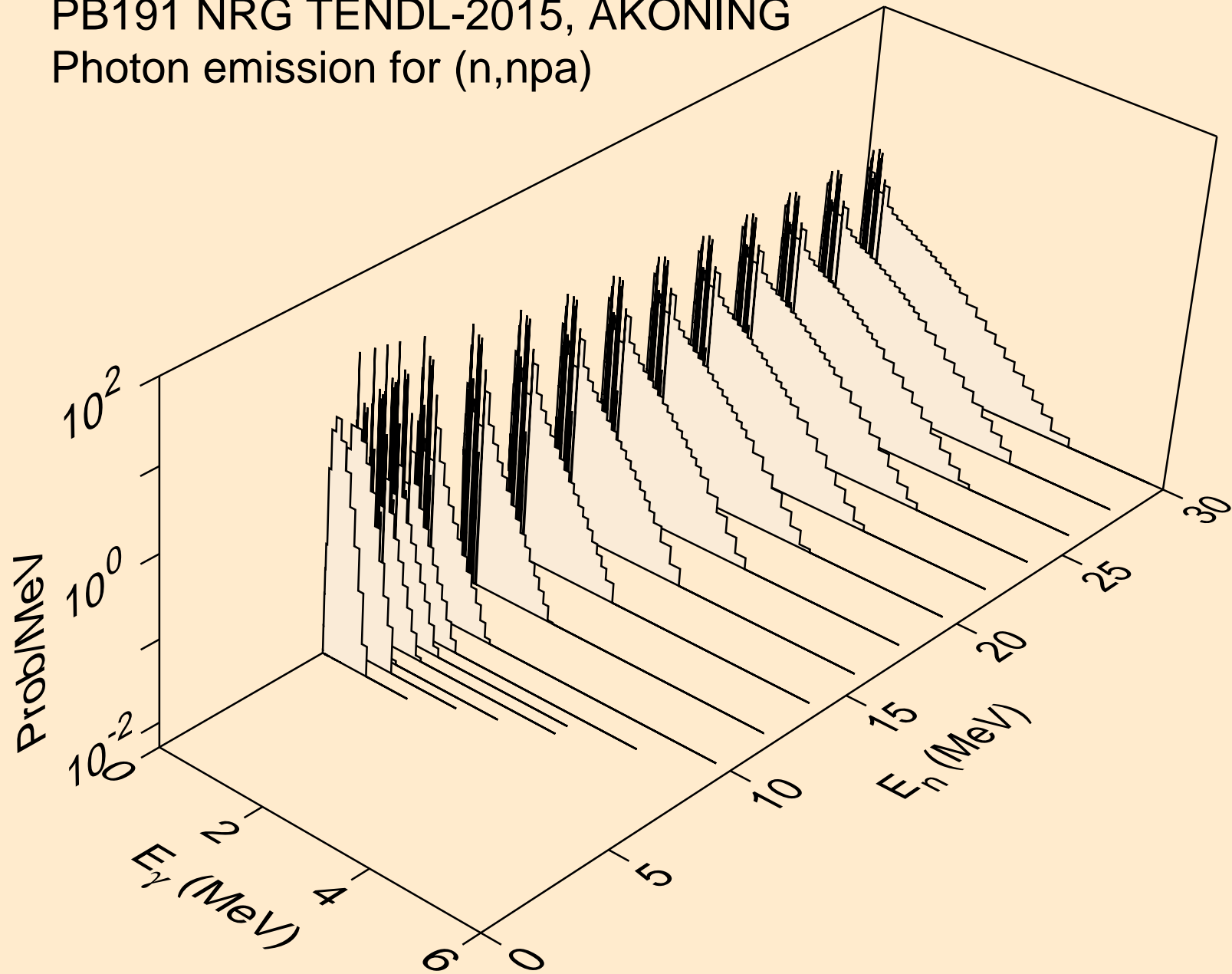

PB191 NRG TENDL-2015, AKONING  
Photon emission for (n,n\*c)

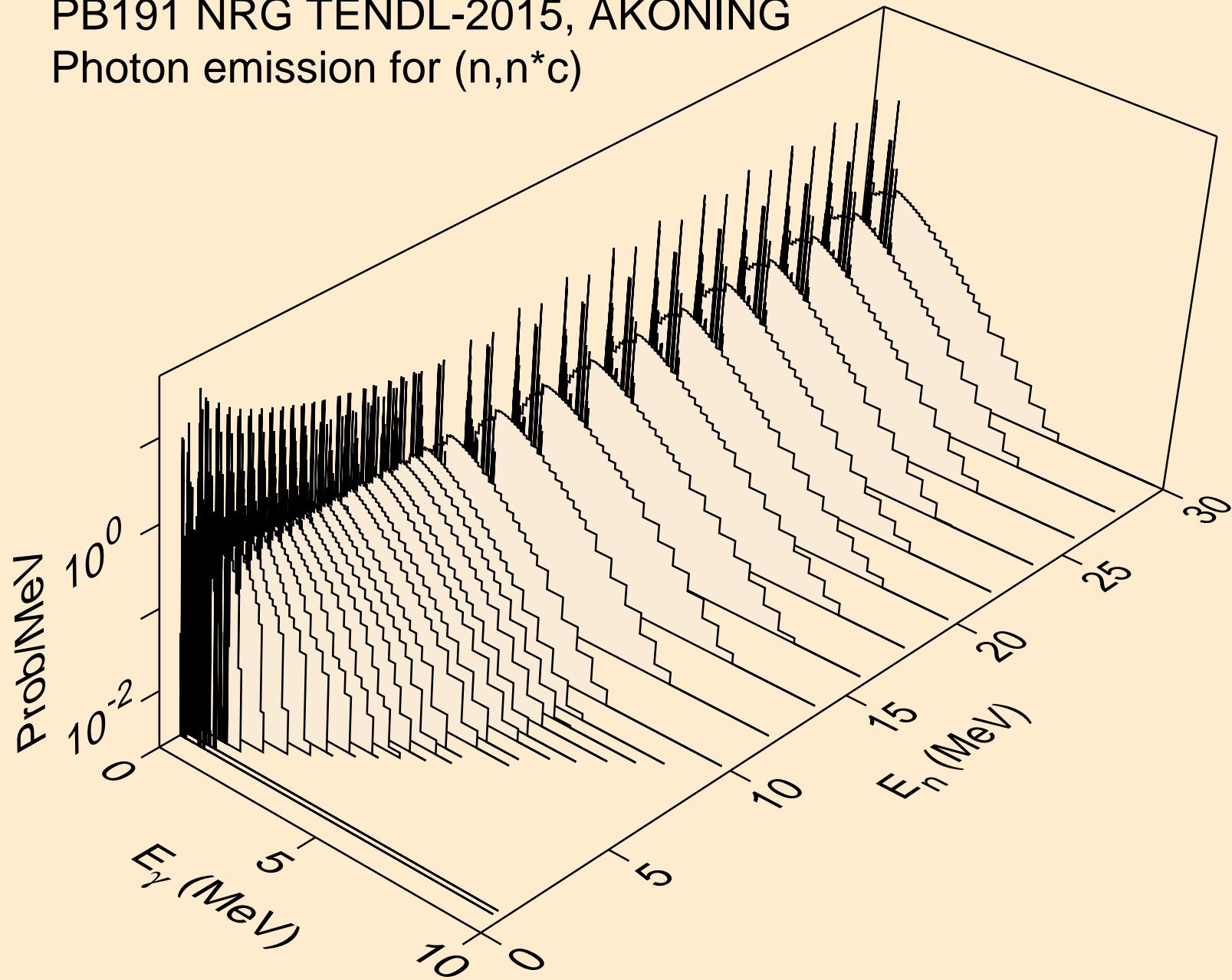

PB191 NRG TENDL-2015, AKONING  
Photon emission for (n,gma)

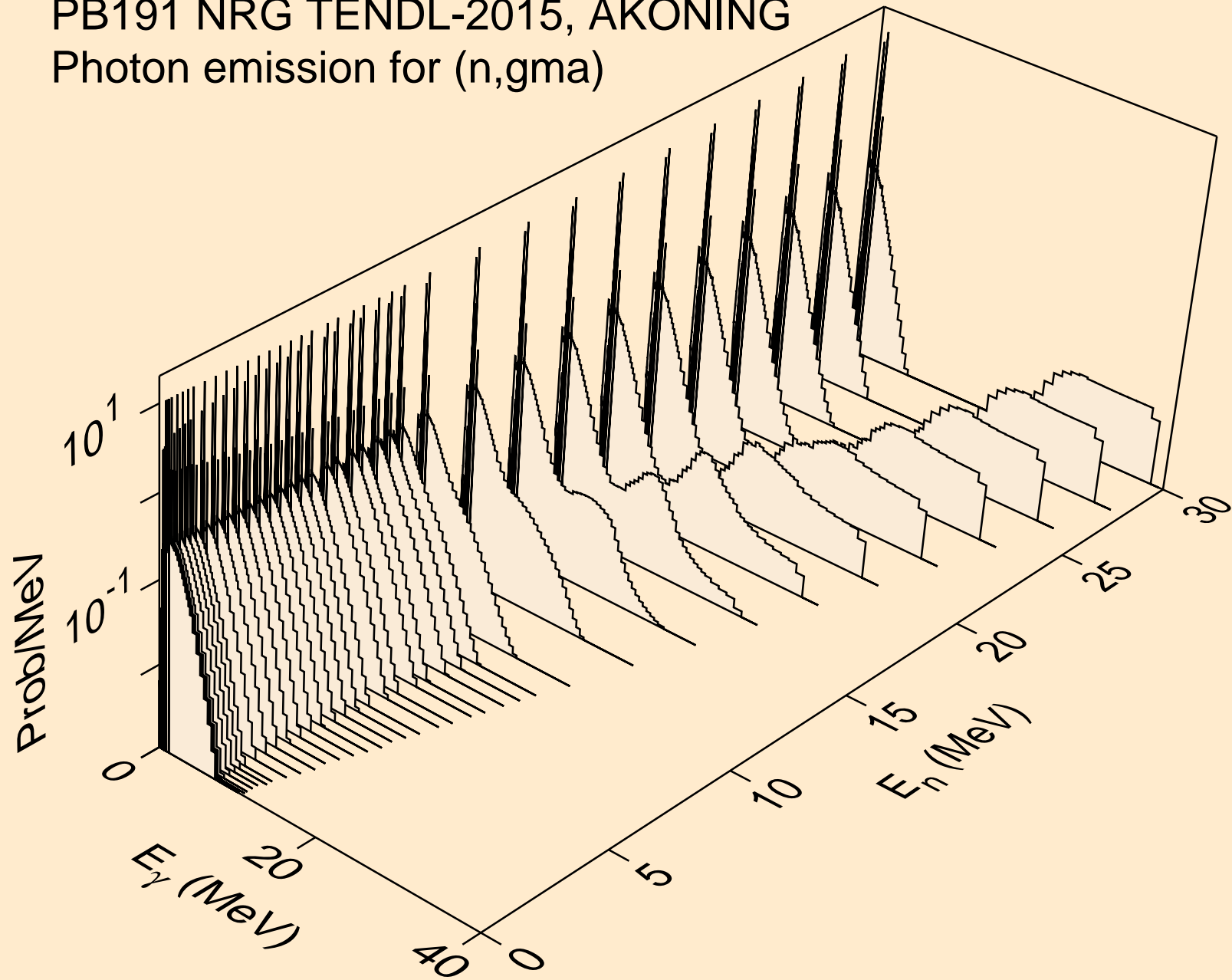

PB191 NRG TENDL-2015, AKONING  
Photon emission for (n,p)

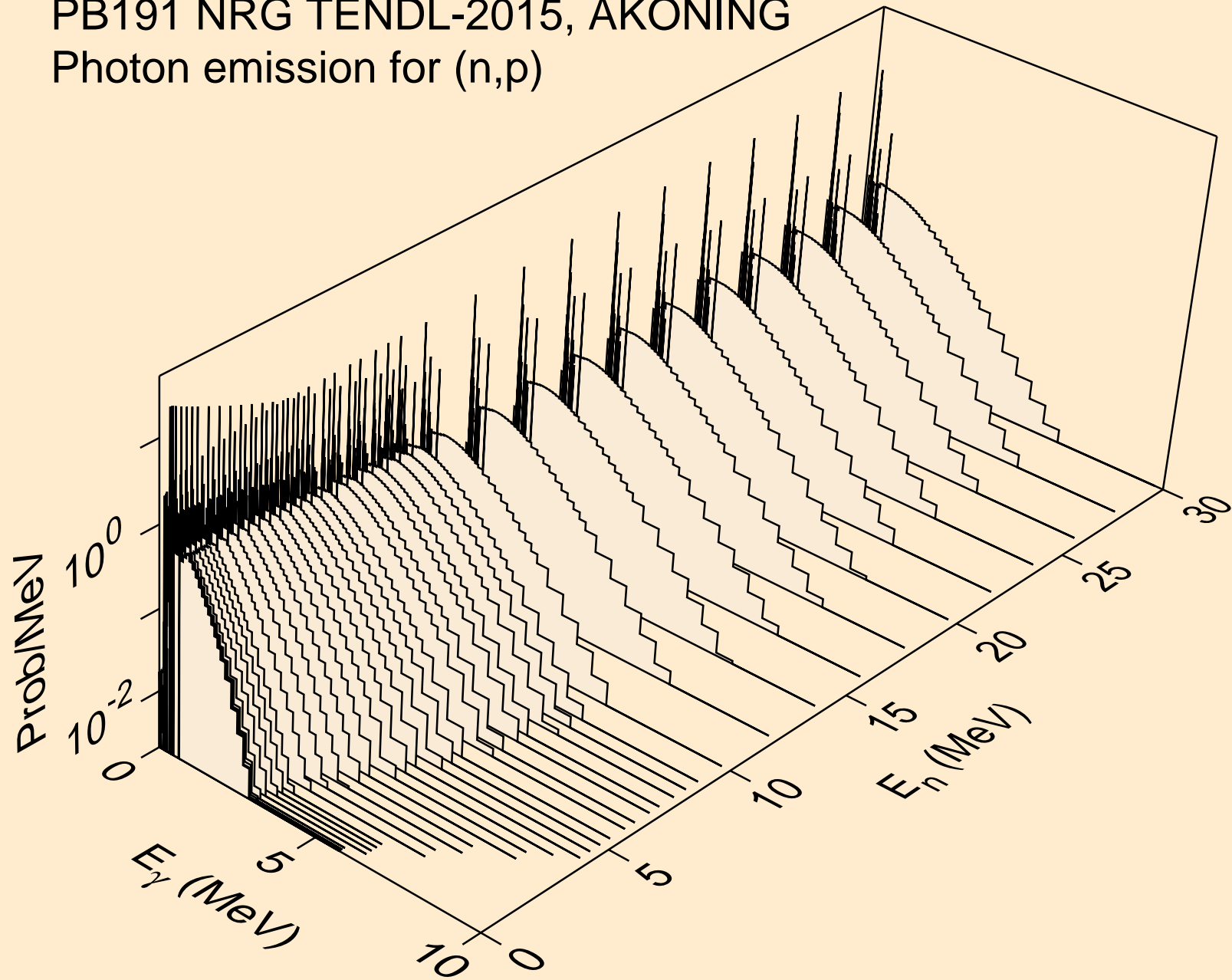

PB191 NRG TENDL-2015, AKONING  
Photon emission for (n,d)

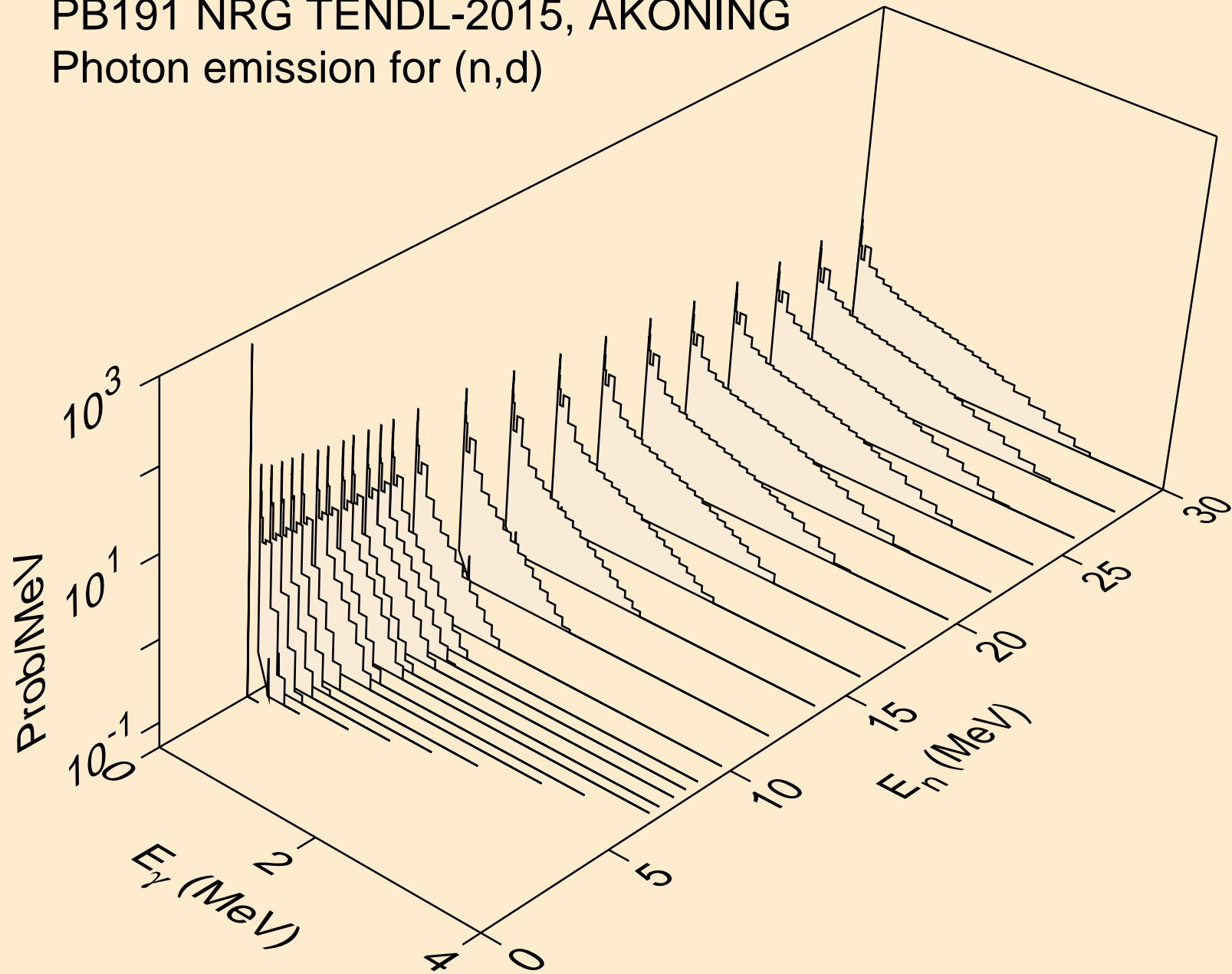

PB191 NRG TENDL-2015, AKONING  
Photon emission for (n,t)

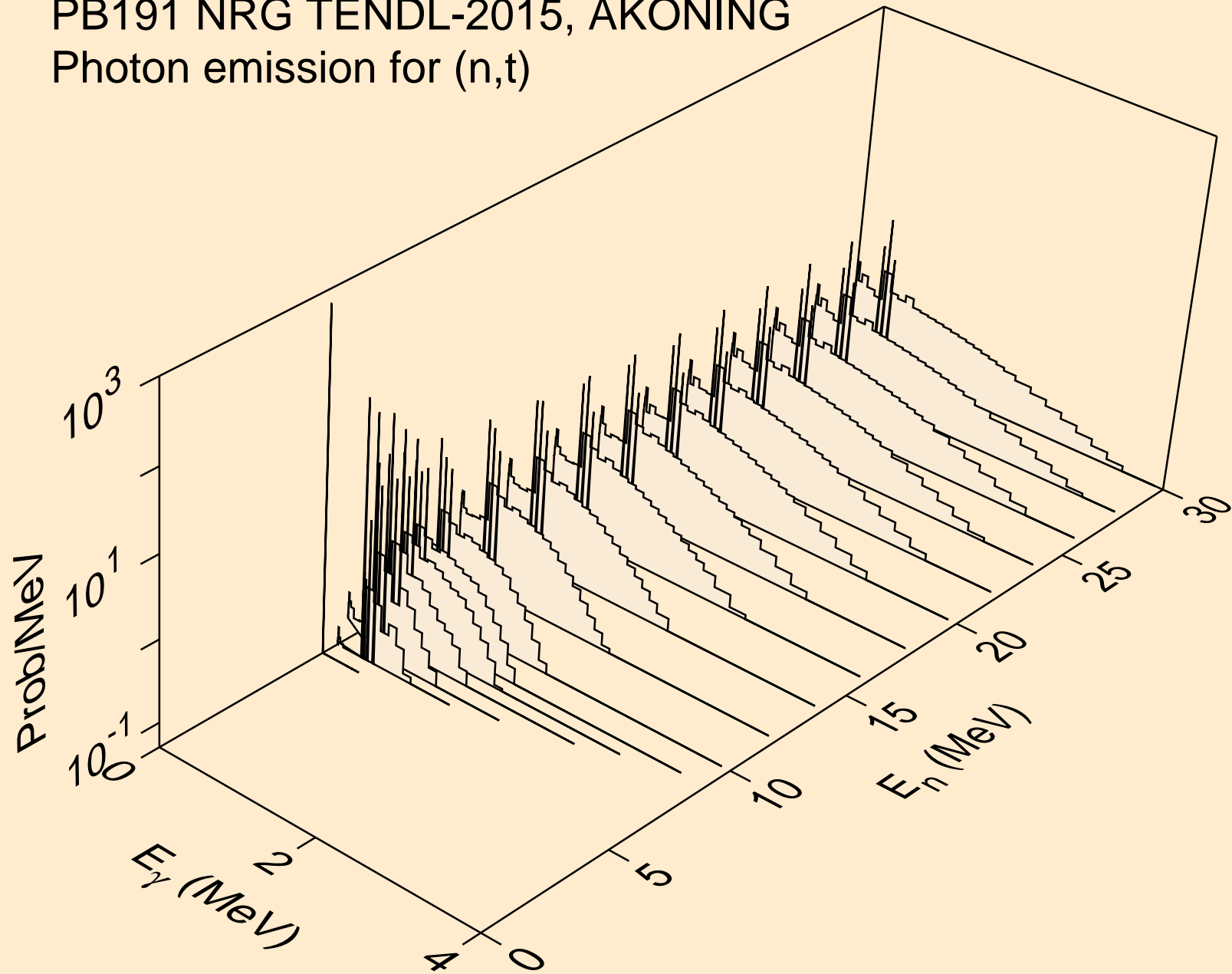



PB191 NRG TENDL-2015, AKONING  
Photon emission for (n,he3)

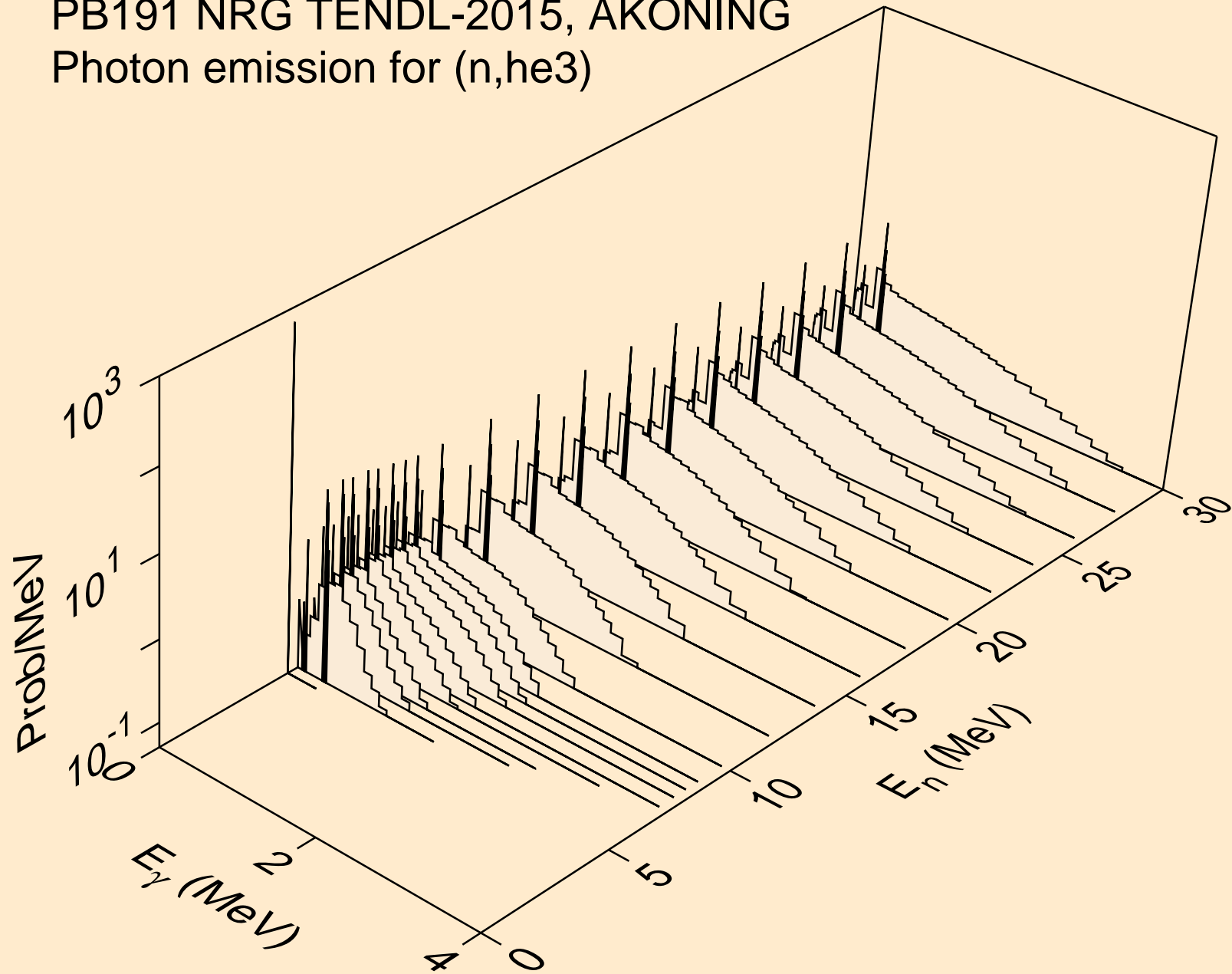

PB191 NRG TENDL-2015, AKONING  
Photon emission for (n,a)

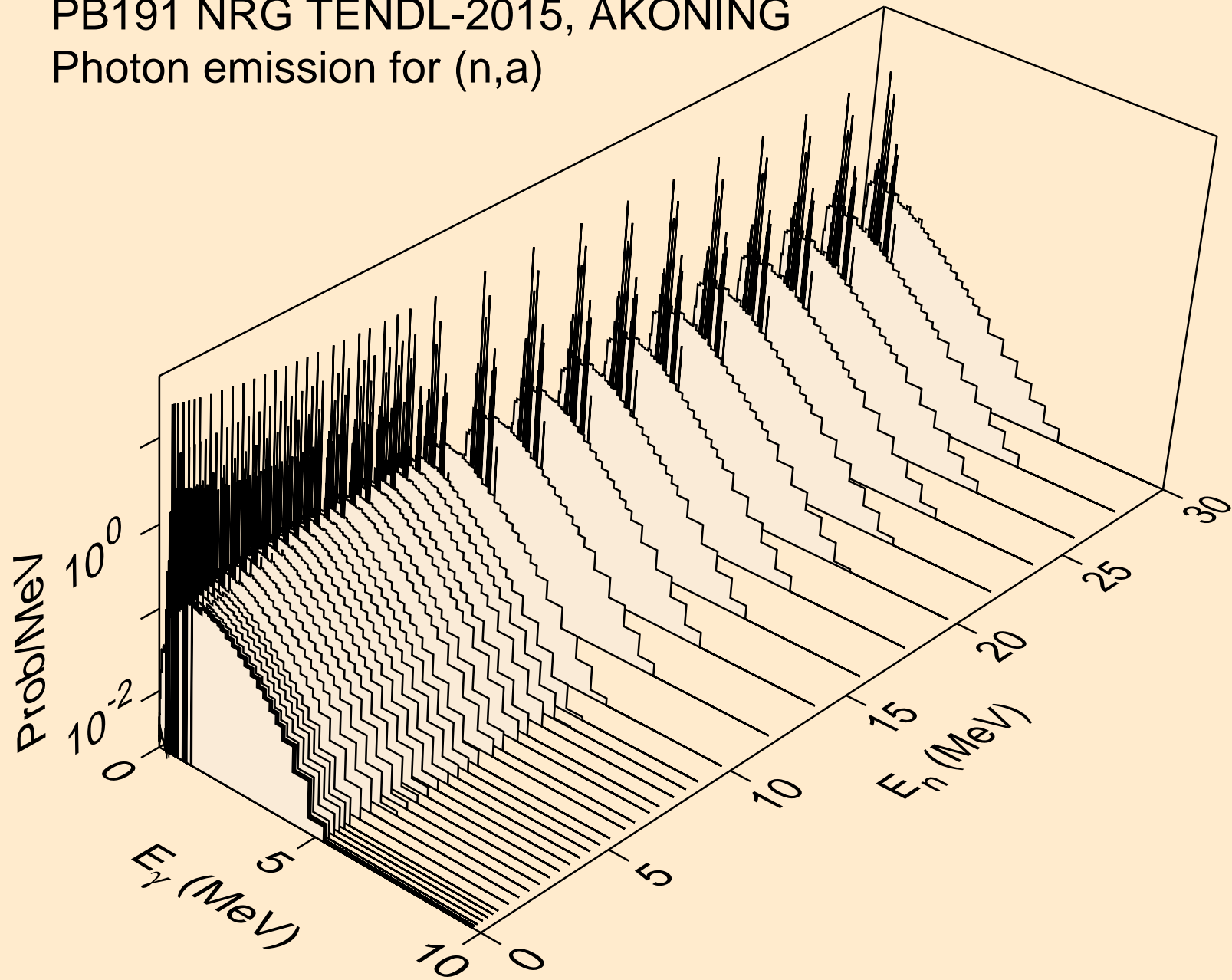

PB191 NRG TENDL-2015, AKONING  
Photon emission for (n,2a)

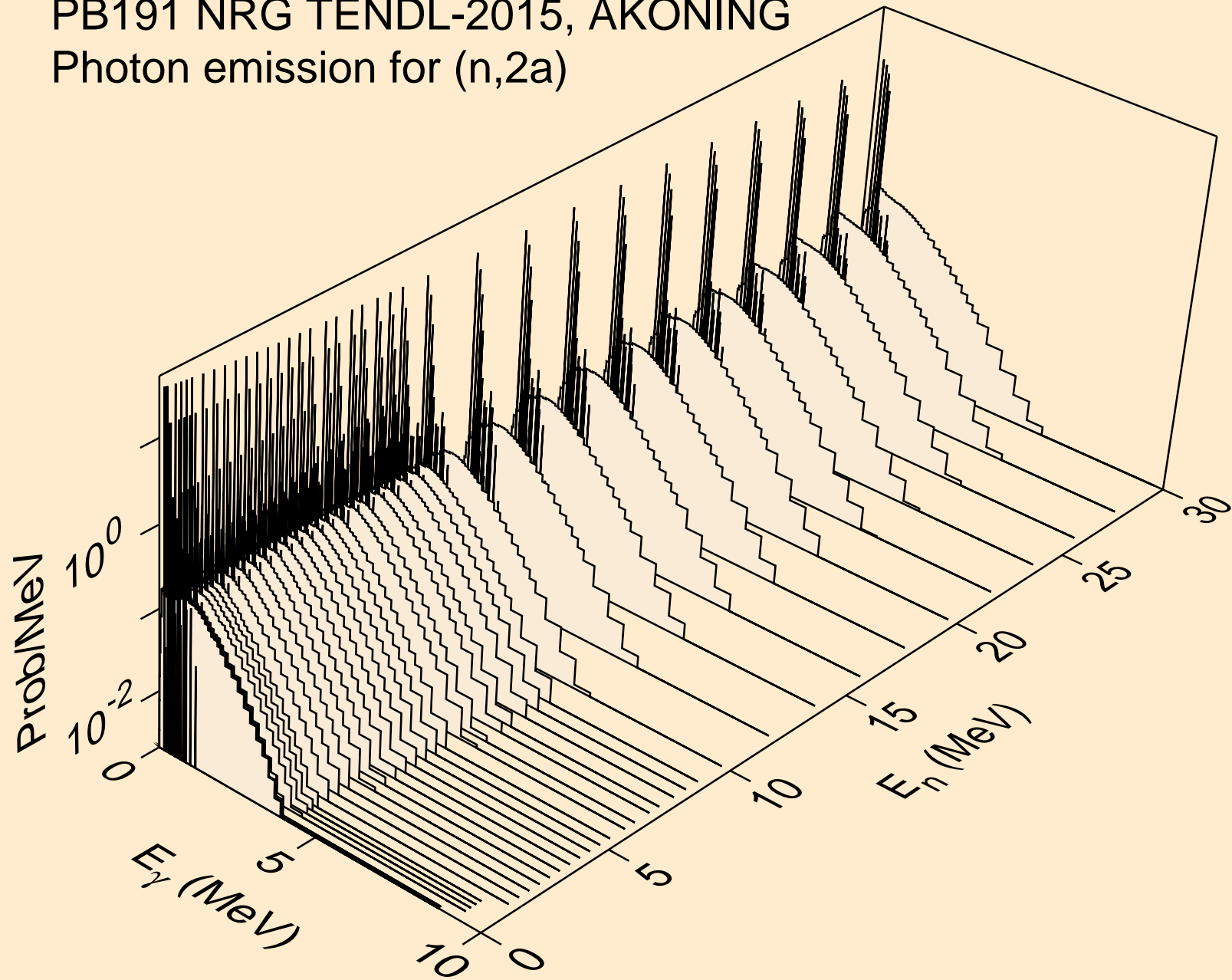

PB191 NRG TENDL-2015, AKONING  
Photon emission for (n,3a)

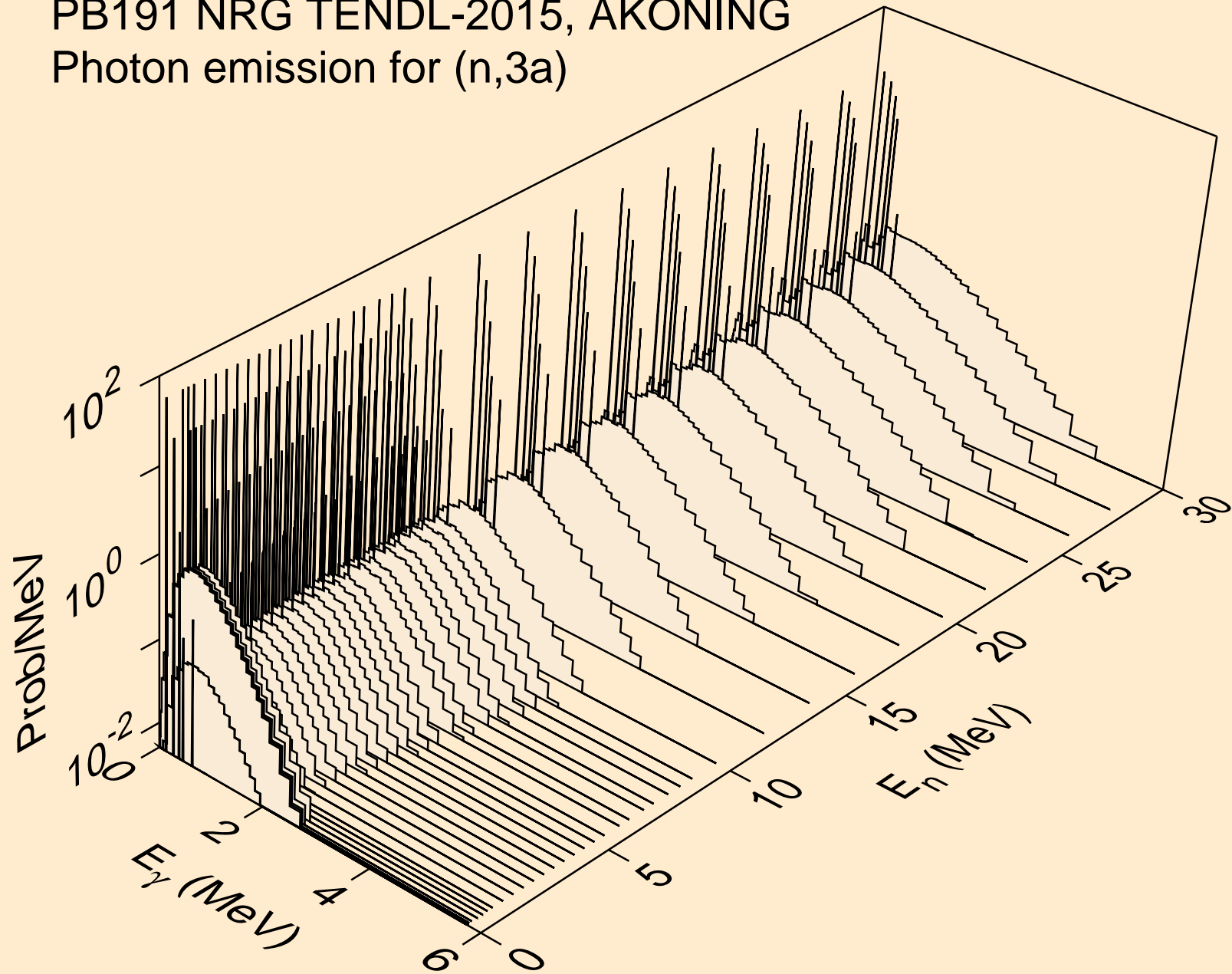

PB191 NRG TENDL-2015, AKONING  
Photon emission for (n,2p)

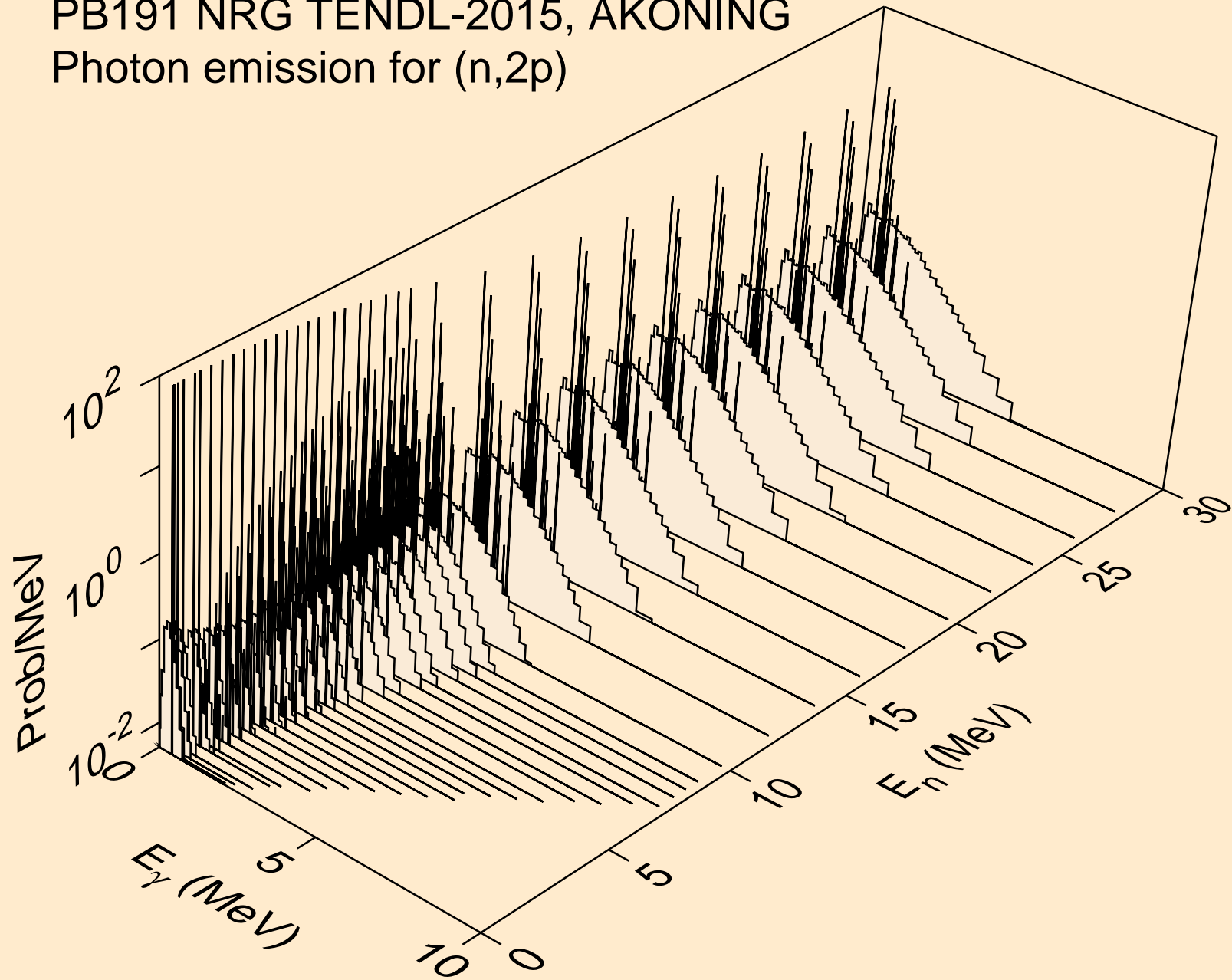

PB191 NRG TENDL-2015, AKONING  
Photon emission for (n,p $\alpha$ )

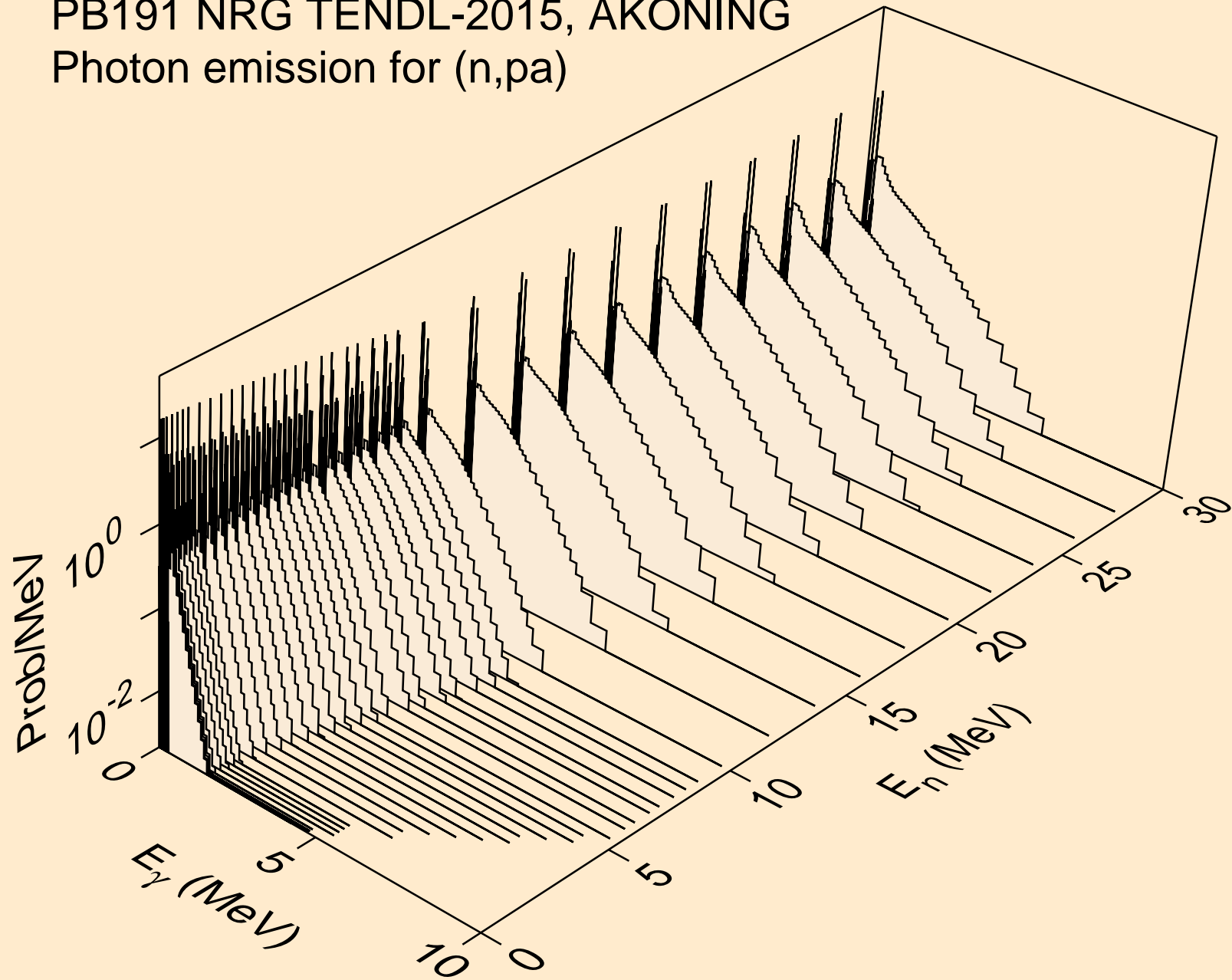

PB191 NRG TENDL-2015, AKONING  
Photon emission for (n,t2a)

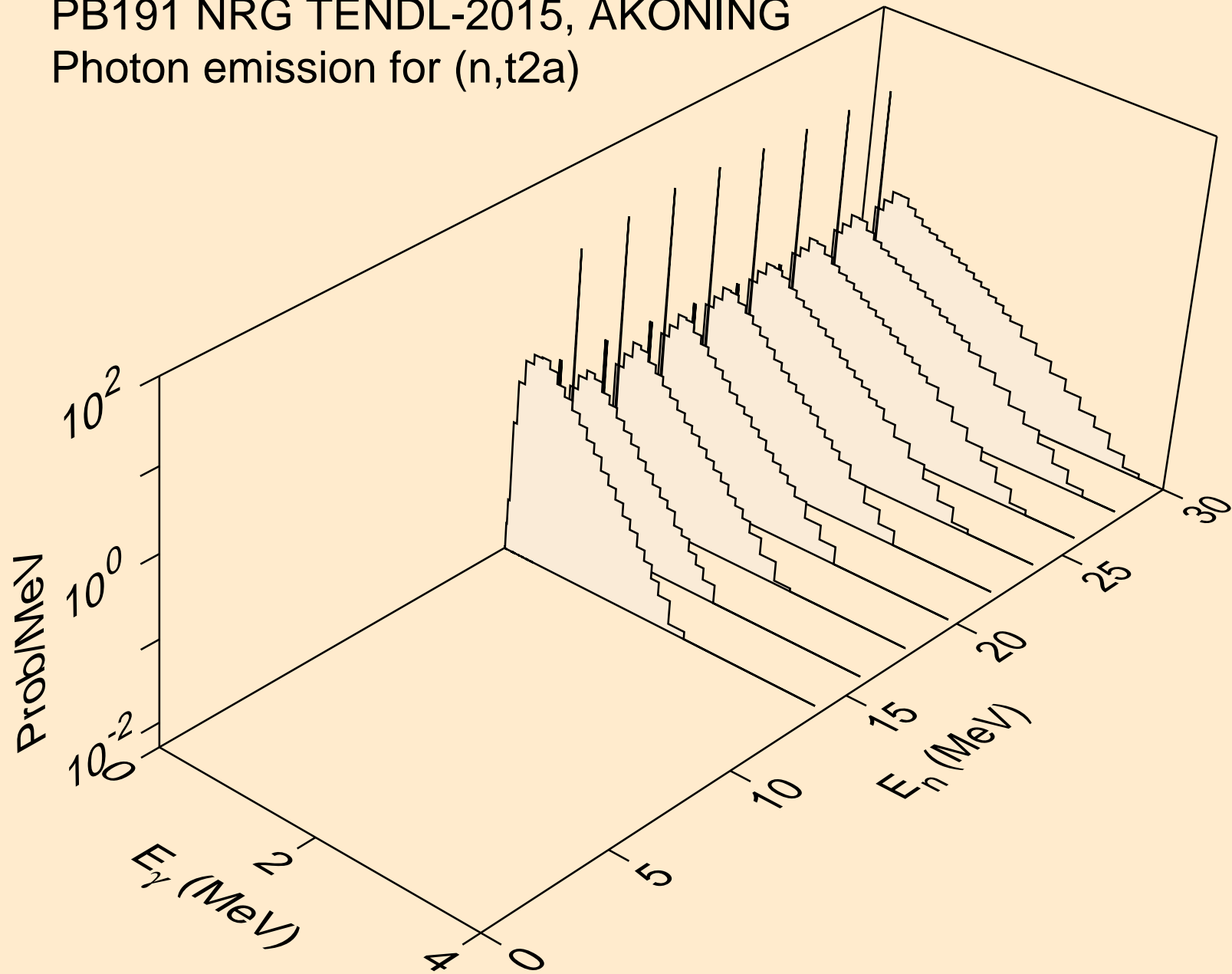

PB191 NRG TENDL-2015, AKONING  
Photon emission for (n,d2a)

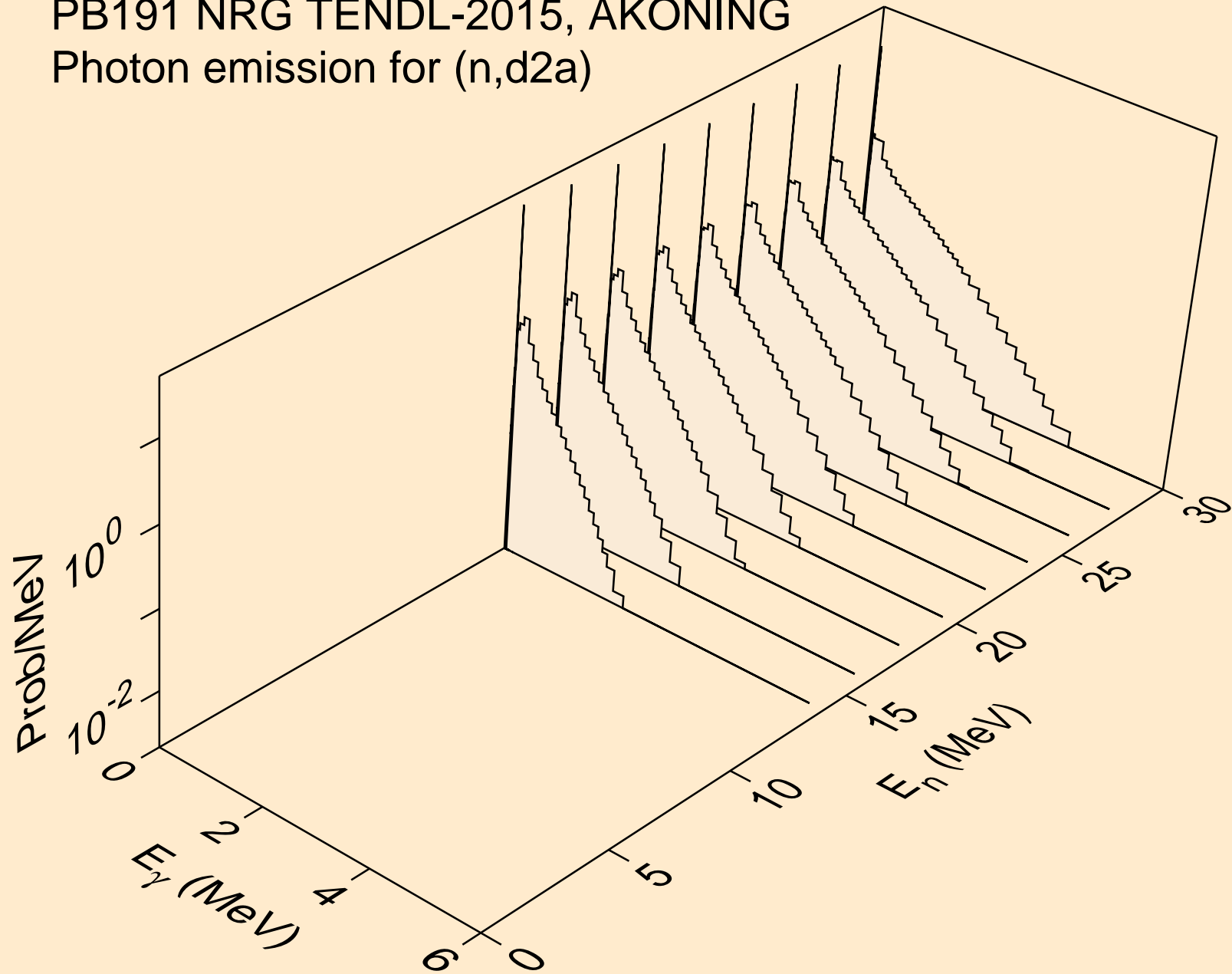



PB191 NRG TENDL-2015, AKONING  
Photon emission for (n,pd)

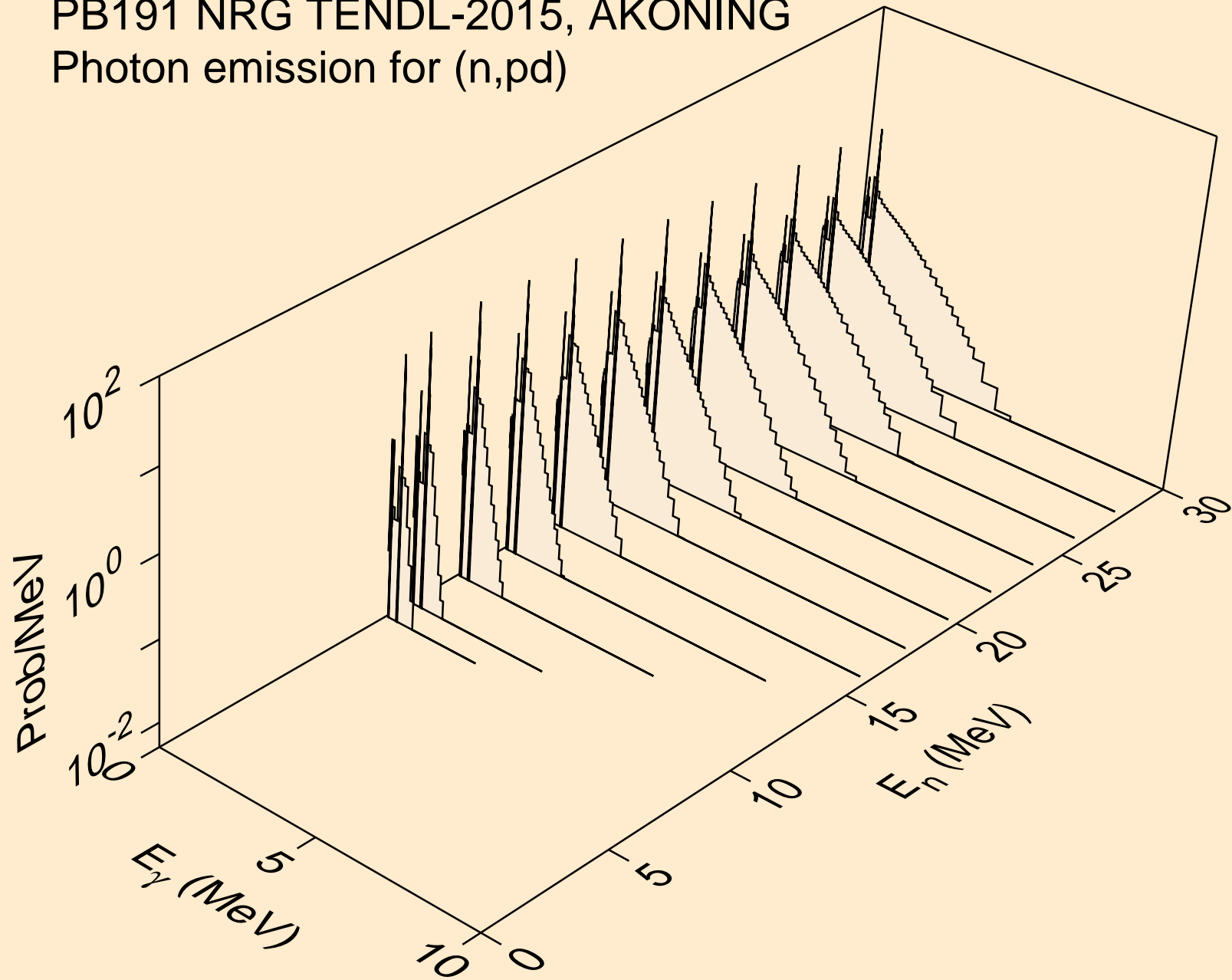

PB191 NRG TENDL-2015, AKONING  
Photon emission for (n,pt)

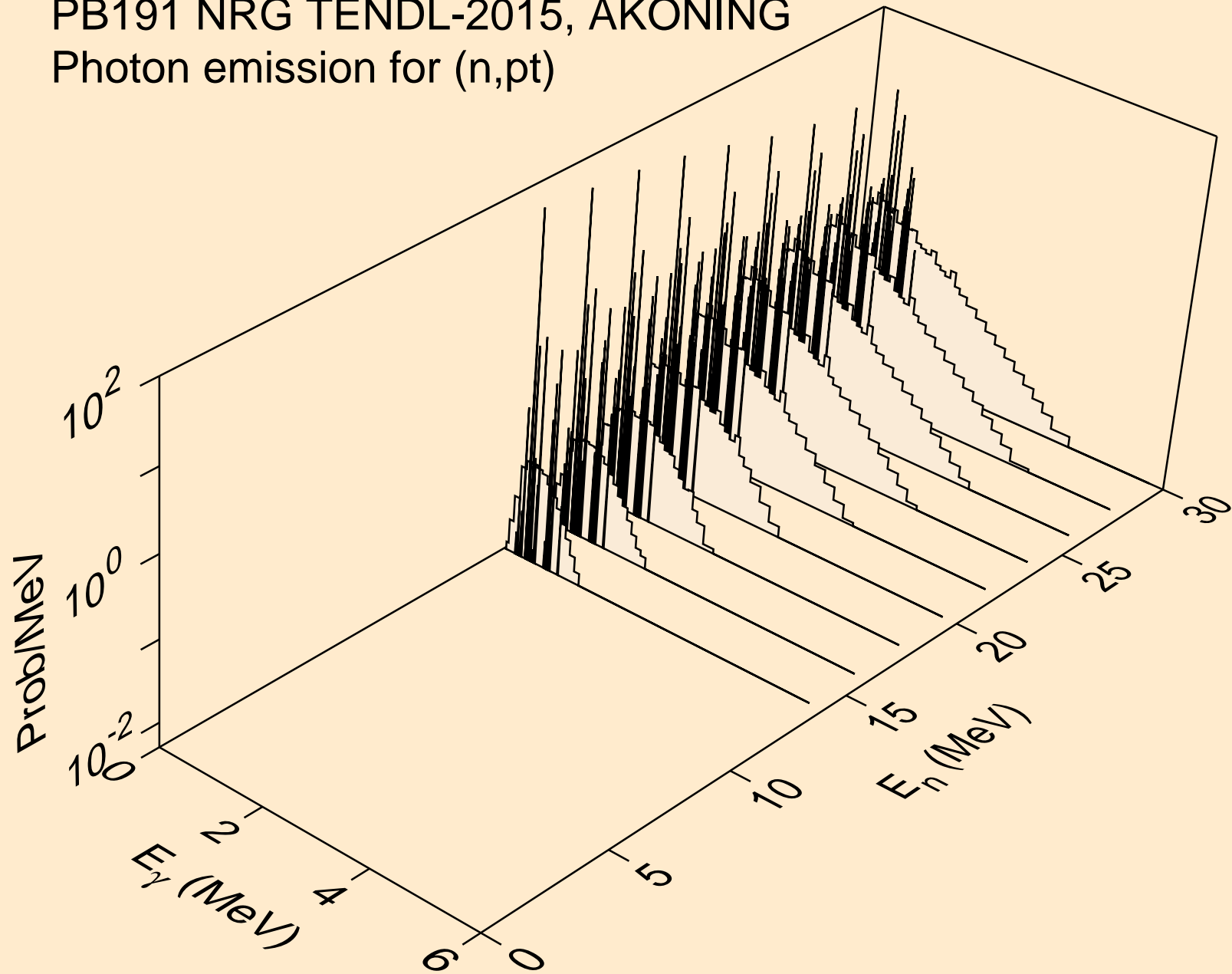

PB191 NRG TENDL-2015, AKONING  
Photon emission for (n,da)

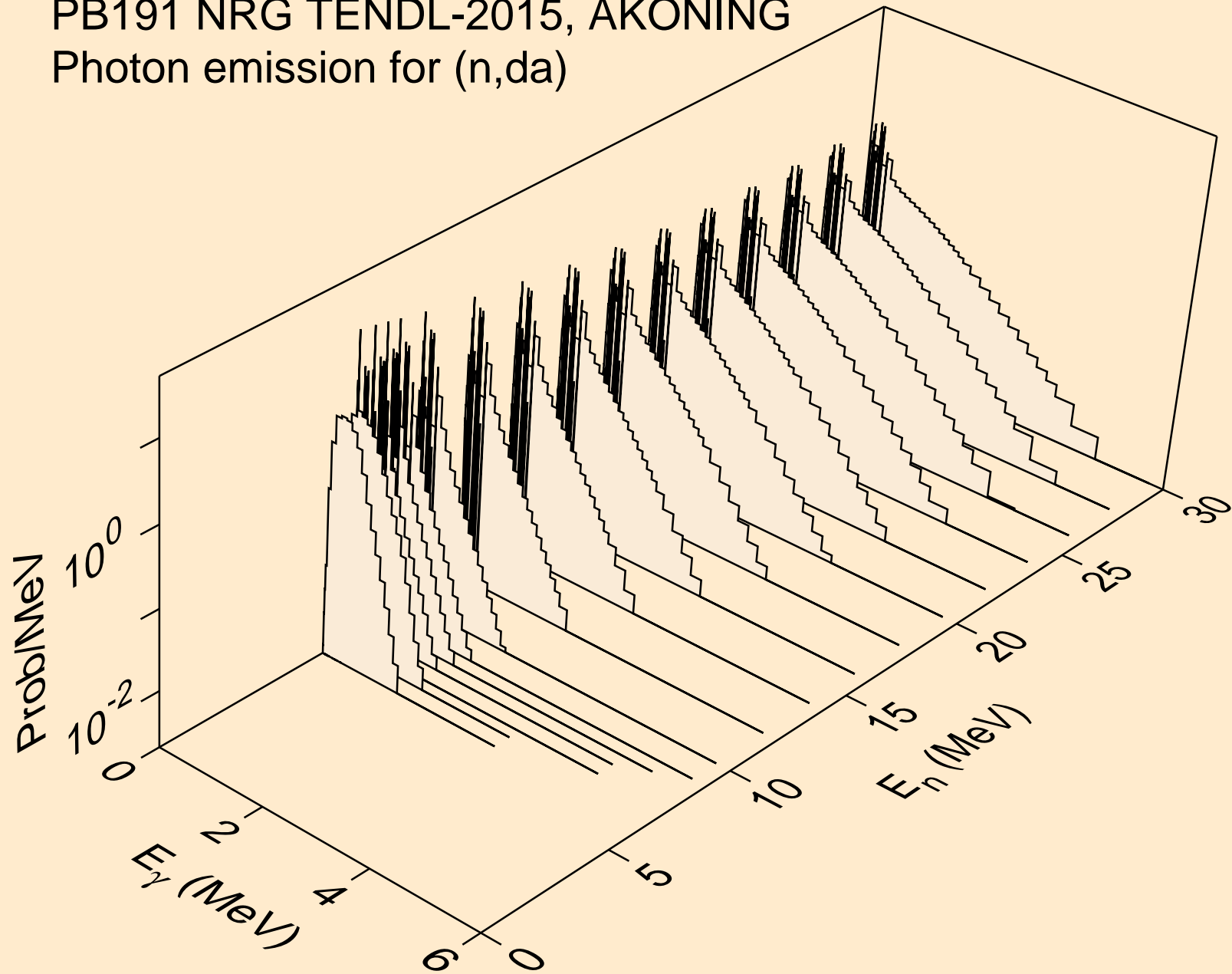

PB191 NRG TENDL-2015, AKONING  
thermal capture photon spectrum

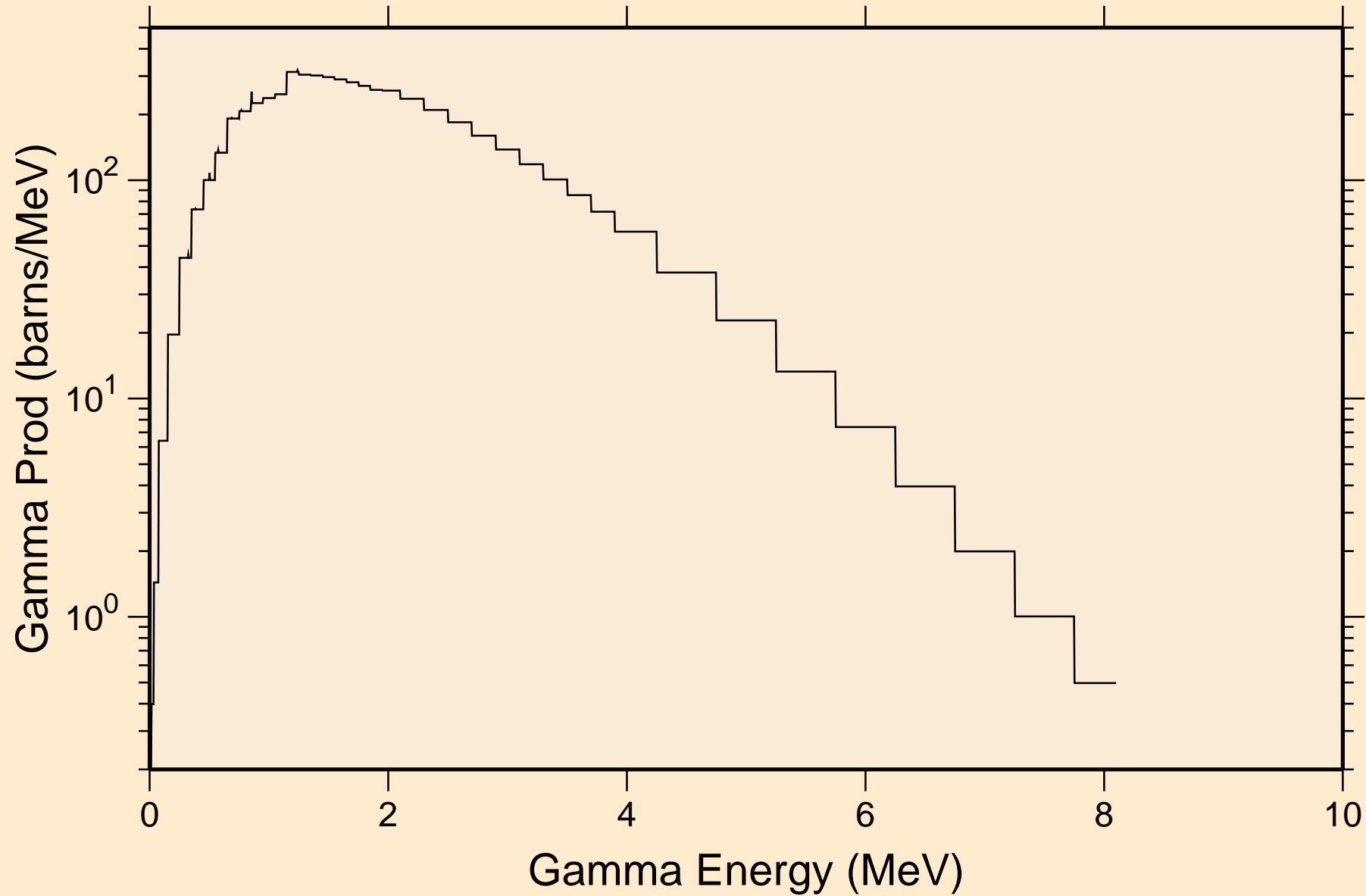

PB191 NRG TENDL-2015, AKONING  
14 MeV photon spectrum

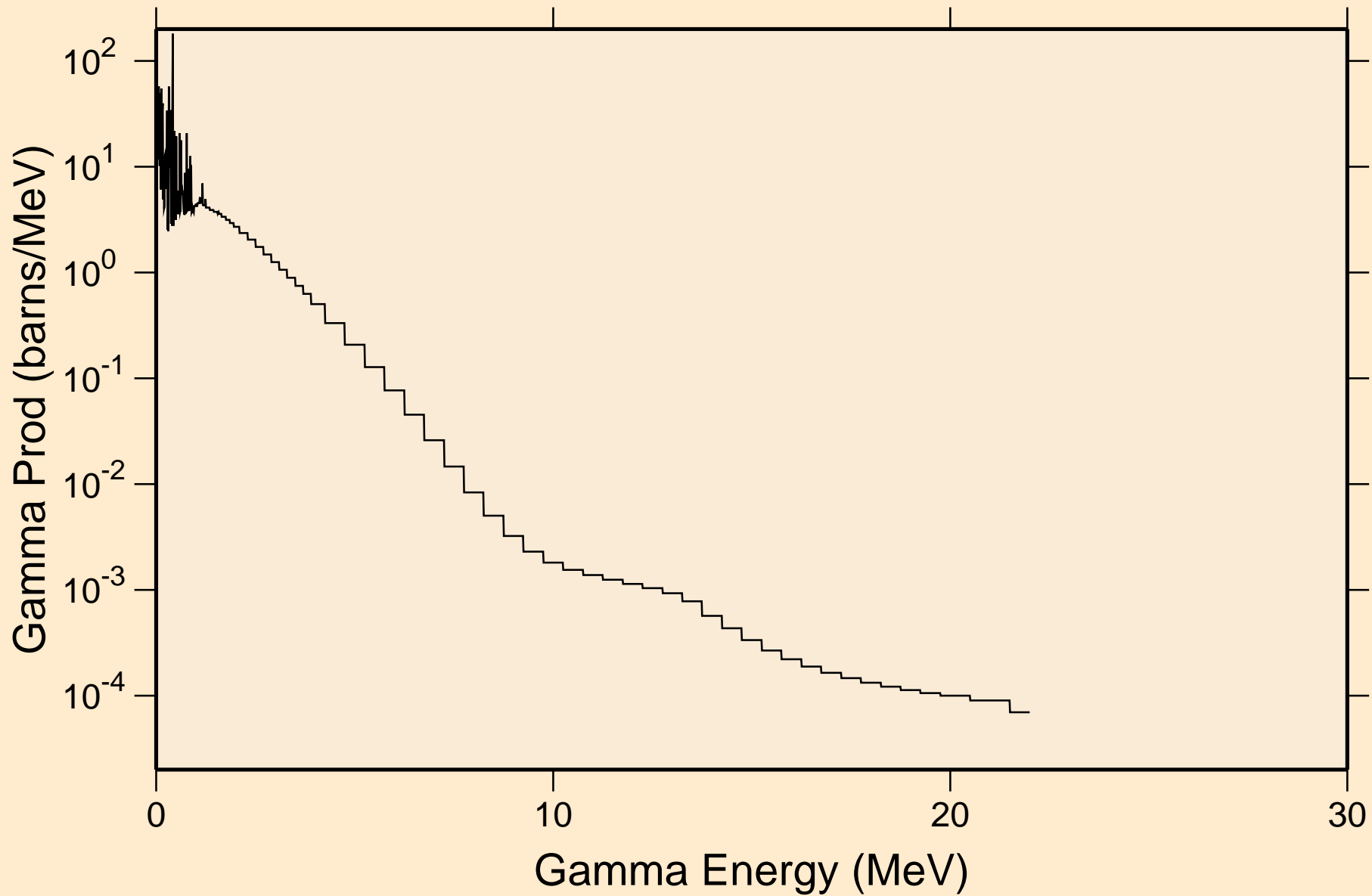

# PB191 NRG TENDL-2015, AKONING

## Particle heating contributions

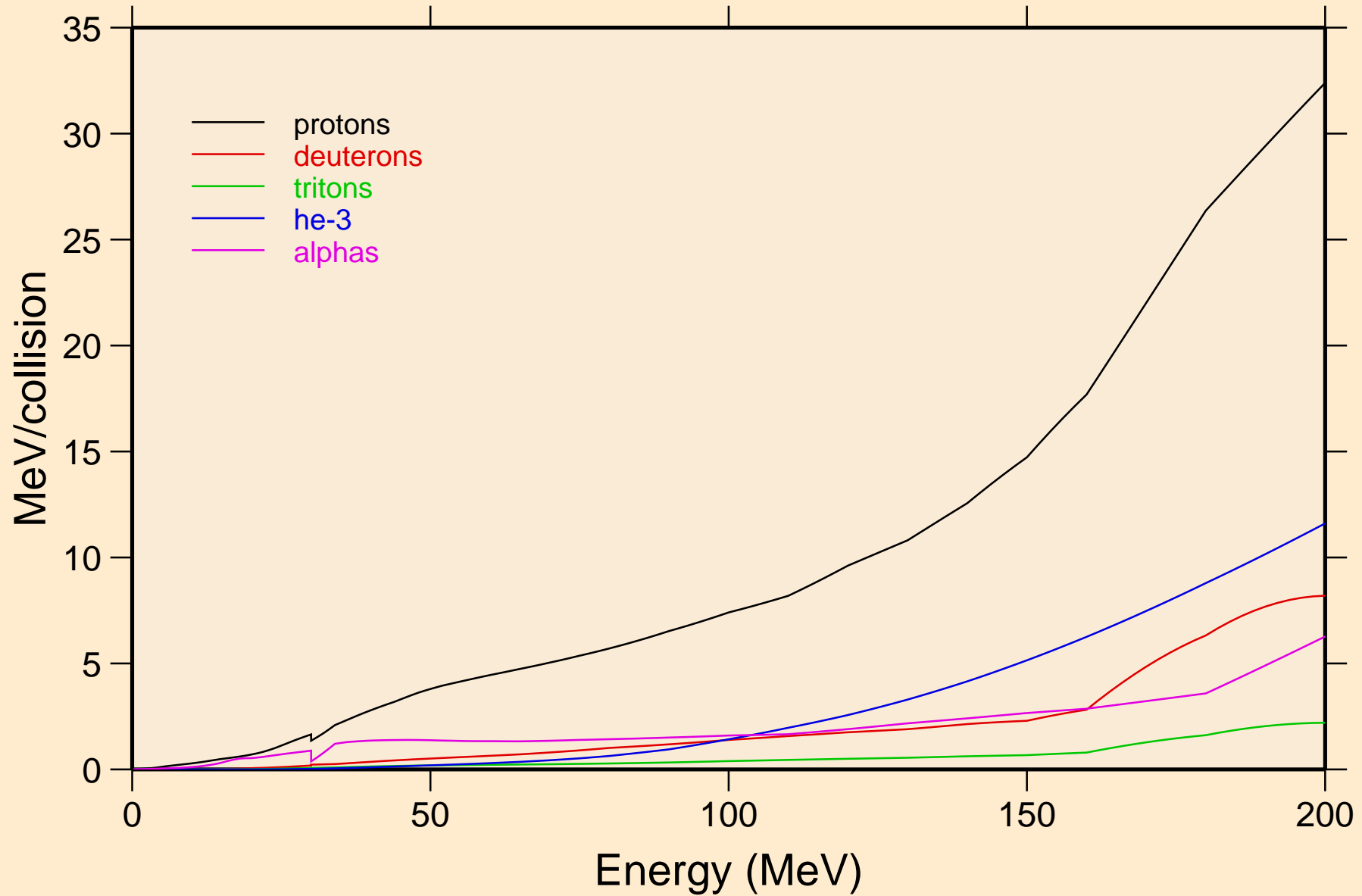

# PB191 NRG TENDL-2015, AKONING

## Recoil Heating

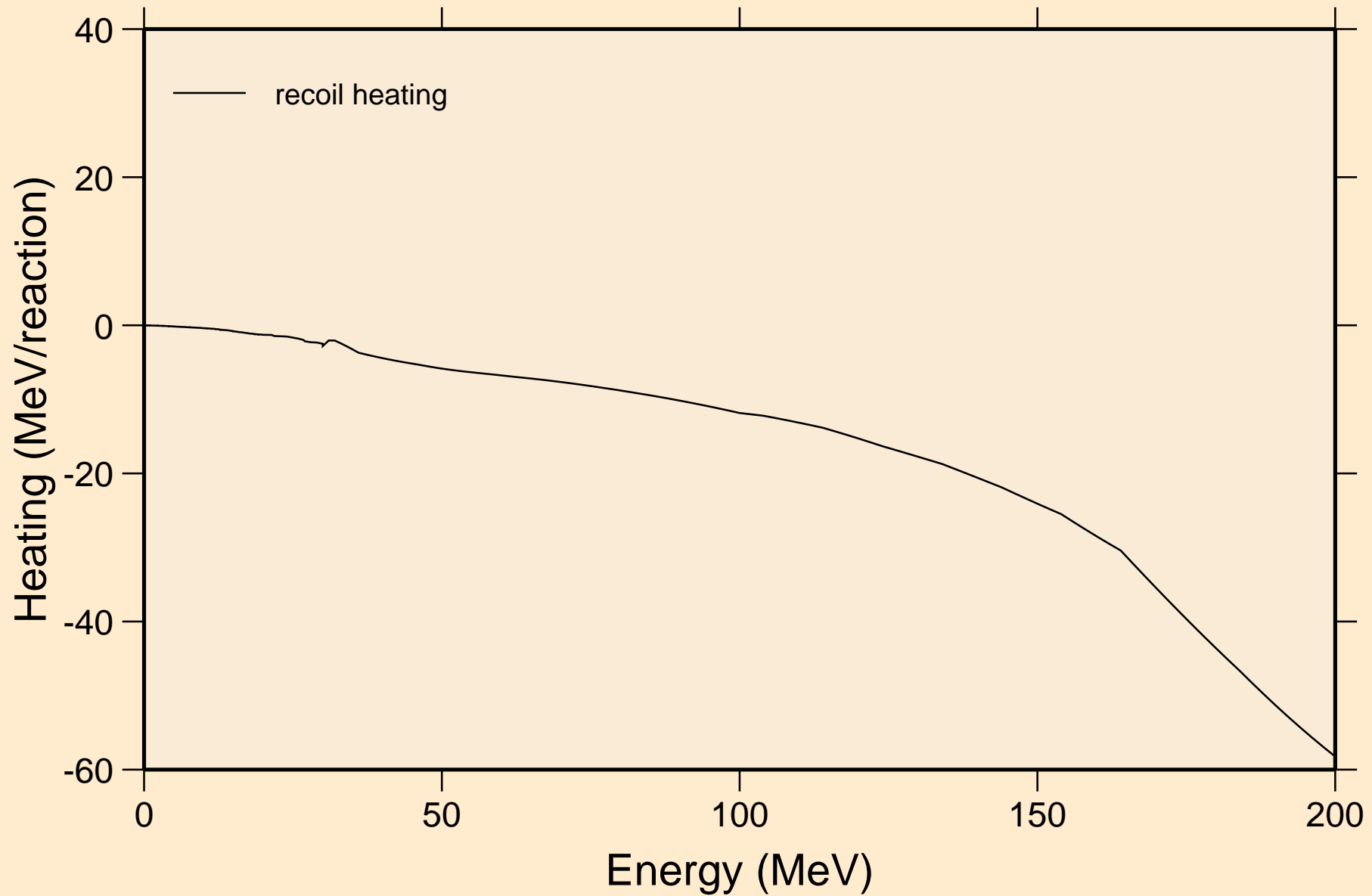

PB191 NRG TENDL-2015, AKONING  
Particle production cross sections

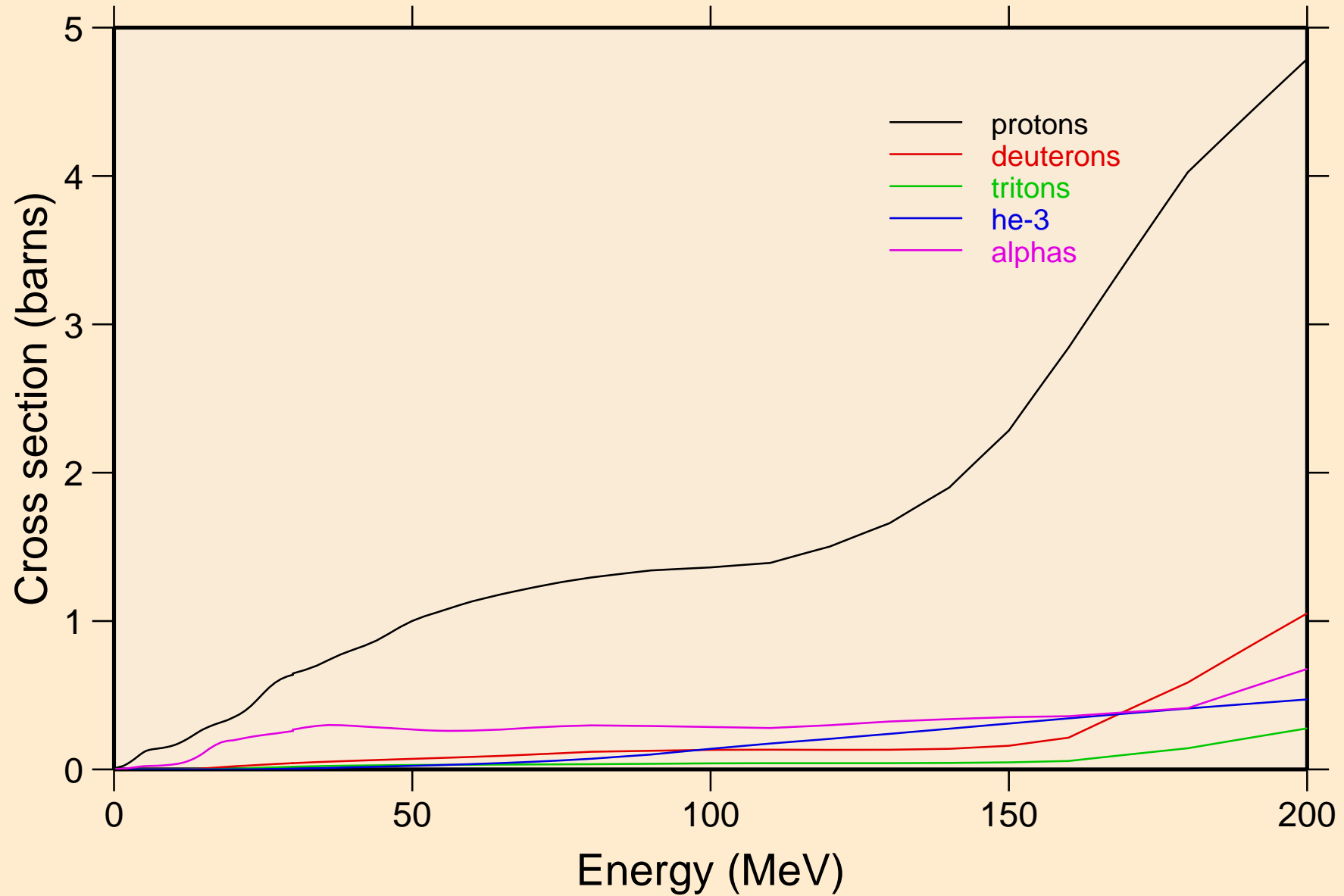



PB191 NRG TENDL-2015, AKONING  
protons from (n,x)

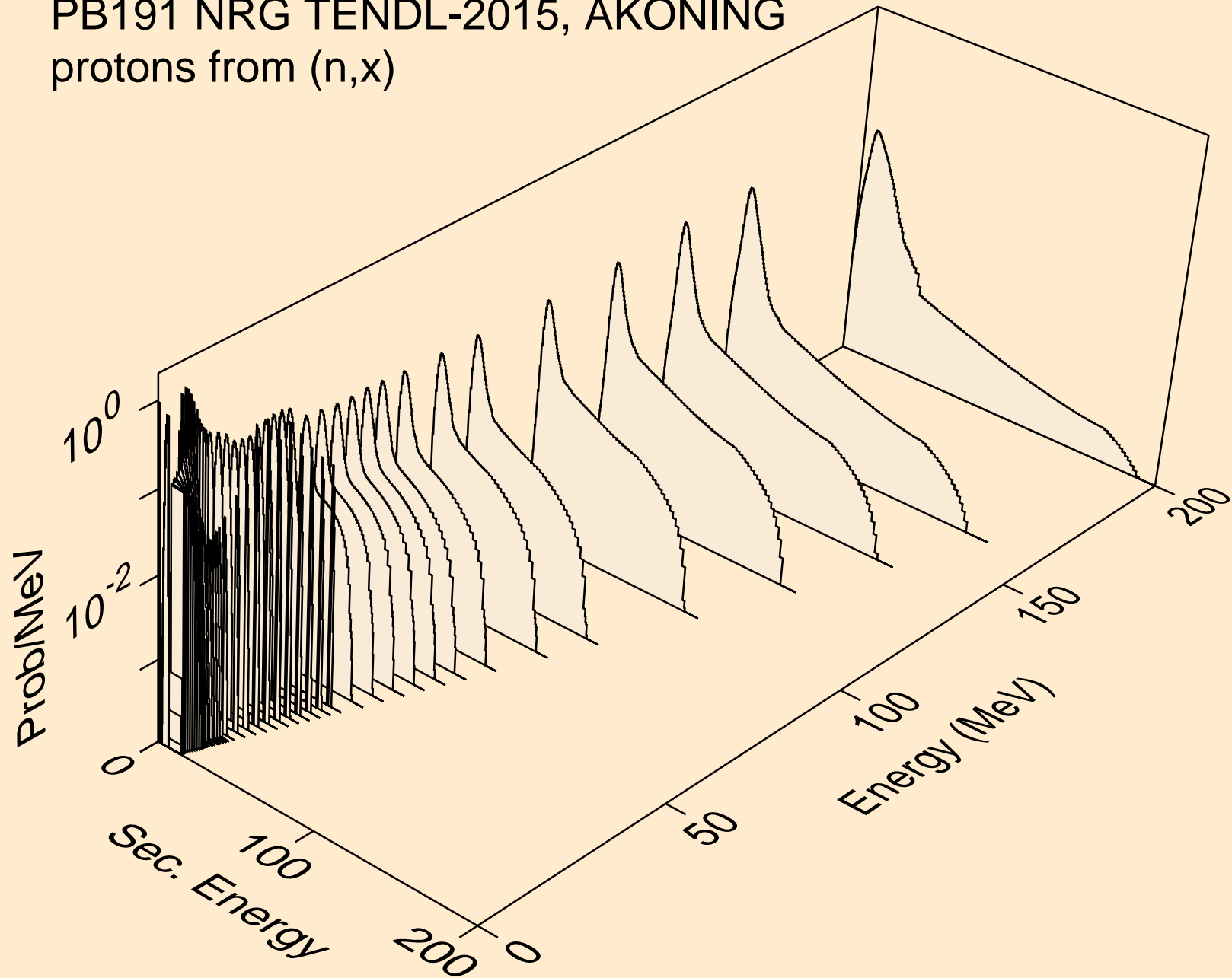

PB191 NRG TENDL-2015, AKONING  
protons from (n,n\*)p

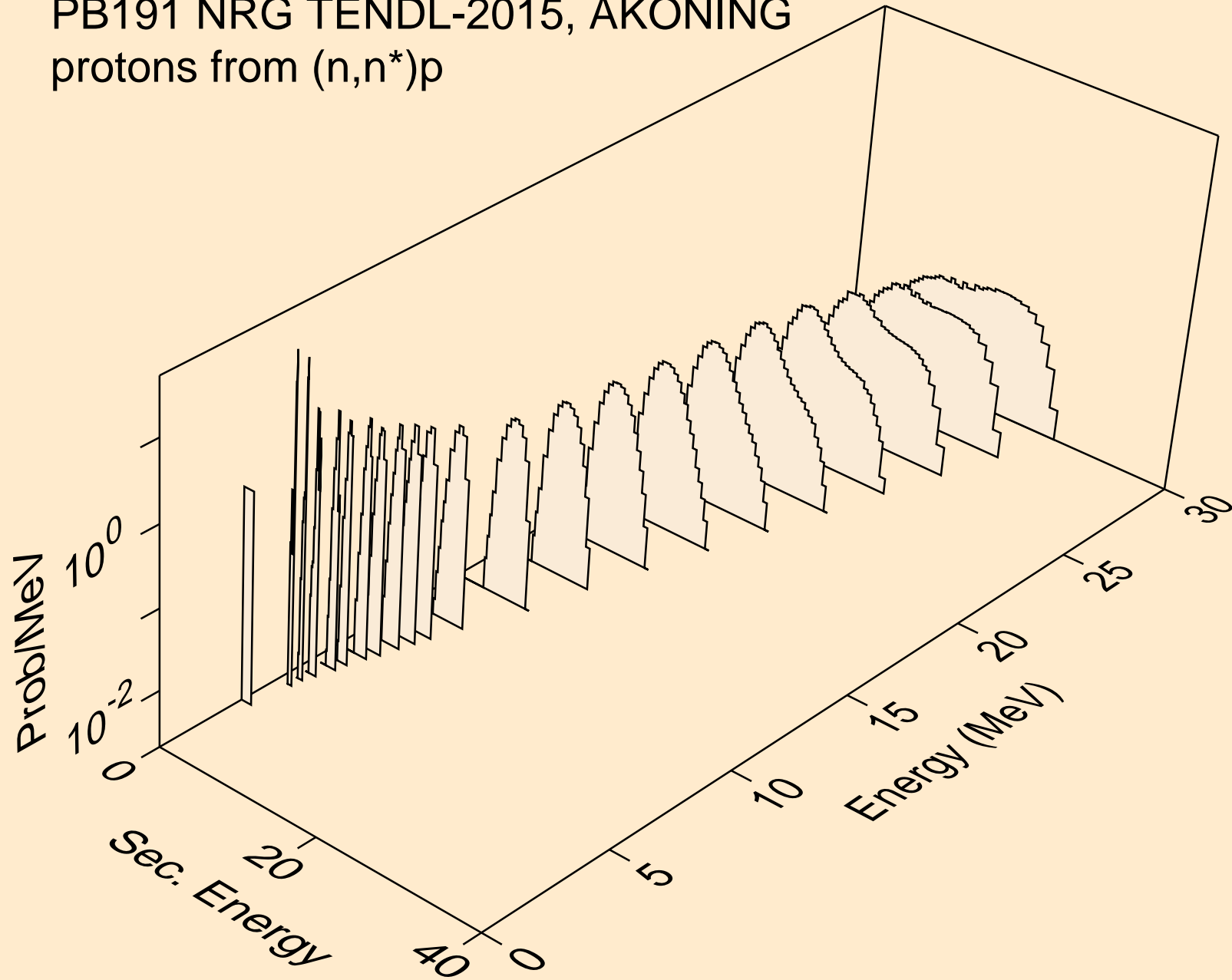

PB191 NRG TENDL-2015, AKONING  
protons from (n,2np)

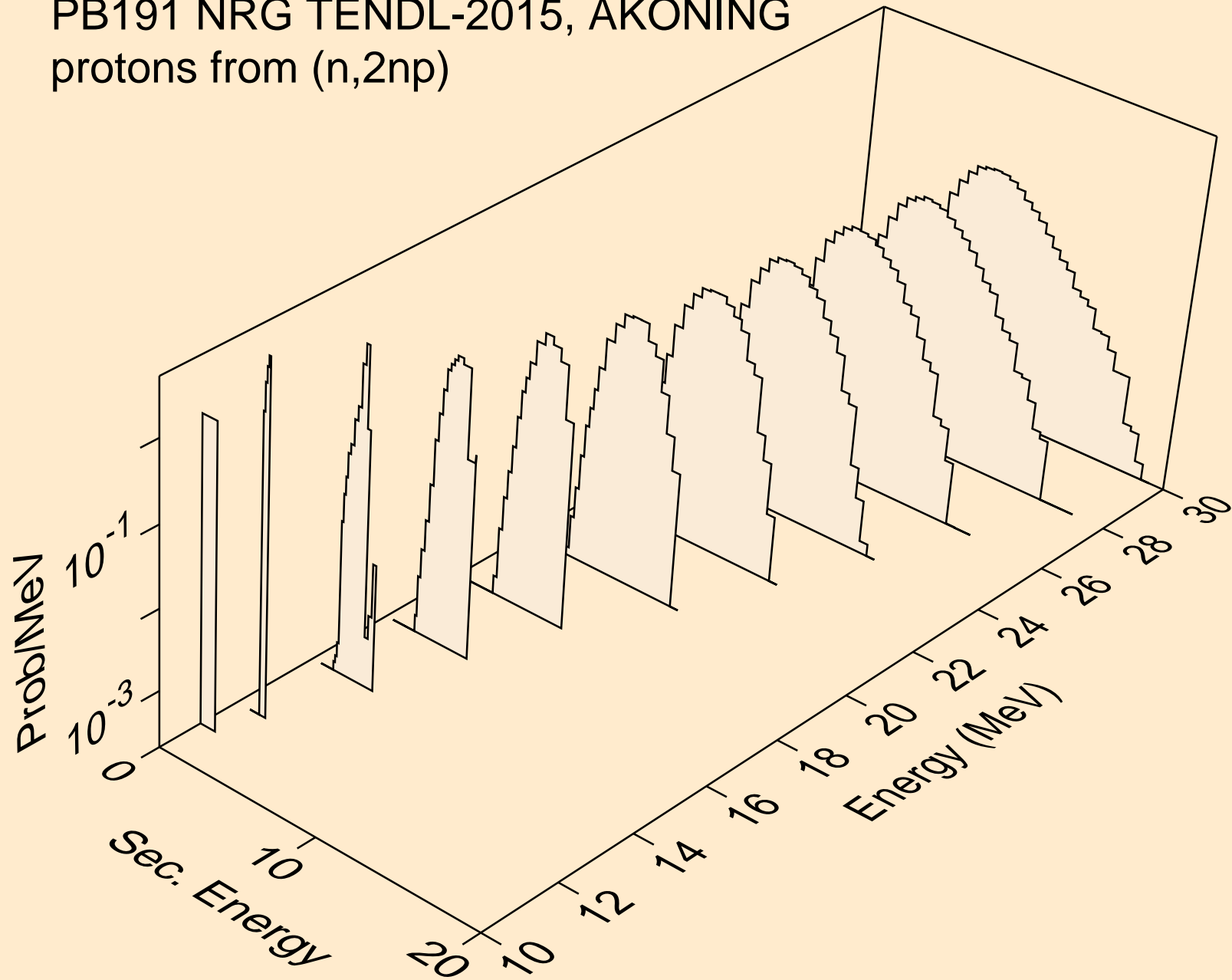

PB191 NRG TENDL-2015, AKONING  
protons from (n,3np)

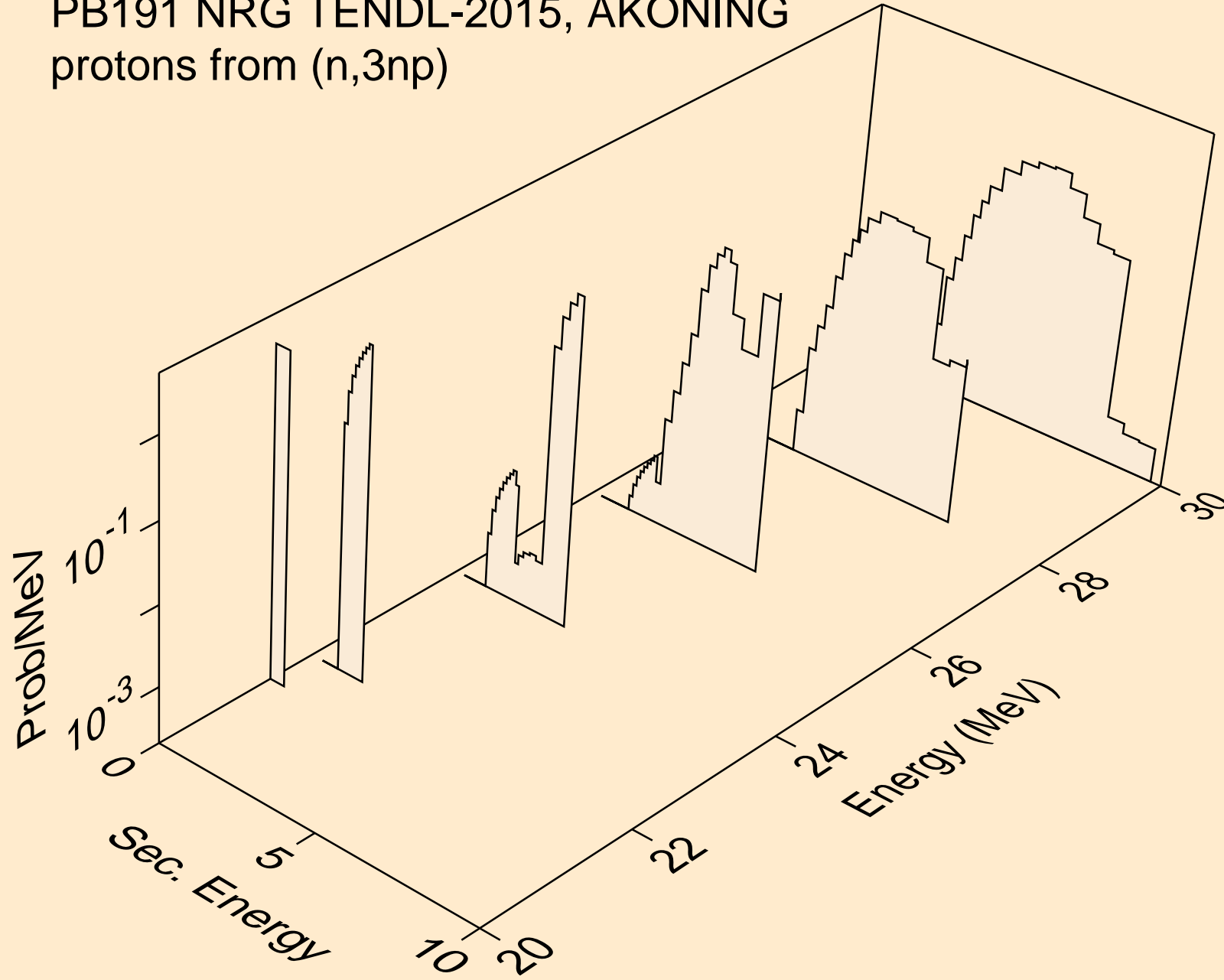

PB191 NRG TENDL-2015, AKONING  
protons from (n,2np)

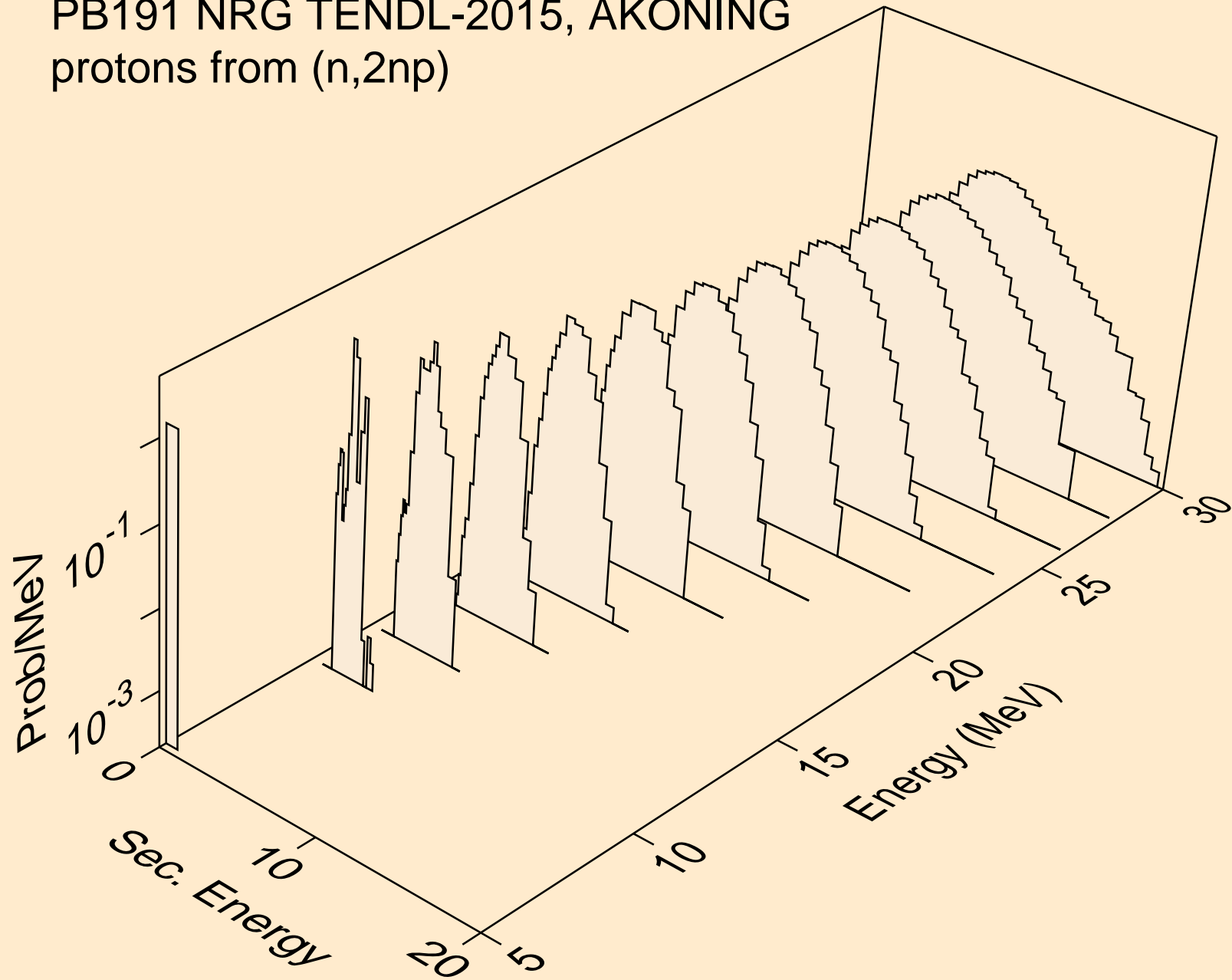

PB191 NRG TENDL-2015, AKONING  
protons from (n,npa)

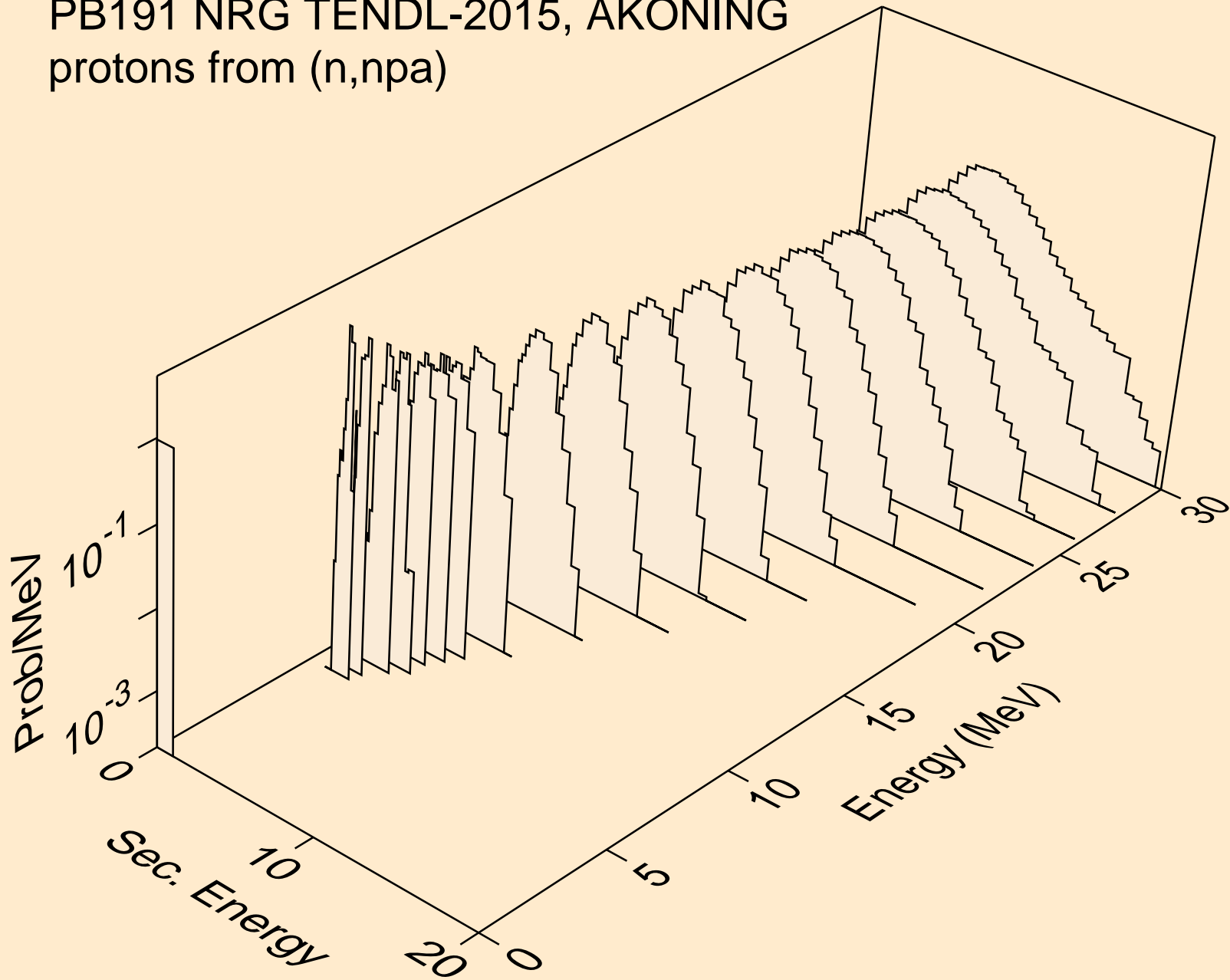

PB191 NRG TENDL-2015, AKONING  
protons from (n,p)

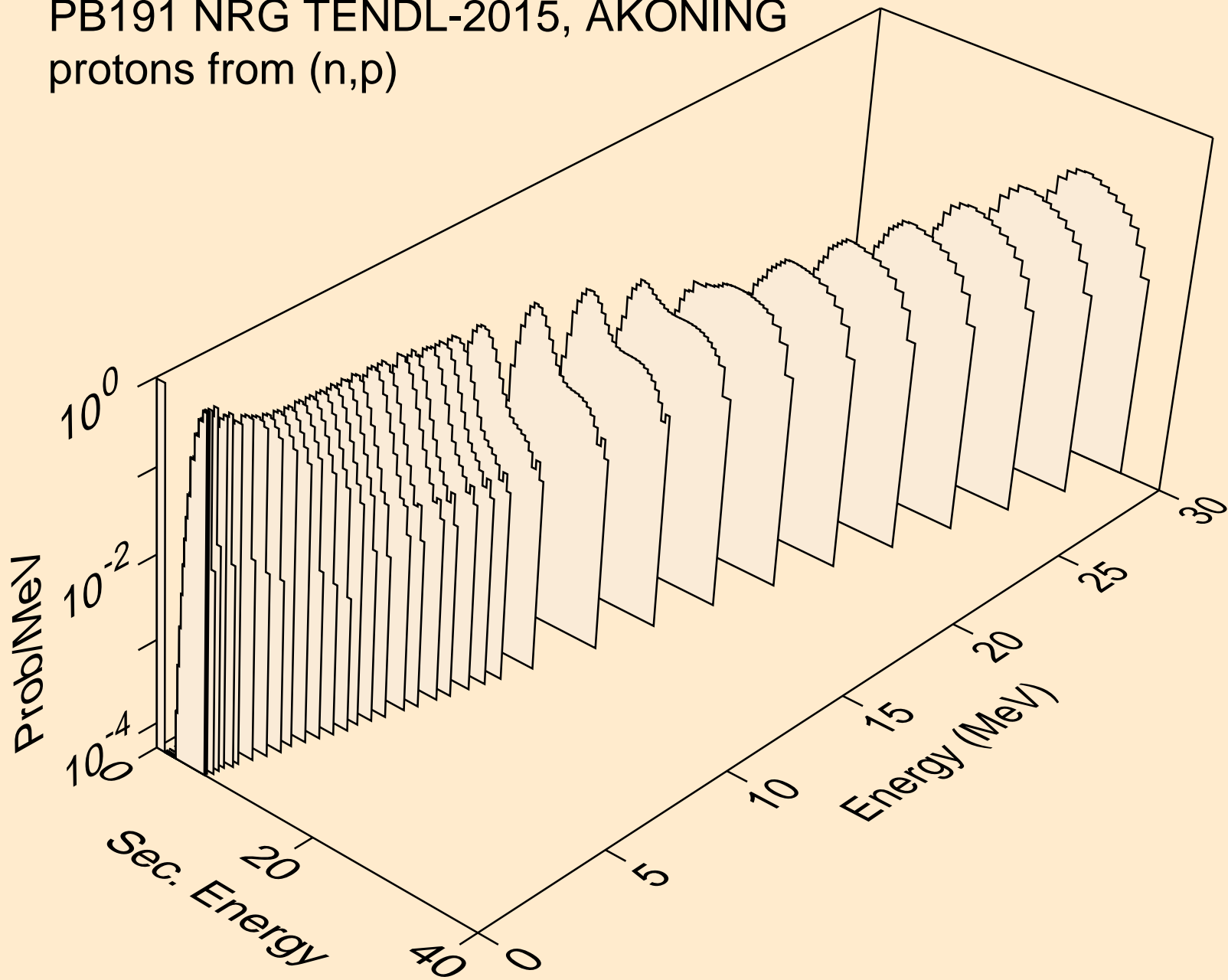

PB191 NRG TENDL-2015, AKONING  
protons from (n,2p)

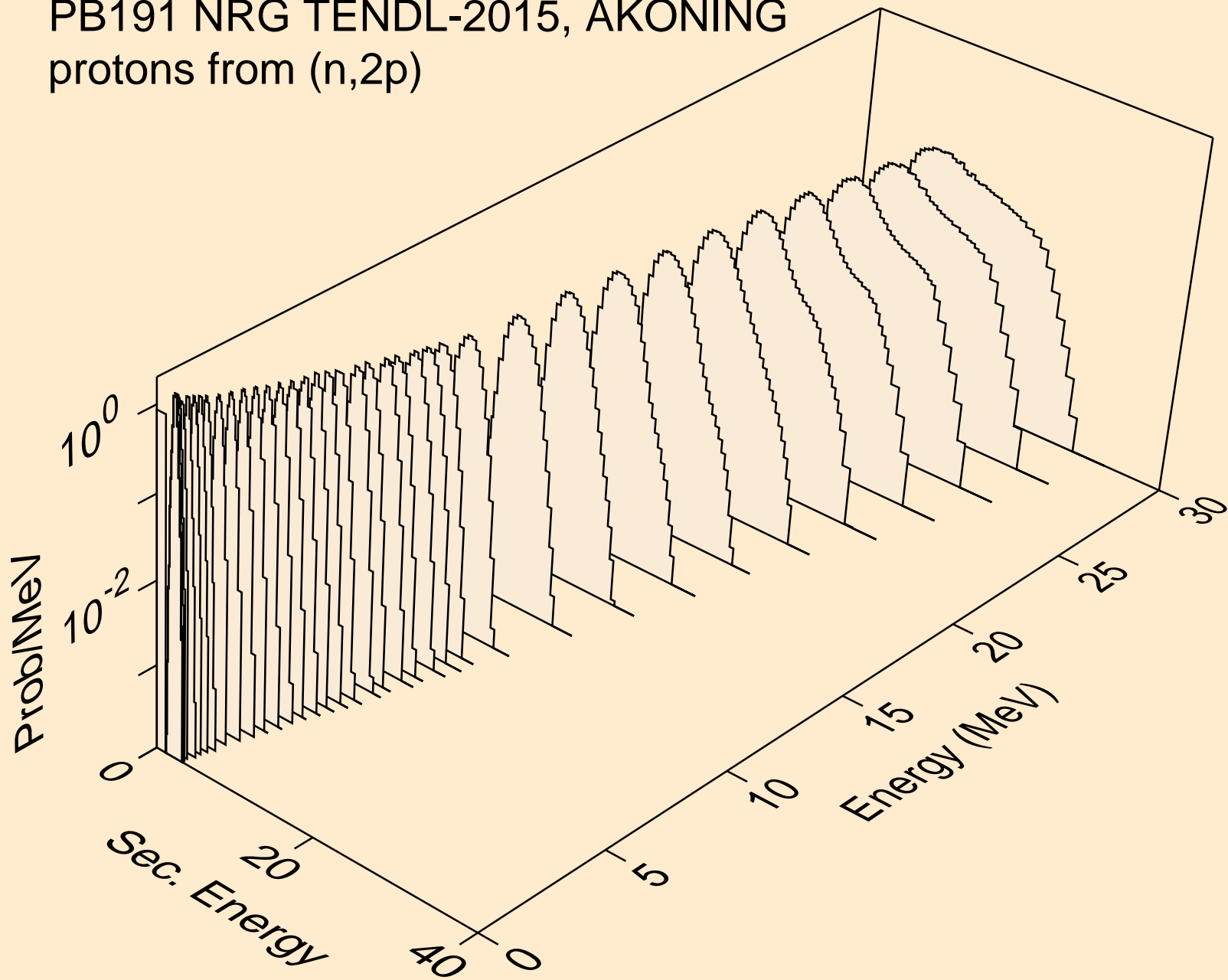



PB191 NRG TENDL-2015, AKONING  
protons from (n,pa)

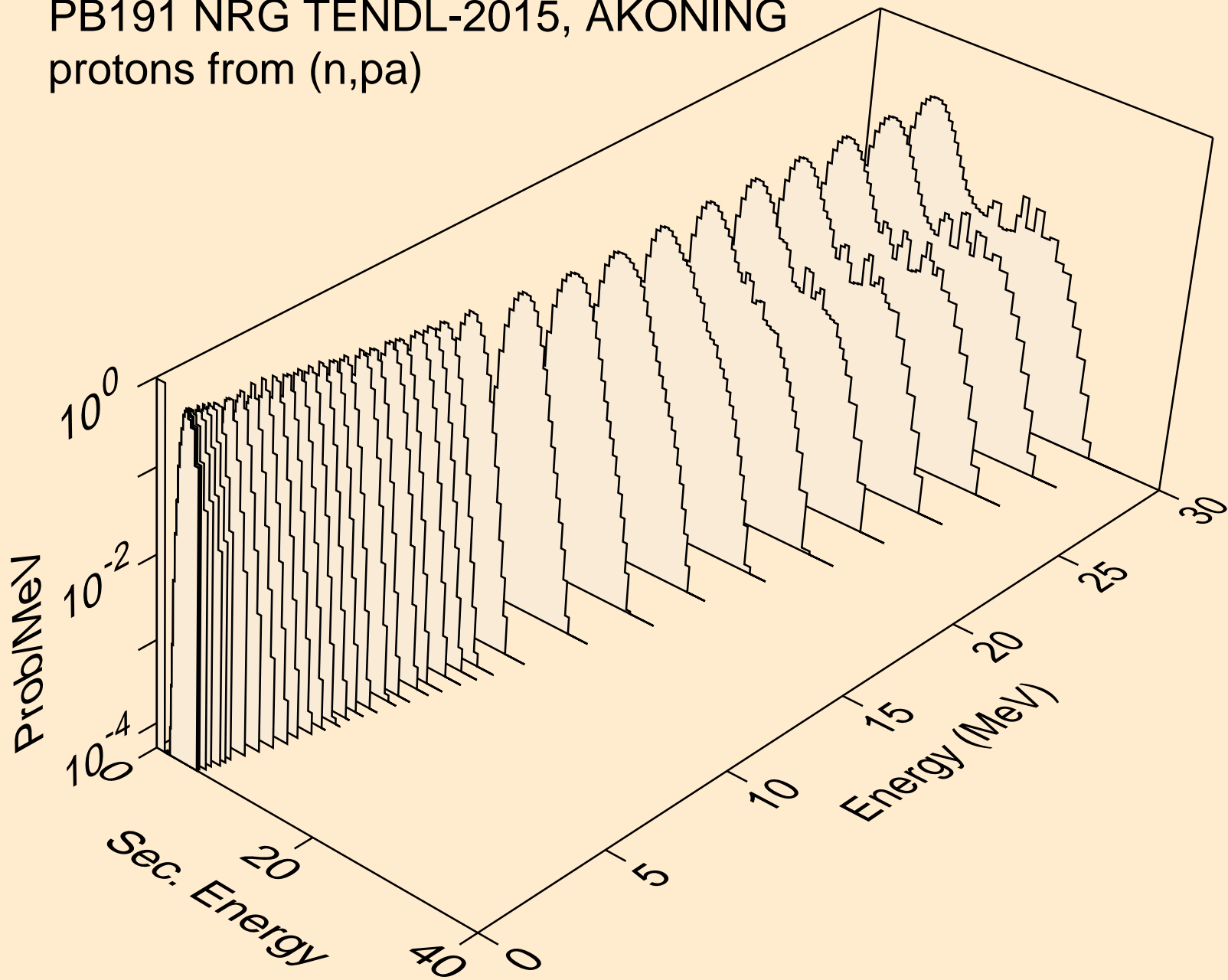

PB191 NRG TENDL-2015, AKONING  
protons from (n,pd)

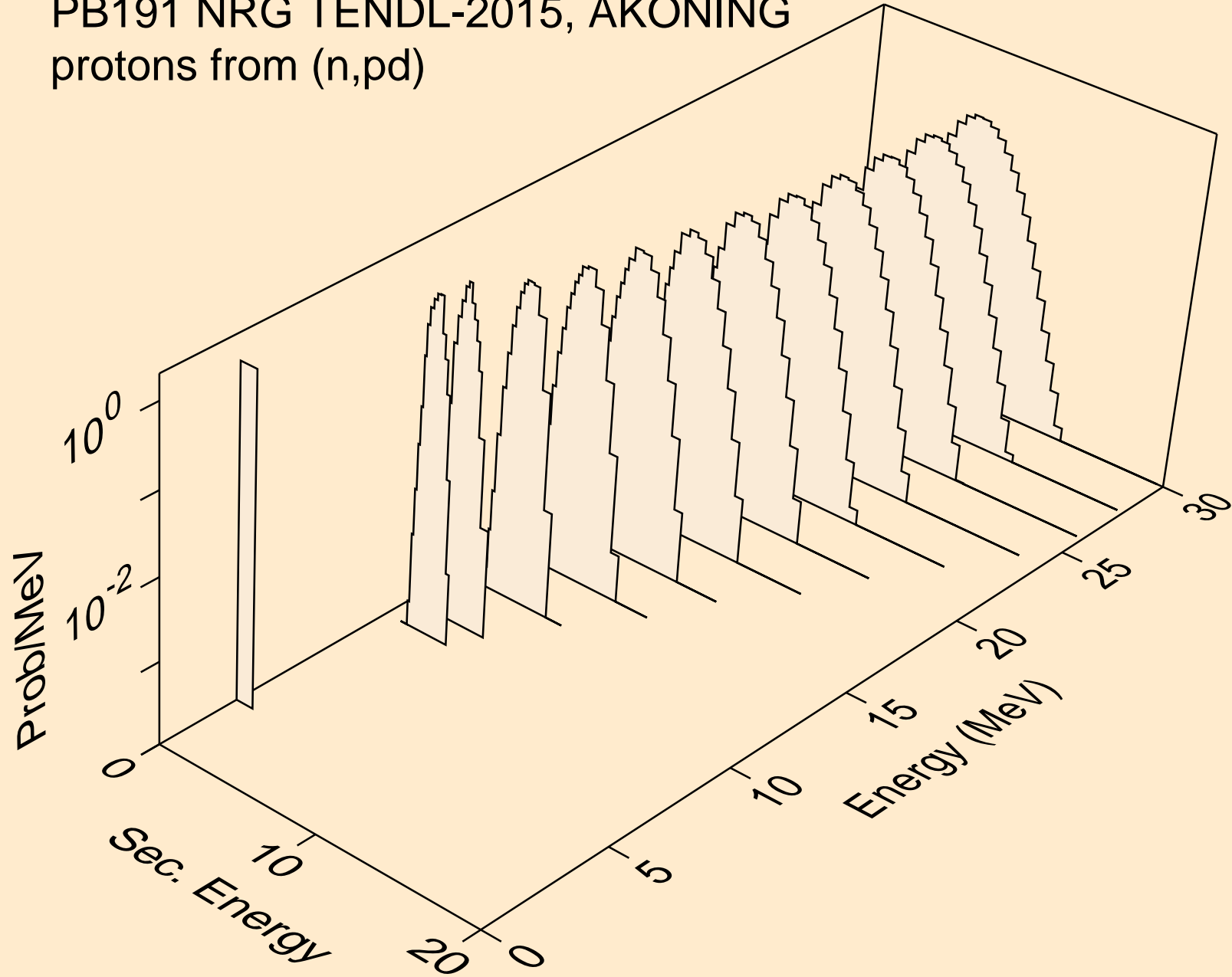

PB191 NRG TENDL-2015, AKONING  
protons from (n,pt)

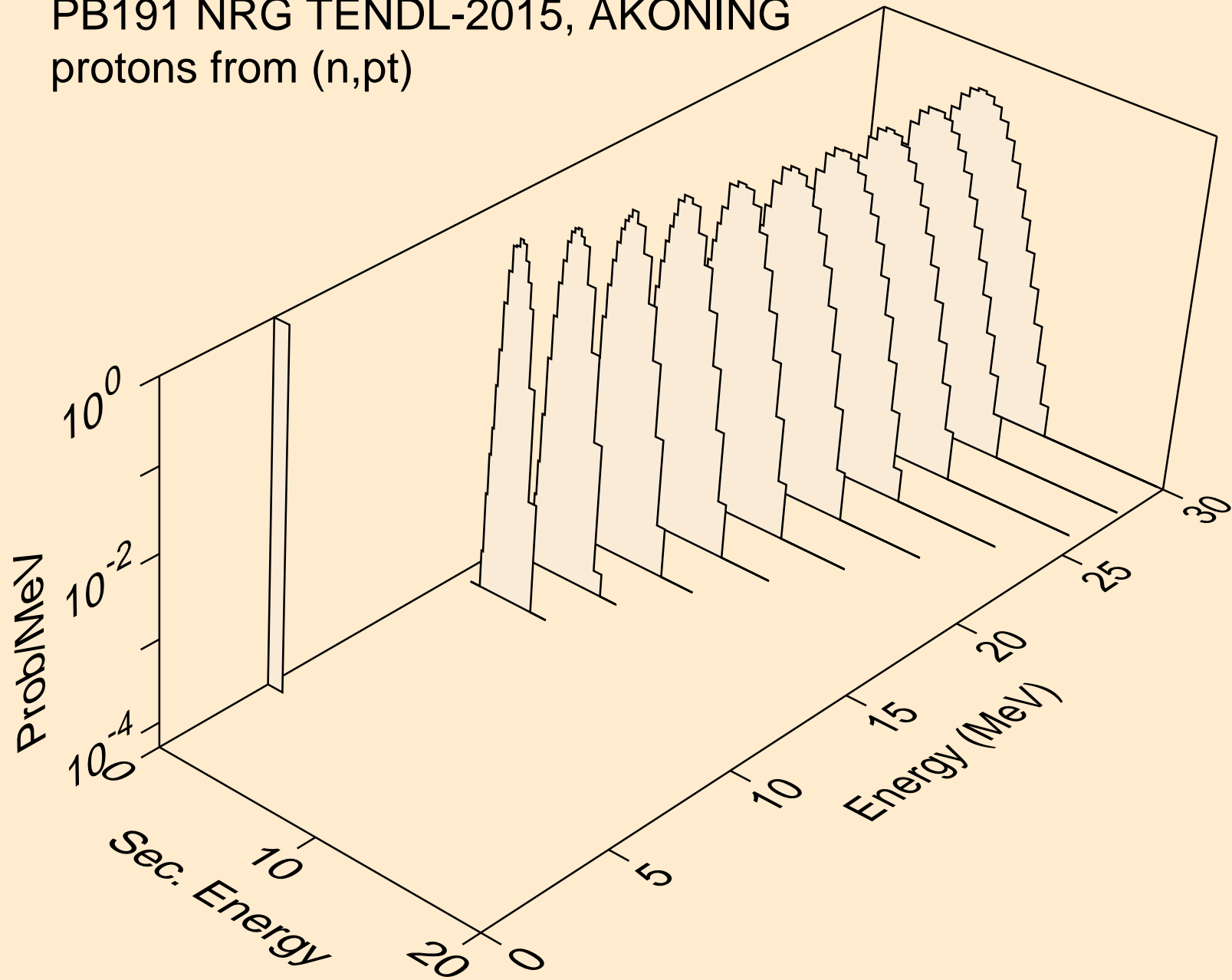

PB191 NRG TENDL-2015, AKONING  
deuterons from (n,x)

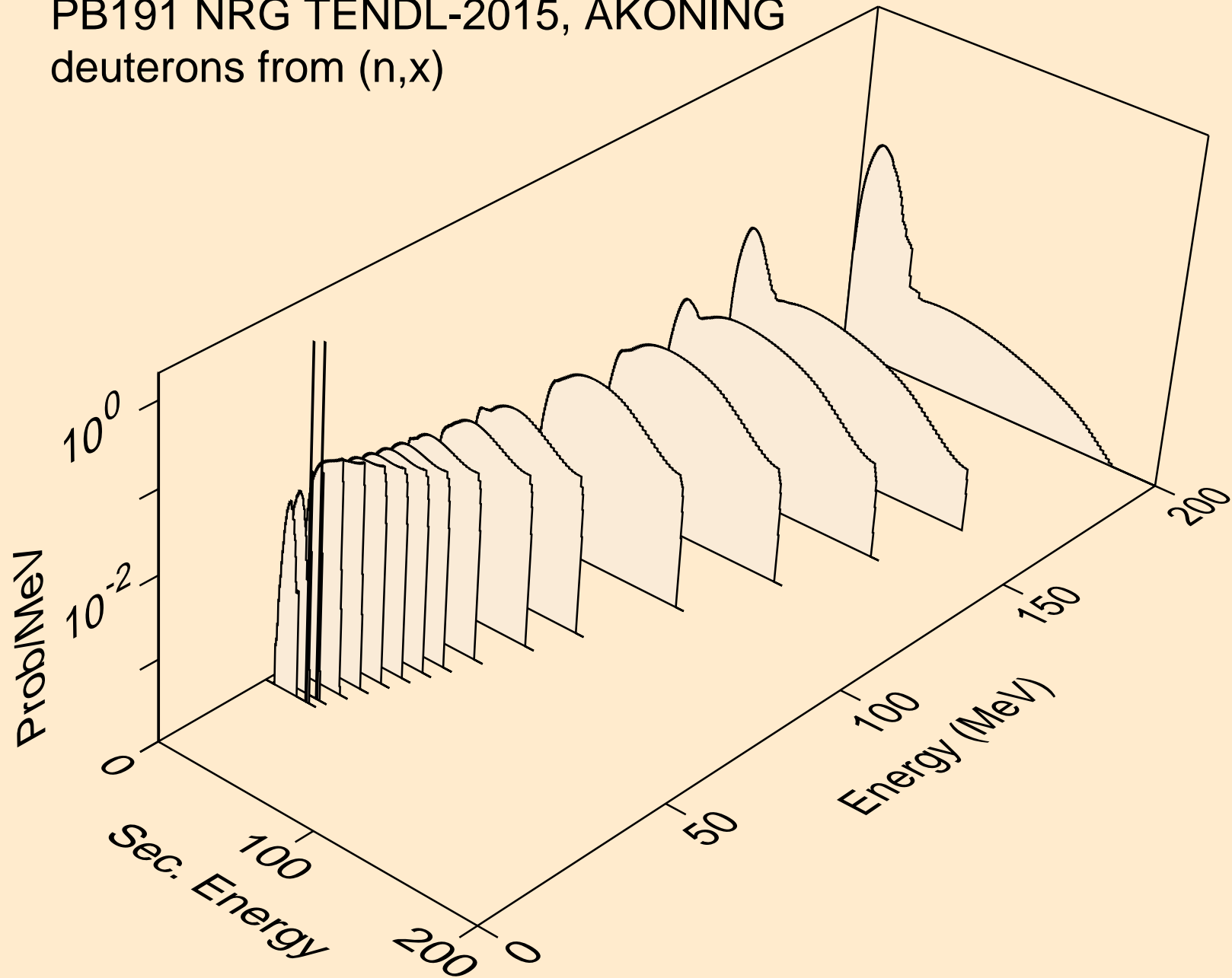

PB191 NRG TENDL-2015, AKONING  
deuterons from (n,2nd)

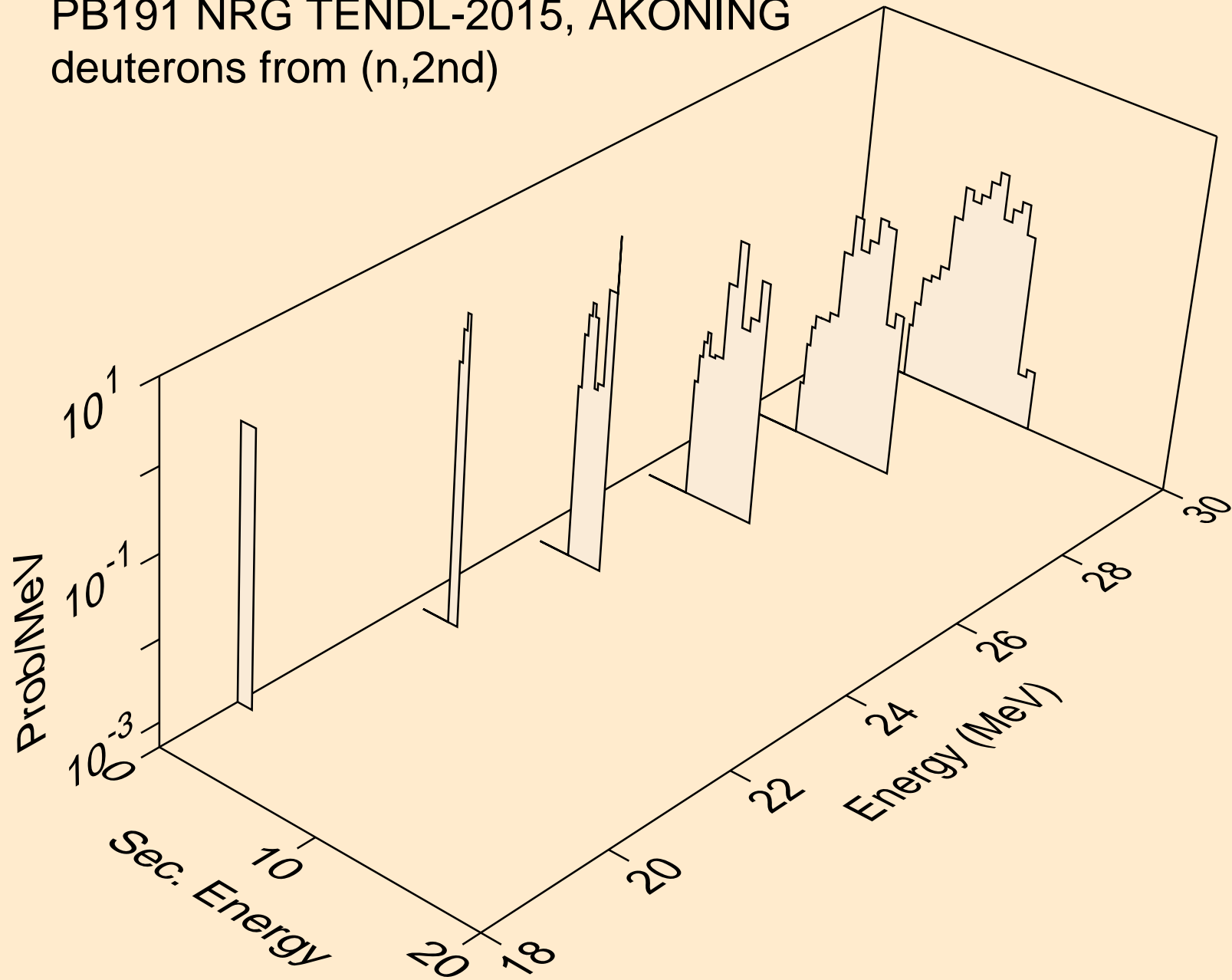

PB191 NRG TENDL-2015, AKONING  
deuterons from (n,n\*)d

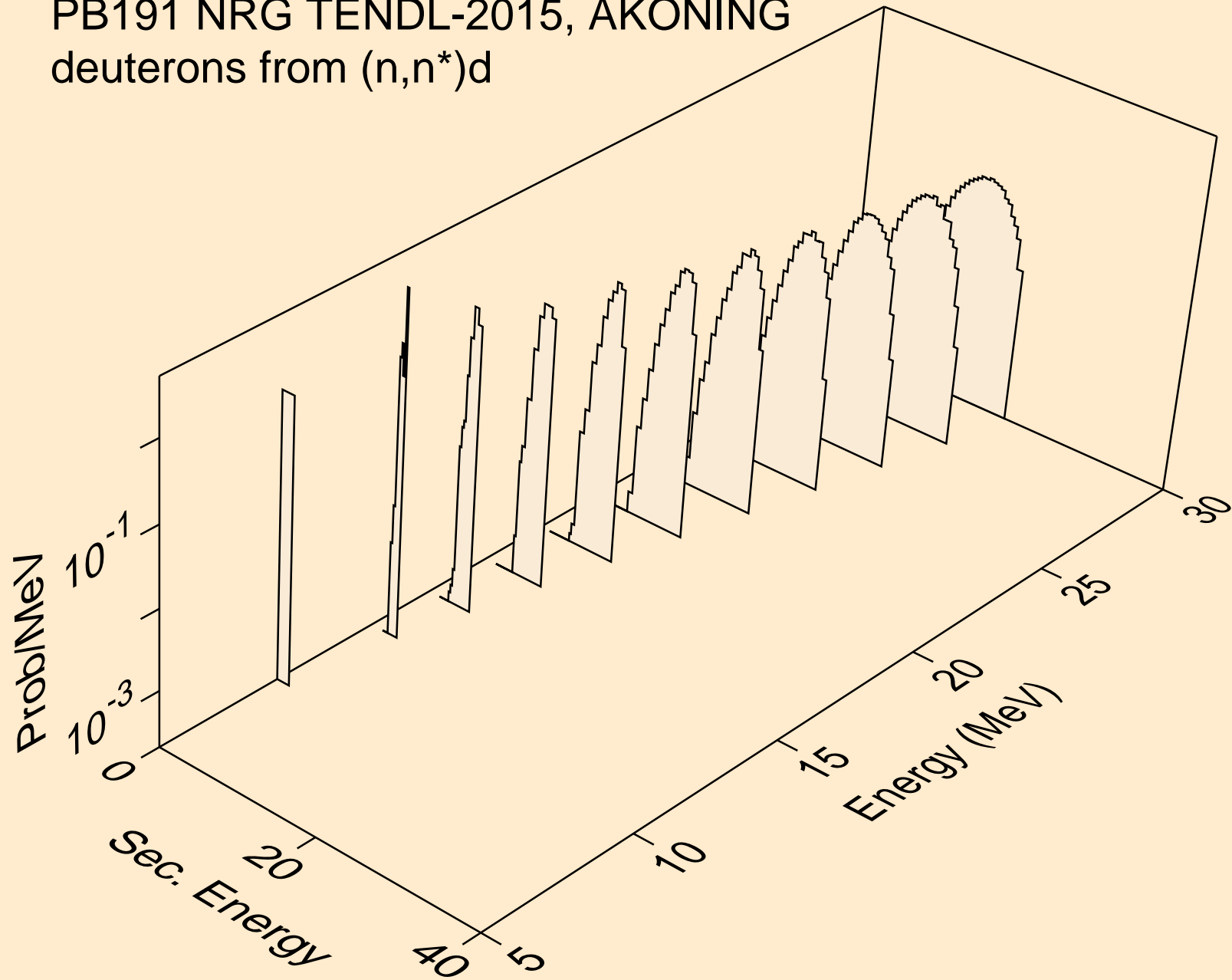

PB191 NRG TENDL-2015, AKONING  
deuterons from (n,d)

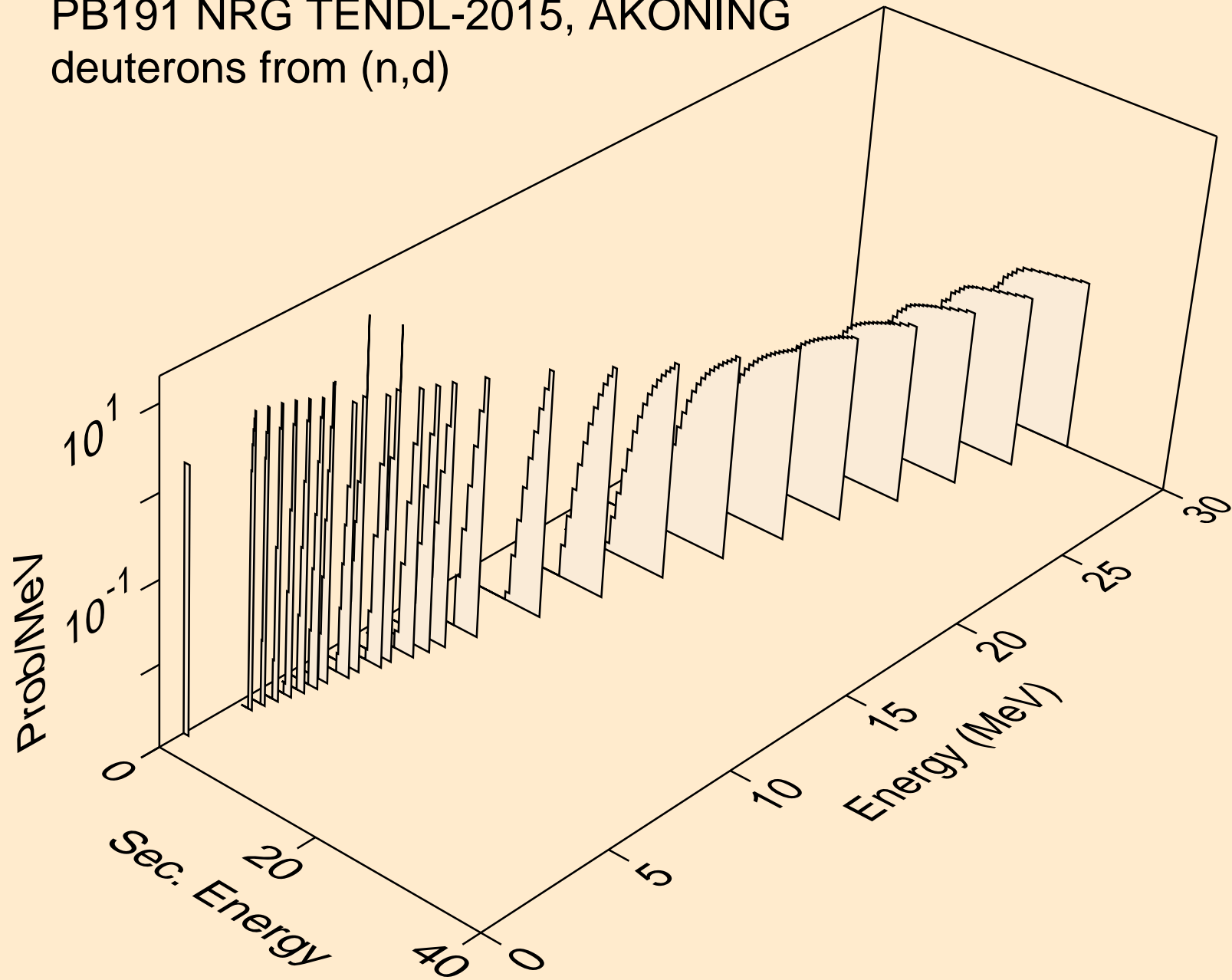

PB191 NRG TENDL-2015, AKONING  
deuterons from (n,d2a)

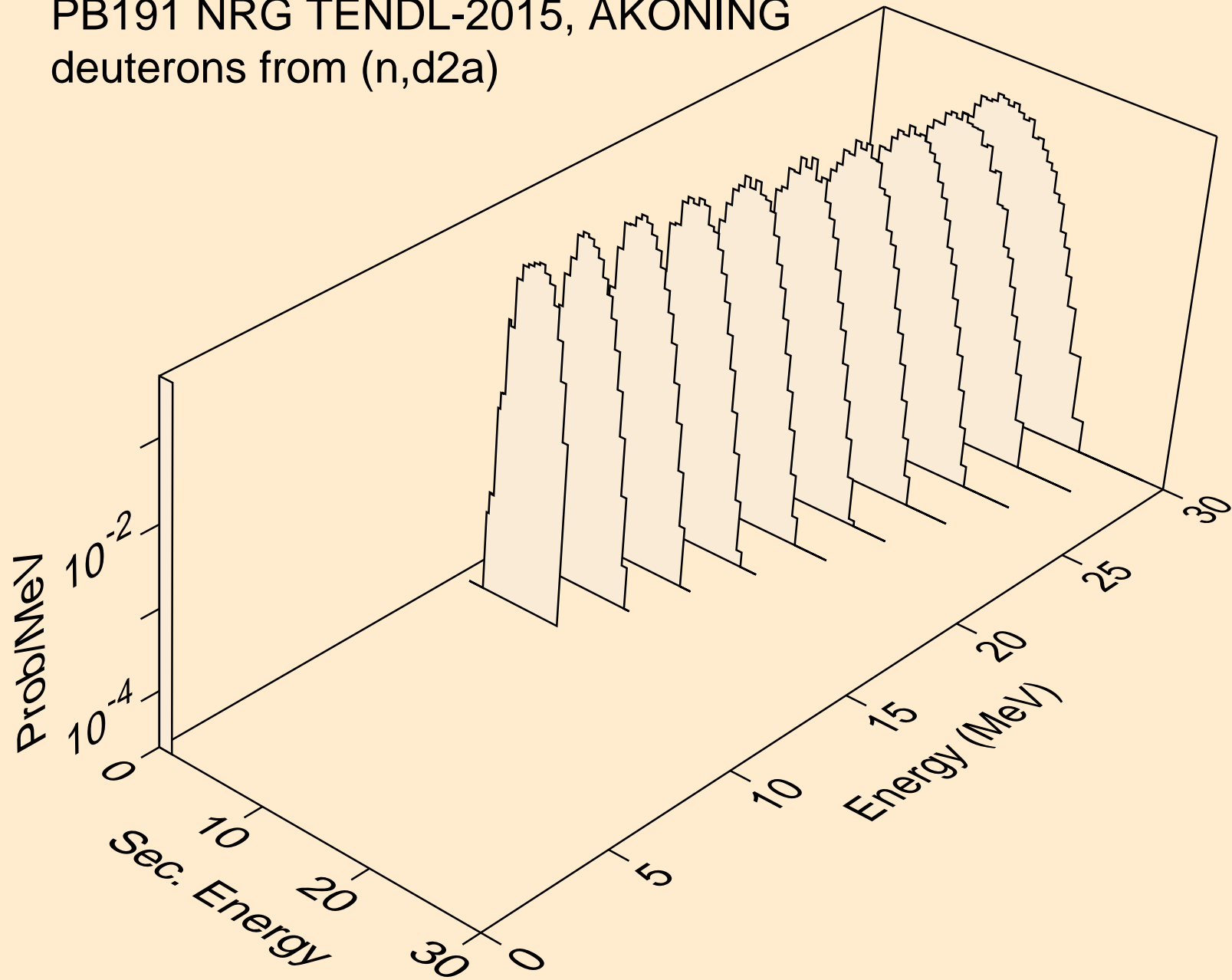



PB191 NRG TENDL-2015, AKONING  
deuterons from (n,pd)

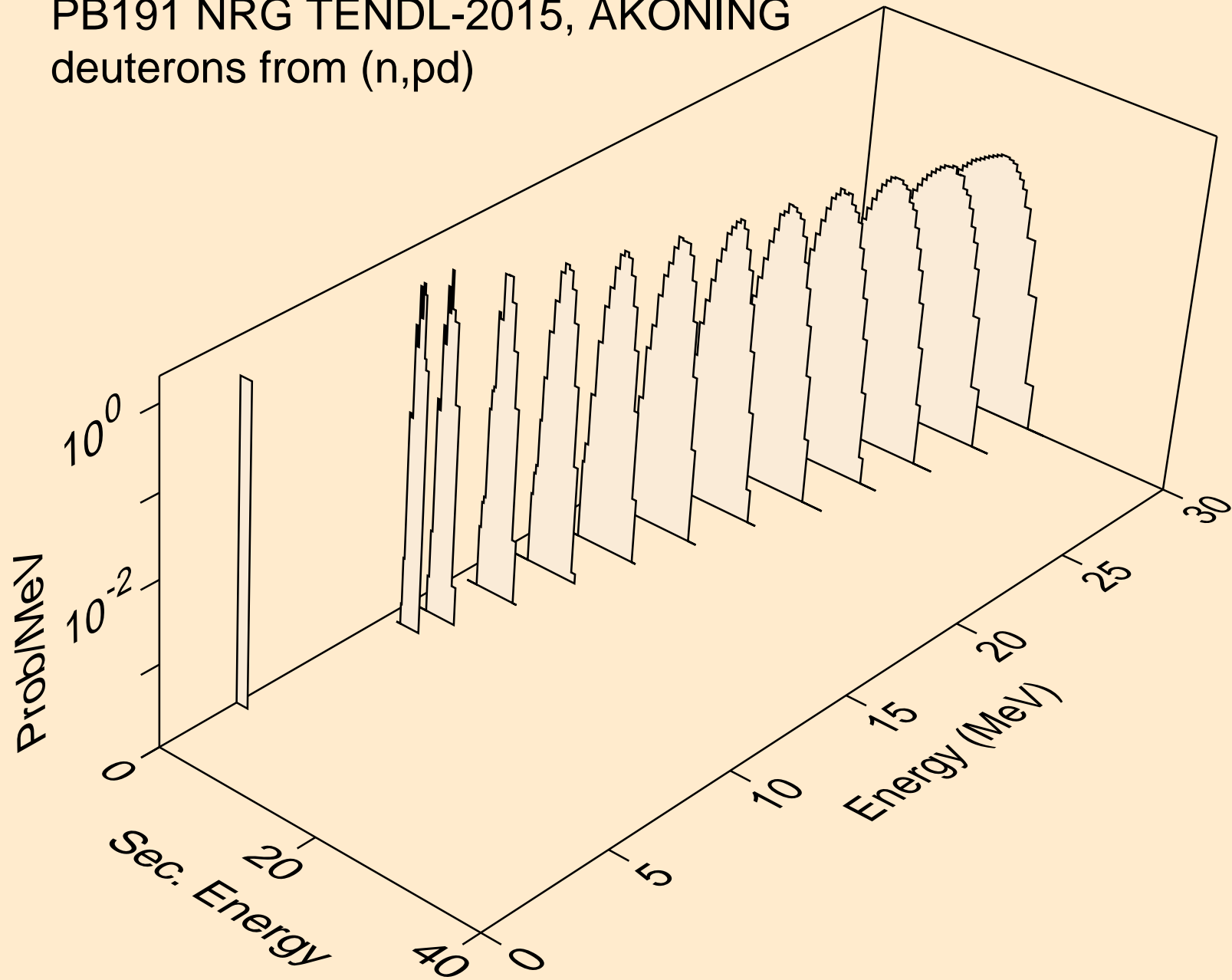

PB191 NRG TENDL-2015, AKONING  
deuterons from (n,da)

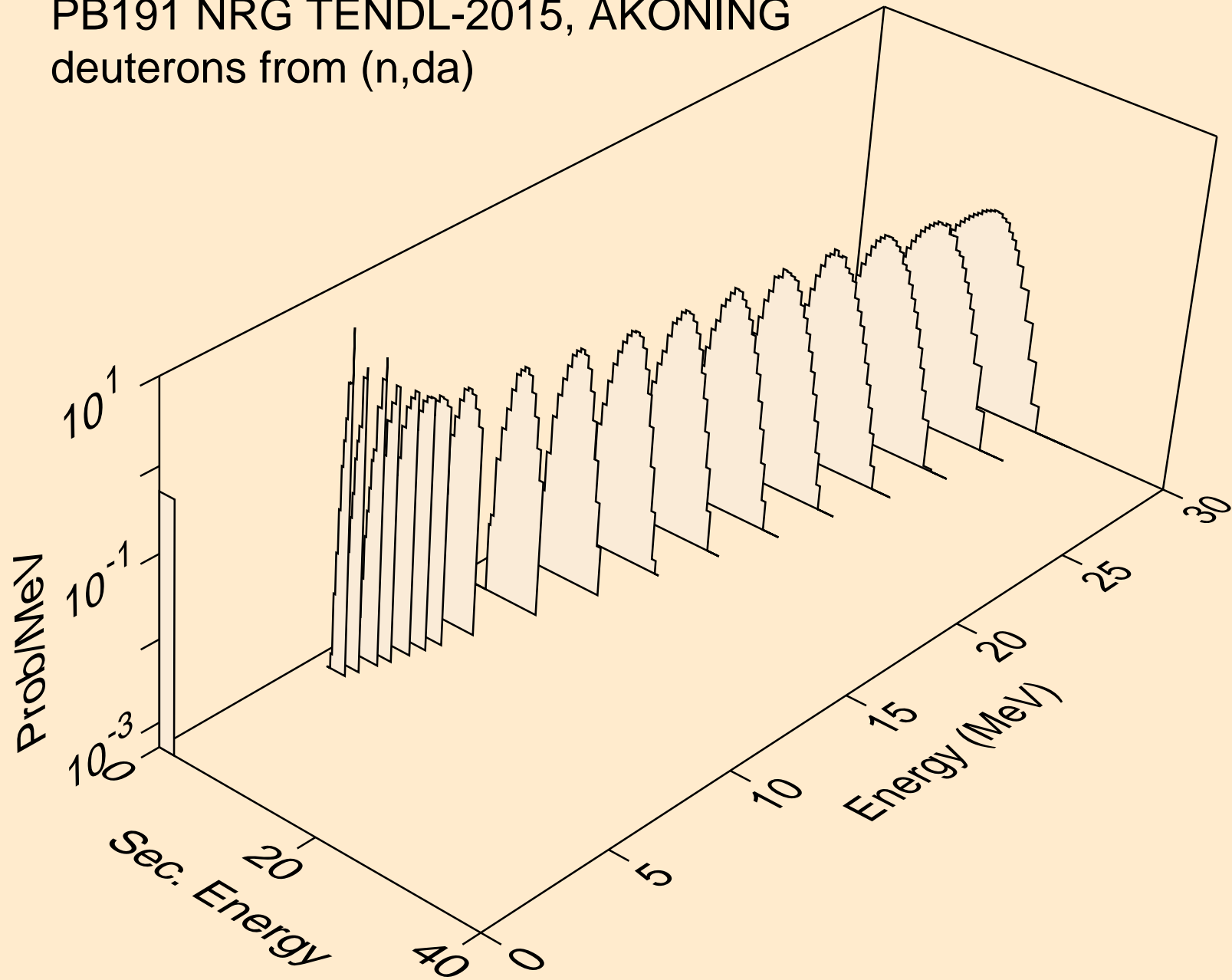

PB191 NRG TENDL-2015, AKONING  
tritons from (n,x)

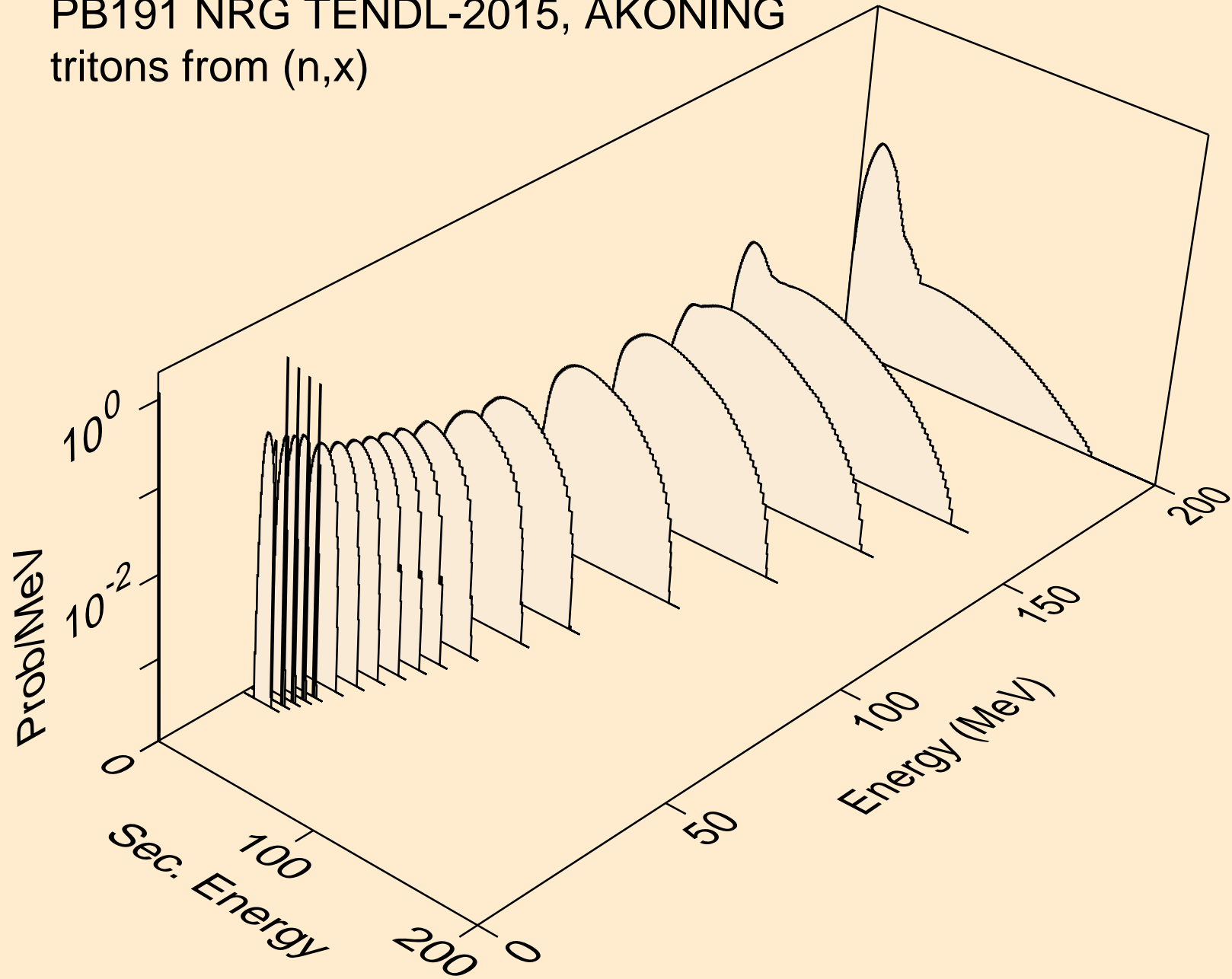

PB191 NRG TENDL-2015, AKONING  
tritons from (n,n\*)t

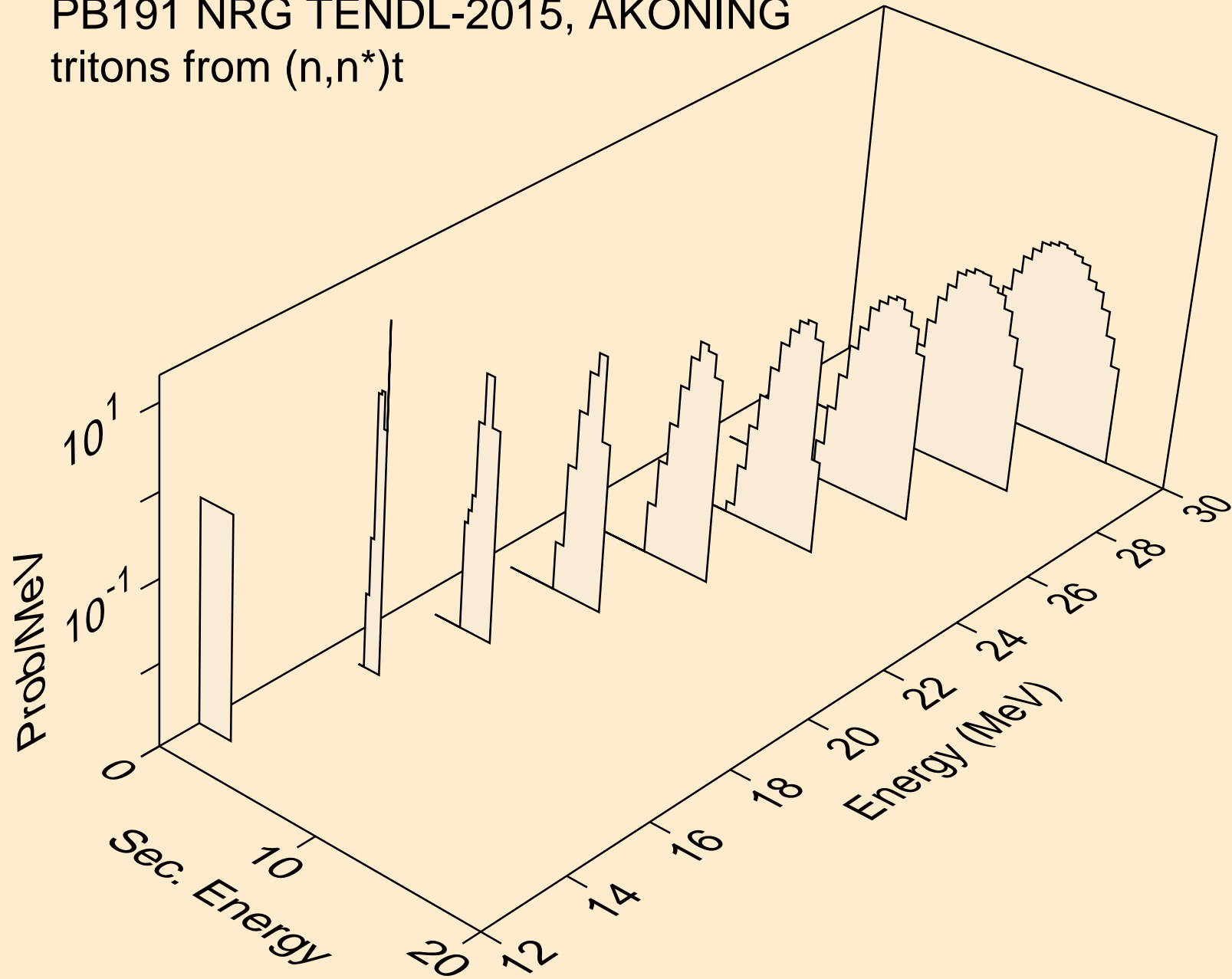

PB191 NRG TENDL-2015, AKONING  
tritons from (n,t)

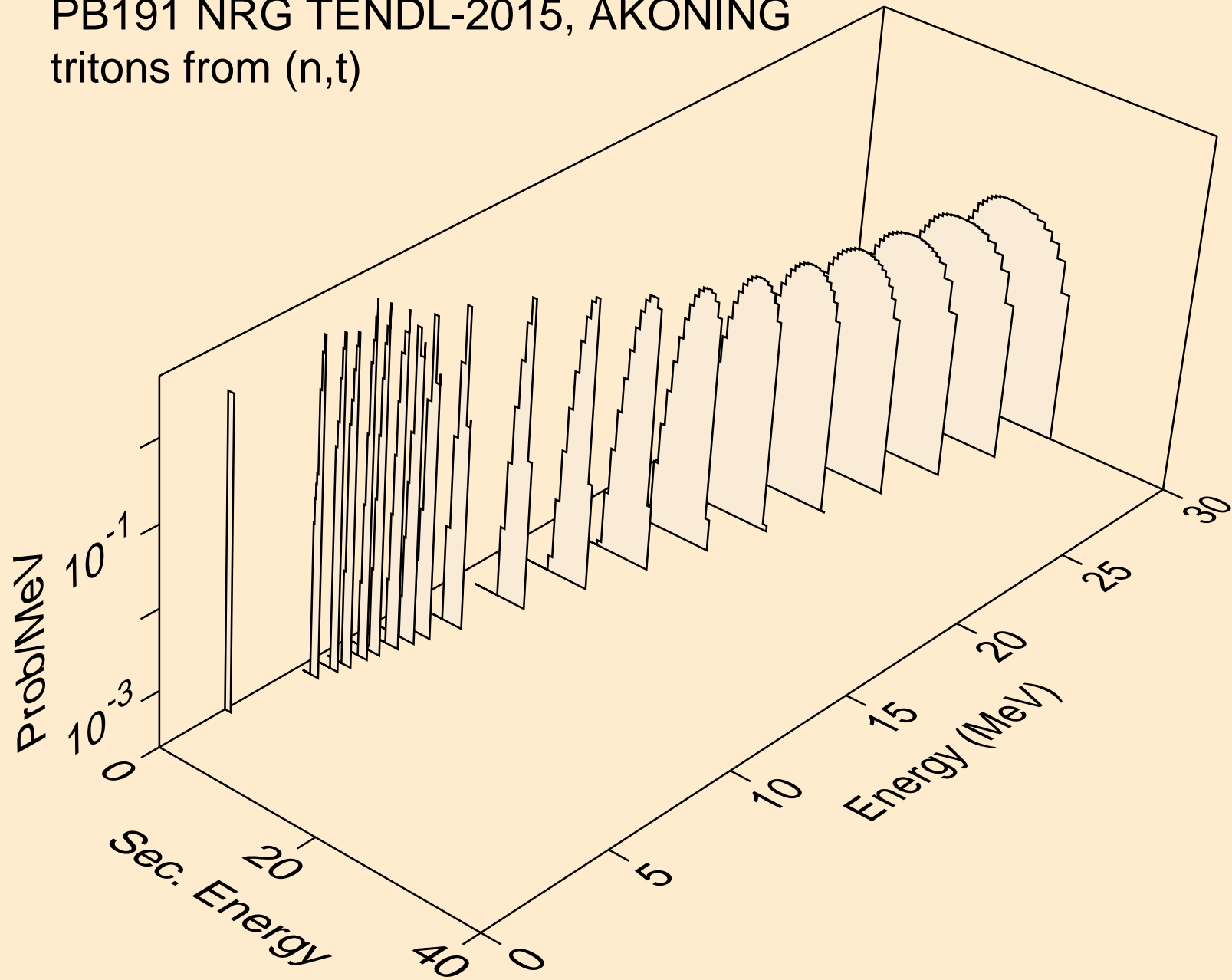

PB191 NRG TENDL-2015, AKONING  
tritons from (n,t2a)

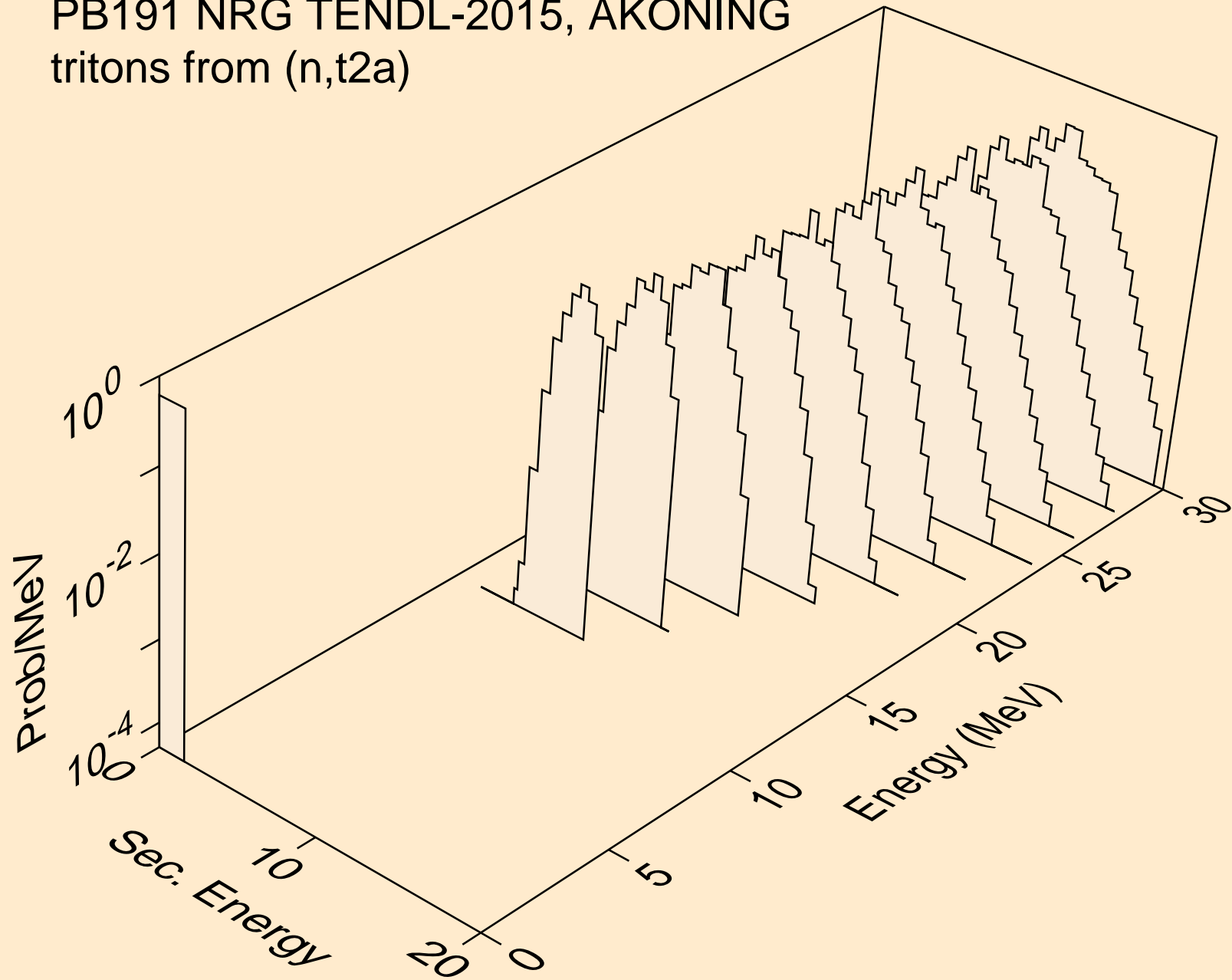

PB191 NRG TENDL-2015, AKONING  
tritons from (n,pt)

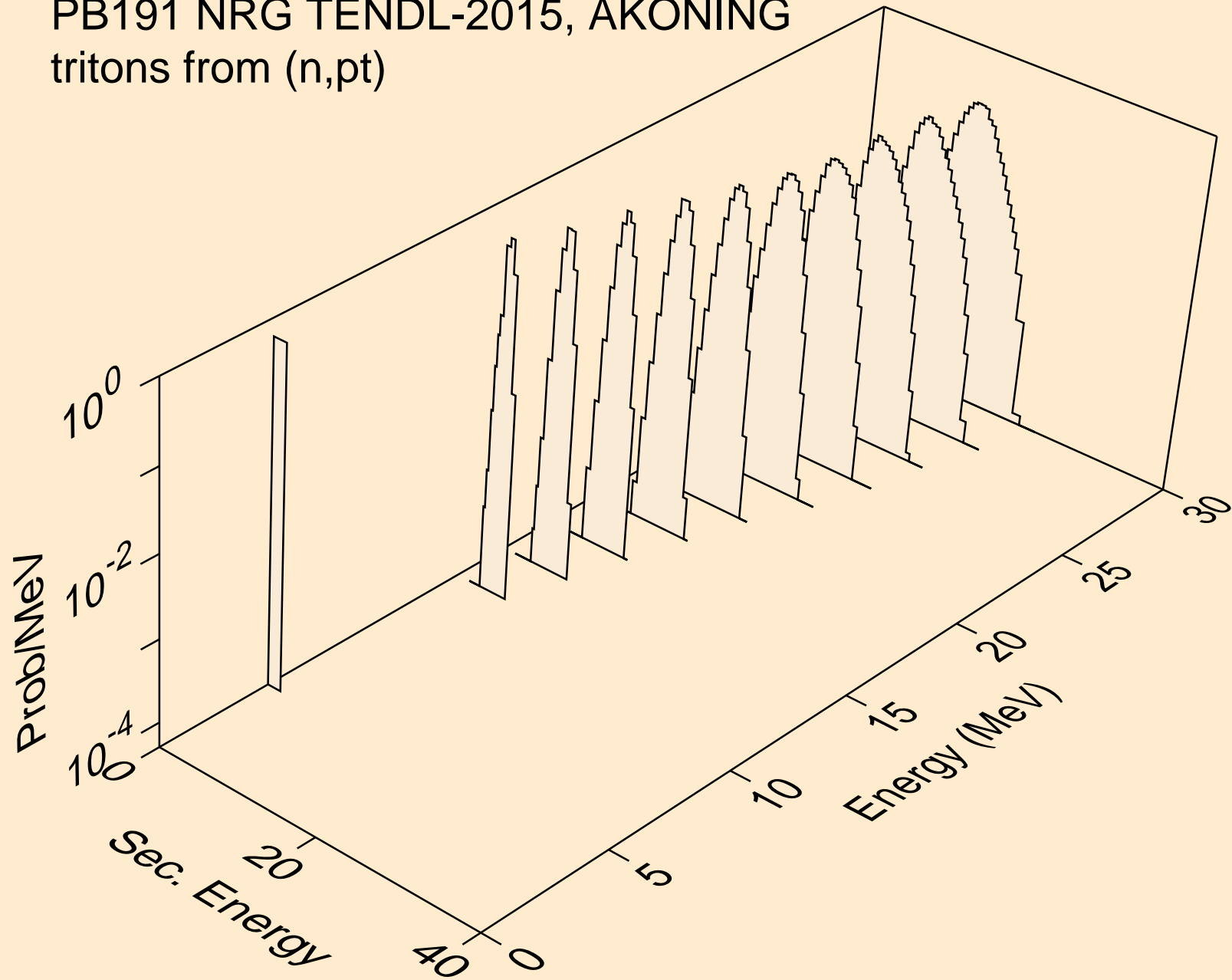

PB191 NRG TENDL-2015, AKONING  
he3s from (n,x)

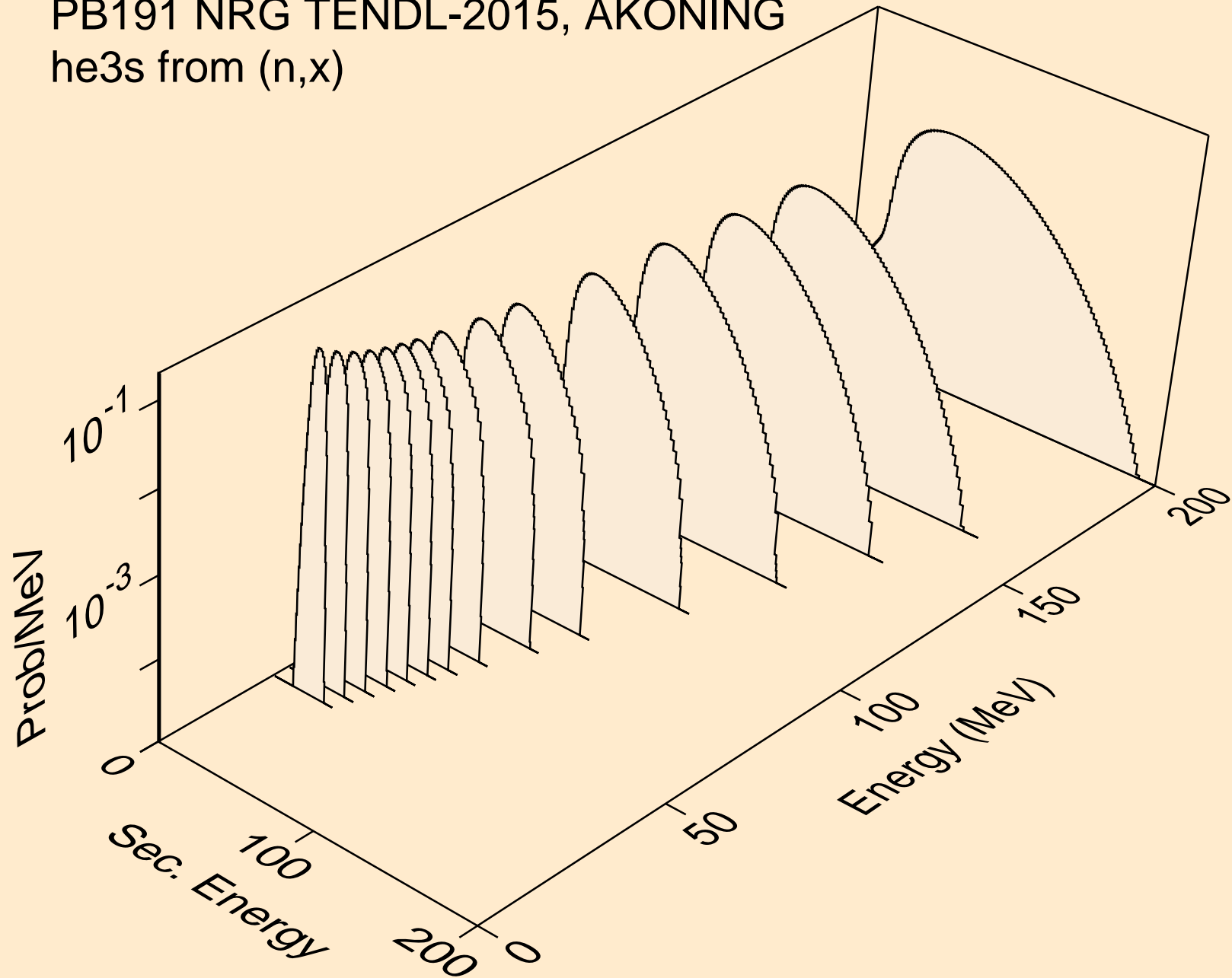



PB191 NRG TENDL-2015, AKONING  
he3s from (n,n\*)he3

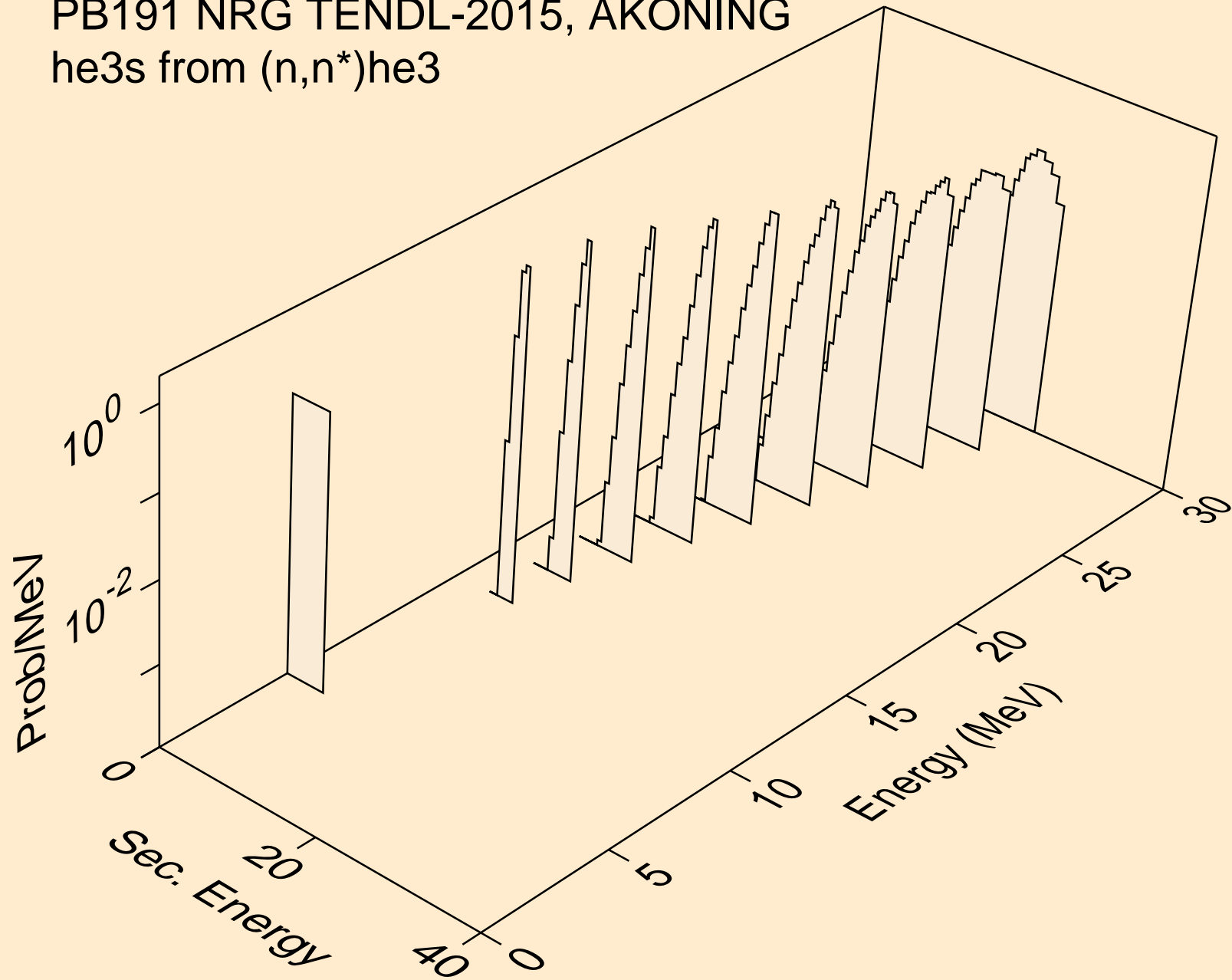

PB191 NRG TENDL-2015, AKONING  
he3s from (n,he3)

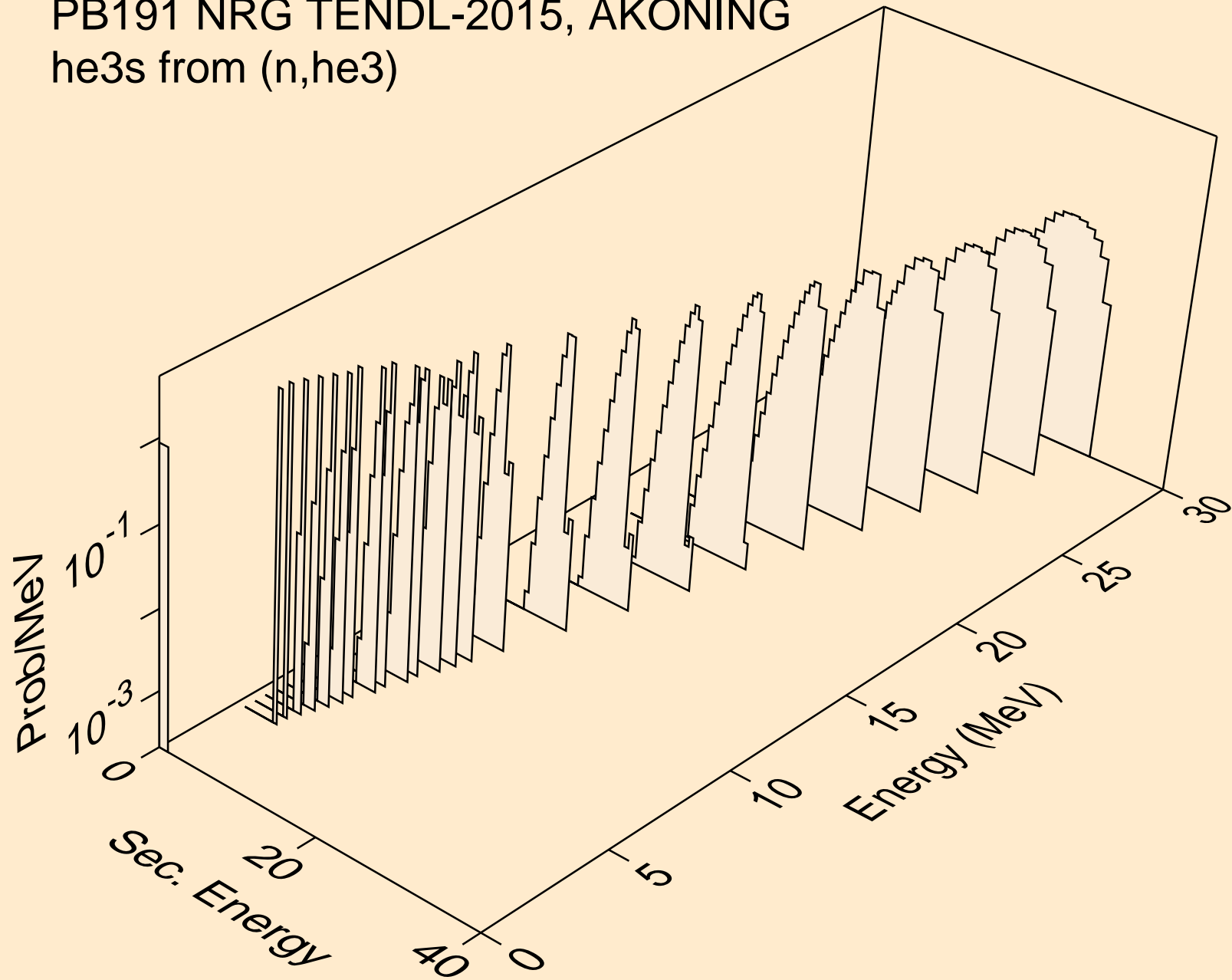

PB191 NRG TENDL-2015, AKONING  
alphas from (n,x)

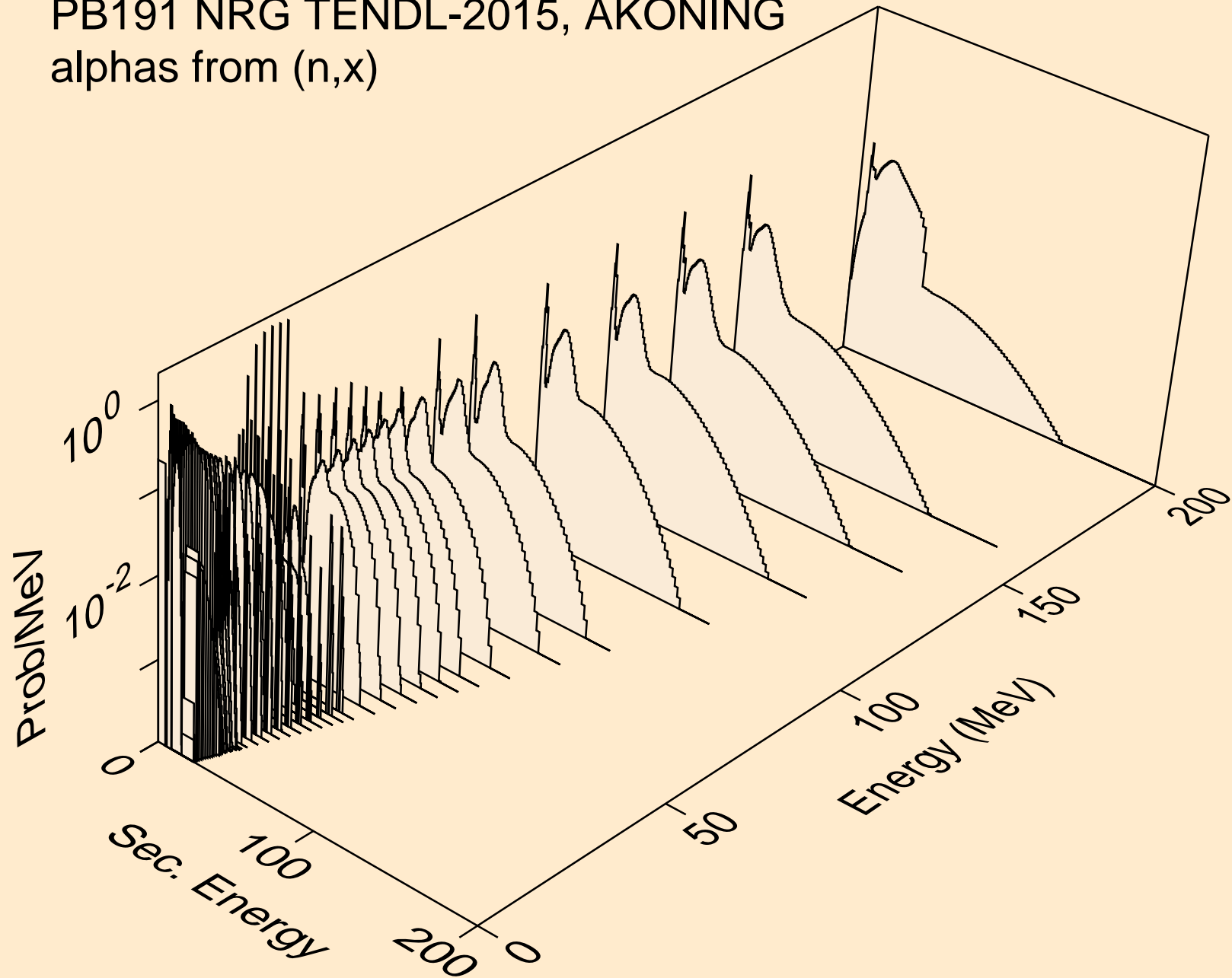

PB191 NRG TENDL-2015, AKONING  
alphas from (n,n\*)a

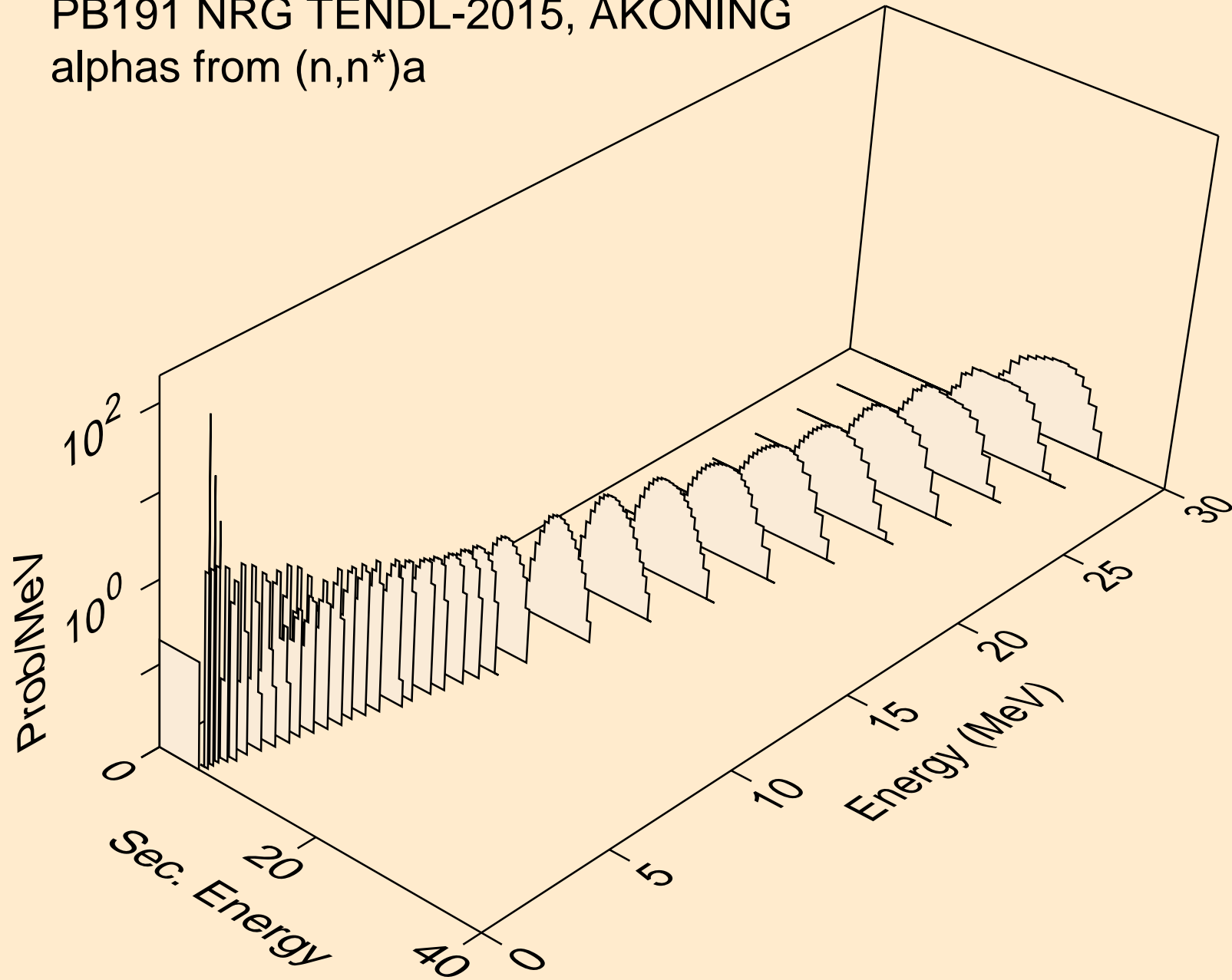

PB191 NRG TENDL-2015, AKONING  
alphas from (n,n\*)3a

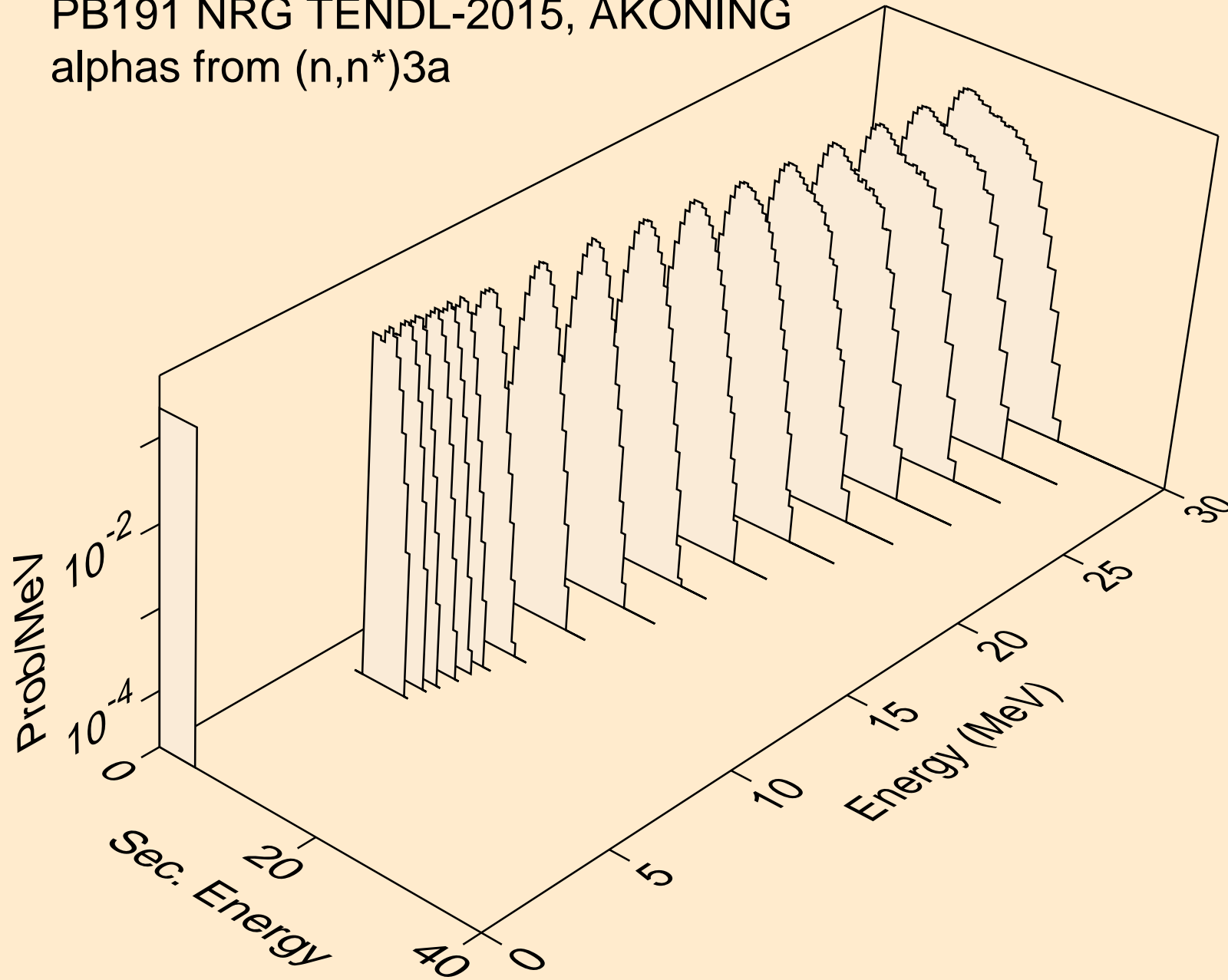

PB191 NRG TENDL-2015, AKONING  
alphas from (n,2n)a

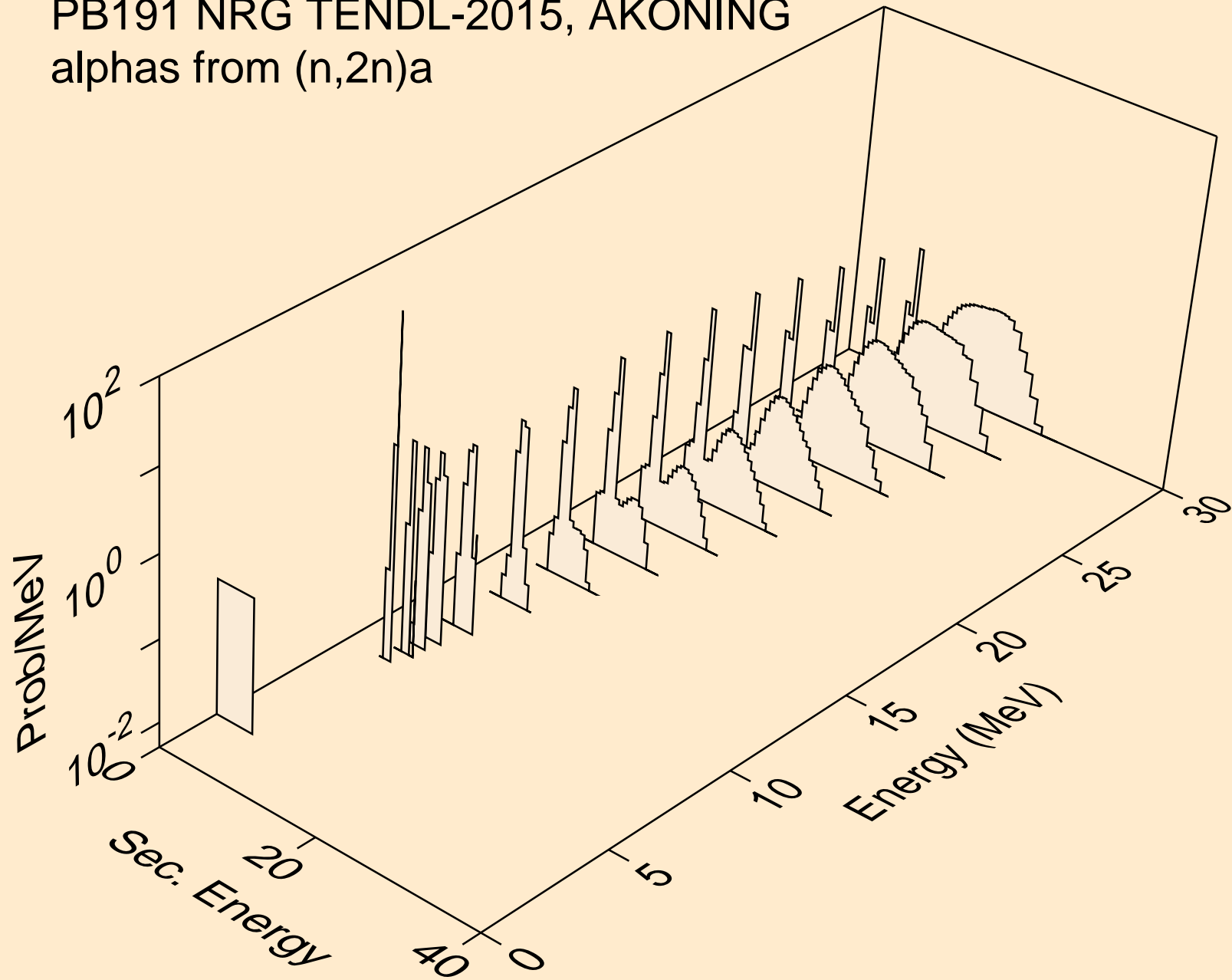

PB191 NRG TENDL-2015, AKONING  
alphas from (n,3n)a

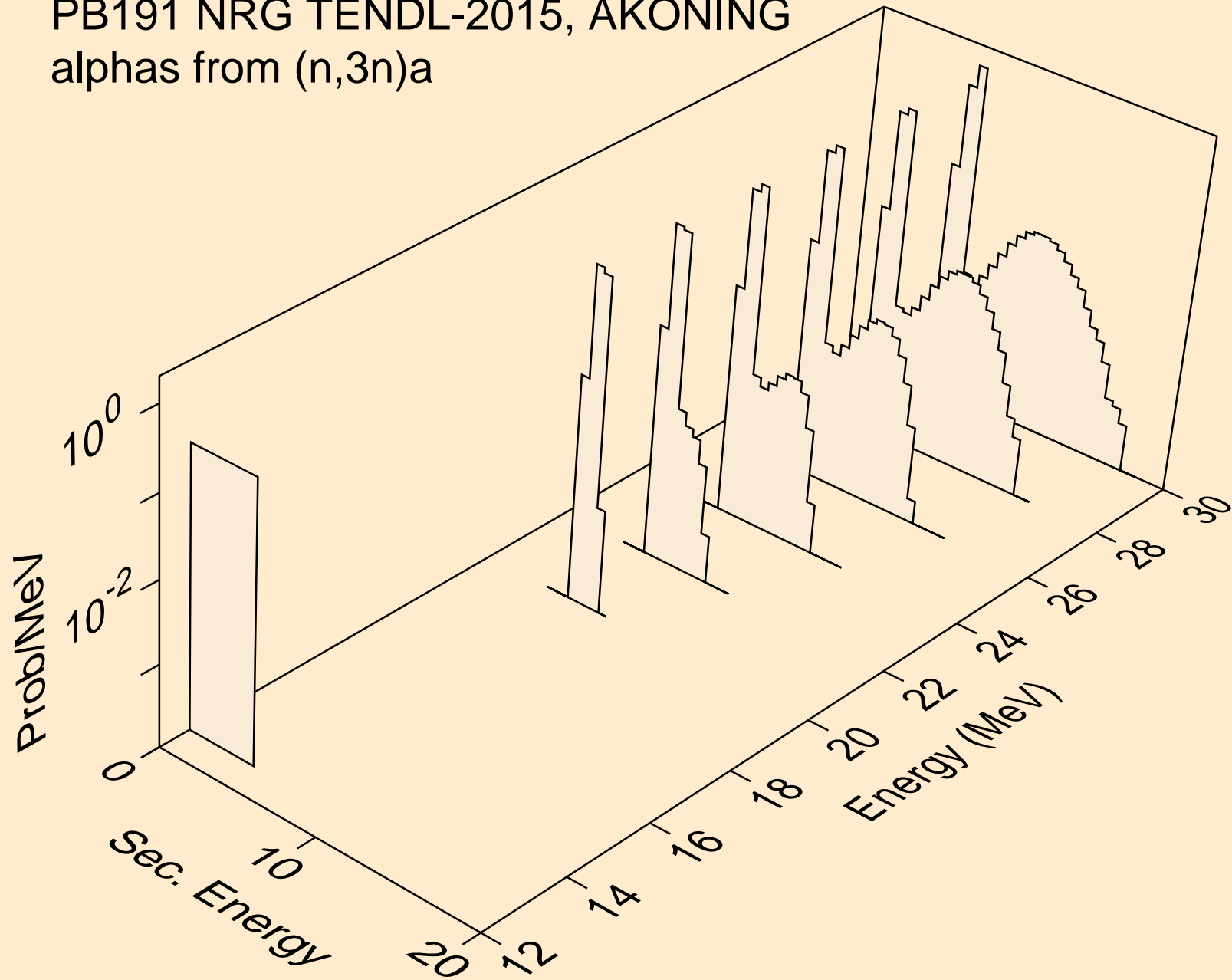

PB191 NRG TENDL-2015, AKONING  
alphas from (n,n\*)2a

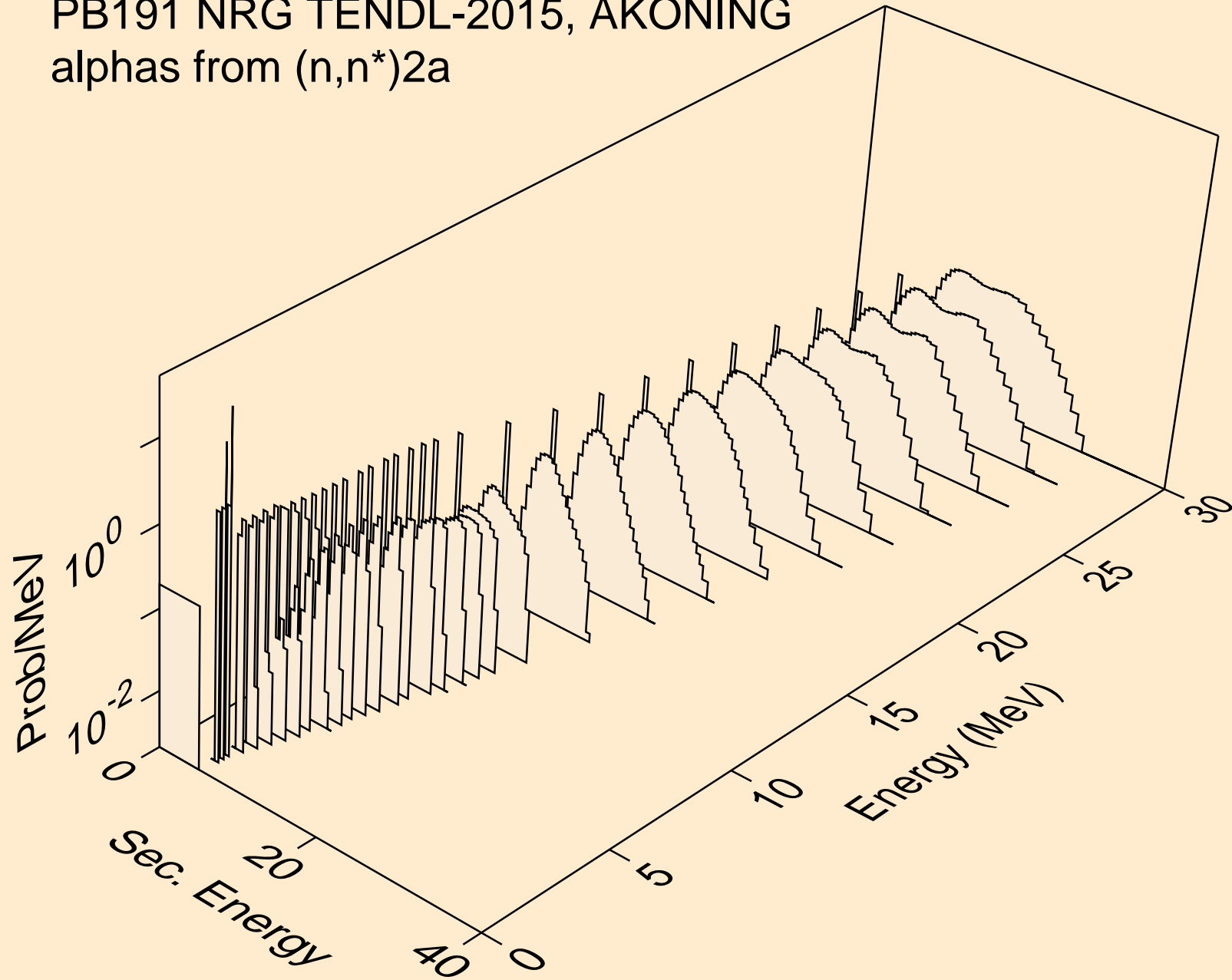



PB191 NRG TENDL-2015, AKONING  
alphas from (n,2n)2a

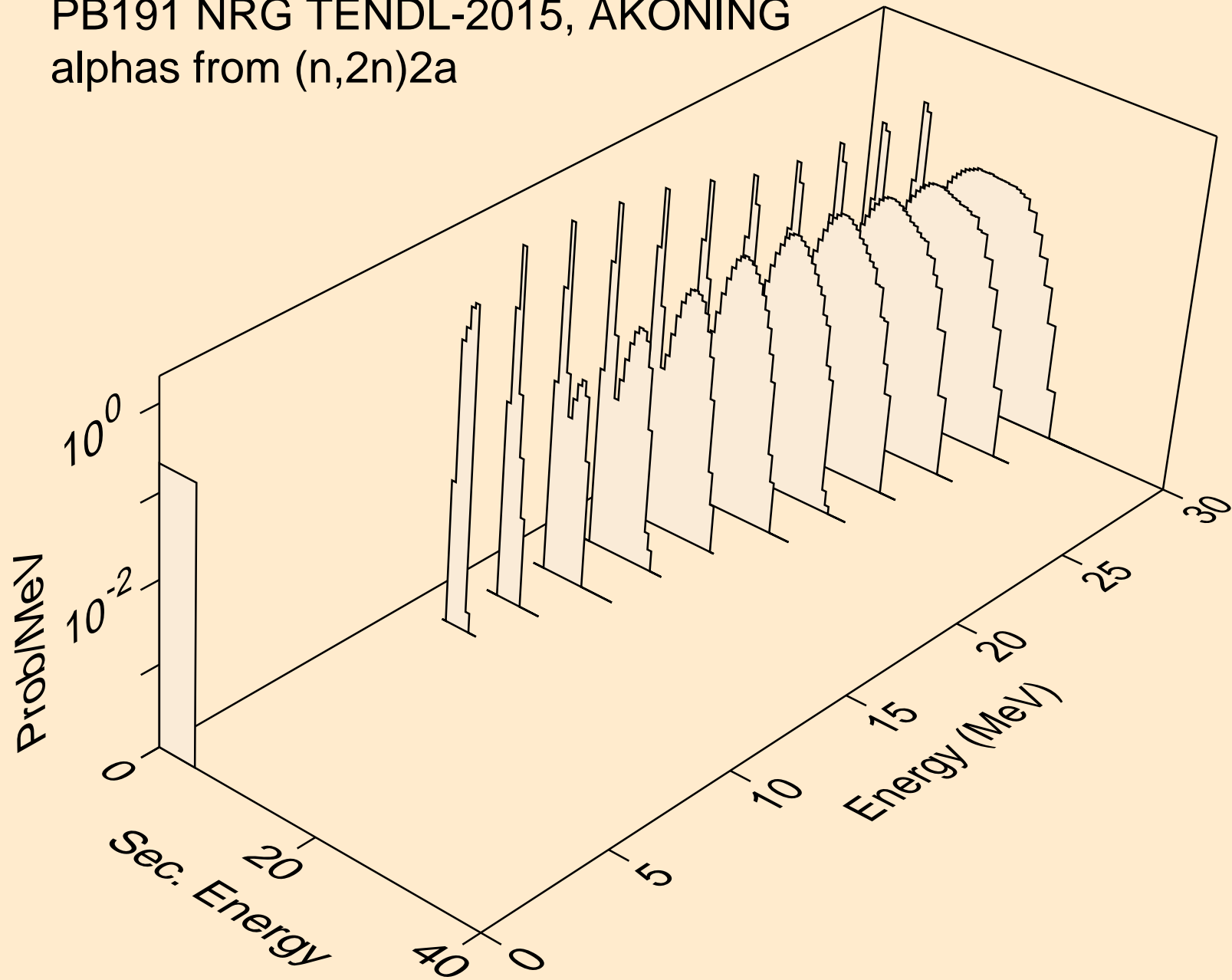

PB191 NRG TENDL-2015, AKONING  
alphas from (n,npa)

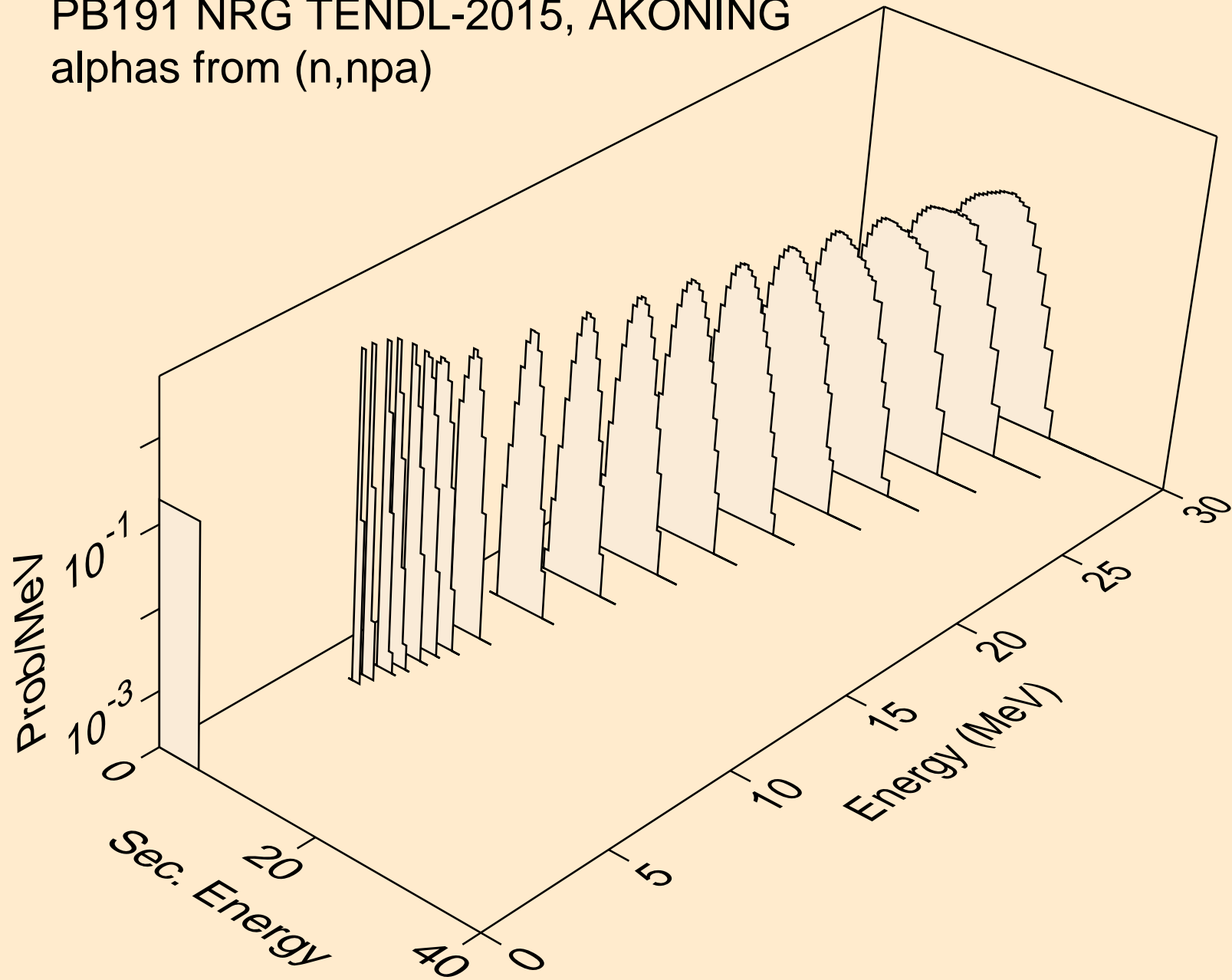

PB191 NRG TENDL-2015, AKONING  
alphas from (n,a)

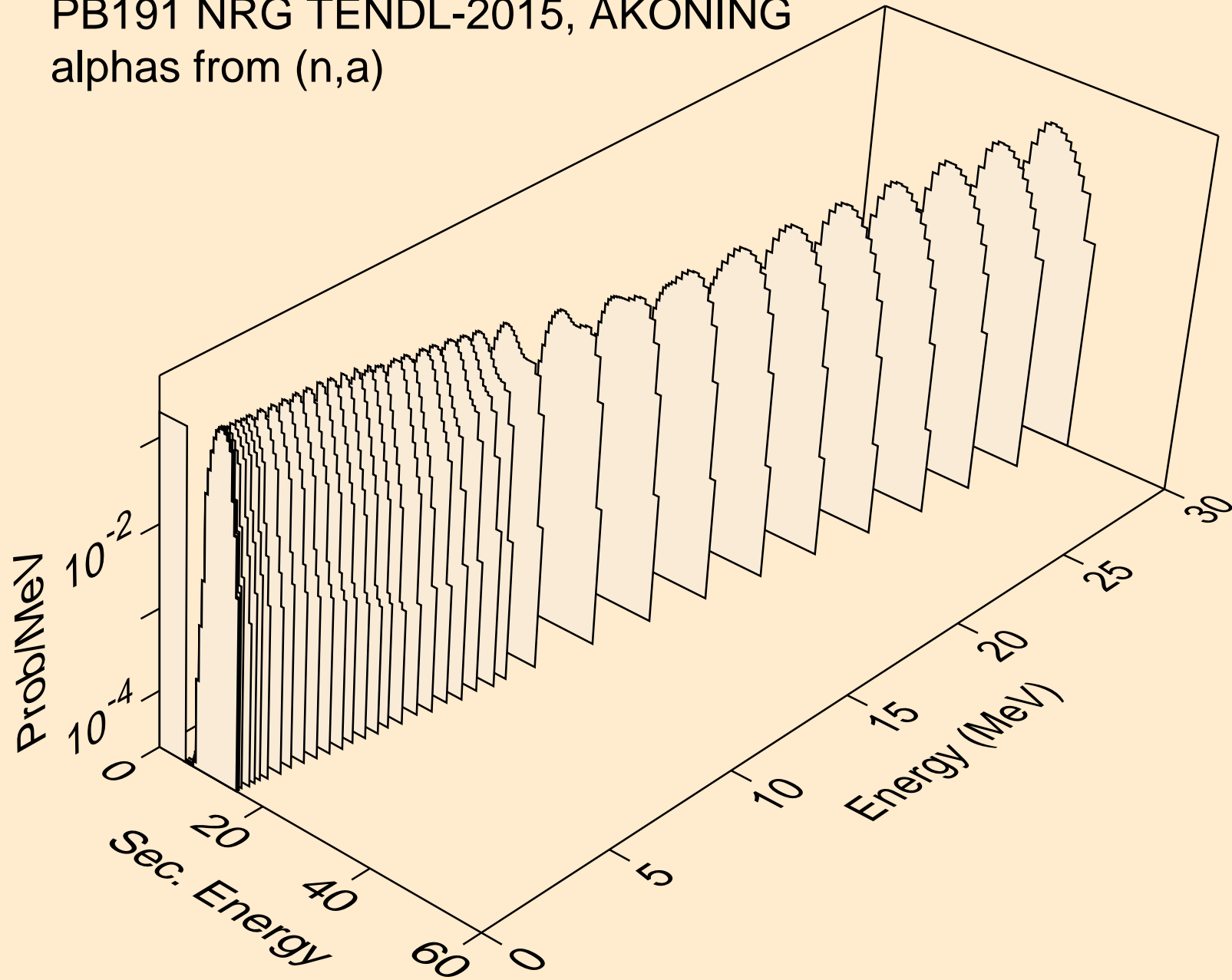

PB191 NRG TENDL-2015, AKONING  
alphas from (n,2a)

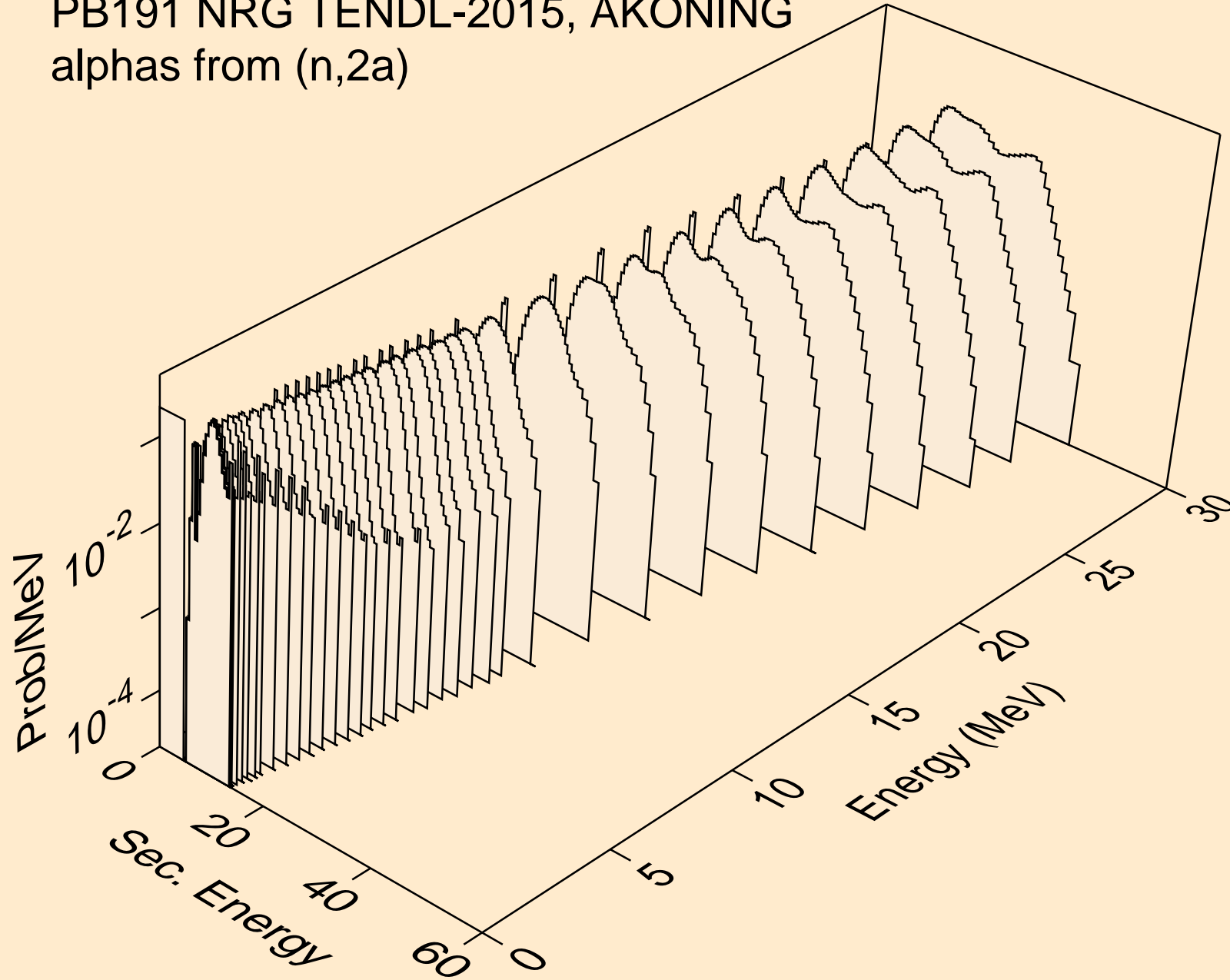

PB191 NRG TENDL-2015, AKONING  
alphas from (n,3a)

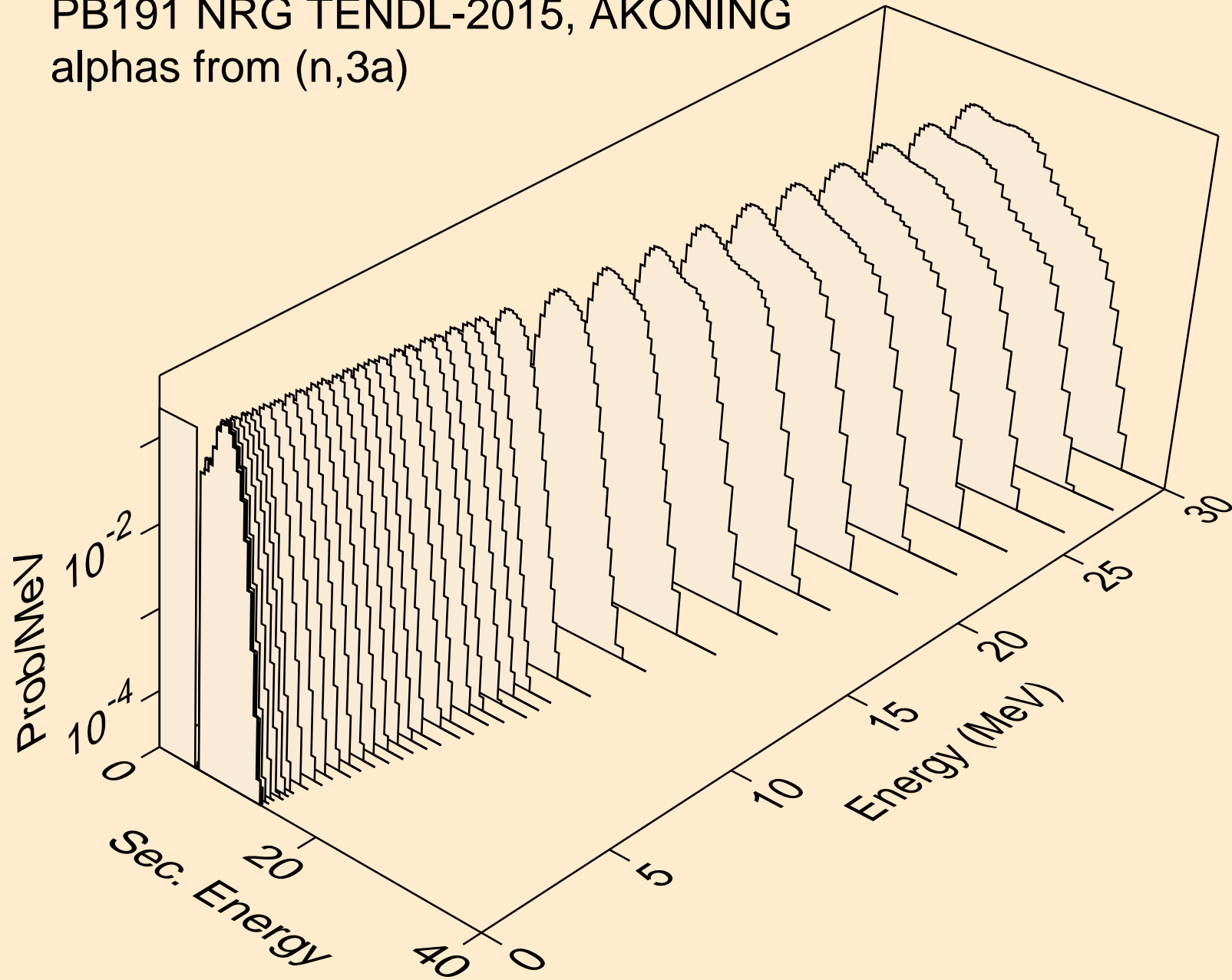

PB191 NRG TENDL-2015, AKONING  
alphas from (n,pa)

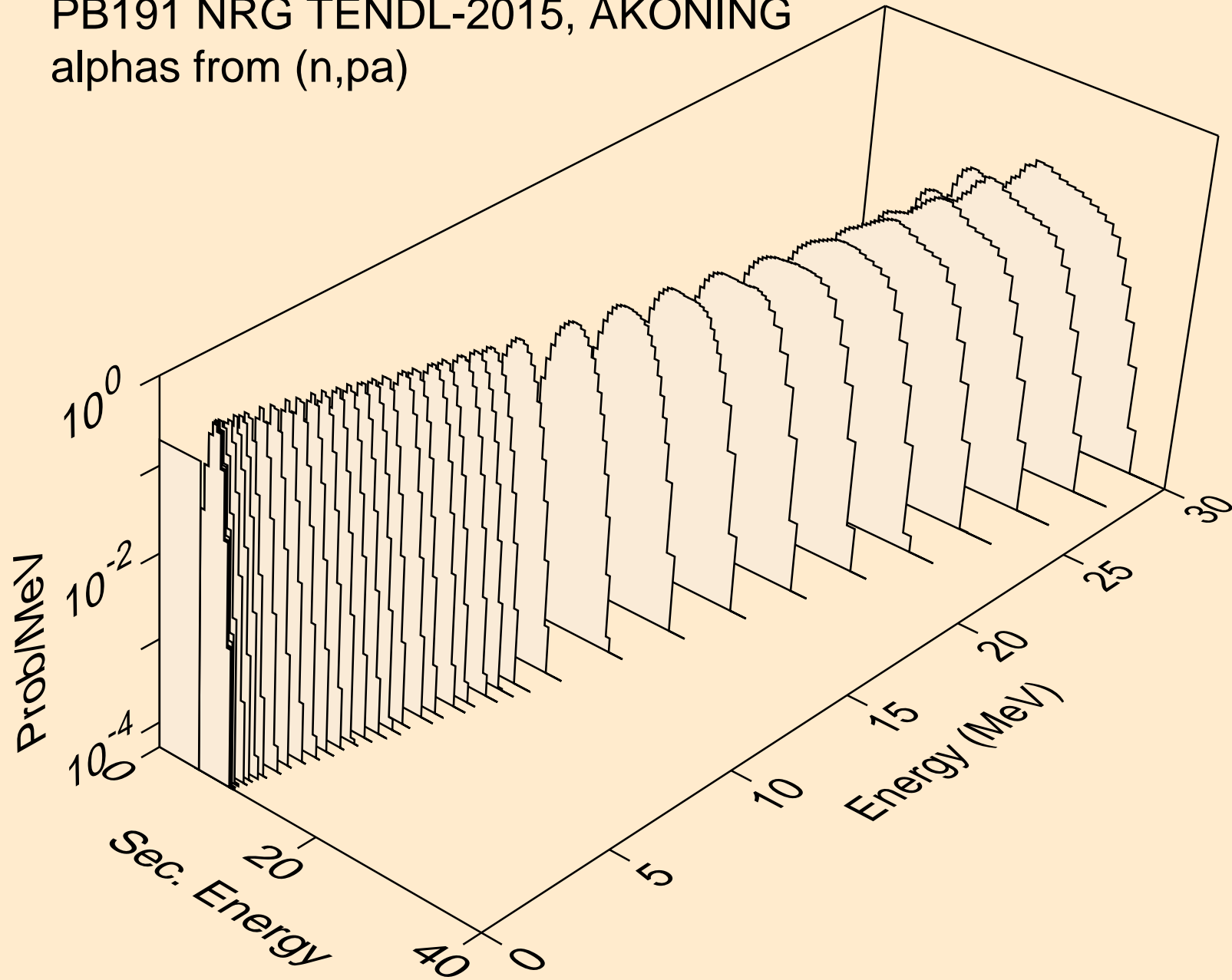

PB191 NRG TENDL-2015, AKONING  
alphas from (n,t2a)

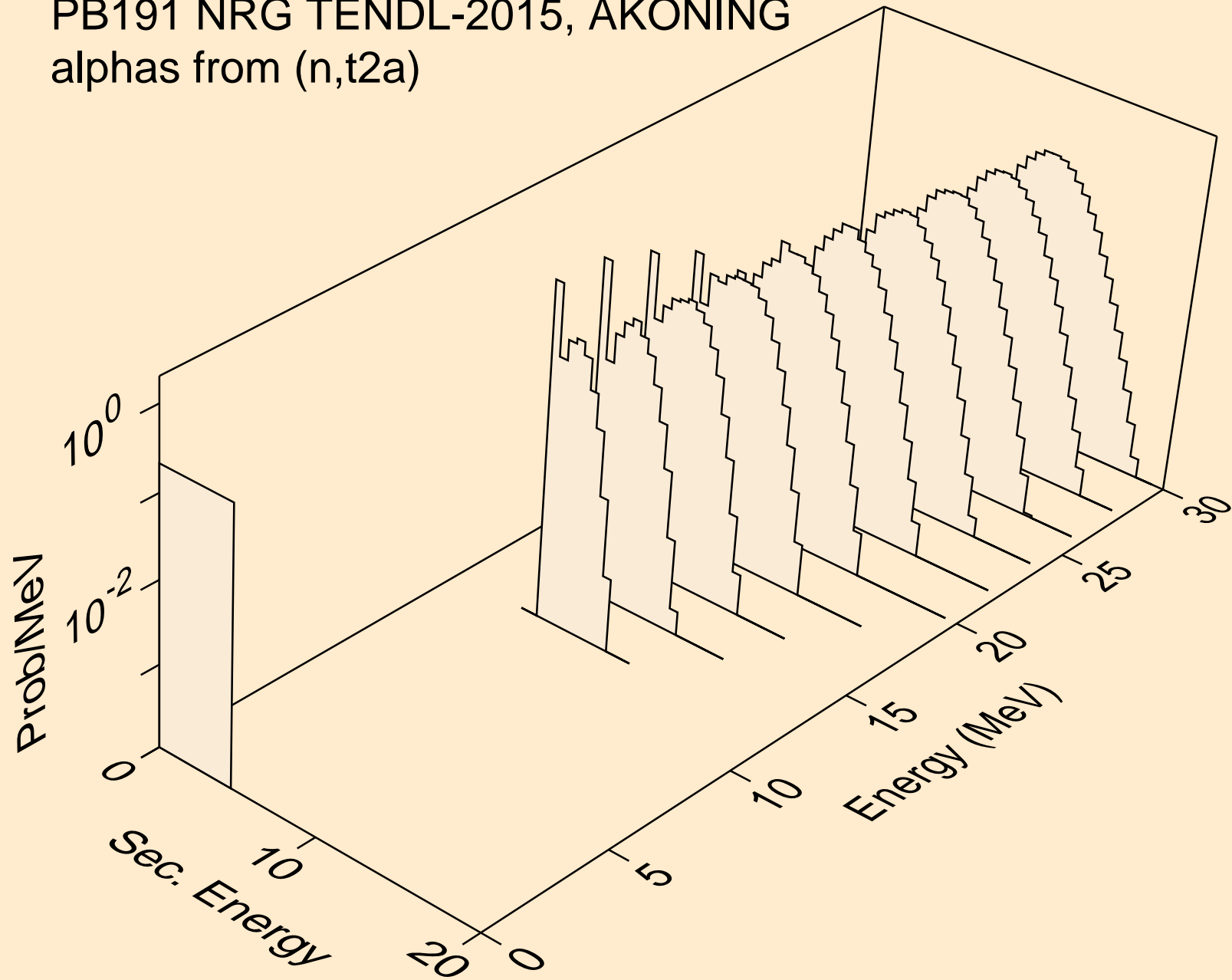

PB191 NRG TENDL-2015, AKONING  
alphas from (n,d2a)

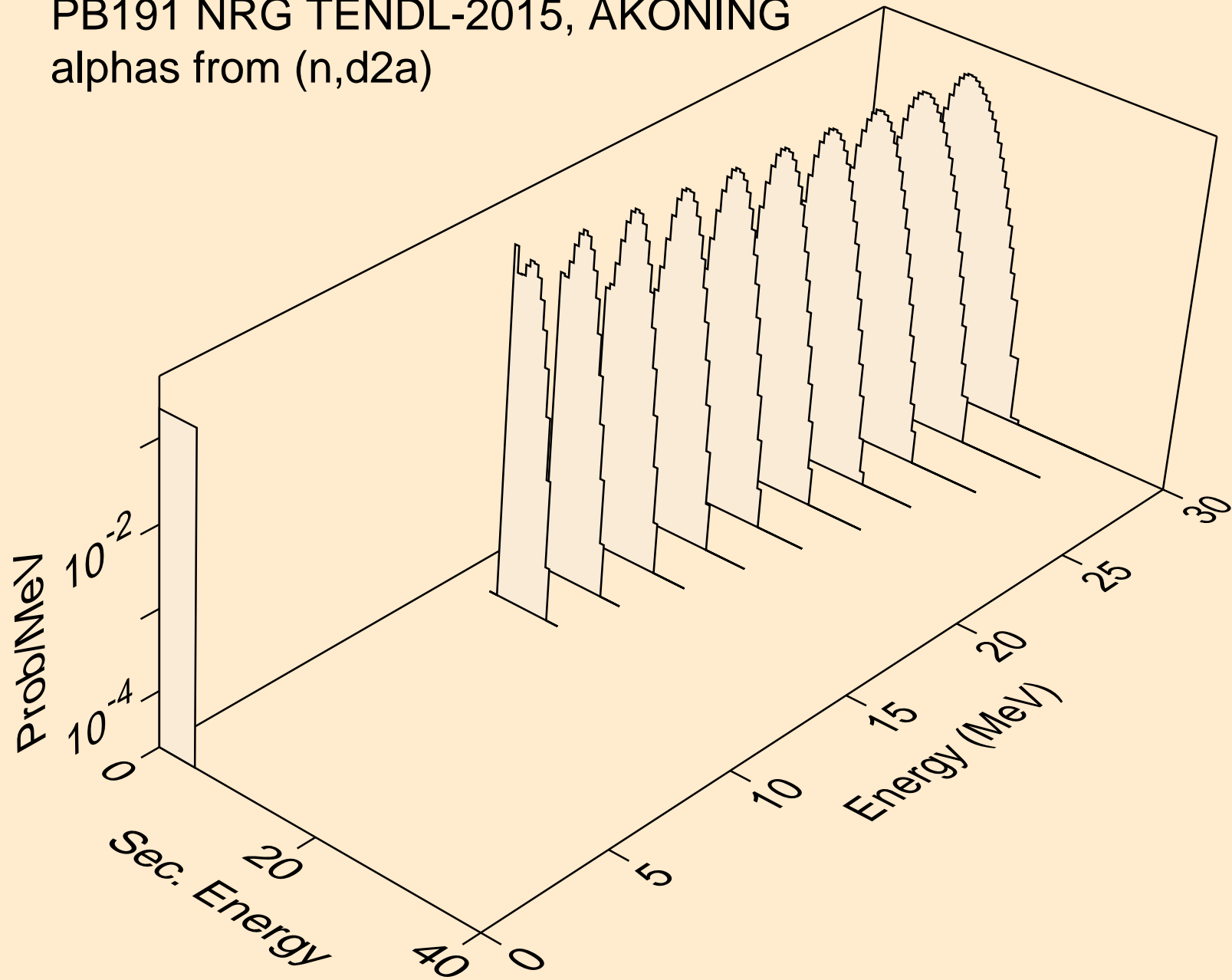



PB191 NRG TENDL-2015, AKONING  
alphas from (n,da)

