

# PB213 NRG TENDL-2015, AKONING

## Principal cross sections

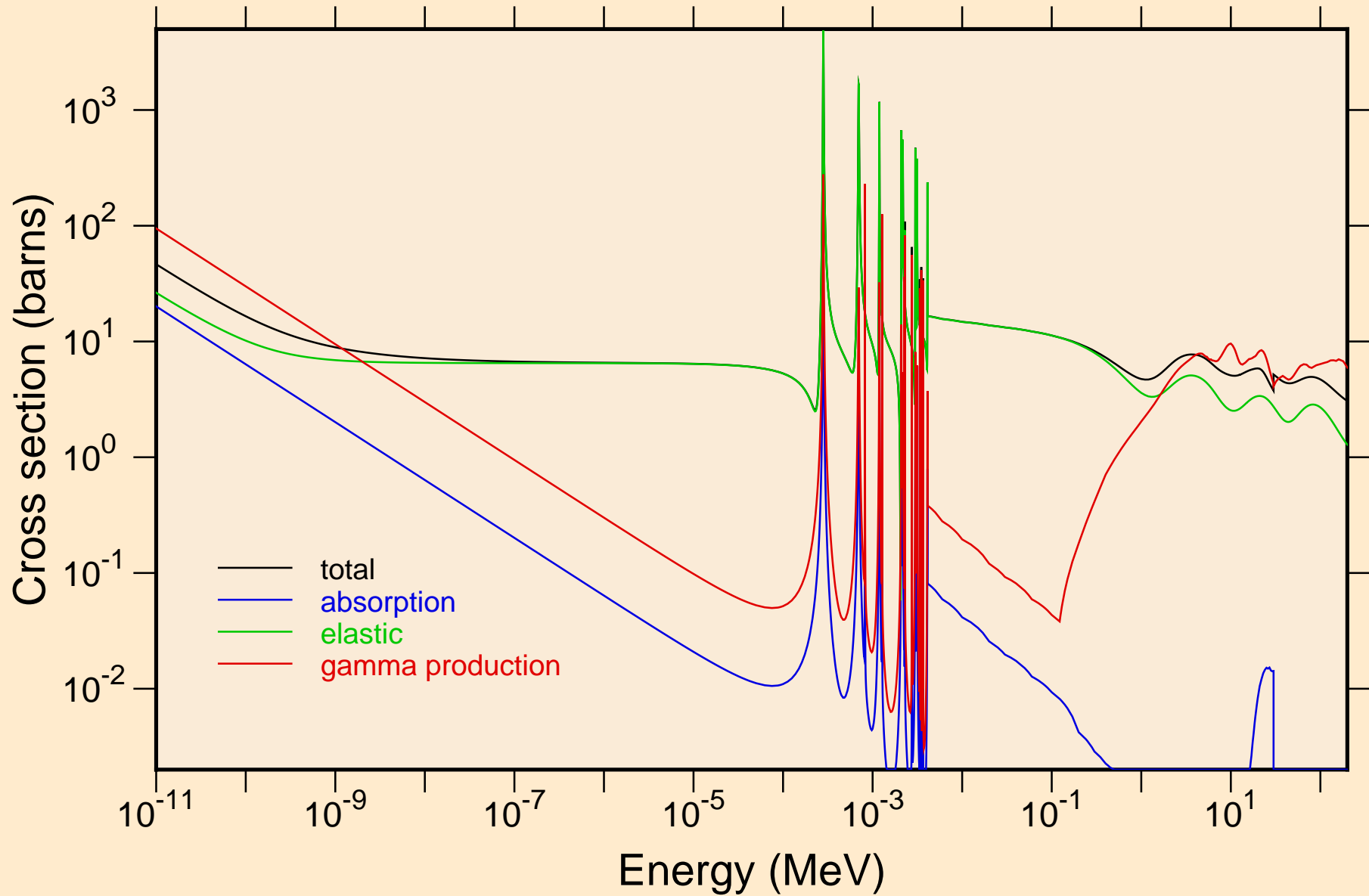

PB213 NRG TENDL-2015, AKONING  
resonance total cross section

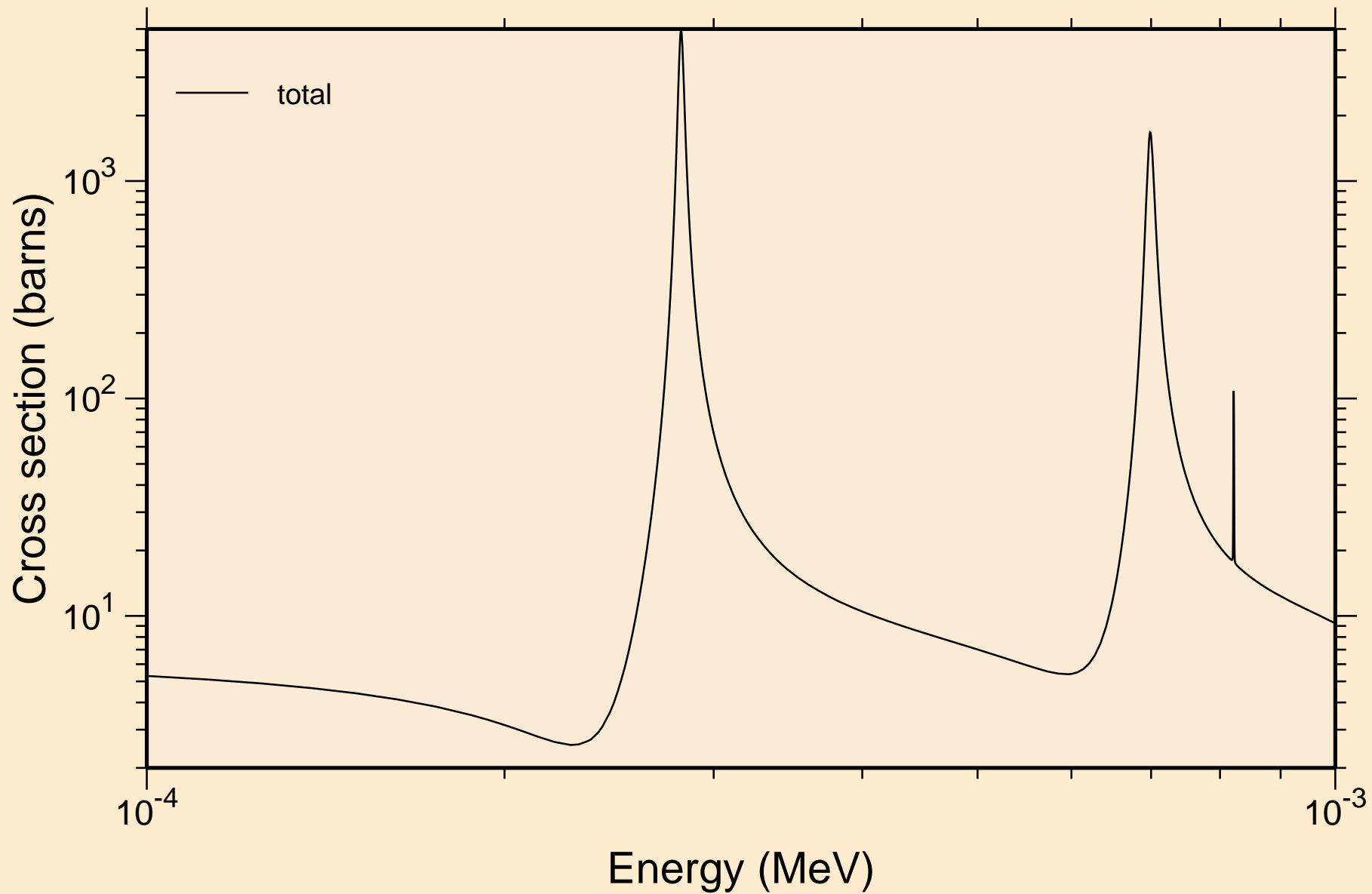

PB213 NRG TENDL-2015, AKONING  
resonance total cross section

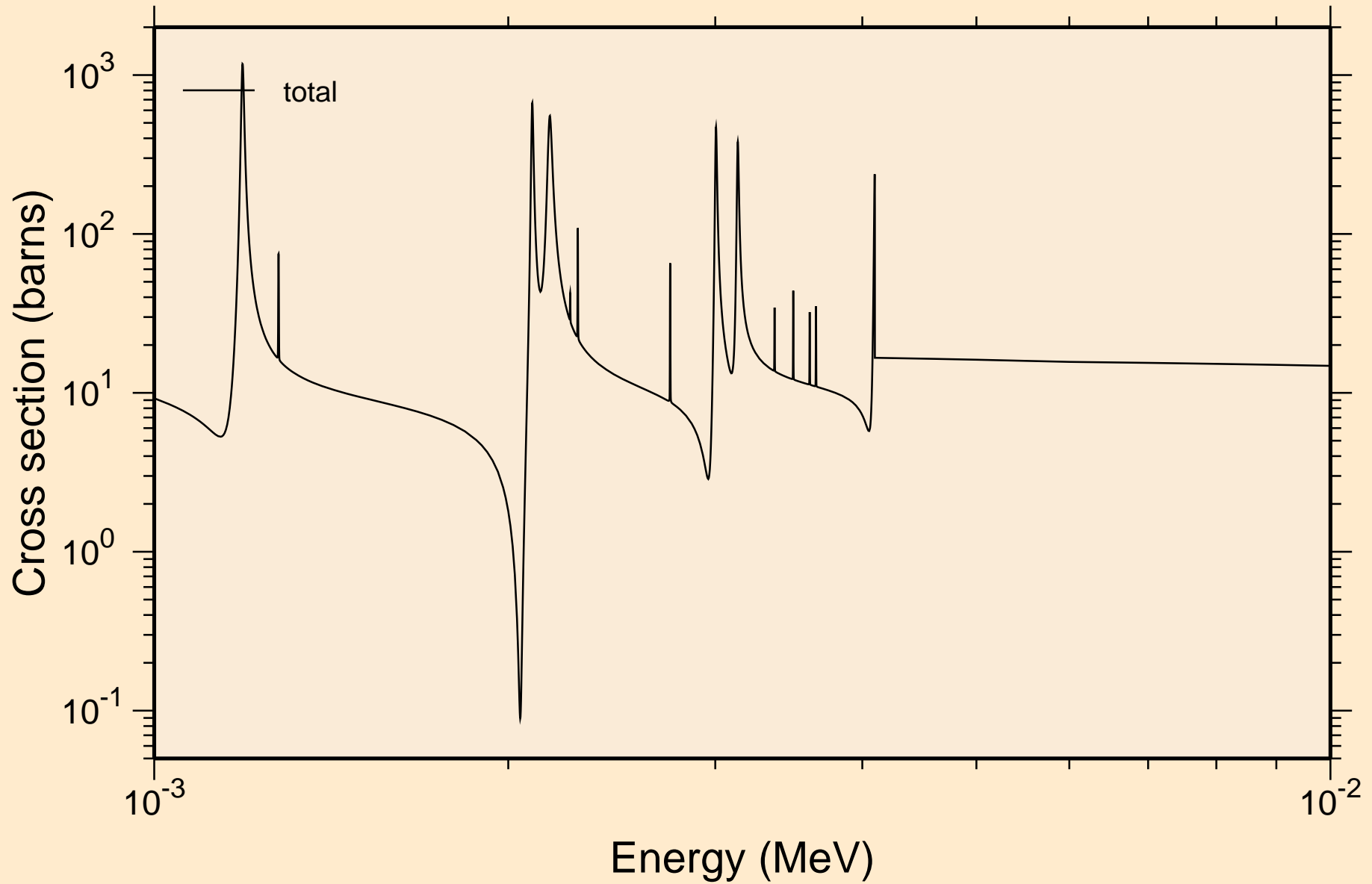

PB213 NRG TENDL-2015, AKONING  
resonance total cross section

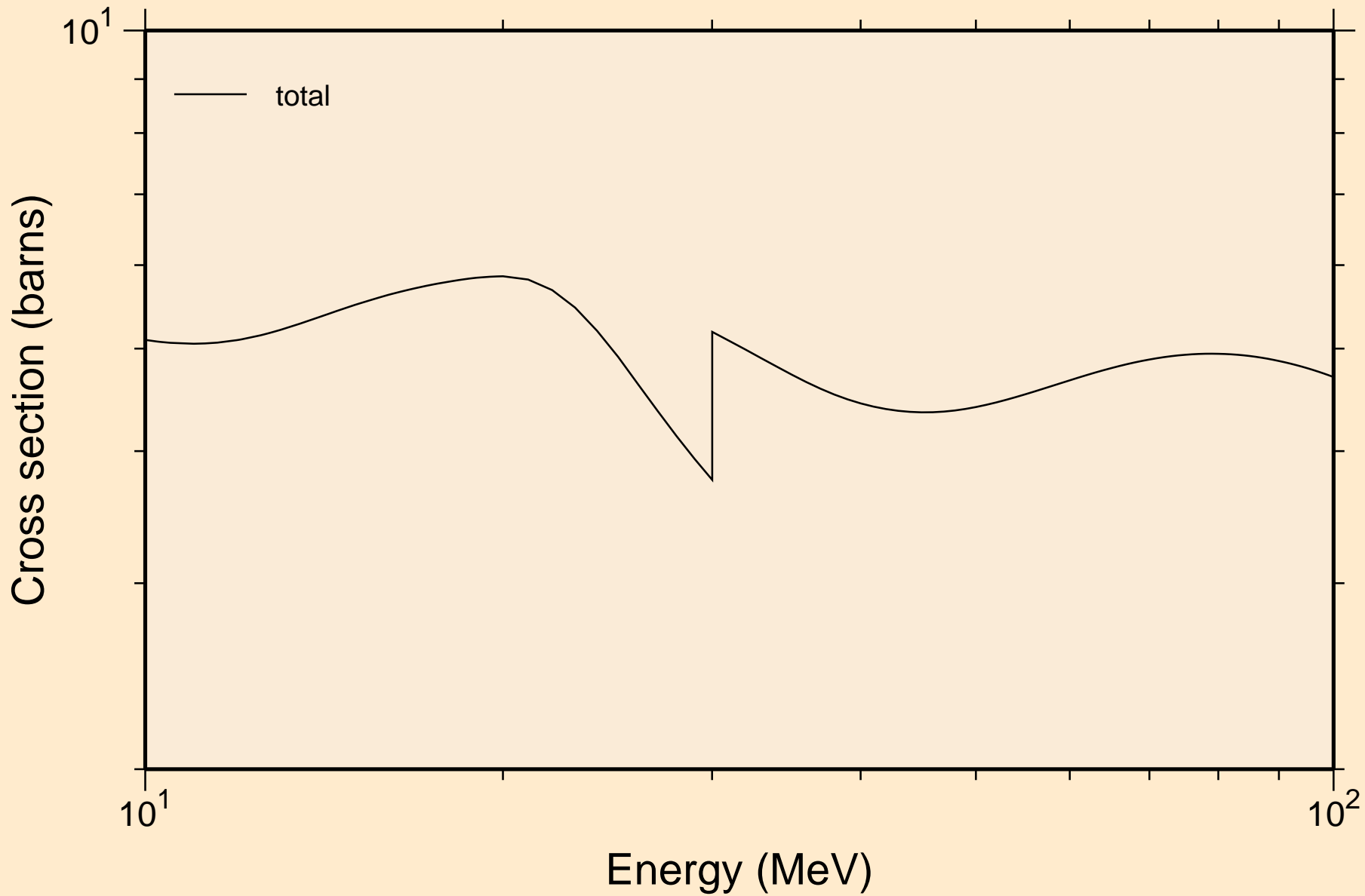

PB213 NRG TENDL-2015, AKONING  
resonance absorption cross sections

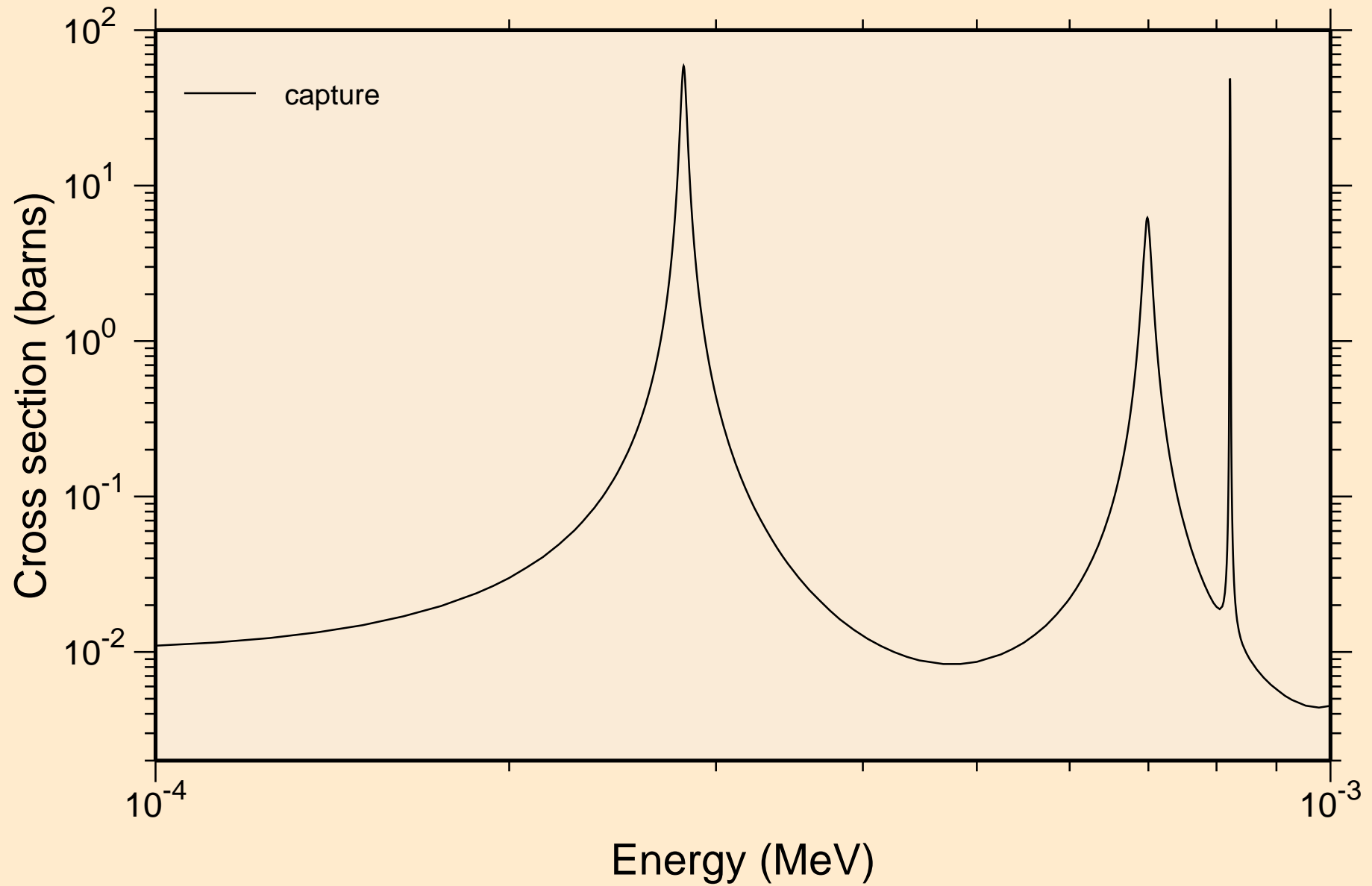

PB213 NRG TENDL-2015, AKONING  
resonance absorption cross sections

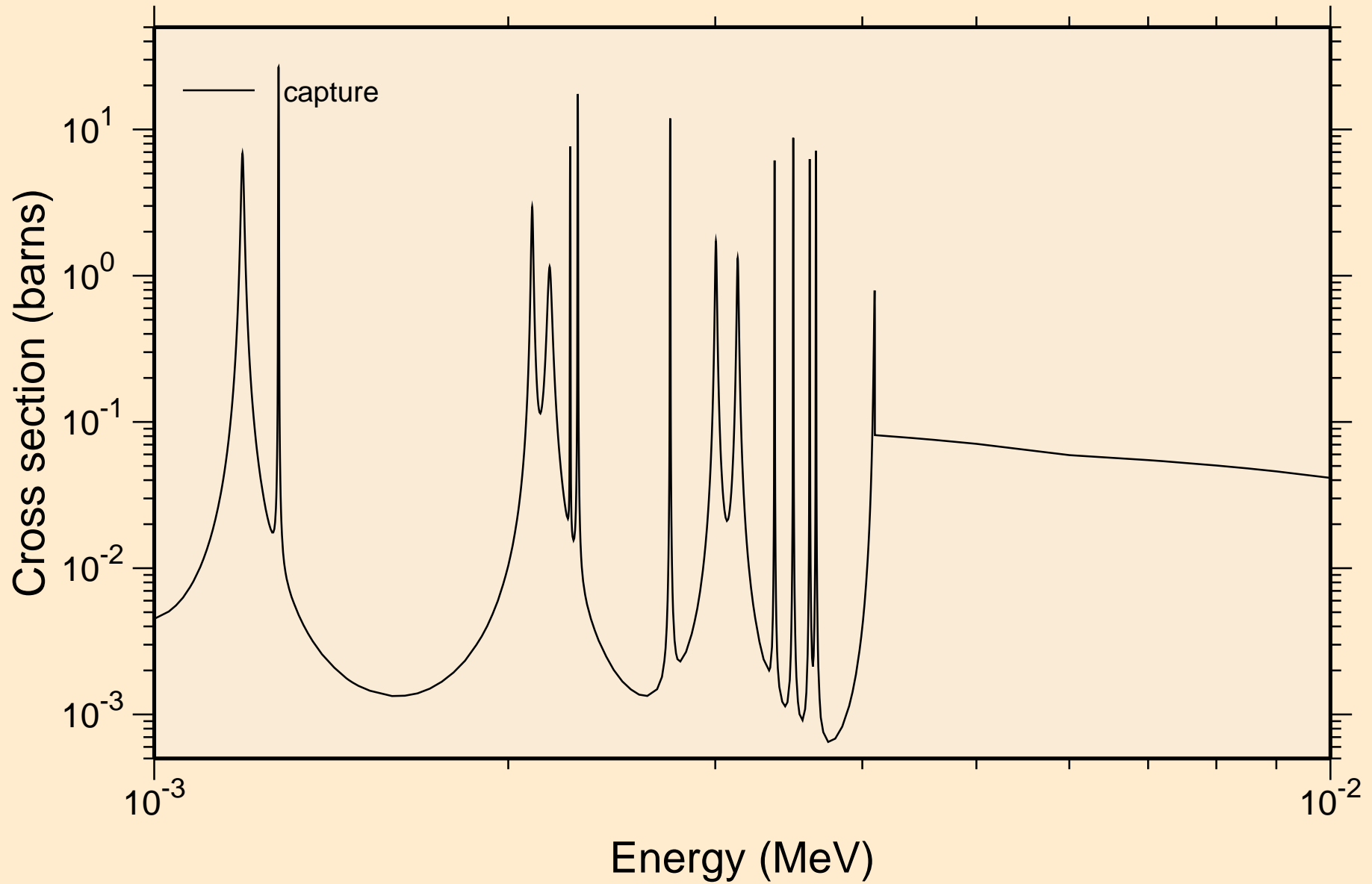

PB213 NRG TENDL-2015, AKONING  
resonance absorption cross sections

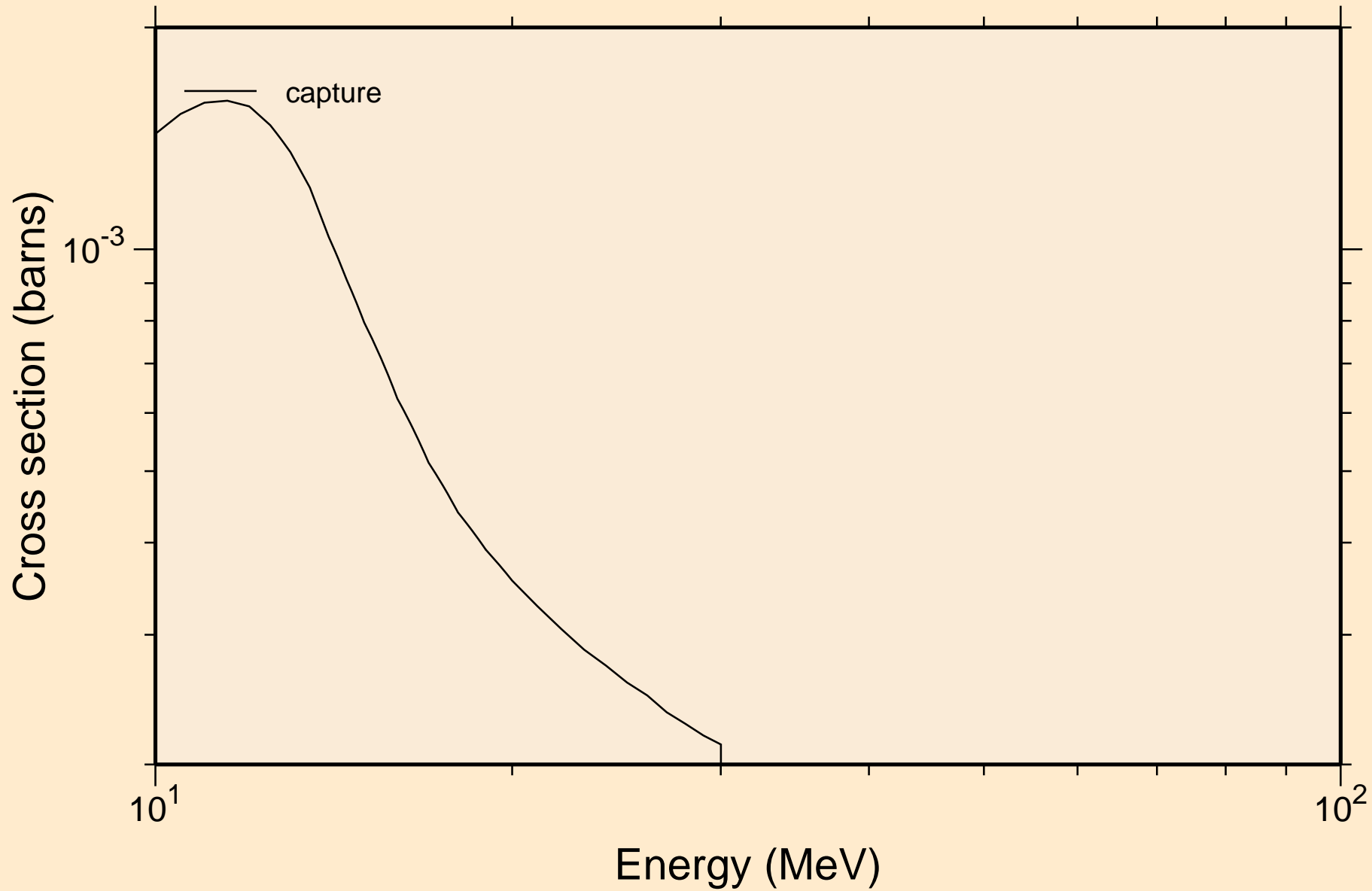

# PB213 NRG TENDL-2015, AKONING

## Non-threshold reactions

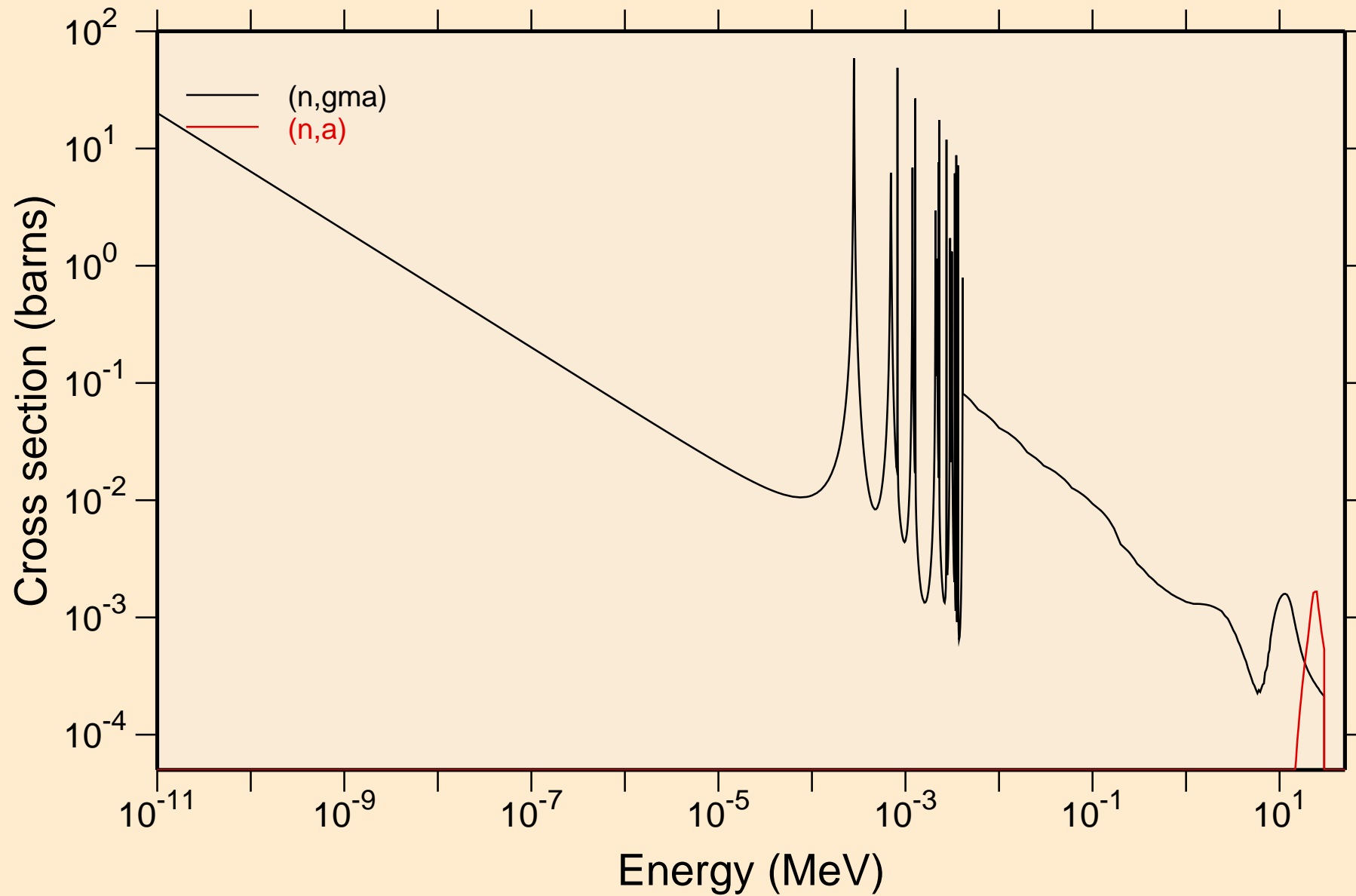



# PB213 NRG TENDL-2015, AKONING

## Principal cross sections

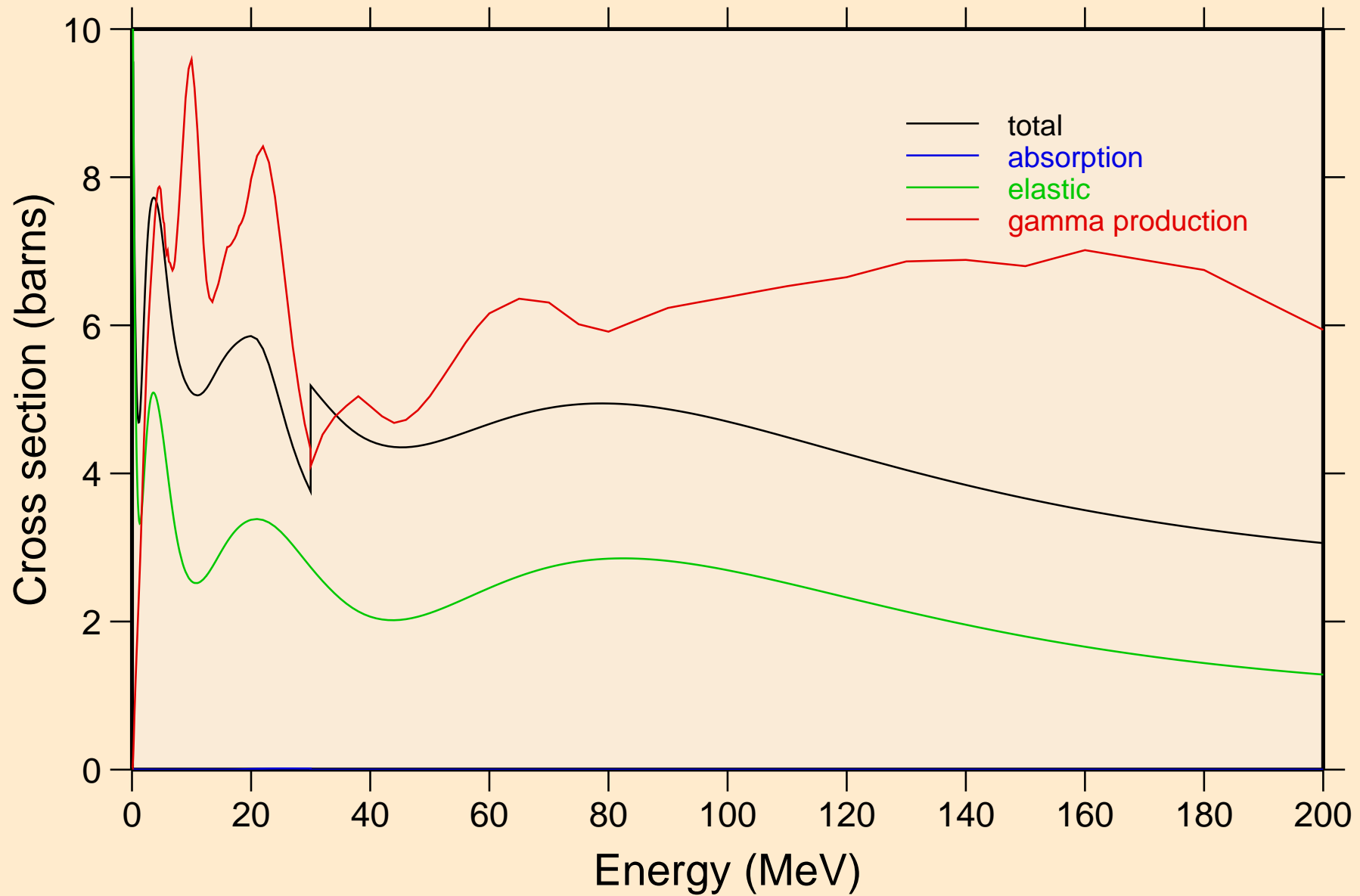

# PB213 NRG TENDL-2015, AKONING

## Non-threshold reactions

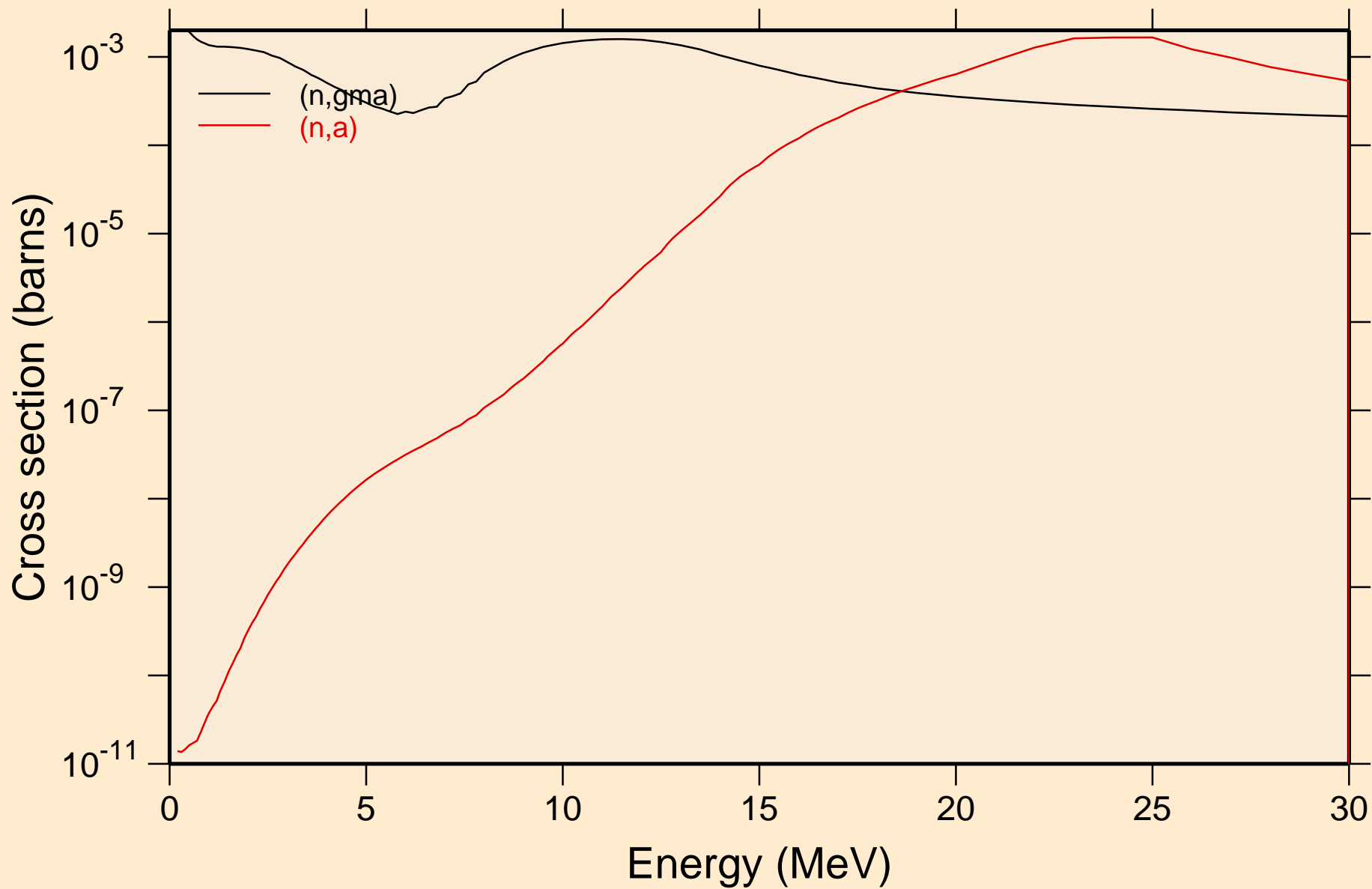

PB213 NRG TENDL-2015, AKONING  
Inelastic levels

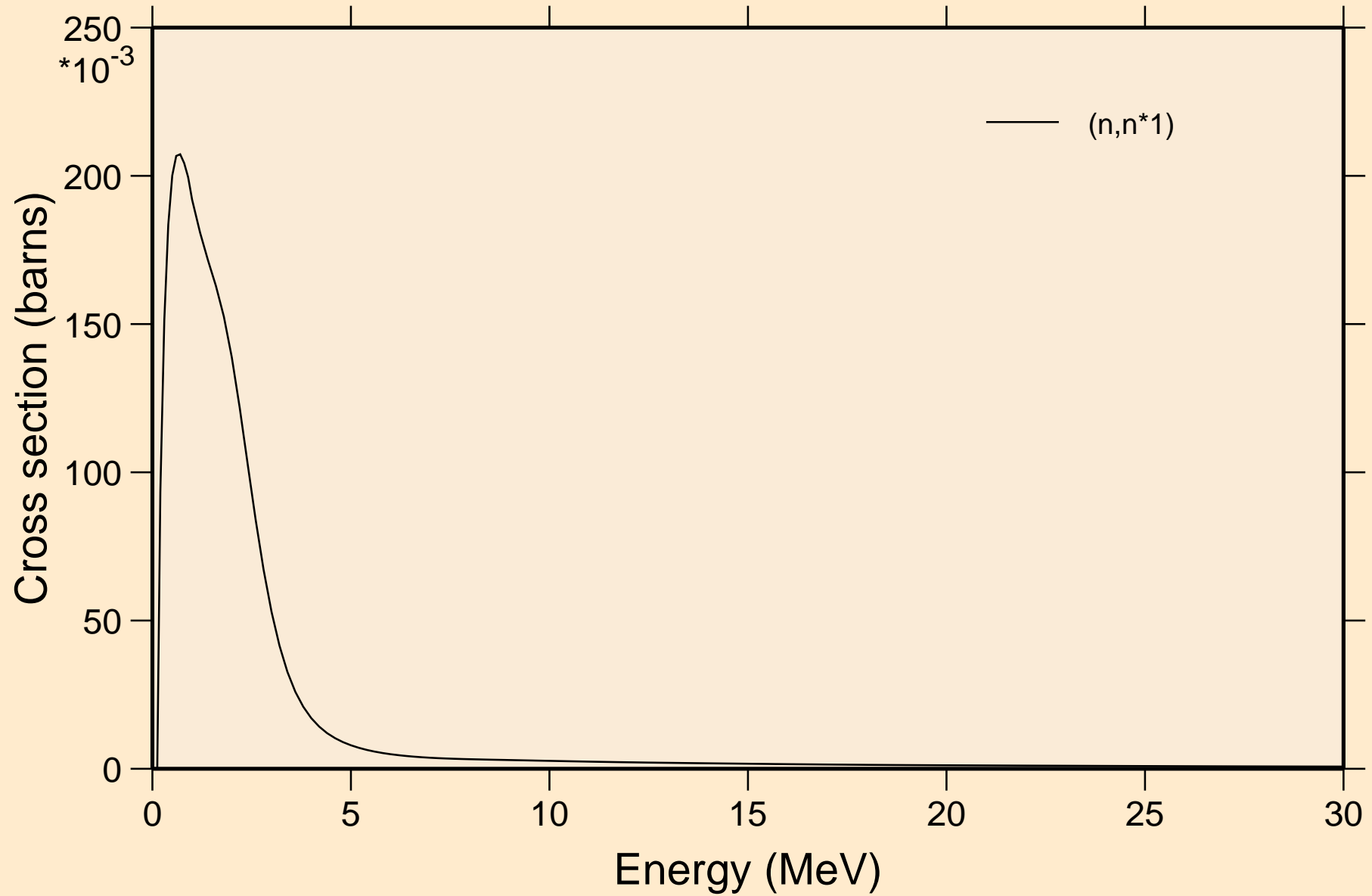

# PB213 NRG TENDL-2015, AKONING

## Threshold reactions

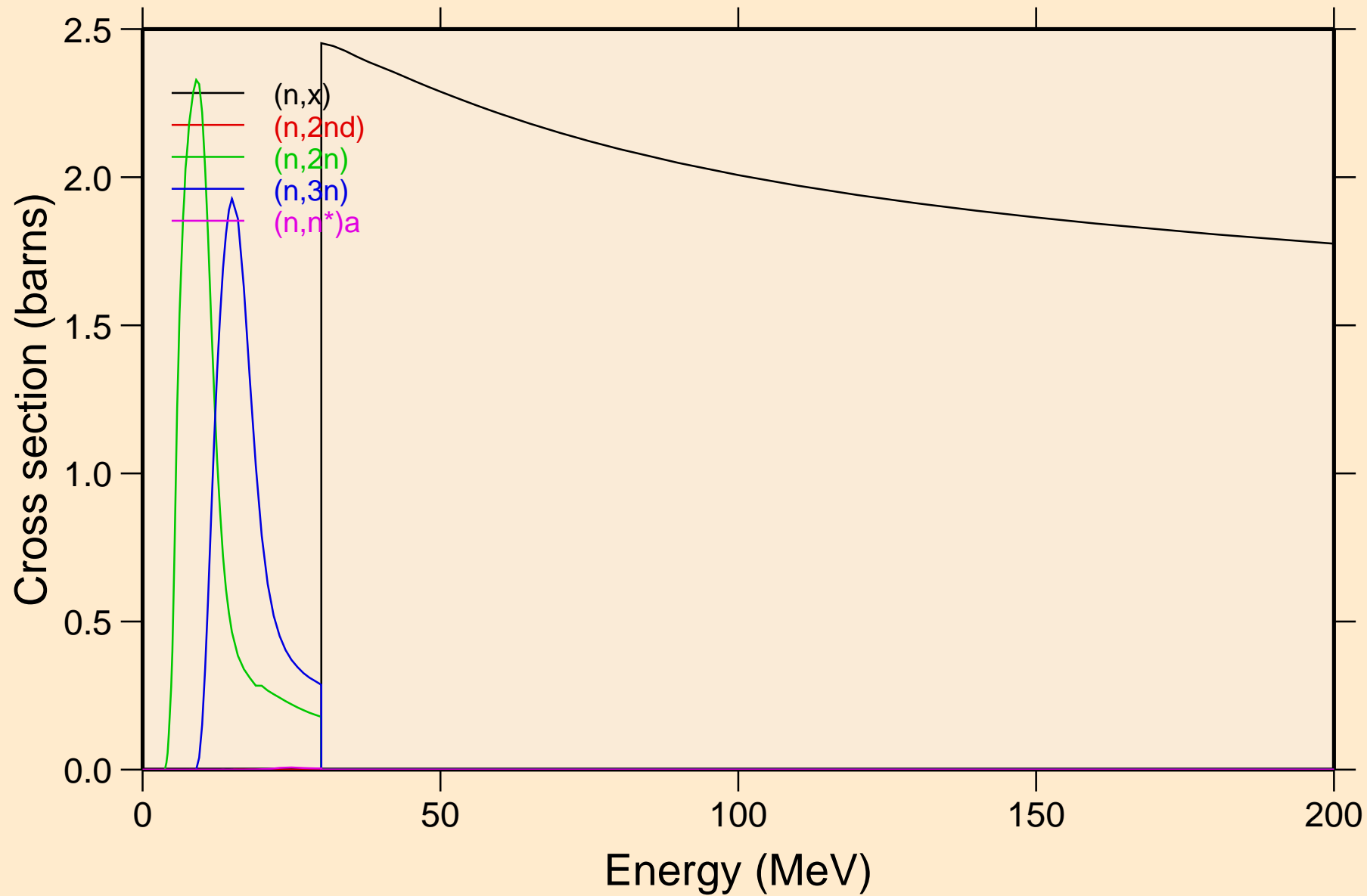

# PB213 NRG TENDL-2015, AKONING

## Threshold reactions

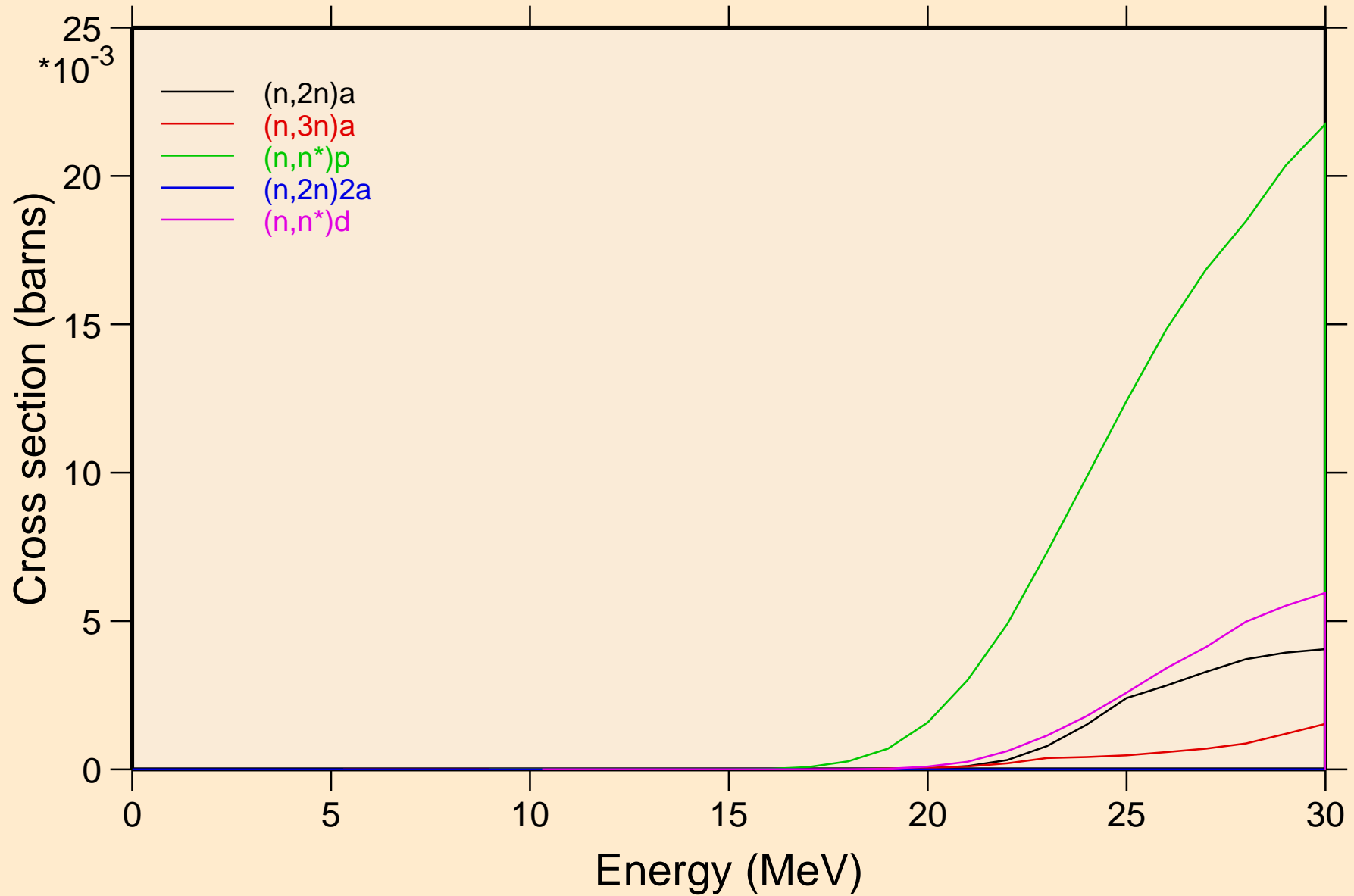

# PB213 NRG TENDL-2015, AKONING

## Threshold reactions

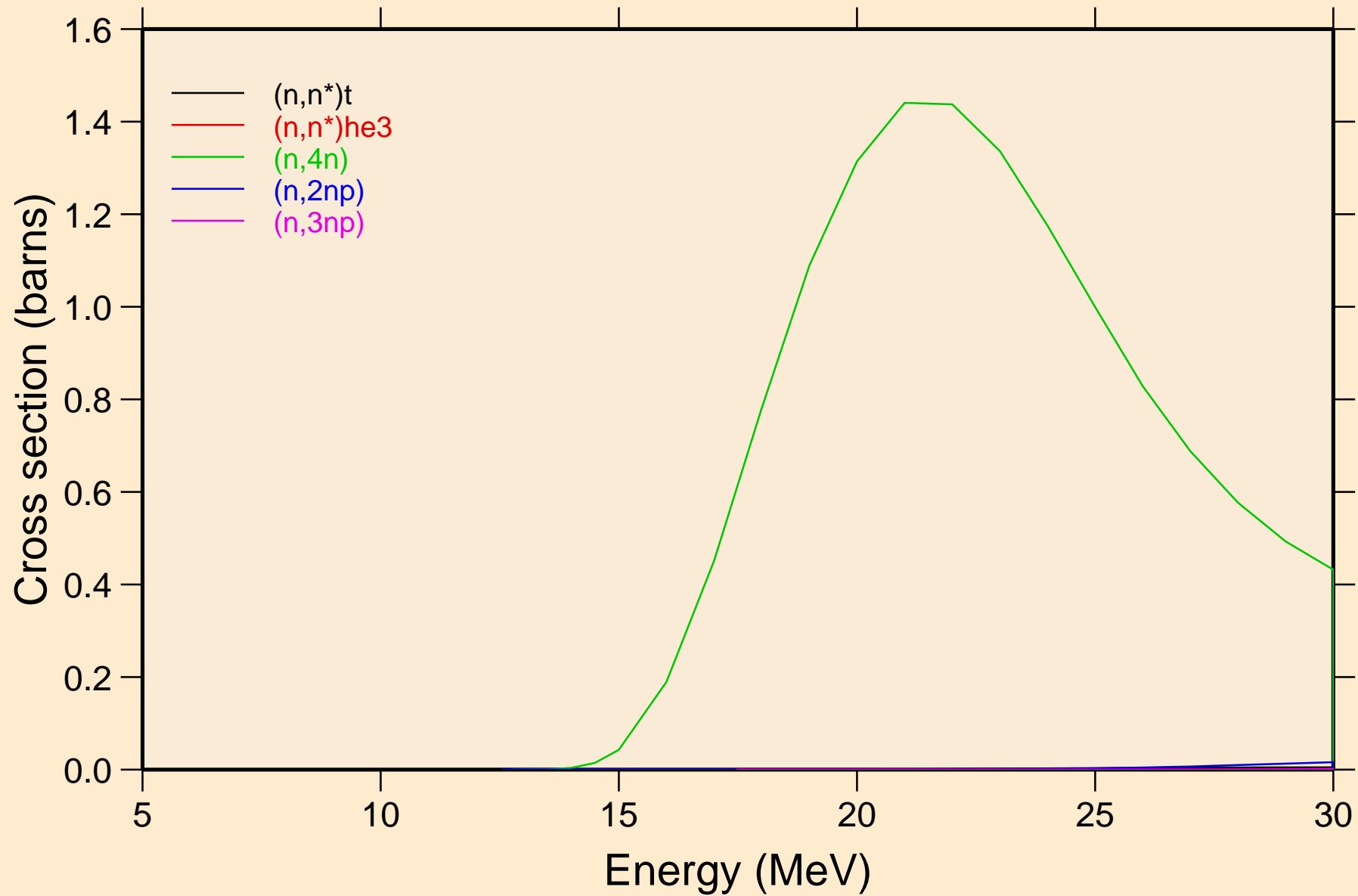

# PB213 NRG TENDL-2015, AKONING

## Threshold reactions

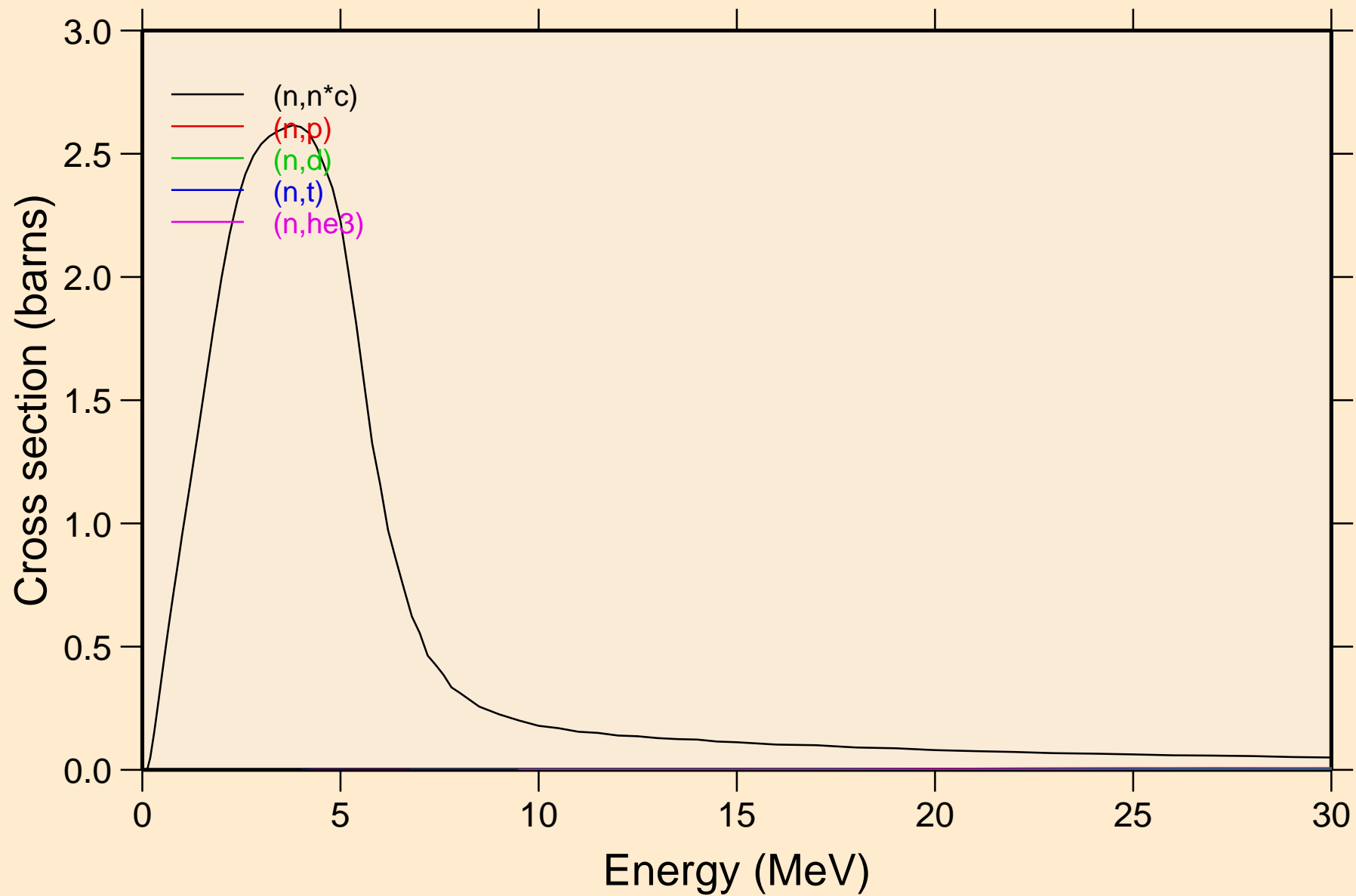

# PB213 NRG TENDL-2015, AKONING

## Threshold reactions

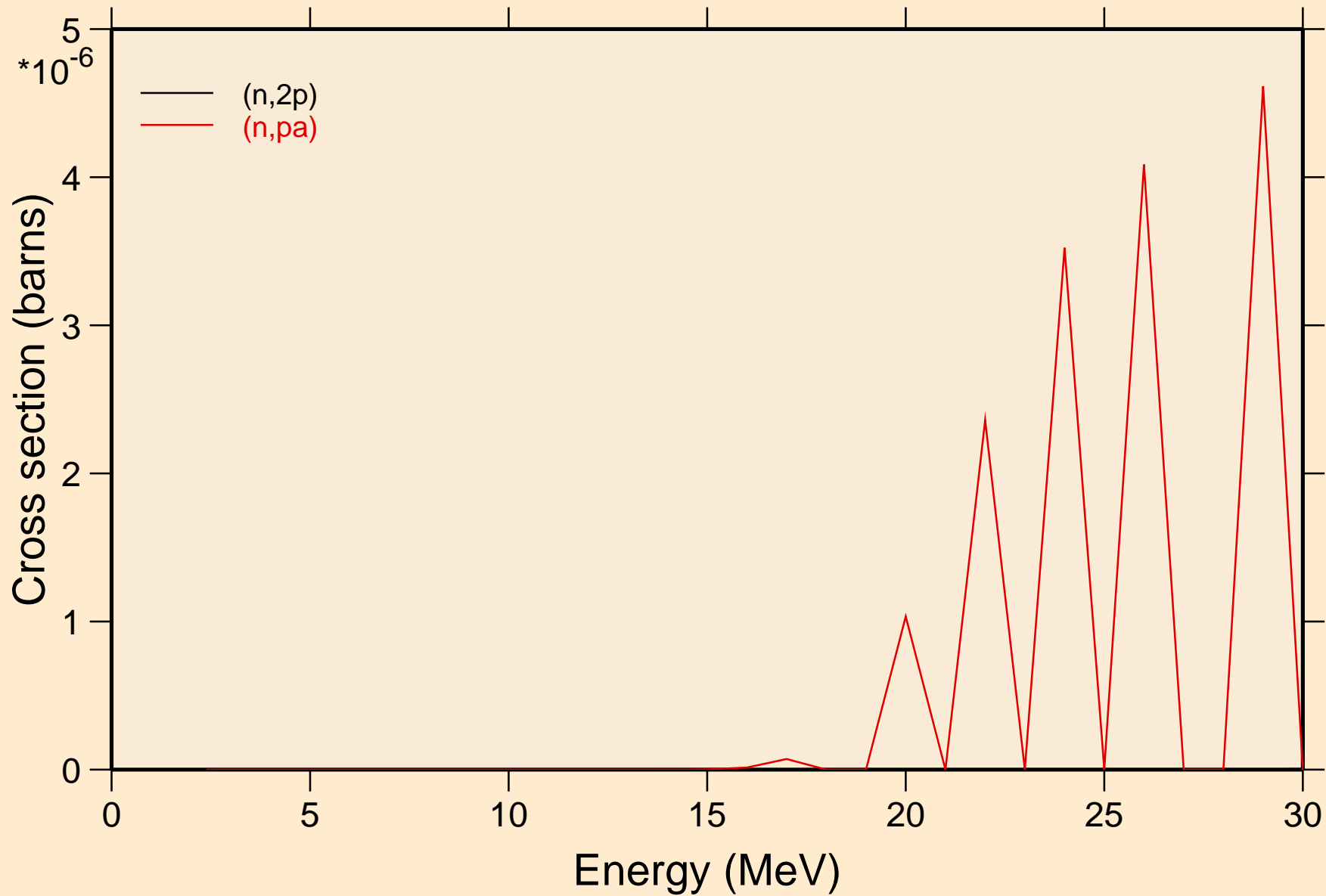



PB213 NRG TENDL-2015, AKONING  
angular distribution for elastic

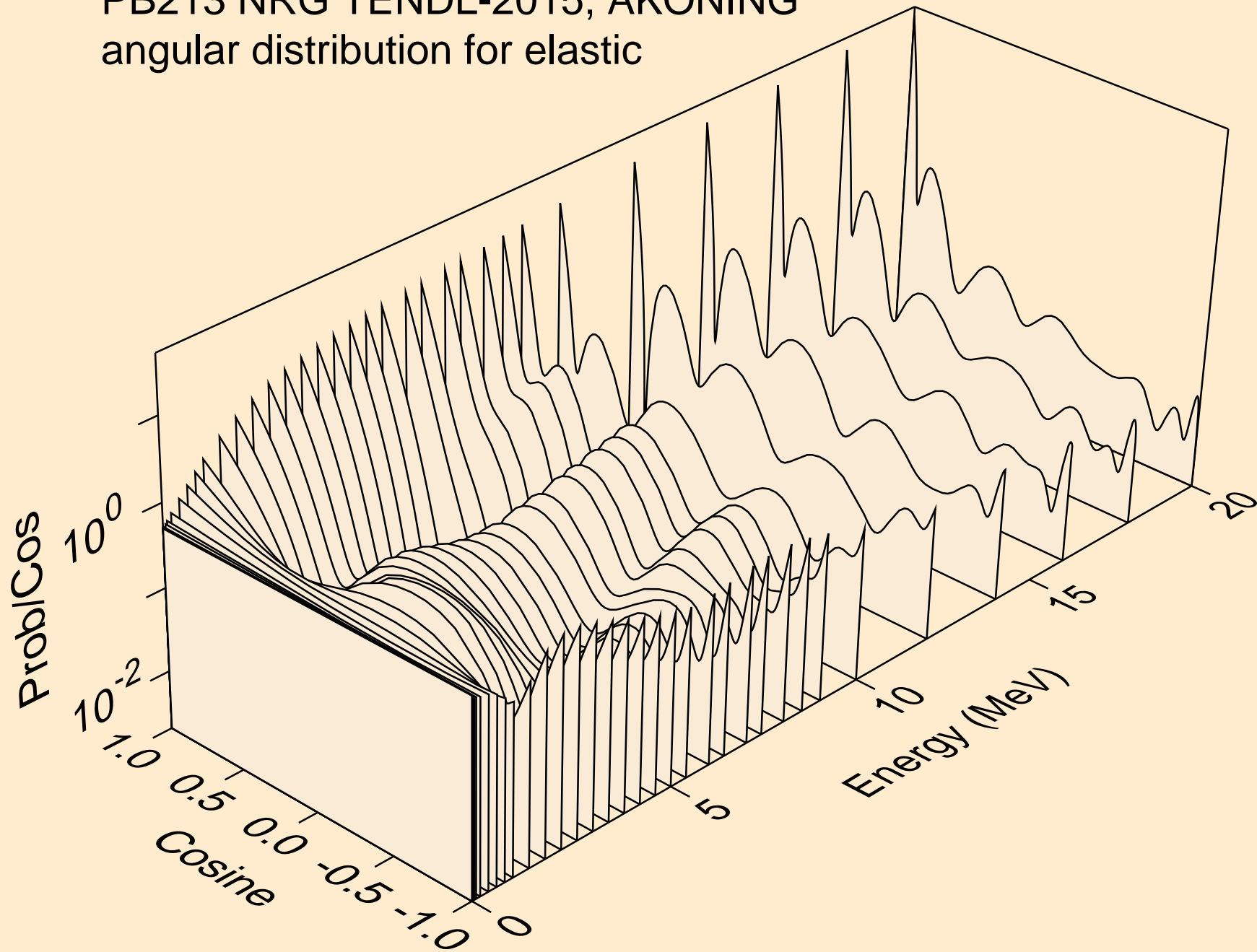

PB213 NRG TENDL-2015, AKONING  
angular distribution for elastic

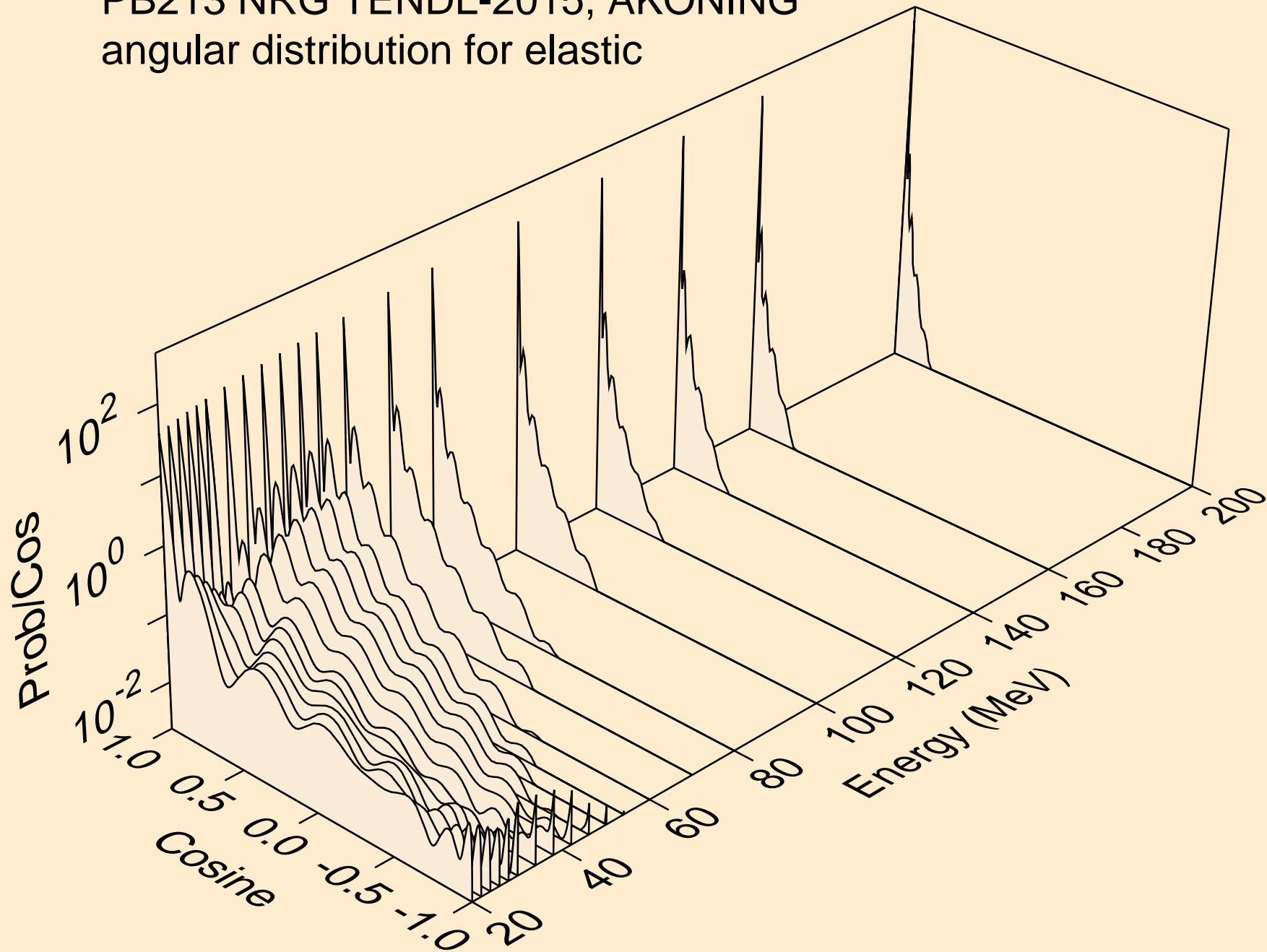

PB213 NRG TENDL-2015, AKONING  
angular distribution for (n,n\*1)

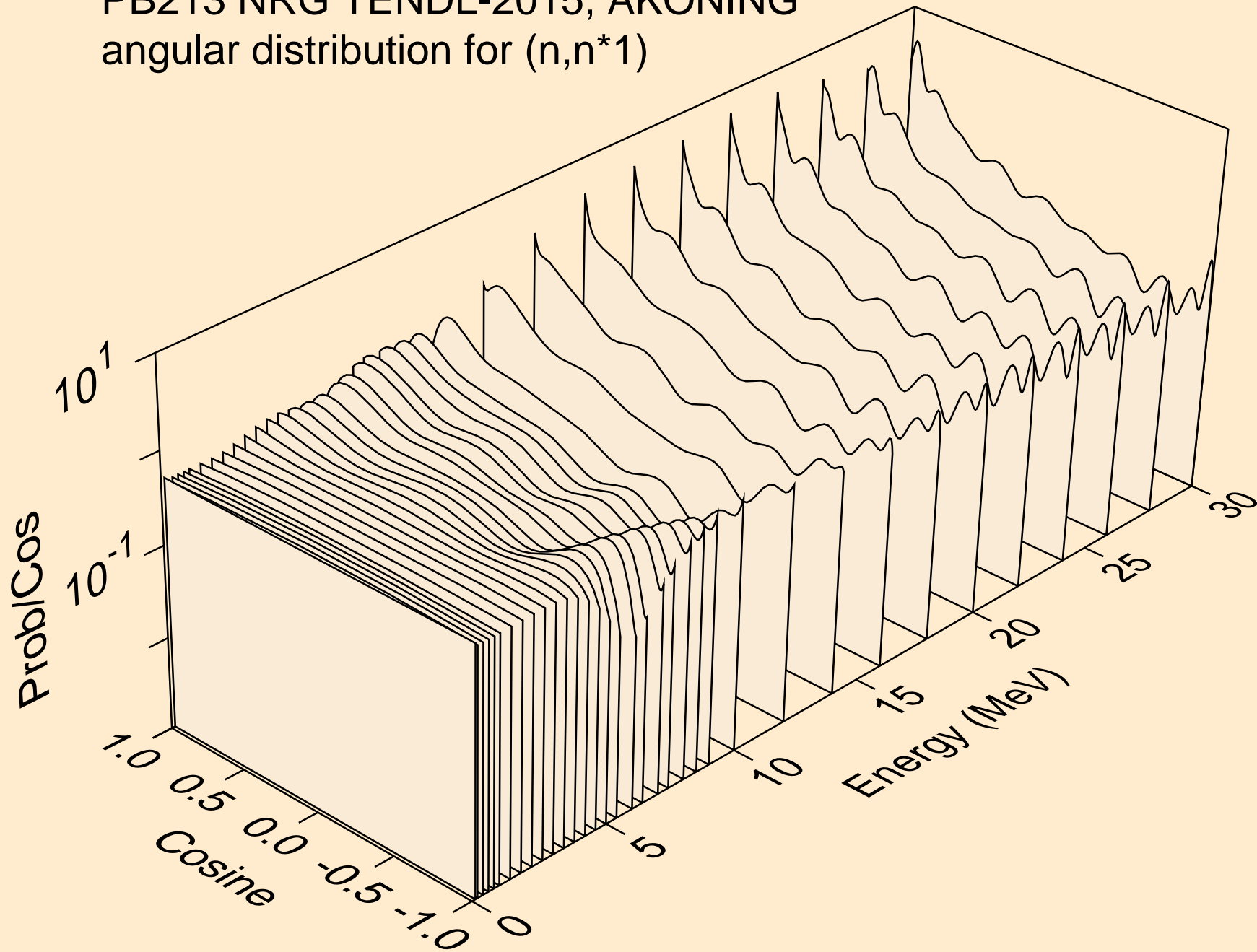

PB213 NRG TENDL-2015, AKONING  
Neutron emission for (n,x)

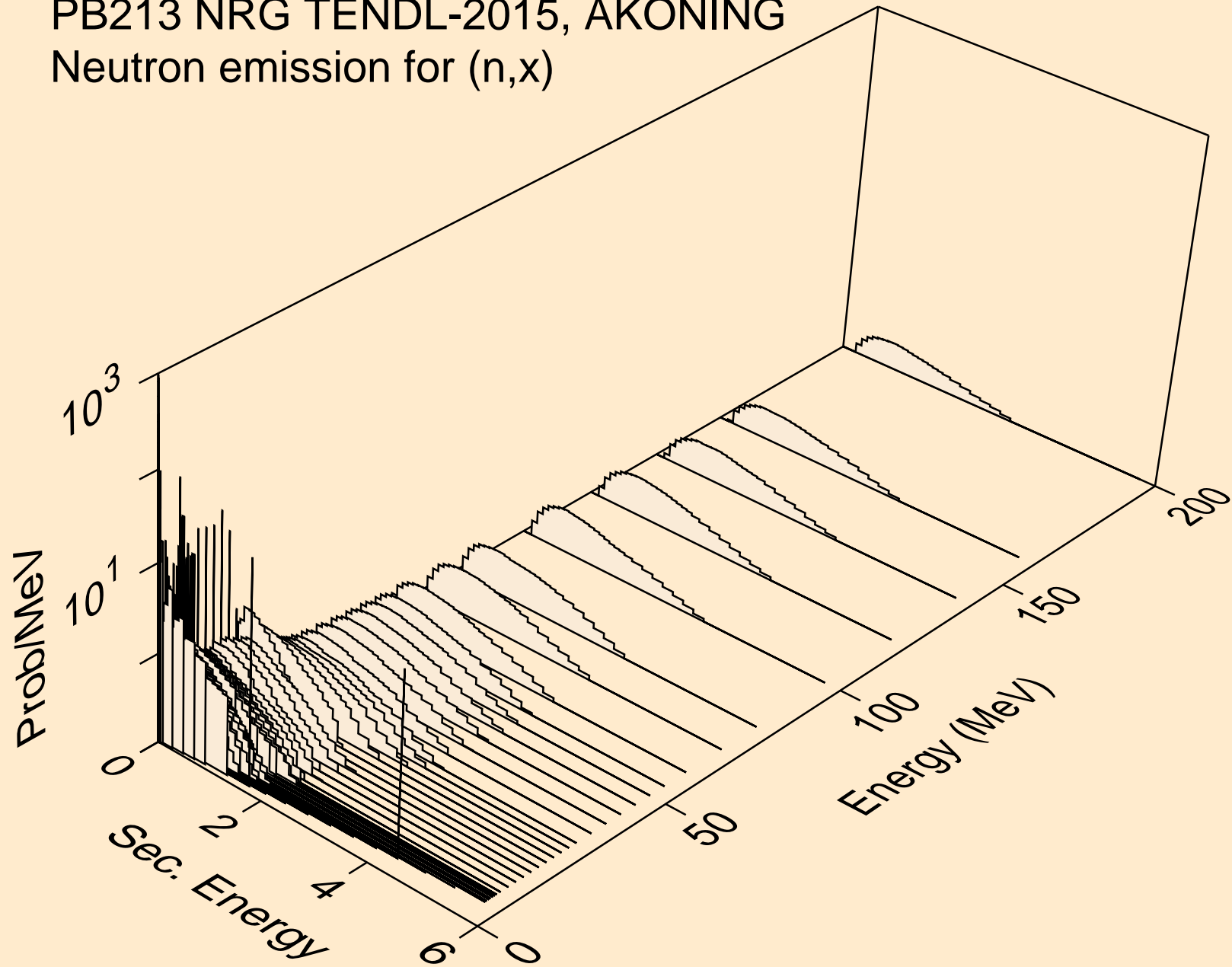

PB213 NRG TENDL-2015, AKONING  
Neutron emission for (n,2nd)

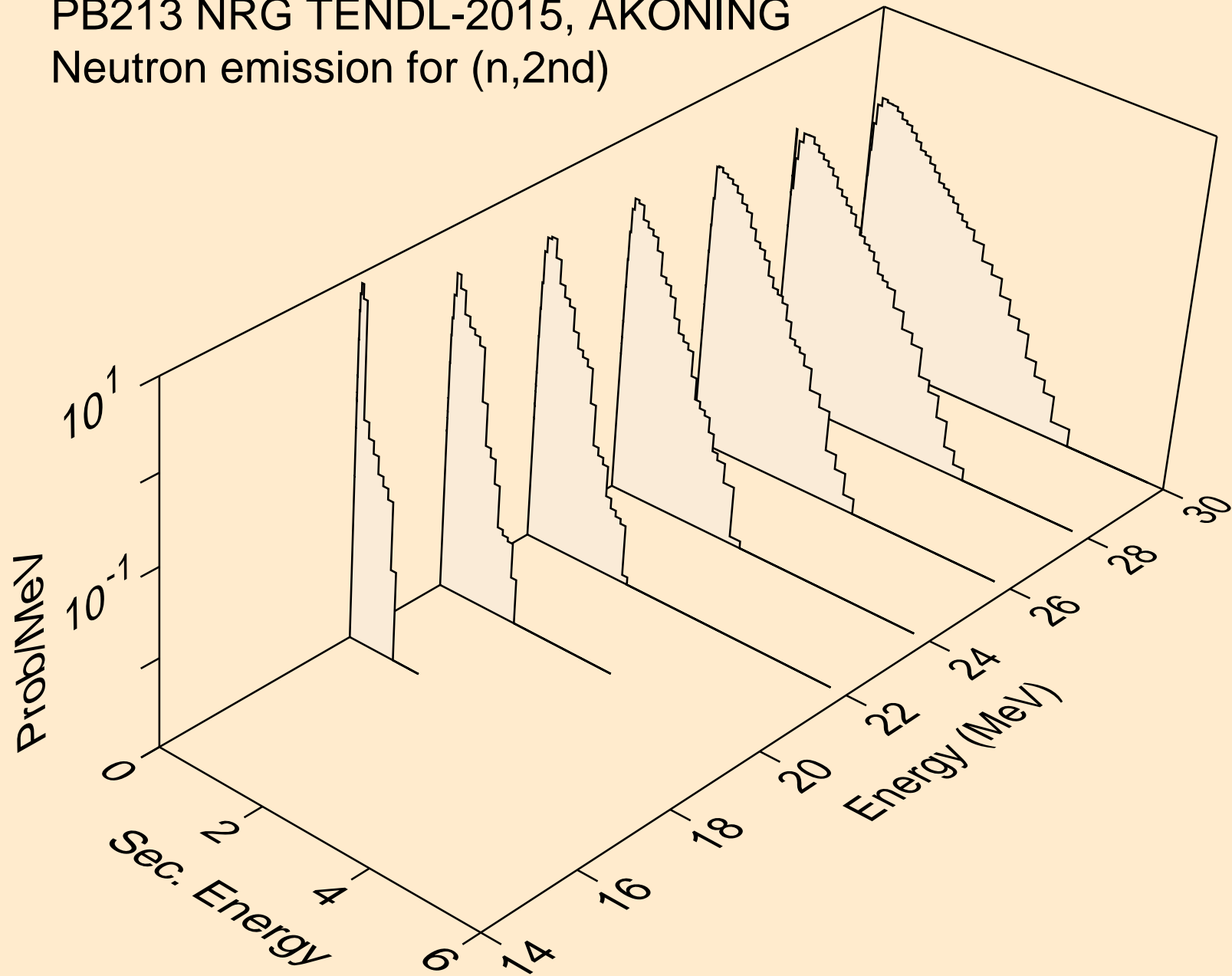

PB213 NRG TENDL-2015, AKONING  
Neutron emission for (n,2n)

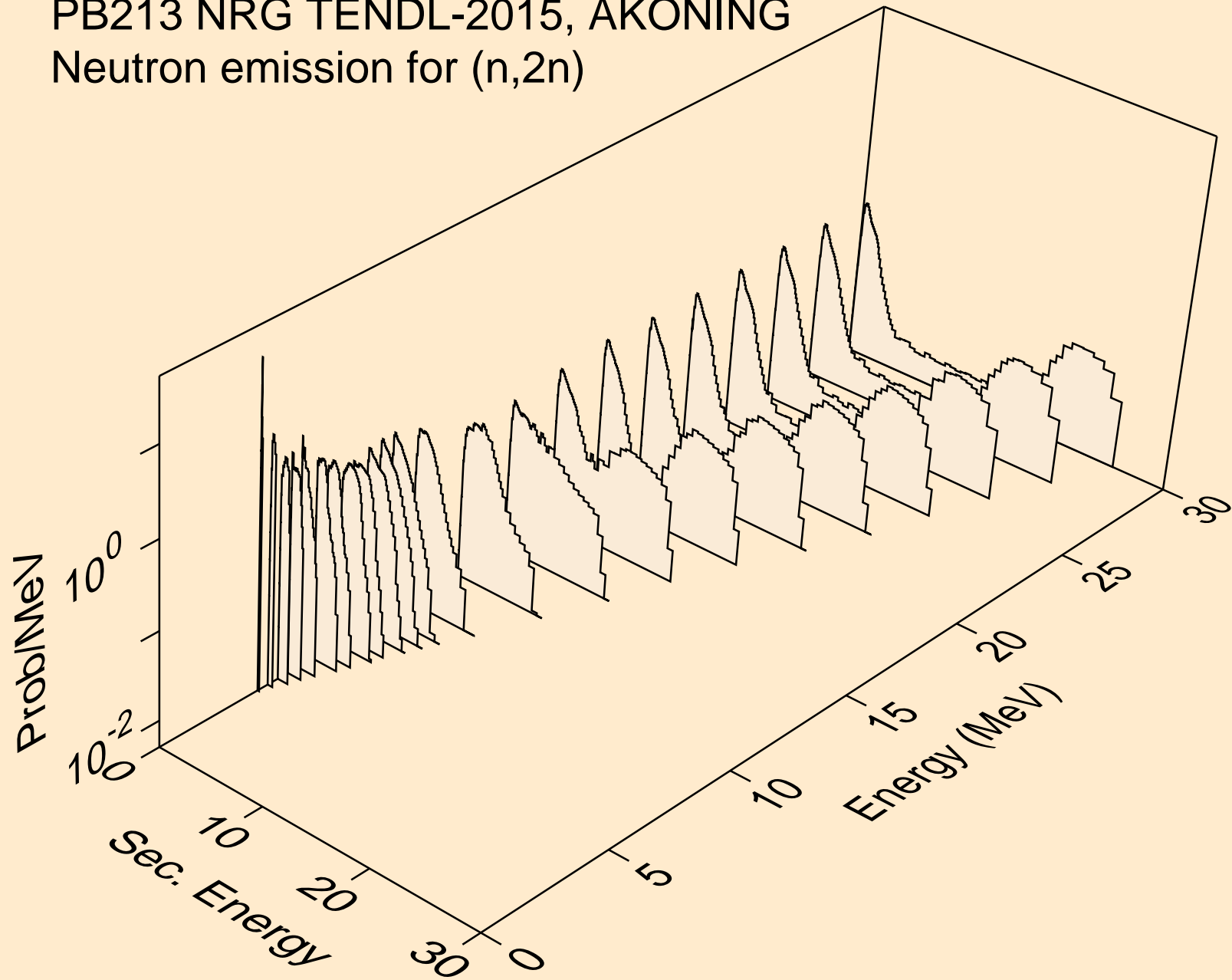

PB213 NRG TENDL-2015, AKONING  
Neutron emission for (n,3n)

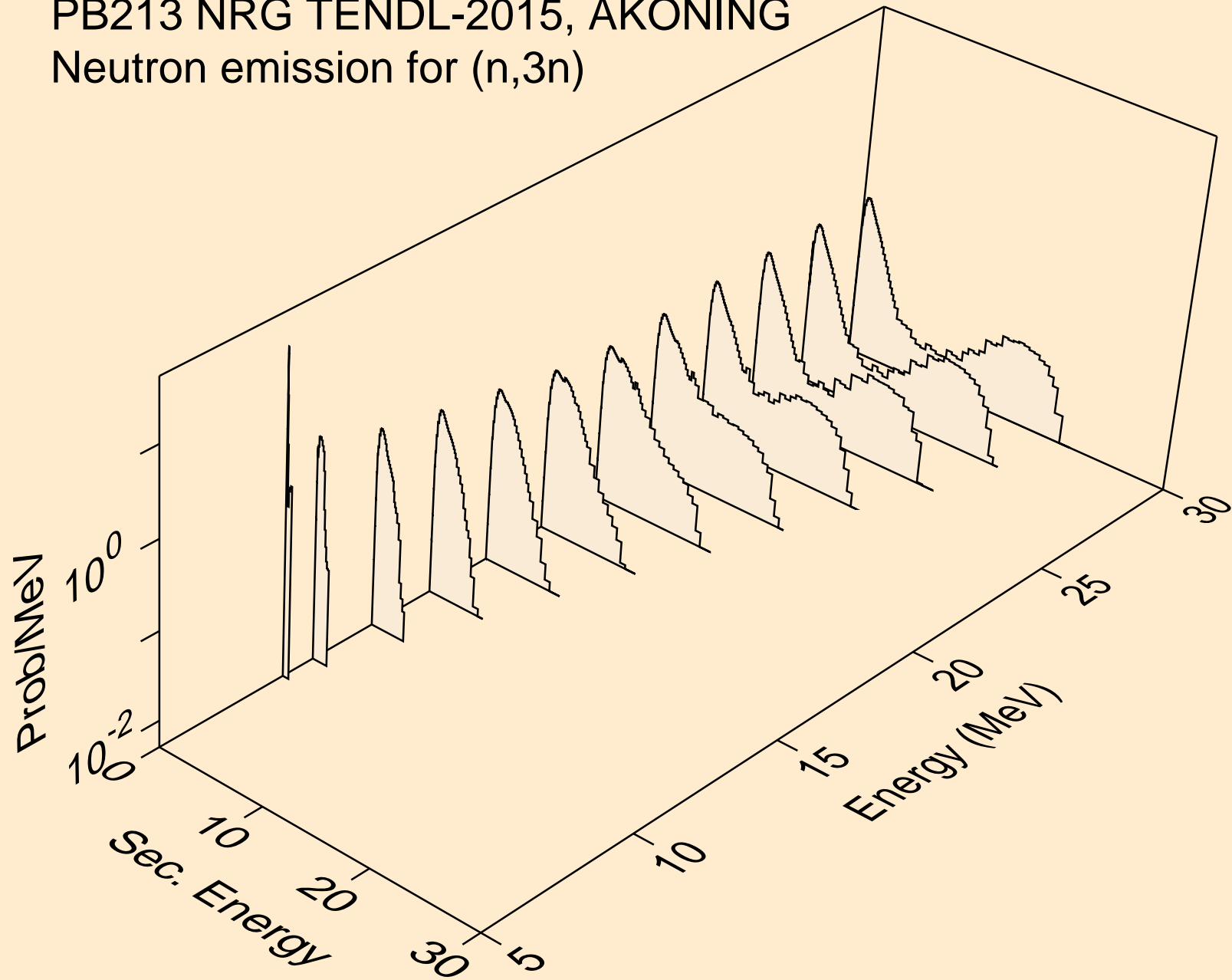

PB213 NRG TENDL-2015, AKONING  
Neutron emission for (n,n\*)a

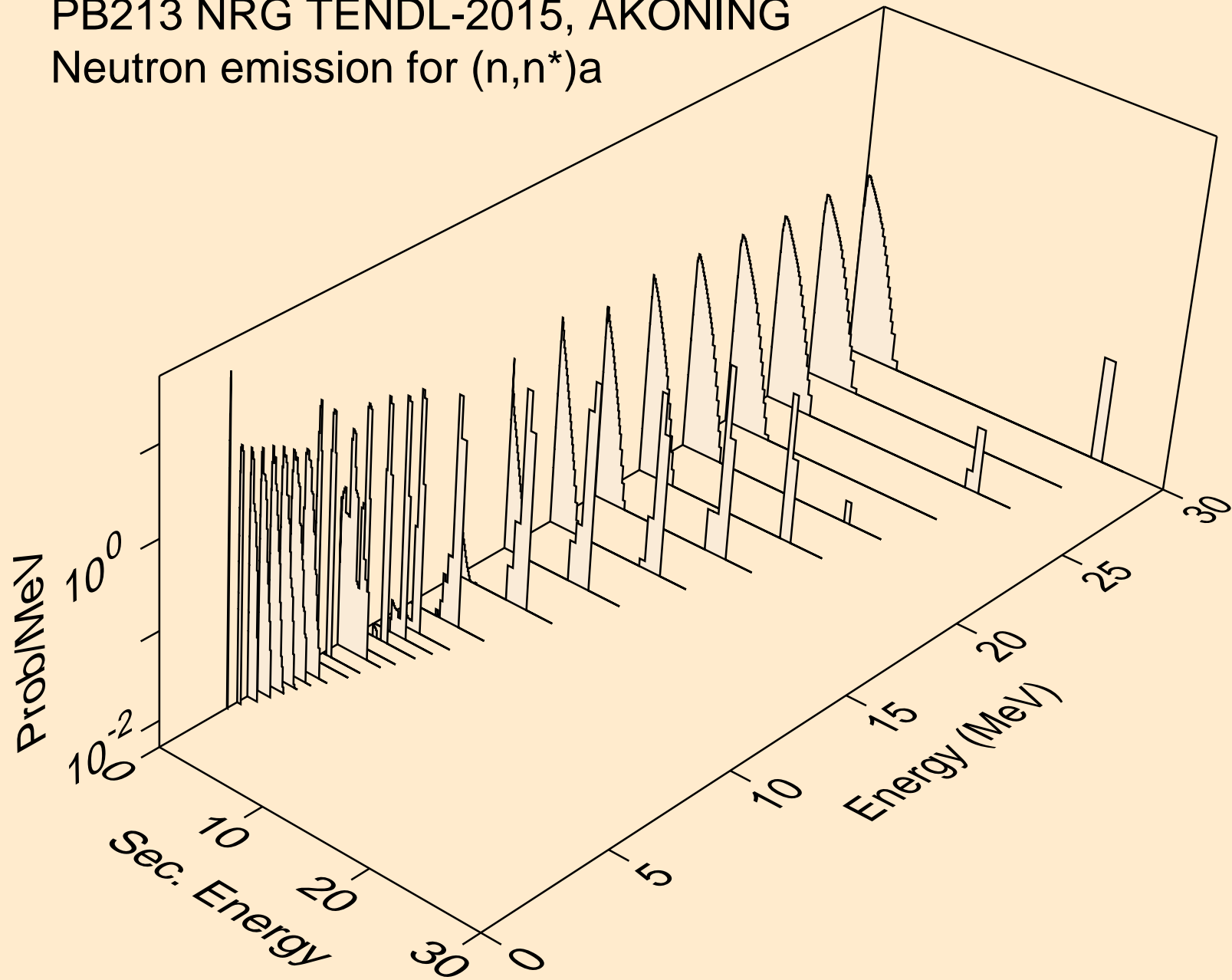



PB213 NRG TENDL-2015, AKONING  
Neutron emission for (n,2n)a

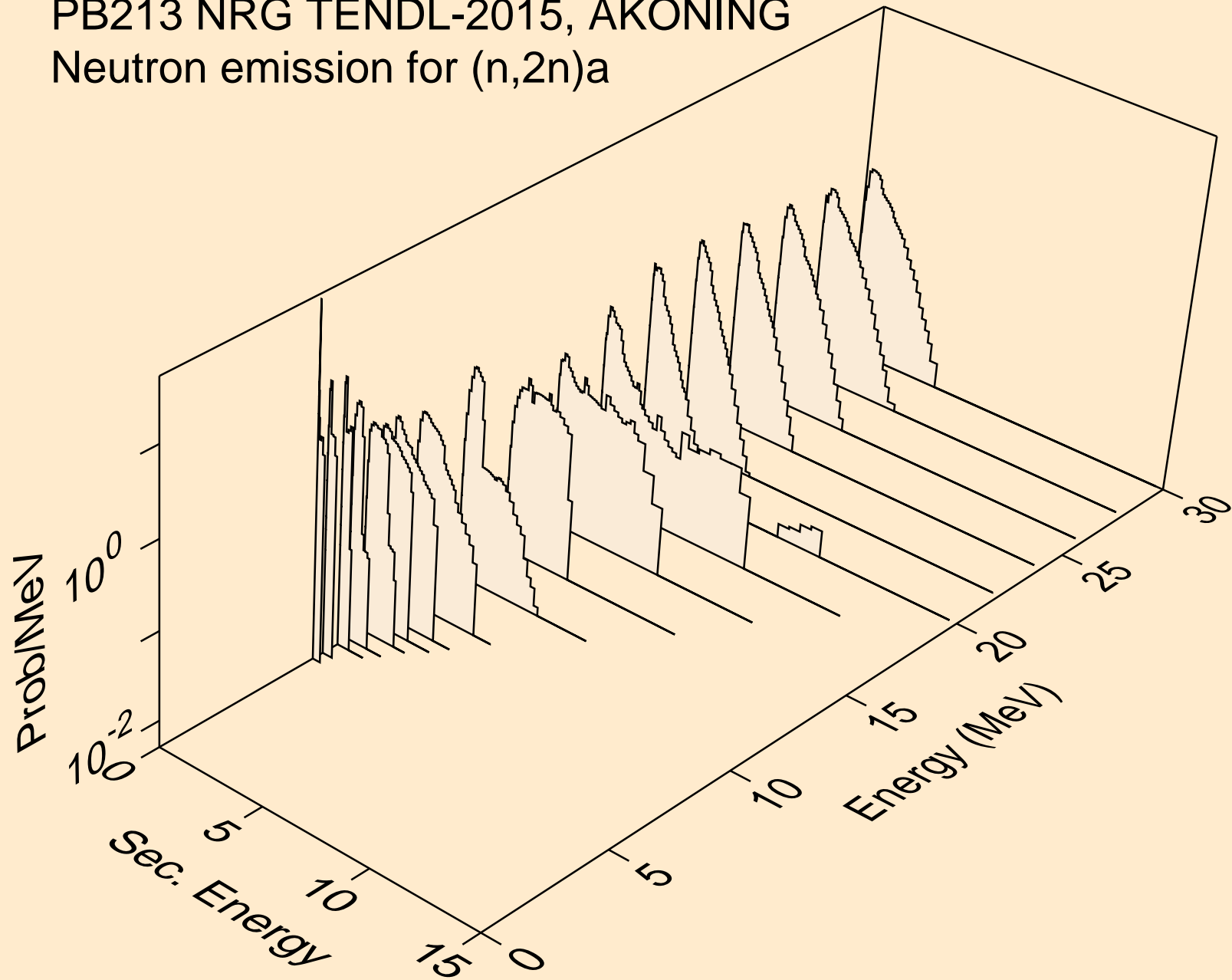

PB213 NRG TENDL-2015, AKONING  
Neutron emission for (n,3n)a

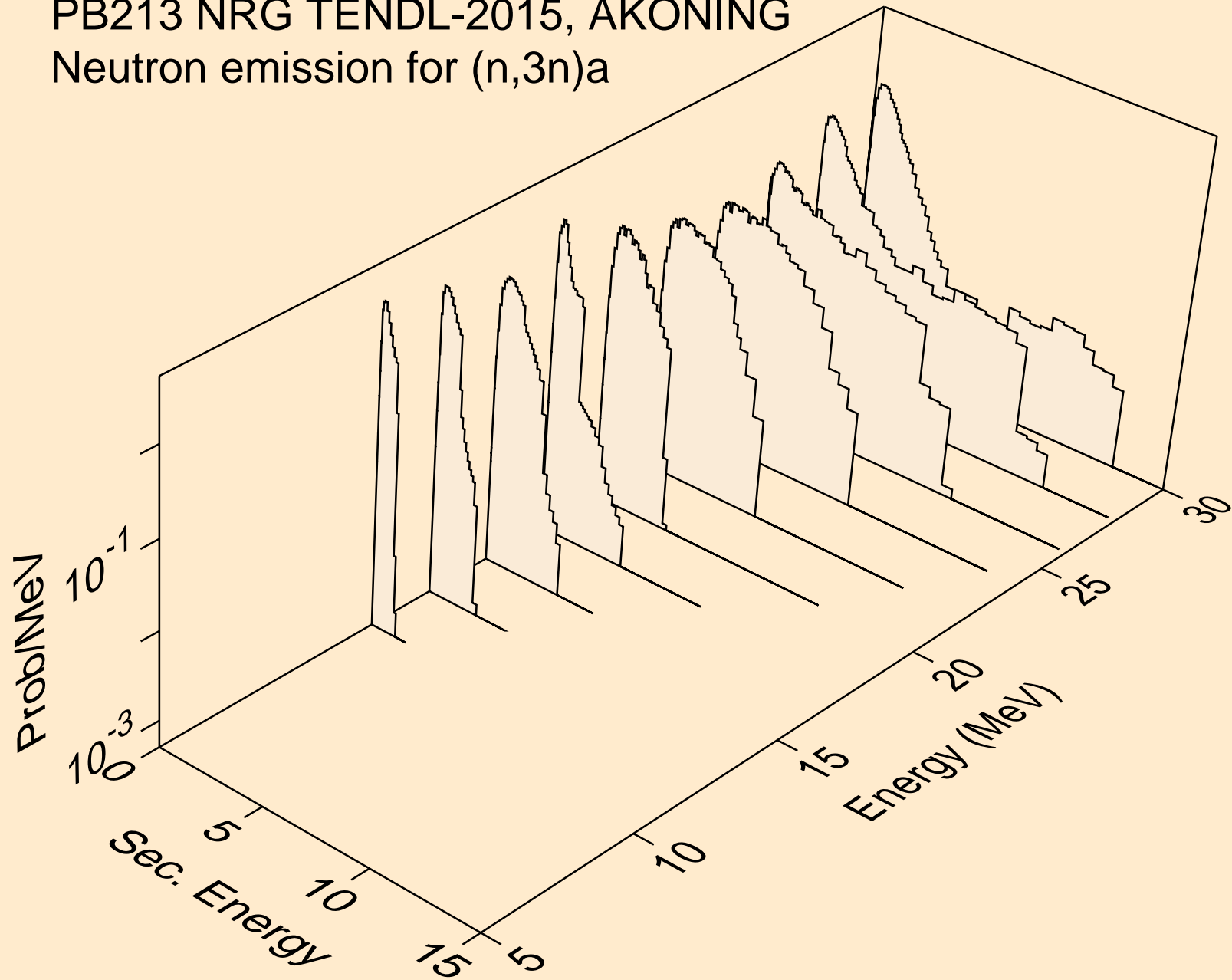

PB213 NRG TENDL-2015, AKONING  
Neutron emission for (n,n\*)p

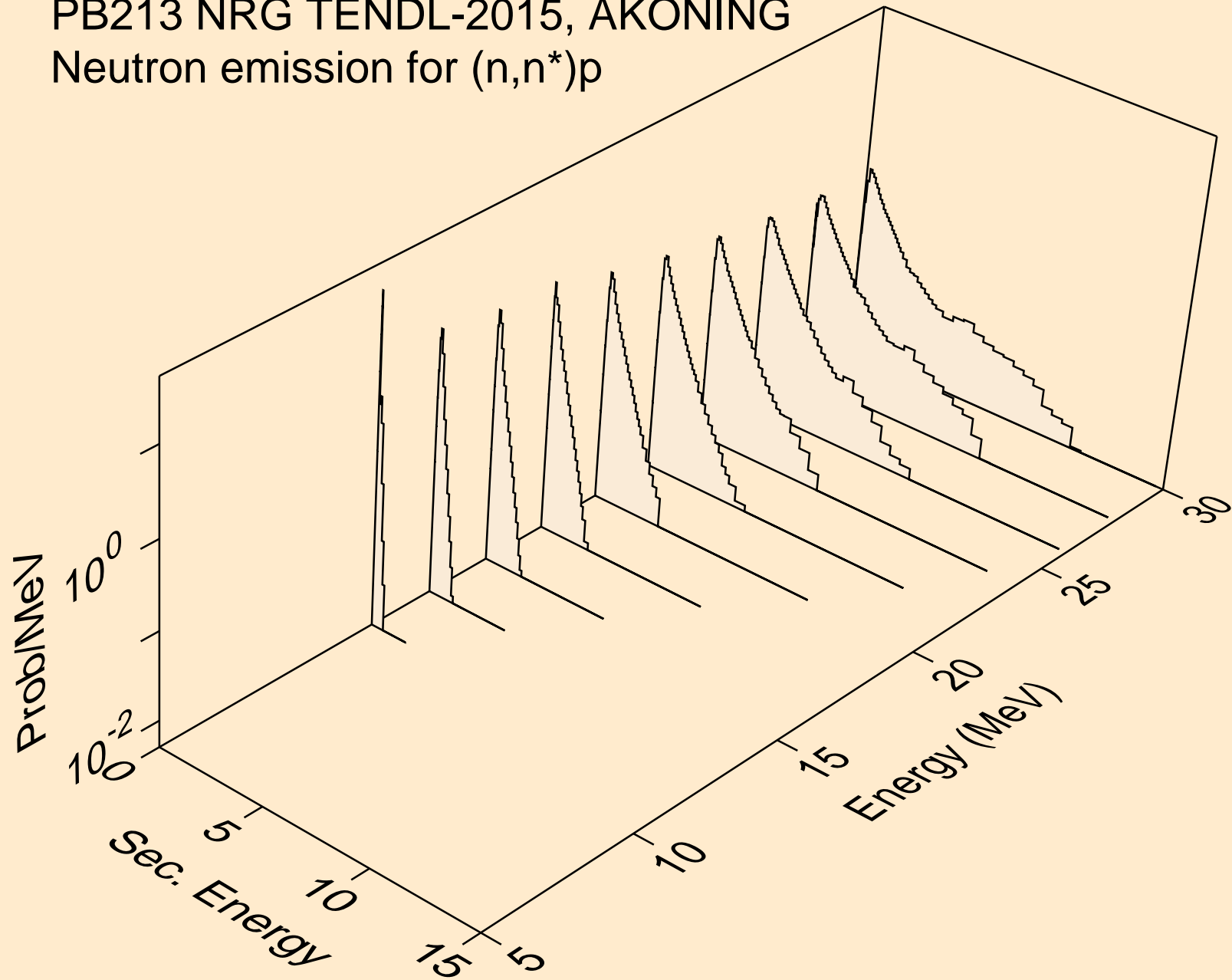

PB213 NRG TENDL-2015, AKONING  
Neutron emission for (n,2n)2a

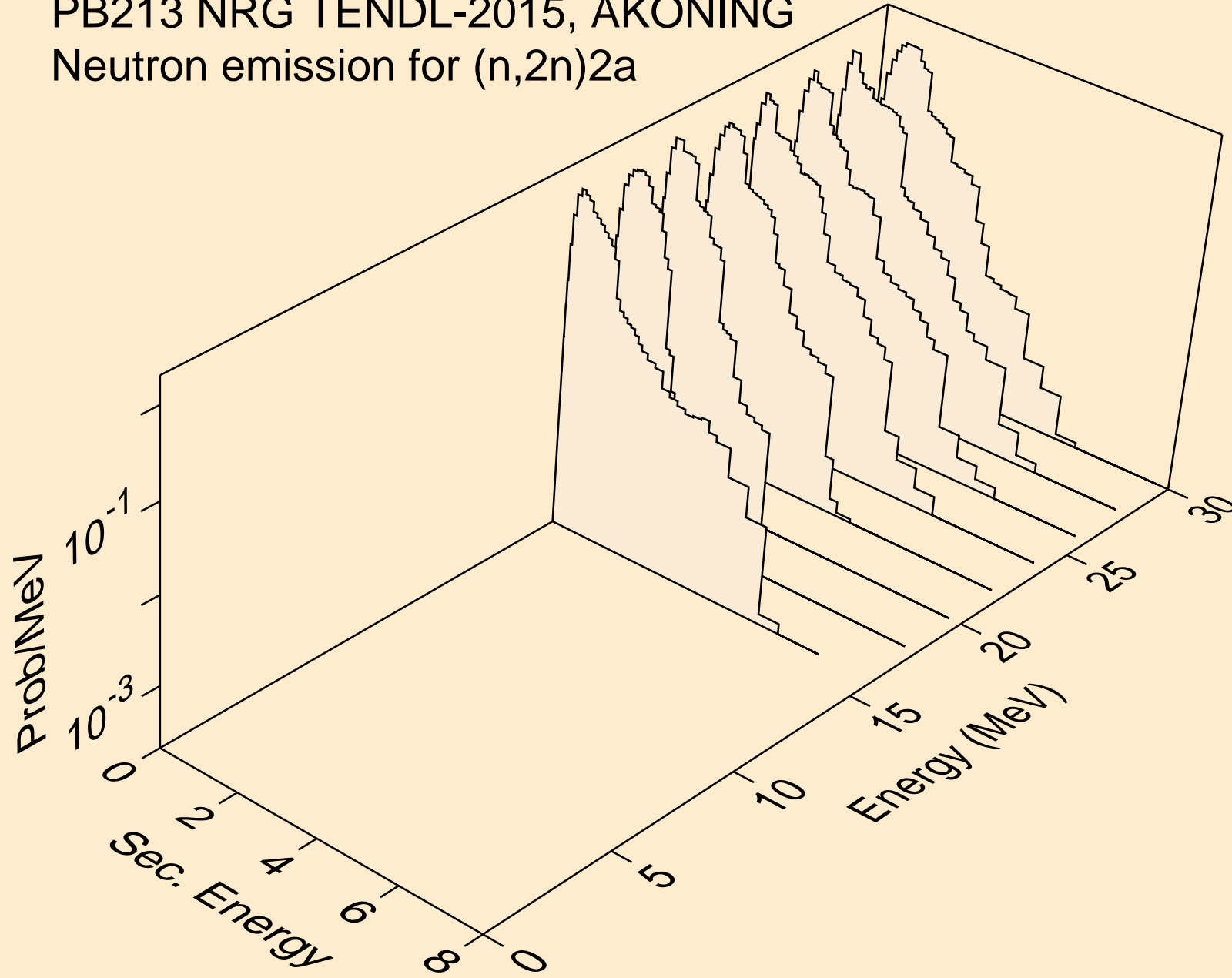

PB213 NRG TENDL-2015, AKONING  
Neutron emission for (n,n\*)d

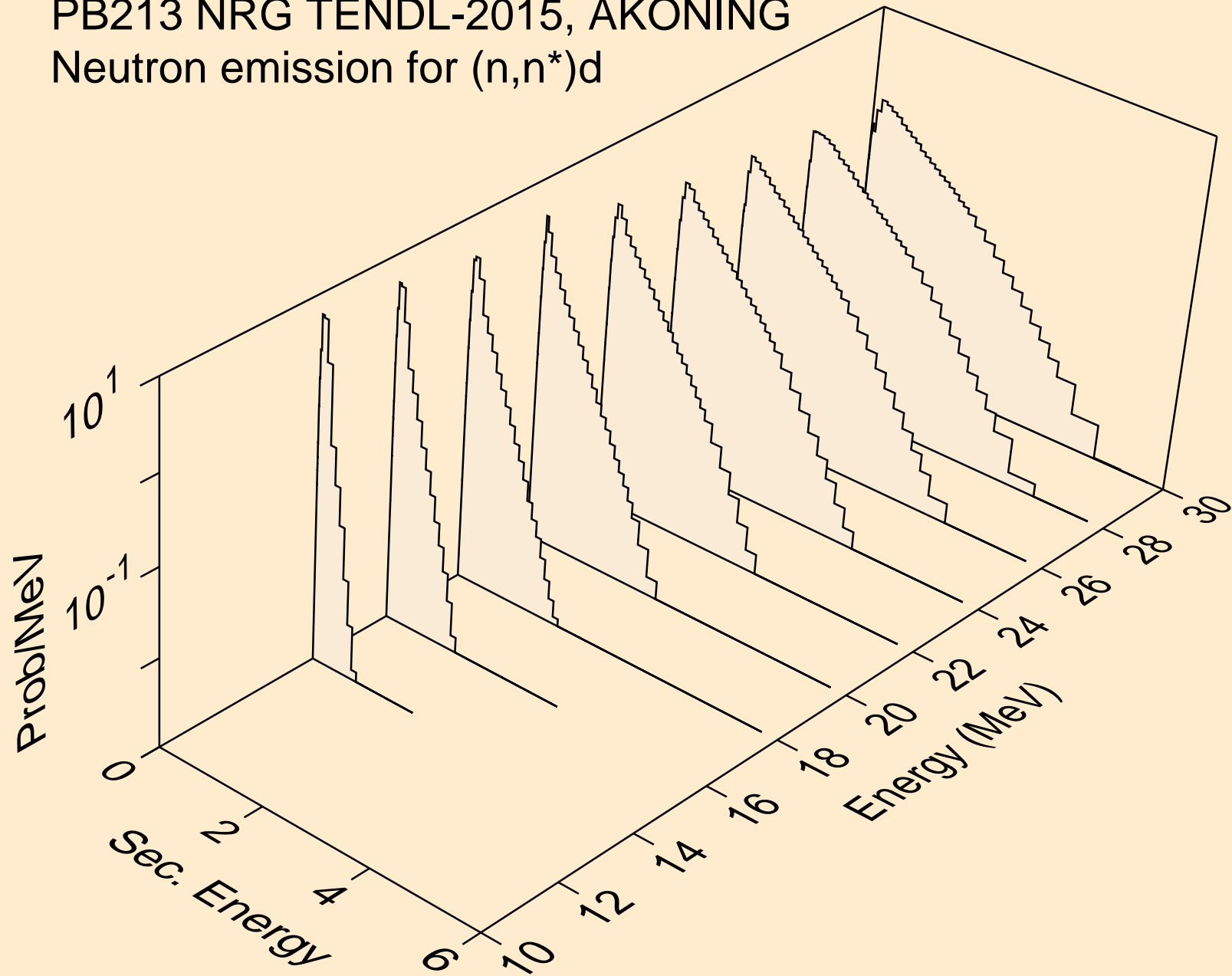

PB213 NRG TENDL-2015, AKONING  
Neutron emission for (n,n\*)t

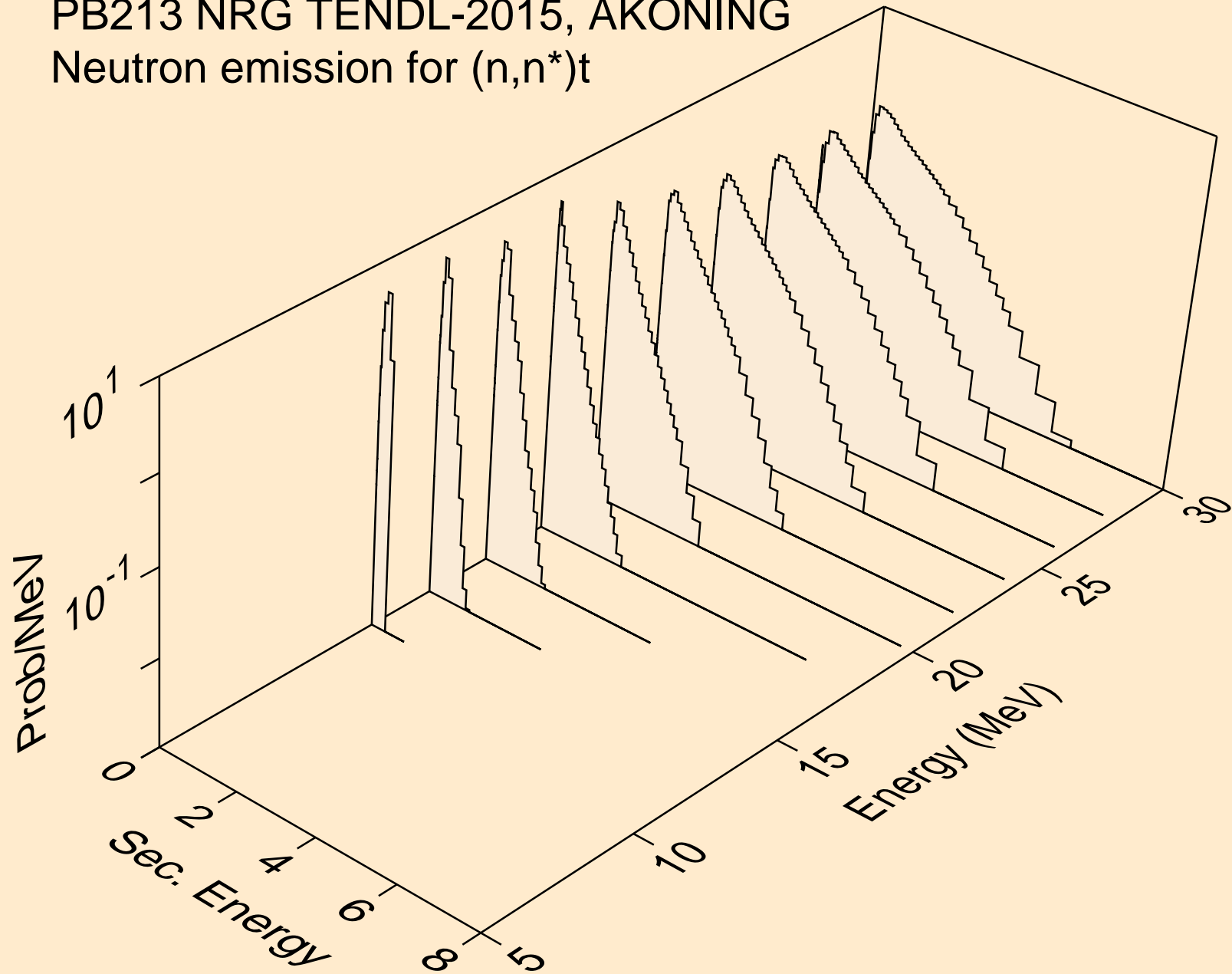

PB213 NRG TENDL-2015, AKONING  
Neutron emission for (n,n\*)he3

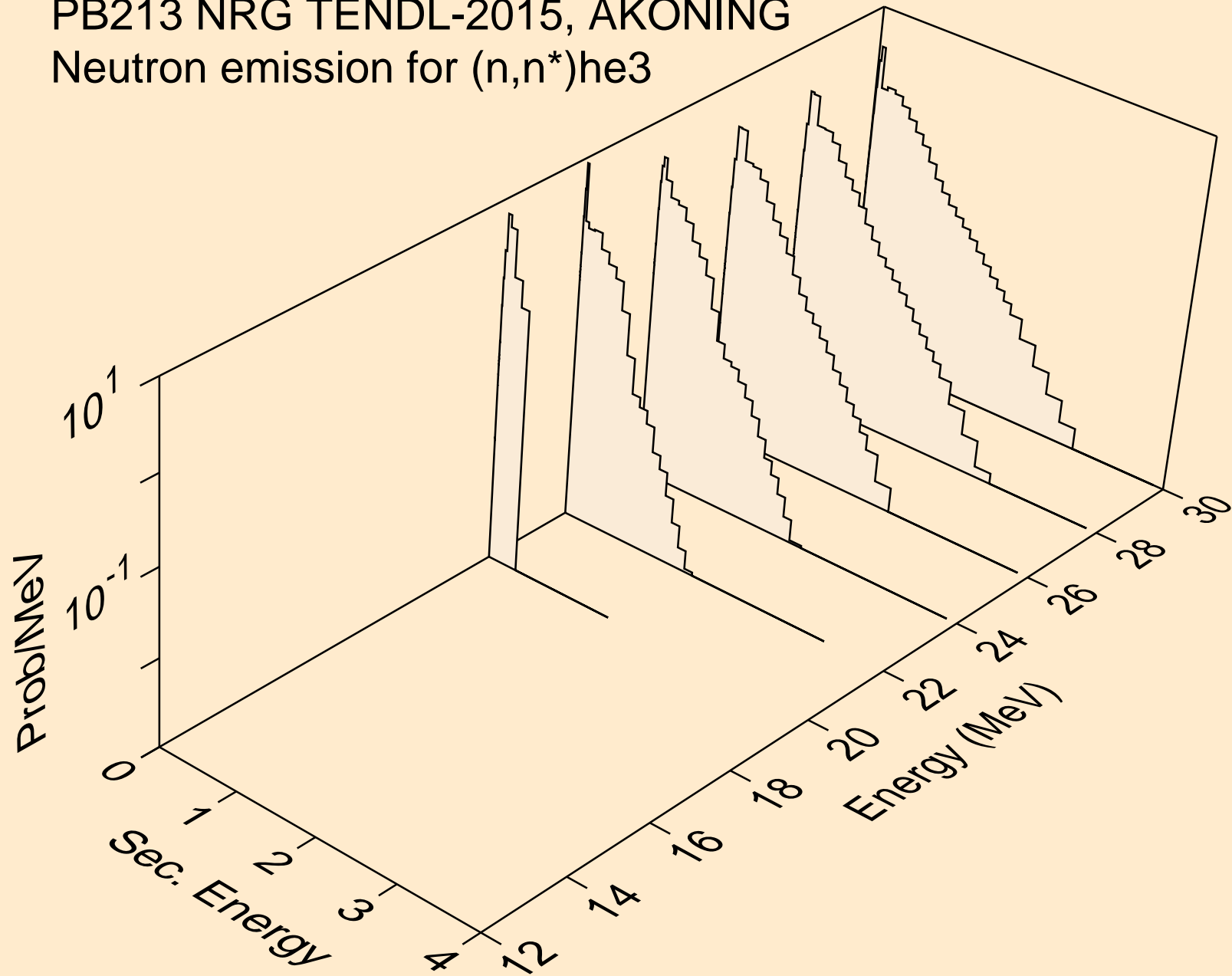

PB213 NRG TENDL-2015, AKONING  
Neutron emission for (n,4n)

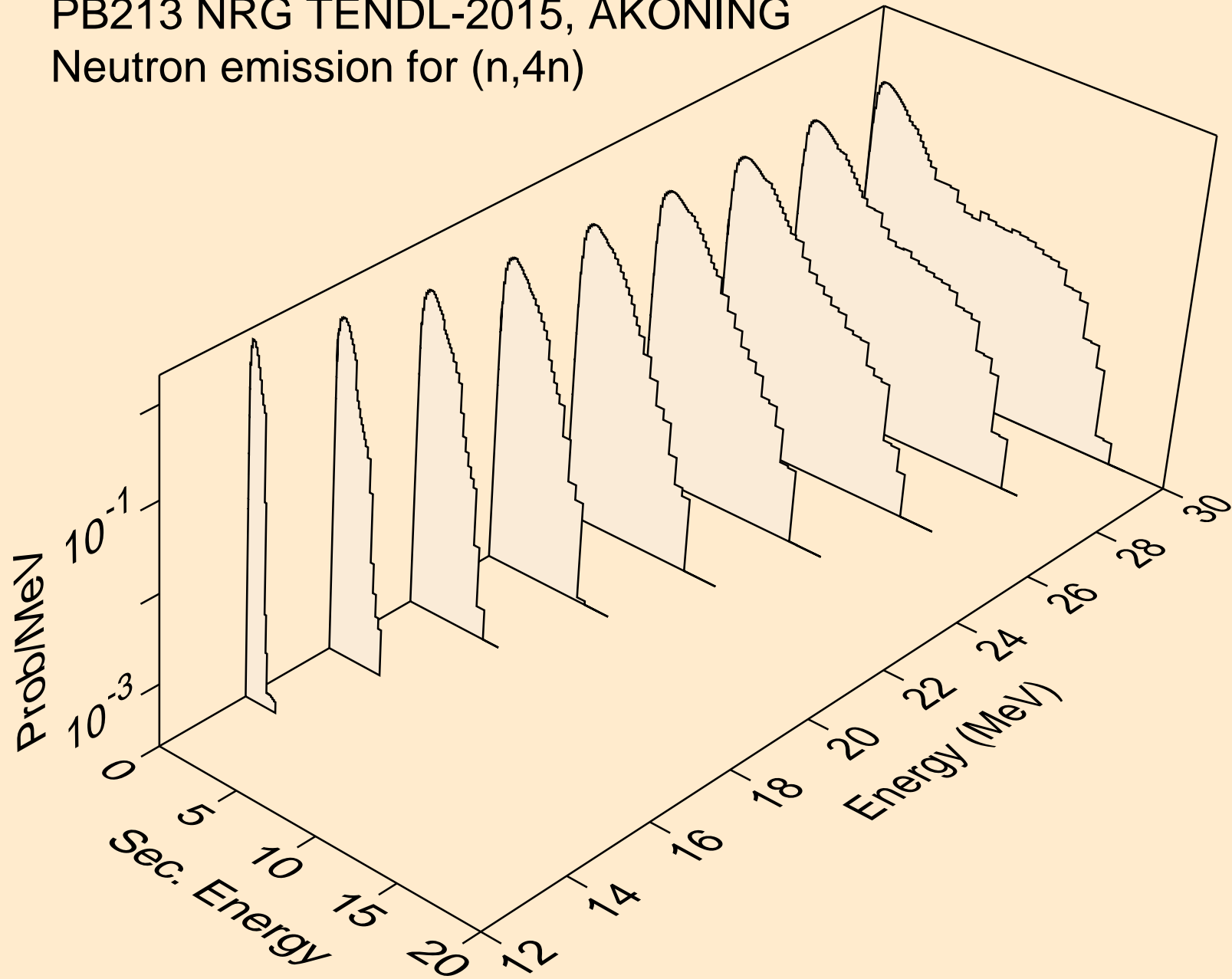



PB213 NRG TENDL-2015, AKONING  
Neutron emission for (n,2np)

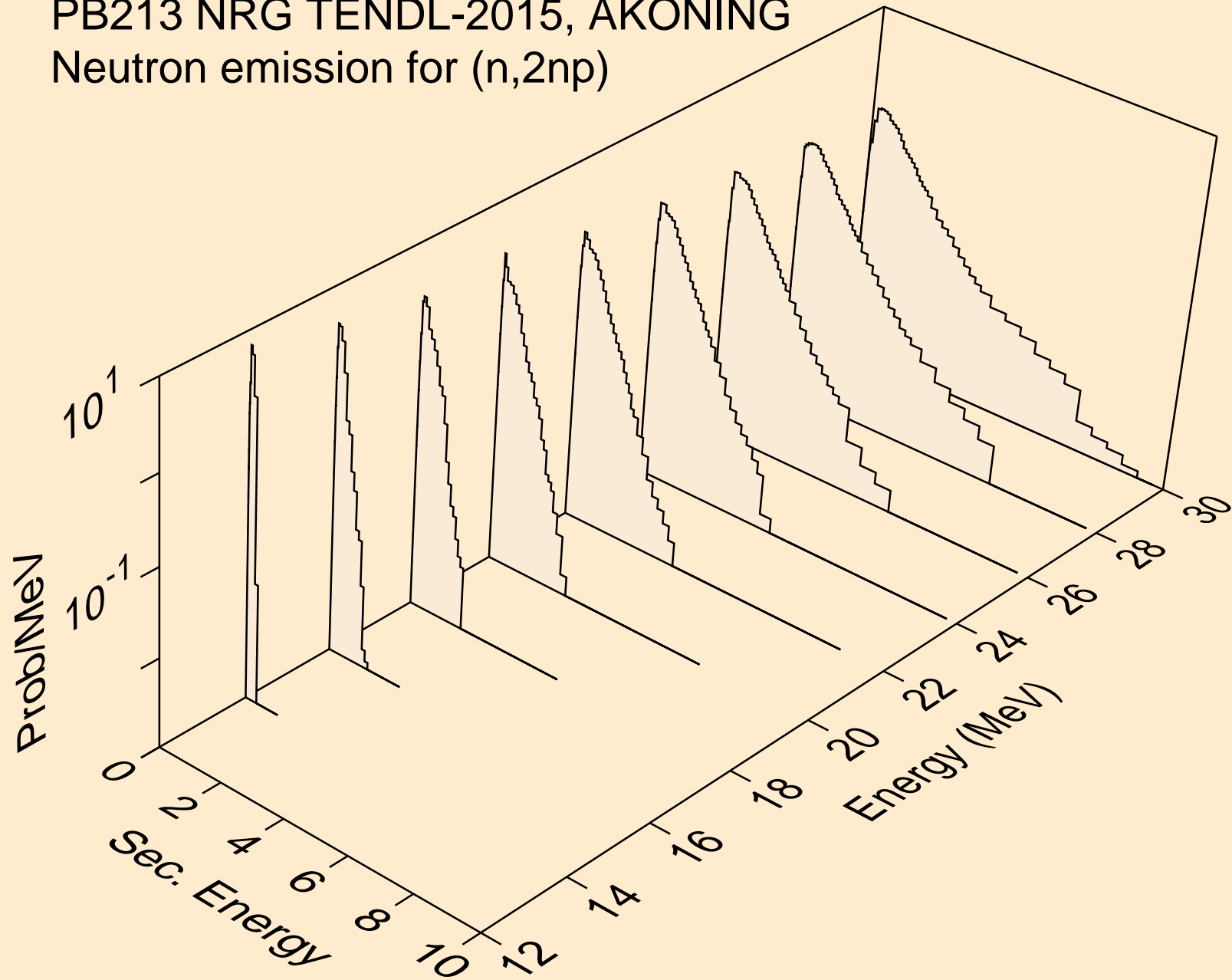

PB213 NRG TENDL-2015, AKONING  
Neutron emission for (n,3np)

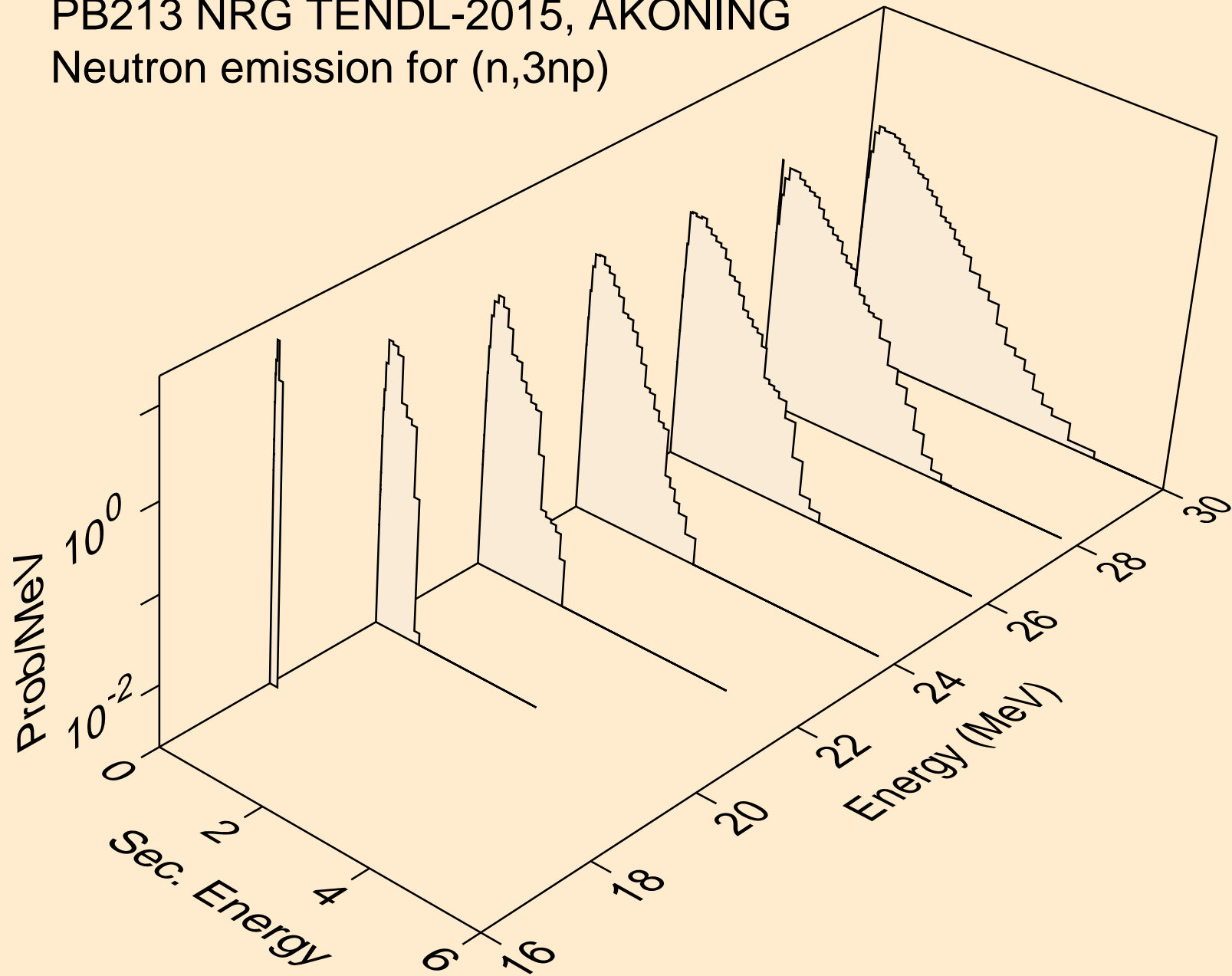

PB213 NRG TENDL-2015, AKONING  
Neutron emission for (n,n\*c)

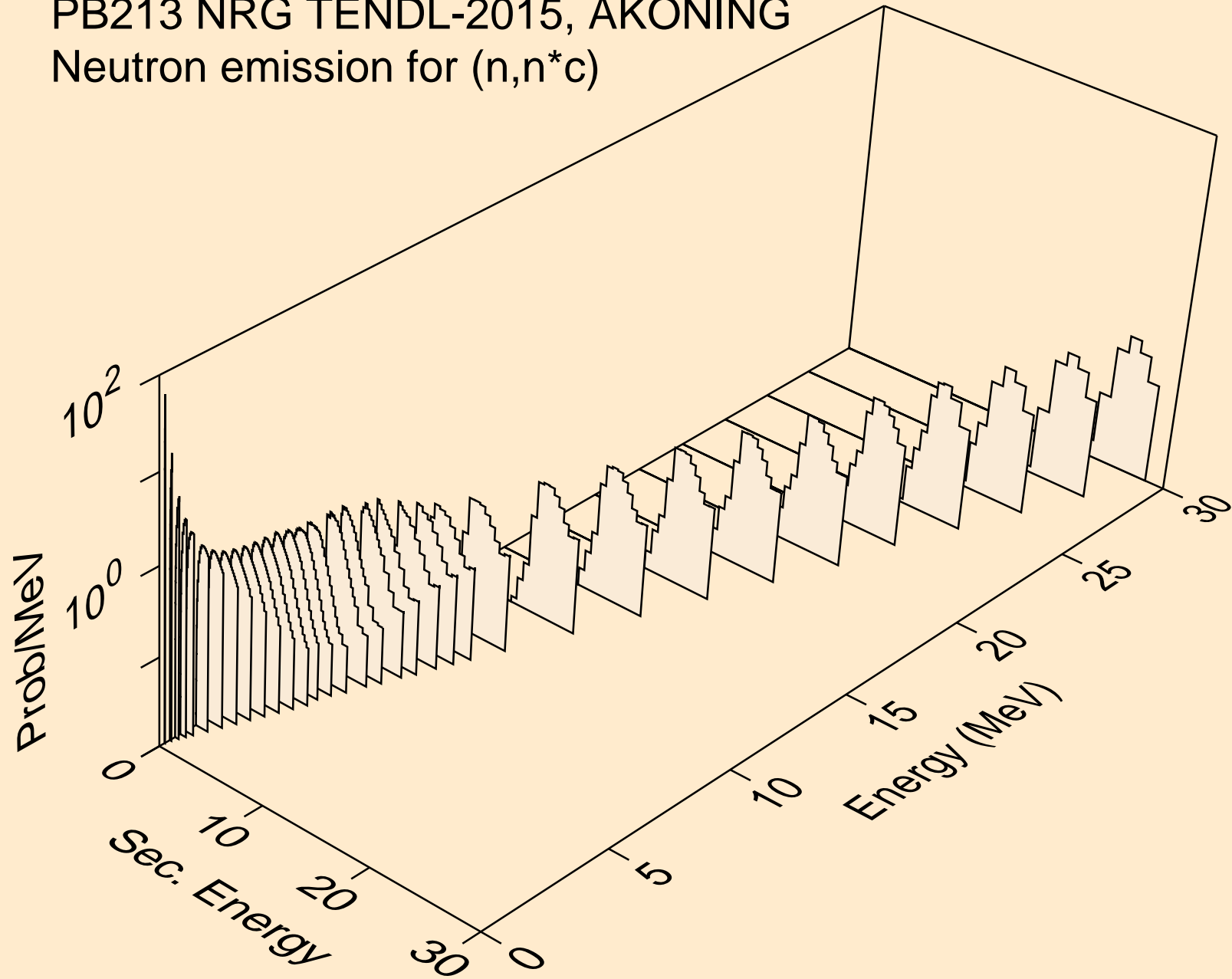

PB213 NRG TENDL-2015, AKONING  
Photon emission for (n,x)

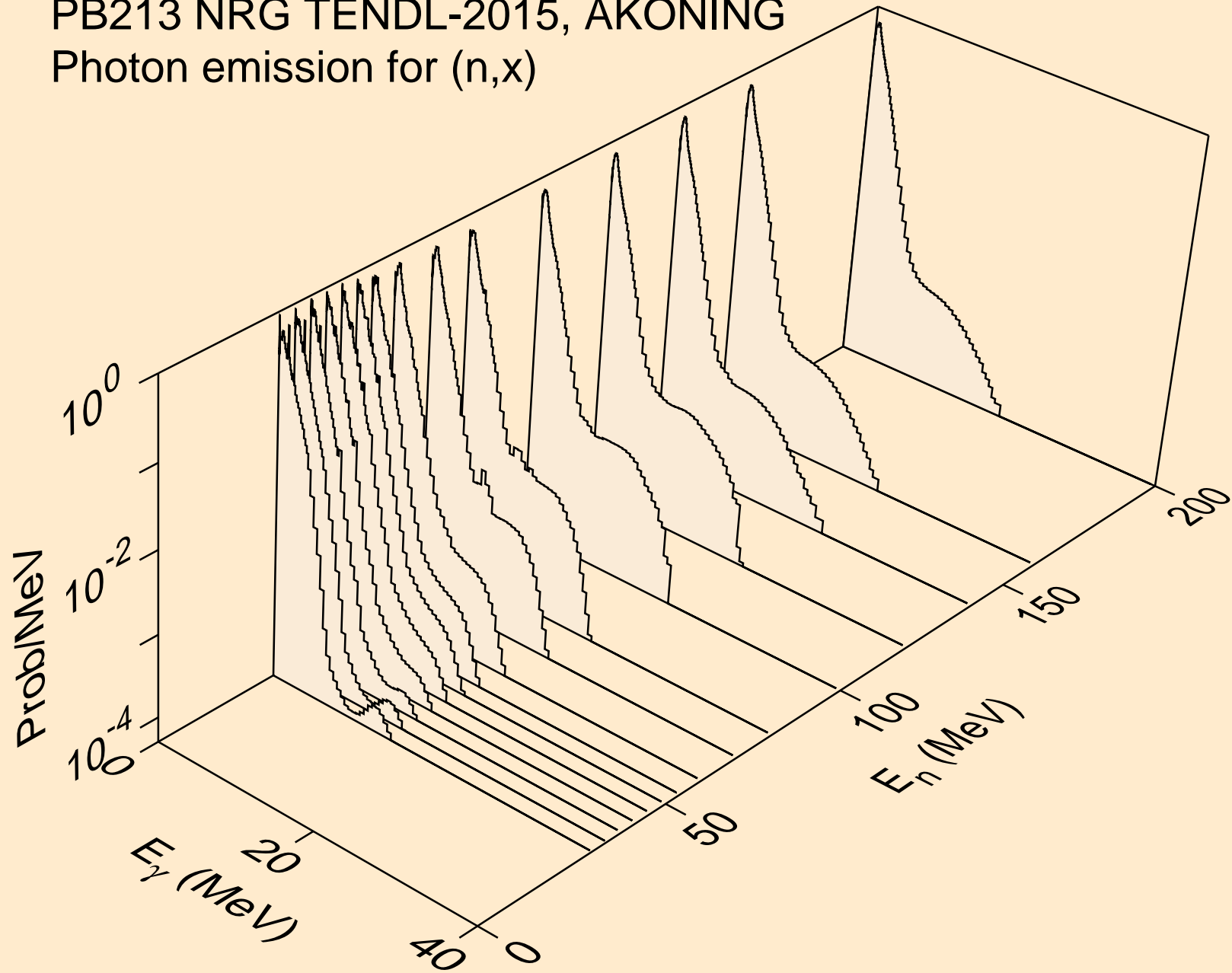

PB213 NRG TENDL-2015, AKONING  
Photon emission for (n,2nd)

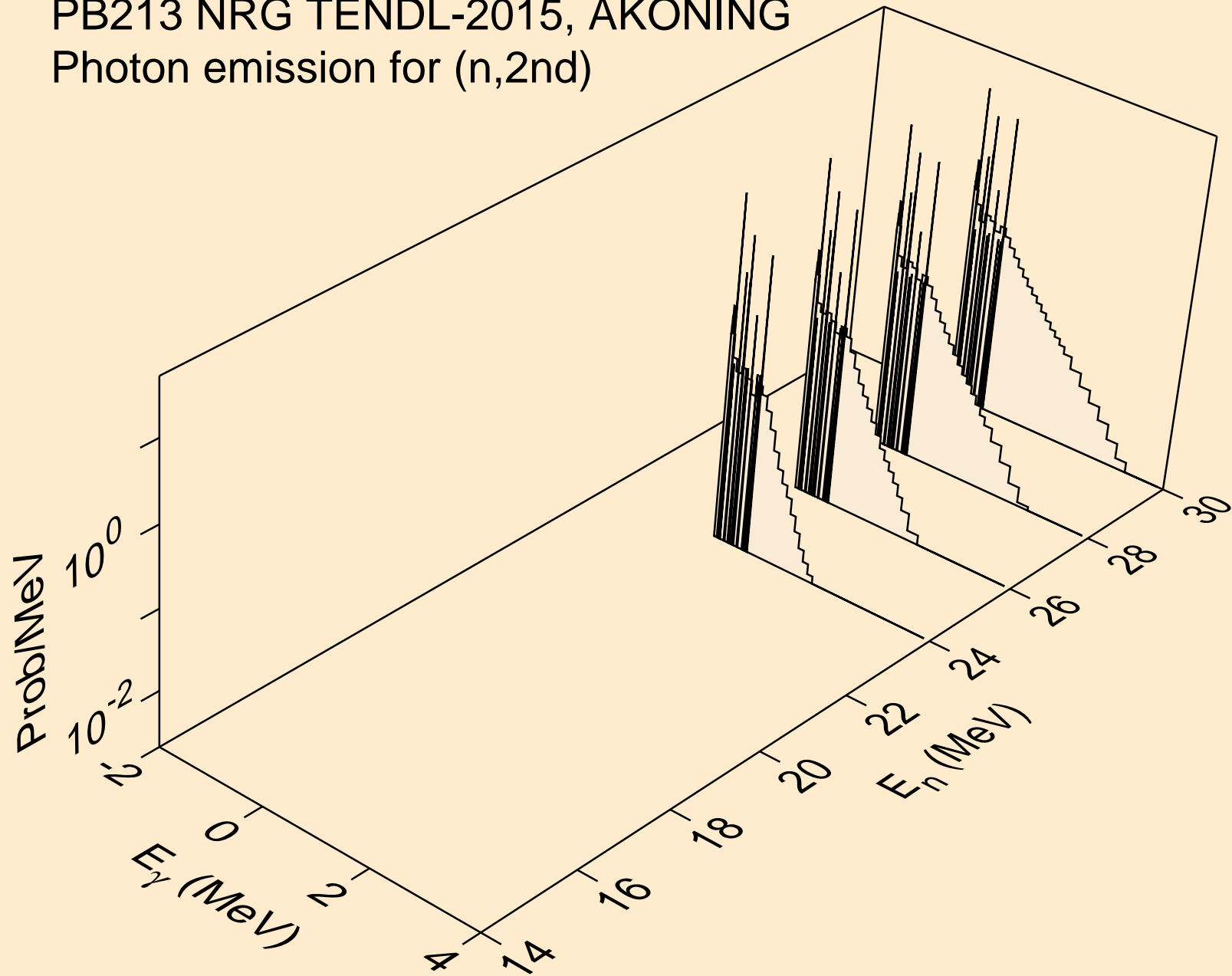

PB213 NRG TENDL-2015, AKONING  
Photon emission for (n,2n)

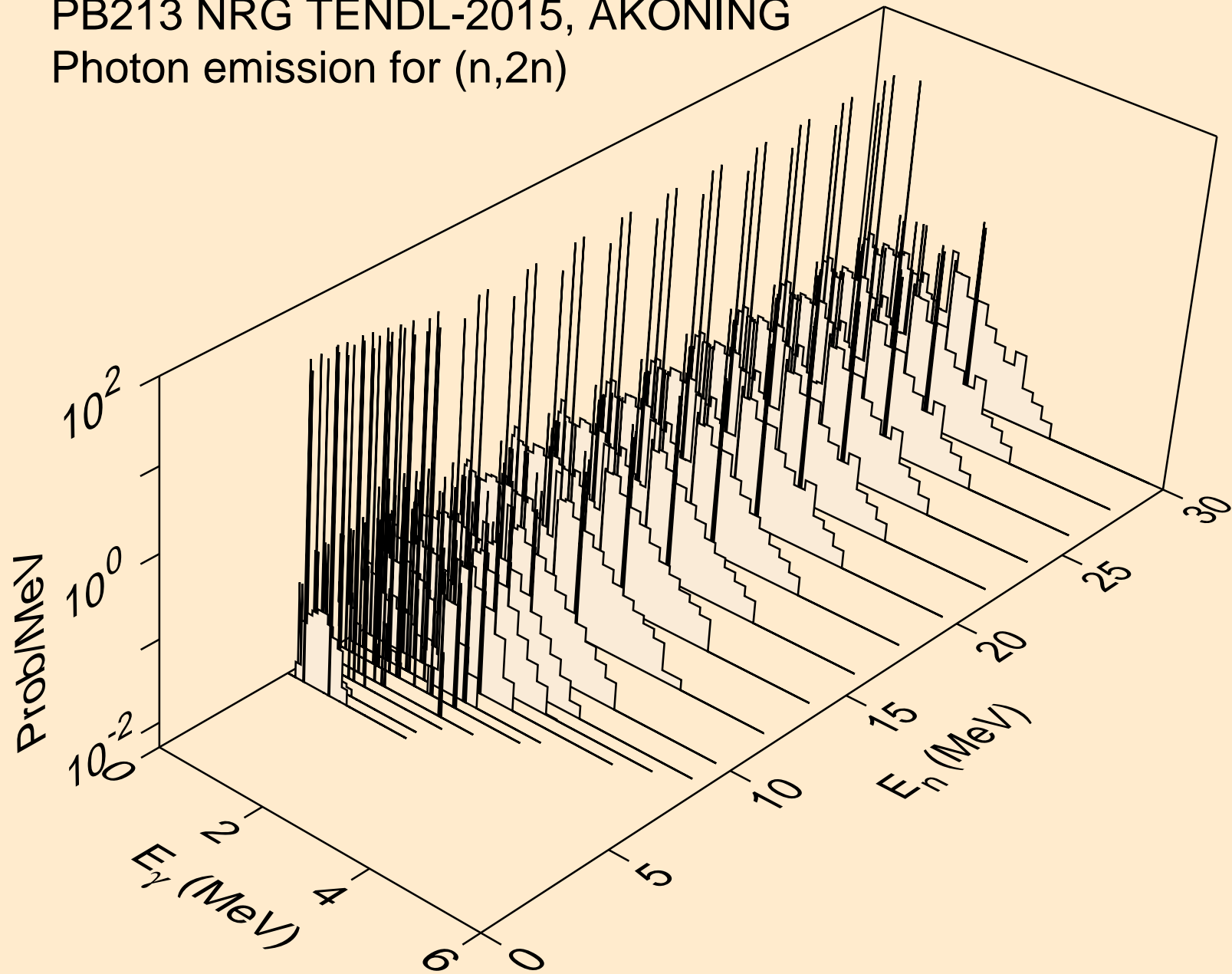

PB213 NRG TENDL-2015, AKONING  
Photon emission for (n,3n)

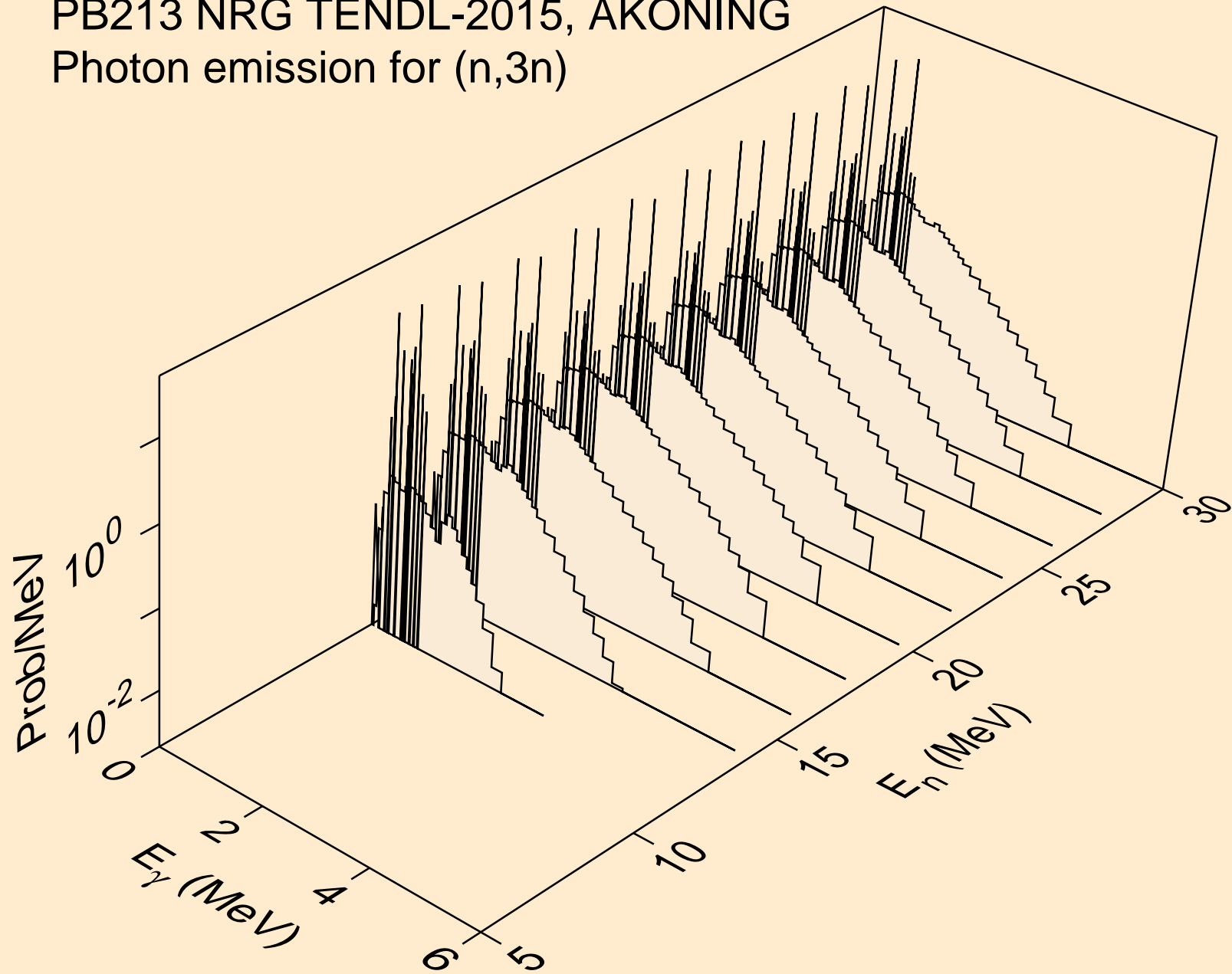

PB213 NRG TENDL-2015, AKONING  
Photon emission for (n,n\*)a

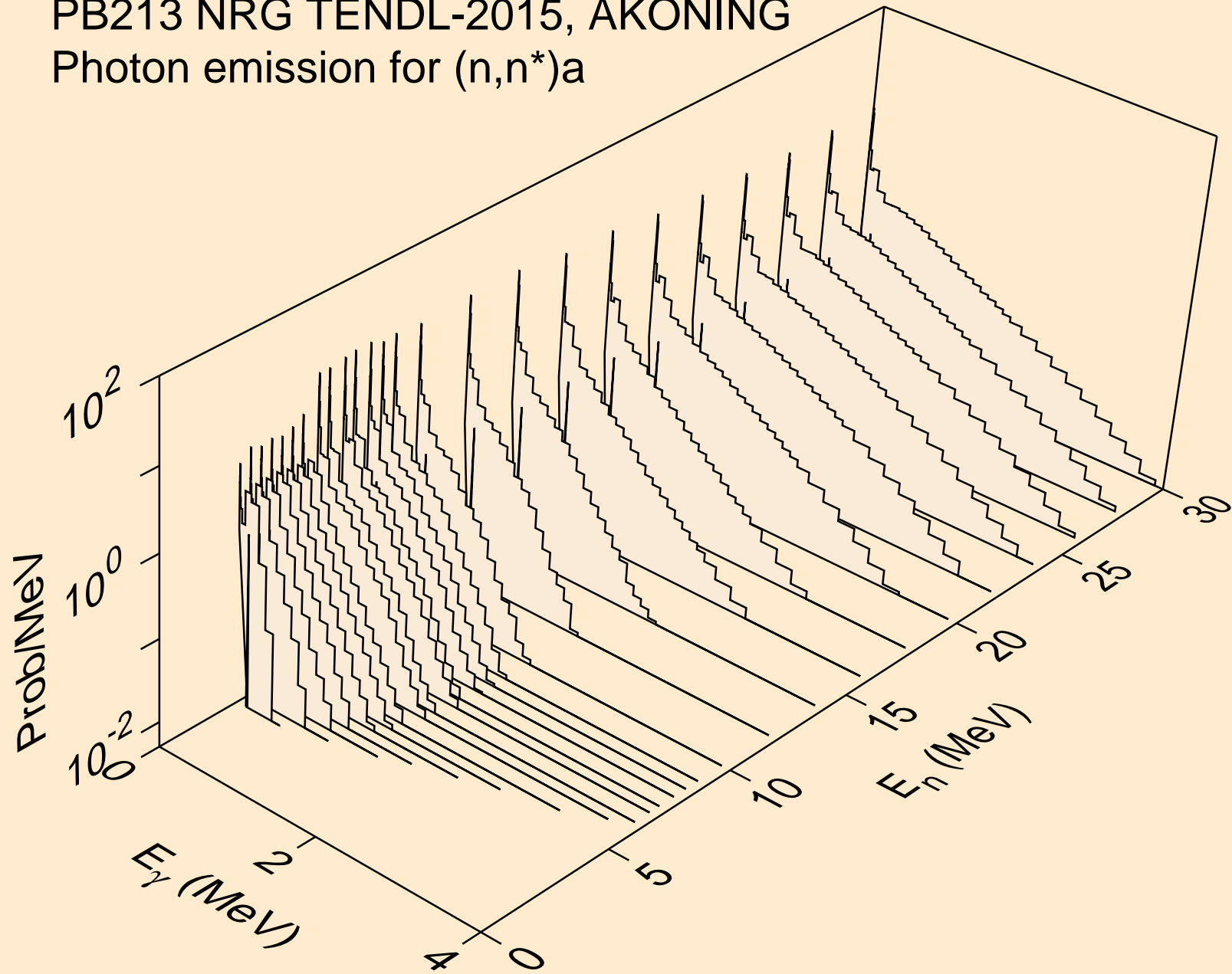



PB213 NRG TENDL-2015, AKONING  
Photon emission for (n,2n)a

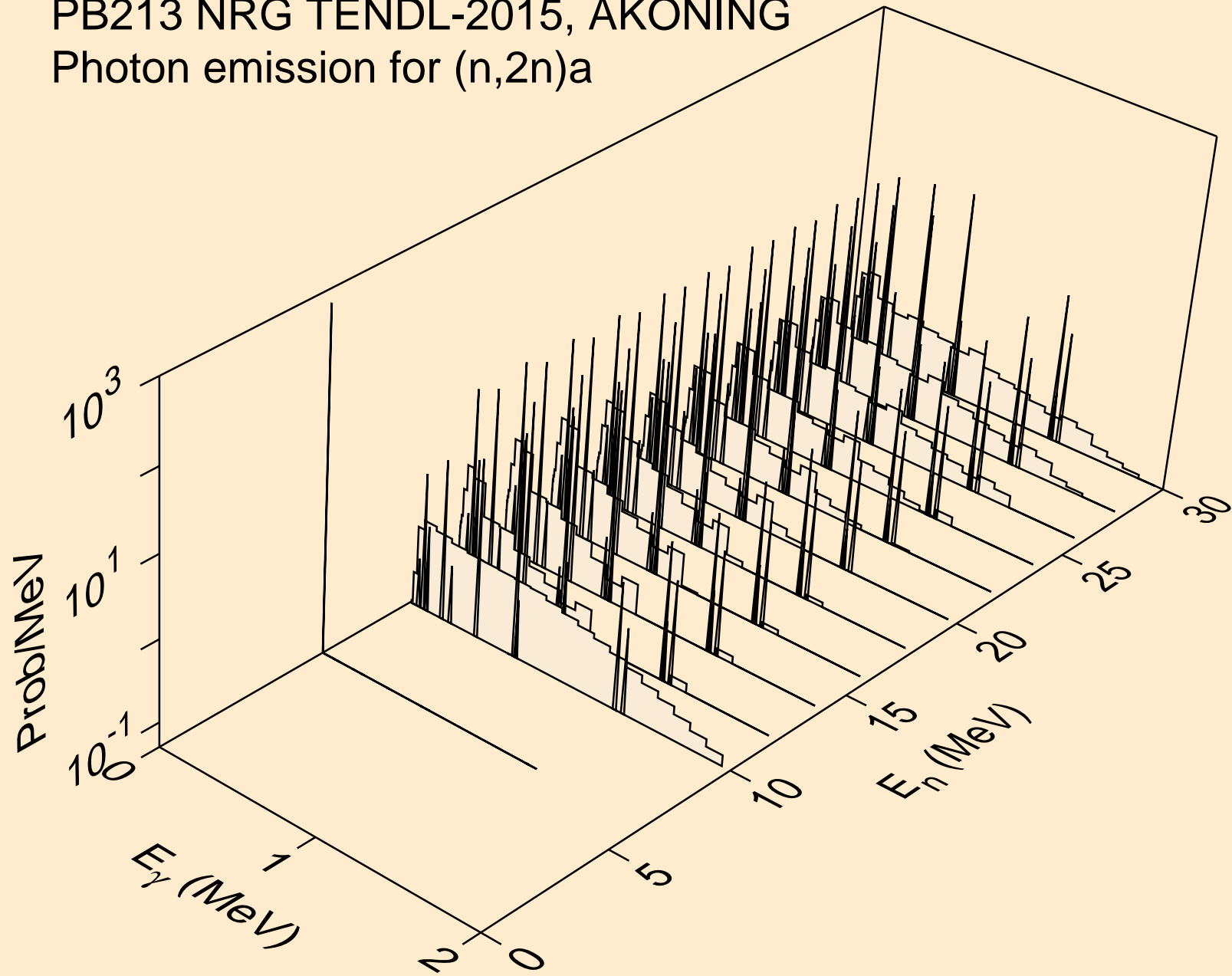

PB213 NRG TENDL-2015, AKONING  
Photon emission for (n,3n)a

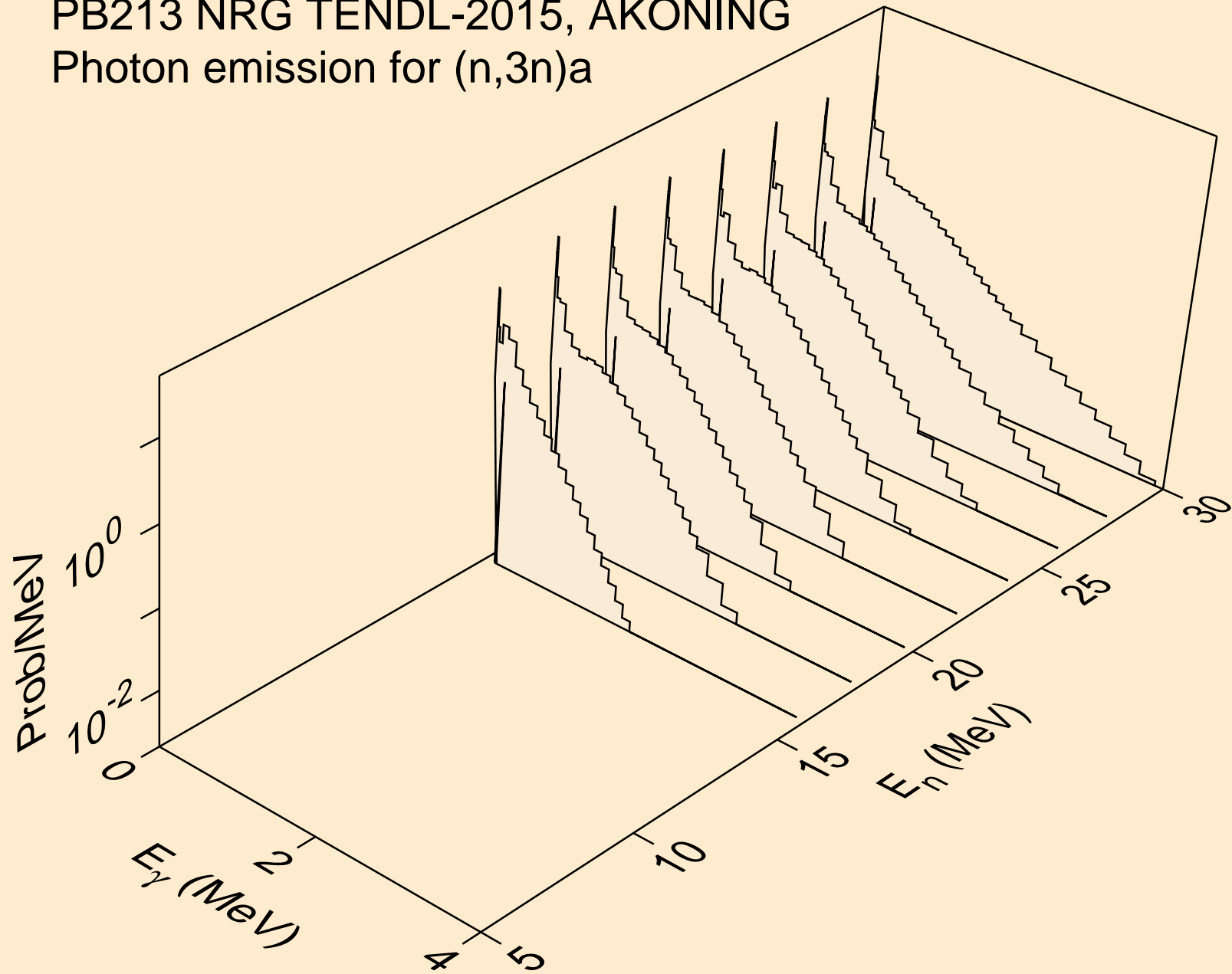

PB213 NRG TENDL-2015, AKONING  
Photon emission for (n,n\*)p

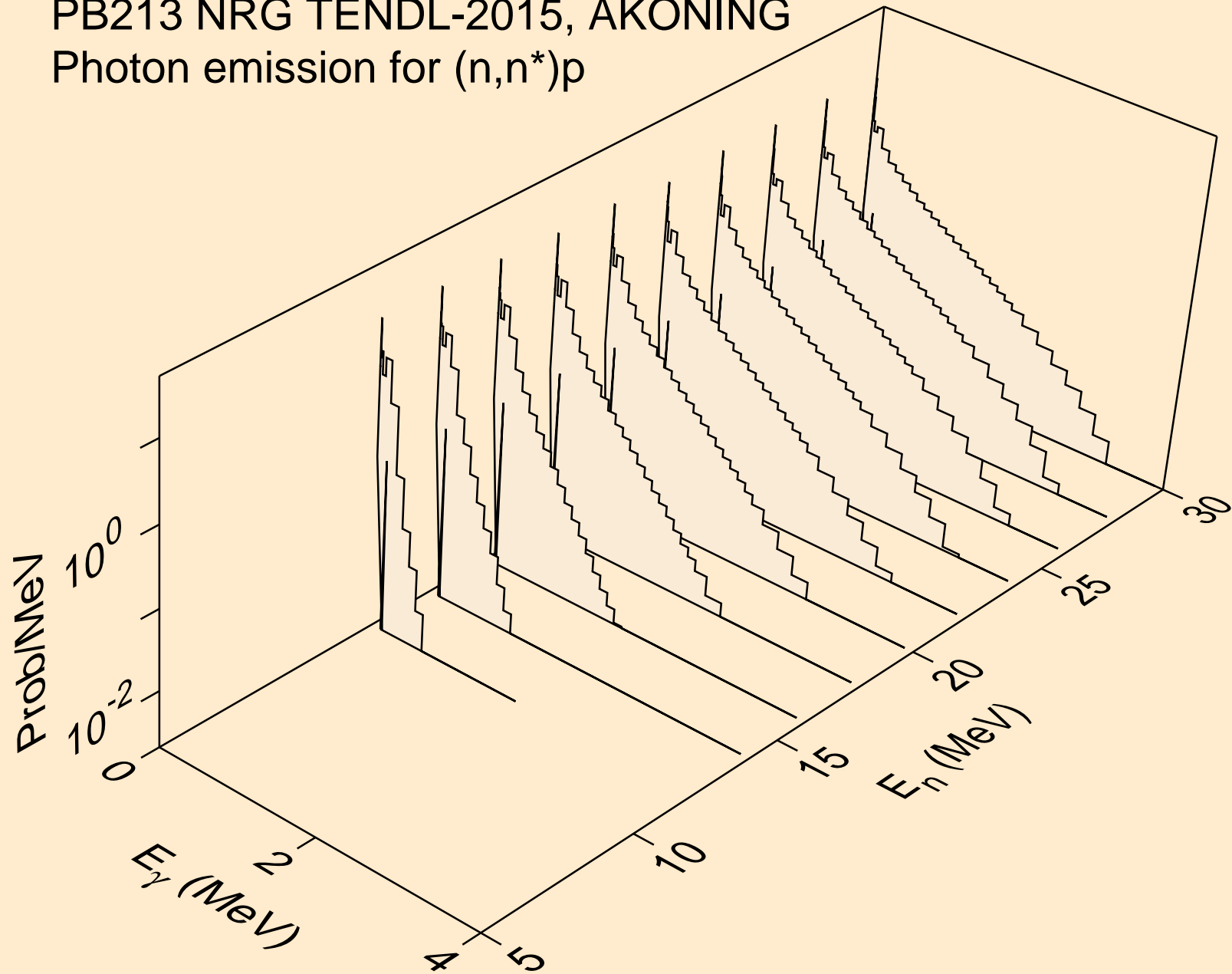

PB213 NRG TENDL-2015, AKONING  
Photon emission for (n,2n)2a

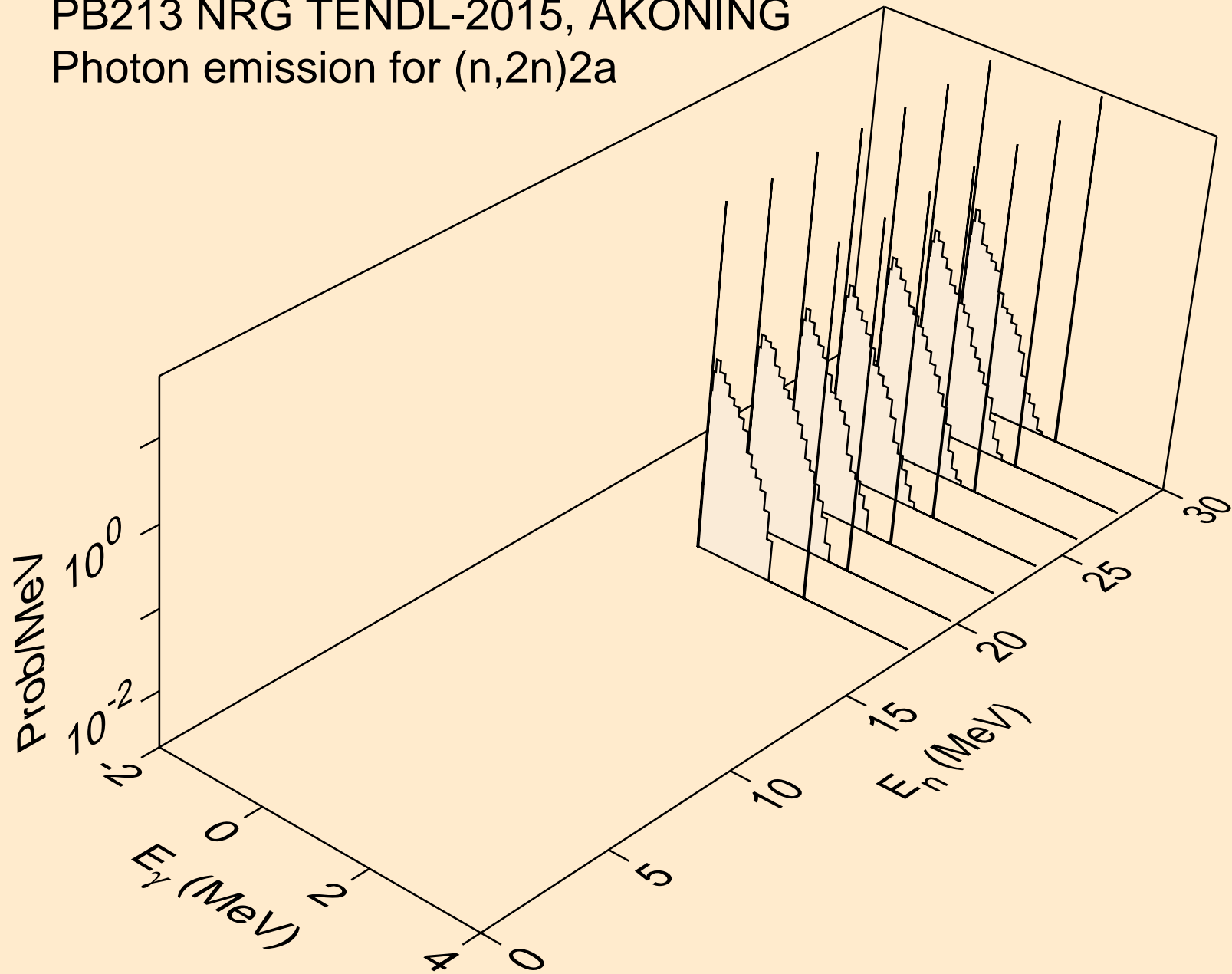

PB213 NRG TENDL-2015, AKONING  
Photon emission for (n,n\*)d

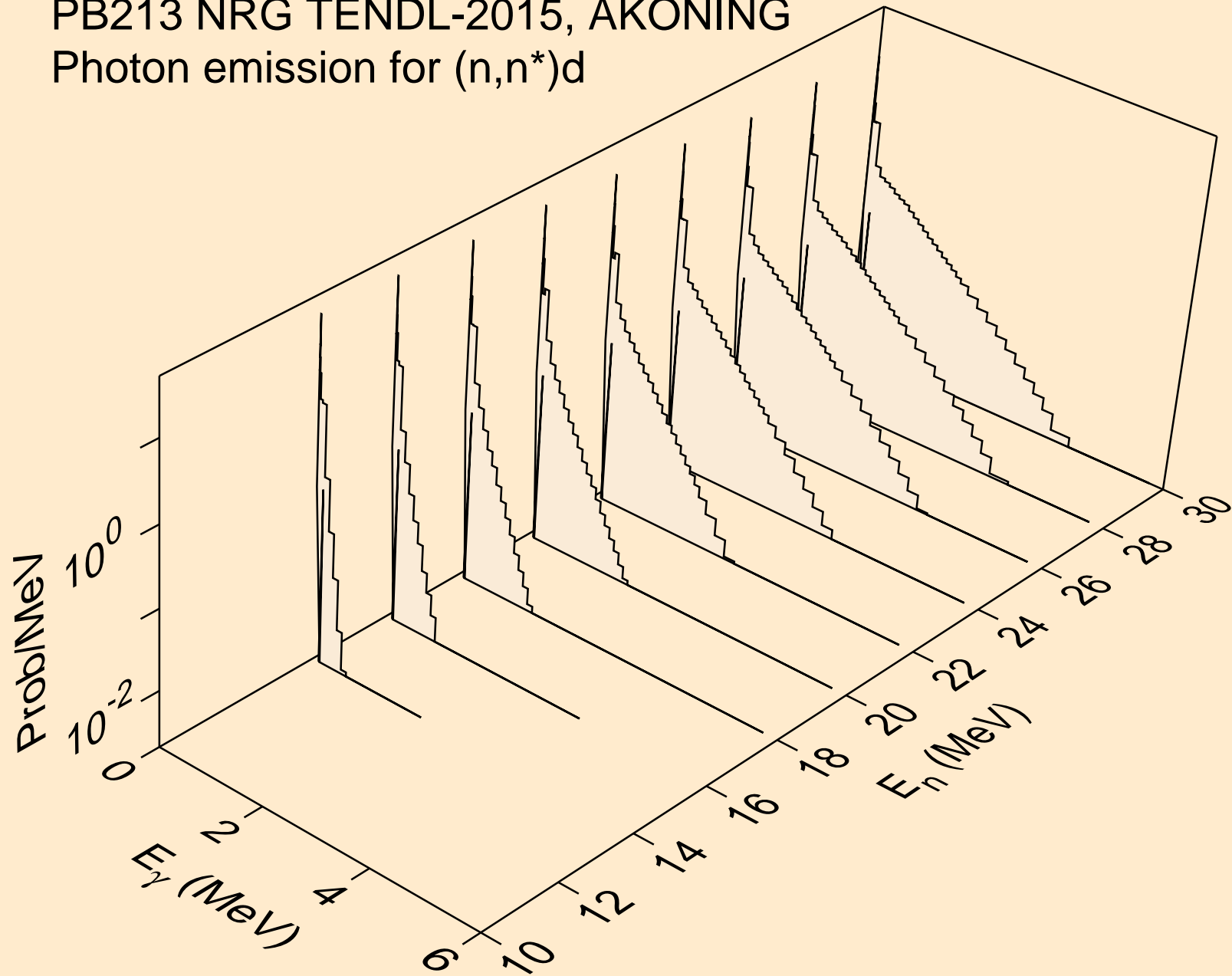

PB213 NRG TENDL-2015, AKONING  
Photon emission for (n,n\*)t

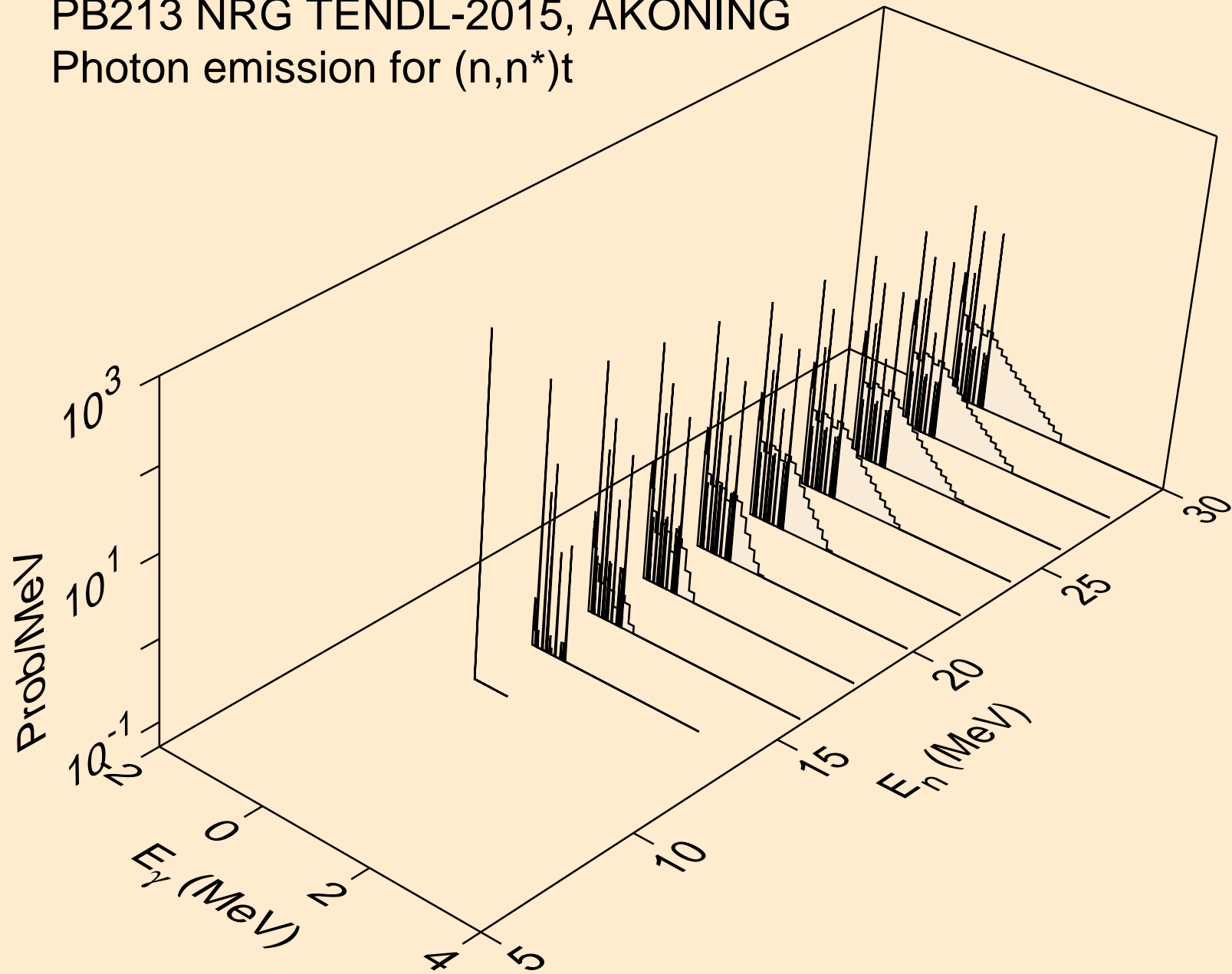

PB213 NRG TENDL-2015, AKONING  
Photon emission for (n,n\*)he3

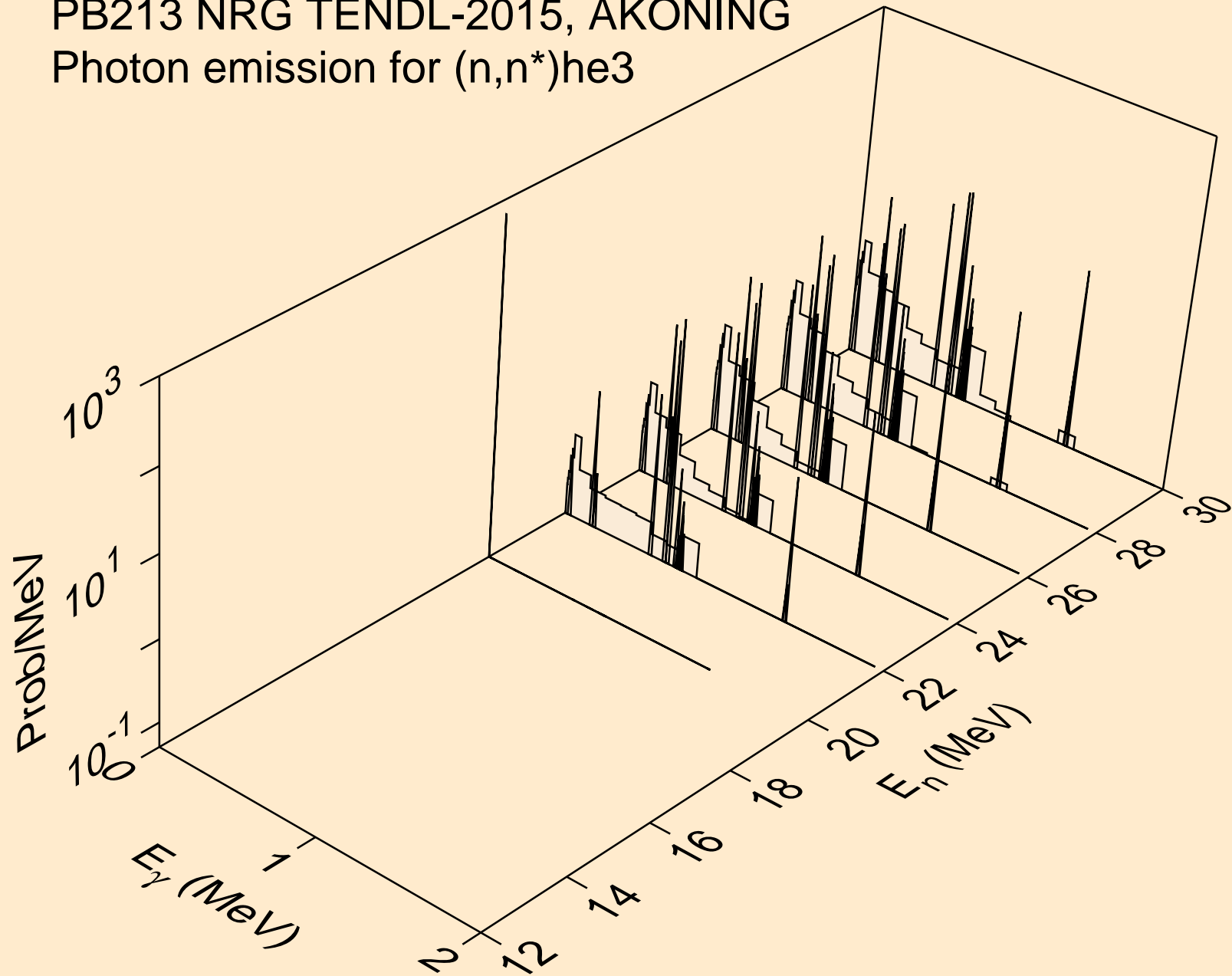

PB213 NRG TENDL-2015, AKONING  
Photon emission for (n,4n)

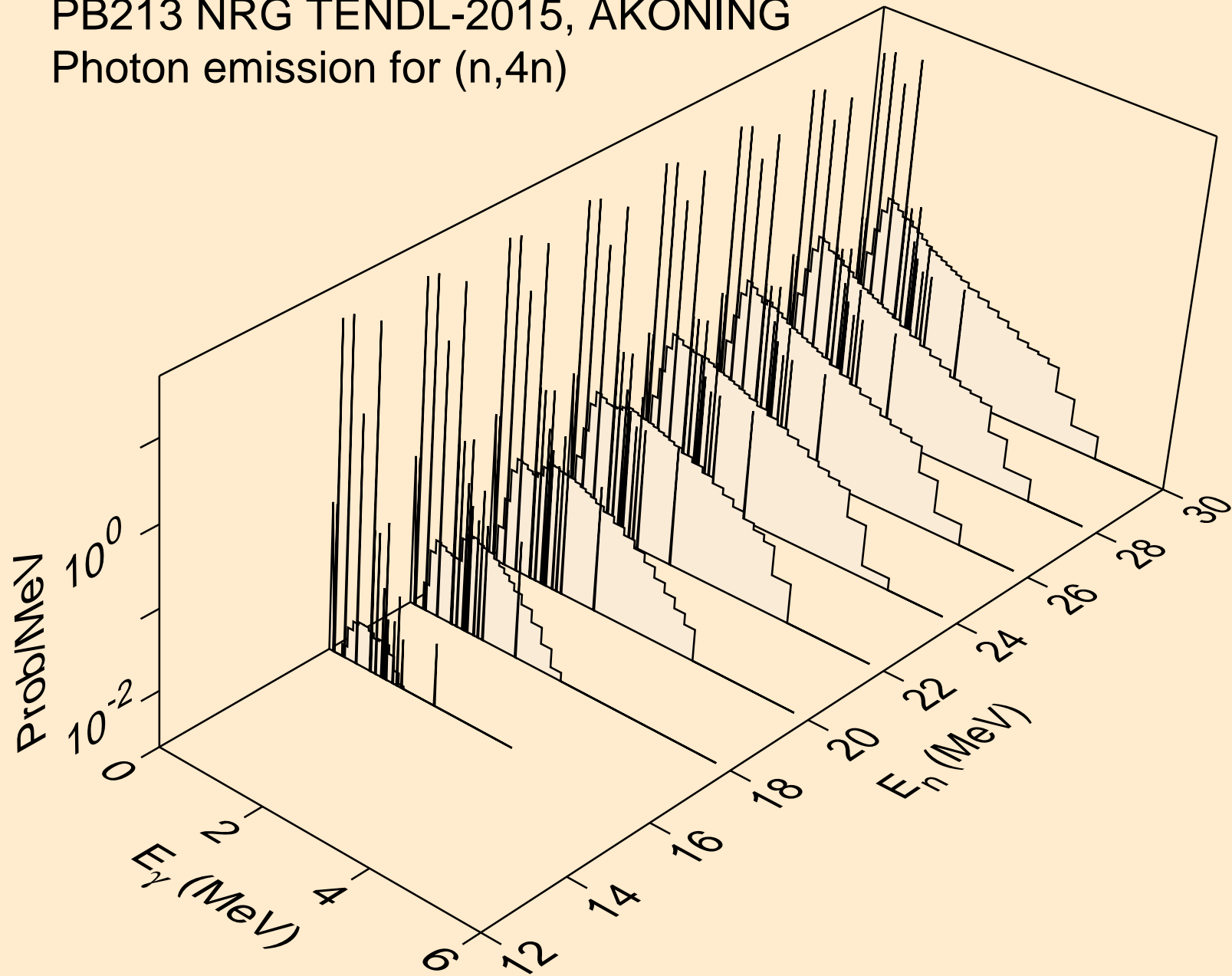



PB213 NRG TENDL-2015, AKONING  
Photon emission for (n,2np)

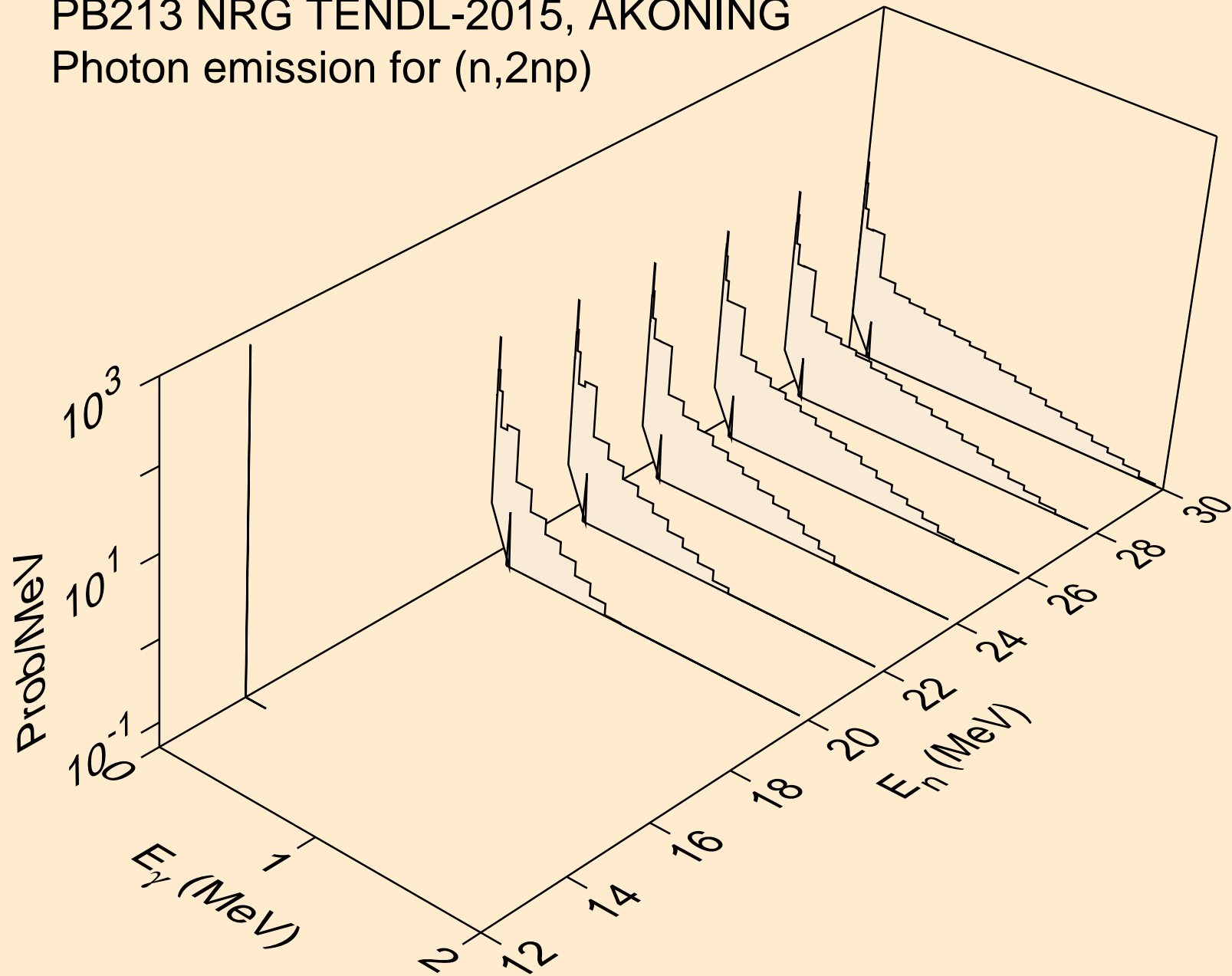

PB213 NRG TENDL-2015, AKONING  
Photon emission for (n,3np)

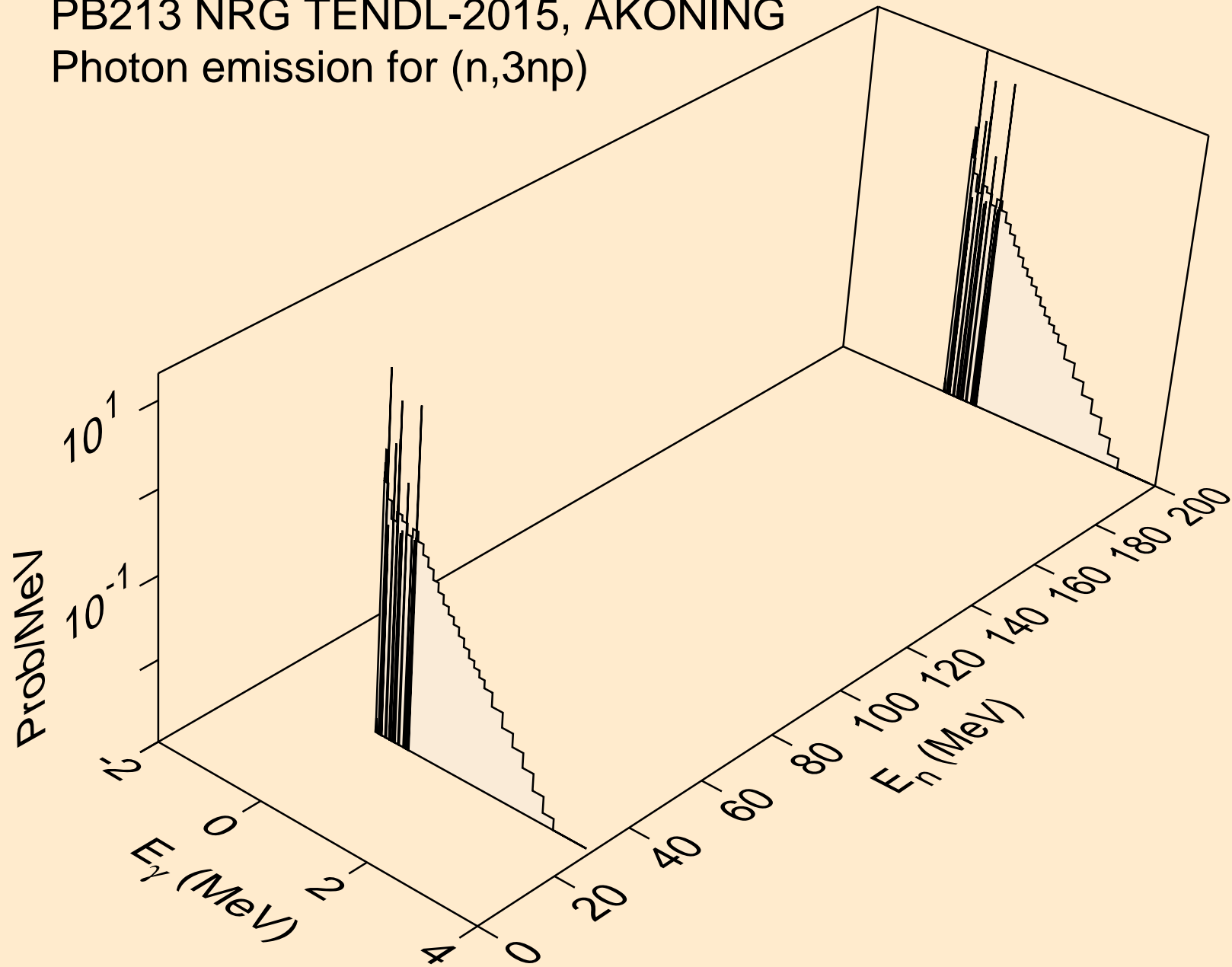

PB213 NRG TENDL-2015, AKONING  
Photon emission for (n,n\*c)

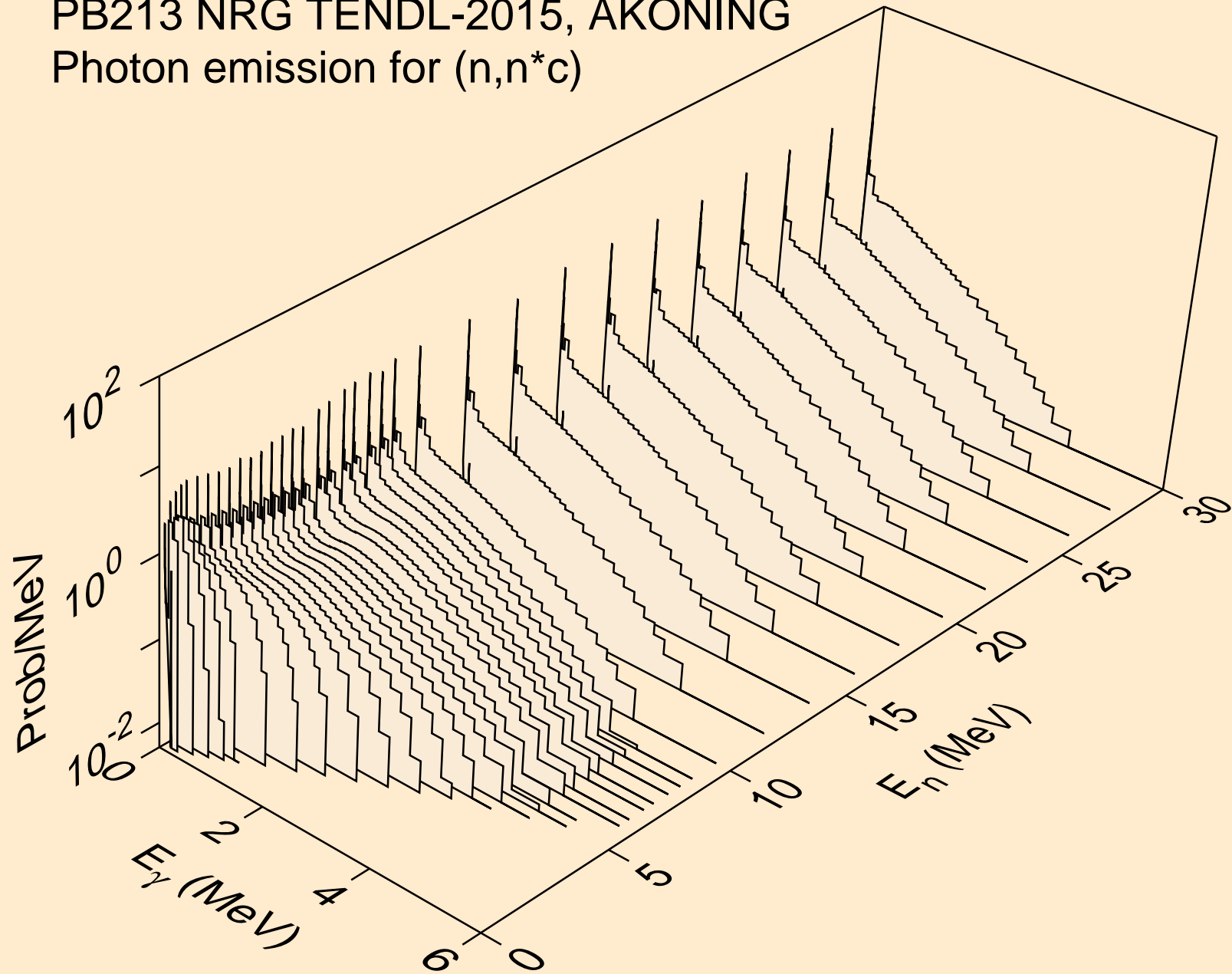

PB213 NRG TENDL-2015, AKONING  
Photon emission for (n,gma)

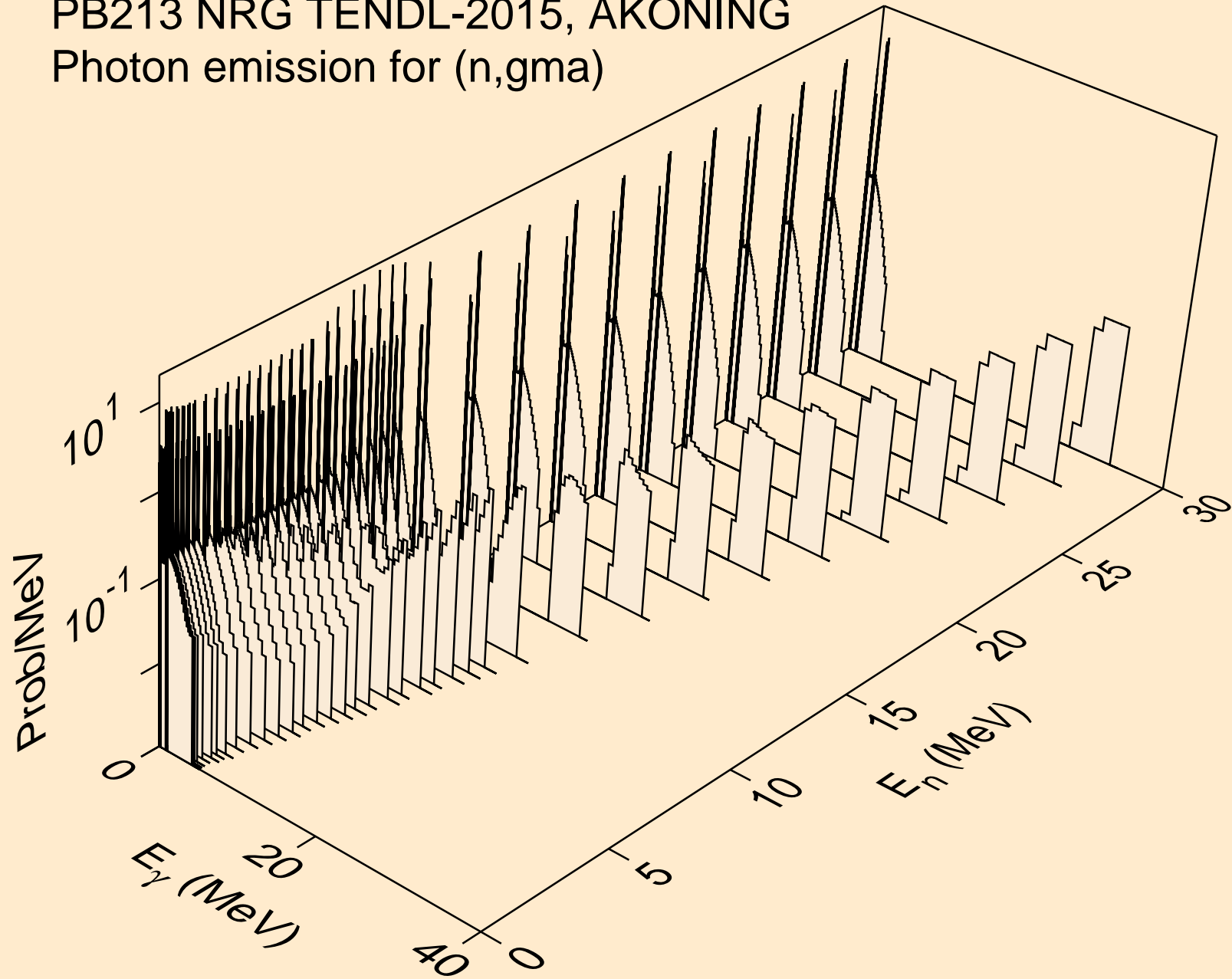

PB213 NRG TENDL-2015, AKONING  
Photon emission for (n,p)

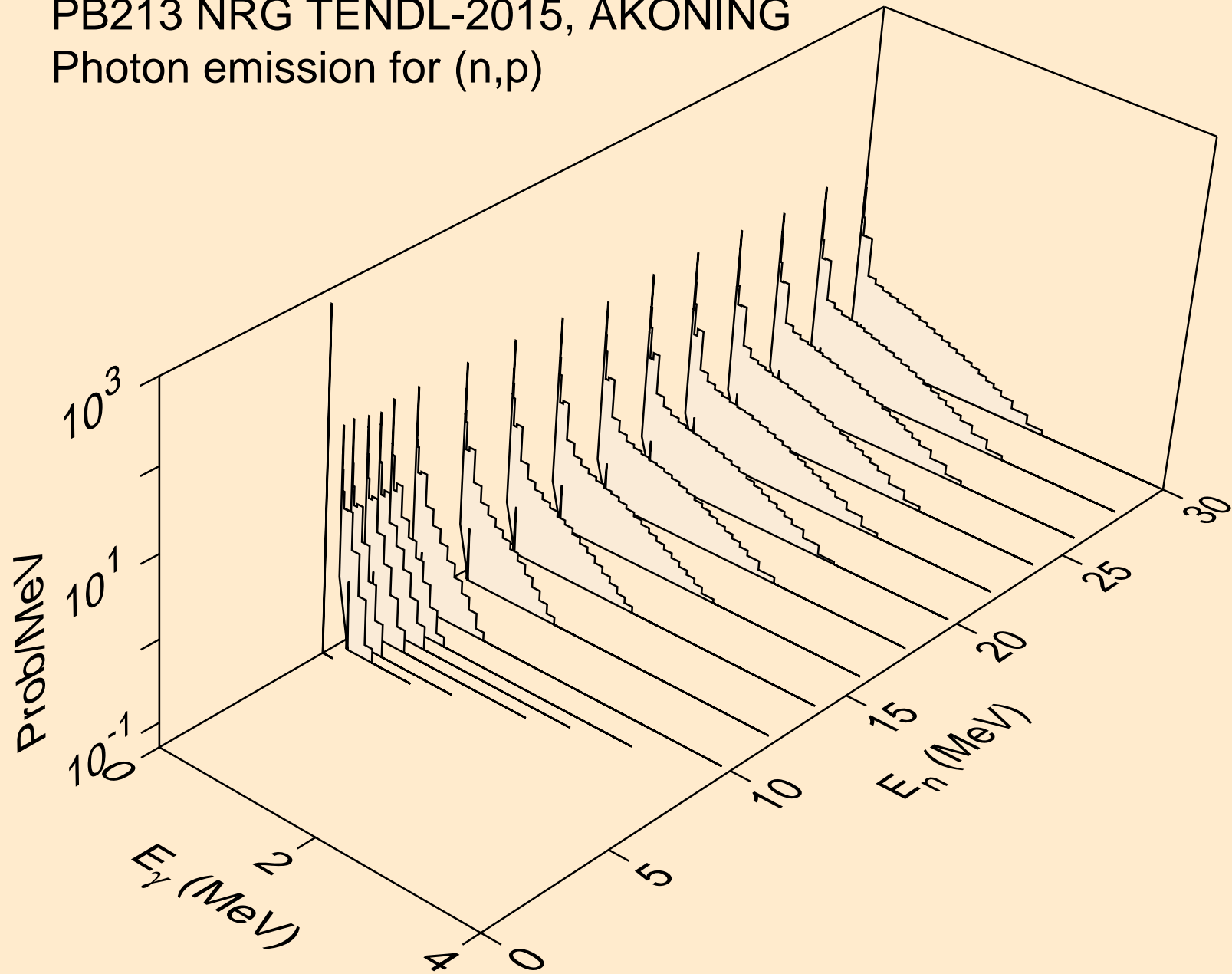

PB213 NRG TENDL-2015, AKONING  
Photon emission for (n,d)

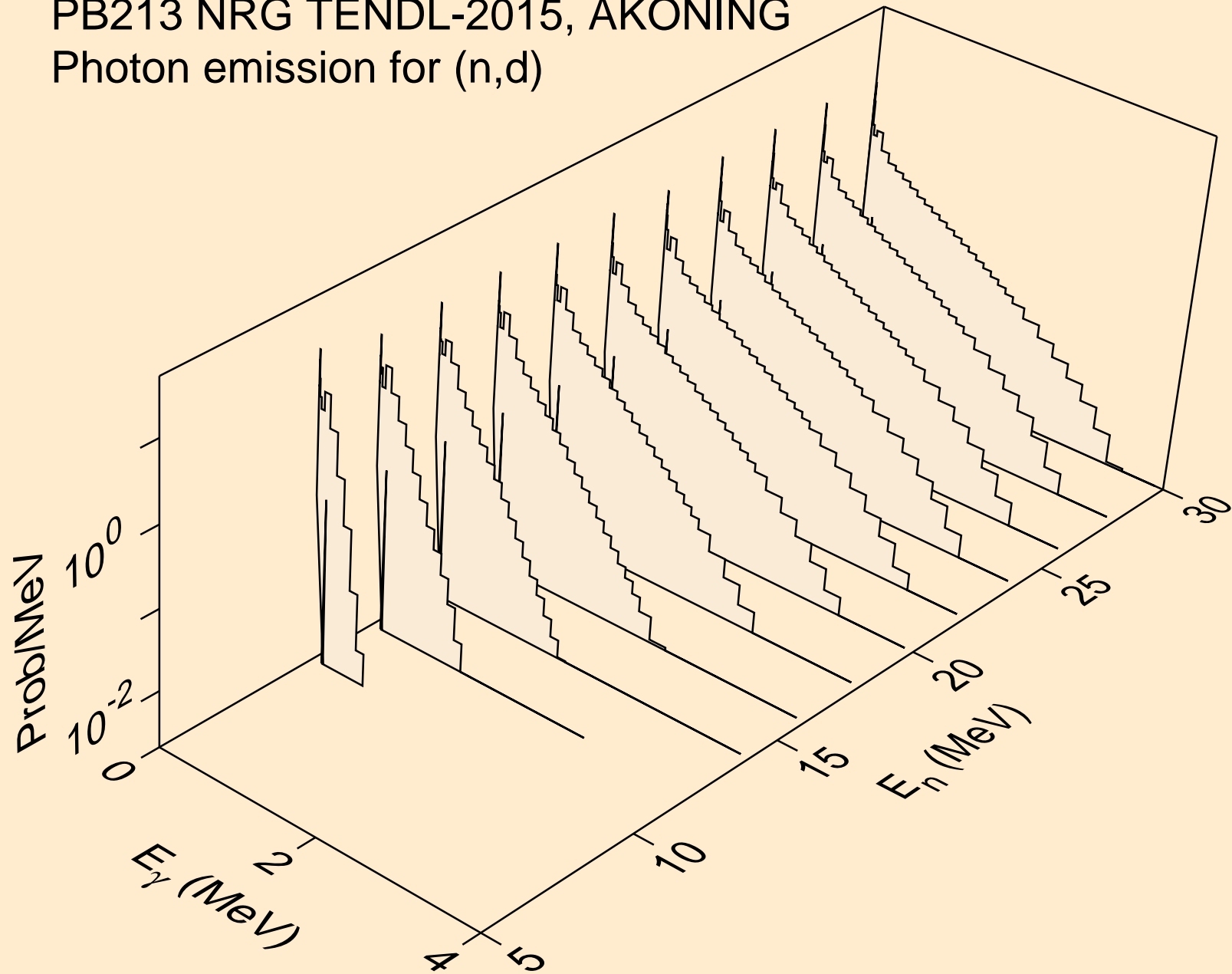

PB213 NRG TENDL-2015, AKONING  
Photon emission for (n,t)

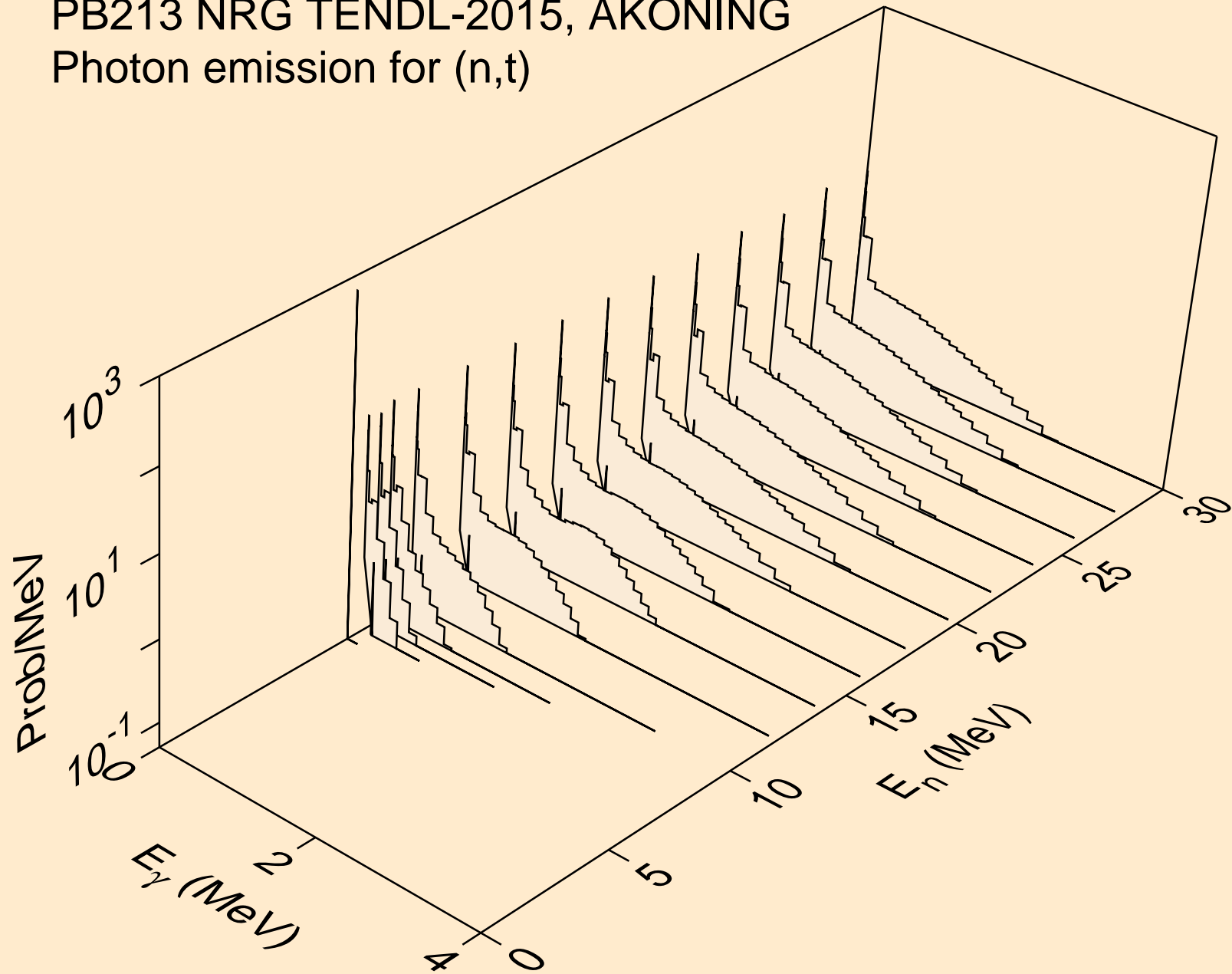

PB213 NRG TENDL-2015, AKONING  
Photon emission for (n,he3)

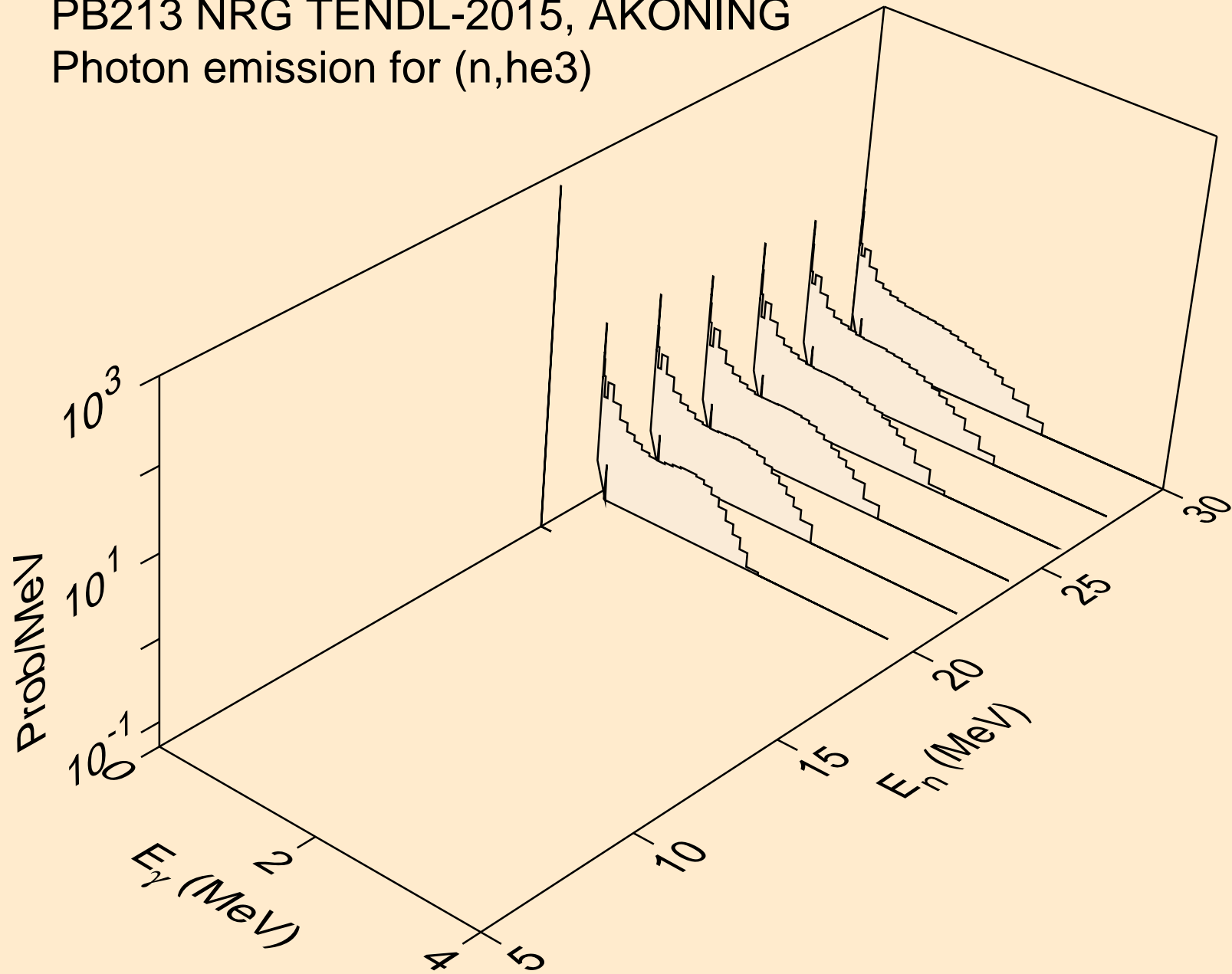



PB213 NRG TENDL-2015, AKONING  
Photon emission for (n,a)

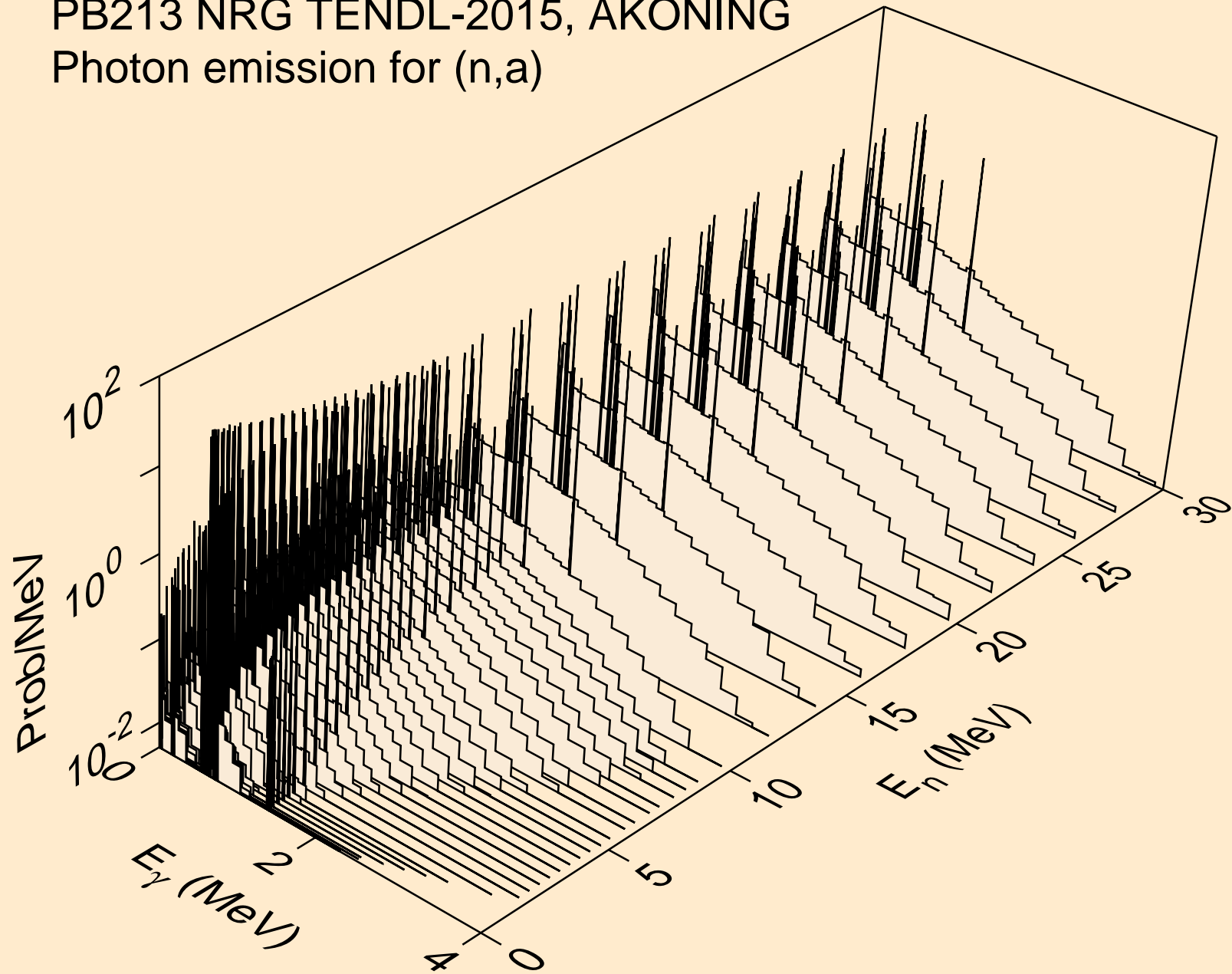

PB213 NRG TENDL-2015, AKONING  
Photon emission for (n,2p)

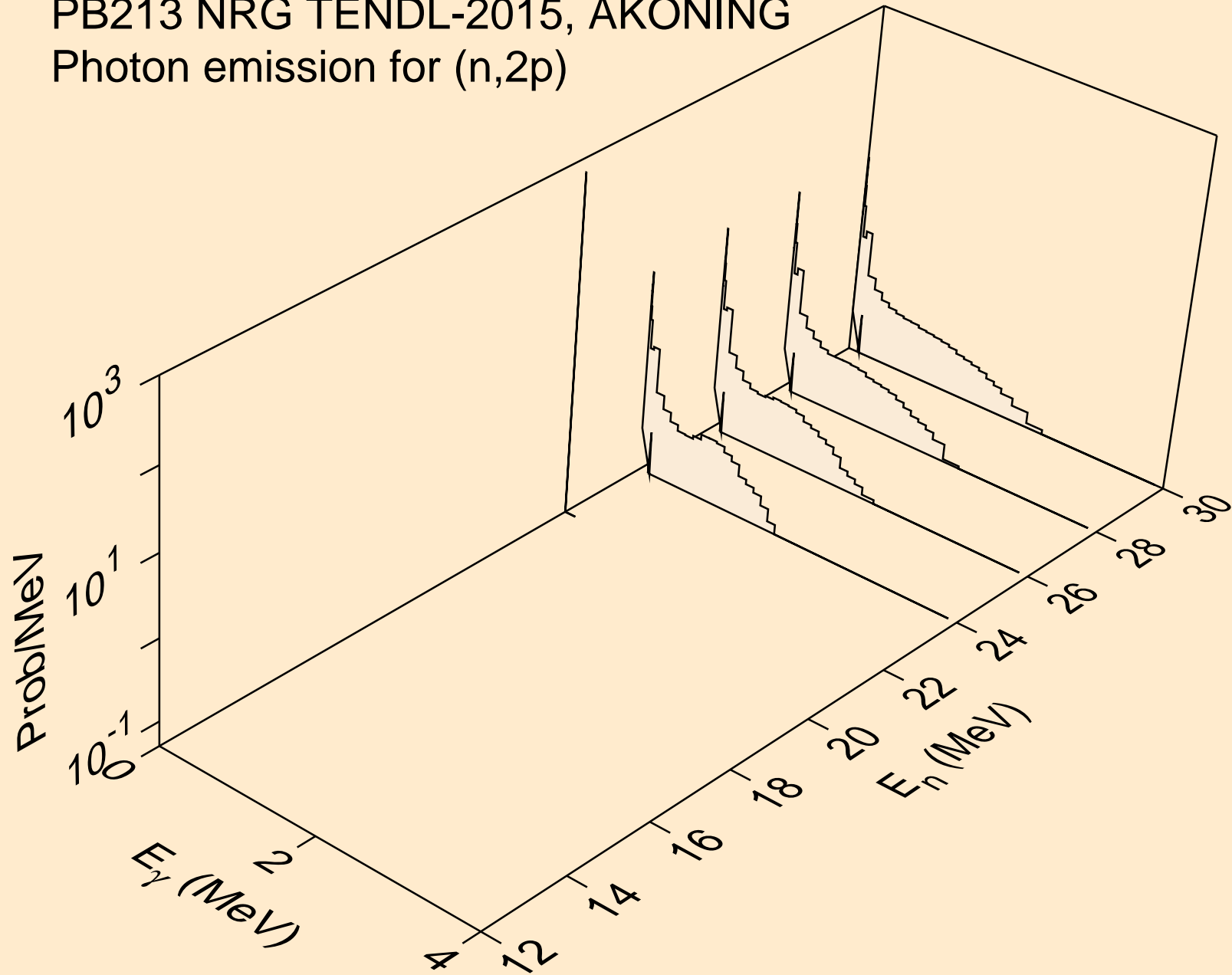

PB213 NRG TENDL-2015, AKONING  
Photon emission for (n,pa)

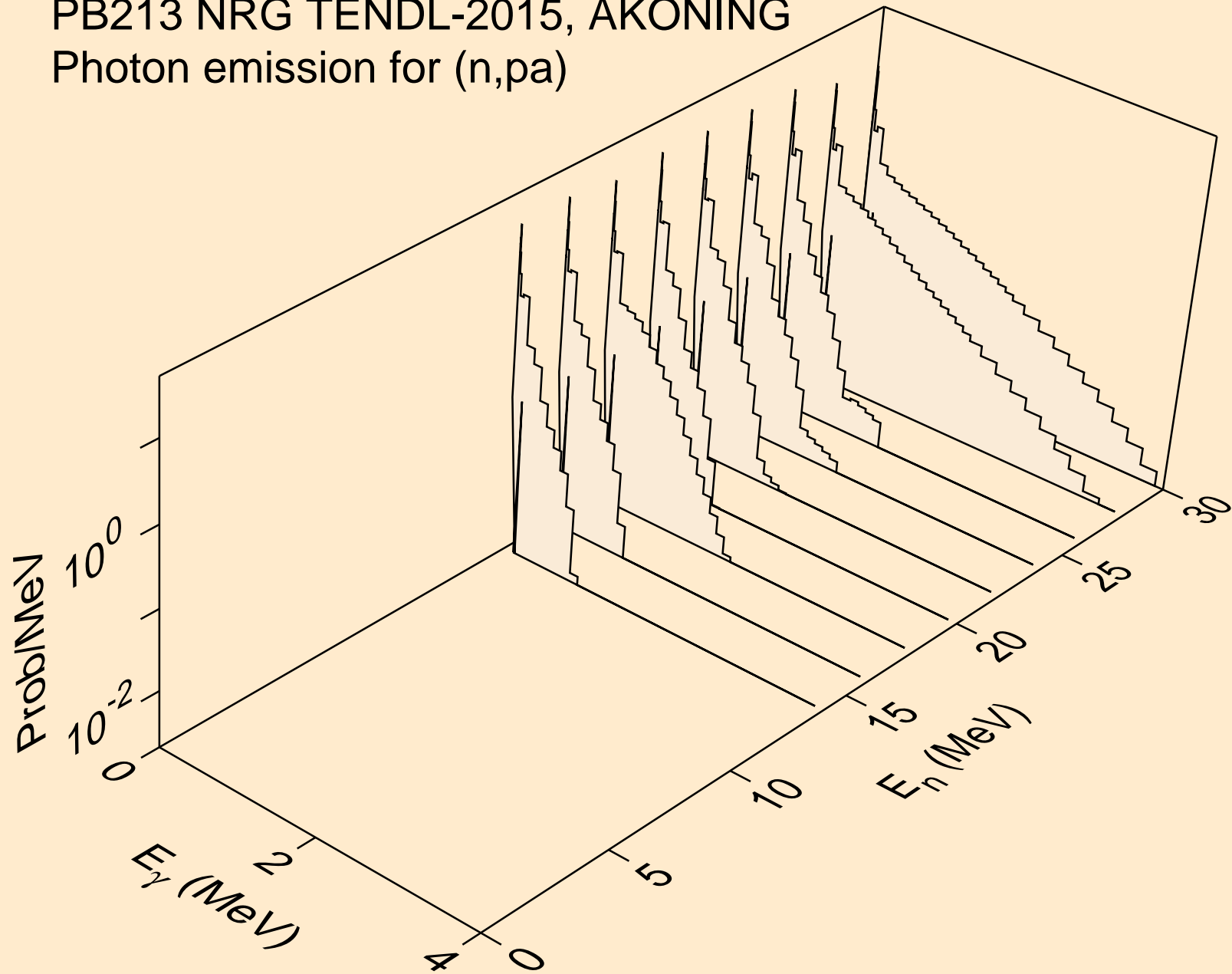

PB213 NRG TENDL-2015, AKONING  
thermal capture photon spectrum

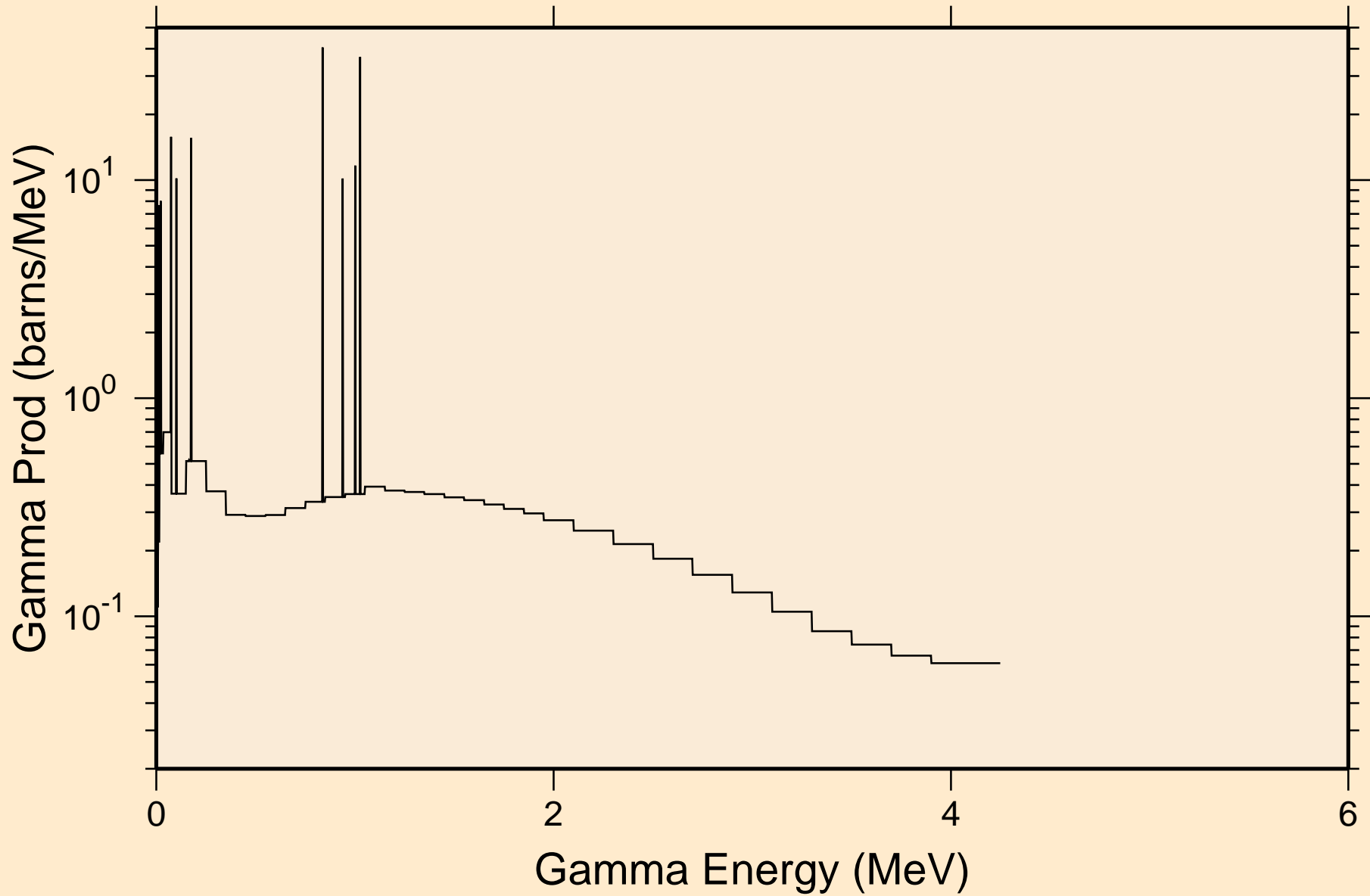

PB213 NRG TENDL-2015, AKONING  
14 MeV photon spectrum

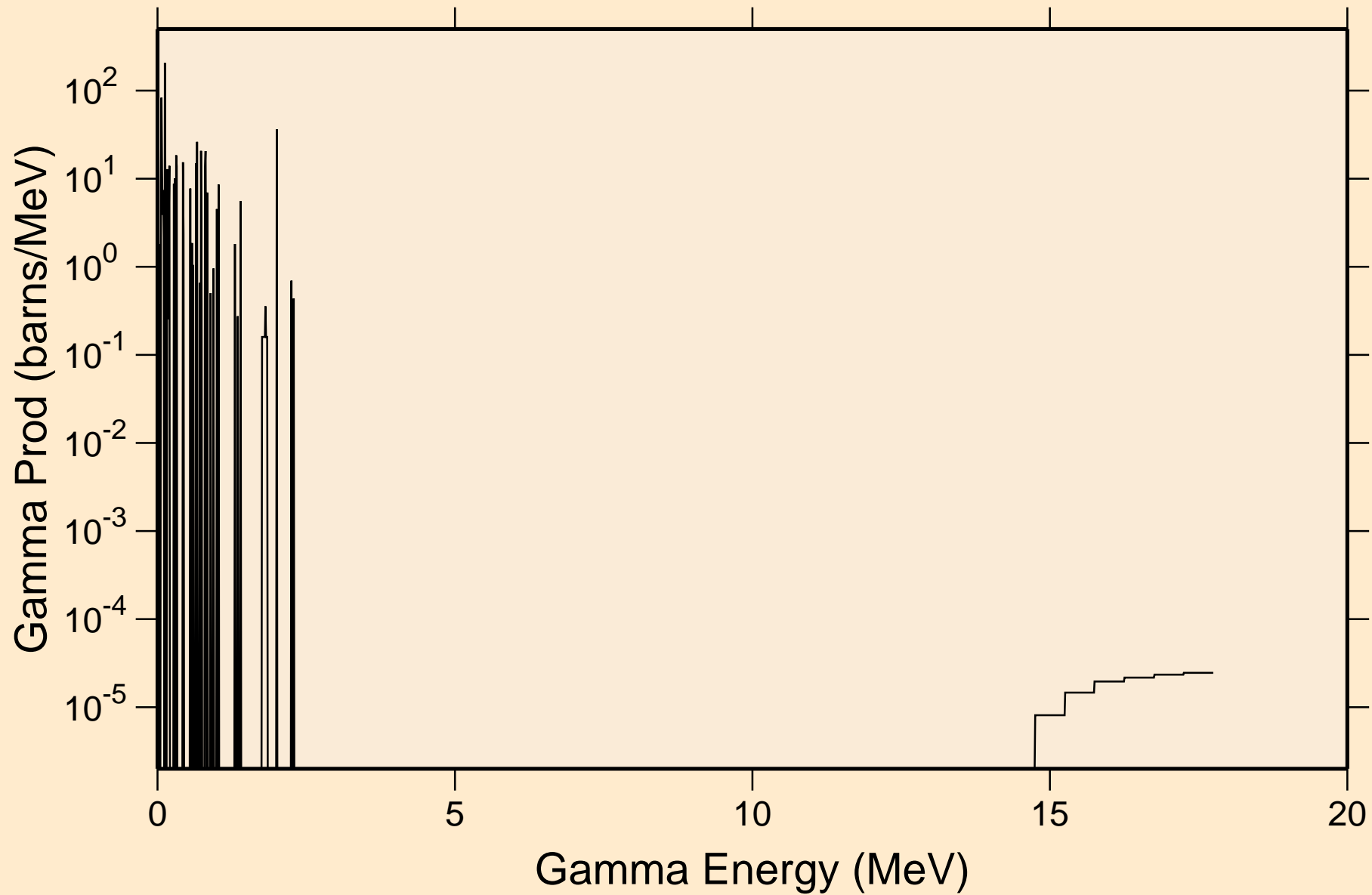

# PB213 NRG TENDL-2015, AKONING

## Particle heating contributions

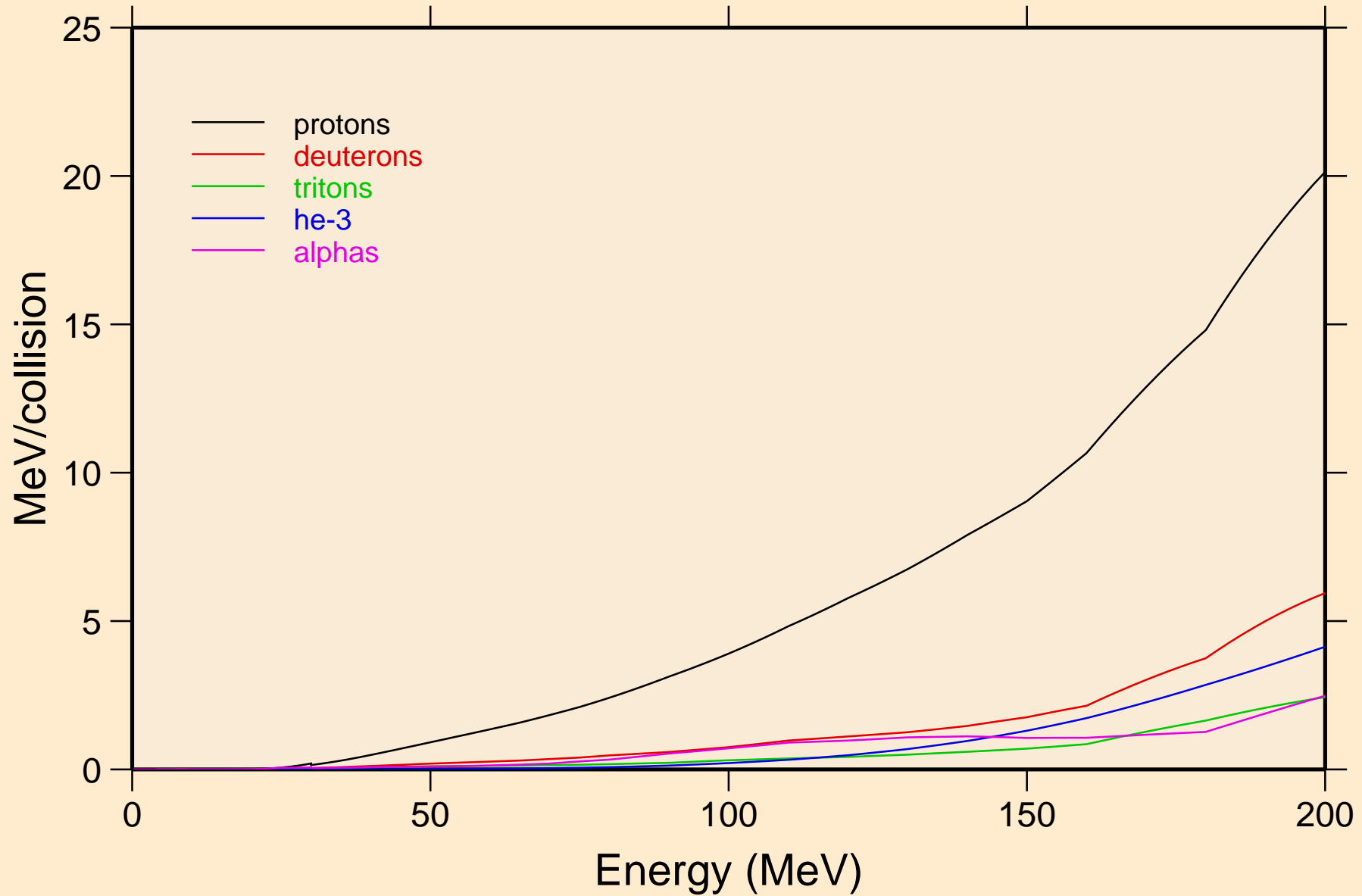

# PB213 NRG TENDL-2015, AKONING

## Recoil Heating

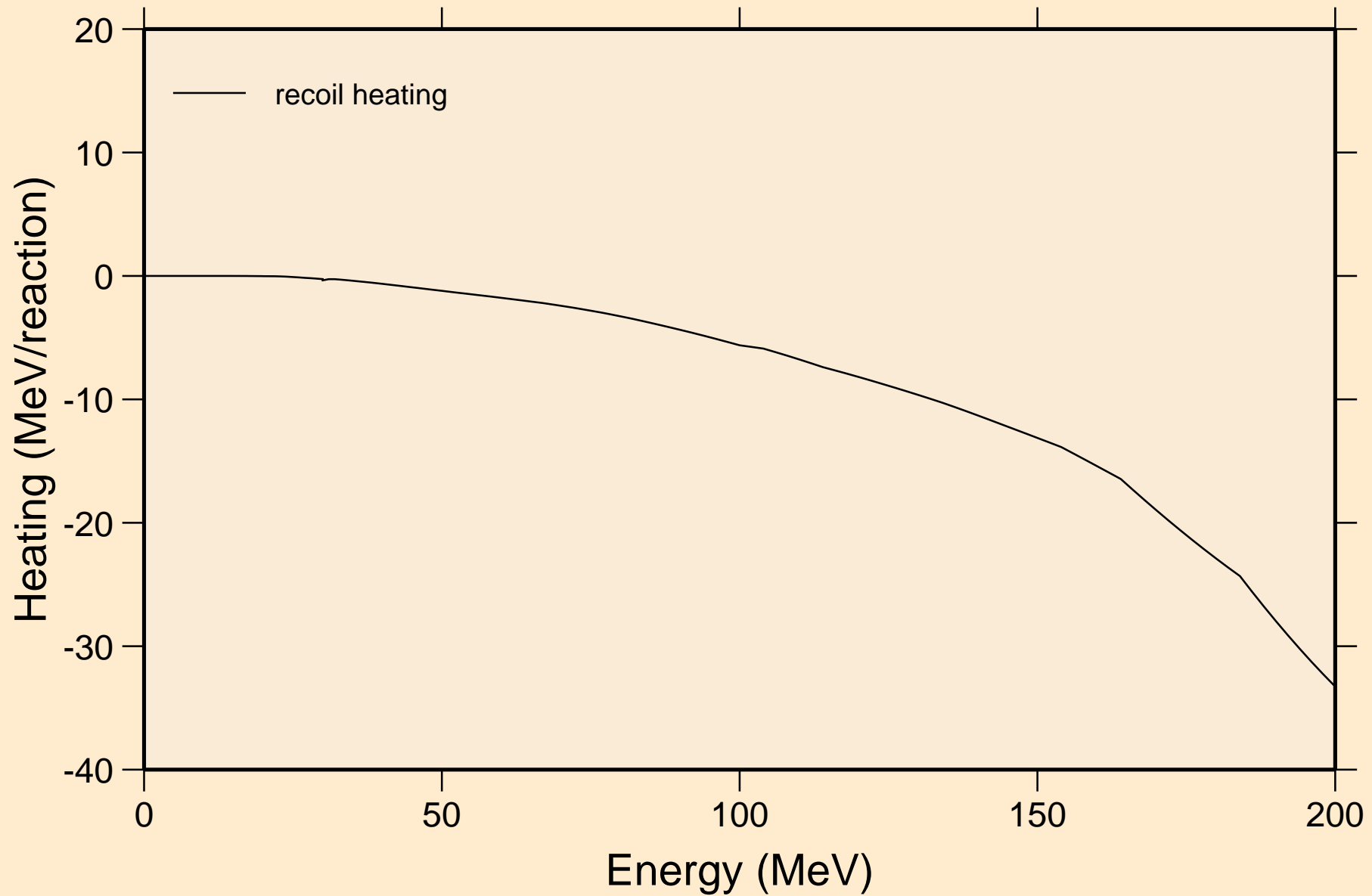

# PB213 NRG TENDL-2015, AKONING

## Particle production cross sections

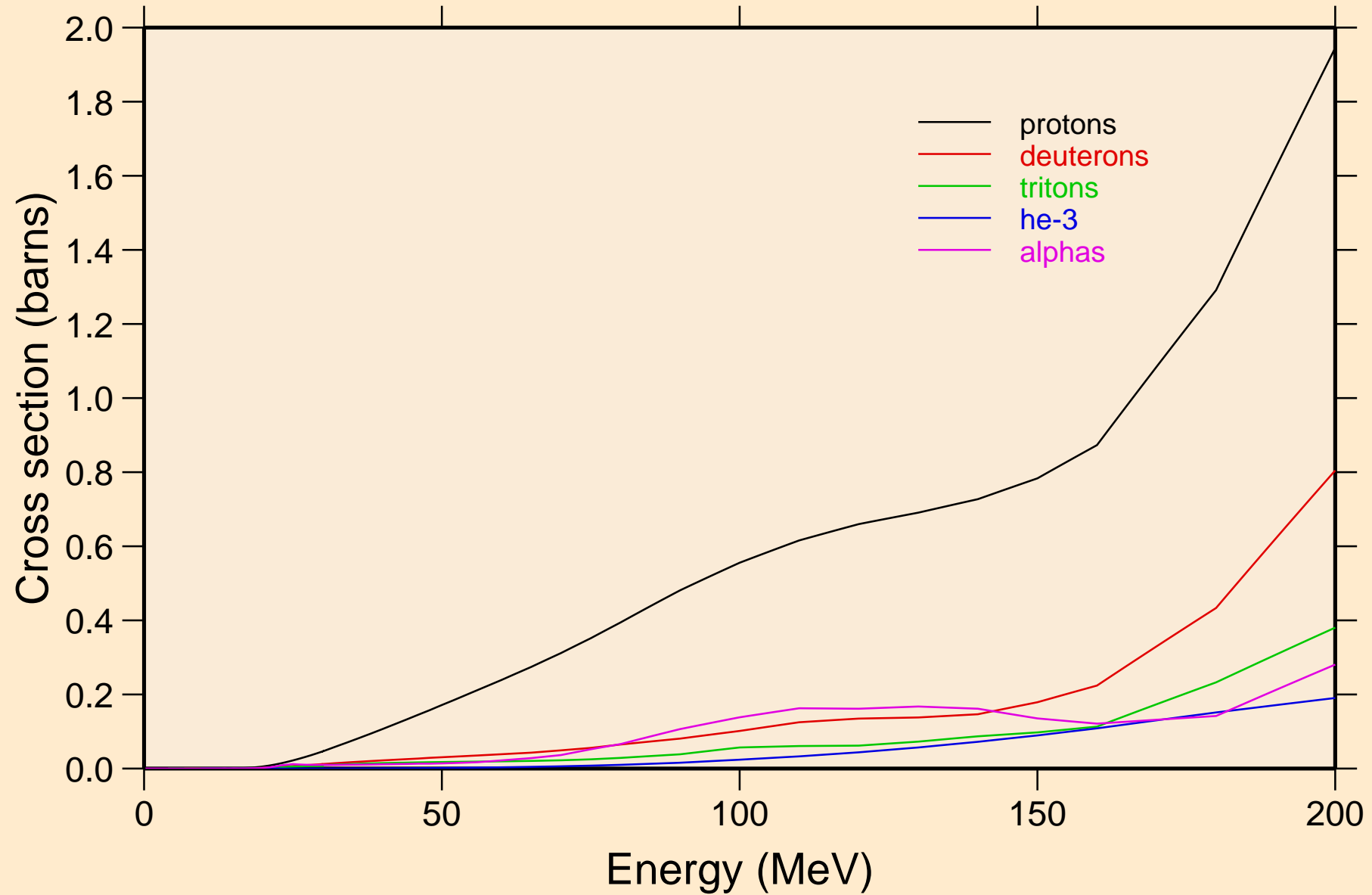



PB213 NRG TENDL-2015, AKONING  
protons from (n,x)

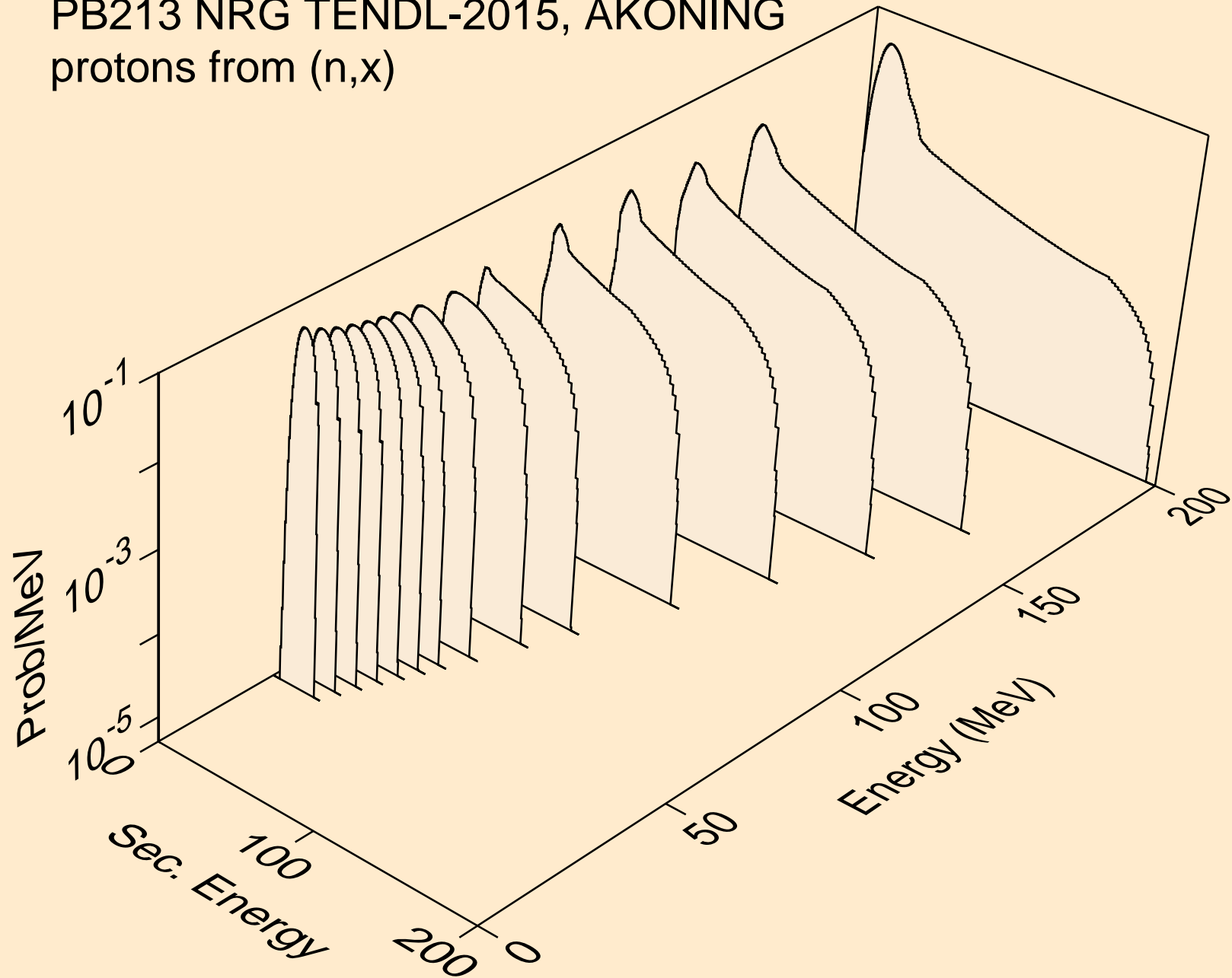

PB213 NRG TENDL-2015, AKONING  
protons from (n,n\*)p

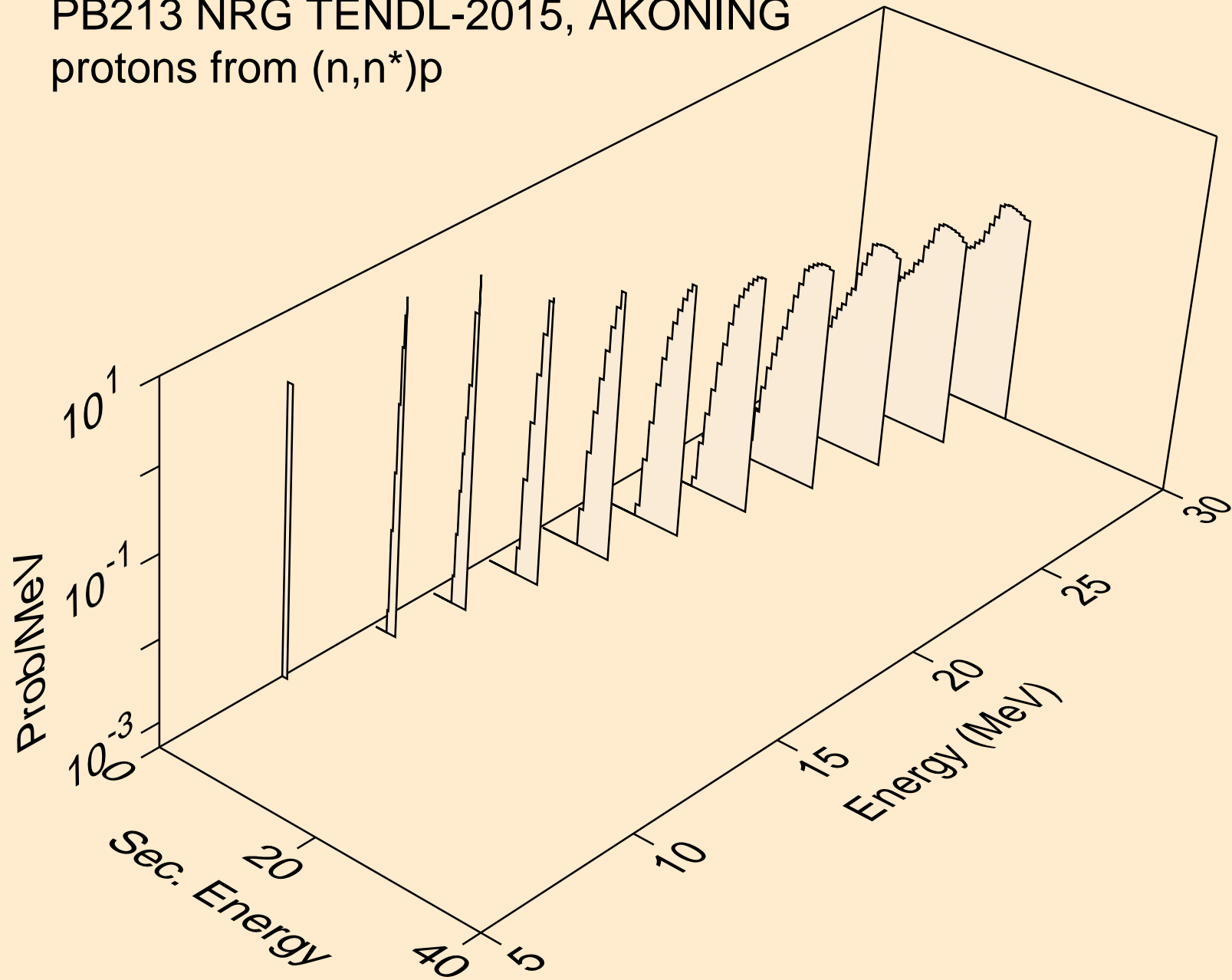

PB213 NRG TENDL-2015, AKONING  
protons from (n,2np)

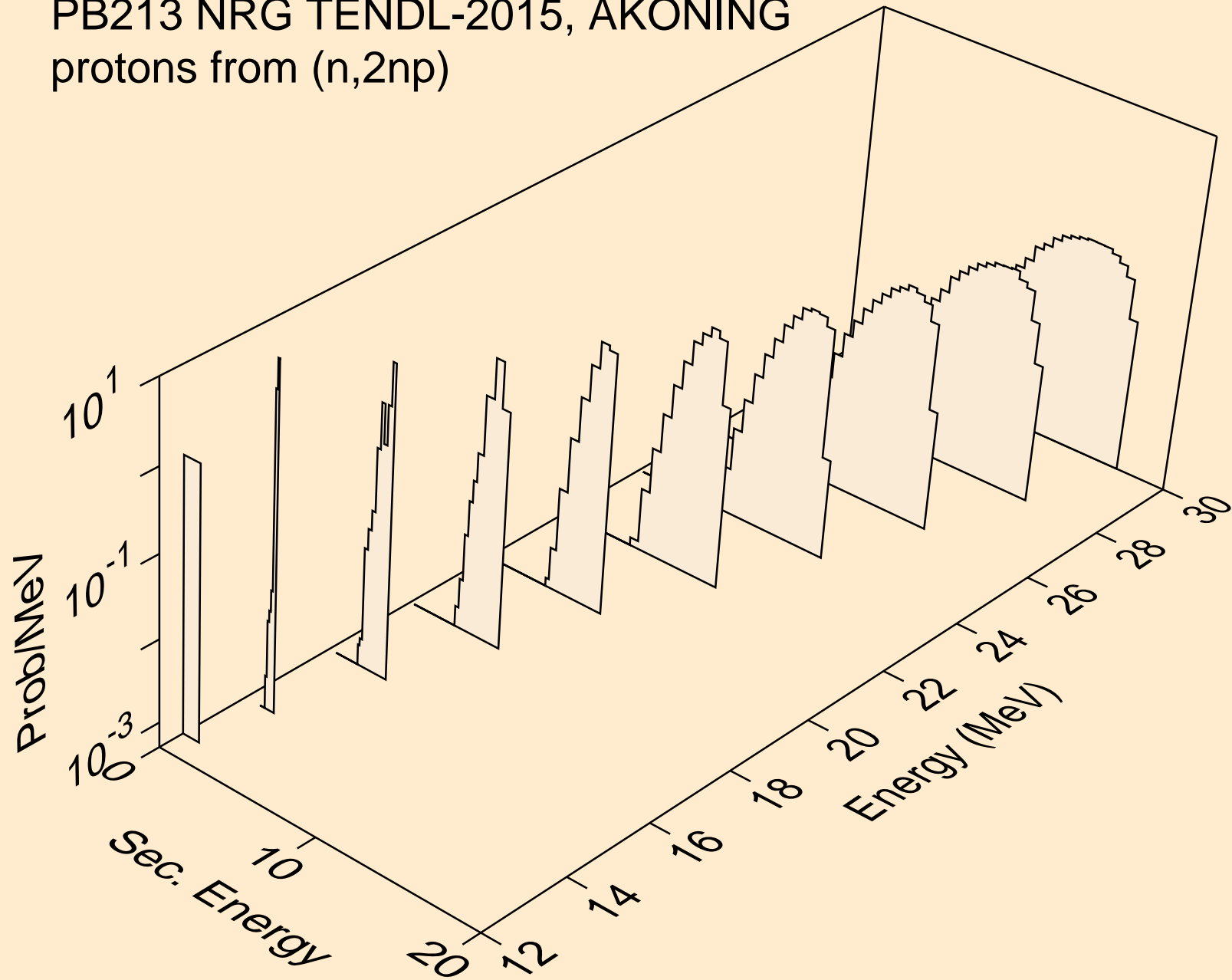

PB213 NRG TENDL-2015, AKONING  
protons from (n,3np)

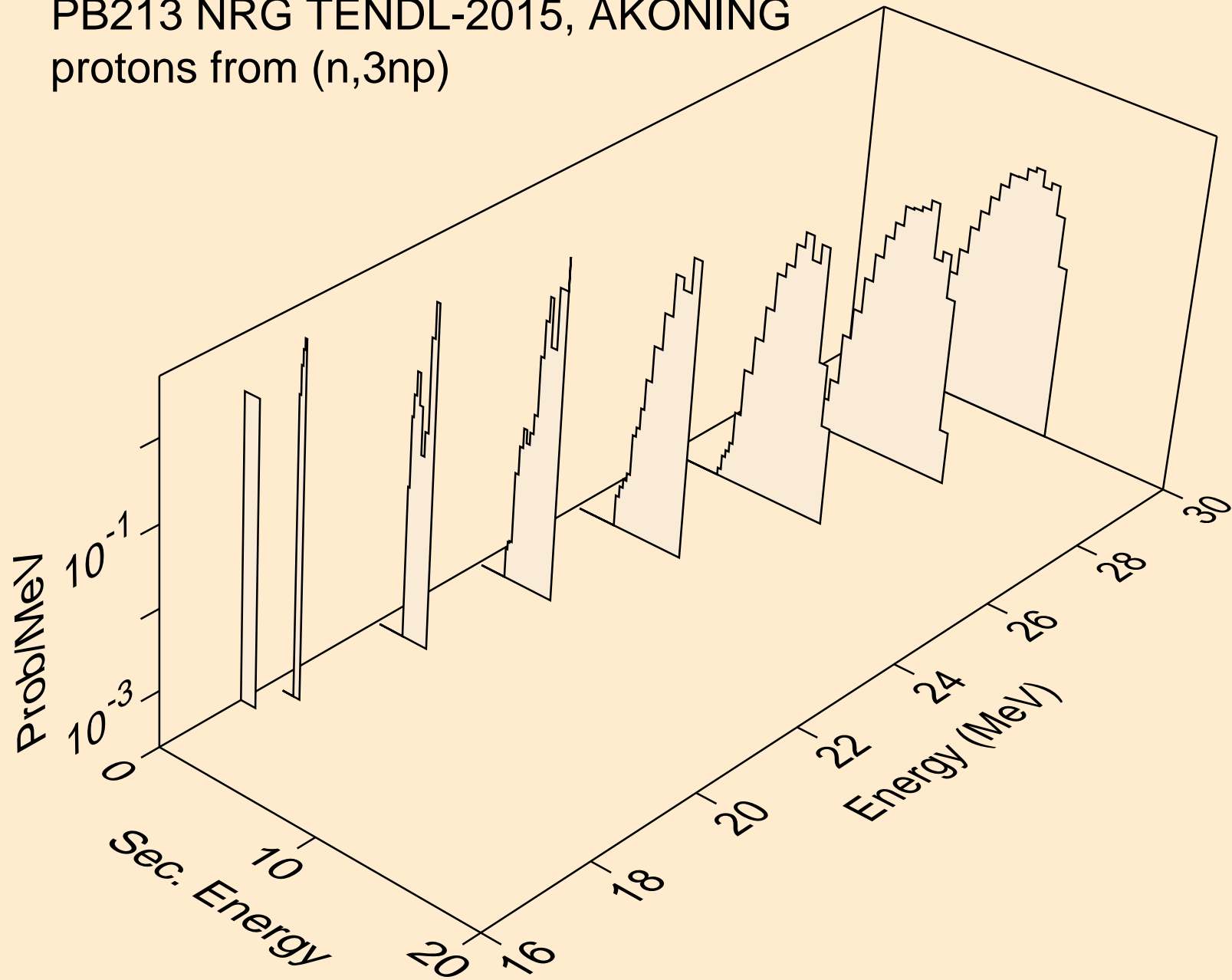

PB213 NRG TENDL-2015, AKONING  
protons from (n,p)

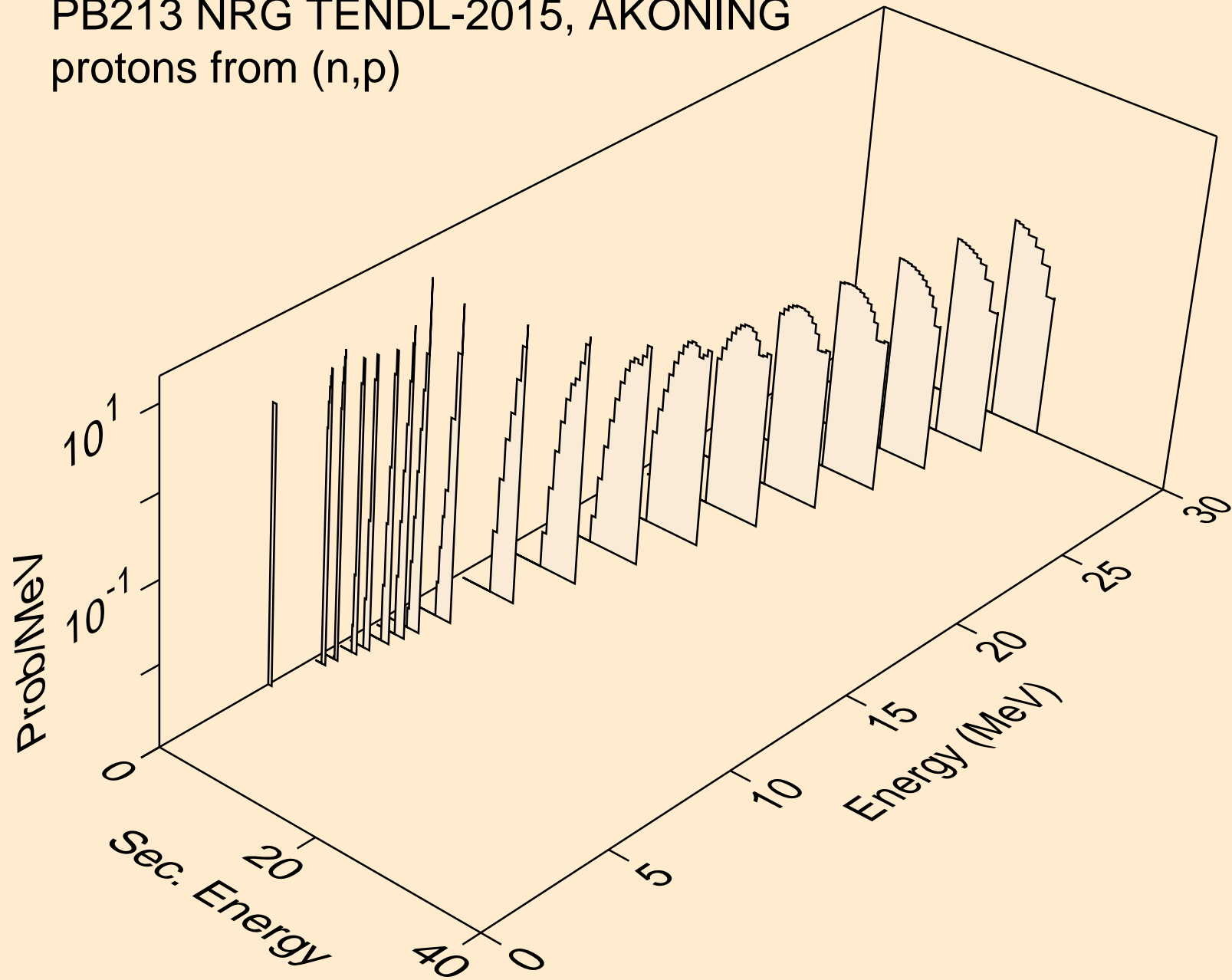

PB213 NRG TENDL-2015, AKONING  
protons from (n,2p)

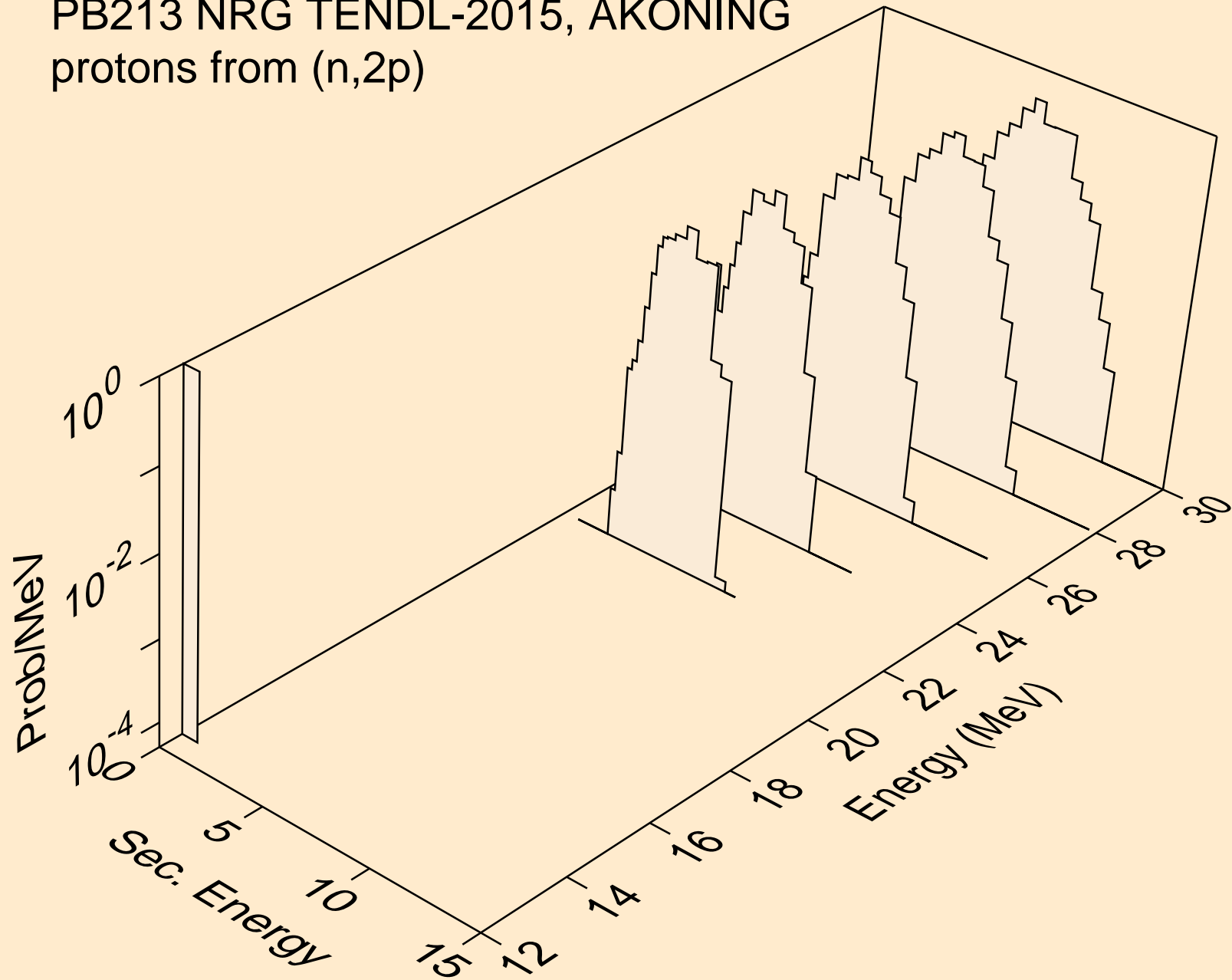

PB213 NRG TENDL-2015, AKONING  
protons from (n,pa)

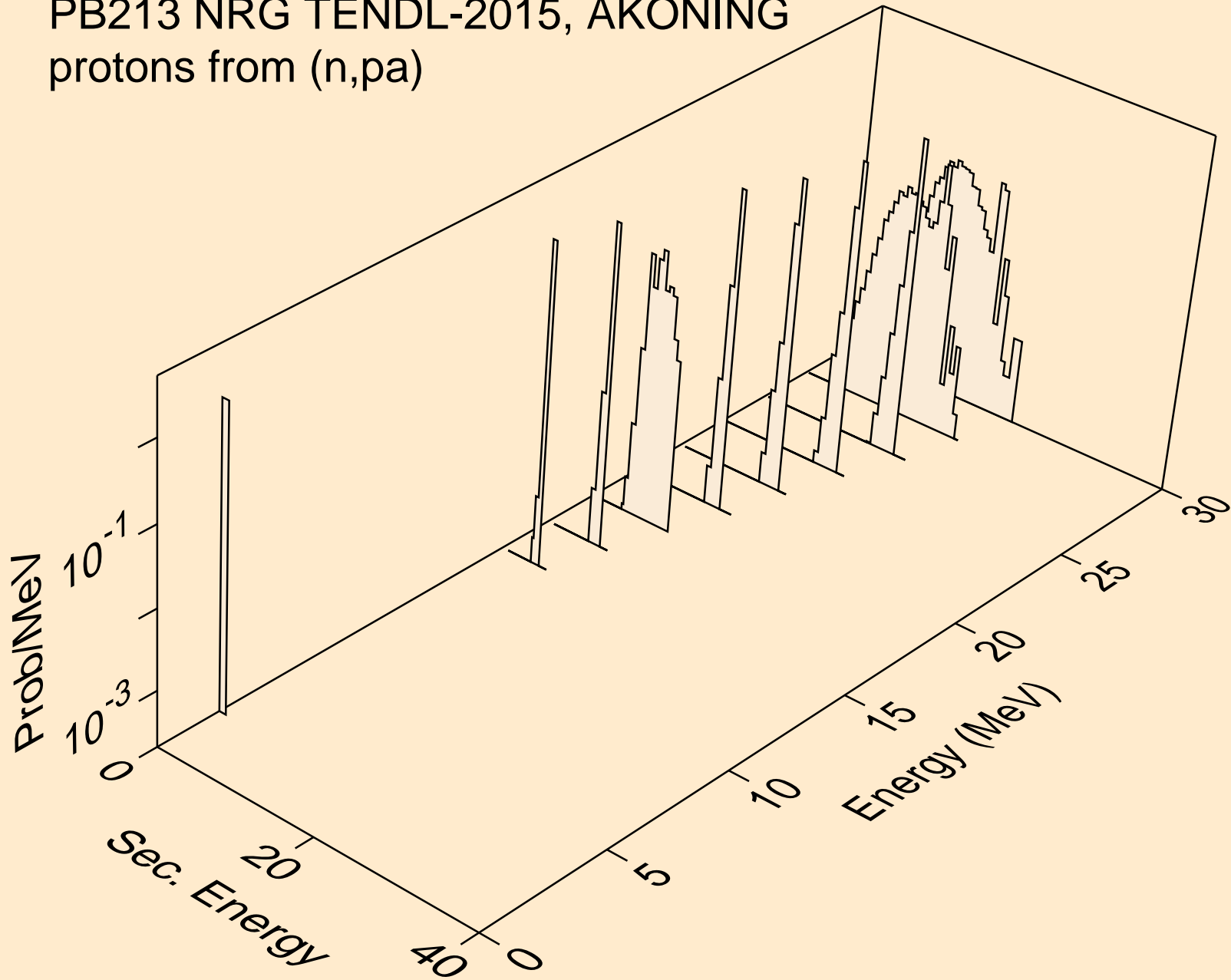

PB213 NRG TENDL-2015, AKONING  
deuterons from (n,x)

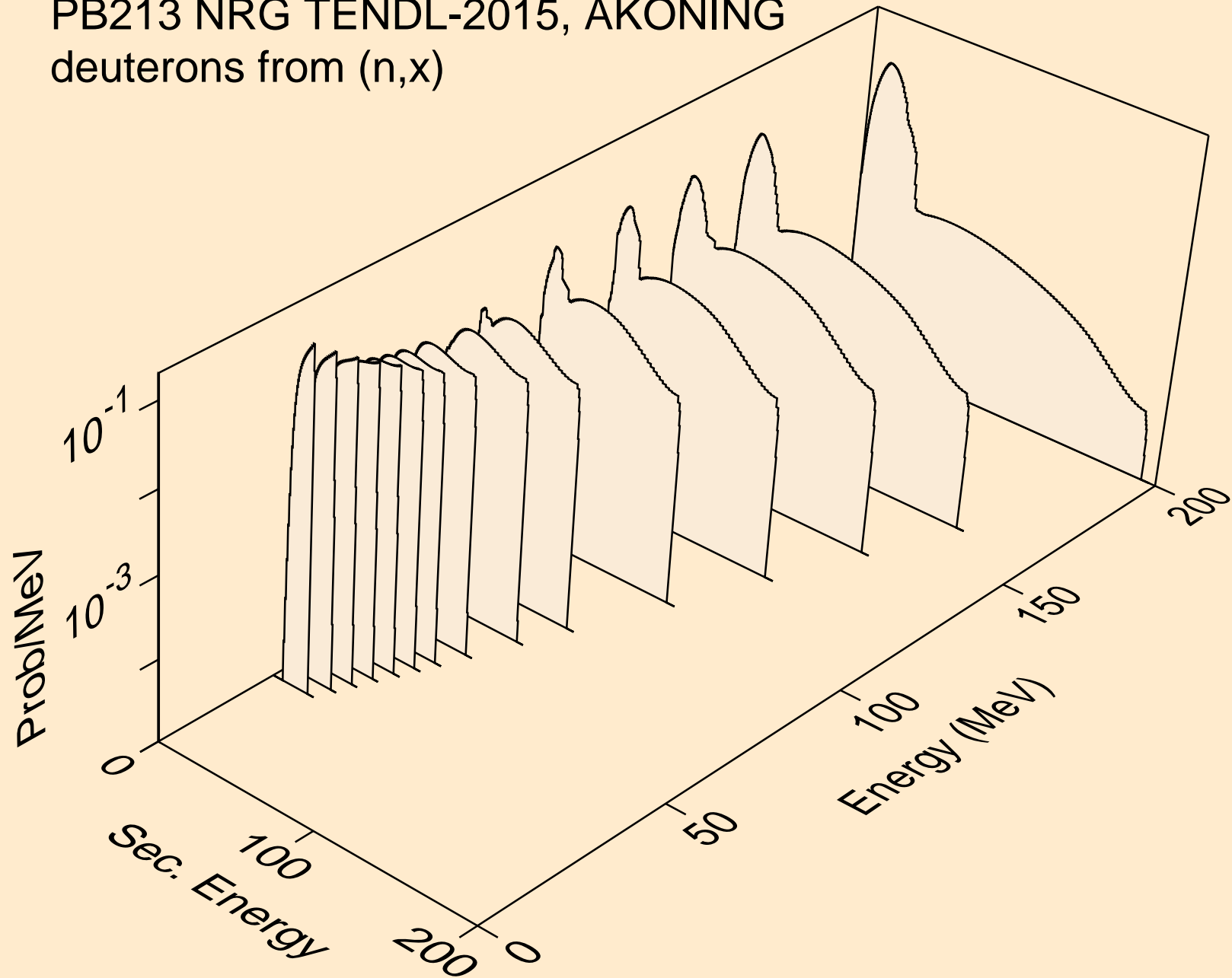



PB213 NRG TENDL-2015, AKONING  
deuterons from (n,2nd)

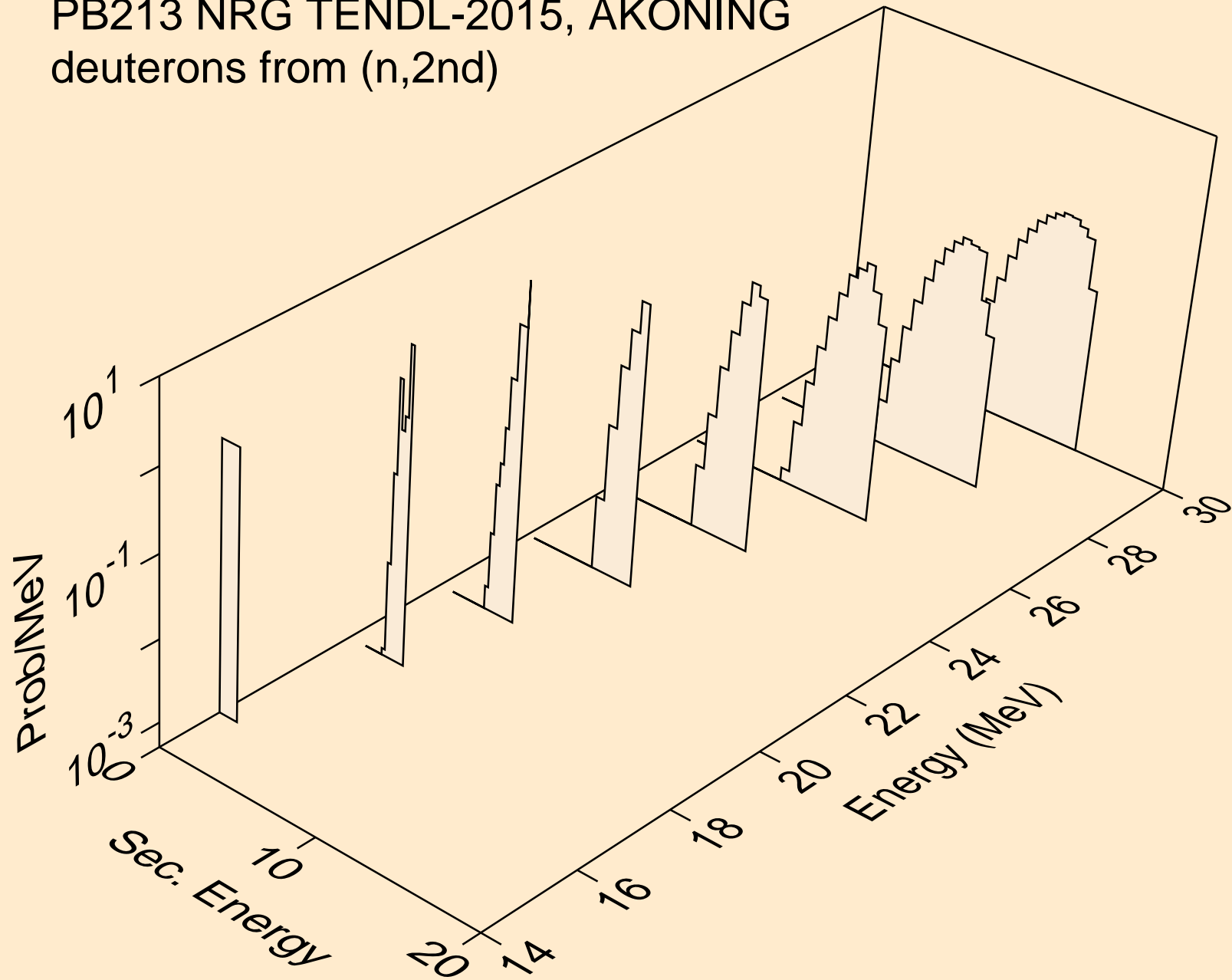

PB213 NRG TENDL-2015, AKONING  
deuterons from (n,n\*)d

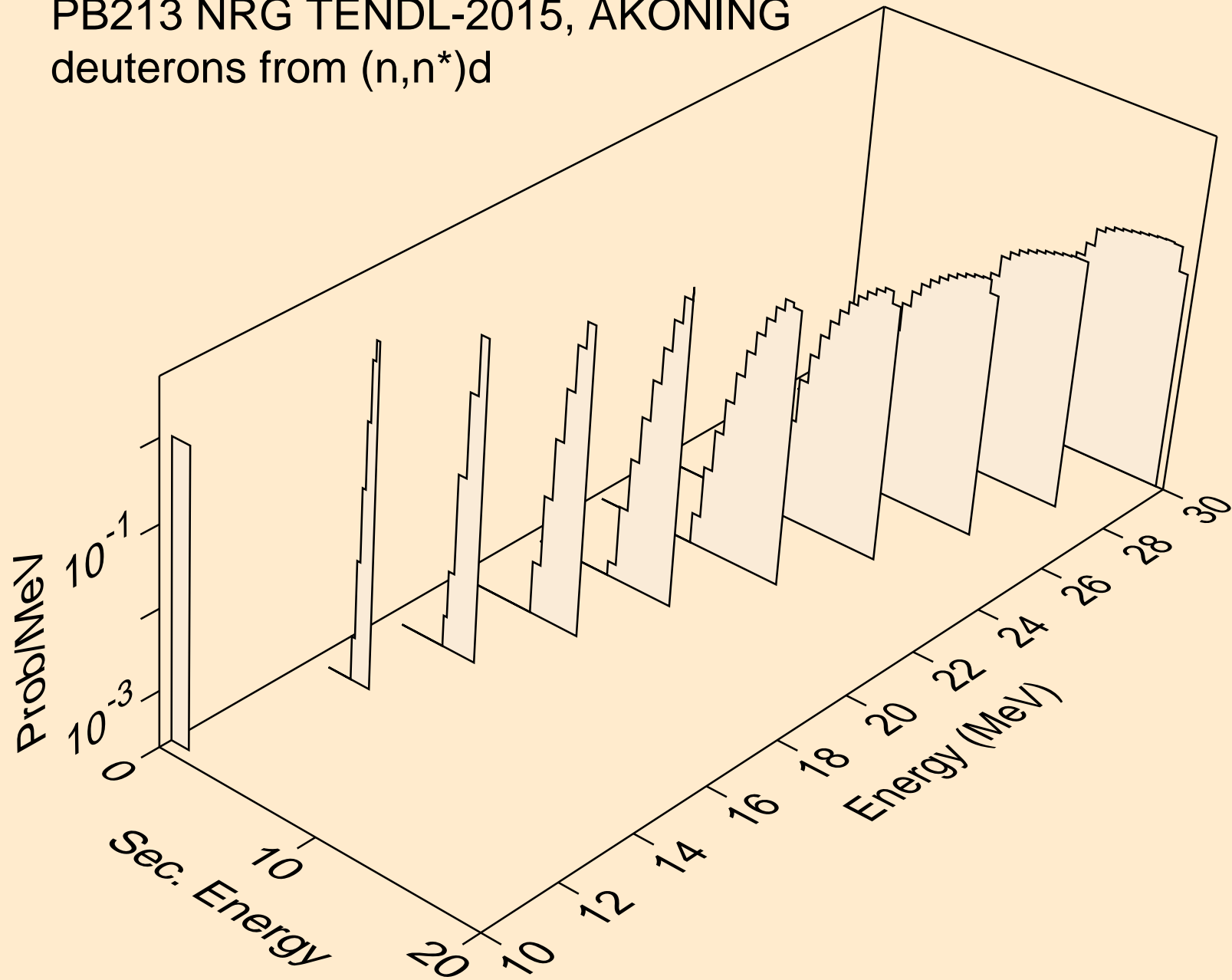

PB213 NRG TENDL-2015, AKONING  
deuterons from (n,d)

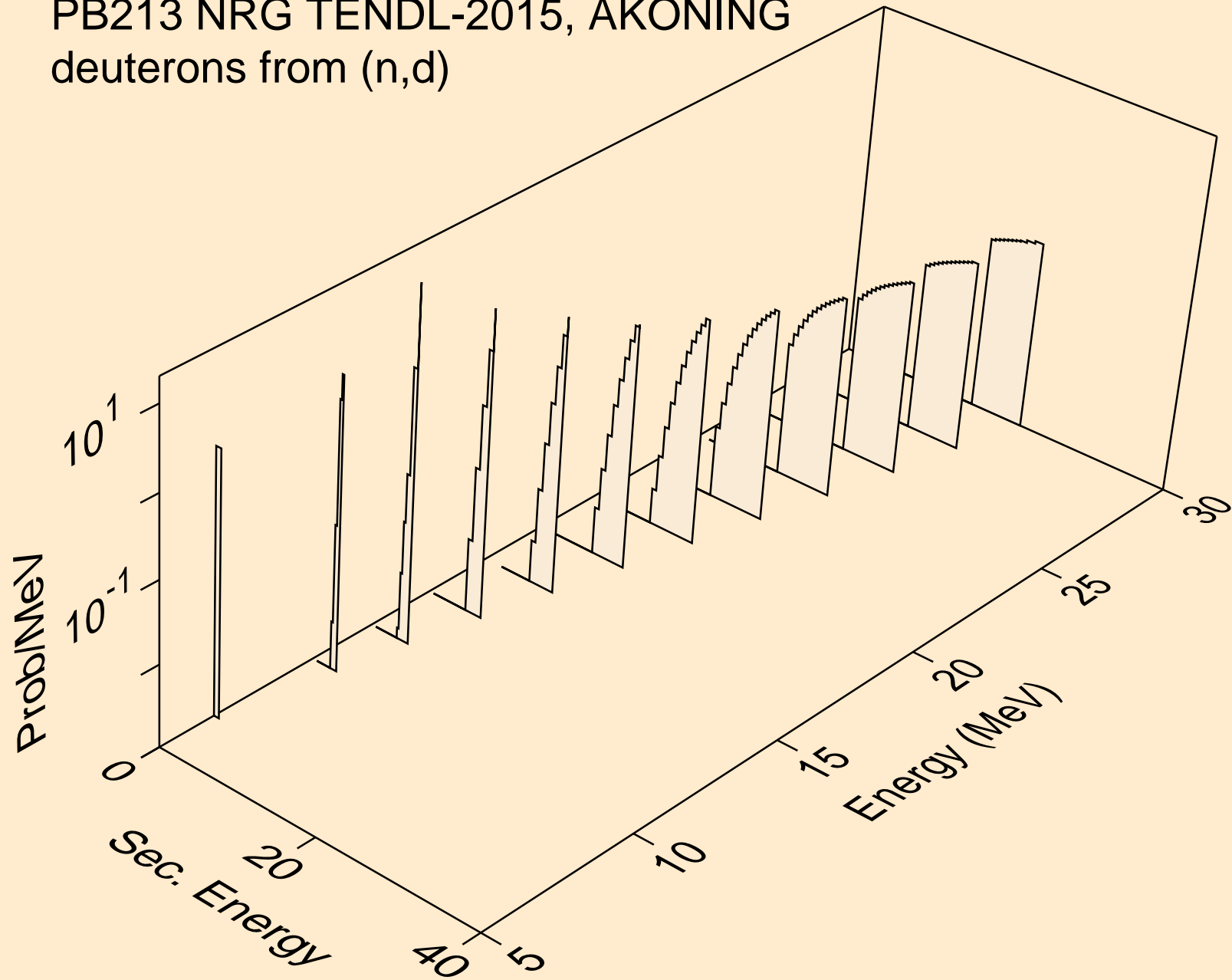

PB213 NRG TENDL-2015, AKONING  
tritons from (n,x)

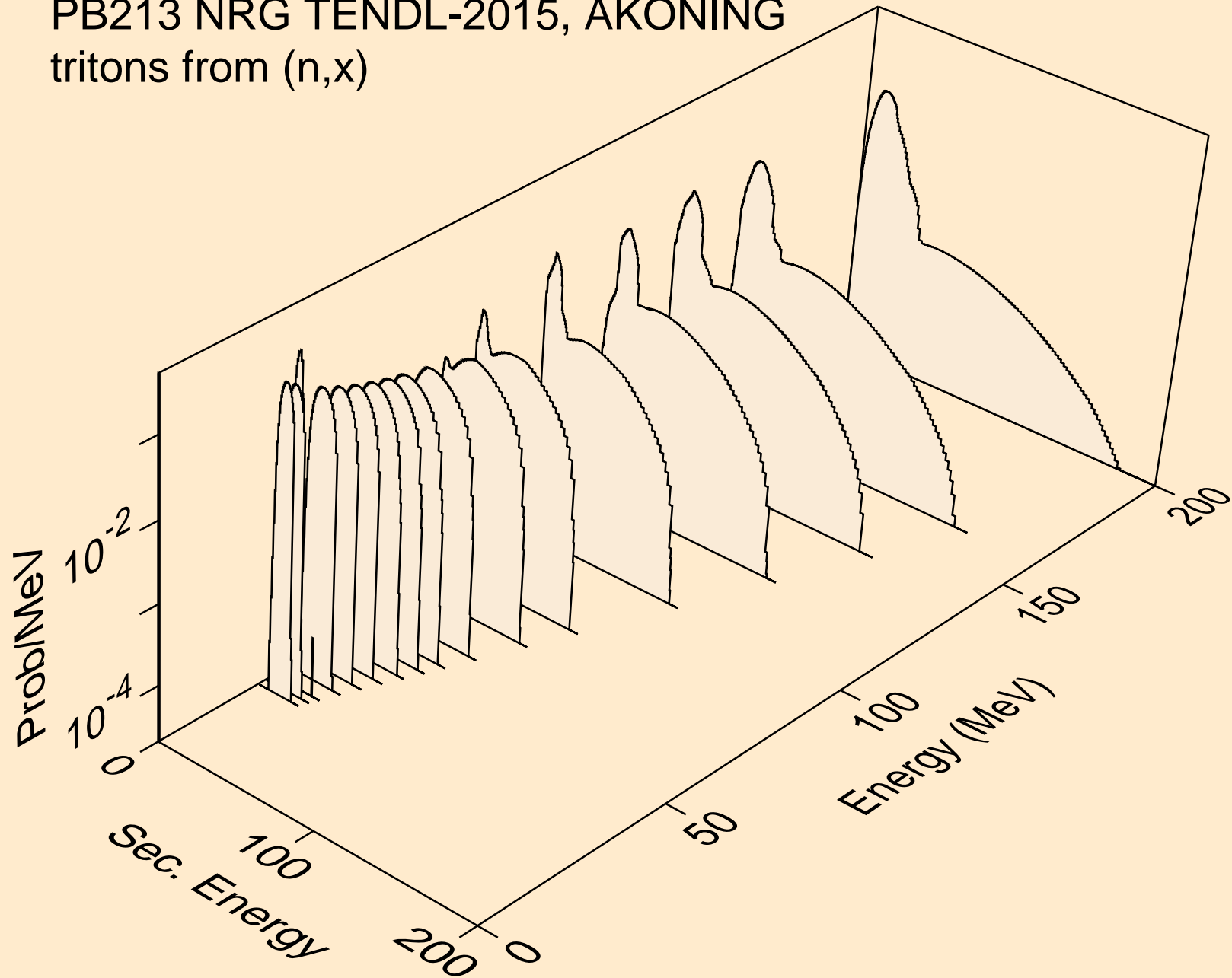

PB213 NRG TENDL-2015, AKONING  
tritons from (n,n\*)t

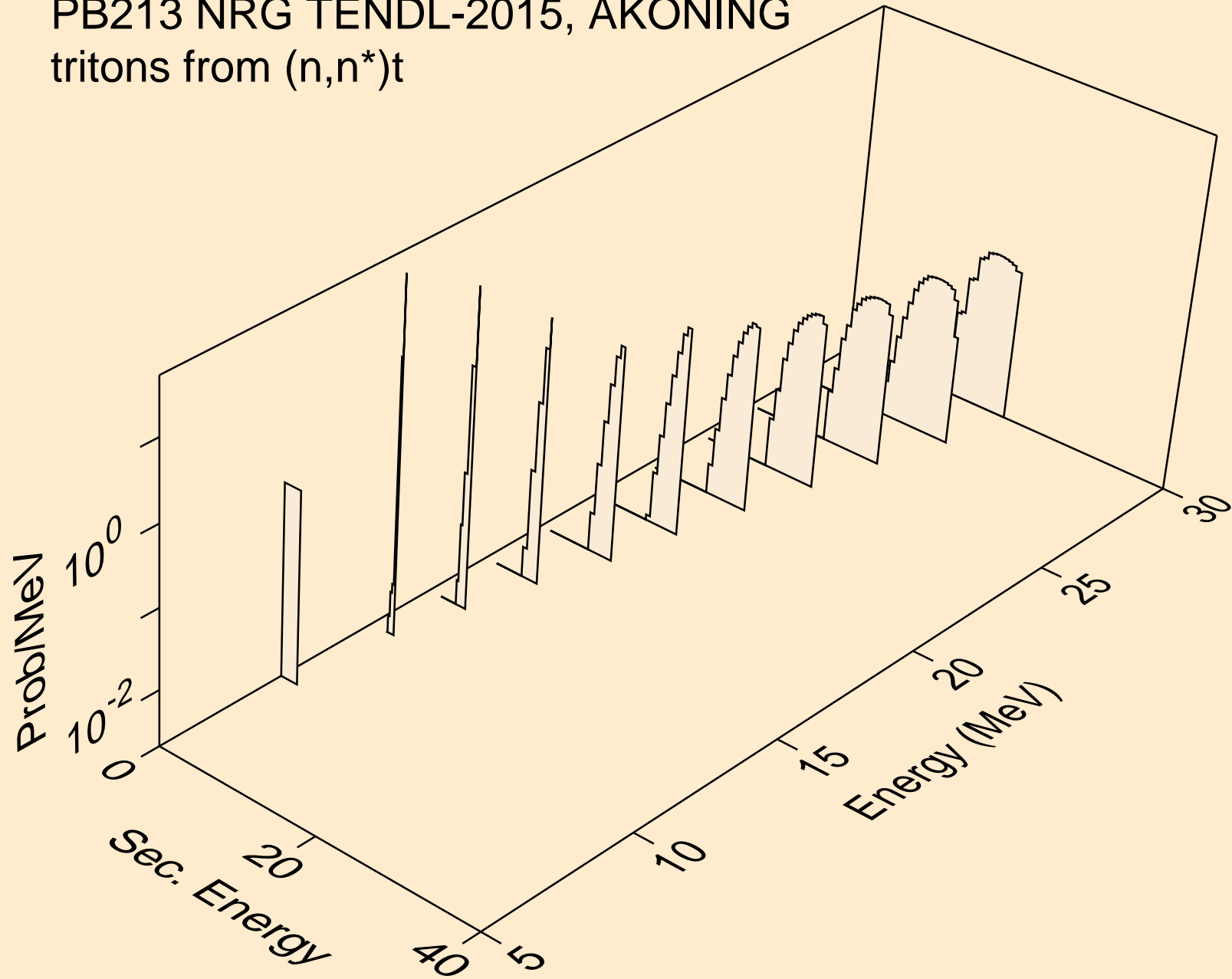

PB213 NRG TENDL-2015, AKONING  
tritons from (n,t)

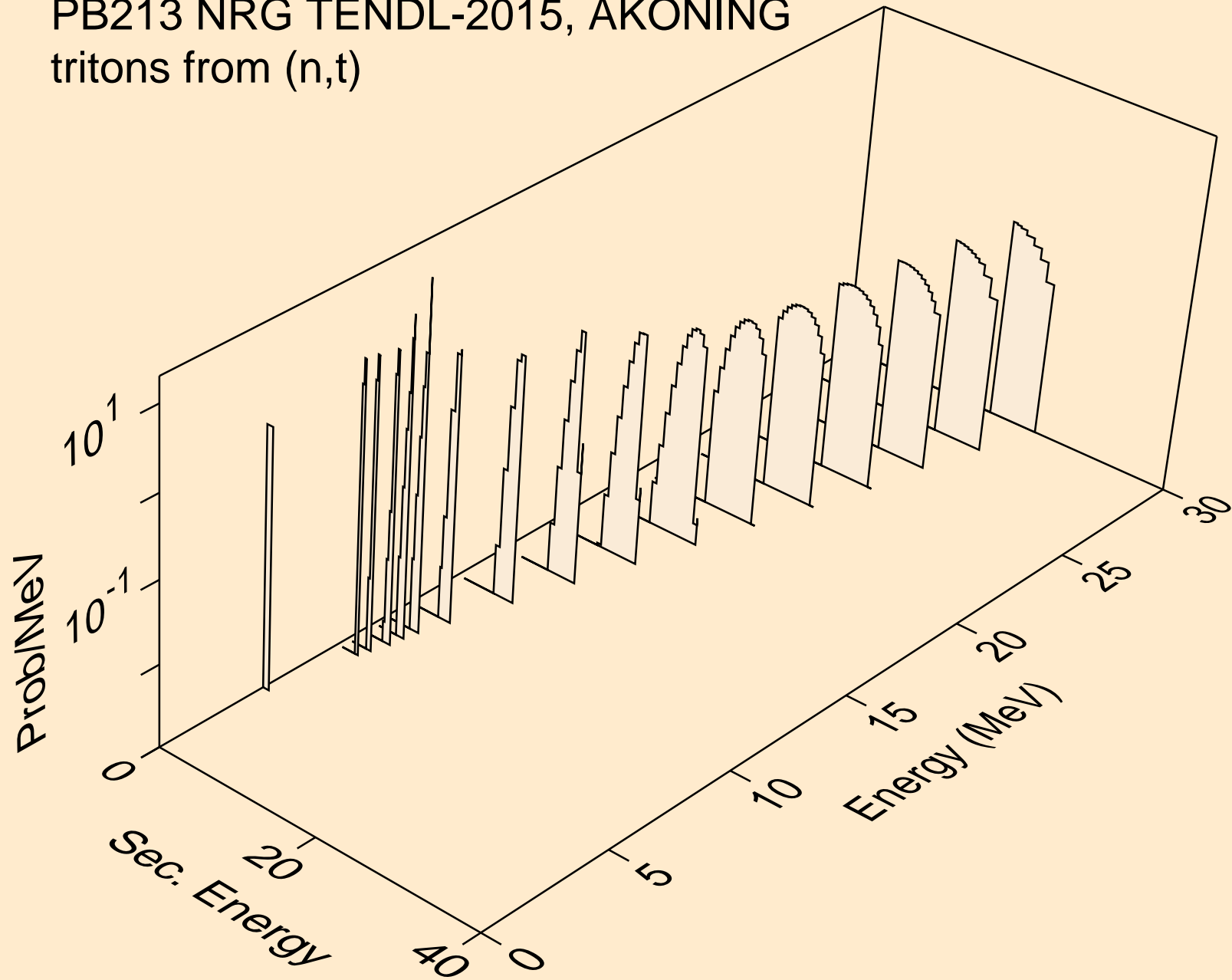

PB213 NRG TENDL-2015, AKONING  
he3s from (n,x)

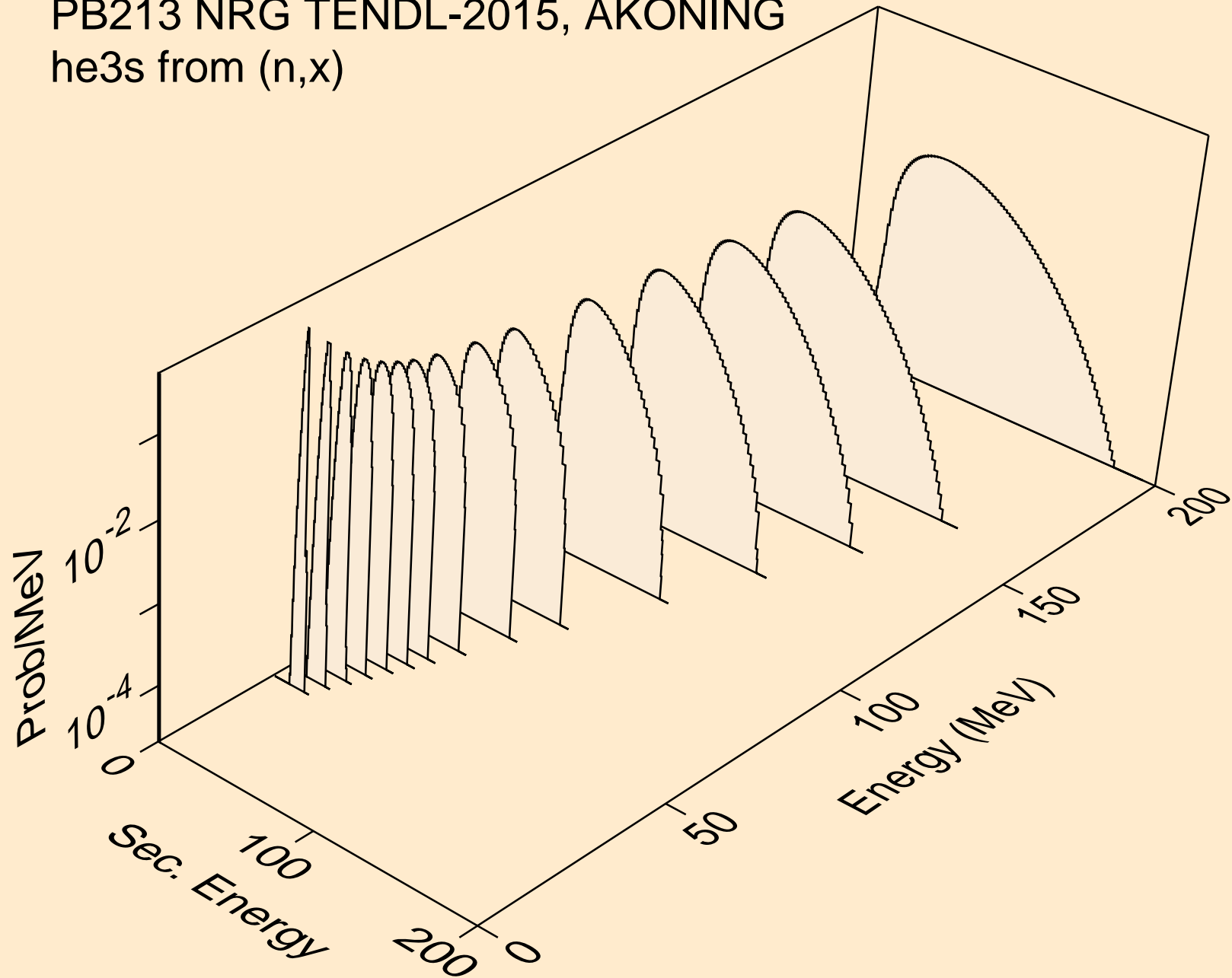

PB213 NRG TENDL-2015, AKONING  
he3s from (n,n\*)he3

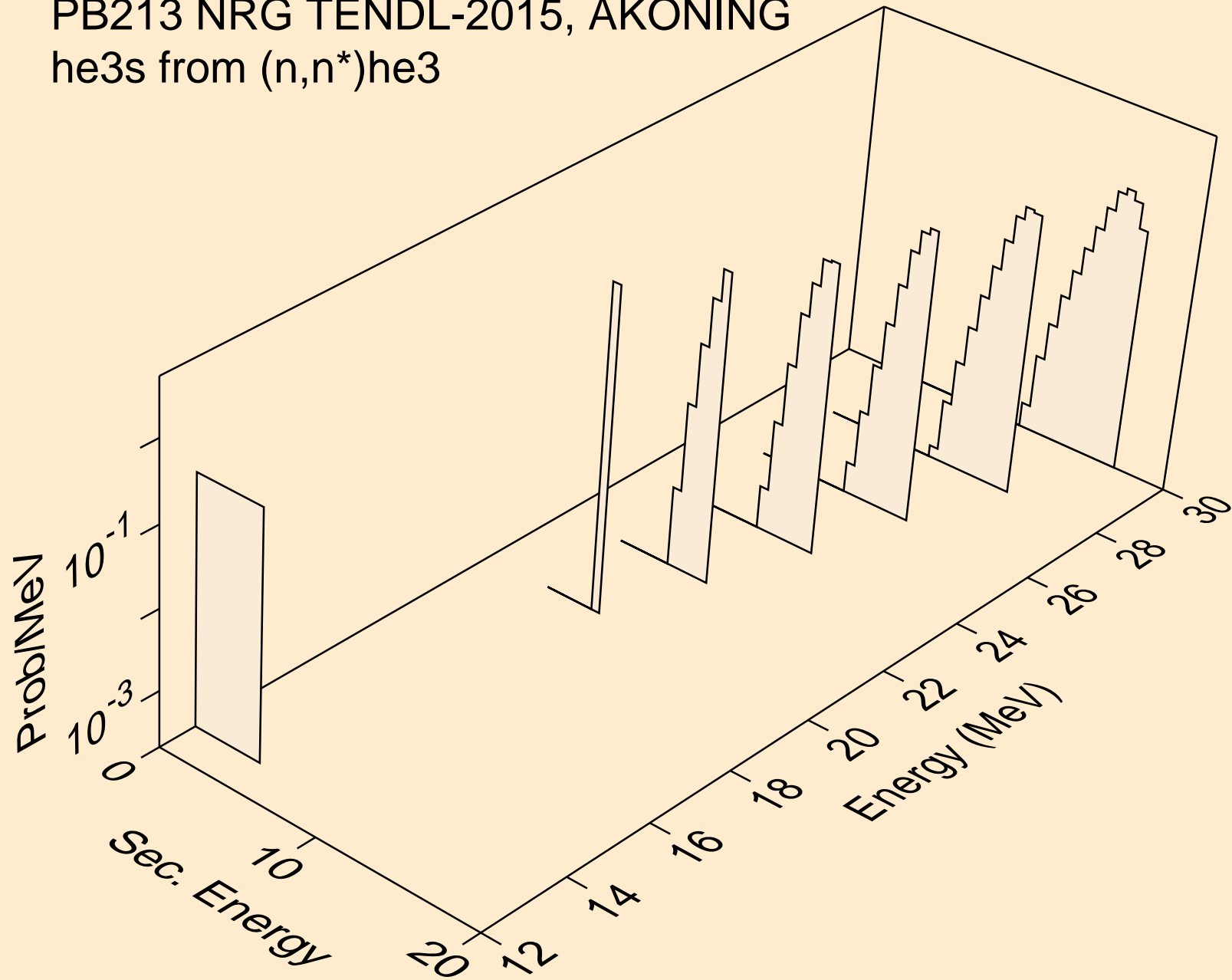



PB213 NRG TENDL-2015, AKONING  
he3s from (n,he3)

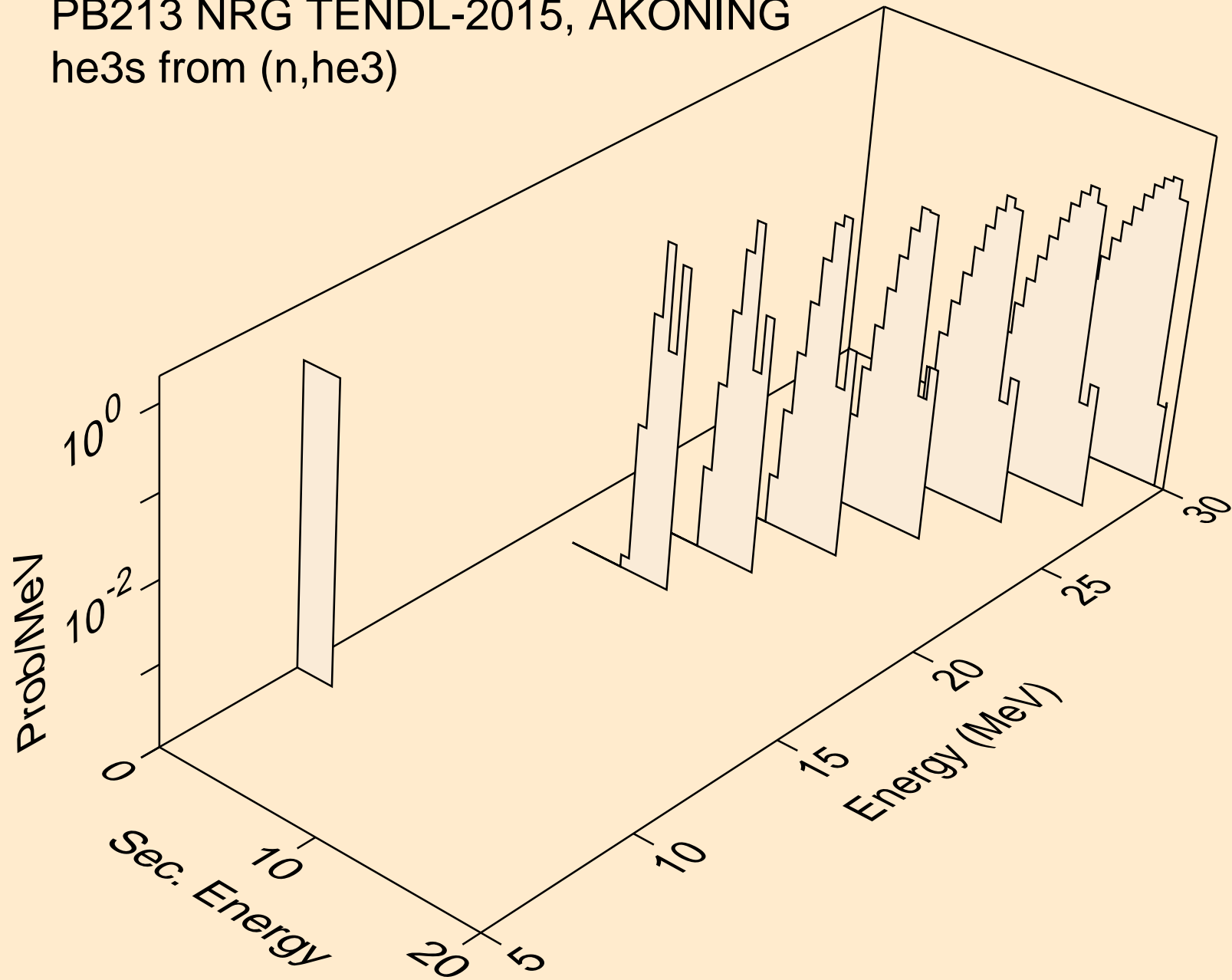

PB213 NRG TENDL-2015, AKONING  
alphas from (n,x)

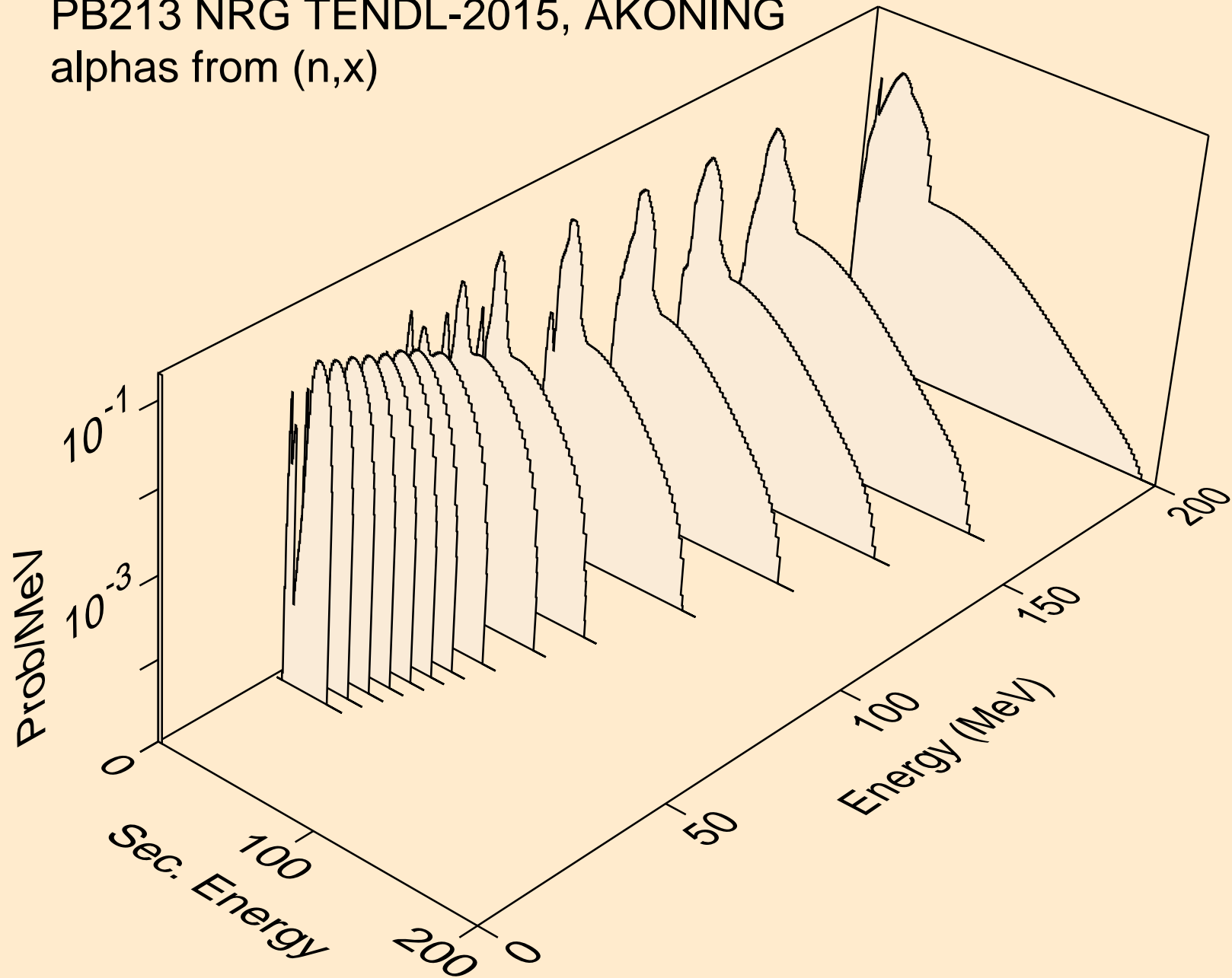

PB213 NRG TENDL-2015, AKONING  
alphas from (n,n\*)a

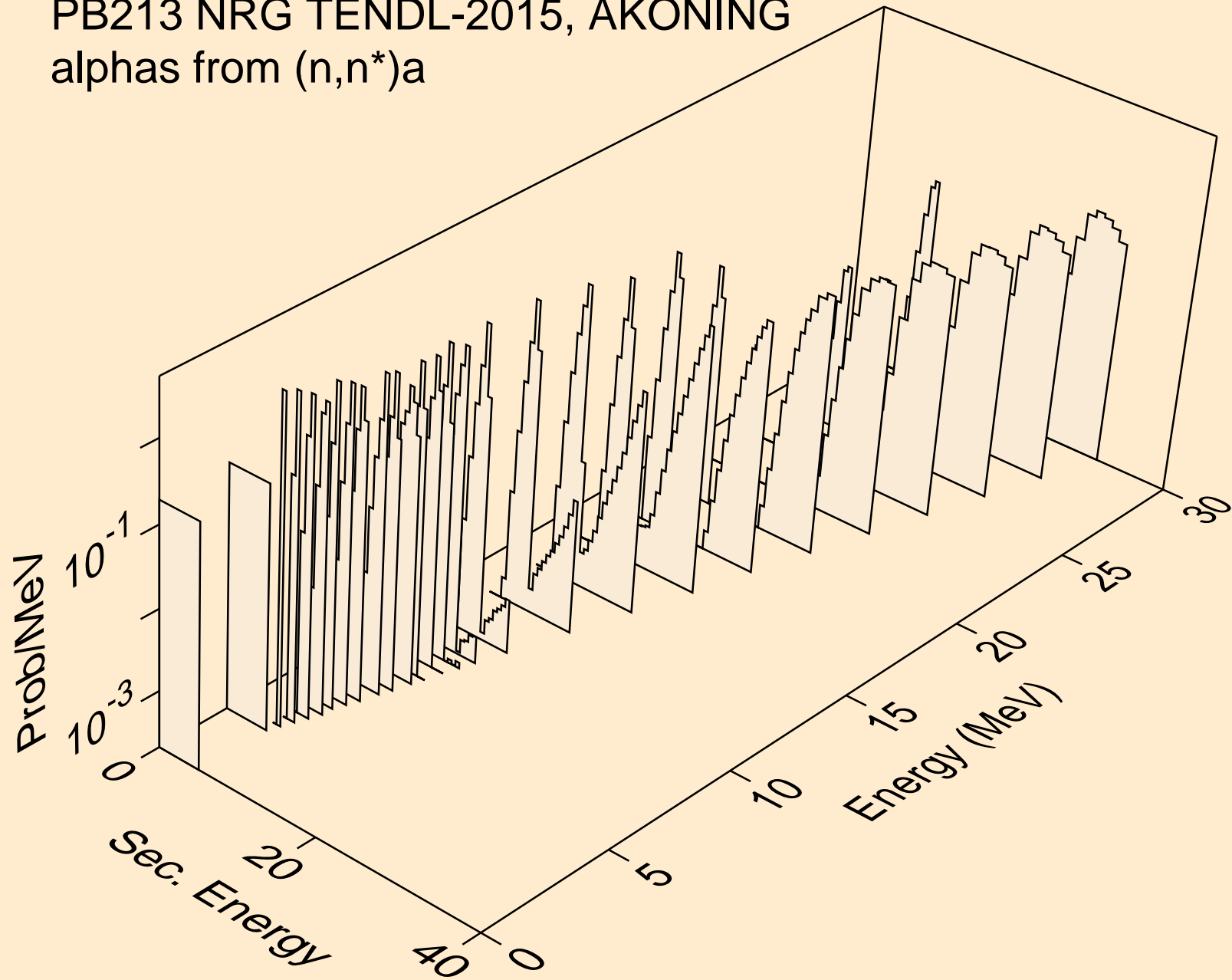

PB213 NRG TENDL-2015, AKONING  
alphas from (n,2n)a

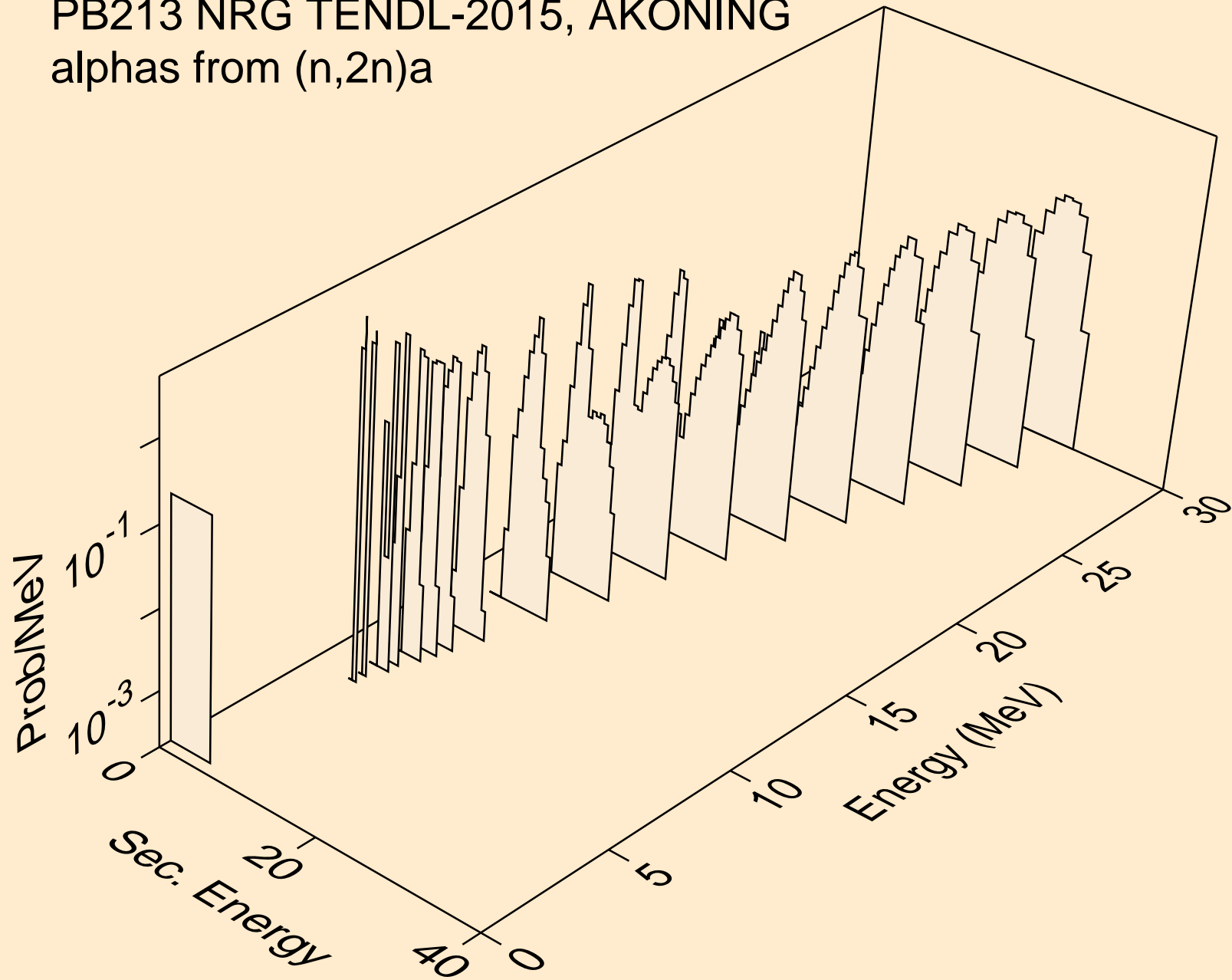

PB213 NRG TENDL-2015, AKONING  
alphas from (n,3n)a

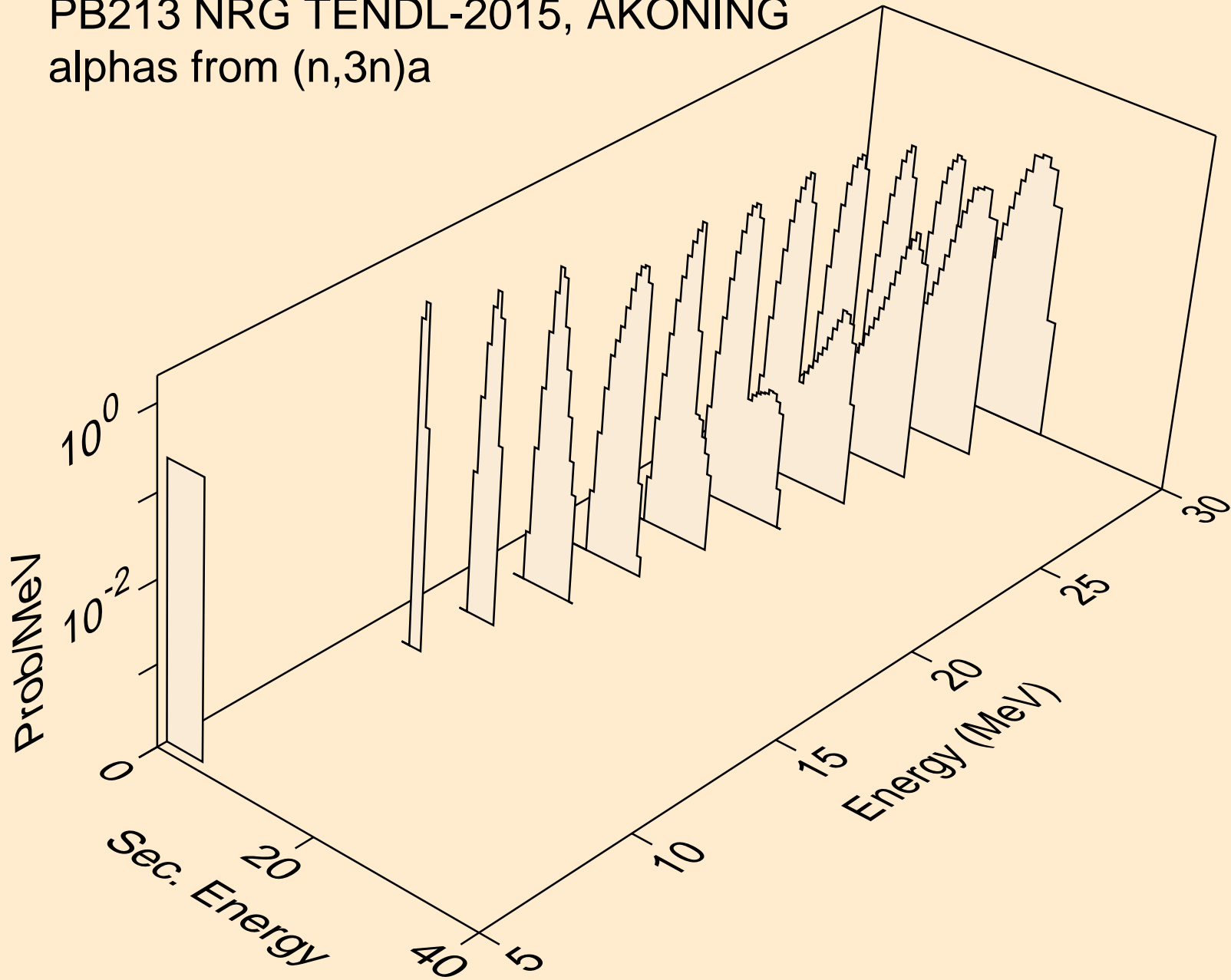

PB213 NRG TENDL-2015, AKONING  
alphas from (n,2n)2a

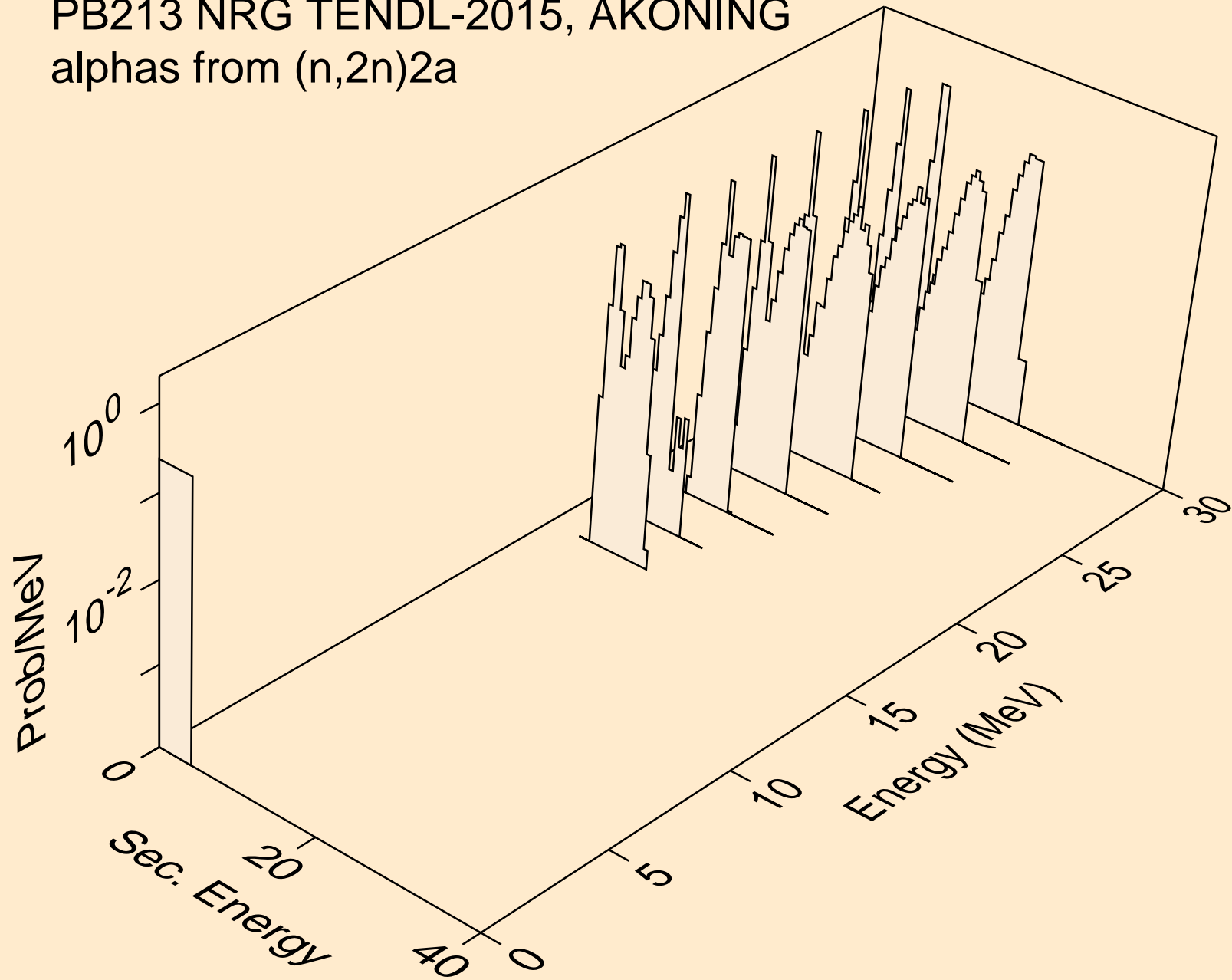

PB213 NRG TENDL-2015, AKONING  
alphas from (n,a)

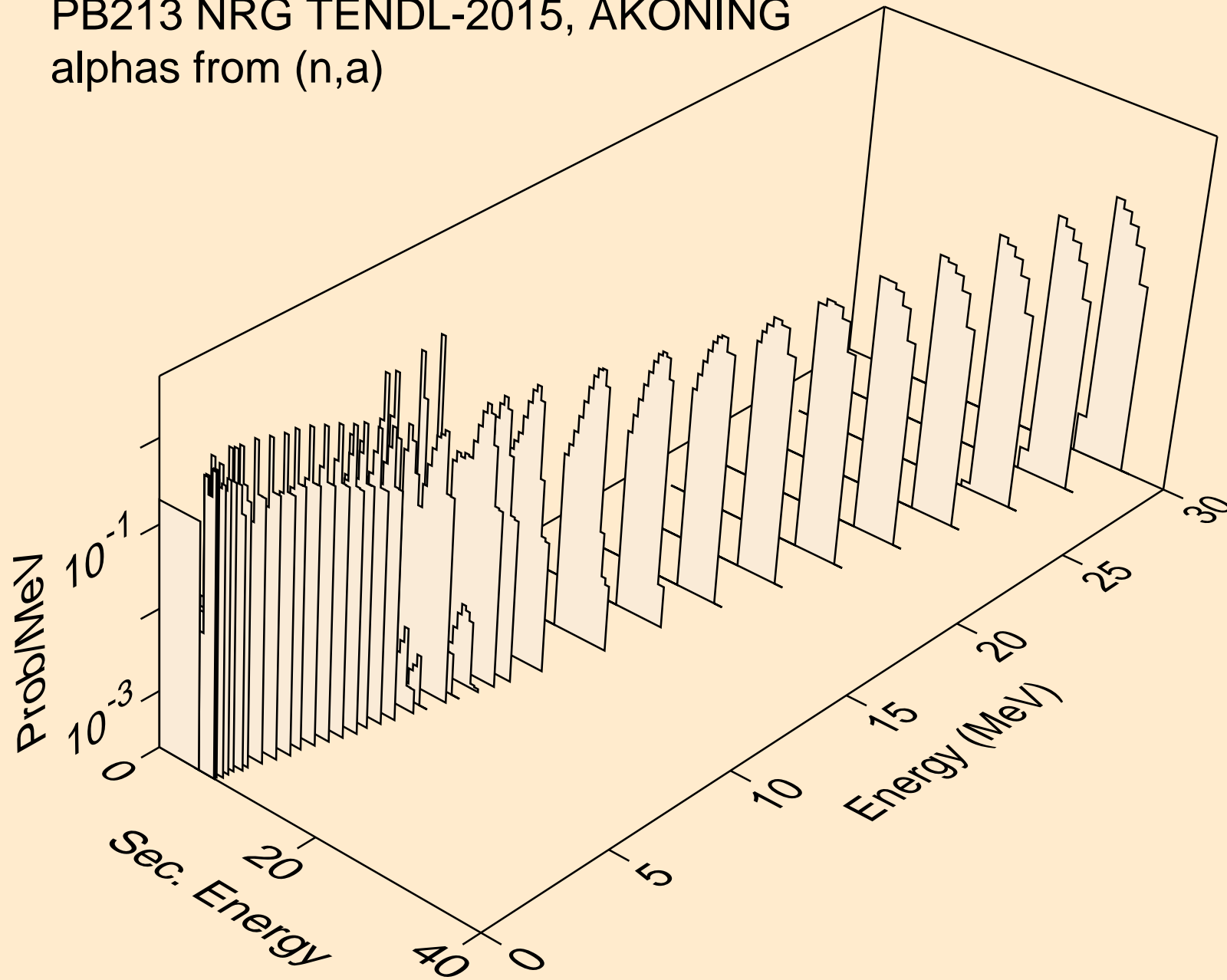

PB213 NRG TENDL-2015, AKONING  
alphas from (n,pa)

