

PB215 NRG TENDL-2015, AKONING

Principal cross sections

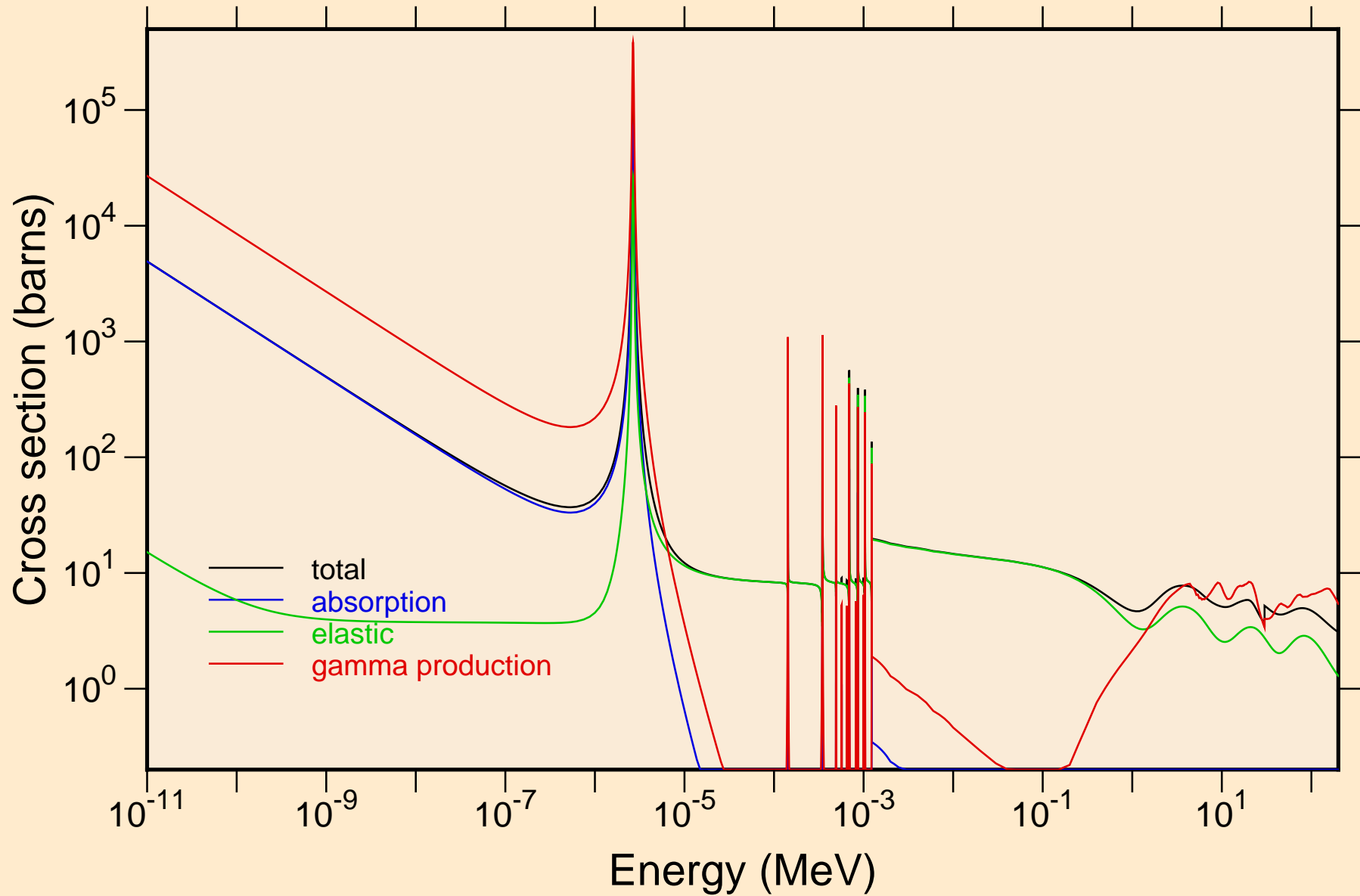

PB215 NRG TENDL-2015, AKONING
resonance total cross section

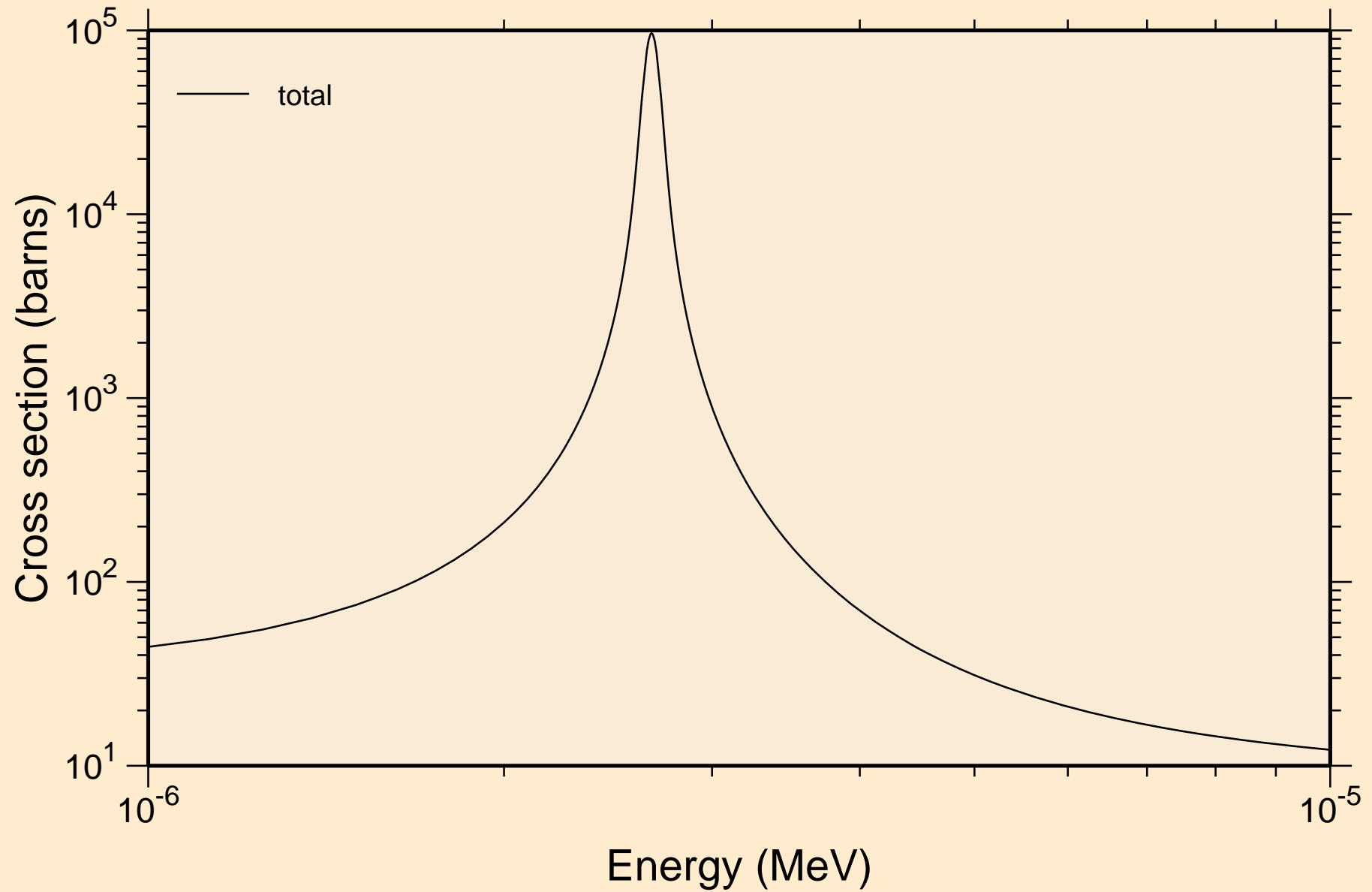

PB215 NRG TENDL-2015, AKONING
resonance total cross section

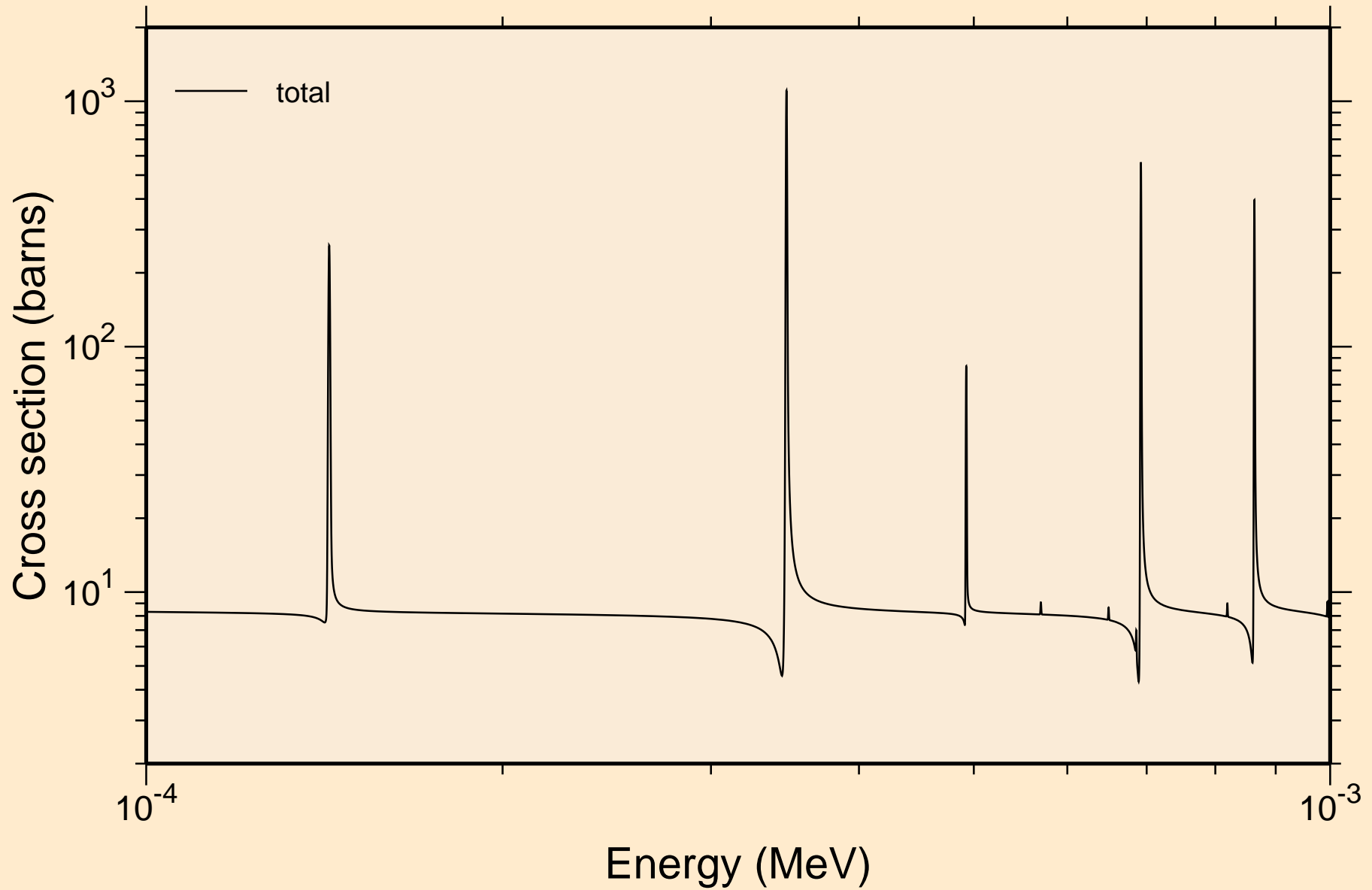

PB215 NRG TENDL-2015, AKONING
resonance total cross section

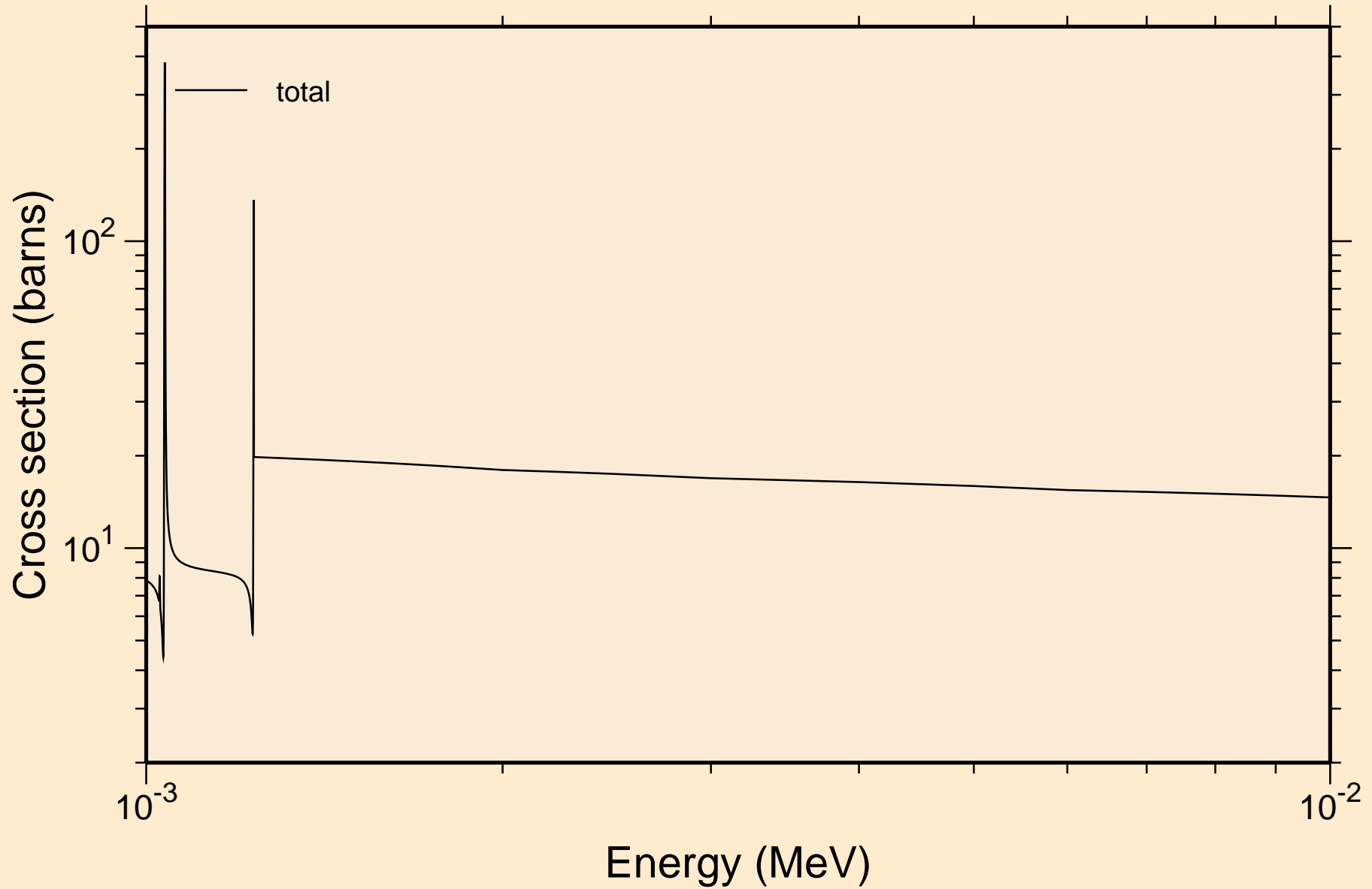

PB215 NRG TENDL-2015, AKONING
resonance total cross section

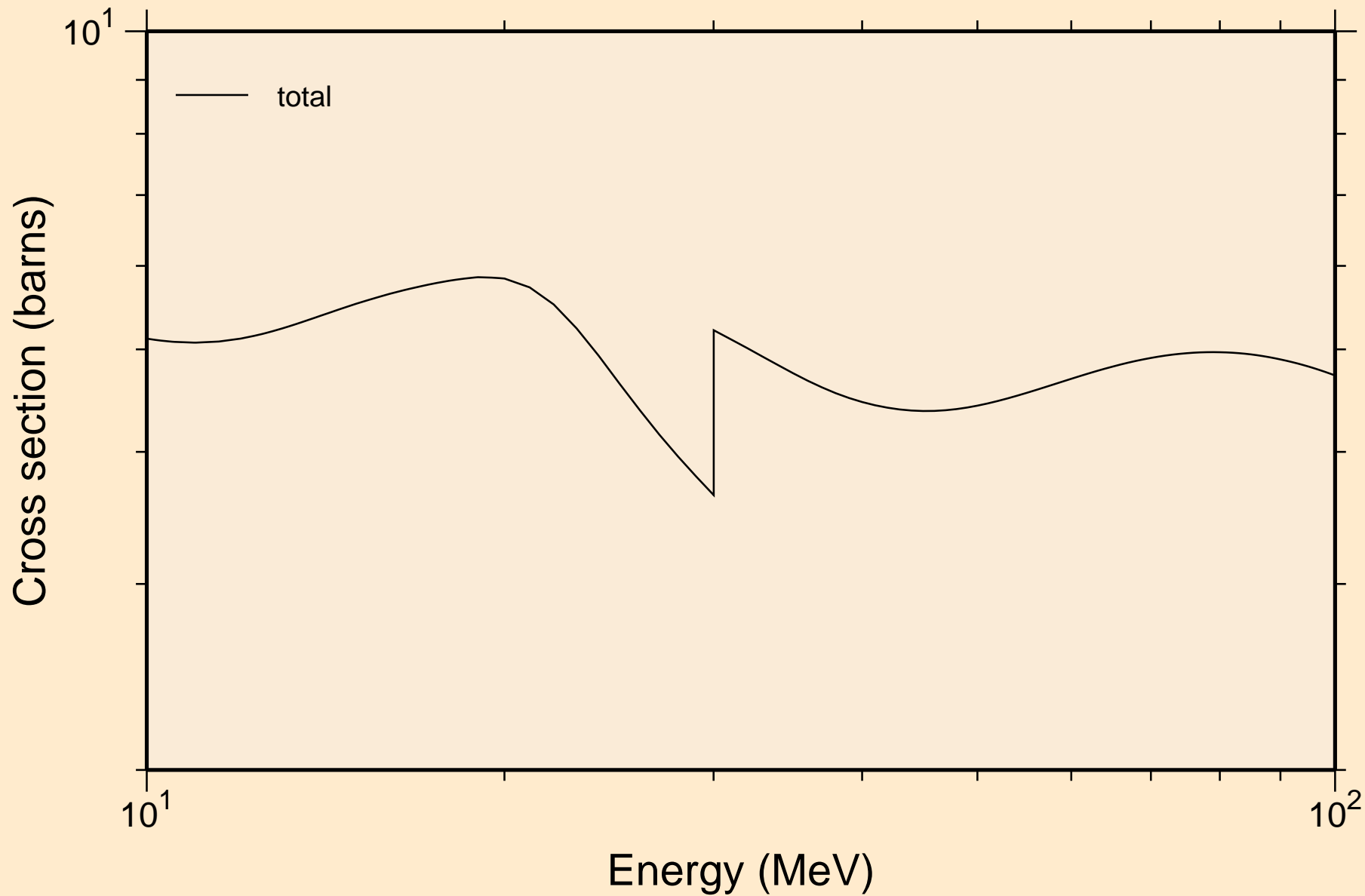

PB215 NRG TENDL-2015, AKONING
resonance absorption cross sections

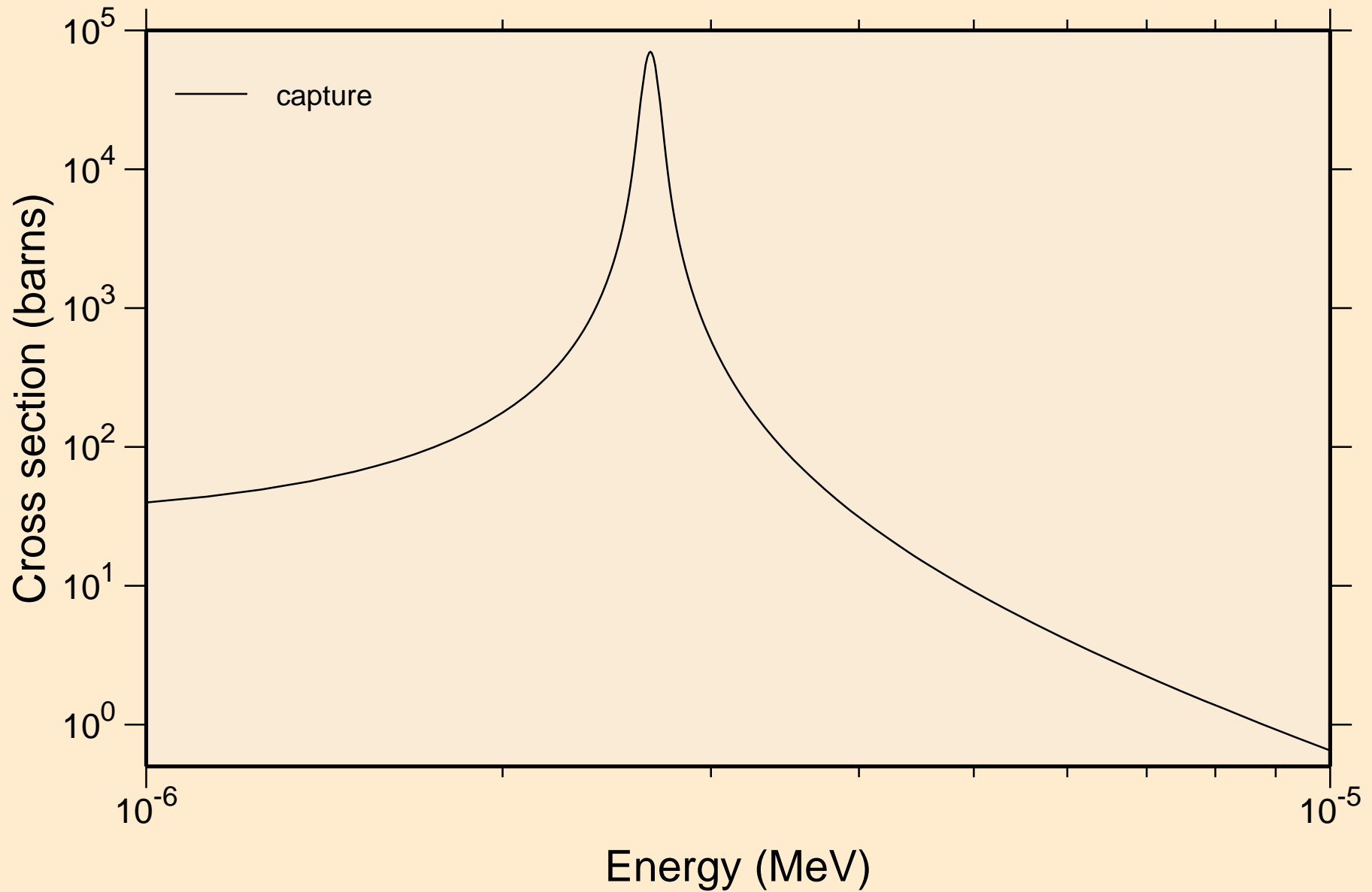

PB215 NRG TENDL-2015, AKONING
resonance absorption cross sections

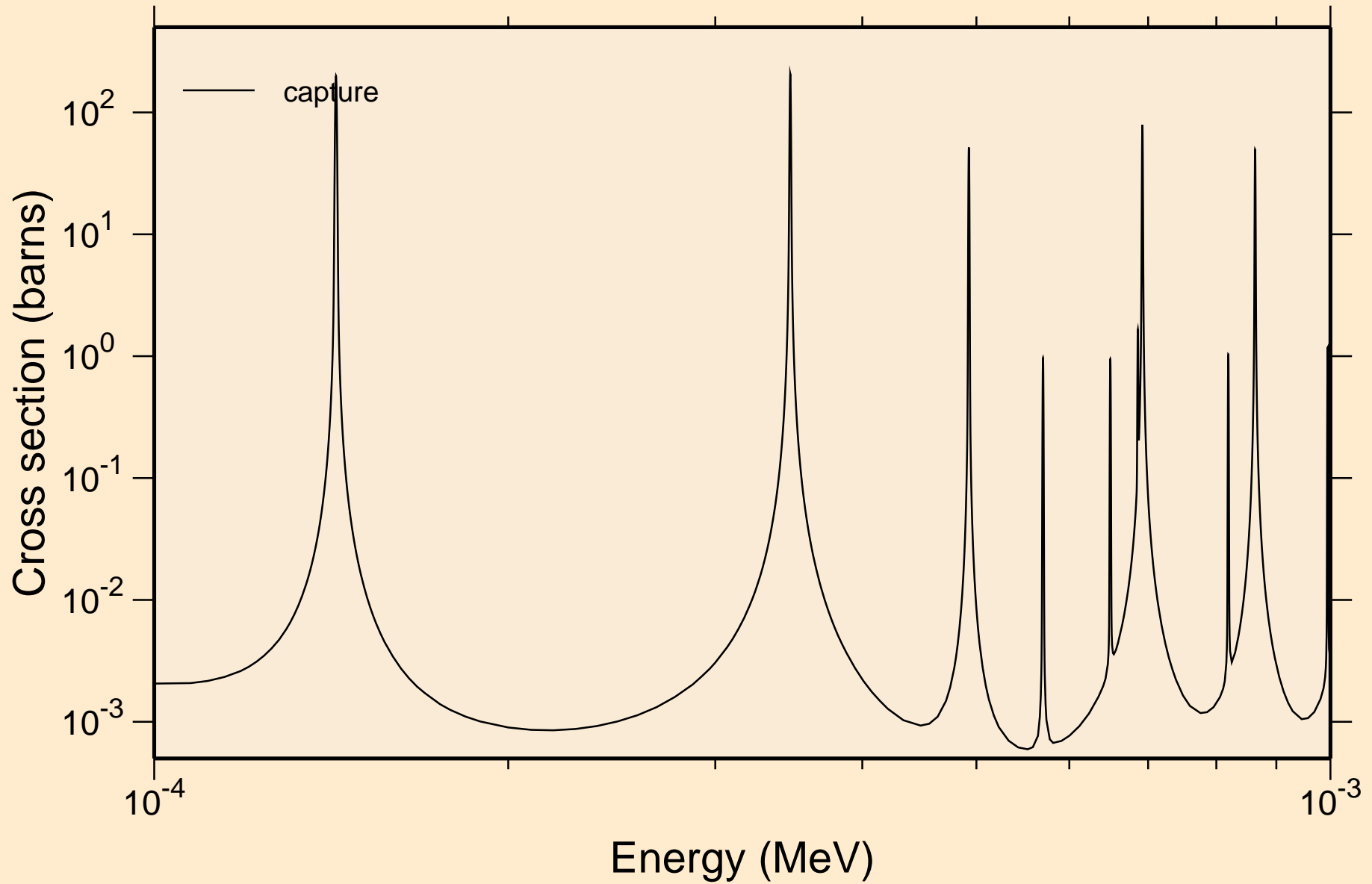

PB215 NRG TENDL-2015, AKONING
resonance absorption cross sections

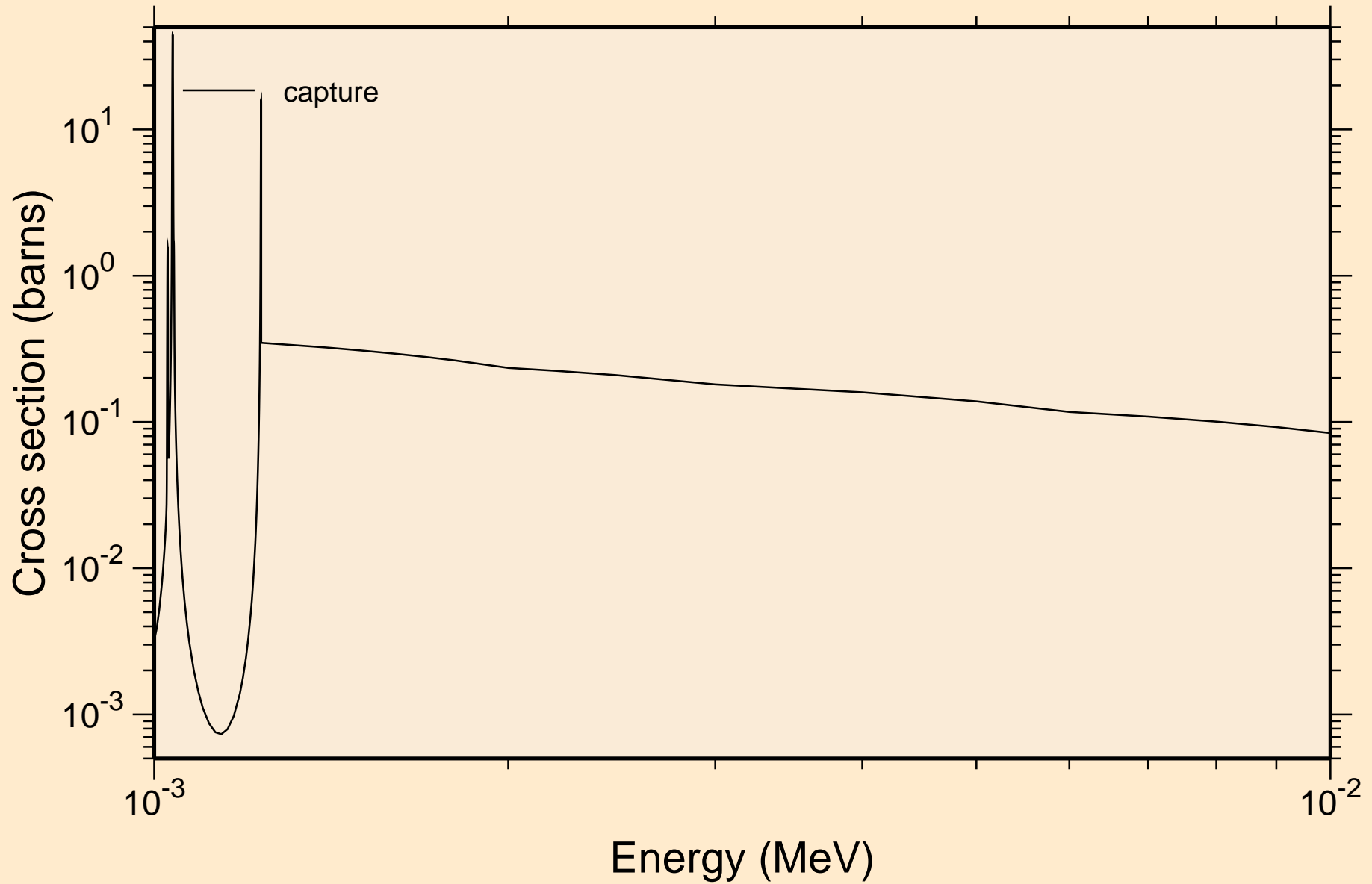

PB215 NRG TENDL-2015, AKONING
resonance absorption cross sections

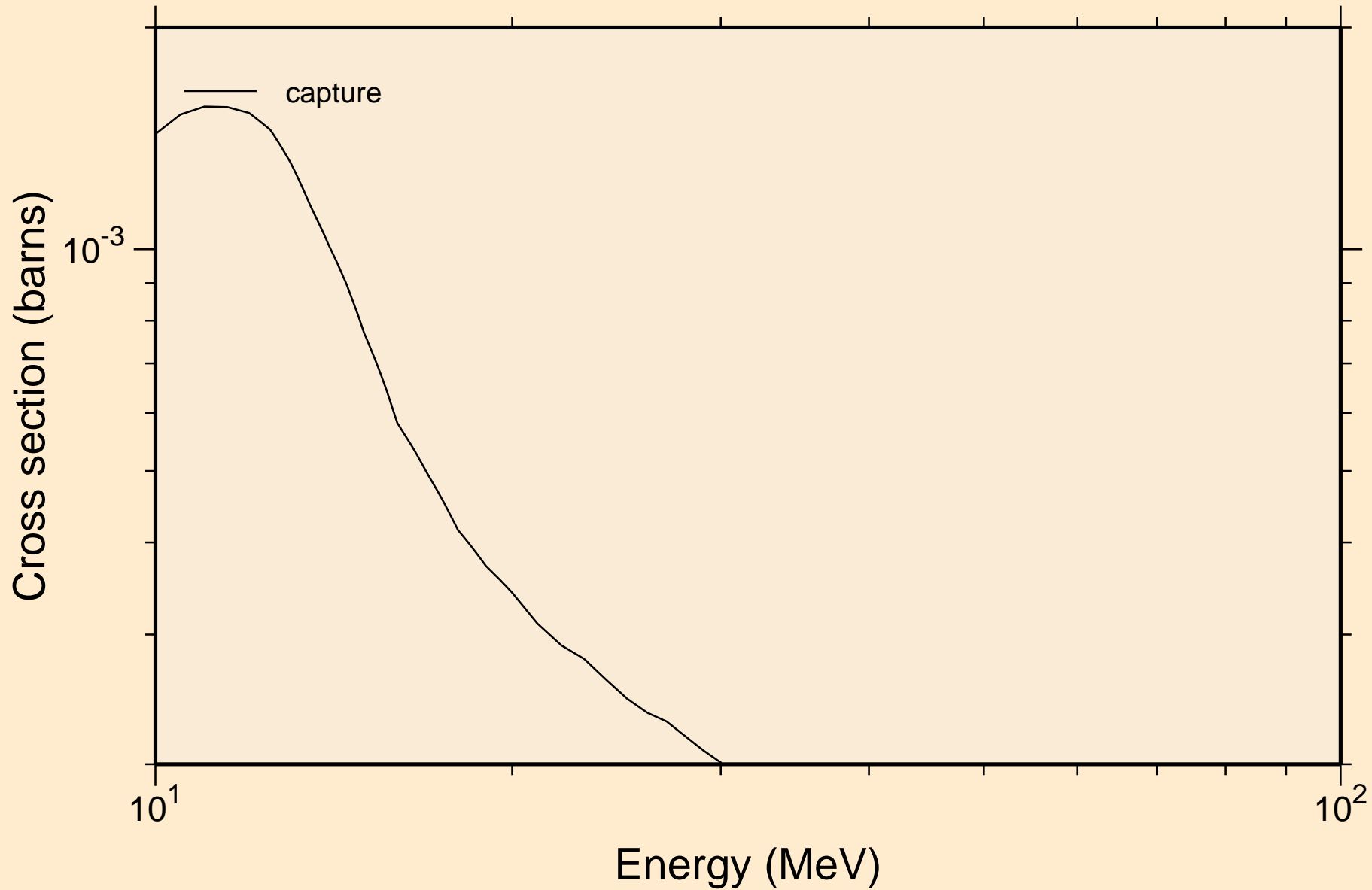

PB215 NRG TENDL-2015, AKONING

Non-threshold reactions

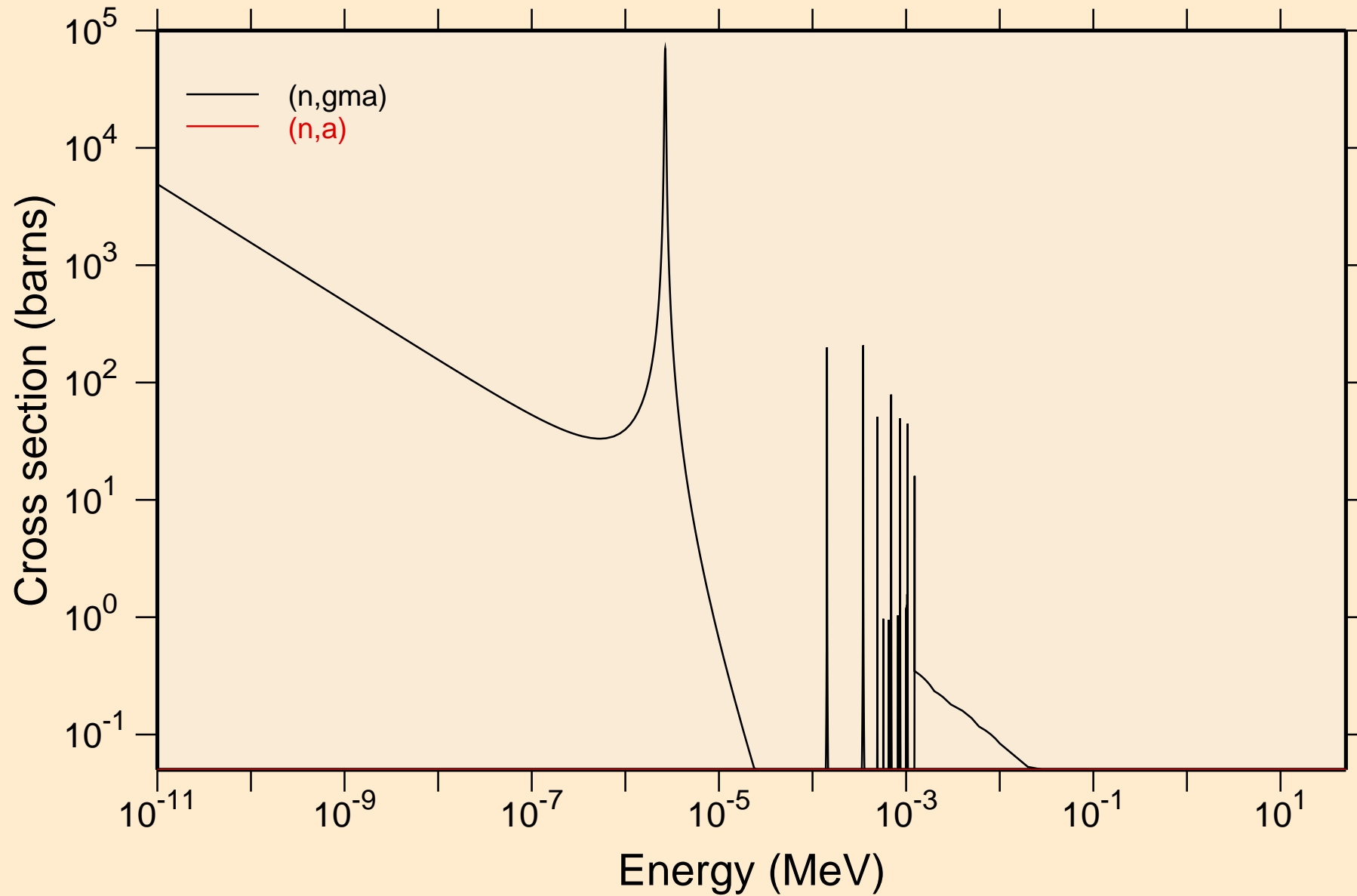

PB215 NRG TENDL-2015, AKONING

Principal cross sections

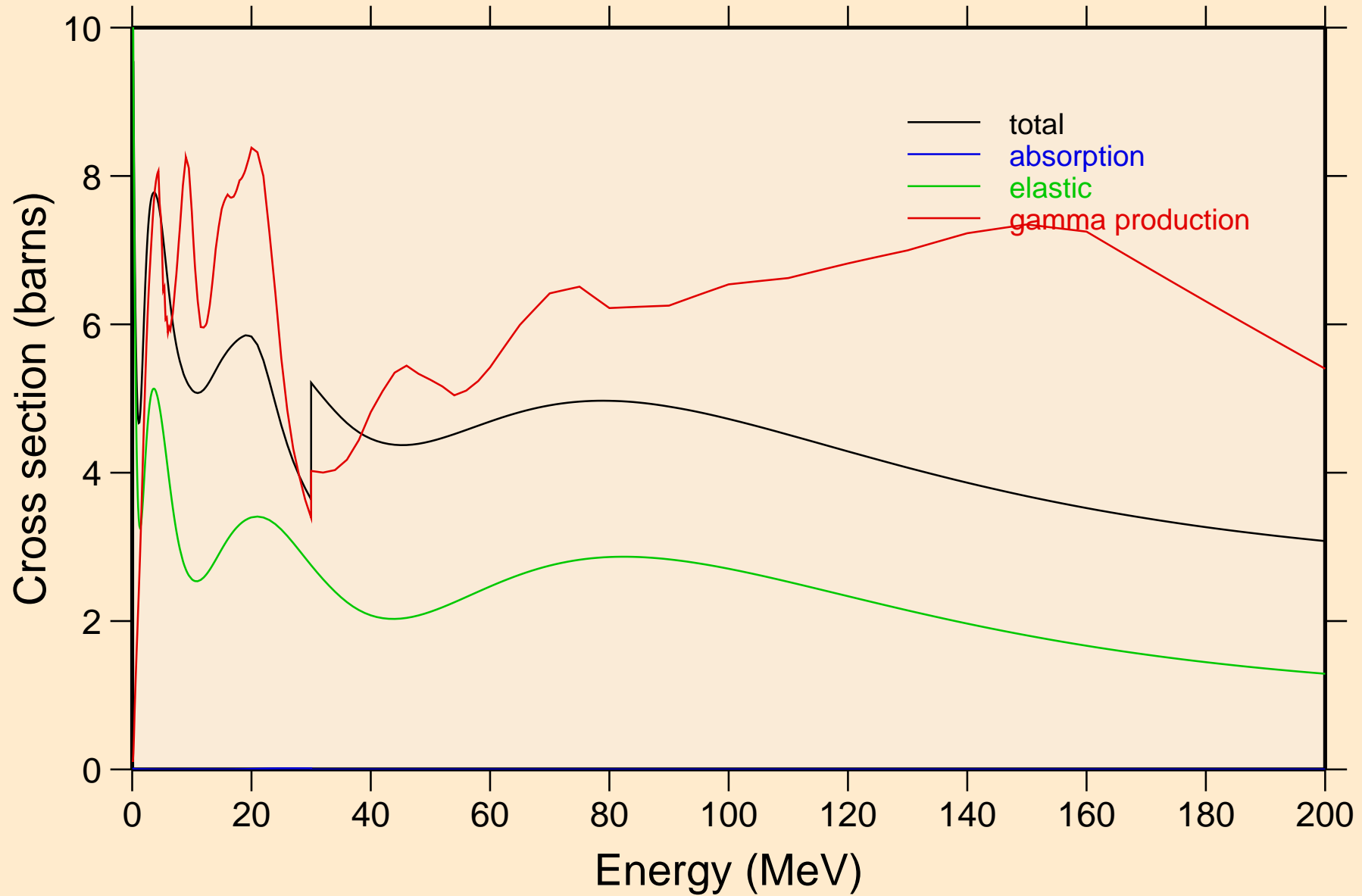

PB215 NRG TENDL-2015, AKONING
Non-threshold reactions

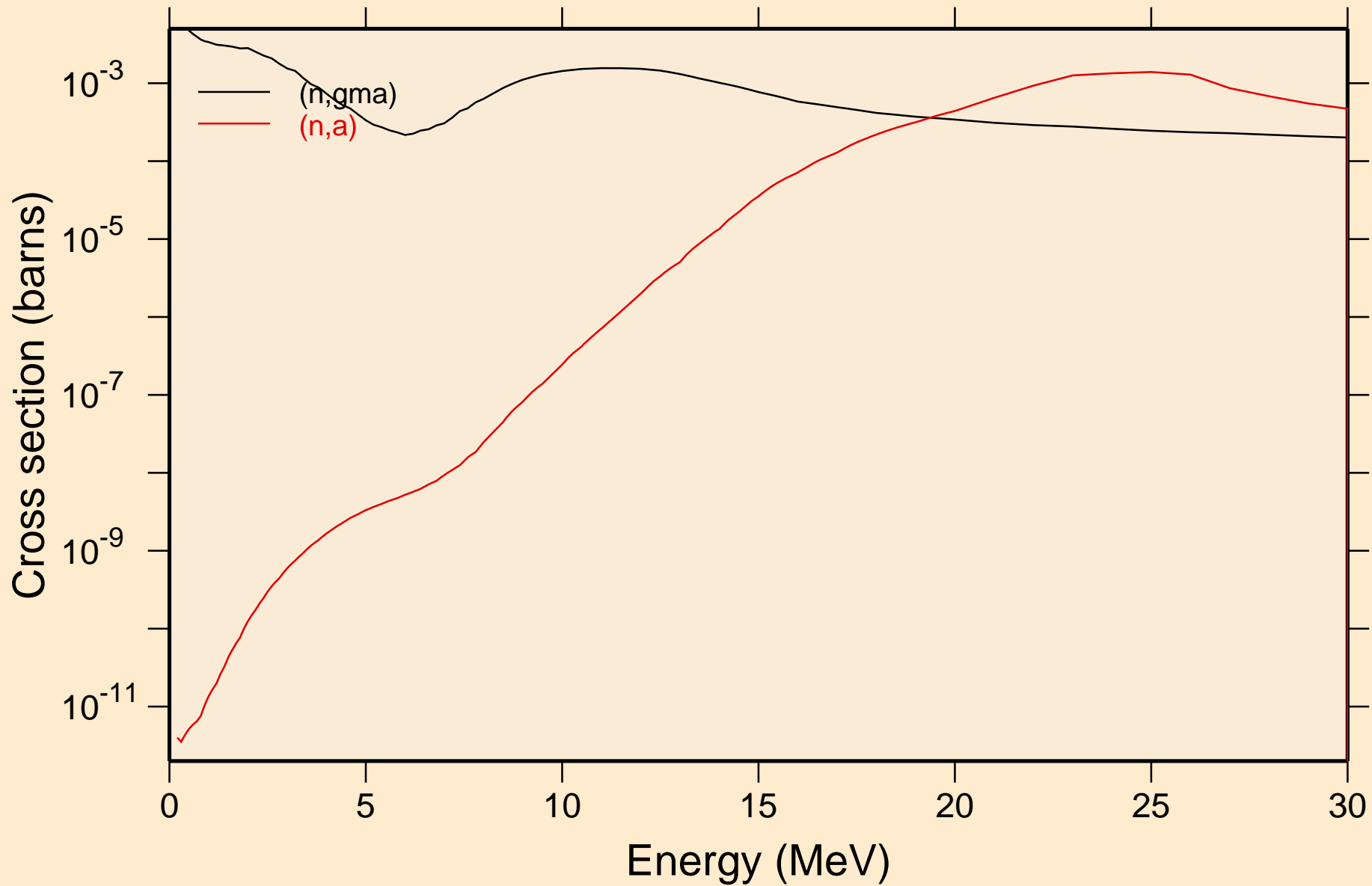

PB215 NRG TENDL-2015, AKONING
Inelastic levels

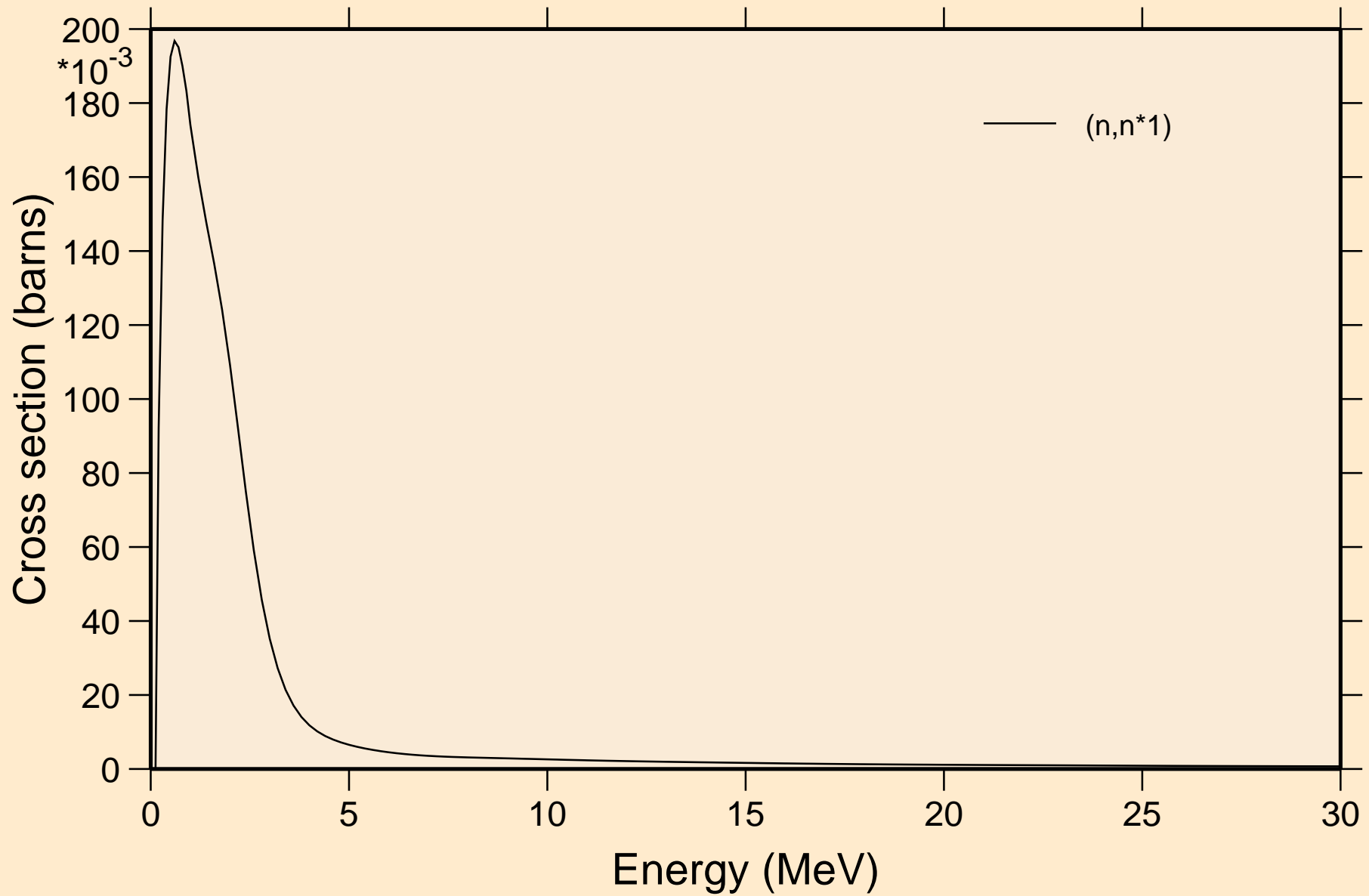

PB215 NRG TENDL-2015, AKONING

Threshold reactions

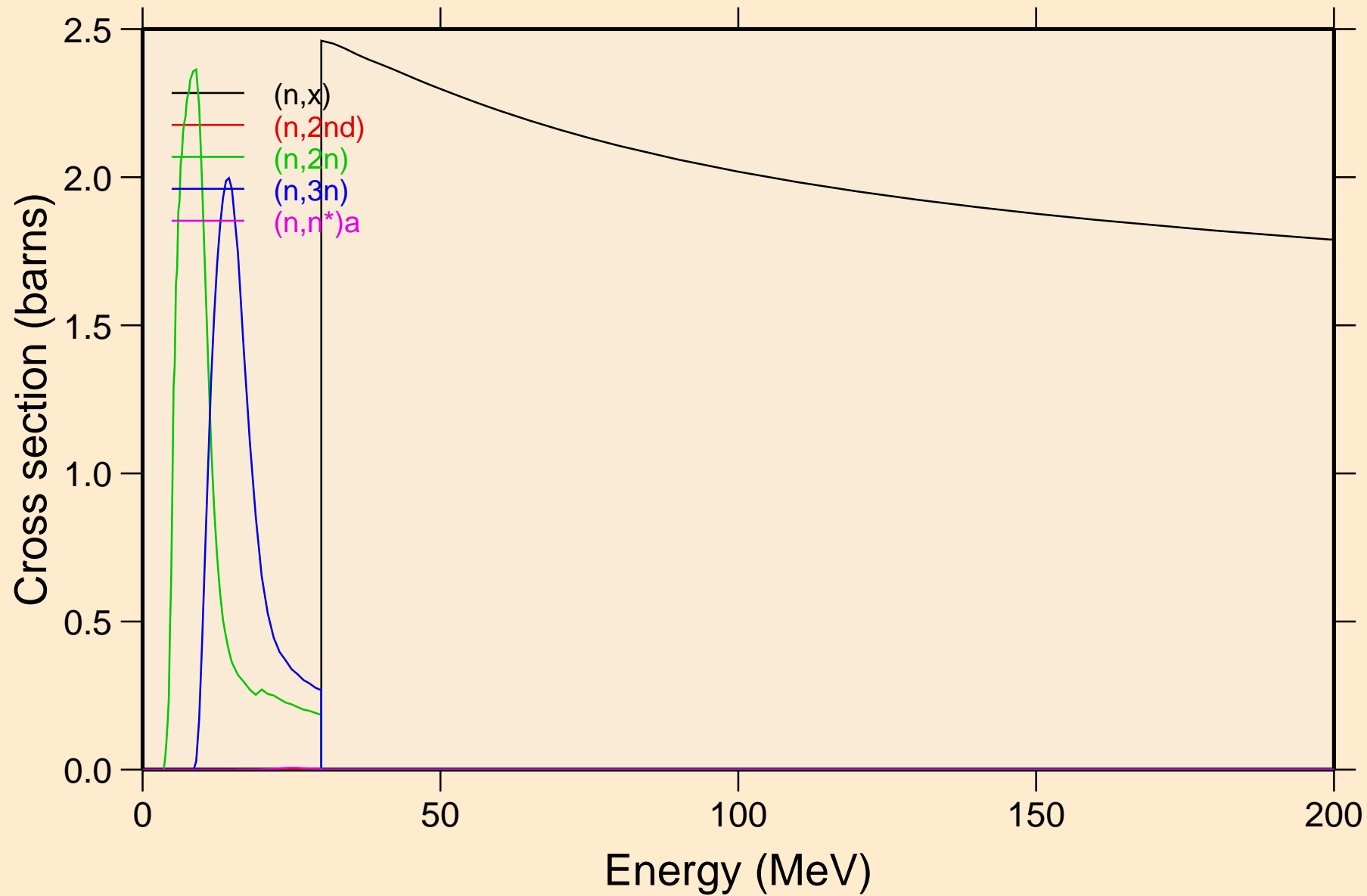

PB215 NRG TENDL-2015, AKONING

Threshold reactions

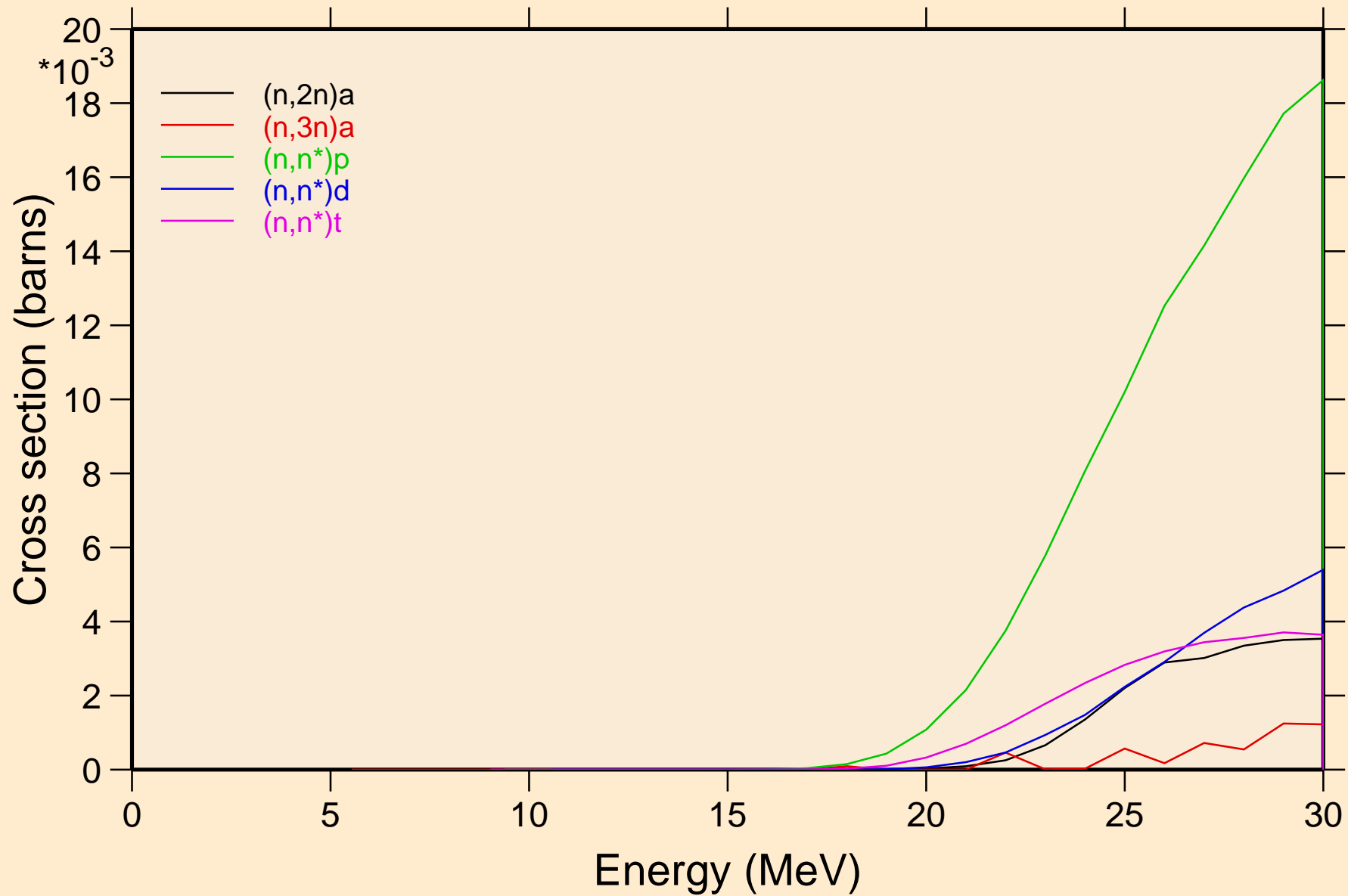

PB215 NRG TENDL-2015, AKONING

Threshold reactions

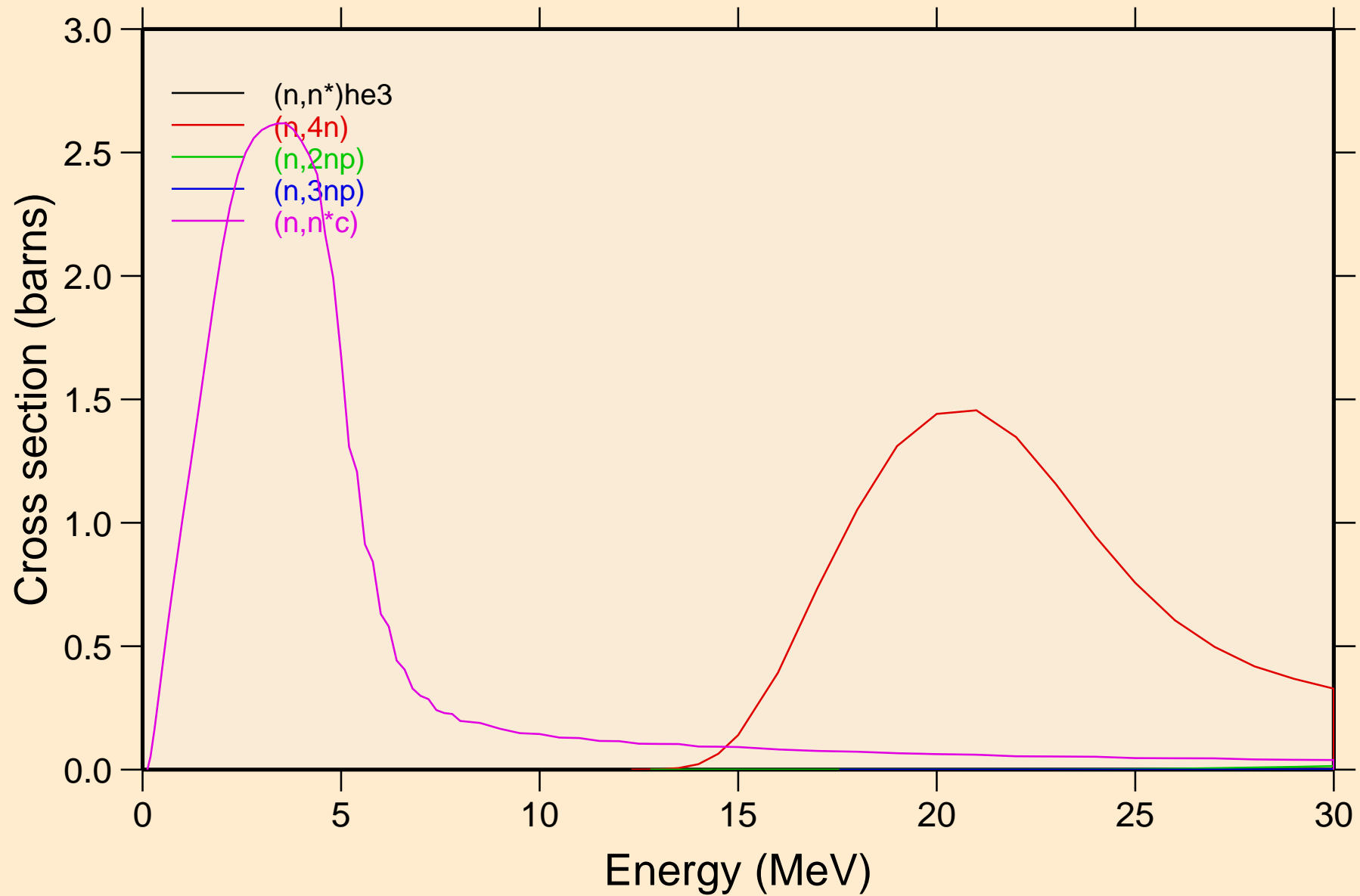

PB215 NRG TENDL-2015, AKONING

Threshold reactions

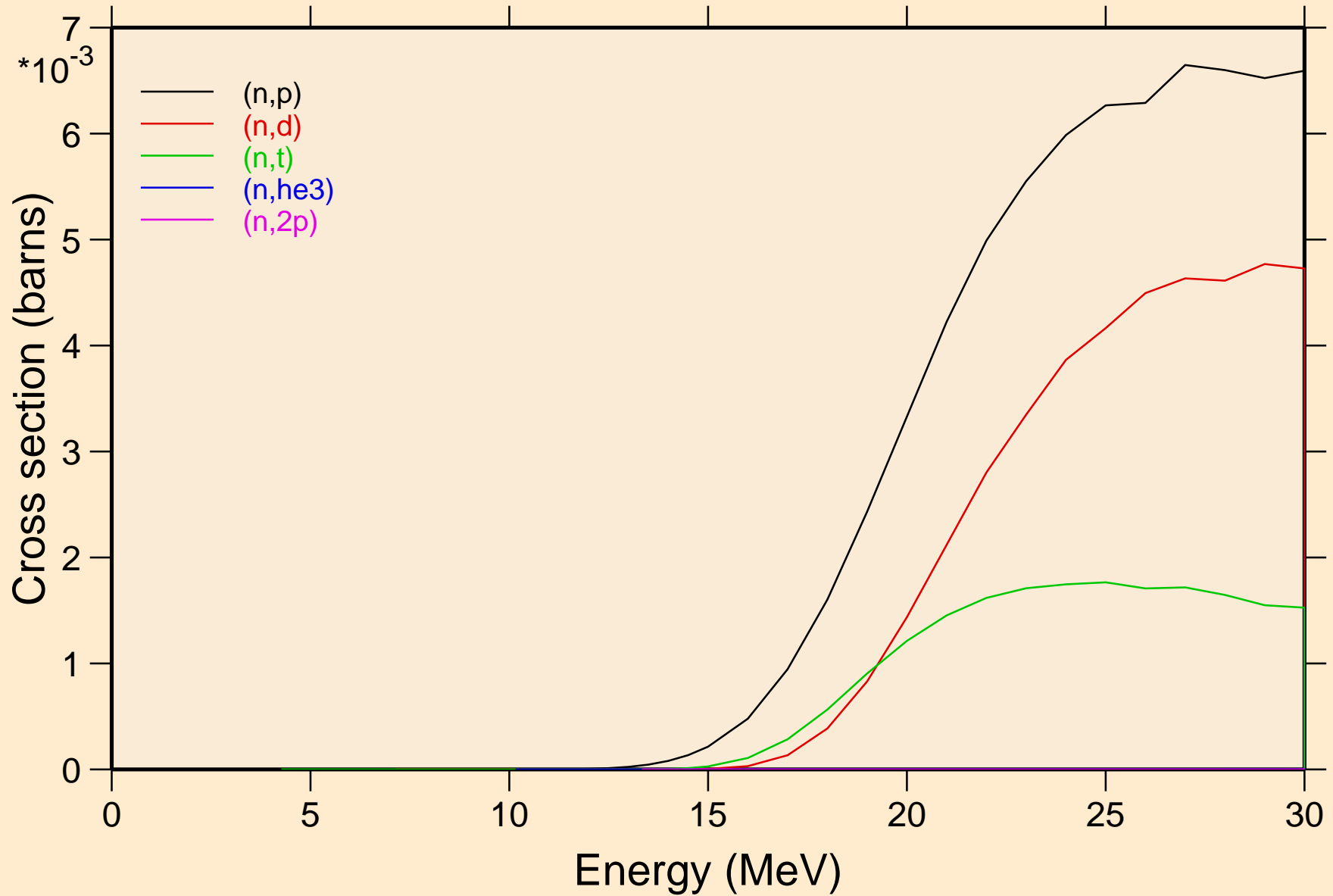

PB215 NRG TENDL-2015, AKONING
angular distribution for elastic

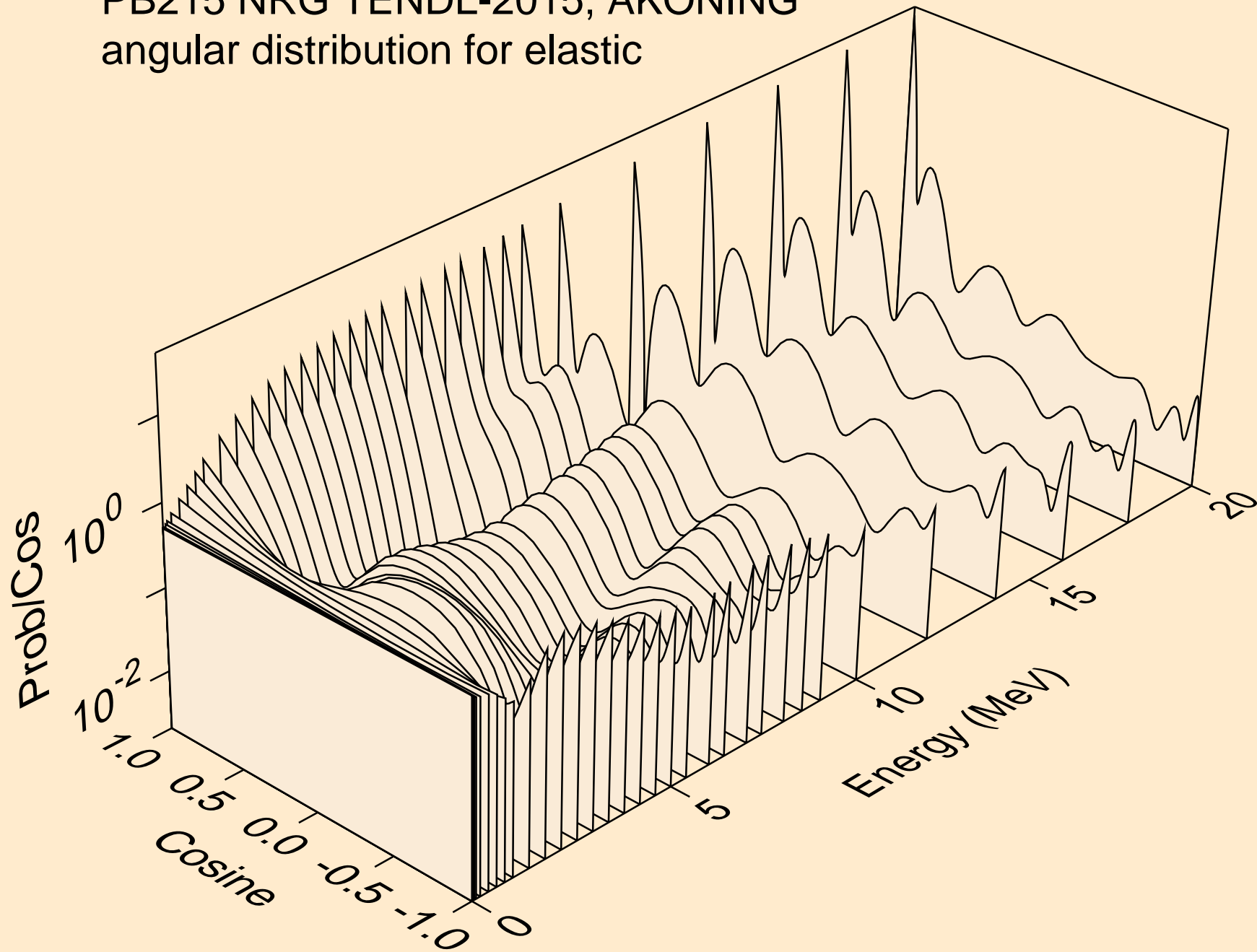

PB215 NRG TENDL-2015, AKONING
angular distribution for elastic

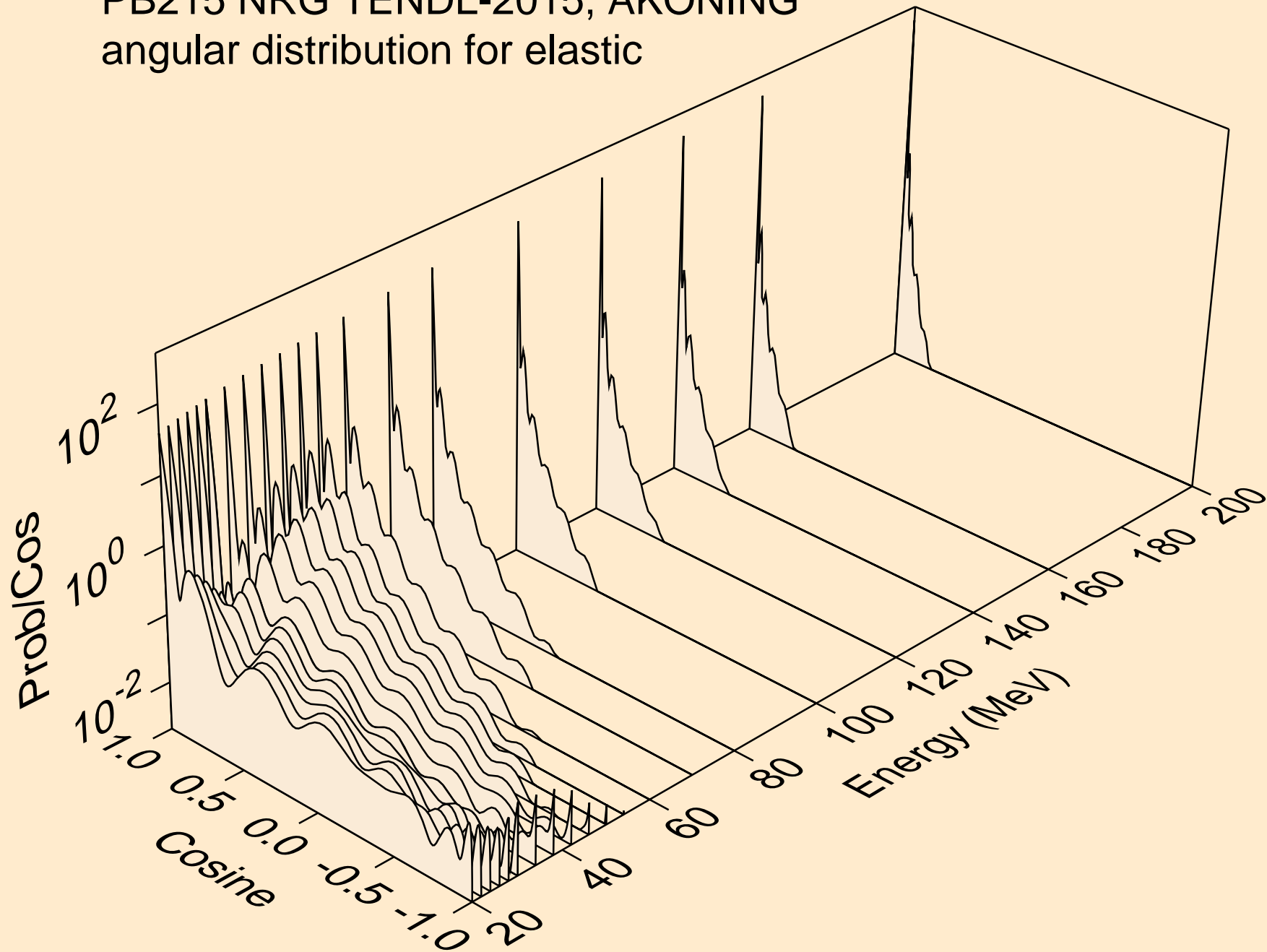

PB215 NRG TENDL-2015, AKONING
angular distribution for (n,n*1)

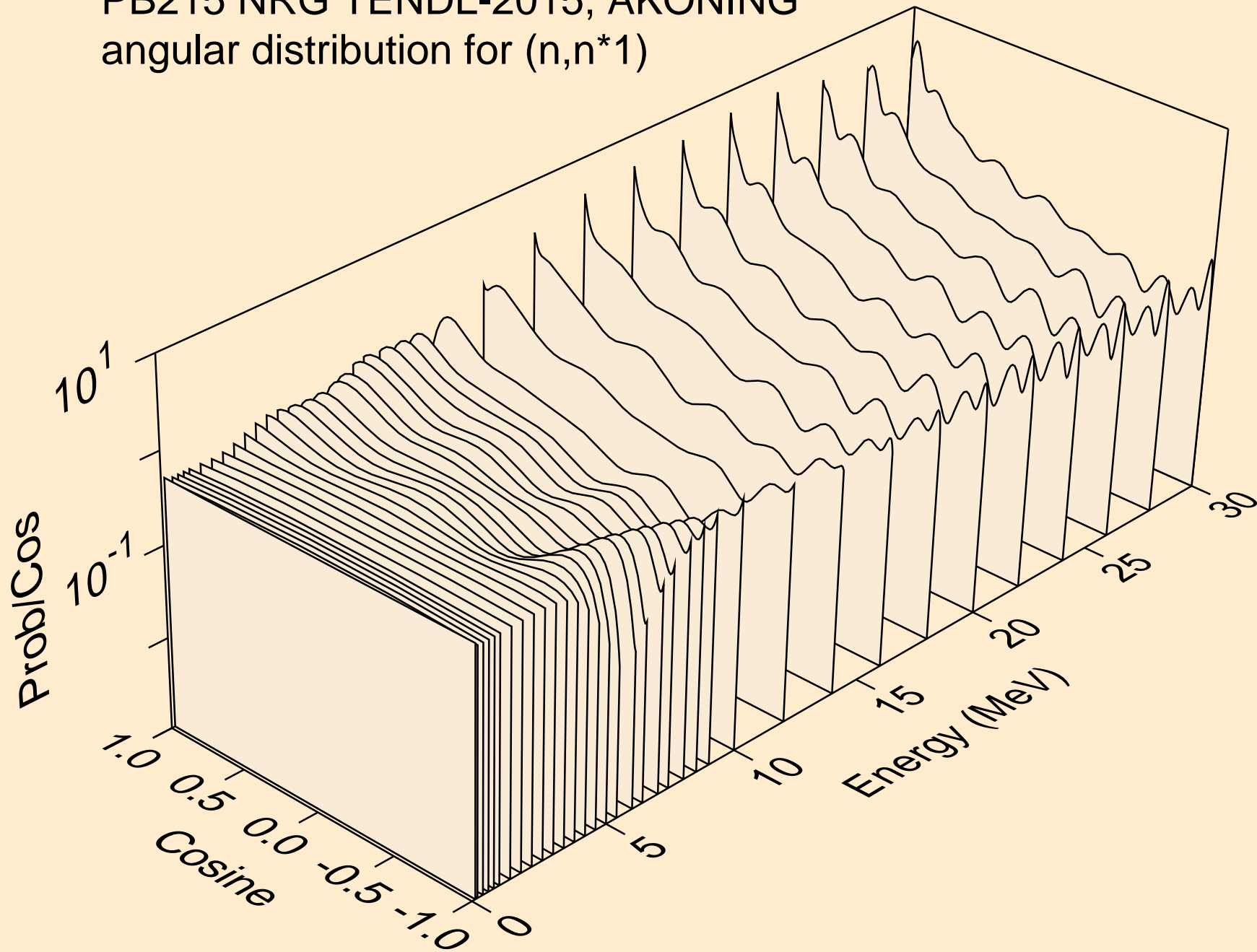

PB215 NRG TENDL-2015, AKONING
Neutron emission for (n,x)

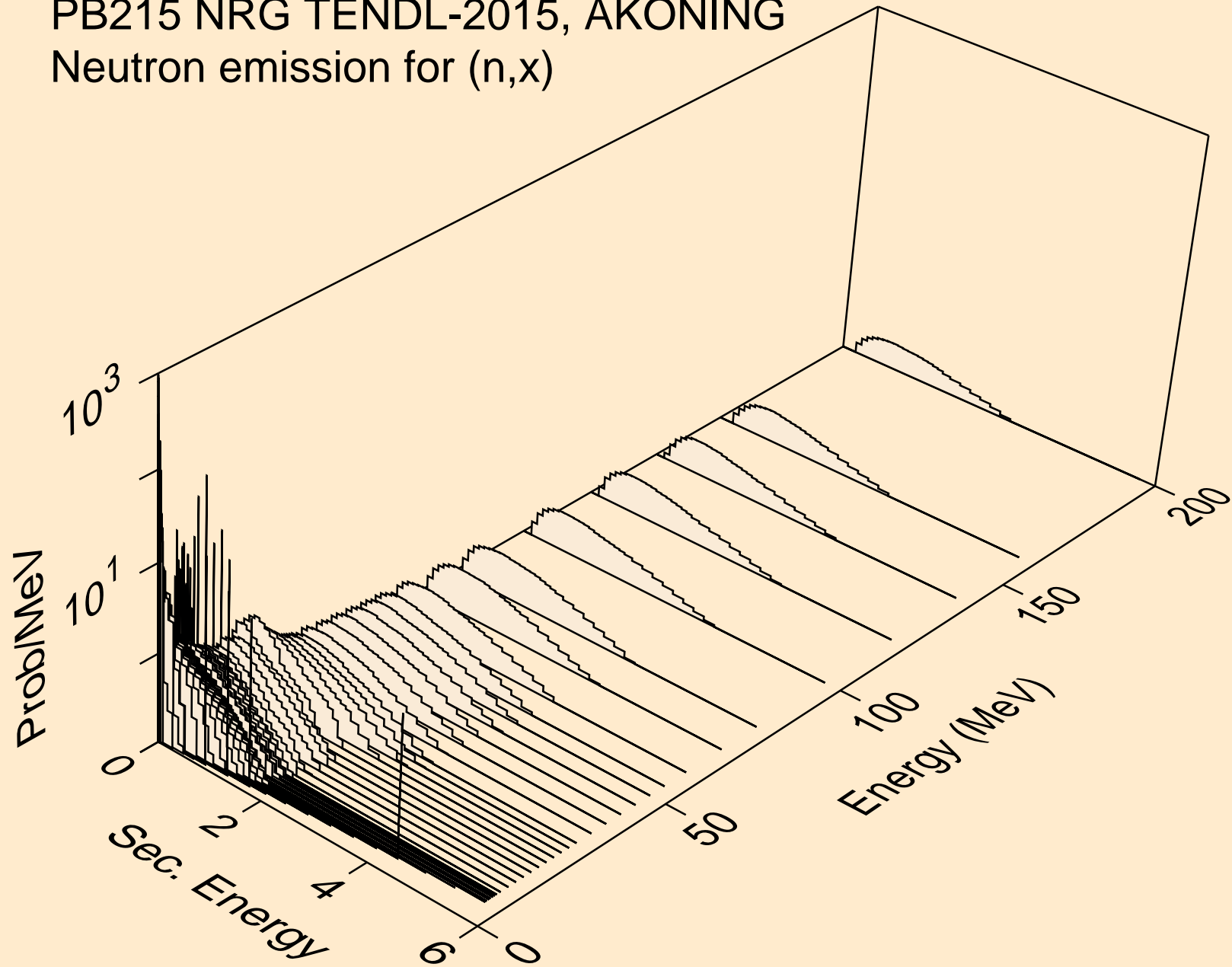

PB215 NRG TENDL-2015, AKONING
Neutron emission for (n,2nd)

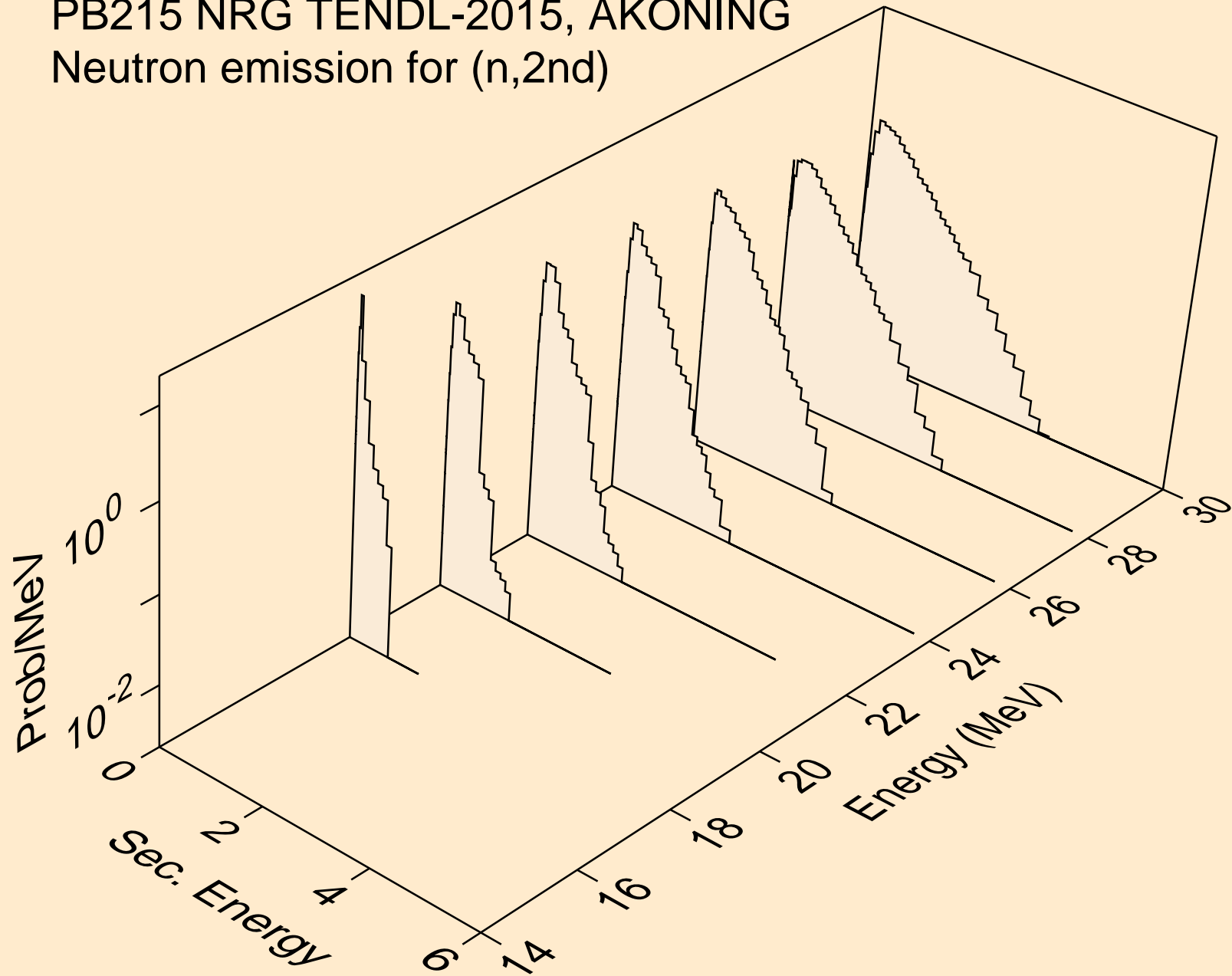

PB215 NRG TENDL-2015, AKONING
Neutron emission for (n,2n)

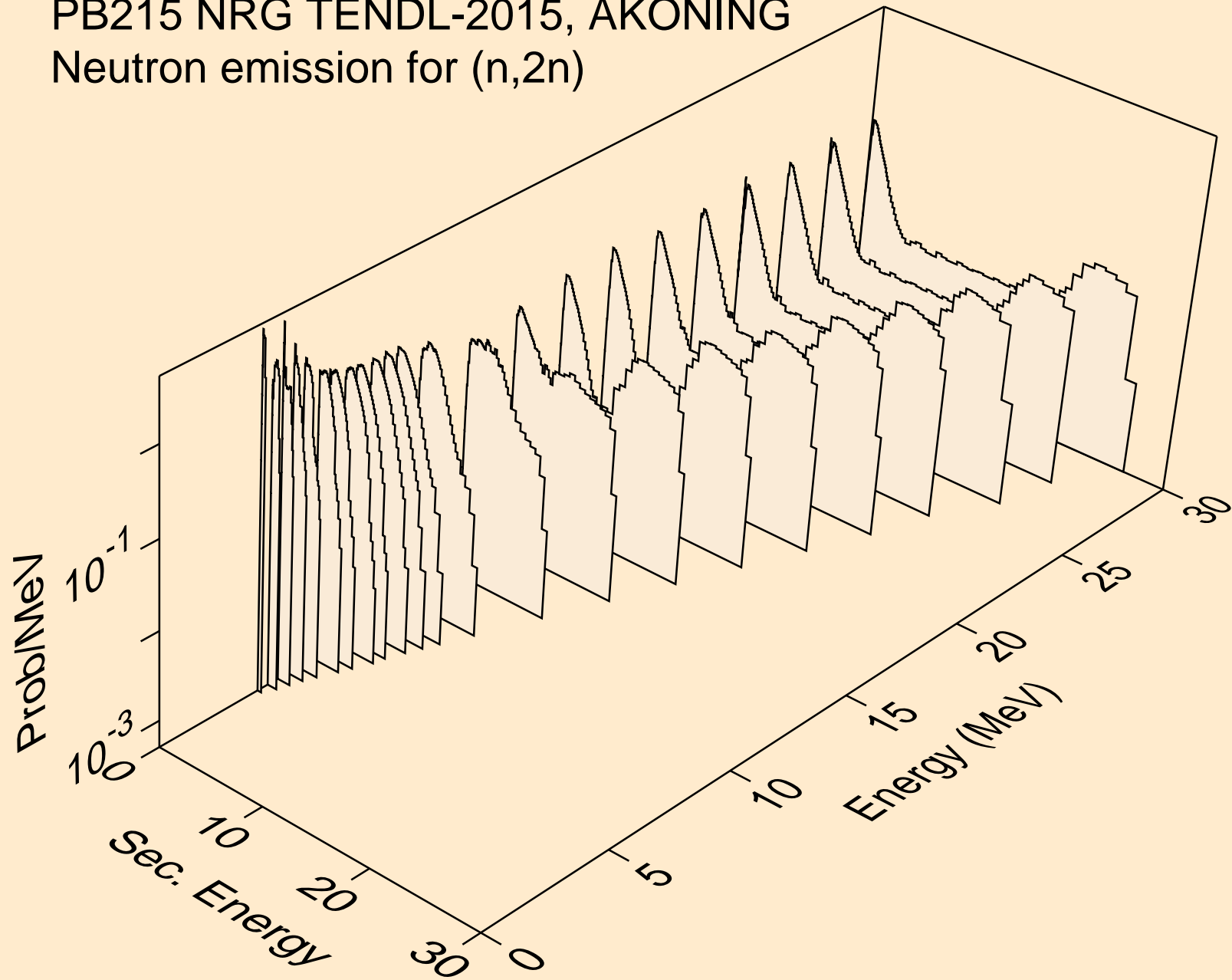

PB215 NRG TENDL-2015, AKONING
Neutron emission for (n,3n)

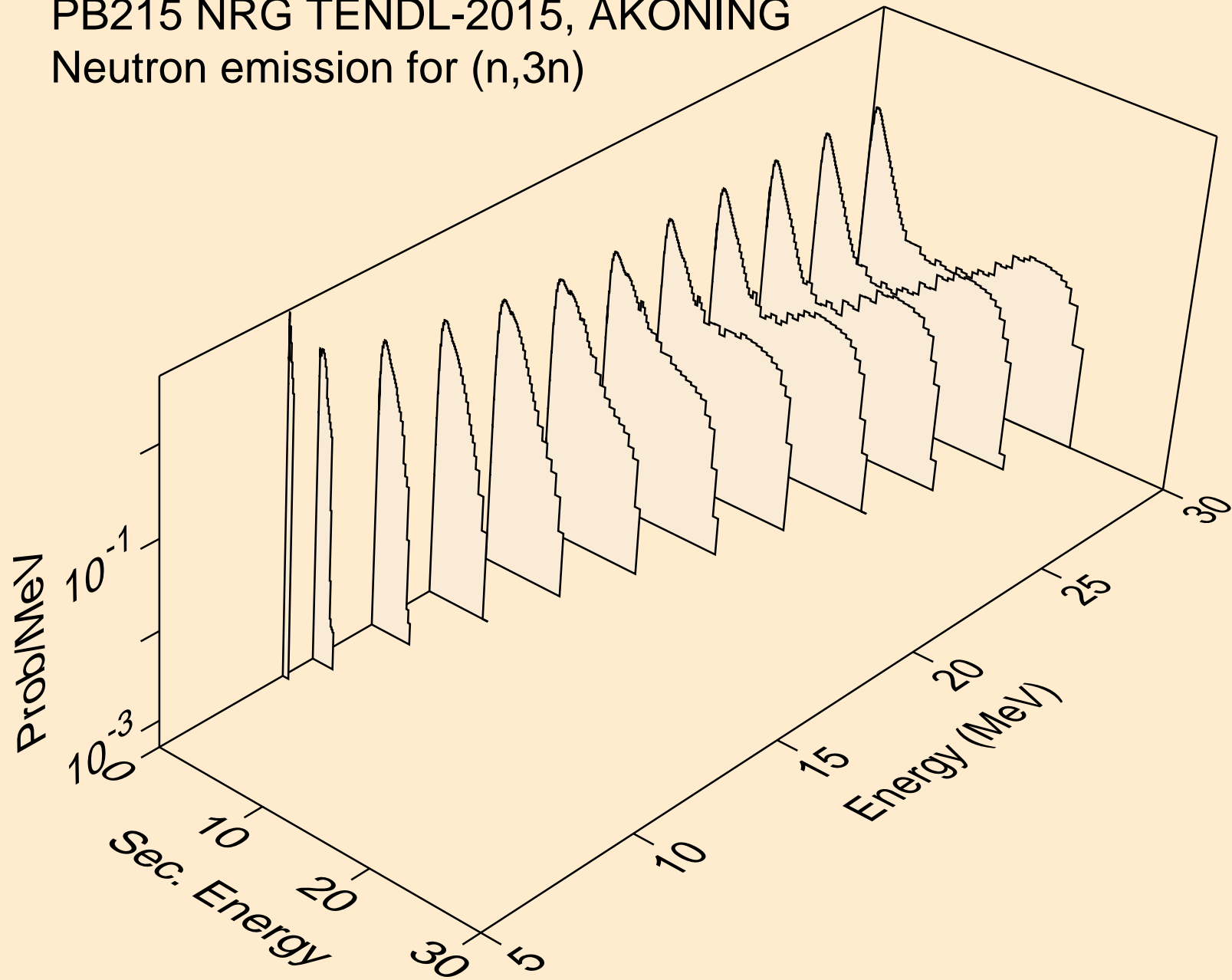

PB215 NRG TENDL-2015, AKONING
Neutron emission for (n,n*)a

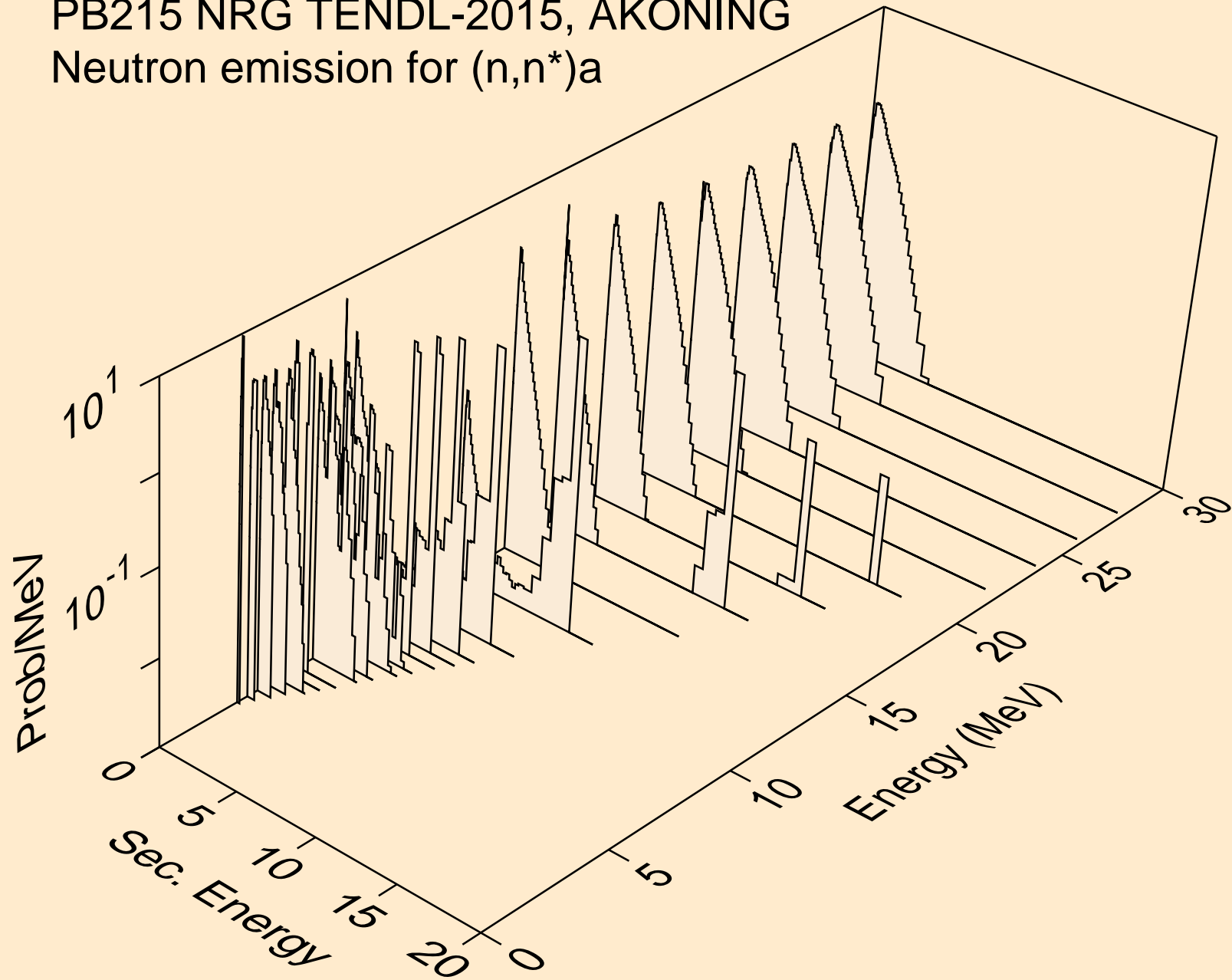

PB215 NRG TENDL-2015, AKONING
Neutron emission for (n,2n)a

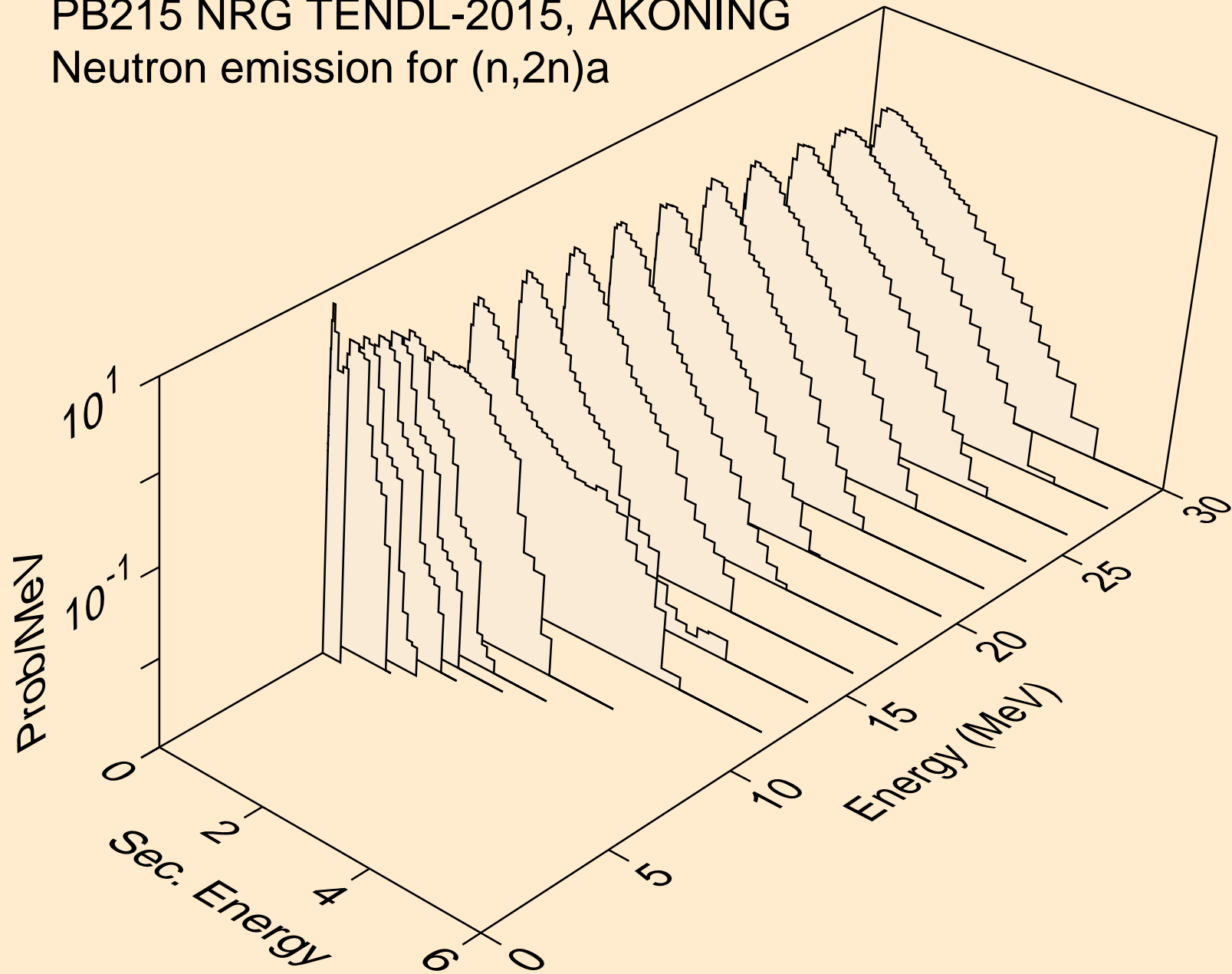

PB215 NRG TENDL-2015, AKONING
Neutron emission for (n,3n)a

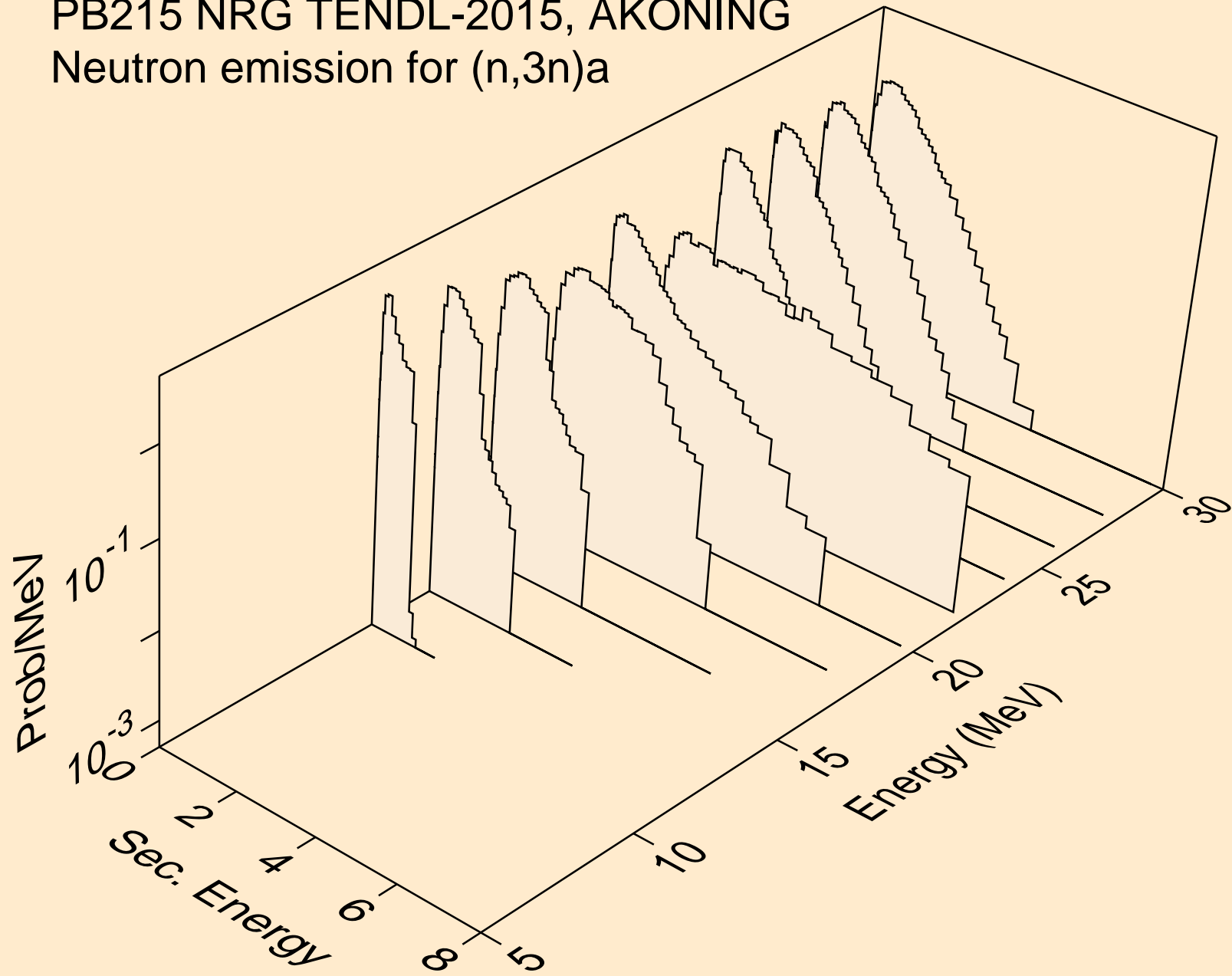

PB215 NRG TENDL-2015, AKONING
Neutron emission for (n,n*)p

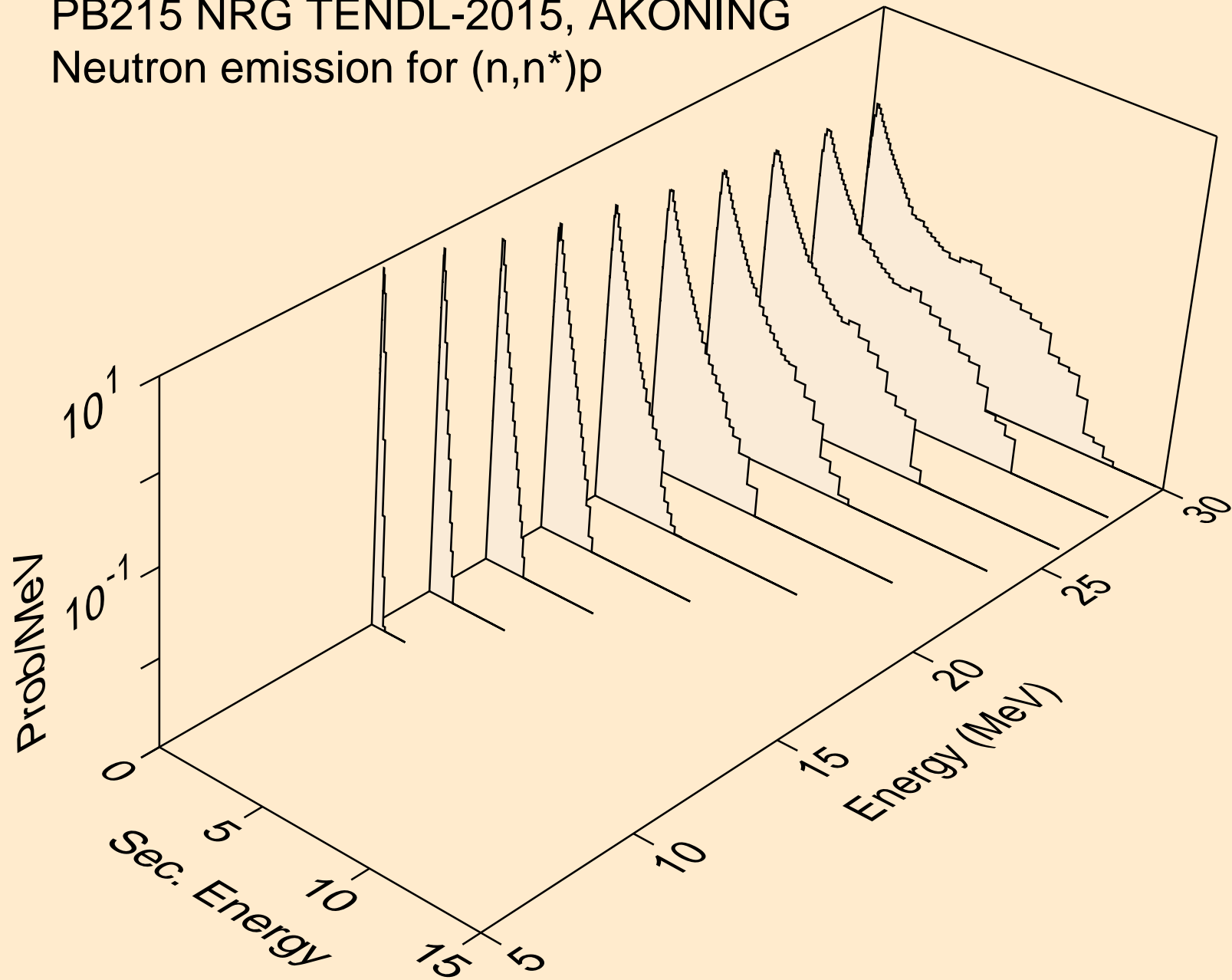

PB215 NRG TENDL-2015, AKONING
Neutron emission for (n,n*)d

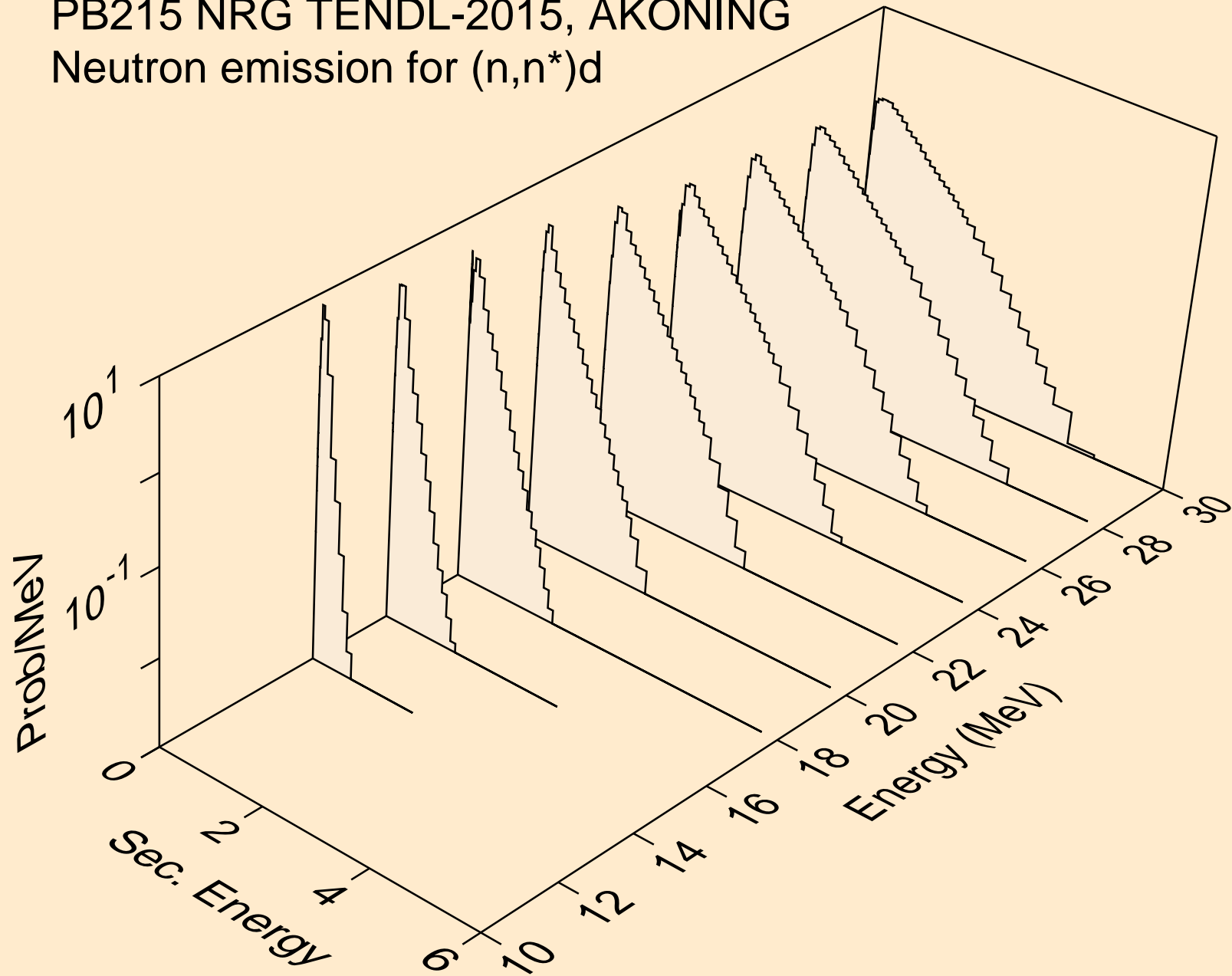

PB215 NRG TENDL-2015, AKONING
Neutron emission for (n,n*)t

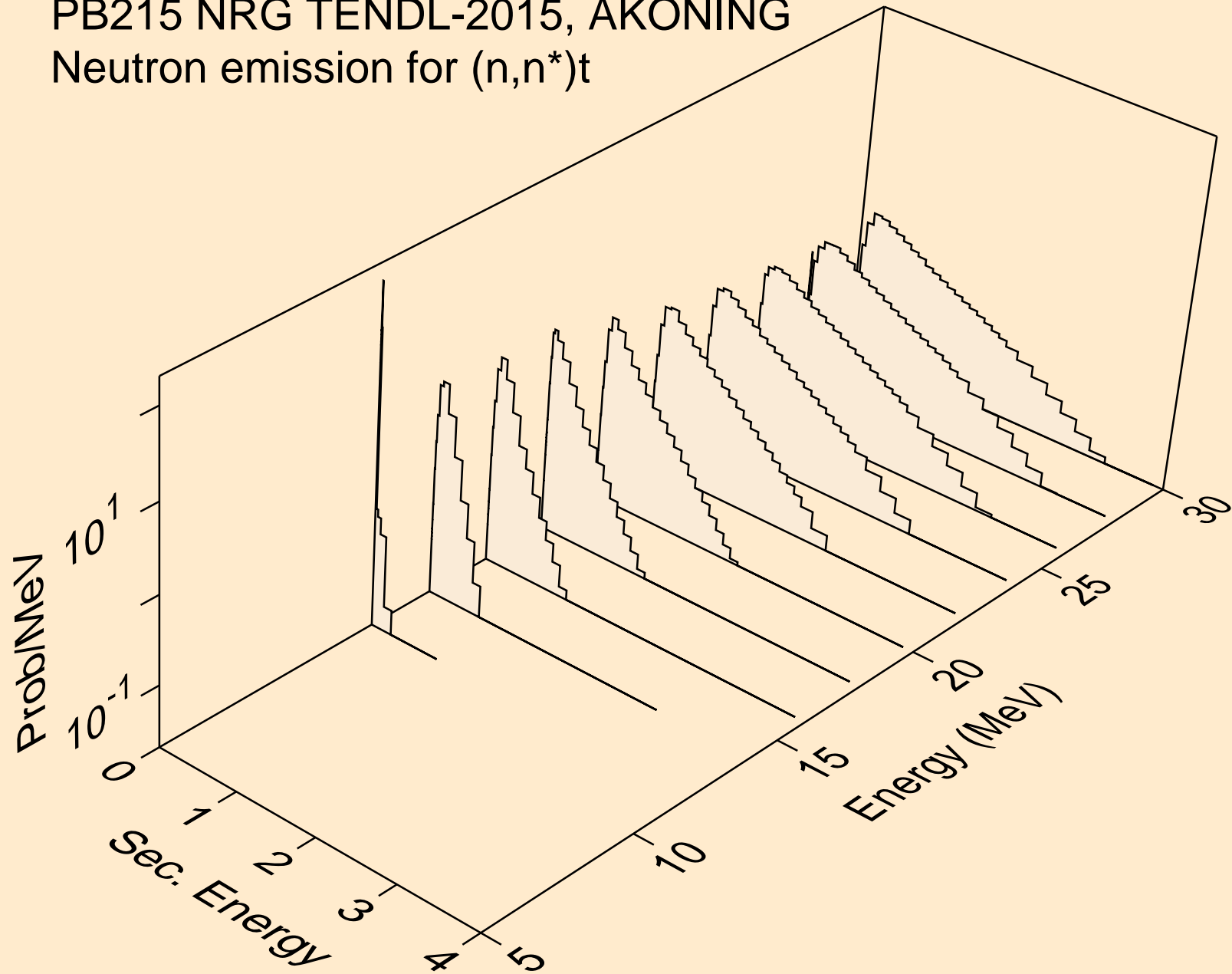

PB215 NRG TENDL-2015, AKONING
Neutron emission for (n,n*)he3

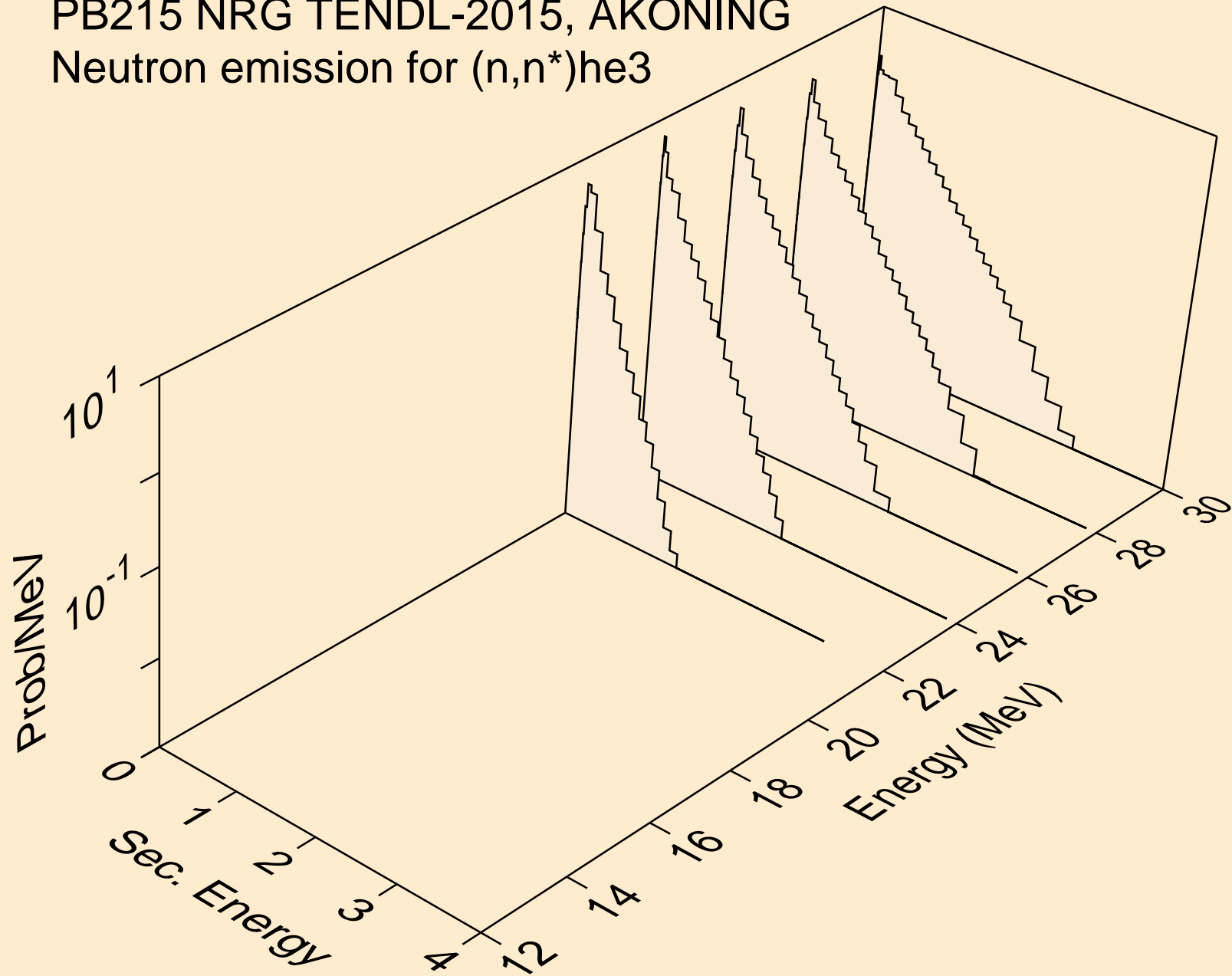

PB215 NRG TENDL-2015, AKONING
Neutron emission for (n,4n)

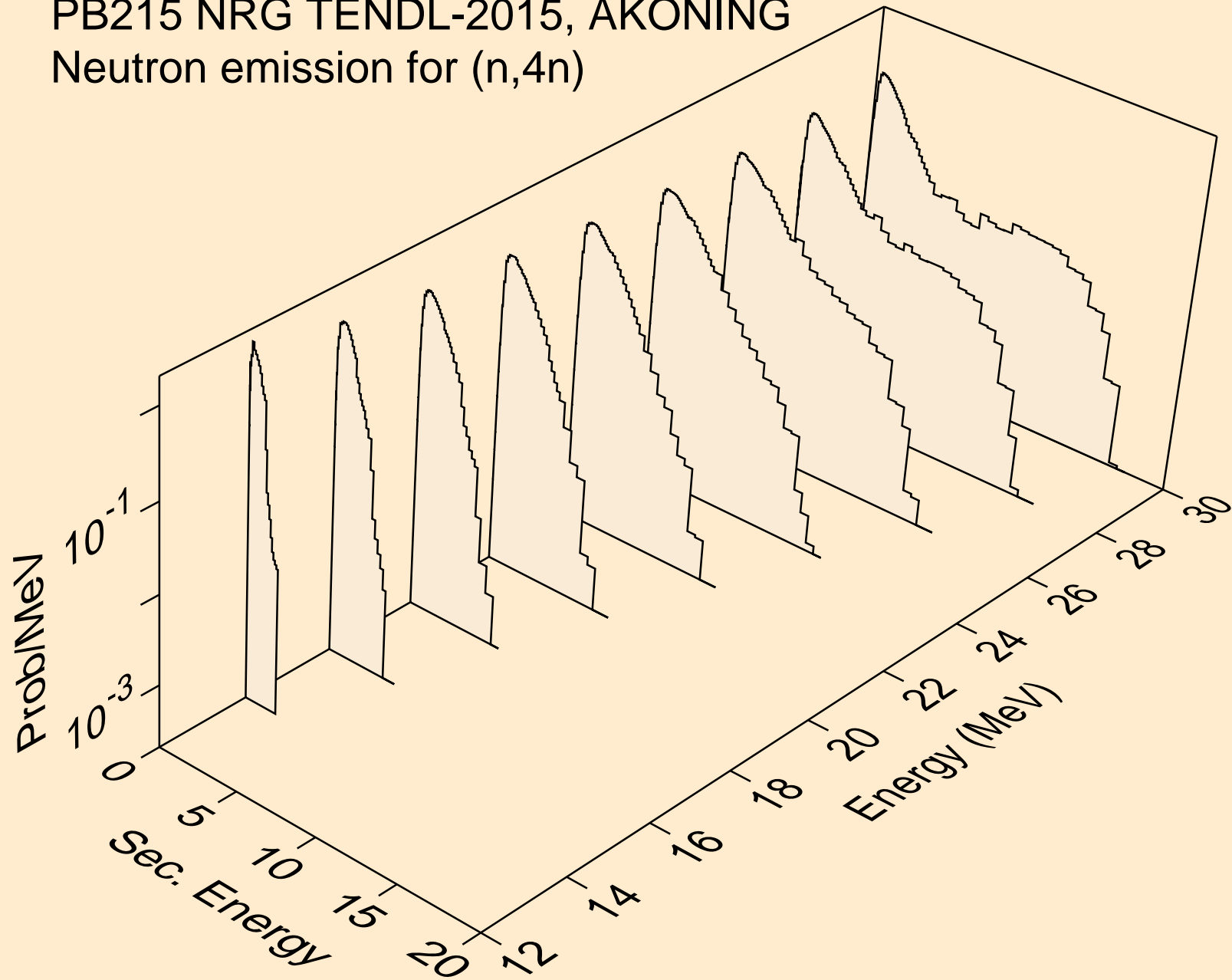

PB215 NRG TENDL-2015, AKONING
Neutron emission for (n,2np)

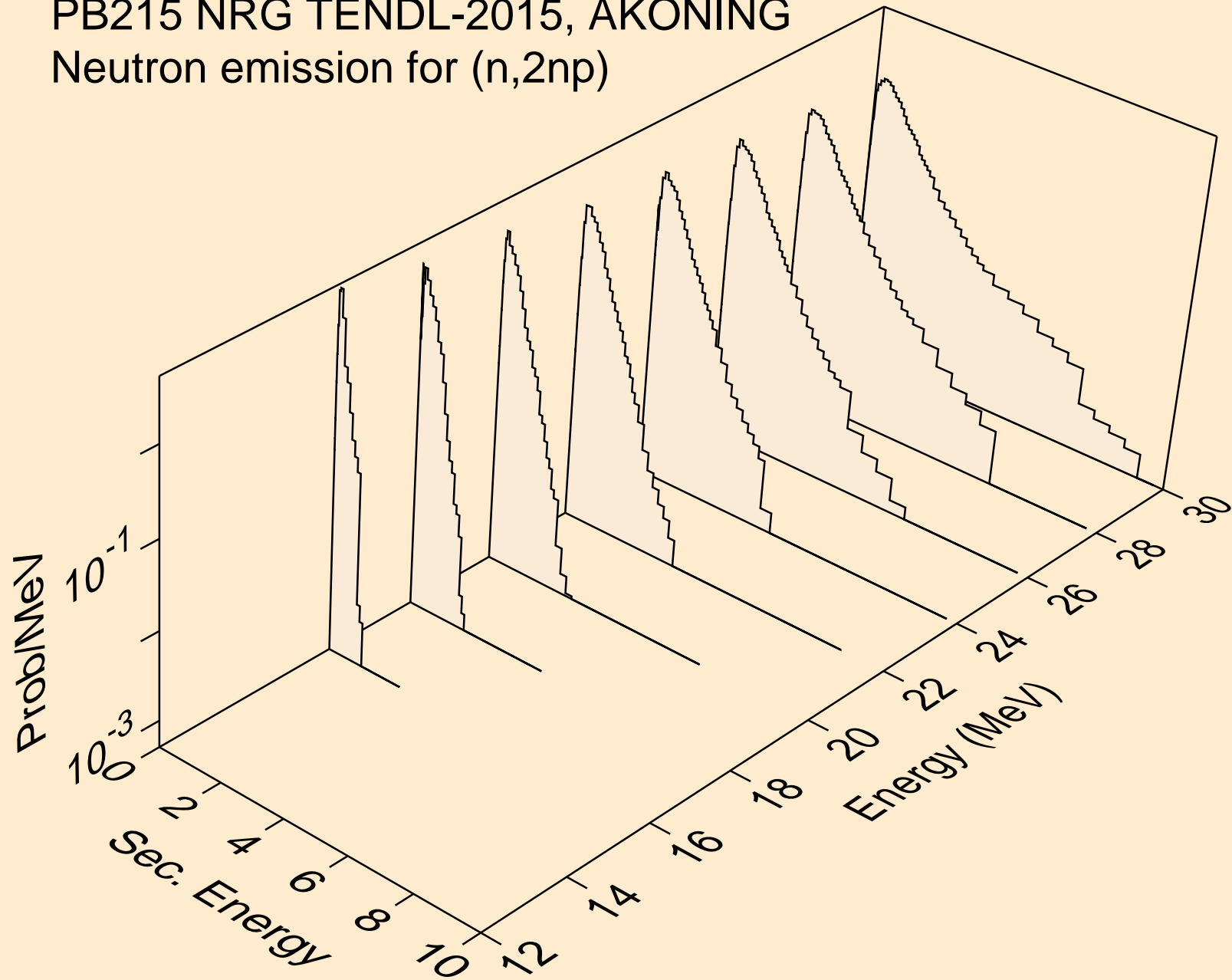

PB215 NRG TENDL-2015, AKONING
Neutron emission for (n,3np)

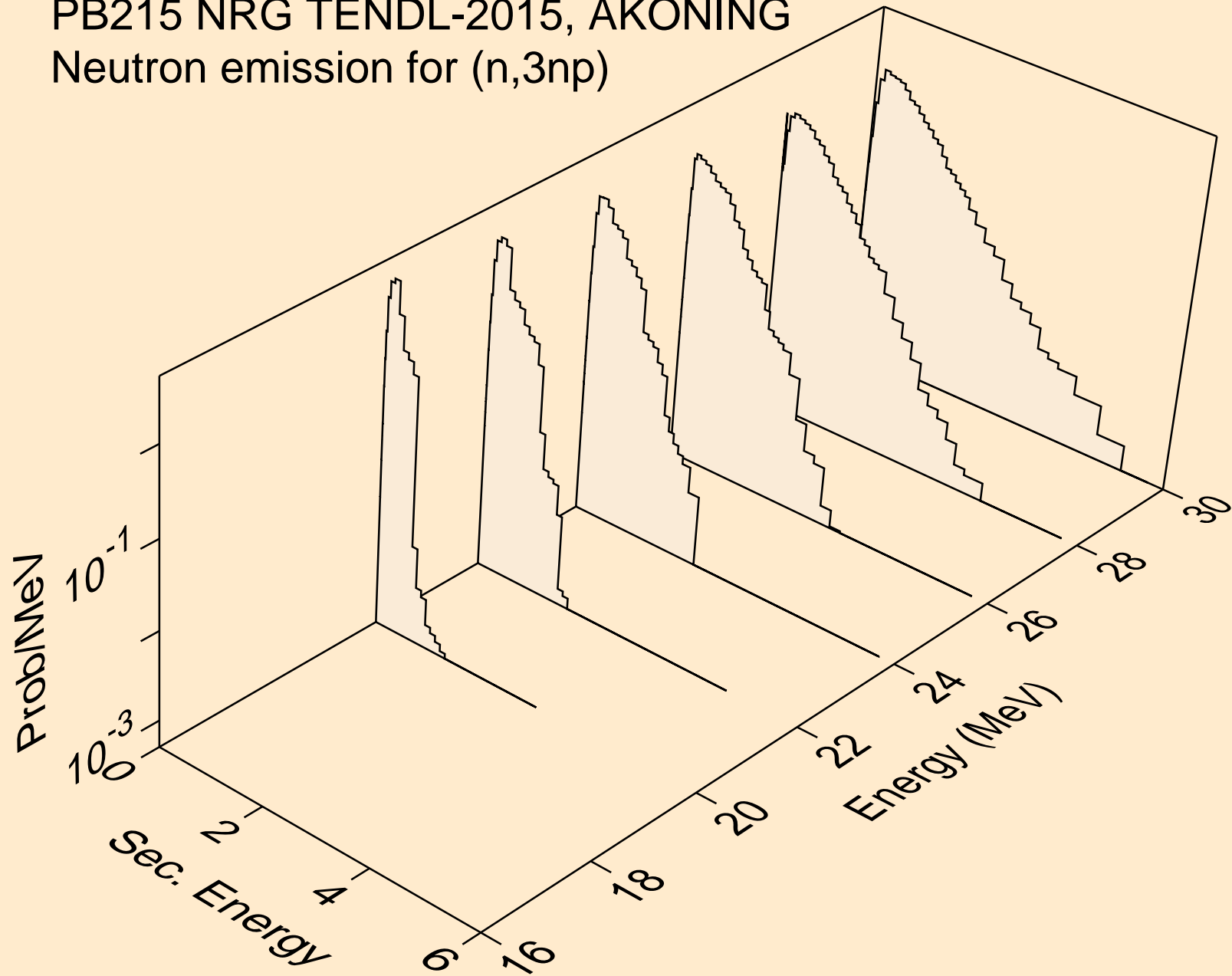

PB215 NRG TENDL-2015, AKONING
Neutron emission for (n,n*c)

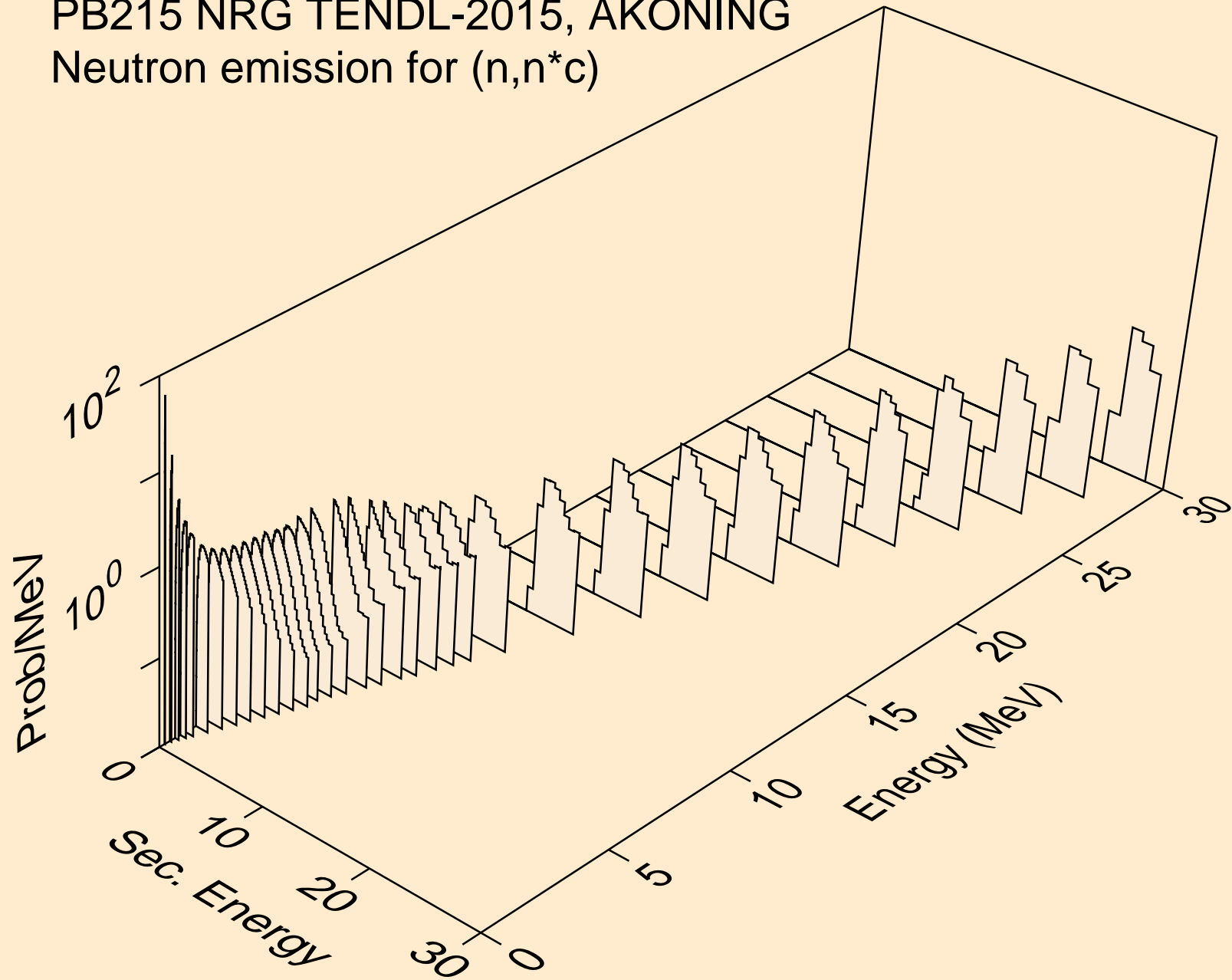

PB215 NRG TENDL-2015, AKONING
Photon emission for (n,x)

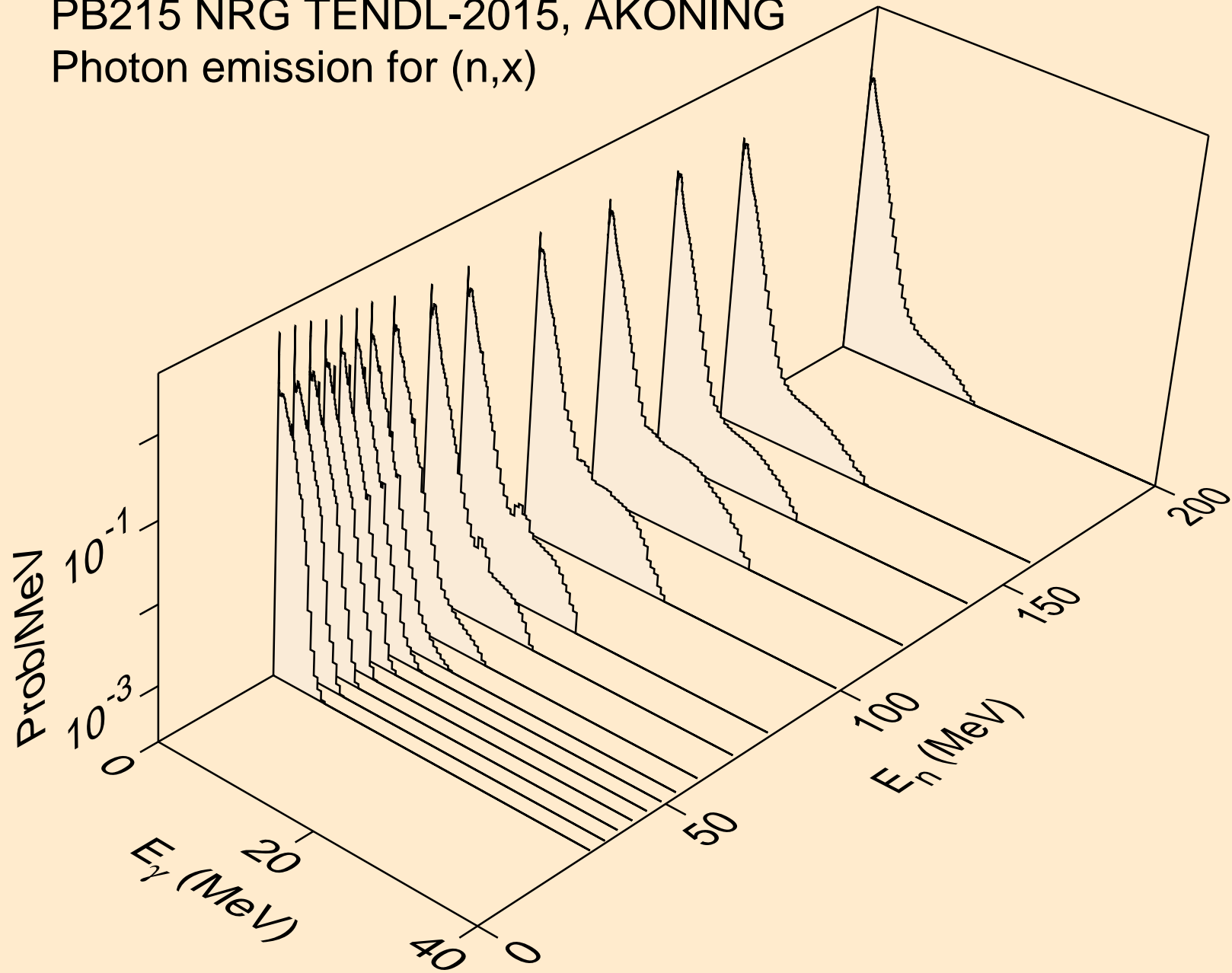

PB215 NRG TENDL-2015, AKONING
Photon emission for (n,2nd)

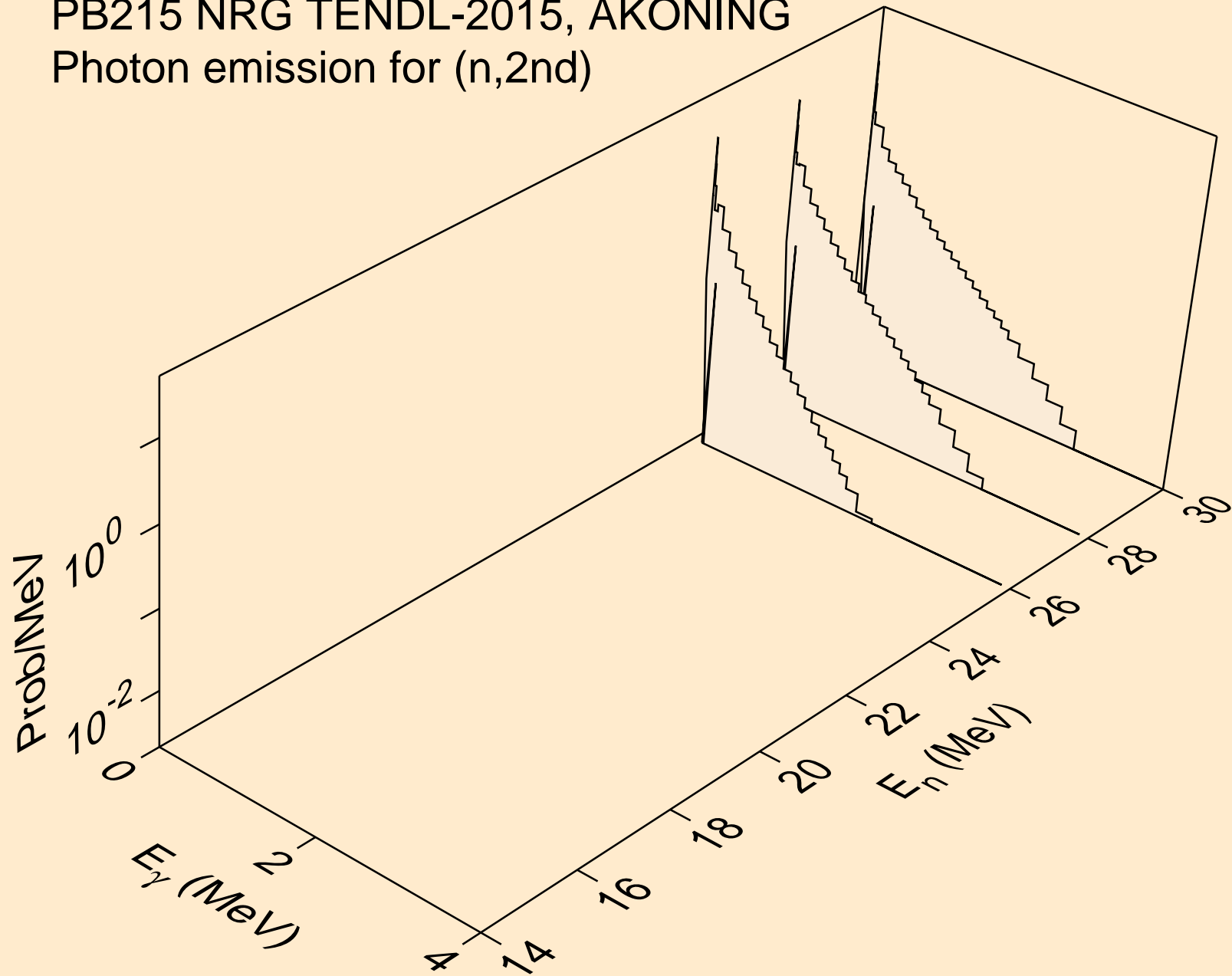

PB215 NRG TENDL-2015, AKONING
Photon emission for (n,2n)

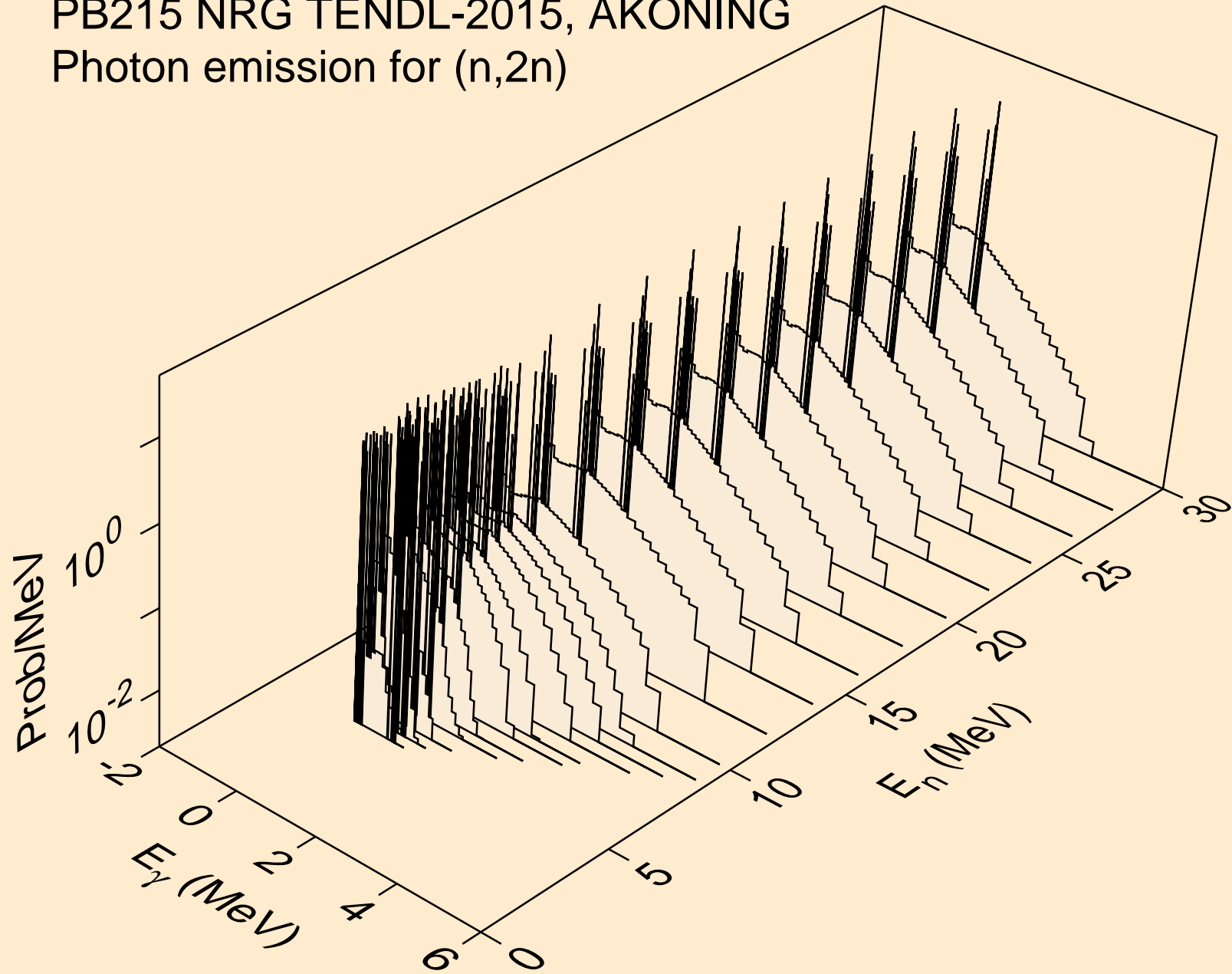

PB215 NRG TENDL-2015, AKONING
Photon emission for (n,3n)

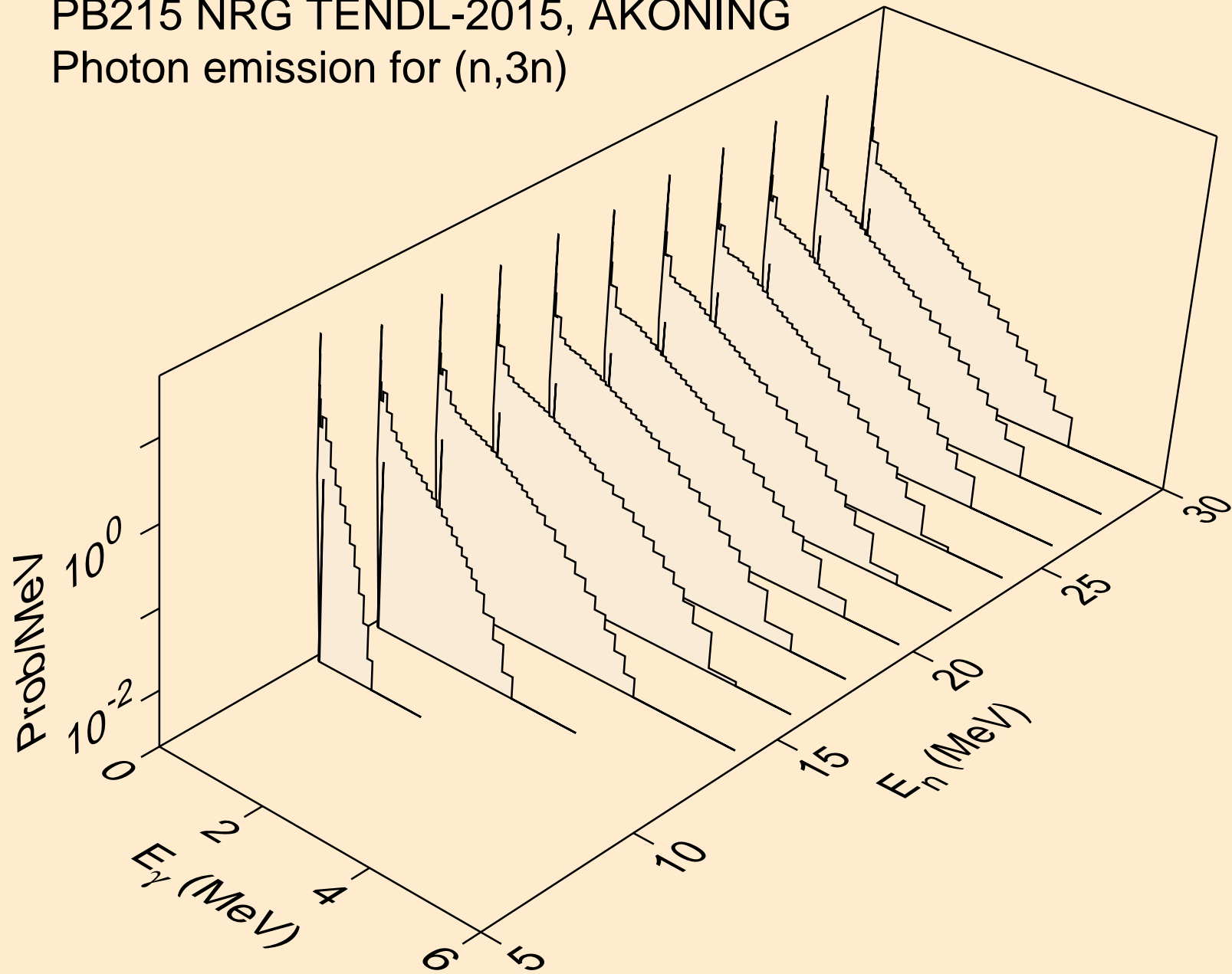

PB215 NRG TENDL-2015, AKONING
Photon emission for (n,n*)a

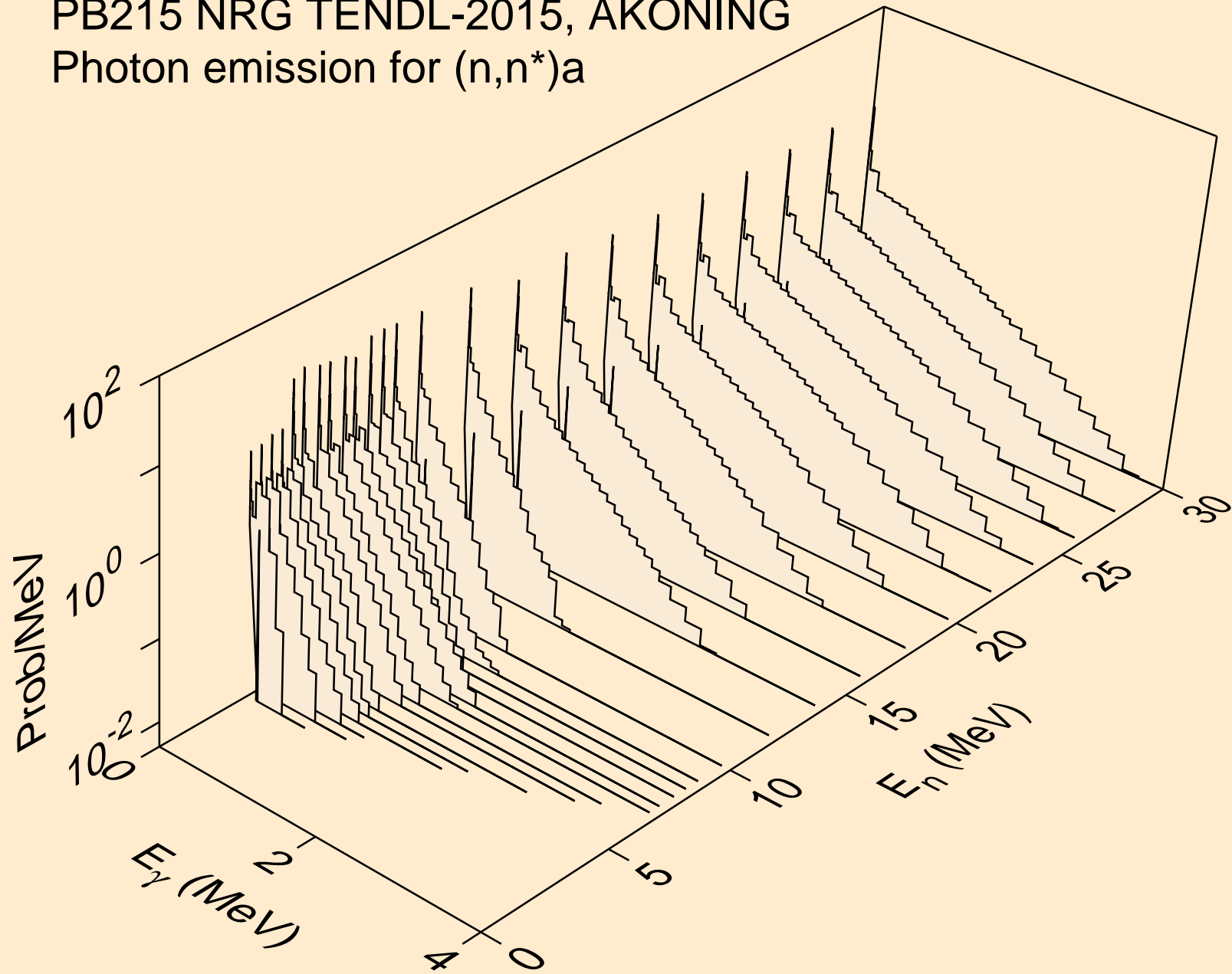

PB215 NRG TENDL-2015, AKONING
Photon emission for (n,2n)a

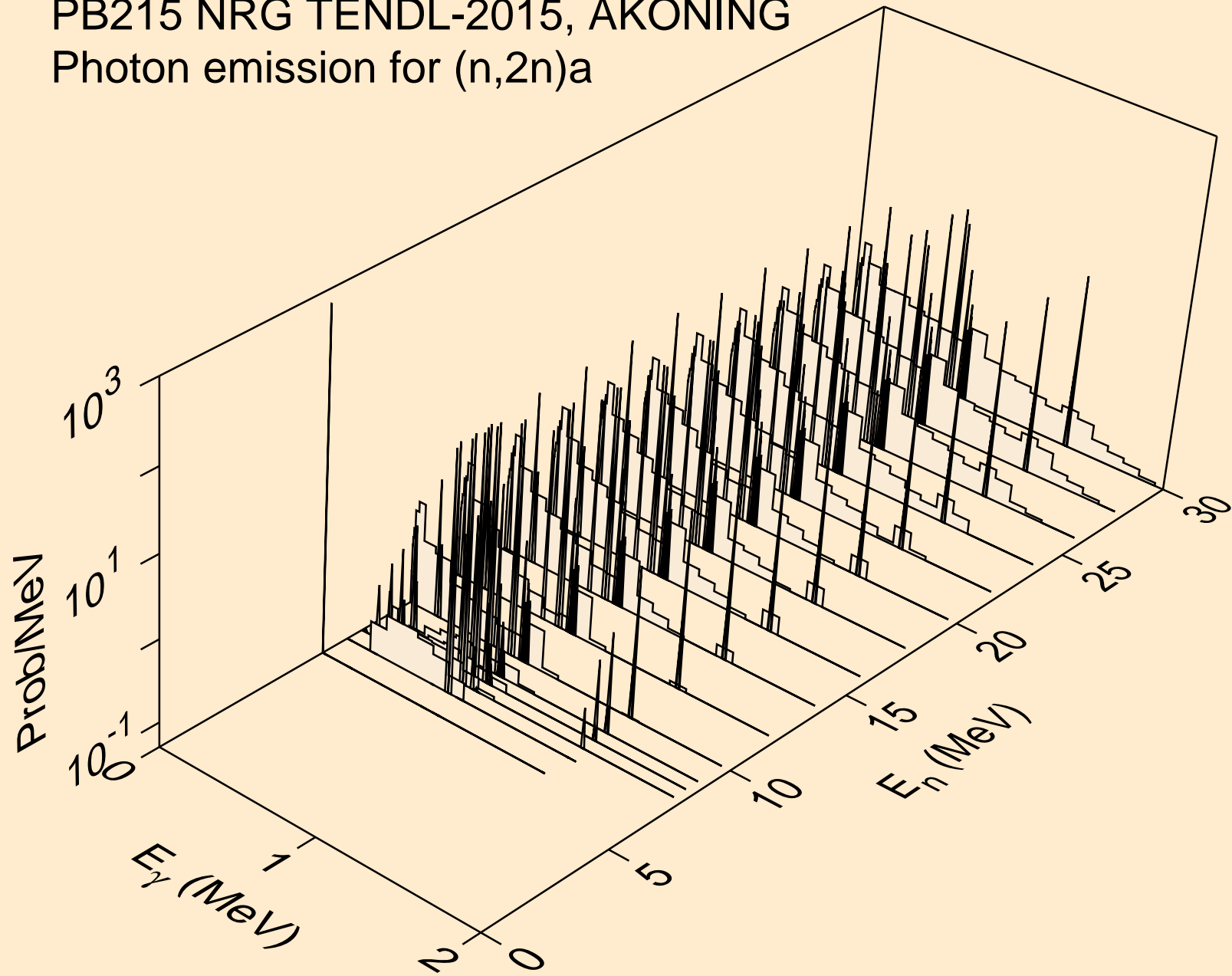

PB215 NRG TENDL-2015, AKONING
Photon emission for (n,3n)a

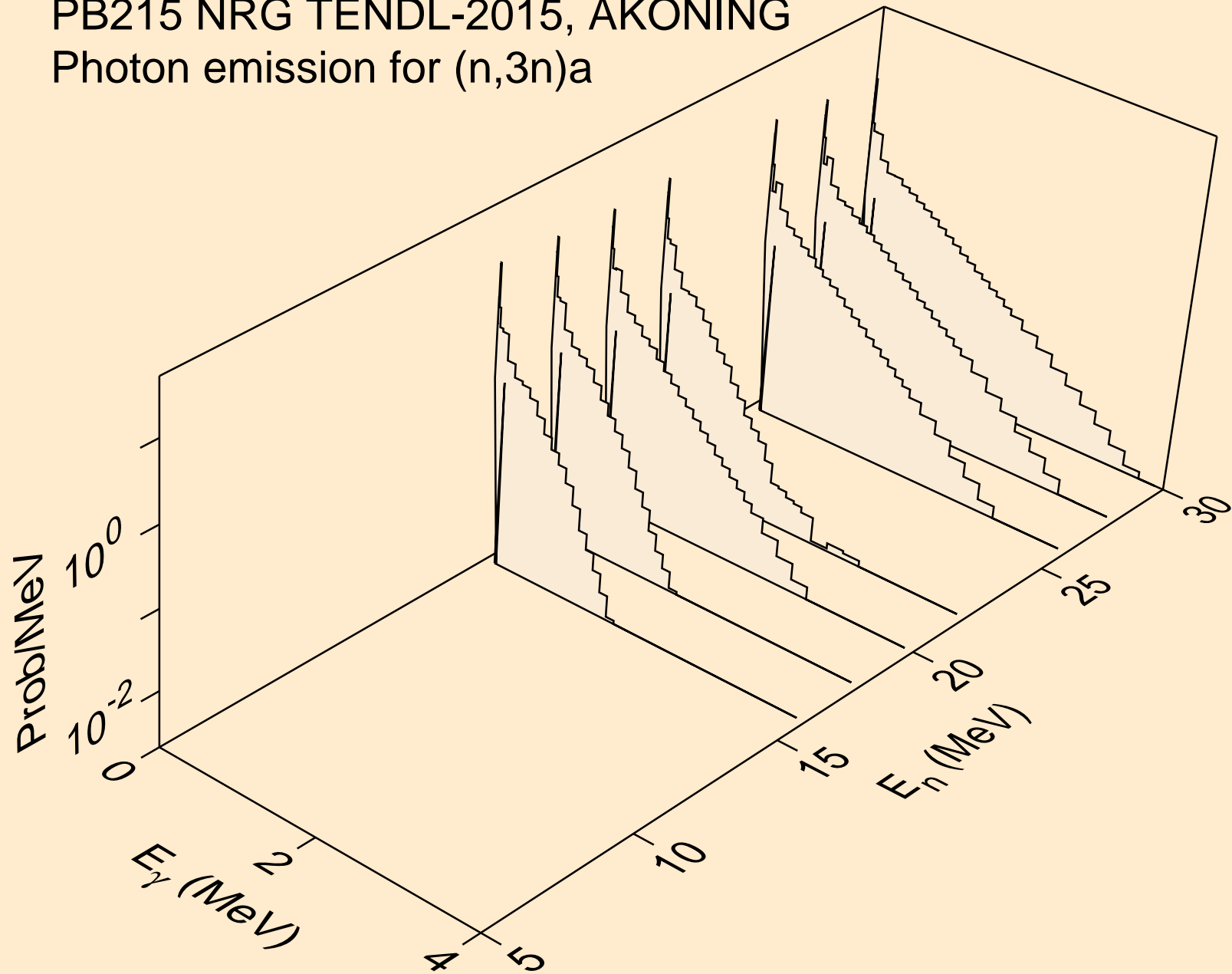

PB215 NRG TENDL-2015, AKONING
Photon emission for (n,n*)p

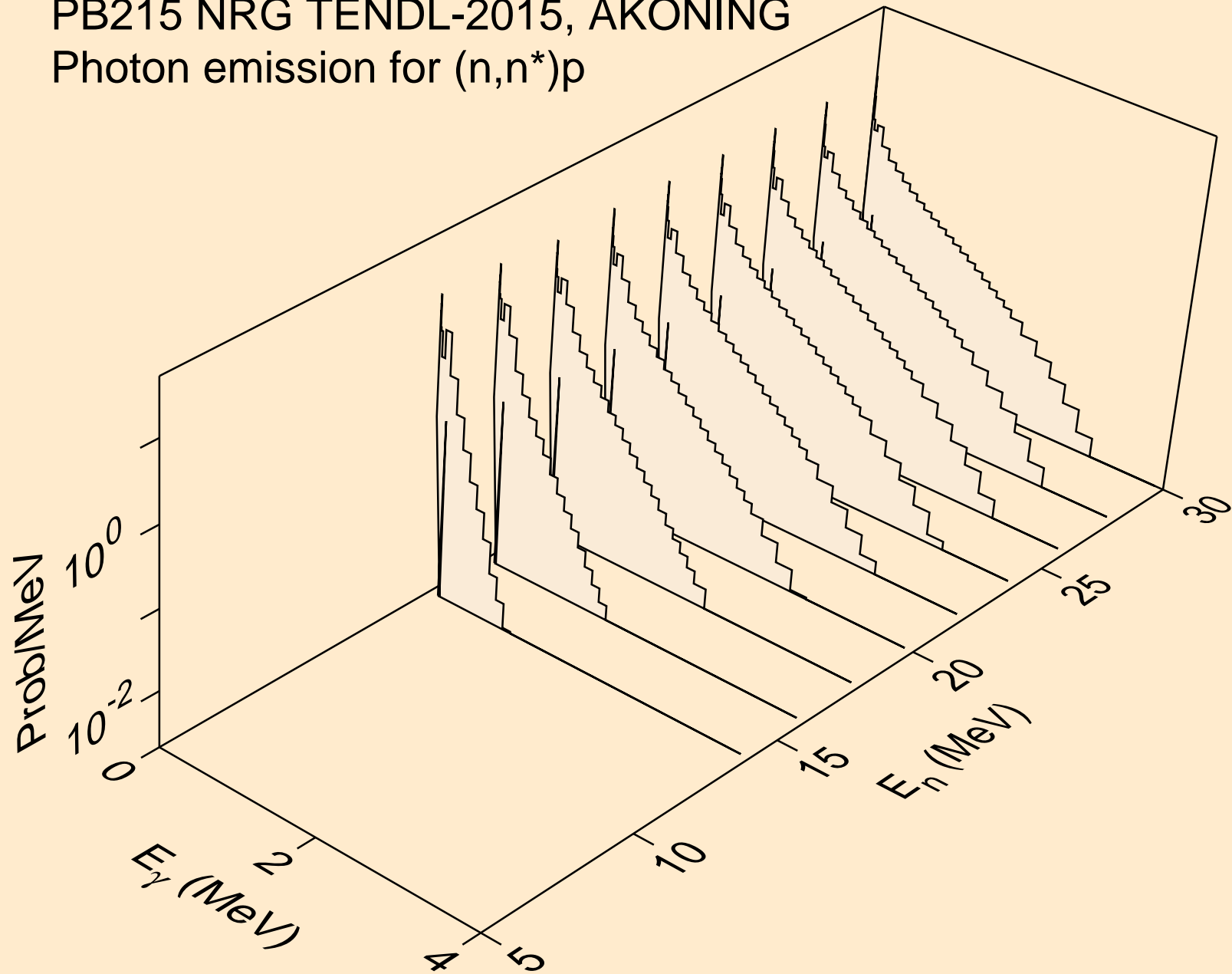

PB215 NRG TENDL-2015, AKONING
Photon emission for (n,n*)d

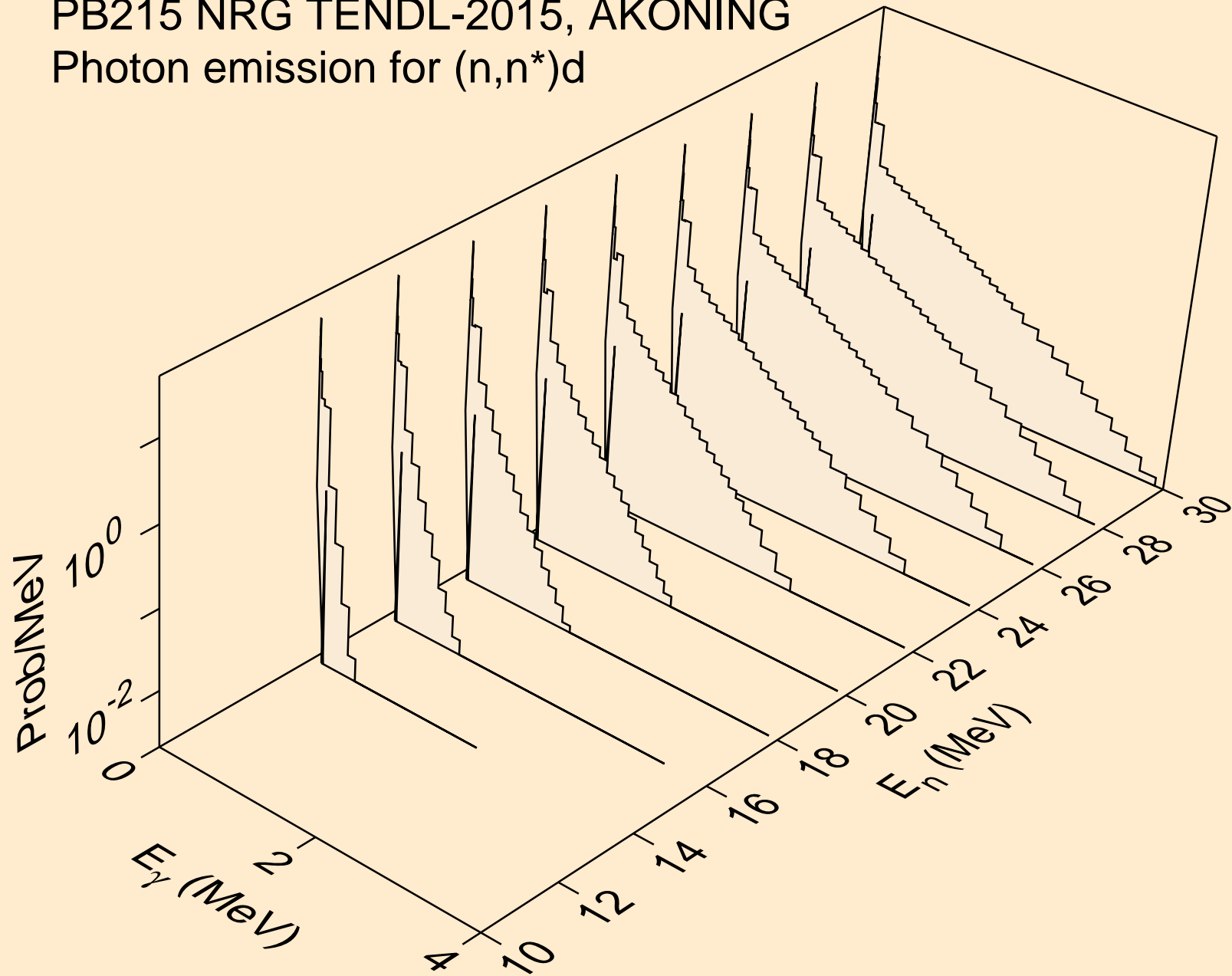

PB215 NRG TENDL-2015, AKONING
Photon emission for (n,n*)t

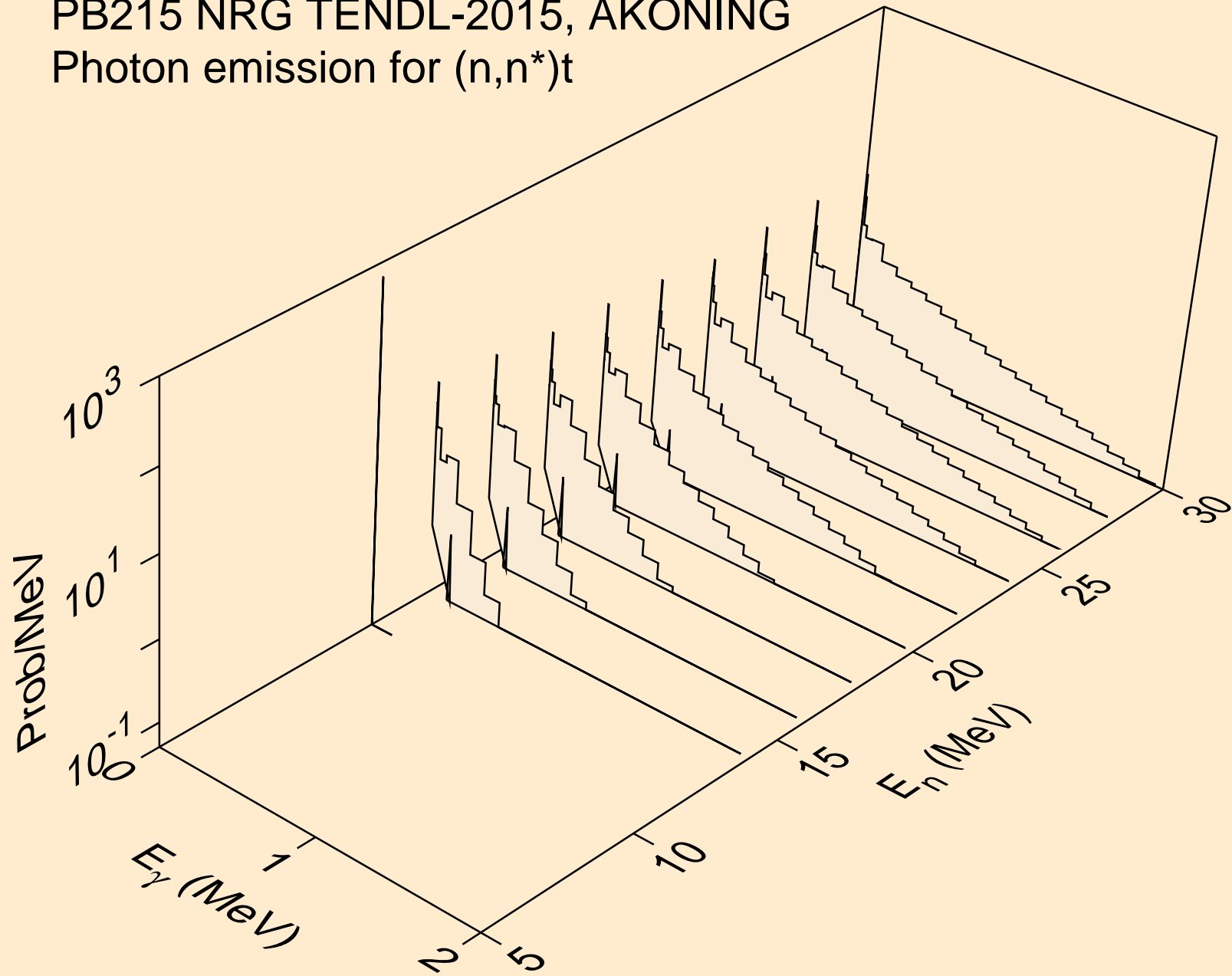

PB215 NRG TENDL-2015, AKONING
Photon emission for (n,n*)he3

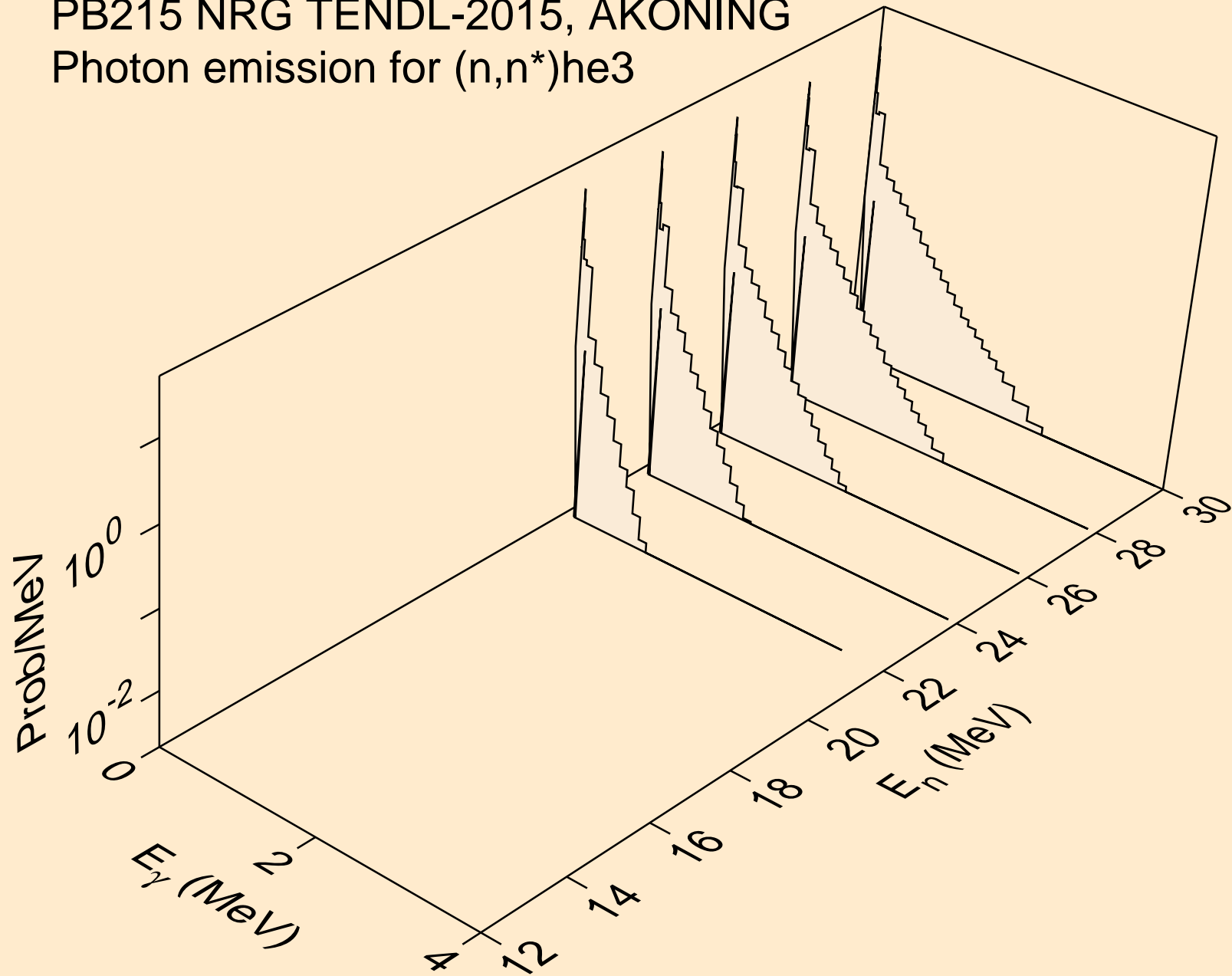

PB215 NRG TENDL-2015, AKONING
Photon emission for (n,4n)

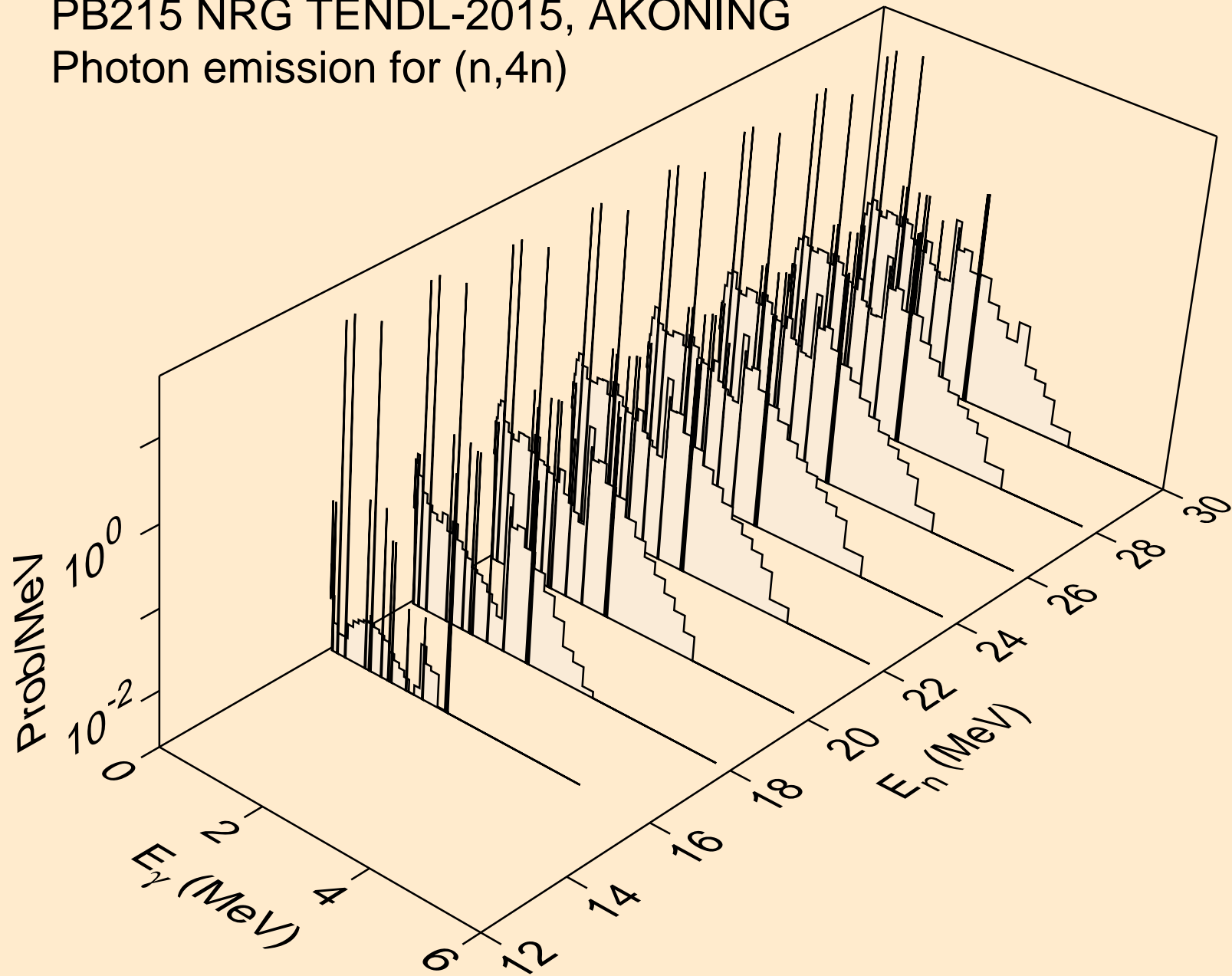

PB215 NRG TENDL-2015, AKONING
Photon emission for (n,2np)

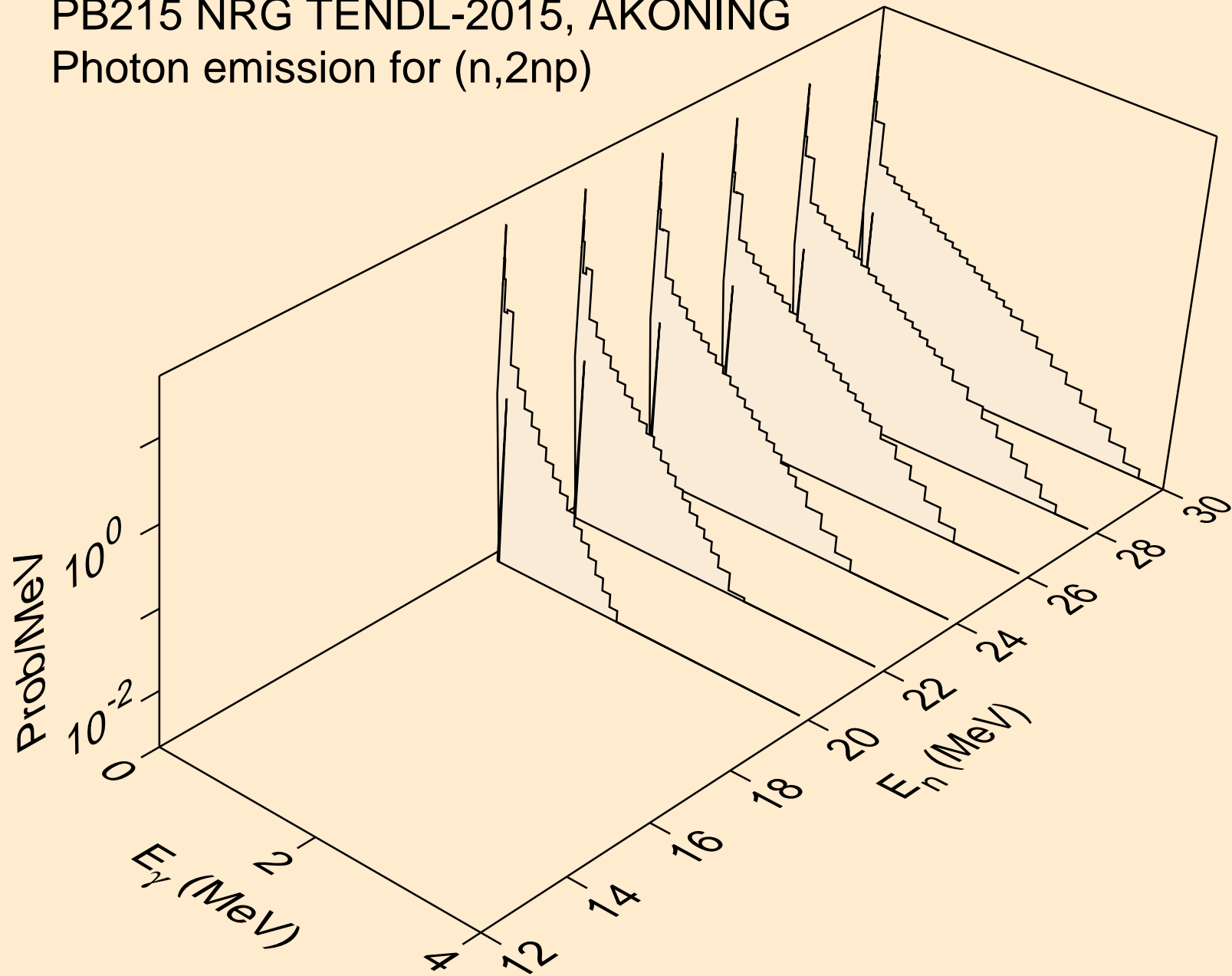

PB215 NRG TENDL-2015, AKONING
Photon emission for (n,3np)

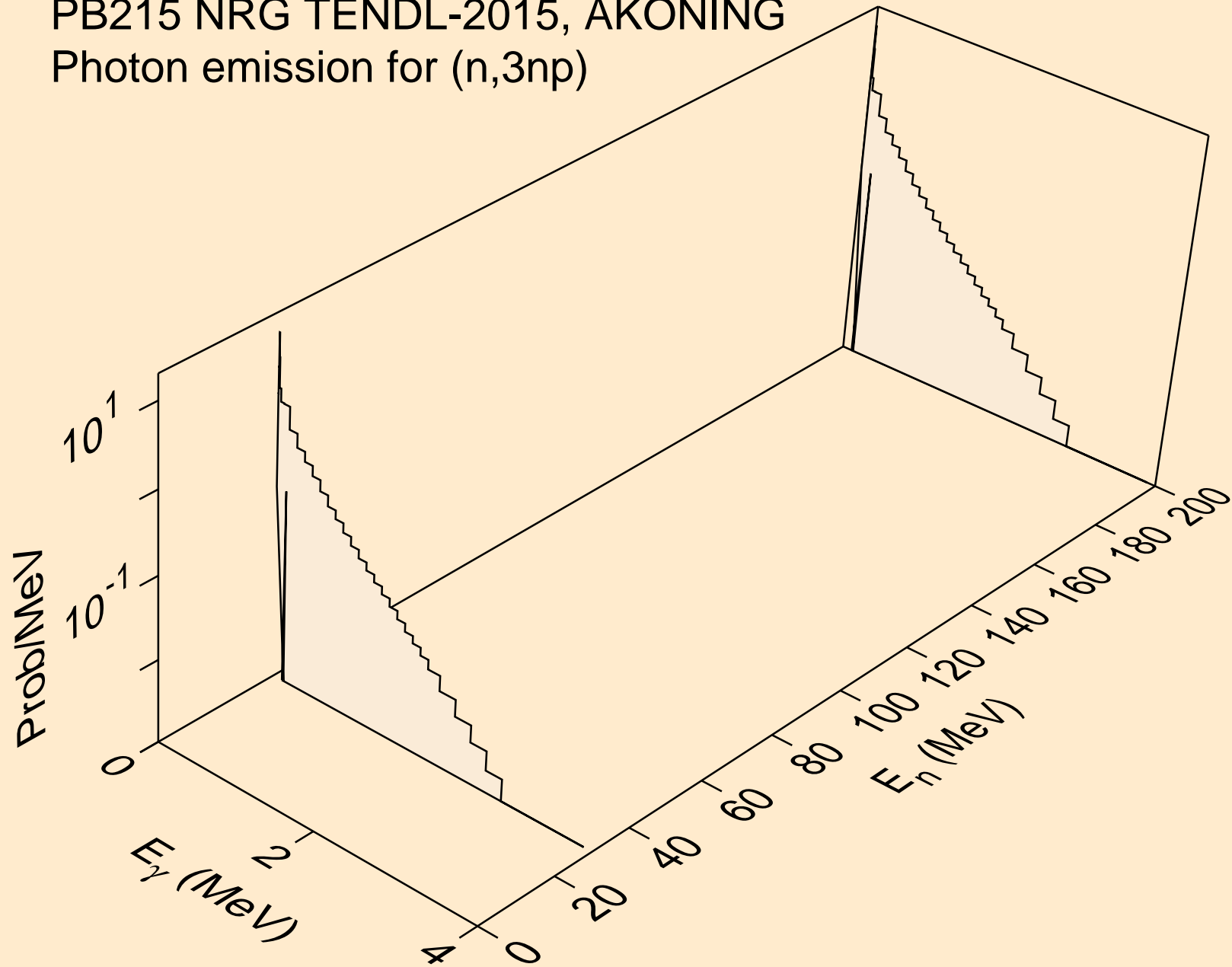

PB215 NRG TENDL-2015, AKONING
Photon emission for (n,n*c)

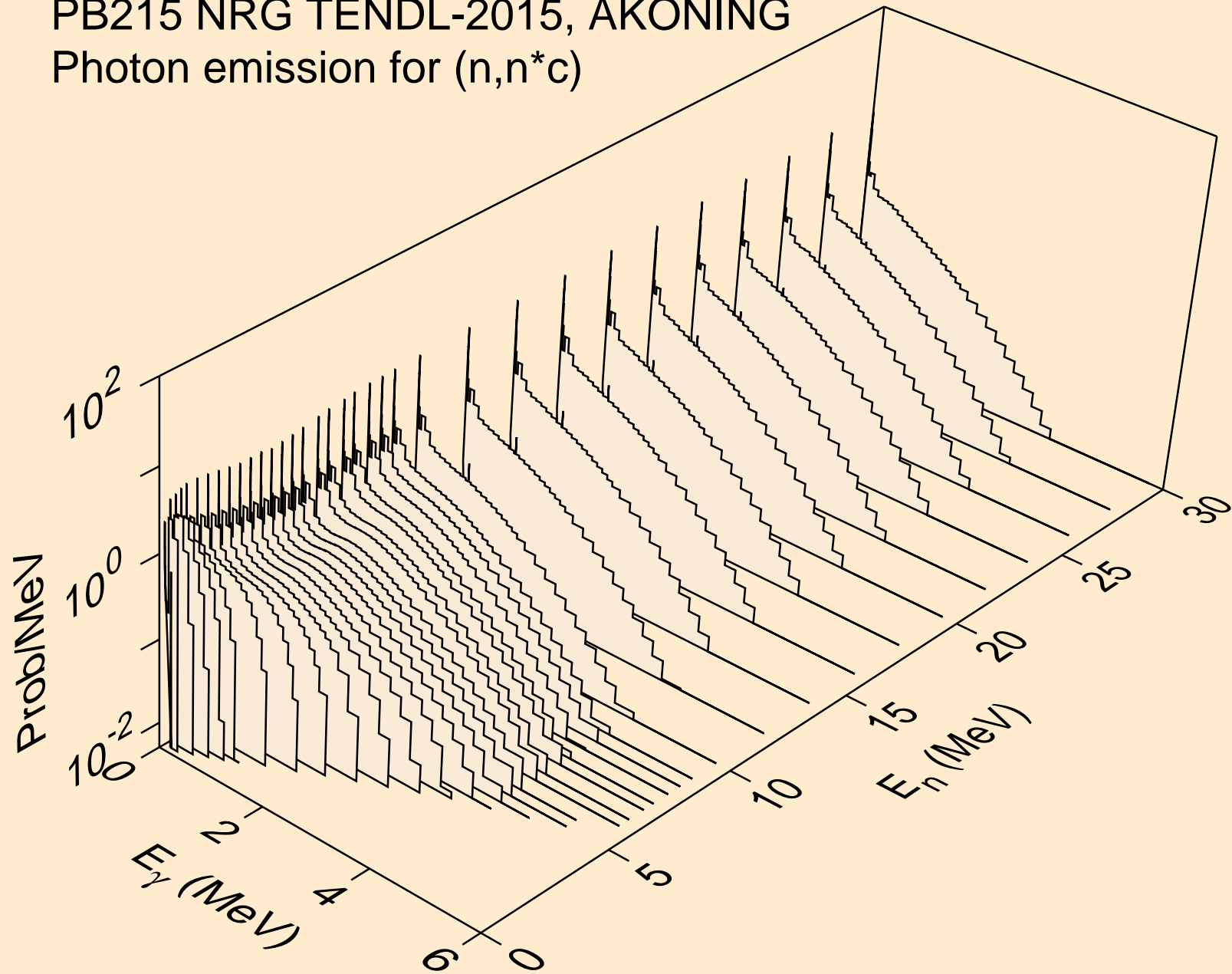

PB215 NRG TENDL-2015, AKONING
Photon emission for (n,gma)

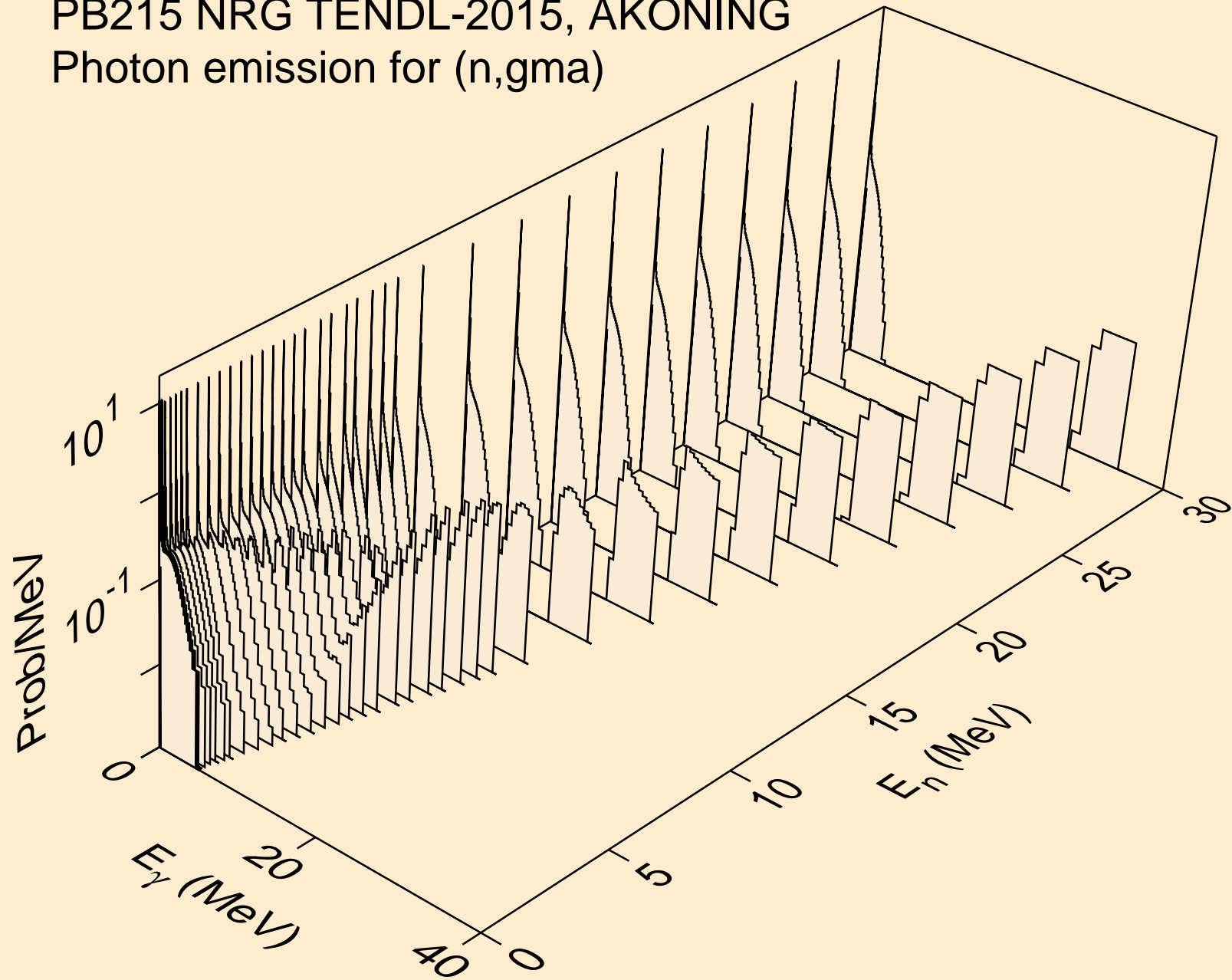

PB215 NRG TENDL-2015, AKONING
Photon emission for (n,p)

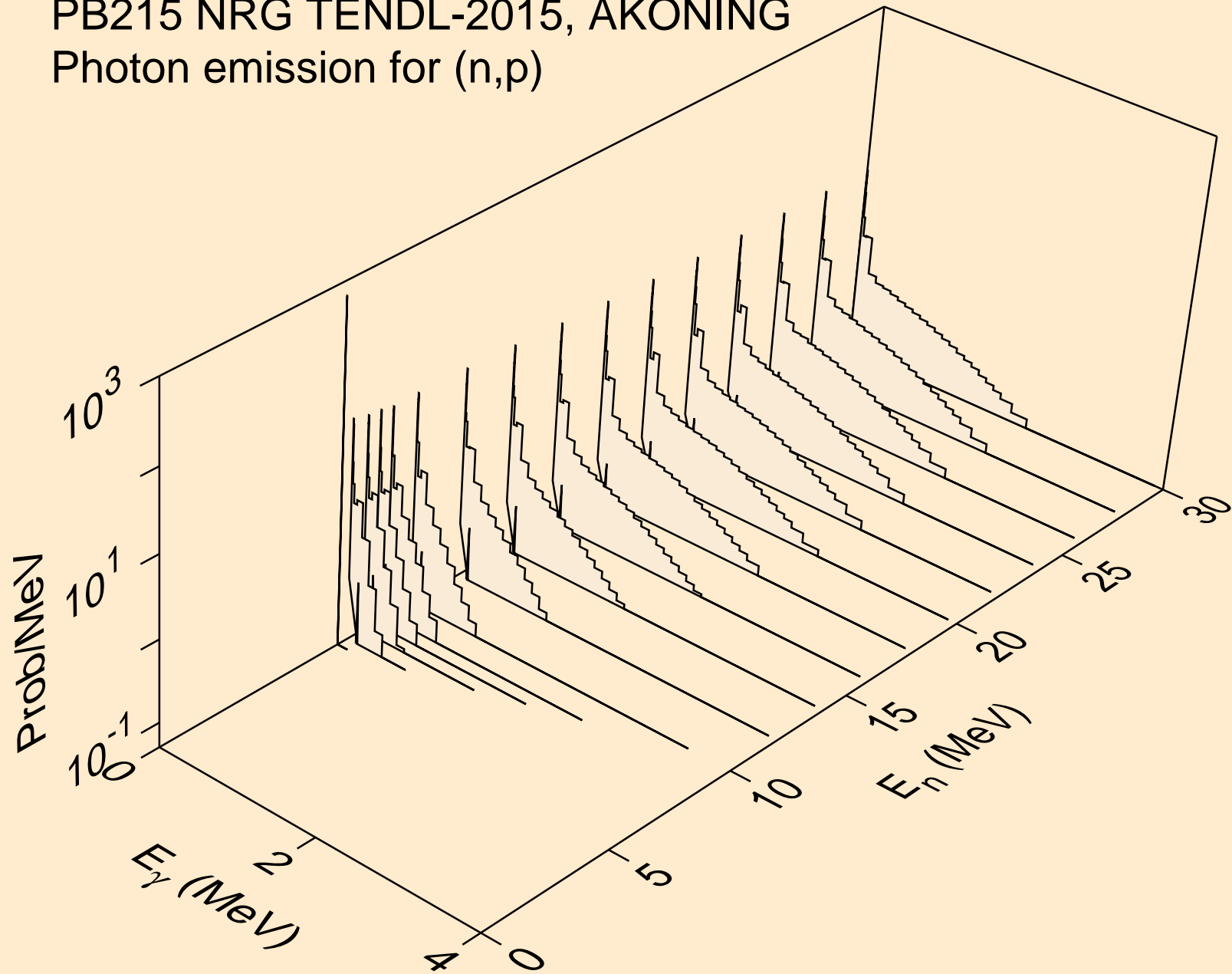

PB215 NRG TENDL-2015, AKONING
Photon emission for (n,d)

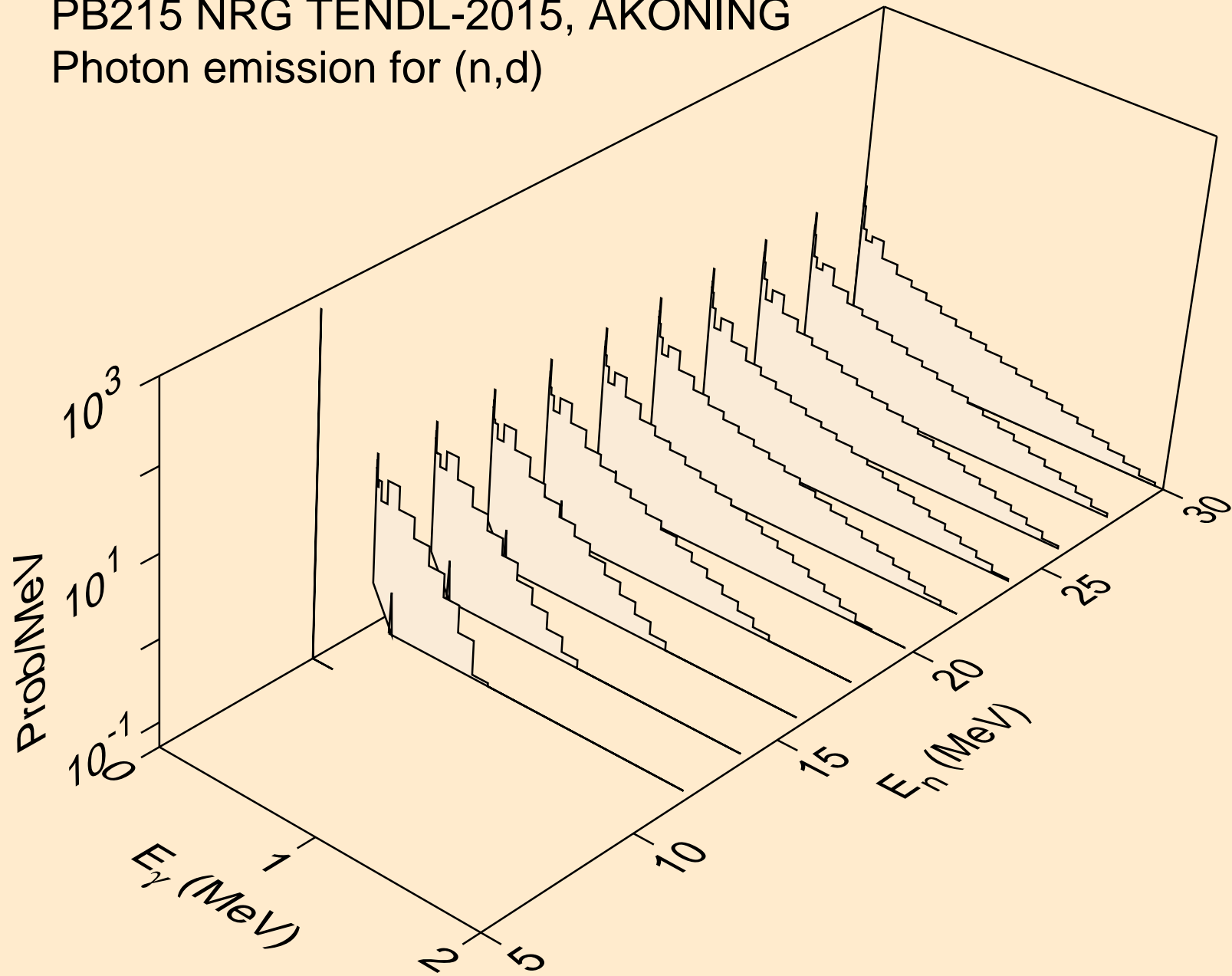

PB215 NRG TENDL-2015, AKONING
Photon emission for (n,t)

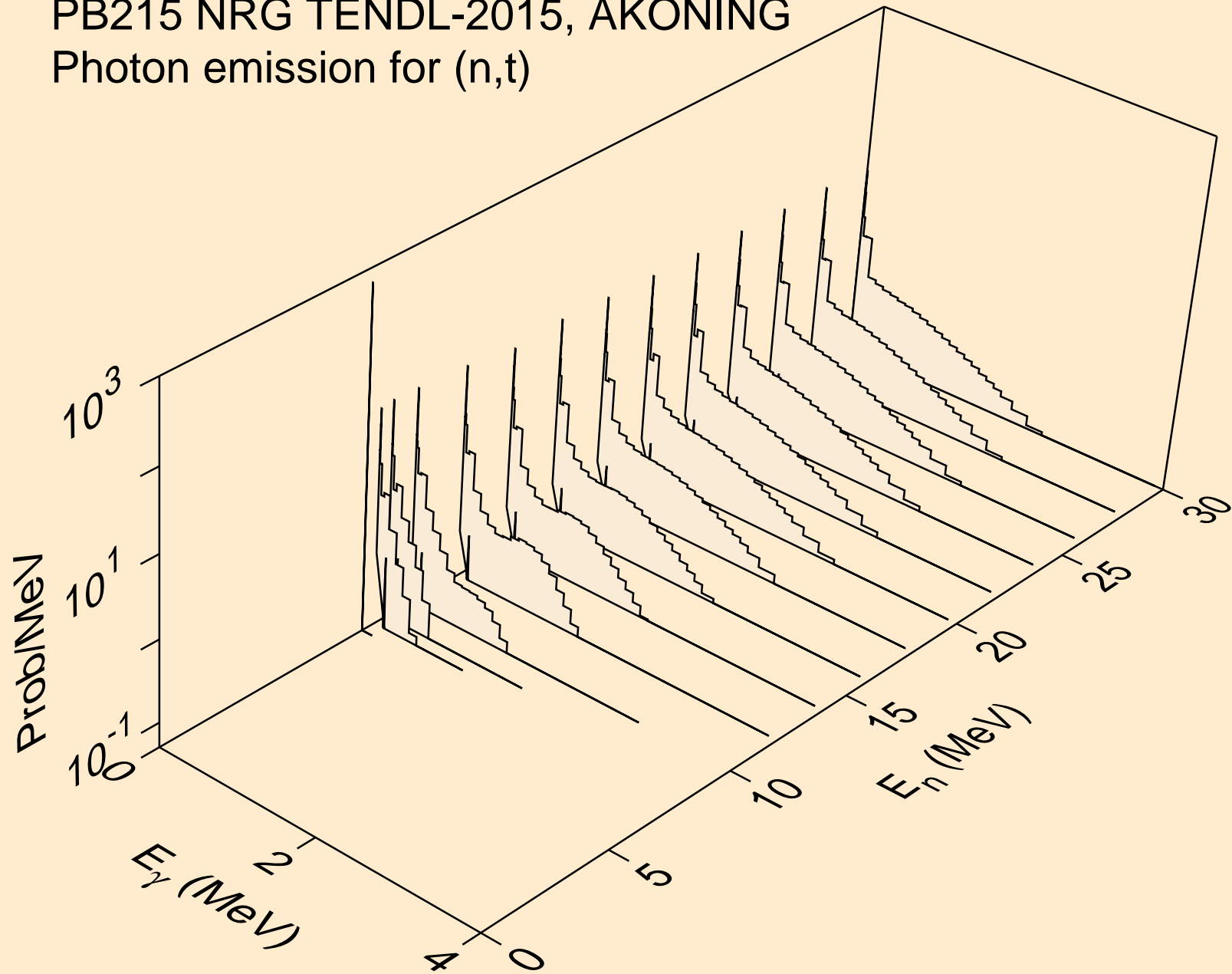

PB215 NRG TENDL-2015, AKONING
Photon emission for (n,he3)

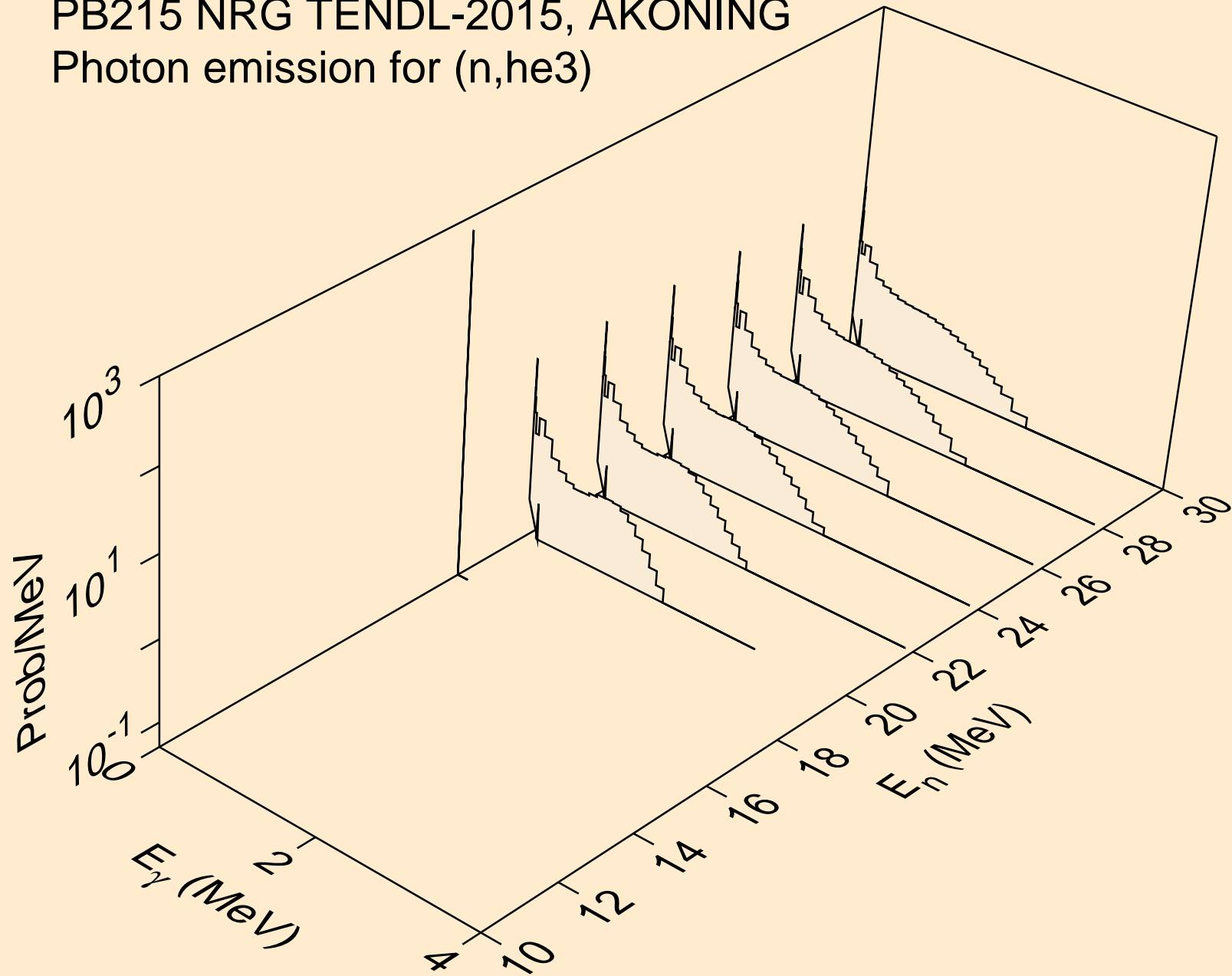

PB215 NRG TENDL-2015, AKONING
Photon emission for (n,a)

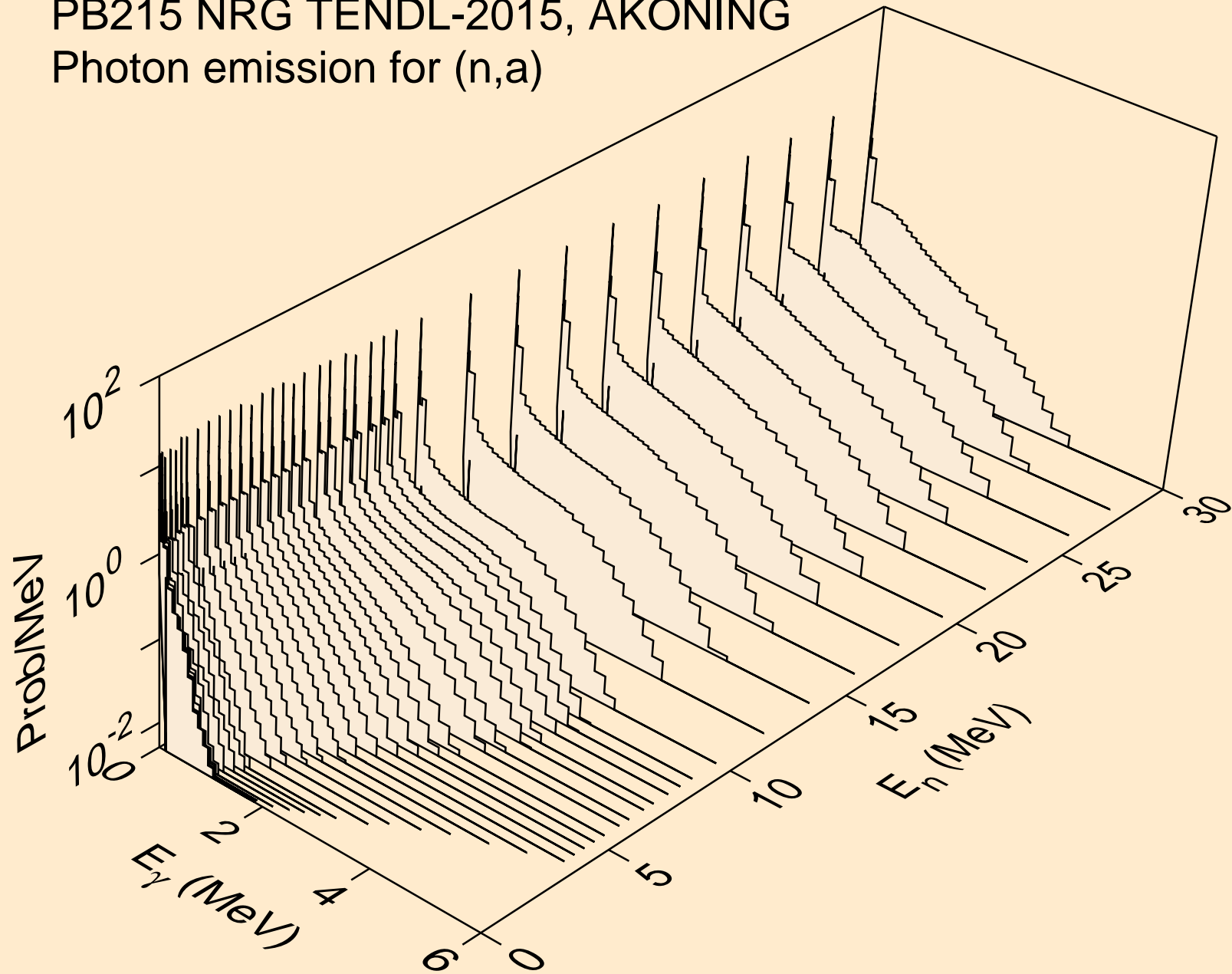

PB215 NRG TENDL-2015, AKONING
Photon emission for (n,2p)

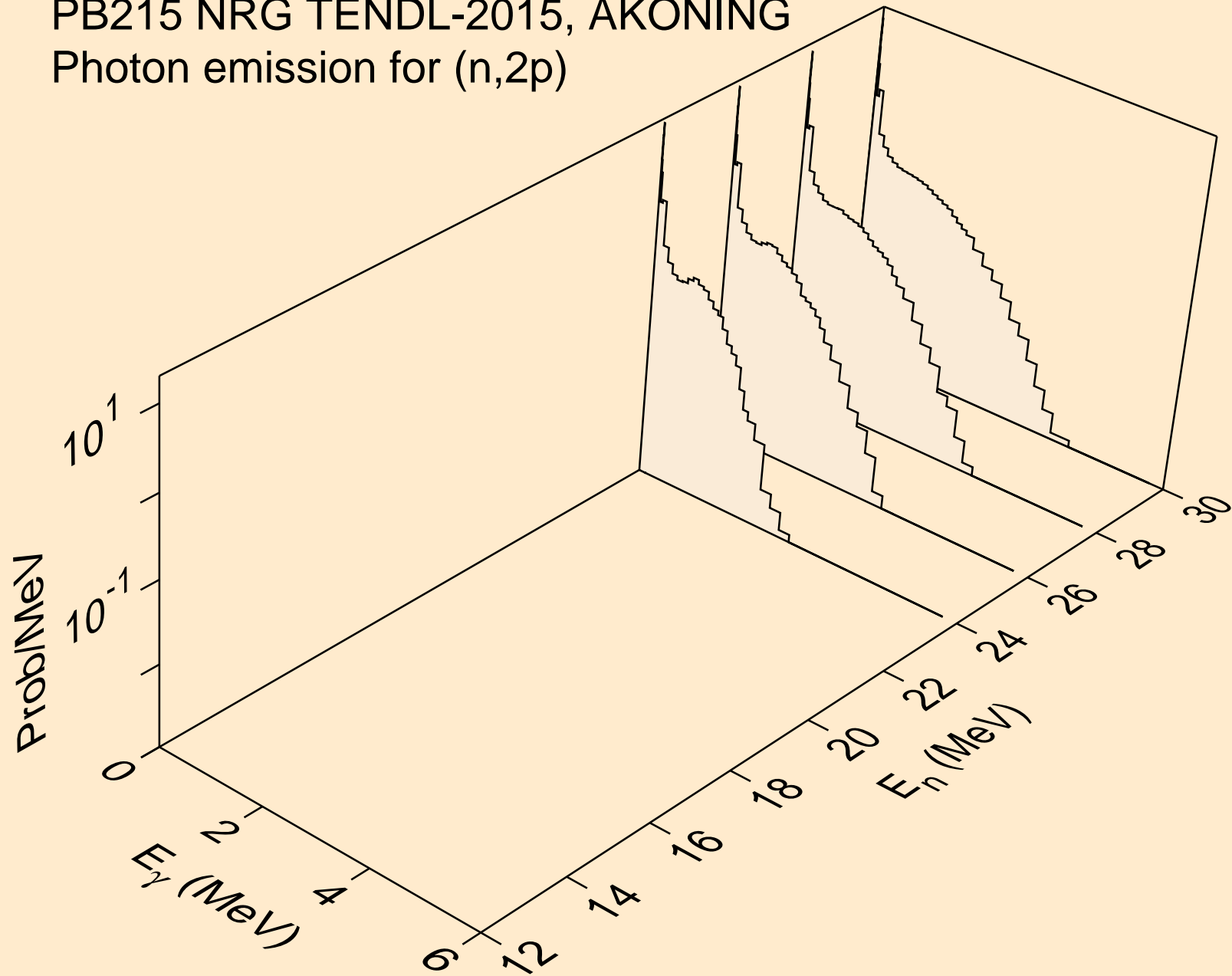

PB215 NRG TENDL-2015, AKONING
thermal capture photon spectrum

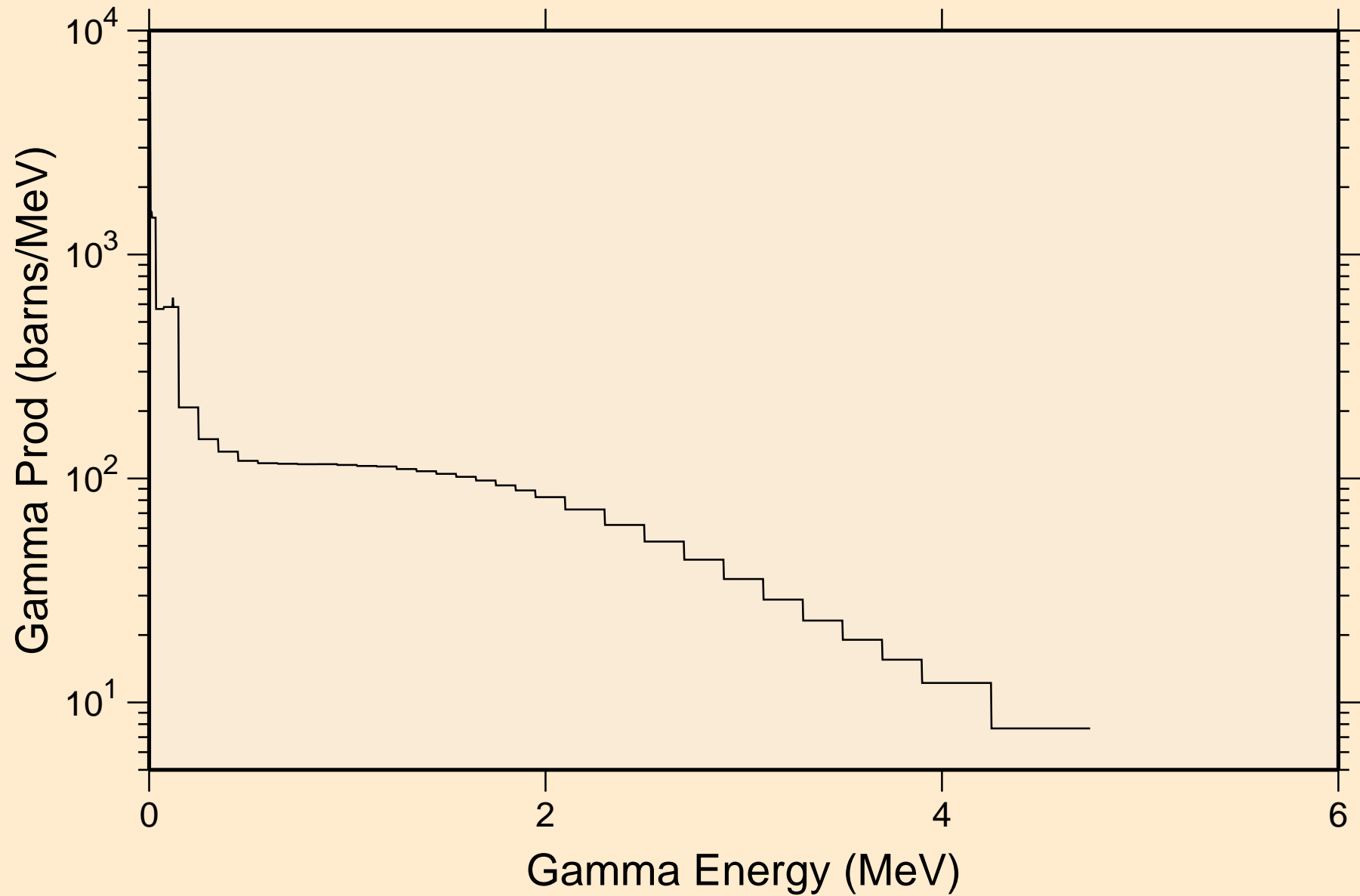

PB215 NRG TENDL-2015, AKONING
14 MeV photon spectrum

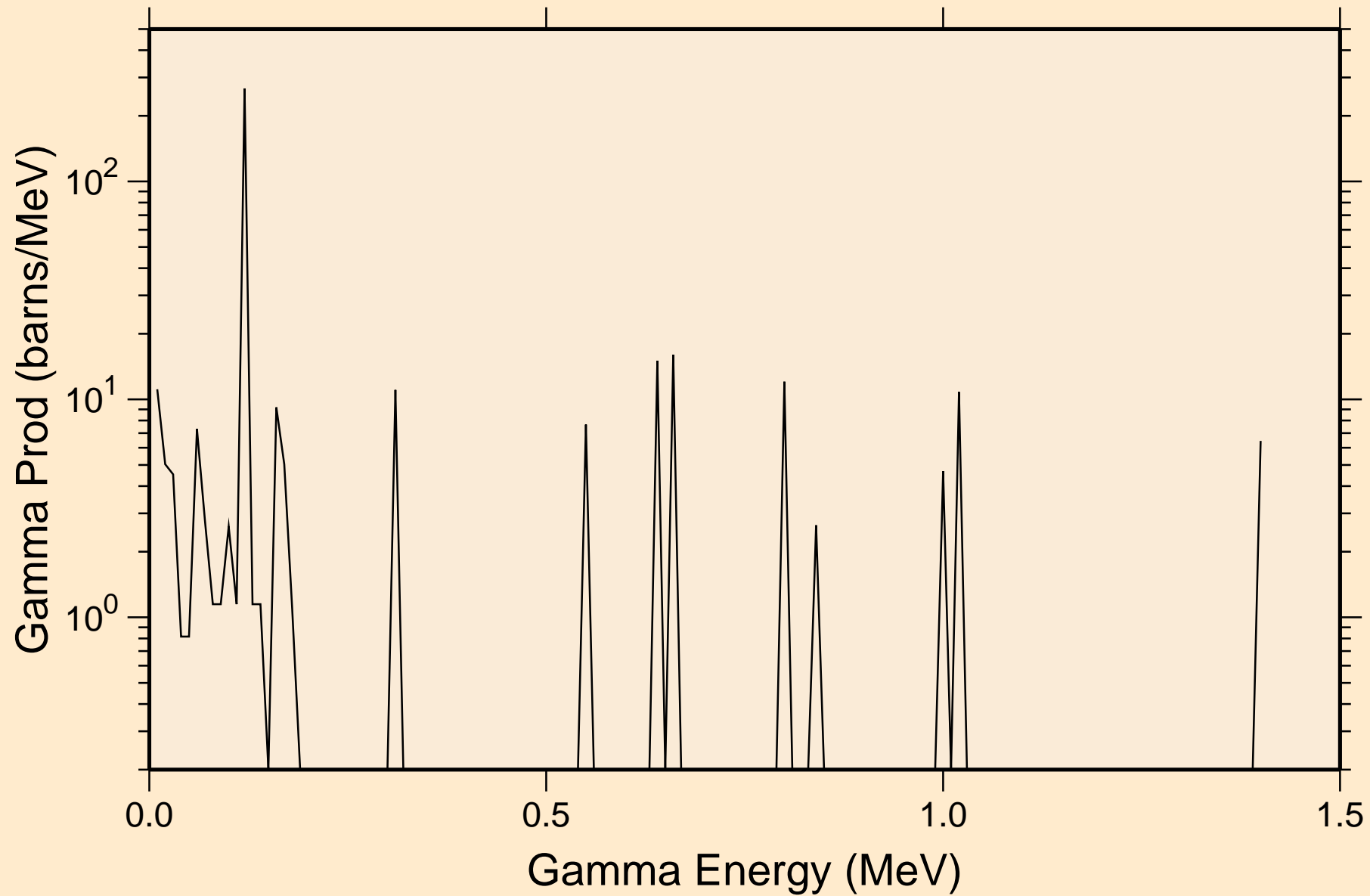

PB215 NRG TENDL-2015, AKONING

Particle heating contributions

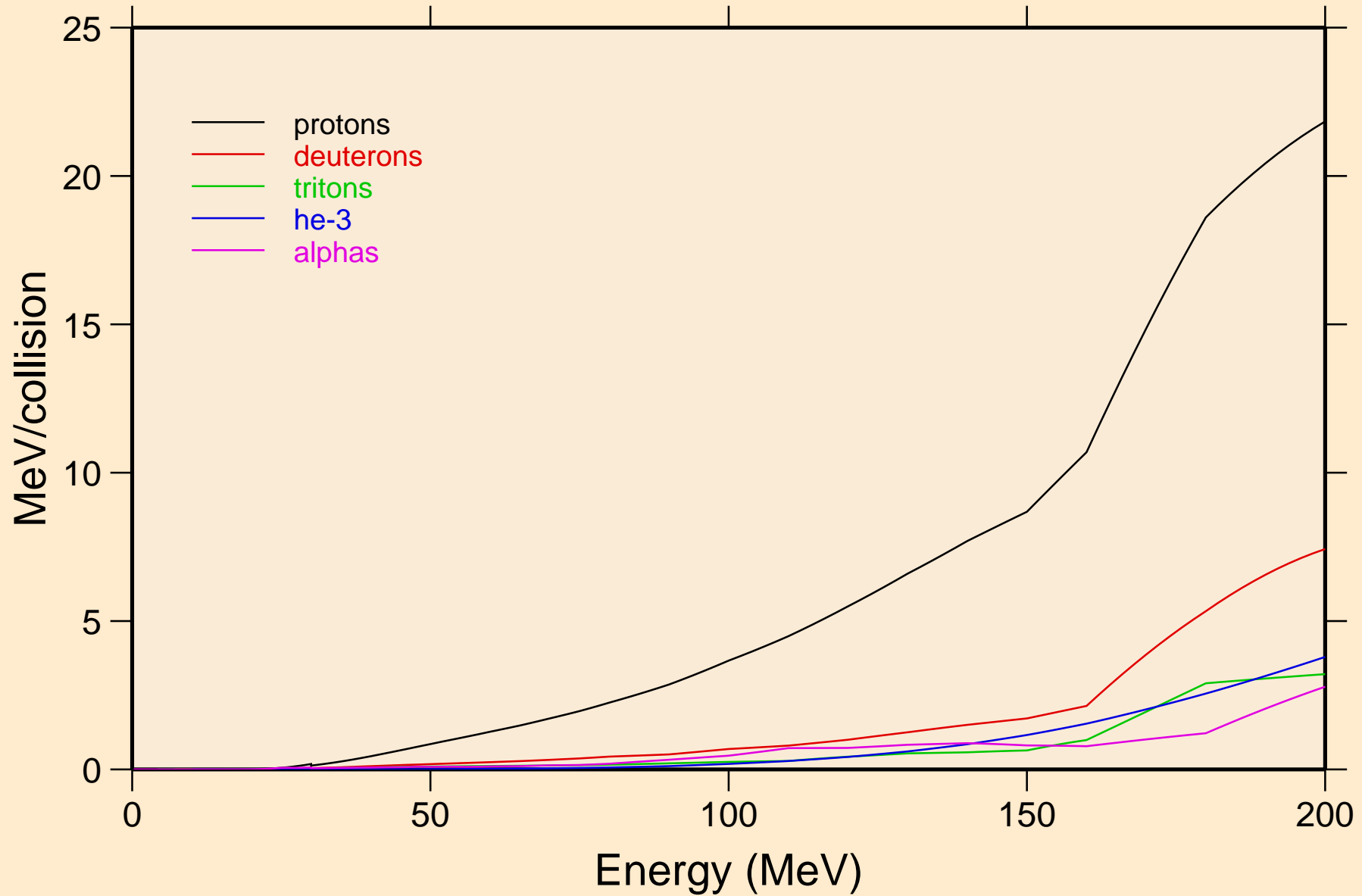

PB215 NRG TENDL-2015, AKONING

Recoil Heating

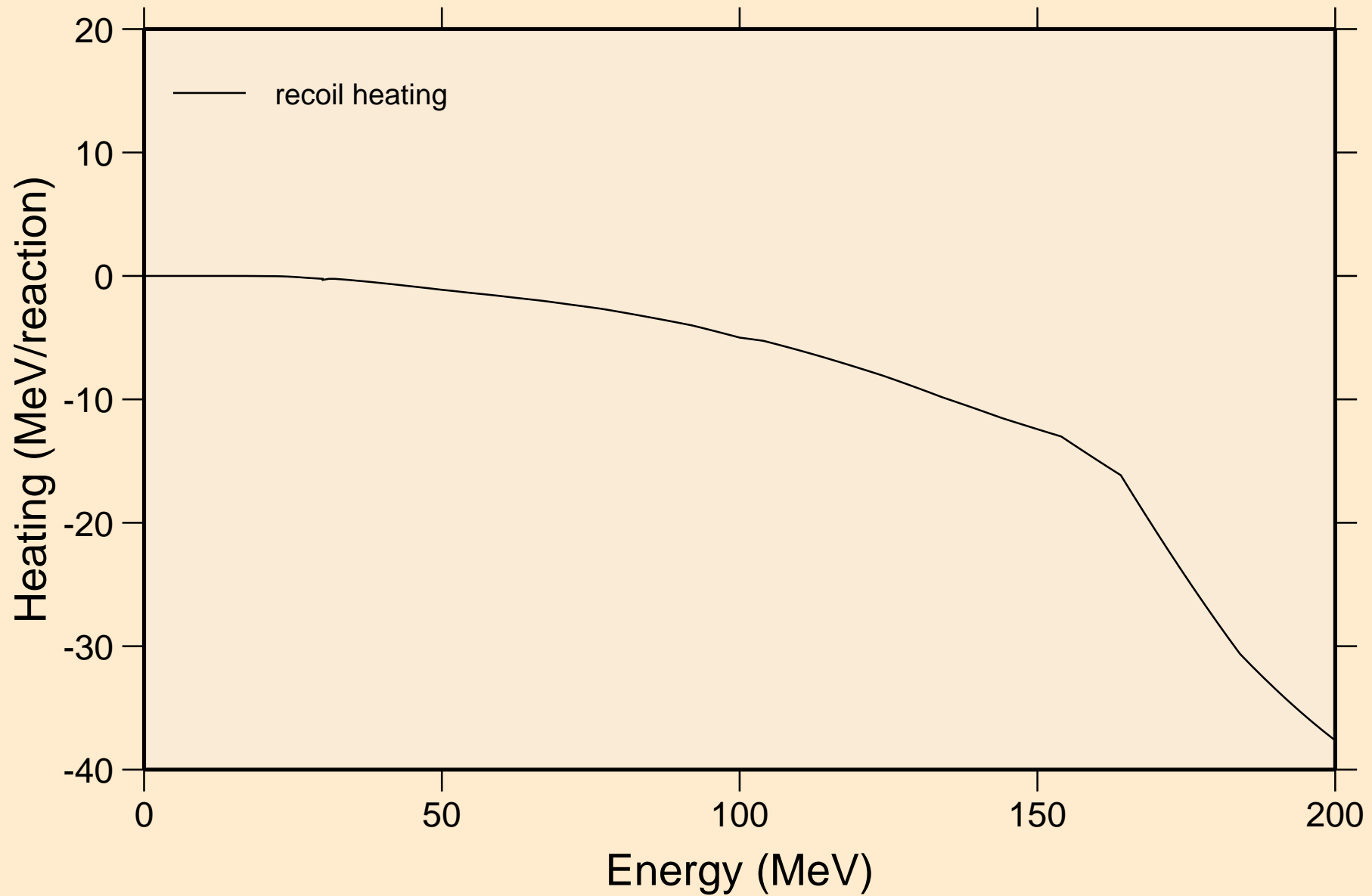

PB215 NRG TENDL-2015, AKONING

Particle production cross sections

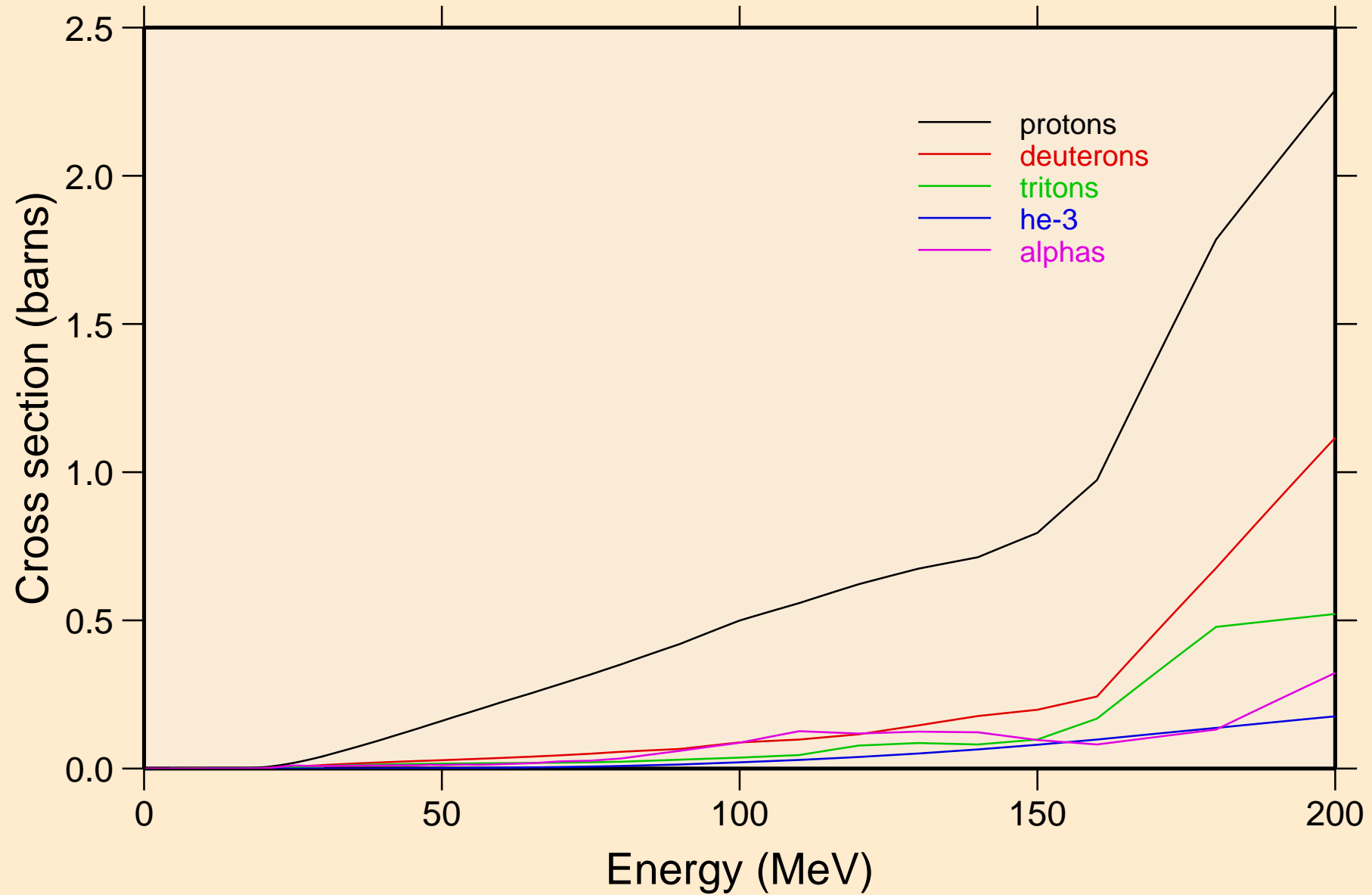

PB215 NRG TENDL-2015, AKONING
protons from (n,x)

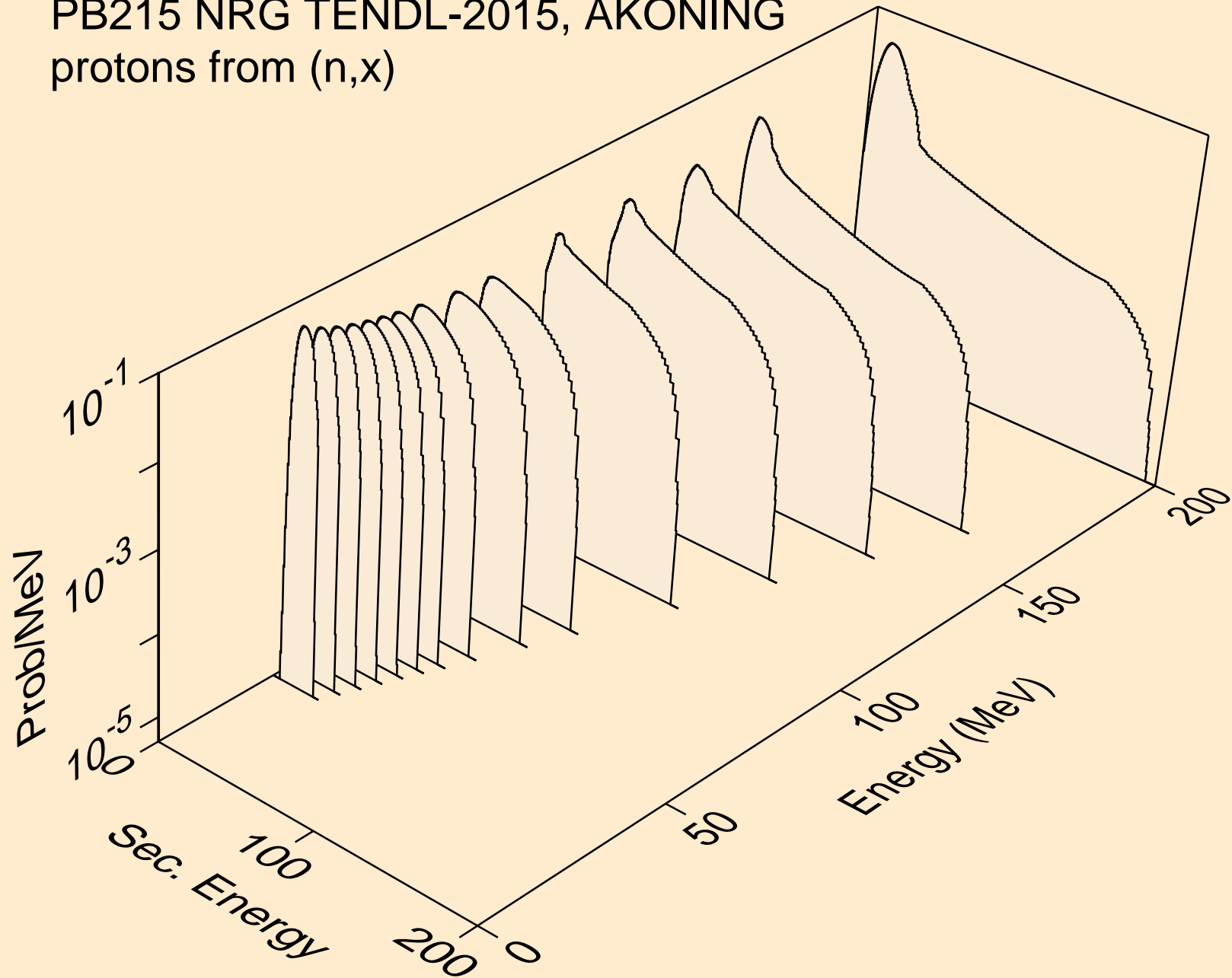

PB215 NRG TENDL-2015, AKONING
protons from (n,n*)p

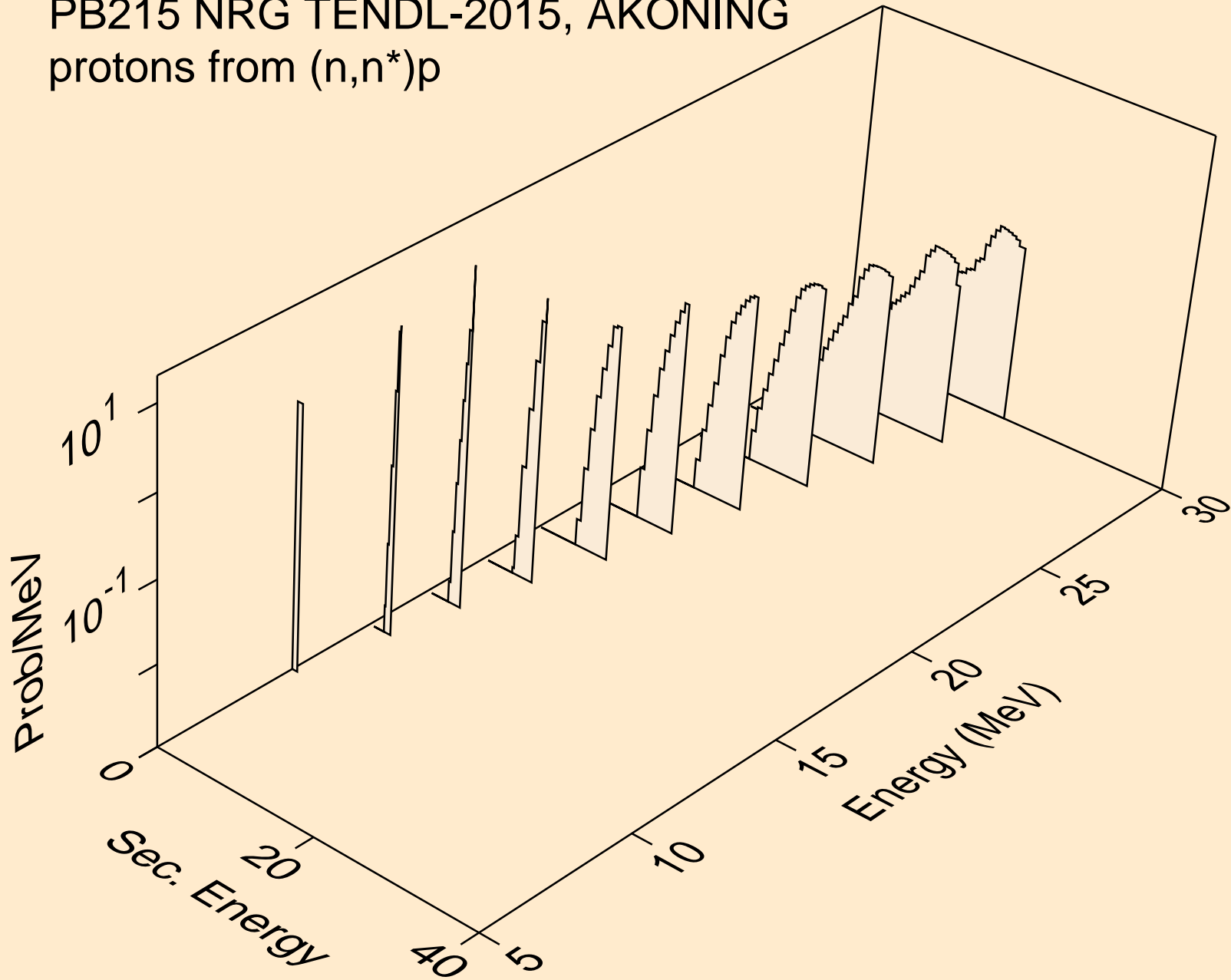

PB215 NRG TENDL-2015, AKONING
protons from (n,2np)

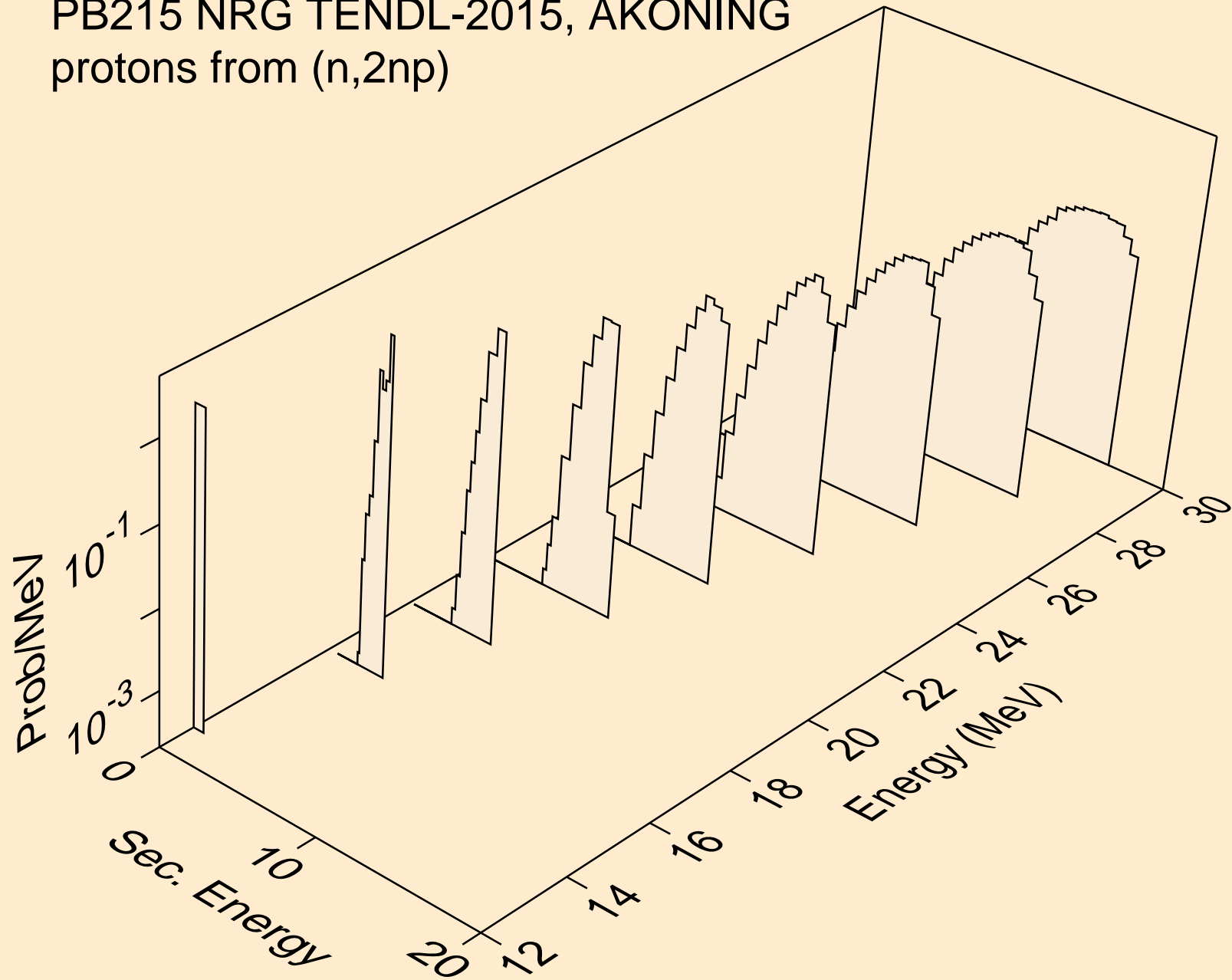

PB215 NRG TENDL-2015, AKONING
protons from (n,3np)

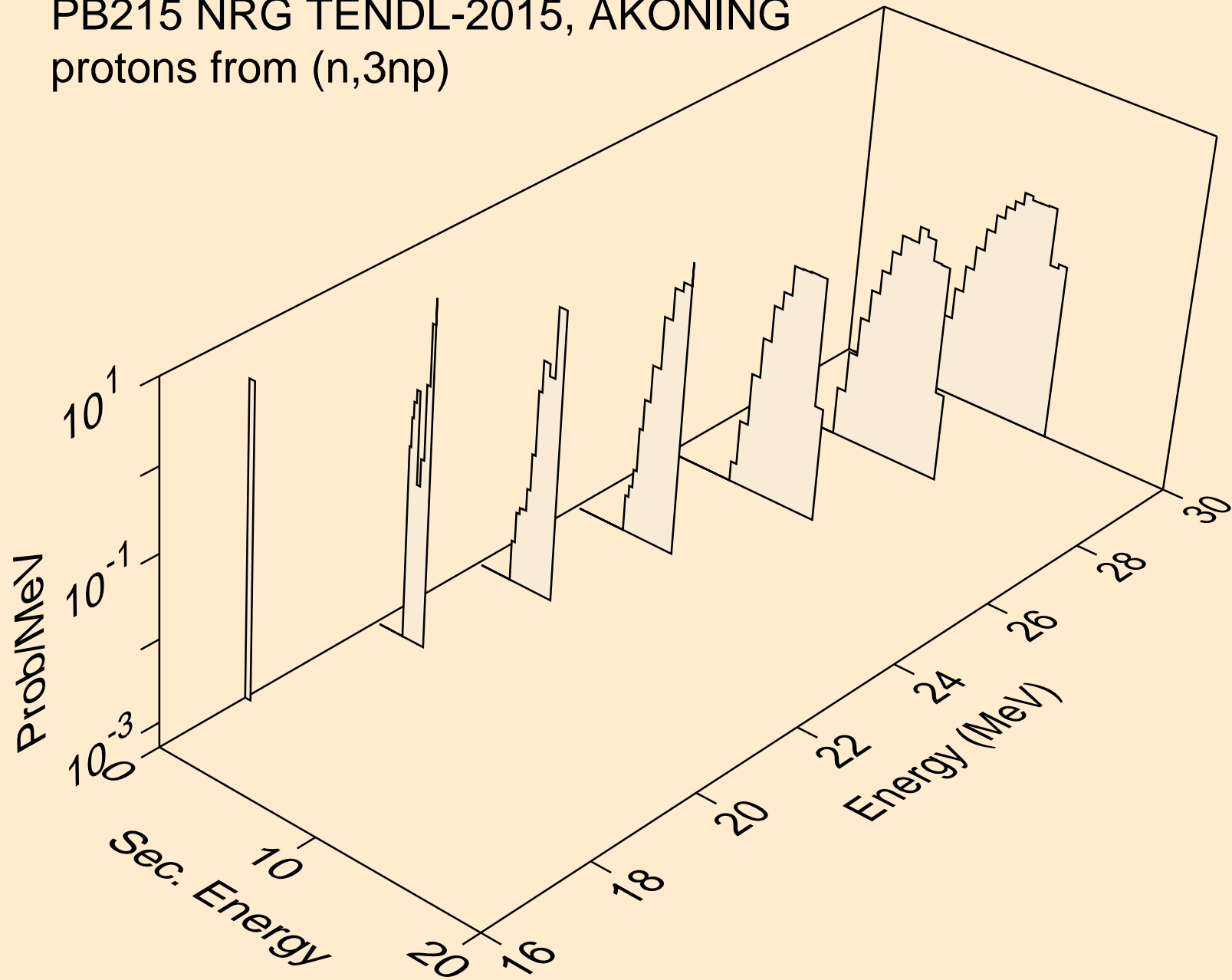

PB215 NRG TENDL-2015, AKONING
protons from (n,p)

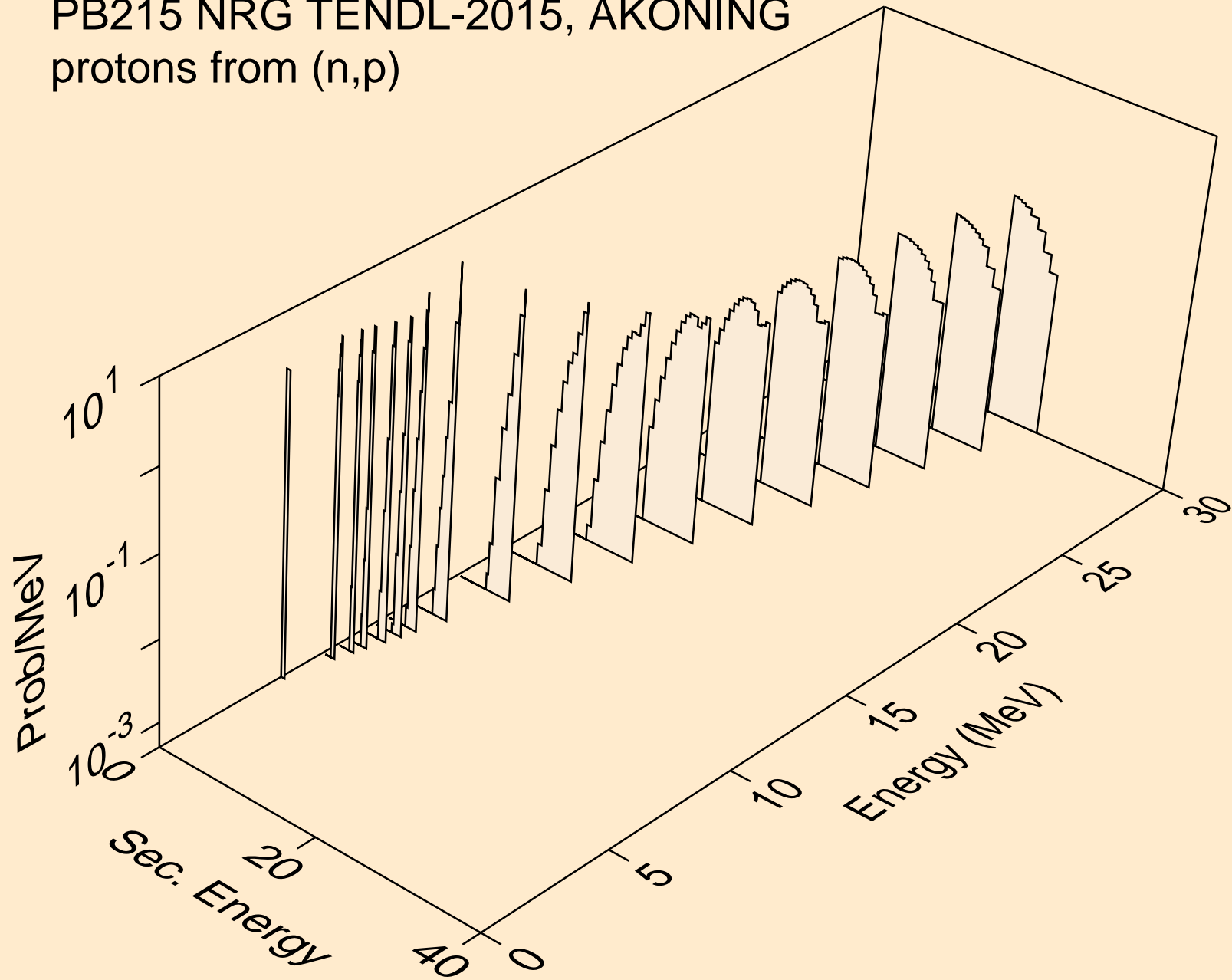

PB215 NRG TENDL-2015, AKONING
protons from (n,2p)

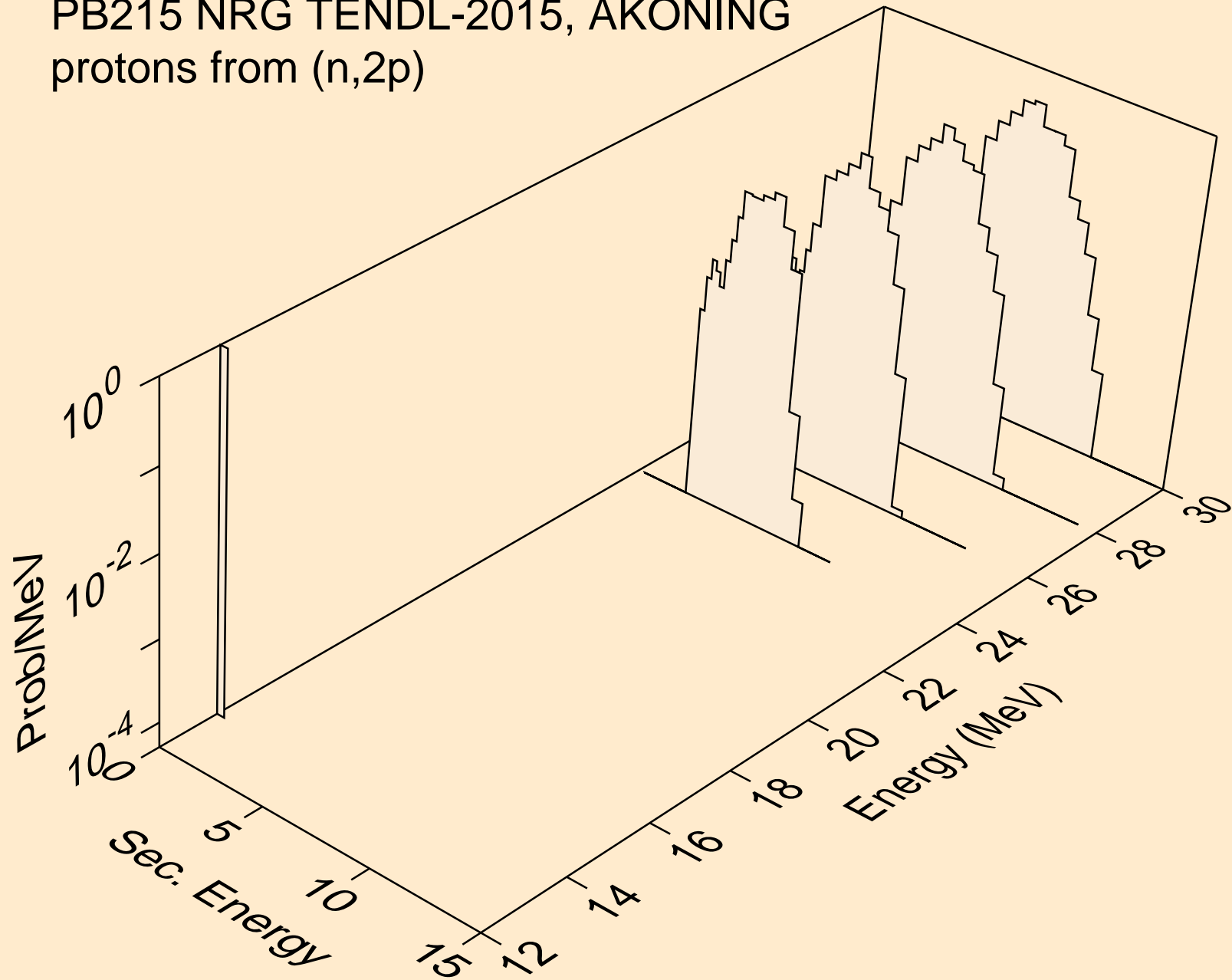

PB215 NRG TENDL-2015, AKONING
deuterons from (n,x)

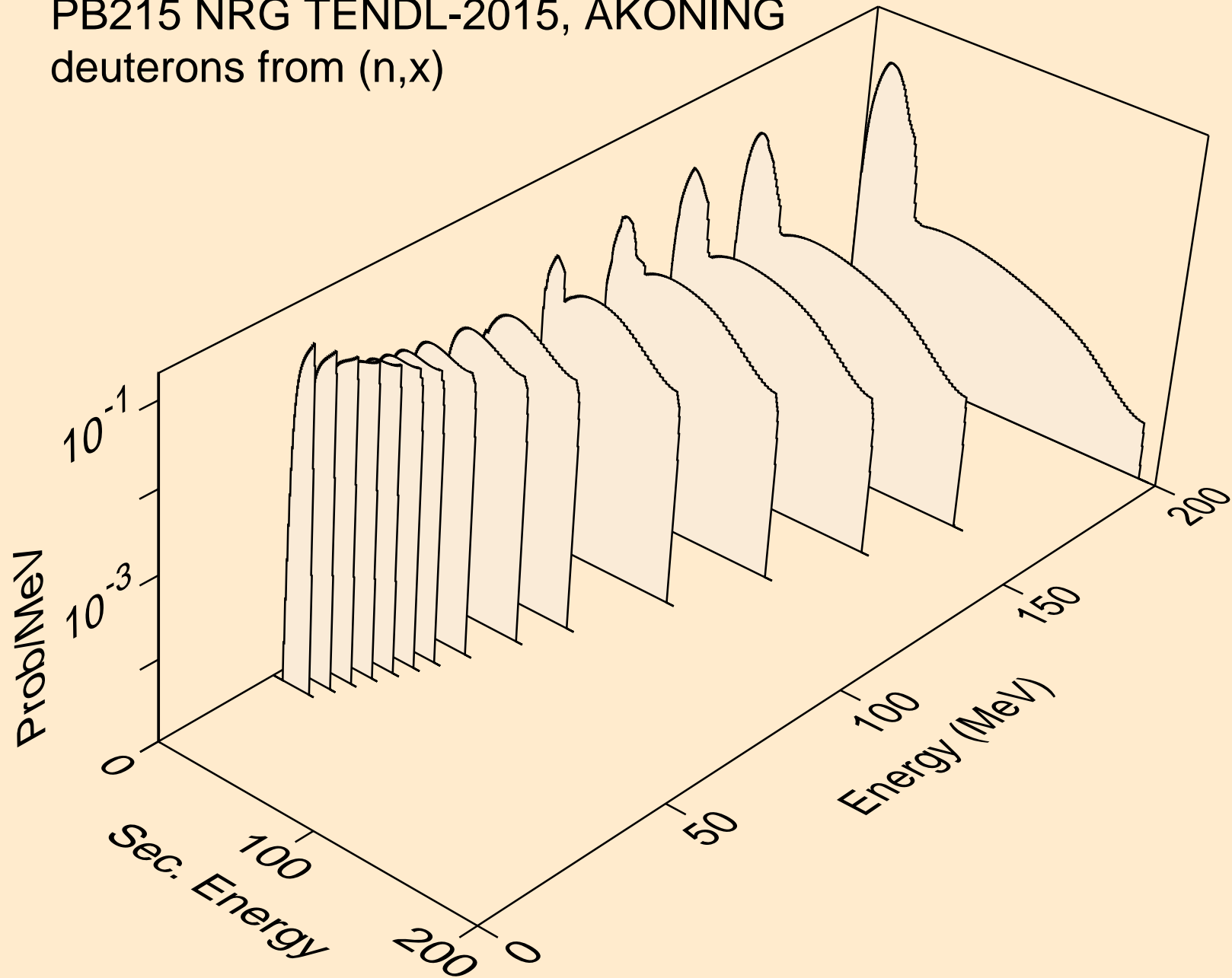

PB215 NRG TENDL-2015, AKONING
deuterons from (n,2nd)

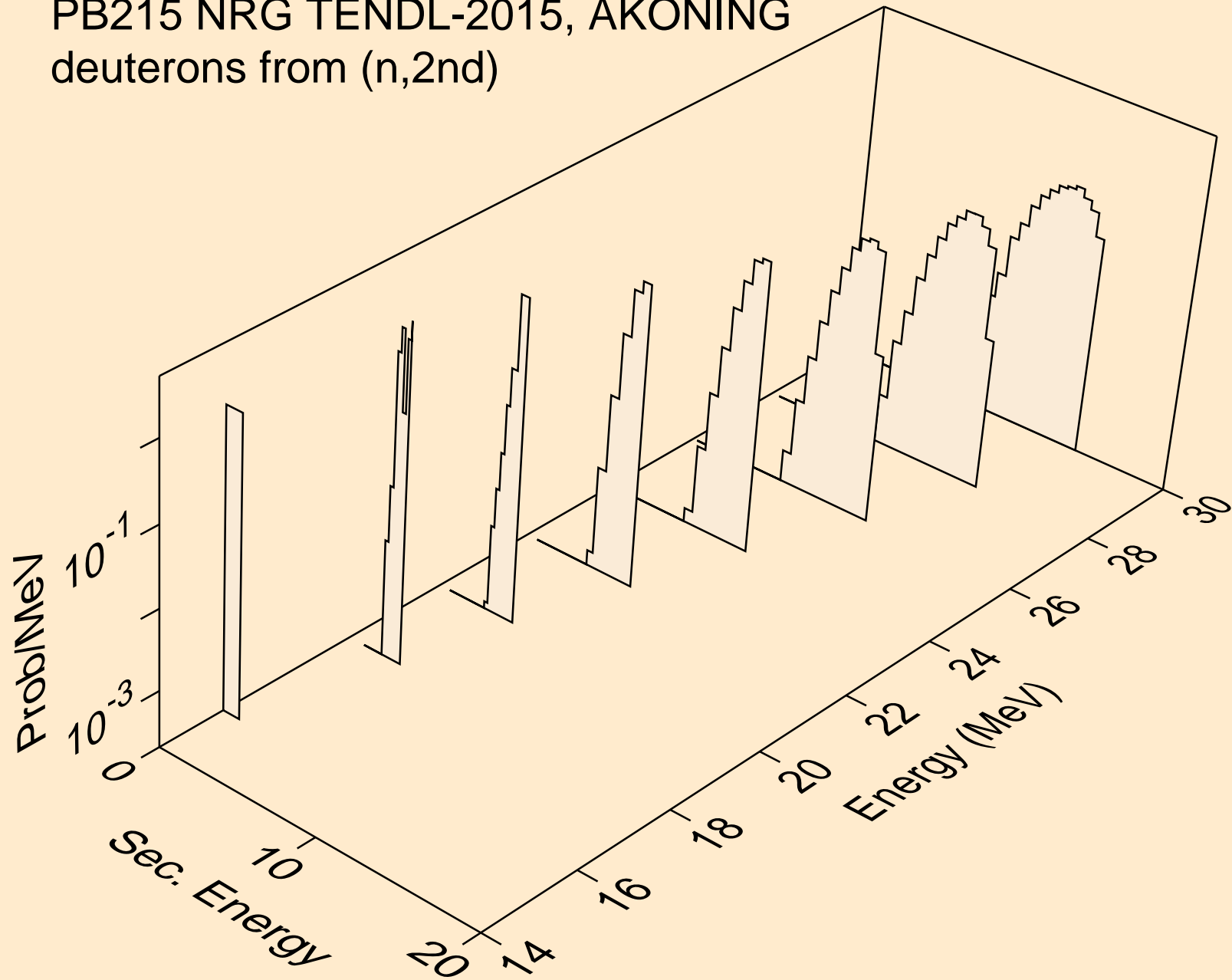

PB215 NRG TENDL-2015, AKONING
deuterons from (n,n*)d

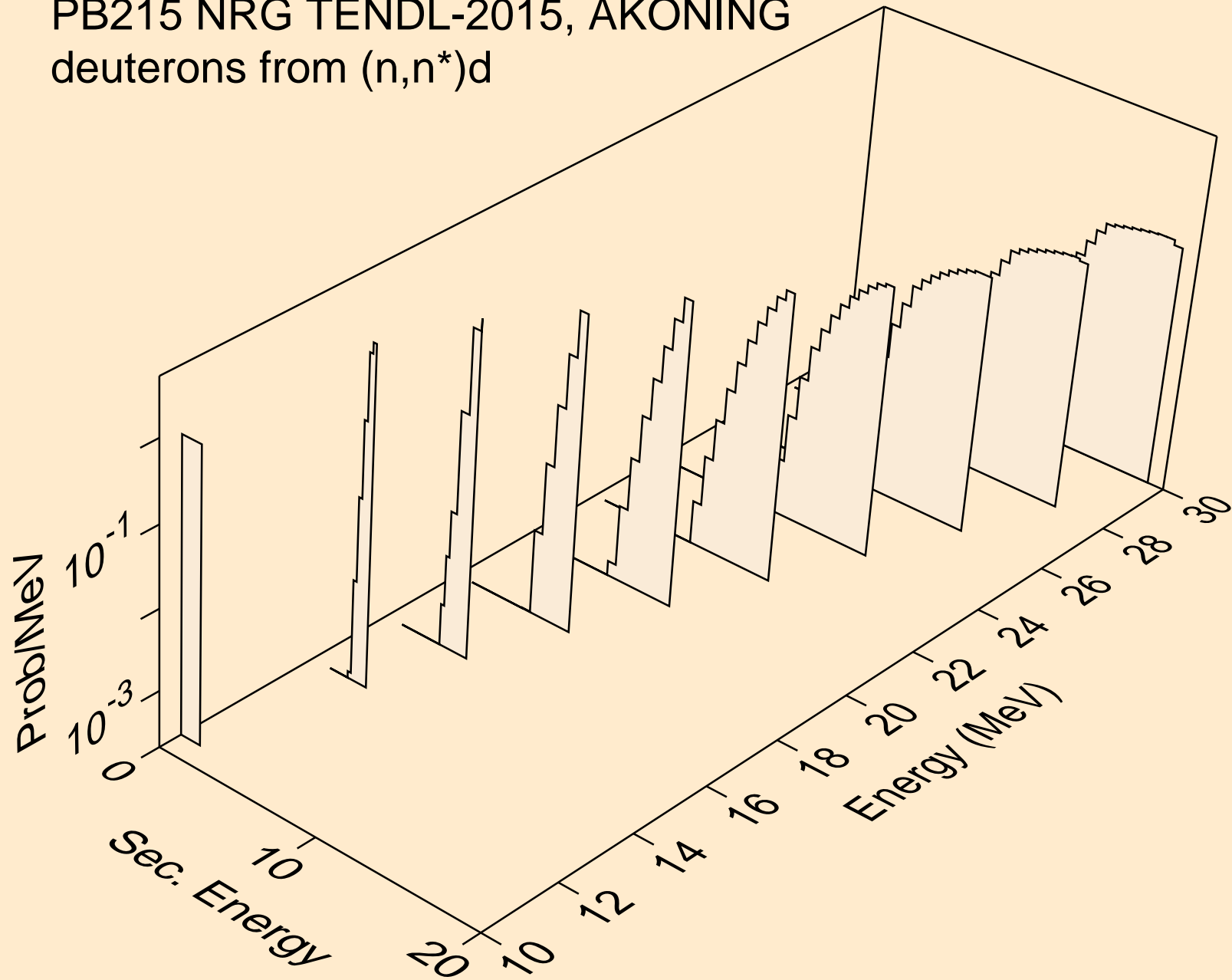

PB215 NRG TENDL-2015, AKONING
deuterons from (n,d)

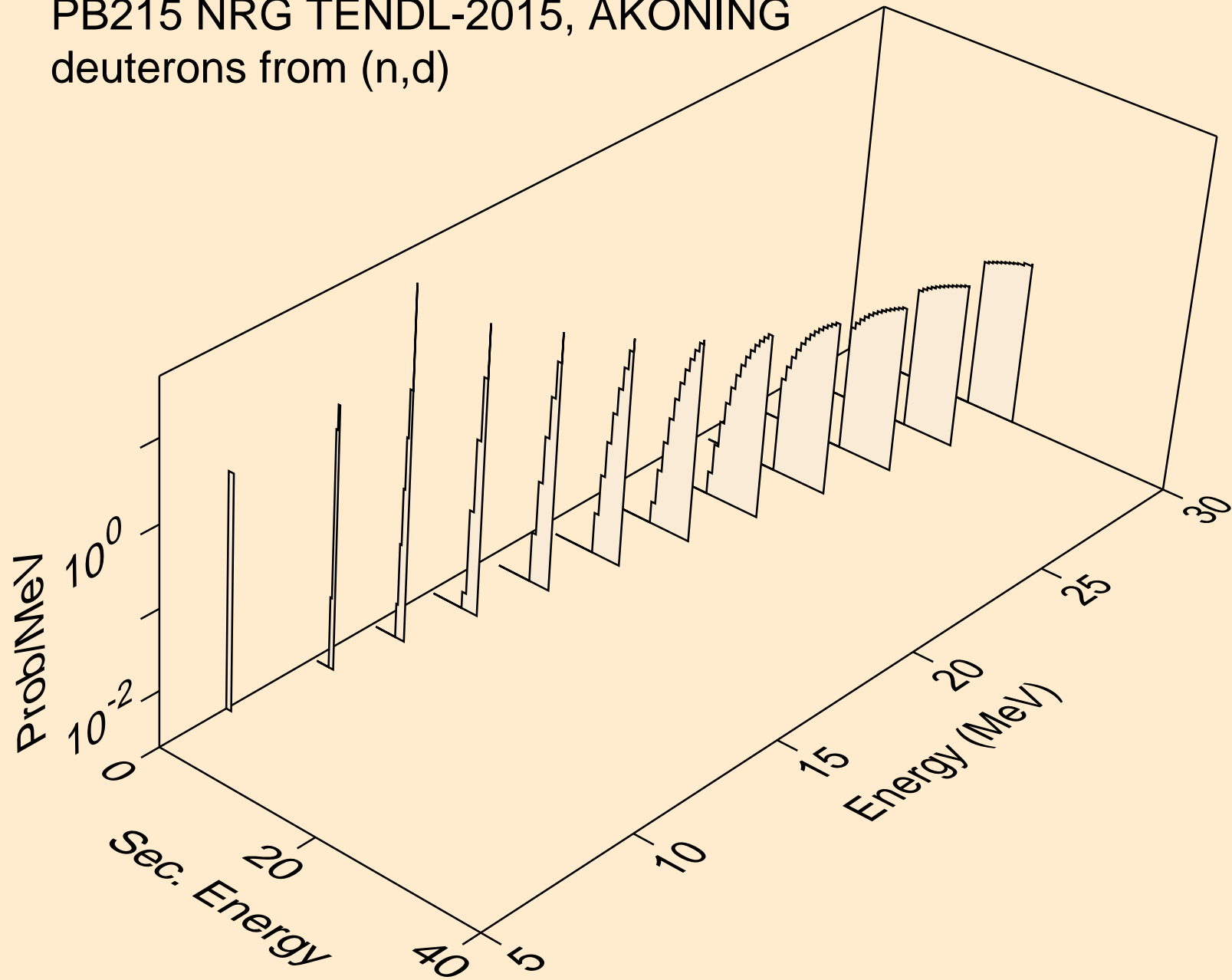

PB215 NRG TENDL-2015, AKONING
tritons from (n,x)

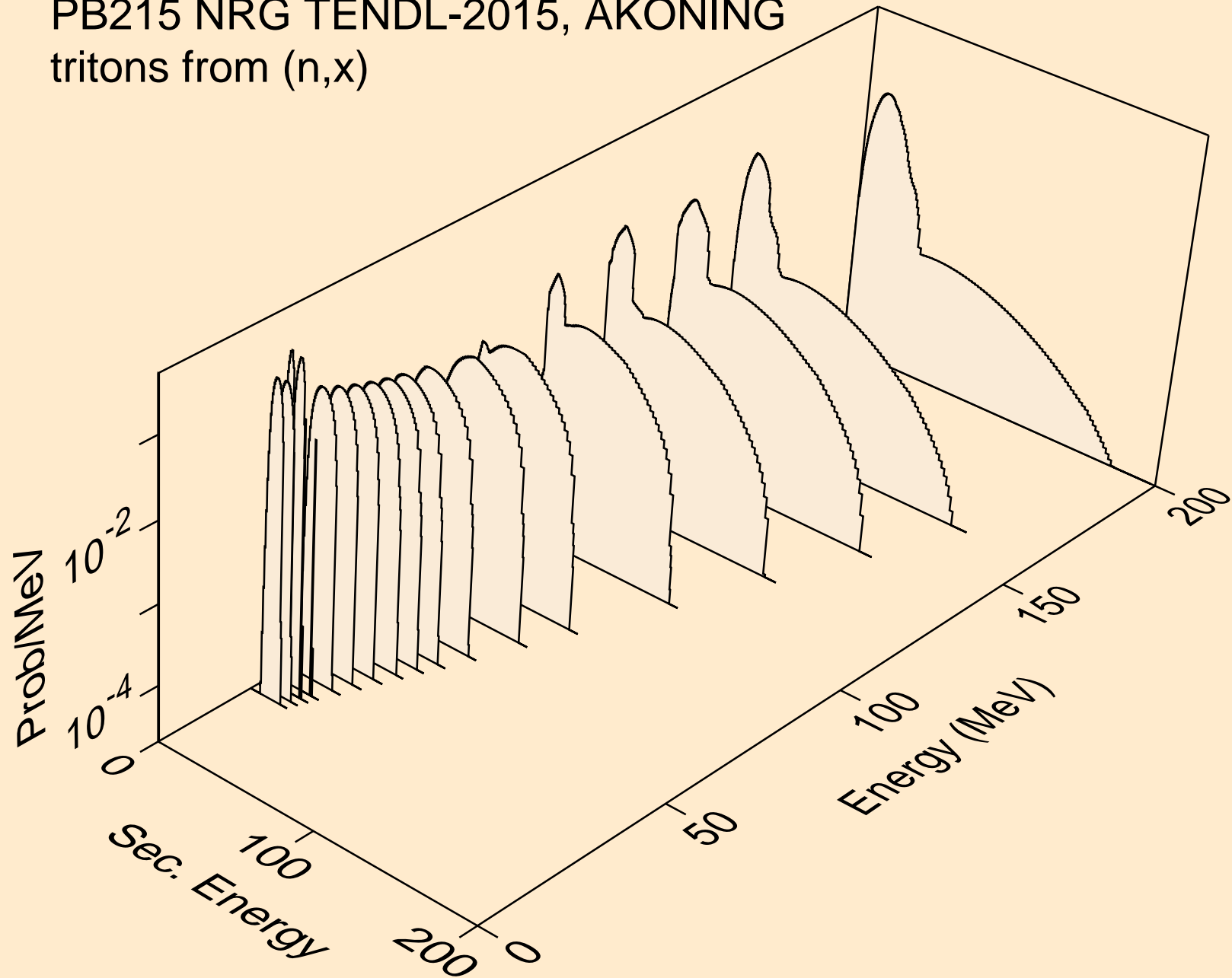

PB215 NRG TENDL-2015, AKONING
tritons from (n,n*)t

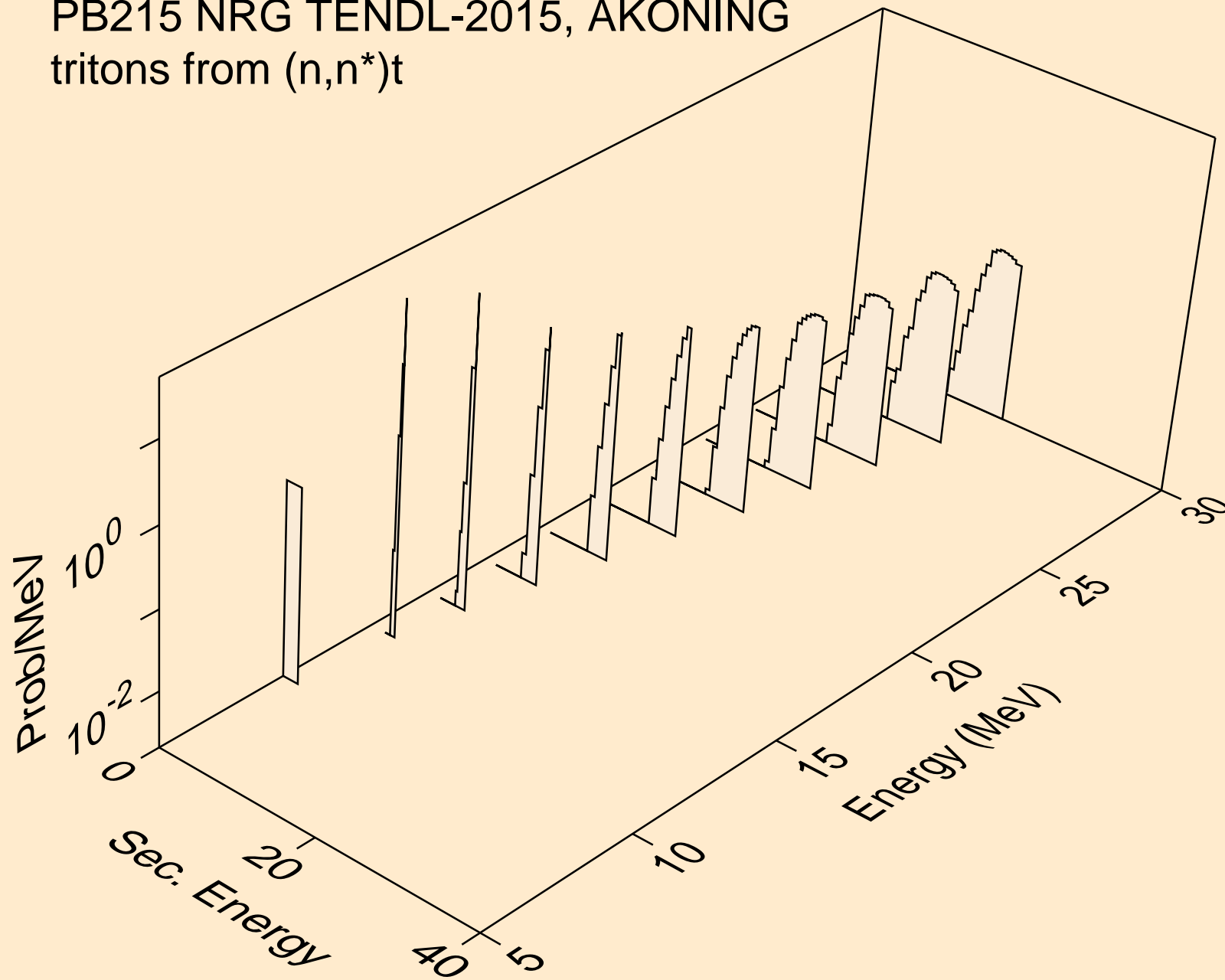

PB215 NRG TENDL-2015, AKONING
tritons from (n,t)

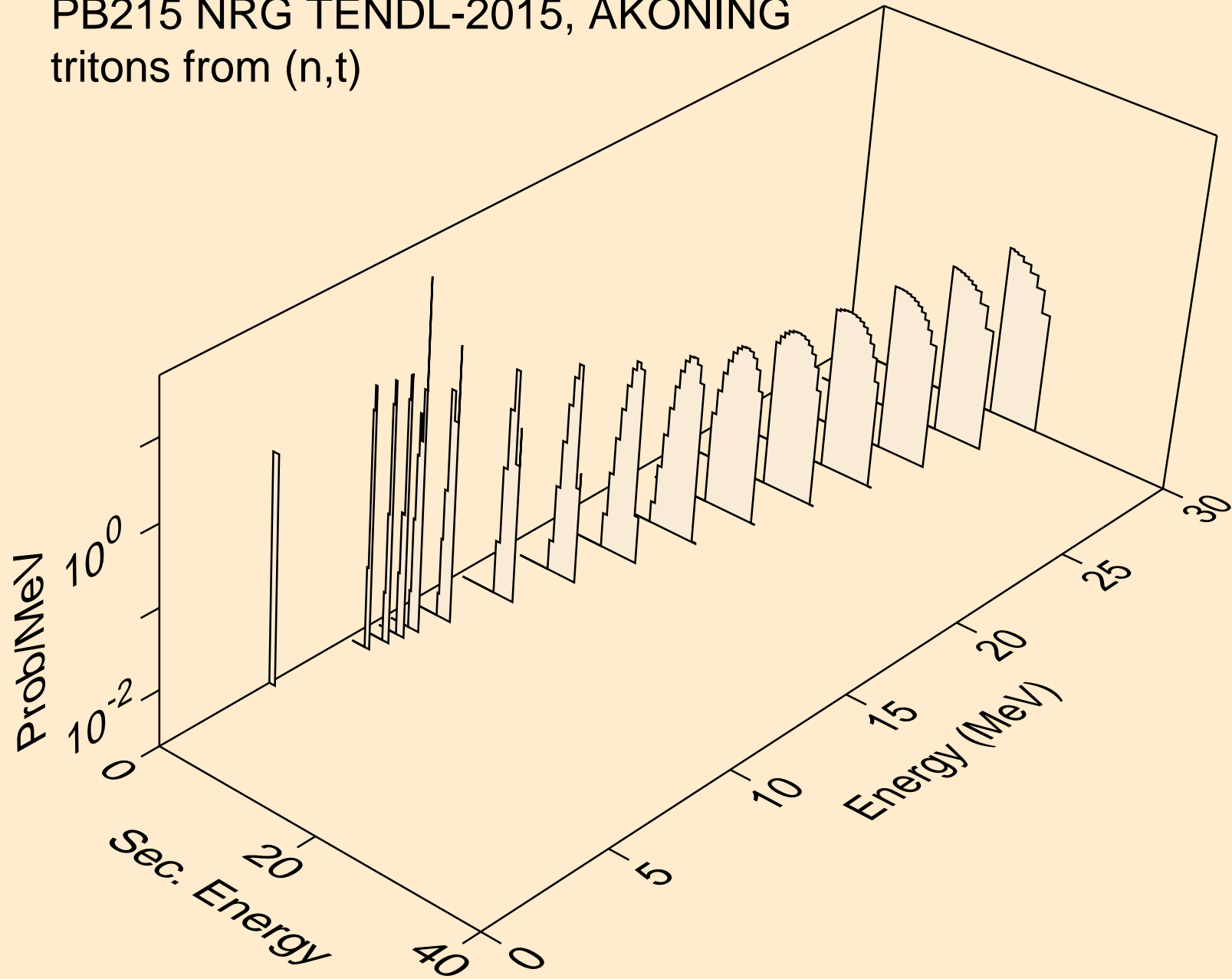

PB215 NRG TENDL-2015, AKONING
he3s from (n,x)

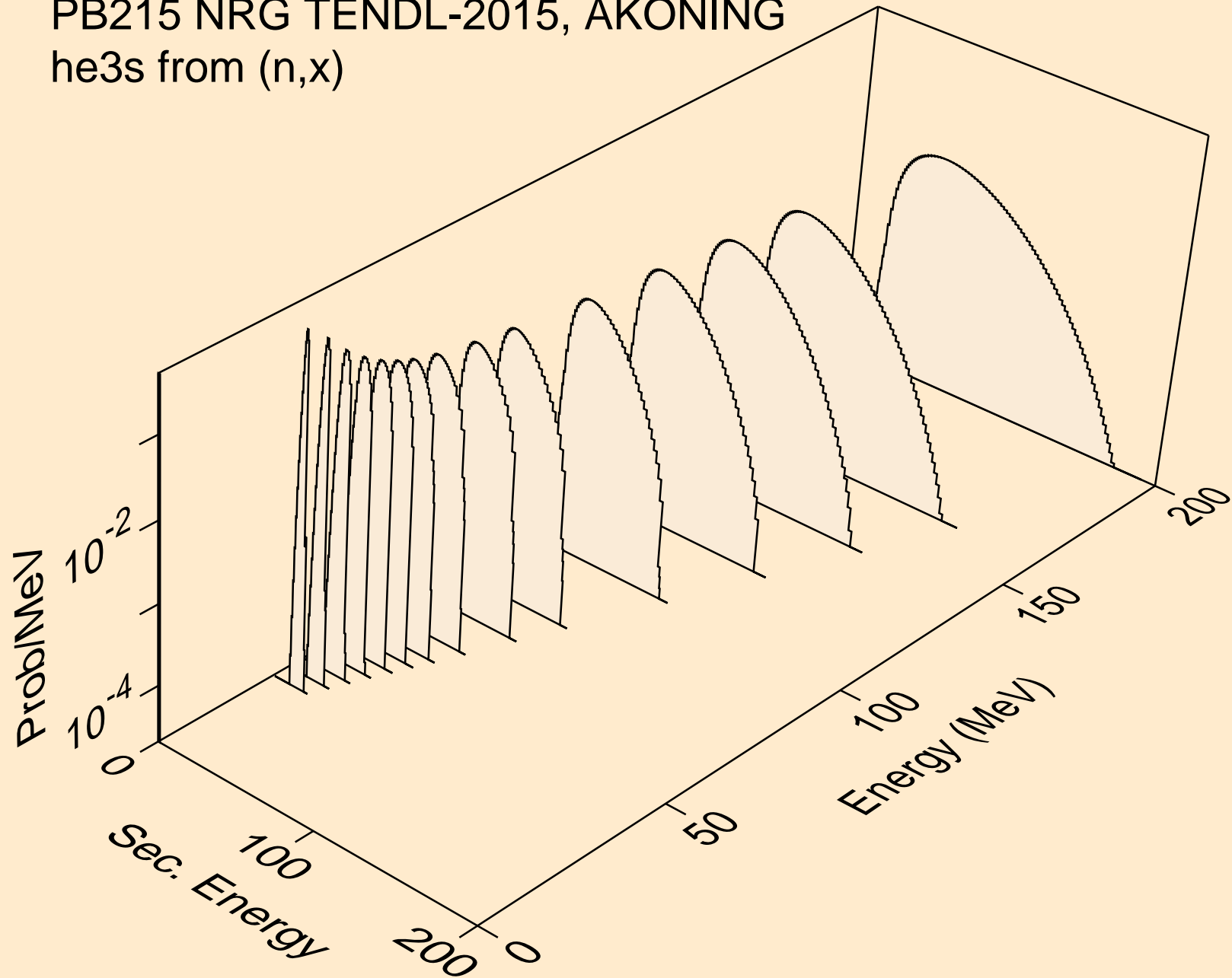

PB215 NRG TENDL-2015, AKONING
he3s from (n,n*)he3

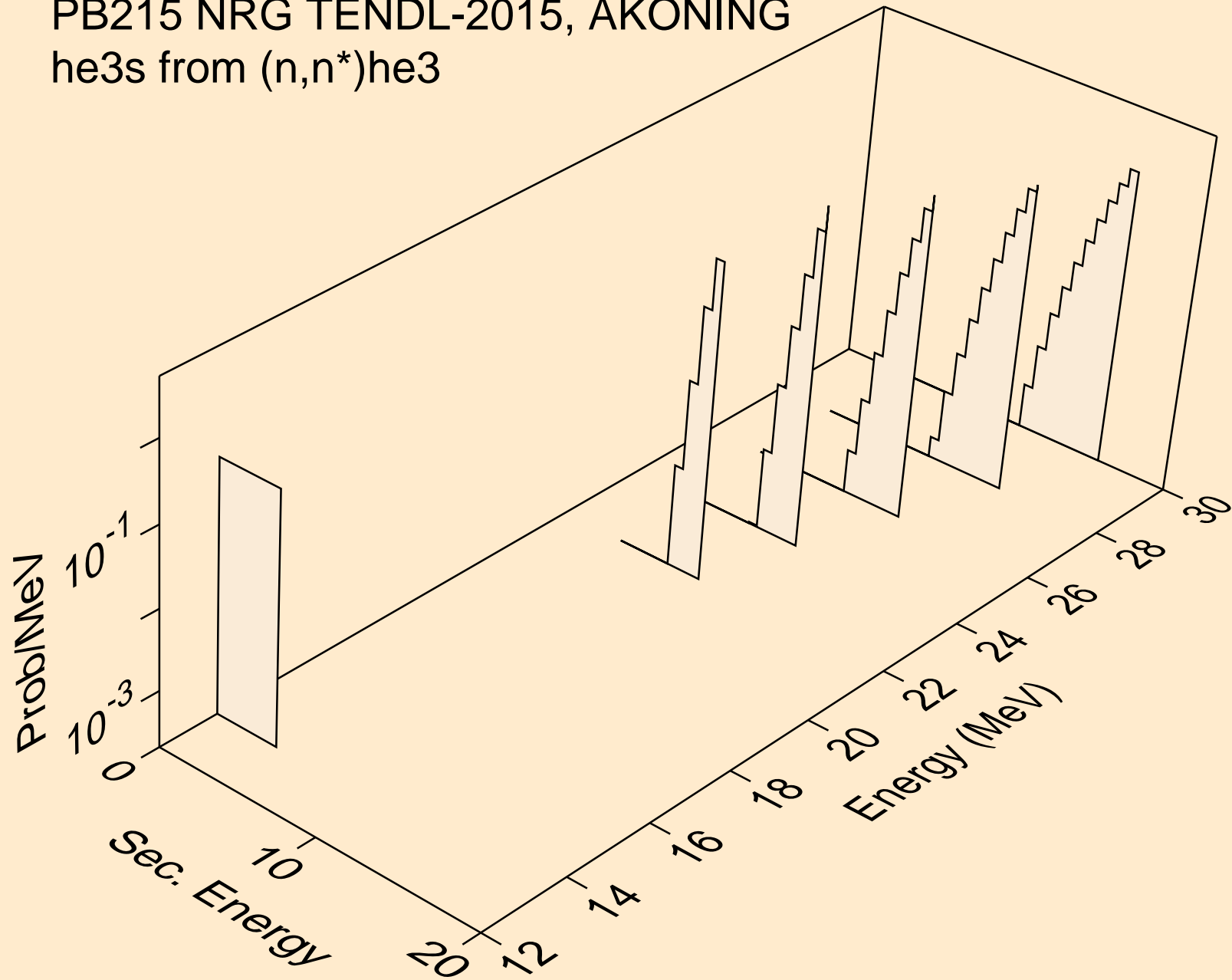

PB215 NRG TENDL-2015, AKONING
he3s from (n,he3)

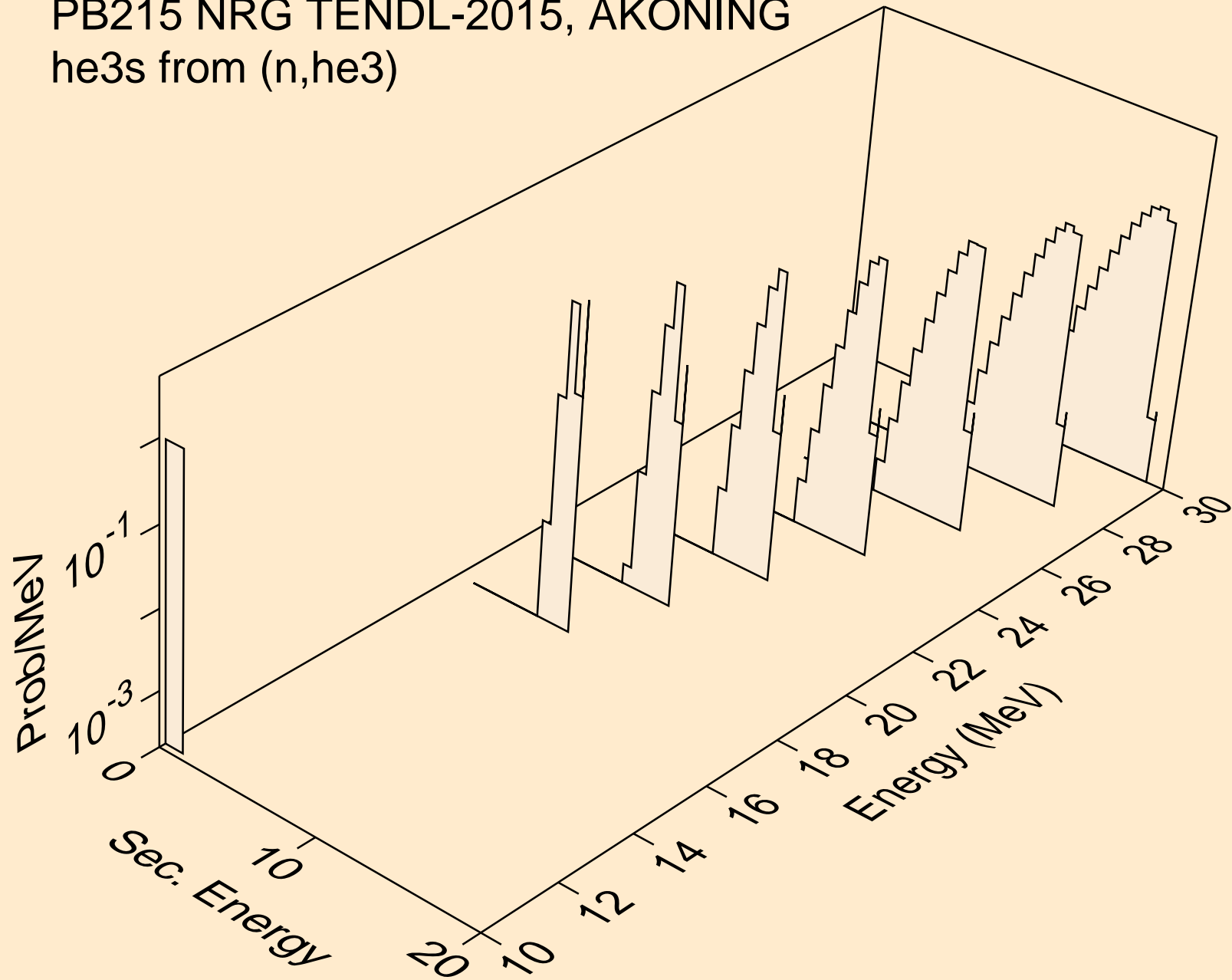

PB215 NRG TENDL-2015, AKONING
alphas from (n,x)

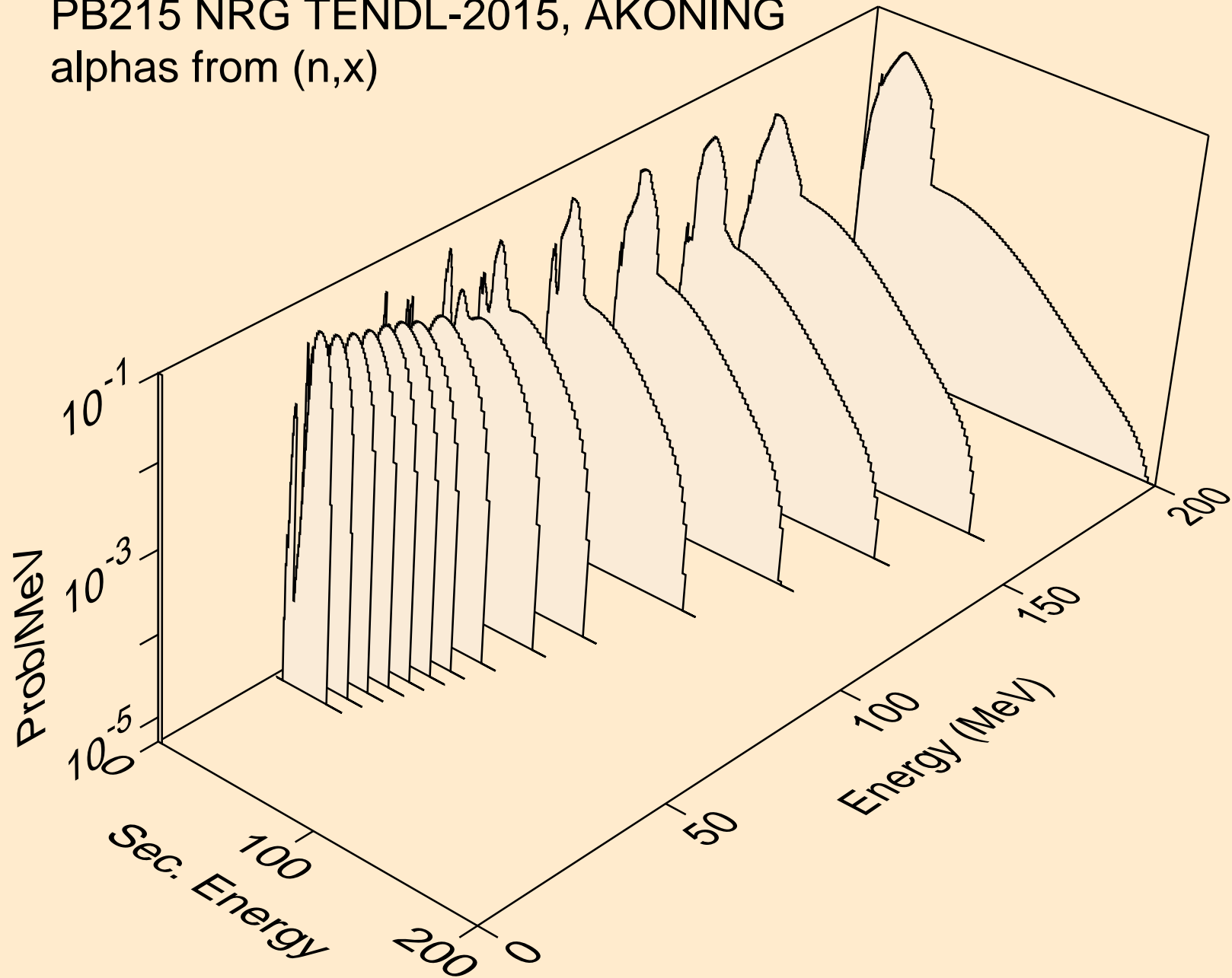

PB215 NRG TENDL-2015, AKONING
alphas from (n,n*)a

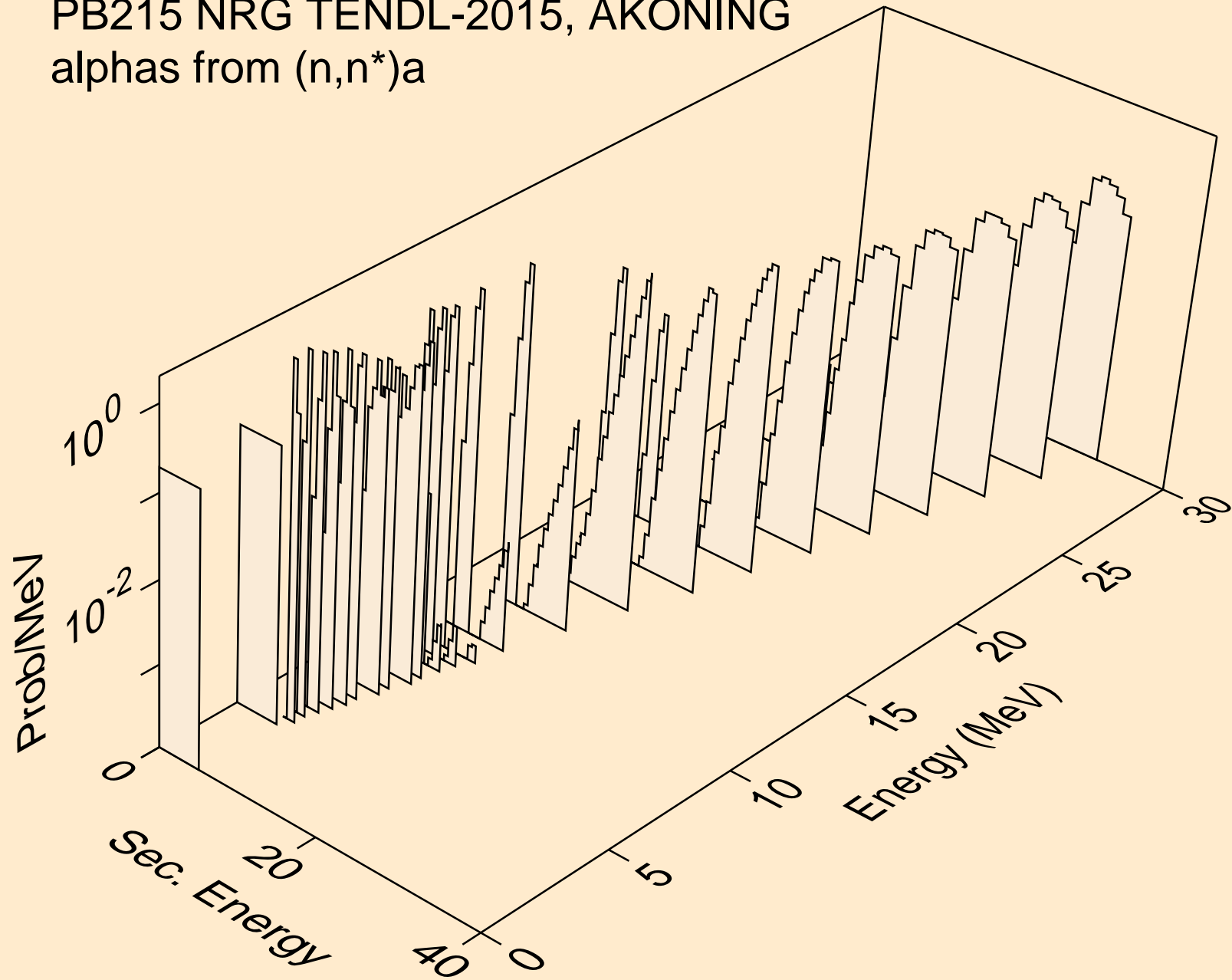

PB215 NRG TENDL-2015, AKONING
alphas from (n,2n)a

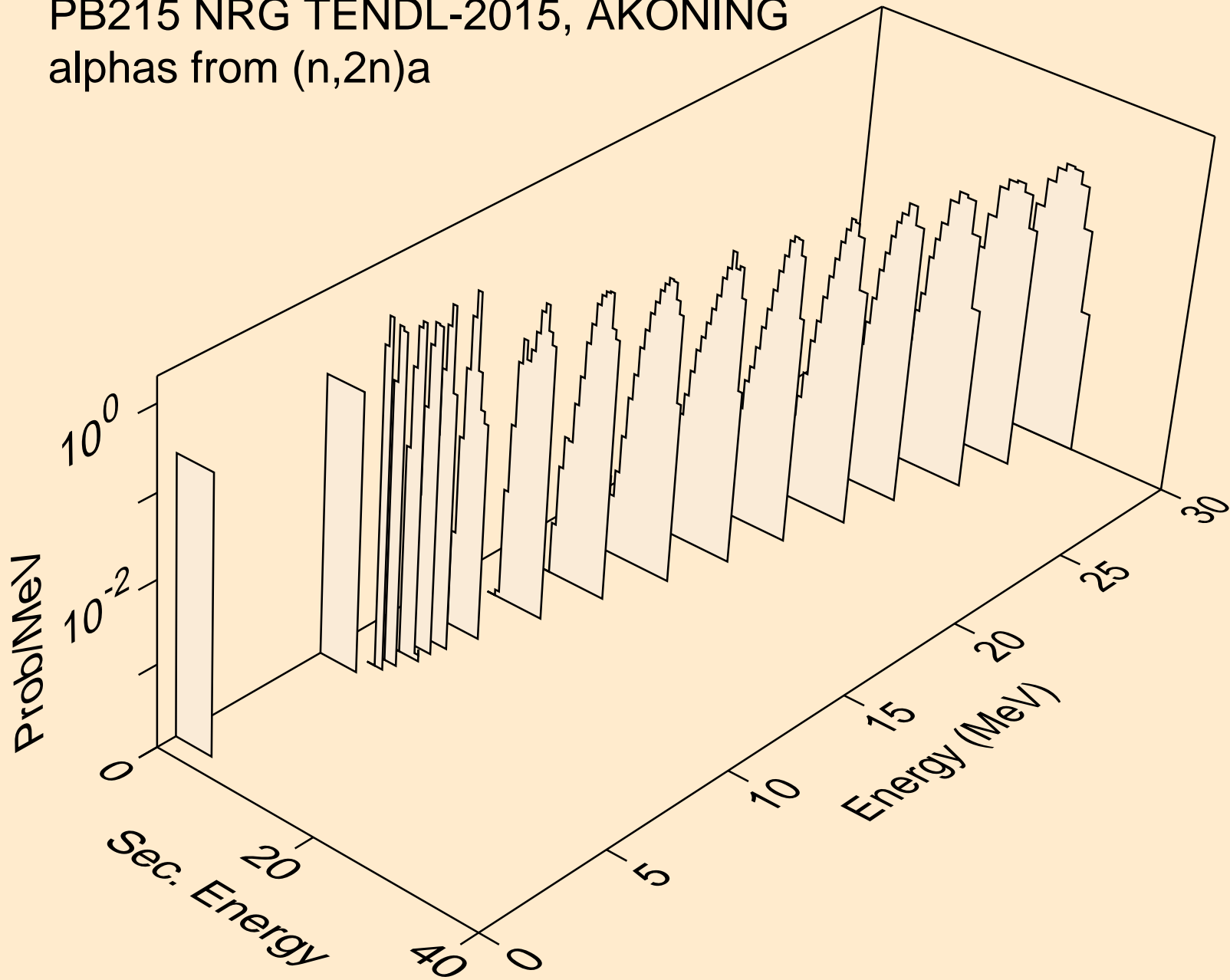

PB215 NRG TENDL-2015, AKONING
alphas from (n,3n)a

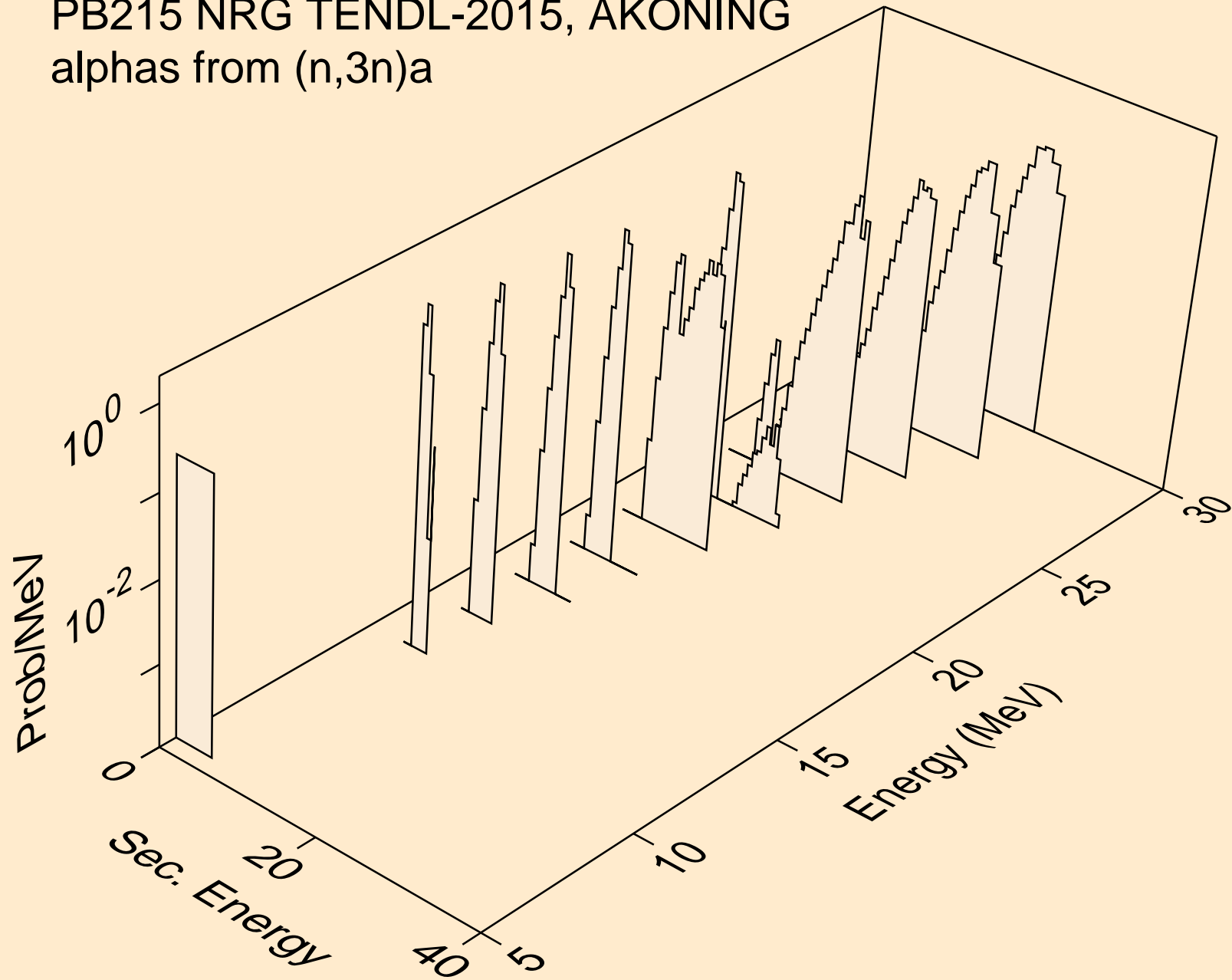

PB215 NRG TENDL-2015, AKONING
alphas from (n,a)

