

# PB217 NRG TENDL-2015, AKONING

## Principal cross sections

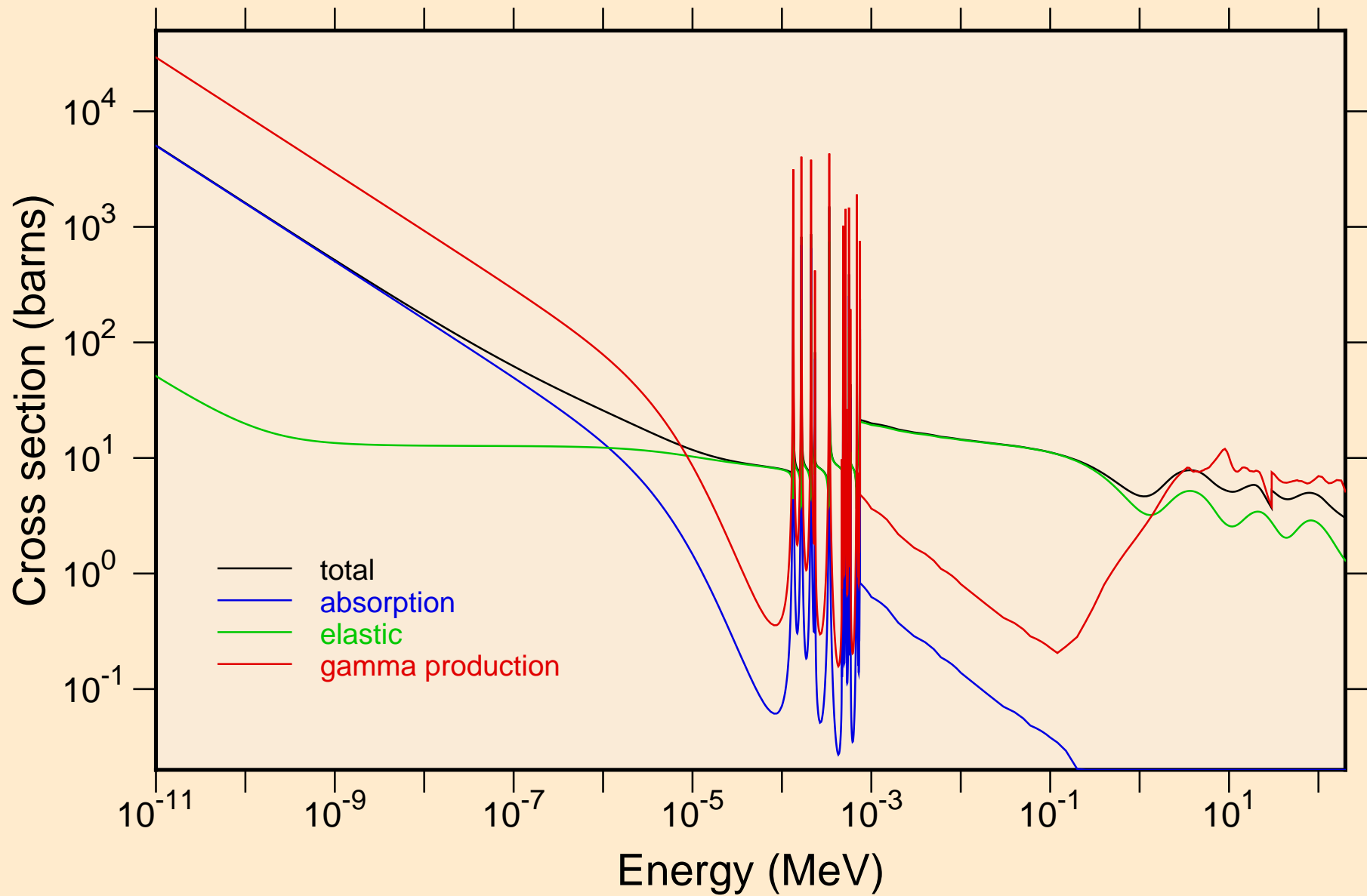

PB217 NRG TENDL-2015, AKONING  
resonance total cross section

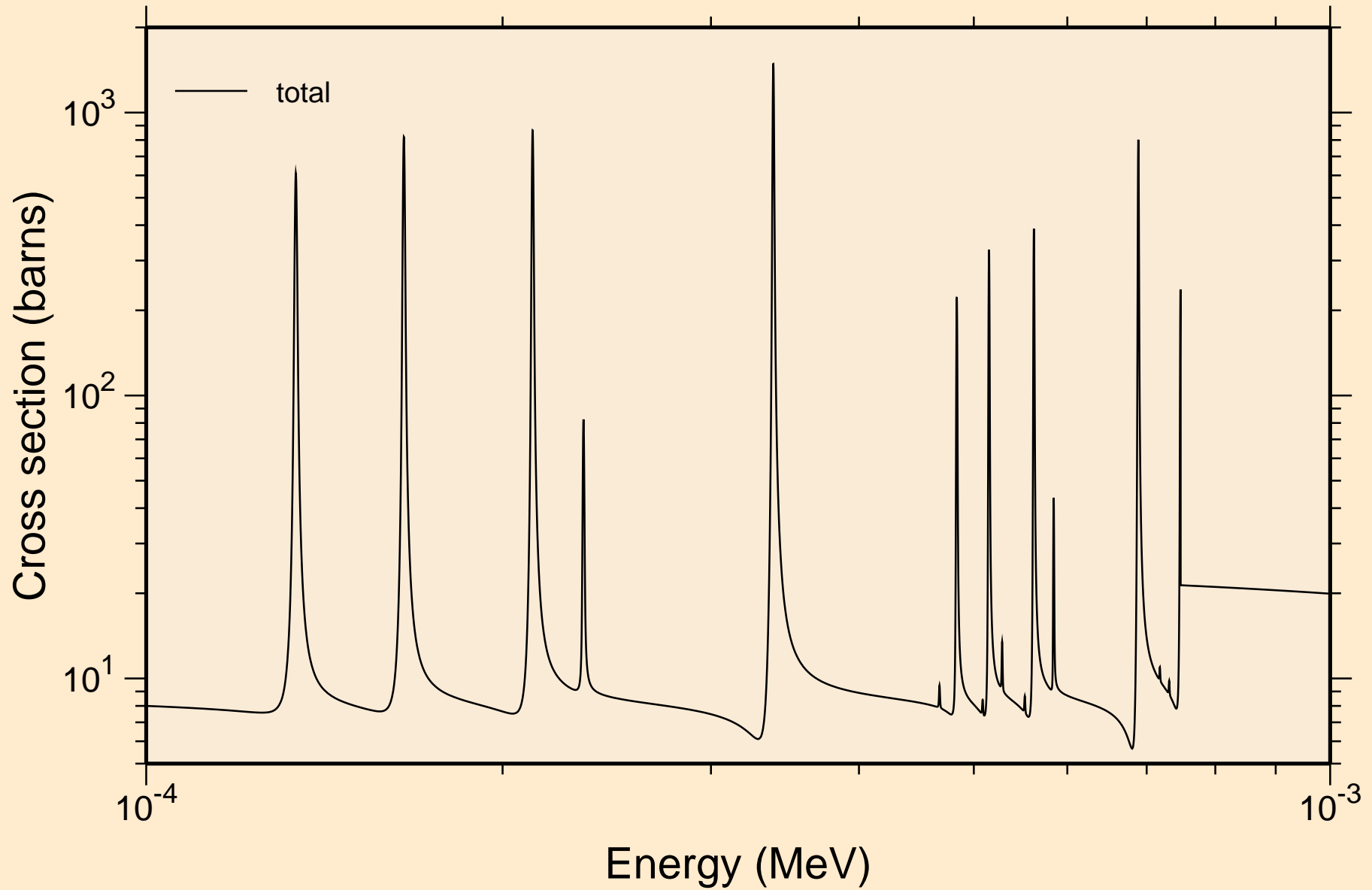

PB217 NRG TENDL-2015, AKONING  
resonance total cross section

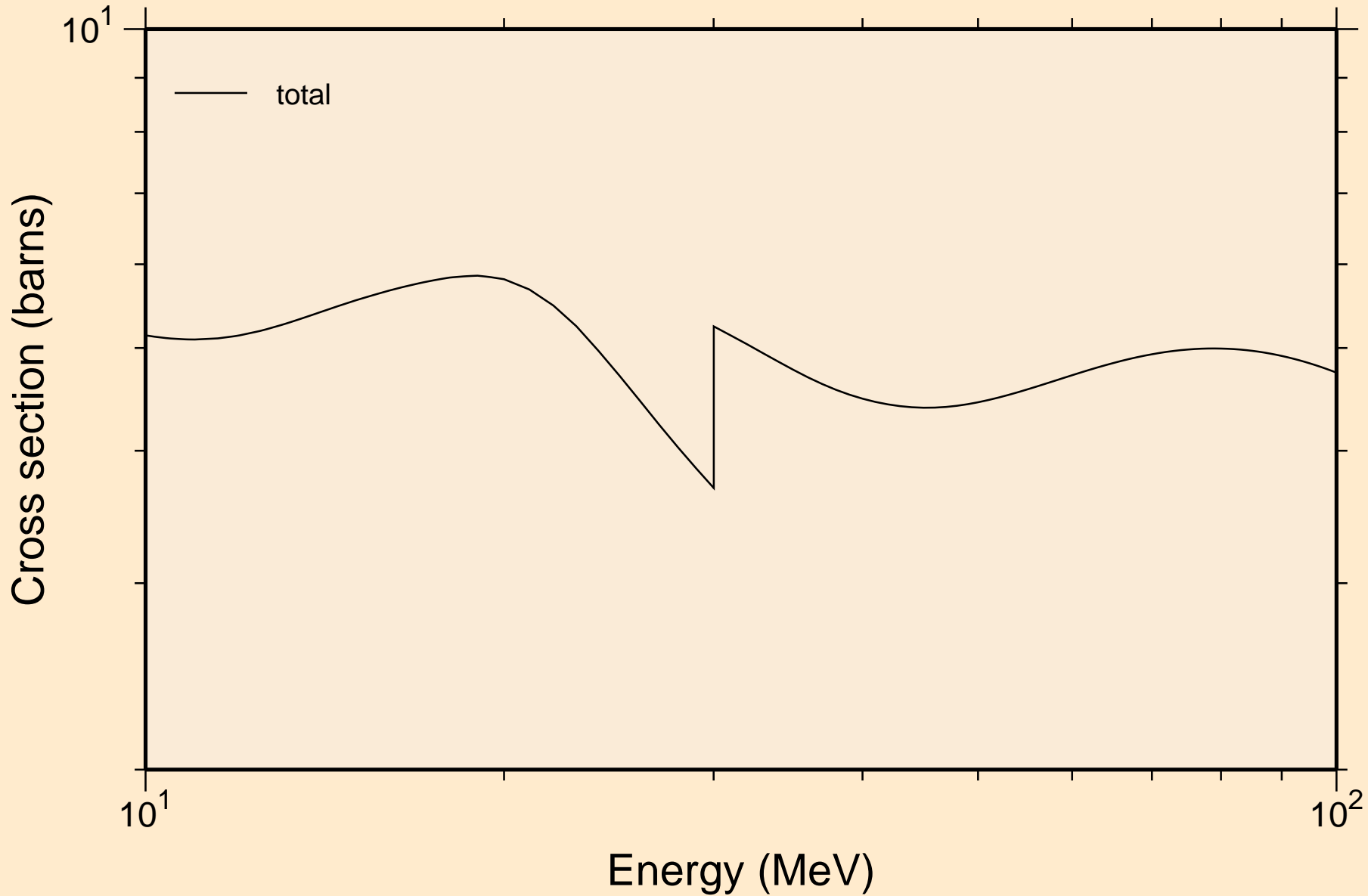

# PB217 NRG TENDL-2015, AKONING

## resonance absorption cross sections

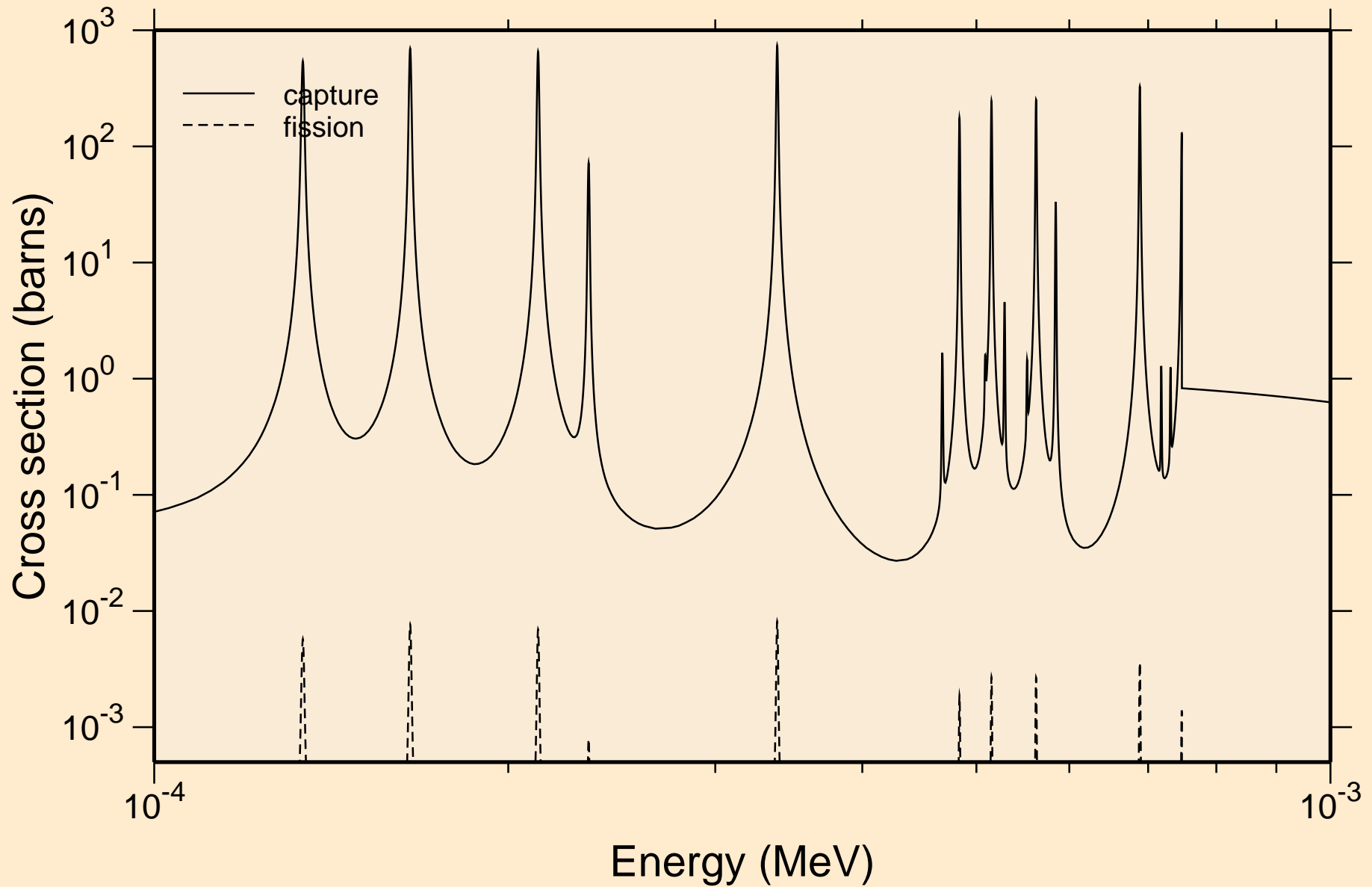

PB217 NRG TENDL-2015, AKONING  
resonance absorption cross sections

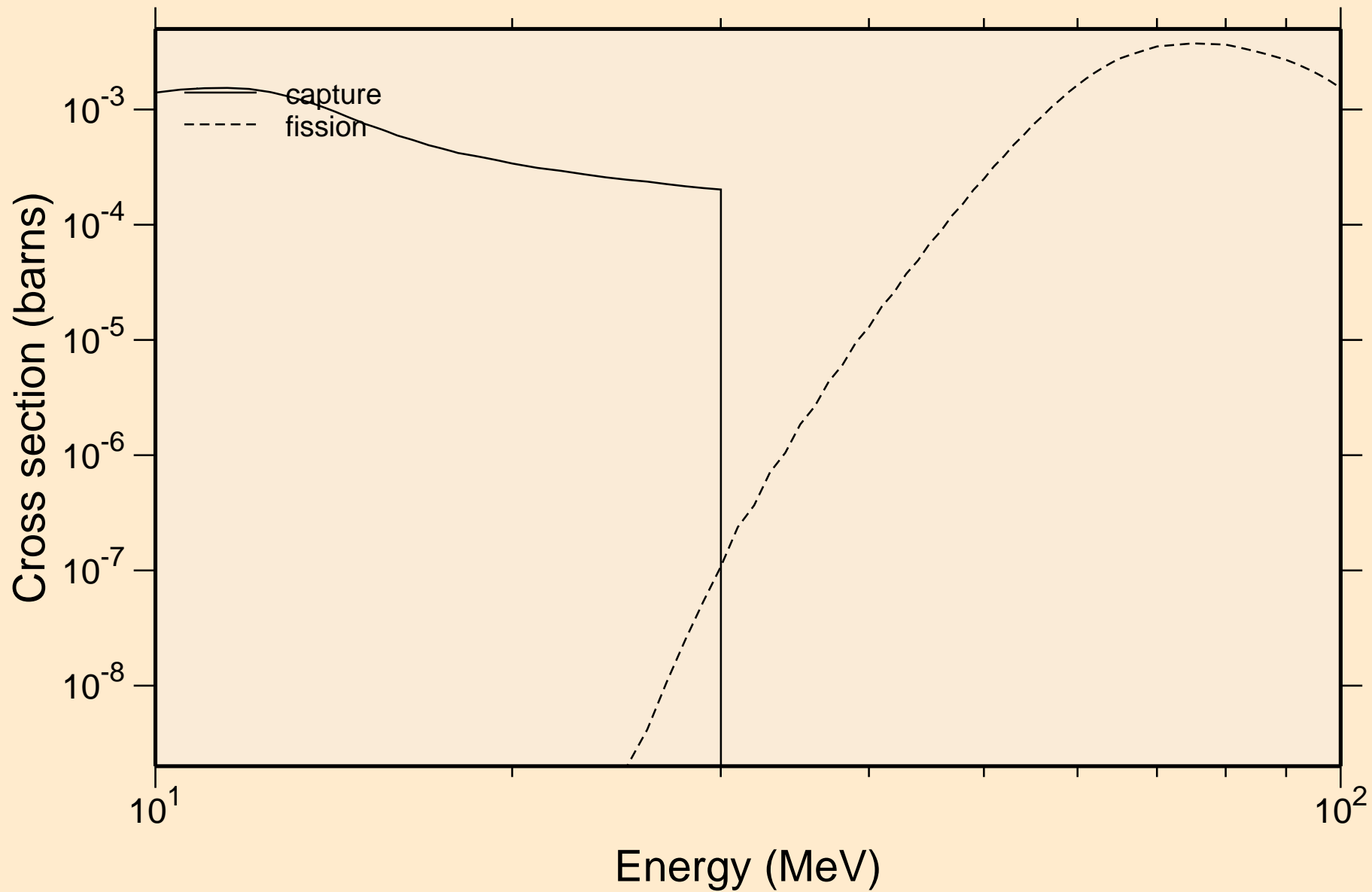

# PB217 NRG TENDL-2015, AKONING

## Non-threshold reactions

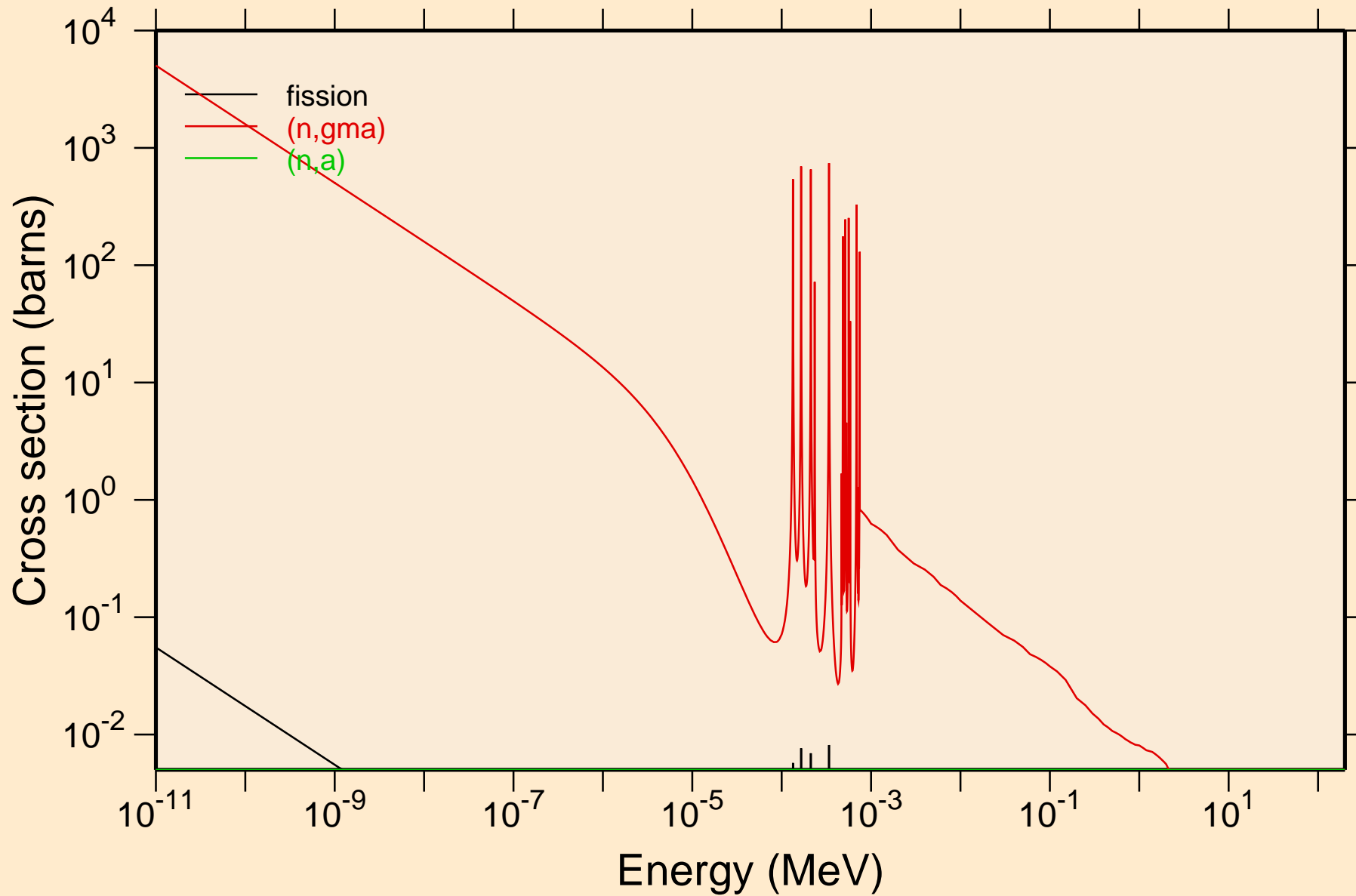

# PB217 NRG TENDL-2015, AKONING

## Principal cross sections

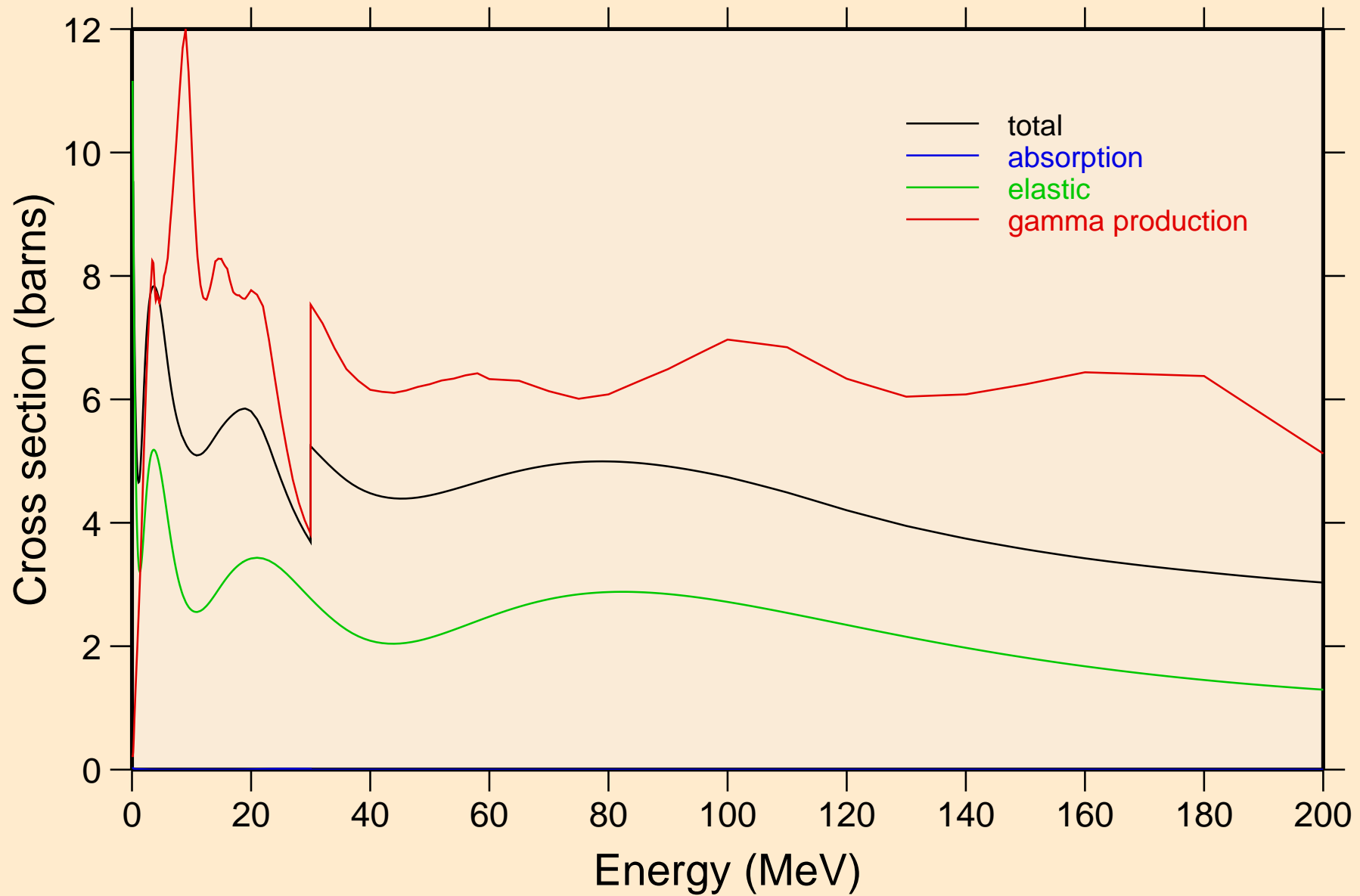

# PB217 NRG TENDL-2015, AKONING

## Non-threshold reactions

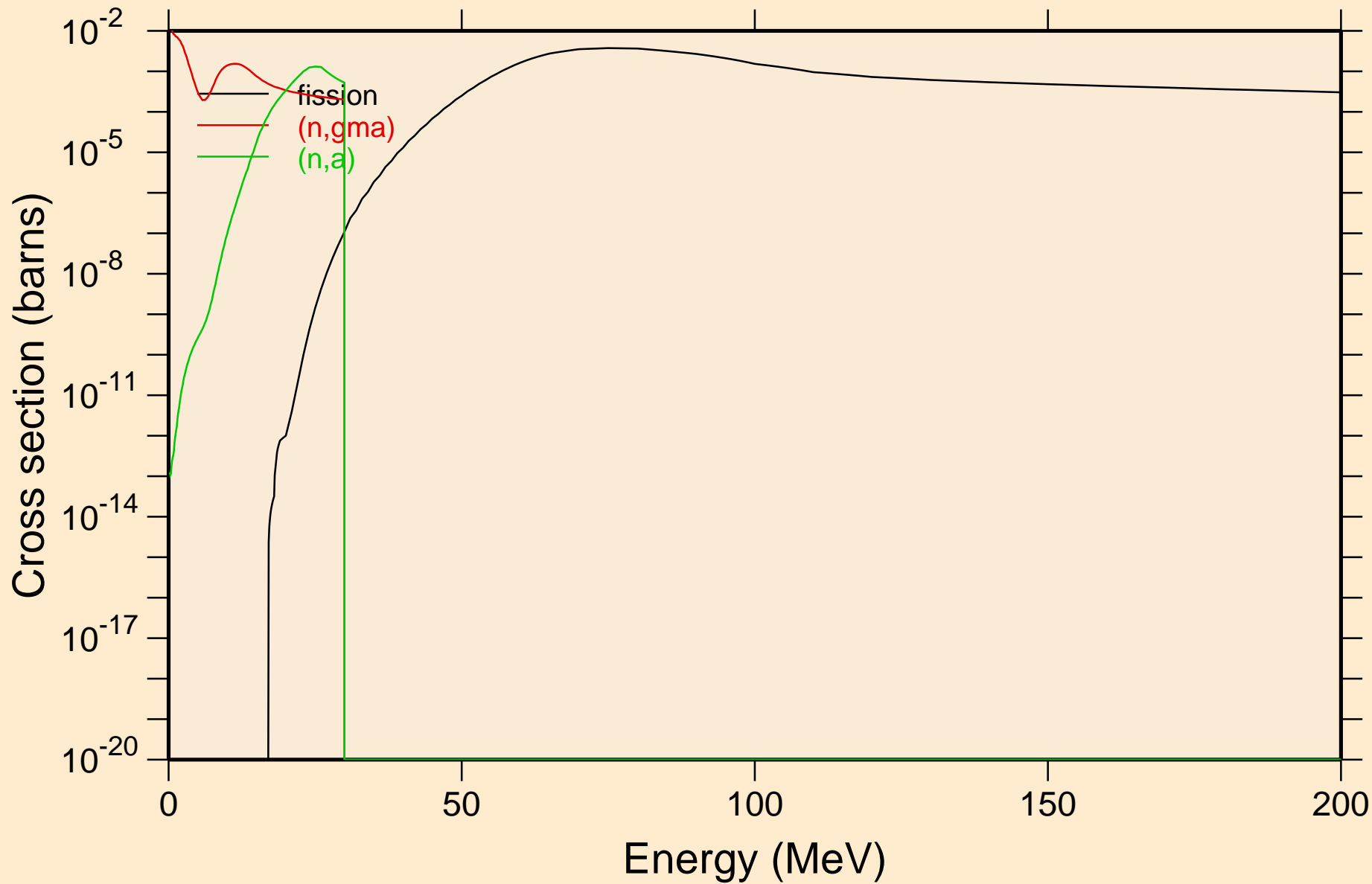



PB217 NRG TENDL-2015, AKONING  
Inelastic levels

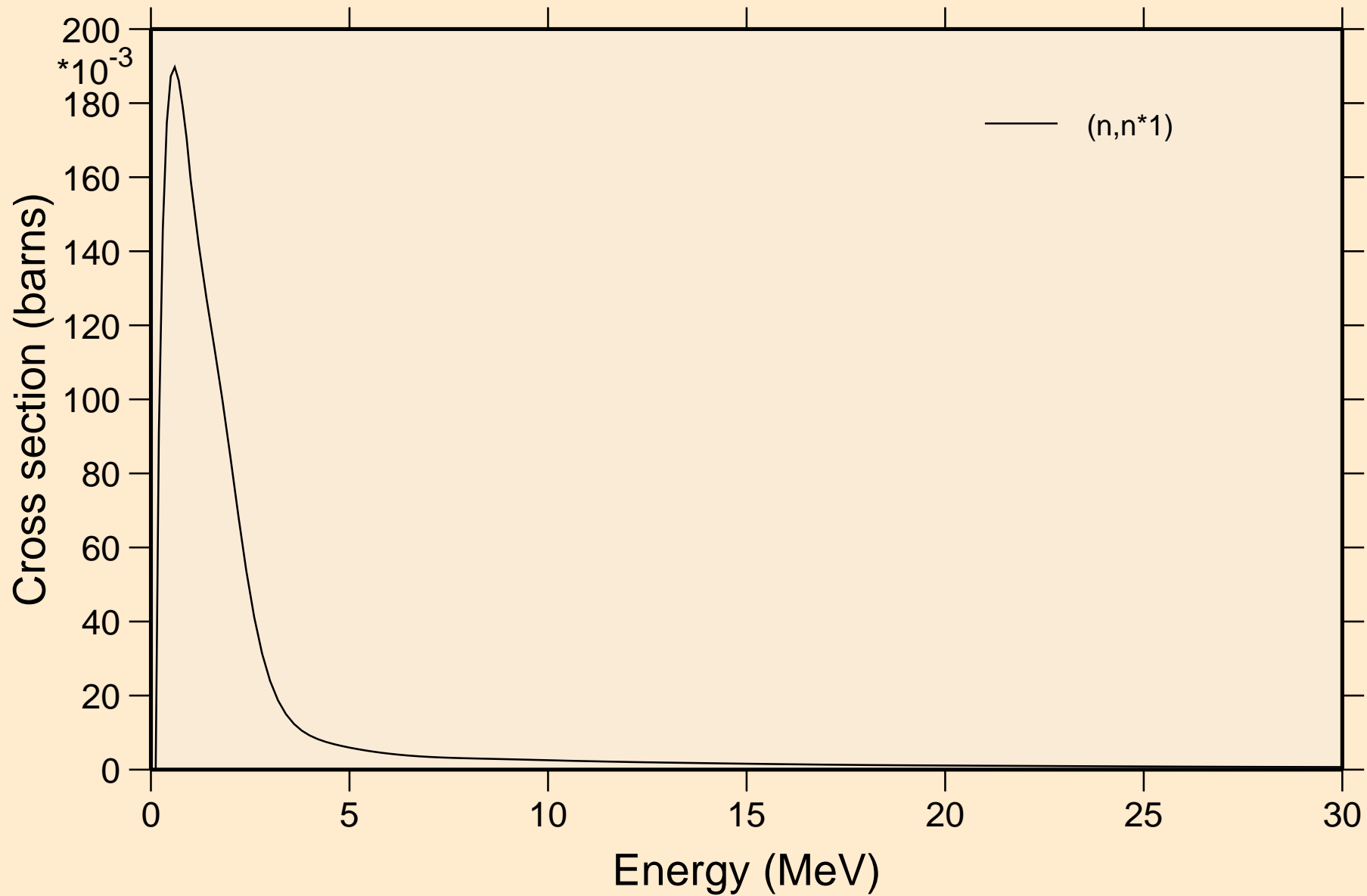

# PB217 NRG TENDL-2015, AKONING

## Threshold reactions

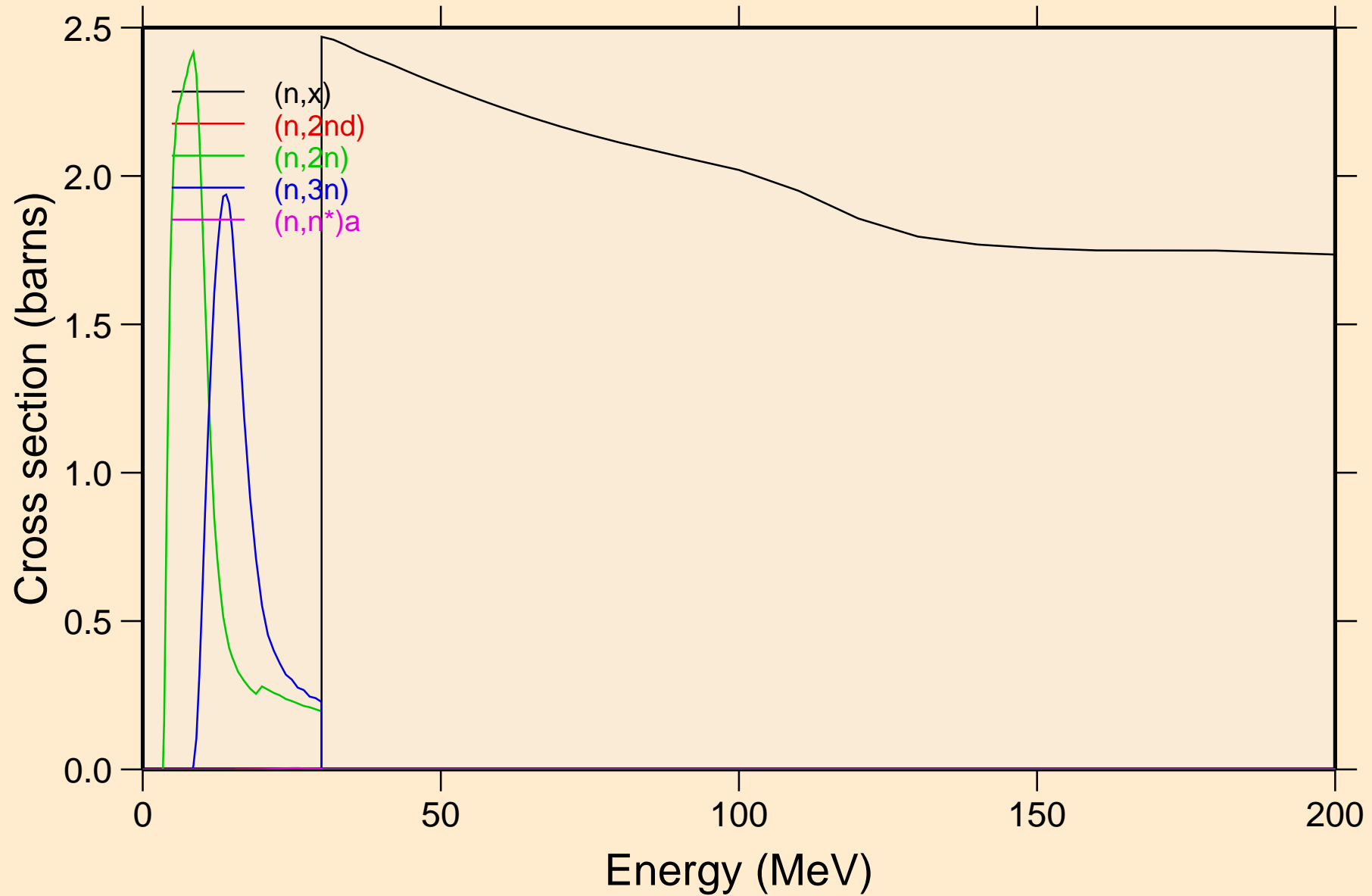

# PB217 NRG TENDL-2015, AKONING

## Threshold reactions

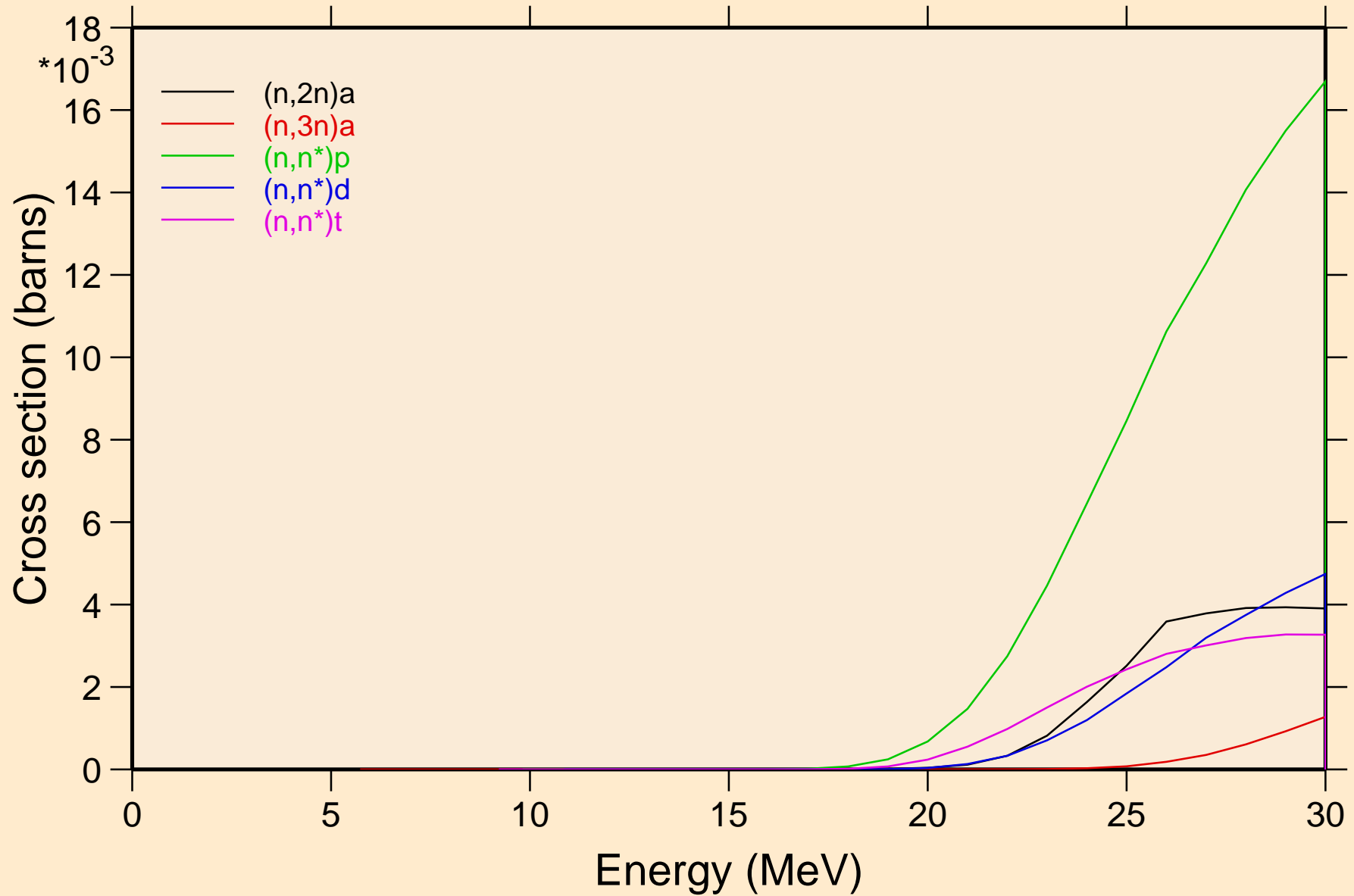

# PB217 NRG TENDL-2015, AKONING

## Threshold reactions

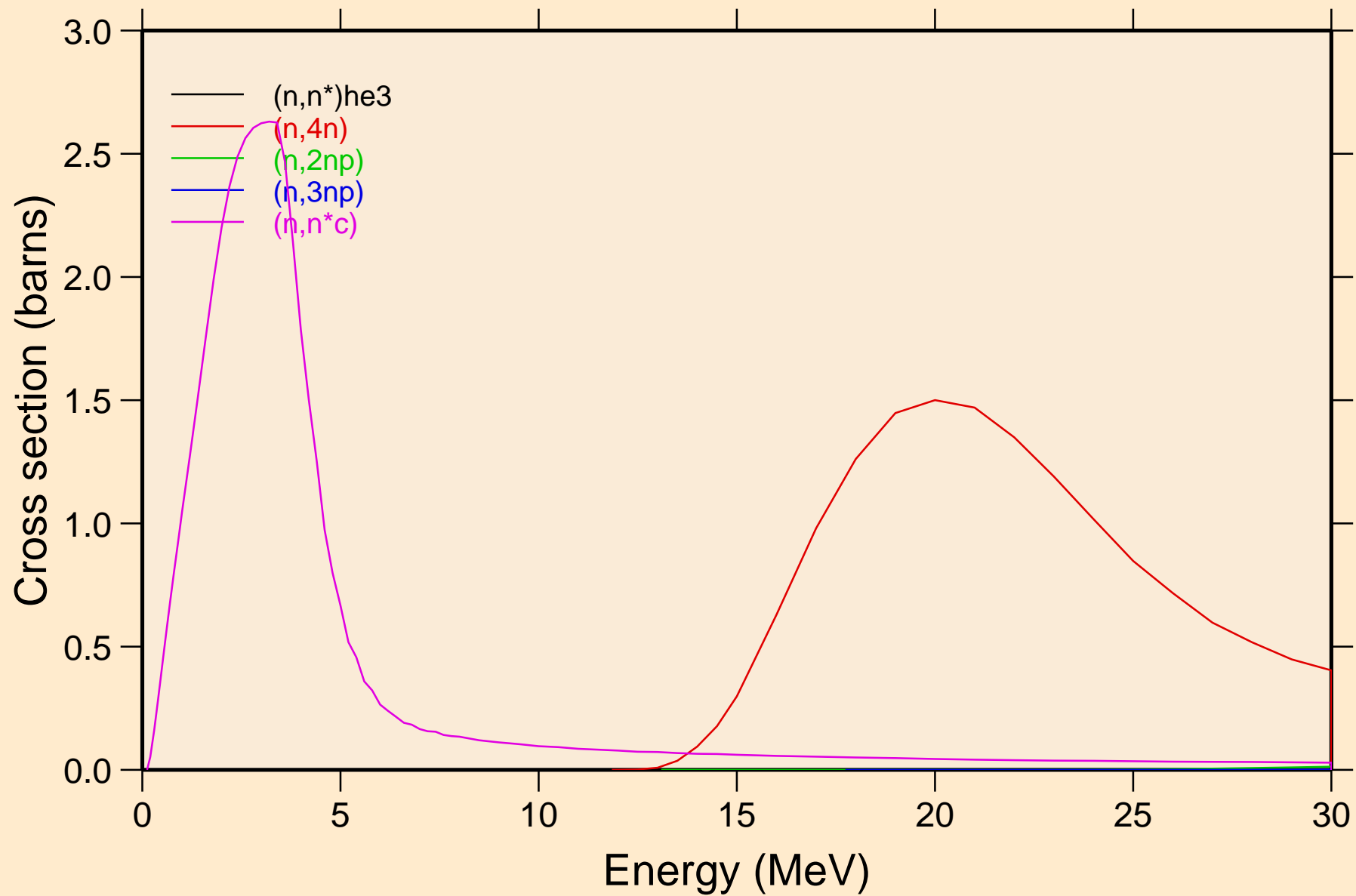

# PB217 NRG TENDL-2015, AKONING

## Threshold reactions

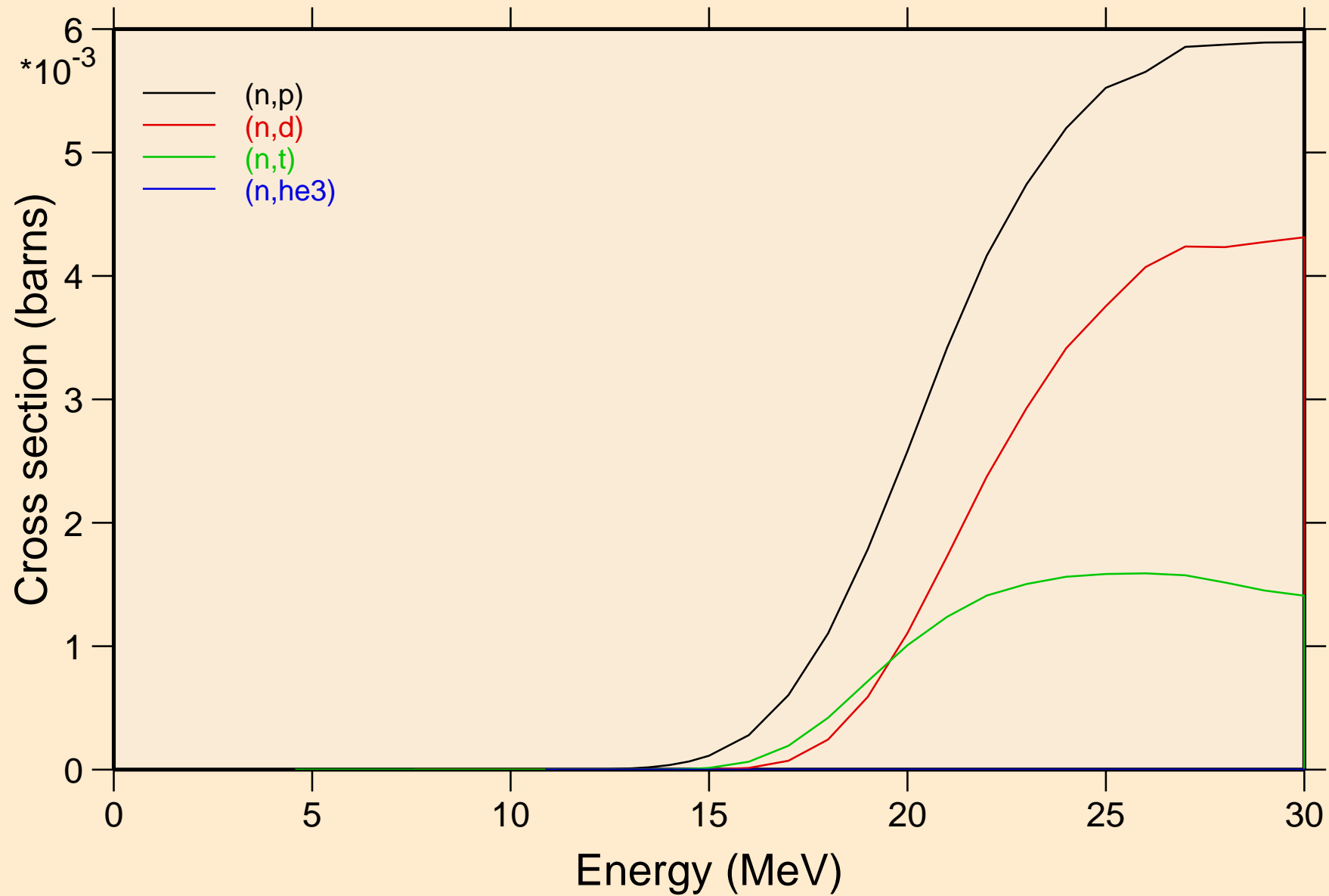

PB217 NRG TENDL-2015, AKONING  
angular distribution for elastic

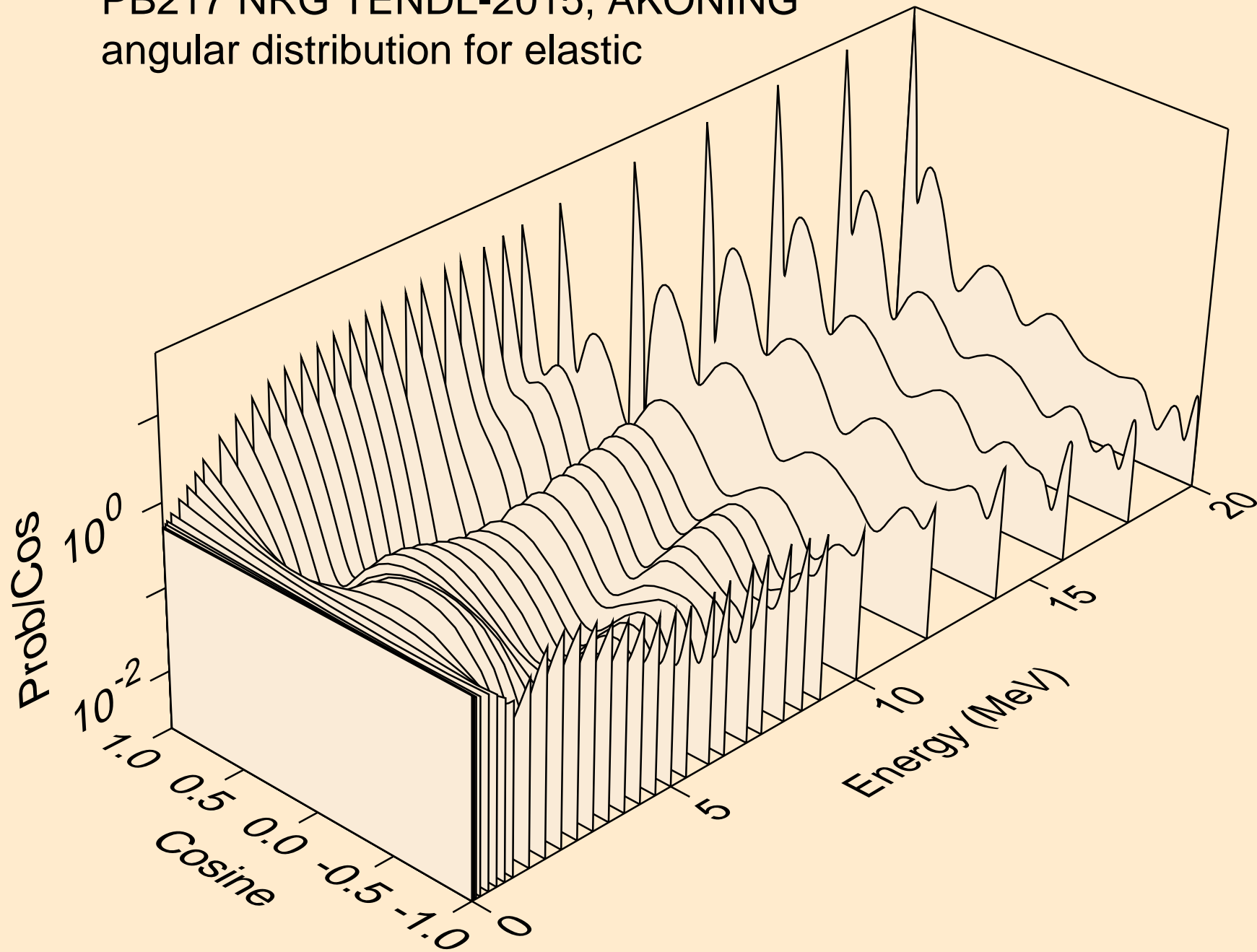

PB217 NRG TENDL-2015, AKONING  
angular distribution for elastic

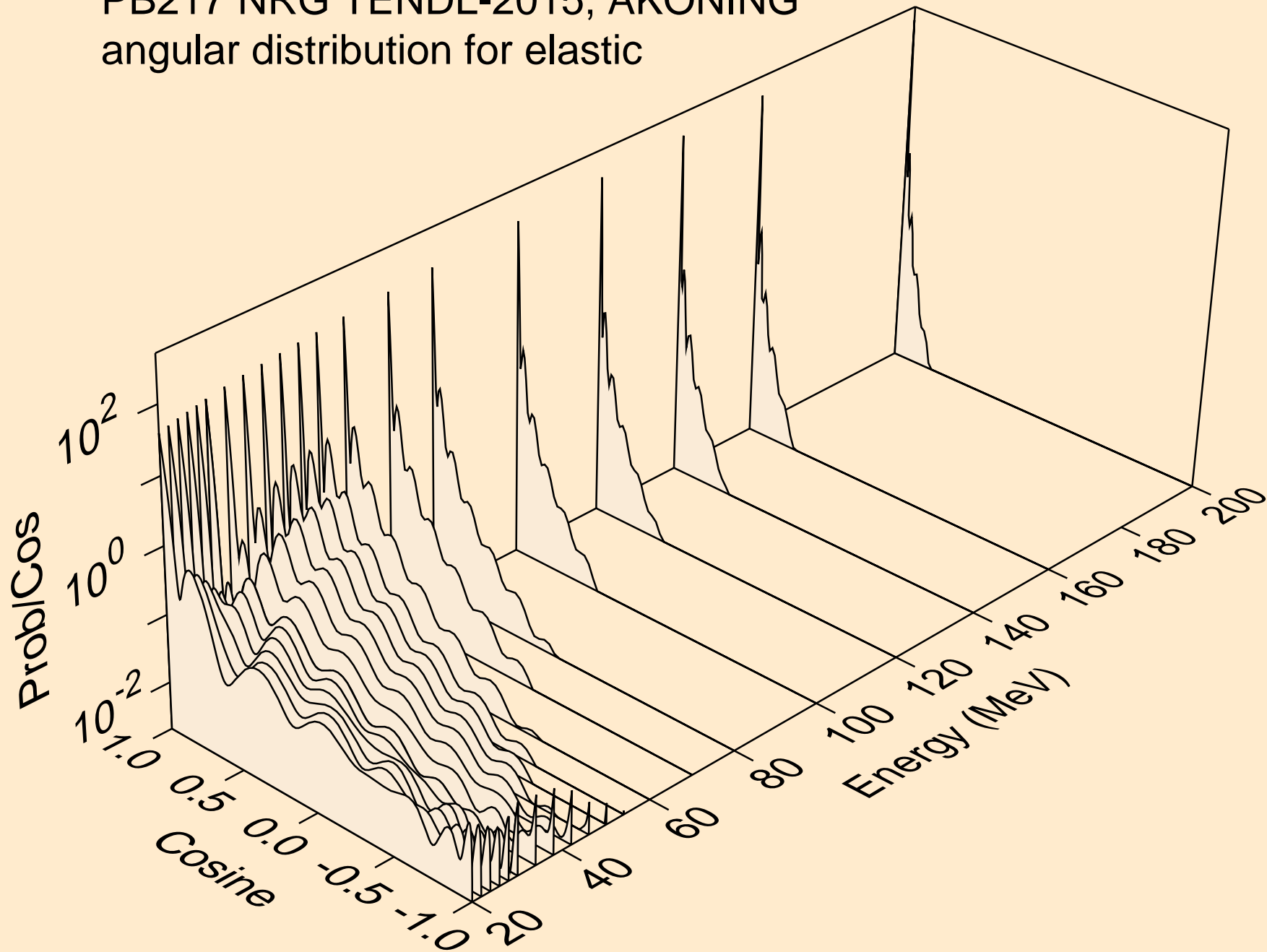

PB217 NRG TENDL-2015, AKONING  
angular distribution for (n,n\*1)

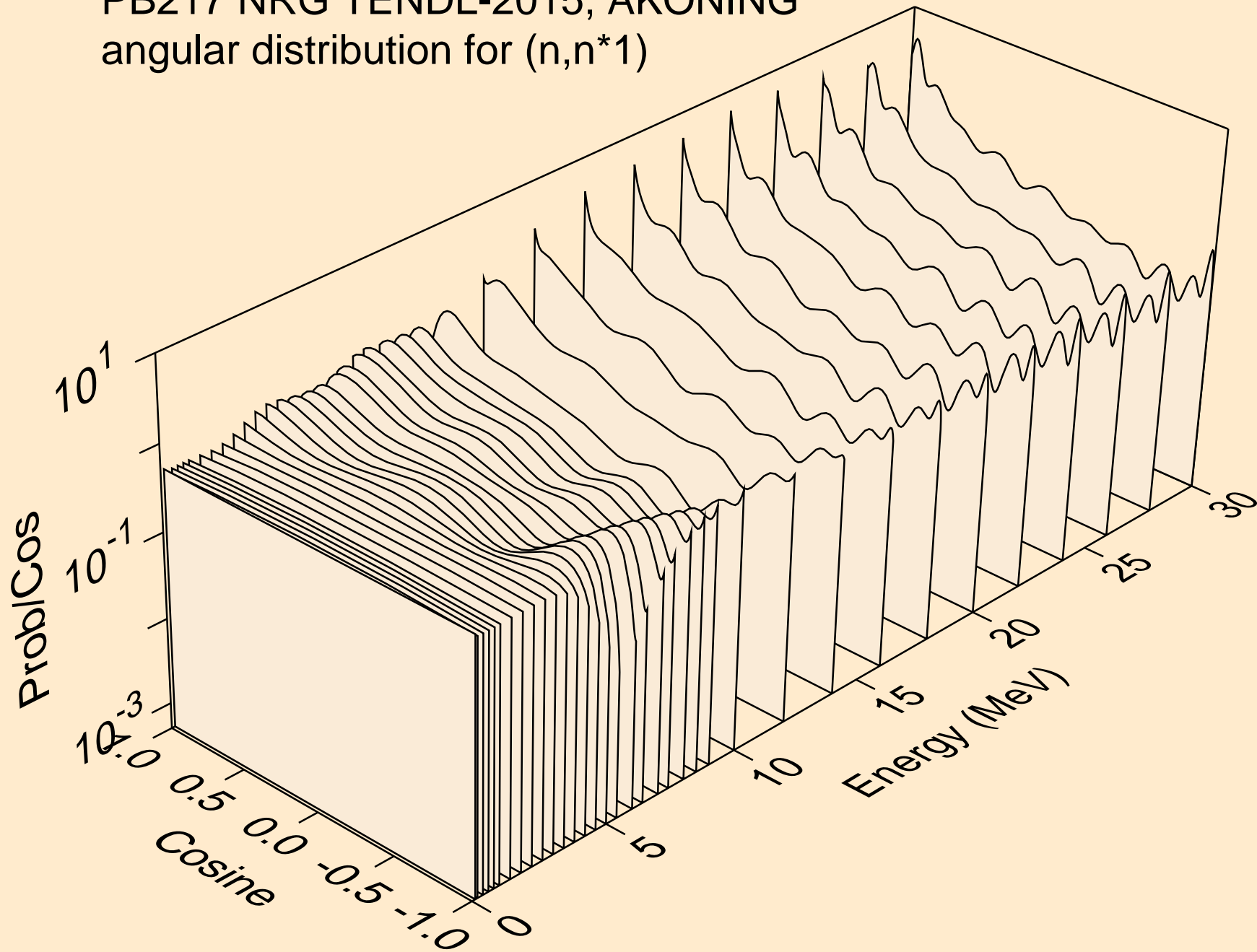



# PB217 NRG TENDL-2015, AKONING

Total fission nubar

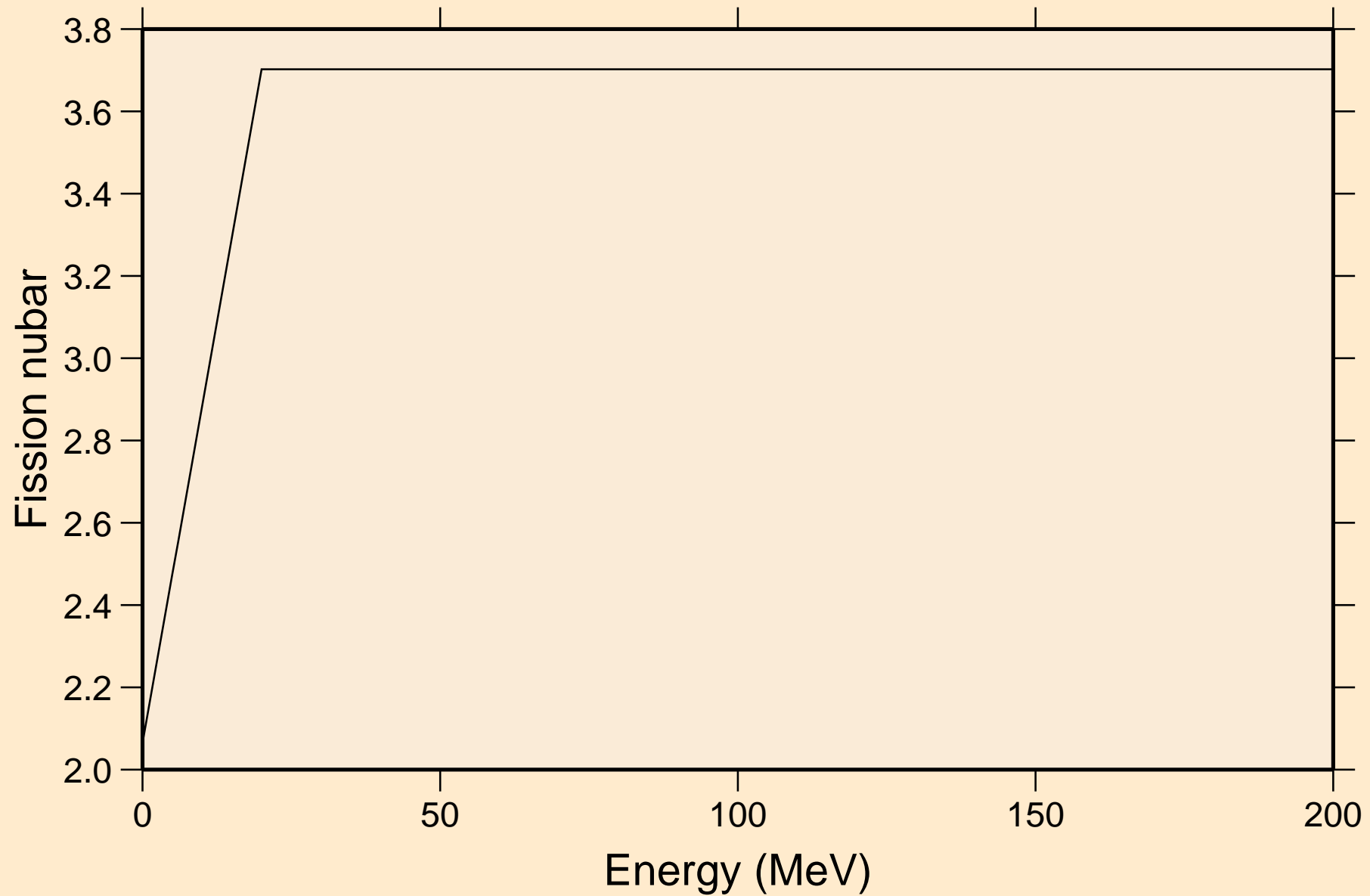

PB217 NRG TENDL-2015, AKONING  
Neutron emission for (n,x)

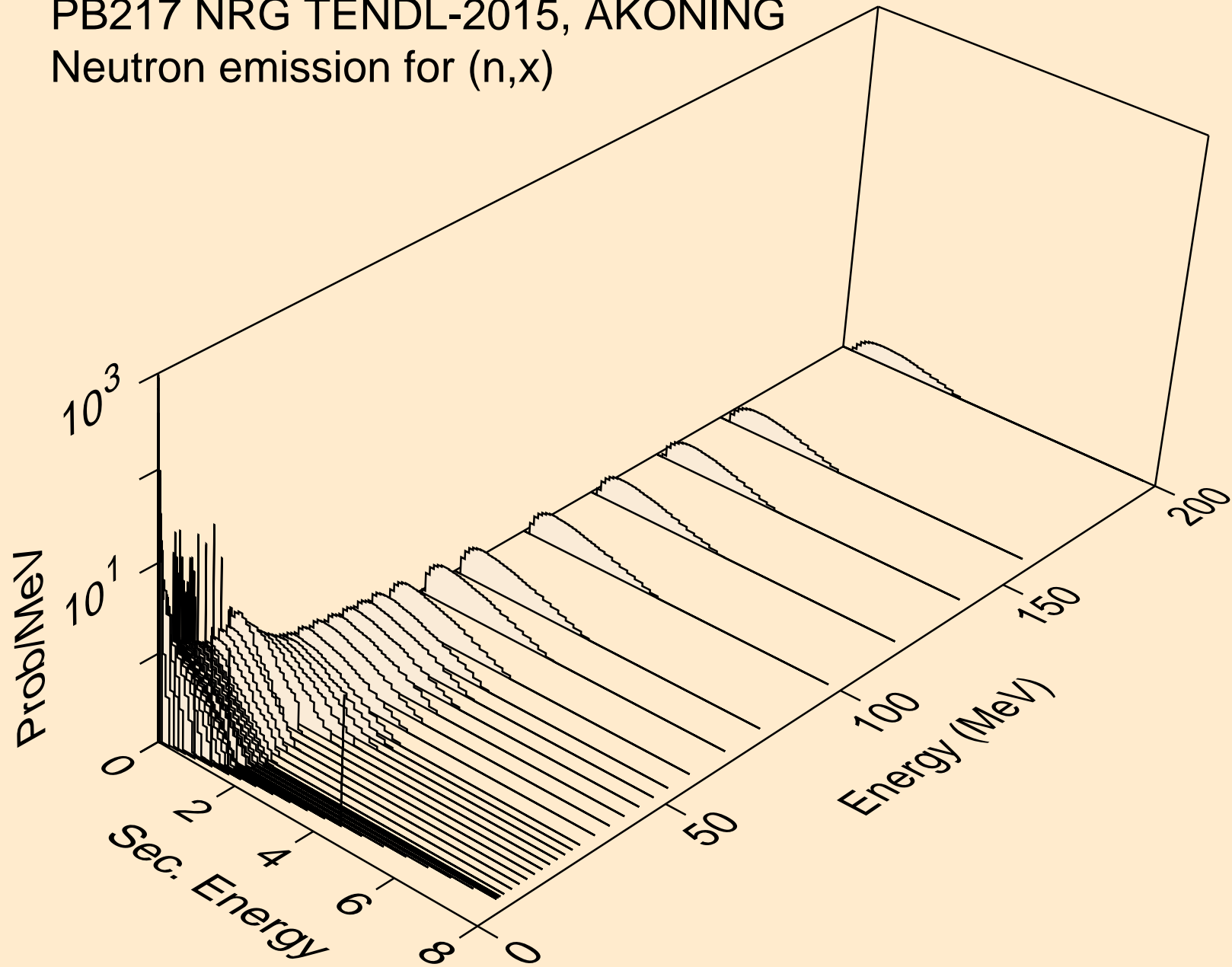

PB217 NRG TENDL-2015, AKONING  
Neutron emission for (n,2nd)

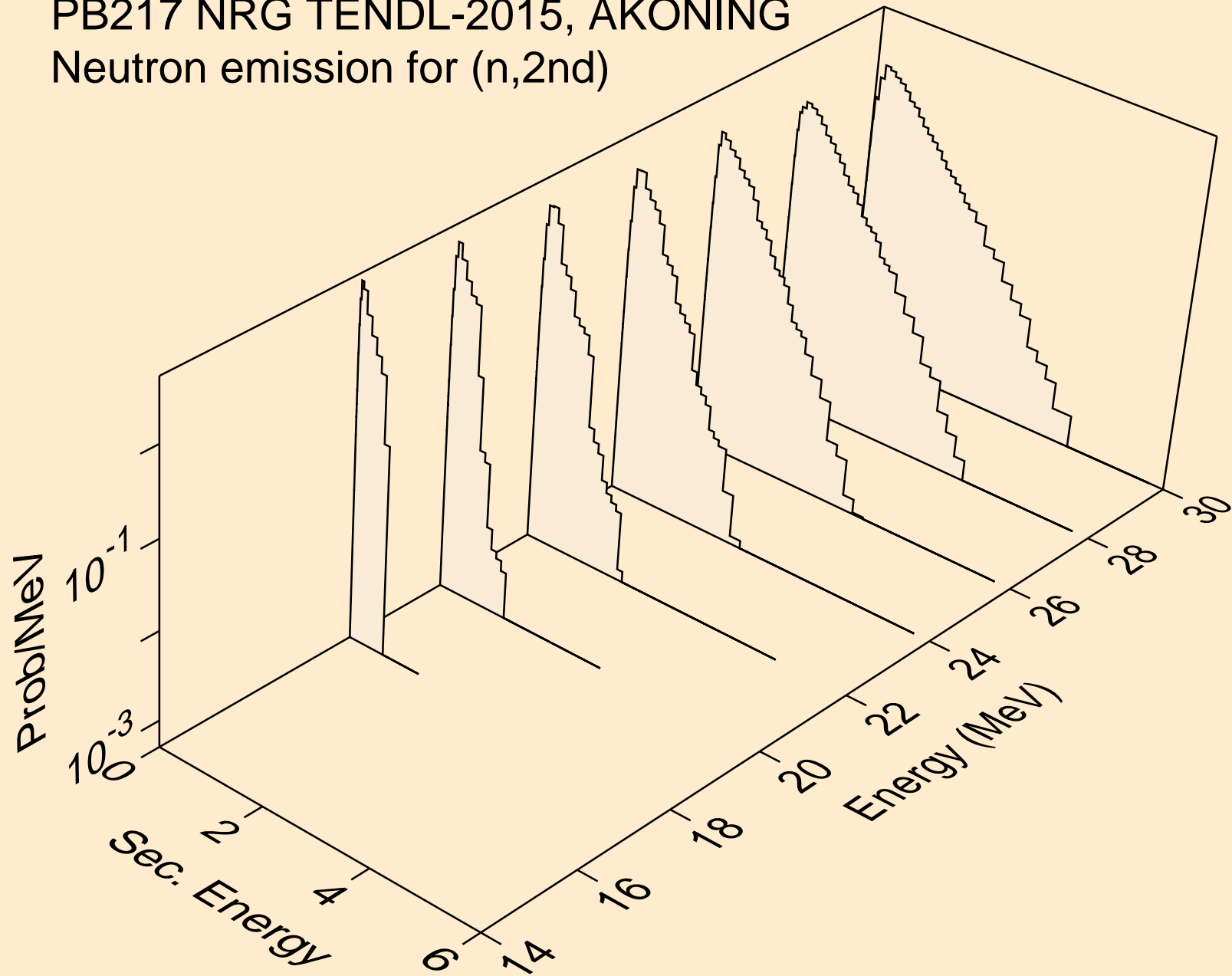

PB217 NRG TENDL-2015, AKONING  
Neutron emission for (n,2n)

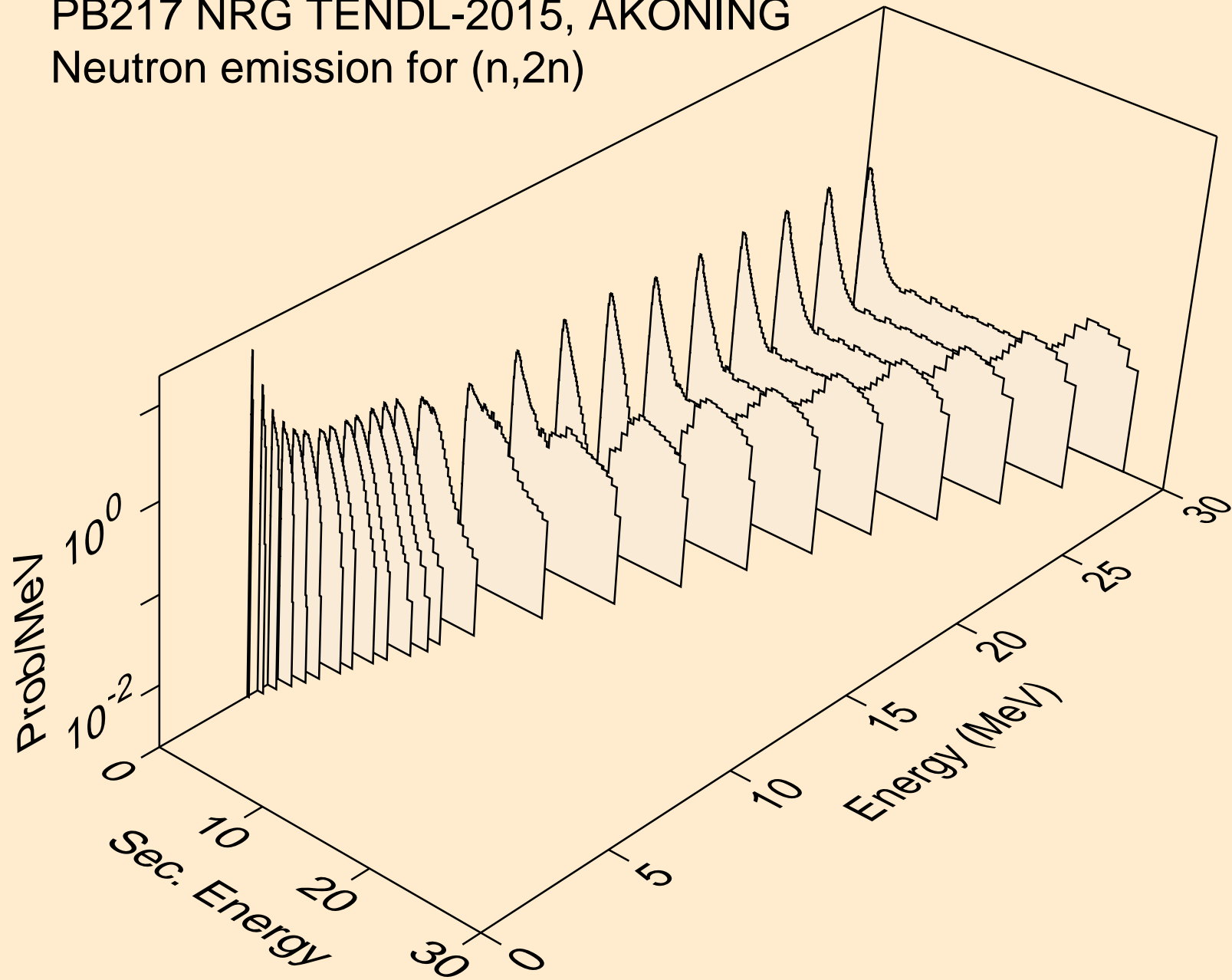

PB217 NRG TENDL-2015, AKONING  
Neutron emission for (n,3n)

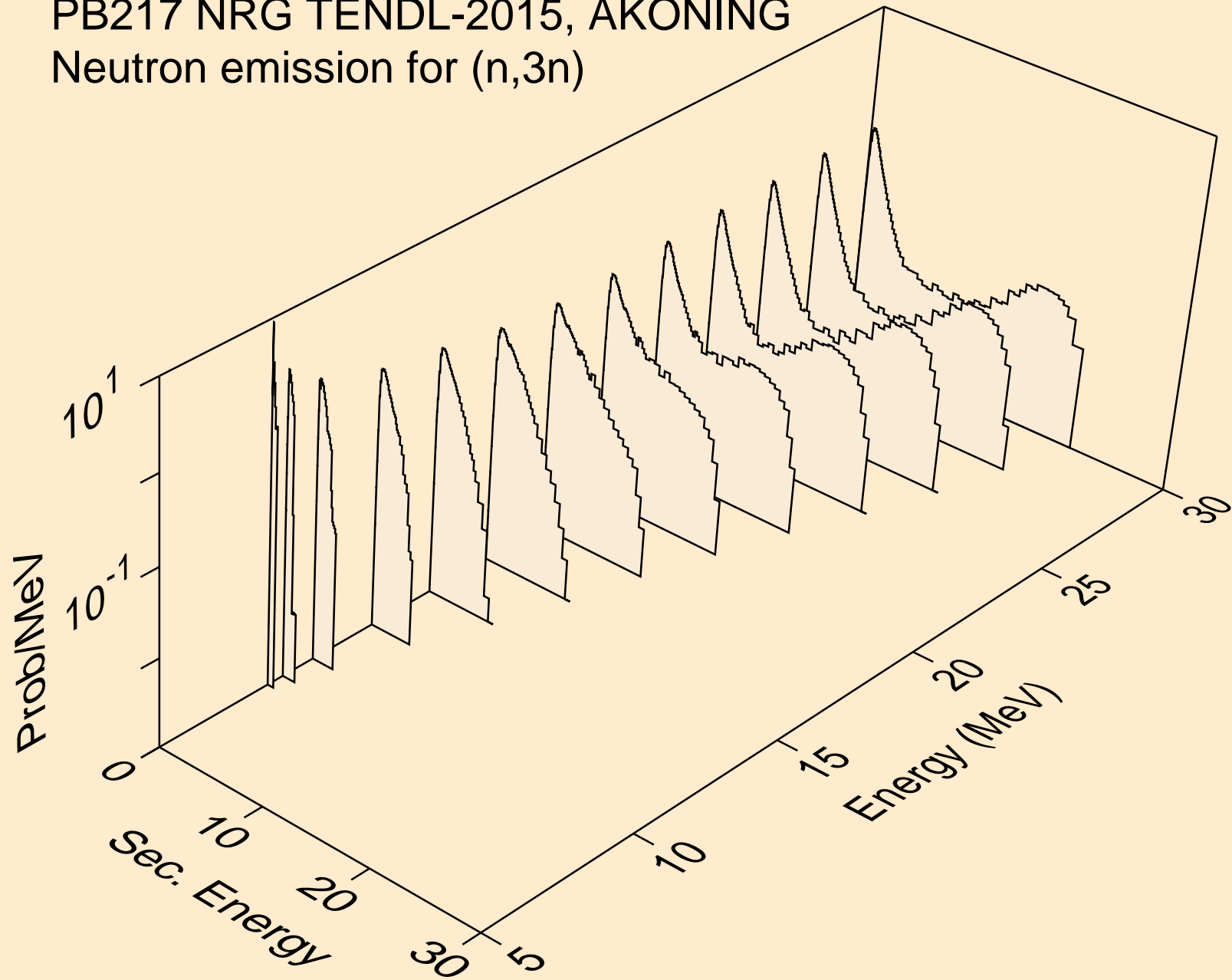

PB217 NRG TENDL-2015, AKONING  
Neutron emission for (n,n\*)a

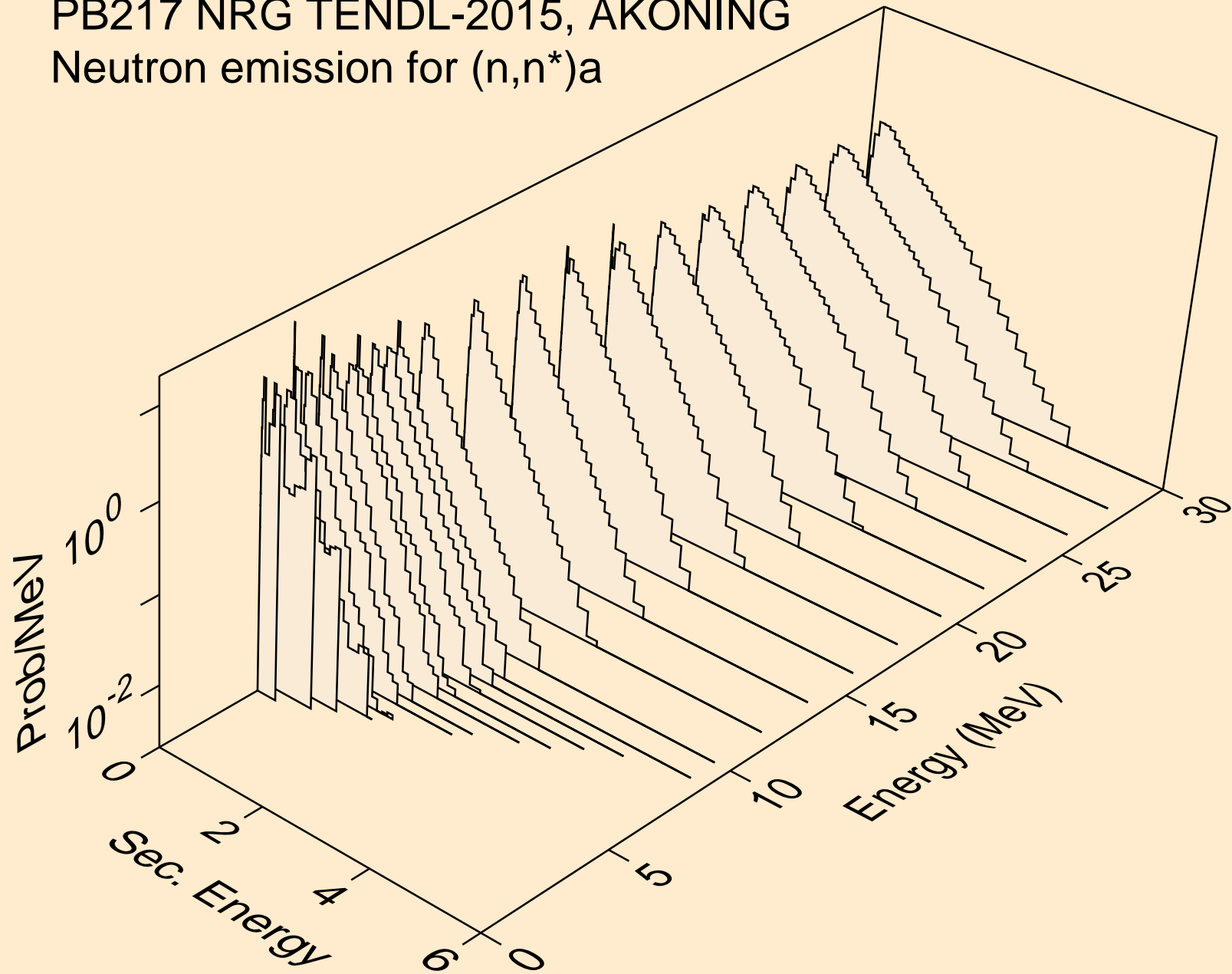

PB217 NRG TENDL-2015, AKONING  
Neutron emission for (n,2n)a

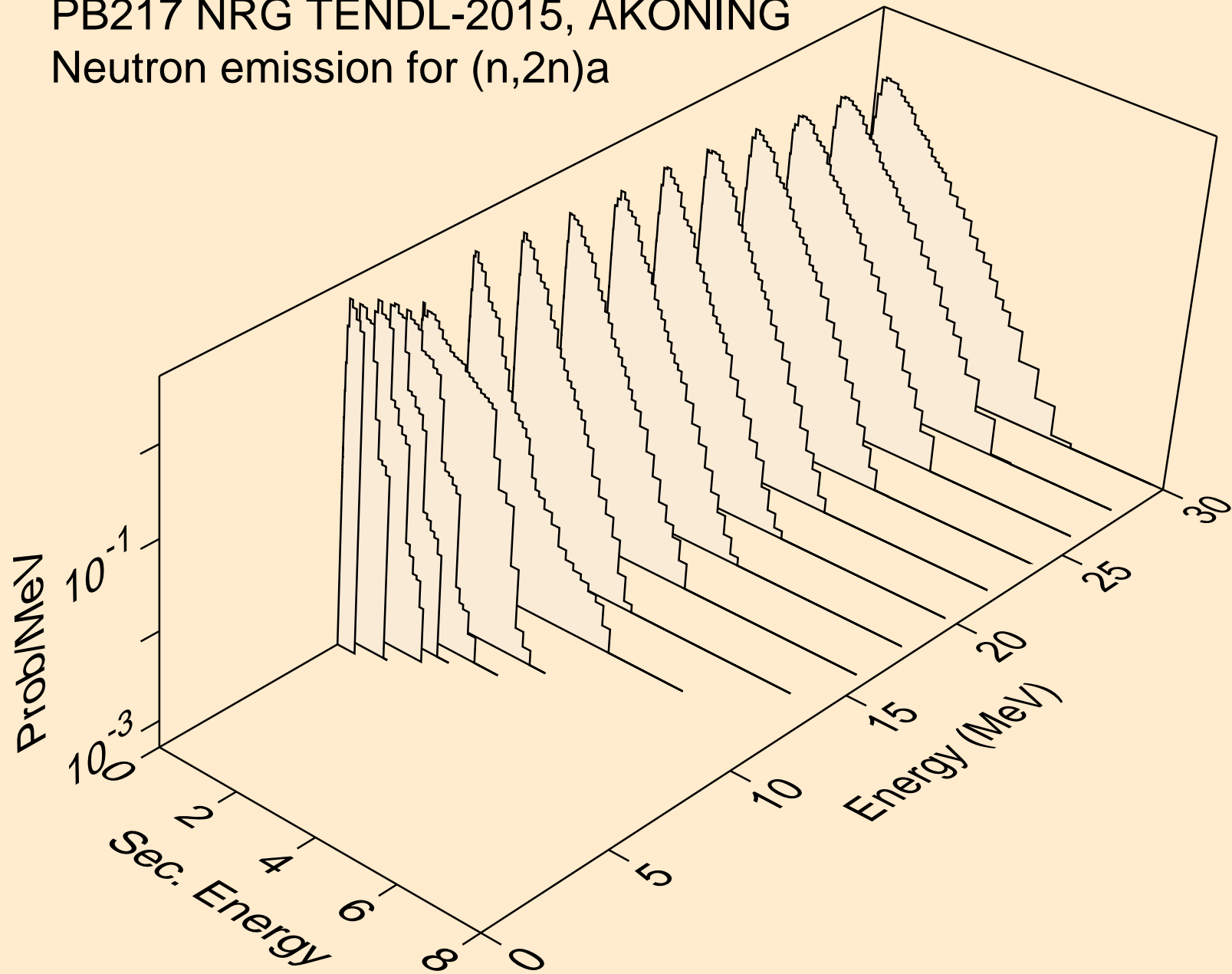

PB217 NRG TENDL-2015, AKONING  
Neutron emission for (n,3n)a

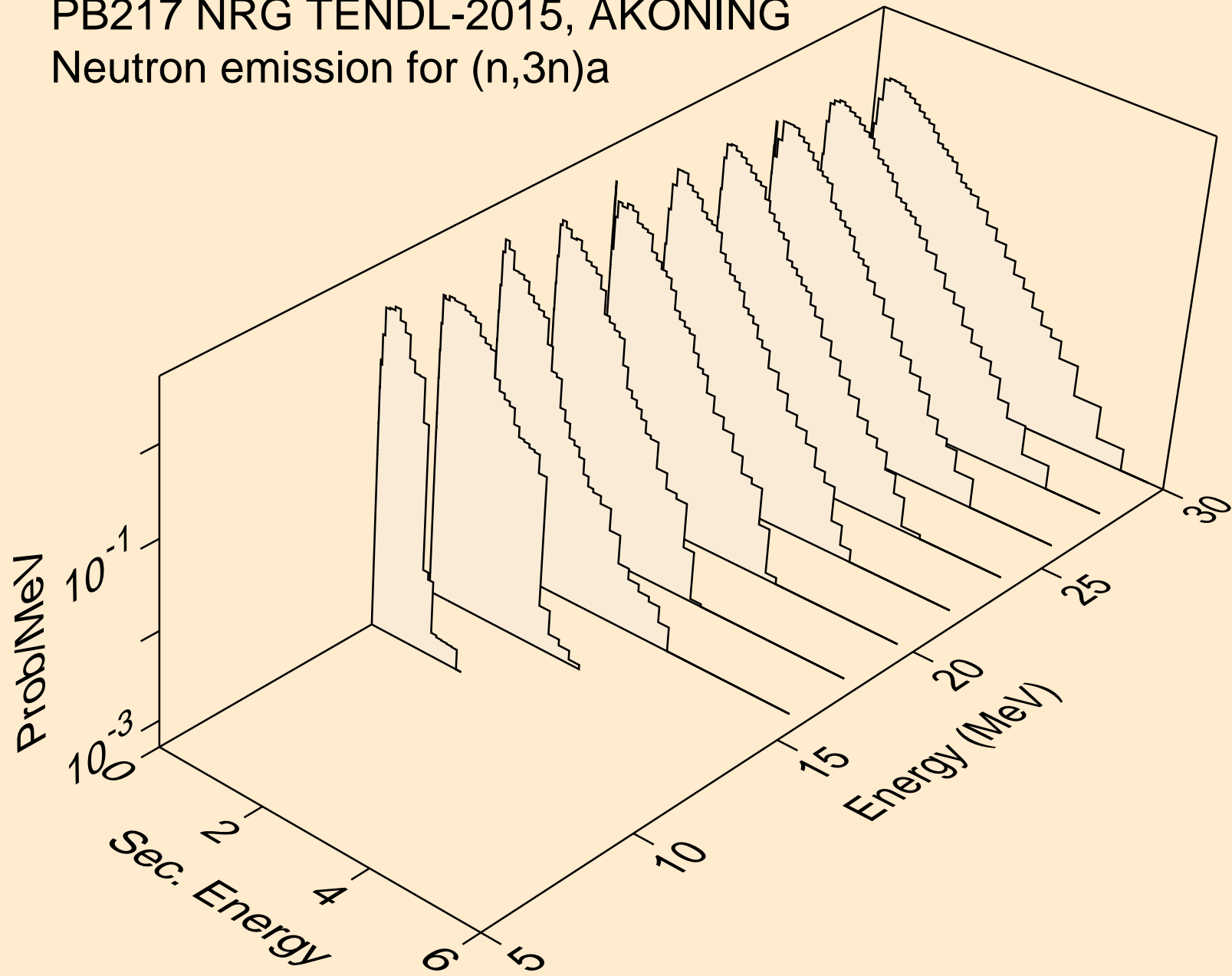



PB217 NRG TENDL-2015, AKONING  
Neutron emission for (n,n\*)p

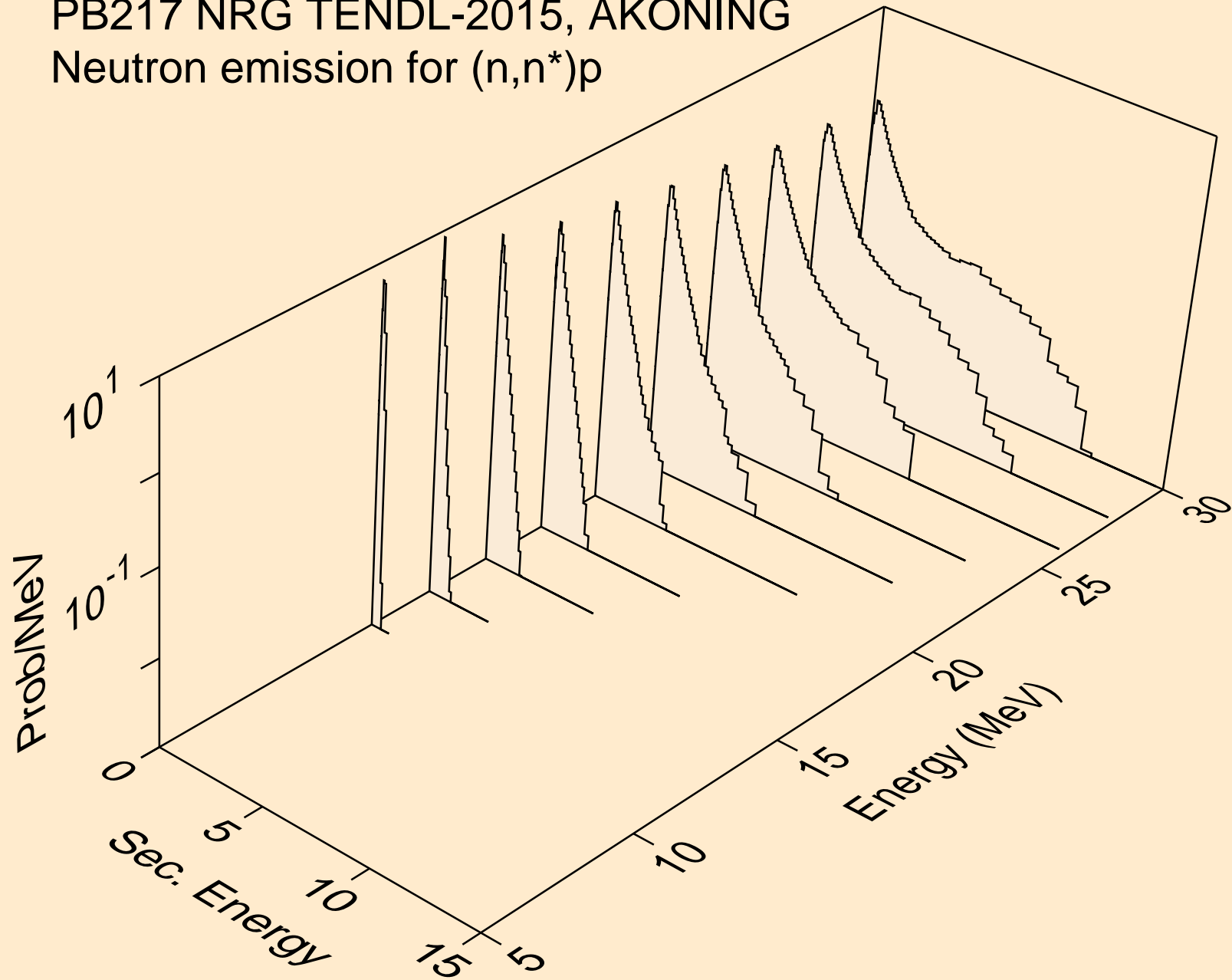

PB217 NRG TENDL-2015, AKONING  
Neutron emission for (n,n\*)d

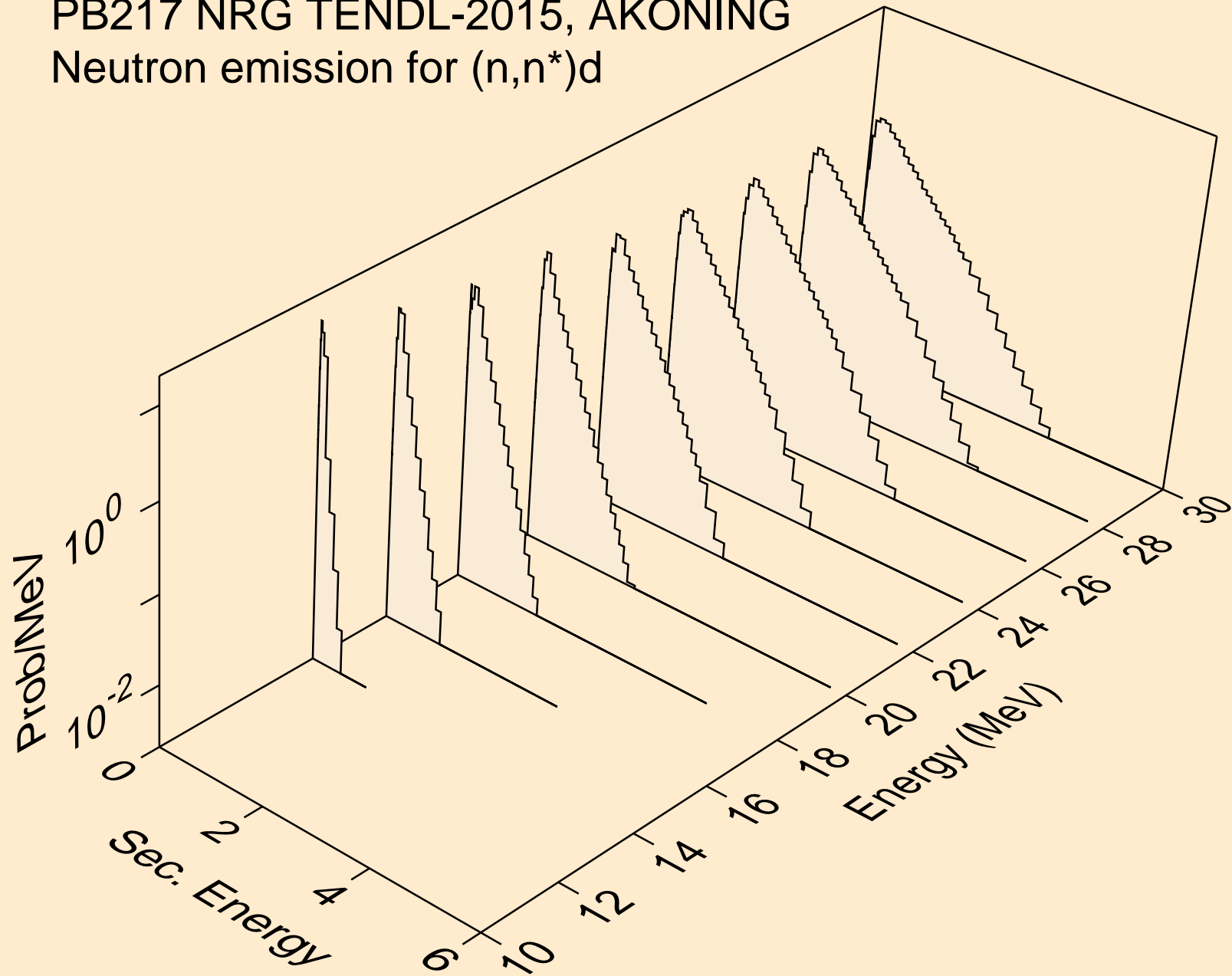

PB217 NRG TENDL-2015, AKONING  
Neutron emission for (n,n\*)t

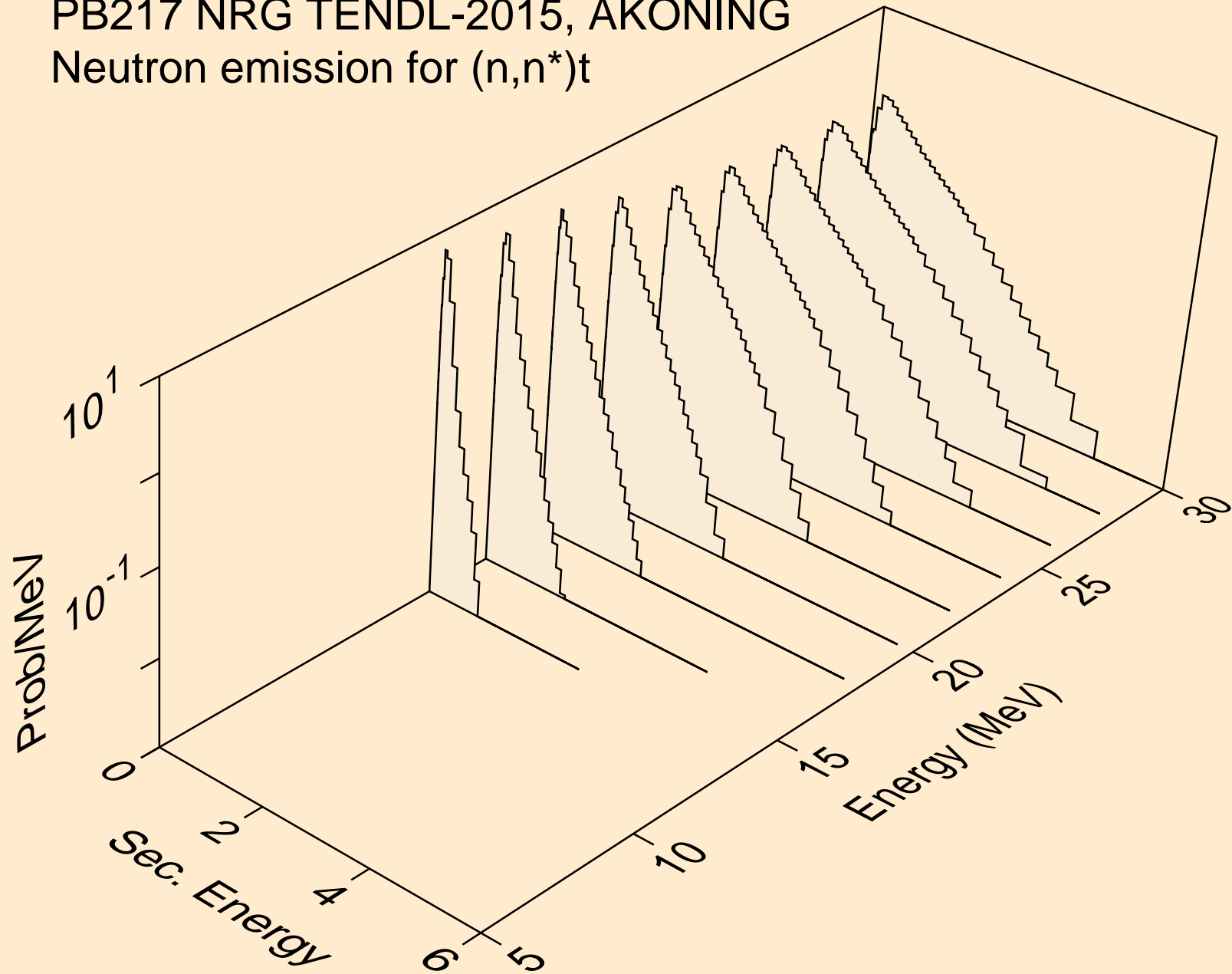

PB217 NRG TENDL-2015, AKONING  
Neutron emission for (n,n\*)he3

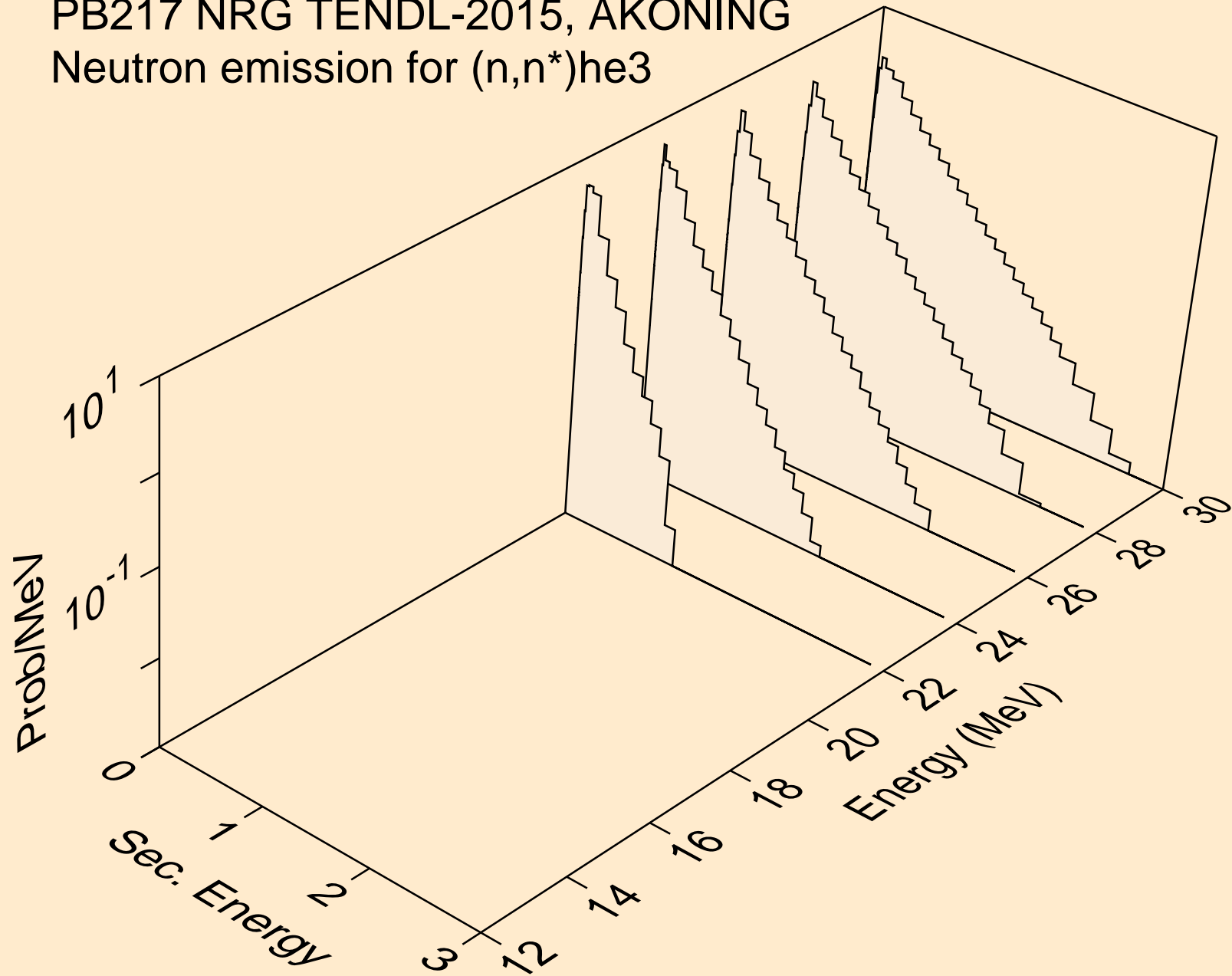

PB217 NRG TENDL-2015, AKONING  
Neutron emission for (n,4n)

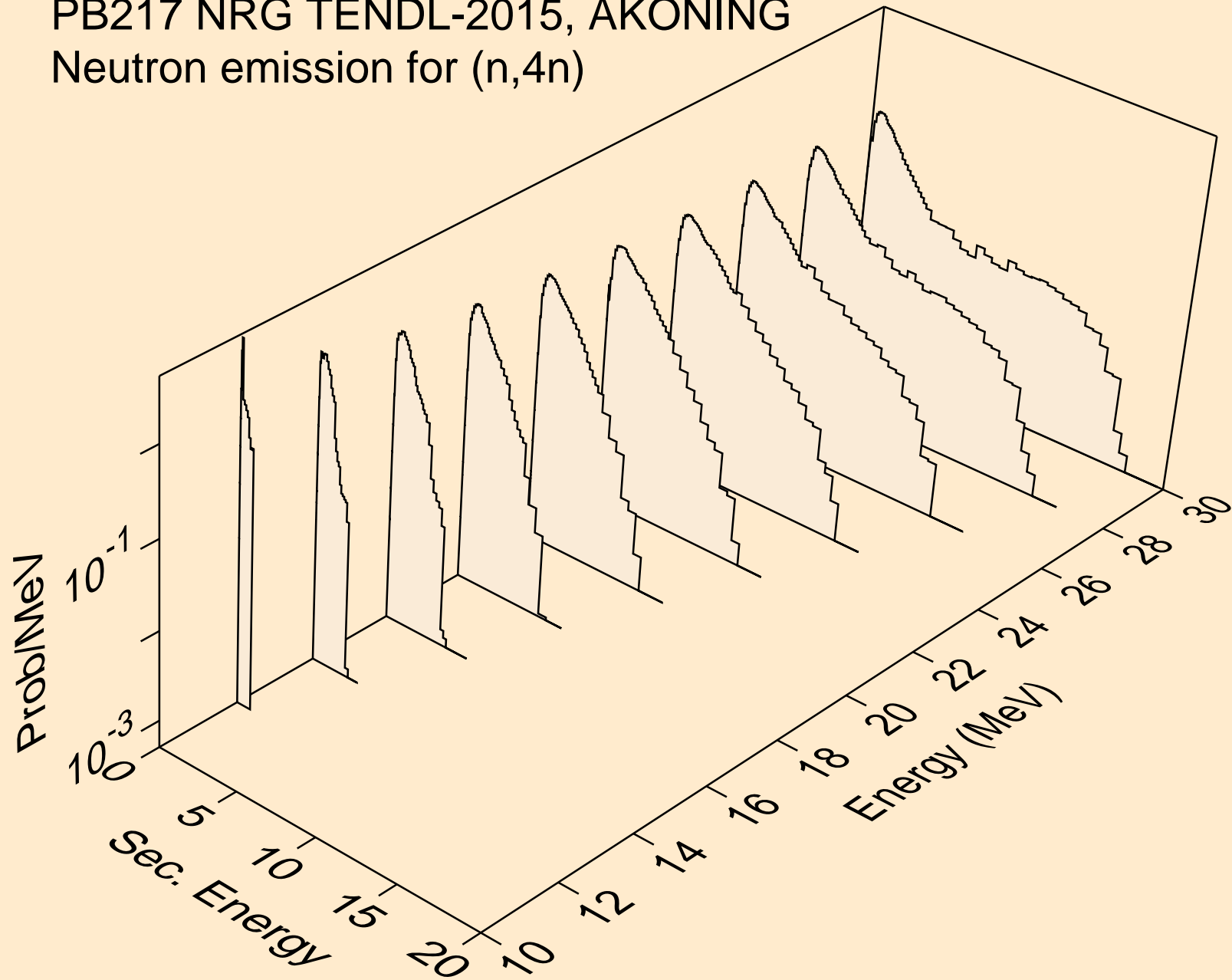

PB217 NRG TENDL-2015, AKONING  
Neutron emission for (n,2np)

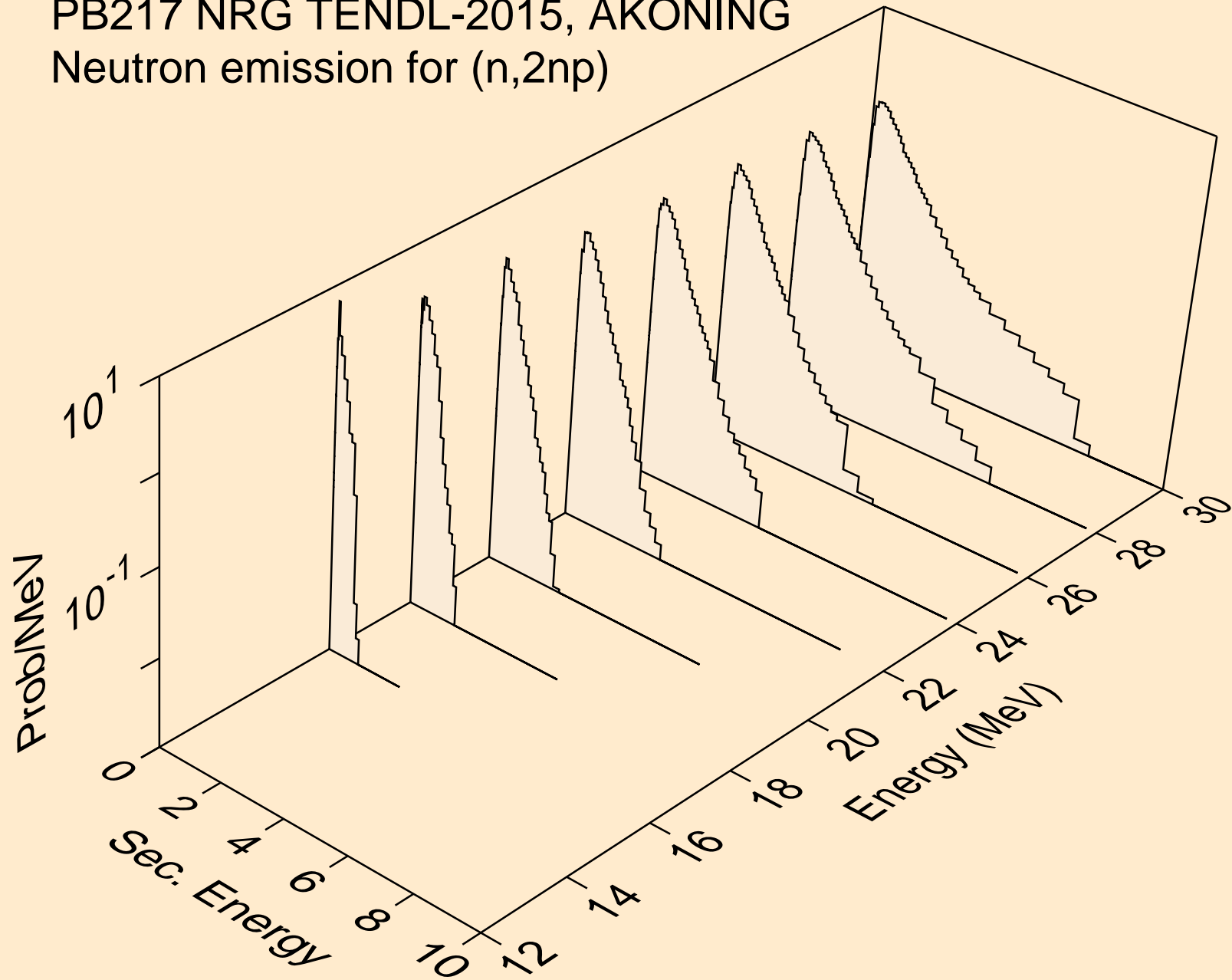

PB217 NRG TENDL-2015, AKONING  
Neutron emission for (n,3np)

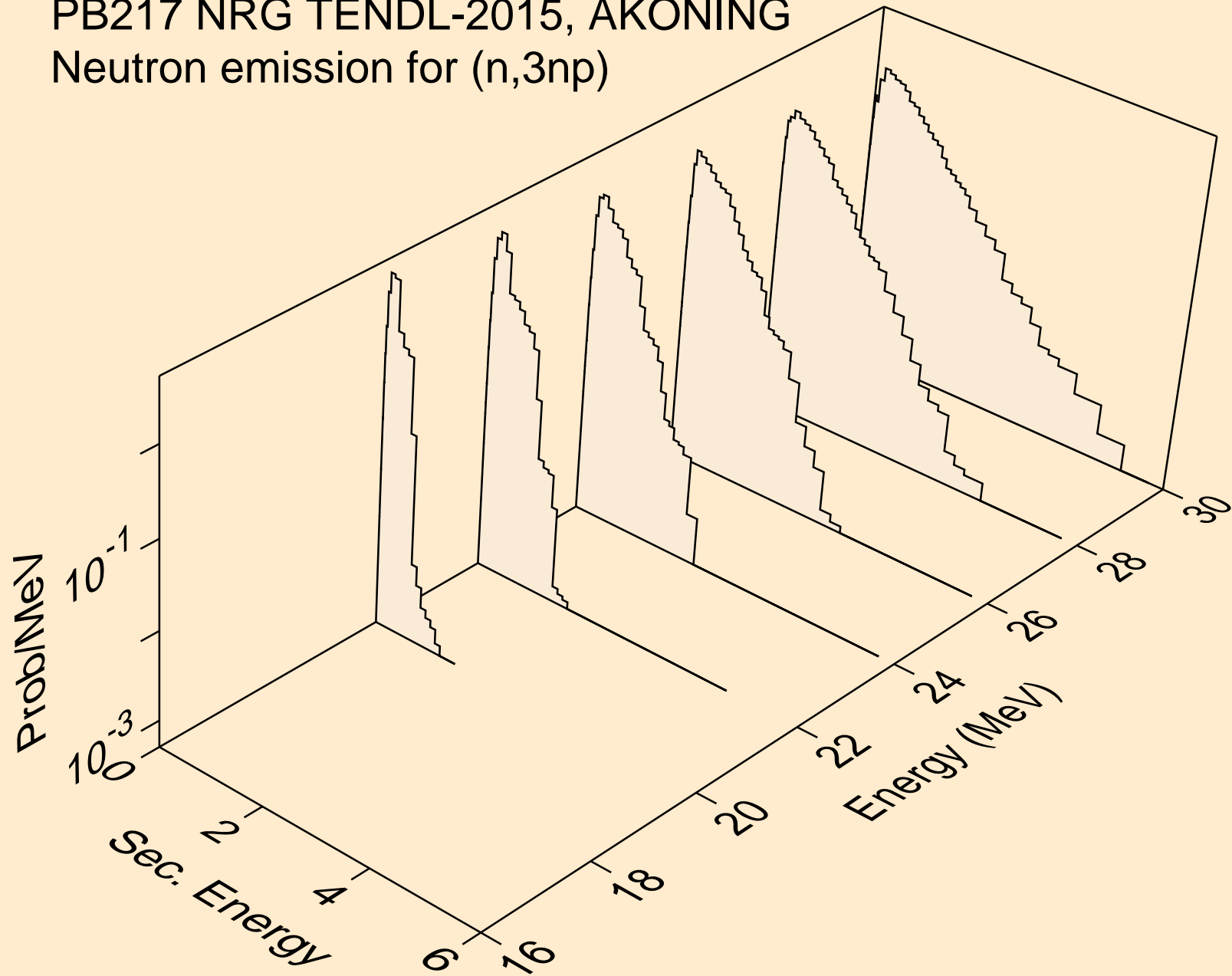

PB217 NRG TENDL-2015, AKONING  
Neutron emission for (n,n\*c)

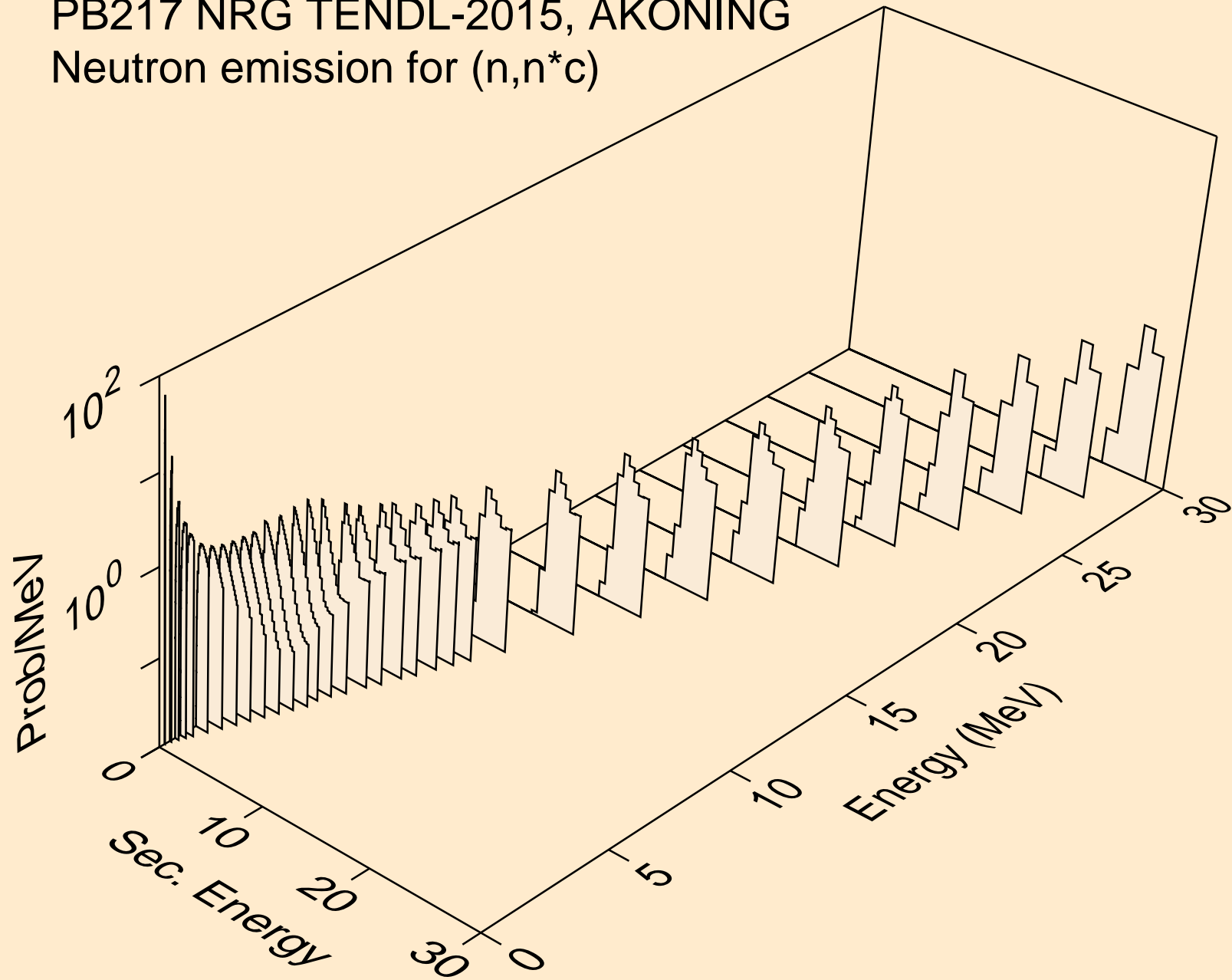



PB217 NRG TENDL-2015, AKONING  
Photon emission for (n,x)

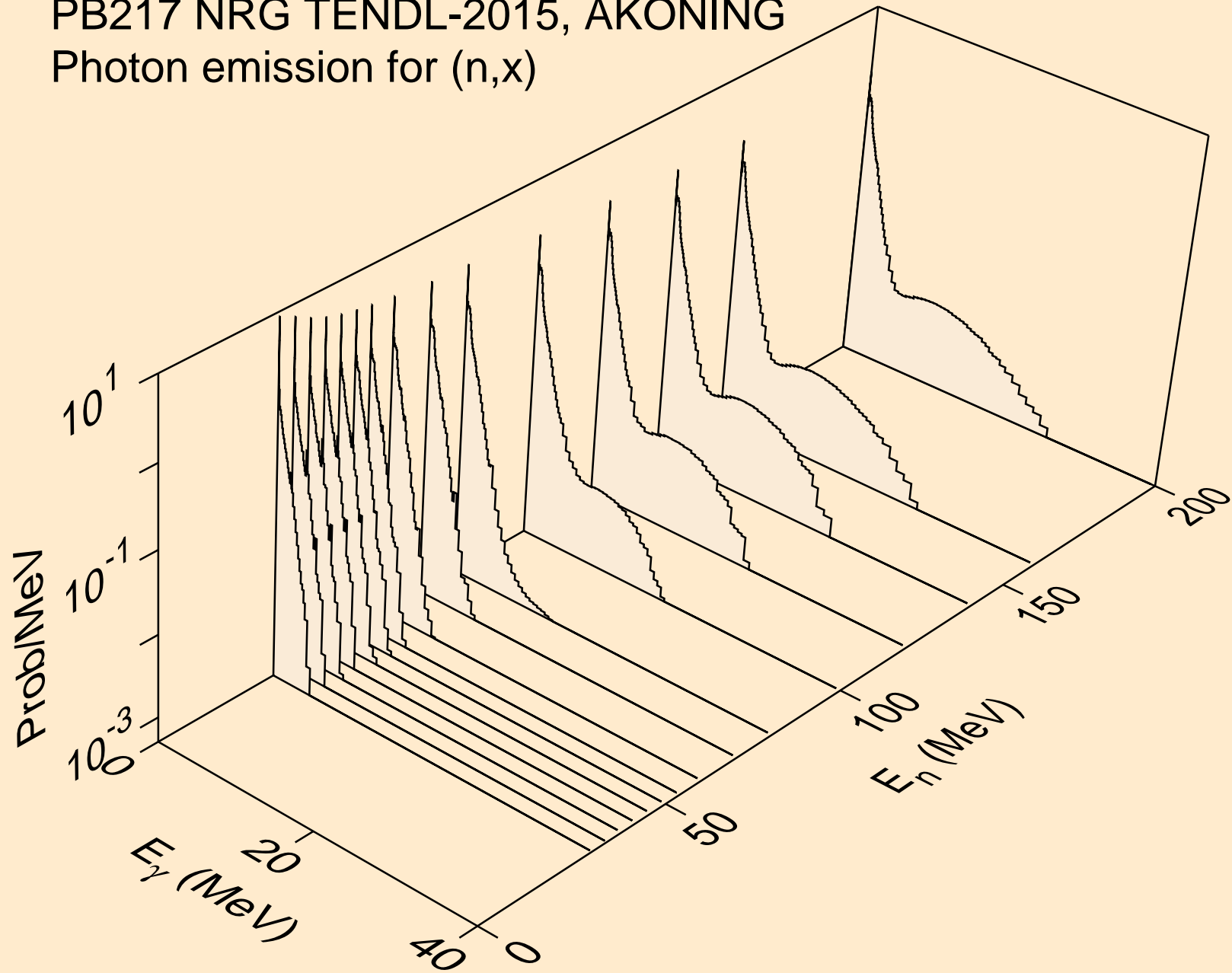

PB217 NRG TENDL-2015, AKONING  
Photon emission for (n,2nd)

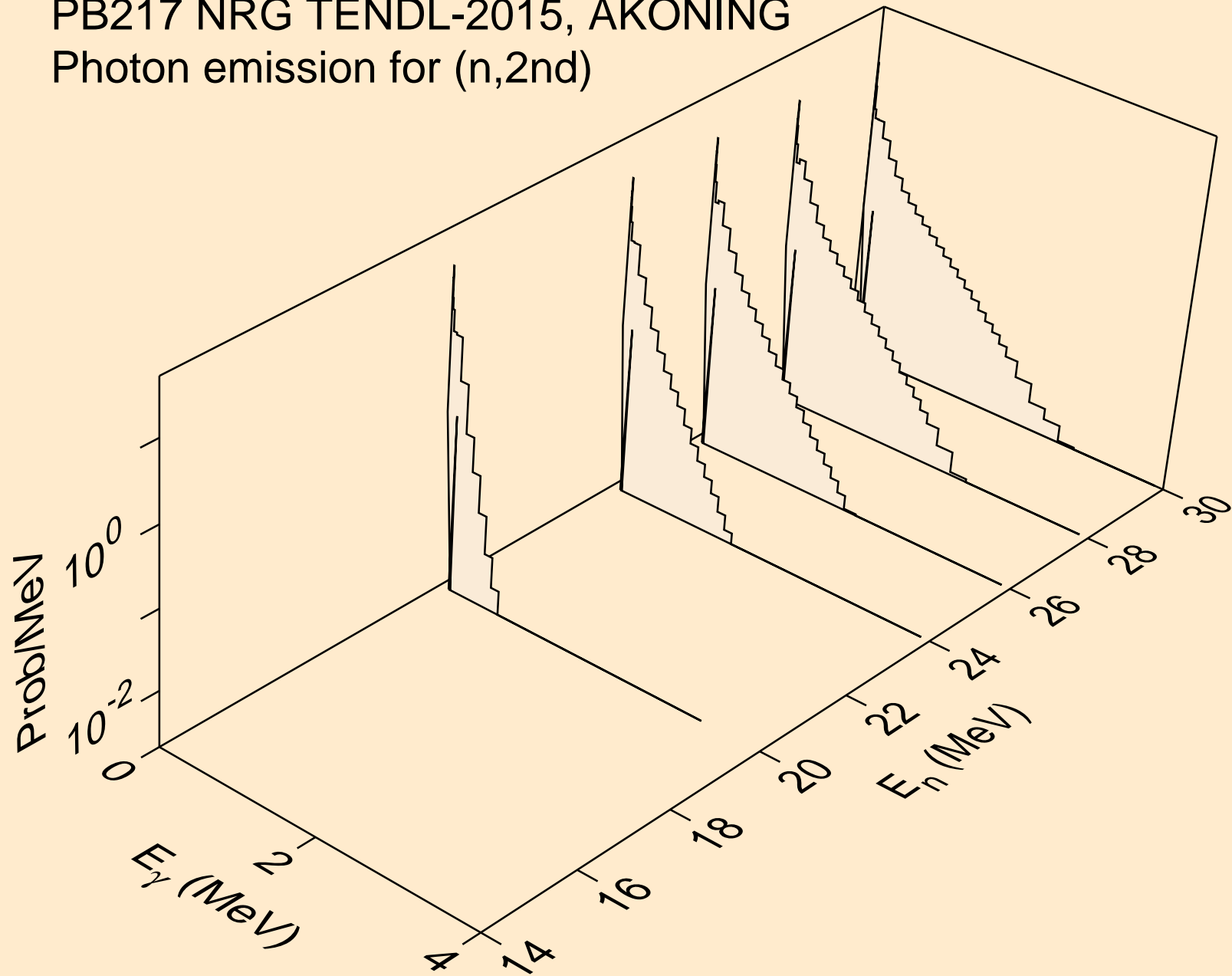

PB217 NRG TENDL-2015, AKONING  
Photon emission for (n,2n)

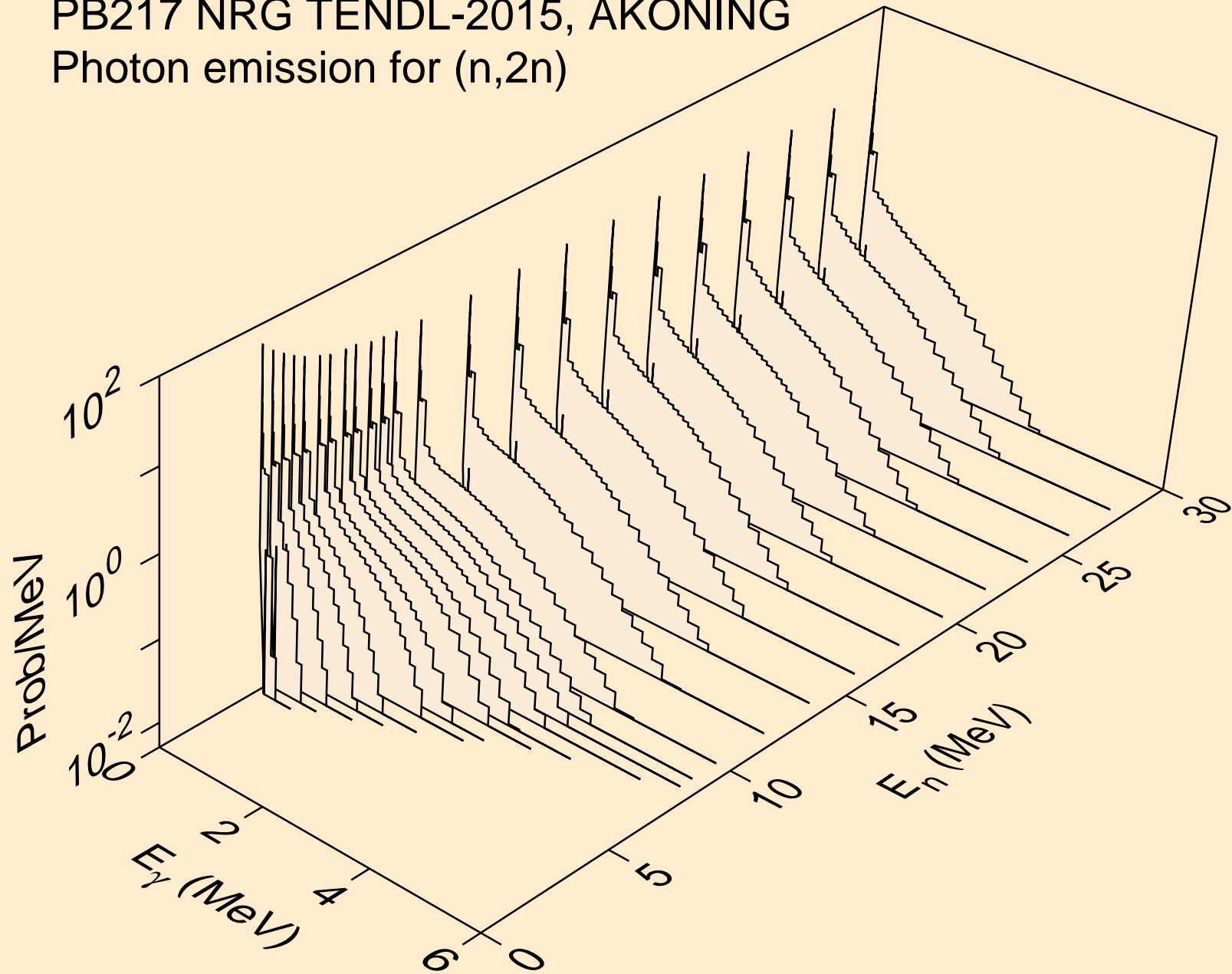

PB217 NRG TENDL-2015, AKONING  
Photon emission for (n,3n)

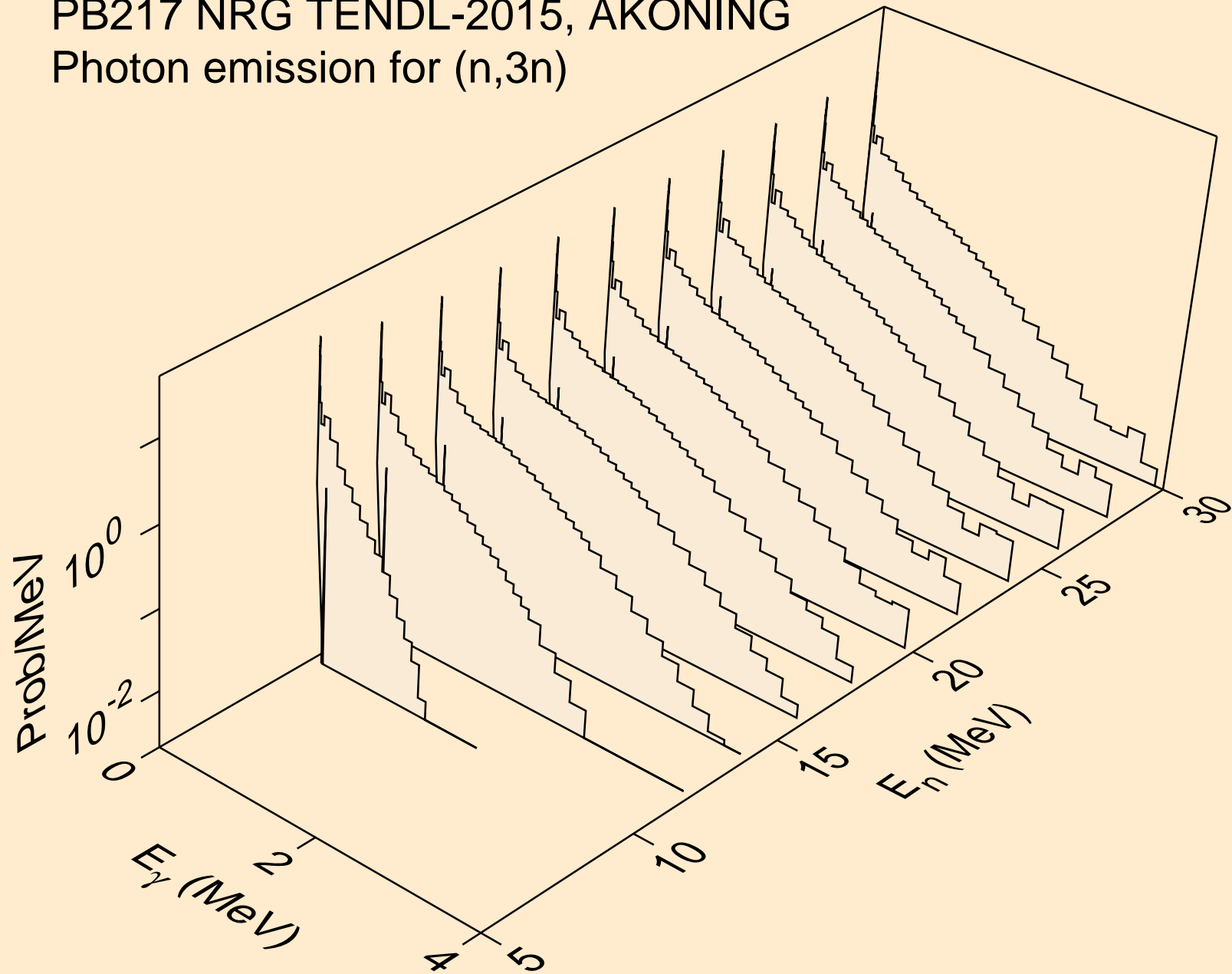

PB217 NRG TENDL-2015, AKONING  
Photon emission for (n,n\*)a

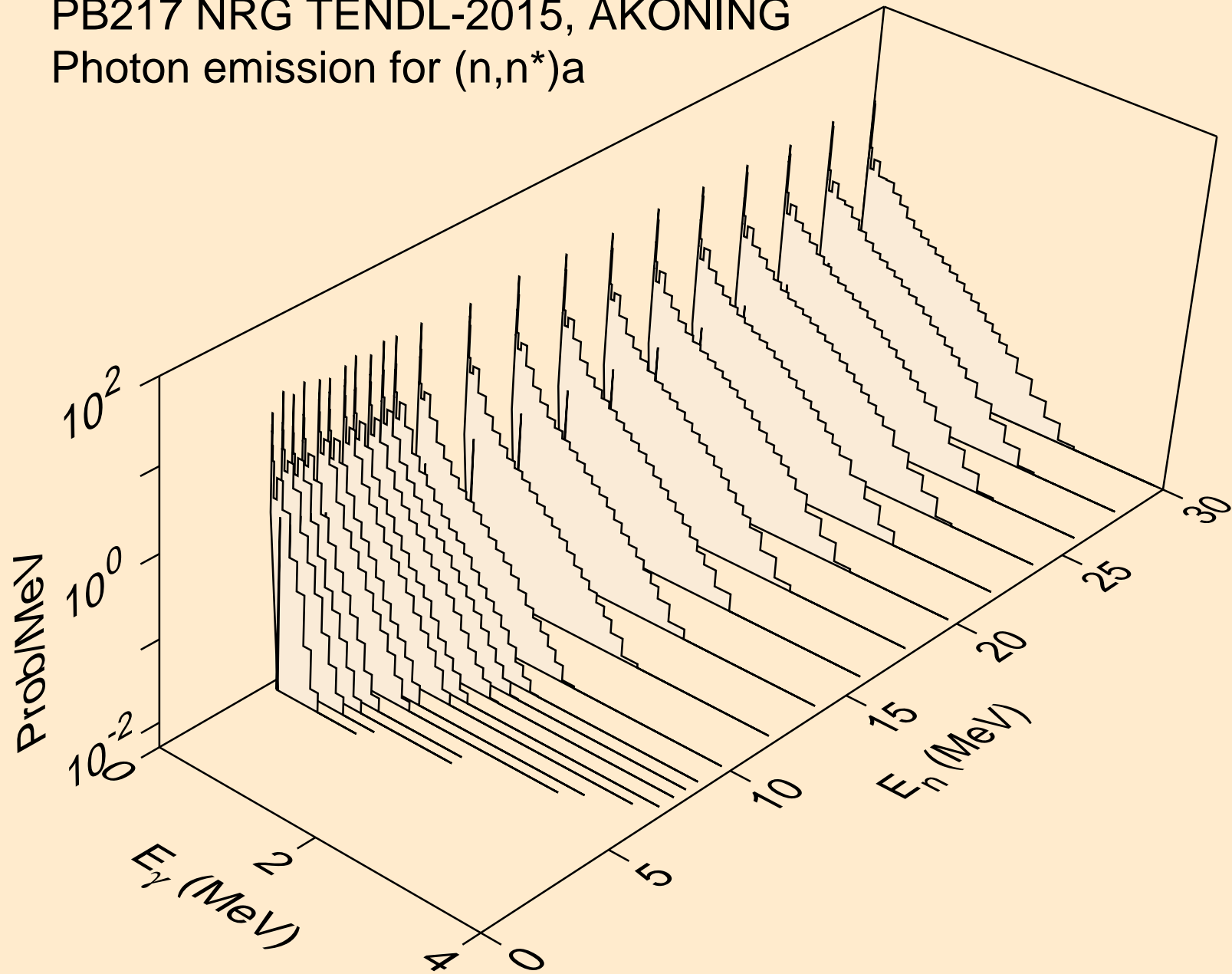

PB217 NRG TENDL-2015, AKONING  
Photon emission for (n,2n)a

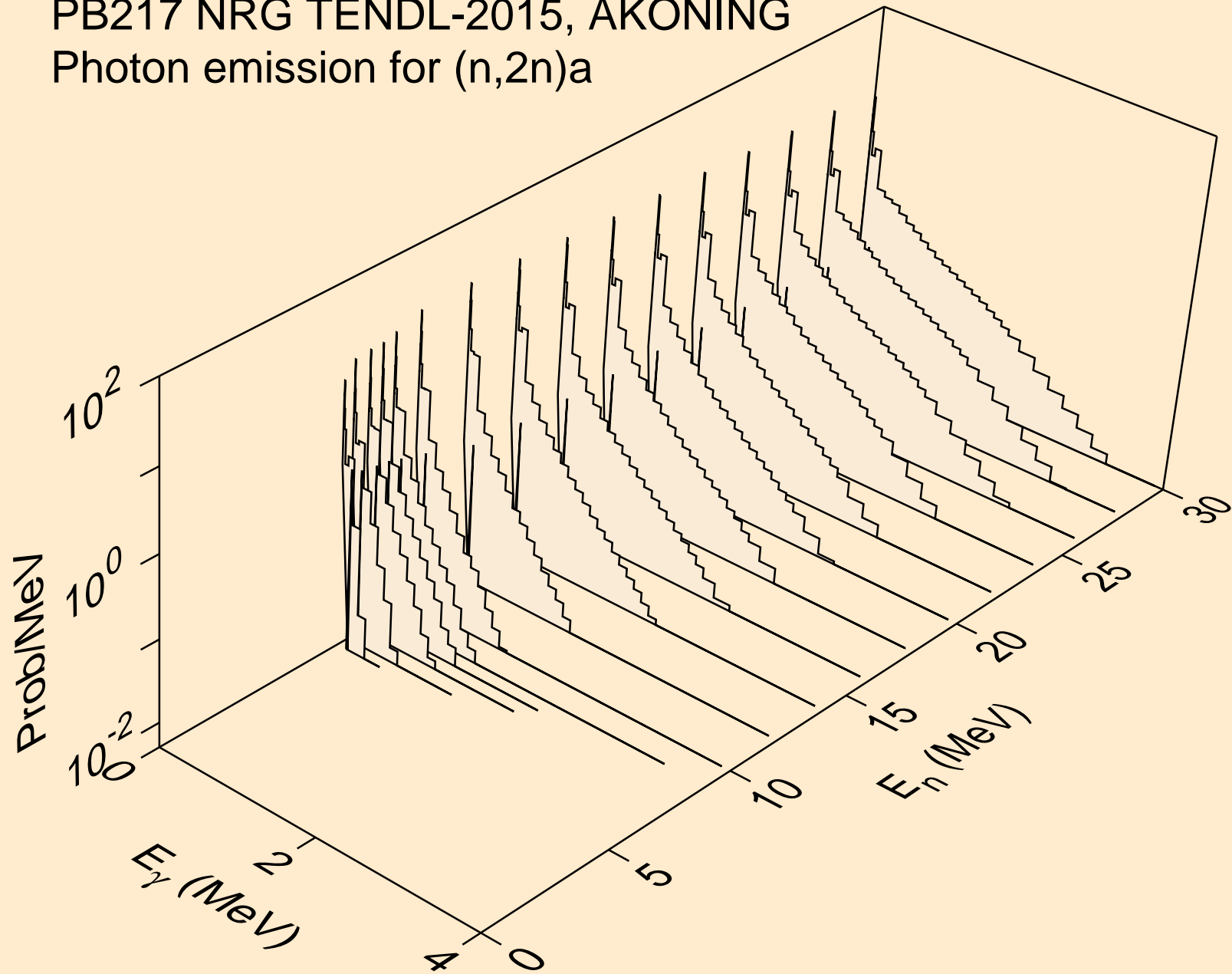

PB217 NRG TENDL-2015, AKONING  
Photon emission for (n,3n)a

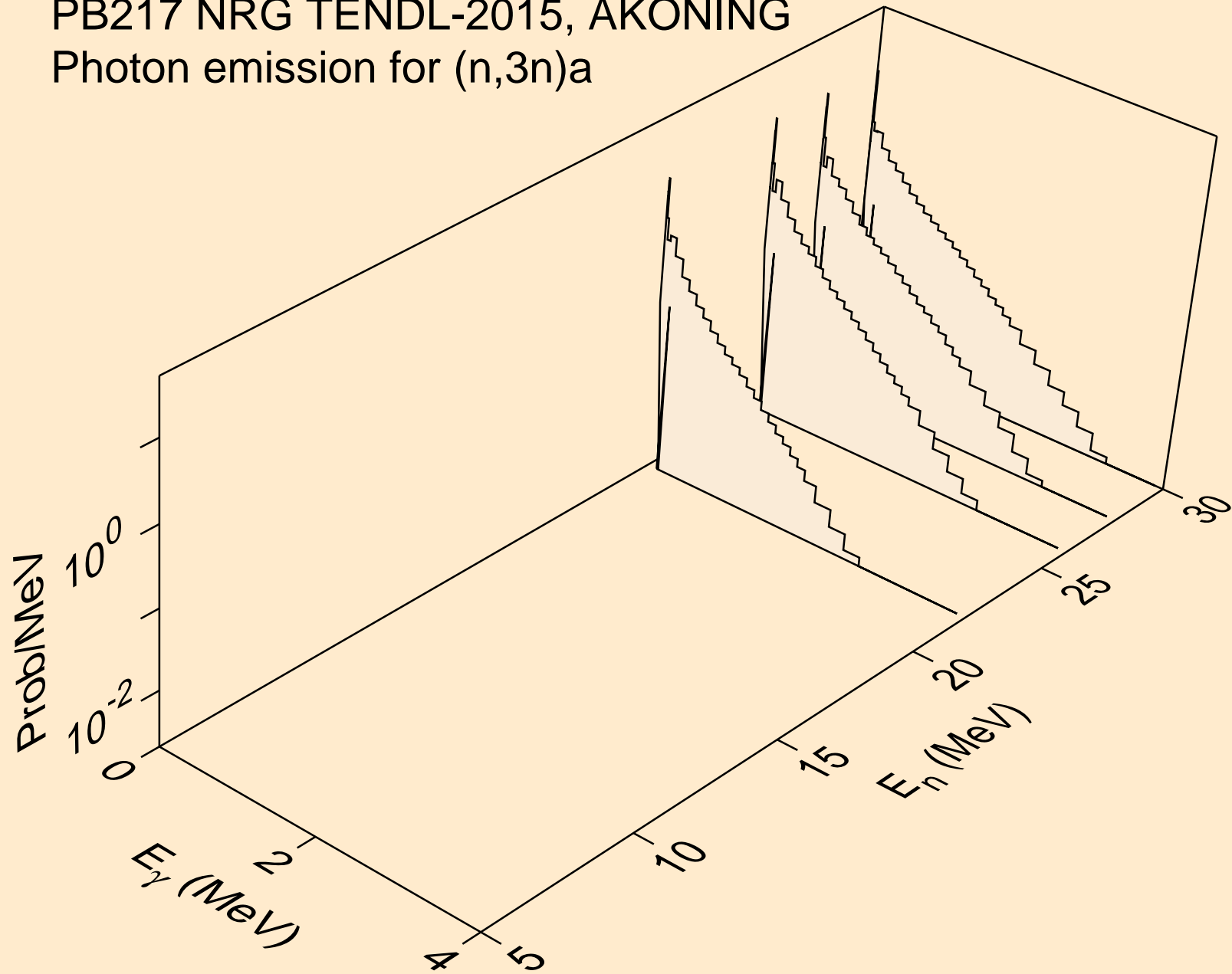

PB217 NRG TENDL-2015, AKONING  
Photon emission for (n,n\*)p

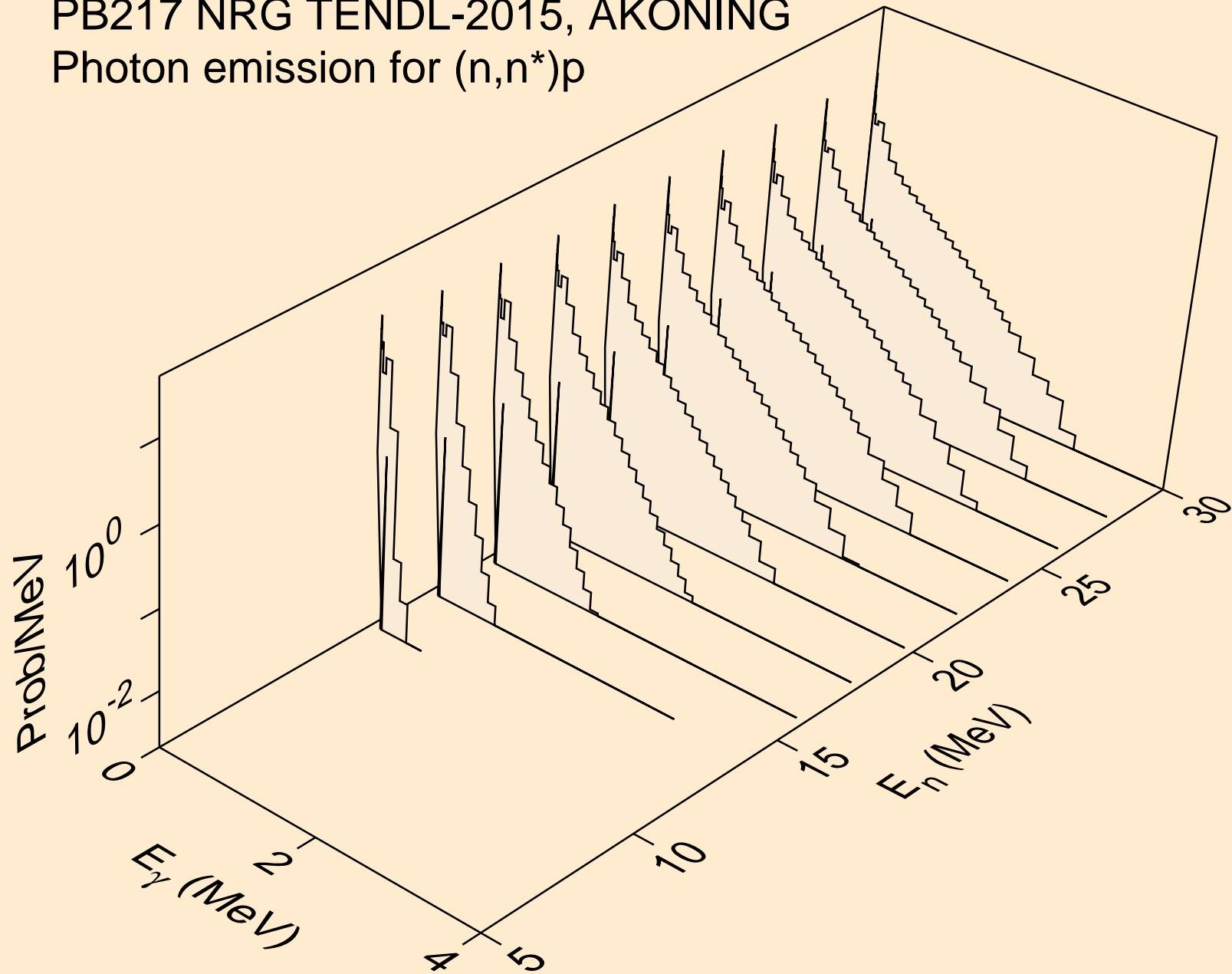



PB217 NRG TENDL-2015, AKONING  
Photon emission for (n,n\*)d

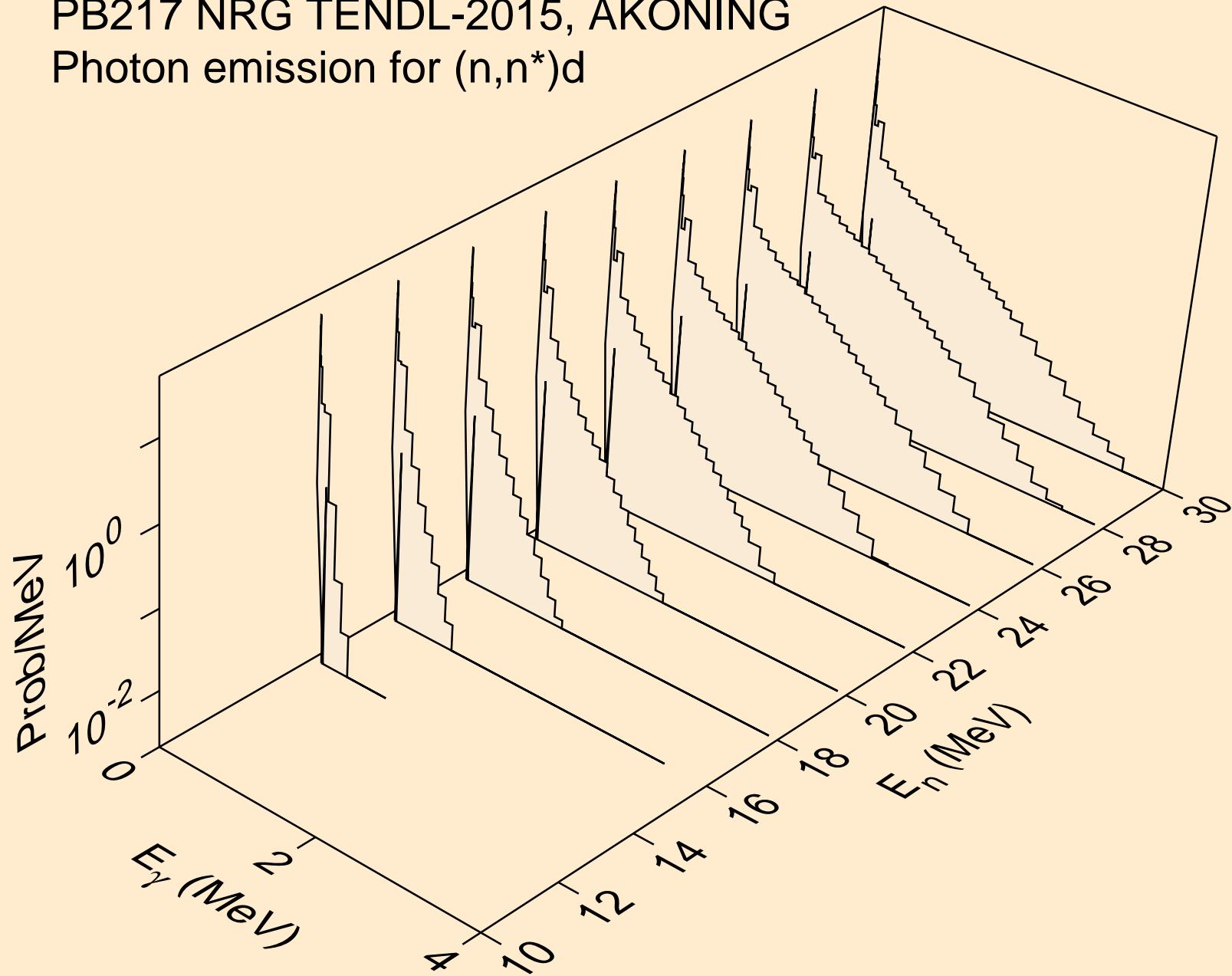

PB217 NRG TENDL-2015, AKONING  
Photon emission for (n,n\*)t

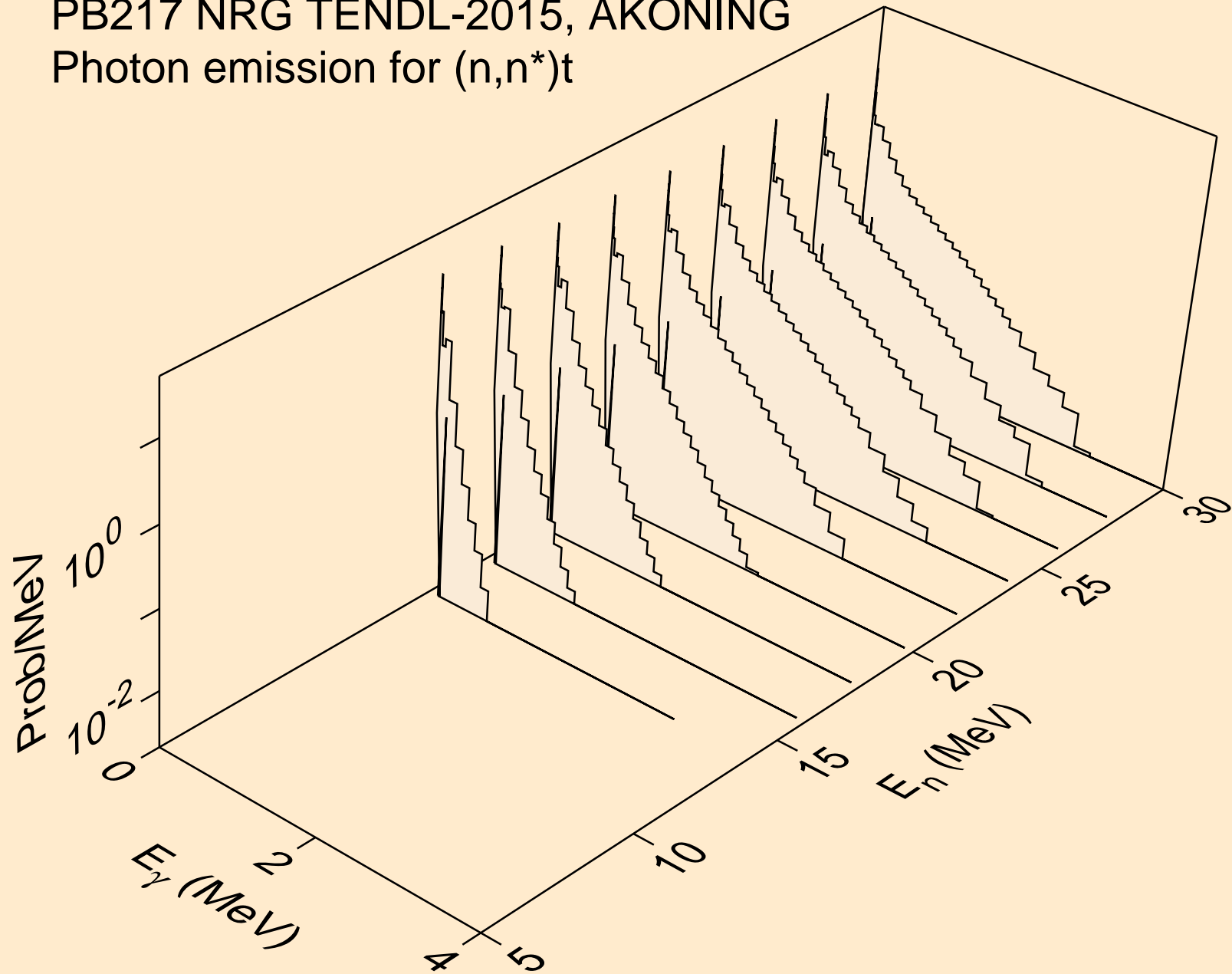

PB217 NRG TENDL-2015, AKONING  
Photon emission for (n,n\*)he3

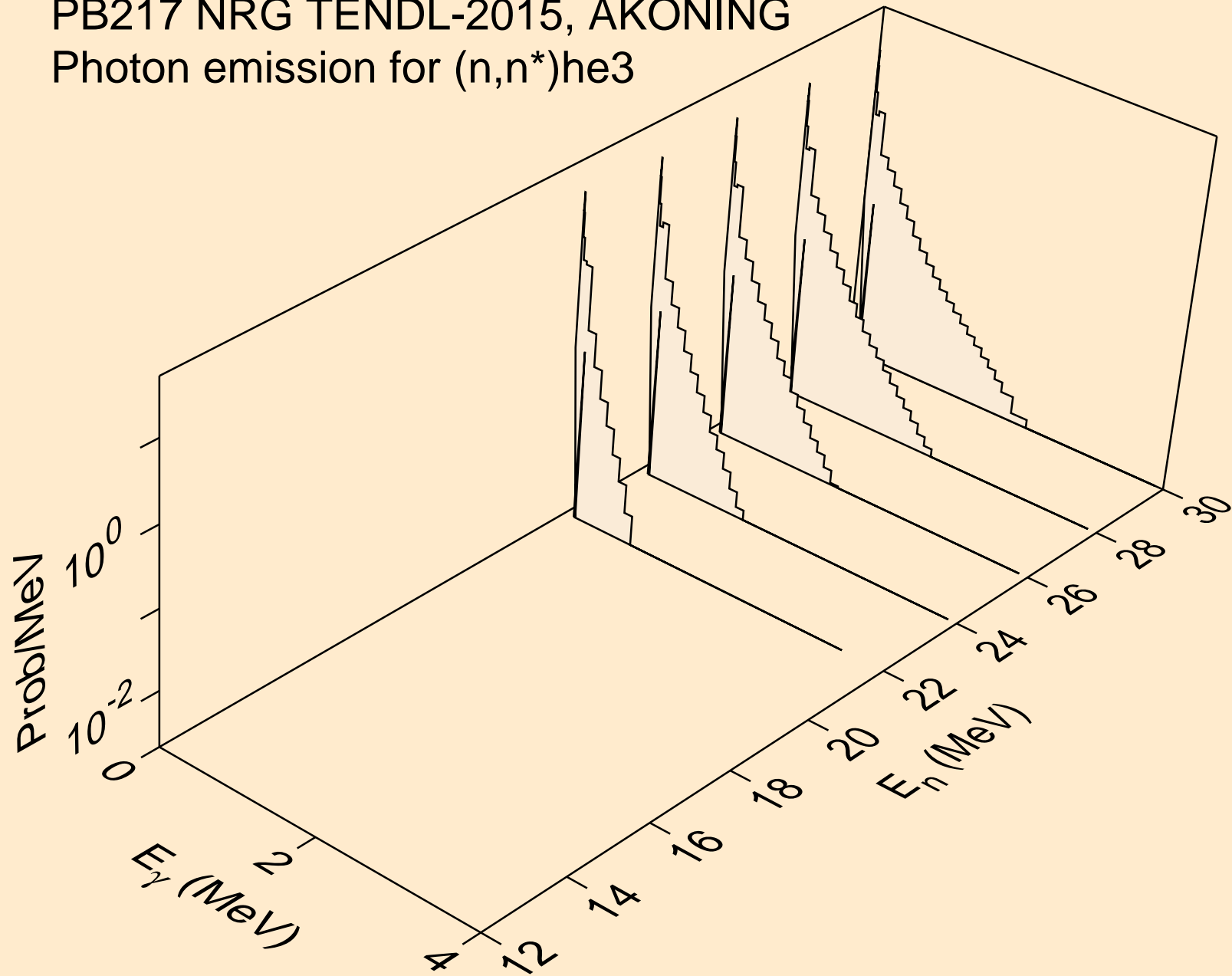

PB217 NRG TENDL-2015, AKONING  
Photon emission for (n,4n)

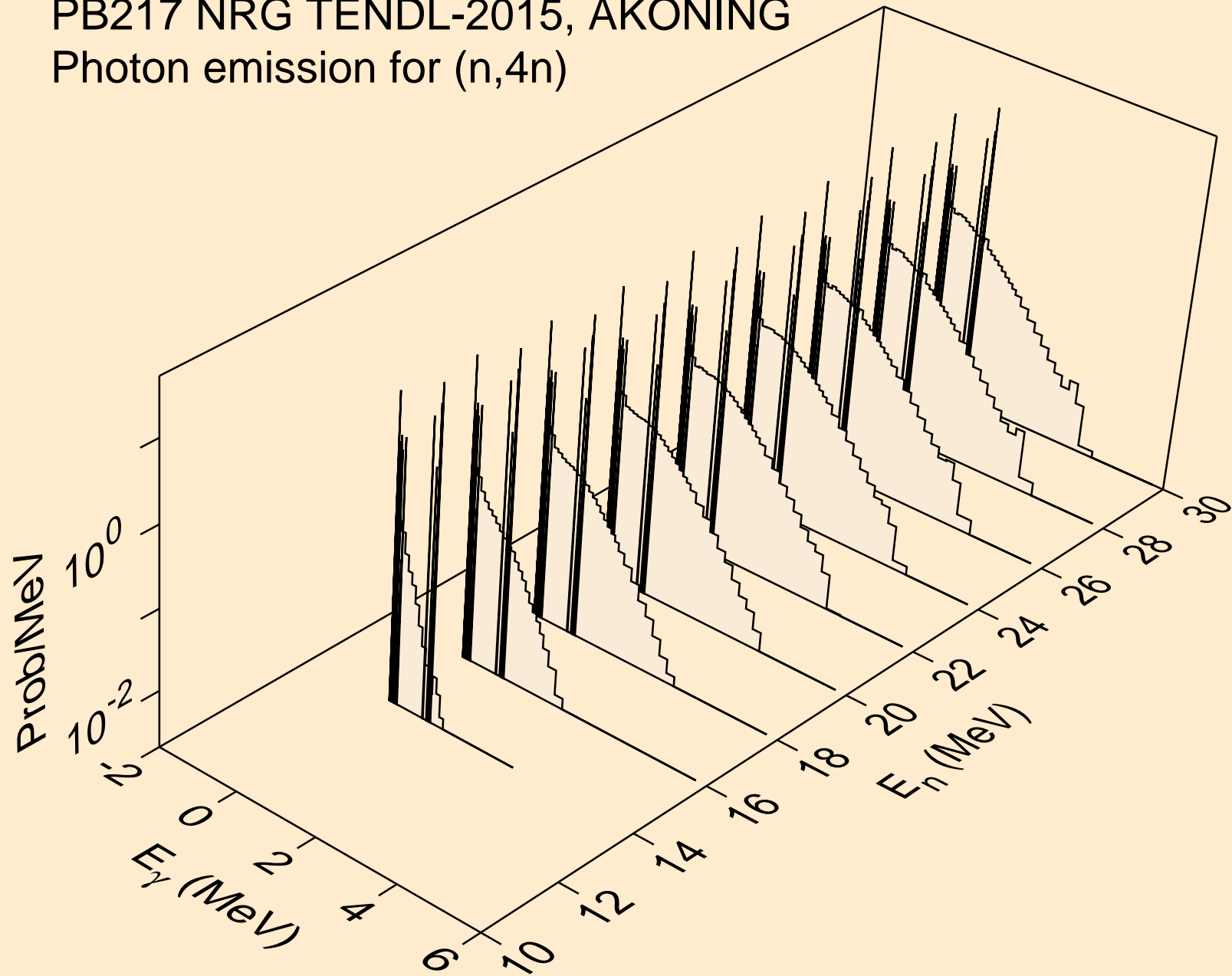

PB217 NRG TENDL-2015, AKONING  
Photon emission for (n,2np)

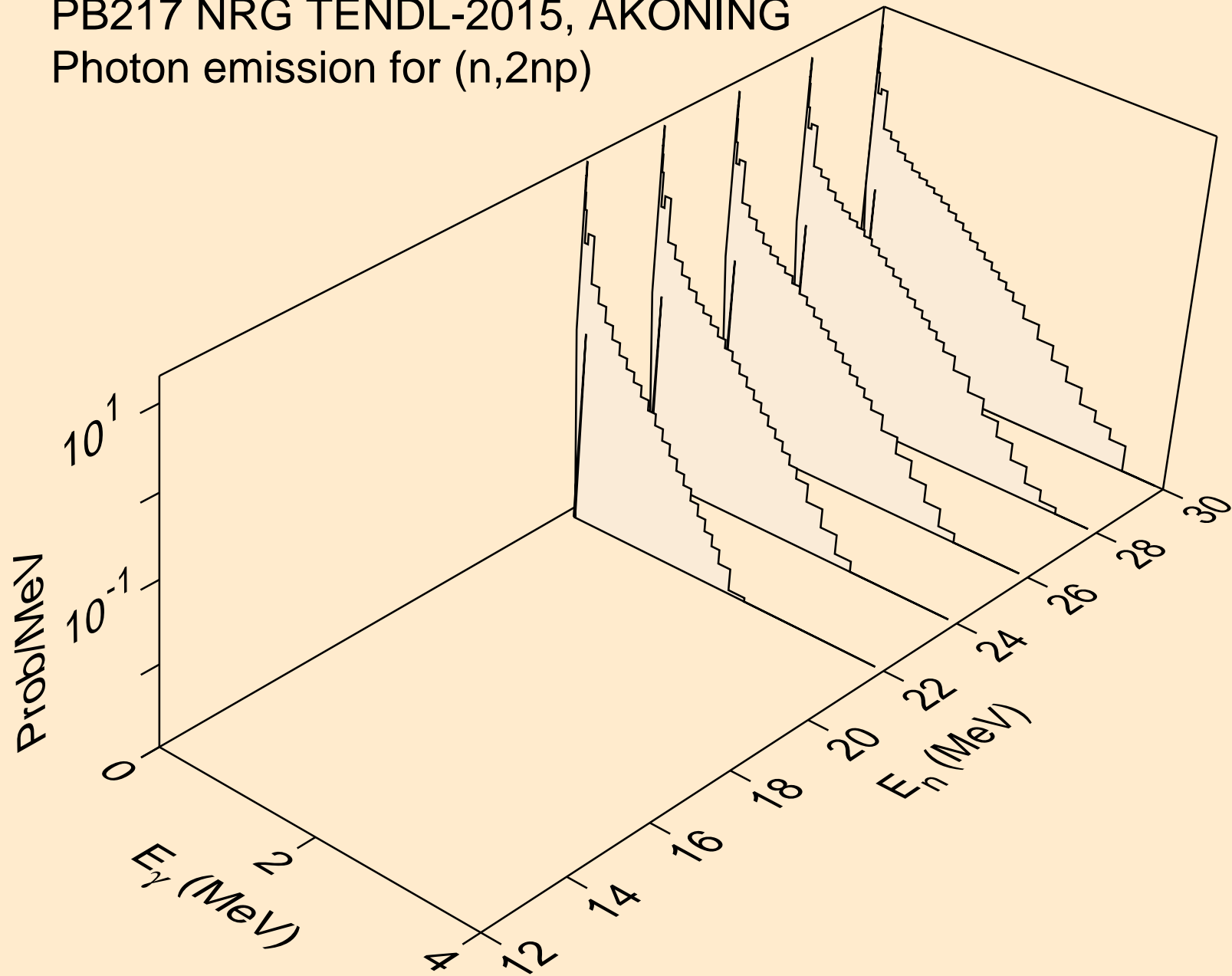

PB217 NRG TENDL-2015, AKONING  
Photon emission for (n,3np)

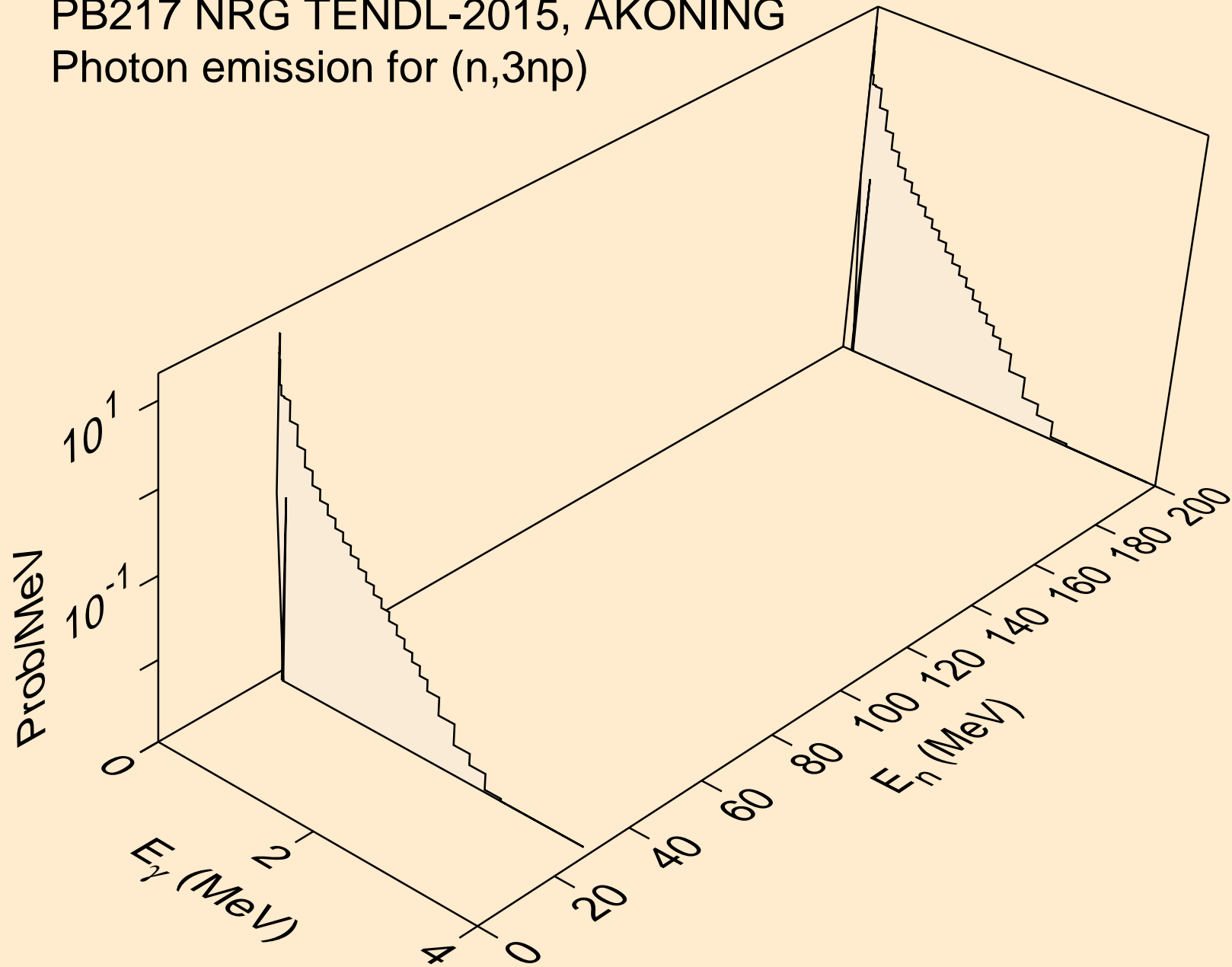

PB217 NRG TENDL-2015, AKONING  
Photon emission for (n,n\*c)

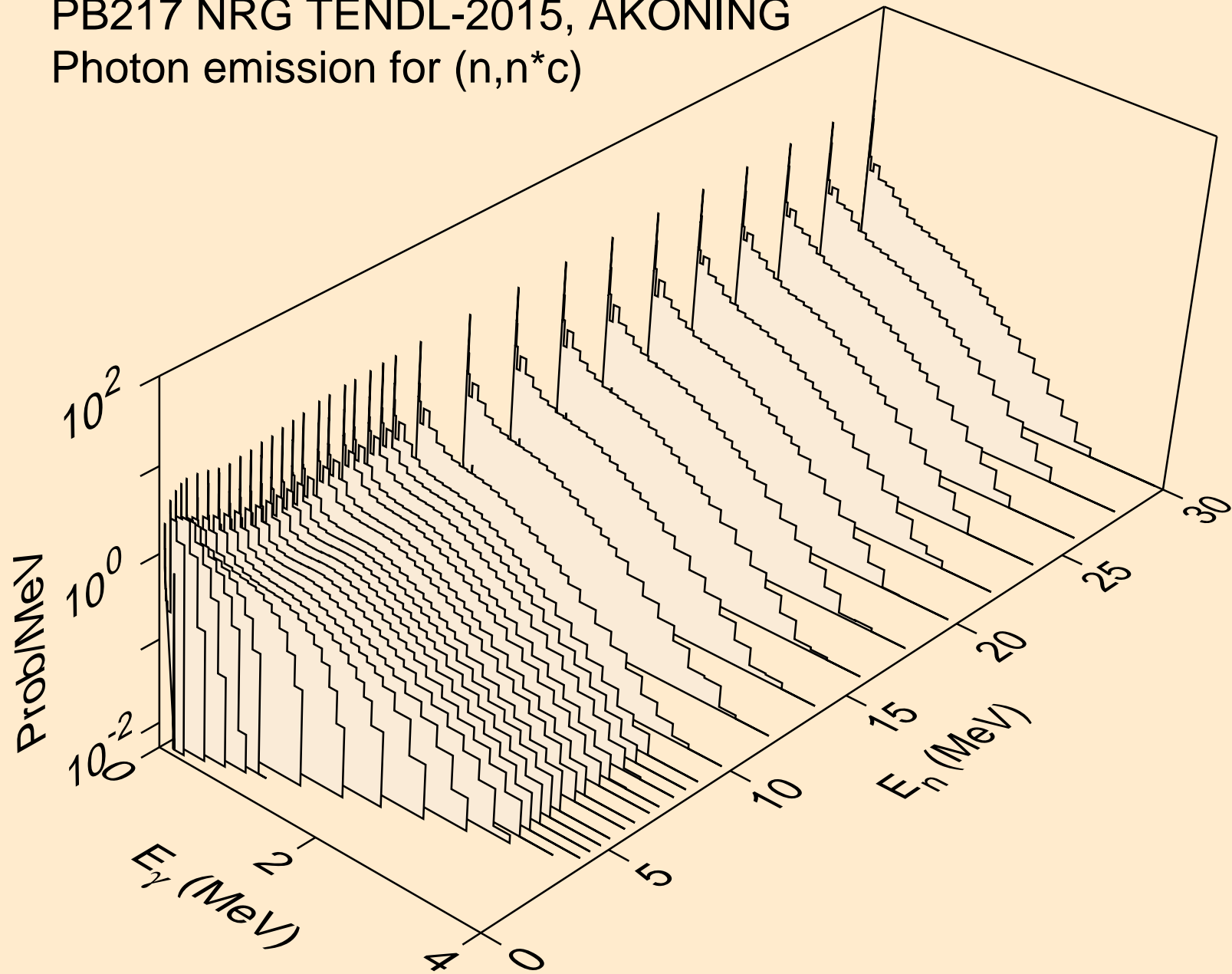

PB217 NRG TENDL-2015, AKONING  
Photon emission for (n,gma)

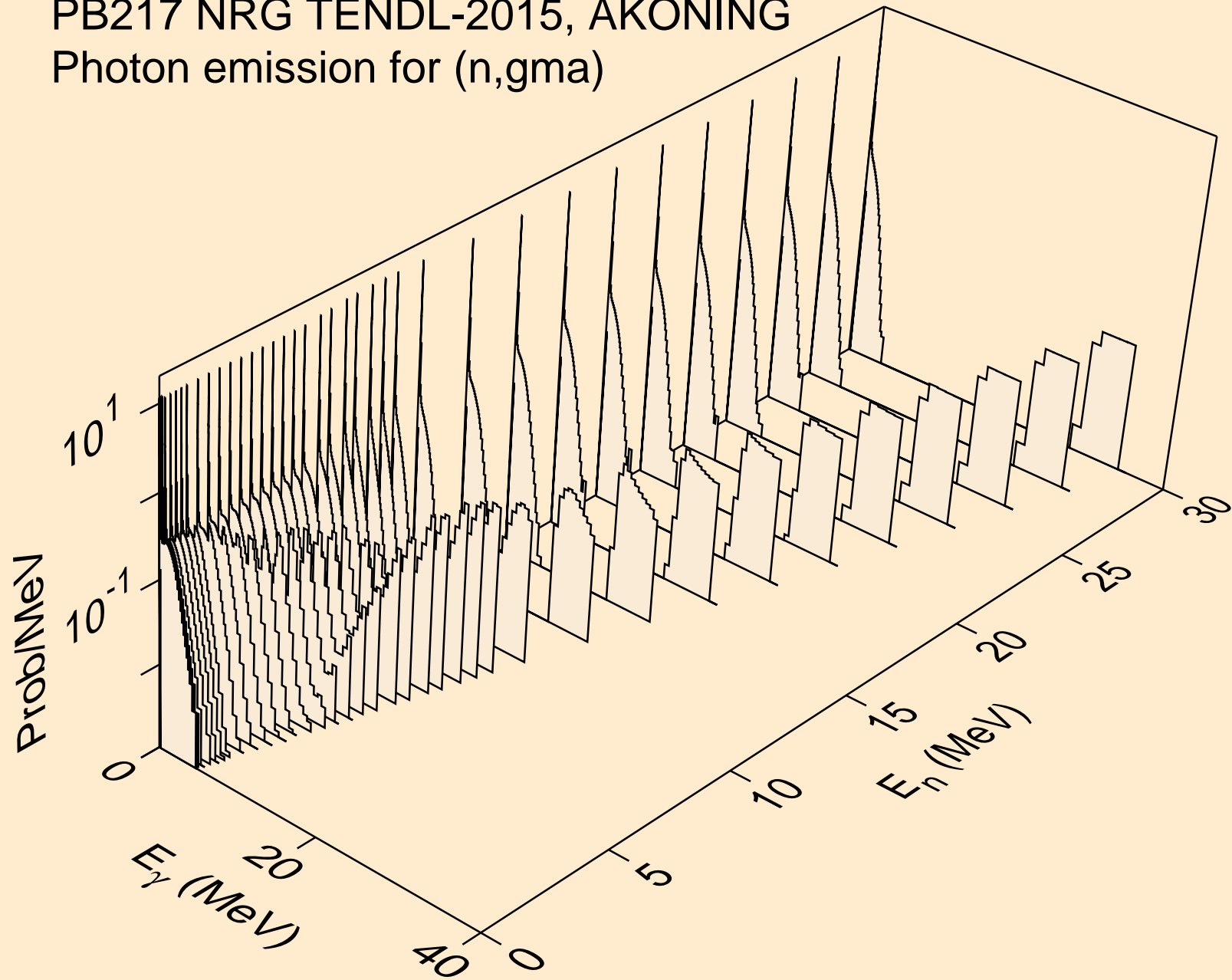



PB217 NRG TENDL-2015, AKONING  
Photon emission for (n,p)

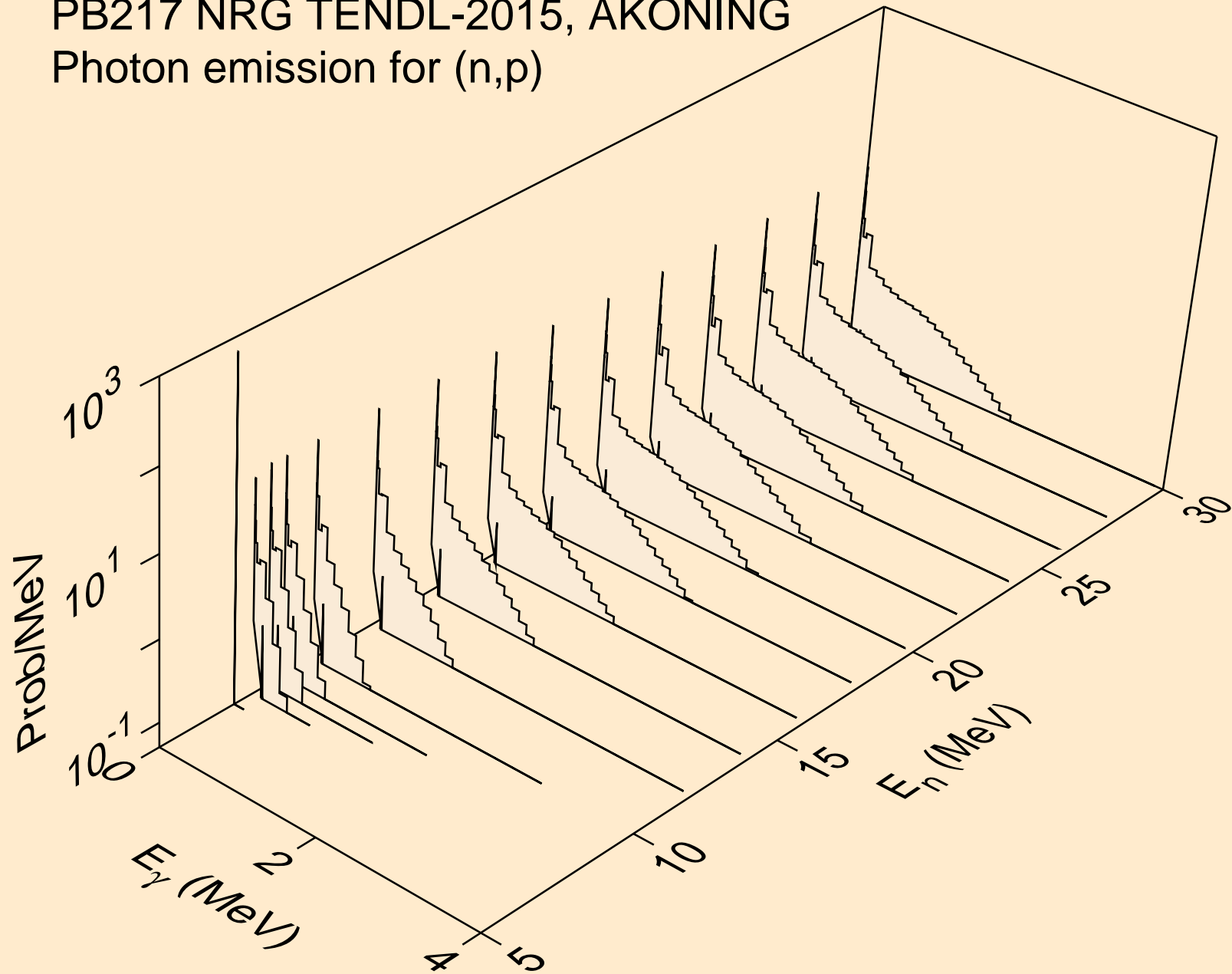

PB217 NRG TENDL-2015, AKONING  
Photon emission for (n,d)

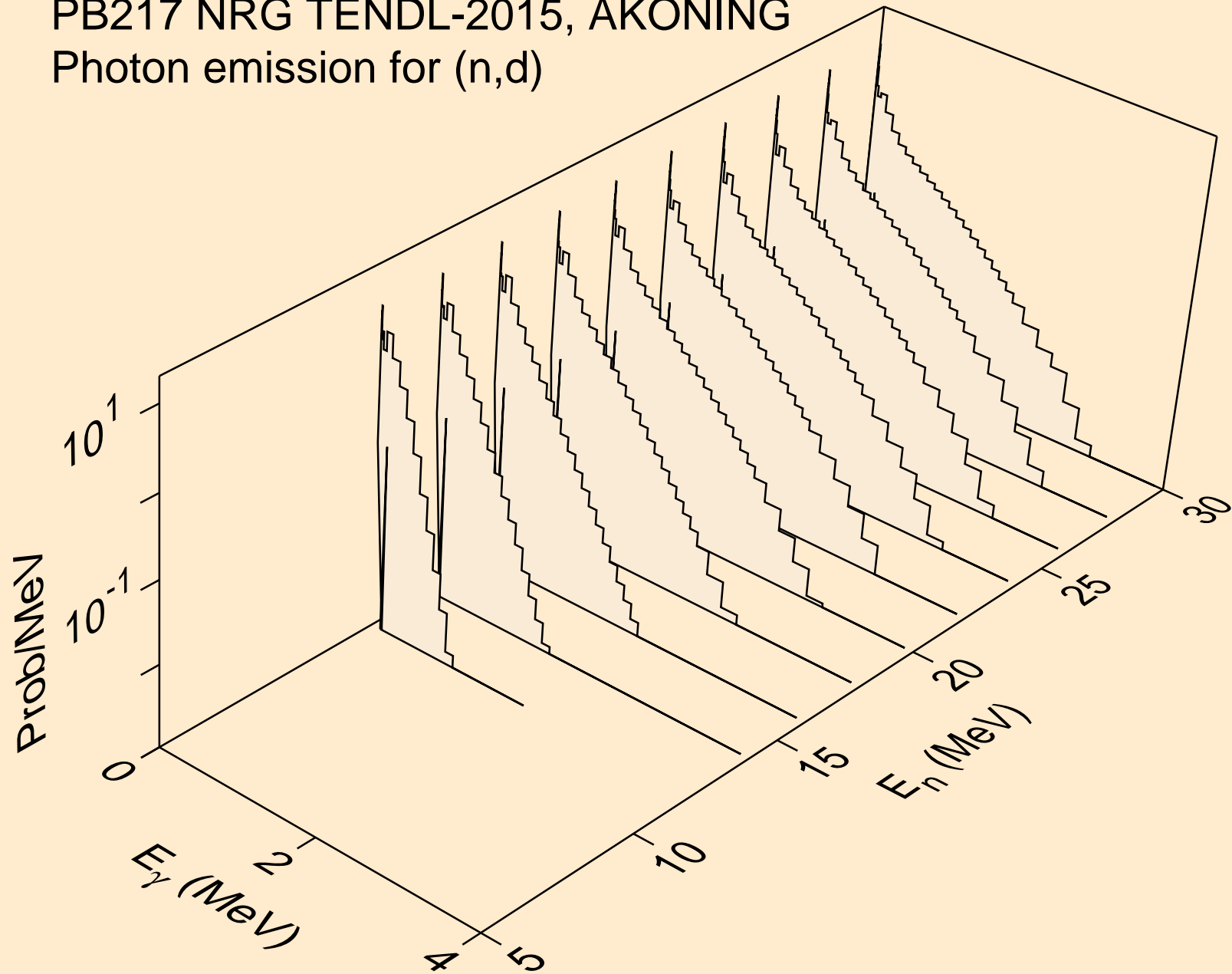

PB217 NRG TENDL-2015, AKONING  
Photon emission for (n,t)

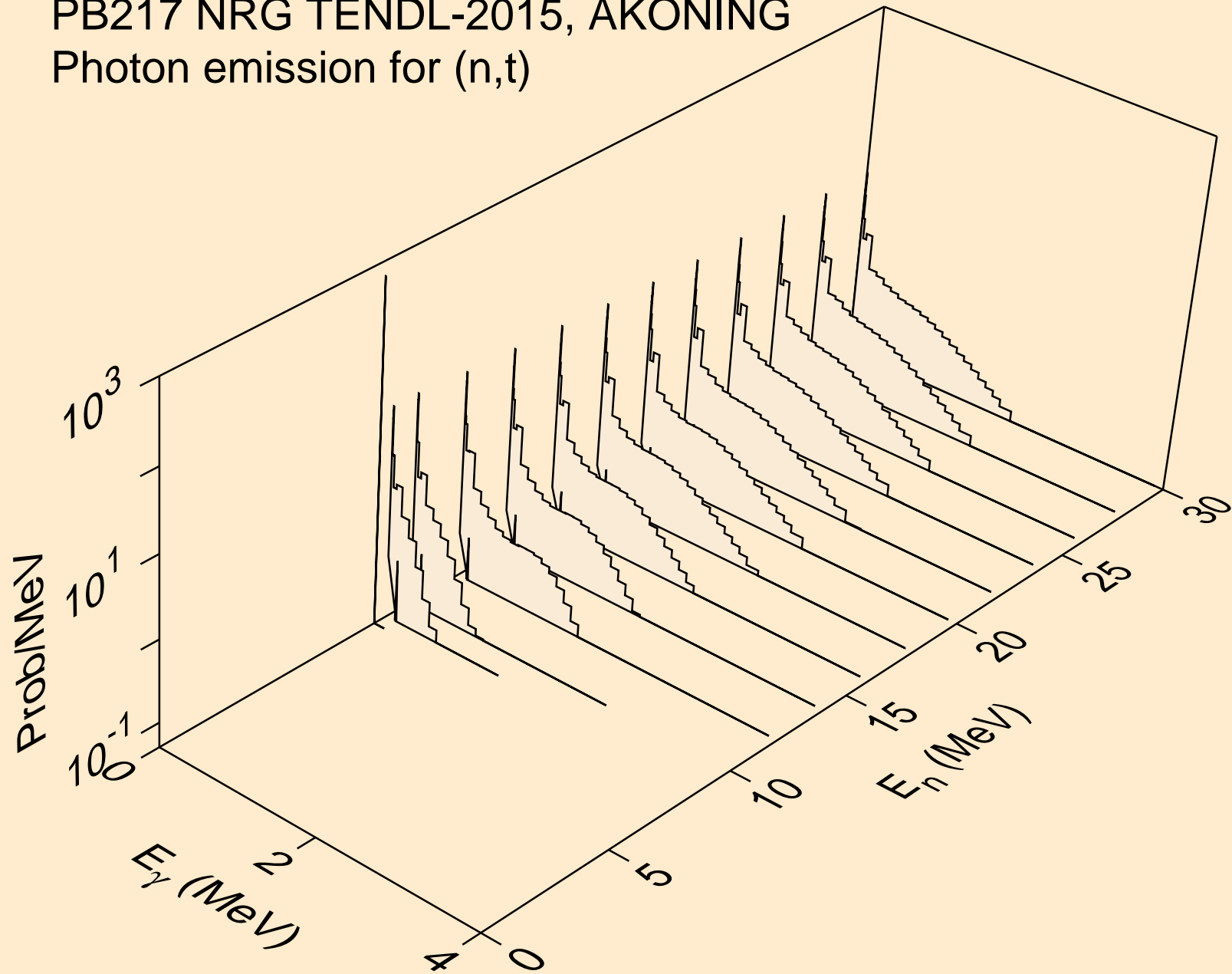

PB217 NRG TENDL-2015, AKONING  
Photon emission for (n,he3)

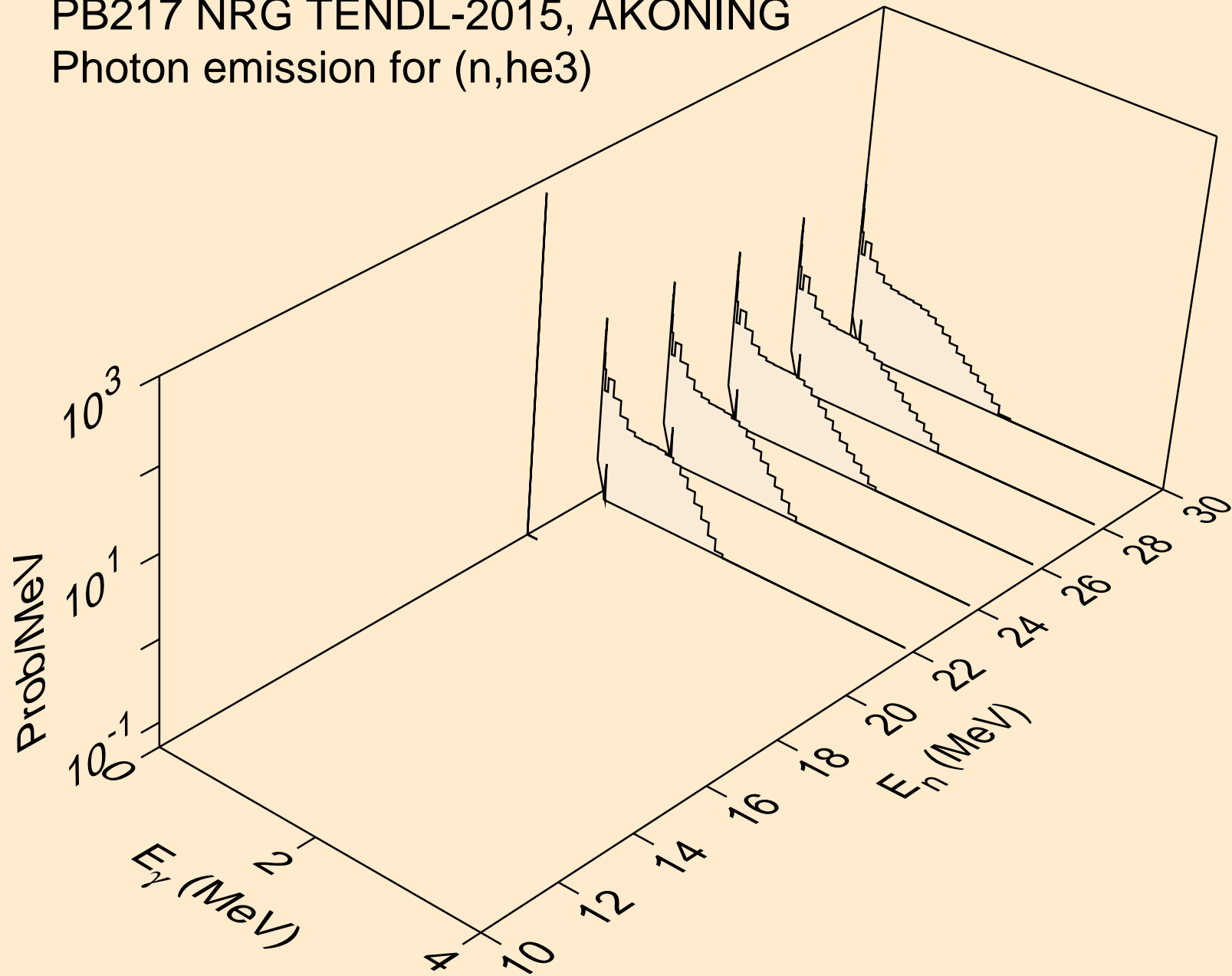

PB217 NRG TENDL-2015, AKONING  
Photon emission for (n,a)

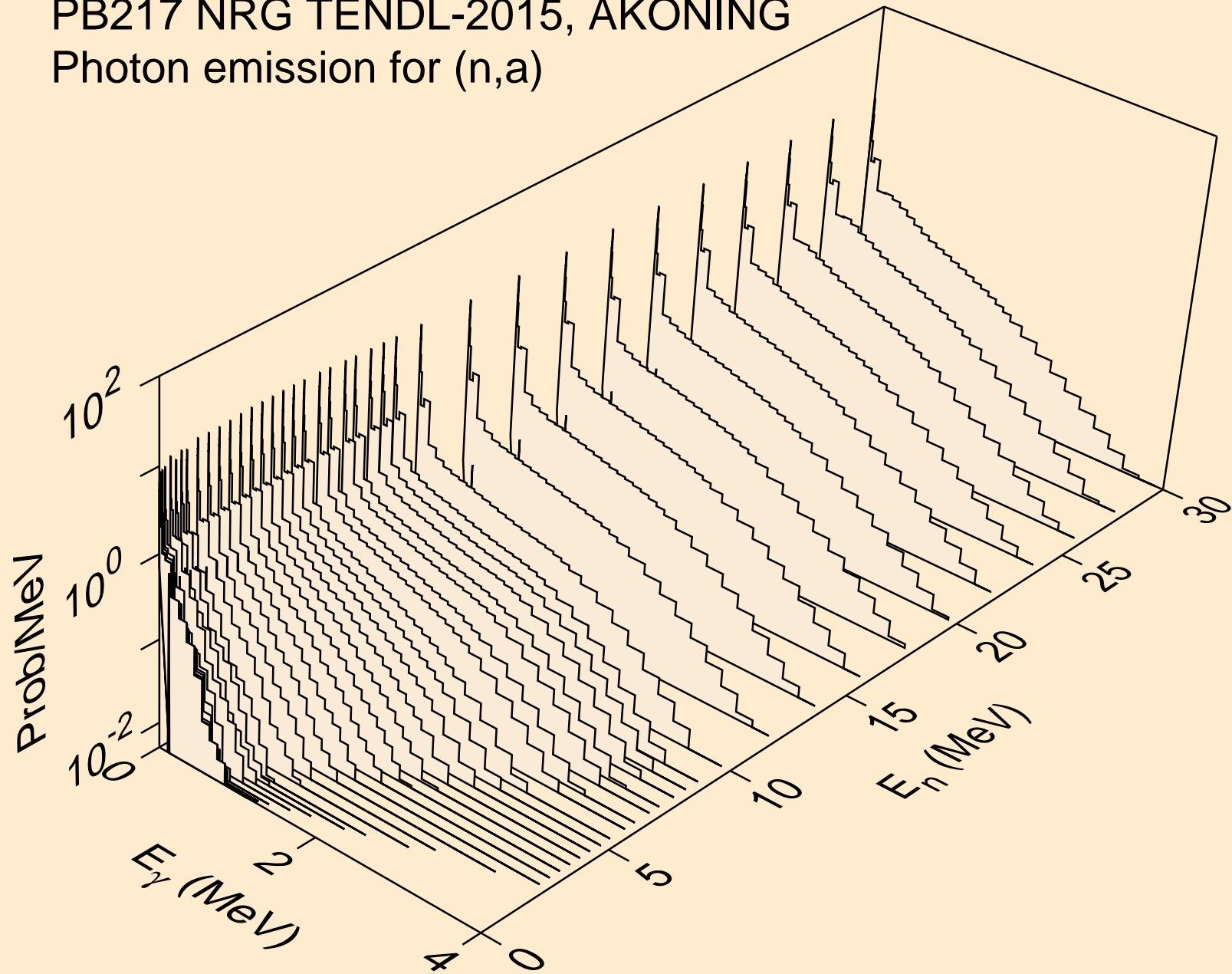

PB217 NRG TENDL-2015, AKONING  
thermal capture photon spectrum

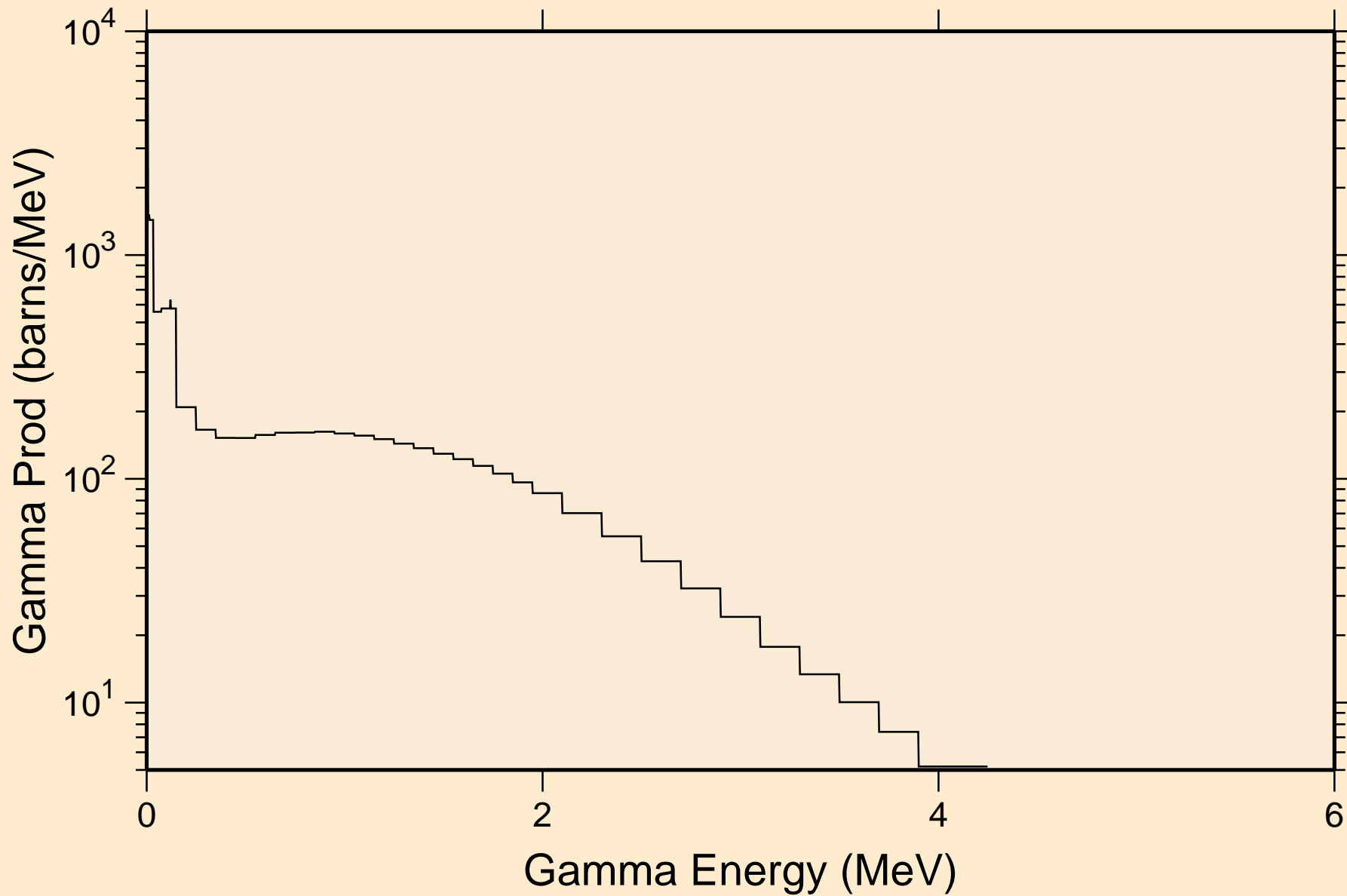

PB217 NRG TENDL-2015, AKONING  
14 MeV photon spectrum

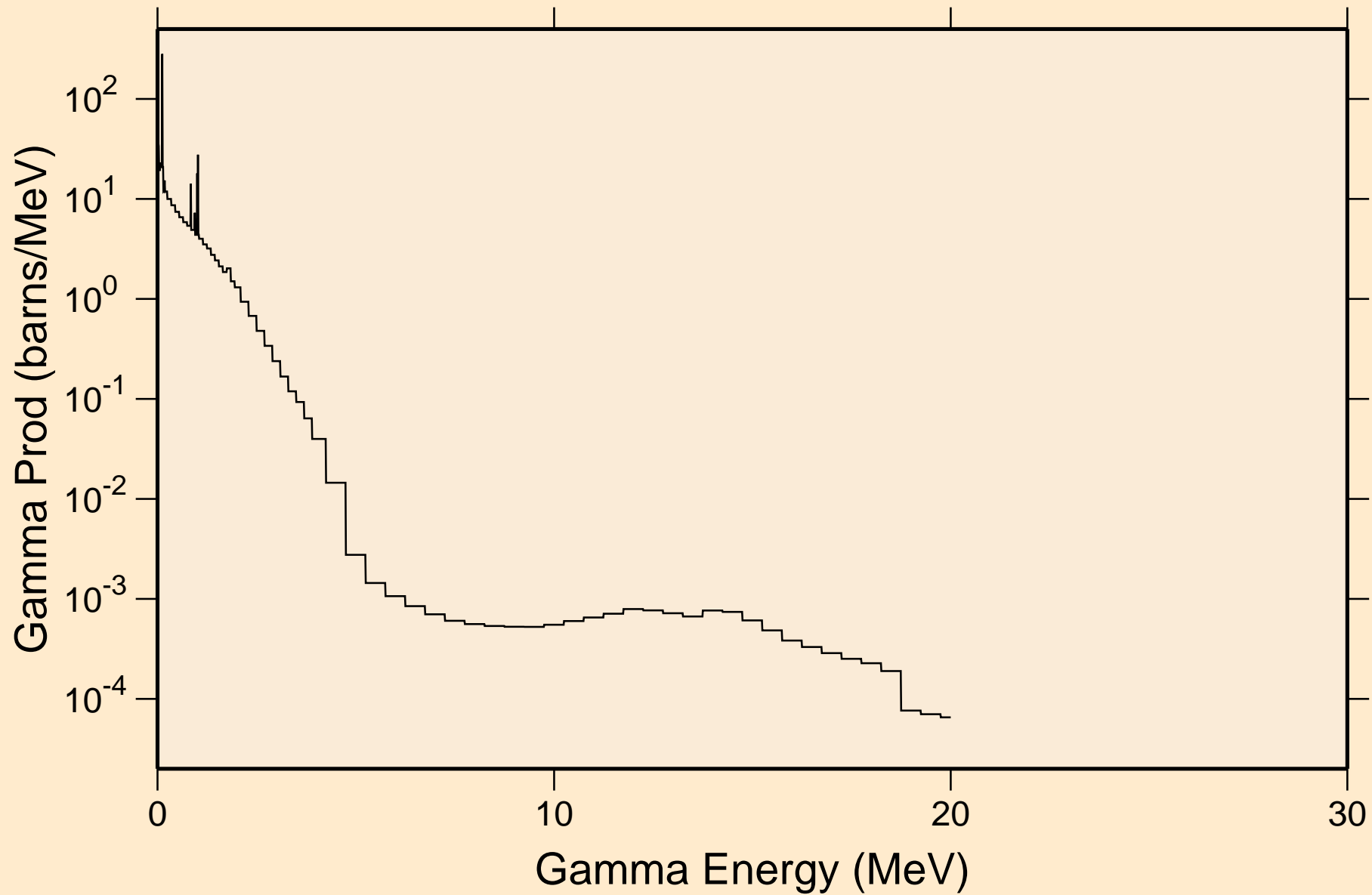

# PB217 NRG TENDL-2015, AKONING

## Particle heating contributions

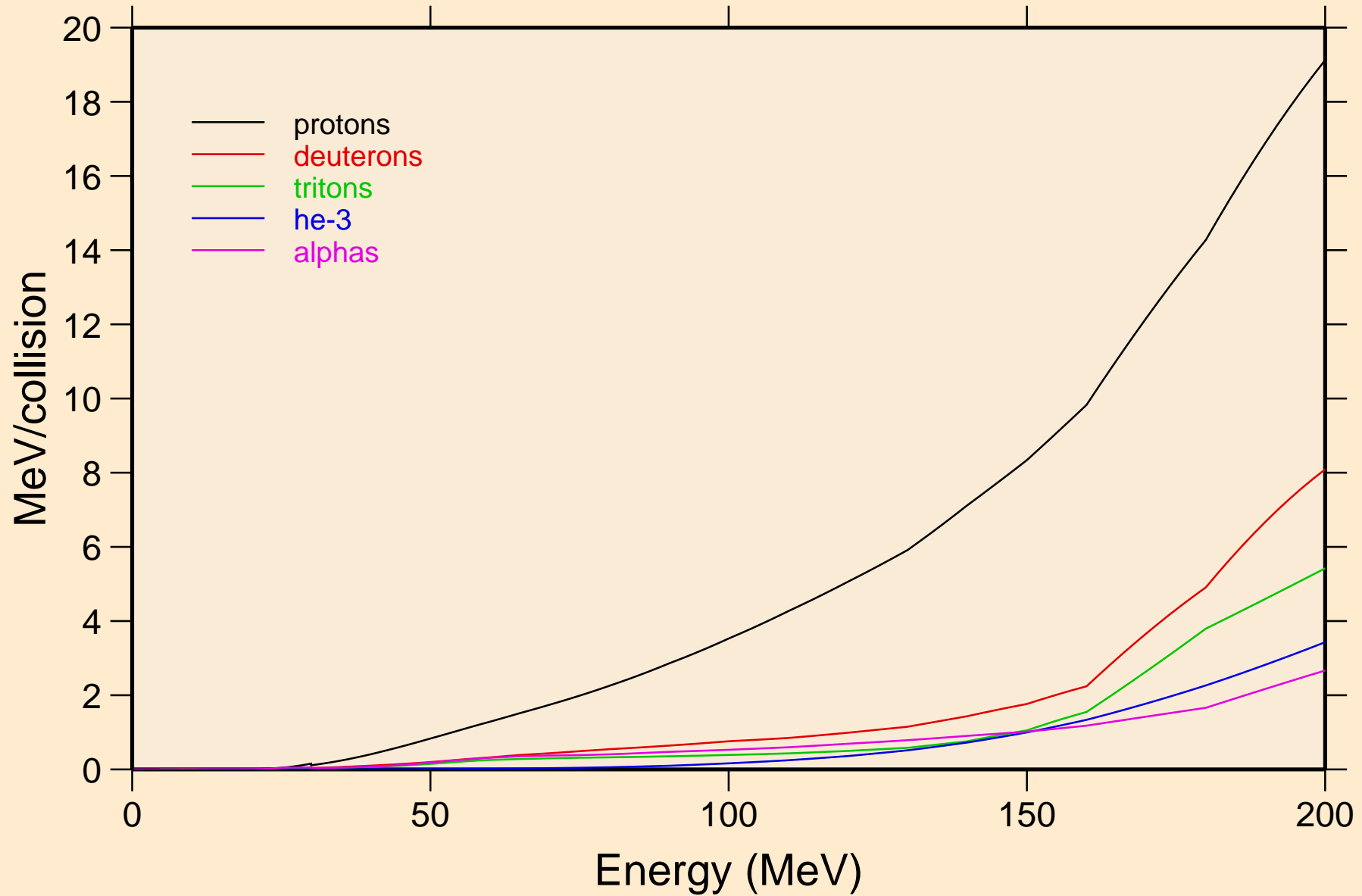



# PB217 NRG TENDL-2015, AKONING

## Recoil Heating

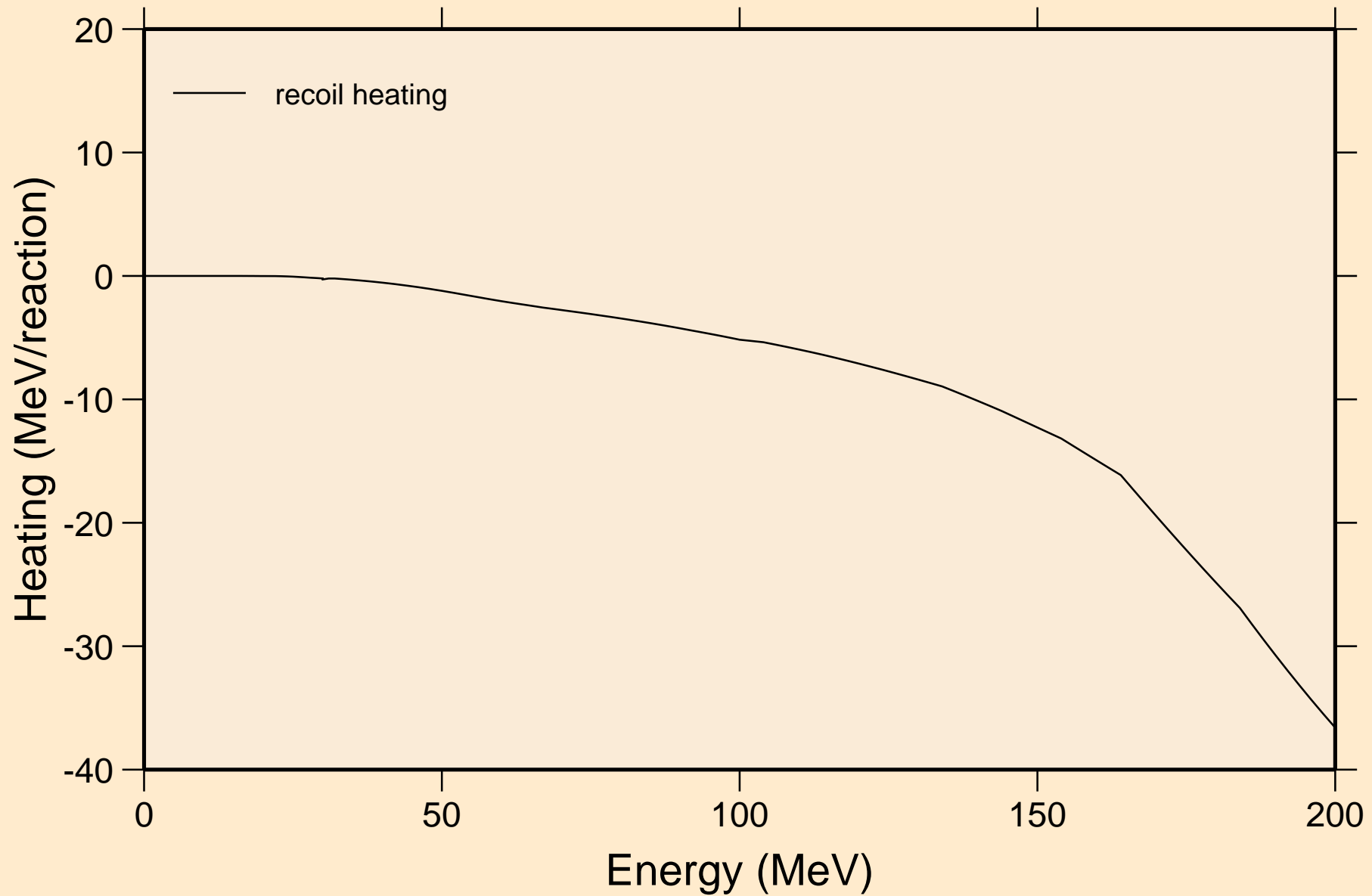

# PB217 NRG TENDL-2015, AKONING

## Particle production cross sections

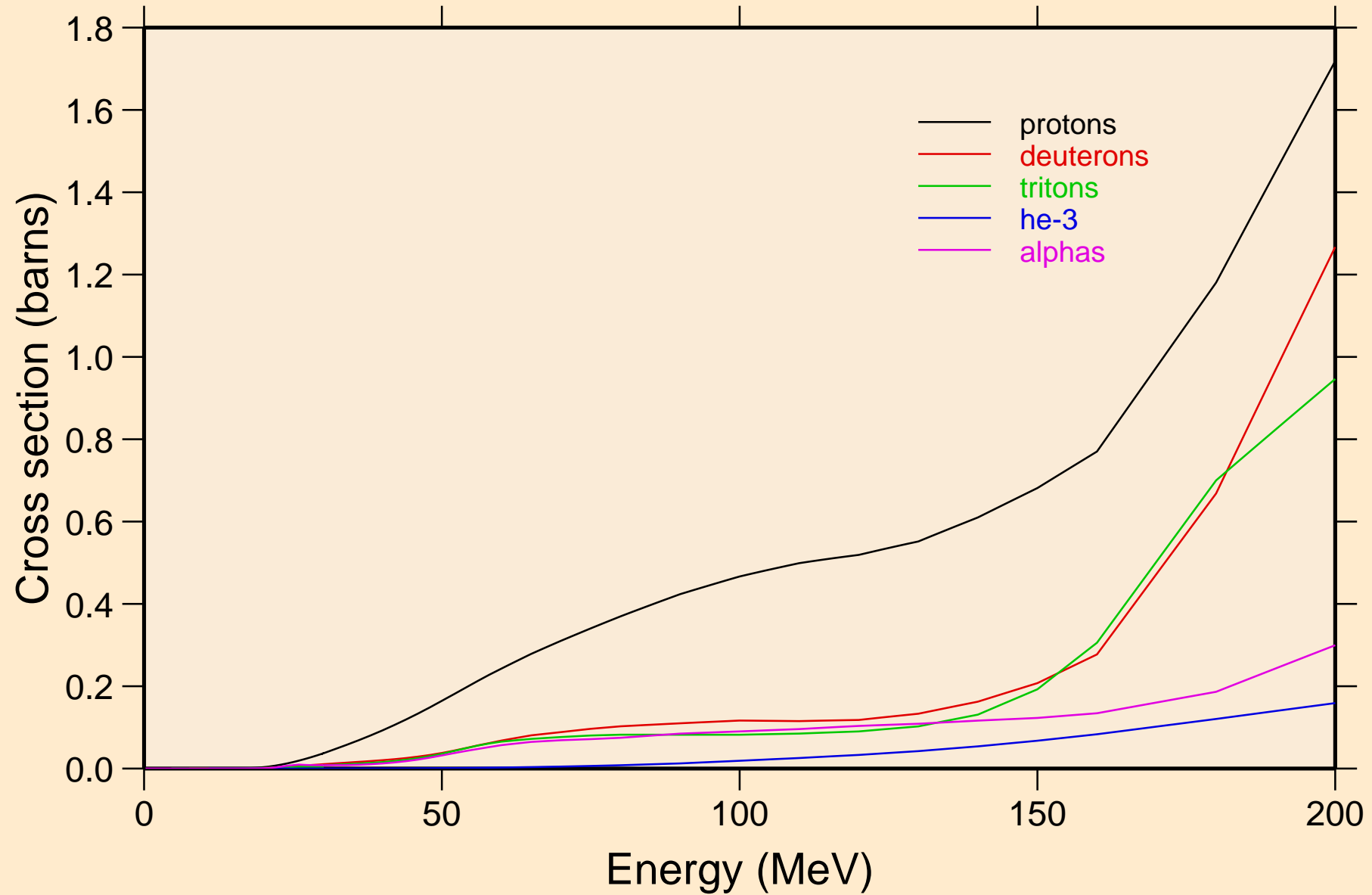

PB217 NRG TENDL-2015, AKONING  
protons from (n,x)

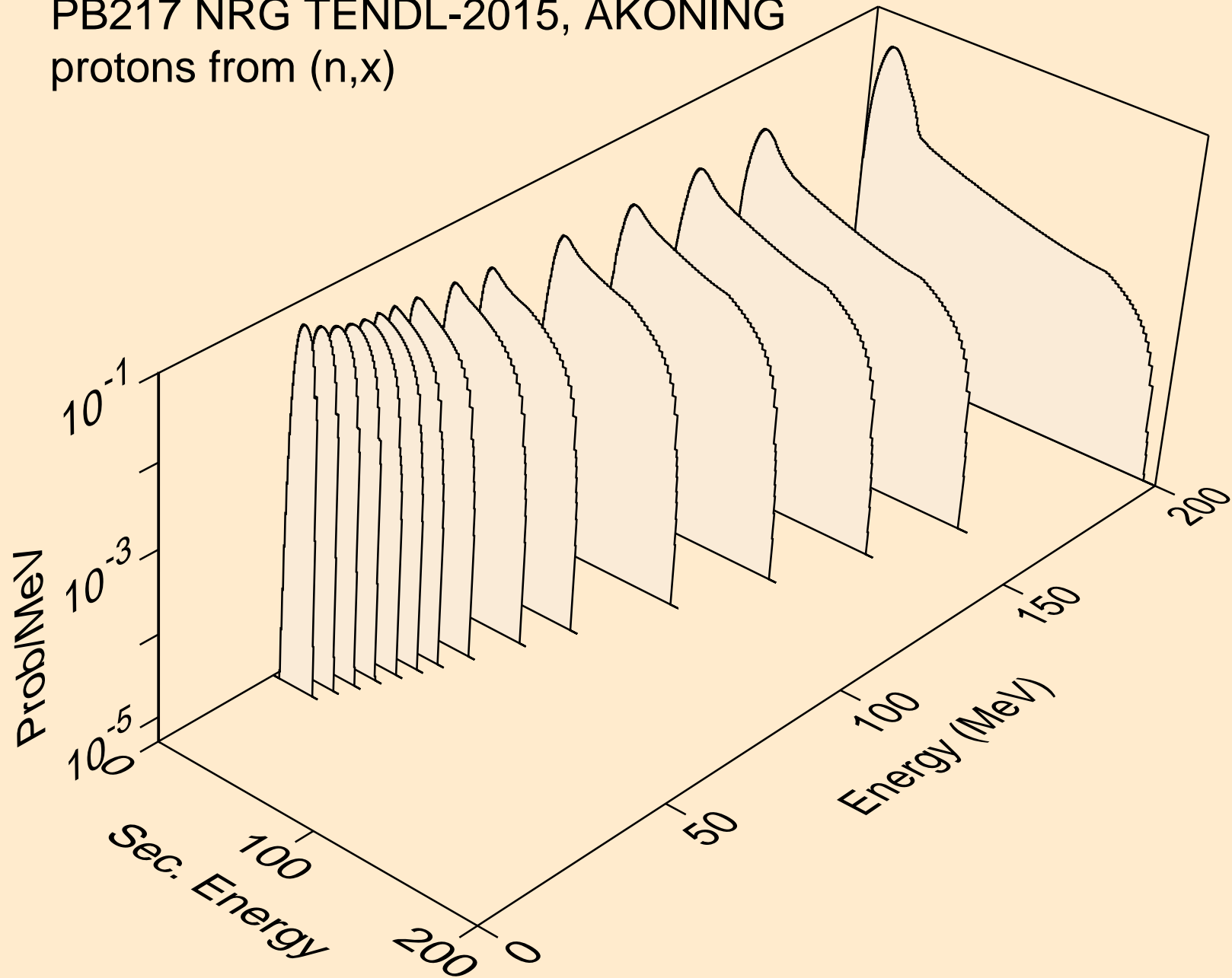

PB217 NRG TENDL-2015, AKONING  
protons from (n,n\*)p

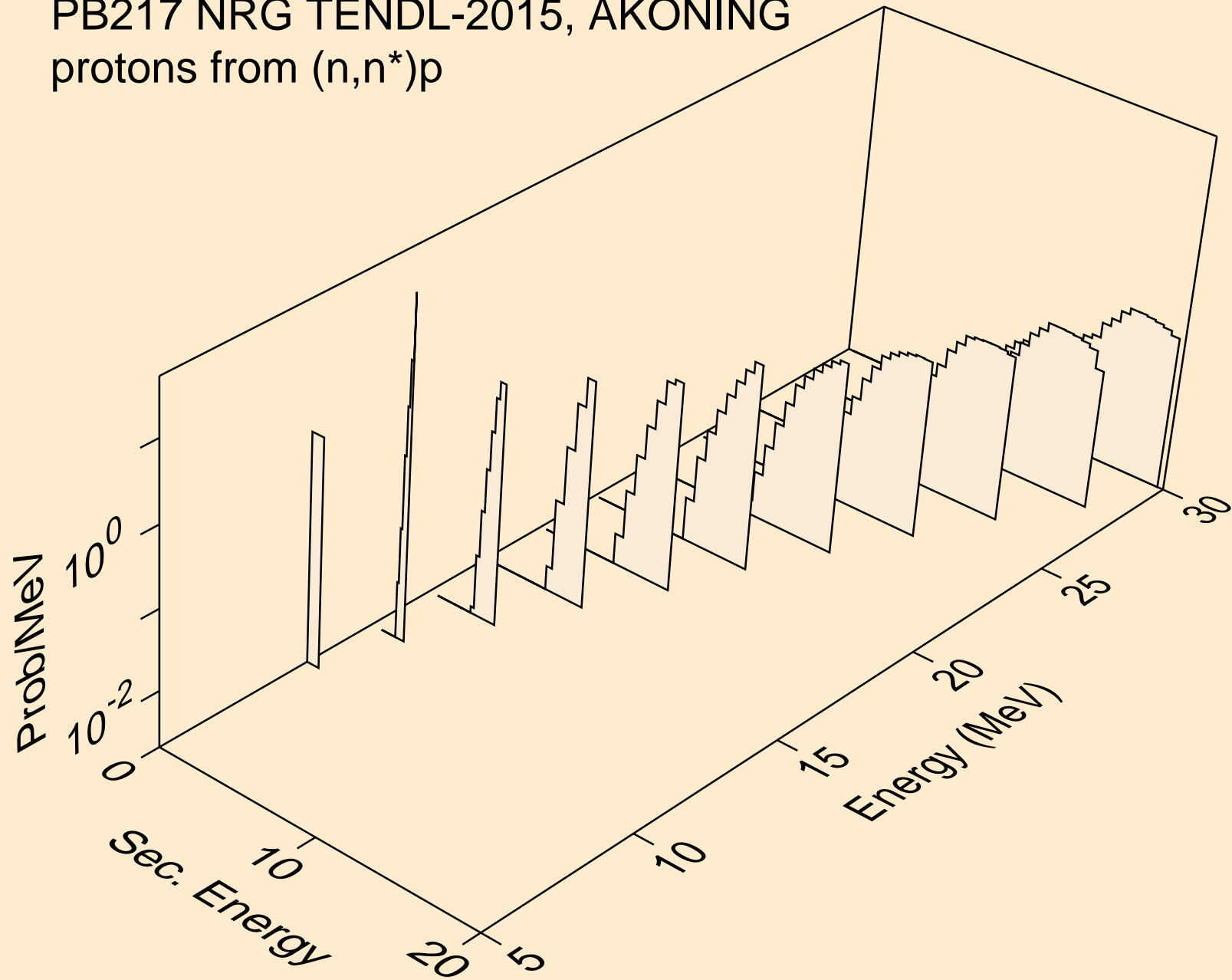

PB217 NRG TENDL-2015, AKONING  
protons from (n,2np)

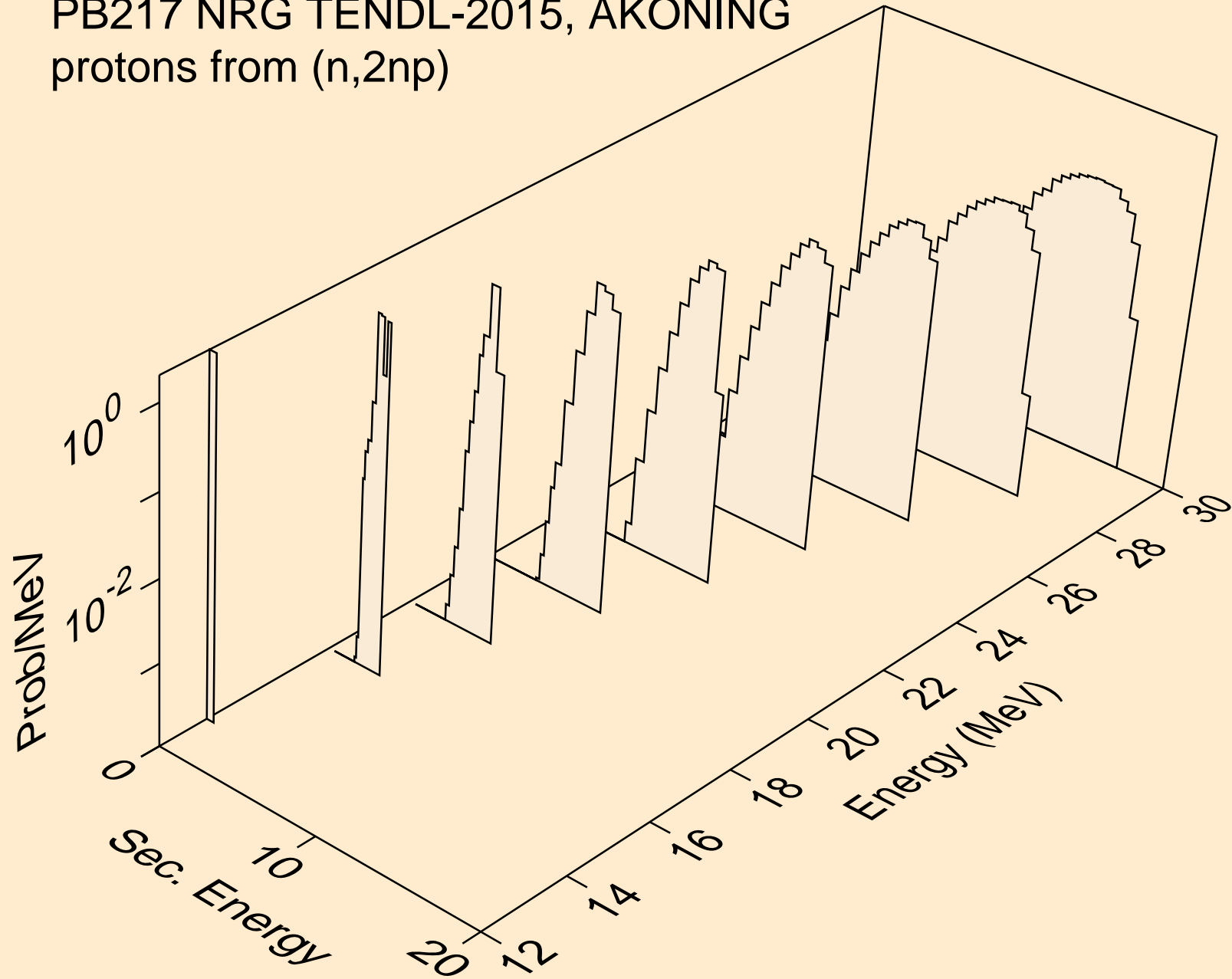

PB217 NRG TENDL-2015, AKONING  
protons from (n,3np)

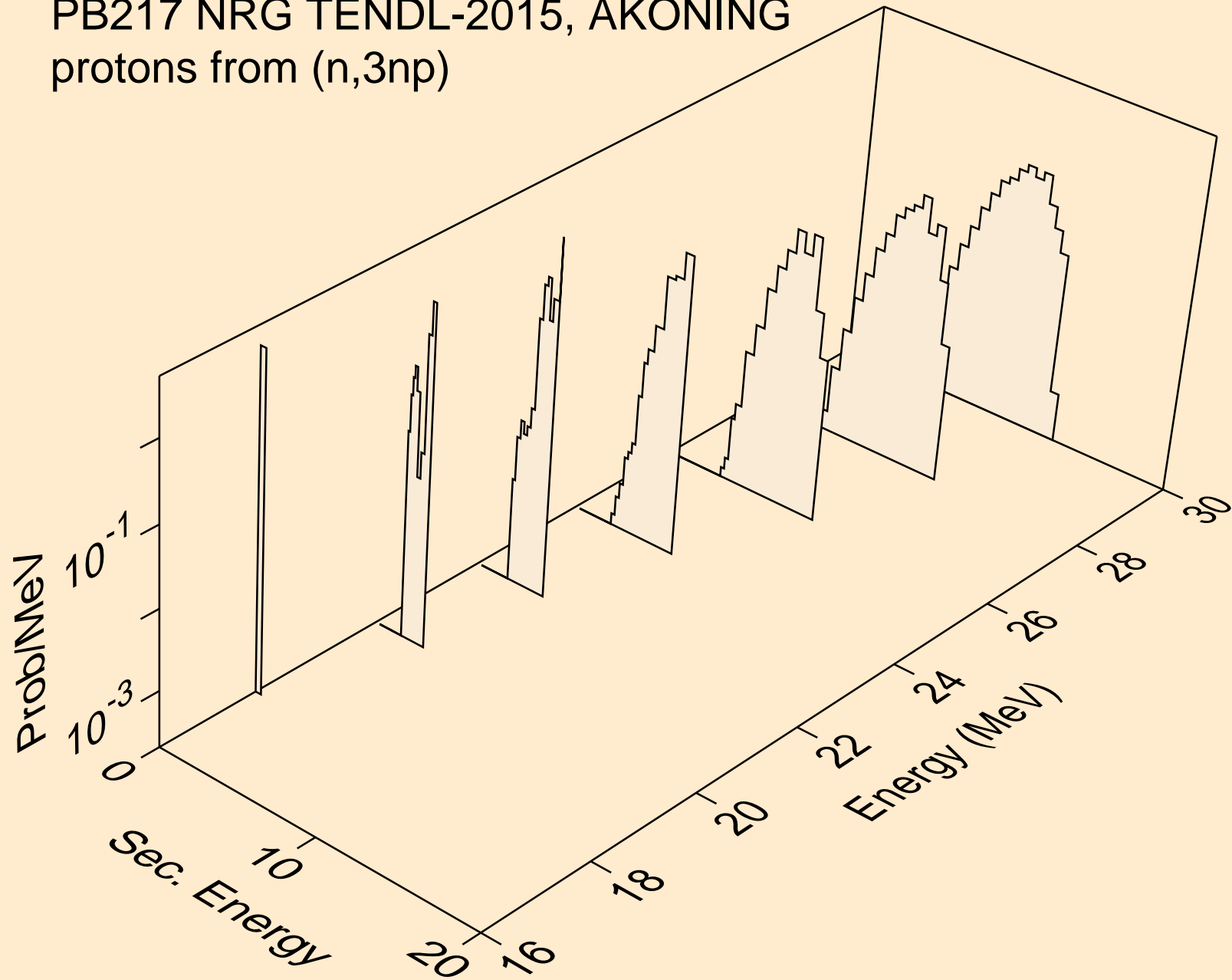

PB217 NRG TENDL-2015, AKONING  
protons from (n,p)

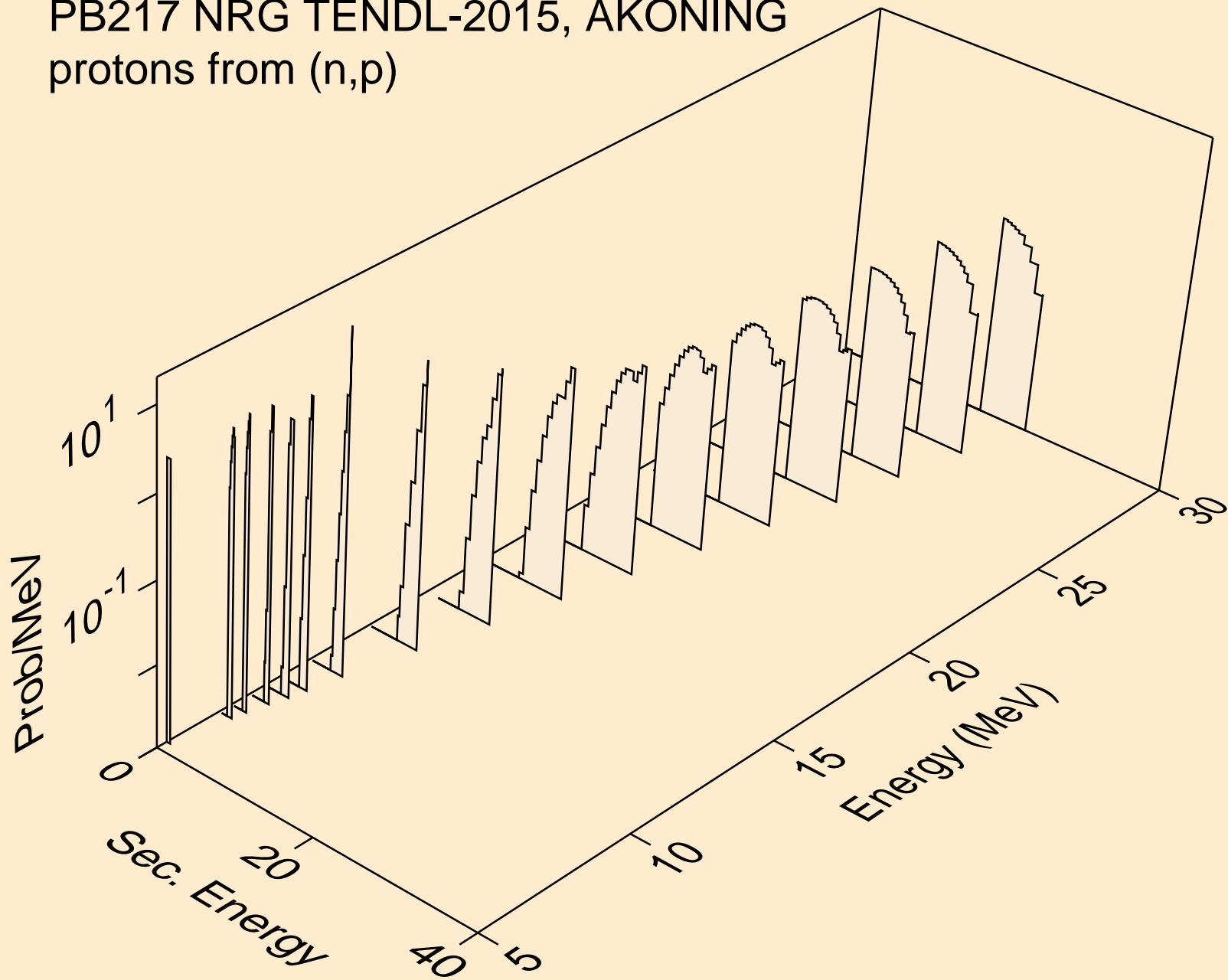

PB217 NRG TENDL-2015, AKONING  
deuterons from (n,x)

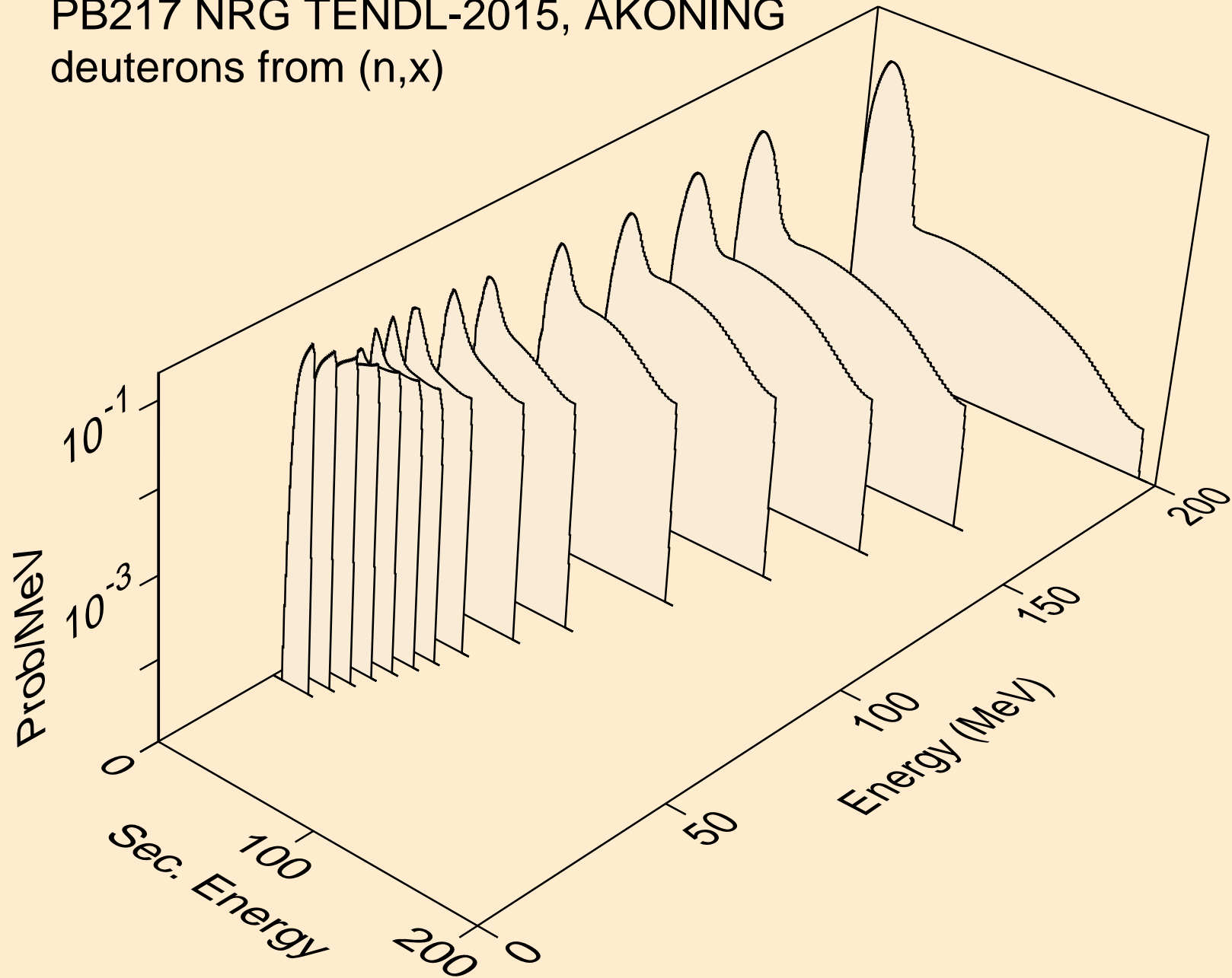



PB217 NRG TENDL-2015, AKONING  
deuterons from (n,2nd)

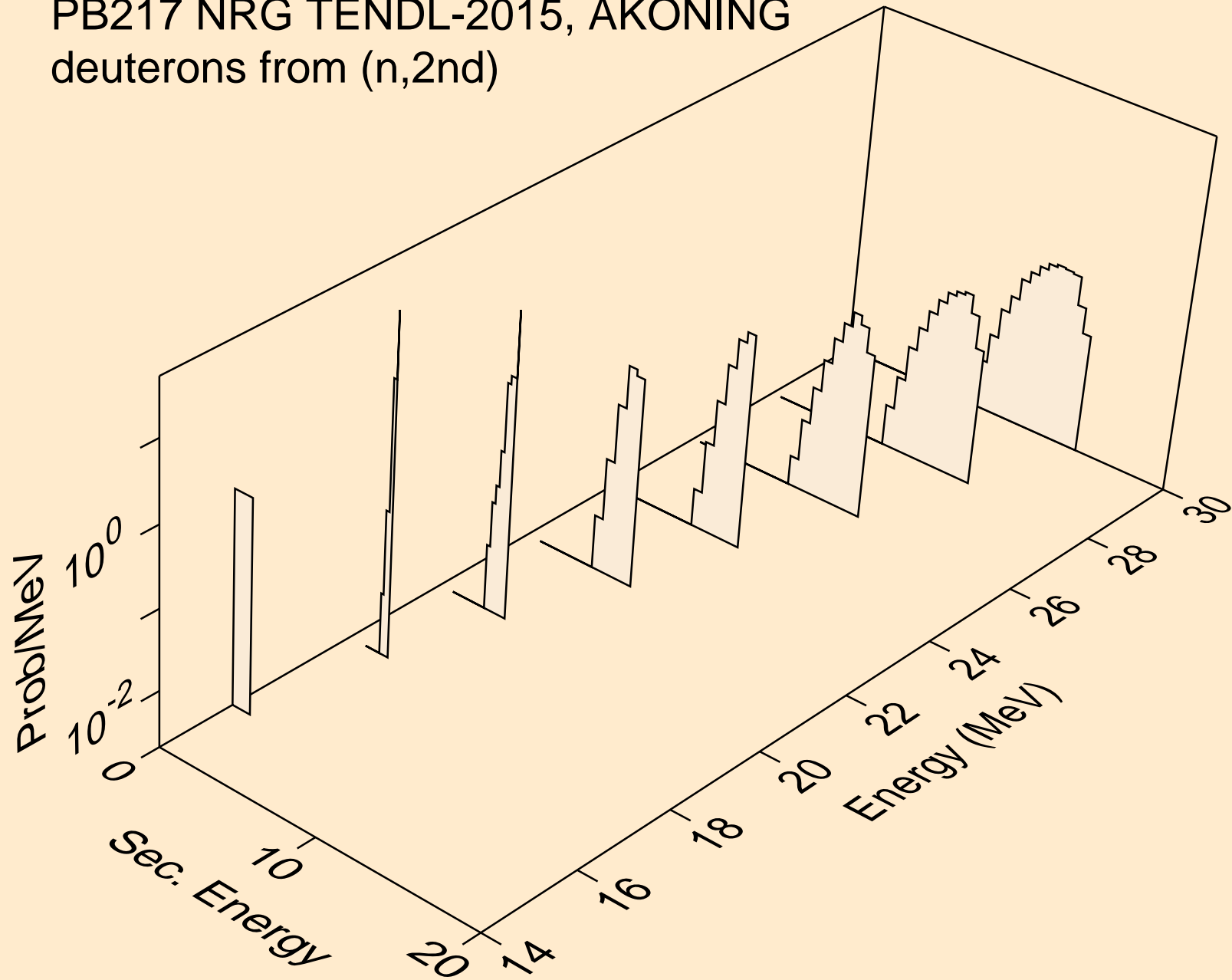

PB217 NRG TENDL-2015, AKONING  
deuterons from (n,n\*)d

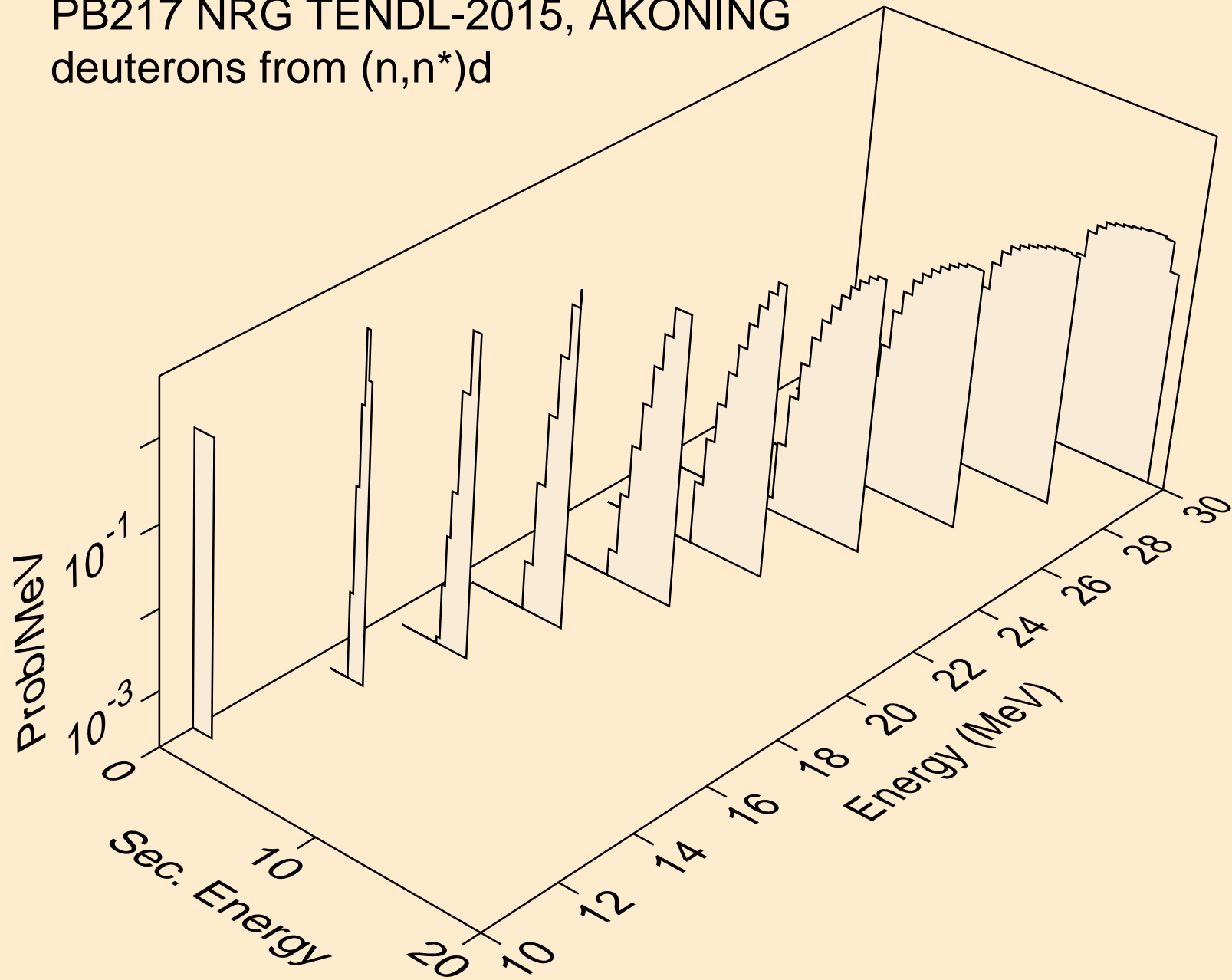

PB217 NRG TENDL-2015, AKONING  
deuterons from (n,d)

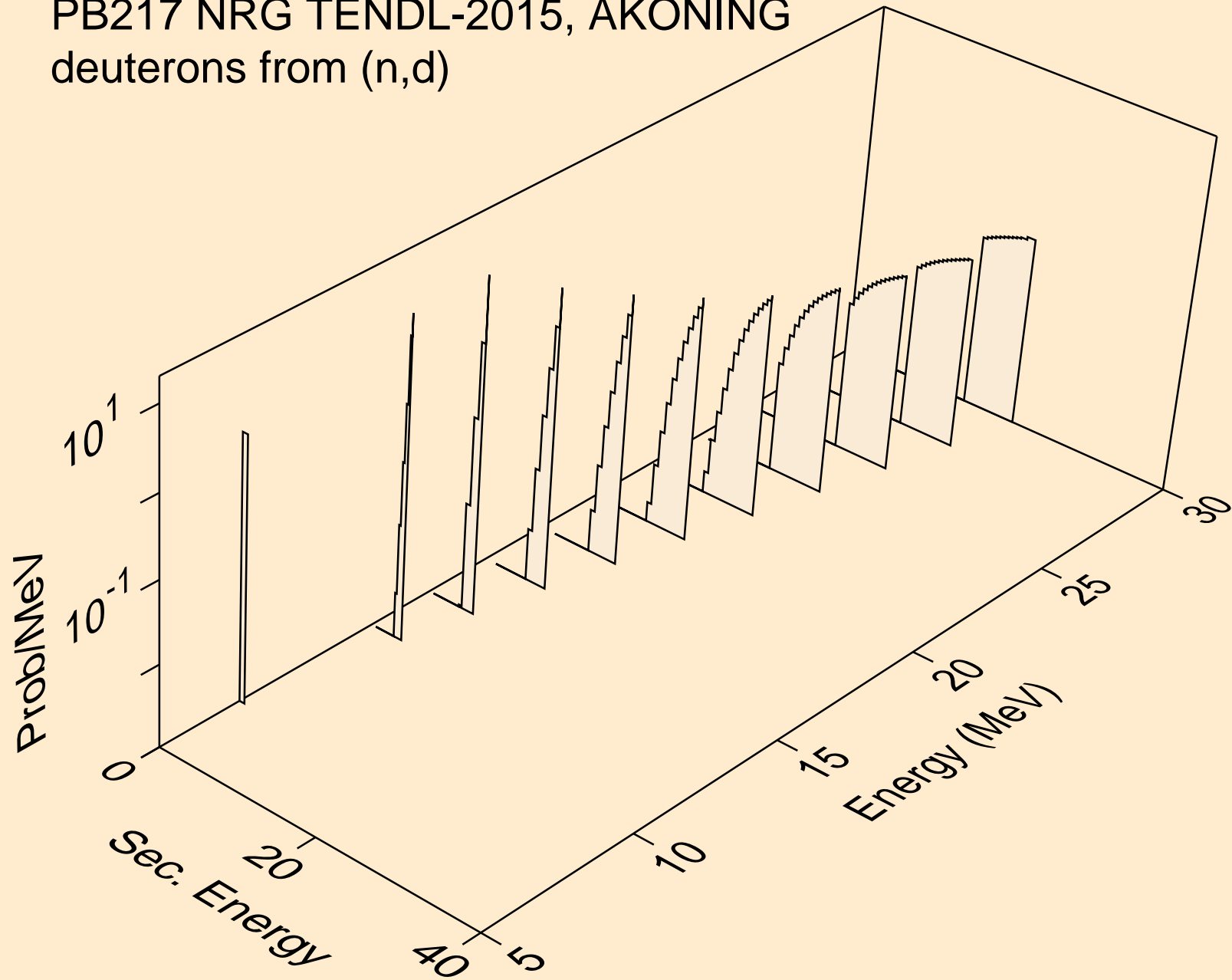

PB217 NRG TENDL-2015, AKONING  
tritons from (n,x)

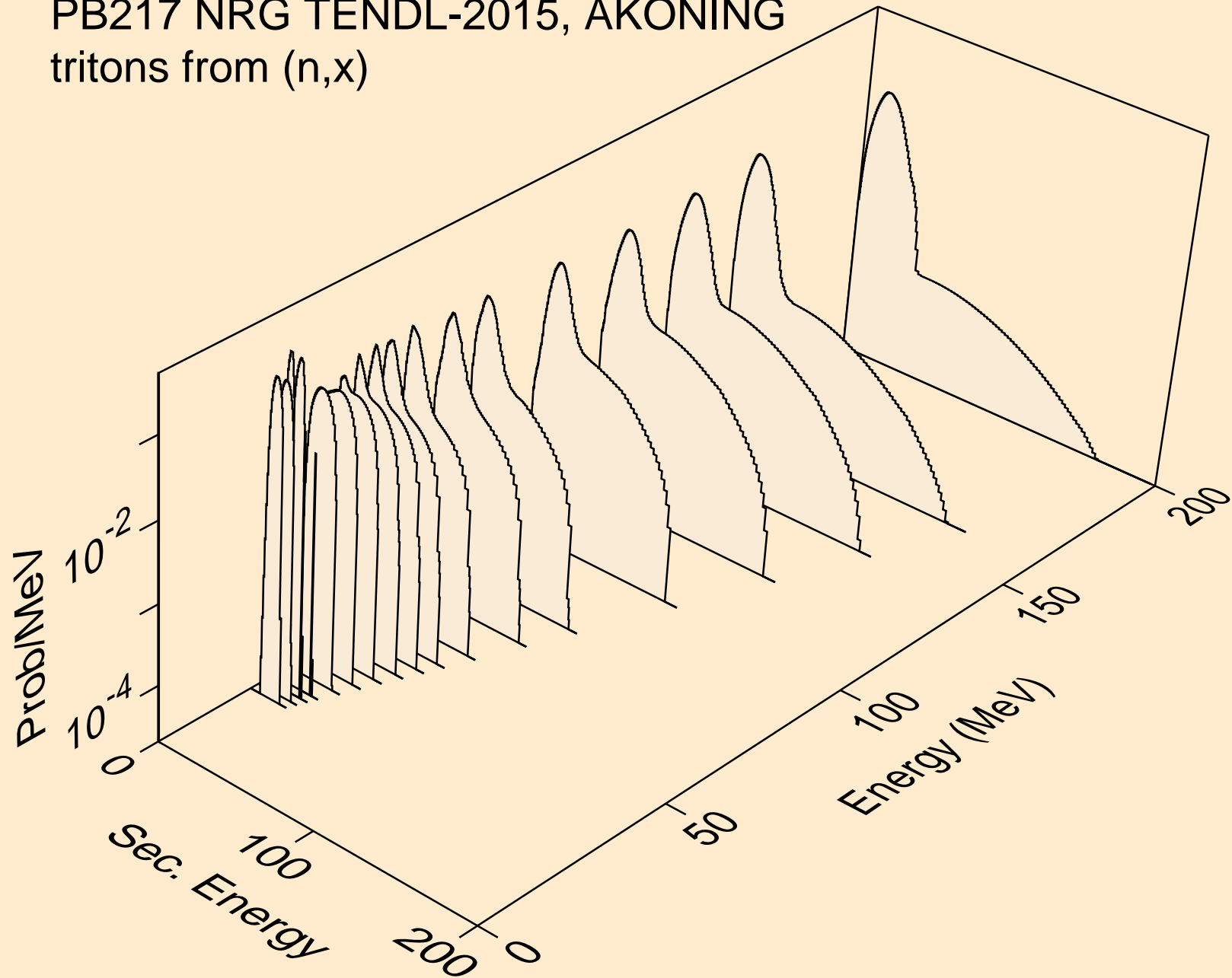

PB217 NRG TENDL-2015, AKONING  
tritons from (n,n\*)t

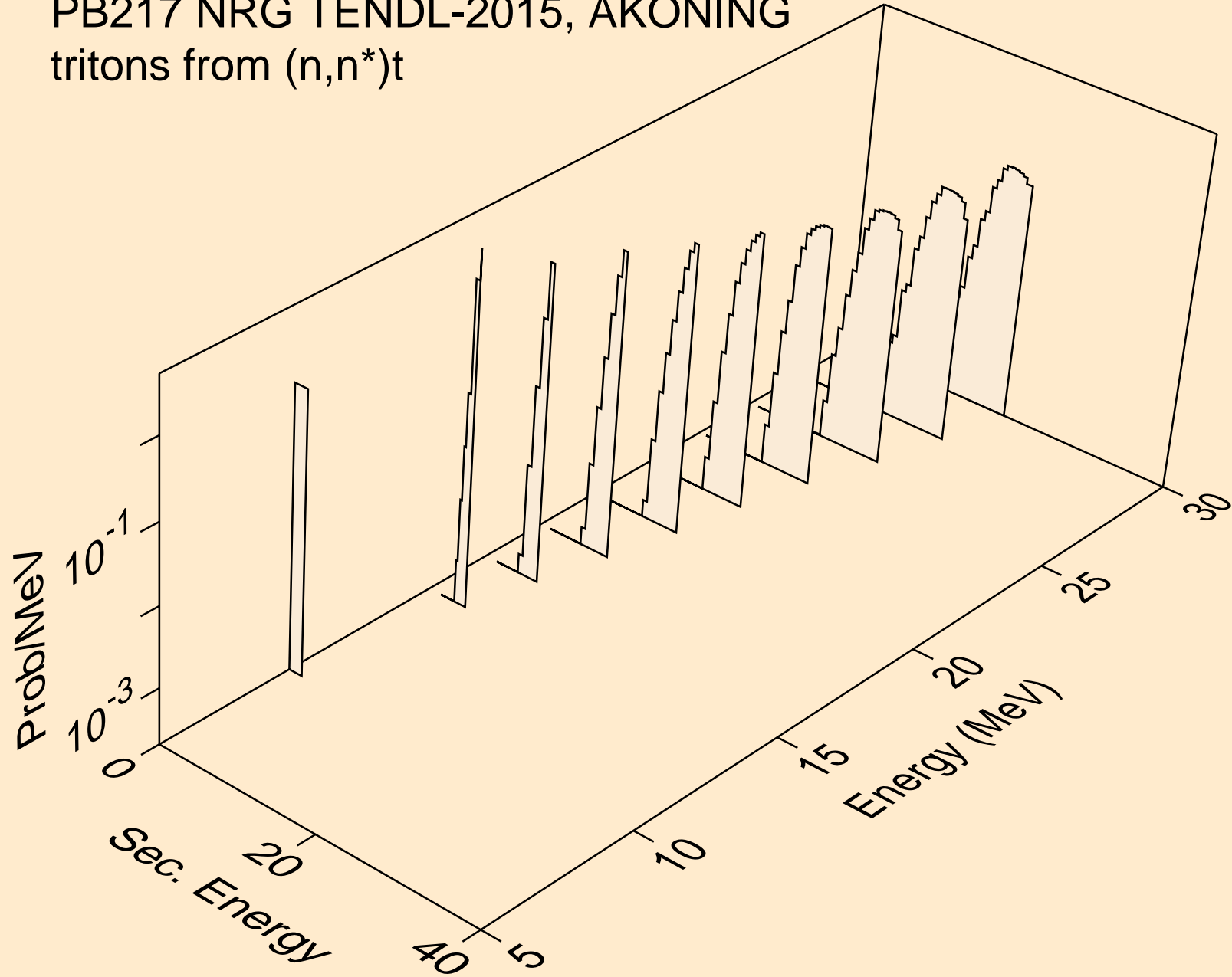

PB217 NRG TENDL-2015, AKONING  
tritons from (n,t)

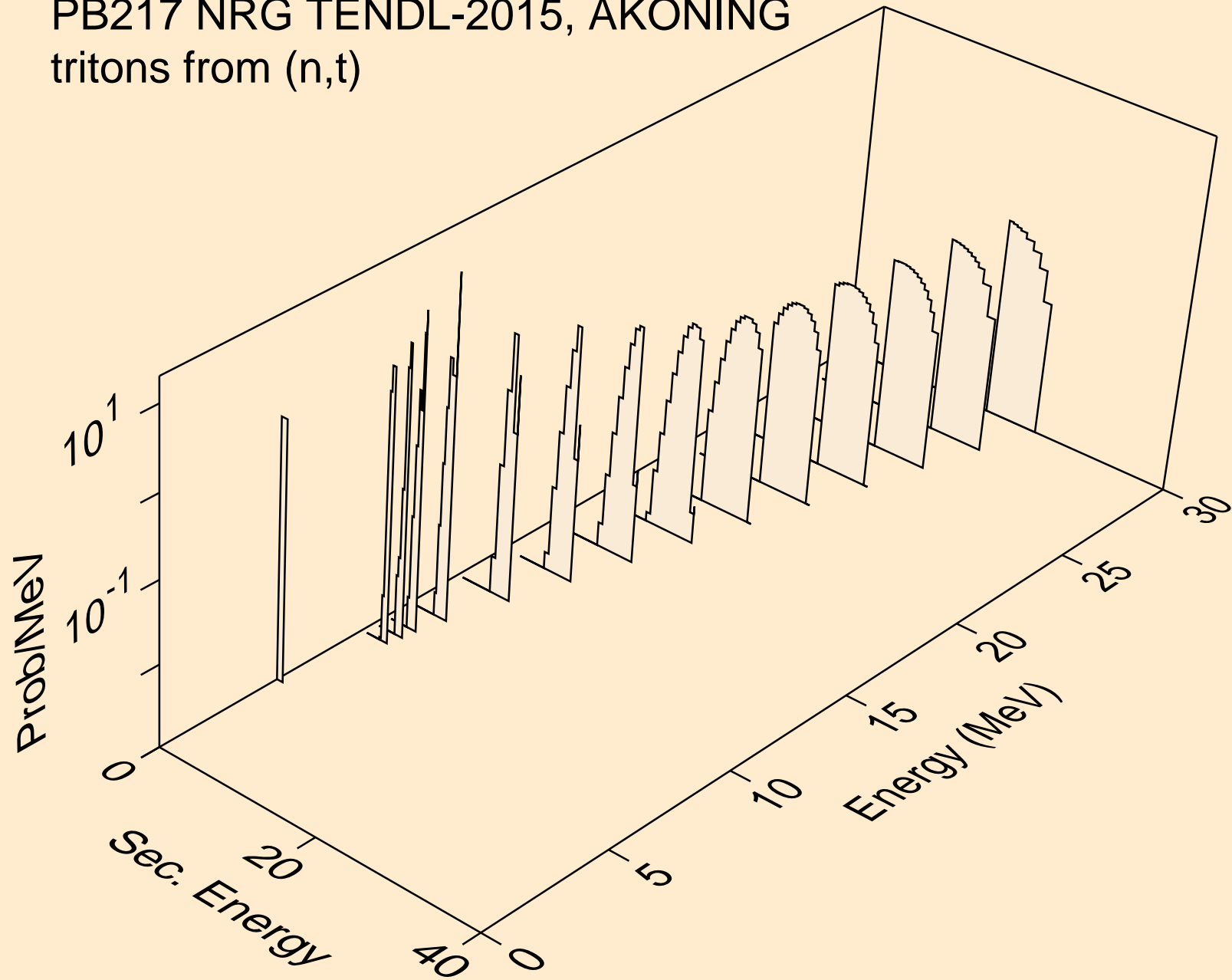

PB217 NRG TENDL-2015, AKONING  
he3s from (n,x)

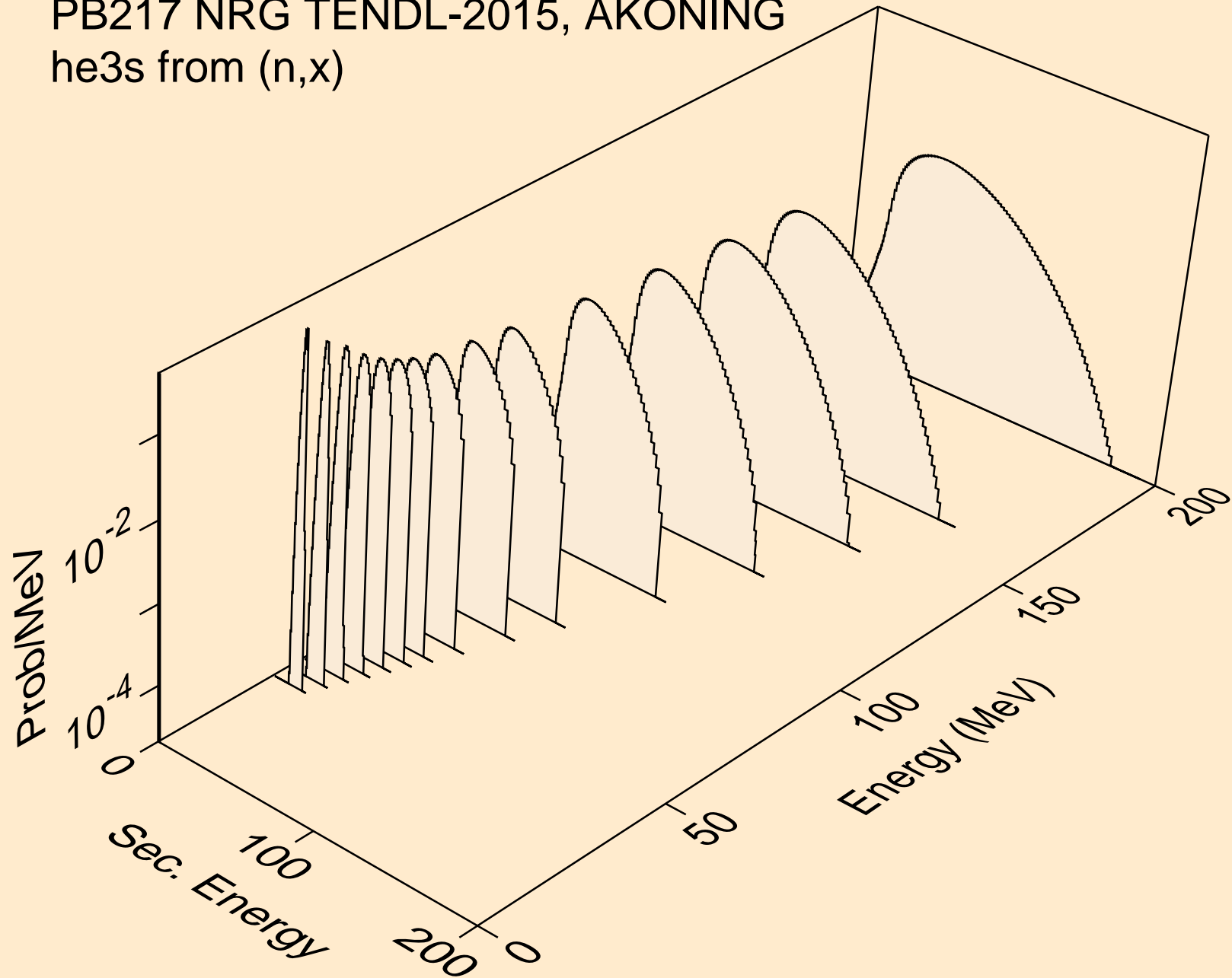

PB217 NRG TENDL-2015, AKONING  
he3s from (n,n\*)he3

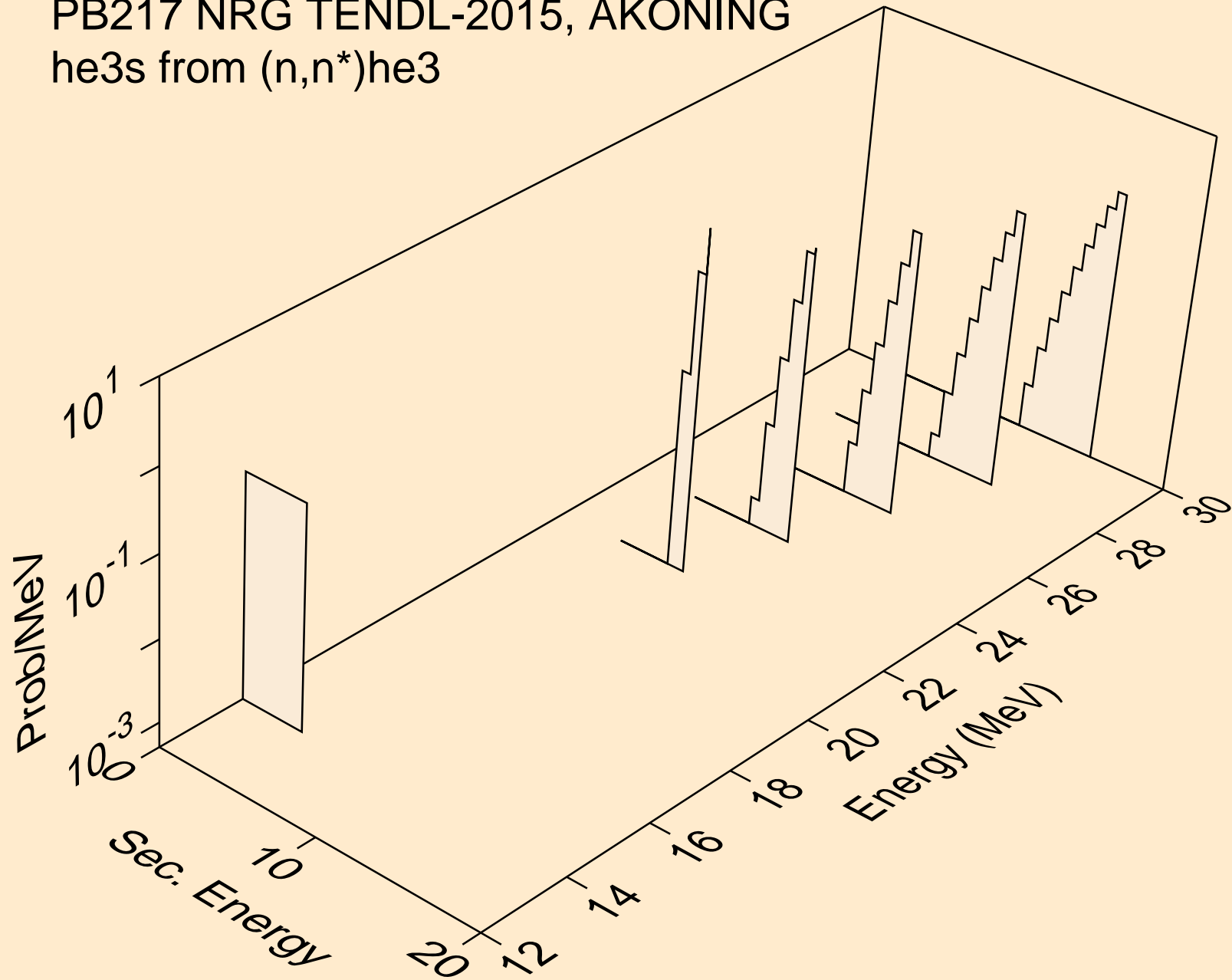



PB217 NRG TENDL-2015, AKONING  
he3s from (n,he3)

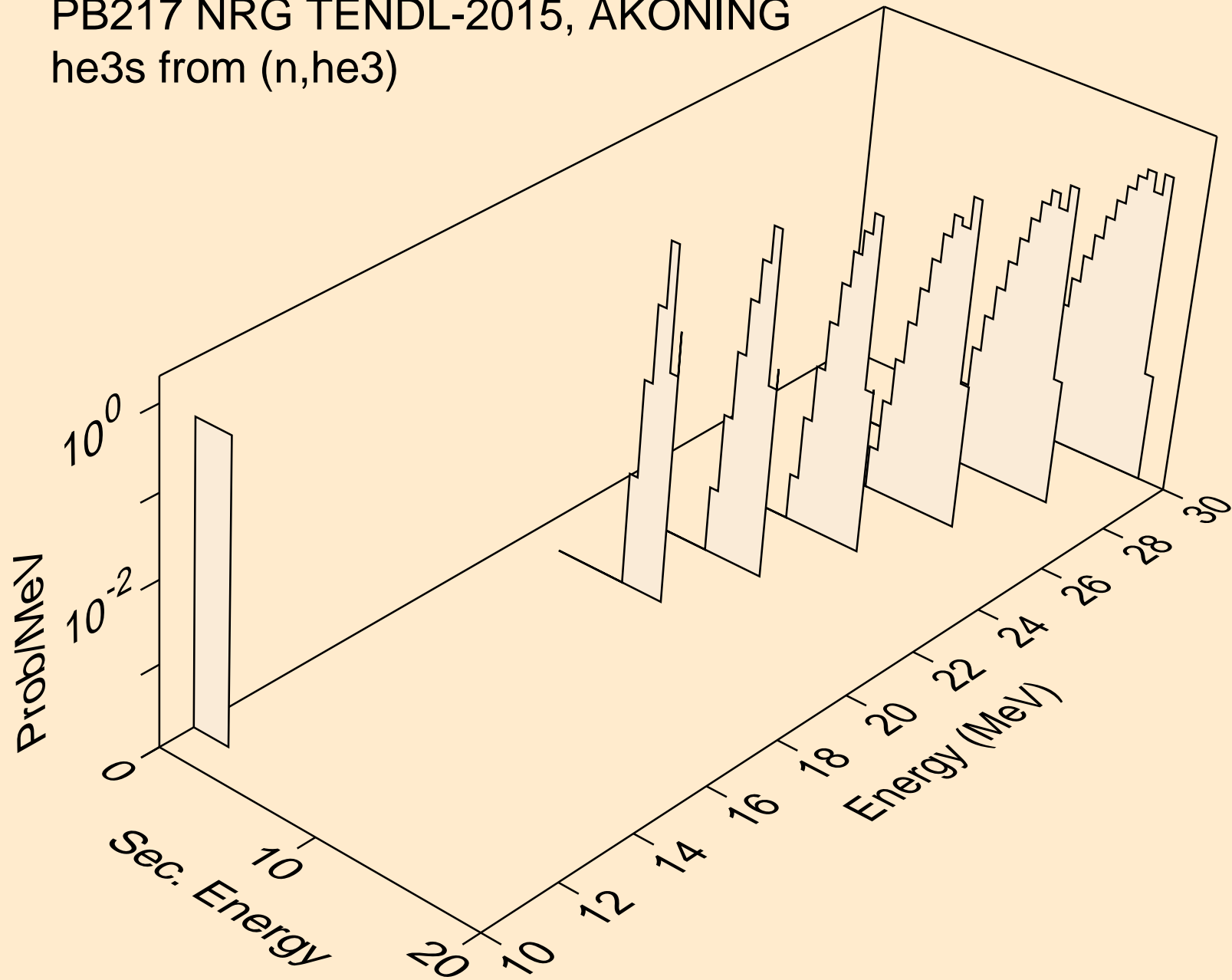

PB217 NRG TENDL-2015, AKONING  
alphas from (n,x)

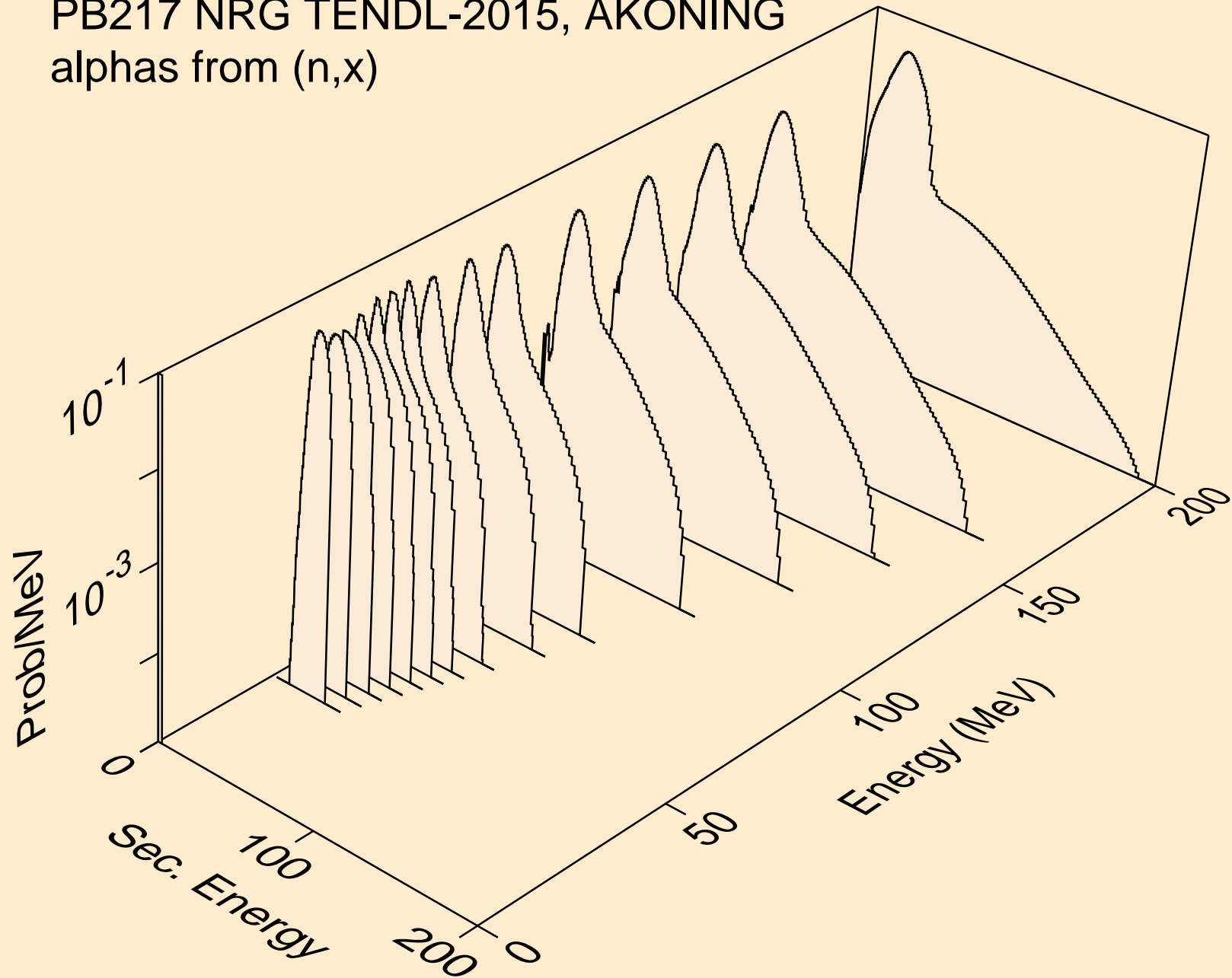

PB217 NRG TENDL-2015, AKONING  
alphas from (n,n\*)a

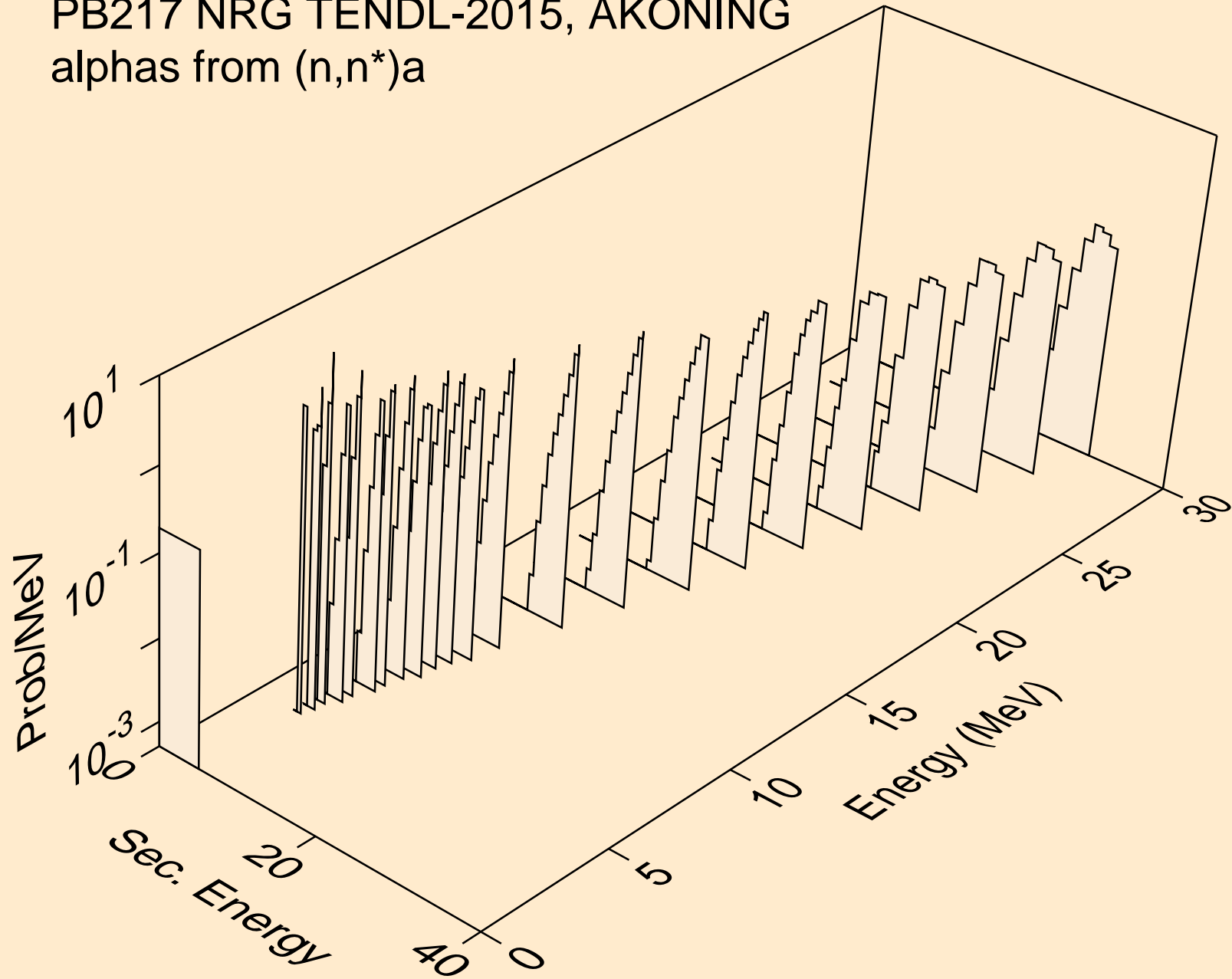

PB217 NRG TENDL-2015, AKONING  
alphas from (n,2n)a

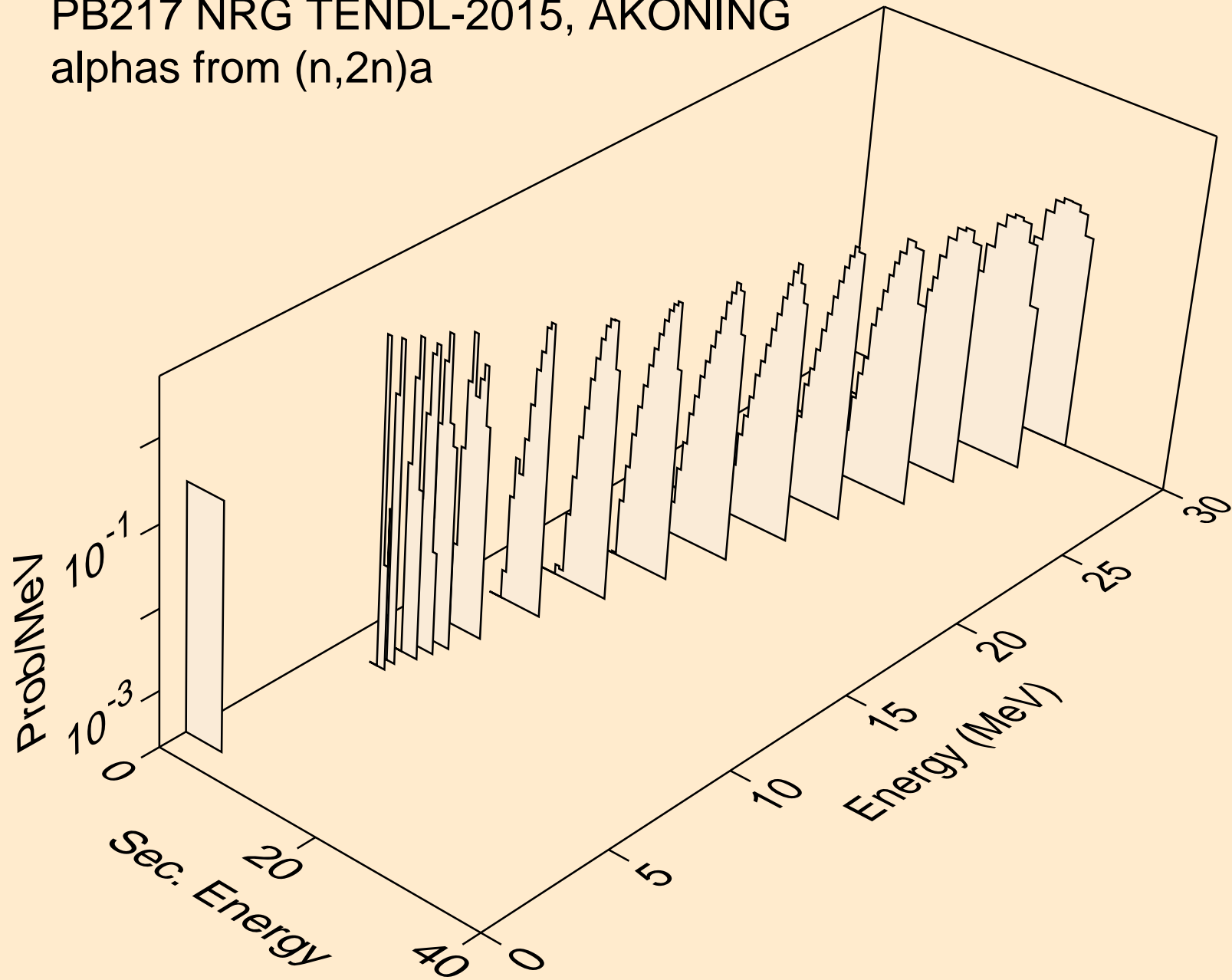

PB217 NRG TENDL-2015, AKONING  
alphas from (n,3n)a

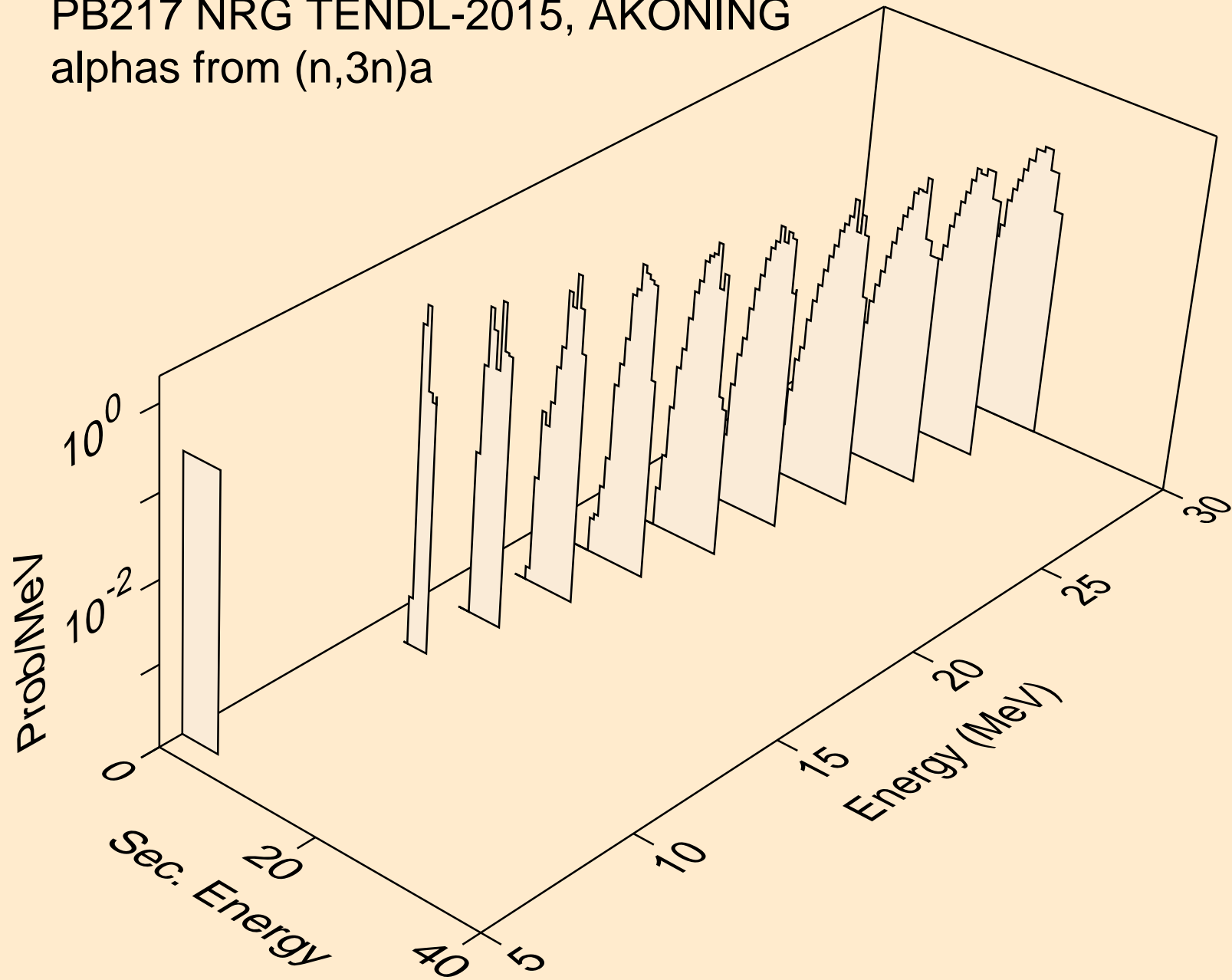

PB217 NRG TENDL-2015, AKONING  
alphas from (n,a)

