

PB218 NRG TENDL-2015, AKONING

Principal cross sections

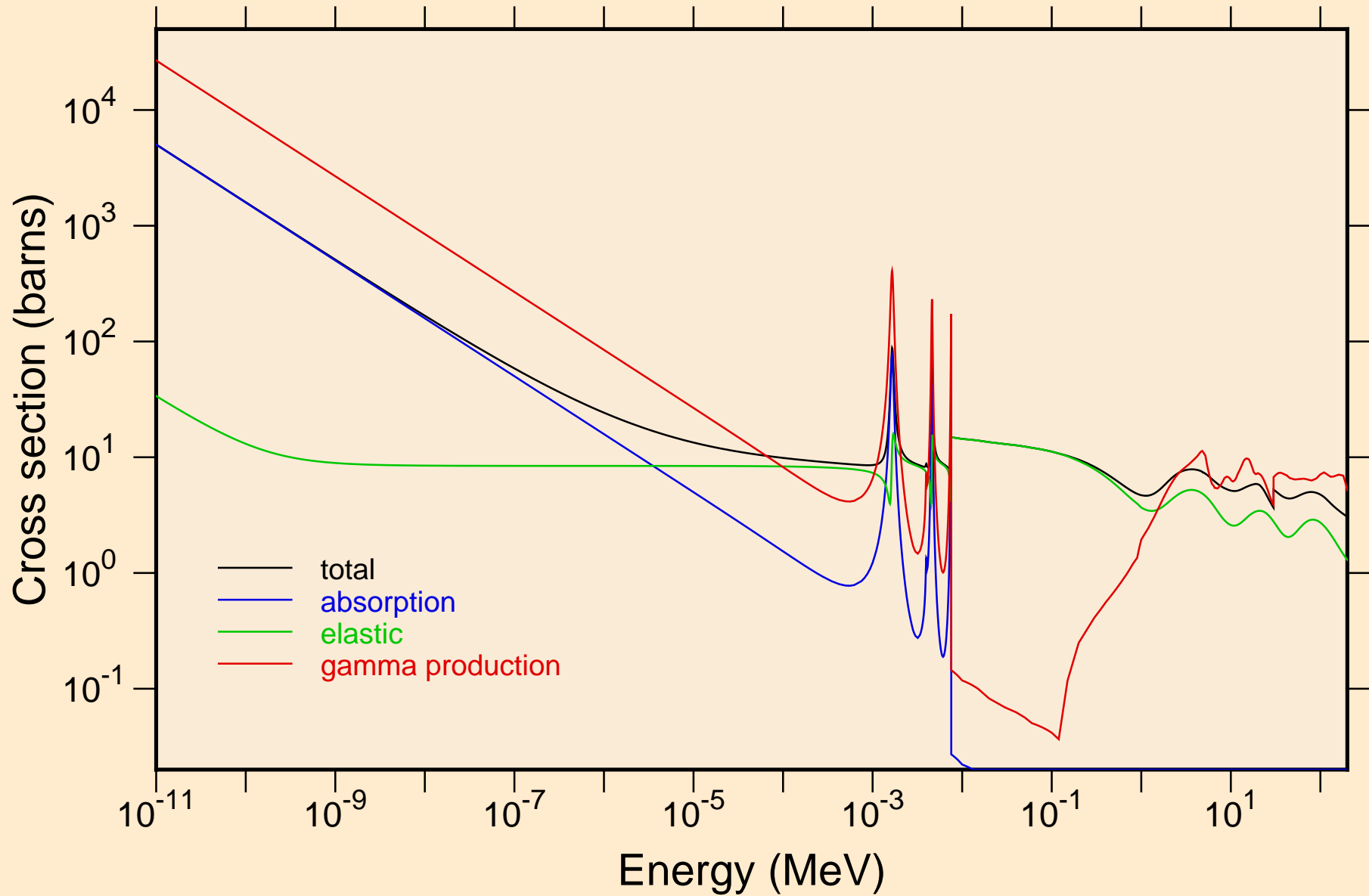

PB218 NRG TENDL-2015, AKONING
Non-threshold reactions

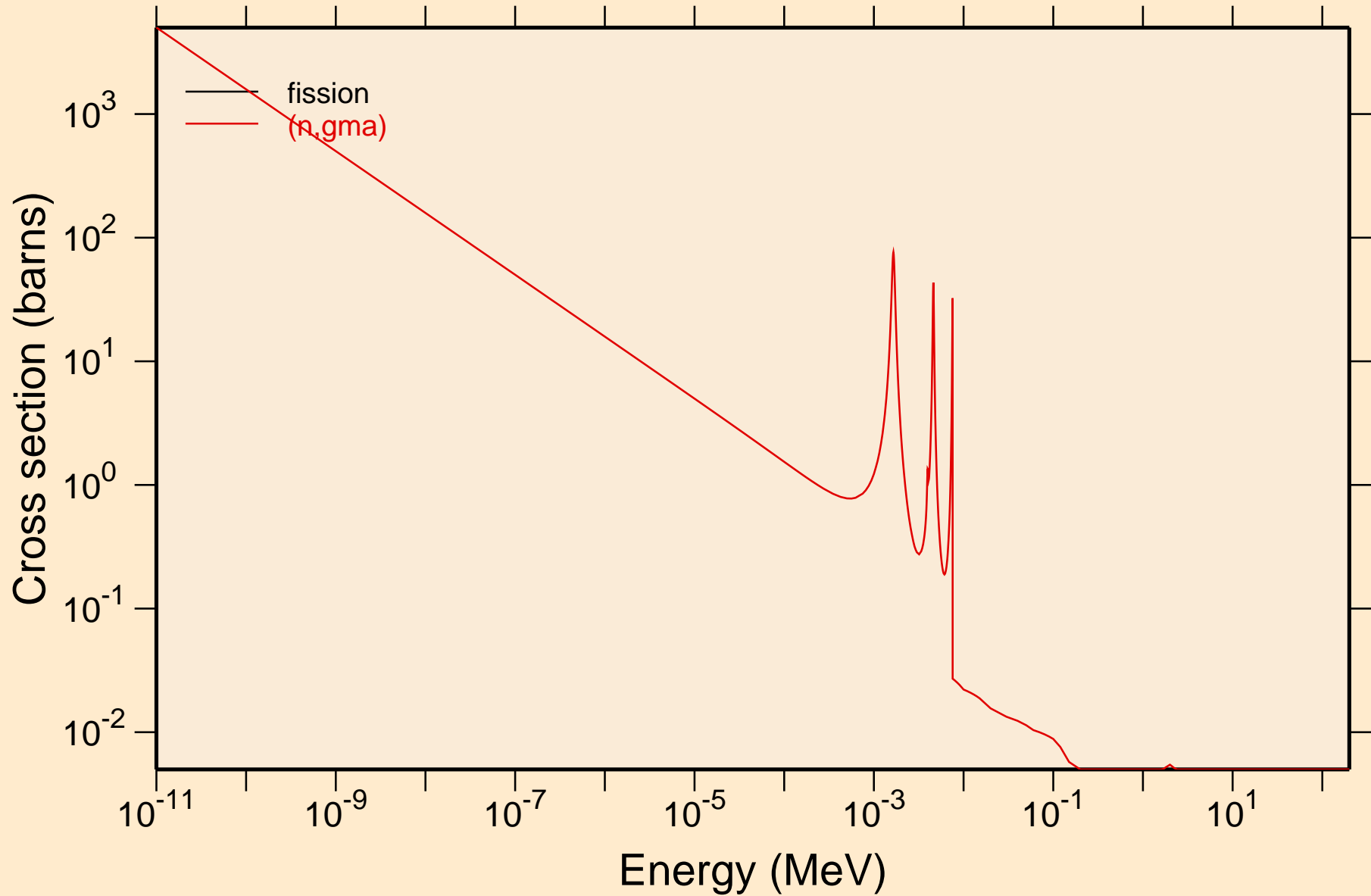

PB218 NRG TENDL-2015, AKONING

Principal cross sections

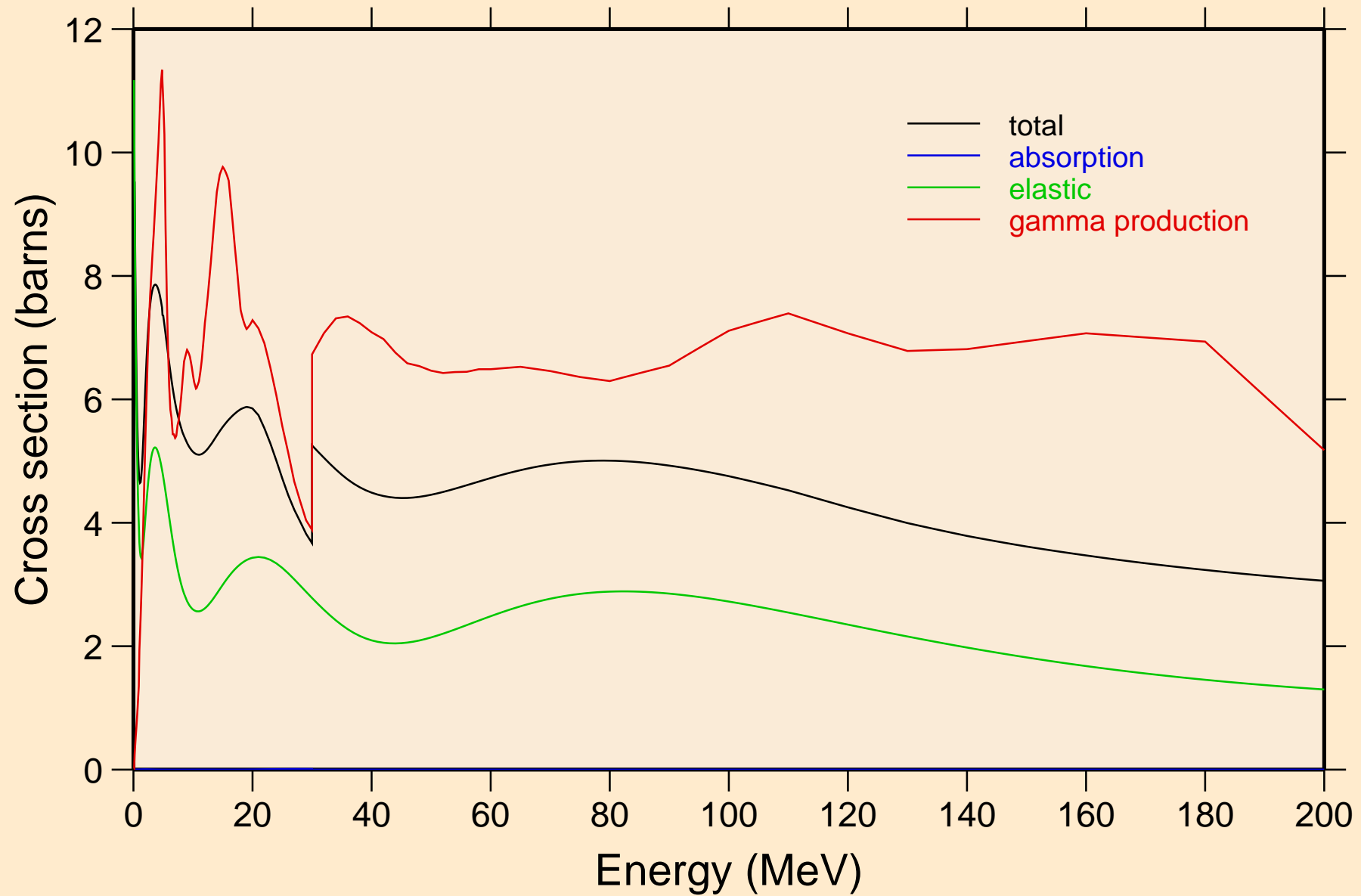

PB218 NRG TENDL-2015, AKONING

Non-threshold reactions

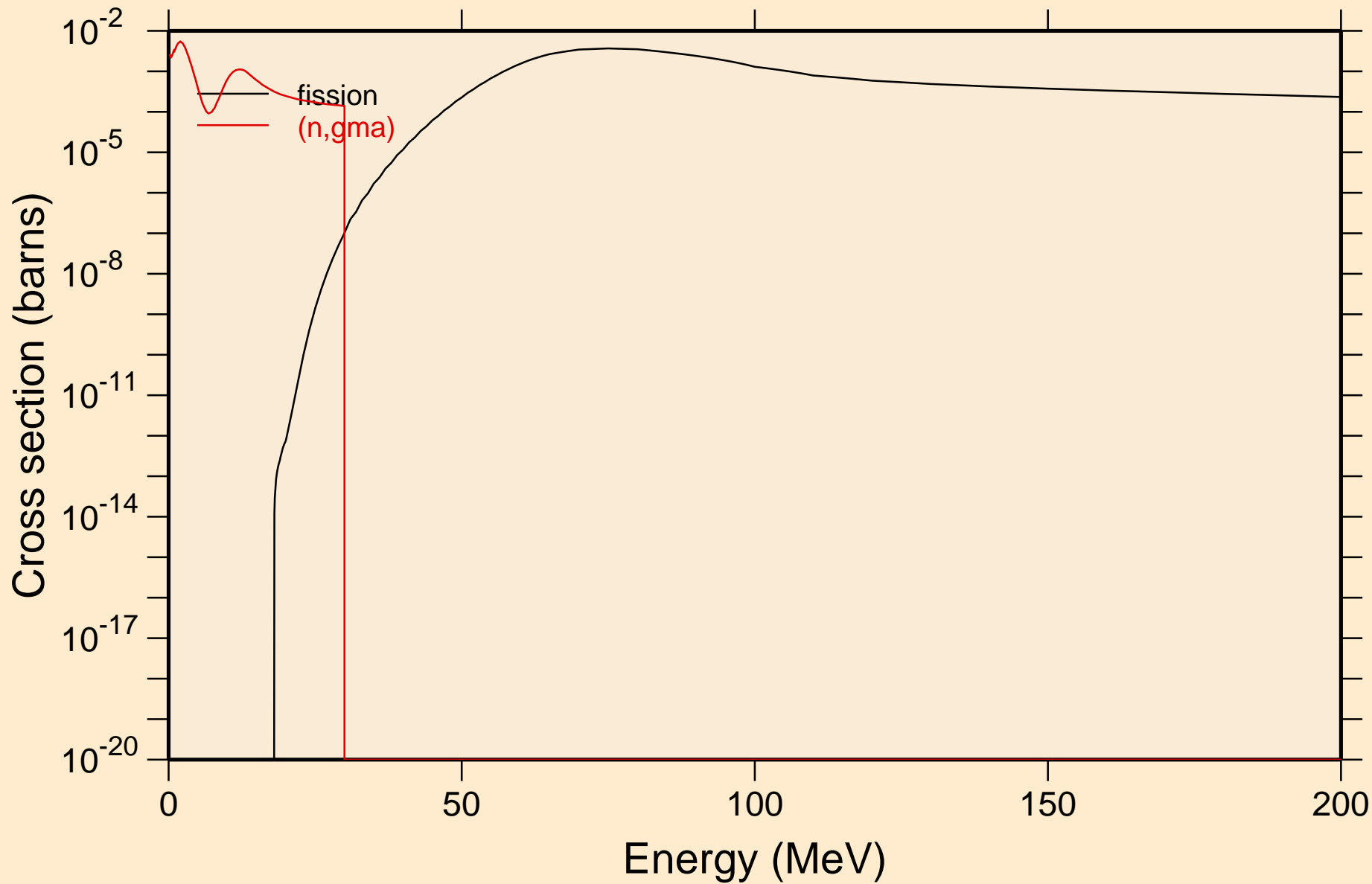

PB218 NRG TENDL-2015, AKONING
Inelastic levels

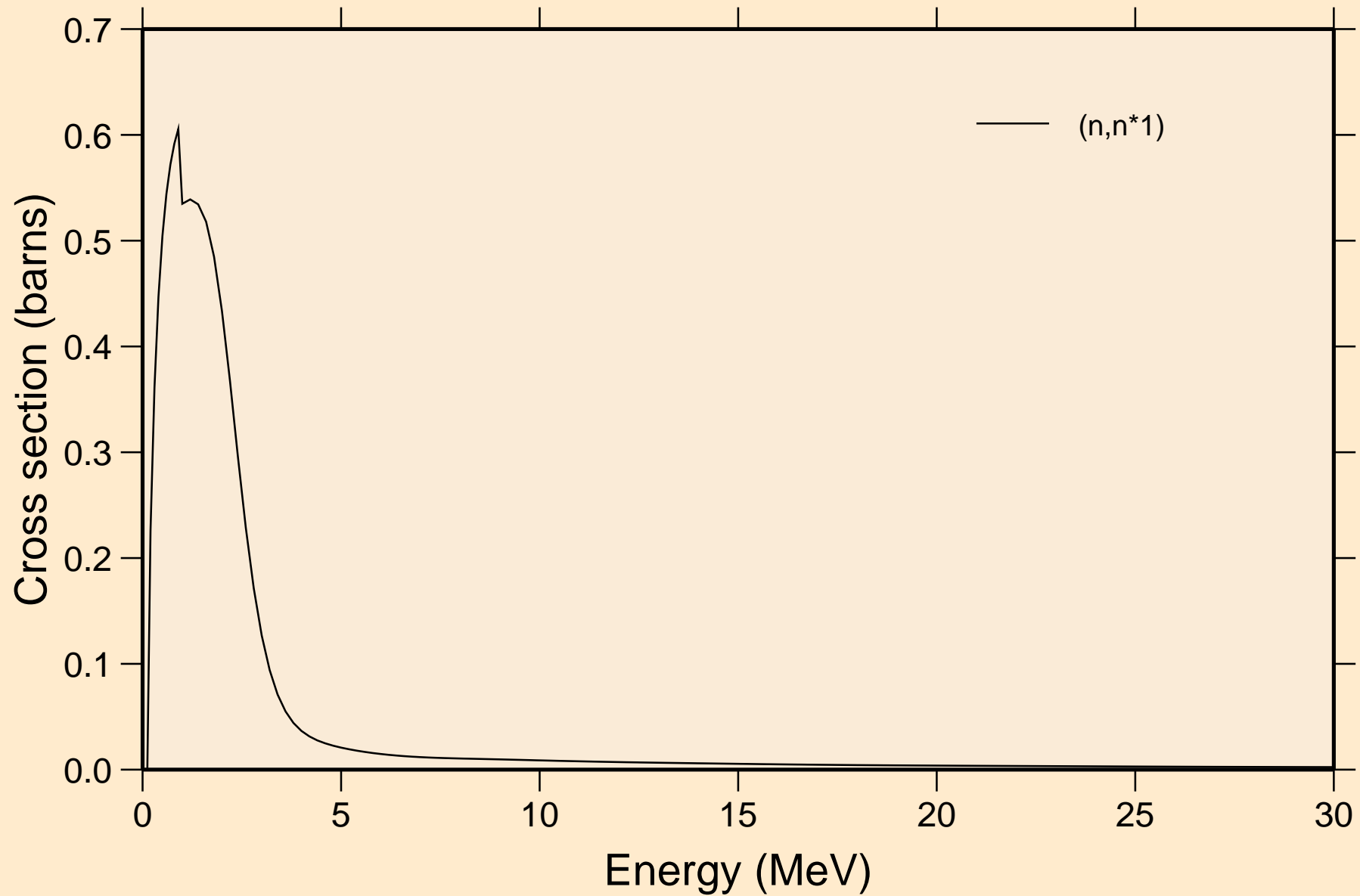

PB218 NRG TENDL-2015, AKONING

Threshold reactions

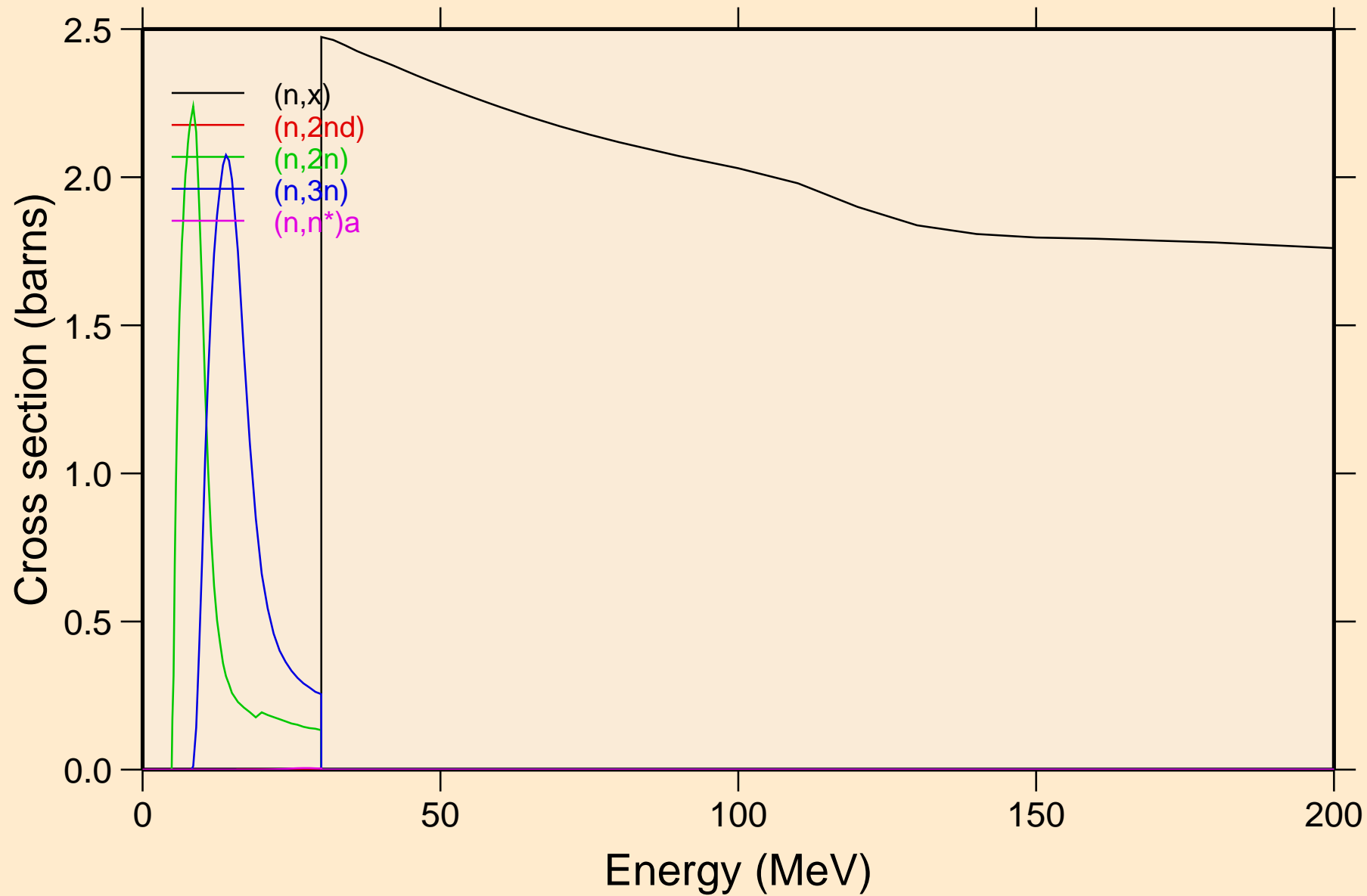

PB218 NRG TENDL-2015, AKONING

Threshold reactions

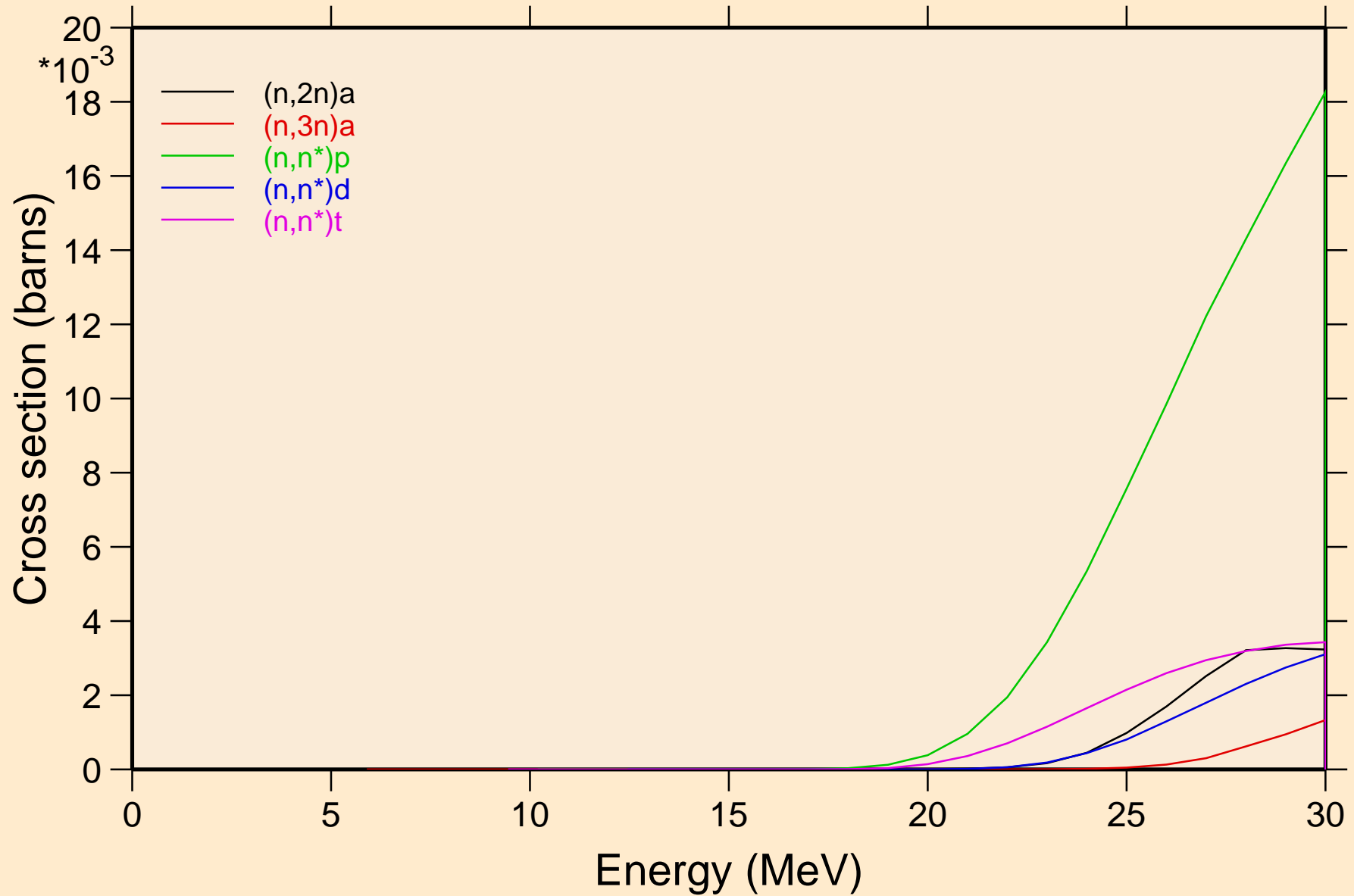

PB218 NRG TENDL-2015, AKONING

Threshold reactions

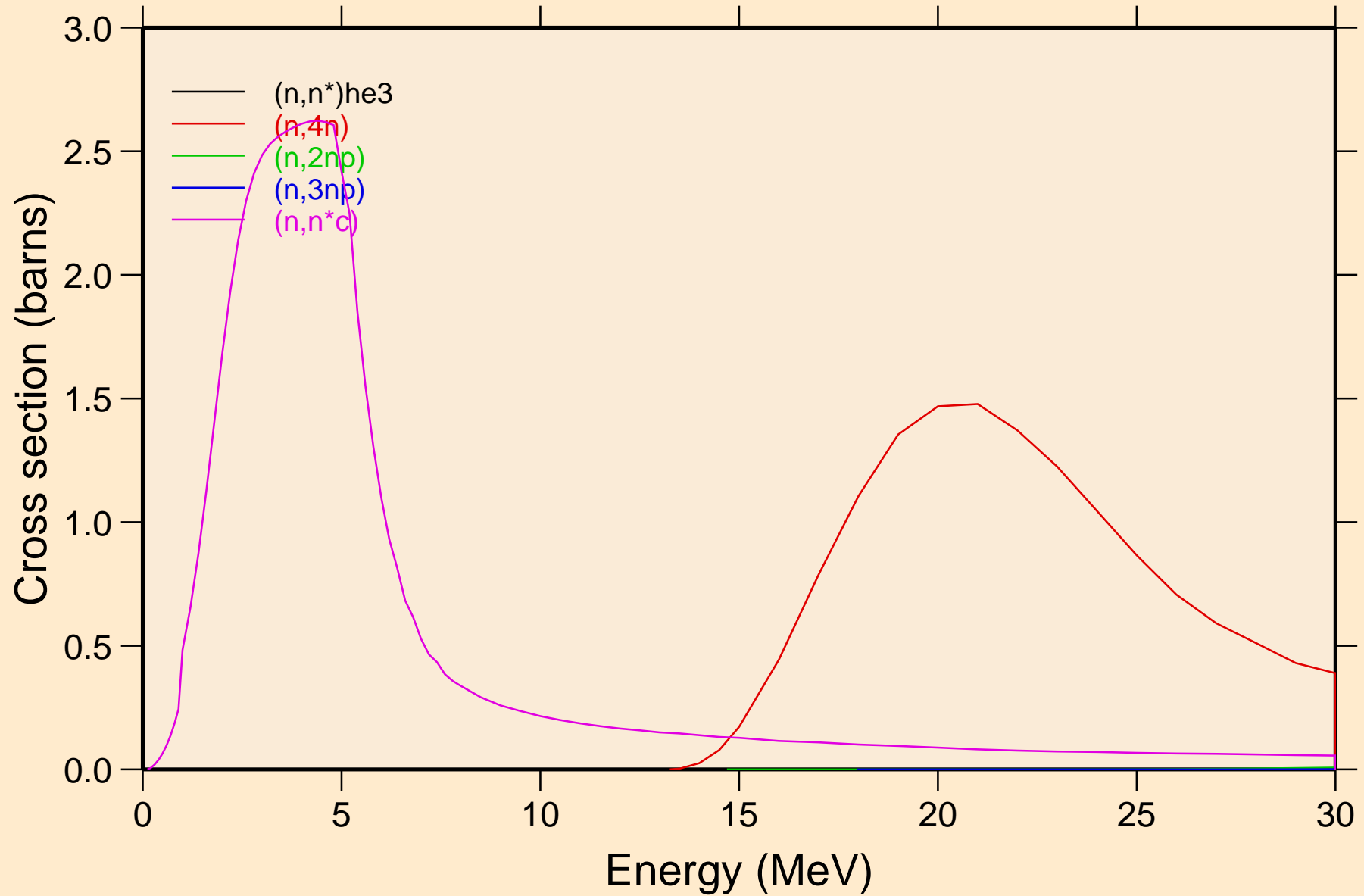

PB218 NRG TENDL-2015, AKONING

Threshold reactions

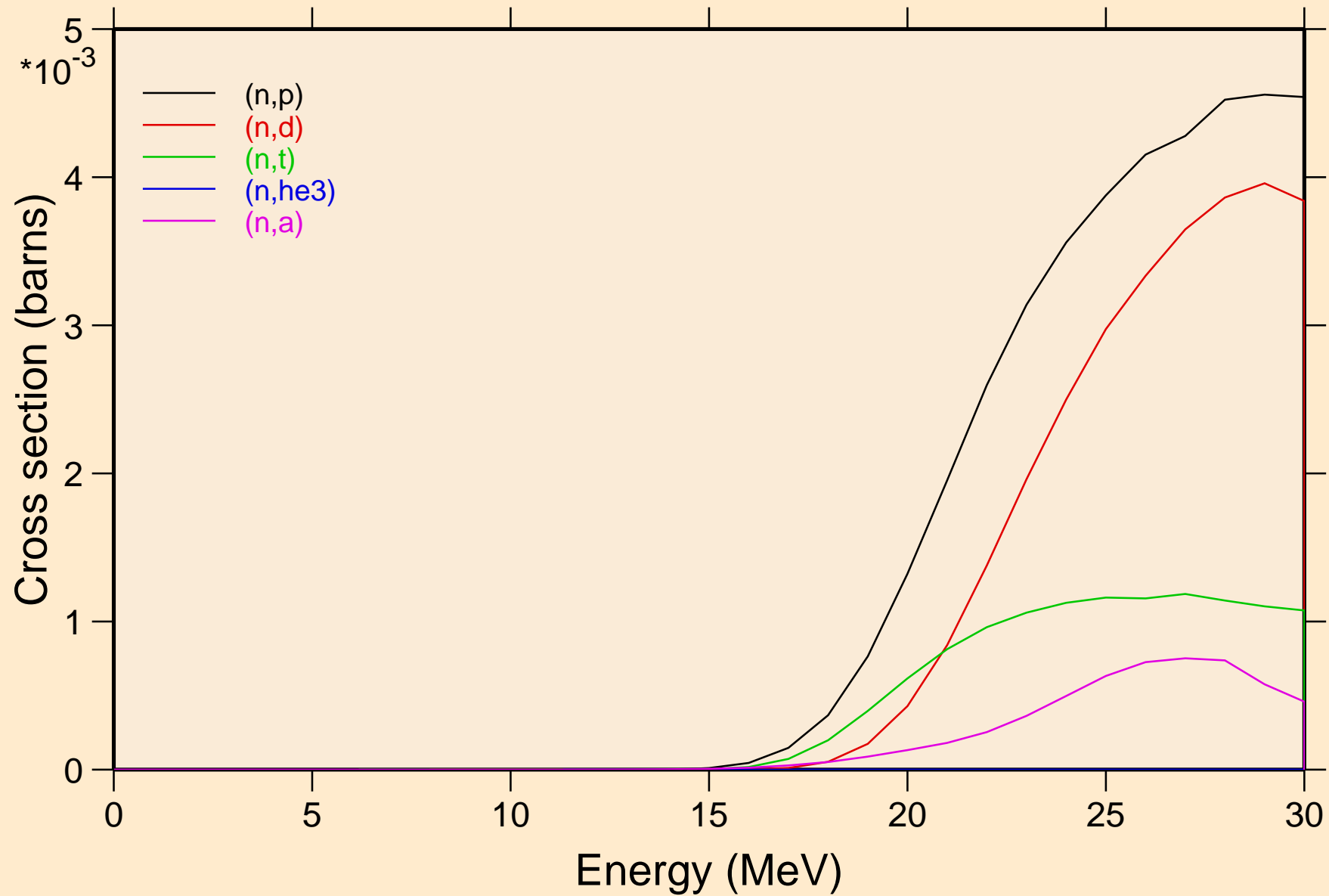

PB218 NRG TENDL-2015, AKONING
angular distribution for elastic

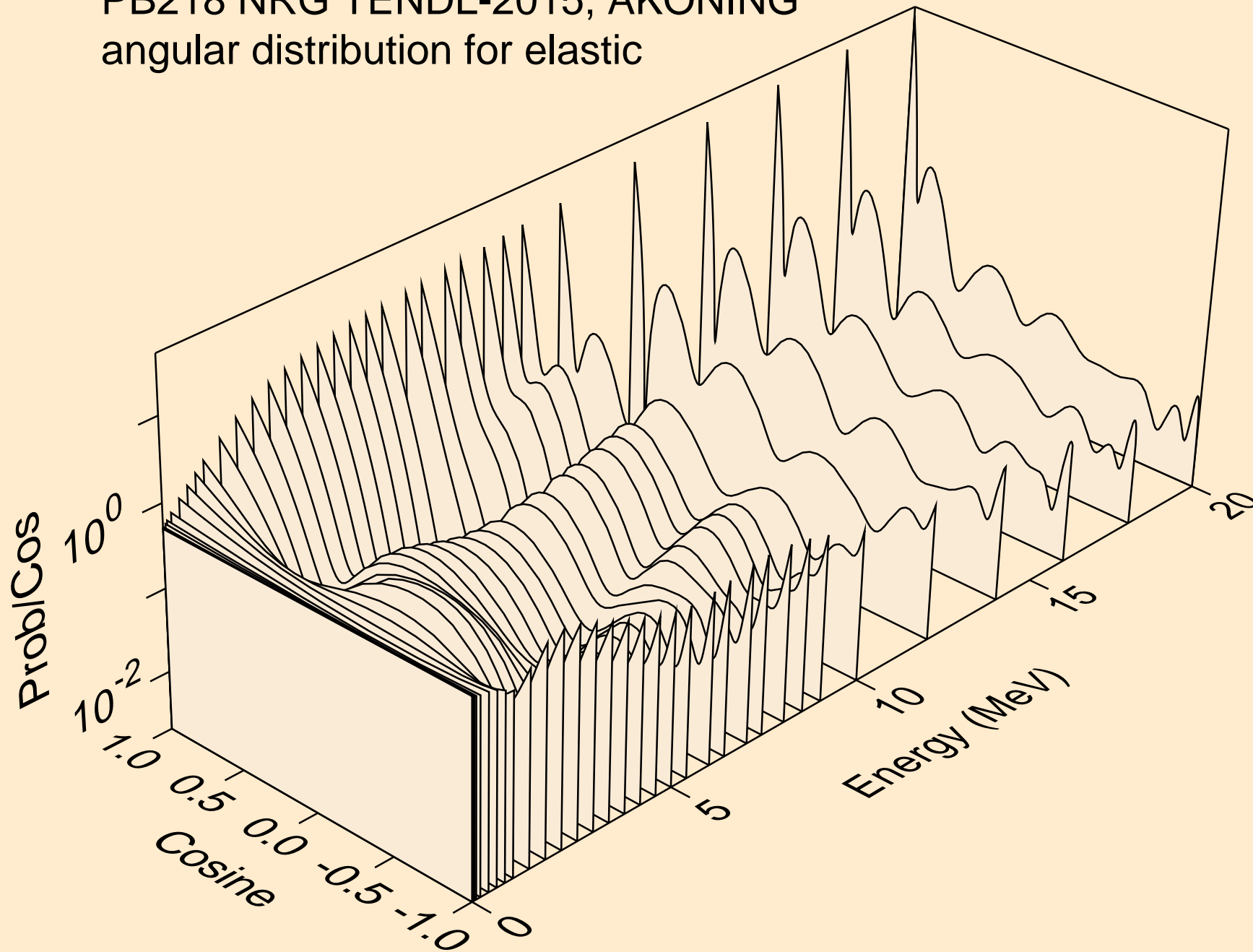

PB218 NRG TENDL-2015, AKONING
angular distribution for elastic

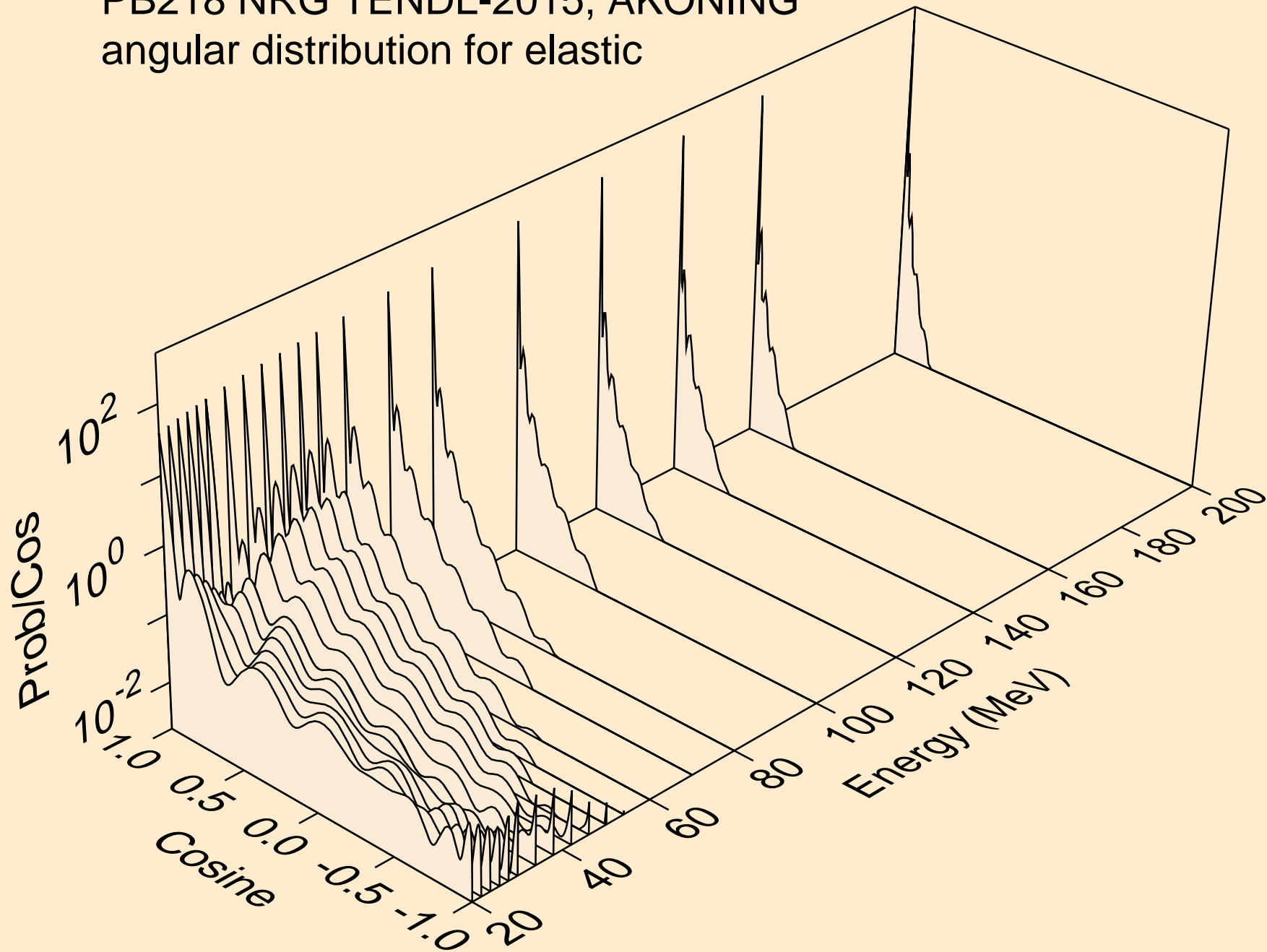

PB218 NRG TENDL-2015, AKONING
angular distribution for (n,n*1)

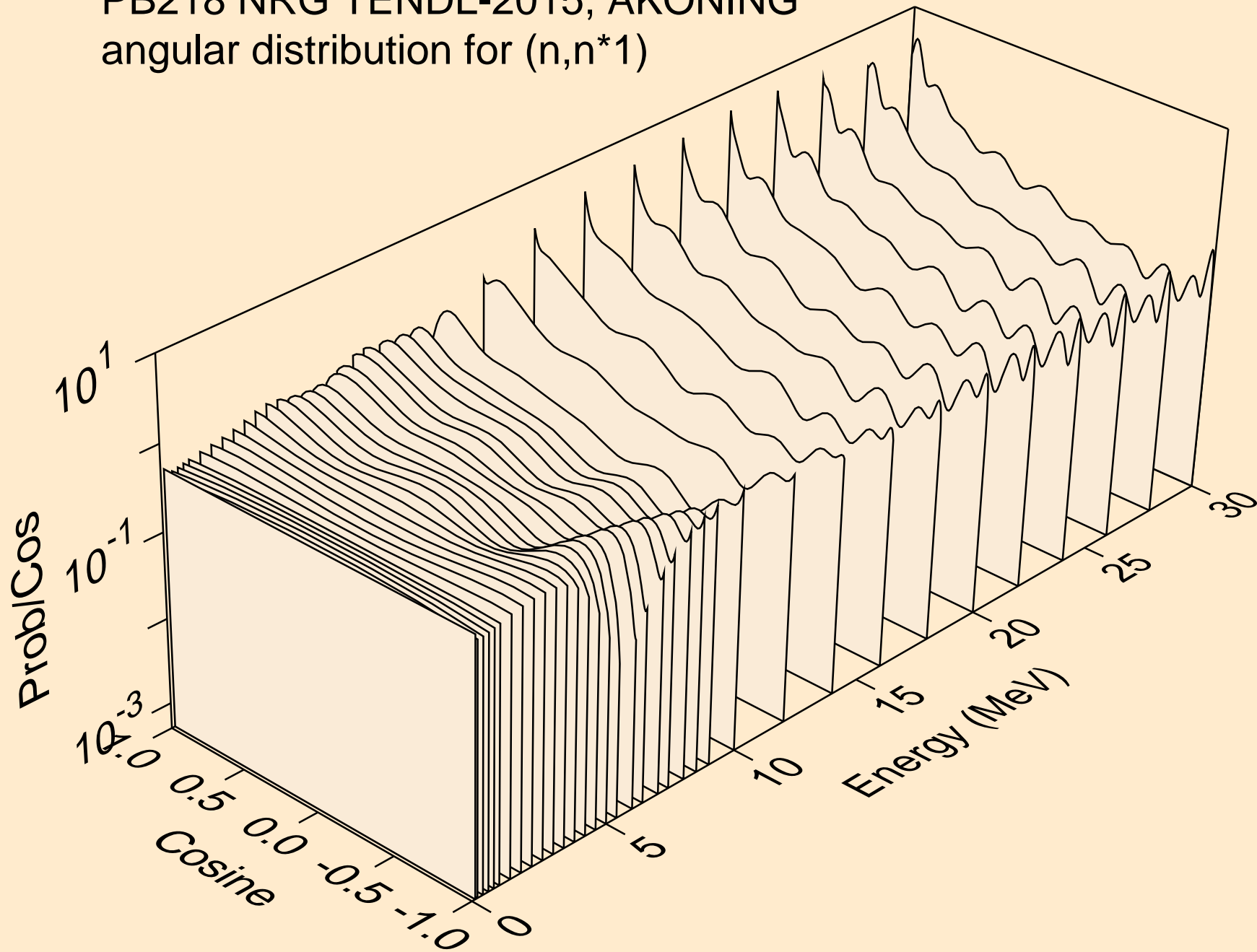

PB218 NRG TENDL-2015, AKONING

Total fission nubar

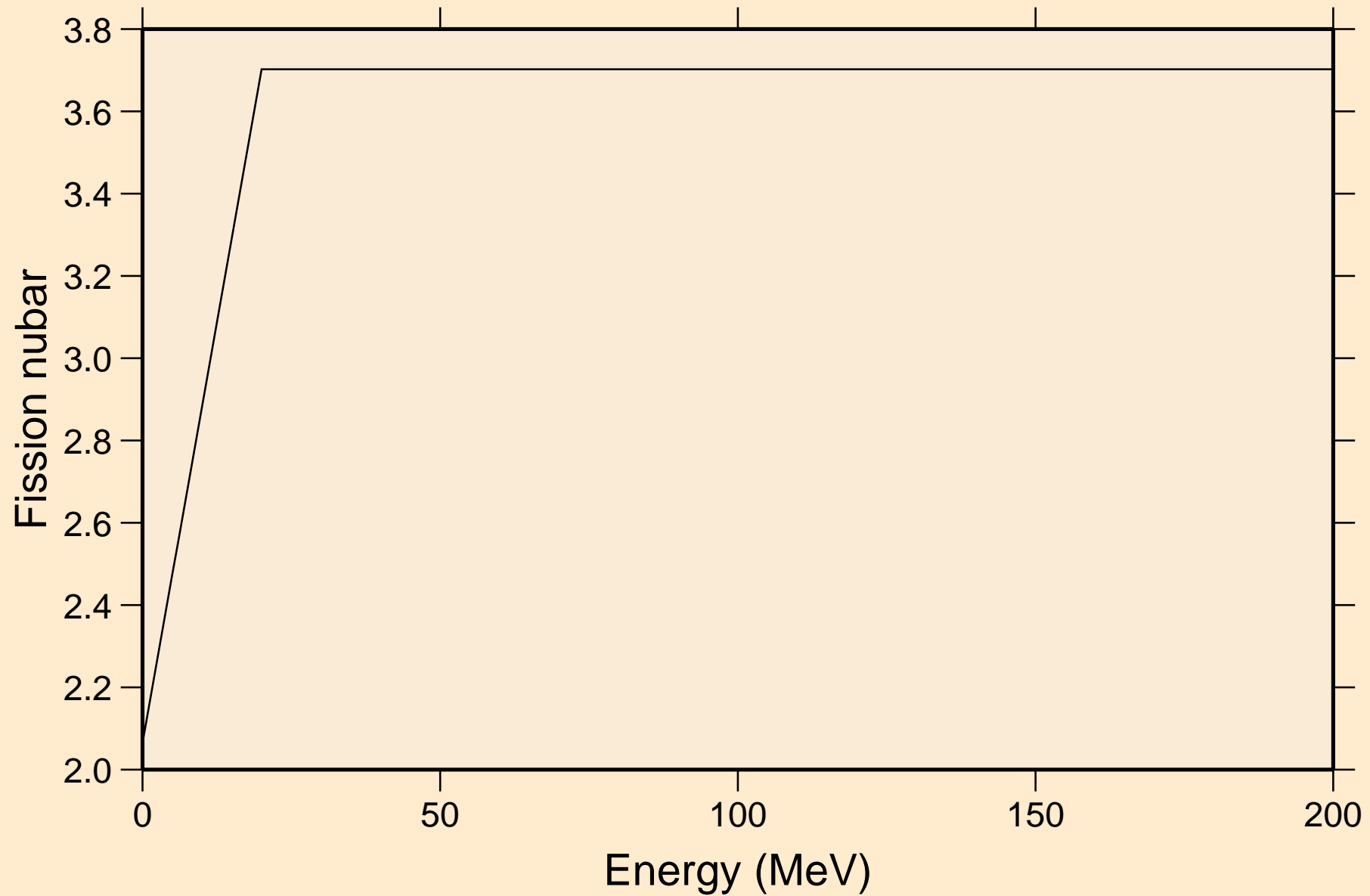

PB218 NRG TENDL-2015, AKONING
Neutron emission for (n,x)

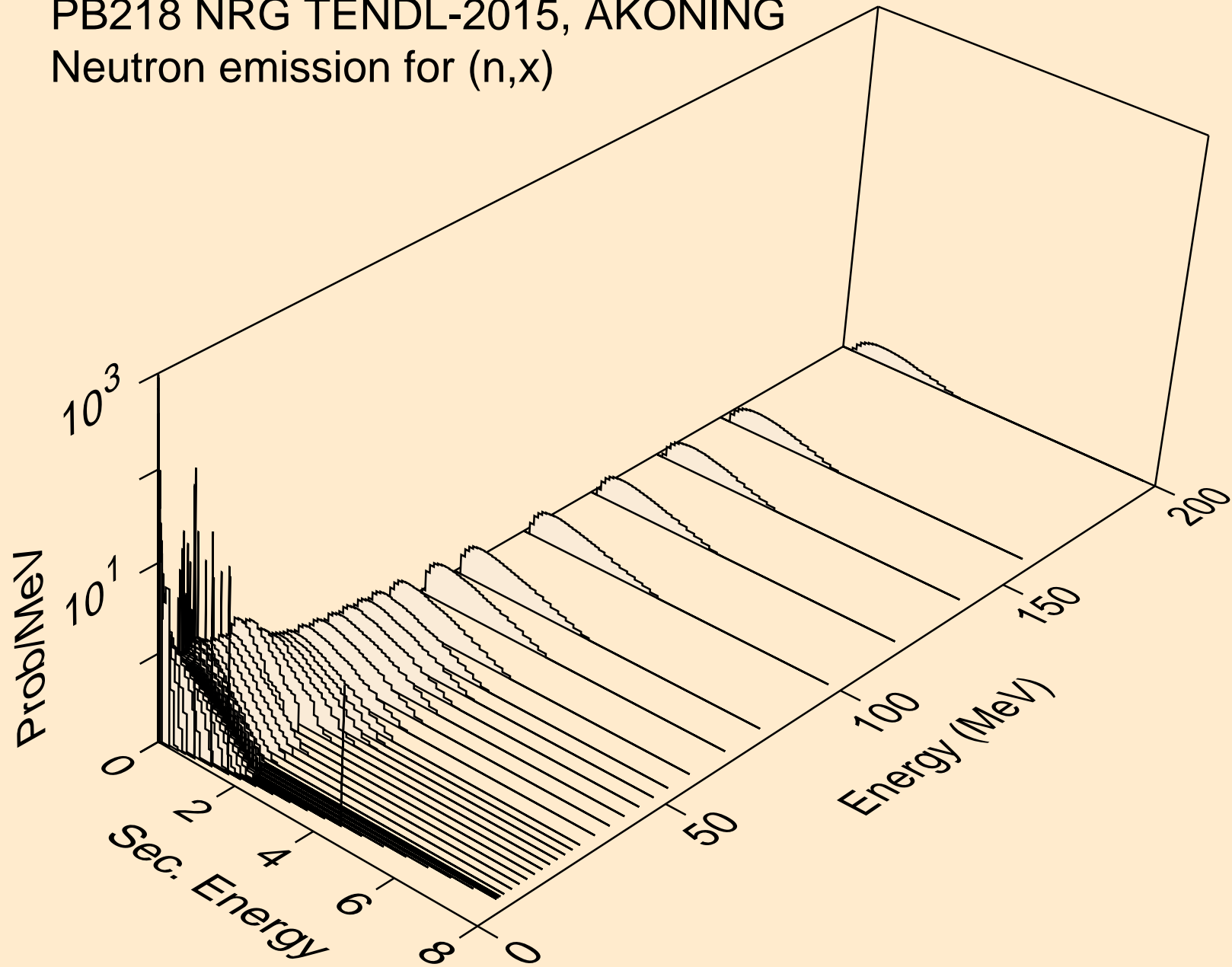

PB218 NRG TENDL-2015, AKONING
Neutron emission for (n,2nd)

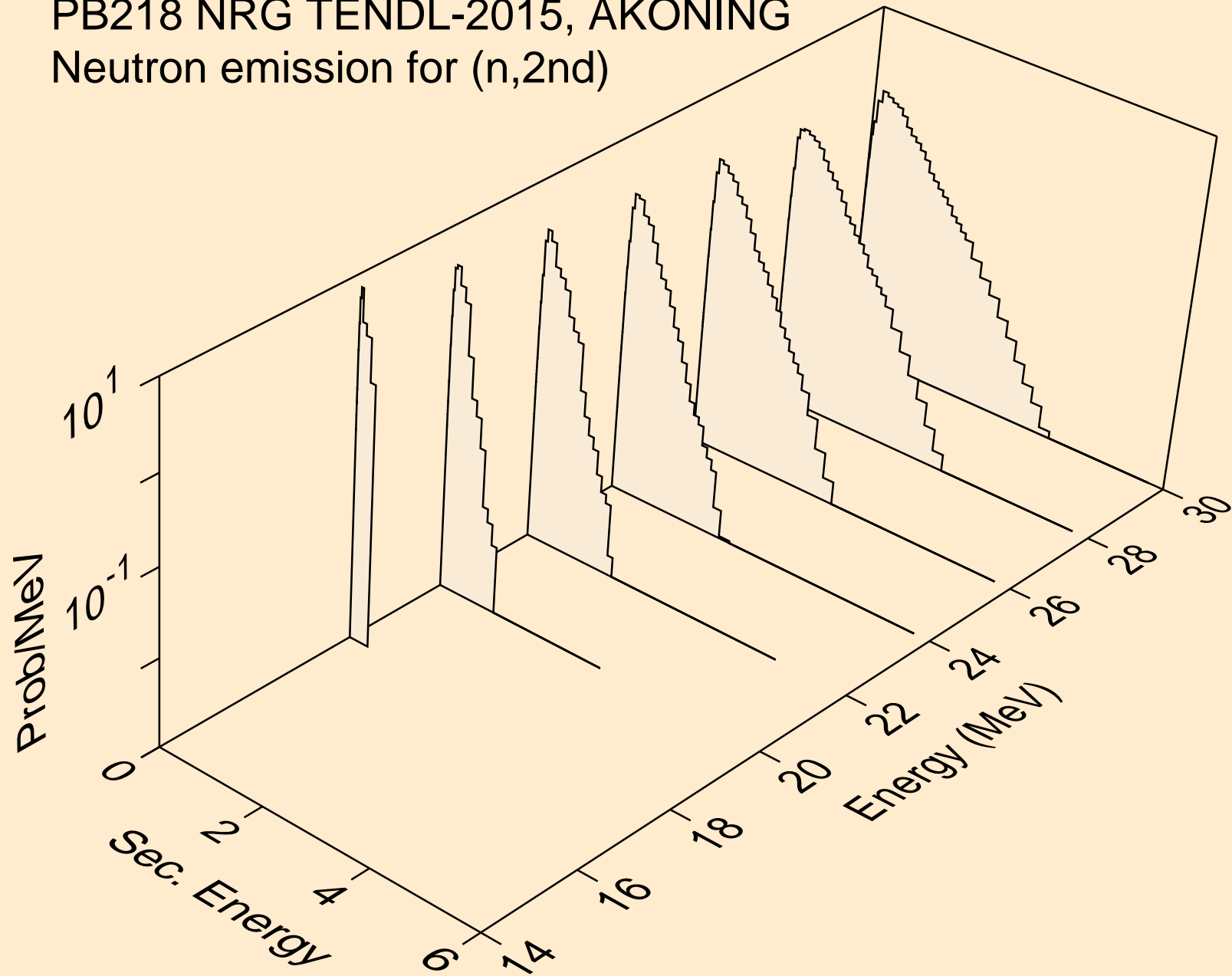

PB218 NRG TENDL-2015, AKONING
Neutron emission for (n,2n)

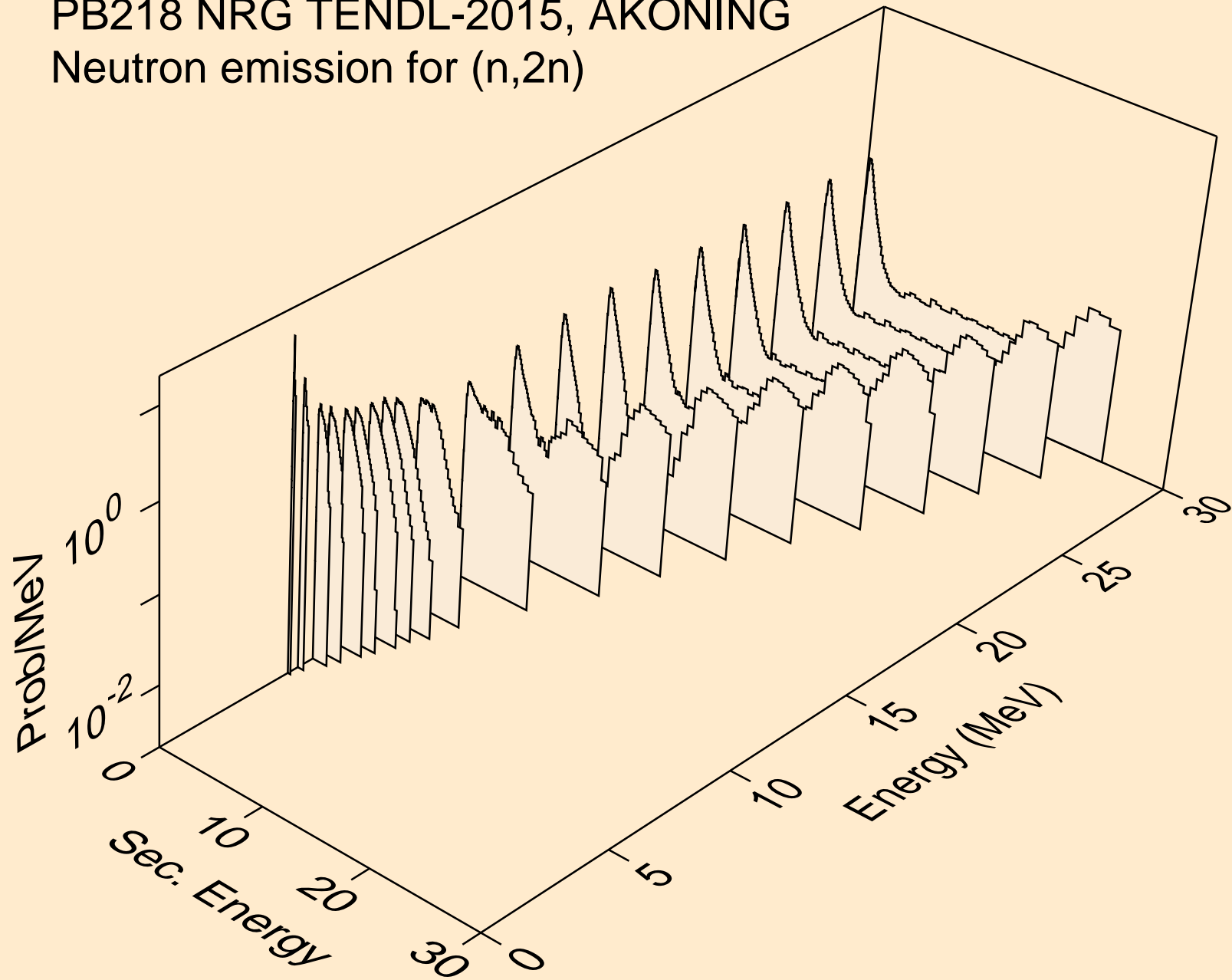

PB218 NRG TENDL-2015, AKONING
Neutron emission for (n,3n)

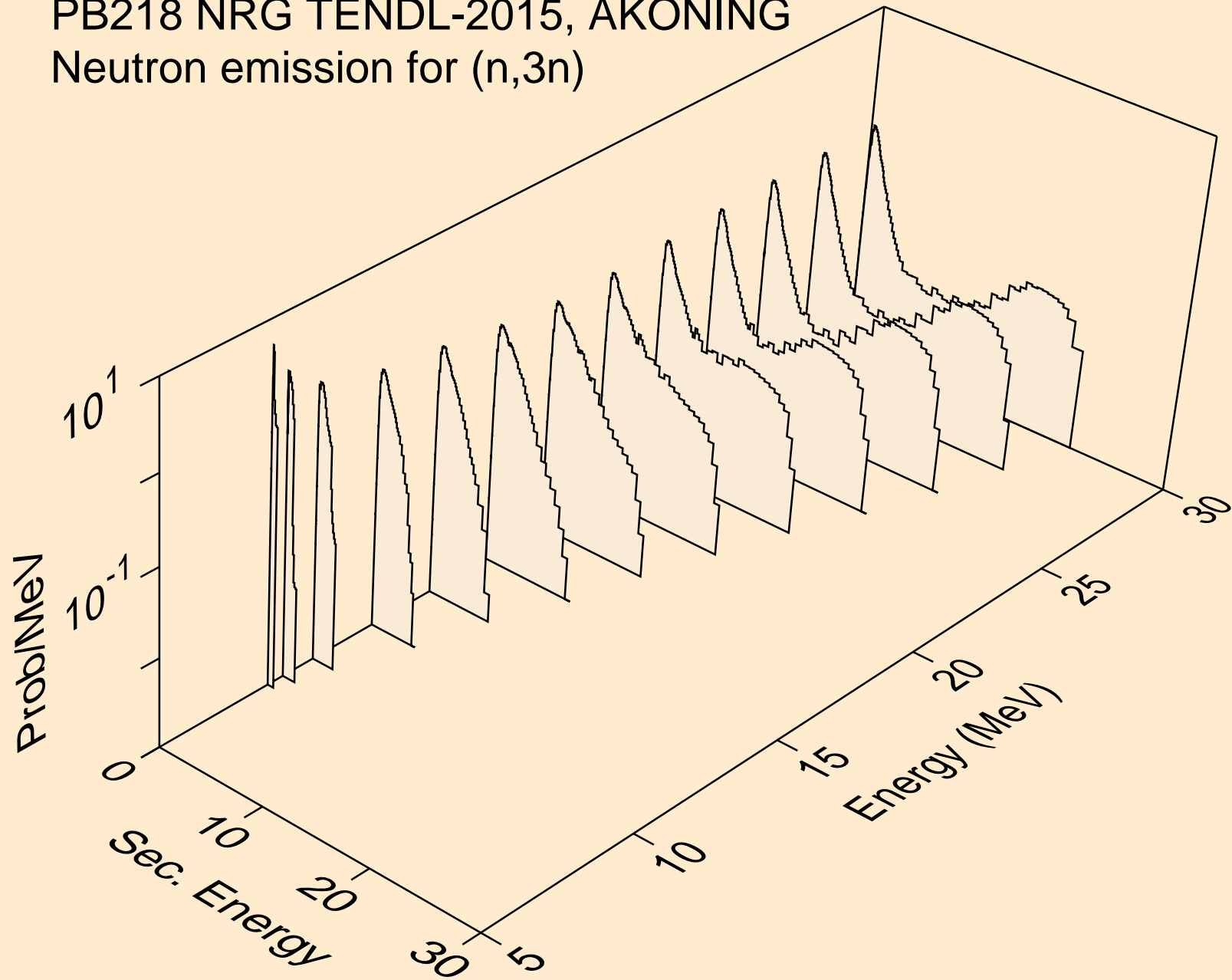

PB218 NRG TENDL-2015, AKONING
Neutron emission for (n,n*)a

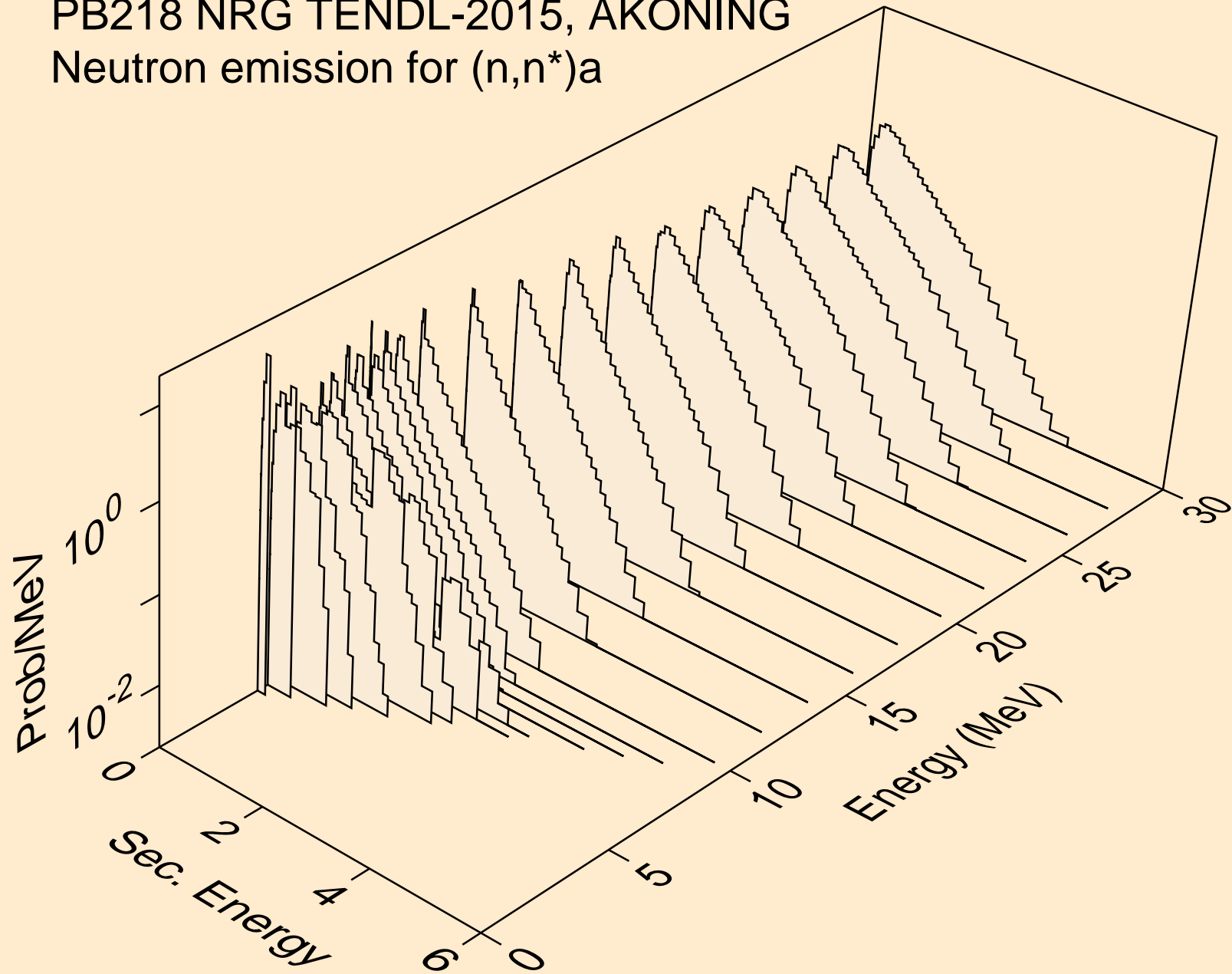

PB218 NRG TENDL-2015, AKONING
Neutron emission for (n,2n)a

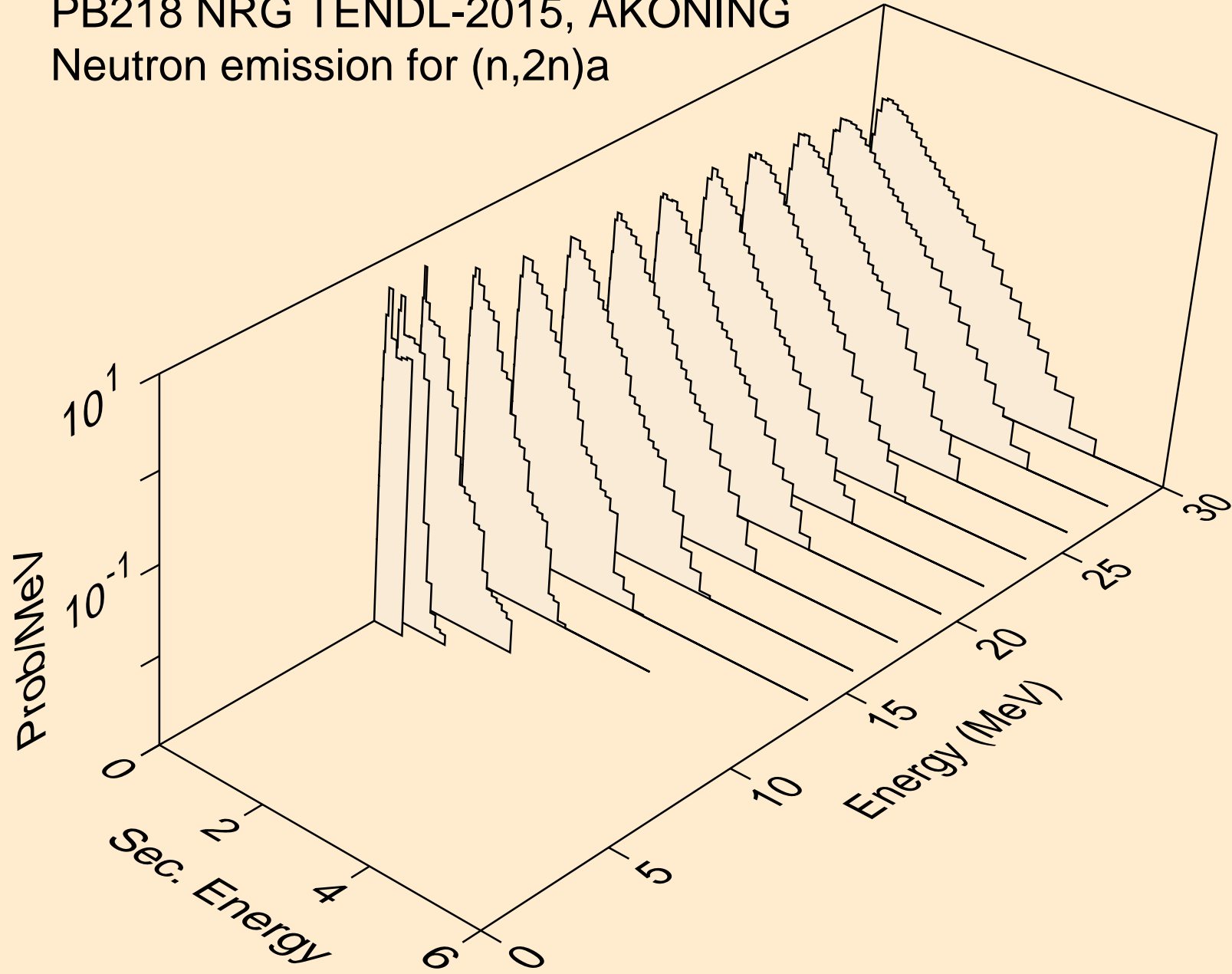

PB218 NRG TENDL-2015, AKONING
Neutron emission for (n,3n)a

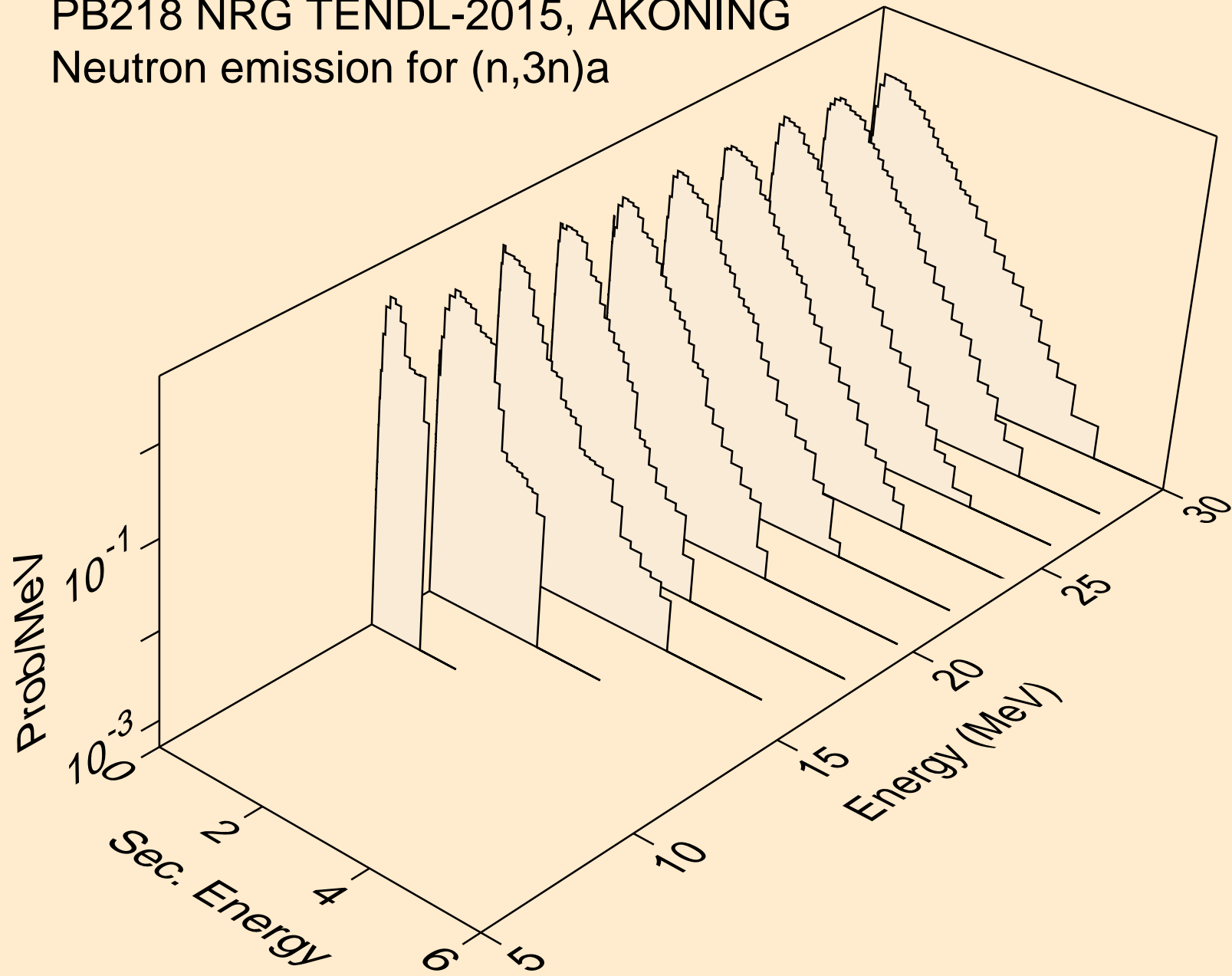

PB218 NRG TENDL-2015, AKONING
Neutron emission for (n,n*)p

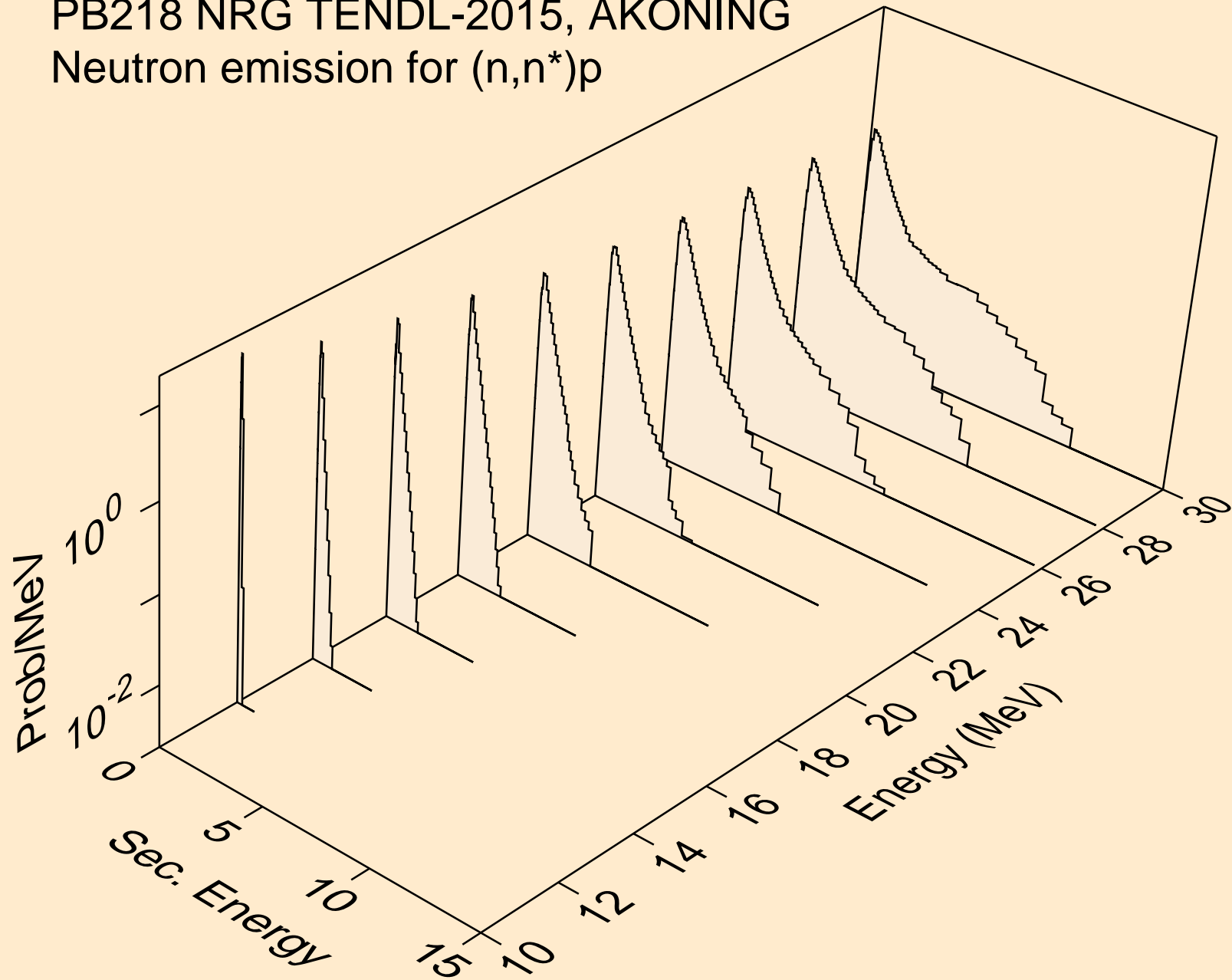

PB218 NRG TENDL-2015, AKONING
Neutron emission for (n,n*)d

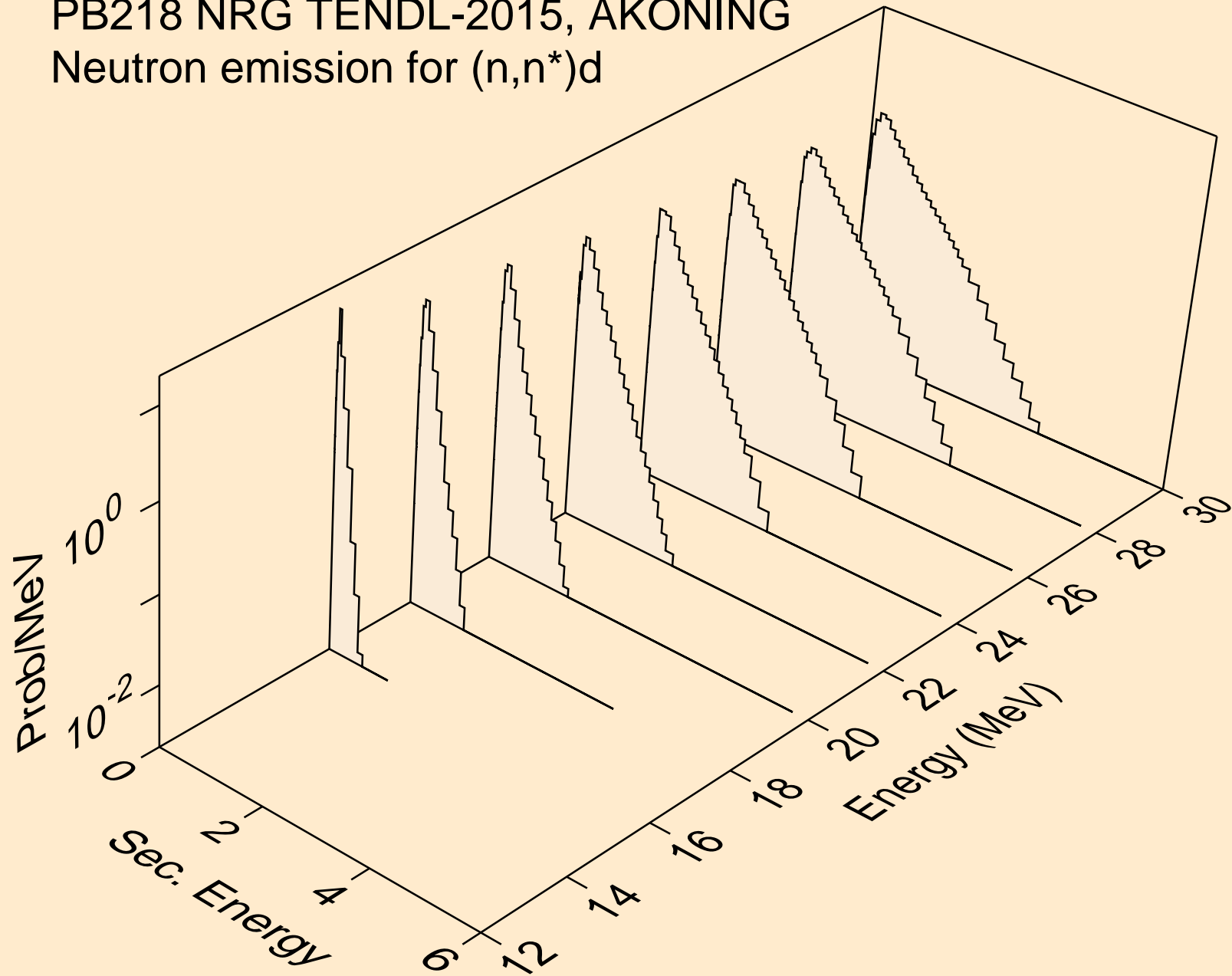

PB218 NRG TENDL-2015, AKONING
Neutron emission for (n,n*)t

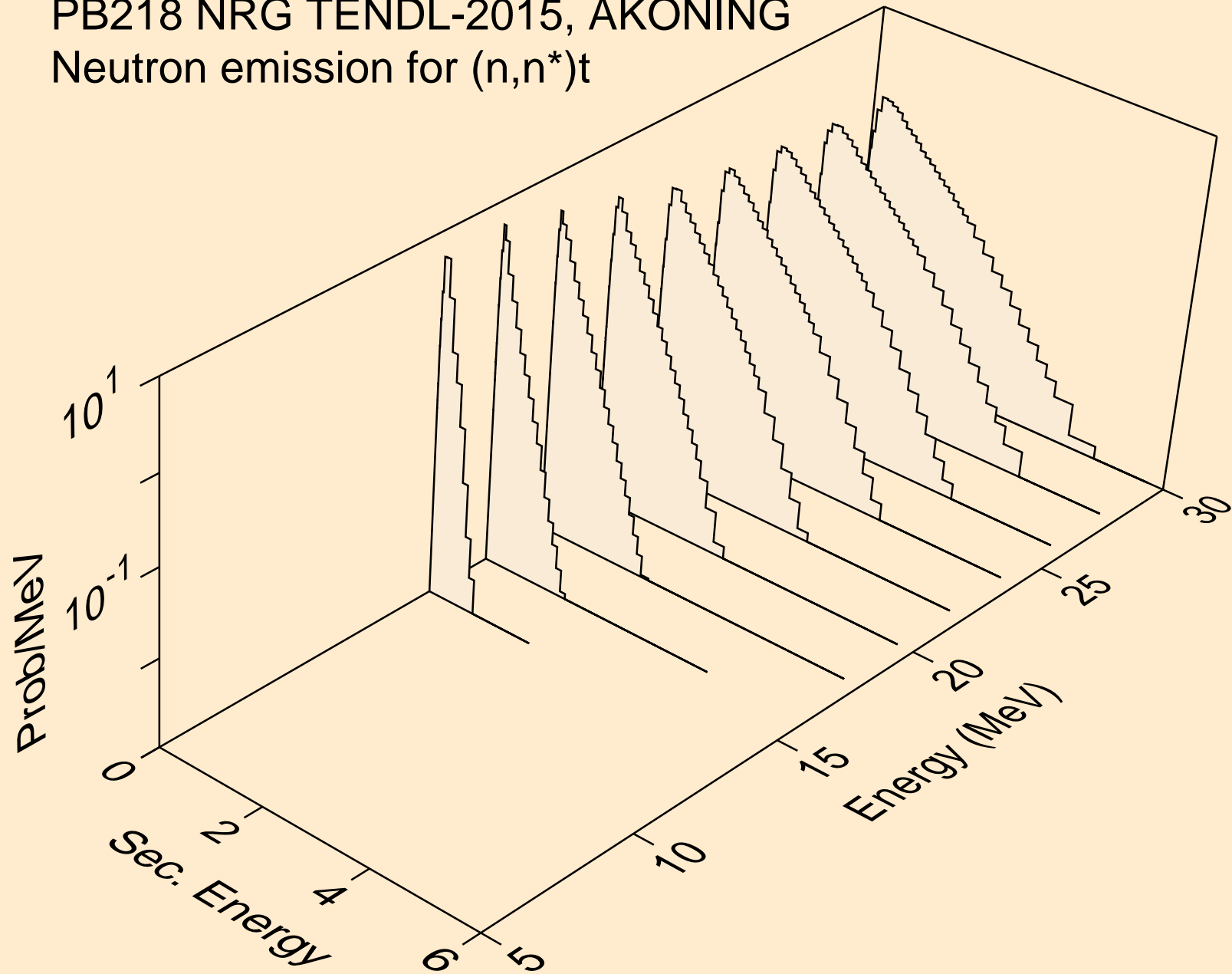

PB218 NRG TENDL-2015, AKONING
Neutron emission for (n,n*)he3

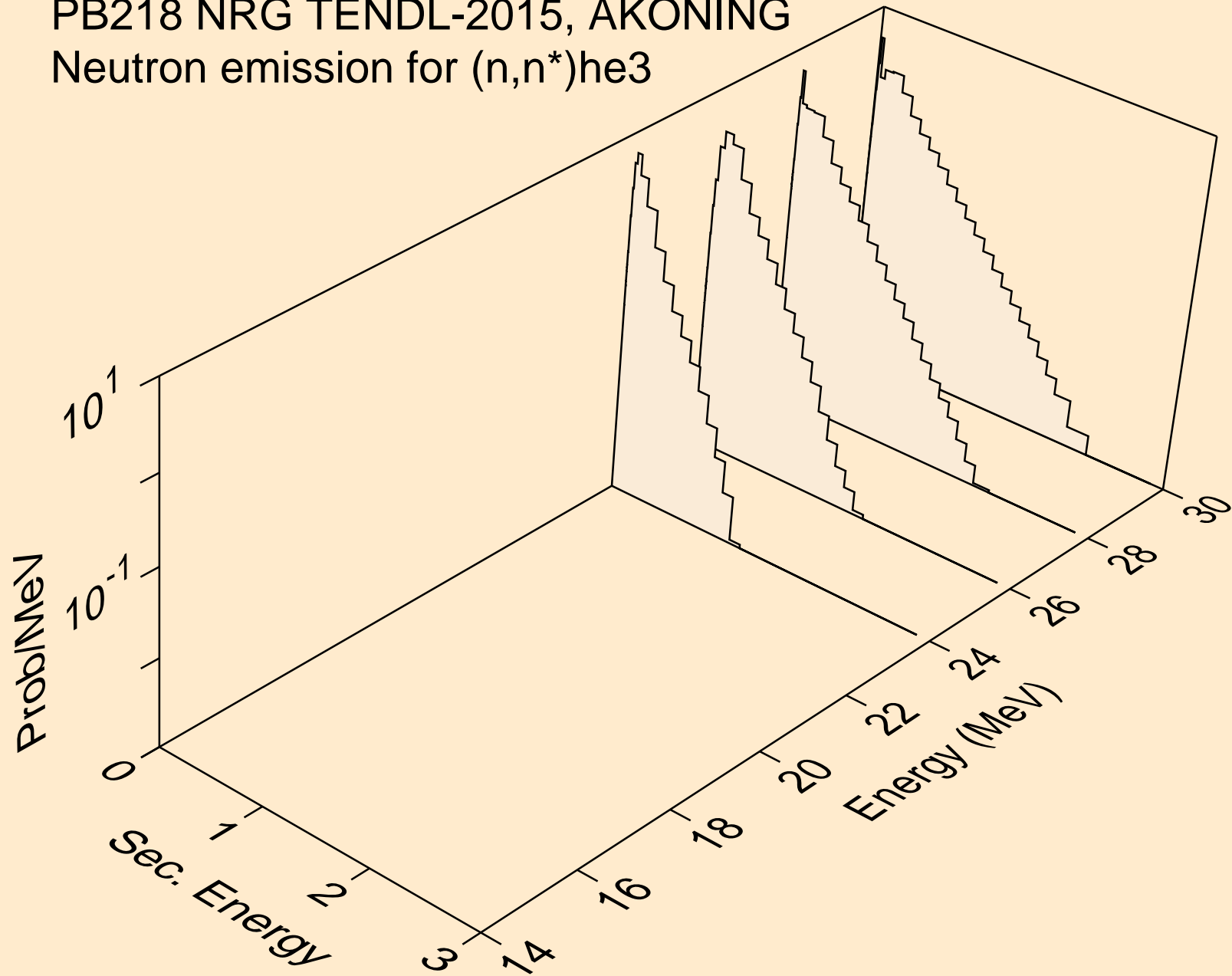

PB218 NRG TENDL-2015, AKONING
Neutron emission for (n,4n)

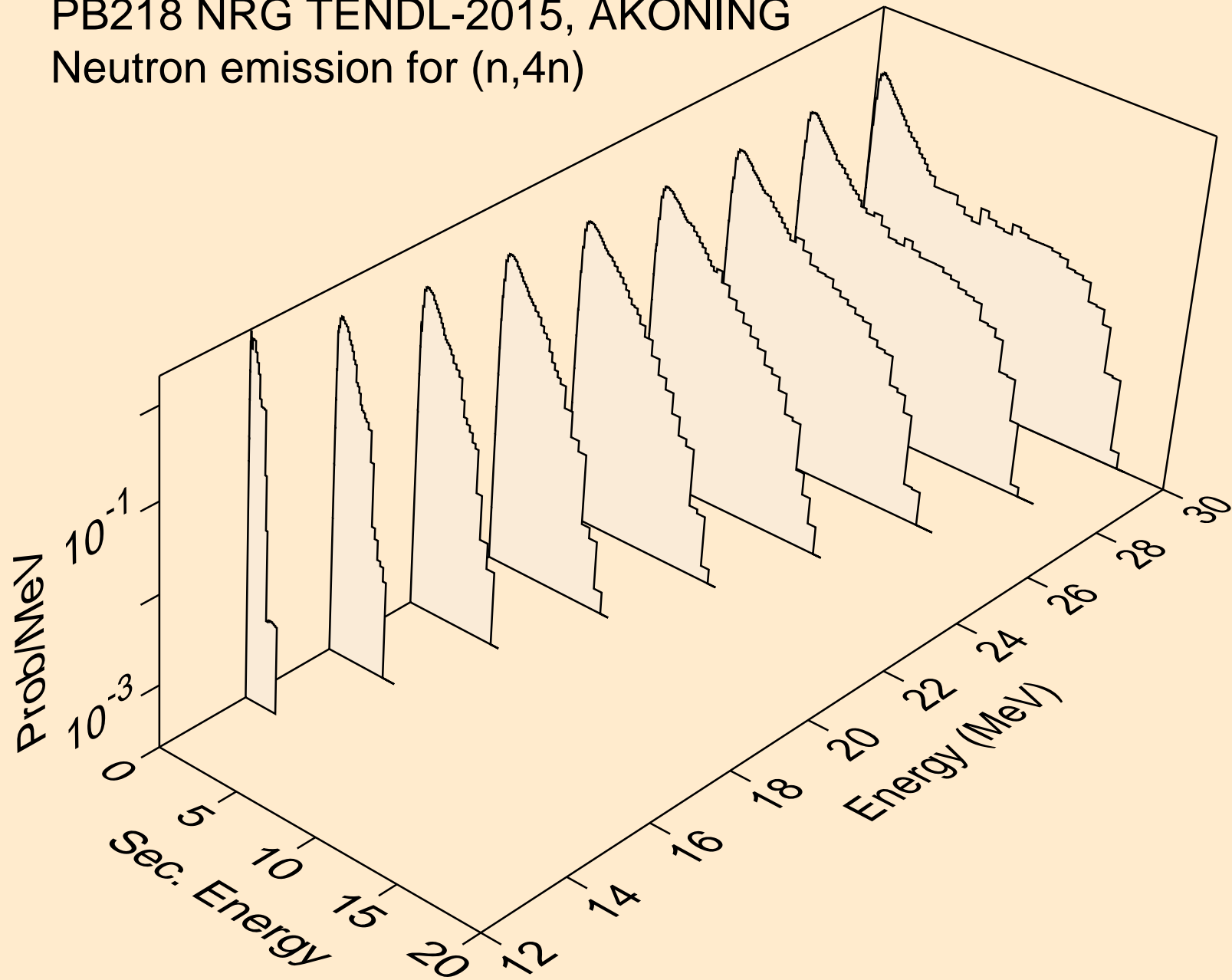

PB218 NRG TENDL-2015, AKONING
Neutron emission for (n,2np)

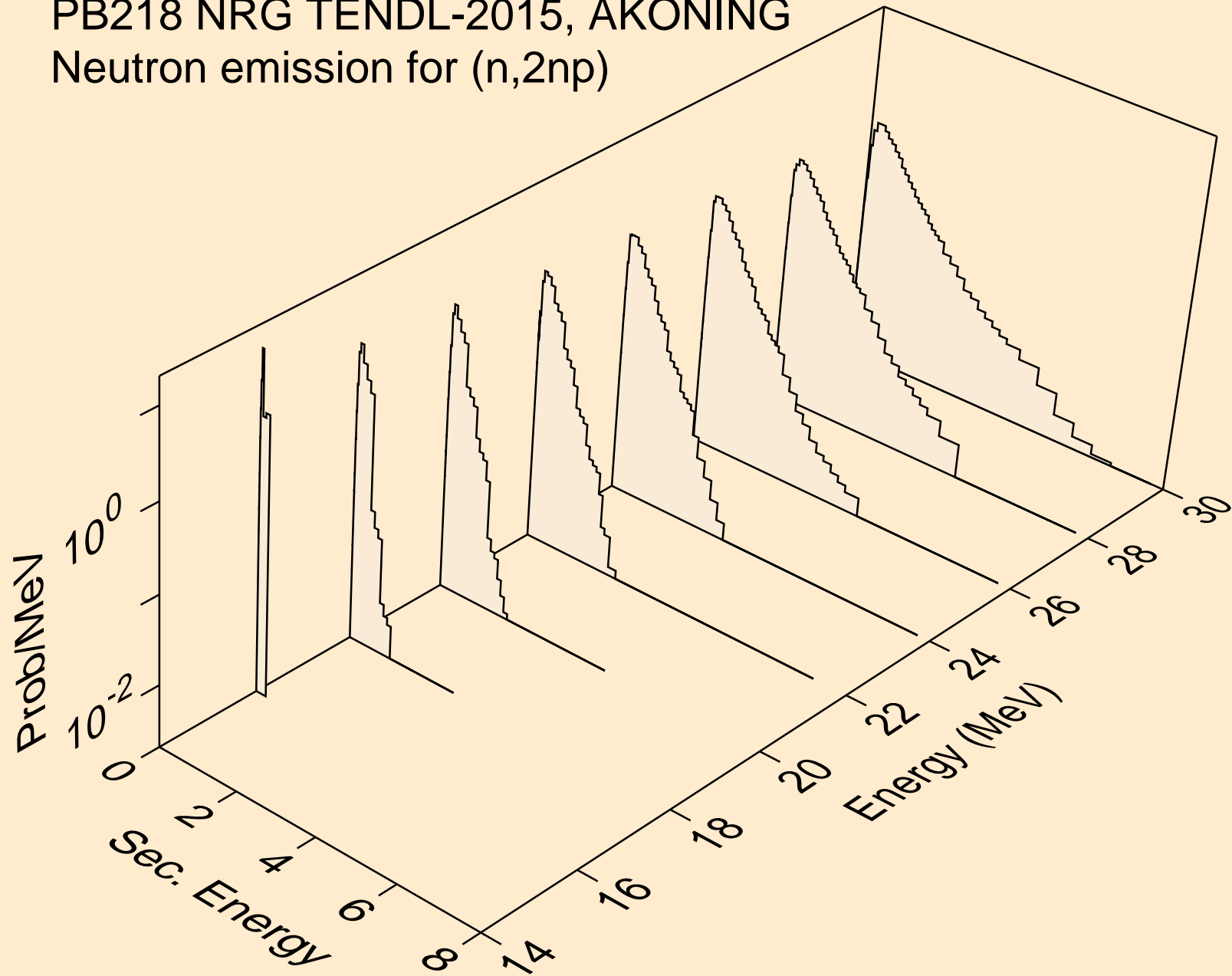

PB218 NRG TENDL-2015, AKONING
Neutron emission for (n,3np)

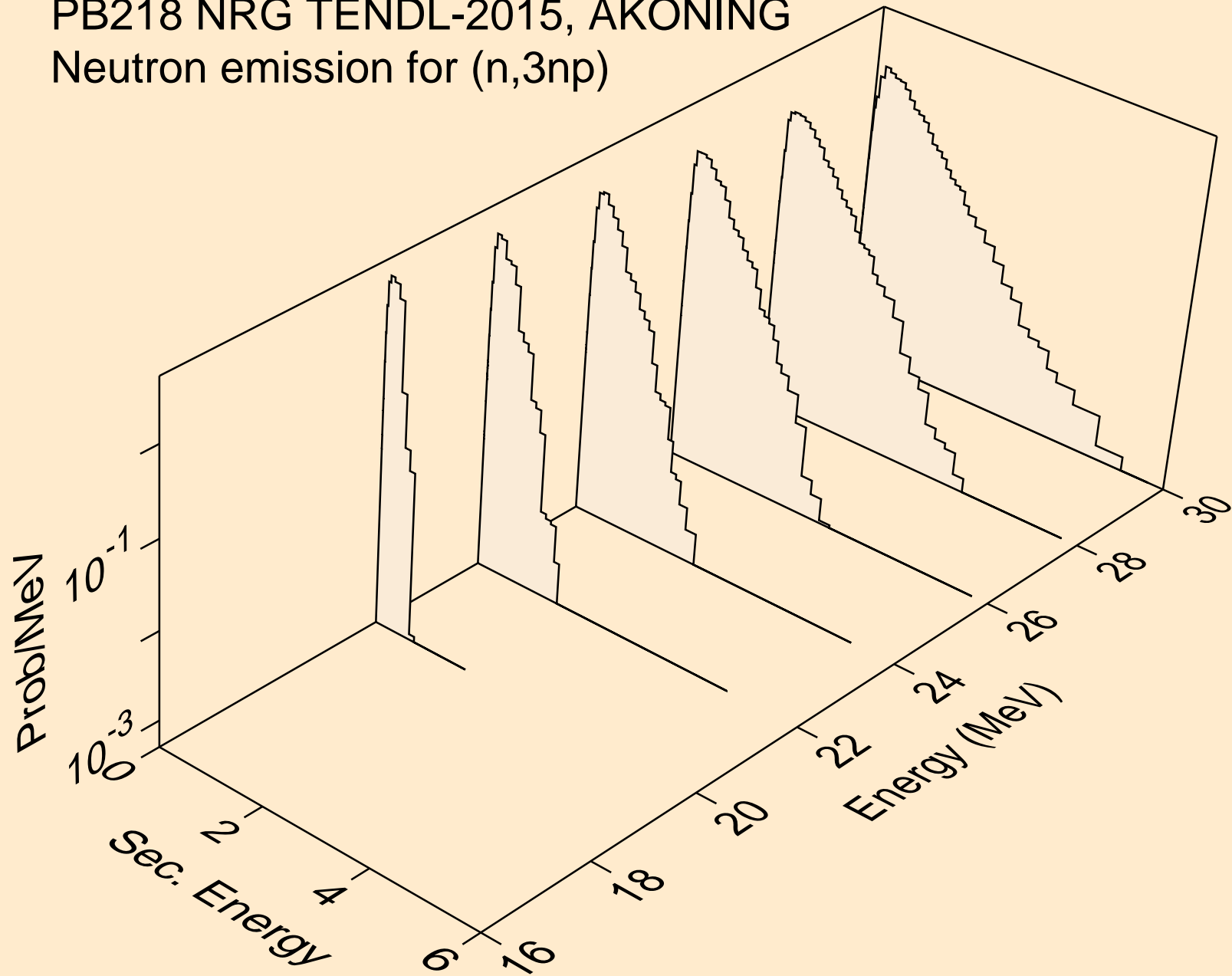

PB218 NRG TENDL-2015, AKONING
Neutron emission for (n,n*c)

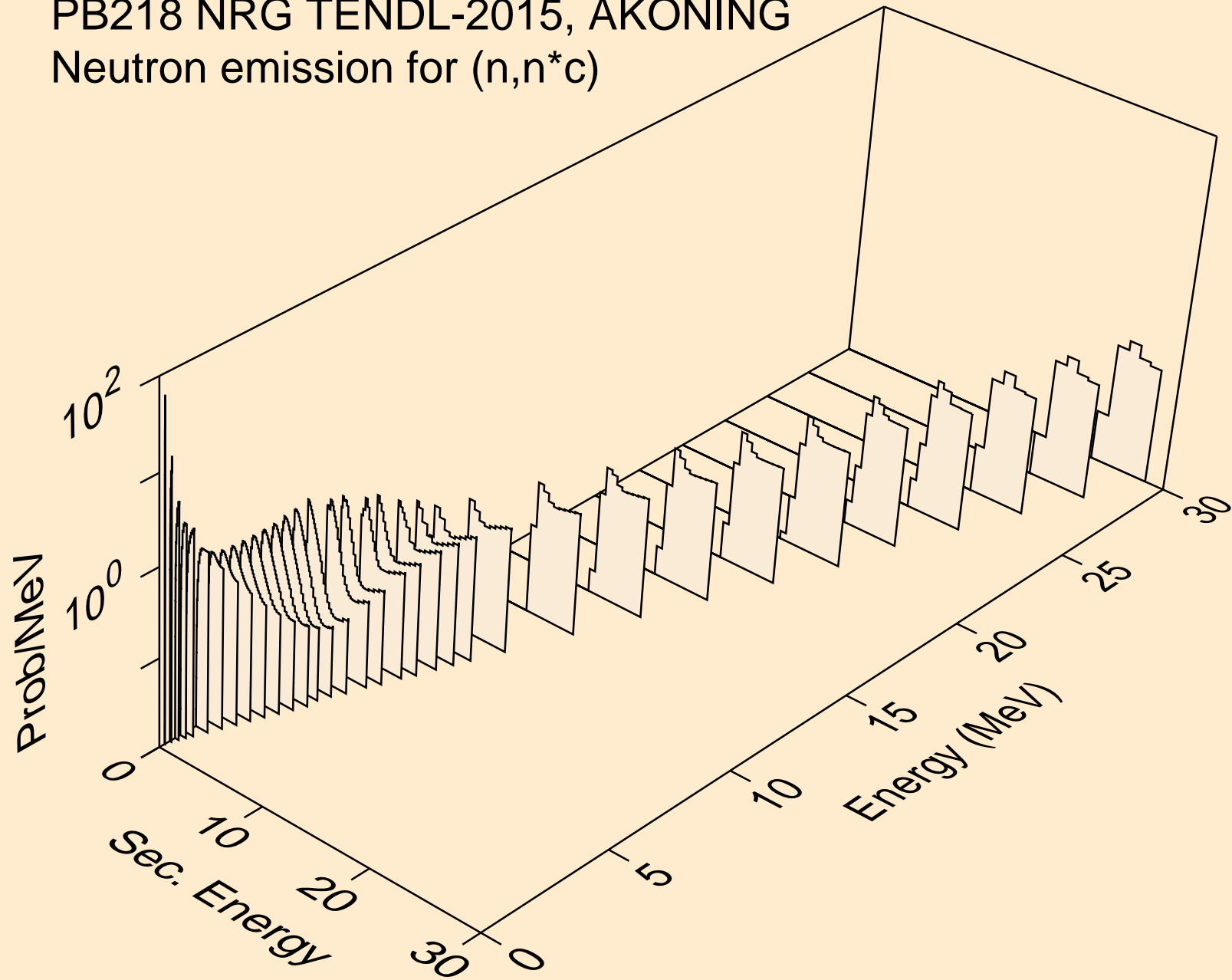

PB218 NRG TENDL-2015, AKONING
Photon emission for (n,x)

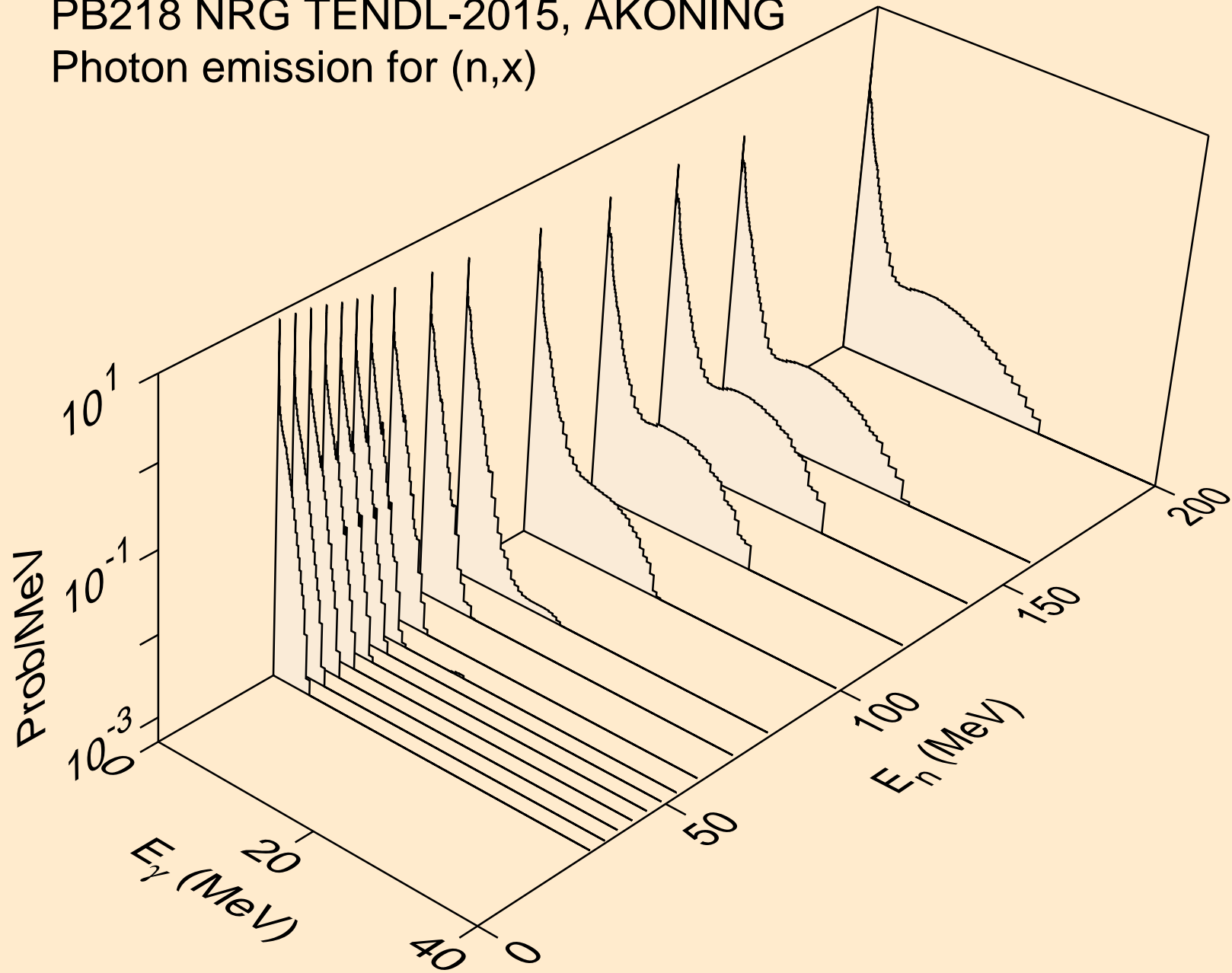

PB218 NRG TENDL-2015, AKONING
Photon emission for (n,2nd)

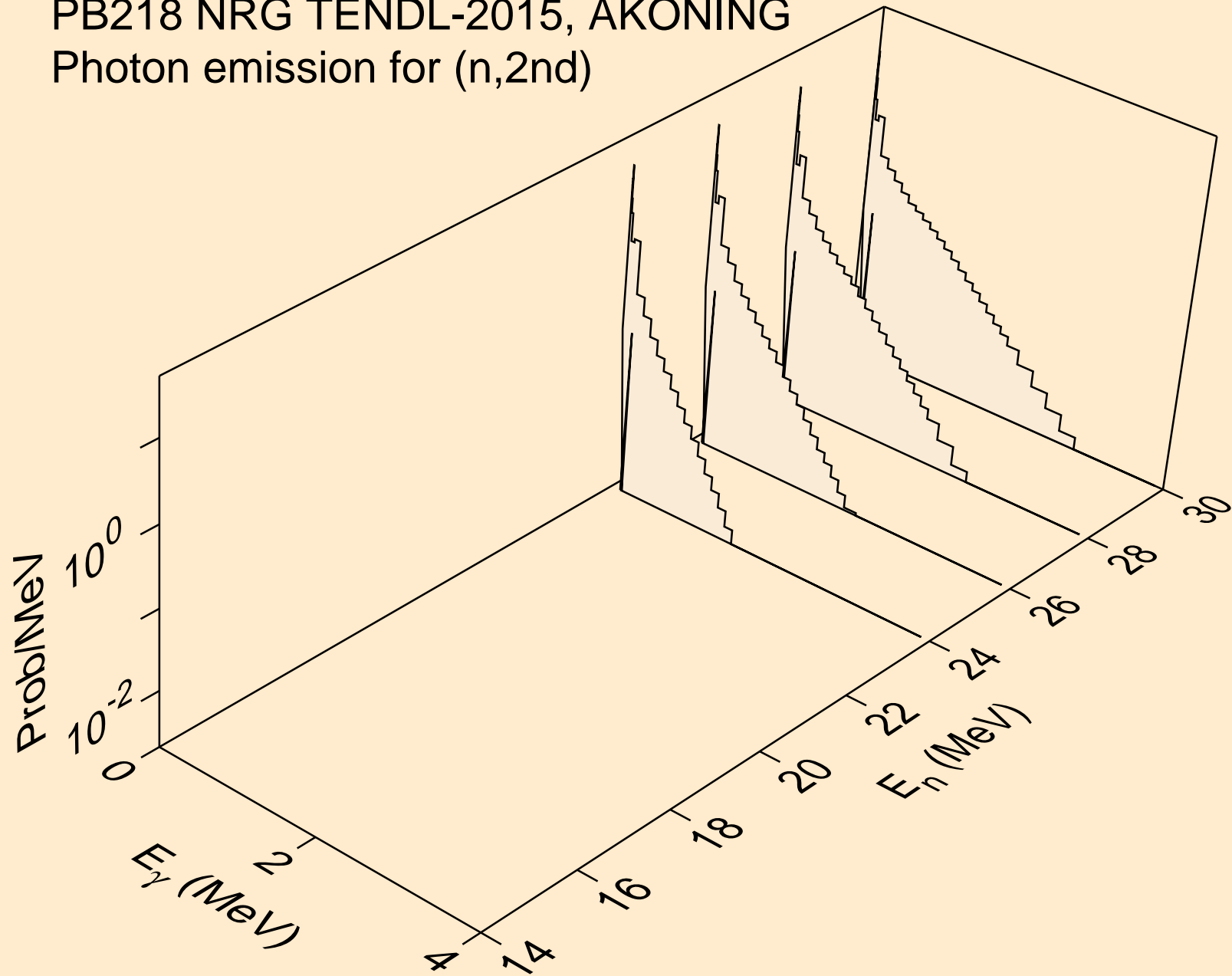

PB218 NRG TENDL-2015, AKONING
Photon emission for (n,2n)

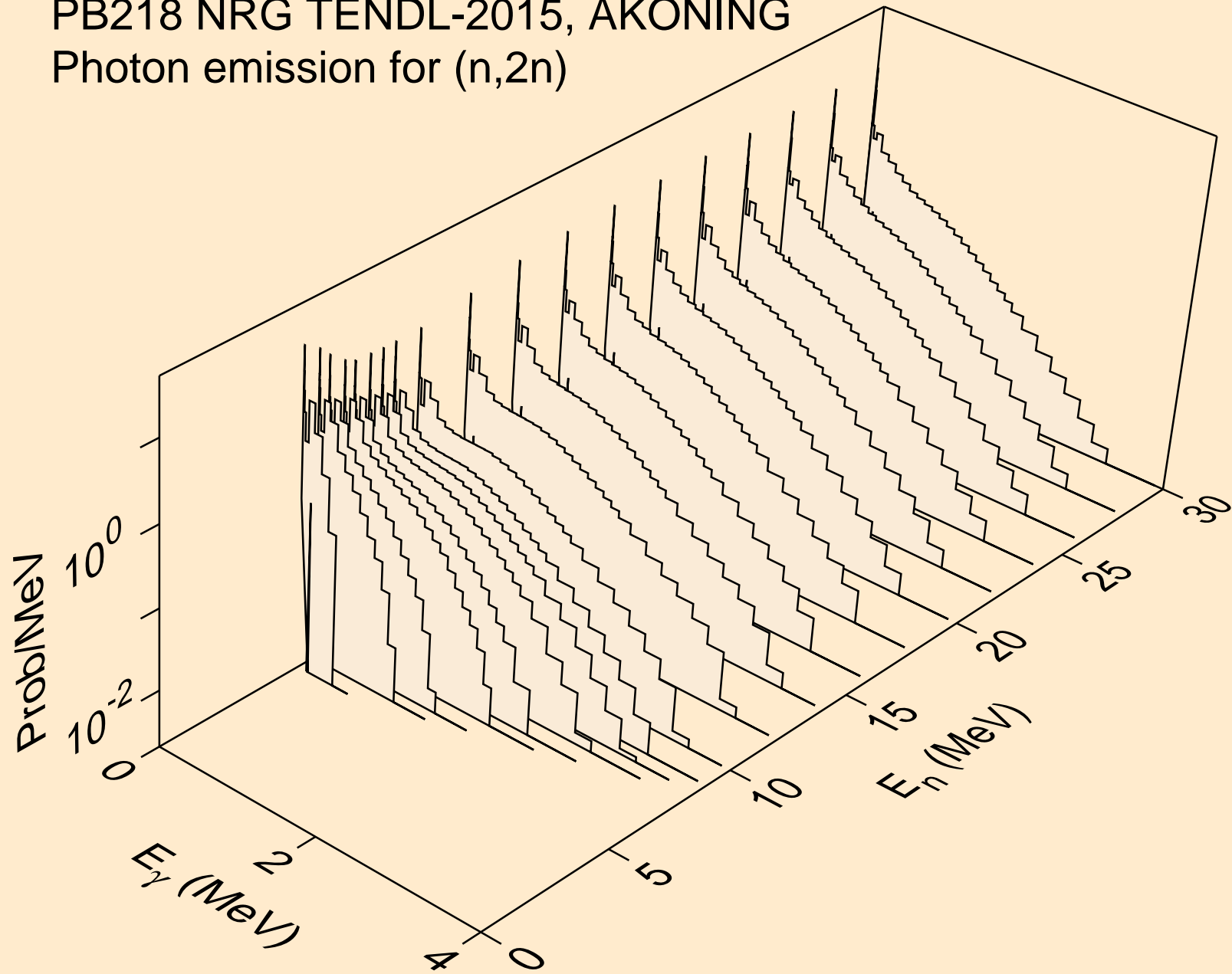

PB218 NRG TENDL-2015, AKONING
Photon emission for (n,3n)

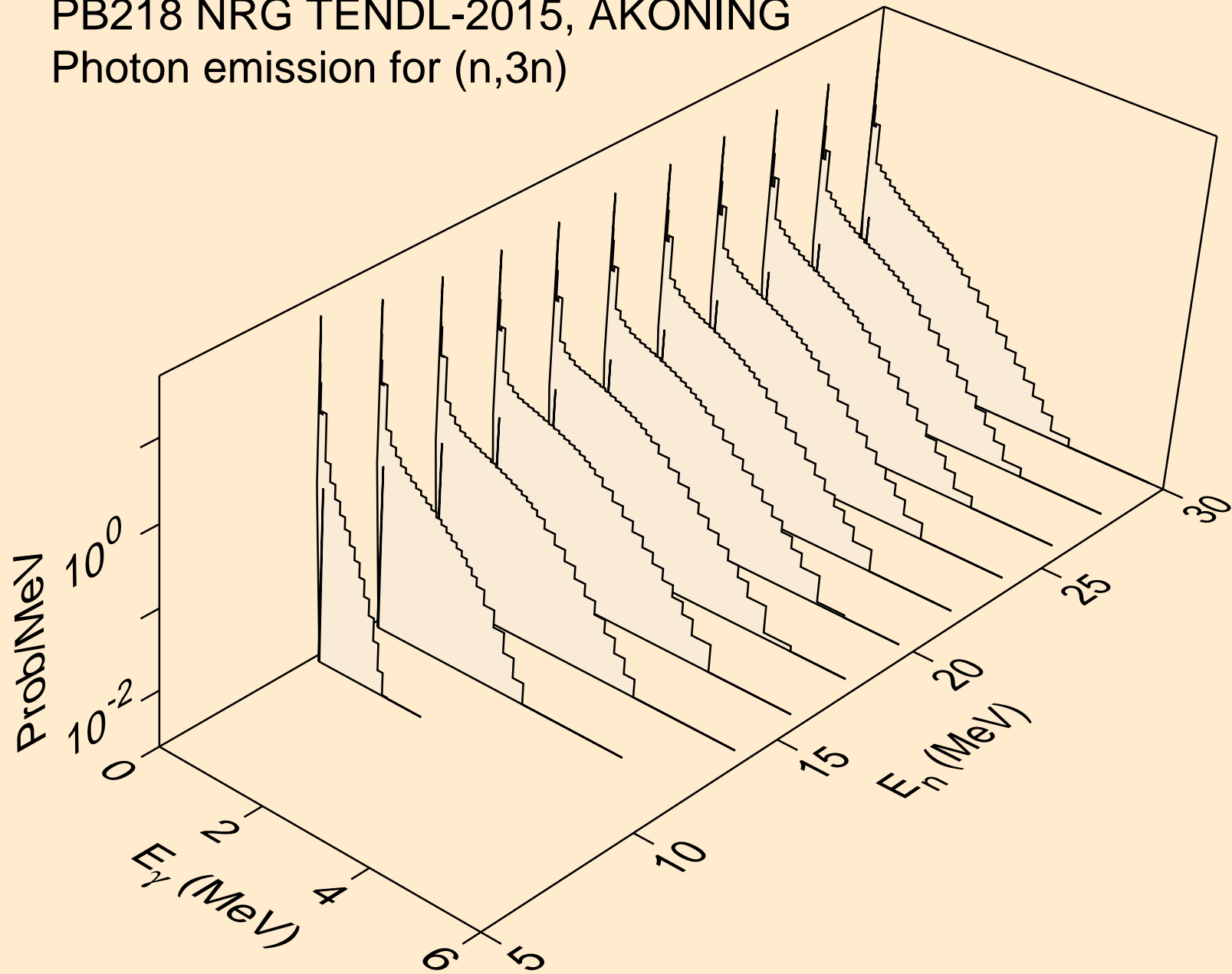

PB218 NRG TENDL-2015, AKONING
Photon emission for (n,n*)a

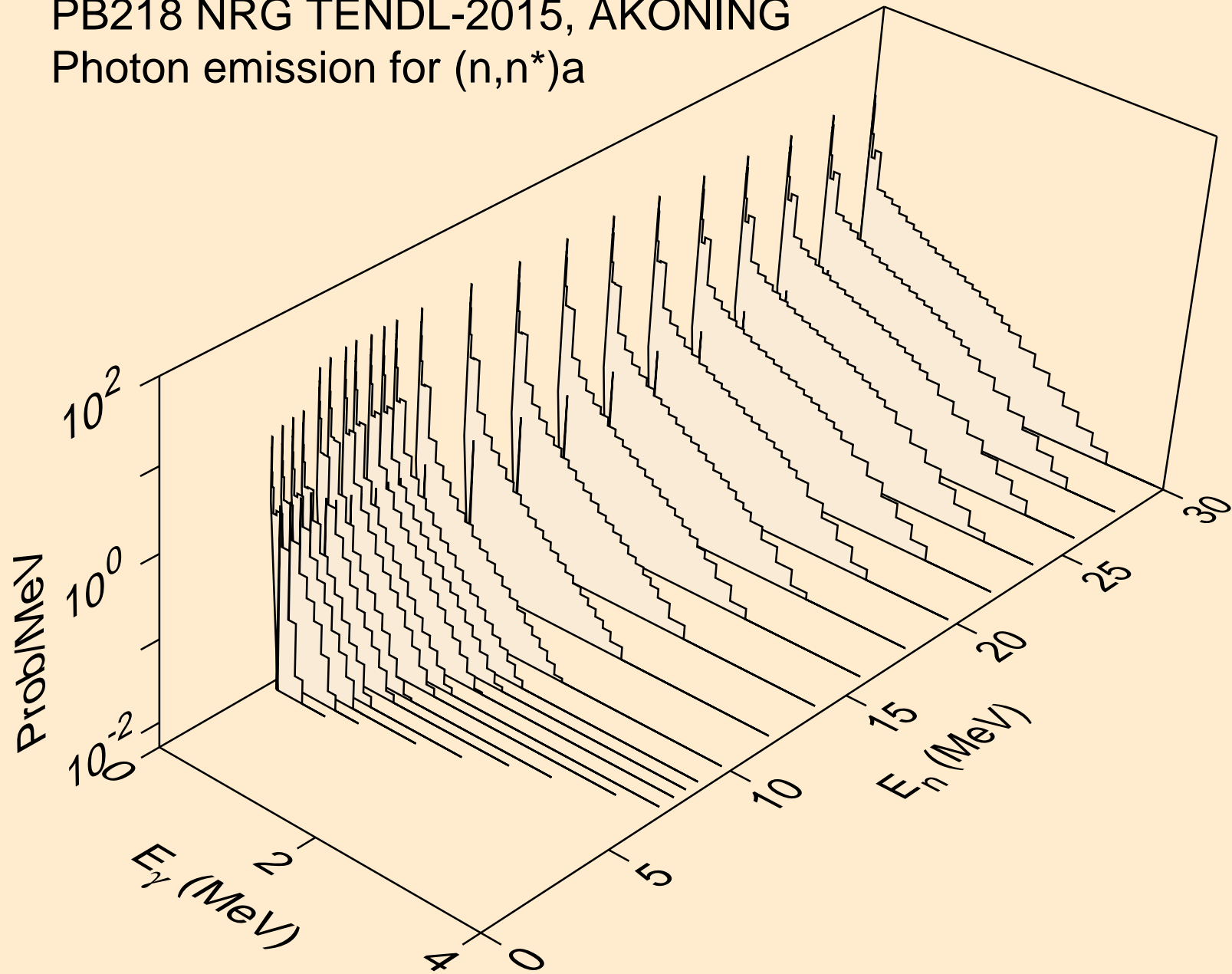

PB218 NRG TENDL-2015, AKONING
Photon emission for (n,2n)a

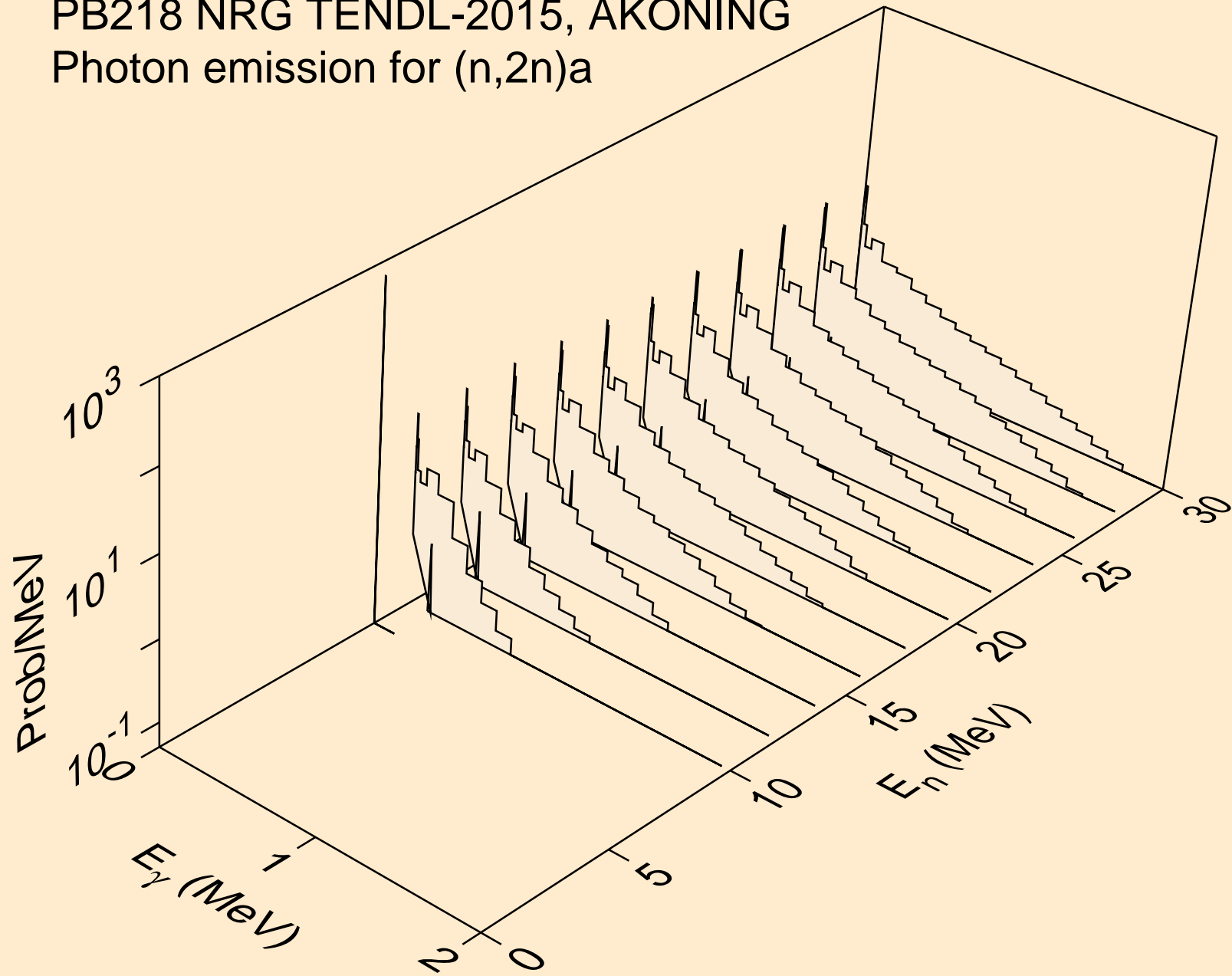

PB218 NRG TENDL-2015, AKONING
Photon emission for (n,3n)a

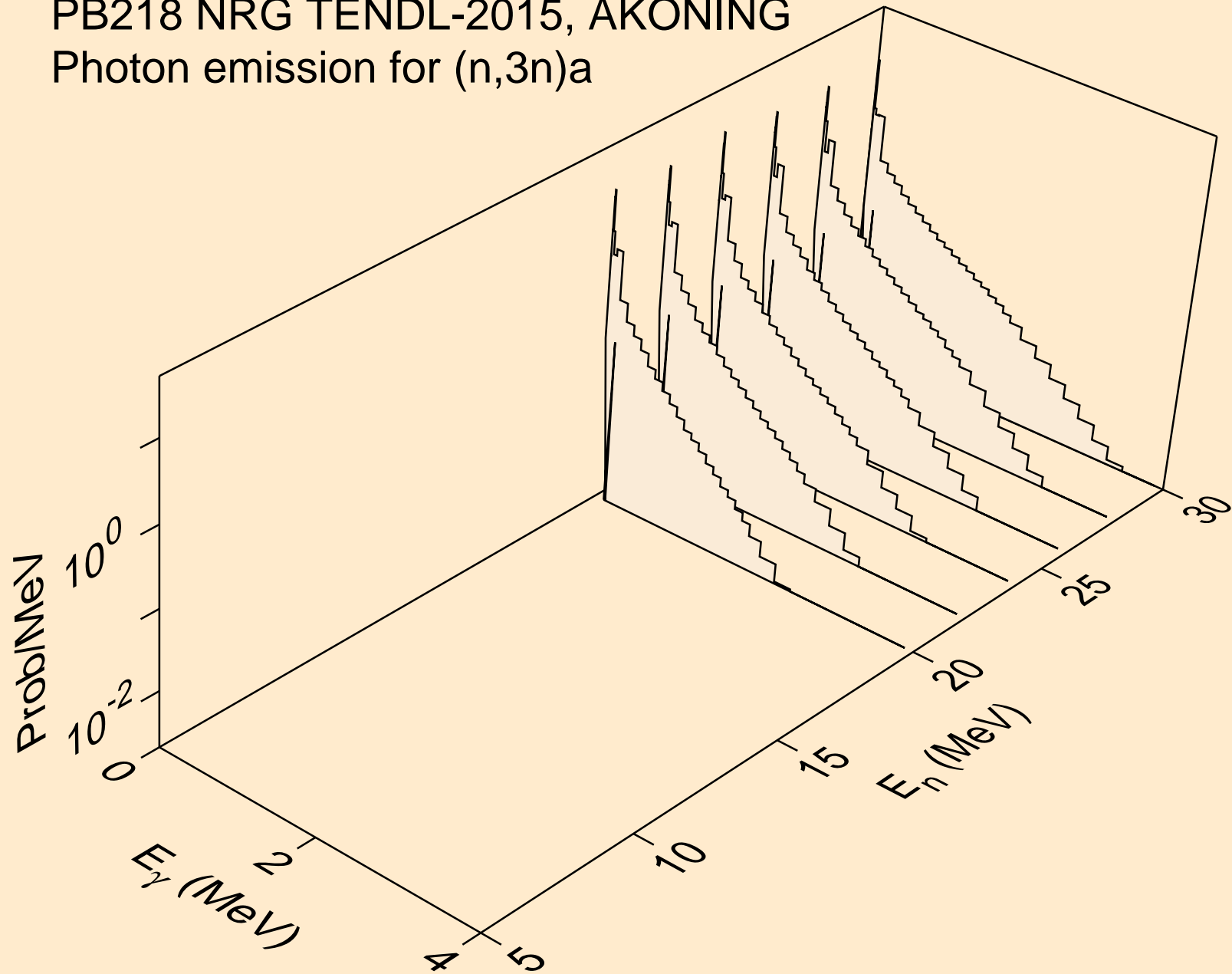

PB218 NRG TENDL-2015, AKONING
Photon emission for (n,n*)p

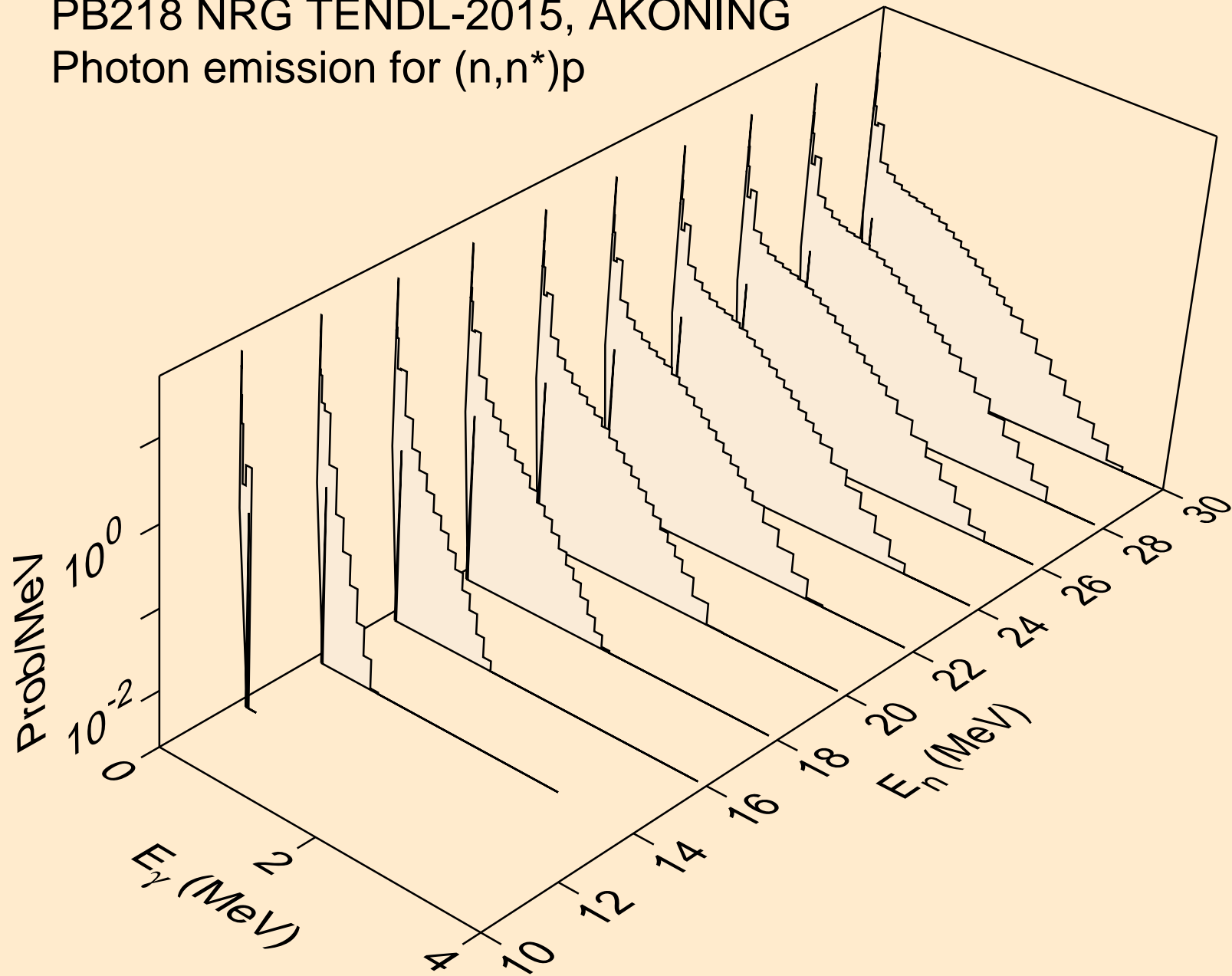

PB218 NRG TENDL-2015, AKONING
Photon emission for (n,n*)d

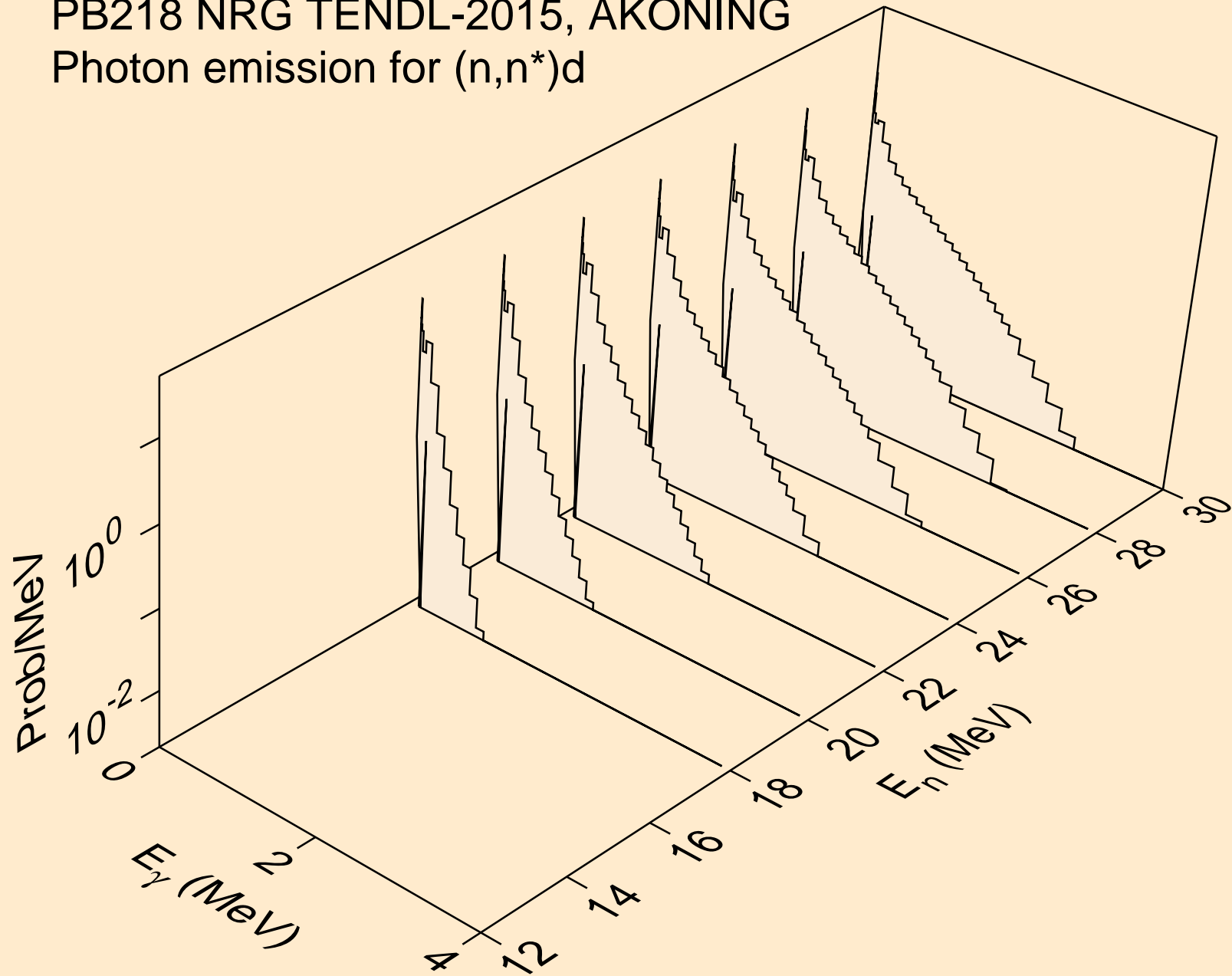

PB218 NRG TENDL-2015, AKONING
Photon emission for (n,n*)t

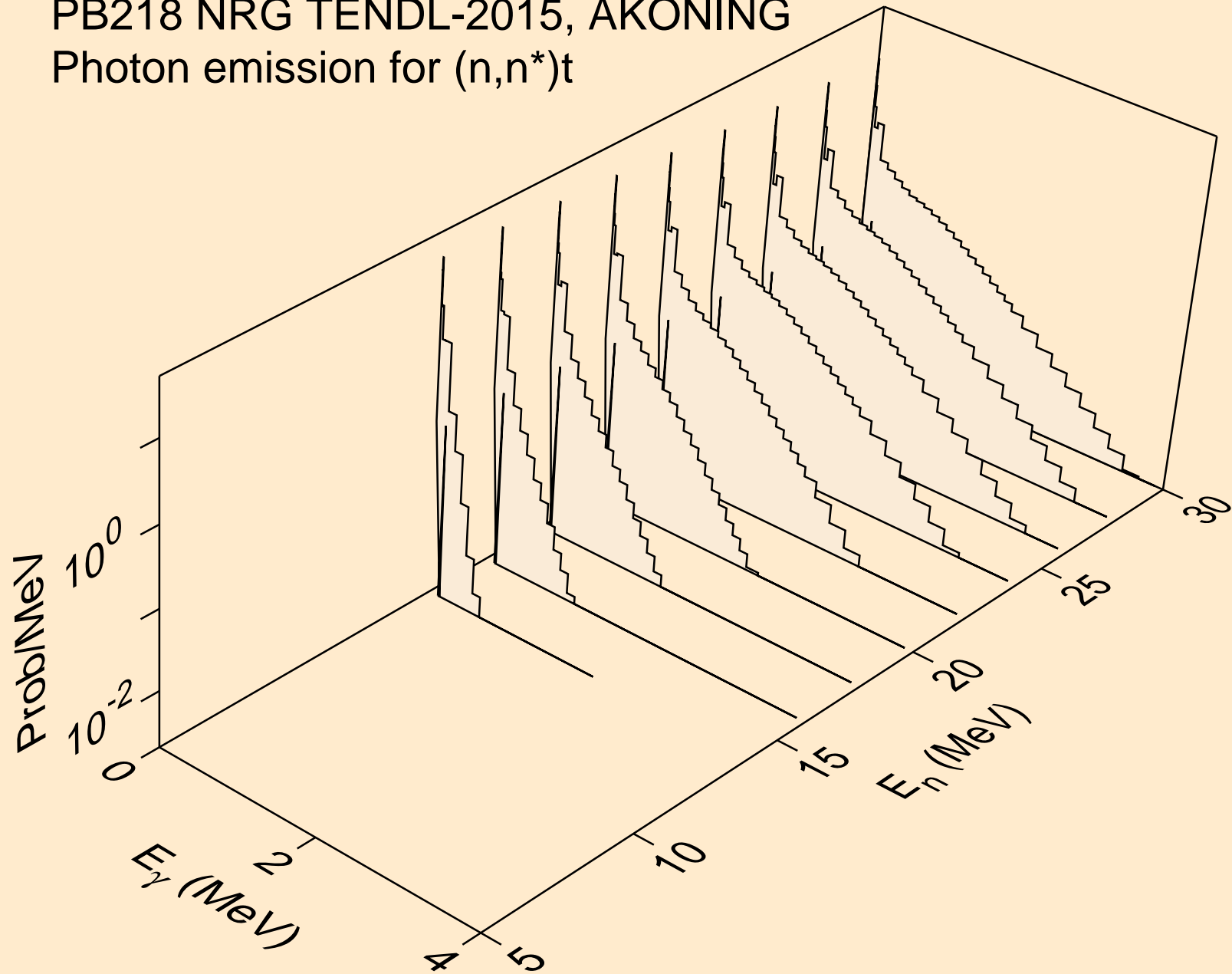

PB218 NRG TENDL-2015, AKONING
Photon emission for (n,n*)he3

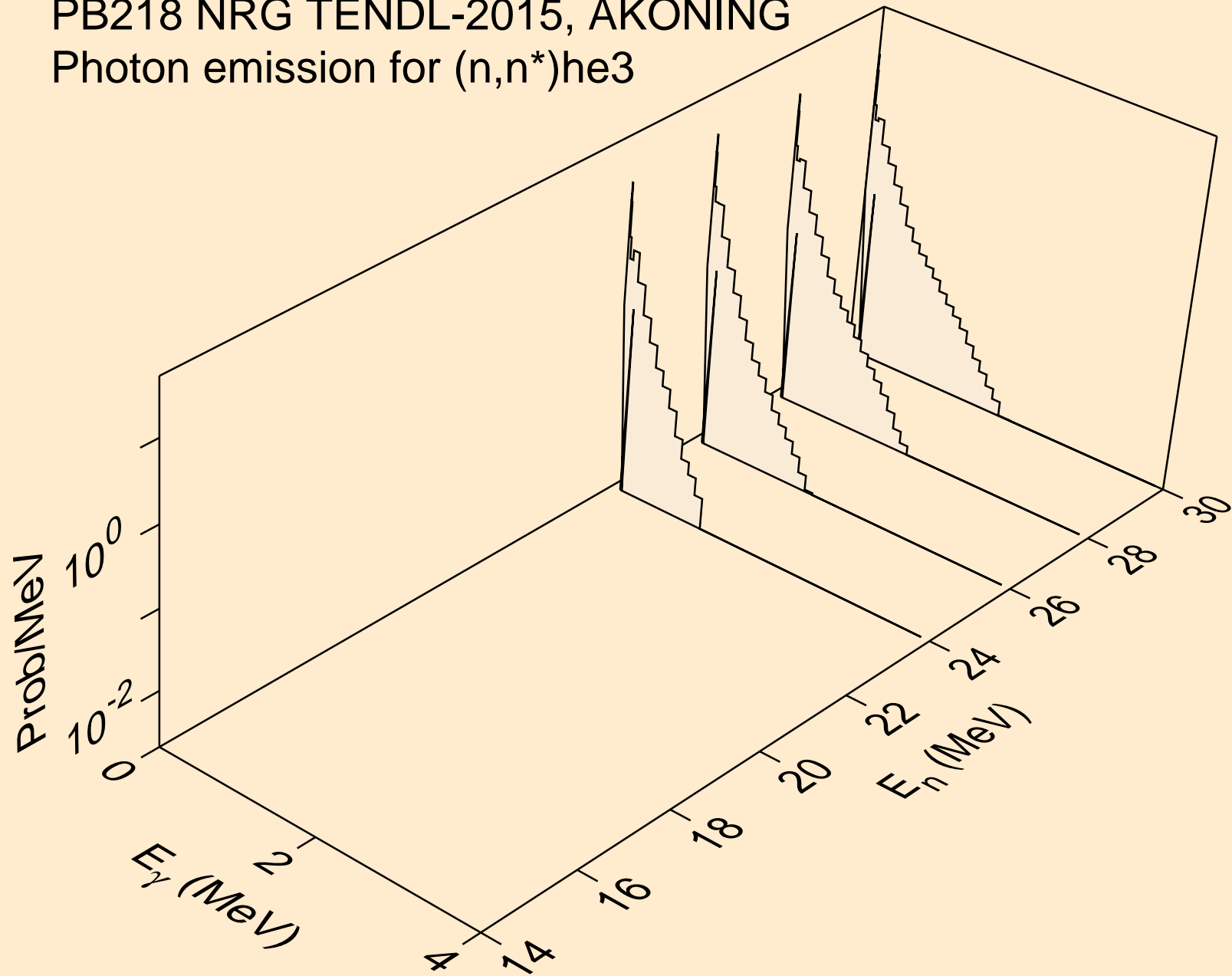

PB218 NRG TENDL-2015, AKONING
Photon emission for (n,4n)

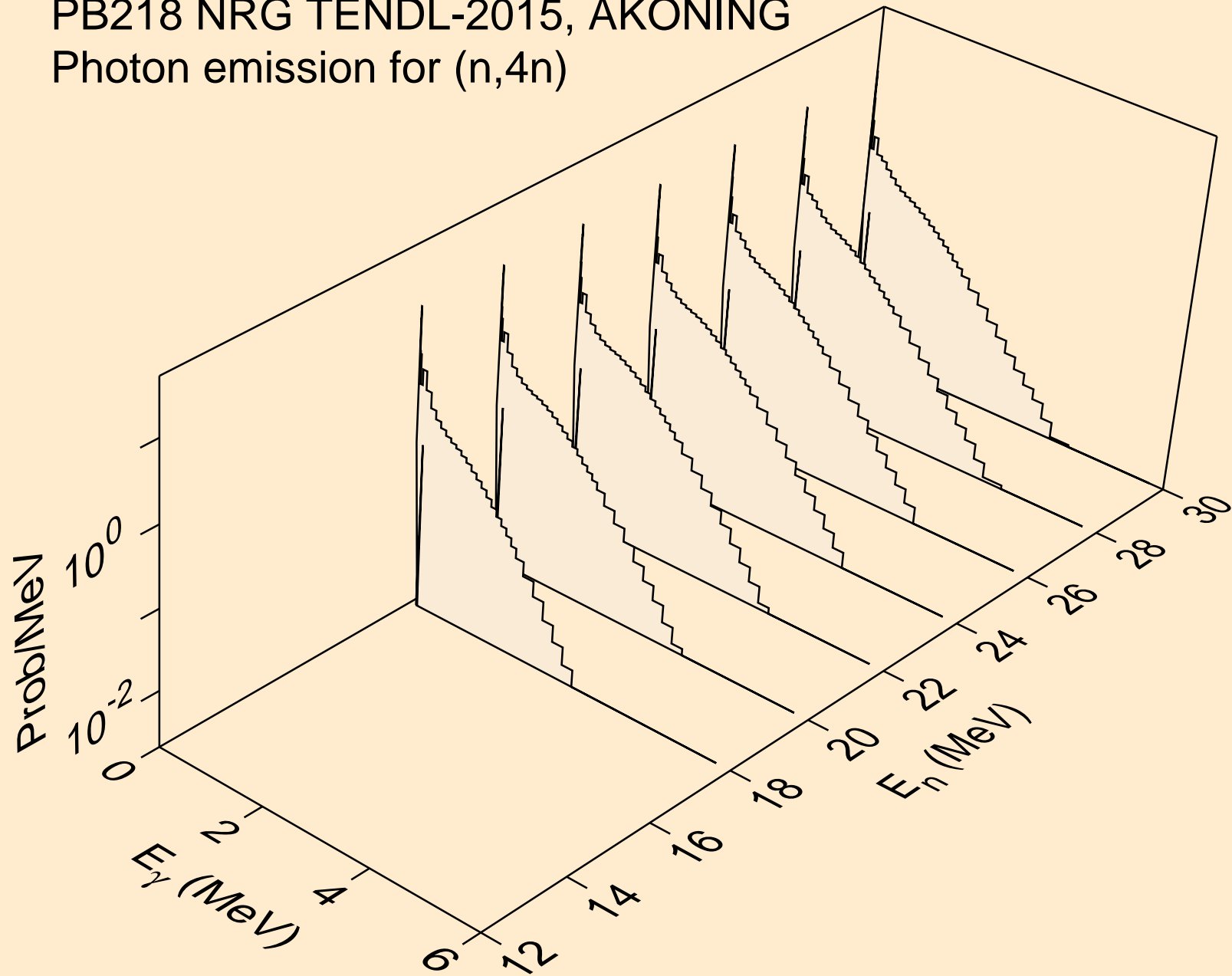

PB218 NRG TENDL-2015, AKONING
Photon emission for (n,2np)

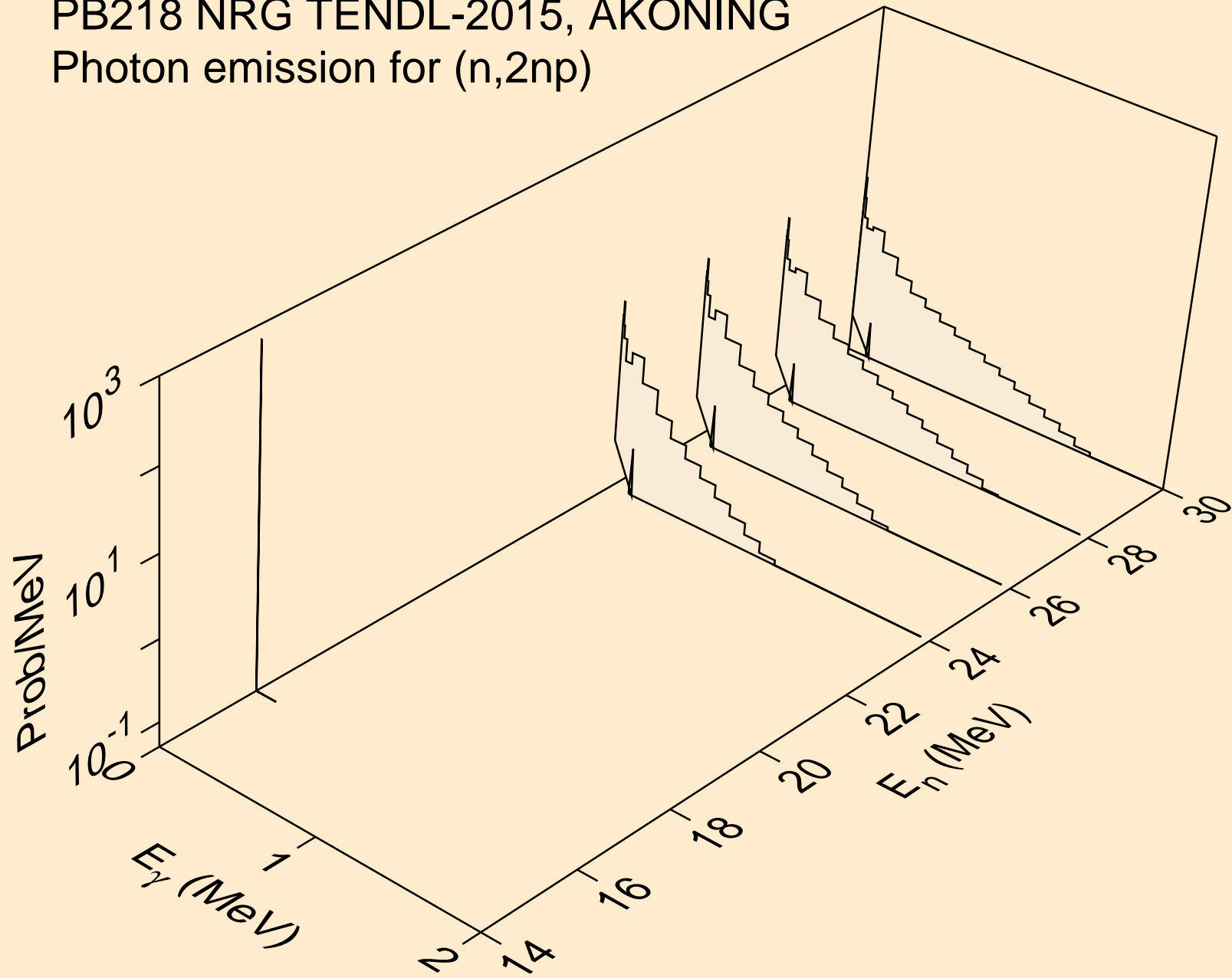

PB218 NRG TENDL-2015, AKONING
Photon emission for (n,3np)

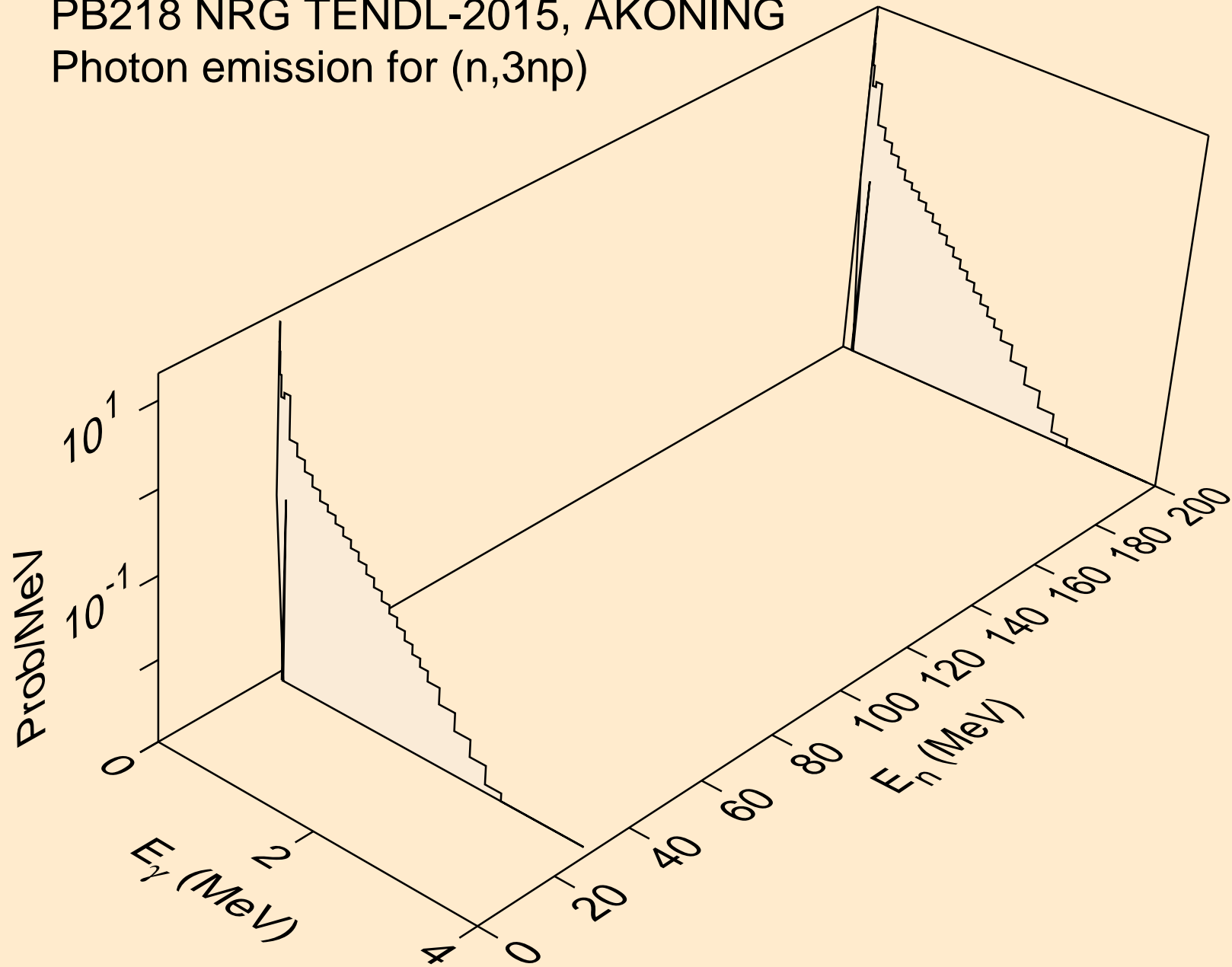

PB218 NRG TENDL-2015, AKONING
Photon emission for (n,n*c)

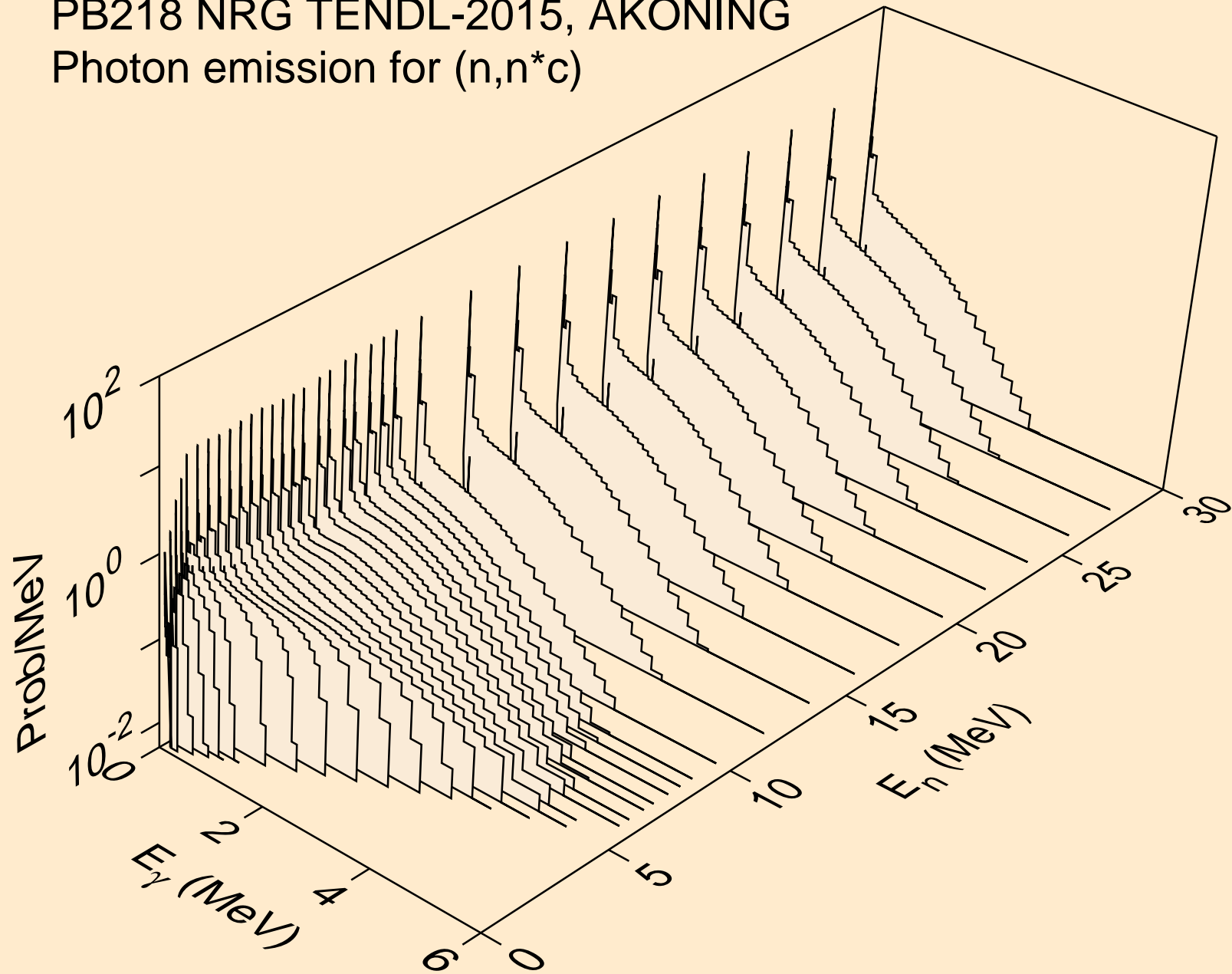

PB218 NRG TENDL-2015, AKONING
Photon emission for (n,gma)

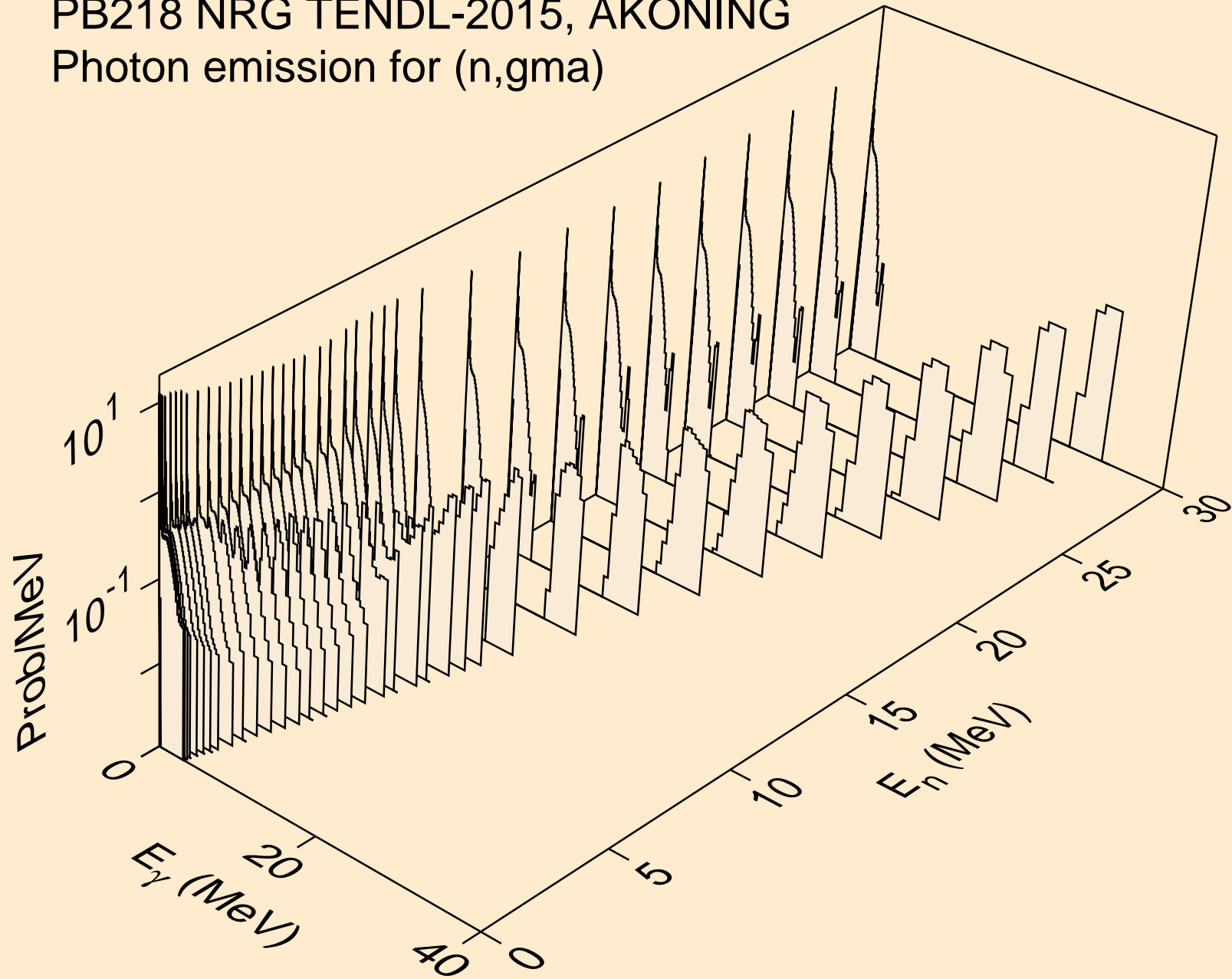

PB218 NRG TENDL-2015, AKONING
Photon emission for (n,p)

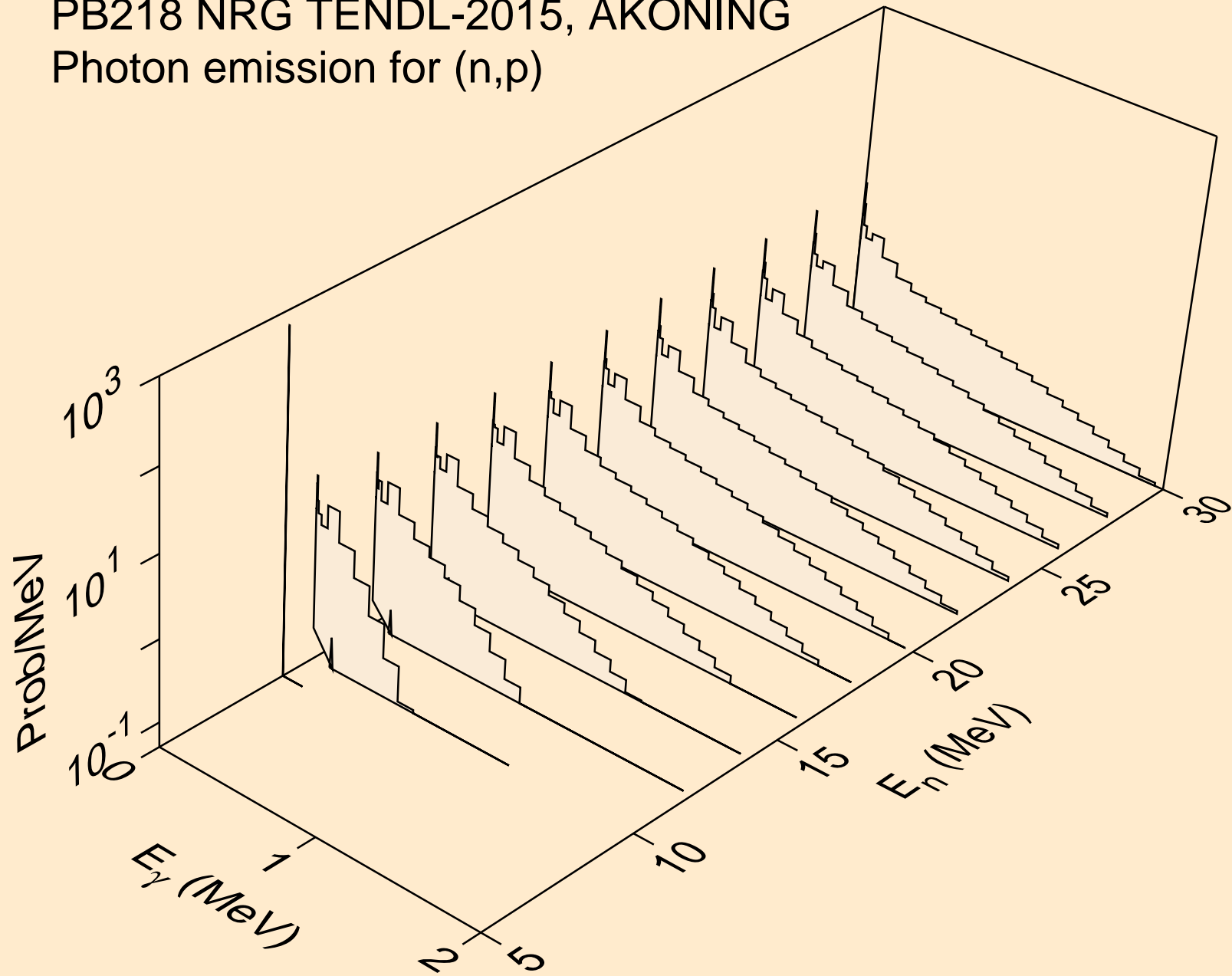

PB218 NRG TENDL-2015, AKONING
Photon emission for (n,d)

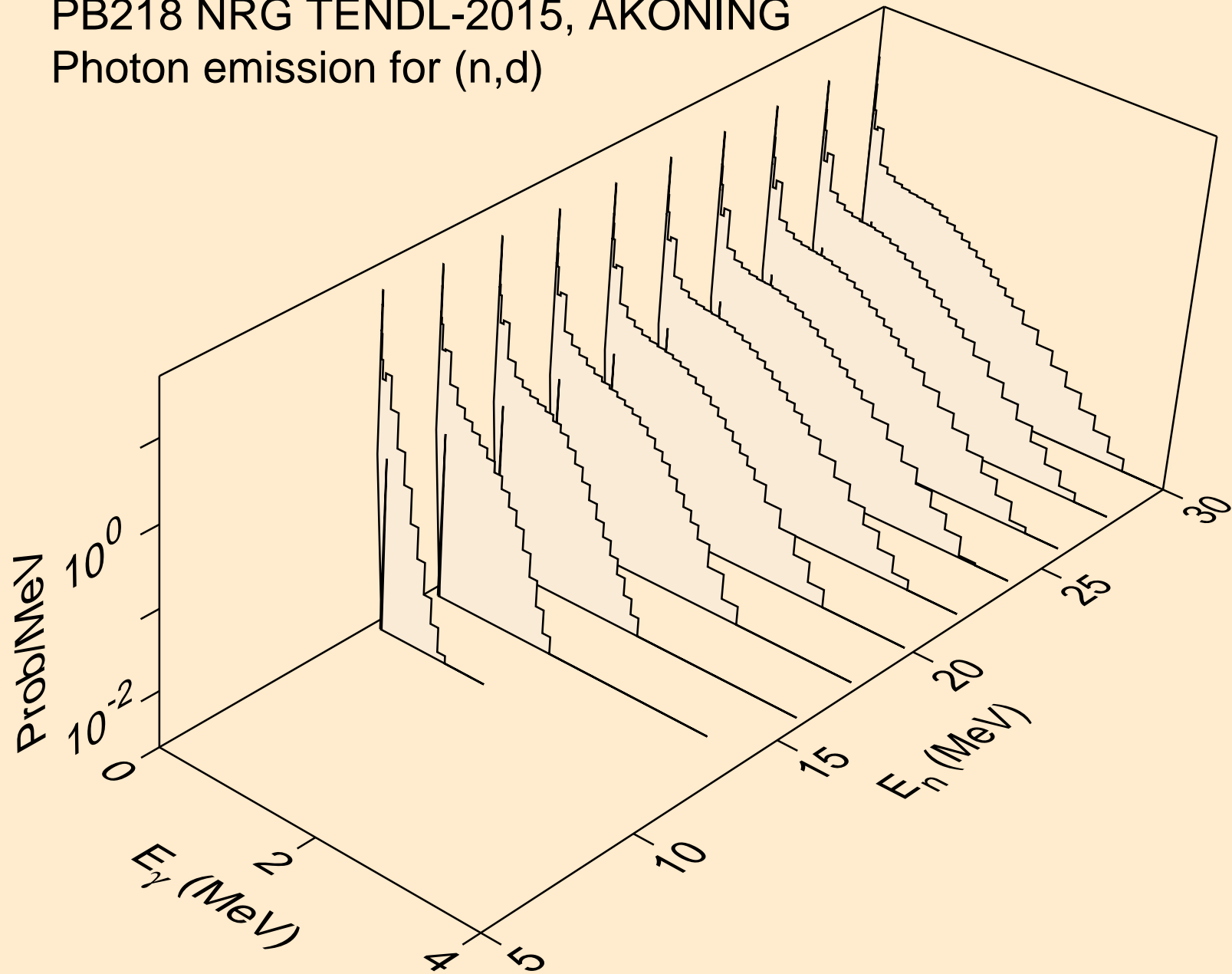

PB218 NRG TENDL-2015, AKONING
Photon emission for (n,t)

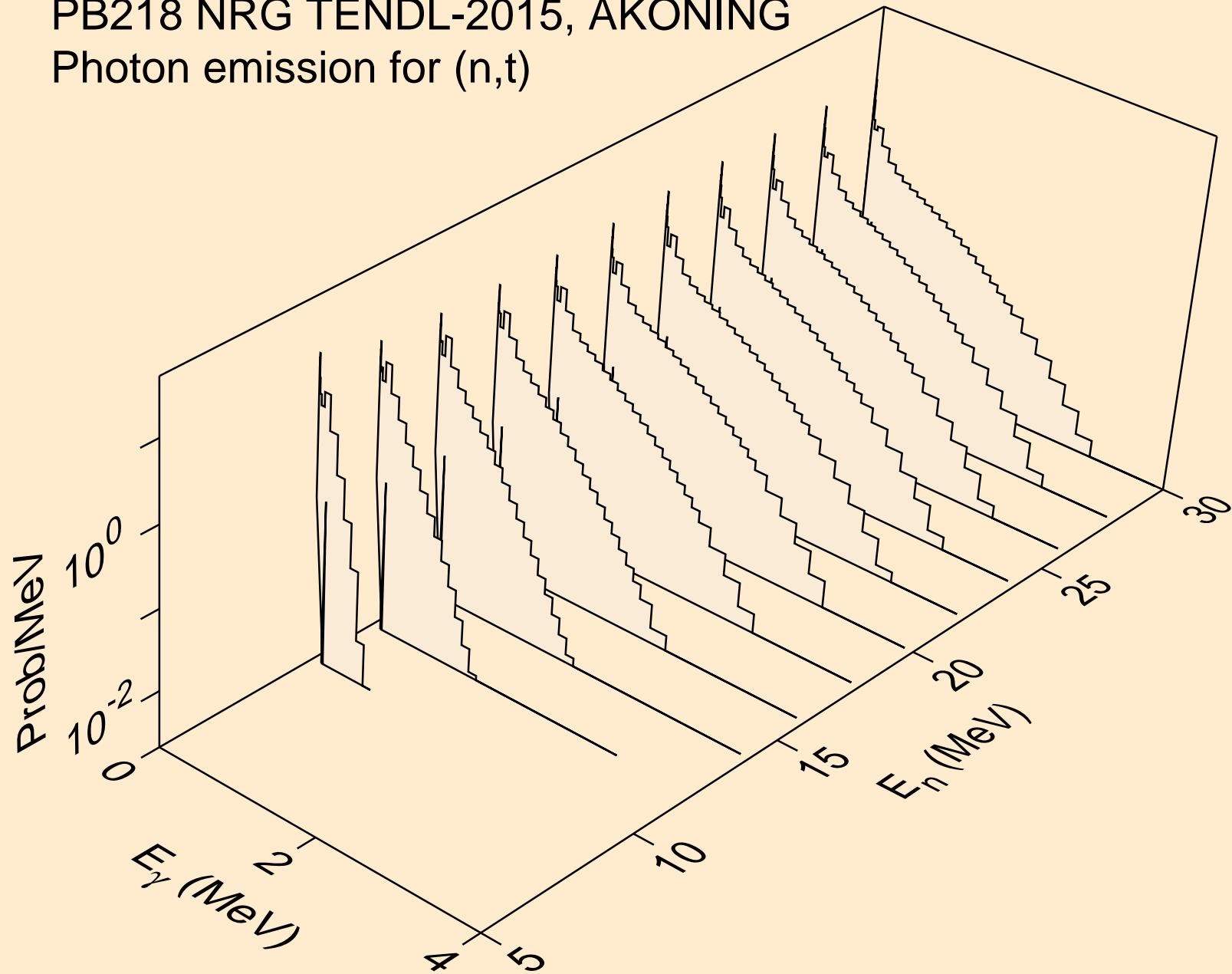

PB218 NRG TENDL-2015, AKONING
Photon emission for (n,he3)

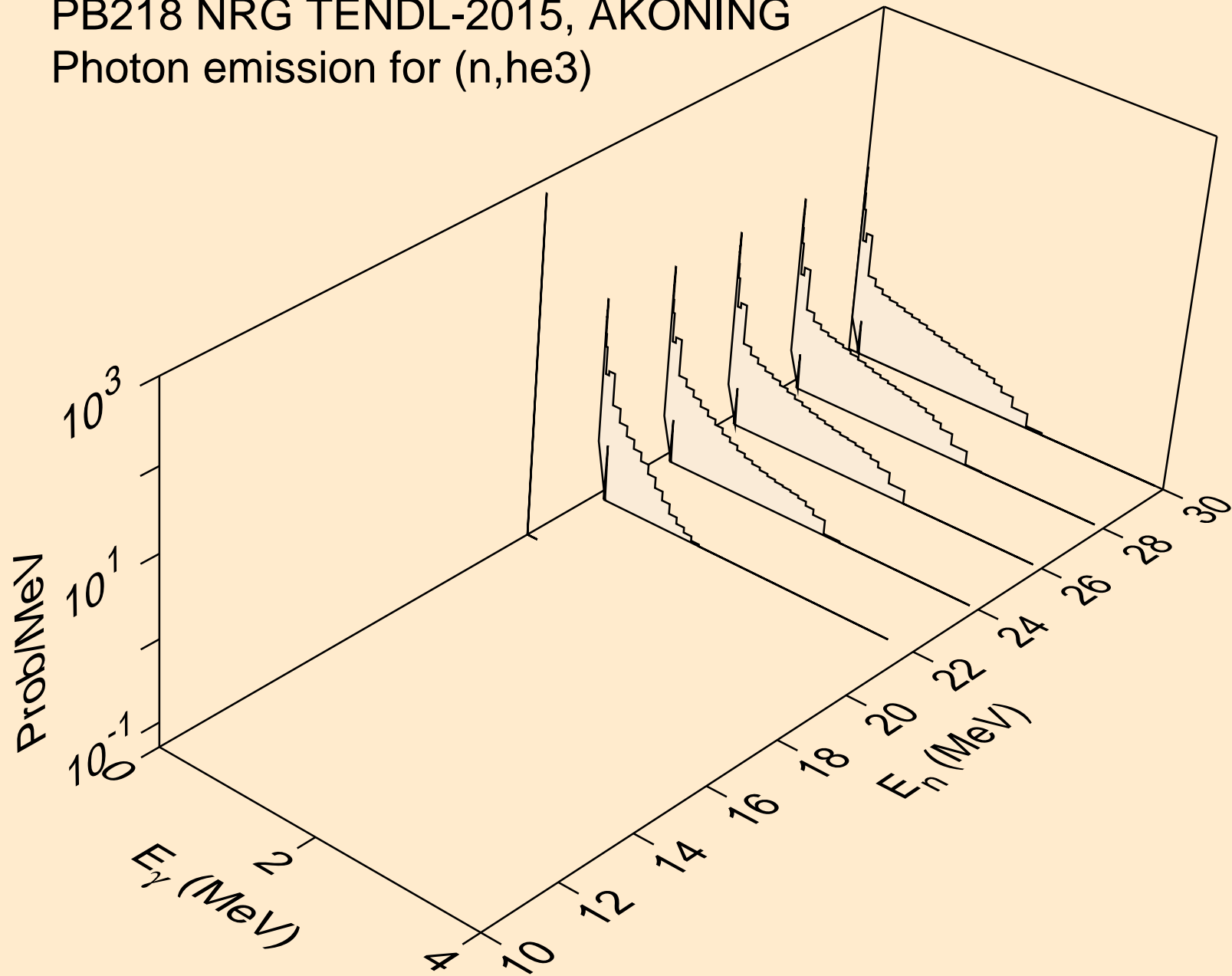

PB218 NRG TENDL-2015, AKONING
Photon emission for (n,a)

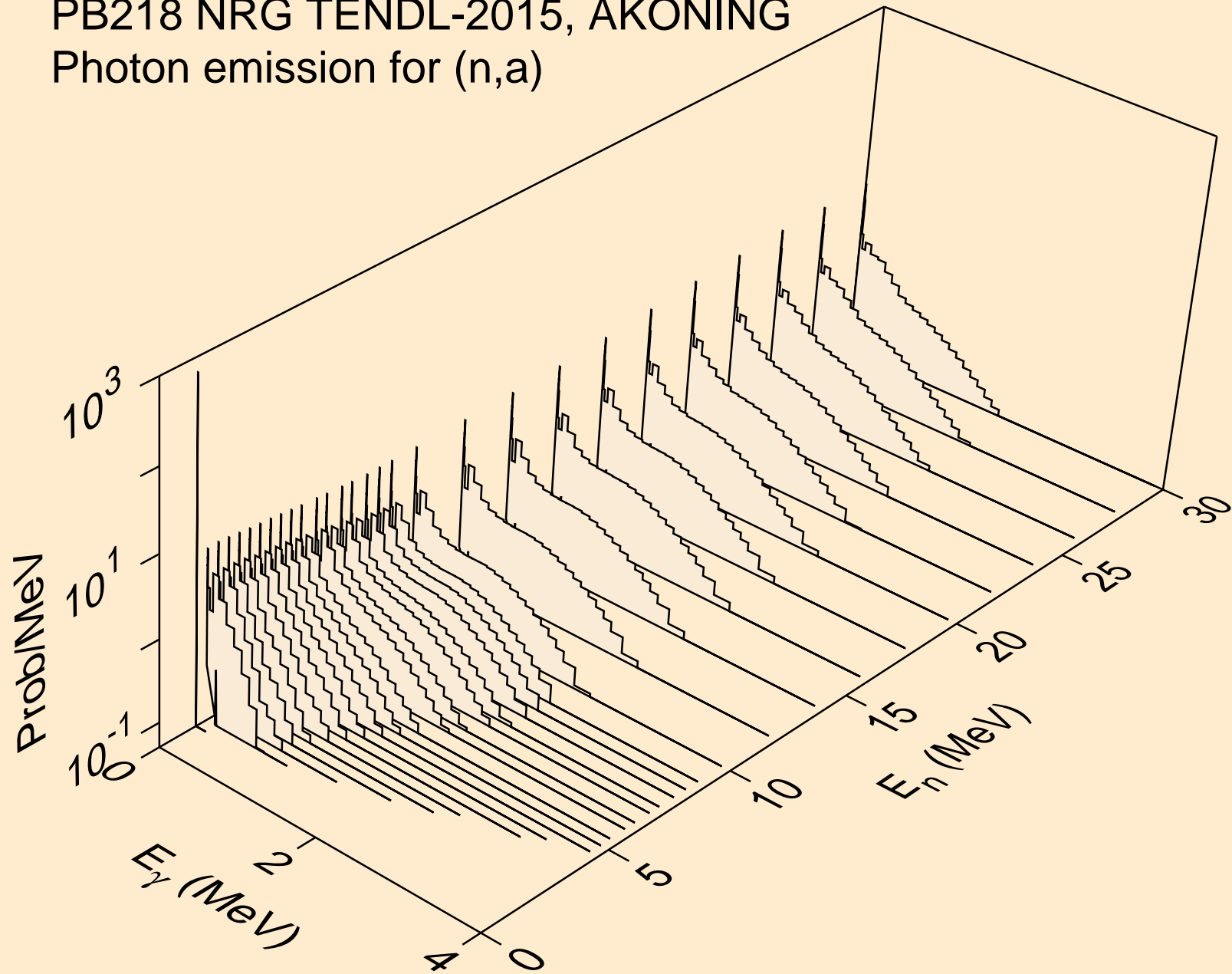

PB218 NRG TENDL-2015, AKONING
thermal capture photon spectrum

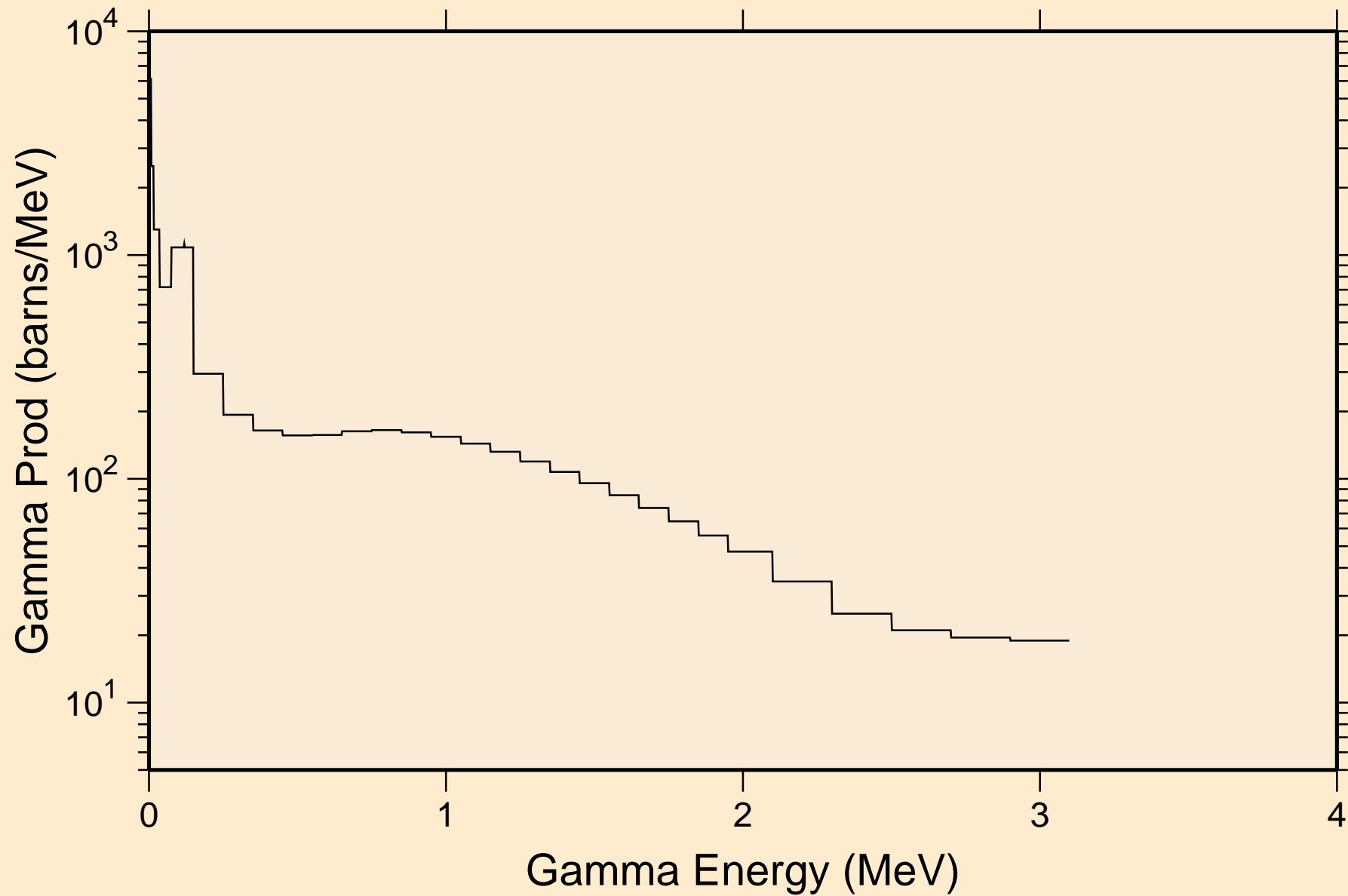

PB218 NRG TENDL-2015, AKONING
14 MeV photon spectrum

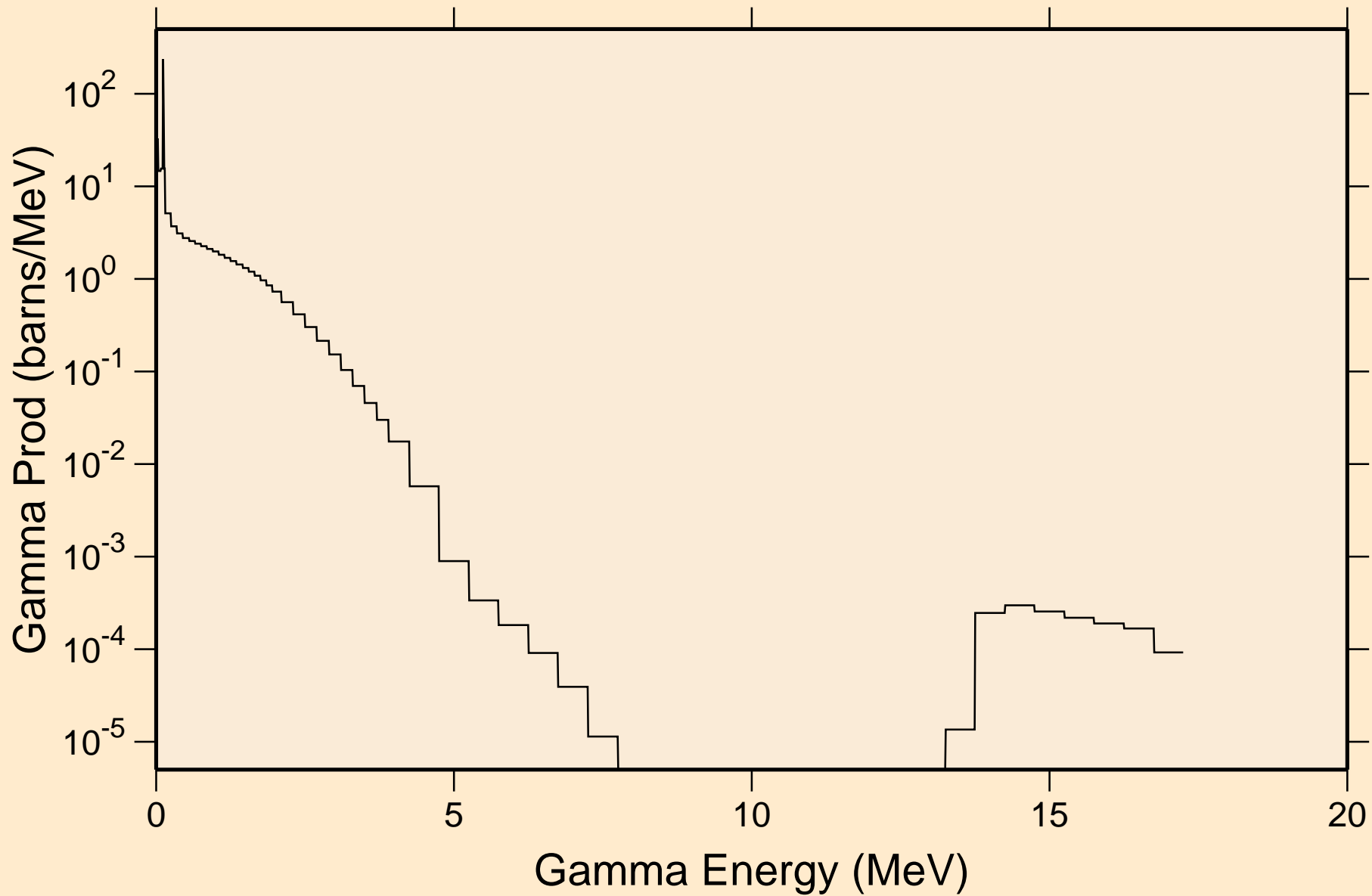

PB218 NRG TENDL-2015, AKONING

Particle heating contributions

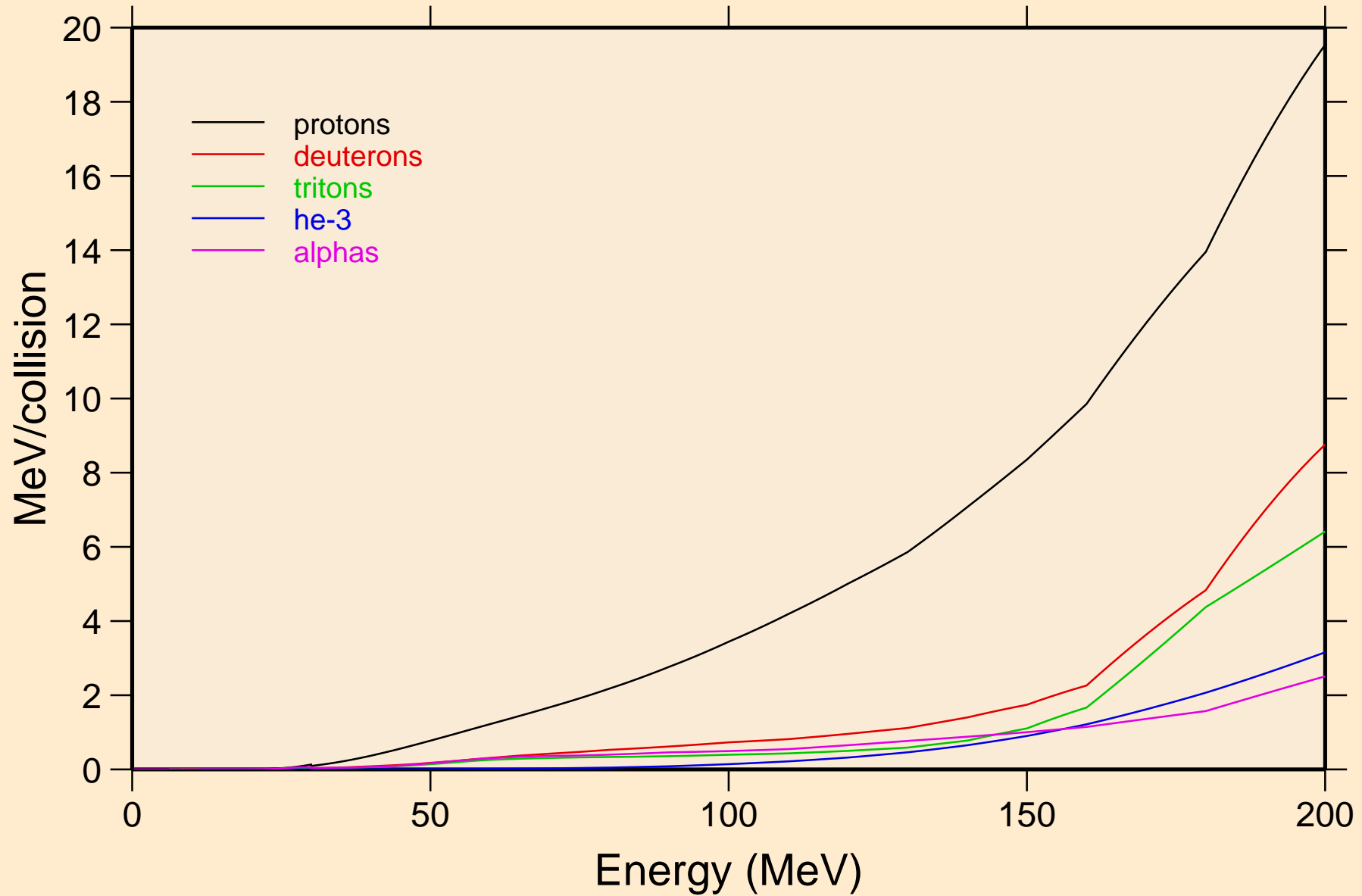

PB218 NRG TENDL-2015, AKONING

Recoil Heating

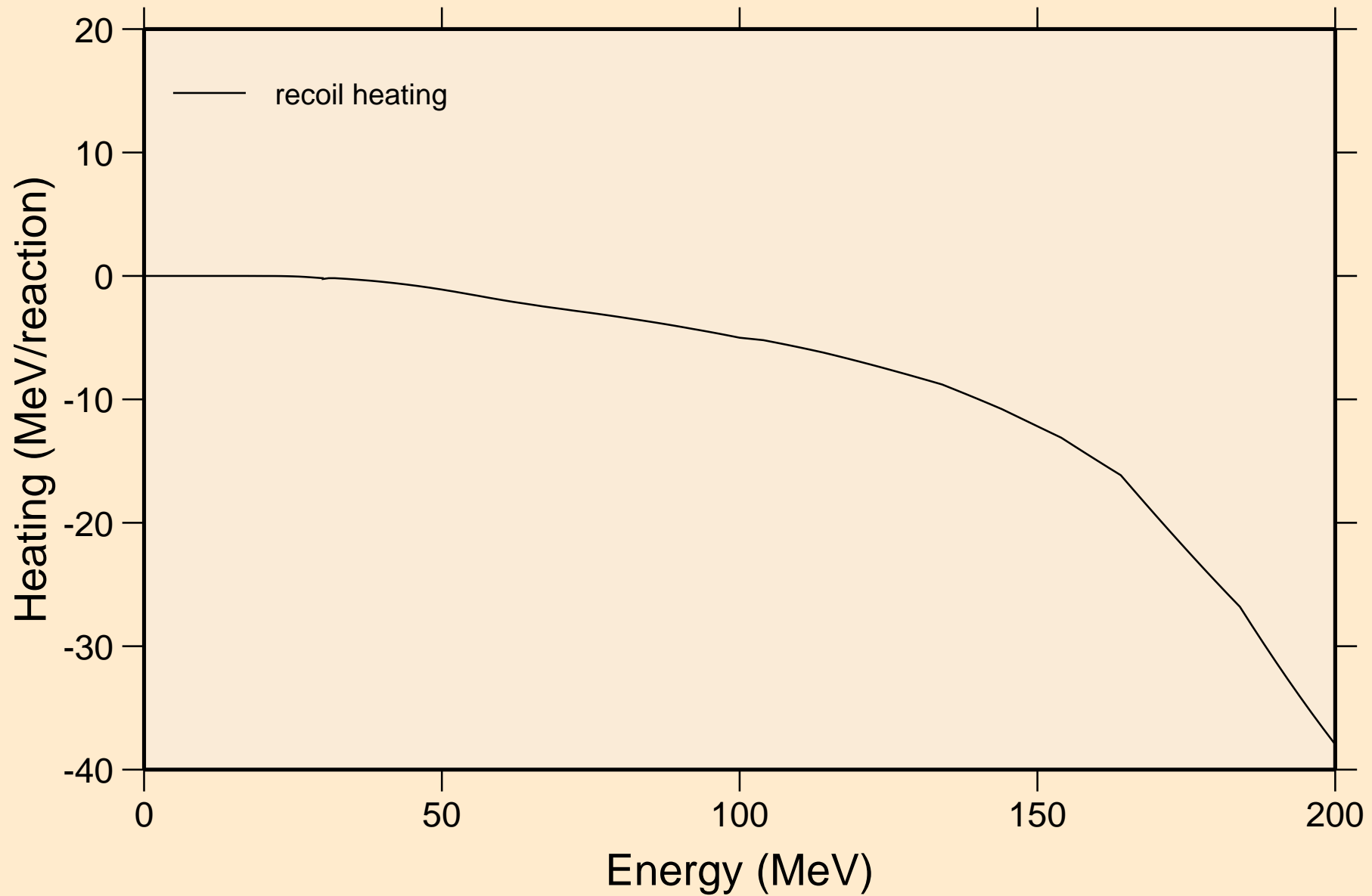

PB218 NRG TENDL-2015, AKONING

Particle production cross sections

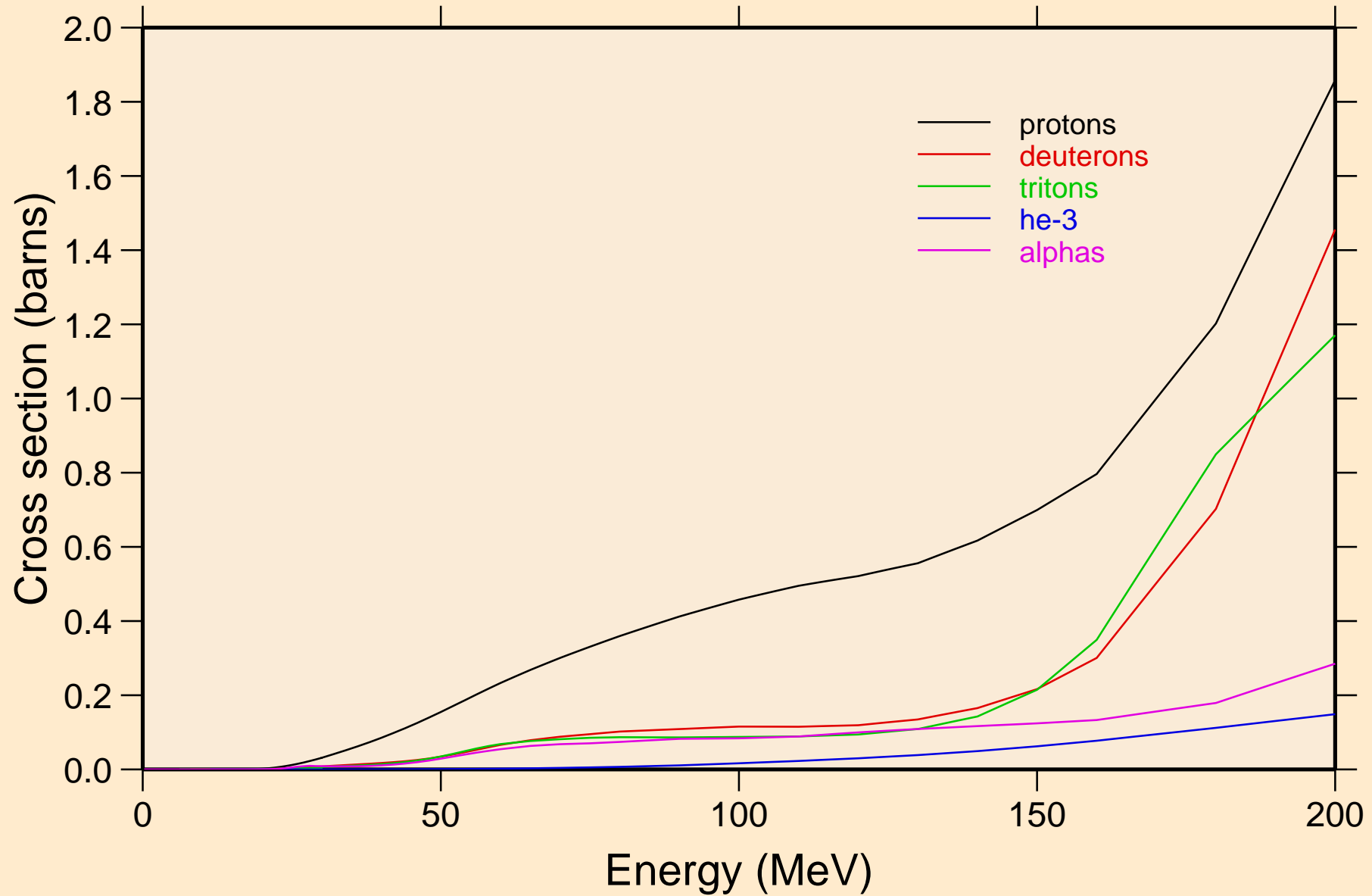

PB218 NRG TENDL-2015, AKONING
protons from (n,x)

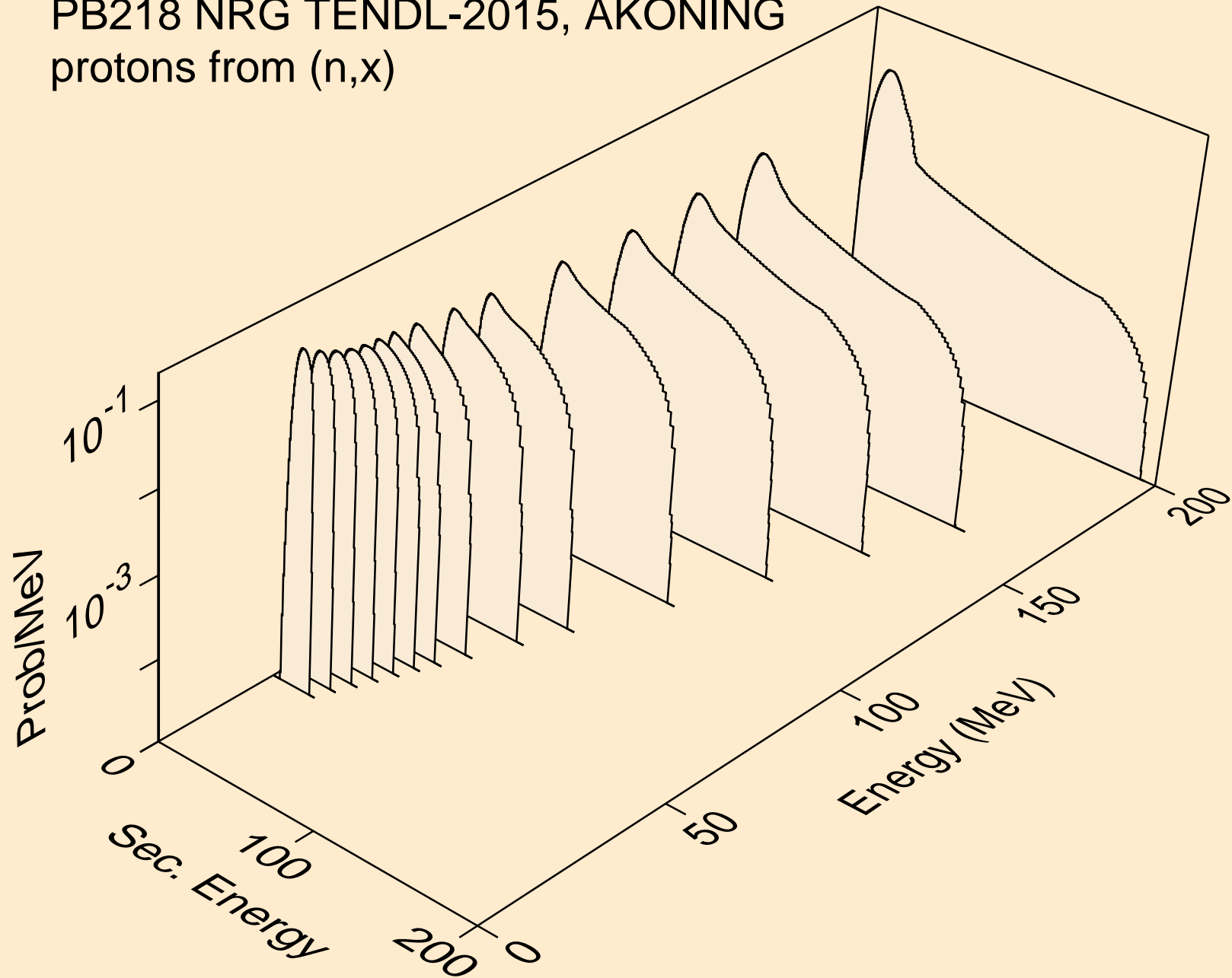

PB218 NRG TENDL-2015, AKONING
protons from (n,n*)p

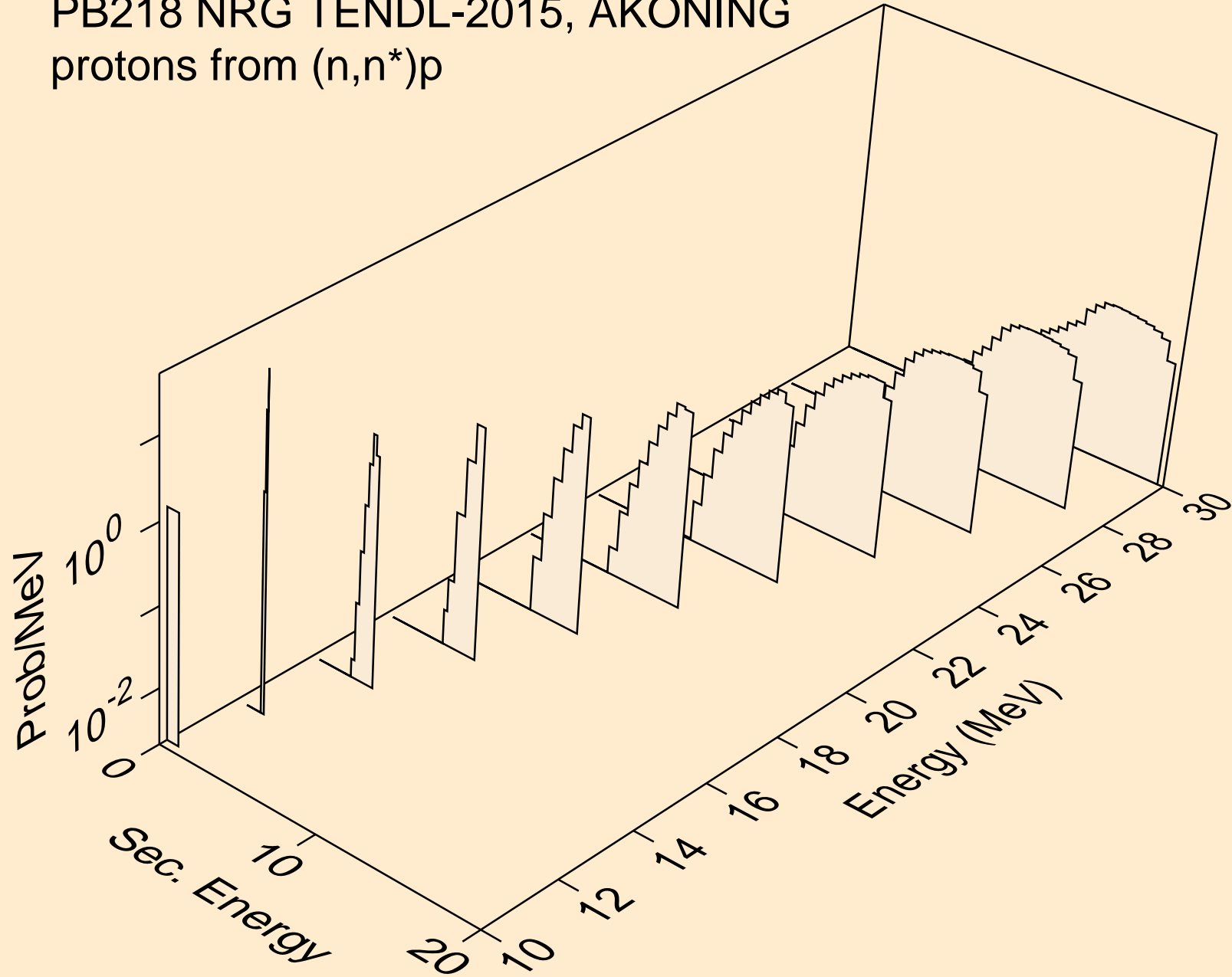

PB218 NRG TENDL-2015, AKONING
protons from (n,2np)

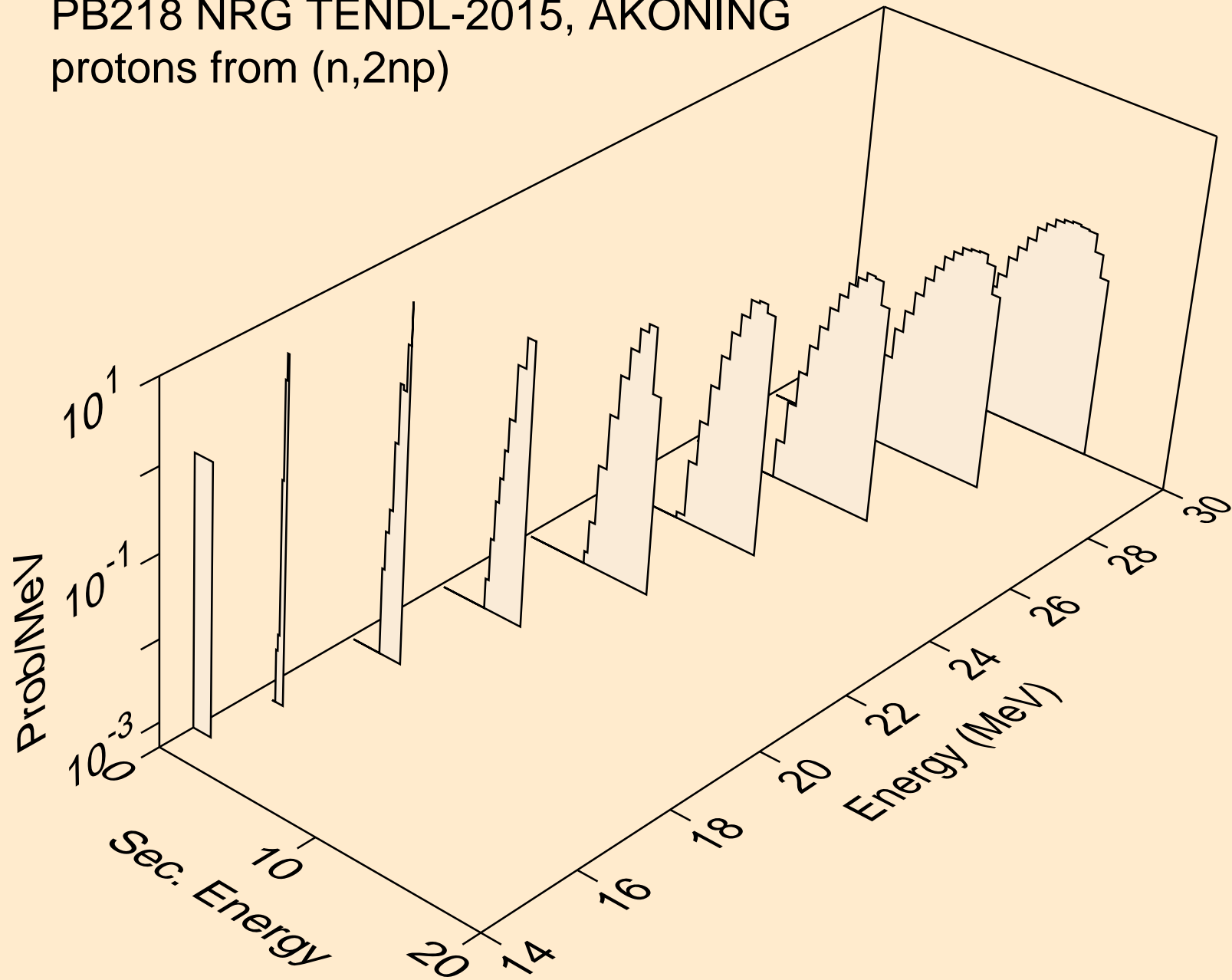

PB218 NRG TENDL-2015, AKONING
protons from (n,3np)

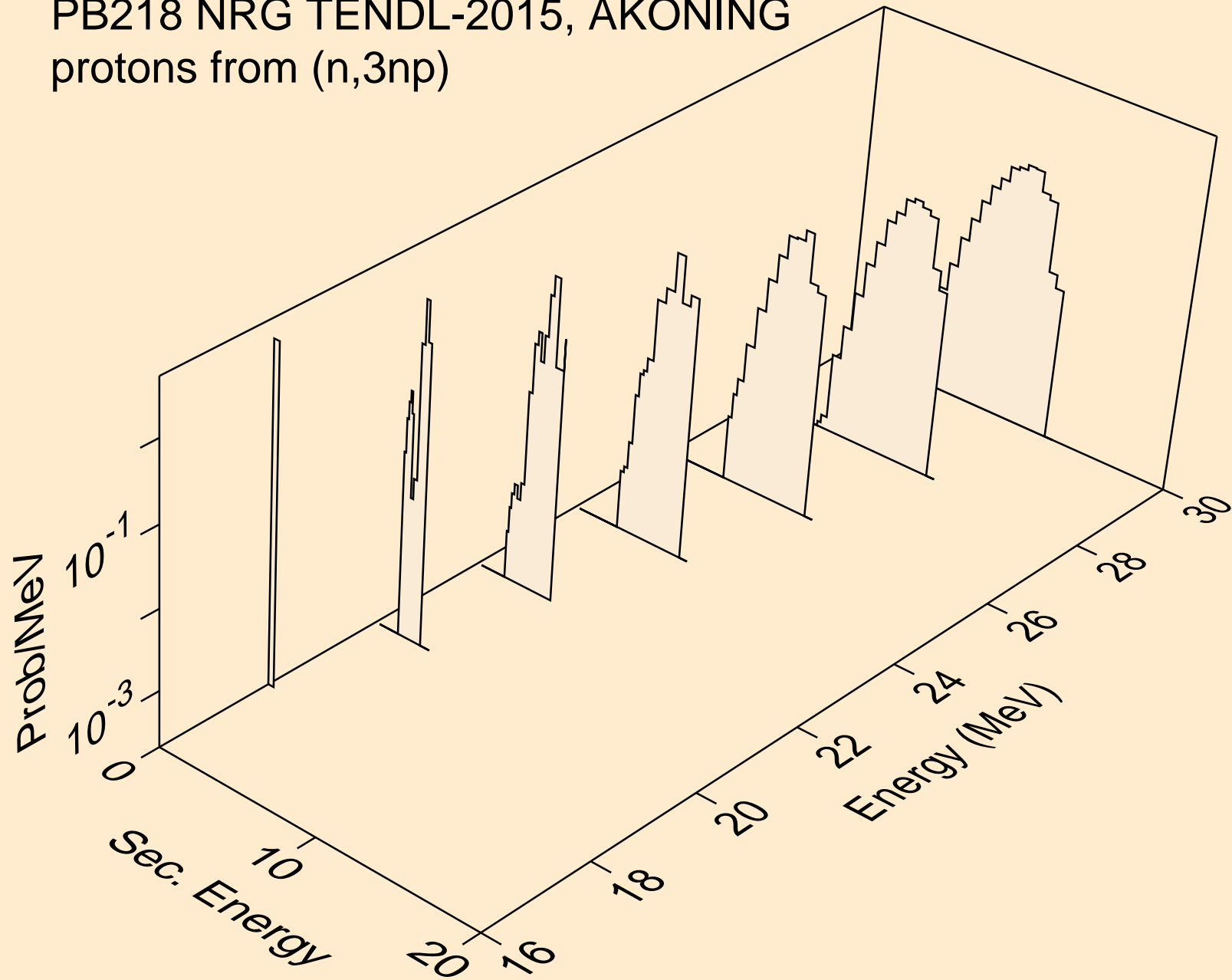

PB218 NRG TENDL-2015, AKONING
protons from (n,p)

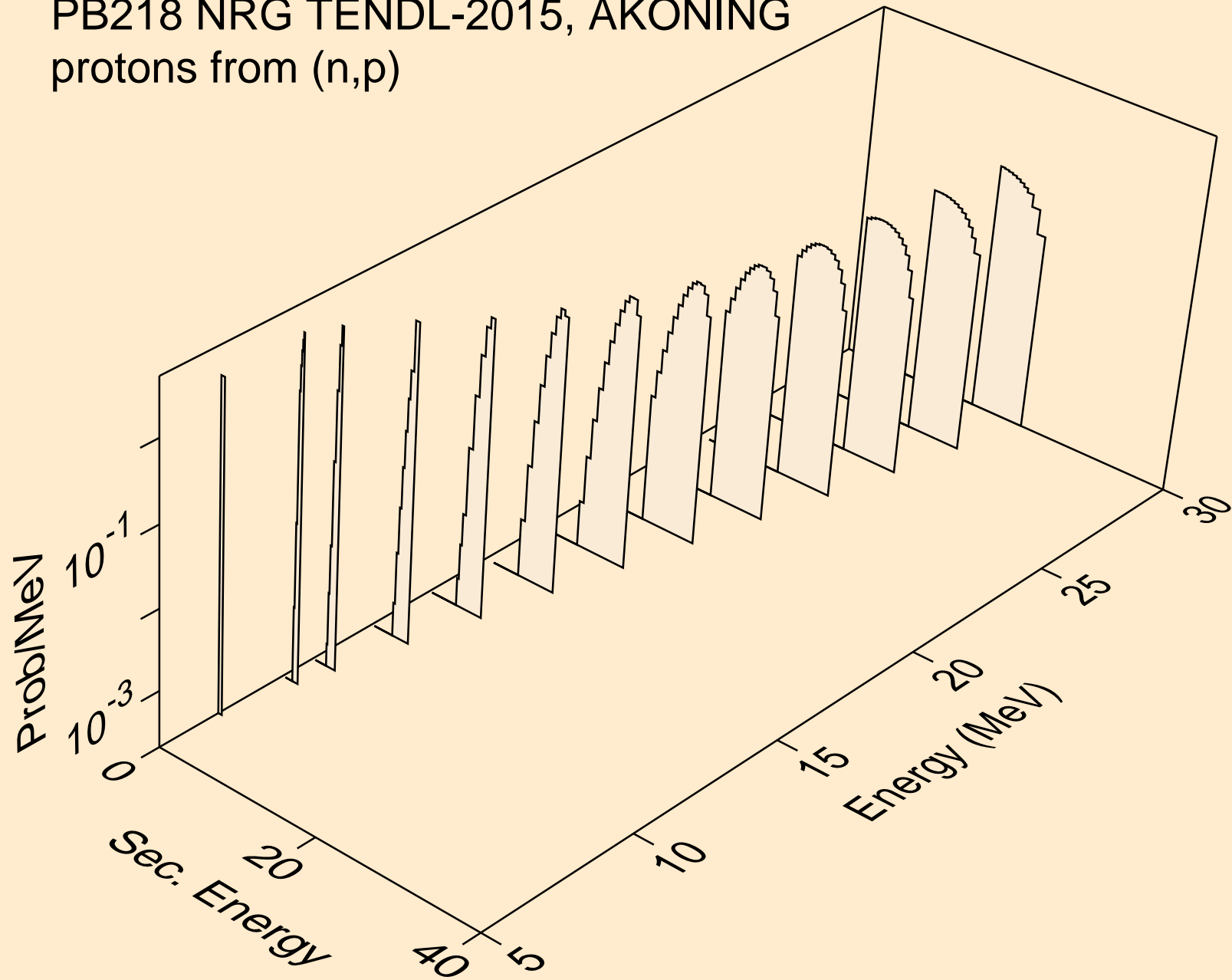

PB218 NRG TENDL-2015, AKONING
deuterons from (n,x)

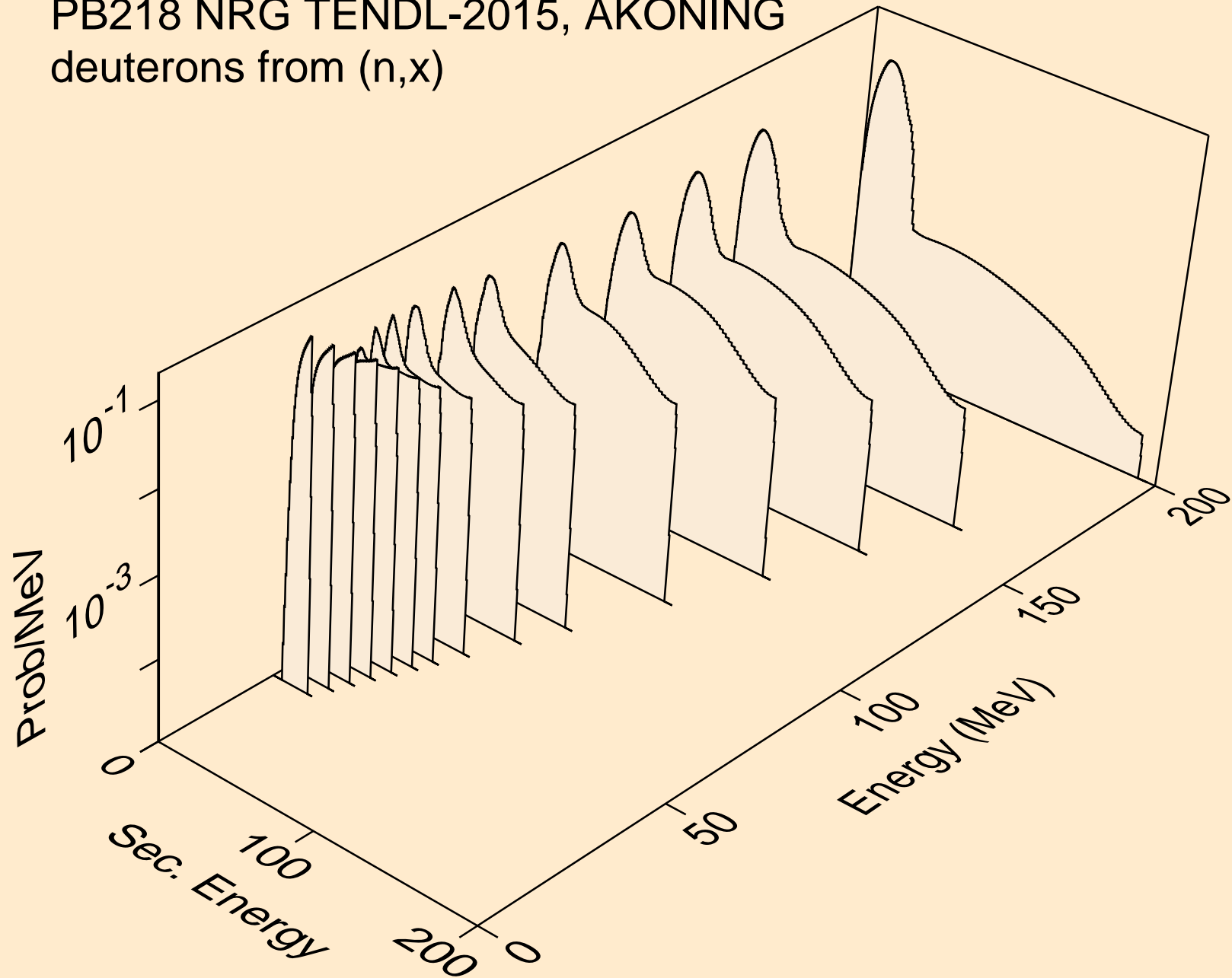

PB218 NRG TENDL-2015, AKONING
deuterons from (n,2nd)

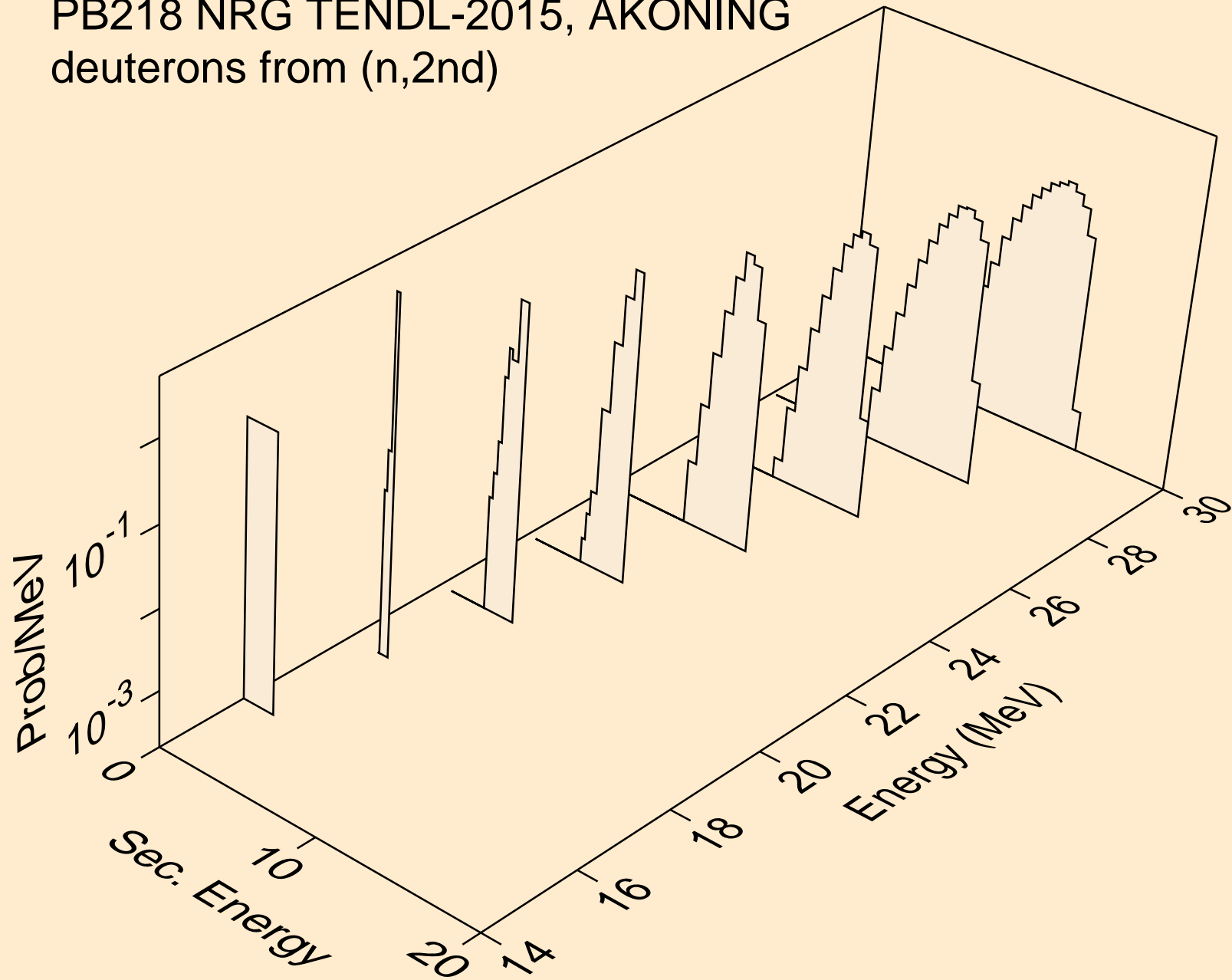

PB218 NRG TENDL-2015, AKONING
deuterons from (n,n*)d

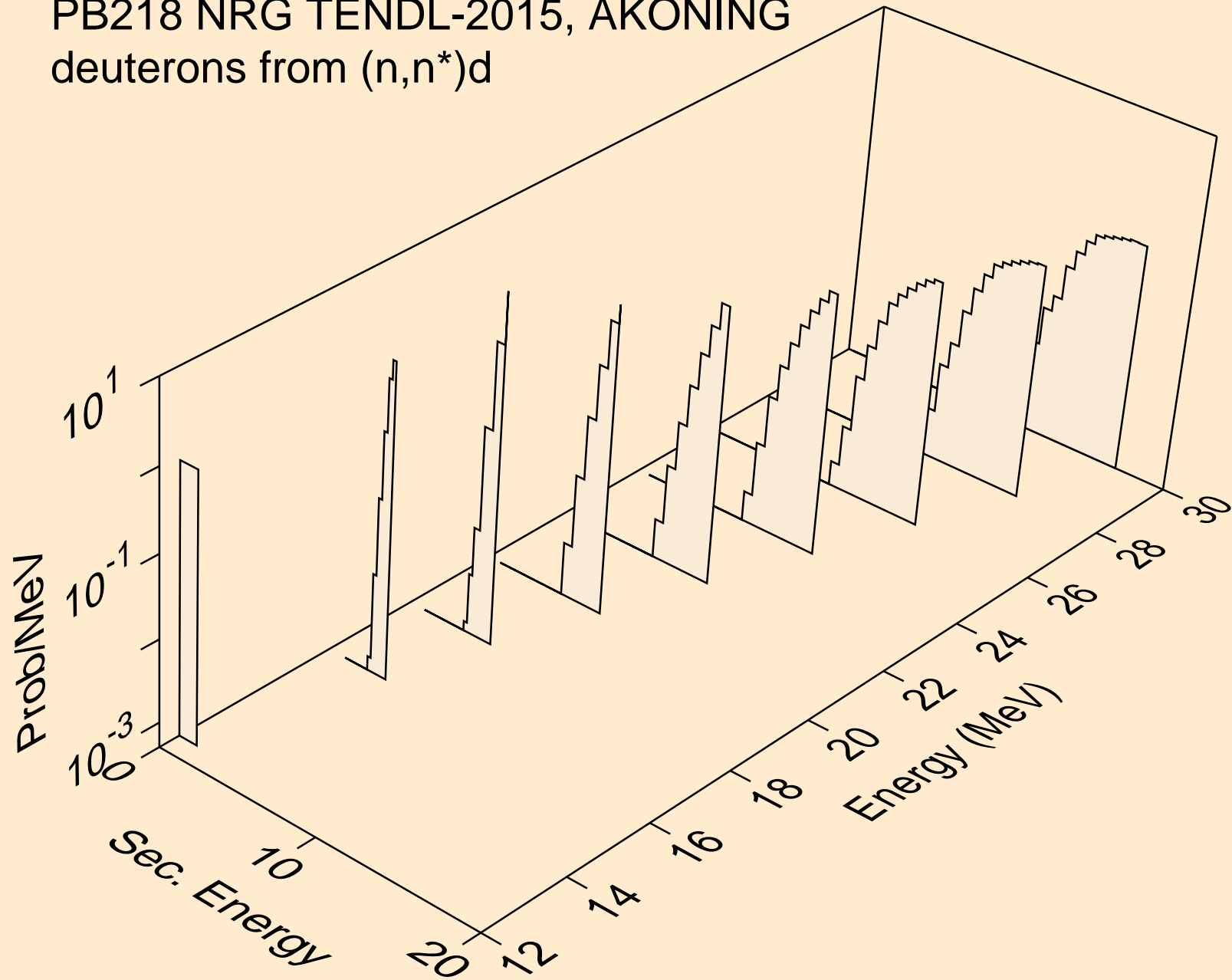

PB218 NRG TENDL-2015, AKONING
deuterons from (n,d)

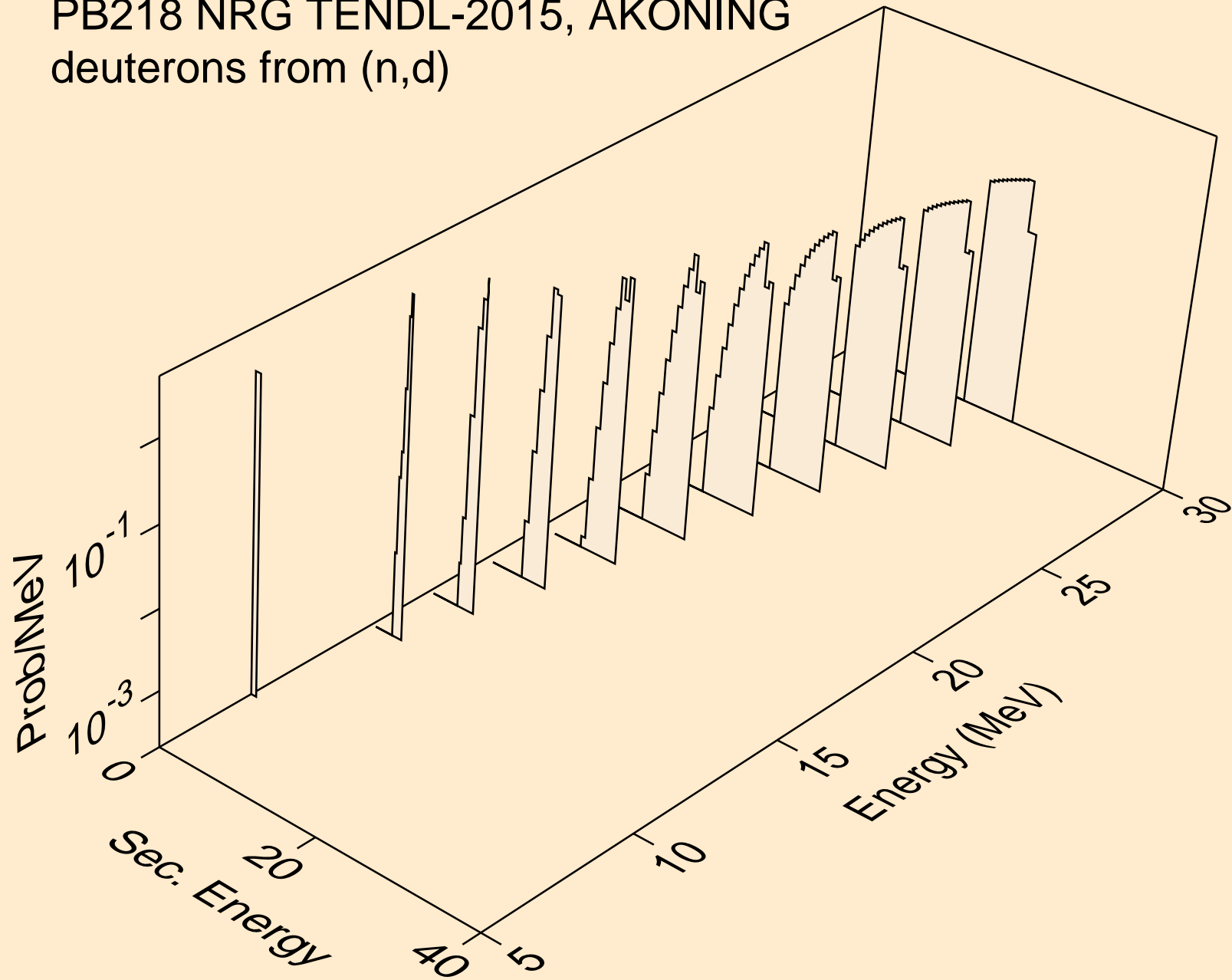

PB218 NRG TENDL-2015, AKONING
tritons from (n,x)

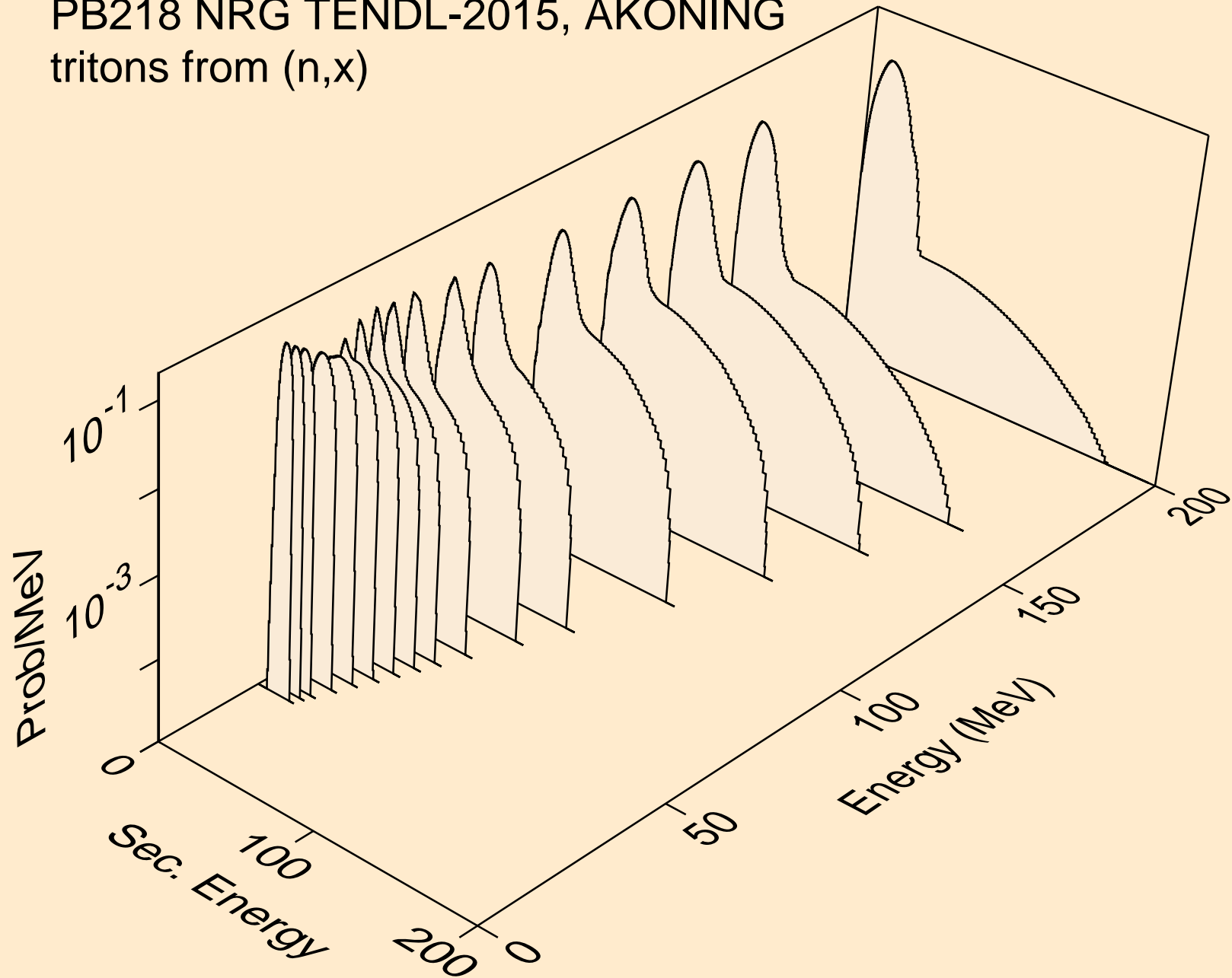

PB218 NRG TENDL-2015, AKONING
tritons from (n,n*)t

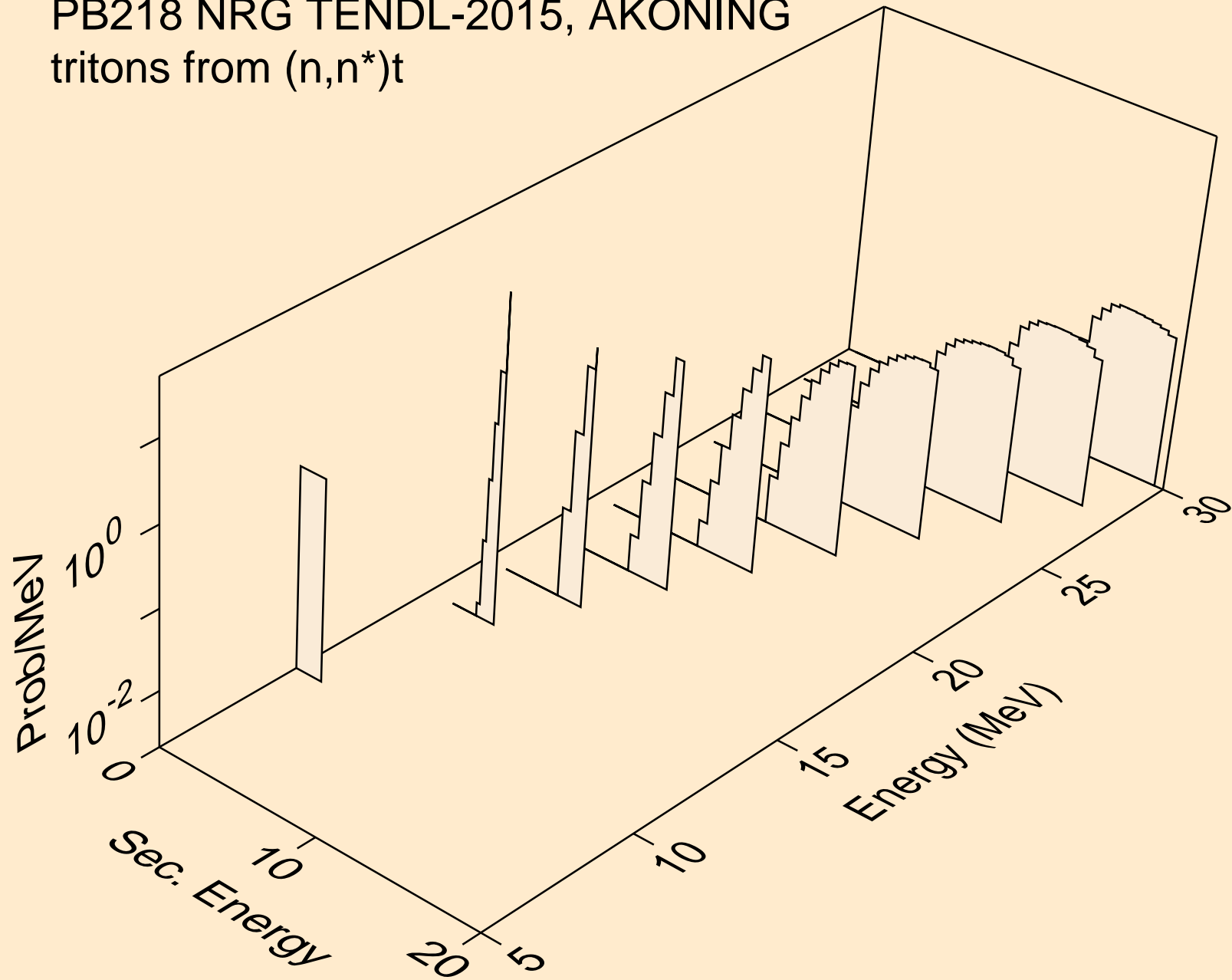

PB218 NRG TENDL-2015, AKONING
tritons from (n,t)

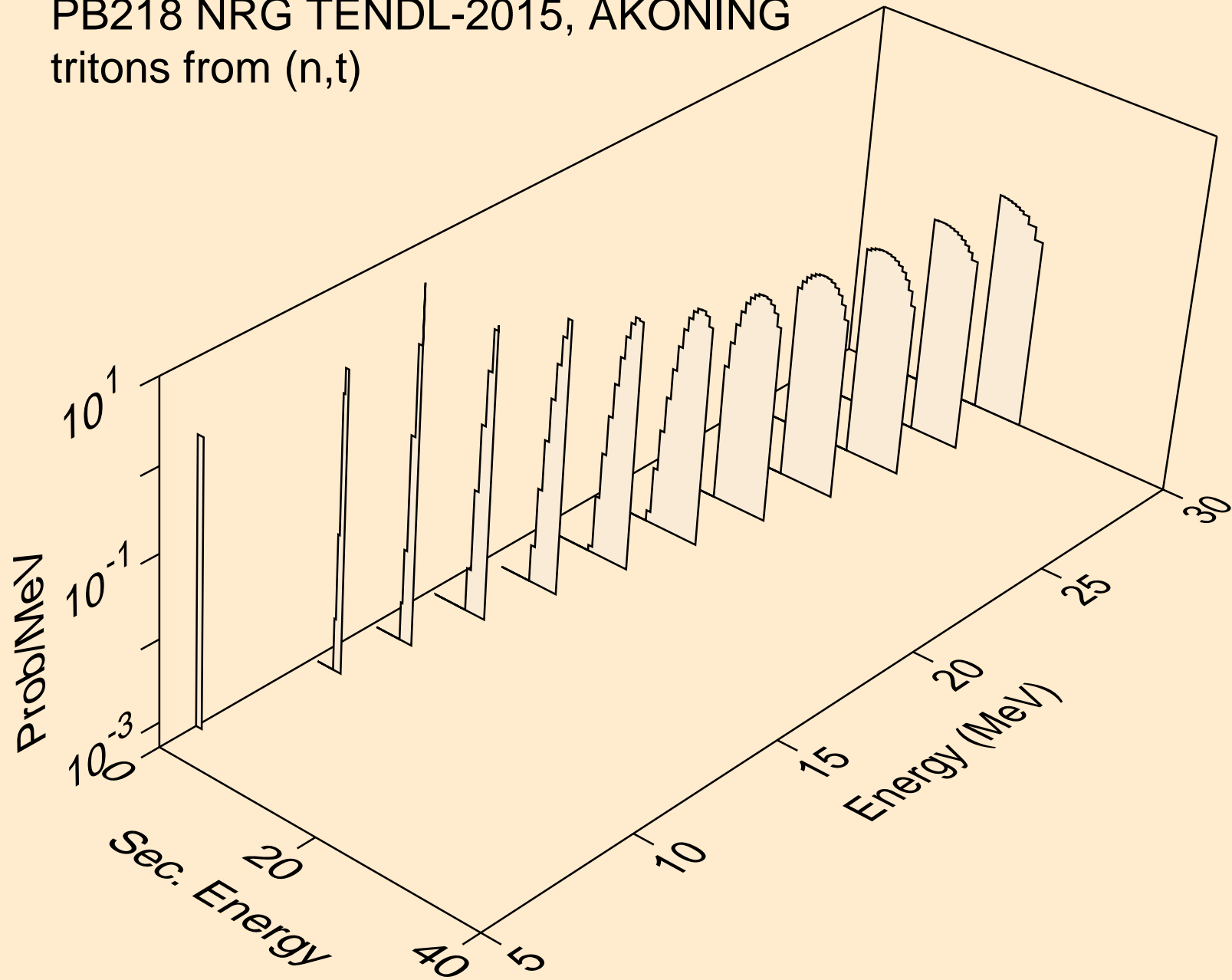

PB218 NRG TENDL-2015, AKONING
he3s from (n,x)

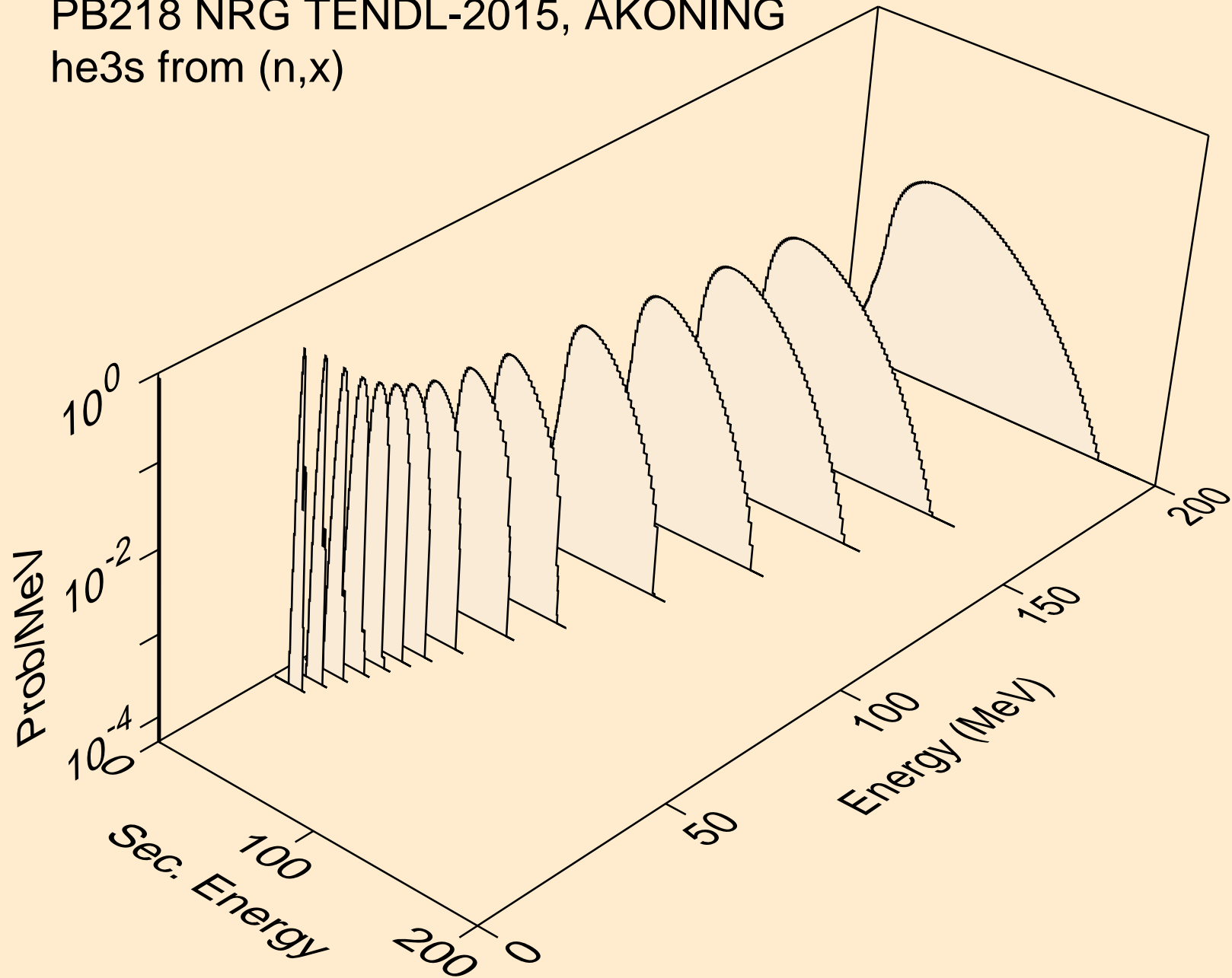

PB218 NRG TENDL-2015, AKONING
he3s from (n,n*)he3

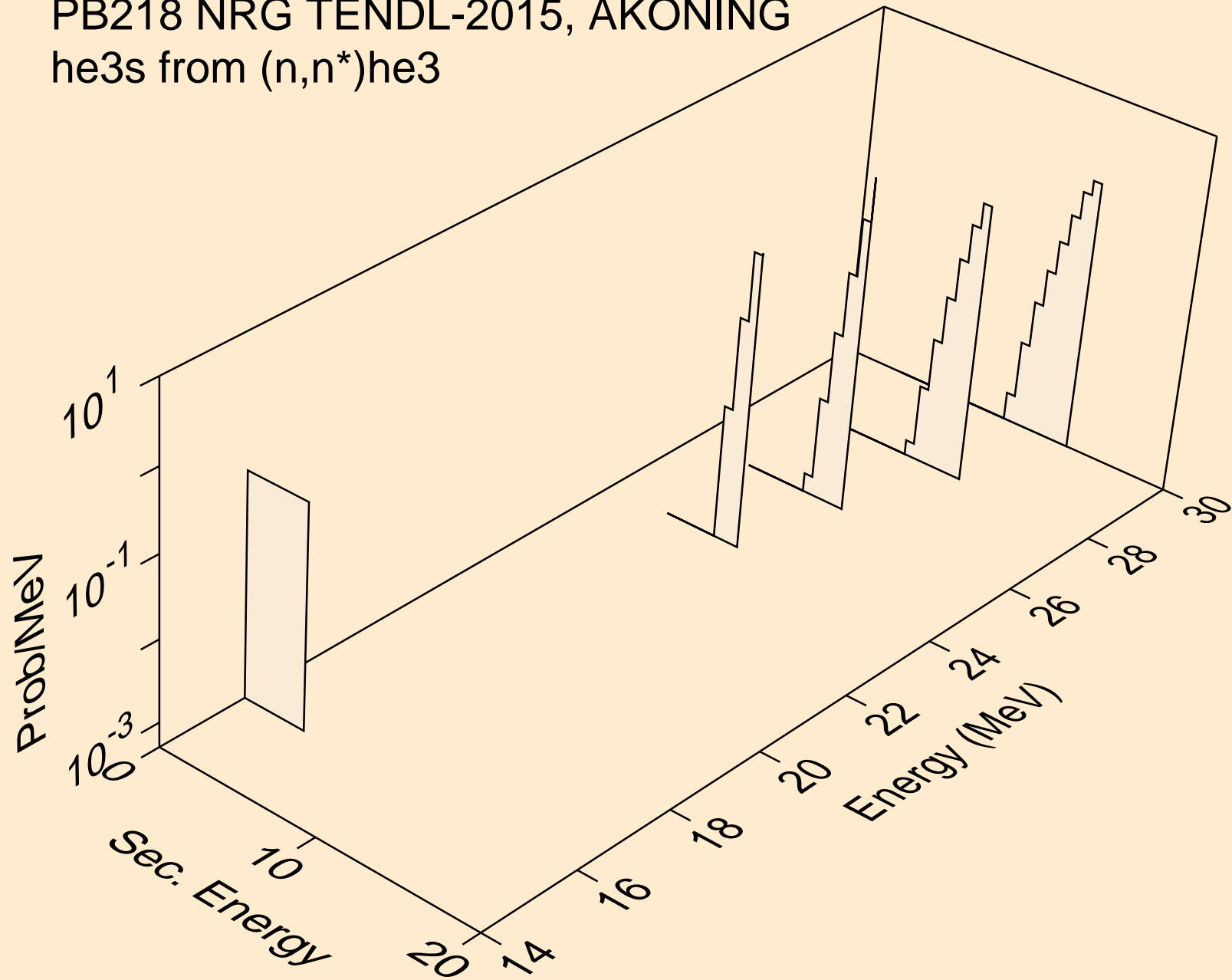

PB218 NRG TENDL-2015, AKONING
he3s from (n,he3)

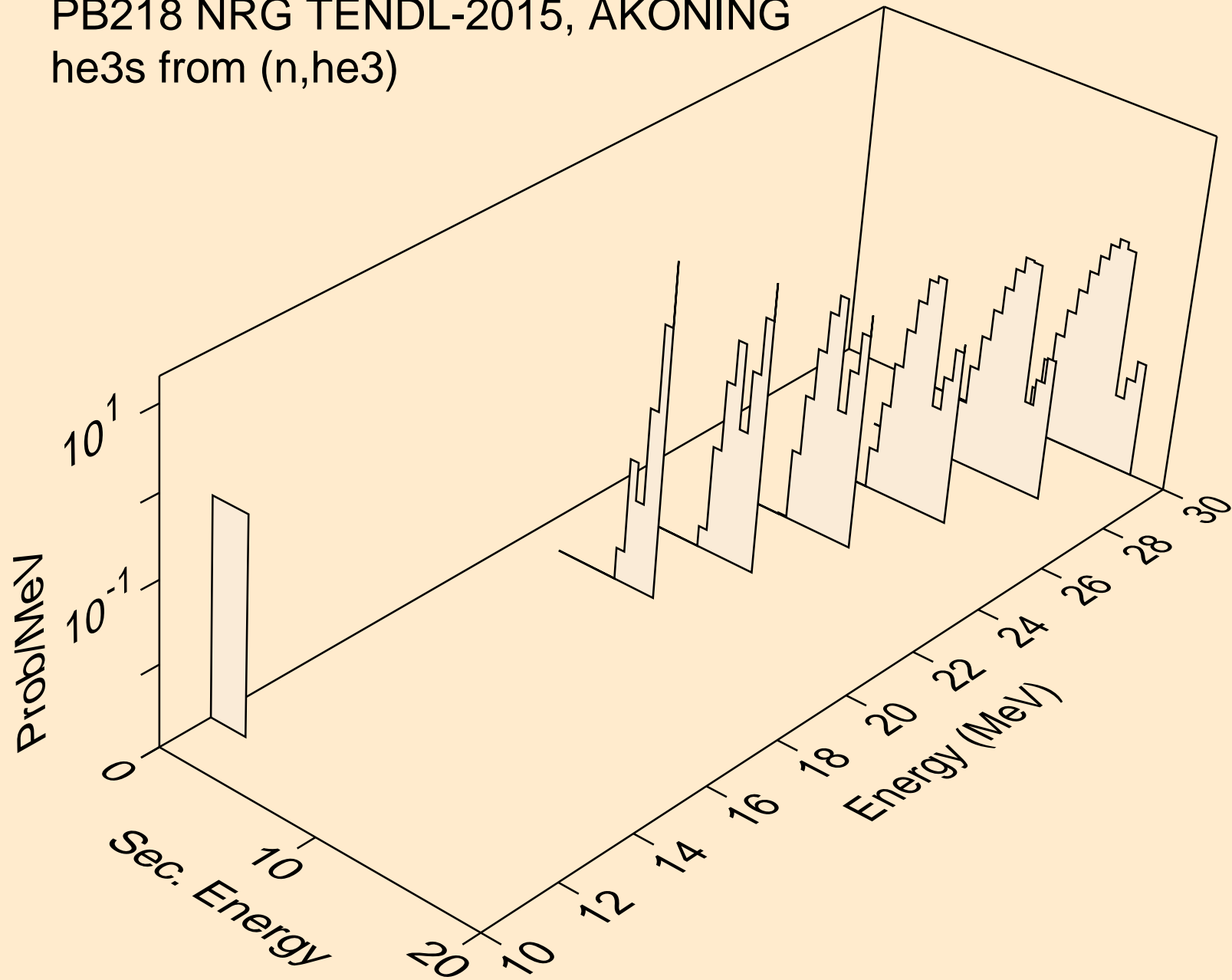

PB218 NRG TENDL-2015, AKONING
alphas from (n,x)

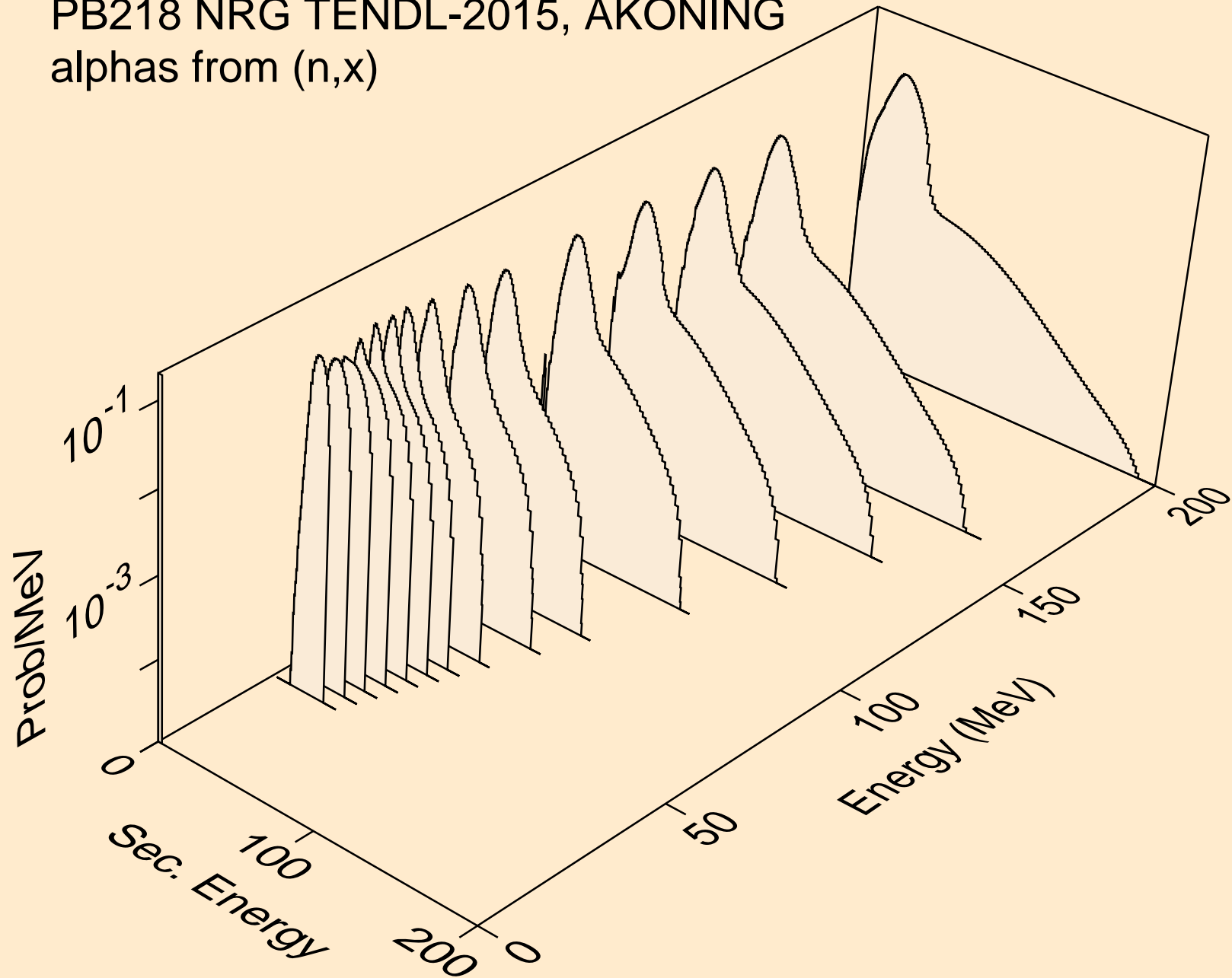

PB218 NRG TENDL-2015, AKONING
alphas from (n,n*)a

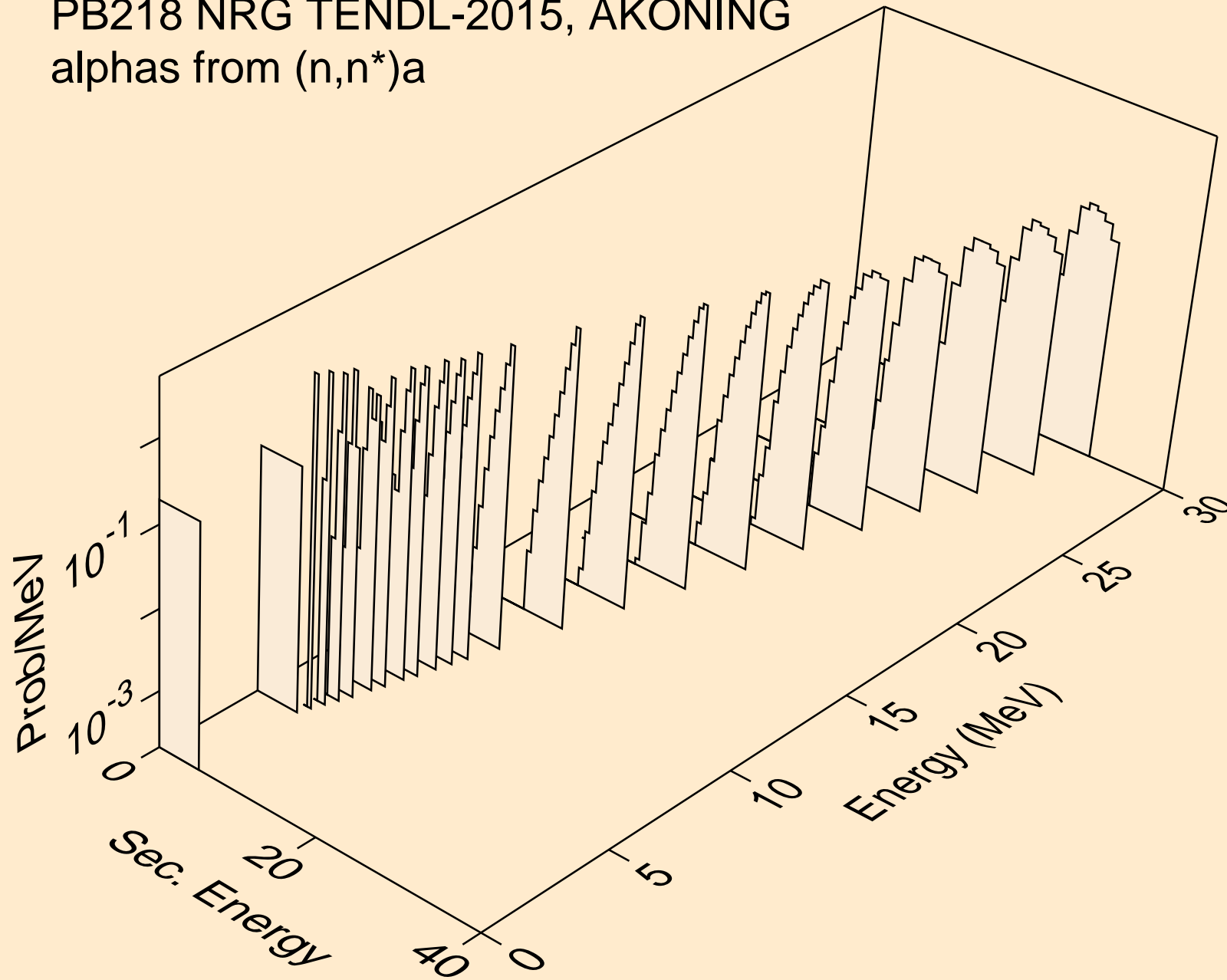

PB218 NRG TENDL-2015, AKONING
alphas from (n,2n)a

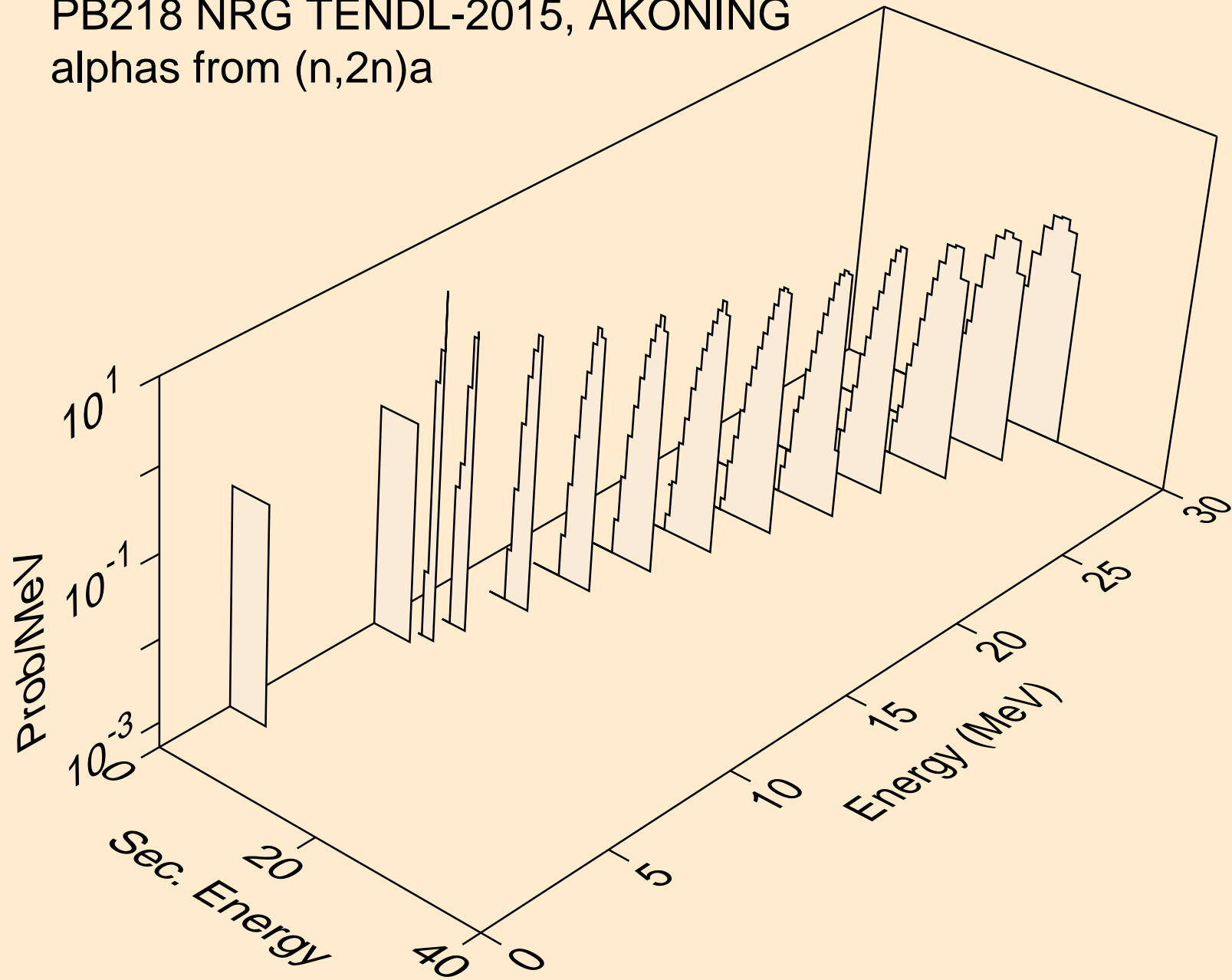

PB218 NRG TENDL-2015, AKONING
alphas from (n,3n)a

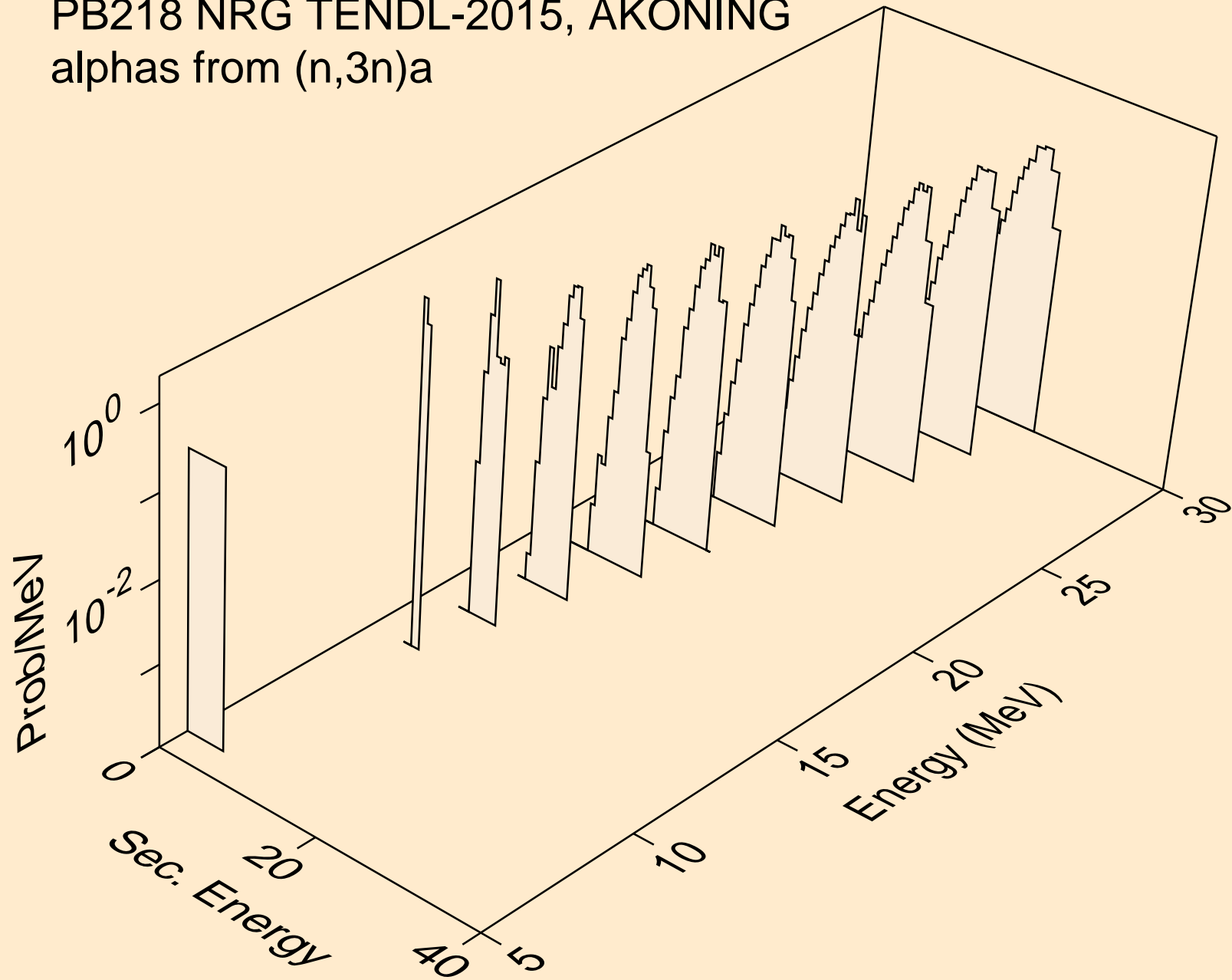

PB218 NRG TENDL-2015, AKONING
alphas from (n,a)

