

PM127 NRG TENDL-2015, AKONING

Principal cross sections

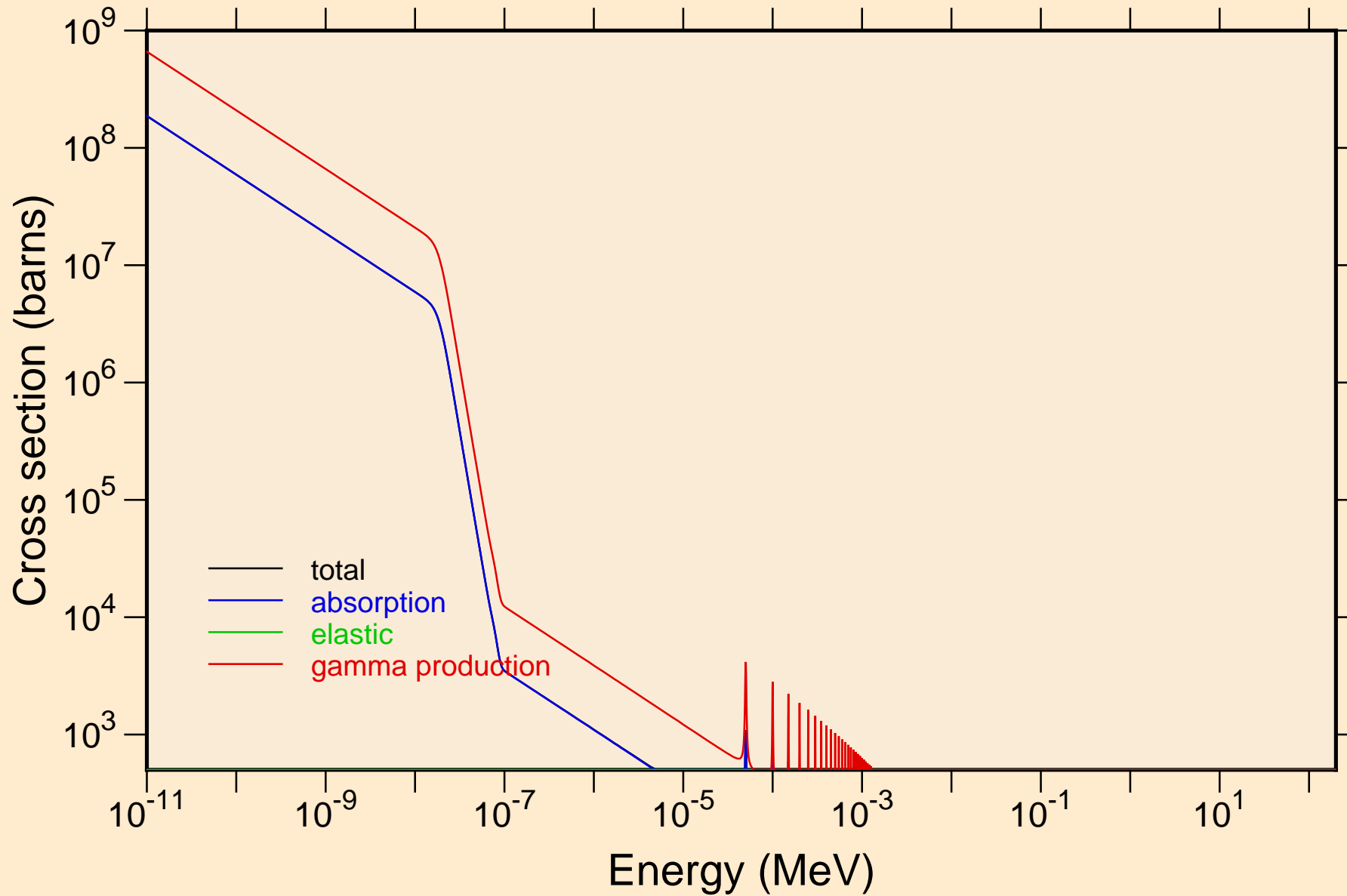

PM127 NRG TENDL-2015, AKONING
resonance total cross section

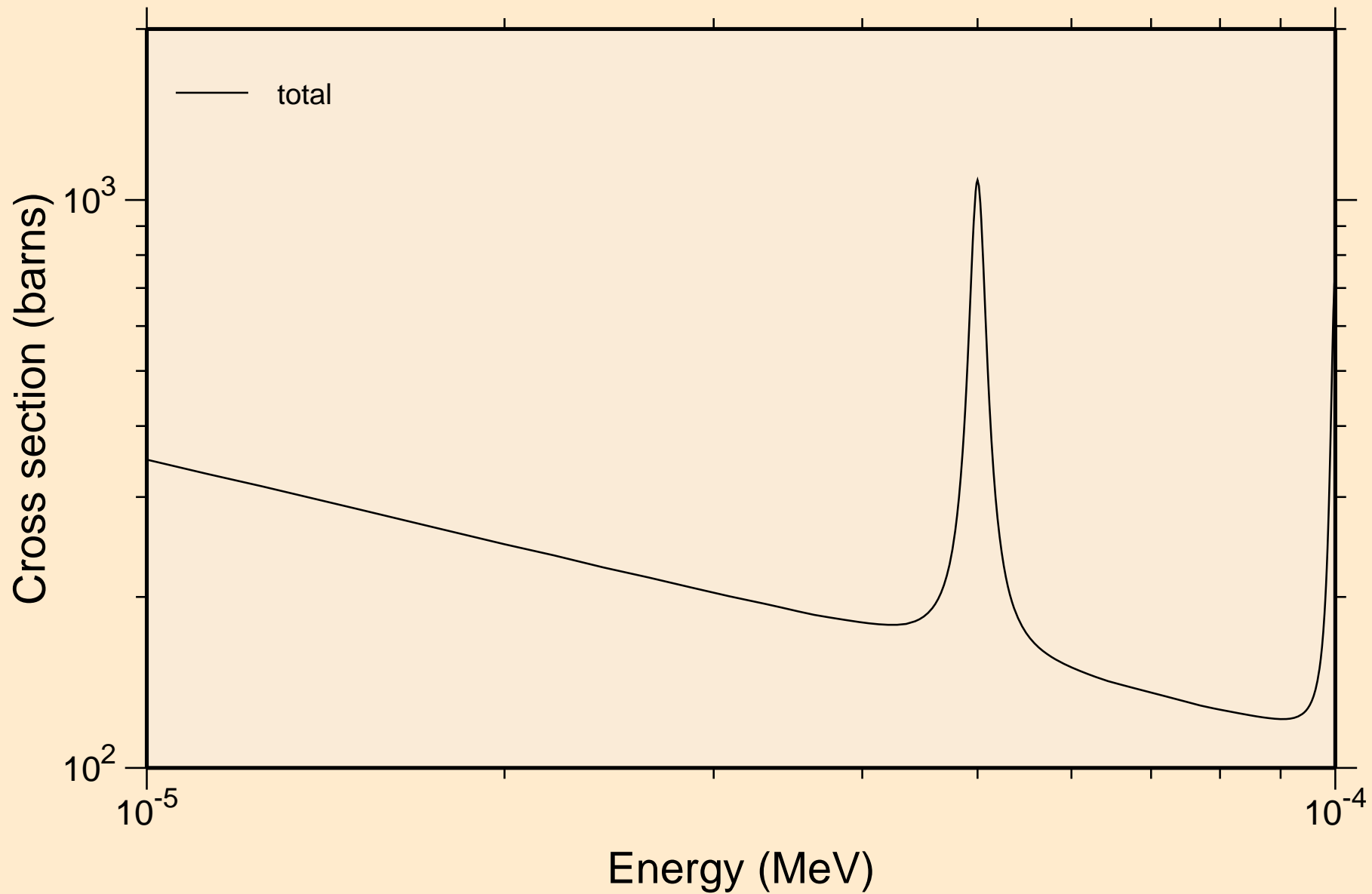

PM127 NRG TENDL-2015, AKONING
resonance total cross section

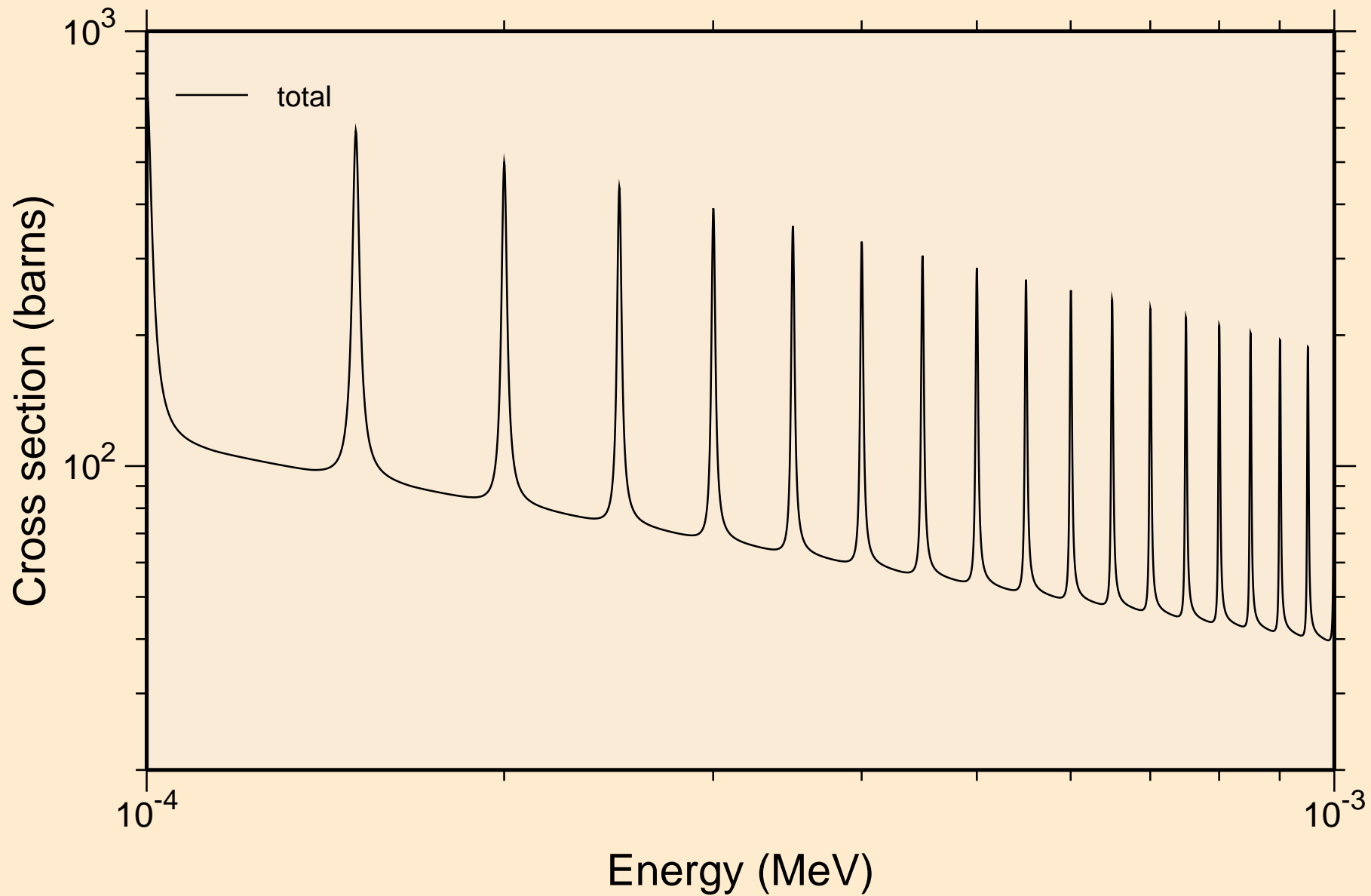

PM127 NRG TENDL-2015, AKONING
resonance total cross section

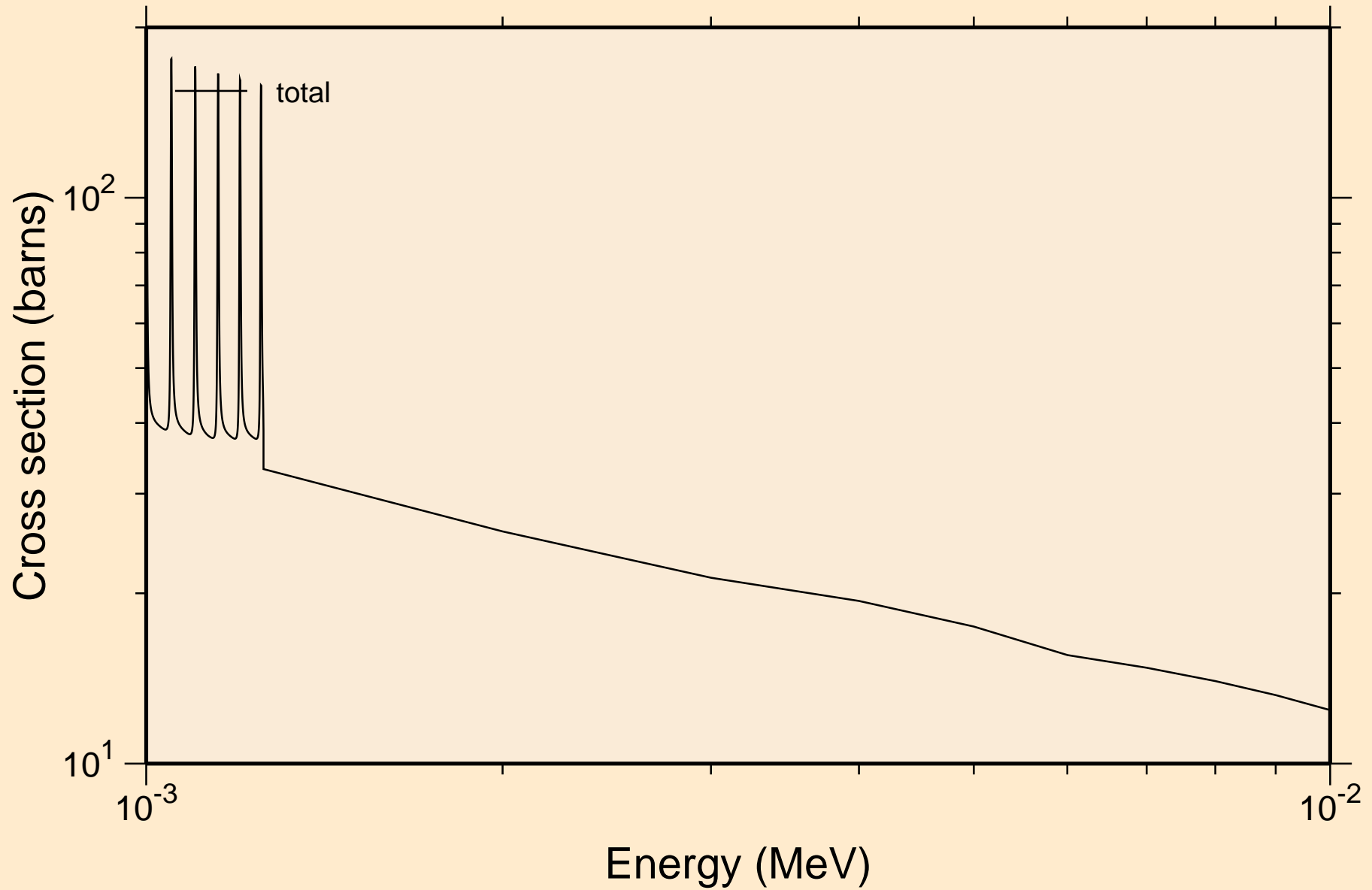

P̄M127 NRG TENDL-2015, AKONING
resonance total cross section

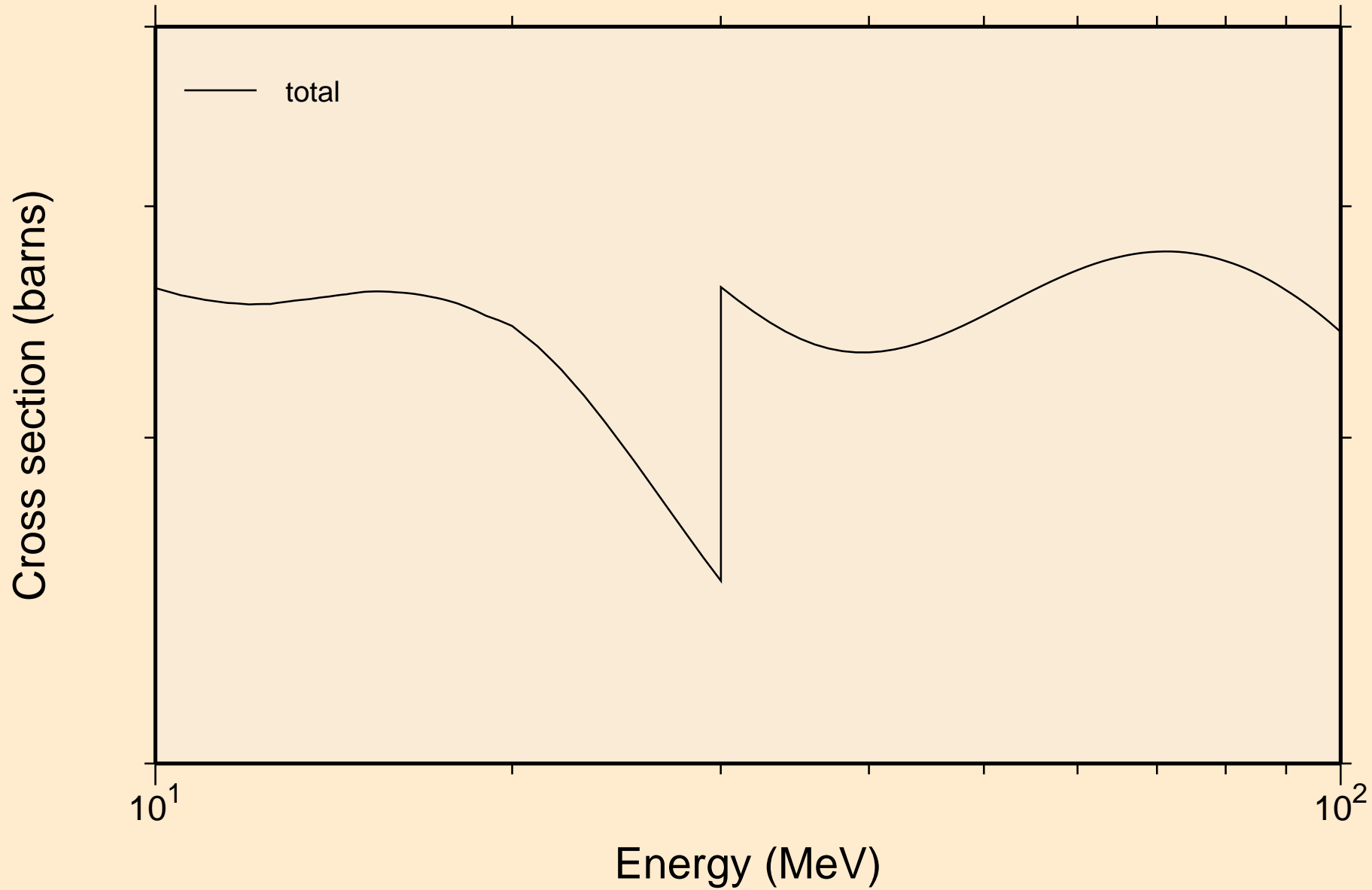

PM127 NRG TENDL-2015, AKONING
resonance absorption cross sections

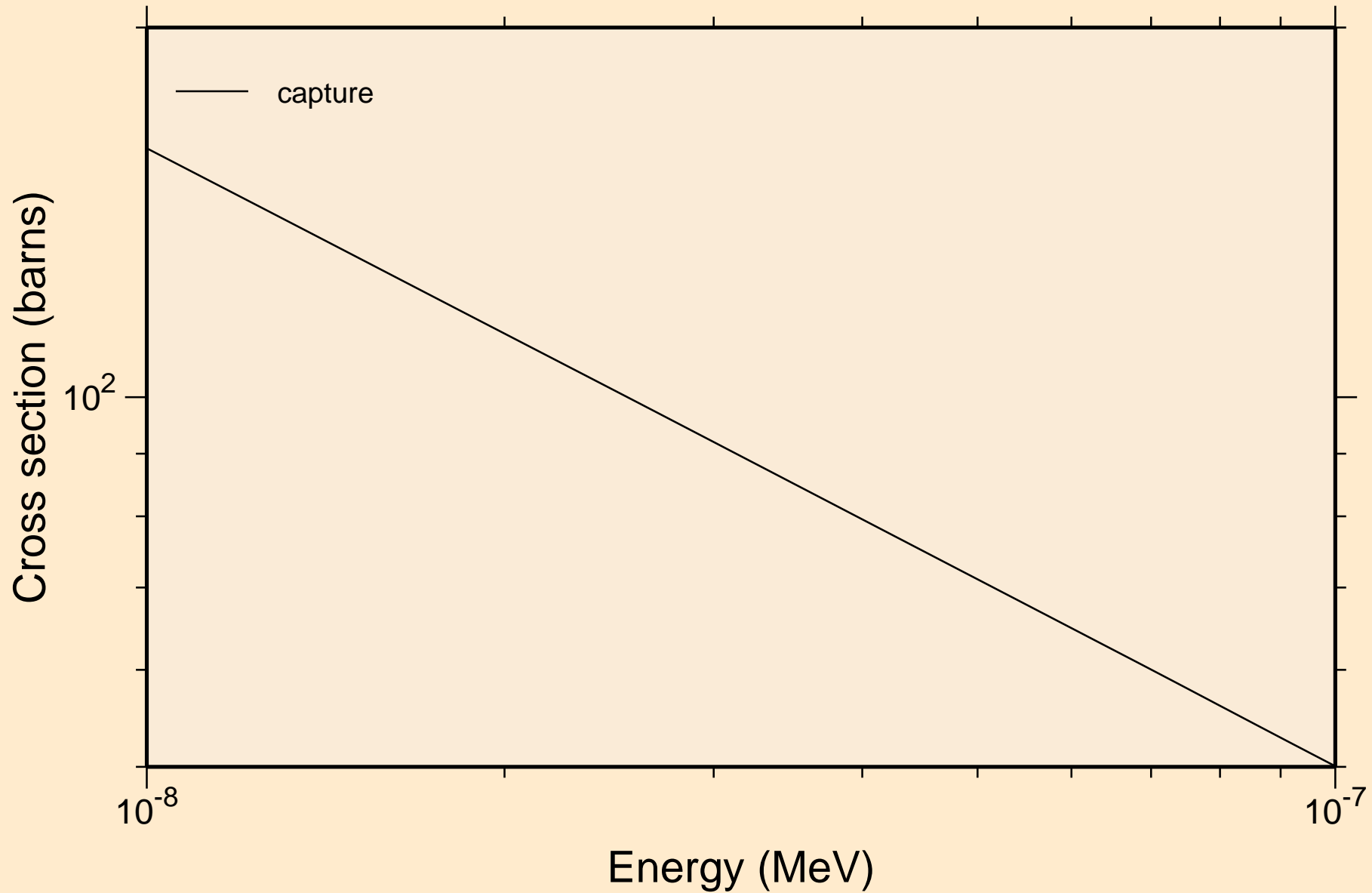

PM127 NRG TENDL-2015, AKONING
resonance absorption cross sections

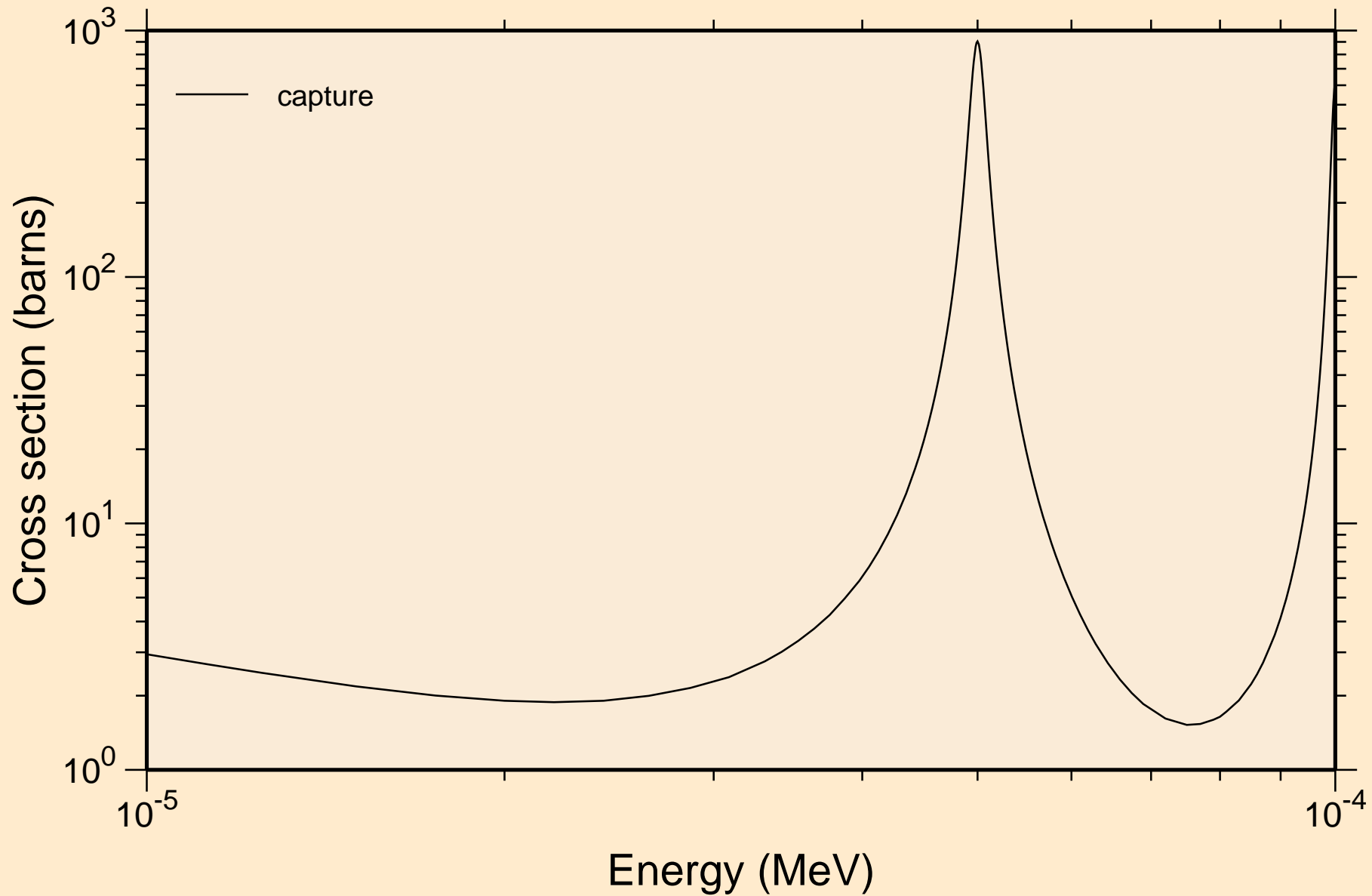

PM127 NRG TENDL-2015, AKONING
resonance absorption cross sections

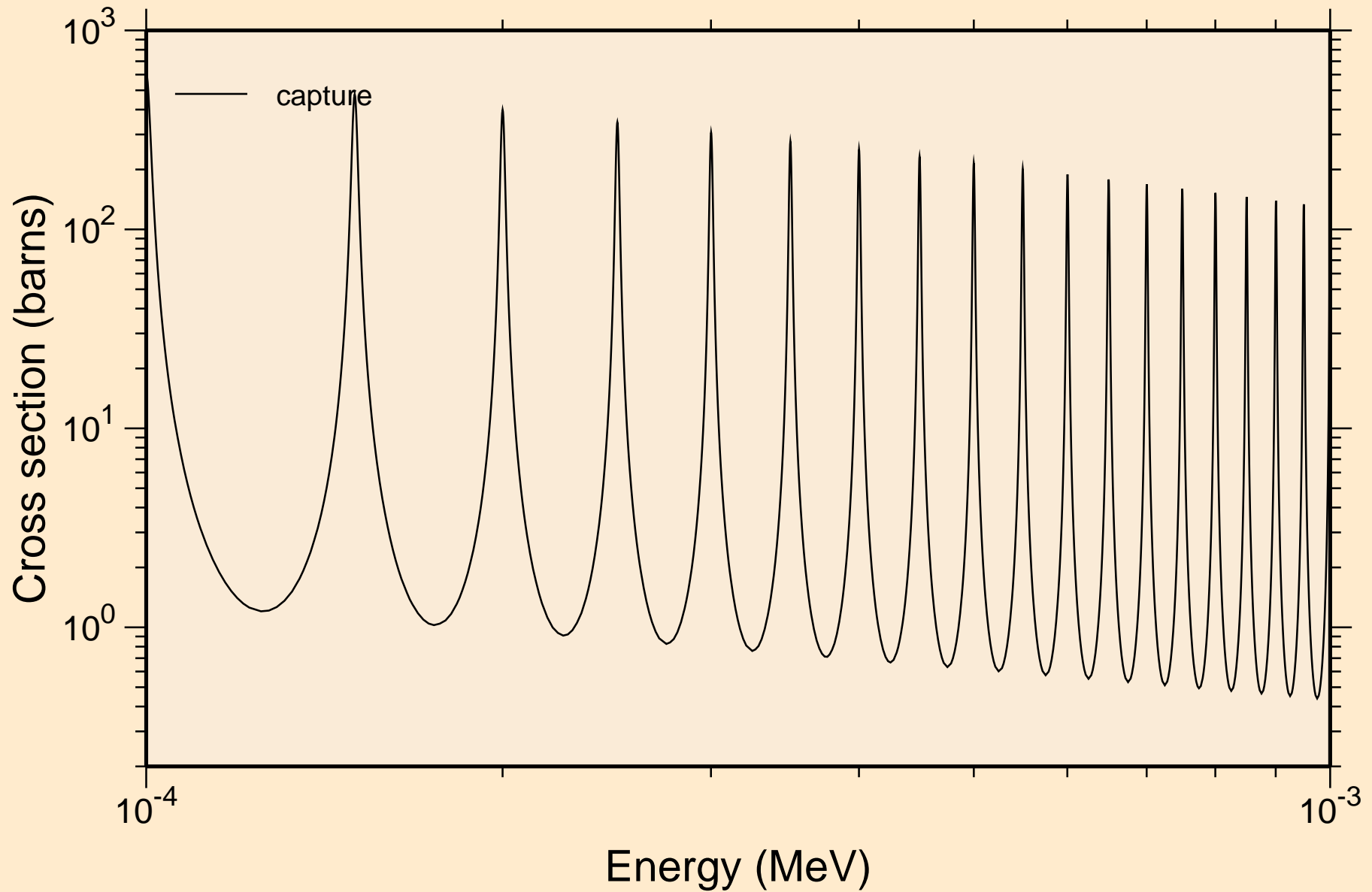

PM127 NRG TENDL-2015, AKONING
resonance absorption cross sections

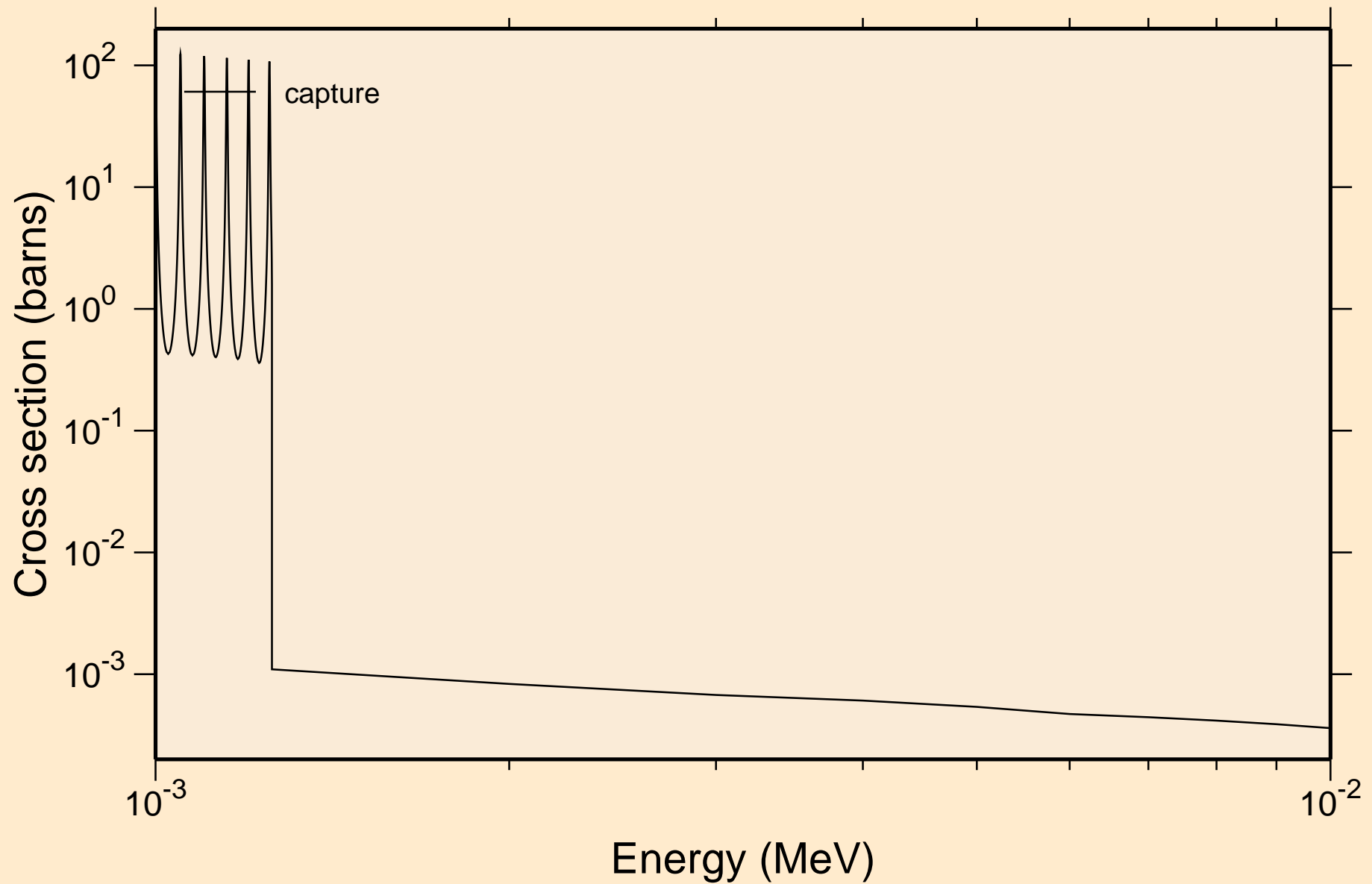

PM127 NRG TENDL-2015, AKONING
resonance absorption cross sections

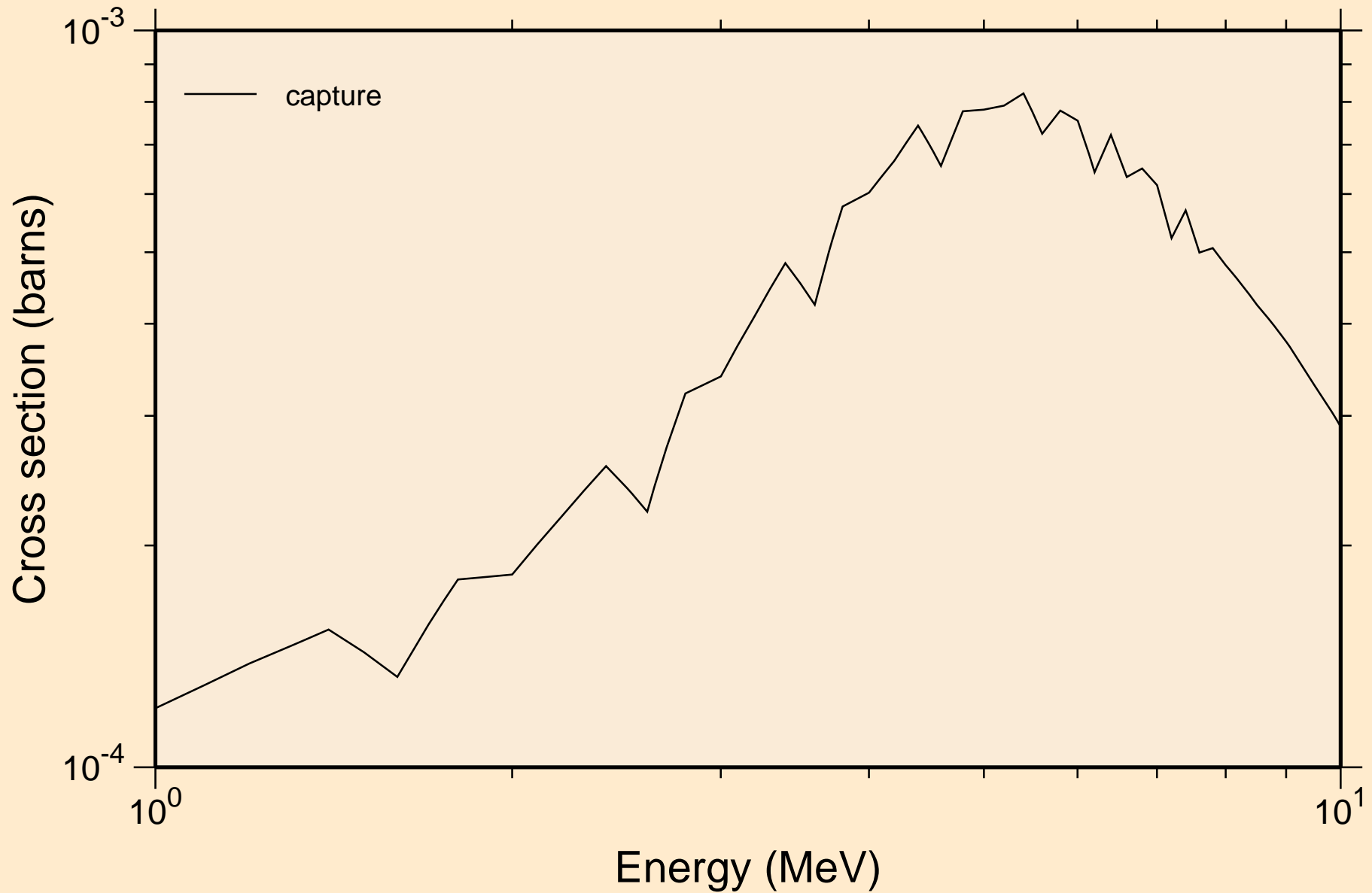

PM127 NRG TENDL-2015, AKONING

Non-threshold reactions

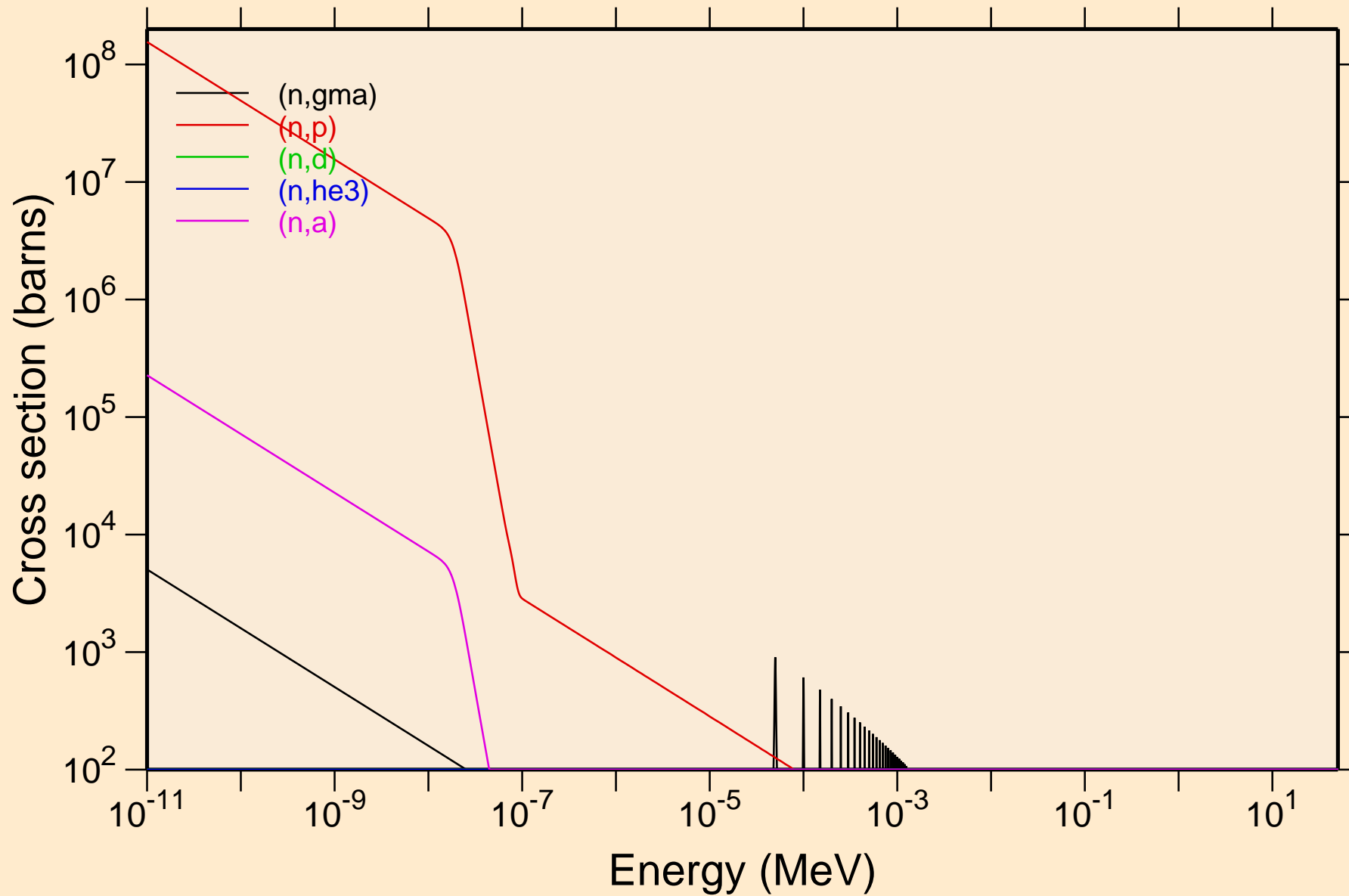

PM127 NRG TENDL-2015, AKONING

Non-threshold reactions

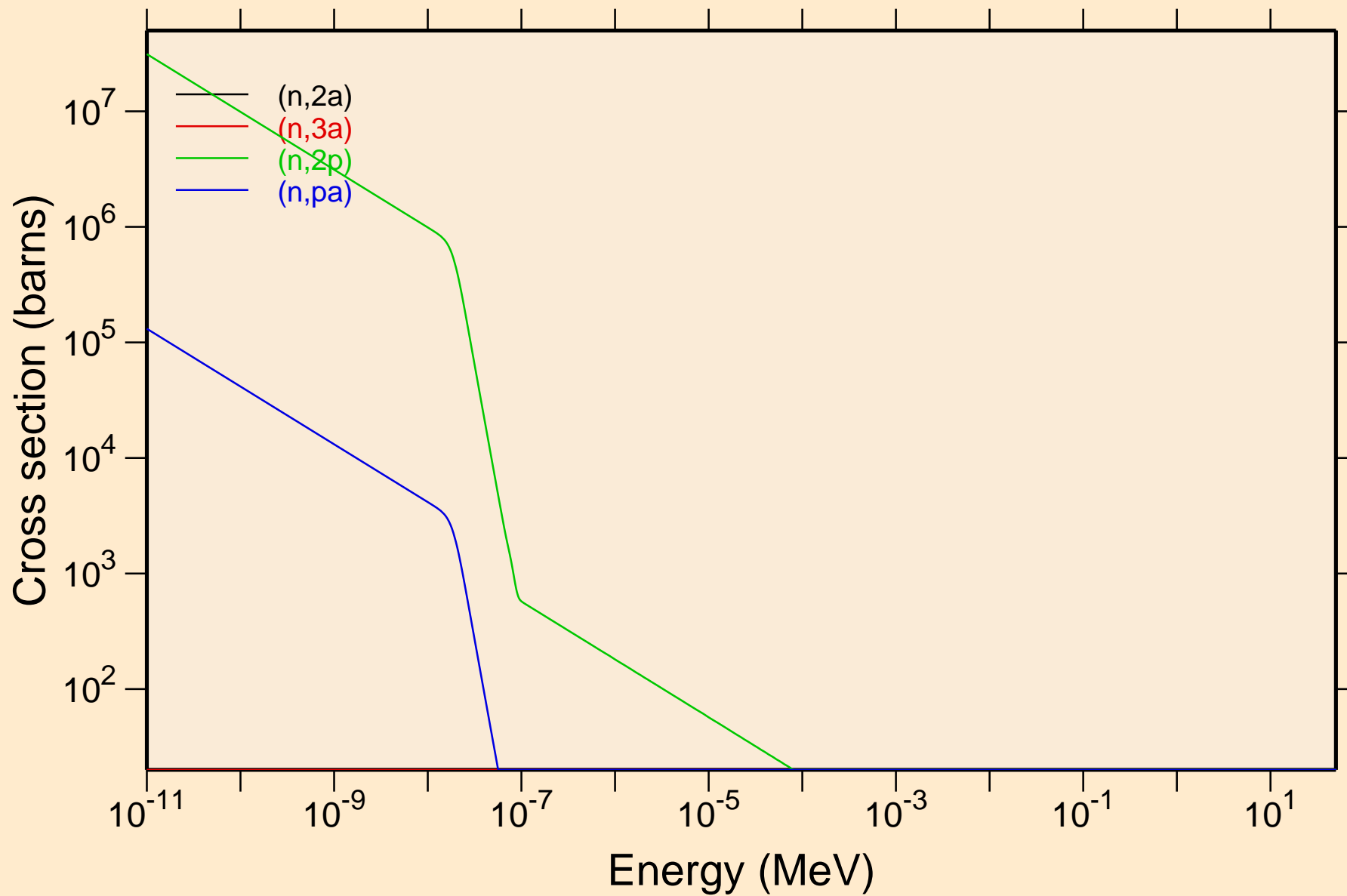

PM127 NRG TENDL-2015, AKONING

Principal cross sections

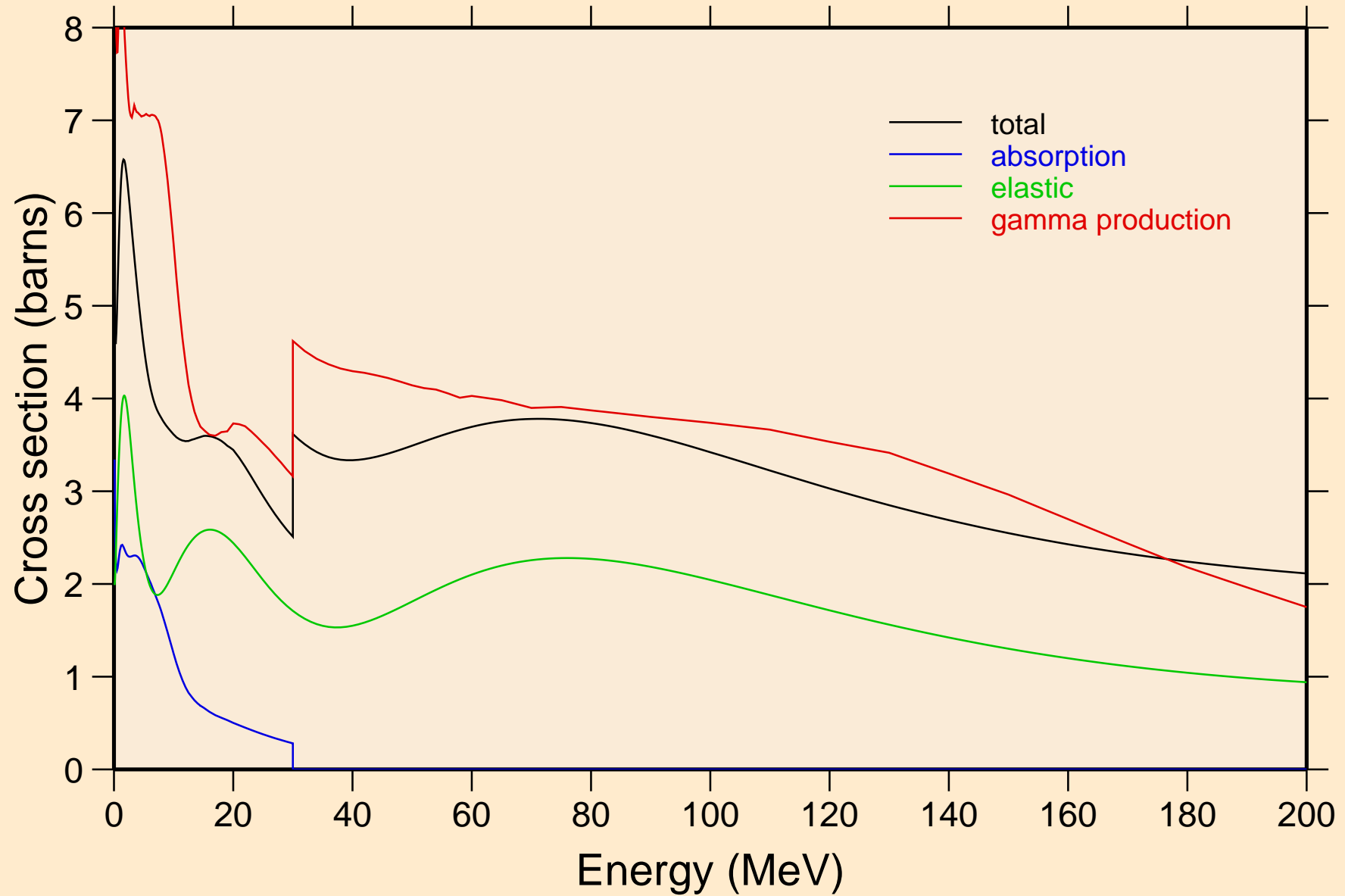

PM127 NRG TENDL-2015, AKONING

Non-threshold reactions

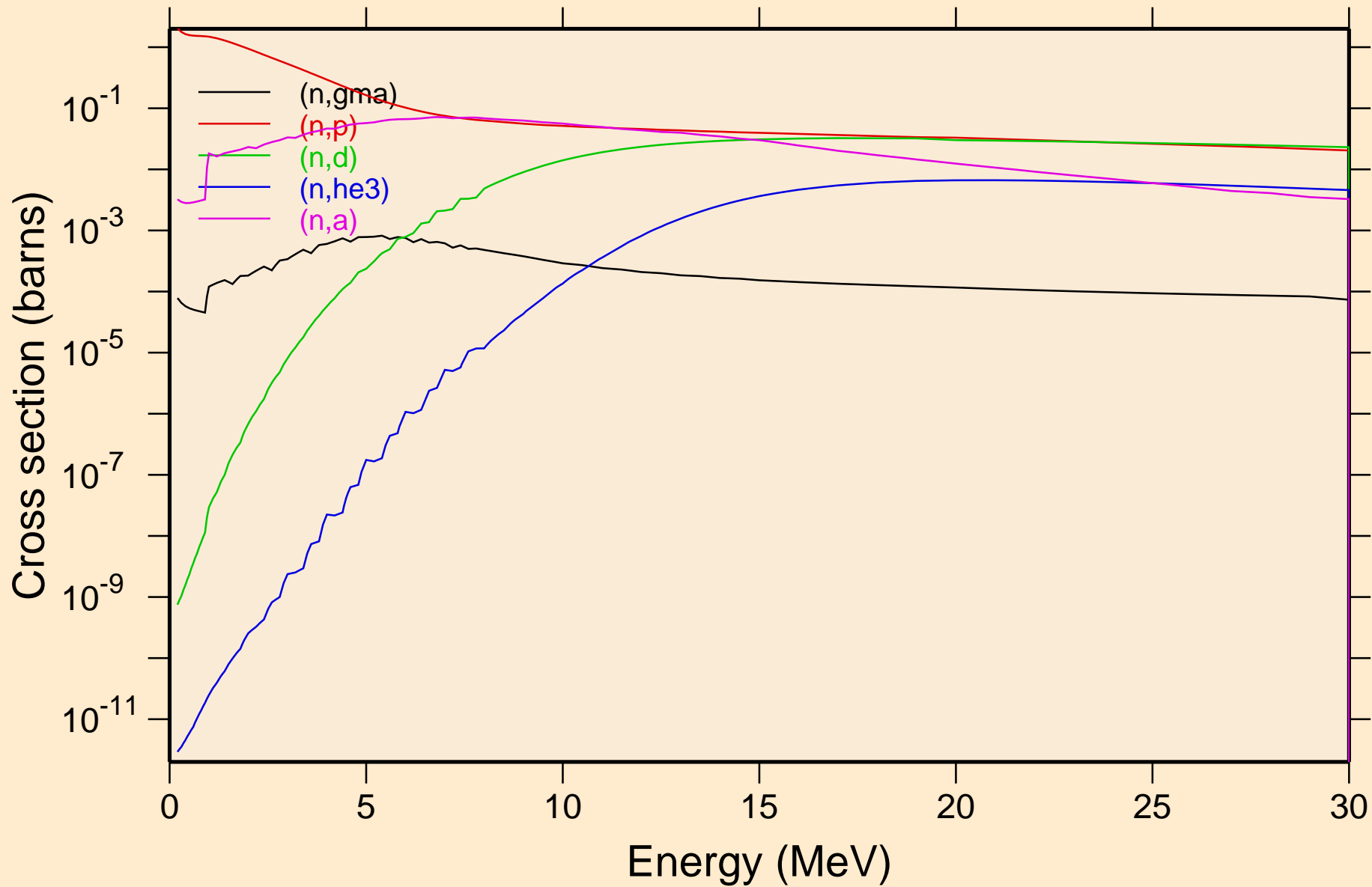

PM127 NRG TENDL-2015, AKONING

Non-threshold reactions

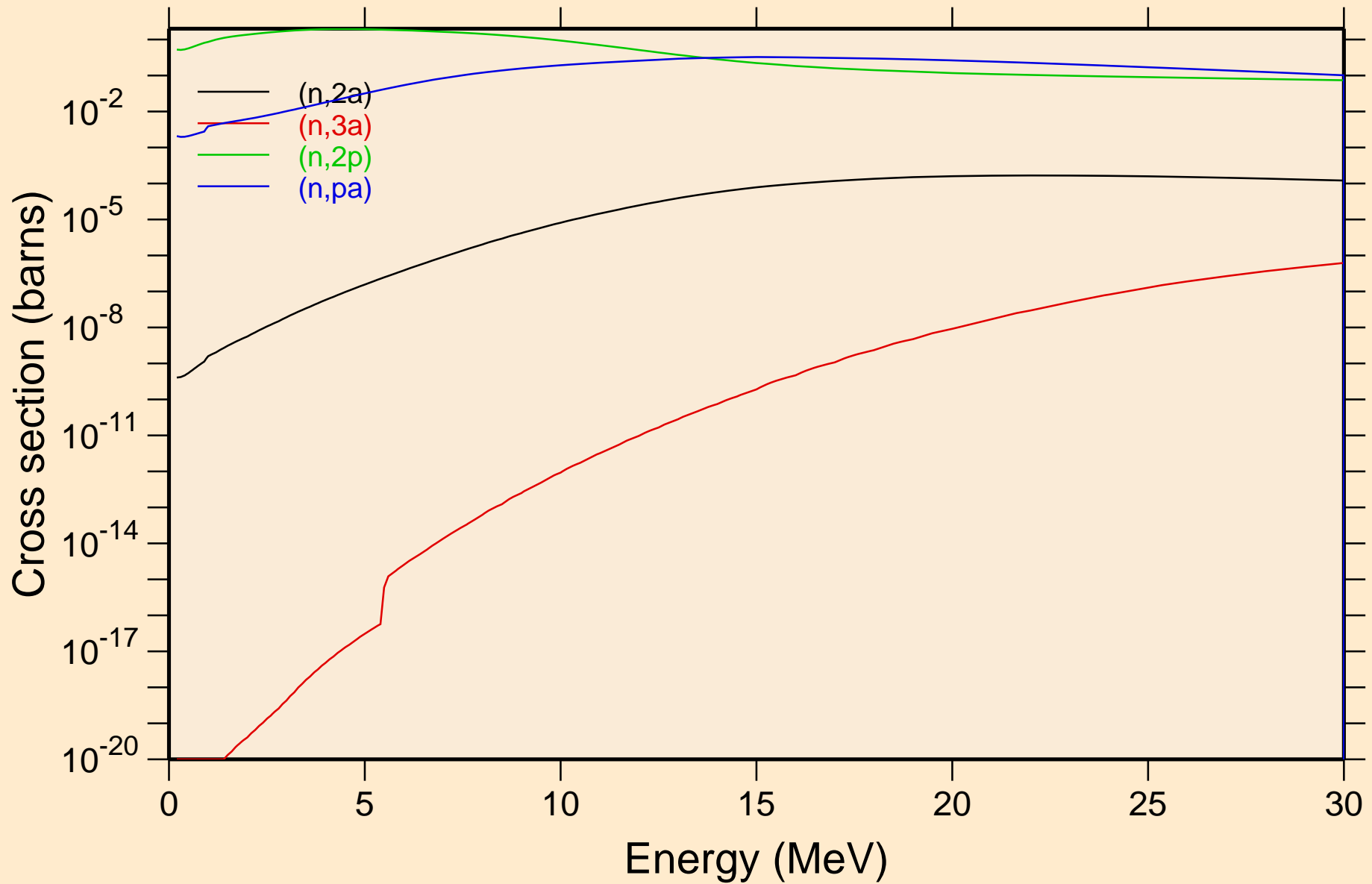

PM127 NRG TENDL-2015, AKONING

Inelastic levels

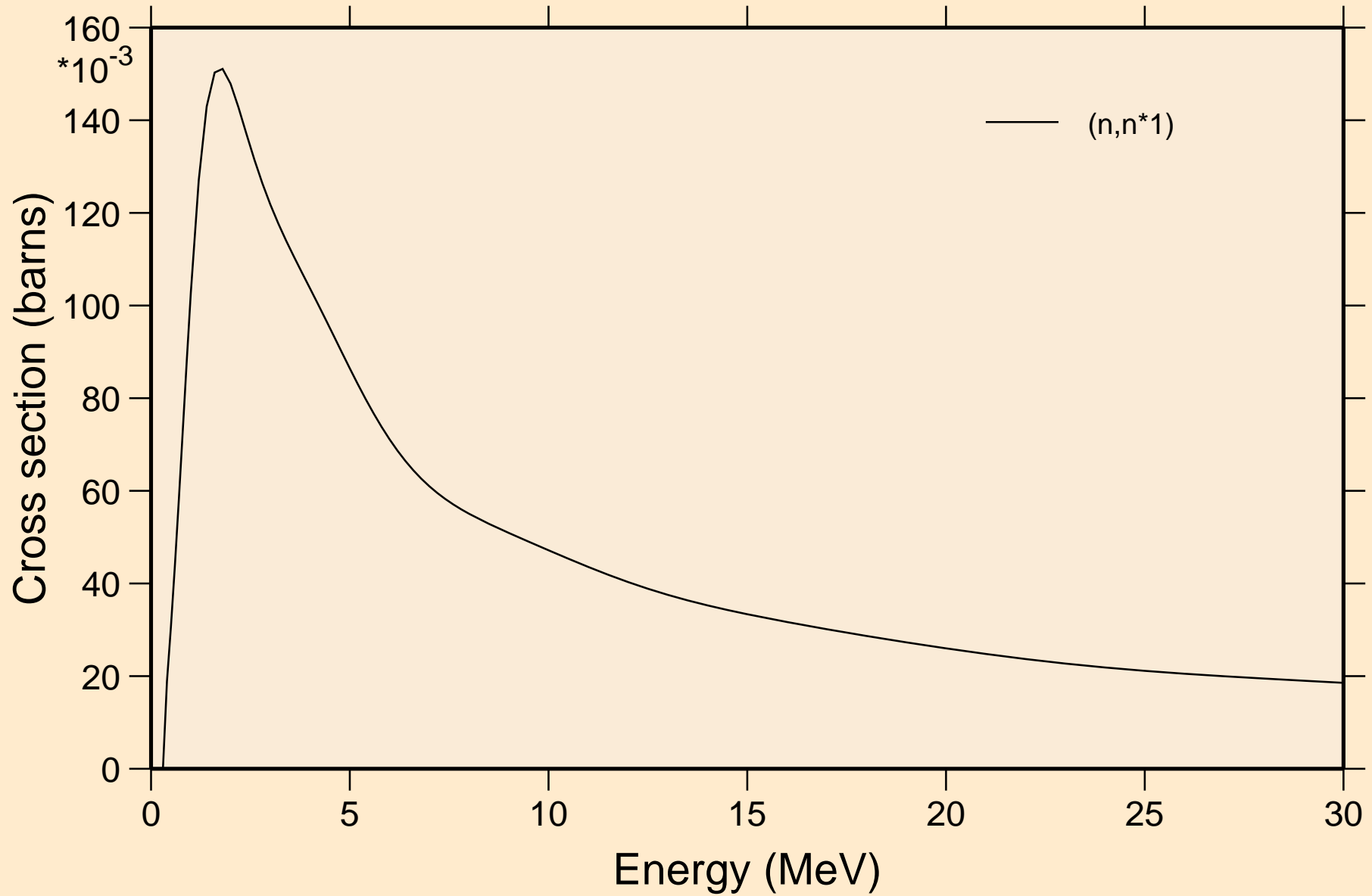

PM127 NRG TENDL-2015, AKONING

Threshold reactions

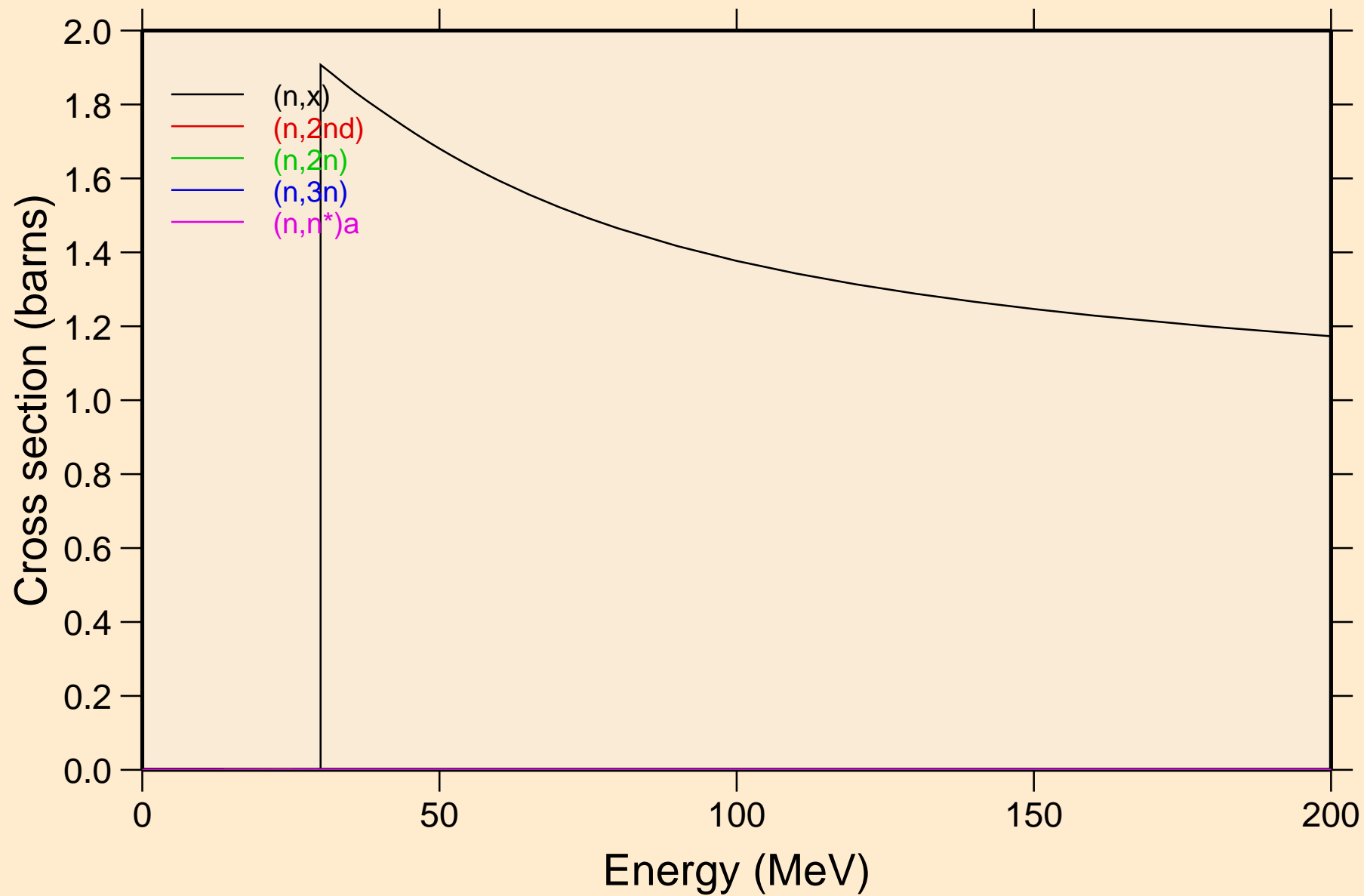

PM127 NRG TENDL-2015, AKONING

Threshold reactions

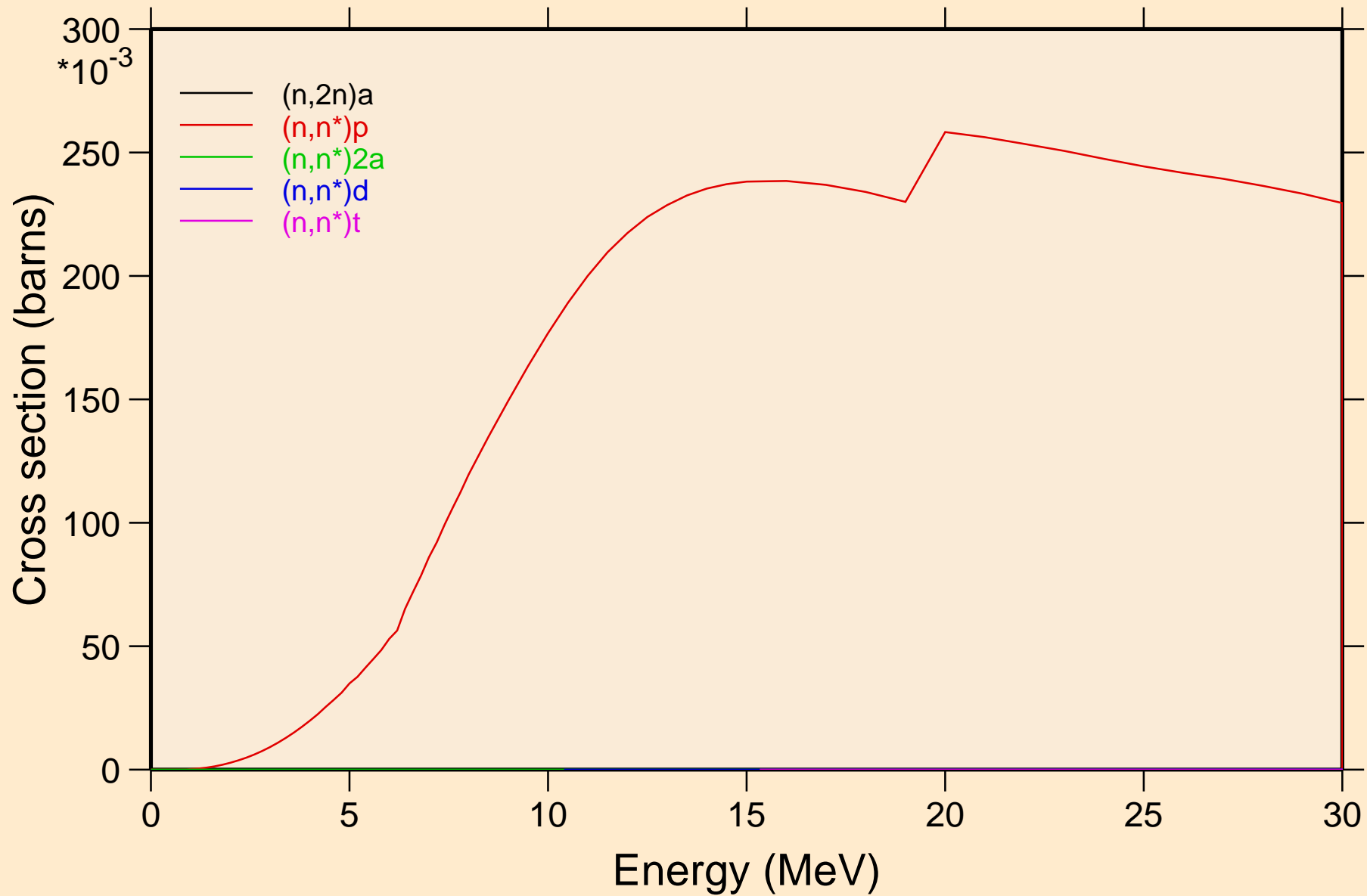

PM127 NRG TENDL-2015, AKONING

Threshold reactions

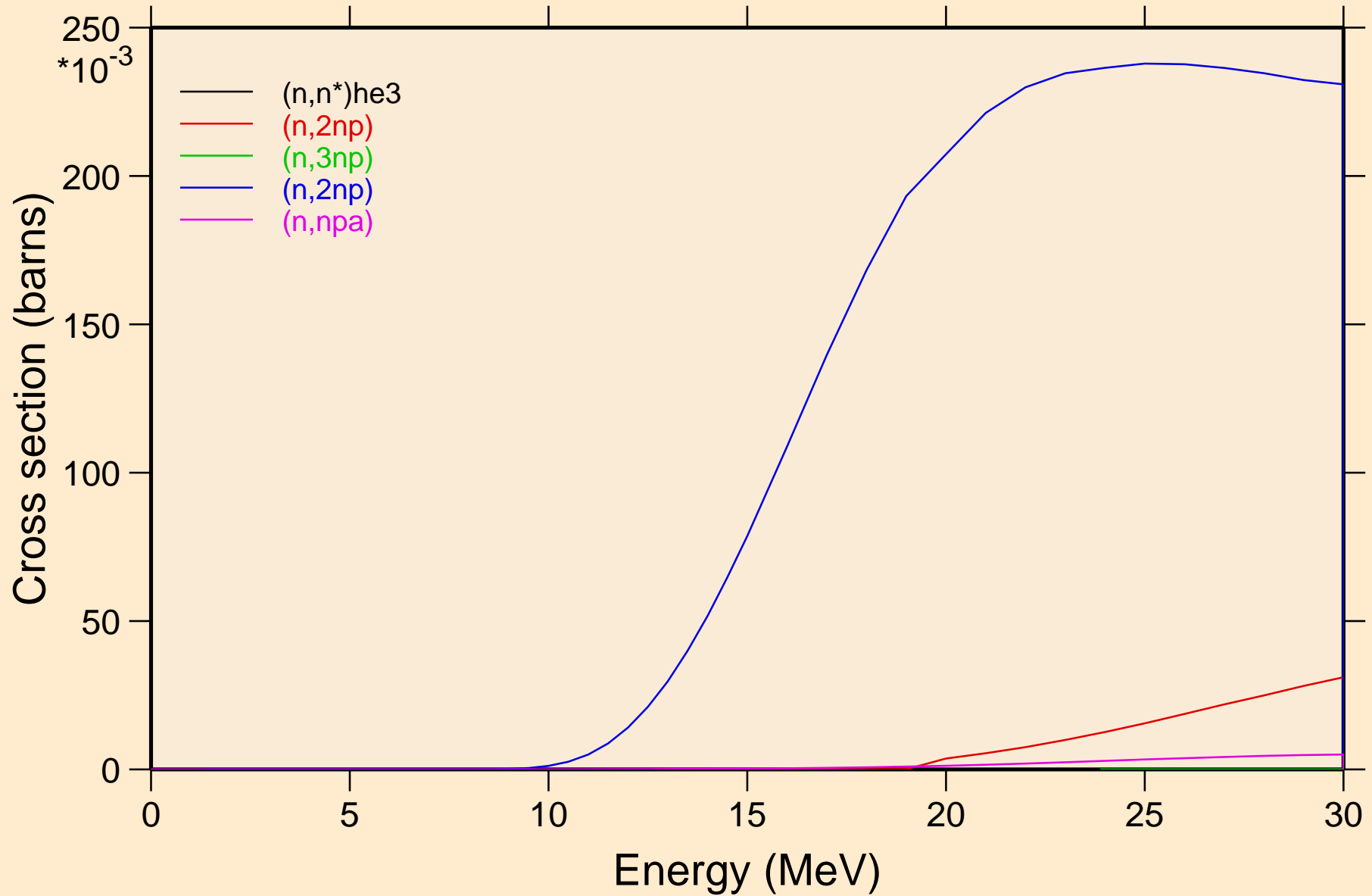

PM127 NRG TENDL-2015, AKONING

Threshold reactions

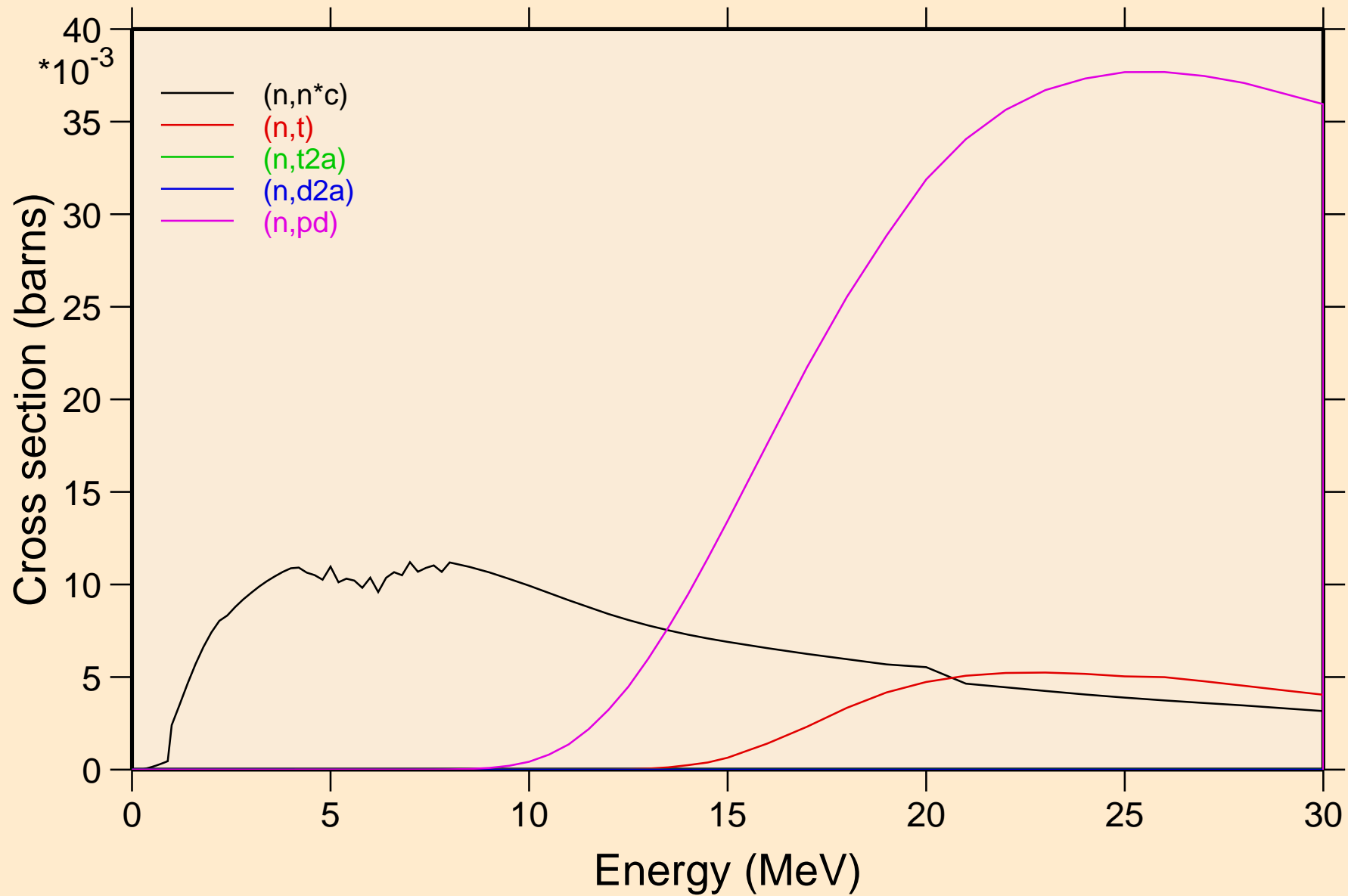

PM127 NRG TENDL-2015, AKONING

Threshold reactions

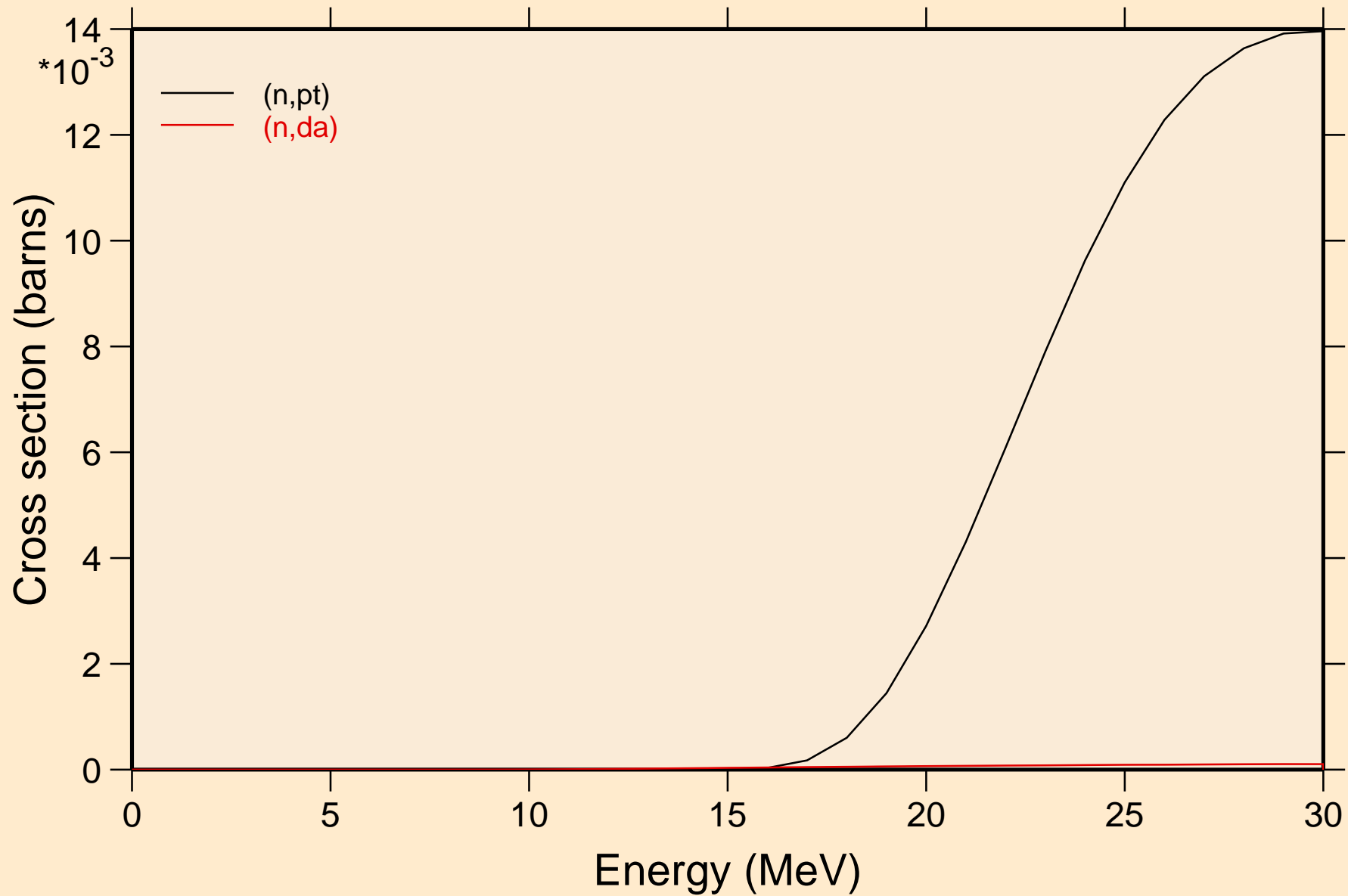

PM127 NRG TENDL-2015, AKONING
angular distribution for elastic

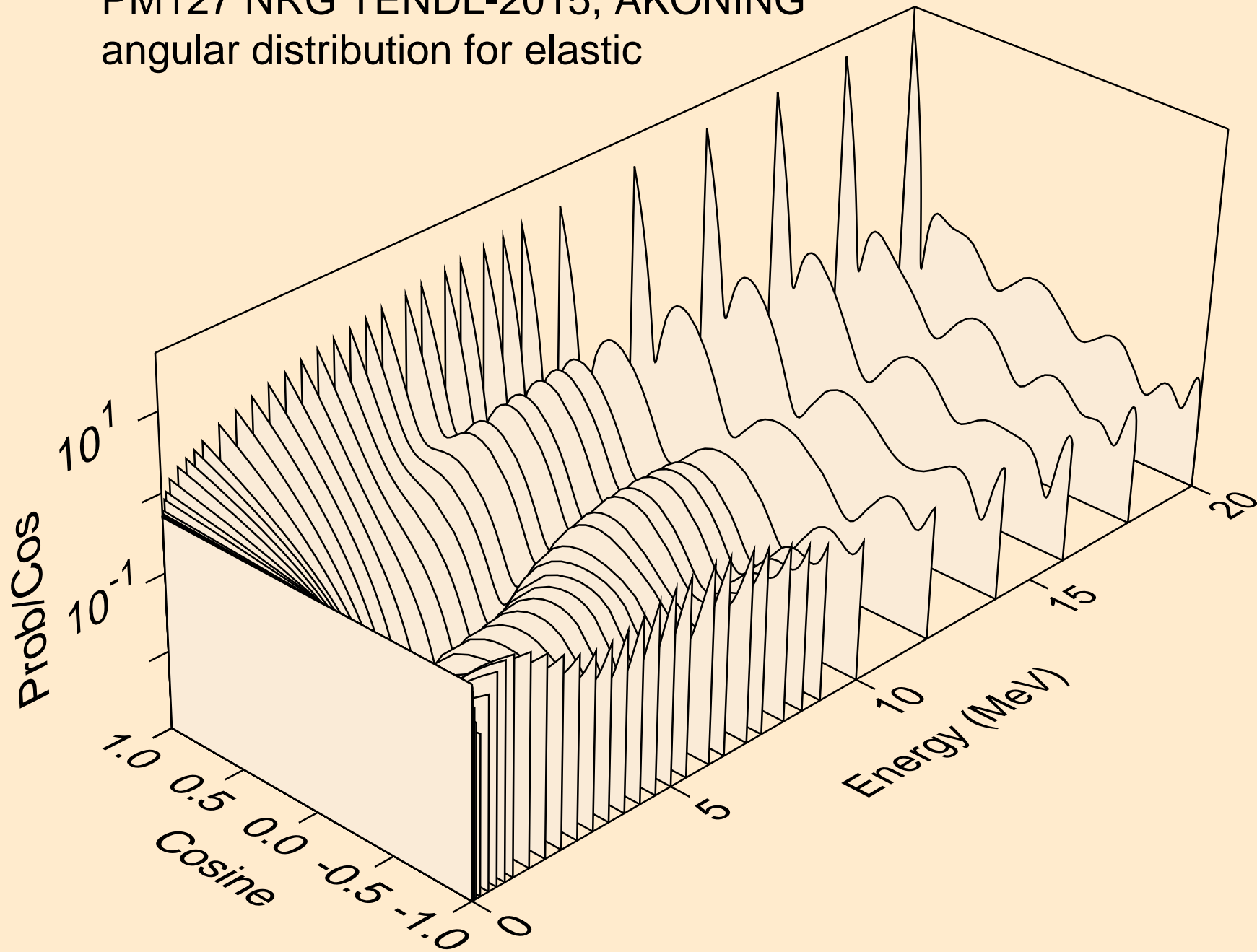

PM127 NRG TENDL-2015, AKONING
angular distribution for elastic

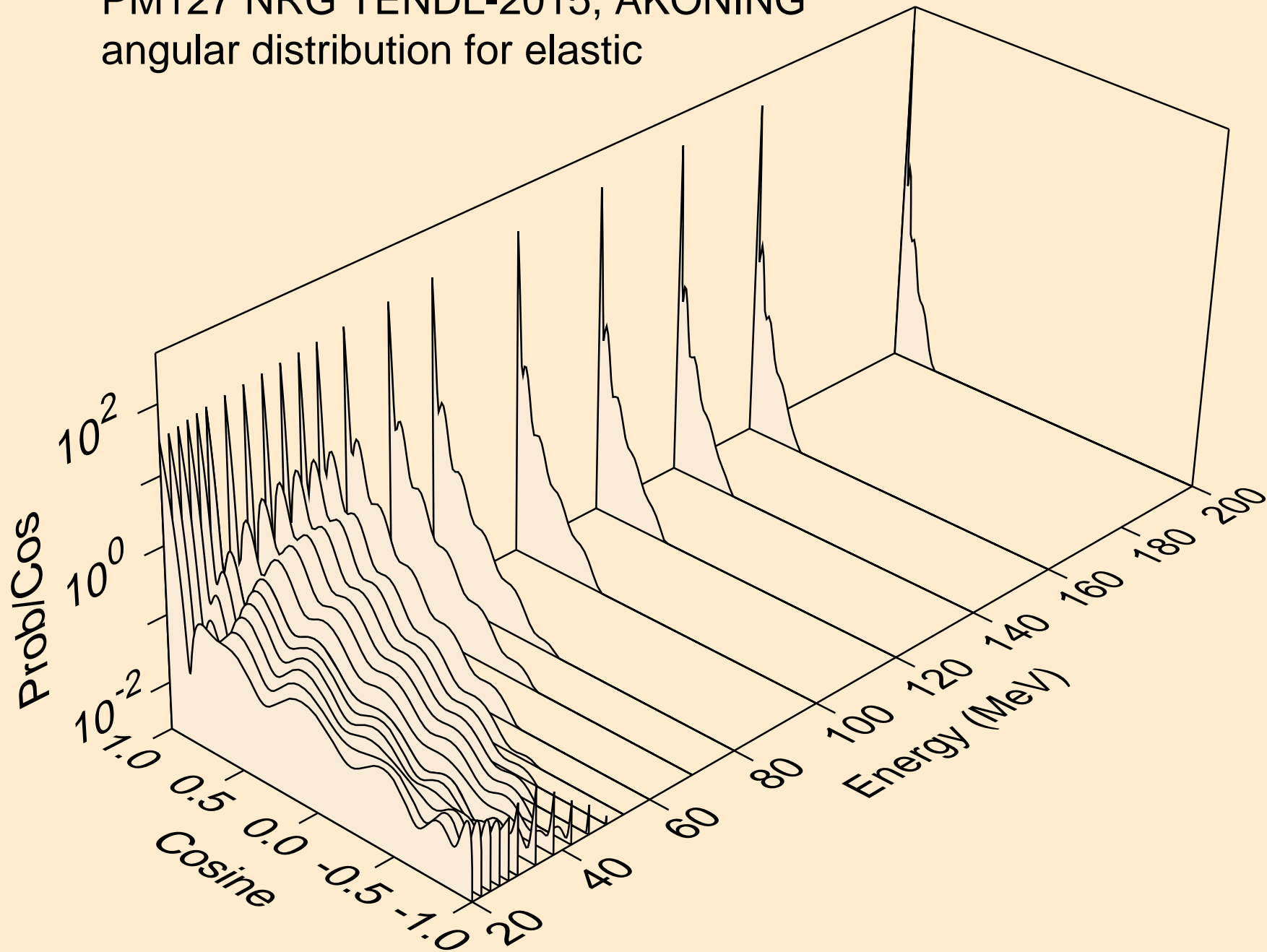

PM127 NRG TENDL-2015, AKONING
angular distribution for (n,n*1)

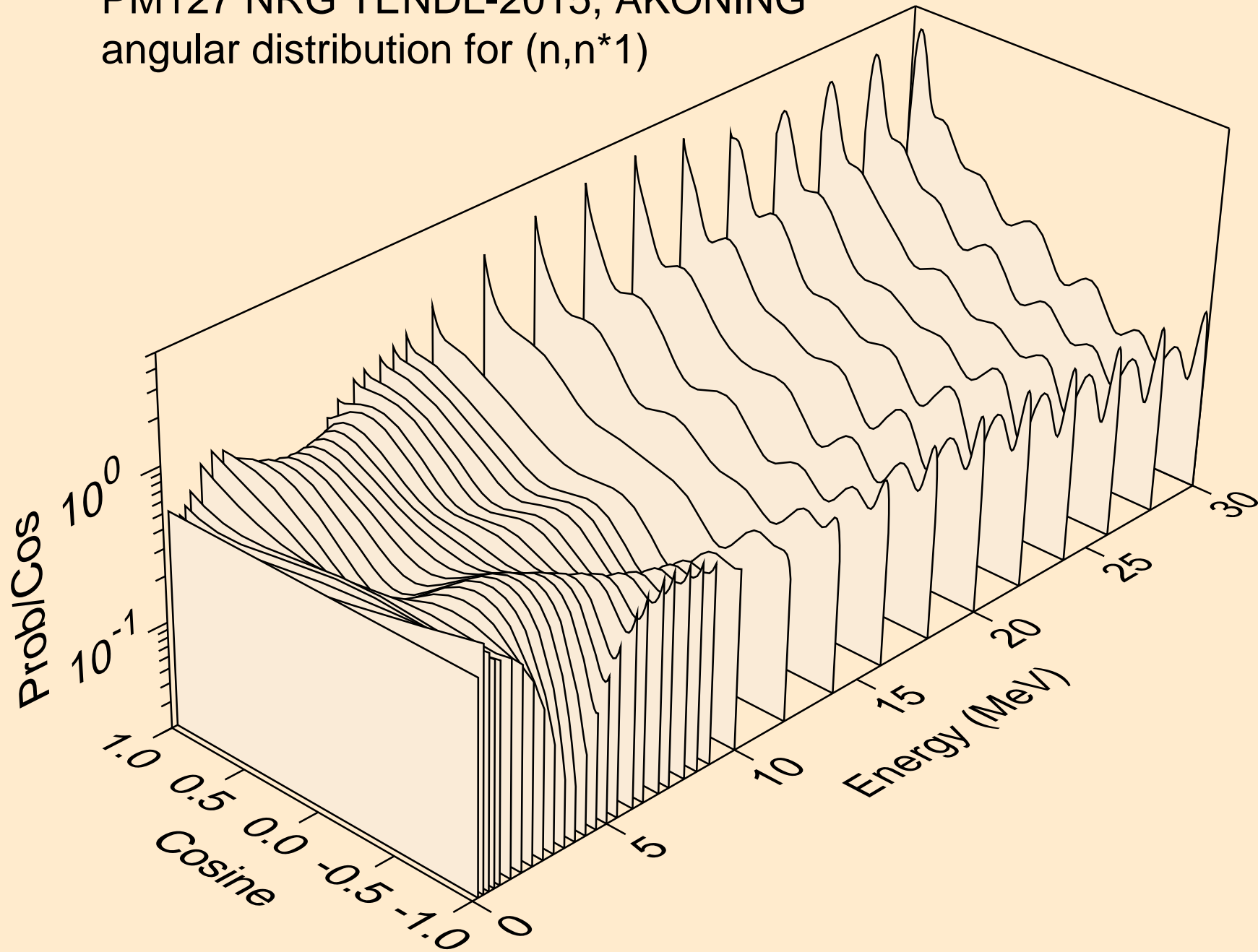

PM127 NRG TENDL-2015, AKONING
Neutron emission for (n,x)

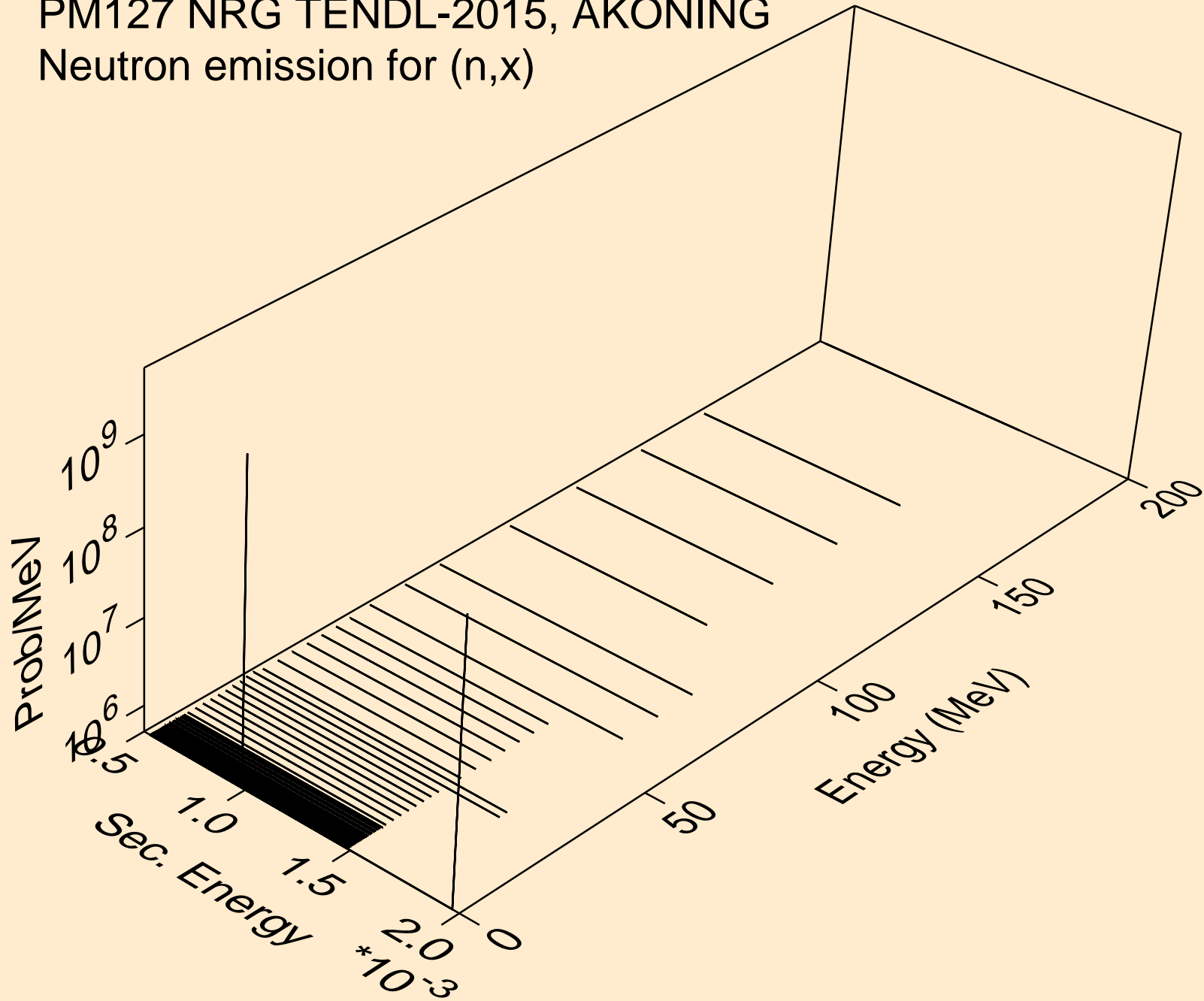

PM127 NRG TENDL-2015, AKONING
Neutron emission for (n,2nd)

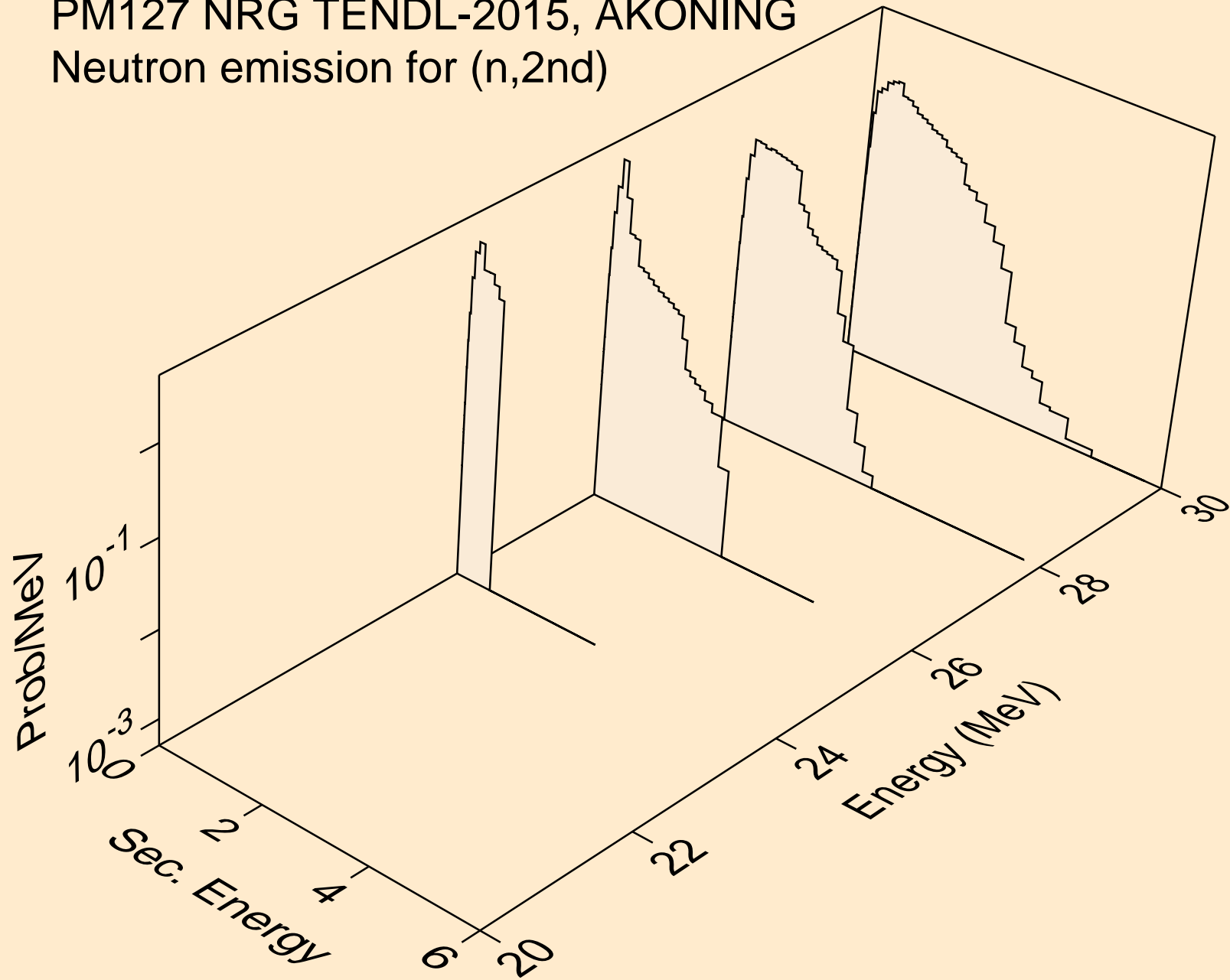

PM127 NRG TENDL-2015, AKONING
Neutron emission for (n,2n)

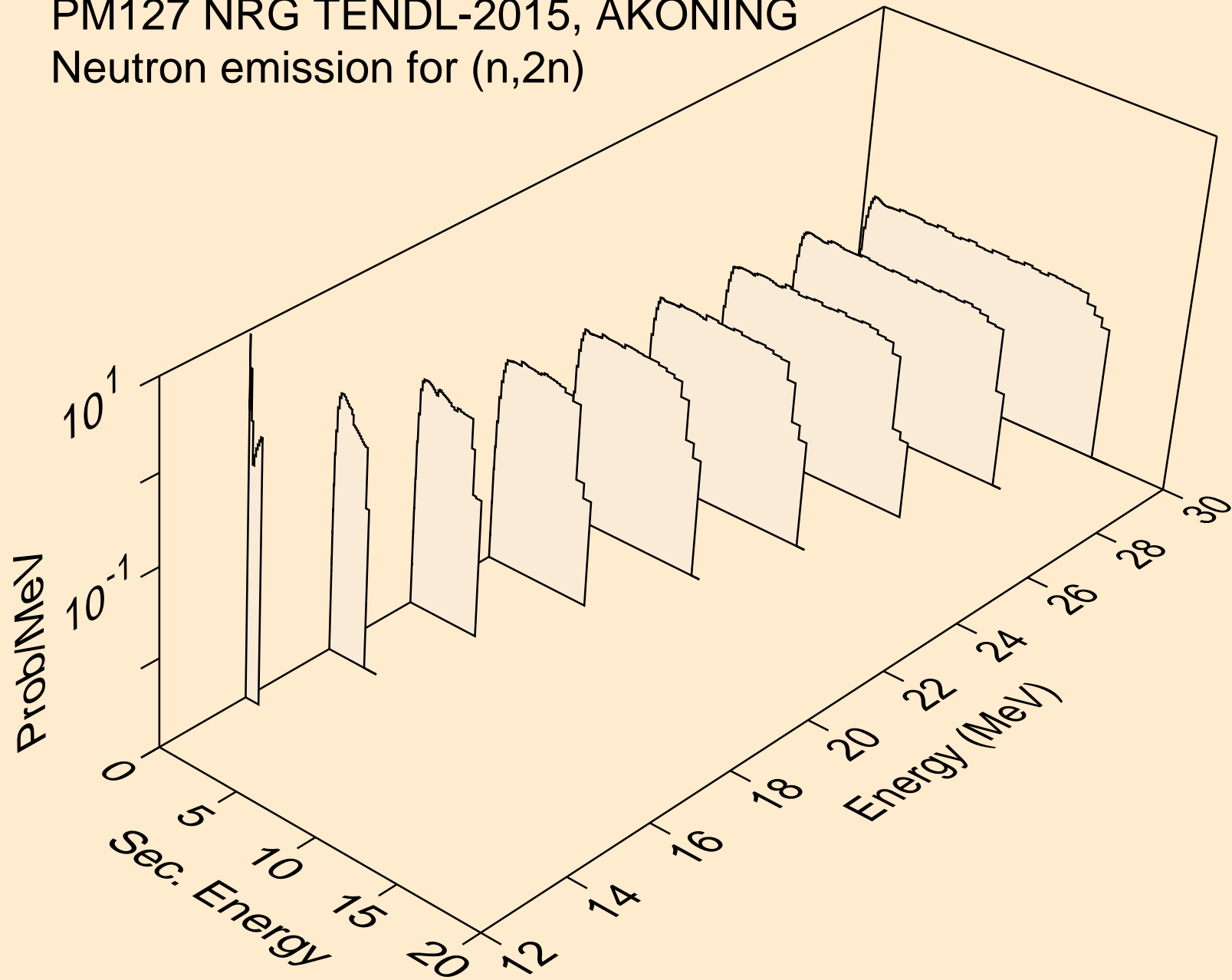

PM127 NRG TENDL-2015, AKONING
Neutron emission for (n,3n)

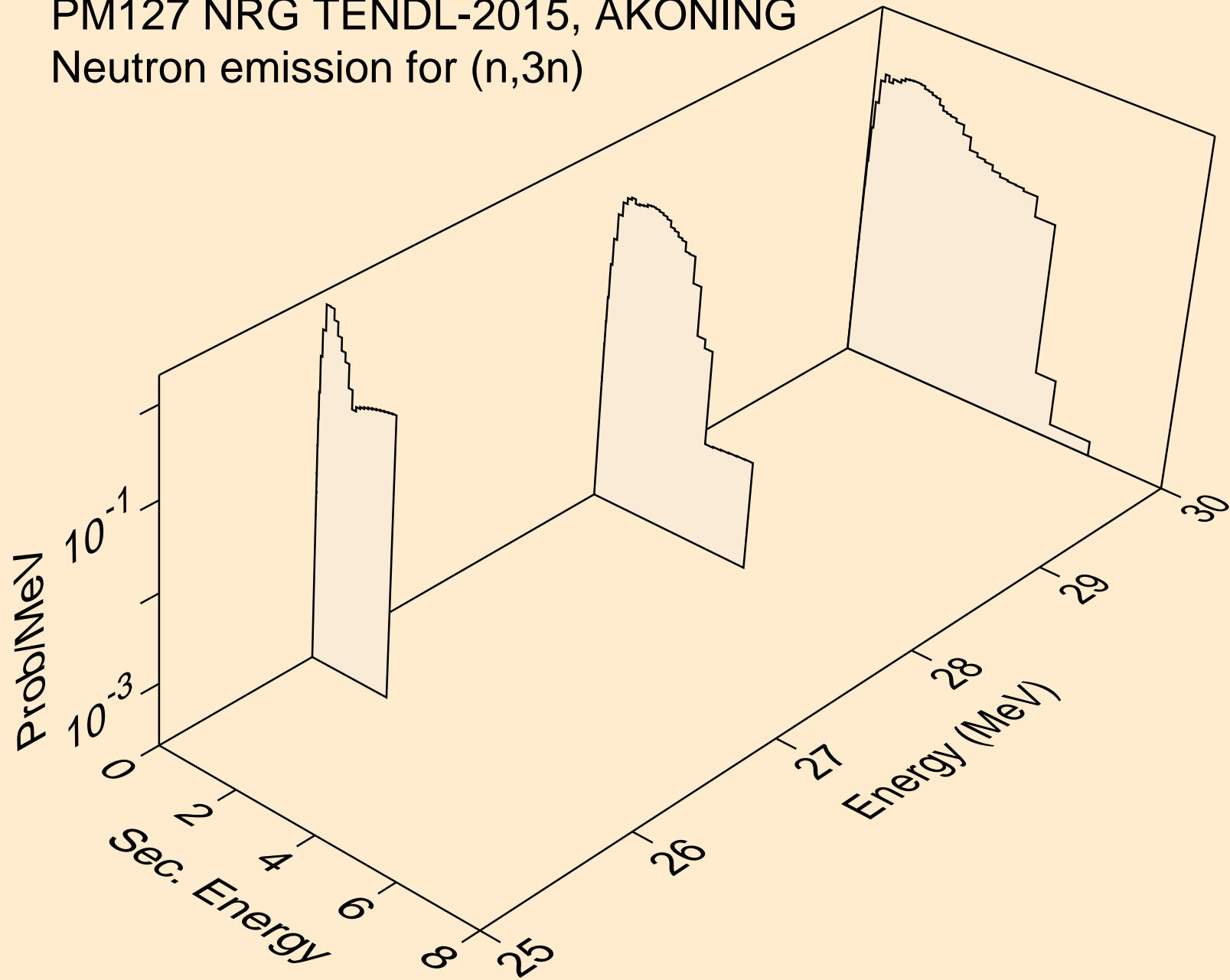

PM127 NRG TENDL-2015, AKONING
Neutron emission for (n,n*)a

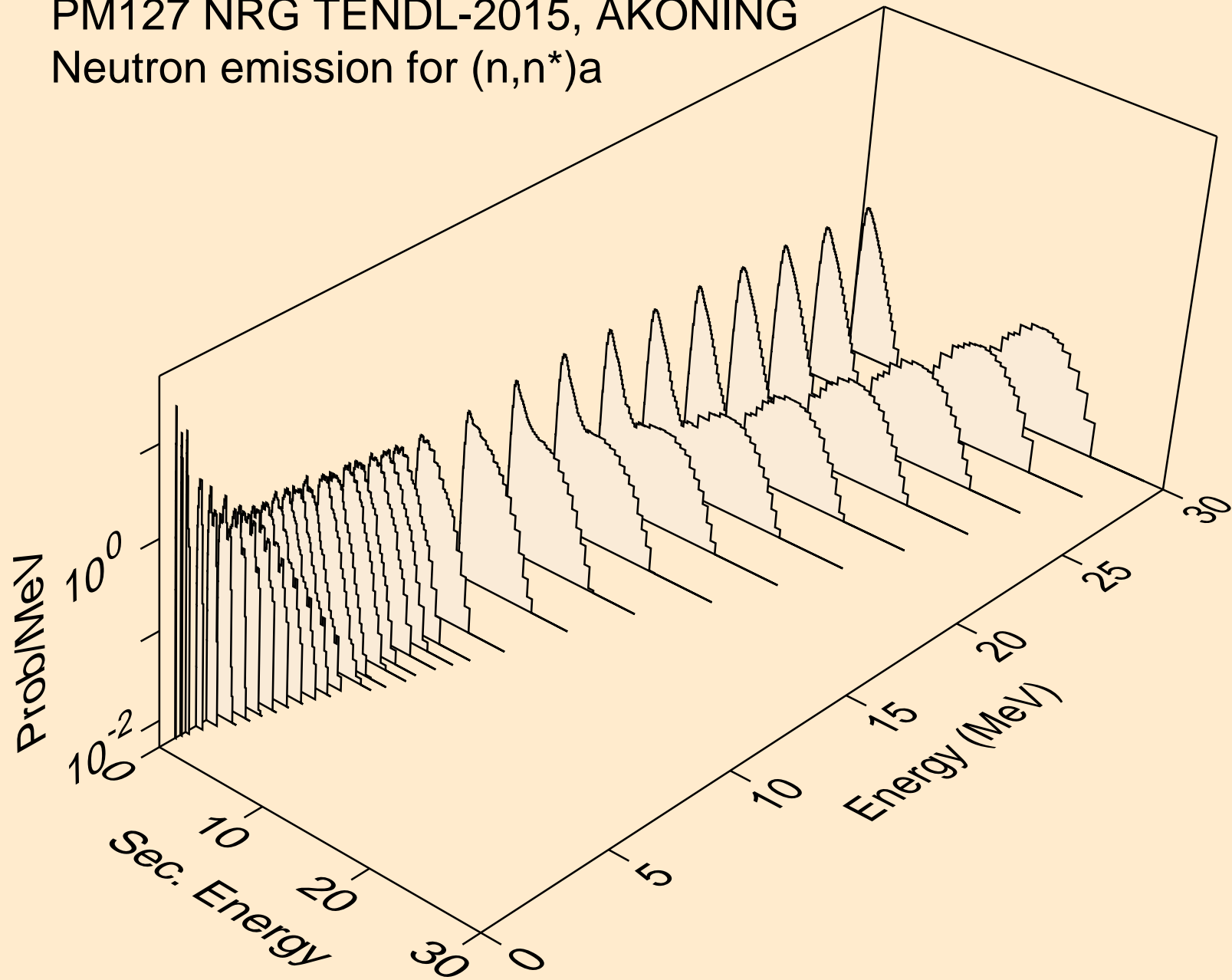

PM127 NRG TENDL-2015, AKONING
Neutron emission for (n,2n)a

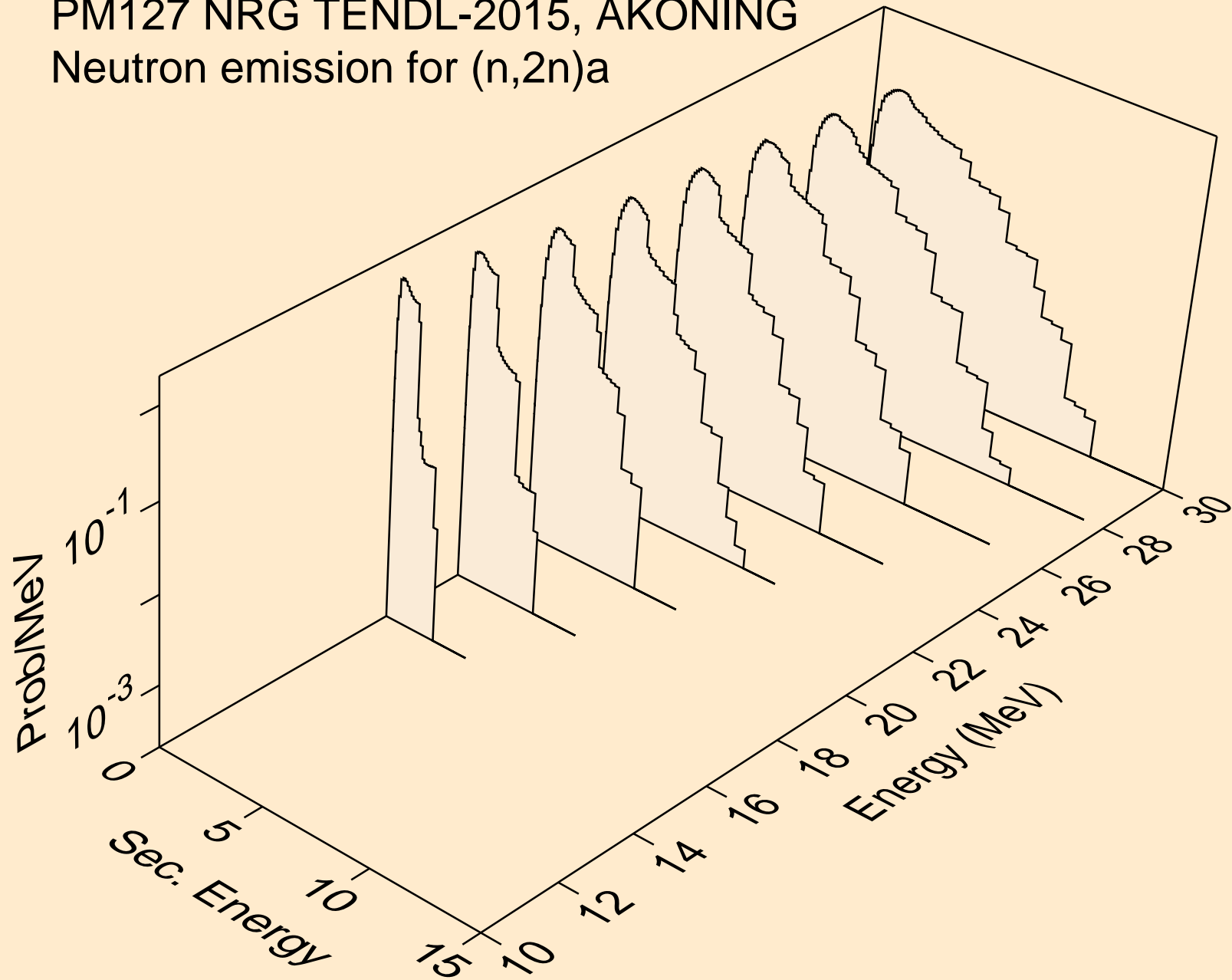

PM127 NRG TENDL-2015, AKONING
Neutron emission for (n,n*)p

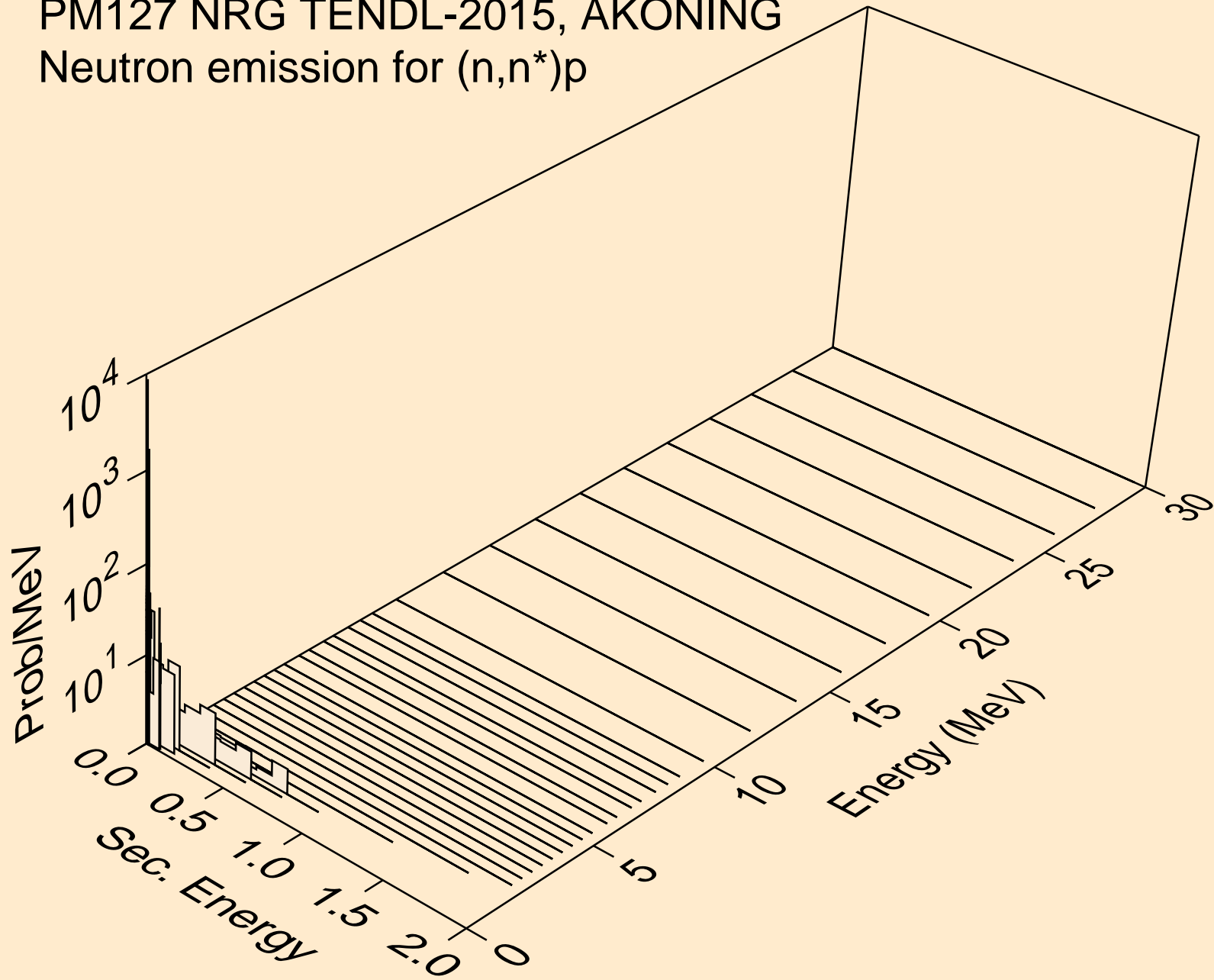

PM127 NRG TENDL-2015, AKONING
Neutron emission for (n,n*)2a

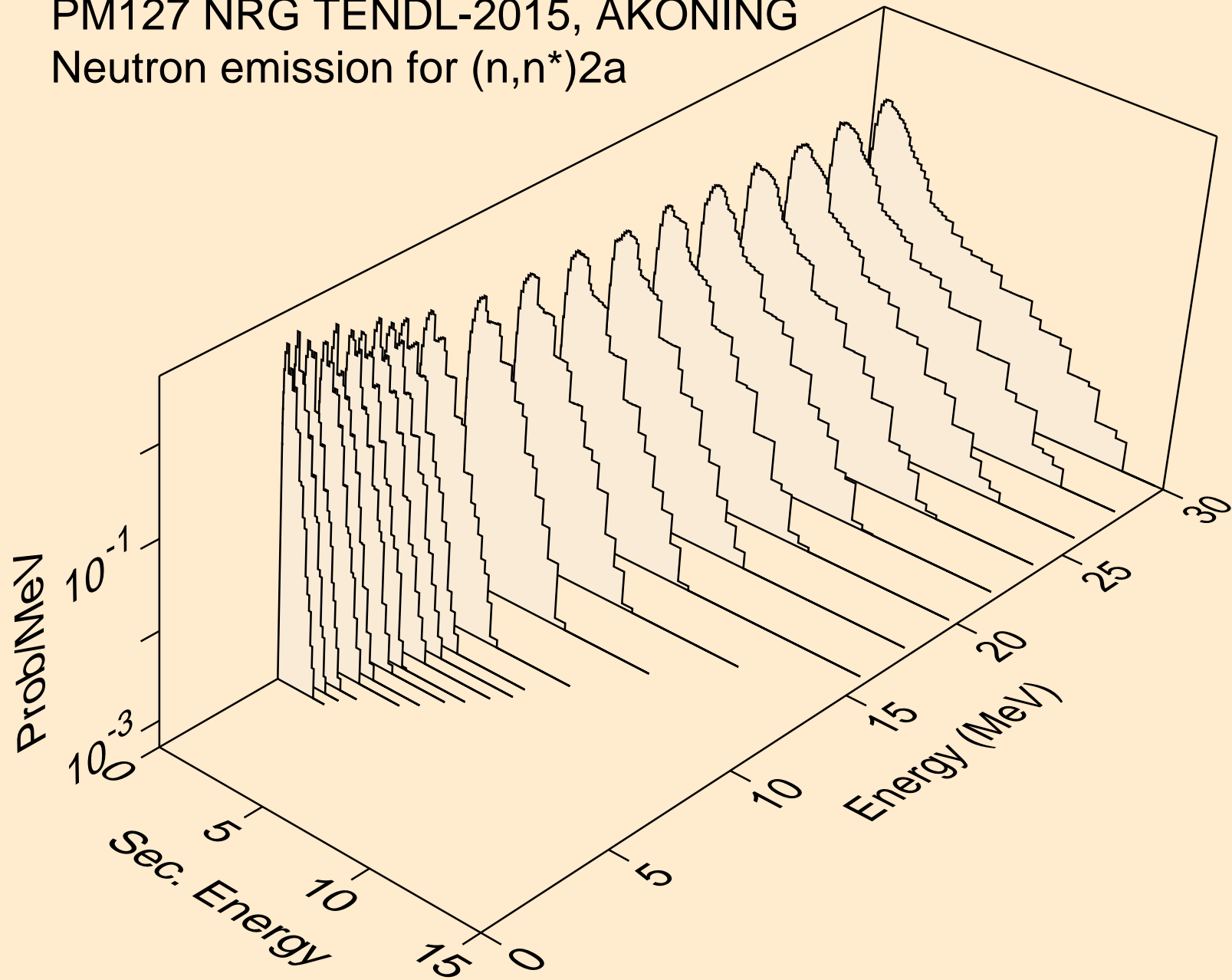

PM127 NRG TENDL-2015, AKONING
Neutron emission for (n,n*)d

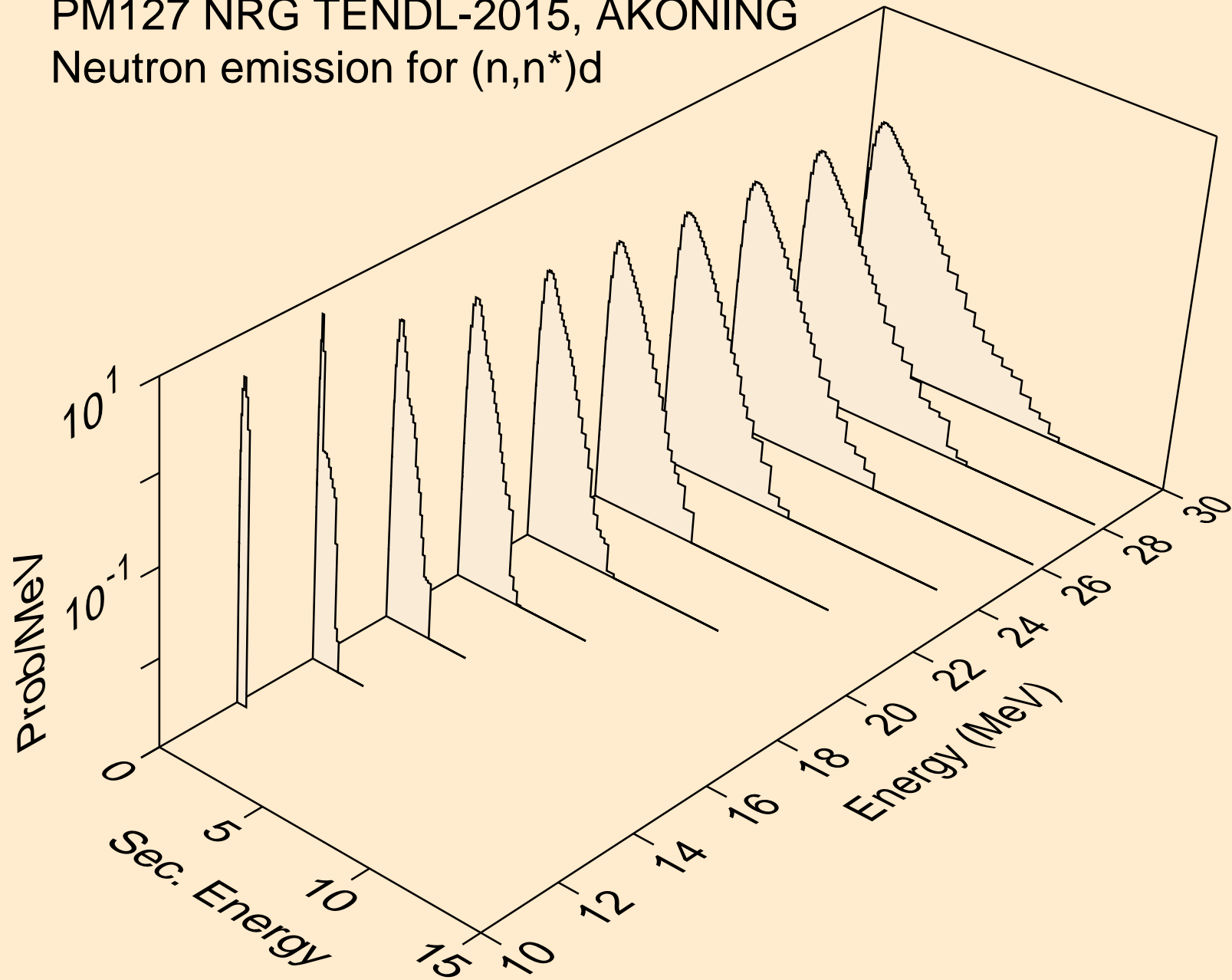

PM127 NRG TENDL-2015, AKONING
Neutron emission for (n,n*)t

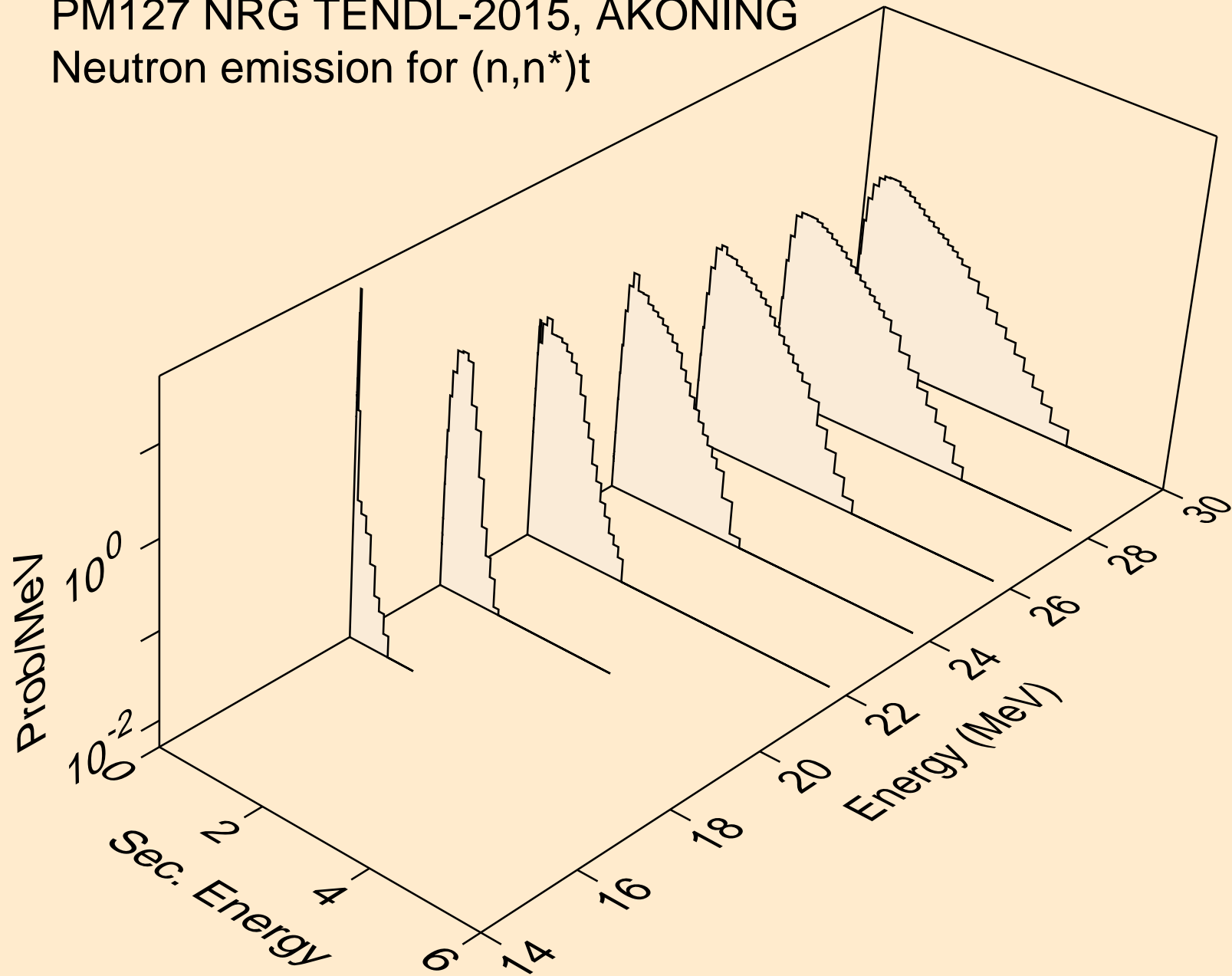

PM127 NRG TENDL-2015, AKONING
Neutron emission for (n,n*)he3

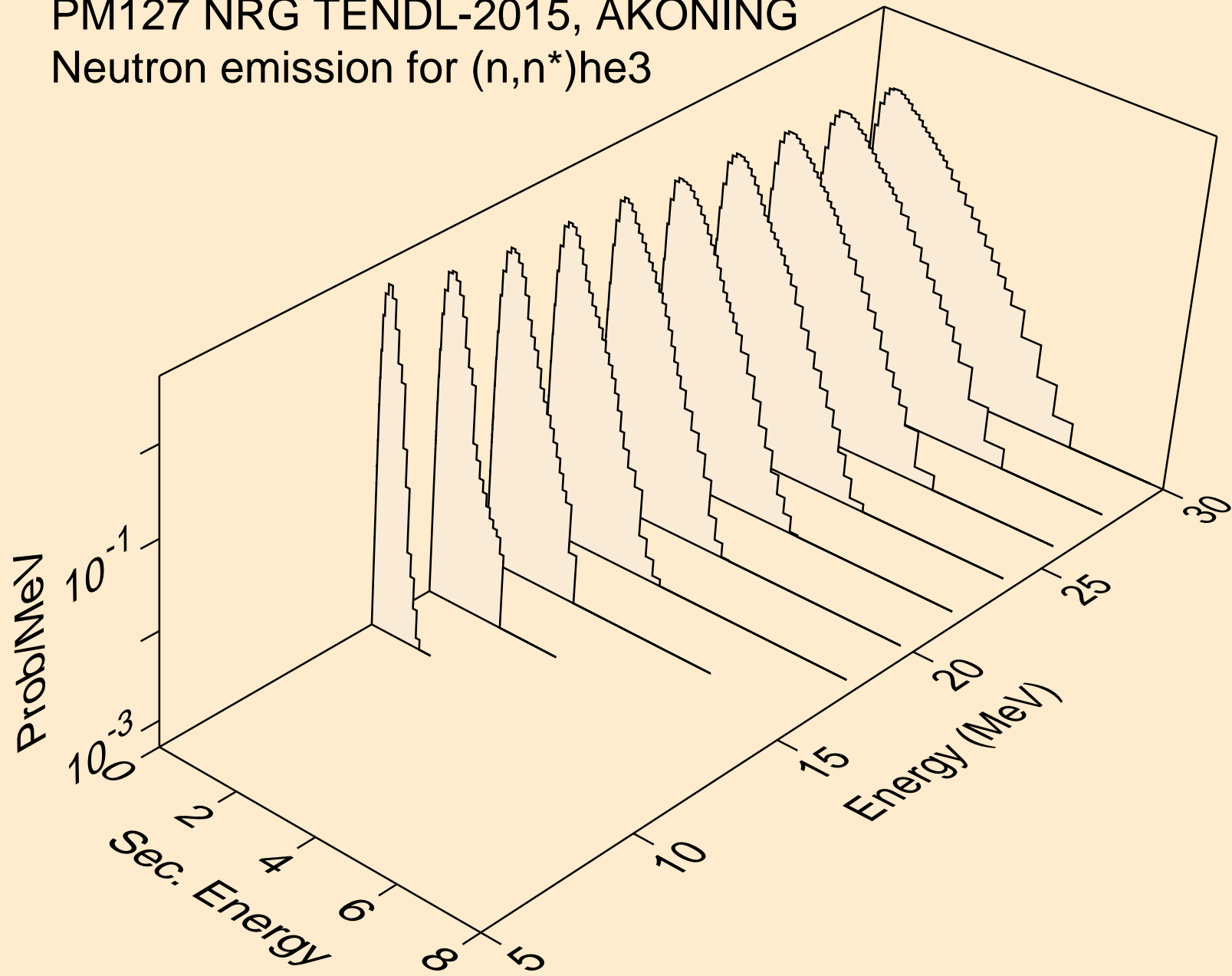

PM127 NRG TENDL-2015, AKONING
Neutron emission for (n,2np)

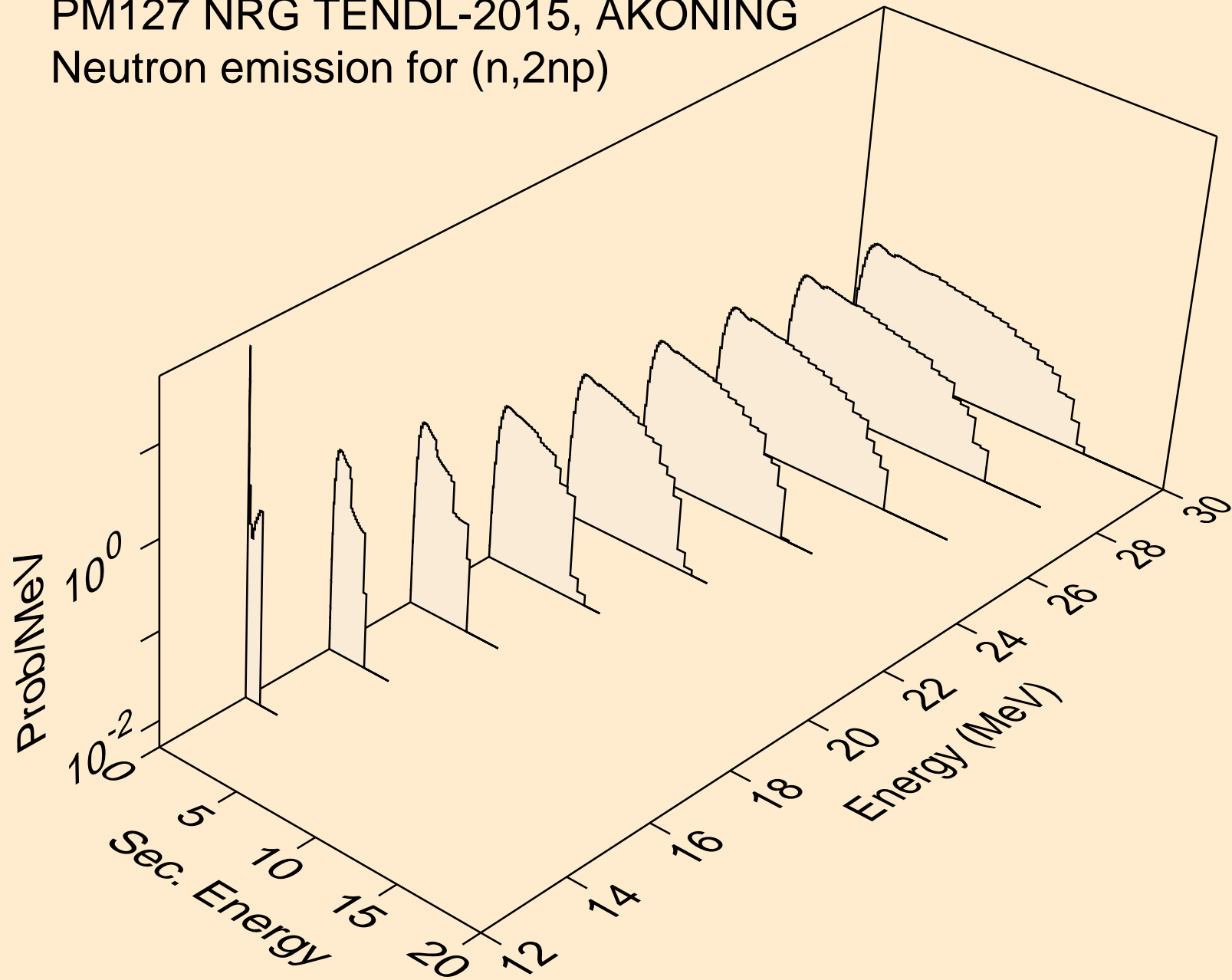

PM127 NRG TENDL-2015, AKONING
Neutron emission for (n,3np)

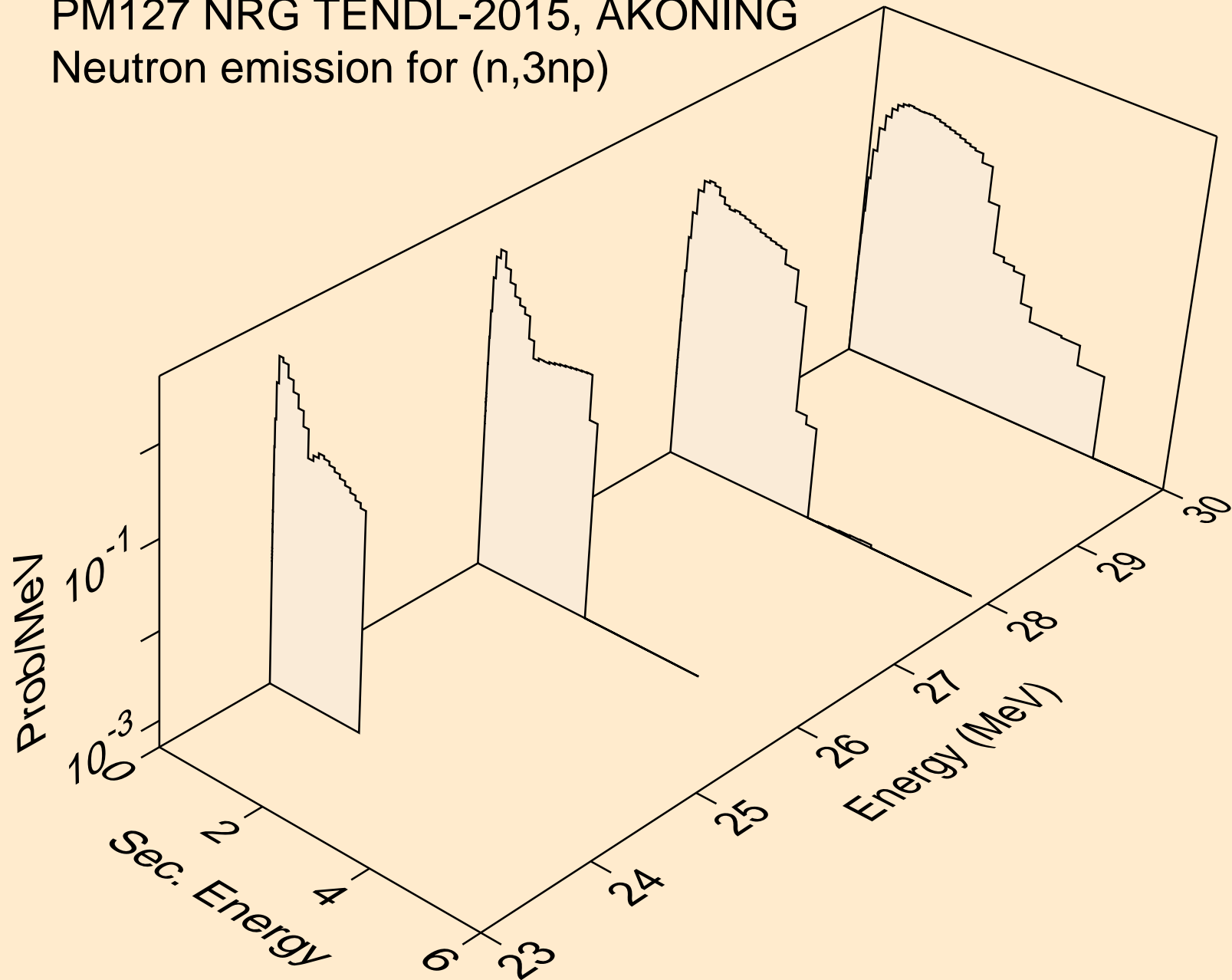

PM127 NRG TENDL-2015, AKONING
Neutron emission for (n,2np)

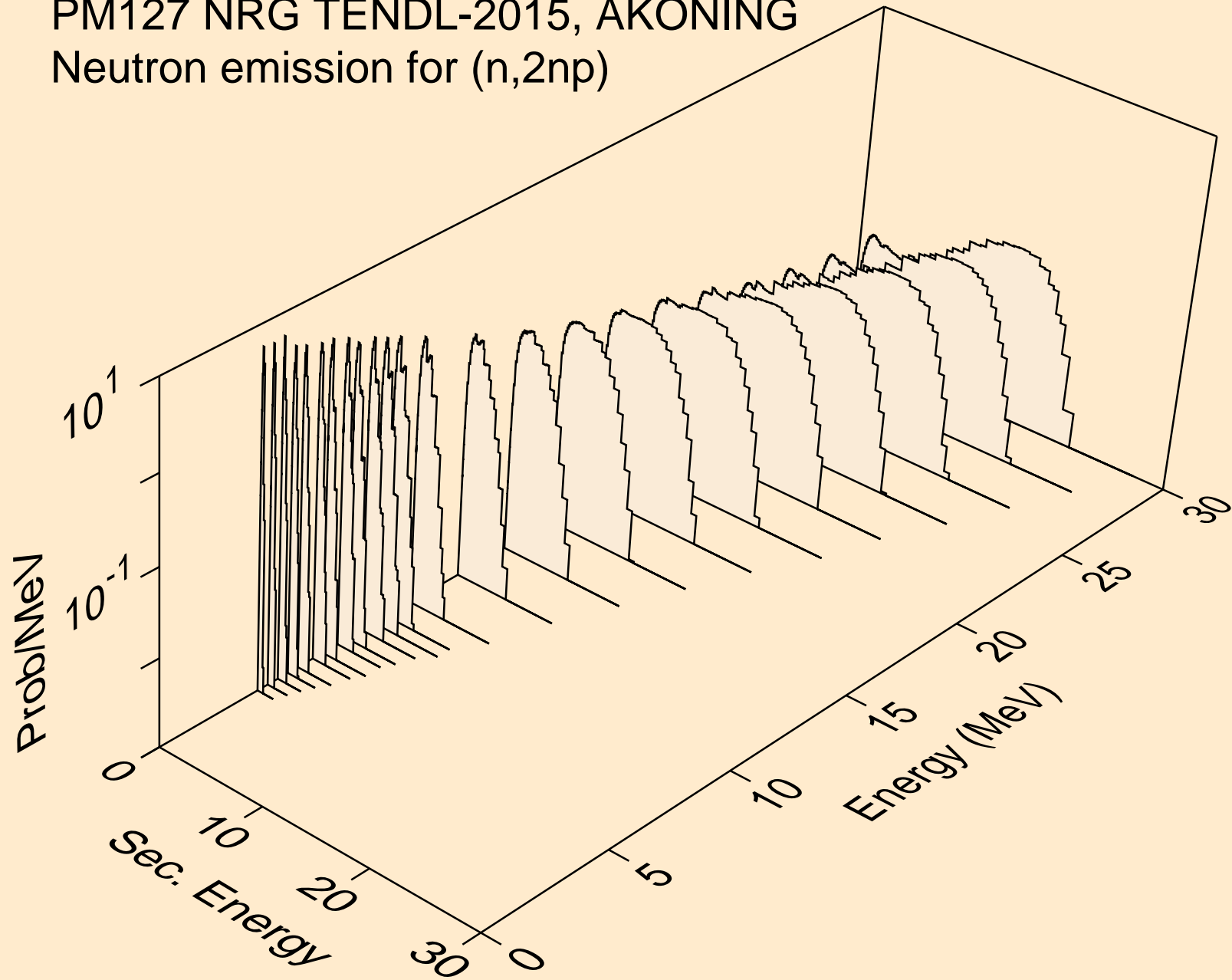

PM127 NRG TENDL-2015, AKONING
Neutron emission for (n,npa)

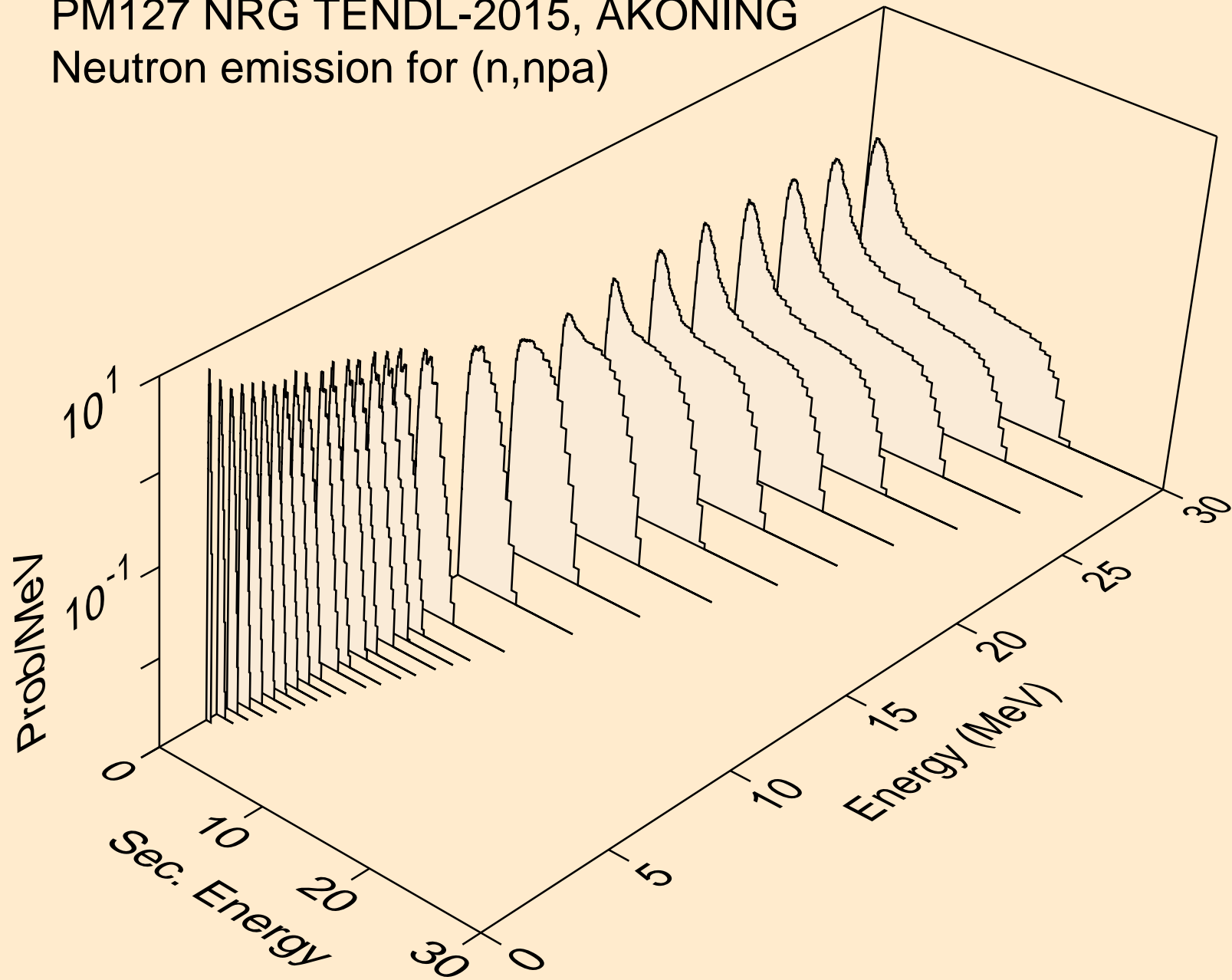

PM127 NRG TENDL-2015, AKONING
Neutron emission for (n,n*c)

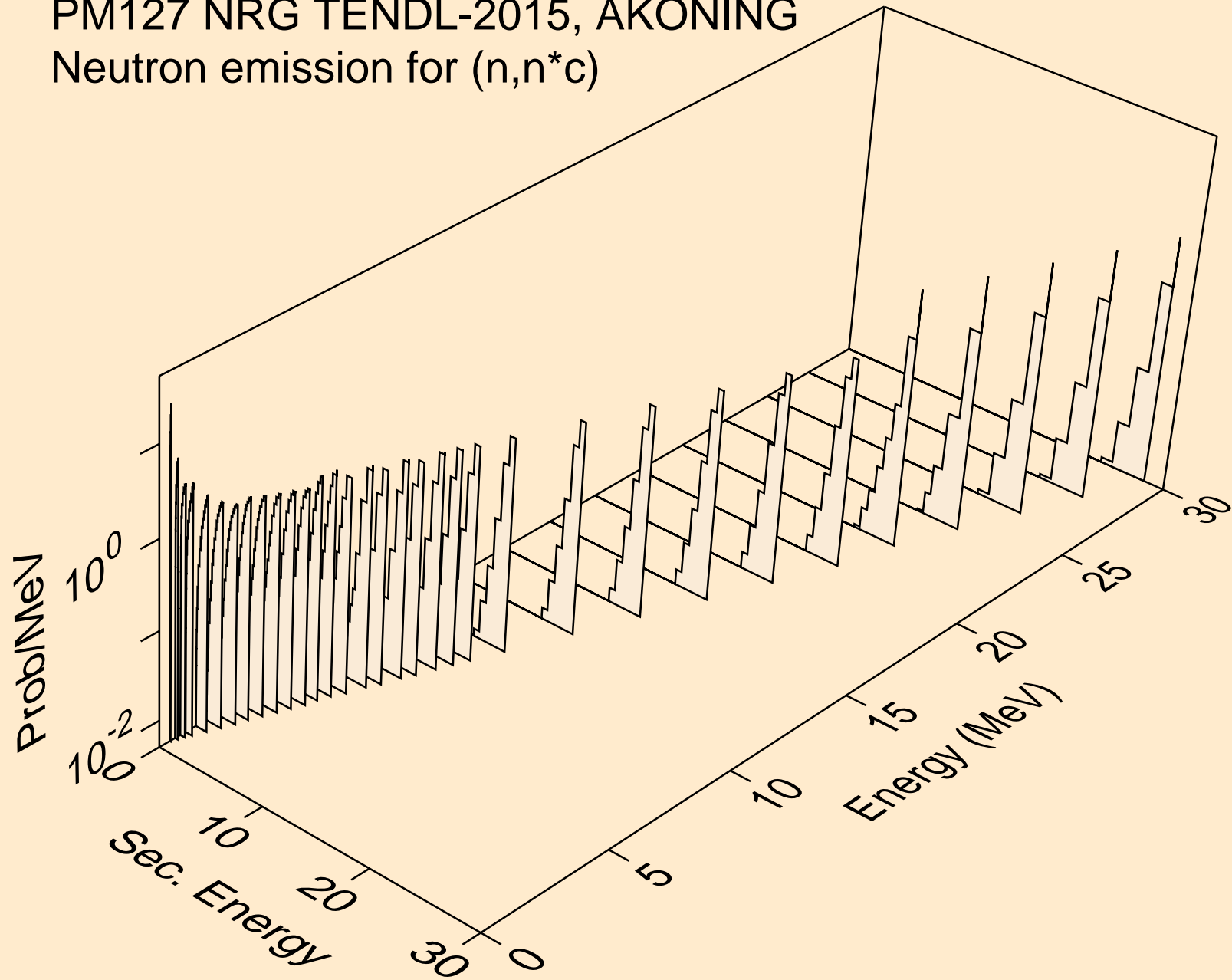

PM127 NRG TENDL-2015, AKONING
Photon emission for (n,x)

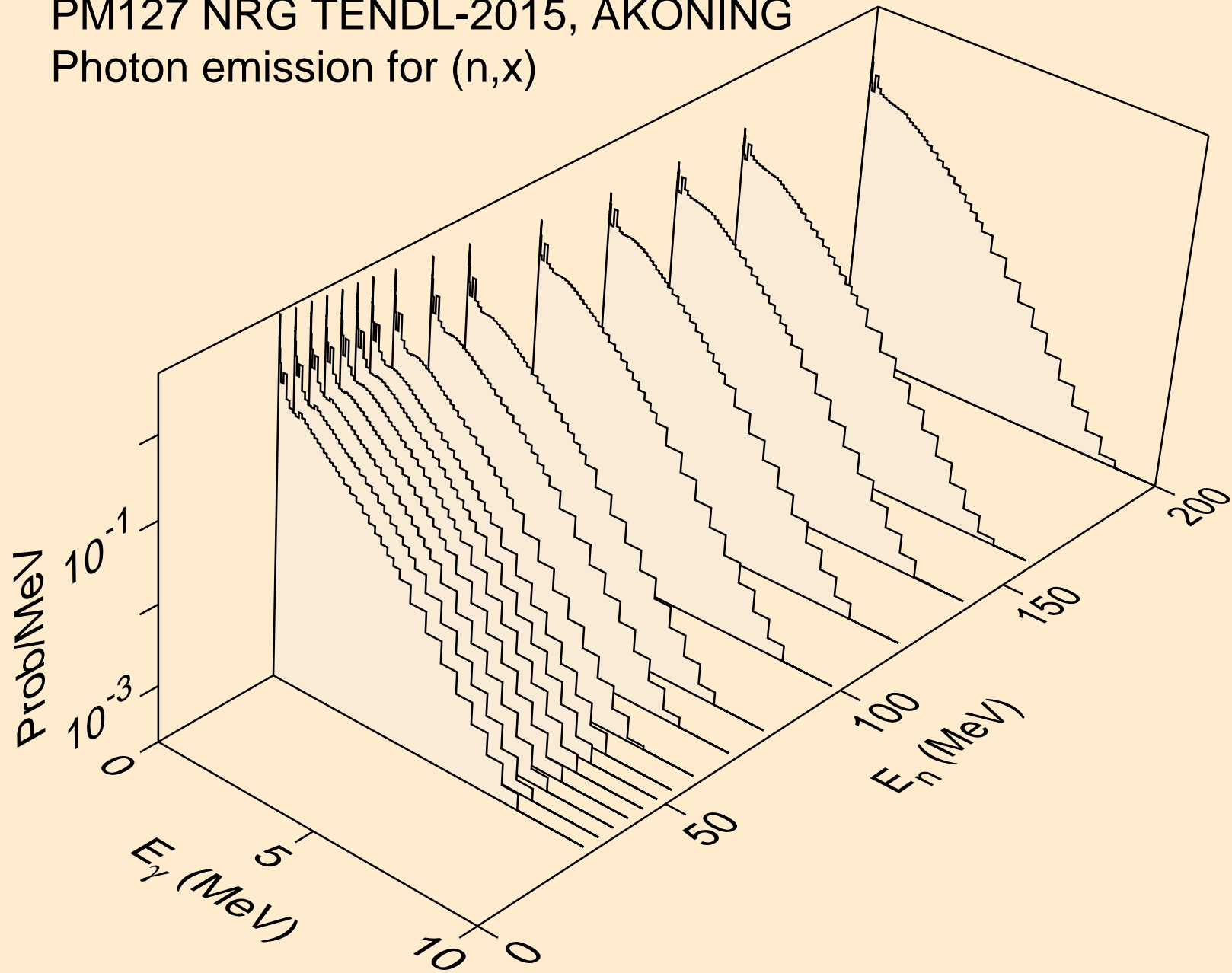

PM127 NRG TENDL-2015, AKONING
Photon emission for (n,2nd)

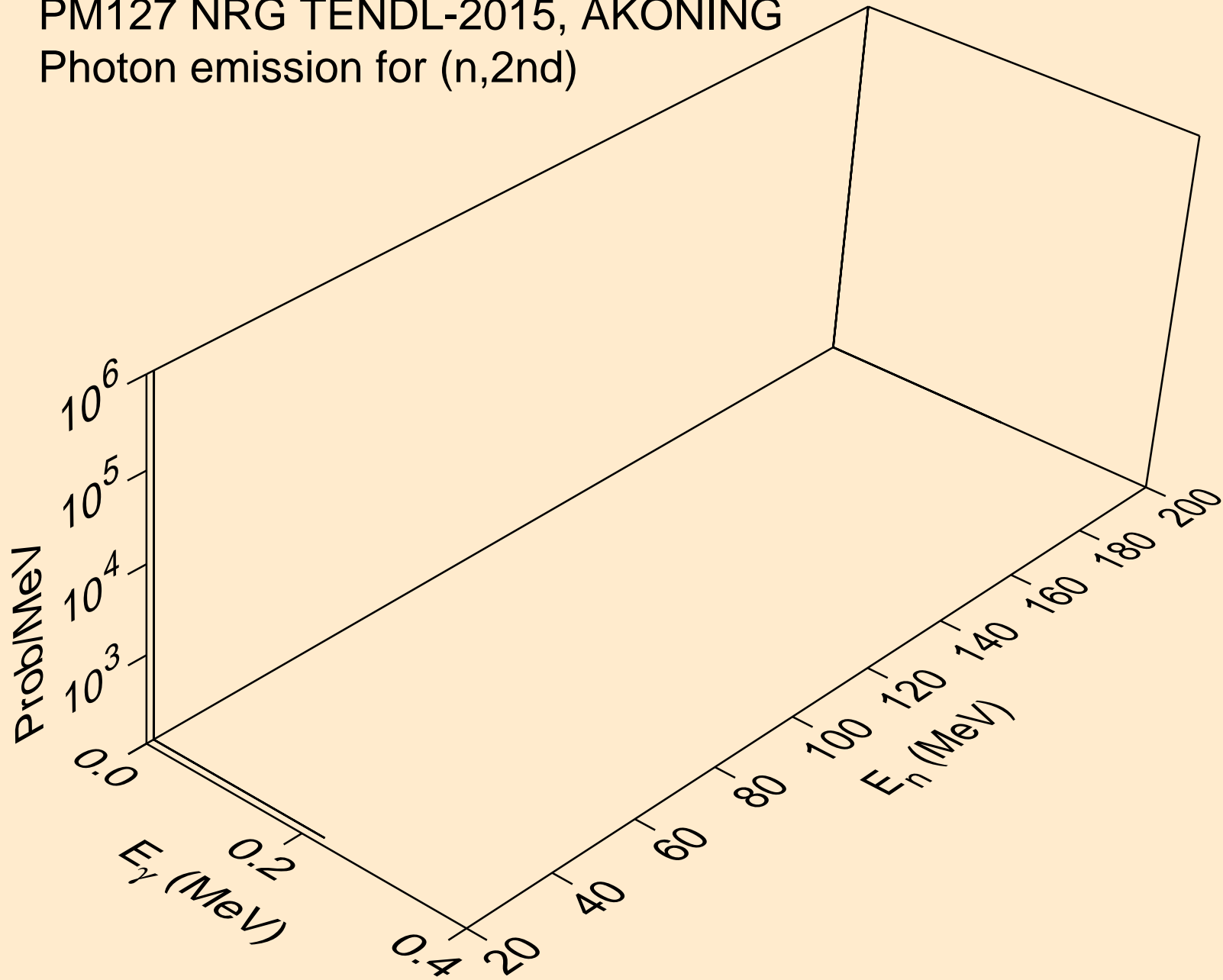

PM127 NRG TENDL-2015, AKONING
Photon emission for (n,2n)

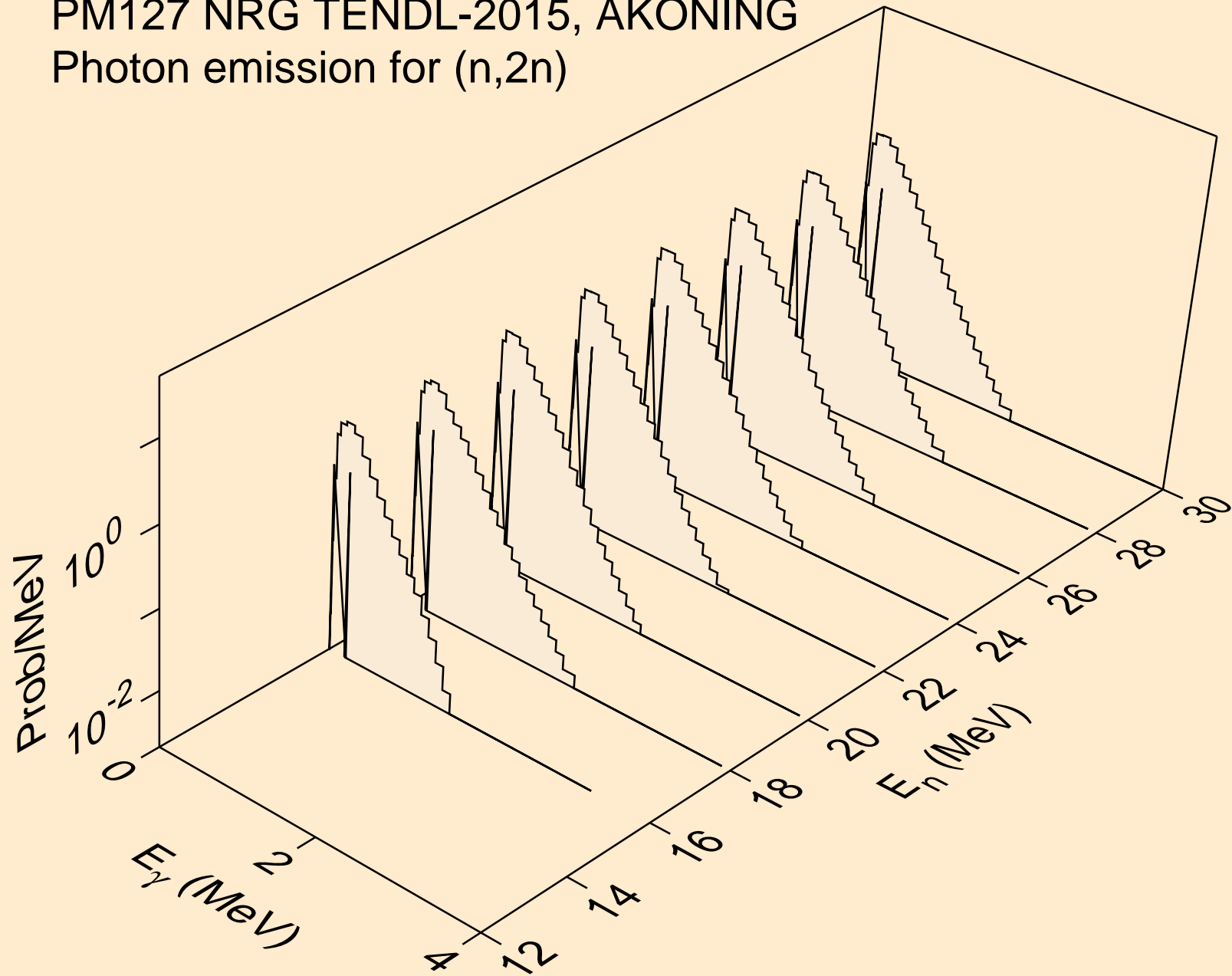

PM127 NRG TENDL-2015, AKONING
Photon emission for (n,3n)

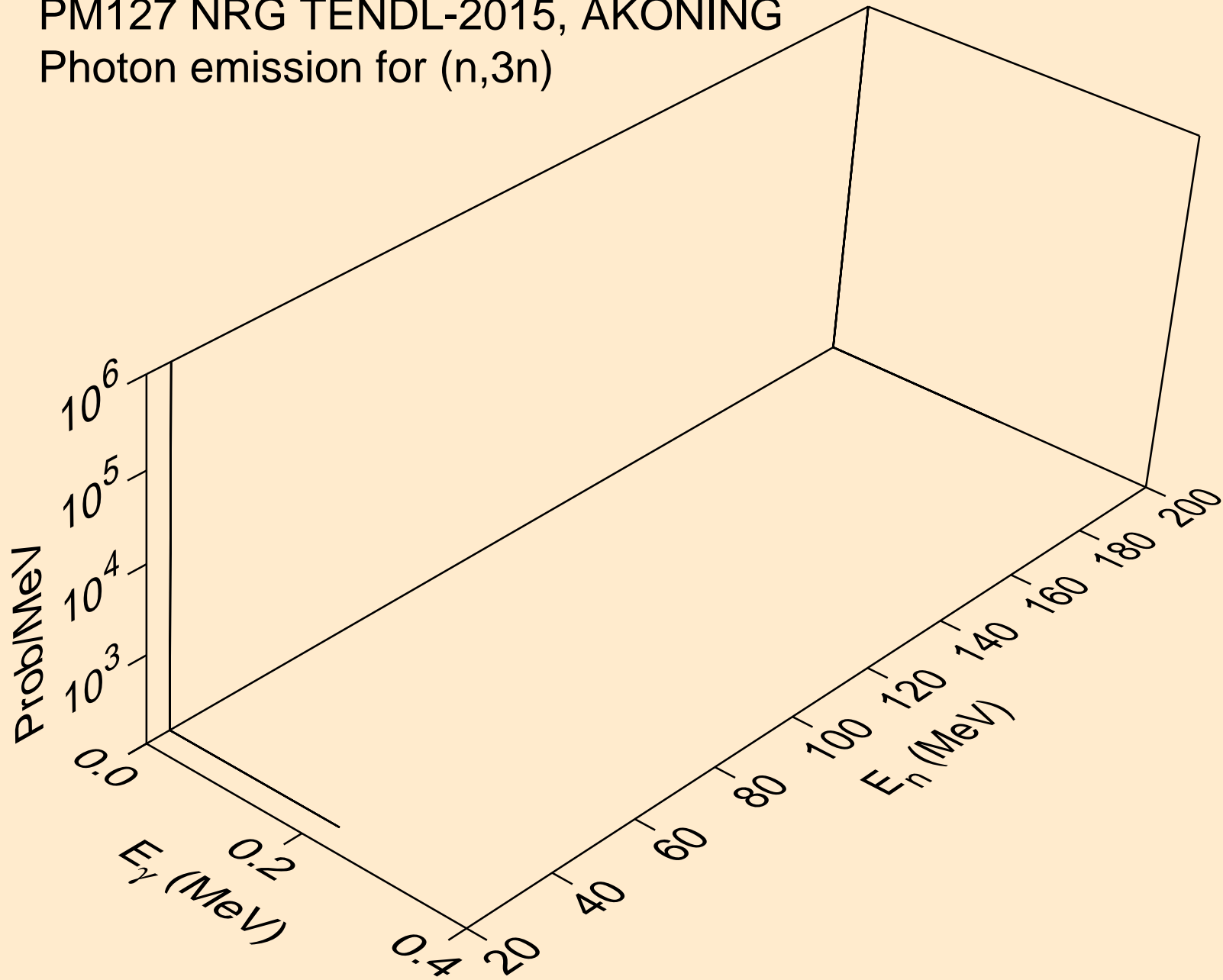

PM127 NRG TENDL-2015, AKONING
Photon emission for (n,n*)a

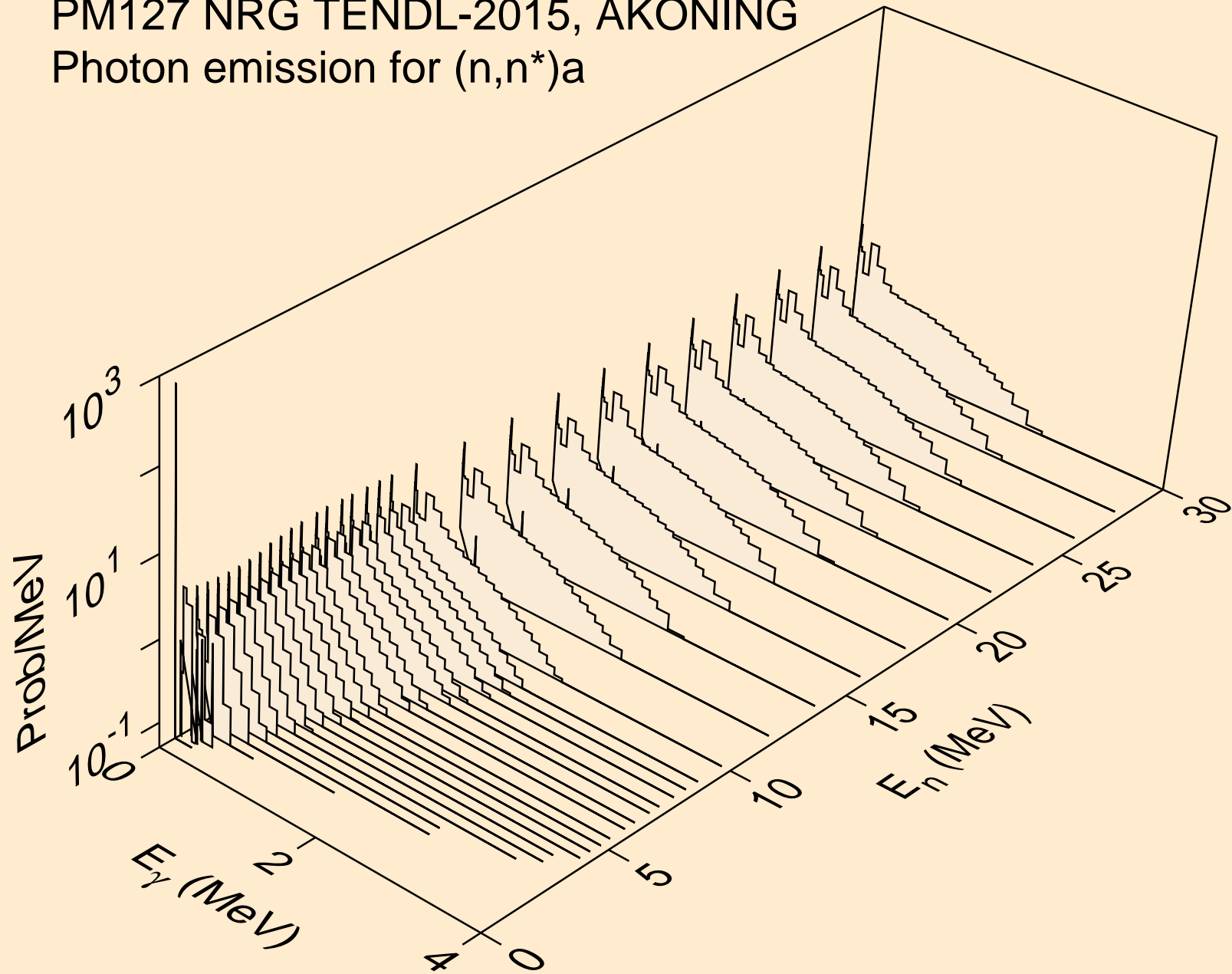

PM127 NRG TENDL-2015, AKONING
Photon emission for (n,2n)a

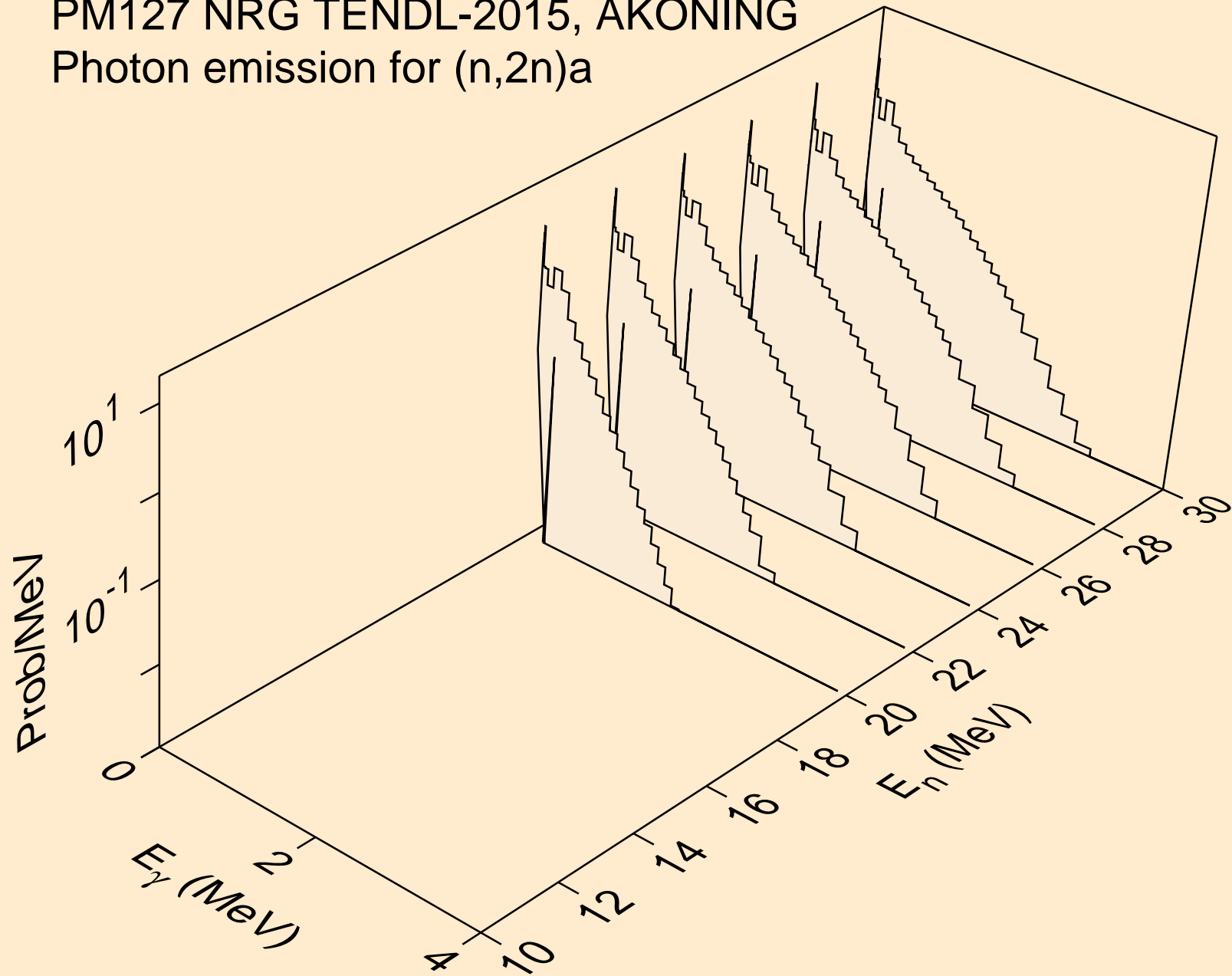

PM127 NRG TENDL-2015, AKONING
Photon emission for (n,n*)p

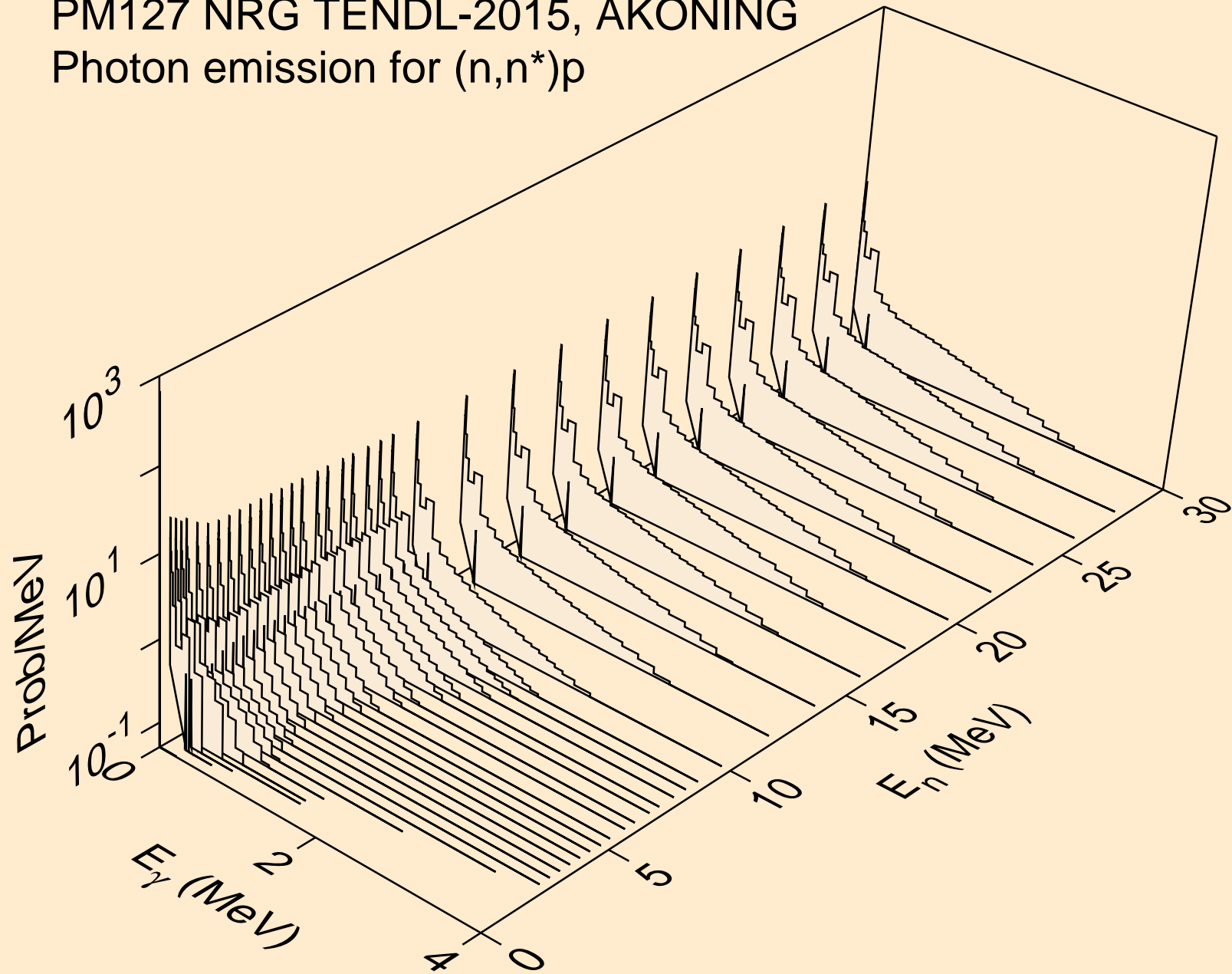

PM127 NRG TENDL-2015, AKONING
Photon emission for (n,n*)2a

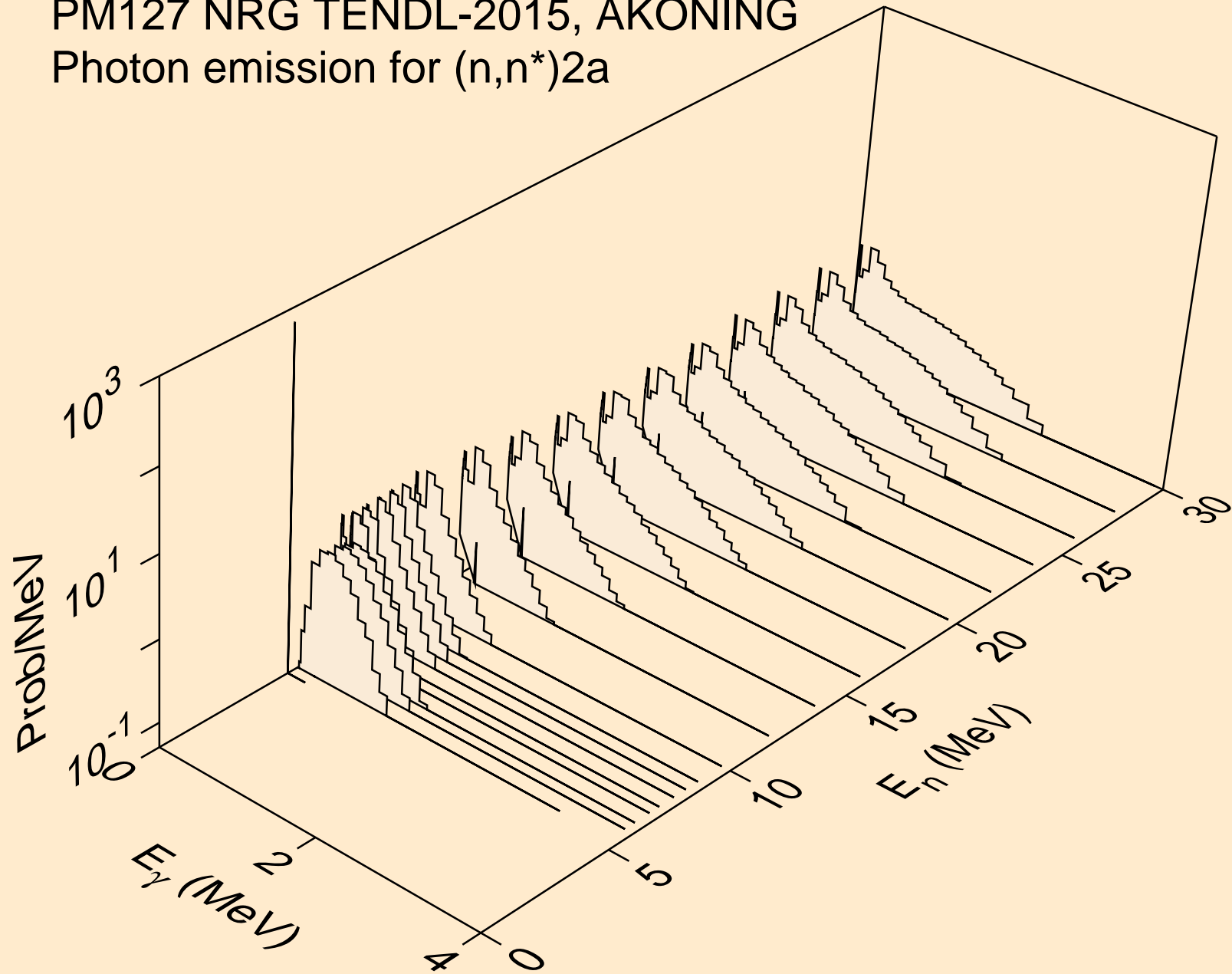

PM127 NRG TENDL-2015, AKONING
Photon emission for (n,n*)d

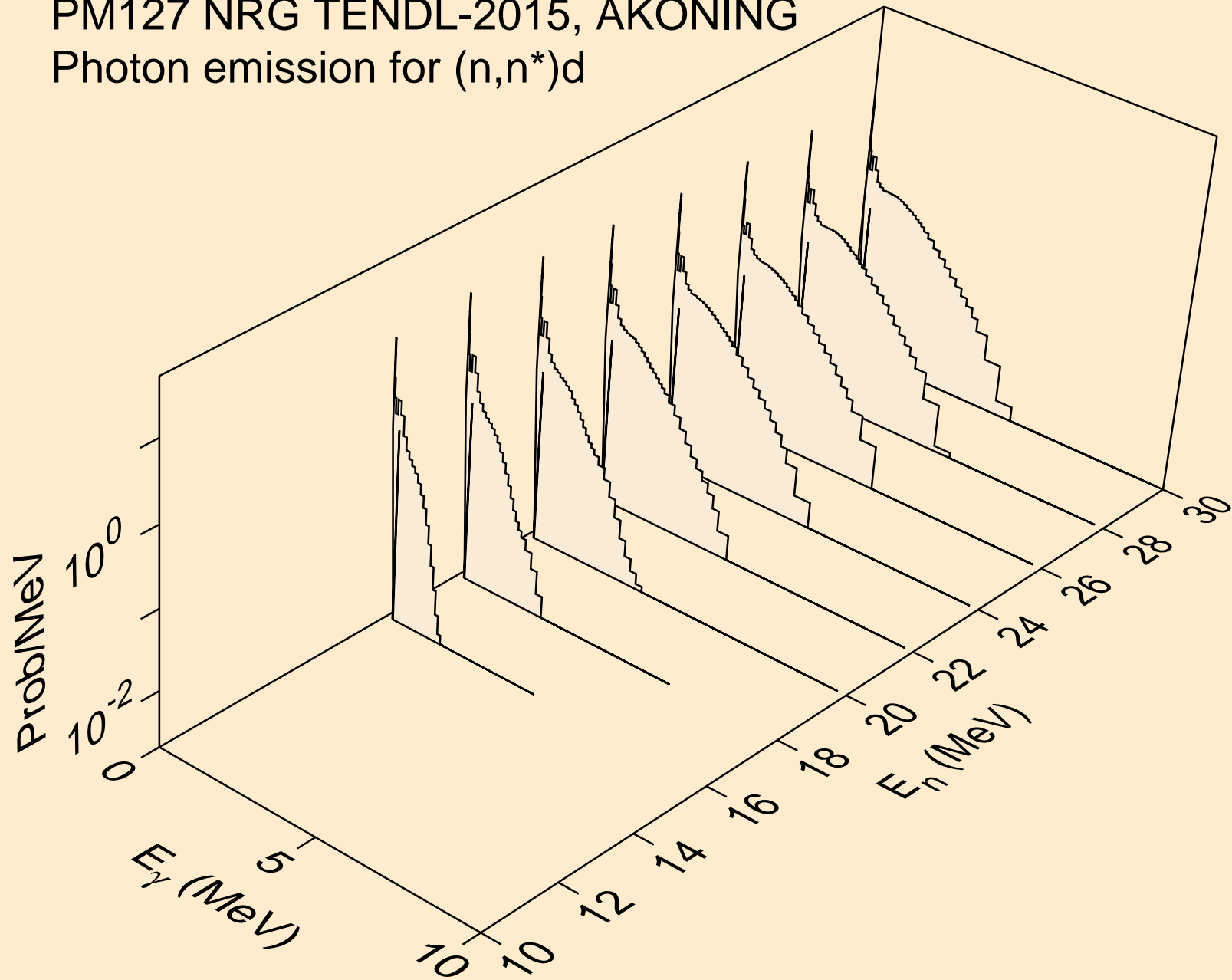

PM127 NRG TENDL-2015, AKONING
Photon emission for (n,n*)t

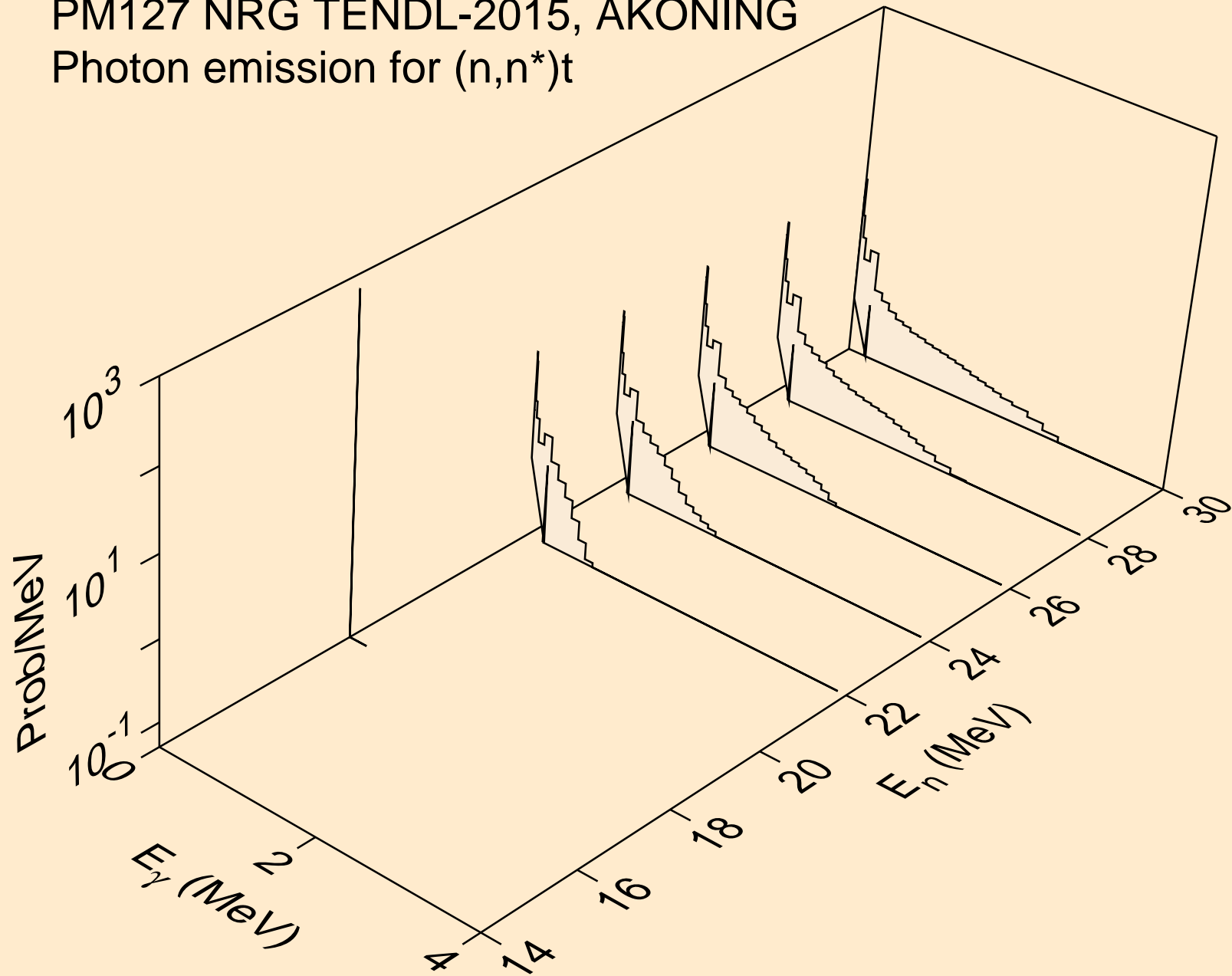

PM127 NRG TENDL-2015, AKONING
Photon emission for (n,n*)he3

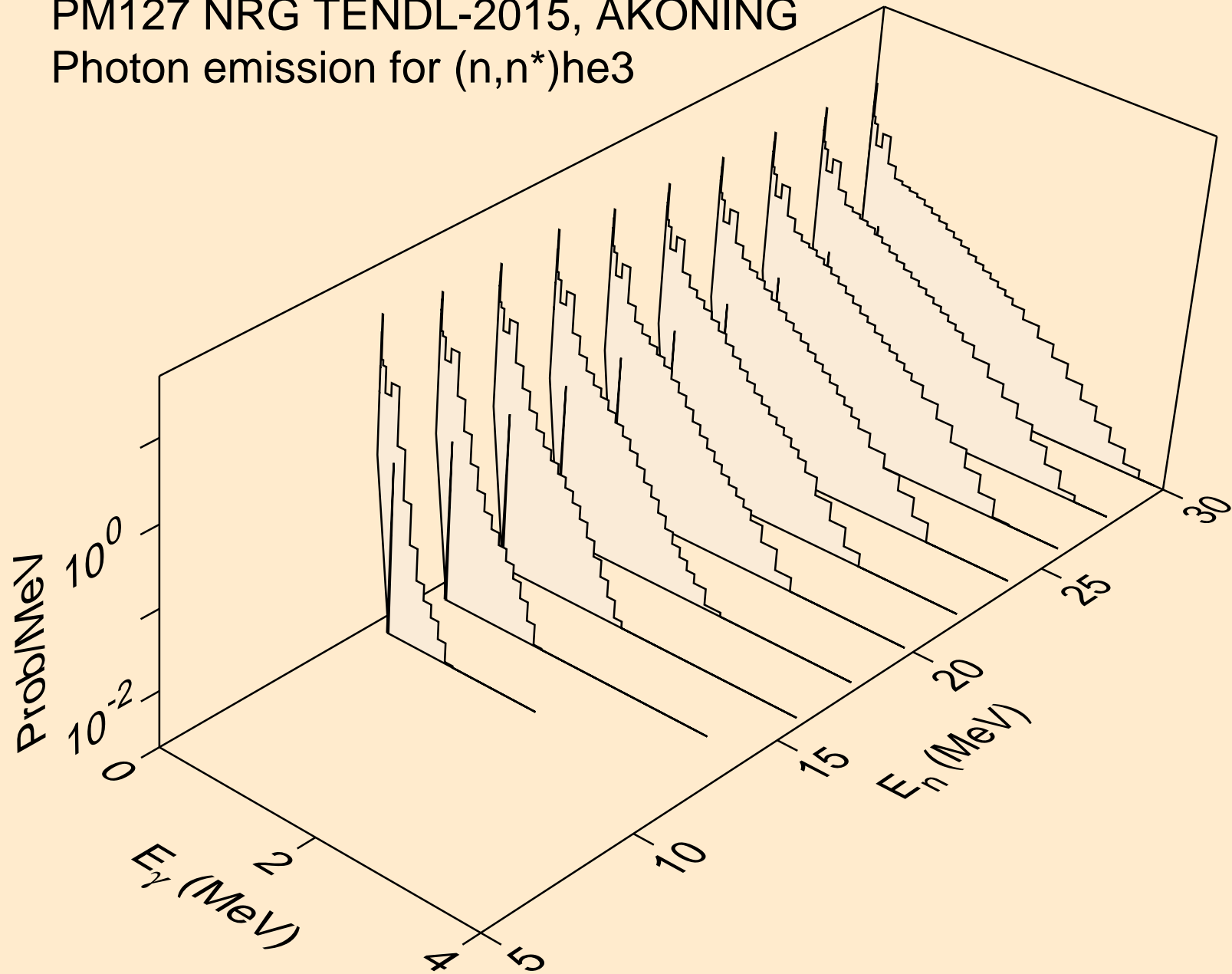

PM127 NRG TENDL-2015, AKONING
Photon emission for (n,2np)

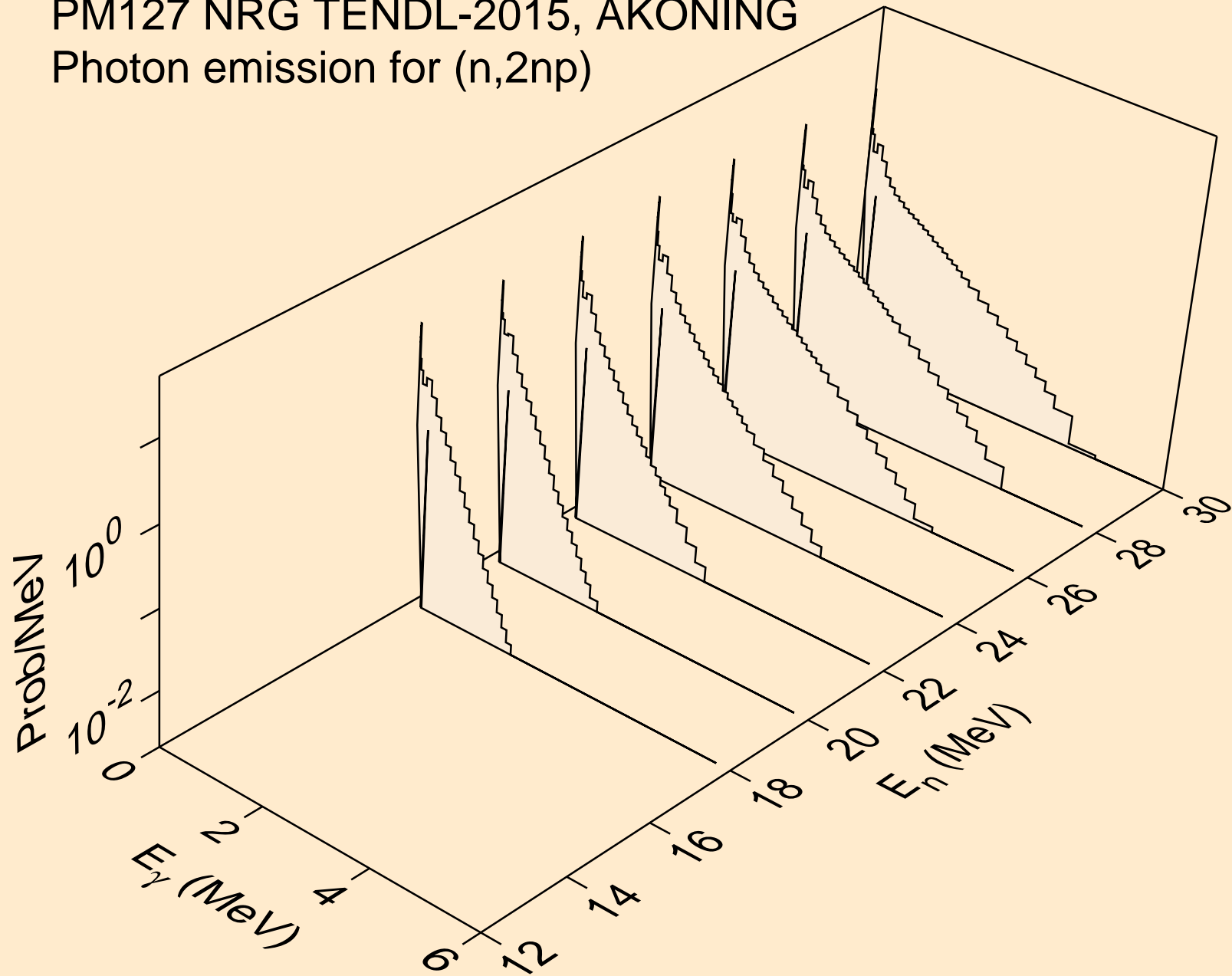

PM127 NRG TENDL-2015, AKONING
Photon emission for (n,3np)

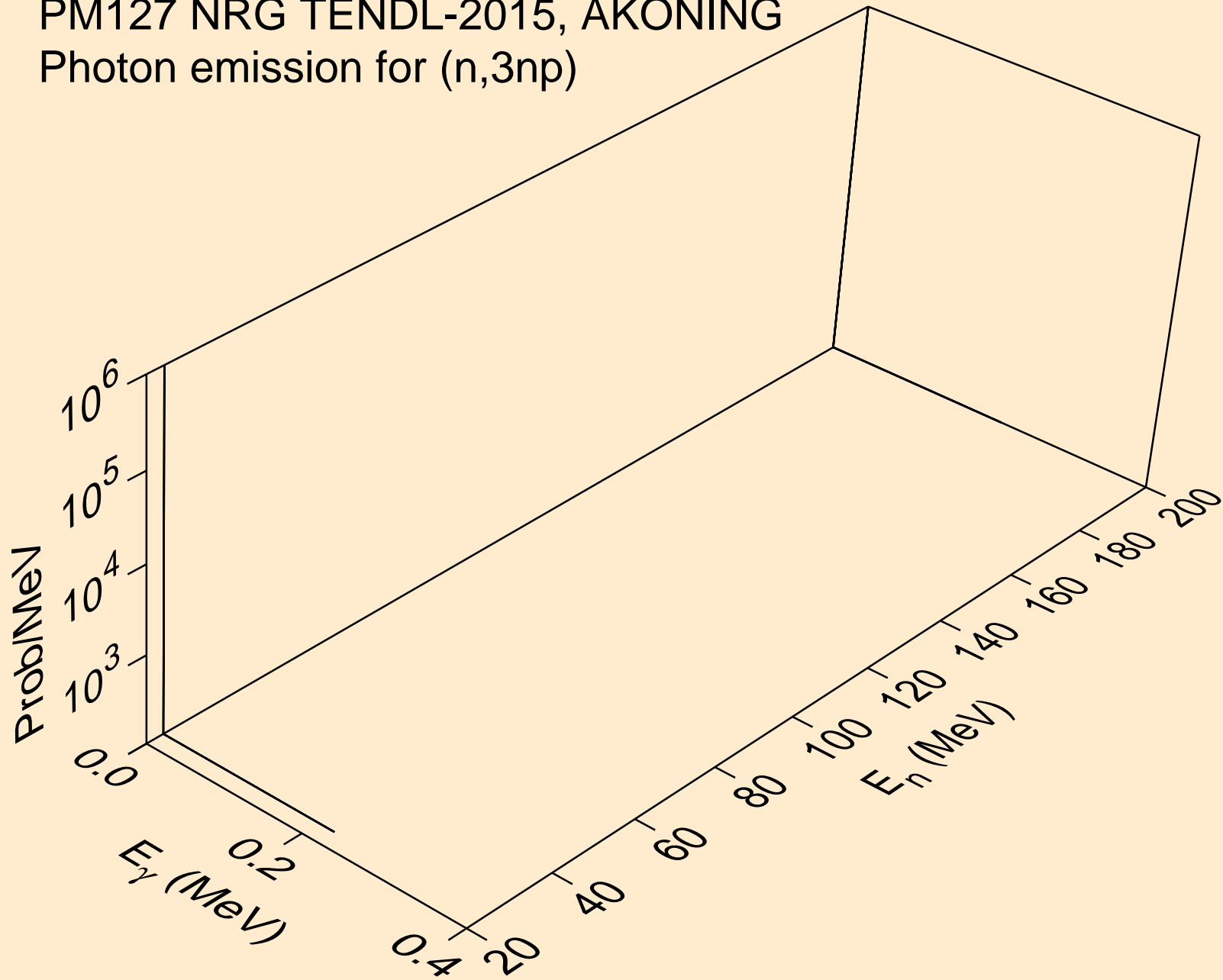

PM127 NRG TENDL-2015, AKONING
Photon emission for (n,2np)

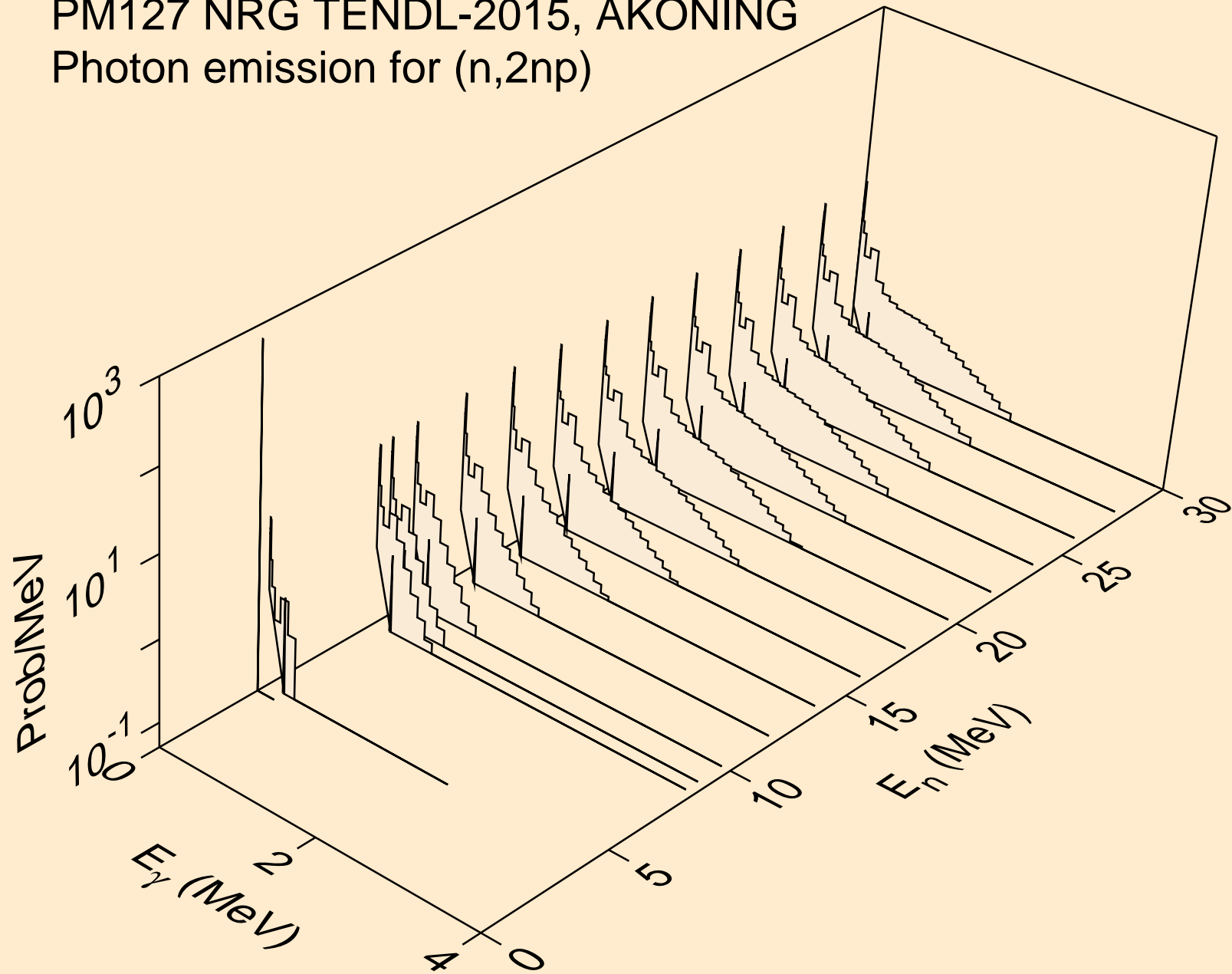

PM127 NRG TENDL-2015, AKONING
Photon emission for (n,npa)

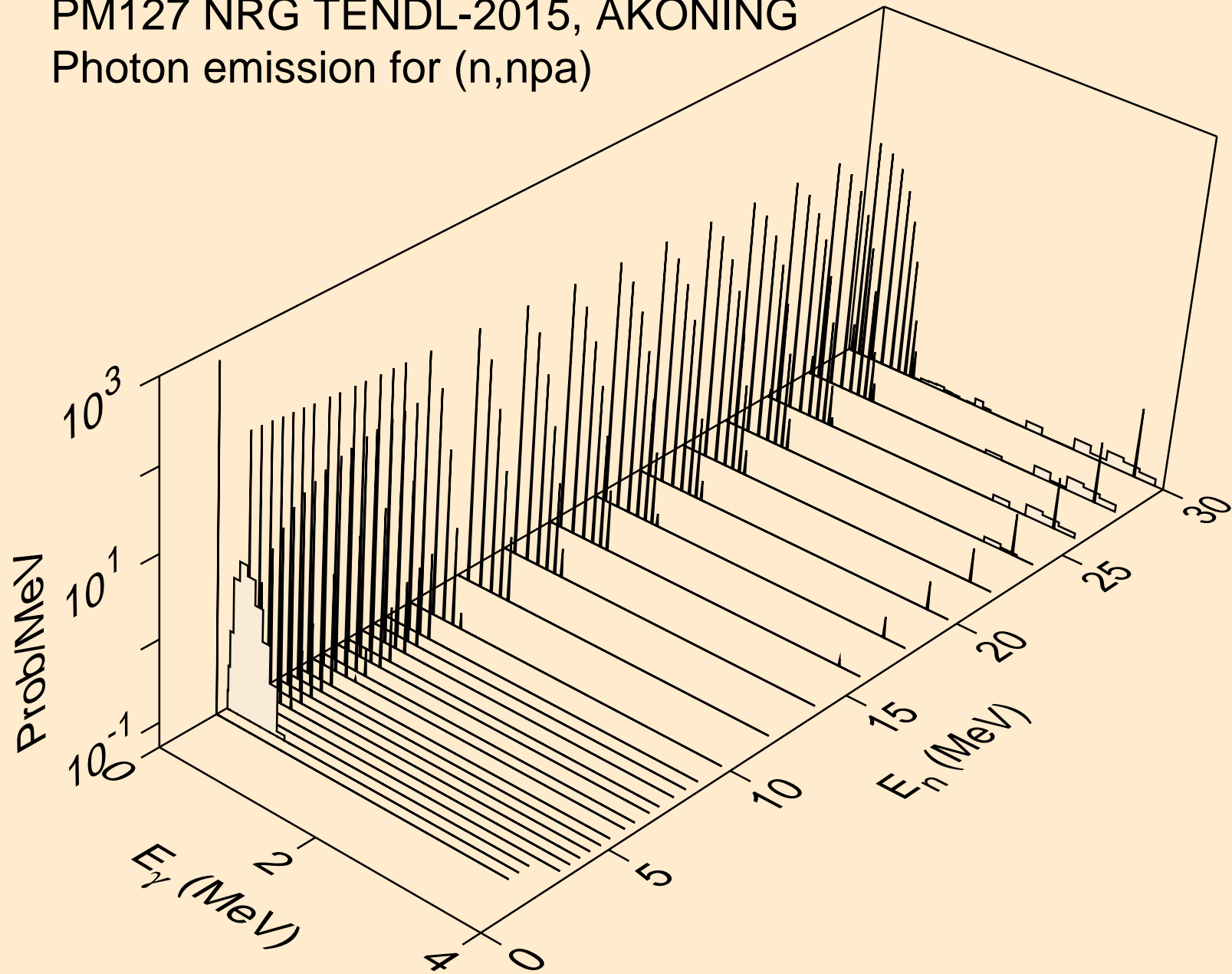

PM127 NRG TENDL-2015, AKONING
Photon emission for (n,n*c)

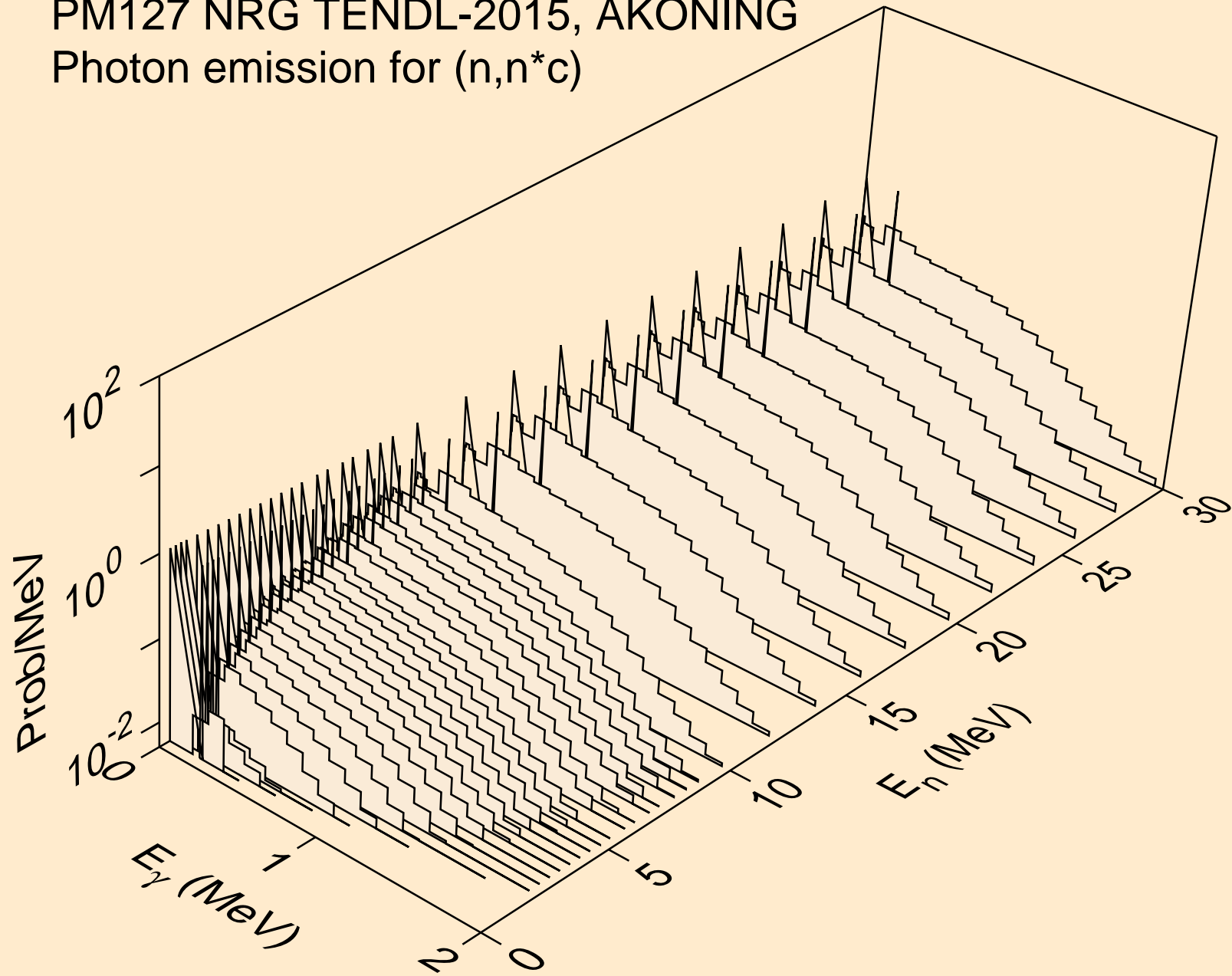

PM127 NRG TENDL-2015, AKONING
Photon emission for (n,gma)

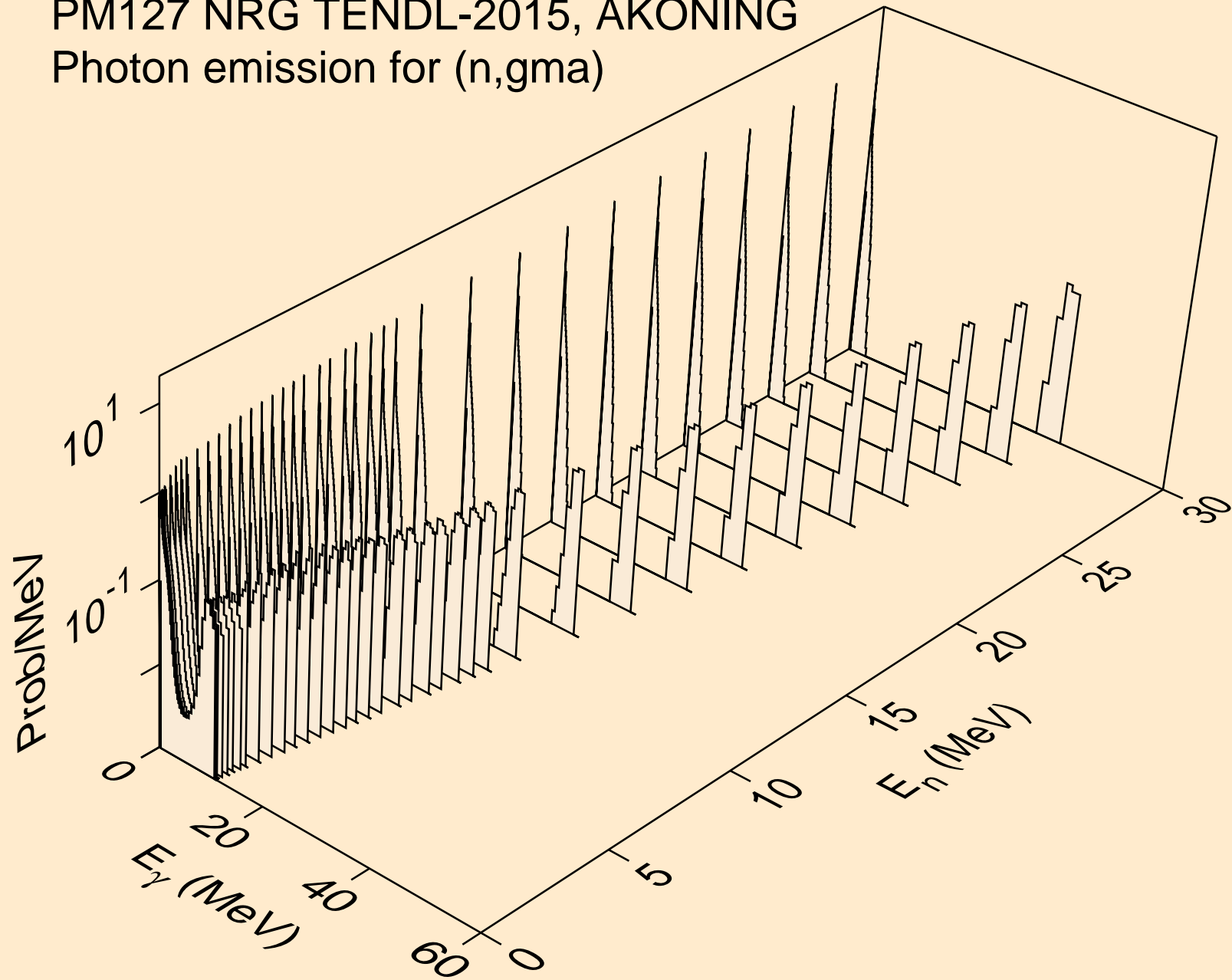

PM127 NRG TENDL-2015, AKONING
Photon emission for (n,p)

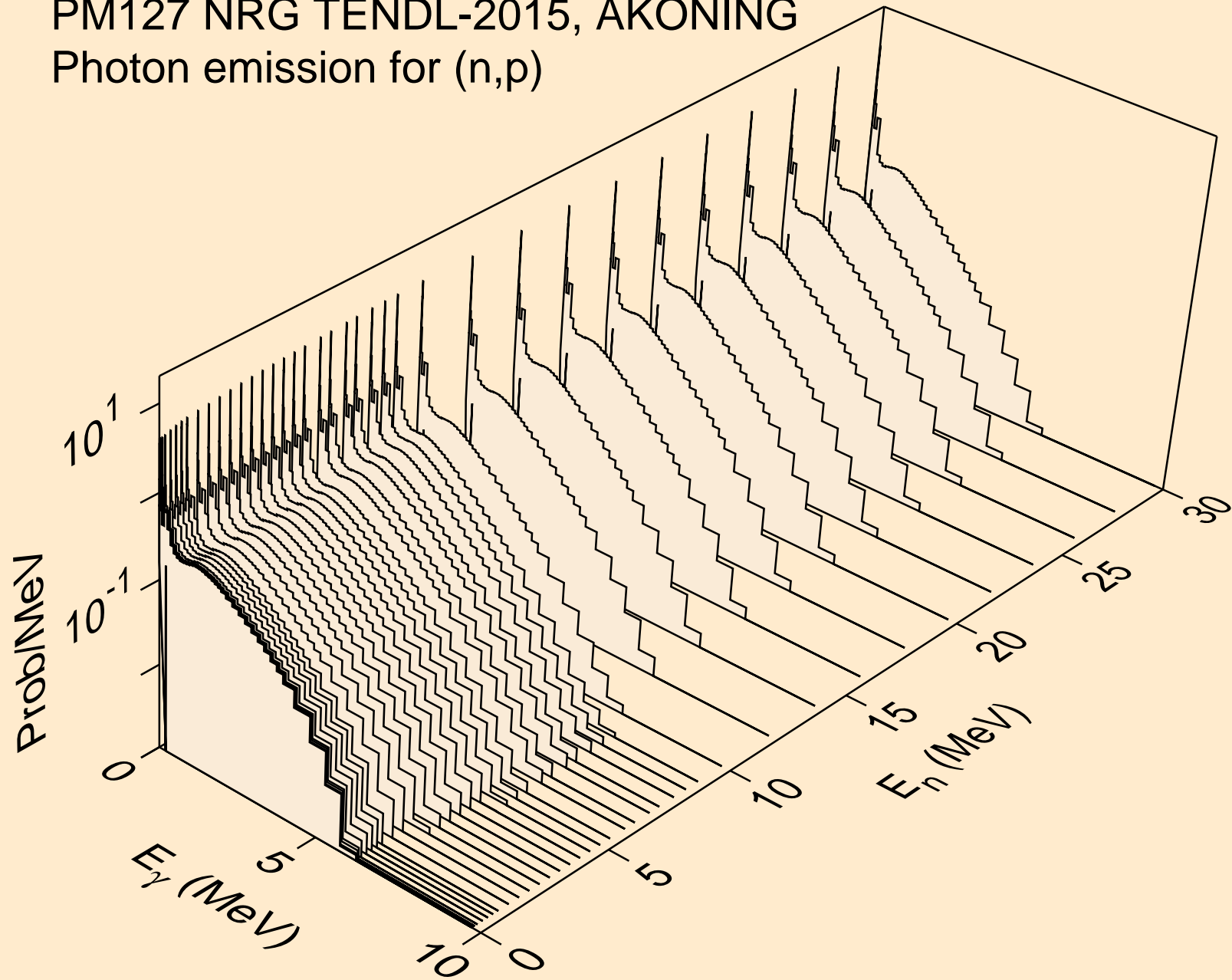

PM127 NRG TENDL-2015, AKONING
Photon emission for (n,d)

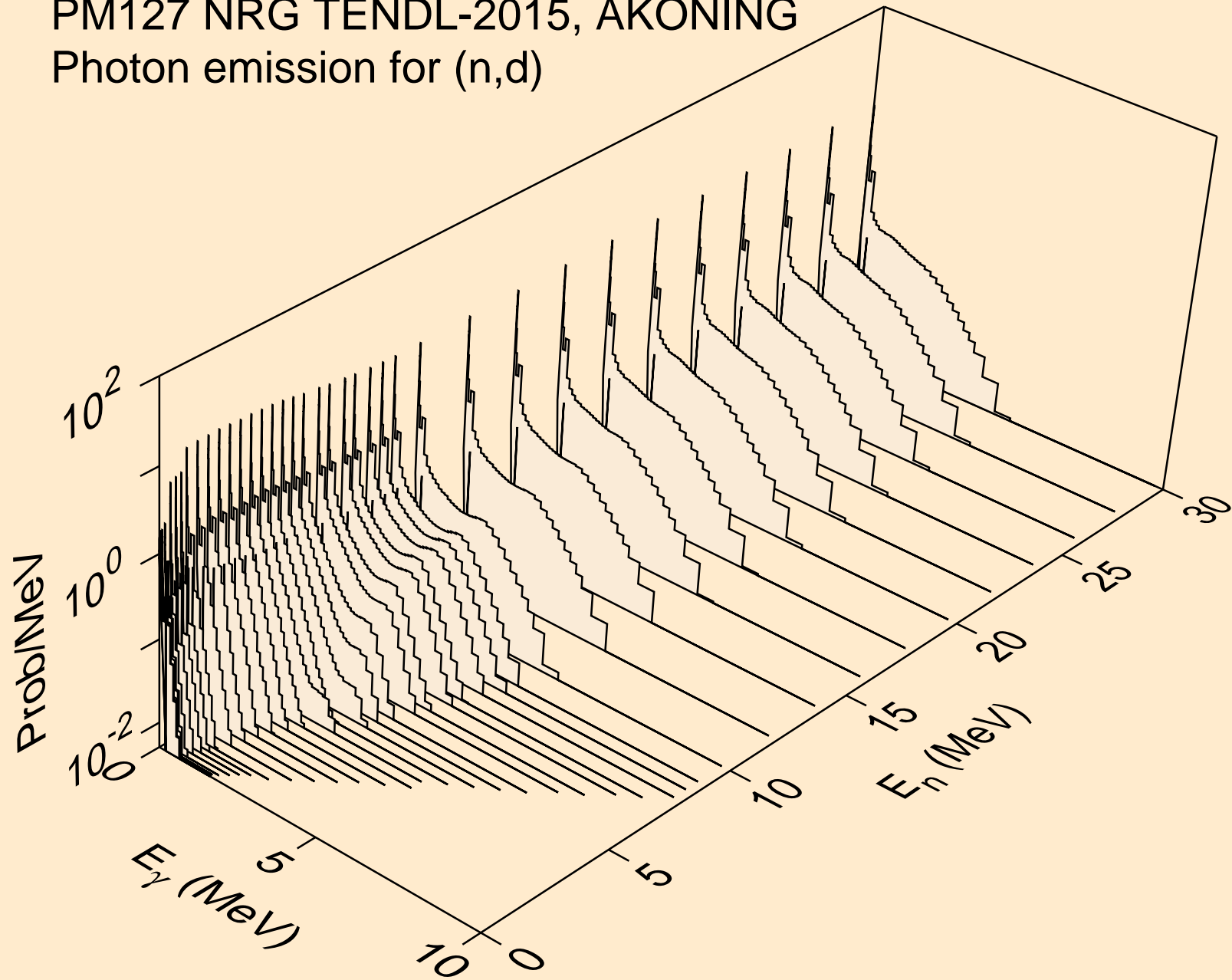

PM127 NRG TENDL-2015, AKONING
Photon emission for (n,t)

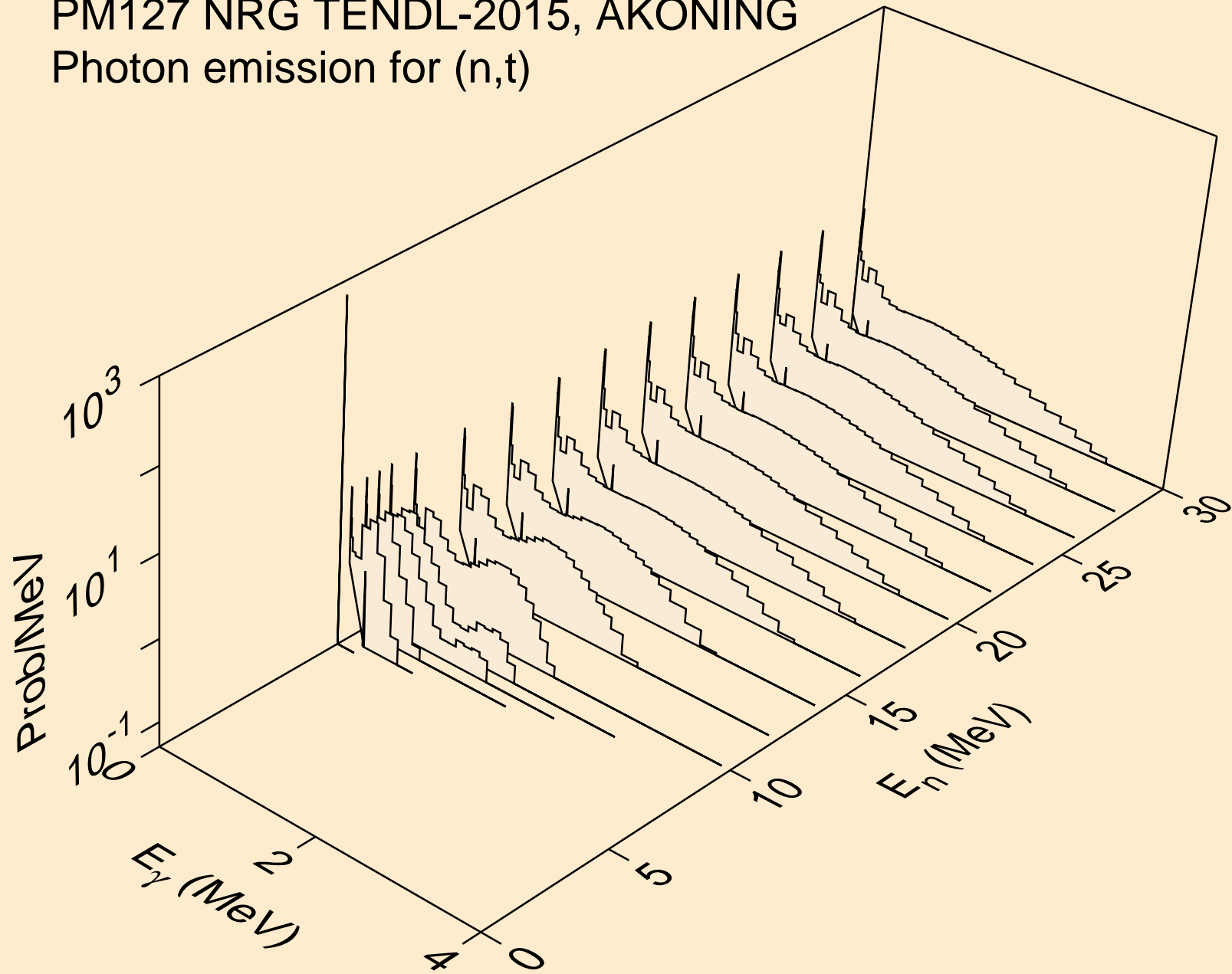

PM127 NRG TENDL-2015, AKONING
Photon emission for (n,he3)

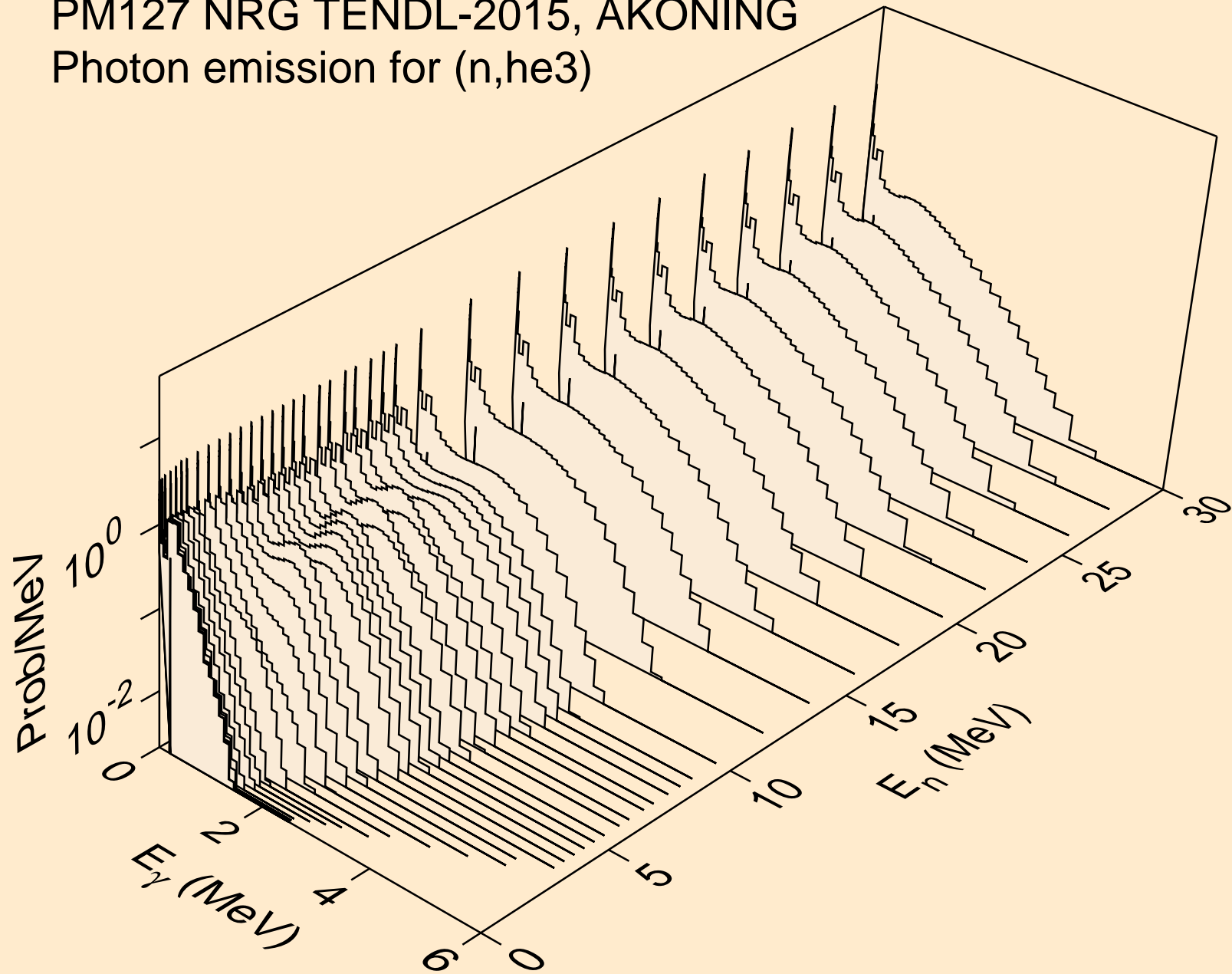

PM127 NRG TENDL-2015, AKONING
Photon emission for (n,a)

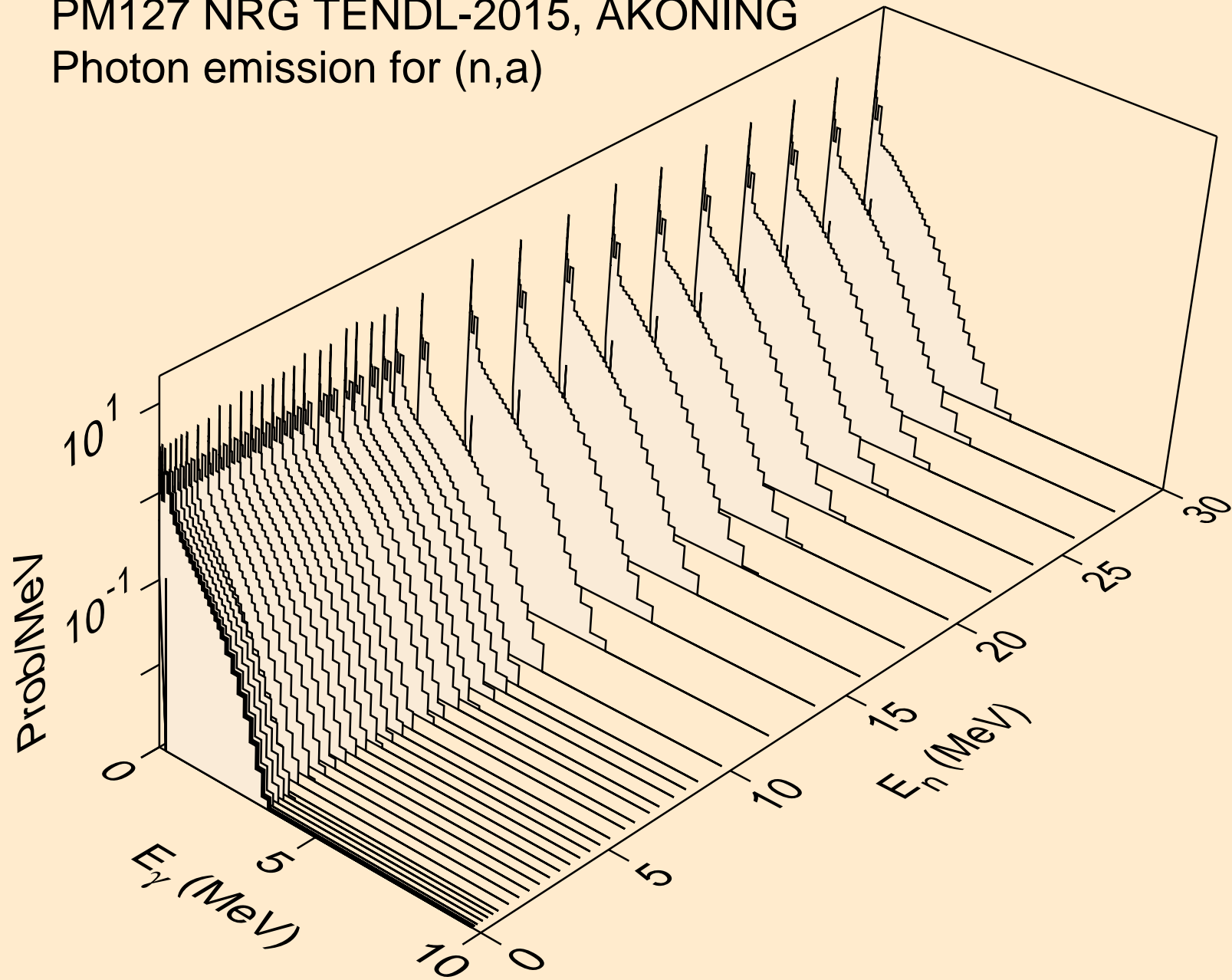

PM127 NRG TENDL-2015, AKONING
Photon emission for (n,2a)

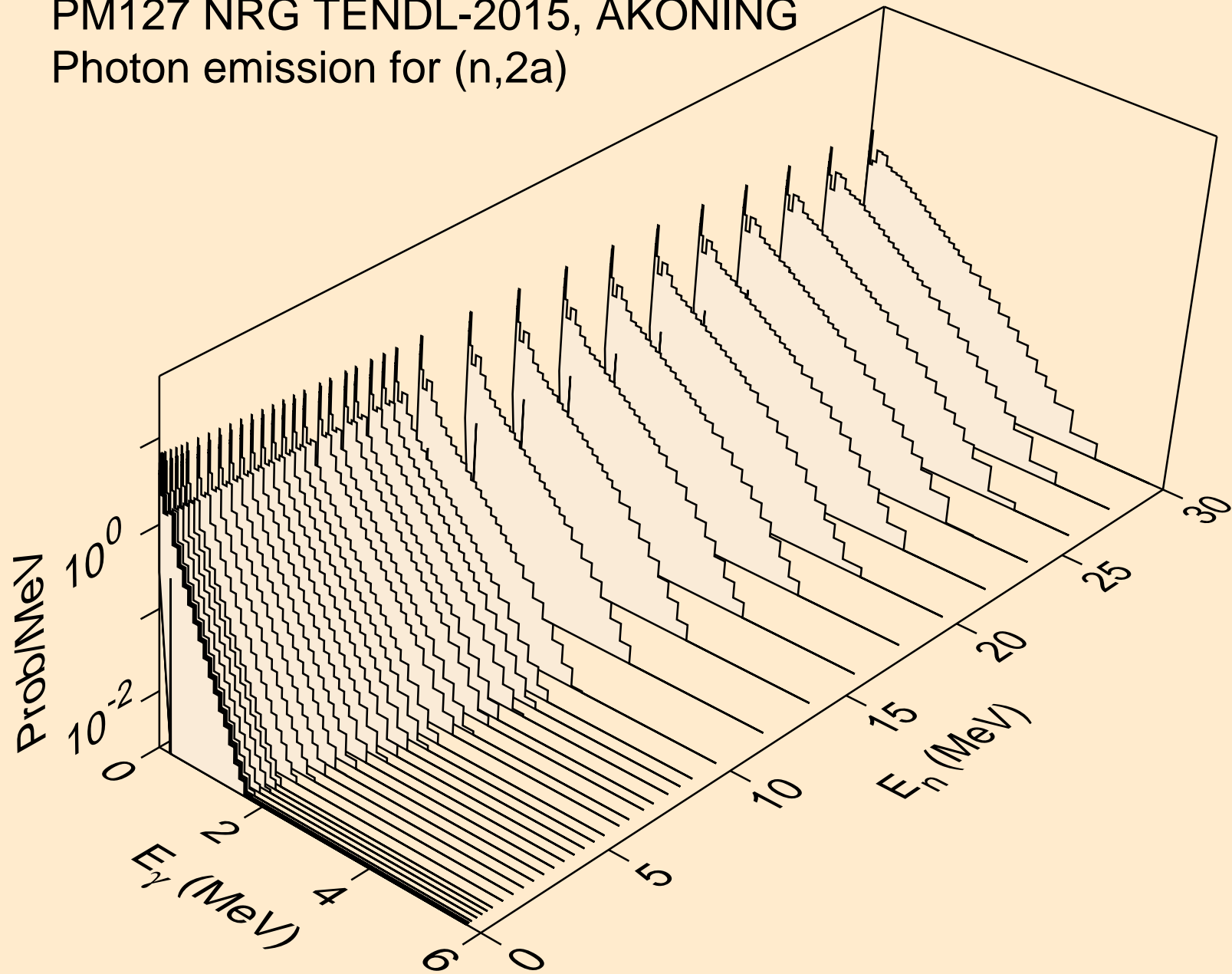

PM127 NRG TENDL-2015, AKONING
Photon emission for (n,3a)

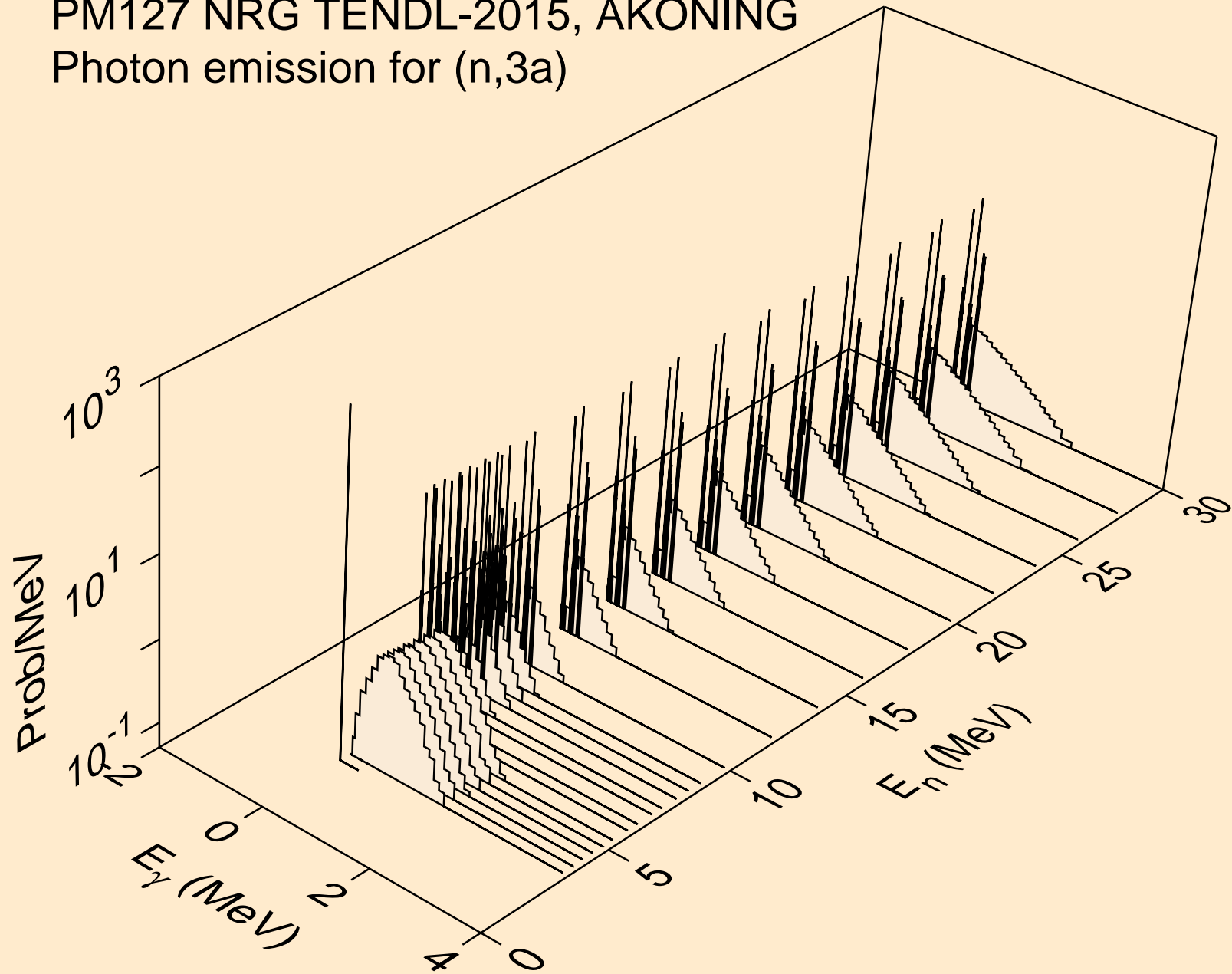

PM127 NRG TENDL-2015, AKONING
Photon emission for (n,2p)

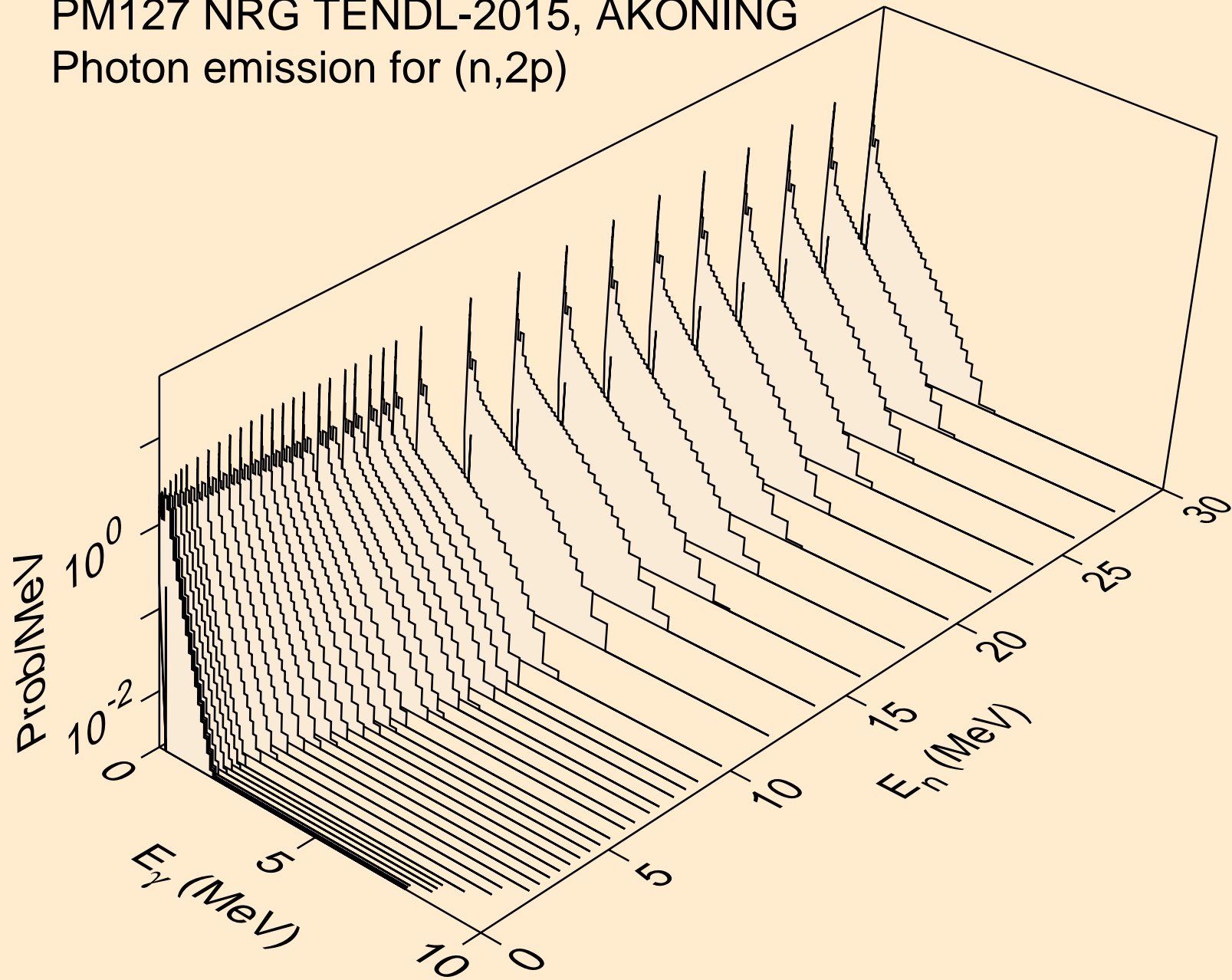

PM127 NRG TENDL-2015, AKONING
Photon emission for (n,p α)

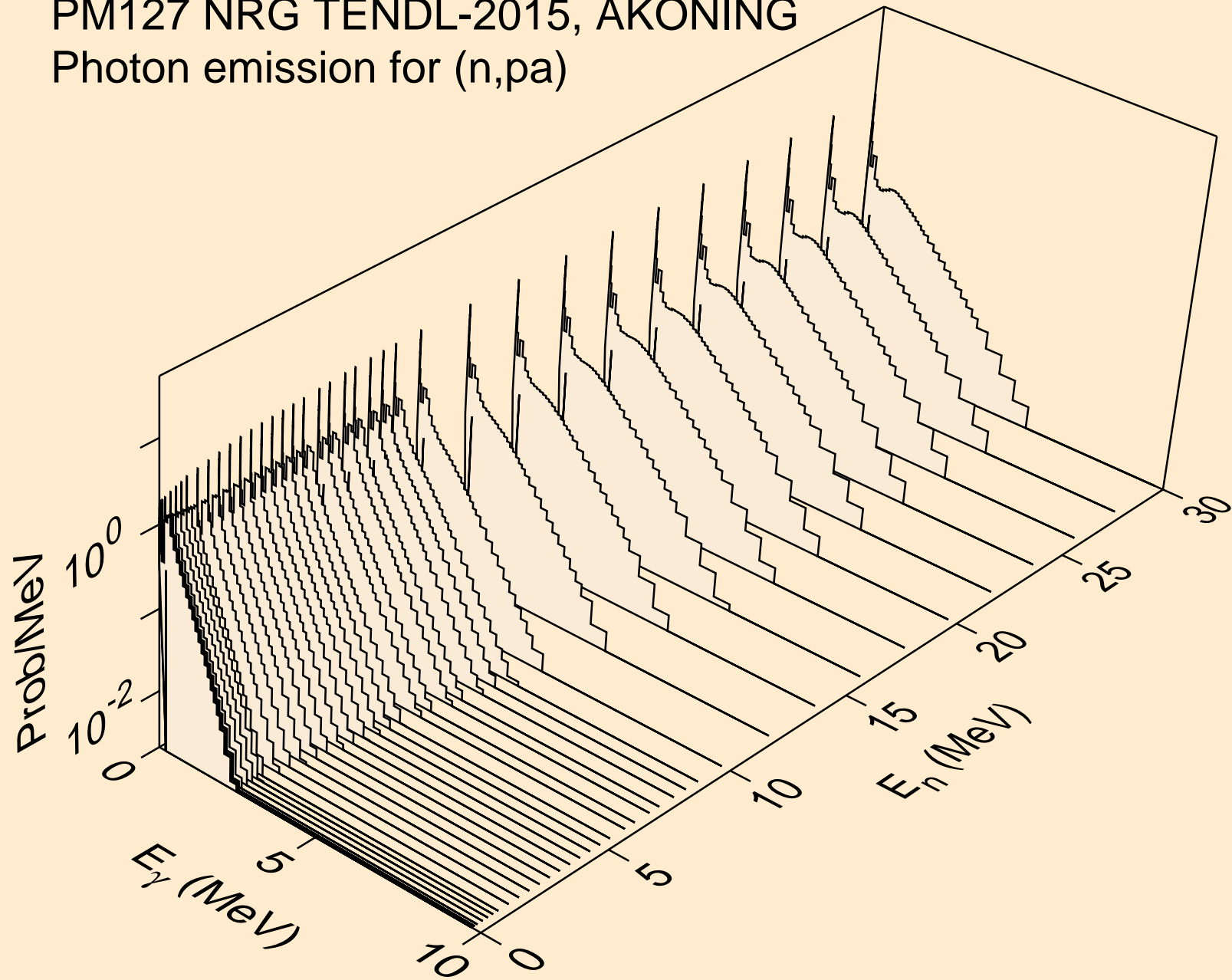

PM127 NRG TENDL-2015, AKONING
Photon emission for (n,t2a)

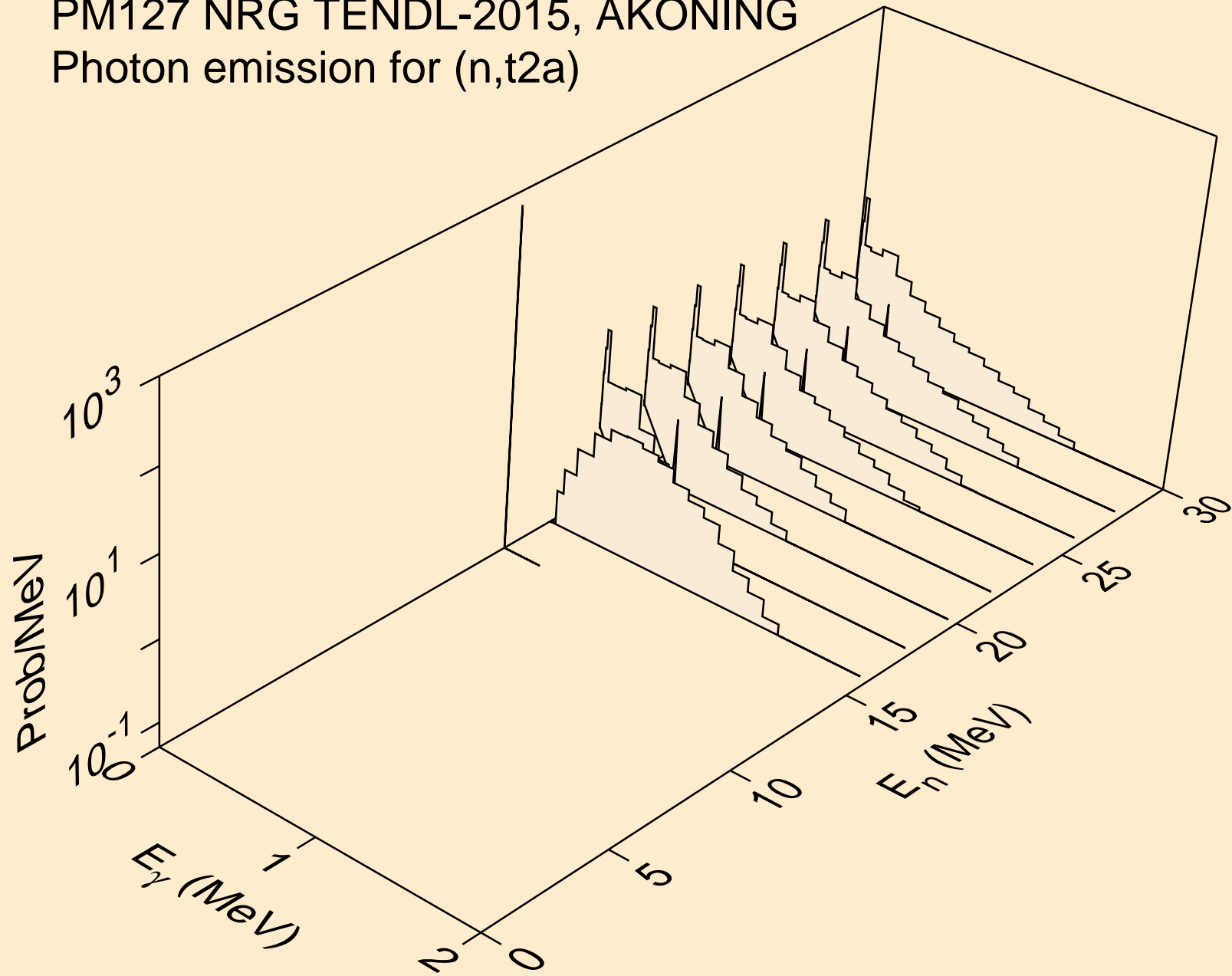

PM127 NRG TENDL-2015, AKONING
Photon emission for (n,d2a)

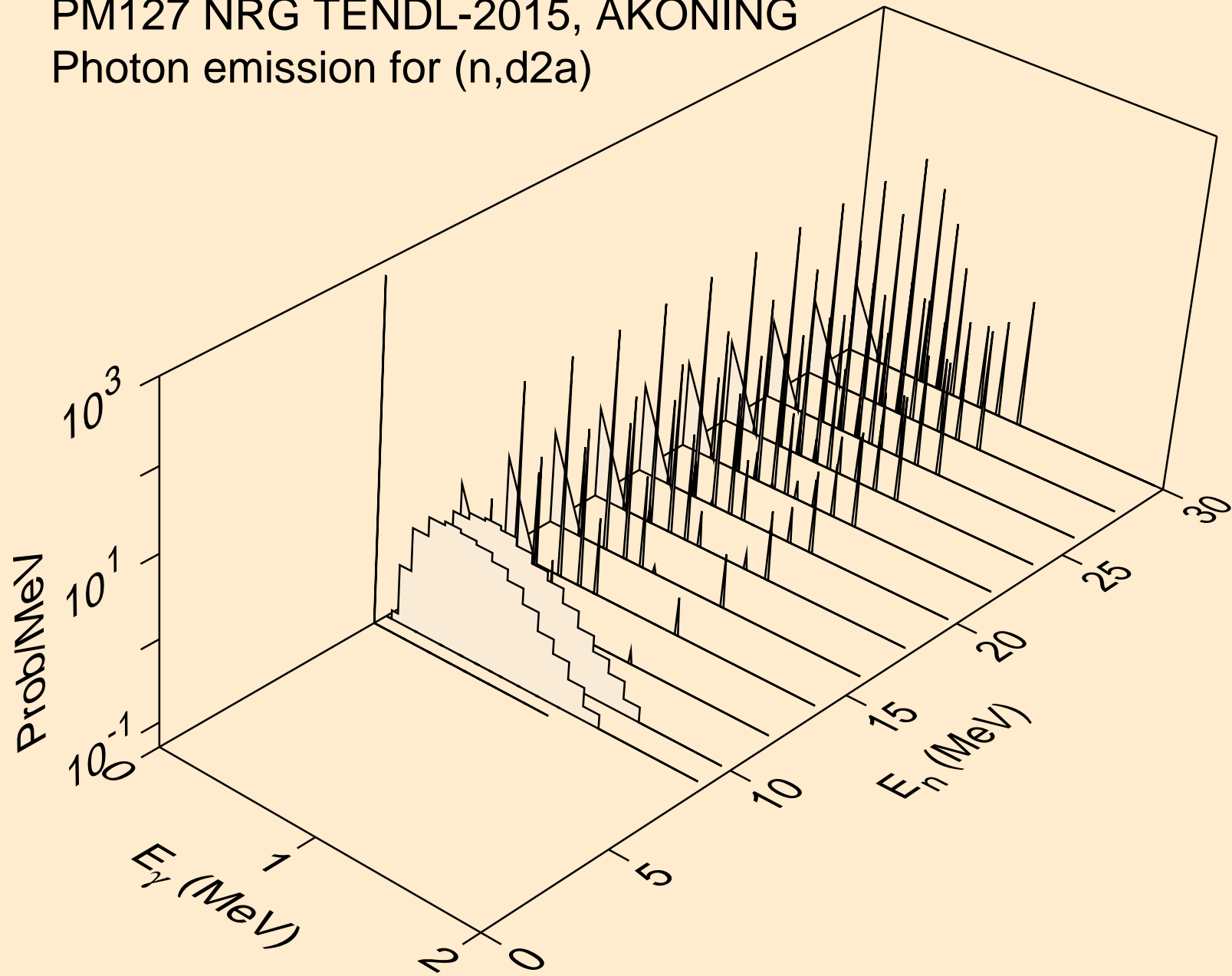

PM127 NRG TENDL-2015, AKONING
Photon emission for (n,pd)

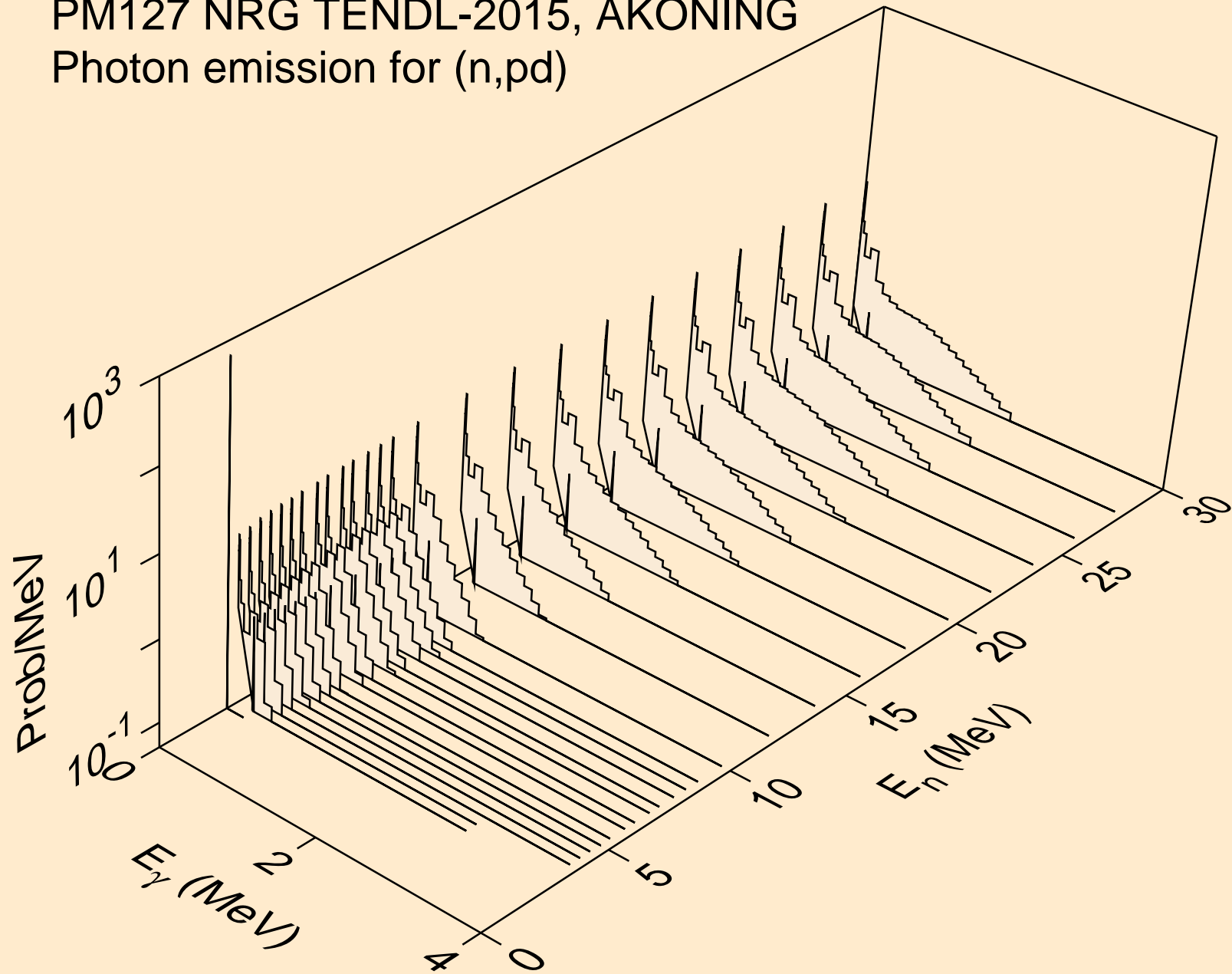

PM127 NRG TENDL-2015, AKONING
Photon emission for (n,pt)

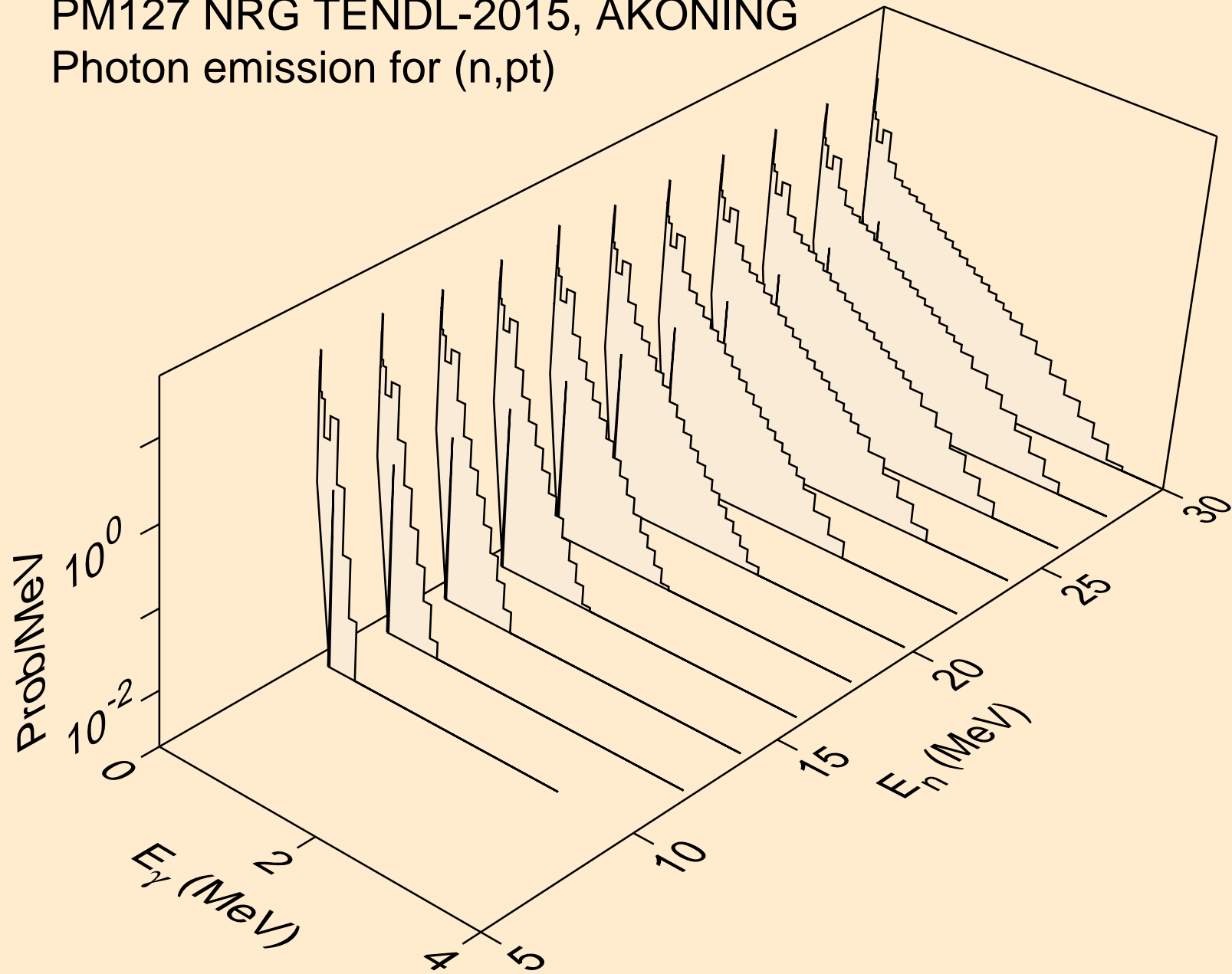

PM127 NRG TENDL-2015, AKONING
Photon emission for (n,da)

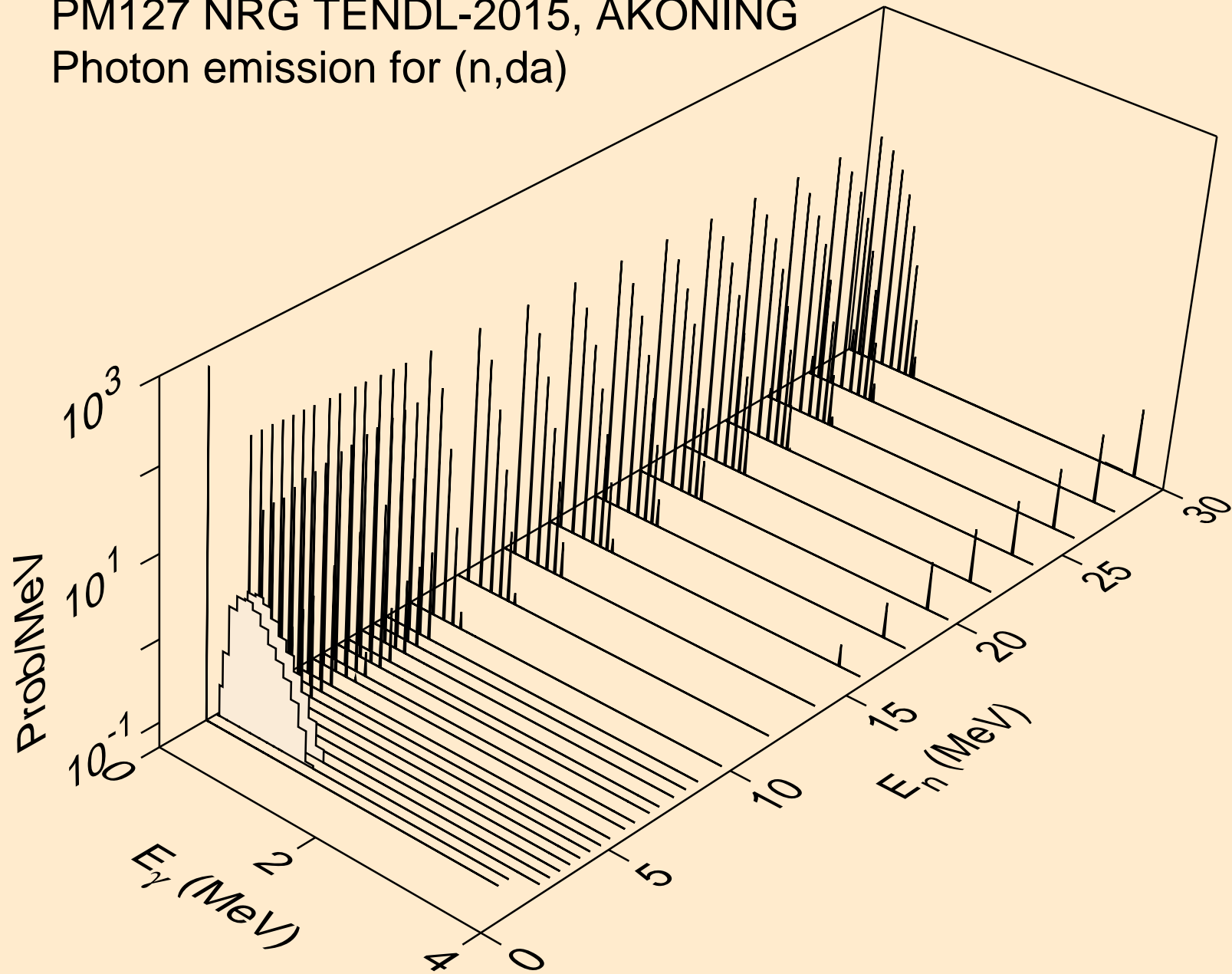

PM127 NRG TENDL-2015, AKONING
thermal capture photon spectrum

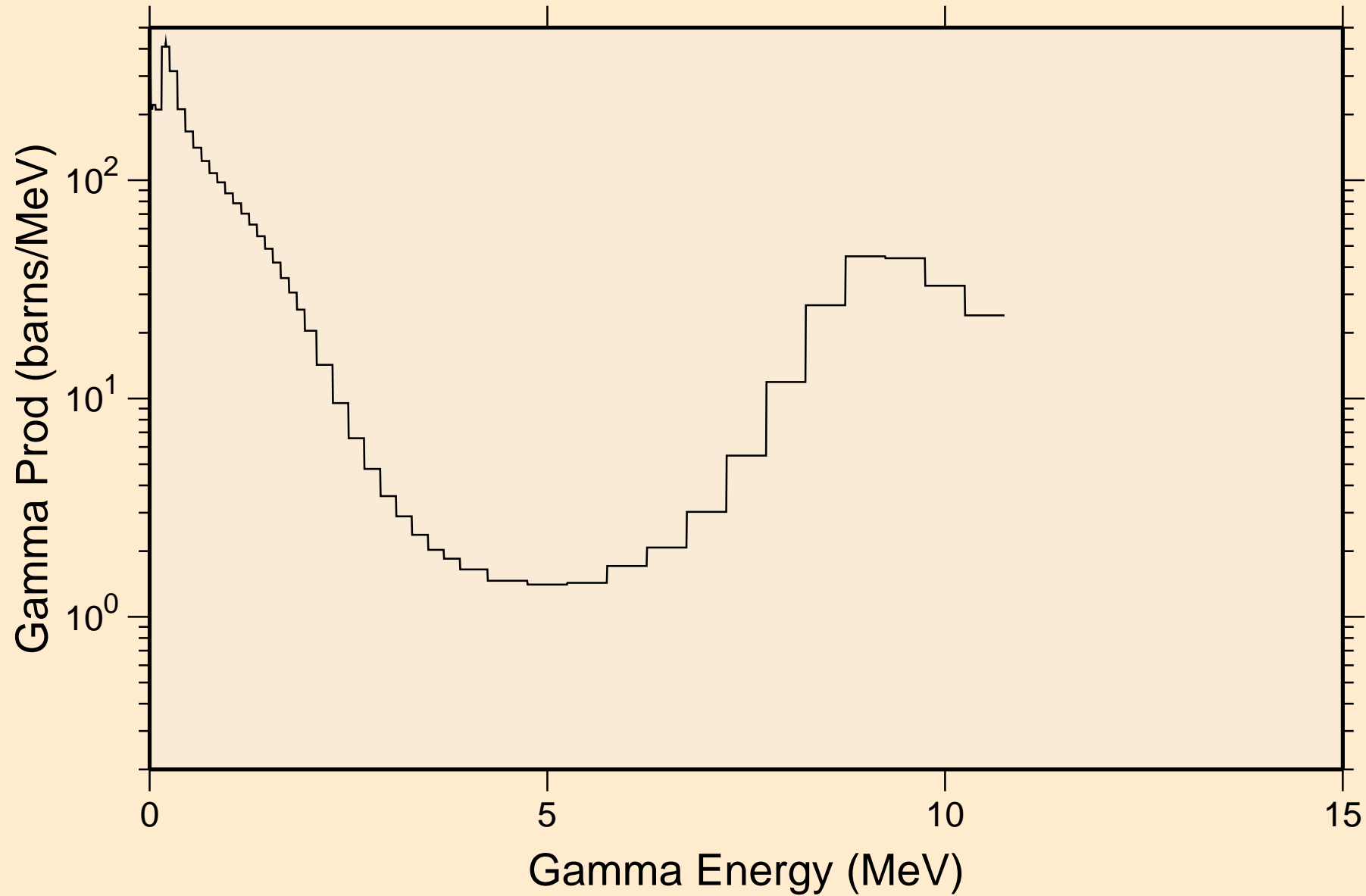

PM127 NRG TENDL-2015, AKONING
14 MeV photon spectrum

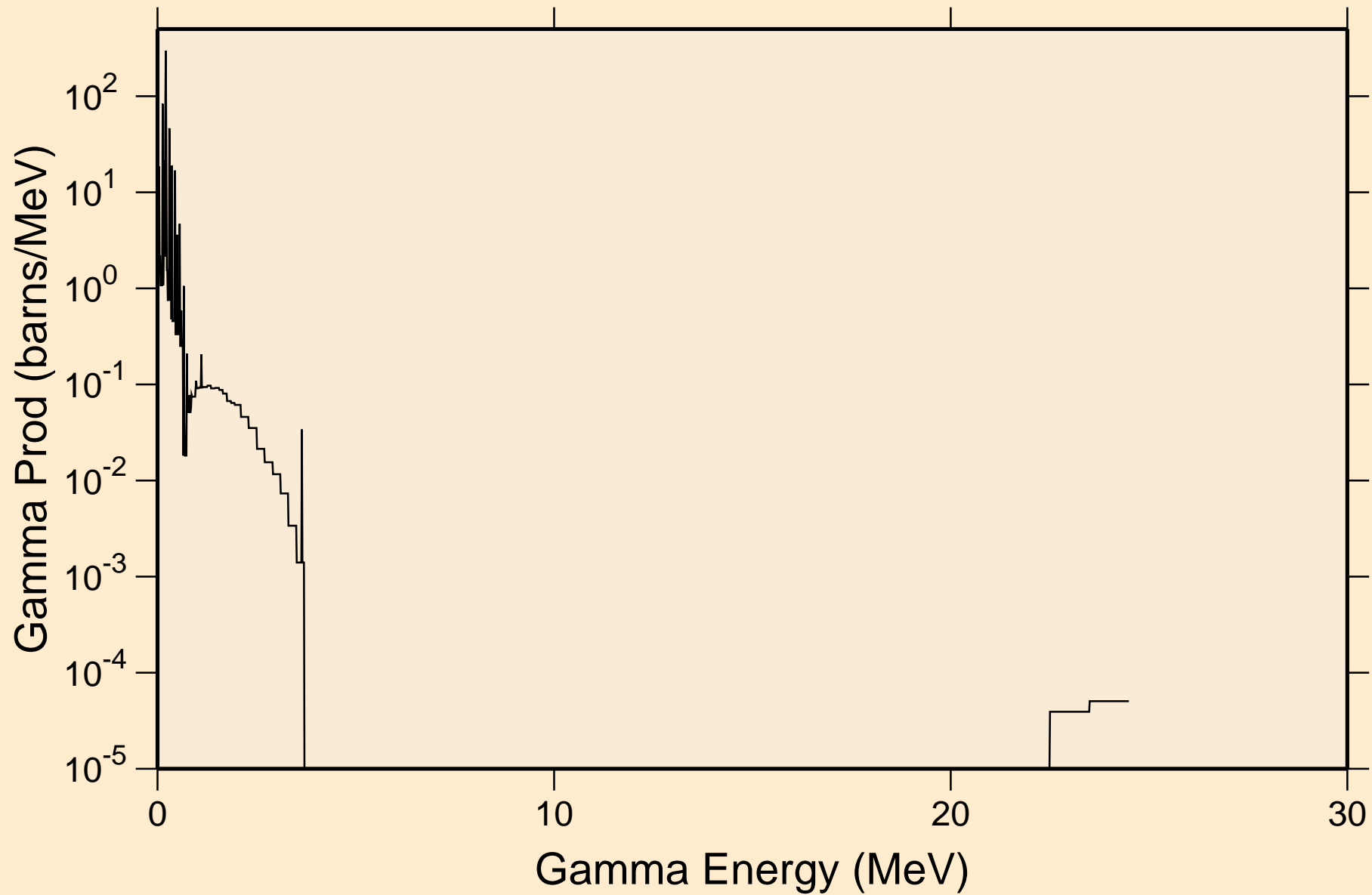

PM127 NRG TENDL-2015, AKONING

Particle heating contributions

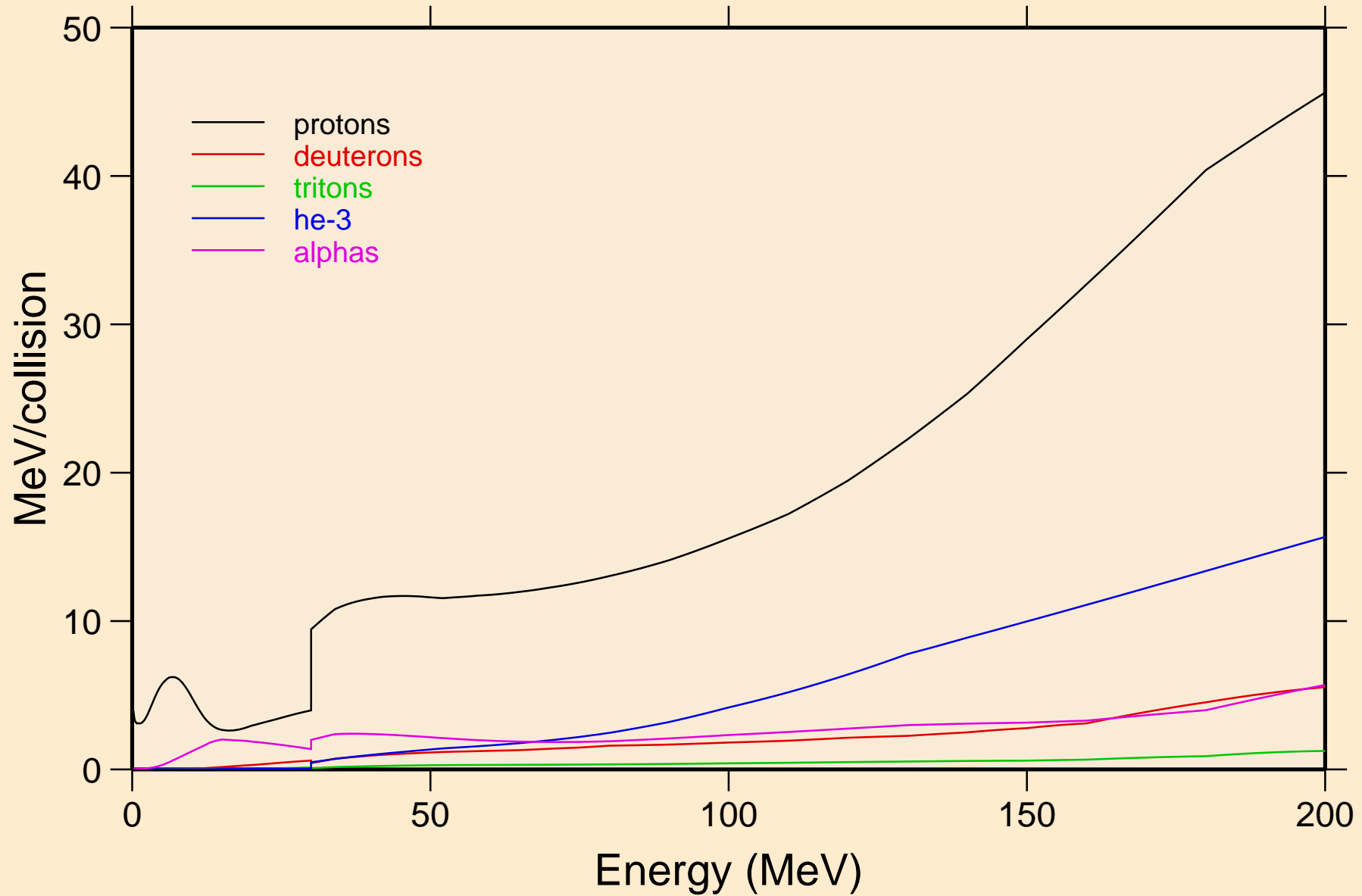

PM127 NRG TENDL-2015, AKONING

Recoil Heating

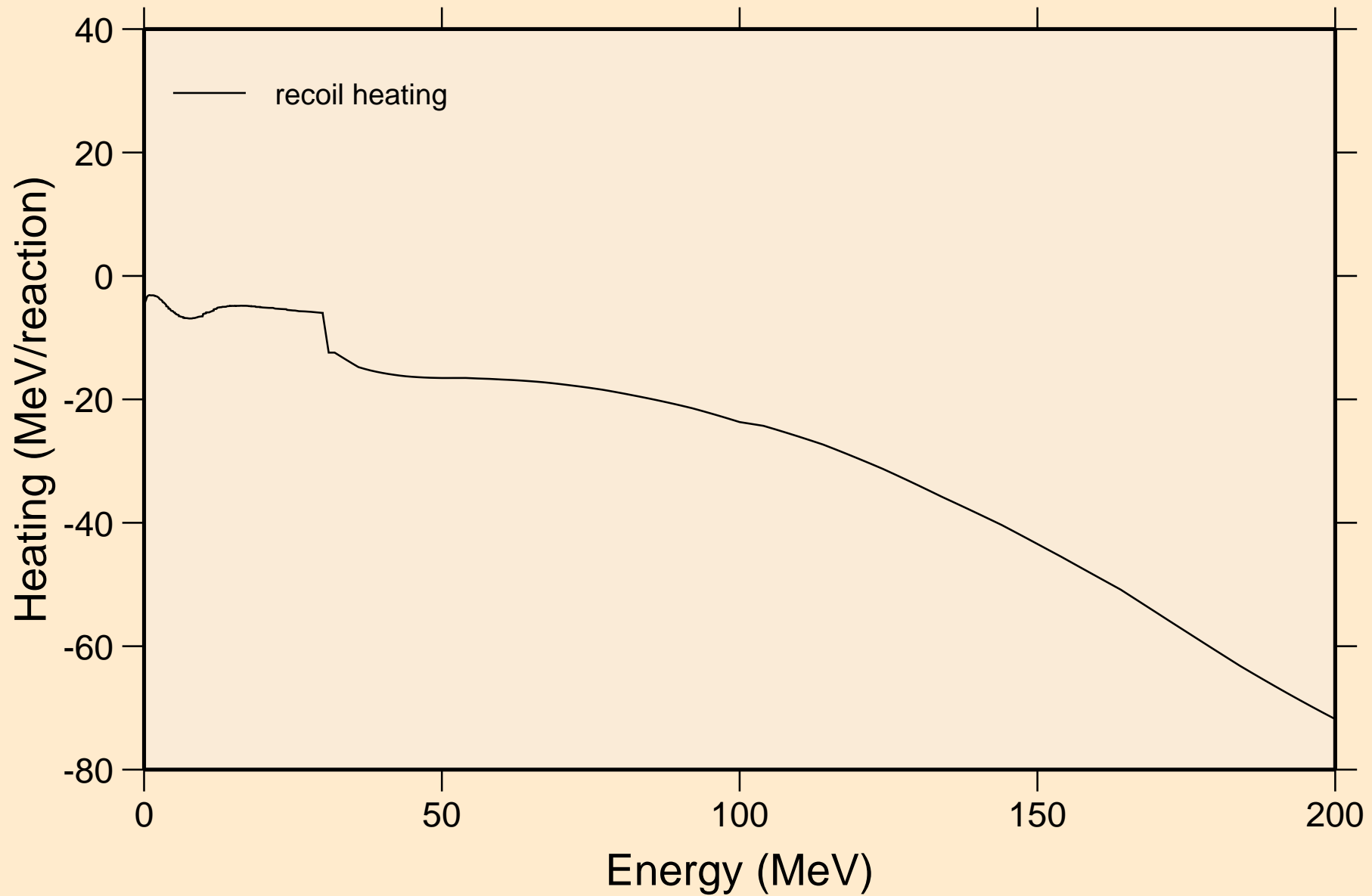

PM127 NRG TENDL-2015, AKONING

Particle production cross sections

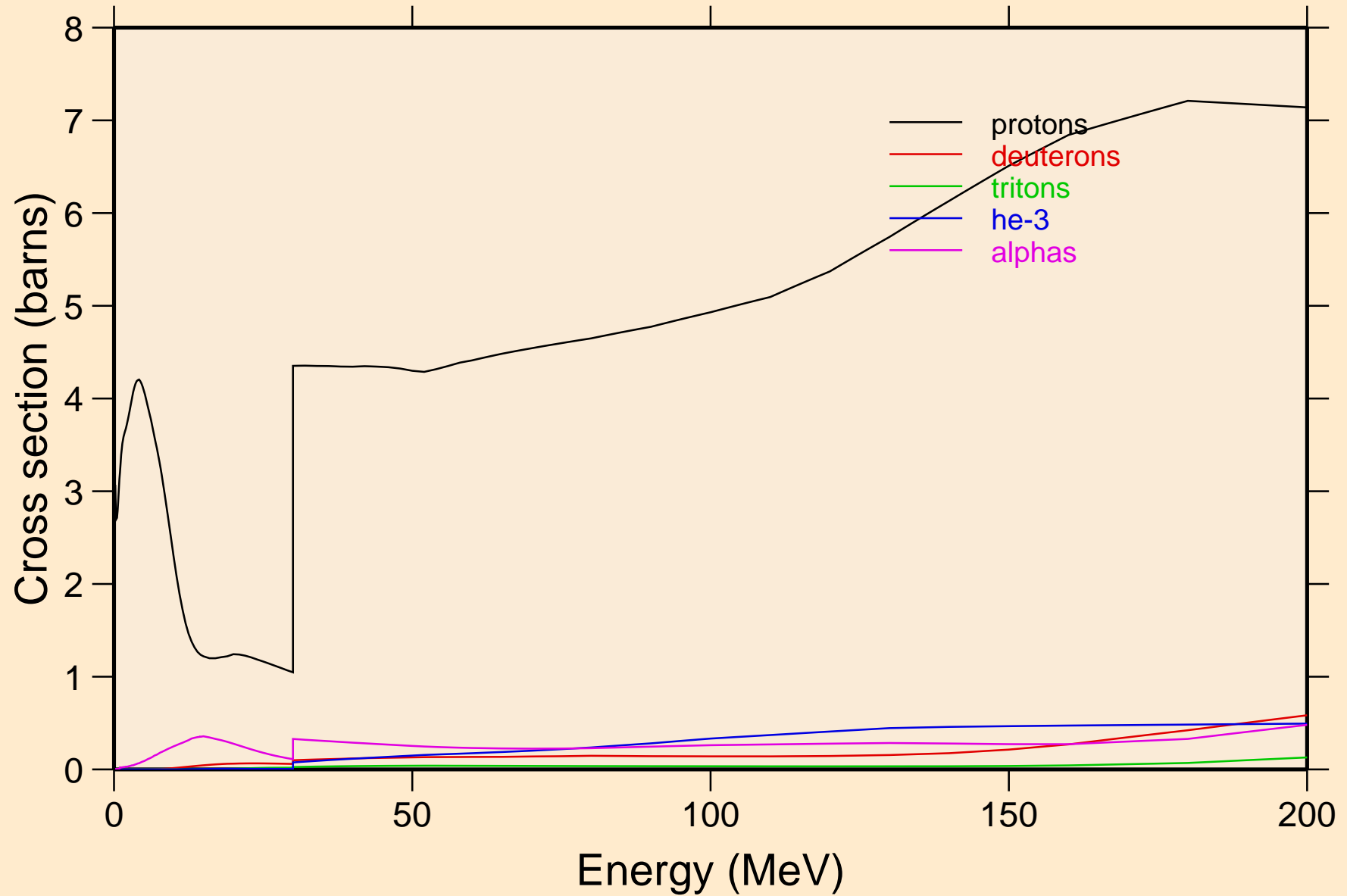

PM127 NRG TENDL-2015, AKONING
protons from (n,x)

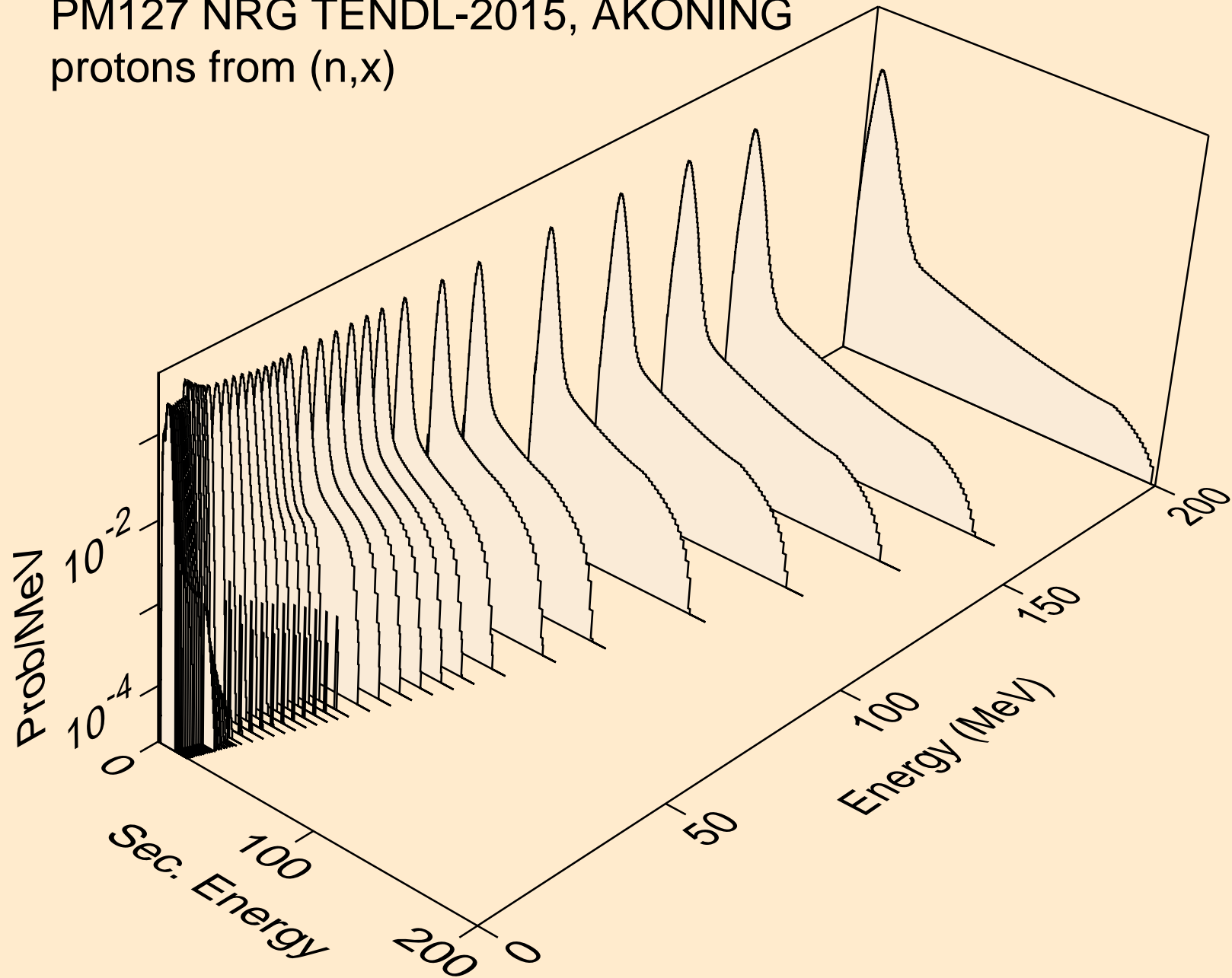

PM127 NRG TENDL-2015, AKONING
protons from (n,n*)p

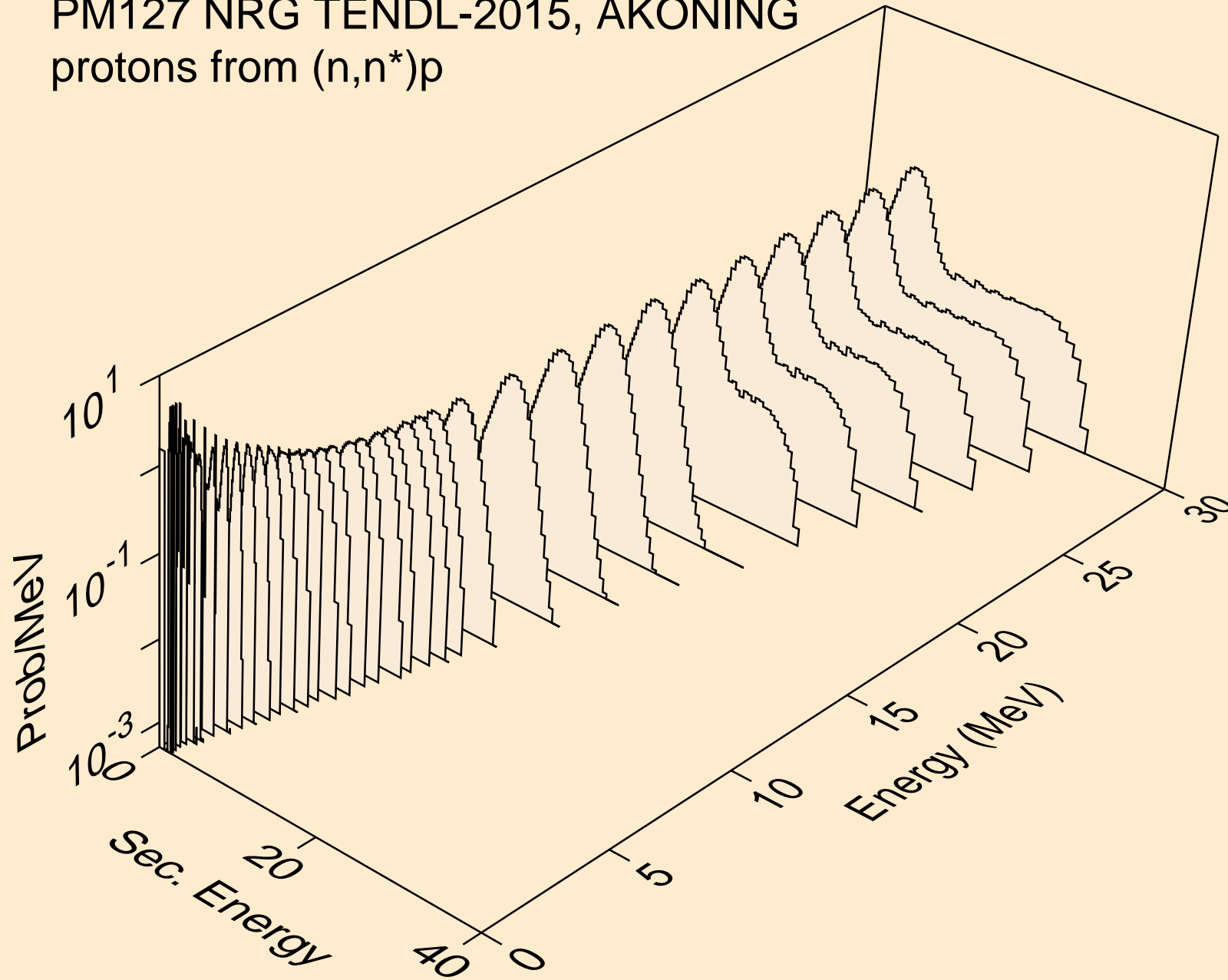

PM127 NRG TENDL-2015, AKONING
protons from (n,2np)

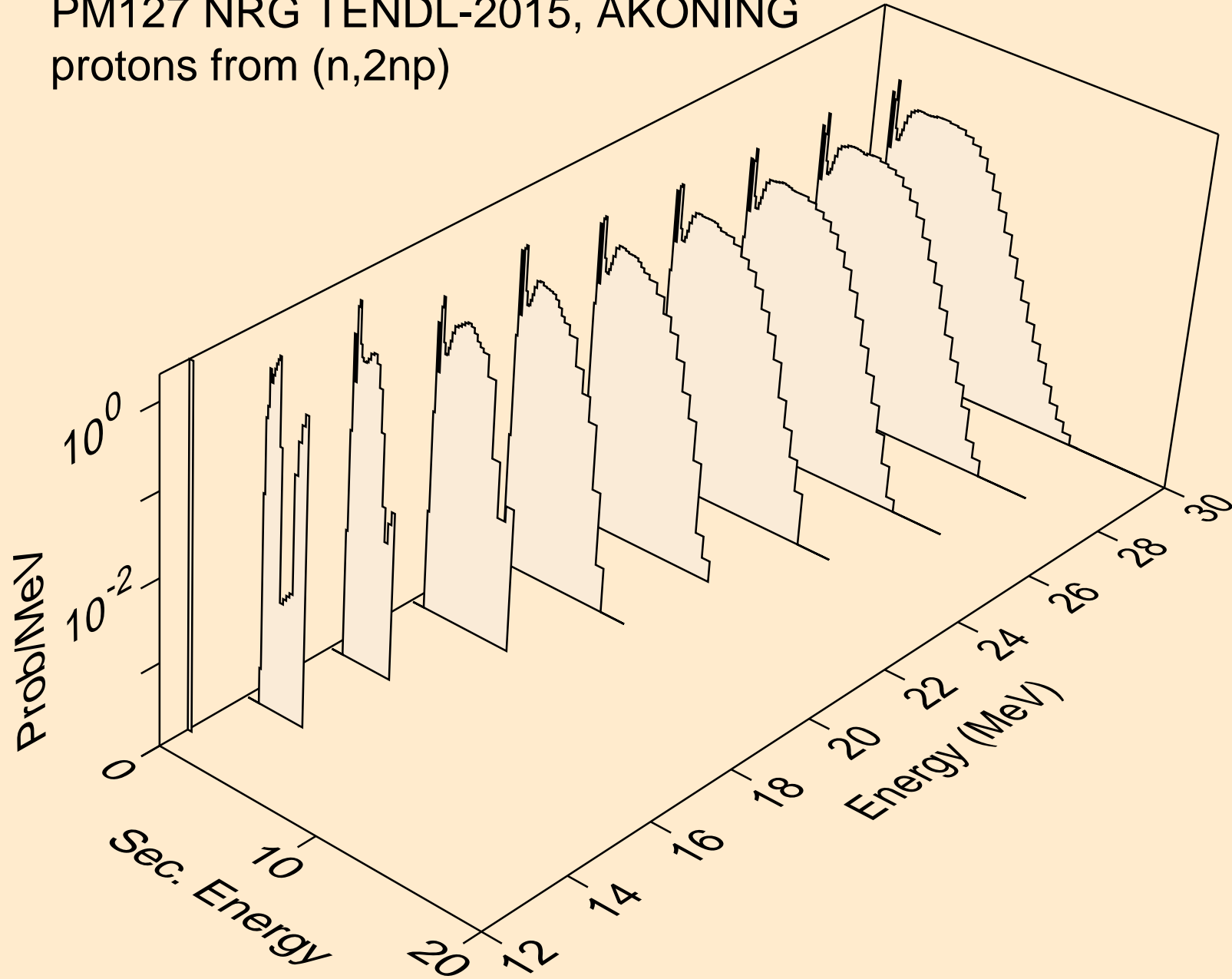

PM127 NRG TENDL-2015, AKONING
protons from (n,3np)

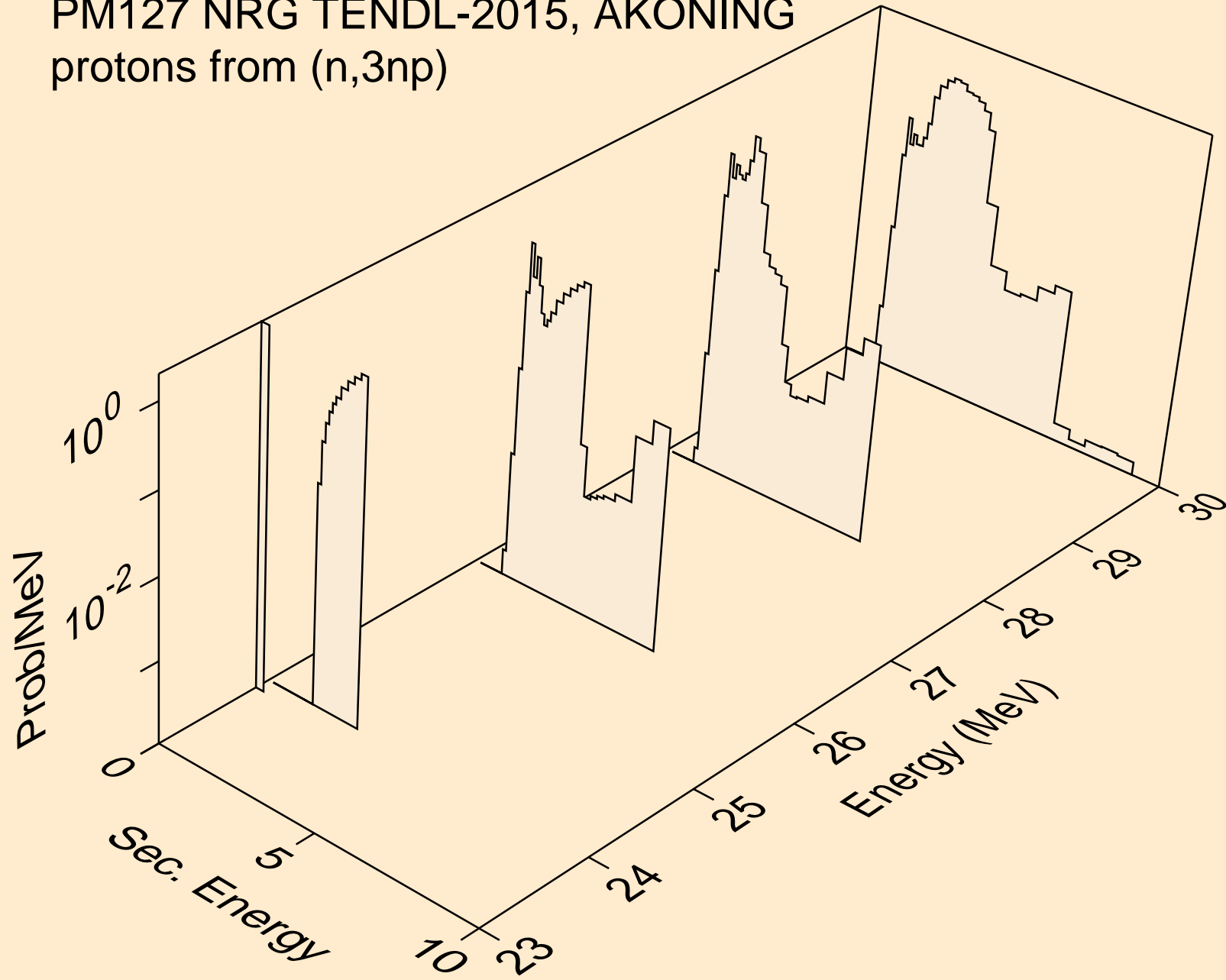

PM127 NRG TENDL-2015, AKONING
protons from (n,2np)

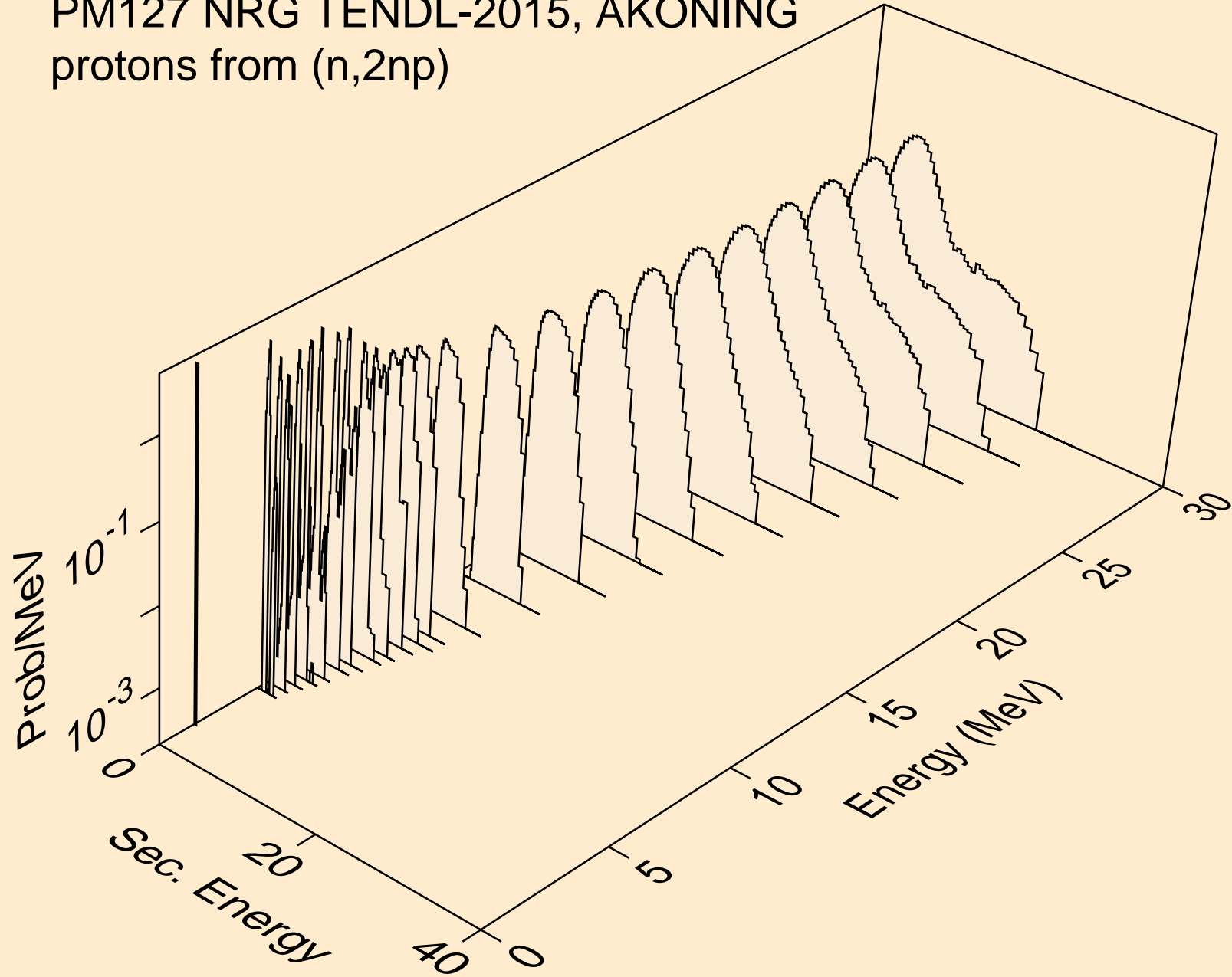

PM127 NRG TENDL-2015, AKONING
protons from (n,npa)

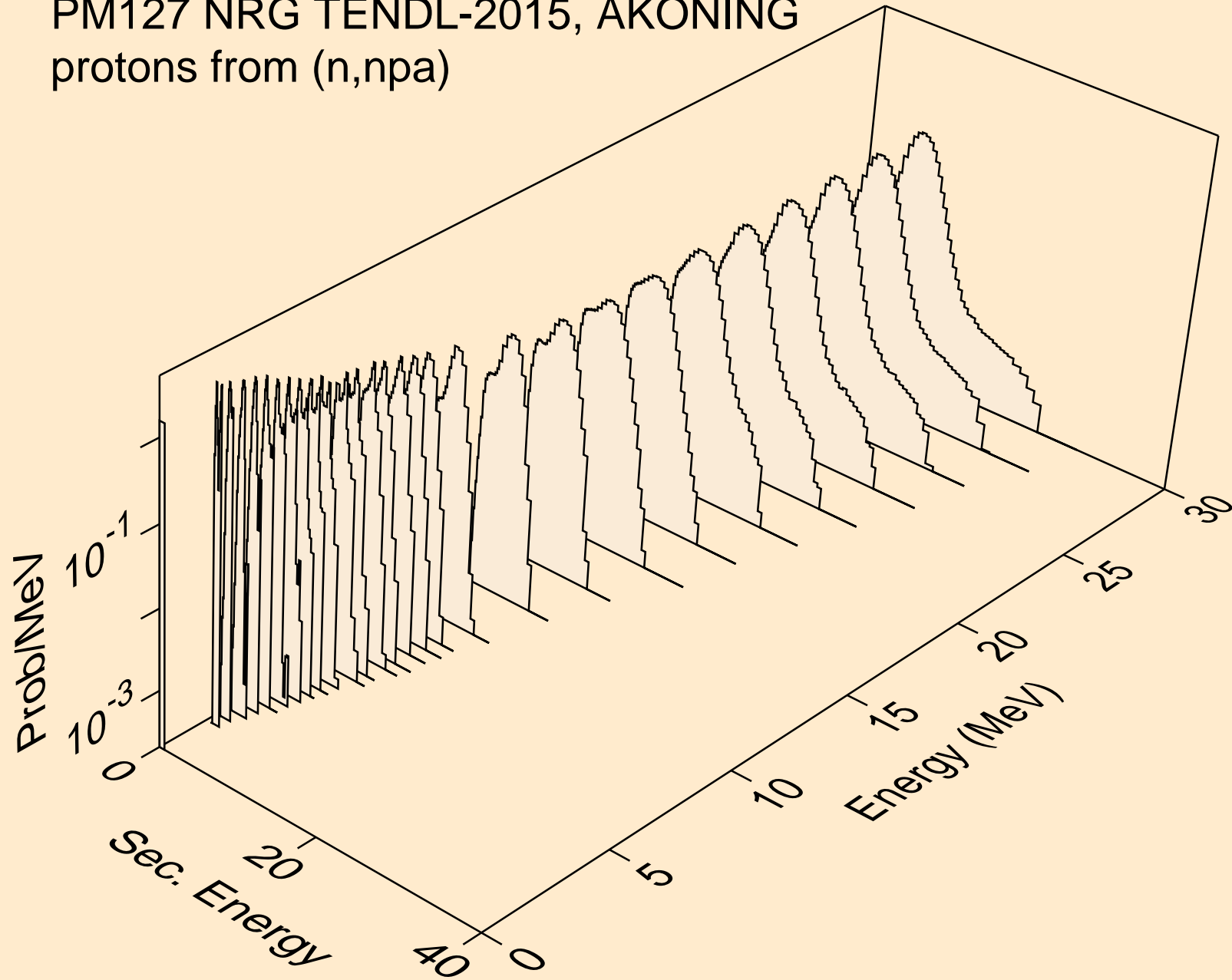

PM127 NRG TENDL-2015, AKONING
protons from (n,p)

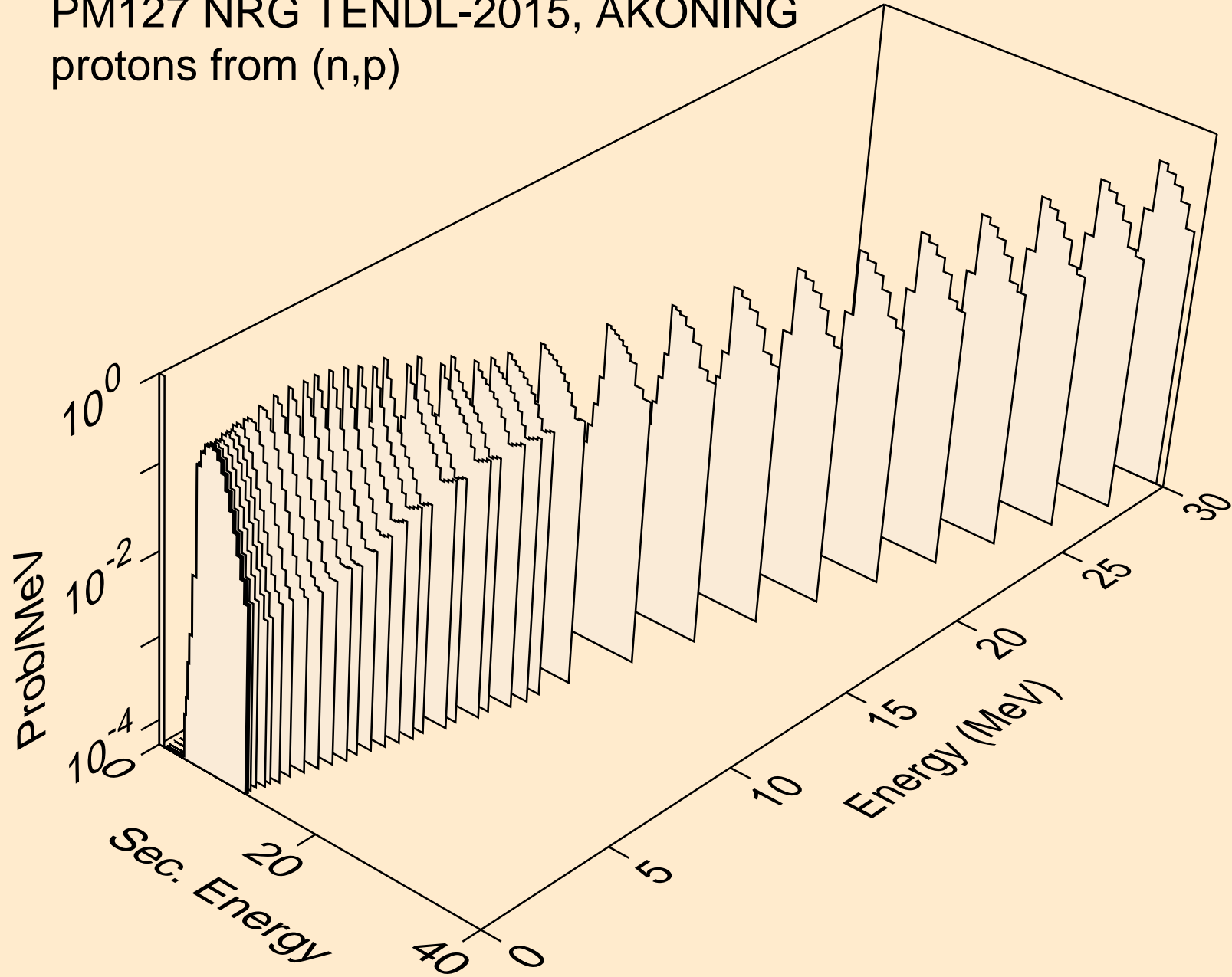

PM127 NRG TENDL-2015, AKONING
protons from (n,2p)

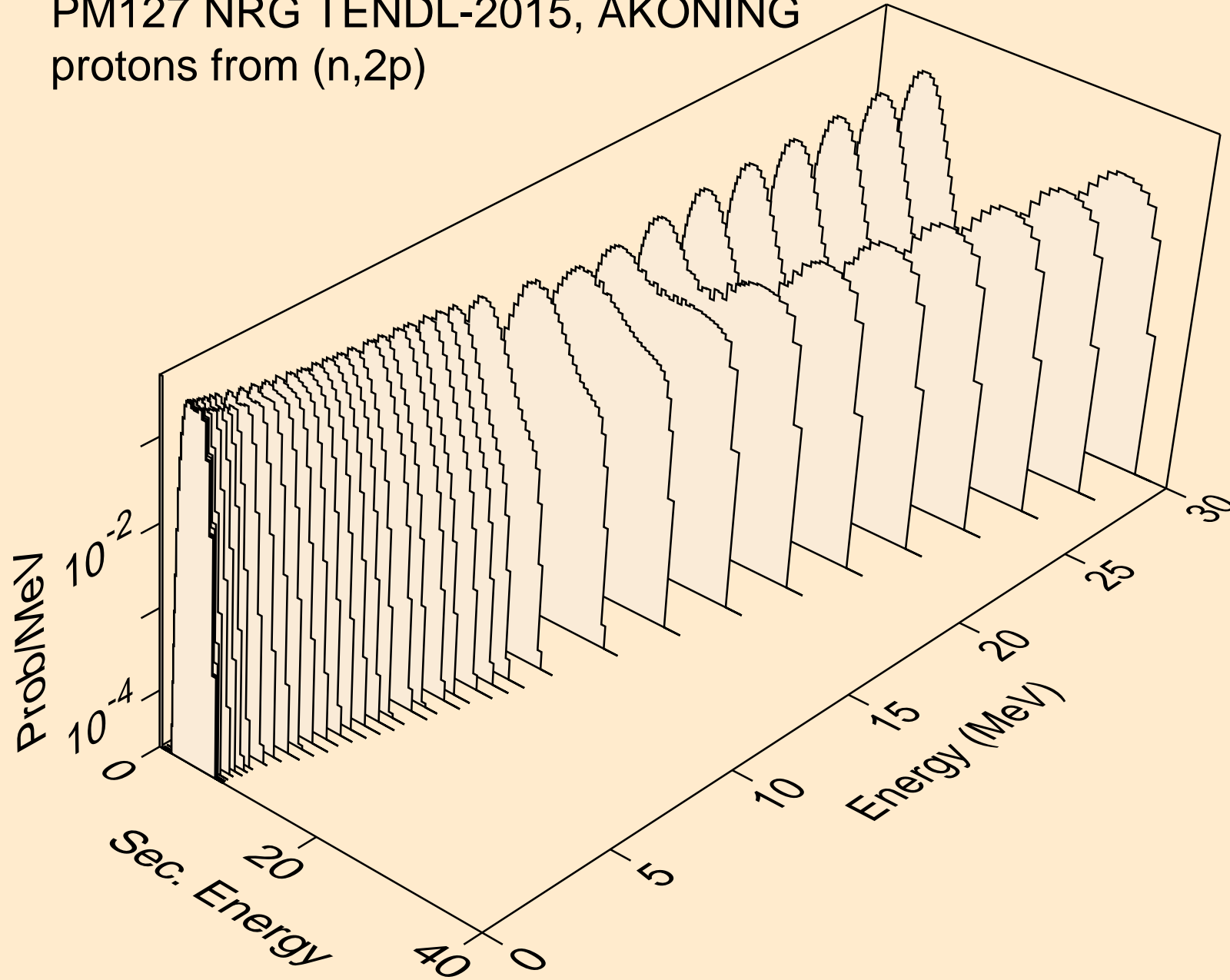

PM127 NRG TENDL-2015, AKONING
protons from (n,pa)

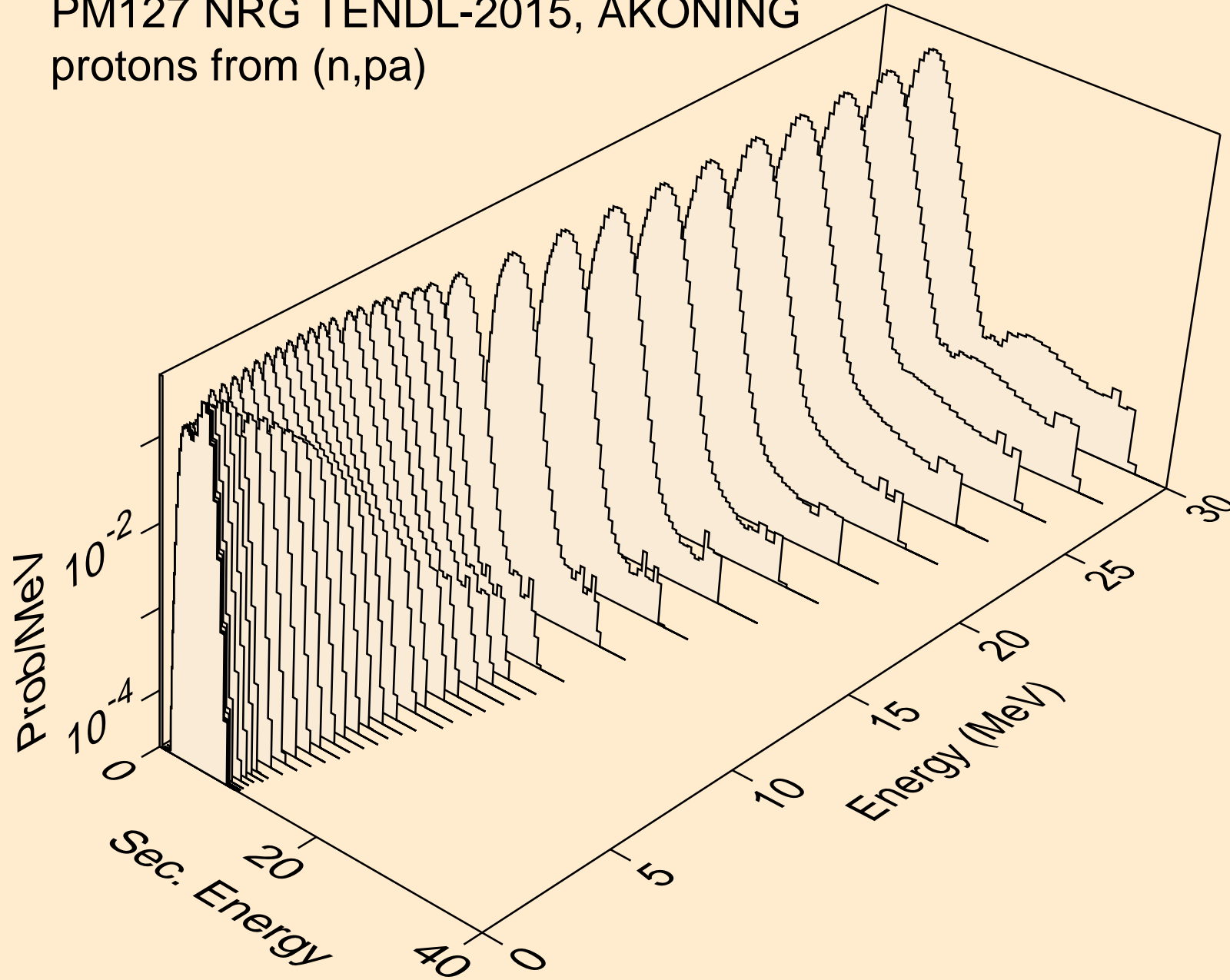

PM127 NRG TENDL-2015, AKONING
protons from (n,pd)

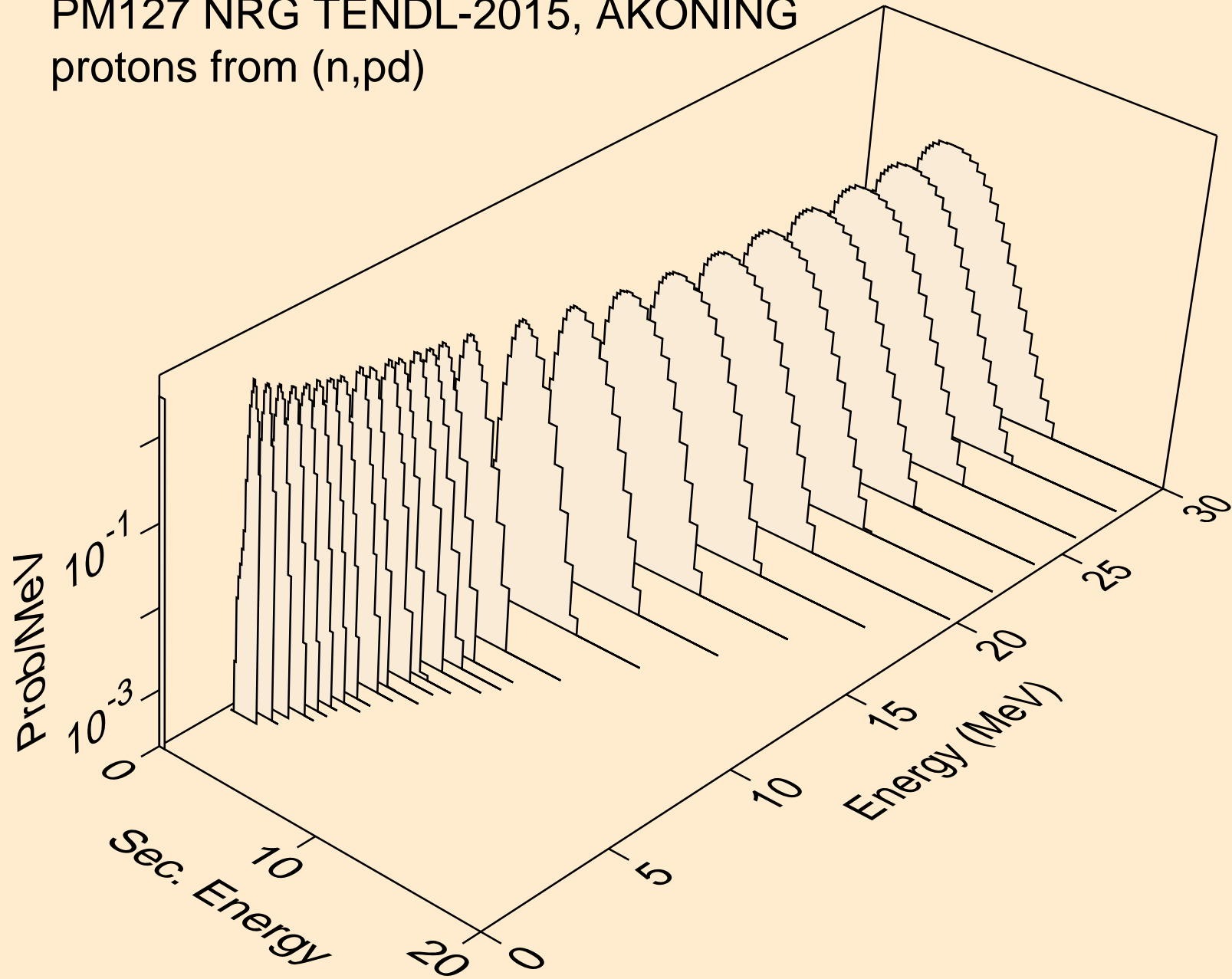

PM127 NRG TENDL-2015, AKONING
protons from (n,pt)

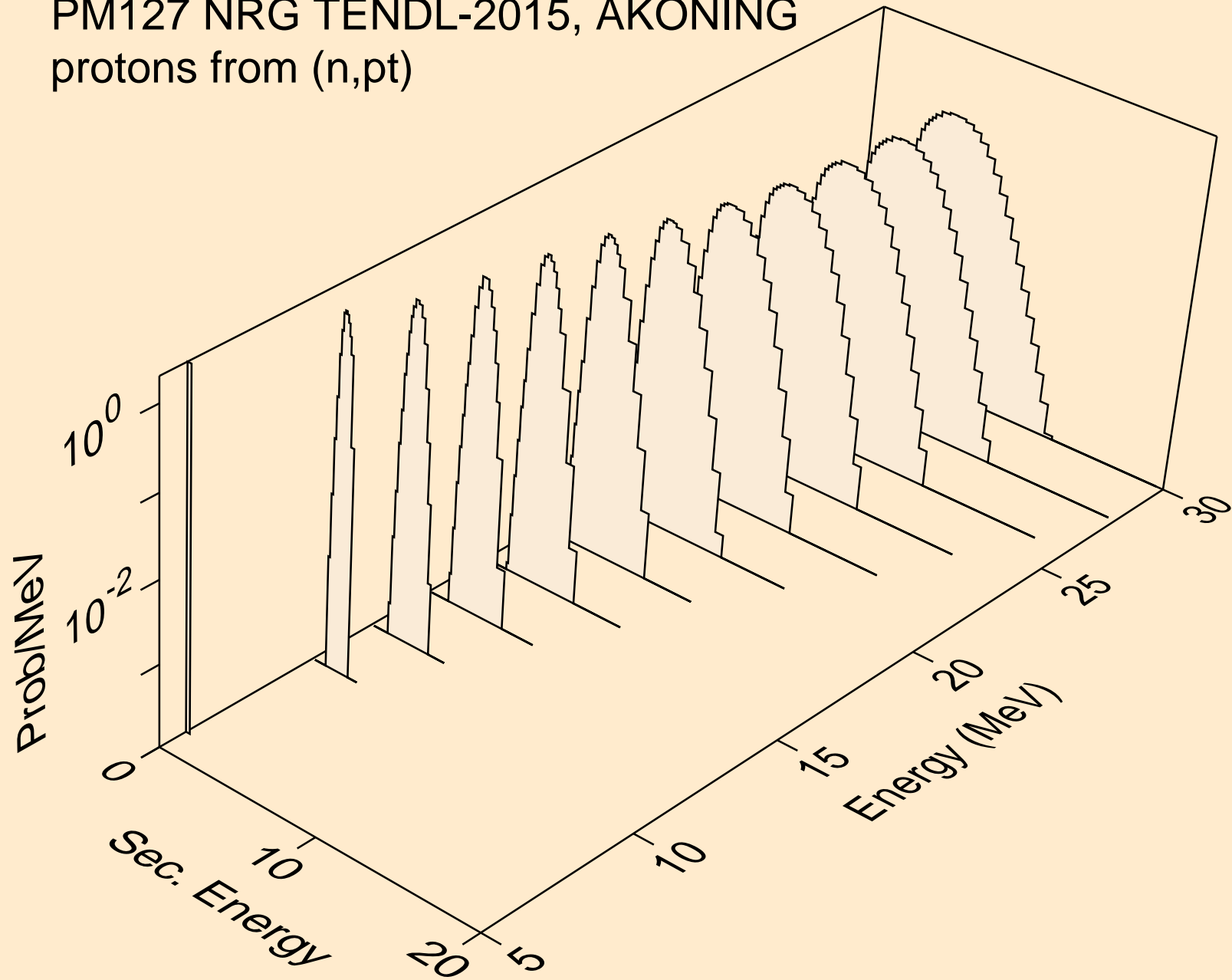

PM127 NRG TENDL-2015, AKONING
deuterons from (n,x)

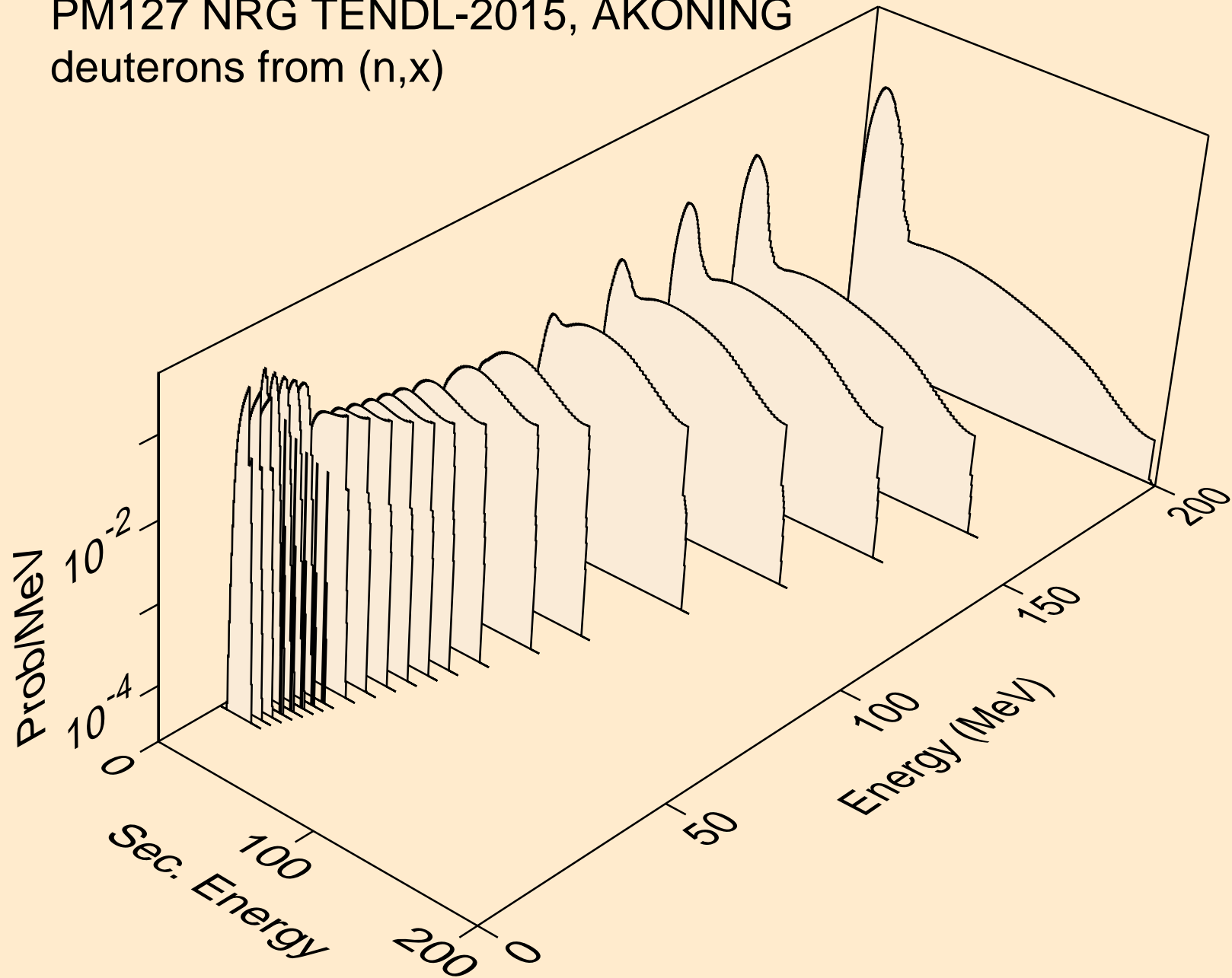

PM127 NRG TENDL-2015, AKONING
deuterons from (n,2nd)

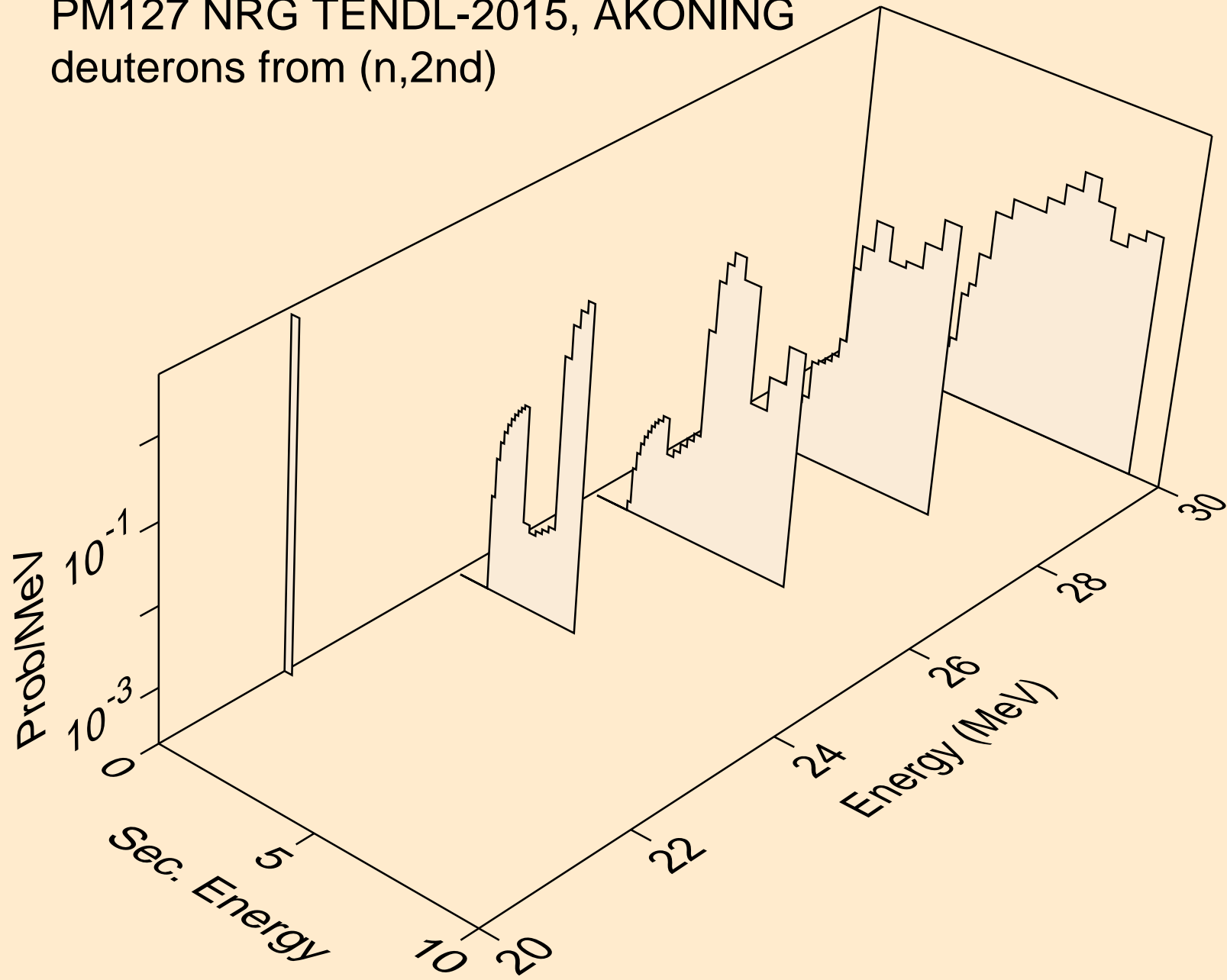

PM127 NRG TENDL-2015, AKONING
deuterons from (n,n*)d

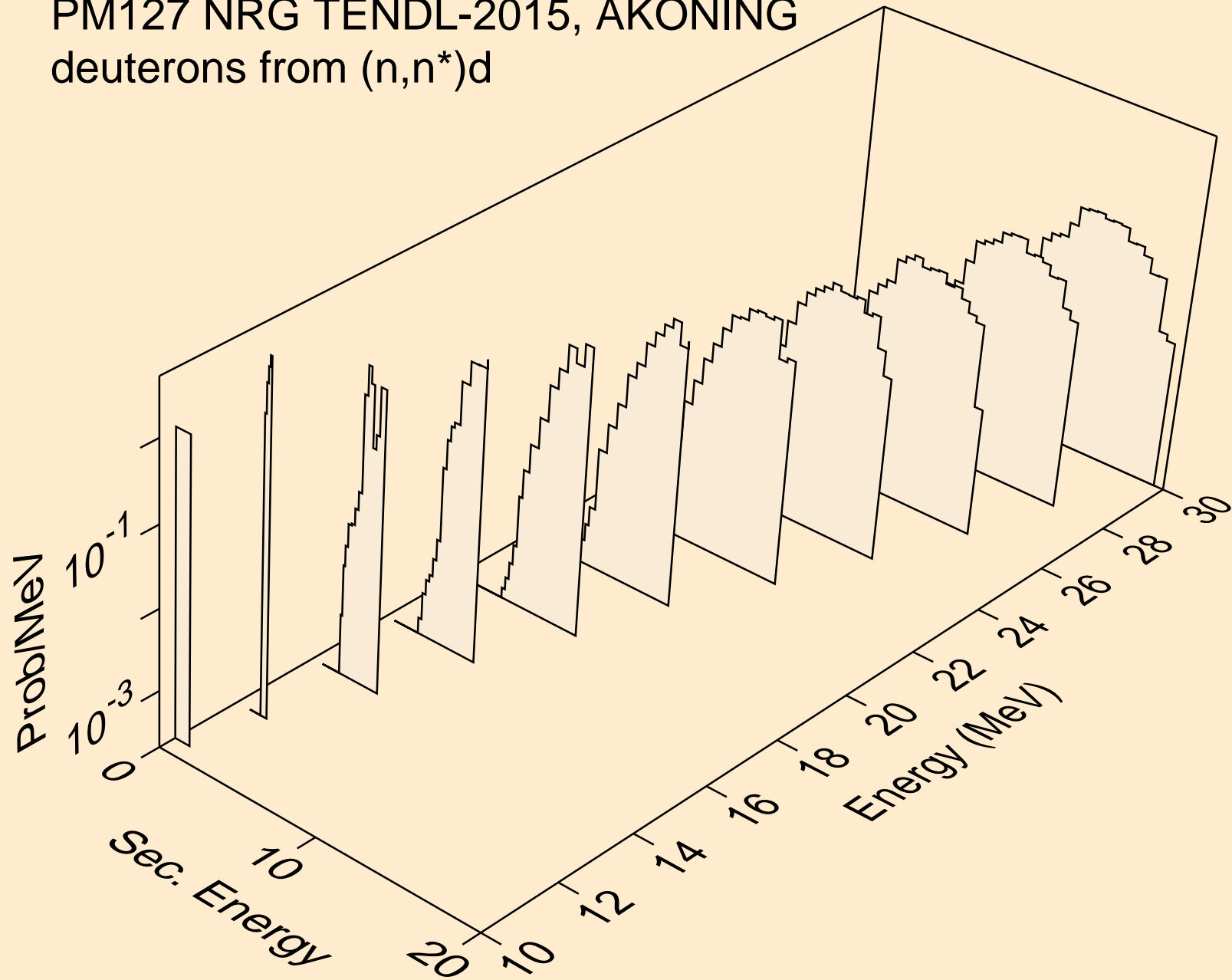

PM127 NRG TENDL-2015, AKONING
deuterons from (n,d)

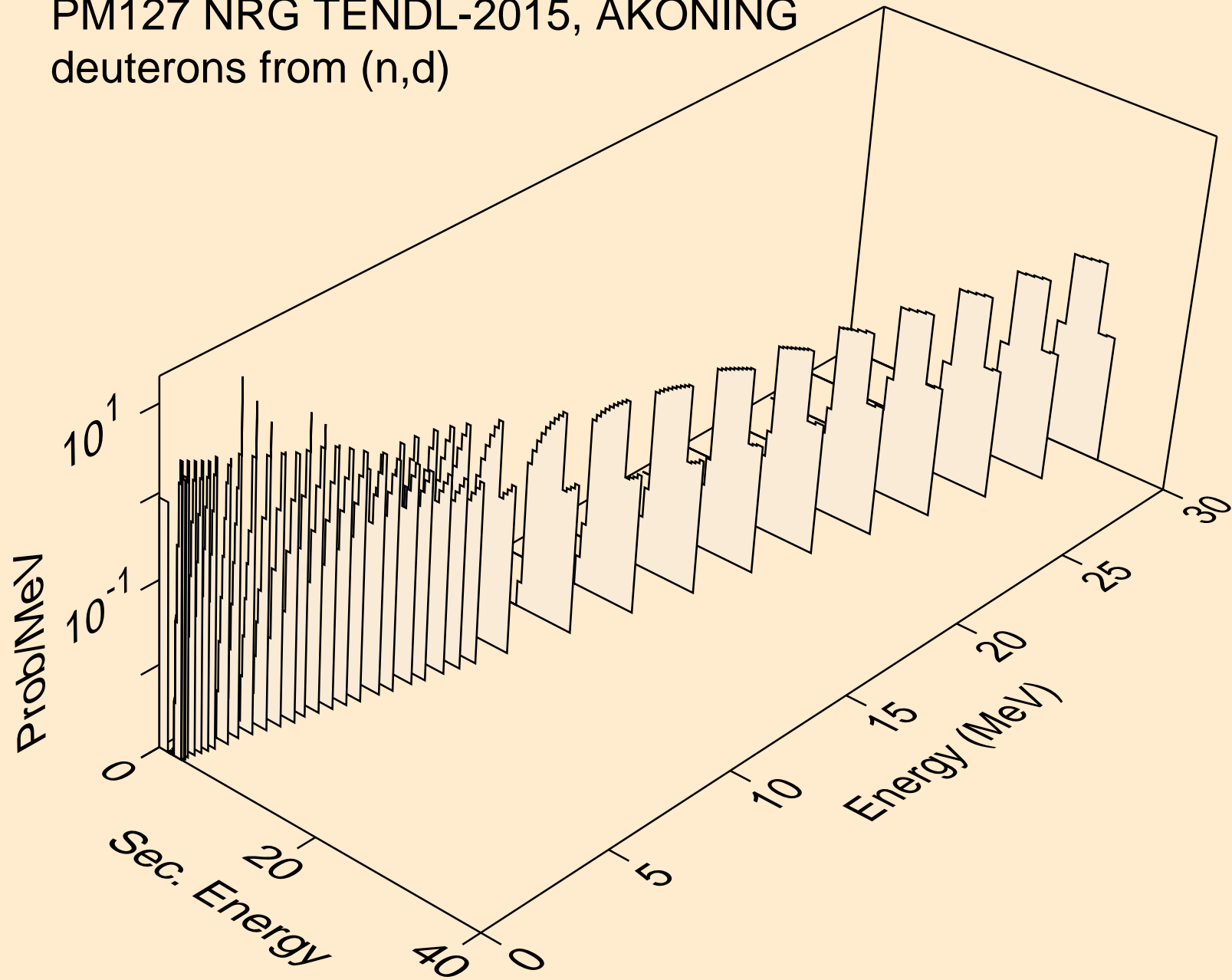

PM127 NRG TENDL-2015, AKONING
deuterons from (n,d2a)

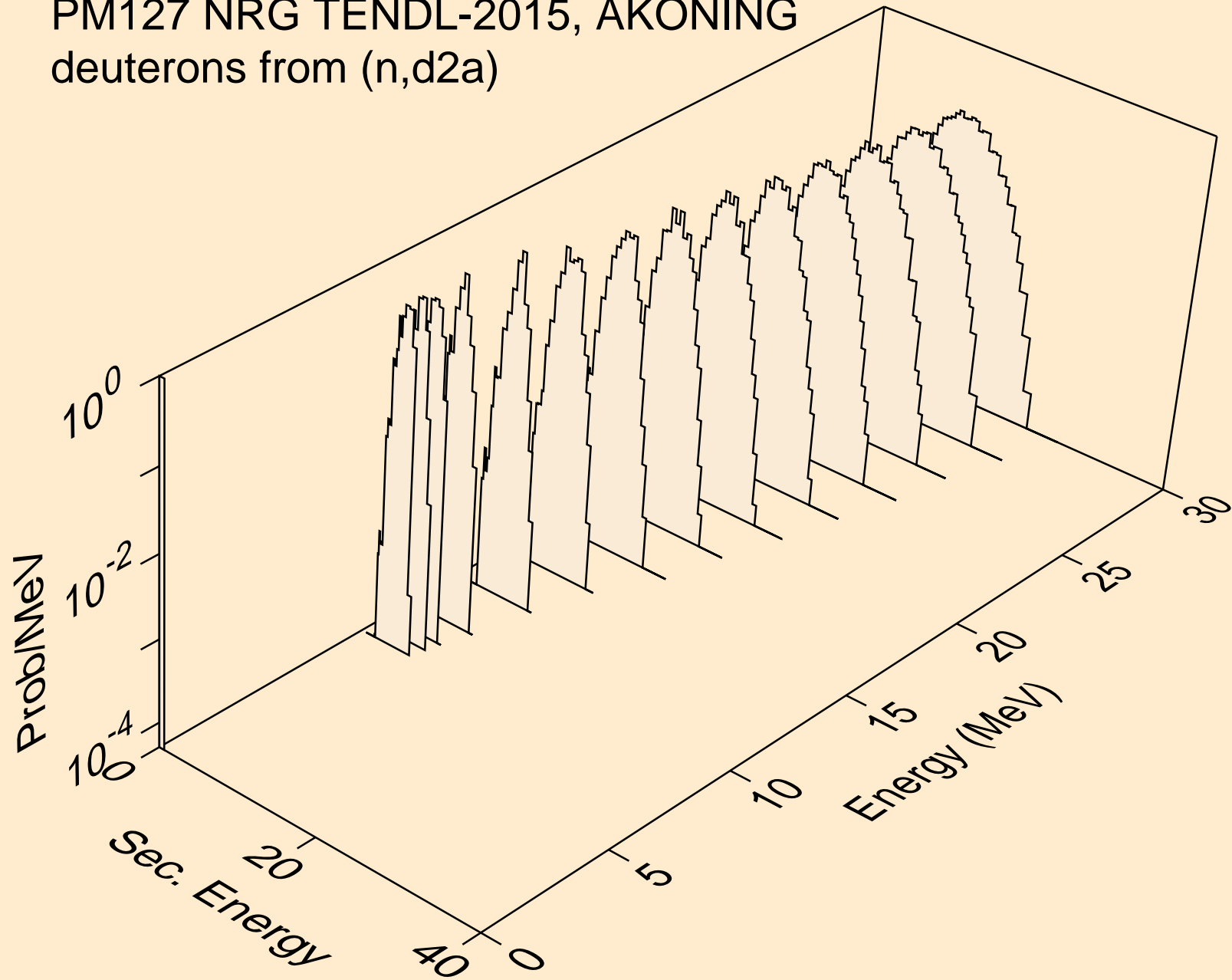

PM127 NRG TENDL-2015, AKONING
deuterons from (n,pd)

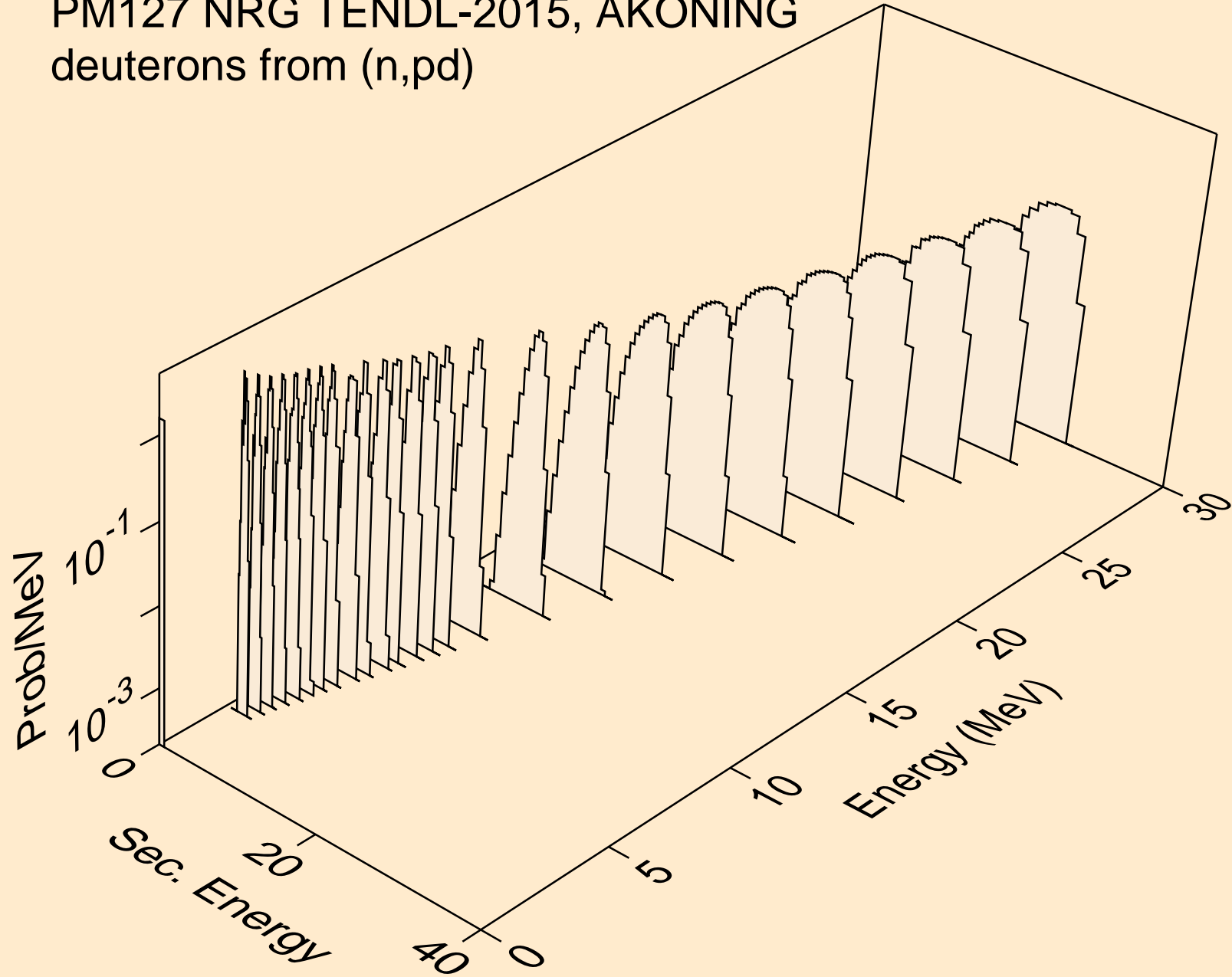

PM127 NRG TENDL-2015, AKONING
deuterons from (n,da)

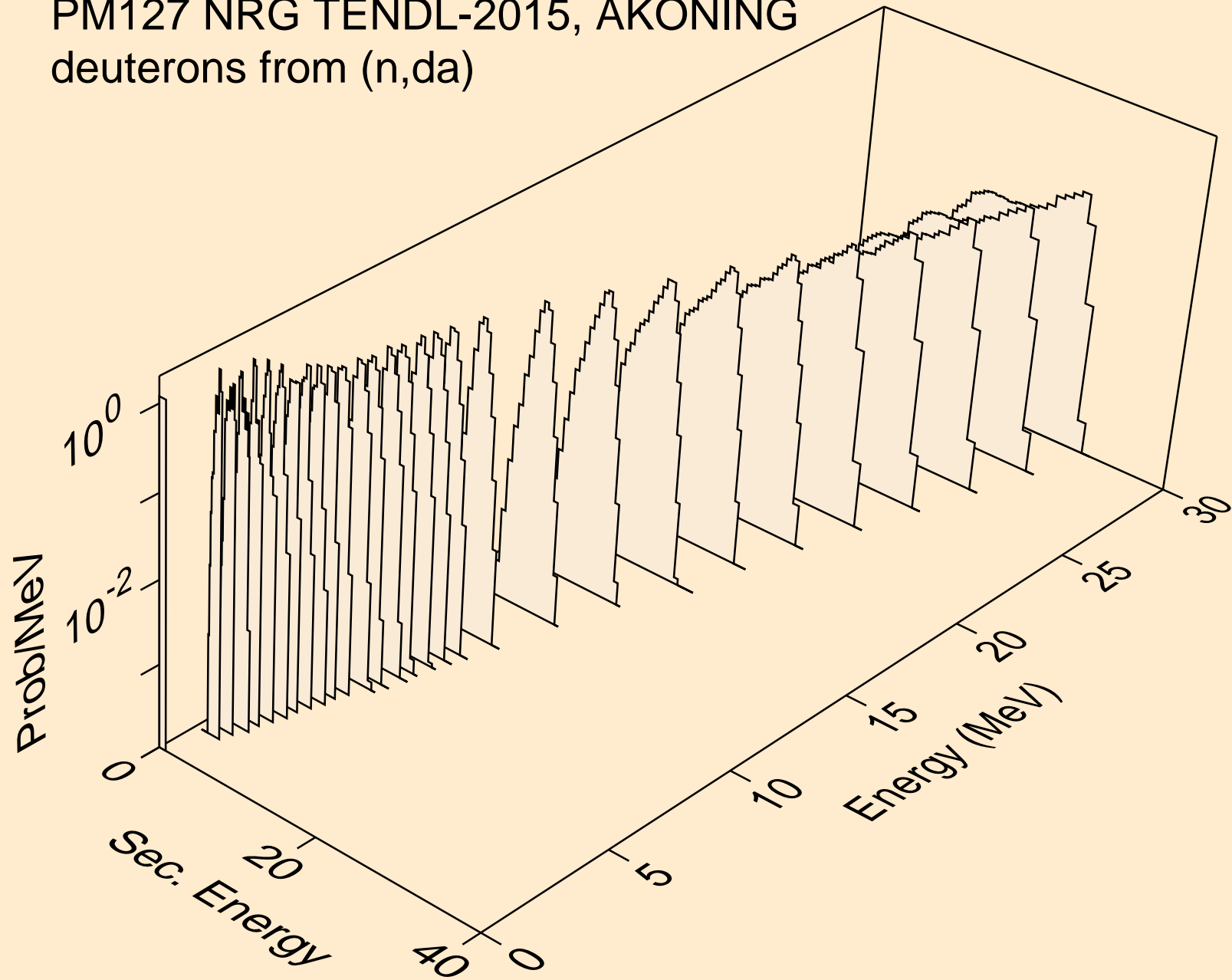

PM127 NRG TENDL-2015, AKONING
tritons from (n,x)

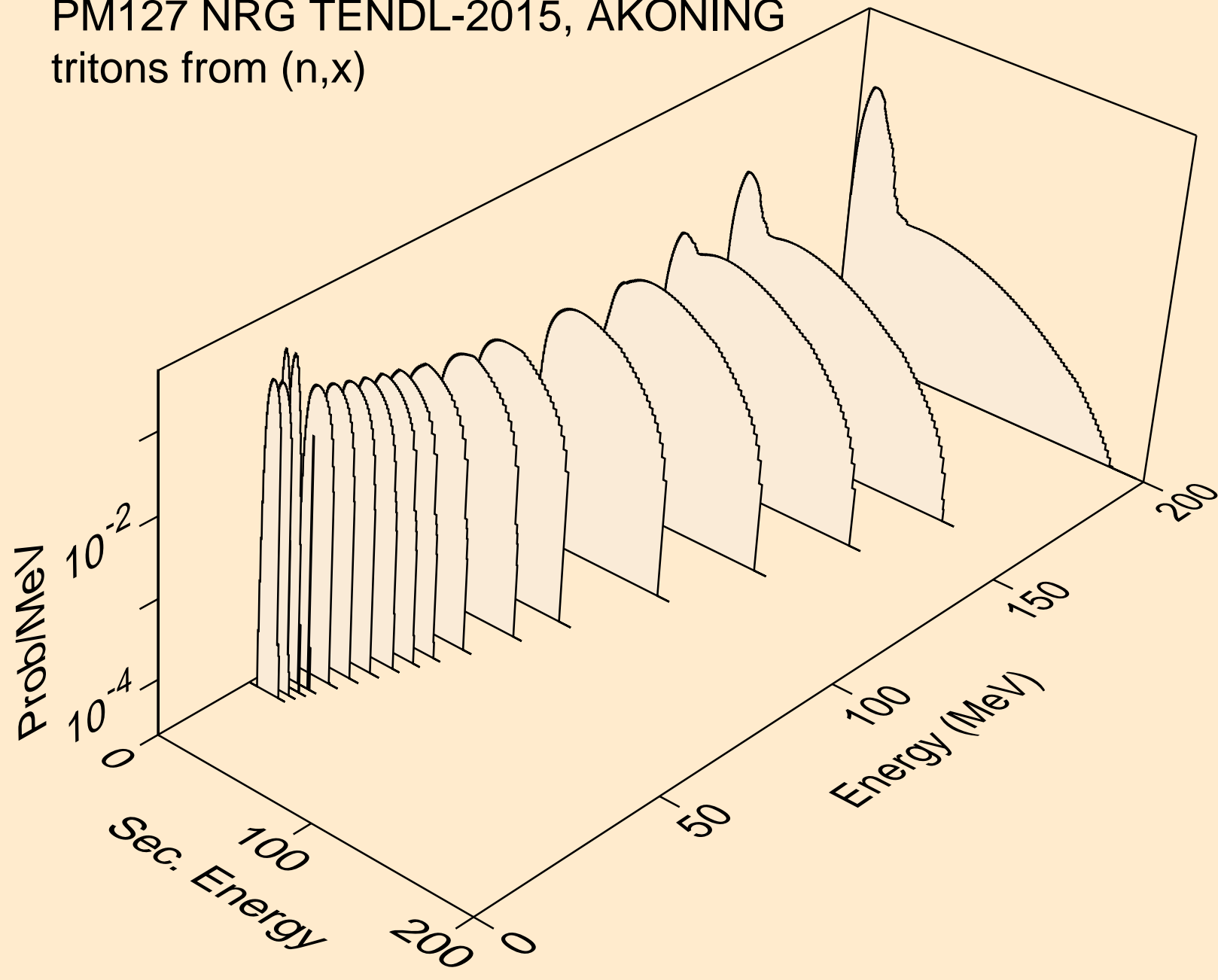

PM127 NRG TENDL-2015, AKONING
tritons from (n,n*)t

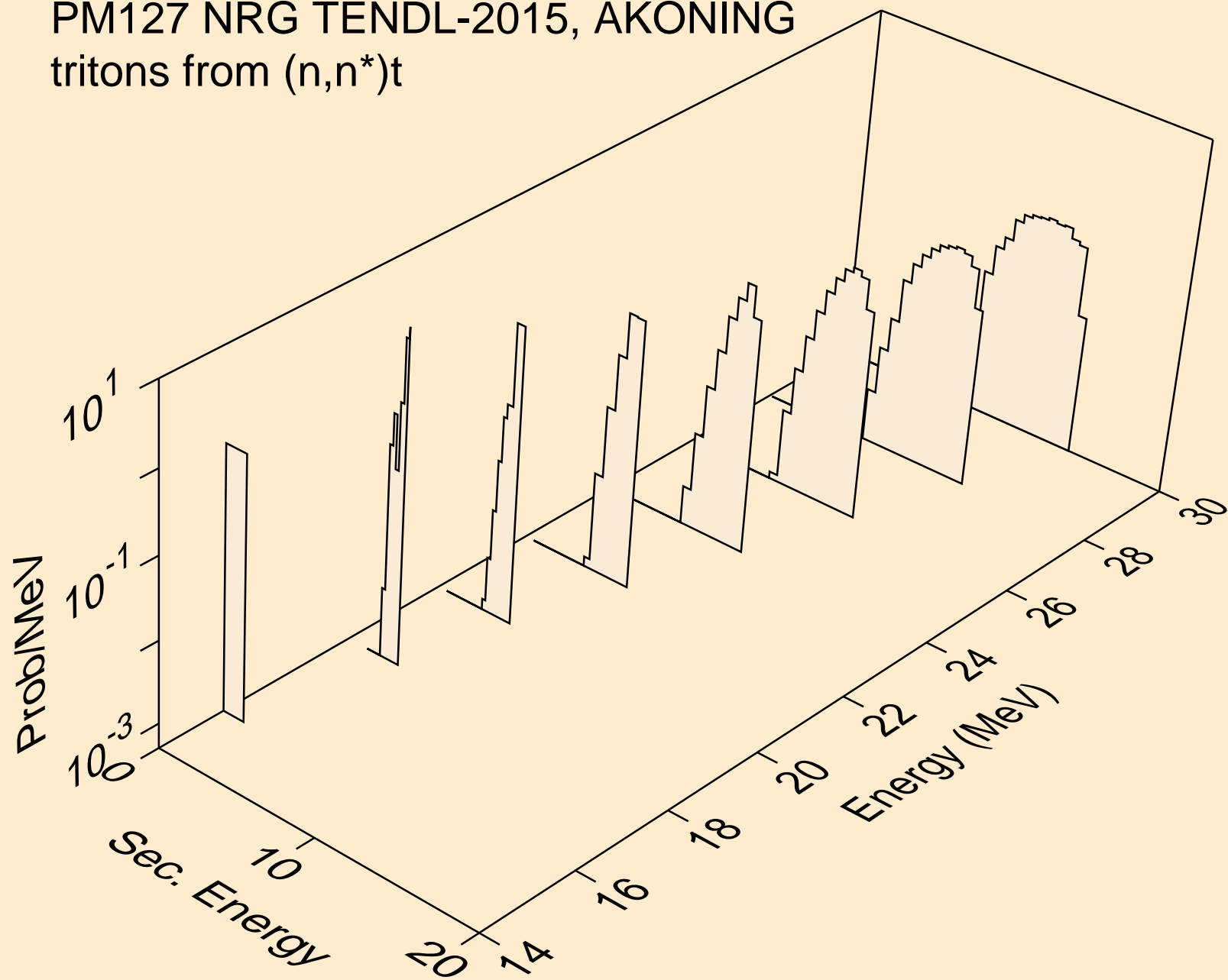

PM127 NRG TENDL-2015, AKONING
tritons from (n,t)

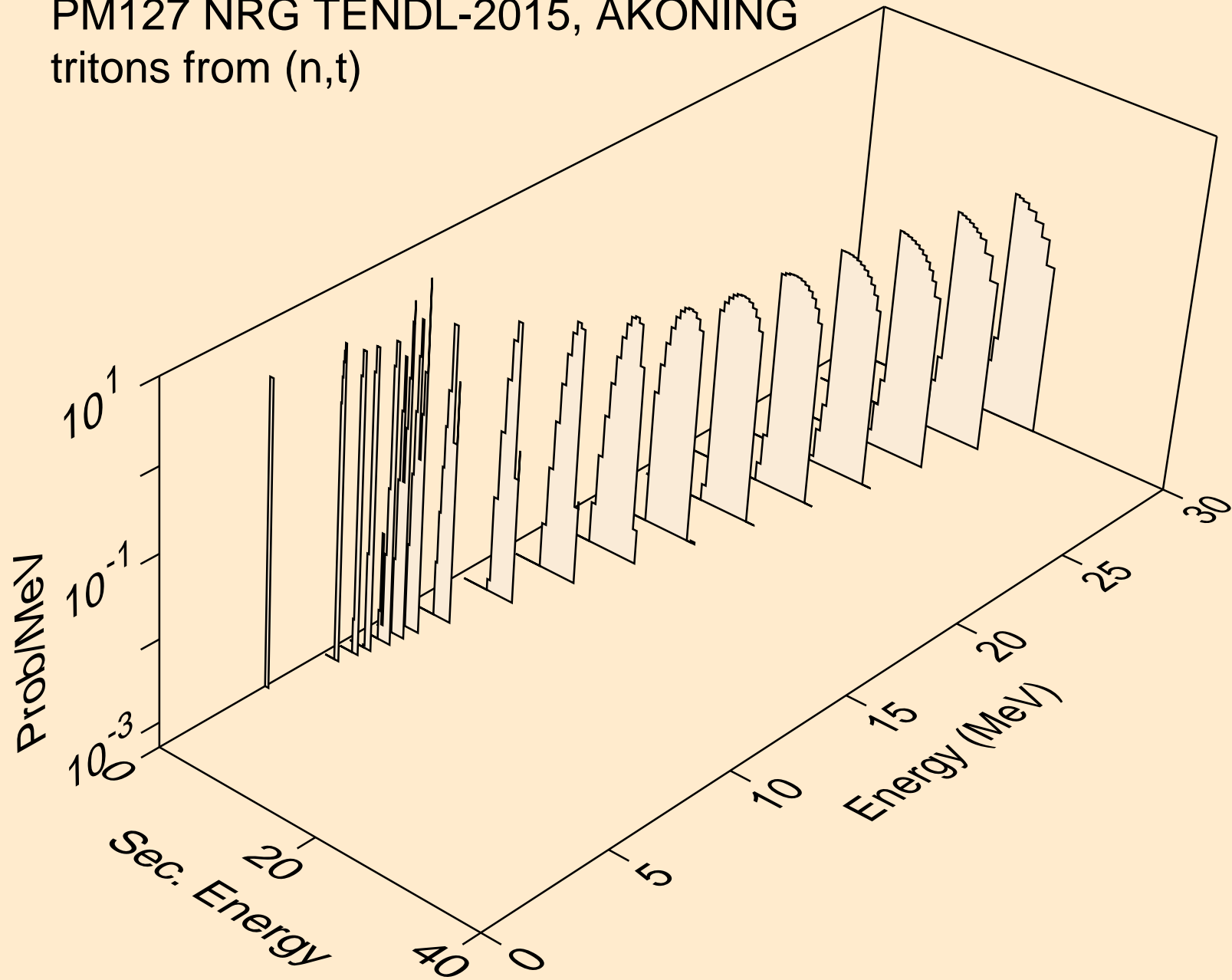

PM127 NRG TENDL-2015, AKONING
tritons from (n,t2a)

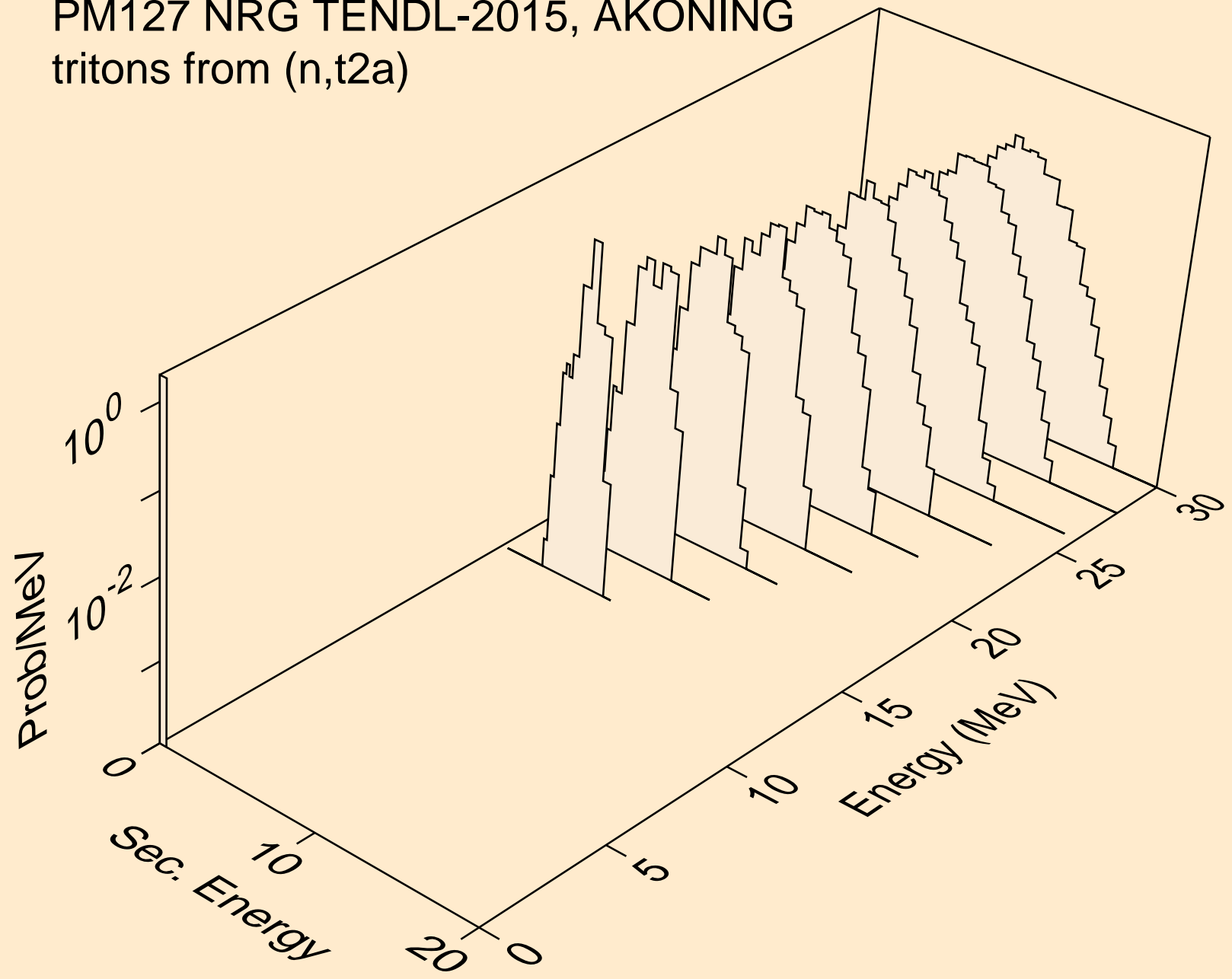

PM127 NRG TENDL-2015, AKONING
tritons from (n,pt)

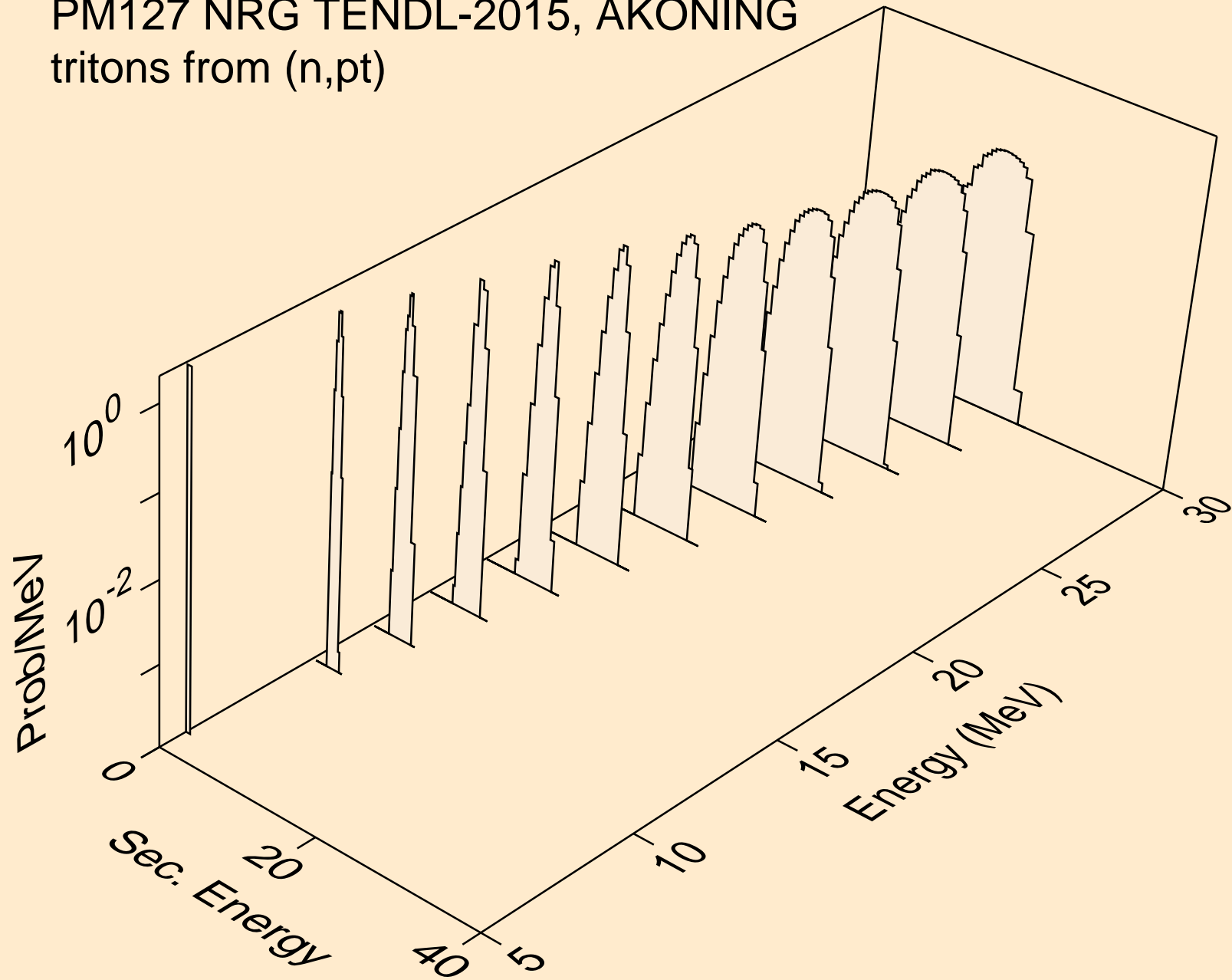

PM127 NRG TENDL-2015, AKONING
he3s from (n,x)

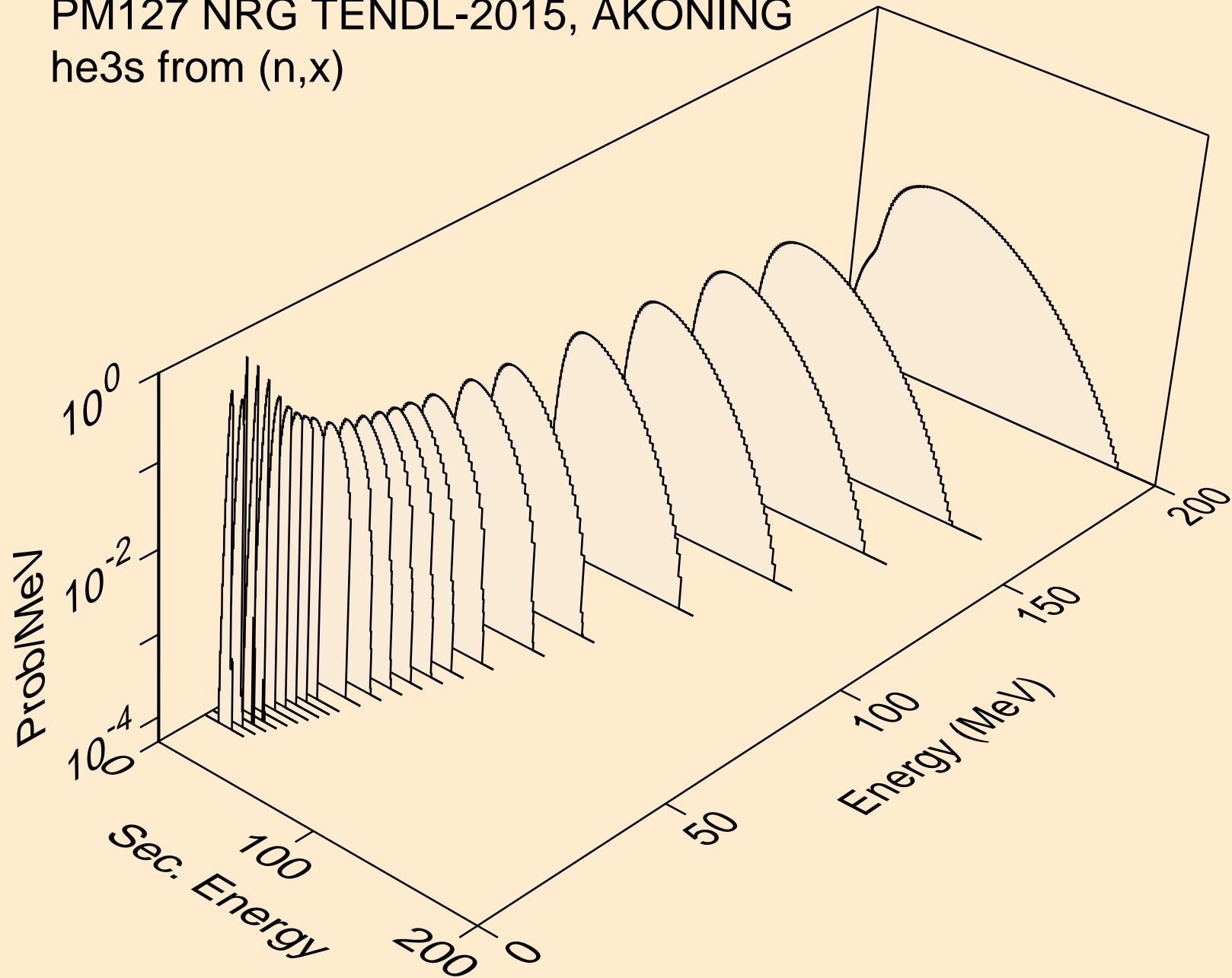

PM127 NRG TENDL-2015, AKONING
he3s from (n,n*)he3

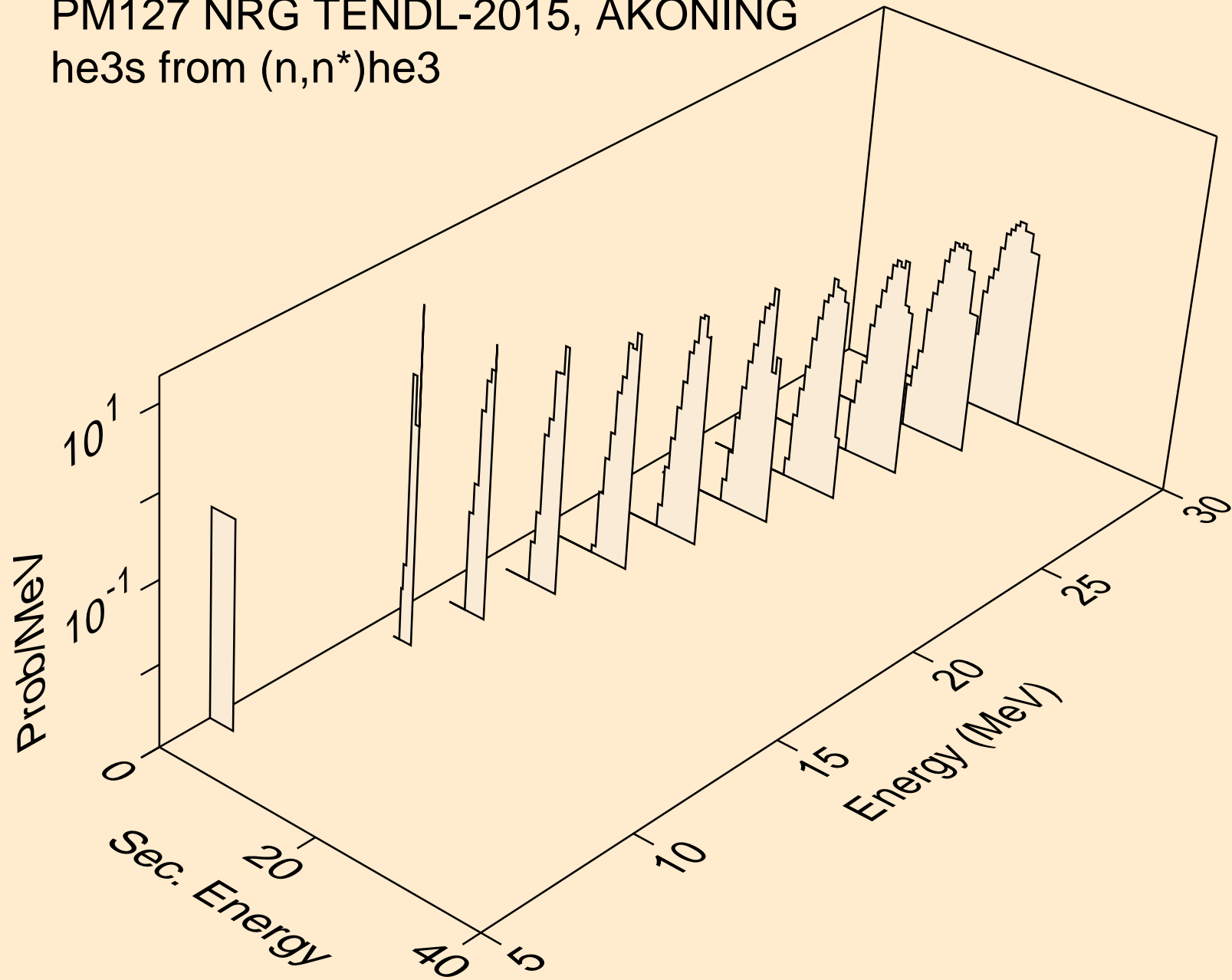

PM127 NRG TENDL-2015, AKONING
he3s from (n,he3)

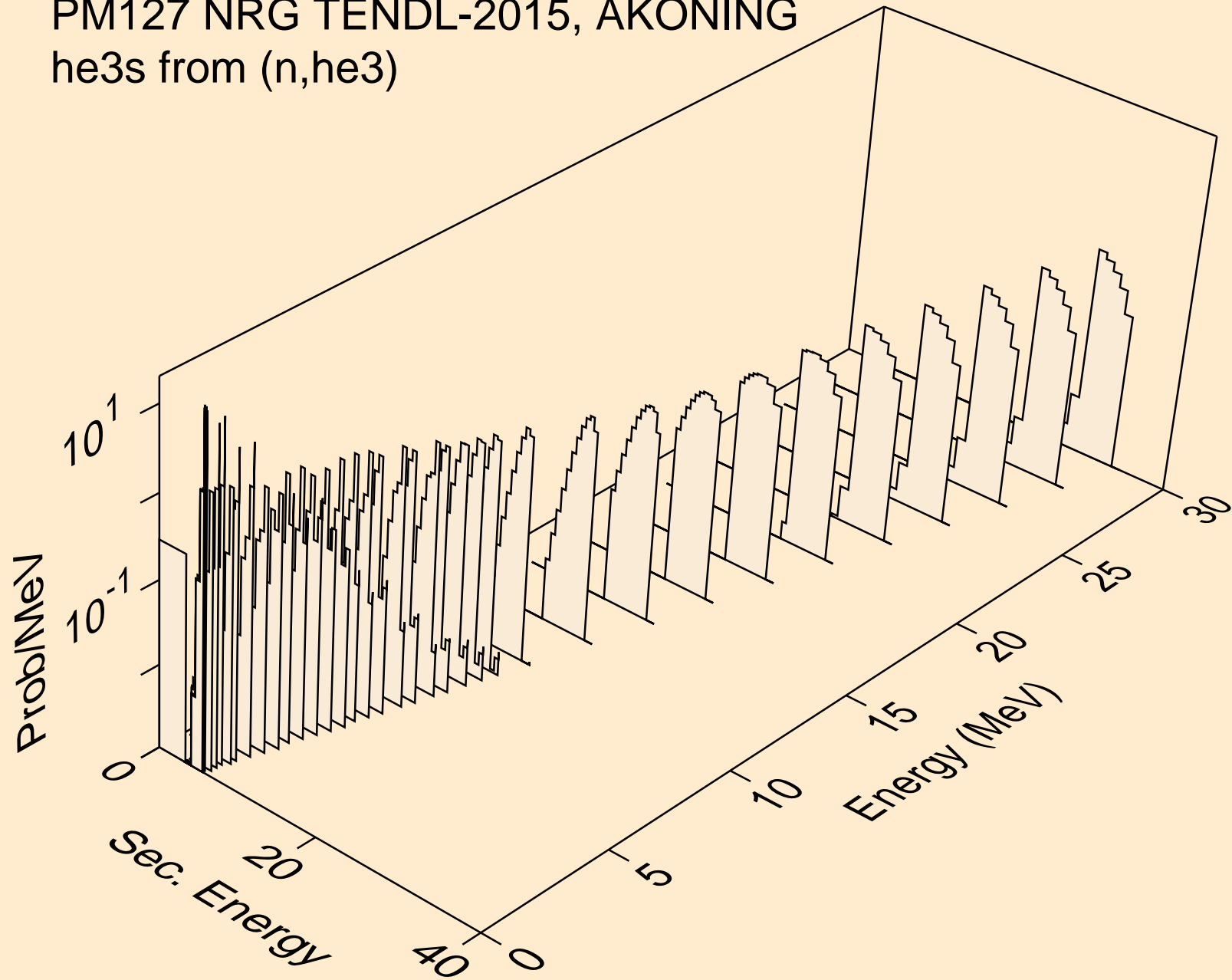

PM127 NRG TENDL-2015, AKONING
alphas from (n,x)

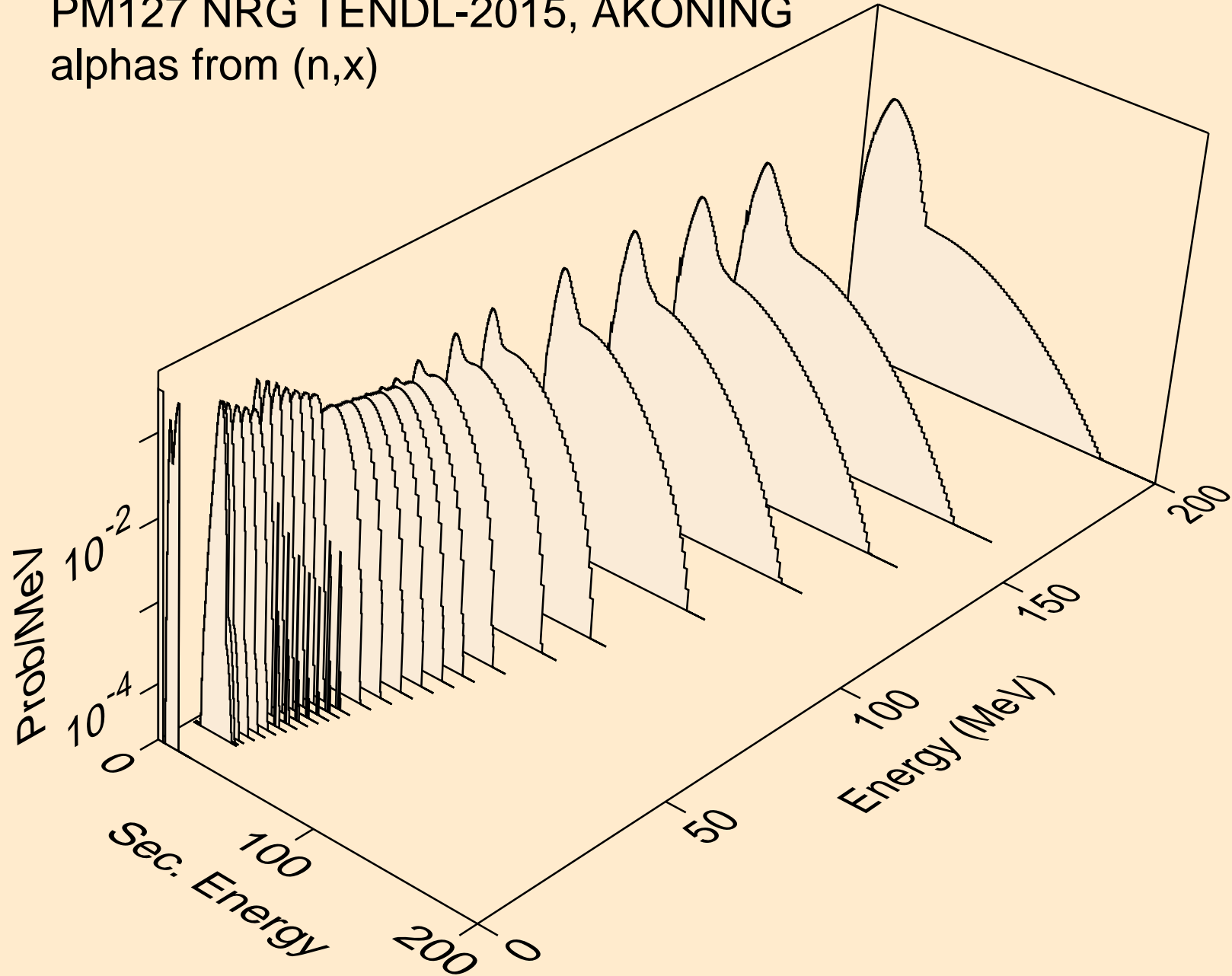

PM127 NRG TENDL-2015, AKONING
alphas from (n,n*)a

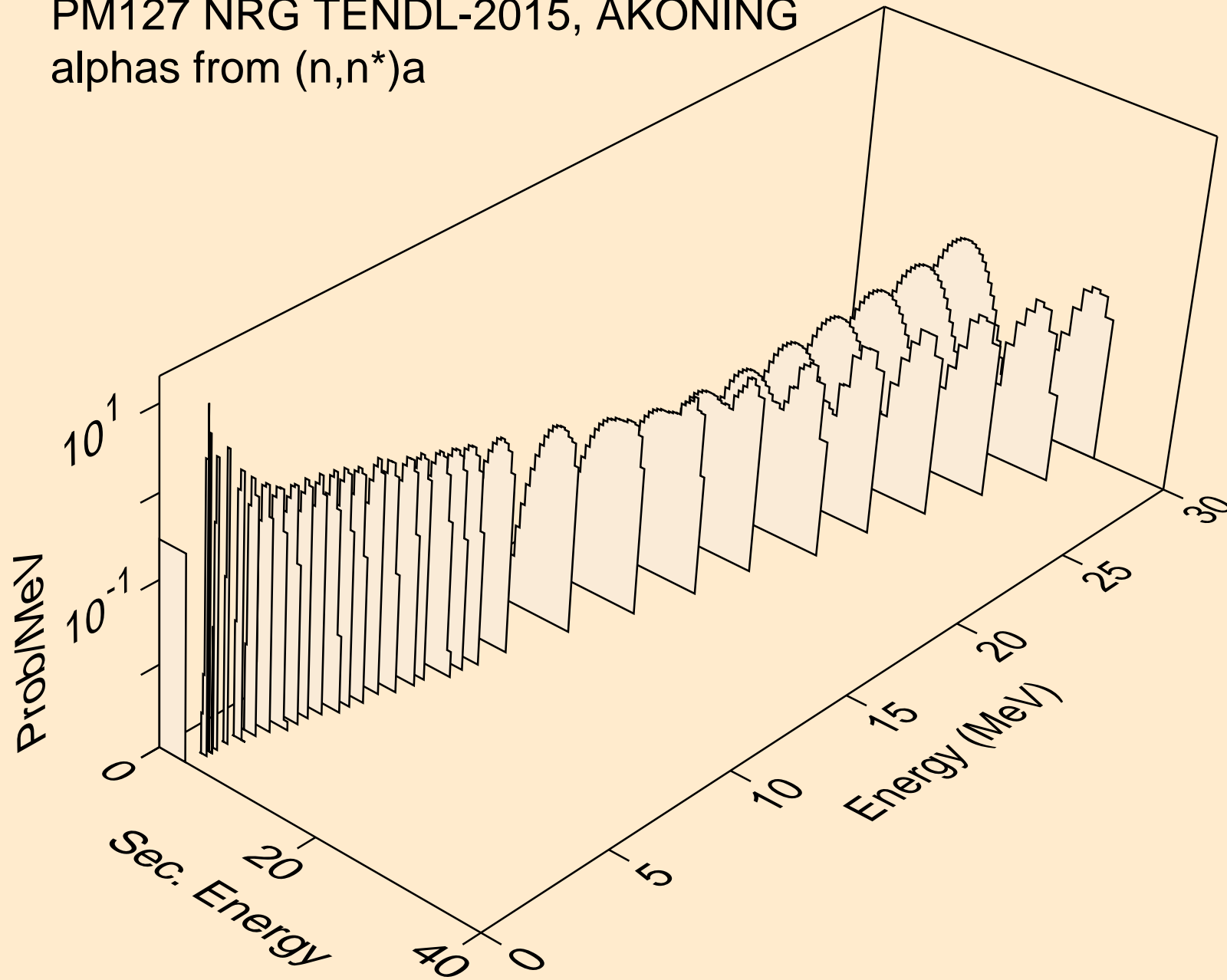

PM127 NRG TENDL-2015, AKONING
alphas from (n,2n)a

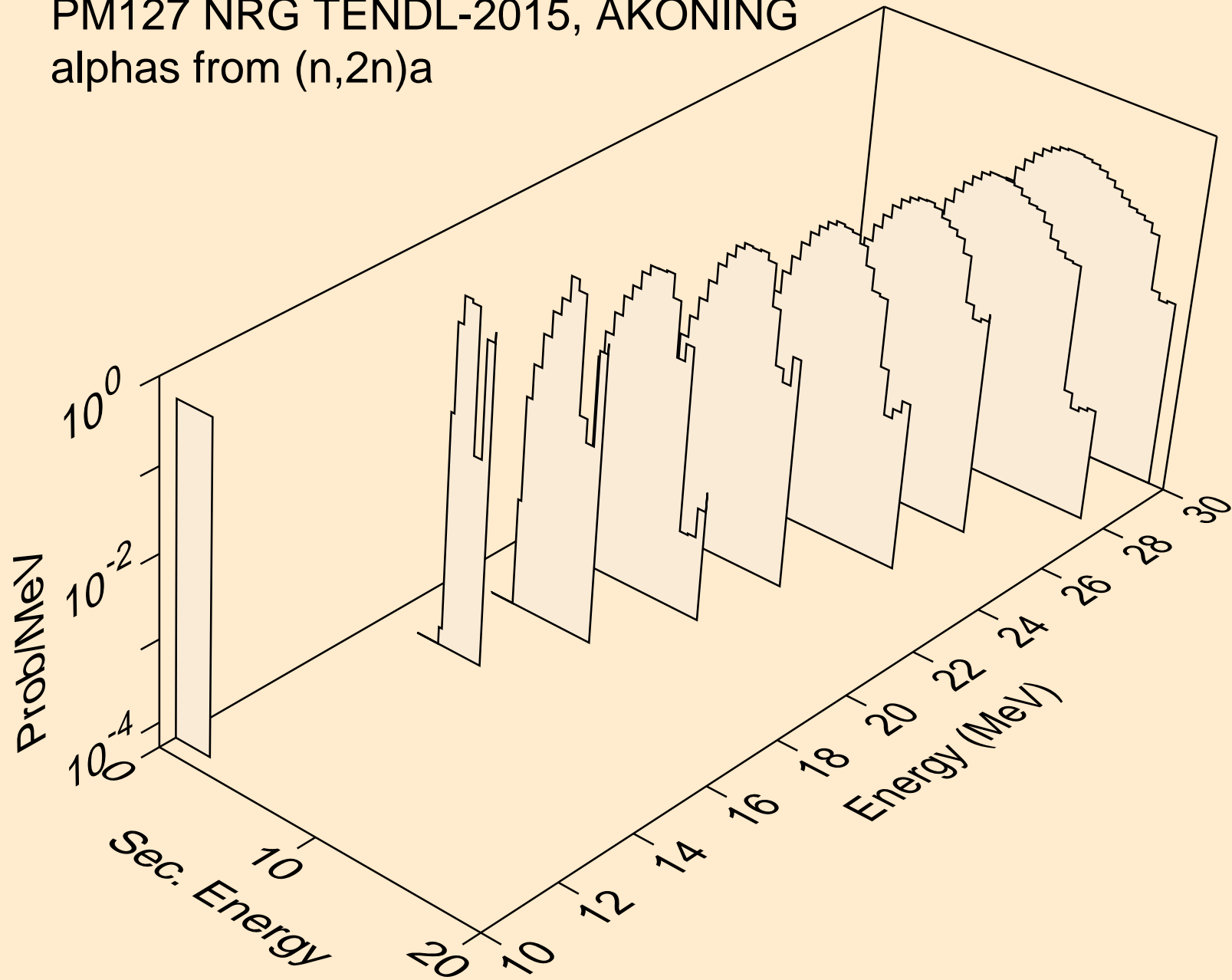

PM127 NRG TENDL-2015, AKONING
alphas from (n,n*)2a

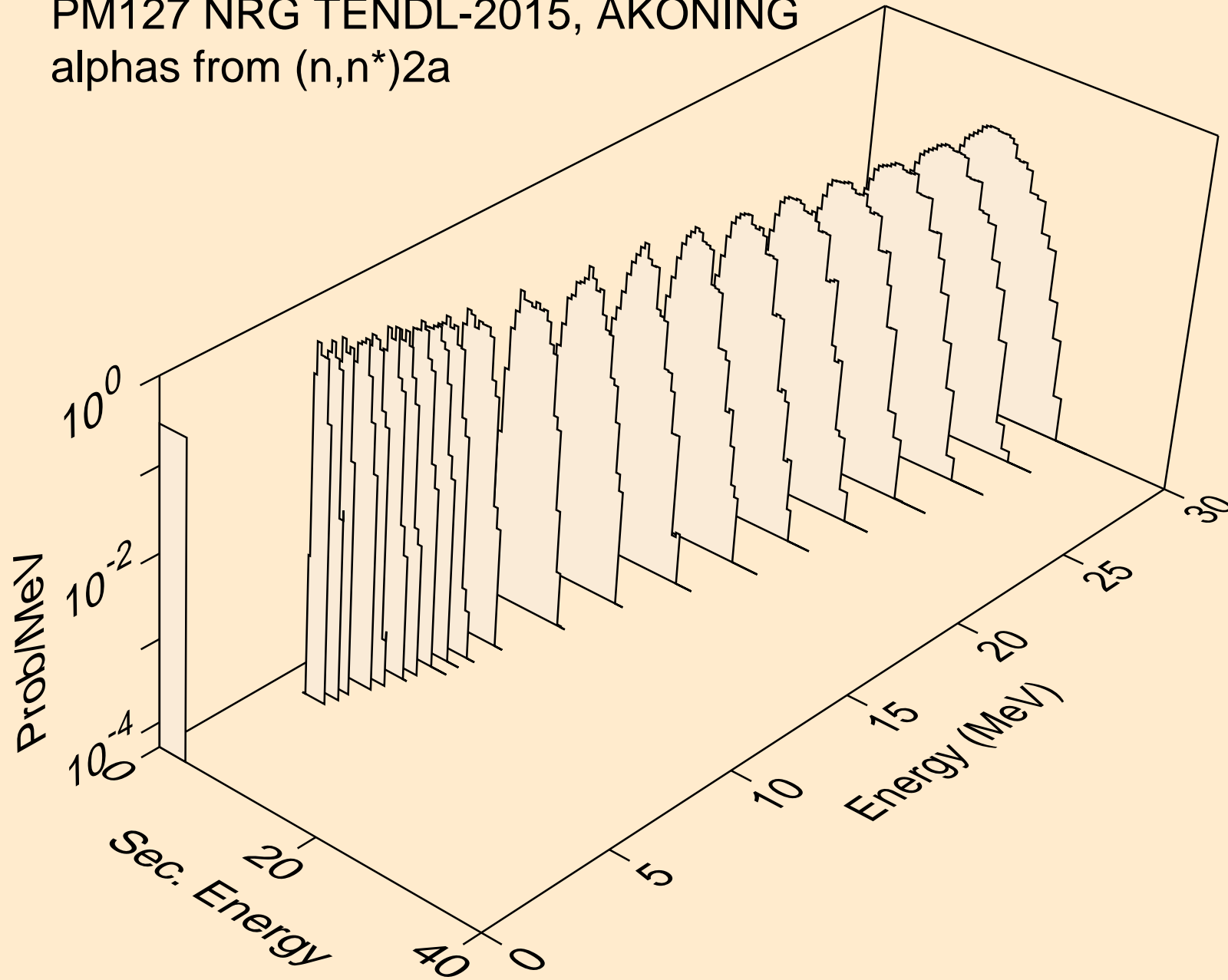

PM127 NRG TENDL-2015, AKONING
alphas from (n,npa)

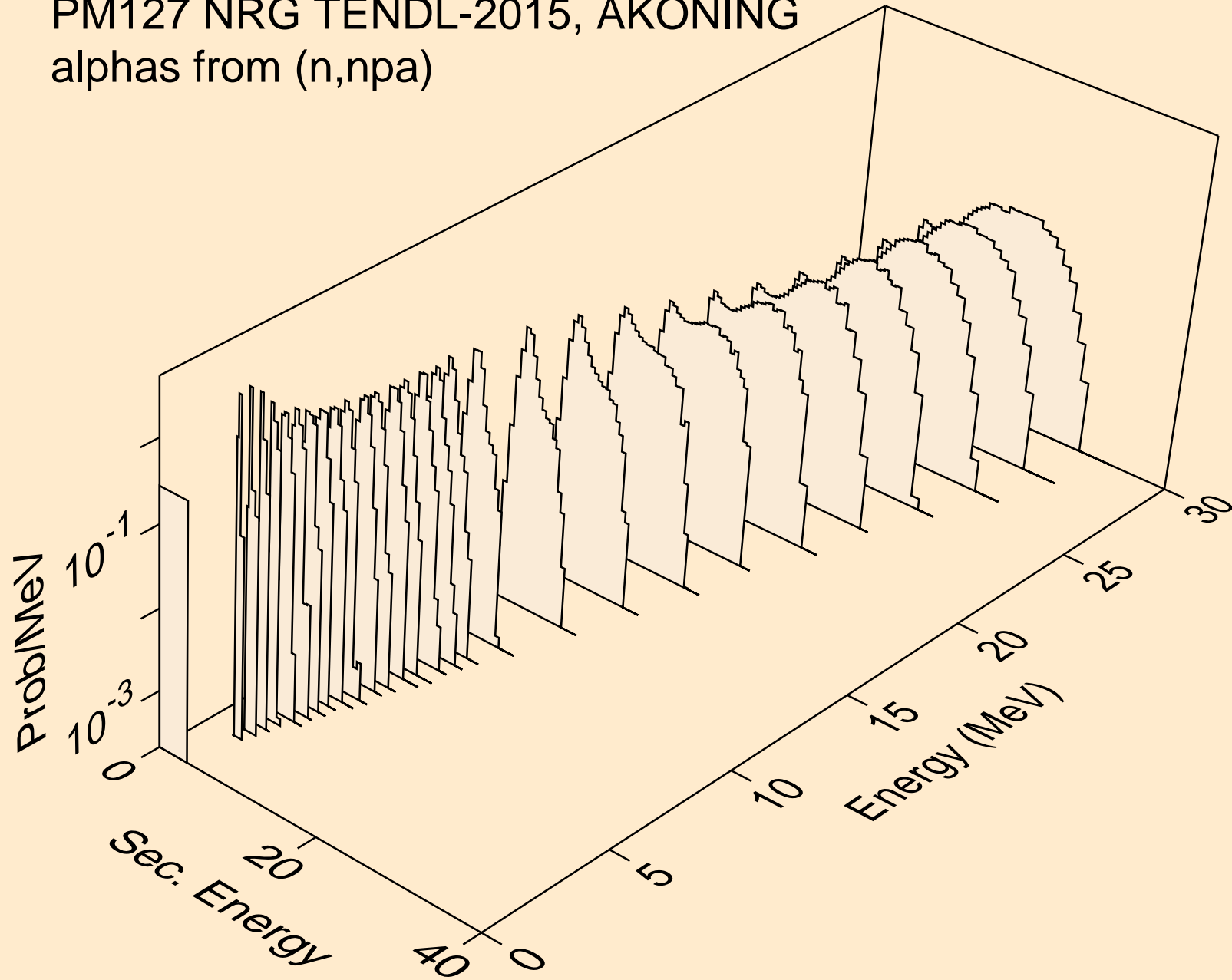

PM127 NRG TENDL-2015, AKONING
alphas from (n,a)

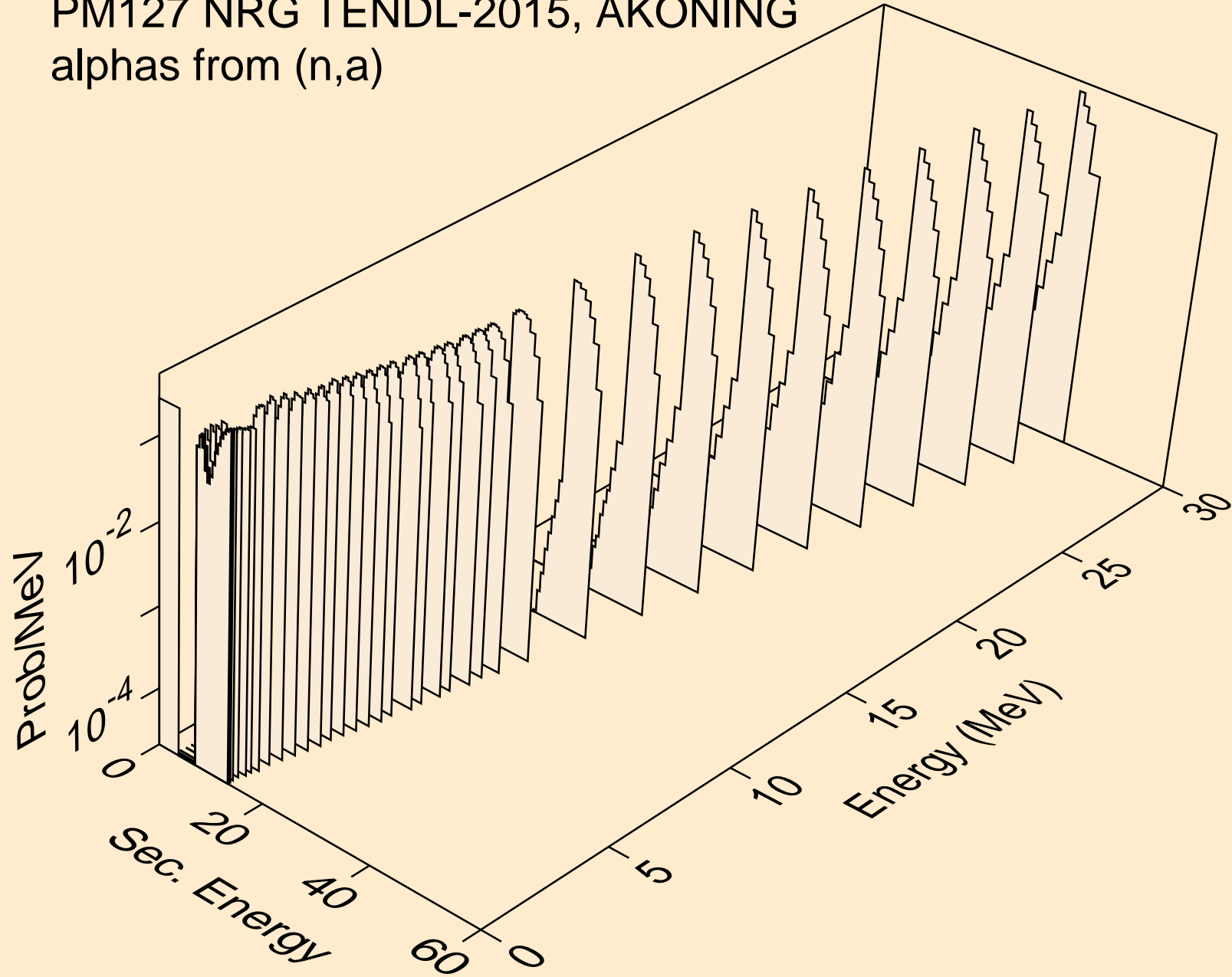

PM127 NRG TENDL-2015, AKONING
alphas from (n,2a)

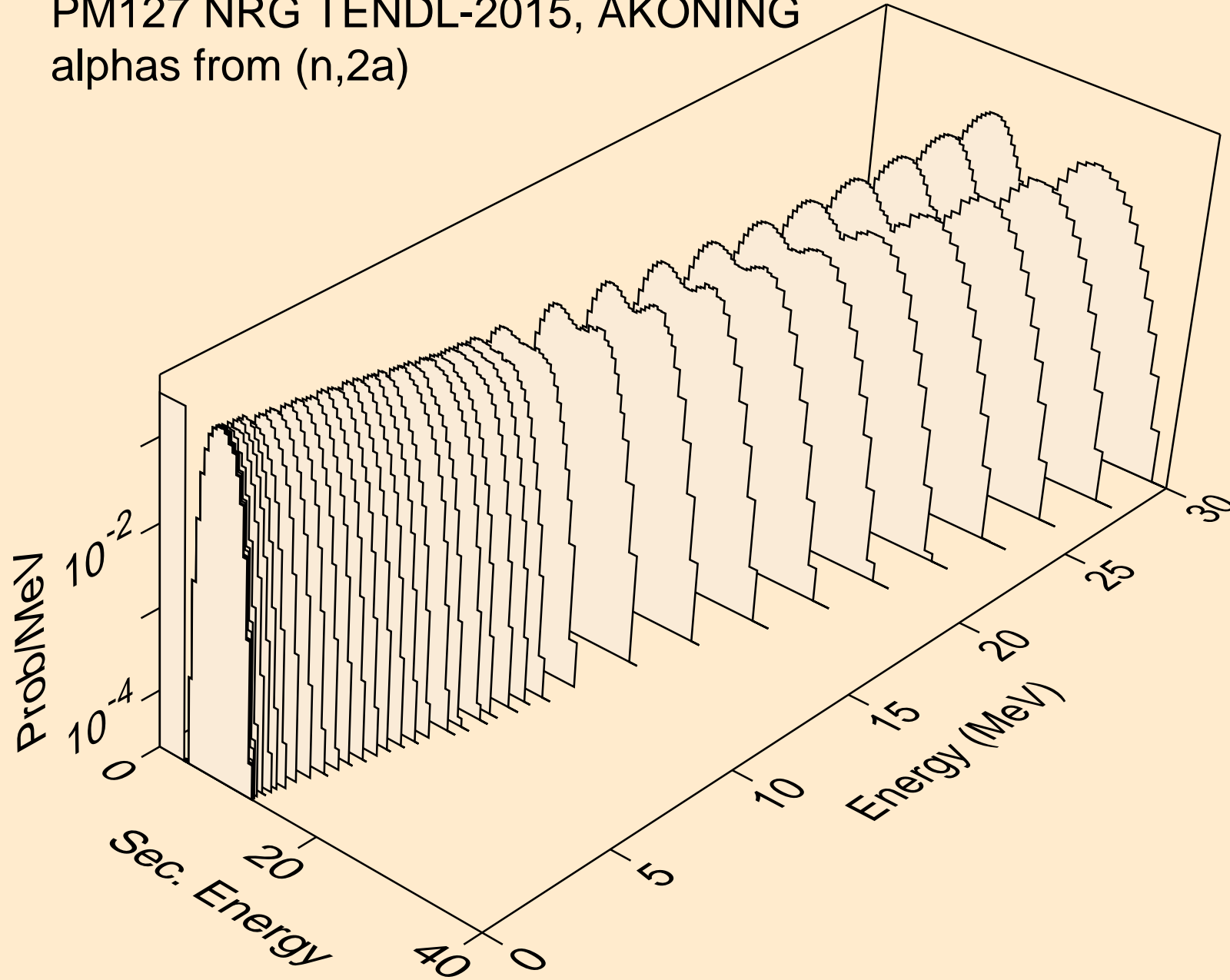

PM127 NRG TENDL-2015, AKONING
alphas from (n,3a)

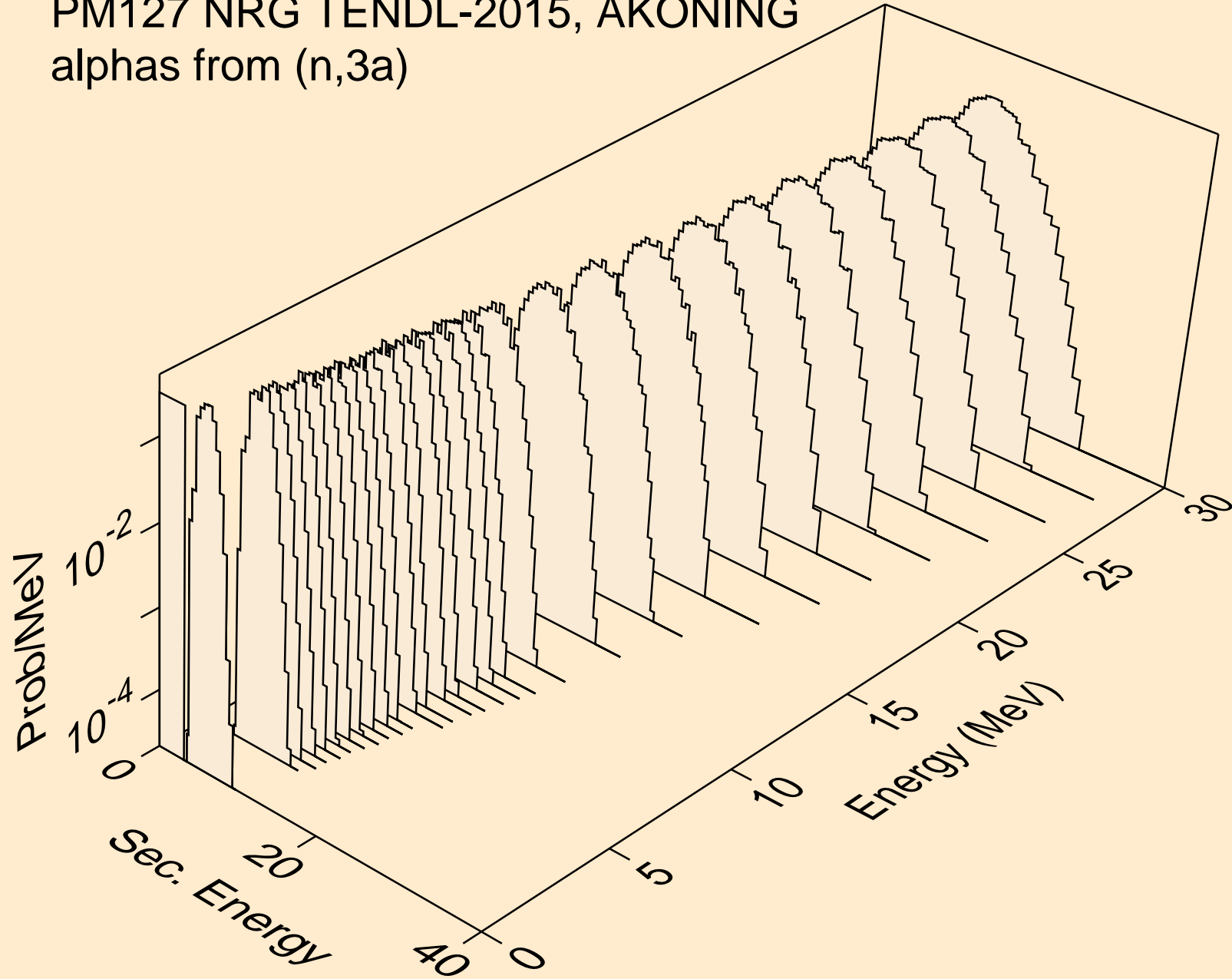

PM127 NRG TENDL-2015, AKONING
alphas from (n,pa)

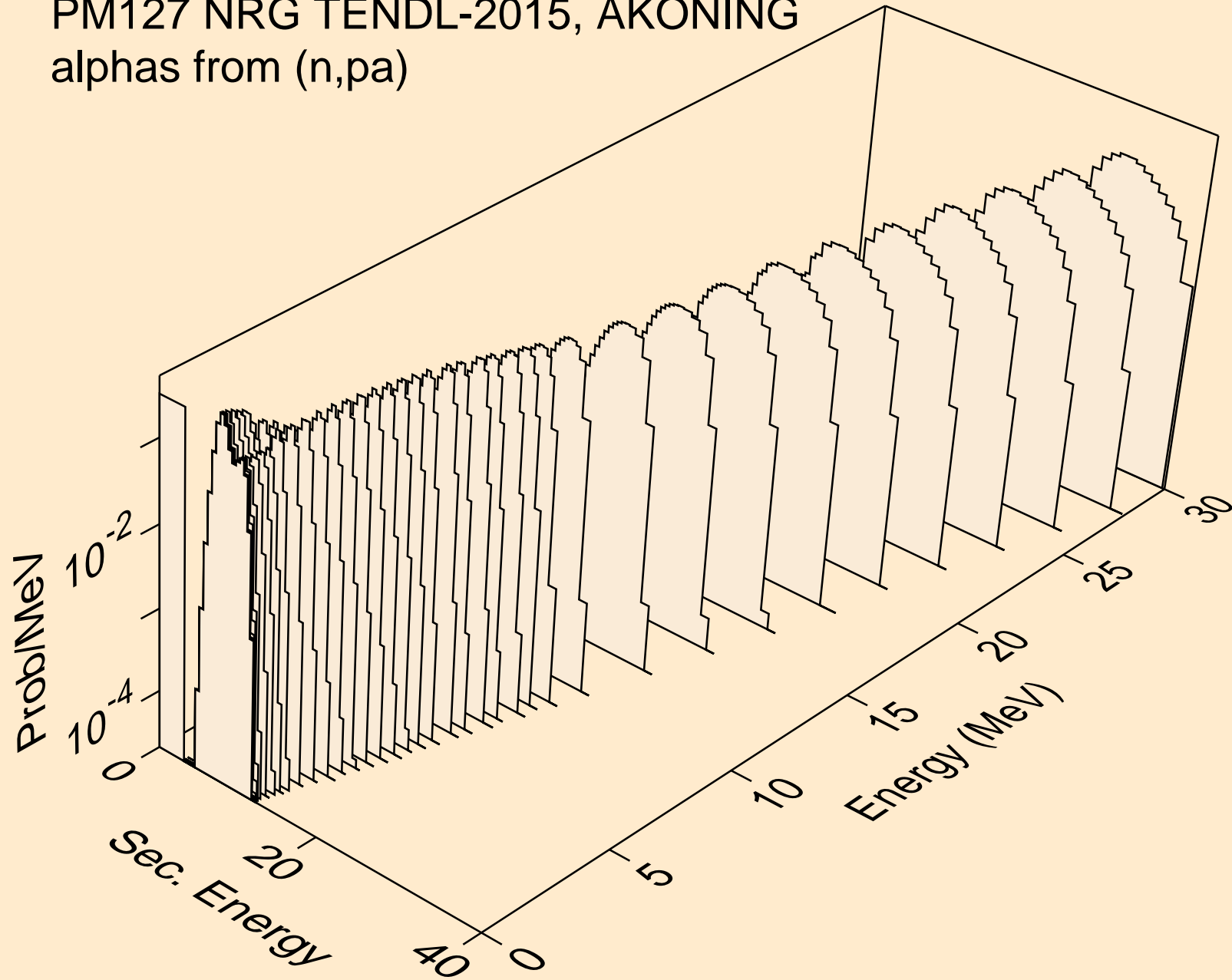

PM127 NRG TENDL-2015, AKONING
alphas from (n,t2a)

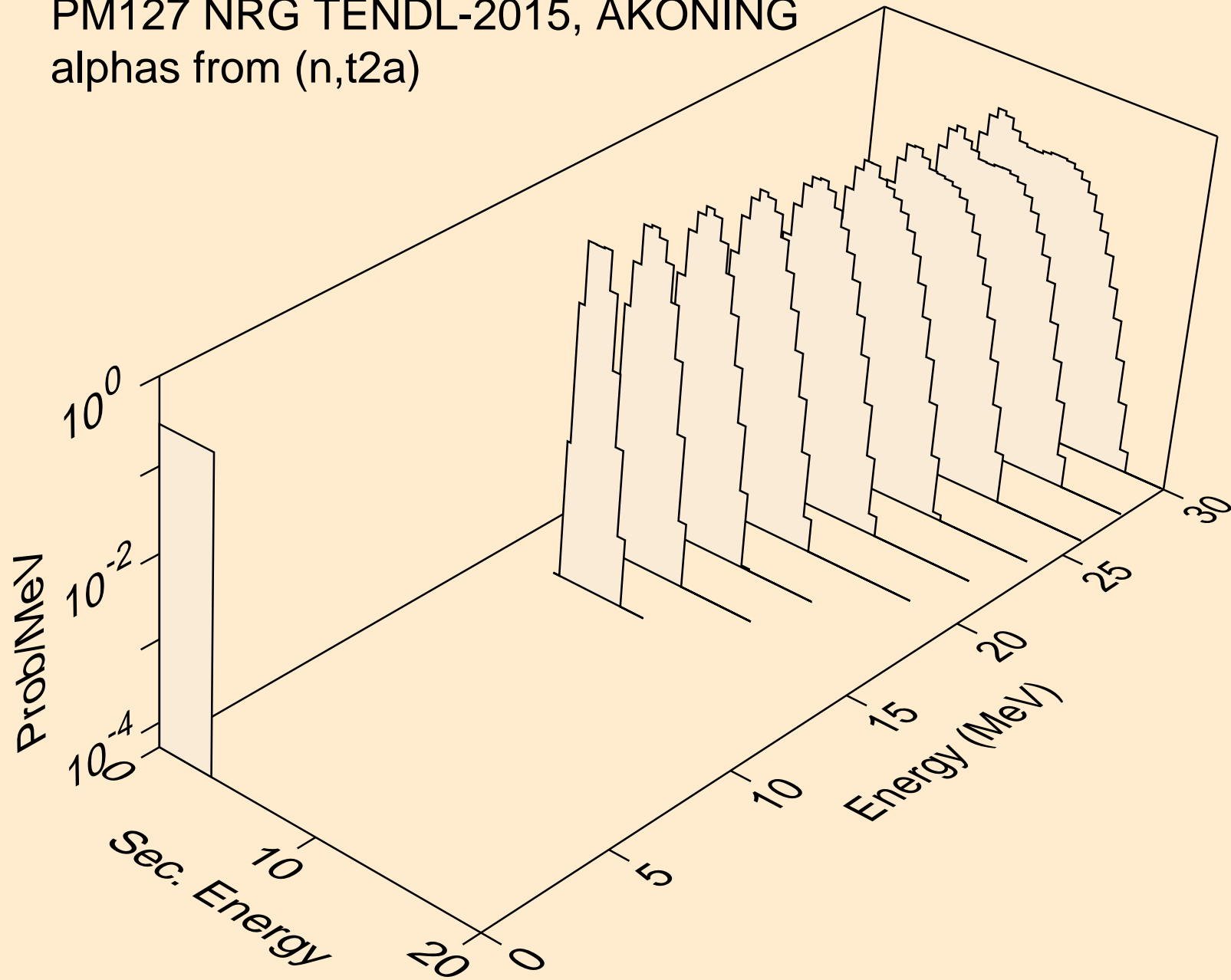

PM127 NRG TENDL-2015, AKONING
alphas from (n,d2a)

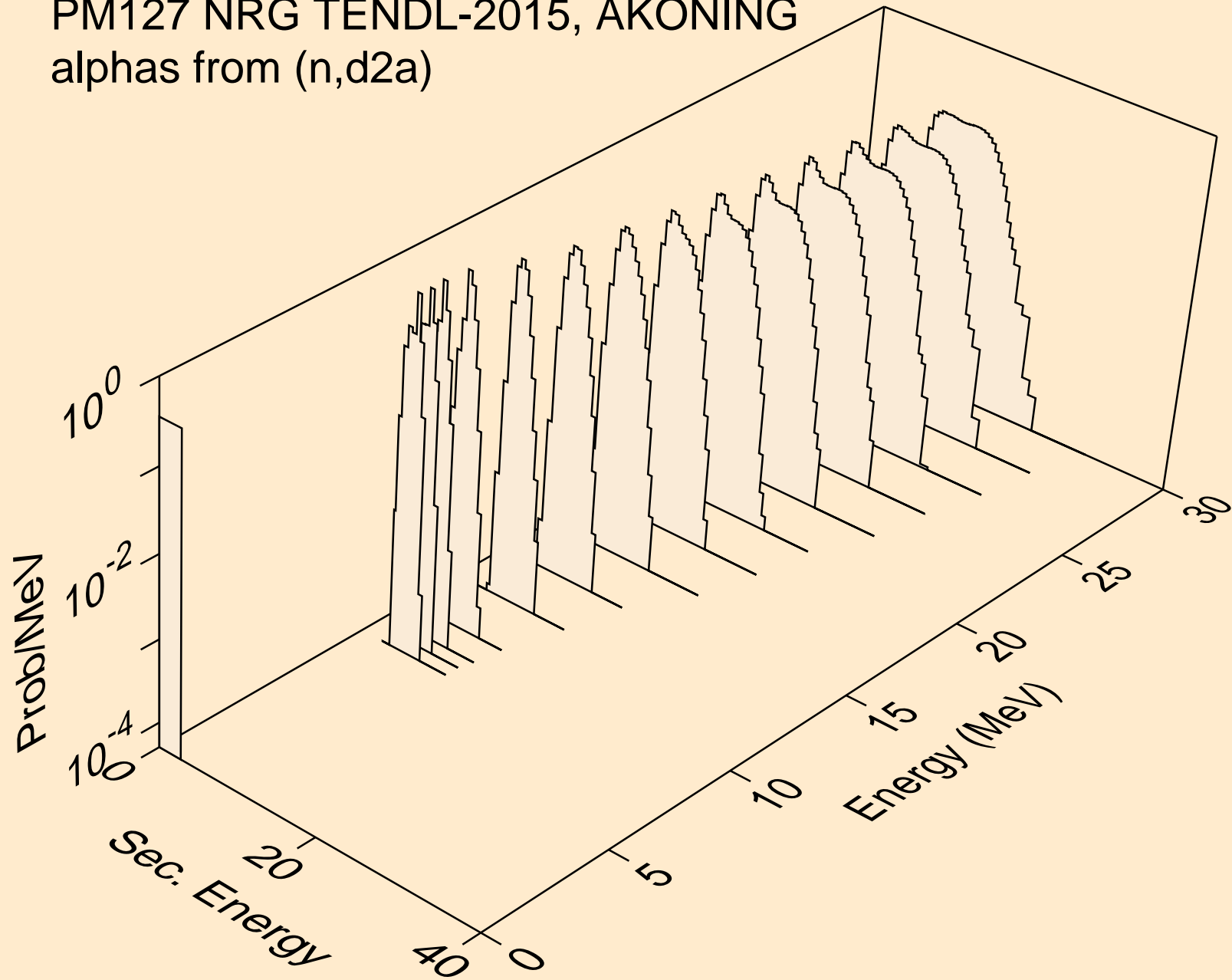

PM127 NRG TENDL-2015, AKONING
alphas from (n,da)

