

# PM129 NRG TENDL-2015, AKONING

## Principal cross sections

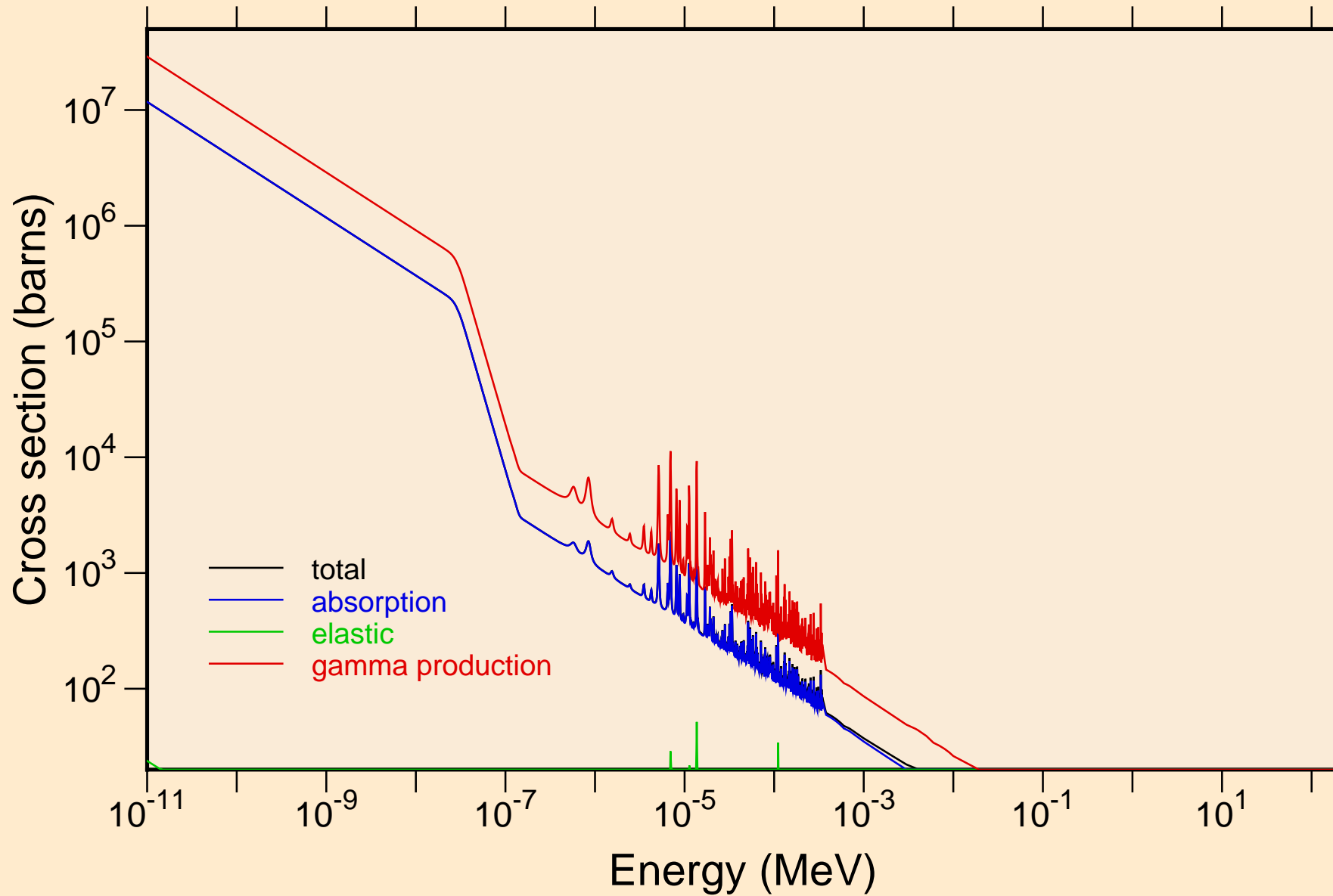

PM129 NRG TENDL-2015, AKONING  
resonance total cross section

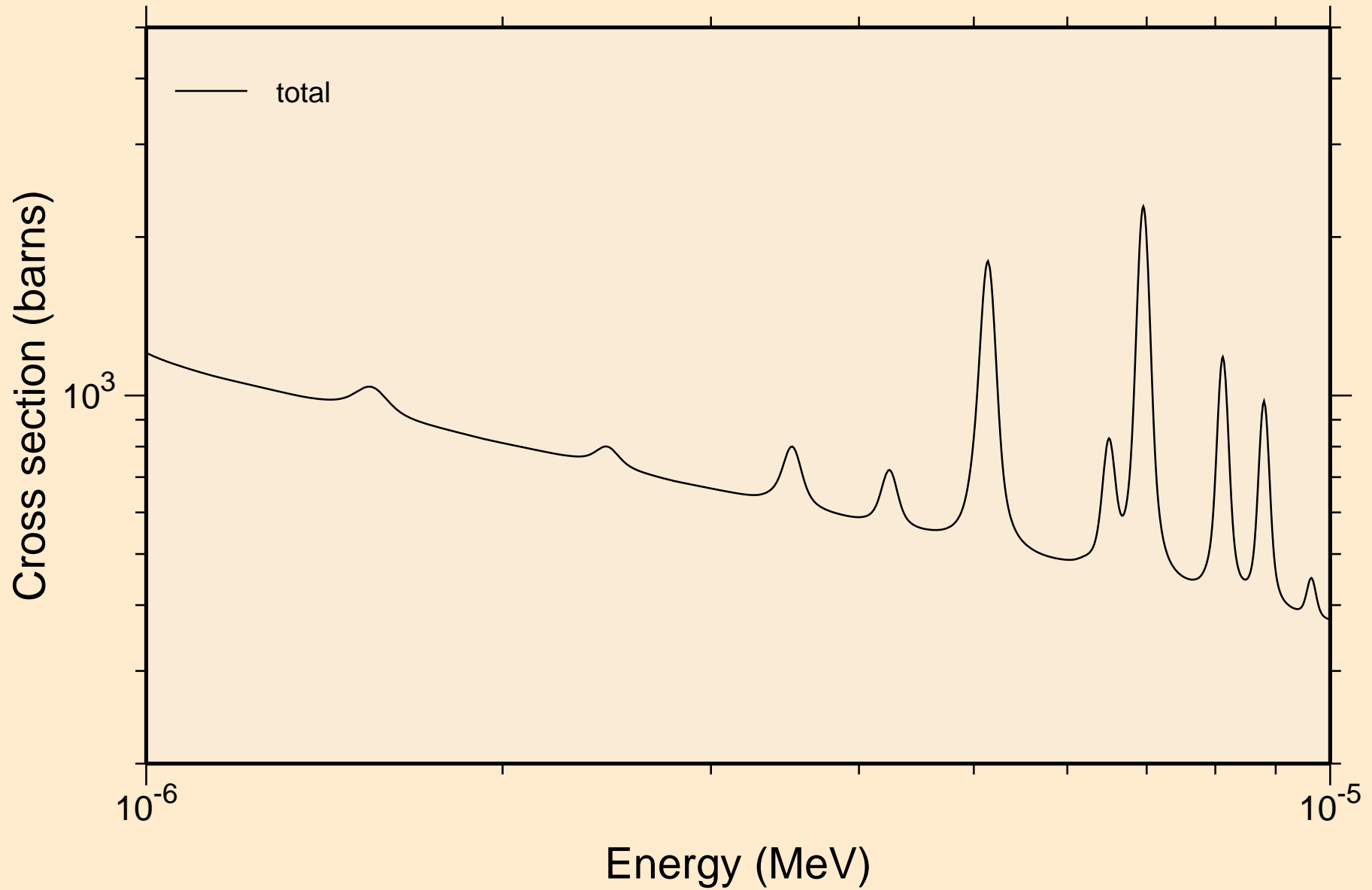

PM129 NRG TENDL-2015, AKONING  
resonance total cross section

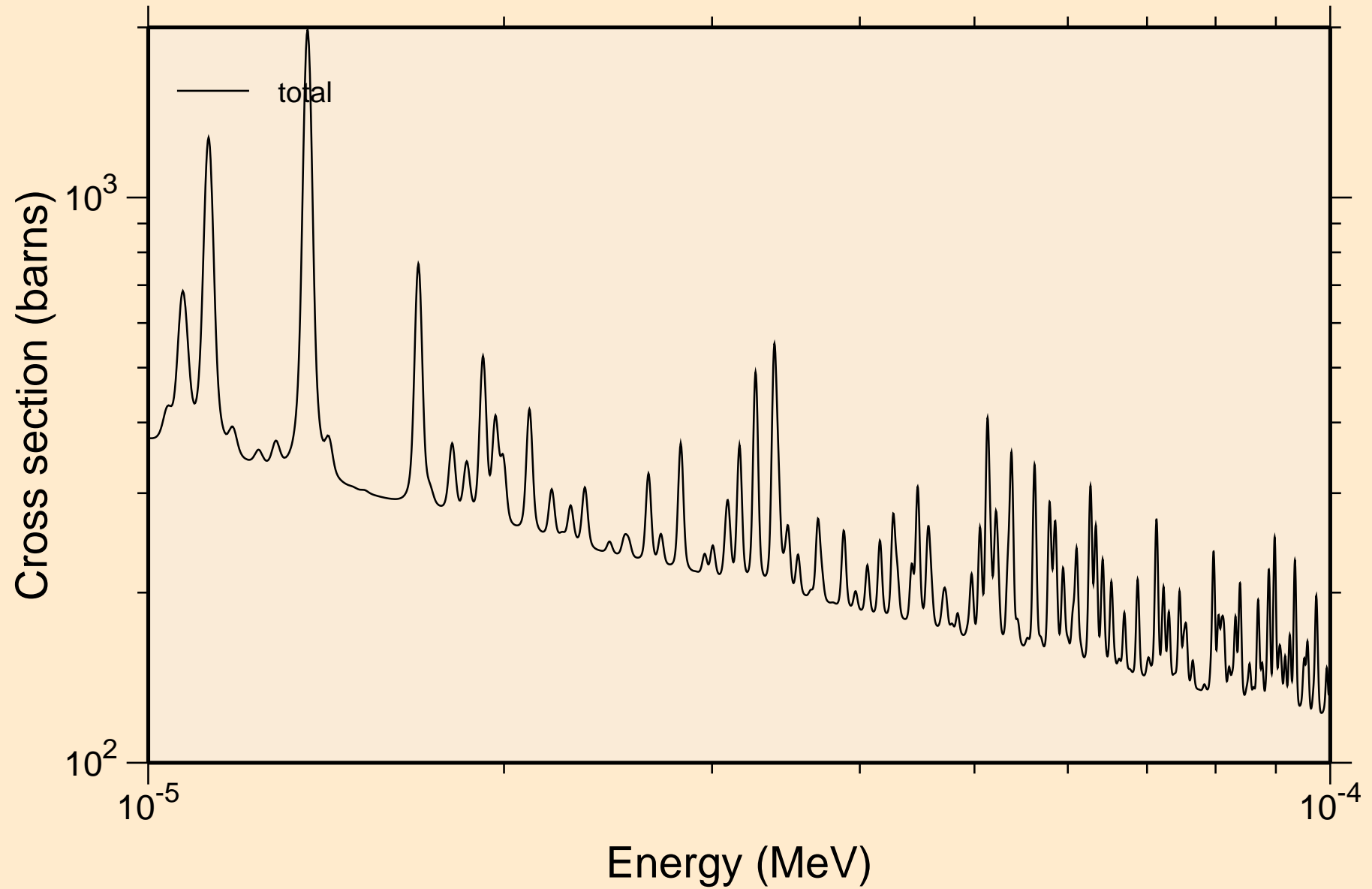

PM129 NRG TENDL-2015, AKONING  
resonance total cross section

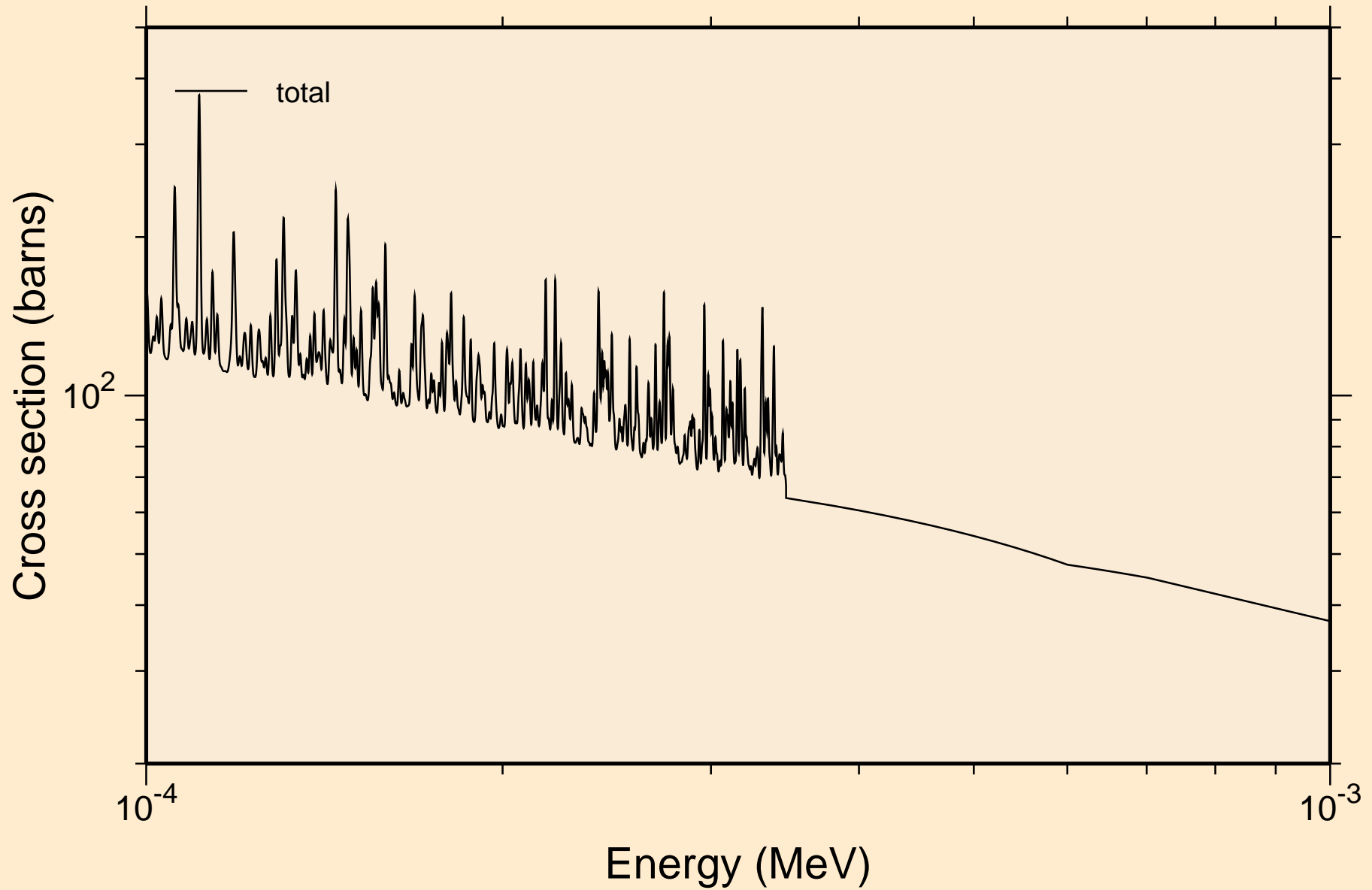

P̄M129 NRG TENDL-2015, AKONING  
resonance total cross section

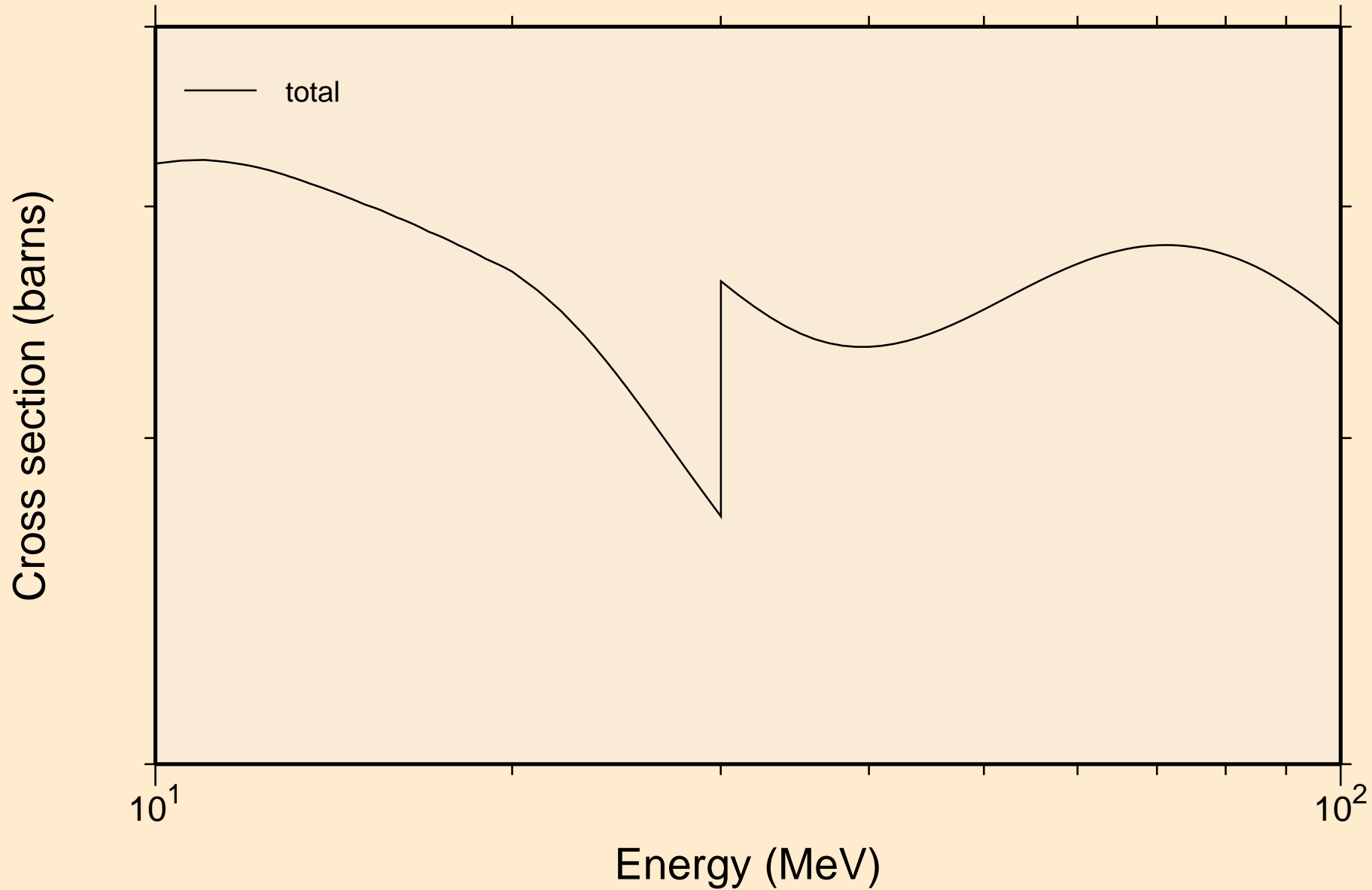

PM129 NRG TENDL-2015, AKONING  
resonance absorption cross sections

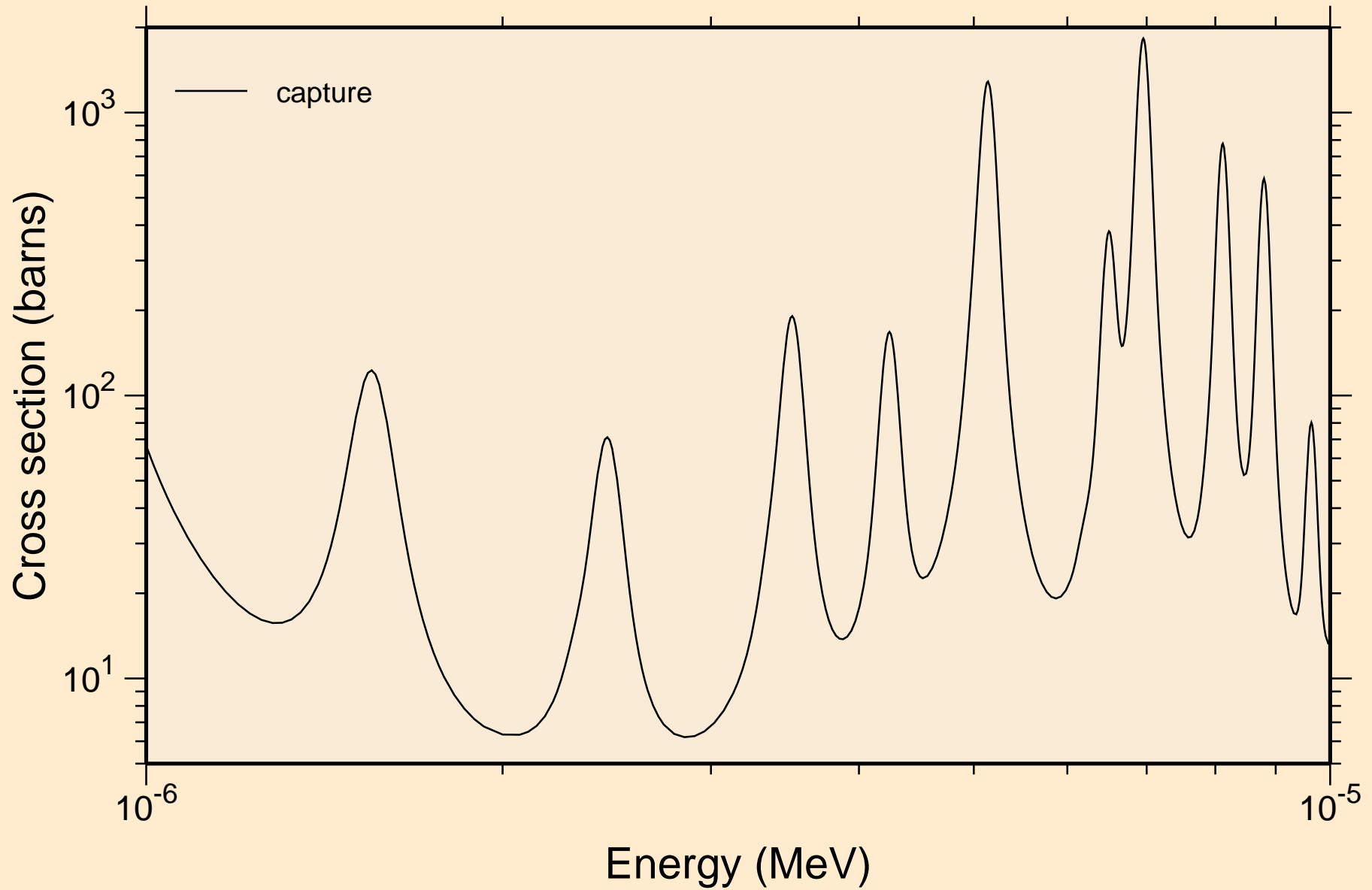

PM129 NRG TENDL-2015, AKONING  
resonance absorption cross sections

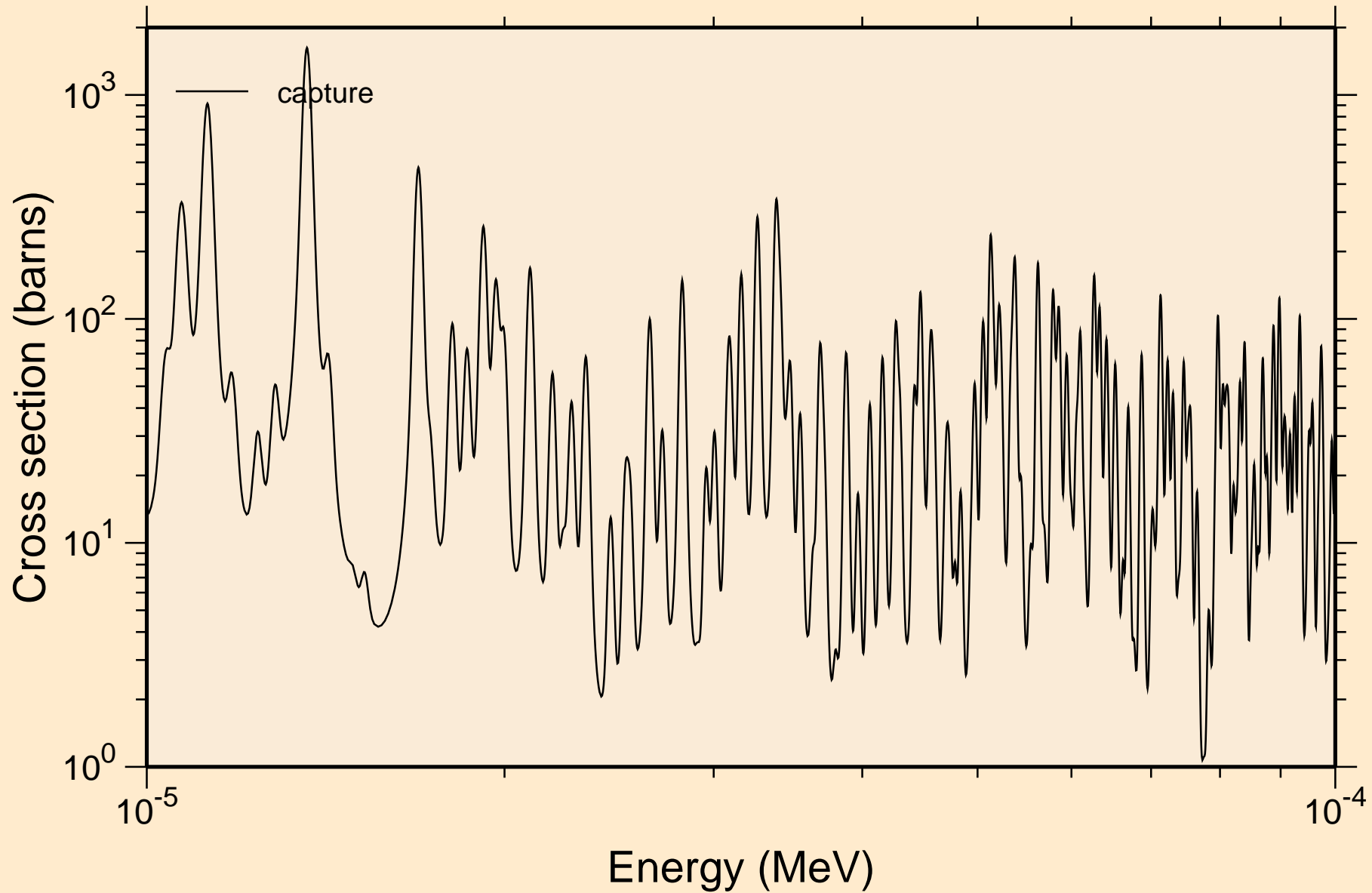

PM129 NRG TENDL-2015, AKONING  
resonance absorption cross sections

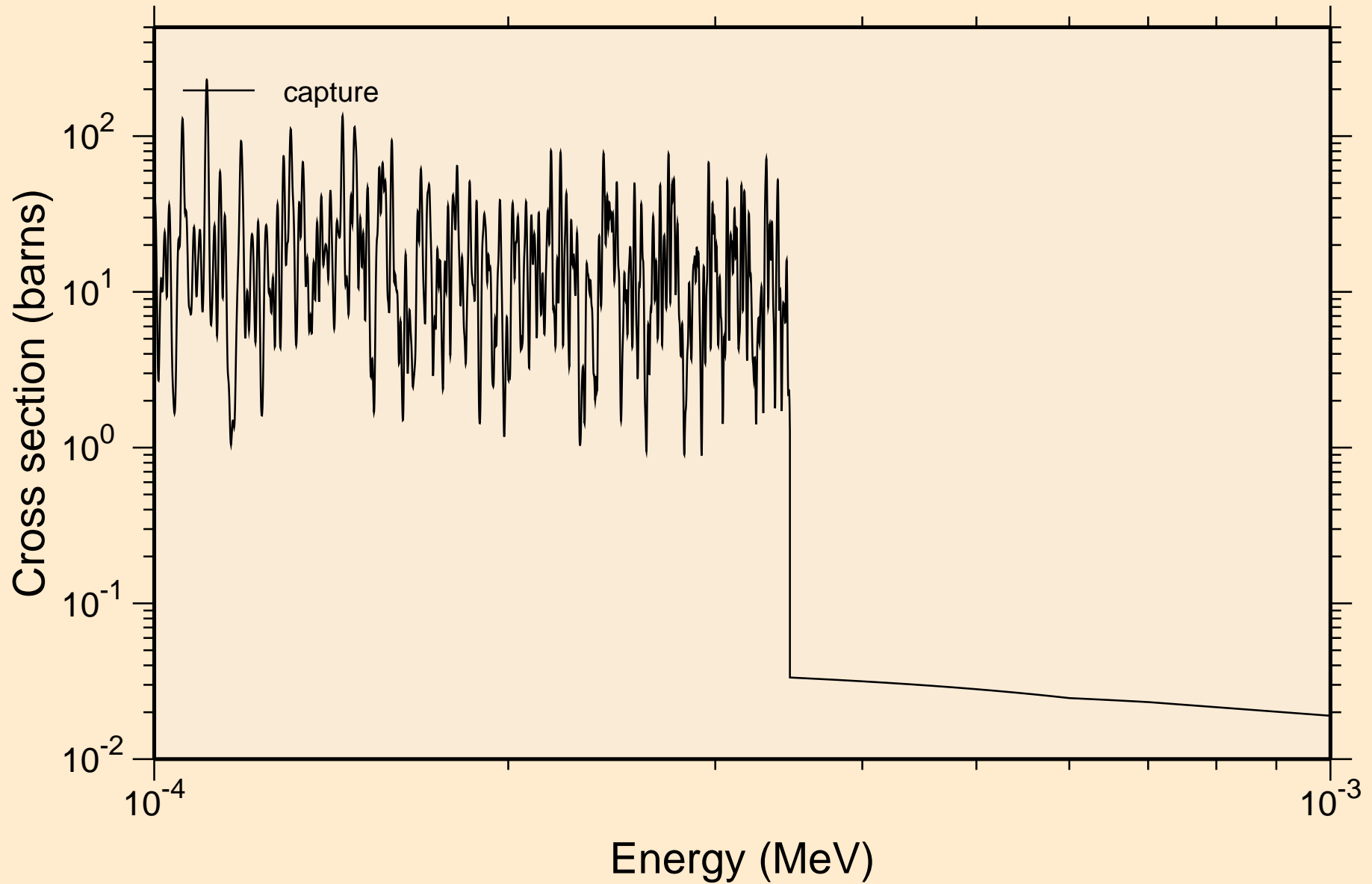



PM129 NRG TENDL-2015, AKONING  
resonance absorption cross sections

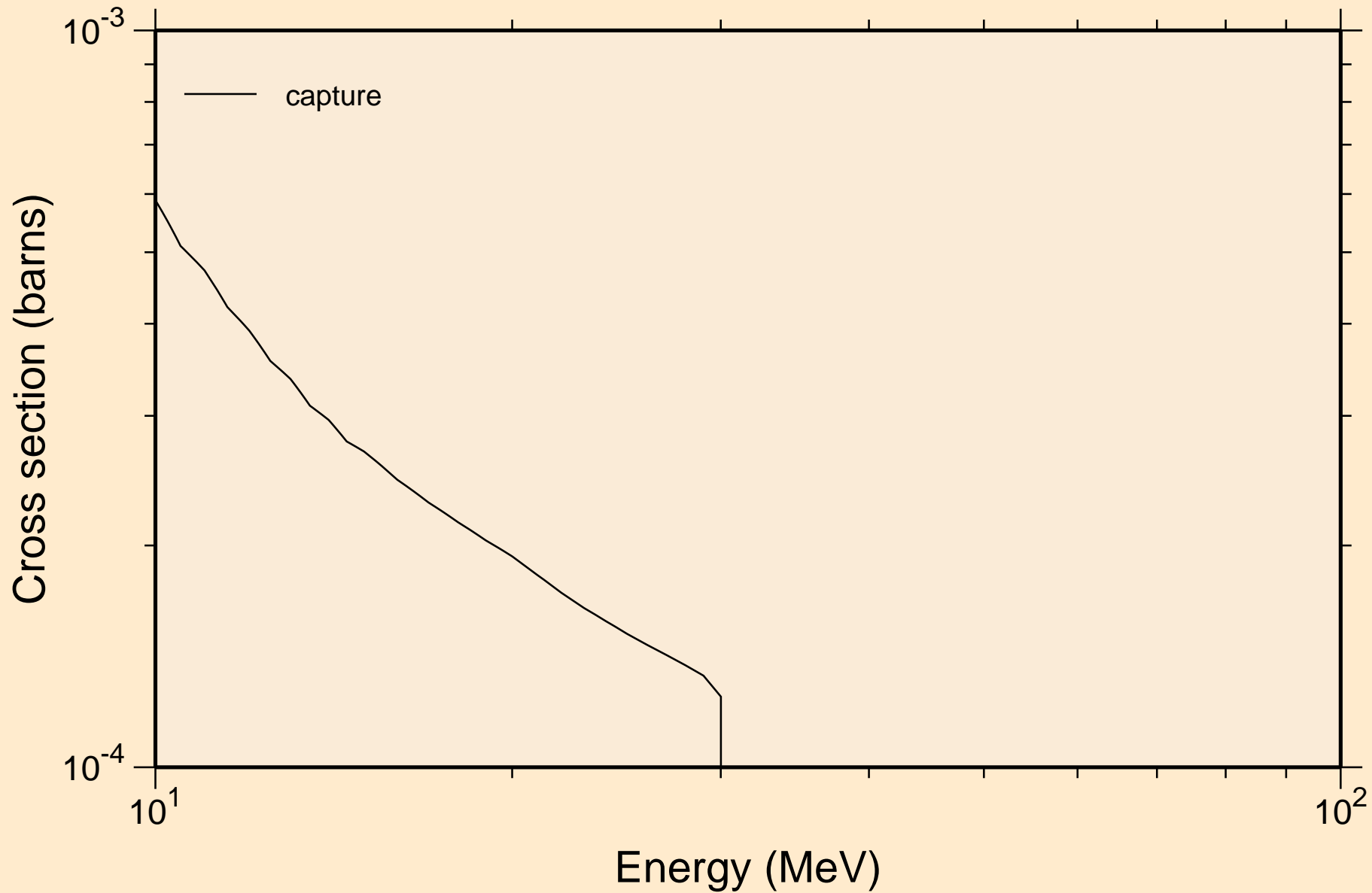



PM129 NRG TENDL-2015, AKONING  
Non-threshold reactions

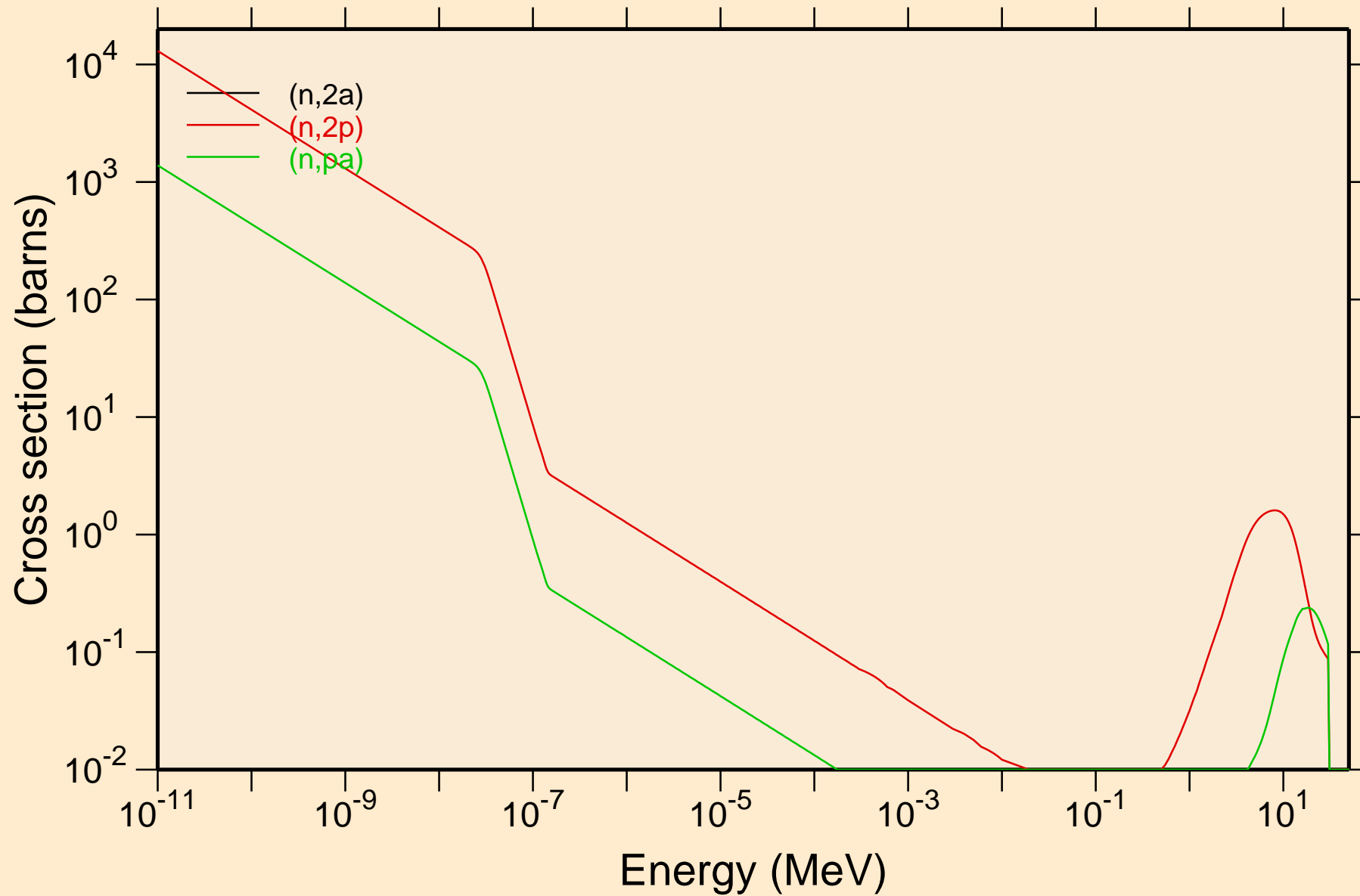

# PM129 NRG TENDL-2015, AKONING

## Principal cross sections

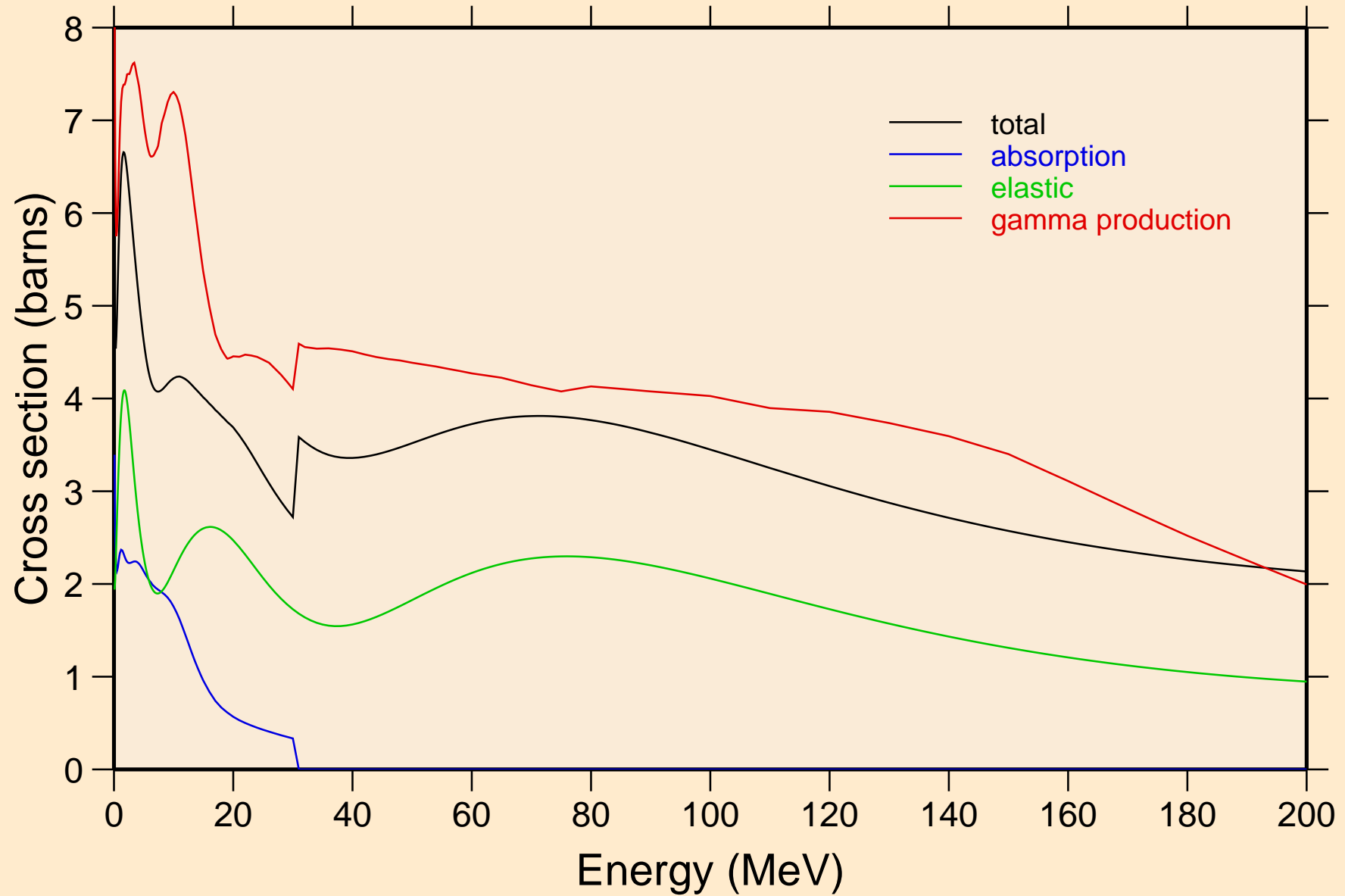

# PM129 NRG TENDL-2015, AKONING

## Non-threshold reactions

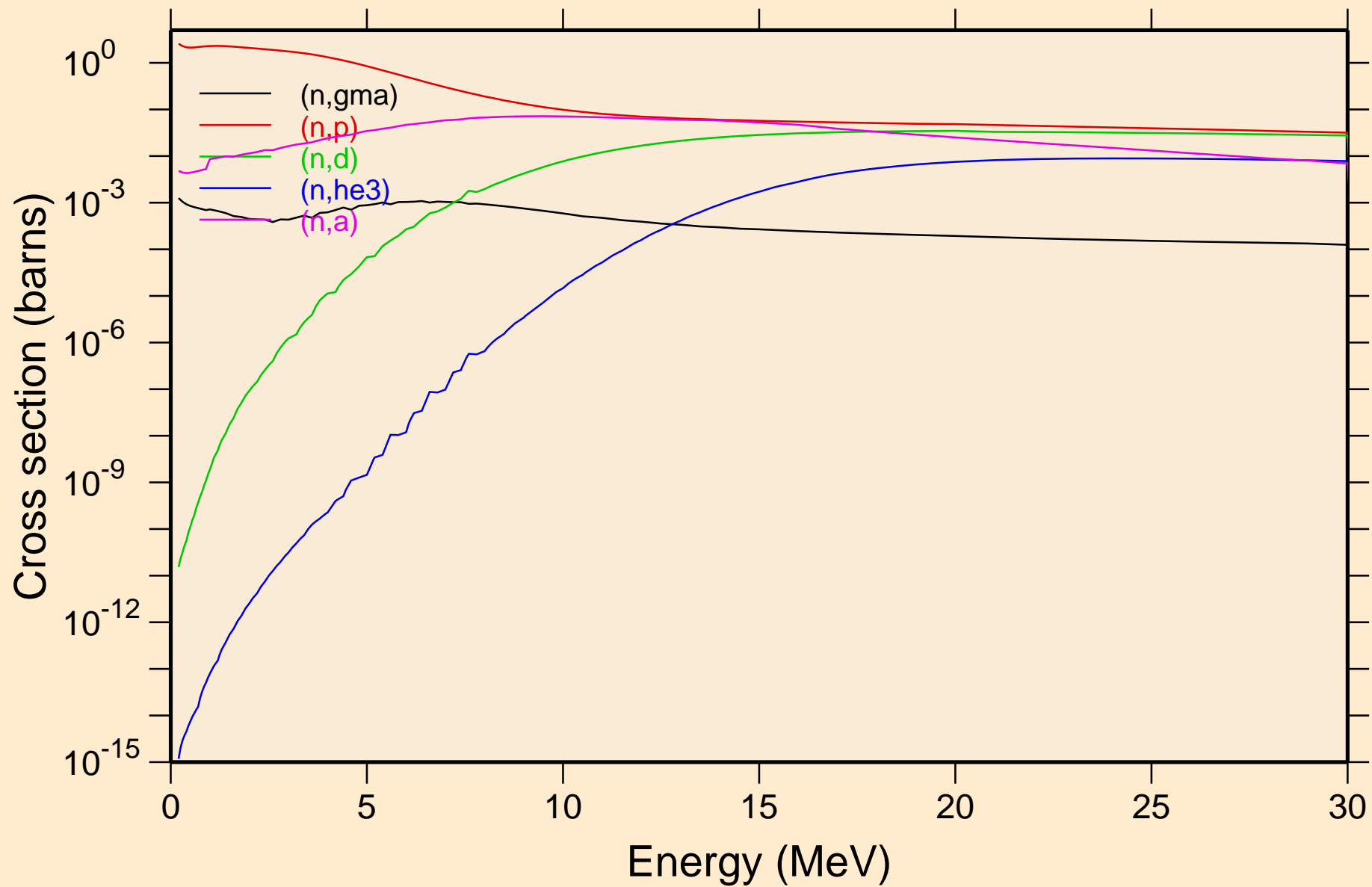

PM129 NRG TENDL-2015, AKONING  
Non-threshold reactions

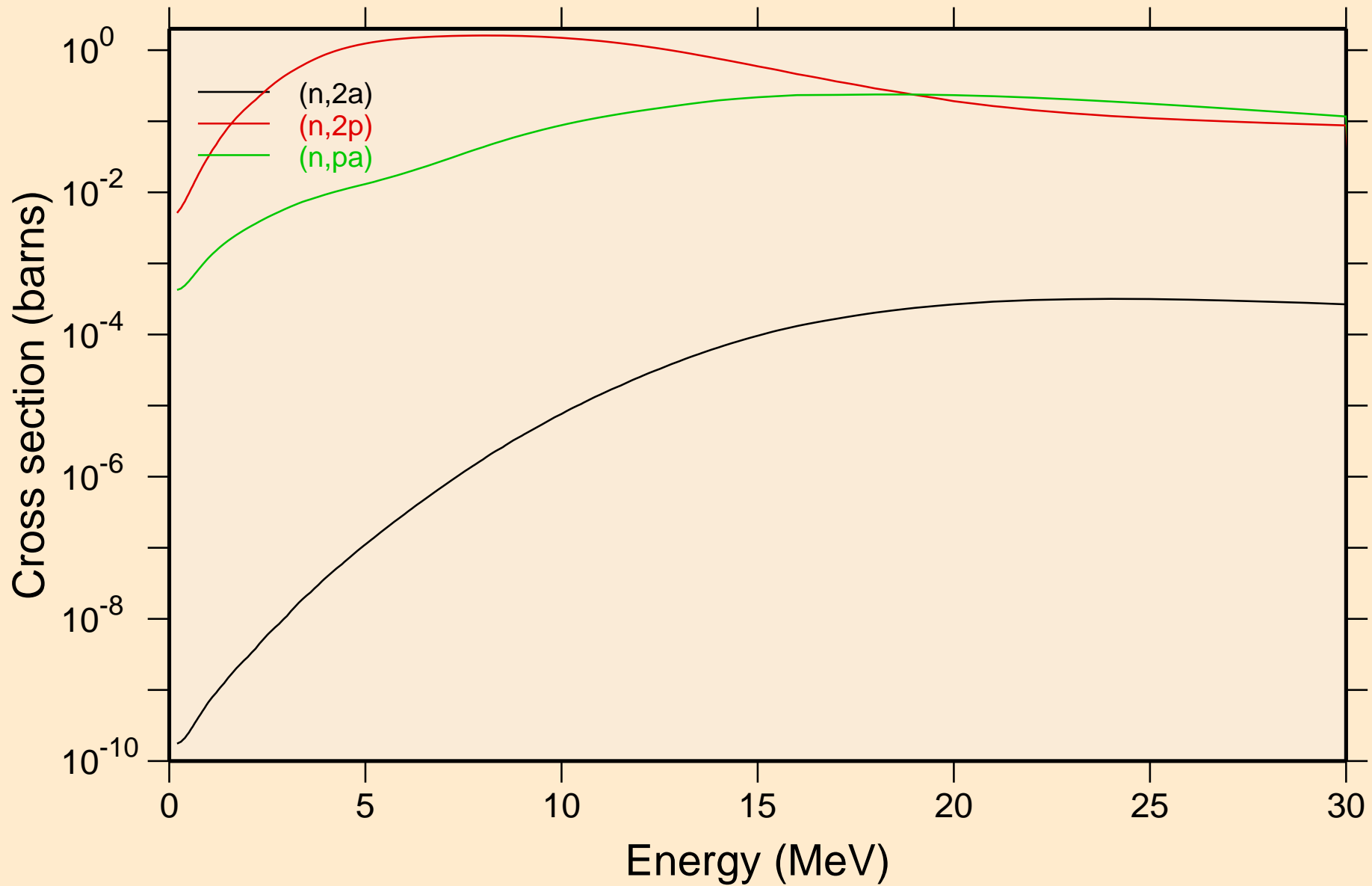

PM129 NRG TENDL-2015, AKONING  
Inelastic levels

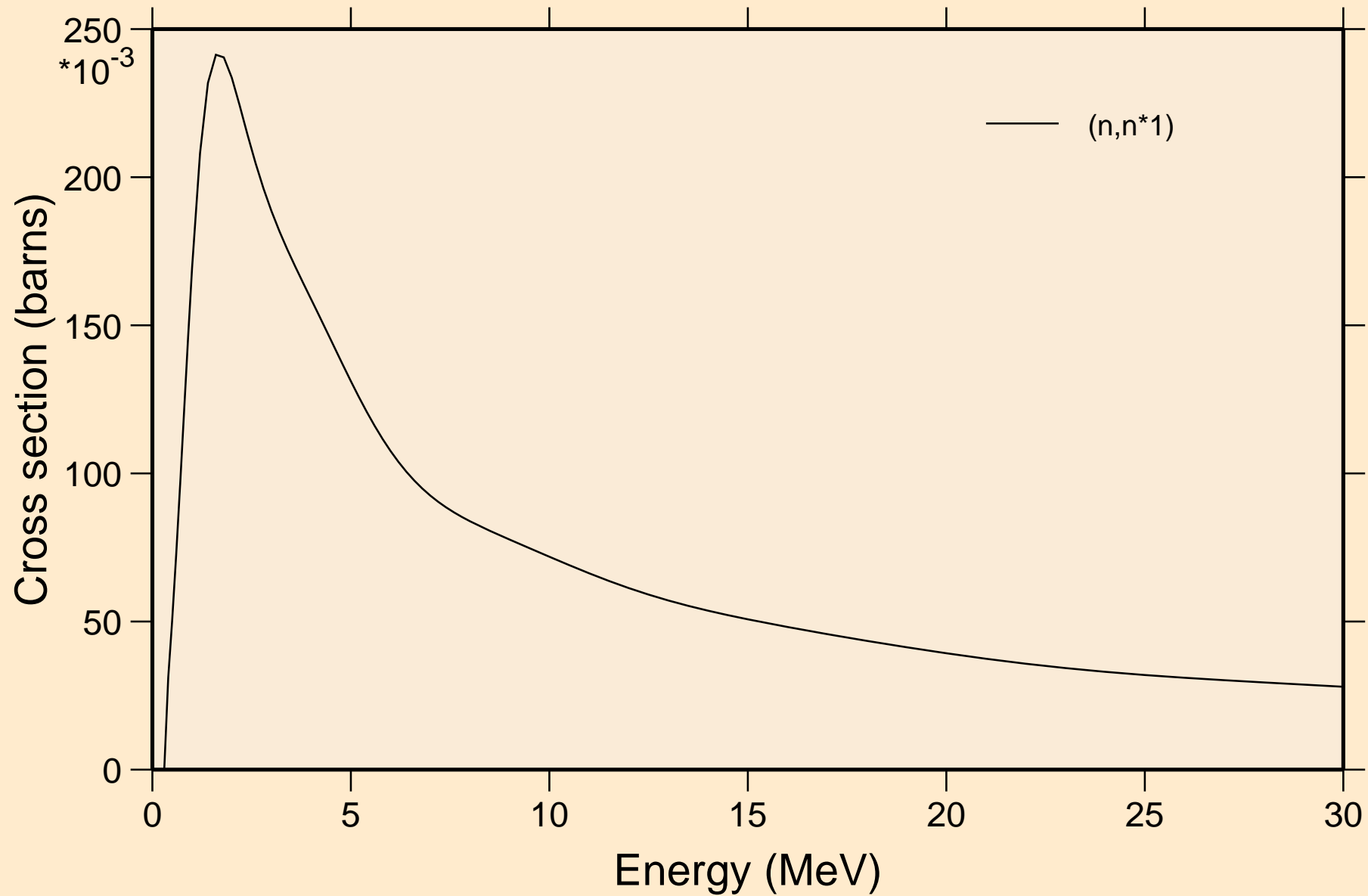

# PM129 NRG TENDL-2015, AKONING

## Threshold reactions

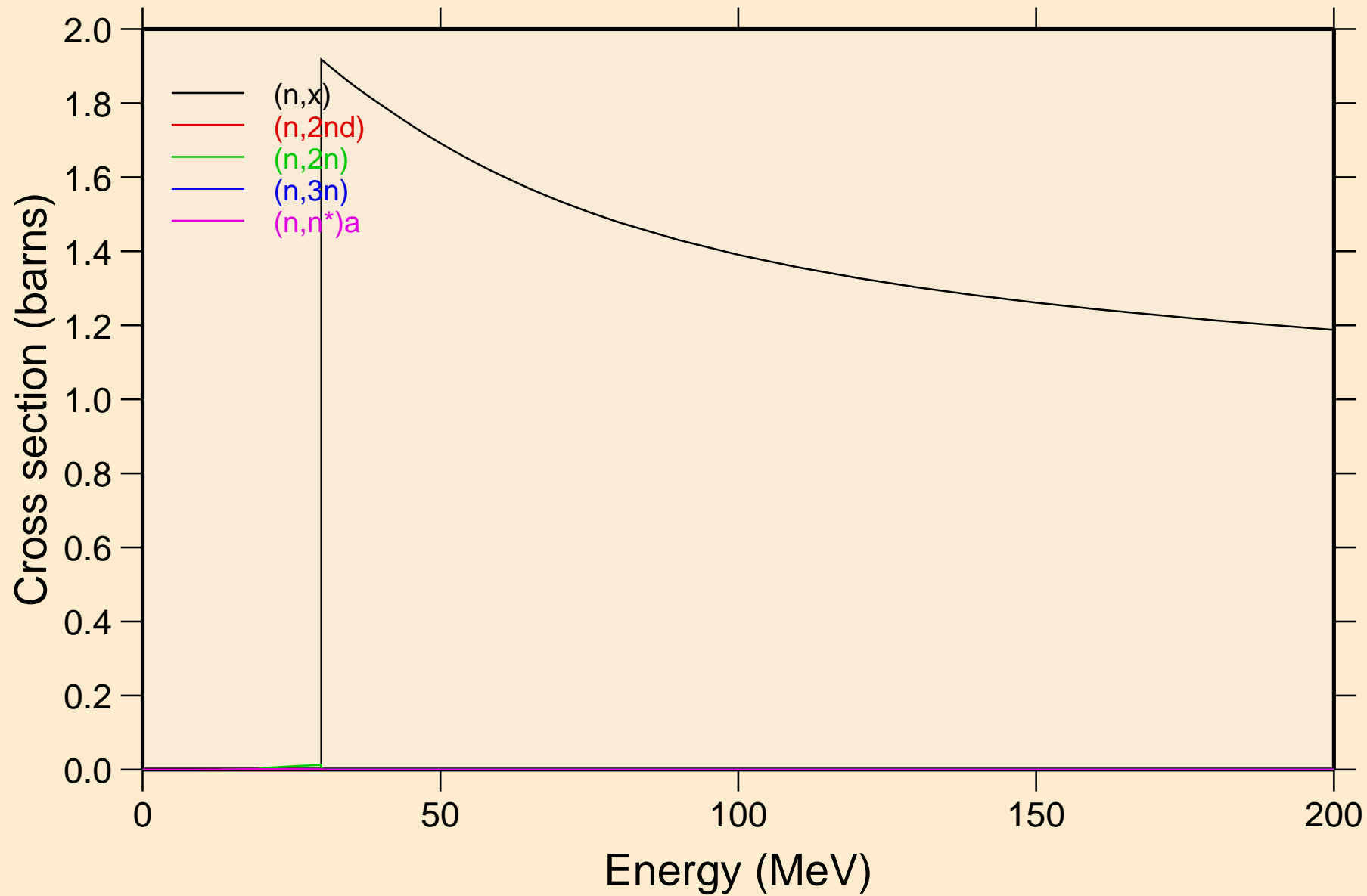



# PM129 NRG TENDL-2015, AKONING

## Threshold reactions

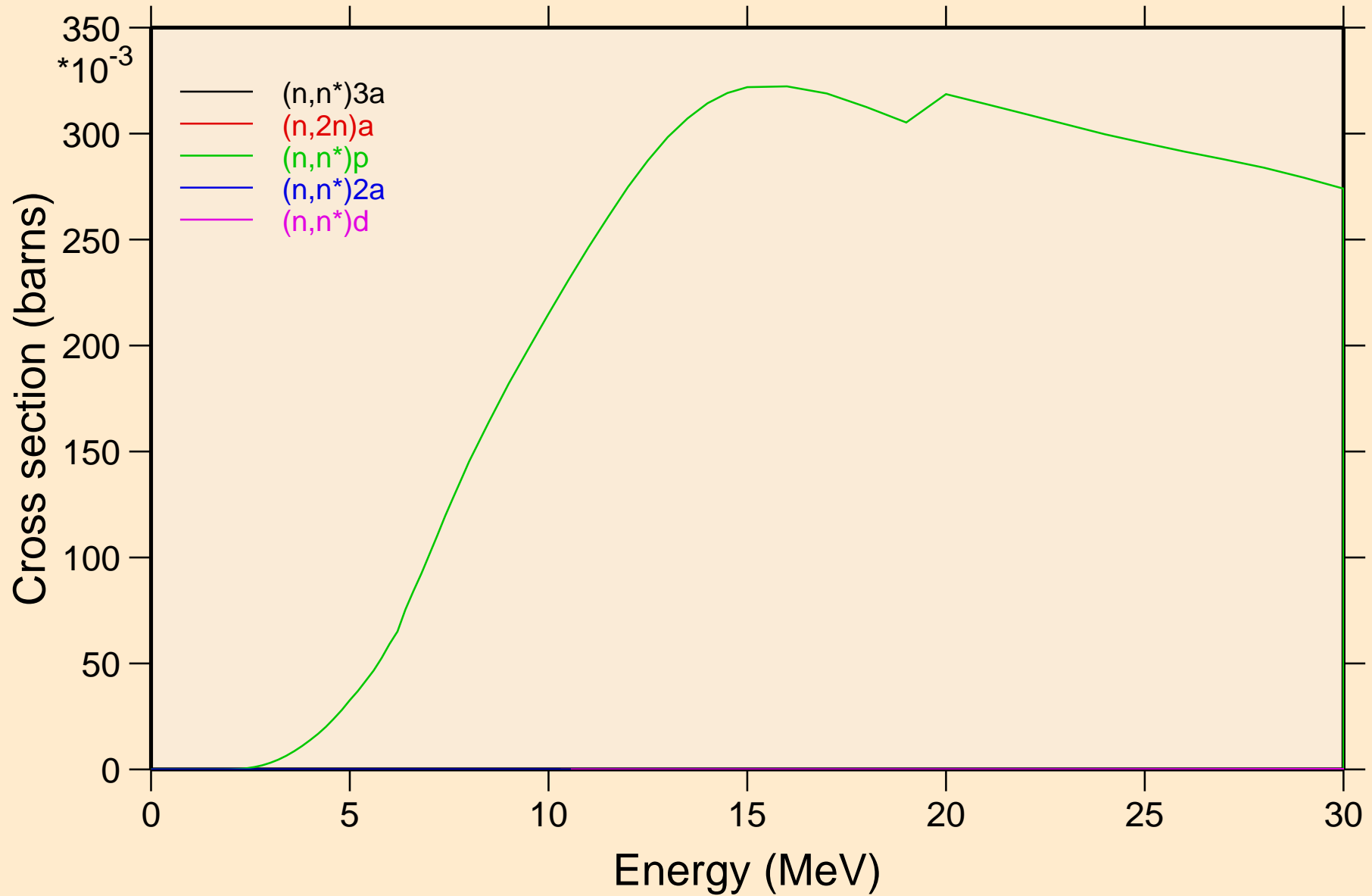

# PM129 NRG TENDL-2015, AKONING

## Threshold reactions

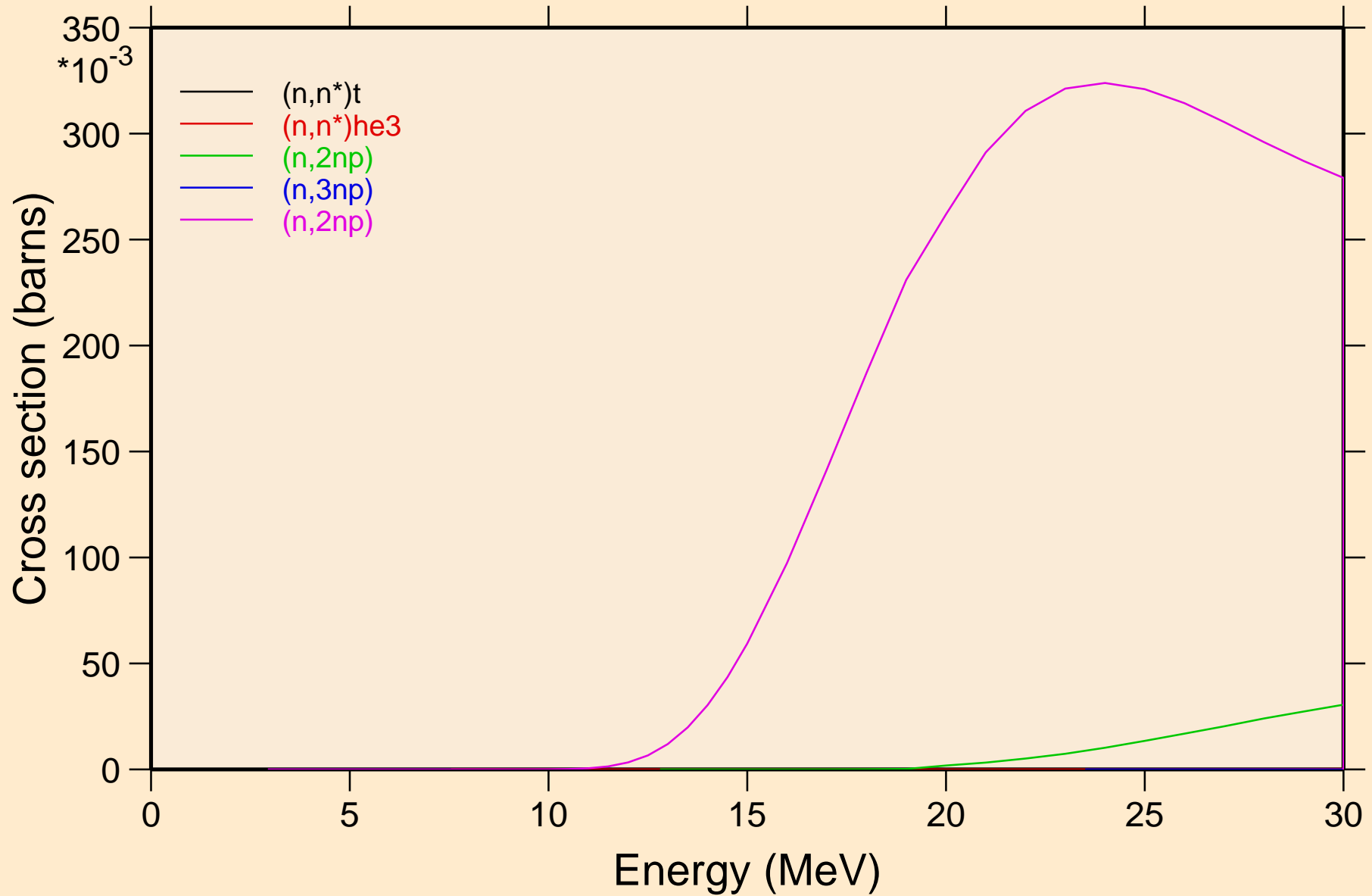

# PM129 NRG TENDL-2015, AKONING

## Threshold reactions

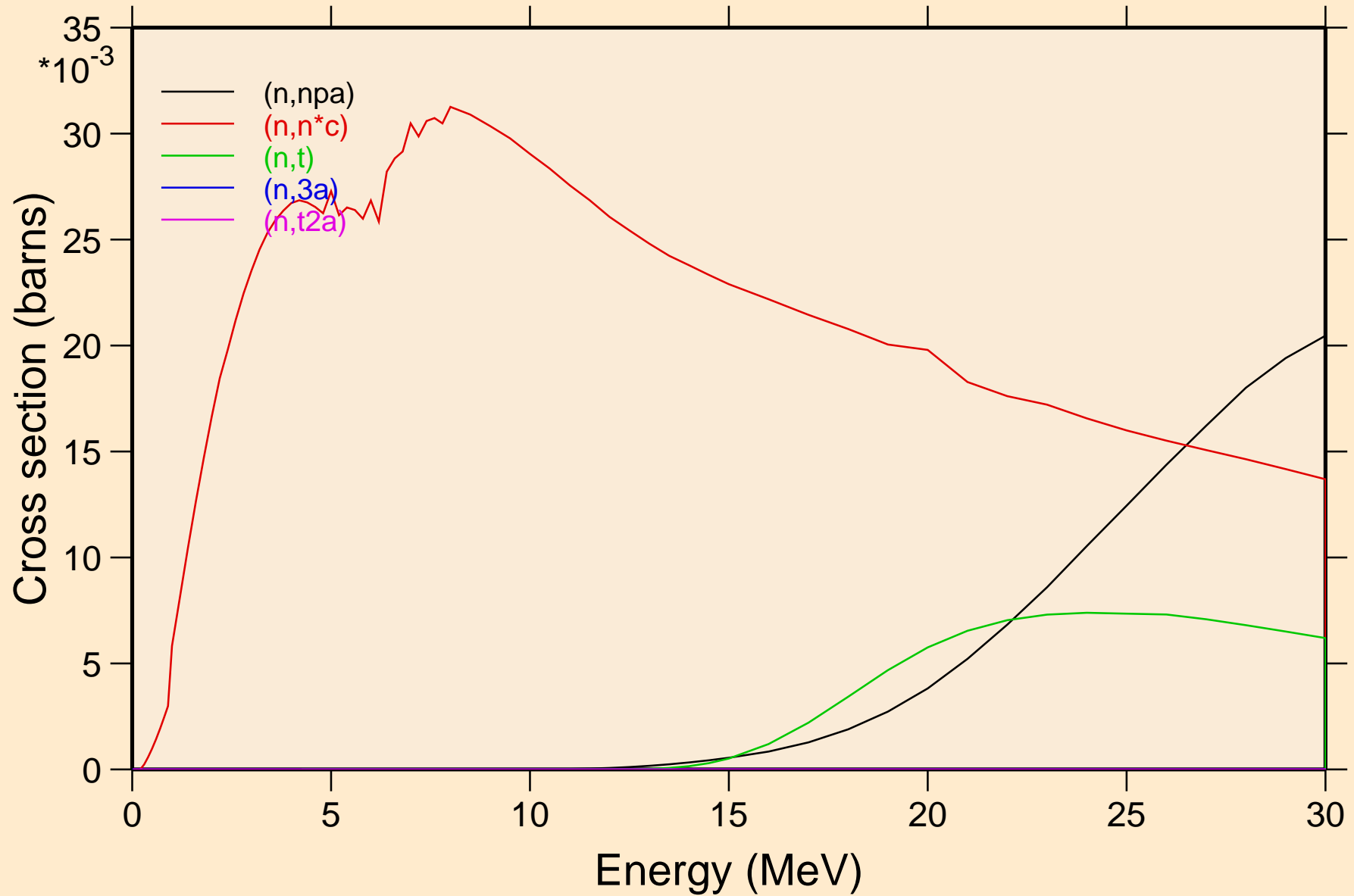

# PM129 NRG TENDL-2015, AKONING

## Threshold reactions

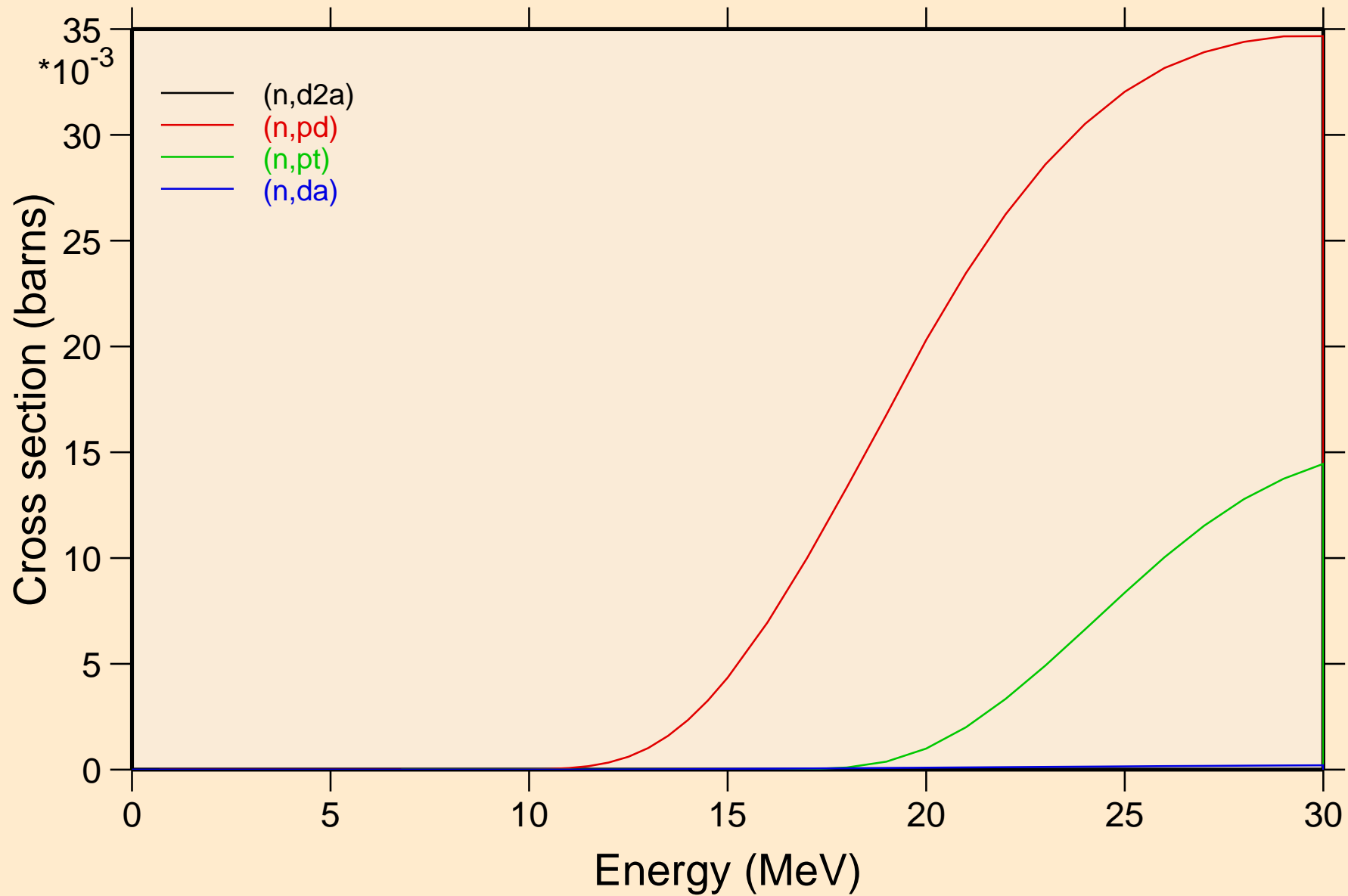

PM129 NRG TENDL-2015, AKONING  
angular distribution for elastic

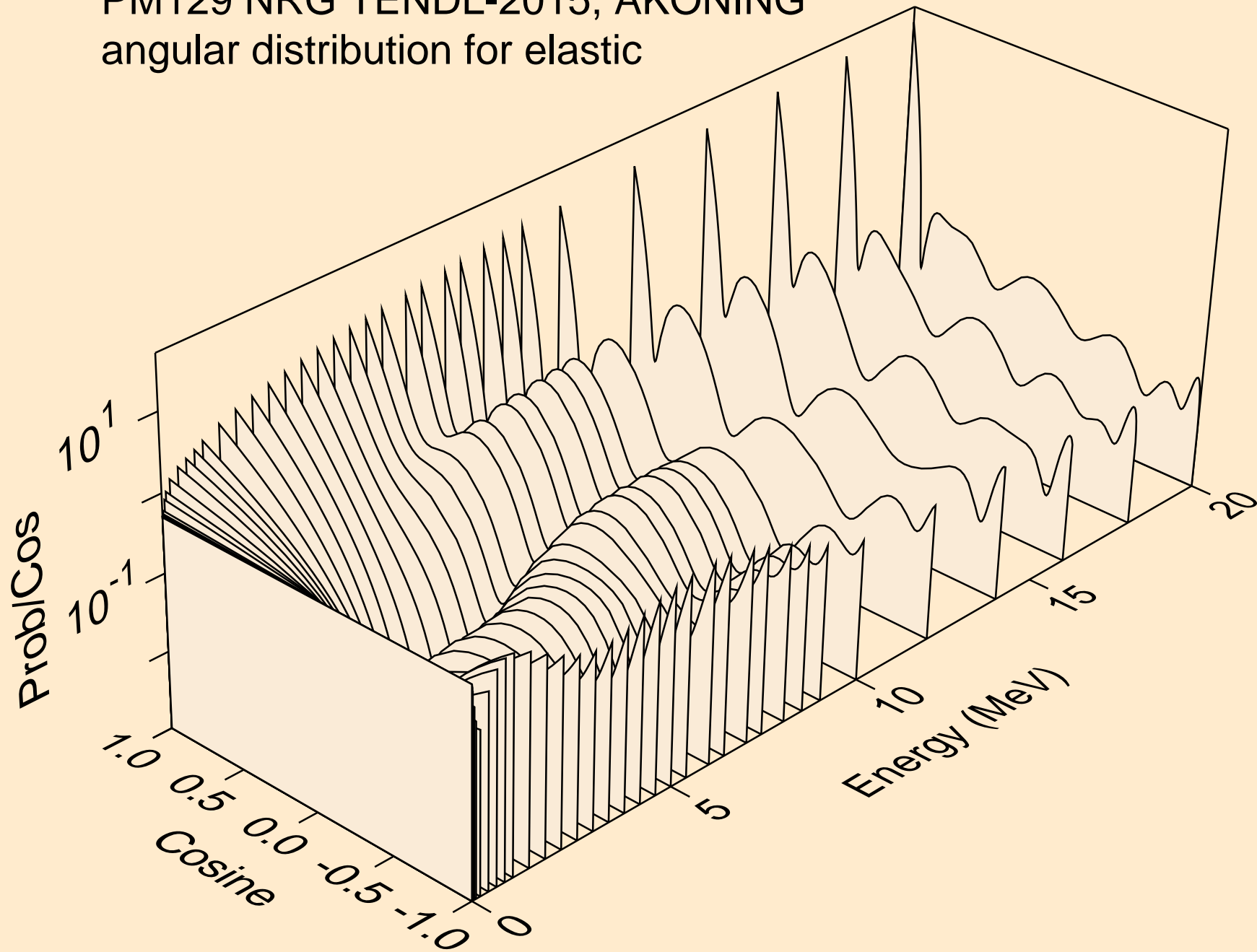

PM129 NRG TENDL-2015, AKONING  
angular distribution for elastic

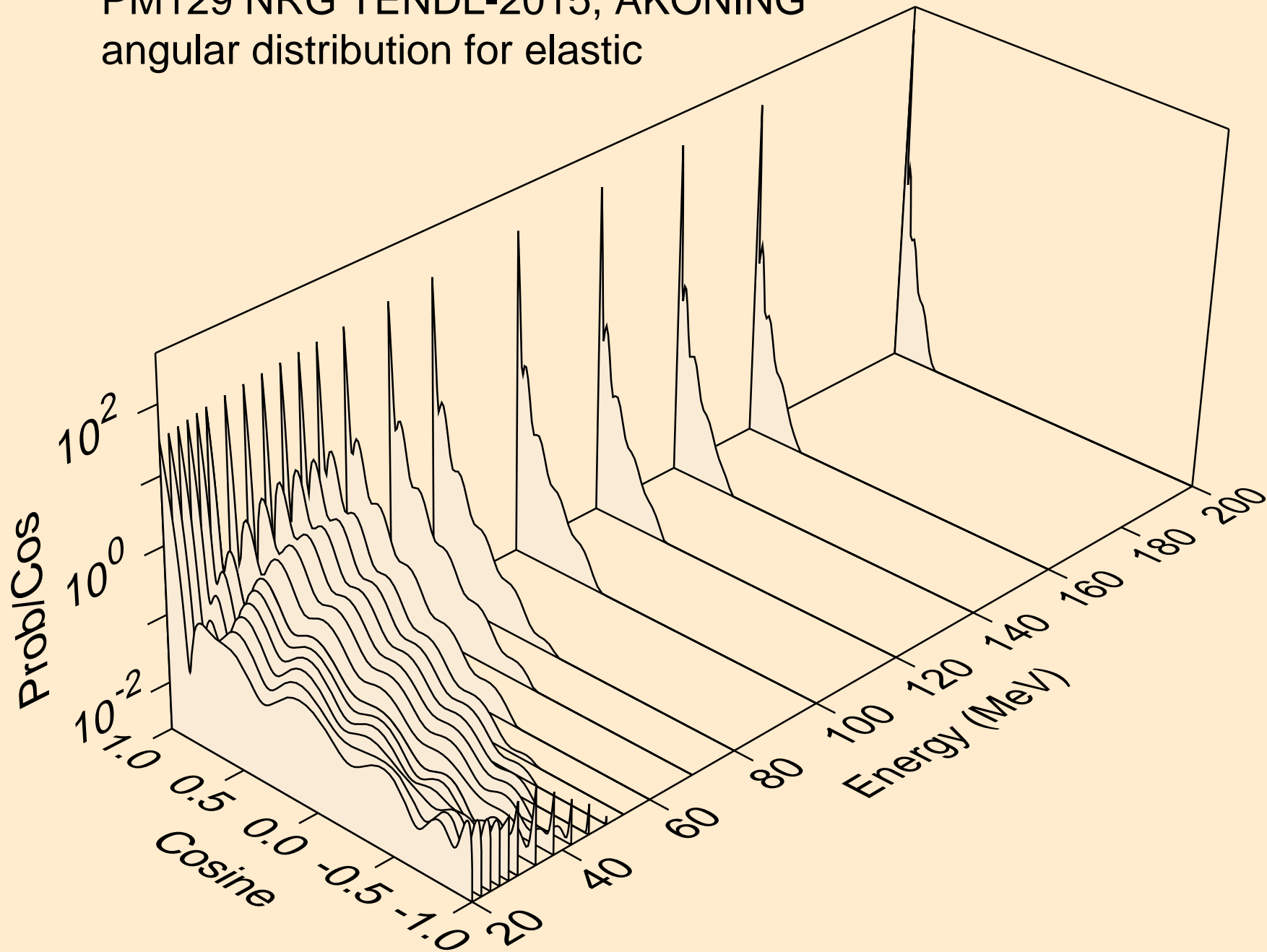

PM129 NRG TENDL-2015, AKONING  
angular distribution for (n,n\*1)

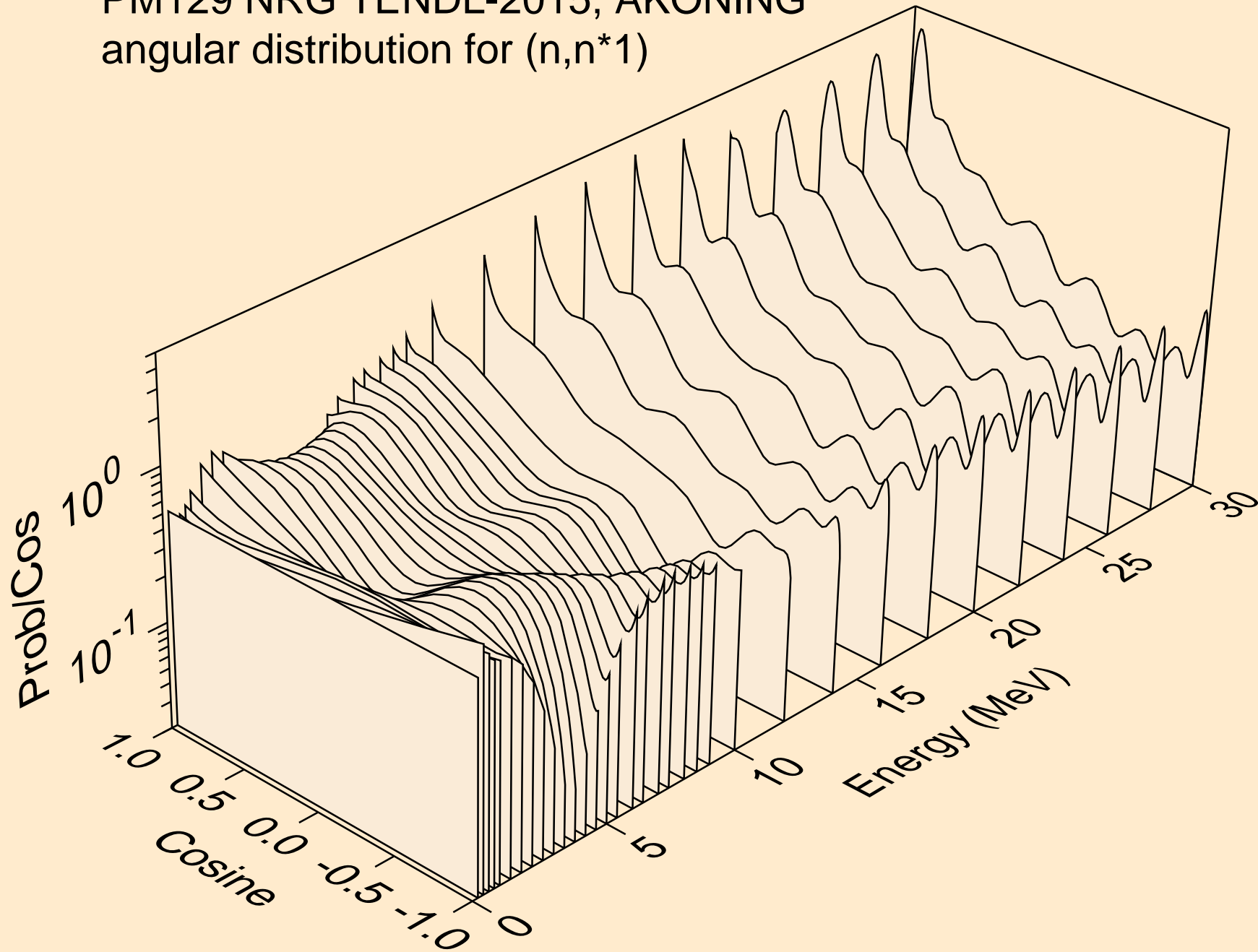

PM129 NRG TENDL-2015, AKONING  
Neutron emission for (n,x)

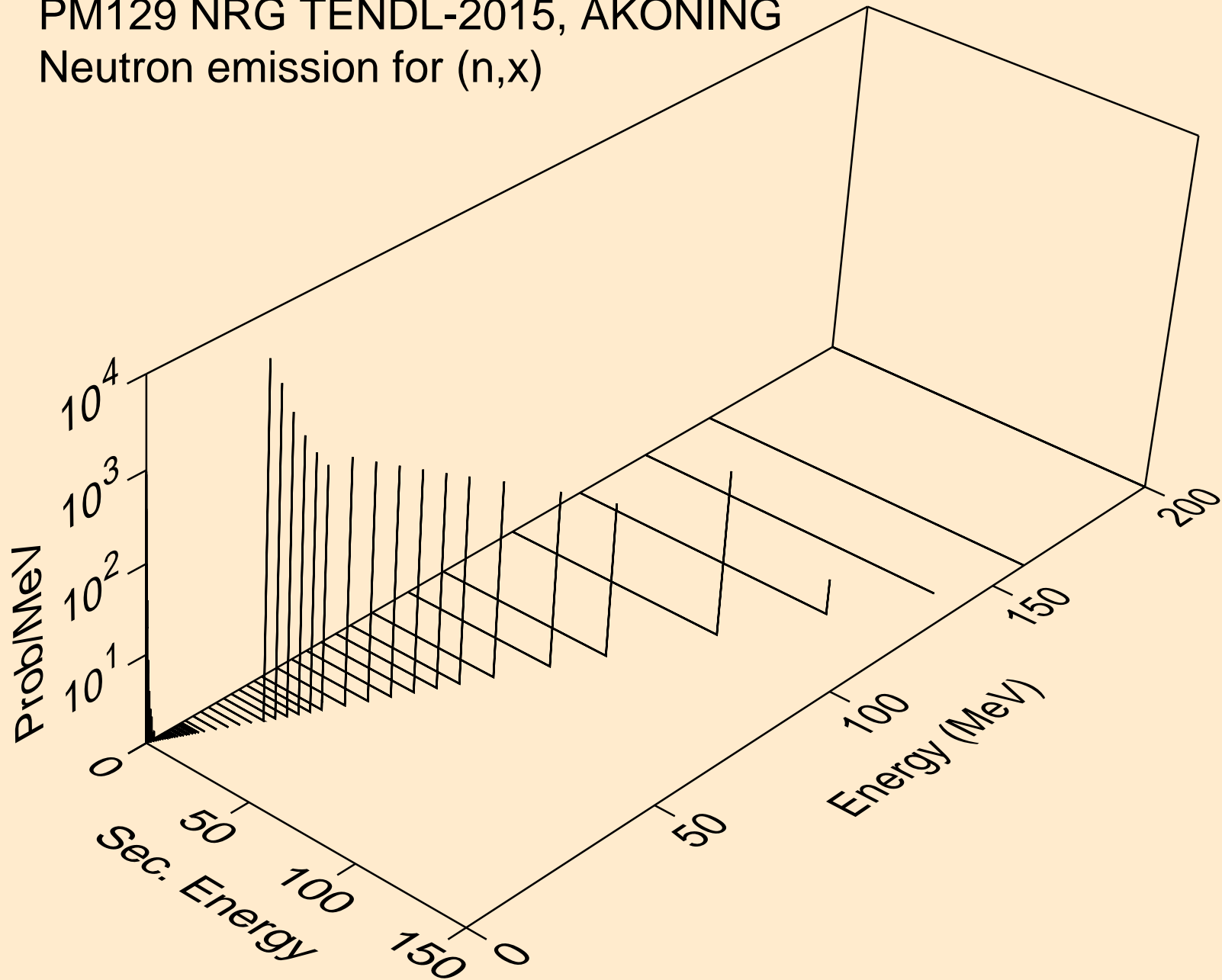



PM129 NRG TENDL-2015, AKONING  
Neutron emission for (n,2nd)

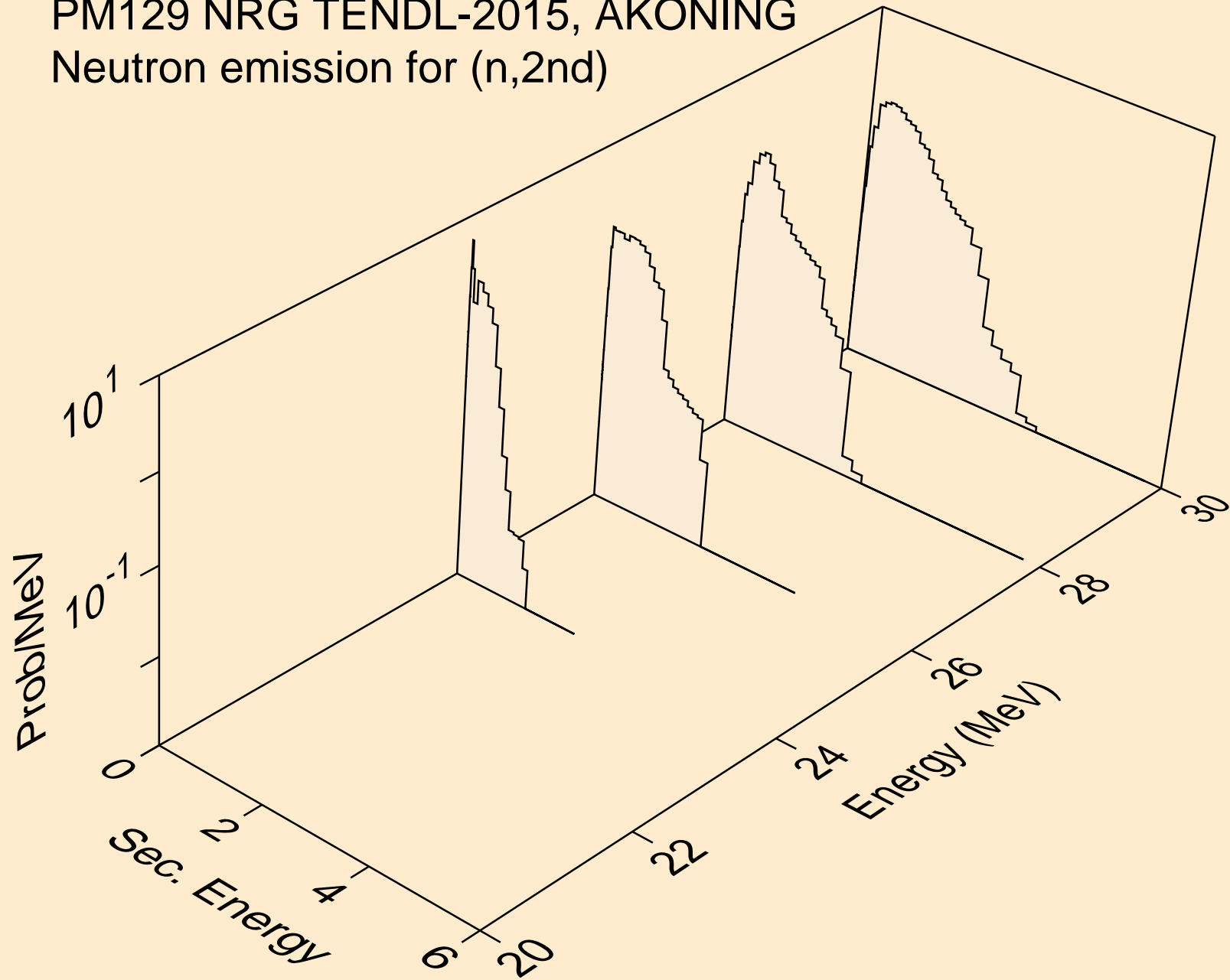

PM129 NRG TENDL-2015, AKONING  
Neutron emission for (n,2n)

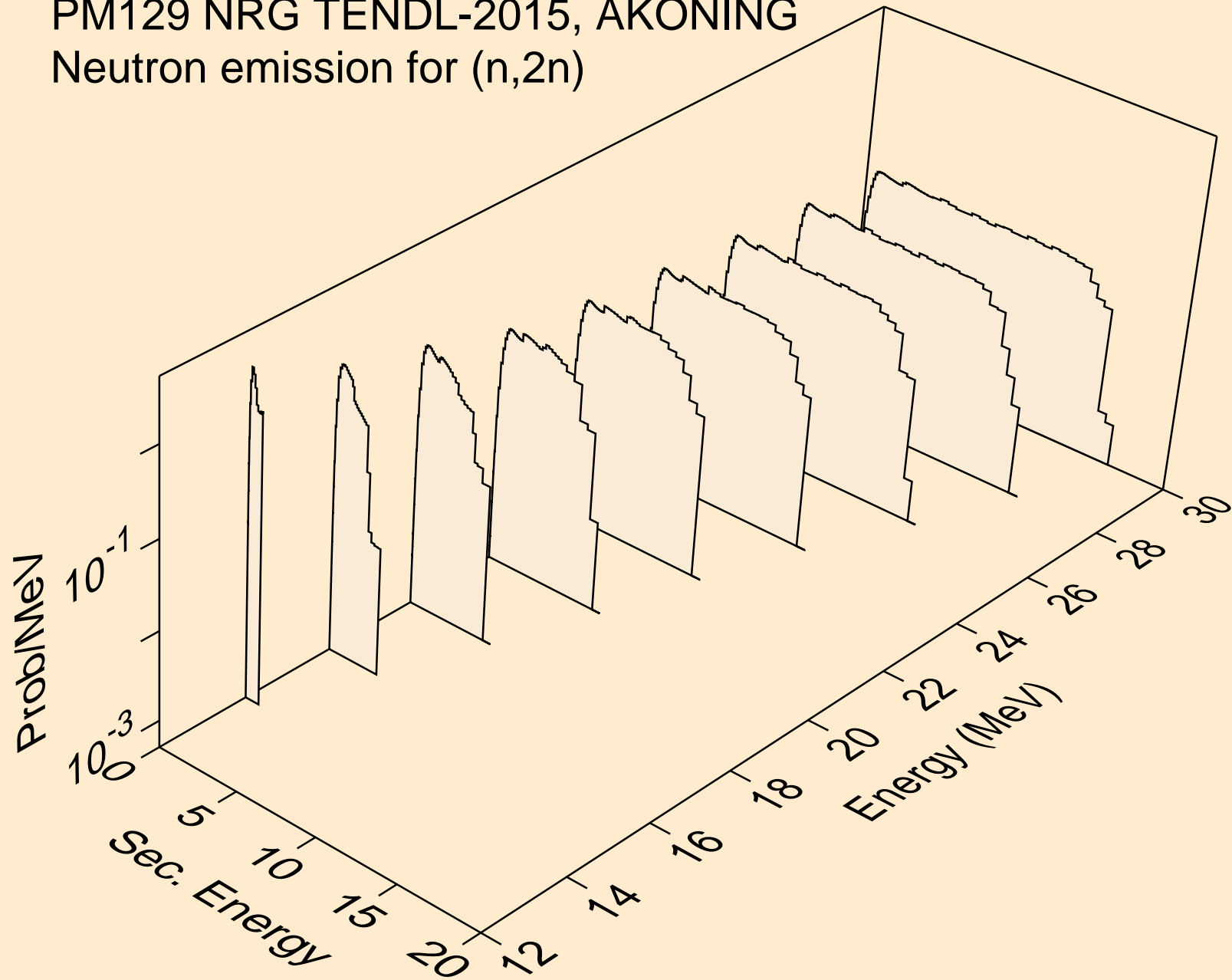

PM129 NRG TENDL-2015, AKONING  
Neutron emission for (n,3n)

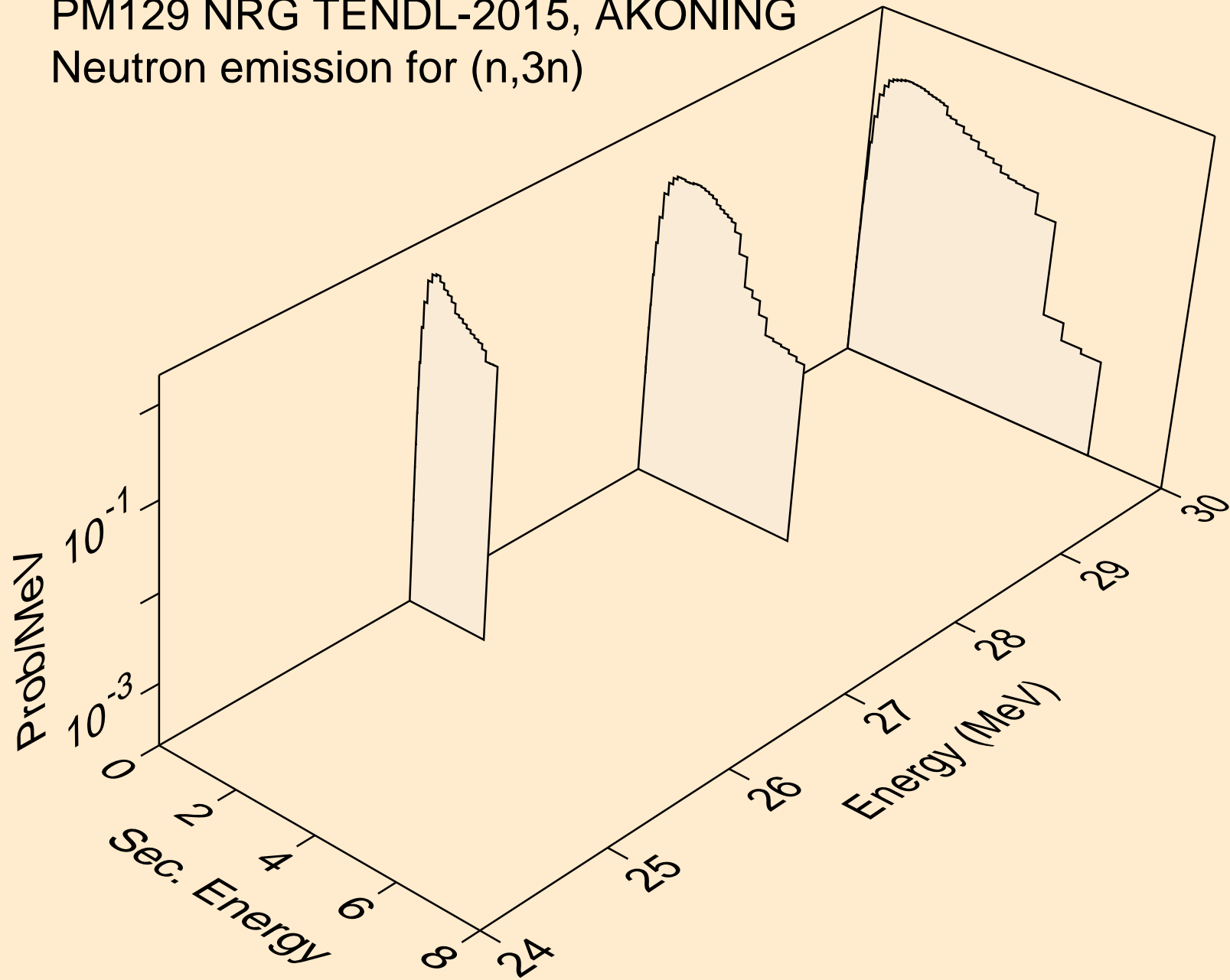

PM129 NRG TENDL-2015, AKONING  
Neutron emission for (n,n\*)a

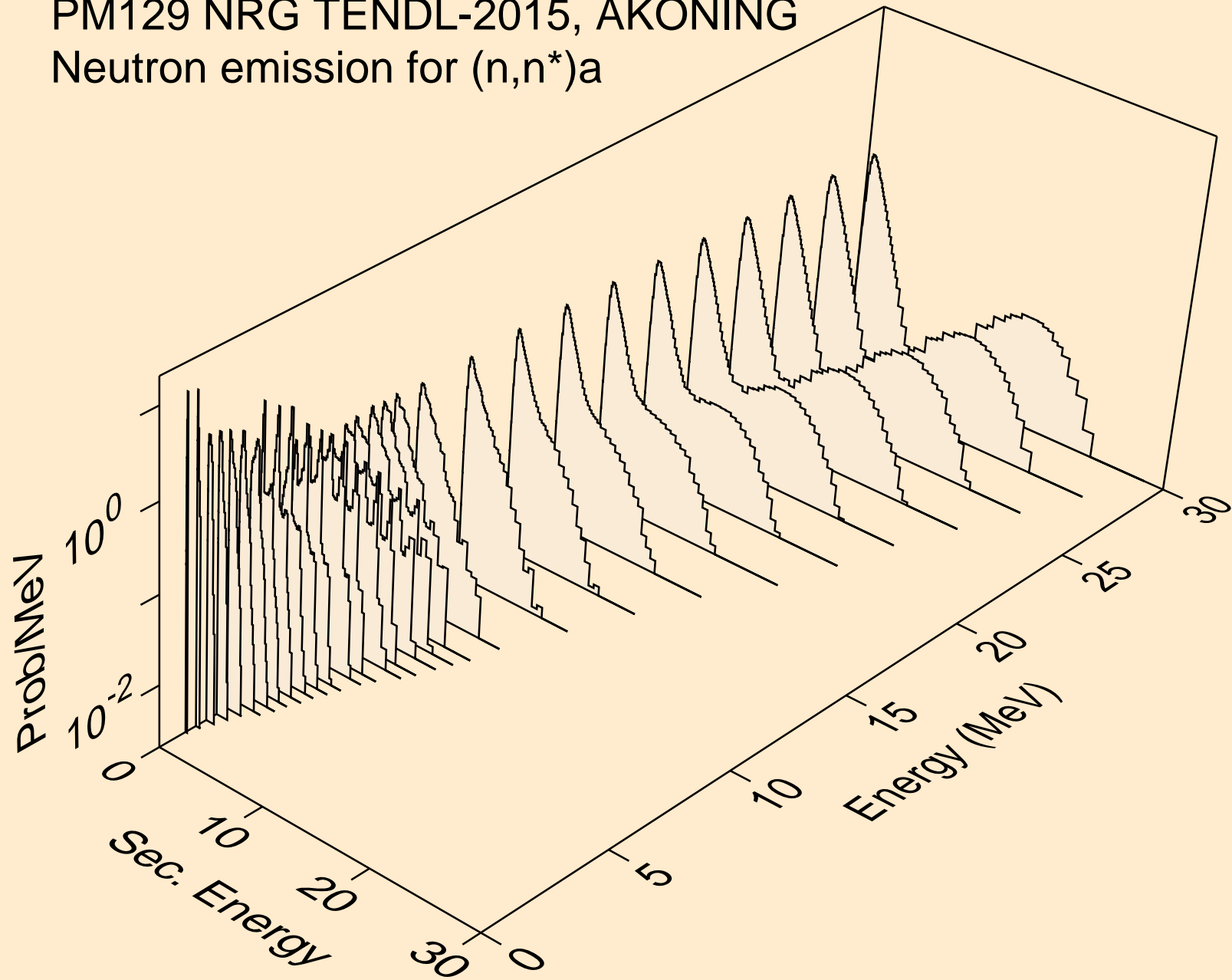

PM129 NRG TENDL-2015, AKONING  
Neutron emission for (n,n\*)3a

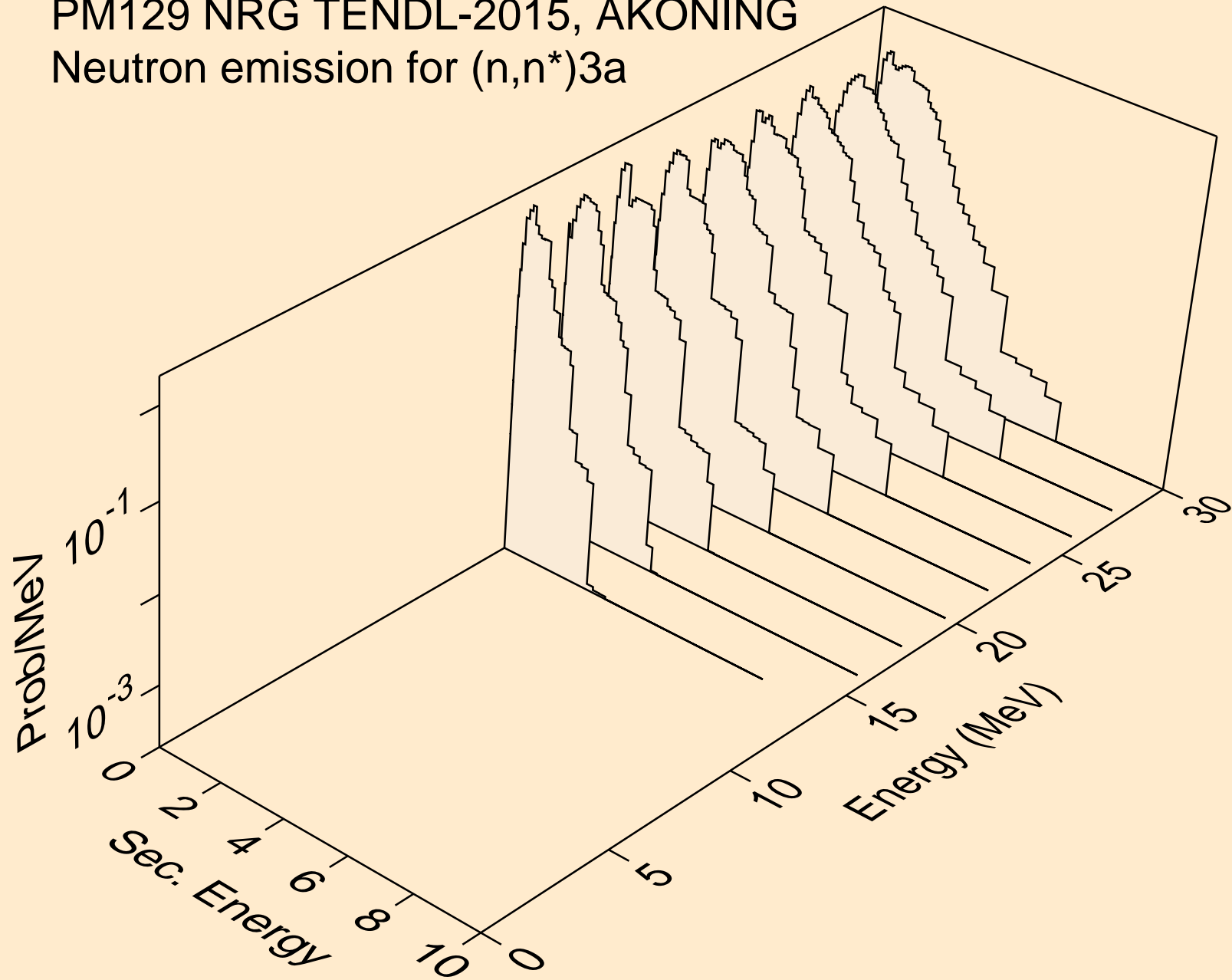

PM129 NRG TENDL-2015, AKONING  
Neutron emission for (n,2n)a

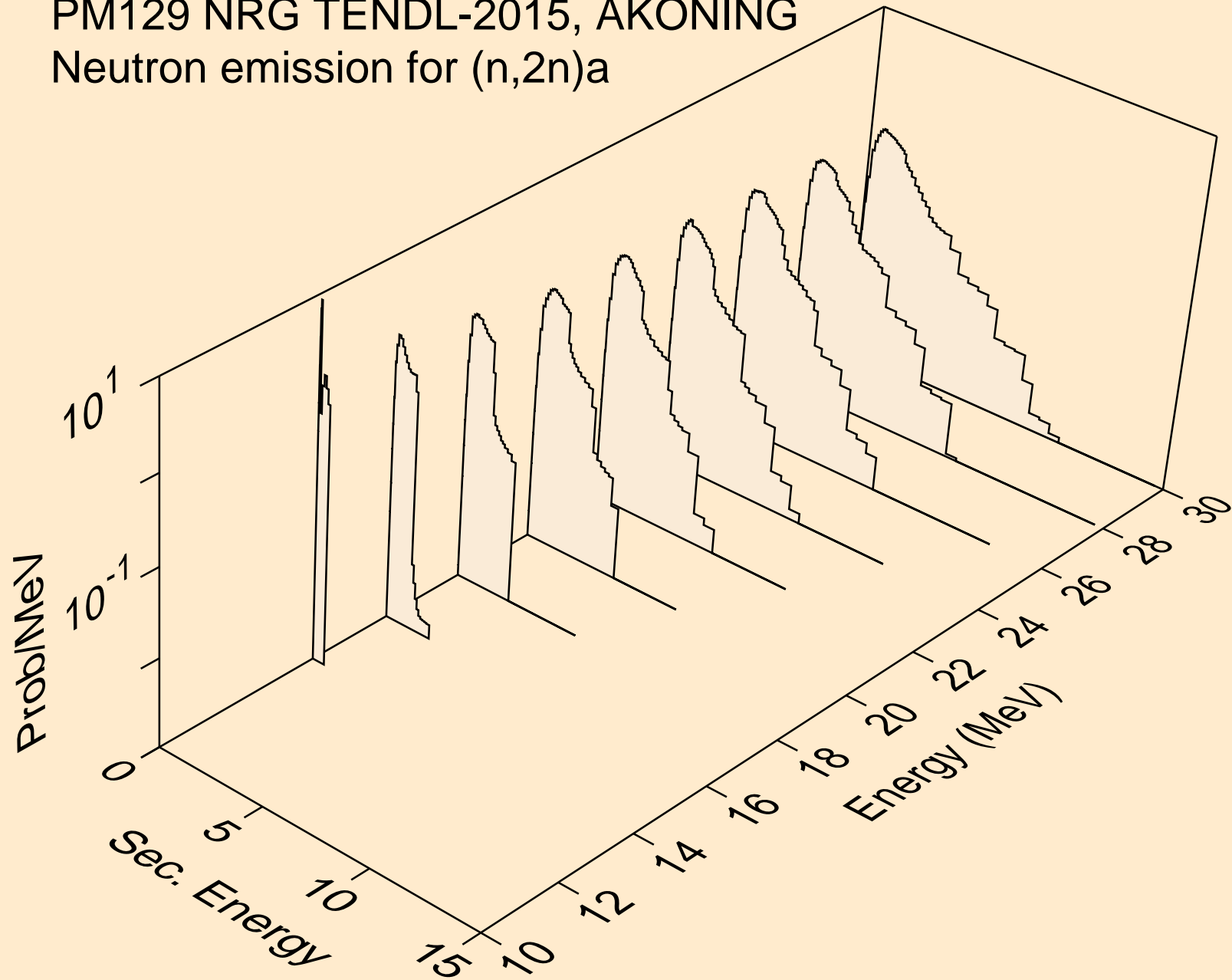

PM129 NRG TENDL-2015, AKONING  
Neutron emission for (n,n\*)p

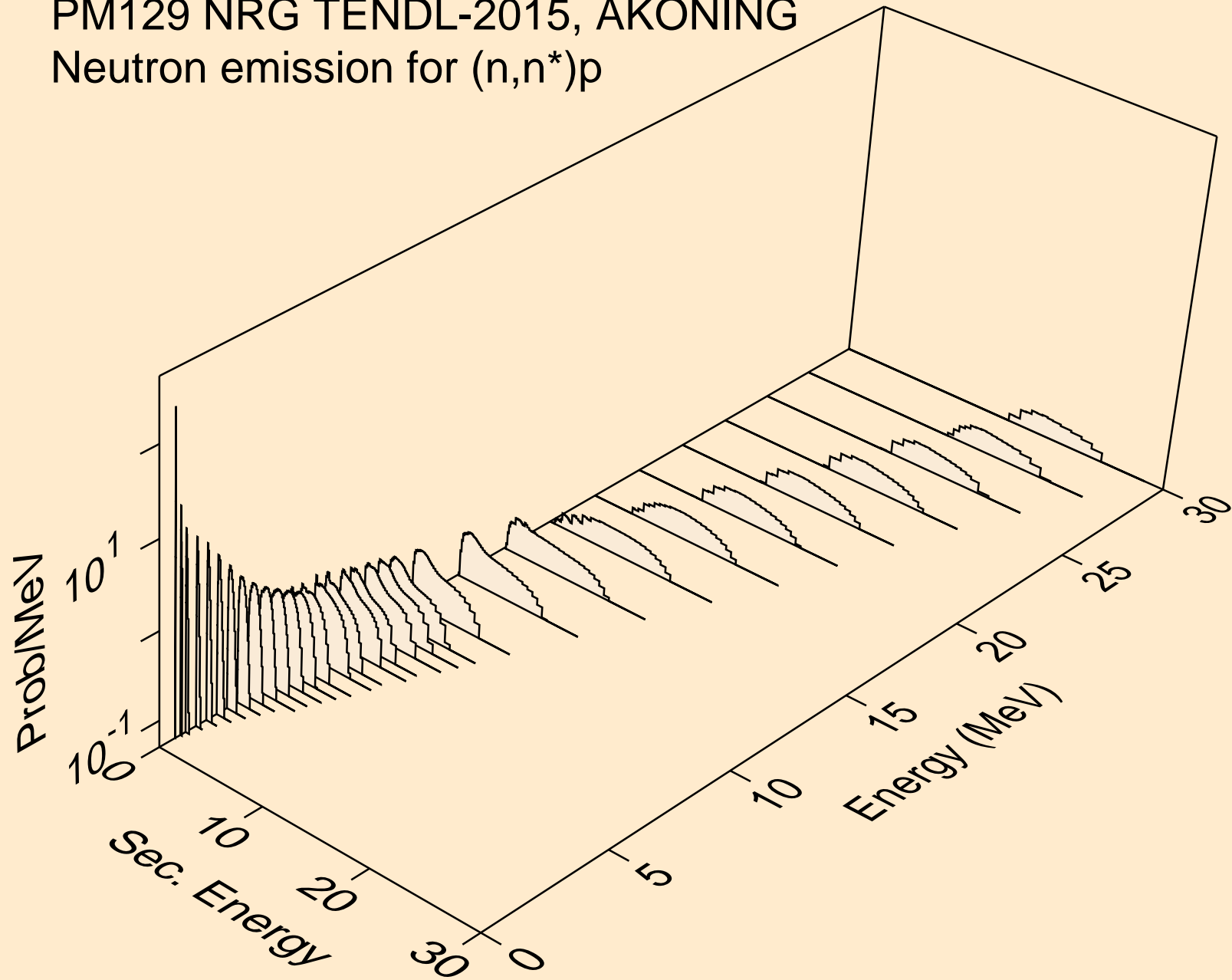

PM129 NRG TENDL-2015, AKONING  
Neutron emission for (n,n\*)2a

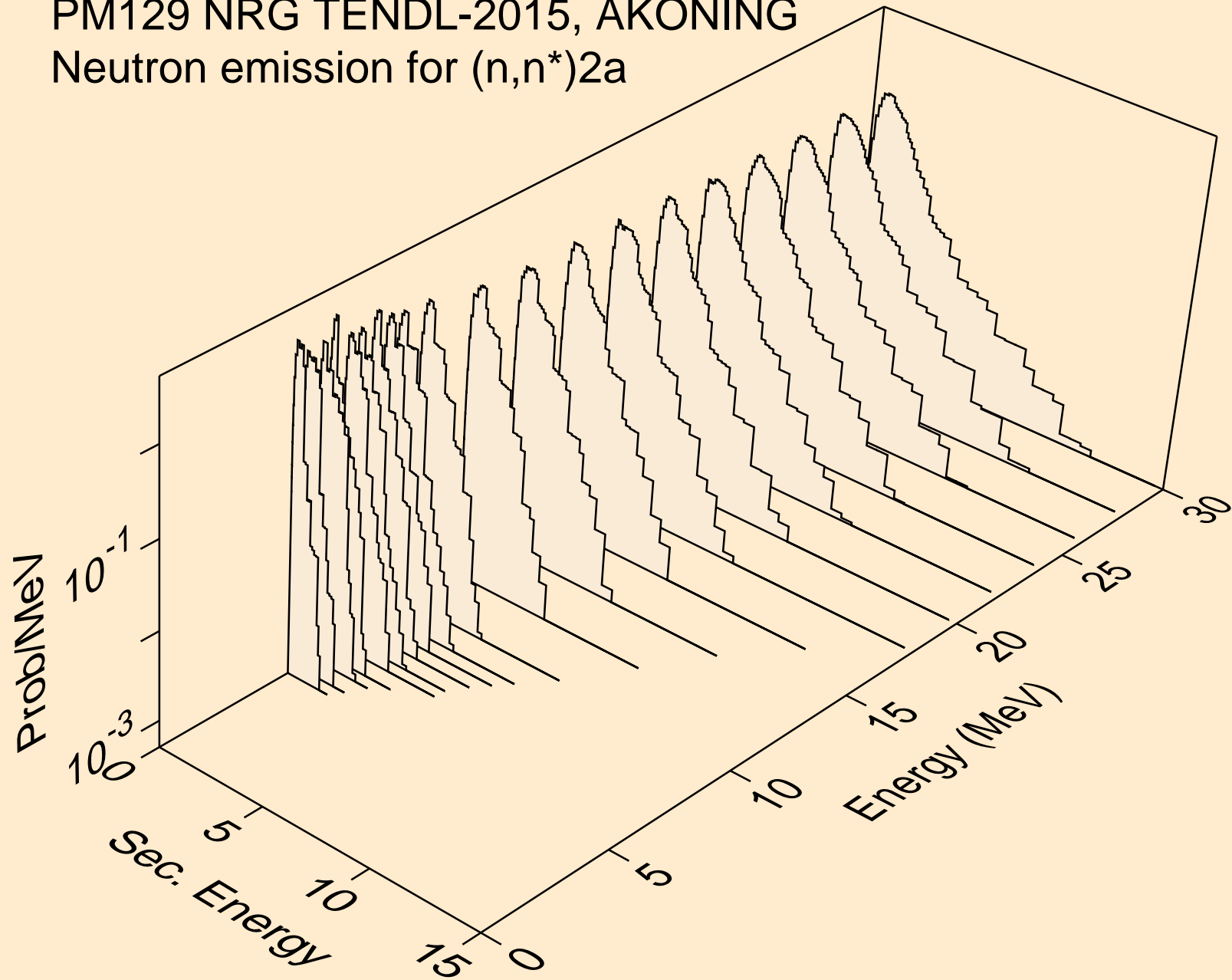



PM129 NRG TENDL-2015, AKONING  
Neutron emission for (n,n\*)d

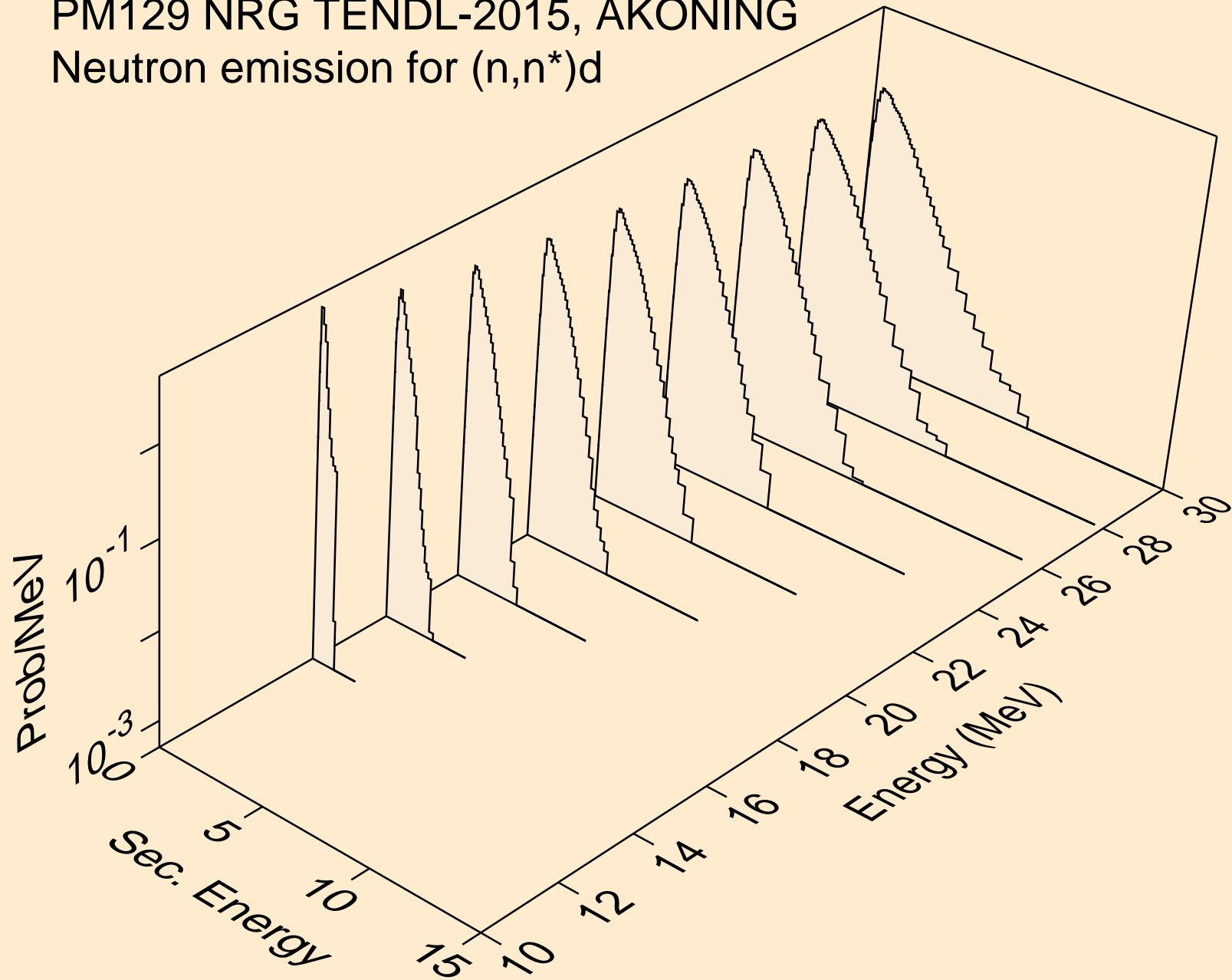

PM129 NRG TENDL-2015, AKONING  
Neutron emission for (n,n\*)t

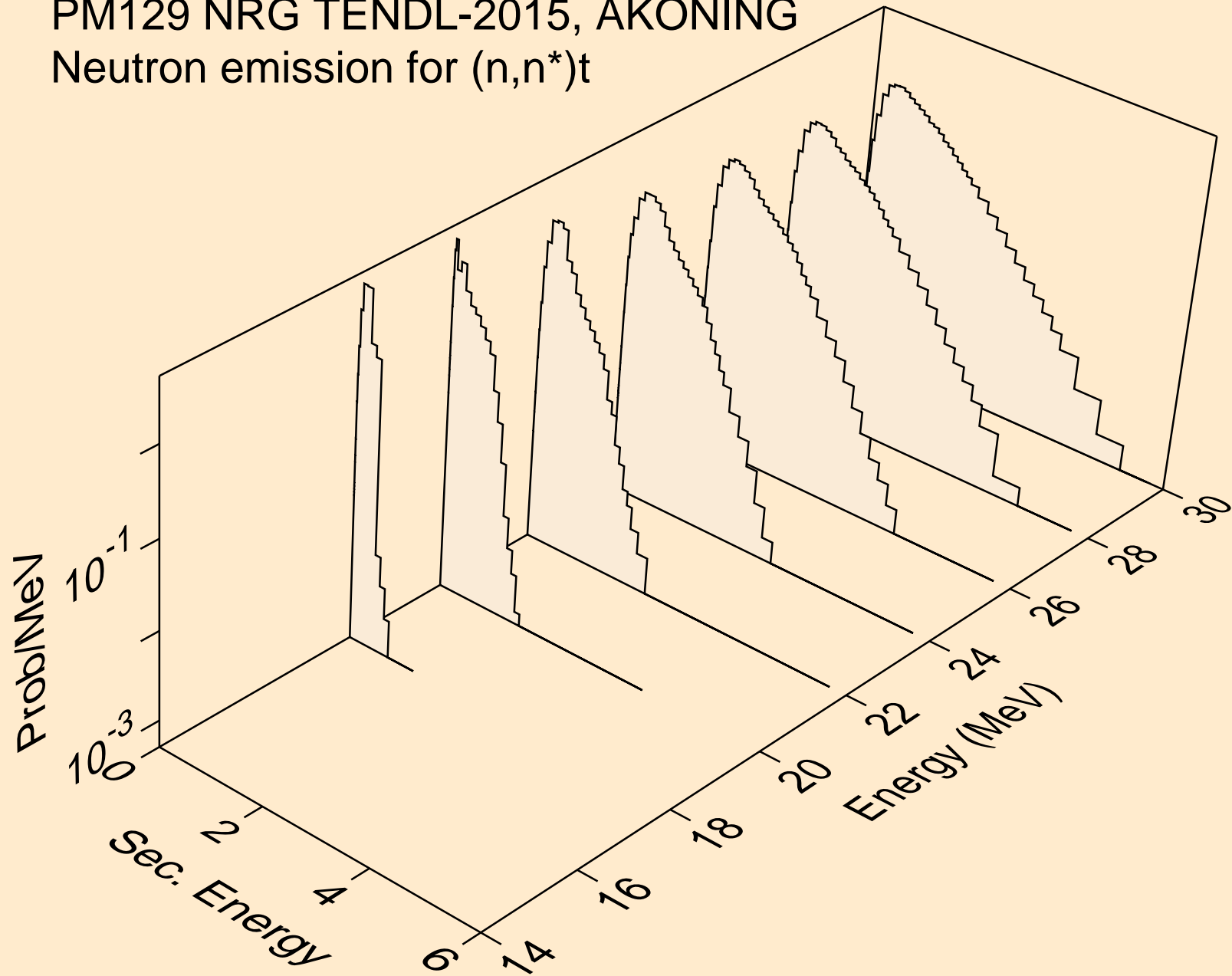

PM129 NRG TENDL-2015, AKONING  
Neutron emission for (n,n\*)he3

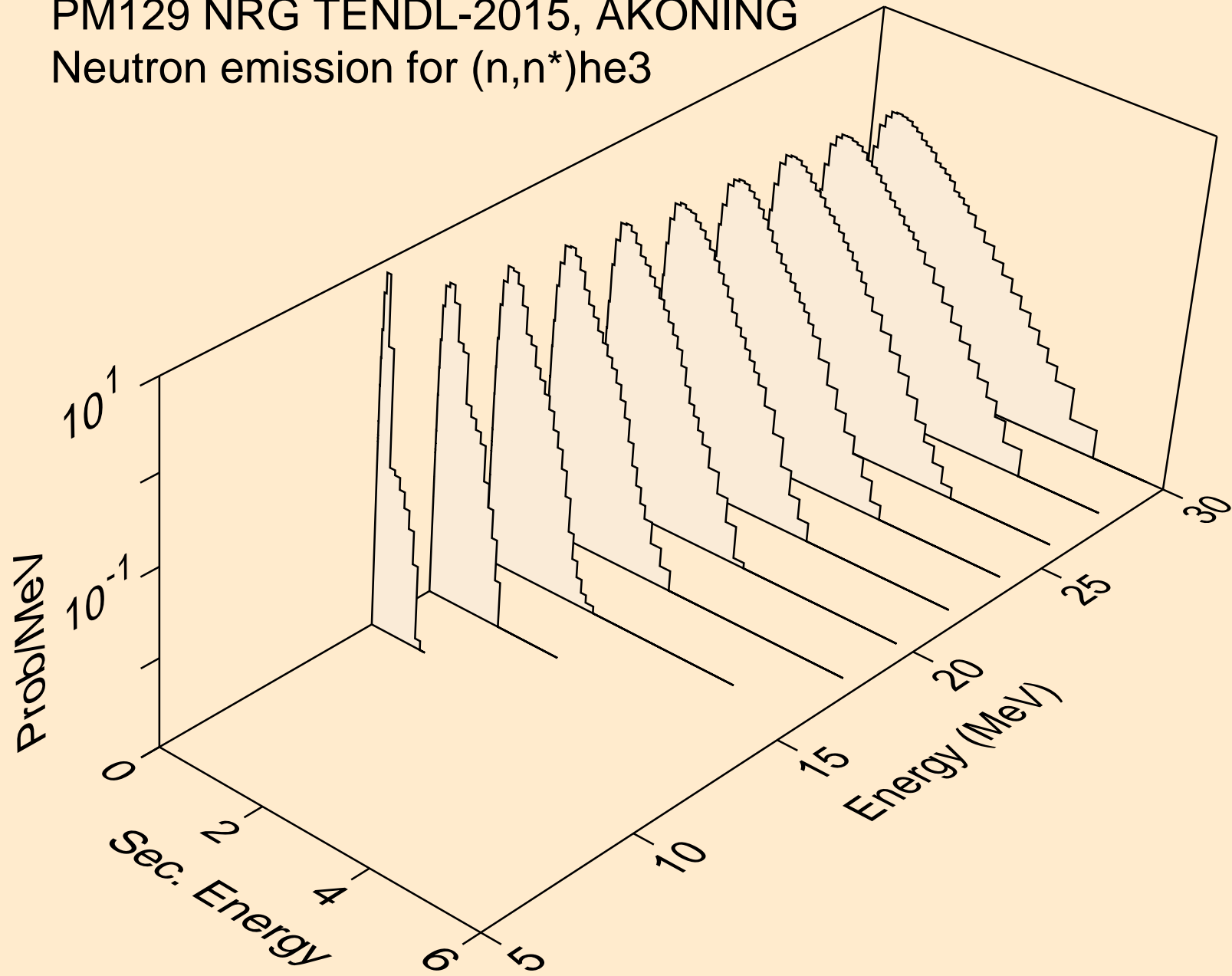

PM129 NRG TENDL-2015, AKONING  
Neutron emission for (n,2np)

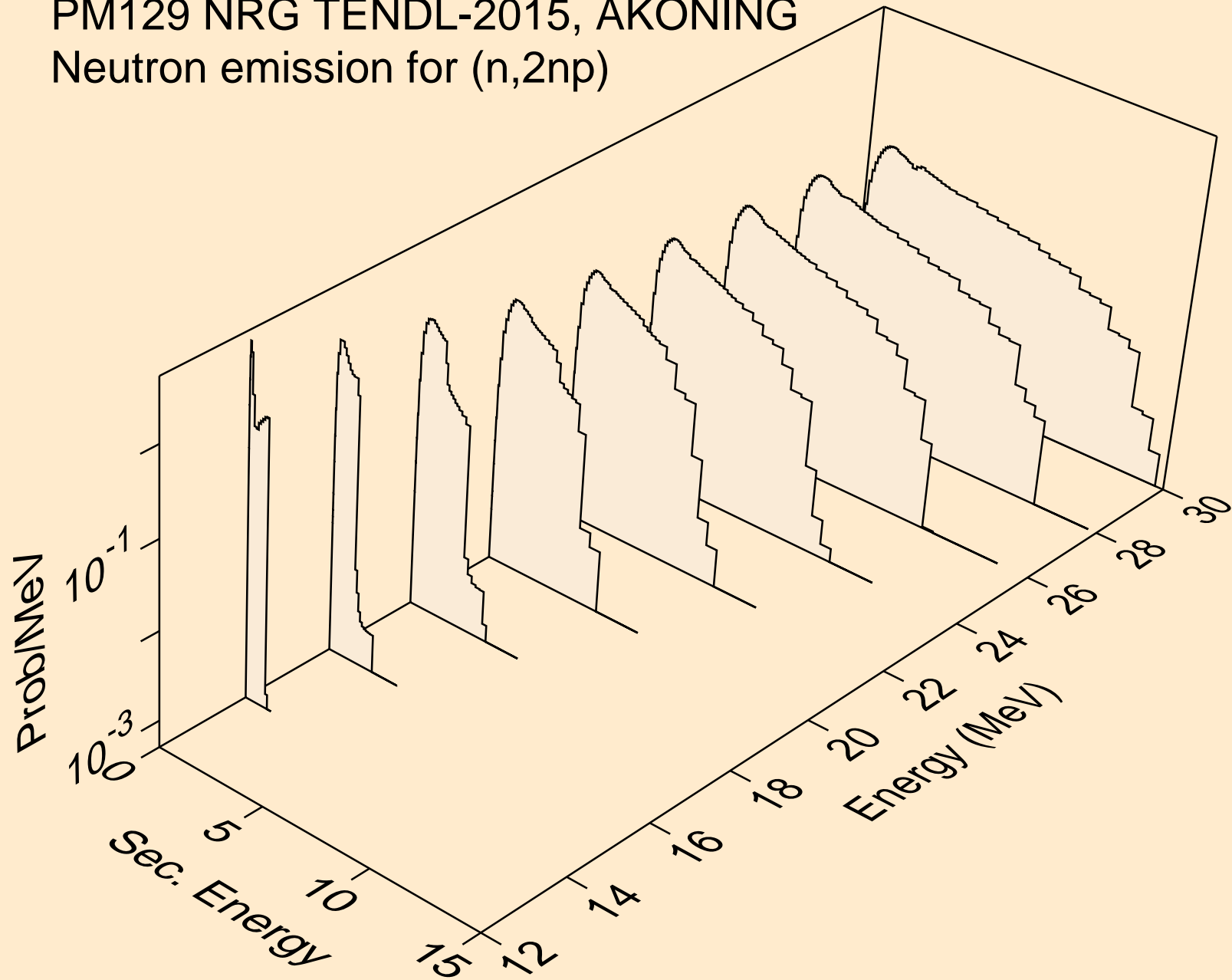

PM129 NRG TENDL-2015, AKONING  
Neutron emission for (n,3np)

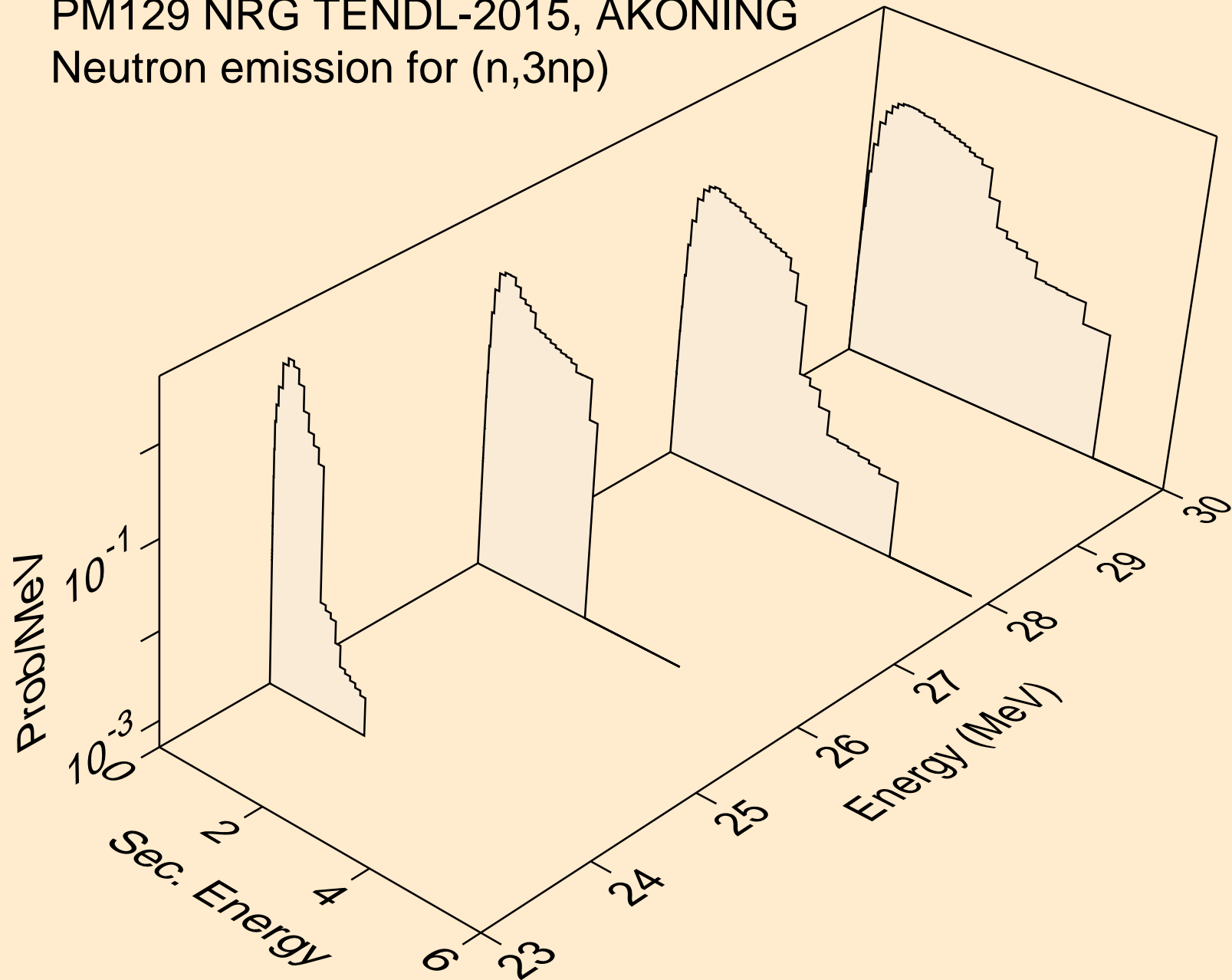

PM129 NRG TENDL-2015, AKONING  
Neutron emission for (n,2np)

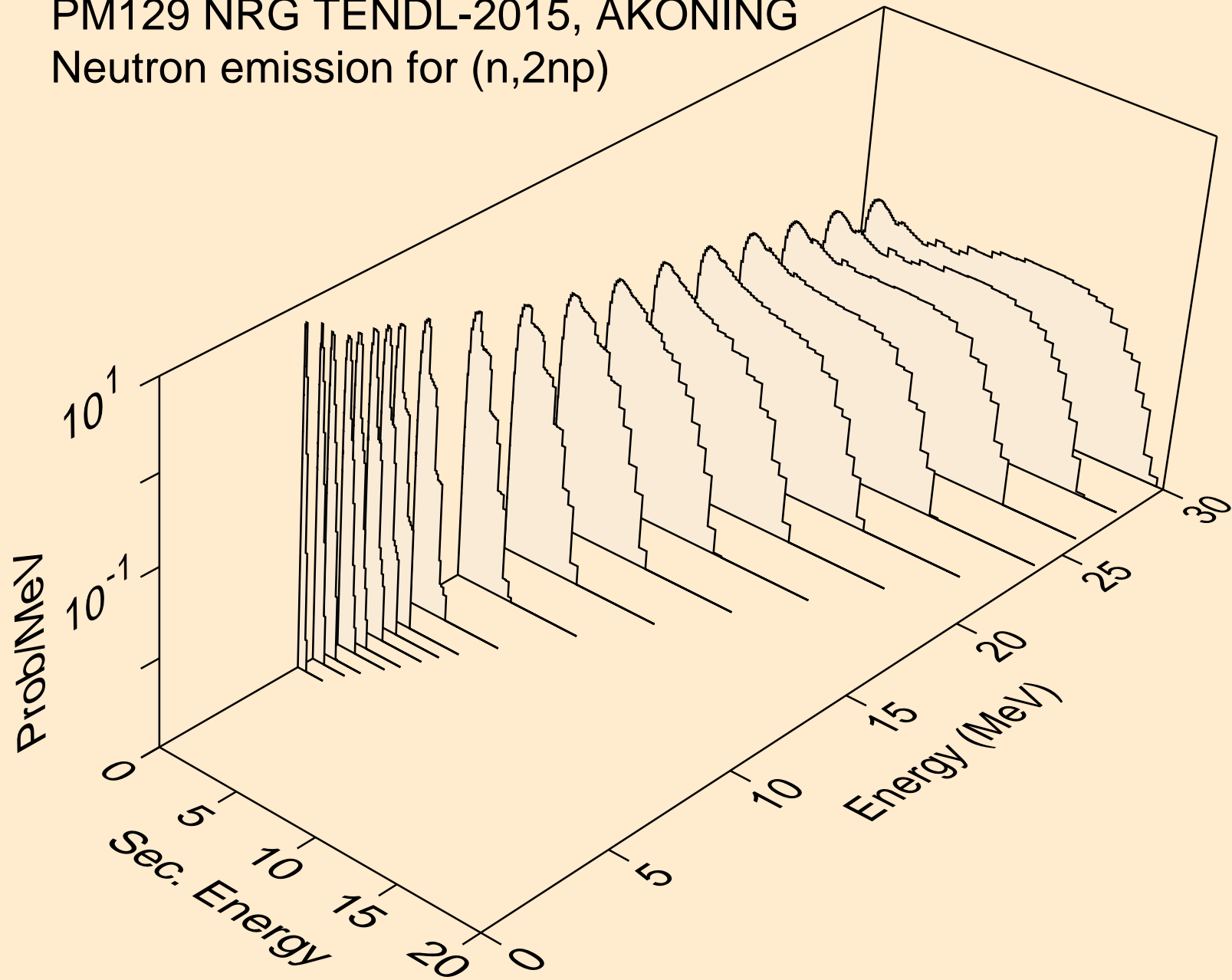

PM129 NRG TENDL-2015, AKONING  
Neutron emission for (n,npa)

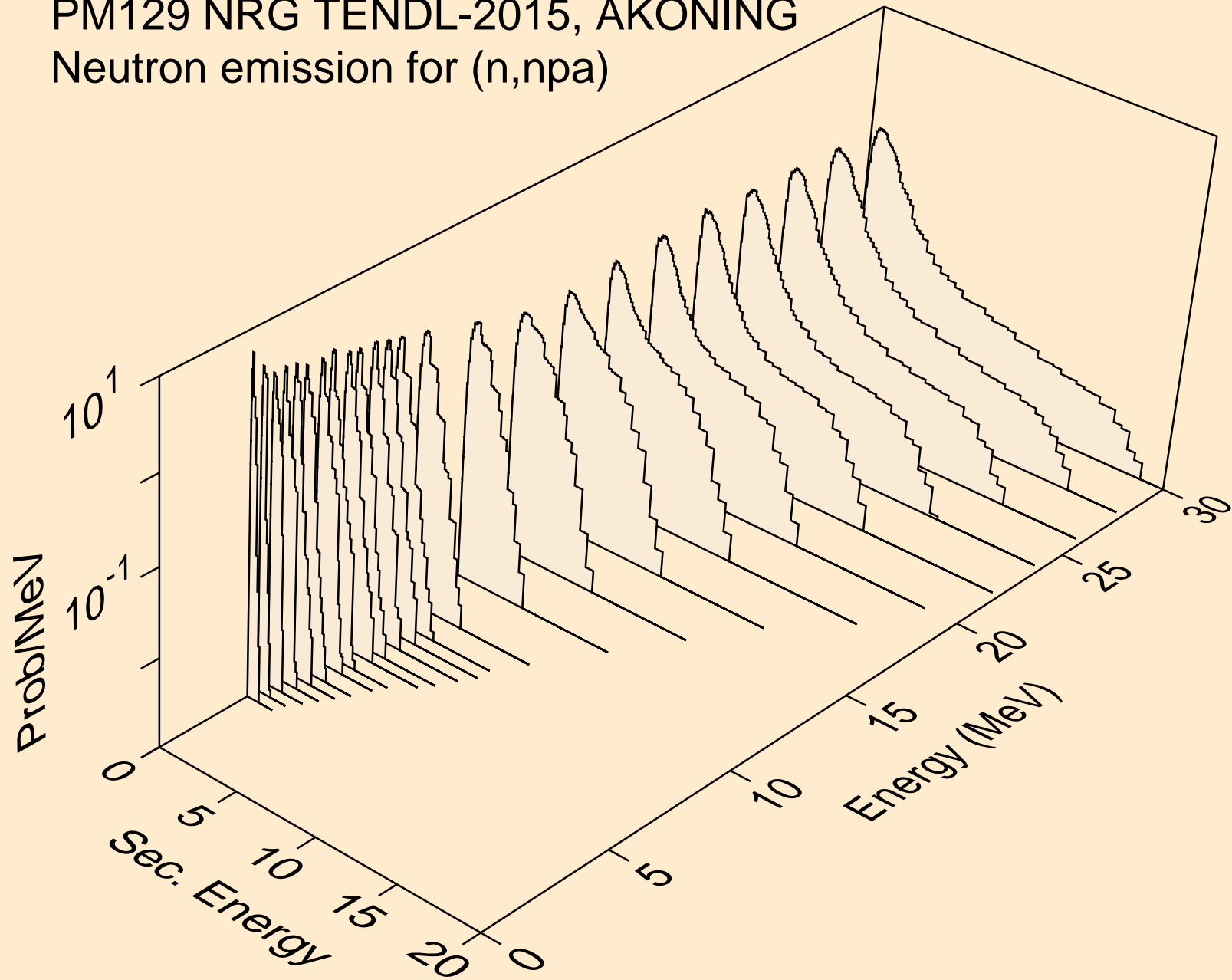

PM129 NRG TENDL-2015, AKONING  
Neutron emission for (n,n\*c)

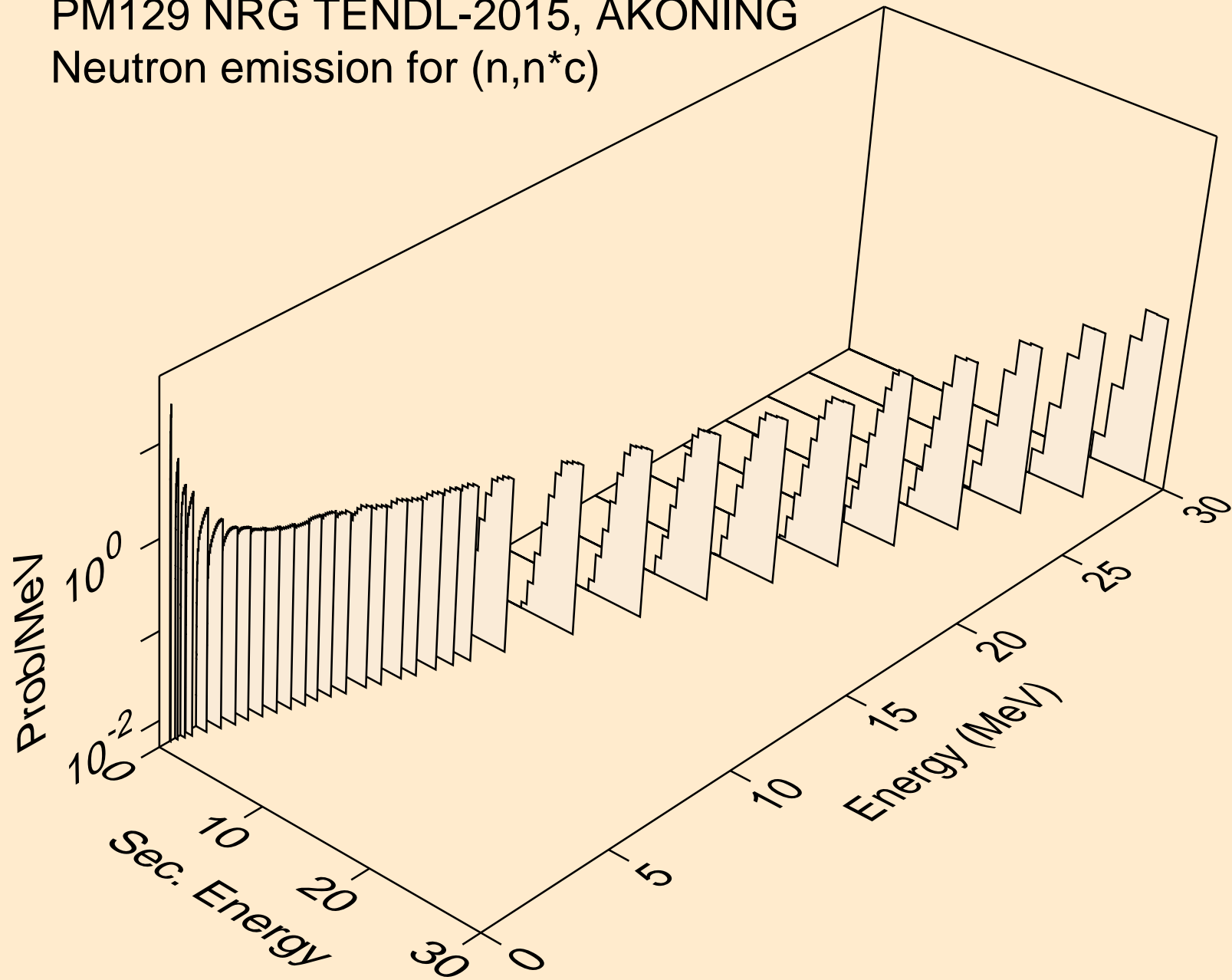



PM129 NRG TENDL-2015, AKONING  
Photon emission for (n,x)

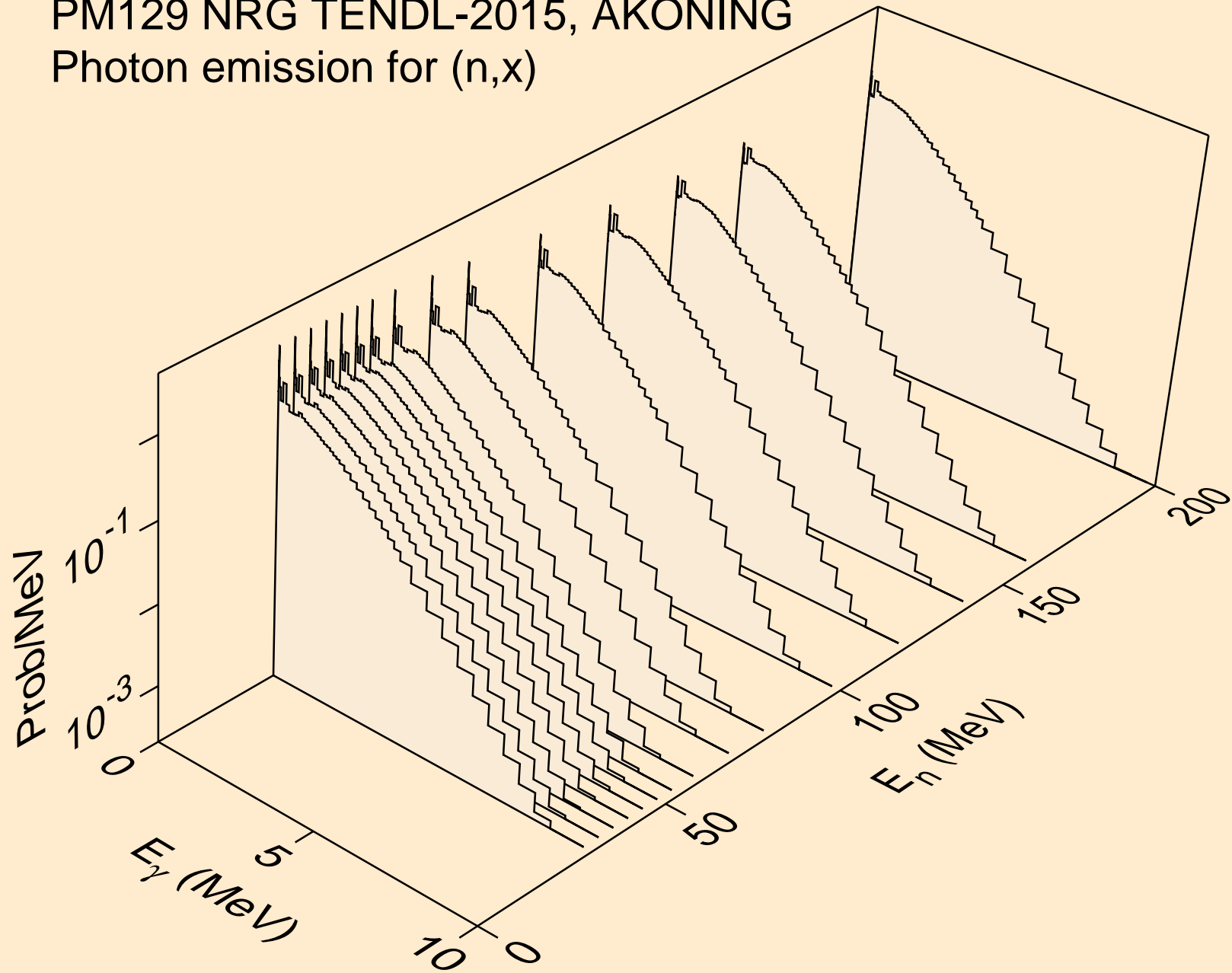

PM129 NRG TENDL-2015, AKONING  
Photon emission for (n,2nd)

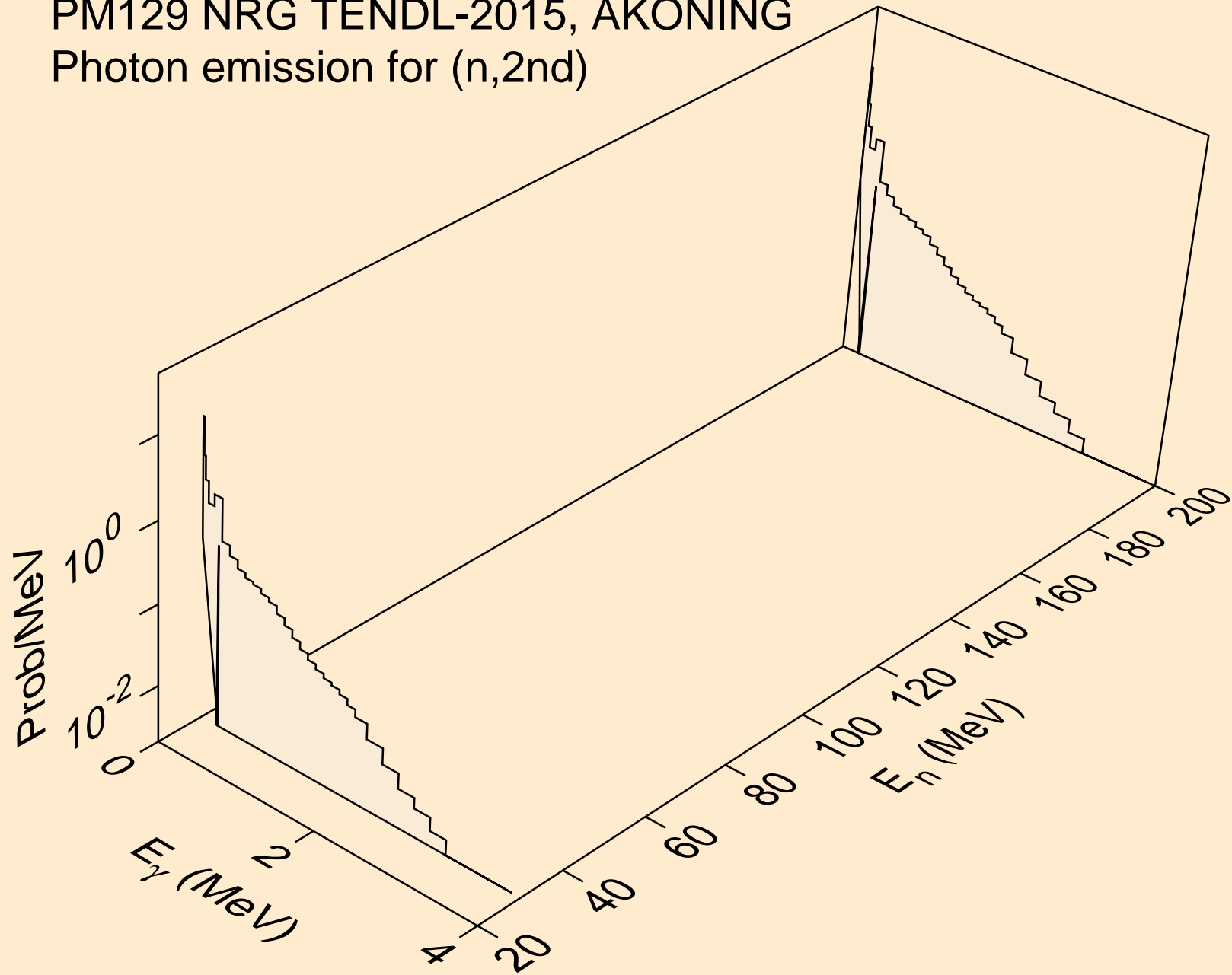

PM129 NRG TENDL-2015, AKONING  
Photon emission for (n,2n)

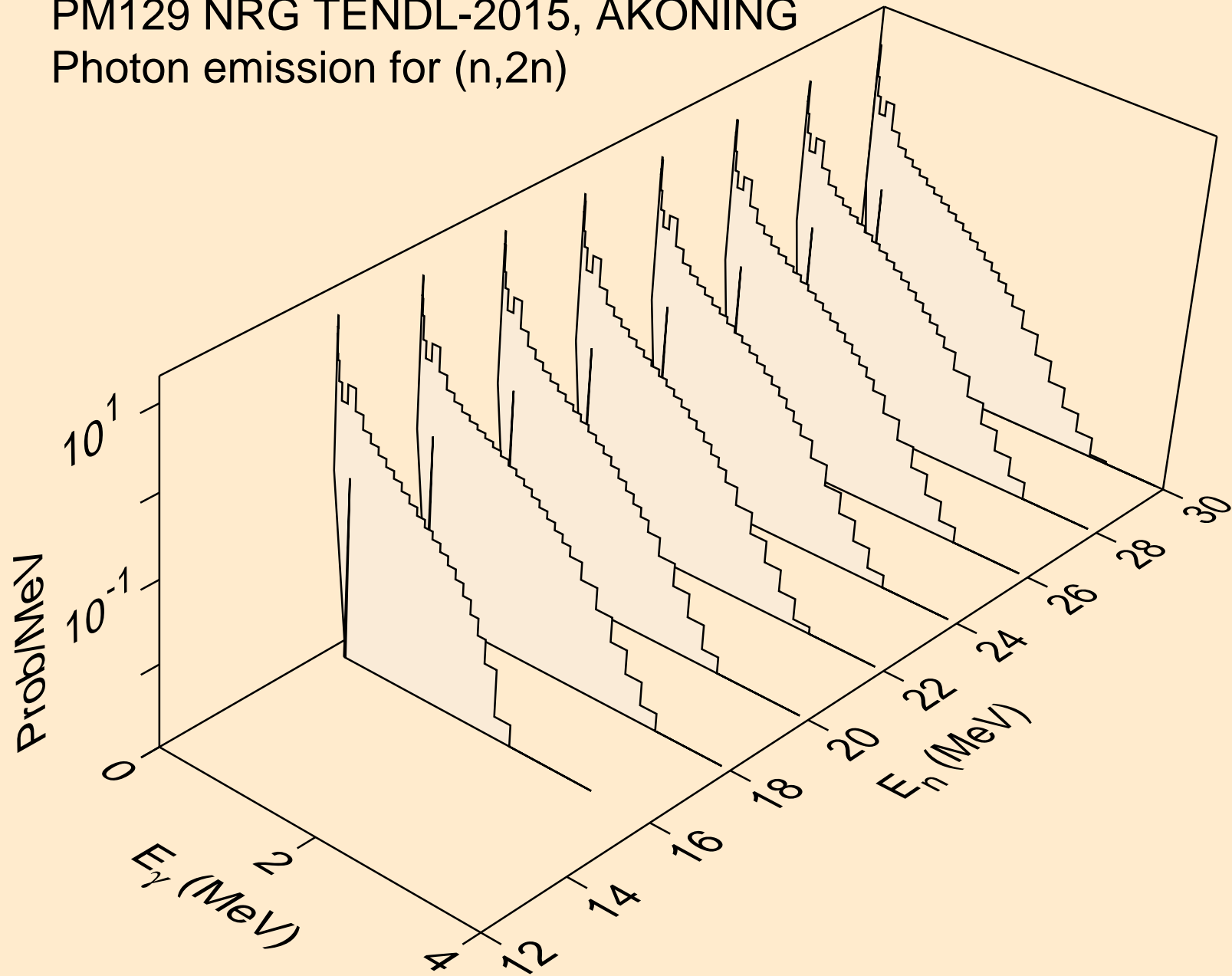

PM129 NRG TENDL-2015, AKONING  
Photon emission for (n,3n)

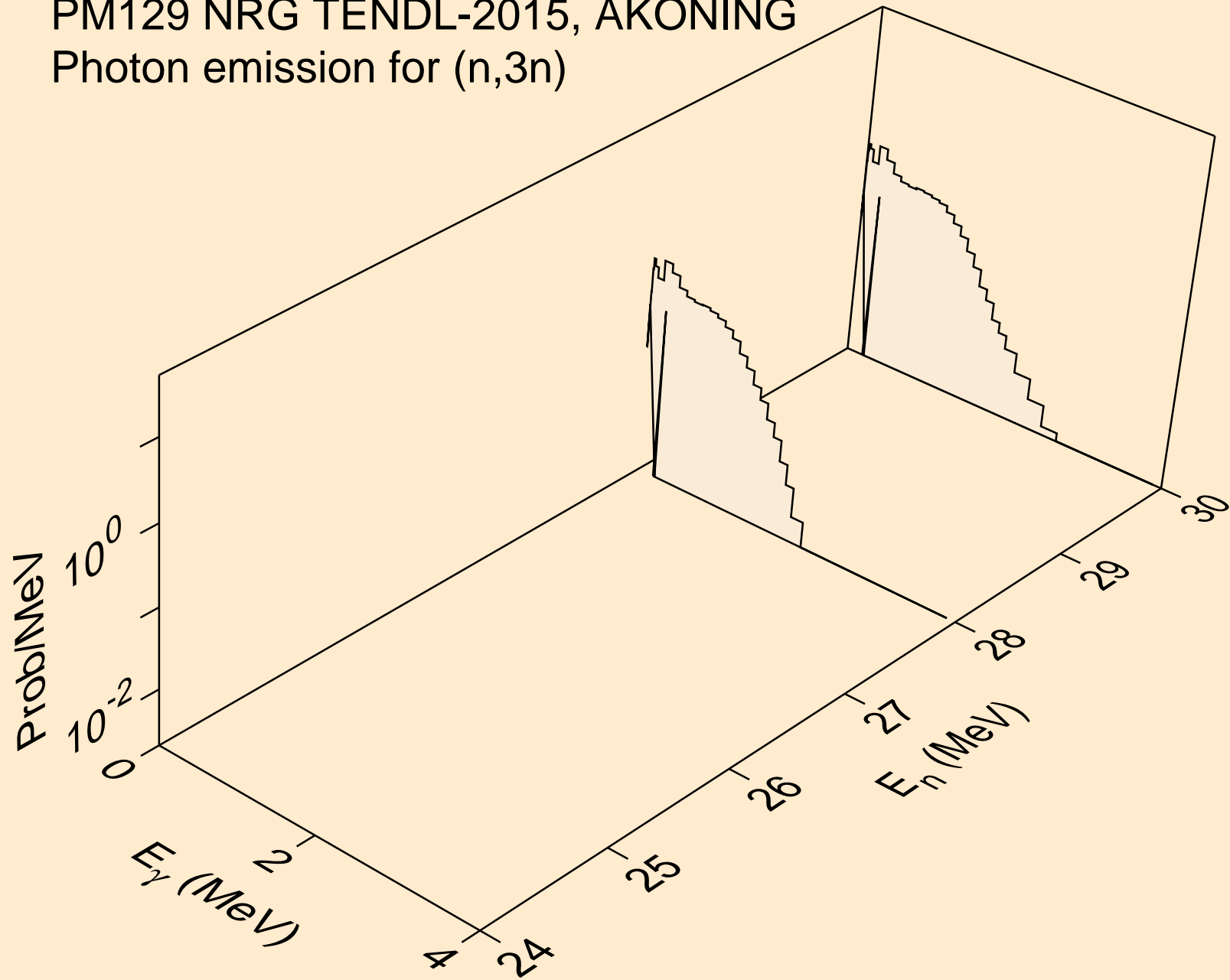

PM129 NRG TENDL-2015, AKONING  
Photon emission for (n,n\*)a

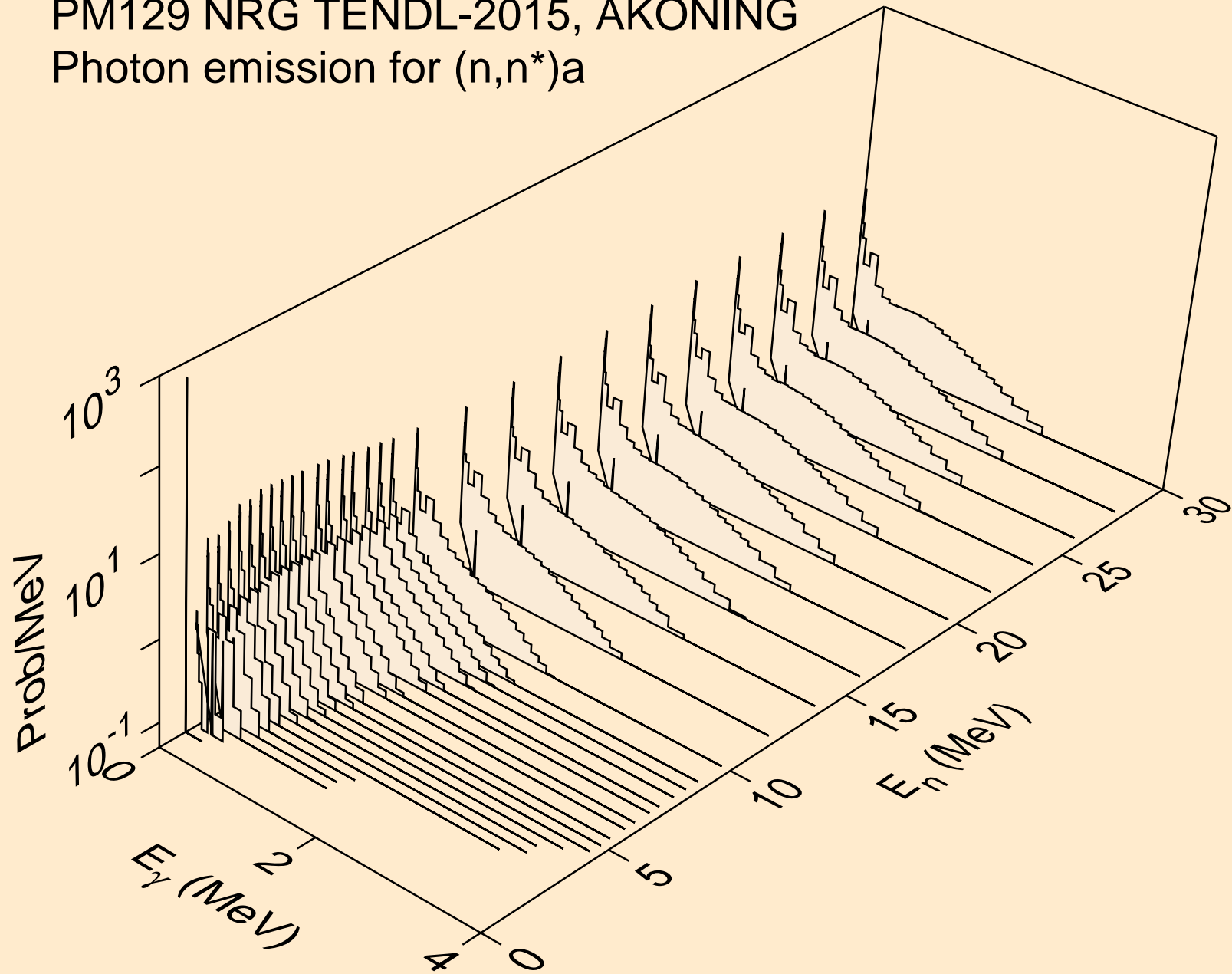

PM129 NRG TENDL-2015, AKONING  
Photon emission for (n,n\*)3a

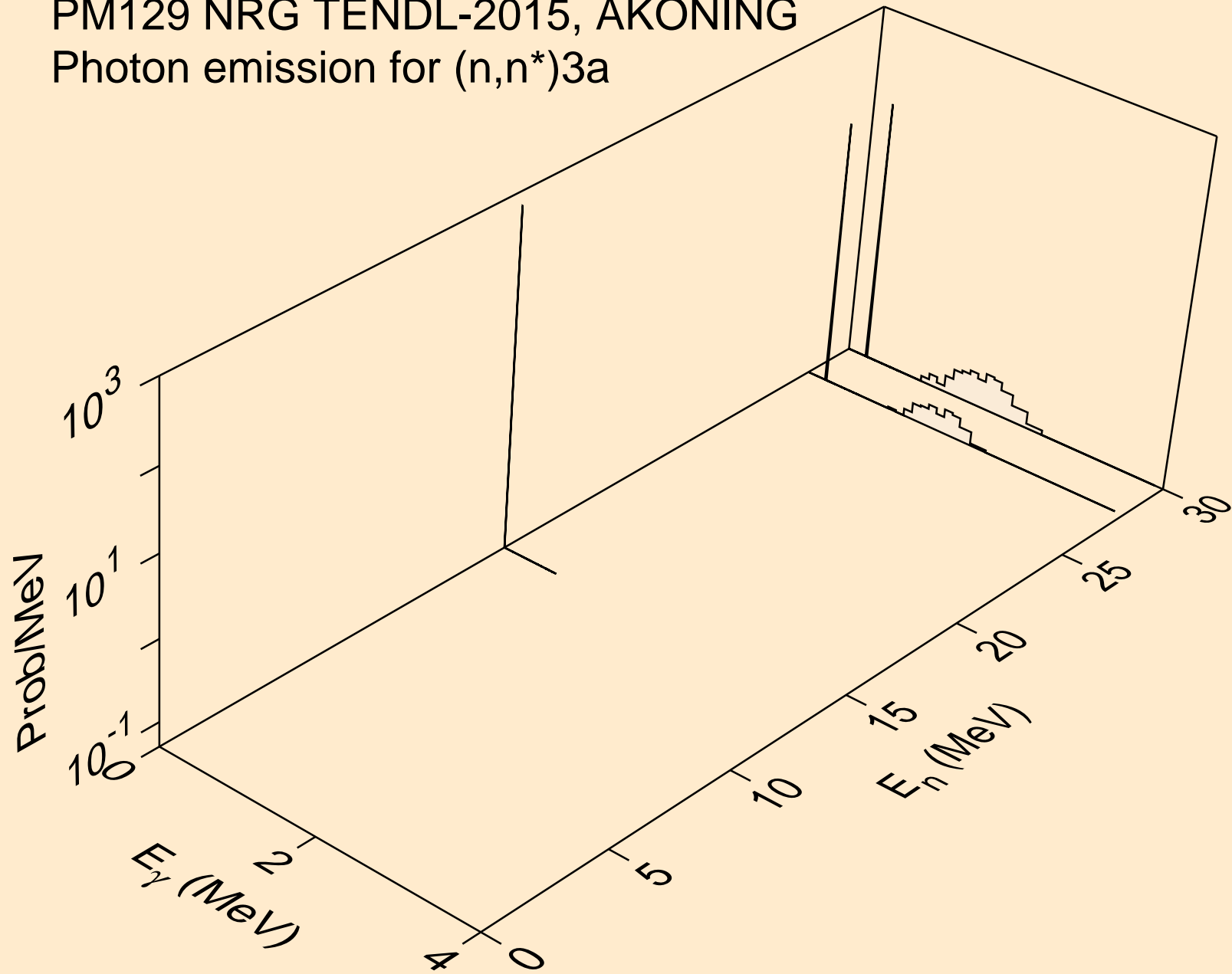

PM129 NRG TENDL-2015, AKONING  
Photon emission for (n,2n)a

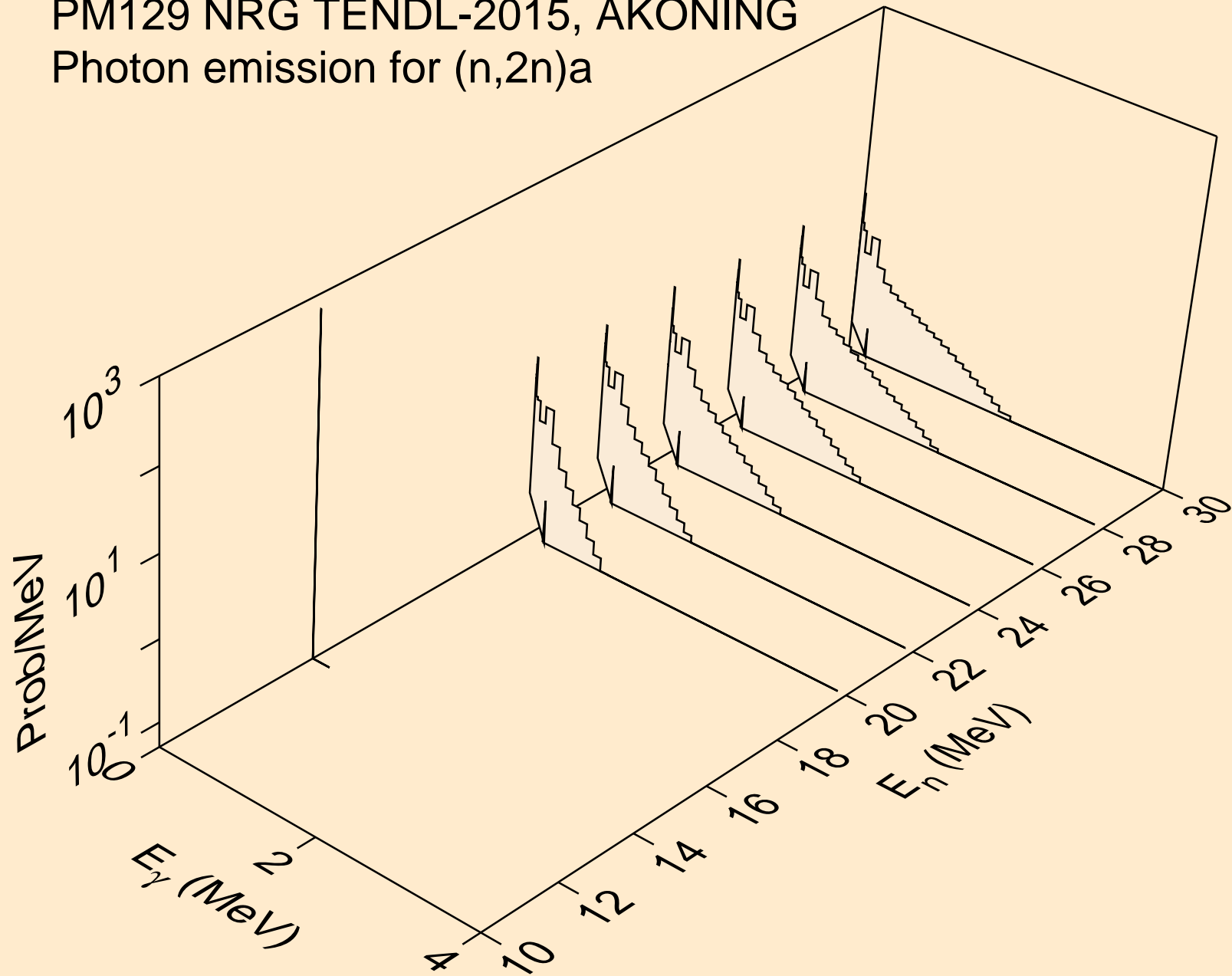

PM129 NRG TENDL-2015, AKONING  
Photon emission for (n,n\*)p

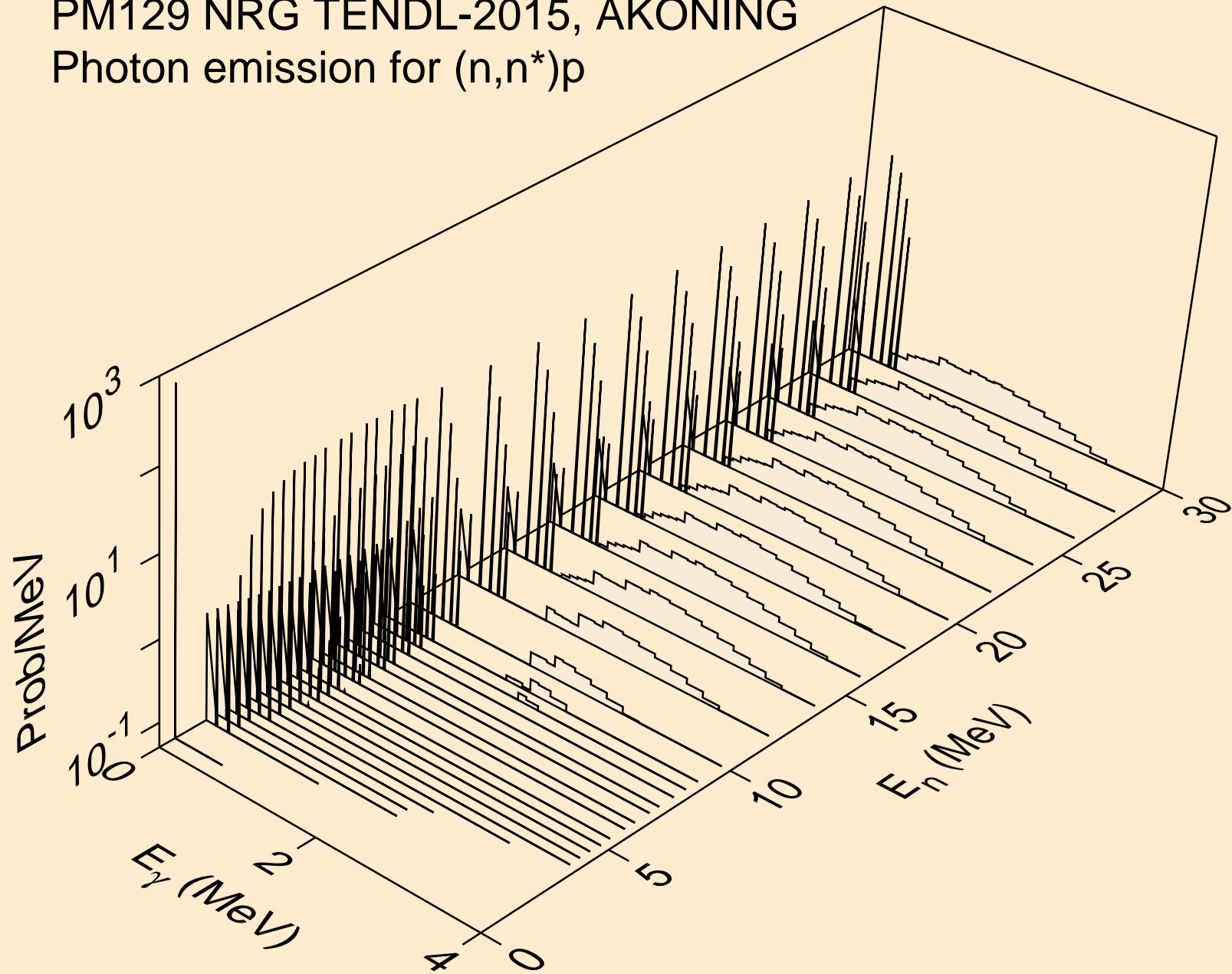



PM129 NRG TENDL-2015, AKONING  
Photon emission for (n,n\*)2a

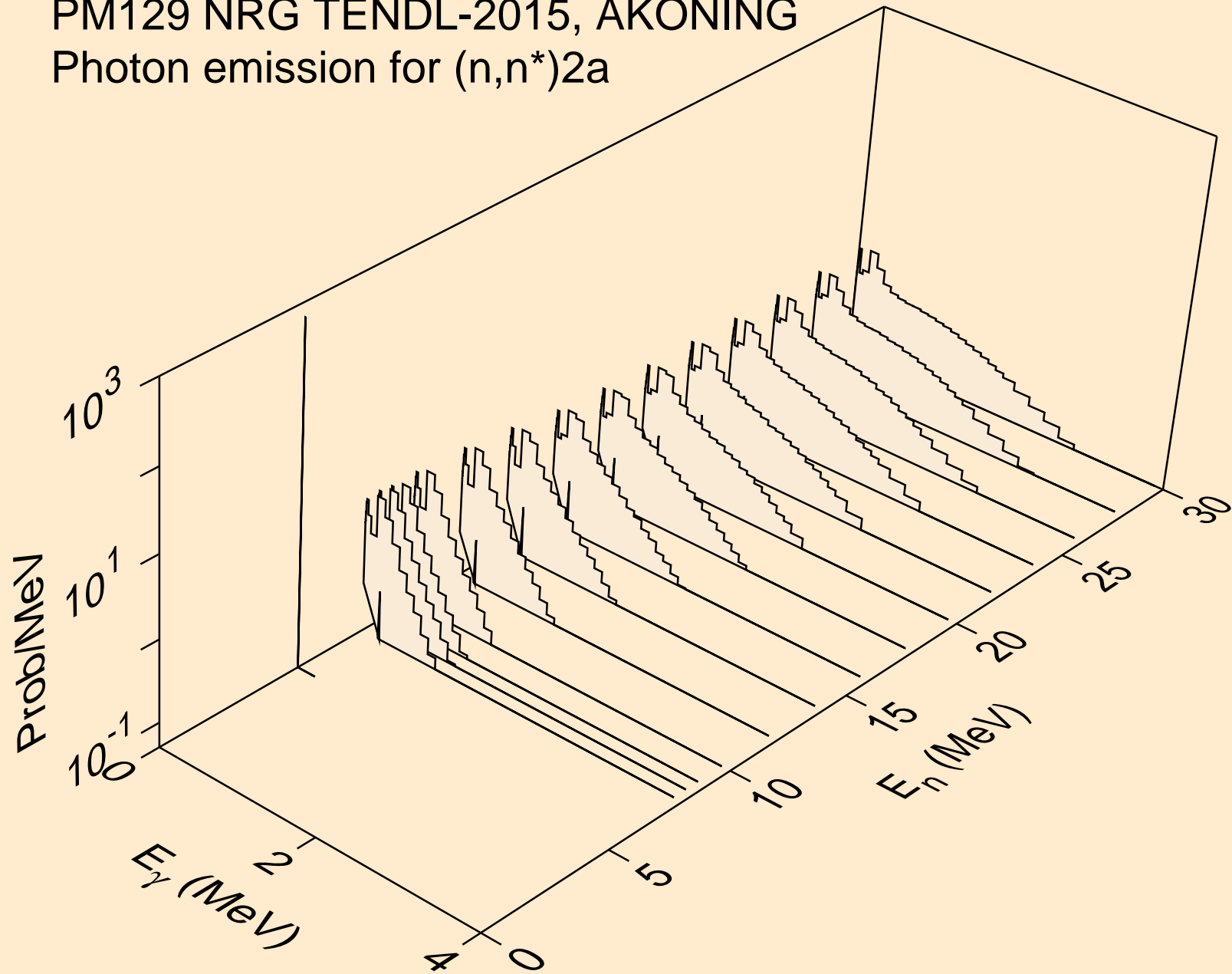

PM129 NRG TENDL-2015, AKONING  
Photon emission for (n,n\*)d

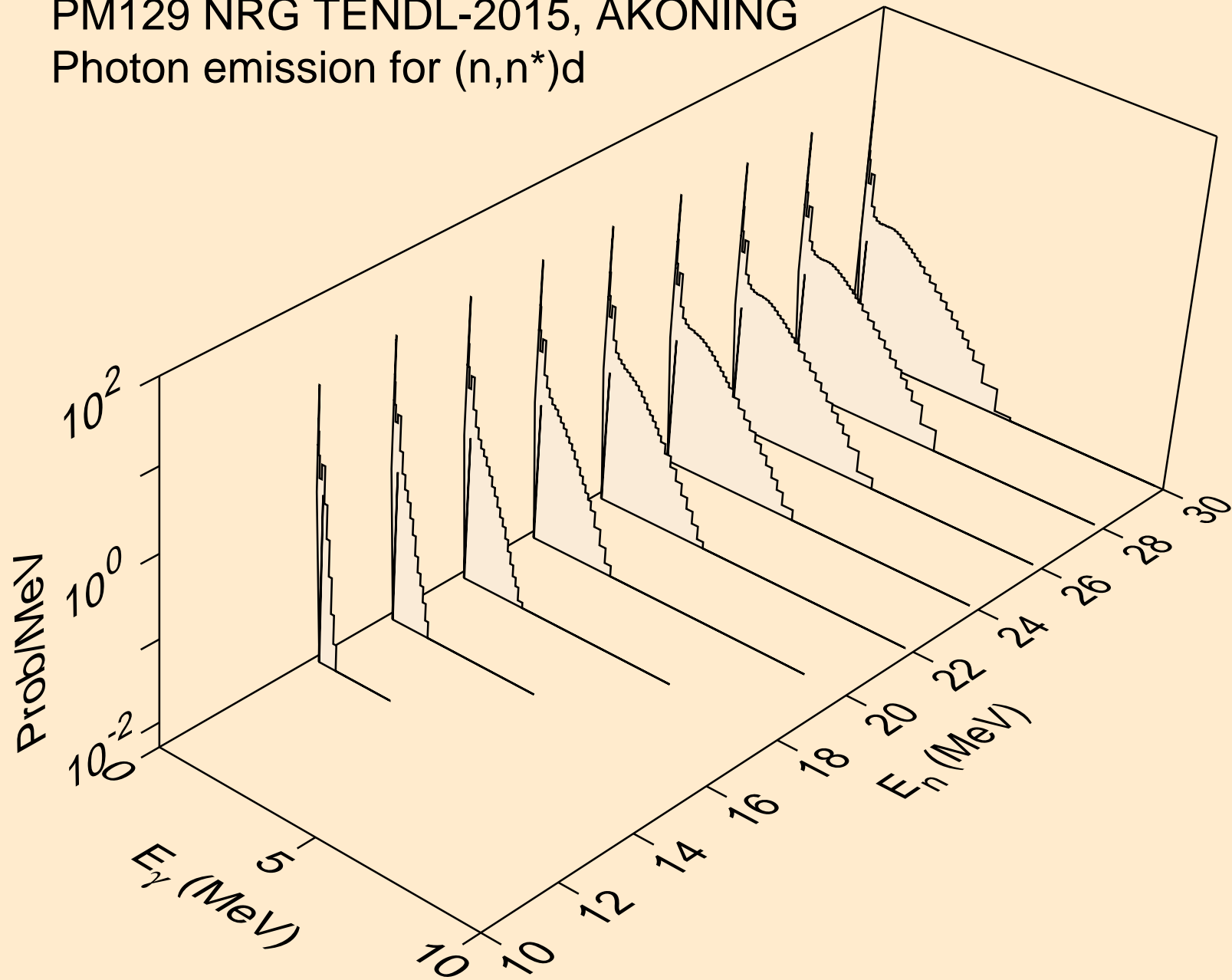

PM129 NRG TENDL-2015, AKONING  
Photon emission for (n,n\*)t

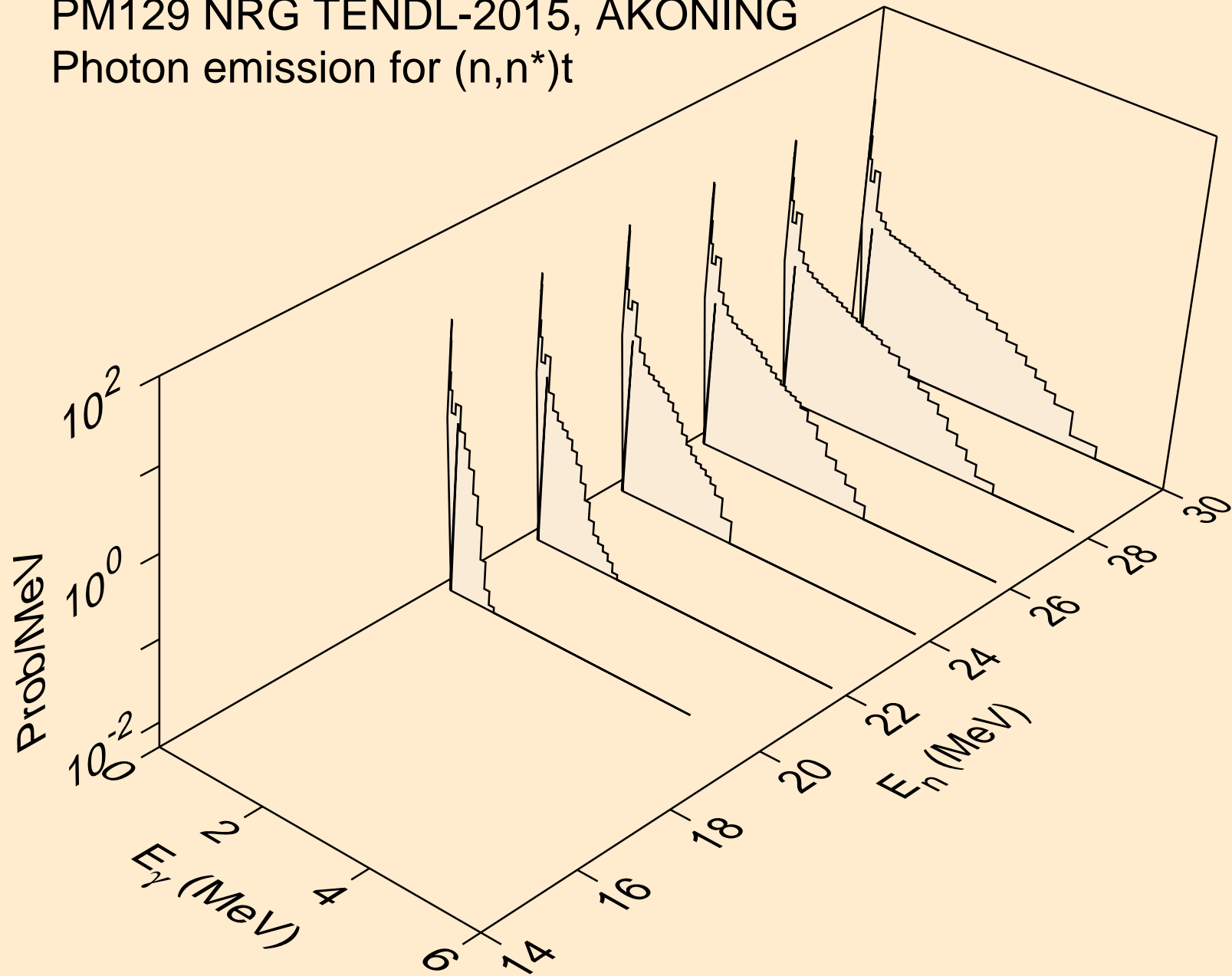

PM129 NRG TENDL-2015, AKONING  
Photon emission for (n,n\*)he3

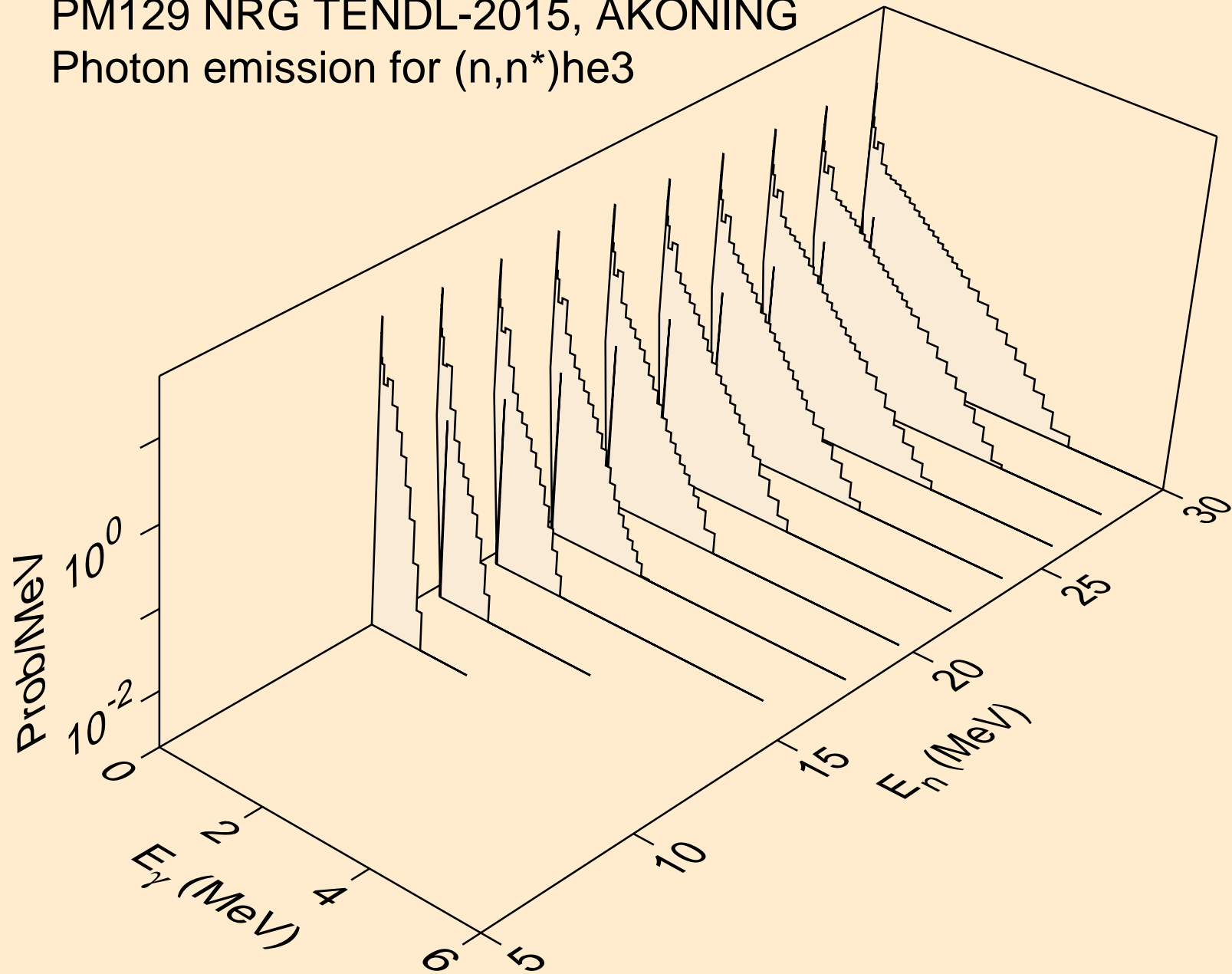

PM129 NRG TENDL-2015, AKONING  
Photon emission for (n,2np)

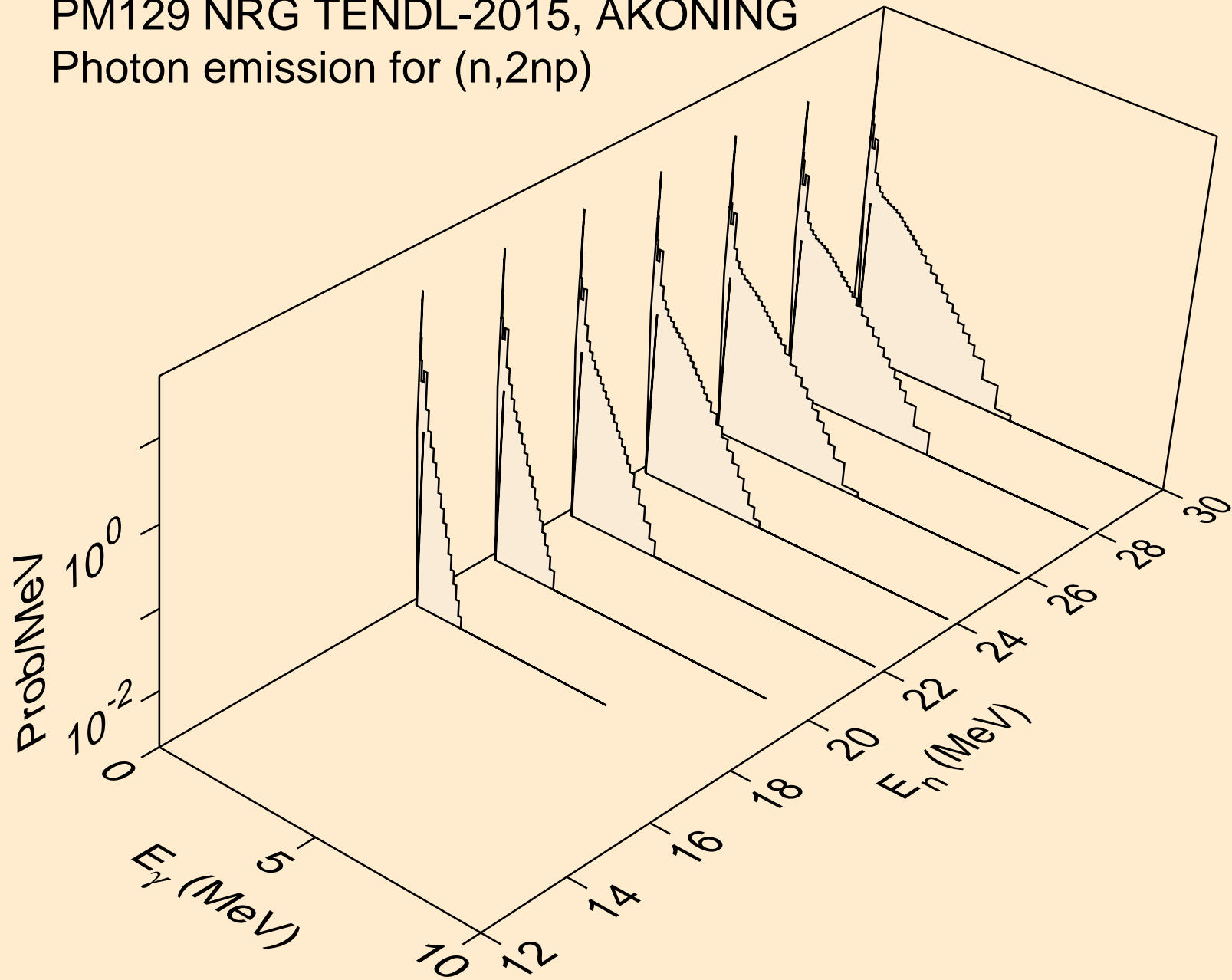

PM129 NRG TENDL-2015, AKONING  
Photon emission for (n,3np)

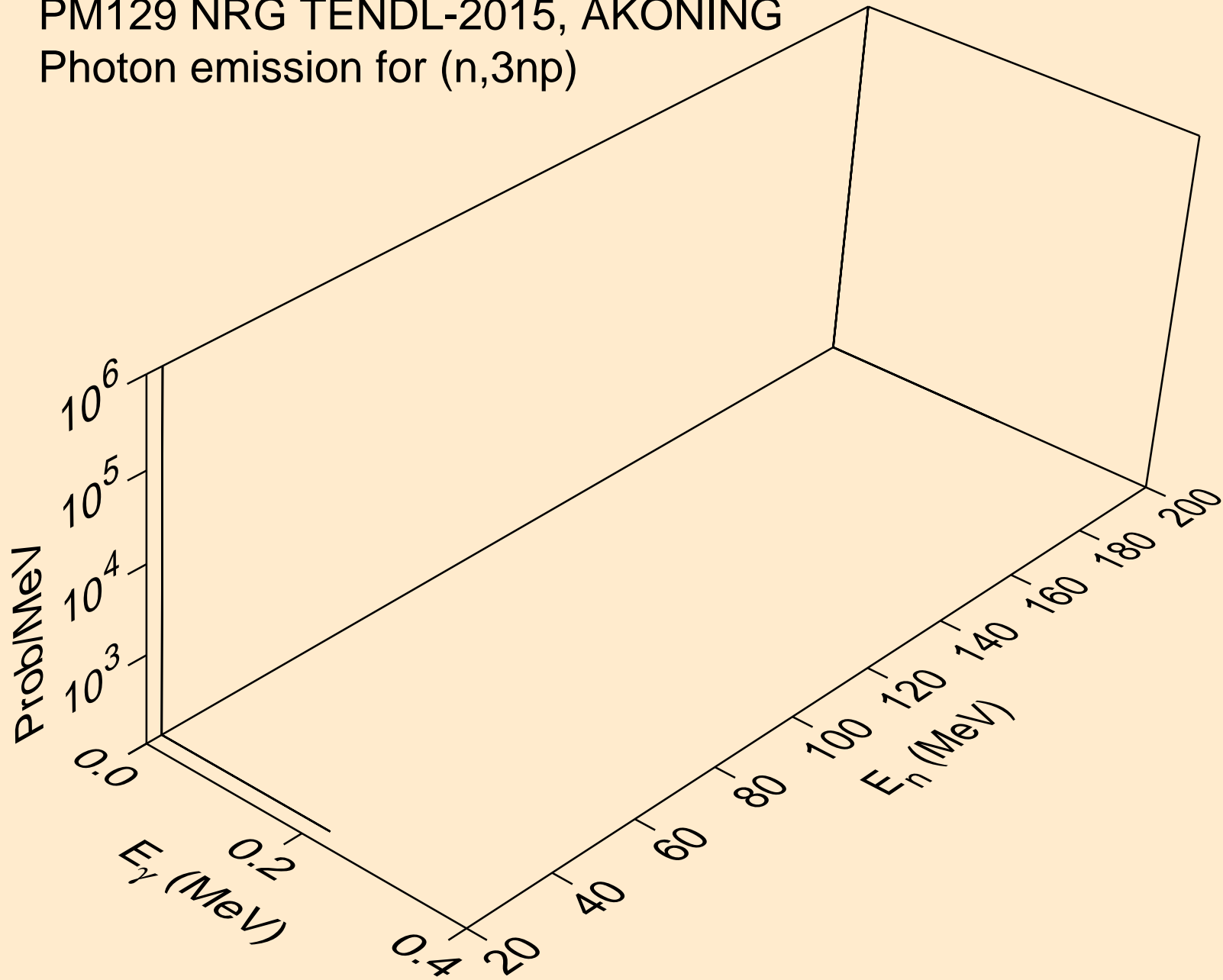

PM129 NRG TENDL-2015, AKONING  
Photon emission for (n,2np)

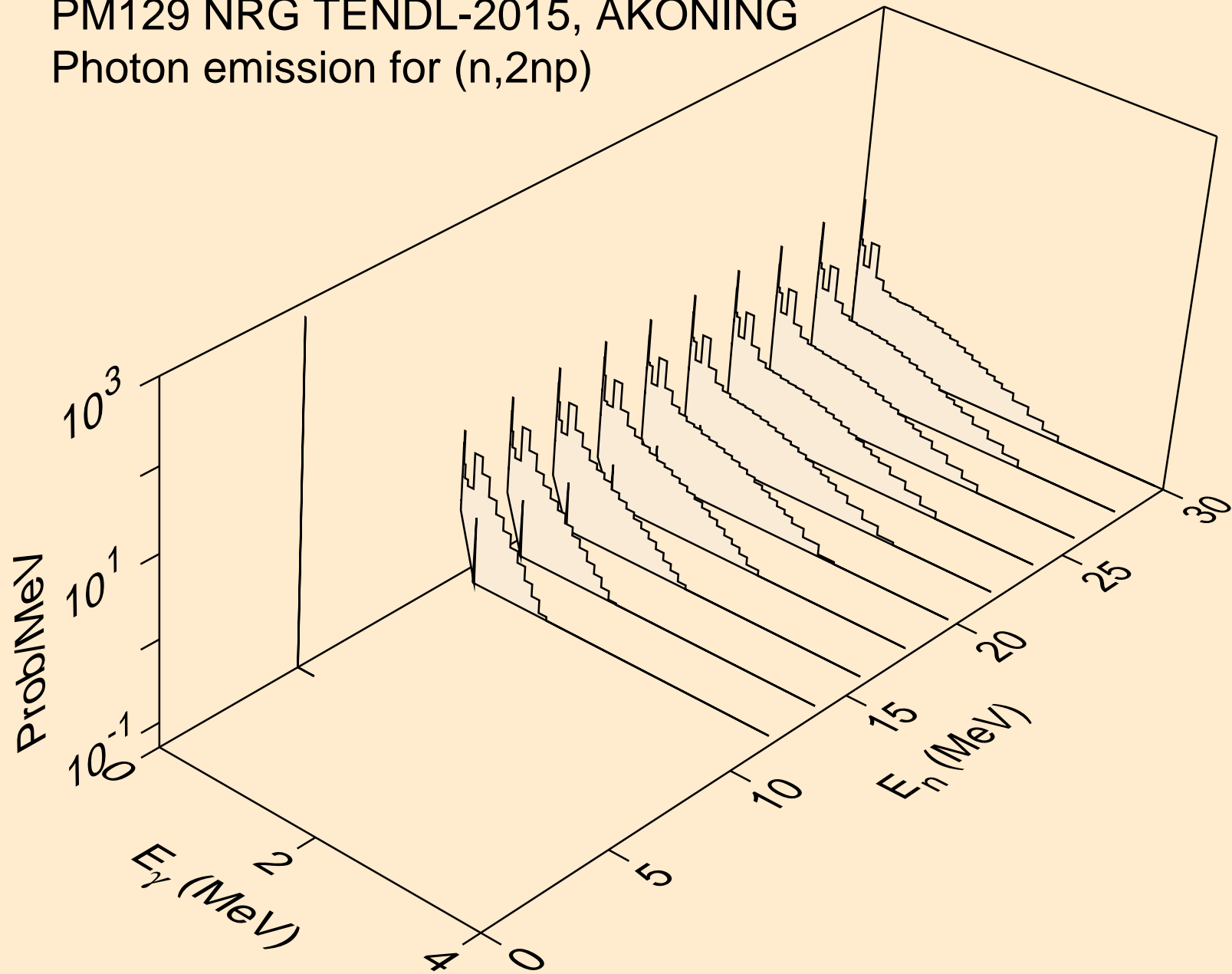

PM129 NRG TENDL-2015, AKONING  
Photon emission for (n,npa)

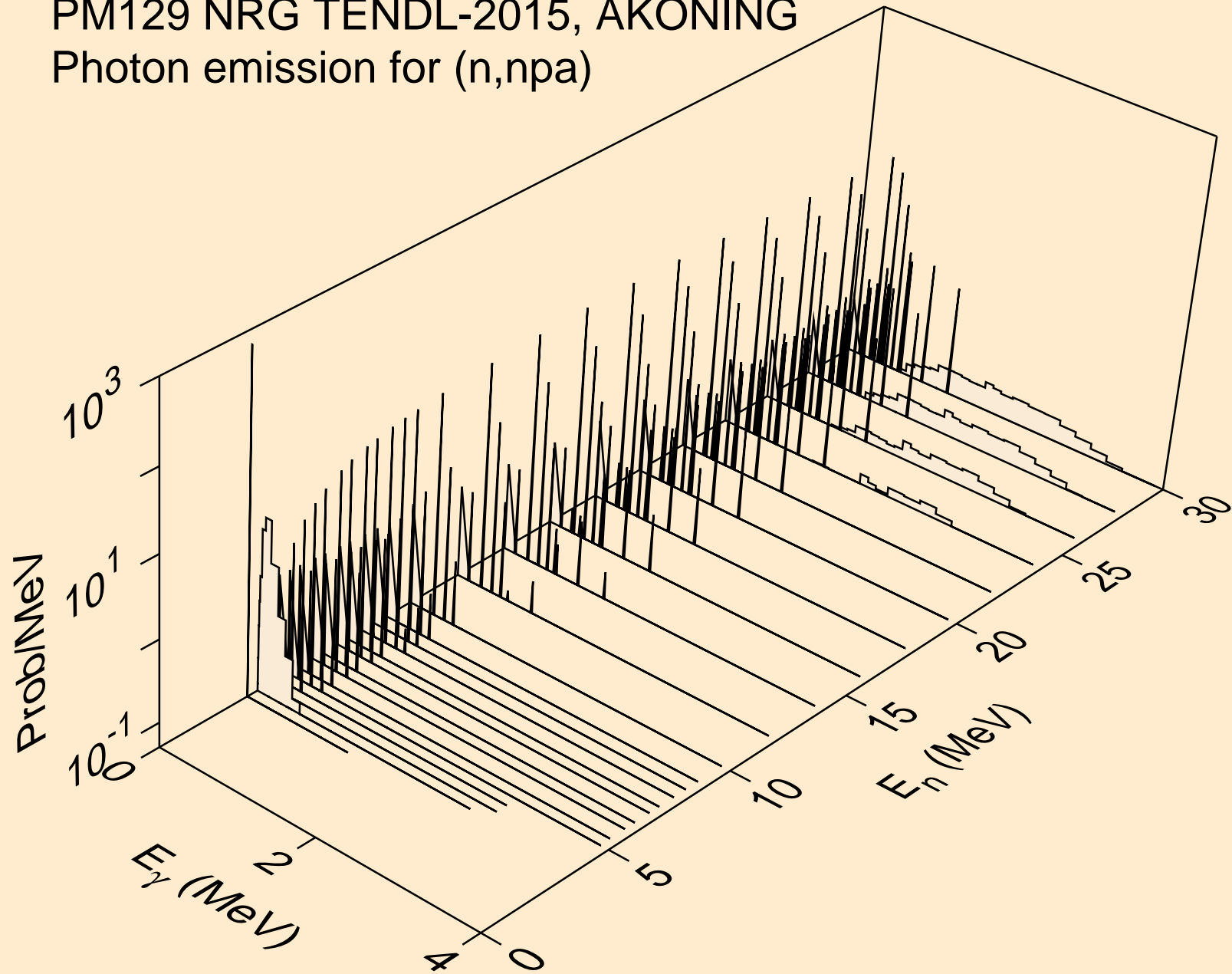



PM129 NRG TENDL-2015, AKONING  
Photon emission for (n,n\*c)

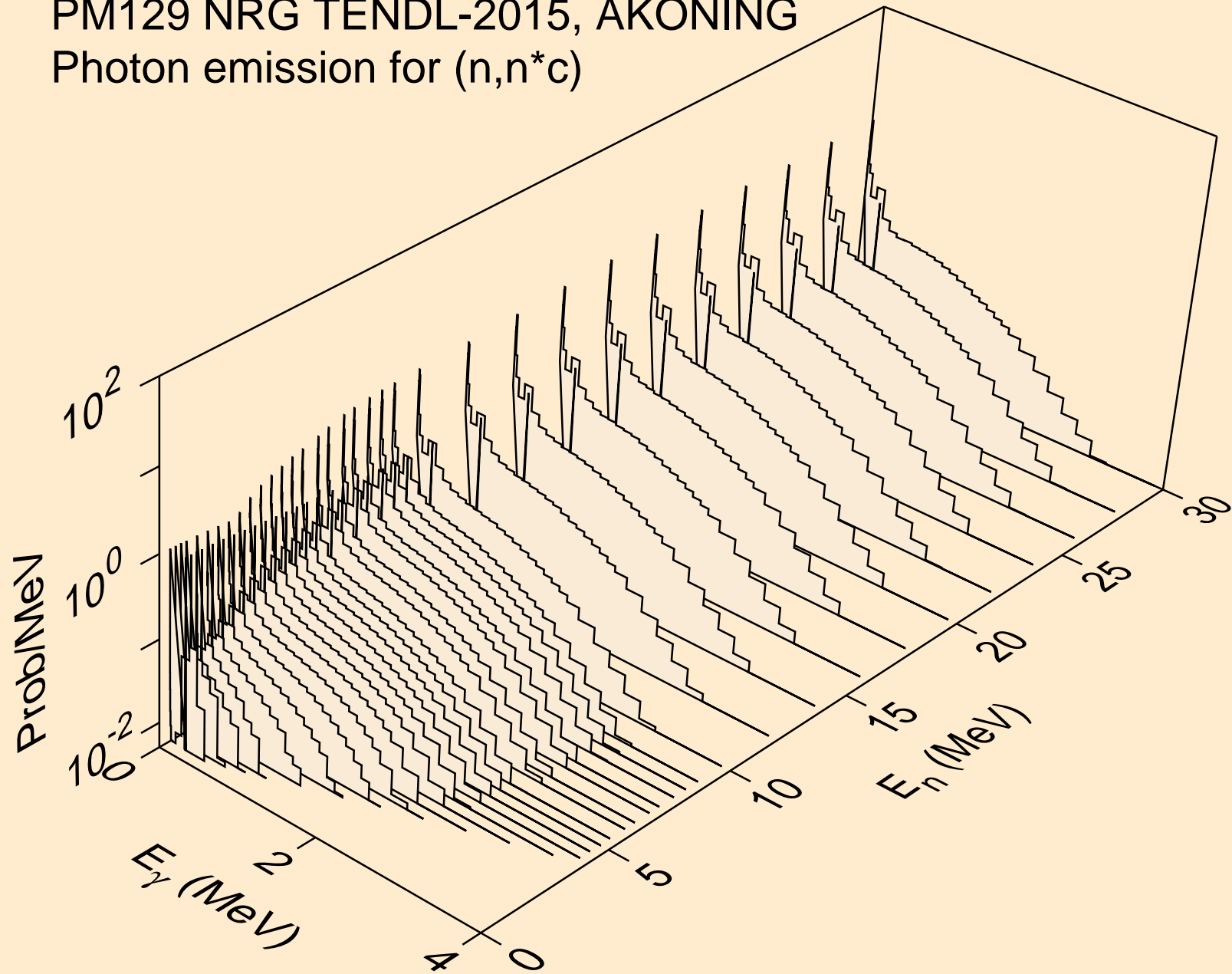

PM129 NRG TENDL-2015, AKONING  
Photon emission for (n,gma)

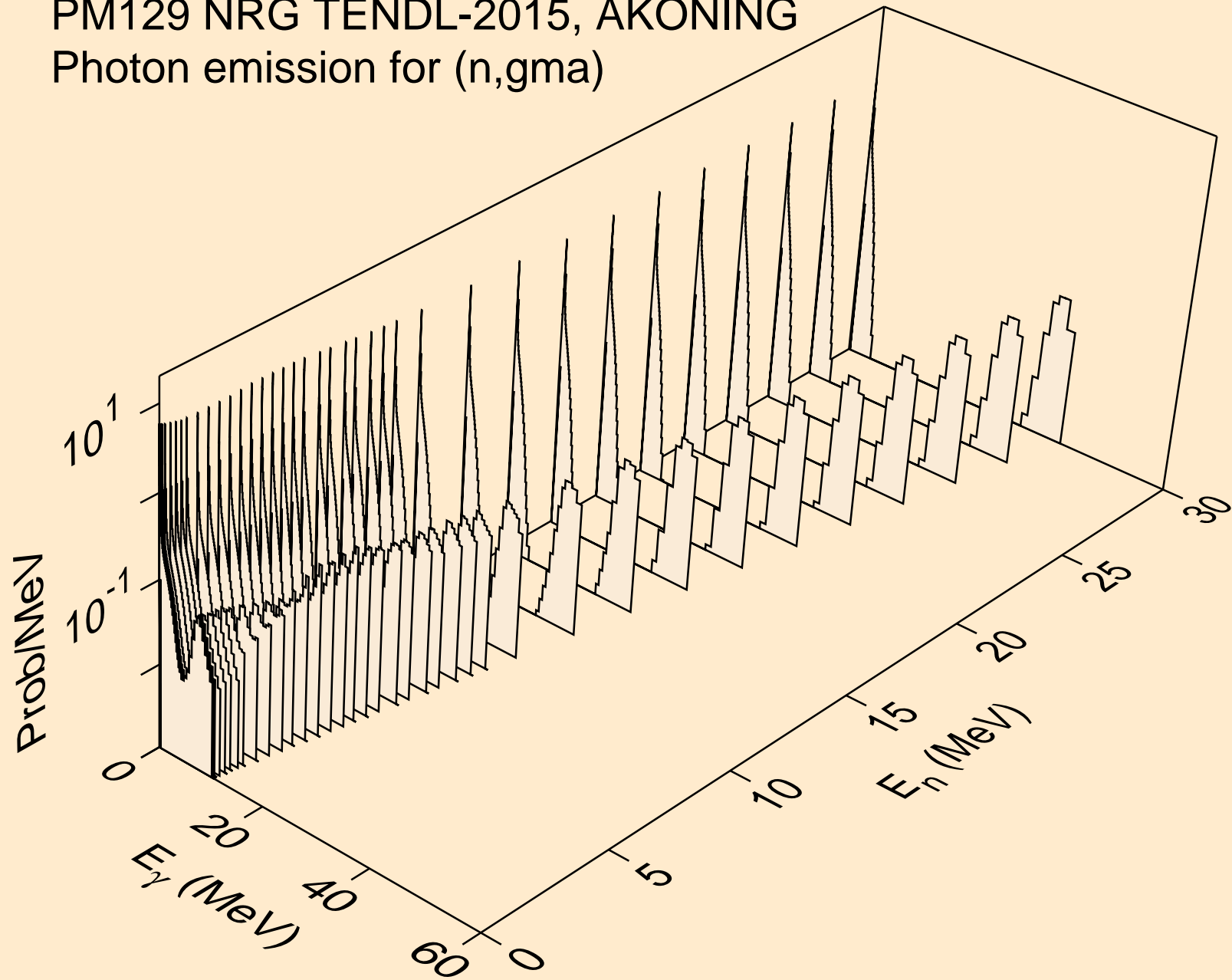

PM129 NRG TENDL-2015, AKONING  
Photon emission for (n,p)

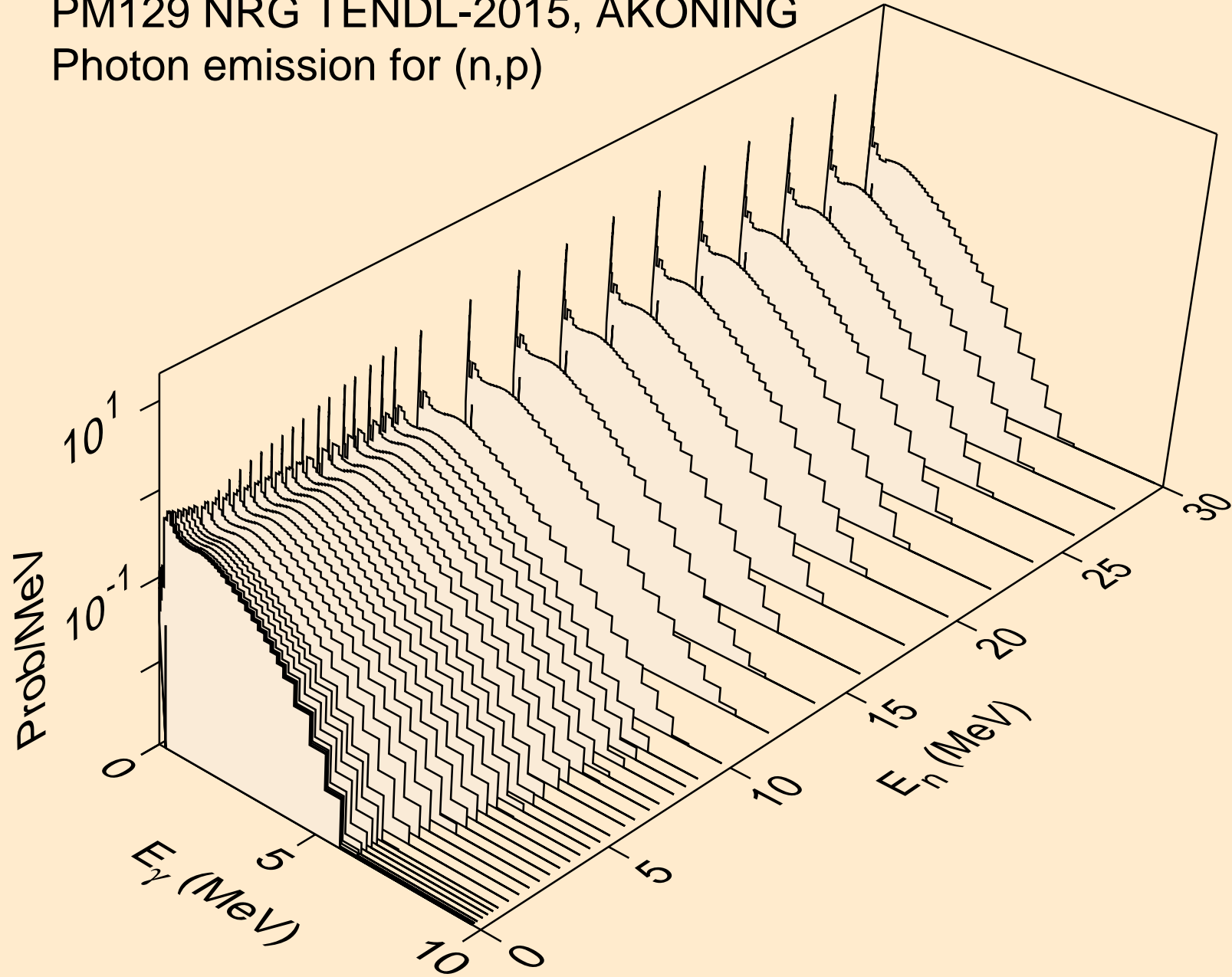

PM129 NRG TENDL-2015, AKONING  
Photon emission for (n,d)

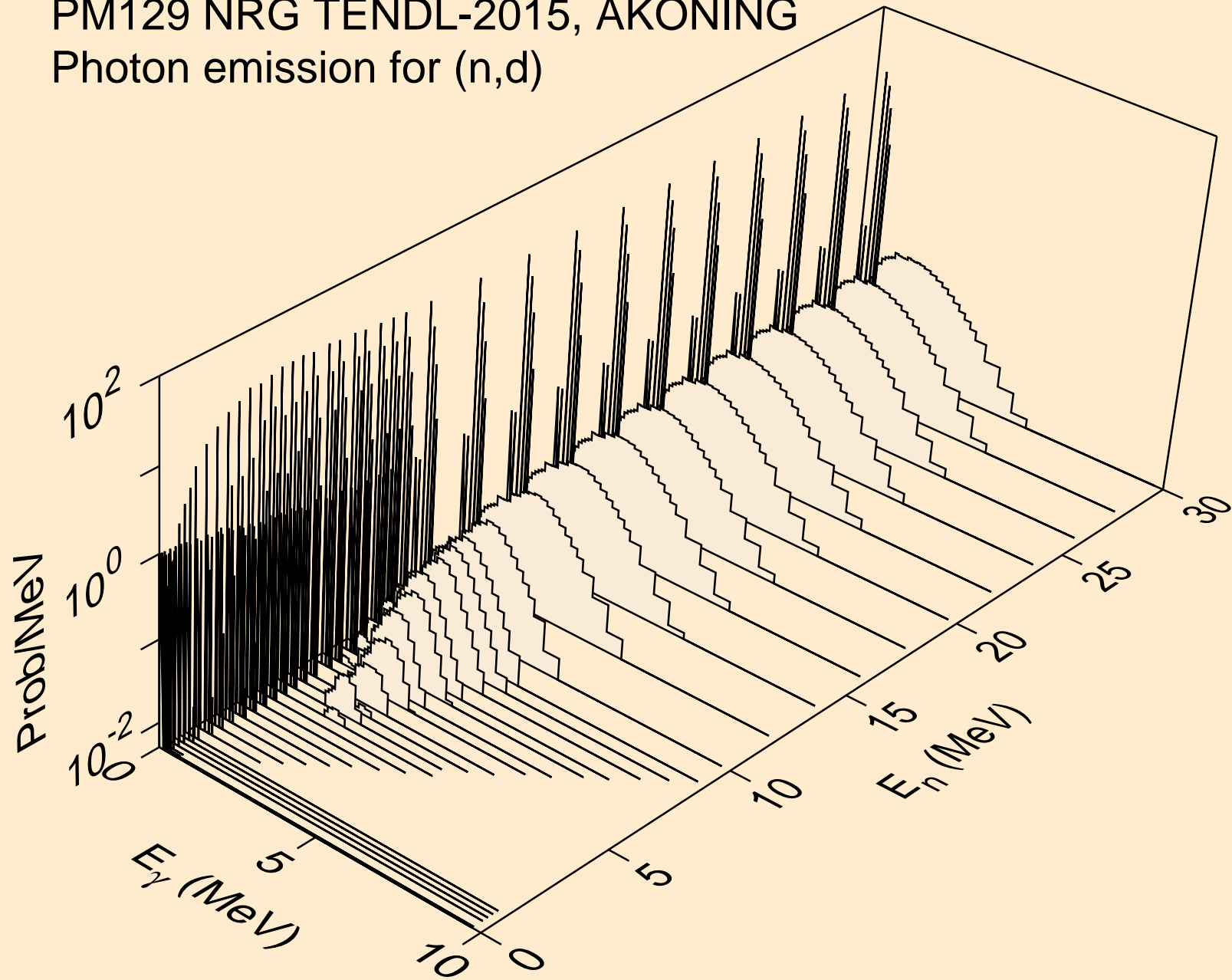

PM129 NRG TENDL-2015, AKONING  
Photon emission for (n,t)

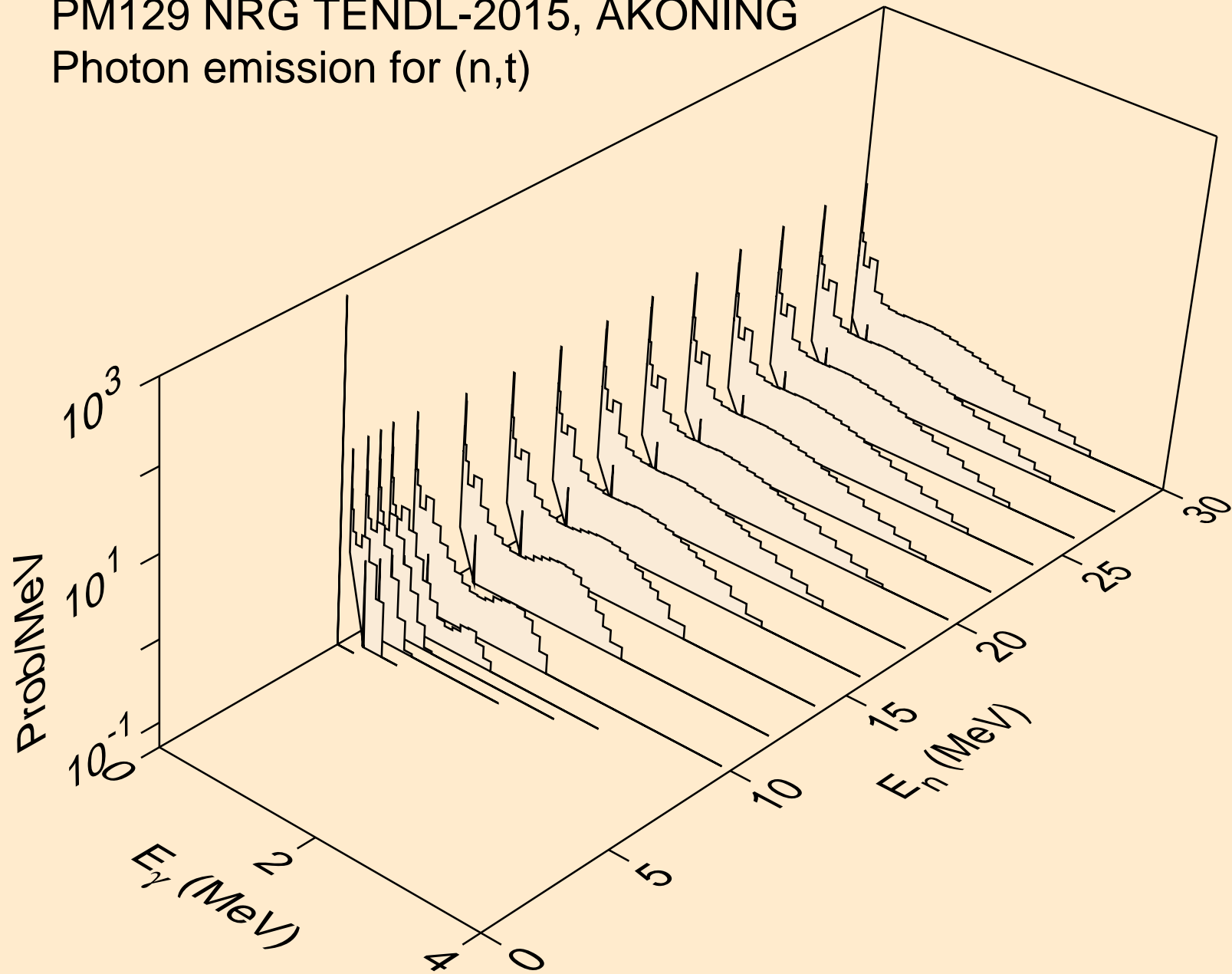

PM129 NRG TENDL-2015, AKONING  
Photon emission for (n,he3)

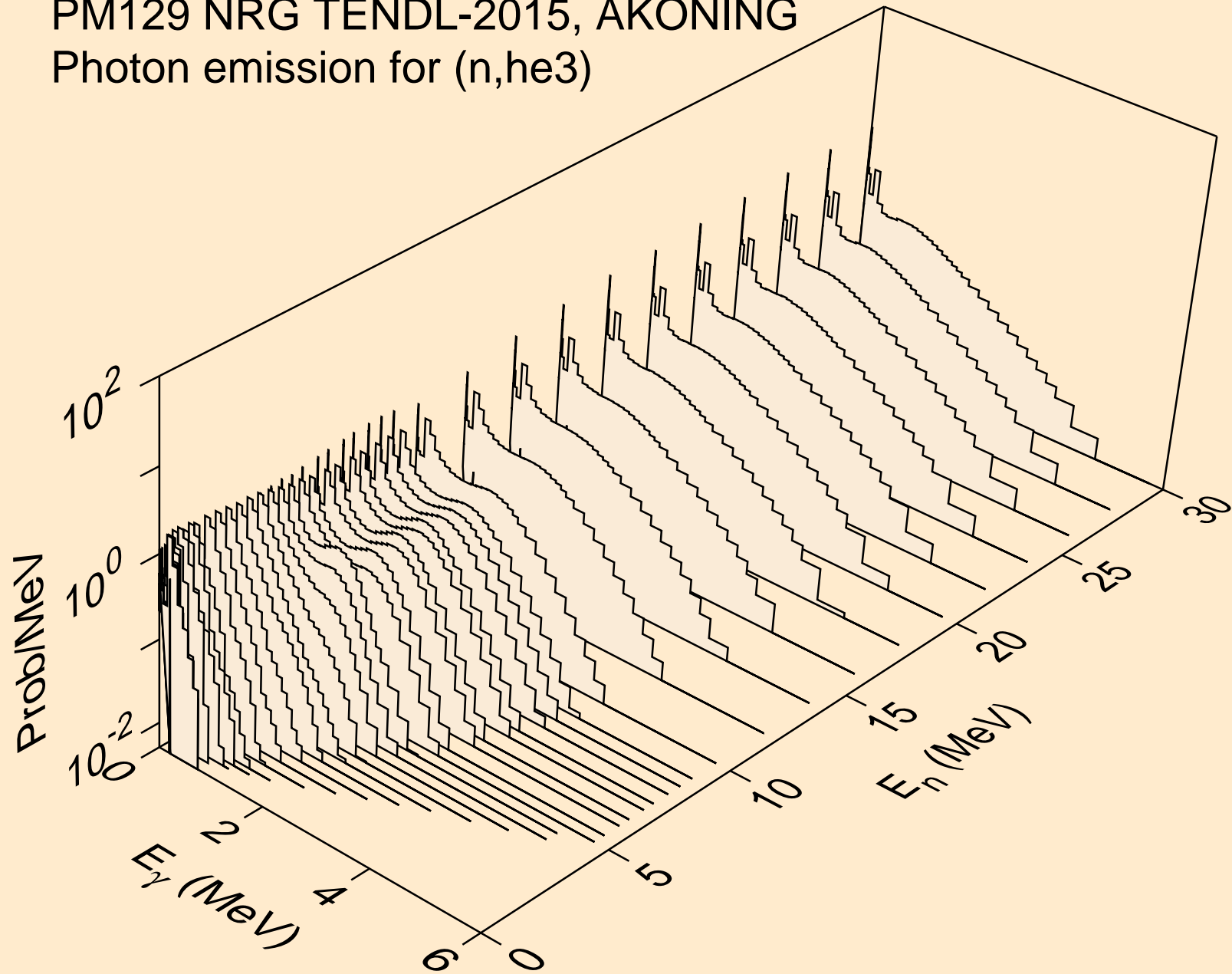

PM129 NRG TENDL-2015, AKONING  
Photon emission for (n,a)

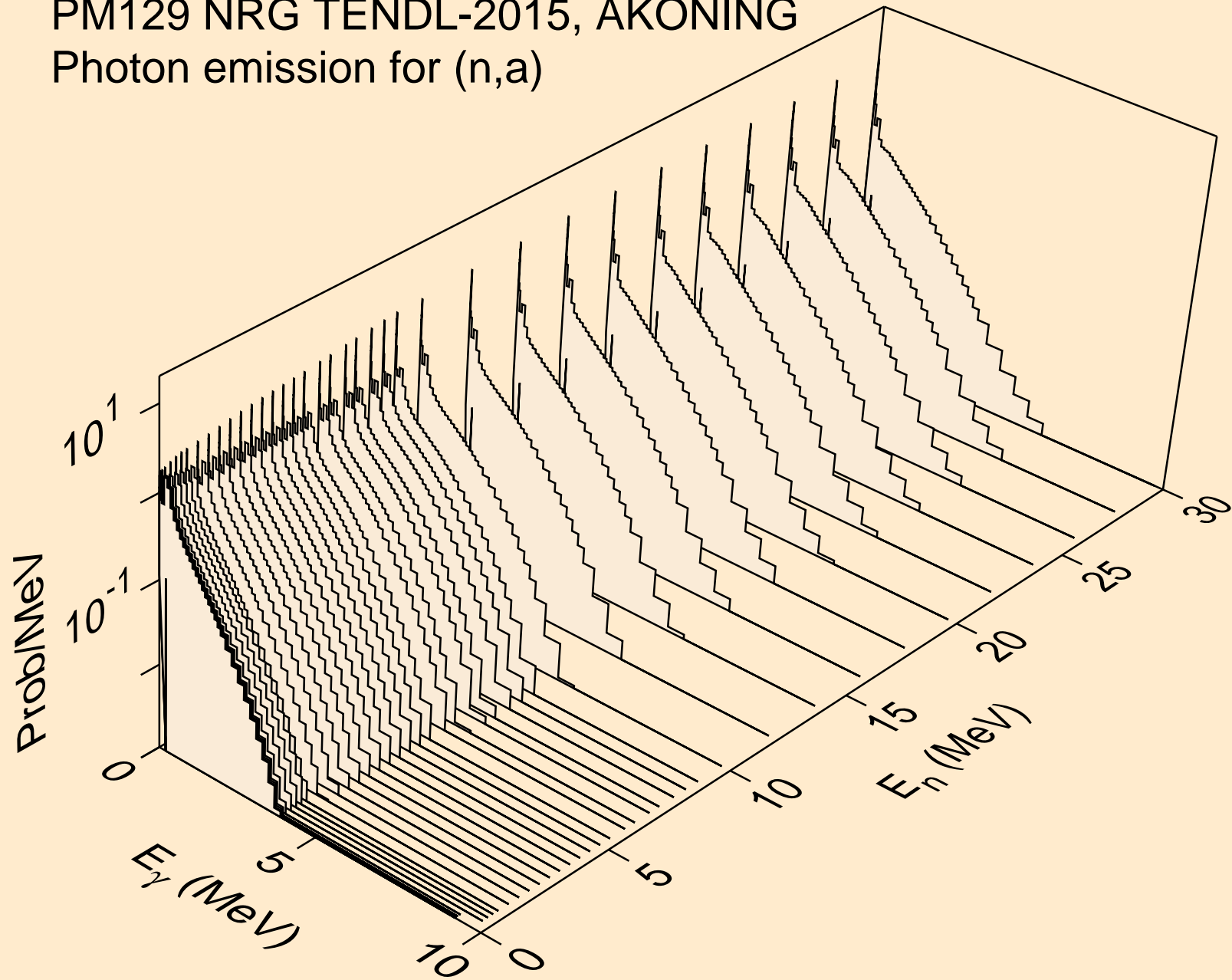

PM129 NRG TENDL-2015, AKONING  
Photon emission for (n,2a)

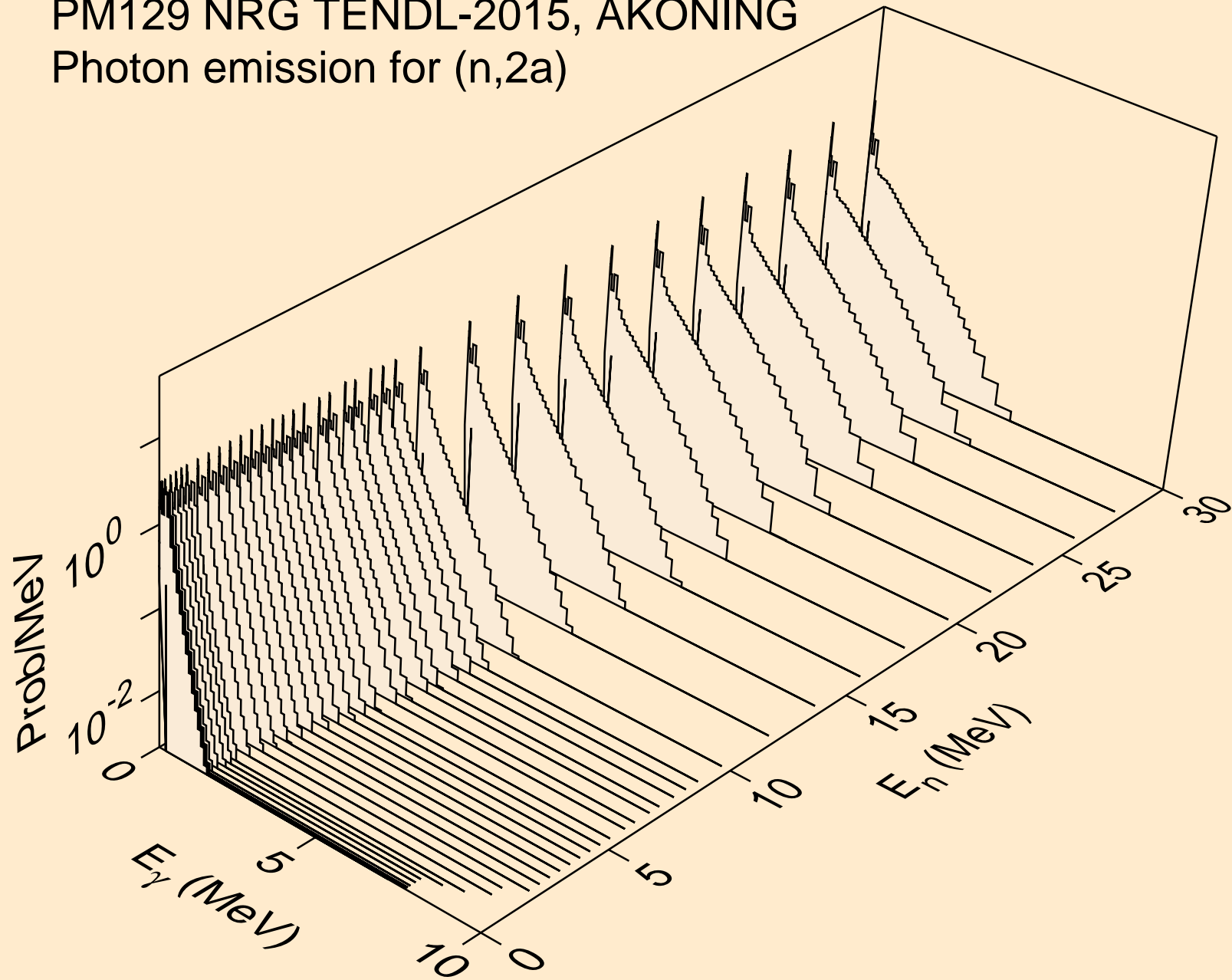



PM129 NRG TENDL-2015, AKONING  
Photon emission for (n,3a)

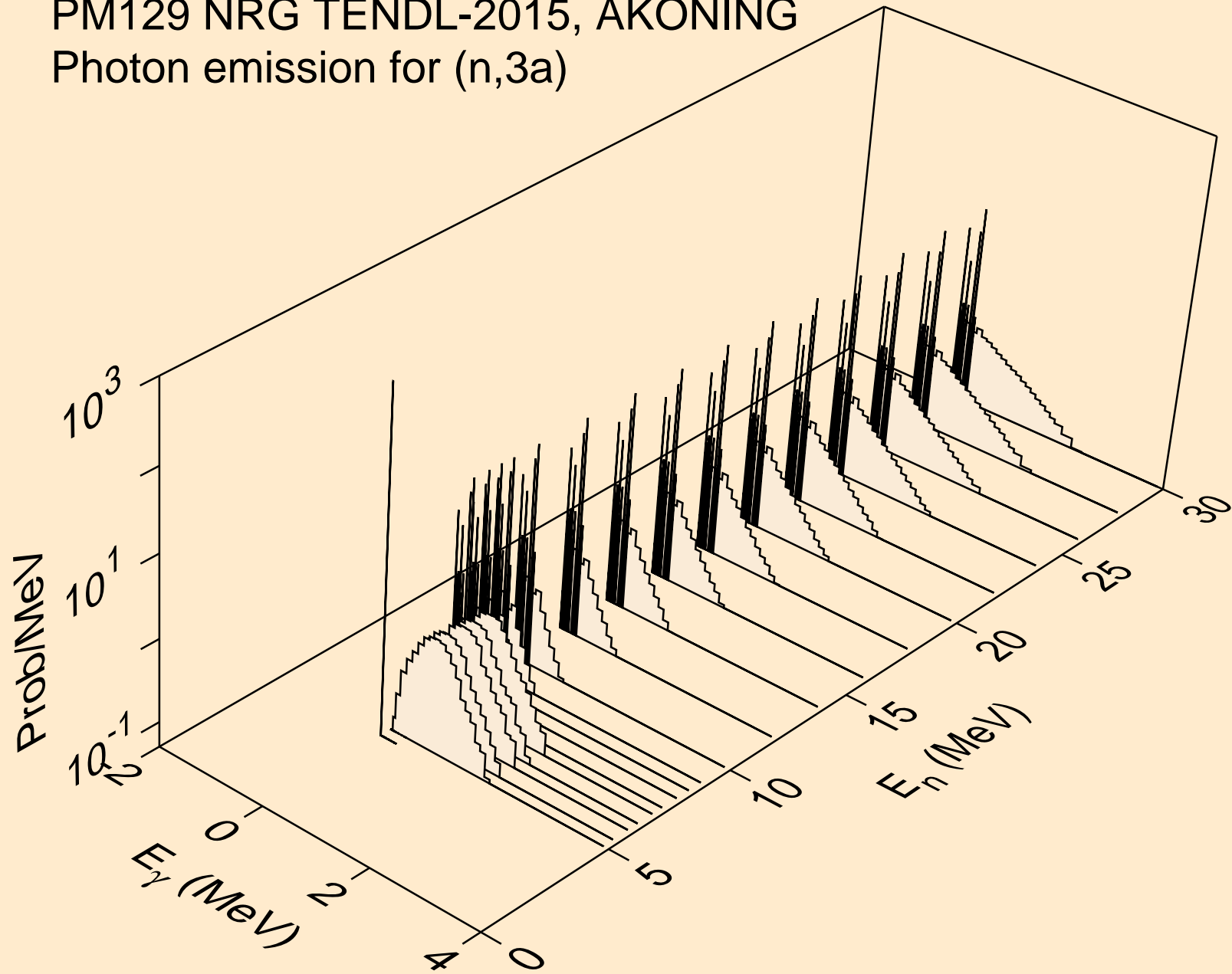

PM129 NRG TENDL-2015, AKONING  
Photon emission for (n,2p)

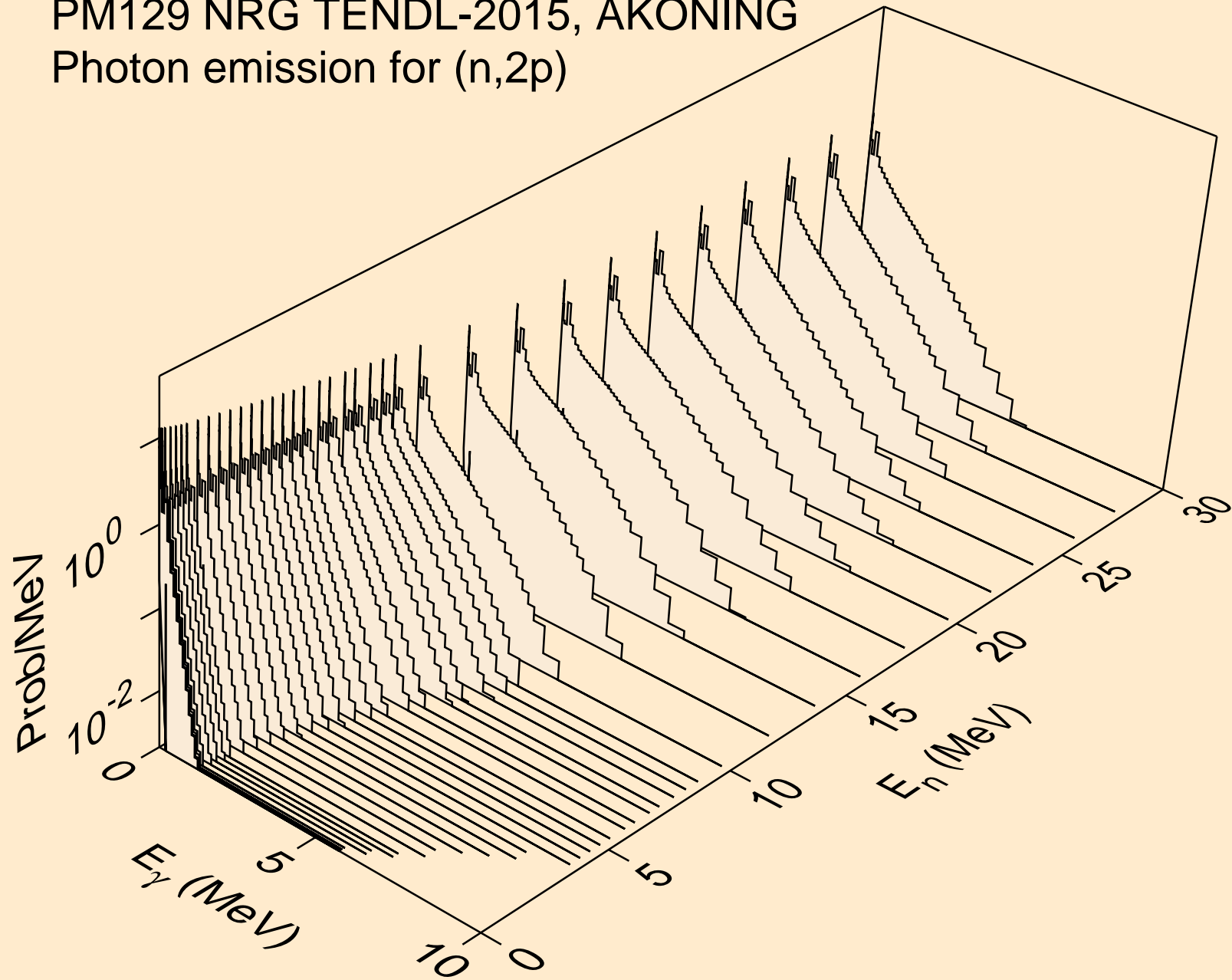

PM129 NRG TENDL-2015, AKONING  
Photon emission for (n,p $\alpha$ )

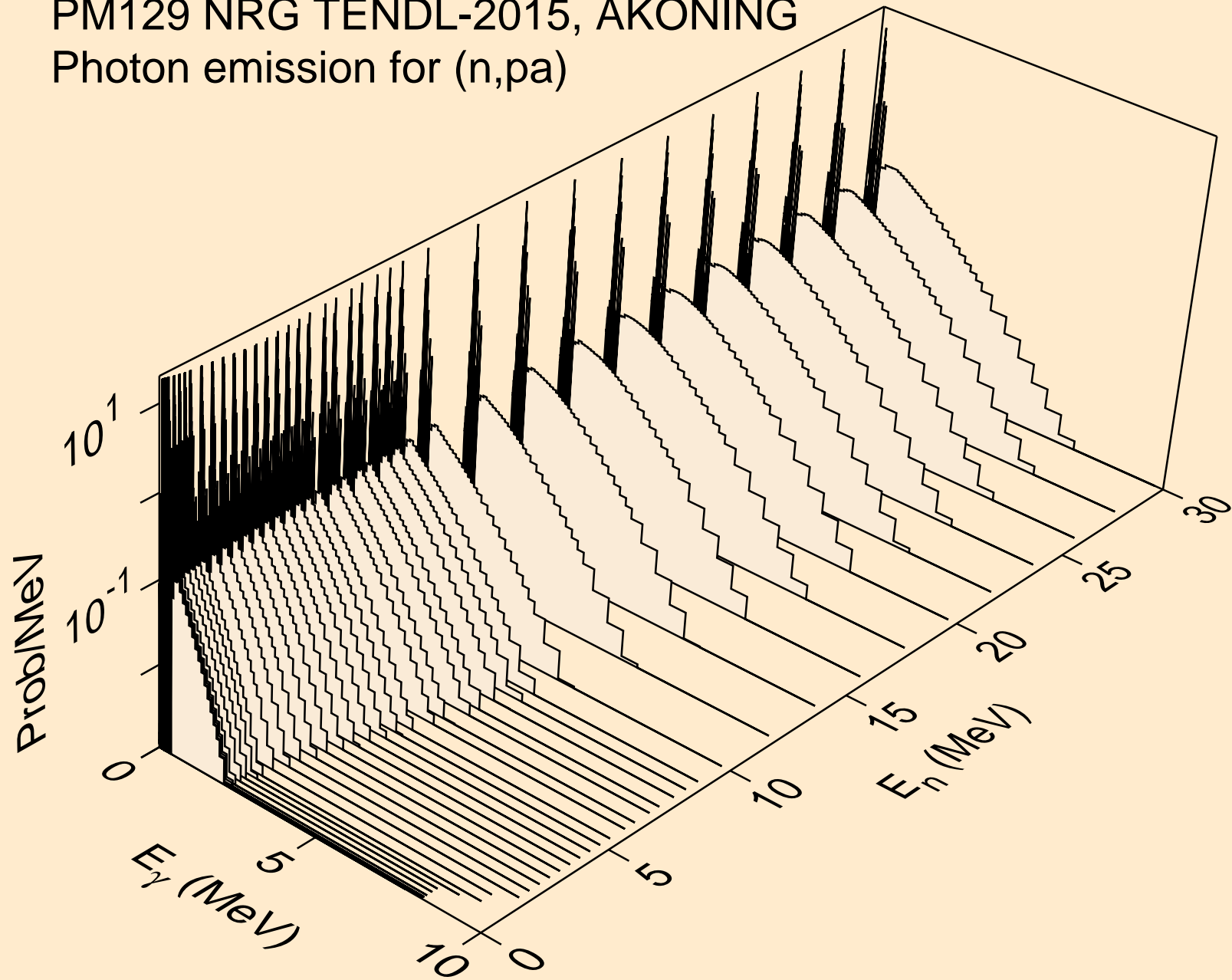

PM129 NRG TENDL-2015, AKONING  
Photon emission for (n,t2a)

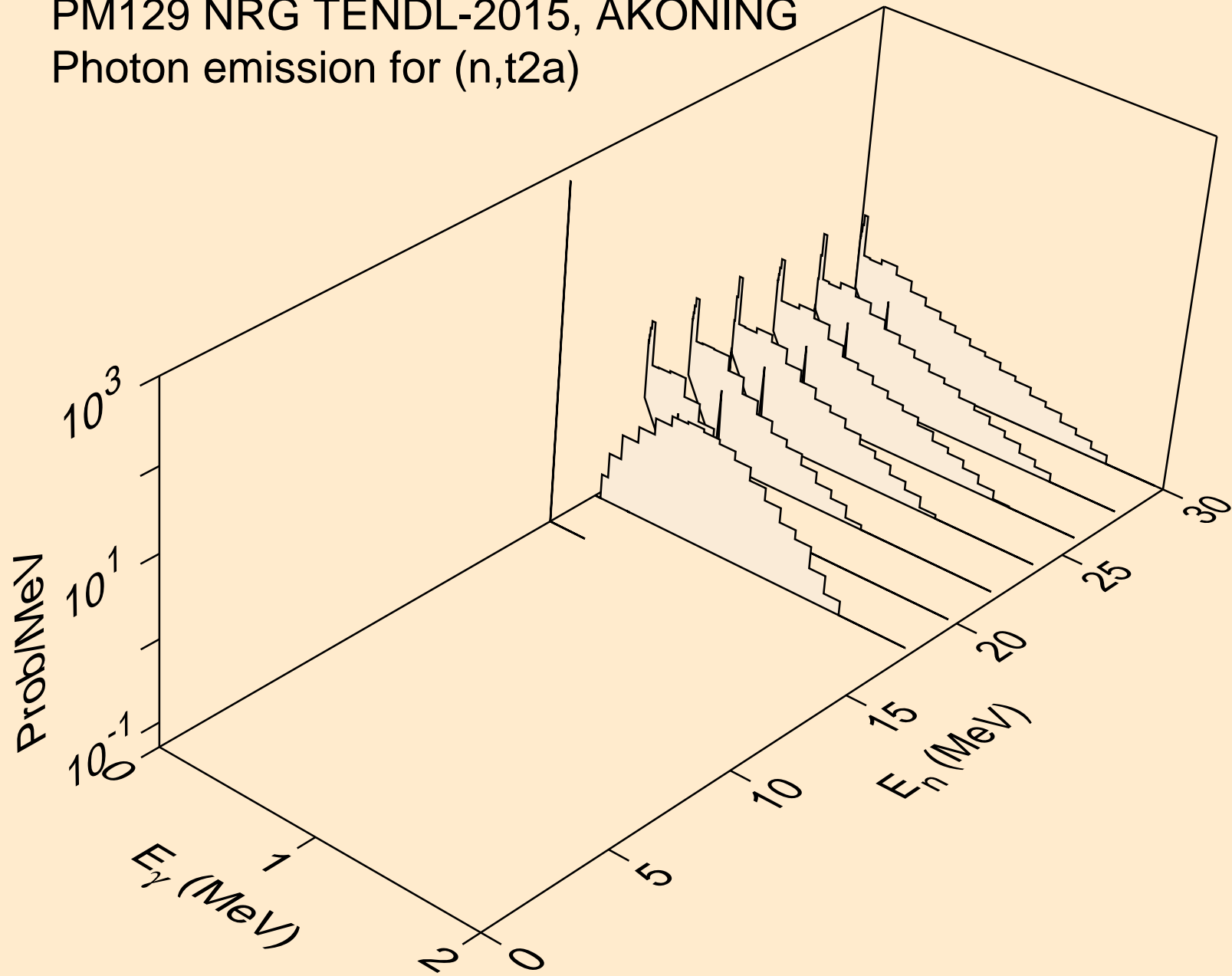

PM129 NRG TENDL-2015, AKONING  
Photon emission for (n,d2a)

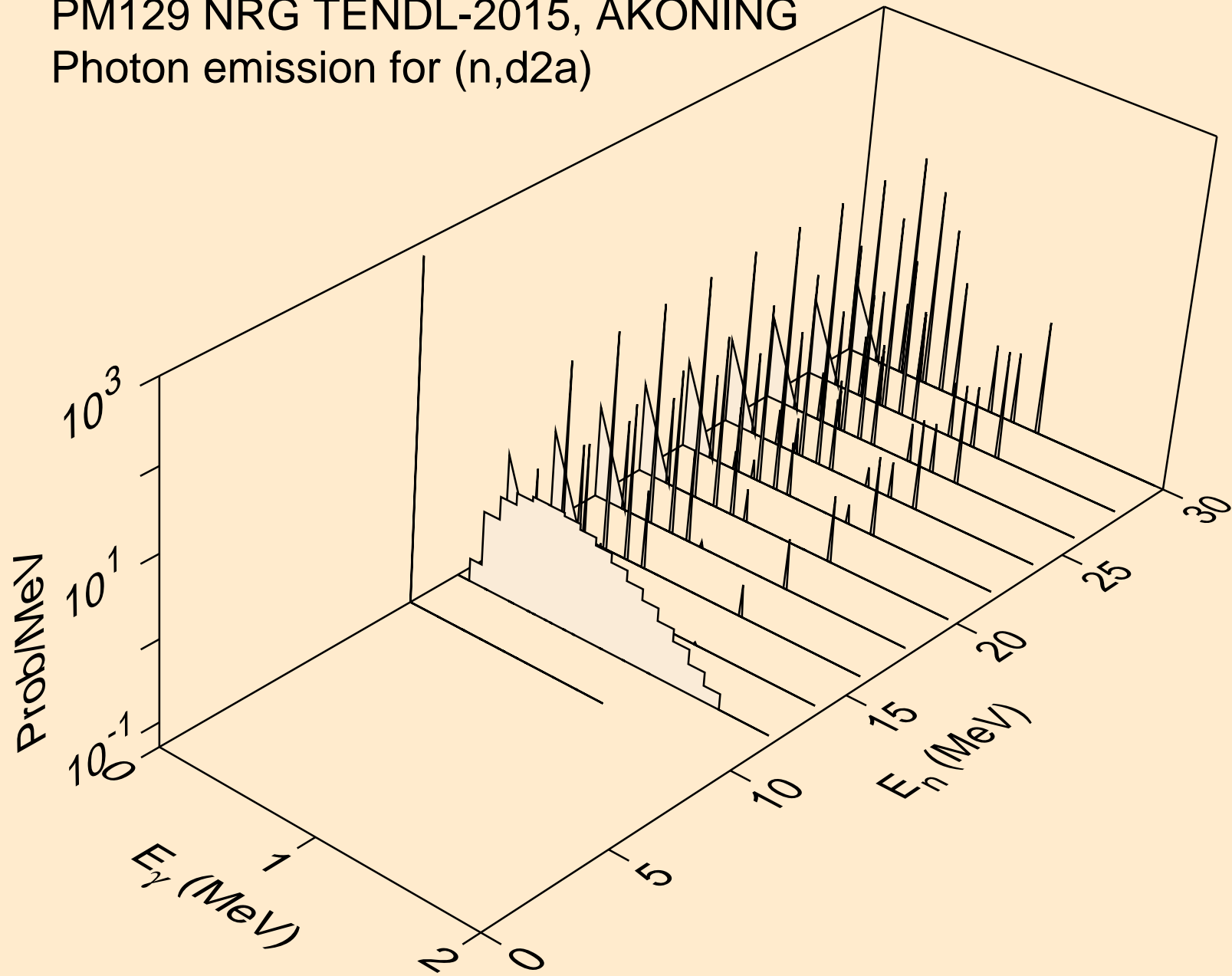

PM129 NRG TENDL-2015, AKONING  
Photon emission for (n,pd)

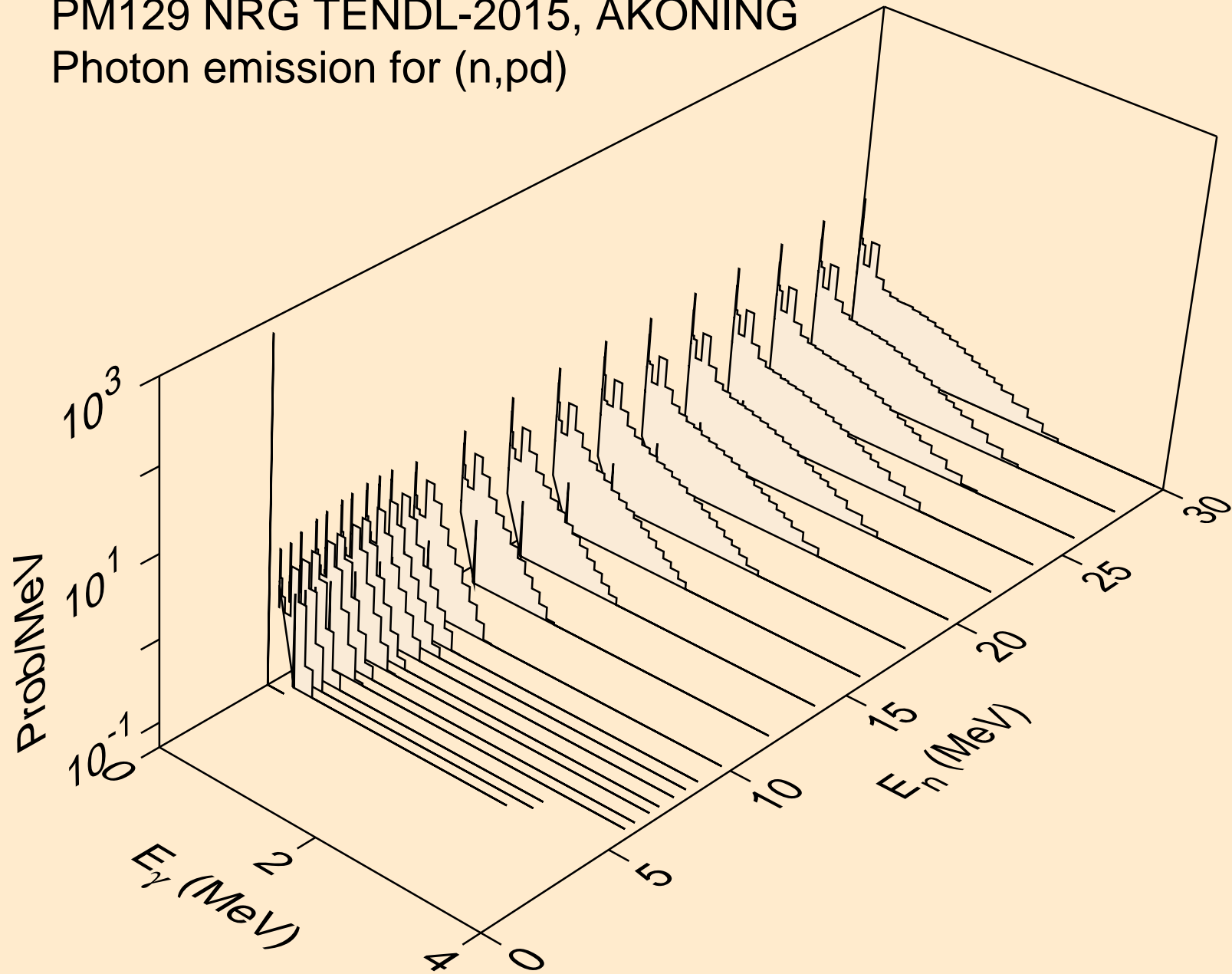

PM129 NRG TENDL-2015, AKONING  
Photon emission for (n,pt)

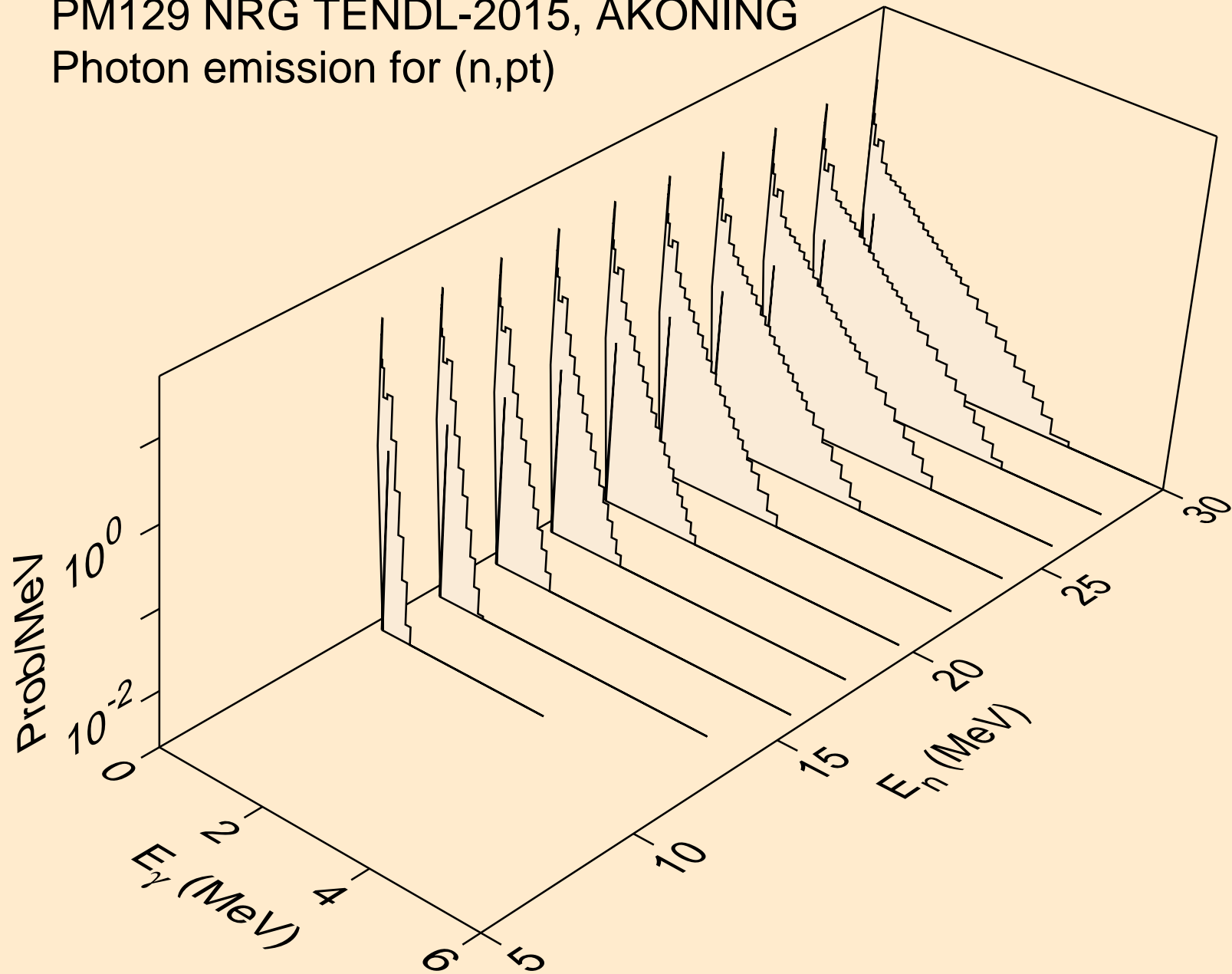

PM129 NRG TENDL-2015, AKONING  
Photon emission for (n,da)

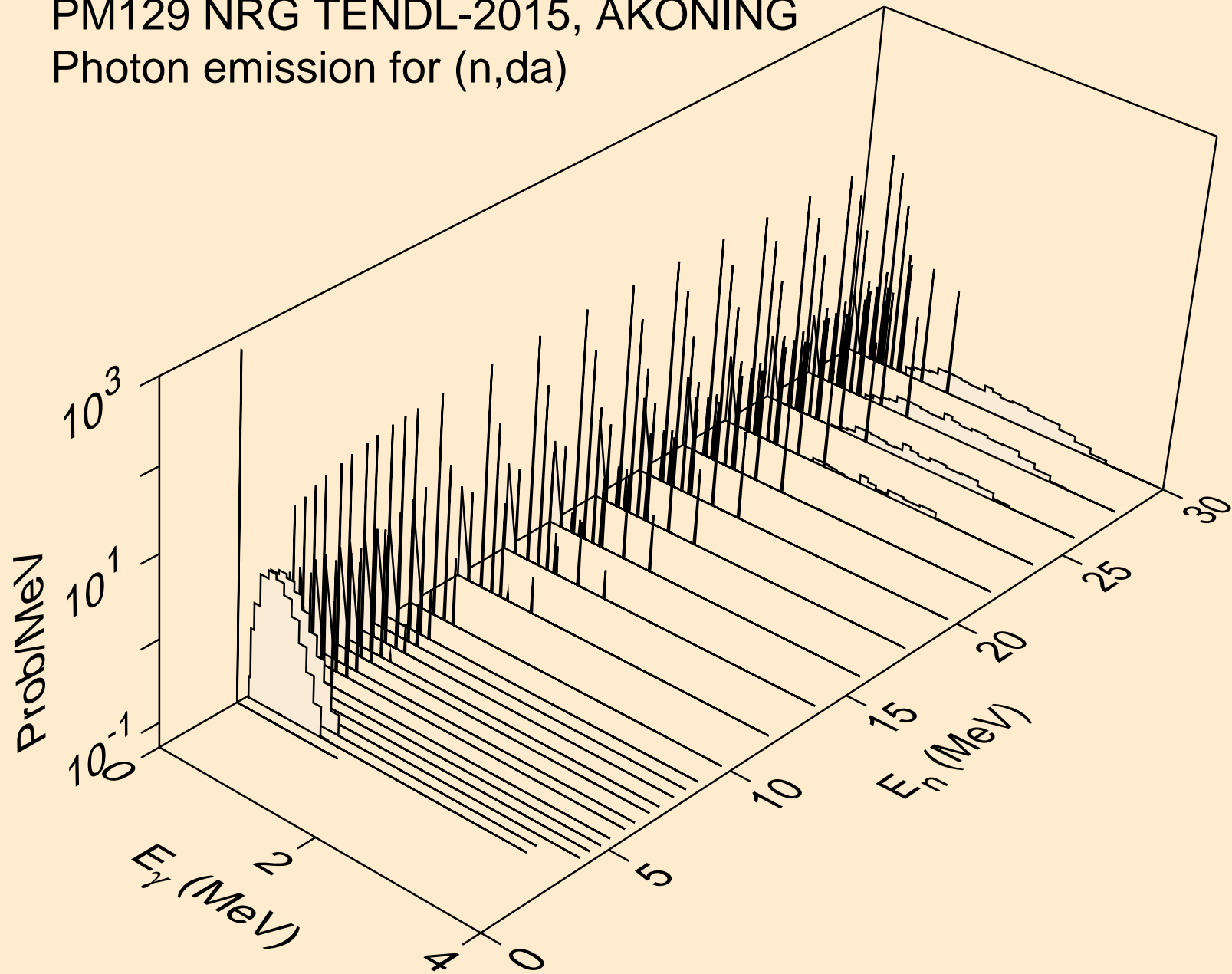



PM129 NRG TENDL-2015, AKONING  
thermal capture photon spectrum

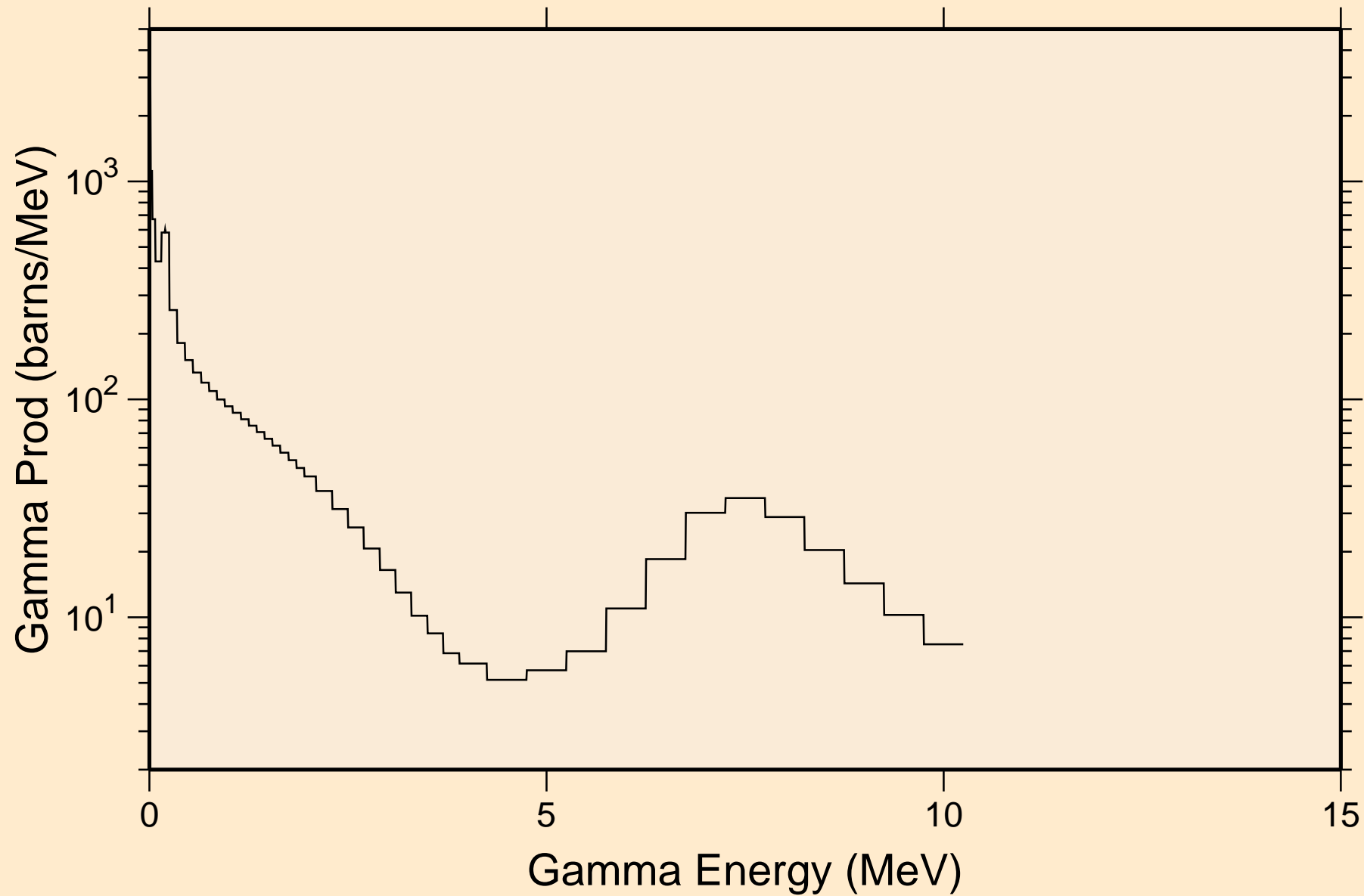

PM129 NRG TENDL-2015, AKONING  
14 MeV photon spectrum

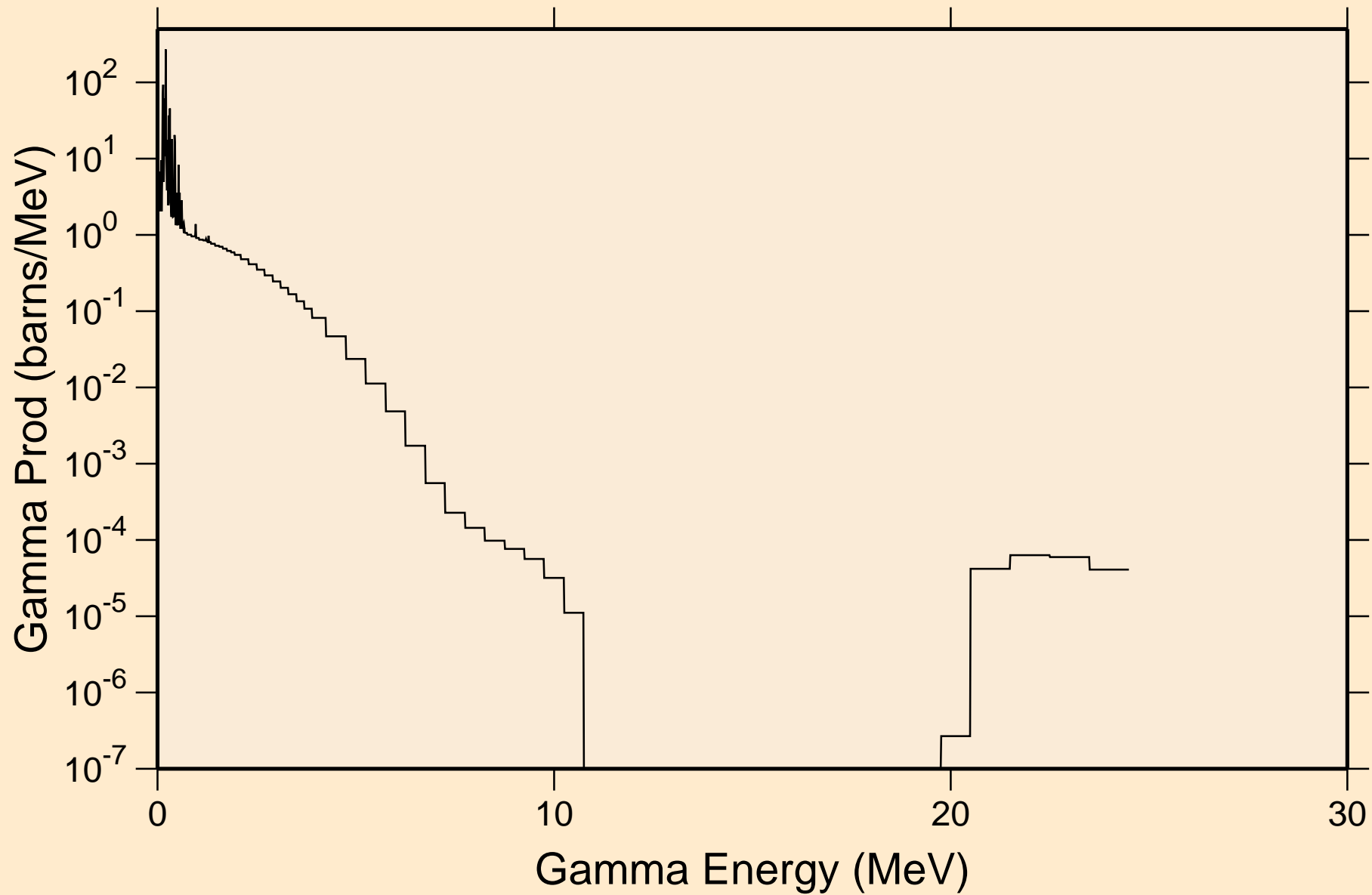

# PM129 NRG TENDL-2015, AKONING

## Particle heating contributions

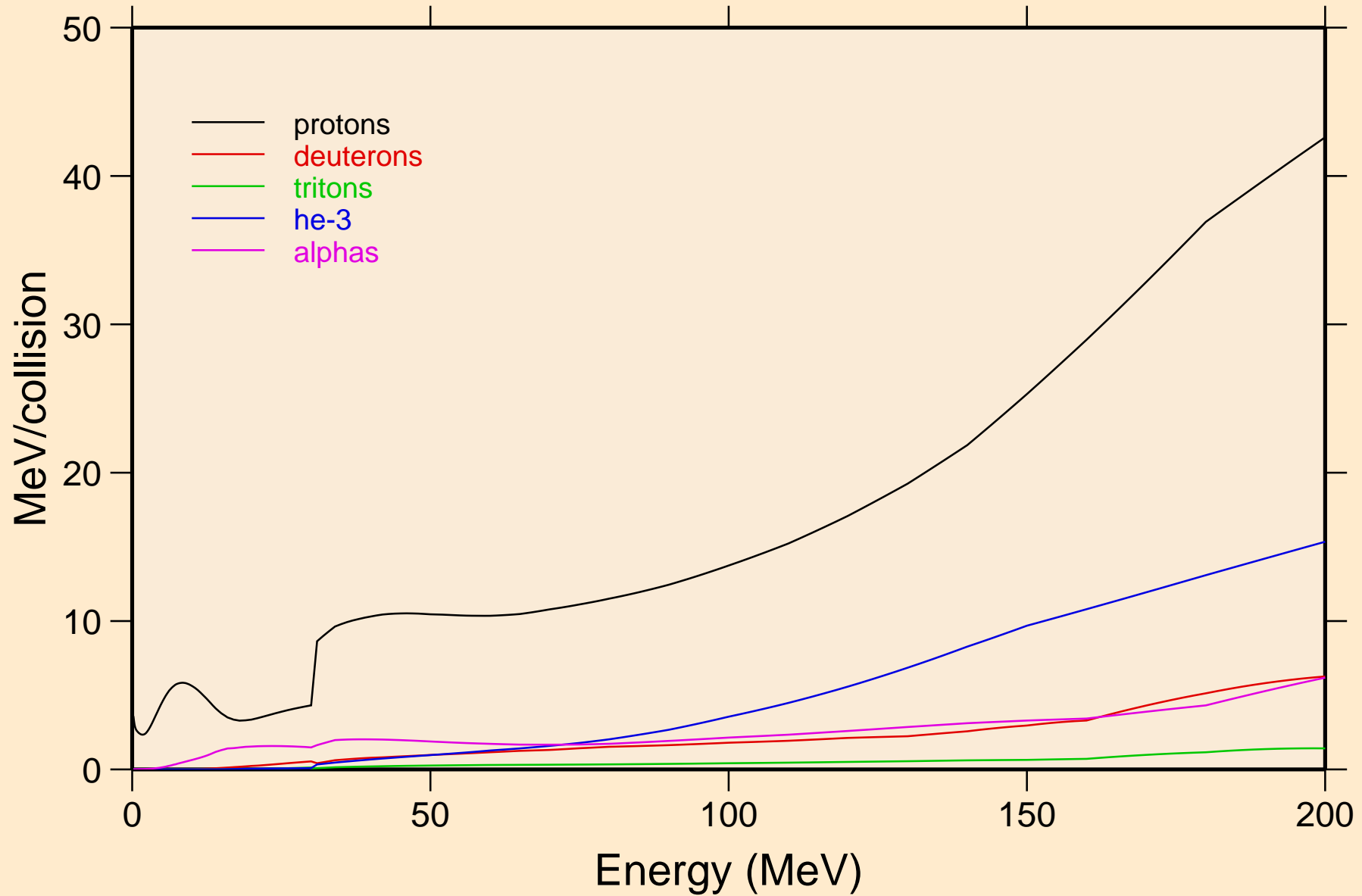

# PM129 NRG TENDL-2015, AKONING

## Recoil Heating

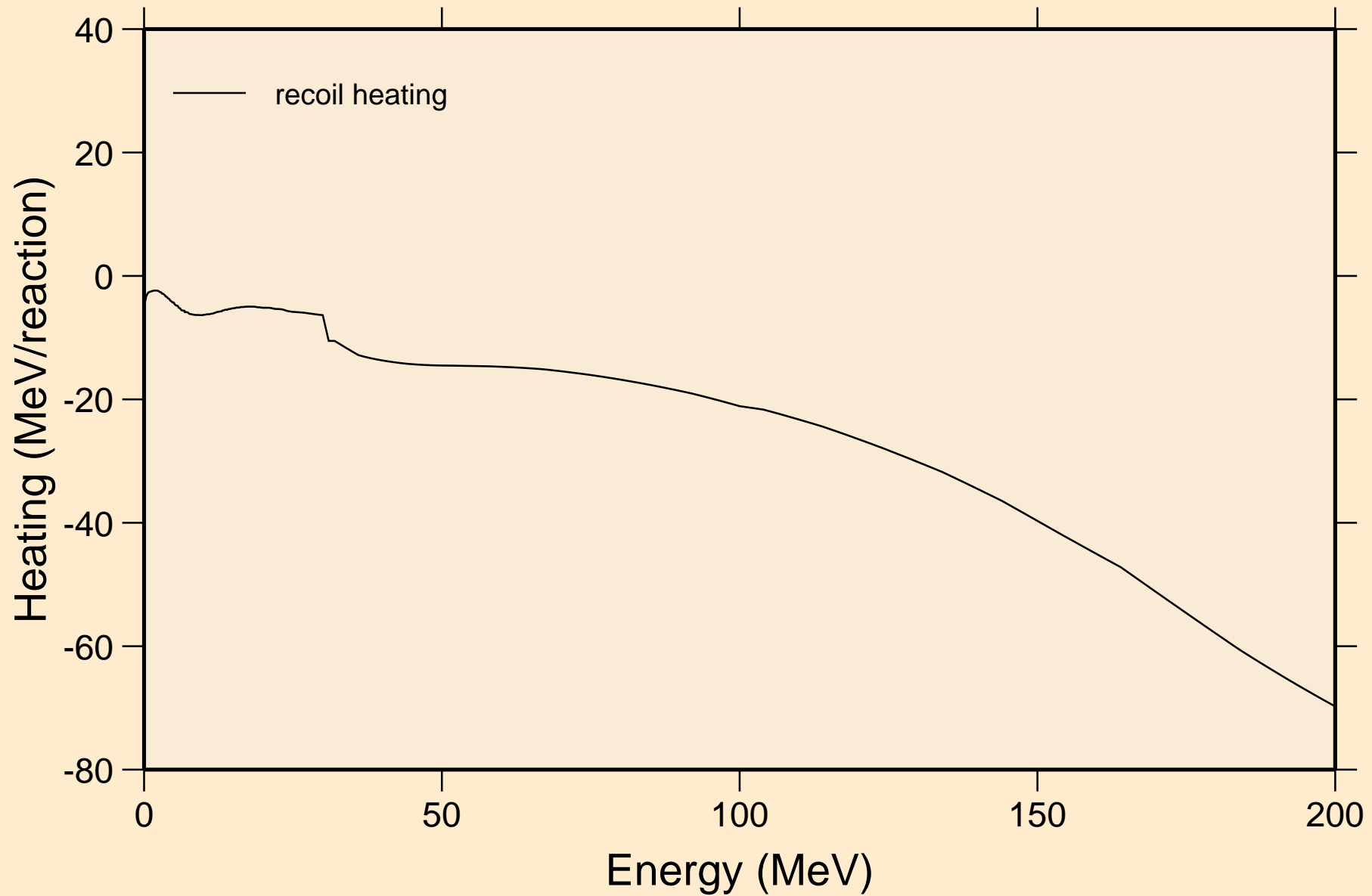

# PM129 NRG TENDL-2015, AKONING

## Particle production cross sections

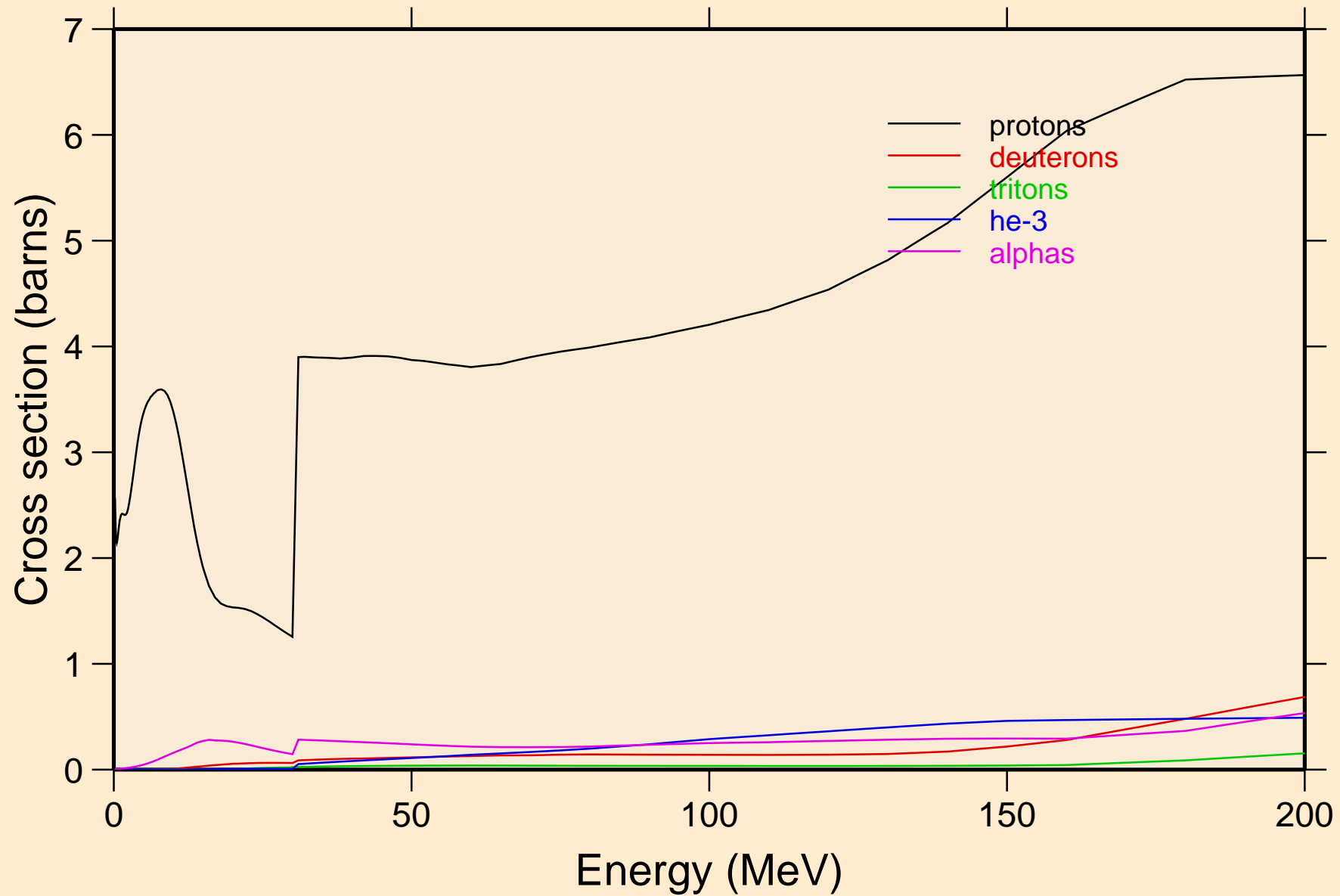

PM129 NRG TENDL-2015, AKONING  
protons from (n,x)

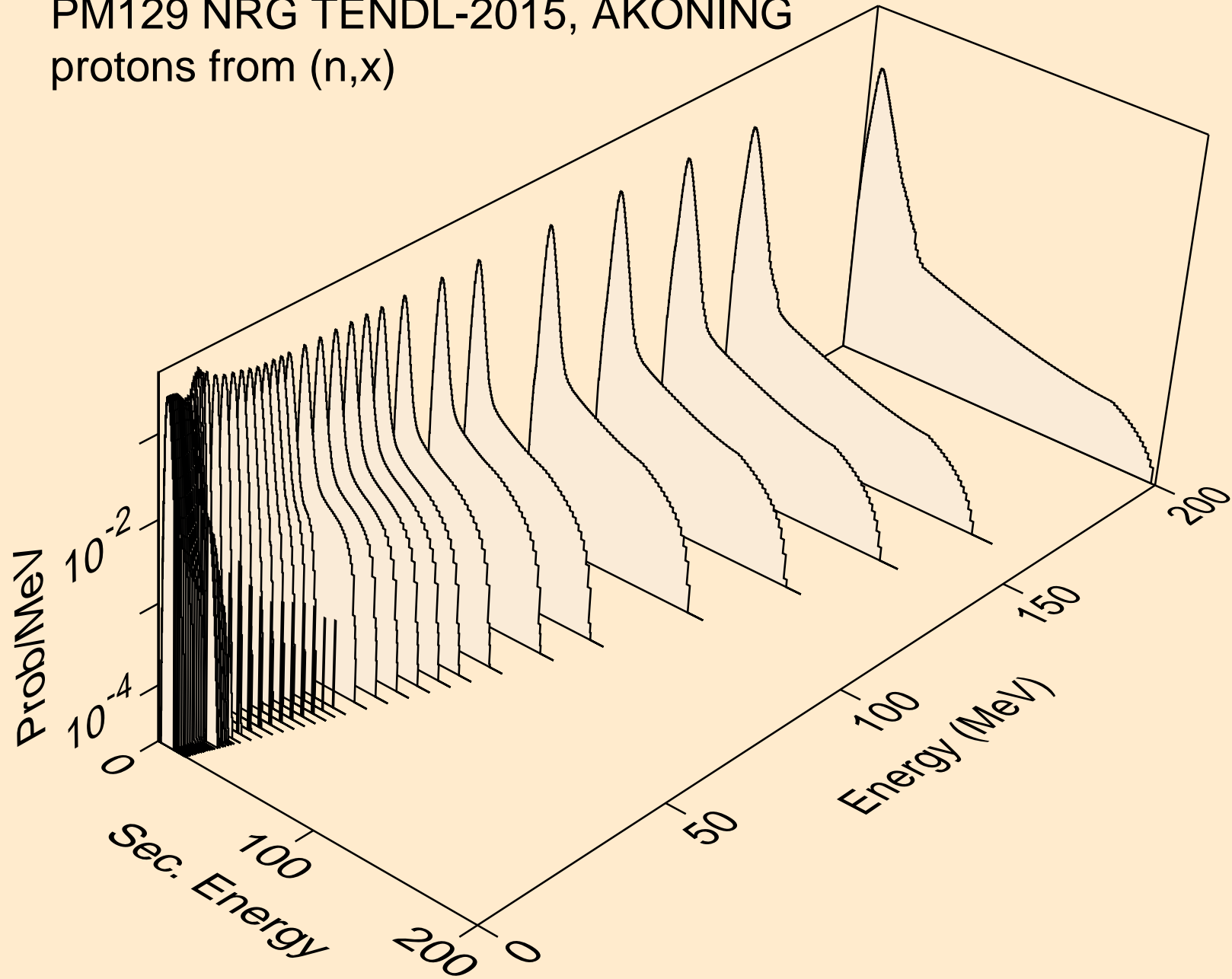

PM129 NRG TENDL-2015, AKONING  
protons from (n,n\*)p

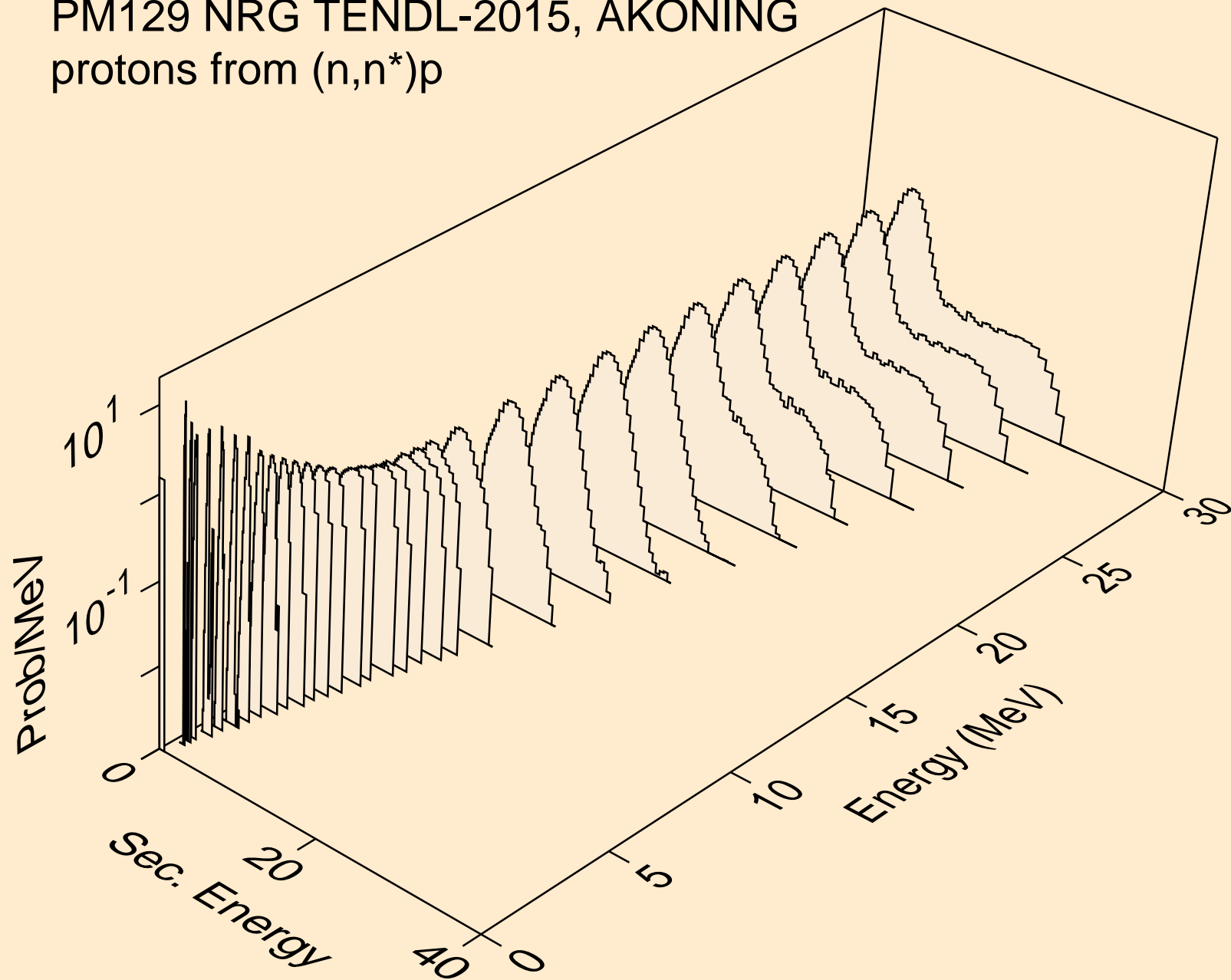

PM129 NRG TENDL-2015, AKONING  
protons from (n,2np)

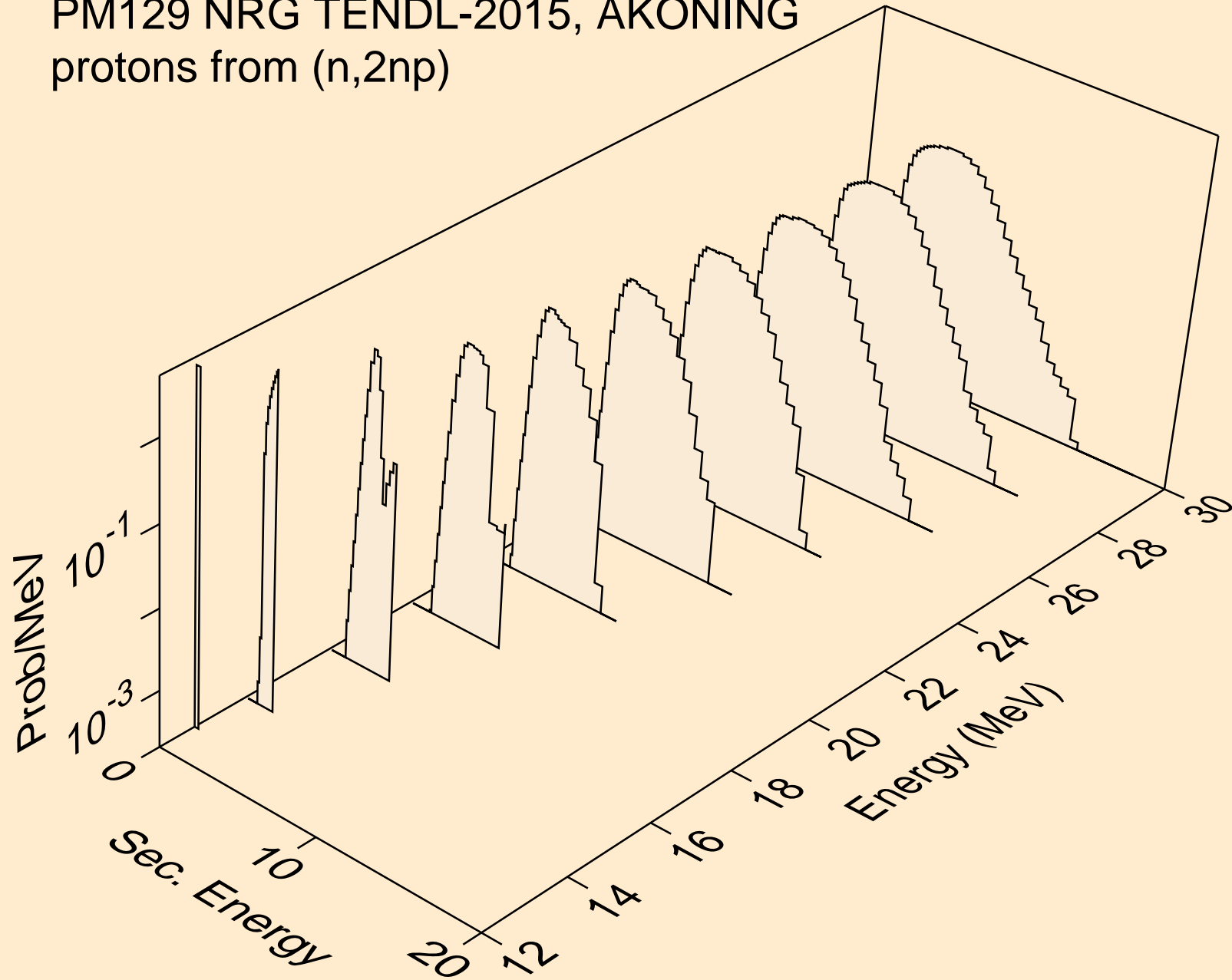



PM129 NRG TENDL-2015, AKONING  
protons from (n,3np)

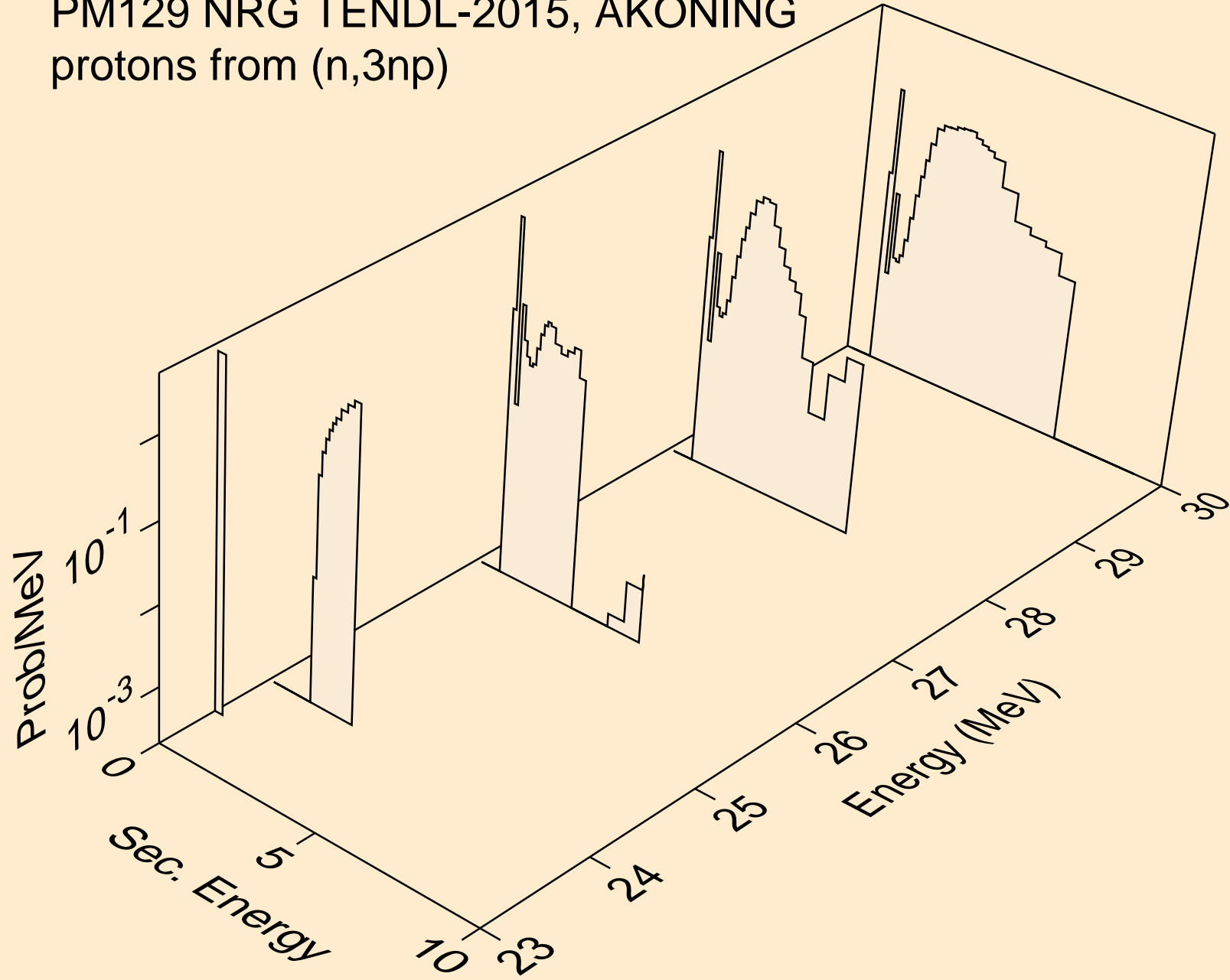

PM129 NRG TENDL-2015, AKONING  
protons from (n,2np)

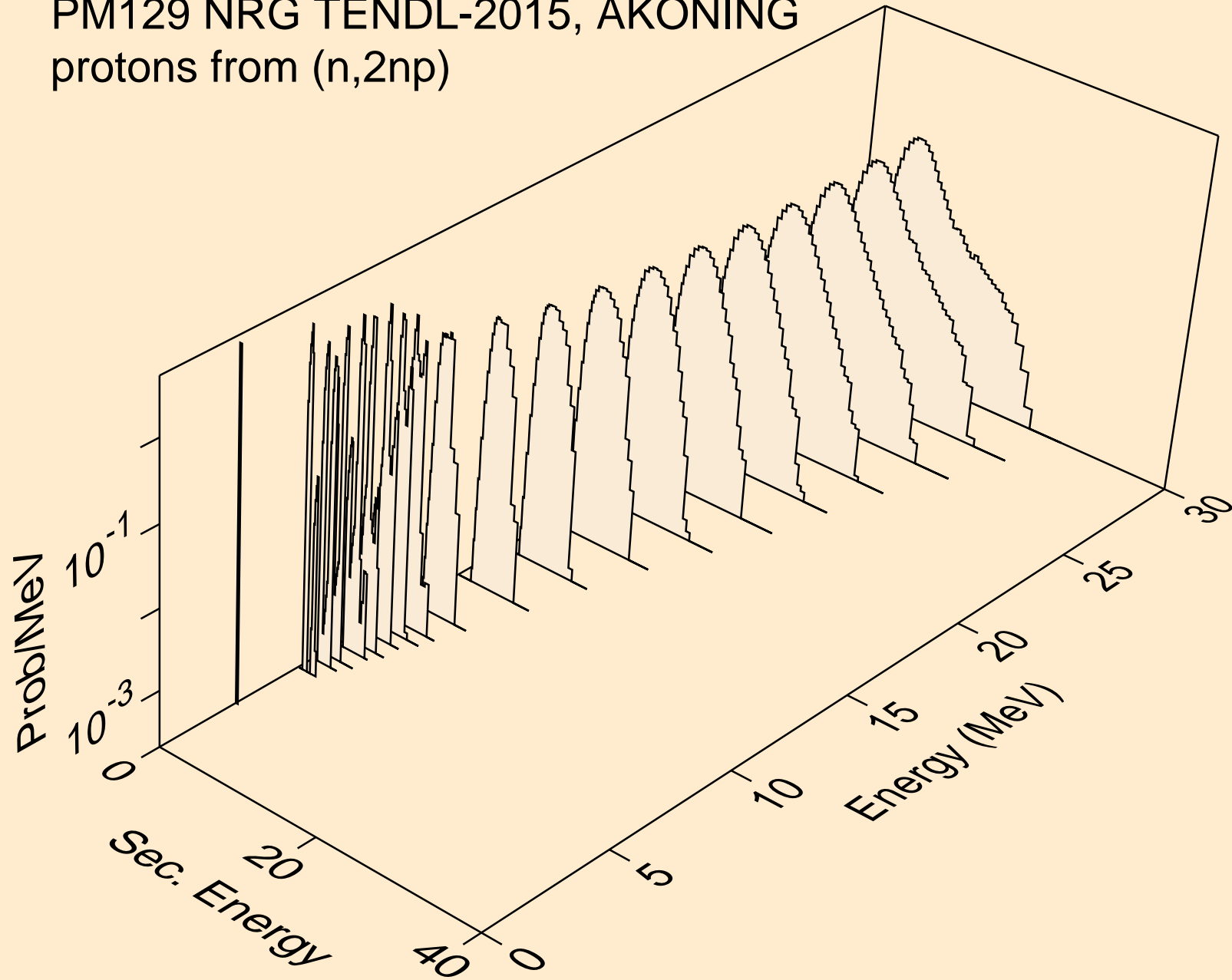

PM129 NRG TENDL-2015, AKONING  
protons from (n,npa)

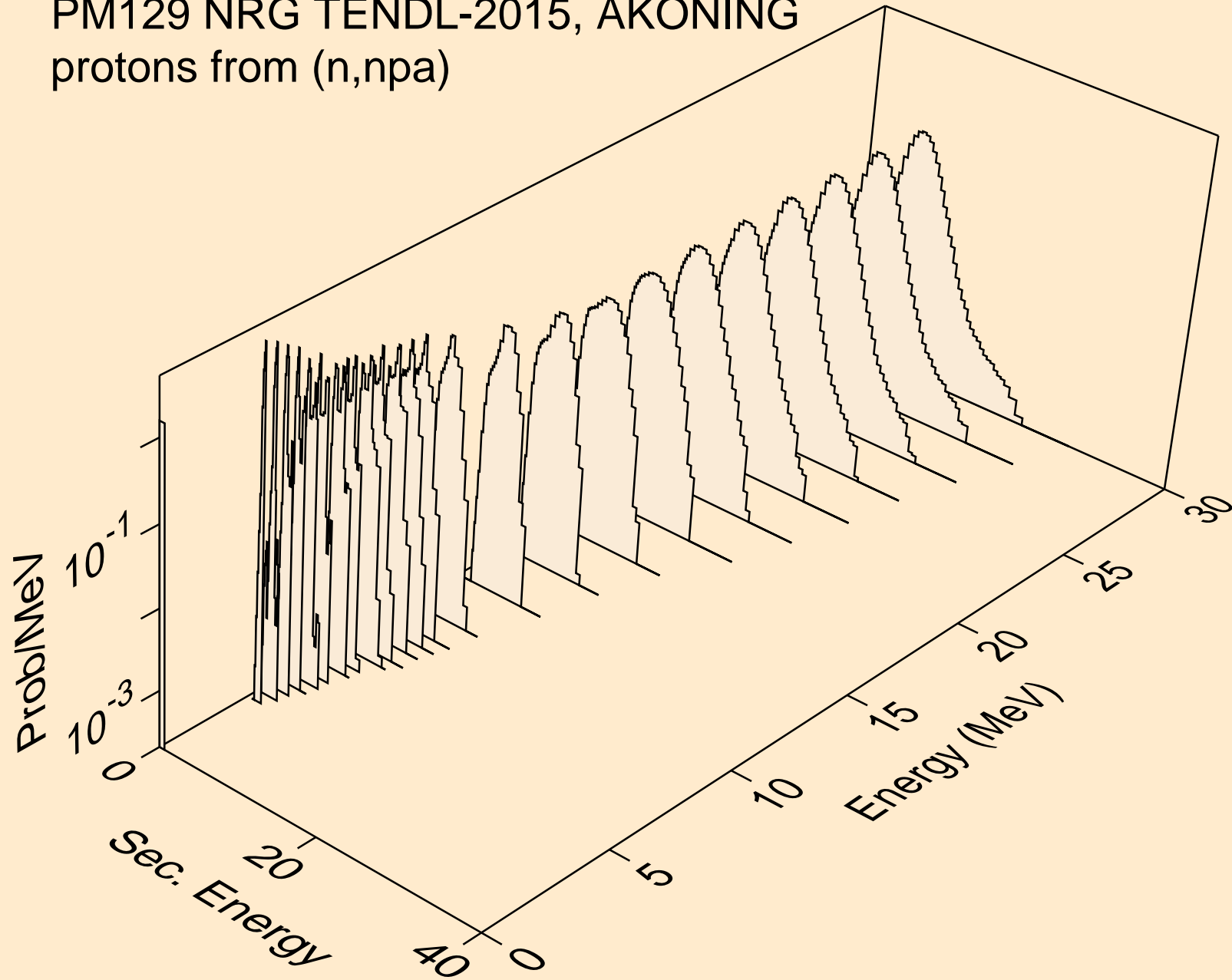

PM129 NRG TENDL-2015, AKONING  
protons from (n,p)

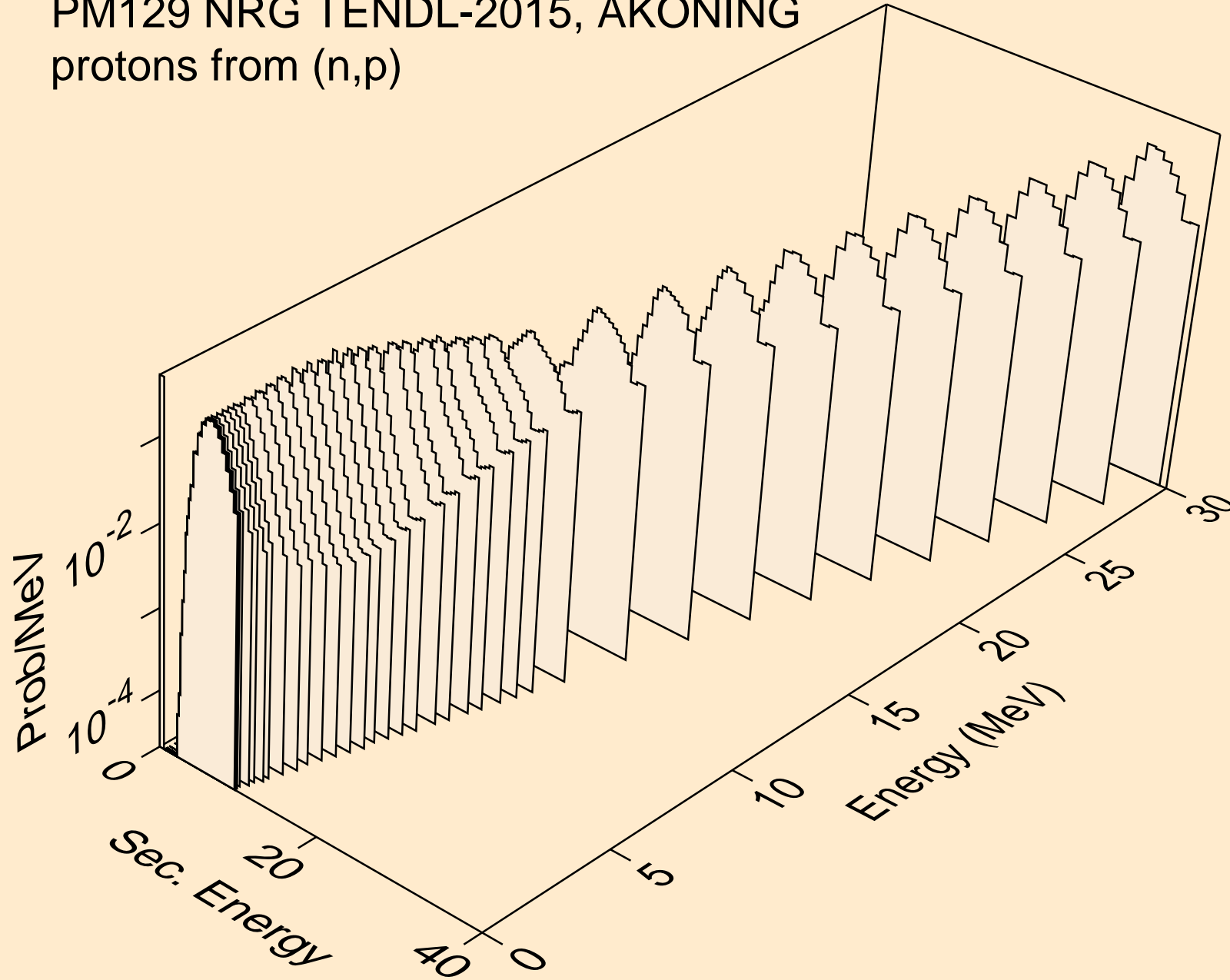

PM129 NRG TENDL-2015, AKONING  
protons from (n,2p)

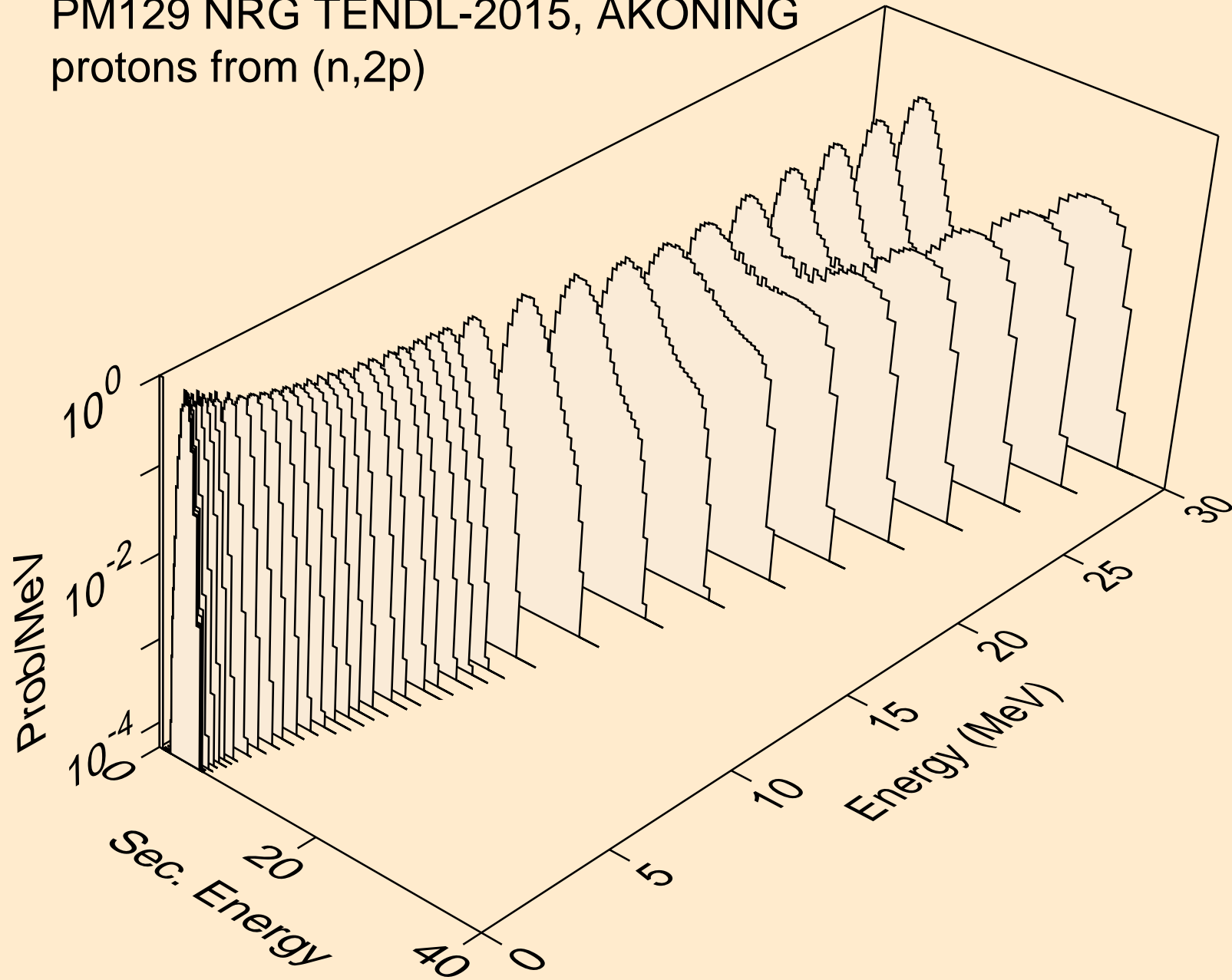

PM129 NRG TENDL-2015, AKONING  
protons from (n,pa)

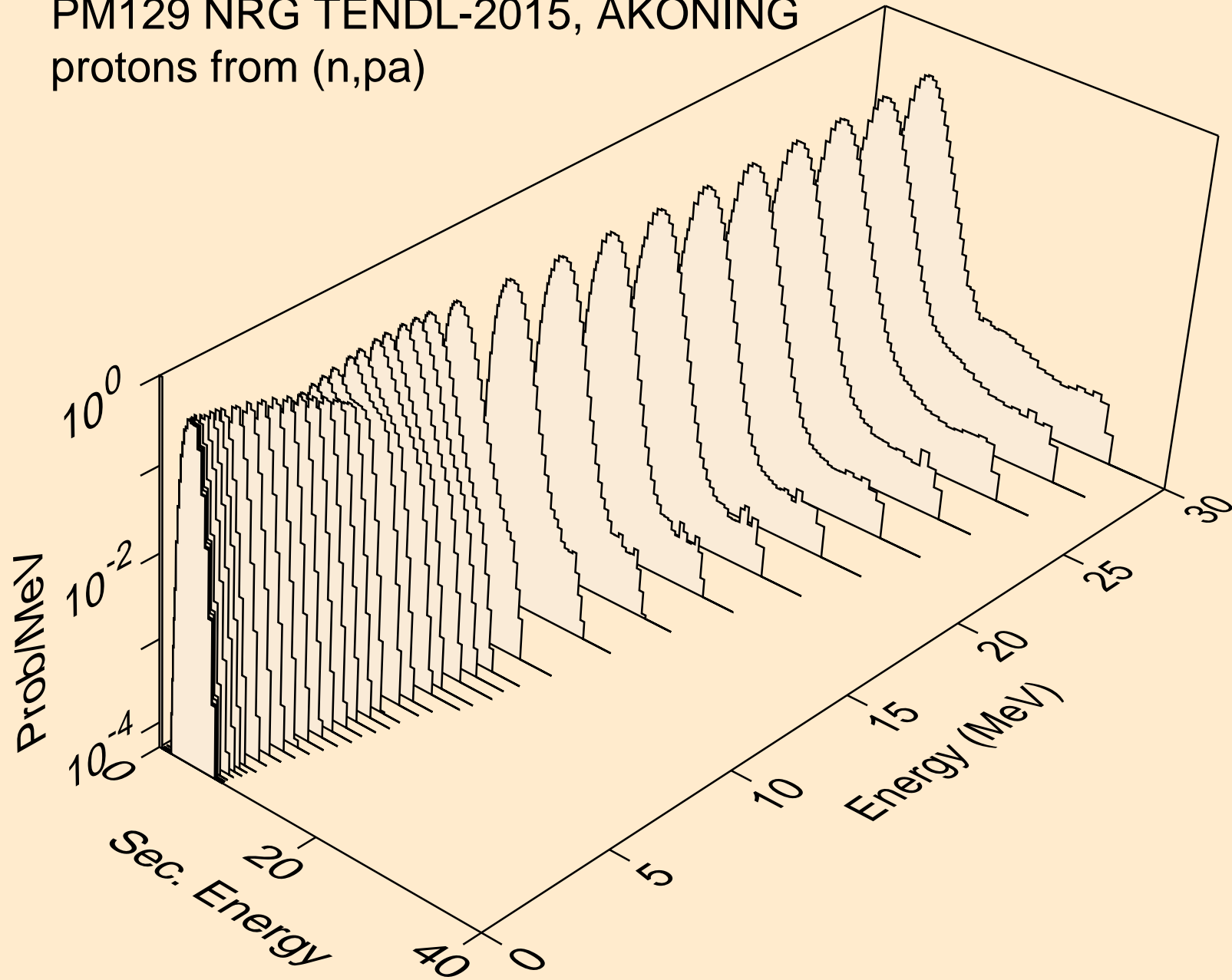

PM129 NRG TENDL-2015, AKONING  
protons from (n,pd)

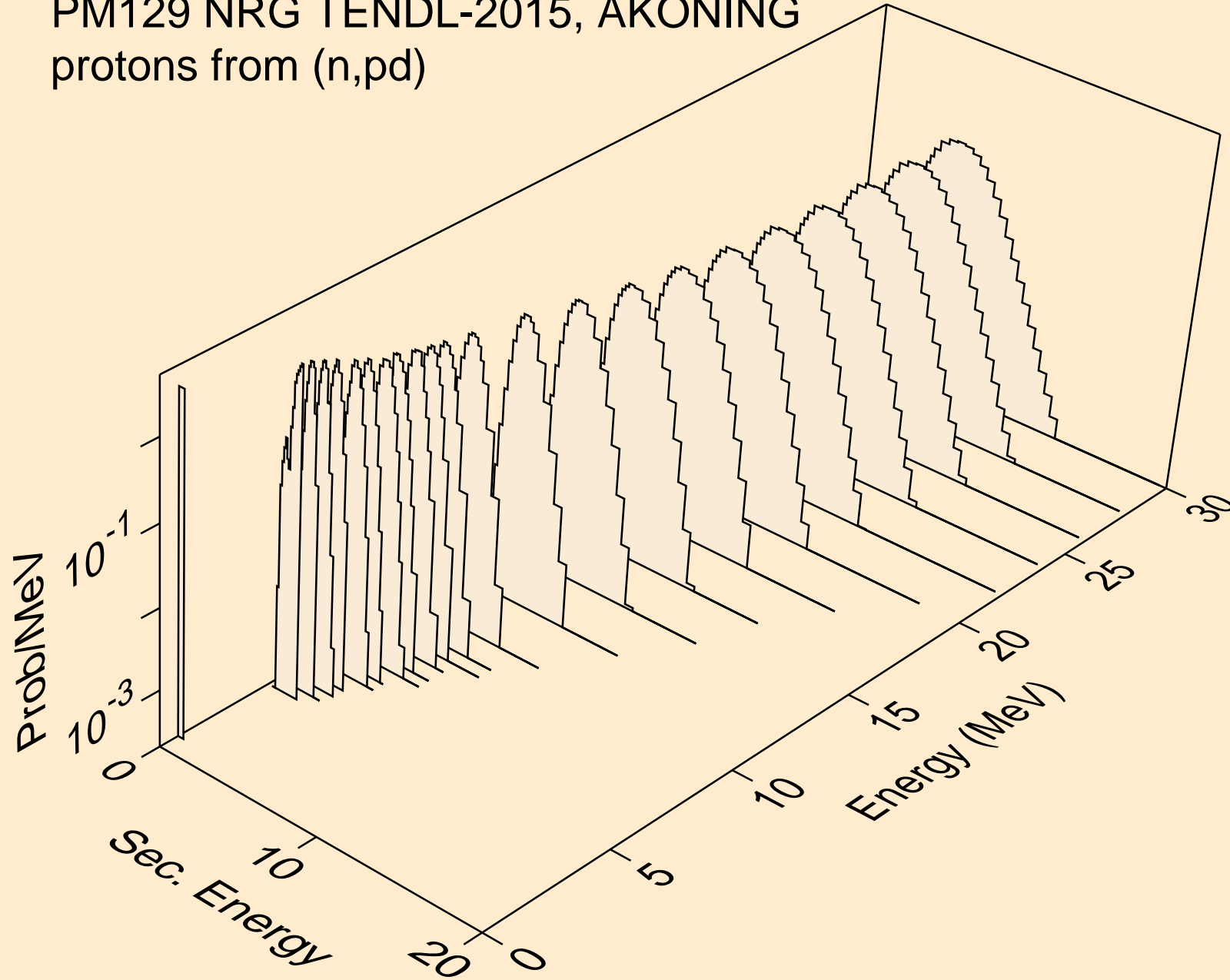

PM129 NRG TENDL-2015, AKONING  
protons from (n,pt)

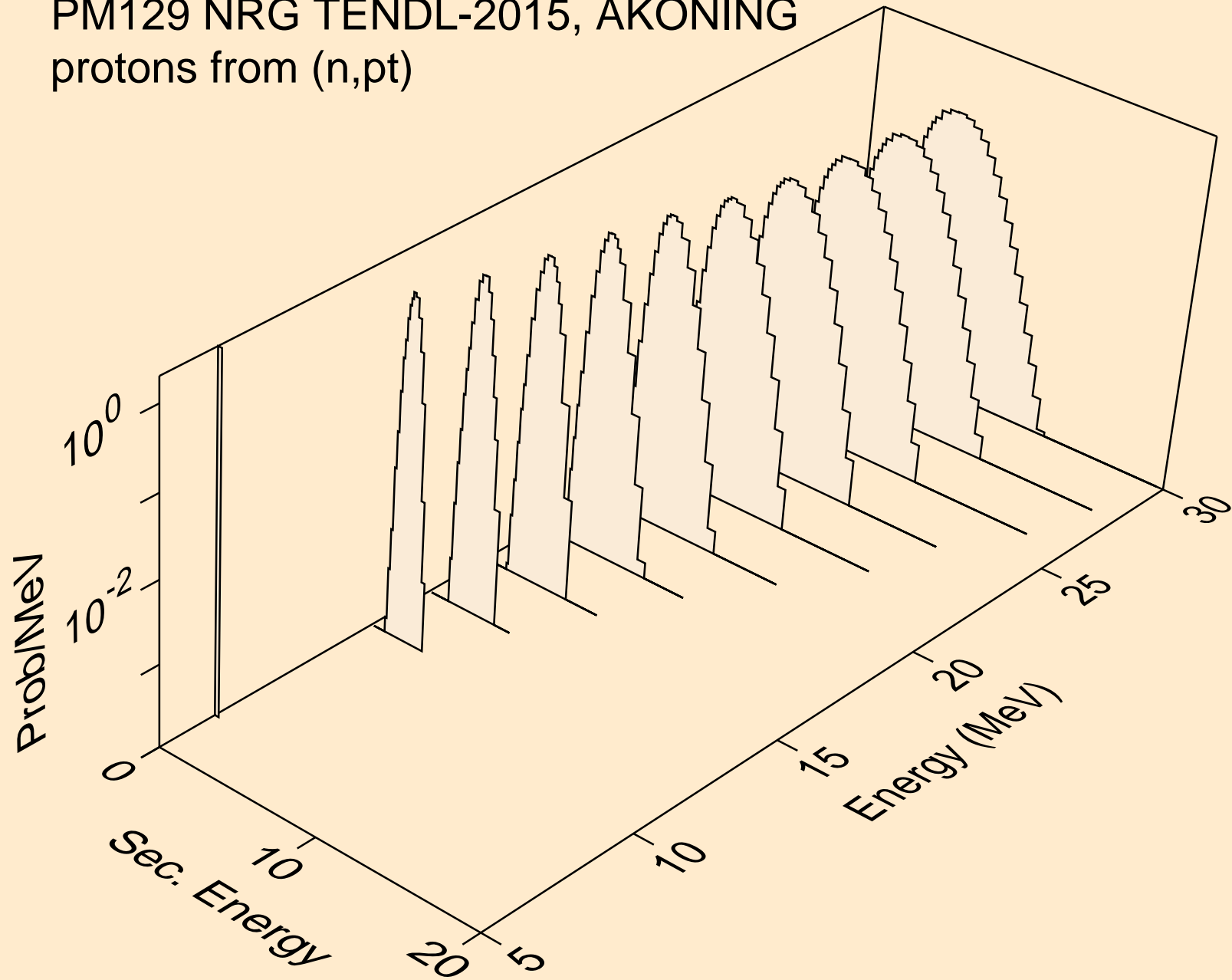



PM129 NRG TENDL-2015, AKONING  
deuterons from (n,x)

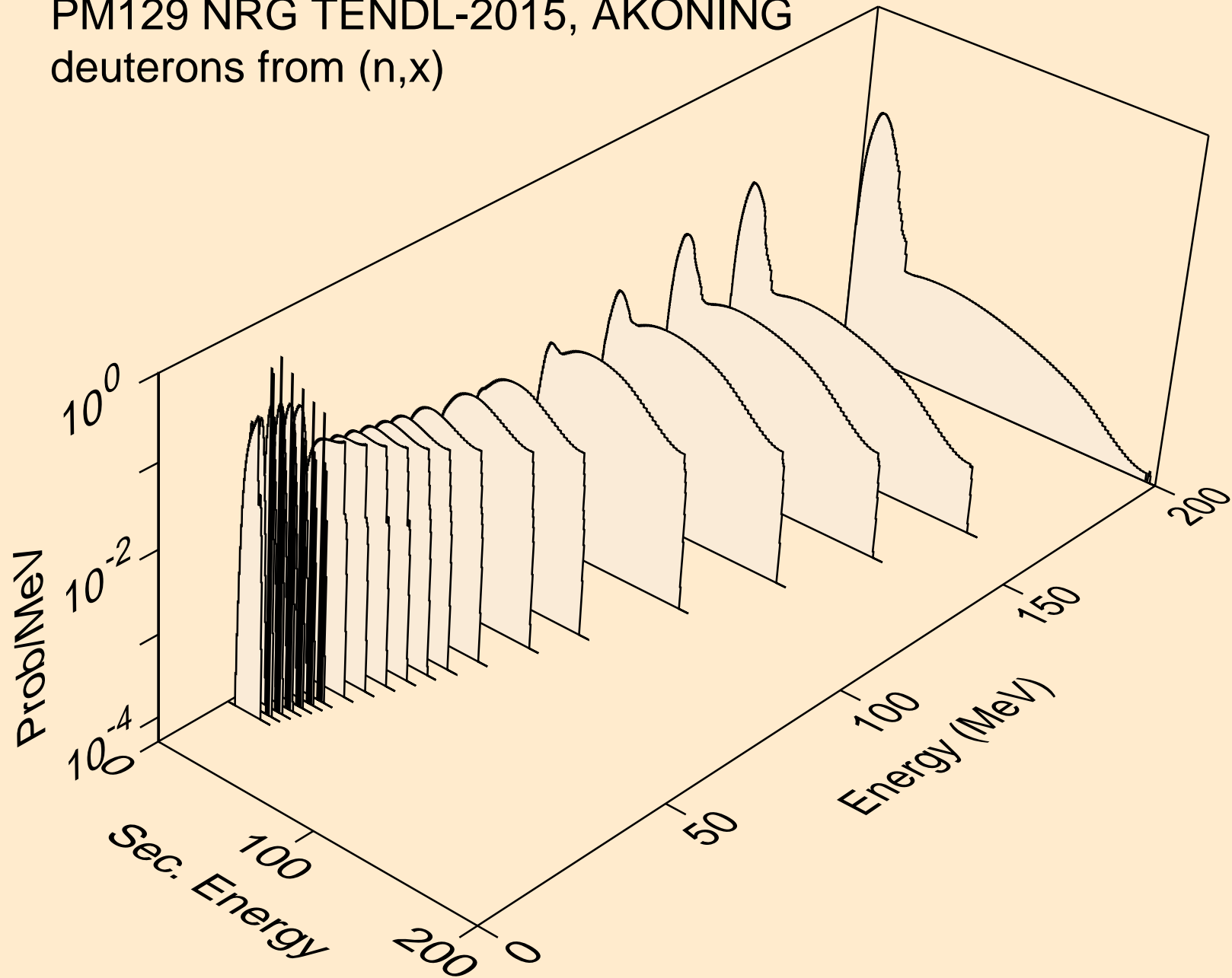

PM129 NRG TENDL-2015, AKONING  
deuterons from (n,2nd)

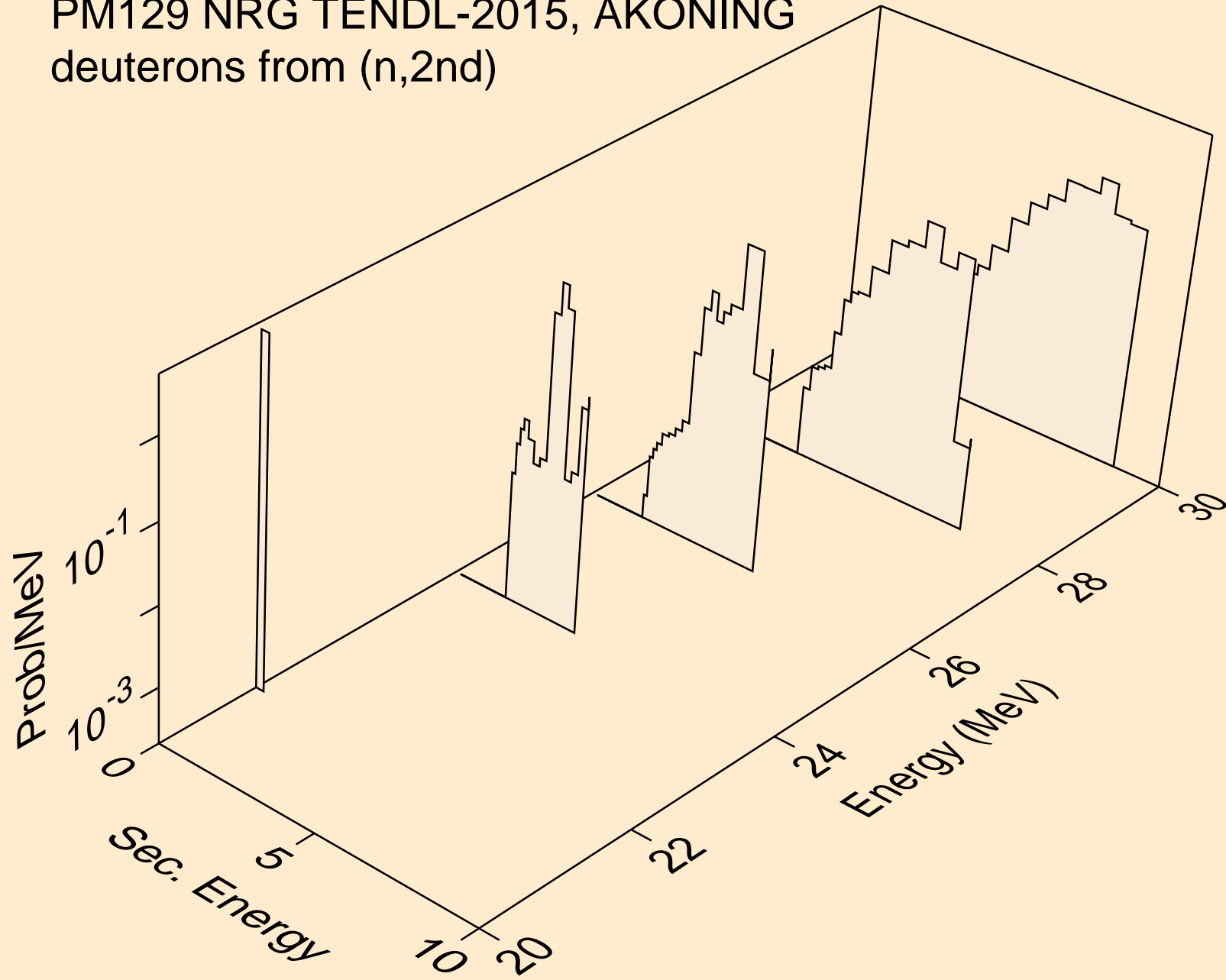

PM129 NRG TENDL-2015, AKONING  
deuterons from (n,n\*)d

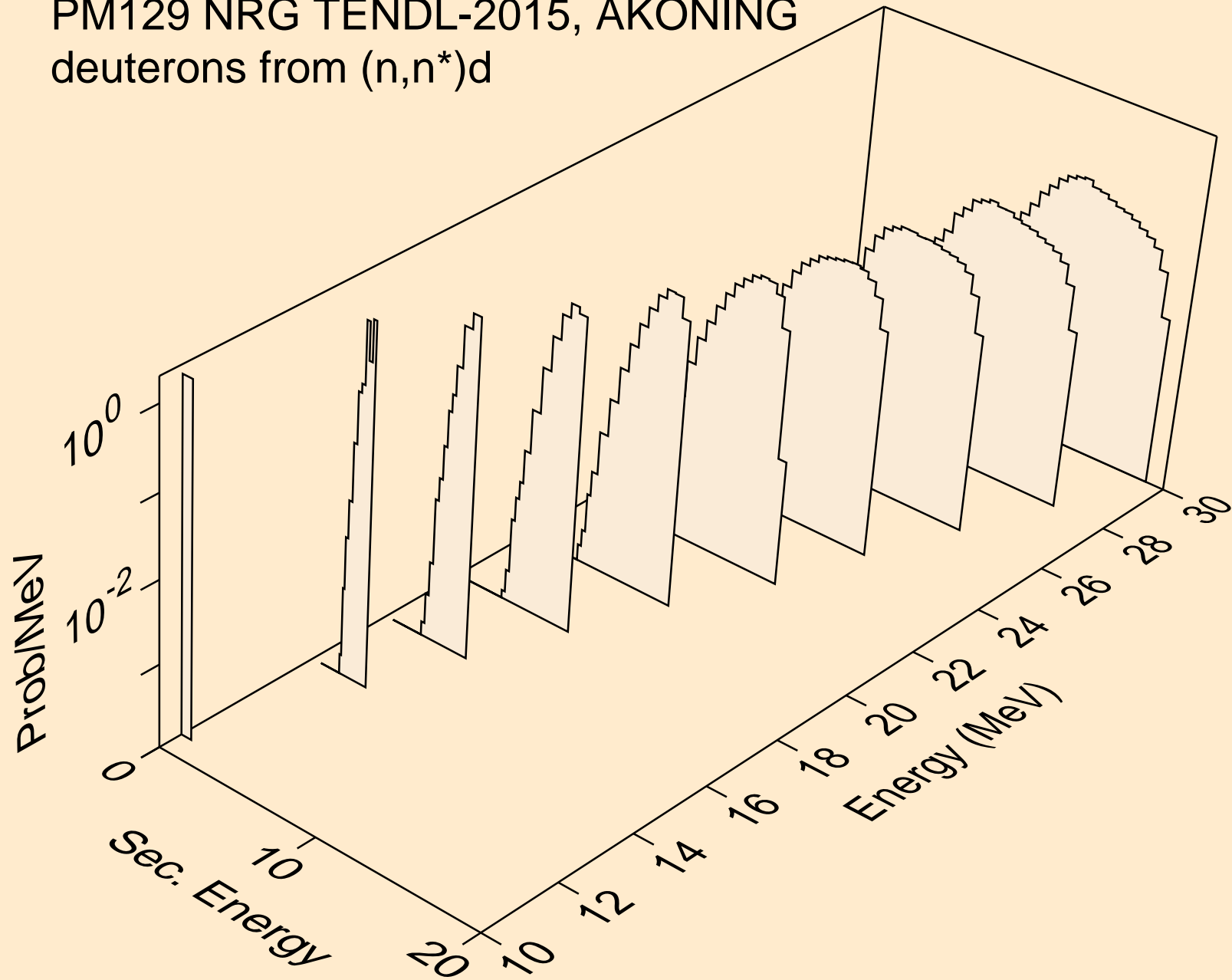

PM129 NRG TENDL-2015, AKONING  
deuterons from (n,d)

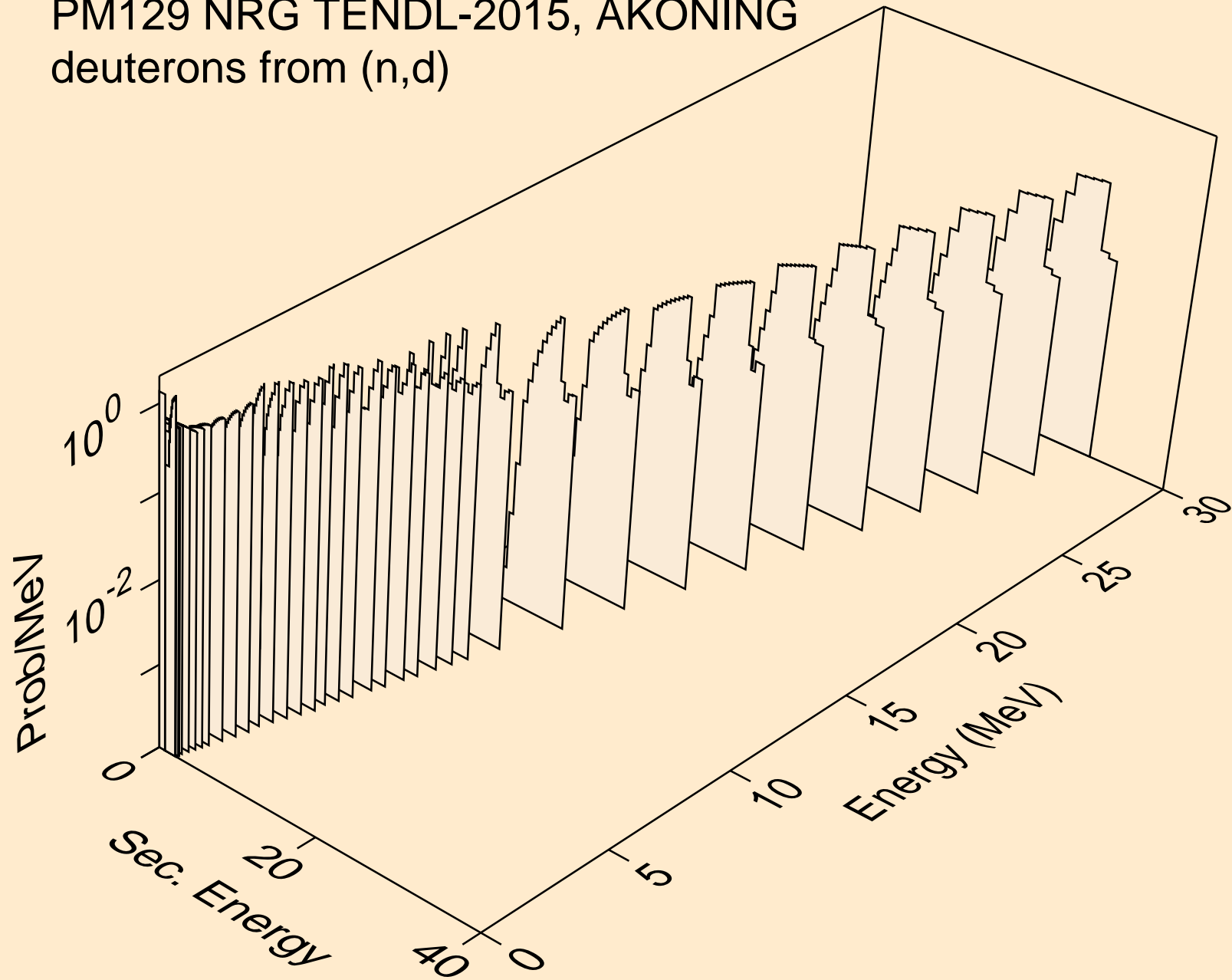

PM129 NRG TENDL-2015, AKONING  
deuterons from (n,d2a)

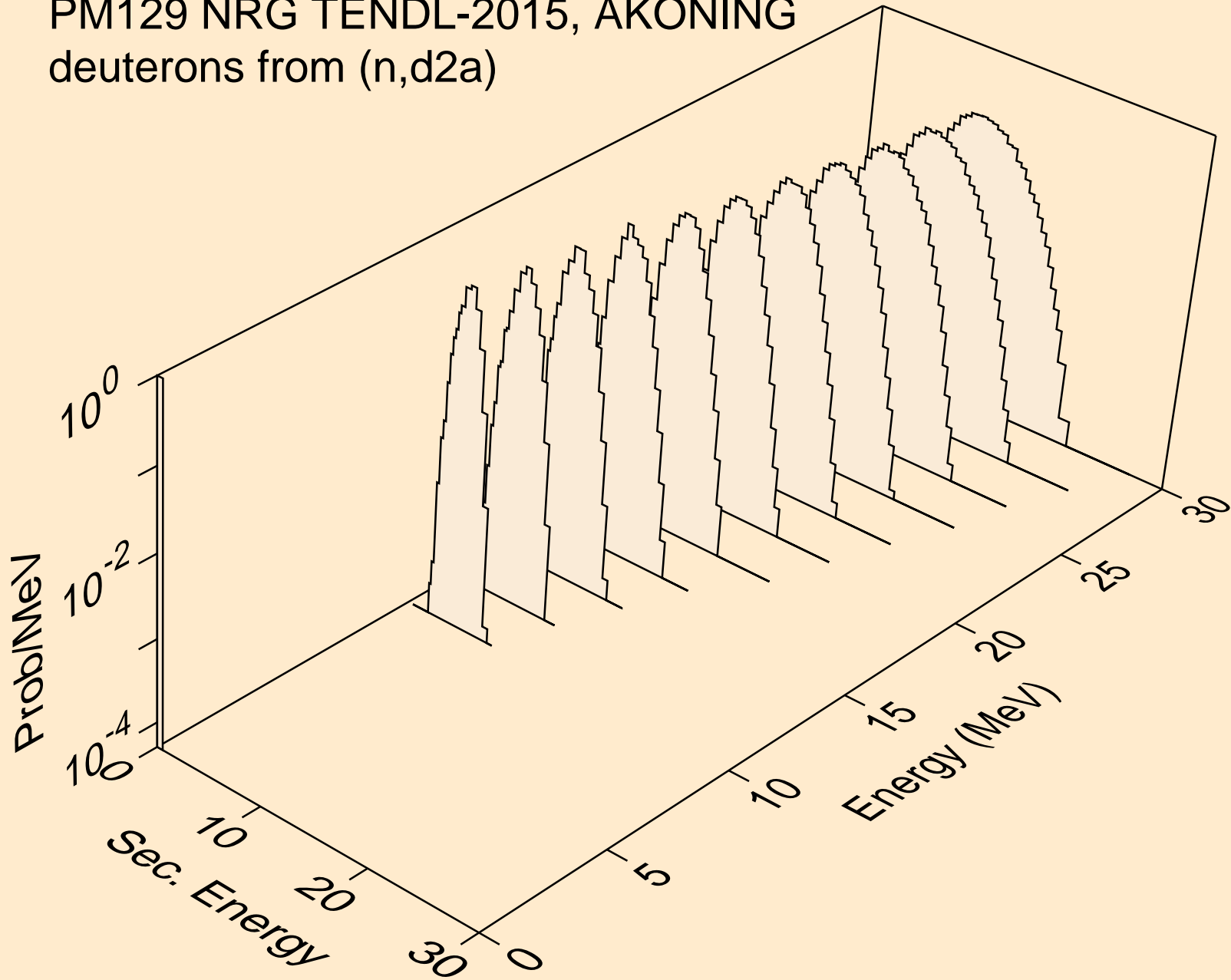

PM129 NRG TENDL-2015, AKONING  
deuterons from (n,pd)

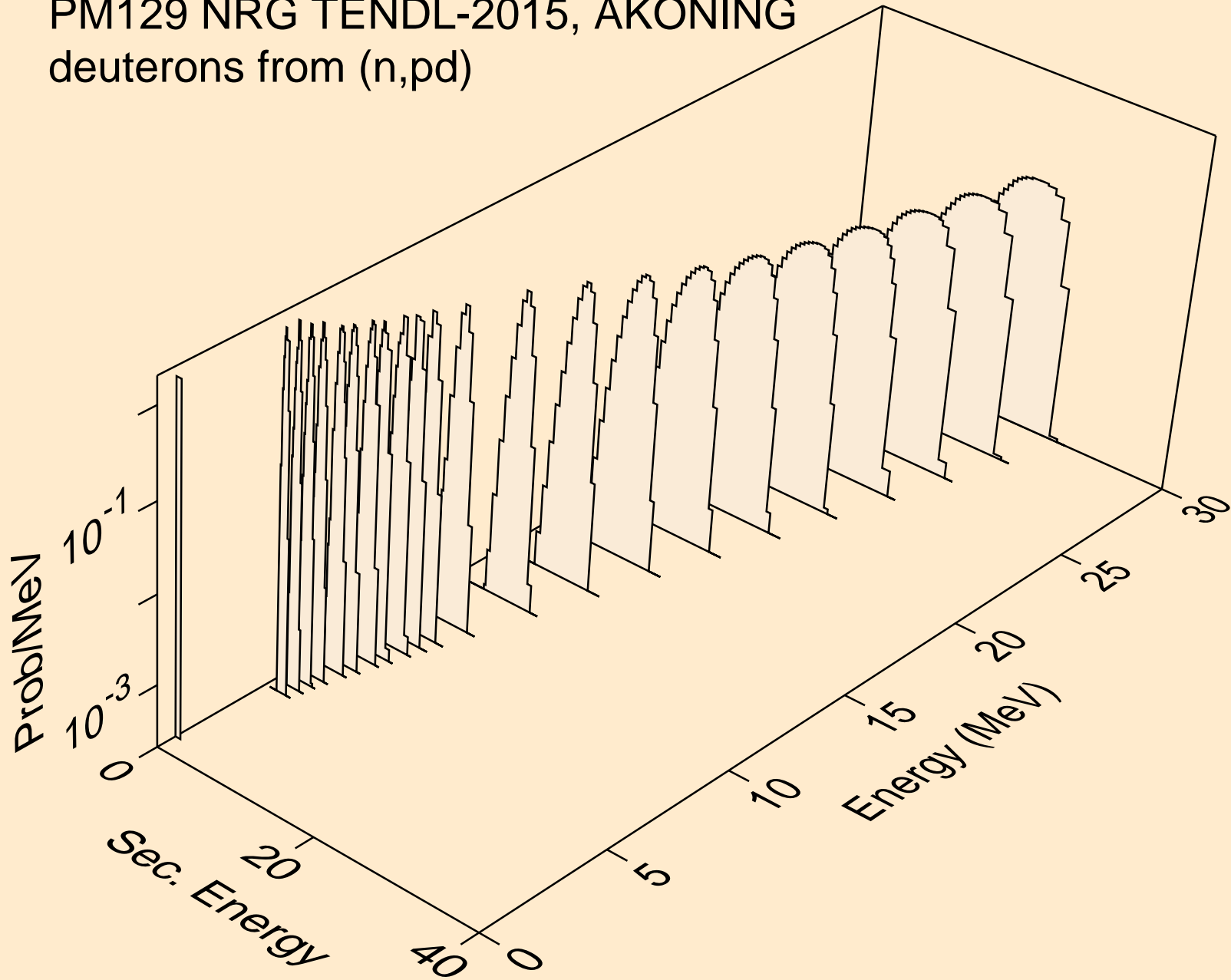

PM129 NRG TENDL-2015, AKONING  
deuterons from (n,da)

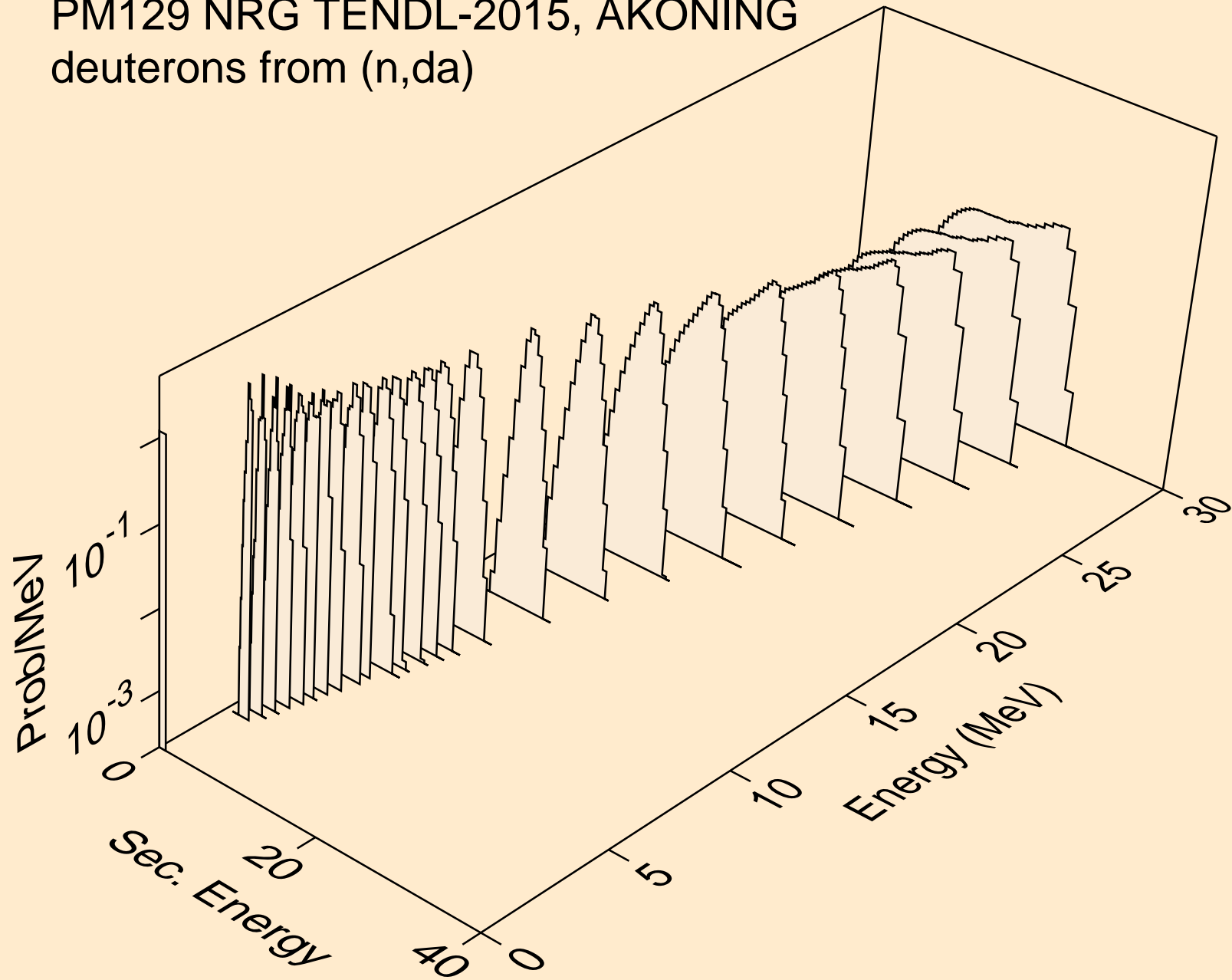

PM129 NRG TENDL-2015, AKONING  
tritons from (n,x)

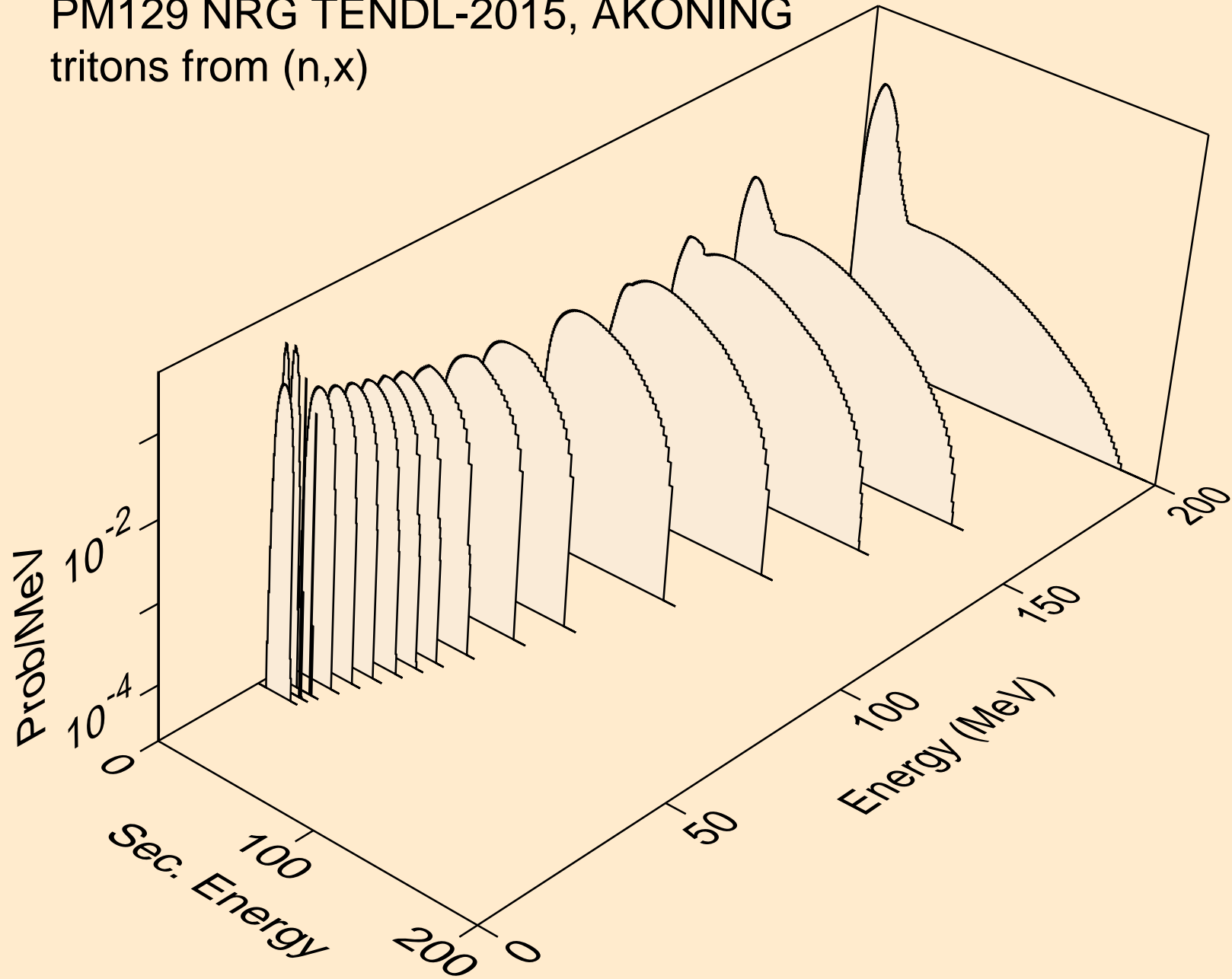



PM129 NRG TENDL-2015, AKONING  
tritons from (n,n\*)t

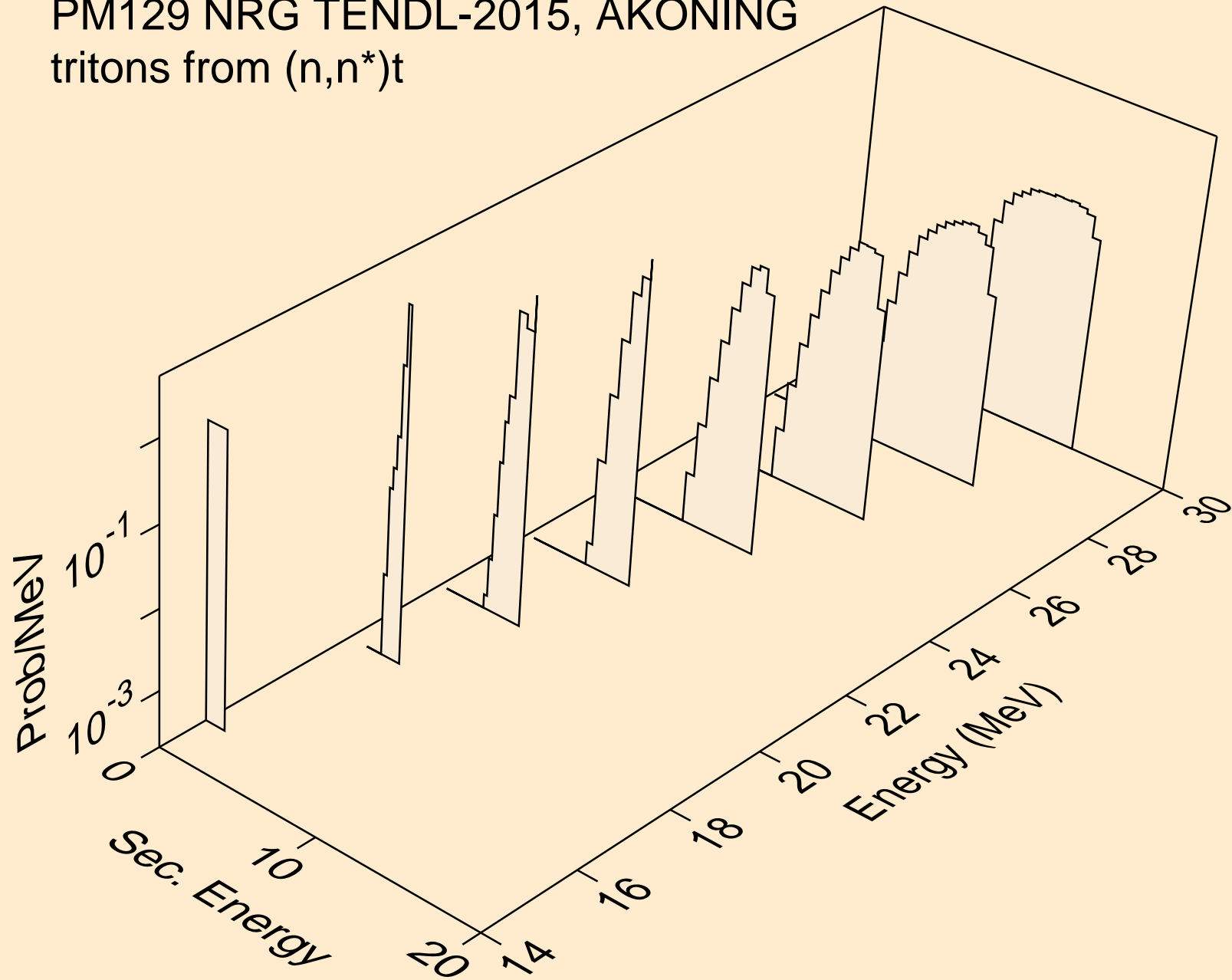

PM129 NRG TENDL-2015, AKONING  
tritons from (n,t)

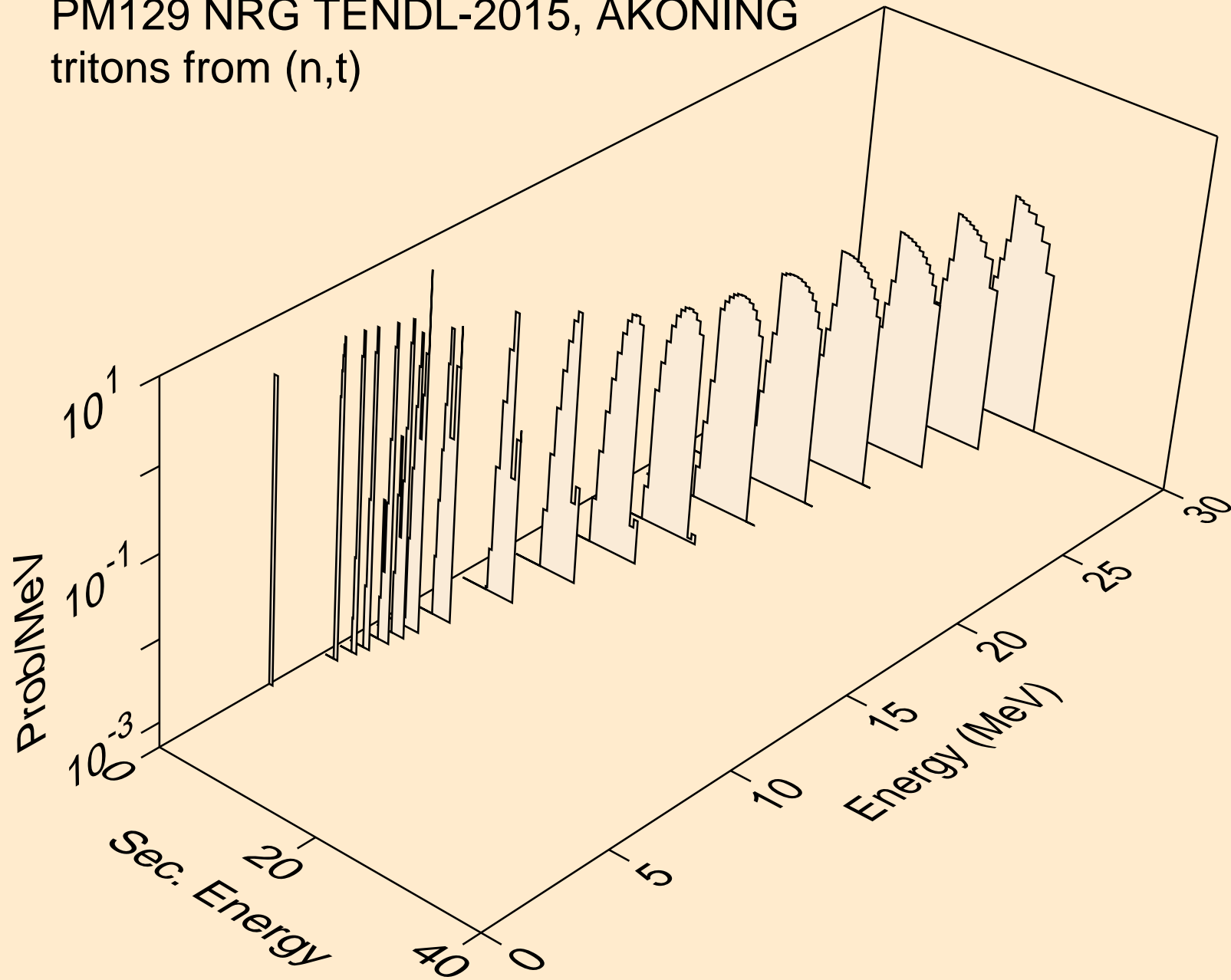

PM129 NRG TENDL-2015, AKONING  
tritons from (n,t2a)

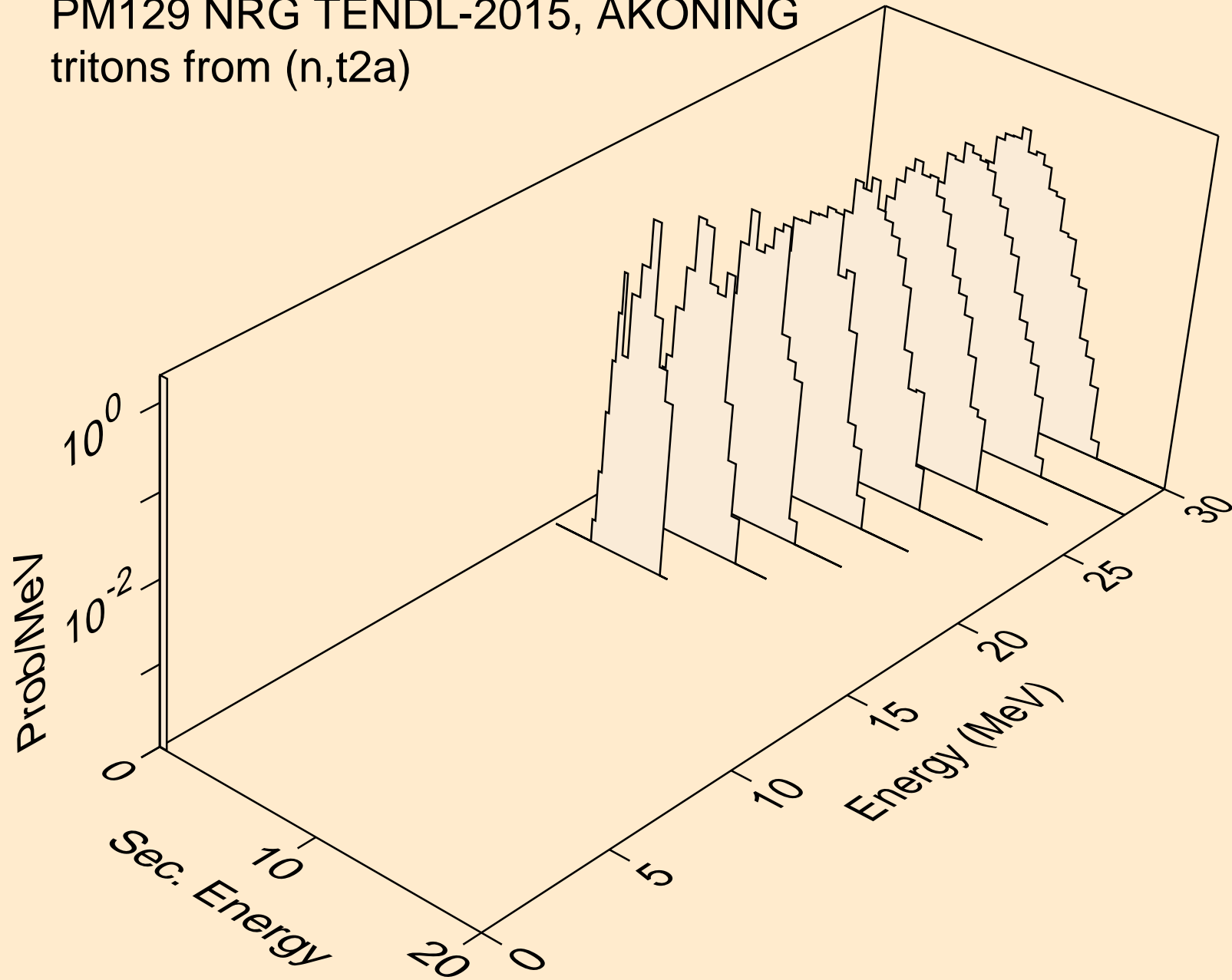

PM129 NRG TENDL-2015, AKONING  
tritons from (n,pt)

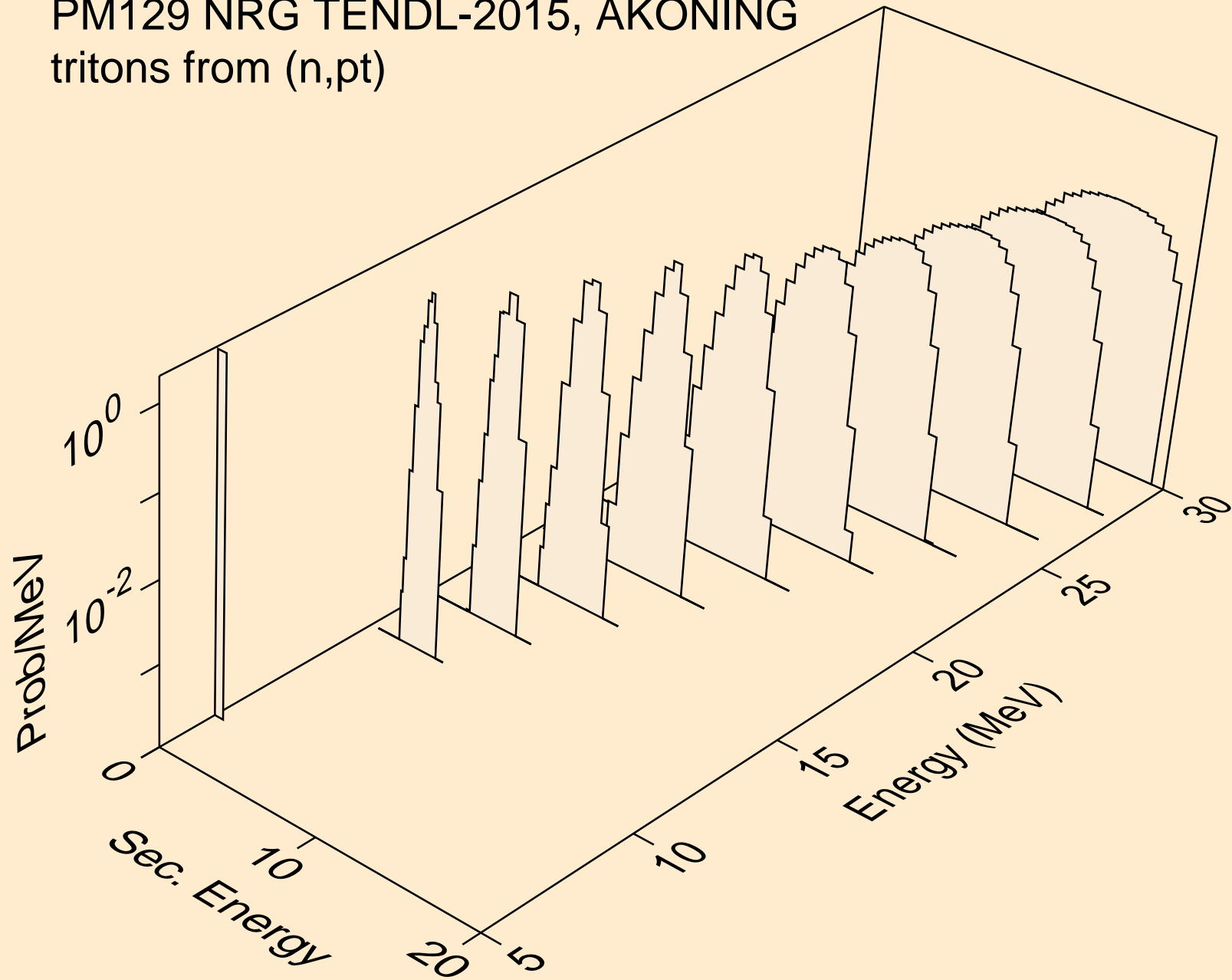

PM129 NRG TENDL-2015, AKONING  
he3s from (n,x)

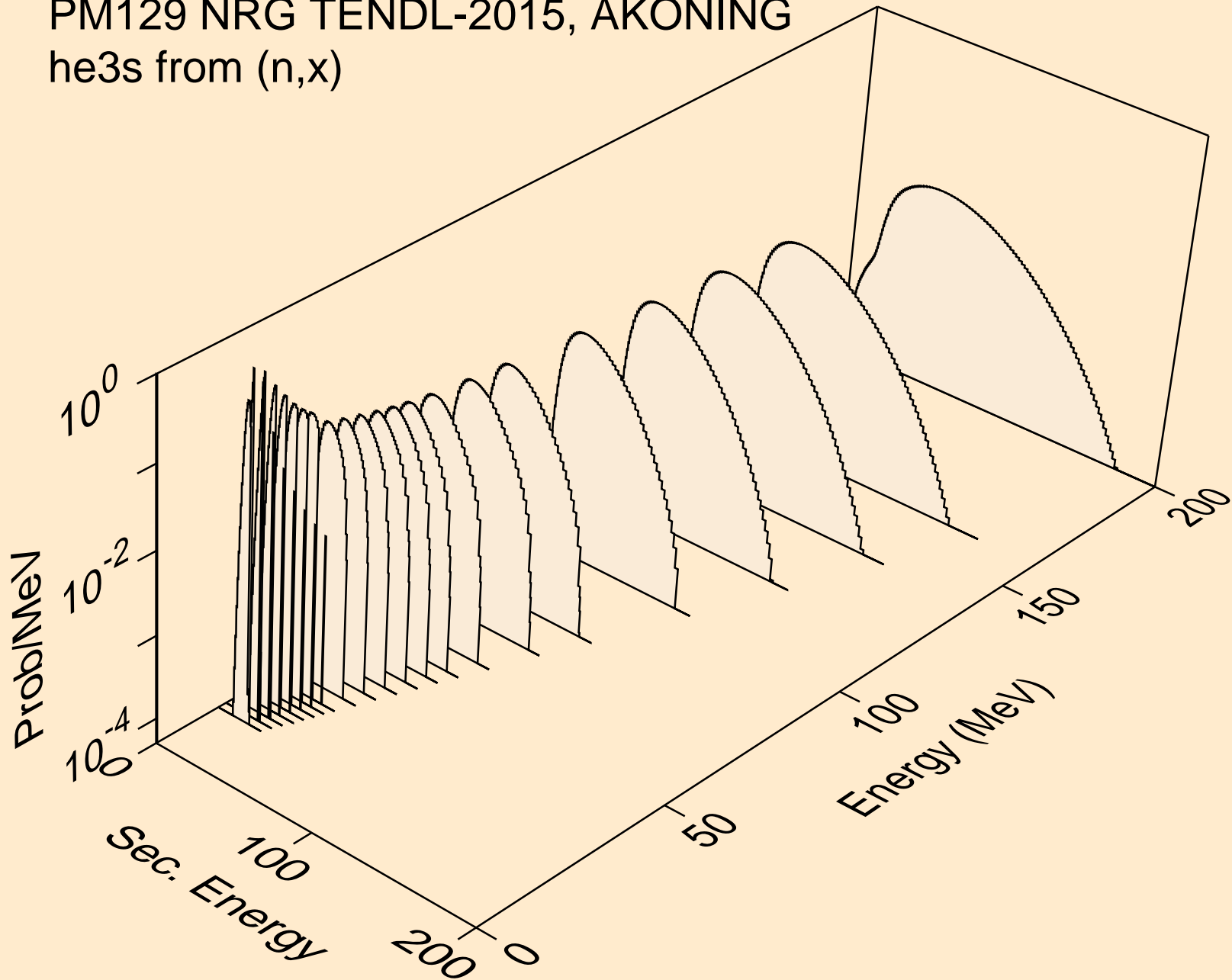

PM129 NRG TENDL-2015, AKONING  
he3s from (n,n\*)he3

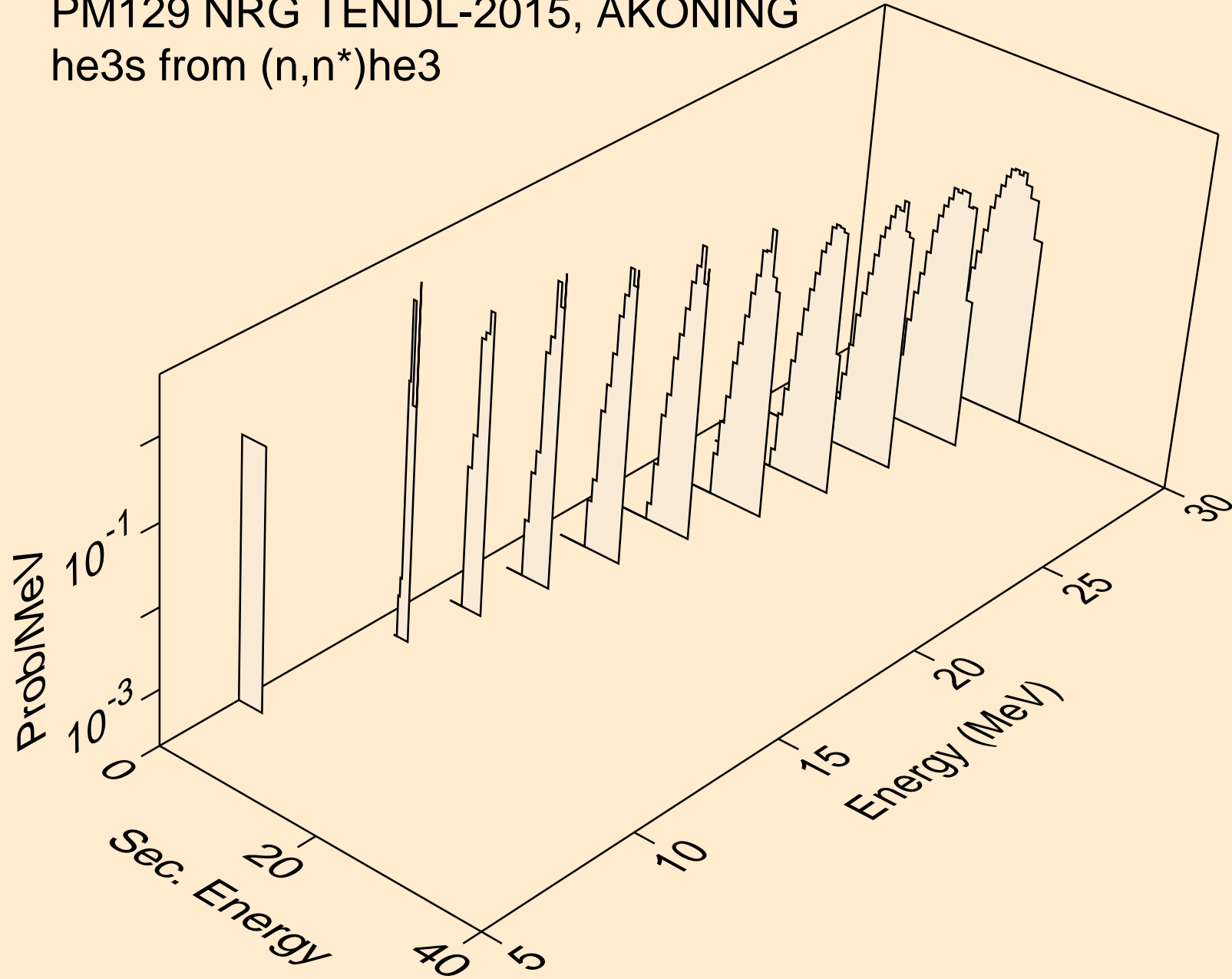

PM129 NRG TENDL-2015, AKONING  
he3s from (n,he3)

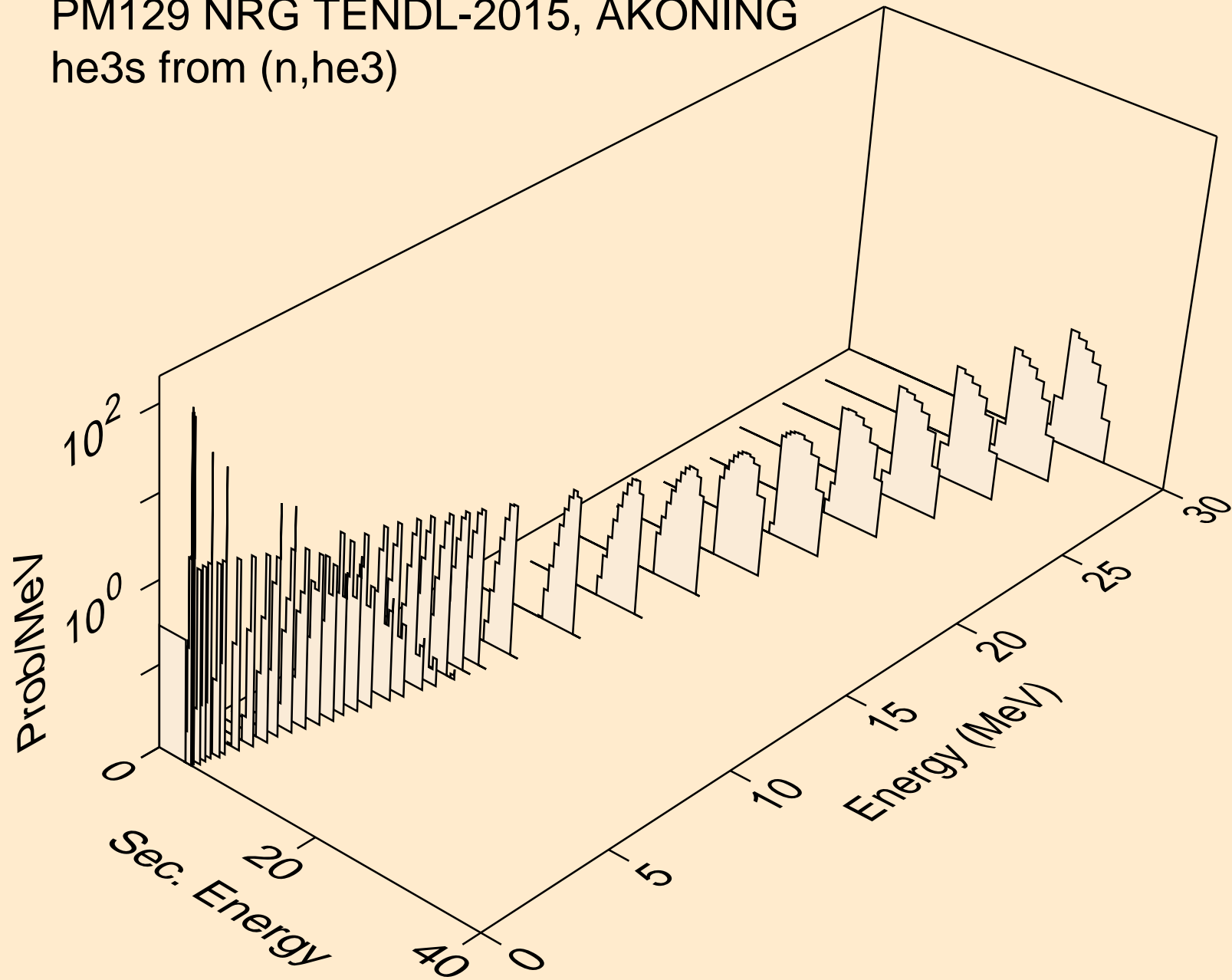

PM129 NRG TENDL-2015, AKONING  
alphas from (n,x)

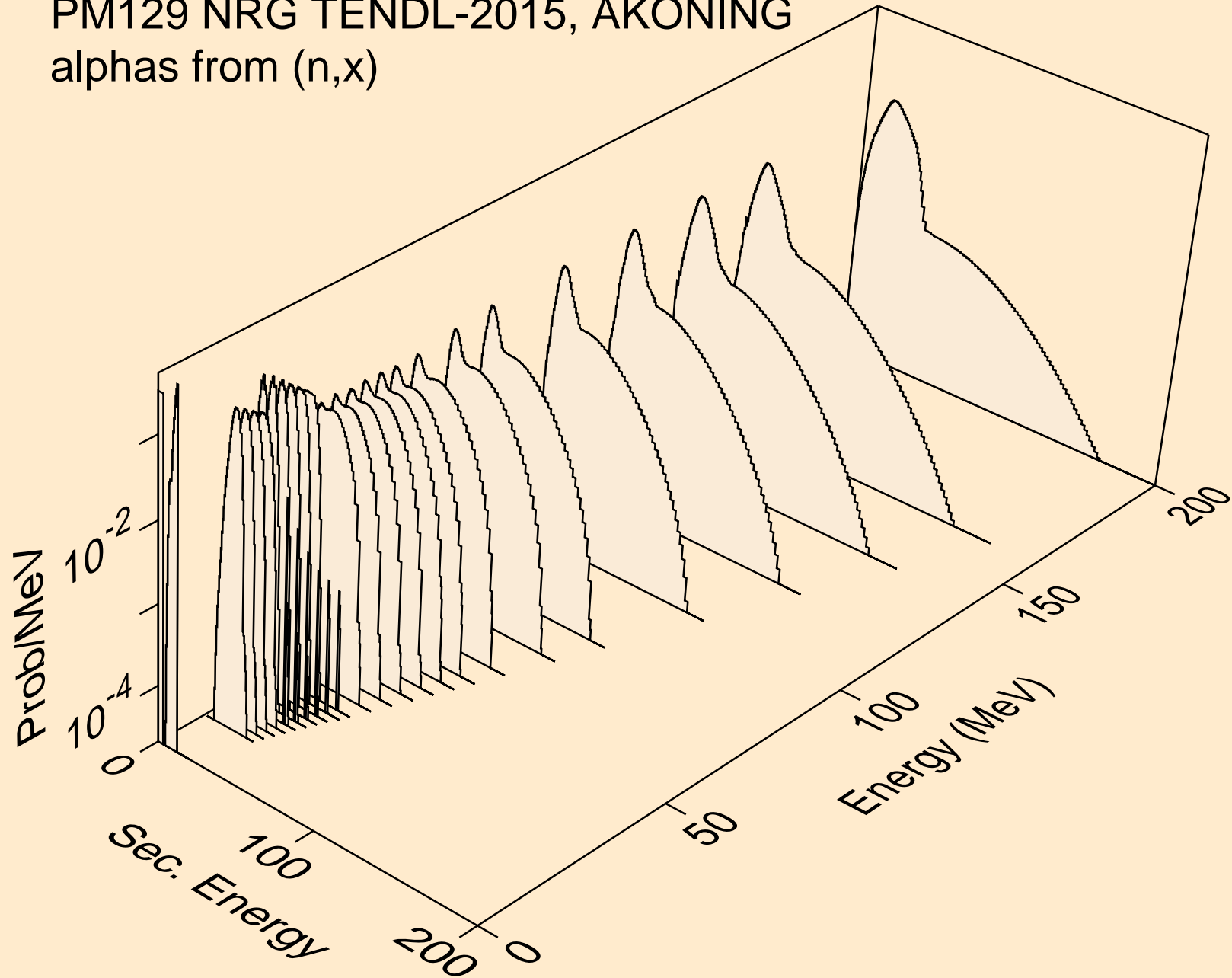



PM129 NRG TENDL-2015, AKONING  
alphas from (n,n\*)a

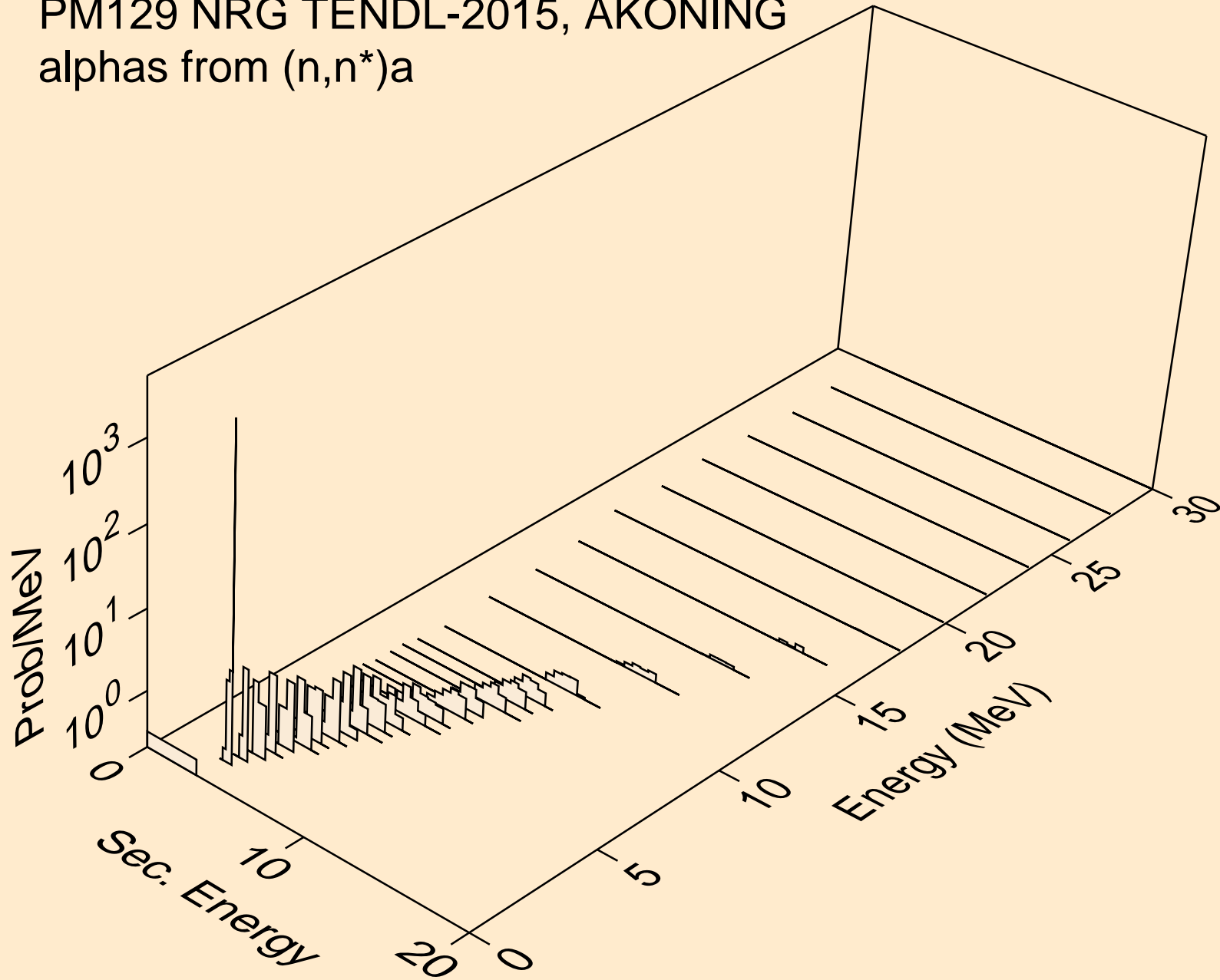

PM129 NRG TENDL-2015, AKONING  
alphas from (n,n\*)3a

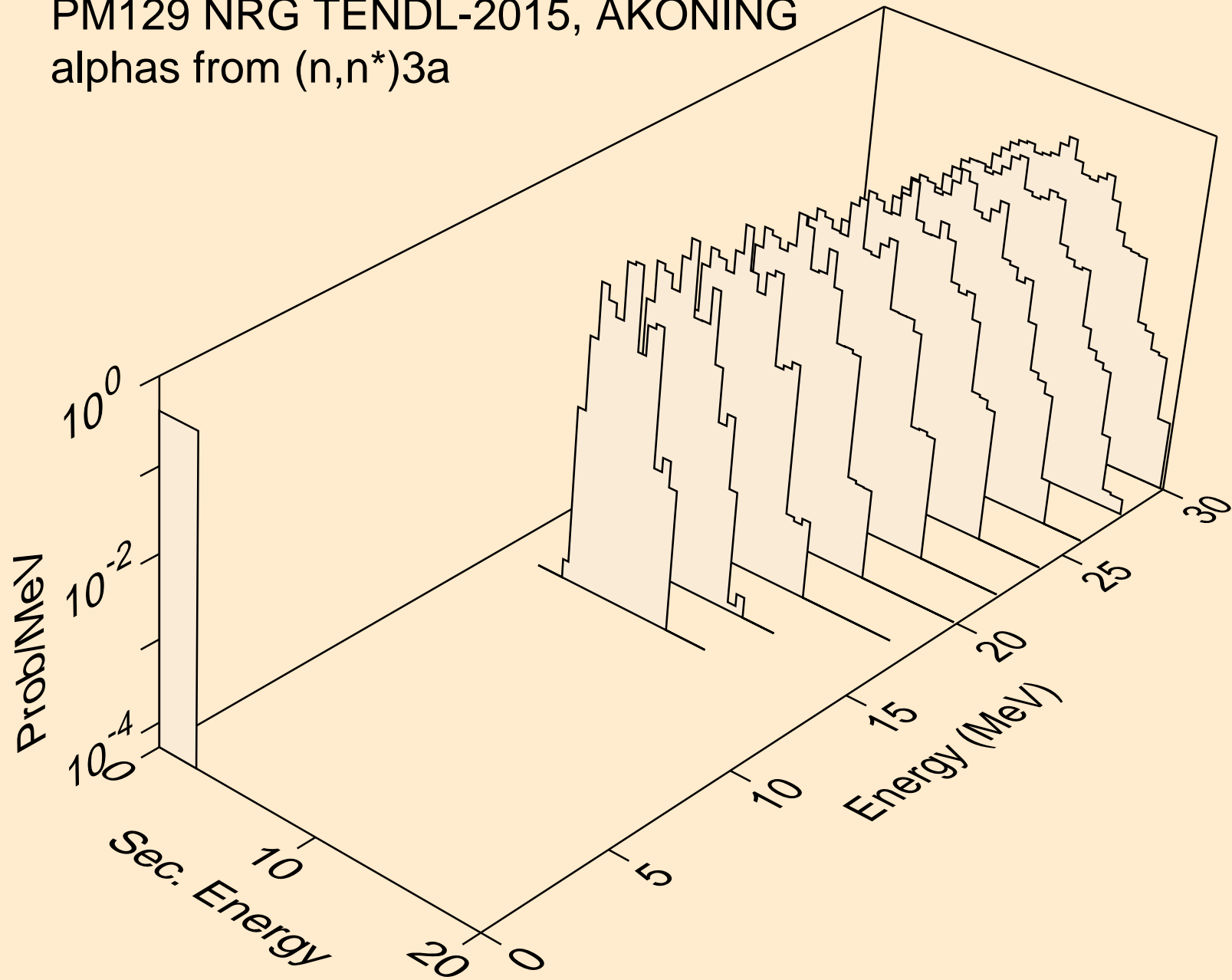

PM129 NRG TENDL-2015, AKONING  
alphas from (n,2n)a

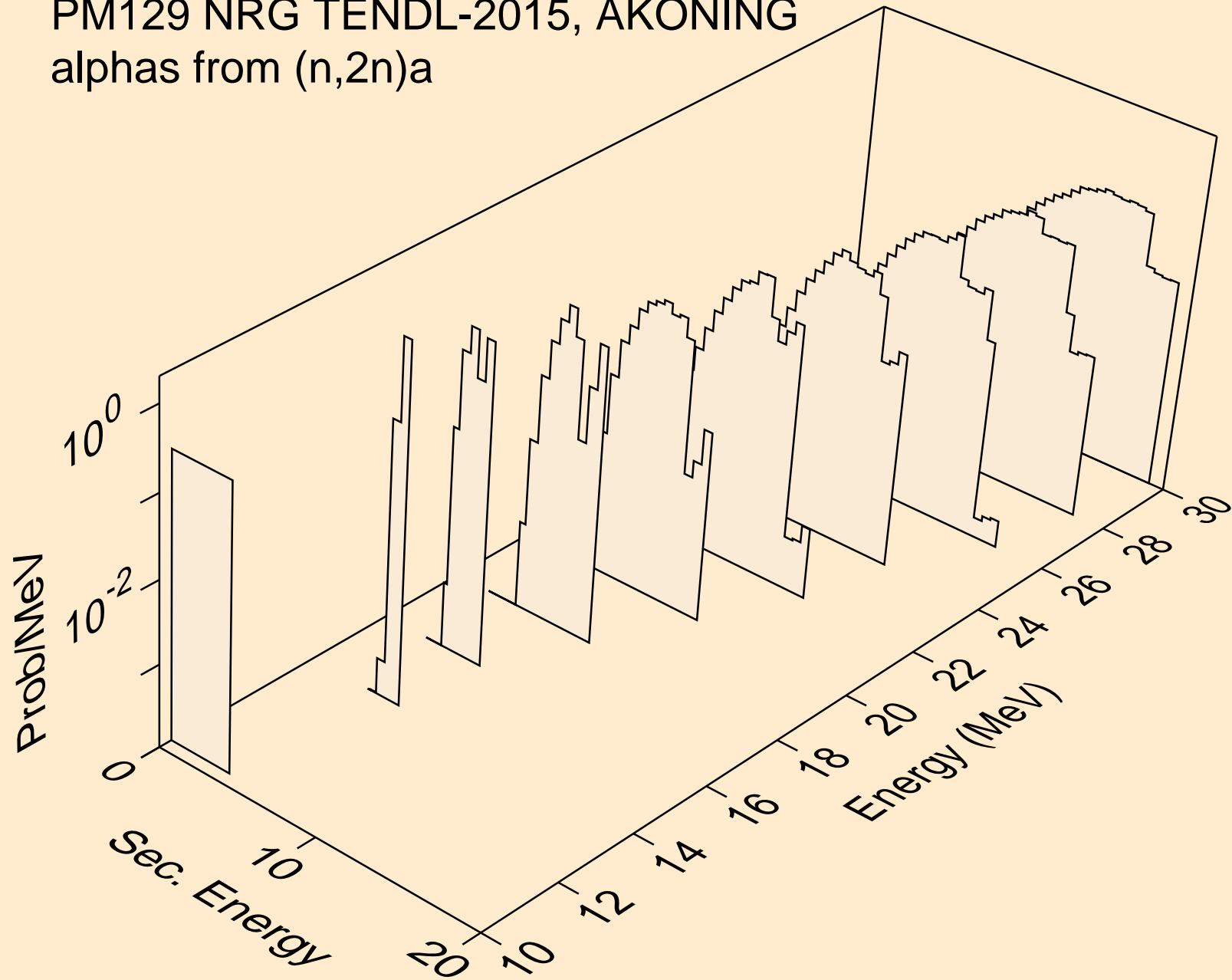

PM129 NRG TENDL-2015, AKONING  
alphas from (n,n\*)2a

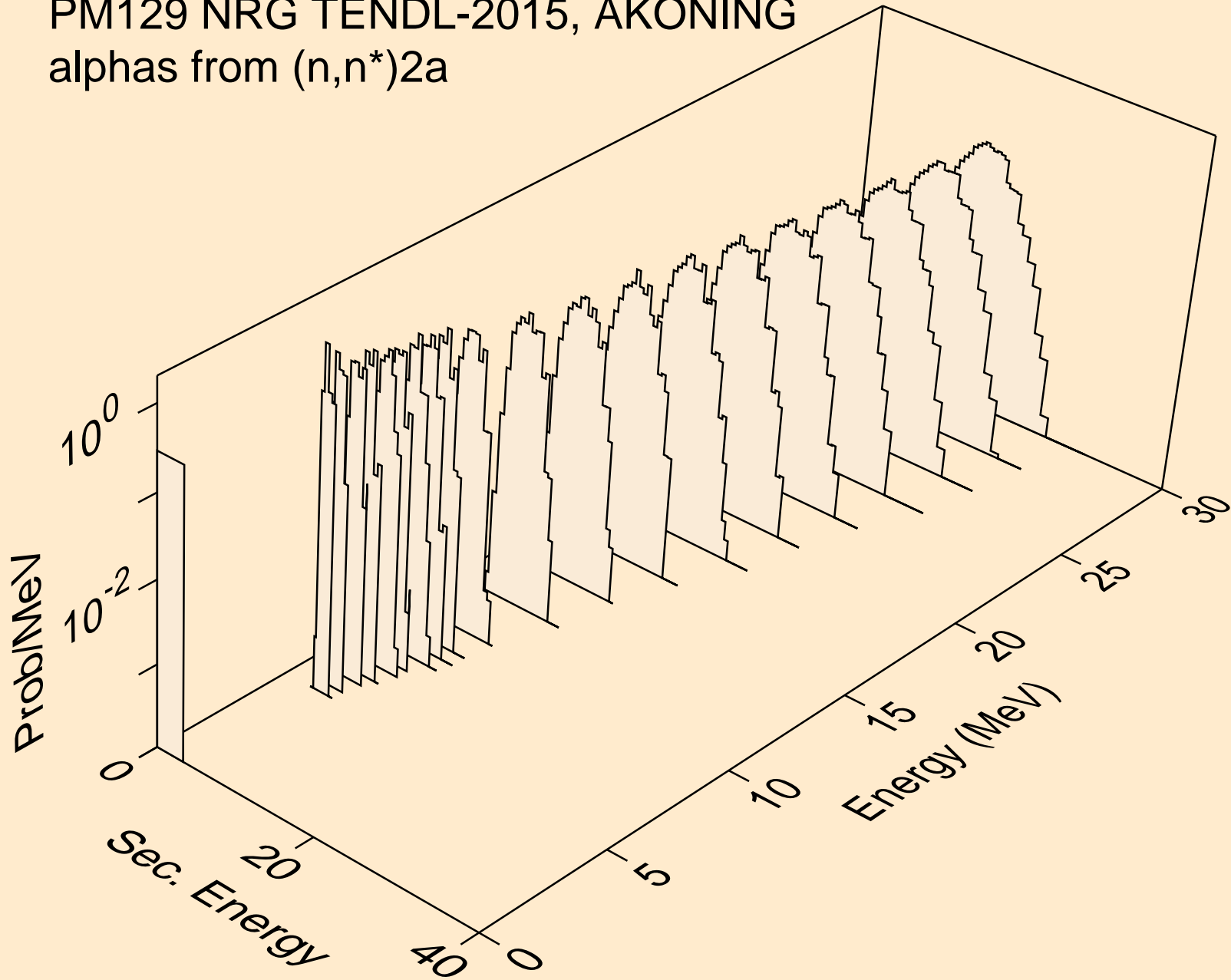

PM129 NRG TENDL-2015, AKONING  
alphas from (n,npa)

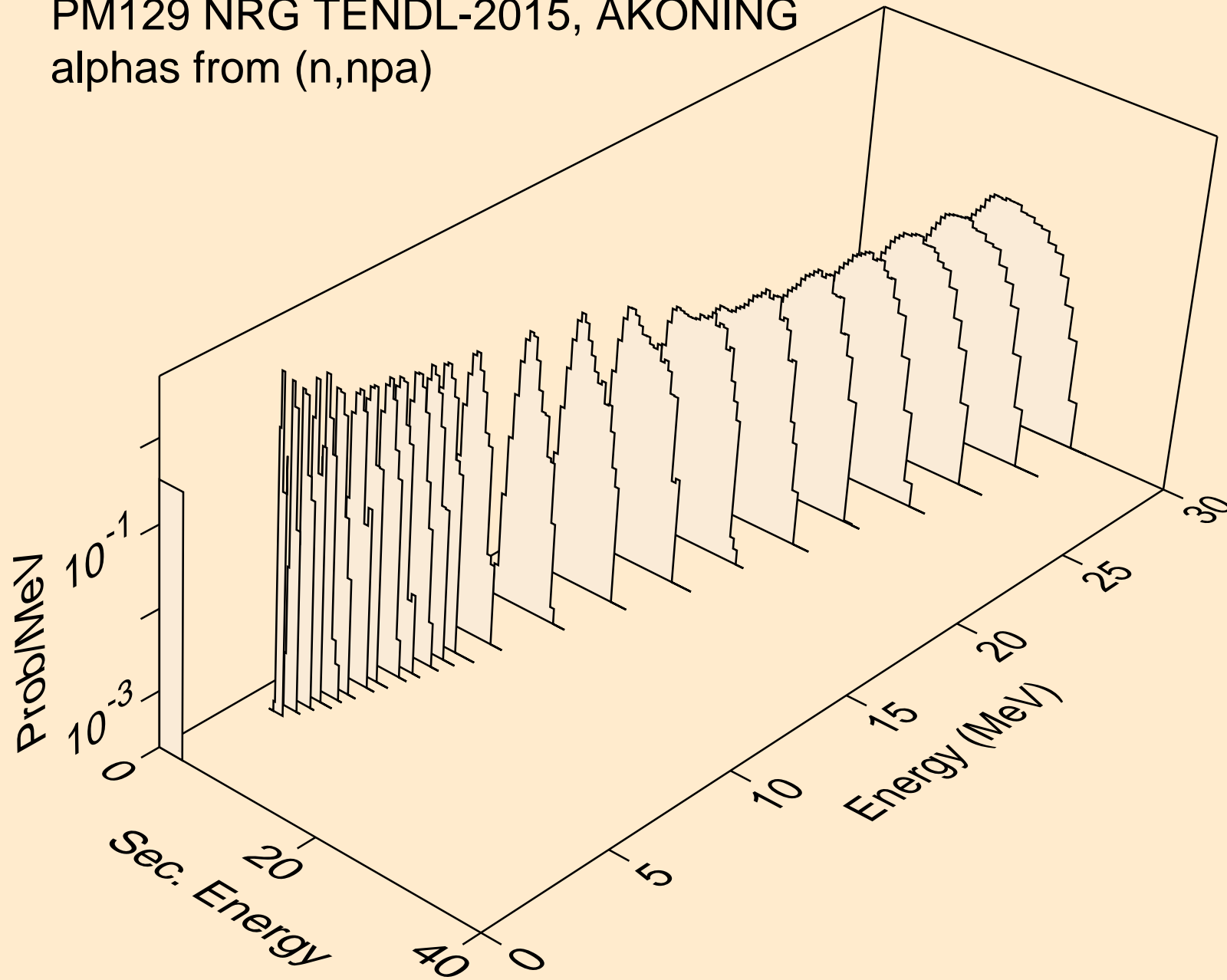

PM129 NRG TENDL-2015, AKONING  
alphas from (n,a)

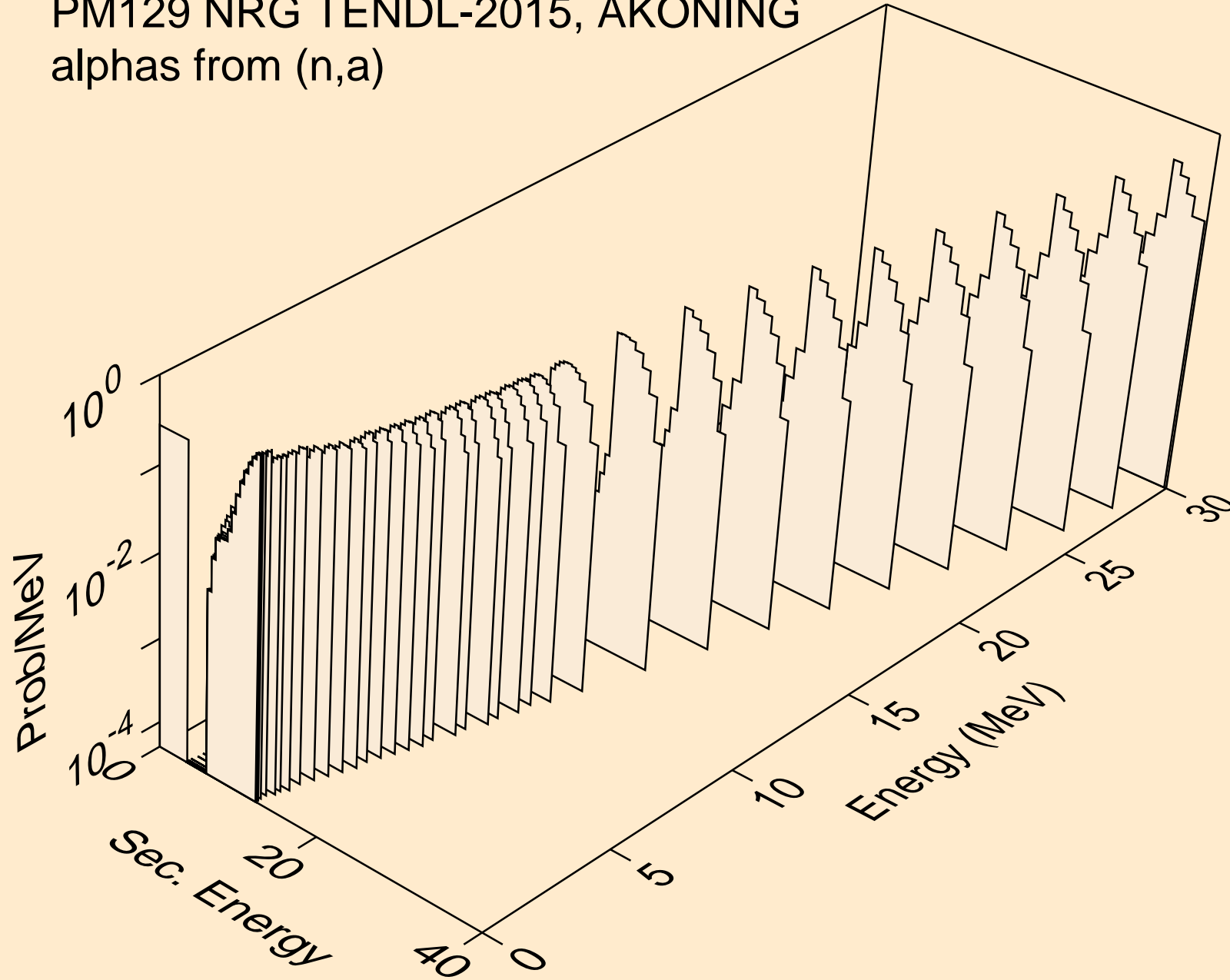

PM129 NRG TENDL-2015, AKONING  
alphas from (n,2a)

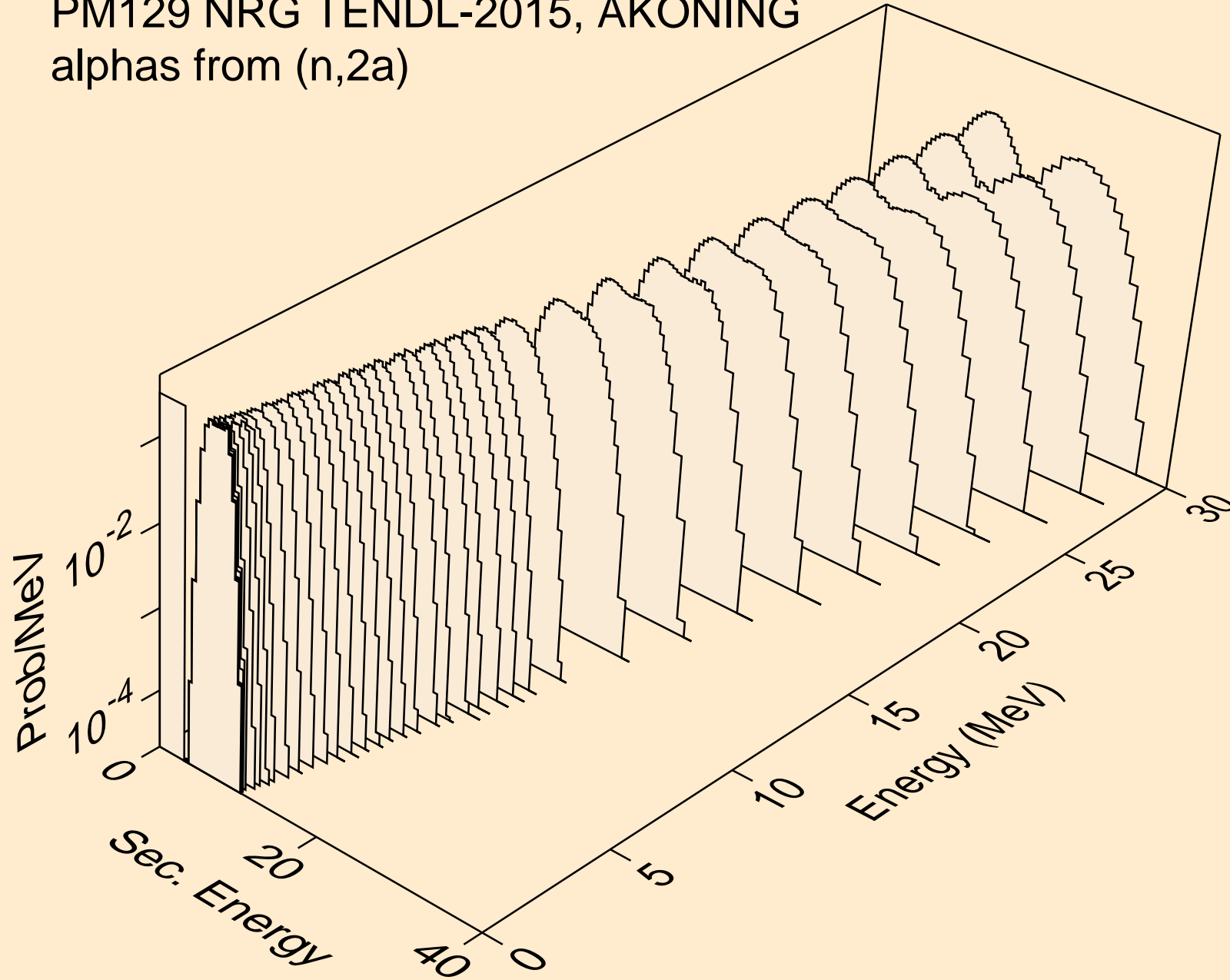

PM129 NRG TENDL-2015, AKONING  
alphas from (n,3a)

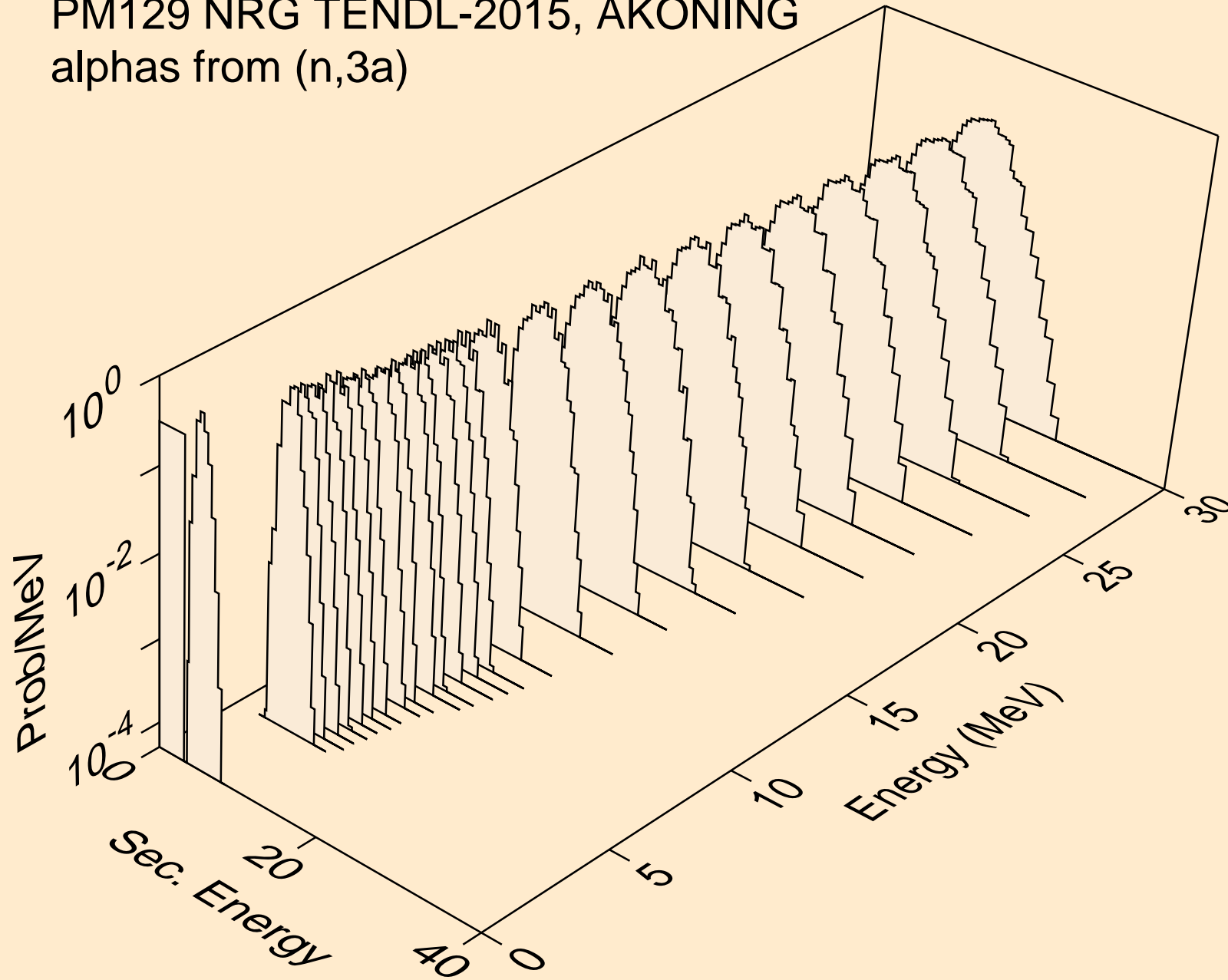



PM129 NRG TENDL-2015, AKONING  
alphas from (n,pa)

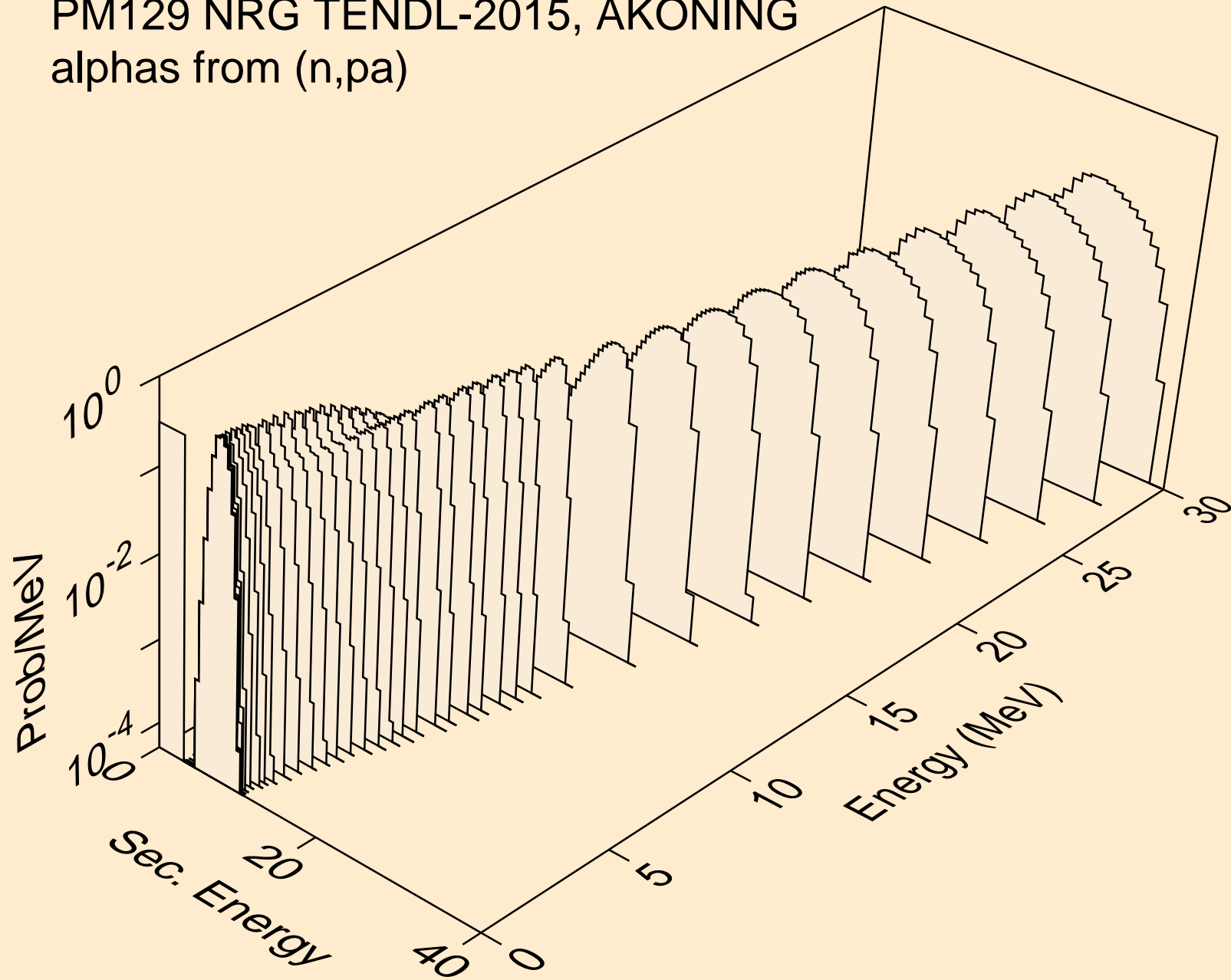

PM129 NRG TENDL-2015, AKONING  
alphas from (n,t2a)

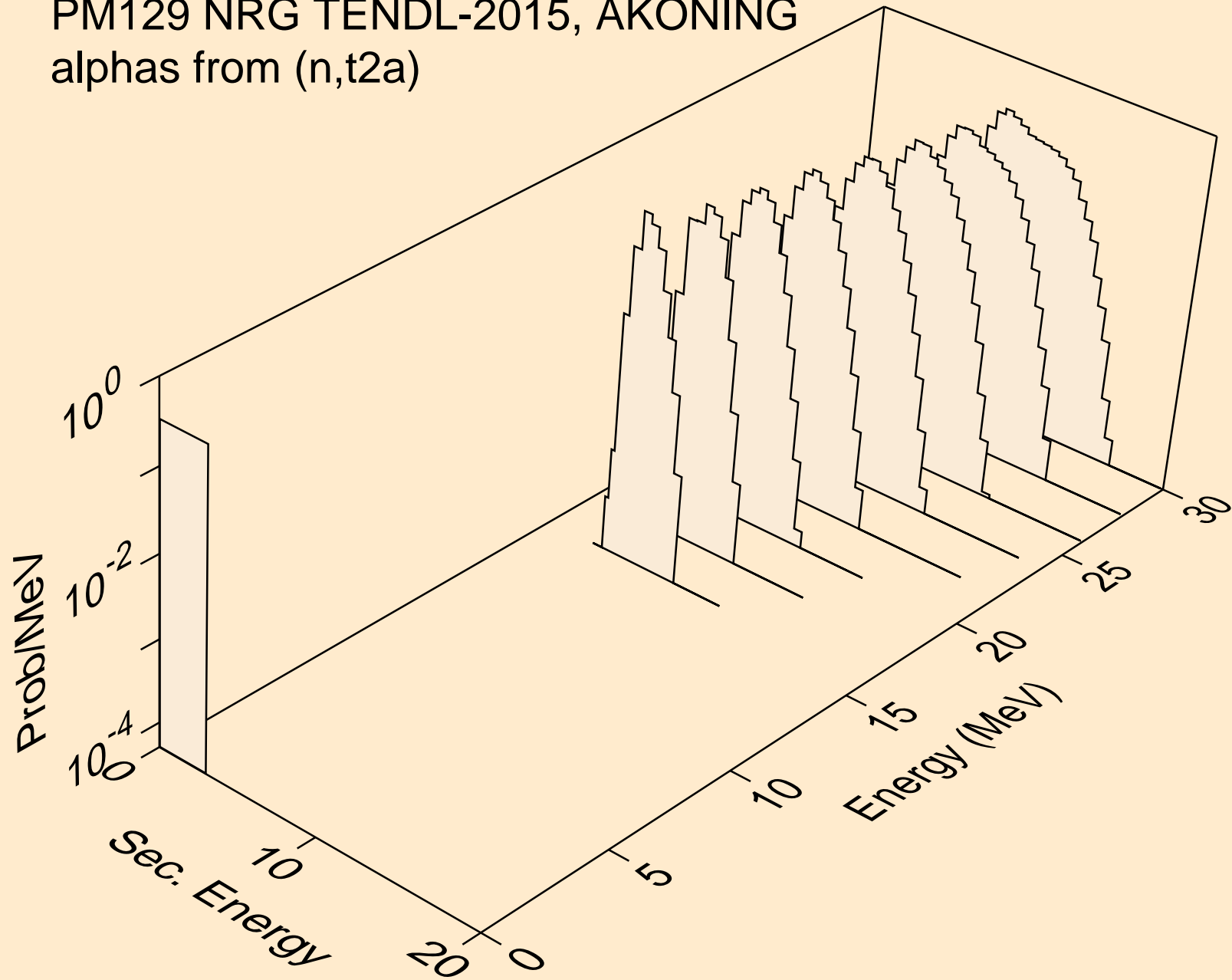

PM129 NRG TENDL-2015, AKONING  
alphas from (n,d2a)

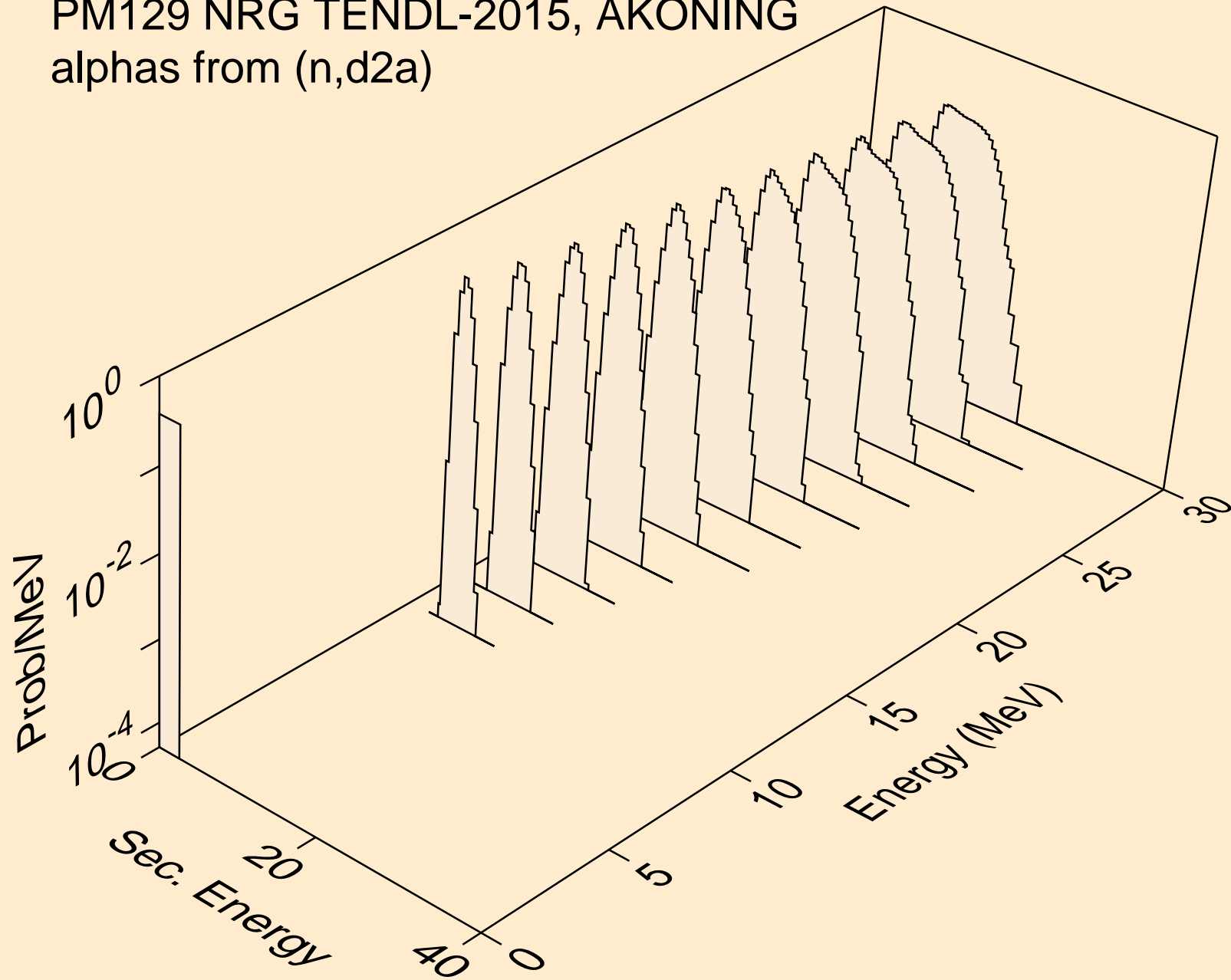

PM129 NRG TENDL-2015, AKONING  
alphas from (n,da)

