

PR124 NRG TENDL-2015, AKONING

Principal cross sections

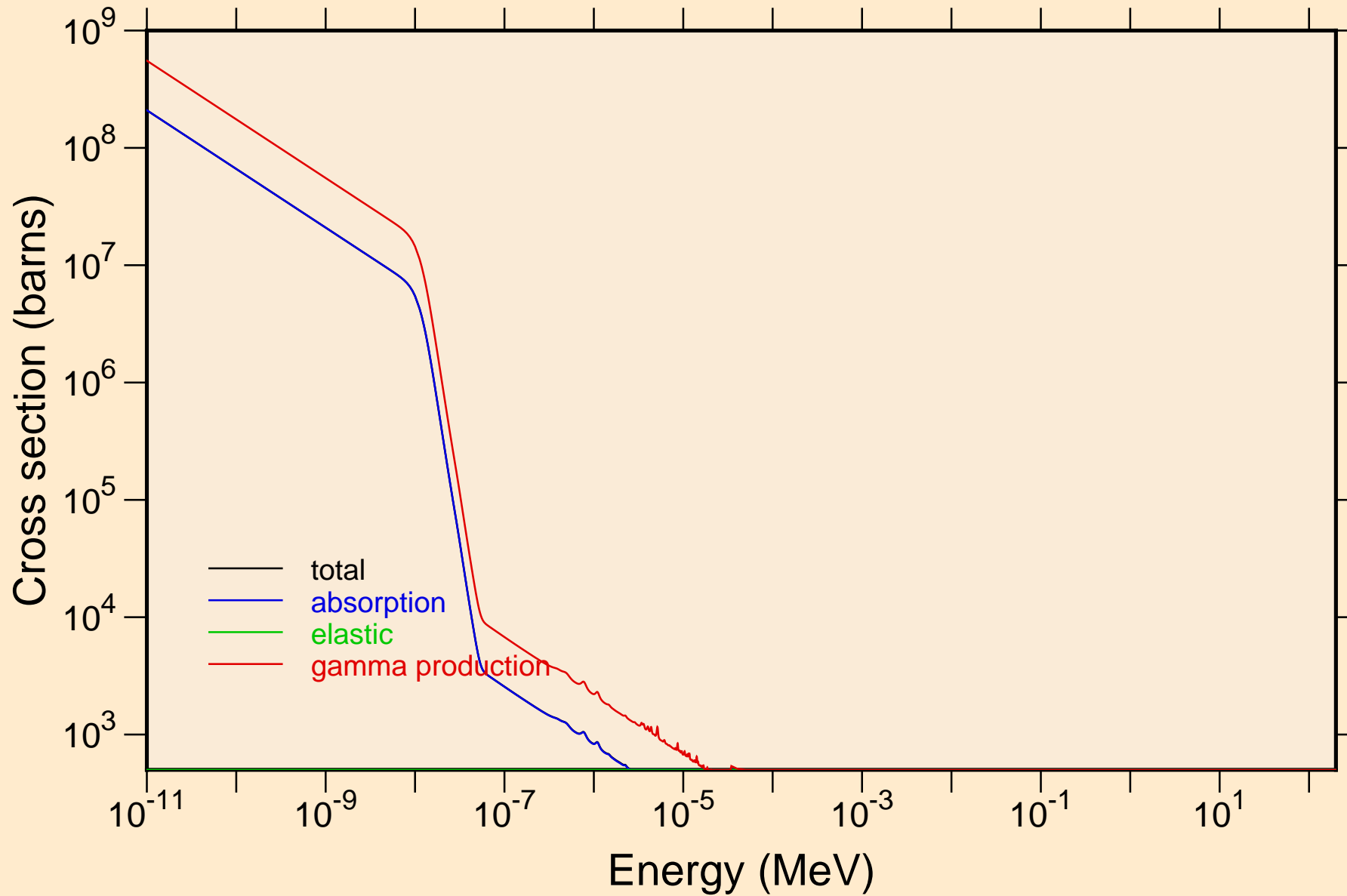

PR124 NRG TENDL-2015, AKONING
resonance total cross section

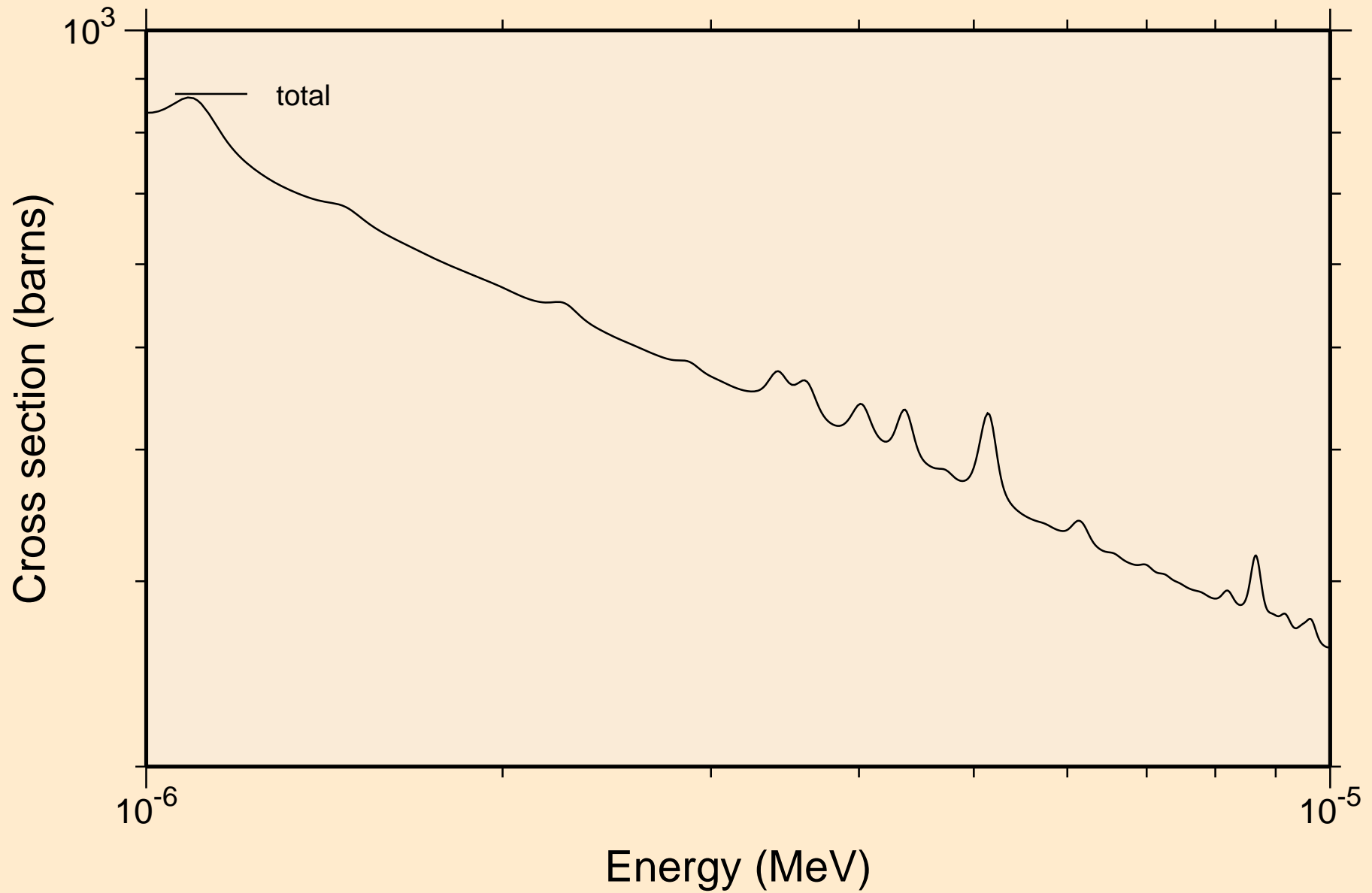

PR124 NRG TENDL-2015, AKONING
resonance total cross section

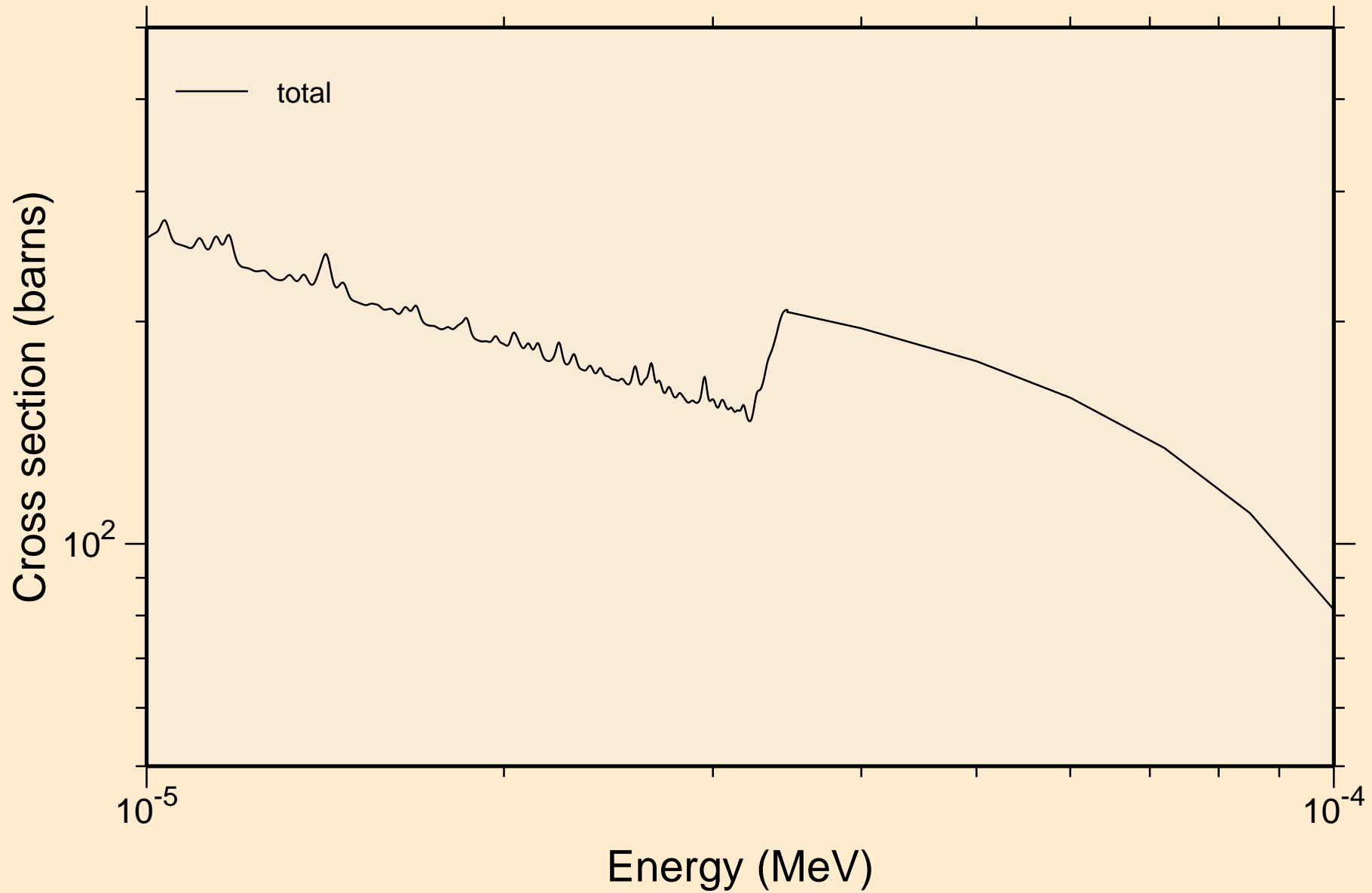

PR124 NRG TENDL-2015, AKONING
resonance total cross section

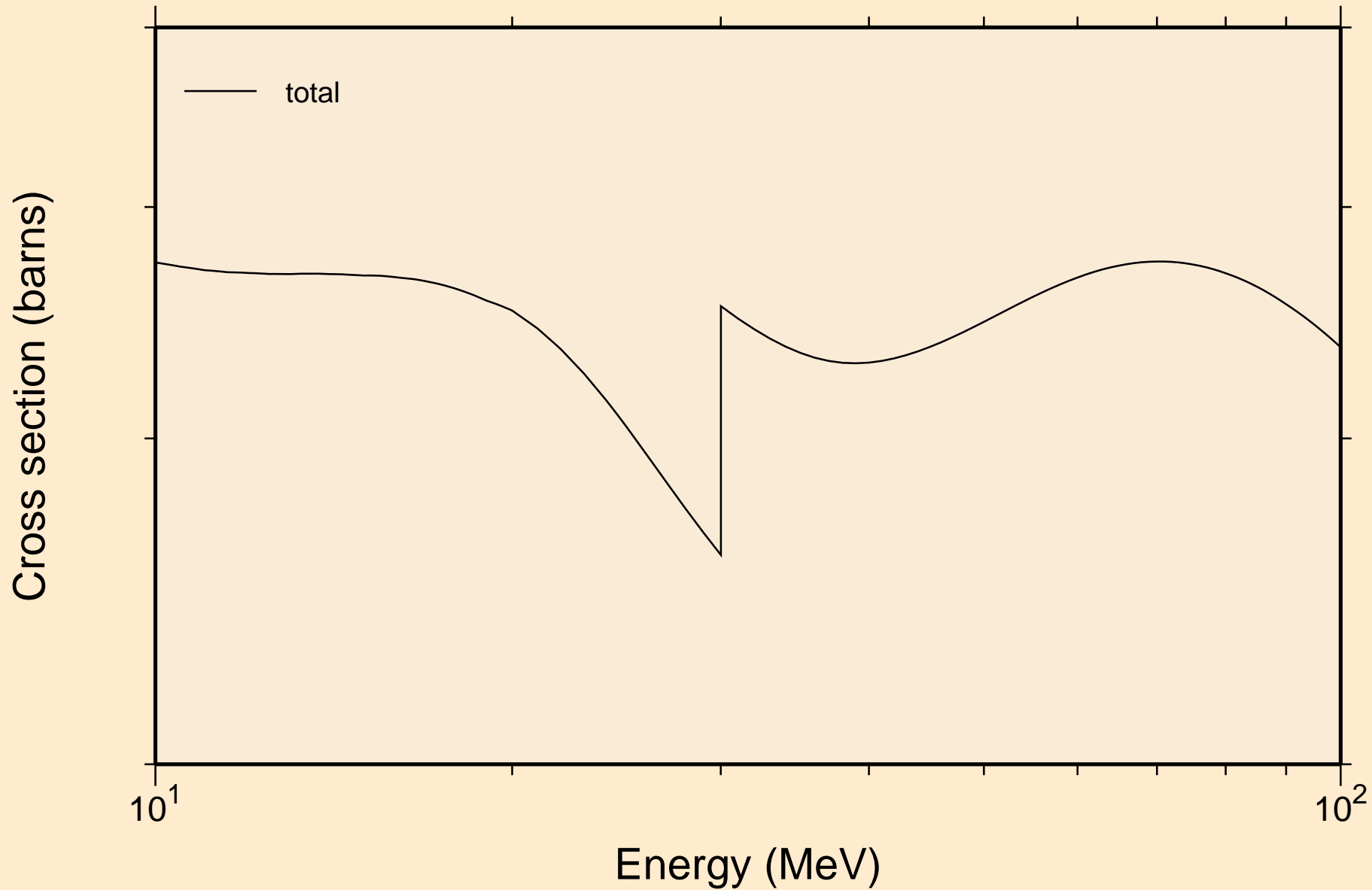

PR124 NRG TENDL-2015, AKONING
resonance absorption cross sections

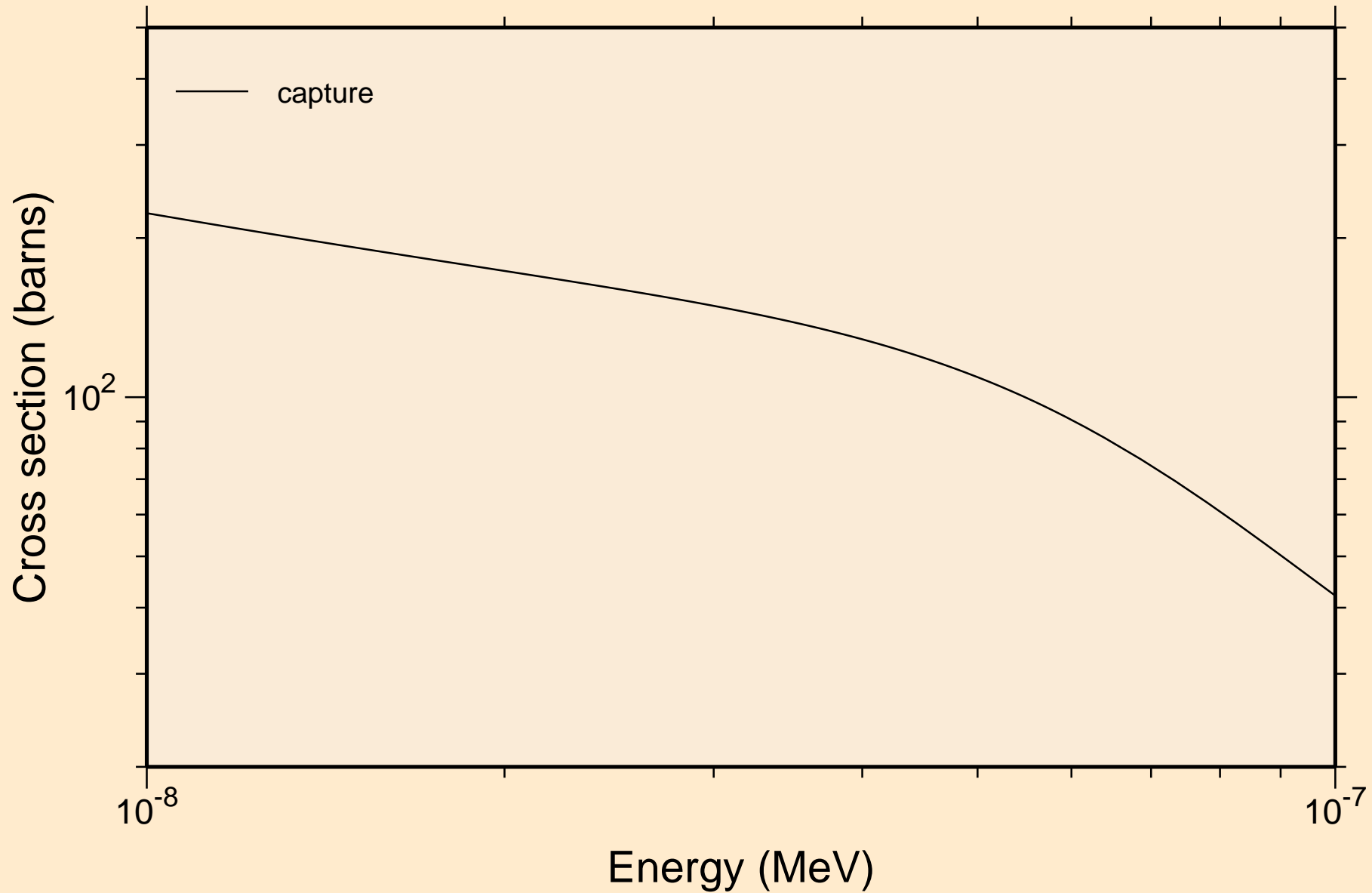

PR124 NRG TENDL-2015, AKONING
resonance absorption cross sections

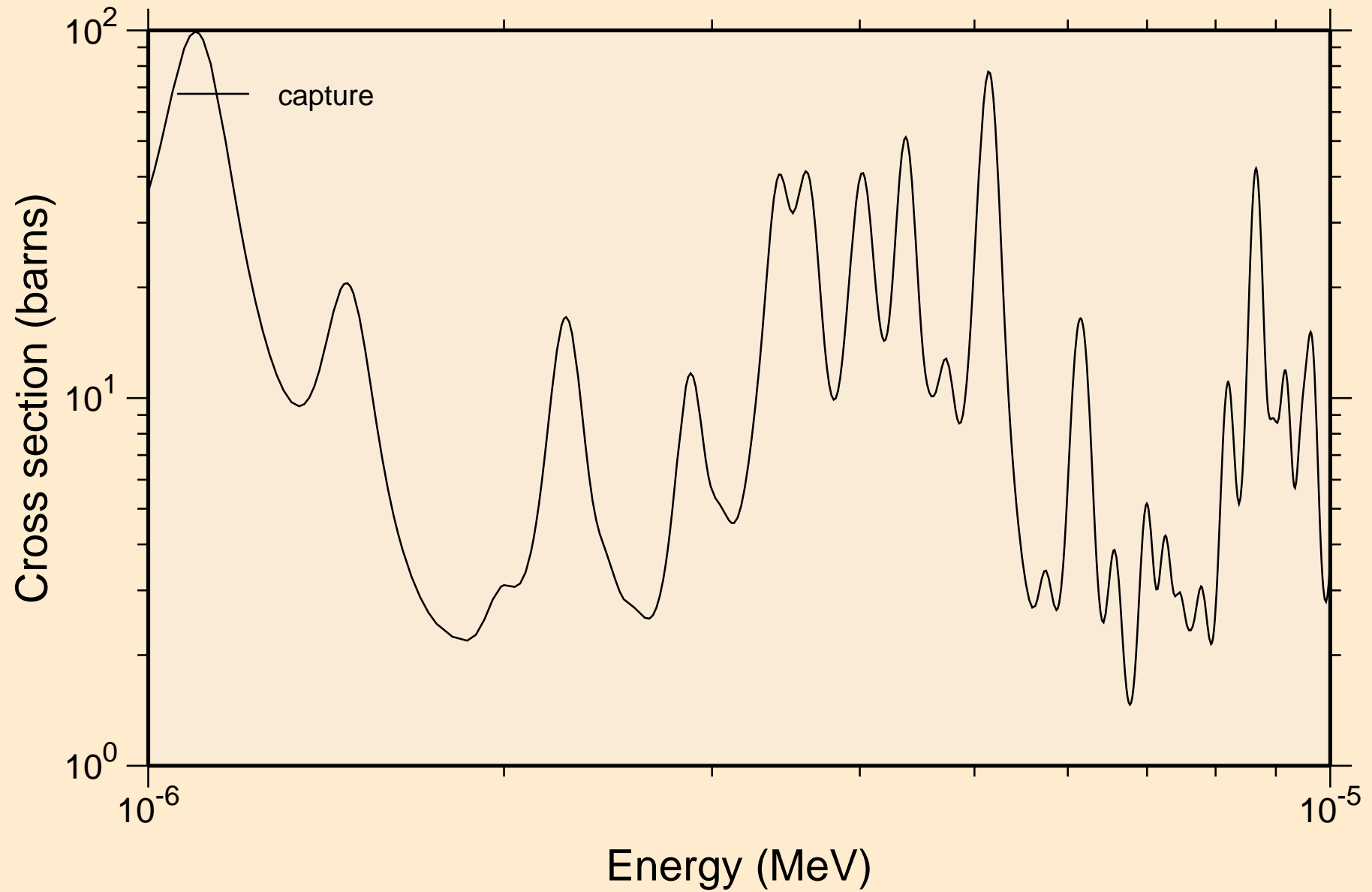

PR124 NRG TENDL-2015, AKONING
resonance absorption cross sections

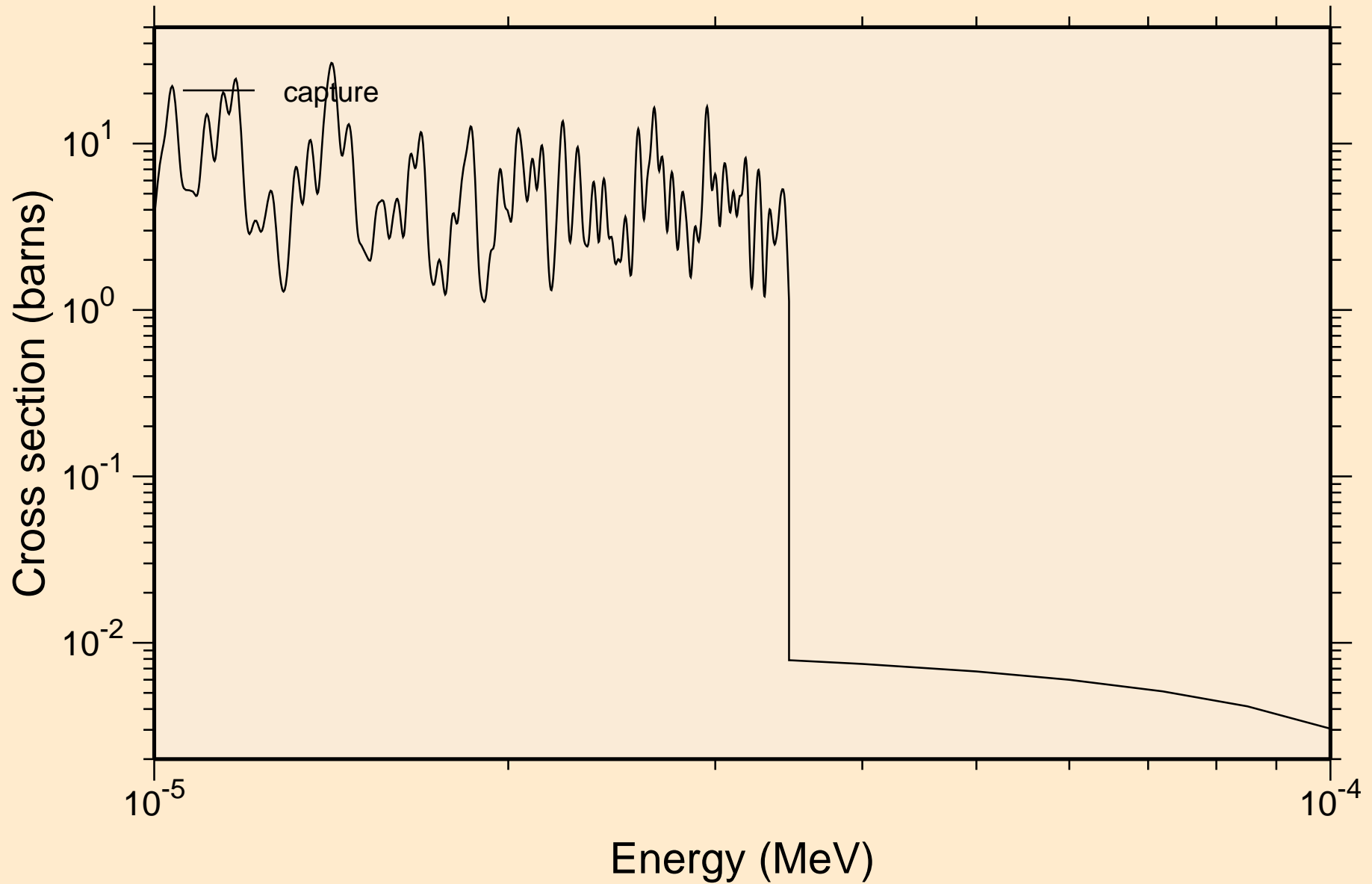

PR124 NRG TENDL-2015, AKONING
resonance absorption cross sections

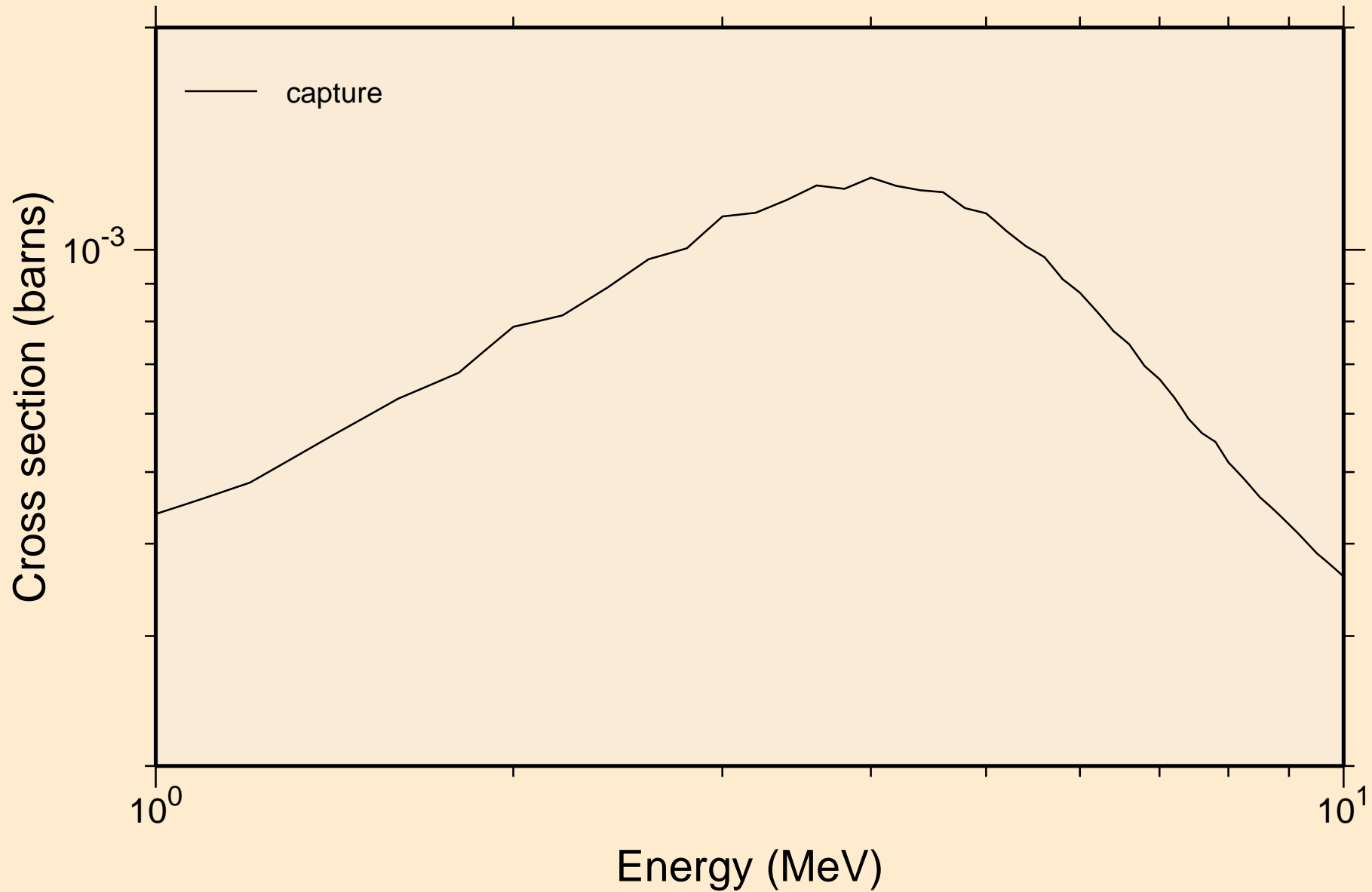

PR124 NRG TENDL-2015, AKONING

Non-threshold reactions

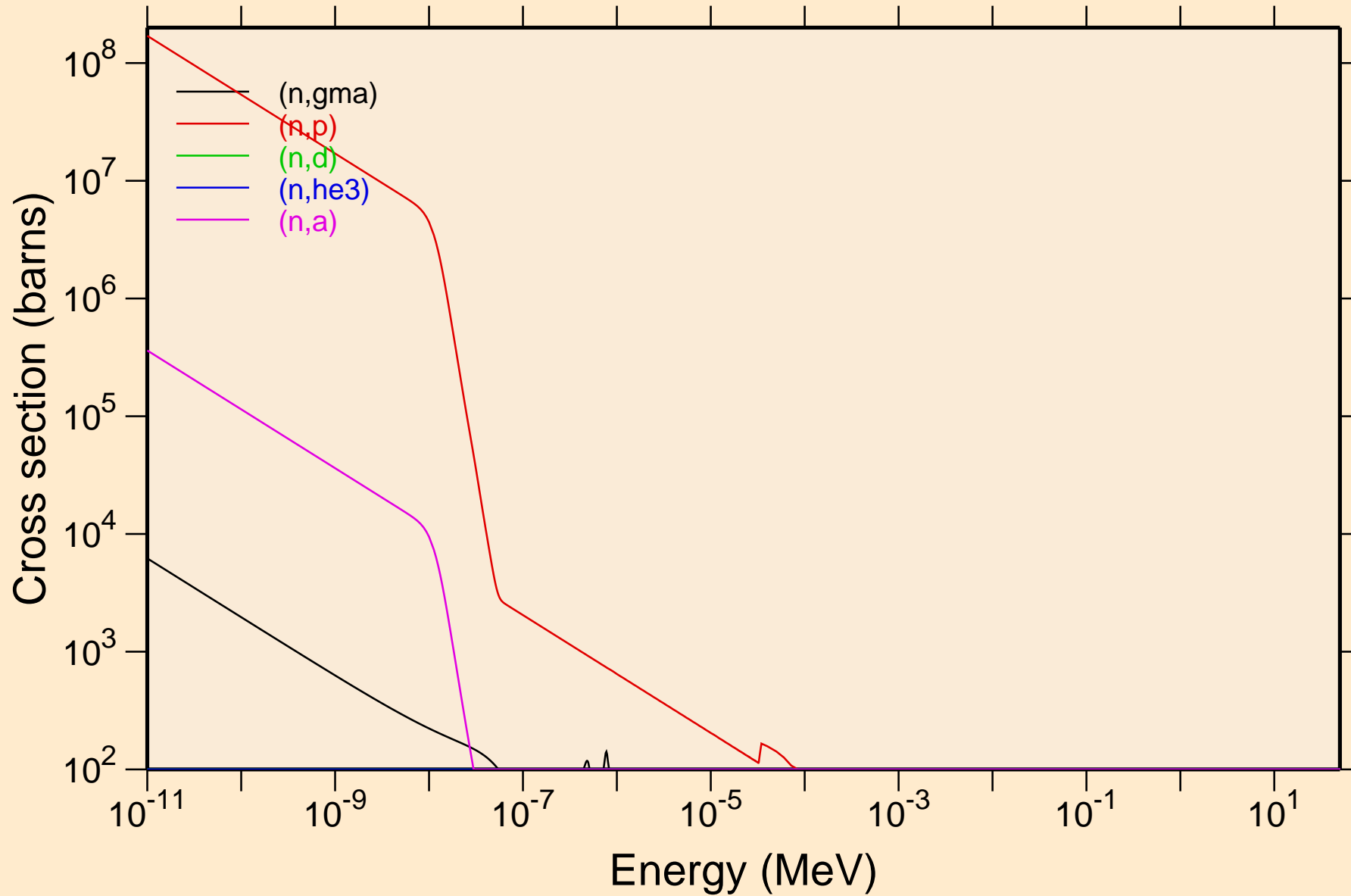

PR124 NRG TENDL-2015, AKONING

Non-threshold reactions

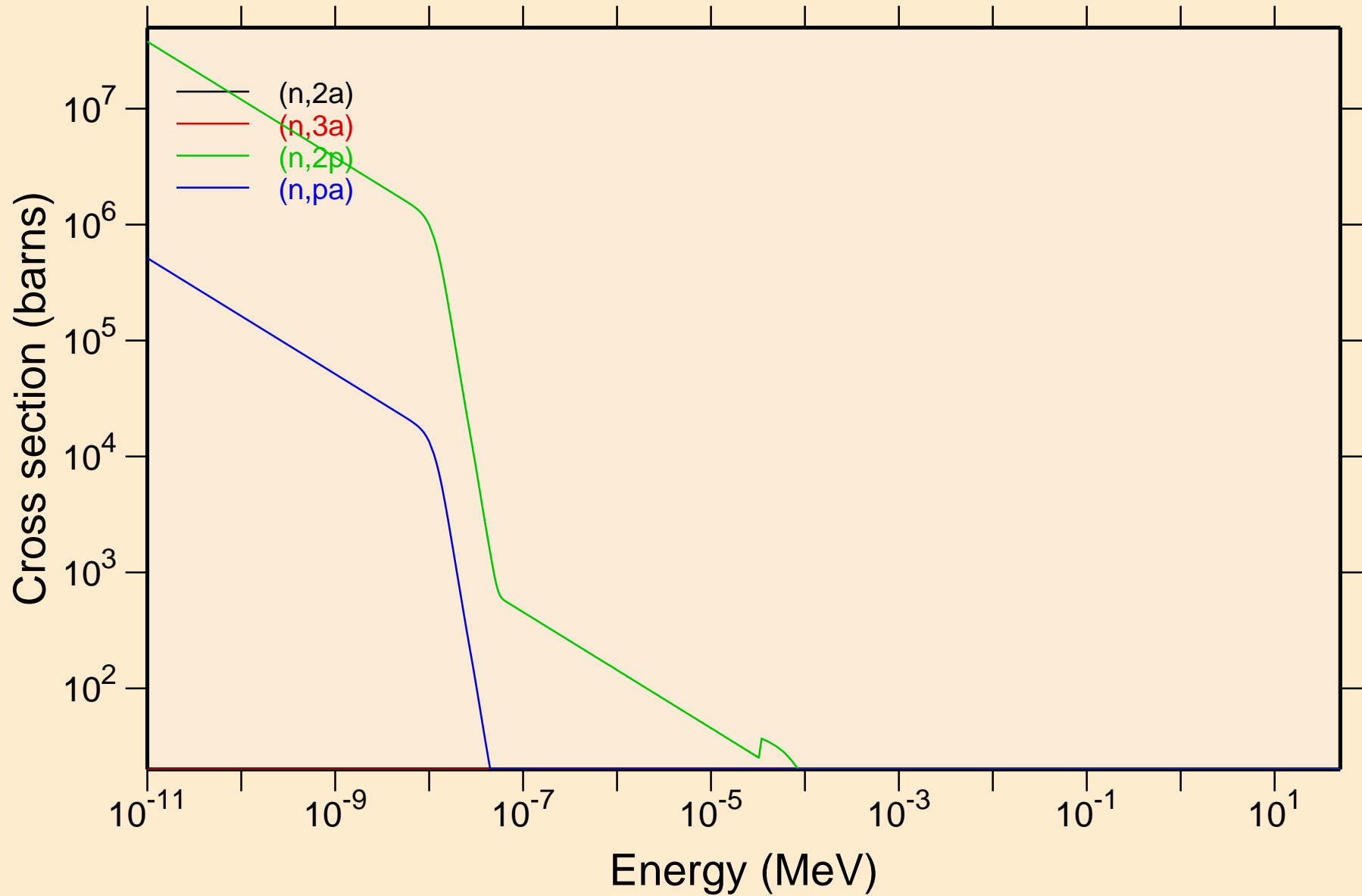

PR124 NRG TENDL-2015, AKONING

Principal cross sections

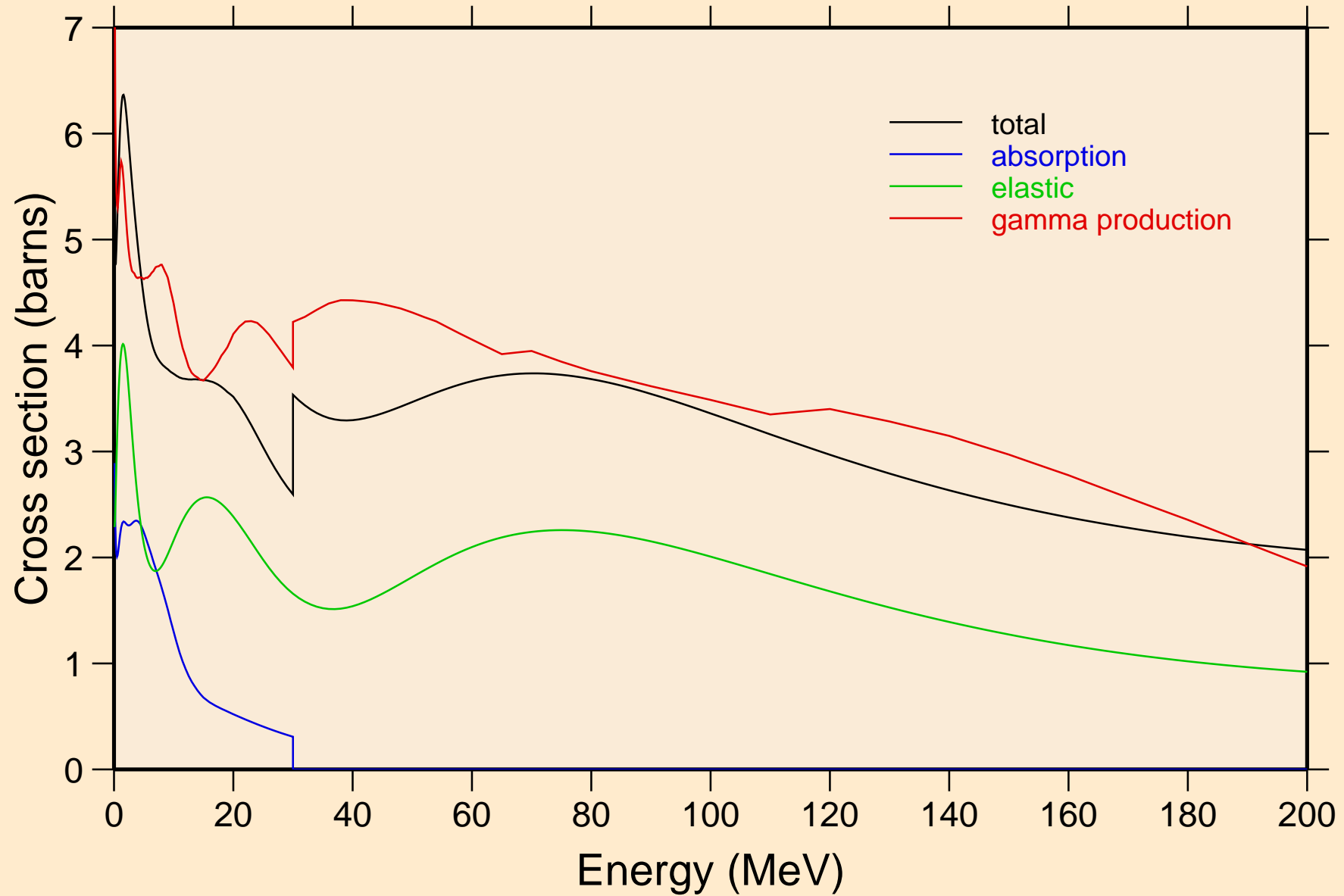

PR124 NRG TENDL-2015, AKONING

Non-threshold reactions

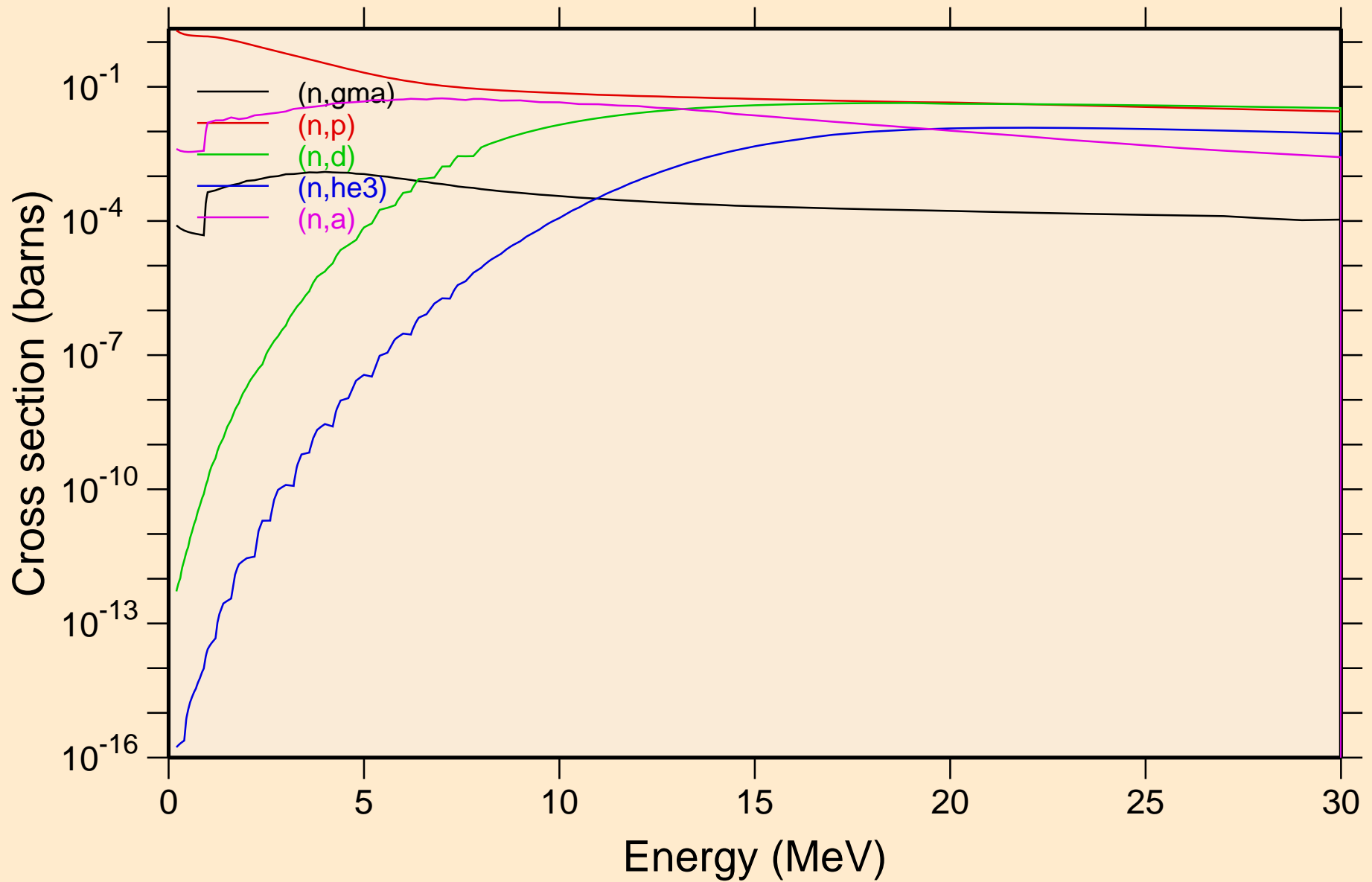

PR124 NRG TENDL-2015, AKONING
Non-threshold reactions

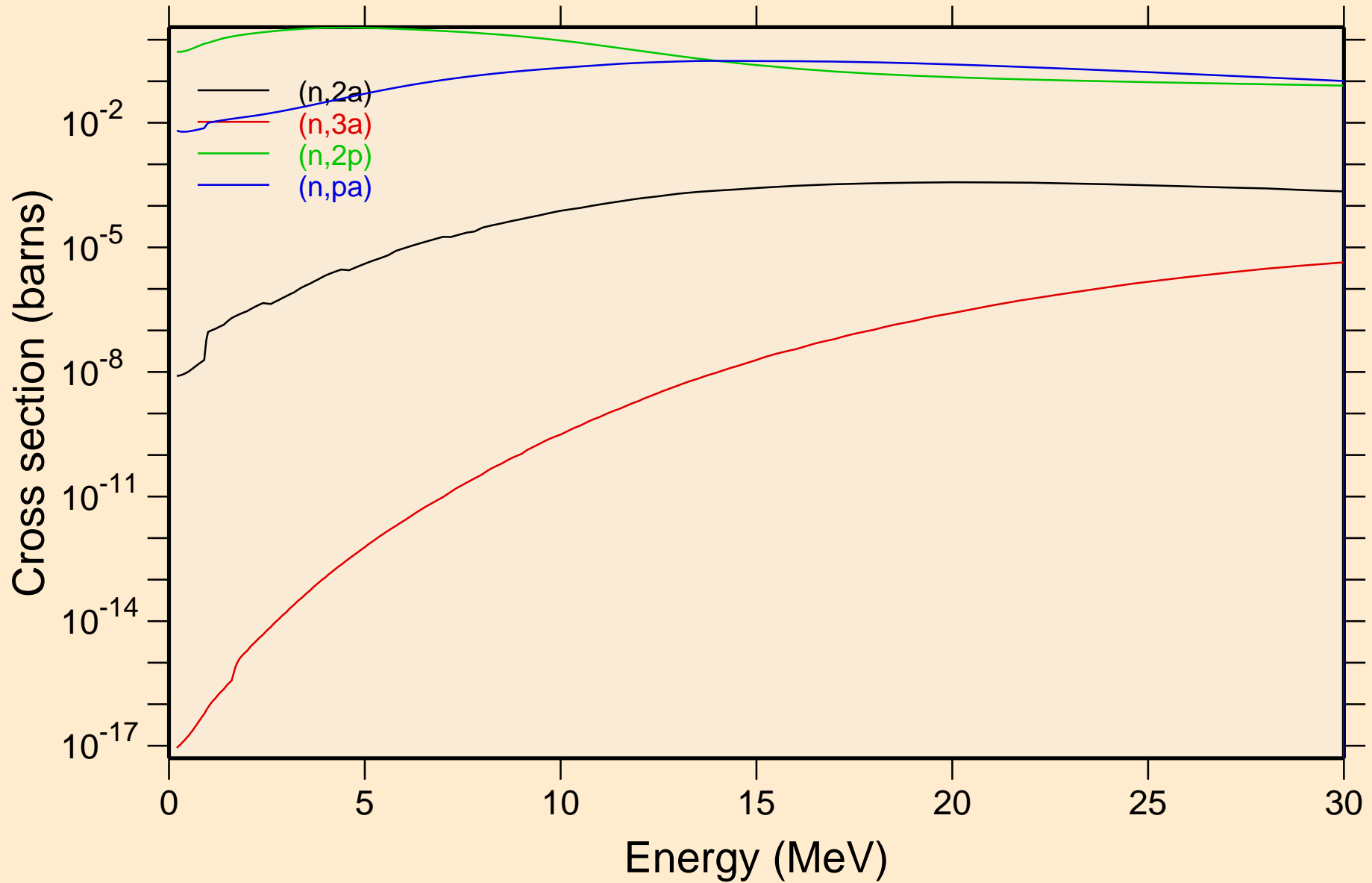

PR124 NRG TENDL-2015, AKONING
Inelastic levels

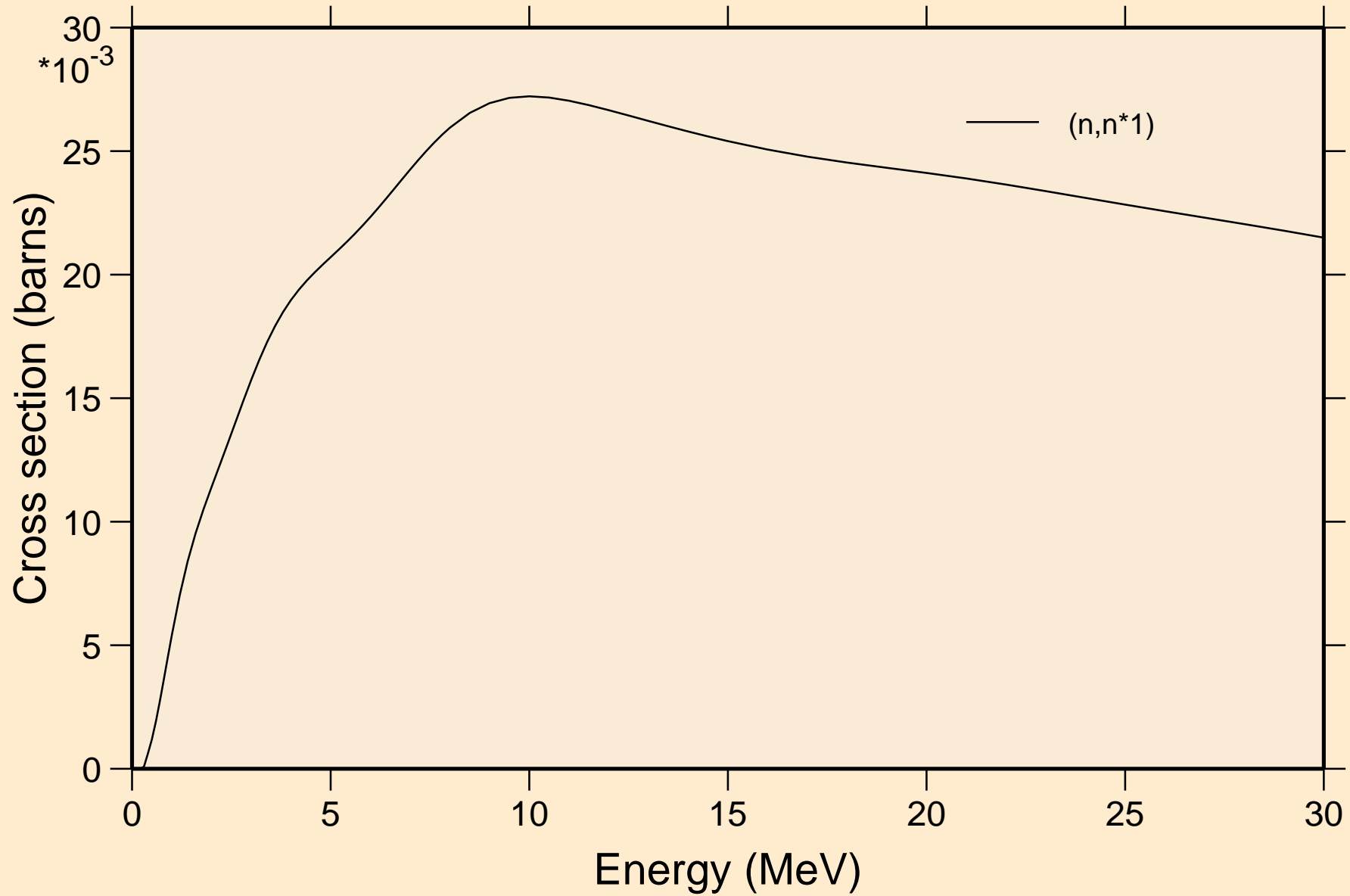

PR124 NRG TENDL-2015, AKONING

Threshold reactions

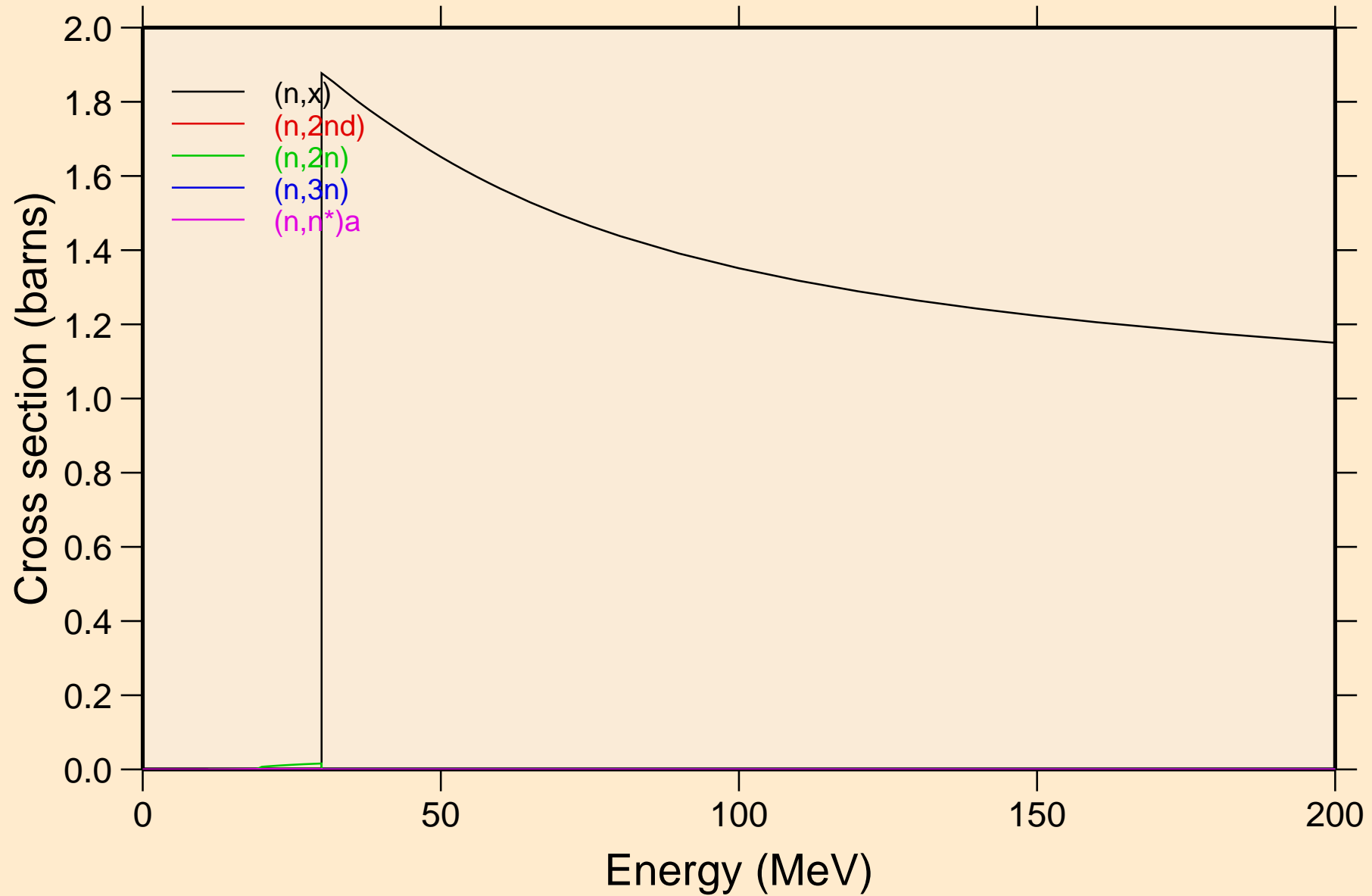

PR124 NRG TENDL-2015, AKONING

Threshold reactions

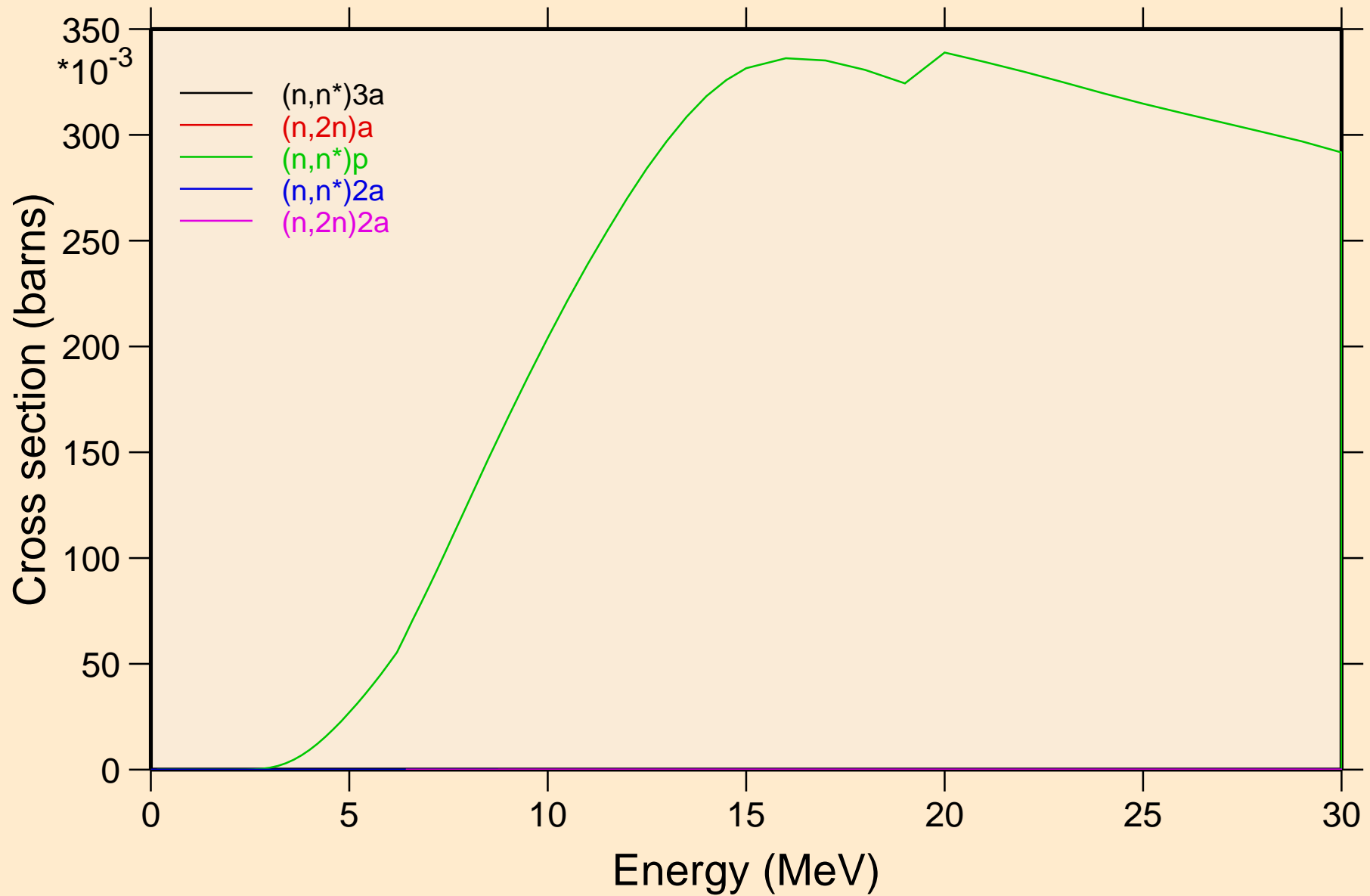

PR124 NRG TENDL-2015, AKONING

Threshold reactions

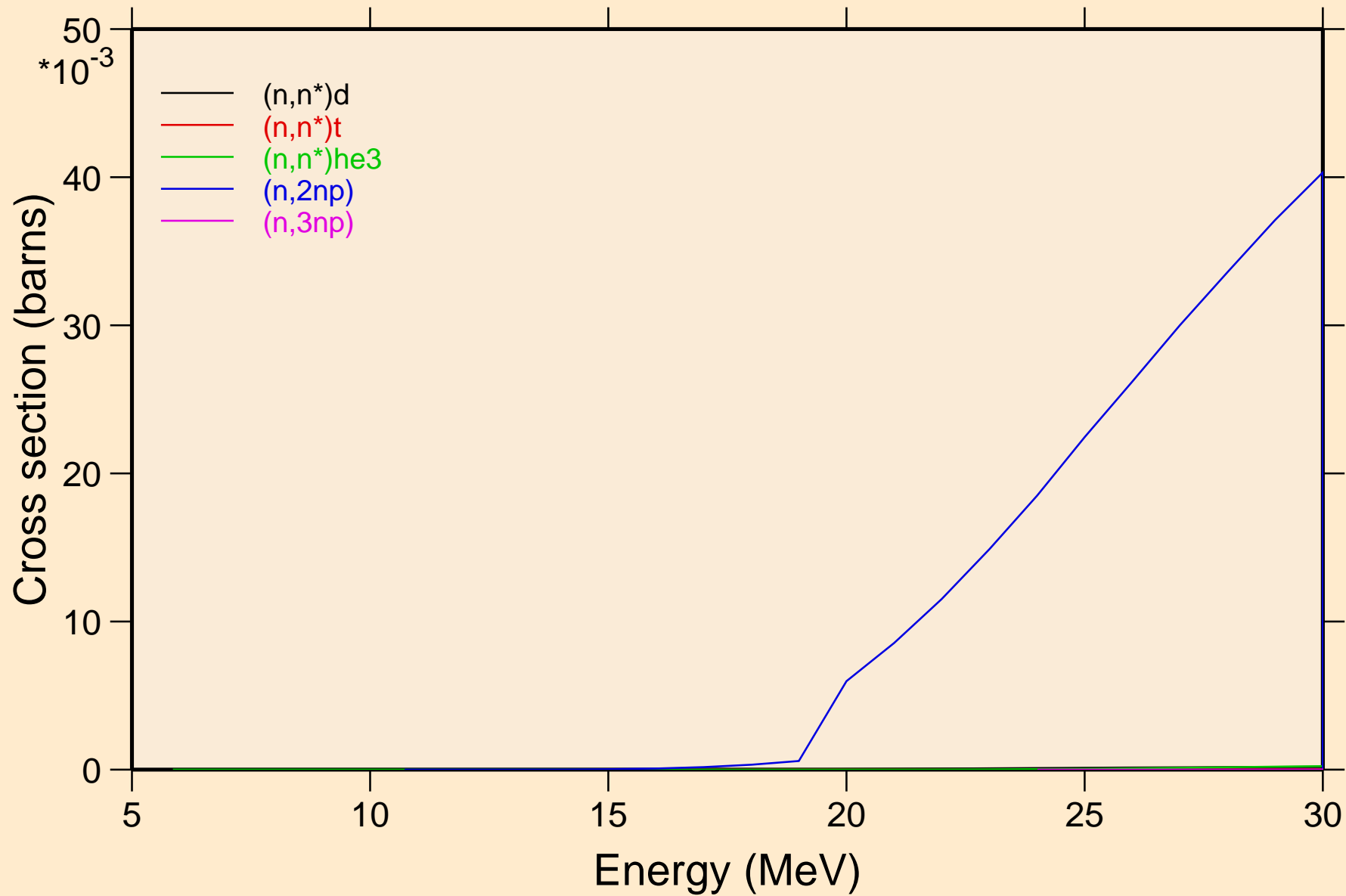

PR124 NRG TENDL-2015, AKONING

Threshold reactions

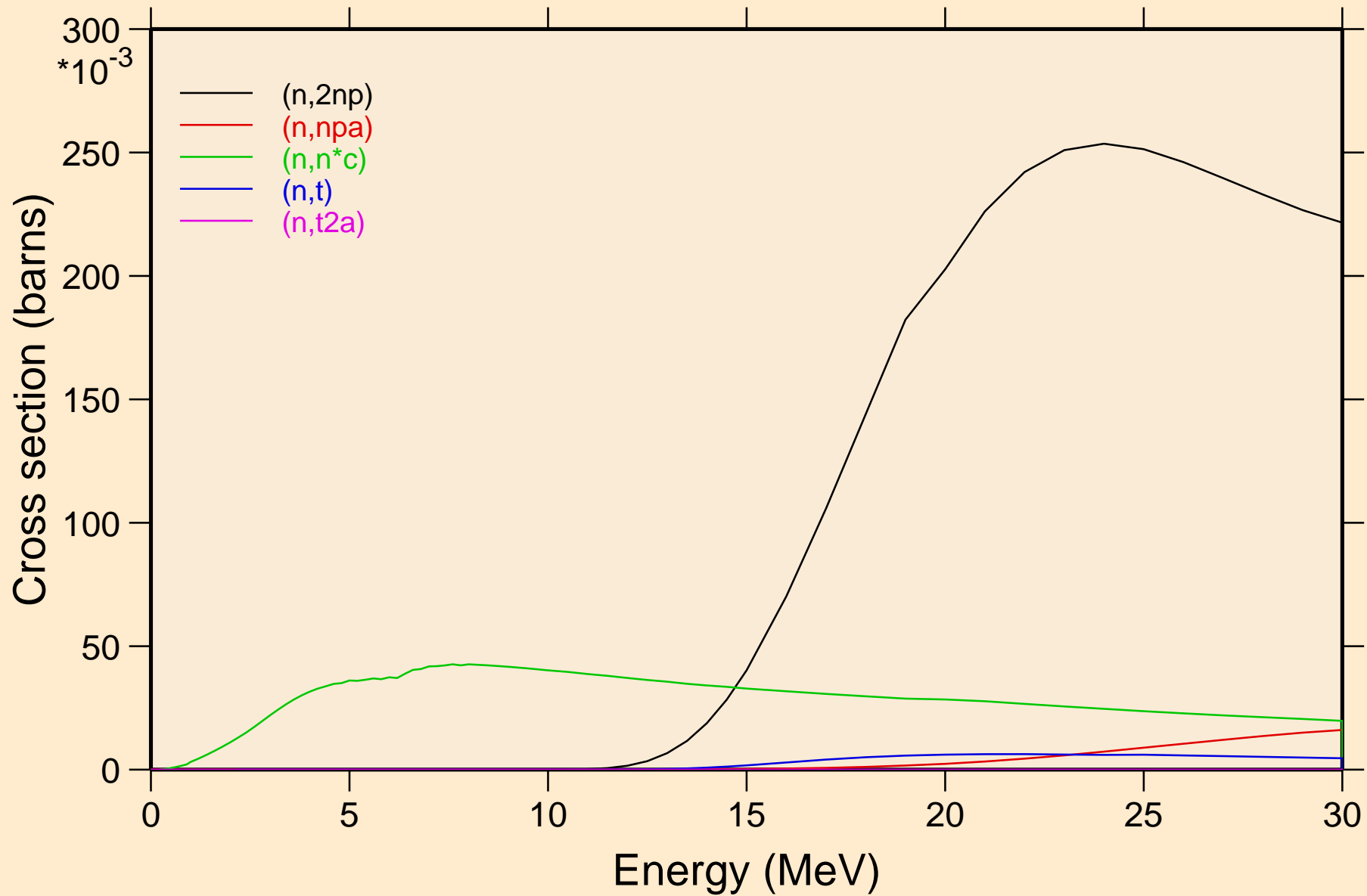

PR124 NRG TENDL-2015, AKONING

Threshold reactions

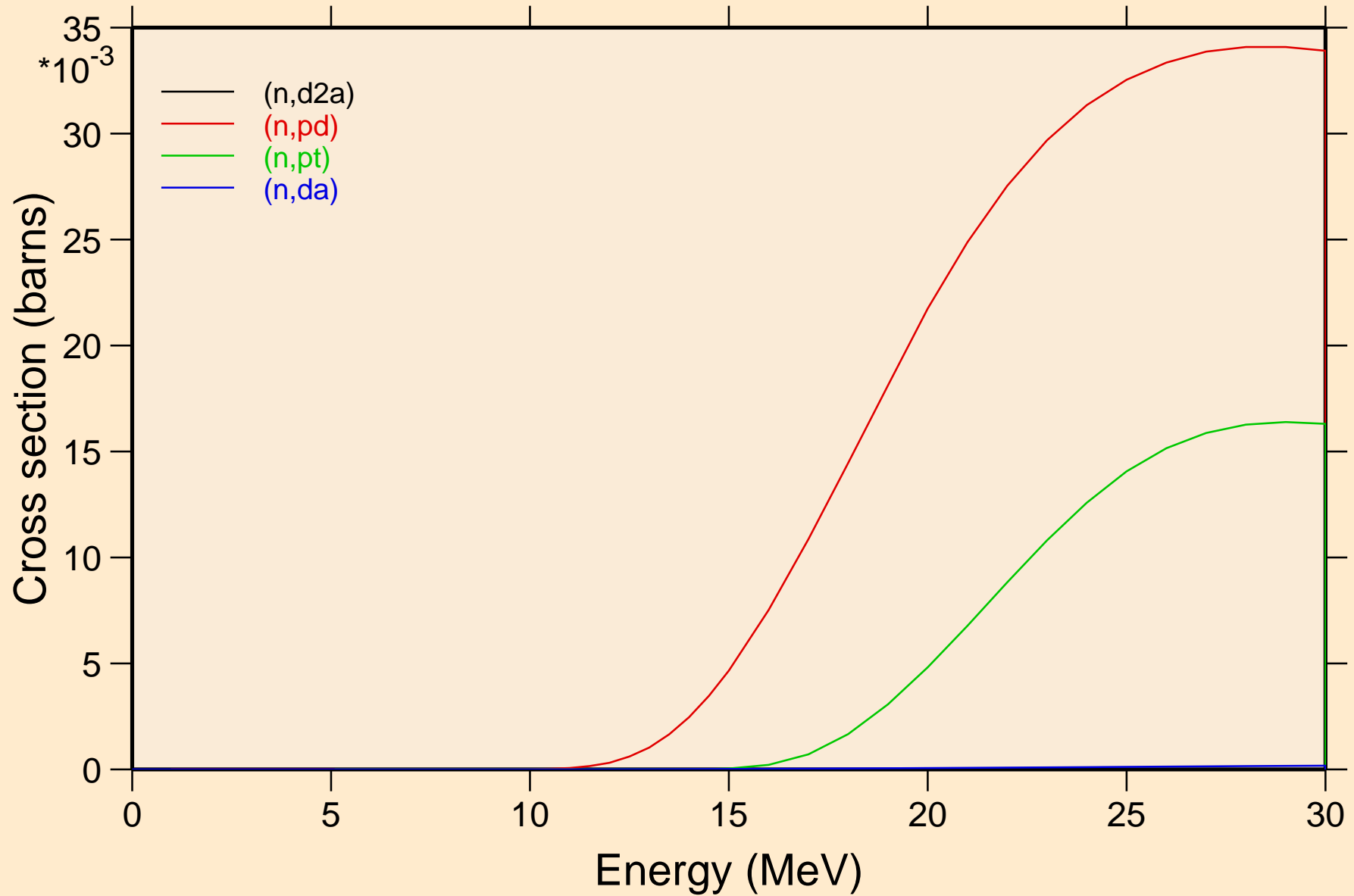

PR124 NRG TENDL-2015, AKONING
angular distribution for elastic

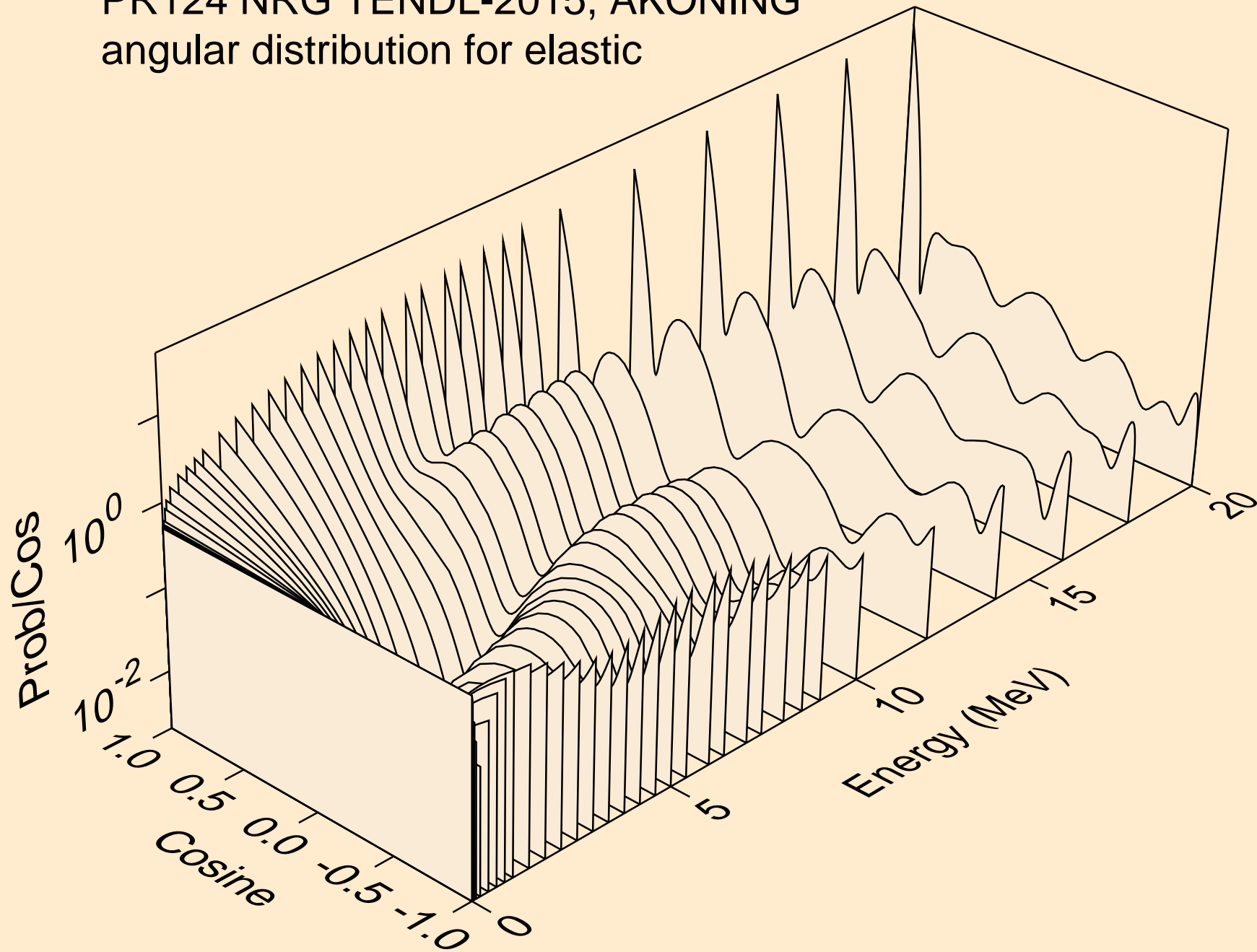

PR124 NRG TENDL-2015, AKONING
angular distribution for elastic

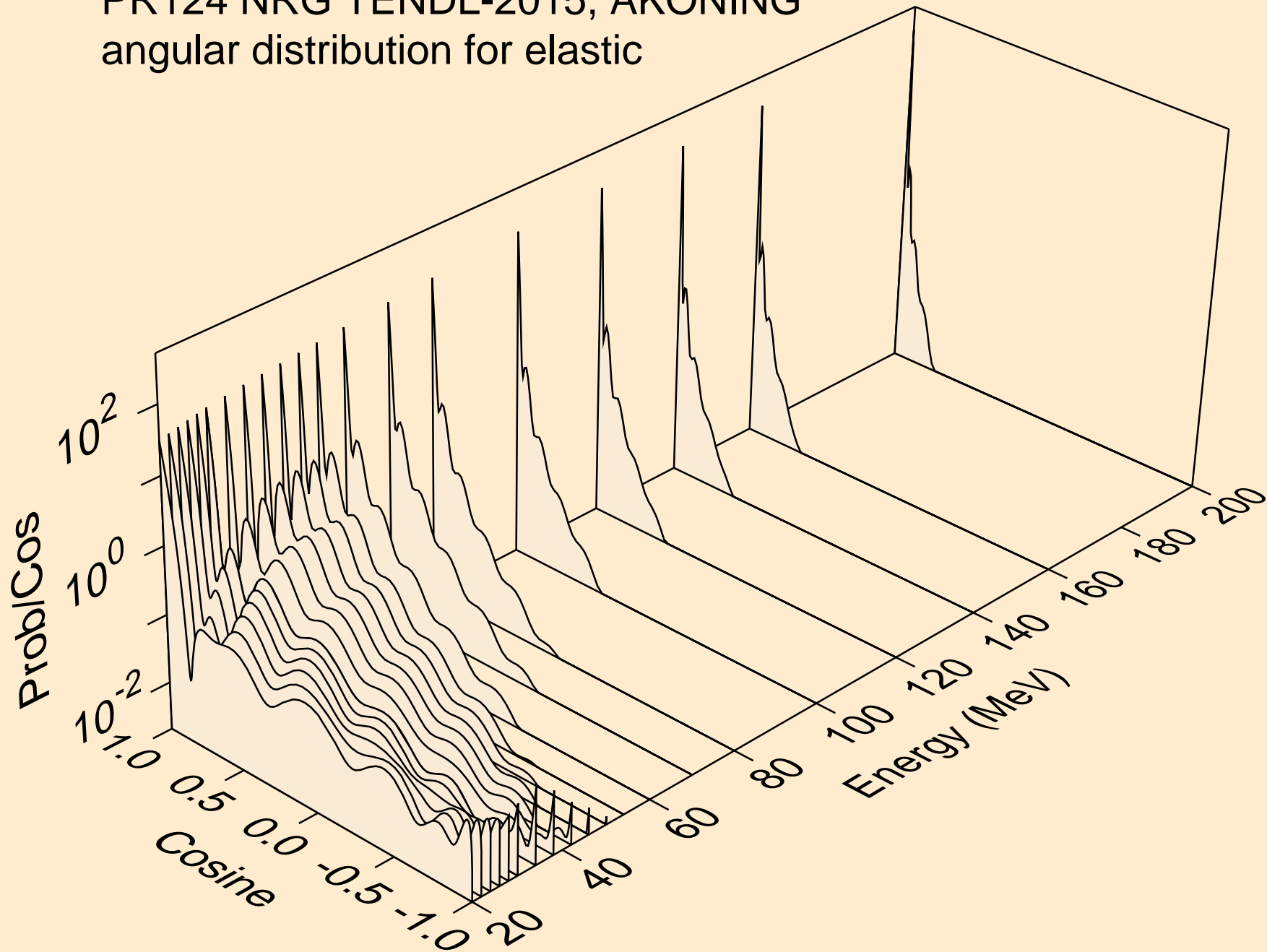

PR124 NRG TENDL-2015, AKONING
angular distribution for (n,n*1)

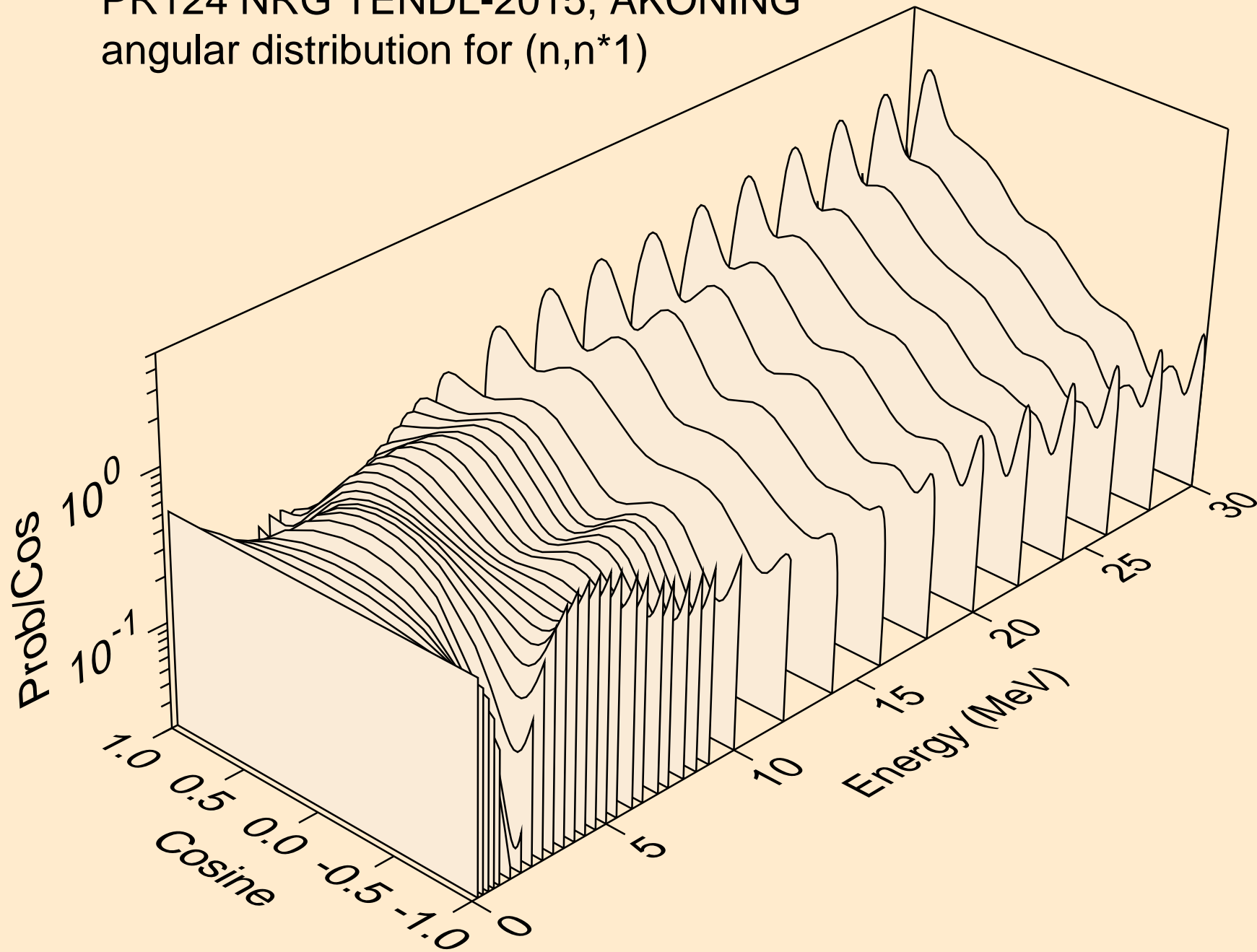

PR124 NRG TENDL-2015, AKONING
Neutron emission for (n,x)

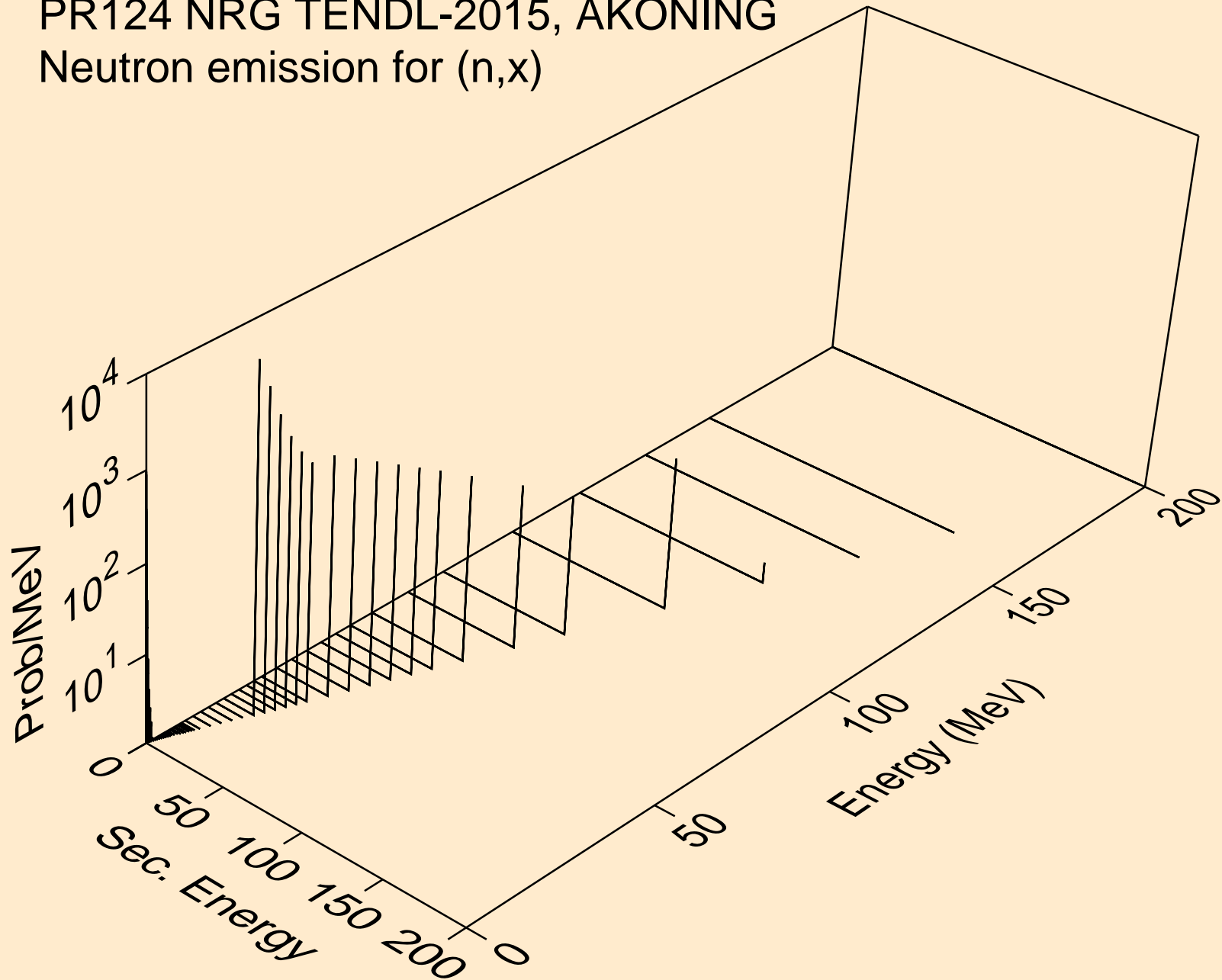

PR124 NRG TENDL-2015, AKONING
Neutron emission for (n,2nd)

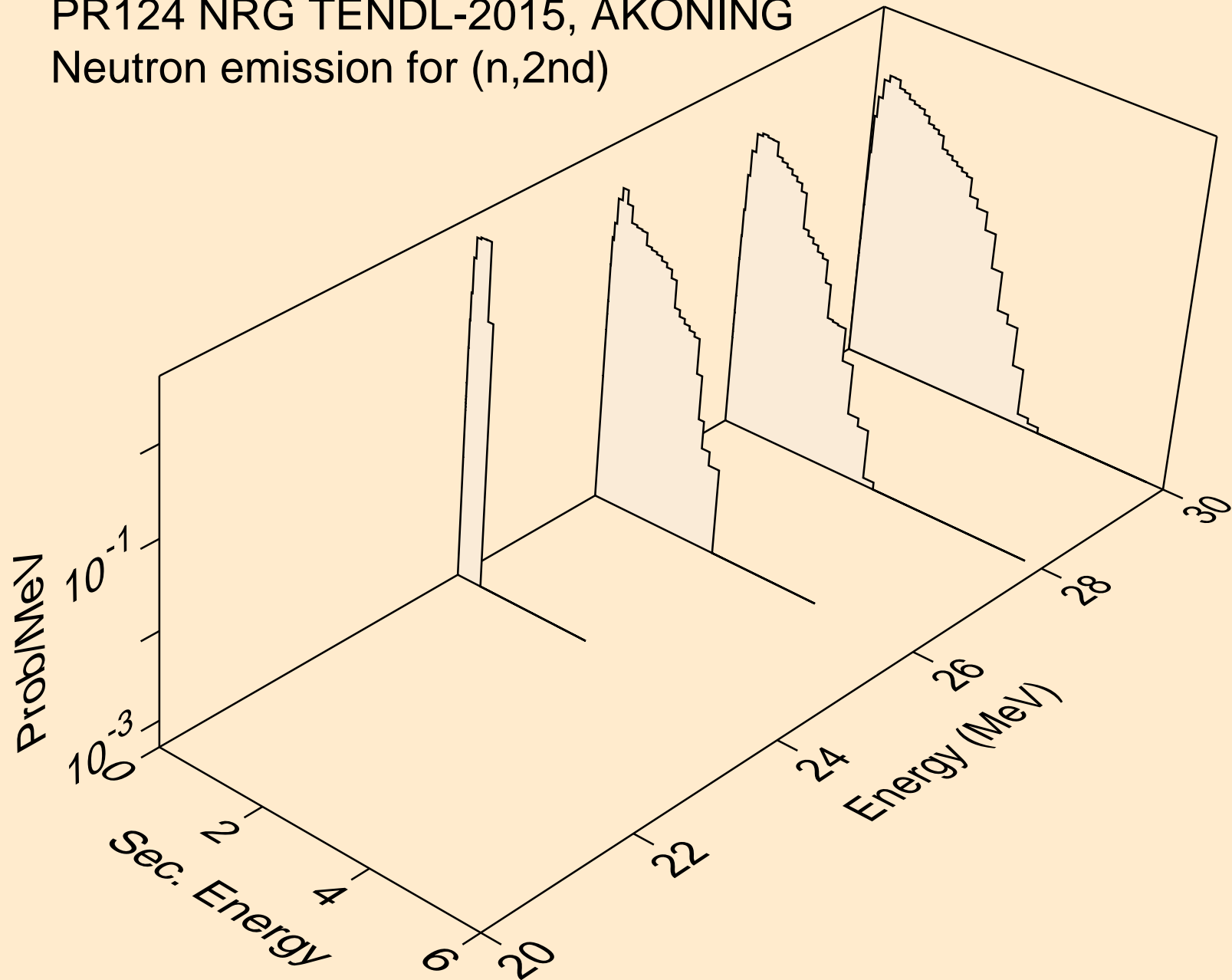

PR124 NRG TENDL-2015, AKONING
Neutron emission for (n,2n)

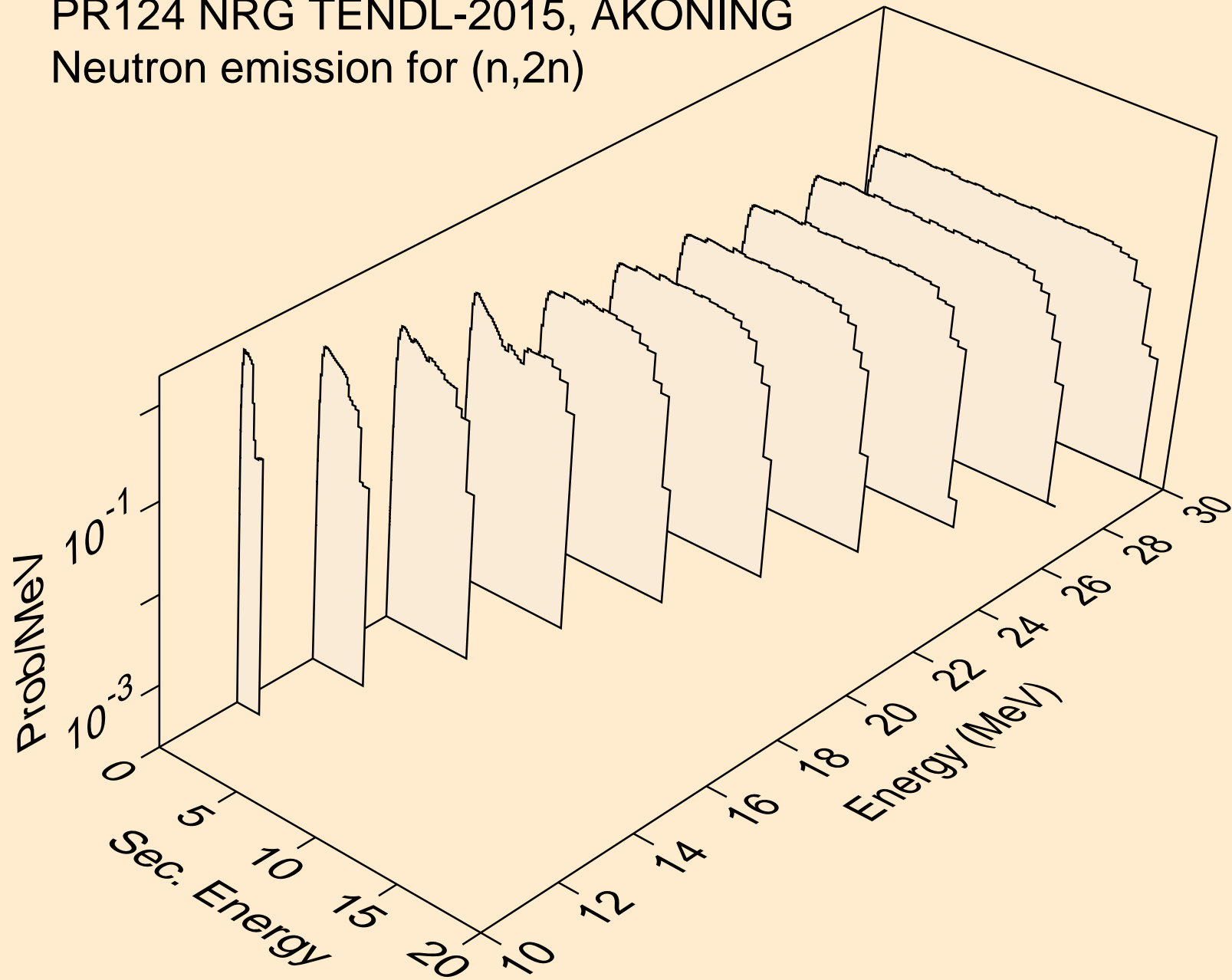

PR124 NRG TENDL-2015, AKONING
Neutron emission for (n,3n)

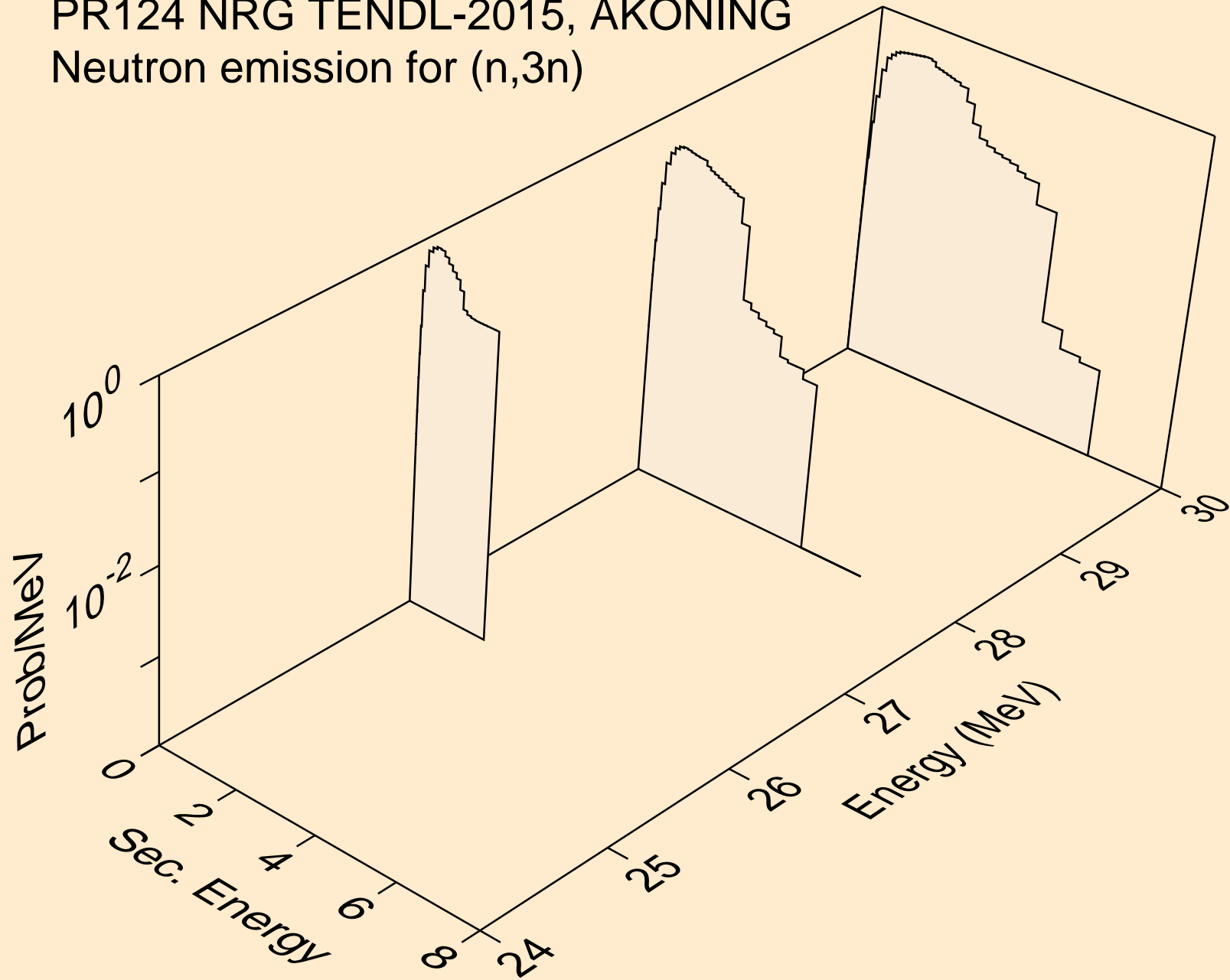

PR124 NRG TENDL-2015, AKONING
Neutron emission for (n,n*)a

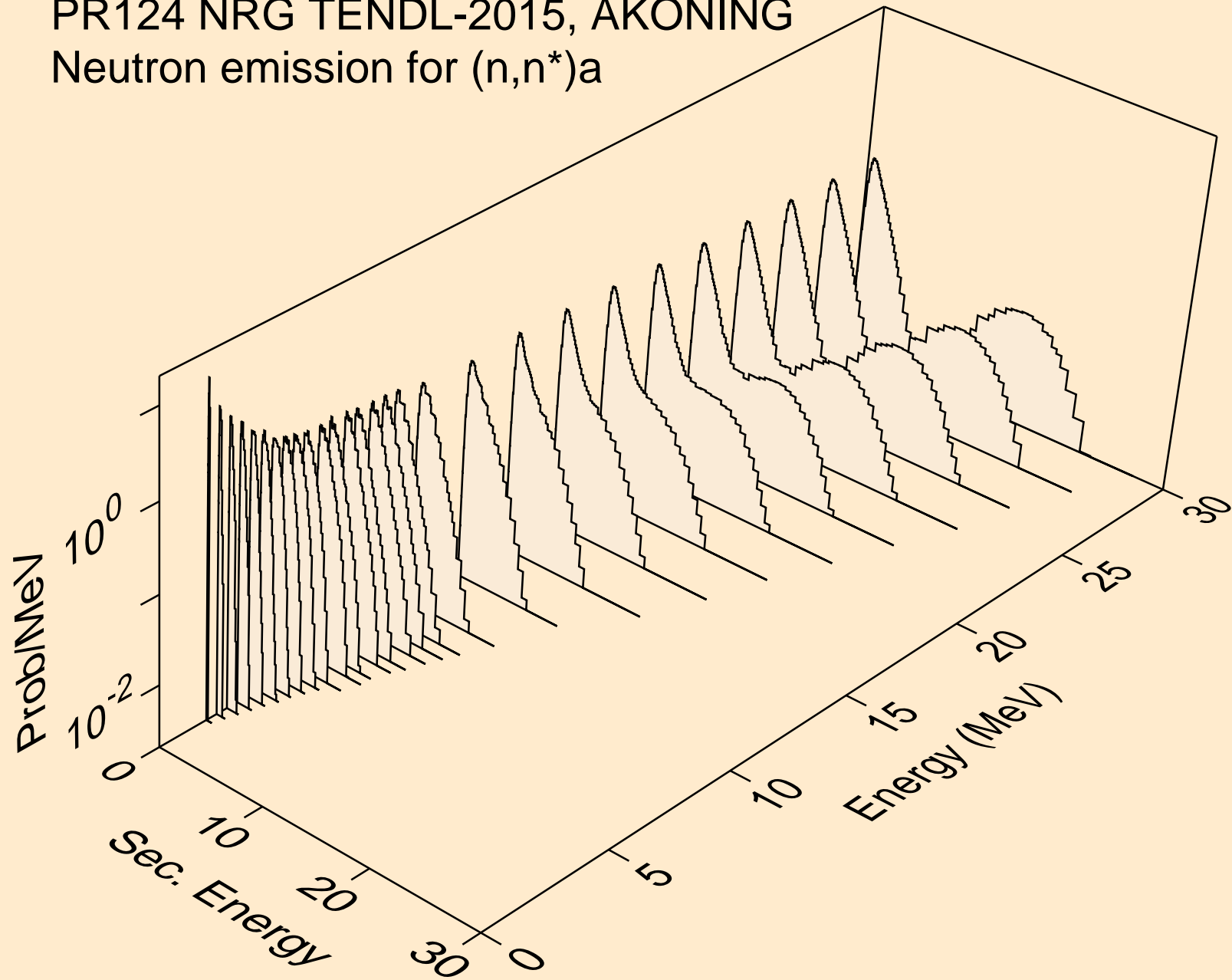

PR124 NRG TENDL-2015, AKONING
Neutron emission for (n,n*)3a

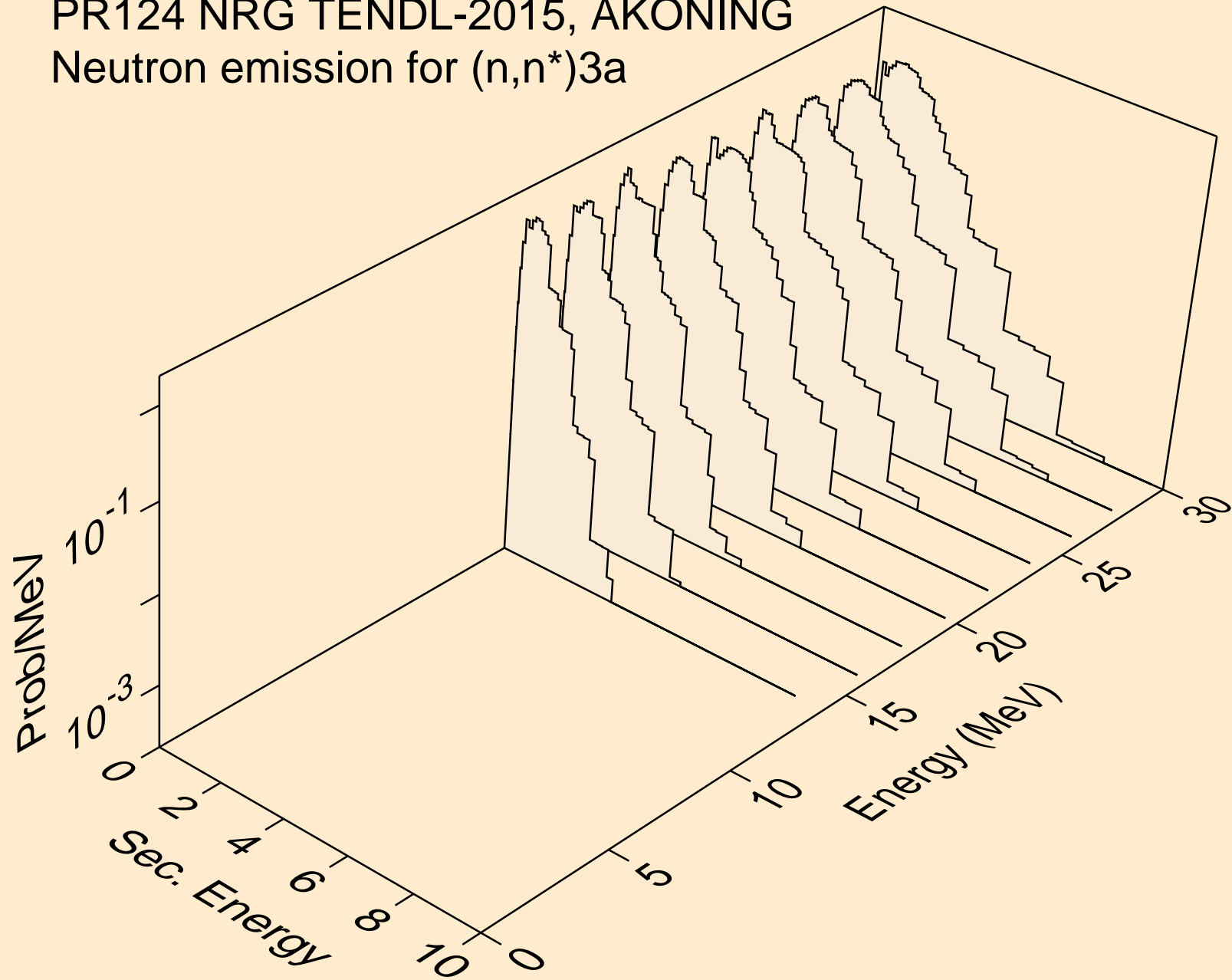

PR124 NRG TENDL-2015, AKONING
Neutron emission for (n,2n)a

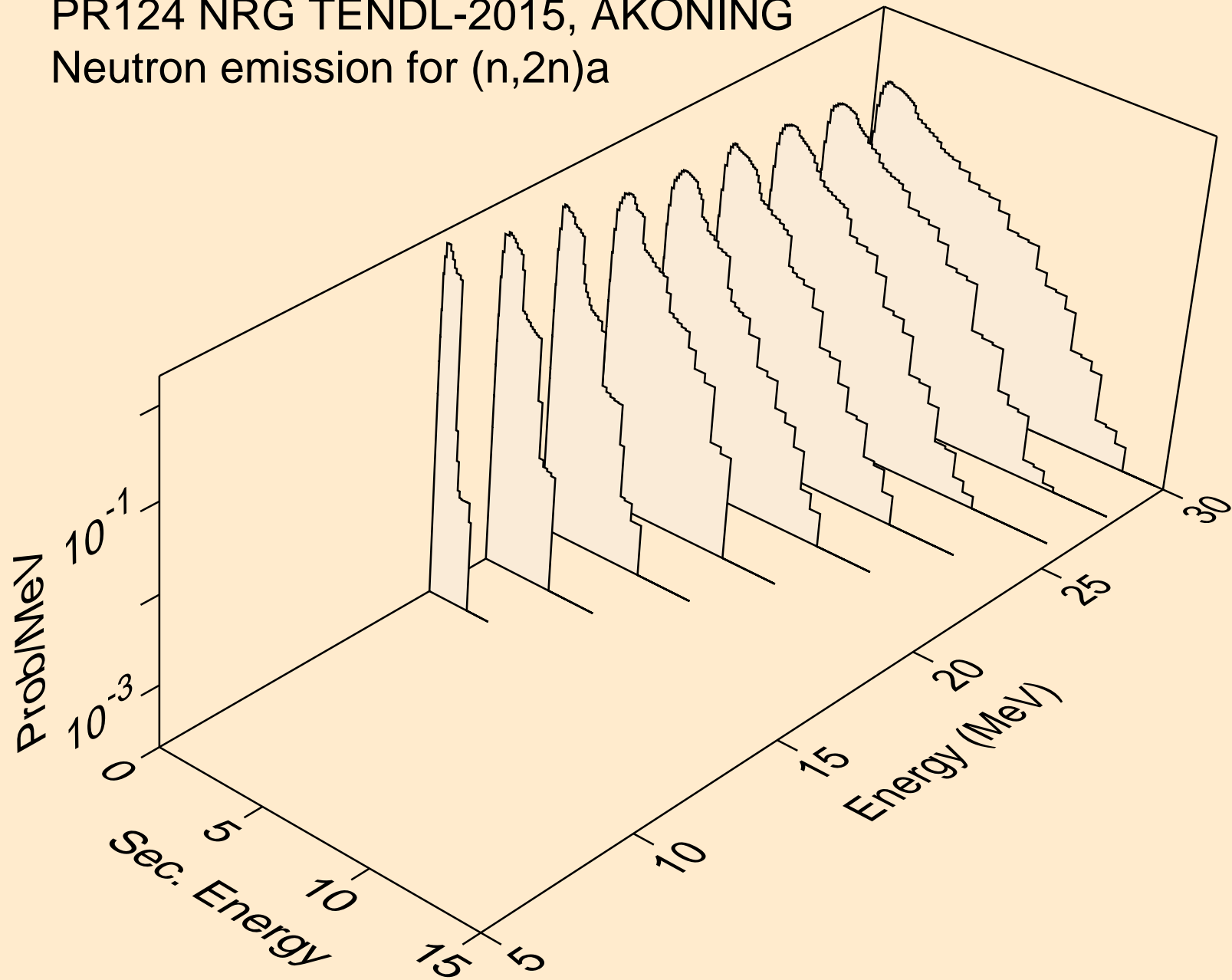

PR124 NRG TENDL-2015, AKONING
Neutron emission for (n,n*)p

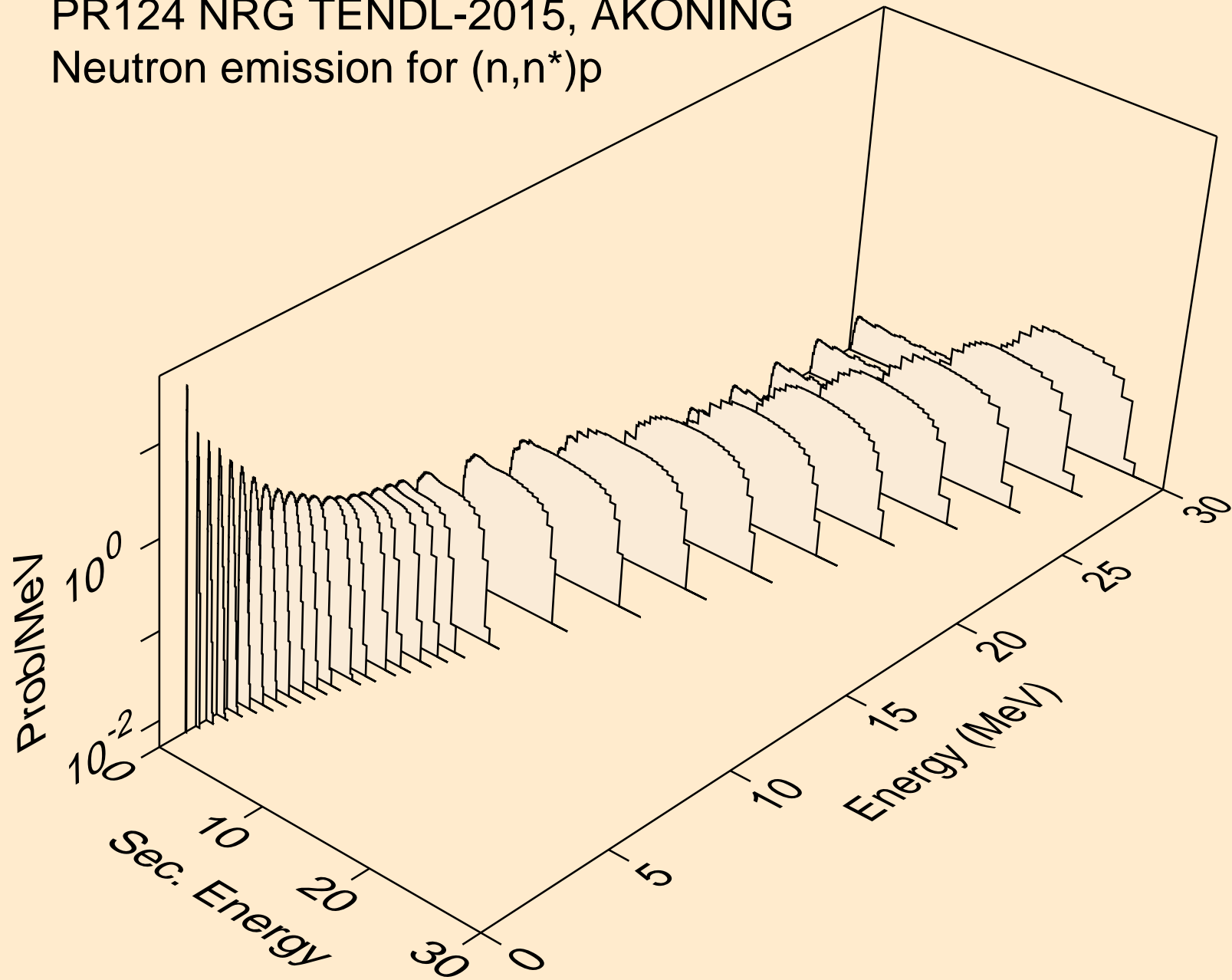

PR124 NRG TENDL-2015, AKONING
Neutron emission for (n,n*)2a

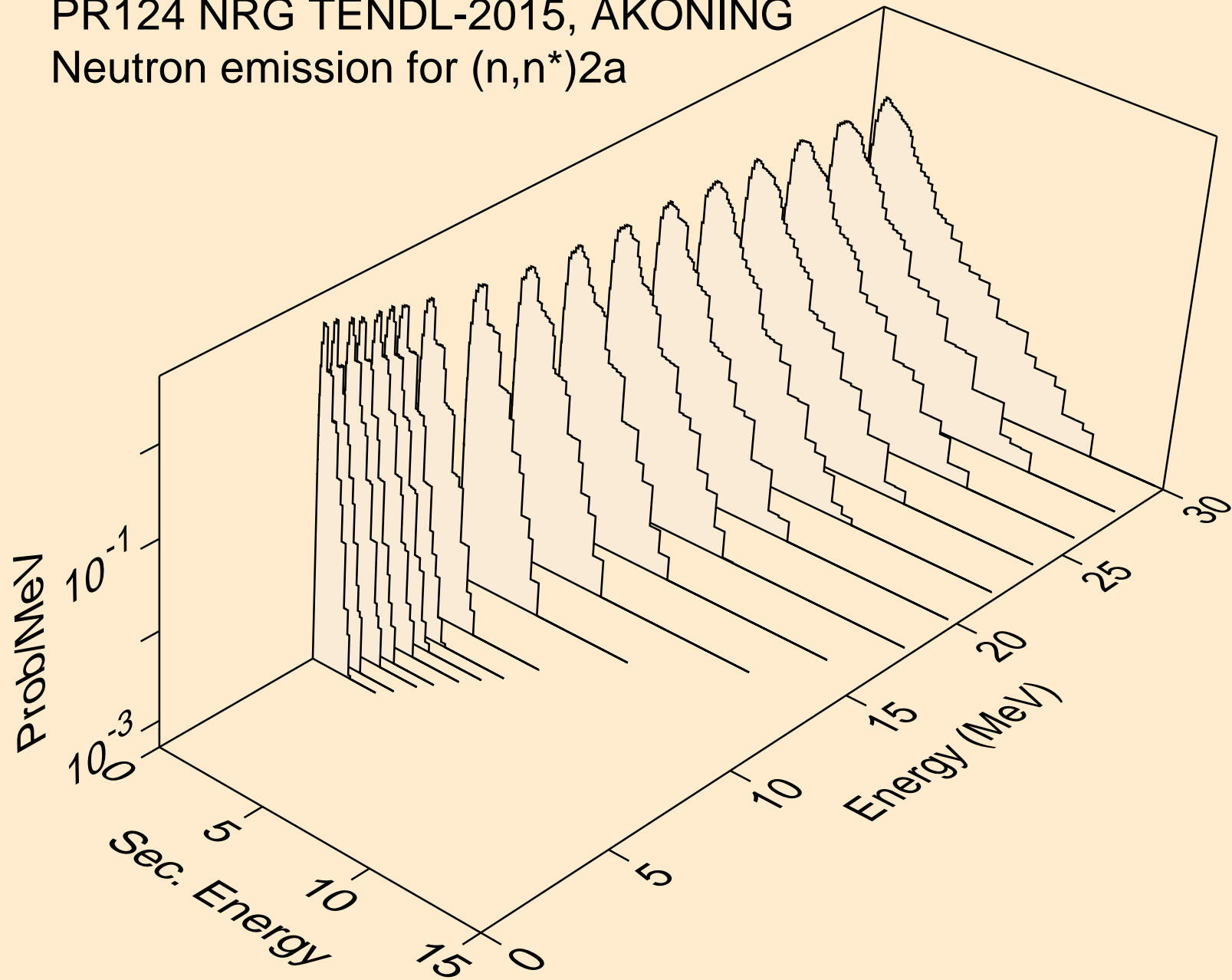

PR124 NRG TENDL-2015, AKONING
Neutron emission for (n,2n)2a

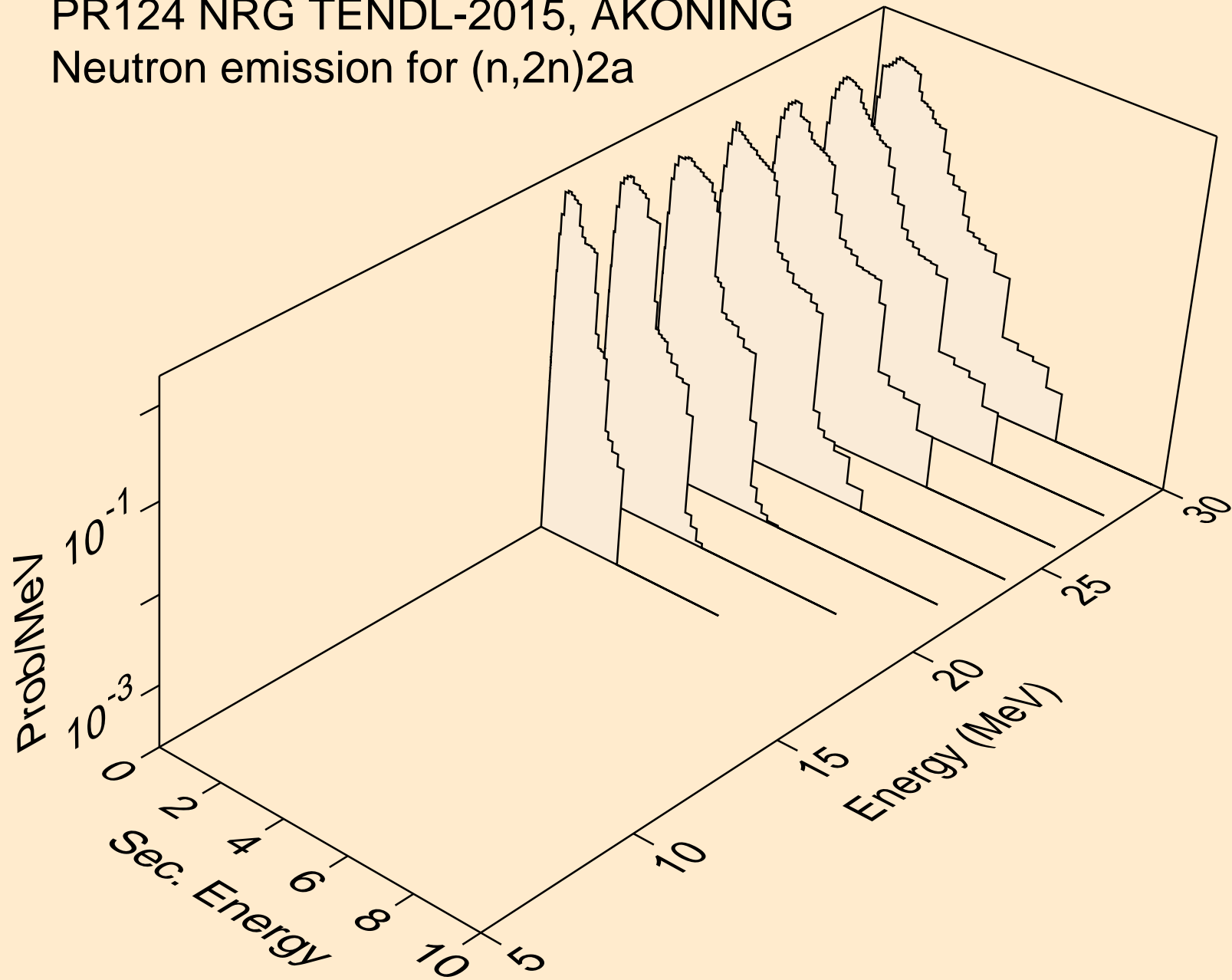

PR124 NRG TENDL-2015, AKONING
Neutron emission for (n,n*)d

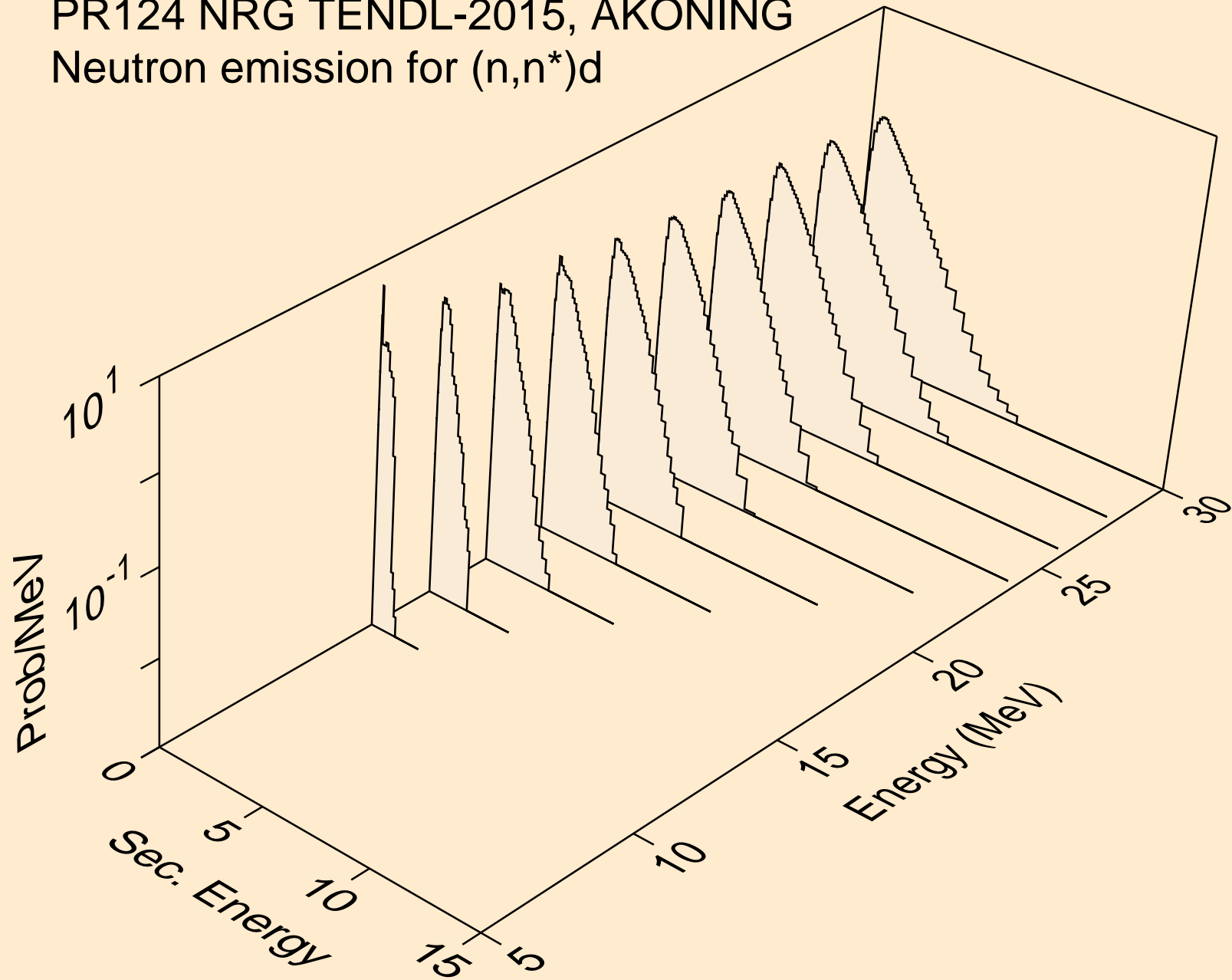

PR124 NRG TENDL-2015, AKONING
Neutron emission for (n,n*)t

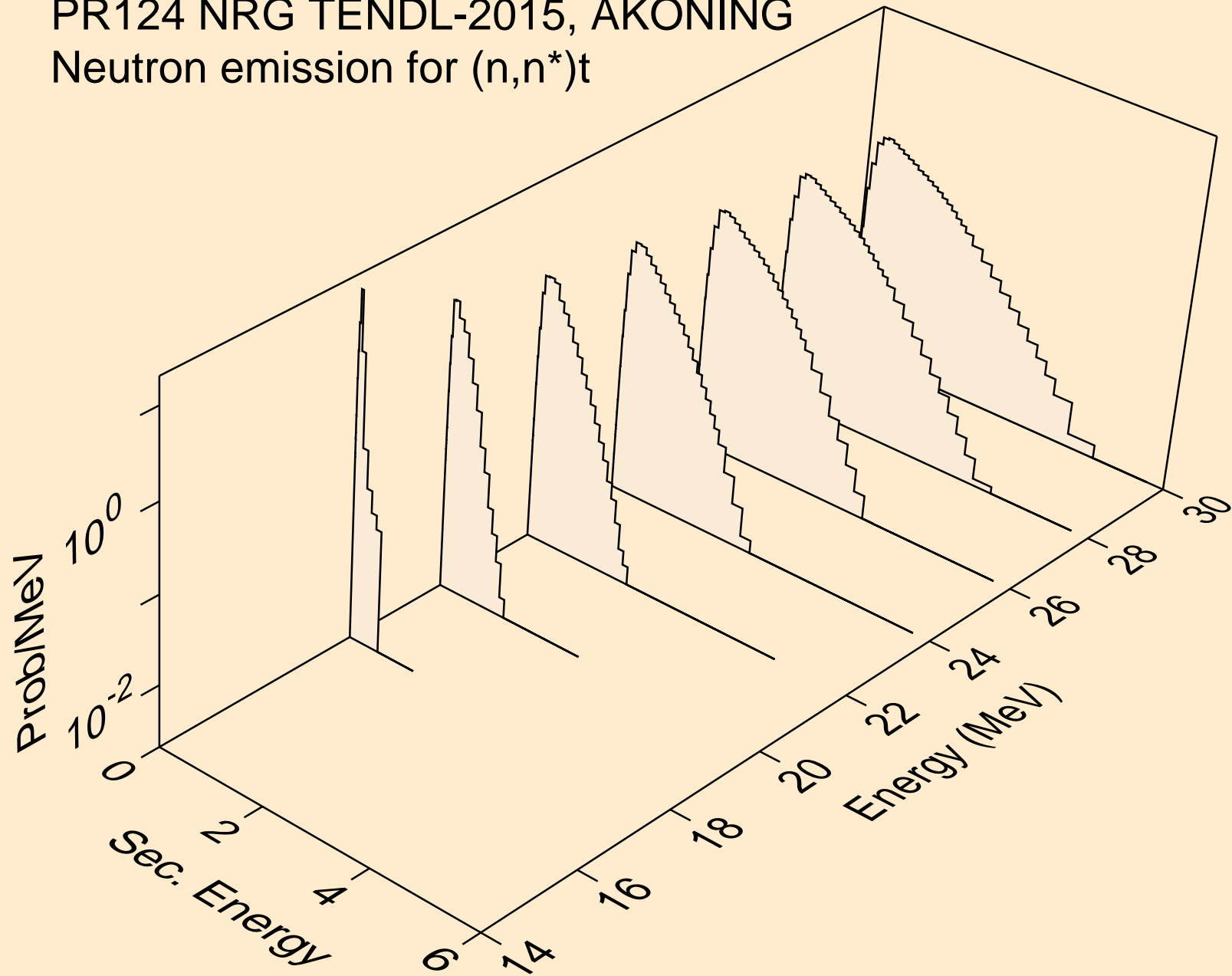

PR124 NRG TENDL-2015, AKONING
Neutron emission for (n,n*)he3

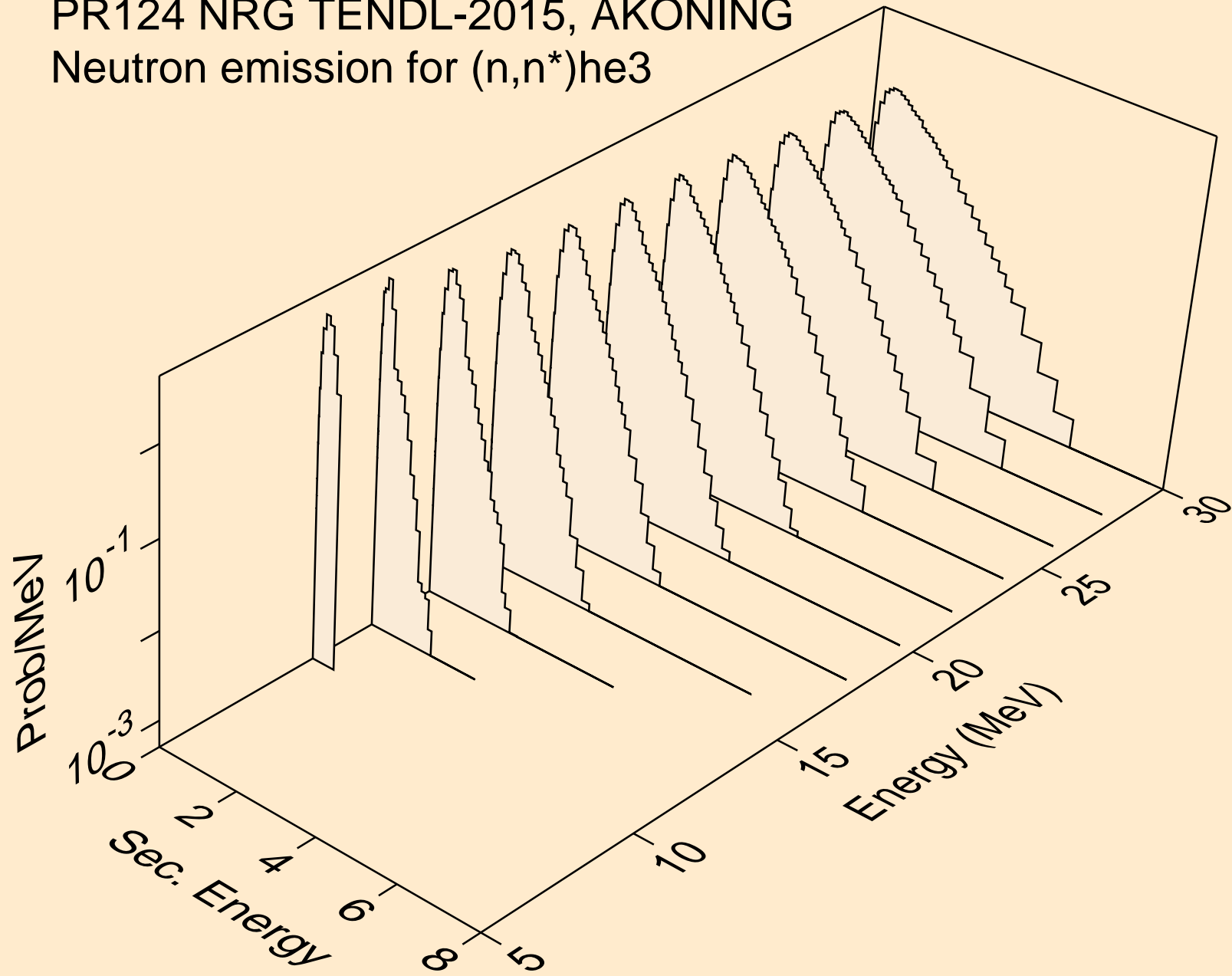

PR124 NRG TENDL-2015, AKONING
Neutron emission for (n,2np)

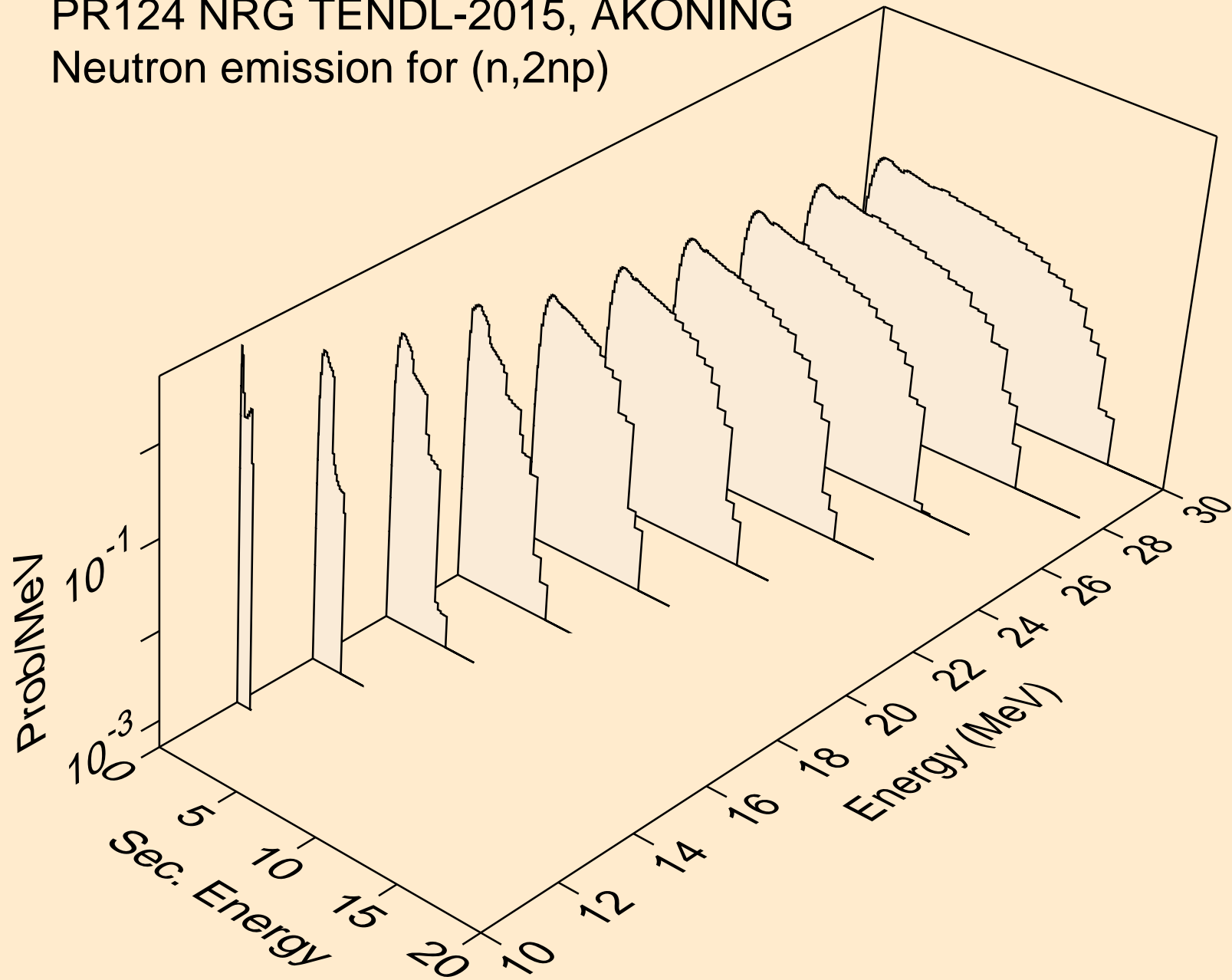

PR124 NRG TENDL-2015, AKONING
Neutron emission for (n,3np)

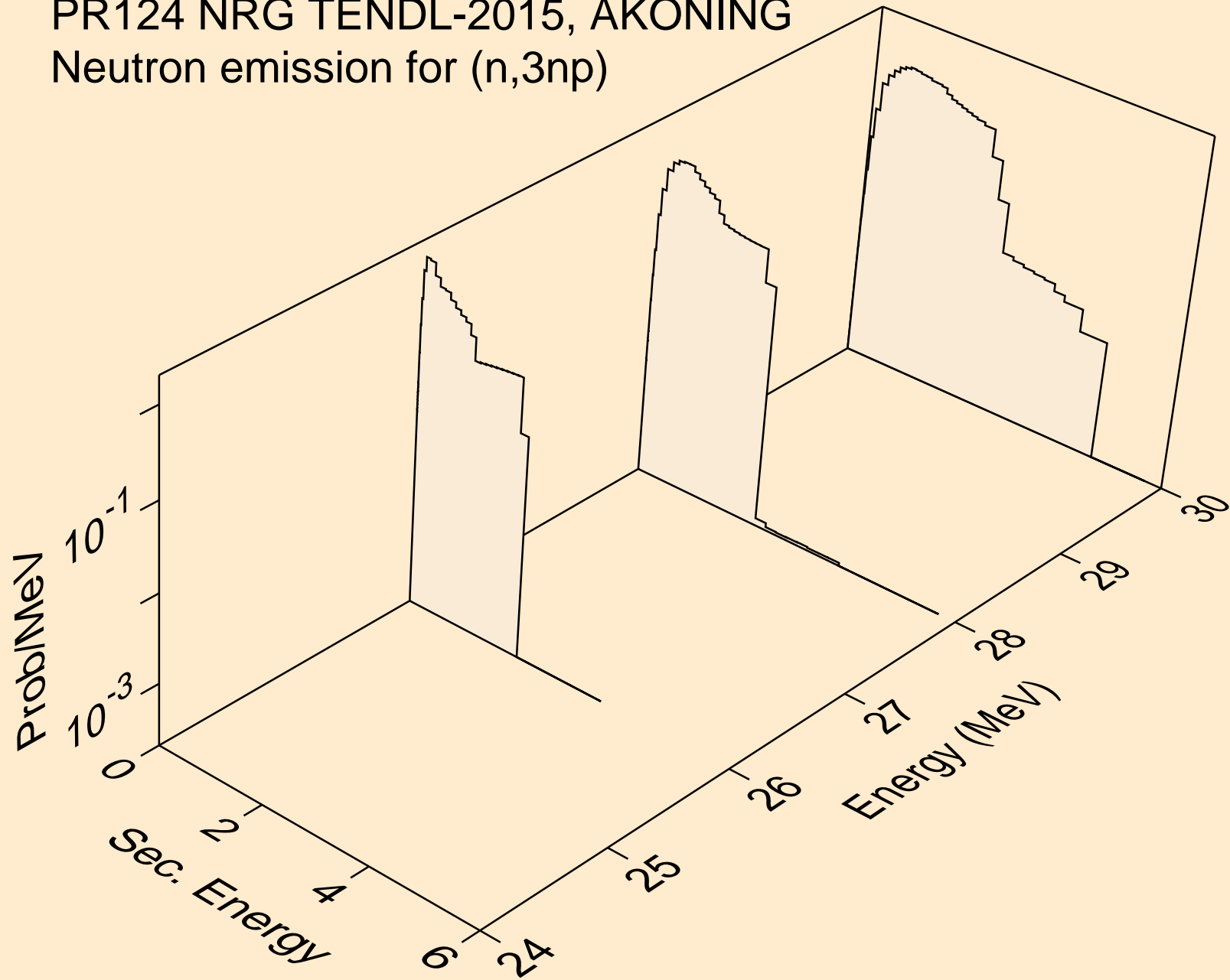

PR124 NRG TENDL-2015, AKONING
Neutron emission for (n,2np)

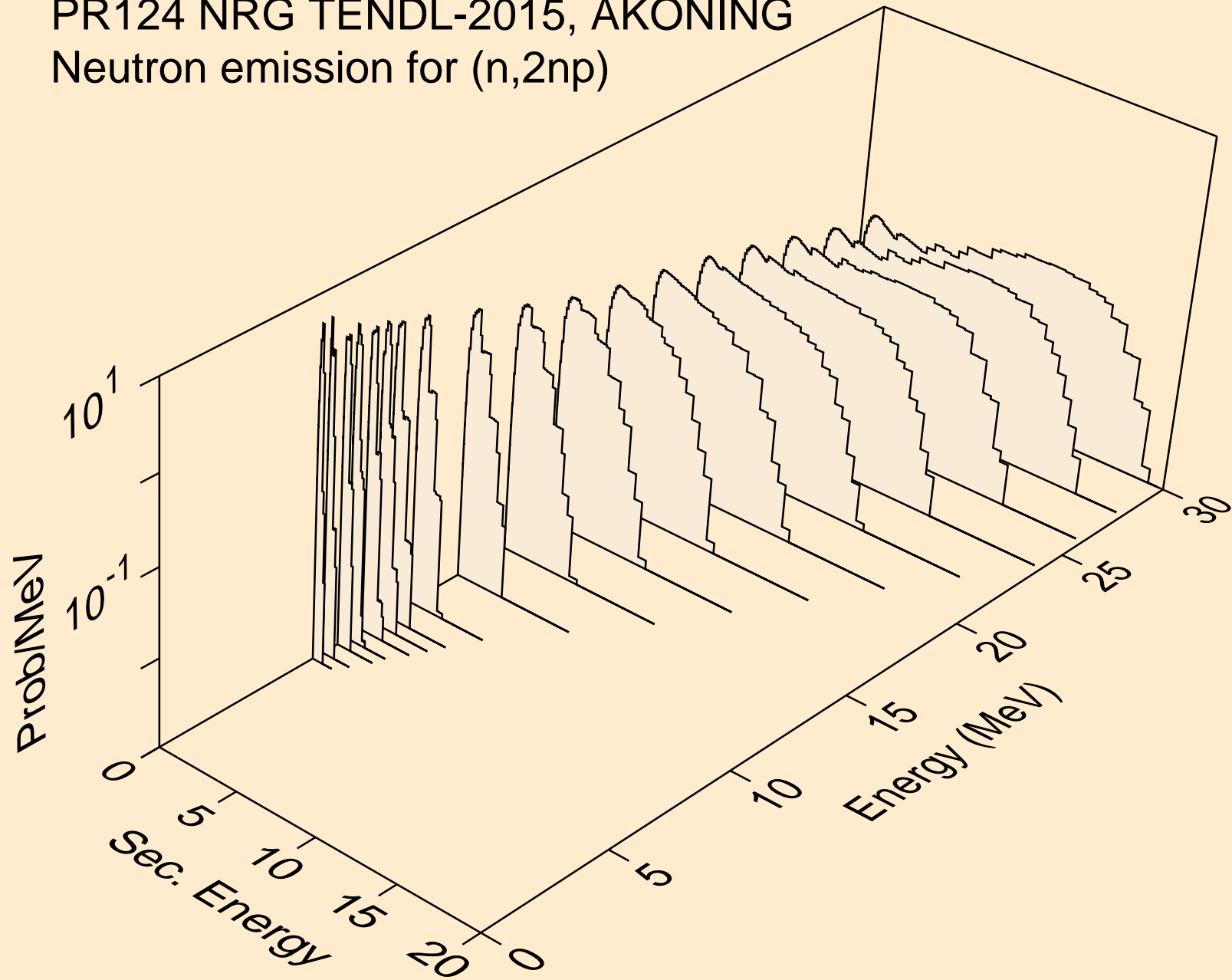

PR124 NRG TENDL-2015, AKONING
Neutron emission for (n,npa)

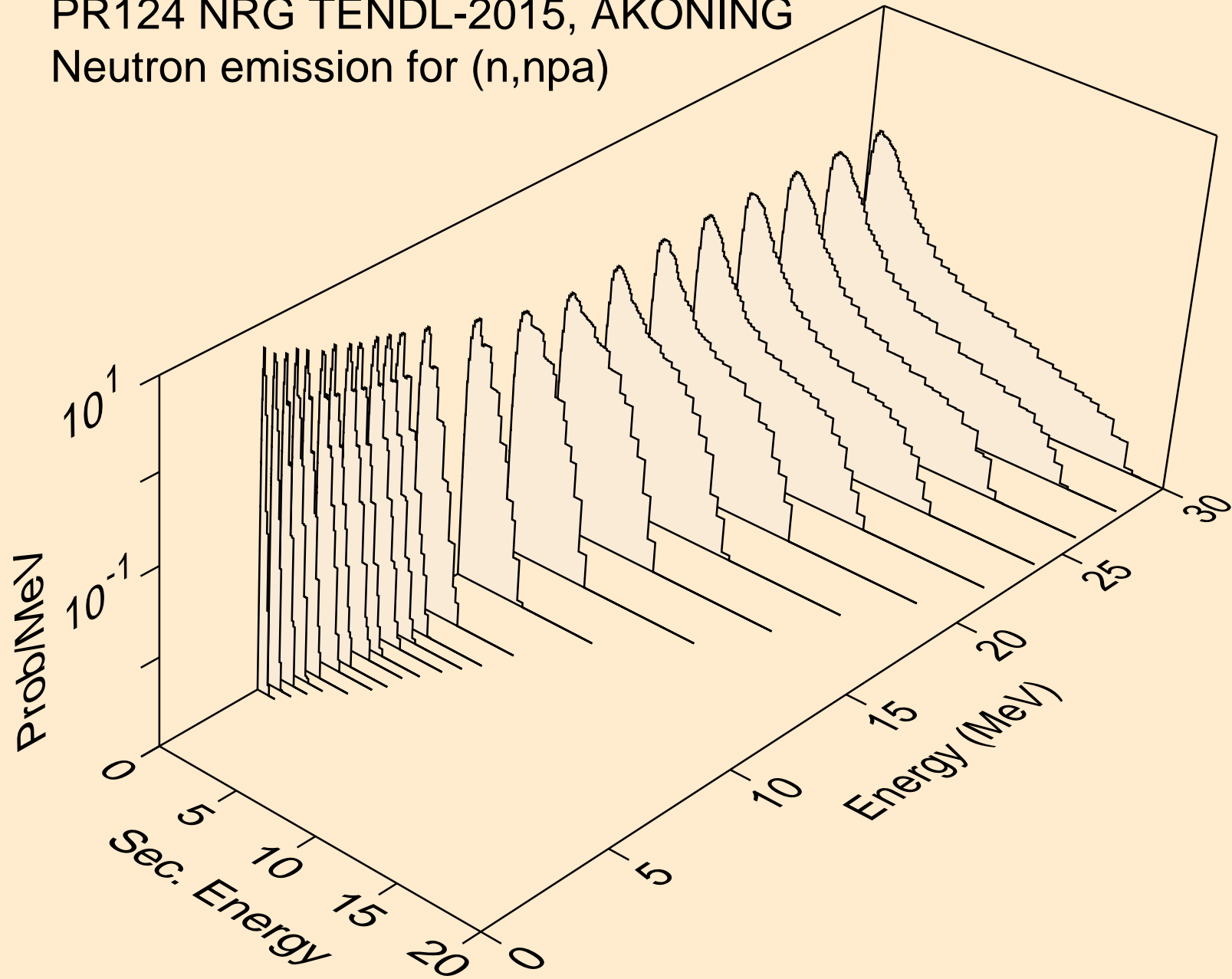

PR124 NRG TENDL-2015, AKONING
Neutron emission for (n,n*c)

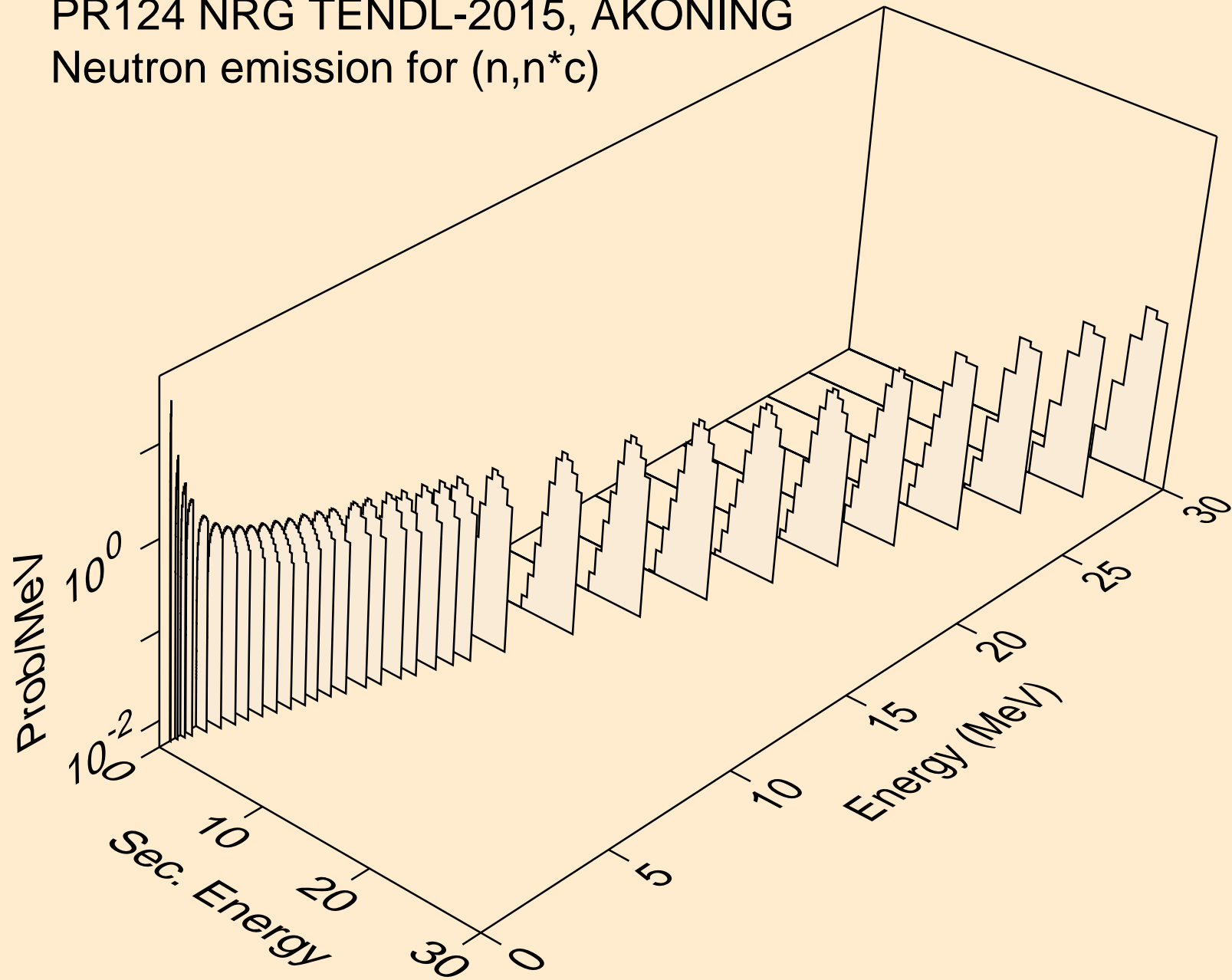

PR124 NRG TENDL-2015, AKONING
Photon emission for (n,x)

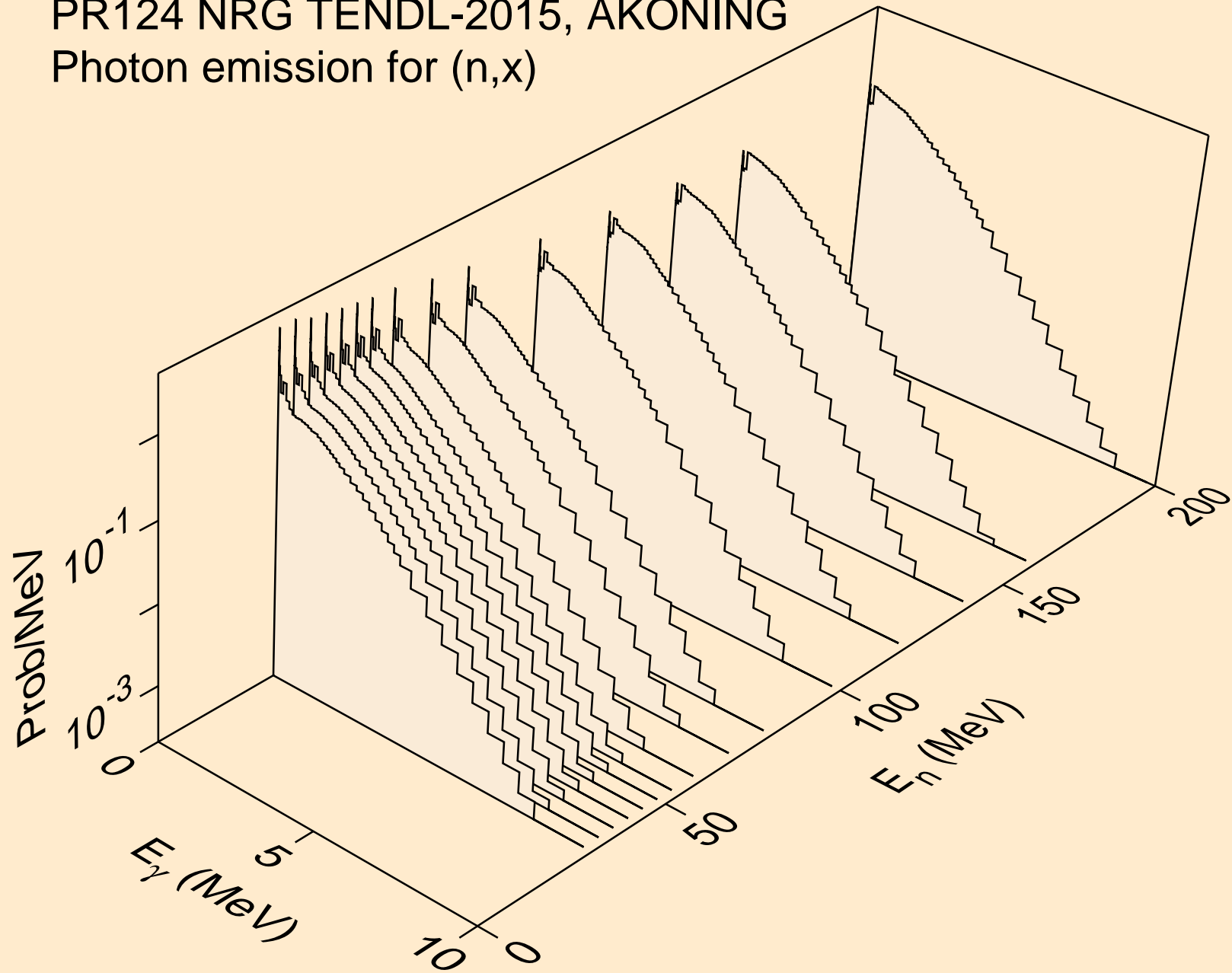

PR124 NRG TENDL-2015, AKONING
Photon emission for (n,2nd)

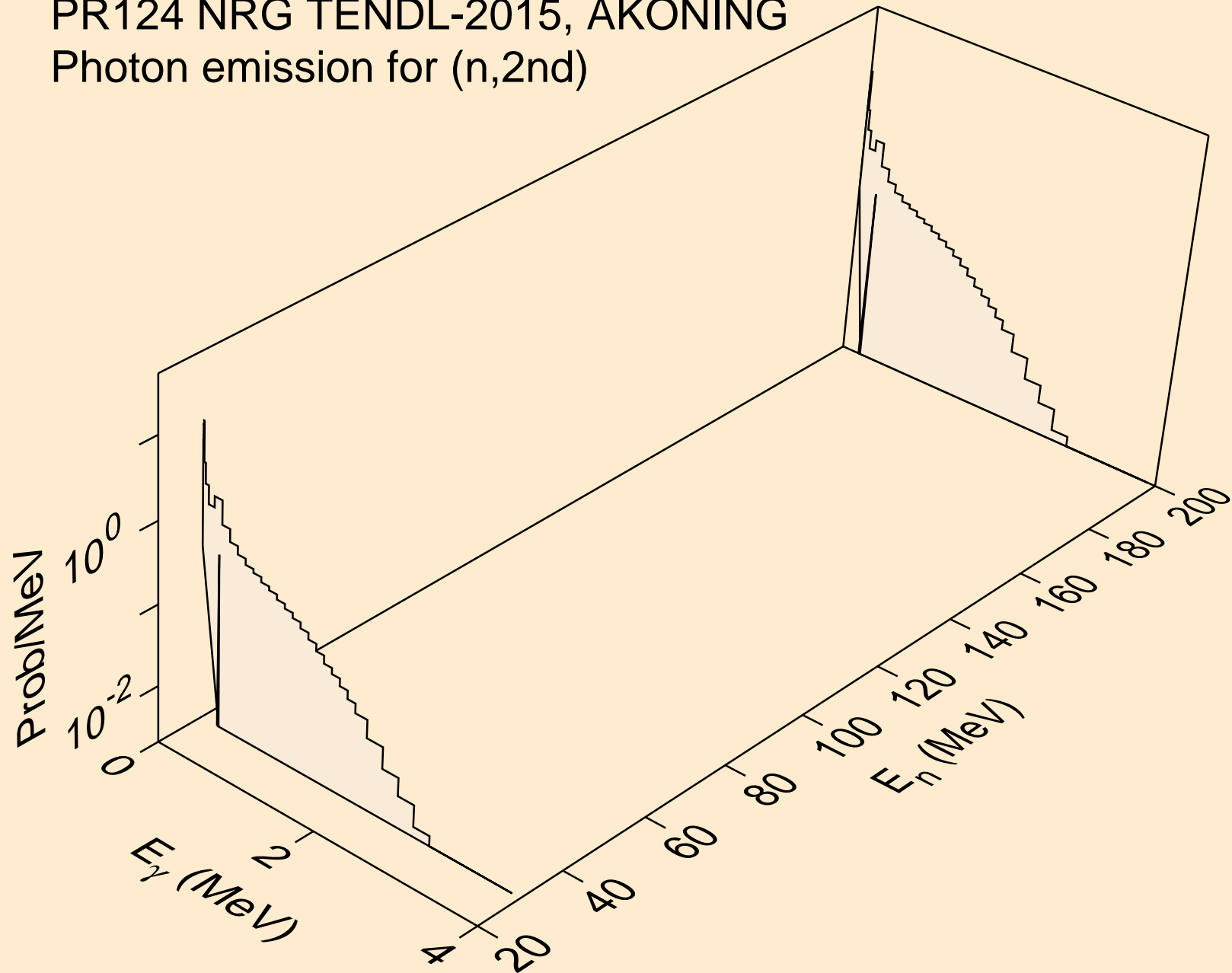

PR124 NRG TENDL-2015, AKONING
Photon emission for (n,2n)

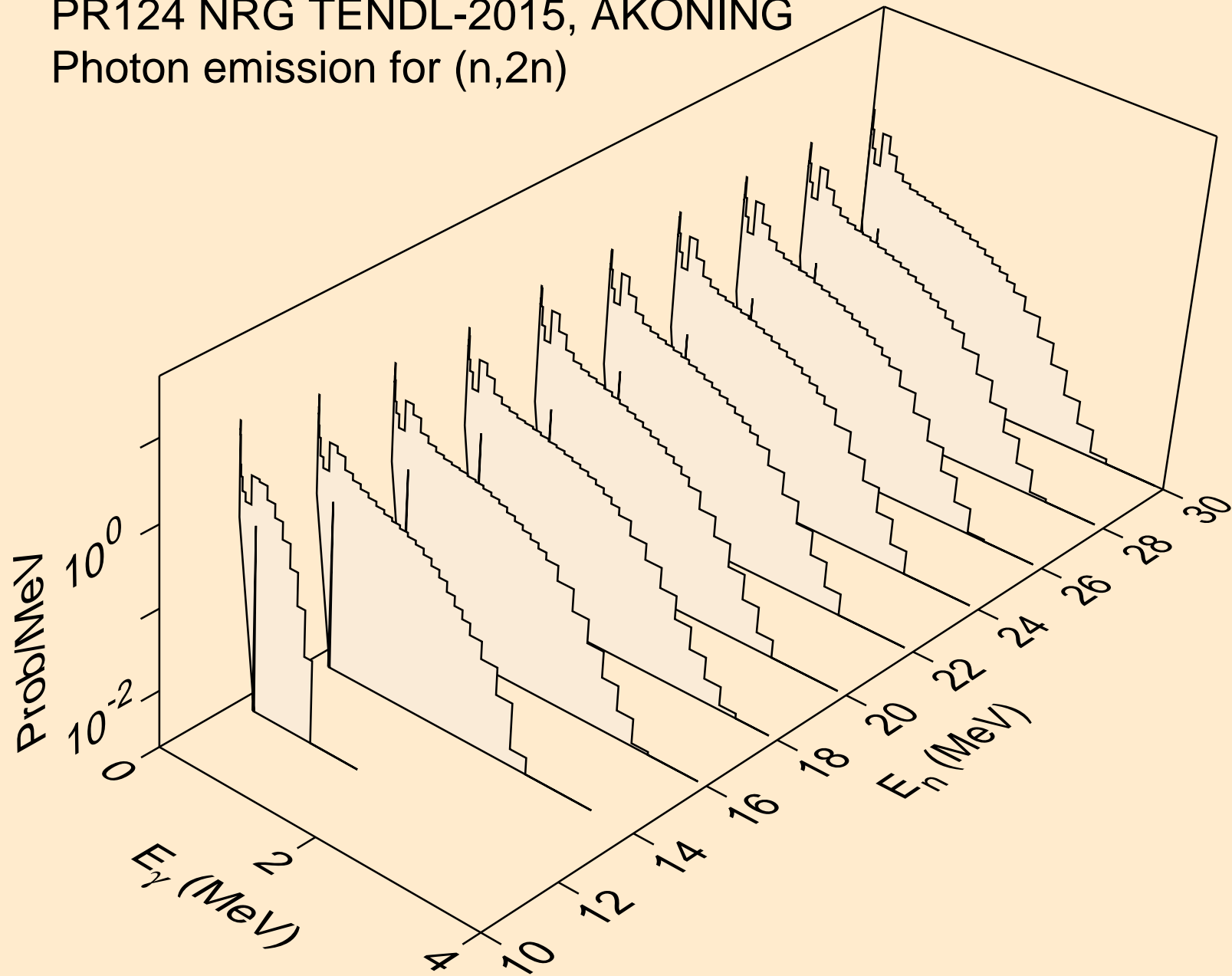

PR124 NRG TENDL-2015, AKONING
Photon emission for (n,3n)

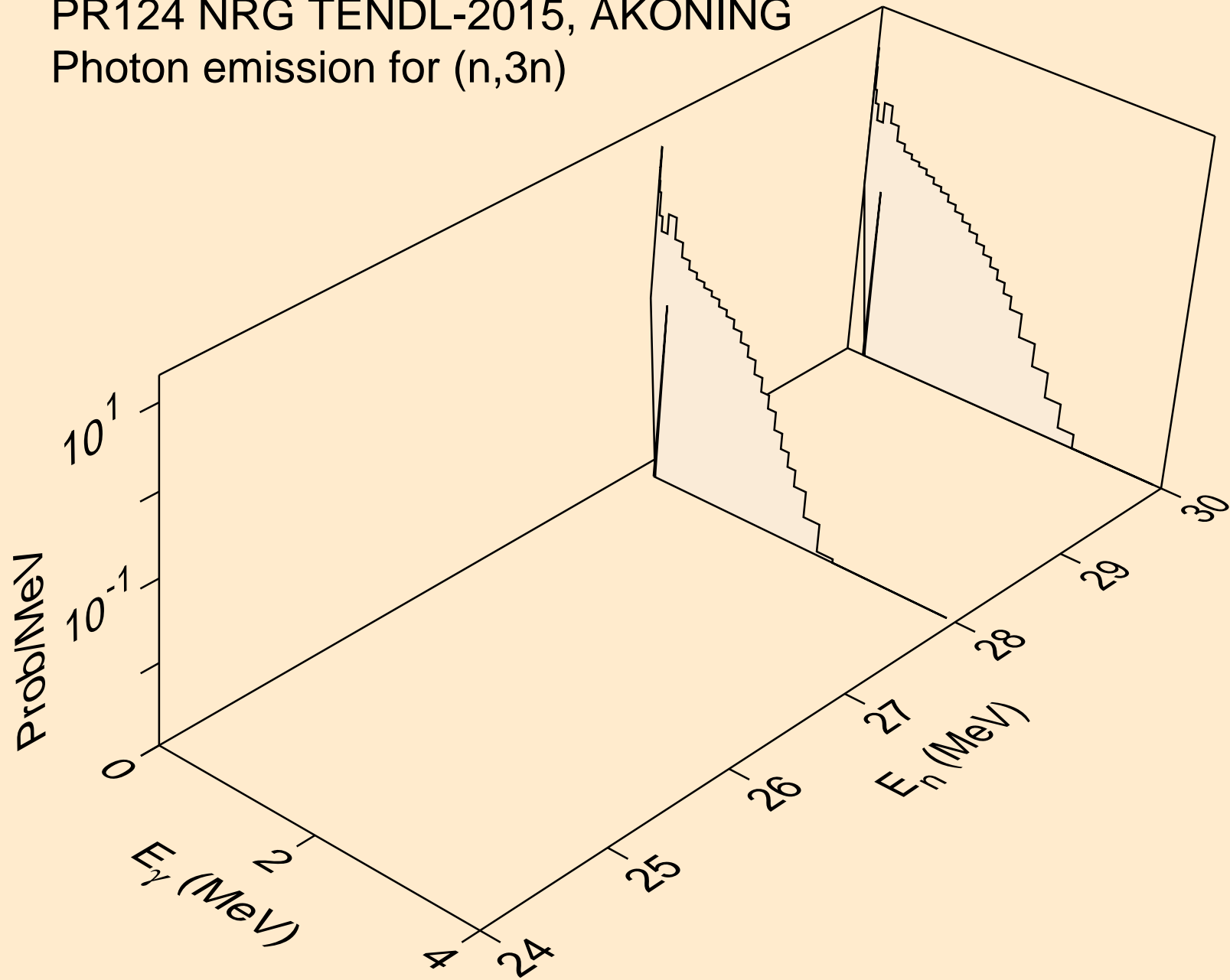

PR124 NRG TENDL-2015, AKONING
Photon emission for (n,n*)a

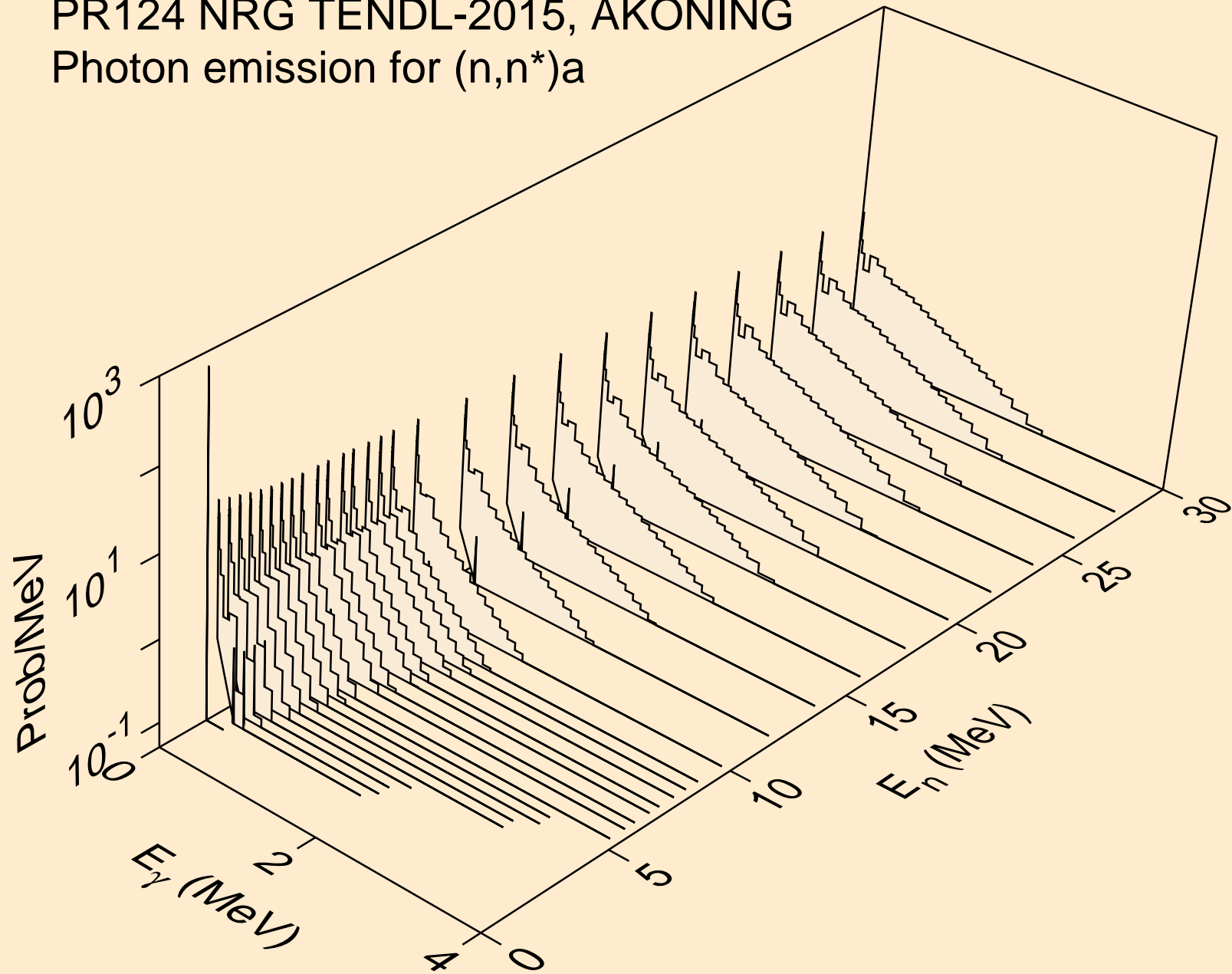

PR124 NRG TENDL-2015, AKONING
Photon emission for (n,n*)3a

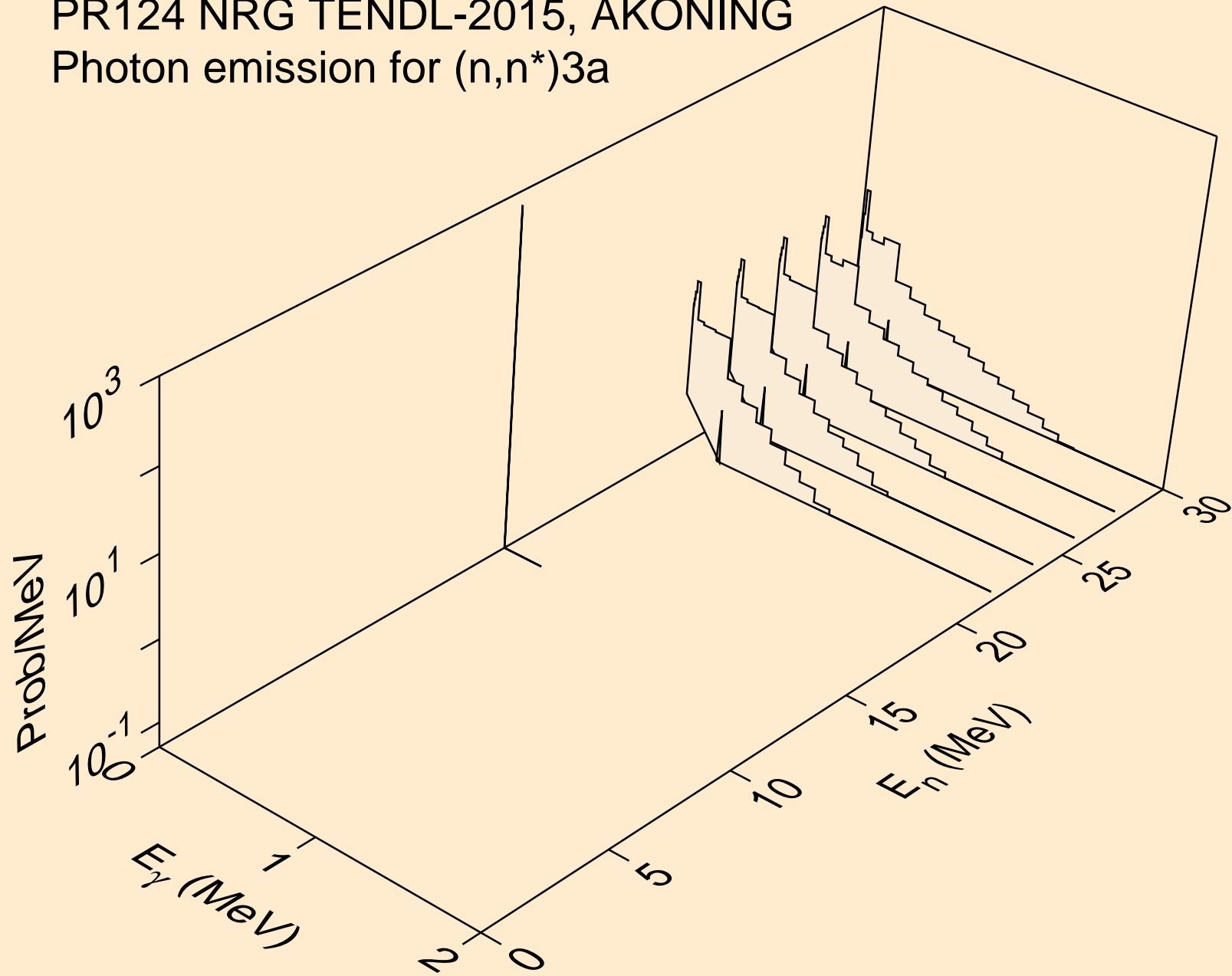

PR124 NRG TENDL-2015, AKONING
Photon emission for (n,2n)a

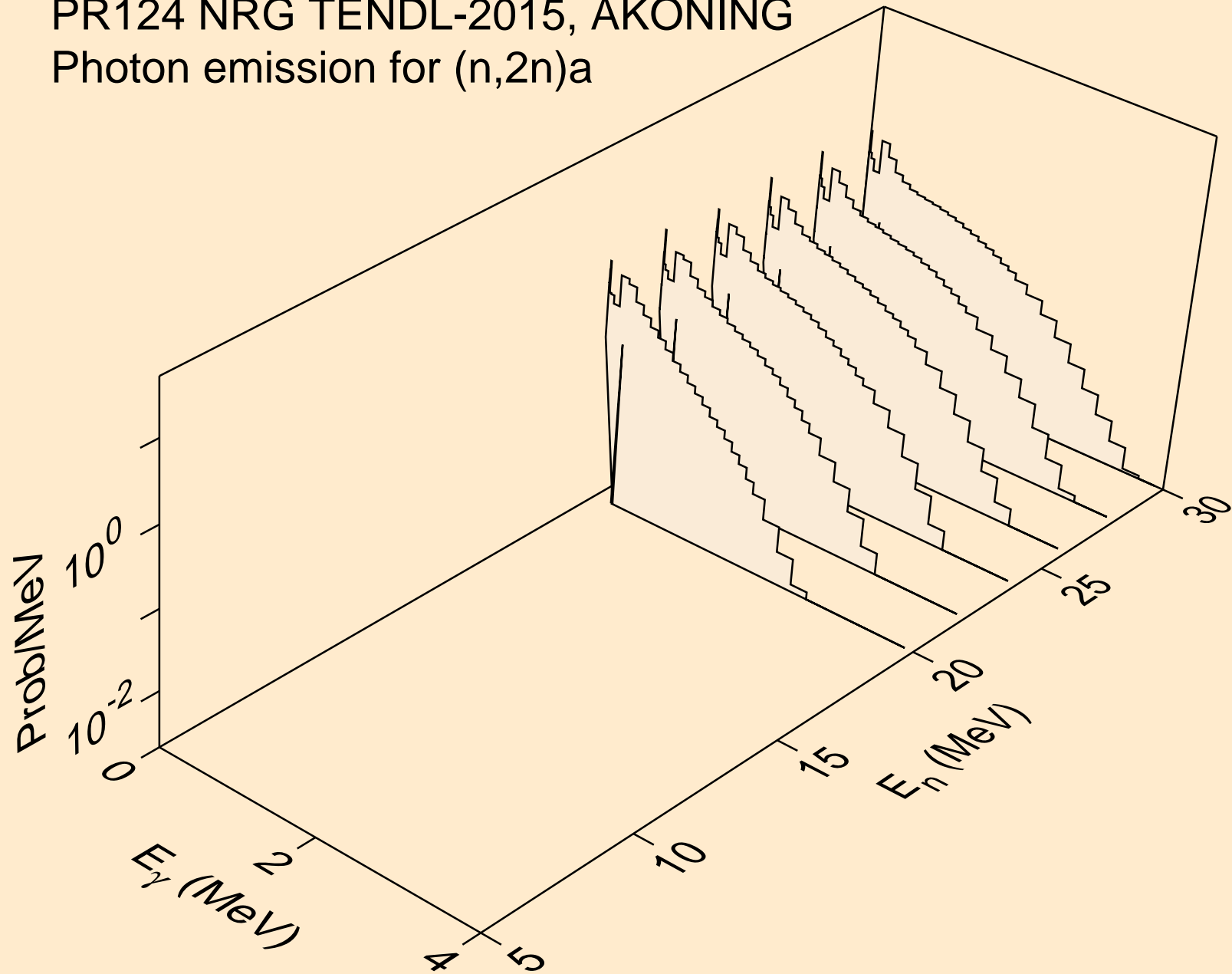

PR124 NRG TENDL-2015, AKONING
Photon emission for (n,n*)p

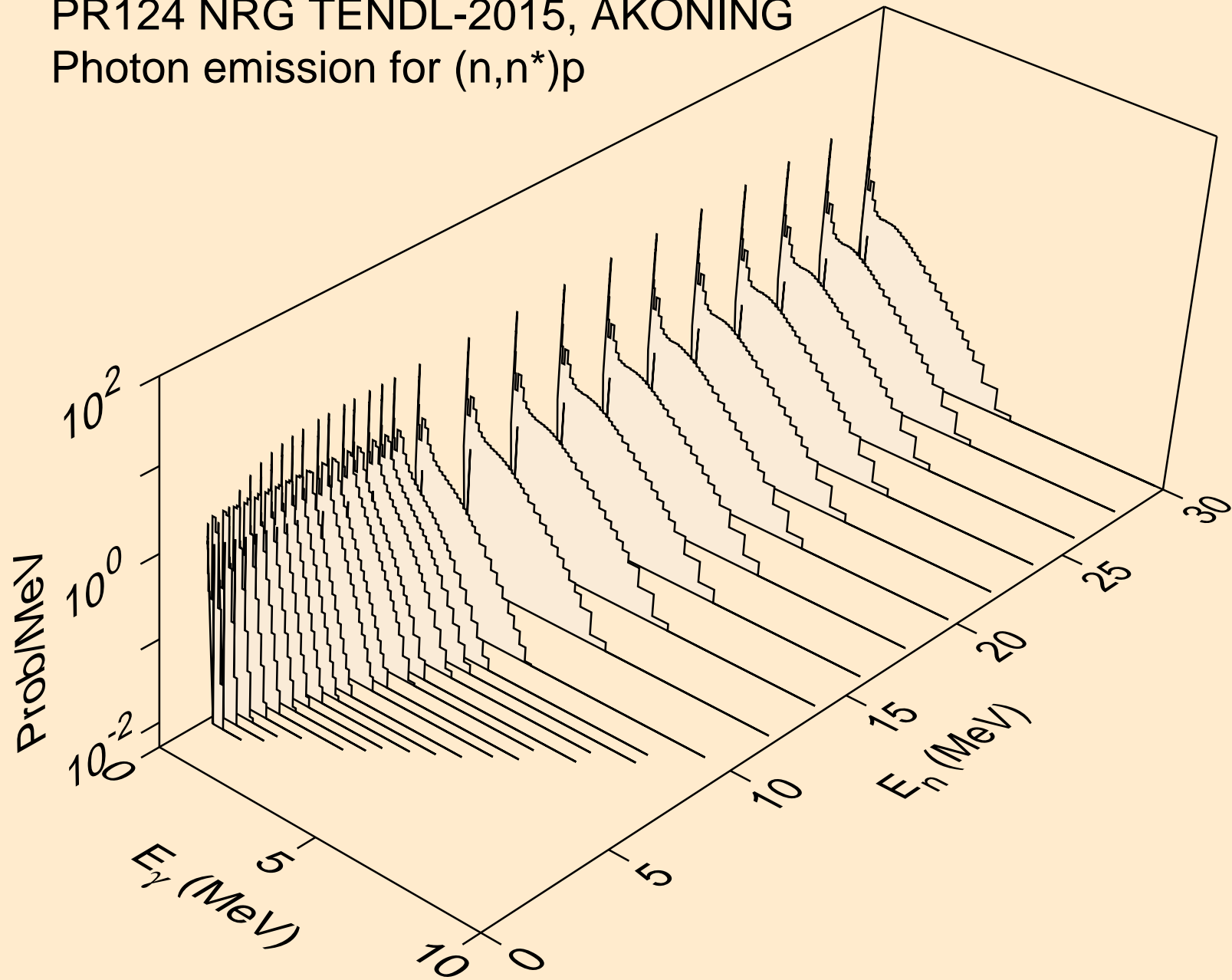

PR124 NRG TENDL-2015, AKONING
Photon emission for (n,n*)2a

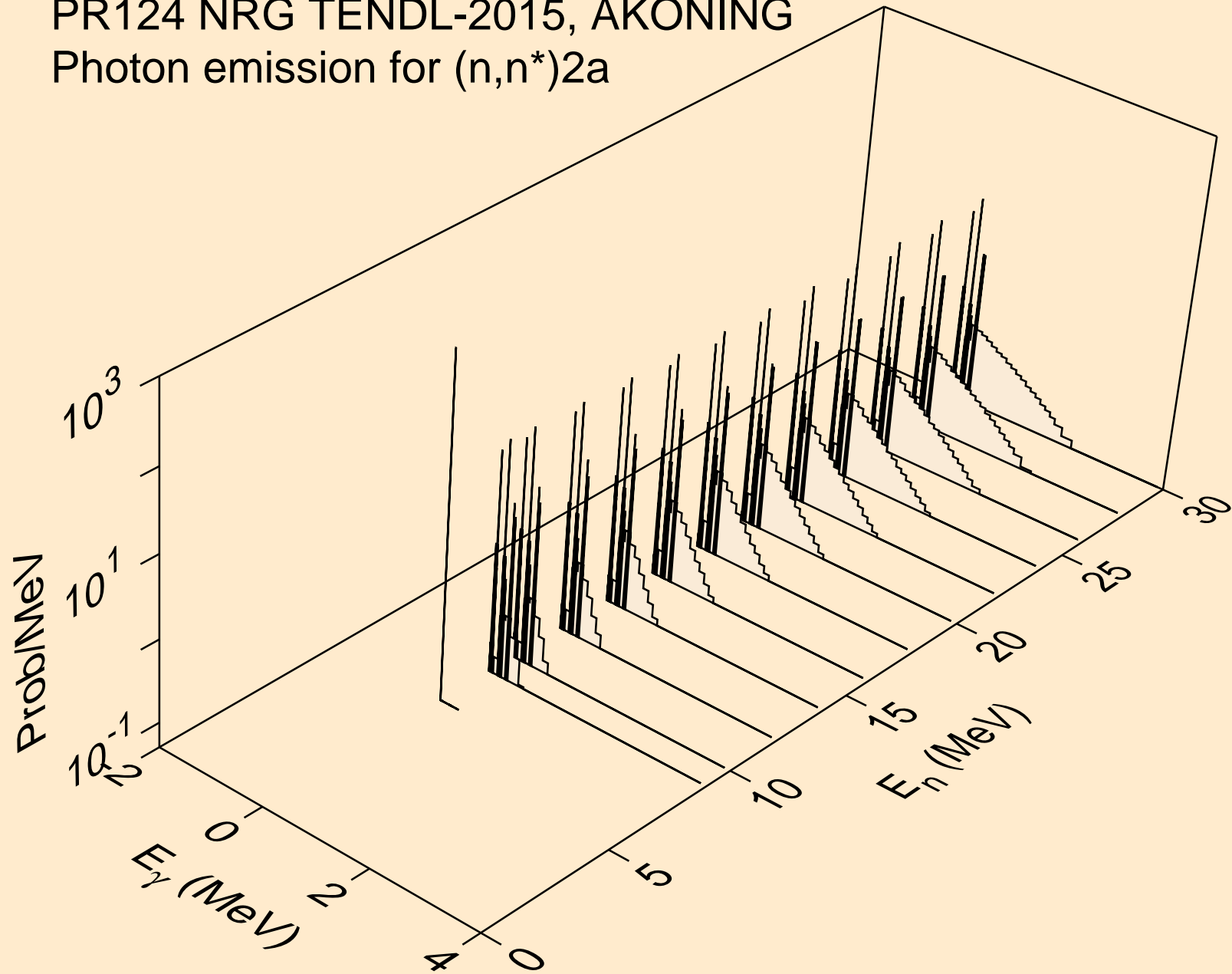

PR124 NRG TENDL-2015, AKONING
Photon emission for (n,2n)2a

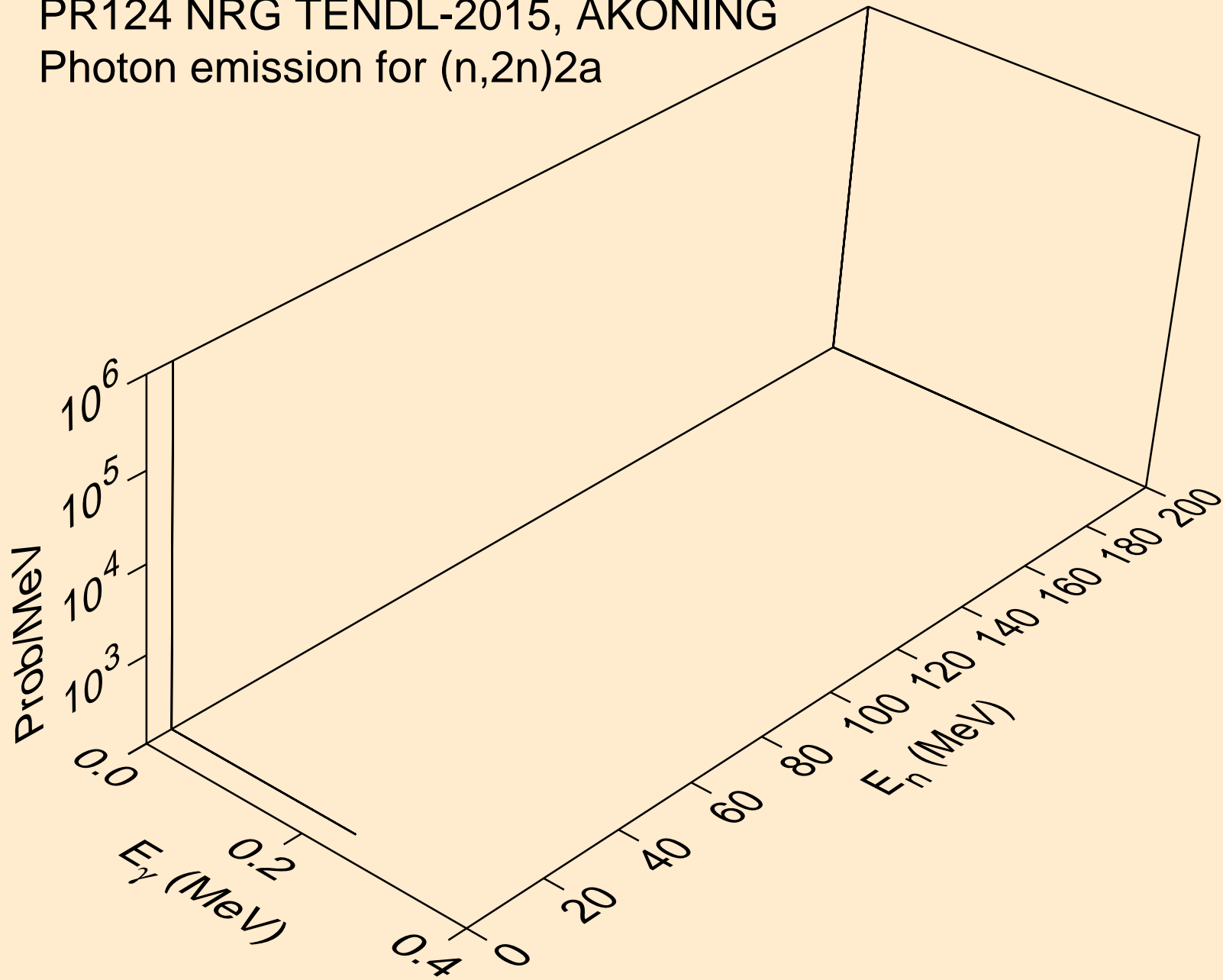

PR124 NRG TENDL-2015, AKONING

Photon emission for (n,n*)d

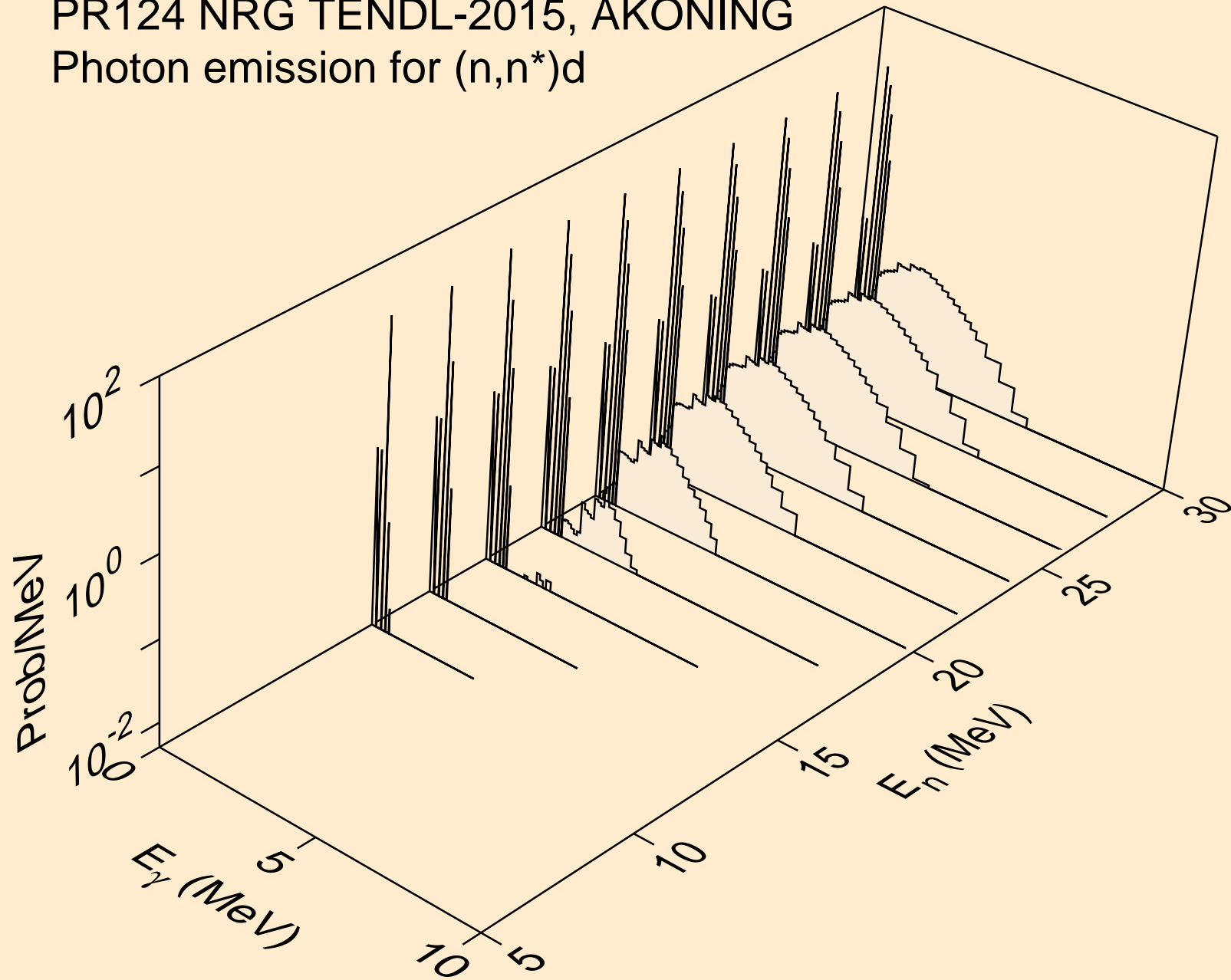

PR124 NRG TENDL-2015, AKONING
Photon emission for (n,n*)t

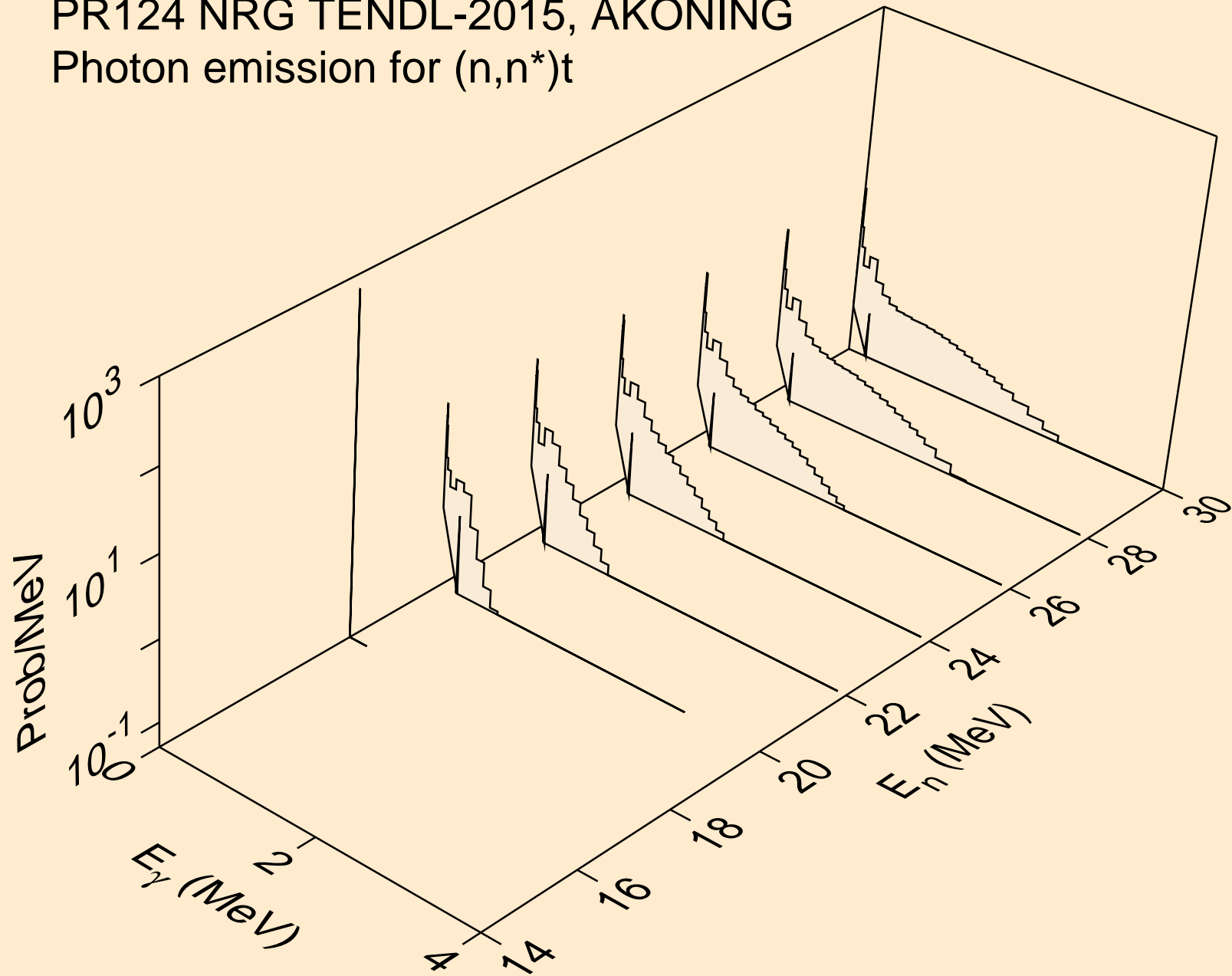

PR124 NRG TENDL-2015, AKONING
Photon emission for (n,n*)he3

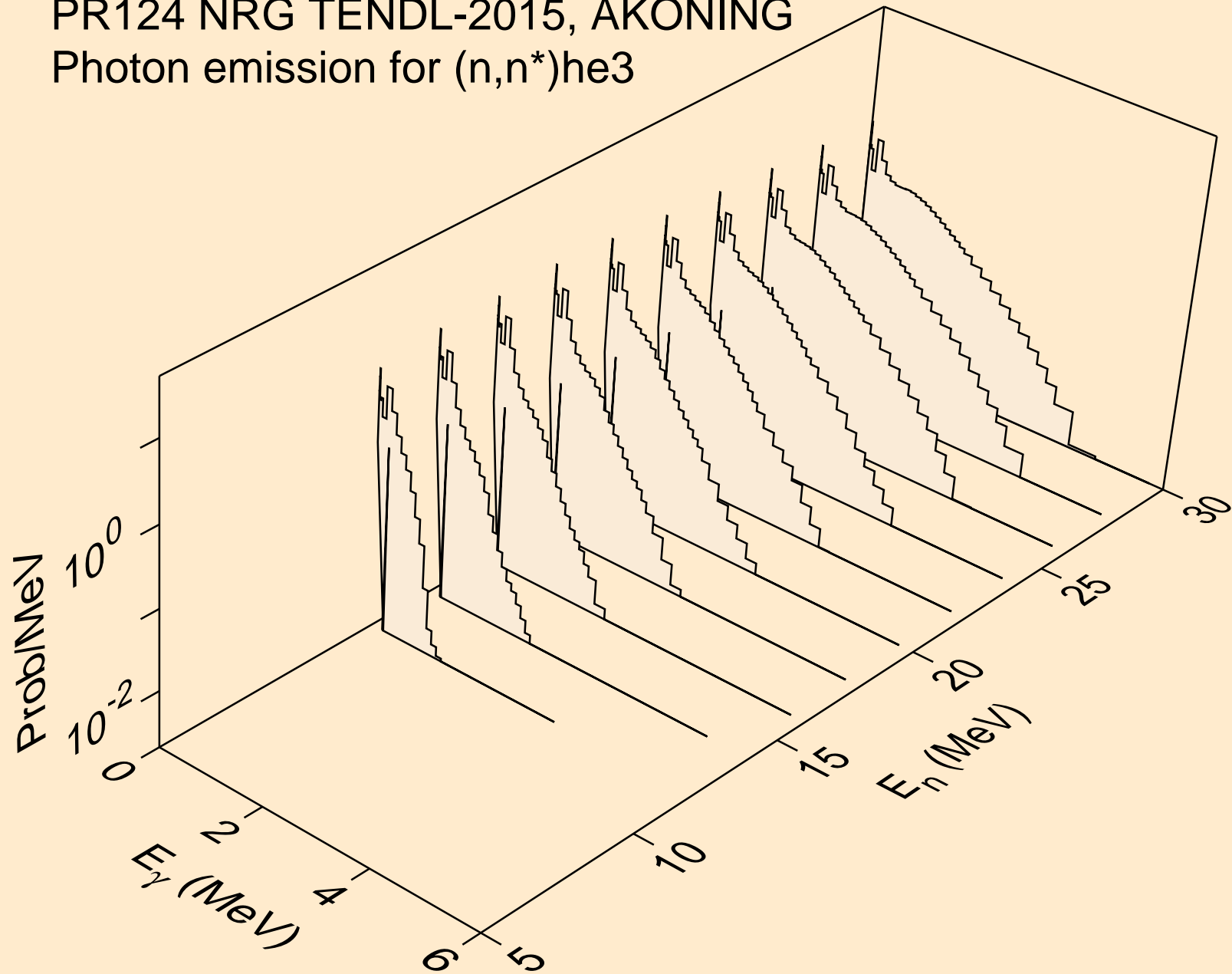

PR124 NRG TENDL-2015, AKONING
Photon emission for (n,2np)

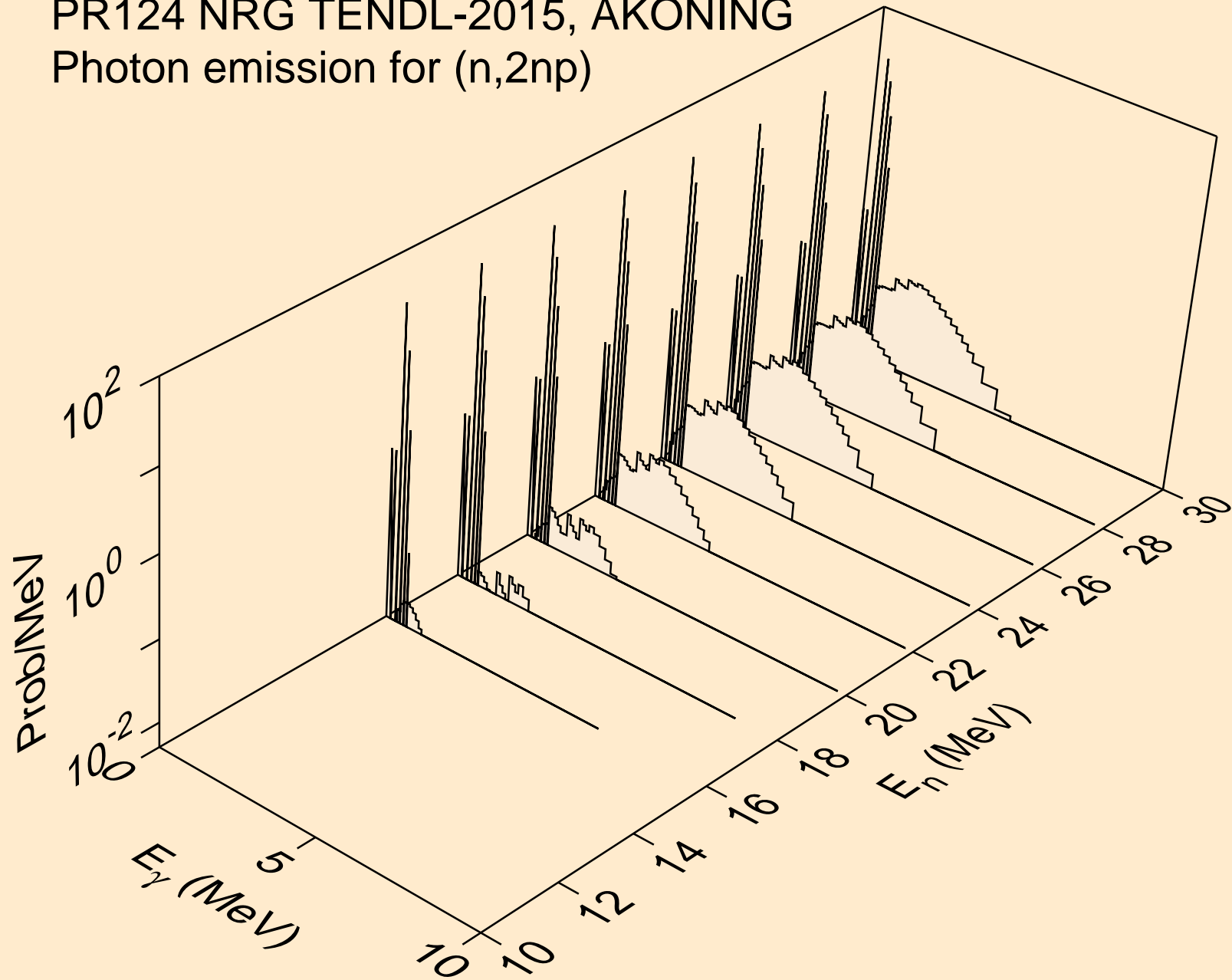

PR124 NRG TENDL-2015, AKONING
Photon emission for (n,3np)

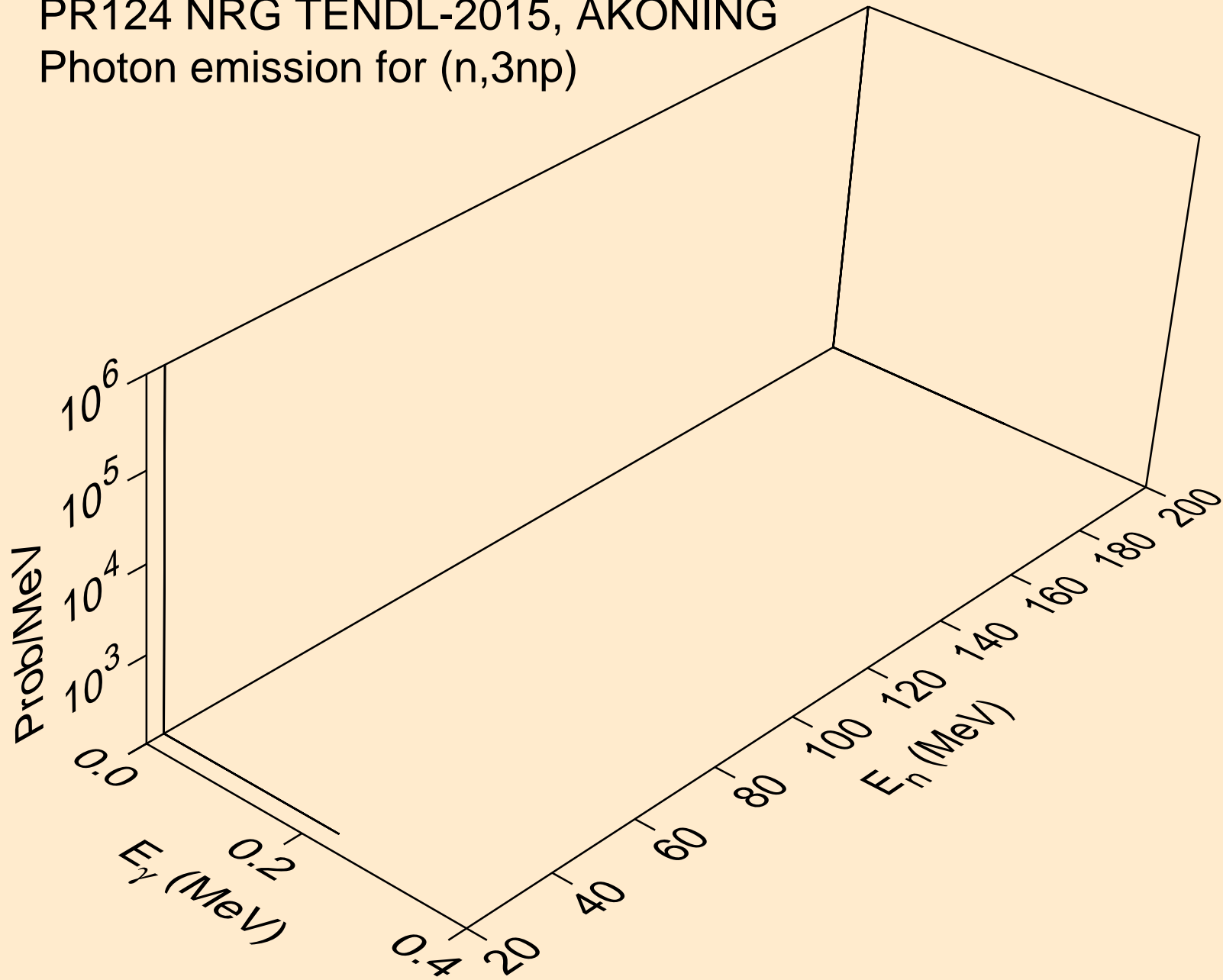

PR124 NRG TENDL-2015, AKONING
Photon emission for (n,2np)

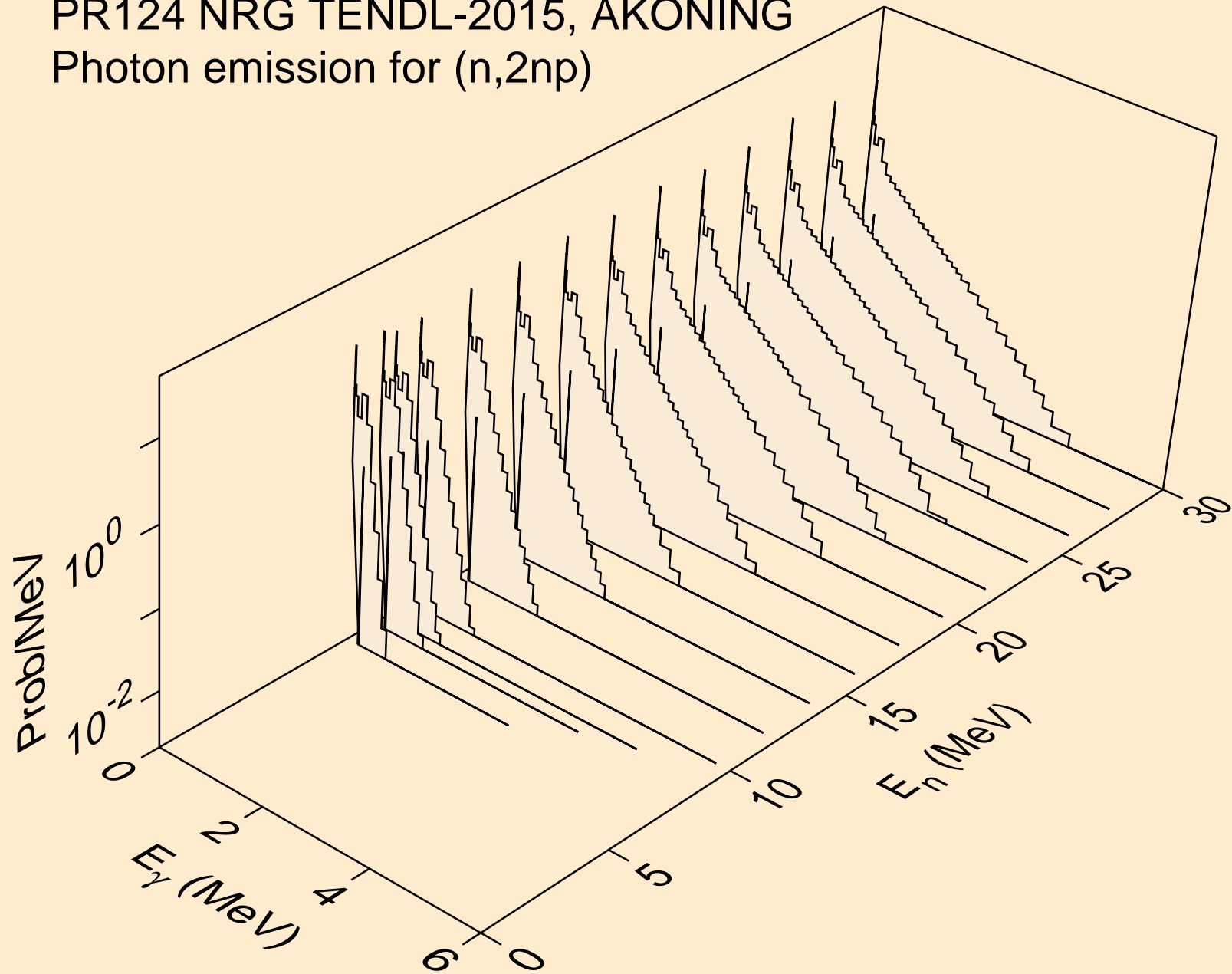

PR124 NRG TENDL-2015, AKONING
Photon emission for (n,npa)

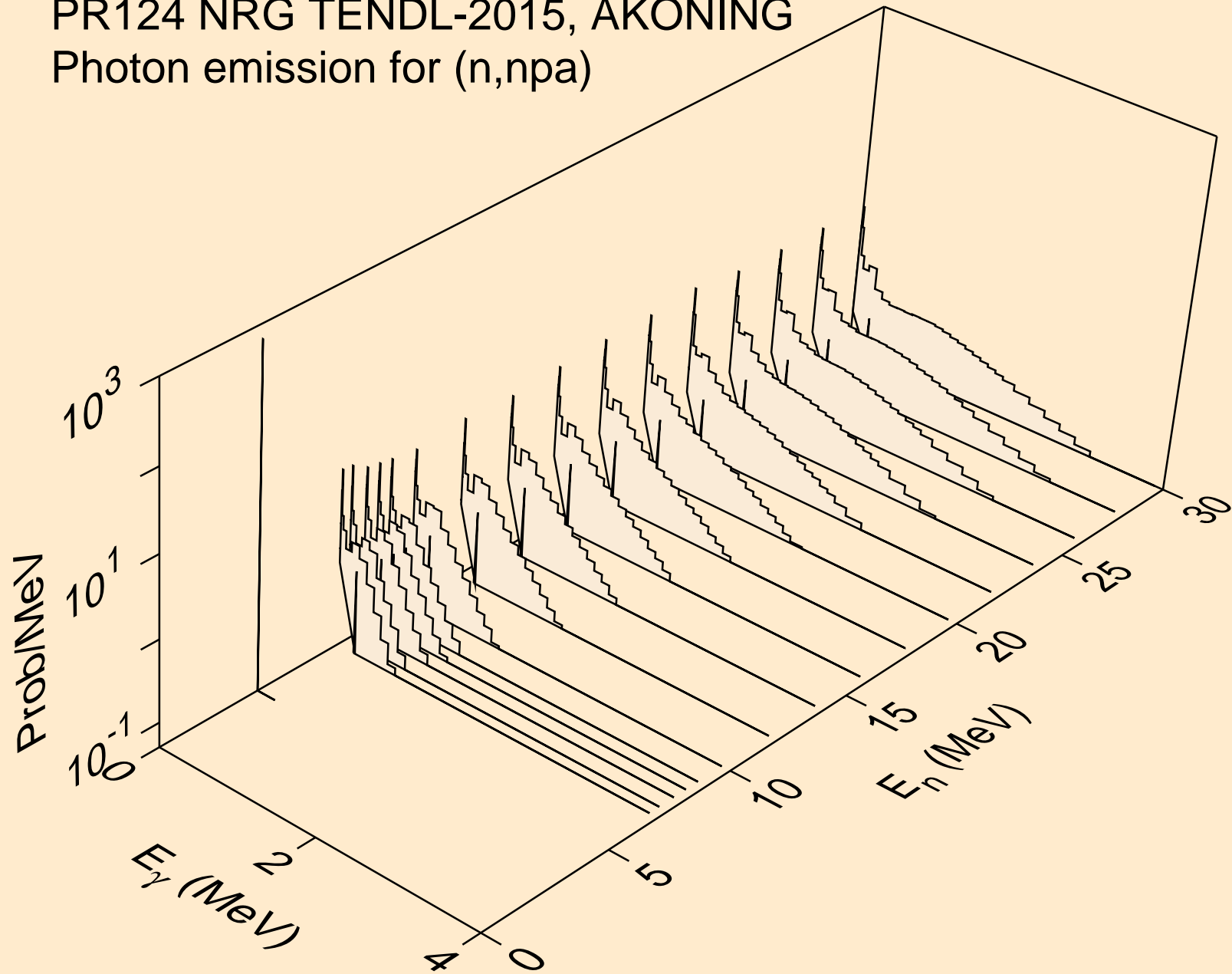

PR124 NRG TENDL-2015, AKONING
Photon emission for (n,n*c)

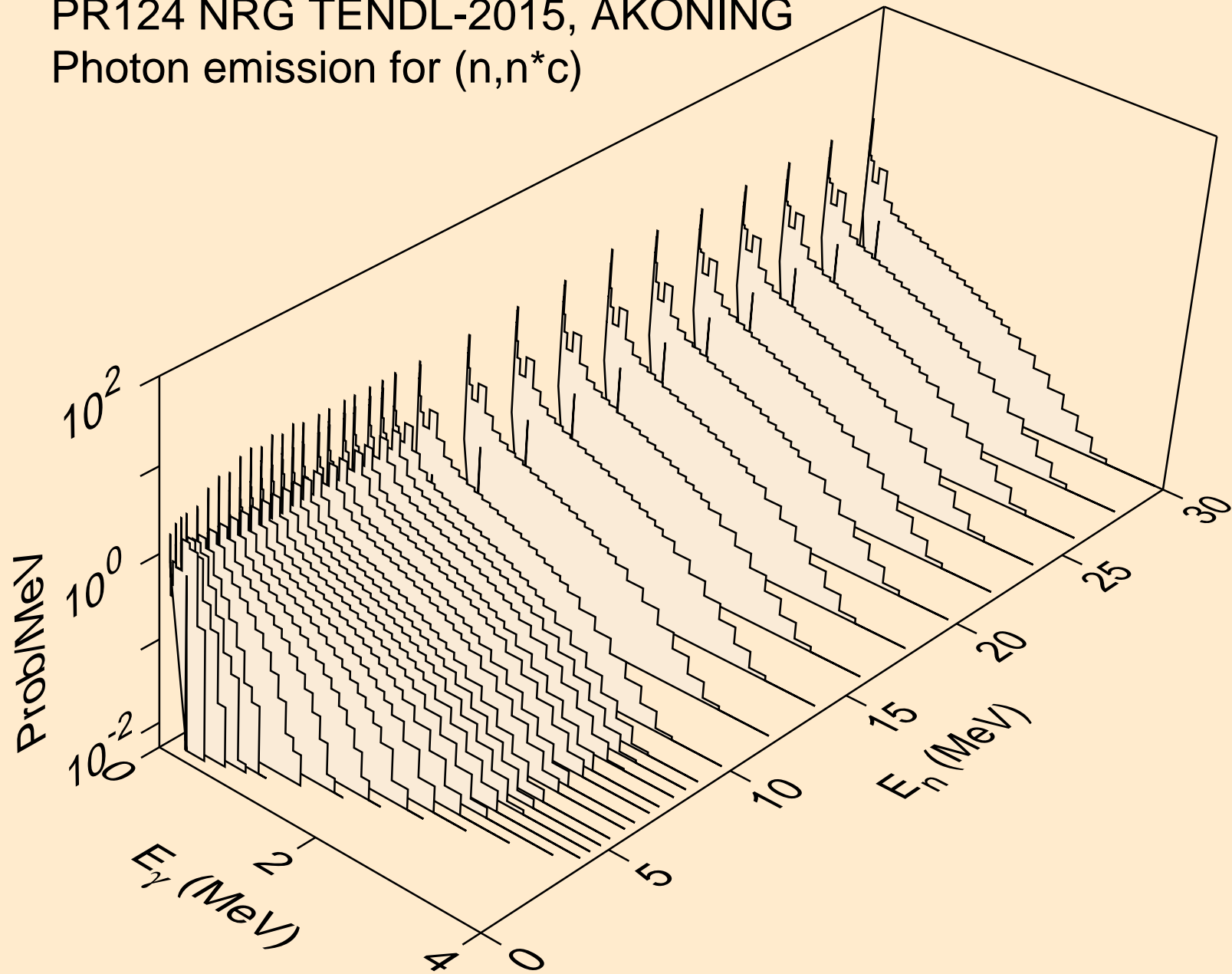

PR124 NRG TENDL-2015, AKONING

Photon emission for (n,gma)

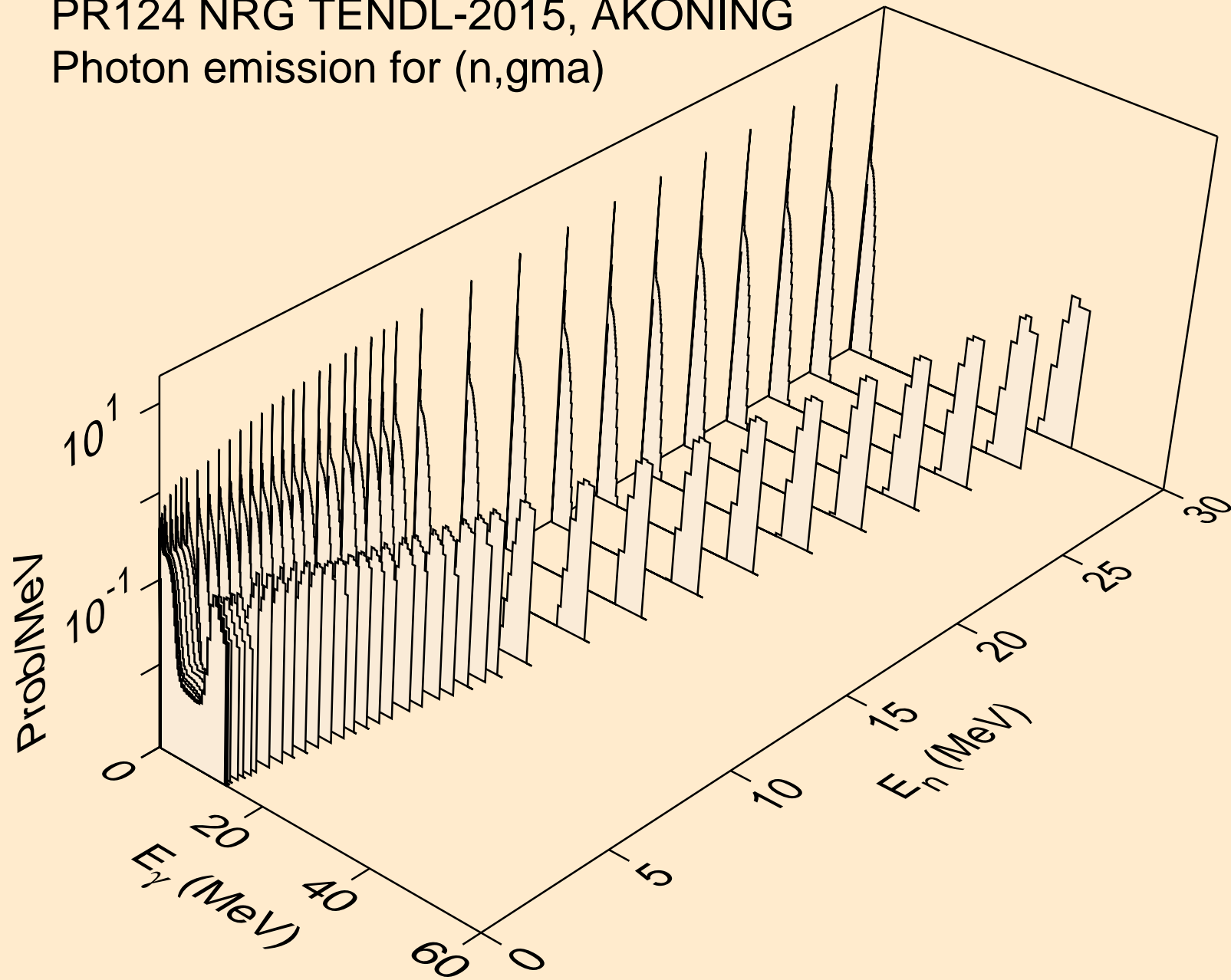

PR124 NRG TENDL-2015, AKONING
Photon emission for (n,p)

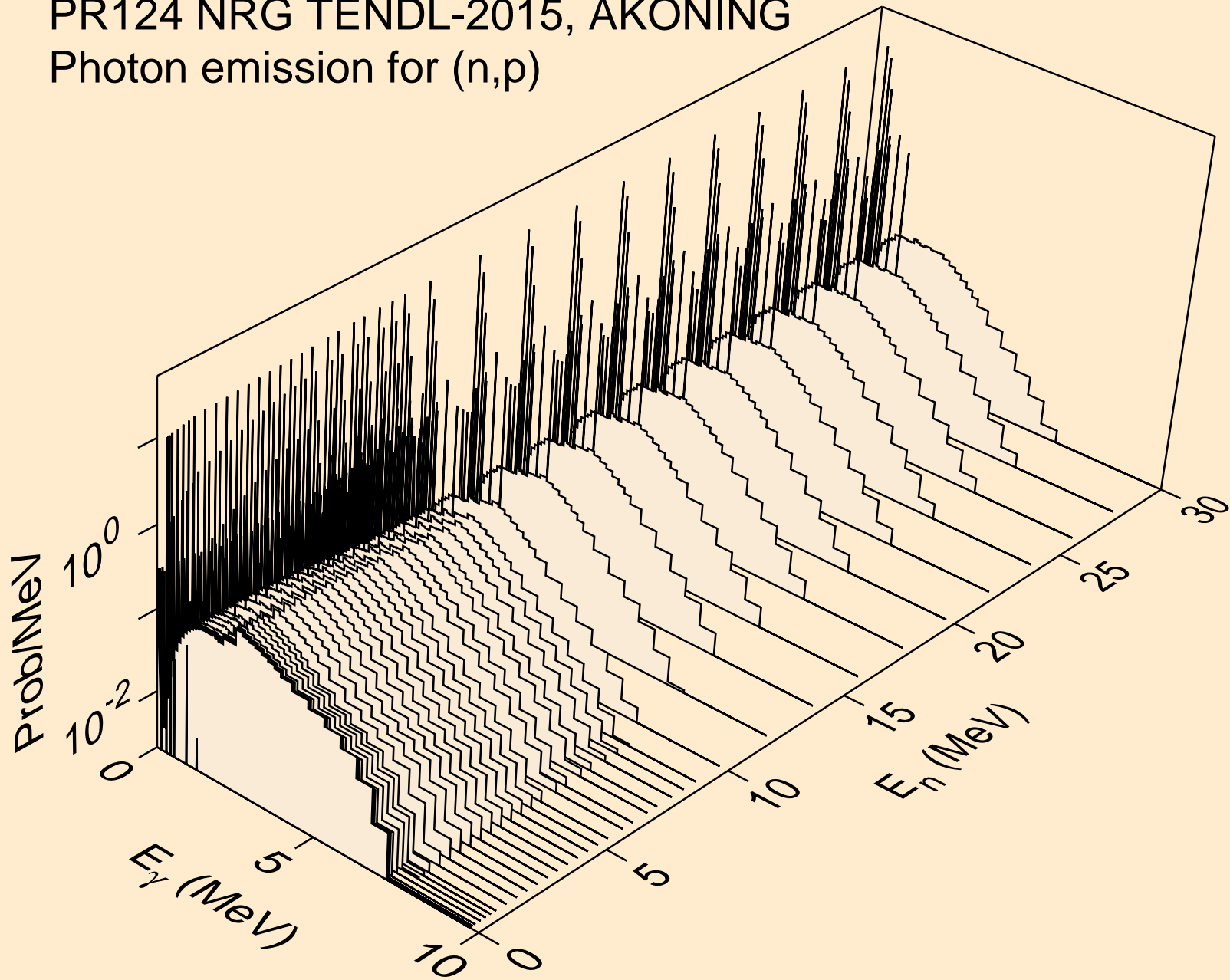

PR124 NRG TENDL-2015, AKONING
Photon emission for (n,d)

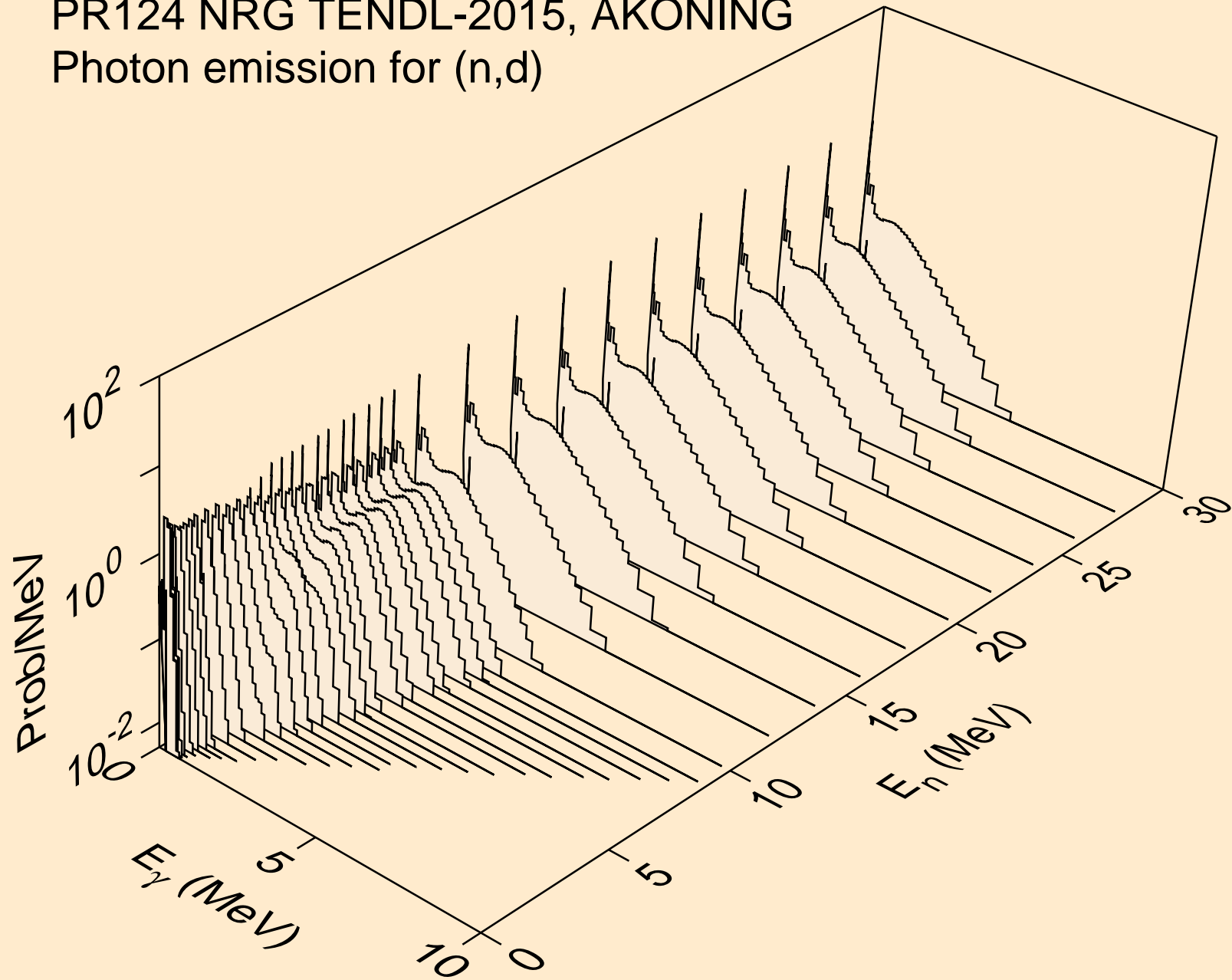

PR124 NRG TENDL-2015, AKONING
Photon emission for (n,t)

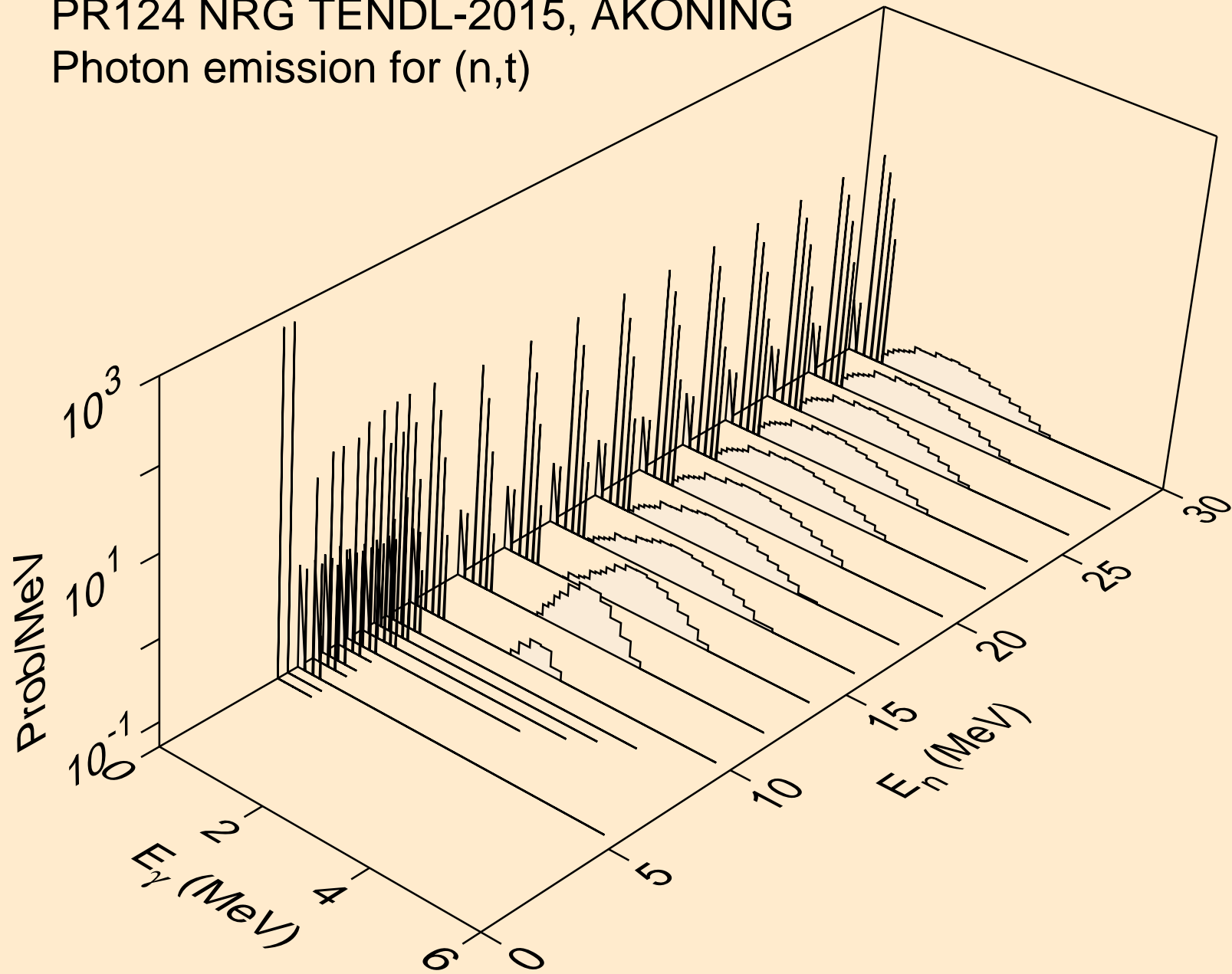

PR124 NRG TENDL-2015, AKONING
Photon emission for (n,he3)

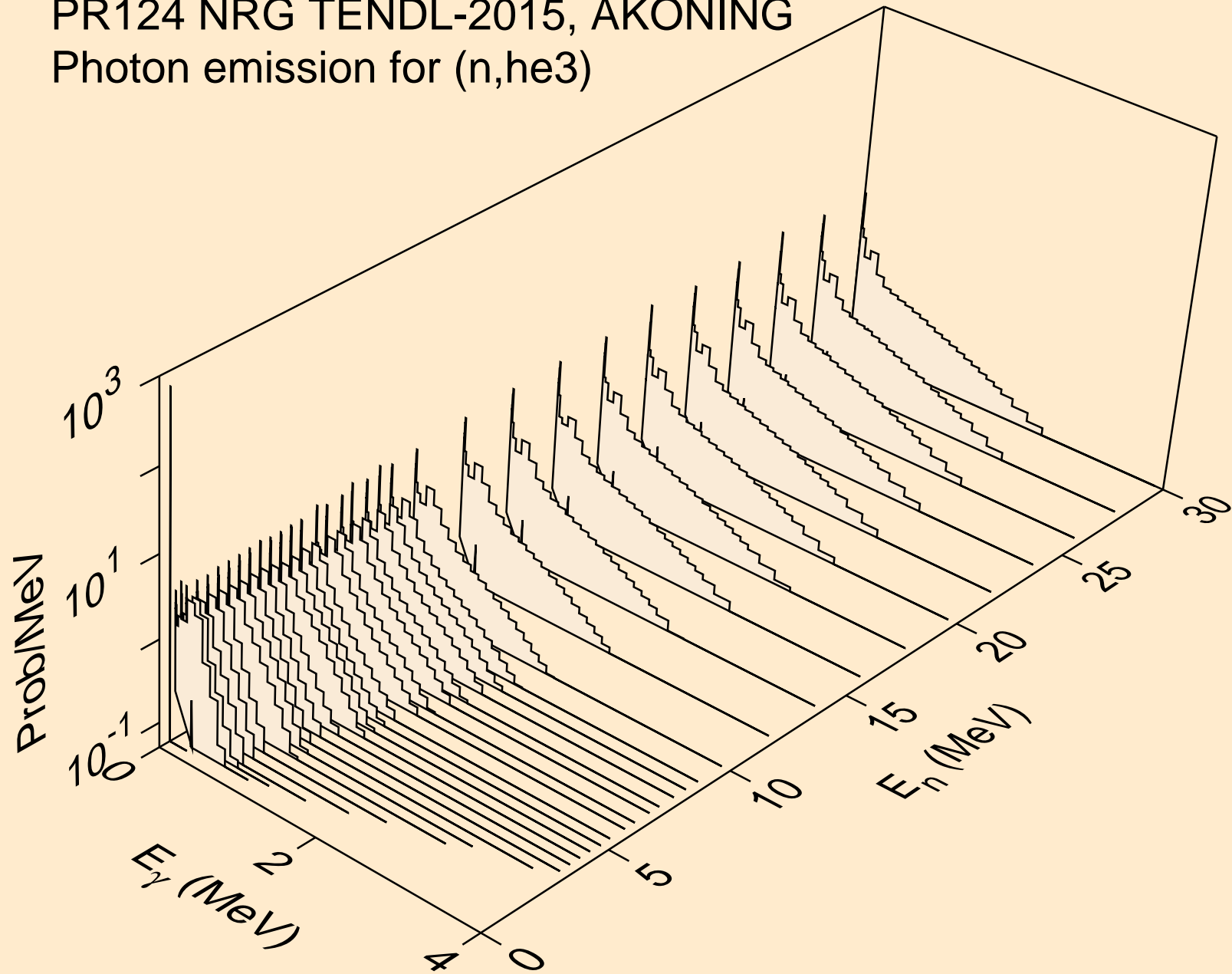

PR124 NRG TENDL-2015, AKONING
Photon emission for (n,a)

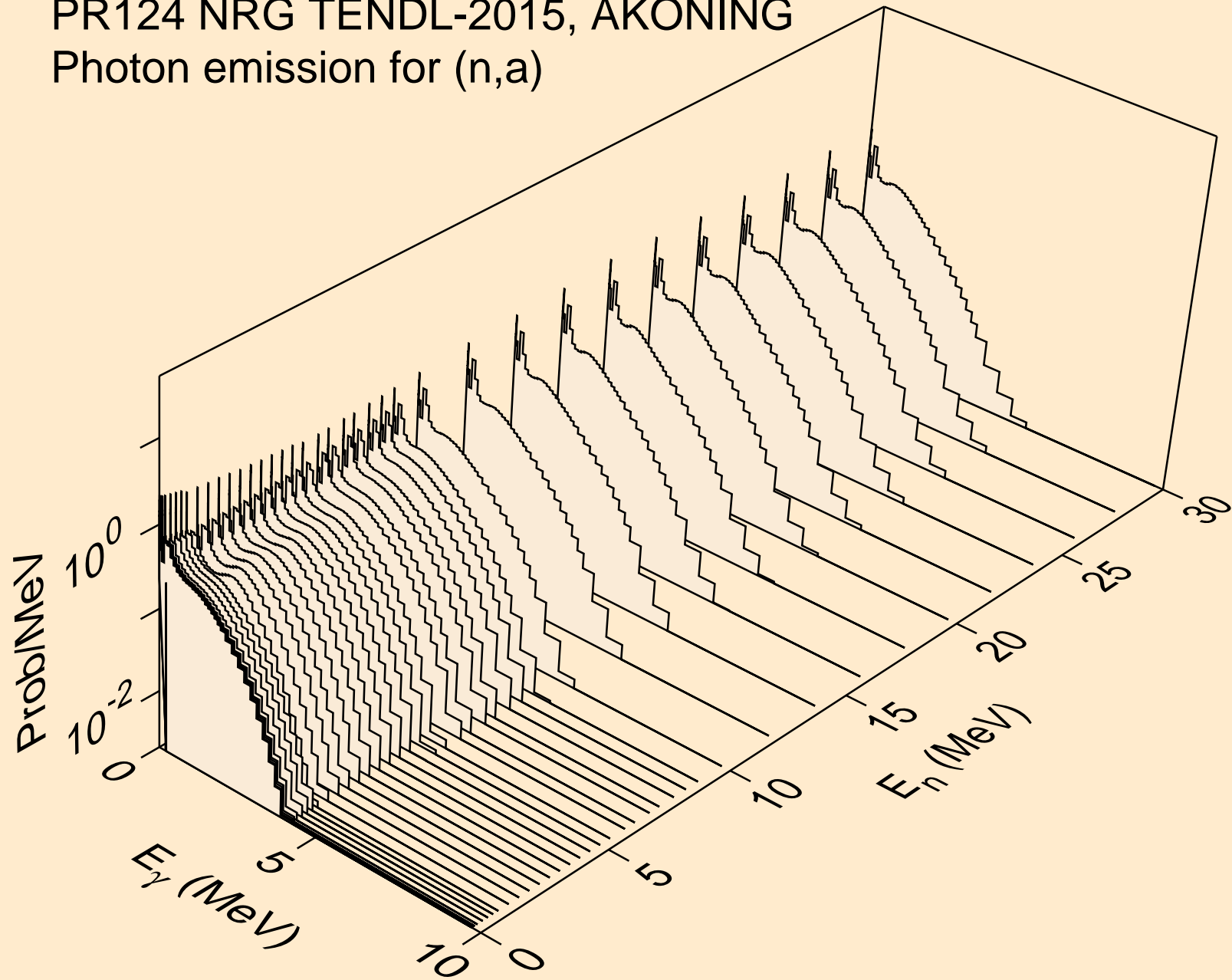

PR124 NRG TENDL-2015, AKONING
Photon emission for (n,2a)

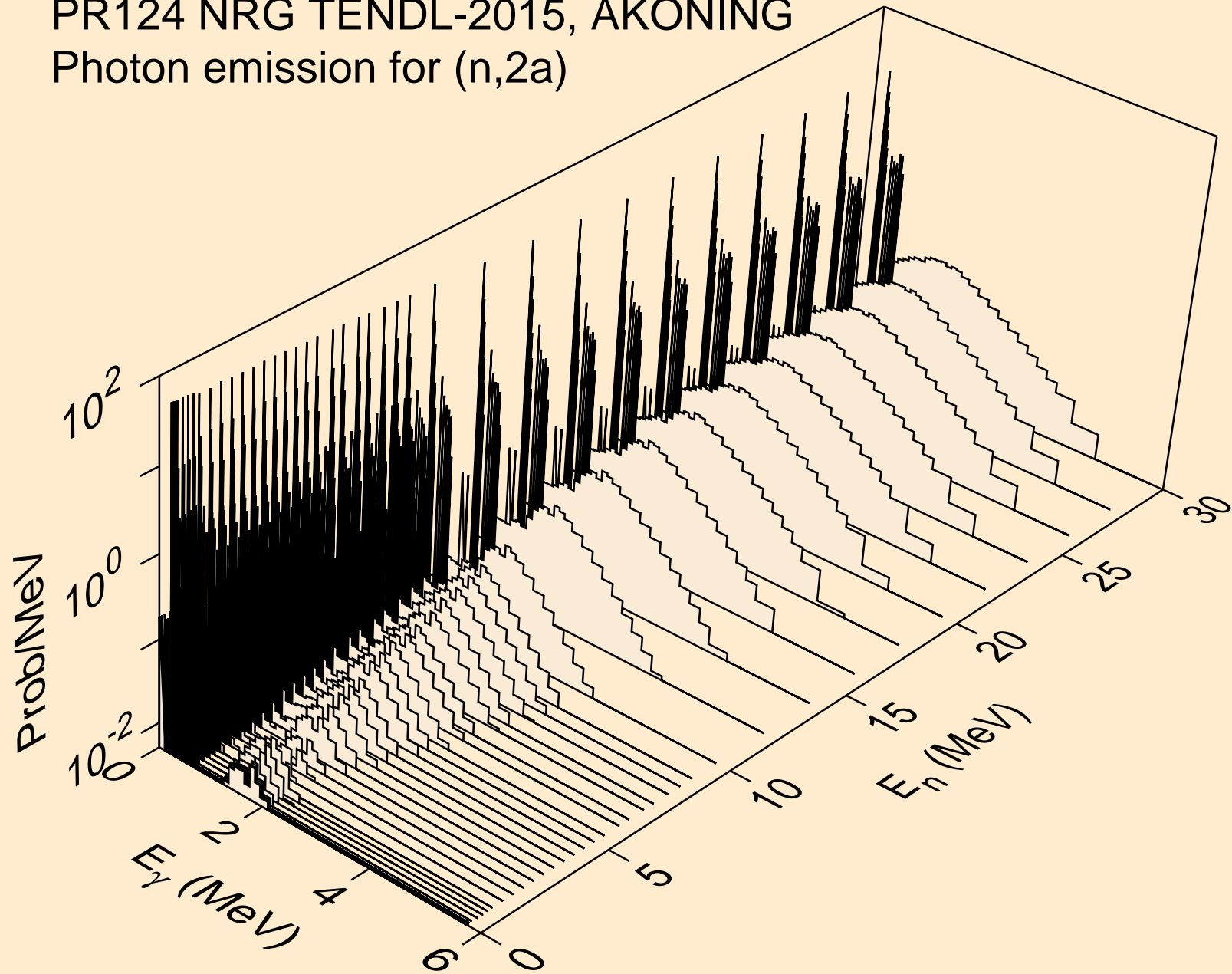

PR124 NRG TENDL-2015, AKONING
Photon emission for (n,3a)

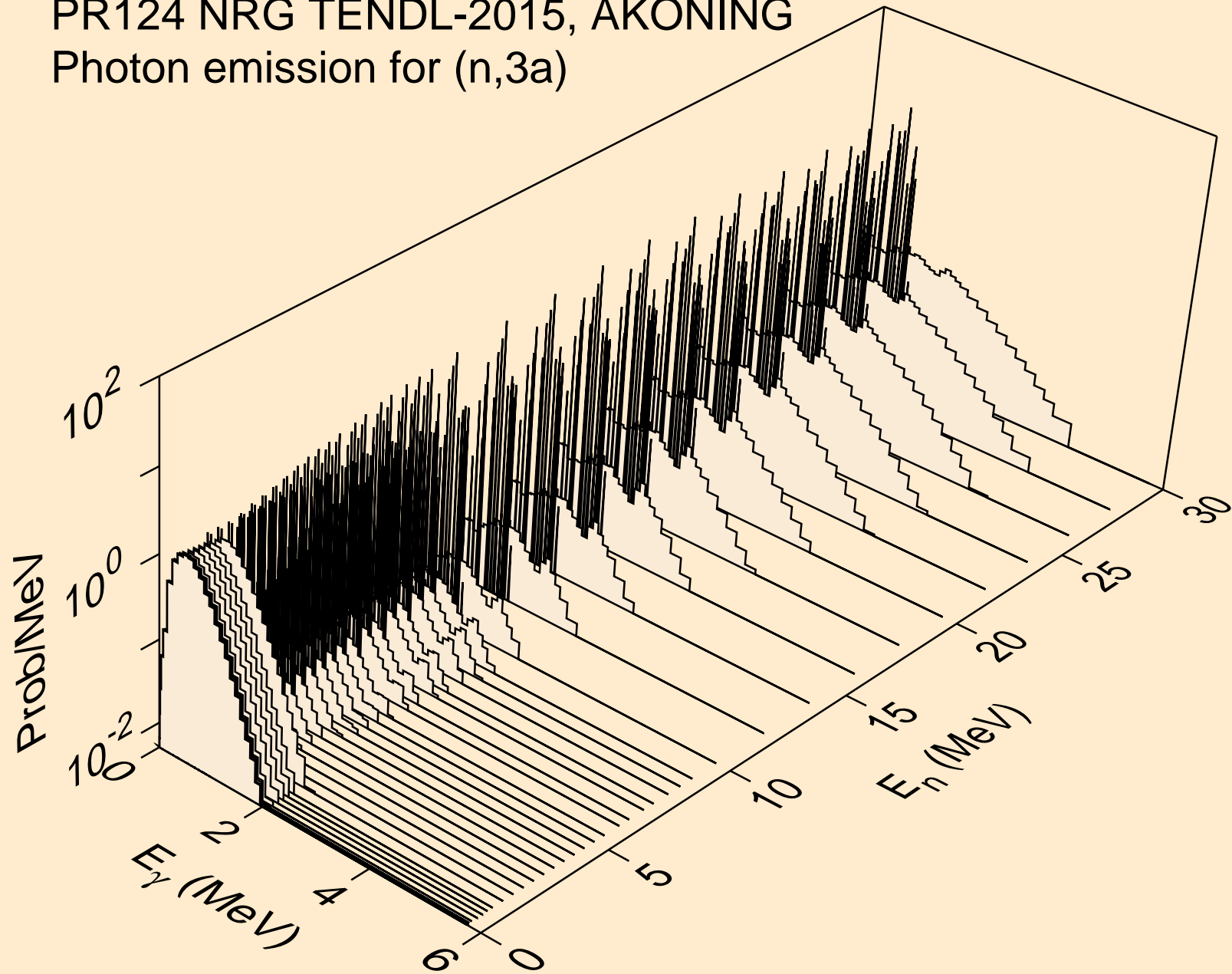

PR124 NRG TENDL-2015, AKONING
Photon emission for (n,2p)

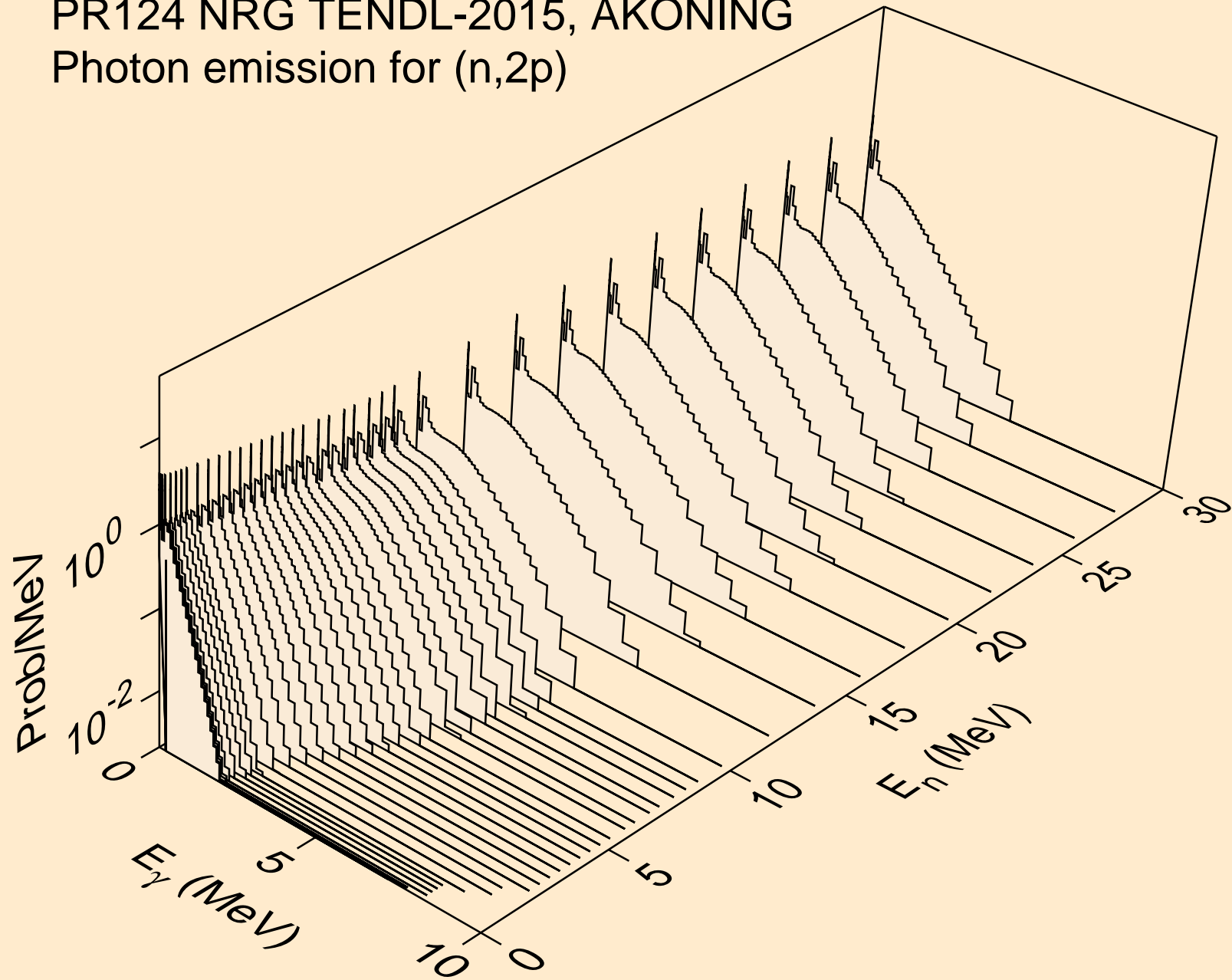

PR124 NRG TENDL-2015, AKONING
Photon emission for (n,p α)

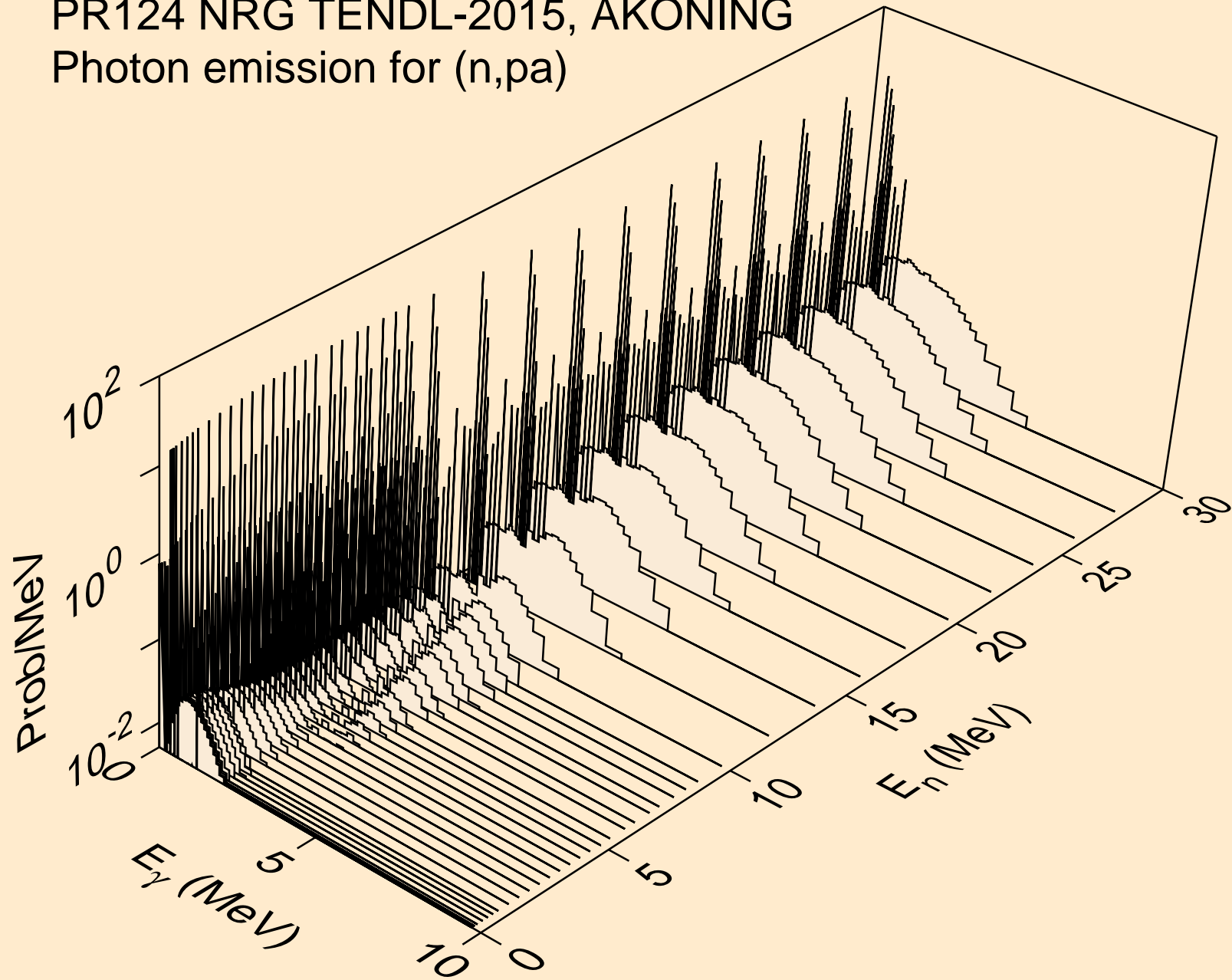

PR124 NRG TENDL-2015, AKONING
Photon emission for (n,t2a)

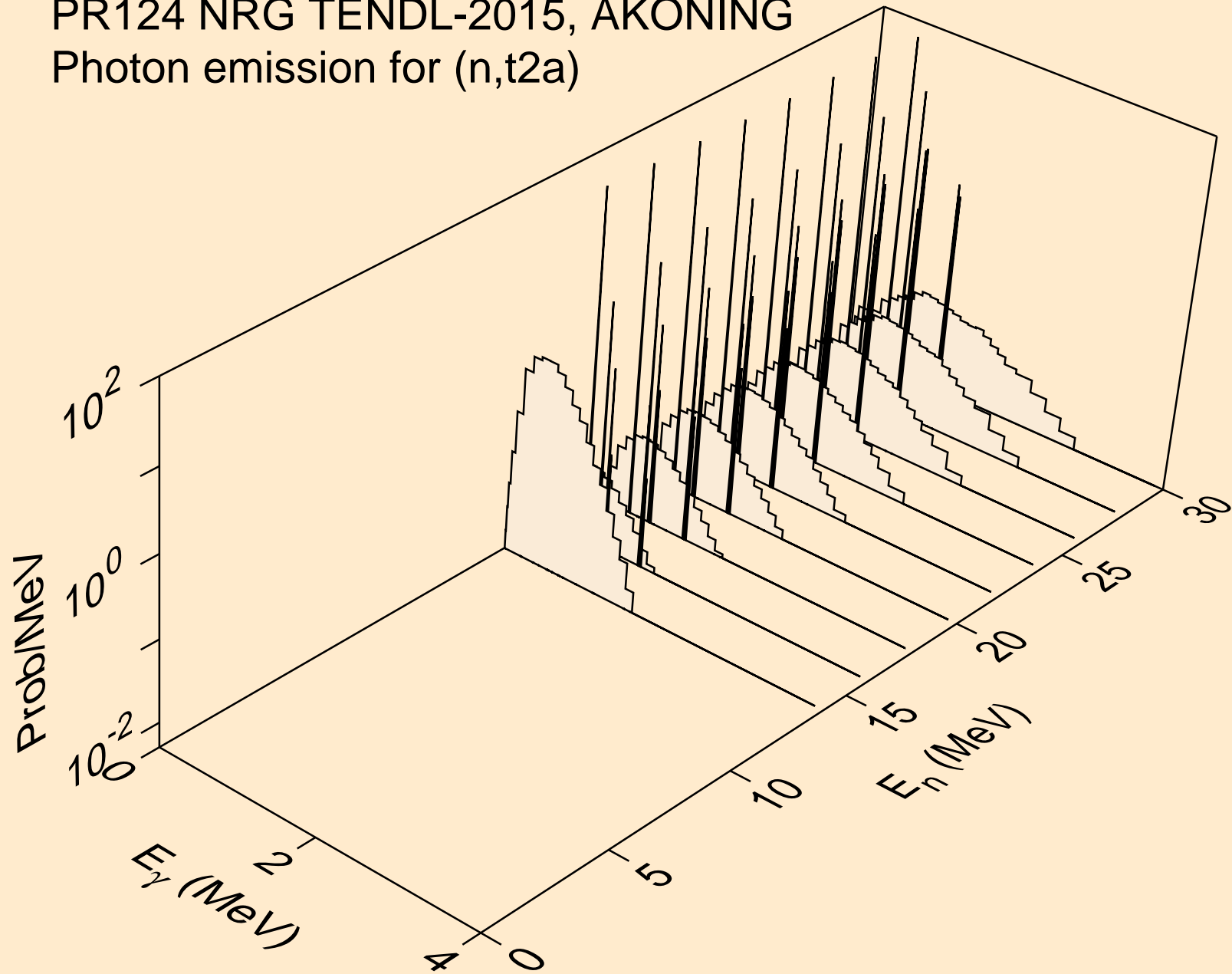

PR124 NRG TENDL-2015, AKONING
Photon emission for (n,d2a)

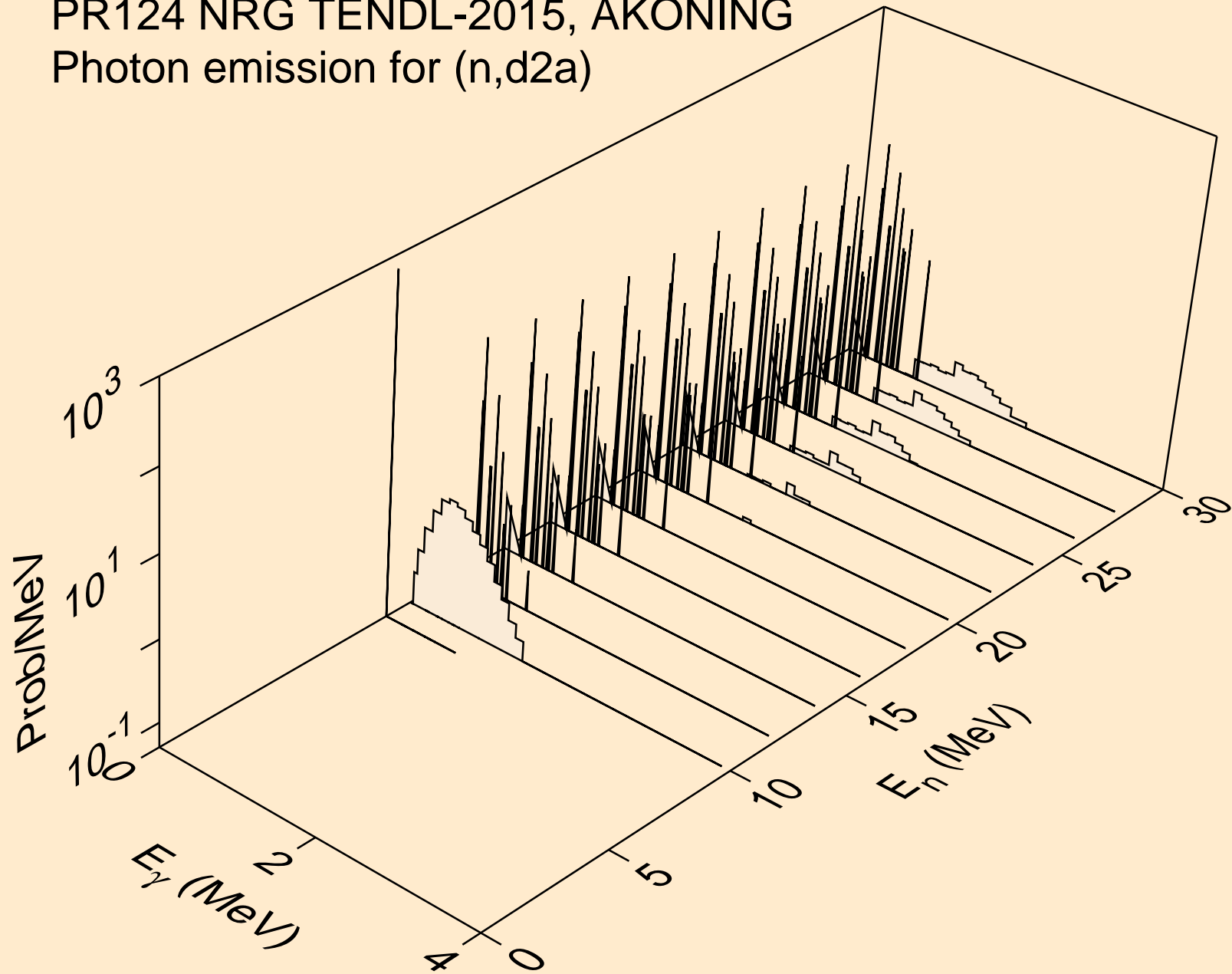

PR124 NRG TENDL-2015, AKONING
Photon emission for (n,pd)

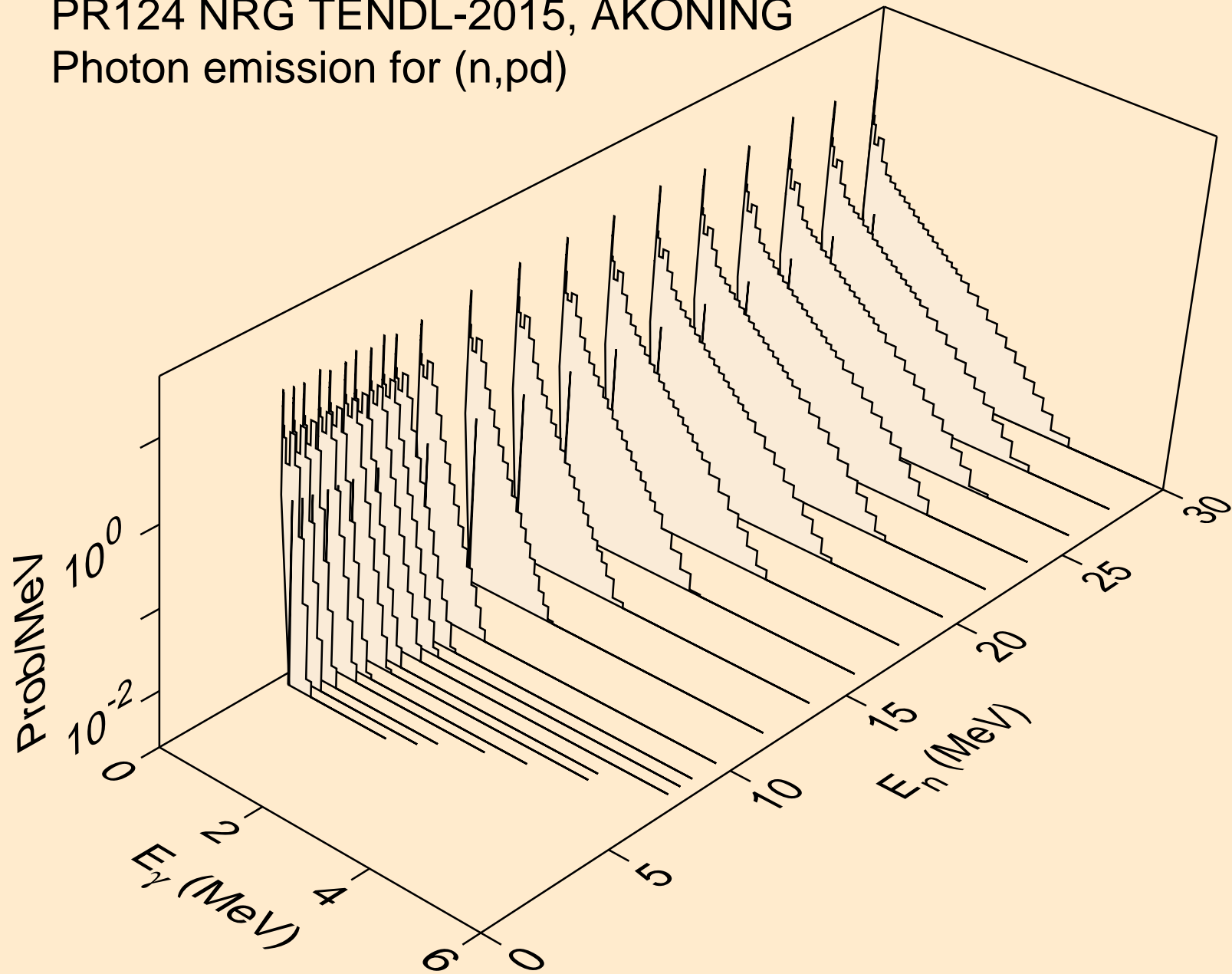

PR124 NRG TENDL-2015, AKONING
Photon emission for (n,pt)

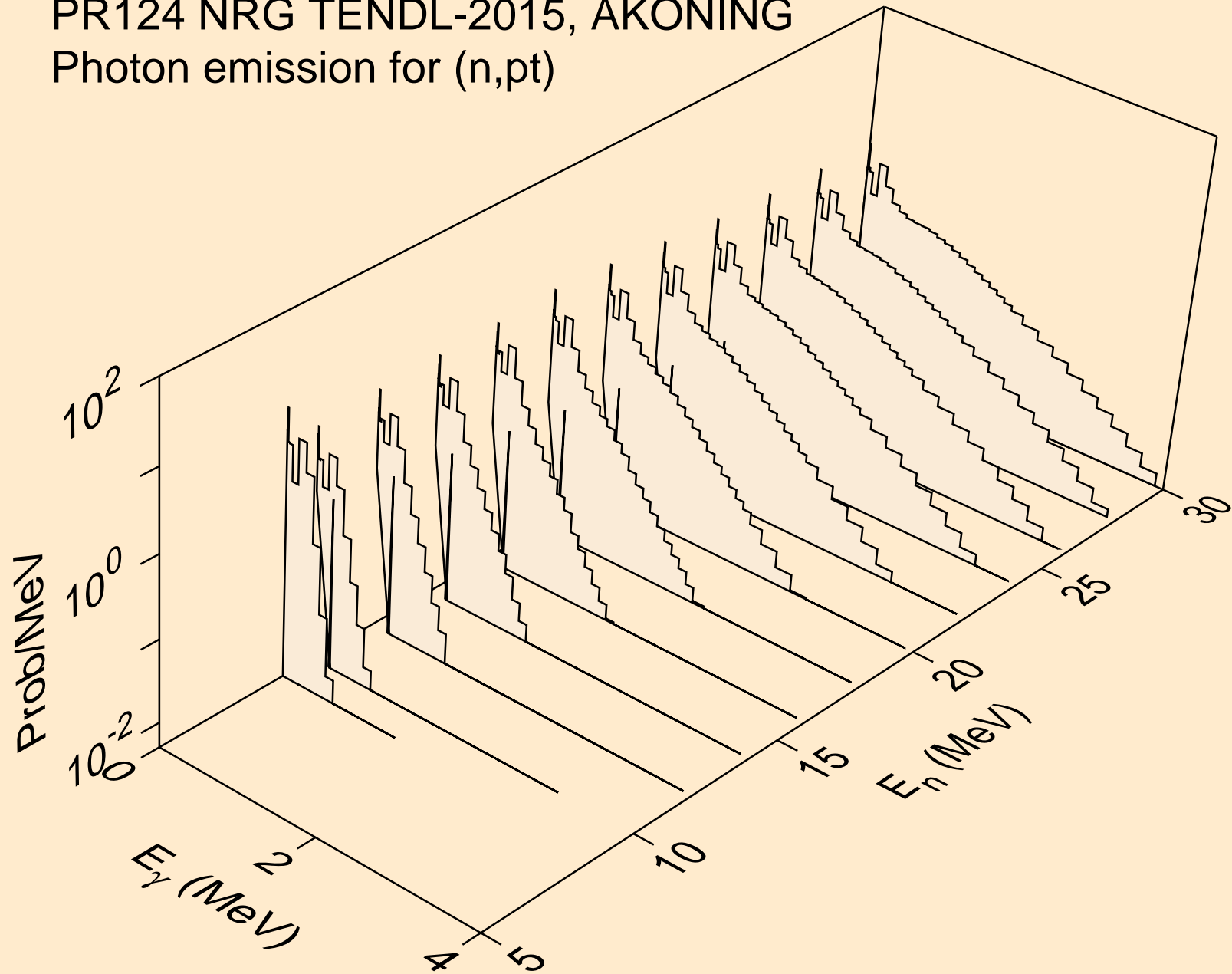

PR124 NRG TENDL-2015, AKONING
Photon emission for (n,da)

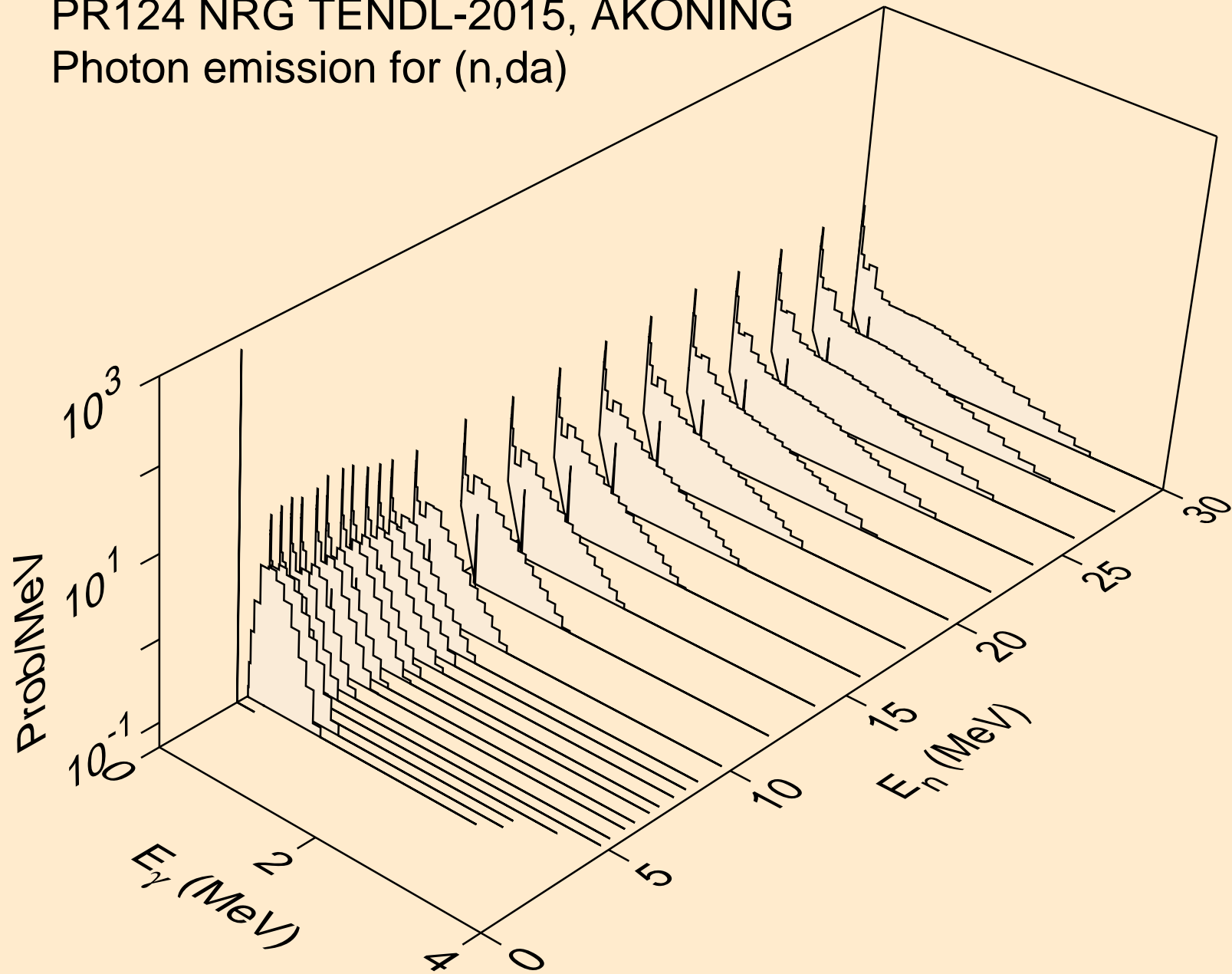

PR124 NRG TENDL-2015, AKONING
thermal capture photon spectrum

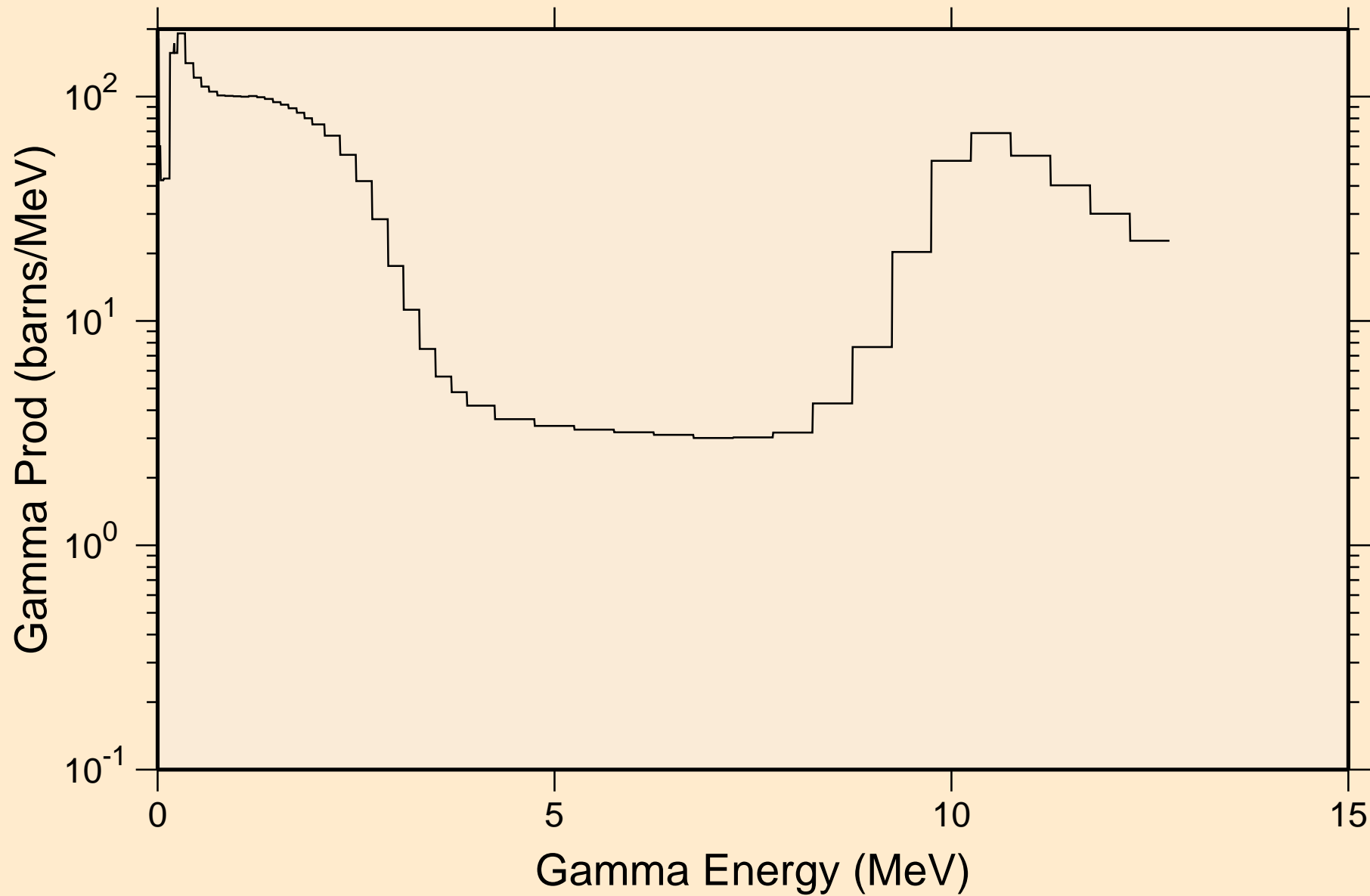

PR124 NRG TENDL-2015, AKONING
14 MeV photon spectrum

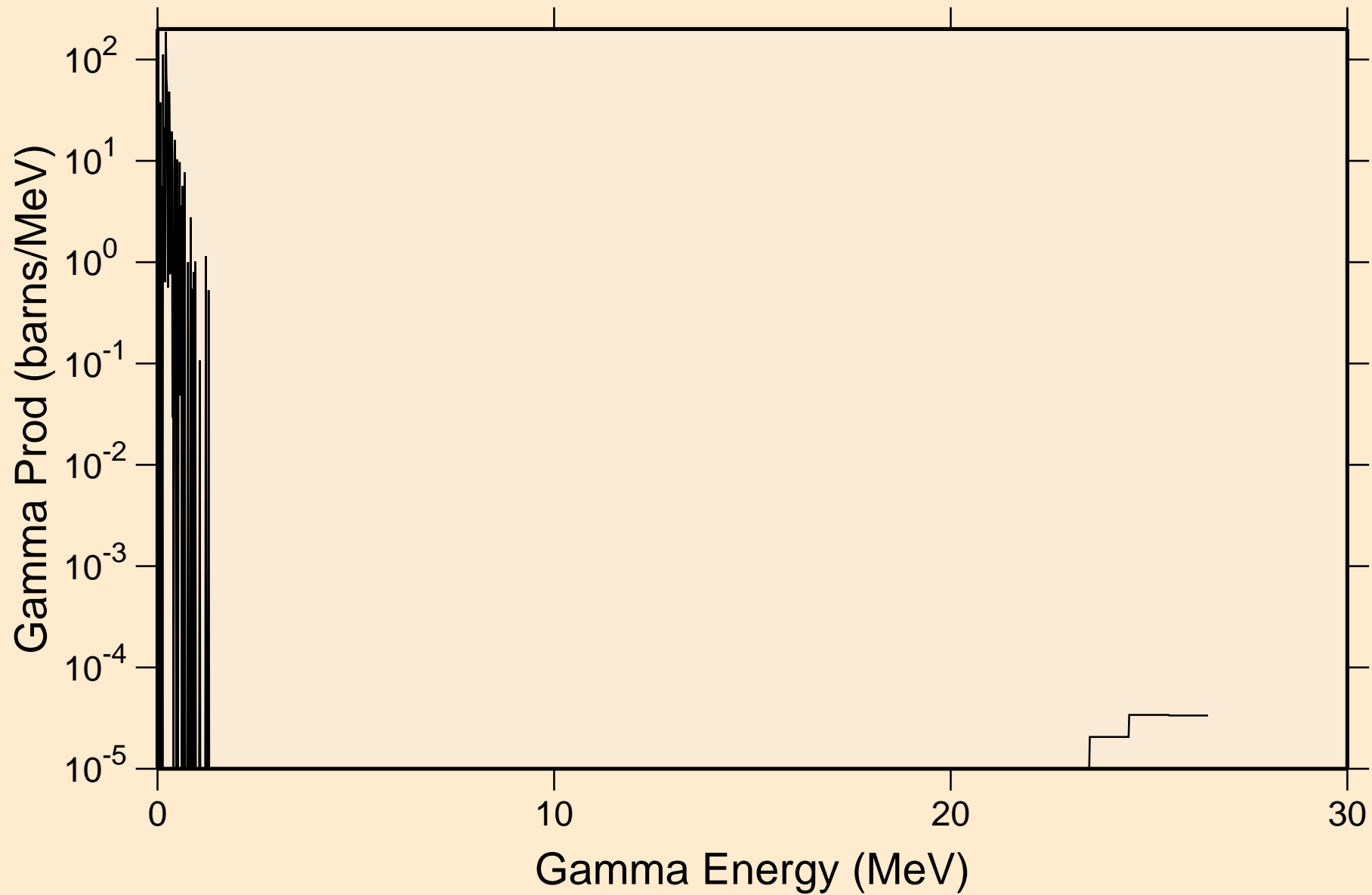

PR124 NRG TENDL-2015, AKONING

Particle heating contributions

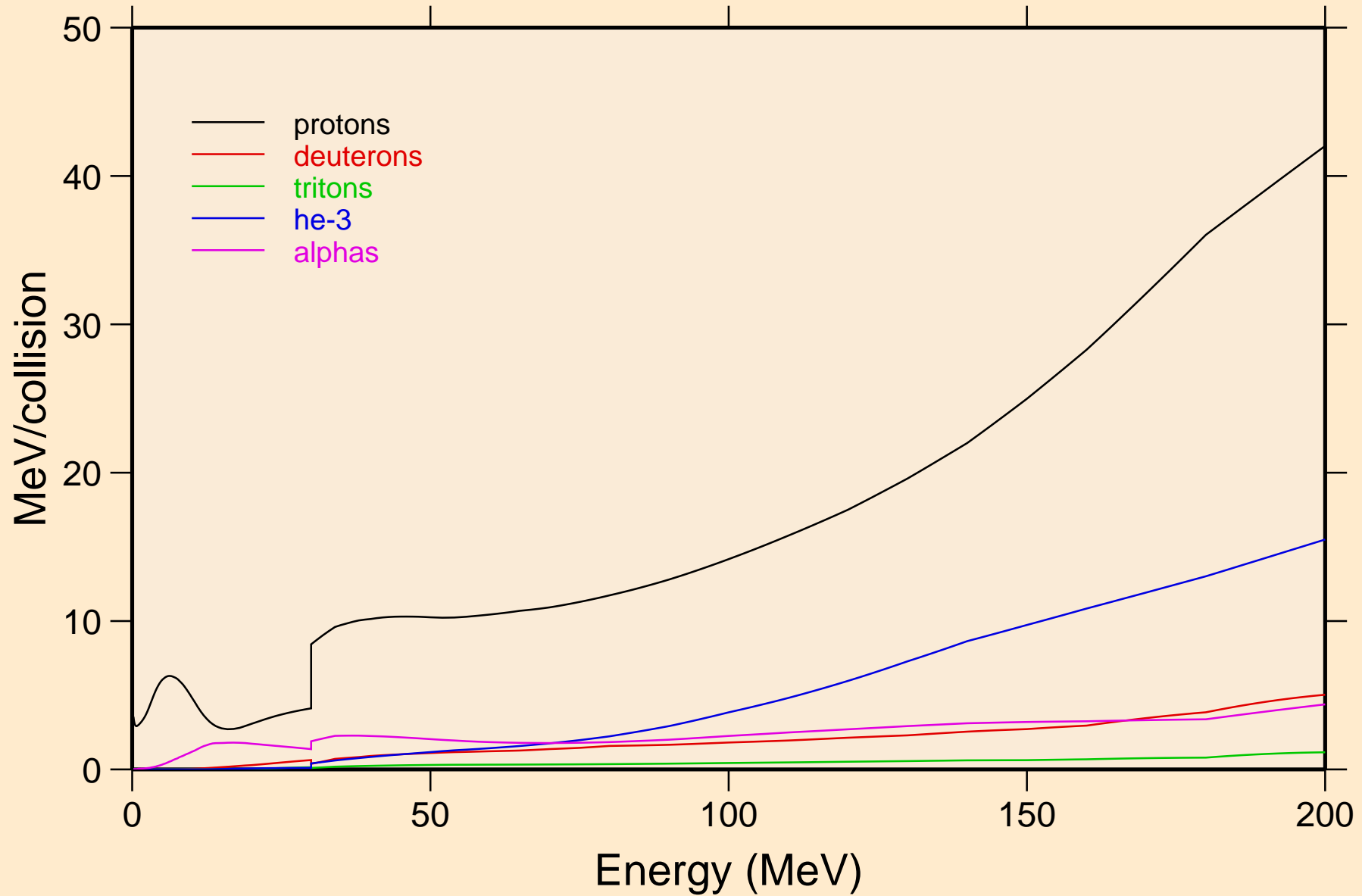

PR124 NRG TENDL-2015, AKONING

Recoil Heating

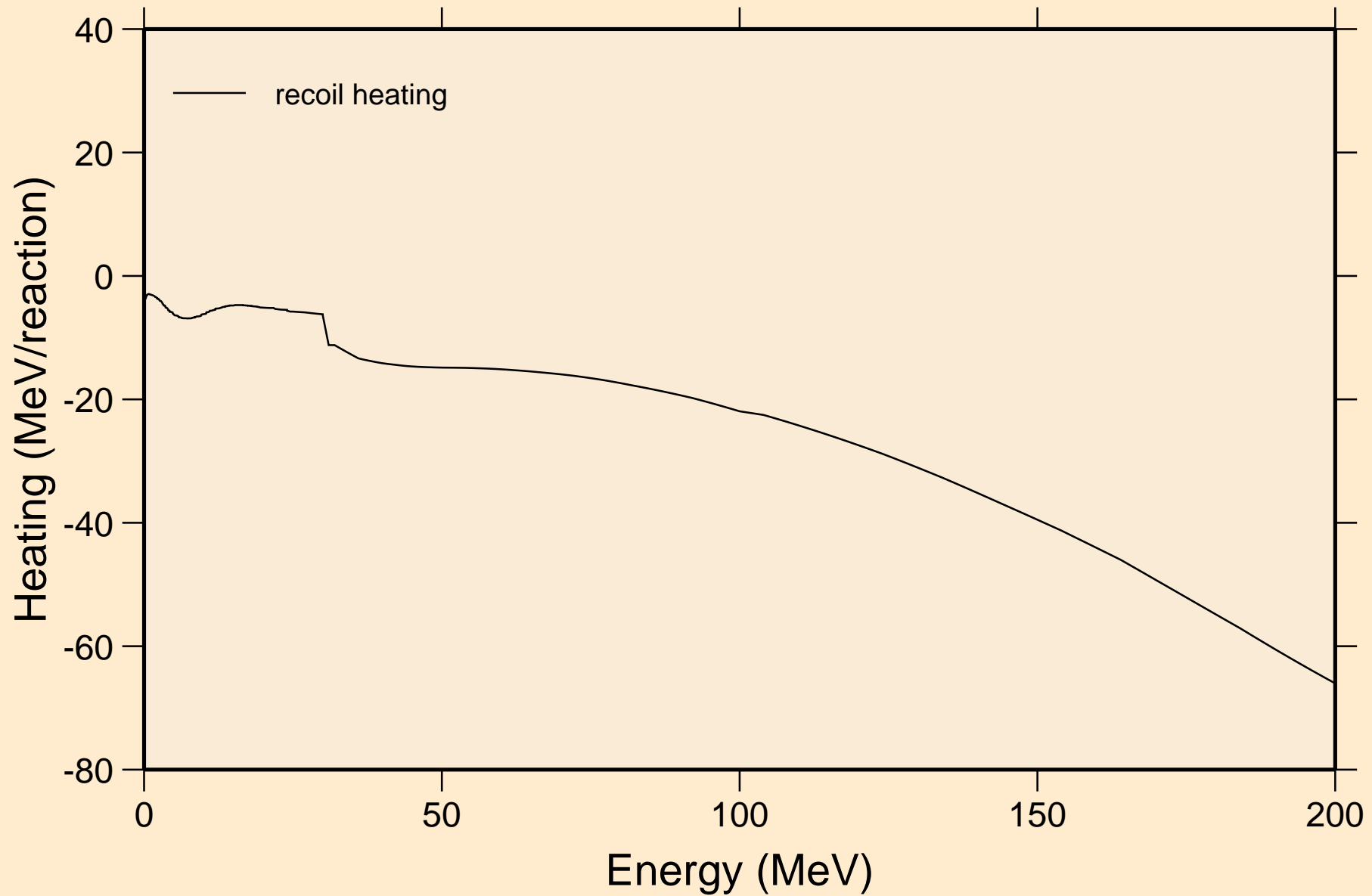

PR124 NRG TENDL-2015, AKONING

Particle production cross sections

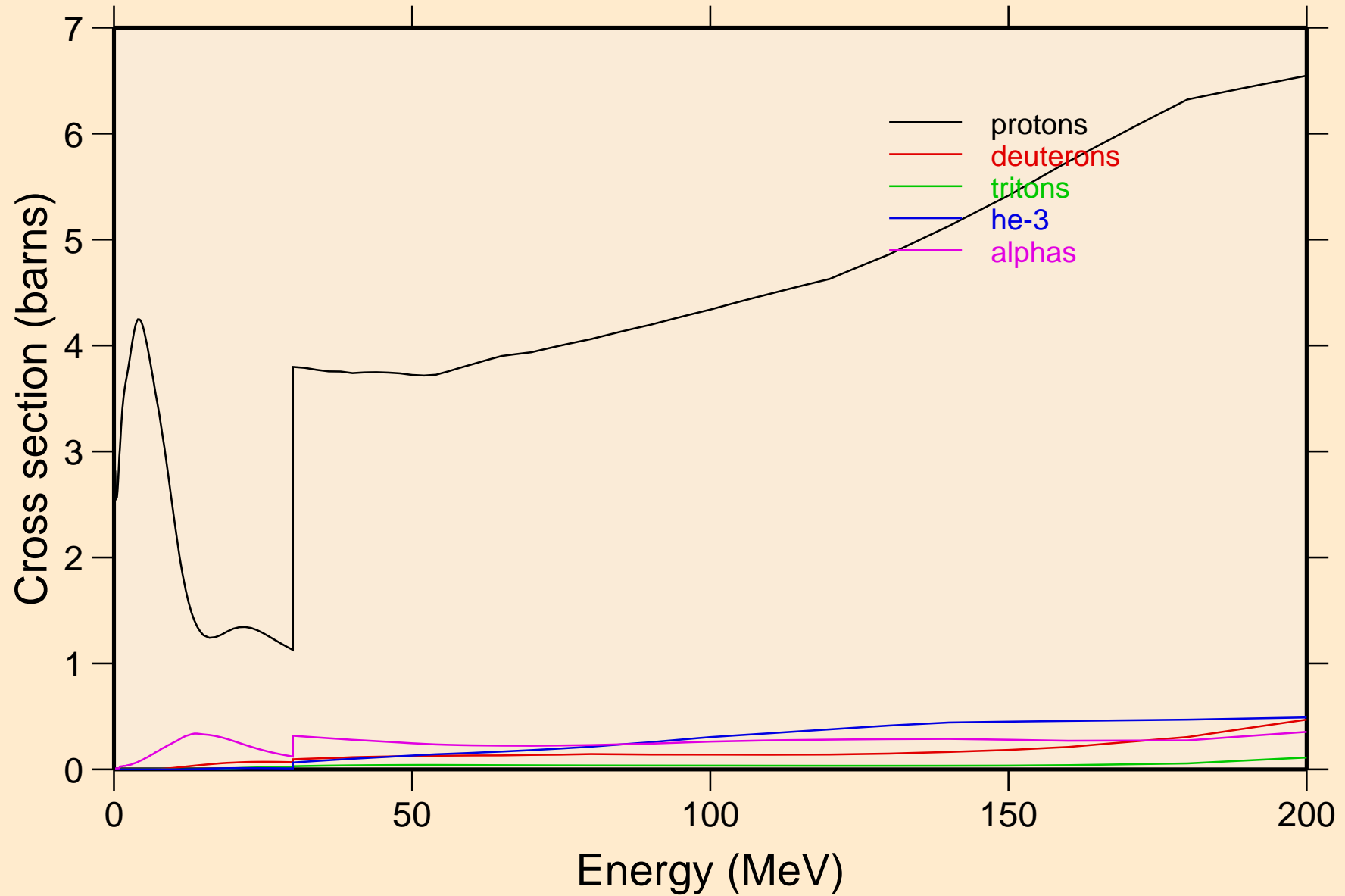

PR124 NRG TENDL-2015, AKONING
protons from (n,x)

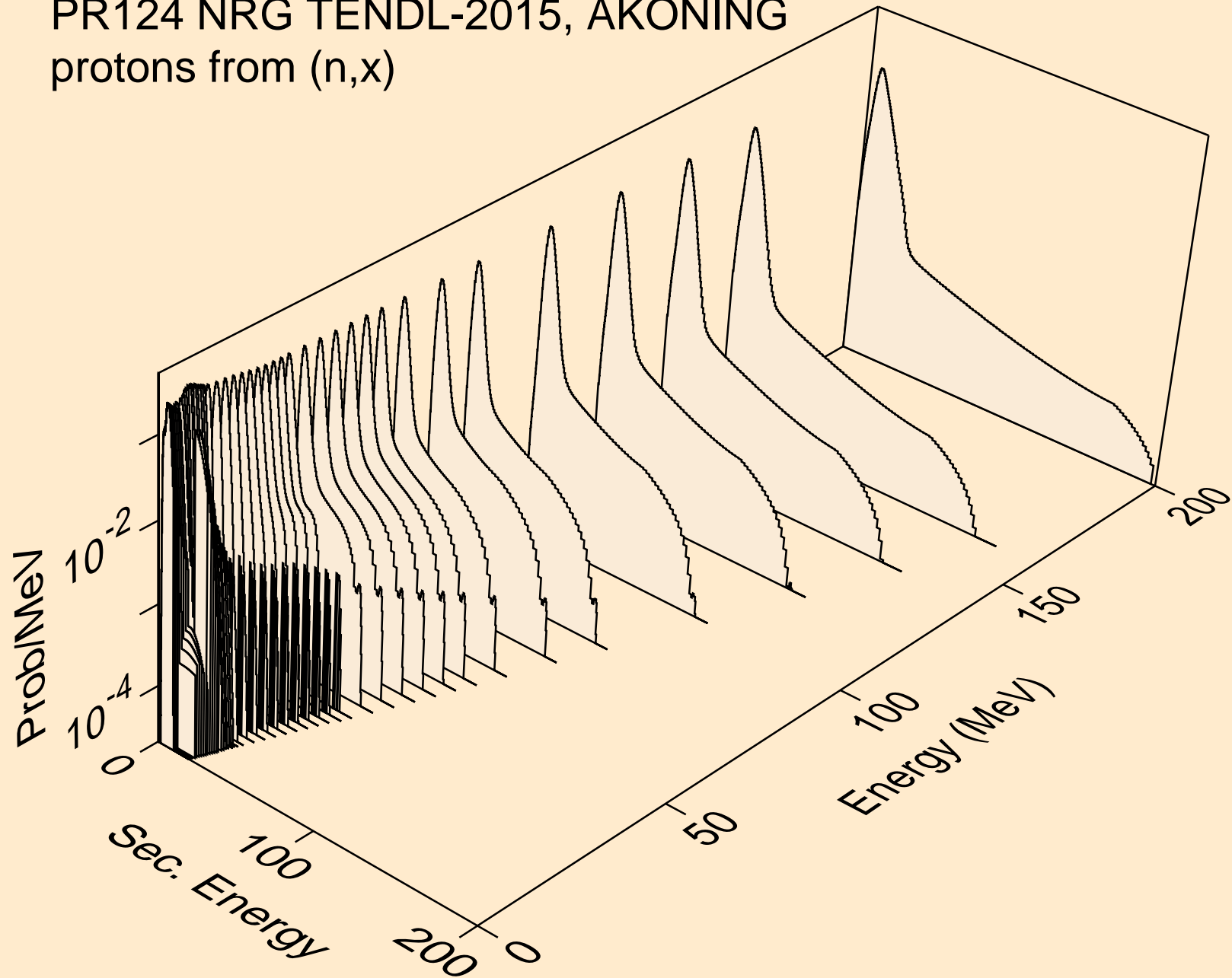

PR124 NRG TENDL-2015, AKONING
protons from (n,n*)p

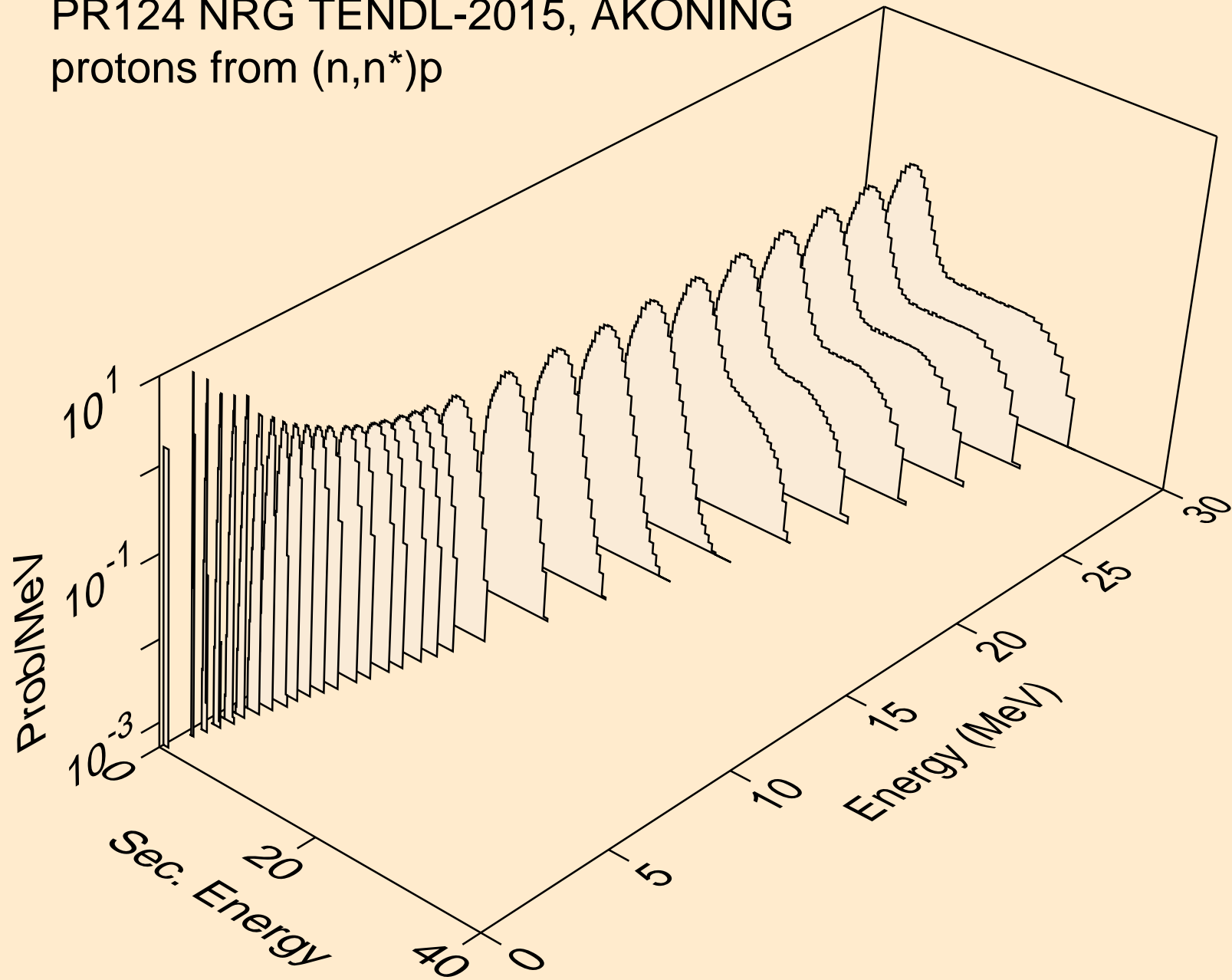

PR124 NRG TENDL-2015, AKONING
protons from (n,2np)

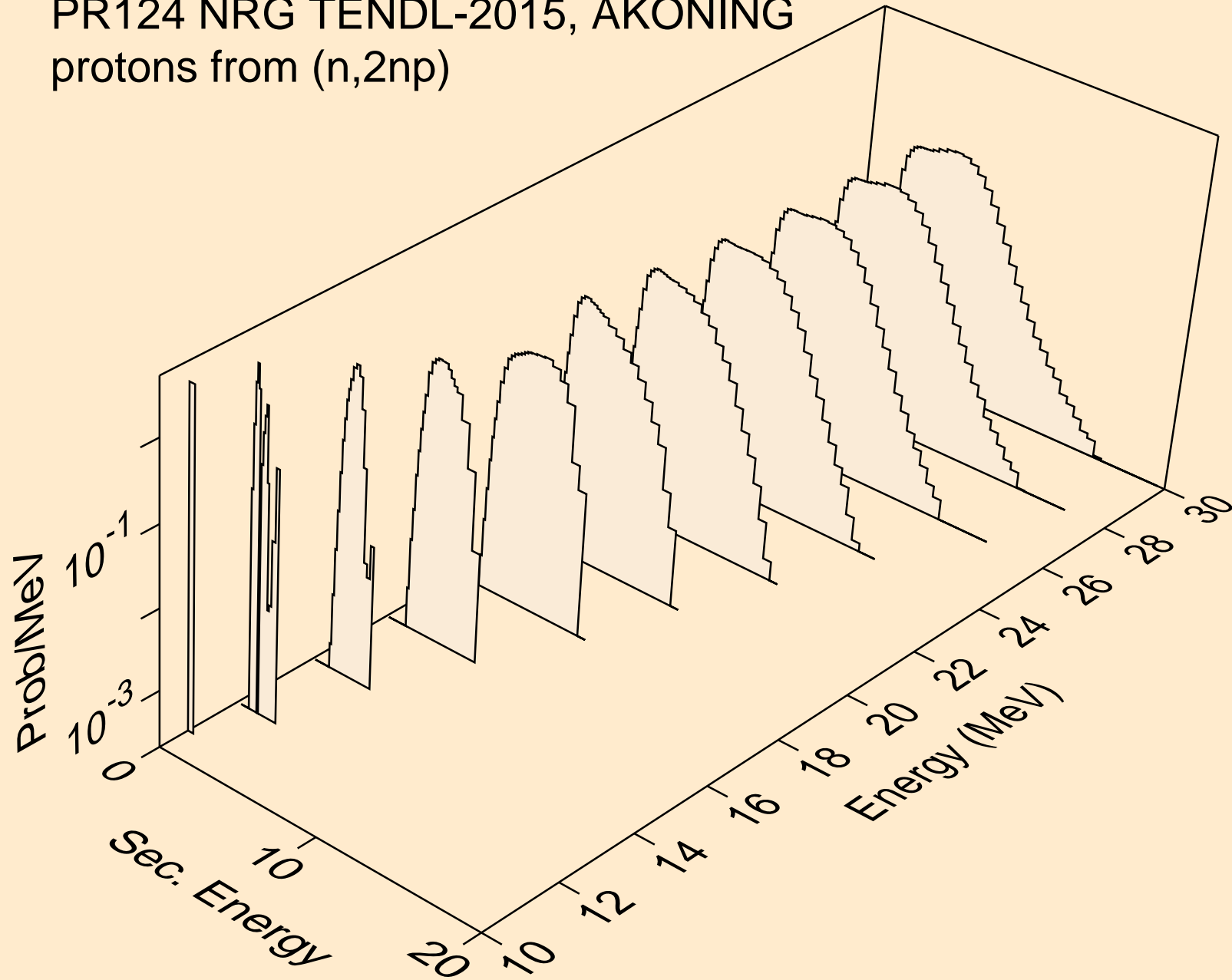

PR124 NRG TENDL-2015, AKONING
protons from (n,3np)

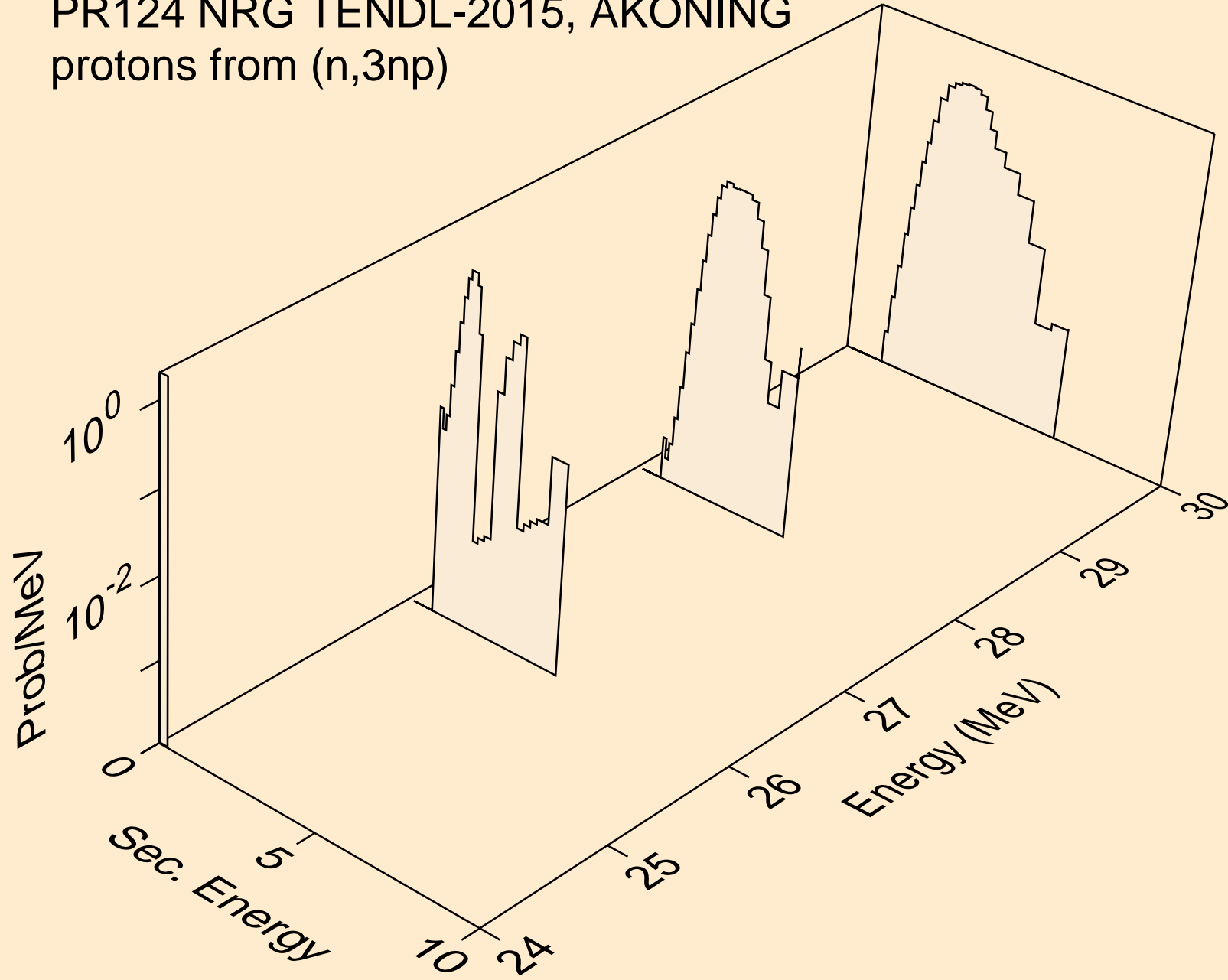

PR124 NRG TENDL-2015, AKONING
protons from (n,2np)

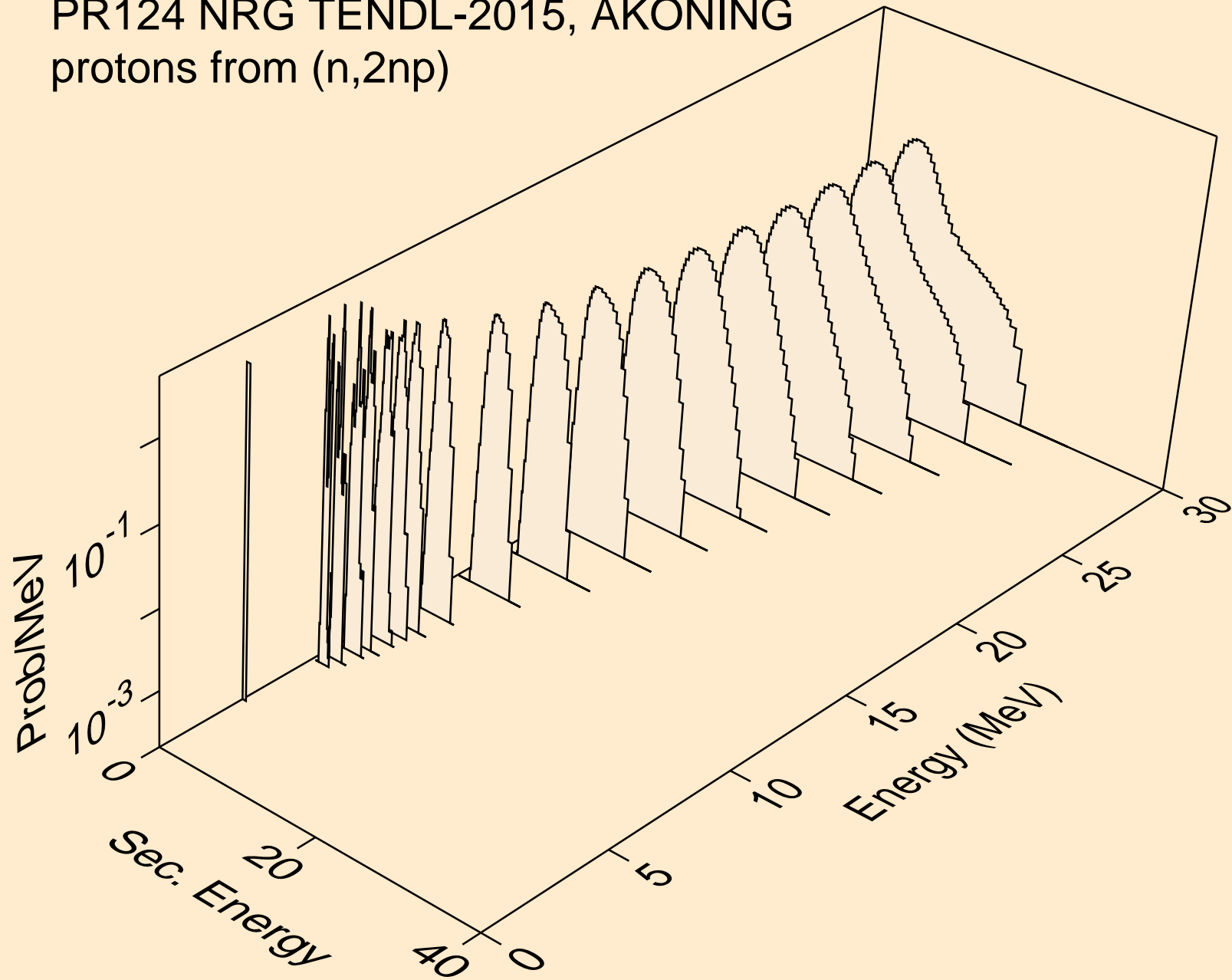

PR124 NRG TENDL-2015, AKONING
protons from (n,npa)

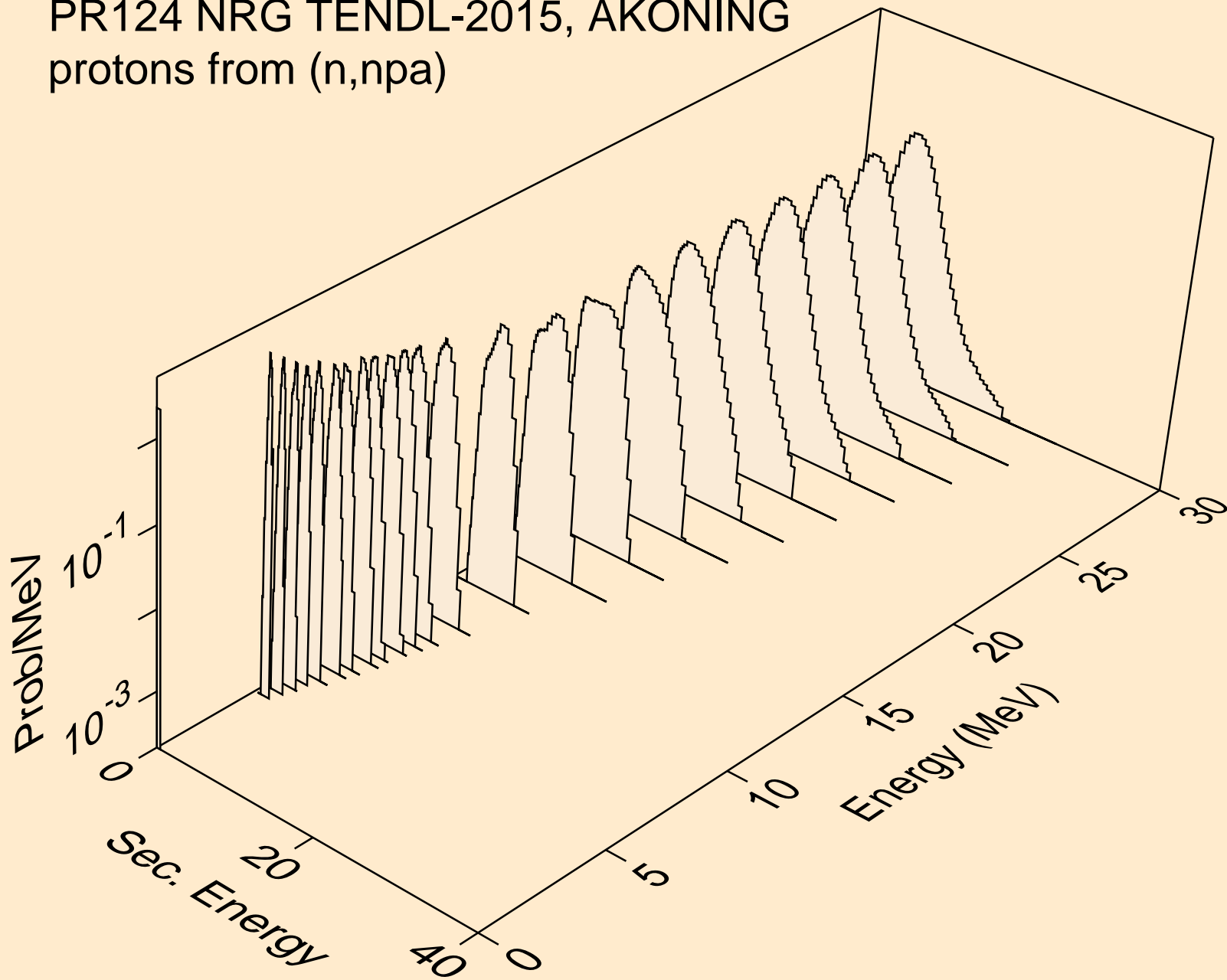

PR124 NRG TENDL-2015, AKONING
protons from (n,p)

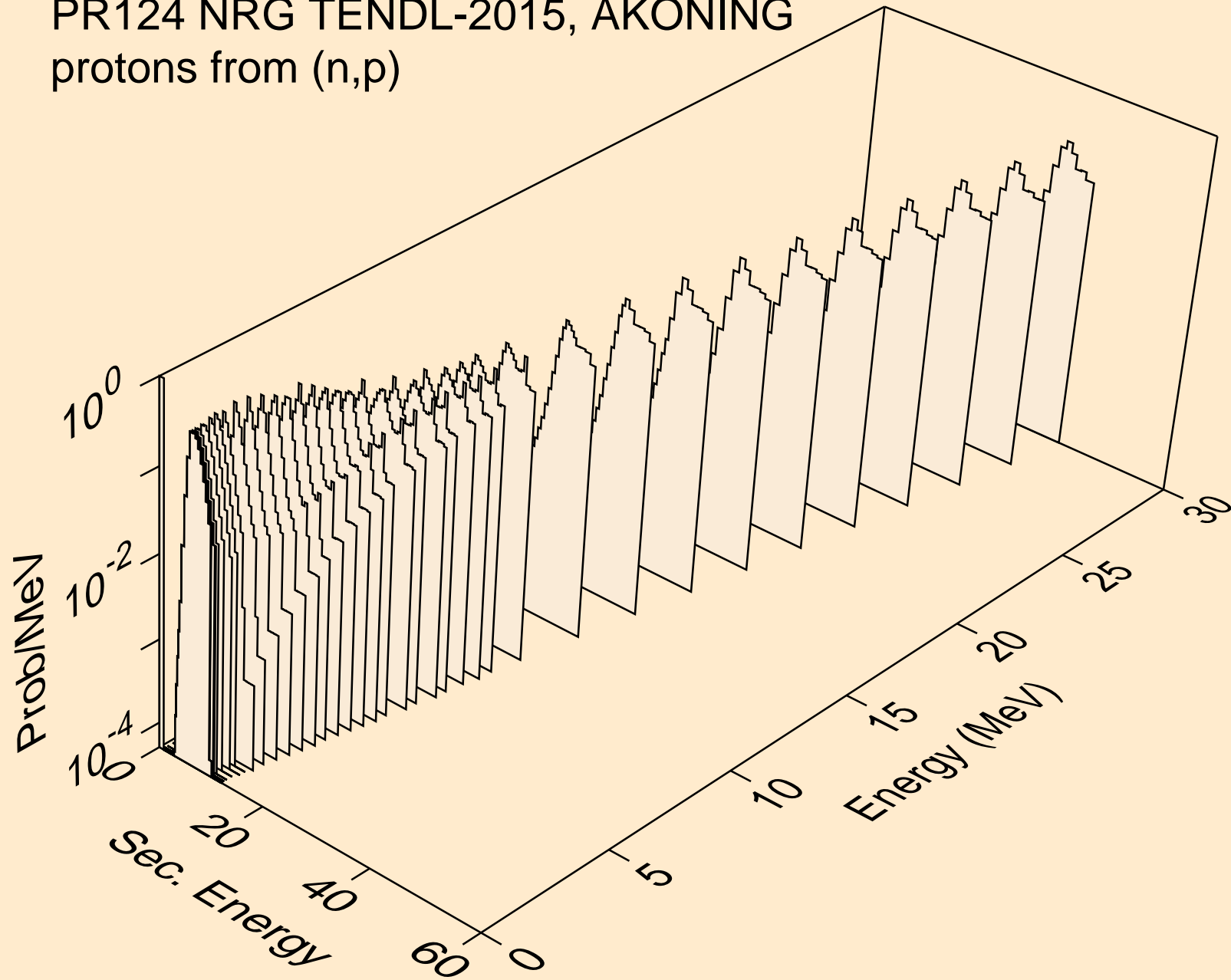

PR124 NRG TENDL-2015, AKONING
protons from (n,2p)

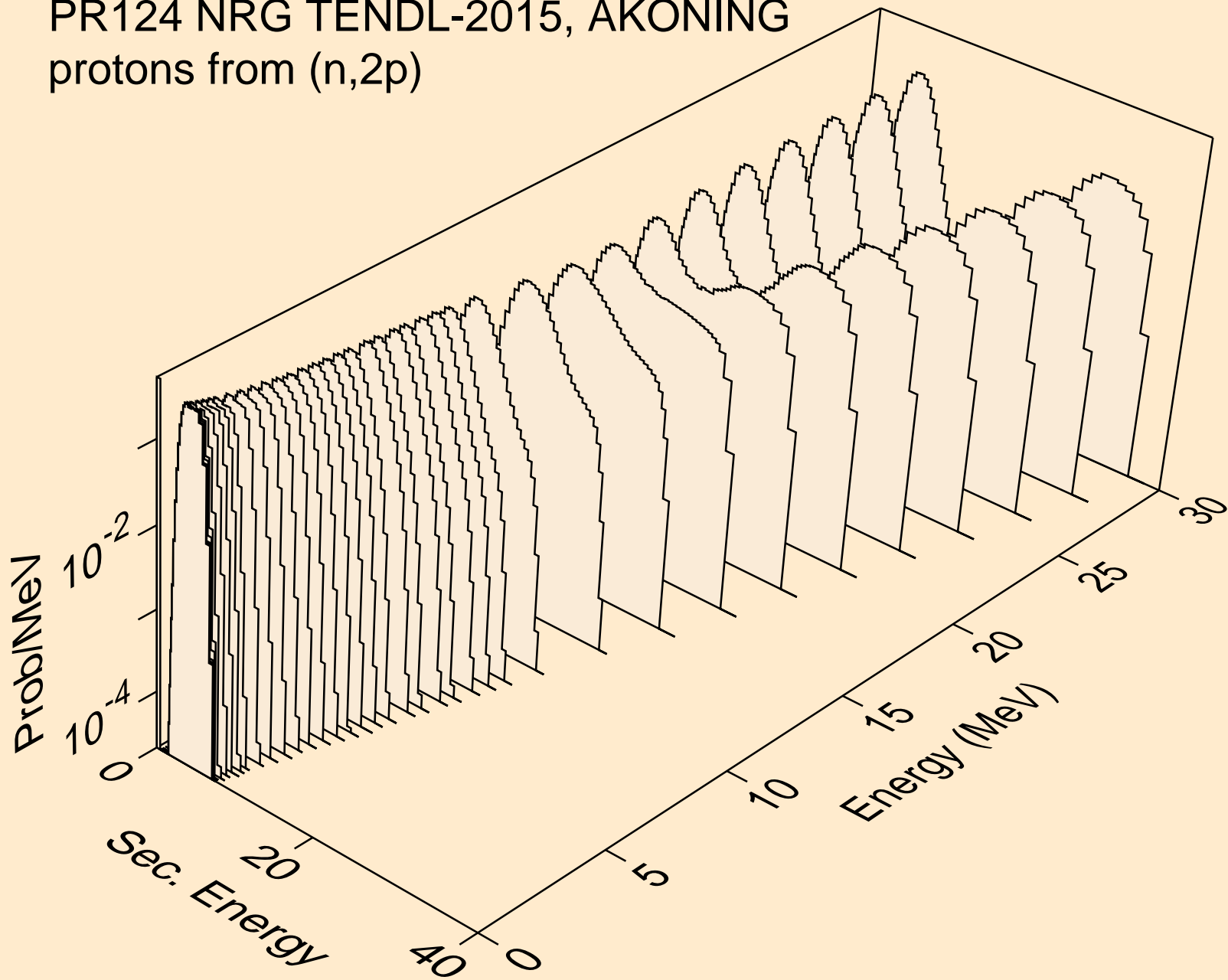

PR124 NRG TENDL-2015, AKONING
protons from (n,pa)

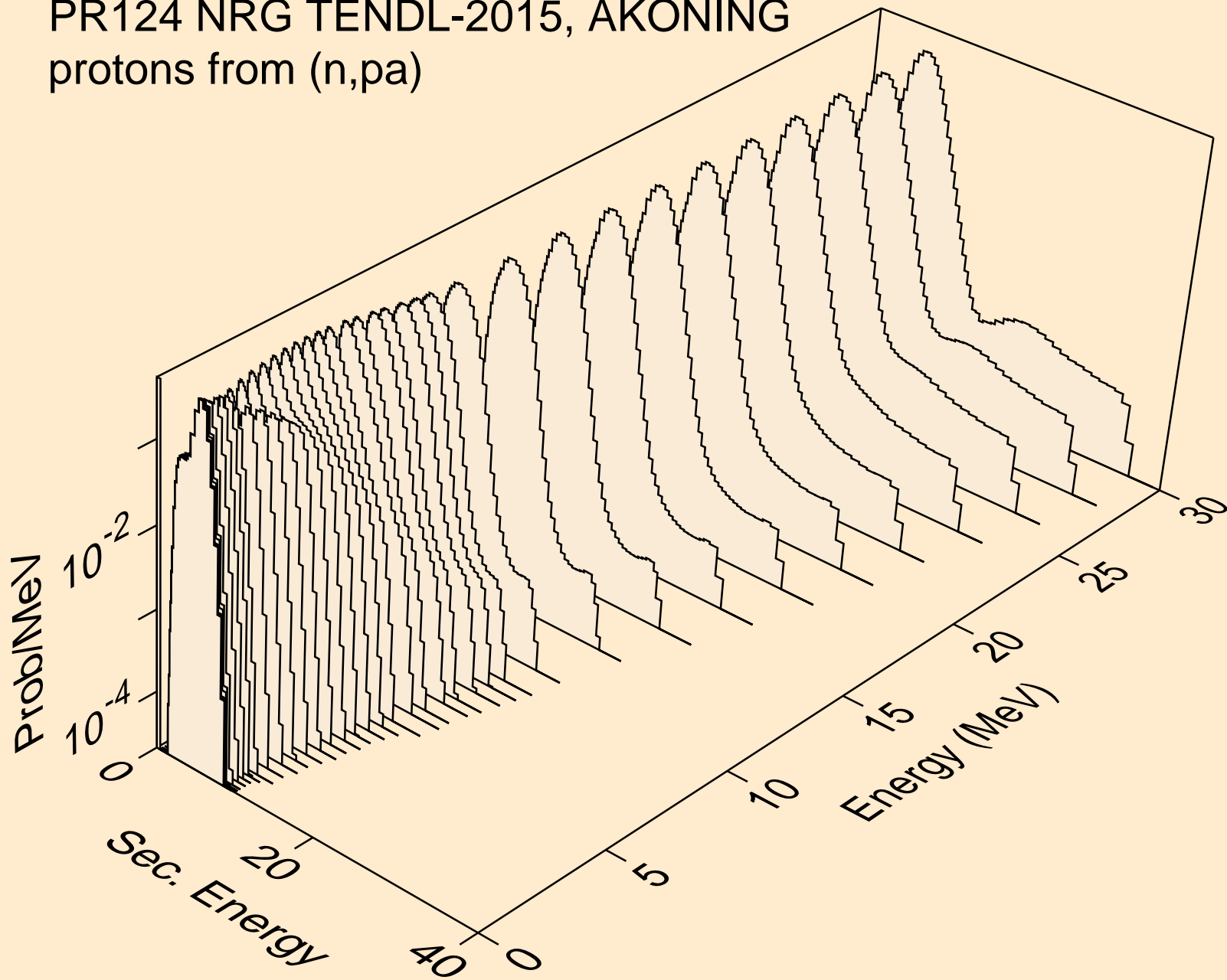

PR124 NRG TENDL-2015, AKONING
protons from (n,pd)

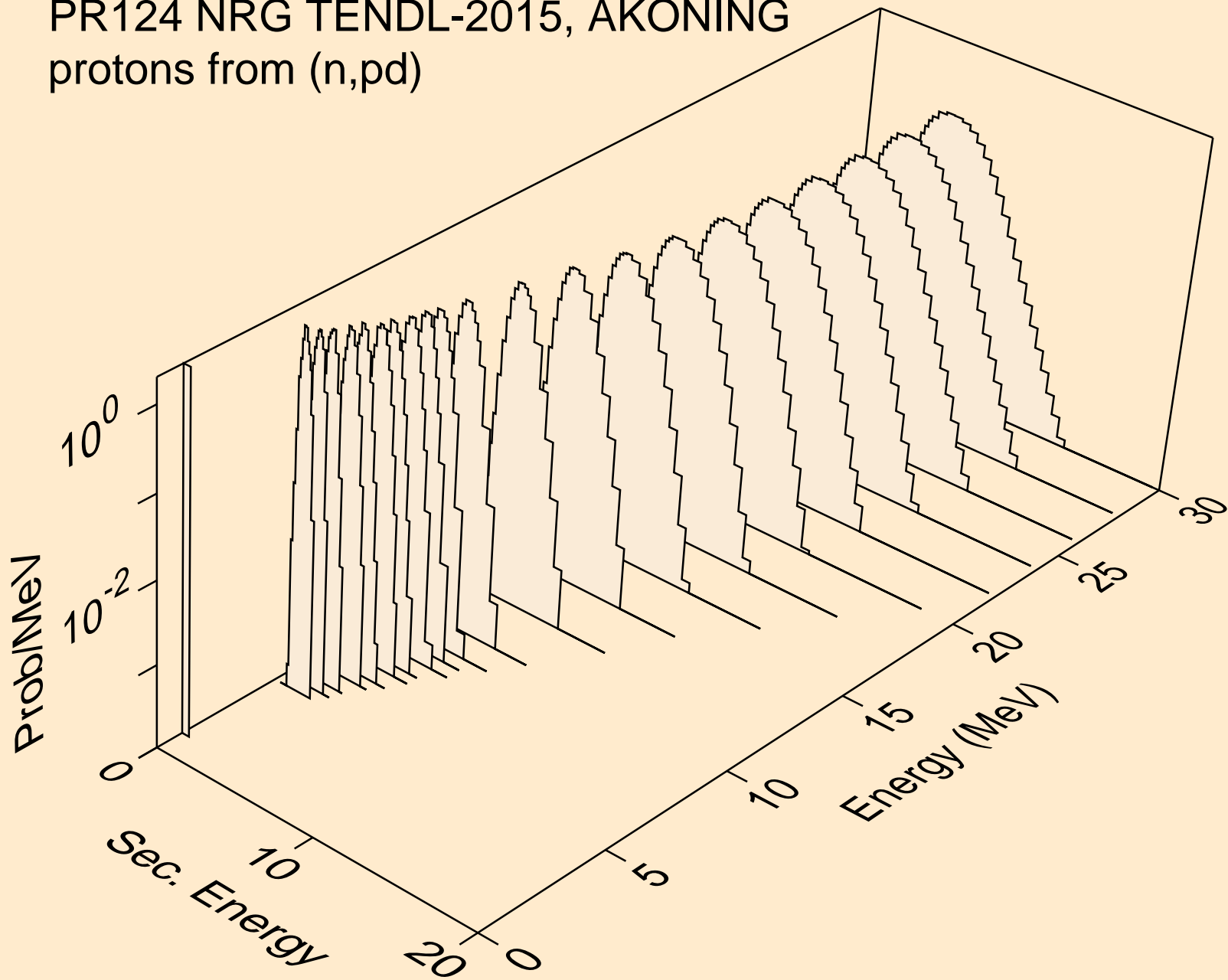

PR124 NRG TENDL-2015, AKONING
protons from (n,pt)

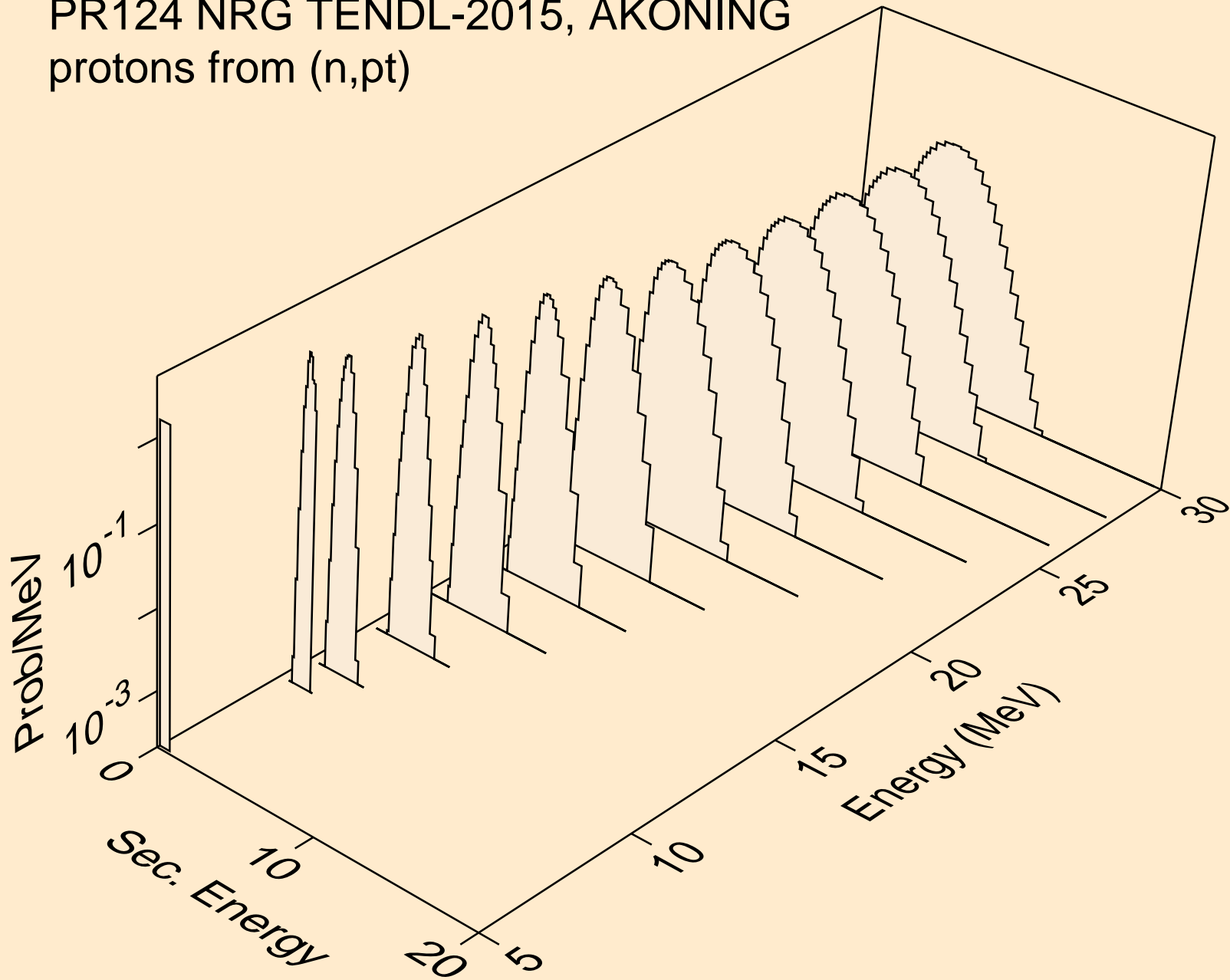

PR124 NRG TENDL-2015, AKONING
deuterons from (n,x)

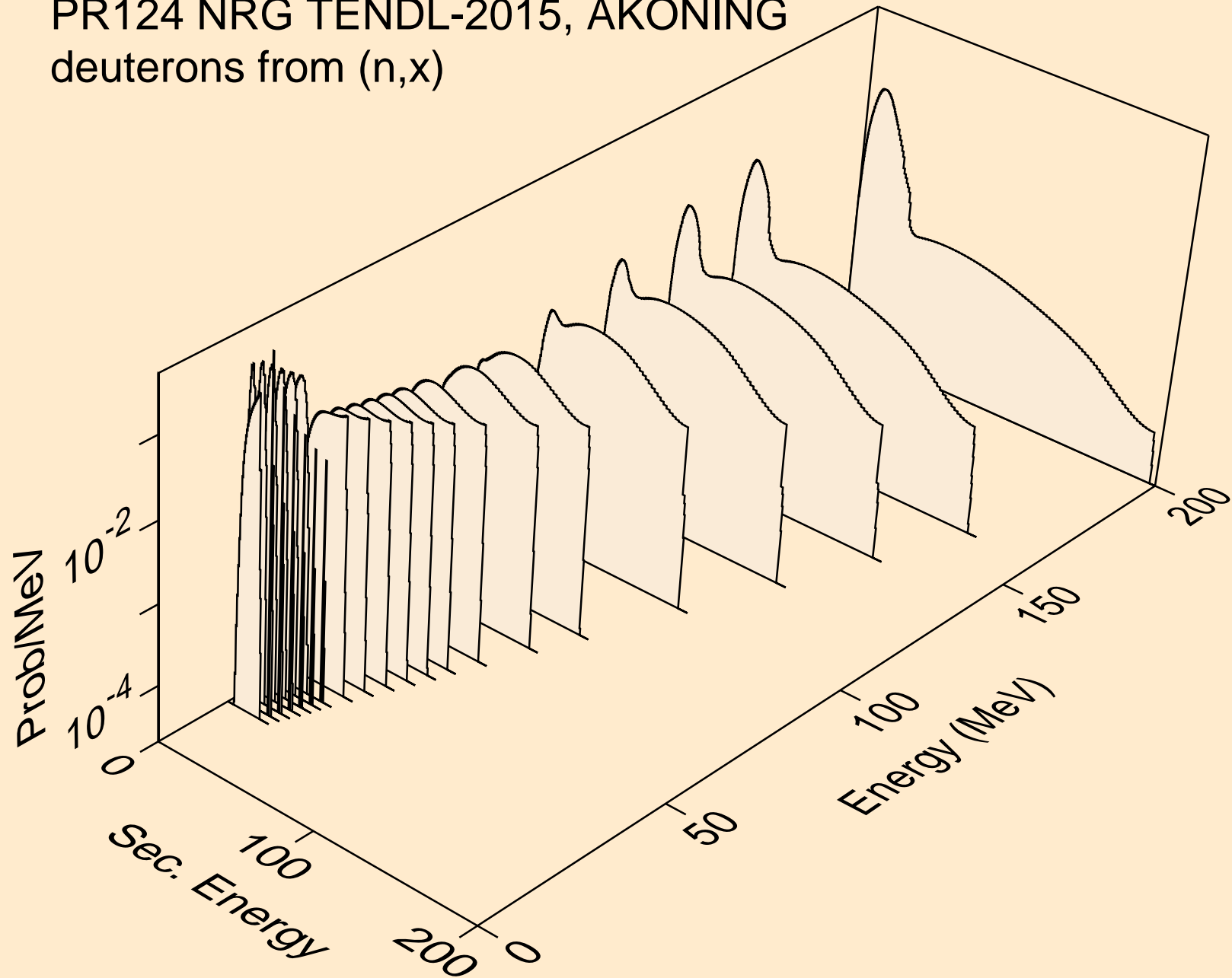

PR124 NRG TENDL-2015, AKONING
deuterons from (n,2nd)

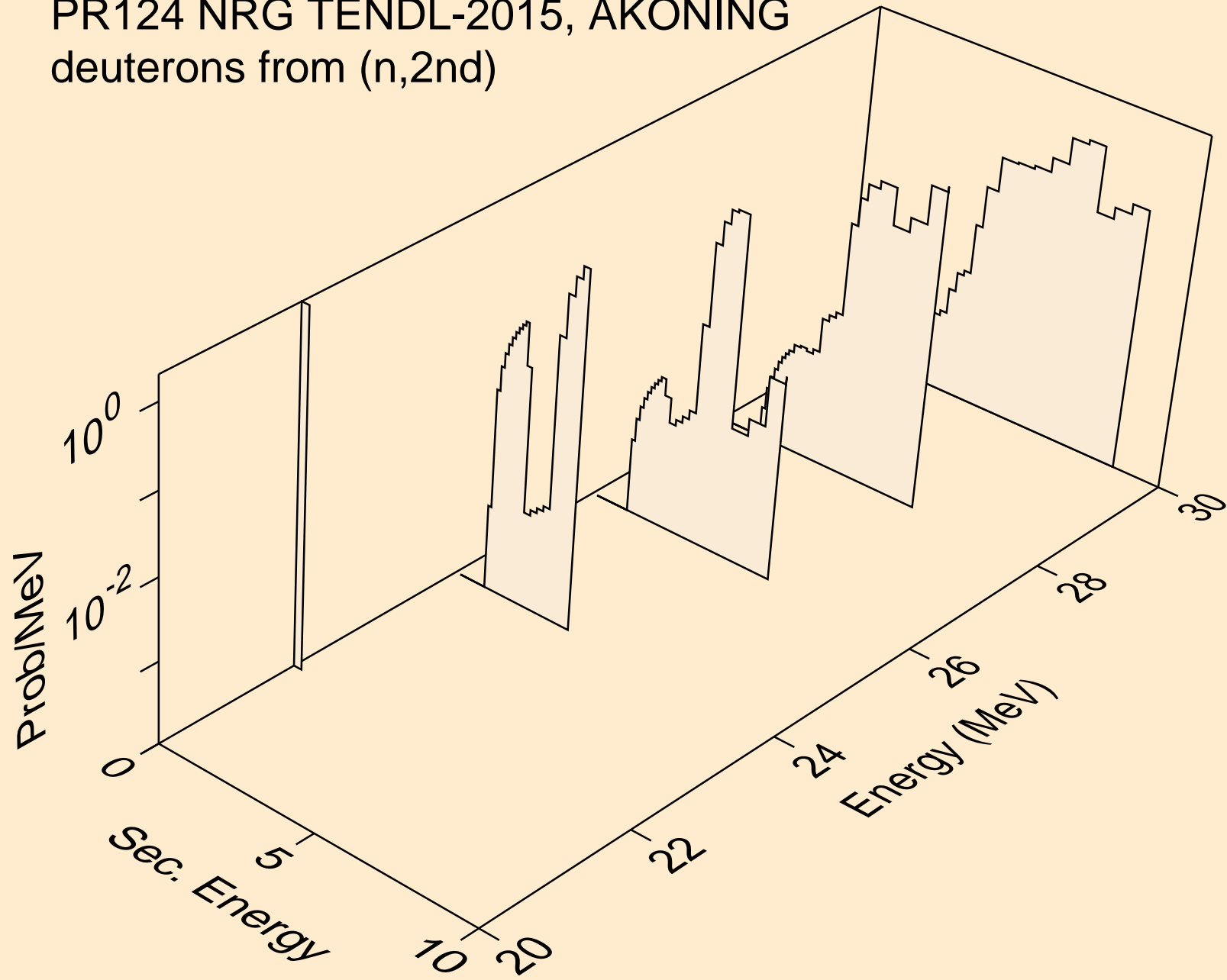

PR124 NRG TENDL-2015, AKONING
deuterons from (n,n*)d

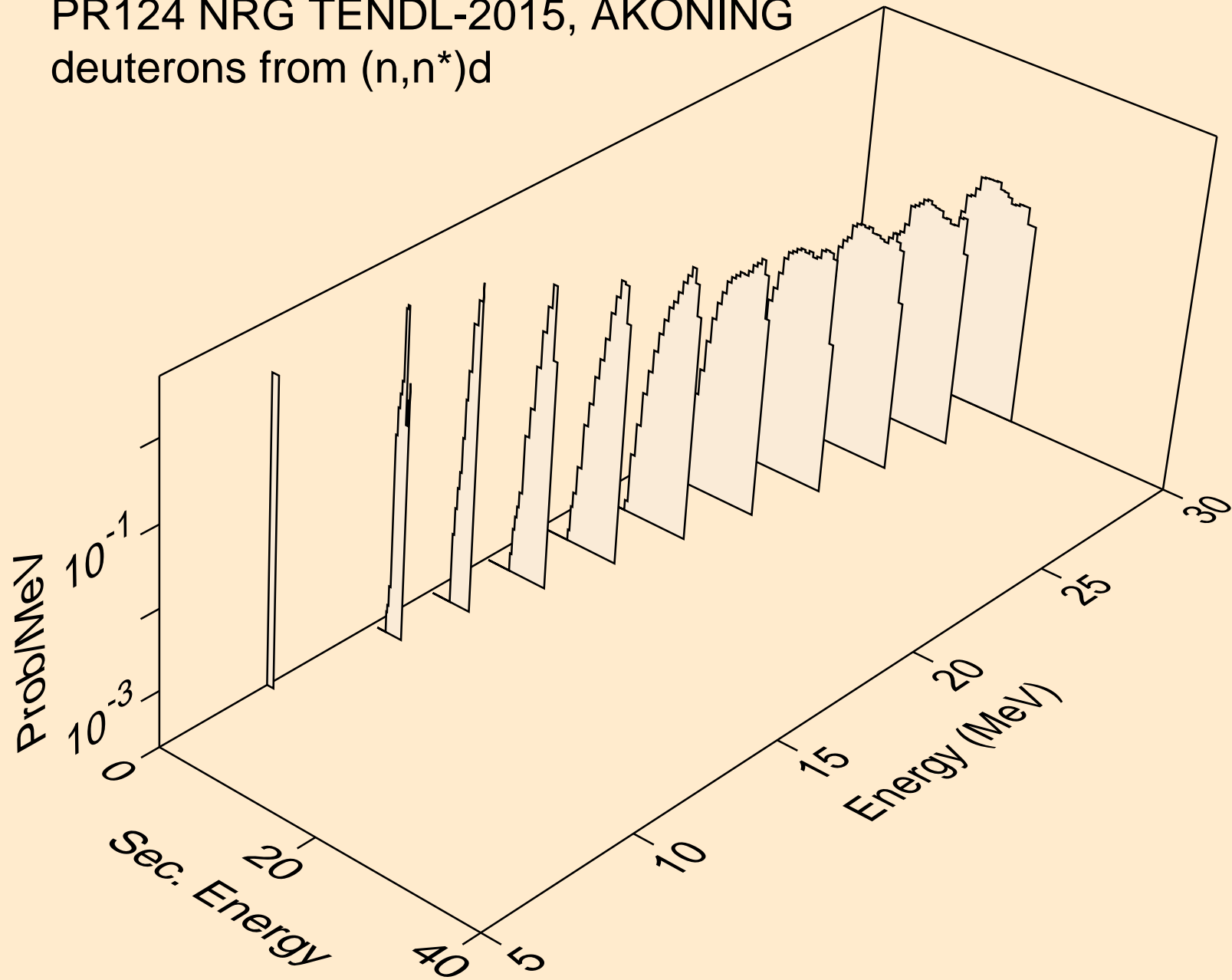

PR124 NRG TENDL-2015, AKONING
deuterons from (n,d)

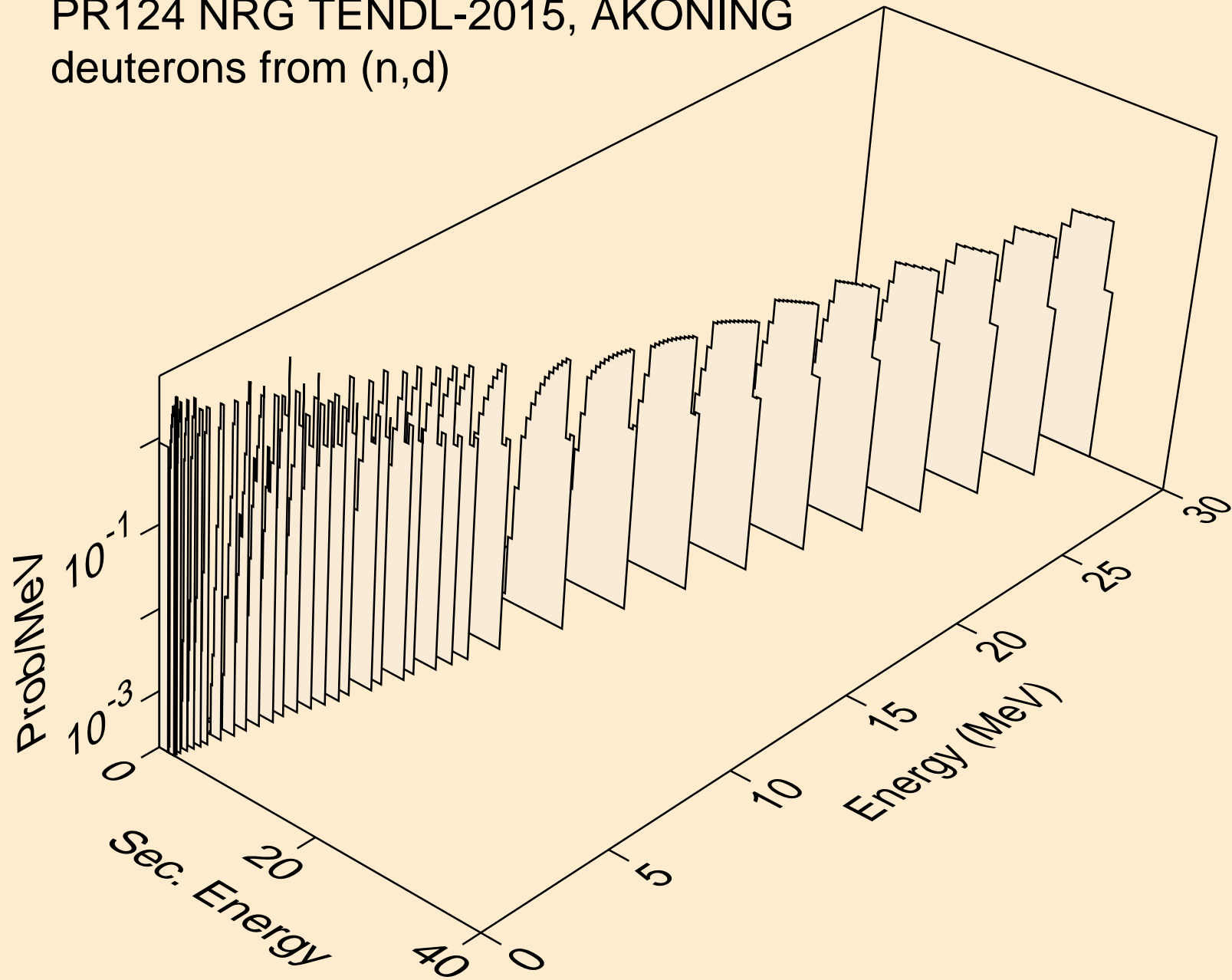

PR124 NRG TENDL-2015, AKONING
deuterons from (n,d2a)

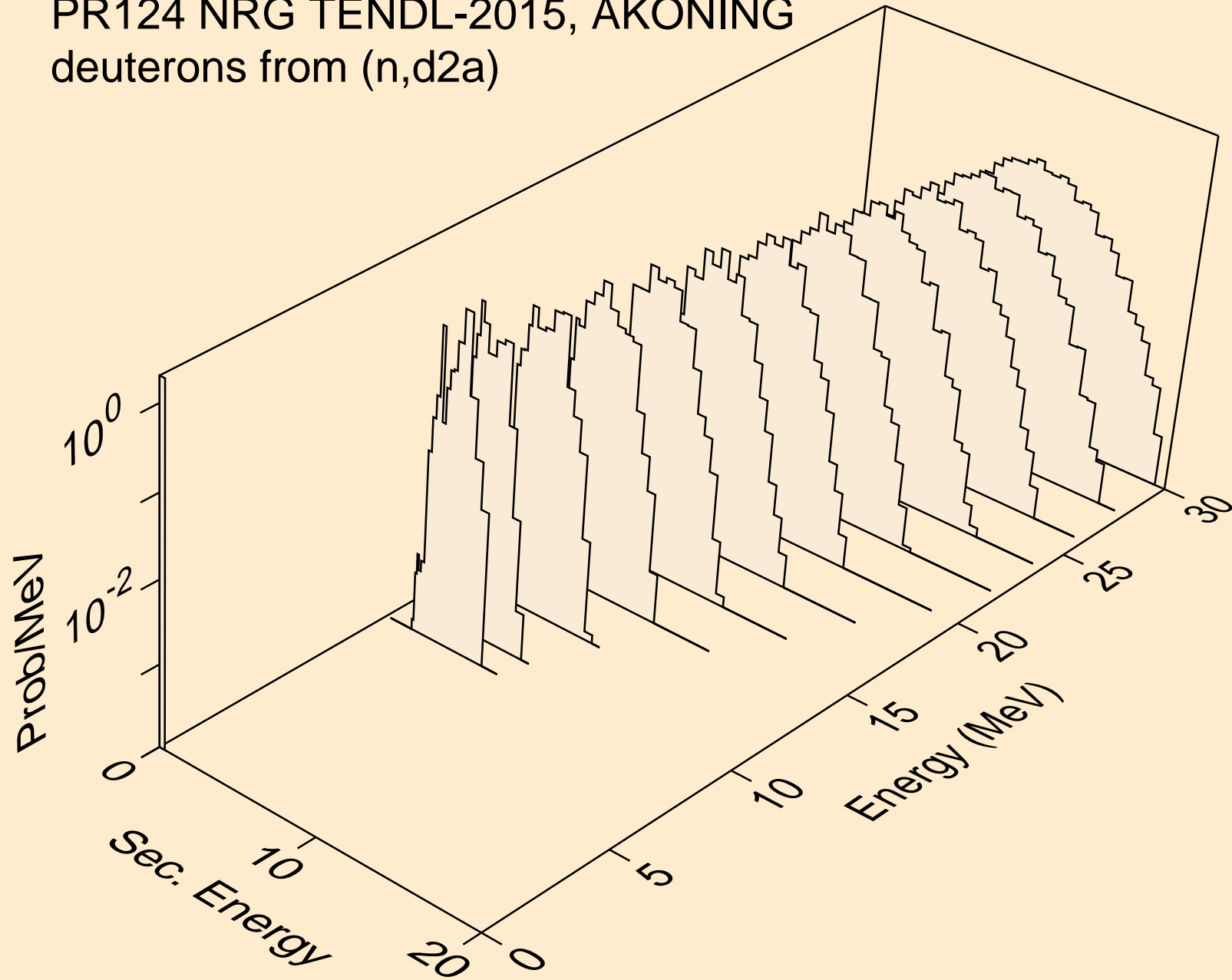

PR124 NRG TENDL-2015, AKONING
deuterons from (n,pd)

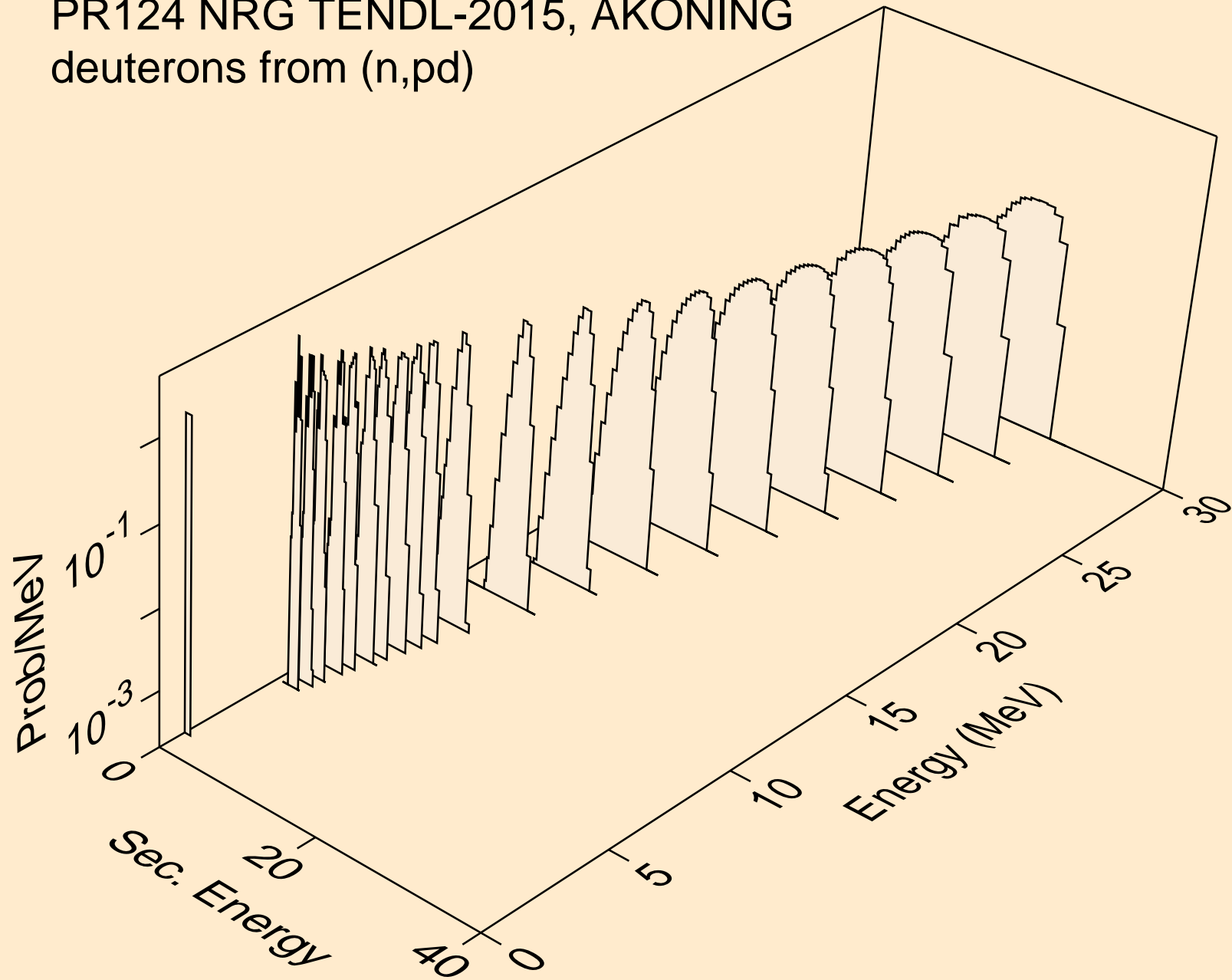

PR124 NRG TENDL-2015, AKONING
deuterons from (n,da)

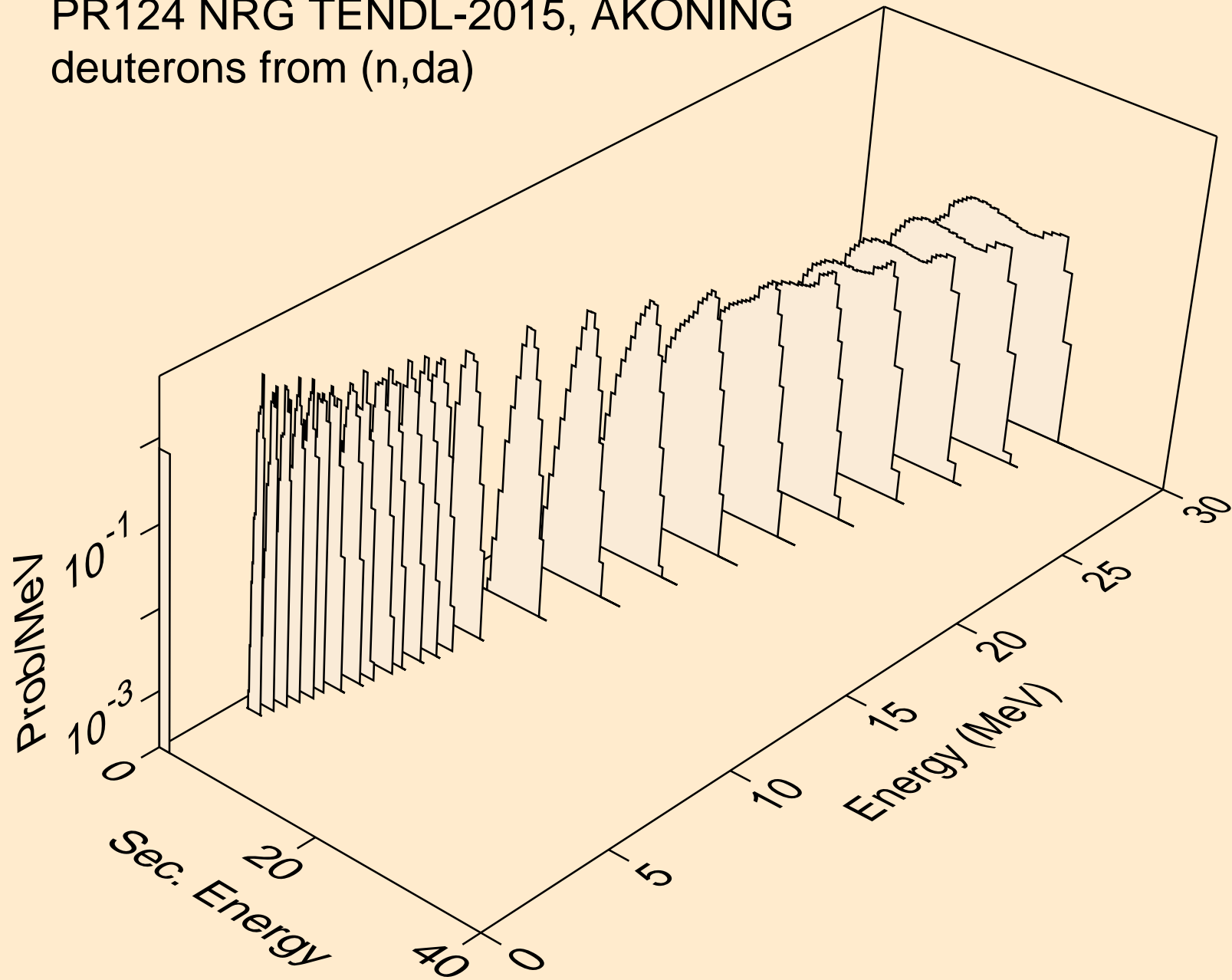

PR124 NRG TENDL-2015, AKONING
tritons from (n,x)

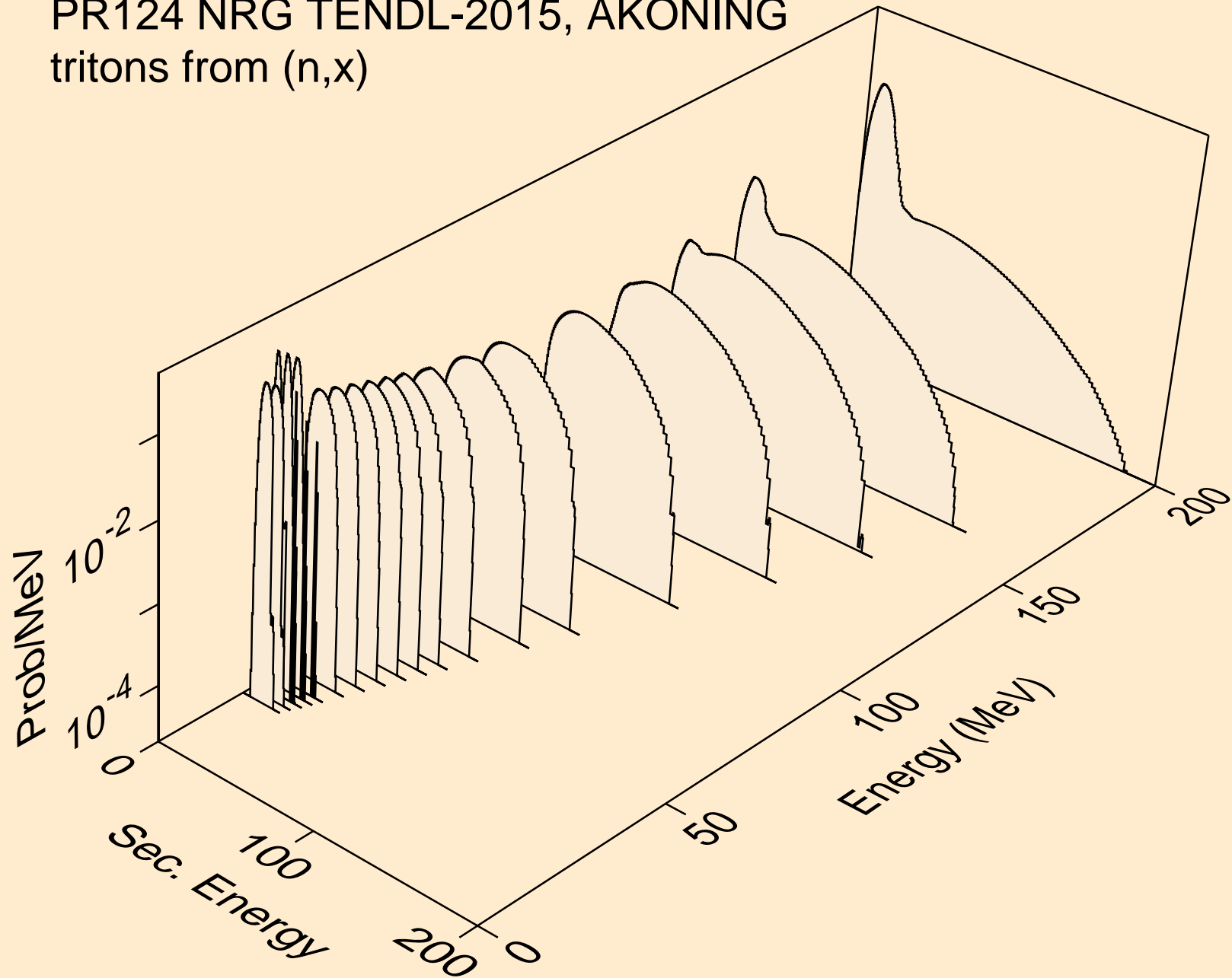

PR124 NRG TENDL-2015, AKONING
tritons from (n,n*)t

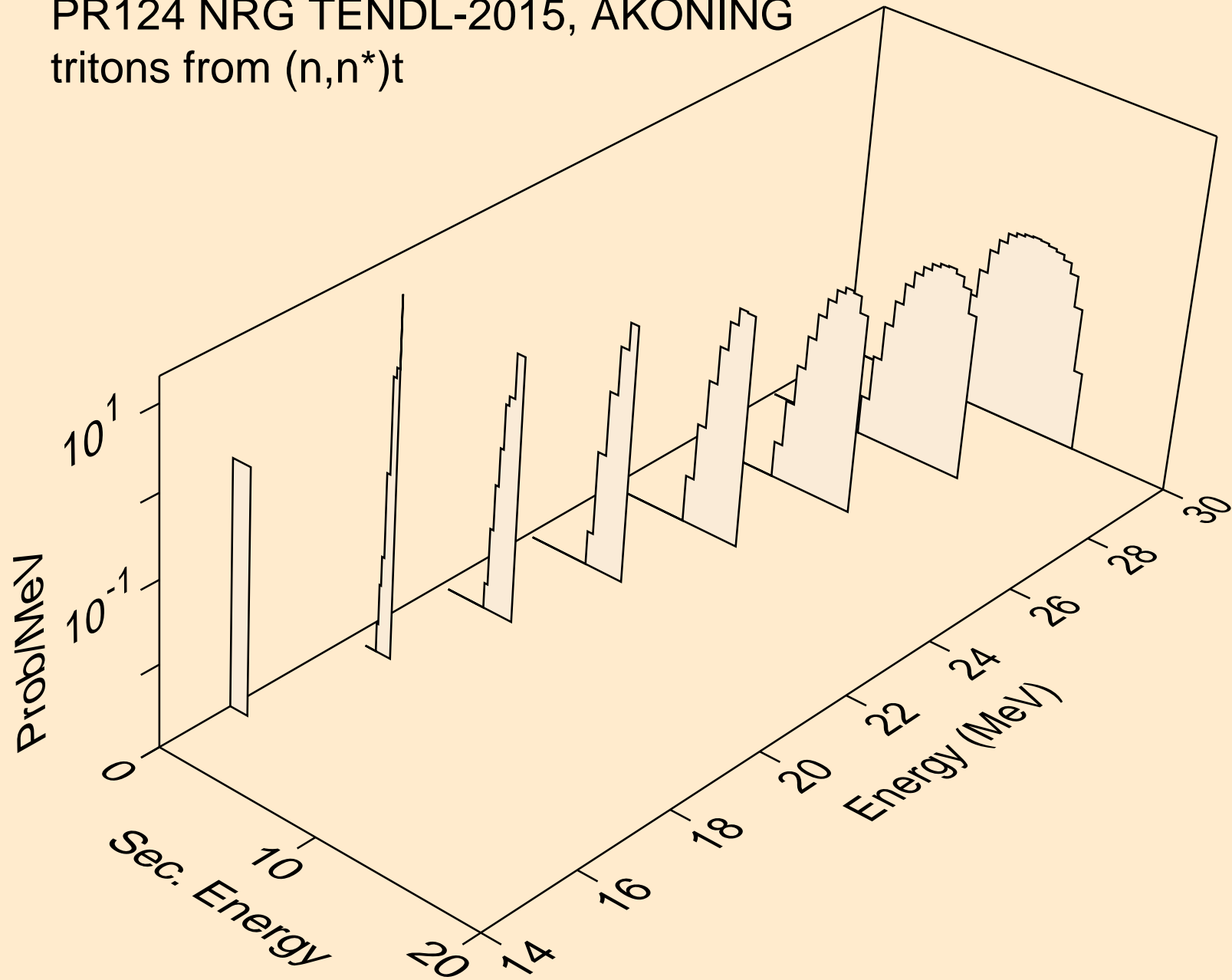

PR124 NRG TENDL-2015, AKONING
tritons from (n,t)

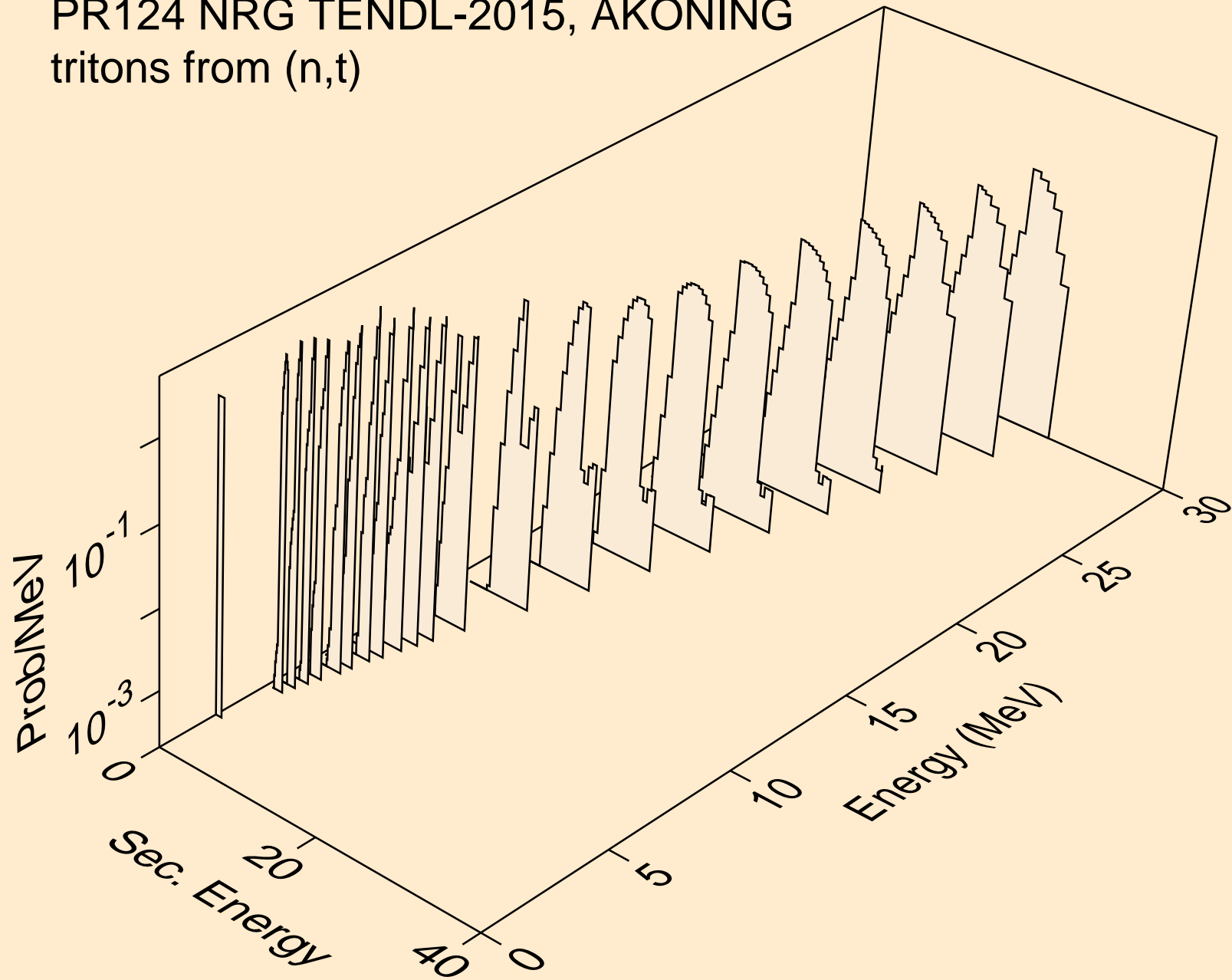

PR124 NRG TENDL-2015, AKONING
tritons from (n,t2a)

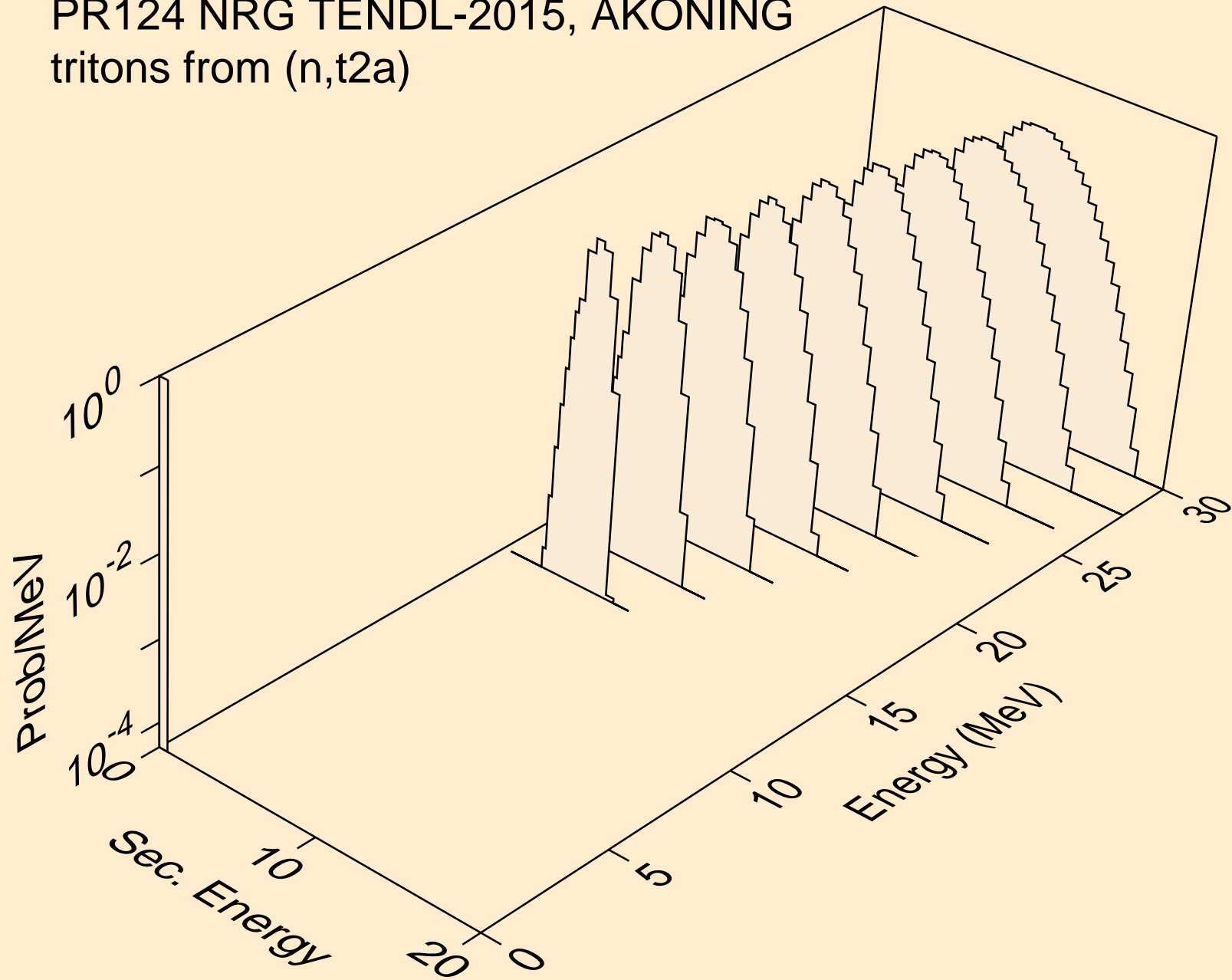

PR124 NRG TENDL-2015, AKONING
tritons from (n,pt)

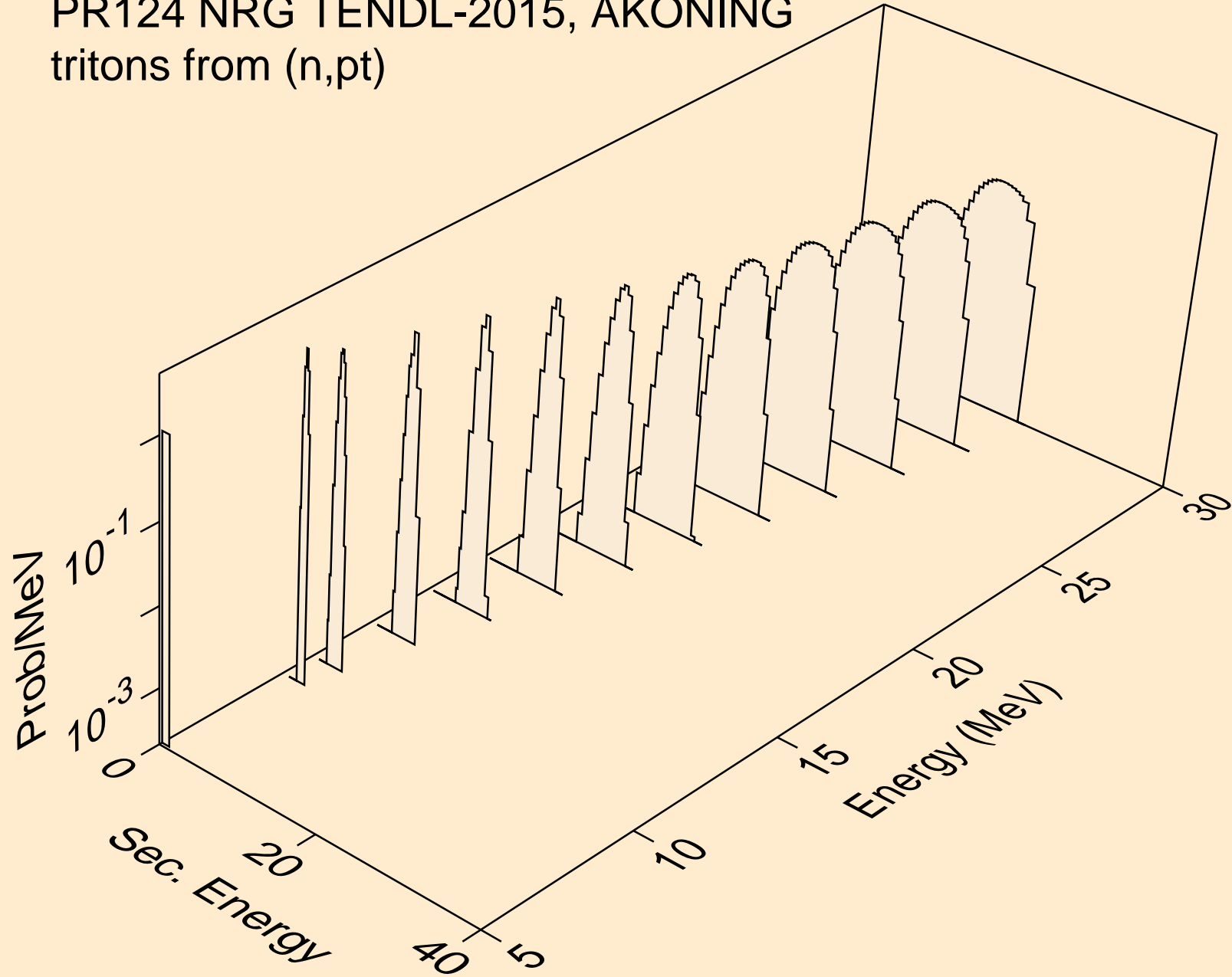

PR124 NRG TENDL-2015, AKONING
he3s from (n,x)

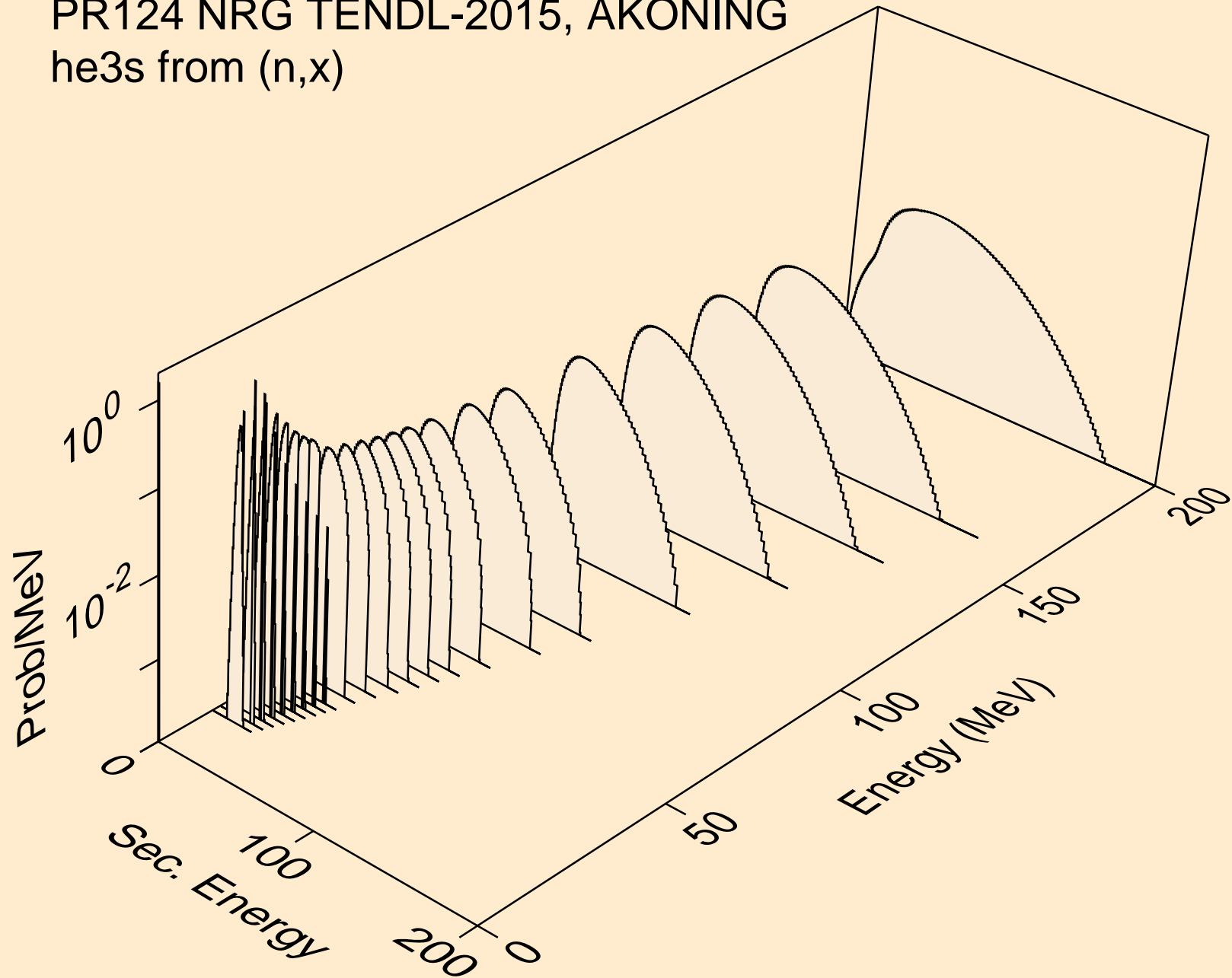

PR124 NRG TENDL-2015, AKONING
he3s from (n,n*)he3

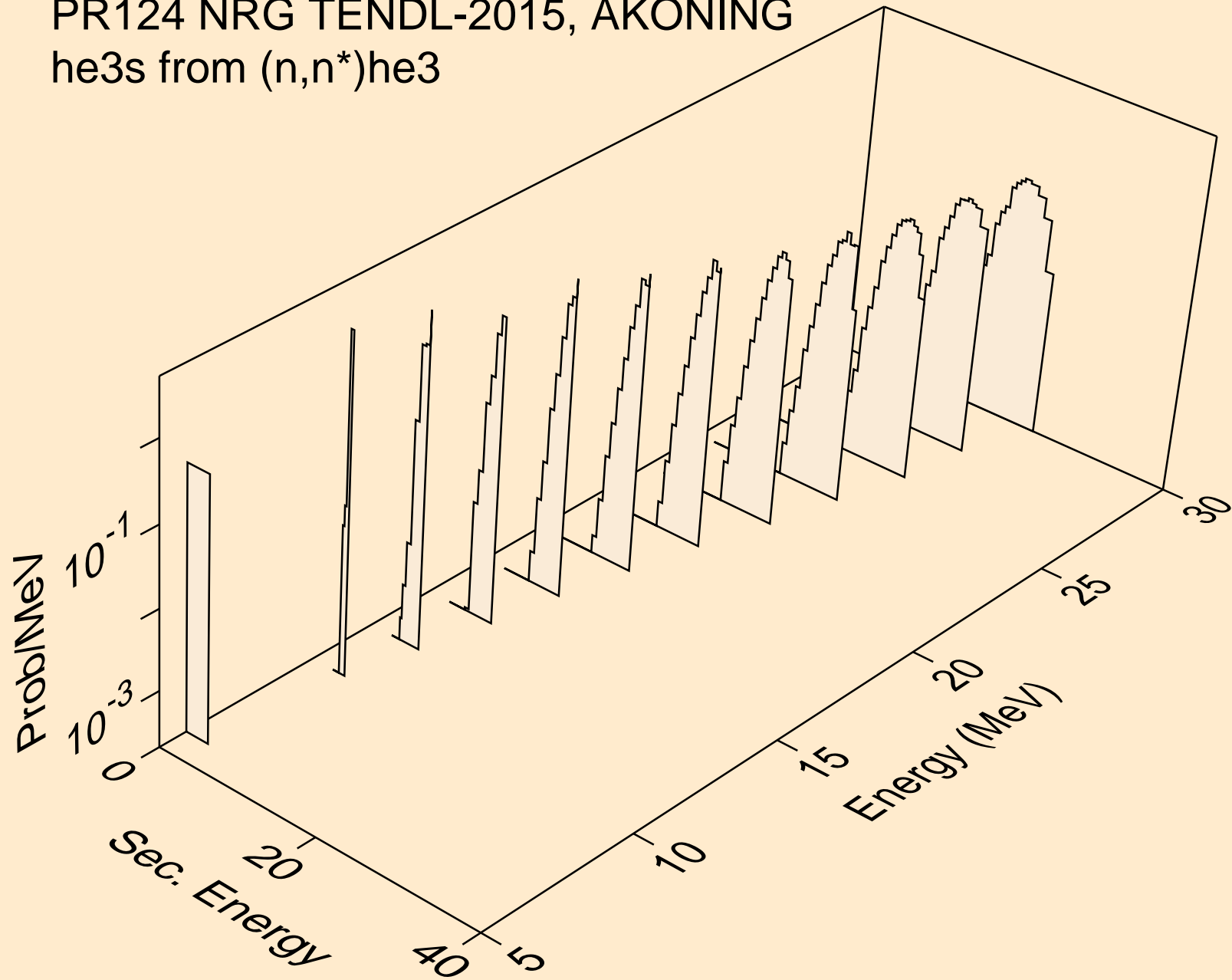

PR124 NRG TENDL-2015, AKONING
he3s from (n,he3)

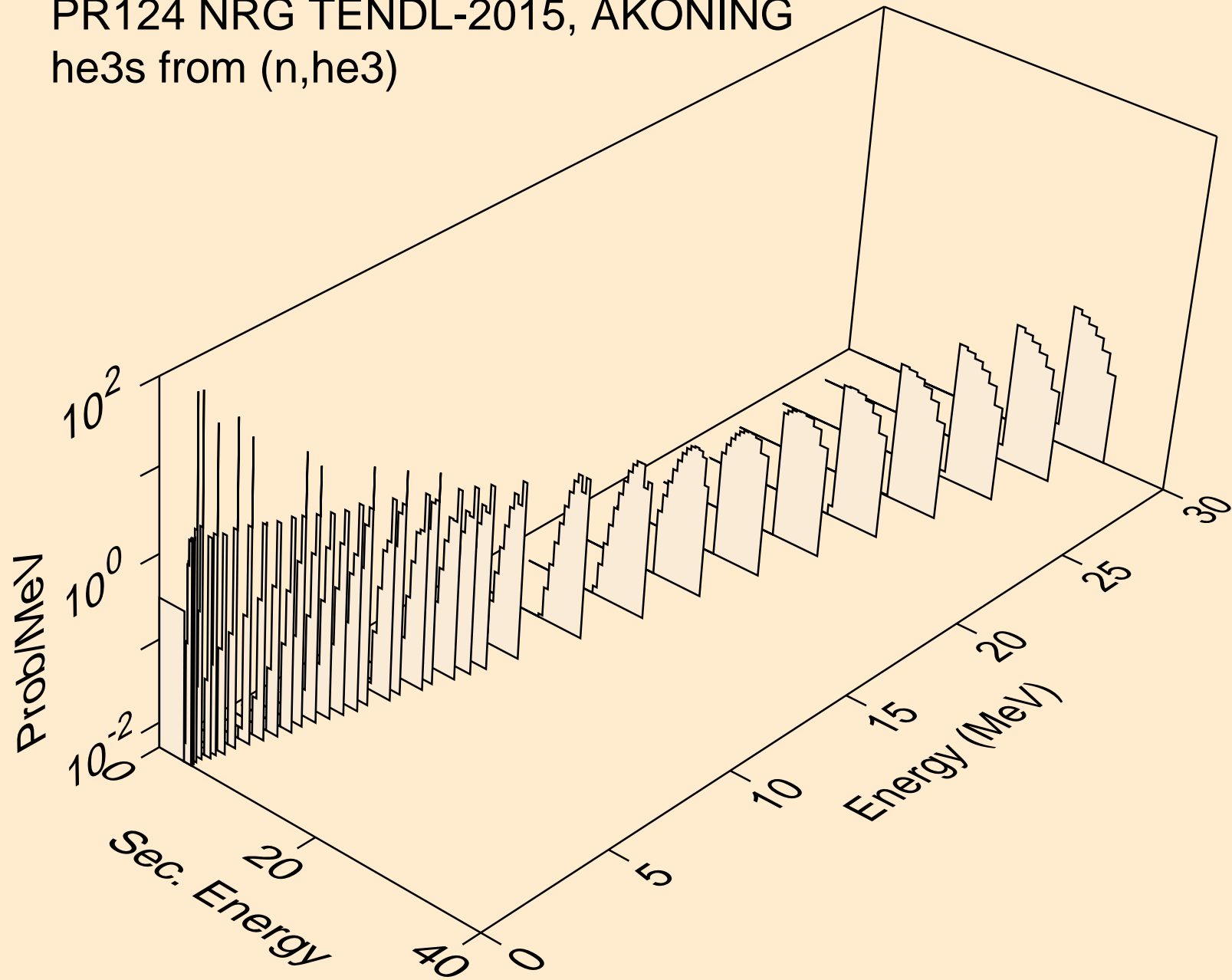

PR124 NRG TENDL-2015, AKONING
alphas from (n,x)

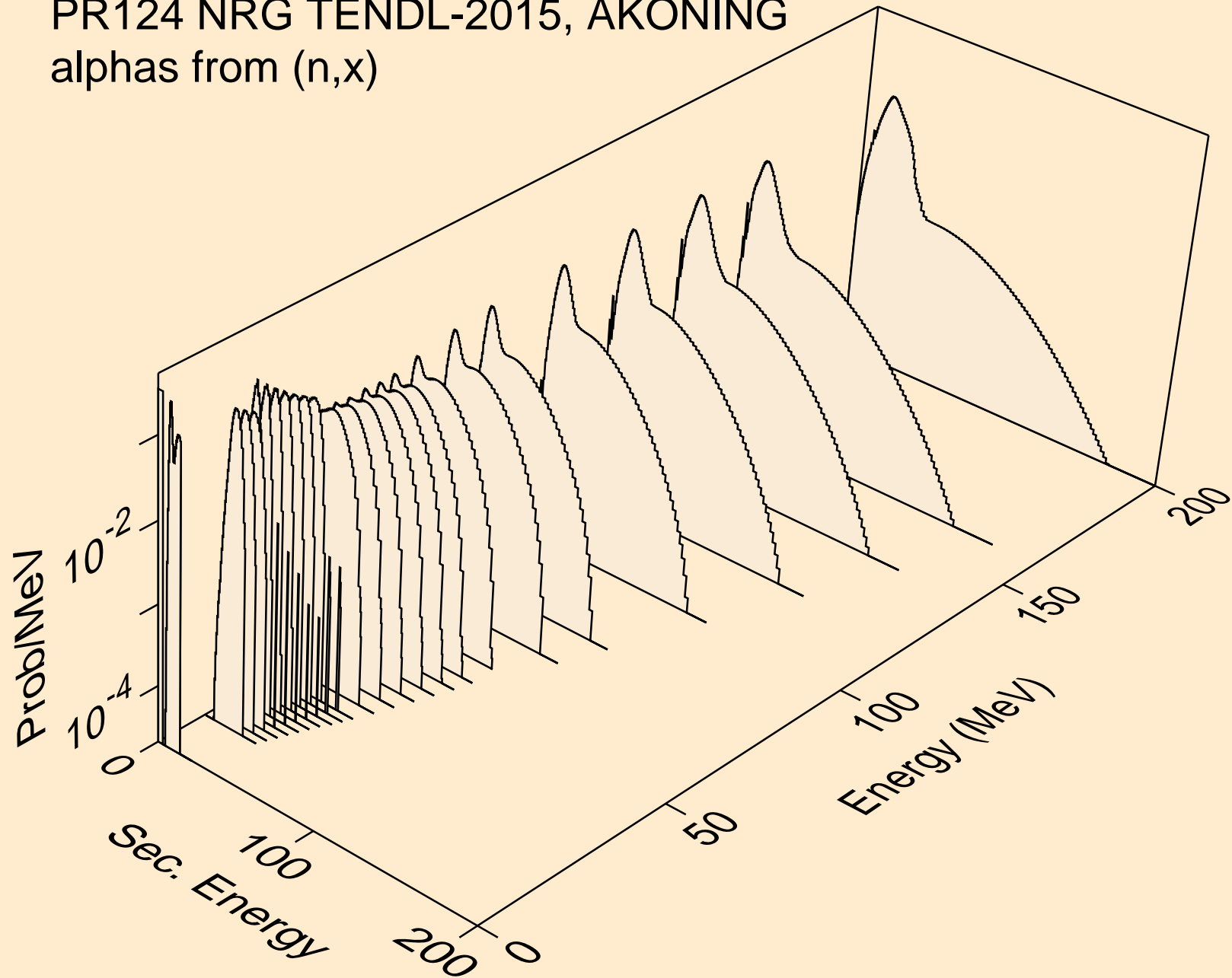

PR124 NRG TENDL-2015, AKONING
alphas from (n,n*)a

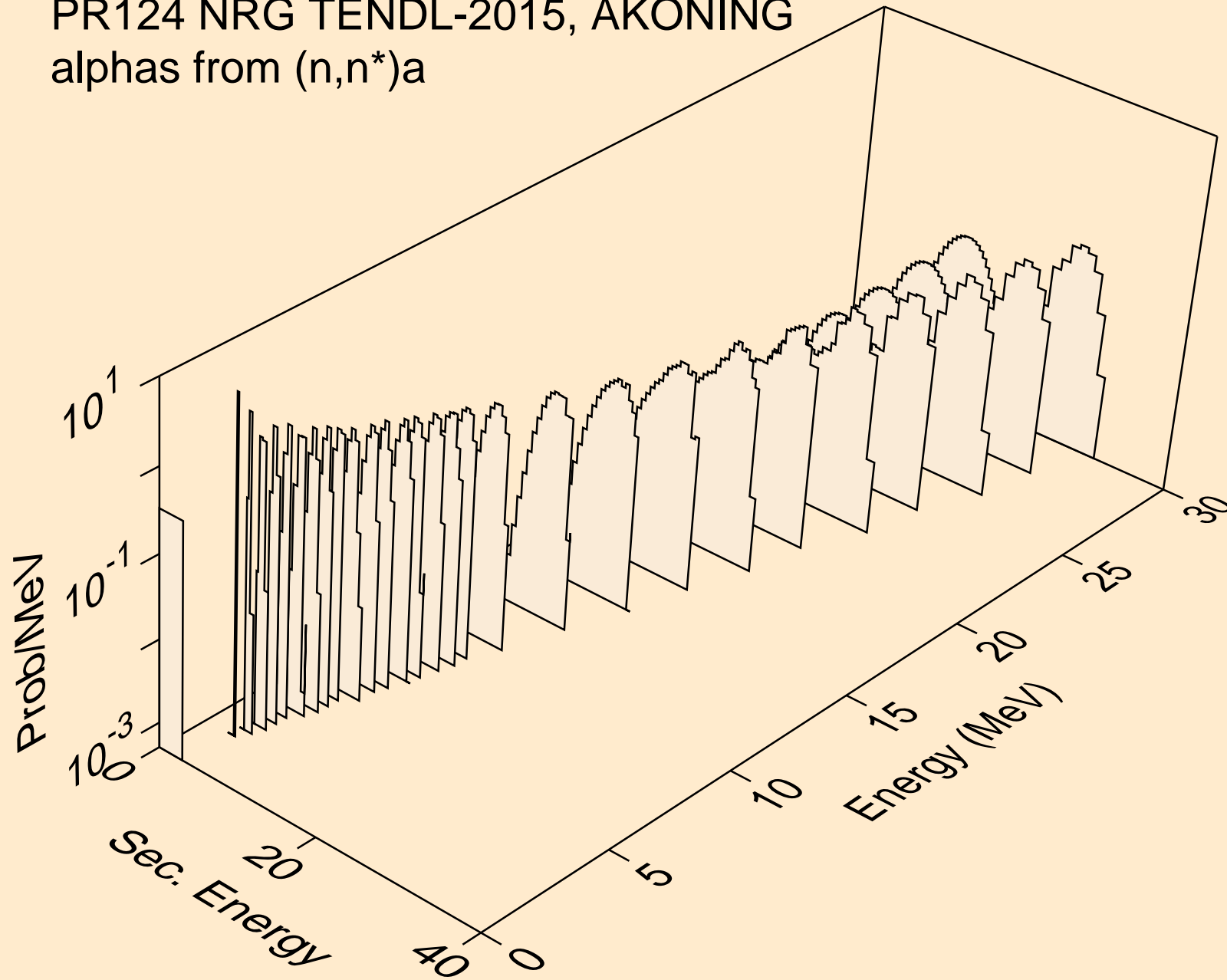

PR124 NRG TENDL-2015, AKONING
alphas from (n,n*)3a

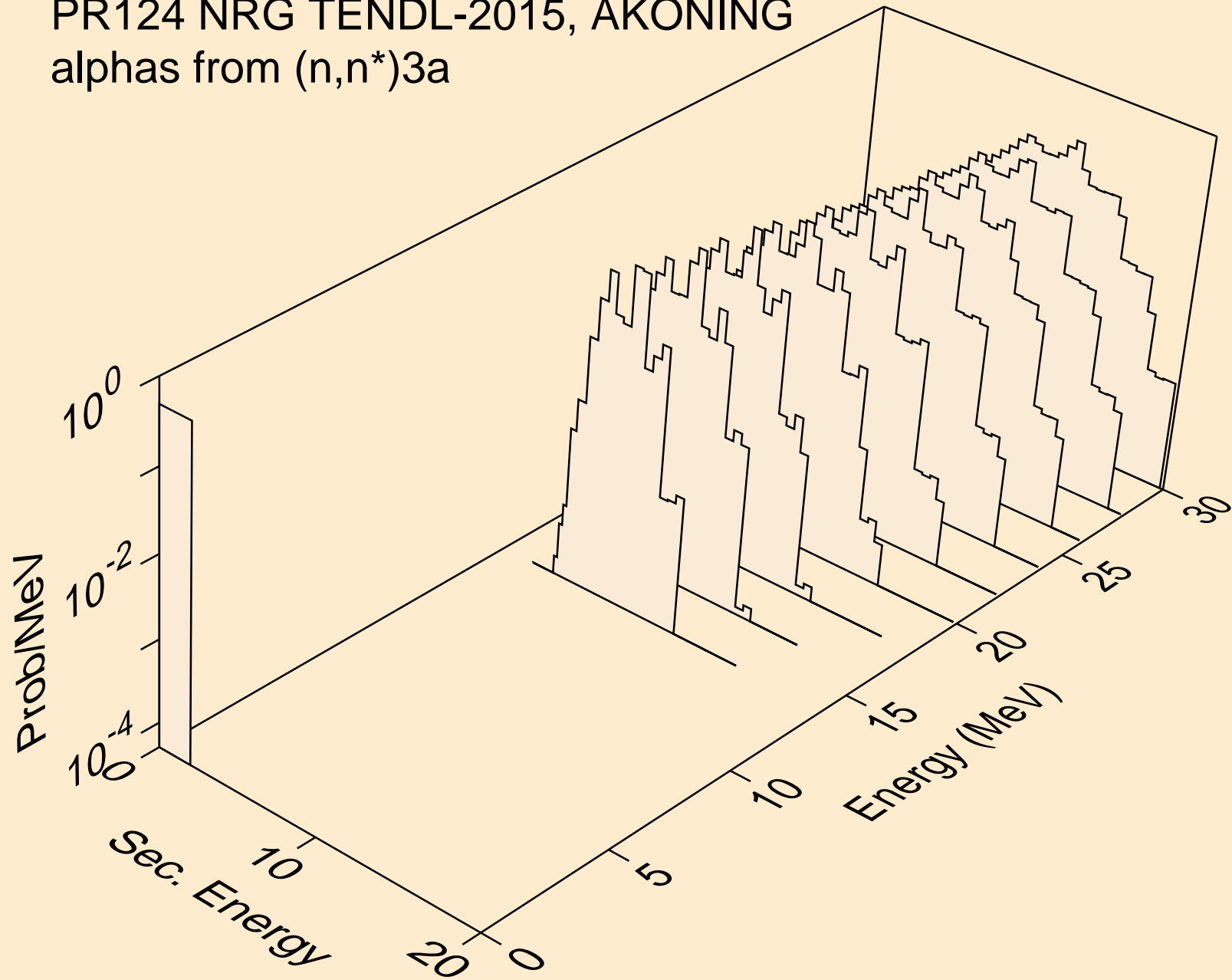

PR124 NRG TENDL-2015, AKONING
alphas from (n,2n)a

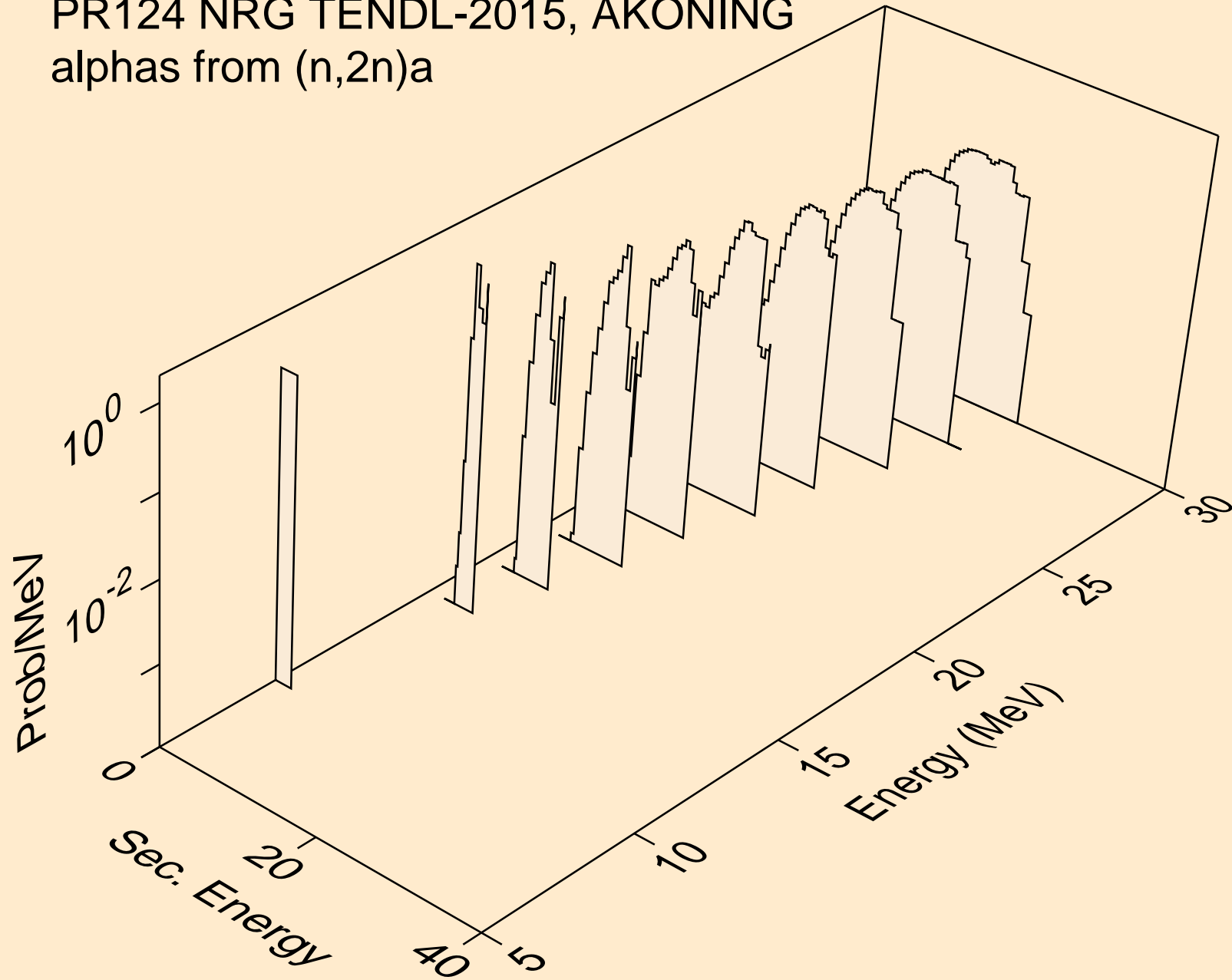

PR124 NRG TENDL-2015, AKONING
alphas from (n,n*)2a

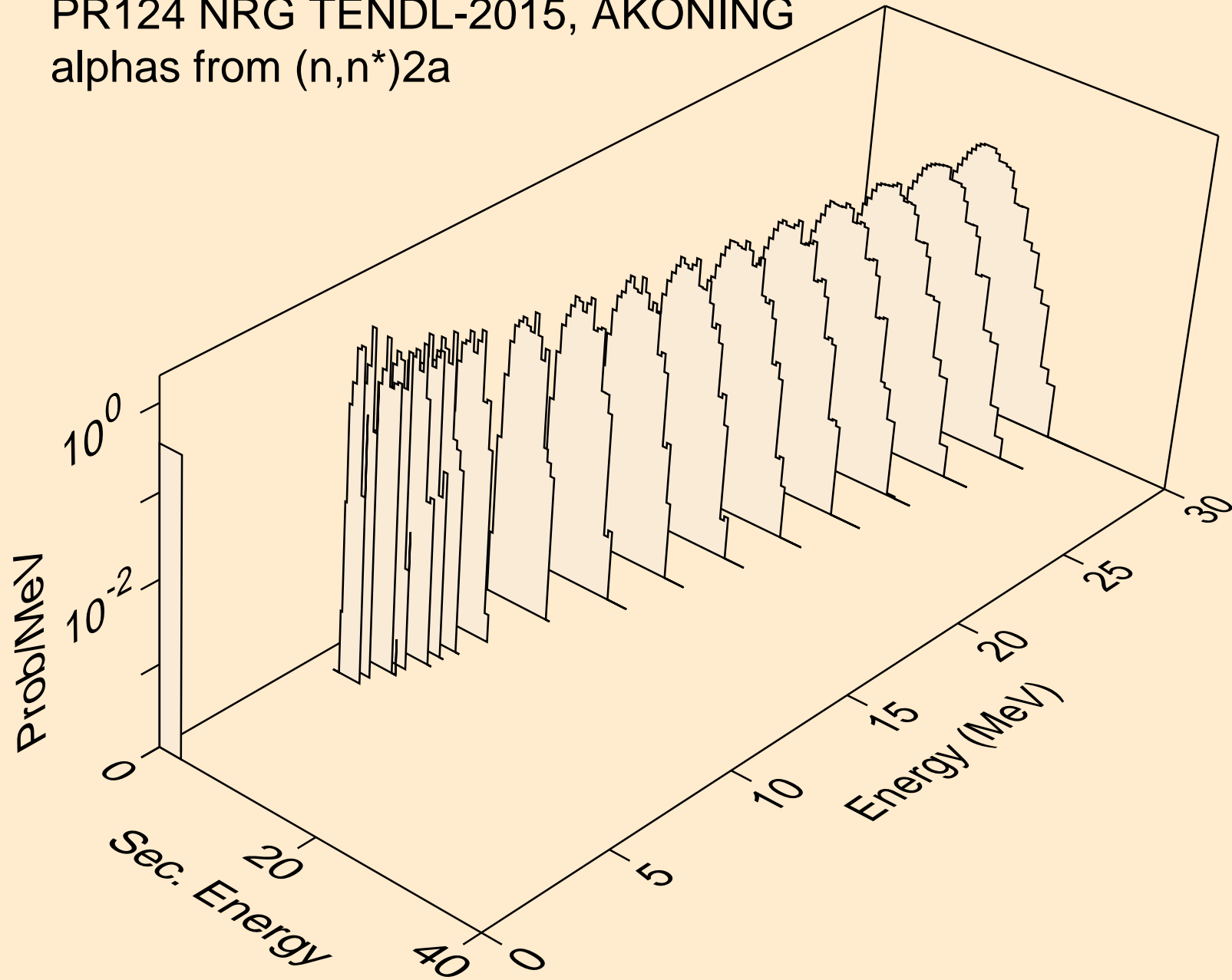

PR124 NRG TENDL-2015, AKONING
alphas from (n,2n)2a

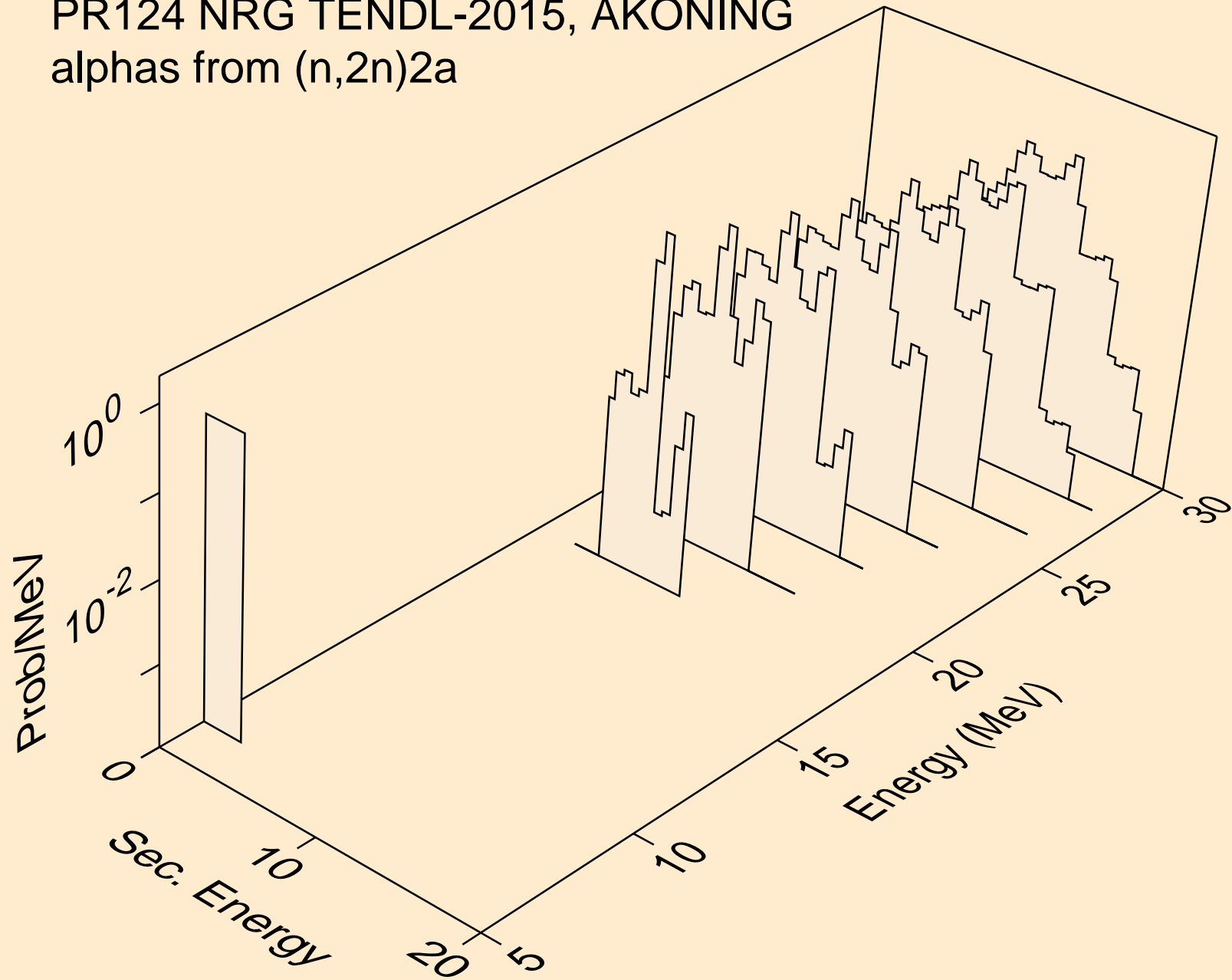

PR124 NRG TENDL-2015, AKONING
alphas from (n,npa)

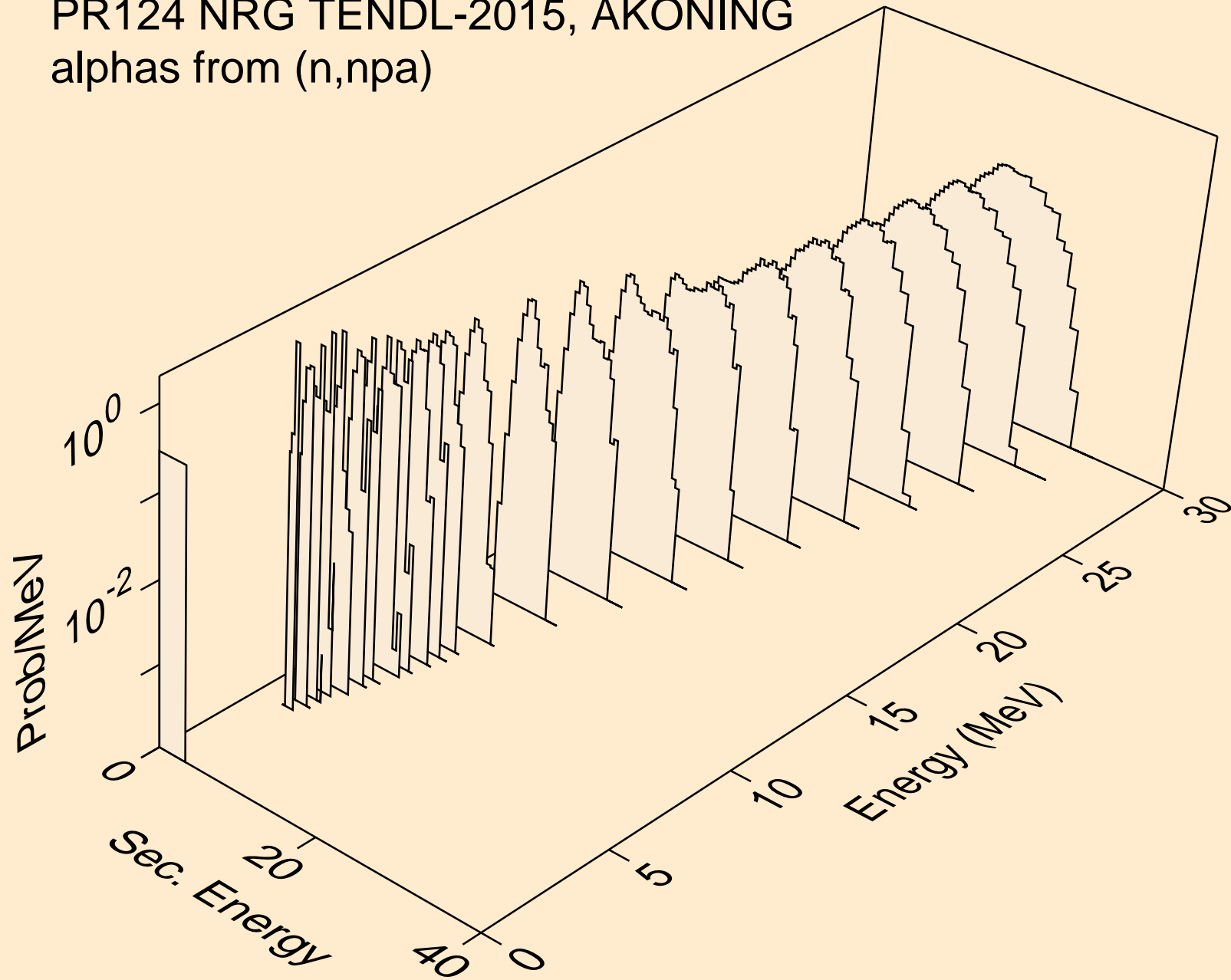

PR124 NRG TENDL-2015, AKONING
alphas from (n,a)

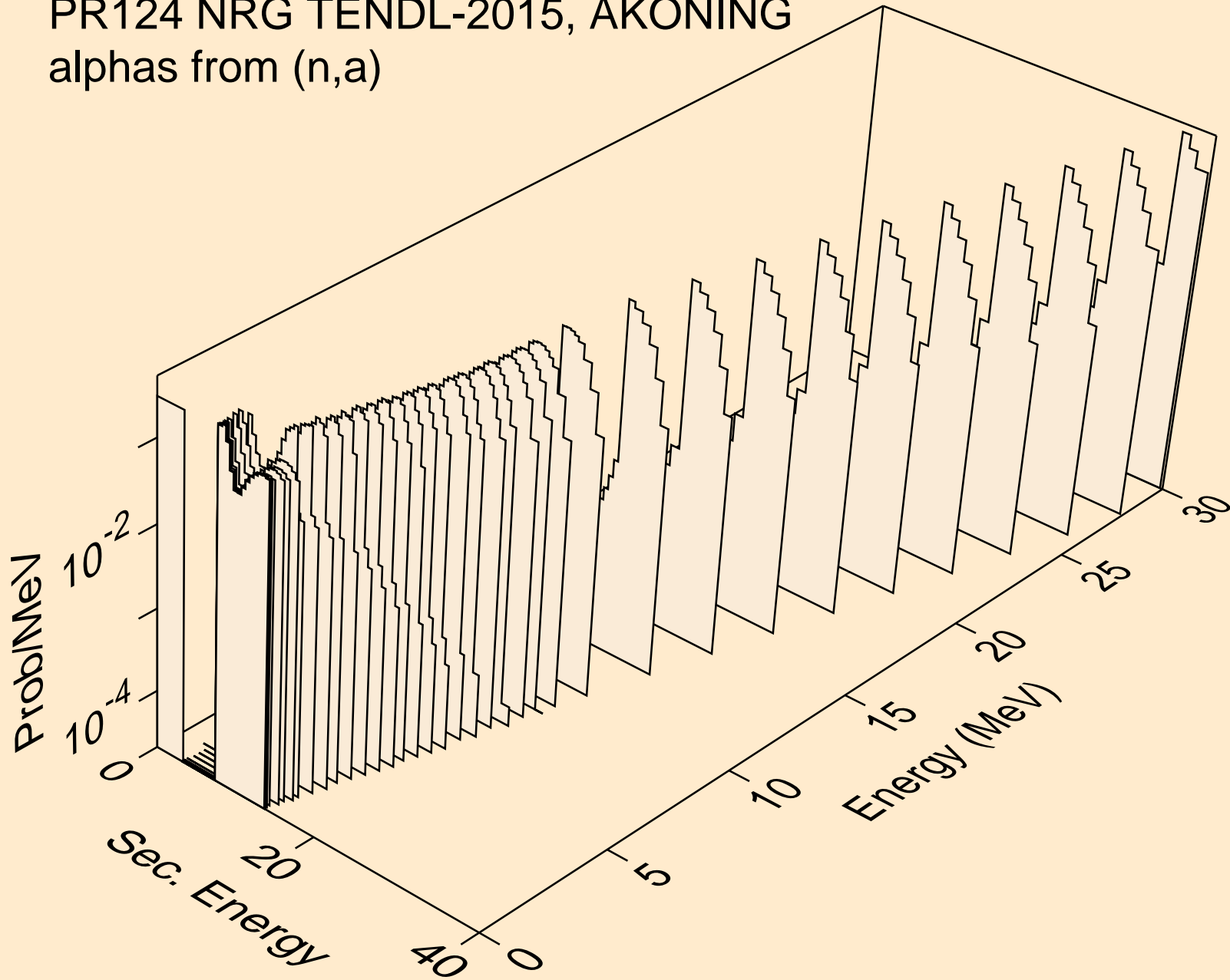

PR124 NRG TENDL-2015, AKONING
alphas from (n,2a)

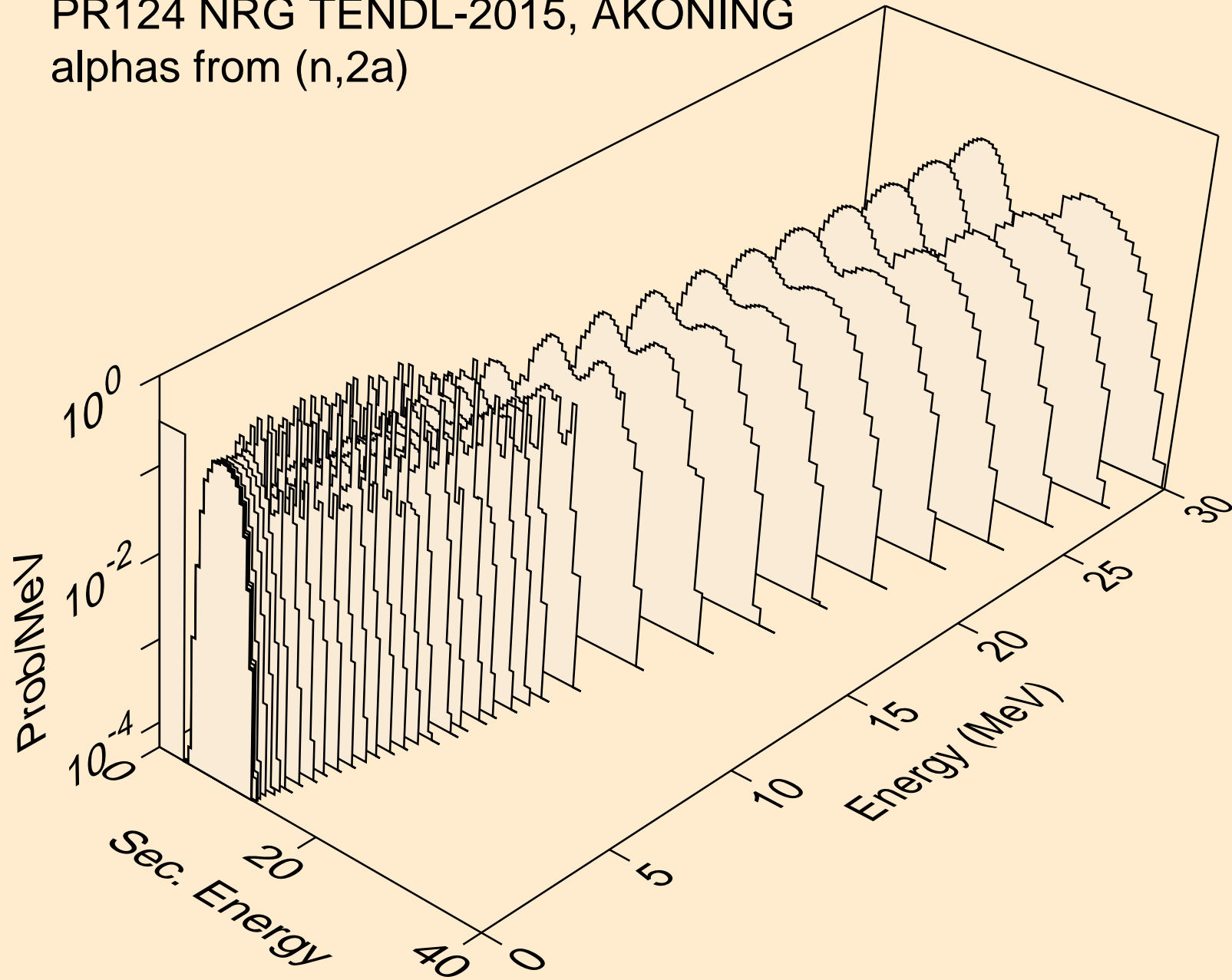

PR124 NRG TENDL-2015, AKONING
alphas from (n,3a)

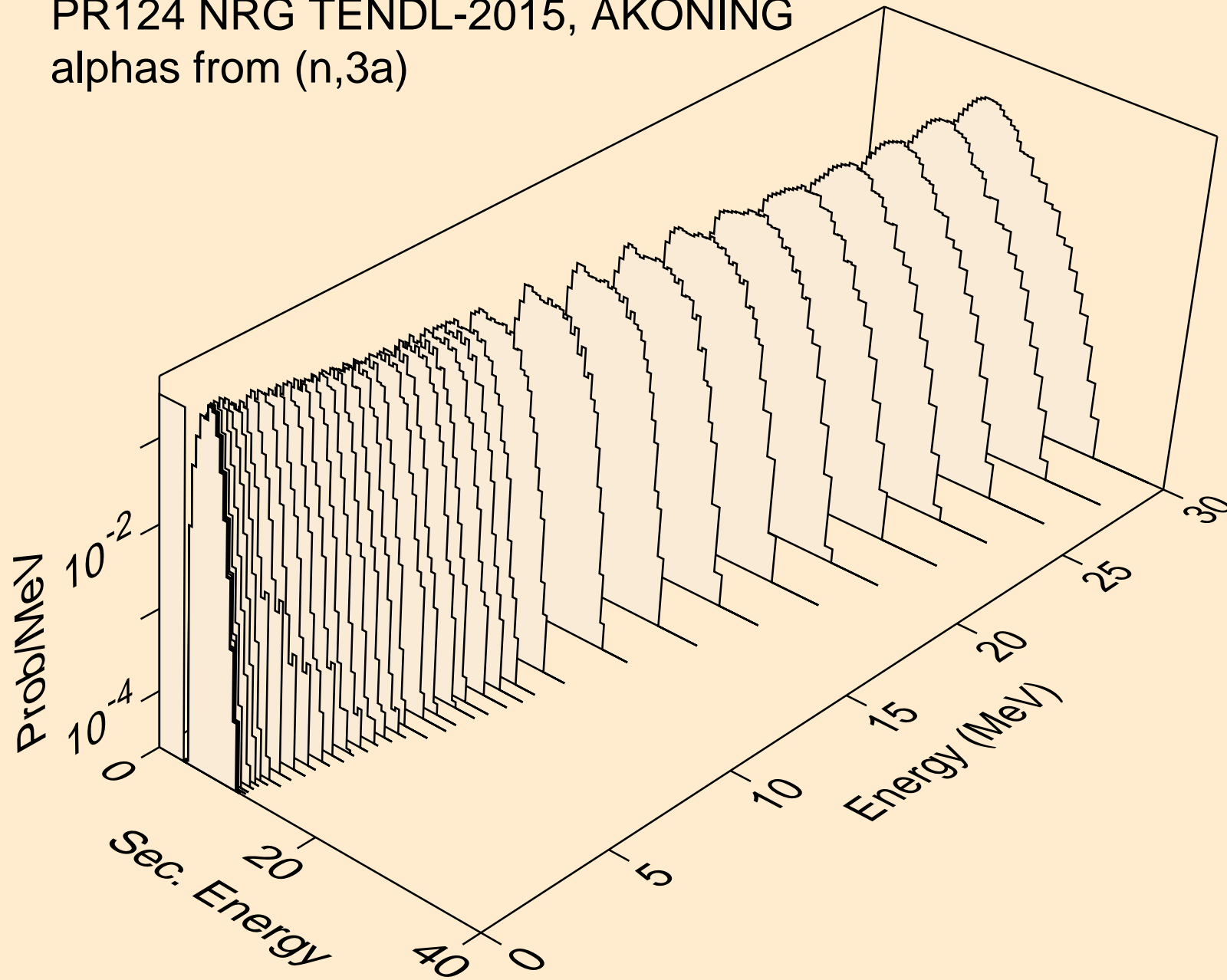

PR124 NRG TENDL-2015, AKONING
alphas from (n,pa)

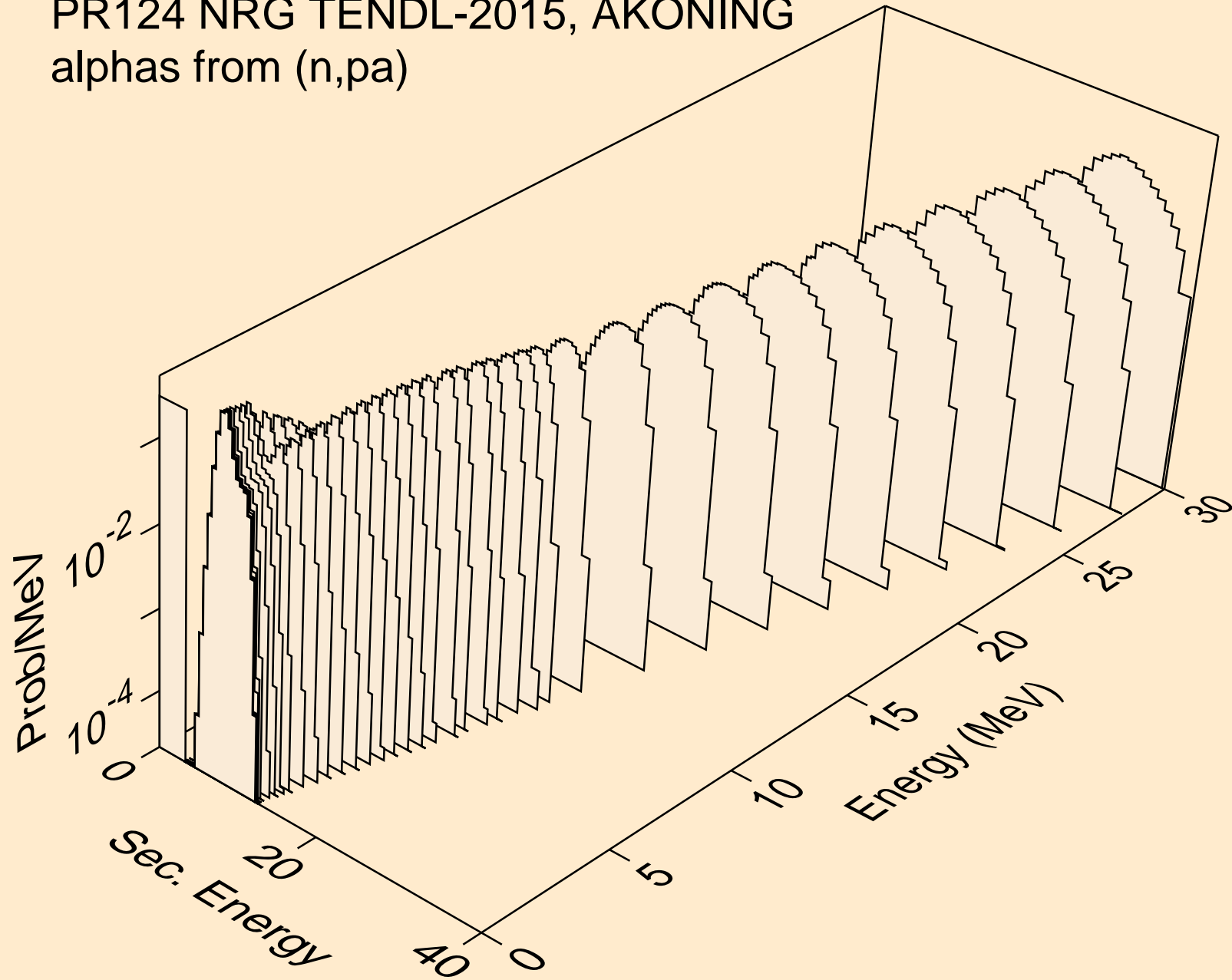

PR124 NRG TENDL-2015, AKONING
alphas from (n,t2a)

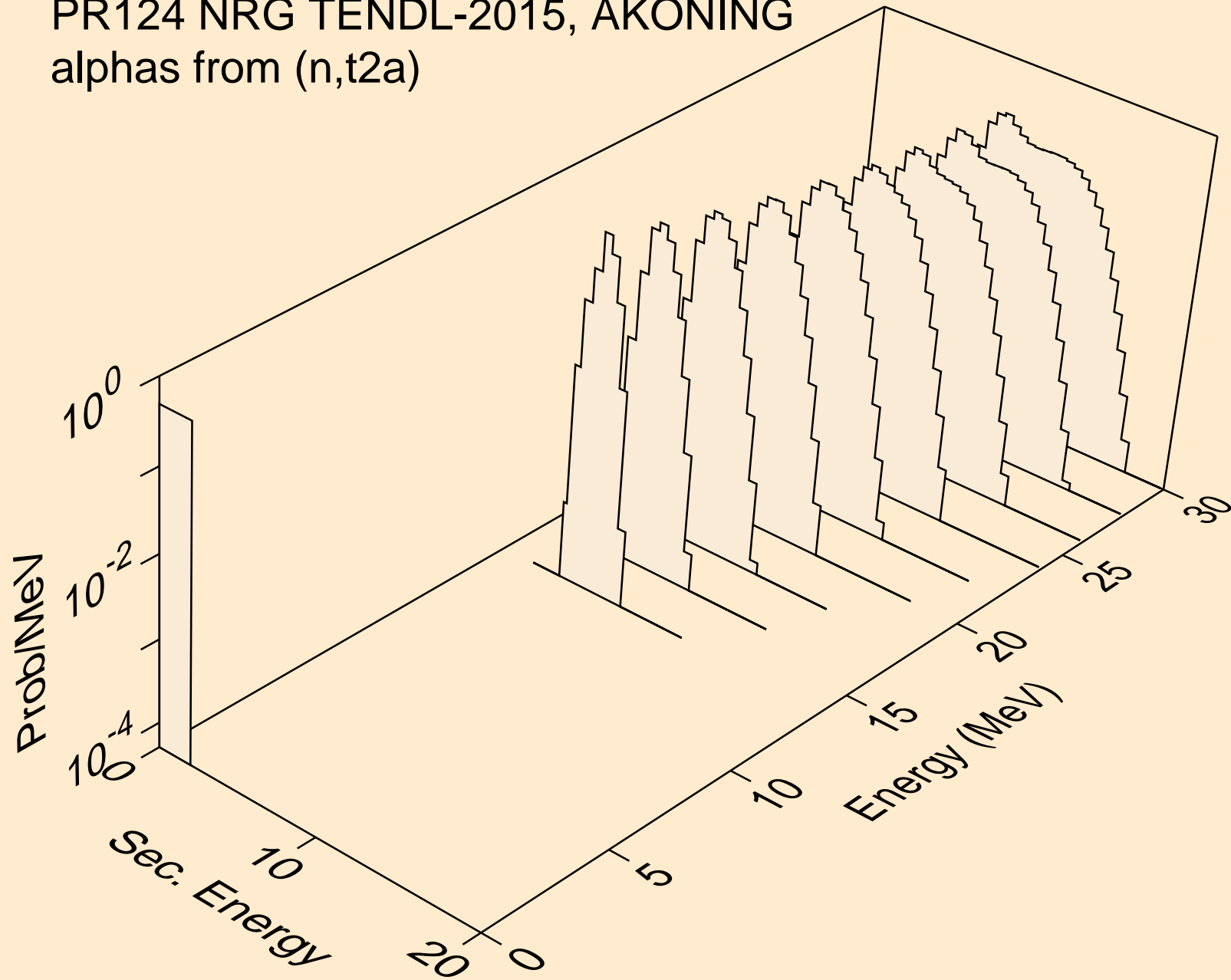

PR124 NRG TENDL-2015, AKONING
alphas from (n,d2a)

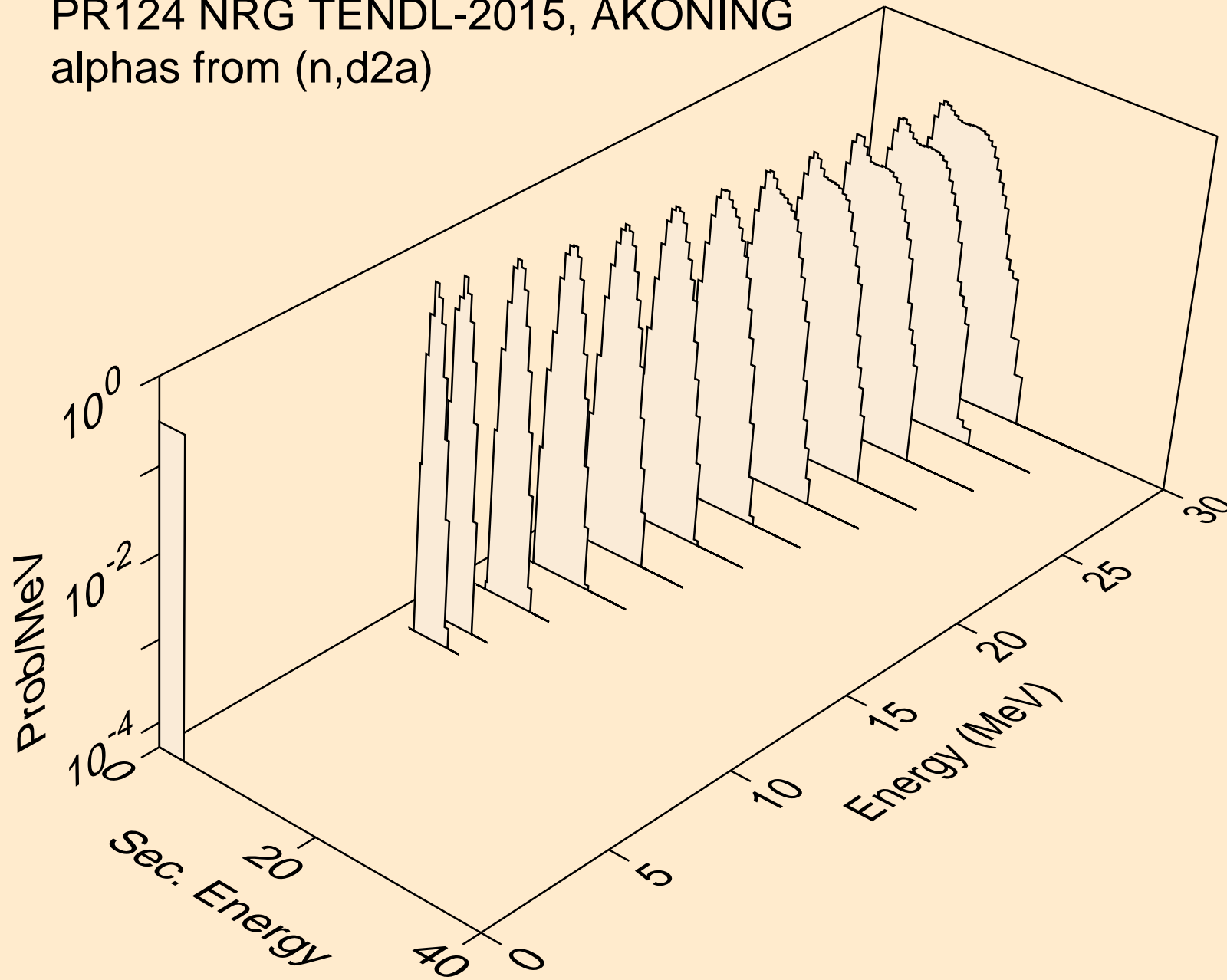

PR124 NRG TENDL-2015, AKONING
alphas from (n,da)

