

# PT175 NRG TENDL-2015, AKONING

## Principal cross sections

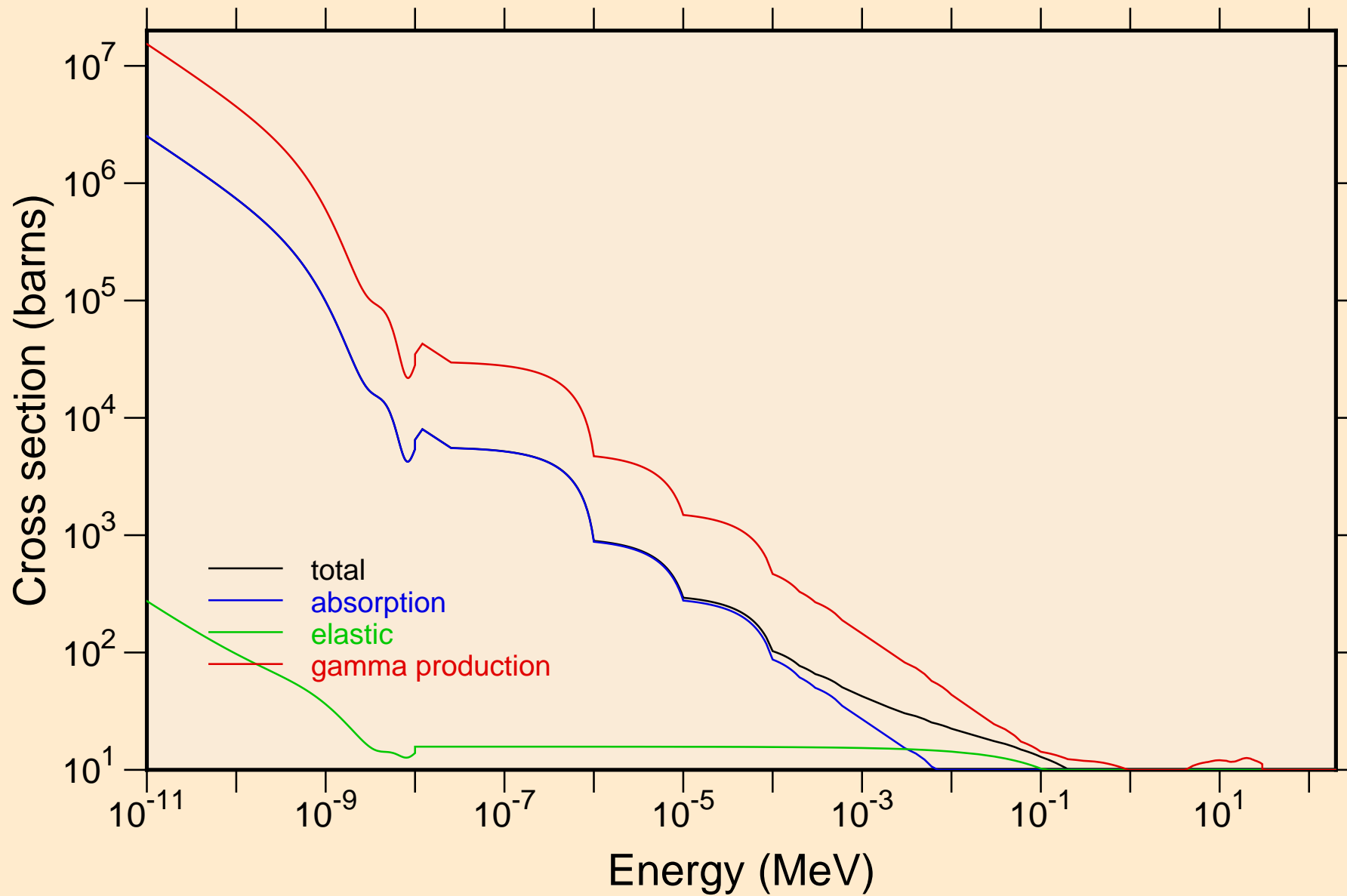

PT175 NRG TENDL-2015, AKONING  
Non-threshold reactions

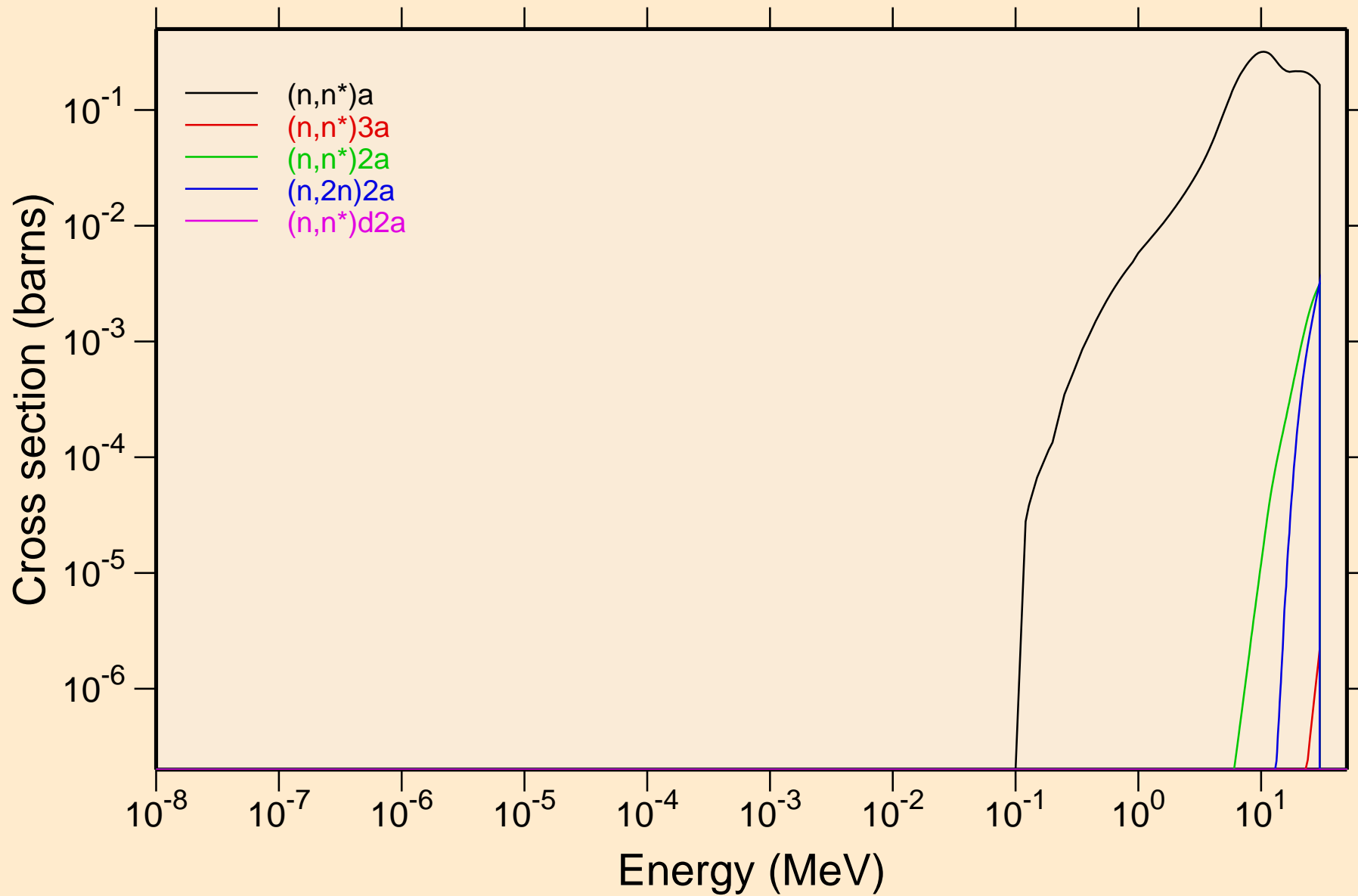

# PT175 NRG TENDL-2015, AKONING

## Non-threshold reactions

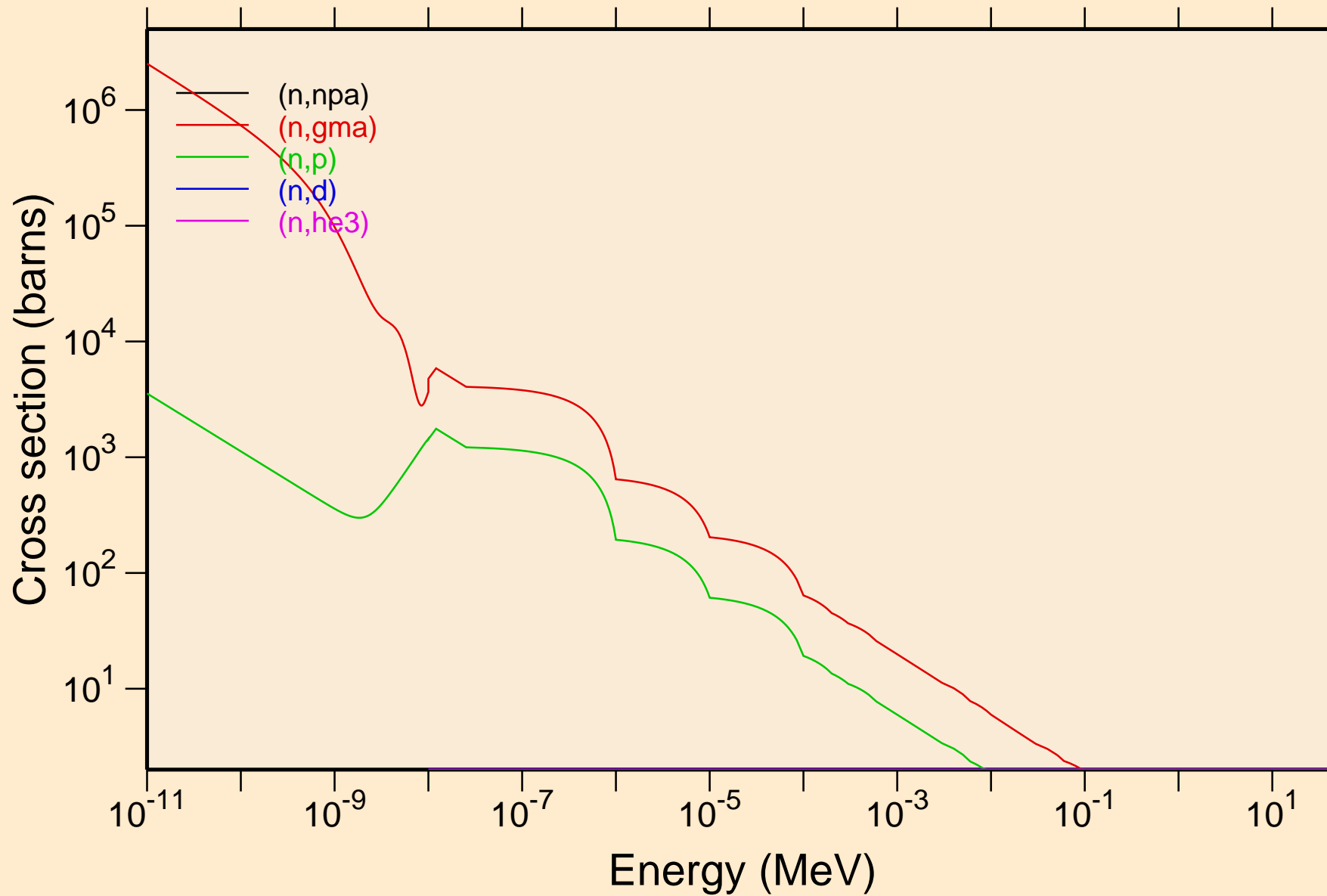

PT175 NRG TENDL-2015, AKONING  
Non-threshold reactions

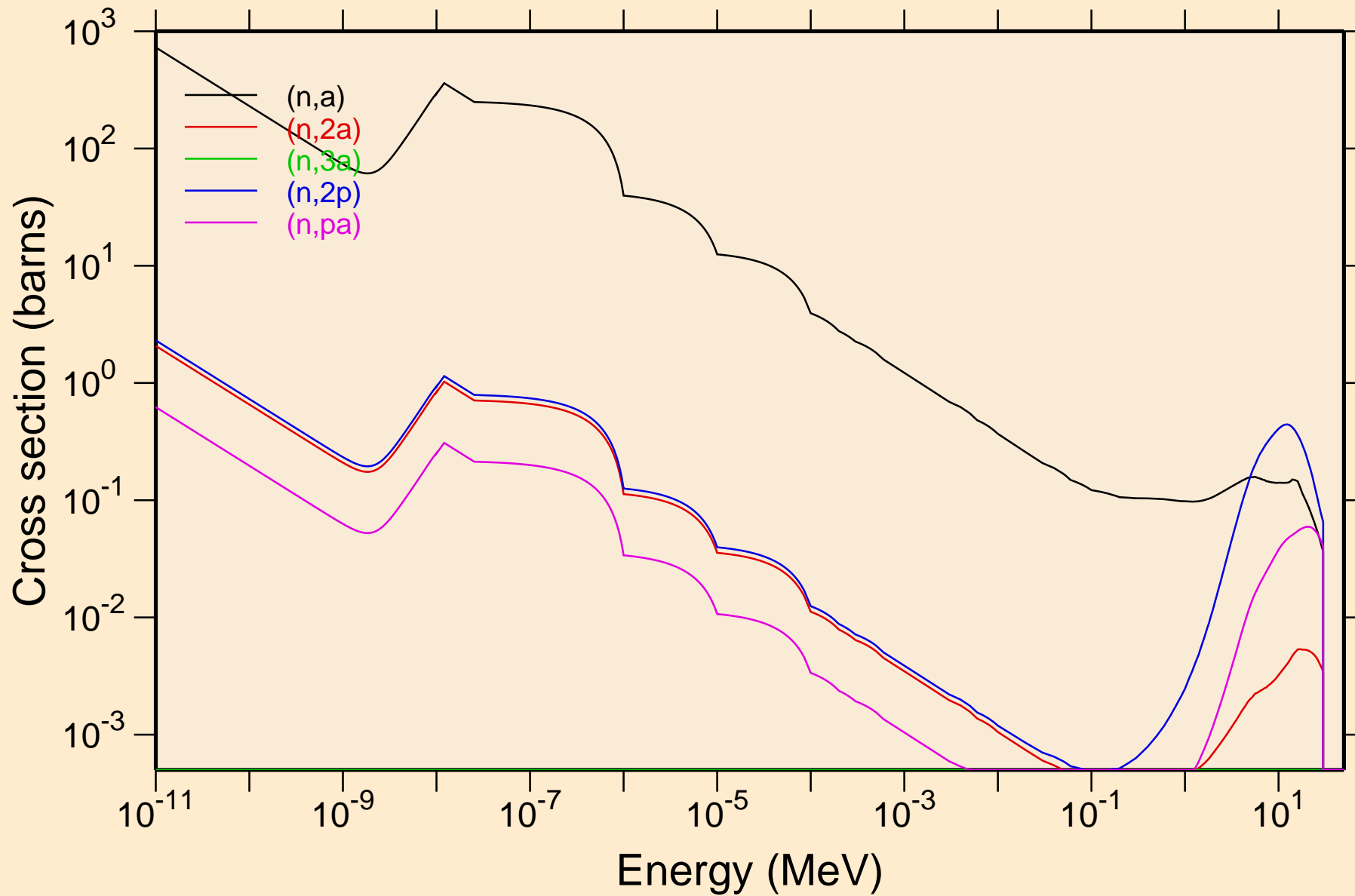

PT175 NRG TENDL-2015, AKONING  
Non-threshold reactions

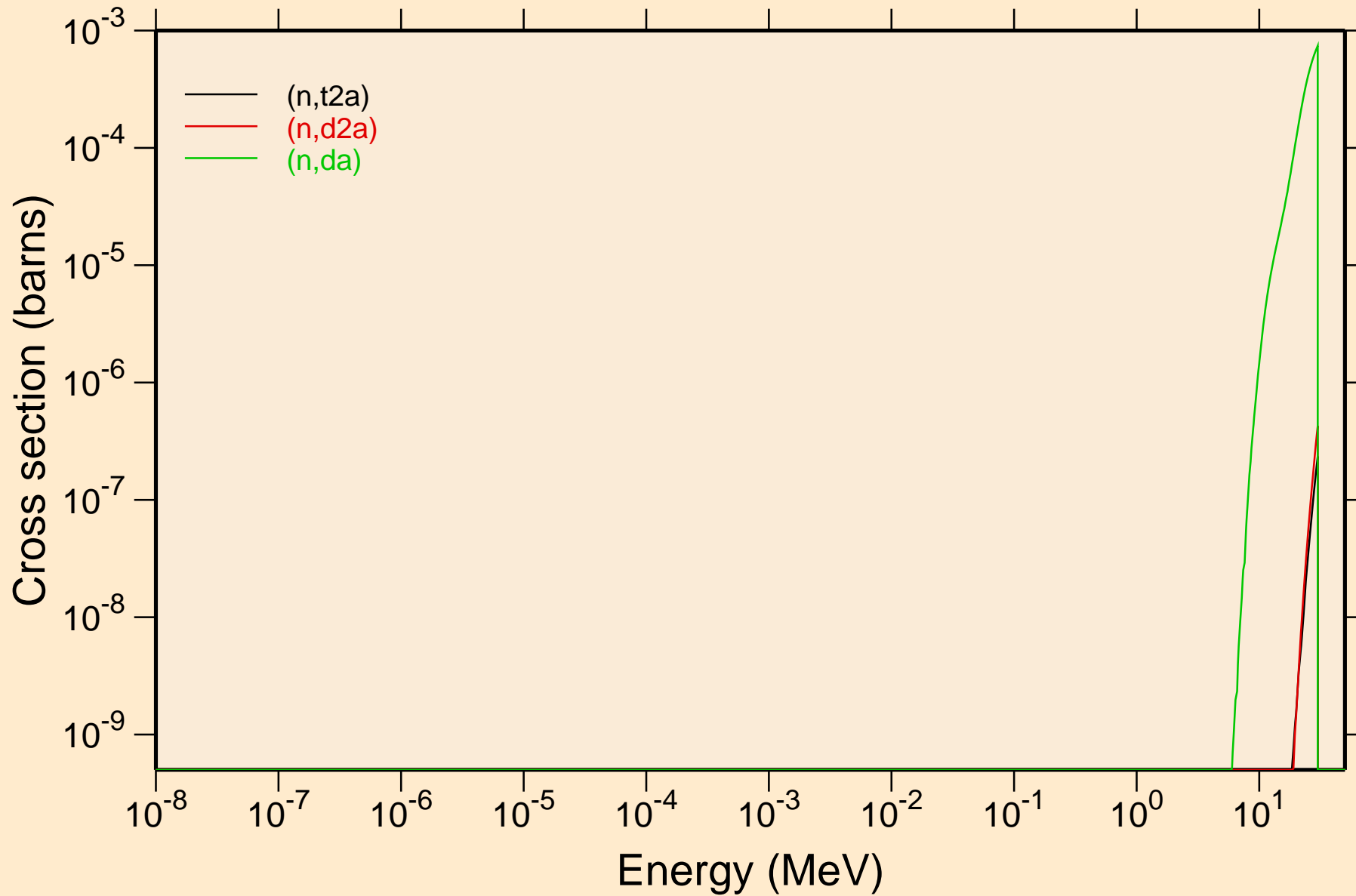

# PT175 NRG TENDL-2015, AKONING

## Principal cross sections

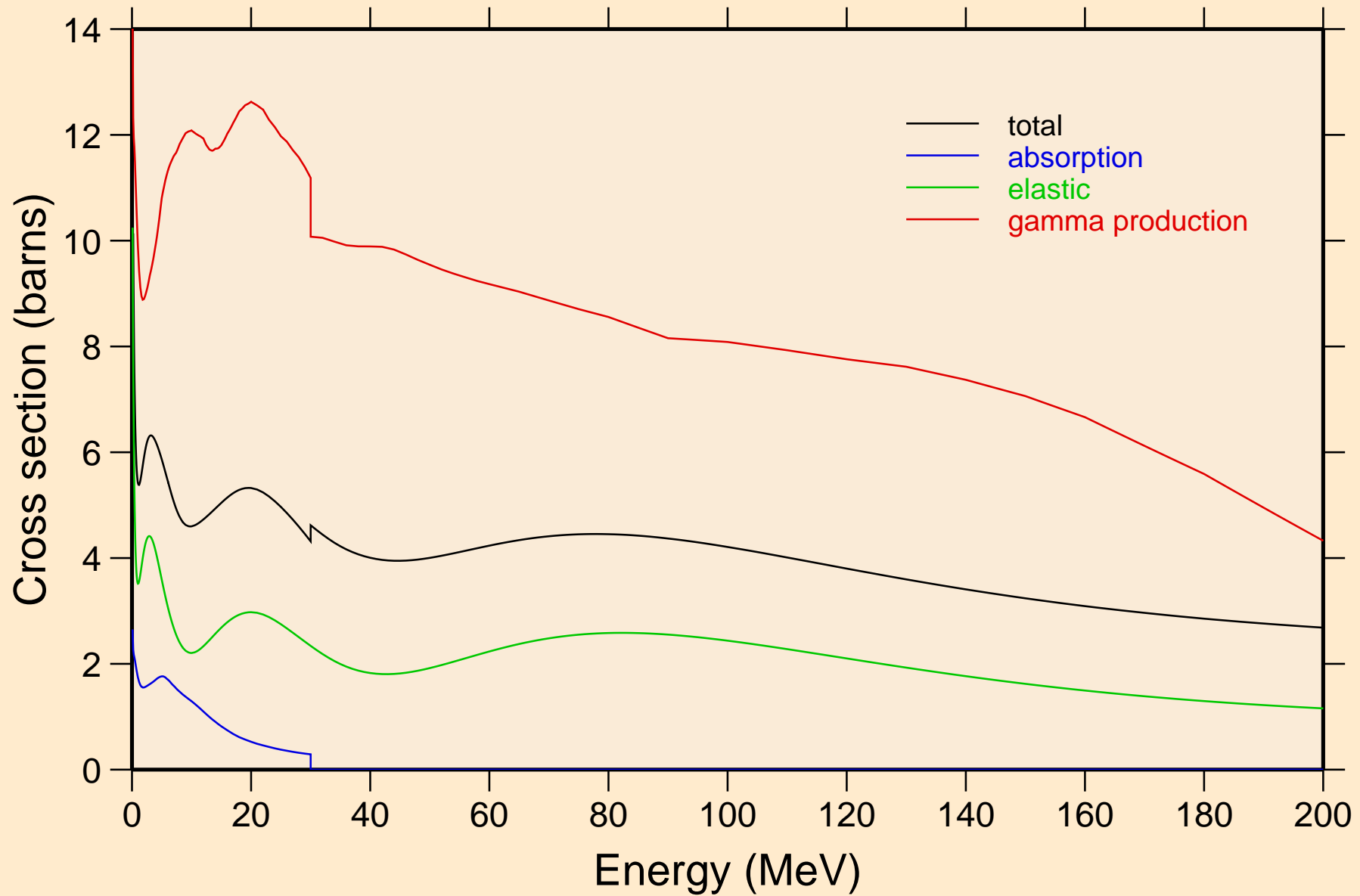

PT175 NRG TENDL-2015, AKONING  
Non-threshold reactions

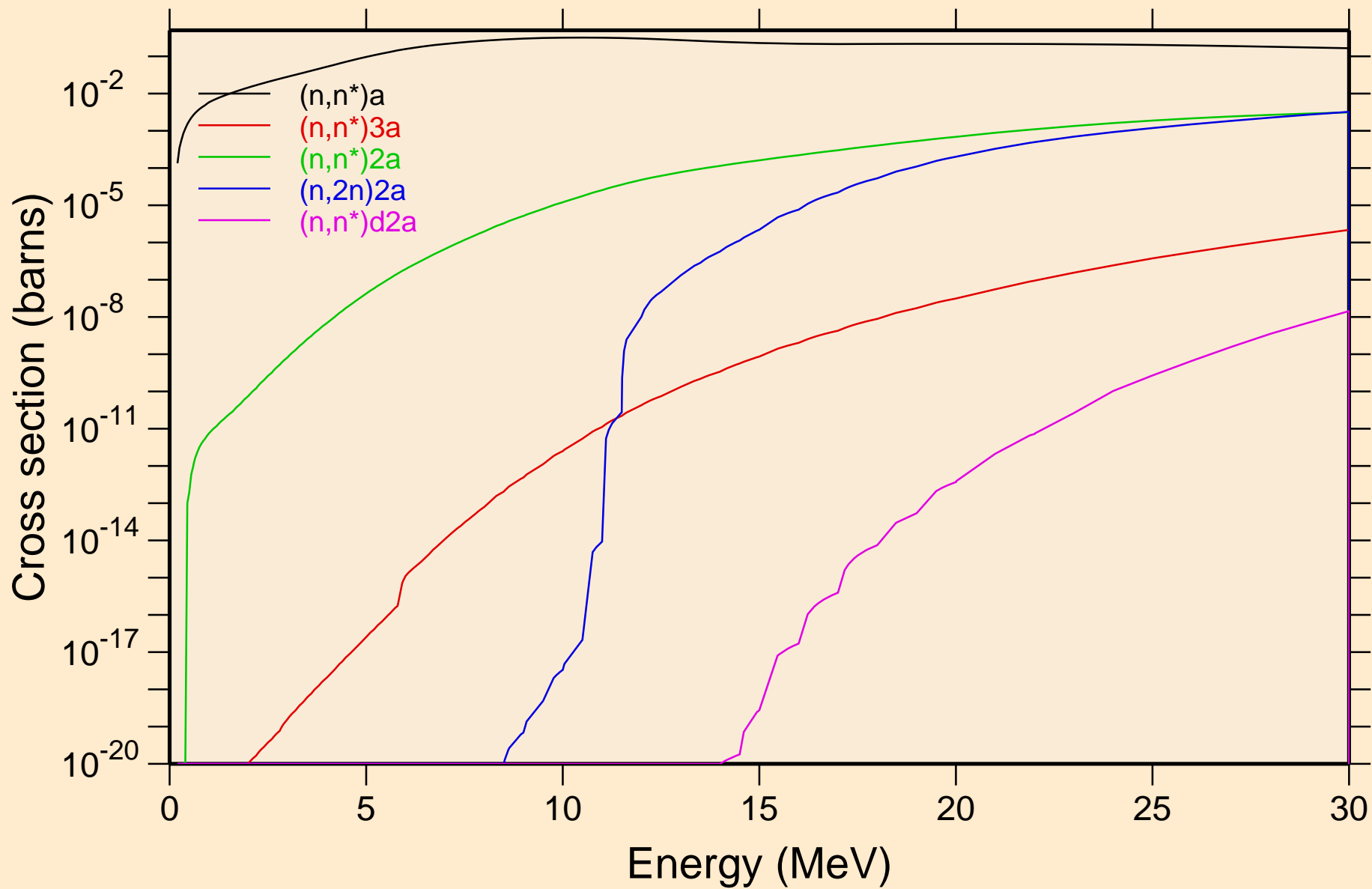

# PT175 NRG TENDL-2015, AKONING

## Non-threshold reactions

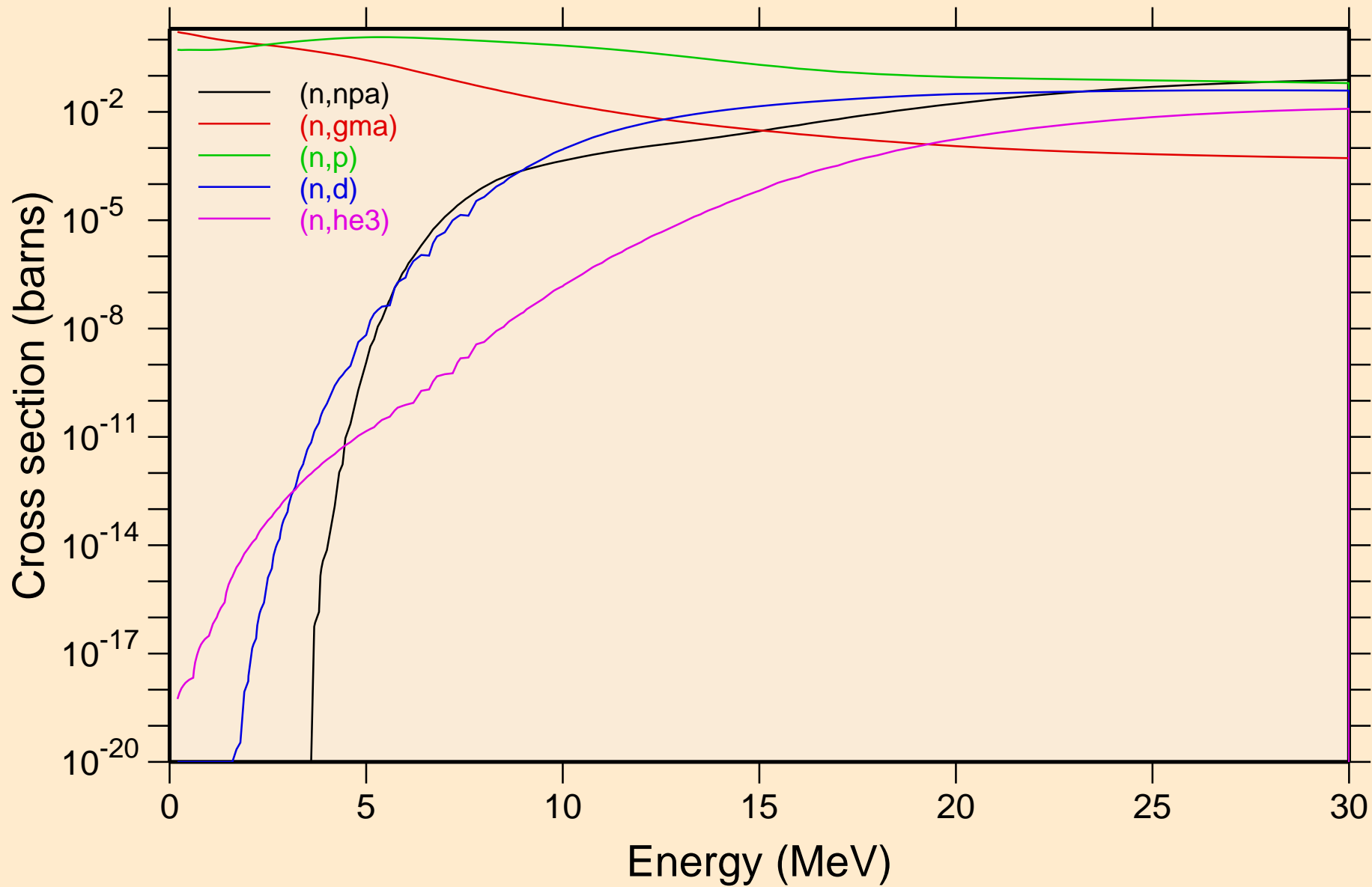



PT175 NRG TENDL-2015, AKONING  
Non-threshold reactions

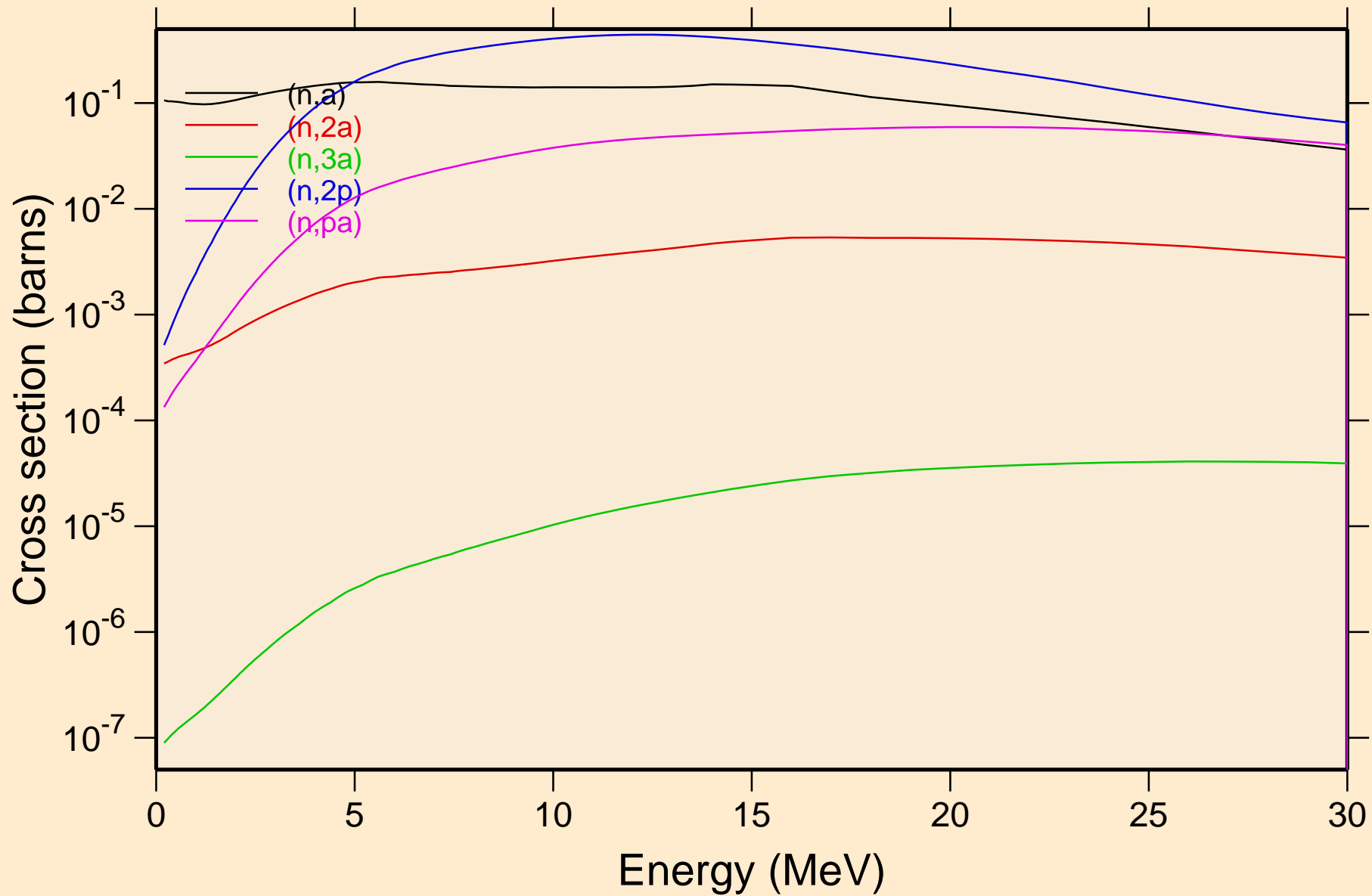

PT175 NRG TENDL-2015, AKONING  
Non-threshold reactions

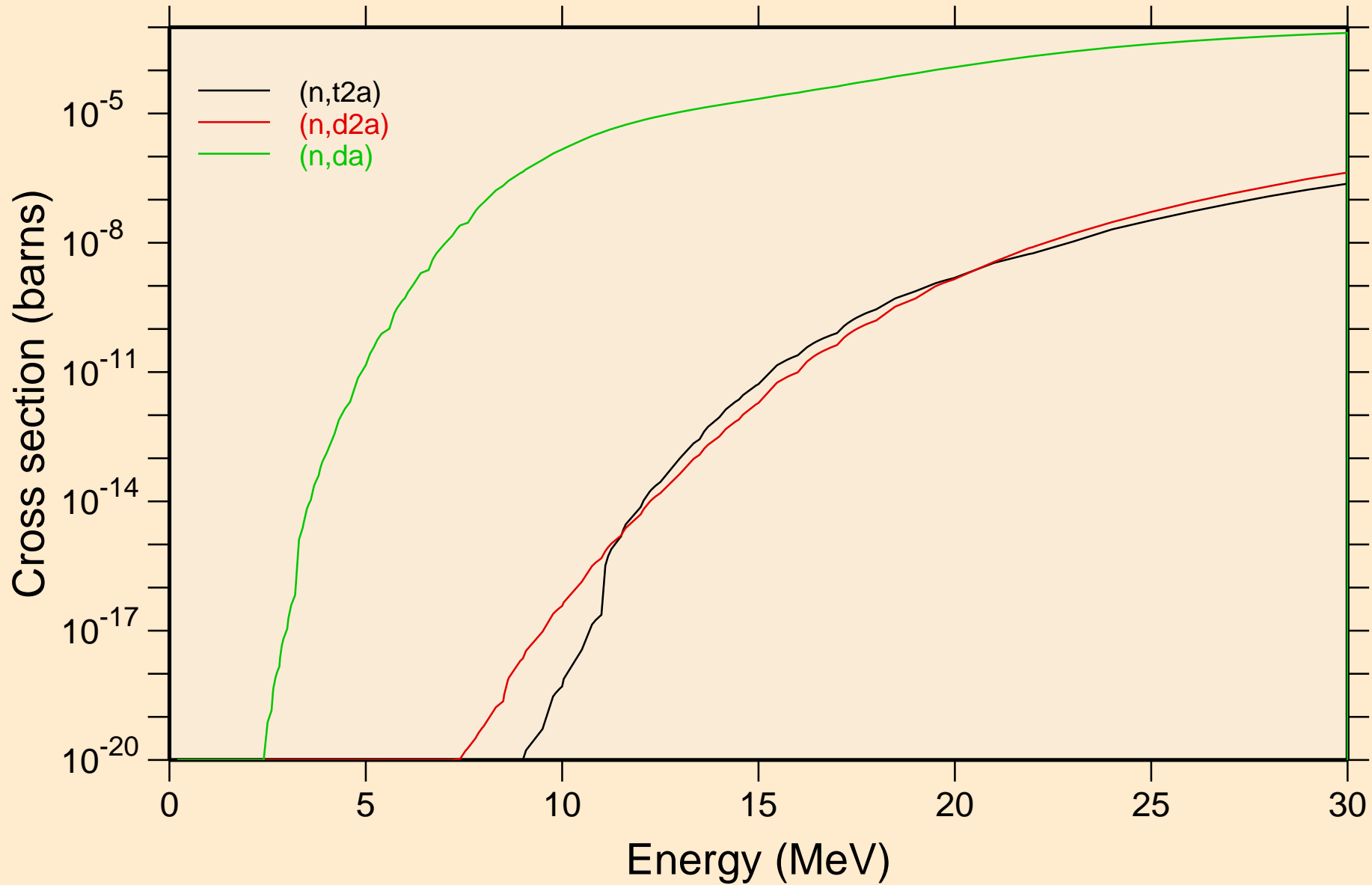

PT175 NRG TENDL-2015, AKONING  
Inelastic levels

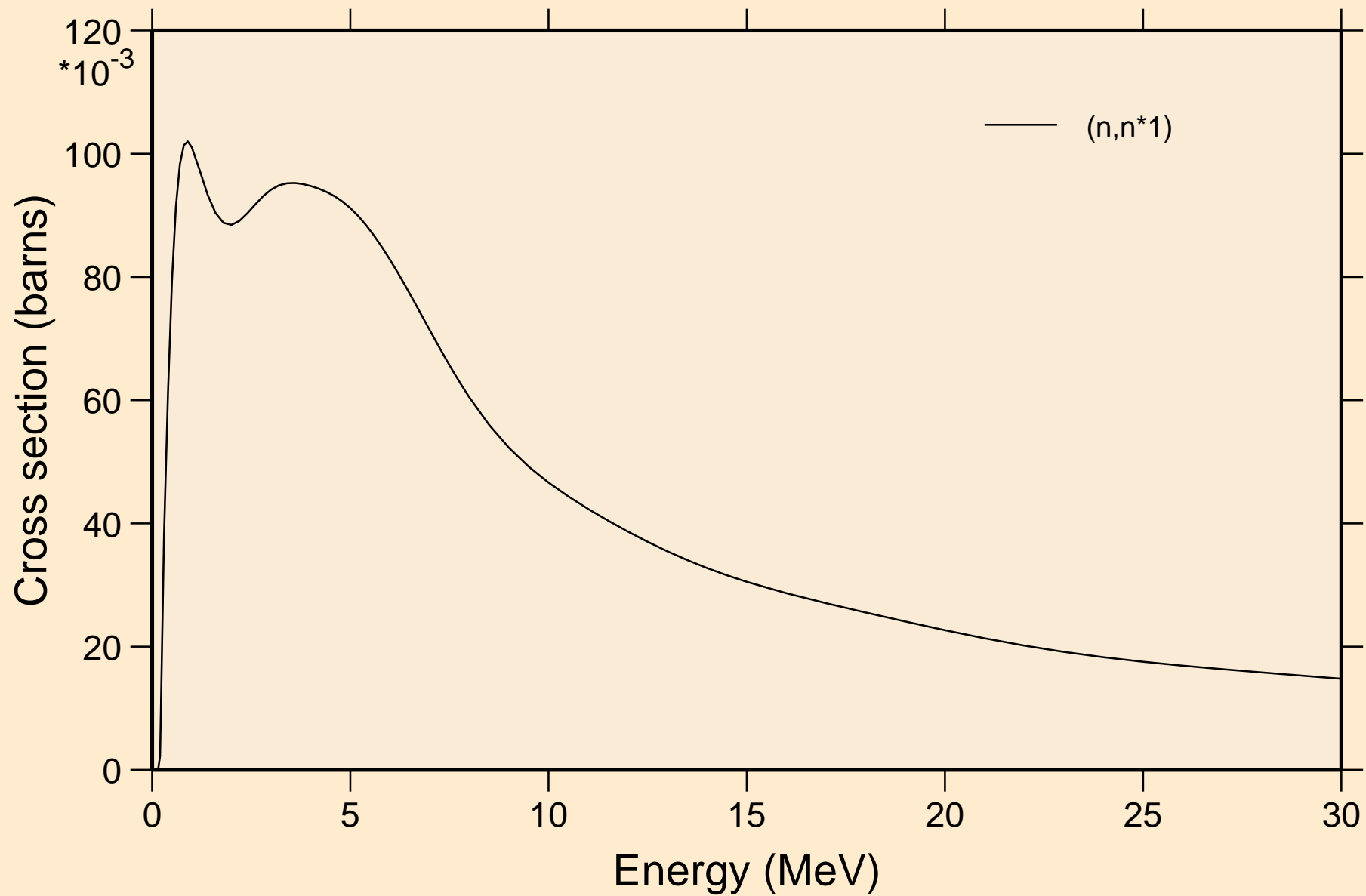

# PT175 NRG TENDL-2015, AKONING

## Threshold reactions

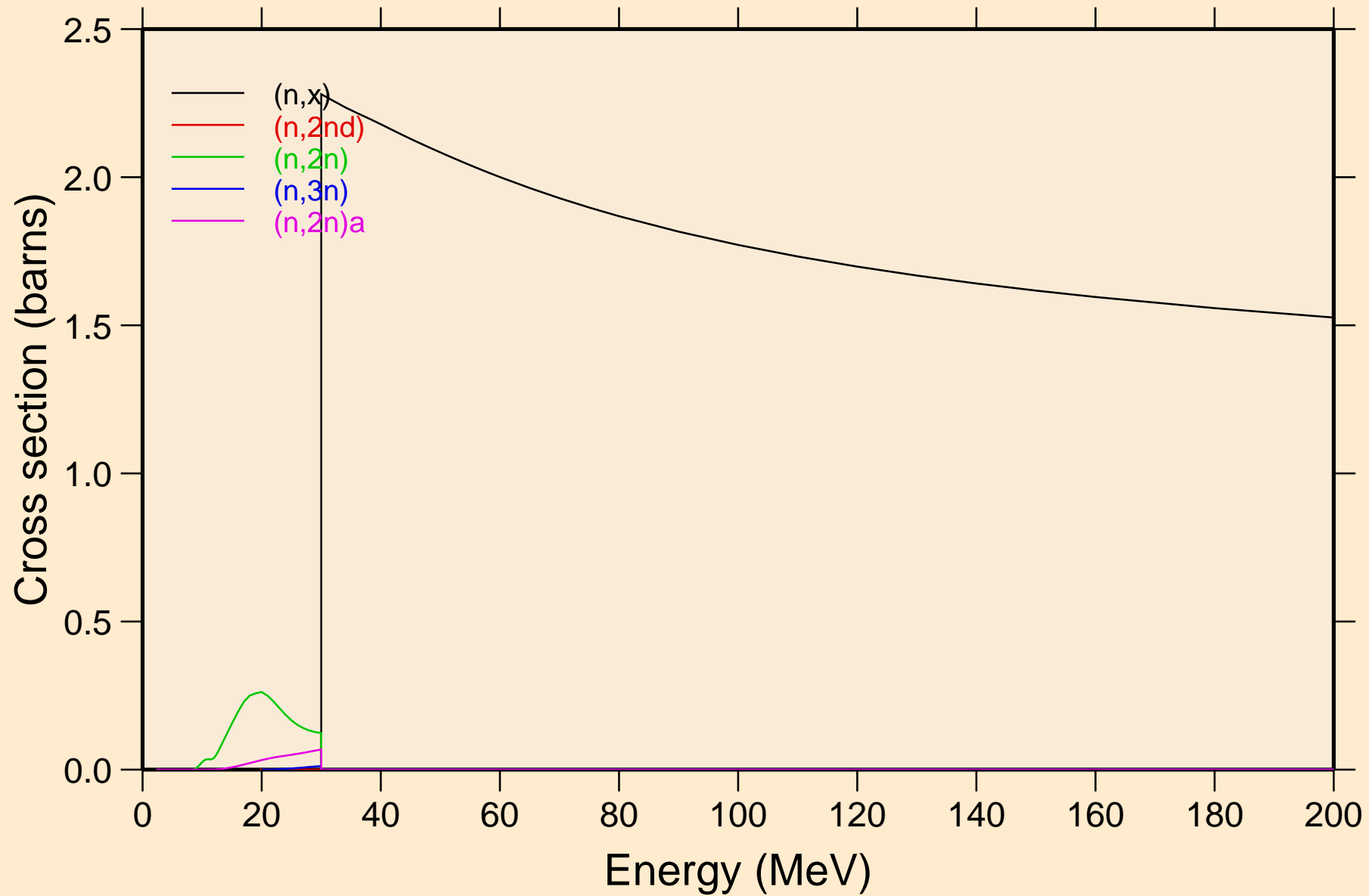

# PT175 NRG TENDL-2015, AKONING

## Threshold reactions

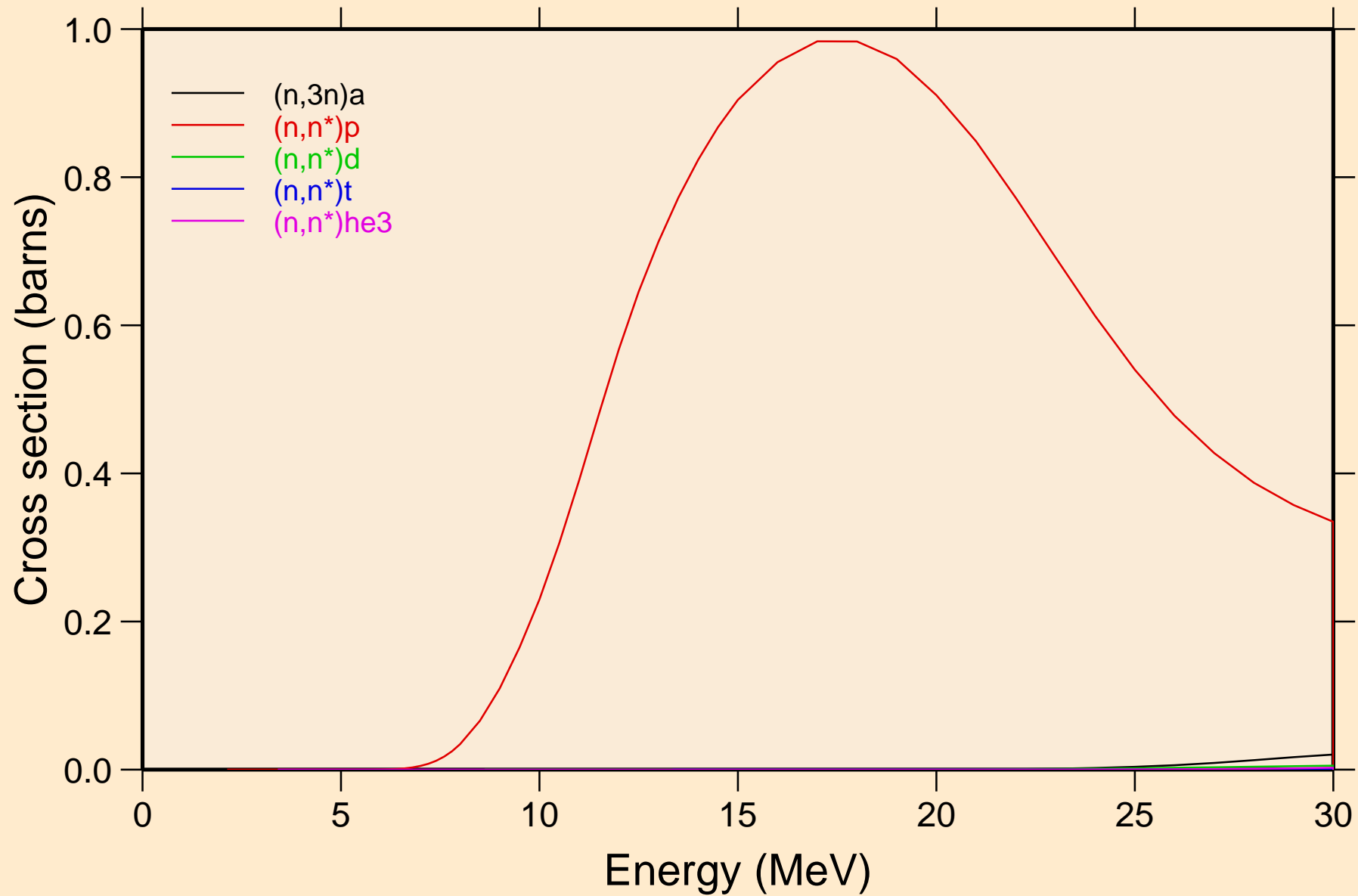

PT175 NRG TENDL-2015, AKONING  
Threshold reactions

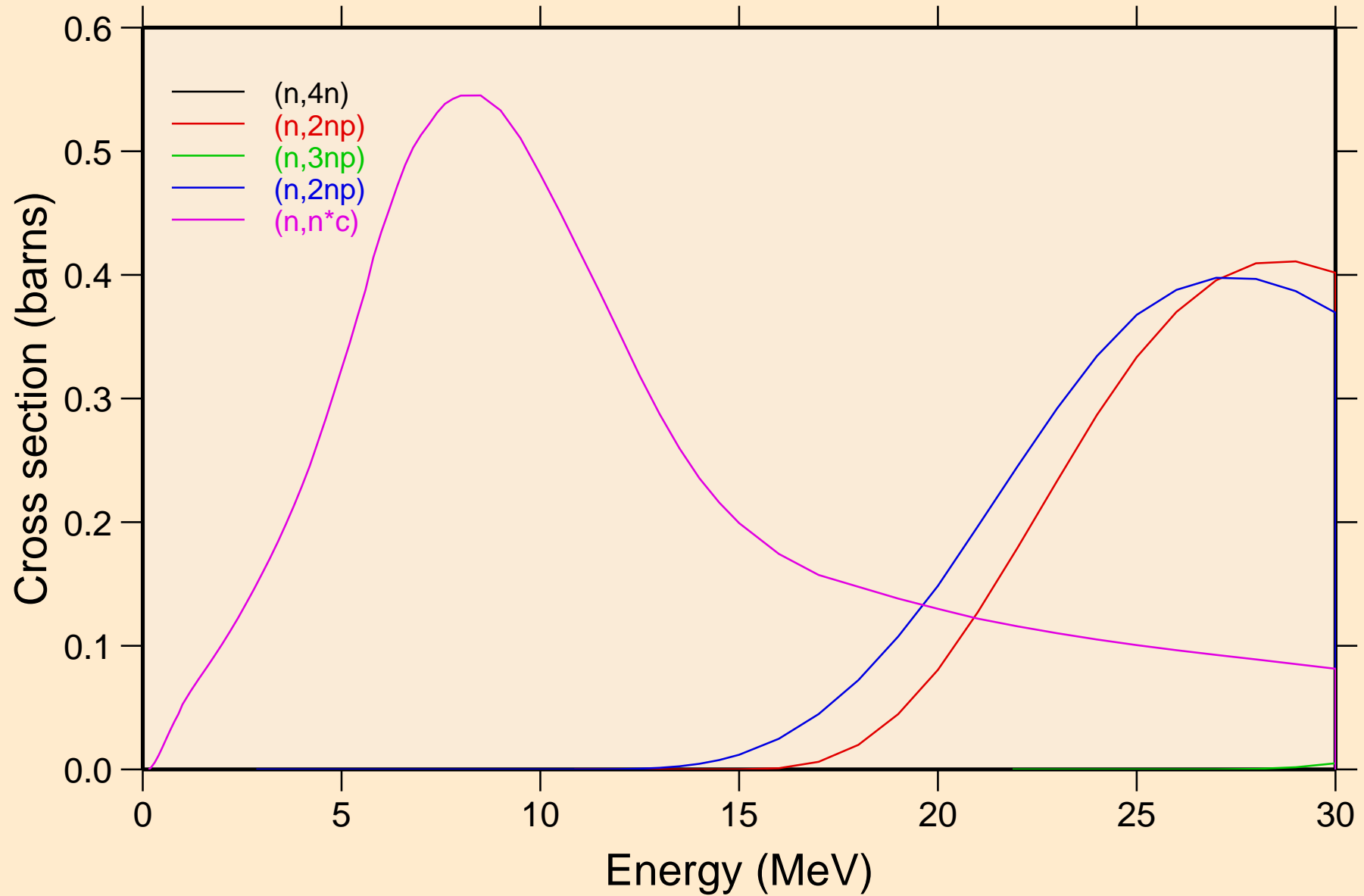

PT175 NRG TENDL-2015, AKONING  
Threshold reactions

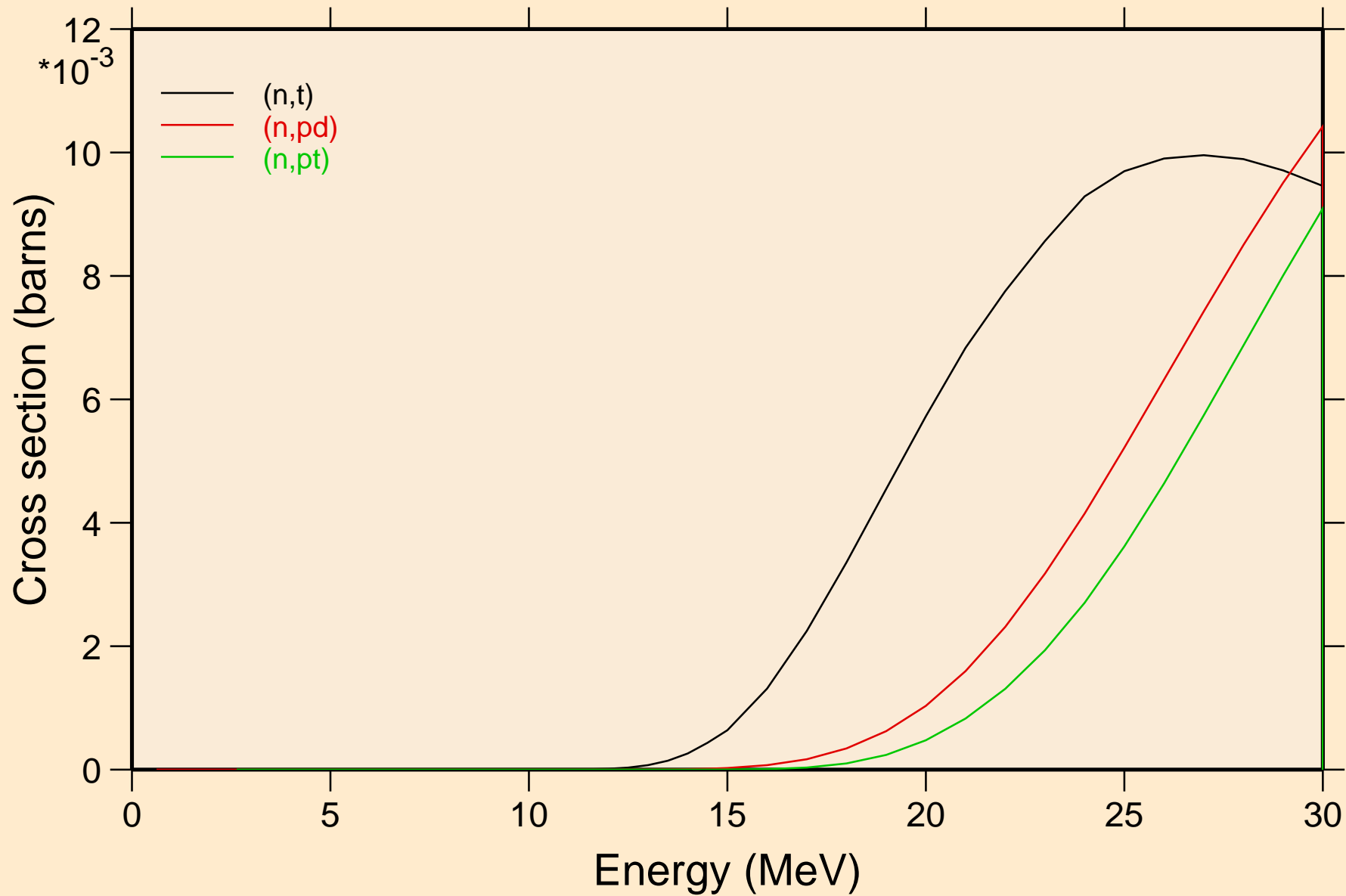

PT175 NRG TENDL-2015, AKONING  
angular distribution for elastic

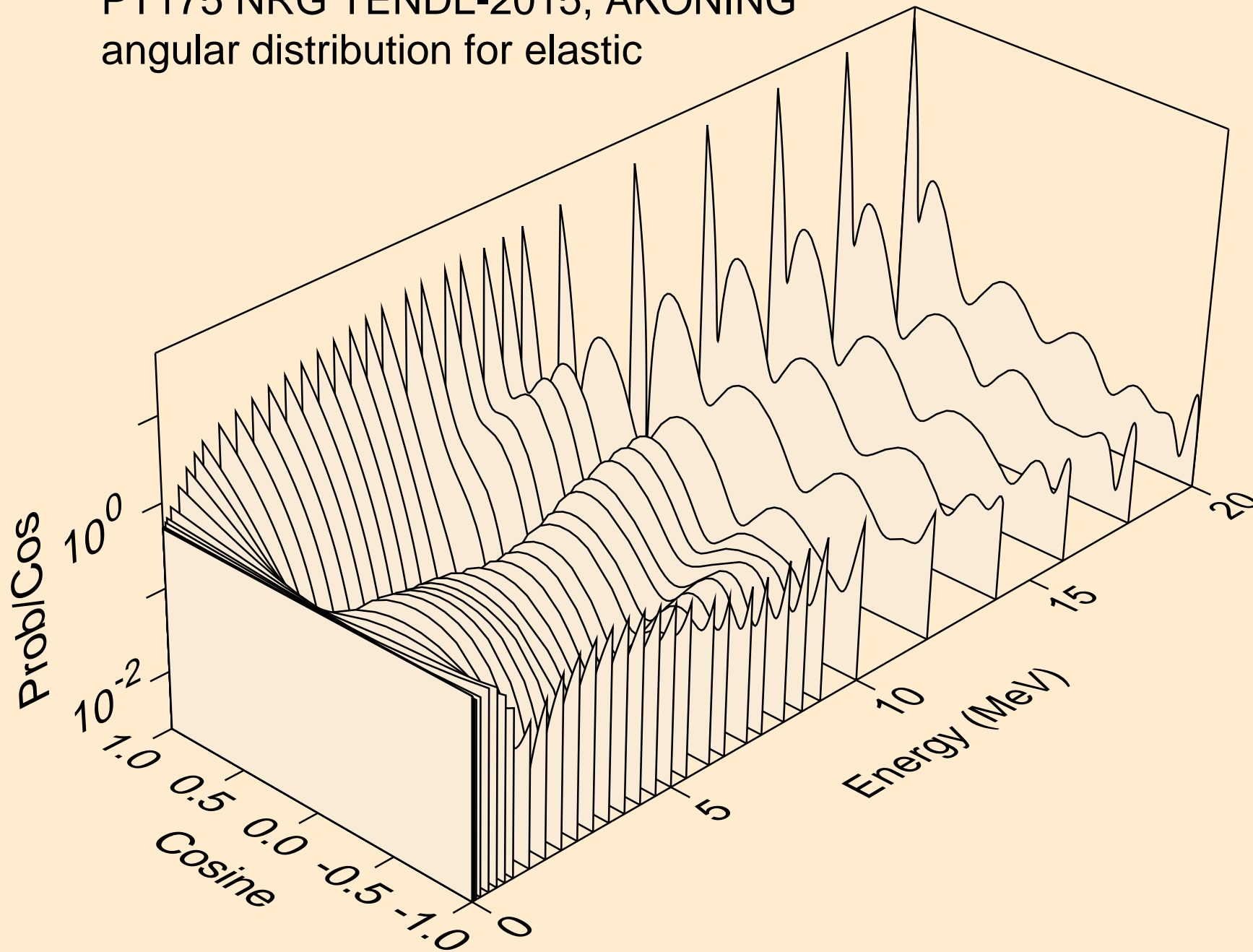



PT175 NRG TENDL-2015, AKONING  
angular distribution for elastic

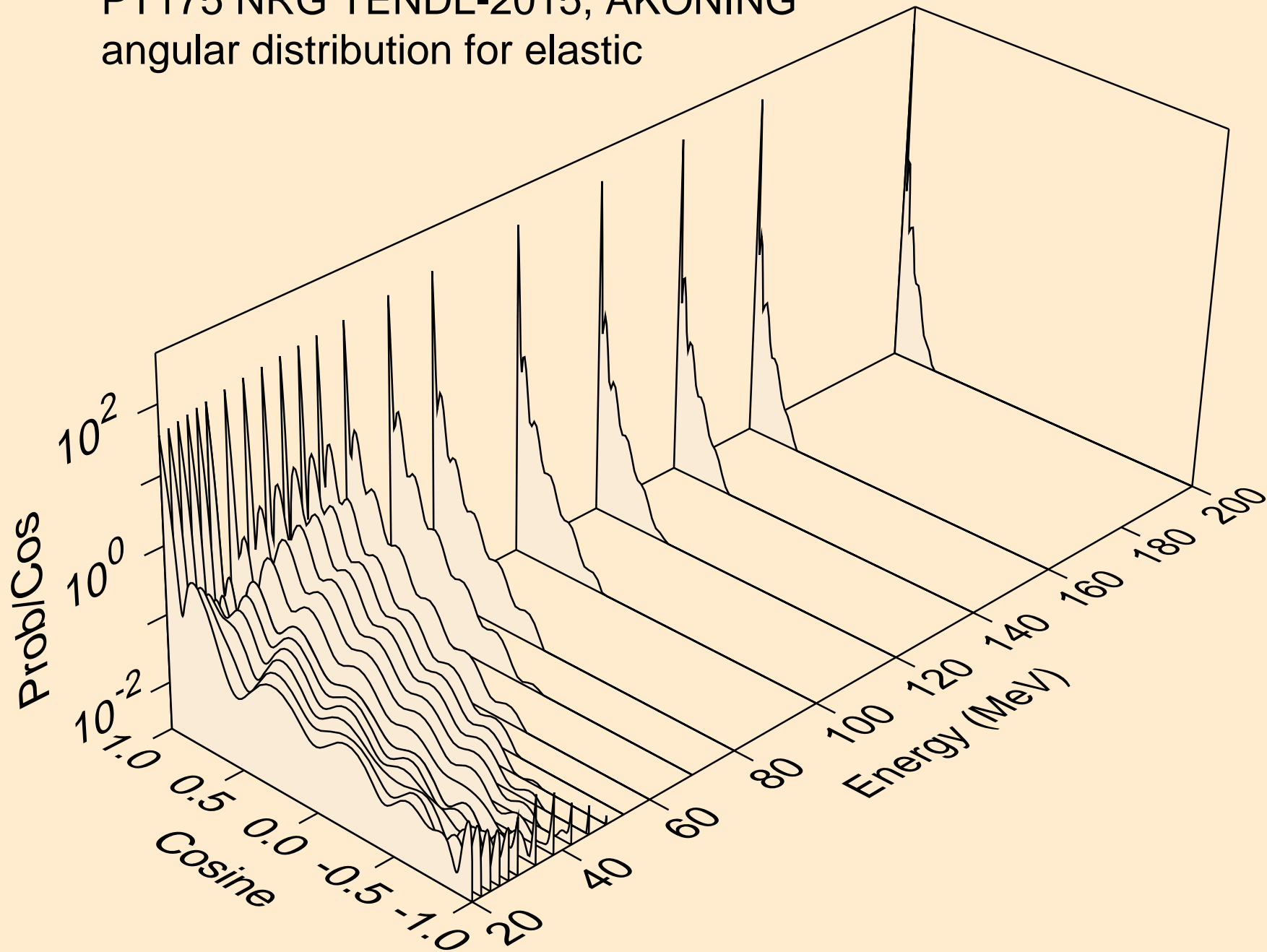

PT175 NRG TENDL-2015, AKONING  
angular distribution for (n,n\*1)

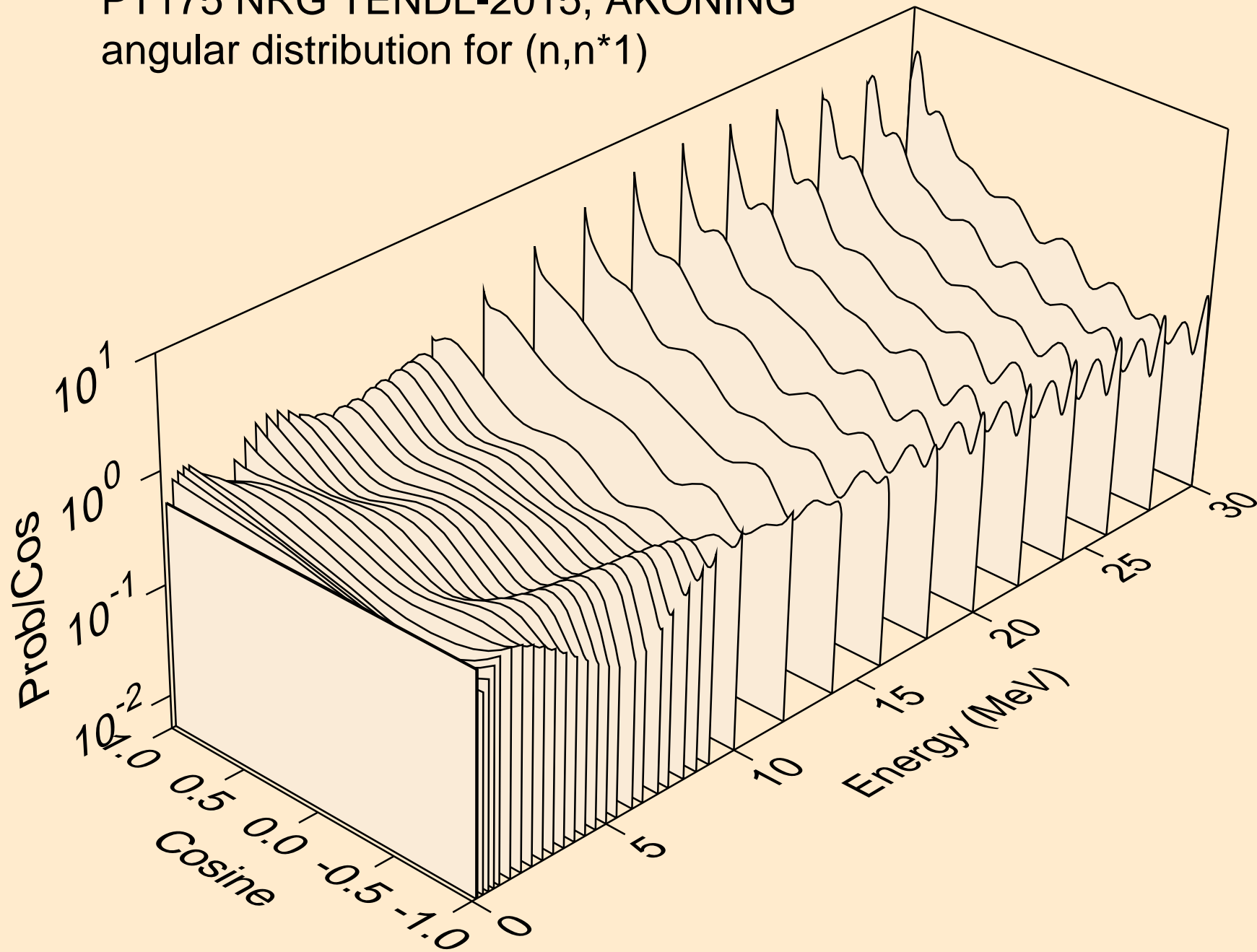

PT175 NRG TENDL-2015, AKONING  
Neutron emission for (n,x)

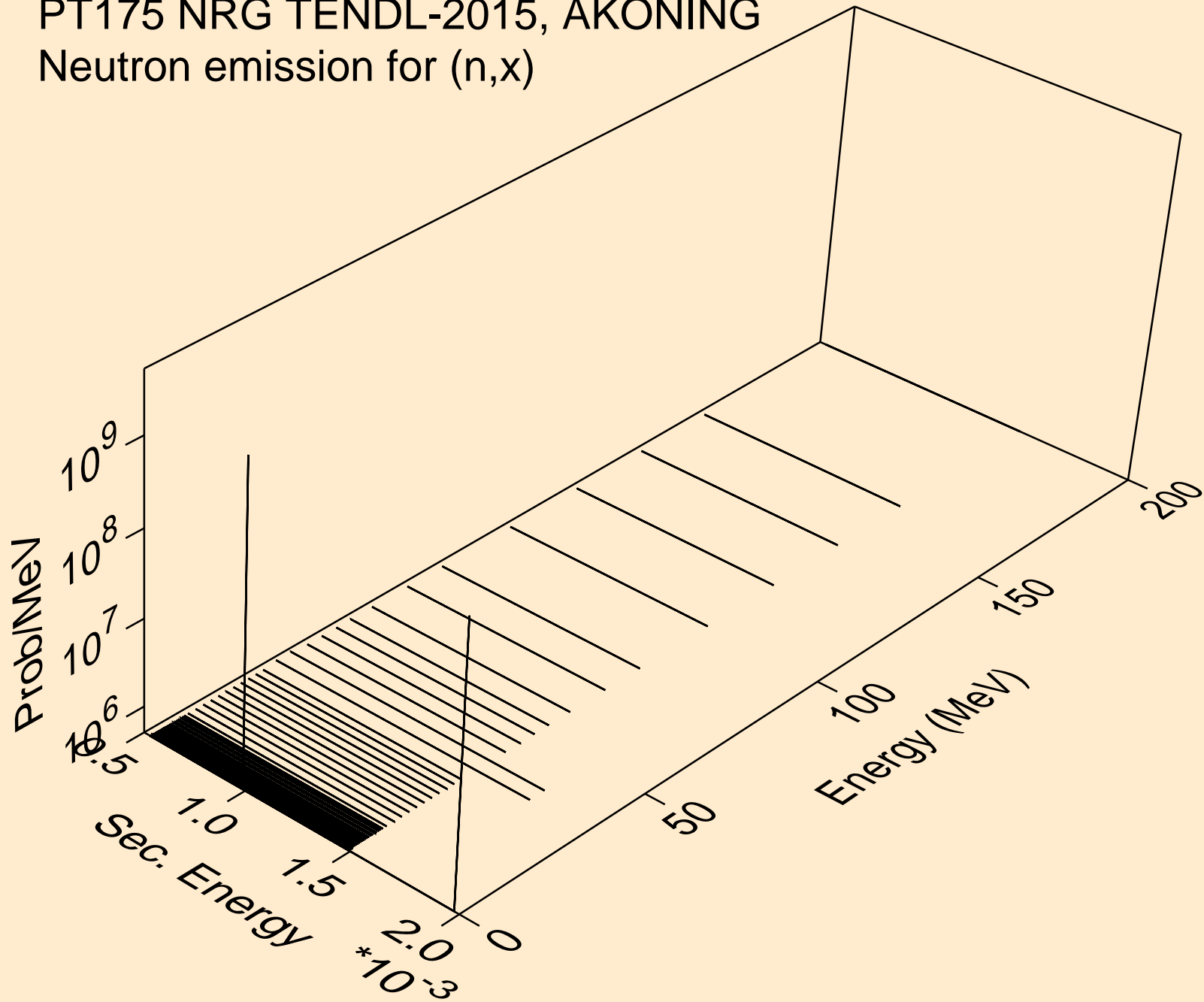

PT175 NRG TENDL-2015, AKONING  
Neutron emission for (n,2nd)

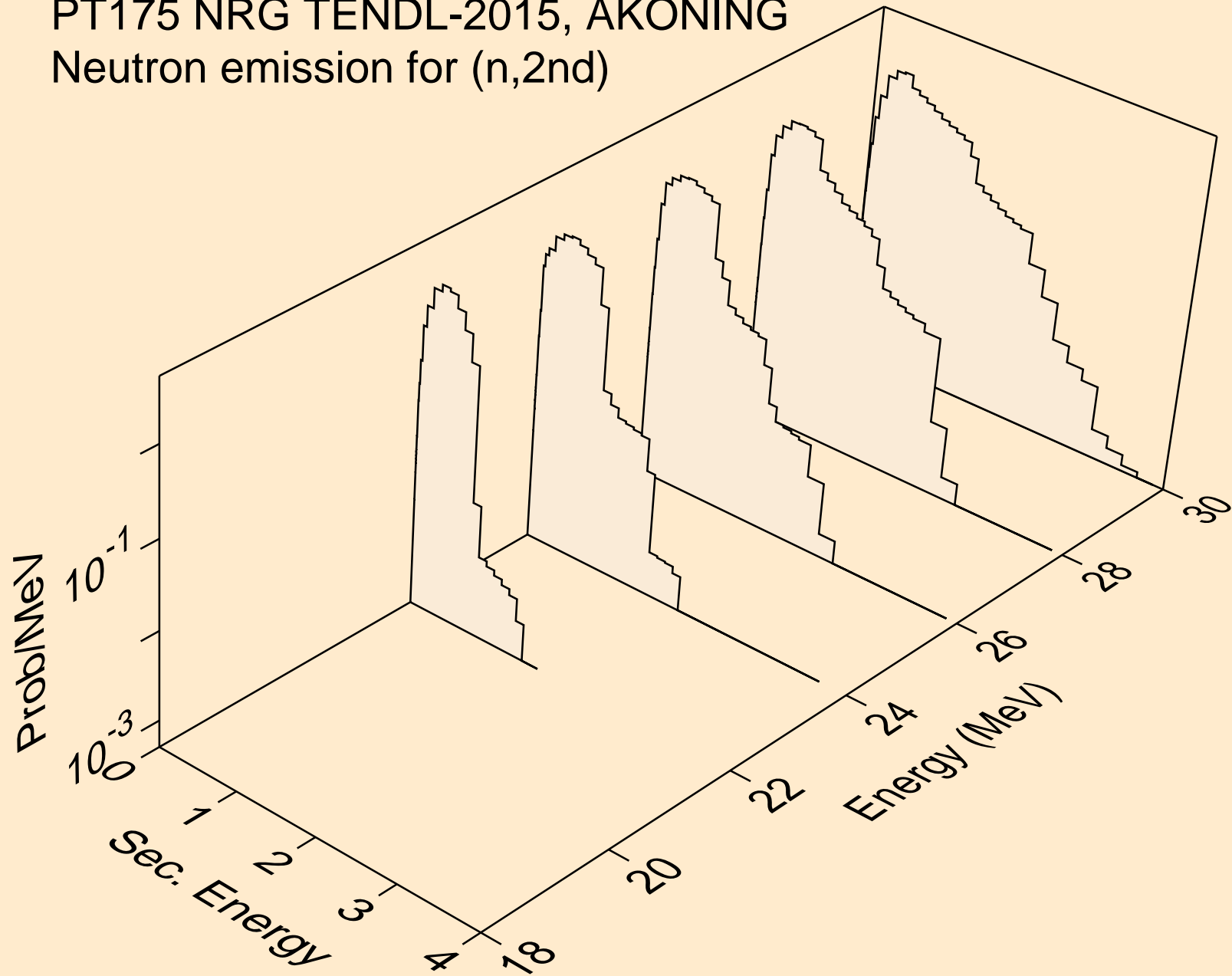

PT175 NRG TENDL-2015, AKONING  
Neutron emission for (n,2n)

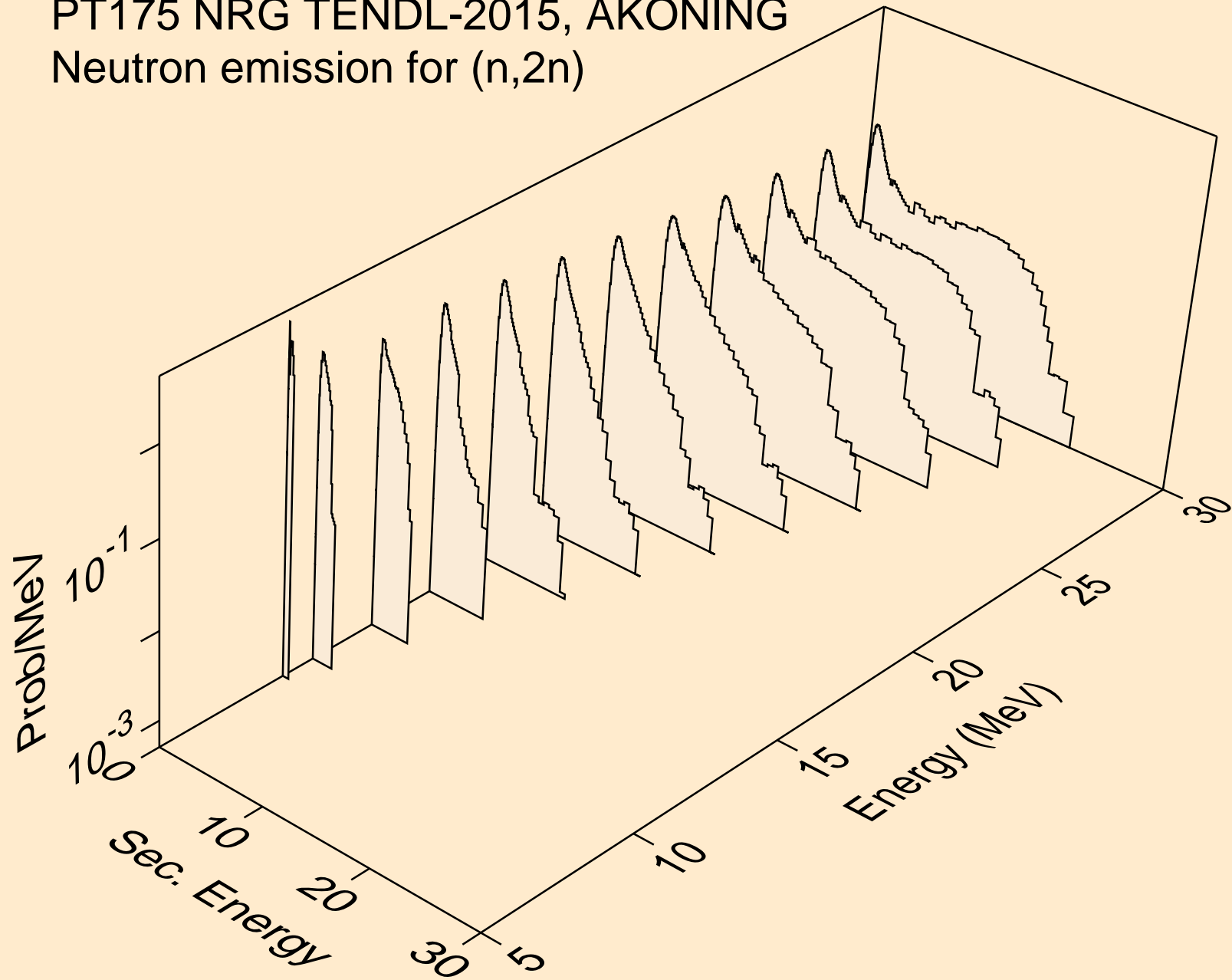

PT175 NRG TENDL-2015, AKONING  
Neutron emission for (n,3n)

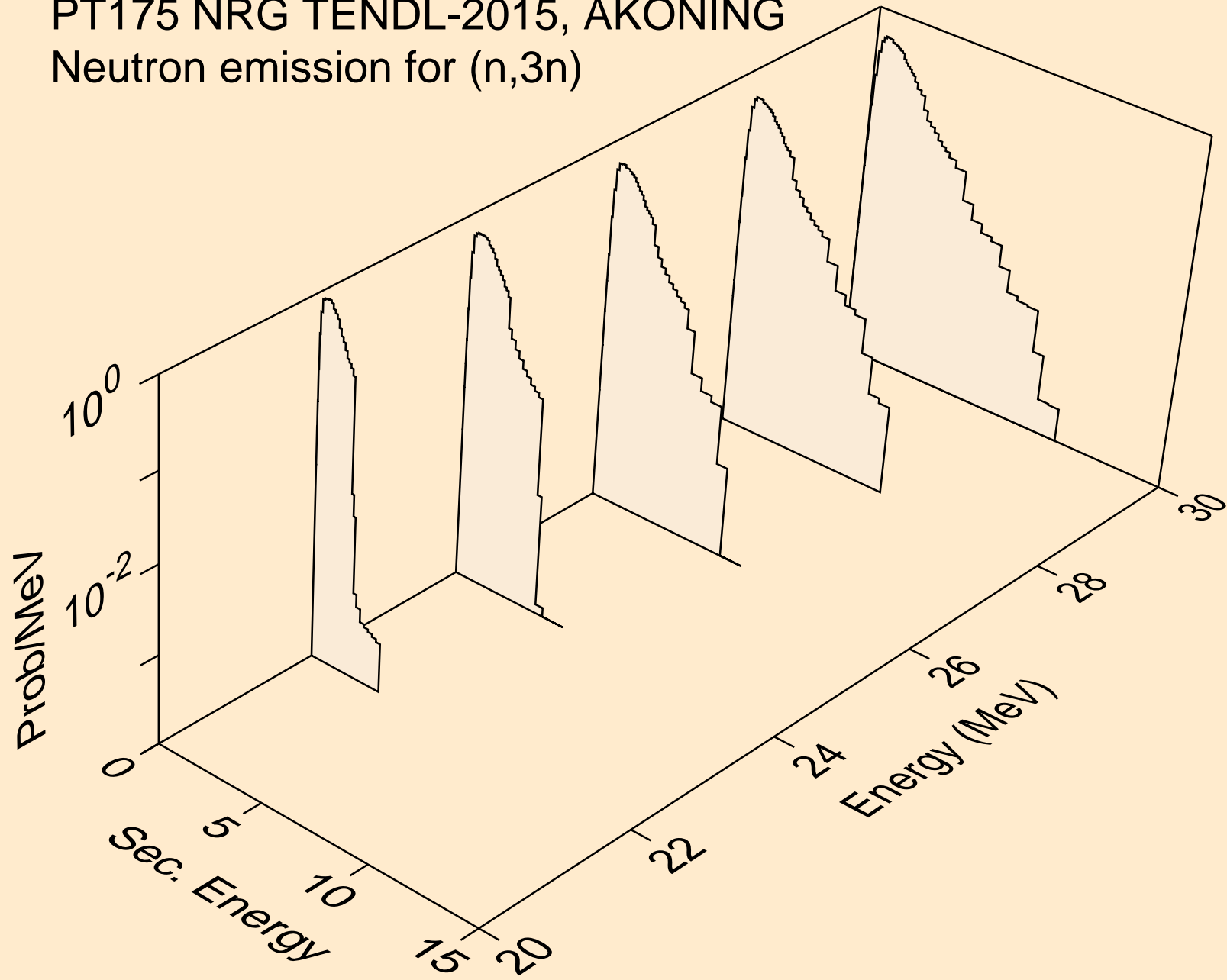

PT175 NRG TENDL-2015, AKONING  
Neutron emission for (n,n\*)a

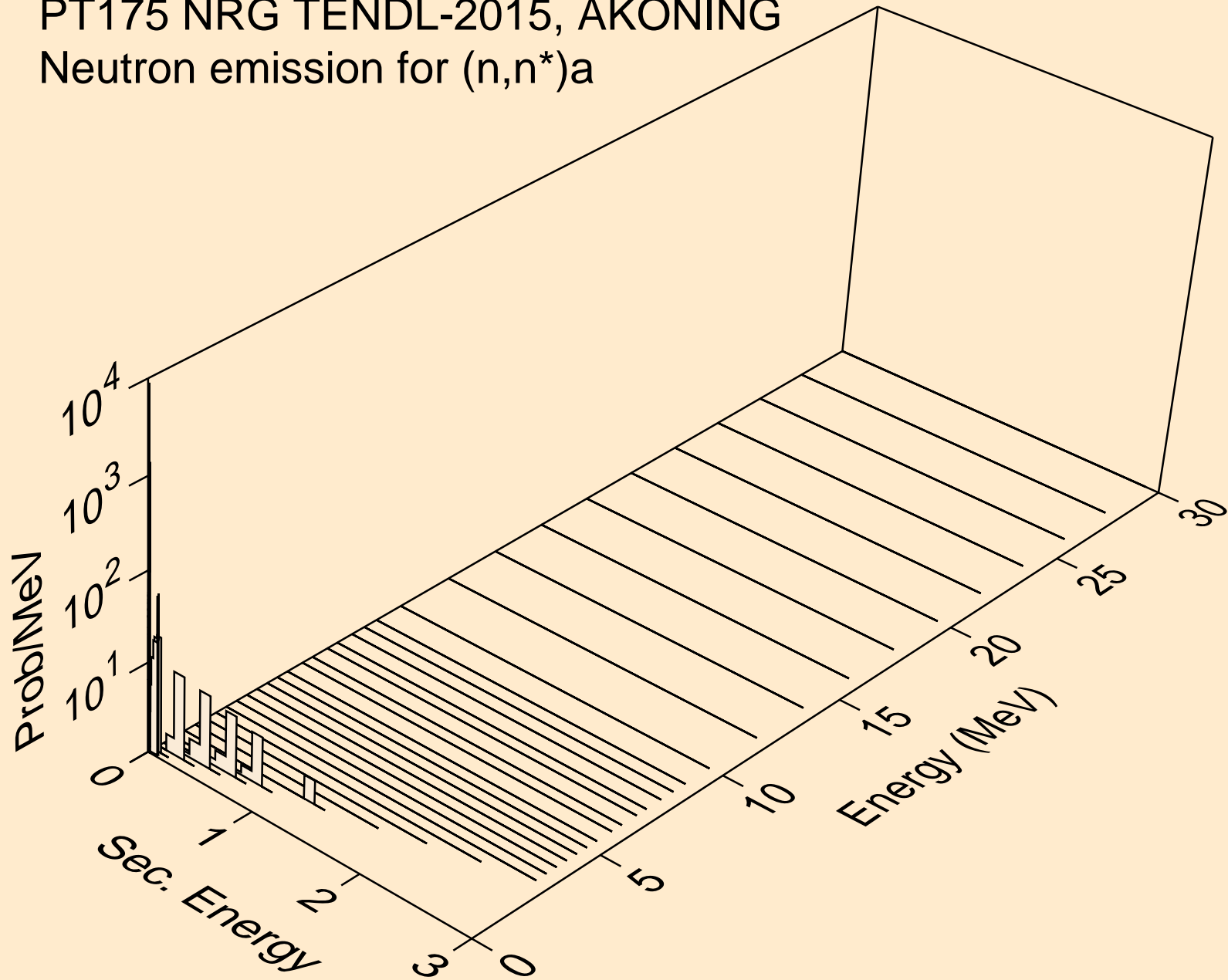

PT175 NRG TENDL-2015, AKONING  
Neutron emission for (n,n\*)3a

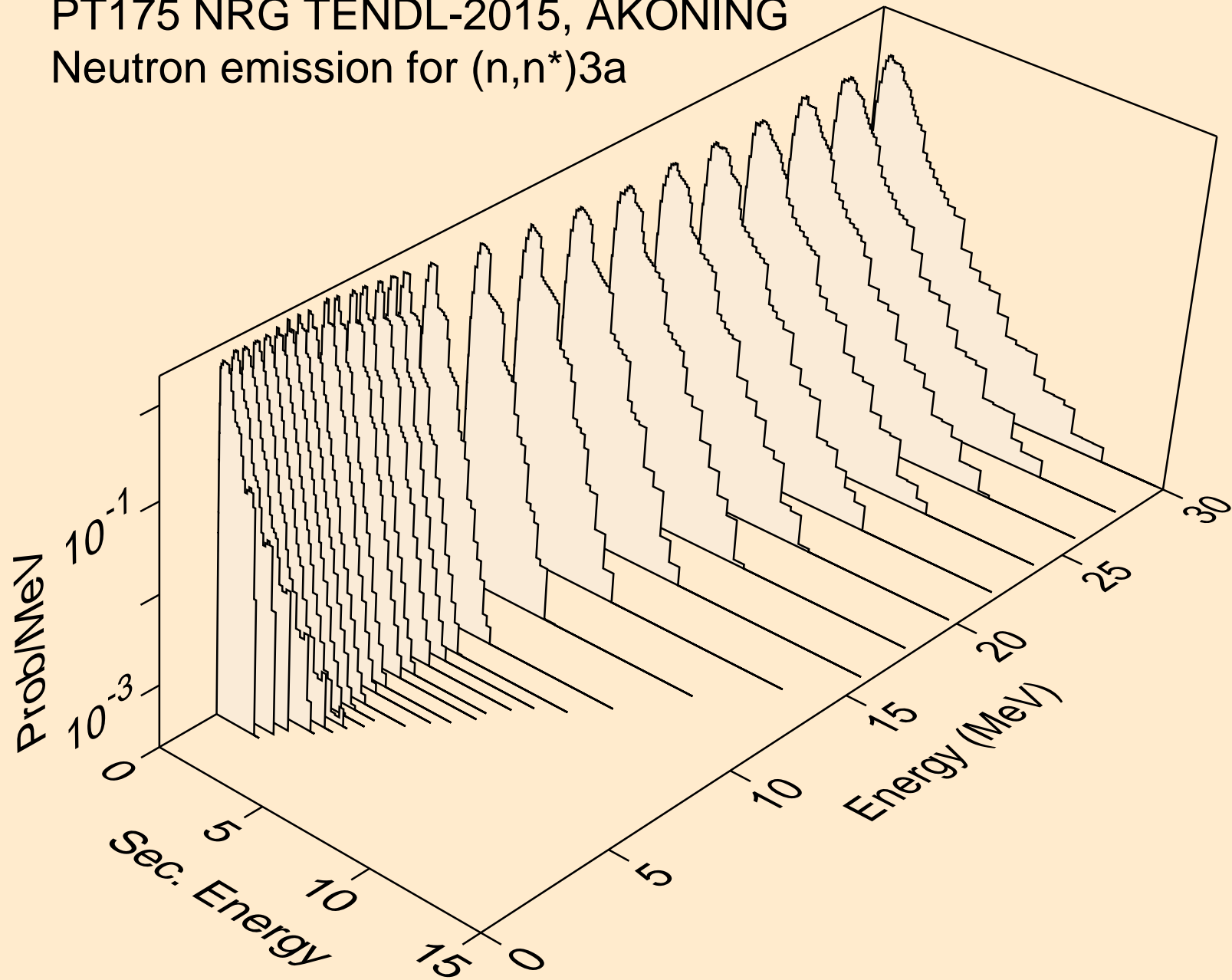



PT175 NRG TENDL-2015, AKONING  
Neutron emission for (n,2n)a

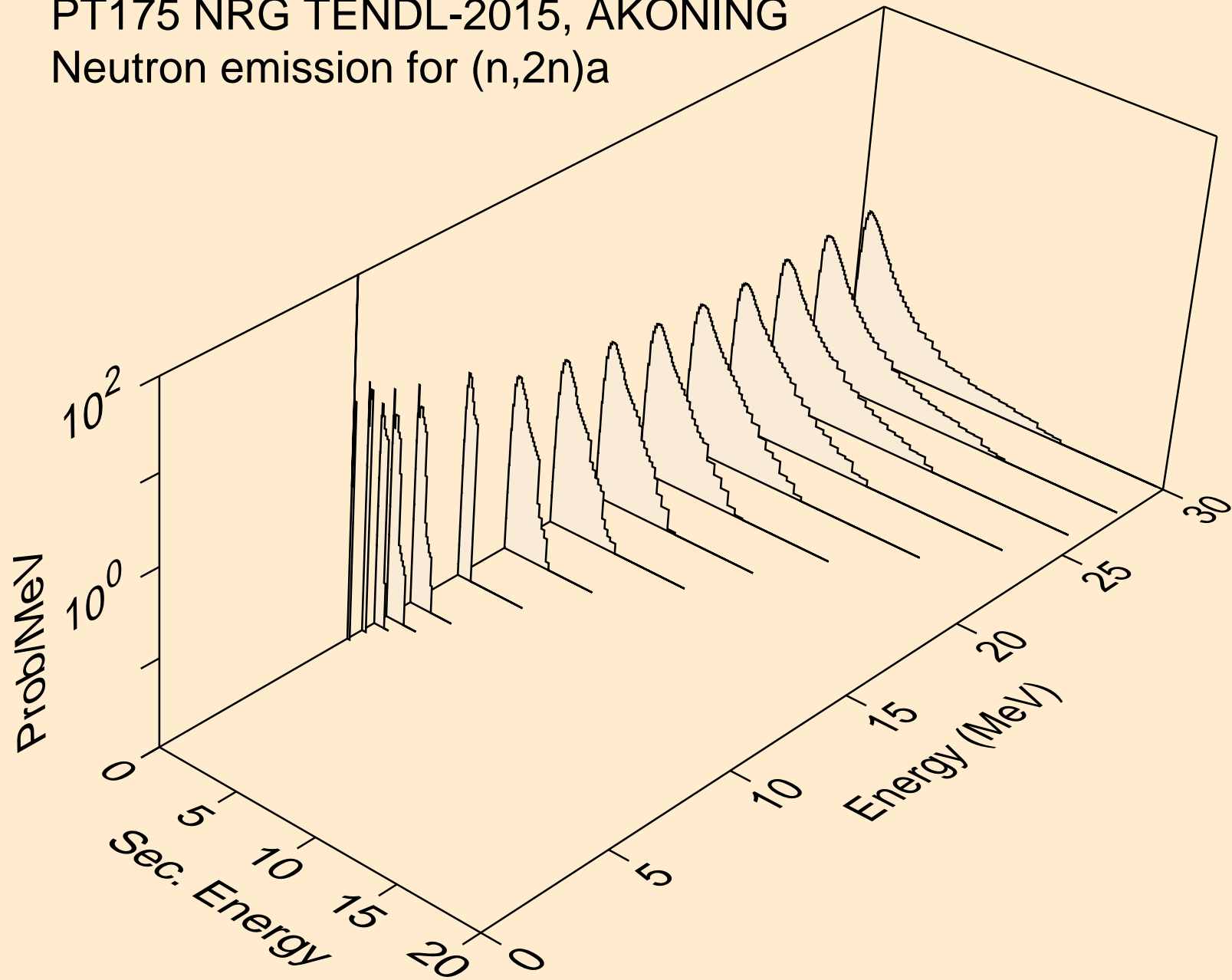

PT175 NRG TENDL-2015, AKONING  
Neutron emission for (n,3n)a

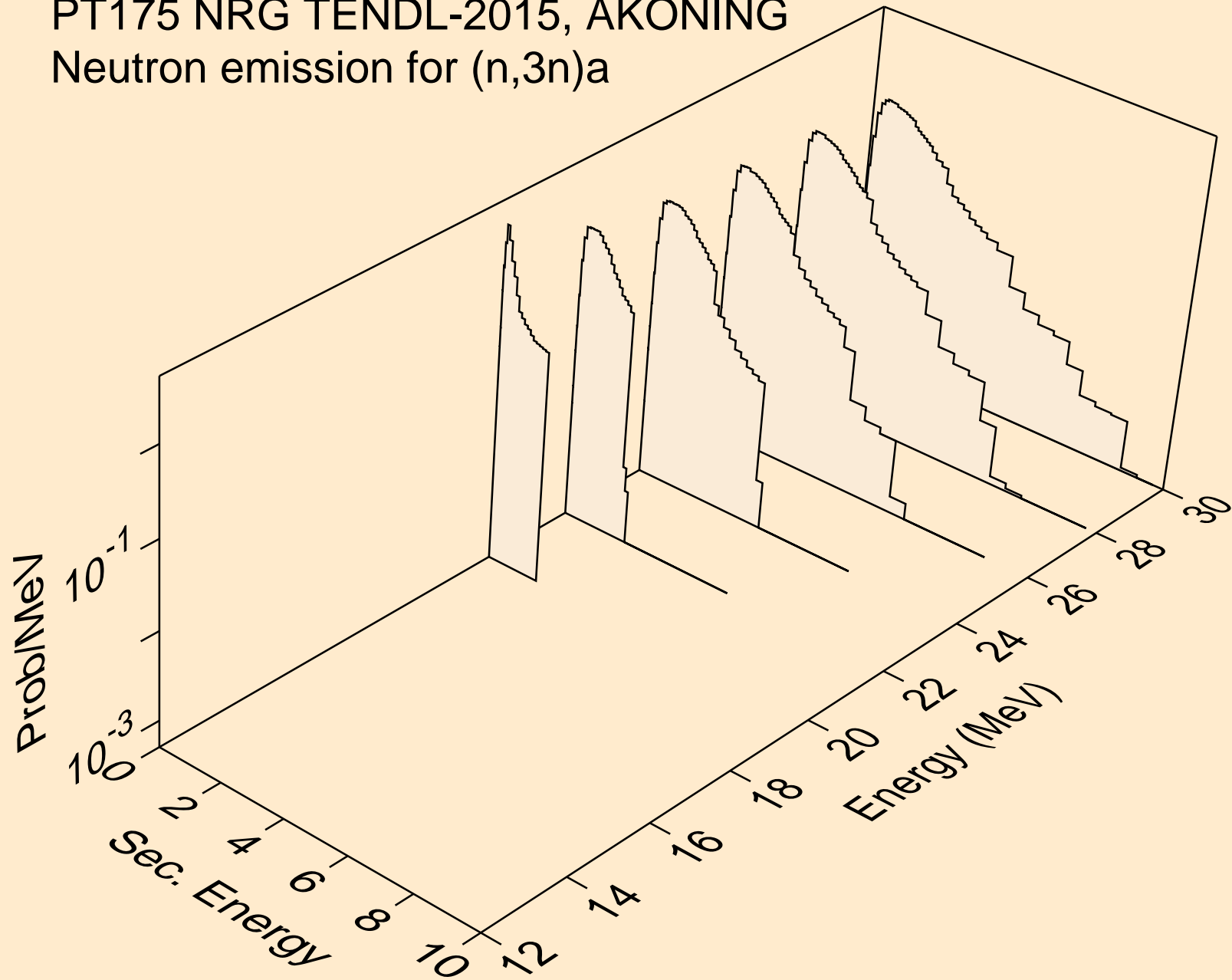

PT175 NRG TENDL-2015, AKONING  
Neutron emission for (n,n\*)p

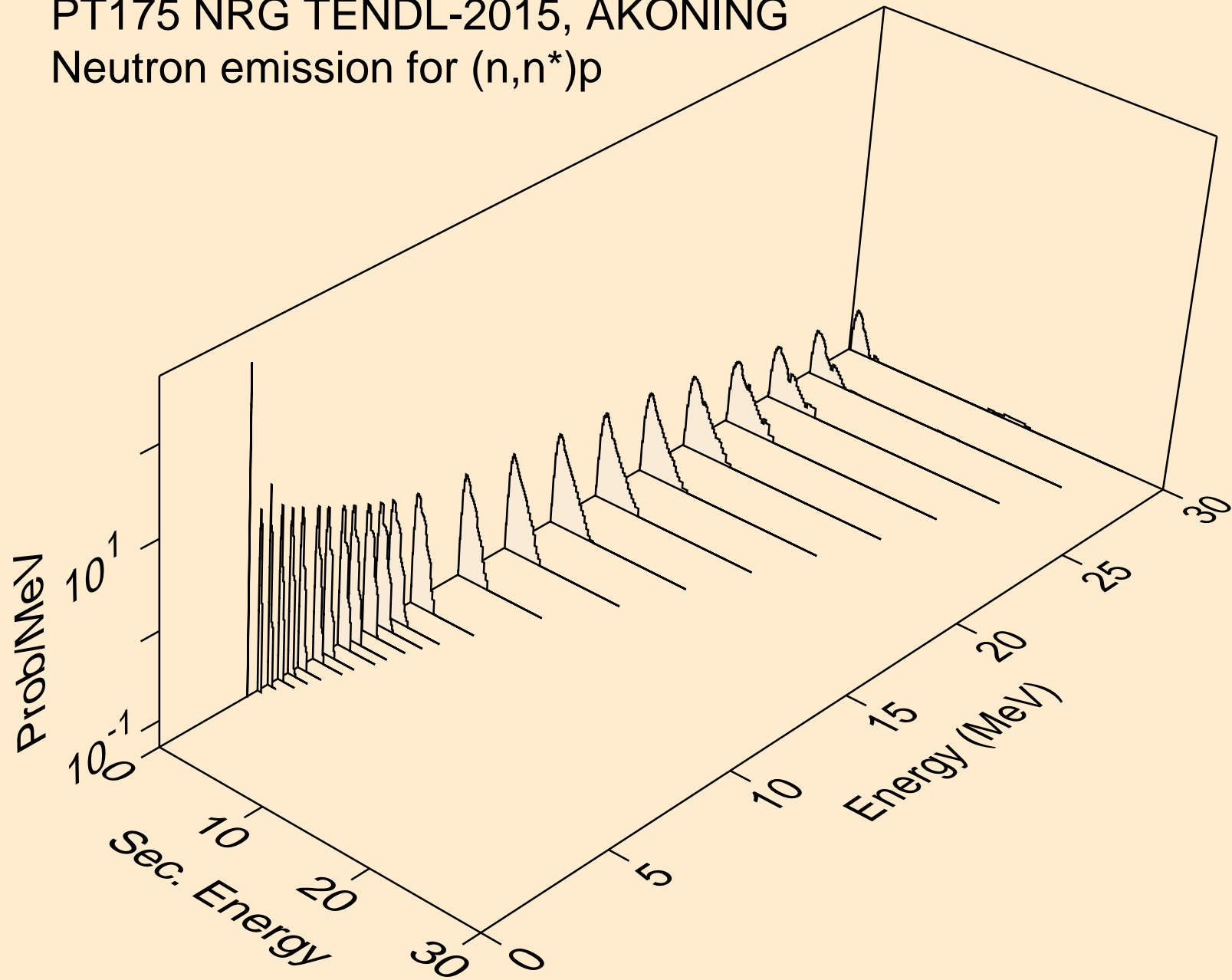

PT175 NRG TENDL-2015, AKONING  
Neutron emission for (n,n\*)2a

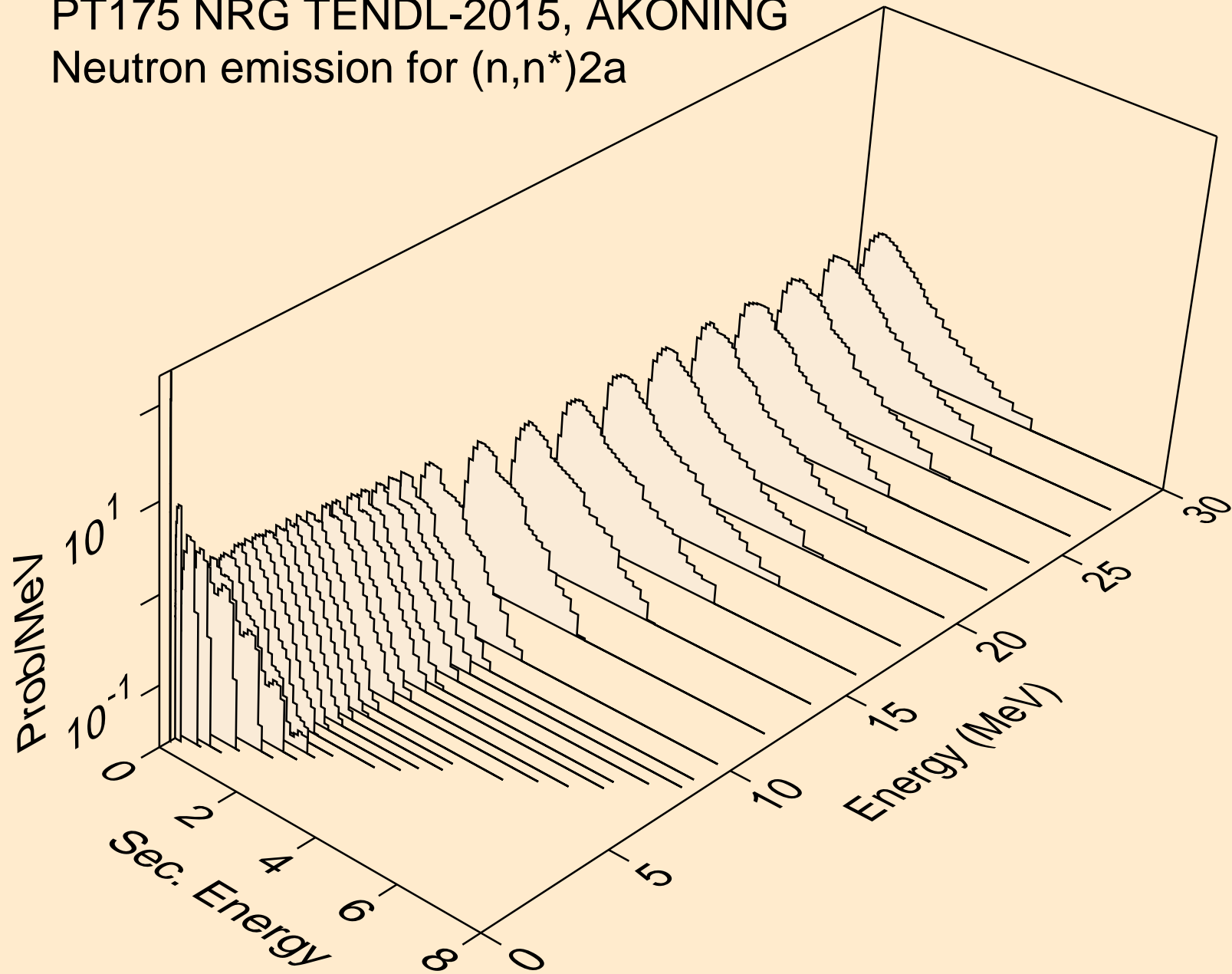

PT175 NRG TENDL-2015, AKONING  
Neutron emission for (n,2n)2a

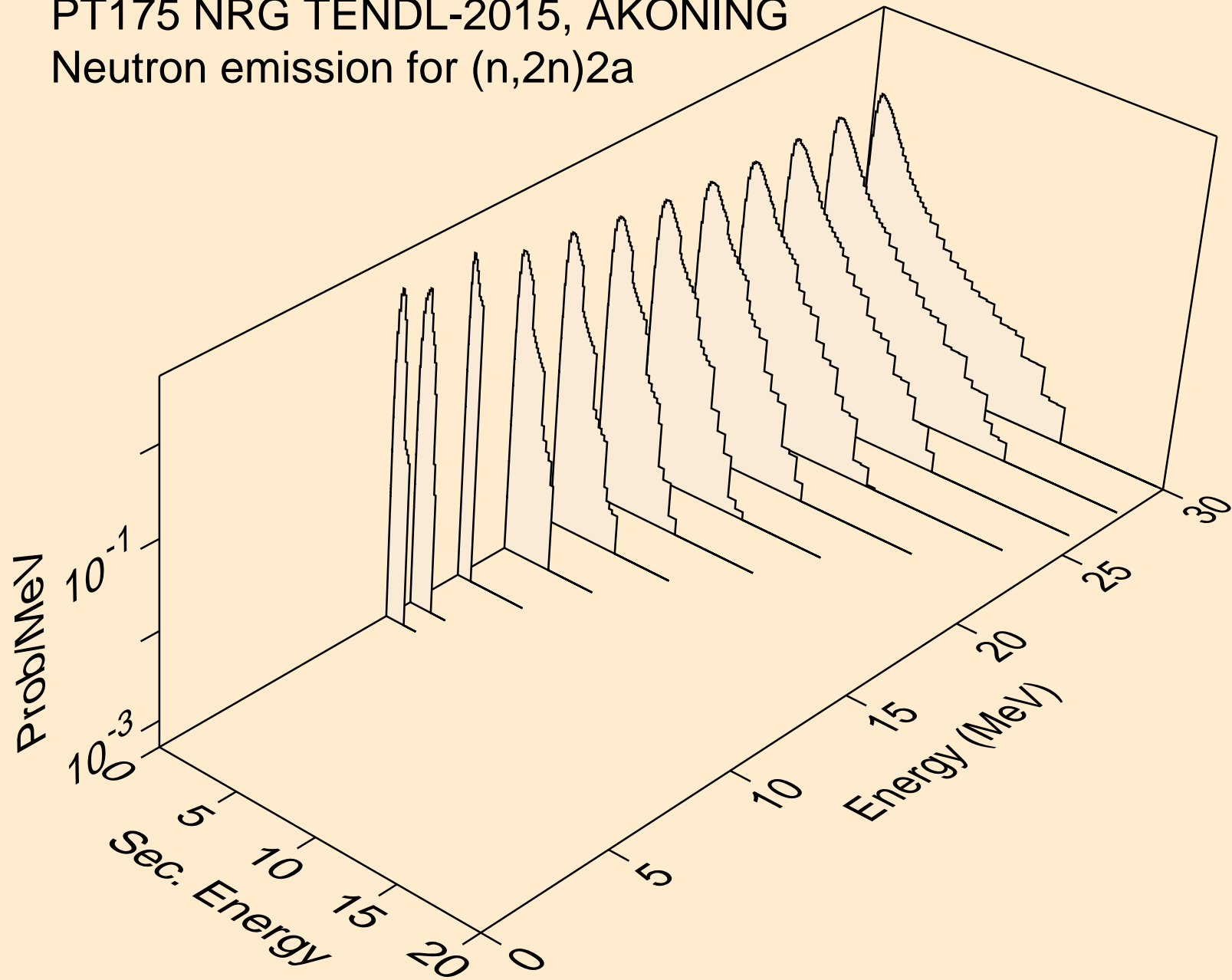

PT175 NRG TENDL-2015, AKONING  
Neutron emission for (n,n\*)d

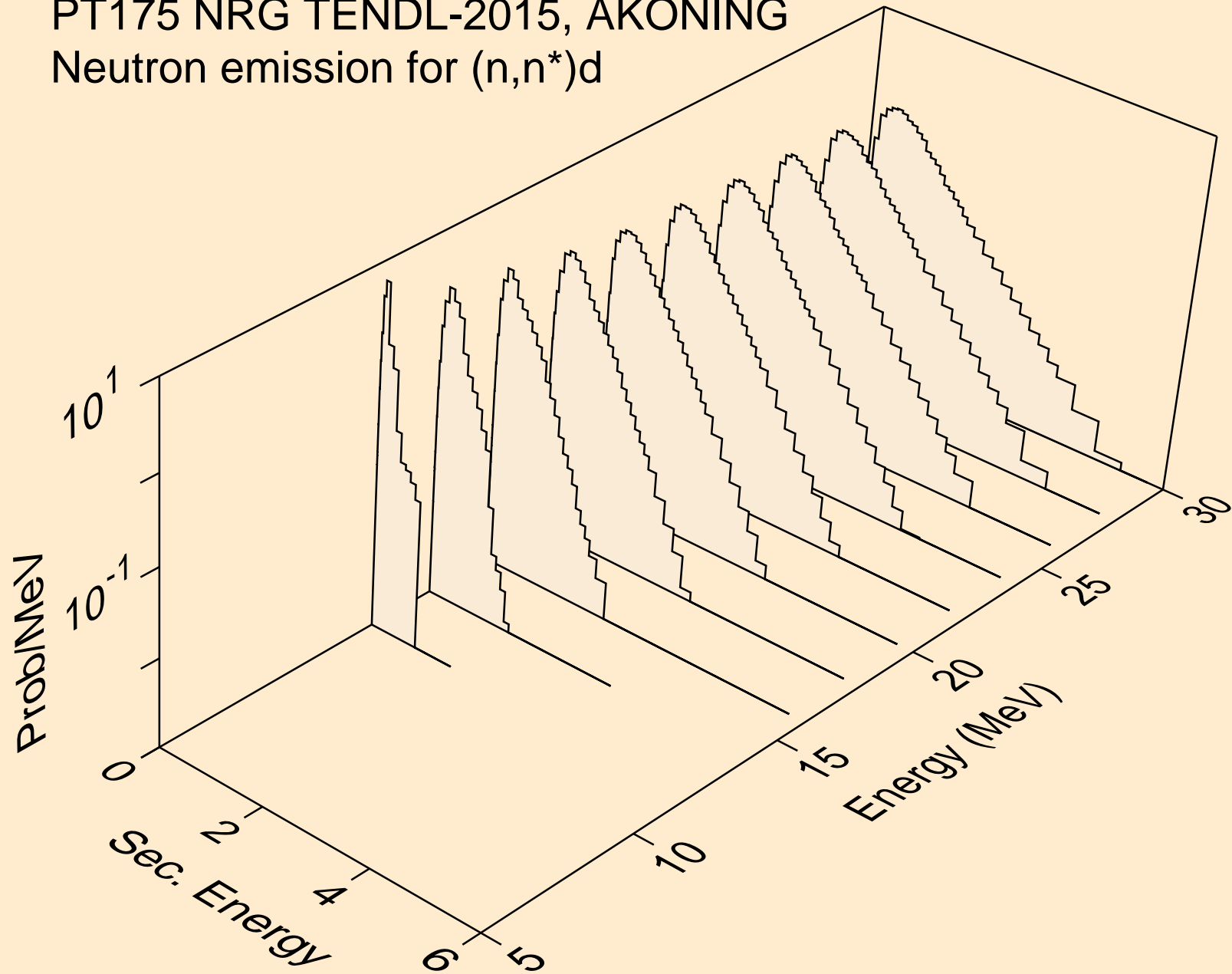

PT175 NRG TENDL-2015, AKONING  
Neutron emission for (n,n\*)t

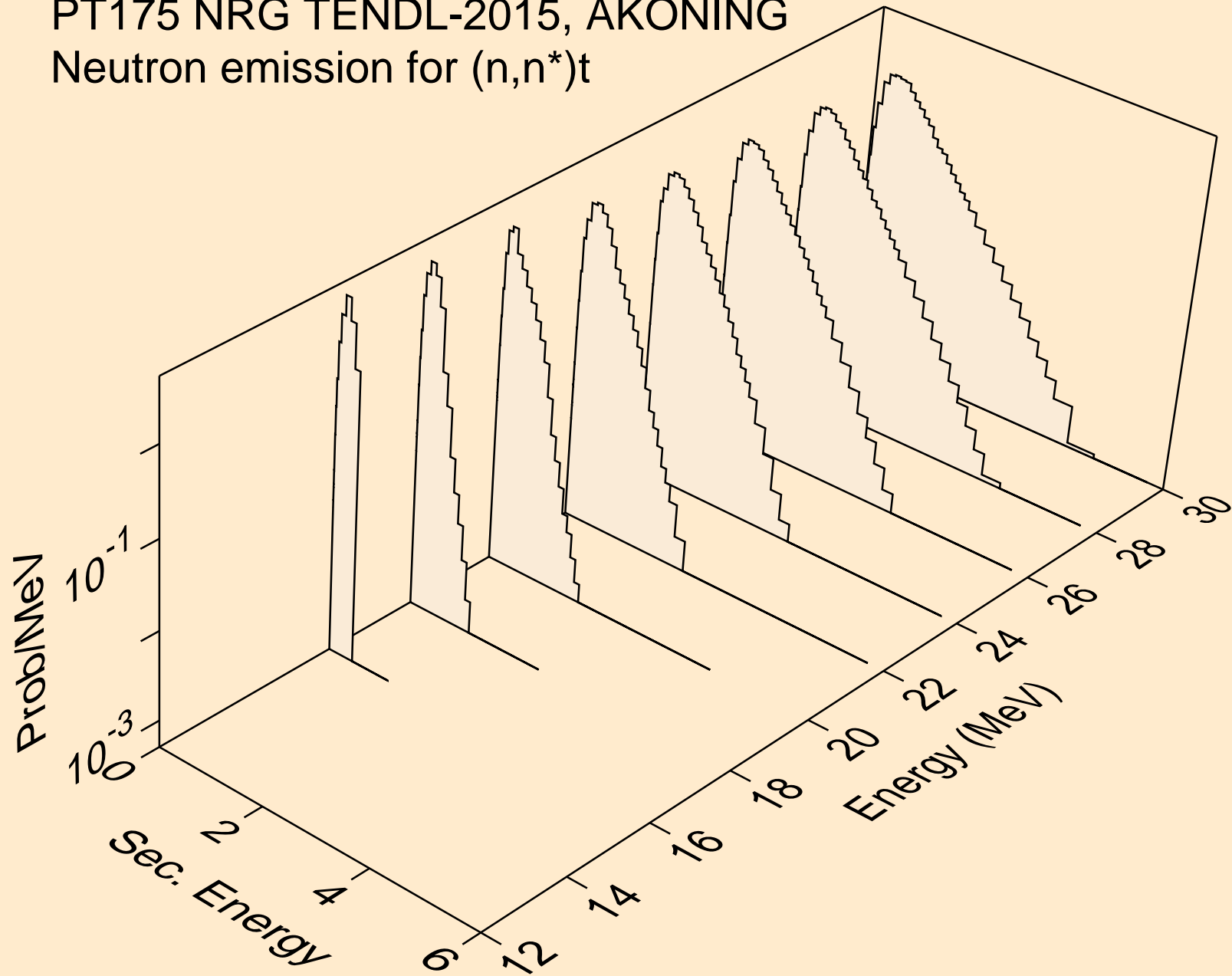

PT175 NRG TENDL-2015, AKONING  
Neutron emission for (n,n\*)he3

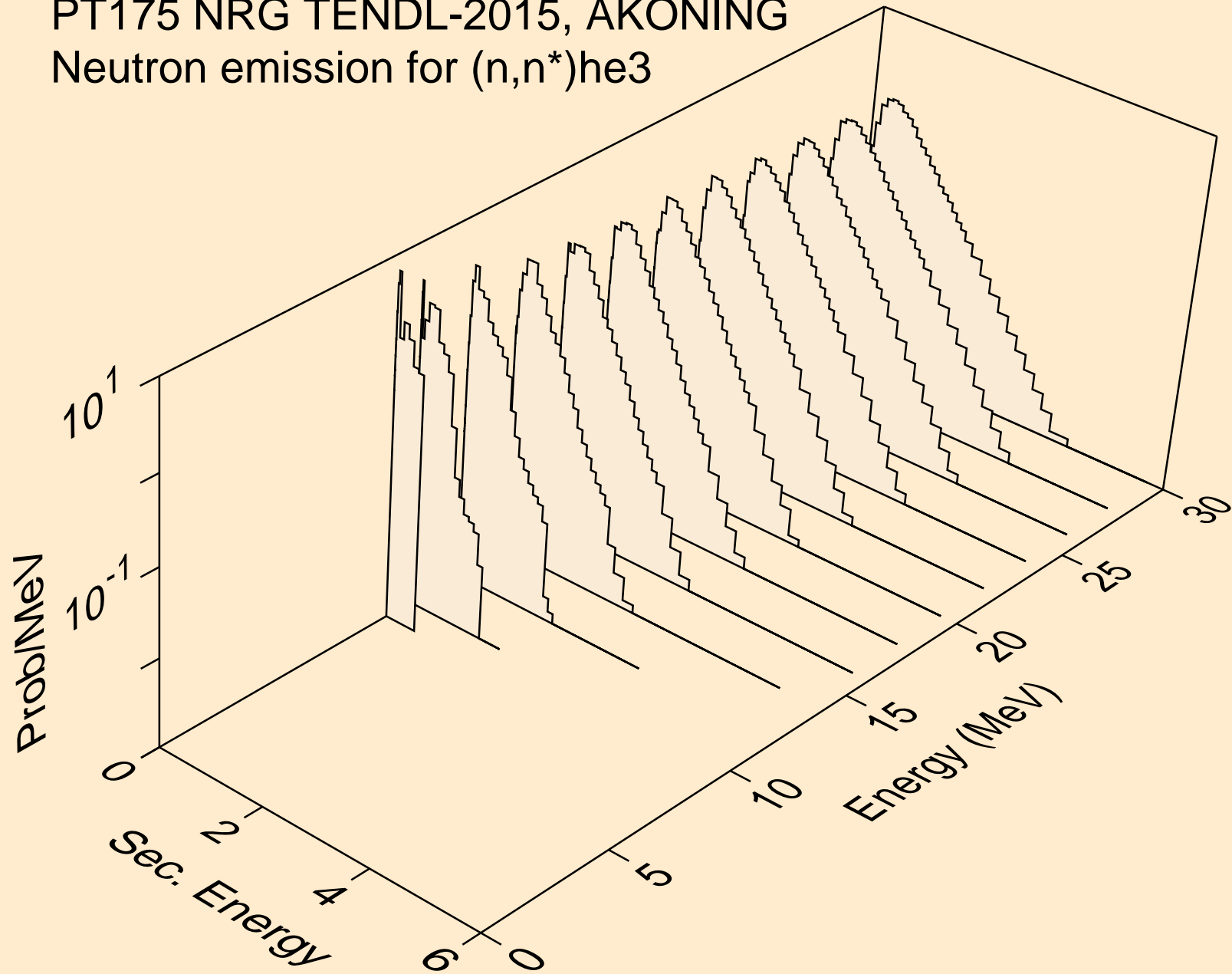



PT175 NRG TENDL-2015, AKONING  
Neutron emission for (n,n\*)d2a

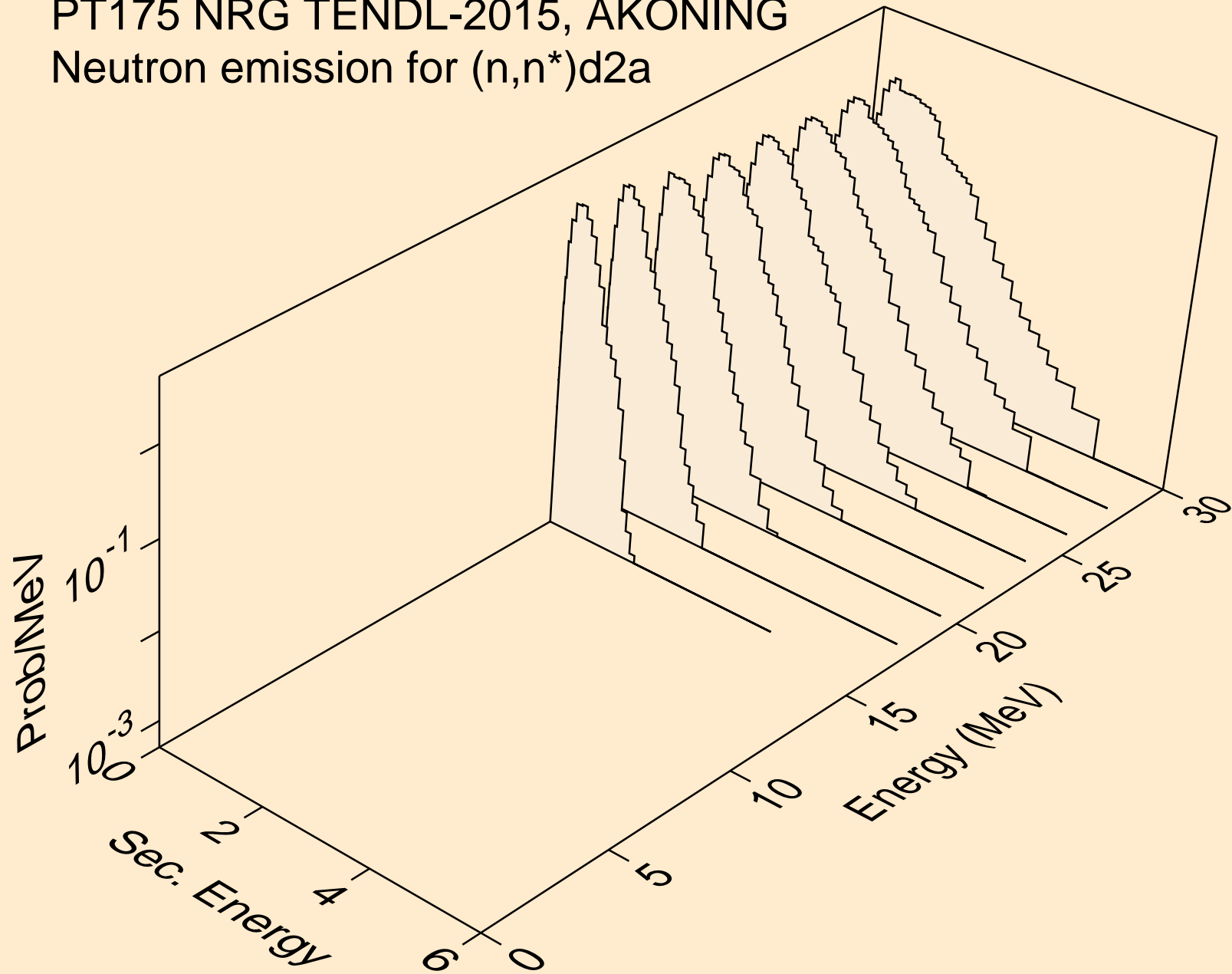

PT175 NRG TENDL-2015, AKONING  
Neutron emission for (n,4n)

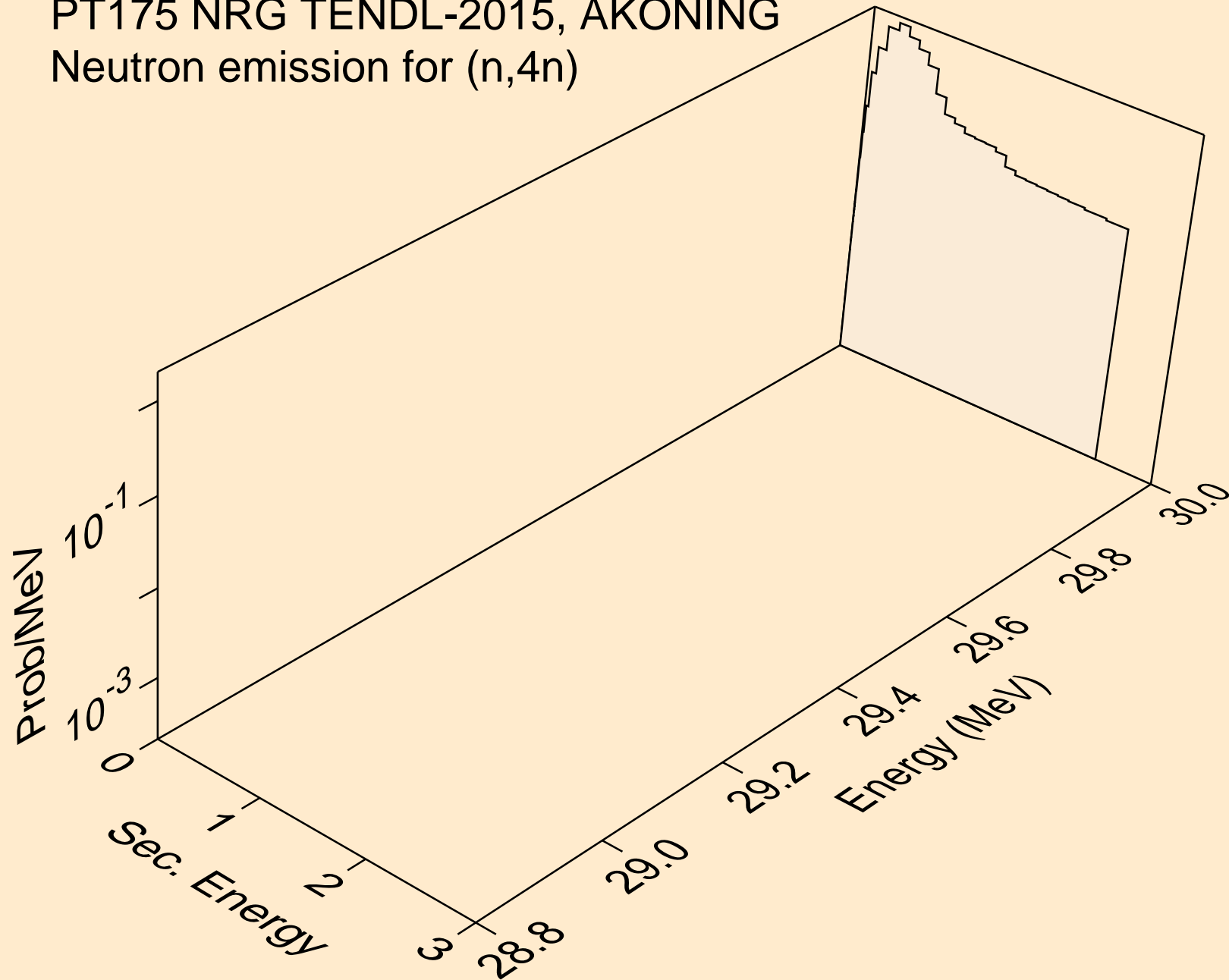

PT175 NRG TENDL-2015, AKONING  
Neutron emission for (n,2np)

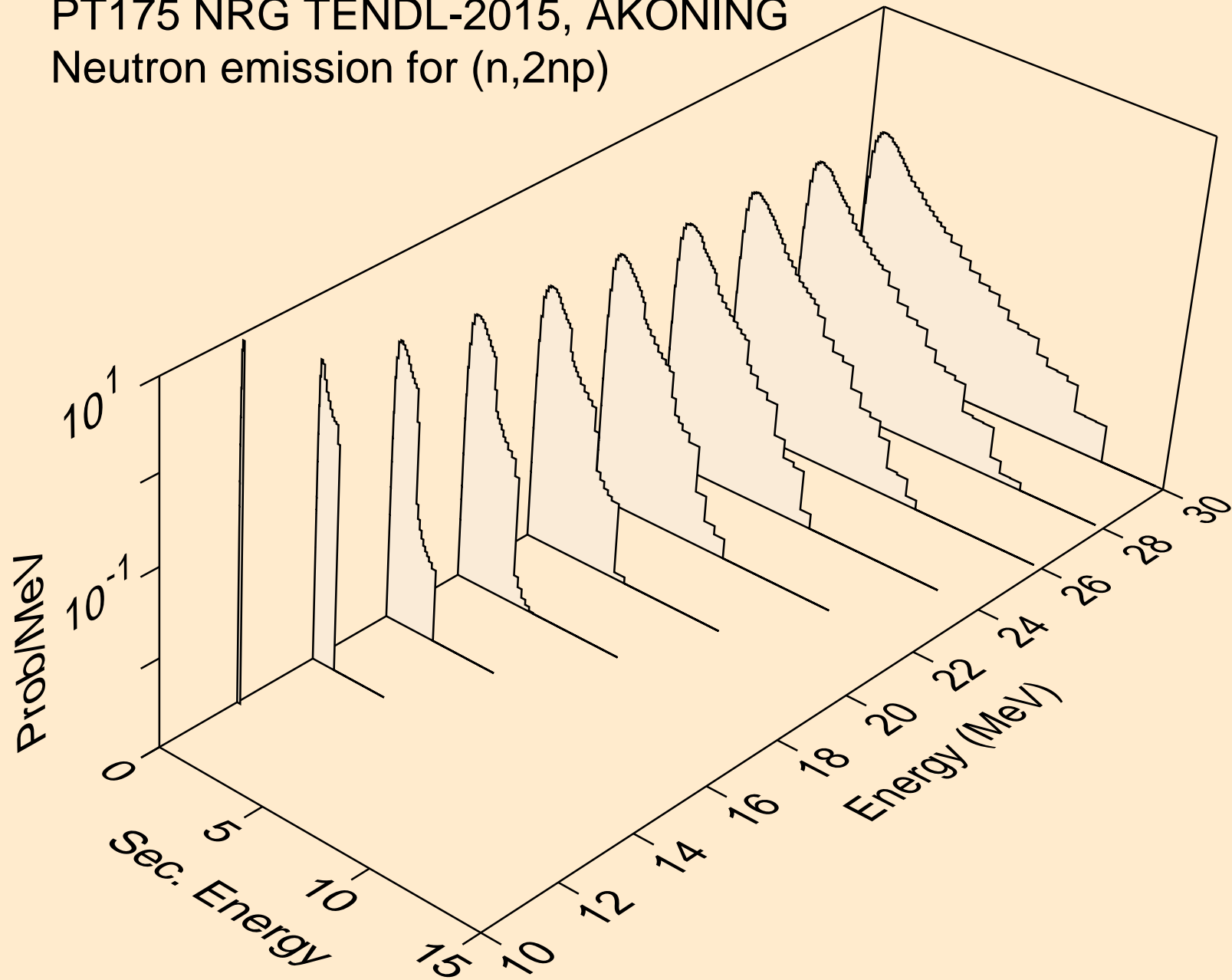

PT175 NRG TENDL-2015, AKONING  
Neutron emission for (n,3np)

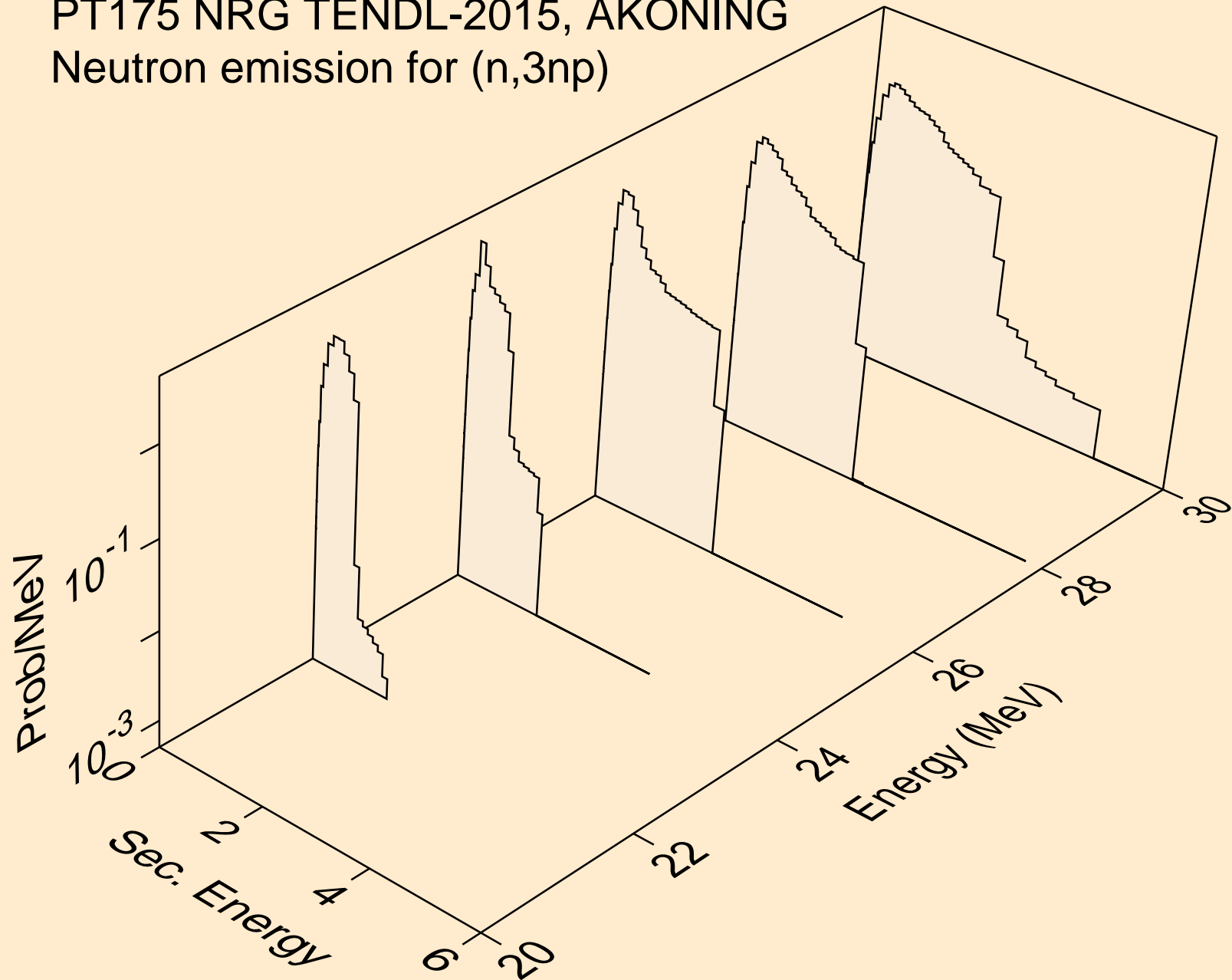

PT175 NRG TENDL-2015, AKONING  
Neutron emission for (n,2np)

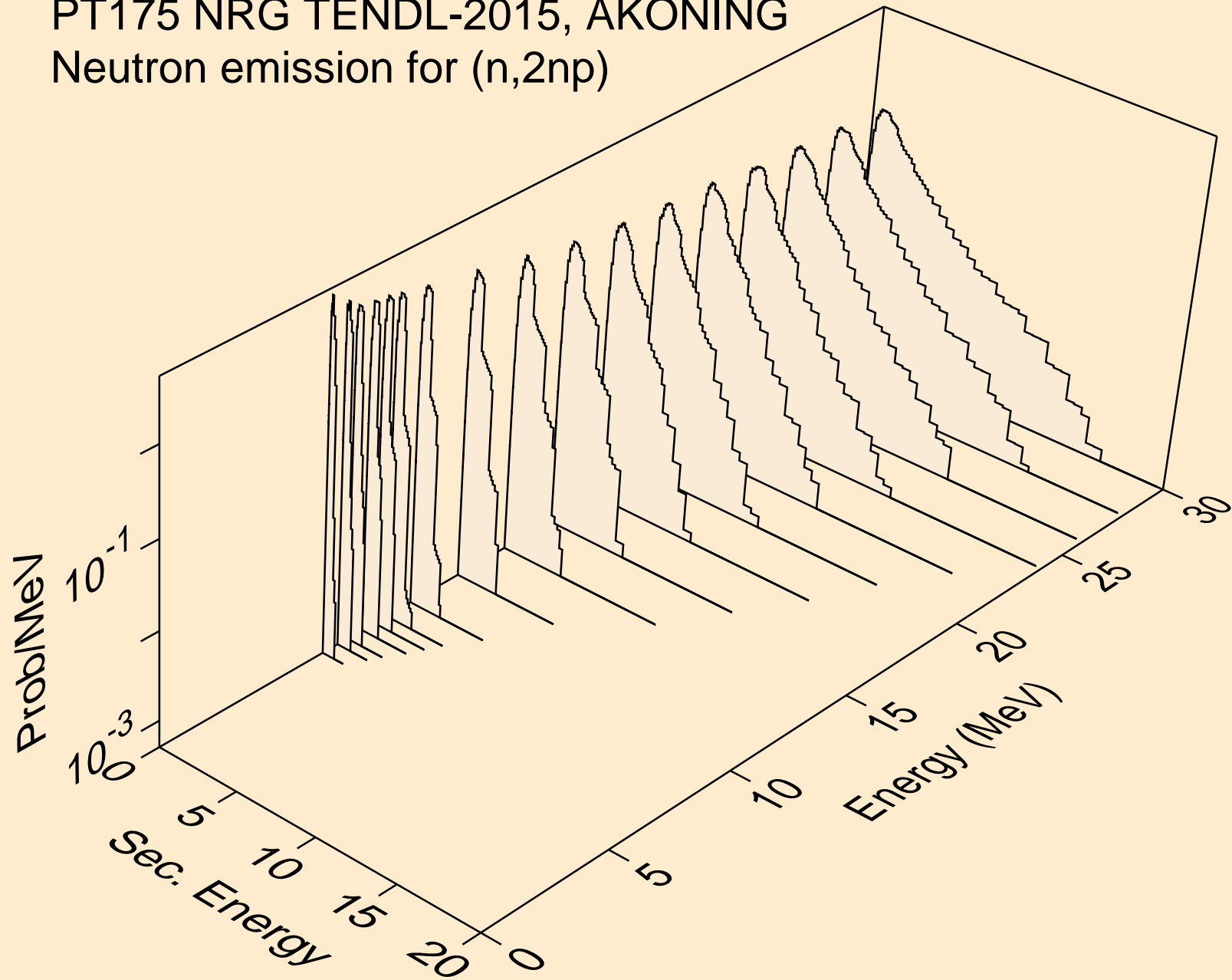

PT175 NRG TENDL-2015, AKONING  
Neutron emission for (n,npa)

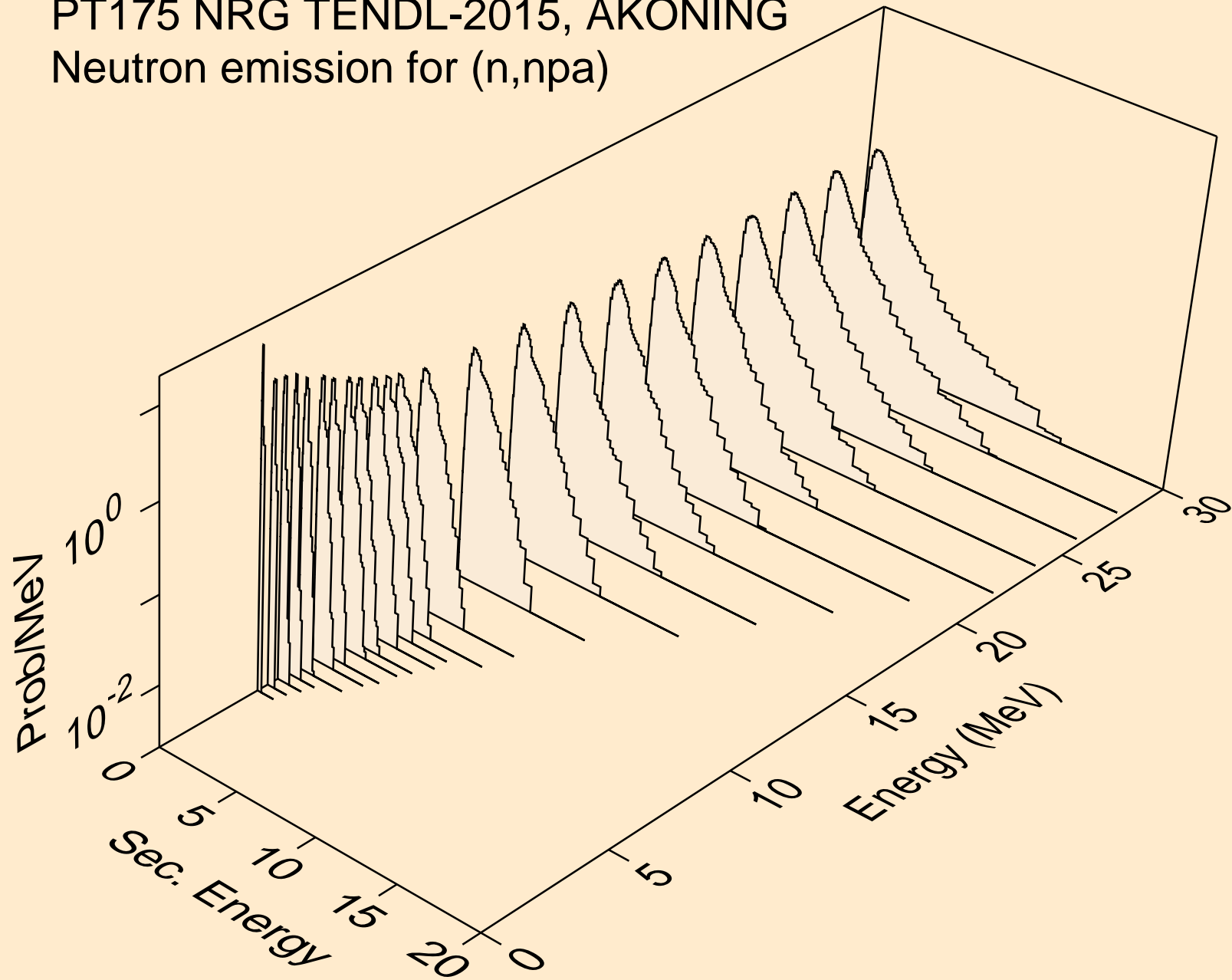

PT175 NRG TENDL-2015, AKONING  
Neutron emission for (n,n\*c)

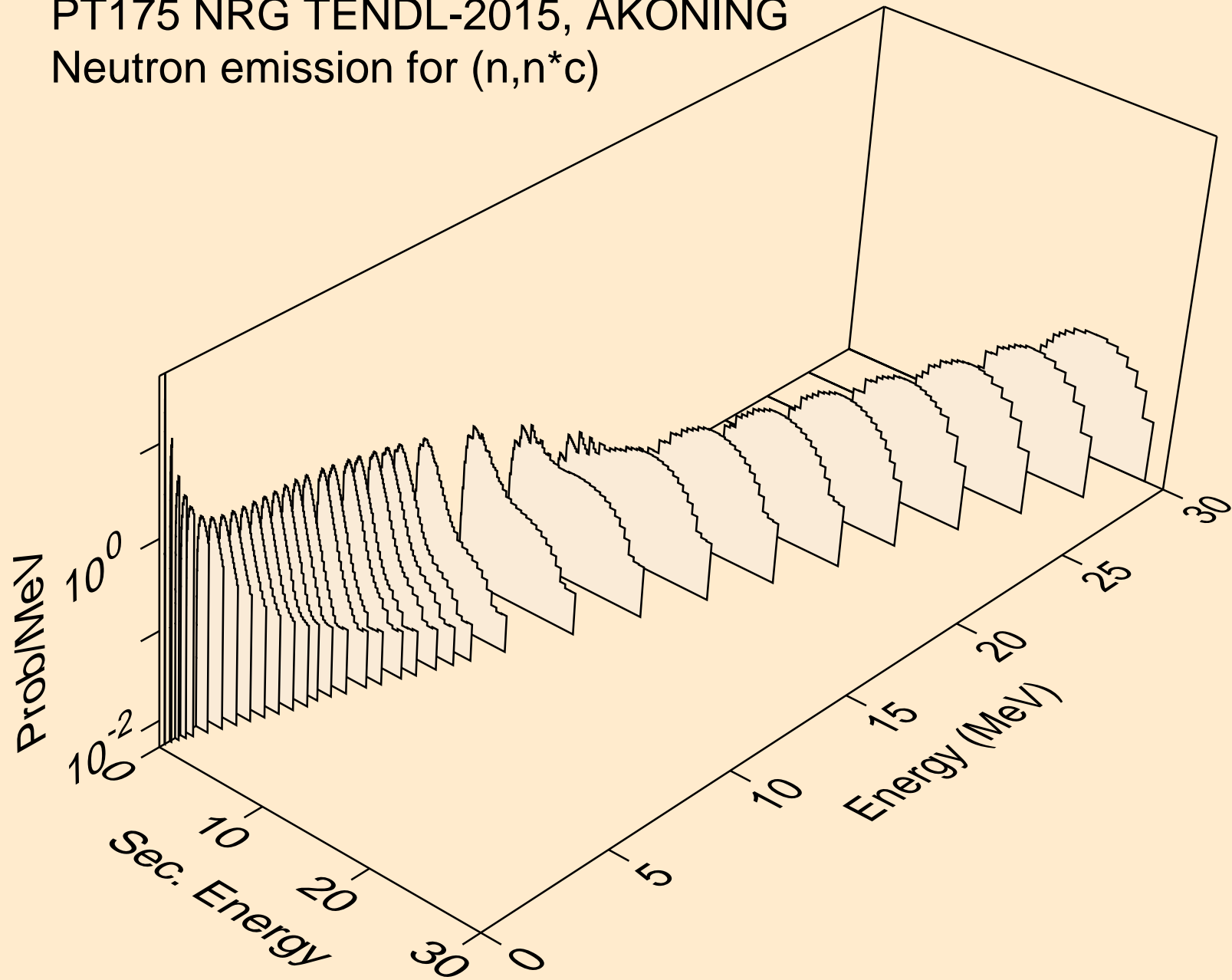

PT175 NRG TENDL-2015, AKONING  
Photon emission for (n,x)

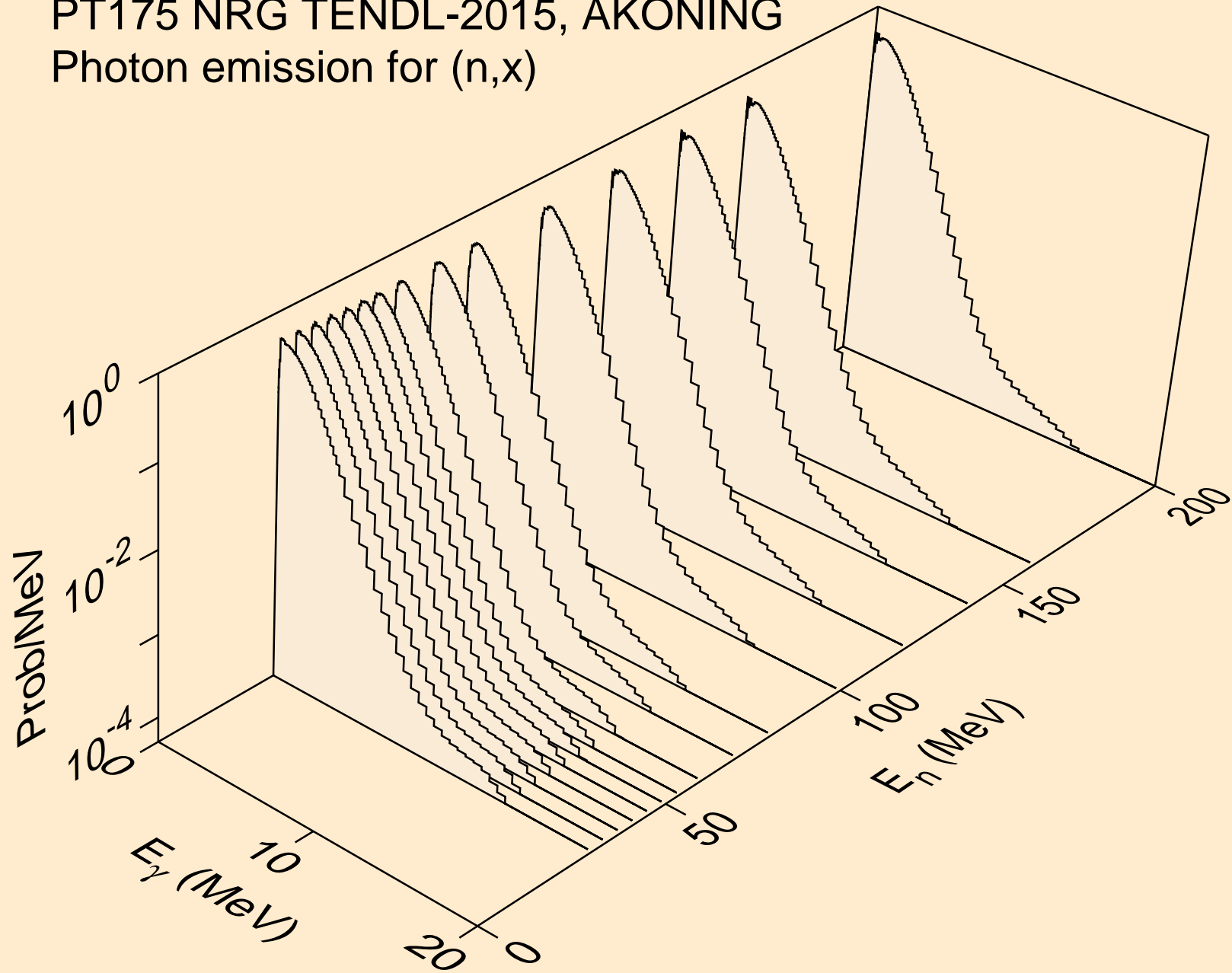



PT175 NRG TENDL-2015, AKONING  
Photon emission for (n,2nd)

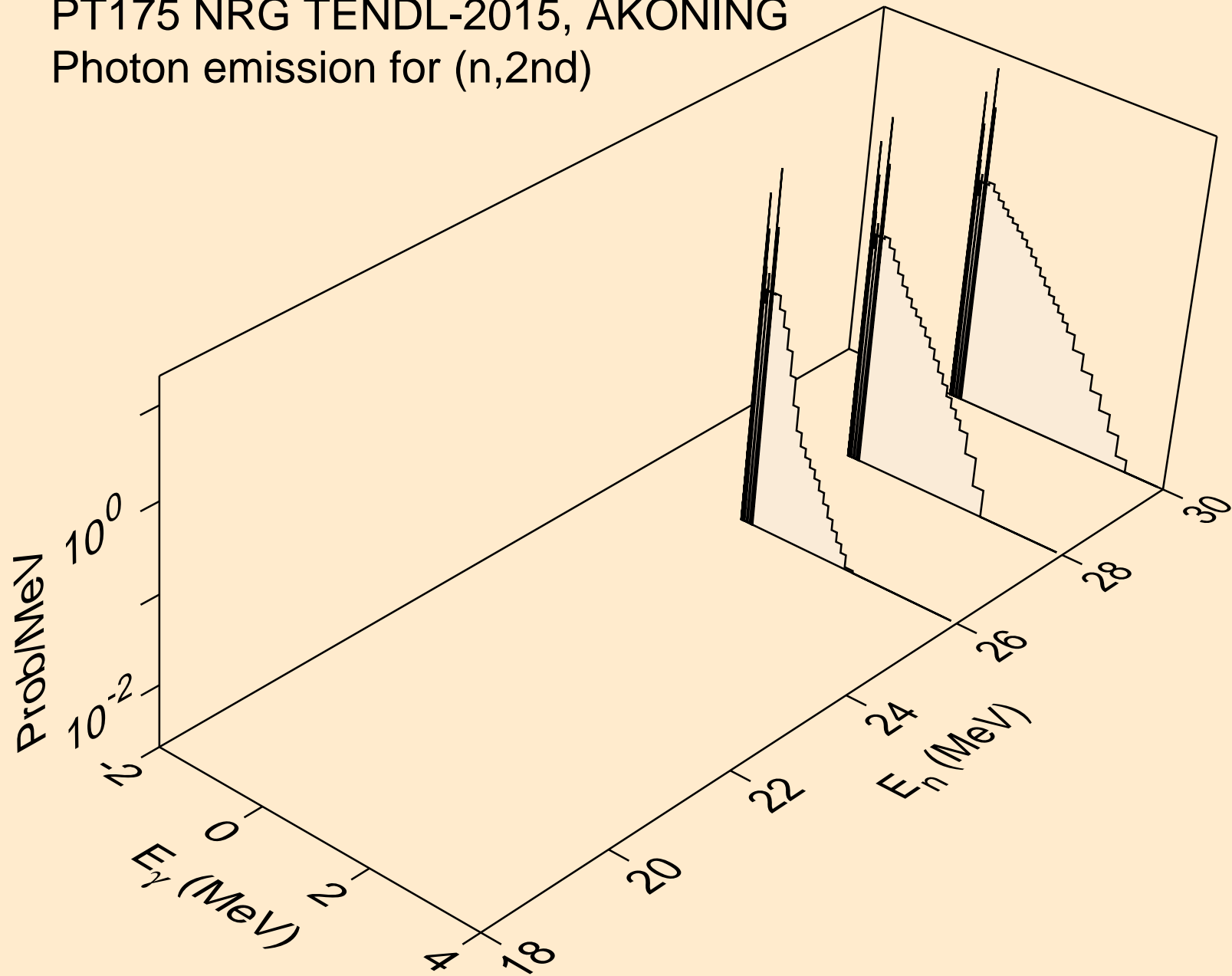

PT175 NRG TENDL-2015, AKONING  
Photon emission for (n,2n)

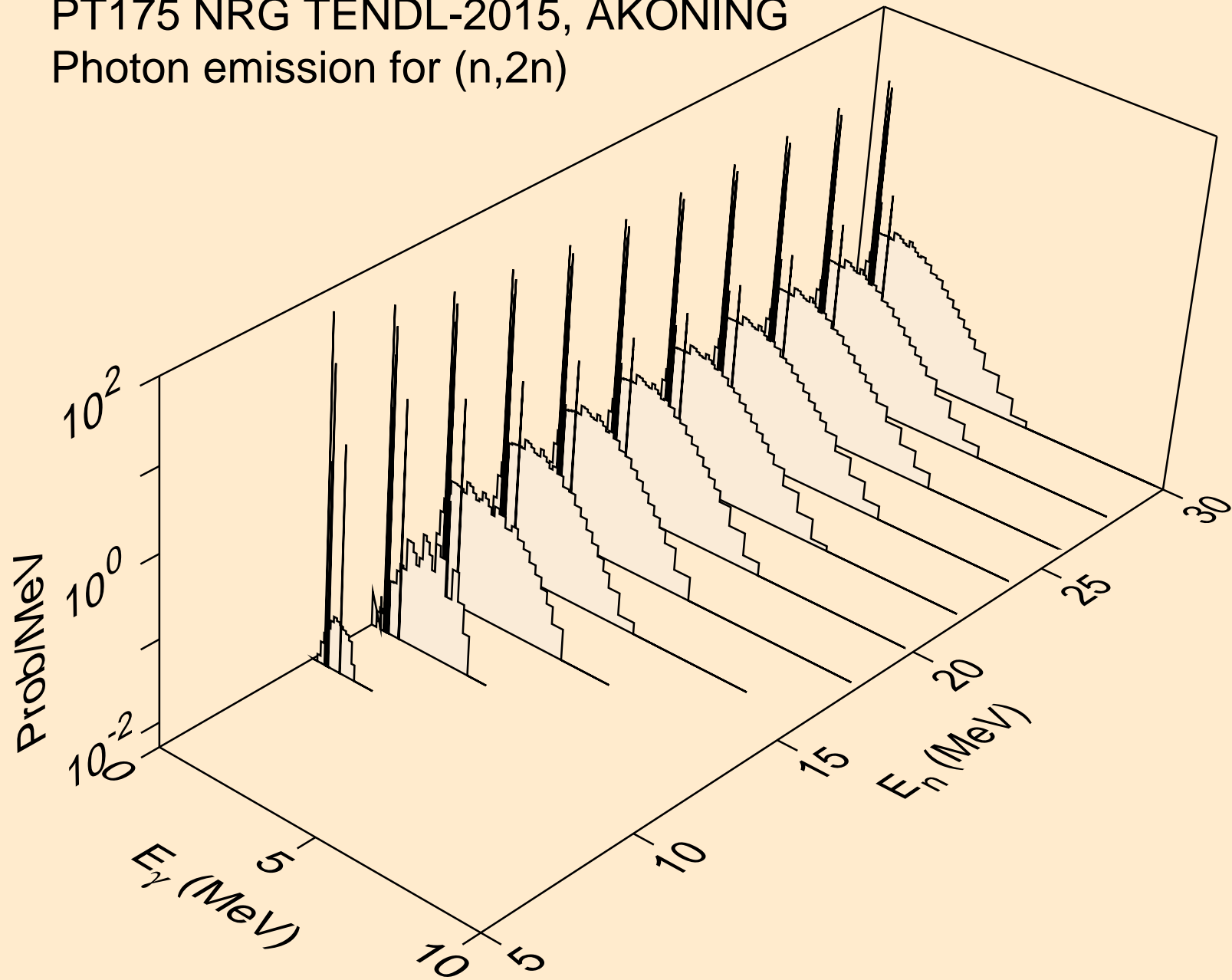

PT175 NRG TENDL-2015, AKONING  
Photon emission for (n,3n)

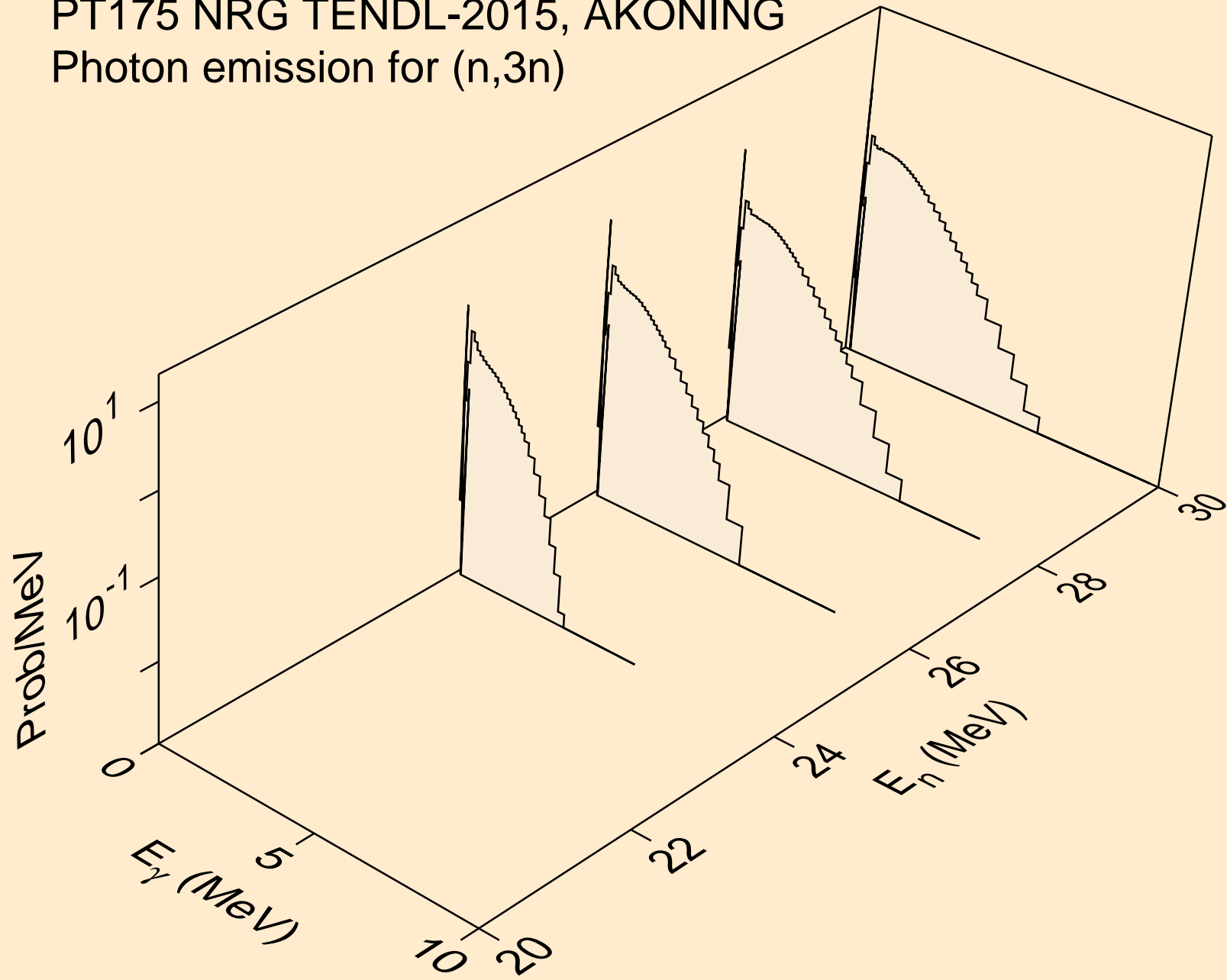

PT175 NRG TENDL-2015, AKONING  
Photon emission for (n,n\*)a

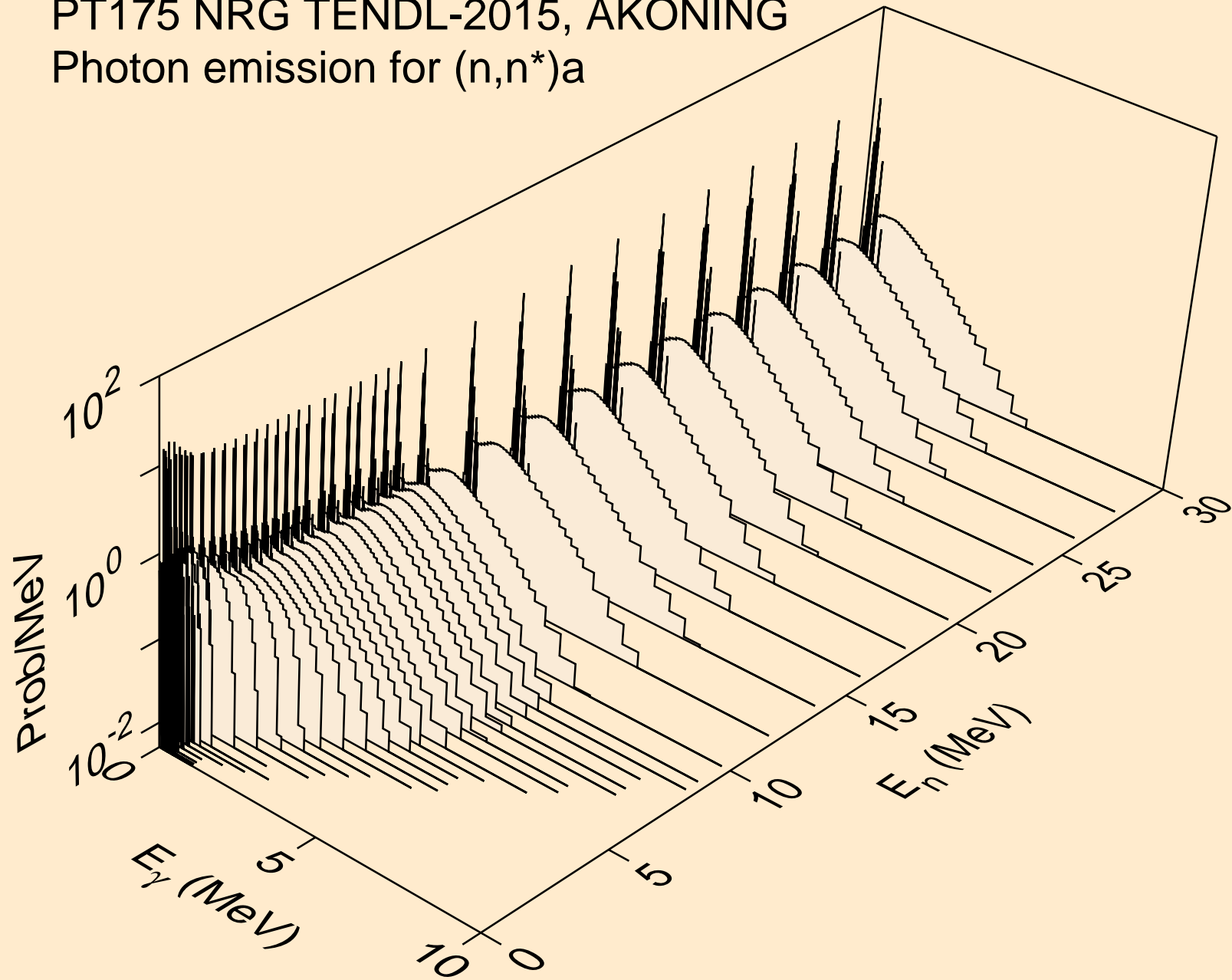

PT175 NRG TENDL-2015, AKONING  
Photon emission for (n,n\*)3a

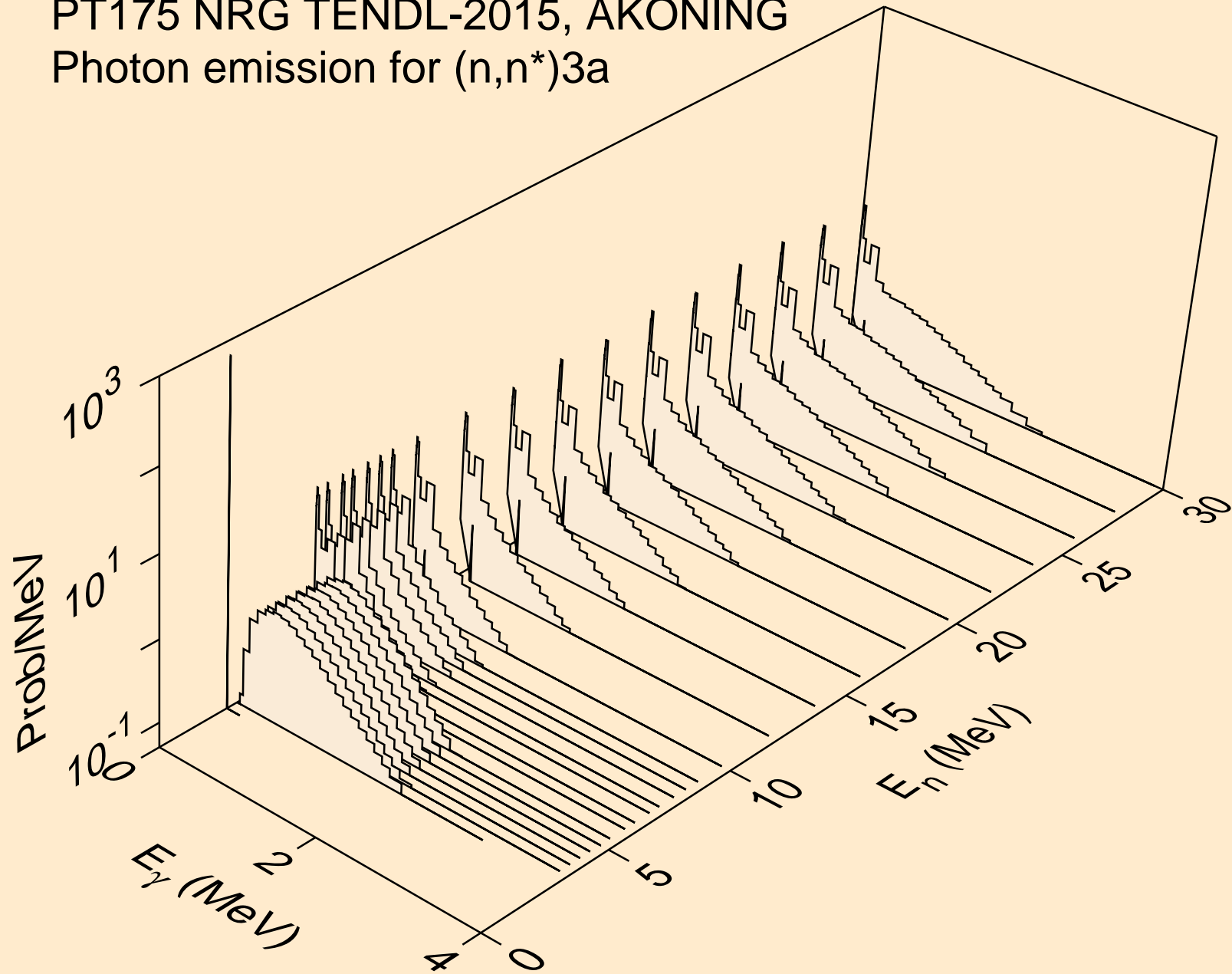

PT175 NRG TENDL-2015, AKONING  
Photon emission for (n,2n)a

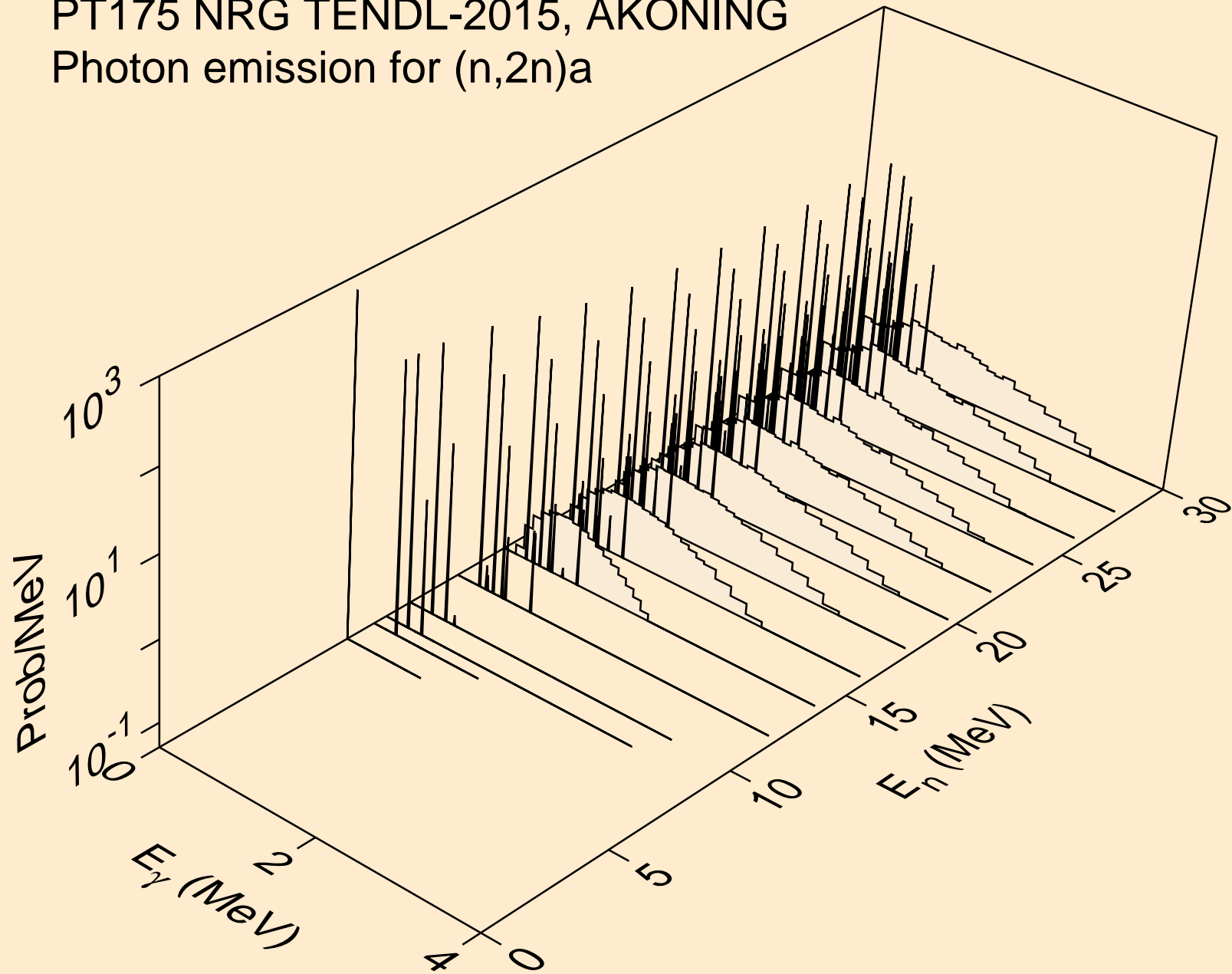

PT175 NRG TENDL-2015, AKONING  
Photon emission for (n,3n)a

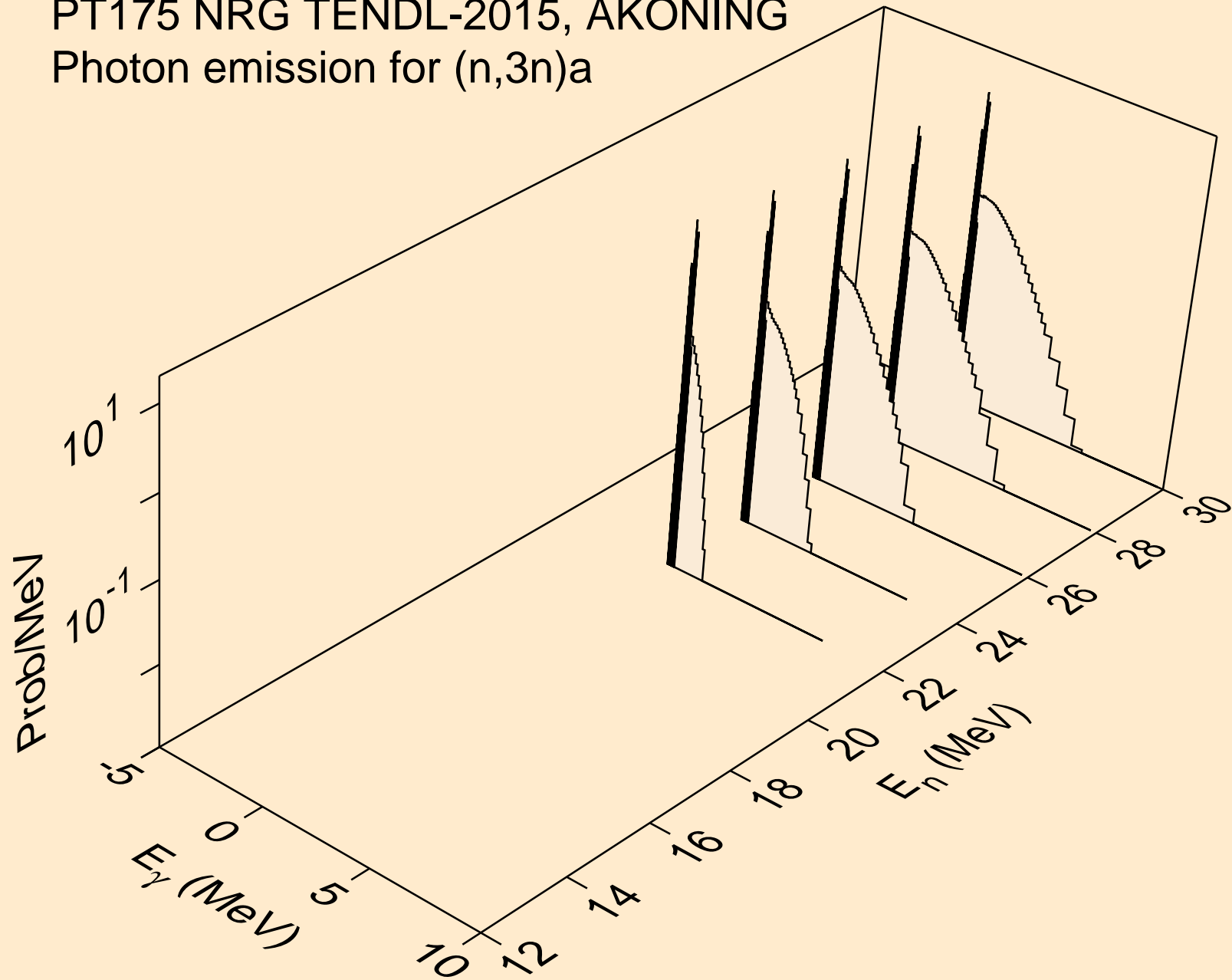

PT175 NRG TENDL-2015, AKONING  
Photon emission for (n,n\*)p

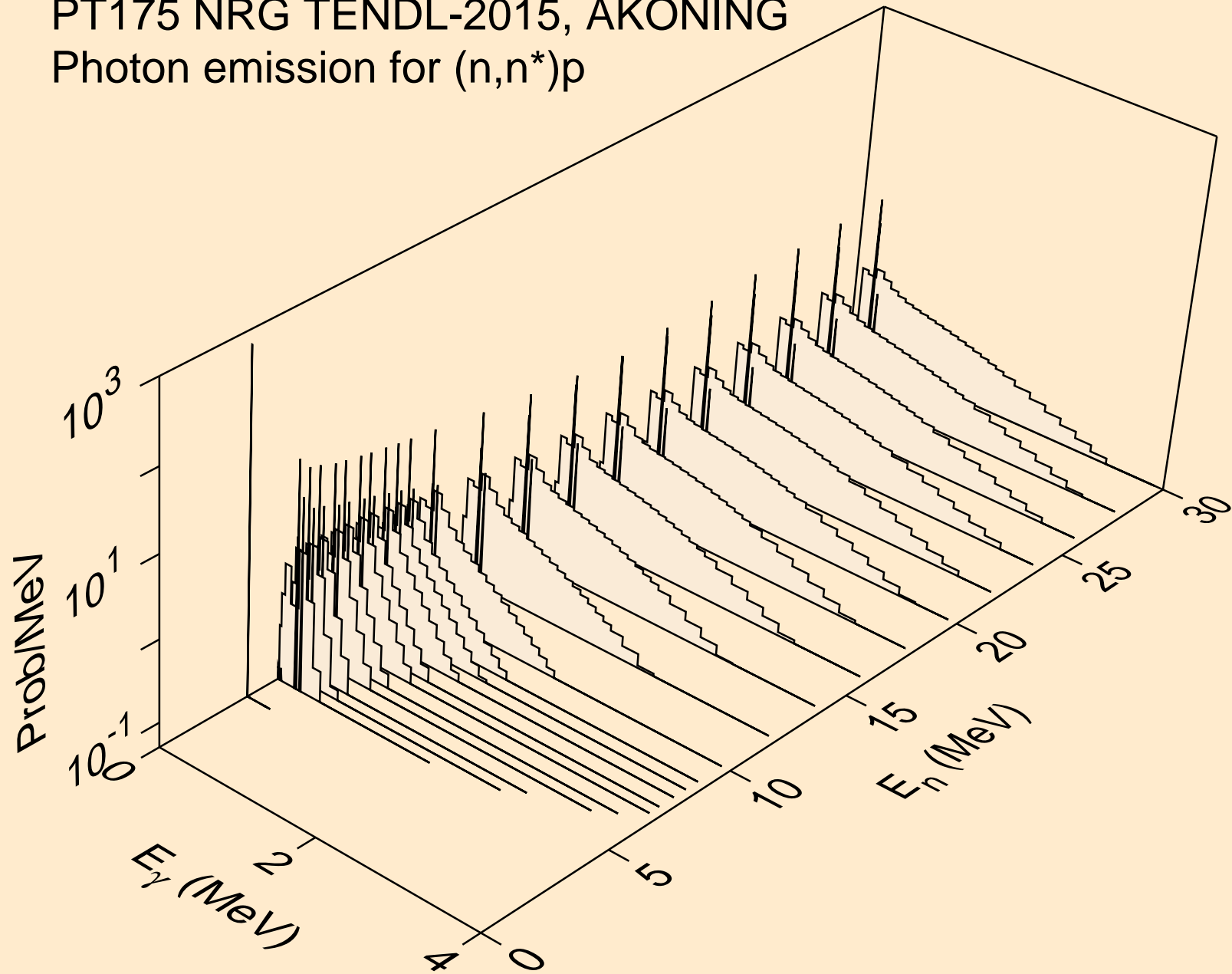



PT175 NRG TENDL-2015, AKONING  
Photon emission for (n,n\*)2a

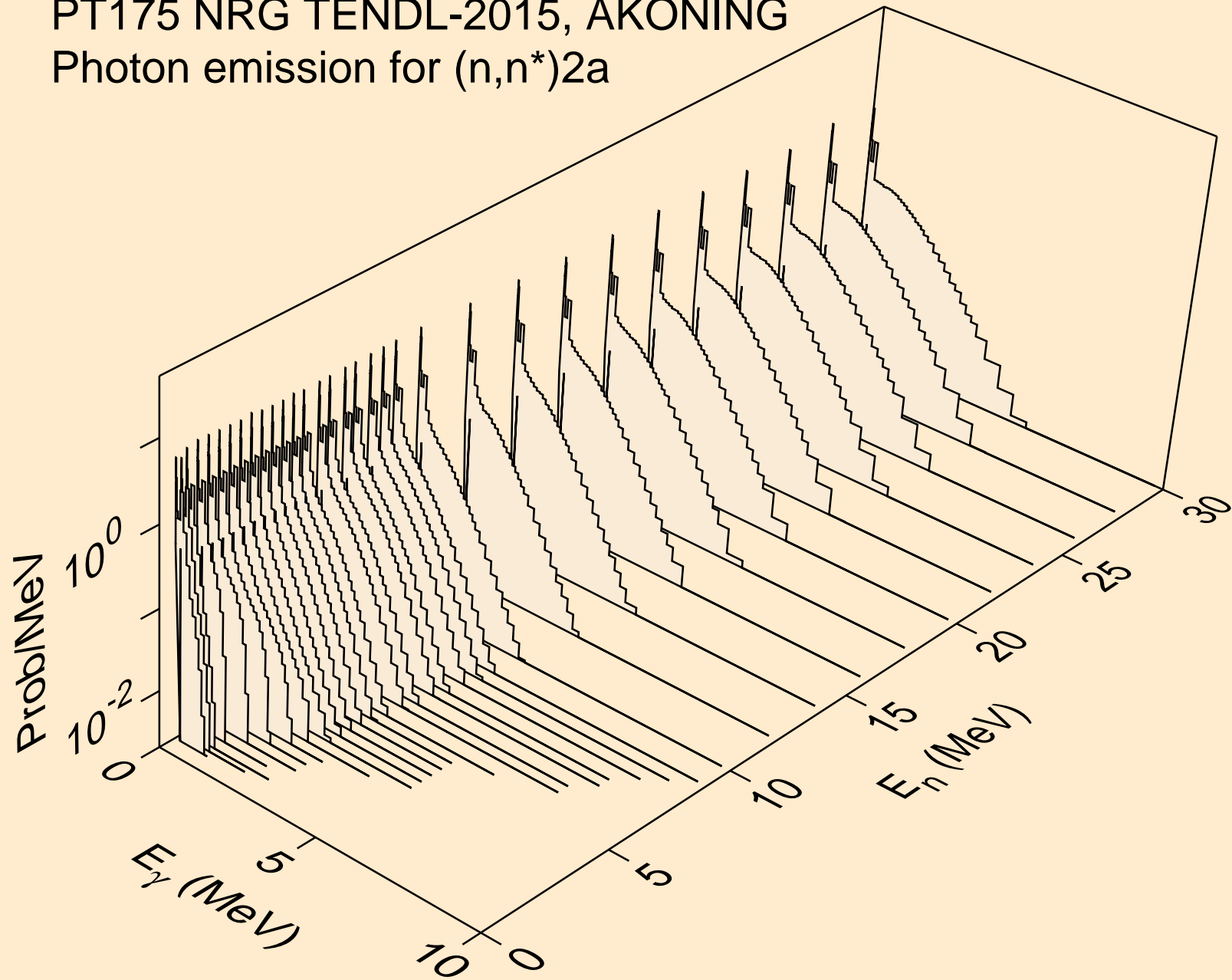

PT175 NRG TENDL-2015, AKONING  
Photon emission for (n,2n)2a

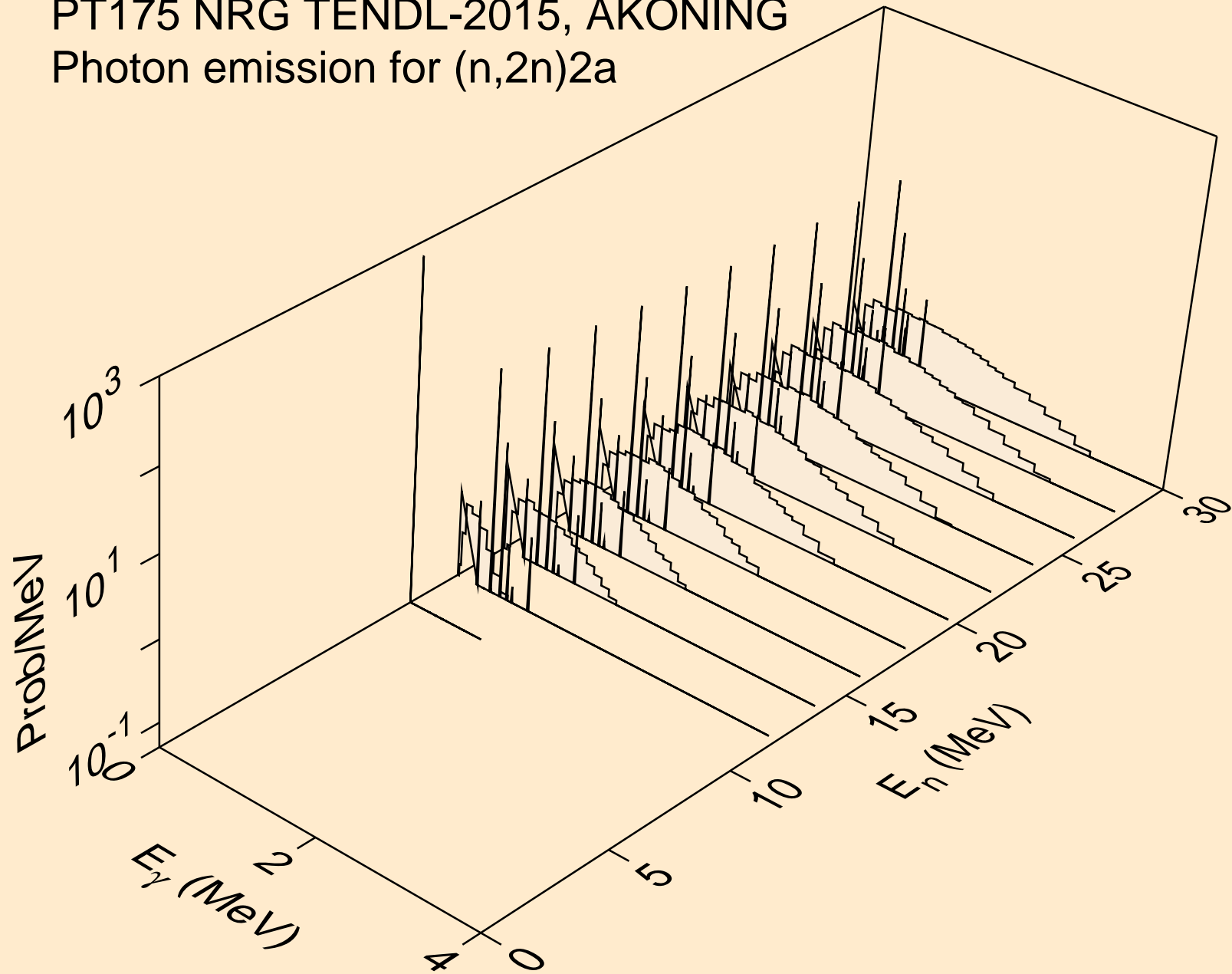

PT175 NRG TENDL-2015, AKONING  
Photon emission for (n,n\*)d

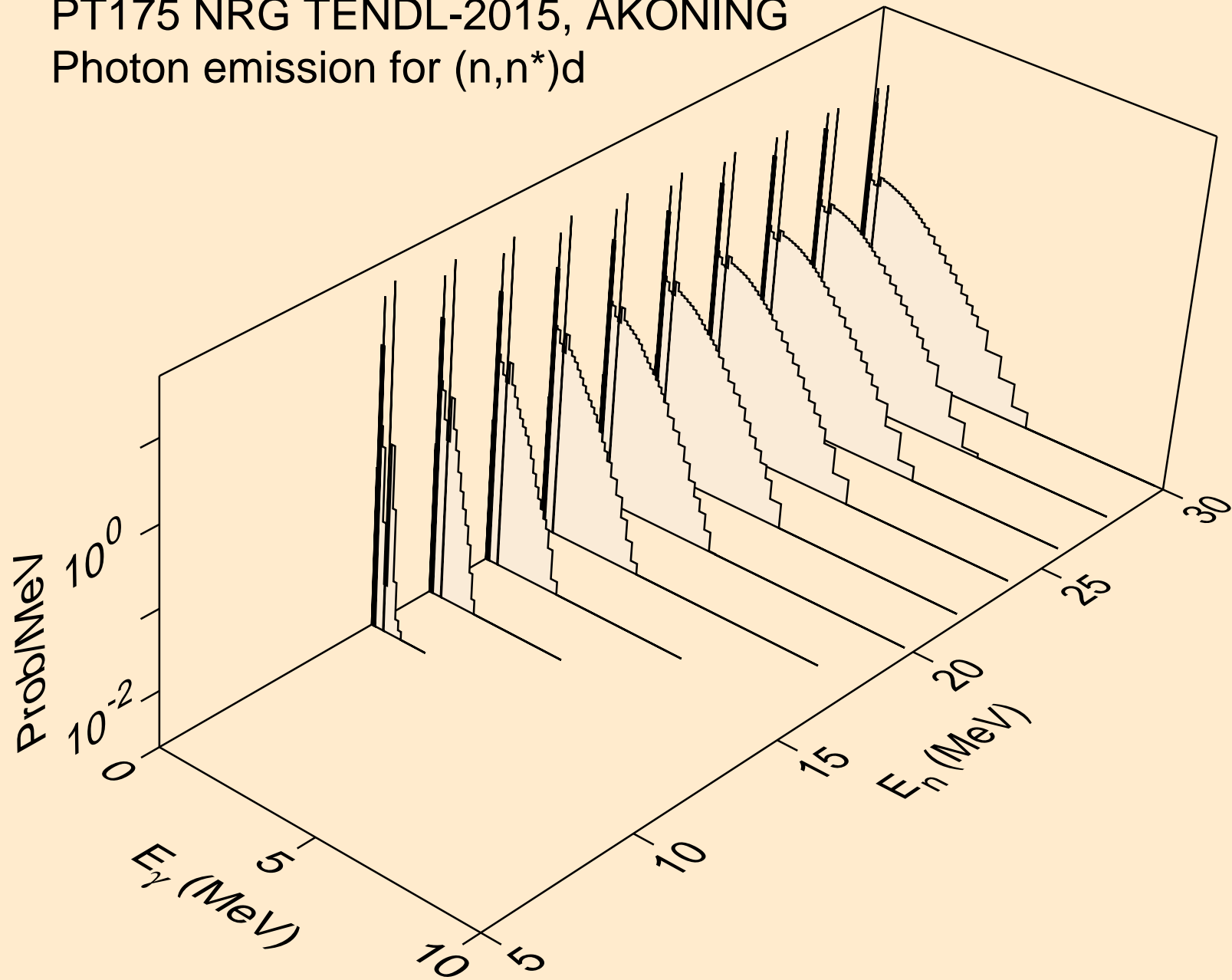

PT175 NRG TENDL-2015, AKONING  
Photon emission for (n,n\*)t

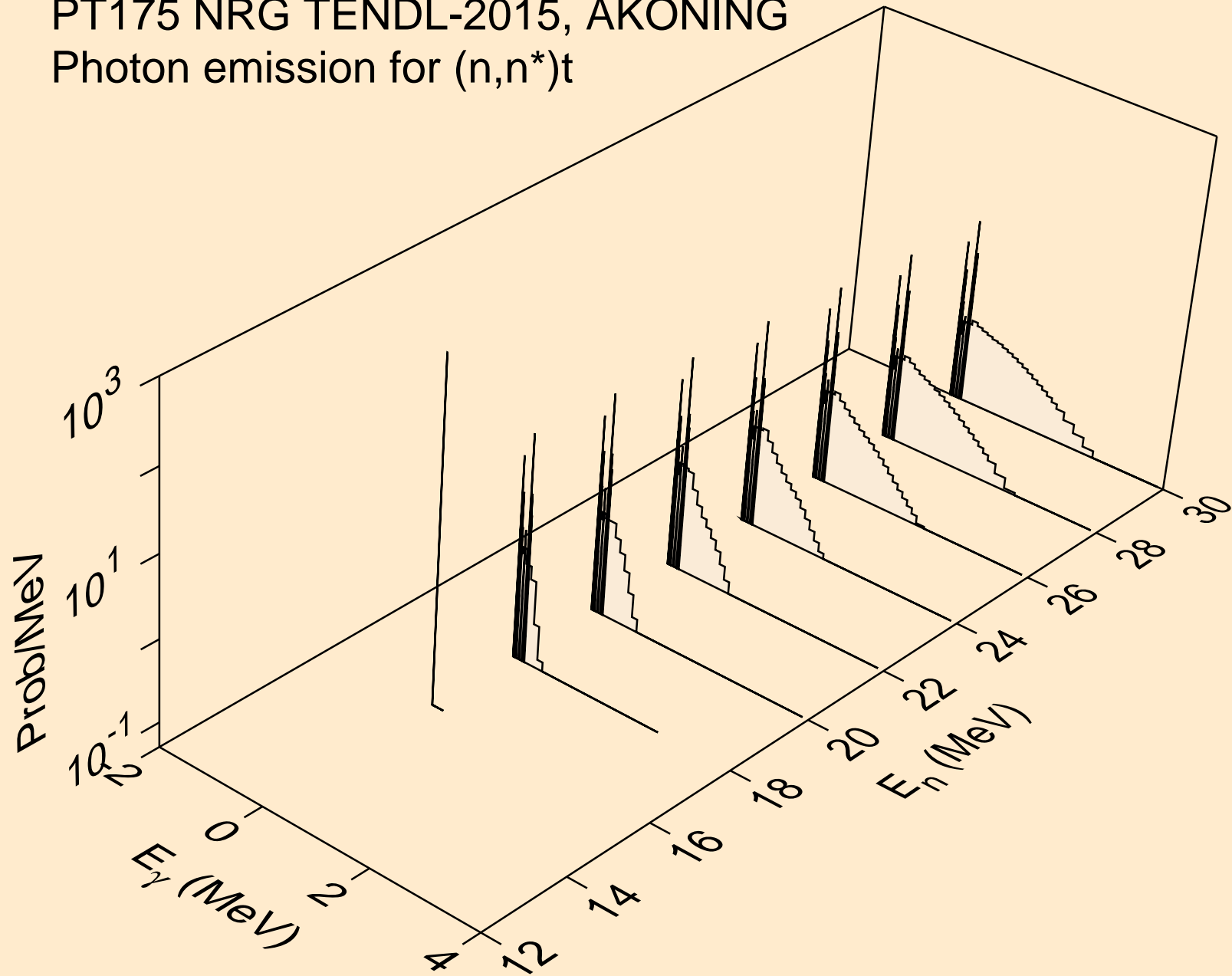

PT175 NRG TENDL-2015, AKONING  
Photon emission for (n,n\*)he3

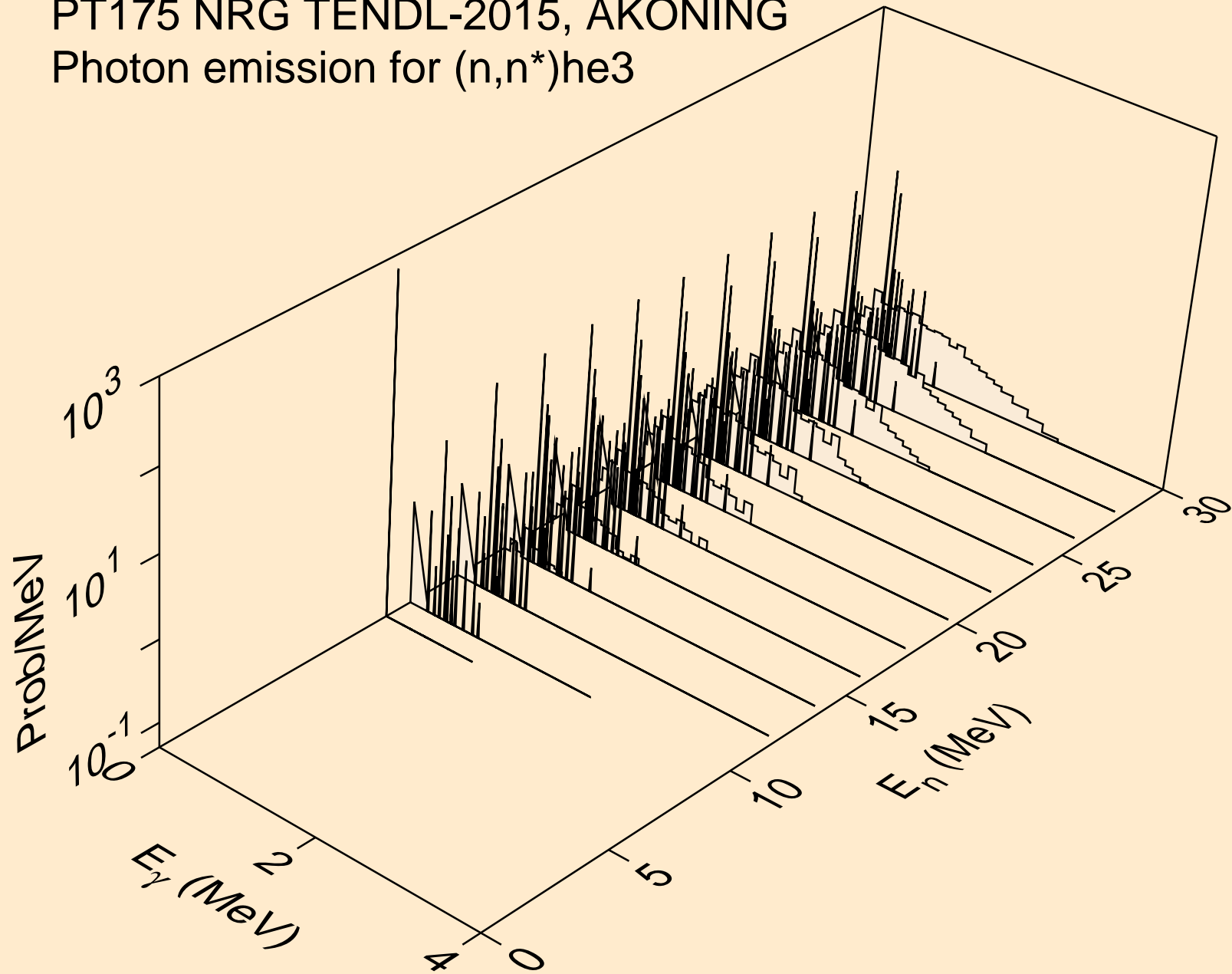

PT175 NRG TENDL-2015, AKONING  
Photon emission for (n,n\*)d2a

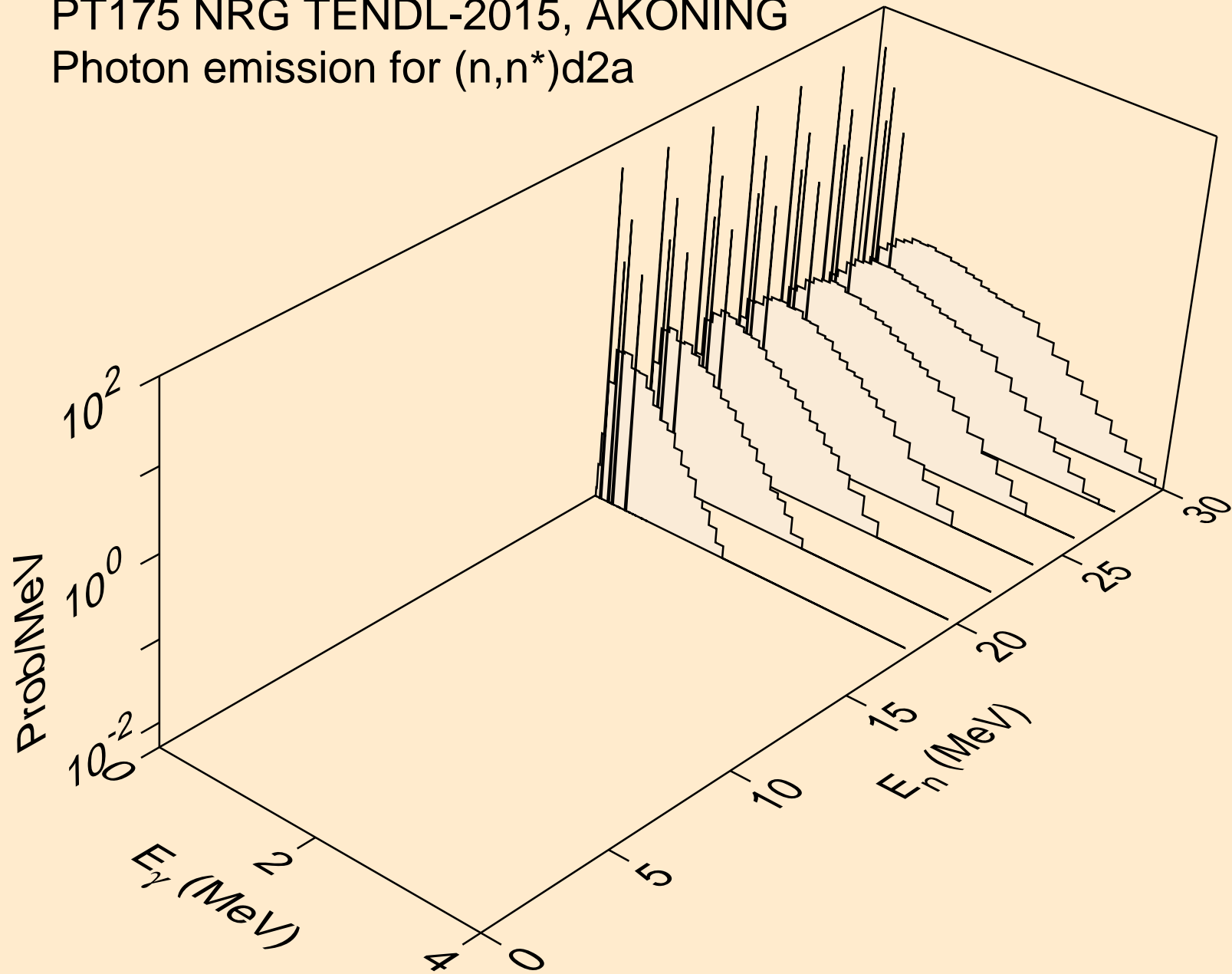

PT175 NRG TENDL-2015, AKONING  
Photon emission for (n,4n)

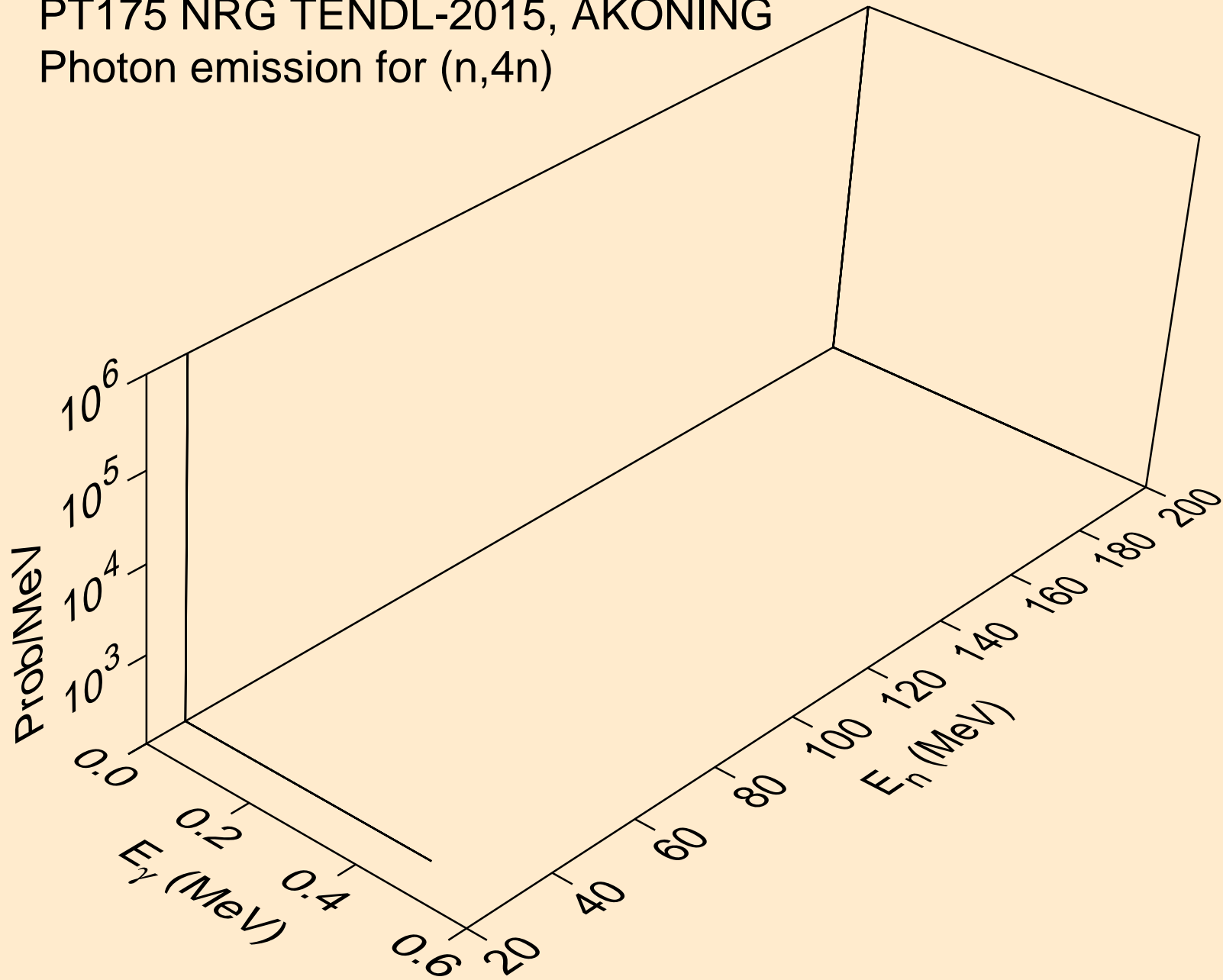

PT175 NRG TENDL-2015, AKONING  
Photon emission for (n,2np)

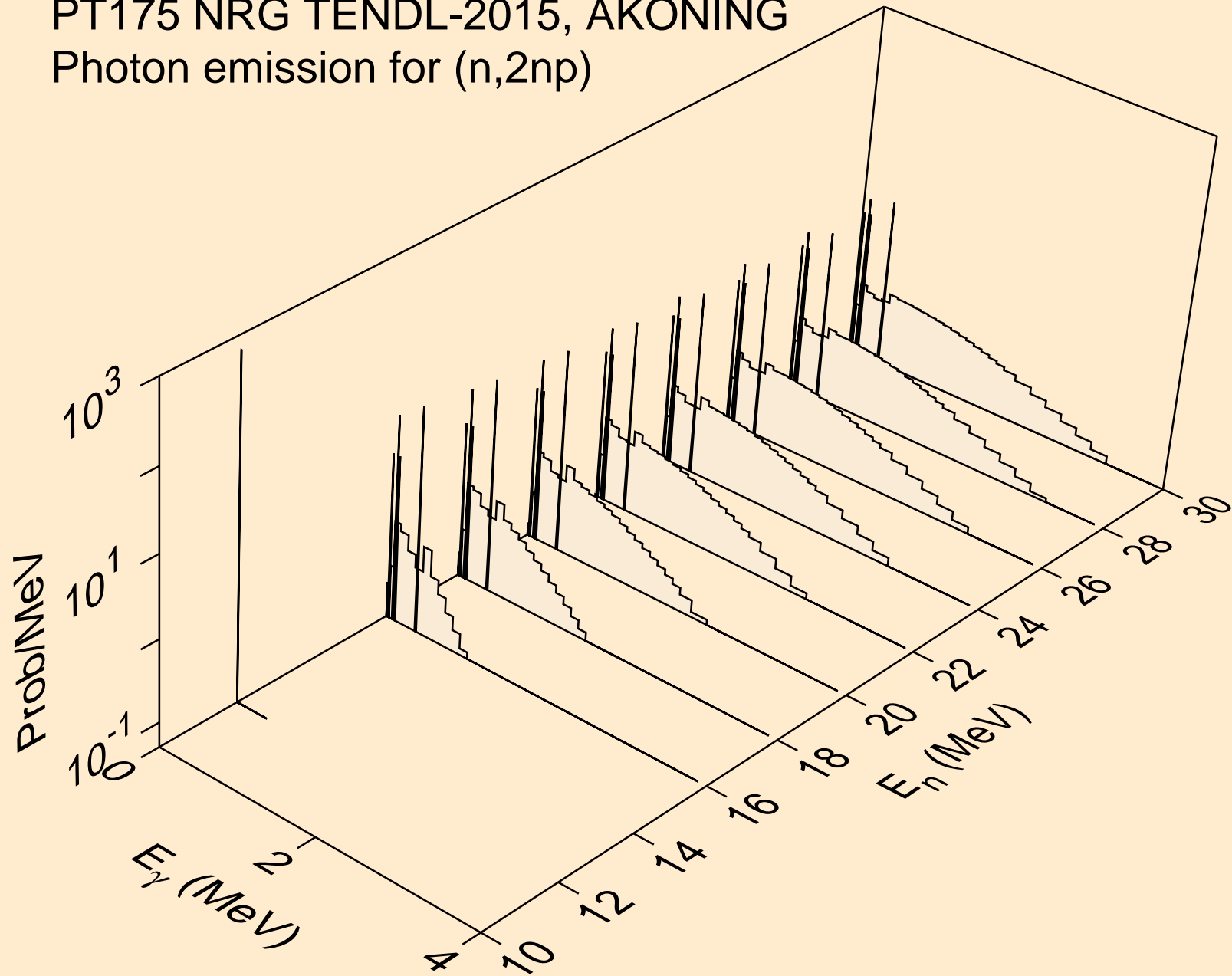



PT175 NRG TENDL-2015, AKONING  
Photon emission for (n,3np)

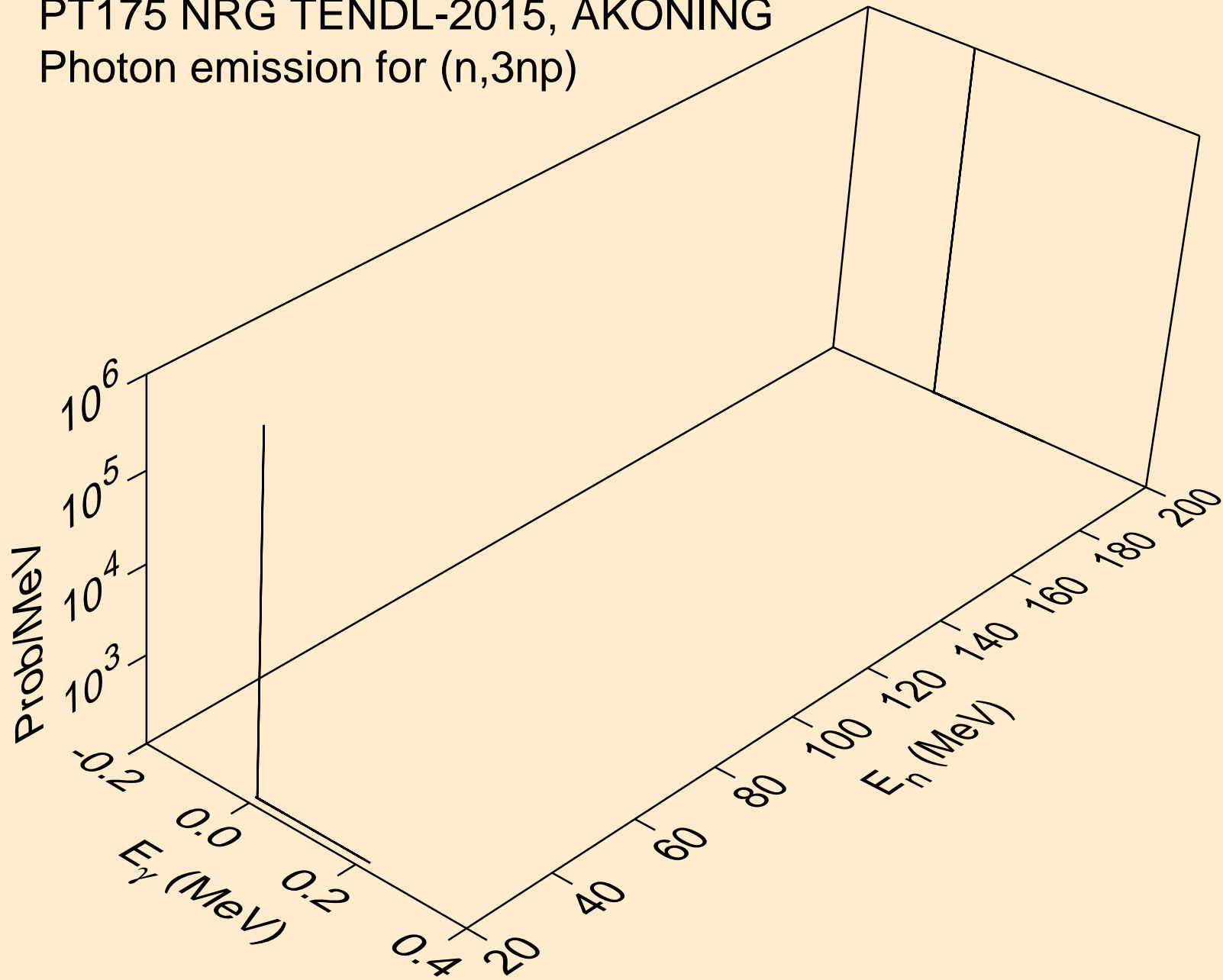

PT175 NRG TENDL-2015, AKONING  
Photon emission for (n,2np)

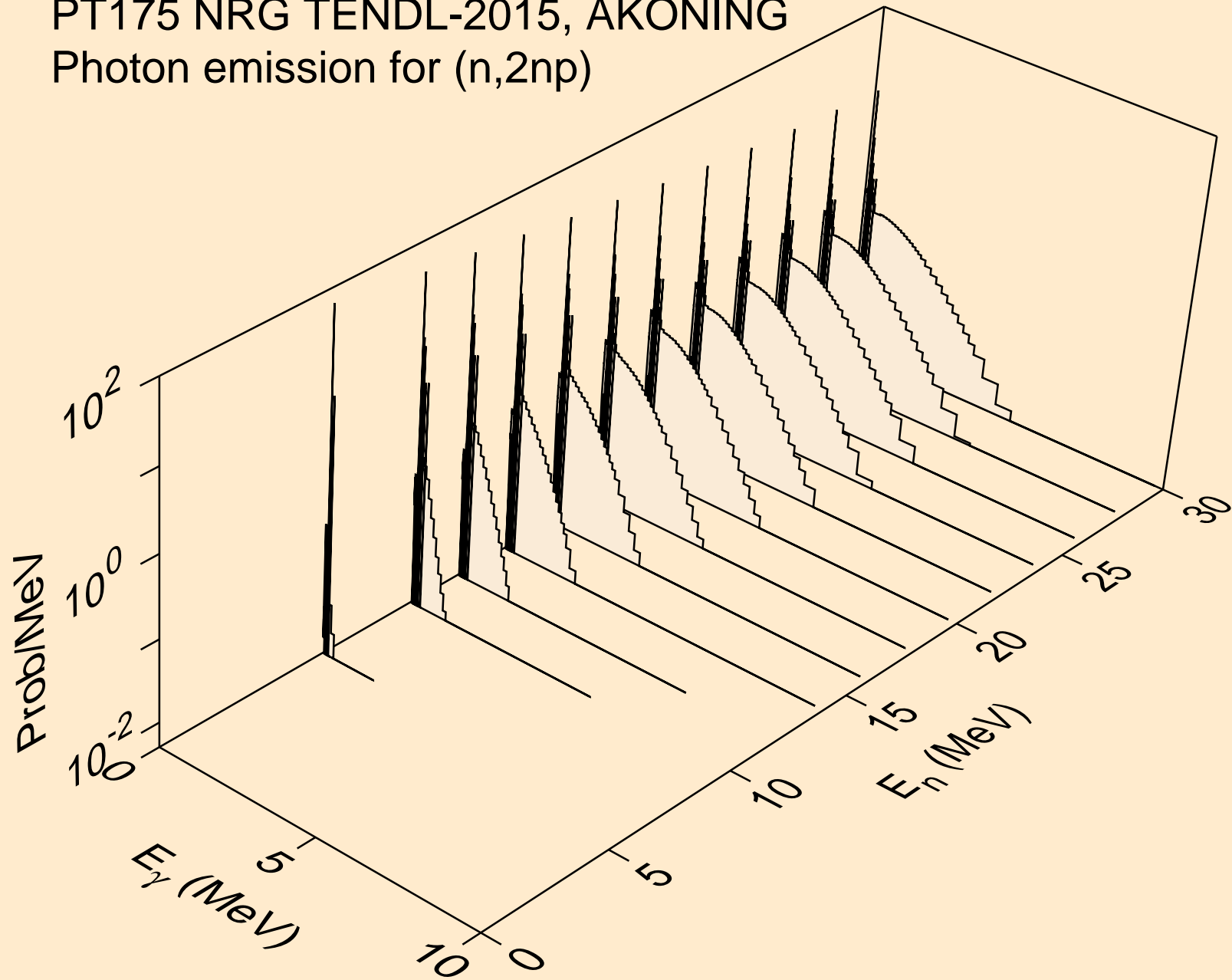

PT175 NRG TENDL-2015, AKONING  
Photon emission for (n,npa)

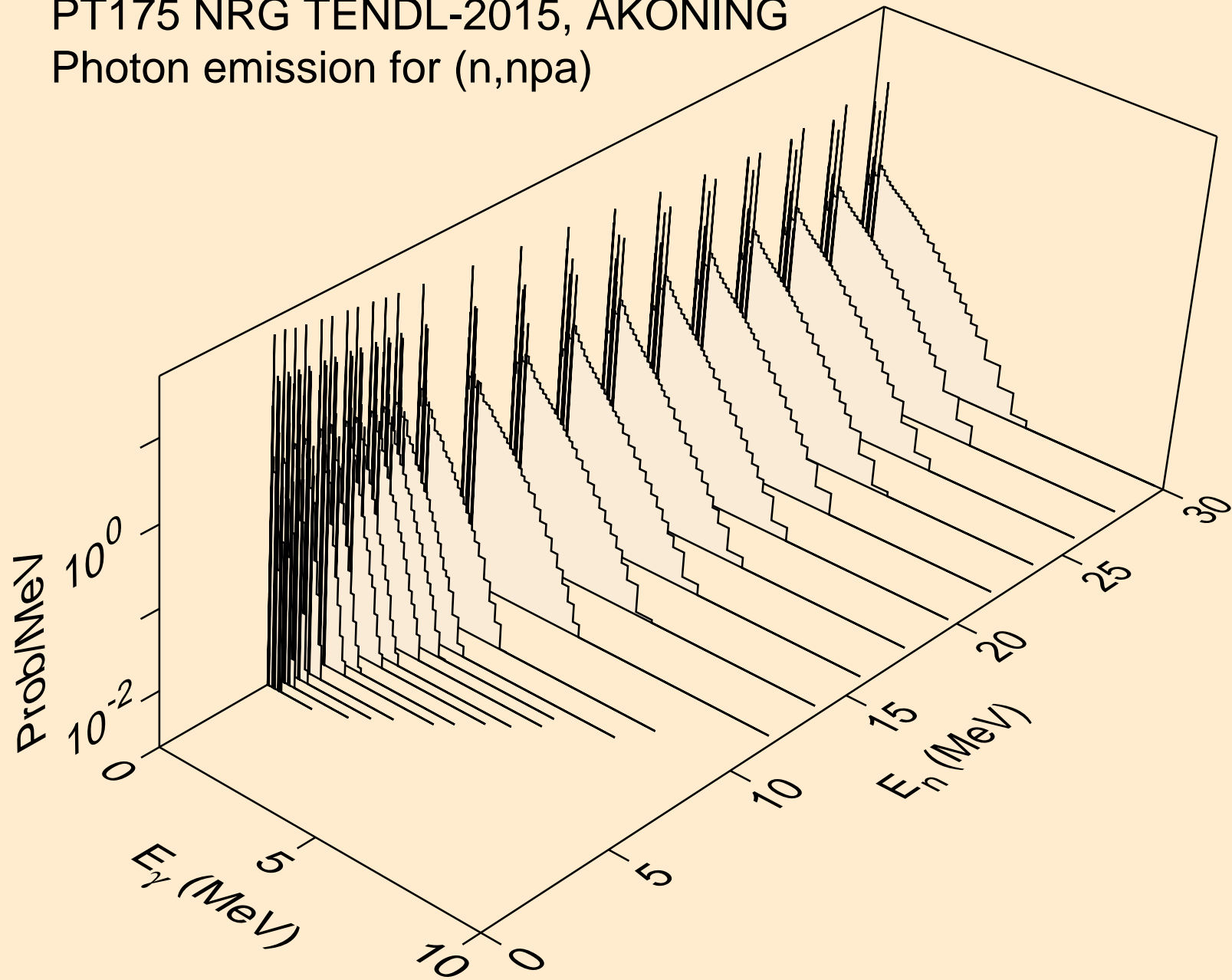

PT175 NRG TENDL-2015, AKONING  
Photon emission for (n,n\*c)

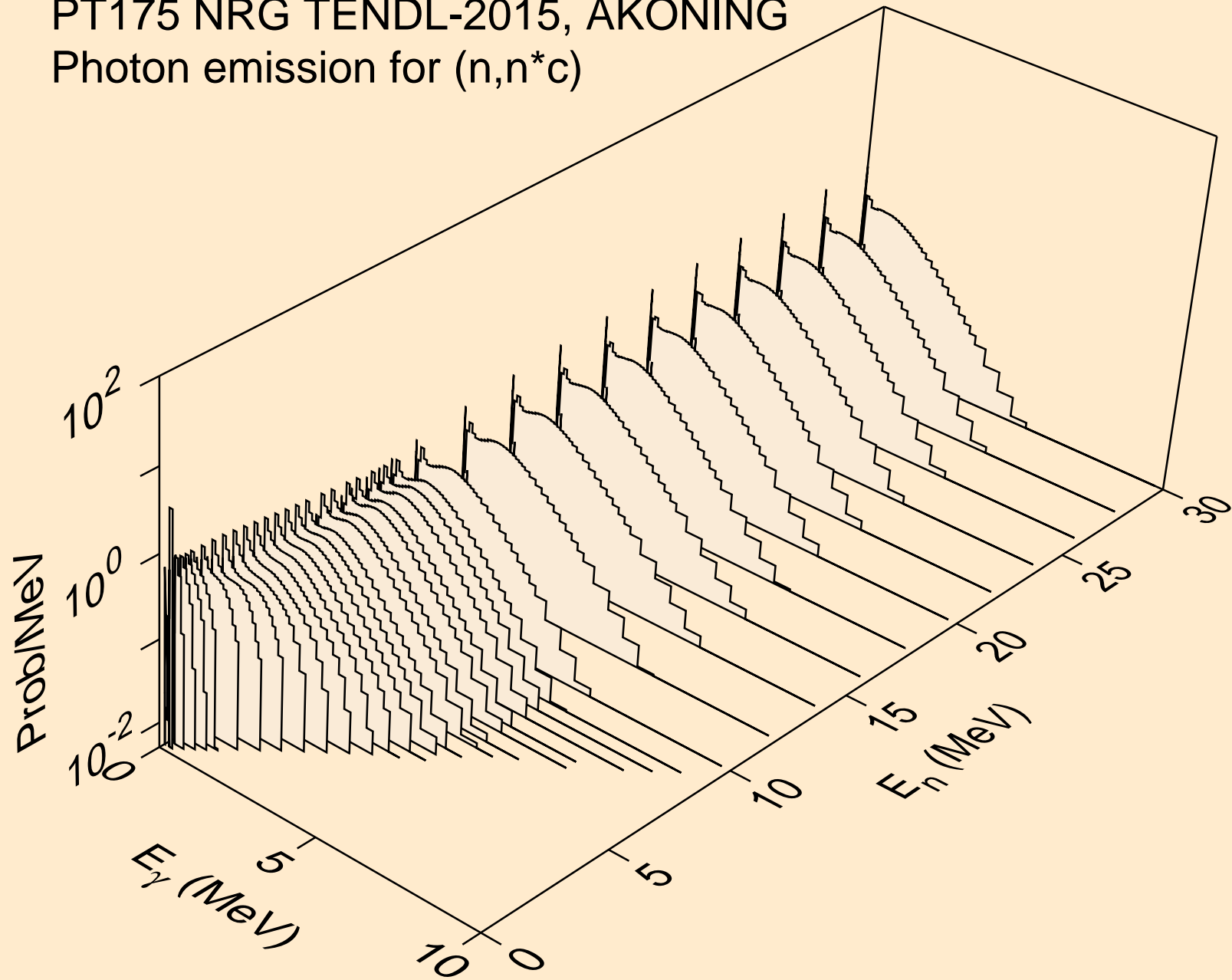

PT175 NRG TENDL-2015, AKONING  
Photon emission for (n,gma)

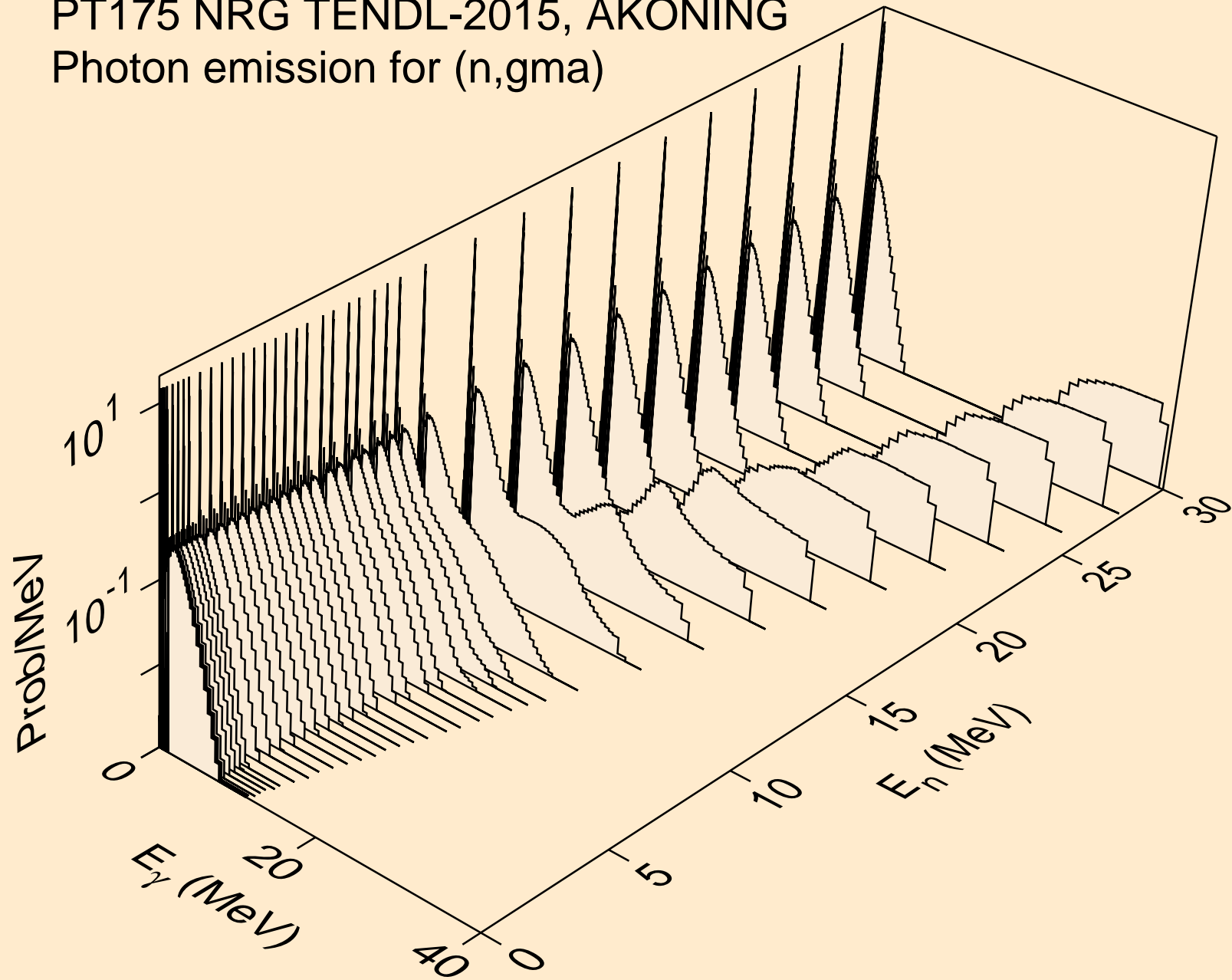

PT175 NRG TENDL-2015, AKONING  
Photon emission for (n,p)

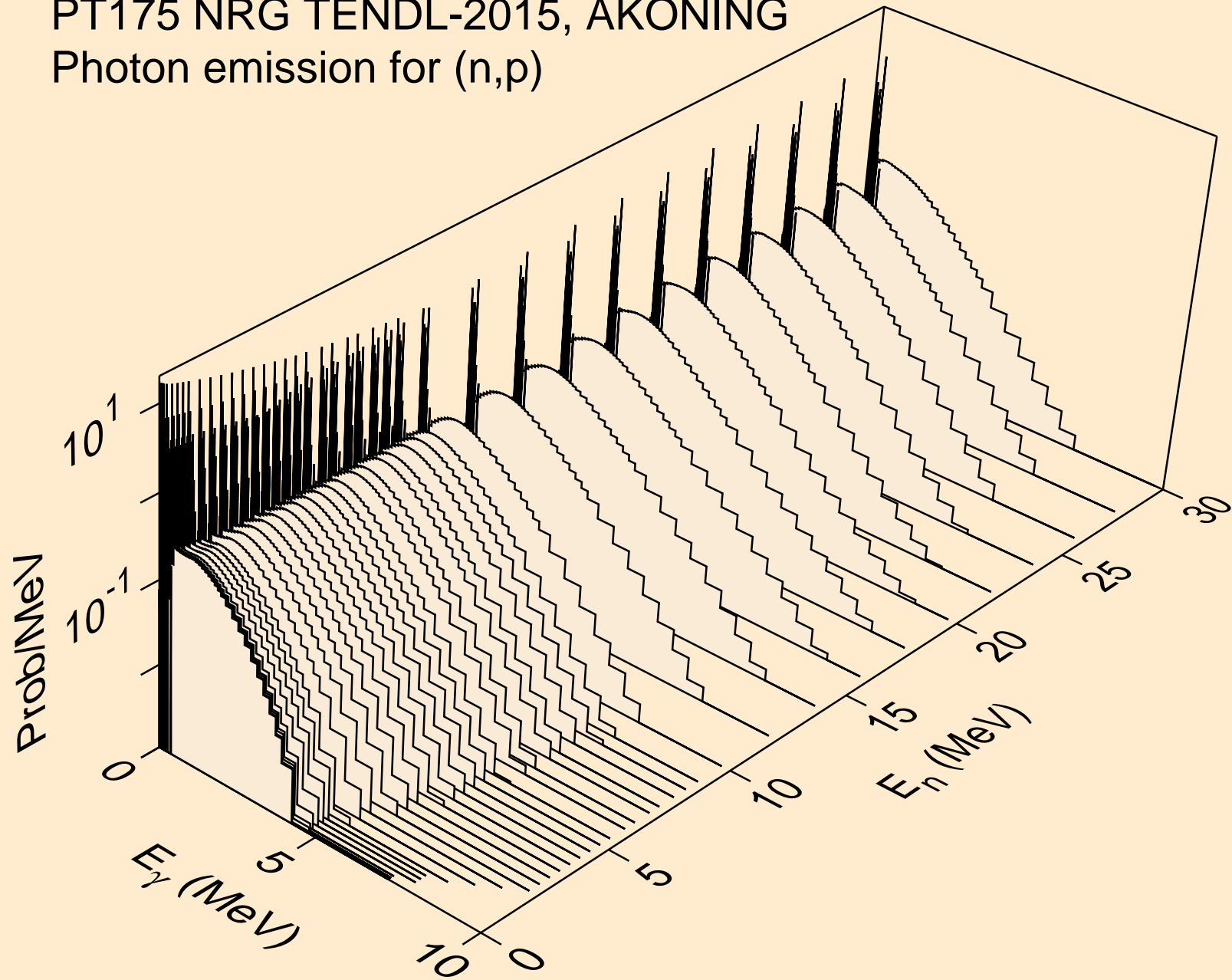

PT175 NRG TENDL-2015, AKONING  
Photon emission for (n,d)

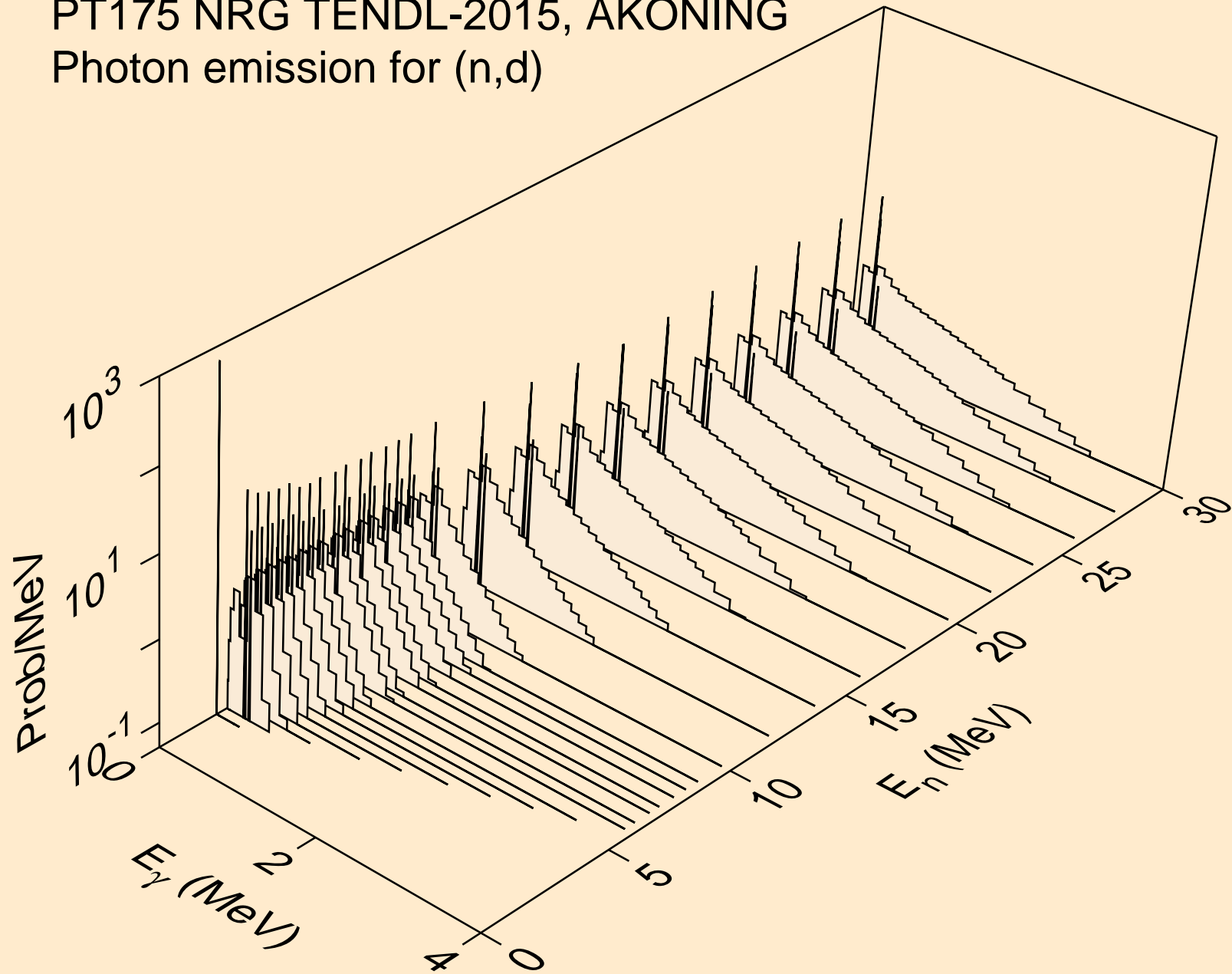

PT175 NRG TENDL-2015, AKONING  
Photon emission for (n,t)

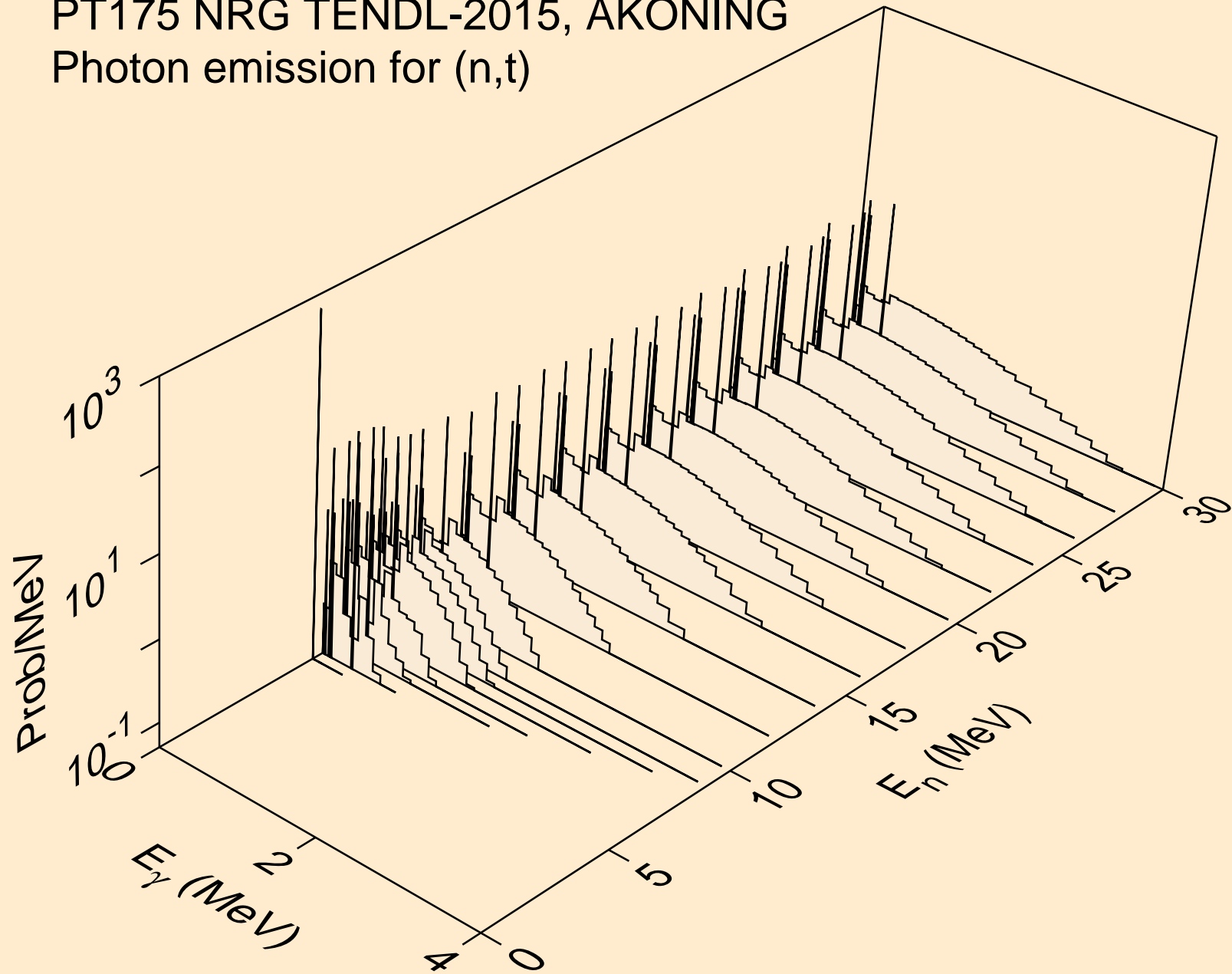



PT175 NRG TENDL-2015, AKONING  
Photon emission for (n,he3)

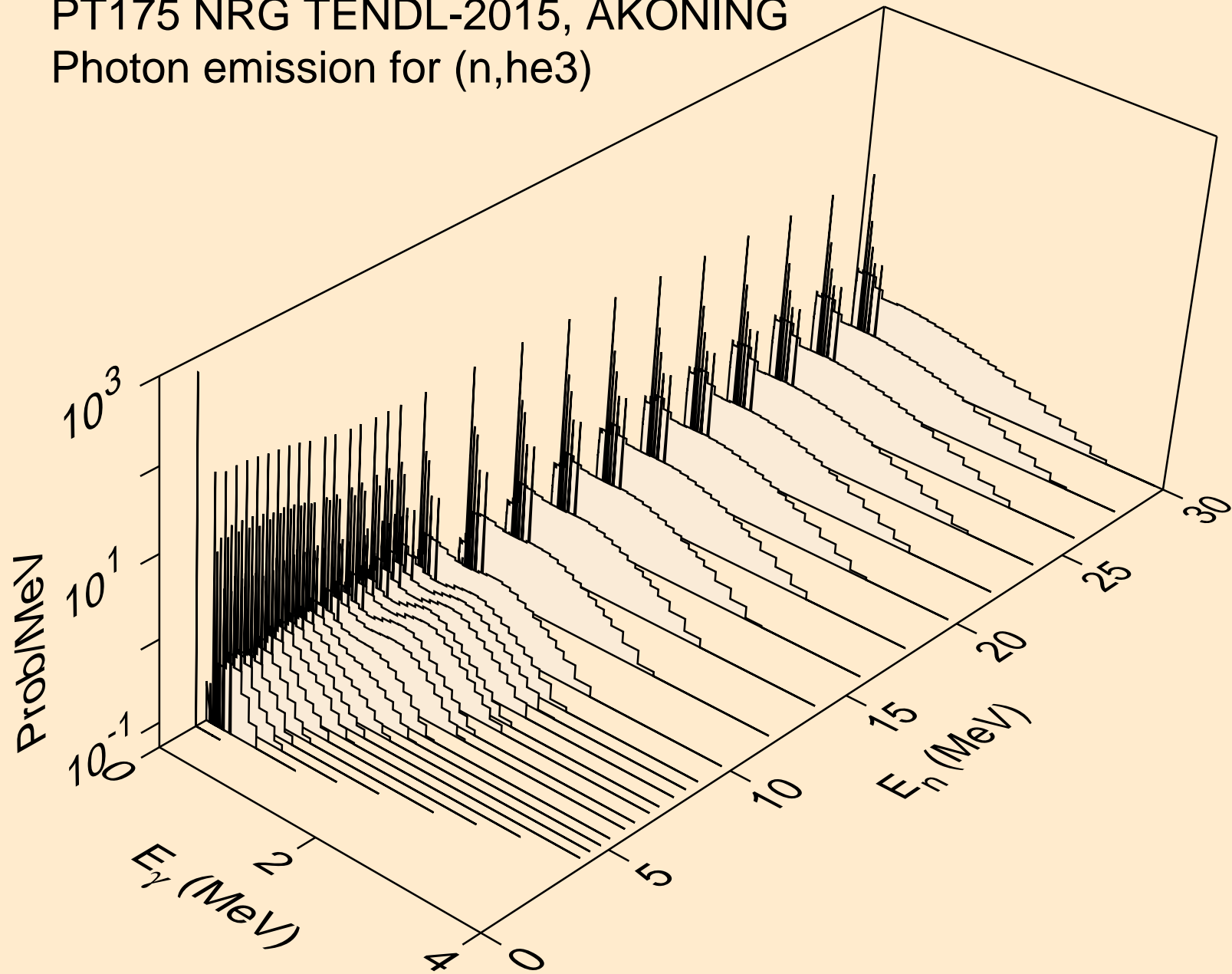

PT175 NRG TENDL-2015, AKONING  
Photon emission for (n,a)

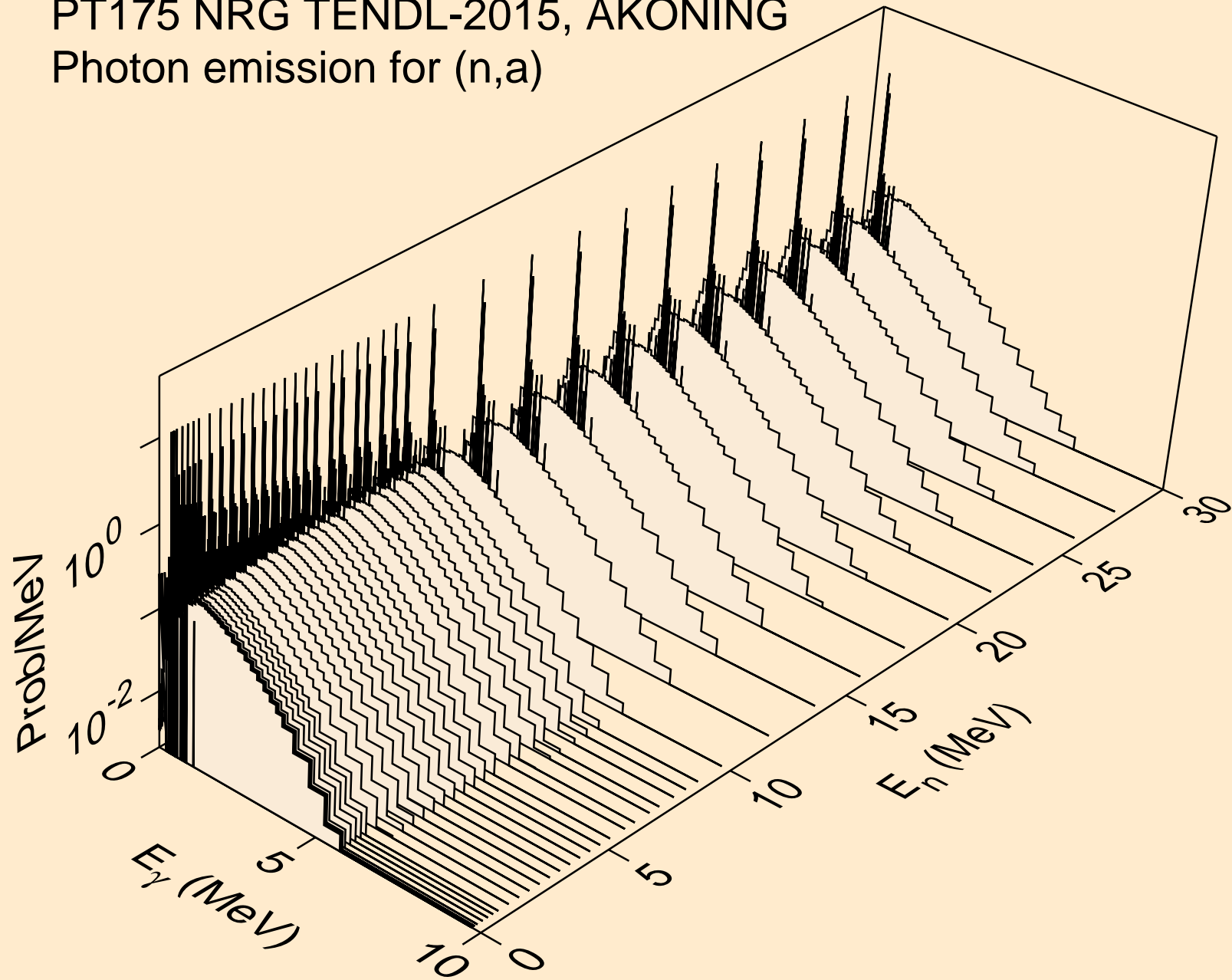

PT175 NRG TENDL-2015, AKONING  
Photon emission for (n,2a)

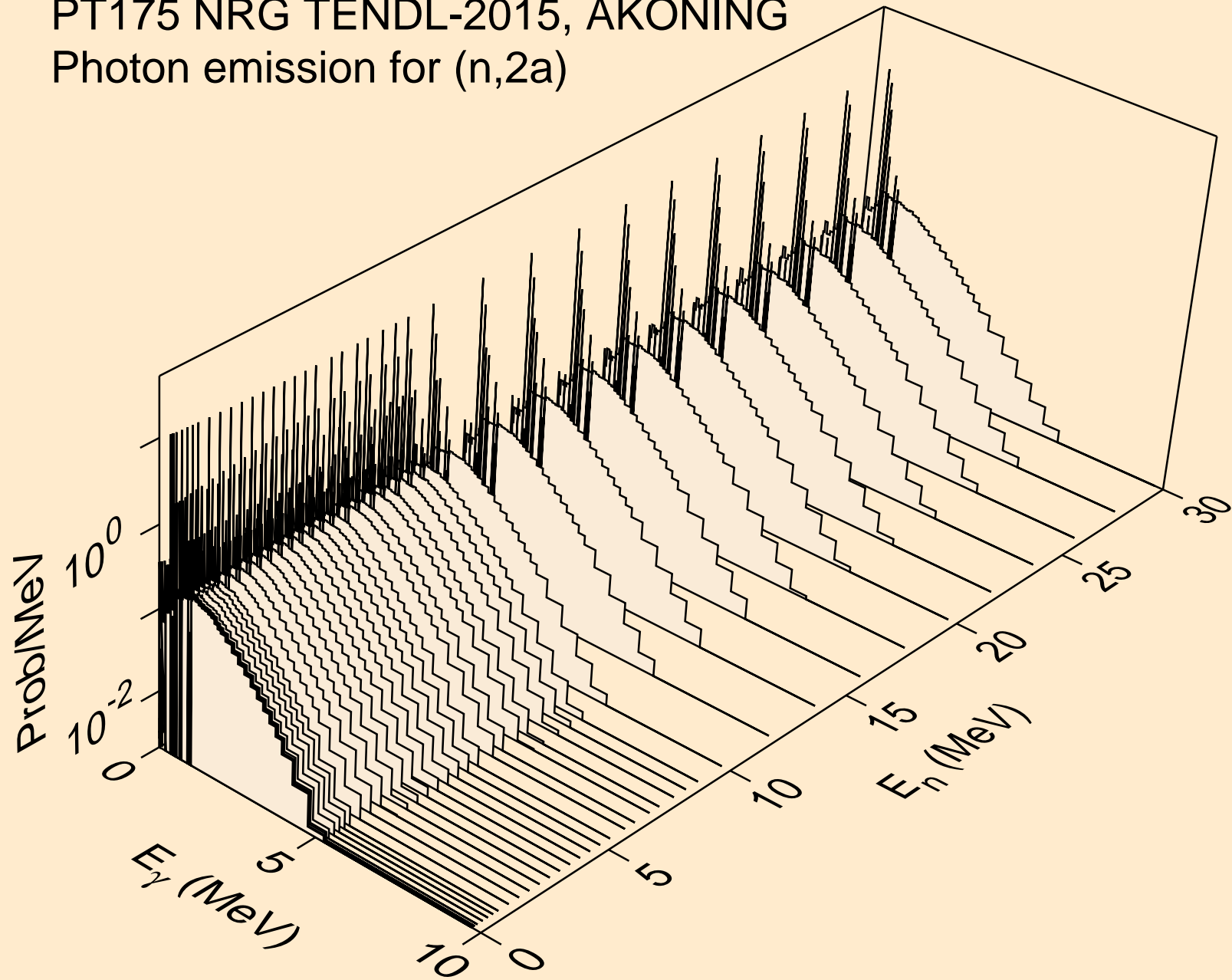

PT175 NRG TENDL-2015, AKONING  
Photon emission for (n,3a)

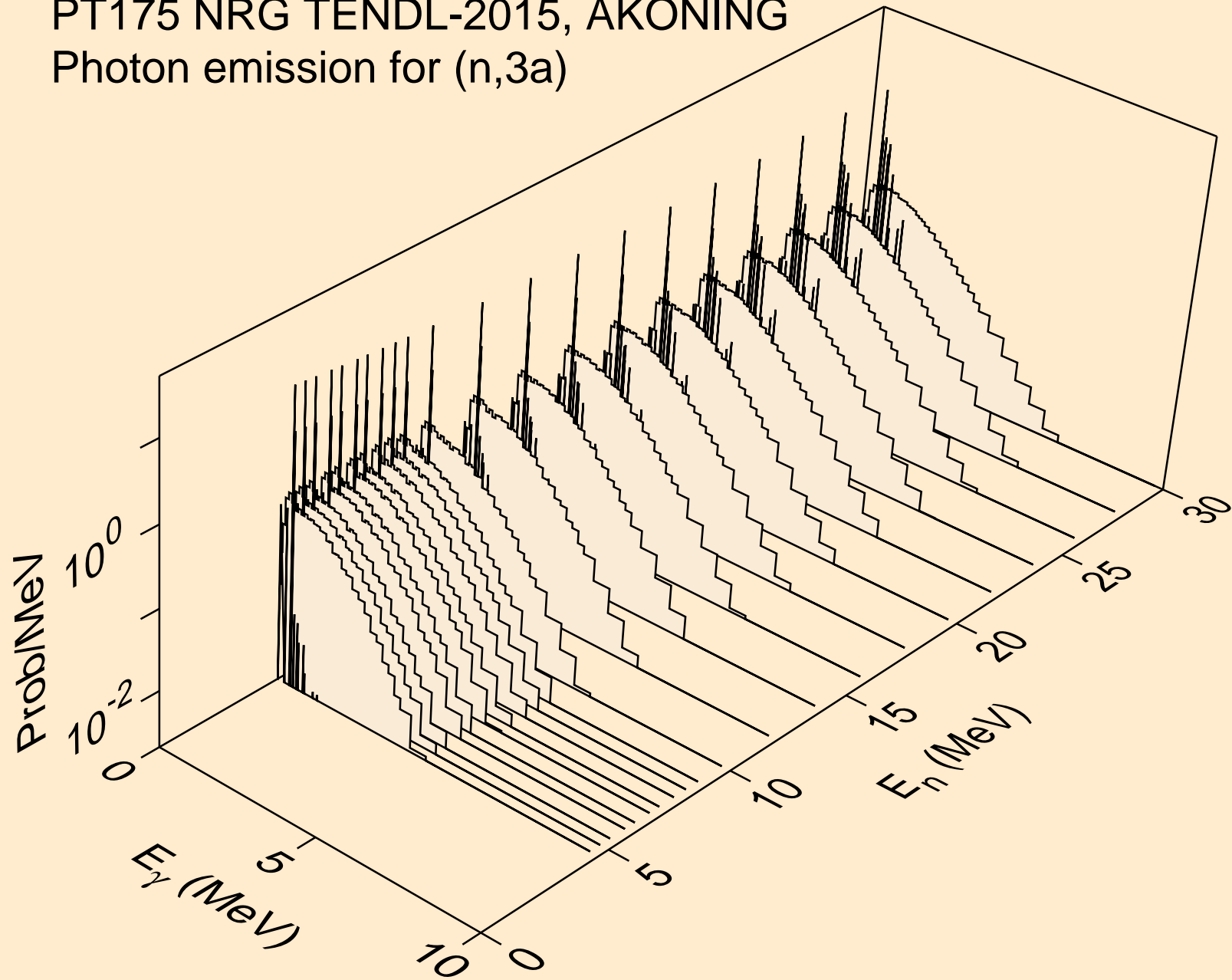

PT175 NRG TENDL-2015, AKONING  
Photon emission for (n,2p)

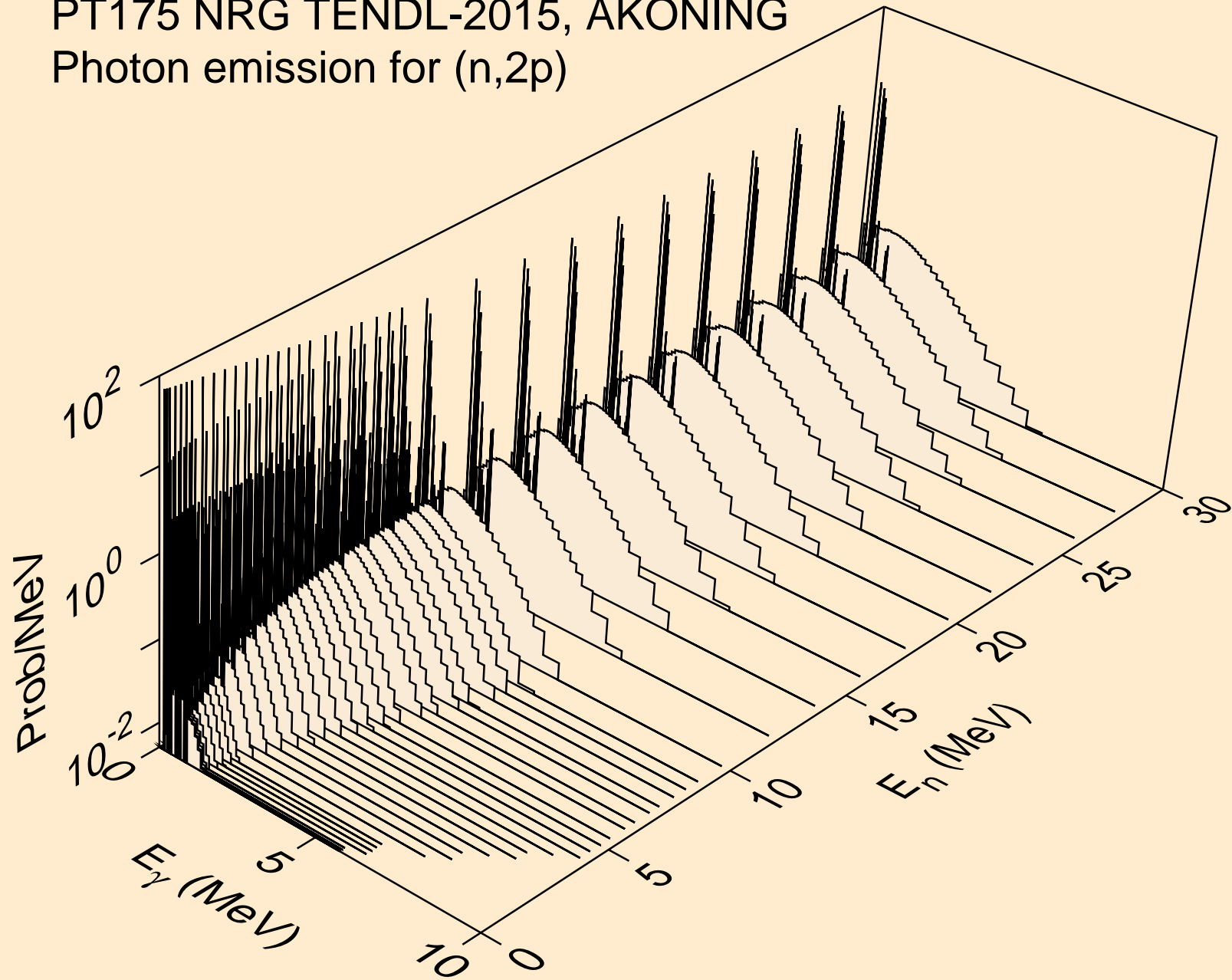

PT175 NRG TENDL-2015, AKONING  
Photon emission for (n,p $\alpha$ )

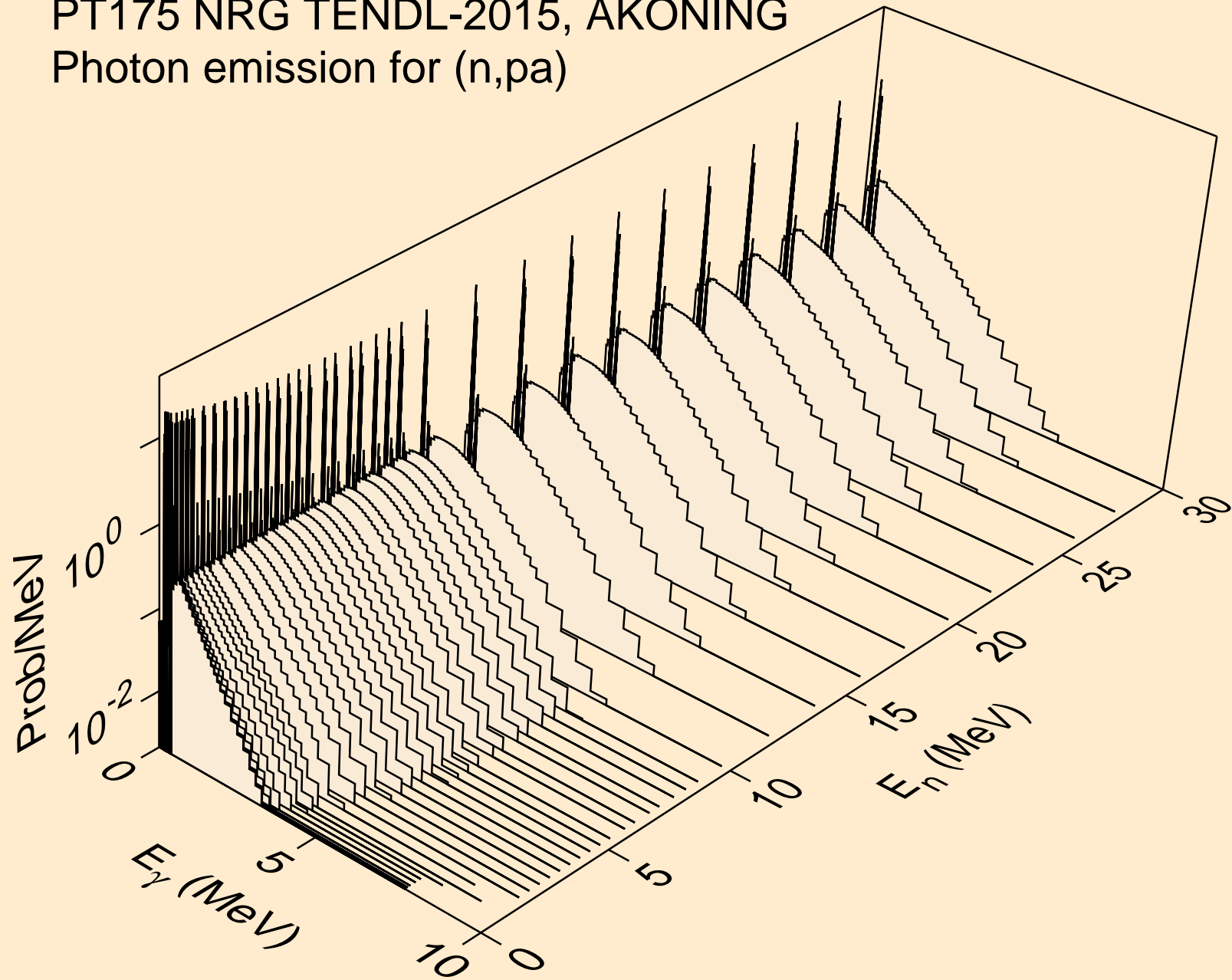

PT175 NRG TENDL-2015, AKONING  
Photon emission for (n,t2a)

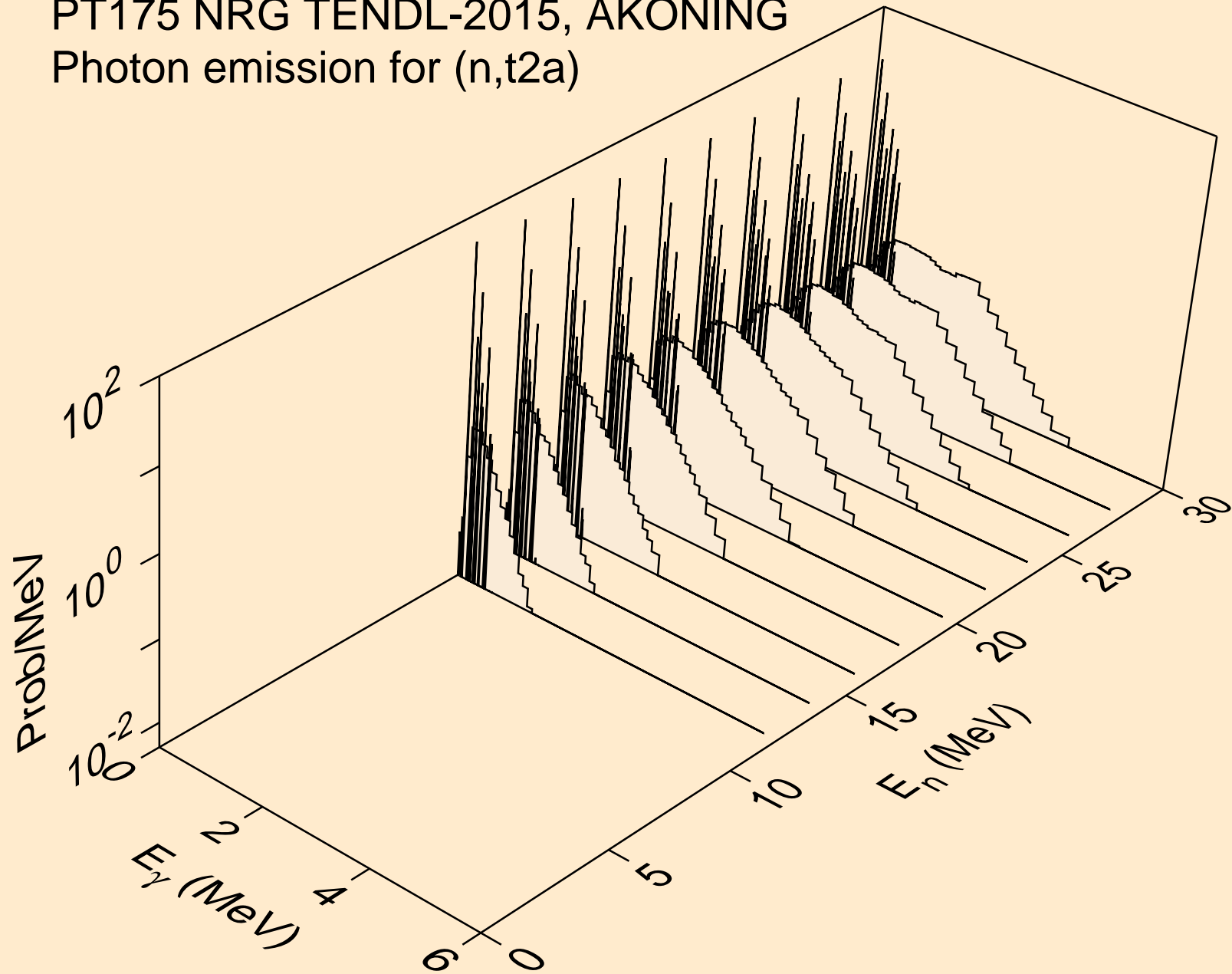

PT175 NRG TENDL-2015, AKONING  
Photon emission for (n,d2a)

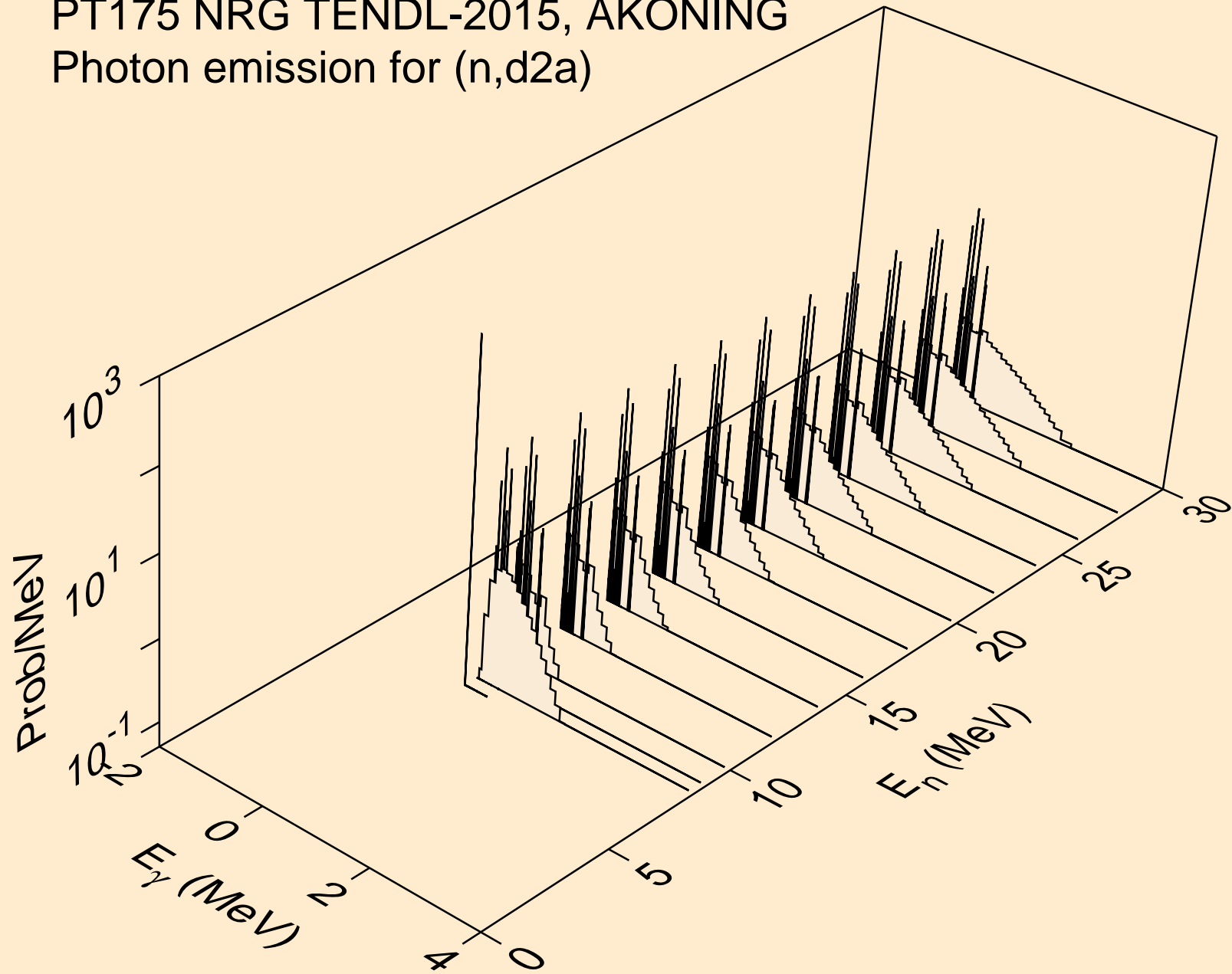



PT175 NRG TENDL-2015, AKONING  
Photon emission for (n,pd)

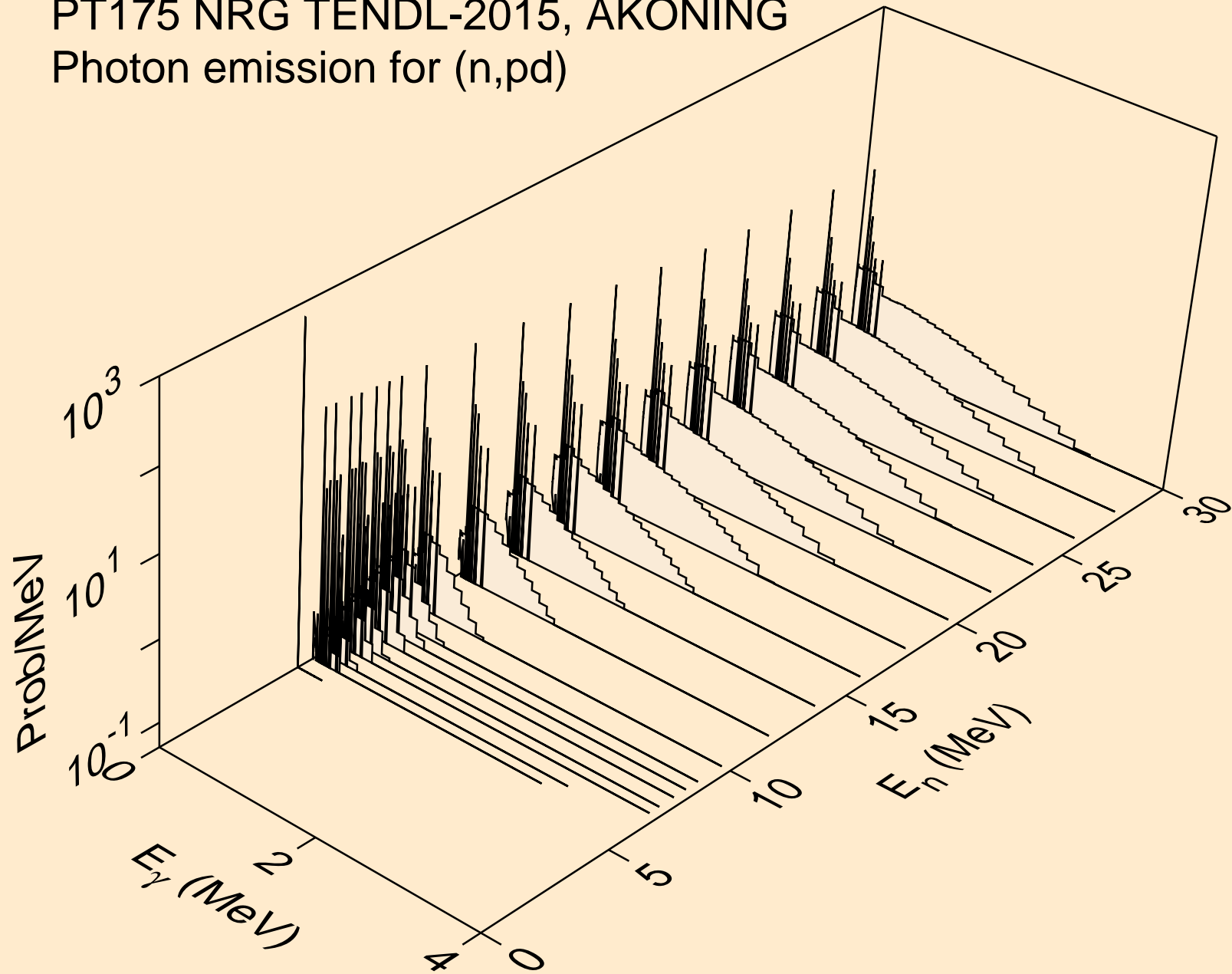

PT175 NRG TENDL-2015, AKONING  
Photon emission for (n,pt)

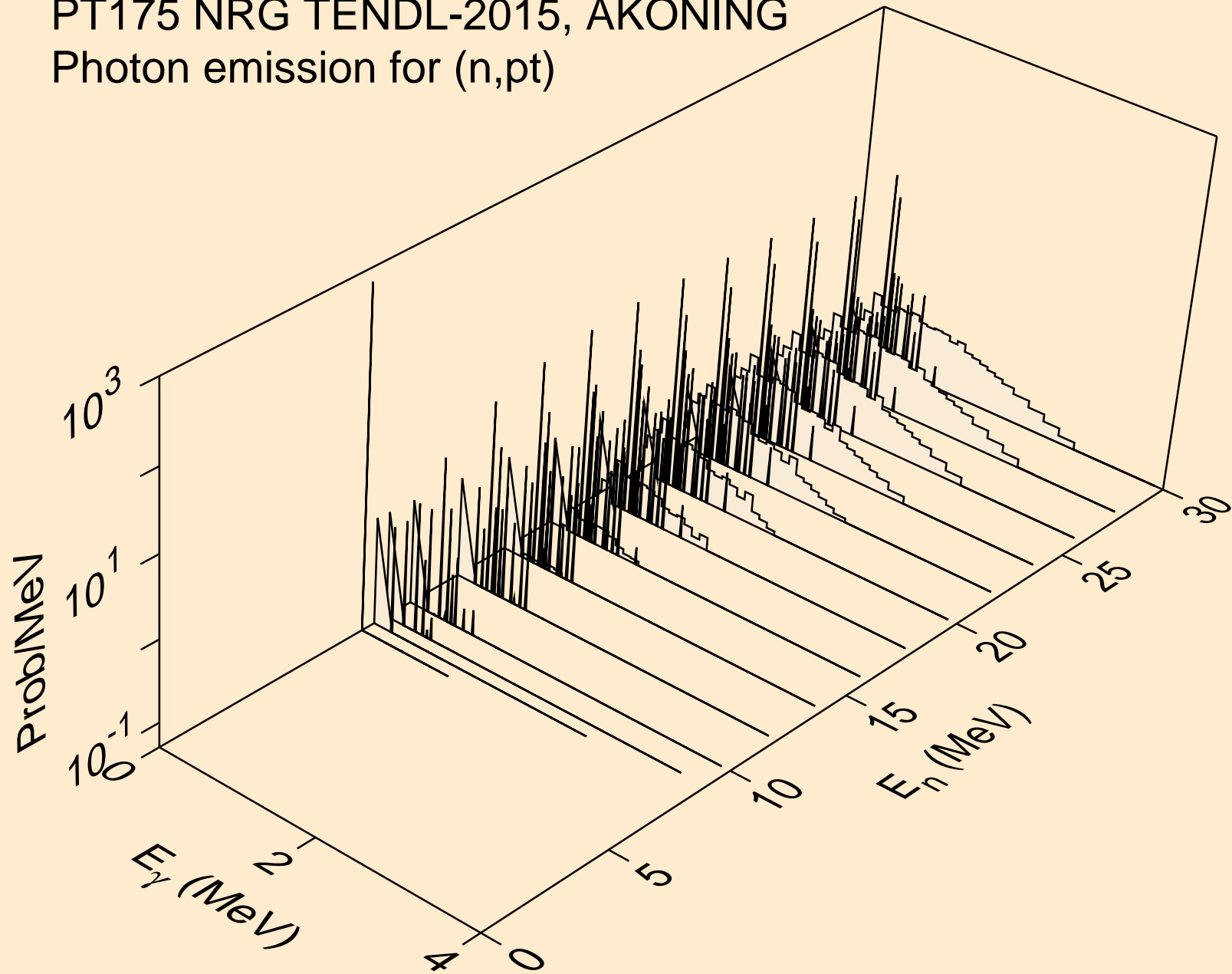

PT175 NRG TENDL-2015, AKONING  
Photon emission for (n,da)

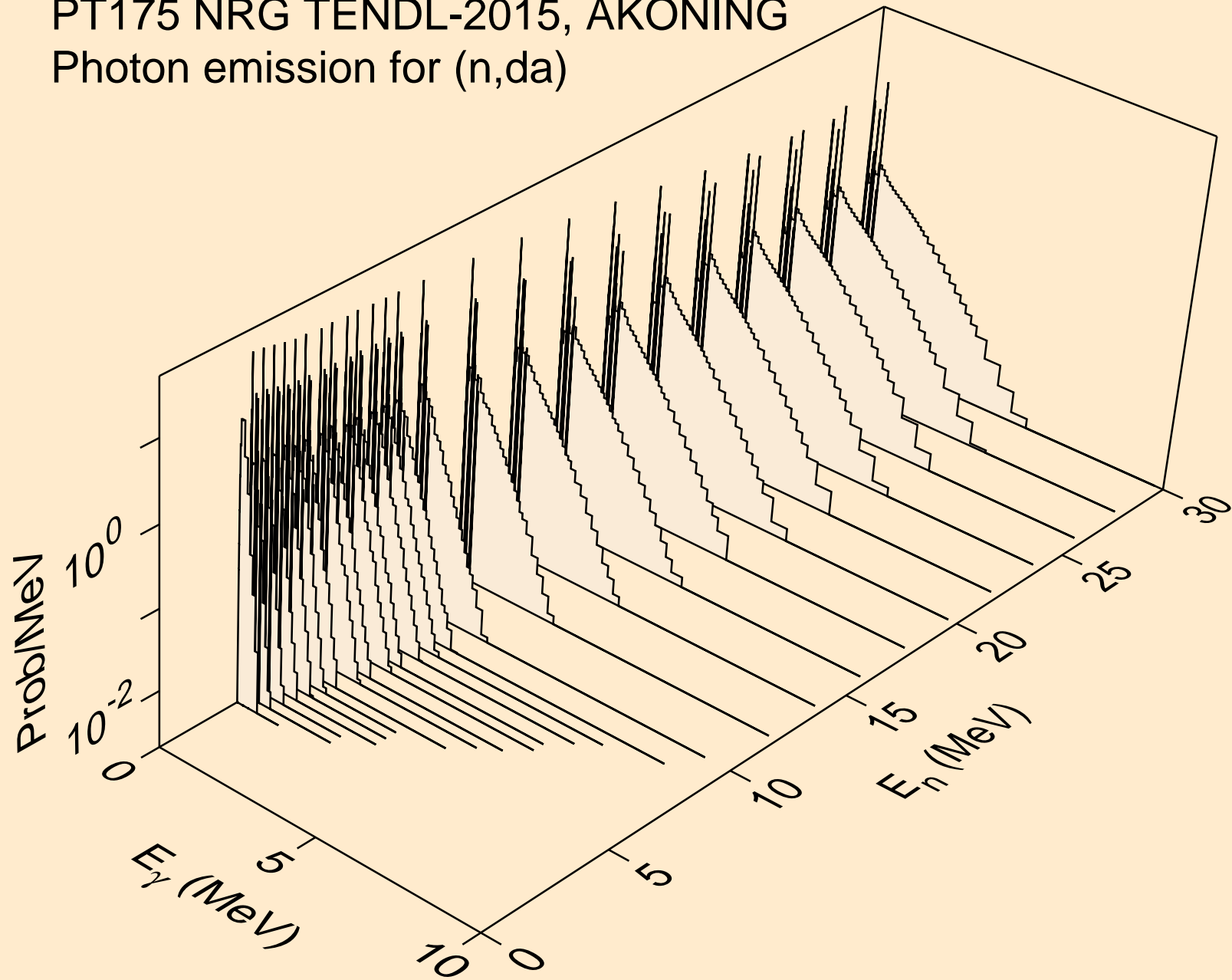

PT175 NRG TENDL-2015, AKONING  
thermal capture photon spectrum

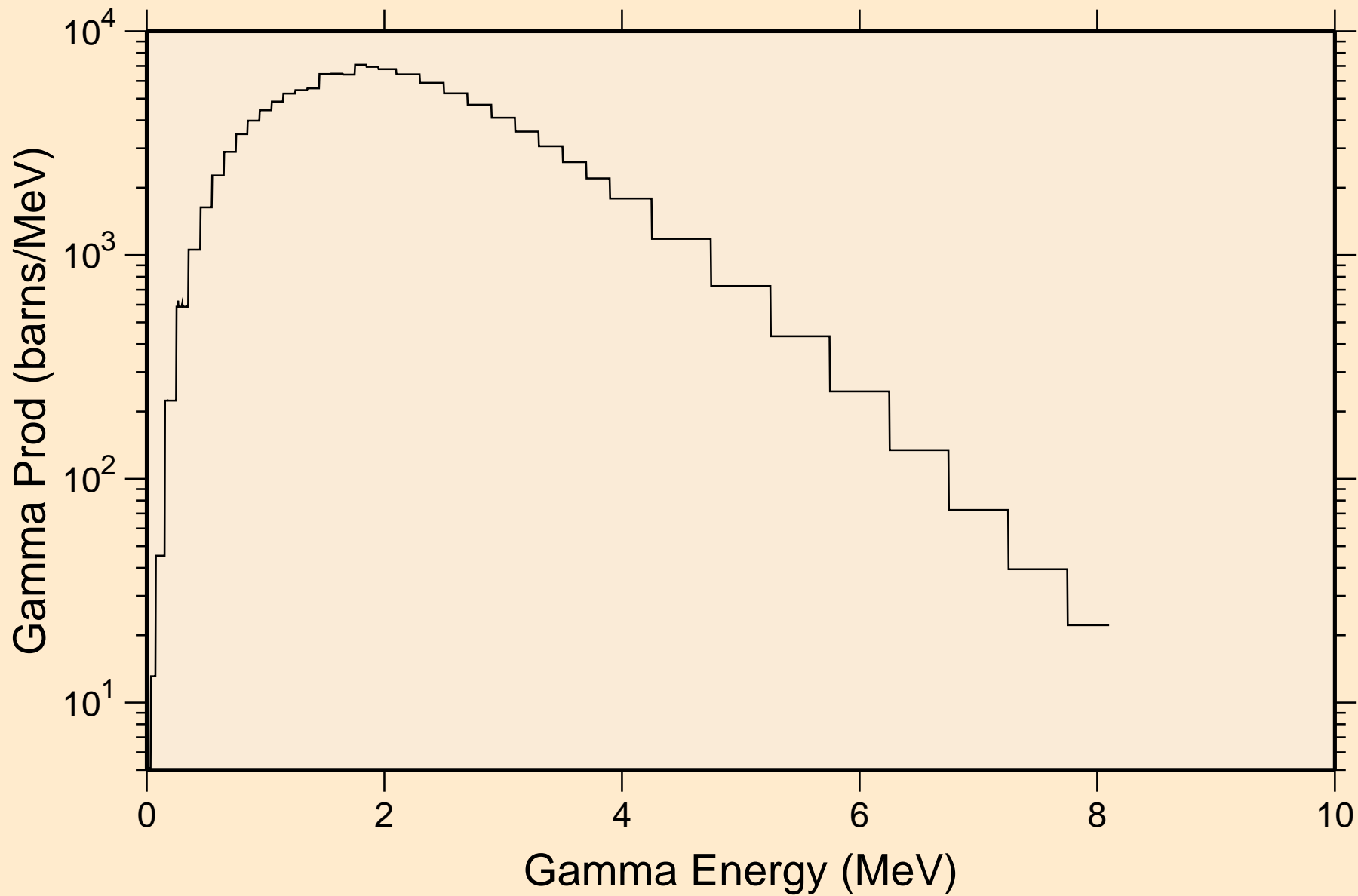

PT175 NRG TENDL-2015, AKONING  
14 MeV photon spectrum

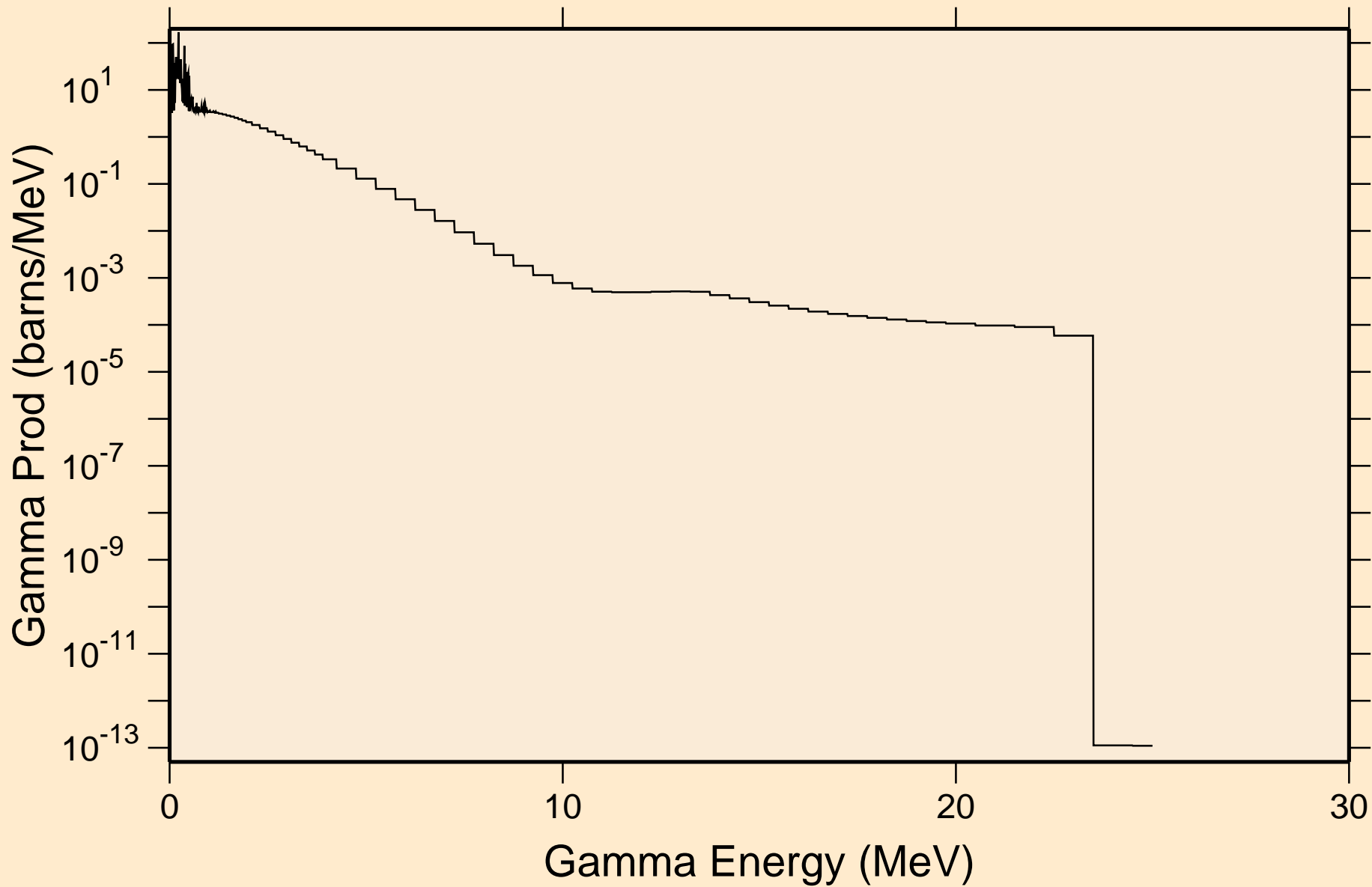

# PT175 NRG TENDL-2015, AKONING

## Particle heating contributions

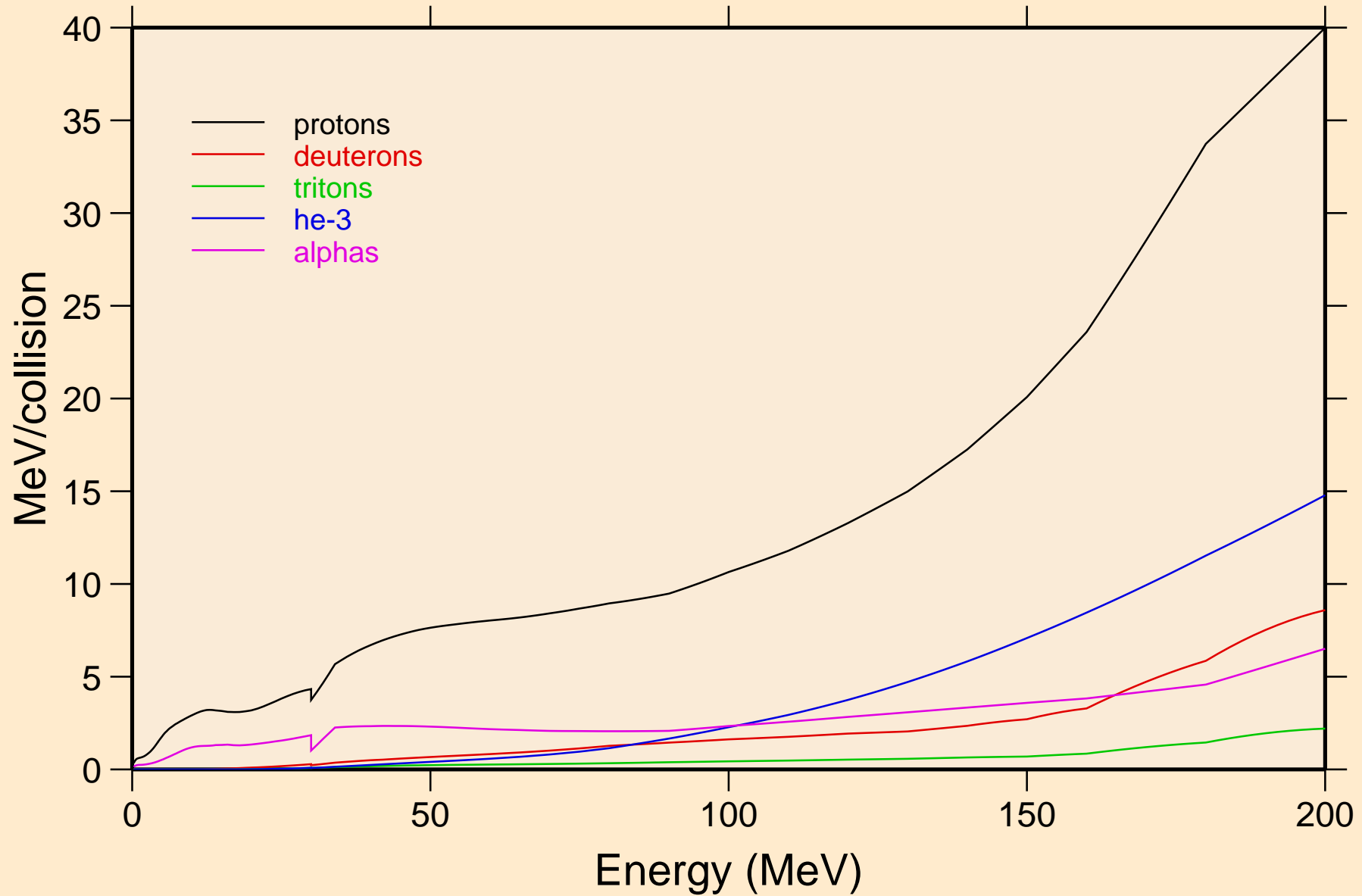

# PT175 NRG TENDL-2015, AKONING

## Recoil Heating

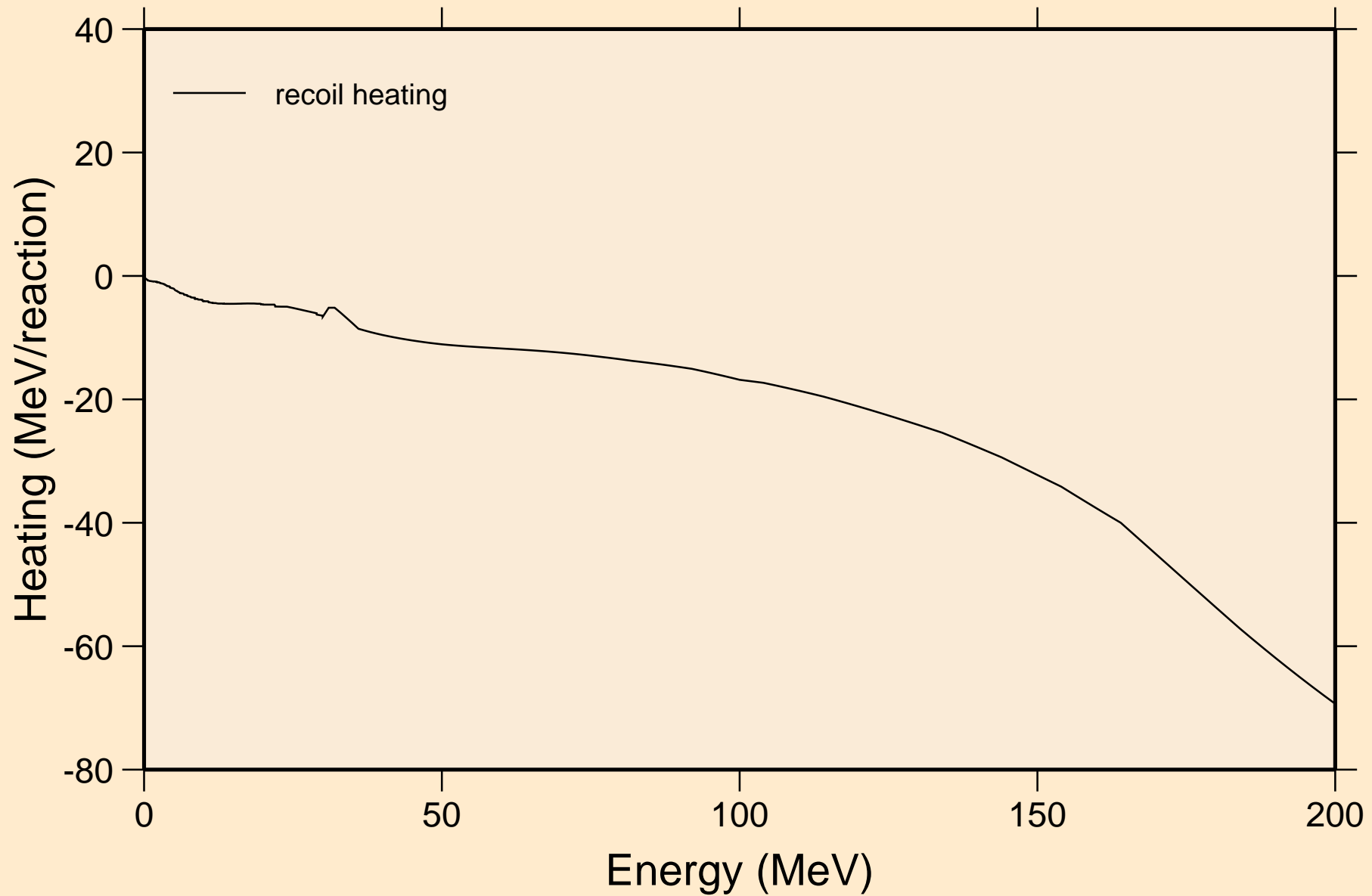

# PT175 NRG TENDL-2015, AKONING

## Particle production cross sections

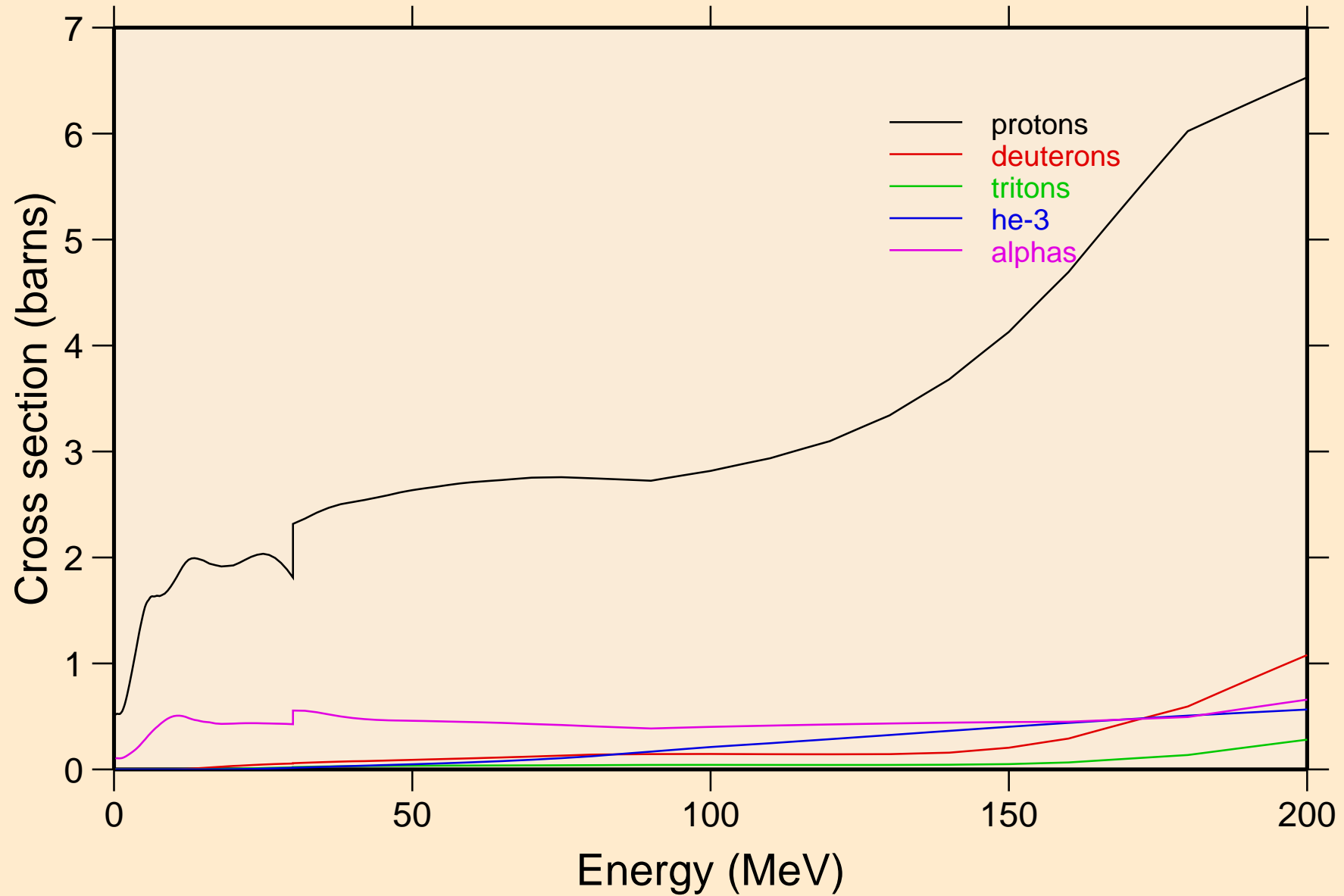



PT175 NRG TENDL-2015, AKONING  
protons from (n,x)

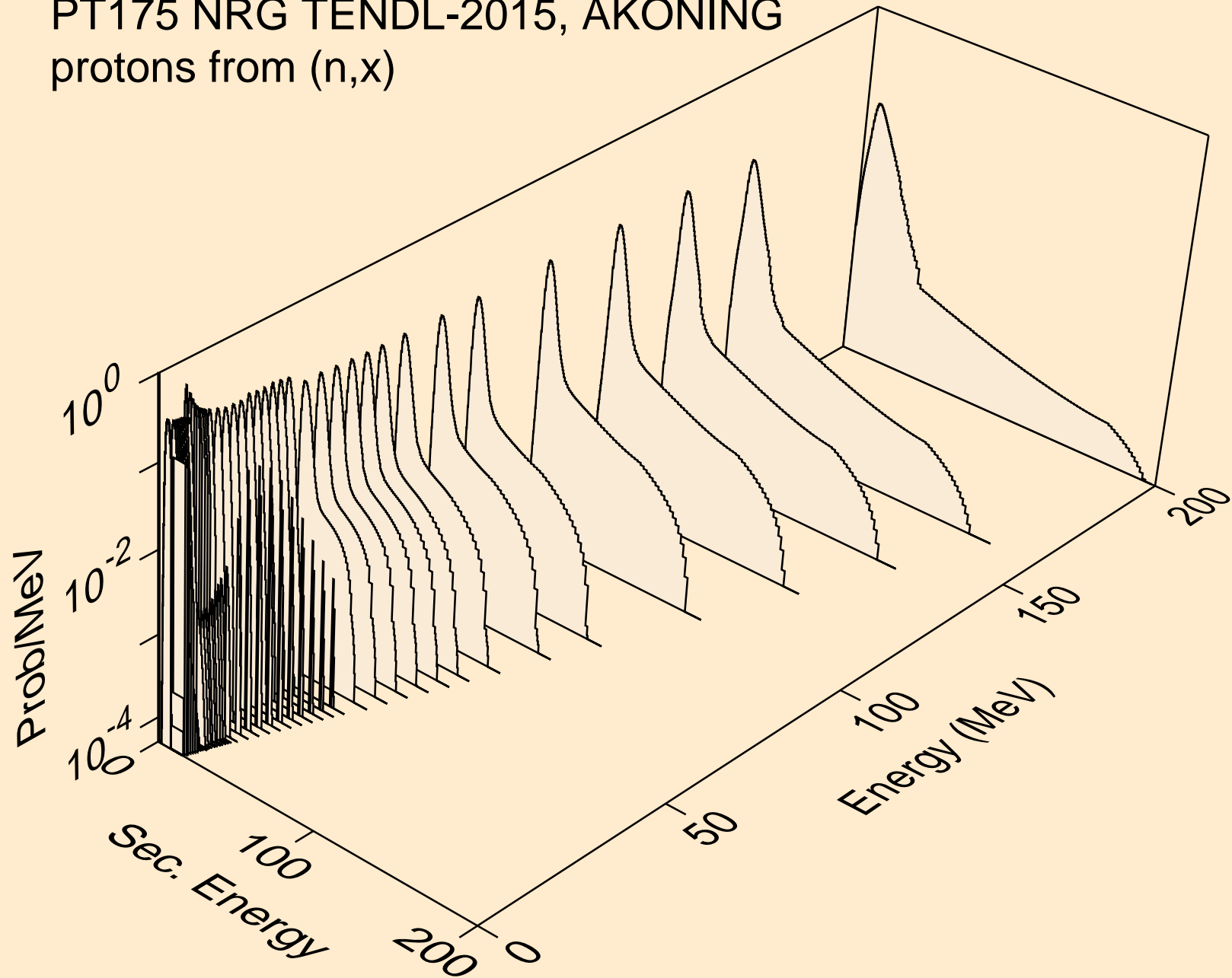

PT175 NRG TENDL-2015, AKONING  
protons from (n,n\*)p

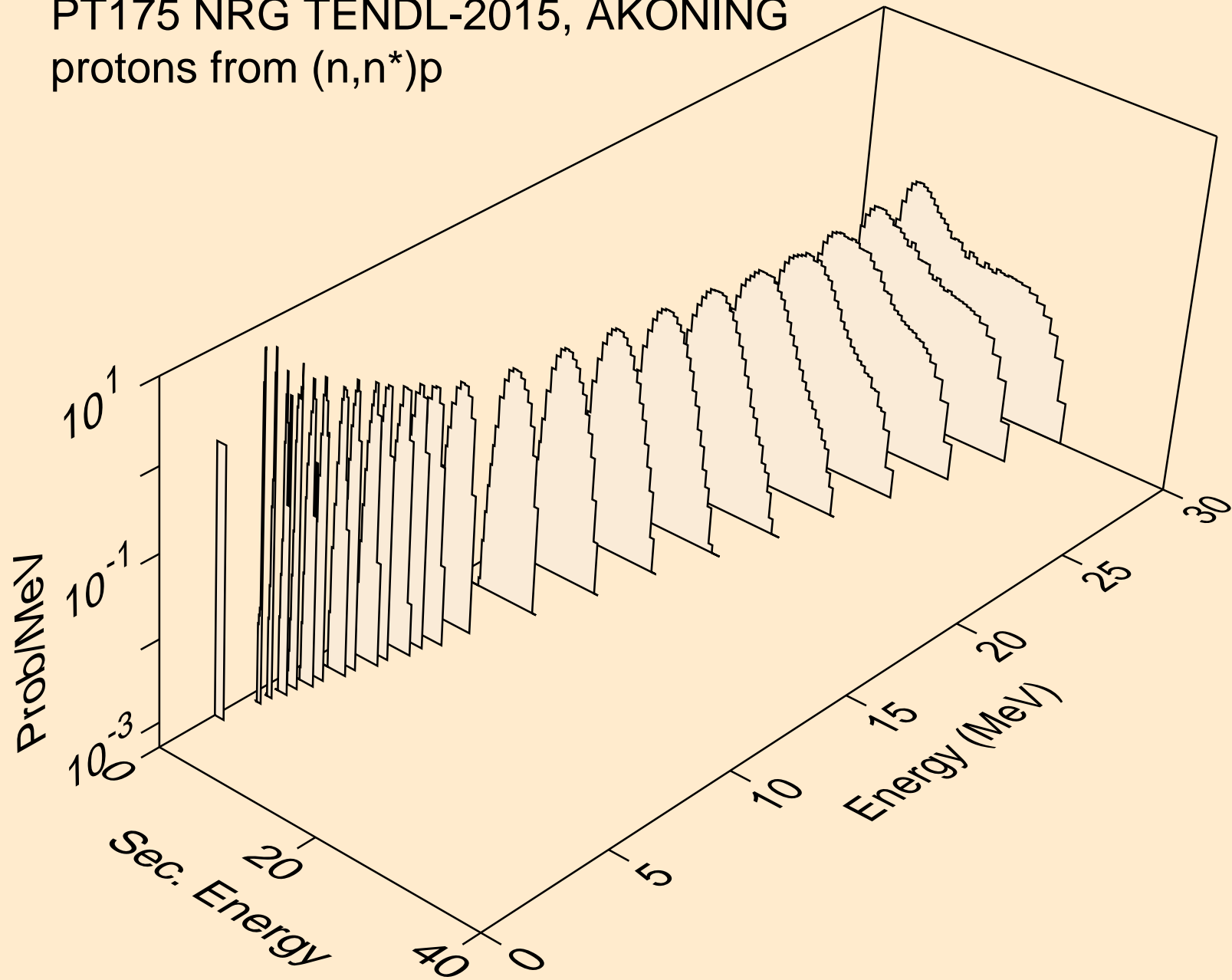

PT175 NRG TENDL-2015, AKONING  
protons from (n,2np)

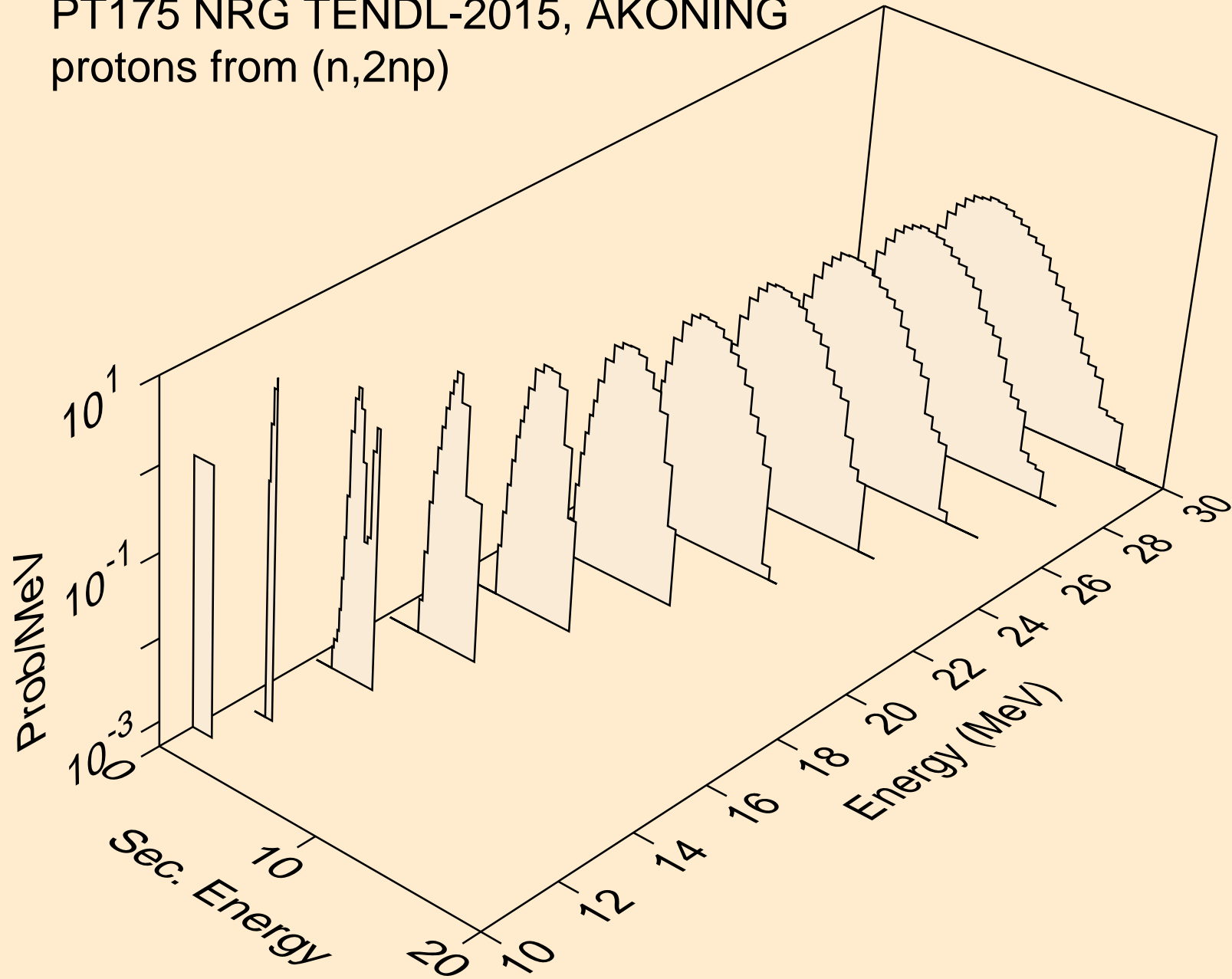

PT175 NRG TENDL-2015, AKONING  
protons from (n,3np)

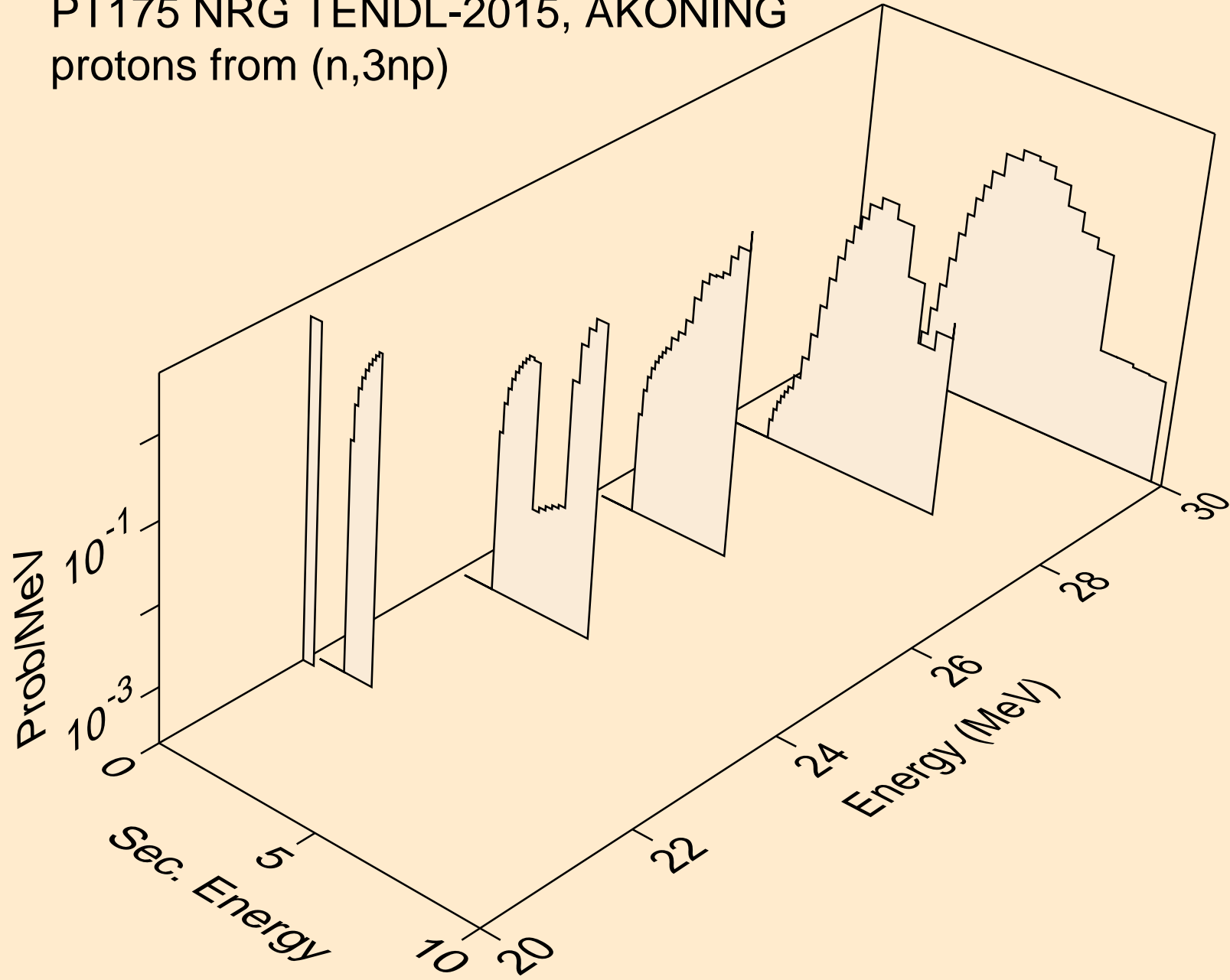

PT175 NRG TENDL-2015, AKONING  
protons from (n,2np)

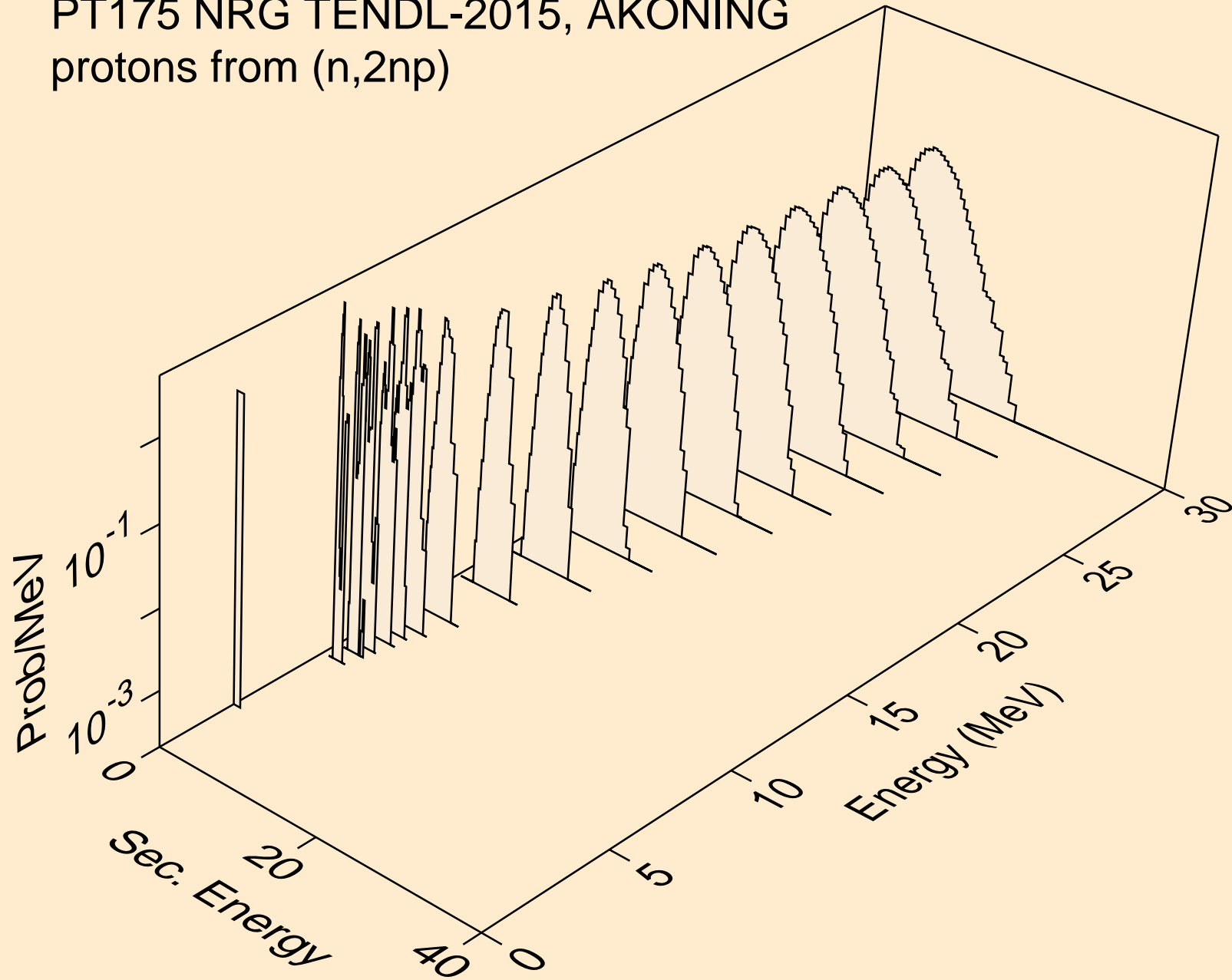

PT175 NRG TENDL-2015, AKONING  
protons from (n,npa)

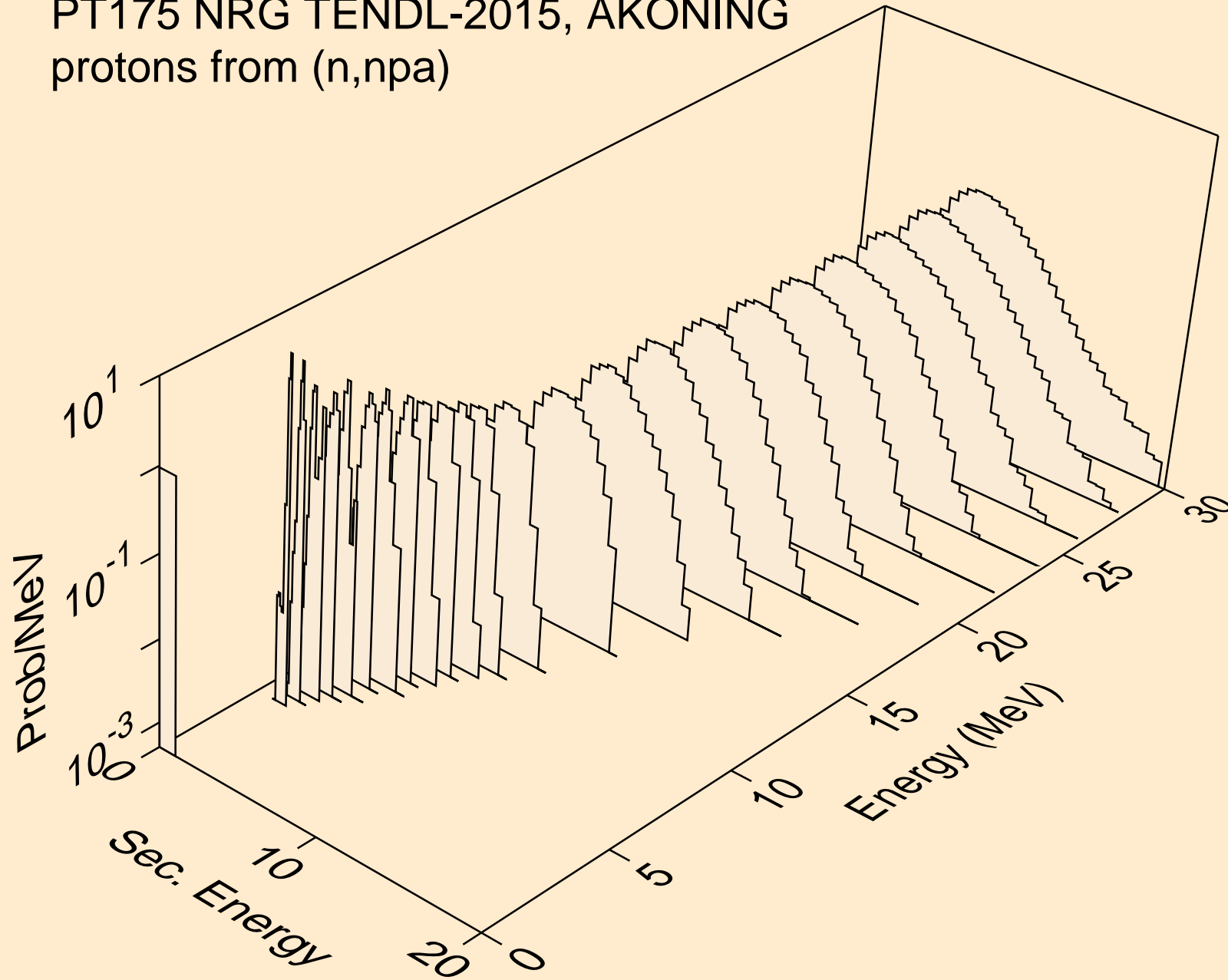

PT175 NRG TENDL-2015, AKONING  
protons from (n,p)

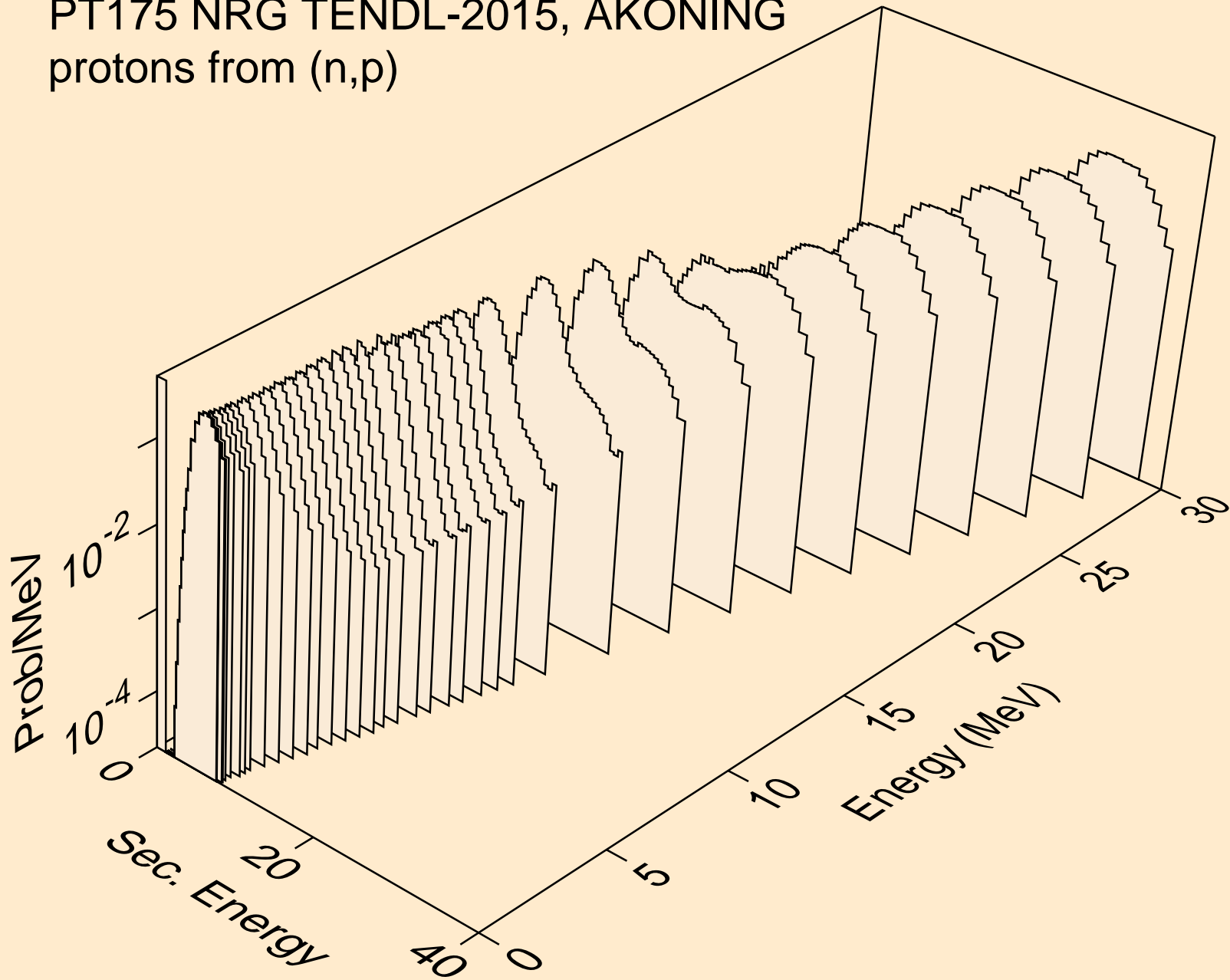

PT175 NRG TENDL-2015, AKONING  
protons from (n,2p)

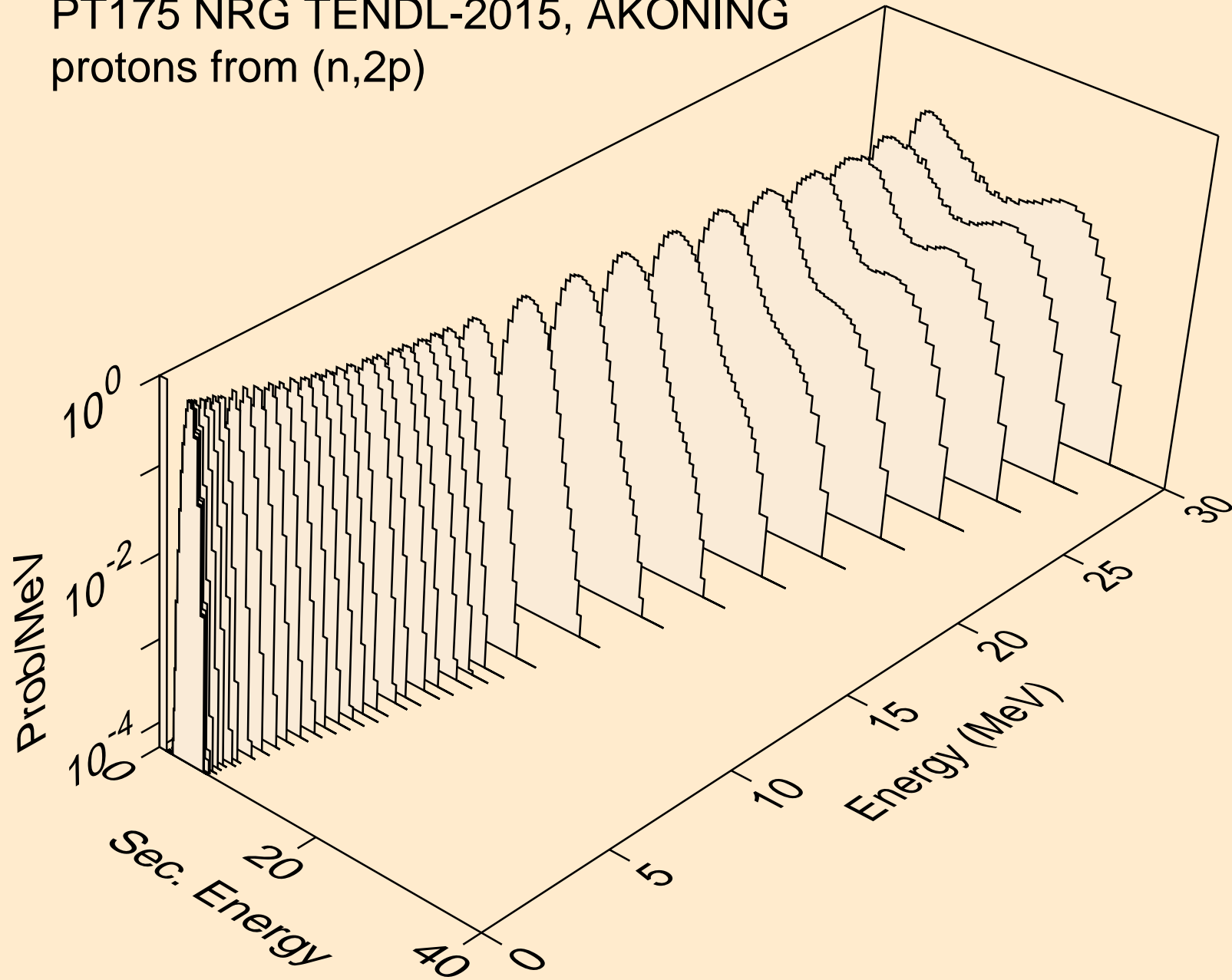



PT175 NRG TENDL-2015, AKONING  
protons from (n,pa)

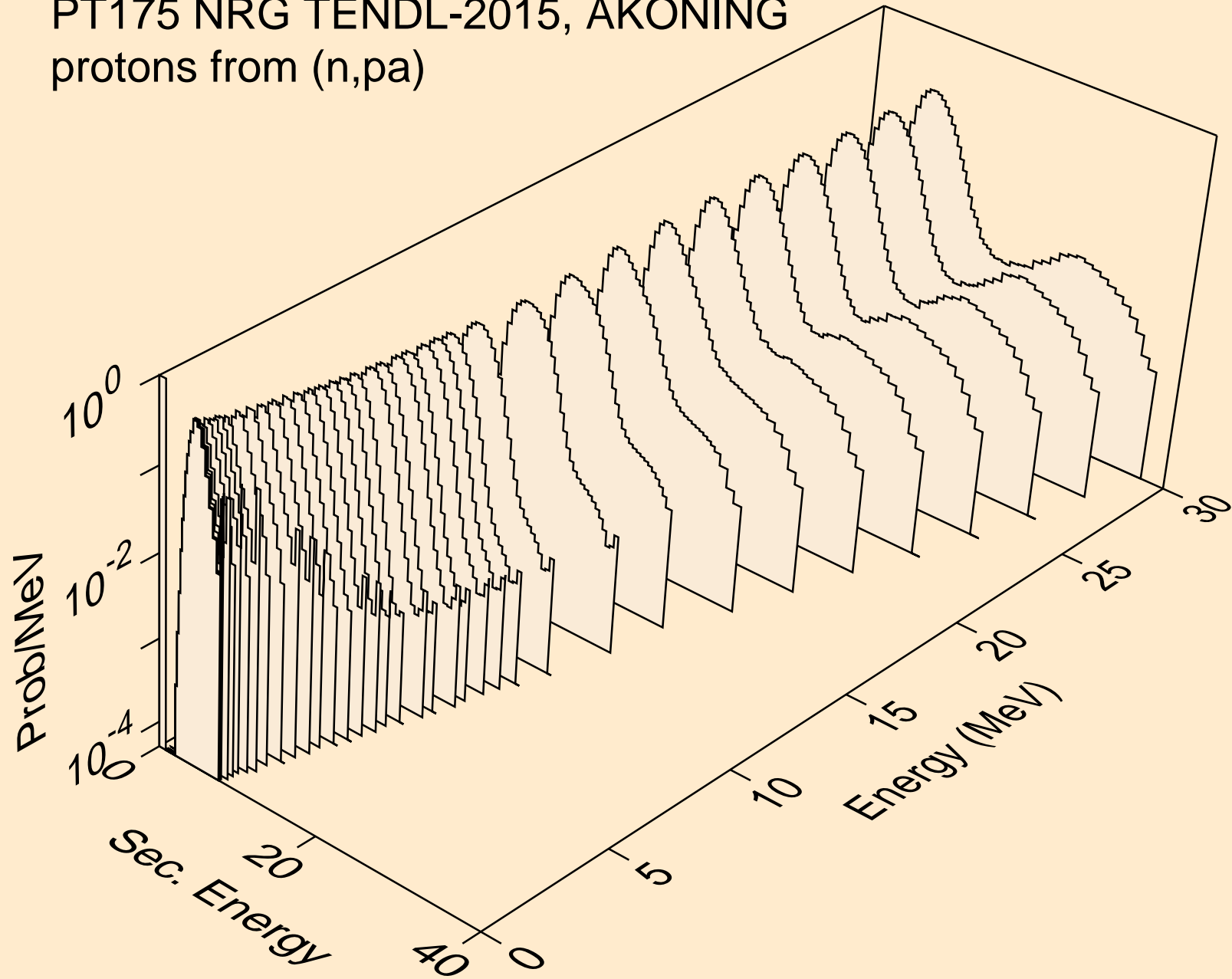

PT175 NRG TENDL-2015, AKONING  
protons from (n,pd)

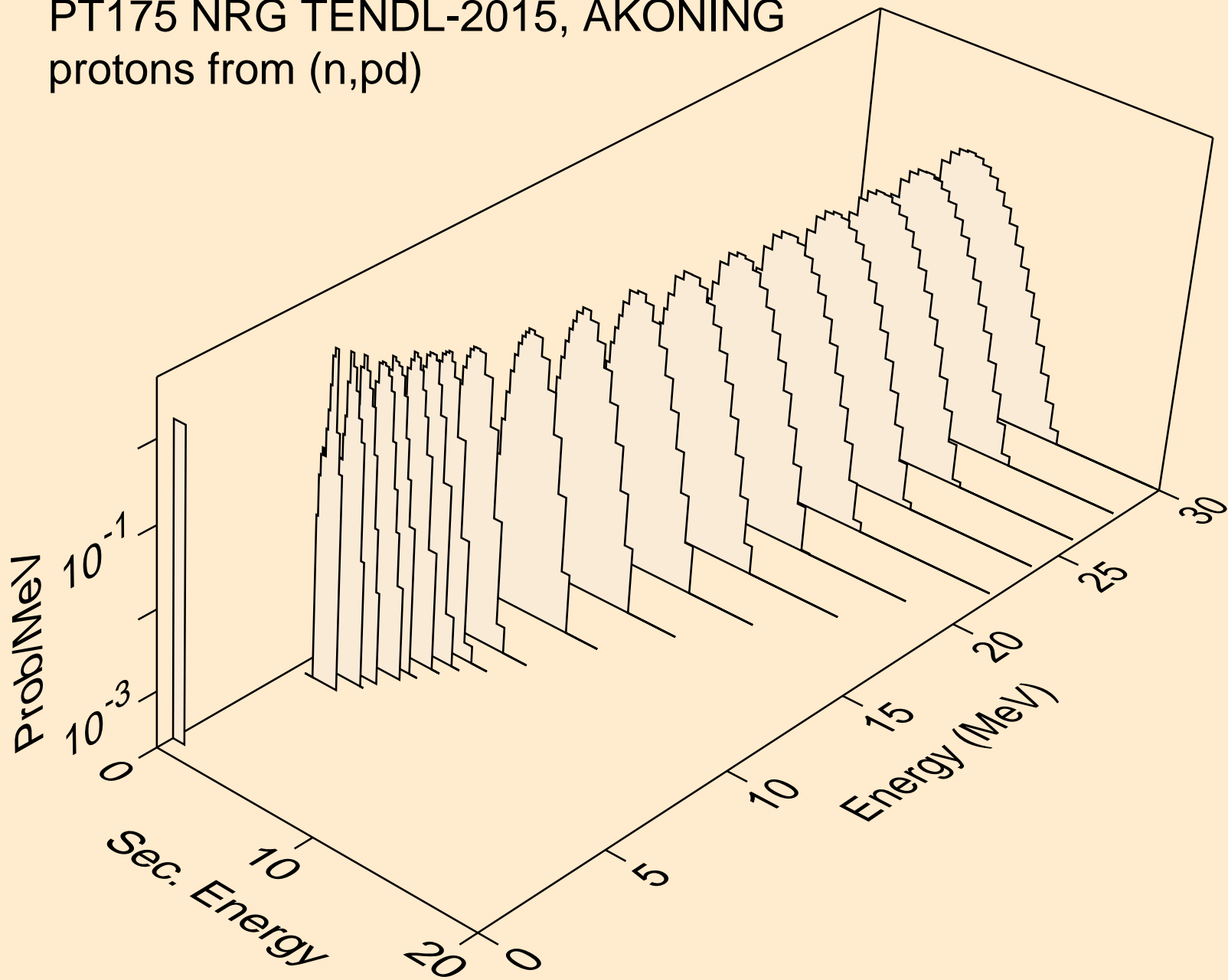

PT175 NRG TENDL-2015, AKONING  
protons from (n,pt)

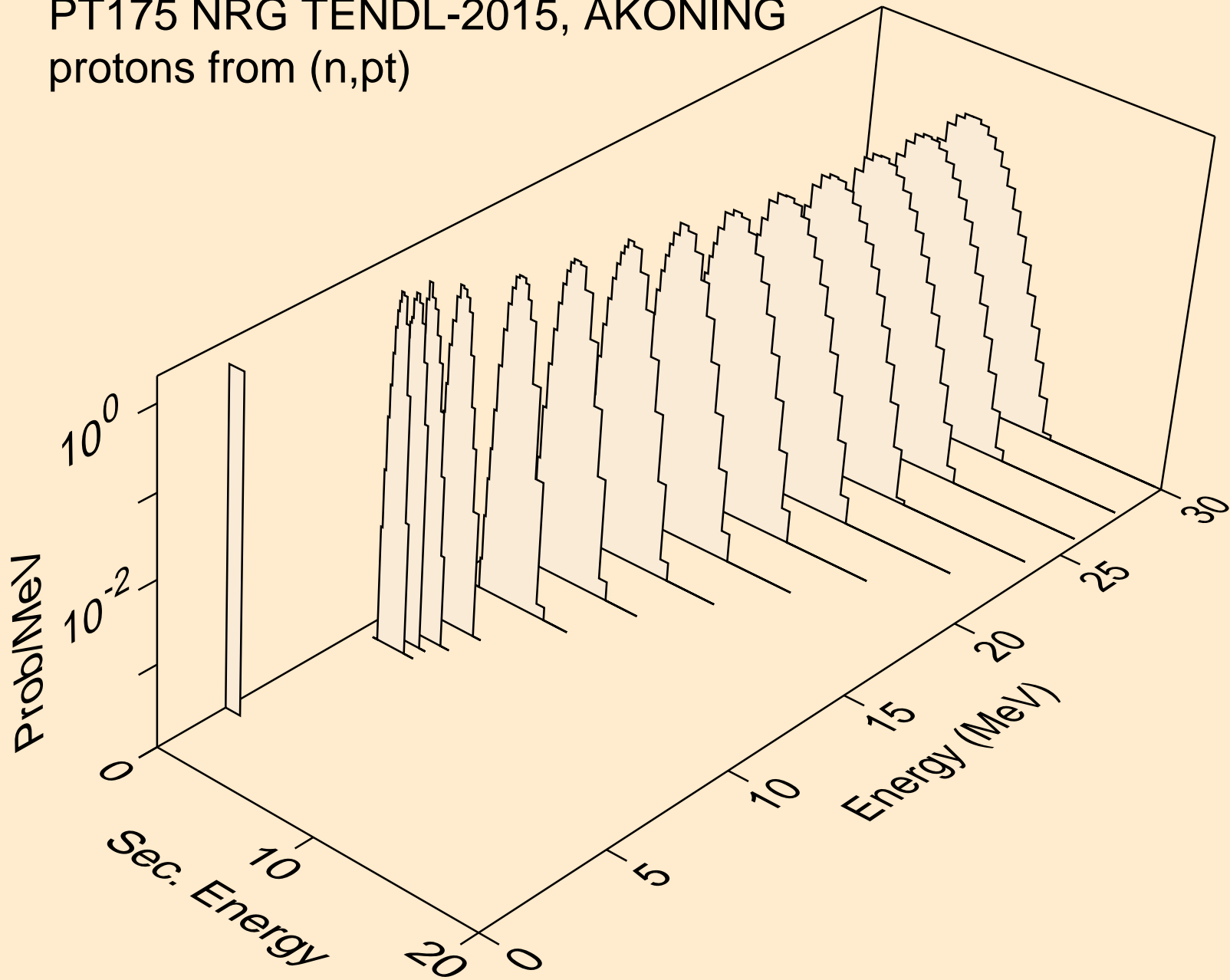

PT175 NRG TENDL-2015, AKONING  
deuterons from (n,x)

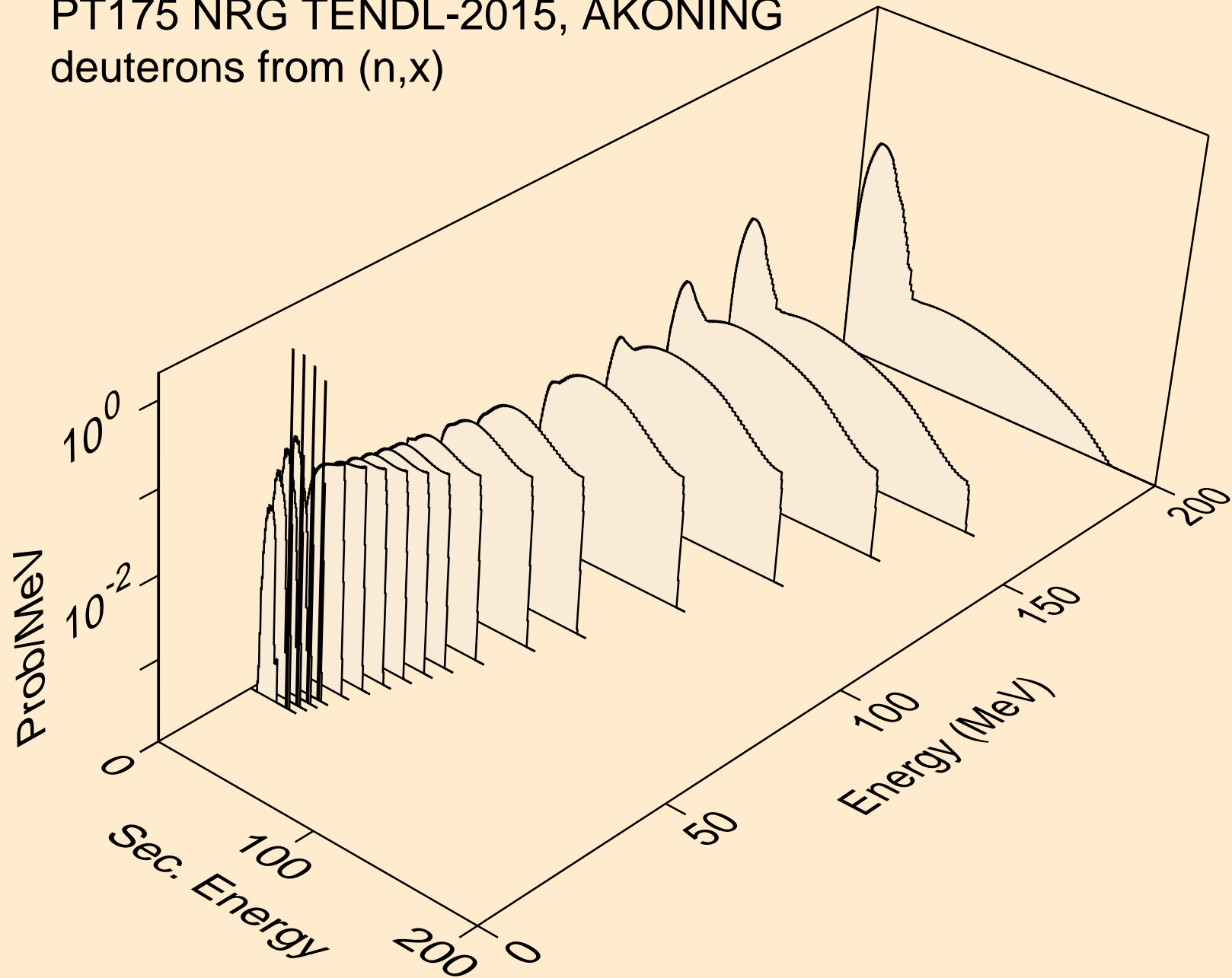

PT175 NRG TENDL-2015, AKONING  
deuterons from (n,2nd)

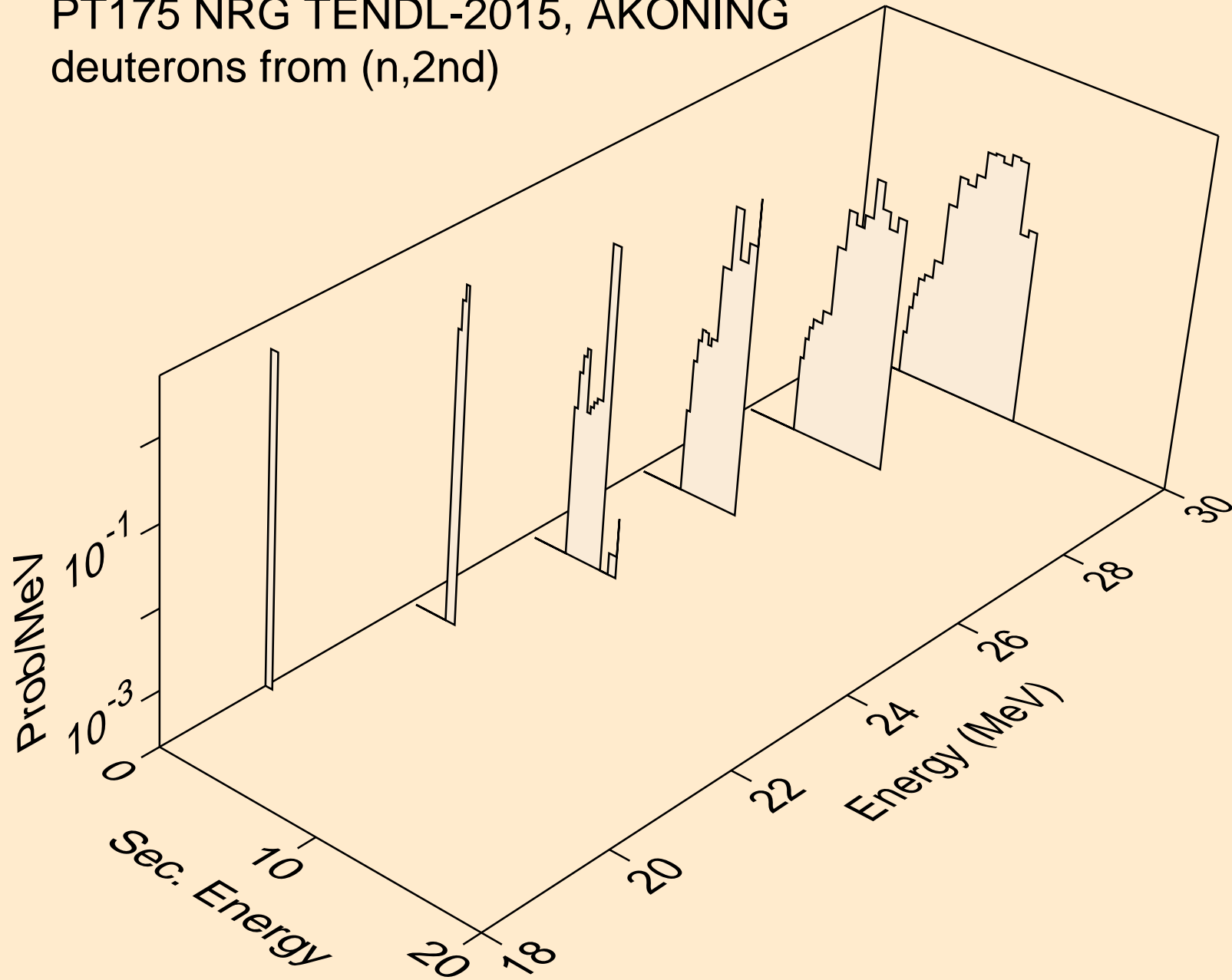

PT175 NRG TENDL-2015, AKONING  
deuterons from (n,n\*)d

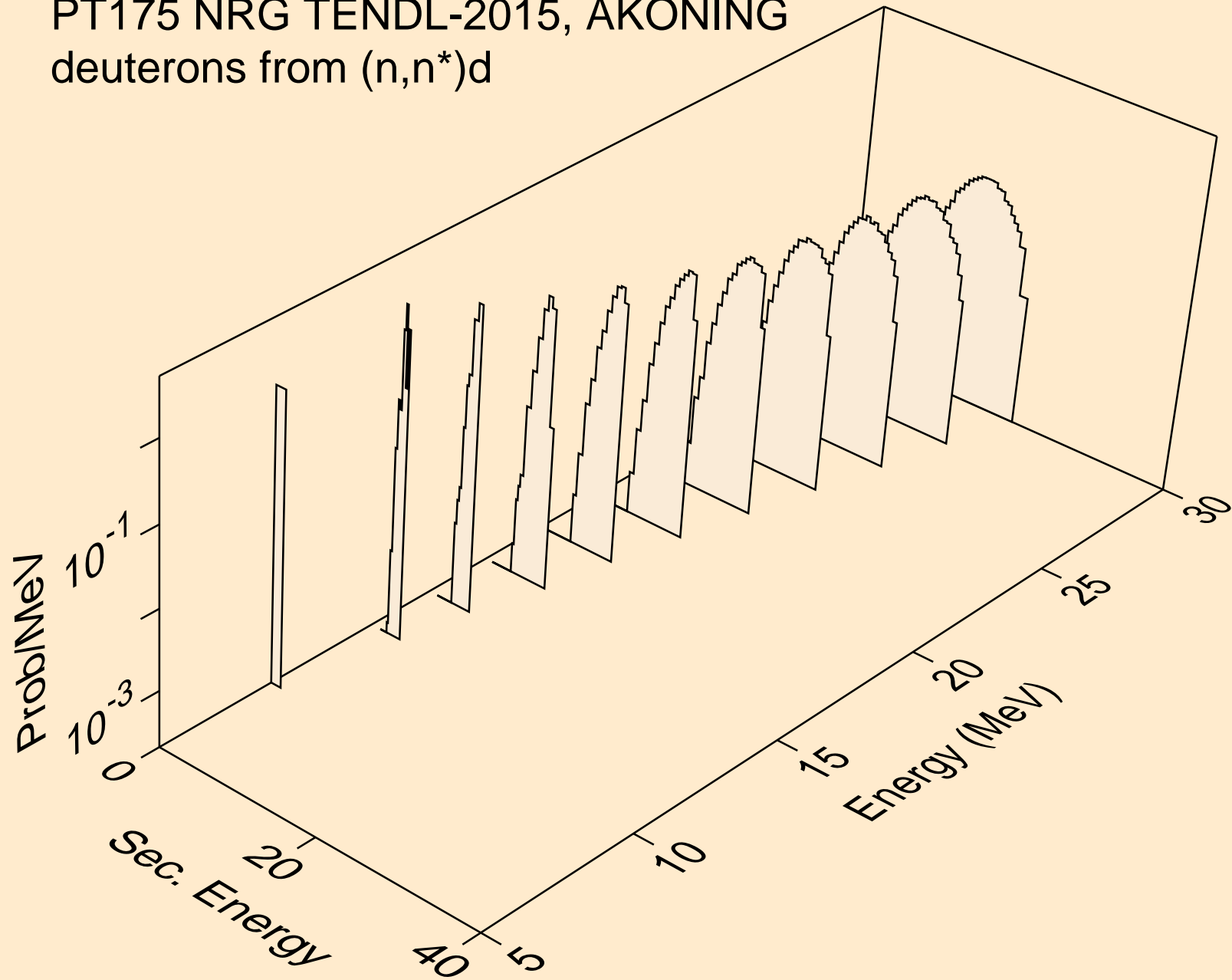

PT175 NRG TENDL-2015, AKONING  
deuterons from (n,n\*)d2a

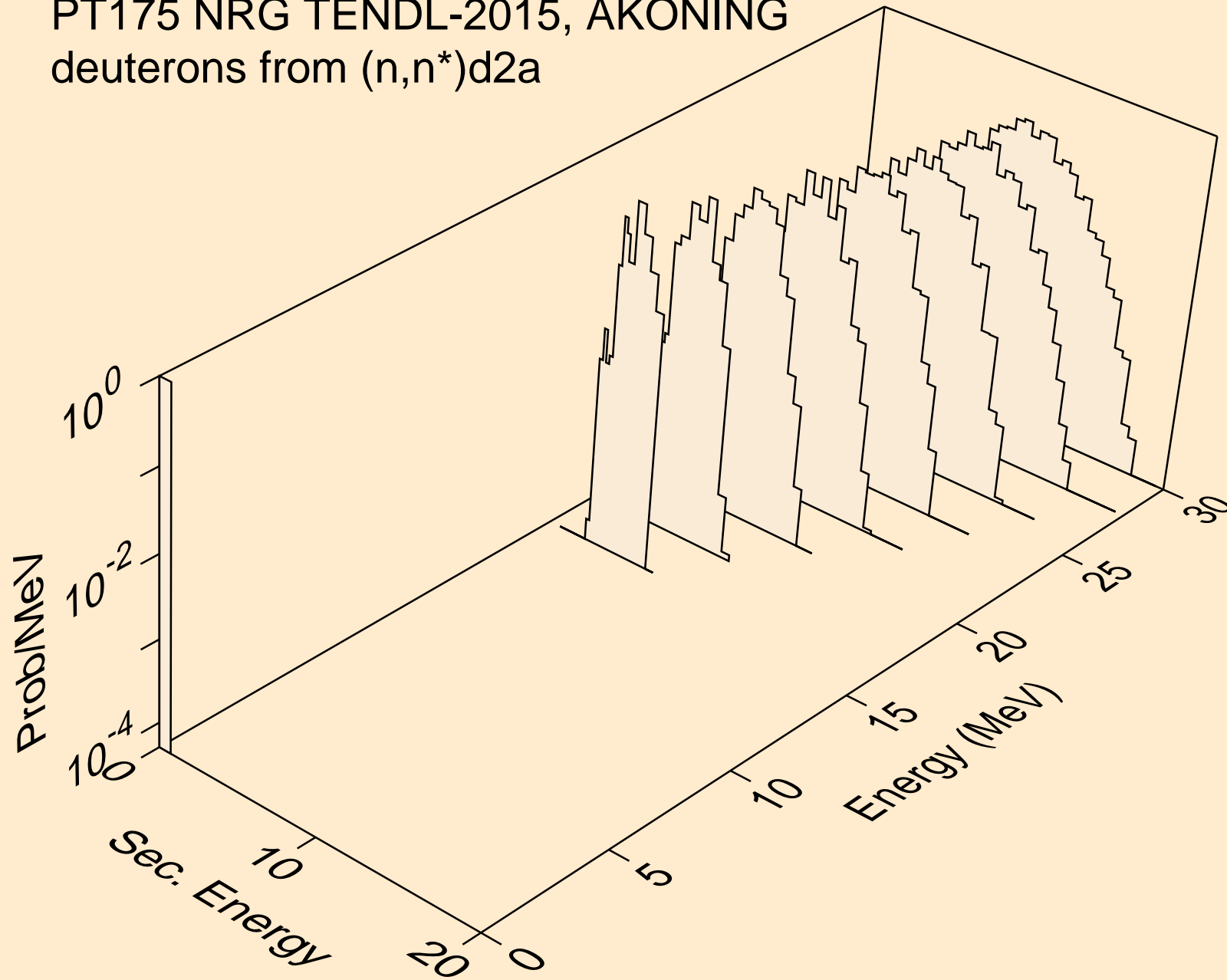

PT175 NRG TENDL-2015, AKONING  
deuterons from (n,d)

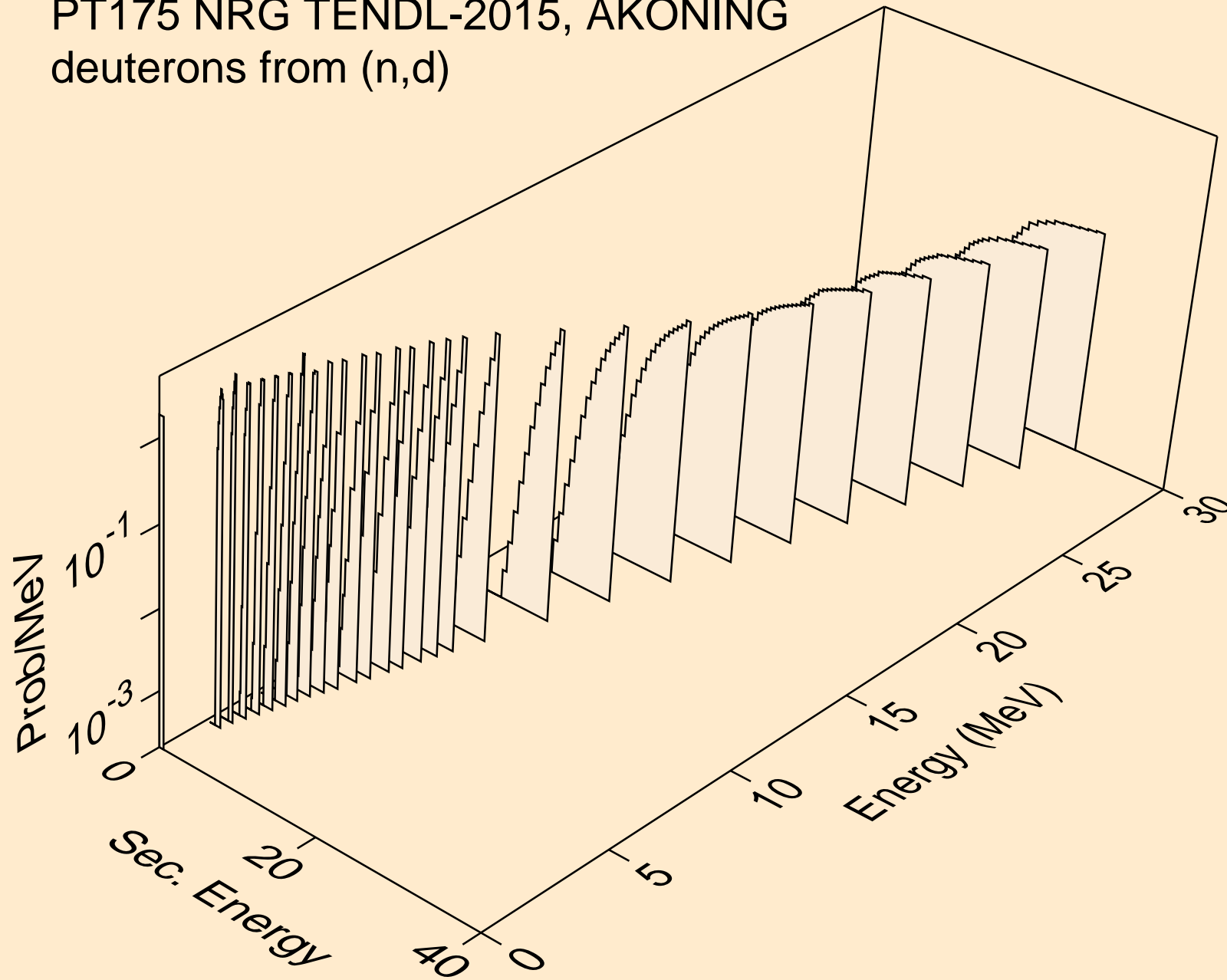



PT175 NRG TENDL-2015, AKONING  
deuterons from (n,d2a)

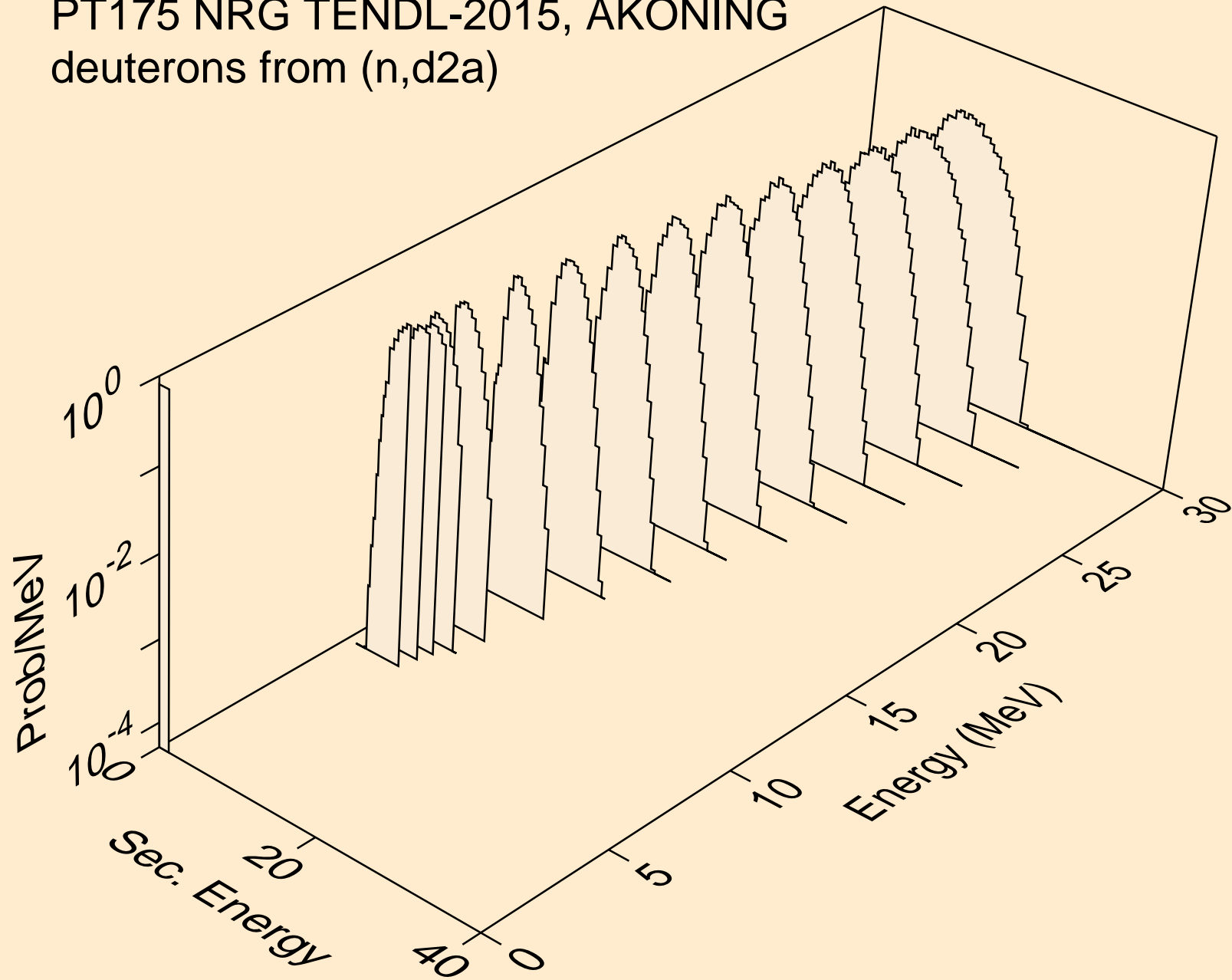

PT175 NRG TENDL-2015, AKONING  
deuterons from (n,pd)

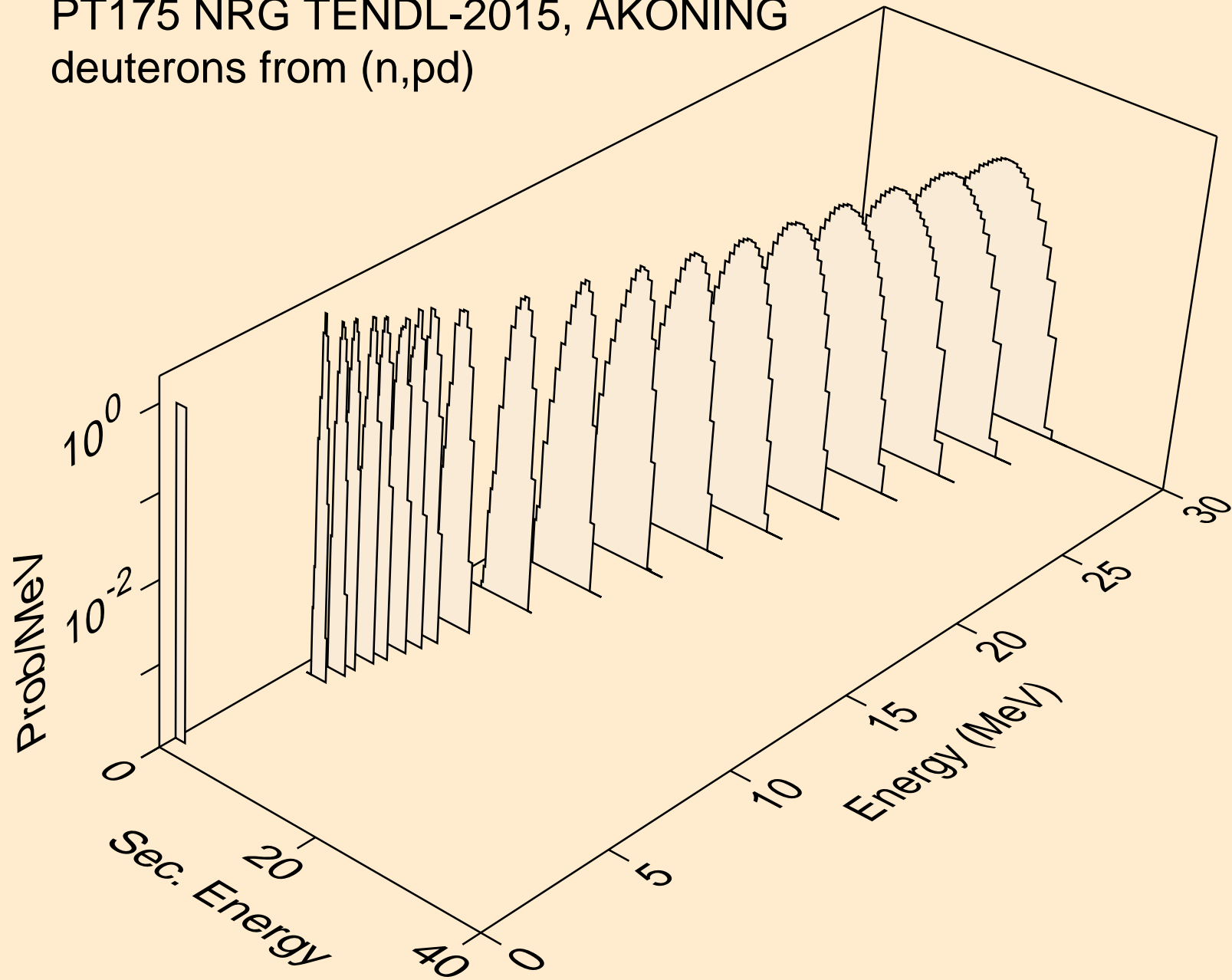

PT175 NRG TENDL-2015, AKONING  
deuterons from (n,da)

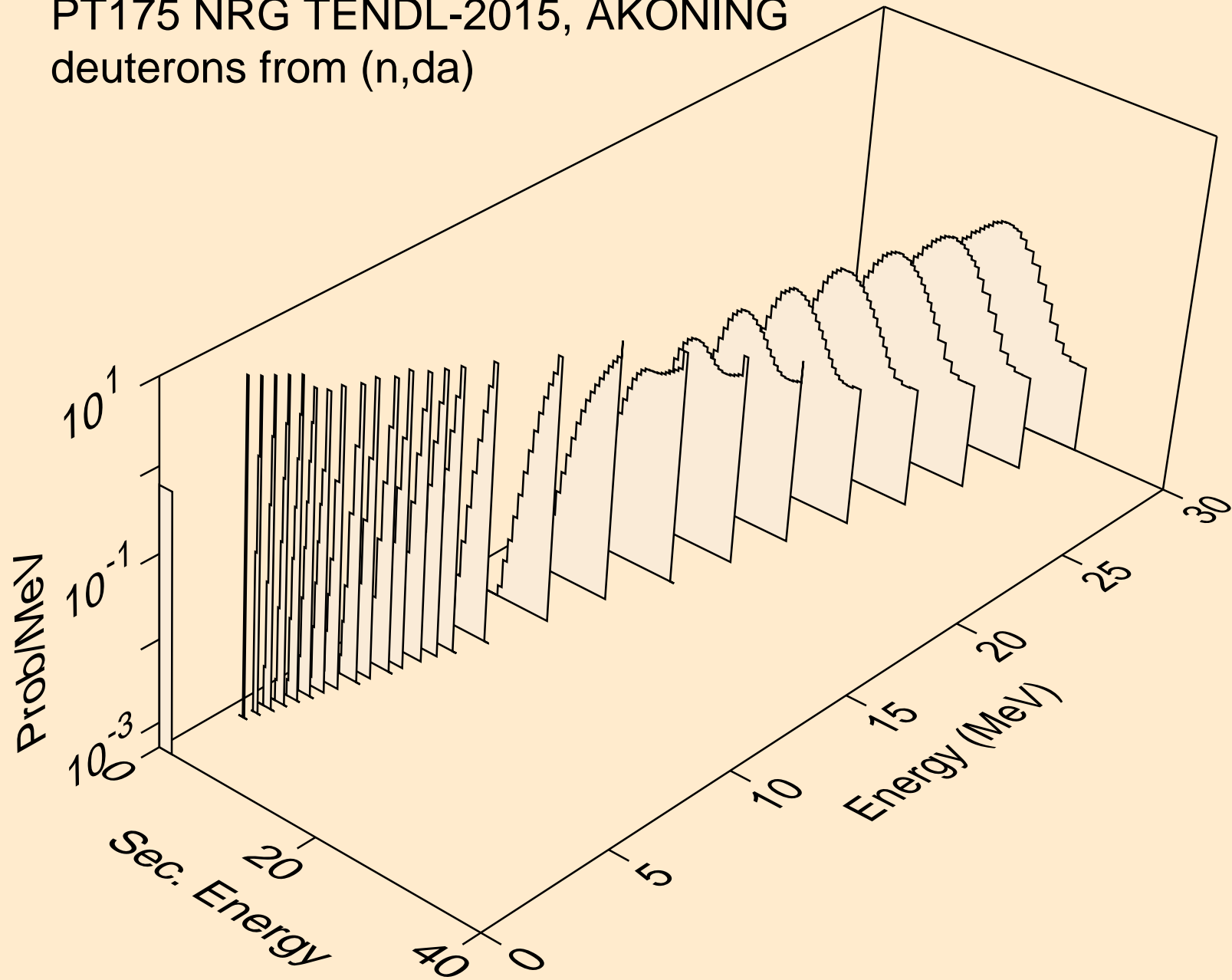

PT175 NRG TENDL-2015, AKONING  
tritons from (n,x)

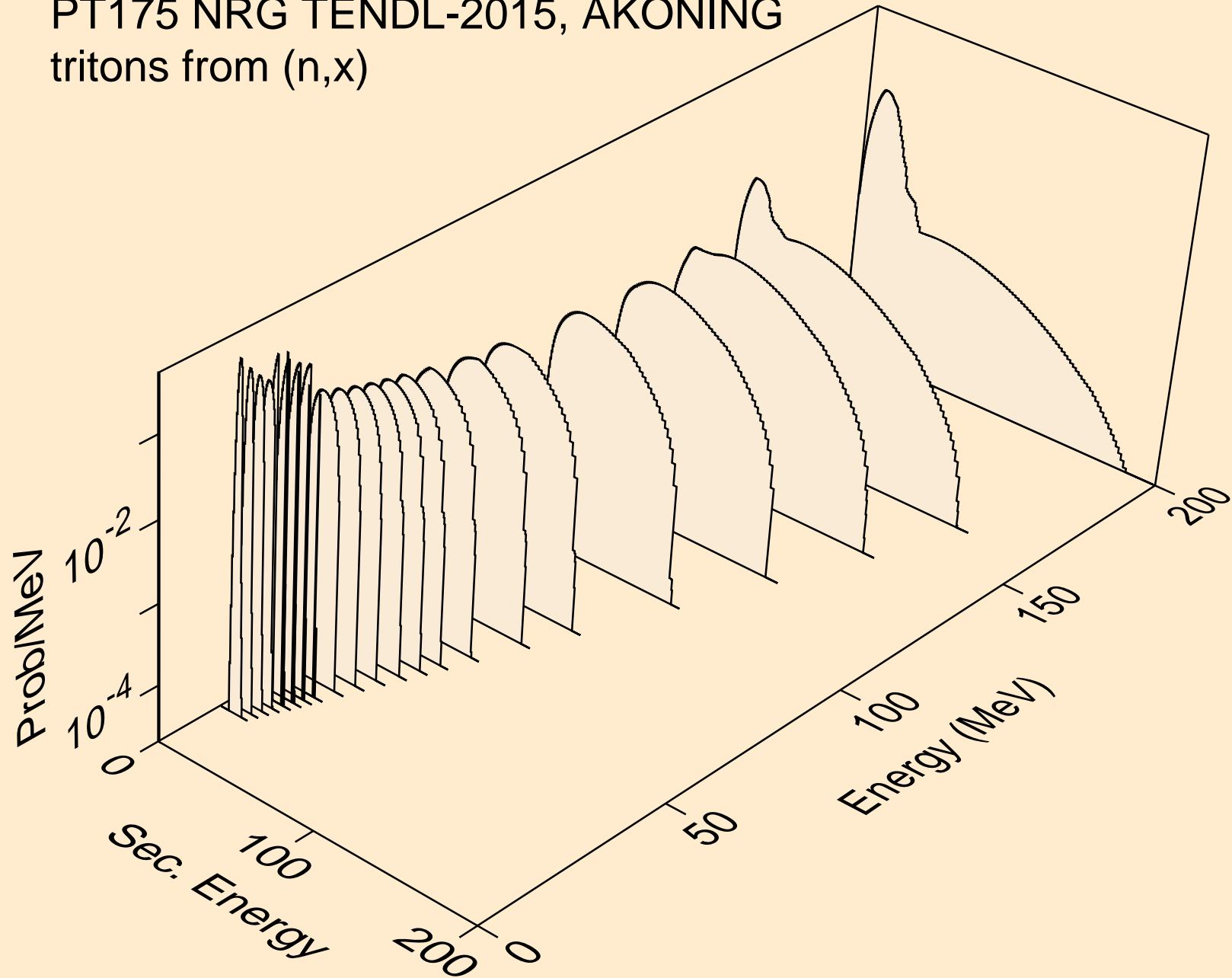

PT175 NRG TENDL-2015, AKONING  
tritons from (n,n\*)t

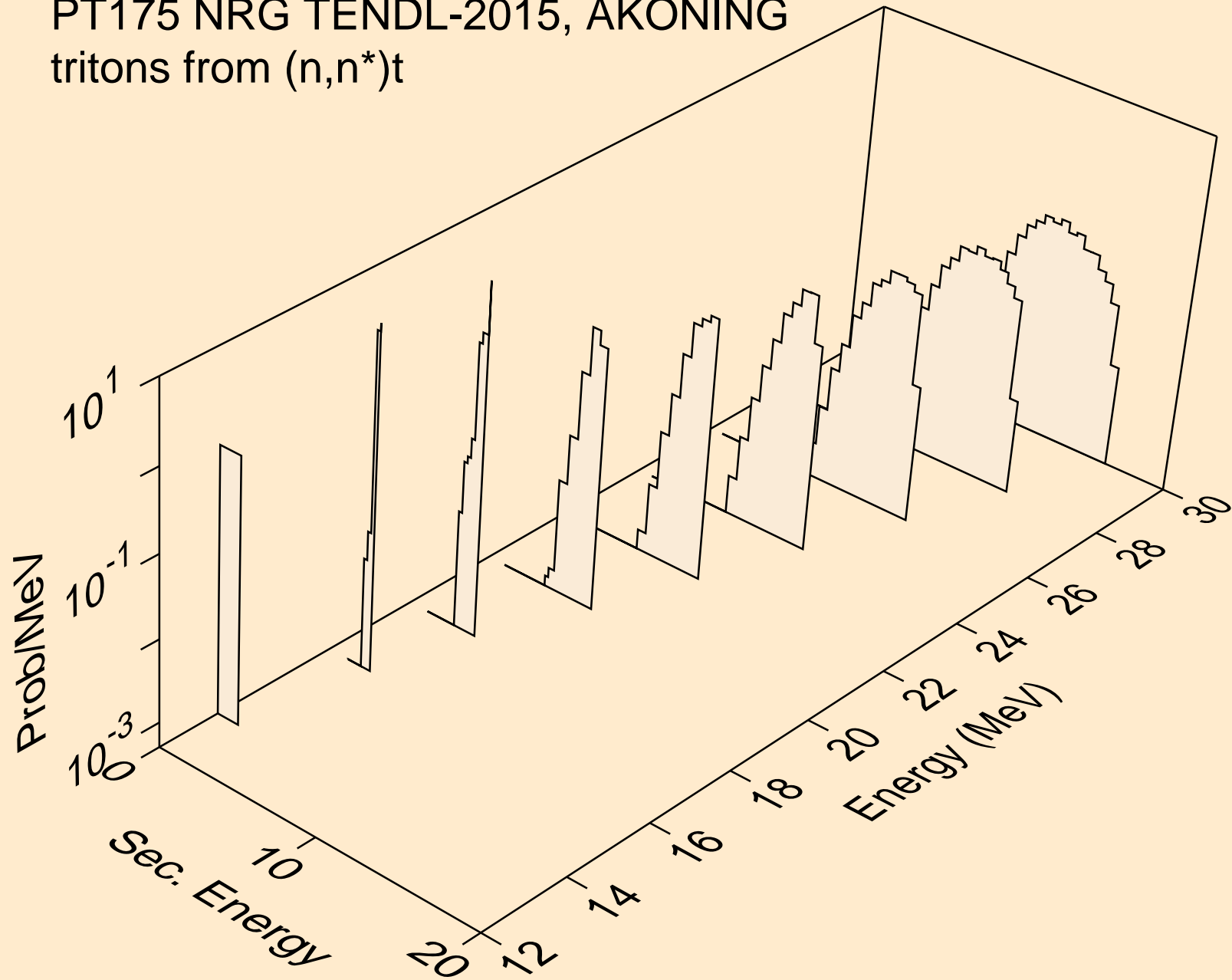

PT175 NRG TENDL-2015, AKONING  
tritons from (n,t)

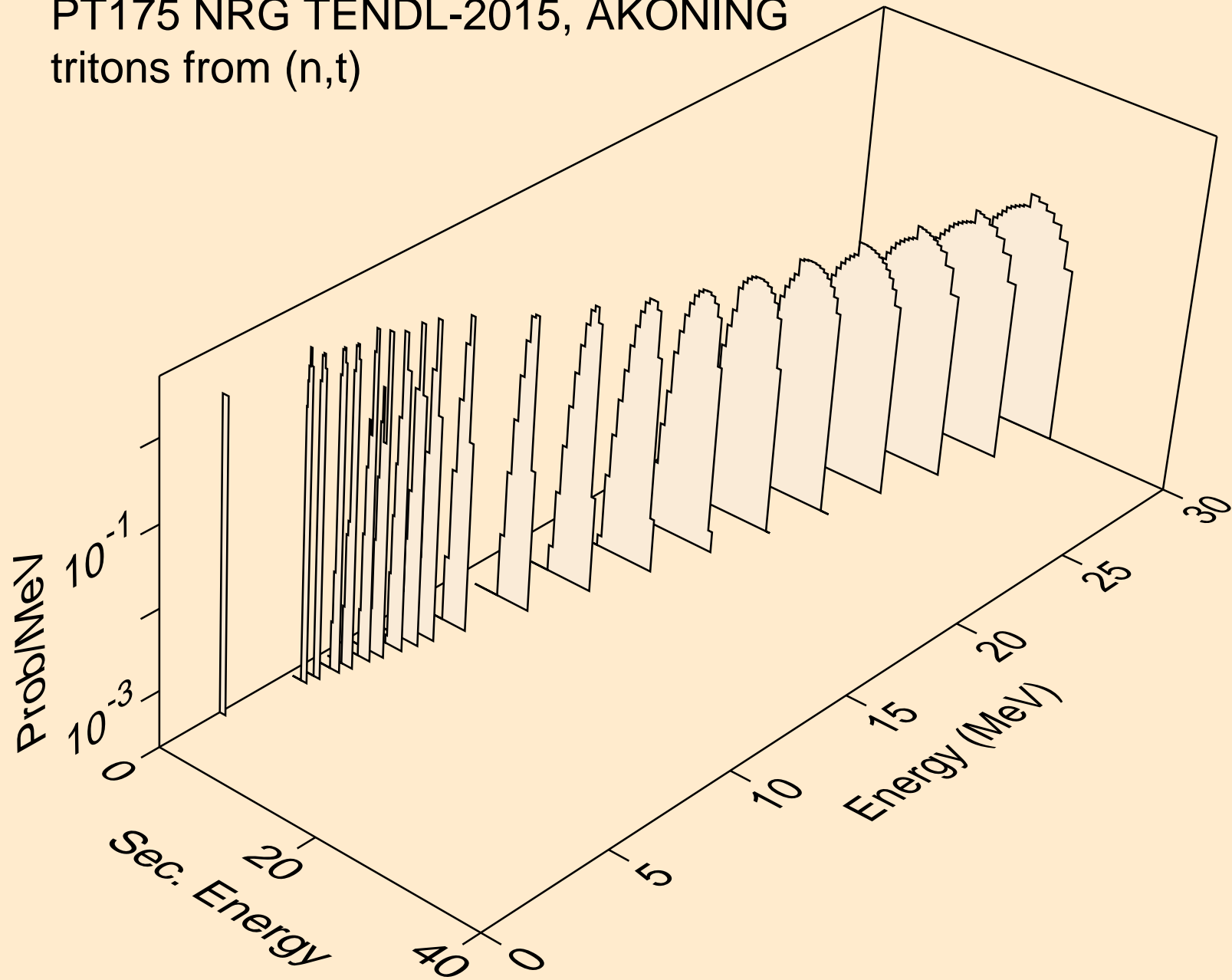

PT175 NRG TENDL-2015, AKONING  
tritons from (n,t2a)

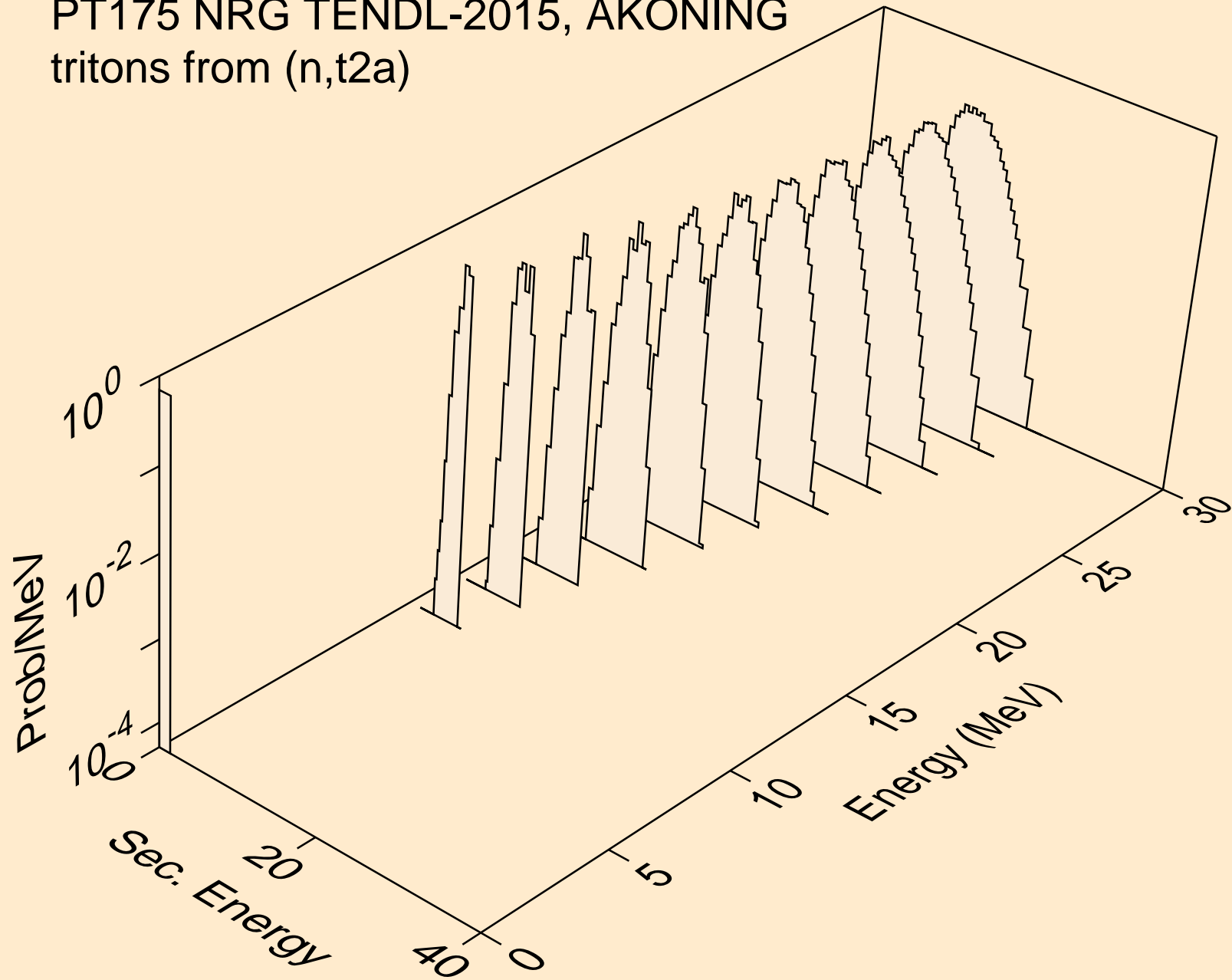

PT175 NRG TENDL-2015, AKONING  
tritons from (n,pt)

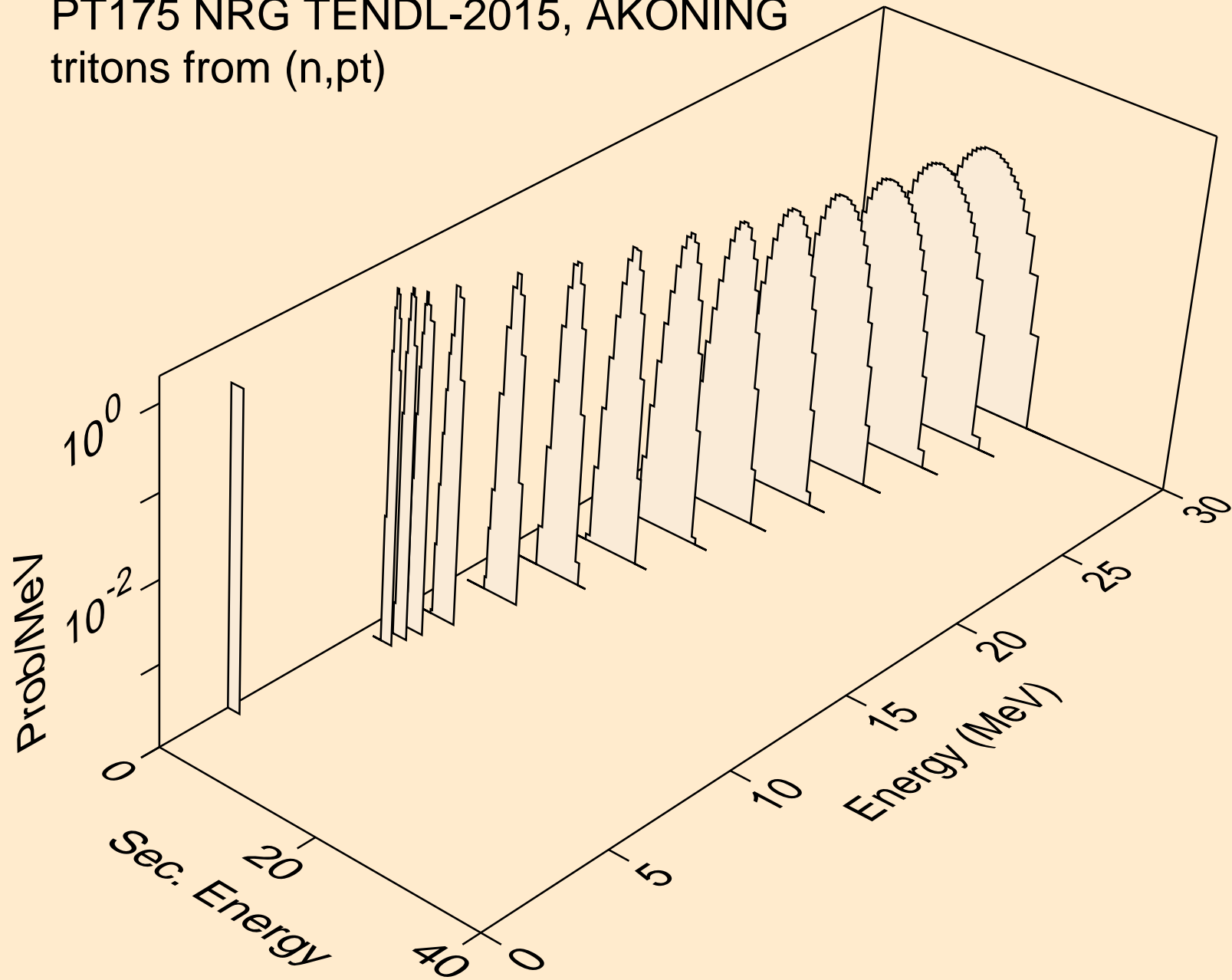



PT175 NRG TENDL-2015, AKONING  
he3s from (n,x)

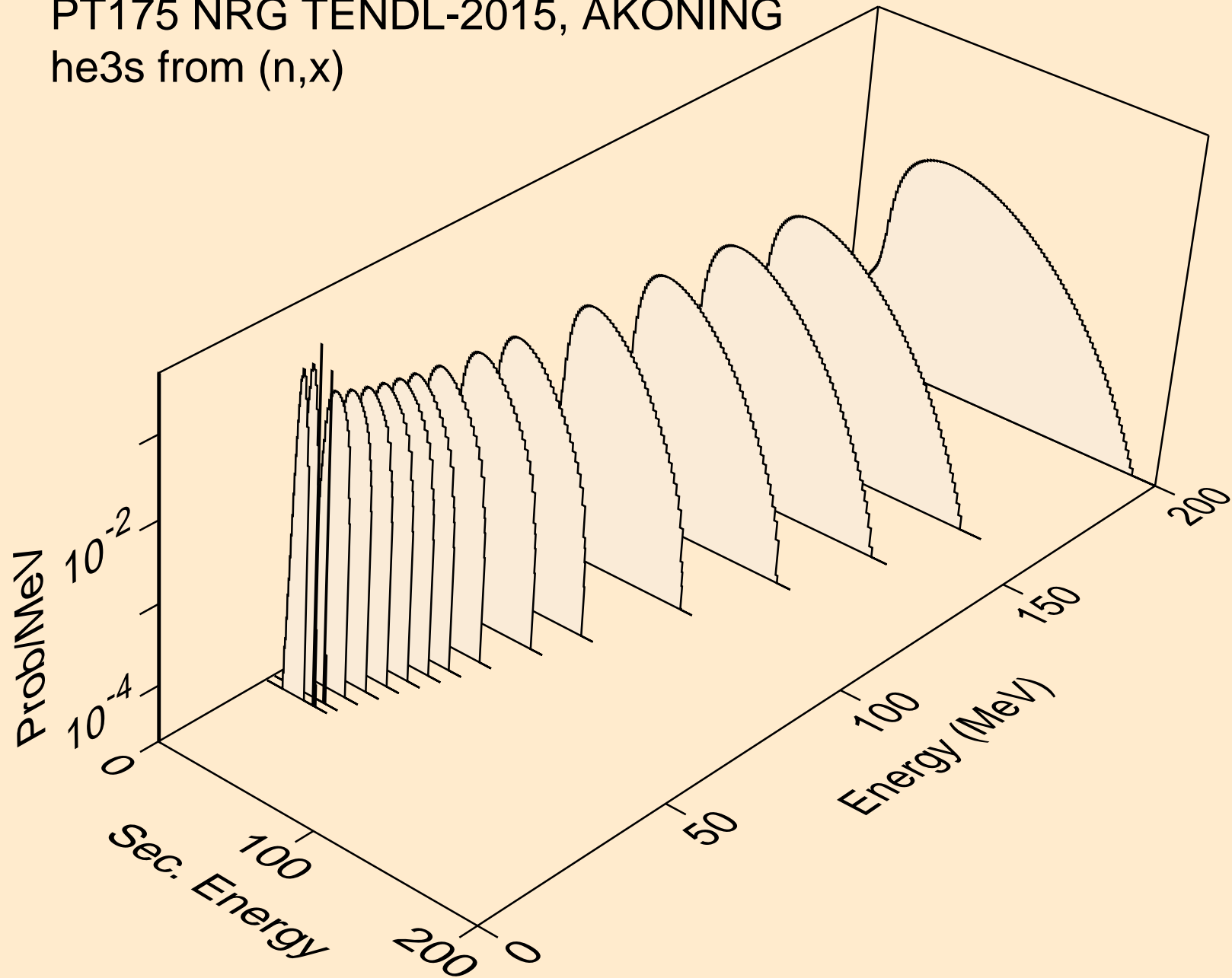

PT175 NRG TENDL-2015, AKONING  
he3s from (n,n\*)he3

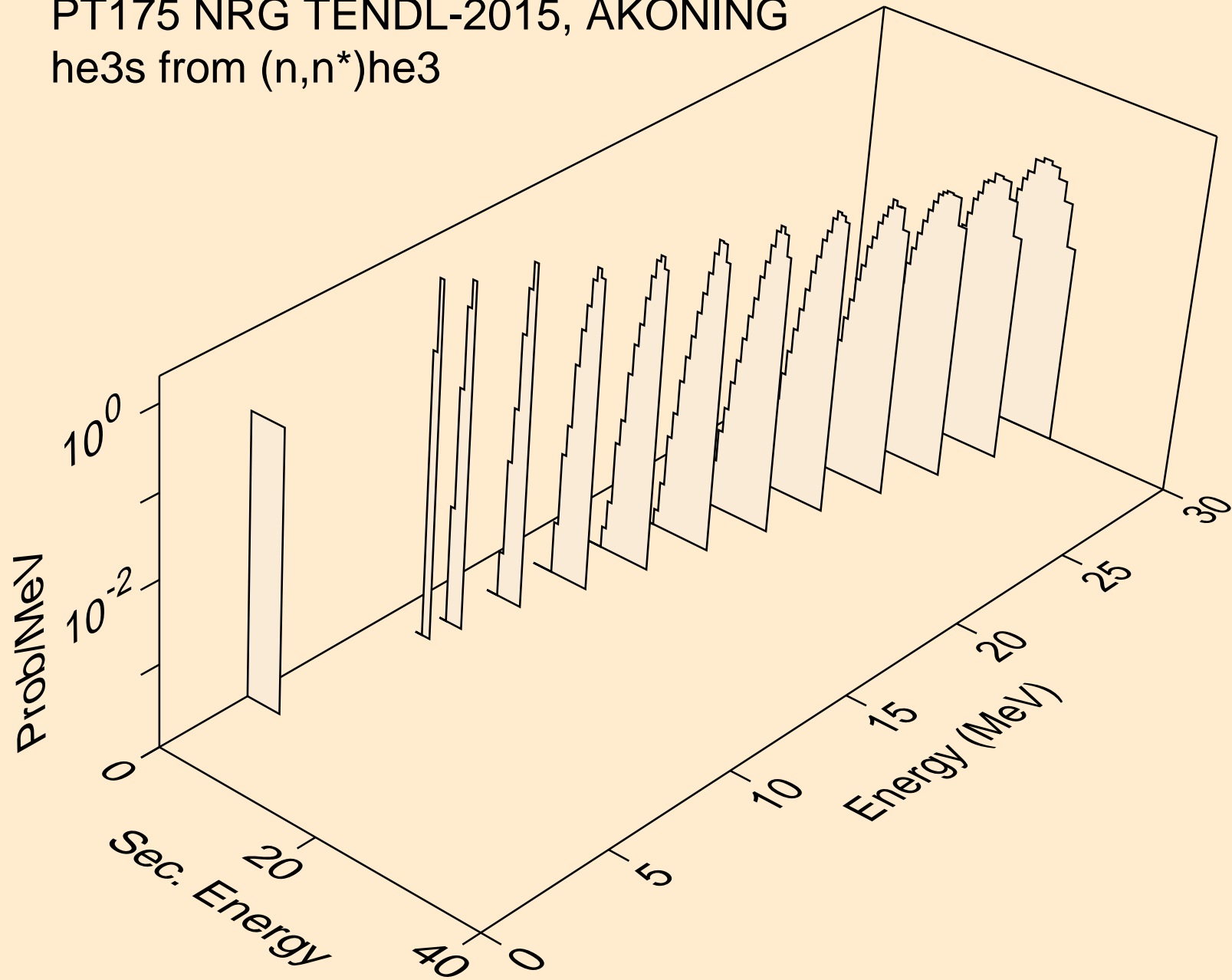

PT175 NRG TENDL-2015, AKONING  
he3s from (n,he3)

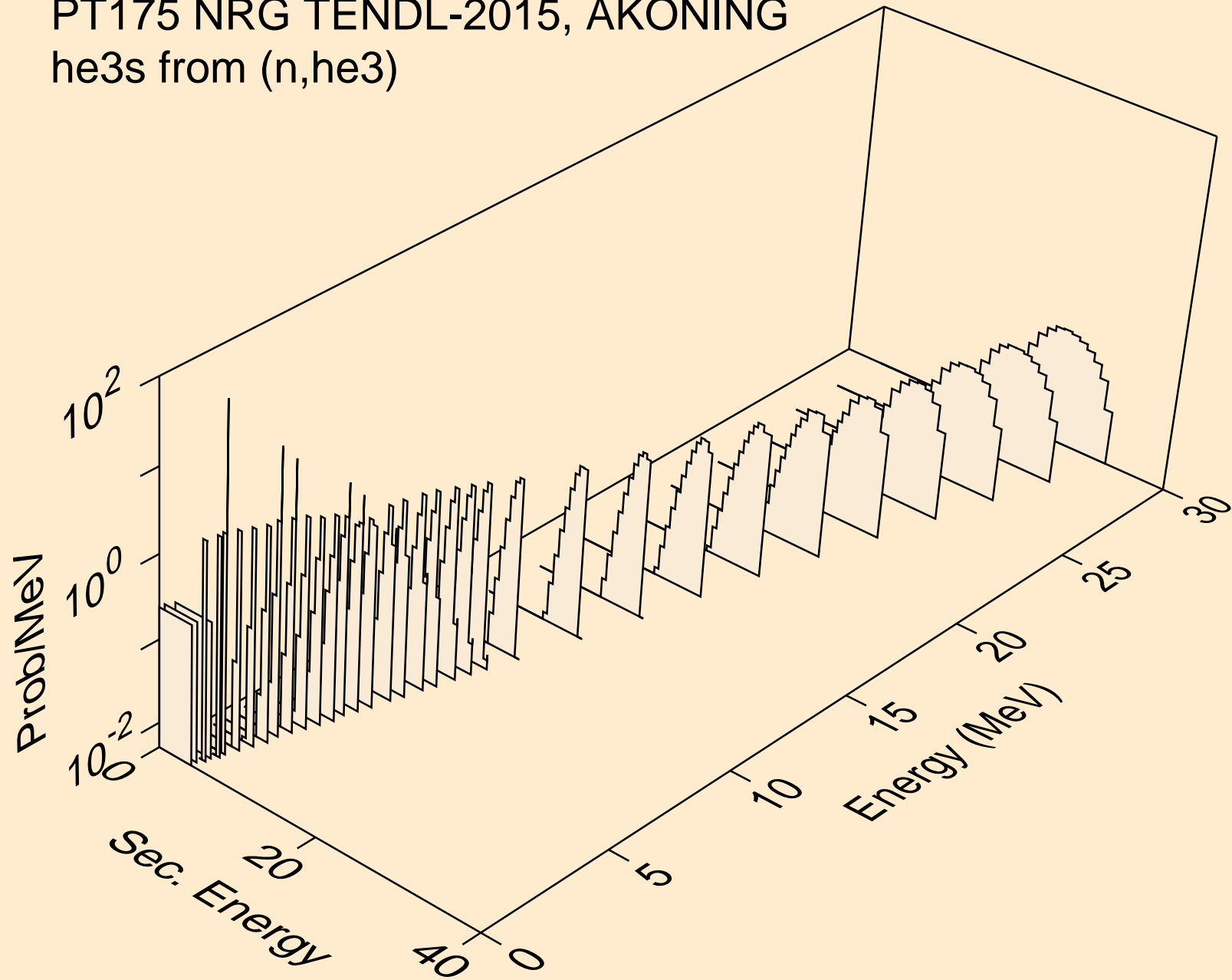

PT175 NRG TENDL-2015, AKONING  
alphas from (n,x)

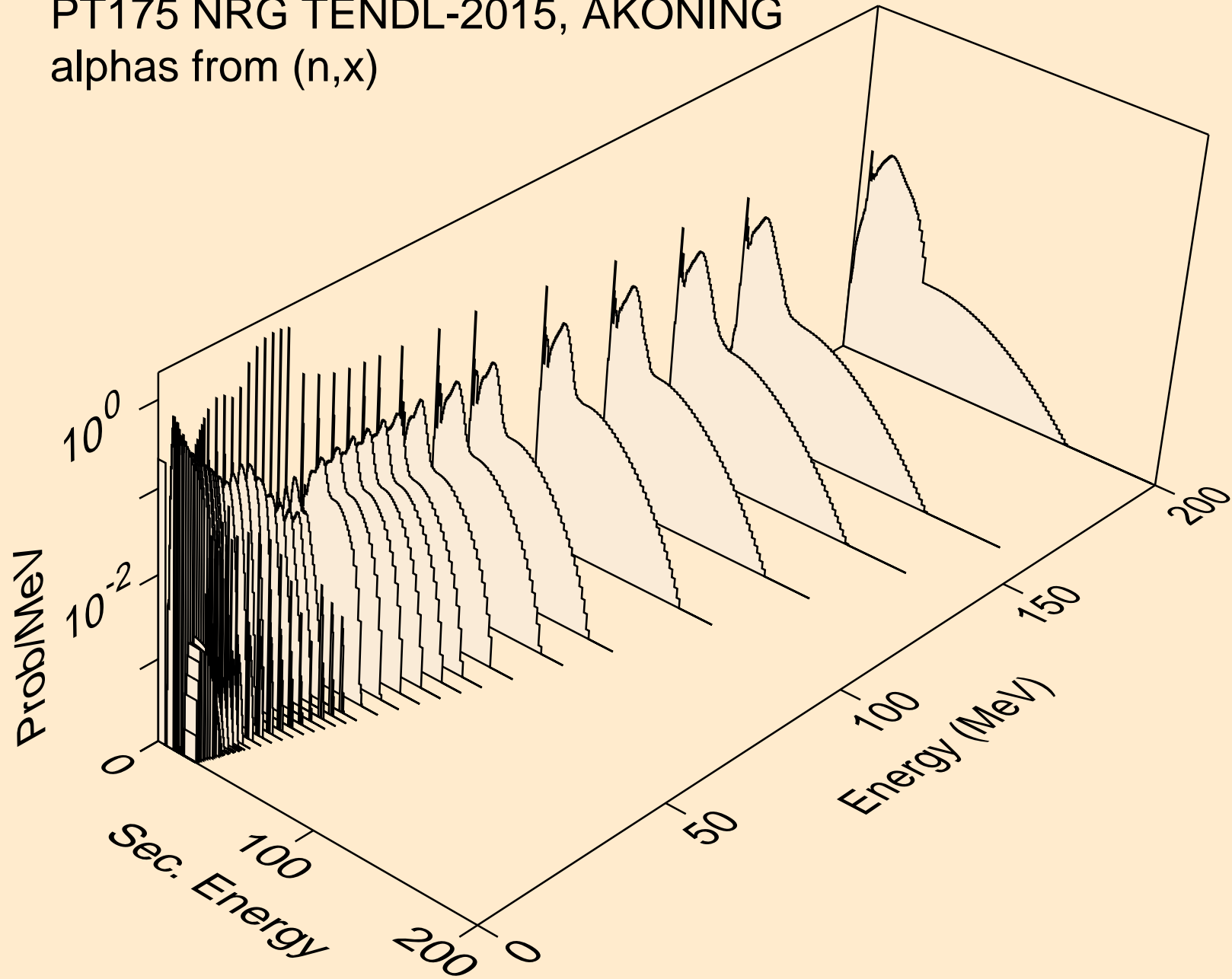

PT175 NRG TENDL-2015, AKONING  
alphas from (n,n\*)a

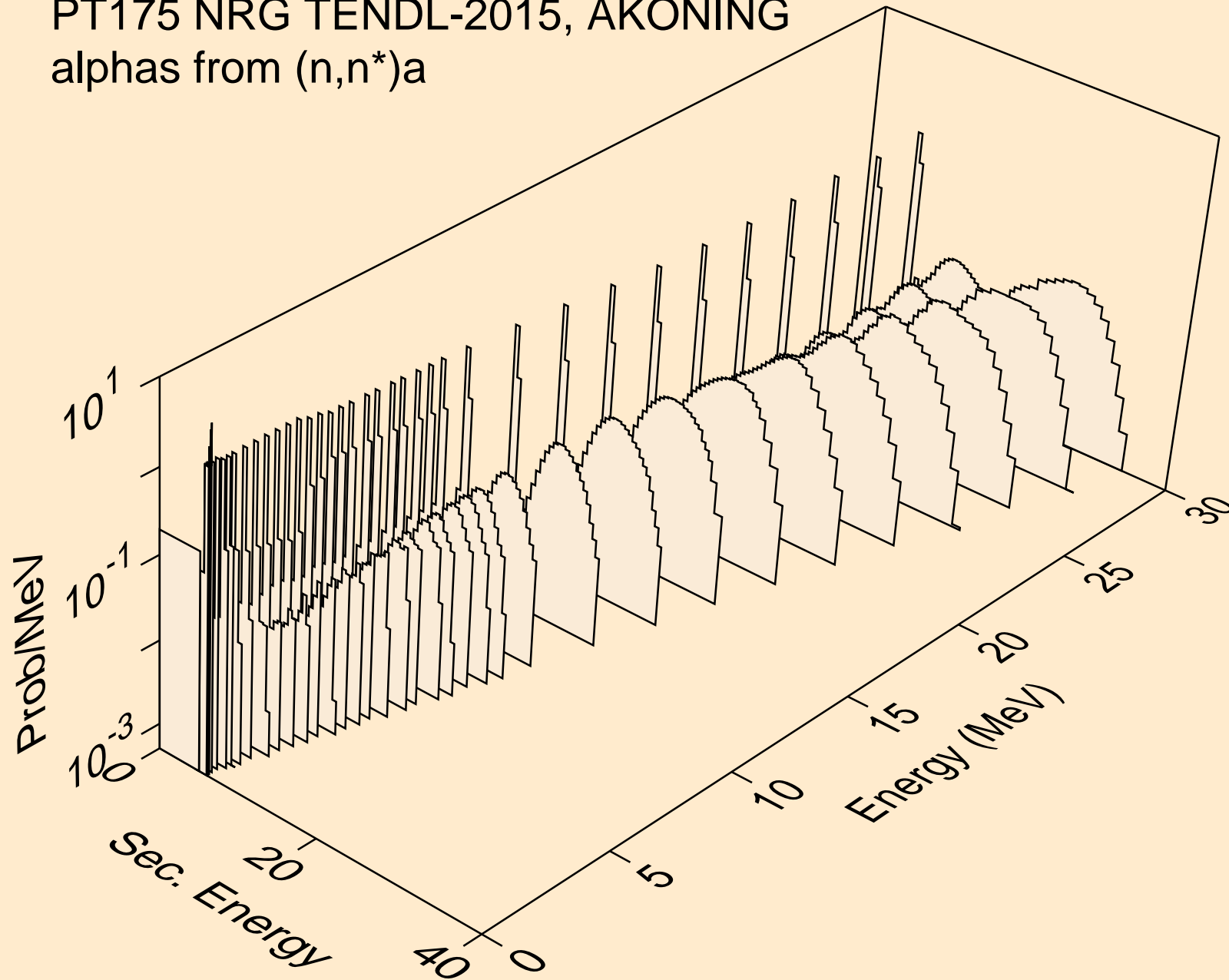

PT175 NRG TENDL-2015, AKONING  
alphas from (n,n\*)3a

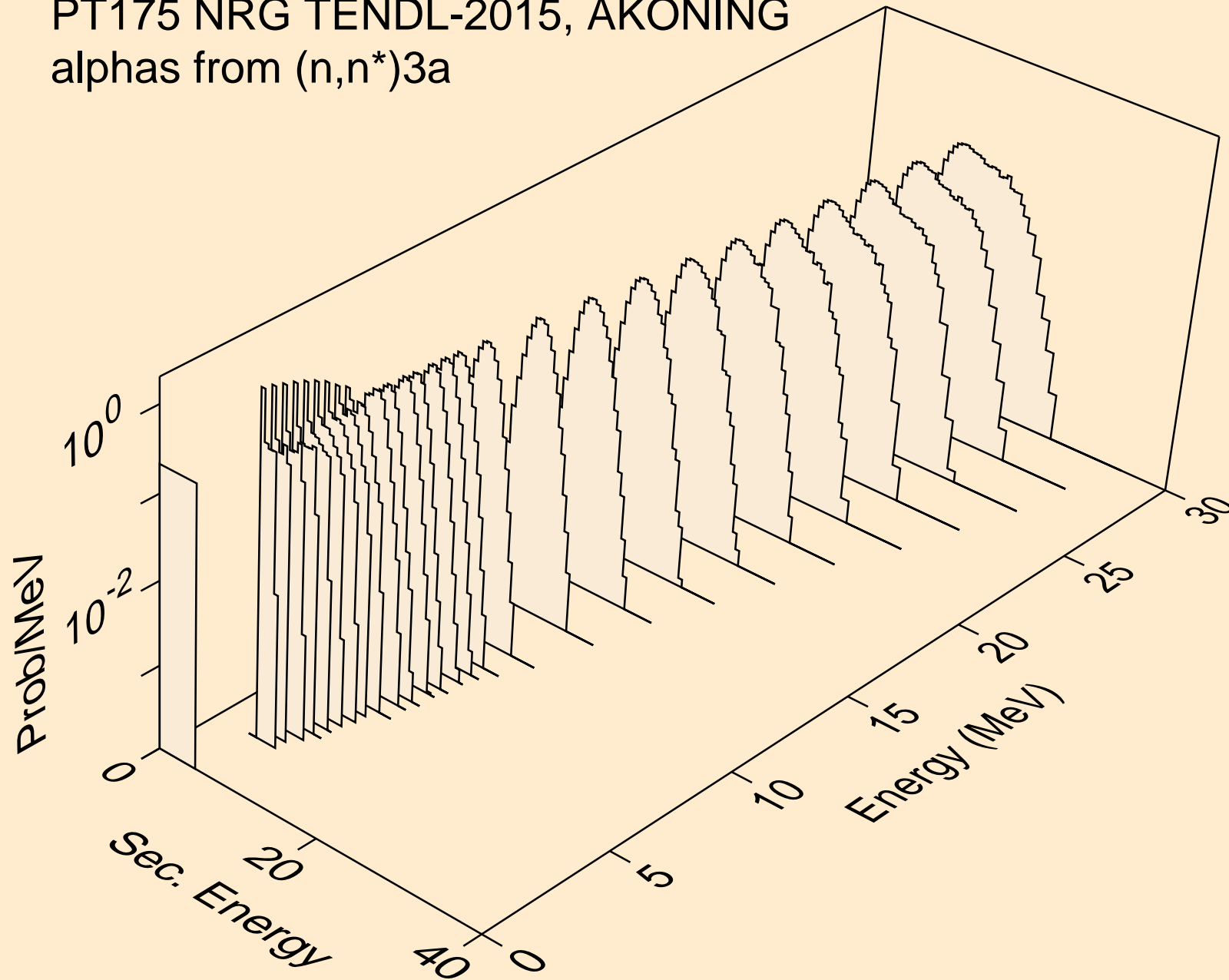

PT175 NRG TENDL-2015, AKONING  
alphas from (n,2n)a

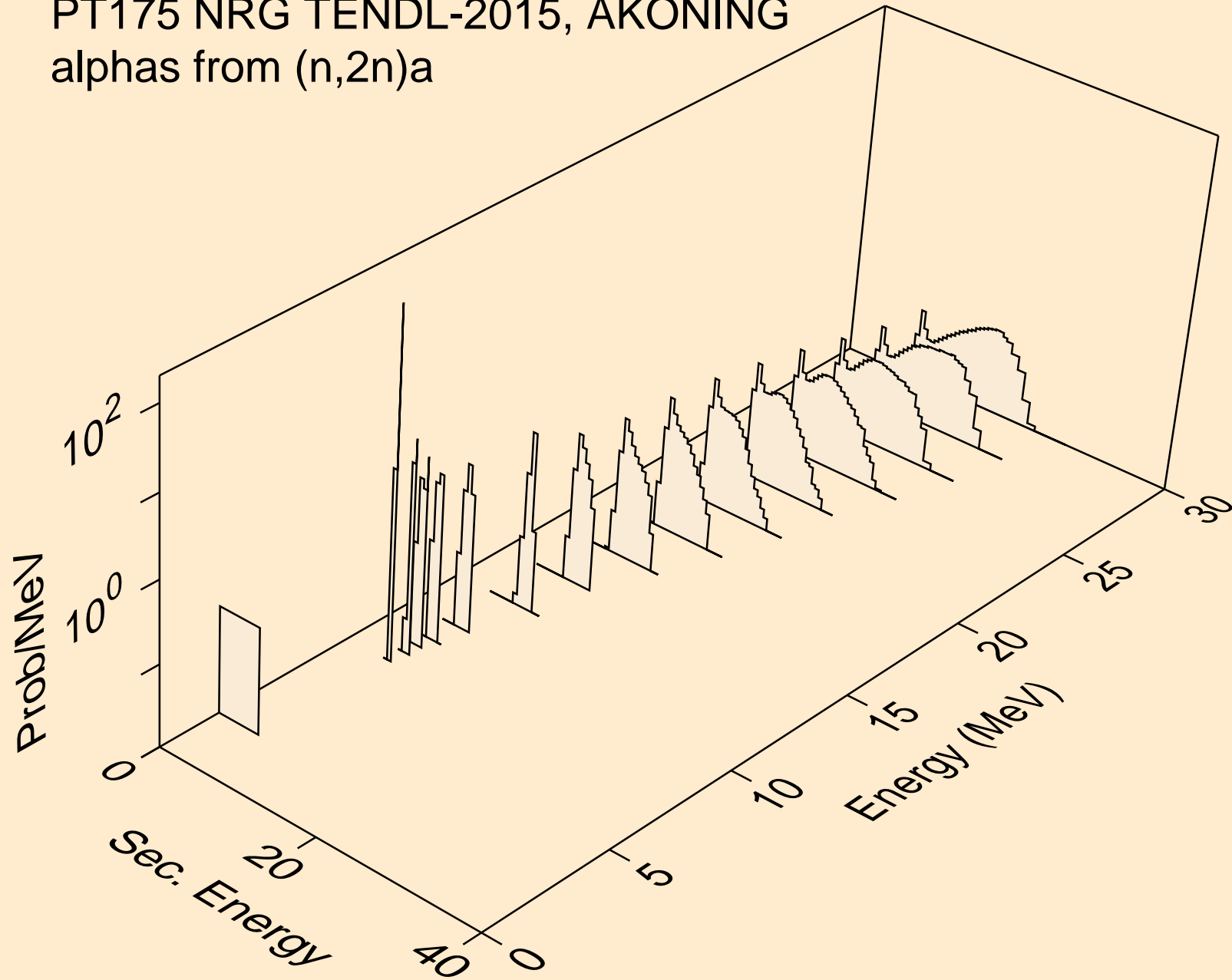

PT175 NRG TENDL-2015, AKONING  
alphas from (n,3n)a

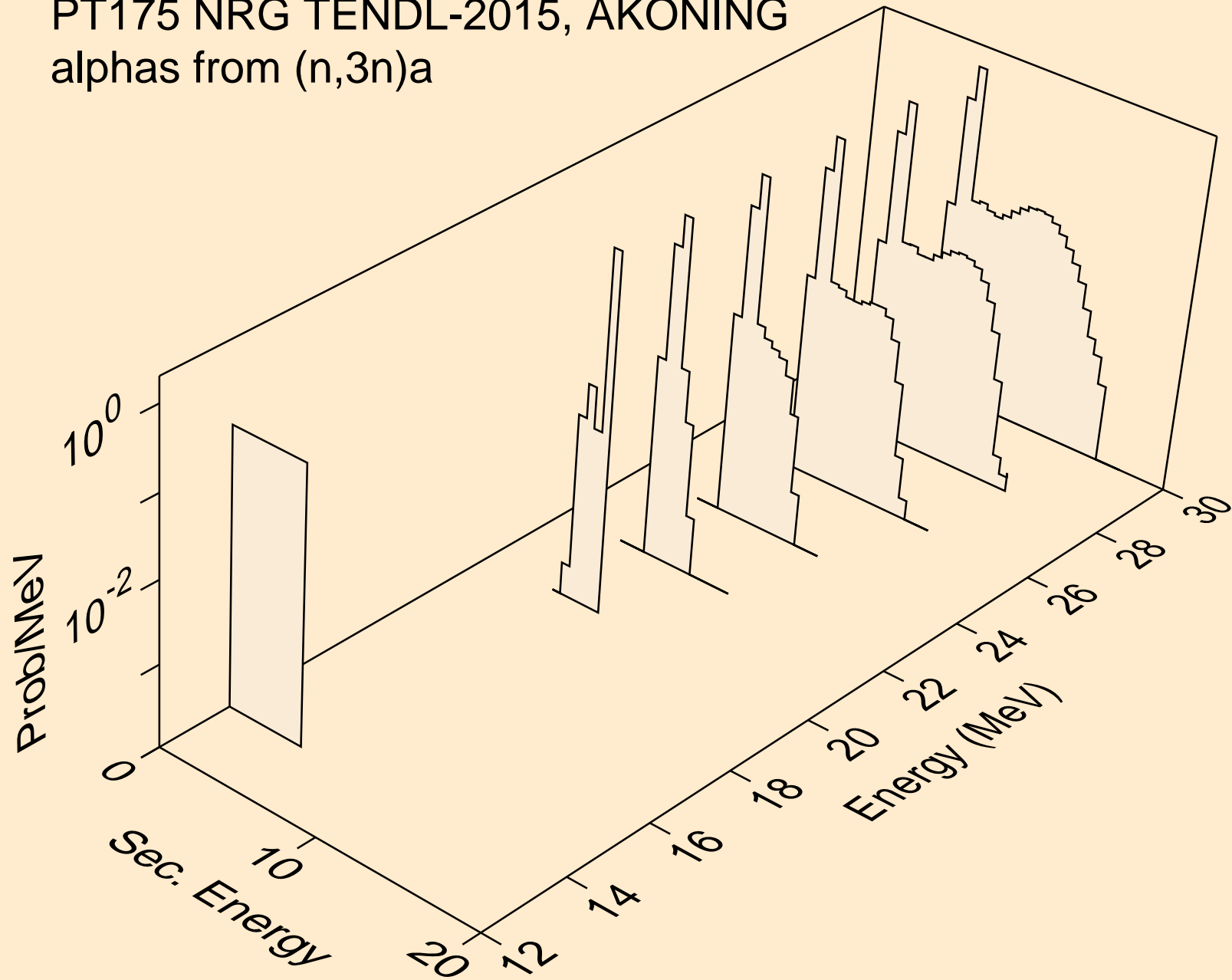



PT175 NRG TENDL-2015, AKONING  
alphas from (n,n\*)2a

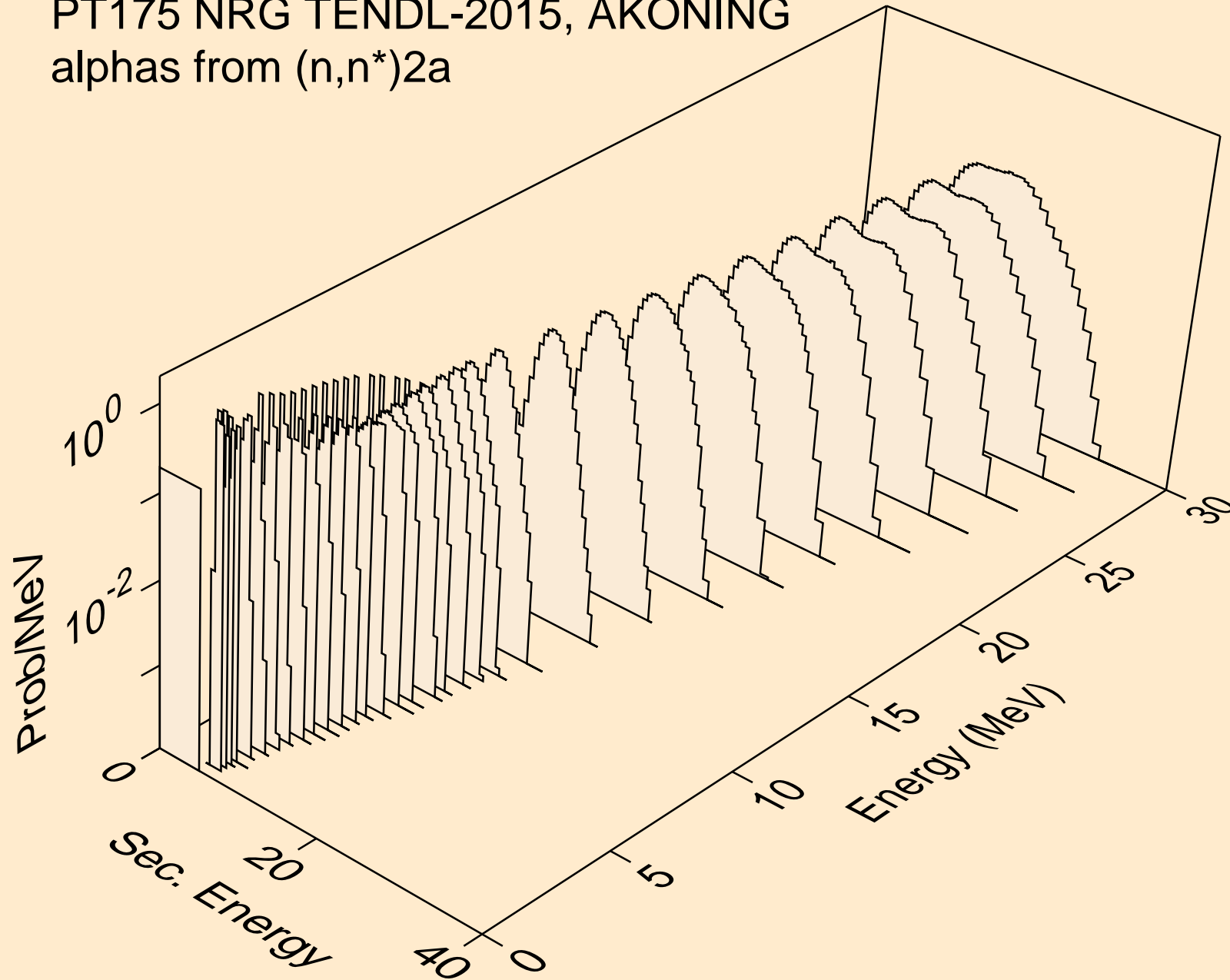

PT175 NRG TENDL-2015, AKONING  
alphas from (n,2n)2a

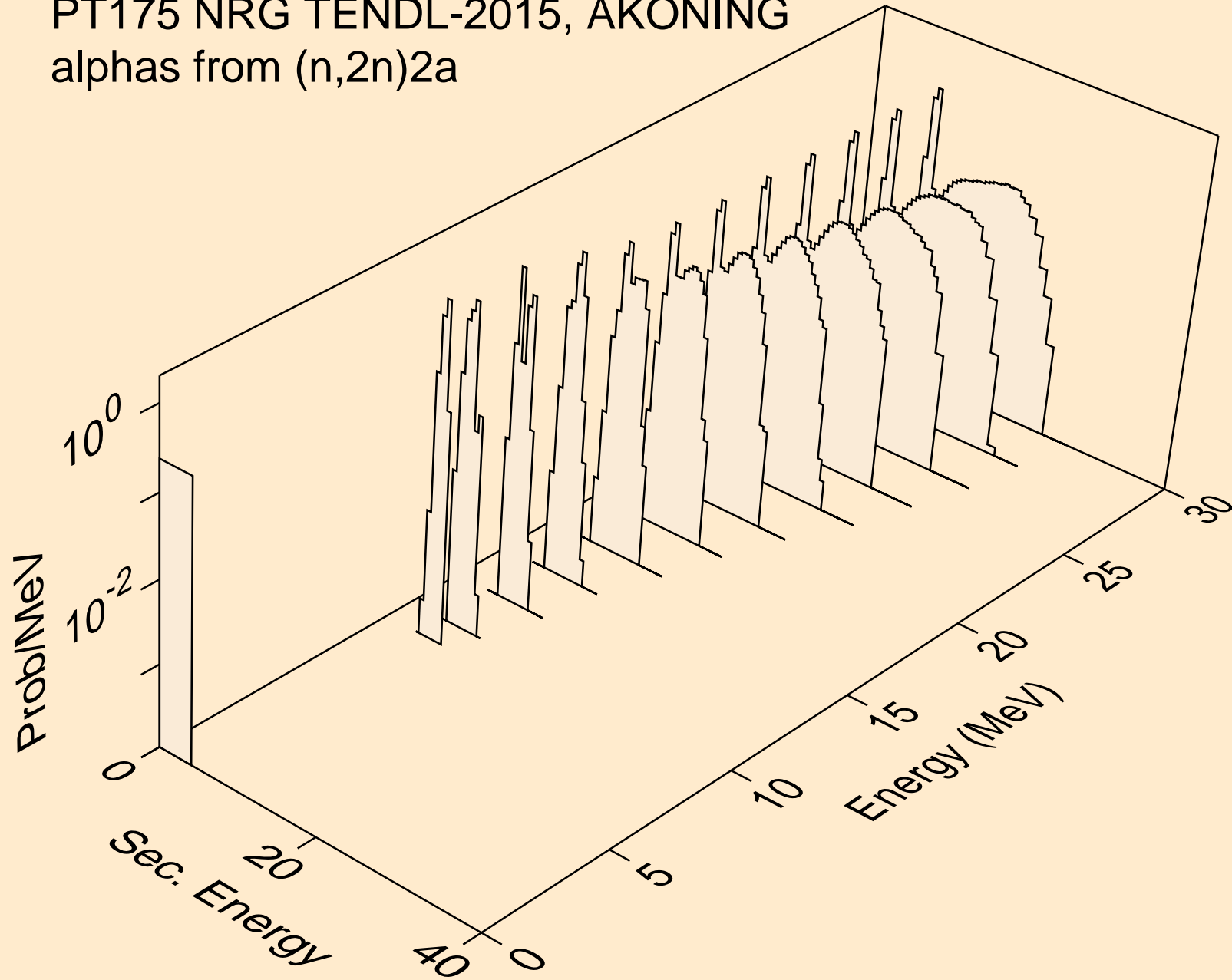

PT175 NRG TENDL-2015, AKONING  
alphas from (n,n\*)d2a

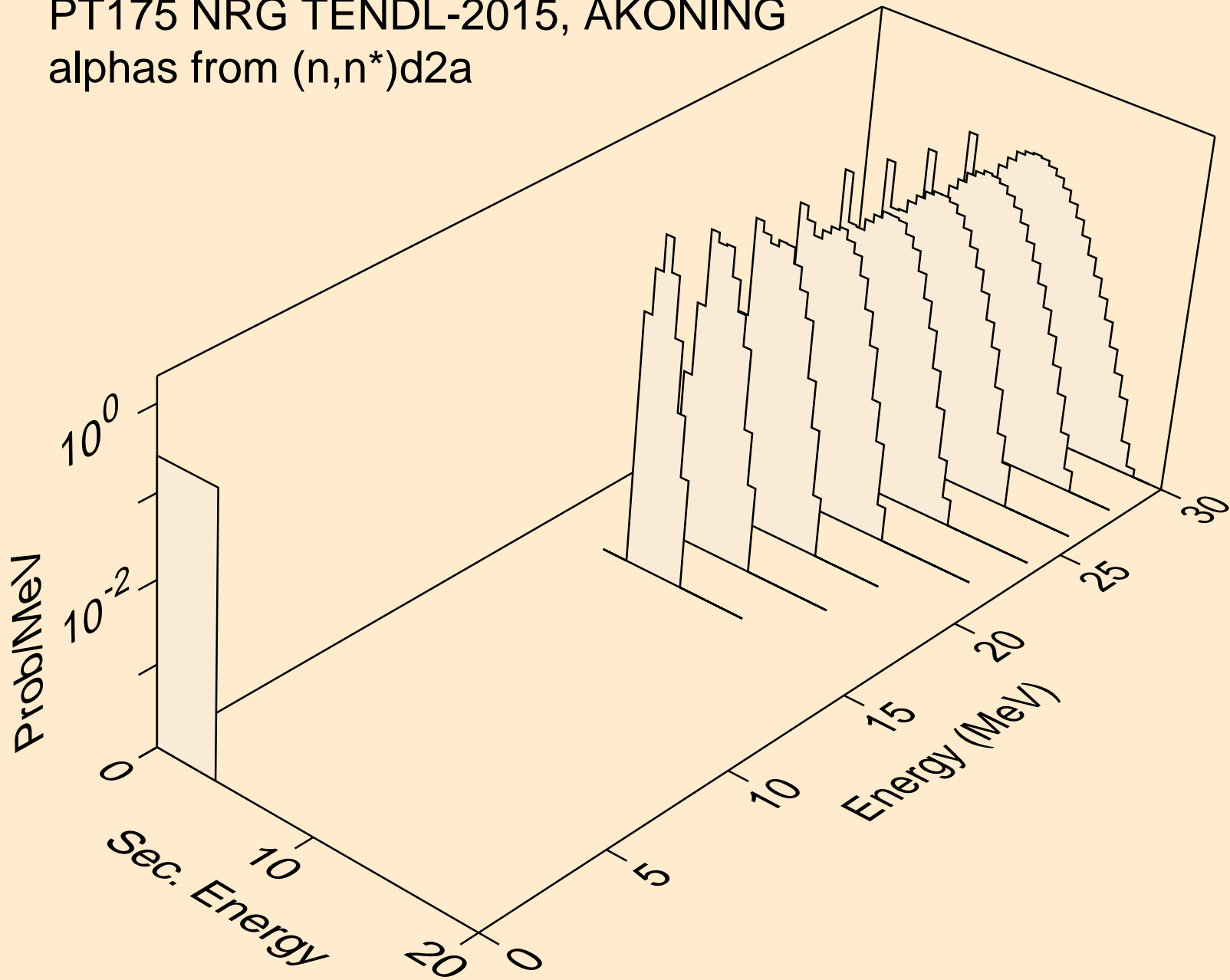

PT175 NRG TENDL-2015, AKONING  
alphas from (n,npa)

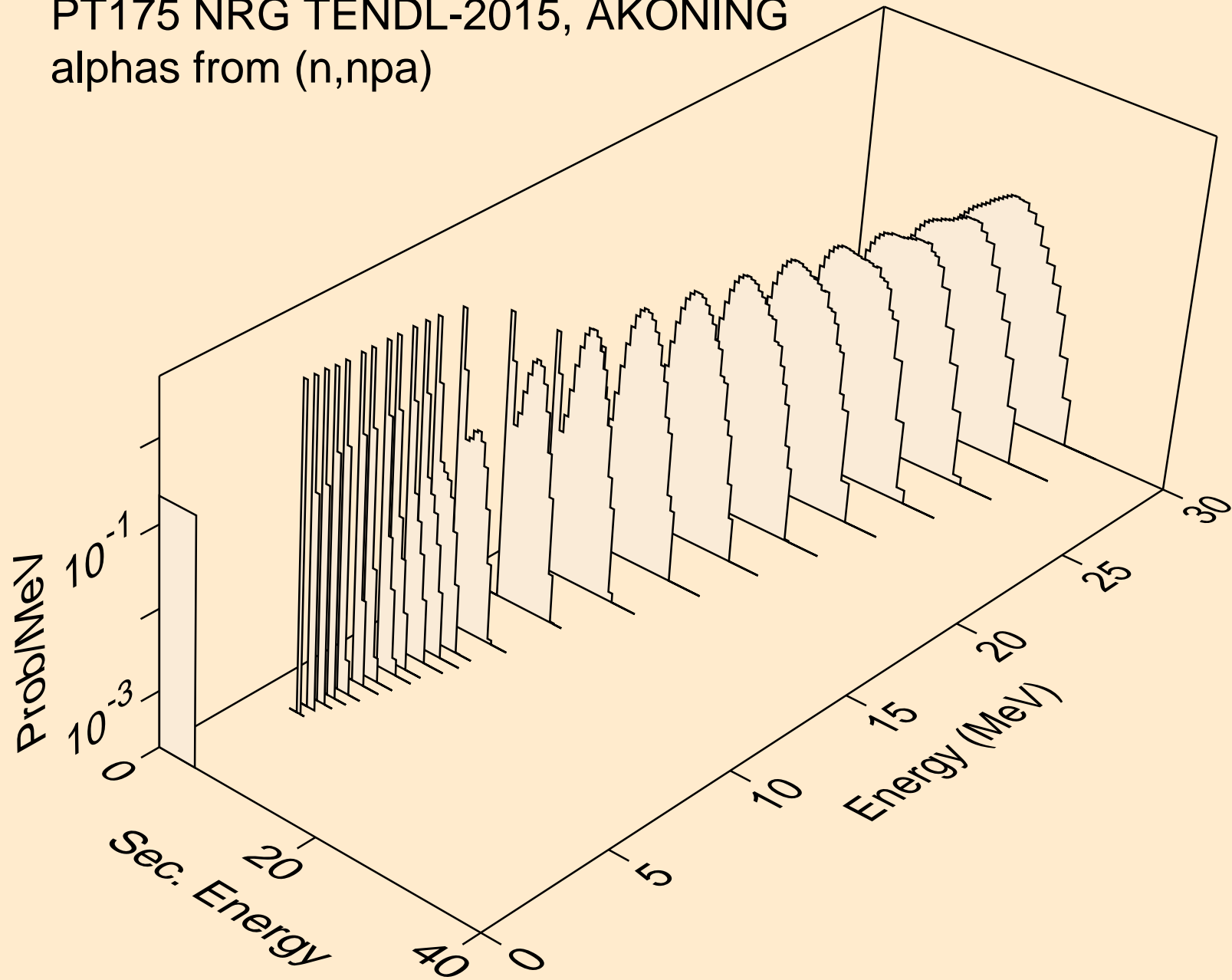

PT175 NRG TENDL-2015, AKONING  
alphas from (n,a)

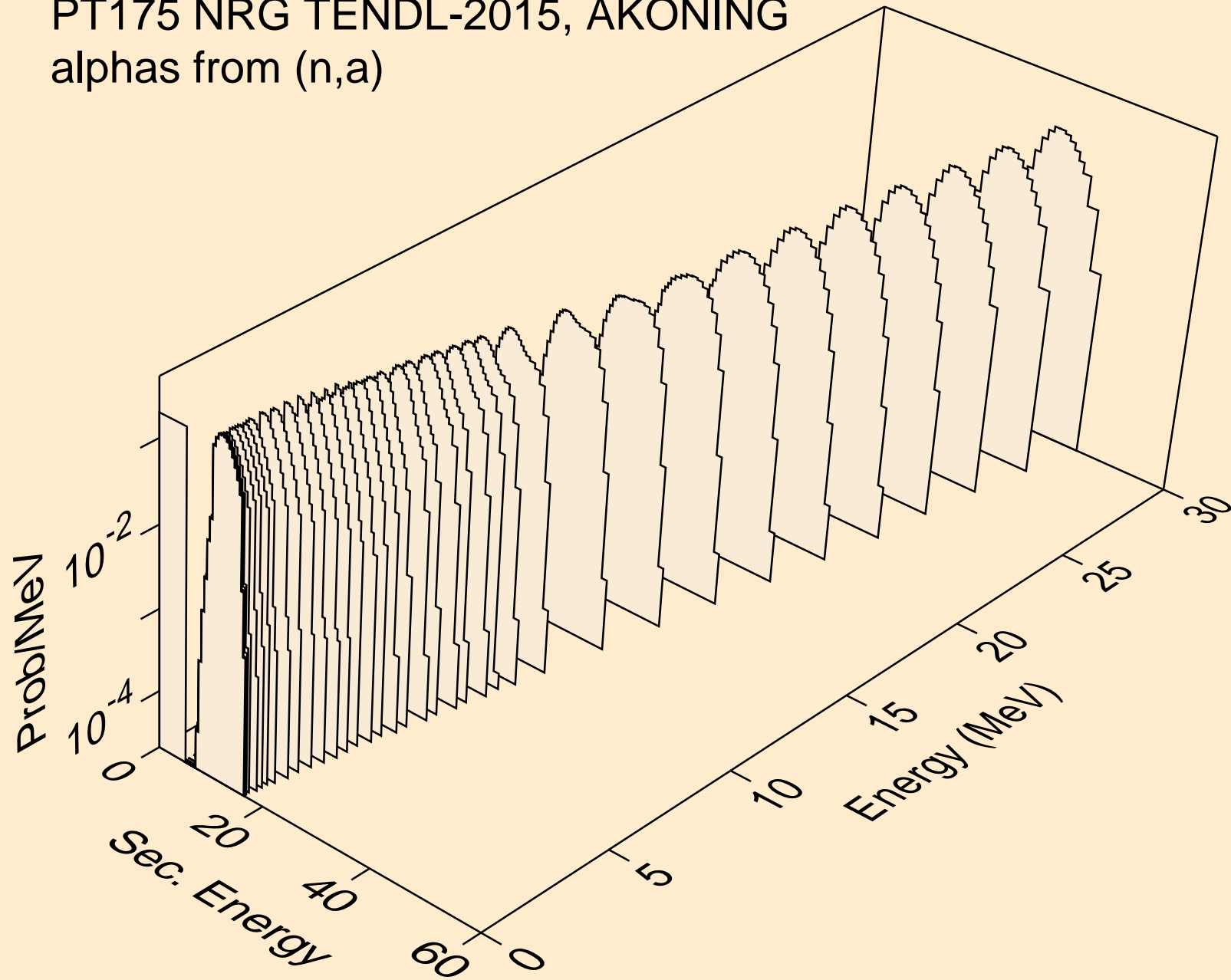

PT175 NRG TENDL-2015, AKONING  
alphas from (n,2a)

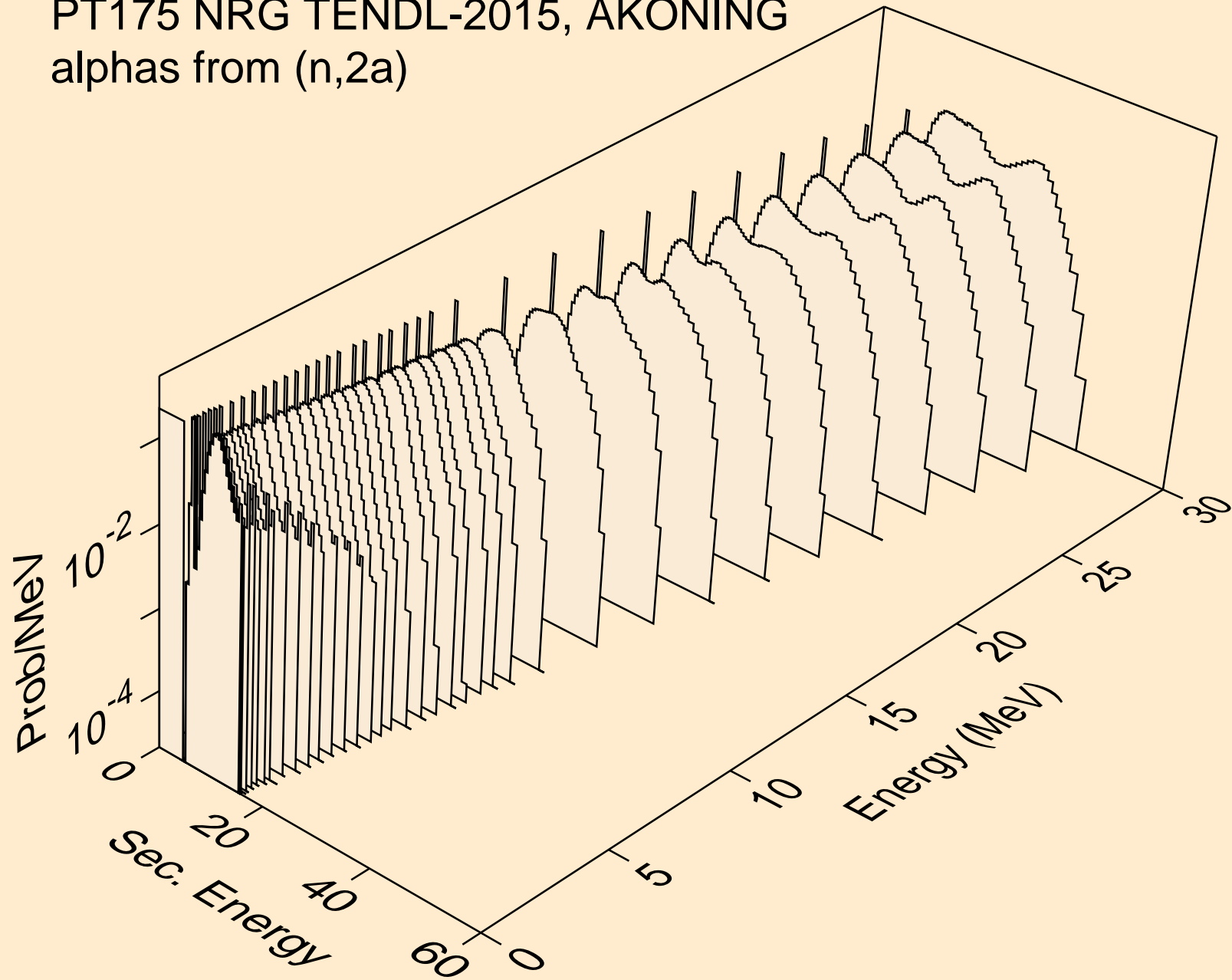

PT175 NRG TENDL-2015, AKONING  
alphas from (n,3a)

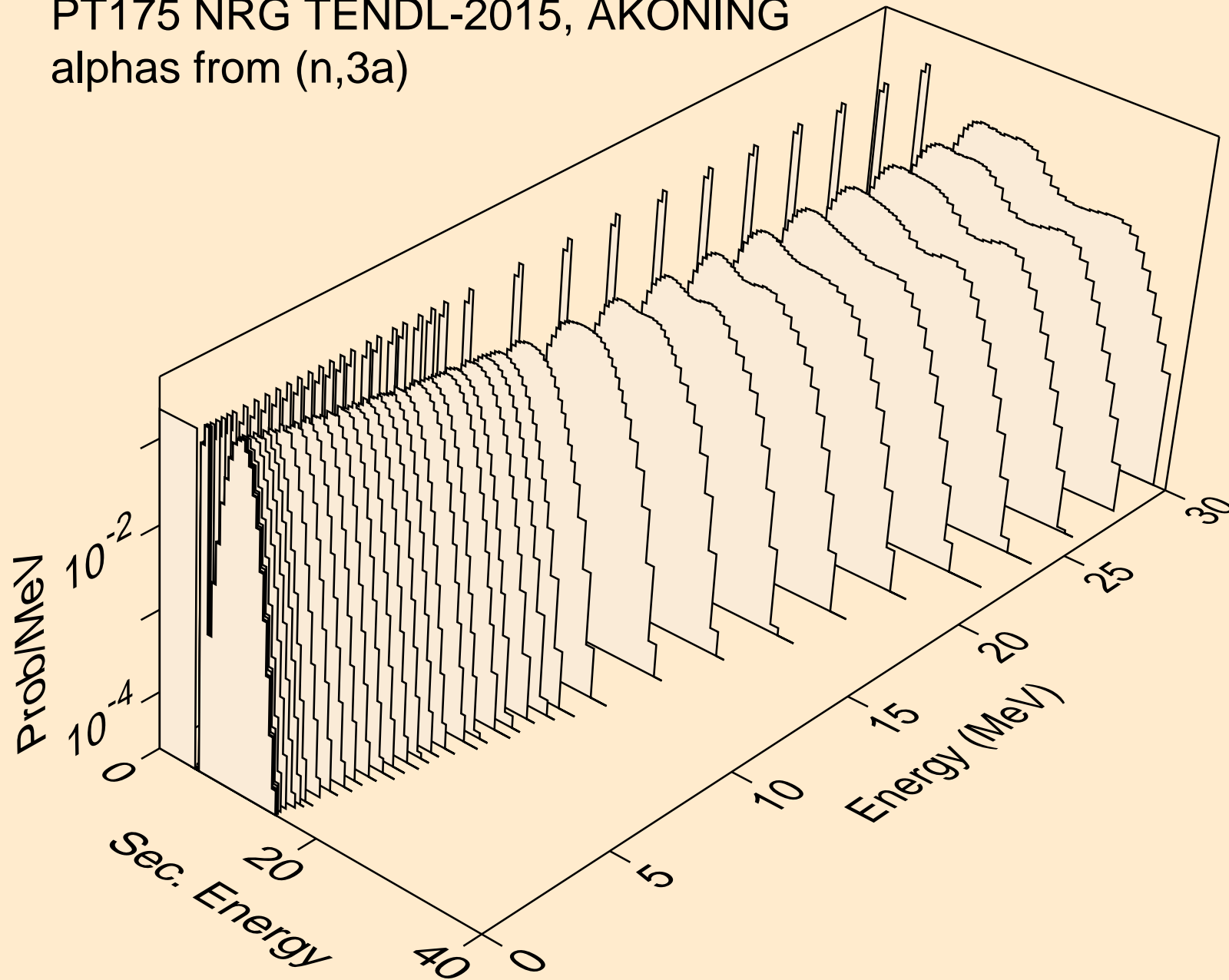

PT175 NRG TENDL-2015, AKONING  
alphas from (n,pa)

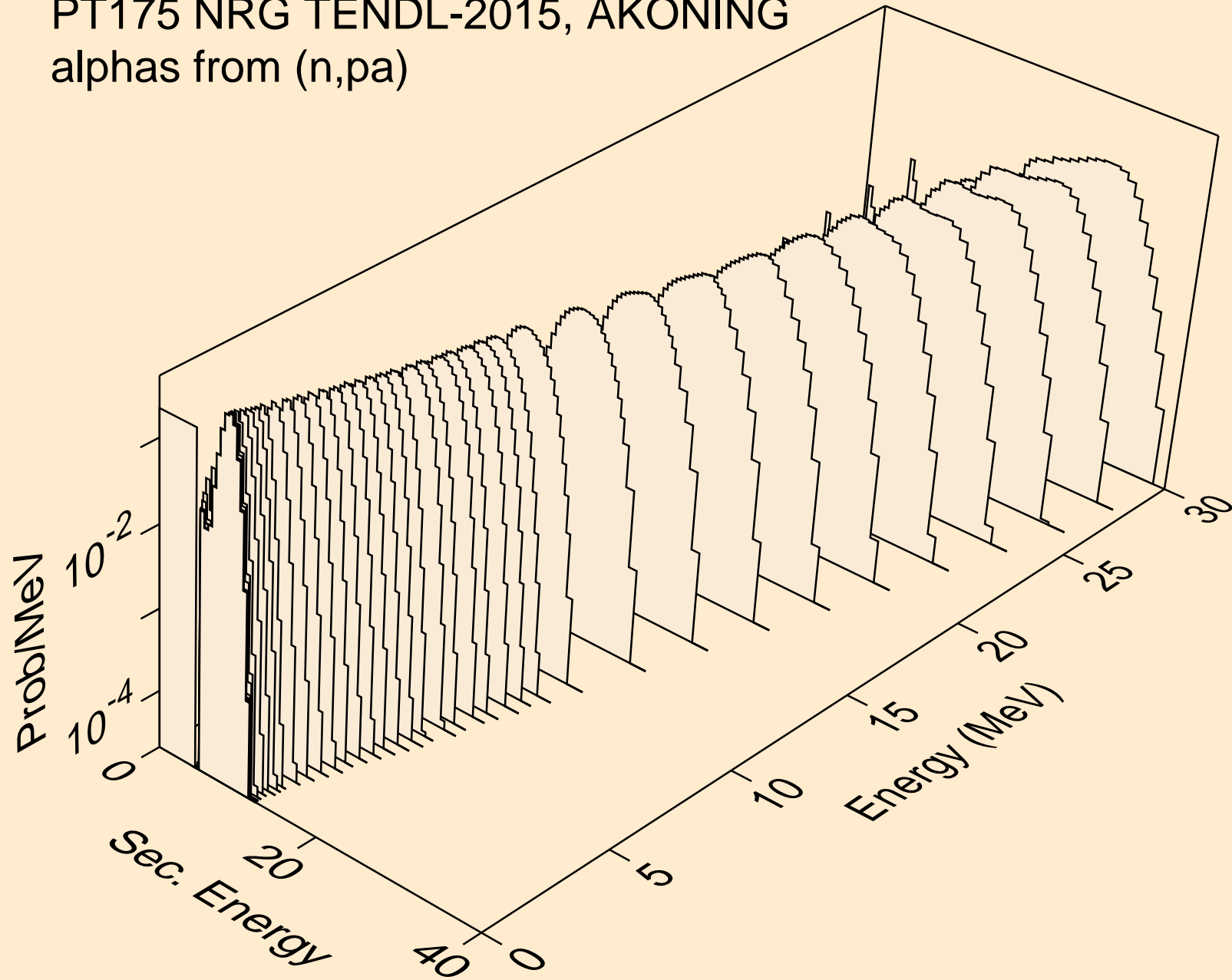



PT175 NRG TENDL-2015, AKONING  
alphas from (n,t2a)

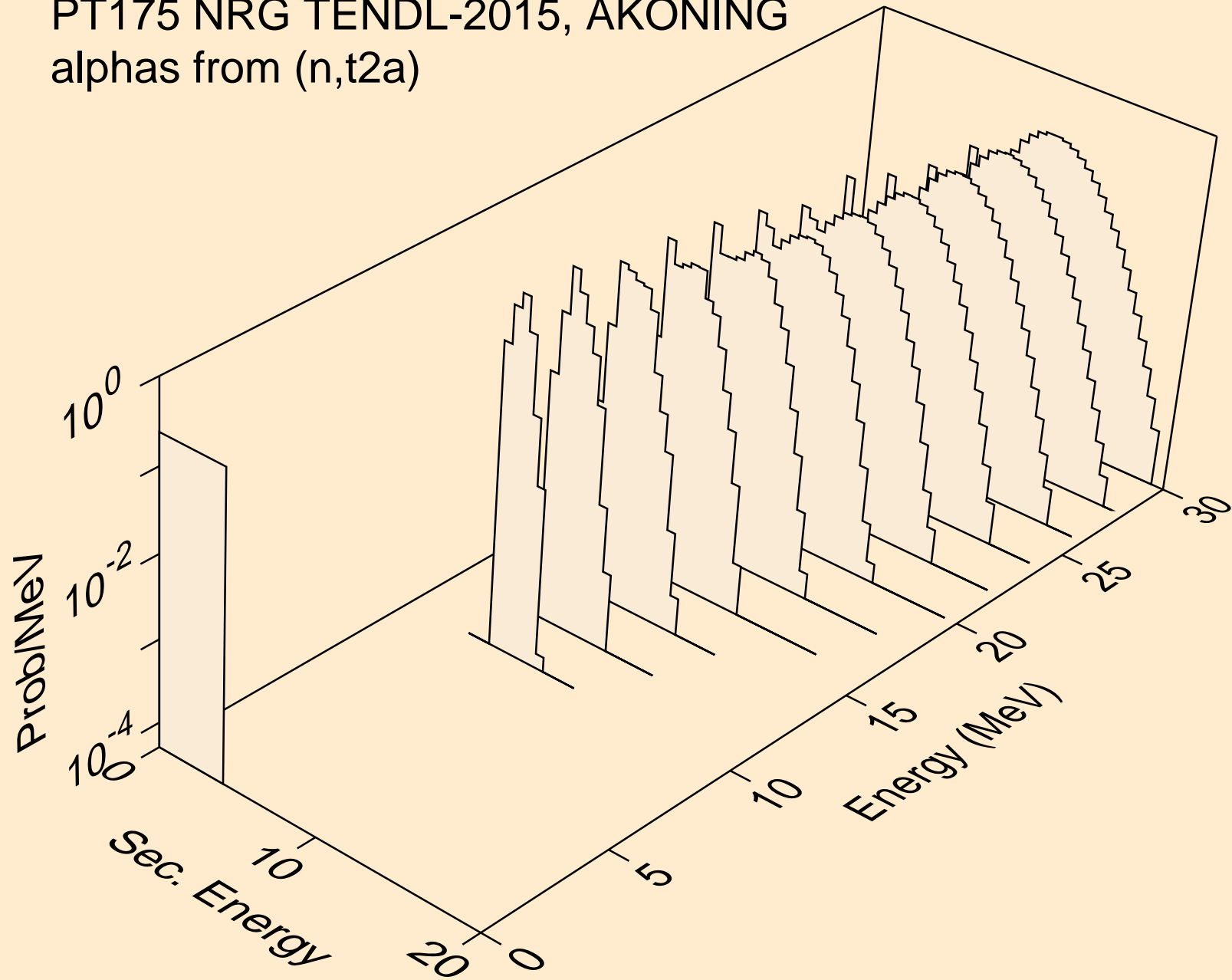

PT175 NRG TENDL-2015, AKONING  
alphas from (n,d2a)

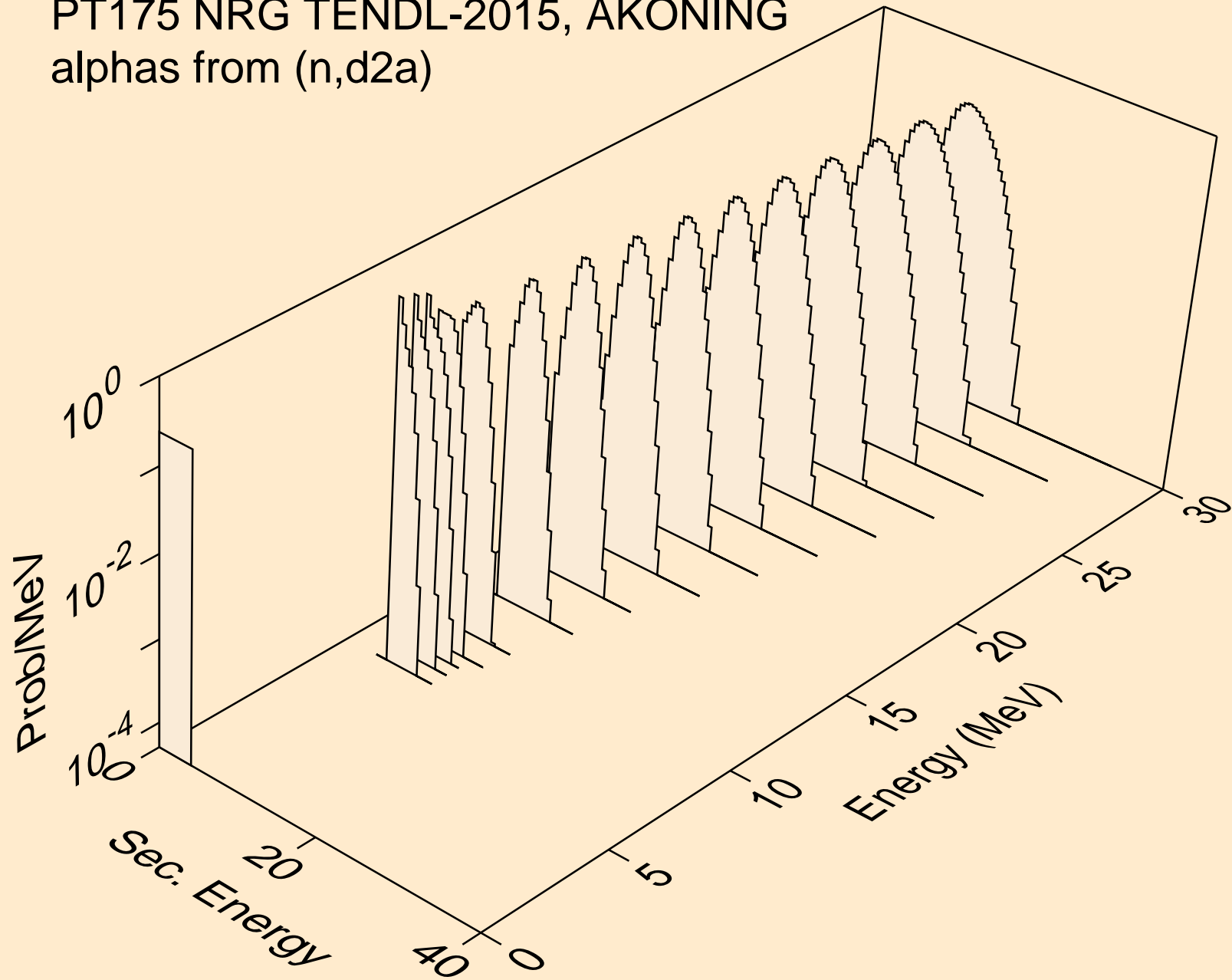

PT175 NRG TENDL-2015, AKONING  
alphas from (n,da)

