

PT177 NRG TENDL-2015, AKONING

Principal cross sections

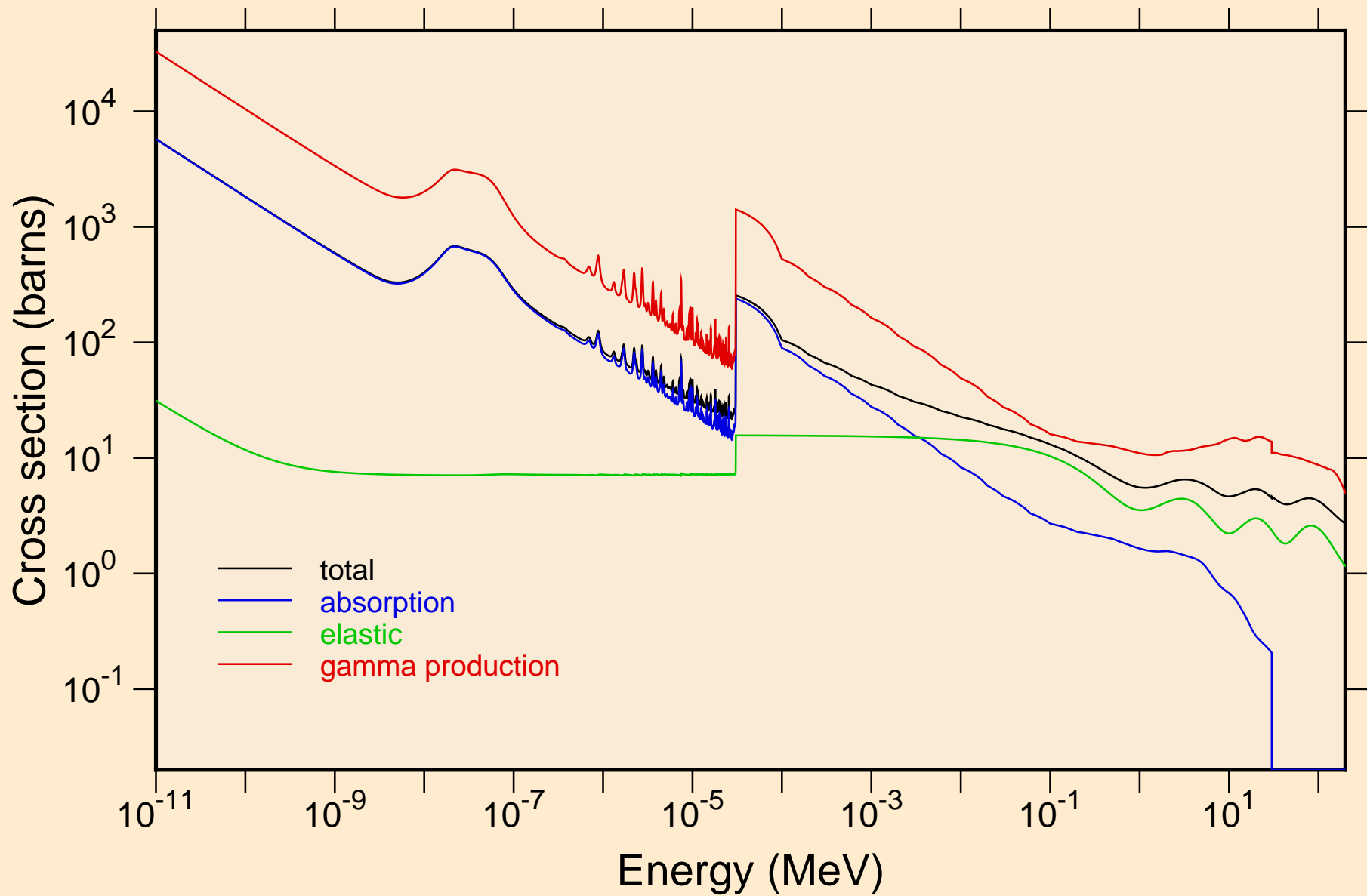

PT177 NRG TENDL-2015, AKONING
resonance total cross section

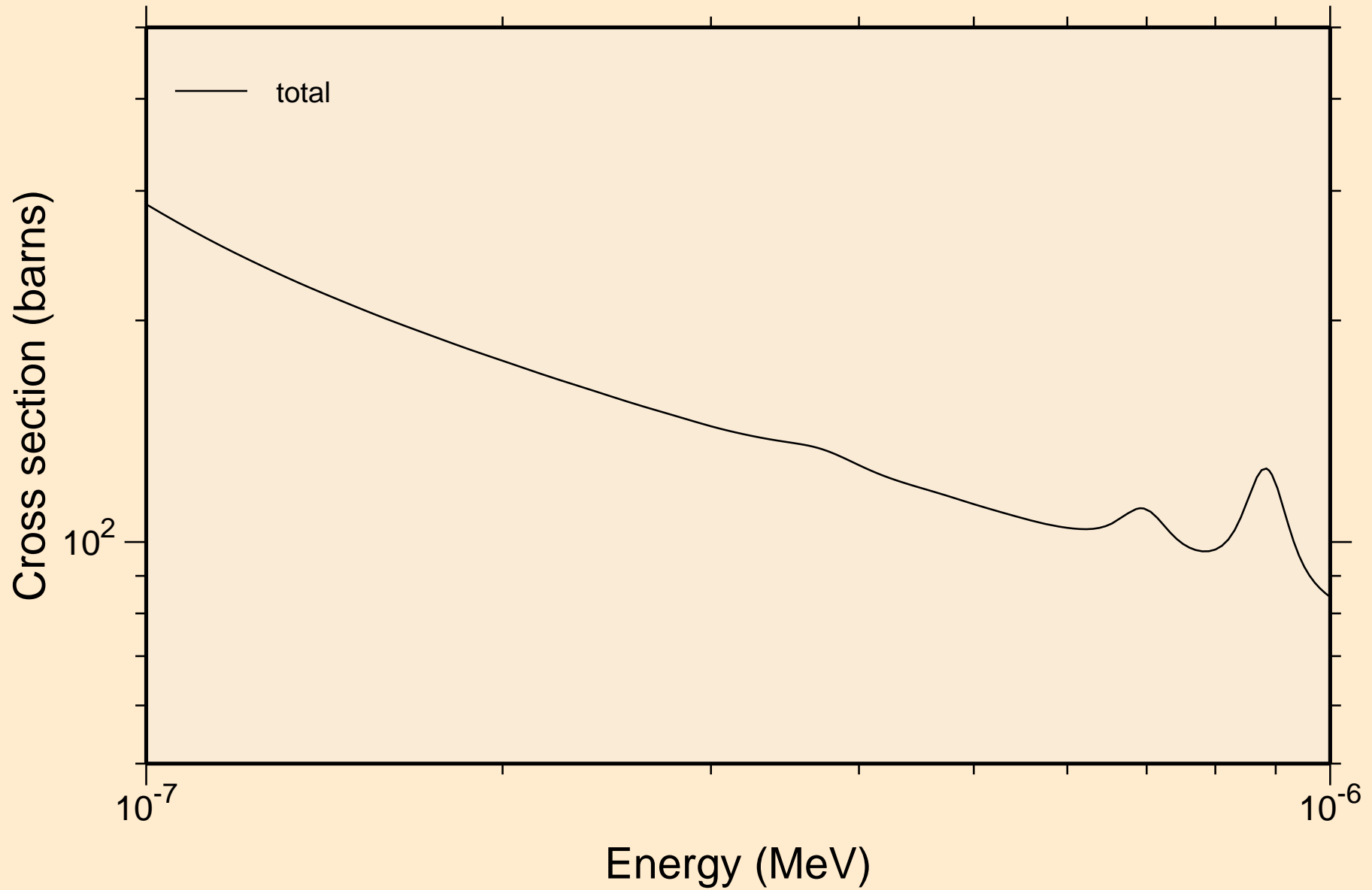

PT177 NRG TENDL-2015, AKONING
resonance total cross section

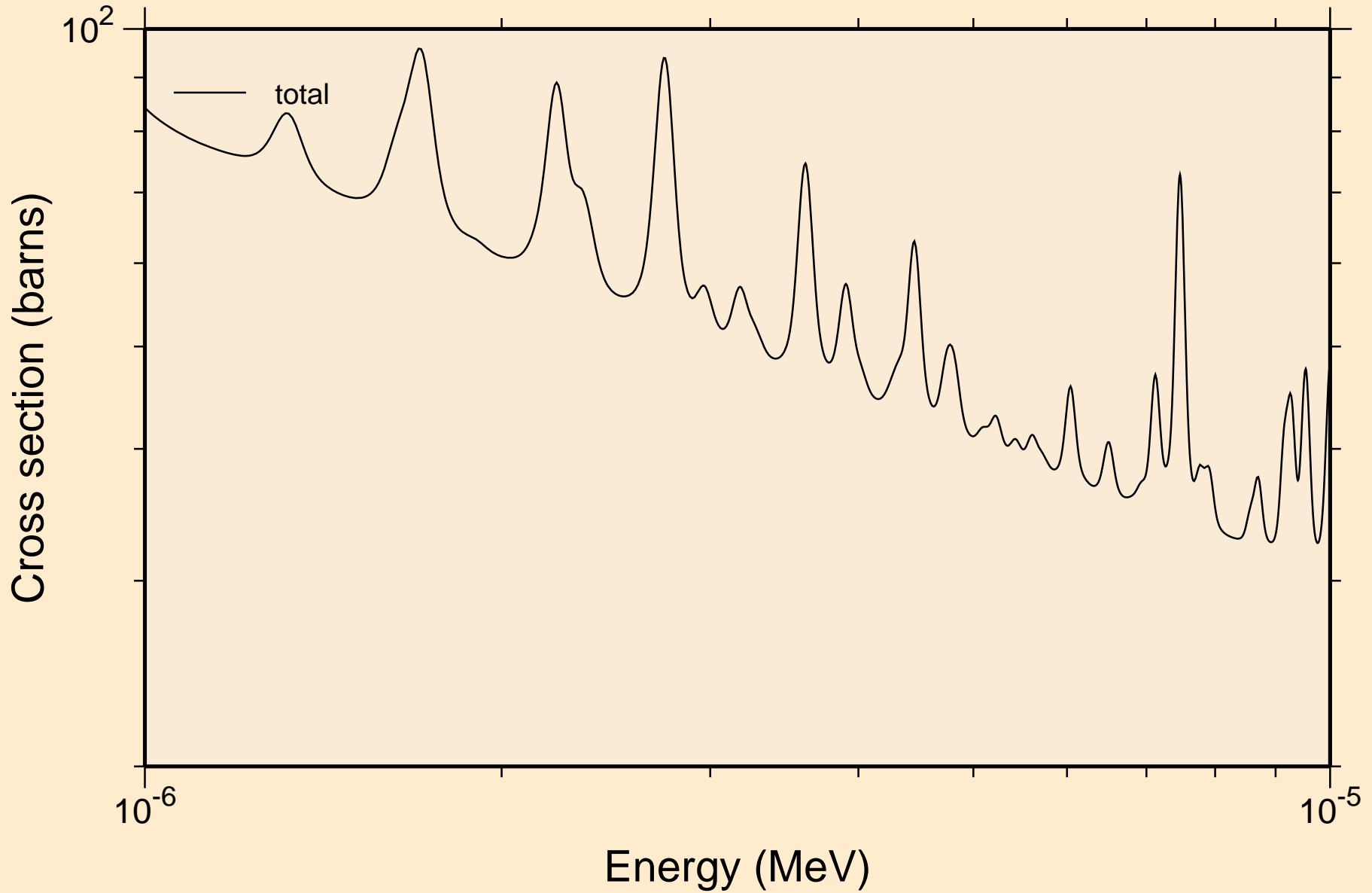

PT177 NRG TENDL-2015, AKONING
resonance total cross section

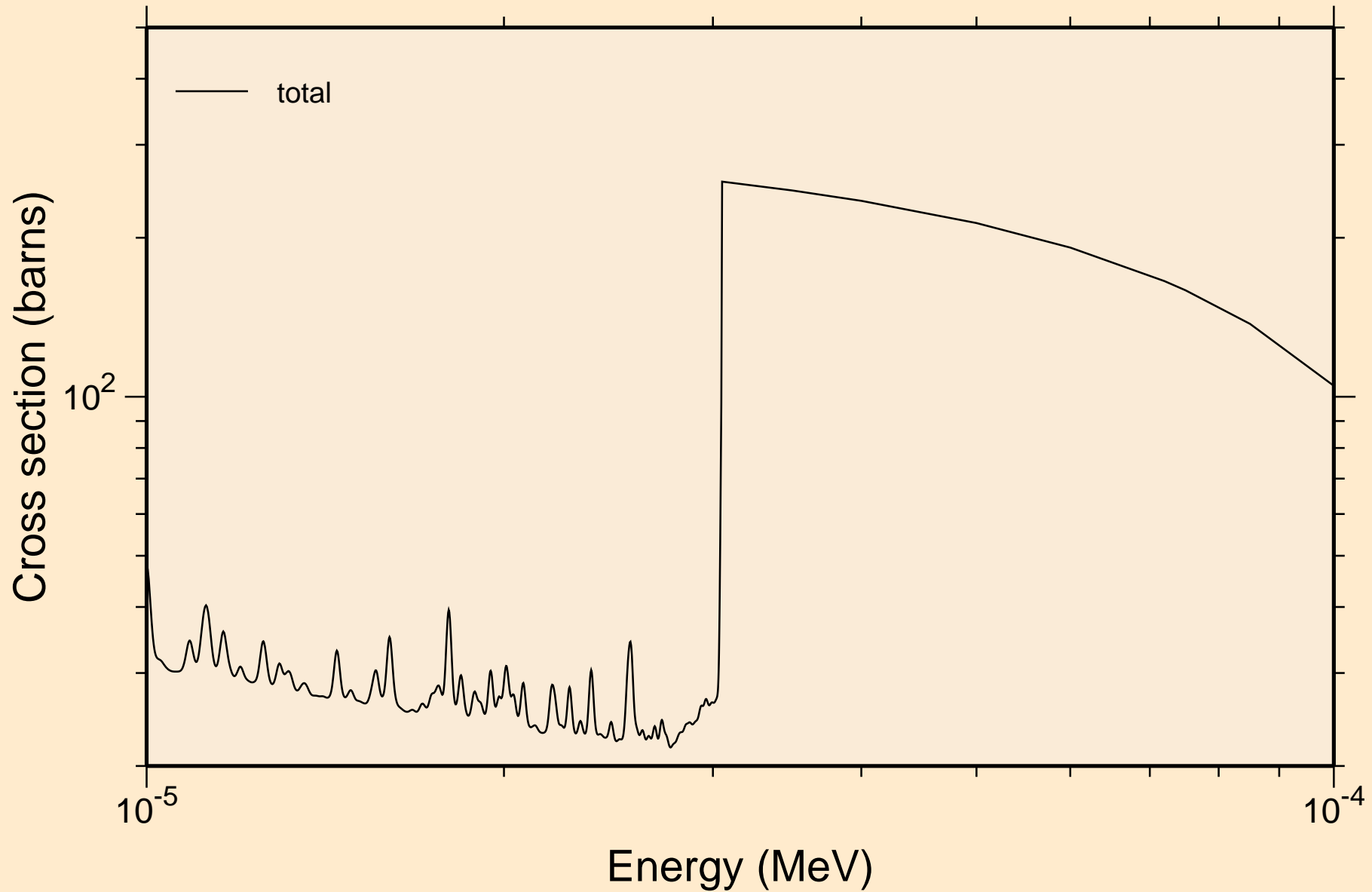

PT177 NRG TENDL-2015, AKONING
resonance total cross section

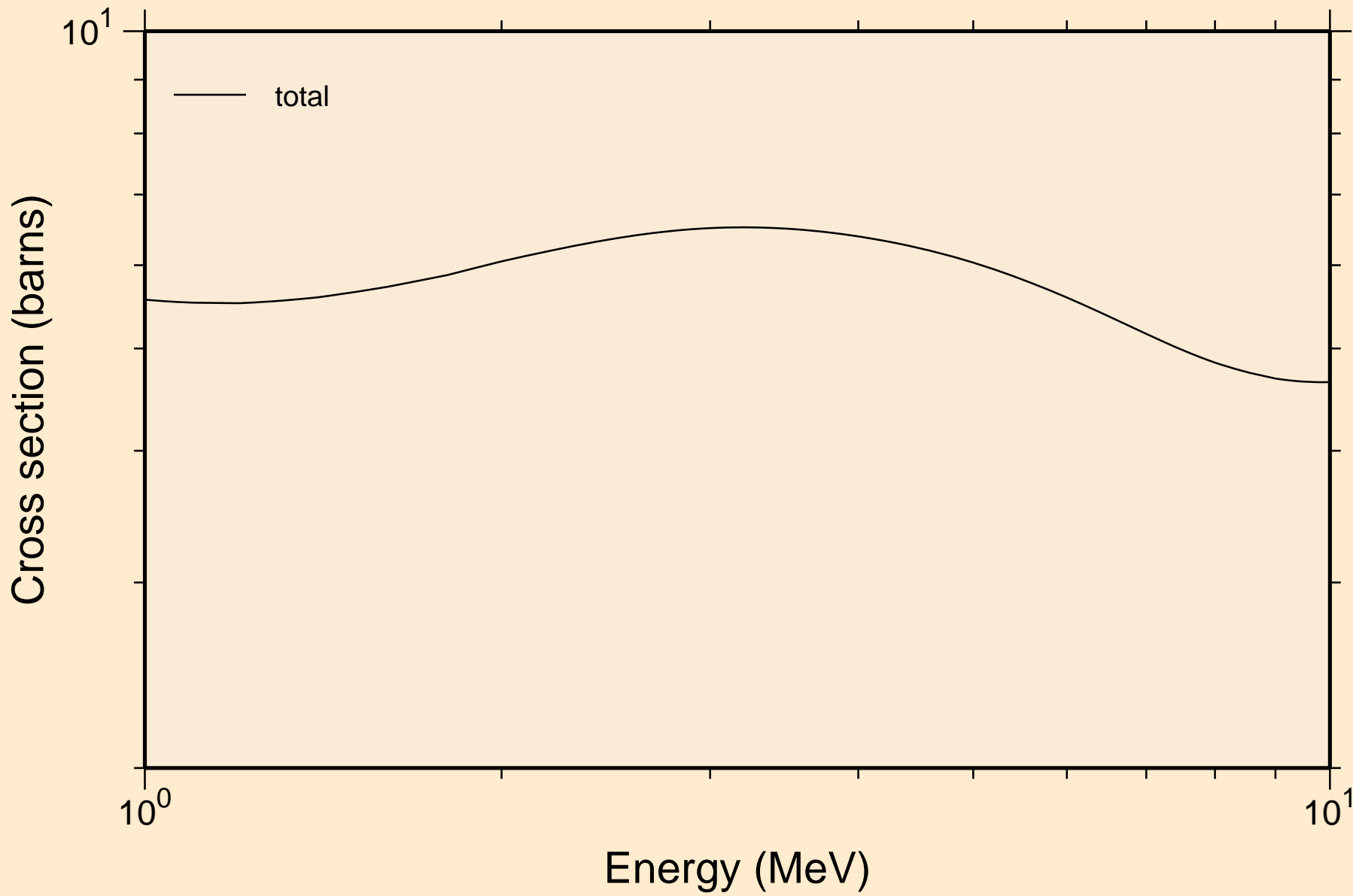

PT177 NRG TENDL-2015, AKONING
resonance absorption cross sections

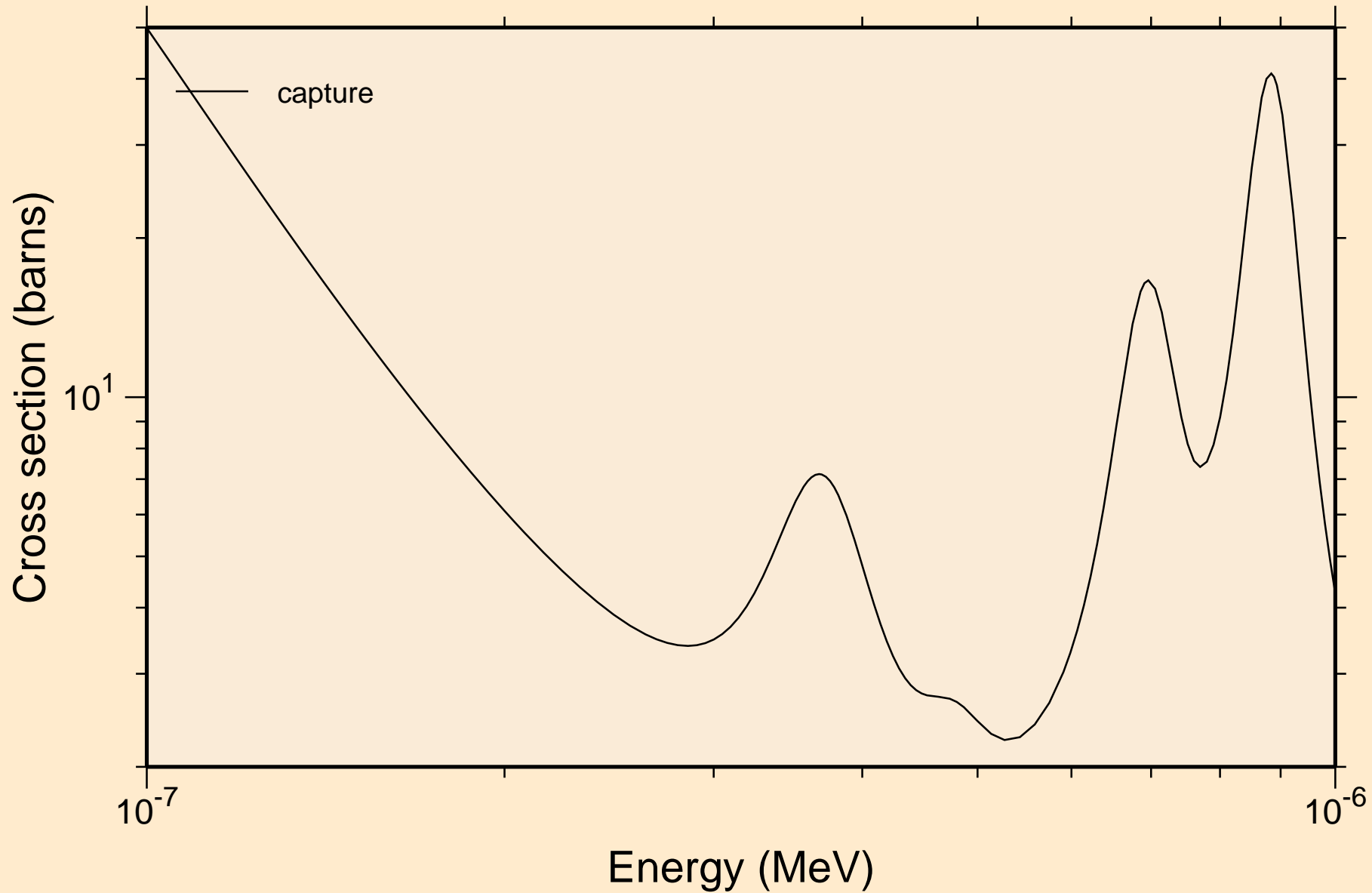

PT177 NRG TENDL-2015, AKONING
resonance absorption cross sections

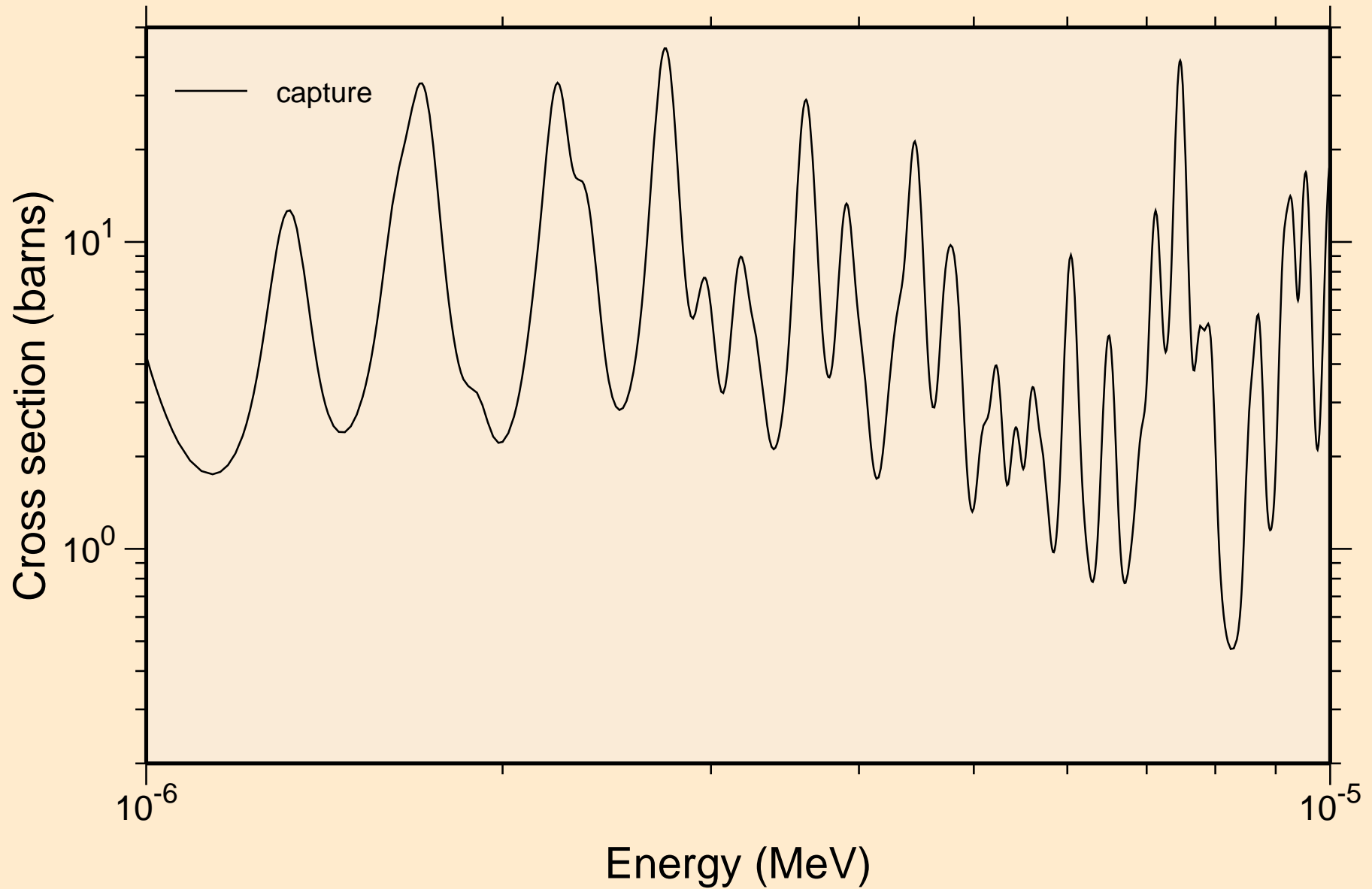

PT177 NRG TENDL-2015, AKONING
resonance absorption cross sections

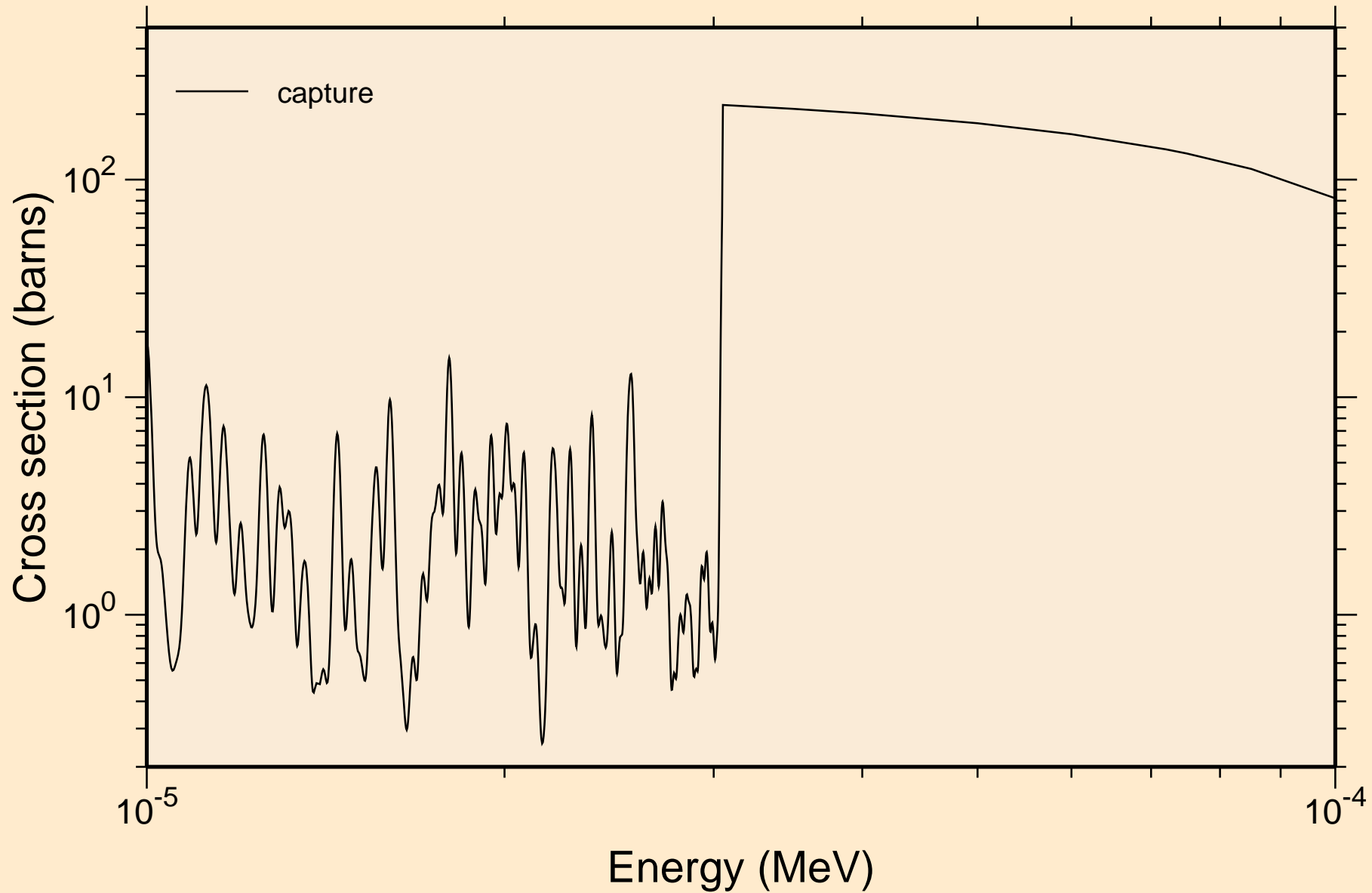

PT177 NRG TENDL-2015, AKONING
resonance absorption cross sections

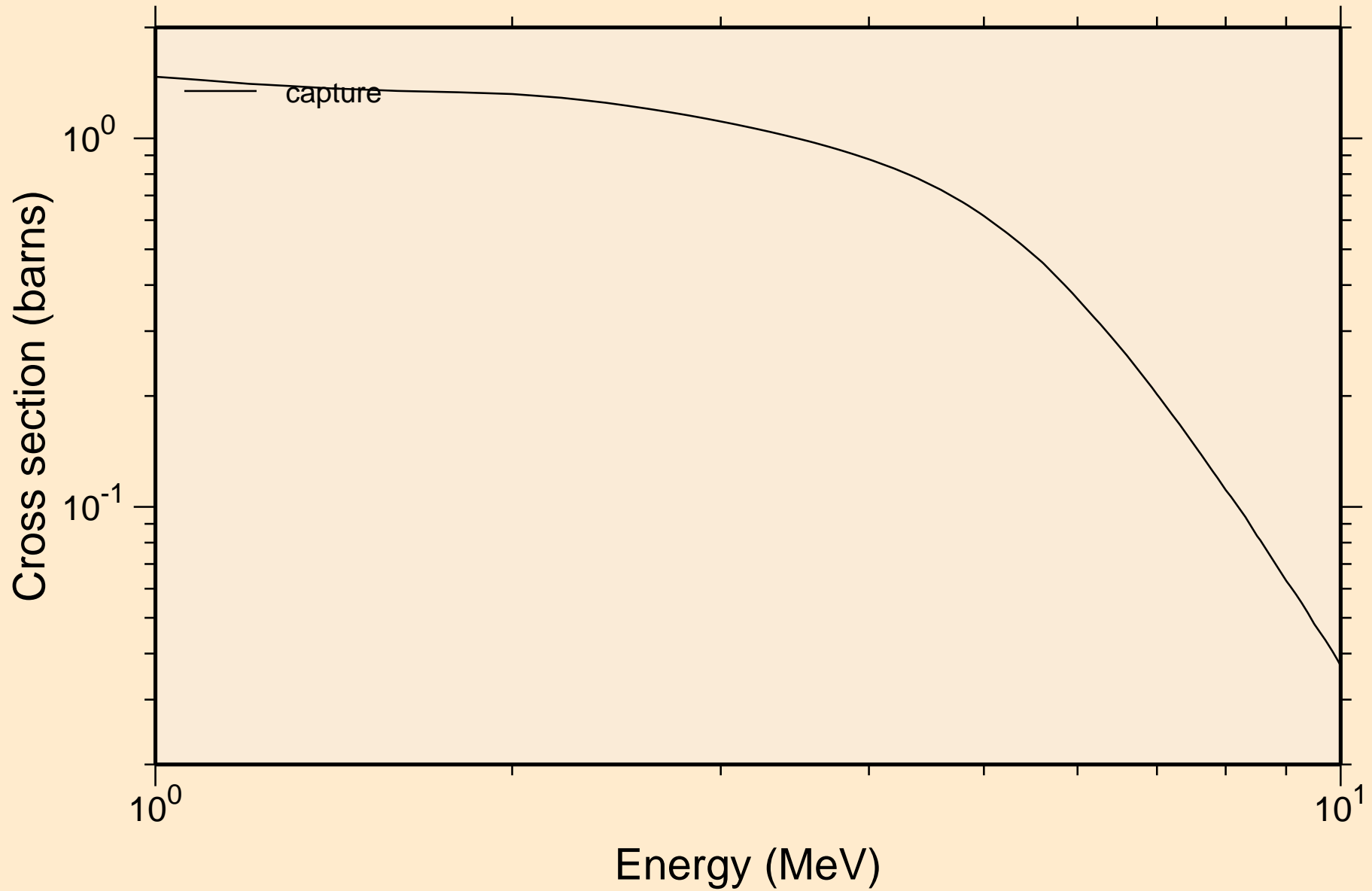

PT177 NRG TENDL-2015, AKONING

Non-threshold reactions

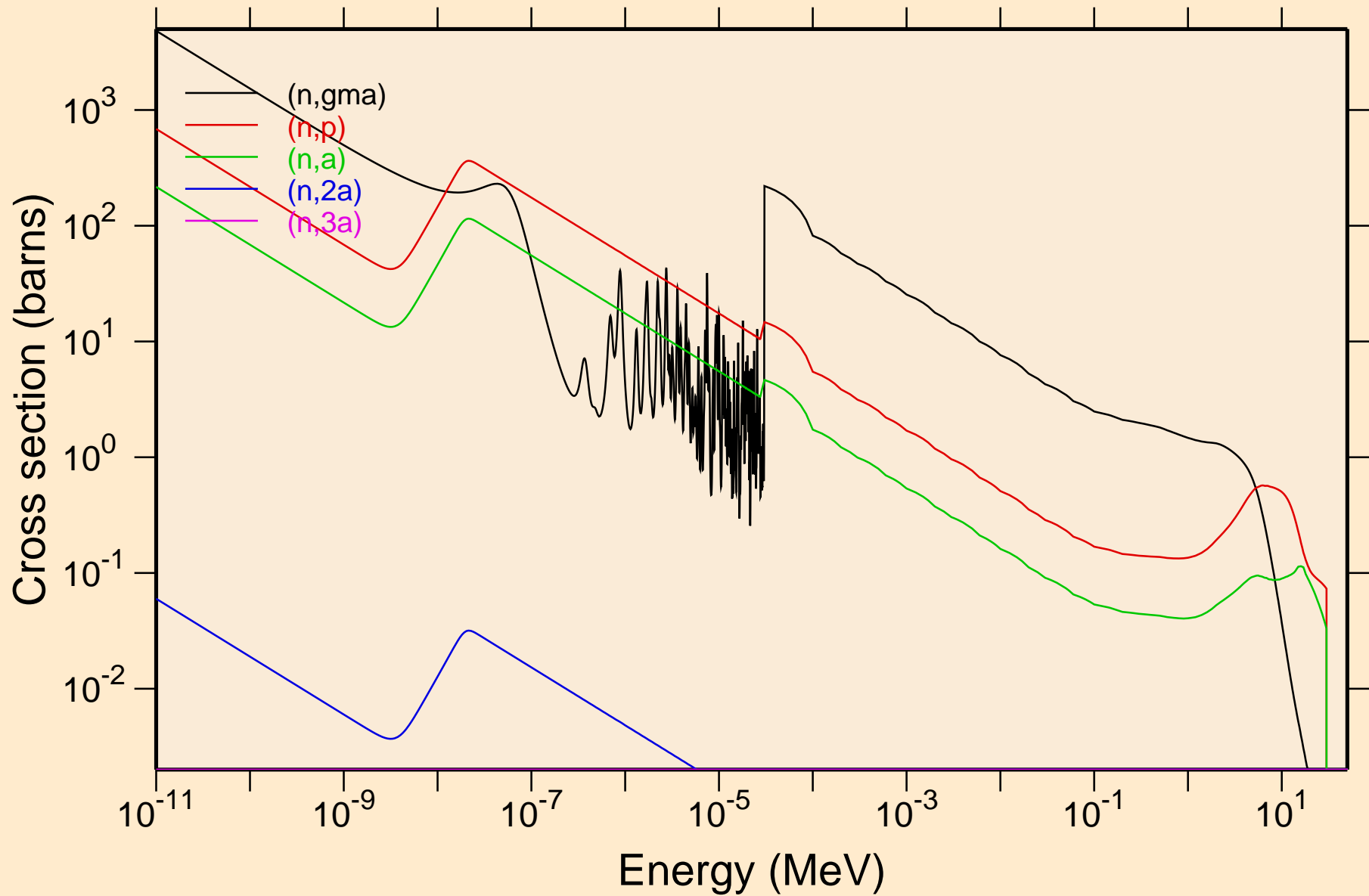

PT177 NRG TENDL-2015, AKONING
Non-threshold reactions

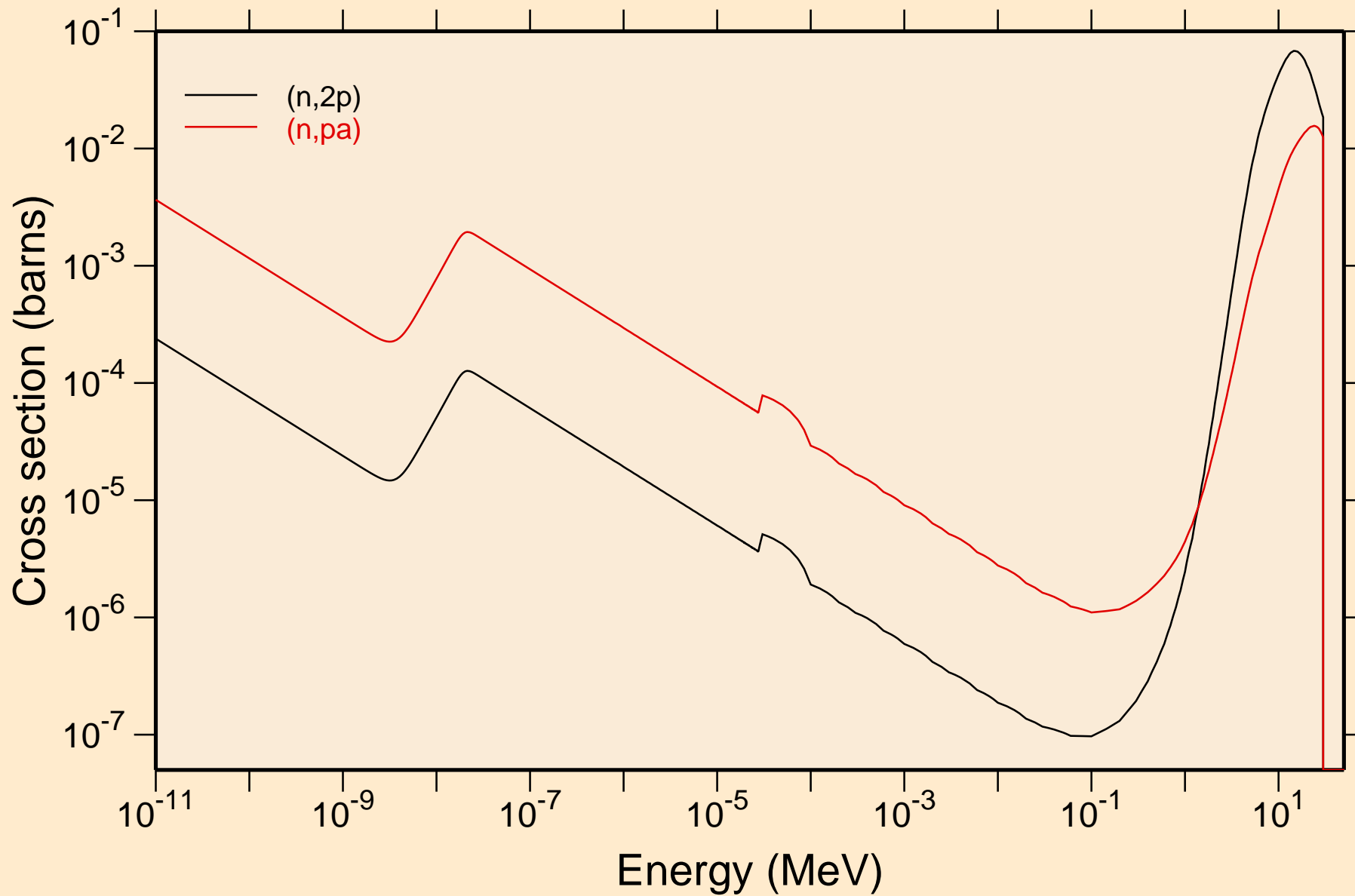

PT177 NRG TENDL-2015, AKONING

Principal cross sections

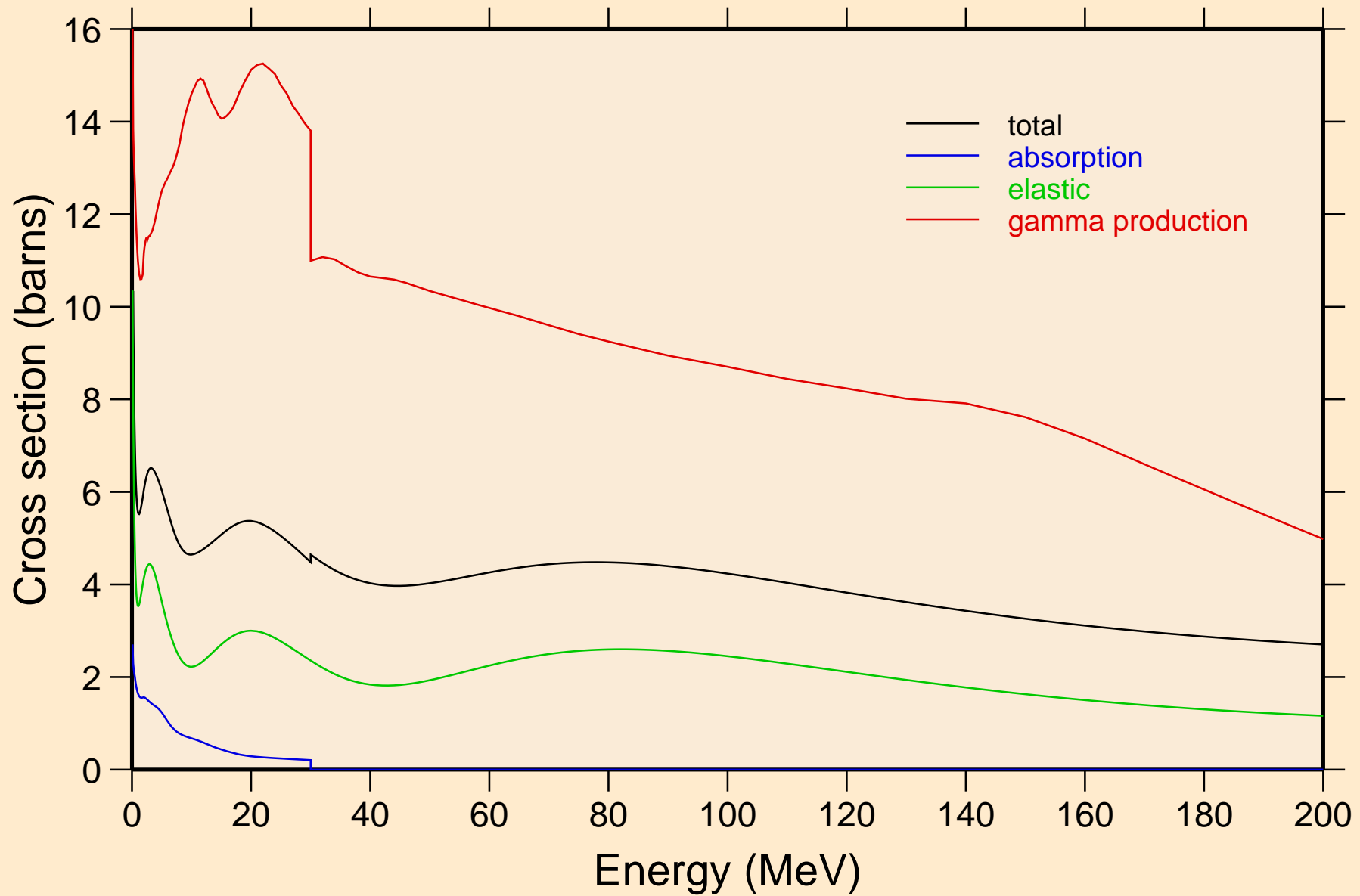

PT177 NRG TENDL-2015, AKONING

Non-threshold reactions

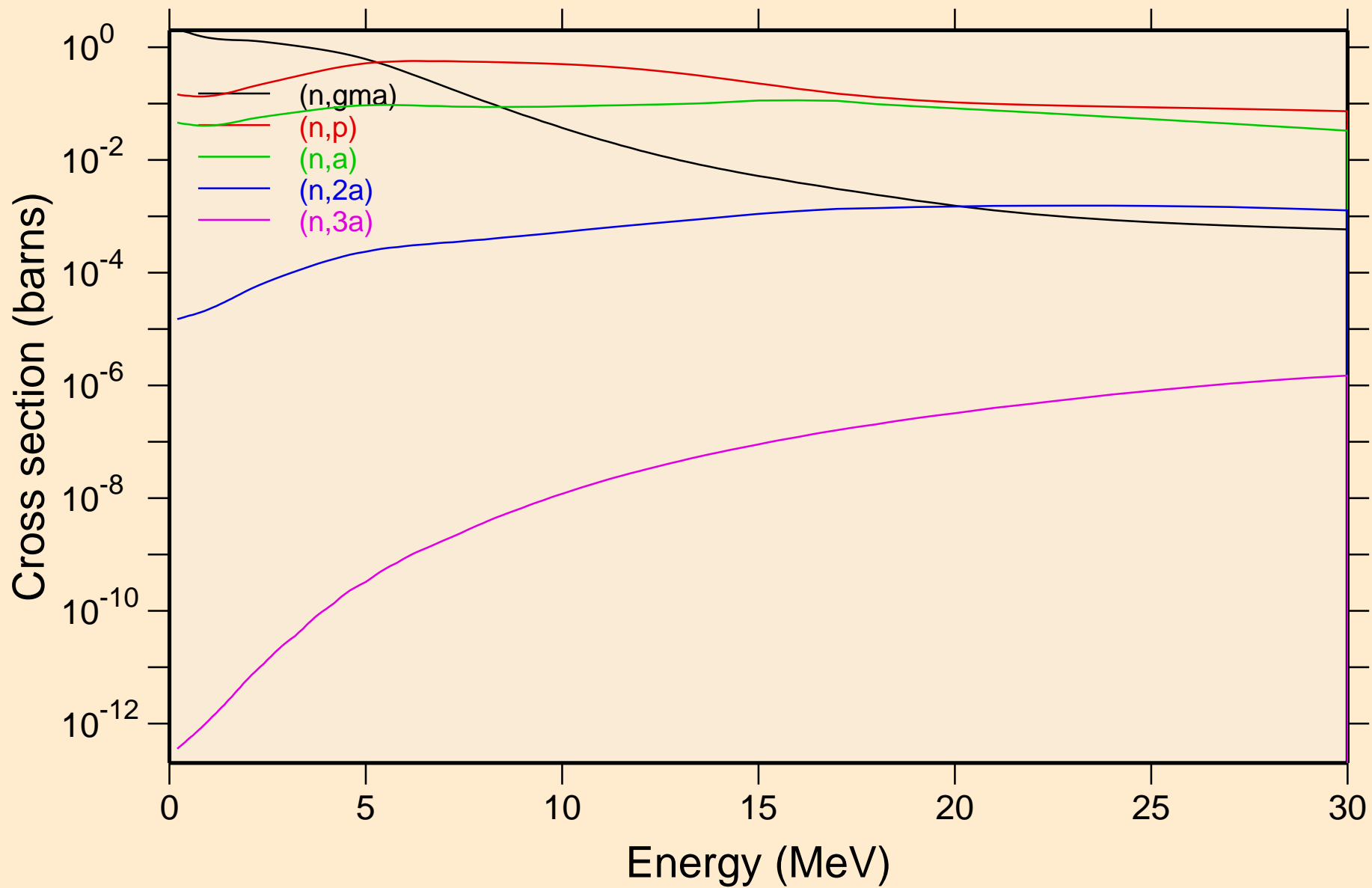

PT177 NRG TENDL-2015, AKONING
Non-threshold reactions

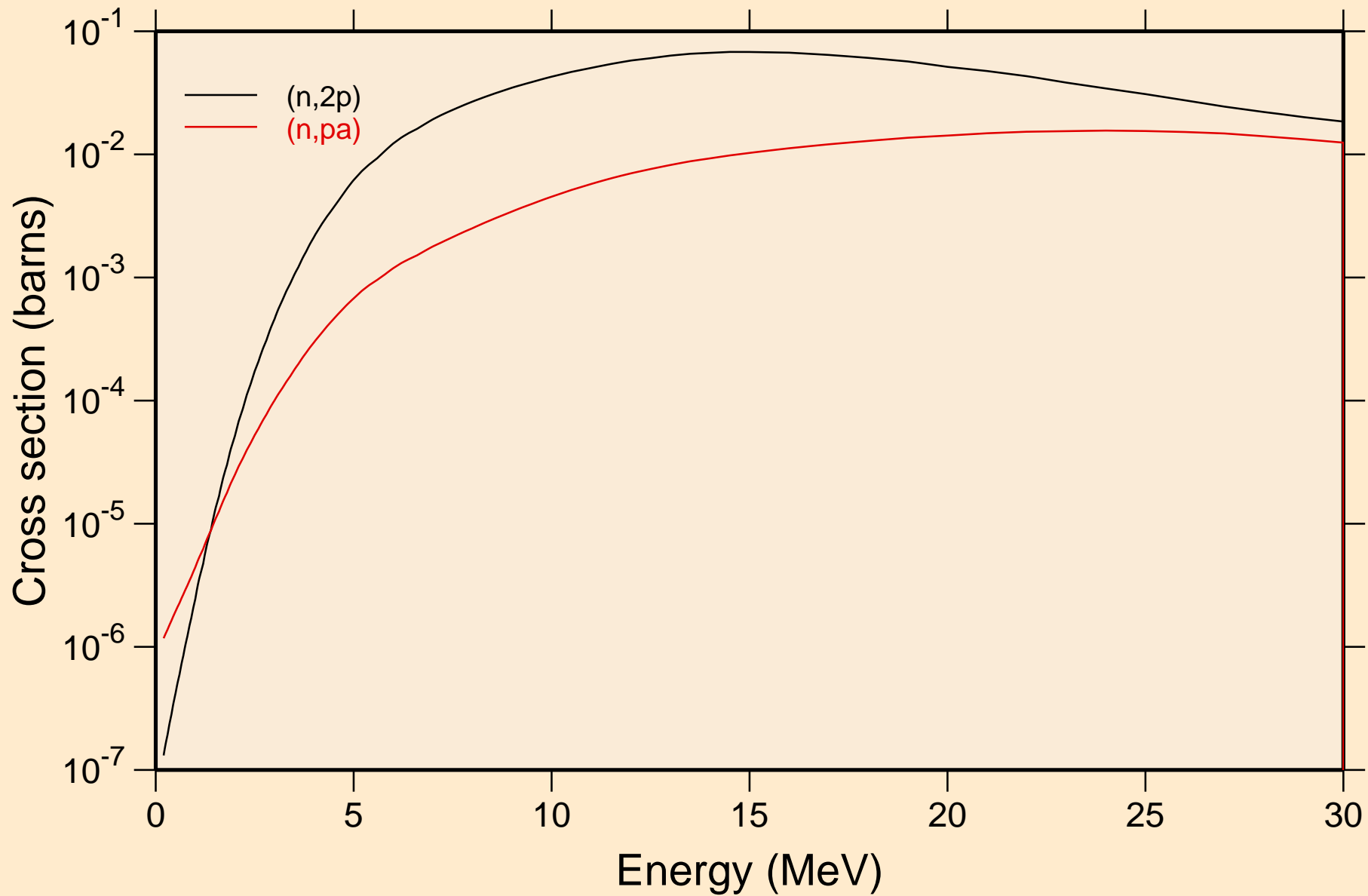

PT177 NRG TENDL-2015, AKONING
Inelastic levels

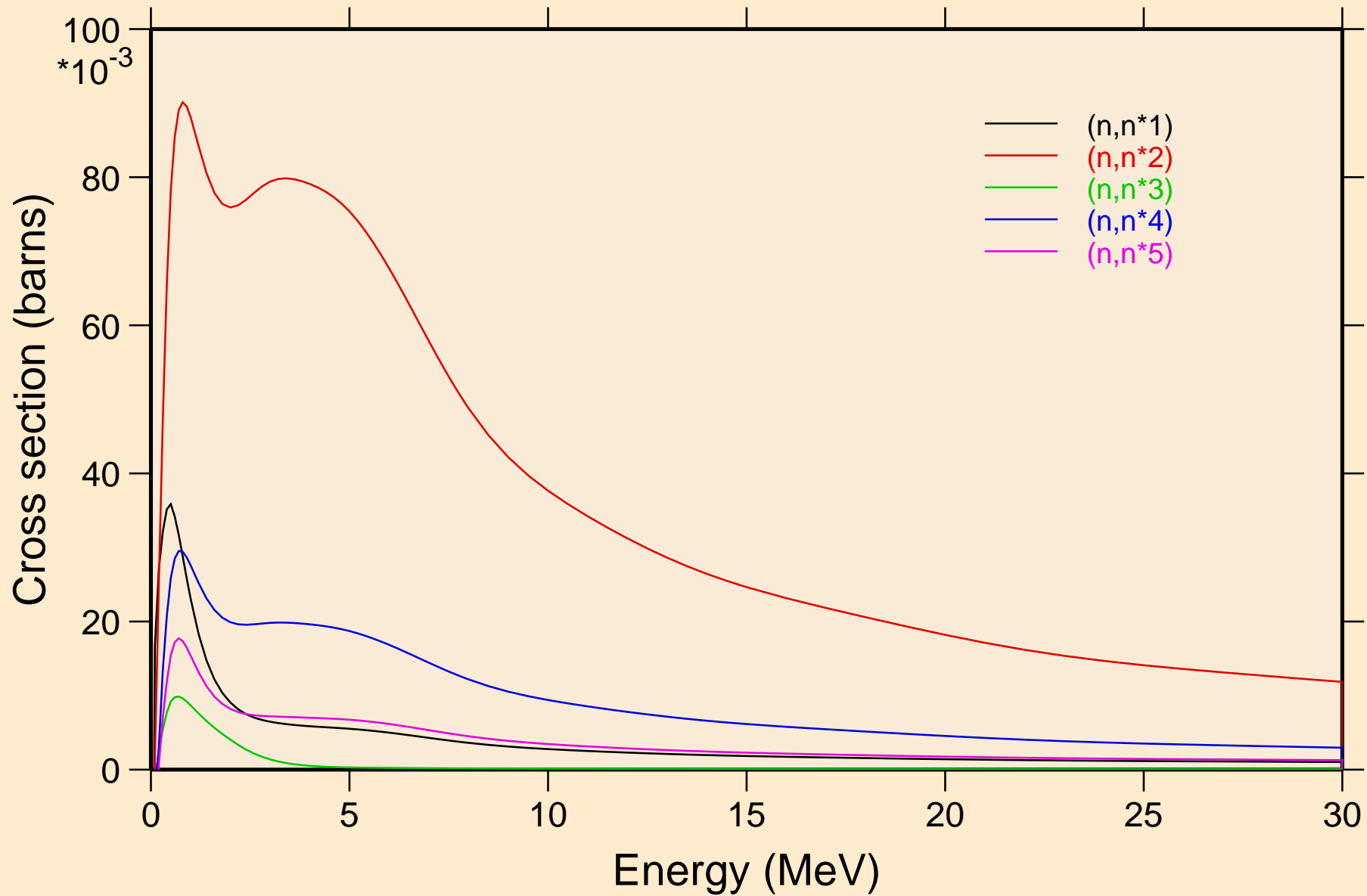

PT177 NRG TENDL-2015, AKONING

Inelastic levels

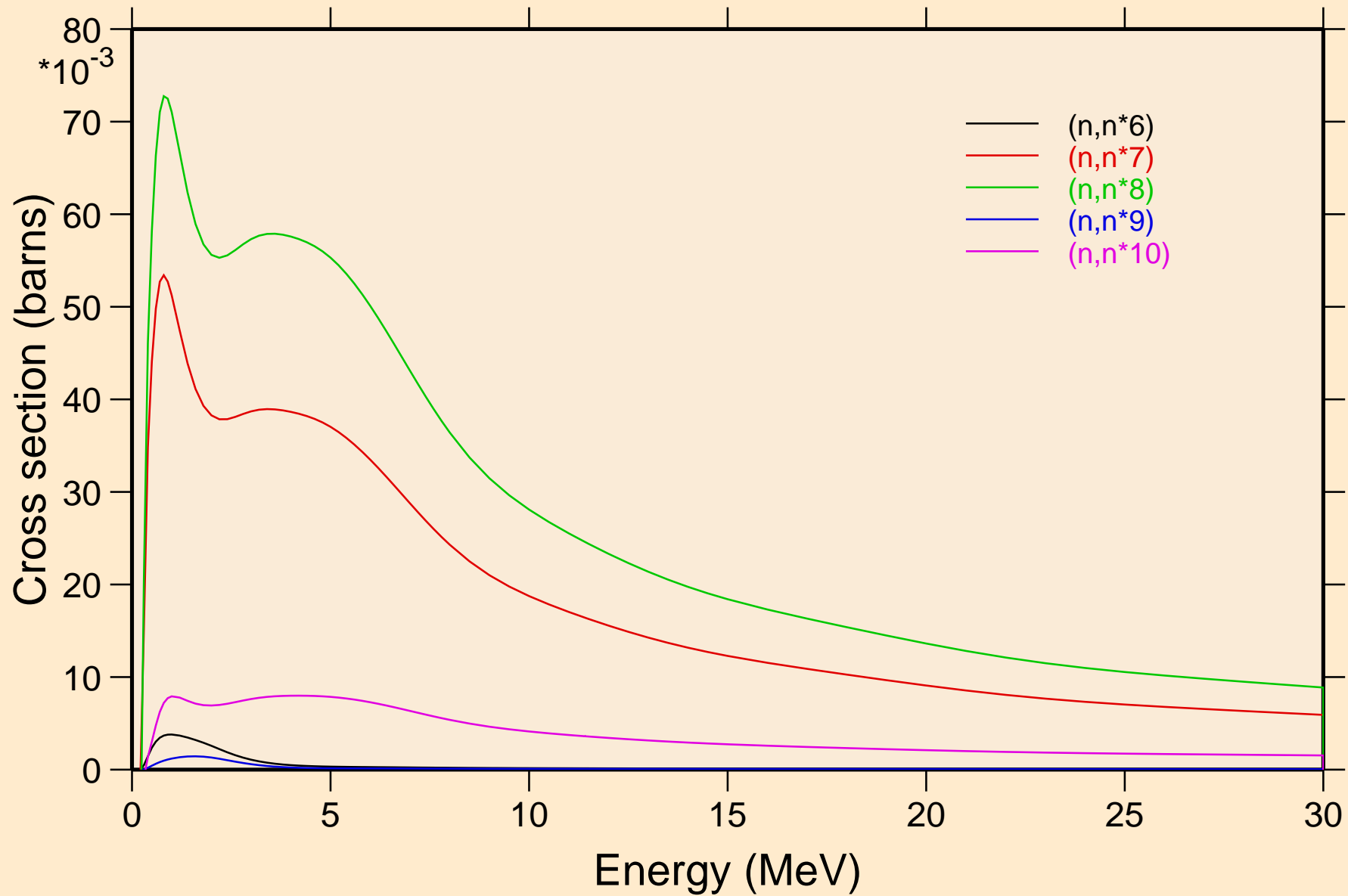

PT177 NRG TENDL-2015, AKONING
Inelastic levels

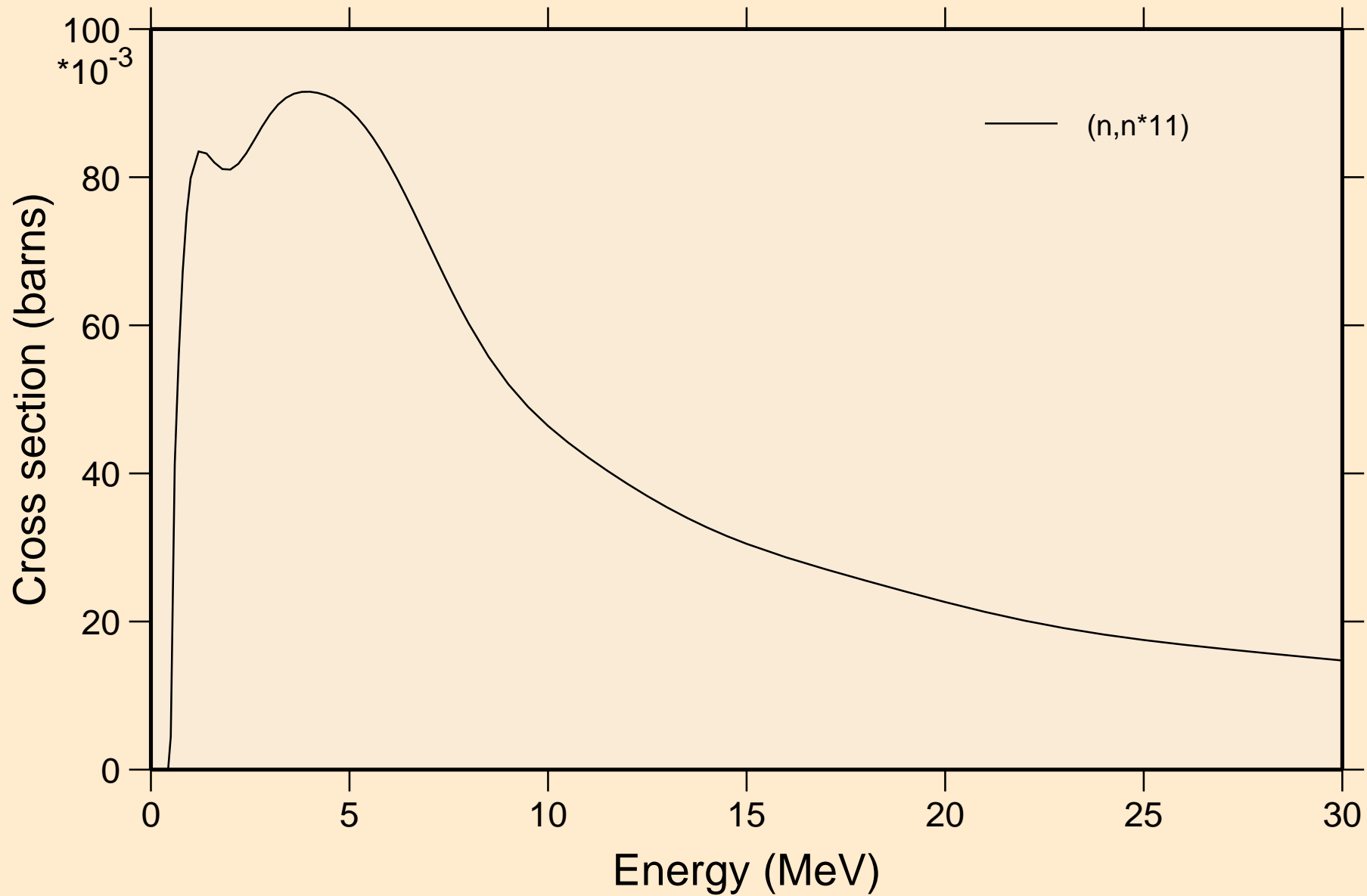

PT177 NRG TENDL-2015, AKONING

Threshold reactions

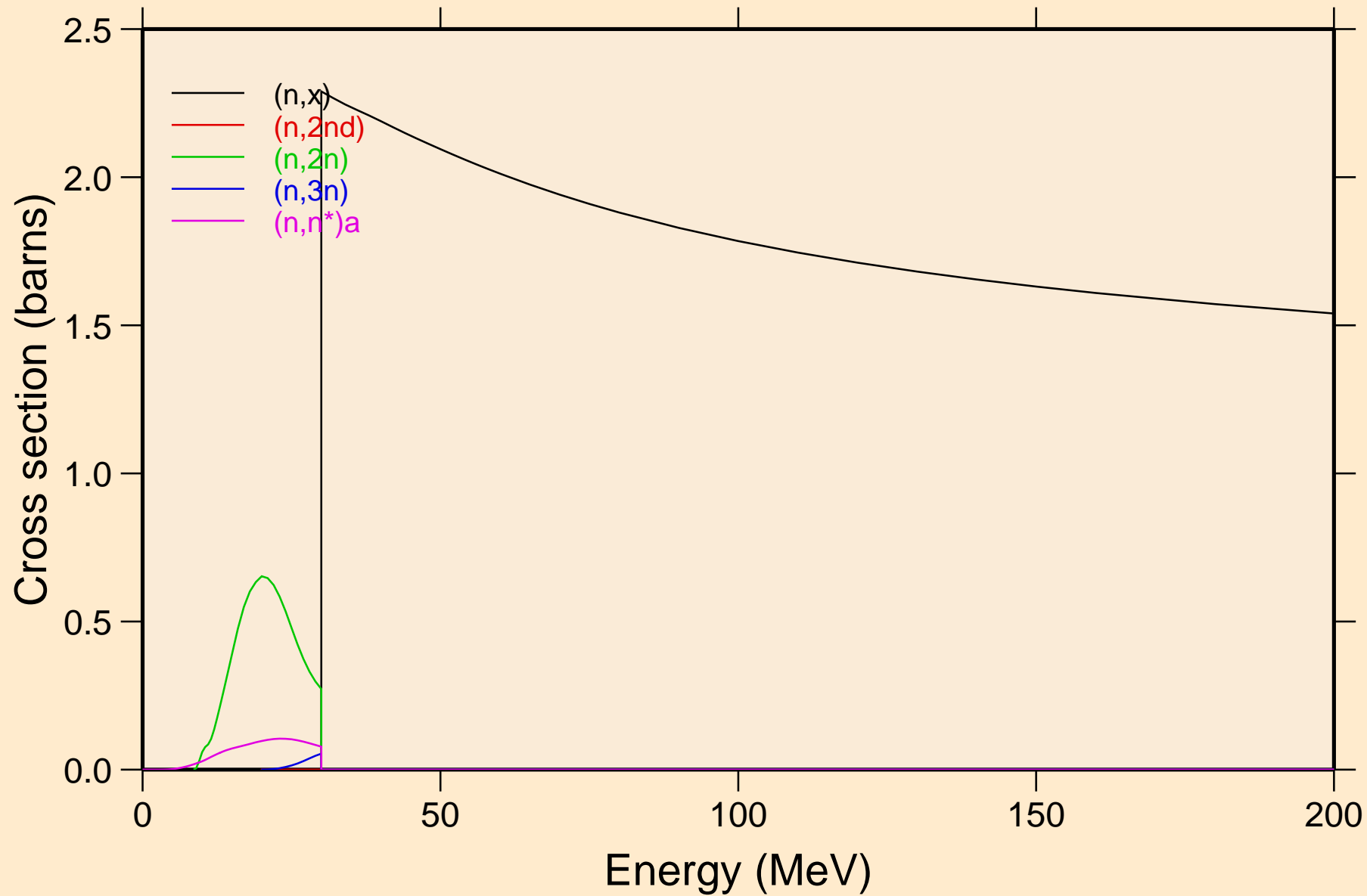

PT177 NRG TENDL-2015, AKONING

Threshold reactions

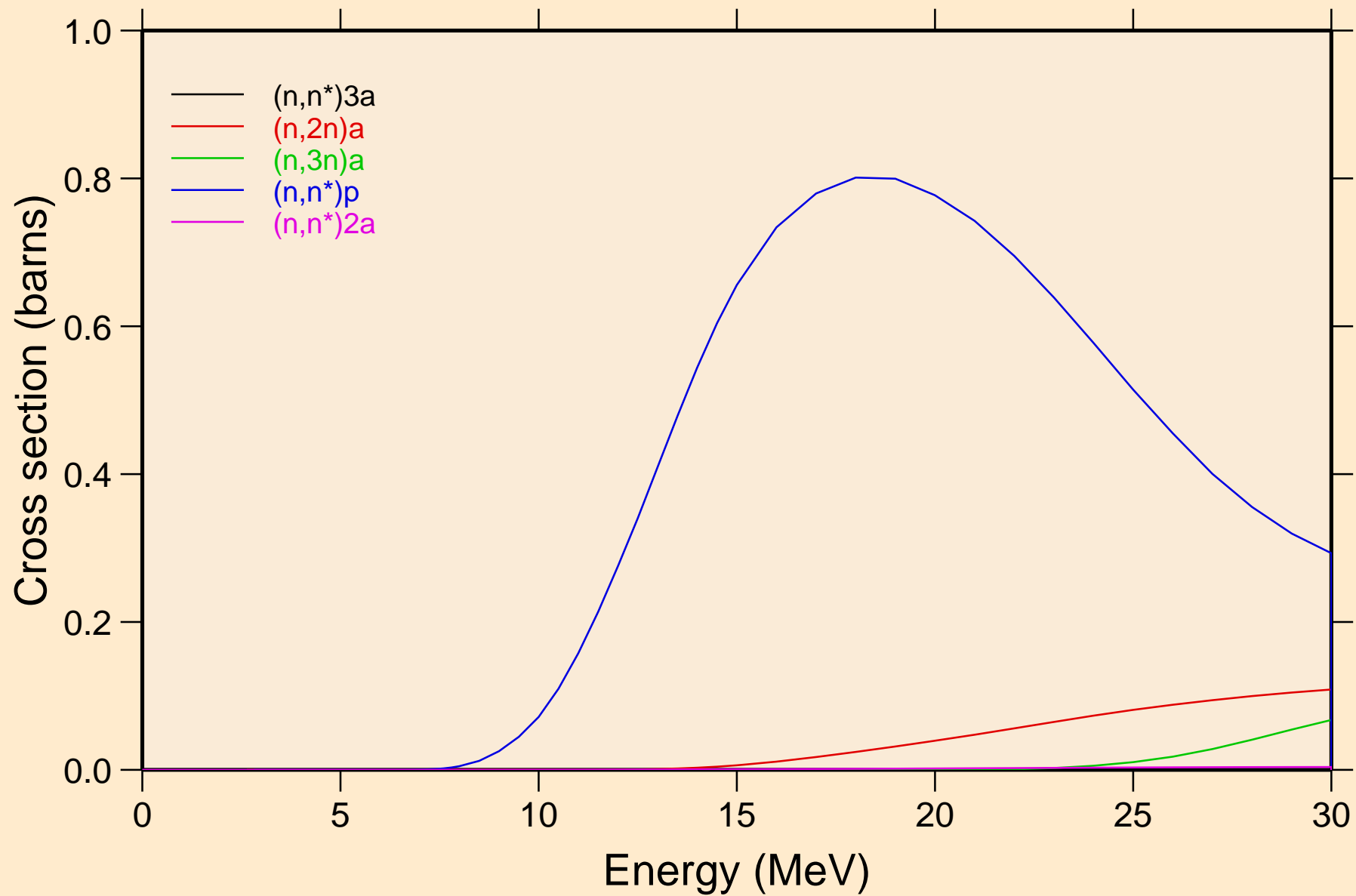

PT177 NRG TENDL-2015, AKONING

Threshold reactions

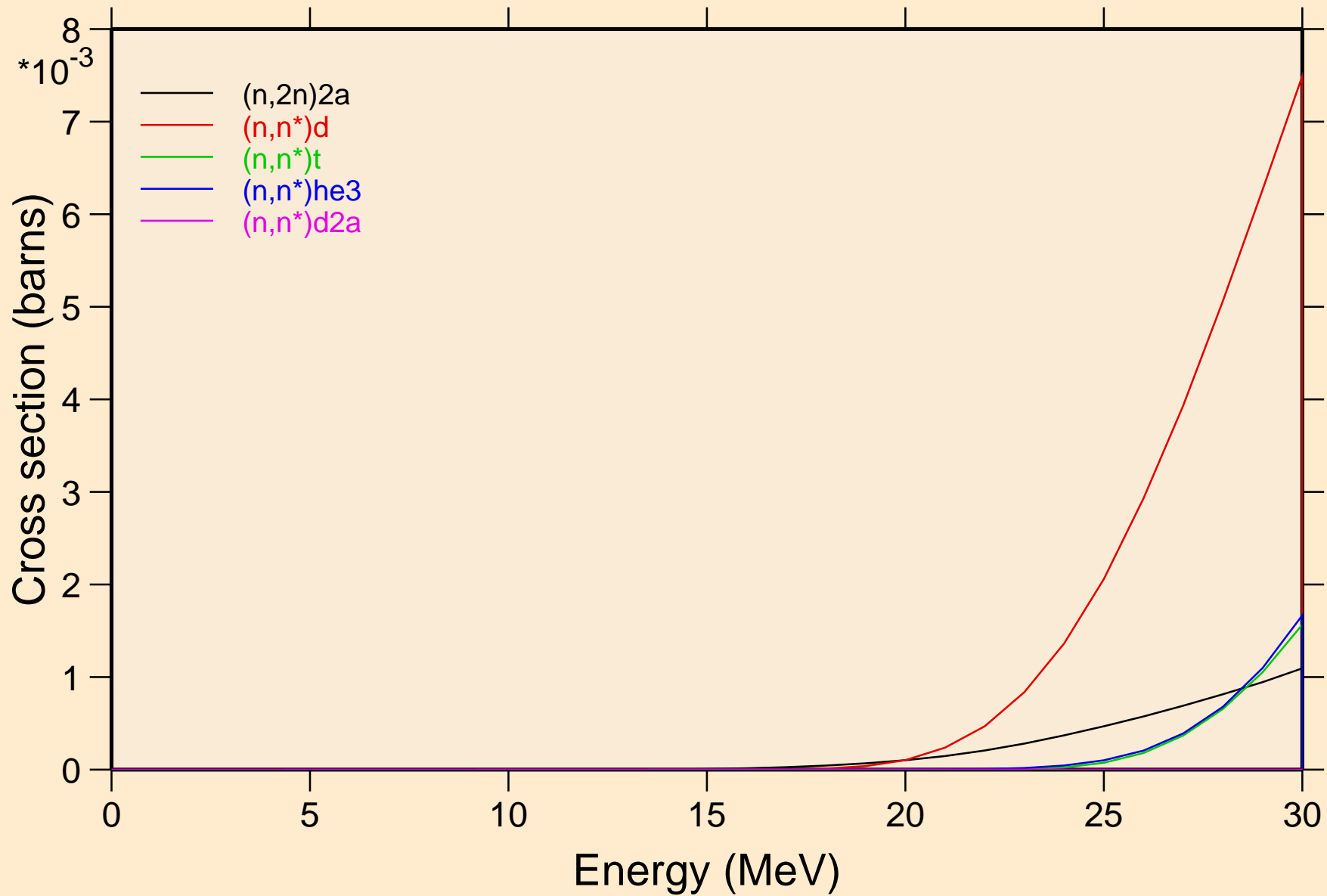

PT177 NRG TENDL-2015, AKONING
Threshold reactions

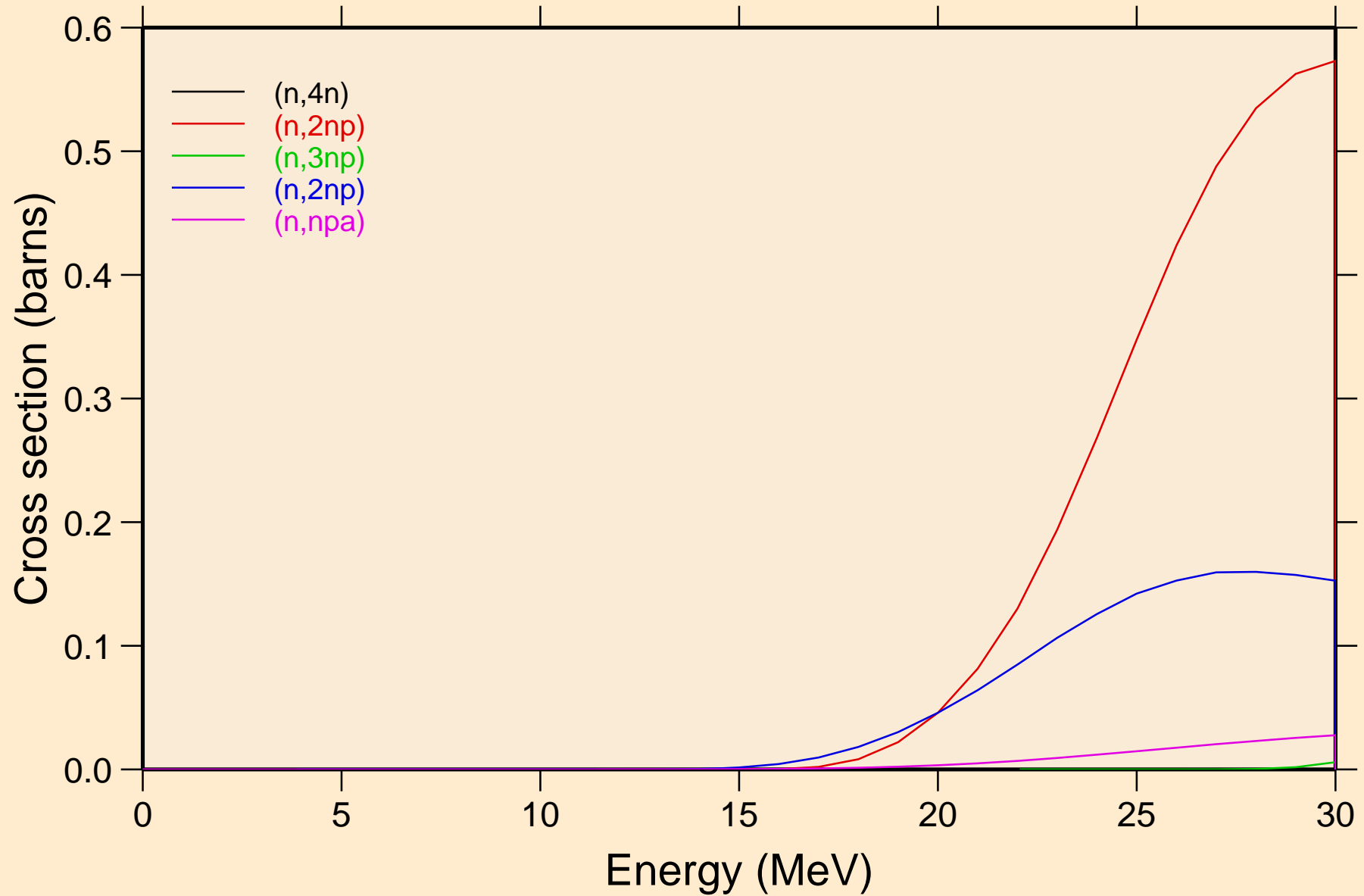

PT177 NRG TENDL-2015, AKONING

Threshold reactions

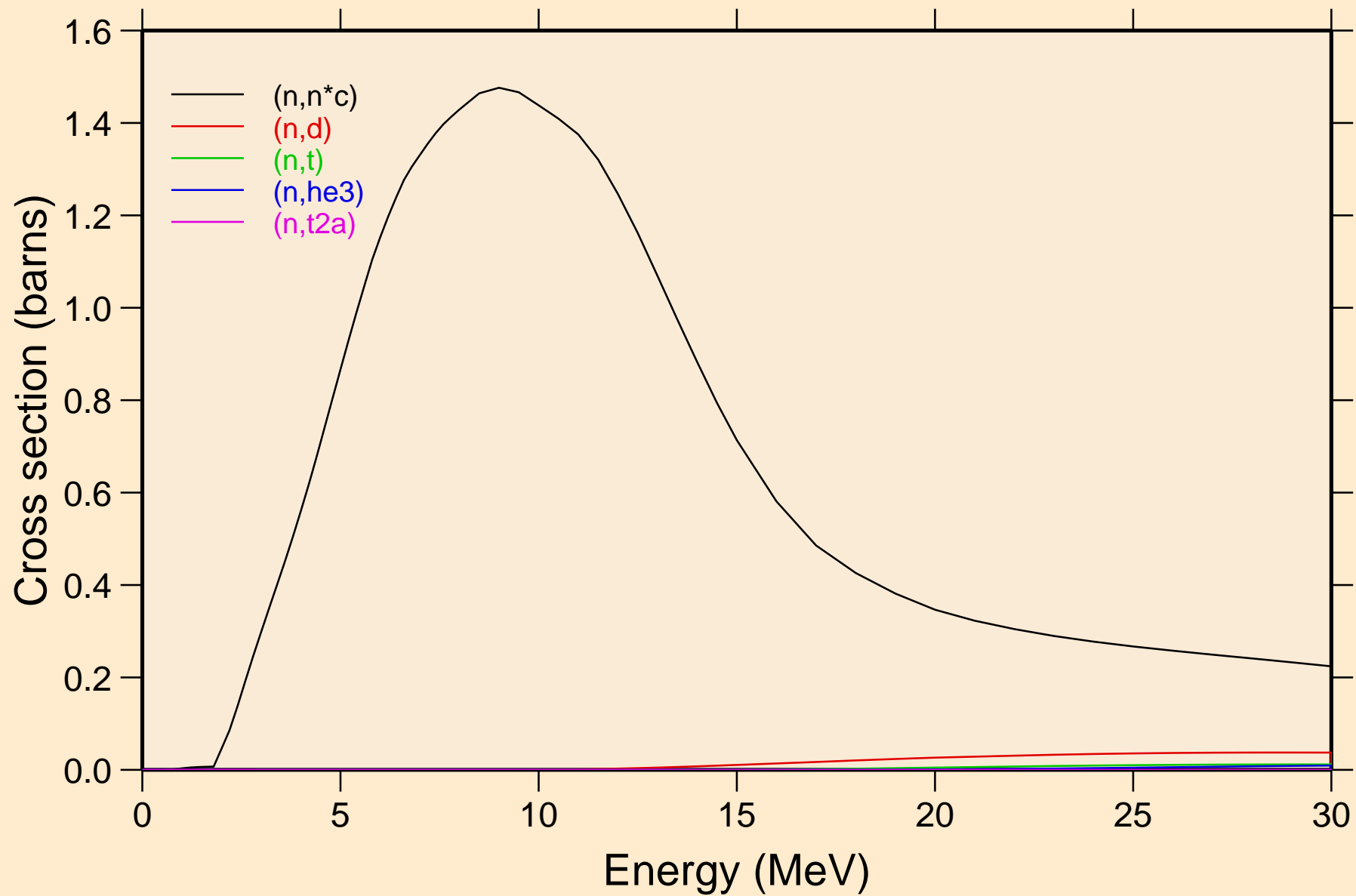

PT177 NRG TENDL-2015, AKONING
Threshold reactions

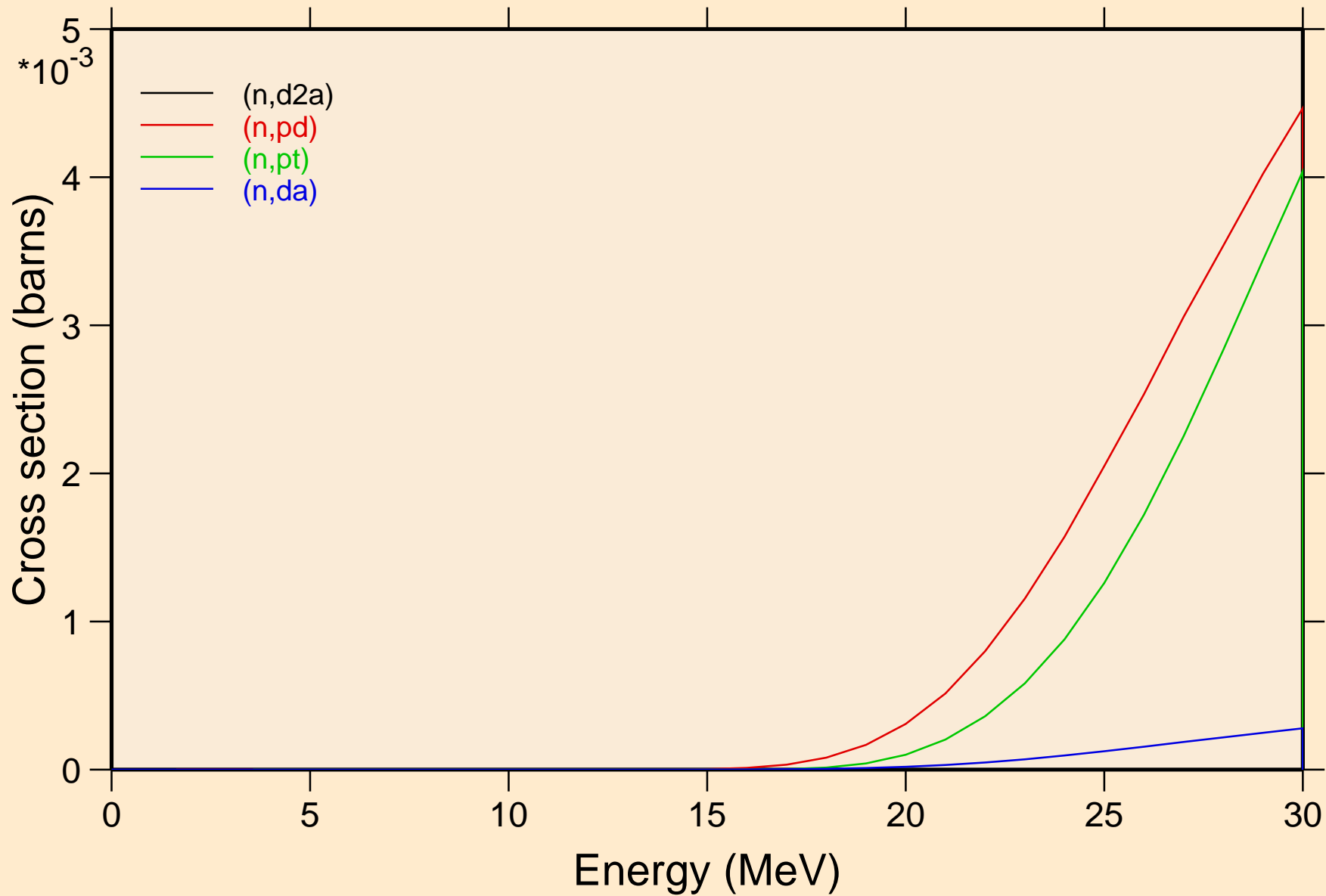

PT177 NRG TENDL-2015, AKONING
angular distribution for elastic

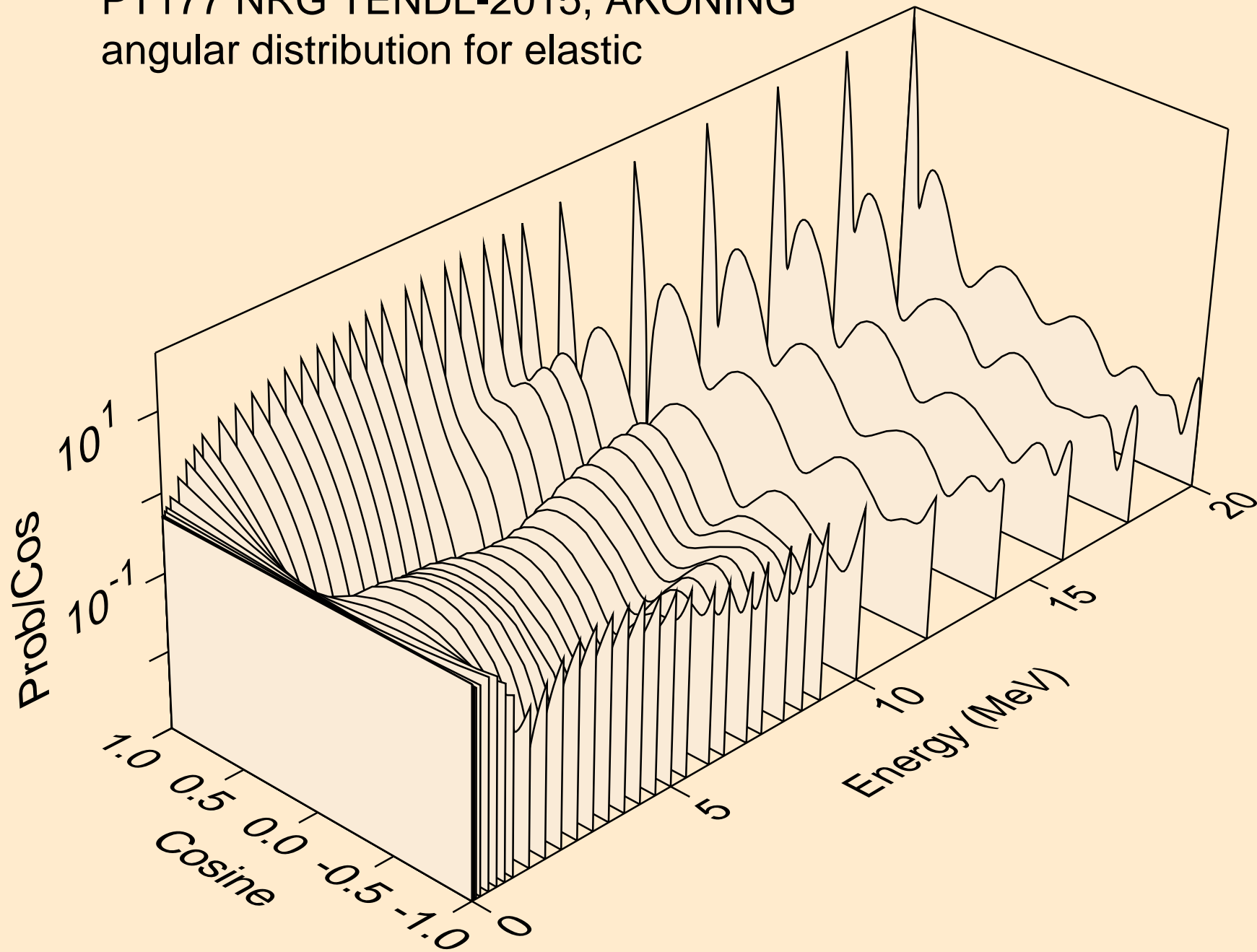

PT177 NRG TENDL-2015, AKONING
angular distribution for elastic

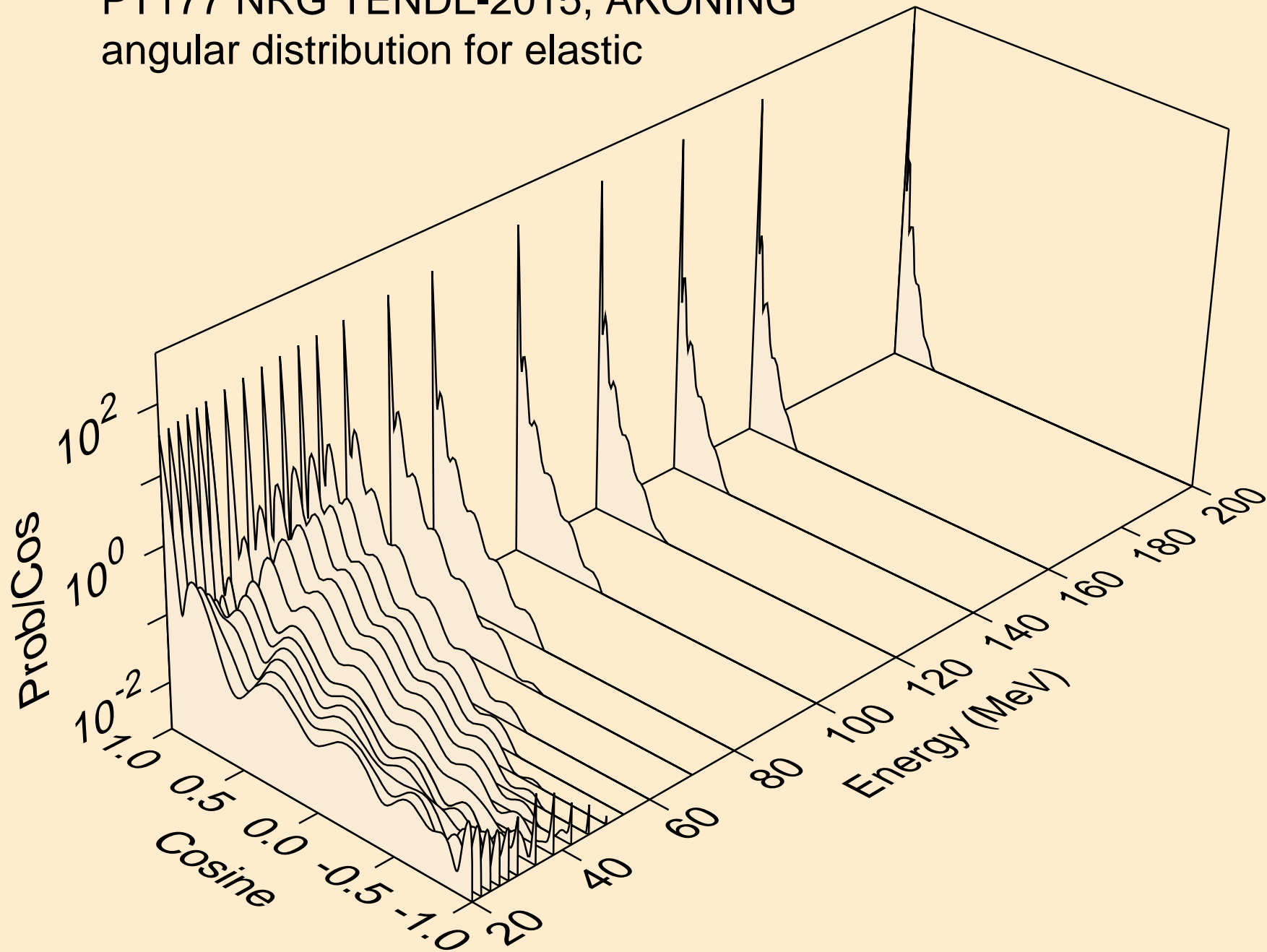

PT177 NRG TENDL-2015, AKONING
angular distribution for (n,n*1)

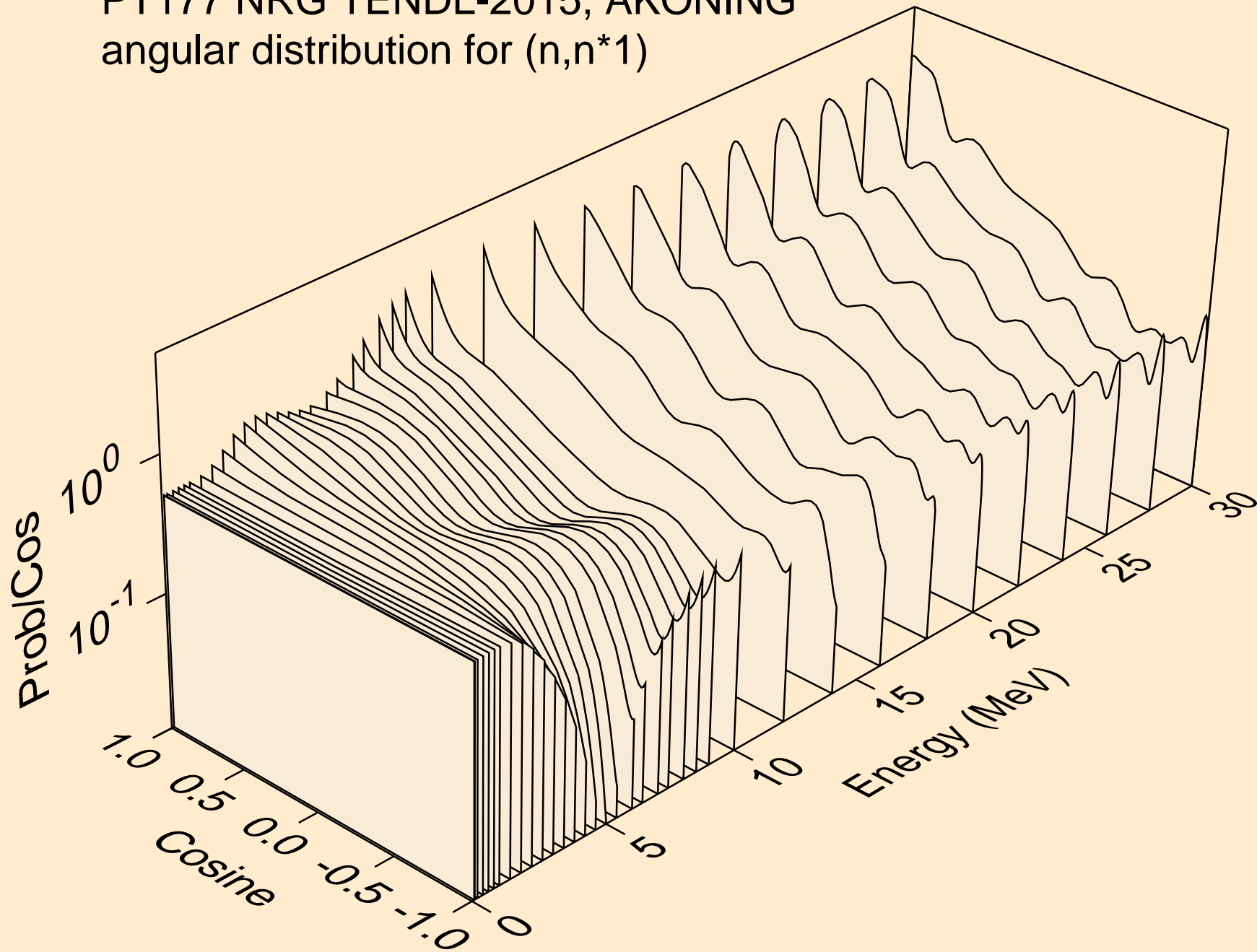

PT177 NRG TENDL-2015, AKONING
angular distribution for (n,n*2)

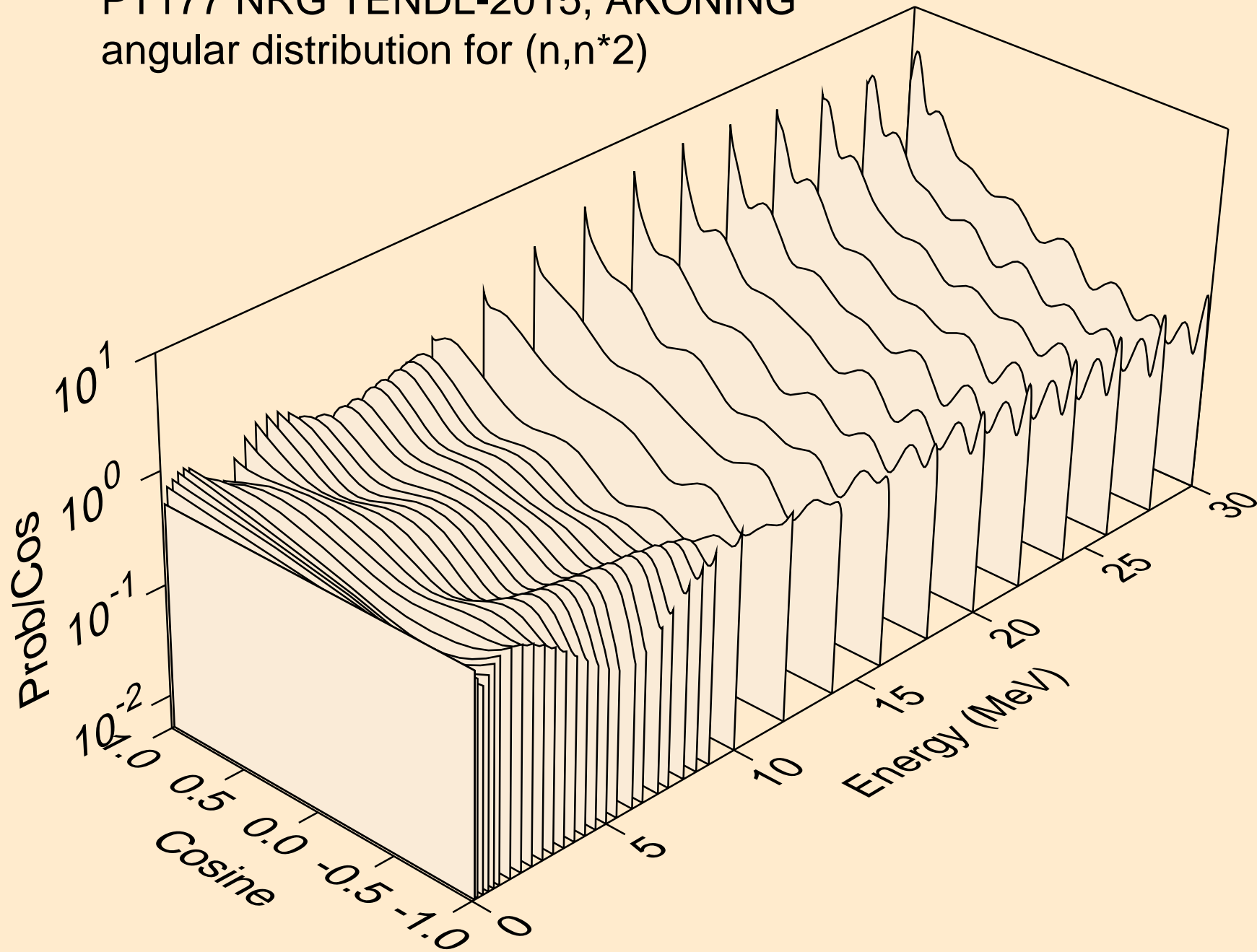

PT177 NRG TENDL-2015, AKONING
angular distribution for (n,n*3)

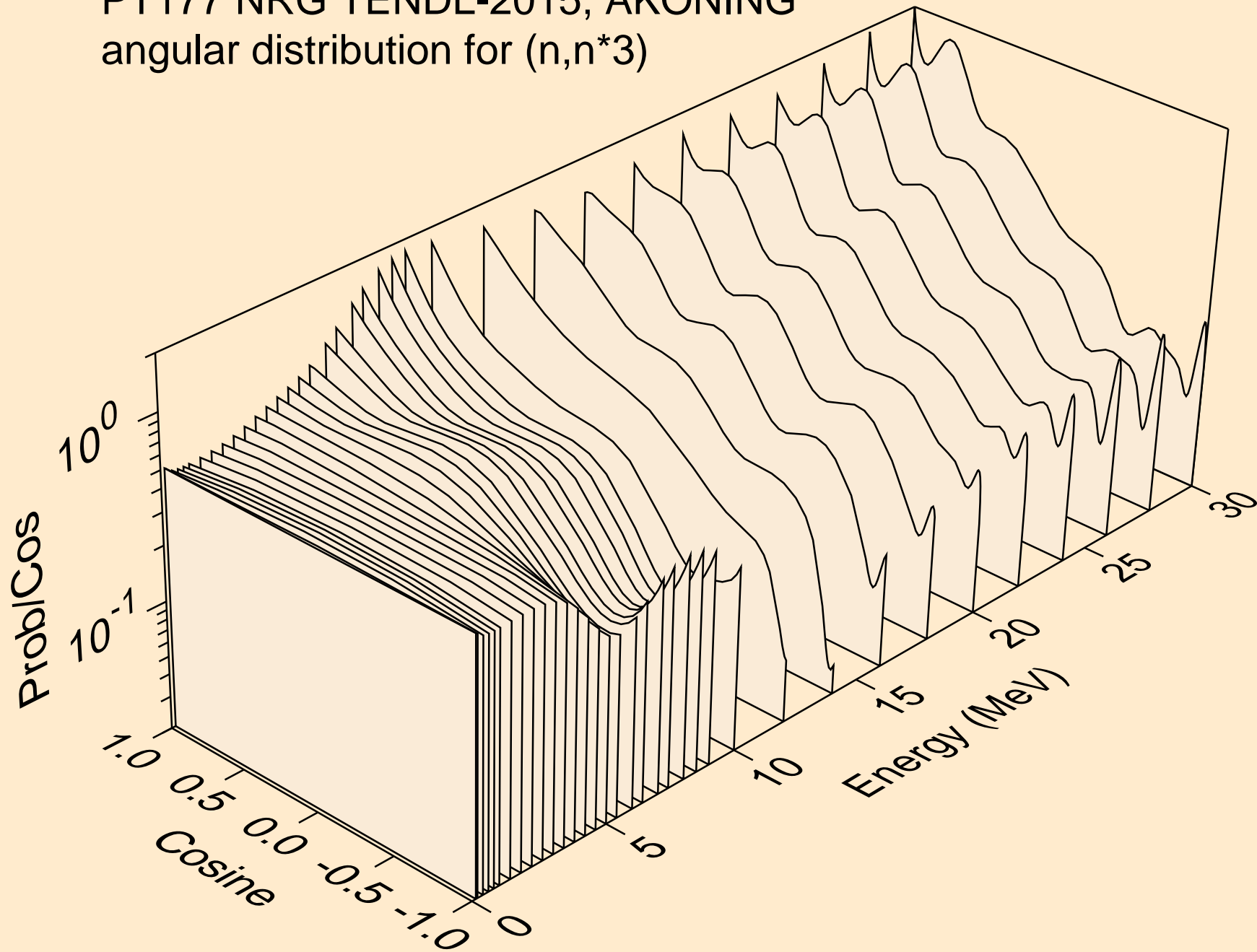

PT177 NRG TENDL-2015, AKONING
angular distribution for (n,n*4)

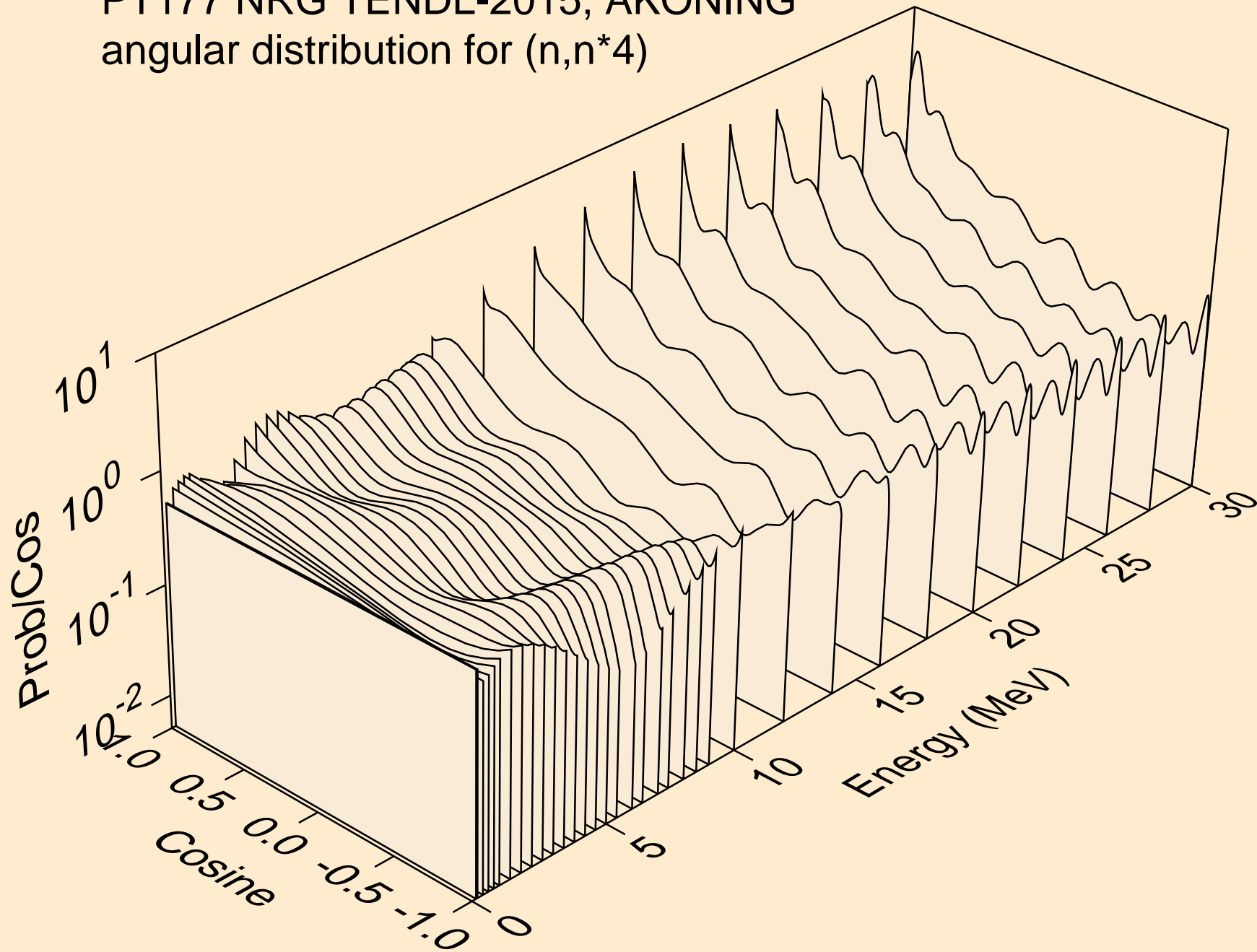

PT177 NRG TENDL-2015, AKONING
angular distribution for (n,n*5)

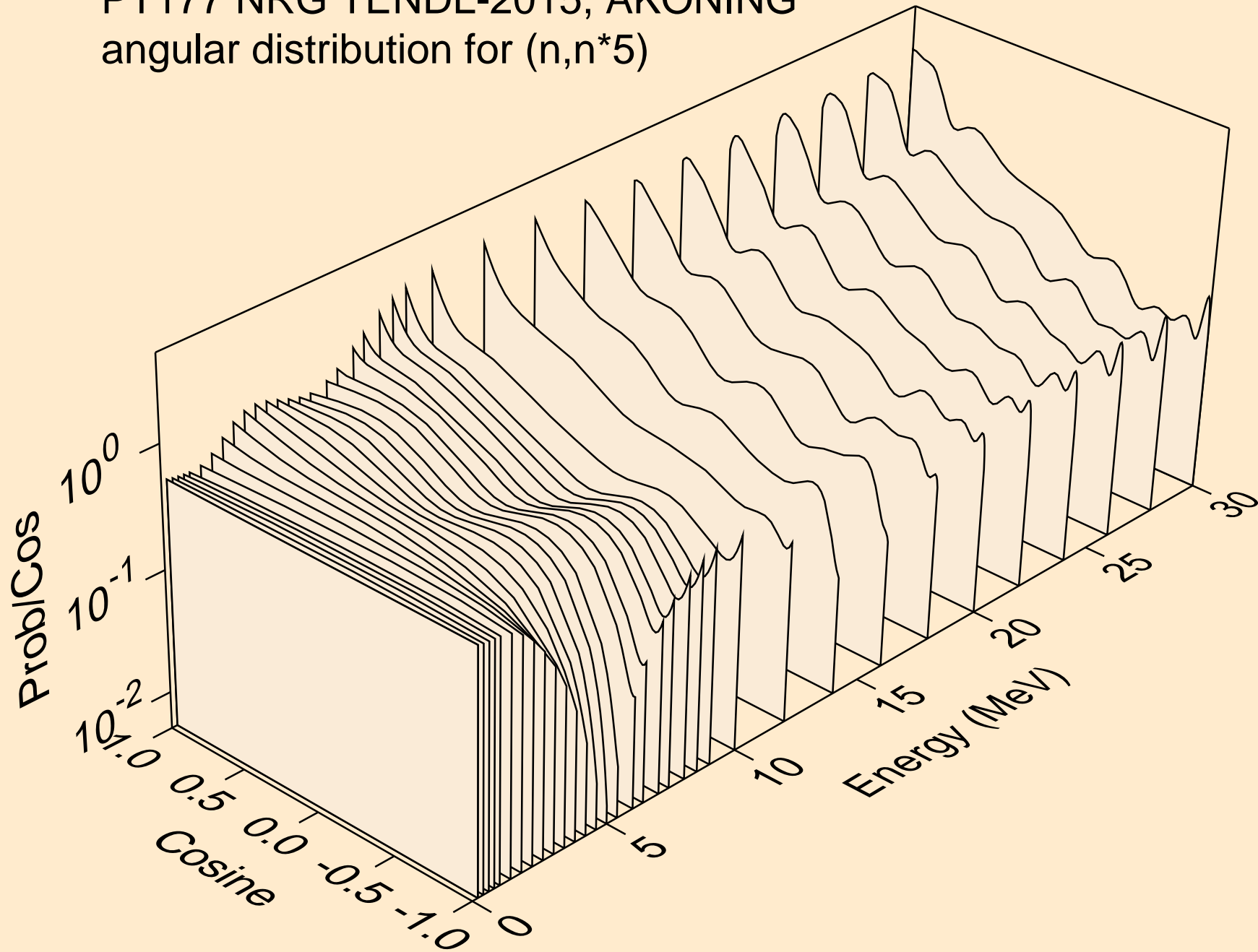

PT177 NRG TENDL-2015, AKONING
angular distribution for (n,n*6)

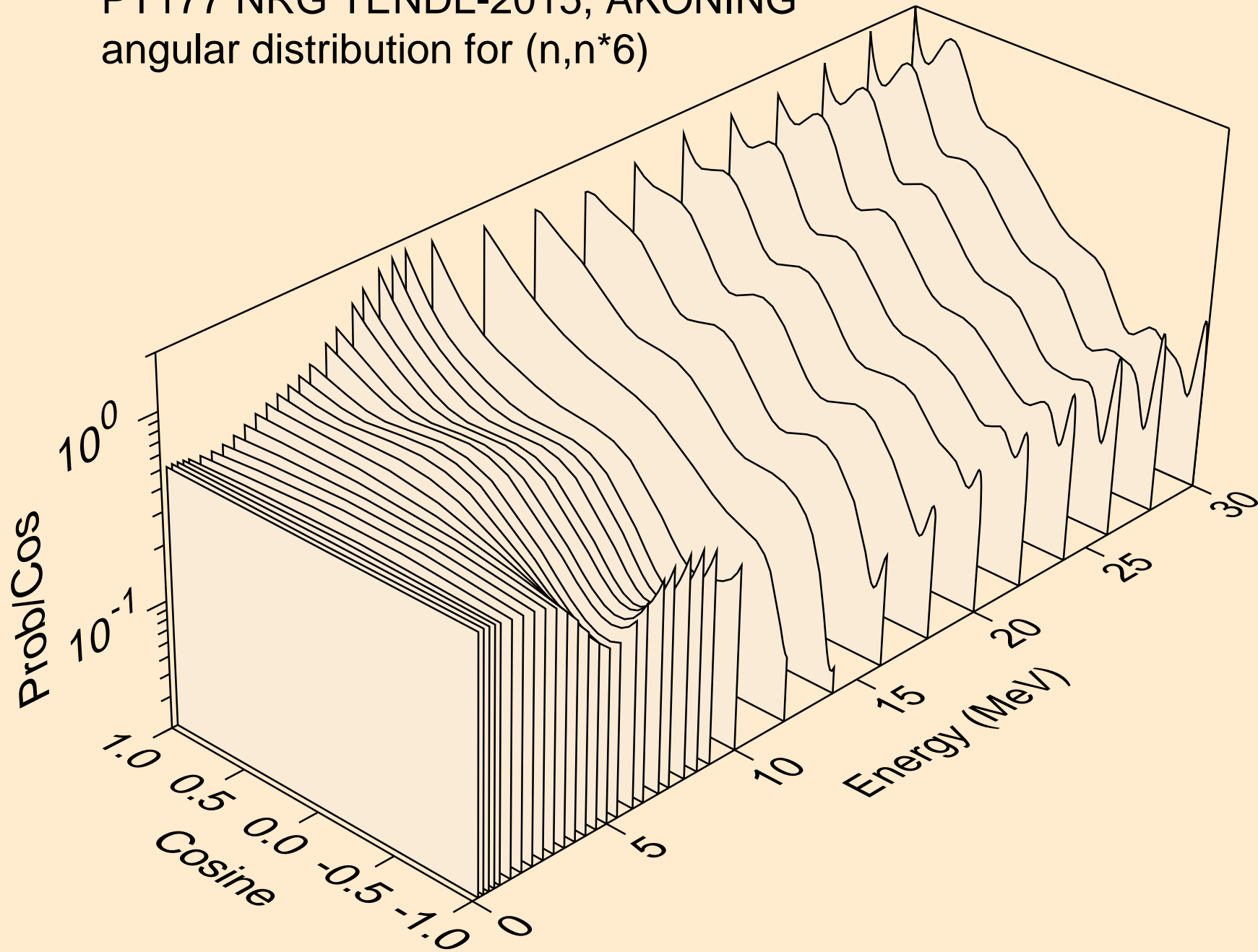

PT177 NRG TENDL-2015, AKONING
angular distribution for (n,n*7)

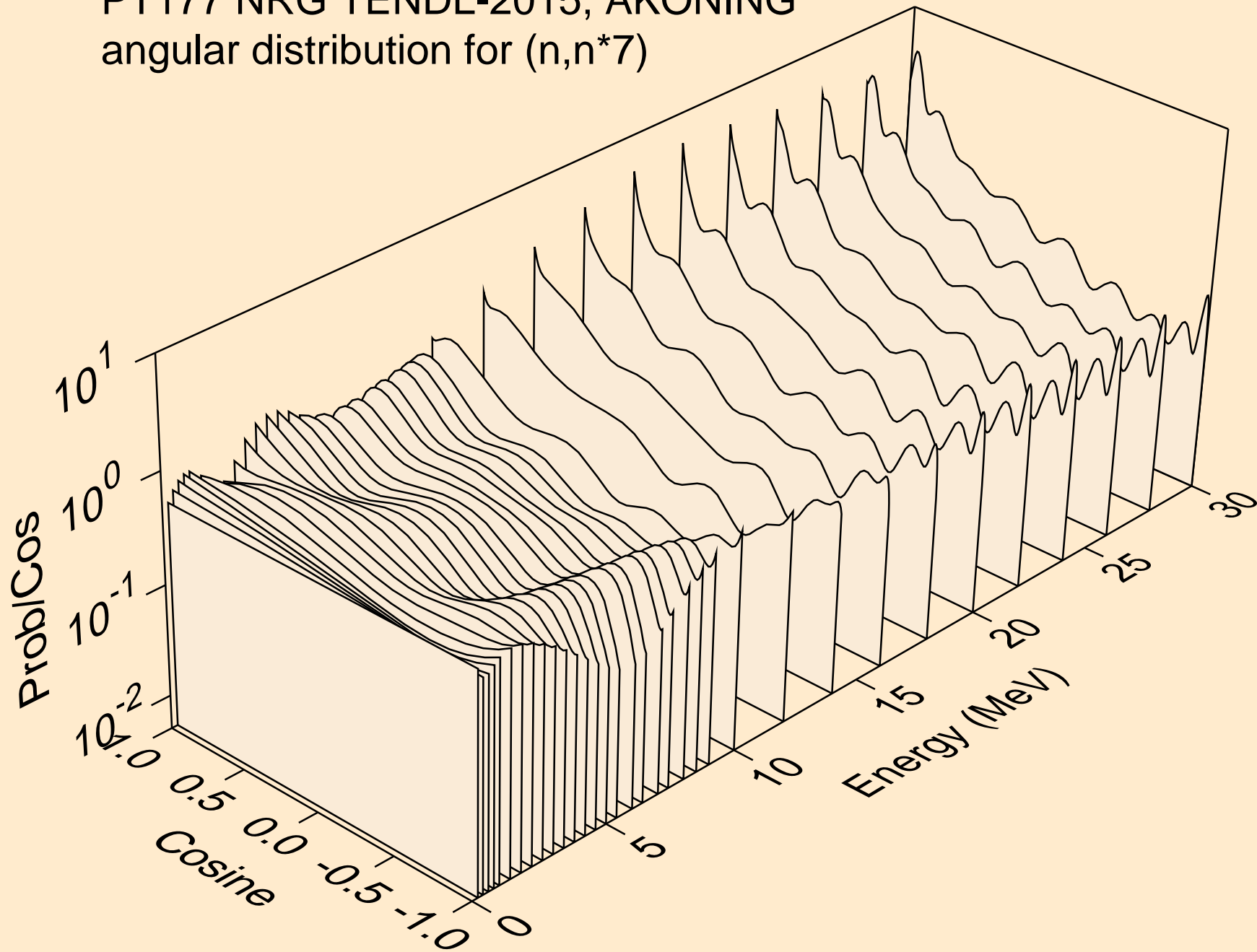

PT177 NRG TENDL-2015, AKONING
angular distribution for (n,n*8)

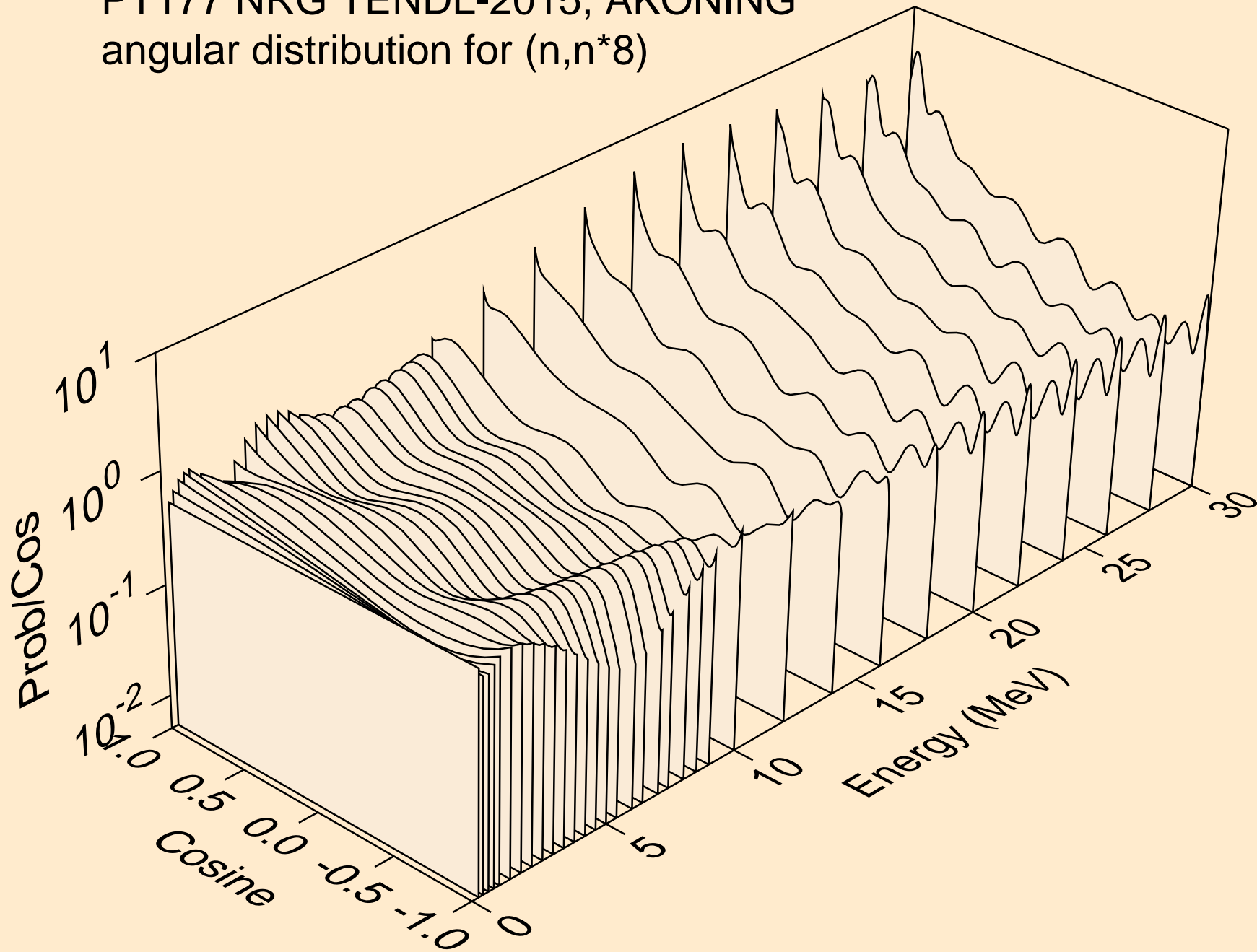

PT177 NRG TENDL-2015, AKONING
angular distribution for (n,n*9)

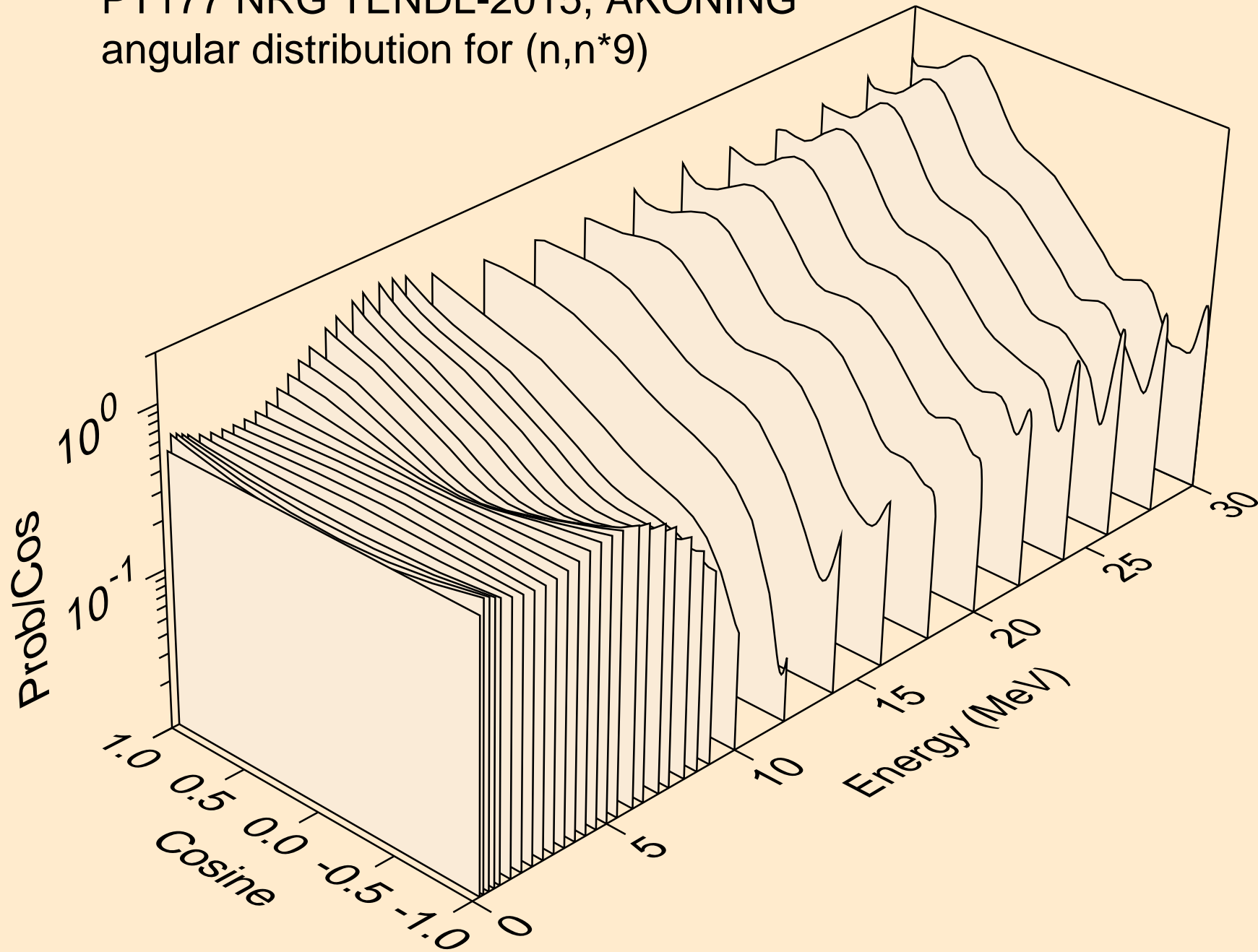

PT177 NRG TENDL-2015, AKONING
angular distribution for (n,n*10)

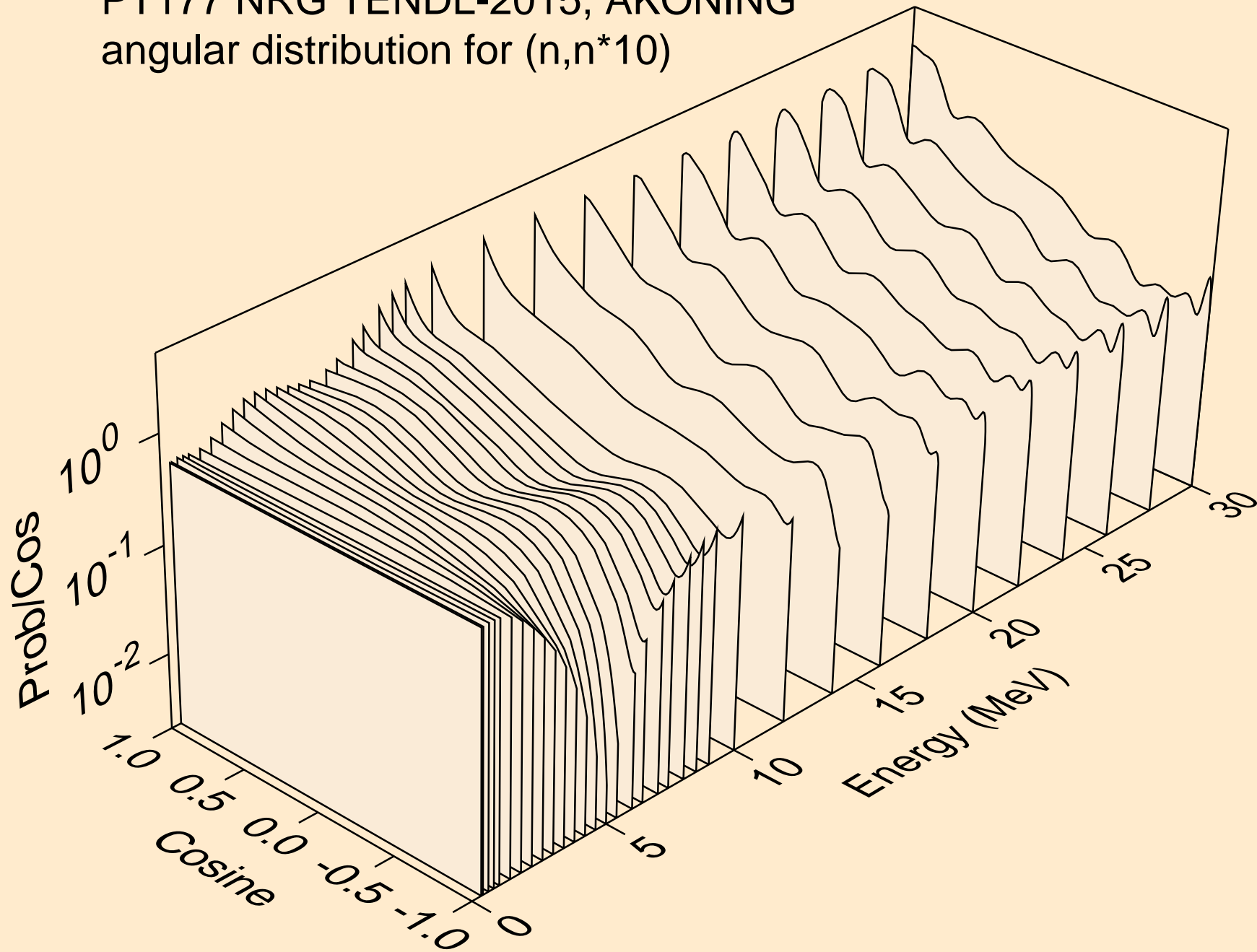

PT177 NRG TENDL-2015, AKONING
angular distribution for (n,n*11)

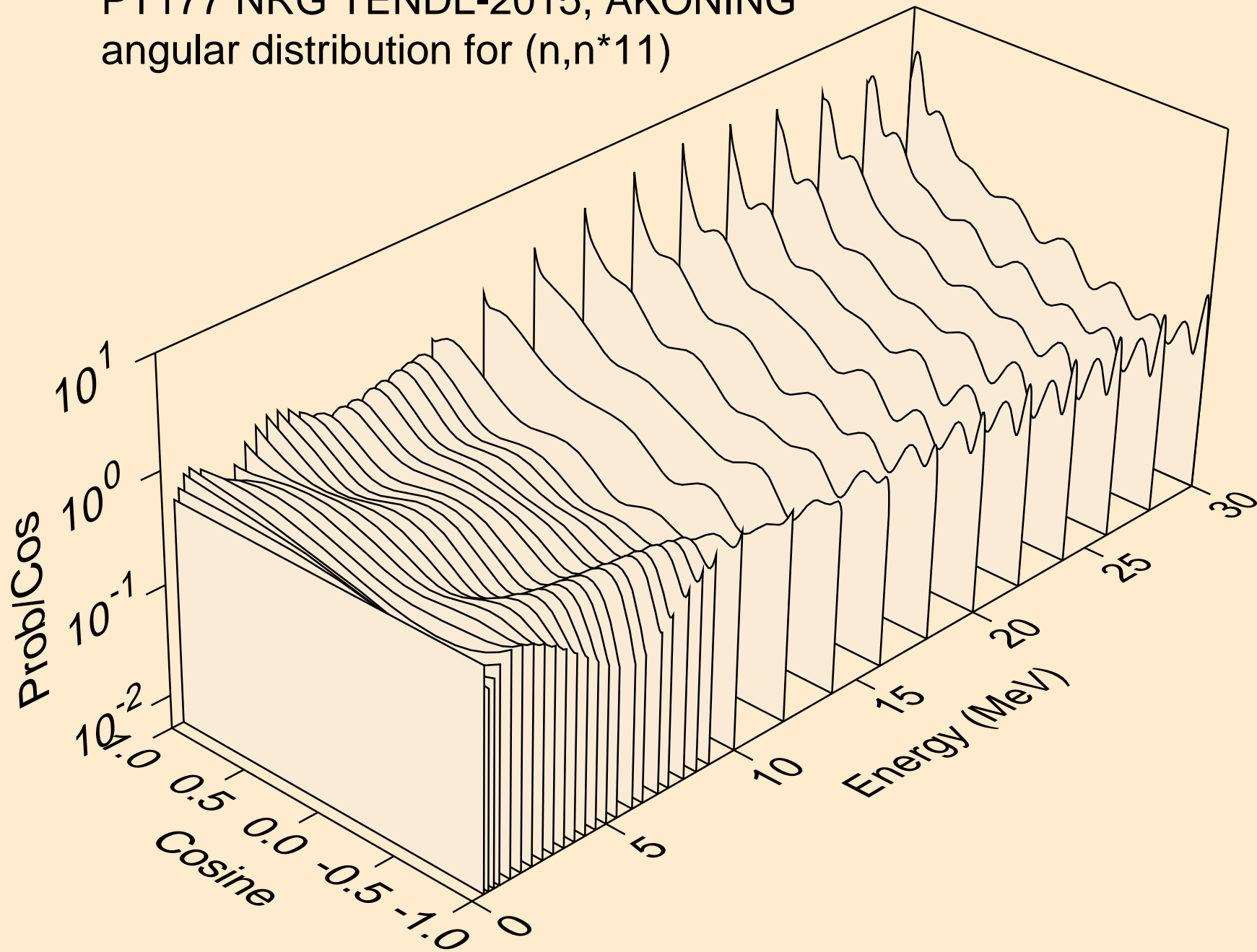

PT177 NRG TENDL-2015, AKONING
Neutron emission for (n,x)

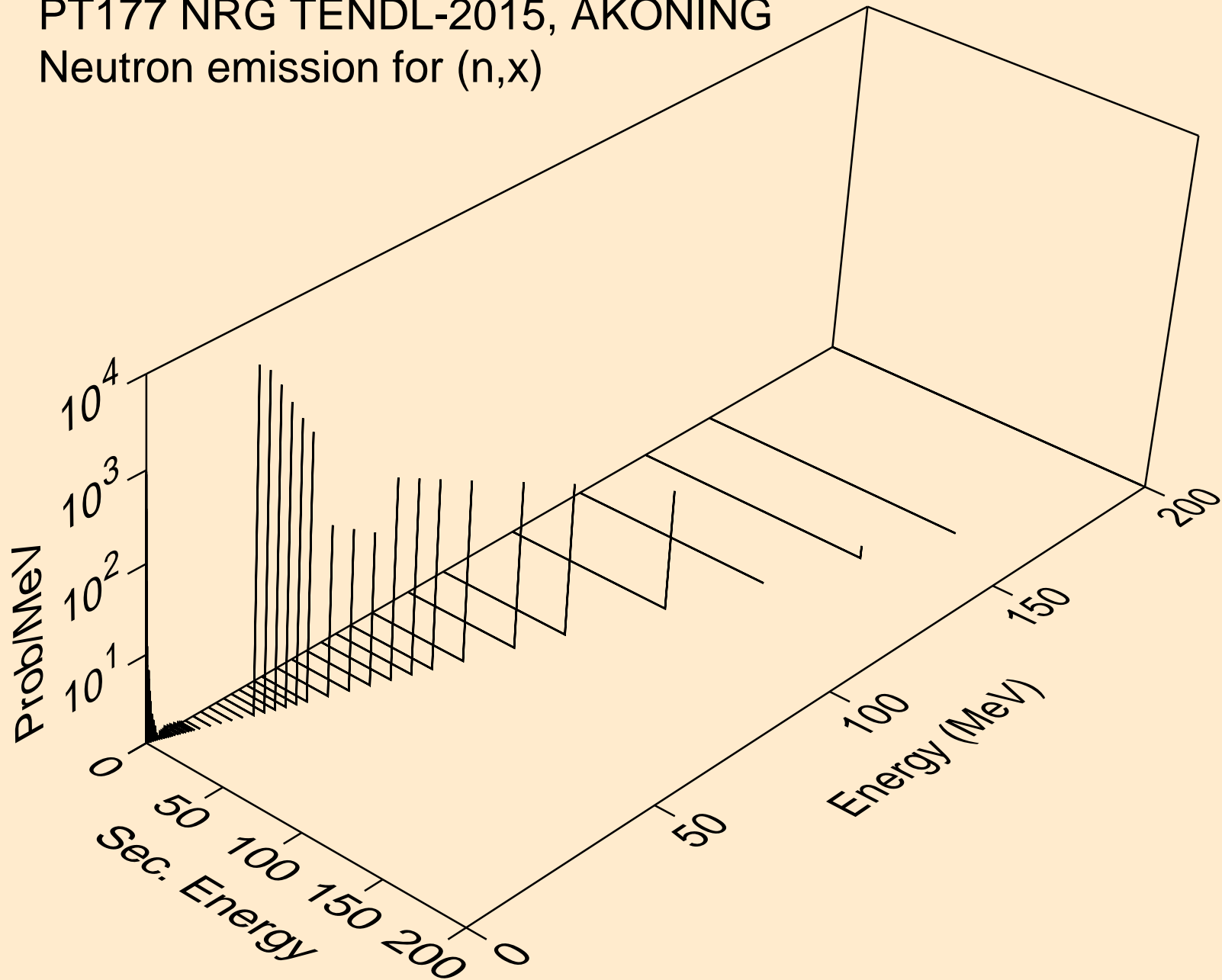

PT177 NRG TENDL-2015, AKONING
Neutron emission for (n,2nd)

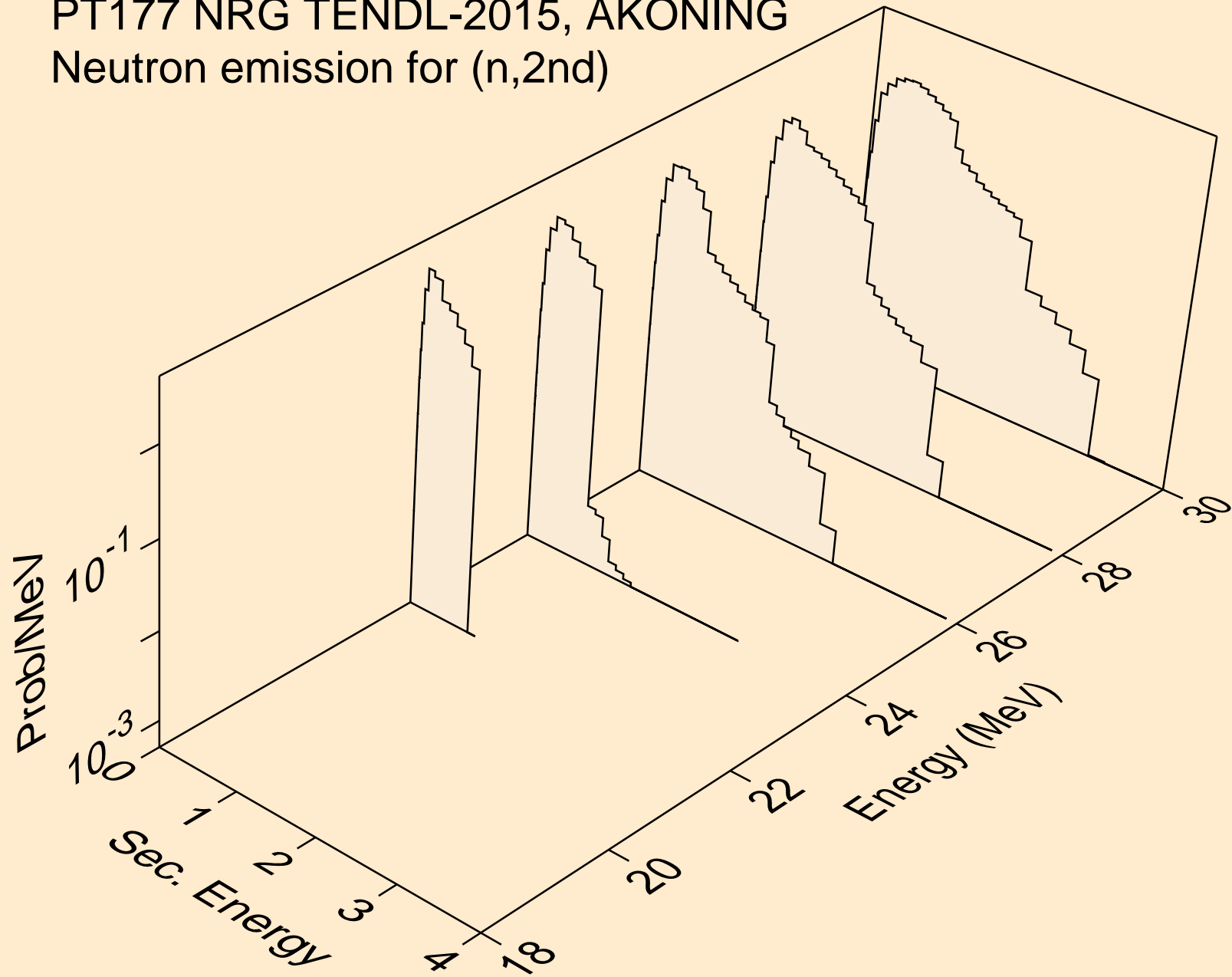

PT177 NRG TENDL-2015, AKONING
Neutron emission for (n,2n)

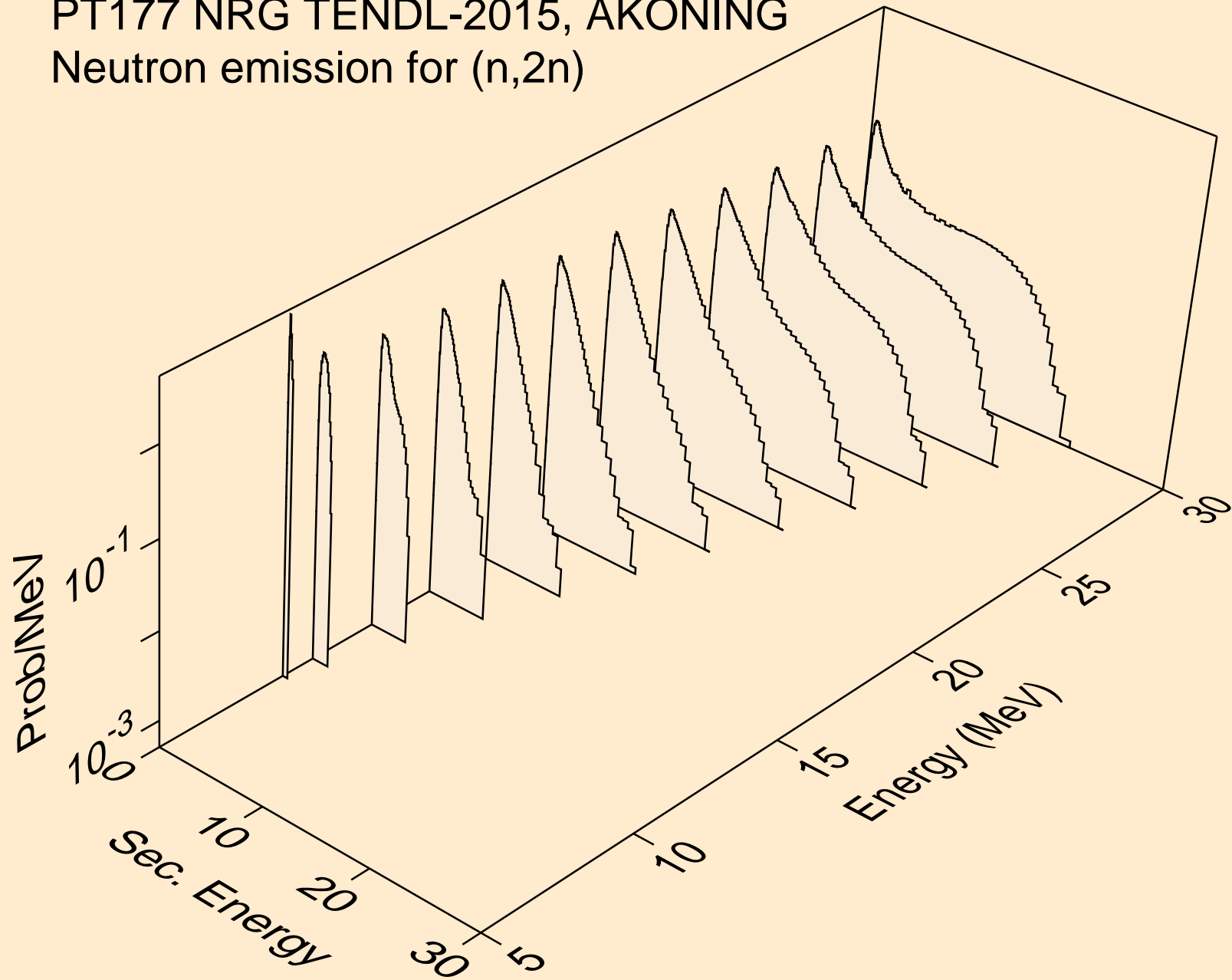

PT177 NRG TENDL-2015, AKONING
Neutron emission for (n,3n)

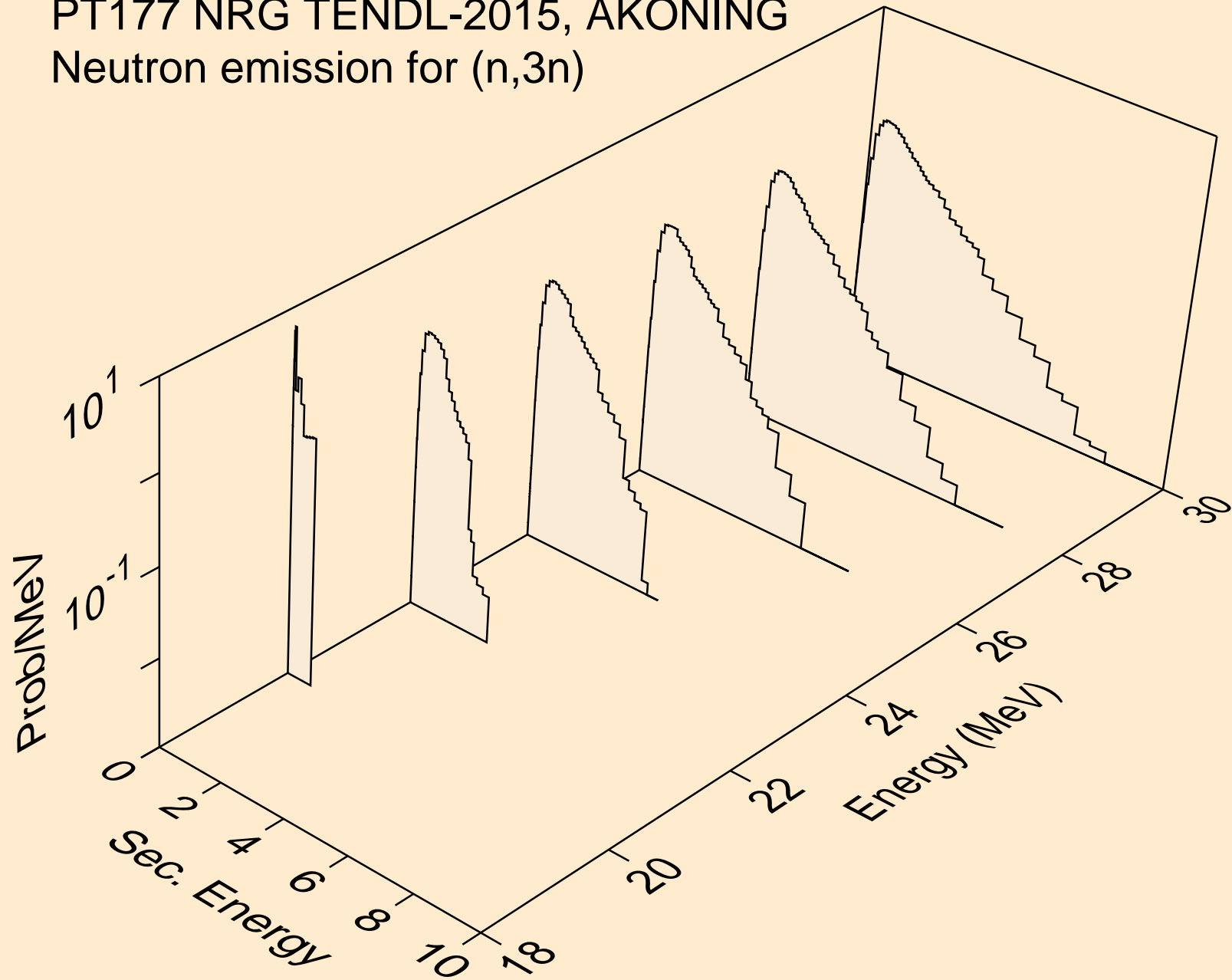

PT177 NRG TENDL-2015, AKONING
Neutron emission for (n,n*)a

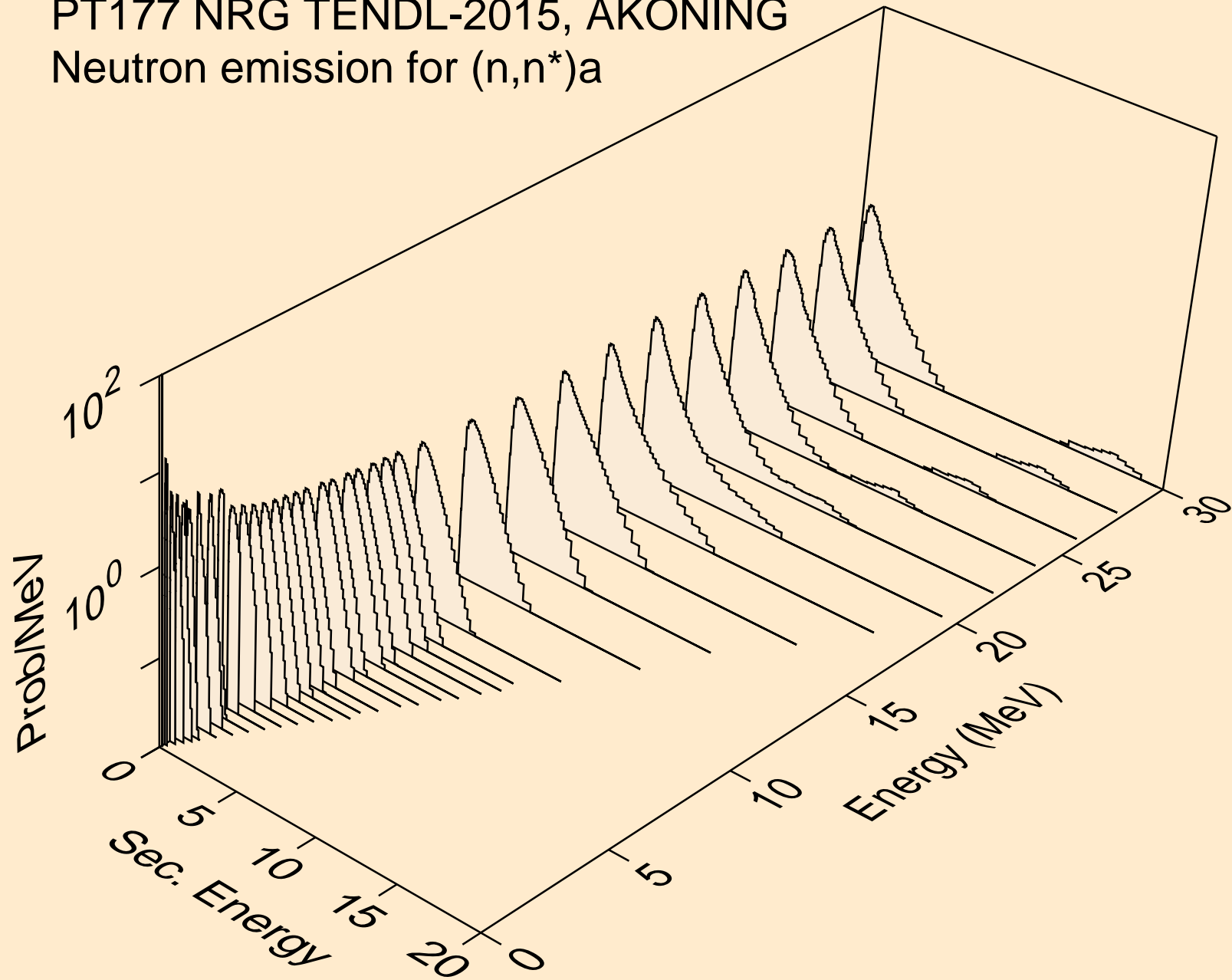

PT177 NRG TENDL-2015, AKONING
Neutron emission for (n,n*)3a

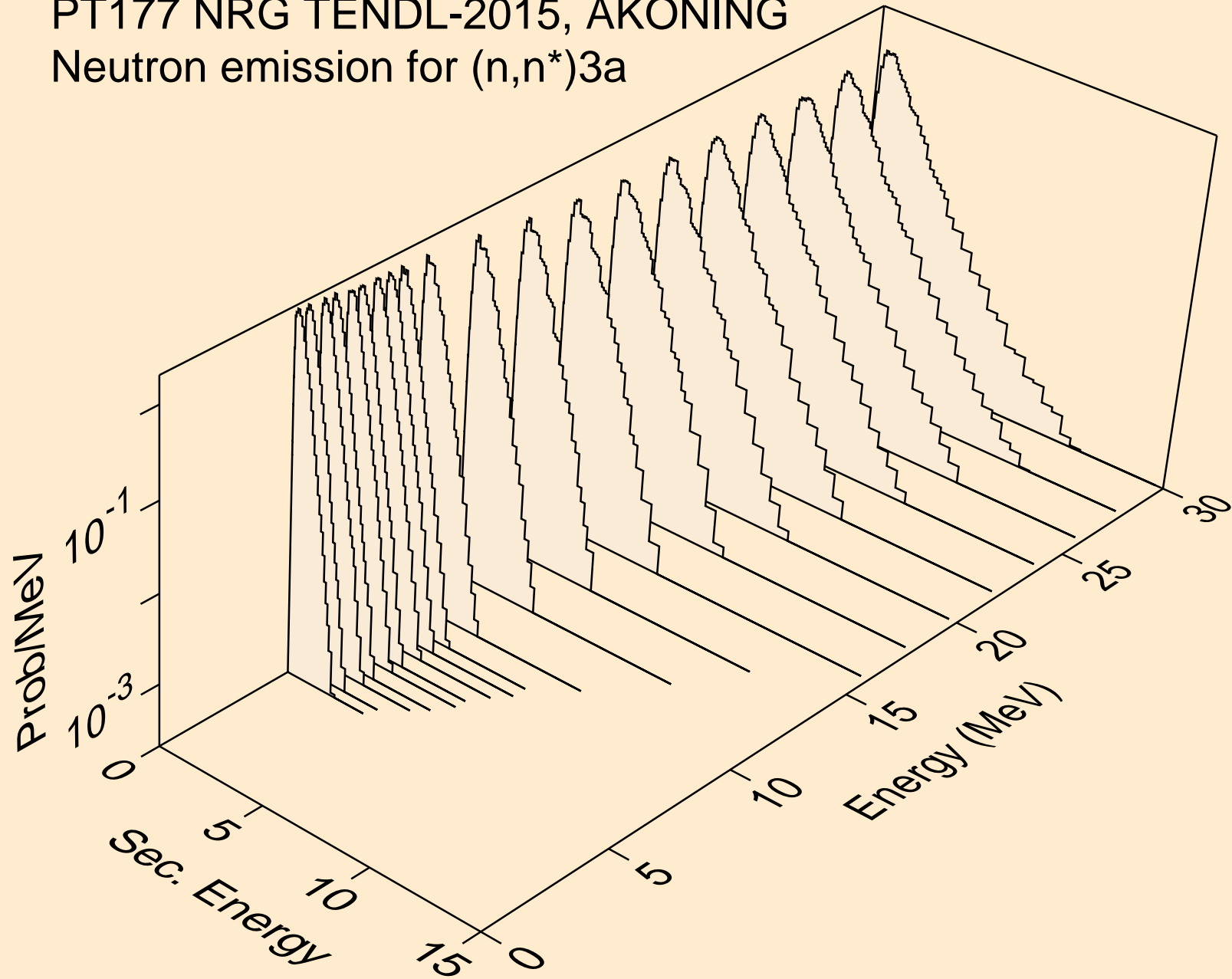

PT177 NRG TENDL-2015, AKONING
Neutron emission for (n,2n)a

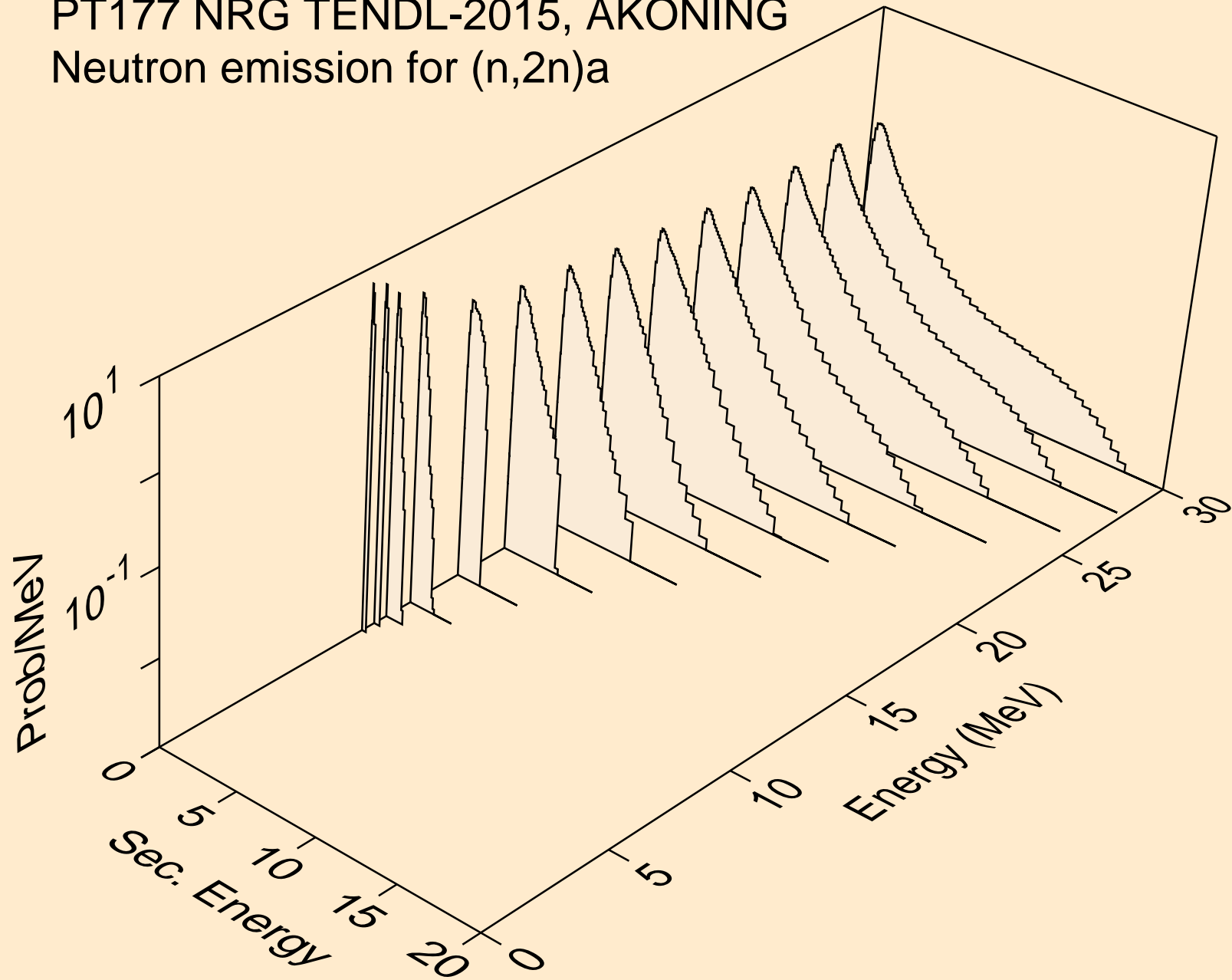

PT177 NRG TENDL-2015, AKONING
Neutron emission for (n,3n)a

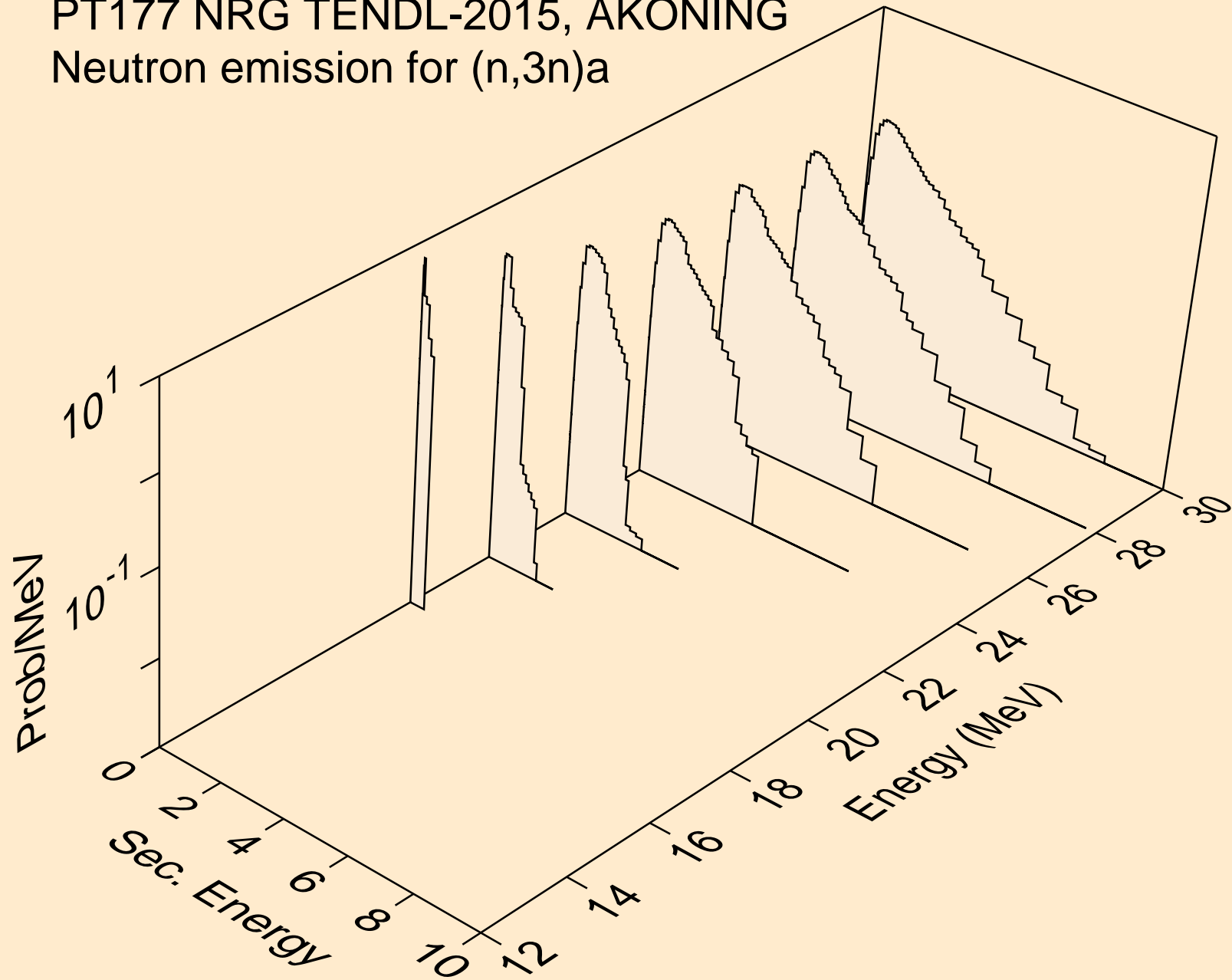

PT177 NRG TENDL-2015, AKONING
Neutron emission for (n,n*)p

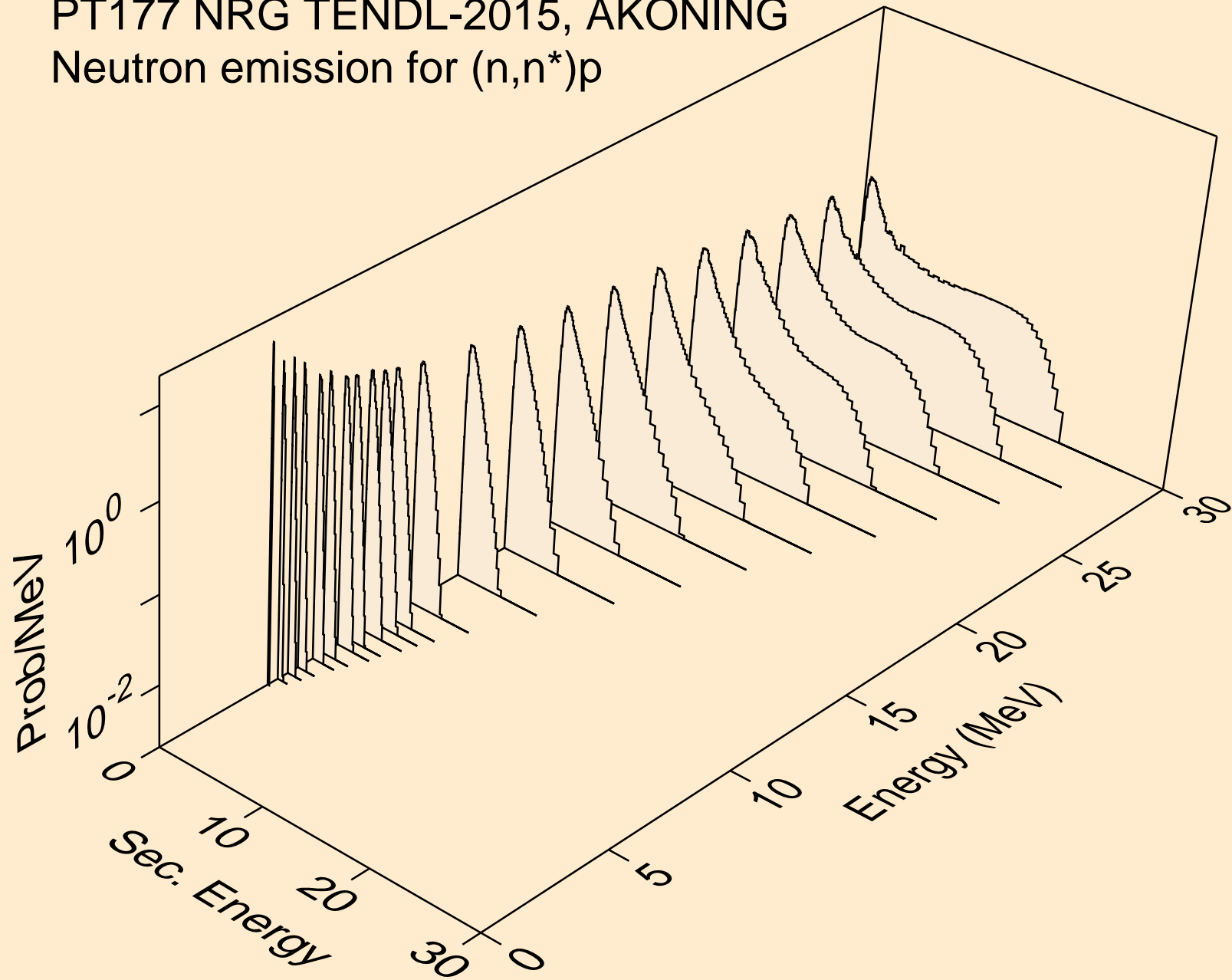

PT177 NRG TENDL-2015, AKONING
Neutron emission for (n,n*)2a

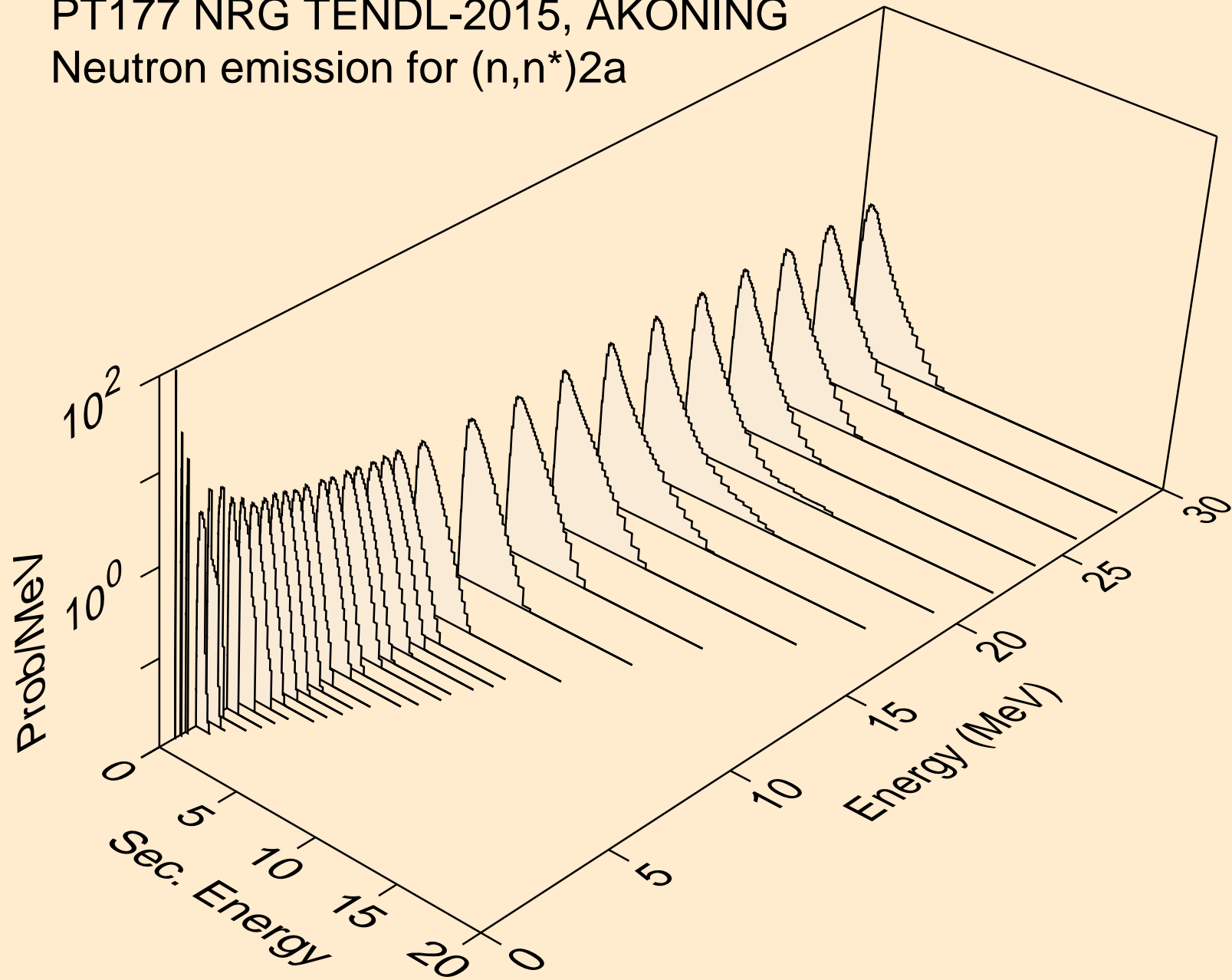

PT177 NRG TENDL-2015, AKONING
Neutron emission for (n,2n)_{2a}

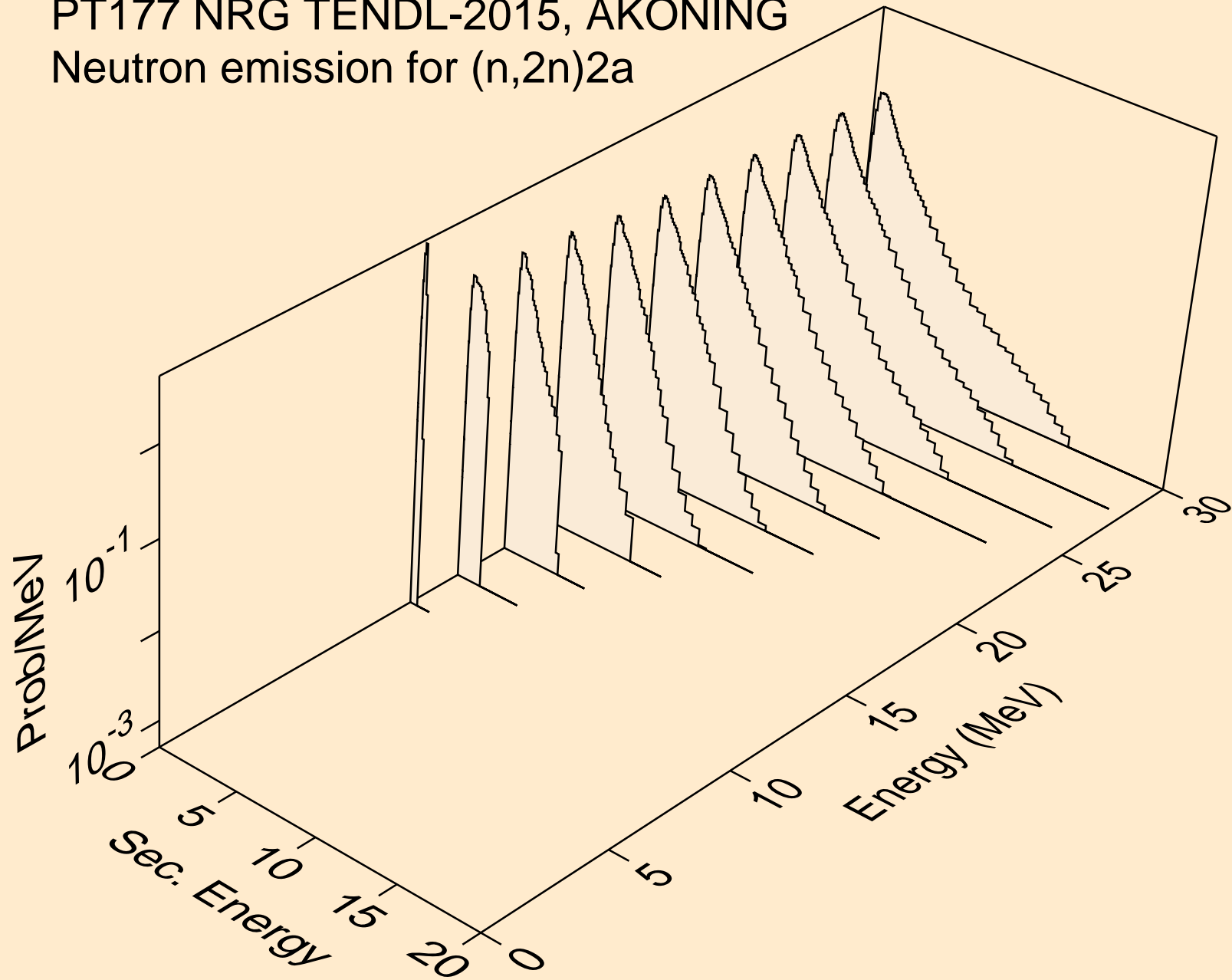

PT177 NRG TENDL-2015, AKONING
Neutron emission for (n,n*)d

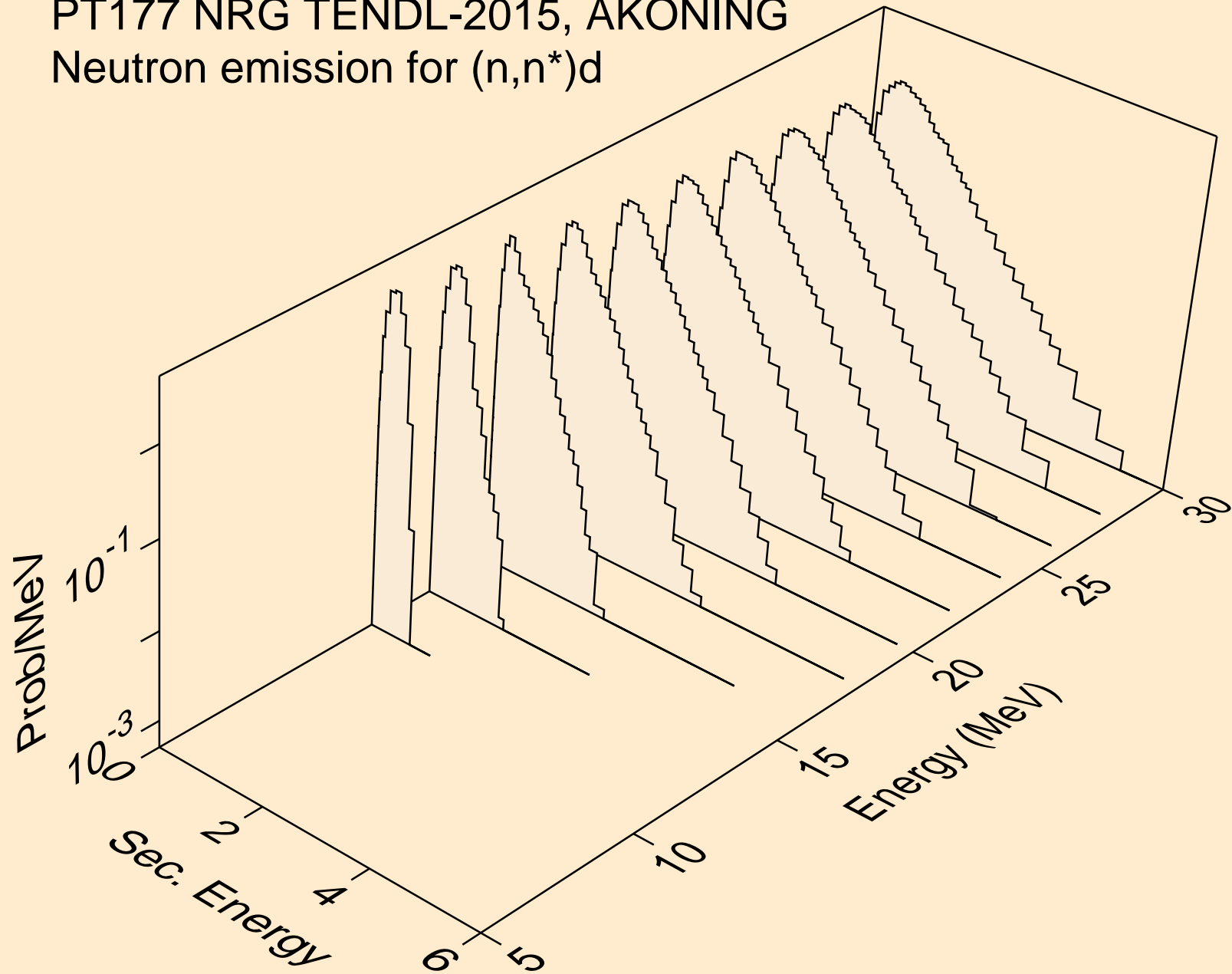

PT177 NRG TENDL-2015, AKONING
Neutron emission for (n,n*)t

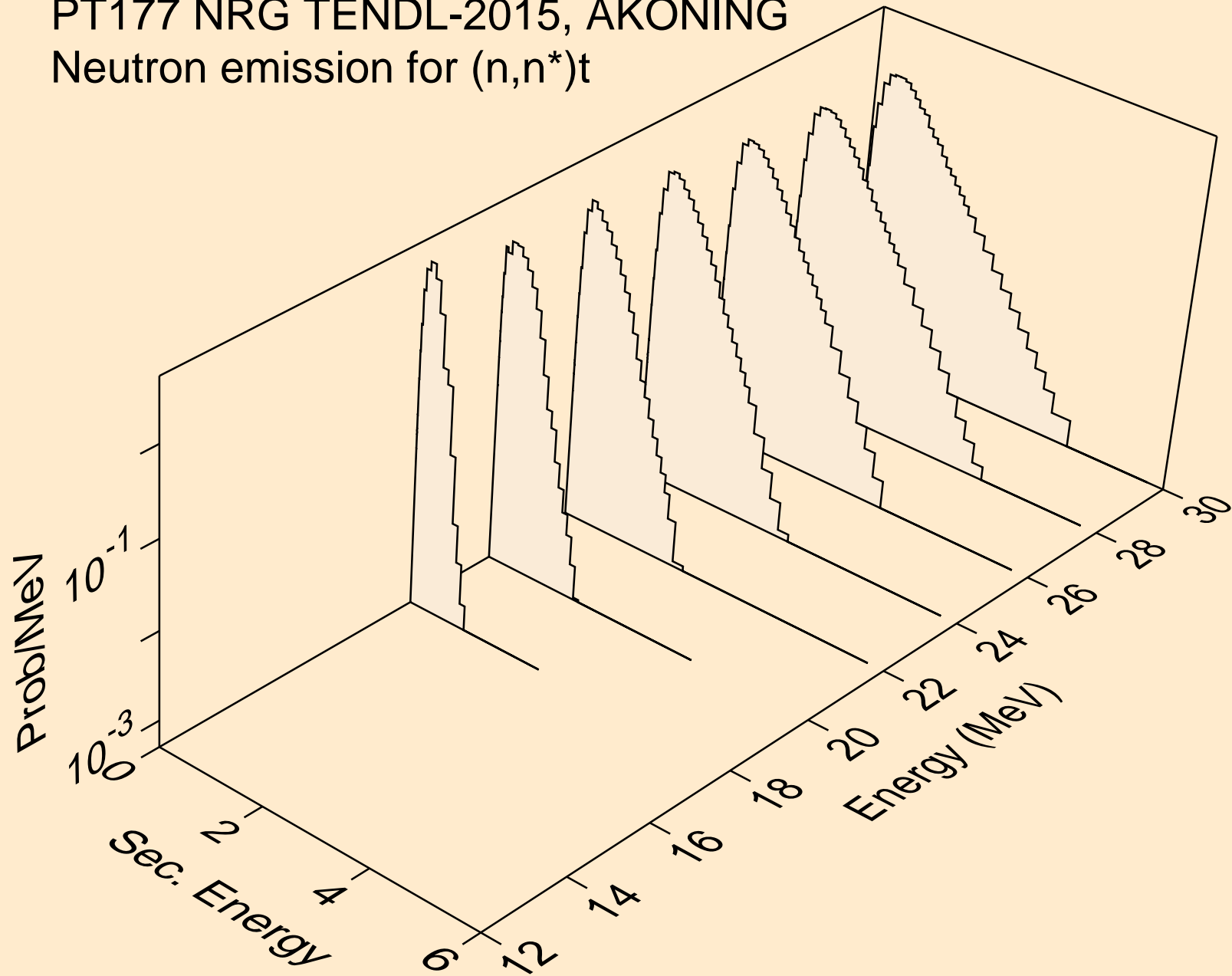

PT177 NRG TENDL-2015, AKONING
Neutron emission for (n,n*)he3

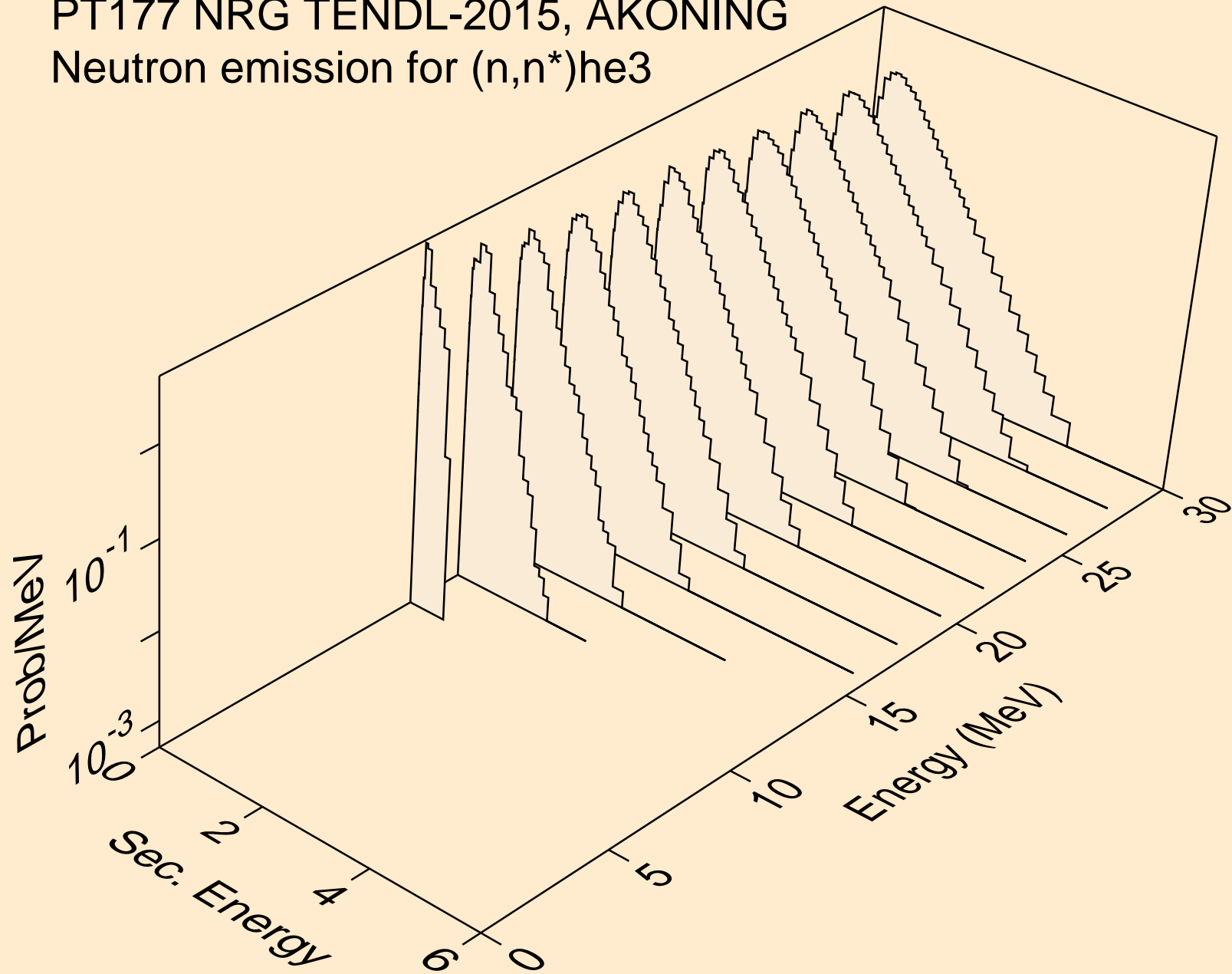

PT177 NRG TENDL-2015, AKONING
Neutron emission for (n,n*)d2a

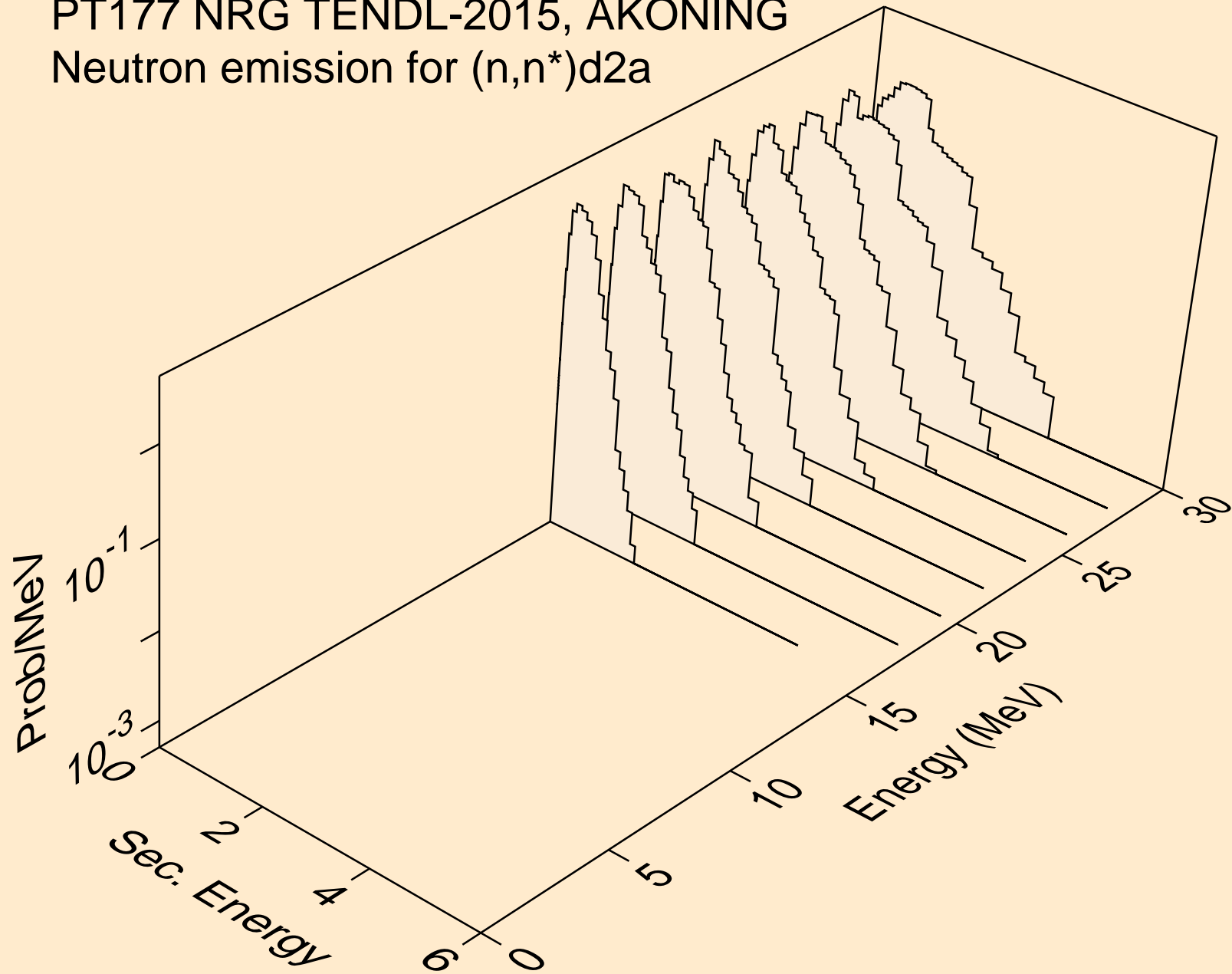

PT177 NRG TENDL-2015, AKONING
Neutron emission for (n,4n)

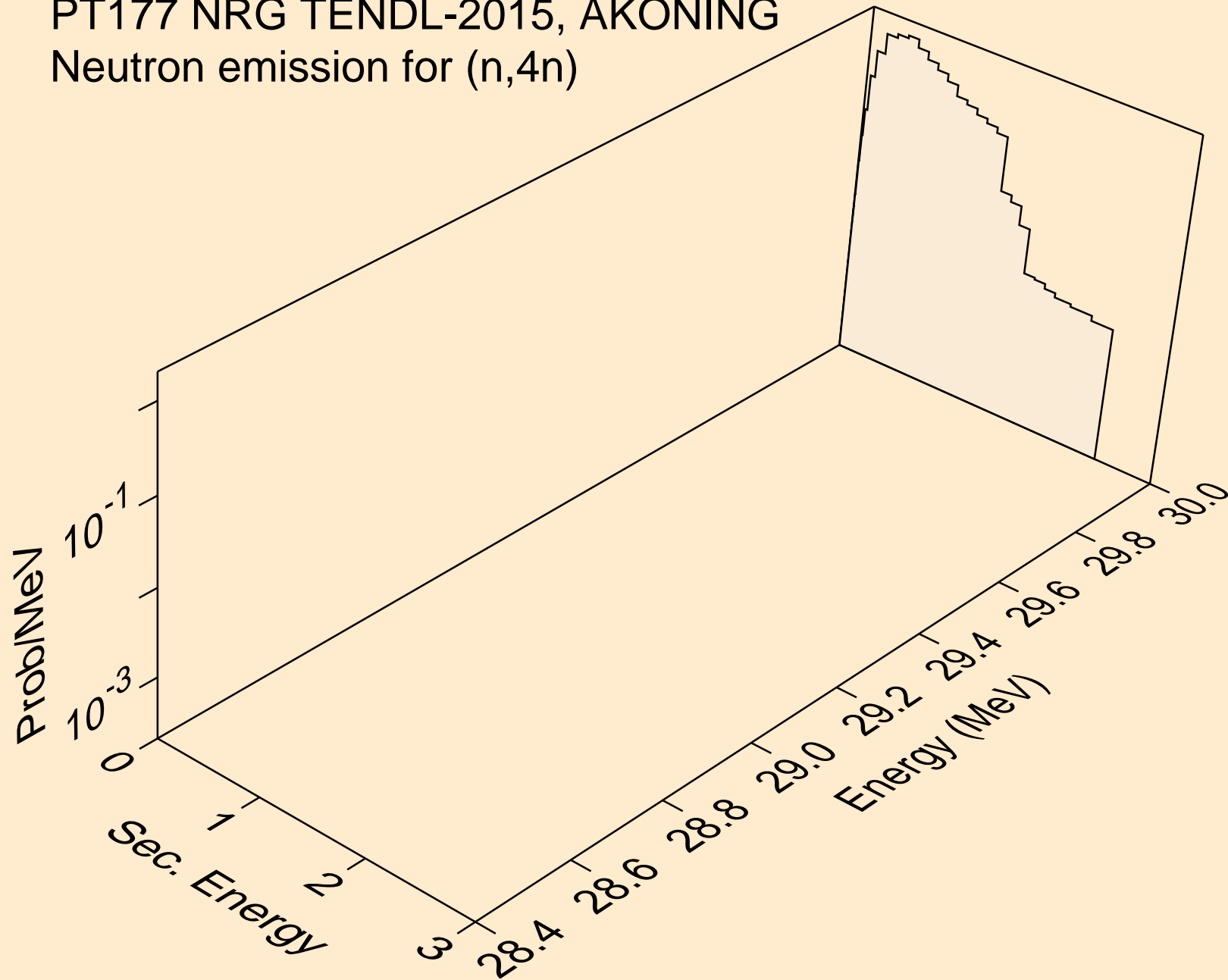

PT177 NRG TENDL-2015, AKONING
Neutron emission for (n,2np)

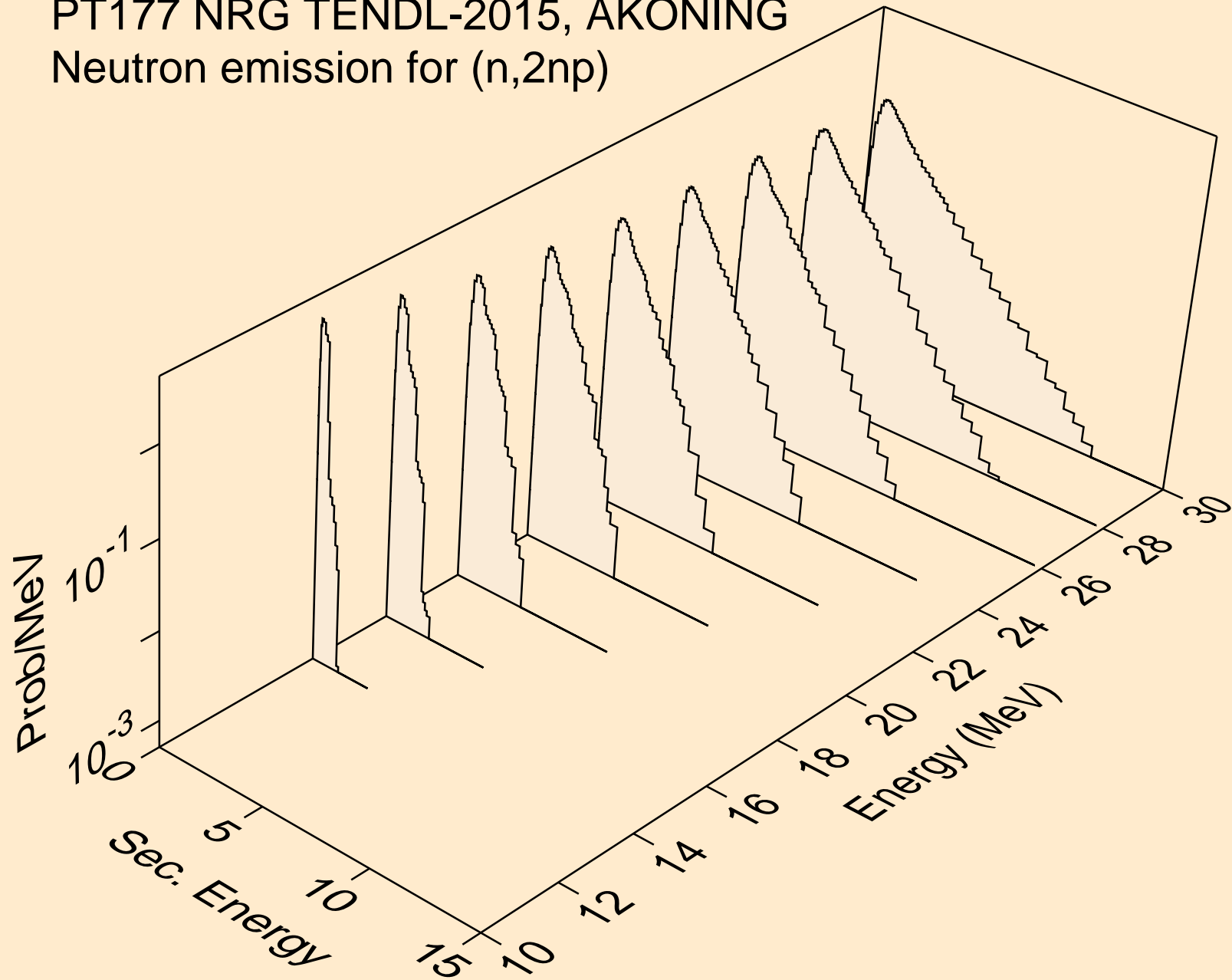

PT177 NRG TENDL-2015, AKONING
Neutron emission for (n,3np)

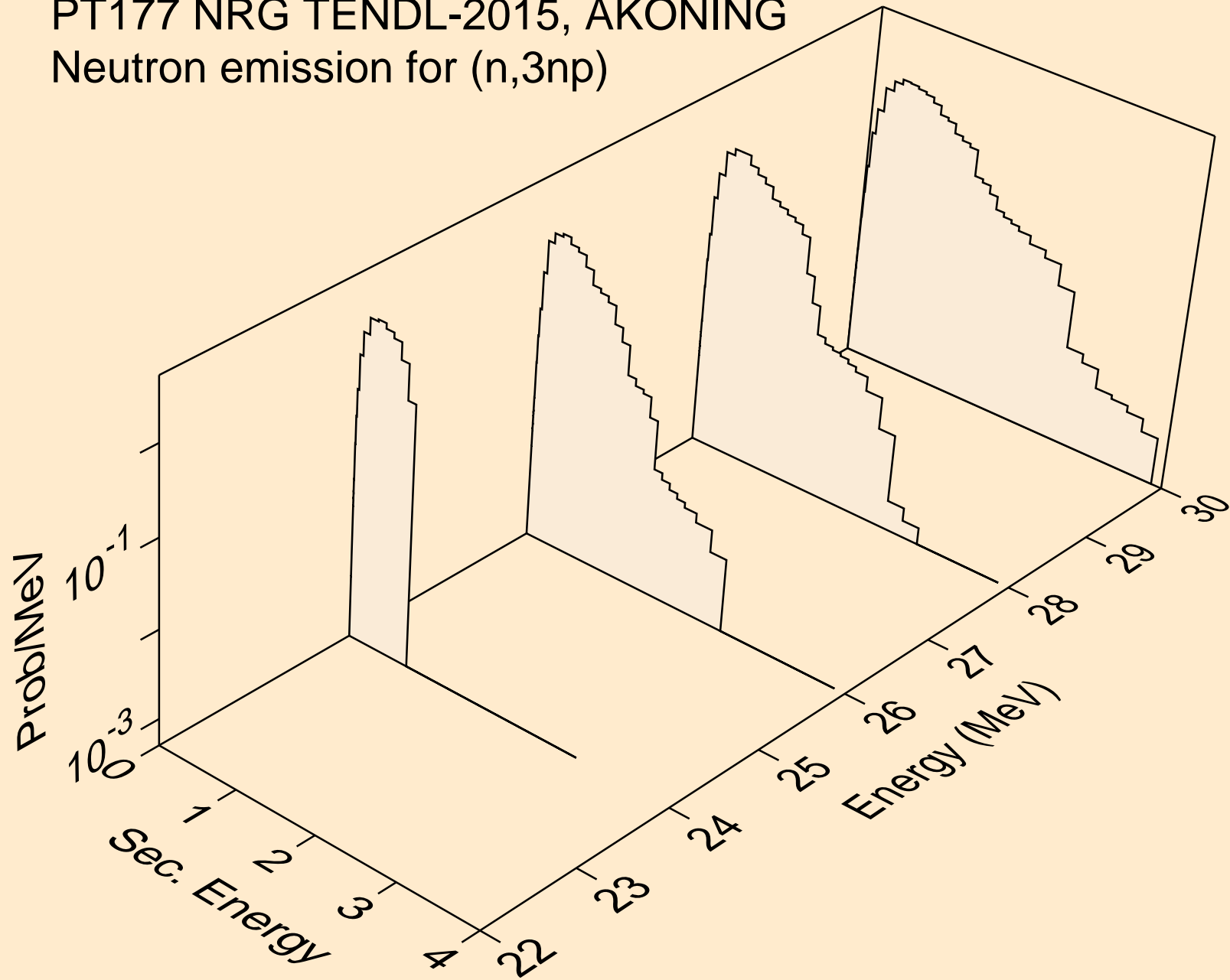

PT177 NRG TENDL-2015, AKONING
Neutron emission for (n,2np)

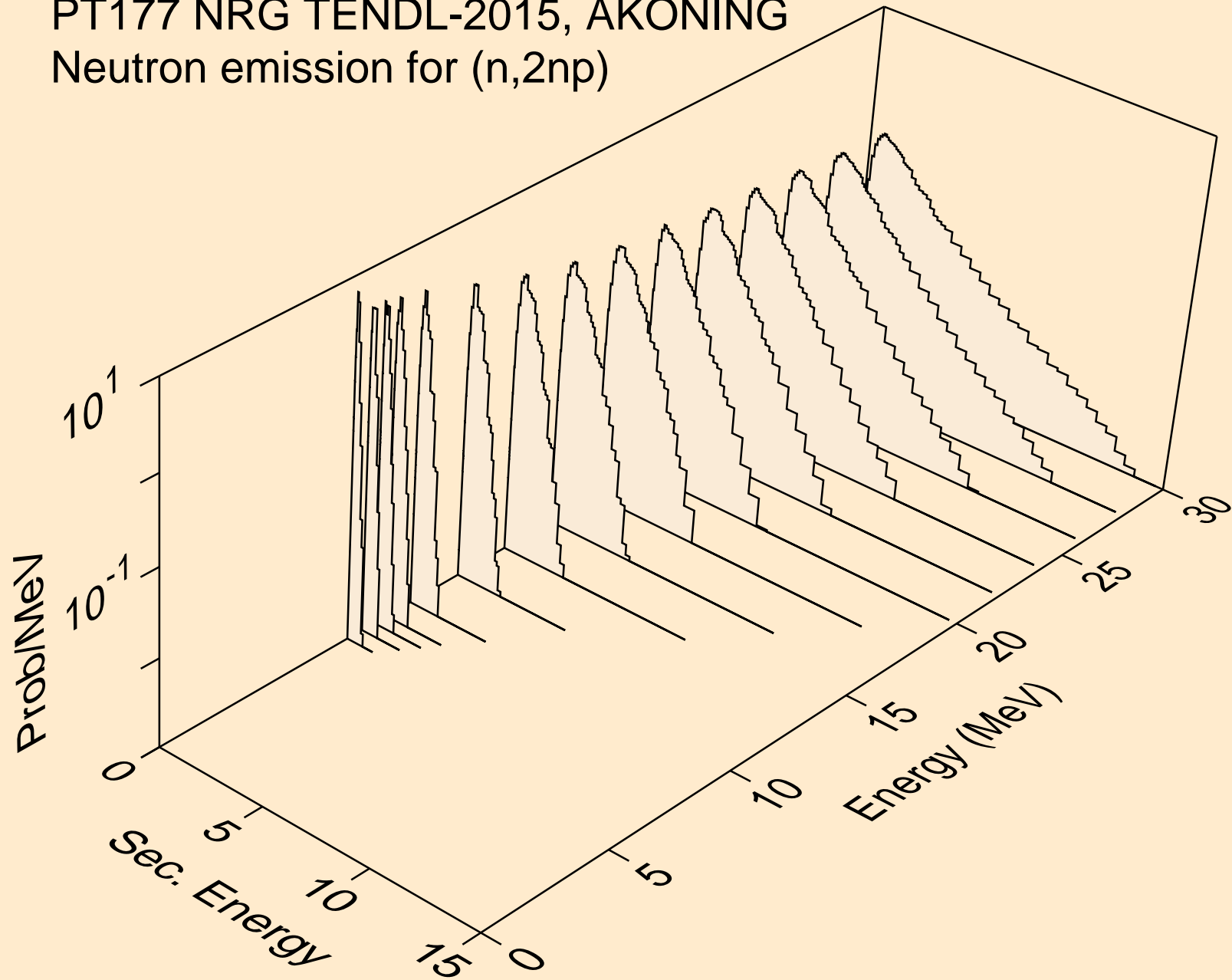

PT177 NRG TENDL-2015, AKONING
Neutron emission for (n,npa)

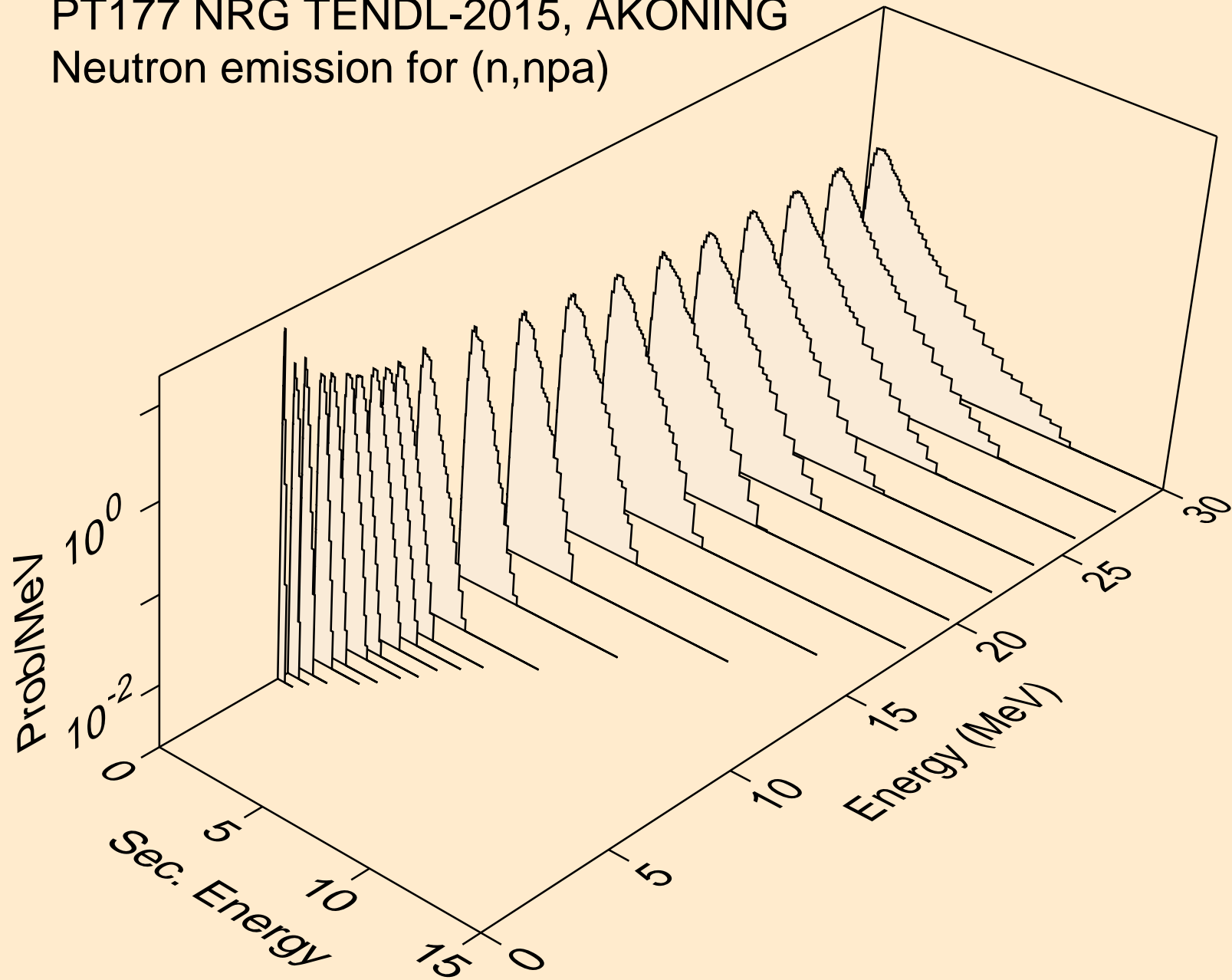

PT177 NRG TENDL-2015, AKONING
Neutron emission for (n,n*c)

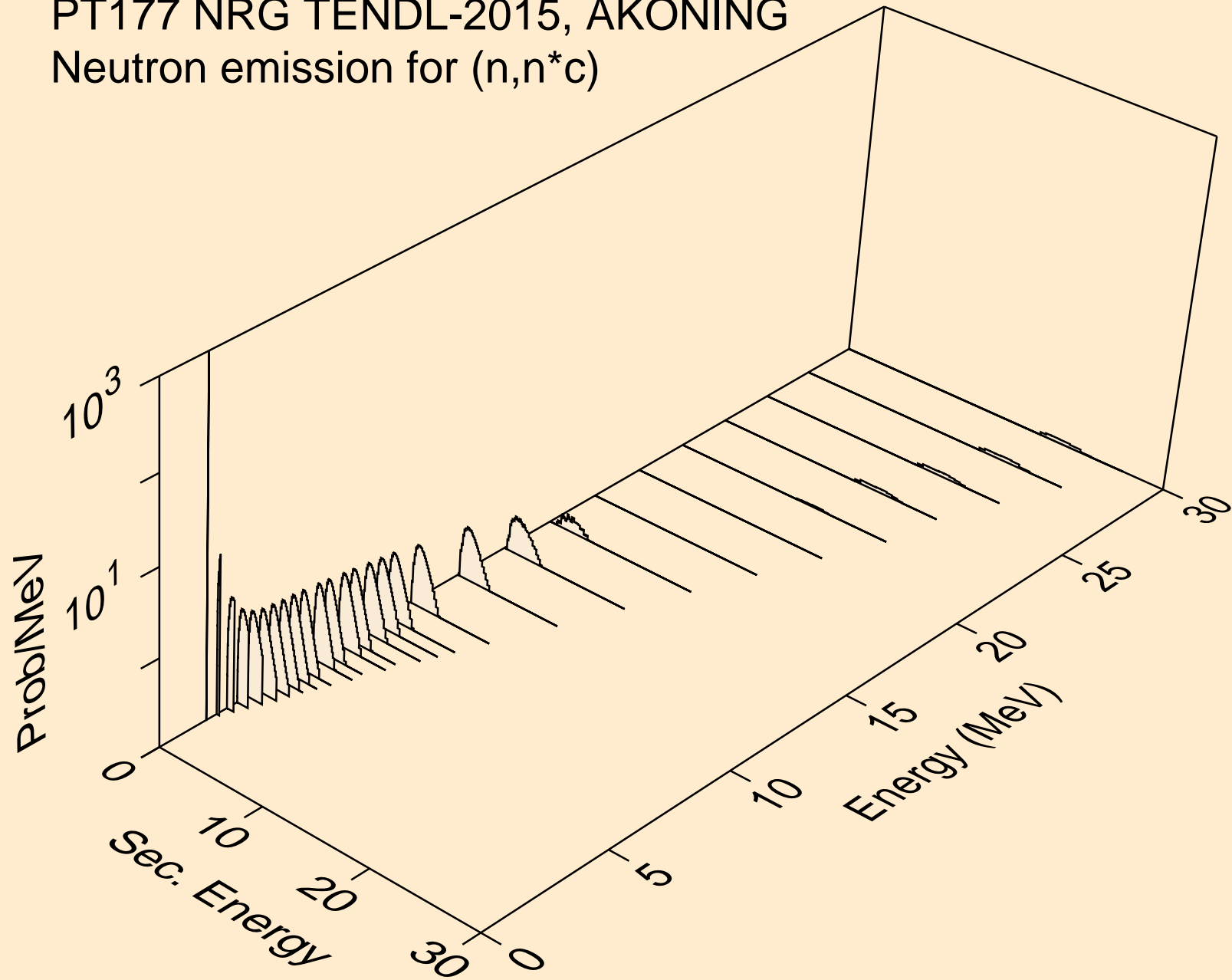

PT177 NRG TENDL-2015, AKONING
Photon emission for (n,x)

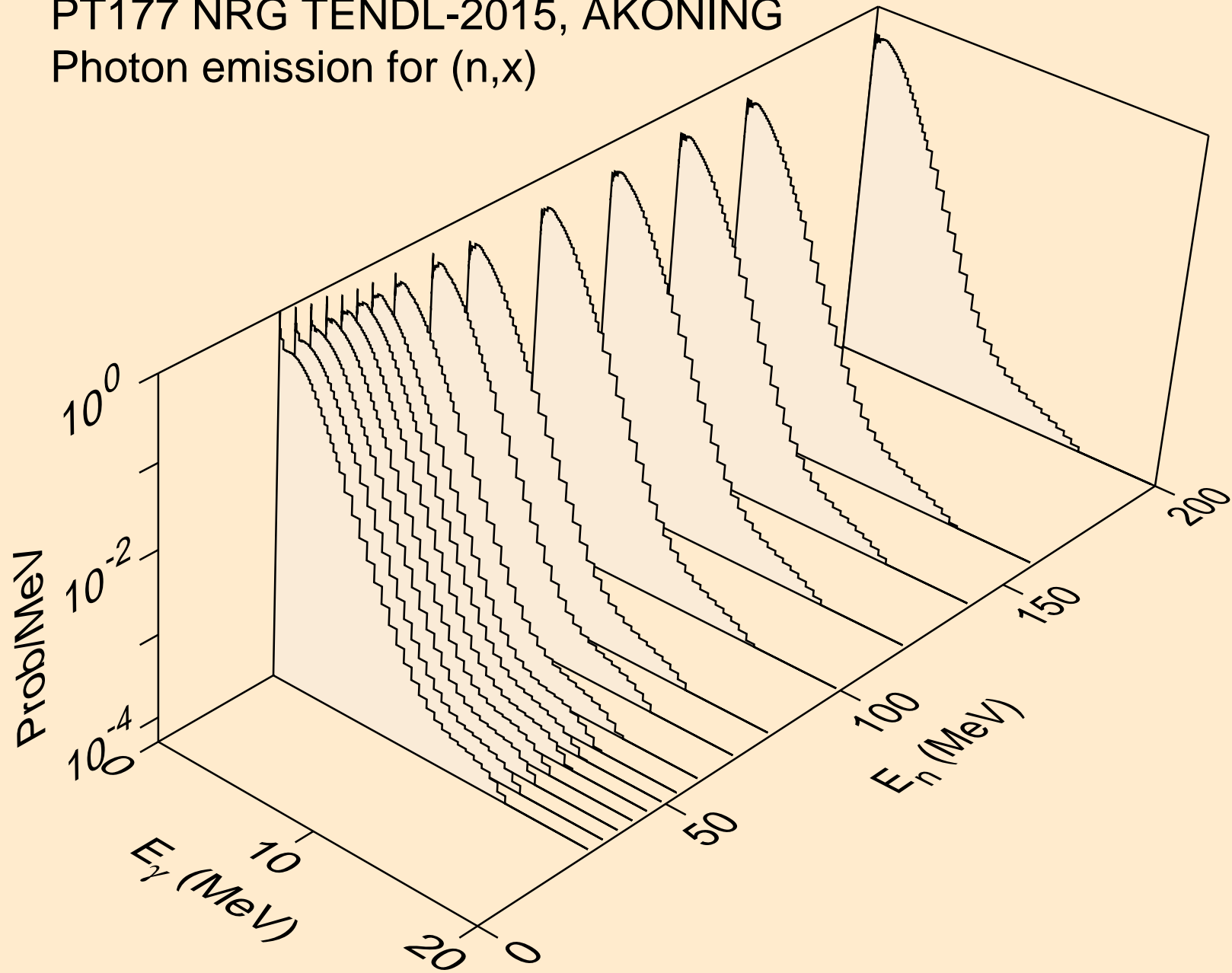

PT177 NRG TENDL-2015, AKONING
Photon emission for (n,2nd)

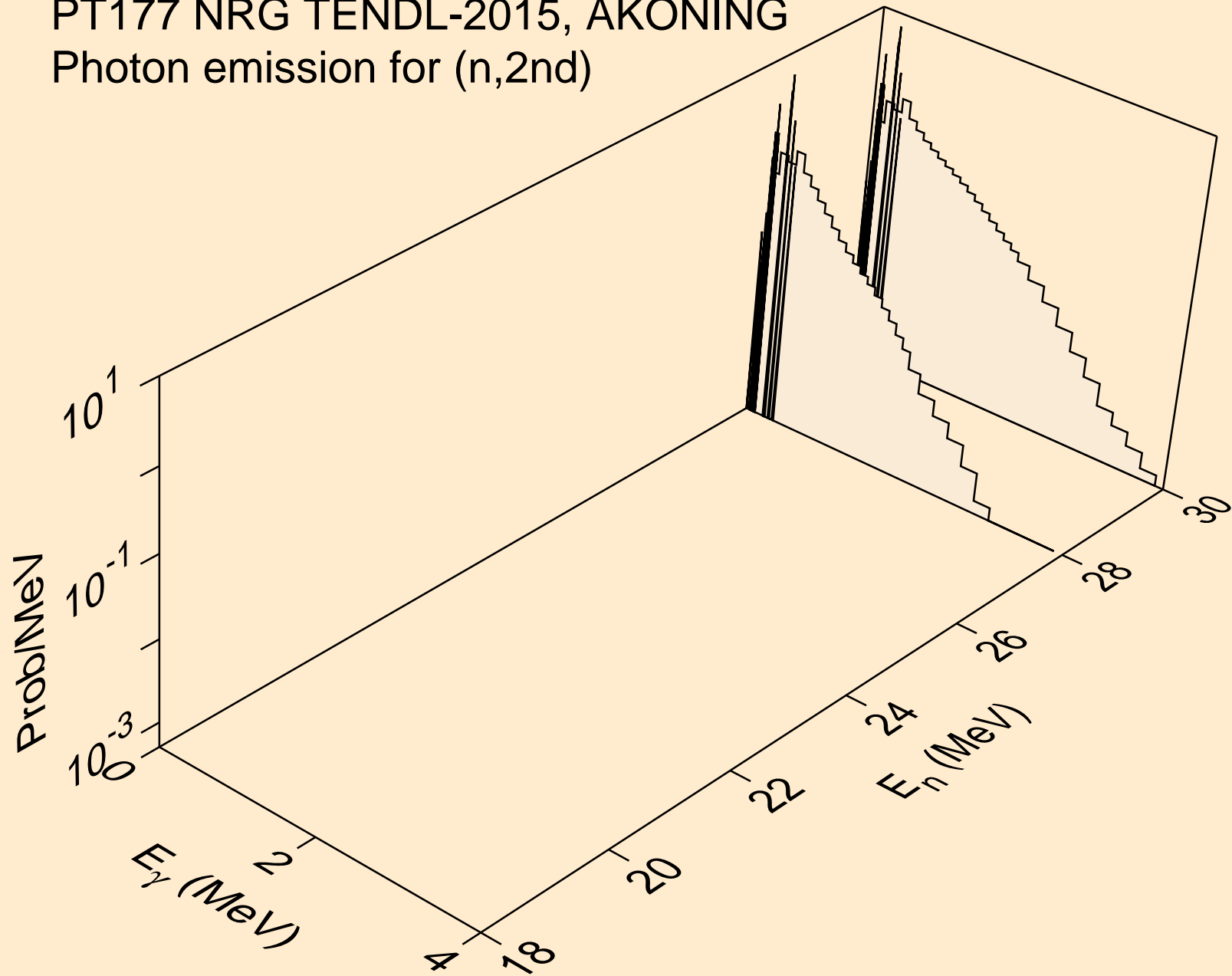

PT177 NRG TENDL-2015, AKONING
Photon emission for (n,2n)

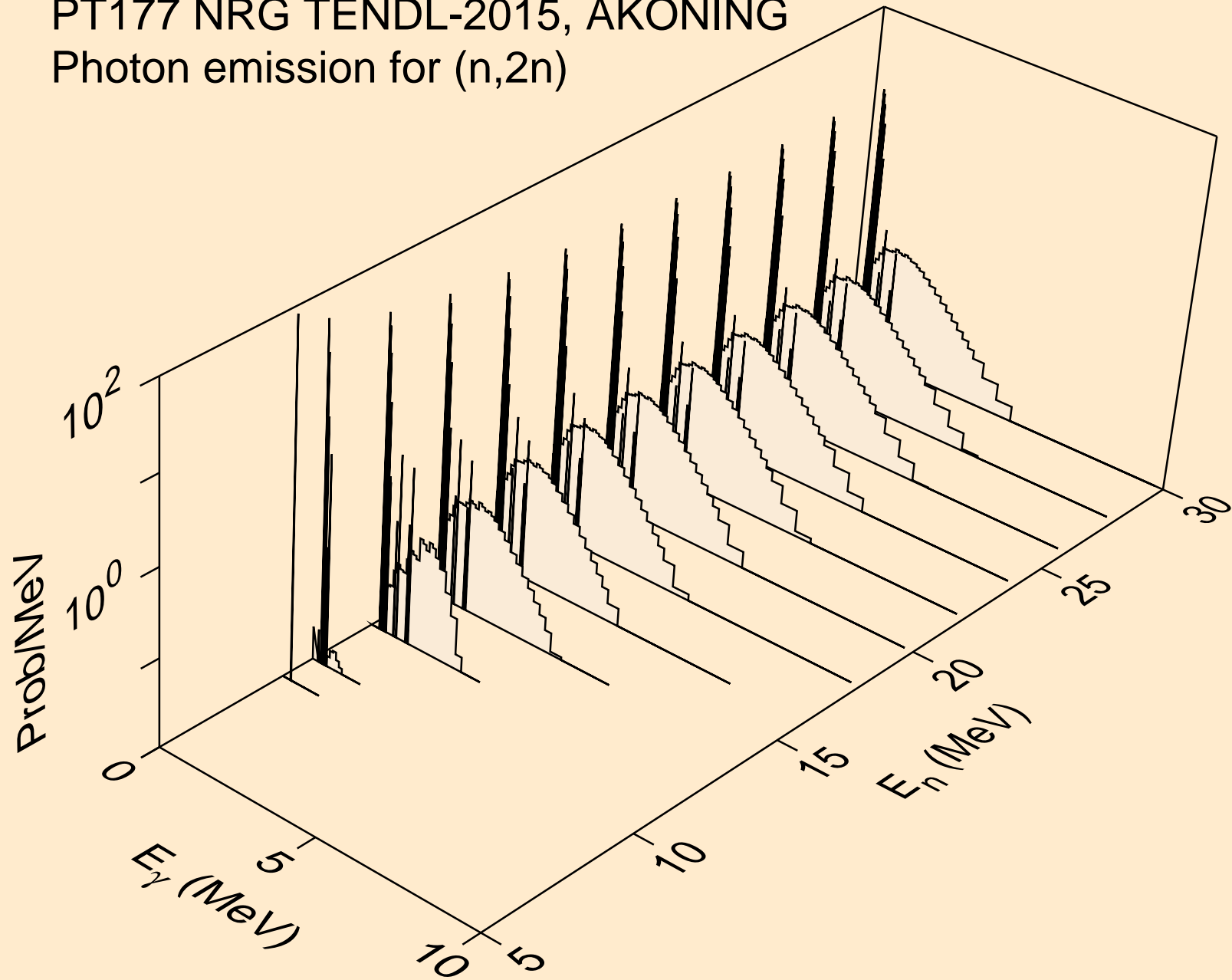

PT177 NRG TENDL-2015, AKONING
Photon emission for (n,3n)

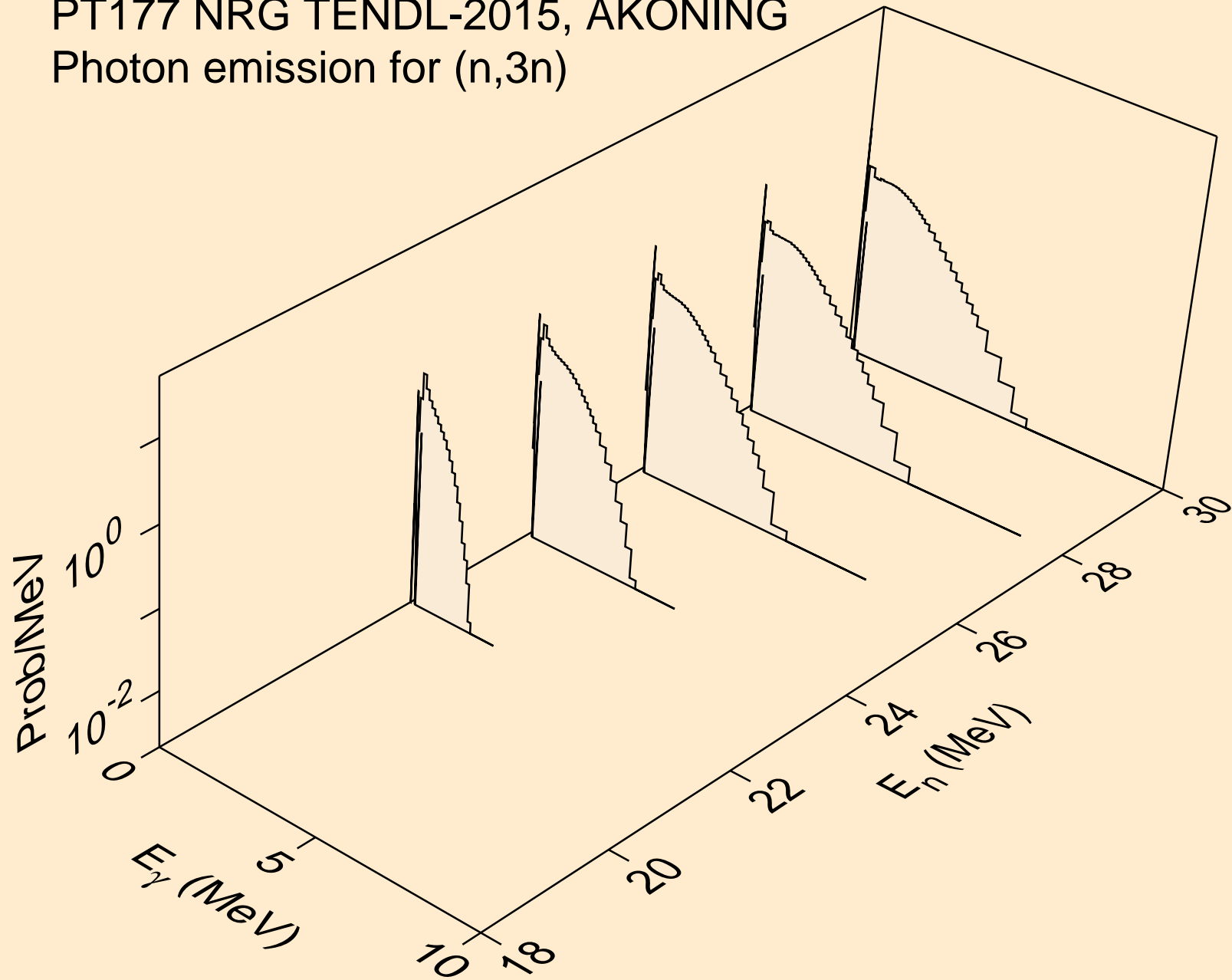

PT177 NRG TENDL-2015, AKONING
Photon emission for (n,n*)a

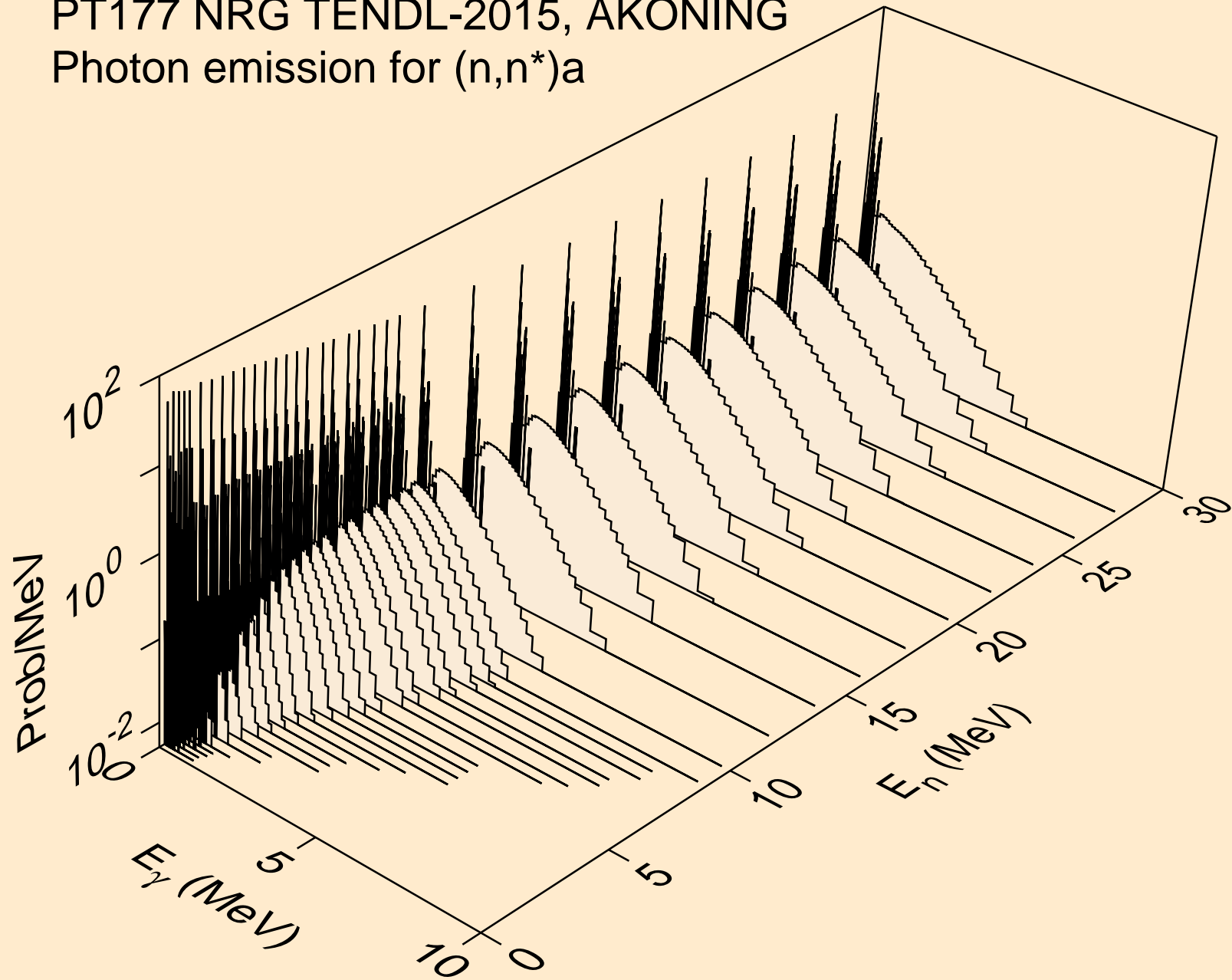

PT177 NRG TENDL-2015, AKONING
Photon emission for (n,n*)3a

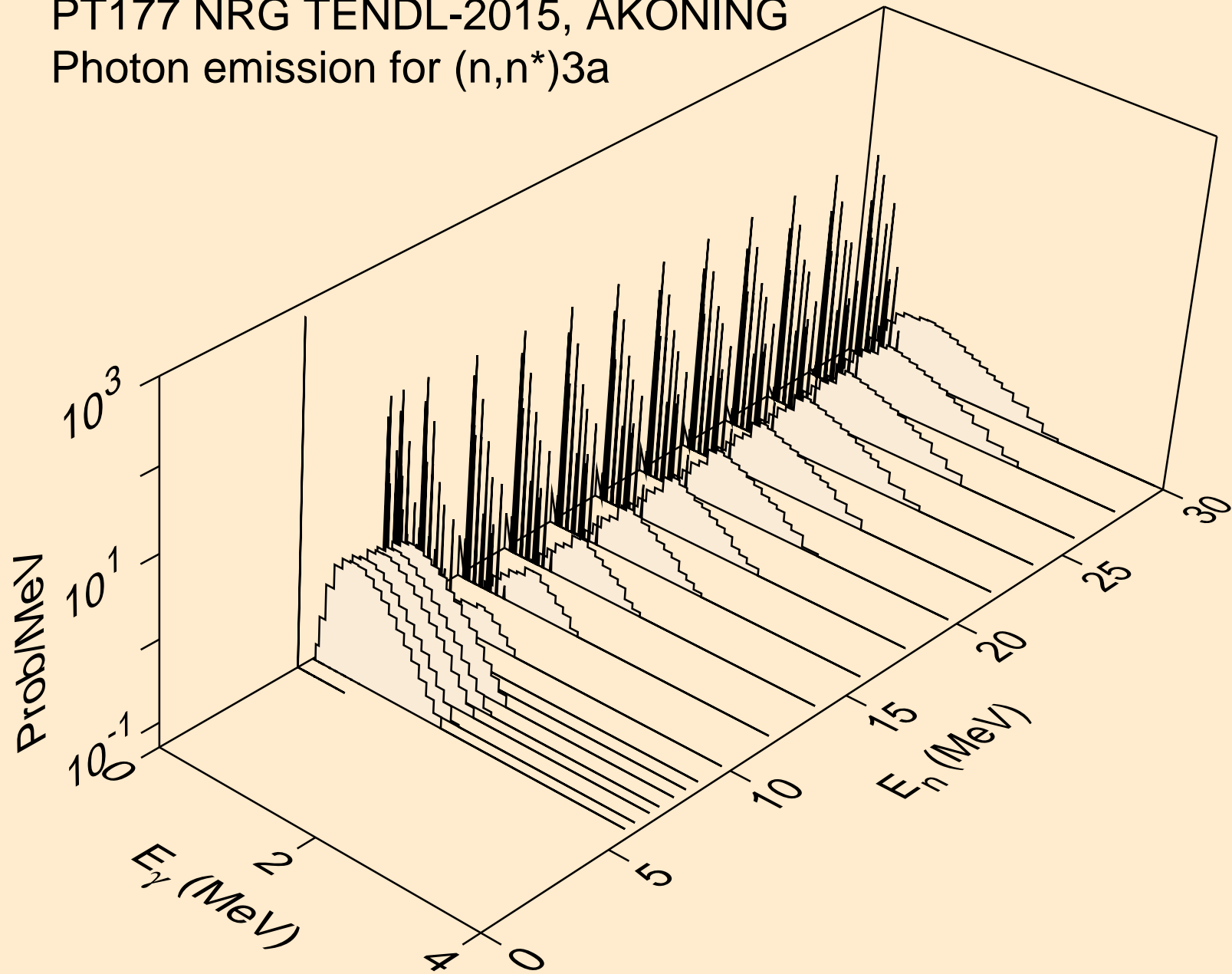

PT177 NRG TENDL-2015, AKONING
Photon emission for (n,2n)a

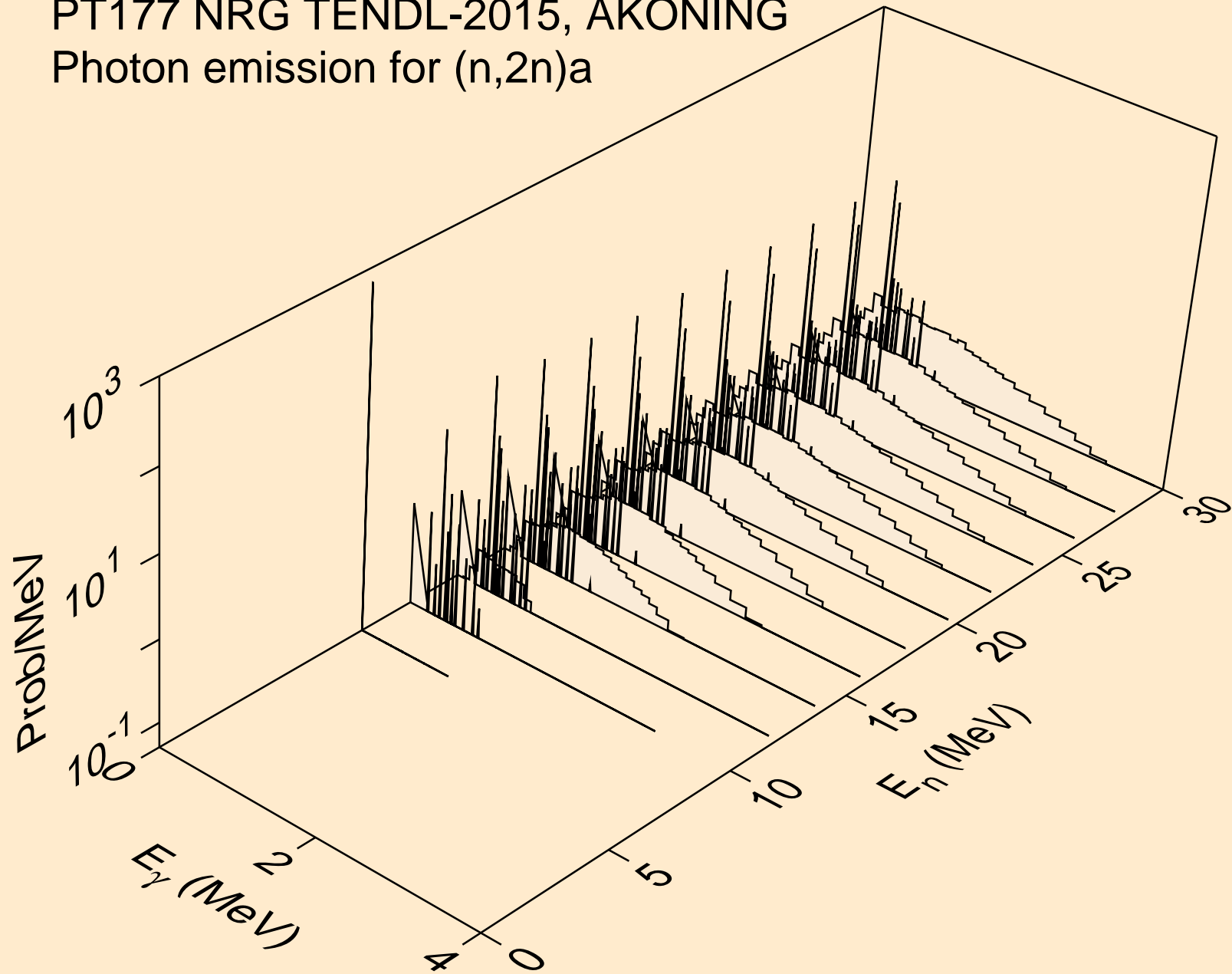

PT177 NRG TENDL-2015, AKONING
Photon emission for (n,3n)a

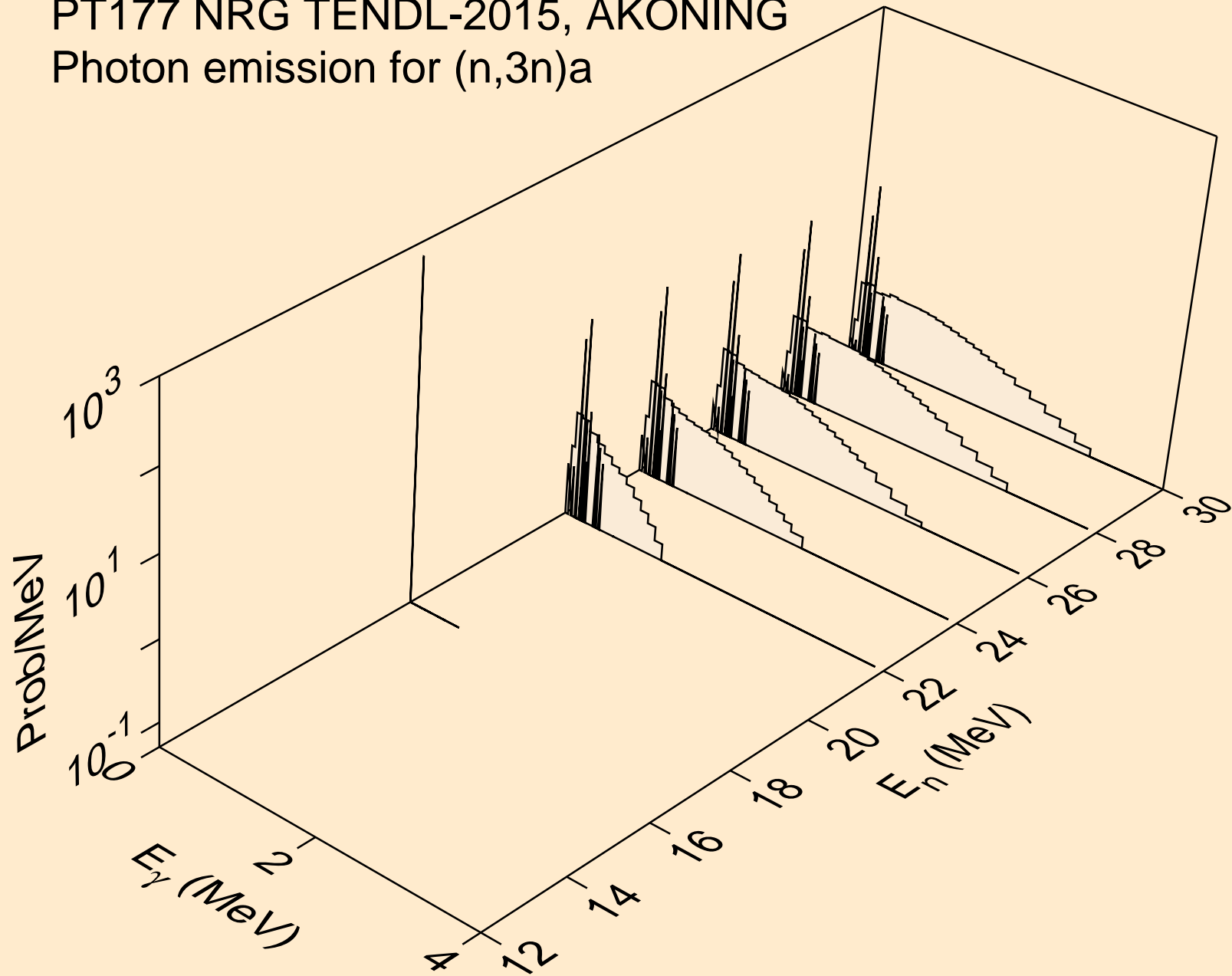

PT177 NRG TENDL-2015, AKONING
Photon emission for (n,n*)p

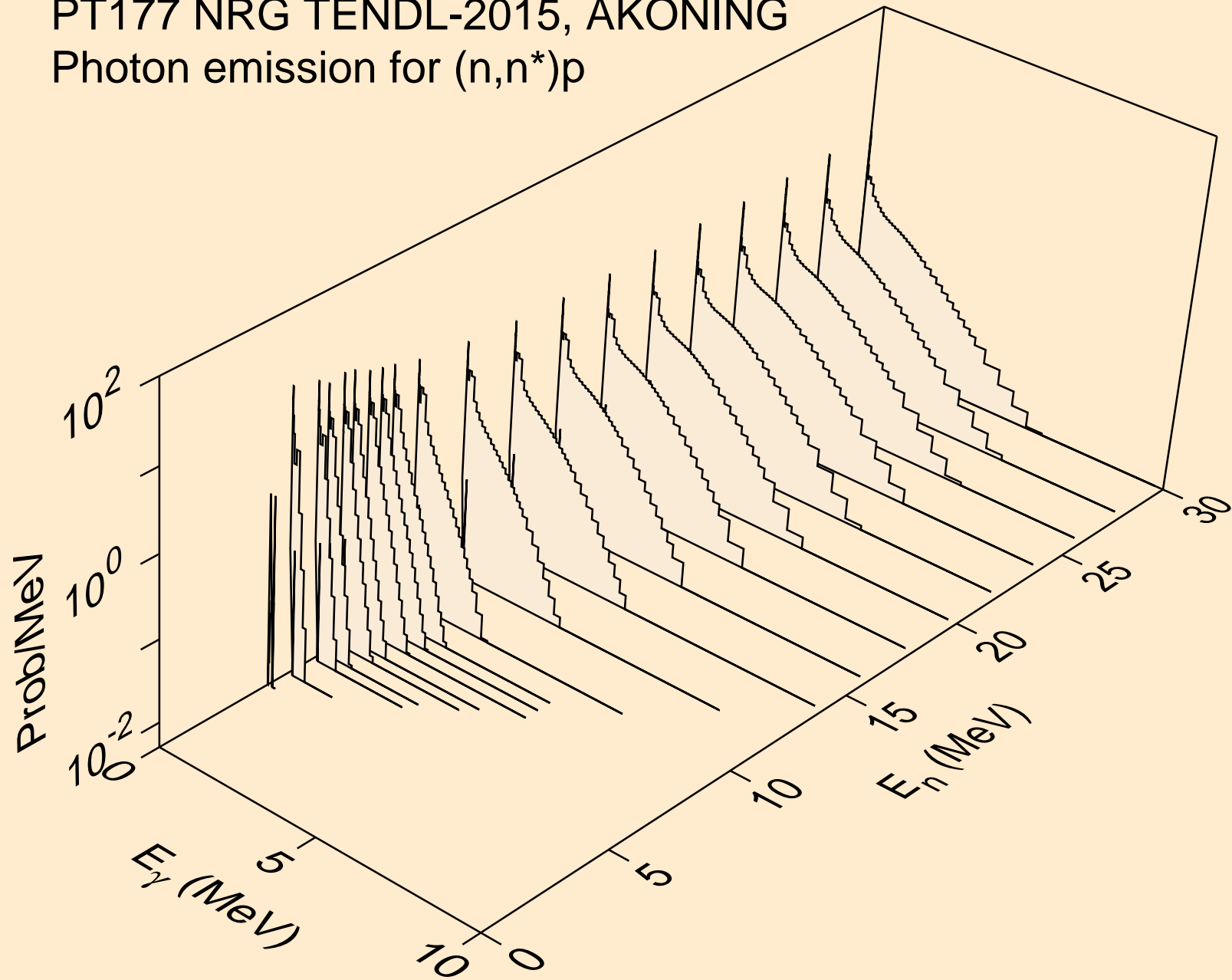

PT177 NRG TENDL-2015, AKONING
Photon emission for (n,n*)2a

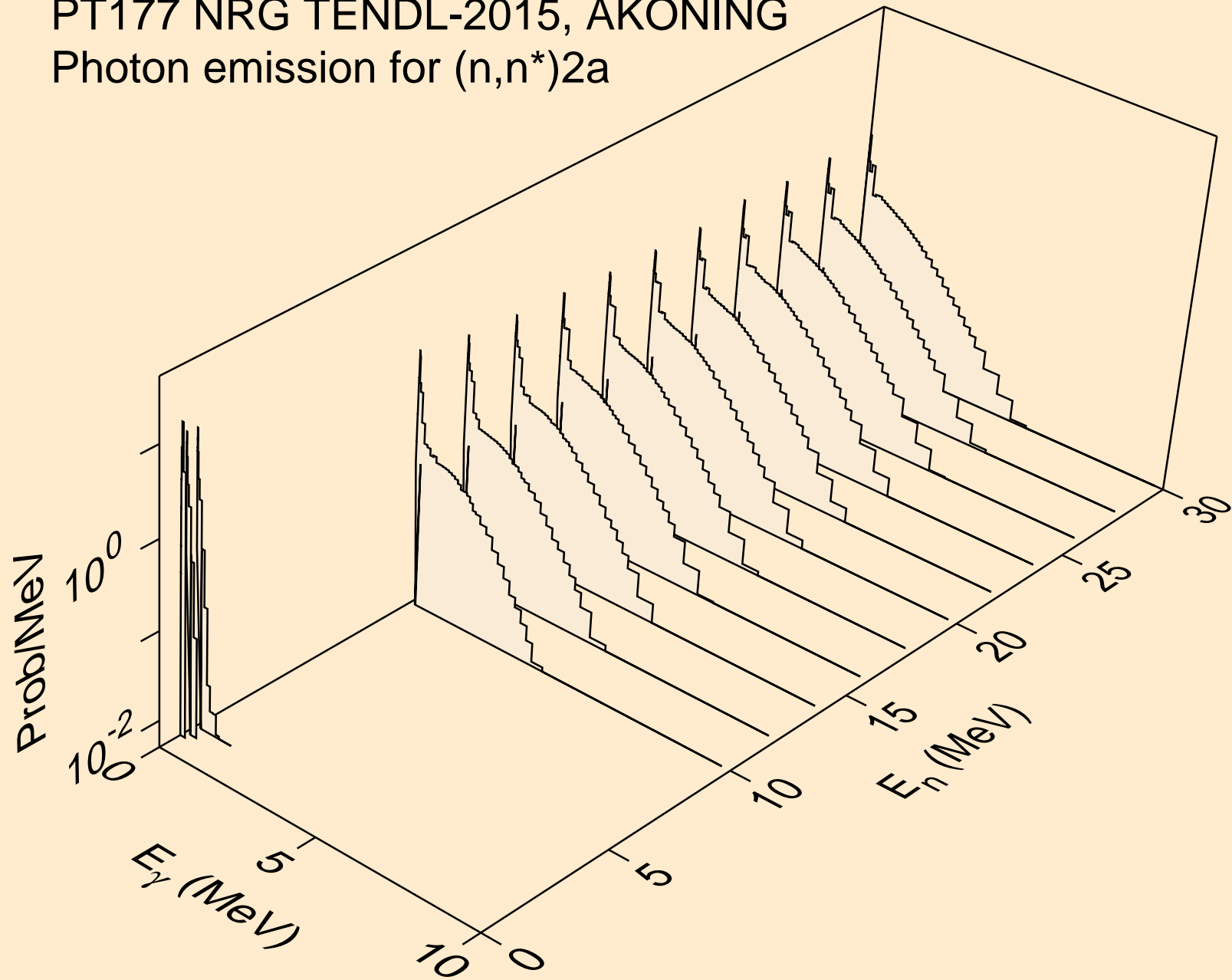

PT177 NRG TENDL-2015, AKONING
Photon emission for (n,2n)2a

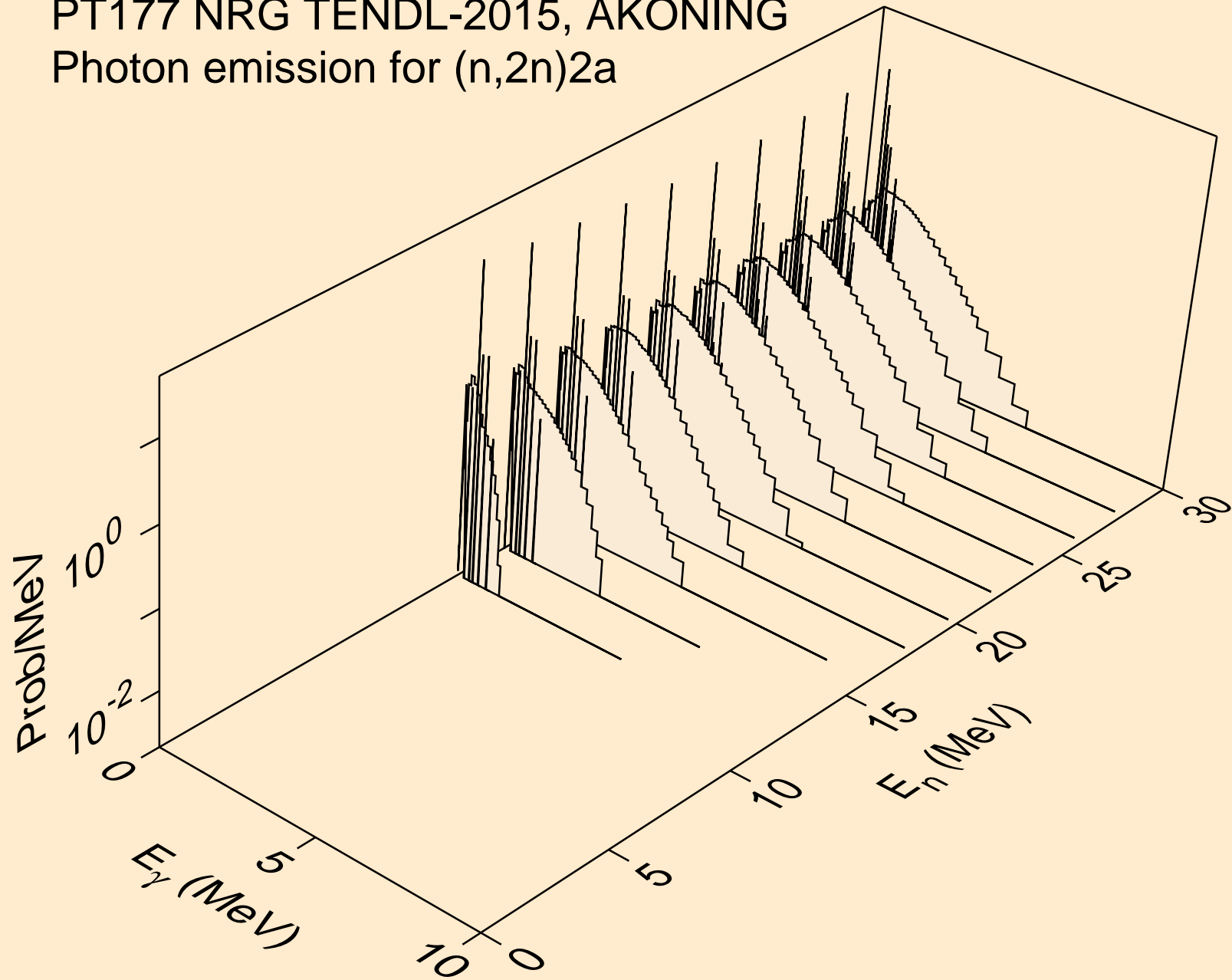

PT177 NRG TENDL-2015, AKONING
Photon emission for (n,n*)d

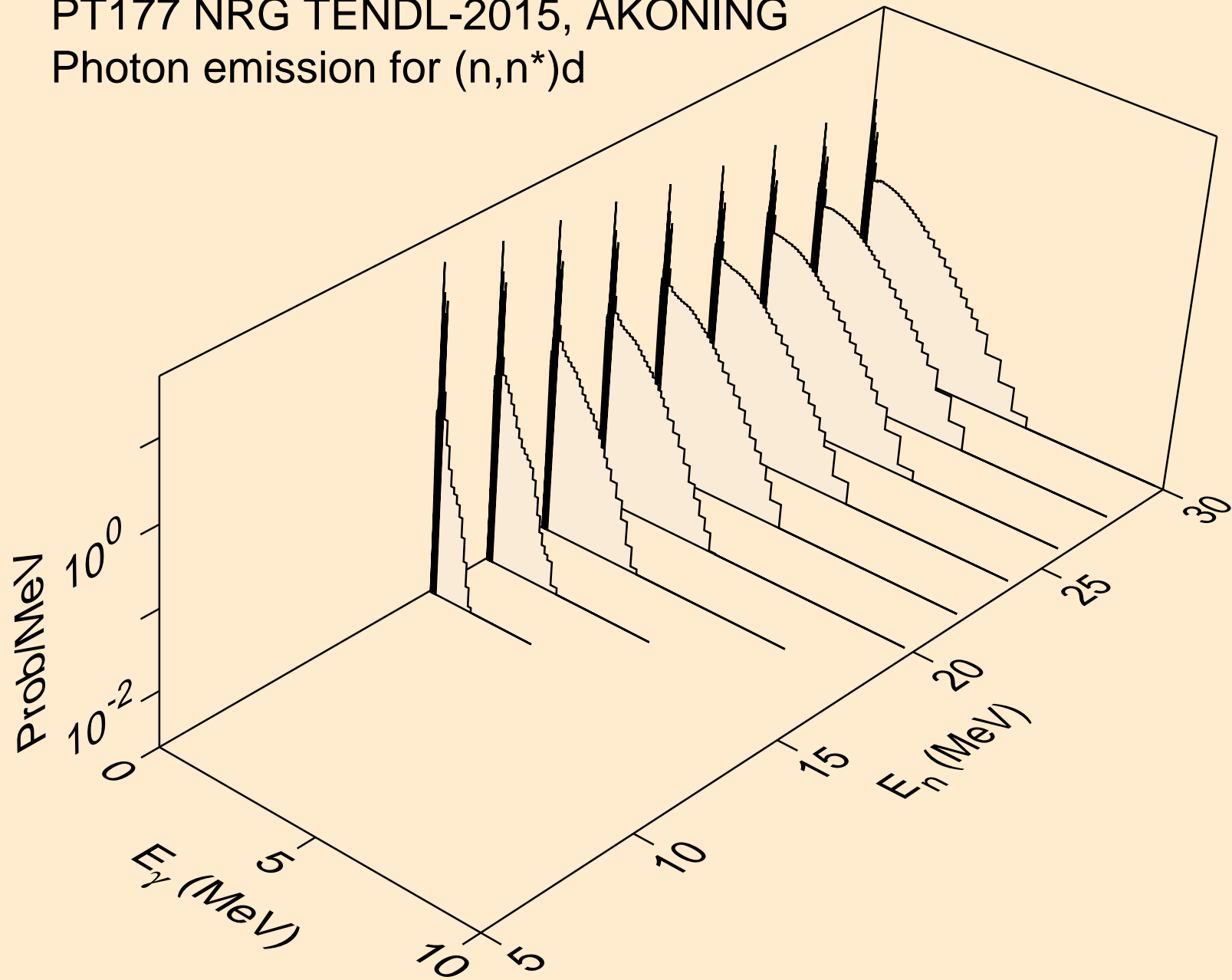

PT177 NRG TENDL-2015, AKONING
Photon emission for (n,n*)t

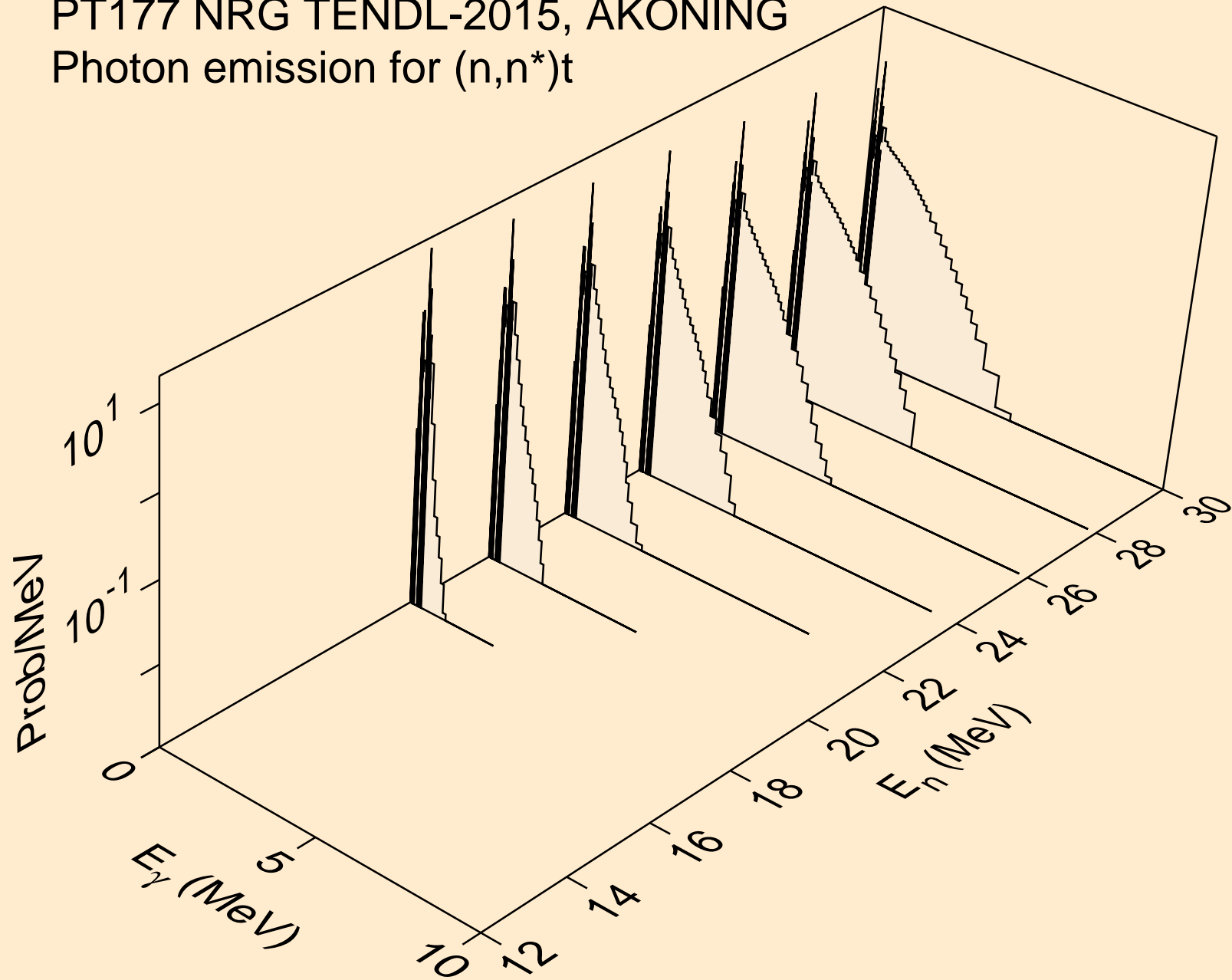

PT177 NRG TENDL-2015, AKONING
Photon emission for (n,n*)he3

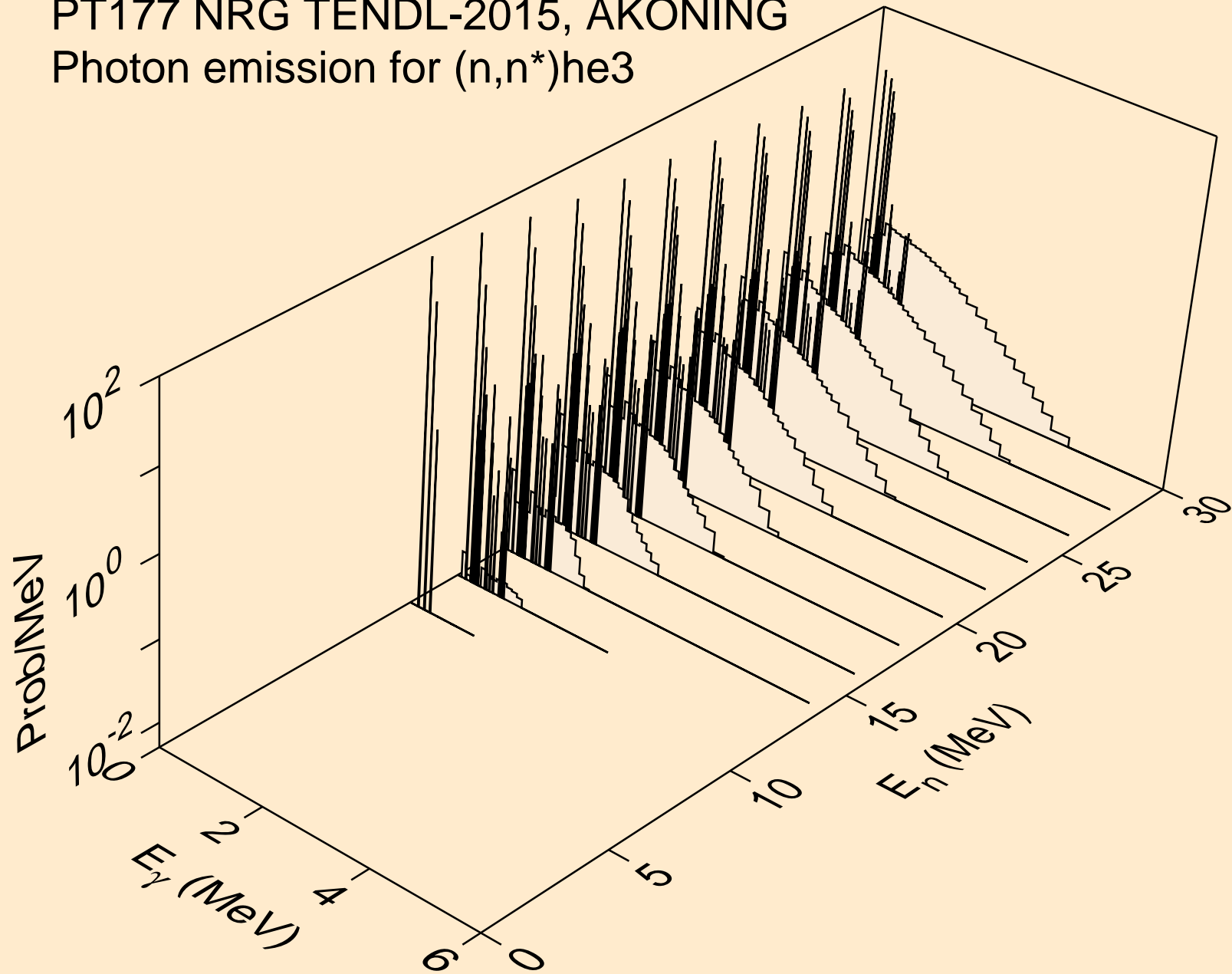

PT177 NRG TENDL-2015, AKONING
Photon emission for (n,n*)d2a

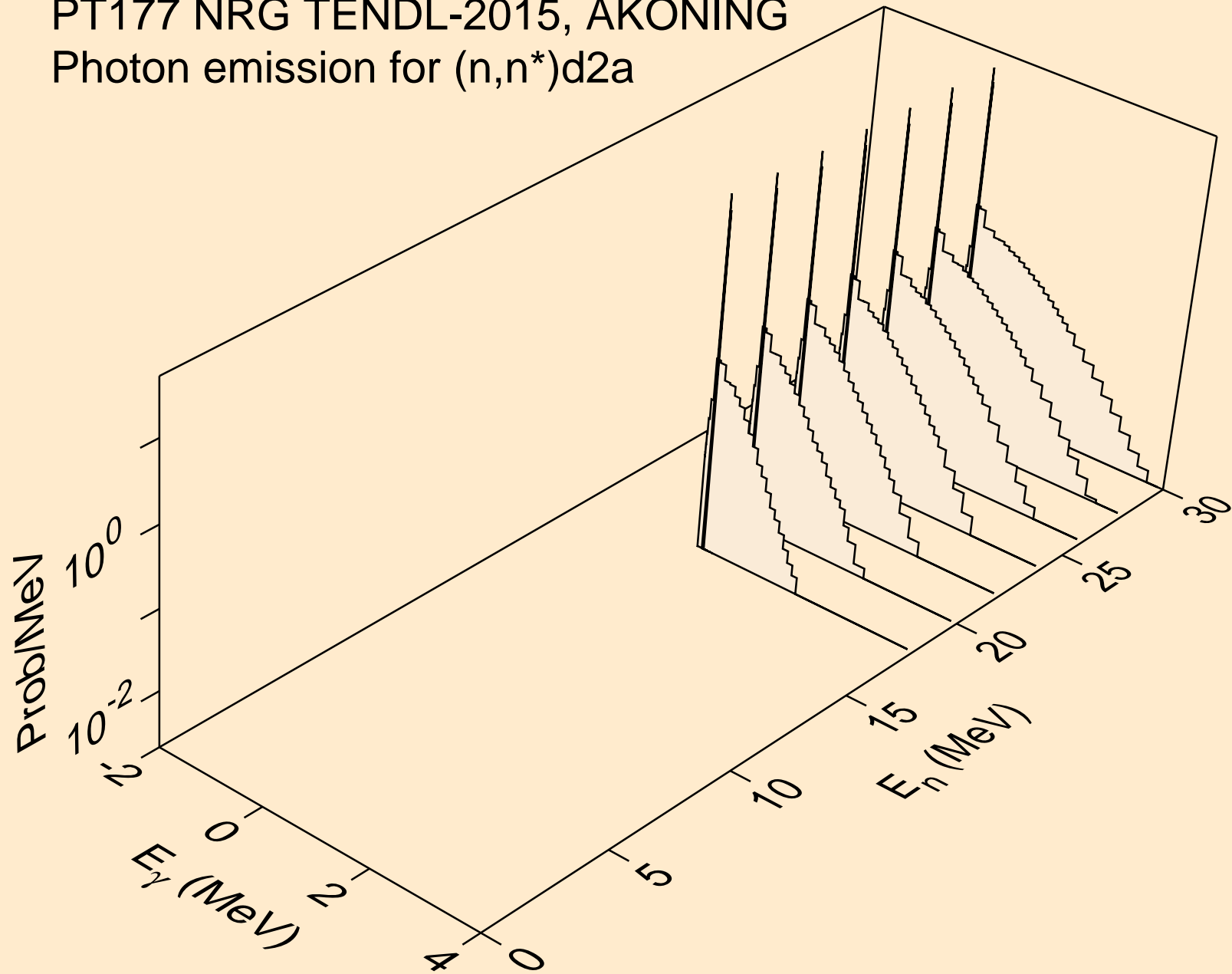

PT177 NRG TENDL-2015, AKONING
Photon emission for (n,4n)

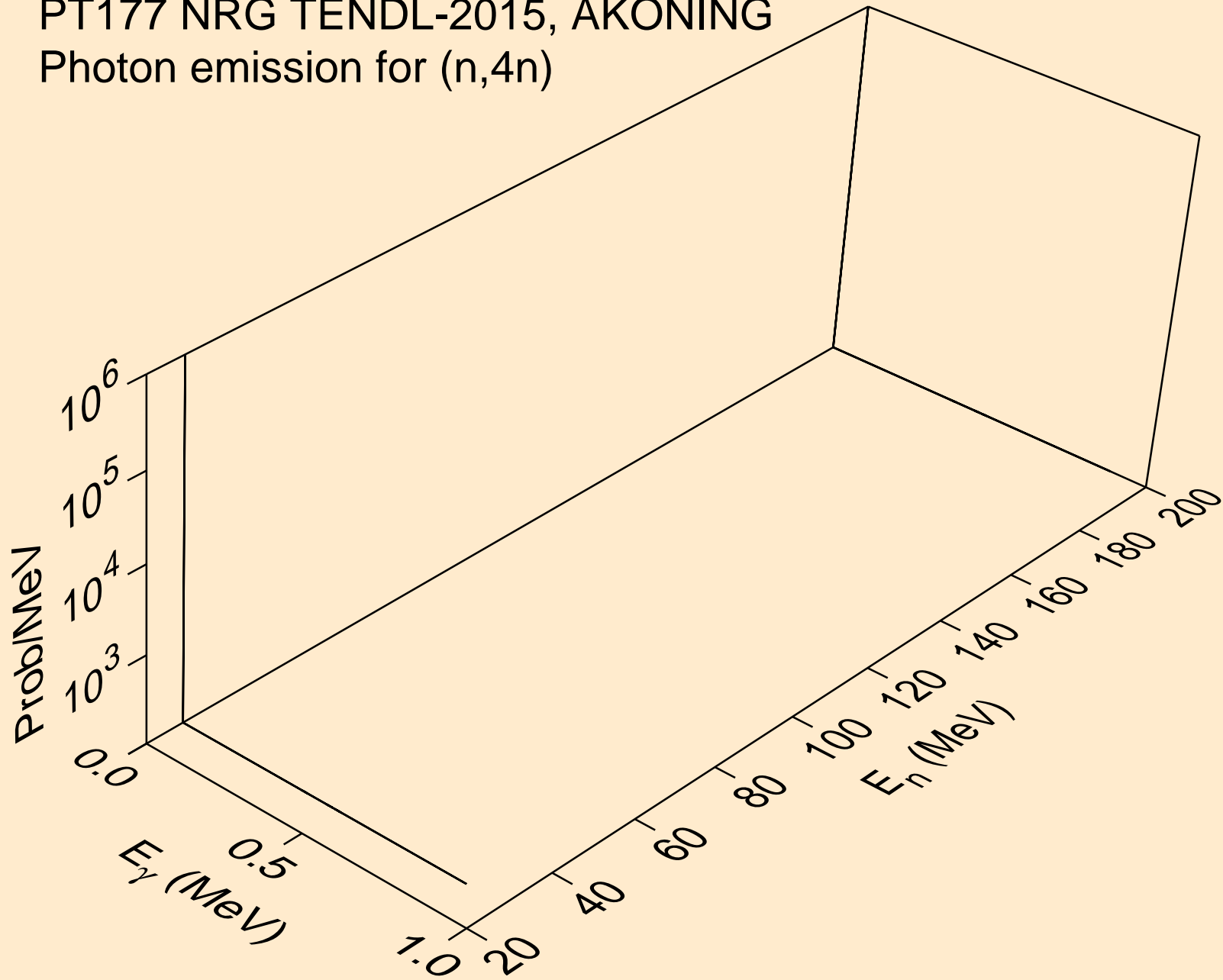

PT177 NRG TENDL-2015, AKONING
Photon emission for (n,2np)

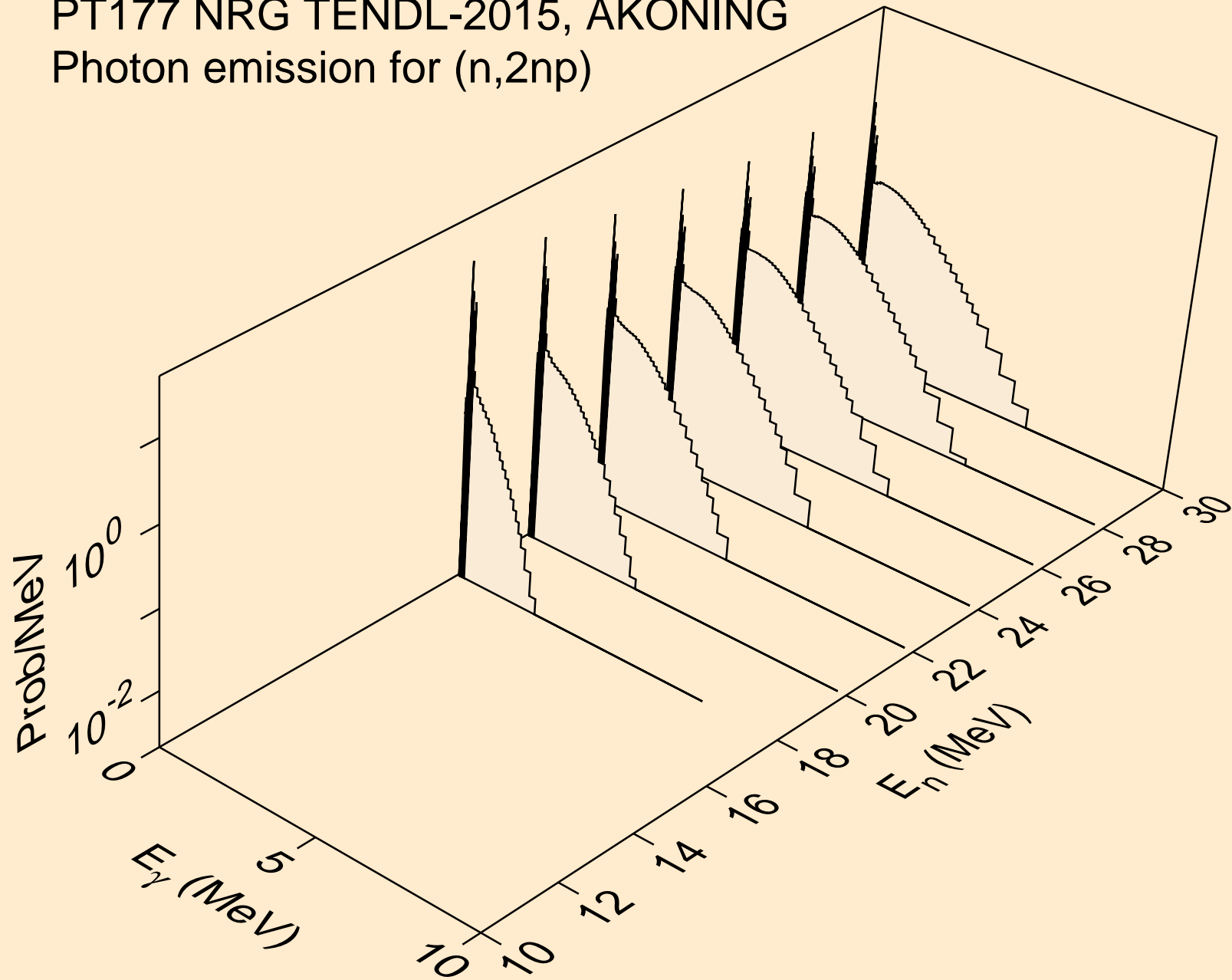

PT177 NRG TENDL-2015, AKONING
Photon emission for (n,3np)

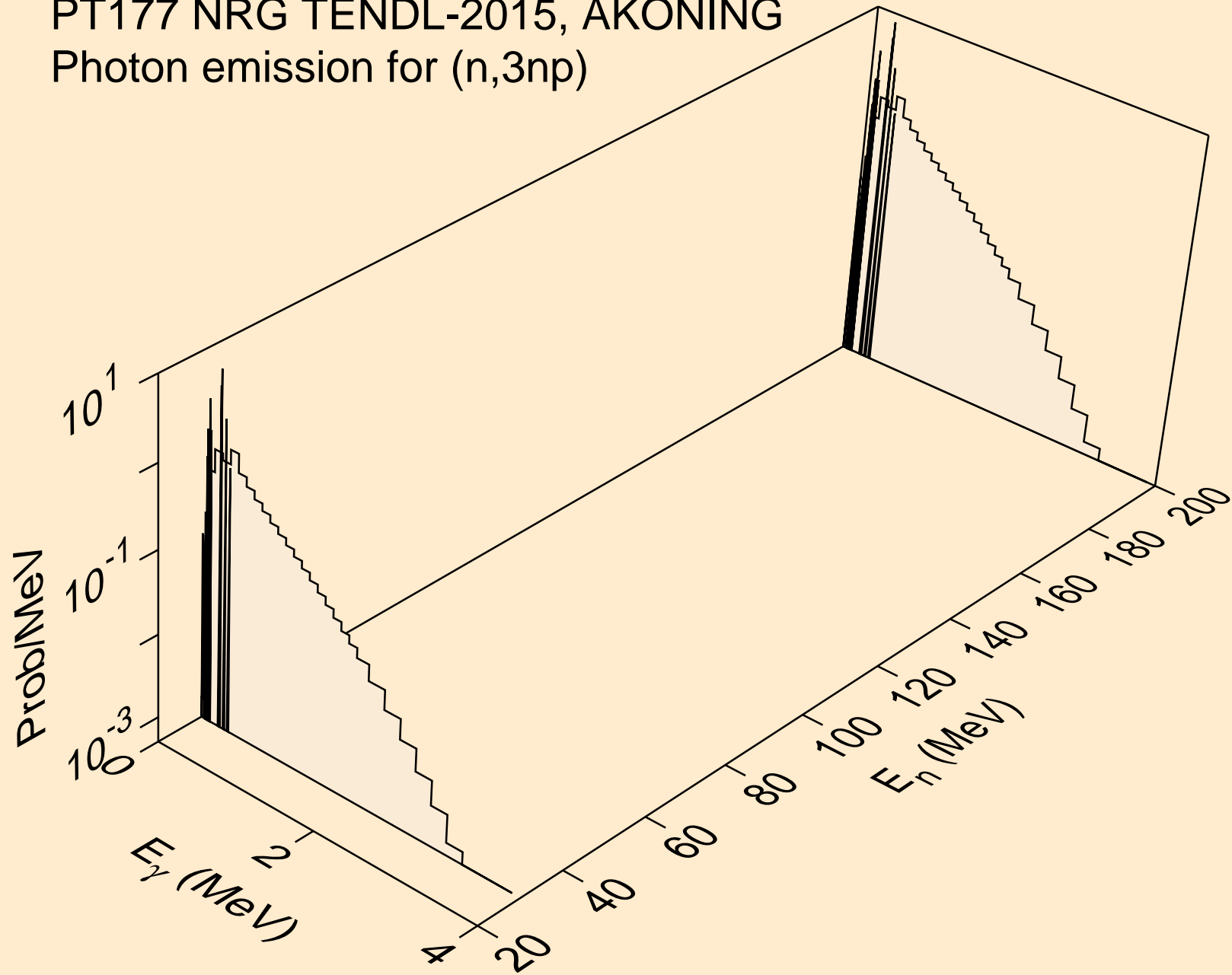

PT177 NRG TENDL-2015, AKONING
Photon emission for (n,2np)

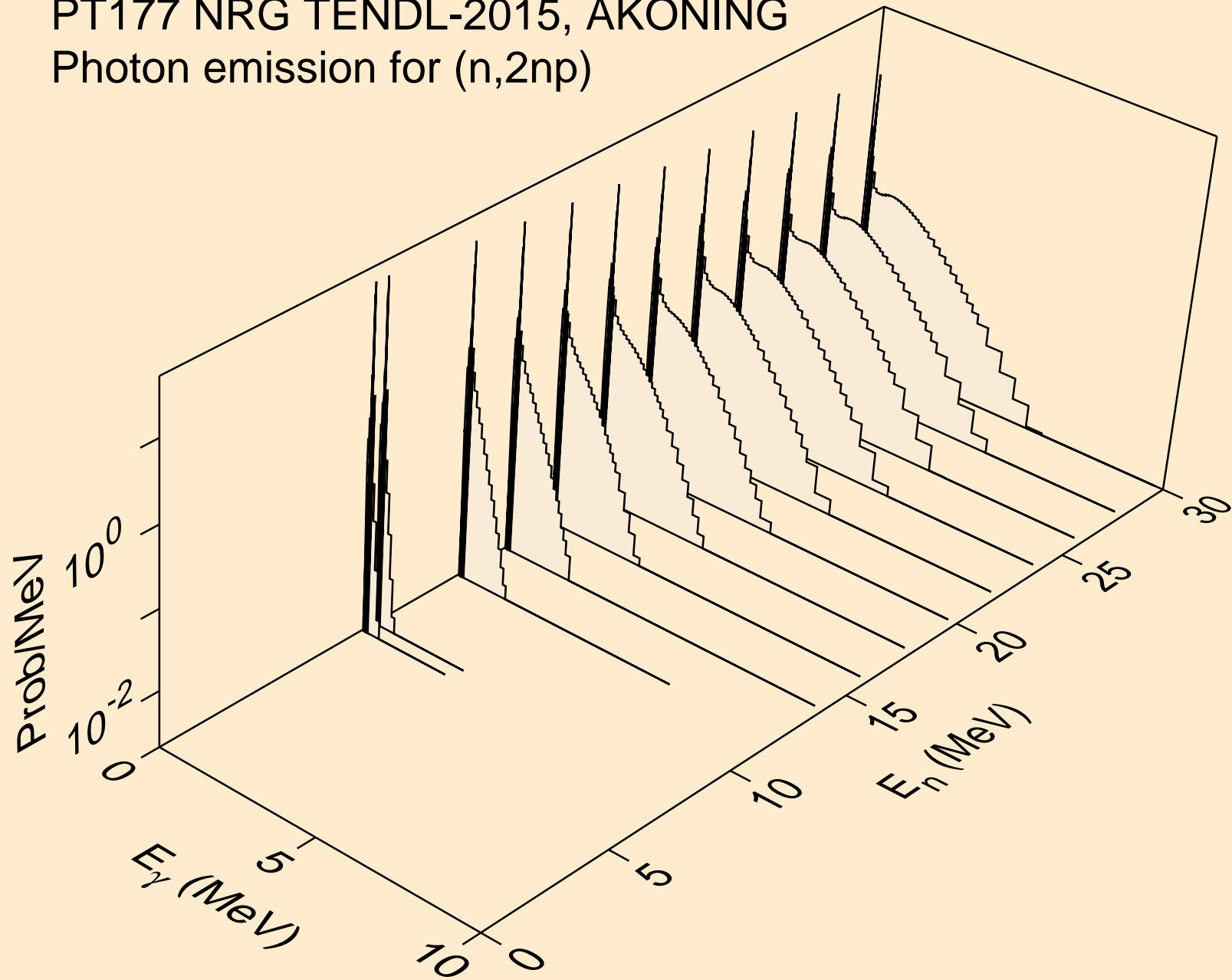

PT177 NRG TENDL-2015, AKONING
Photon emission for (n,npa)

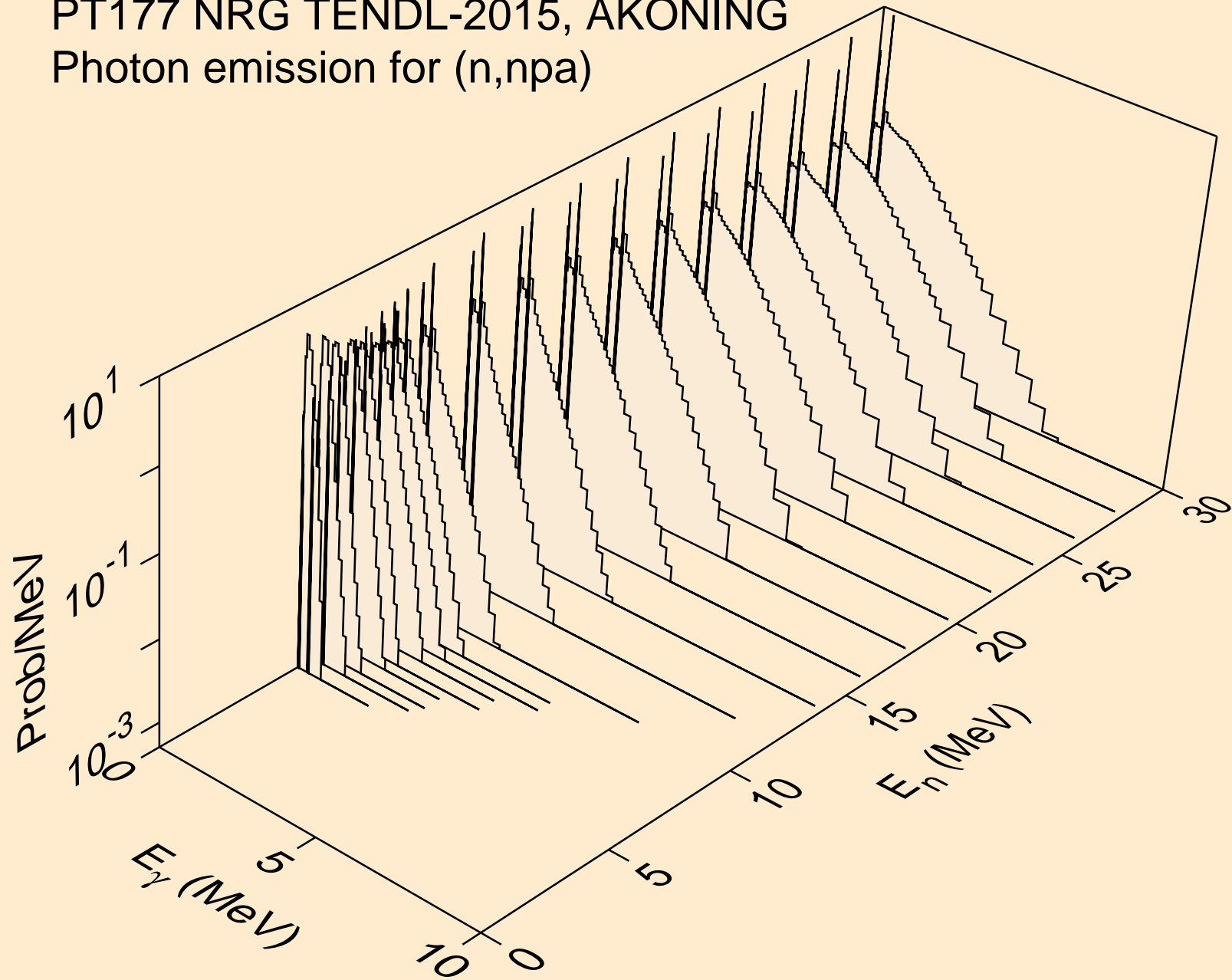

PT177 NRG TENDL-2015, AKONING
Photon emission for (n,n*c)

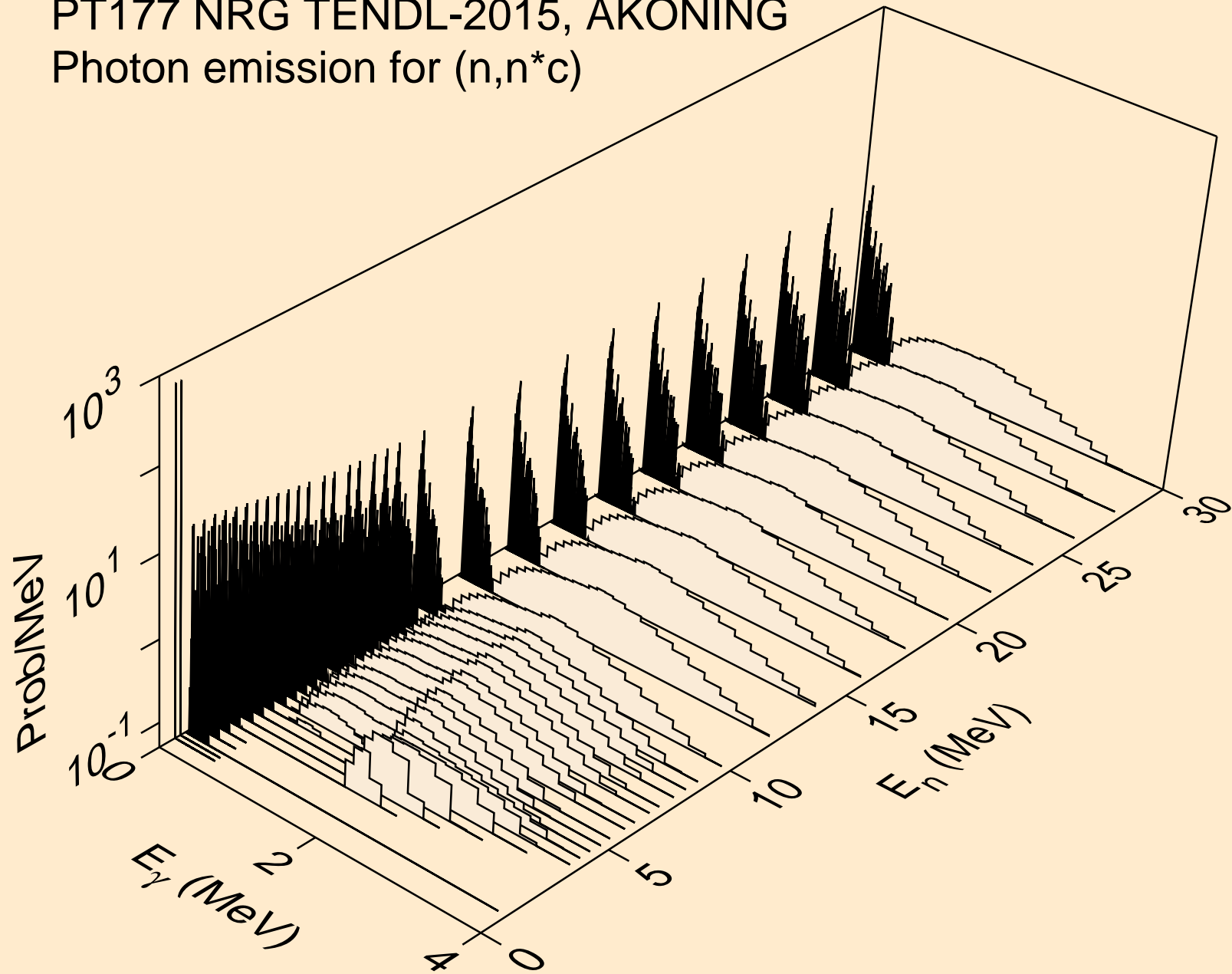

PT177 NRG TENDL-2015, AKONING
Photon emission for (n,gma)

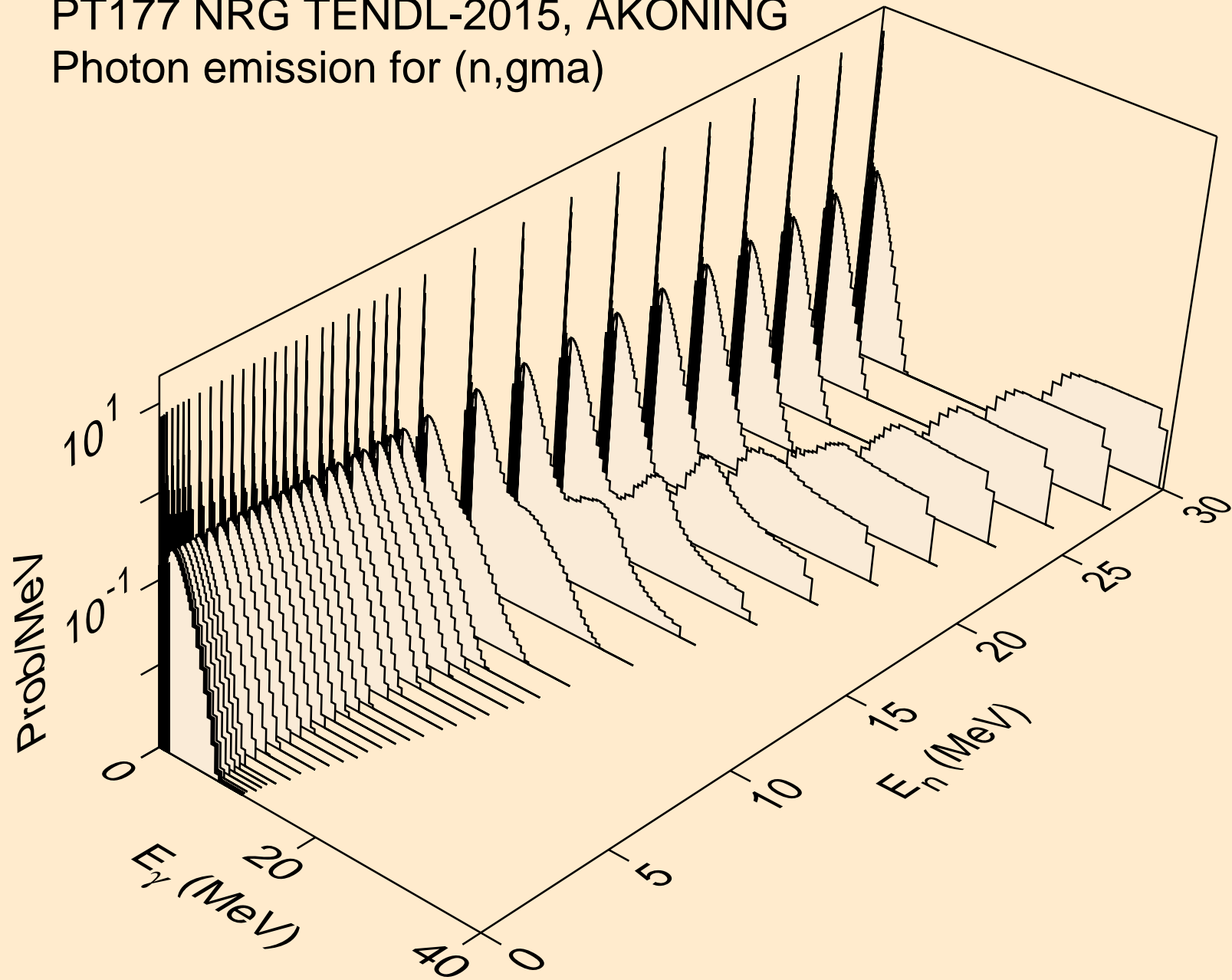

PT177 NRG TENDL-2015, AKONING
Photon emission for (n,p)

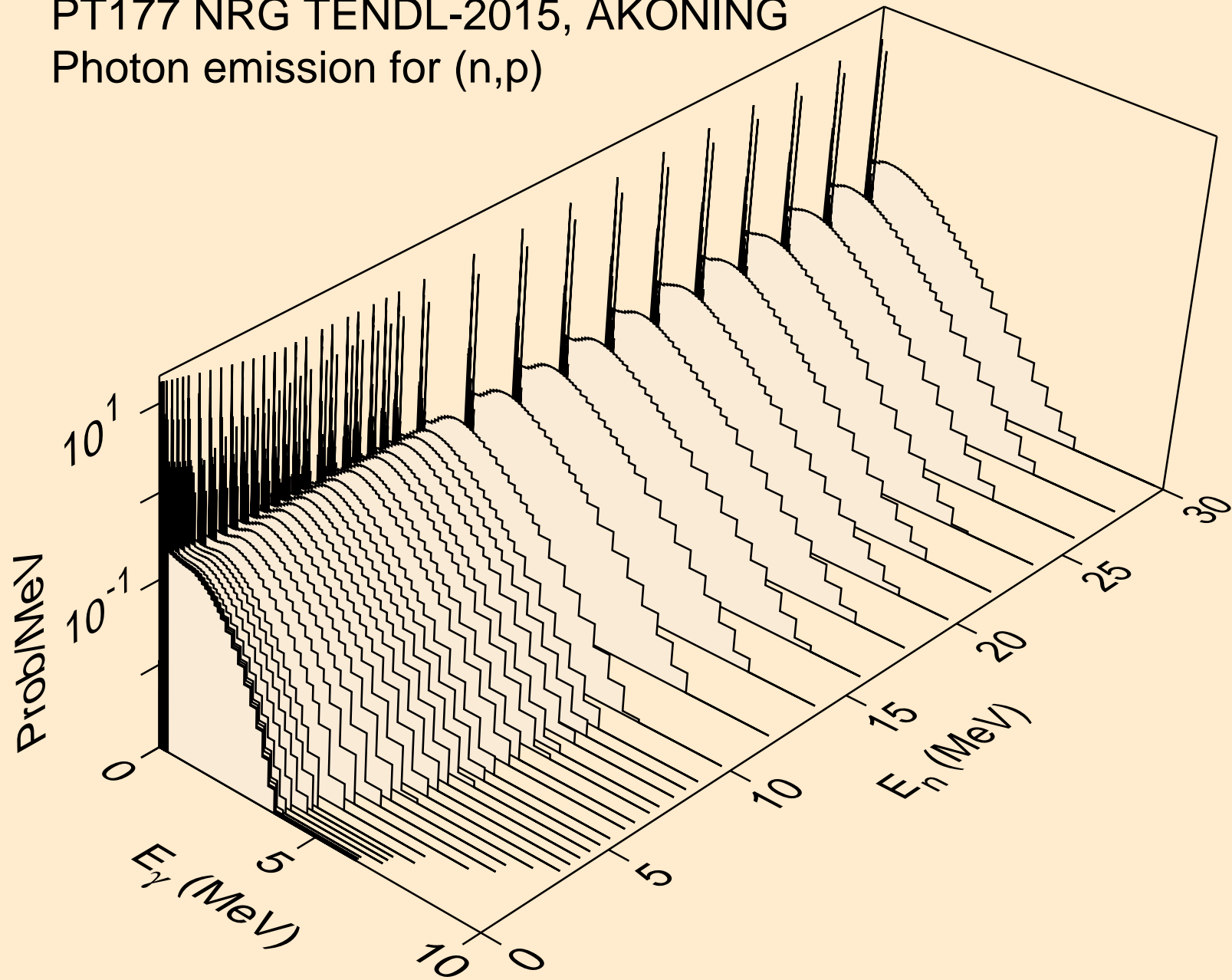

PT177 NRG TENDL-2015, AKONING
Photon emission for (n,d)

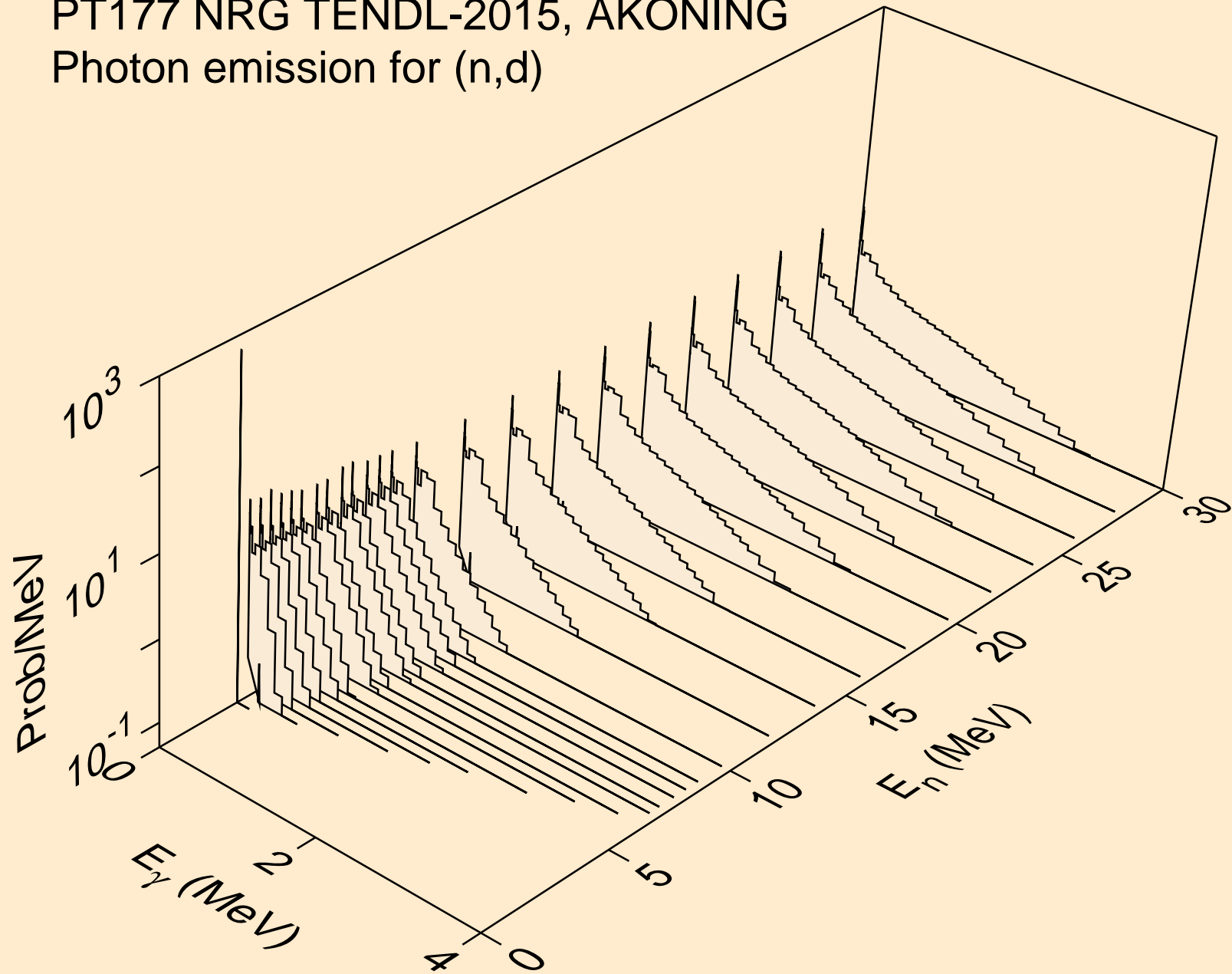

PT177 NRG TENDL-2015, AKONING
Photon emission for (n,t)

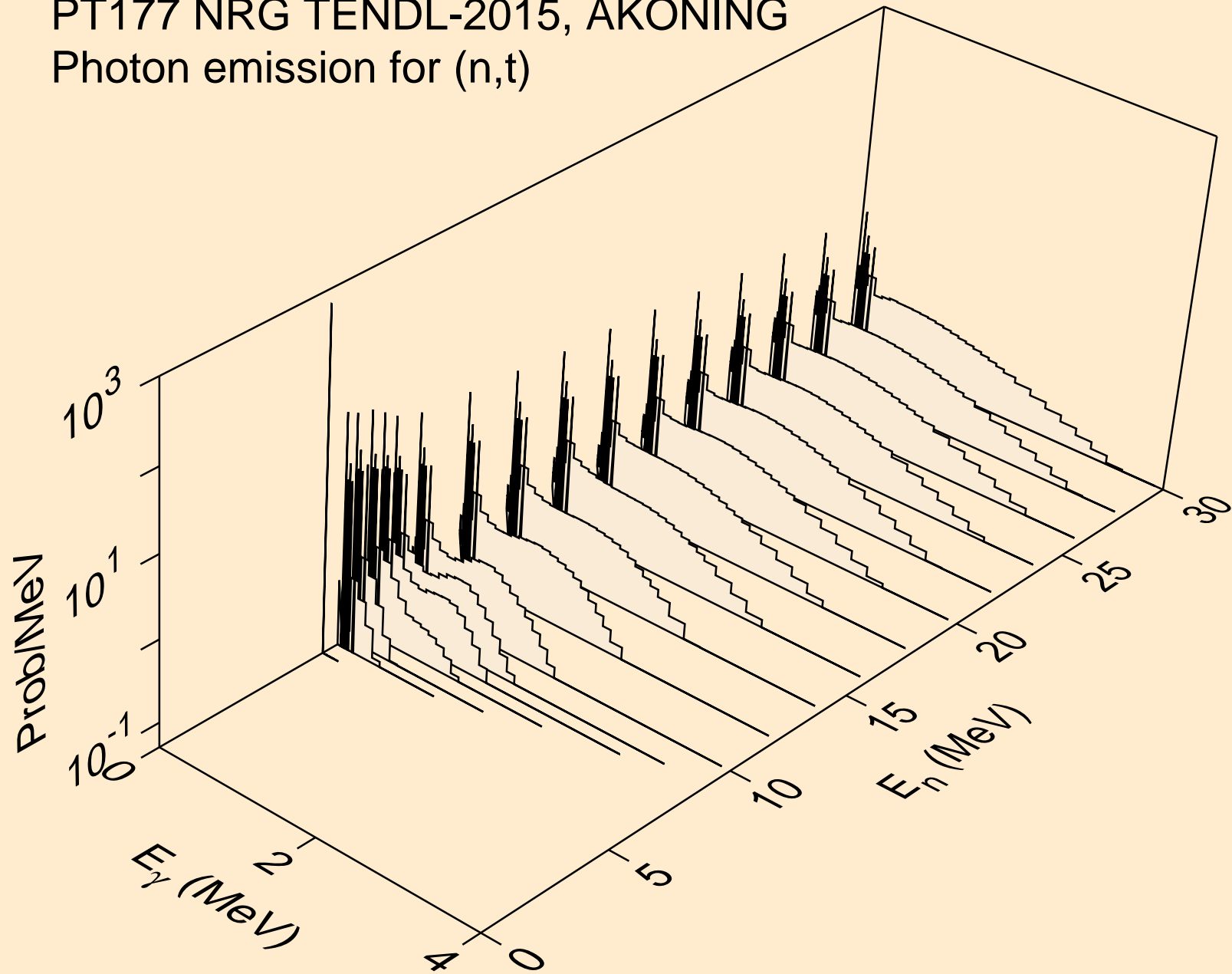

PT177 NRG TENDL-2015, AKONING
Photon emission for (n,he3)

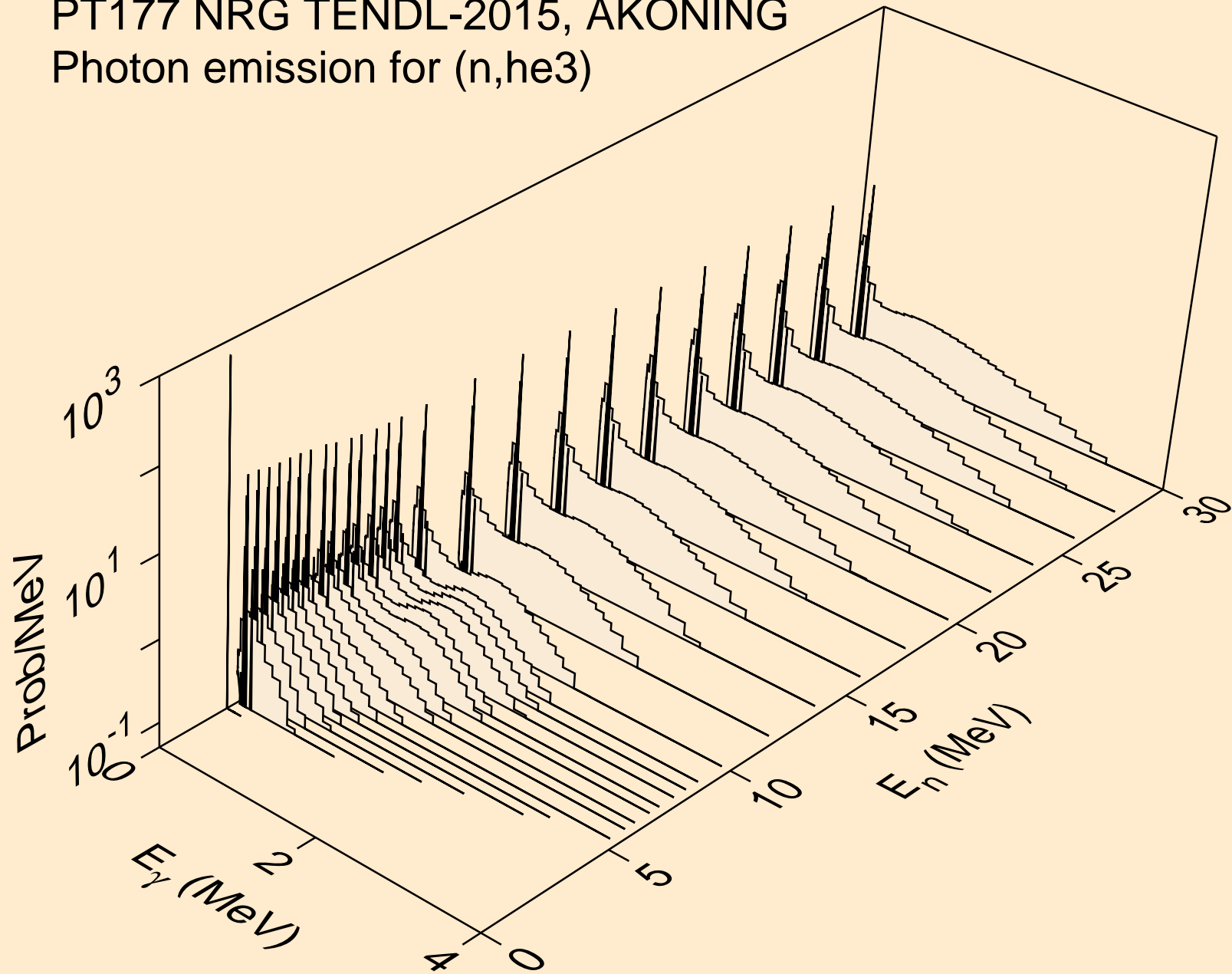

PT177 NRG TENDL-2015, AKONING
Photon emission for (n,a)

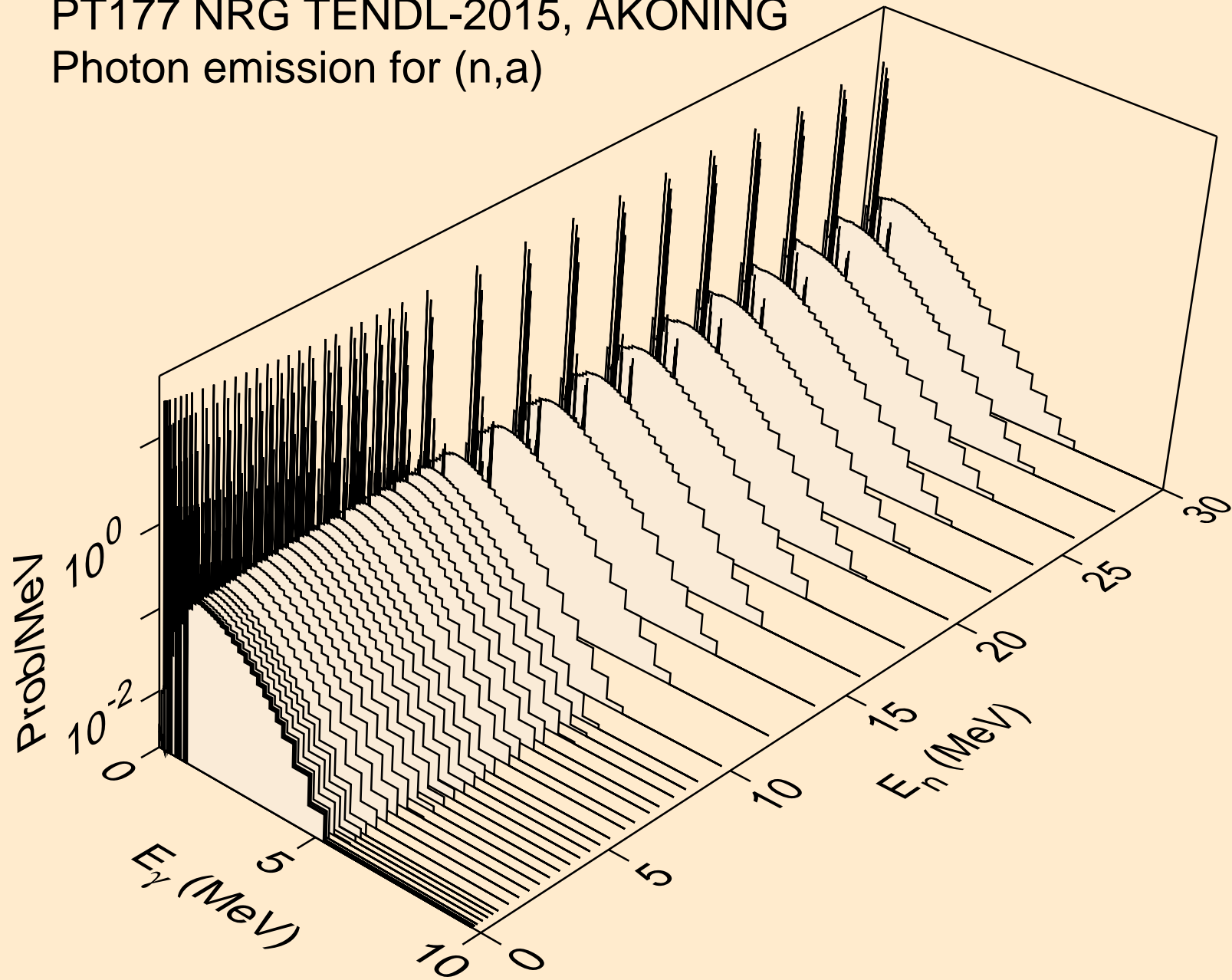

PT177 NRG TENDL-2015, AKONING
Photon emission for (n,2a)

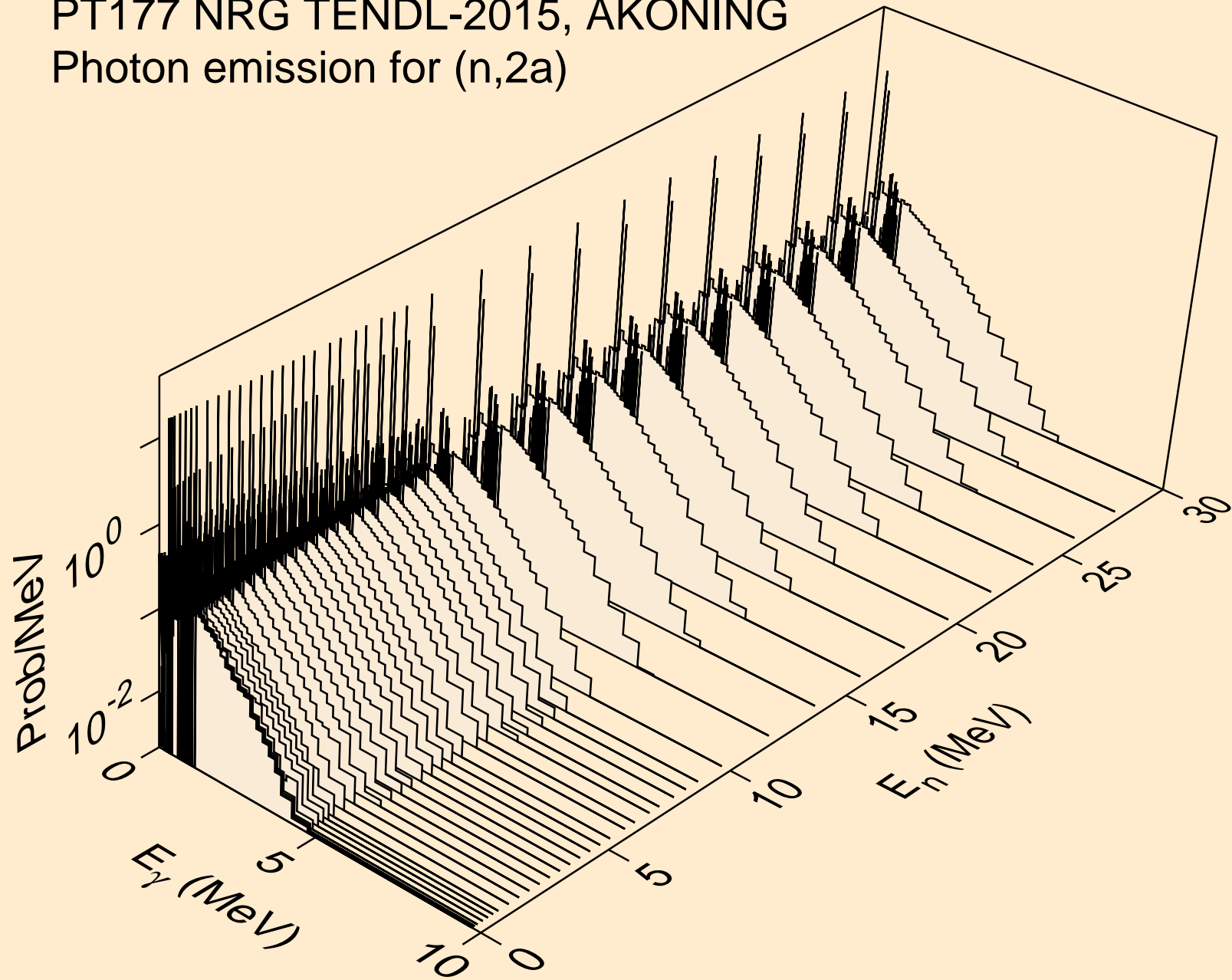

PT177 NRG TENDL-2015, AKONING
Photon emission for (n,3a)

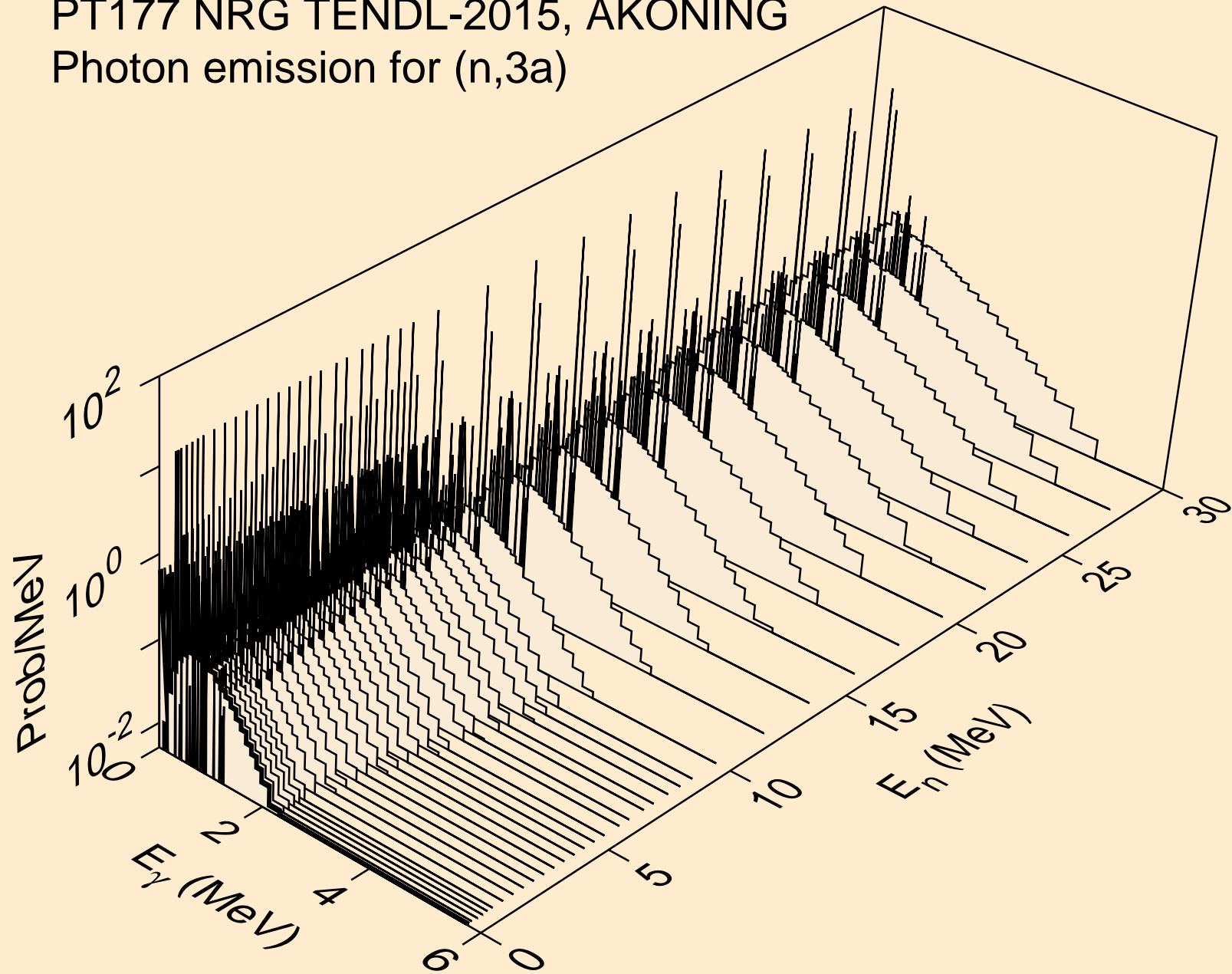

PT177 NRG TENDL-2015, AKONING
Photon emission for (n,2p)

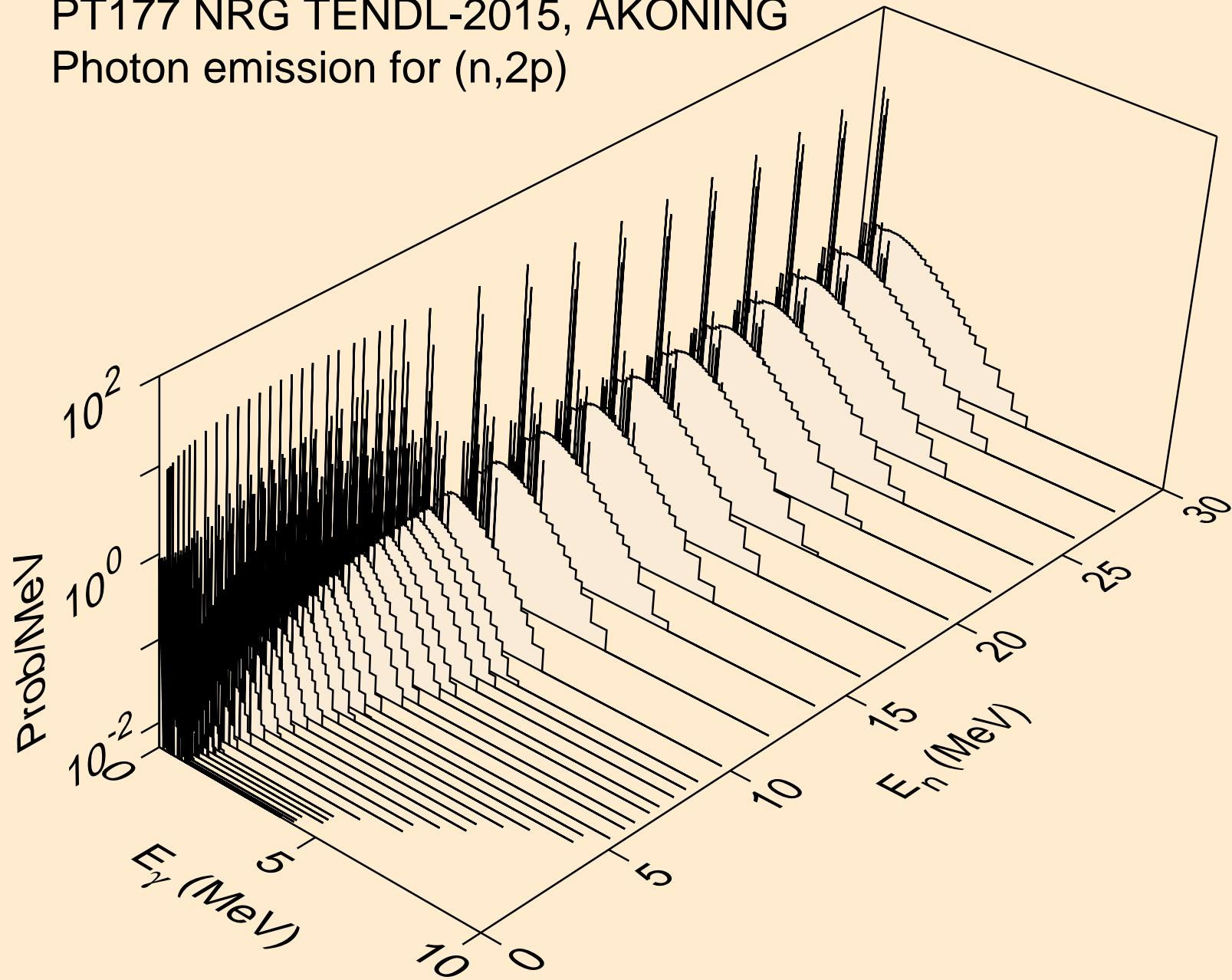

PT177 NRG TENDL-2015, AKONING
Photon emission for (n,p α)

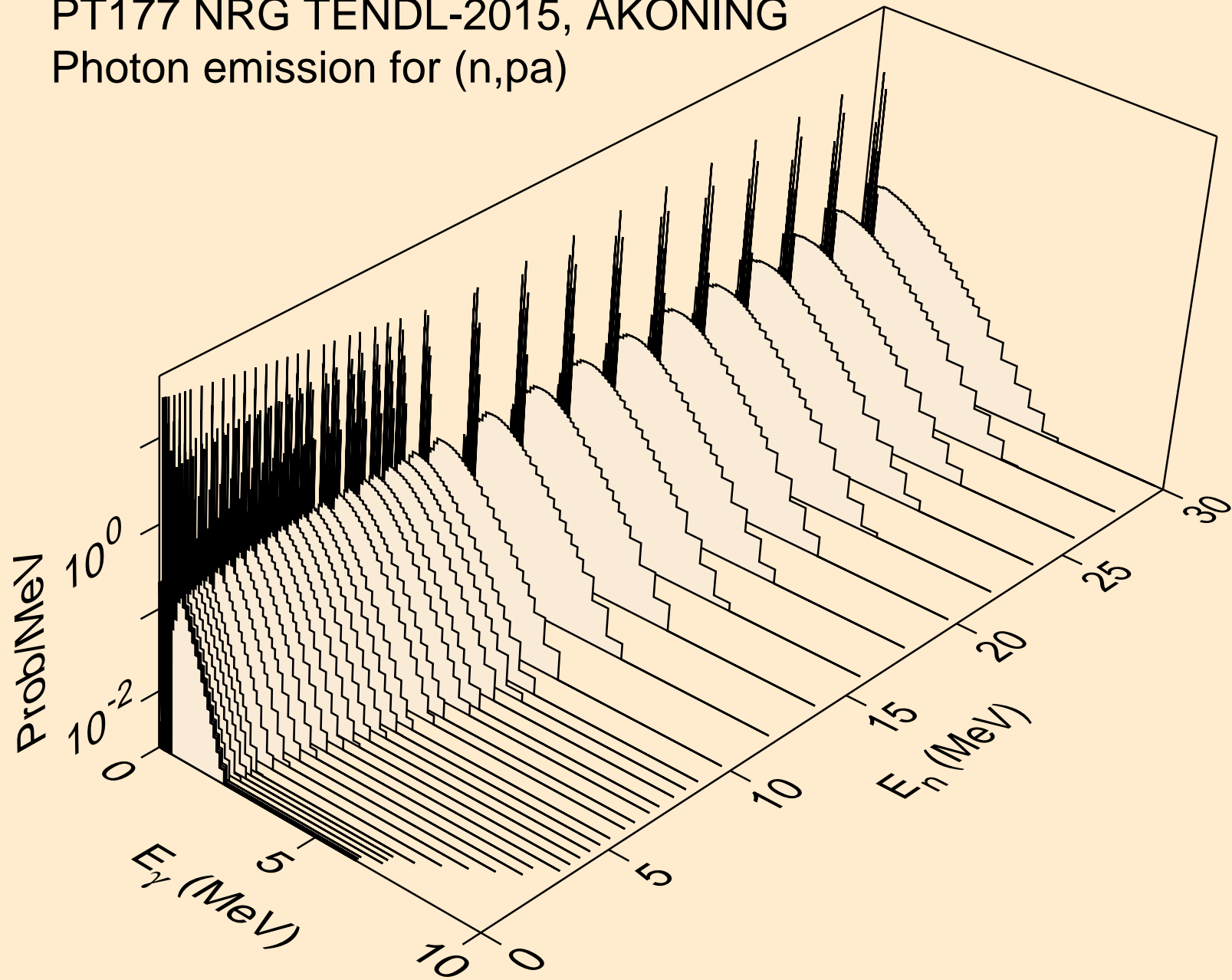

PT177 NRG TENDL-2015, AKONING
Photon emission for (n,t2a)

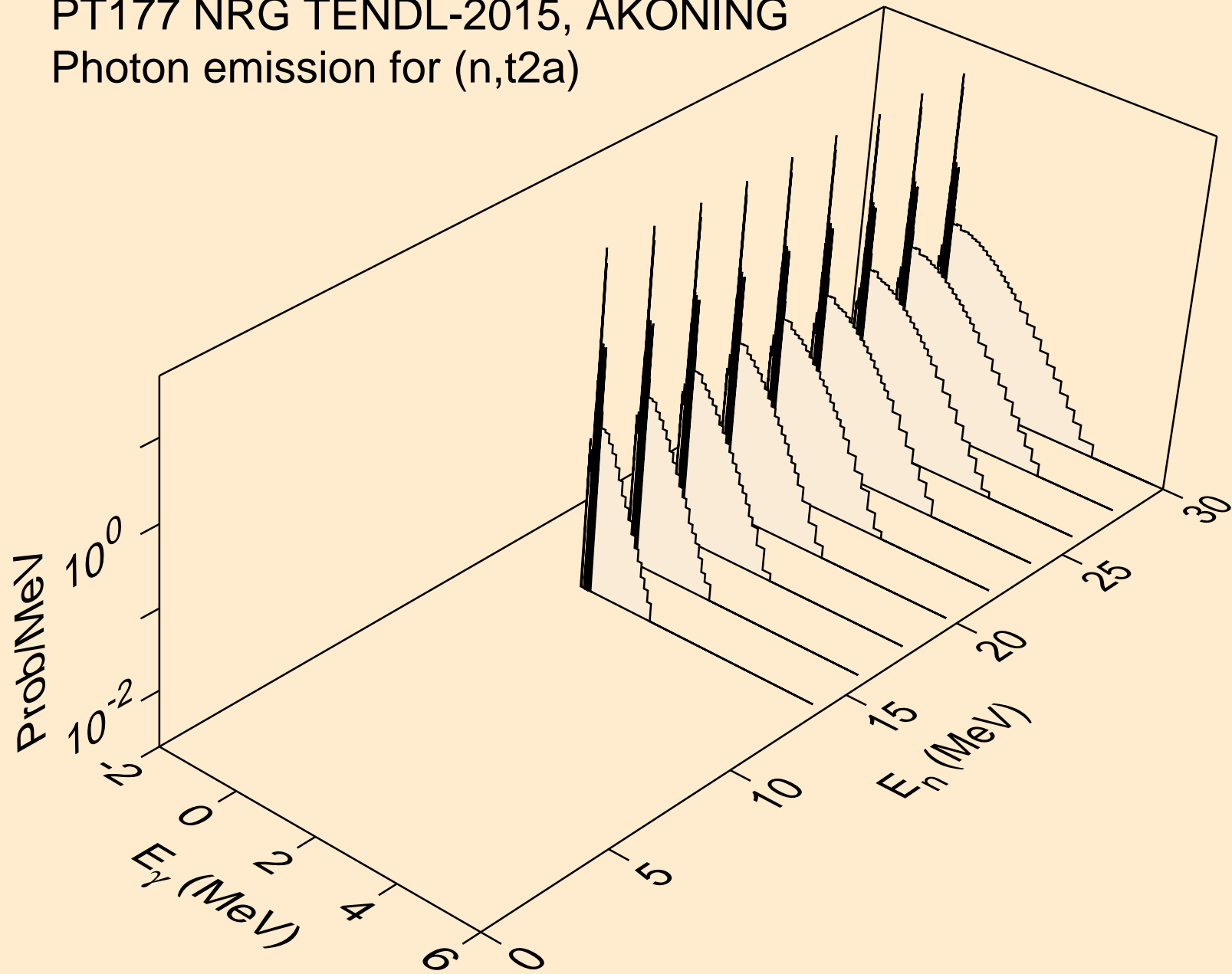

PT177 NRG TENDL-2015, AKONING
Photon emission for (n,d2a)

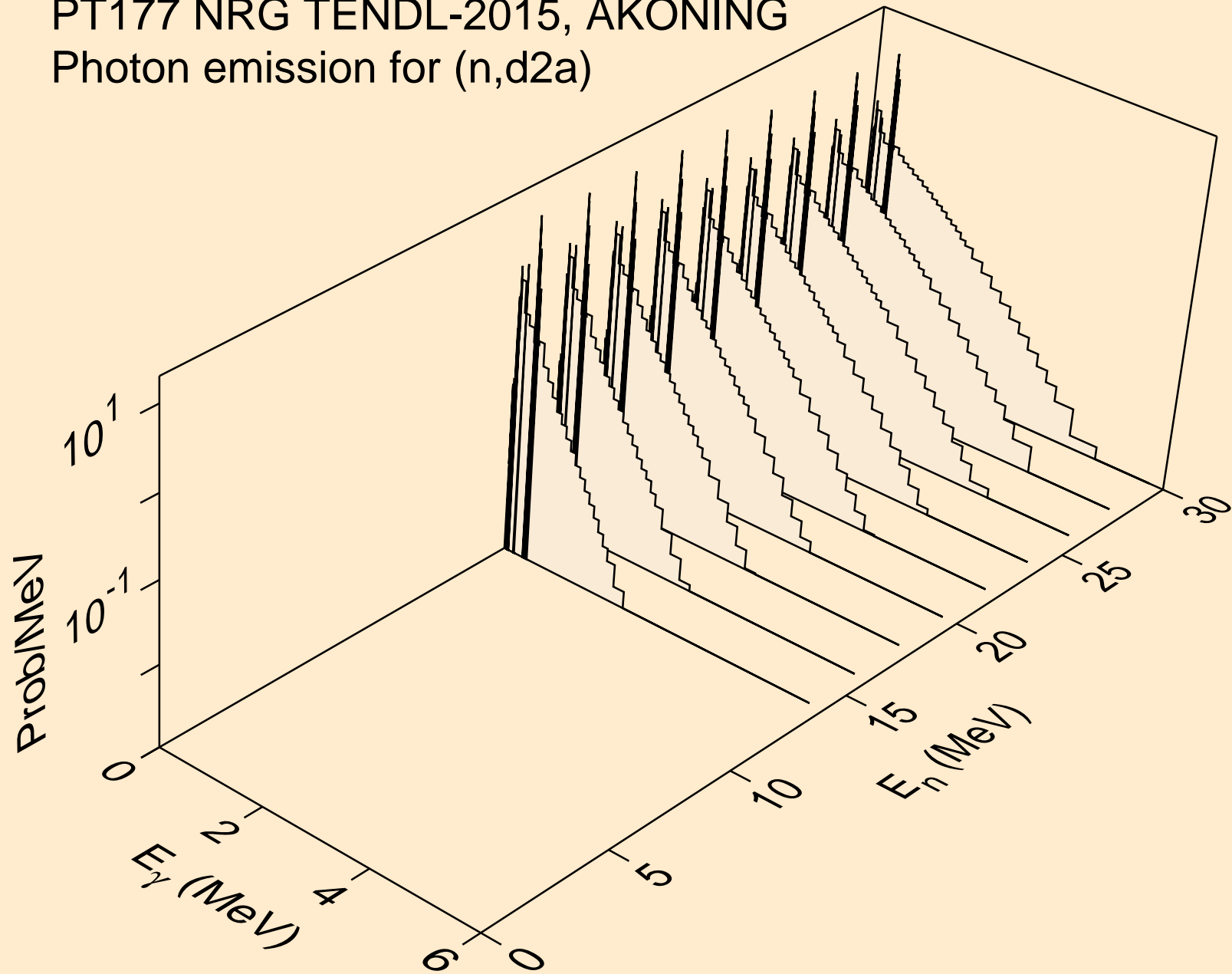

PT177 NRG TENDL-2015, AKONING
Photon emission for (n,pd)

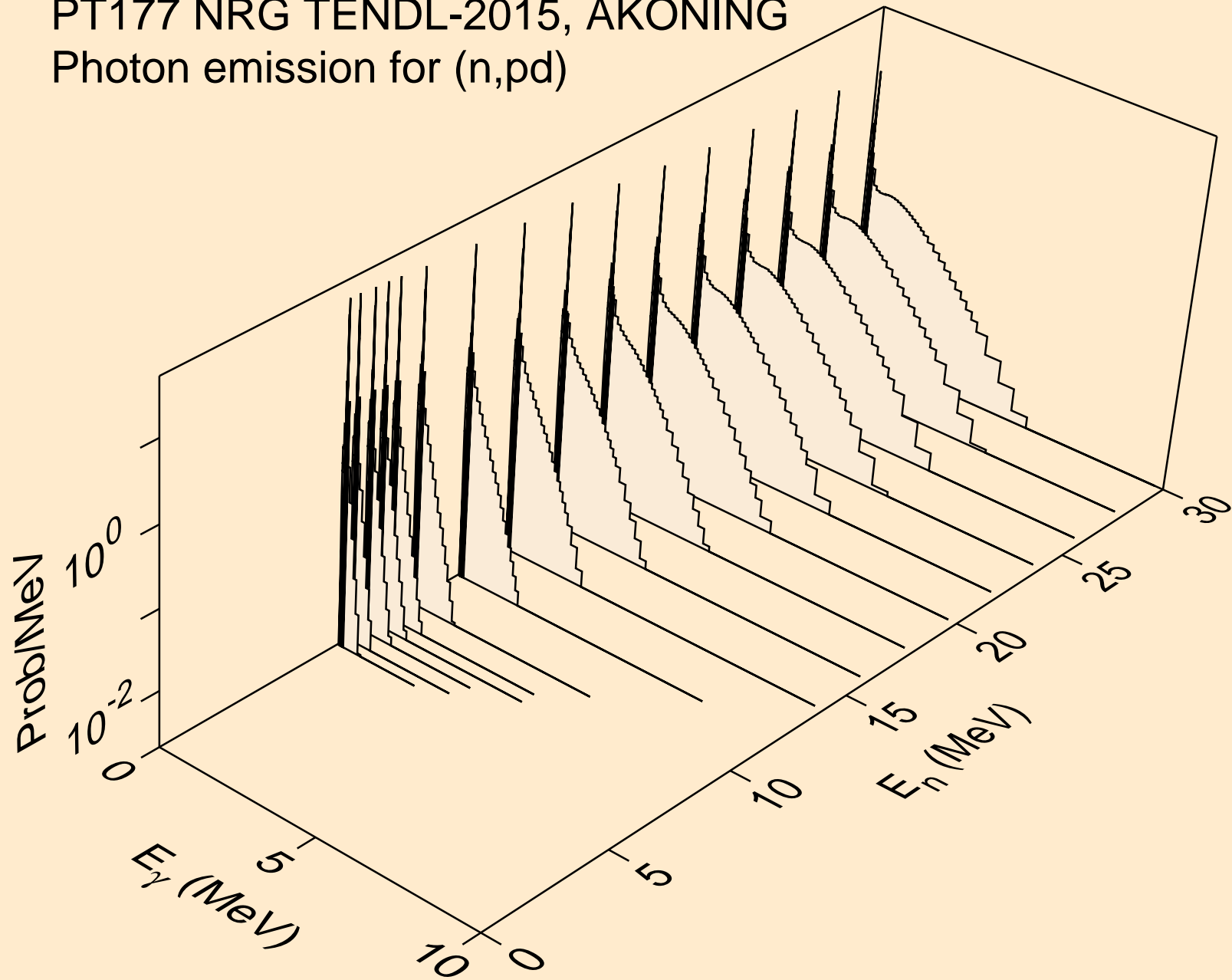

PT177 NRG TENDL-2015, AKONING
Photon emission for (n,pt)

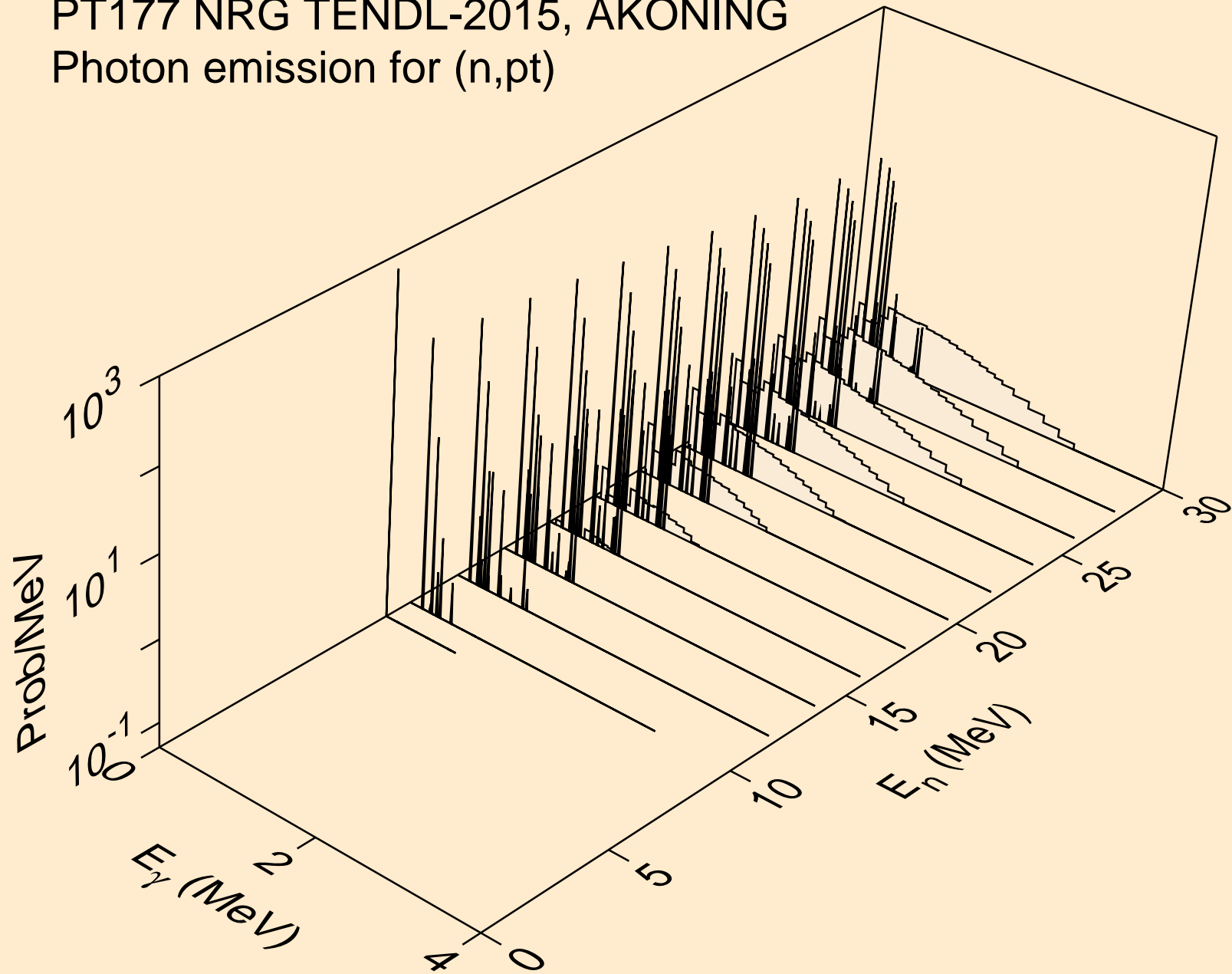

PT177 NRG TENDL-2015, AKONING
Photon emission for (n,da)

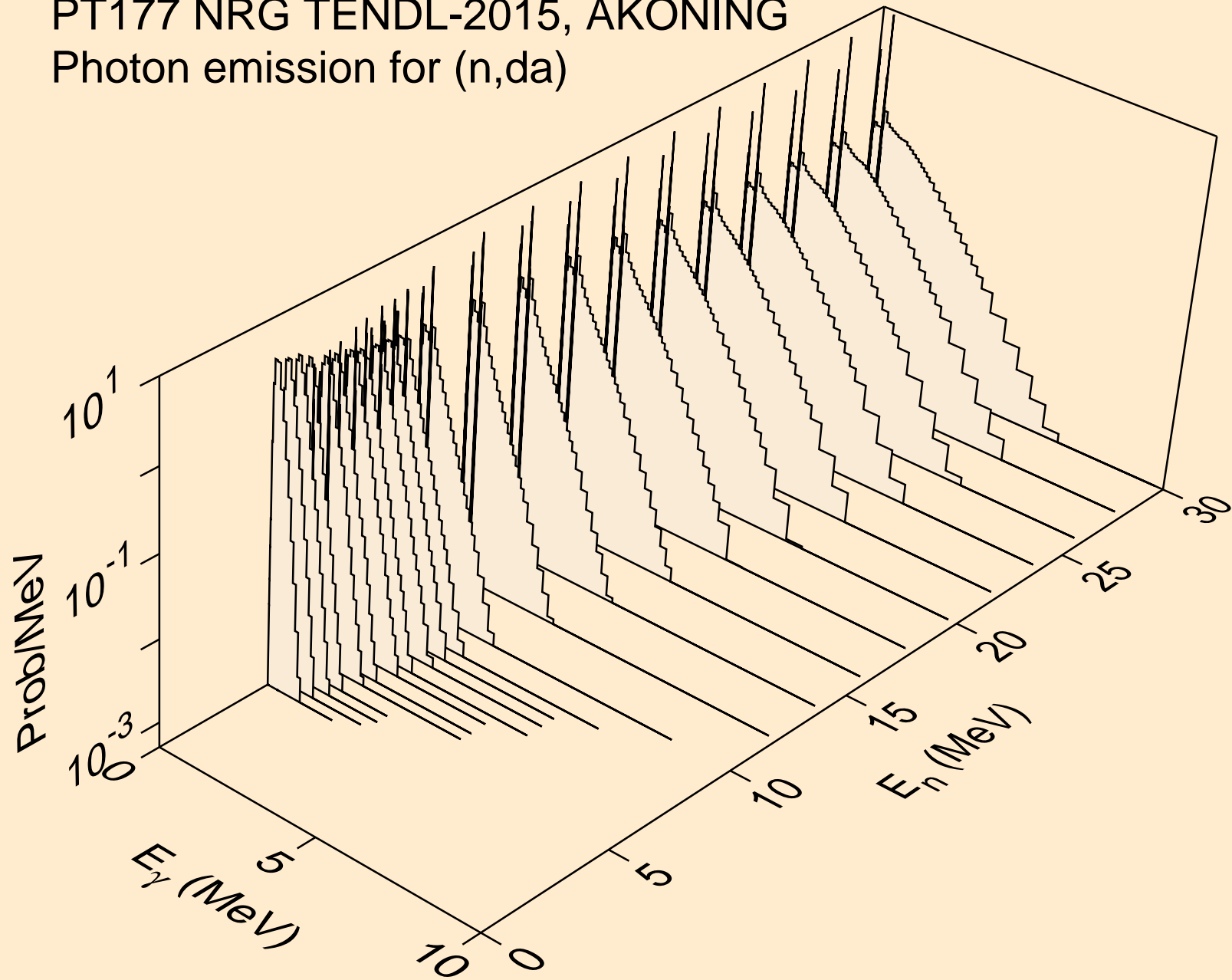

PT177 NRG TENDL-2015, AKONING
thermal capture photon spectrum

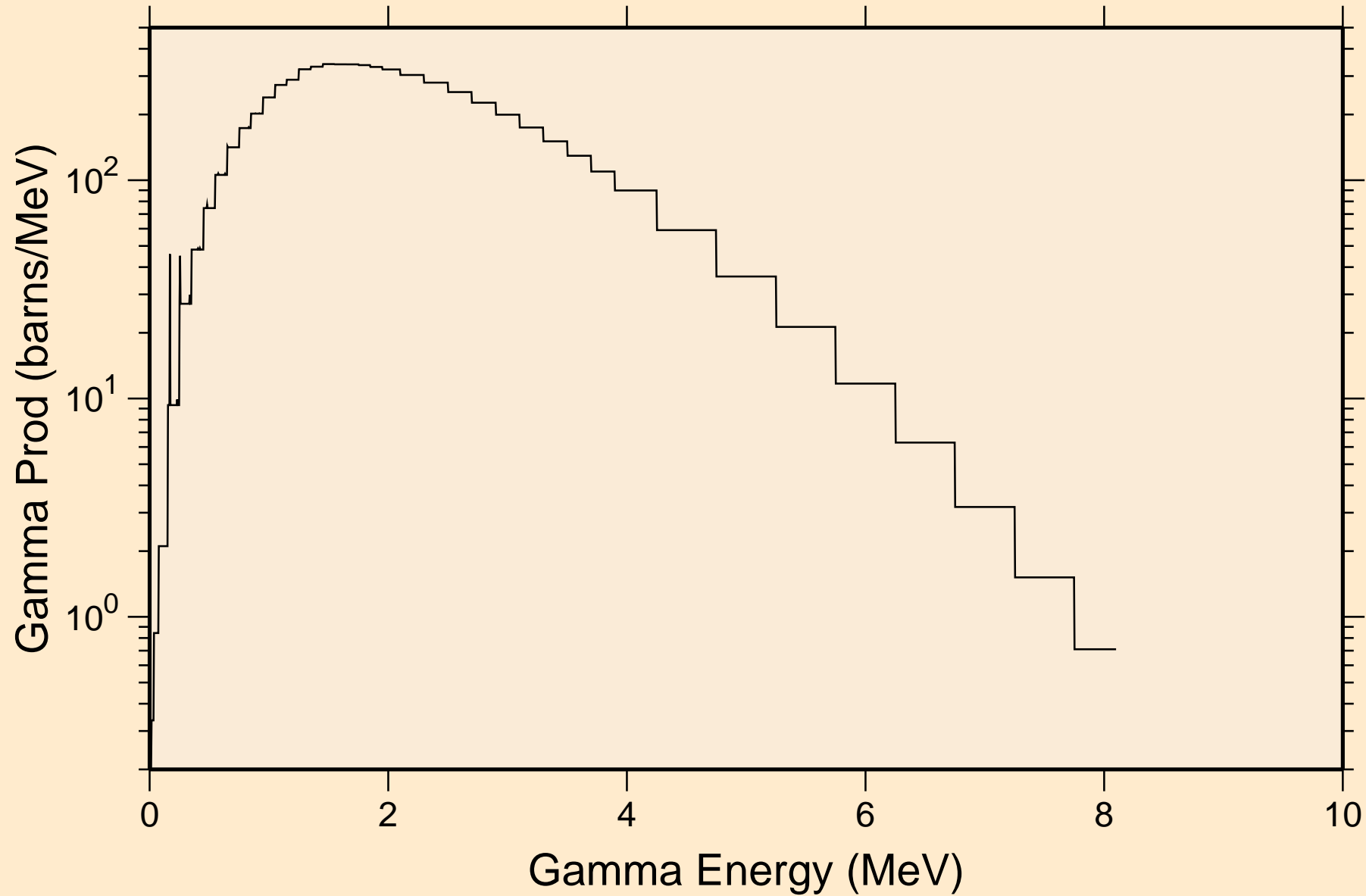

PT177 NRG TENDL-2015, AKONING
14 MeV photon spectrum

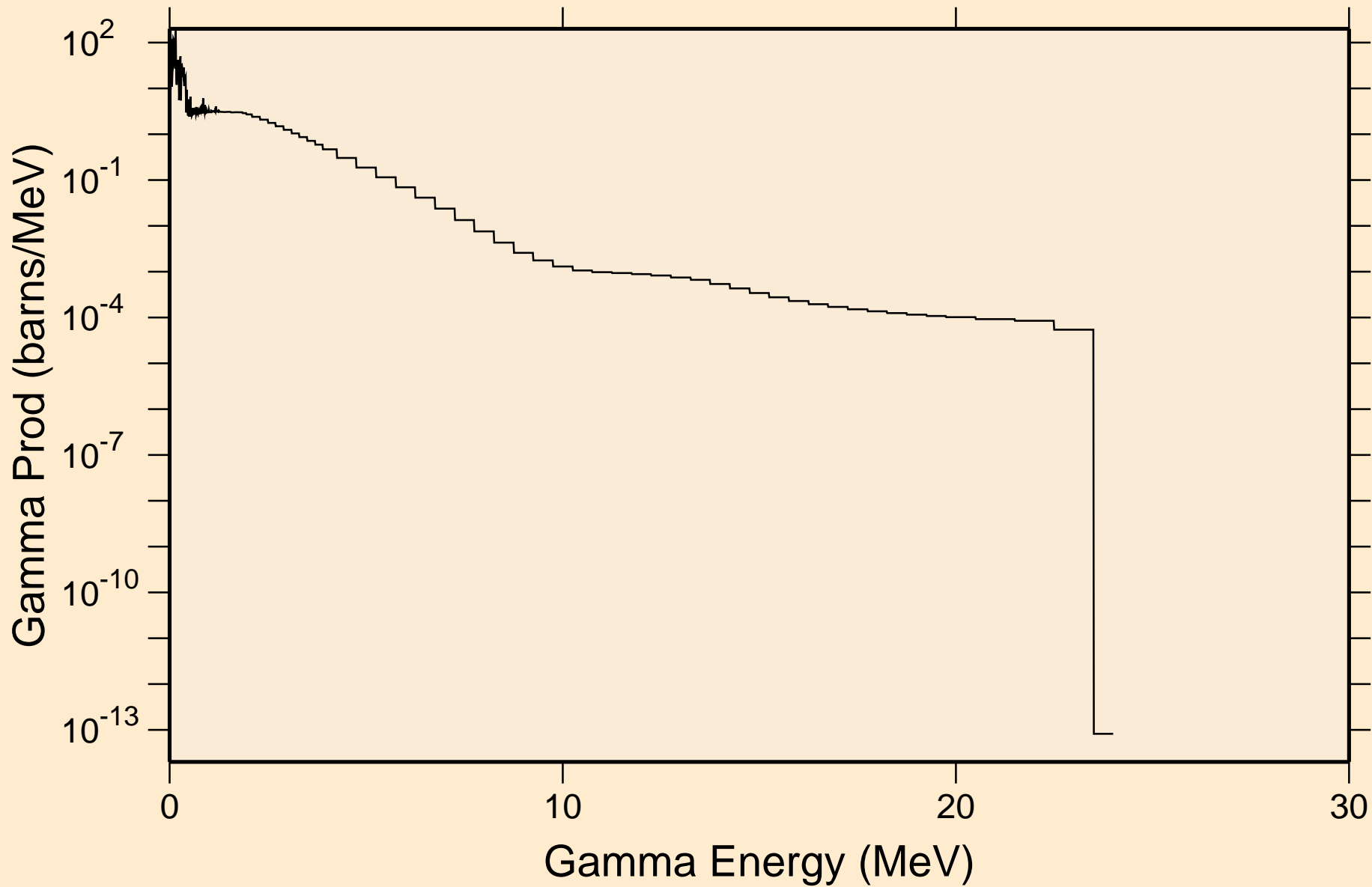

PT177 NRG TENDL-2015, AKONING

Particle heating contributions

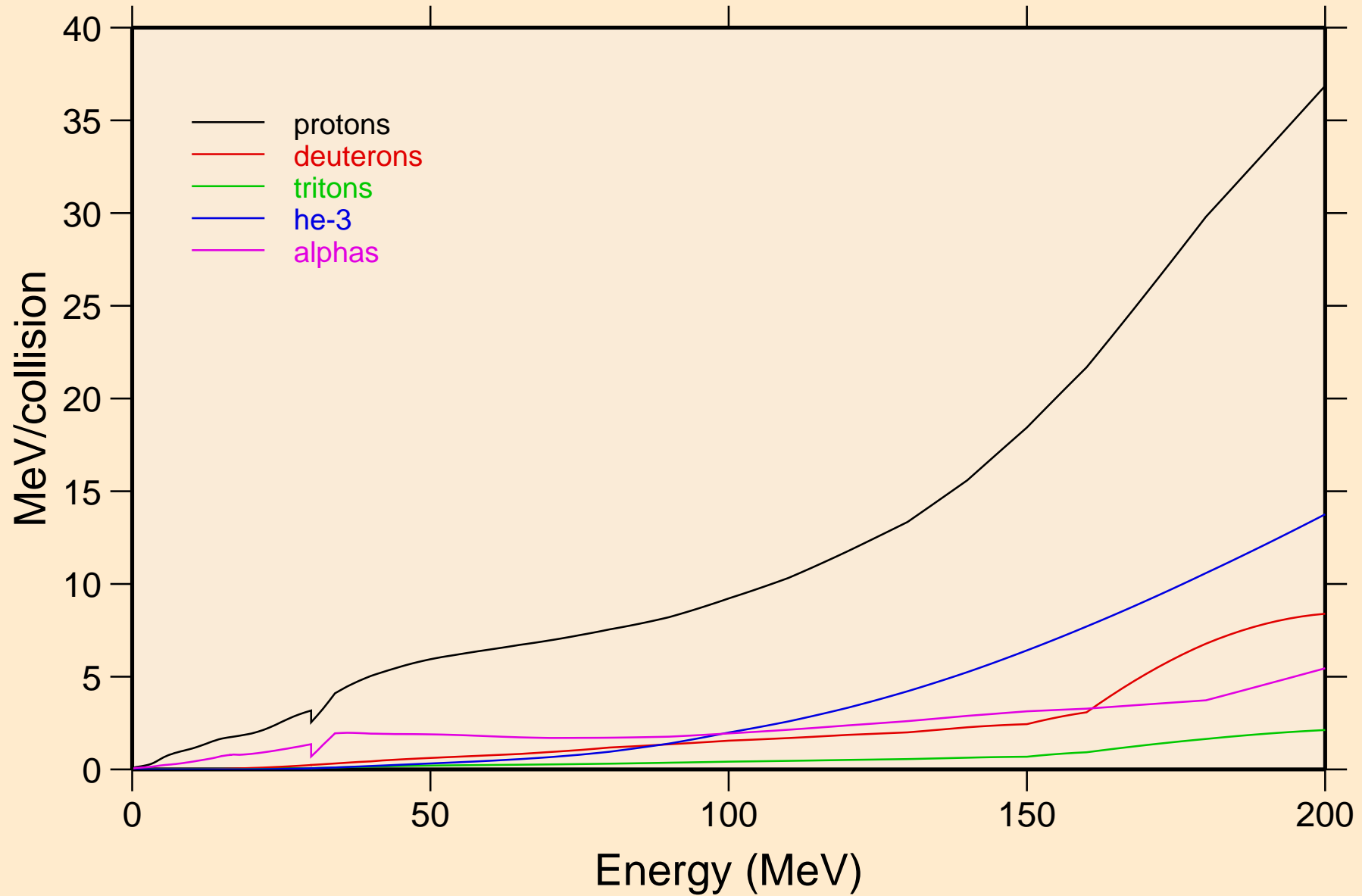

PT177 NRG TENDL-2015, AKONING

Recoil Heating

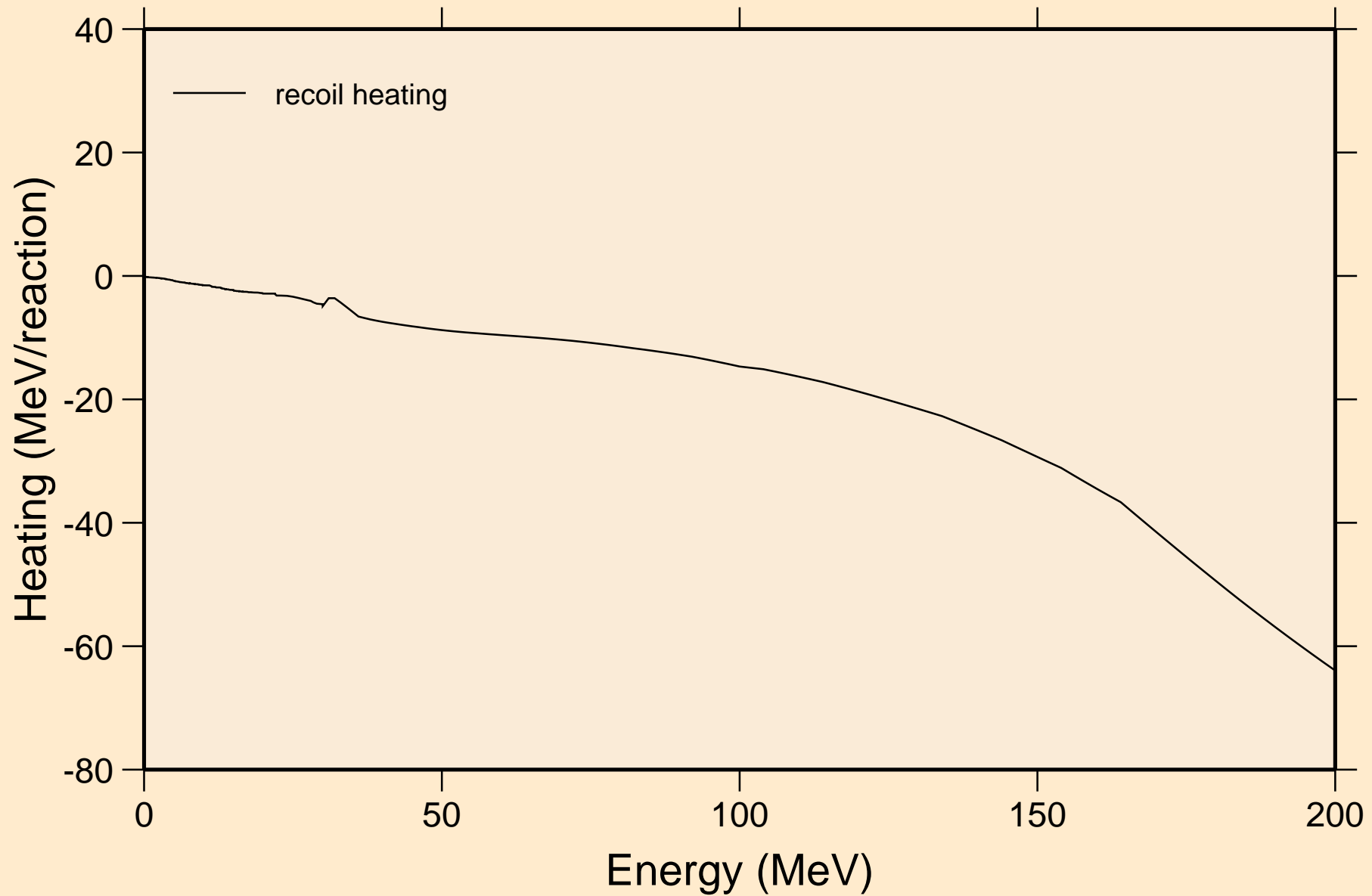

PT177 NRG TENDL-2015, AKONING

Particle production cross sections

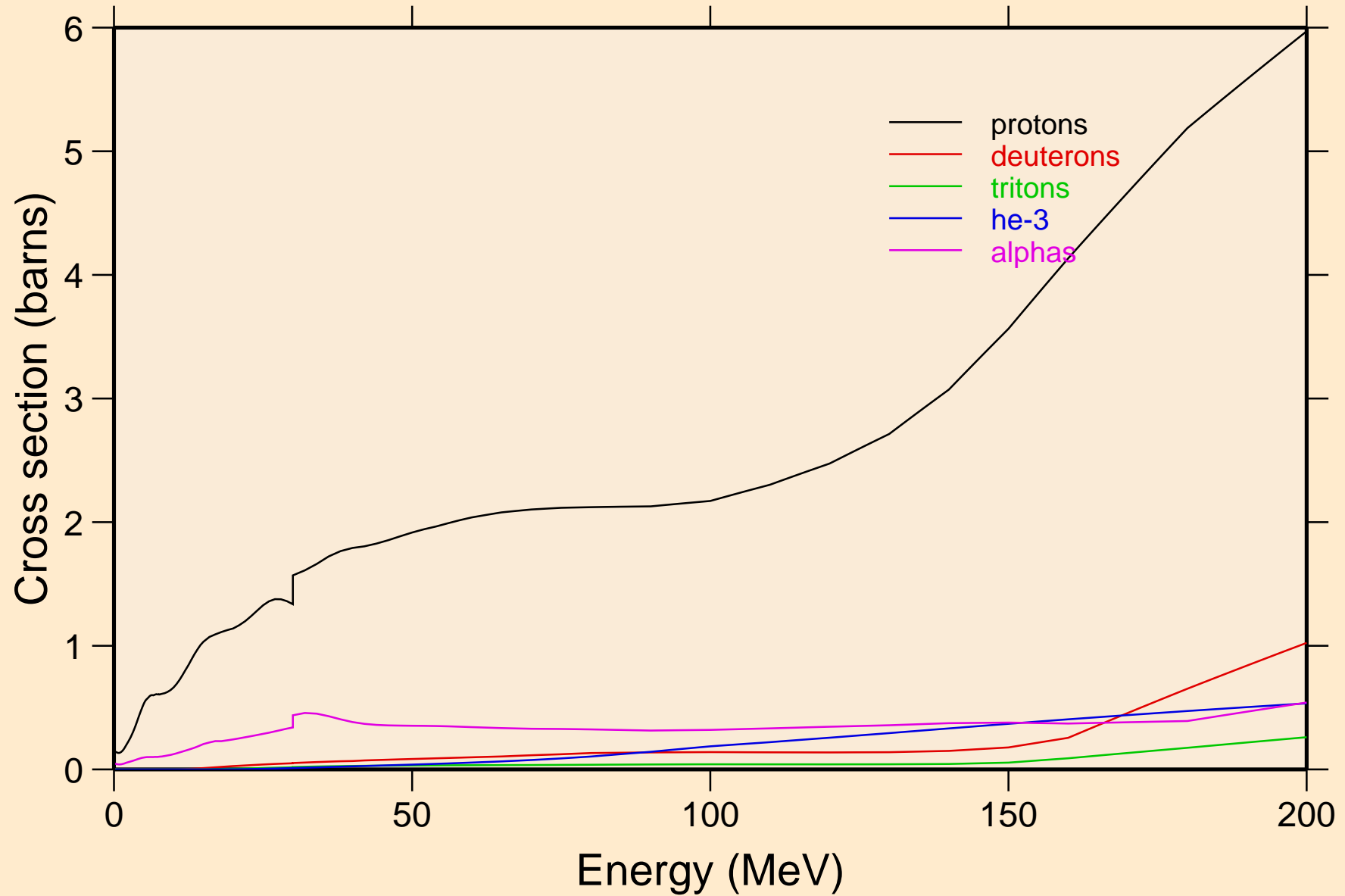

PT177 NRG TENDL-2015, AKONING
protons from (n,x)

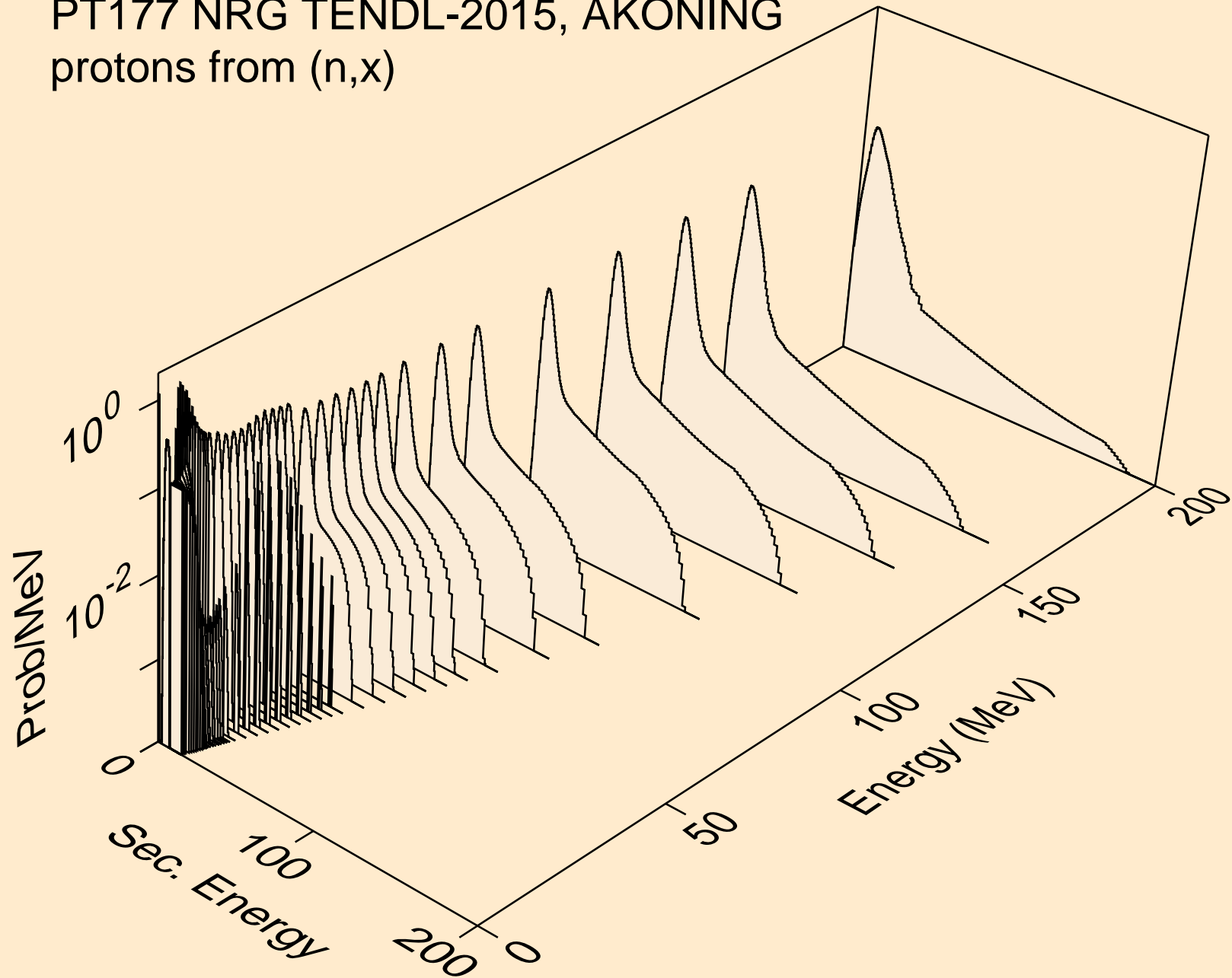

PT177 NRG TENDL-2015, AKONING
protons from (n,n*)p

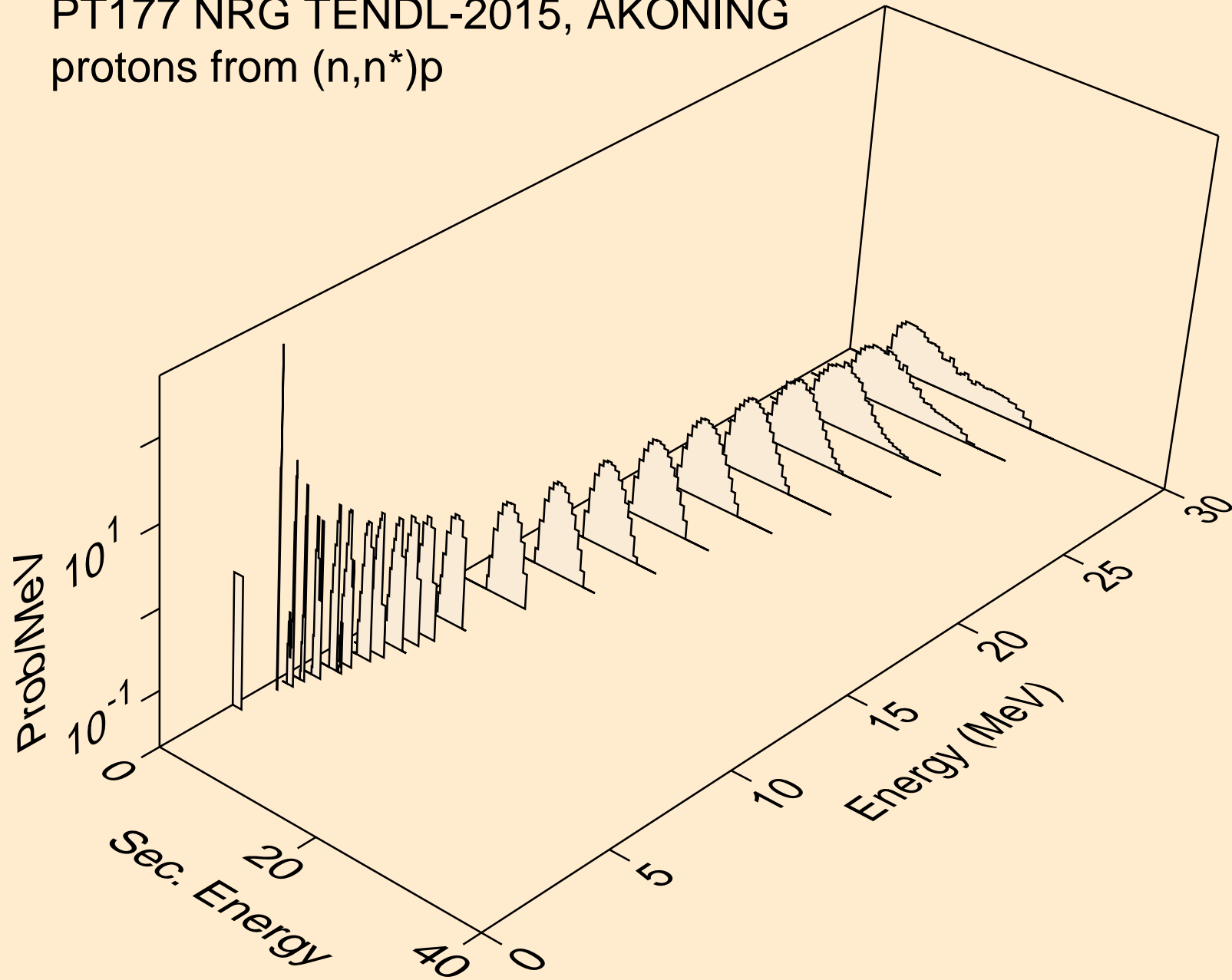

PT177 NRG TENDL-2015, AKONING
protons from (n,2np)

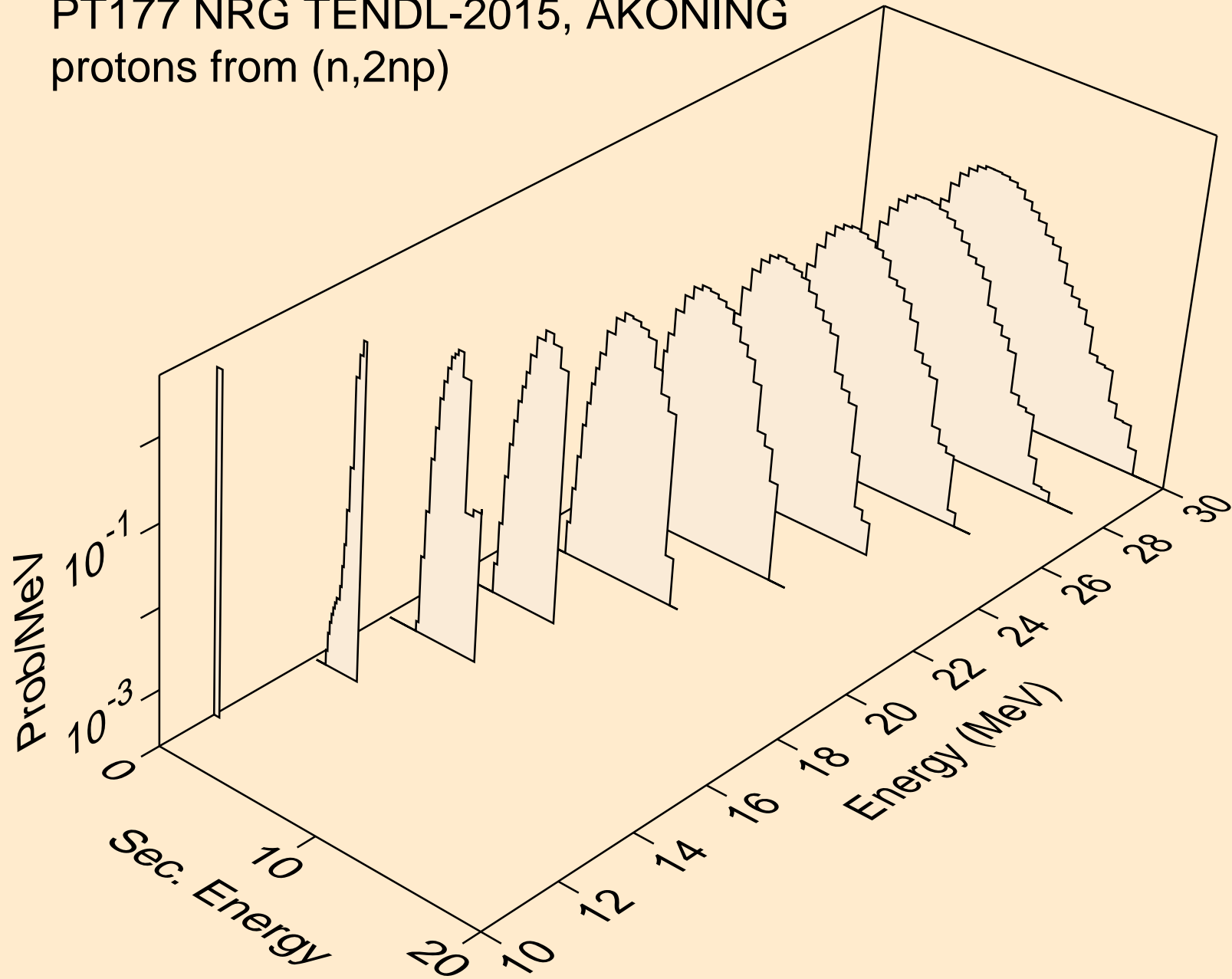

PT177 NRG TENDL-2015, AKONING
protons from (n,3np)

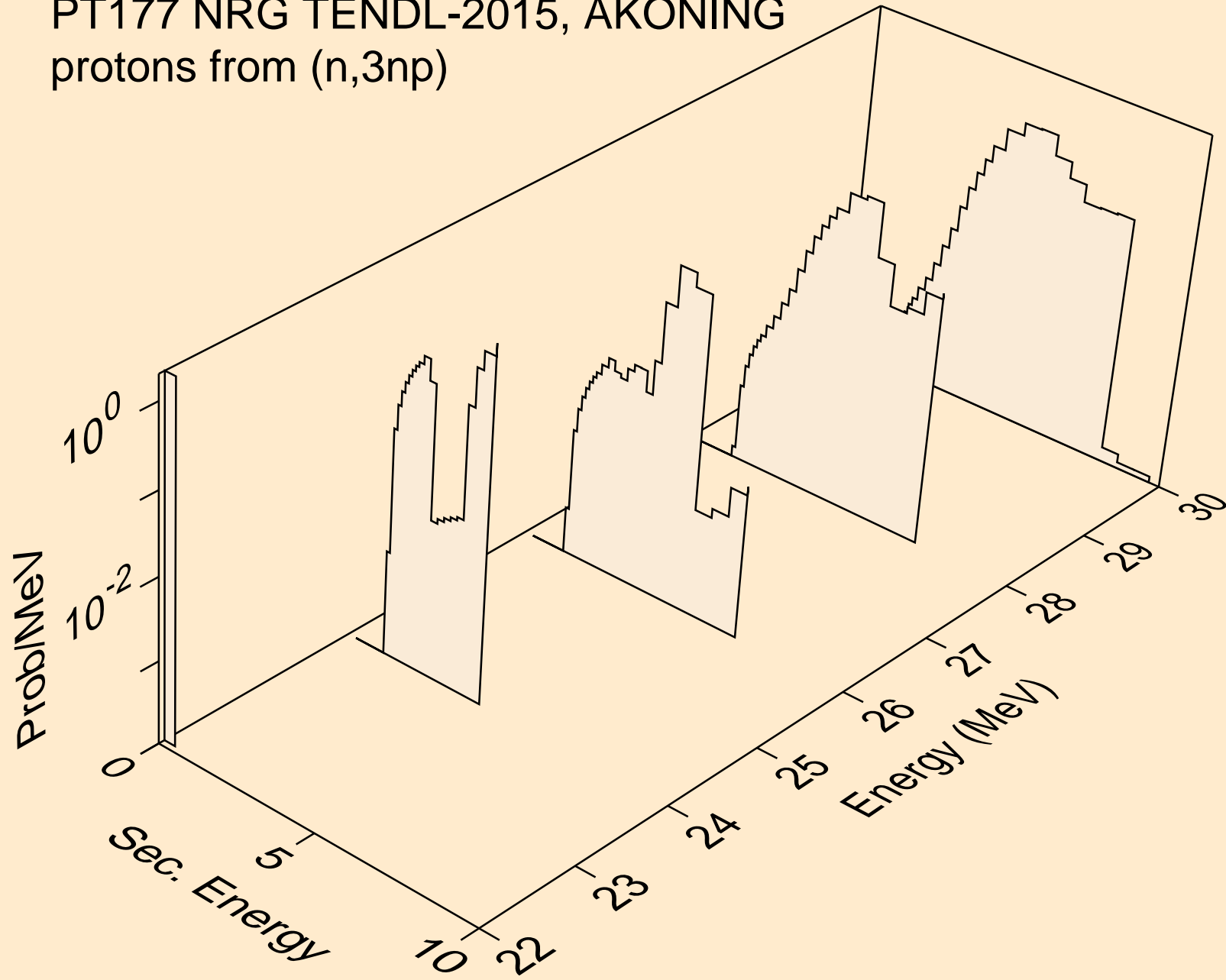

PT177 NRG TENDL-2015, AKONING
protons from (n,2np)

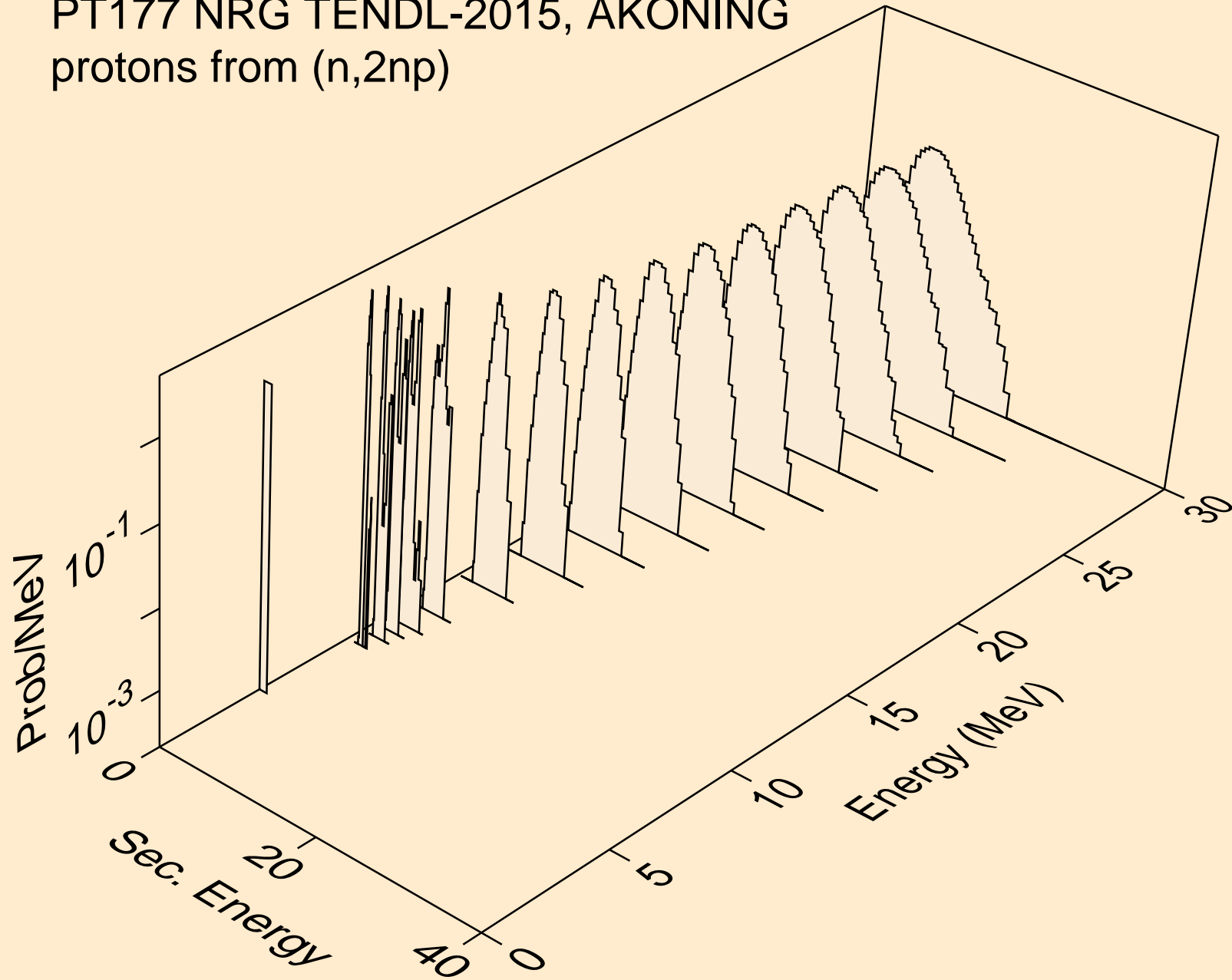

PT177 NRG TENDL-2015, AKONING
protons from (n,npa)

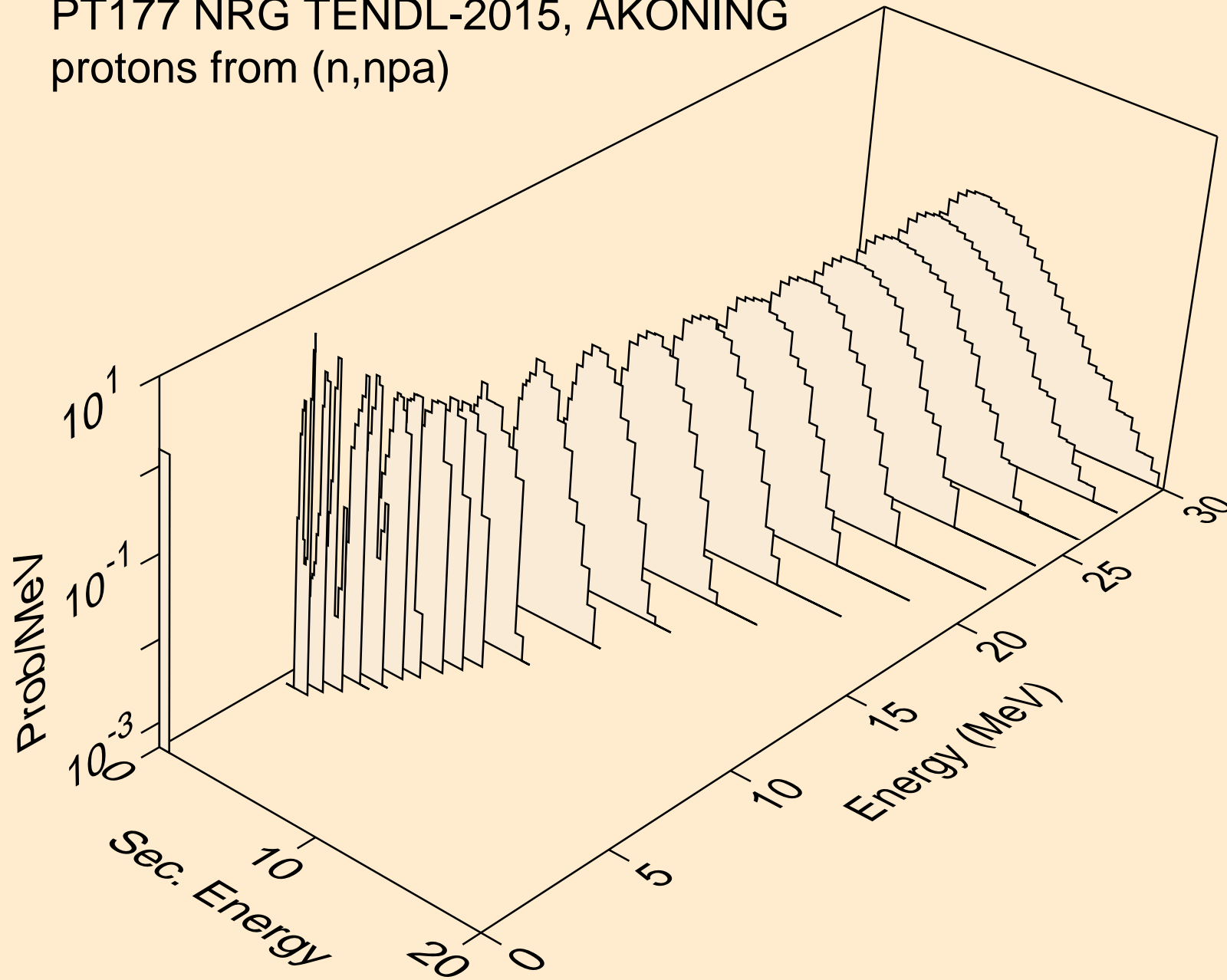

PT177 NRG TENDL-2015, AKONING
protons from (n,p)

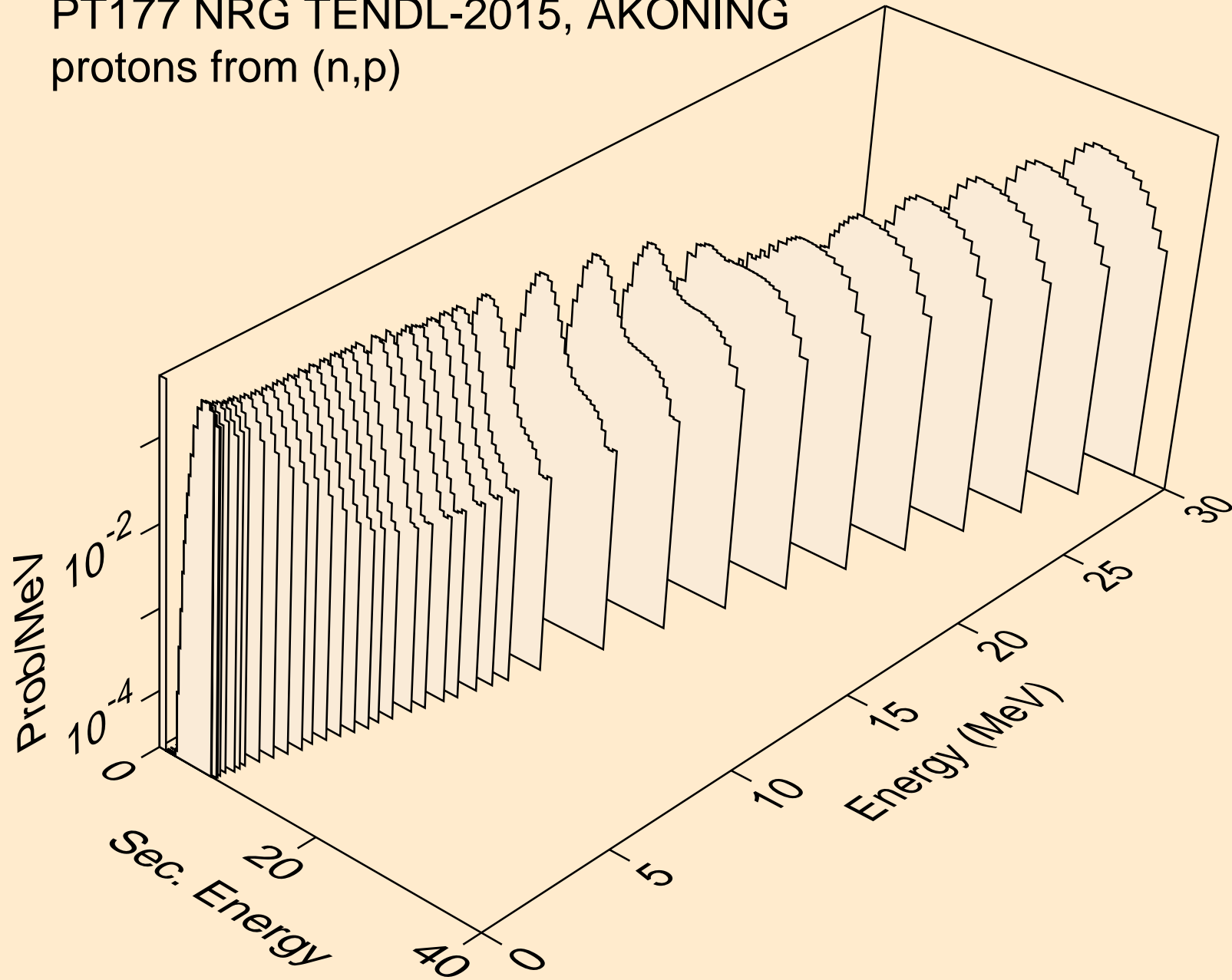

PT177 NRG TENDL-2015, AKONING
protons from (n,2p)

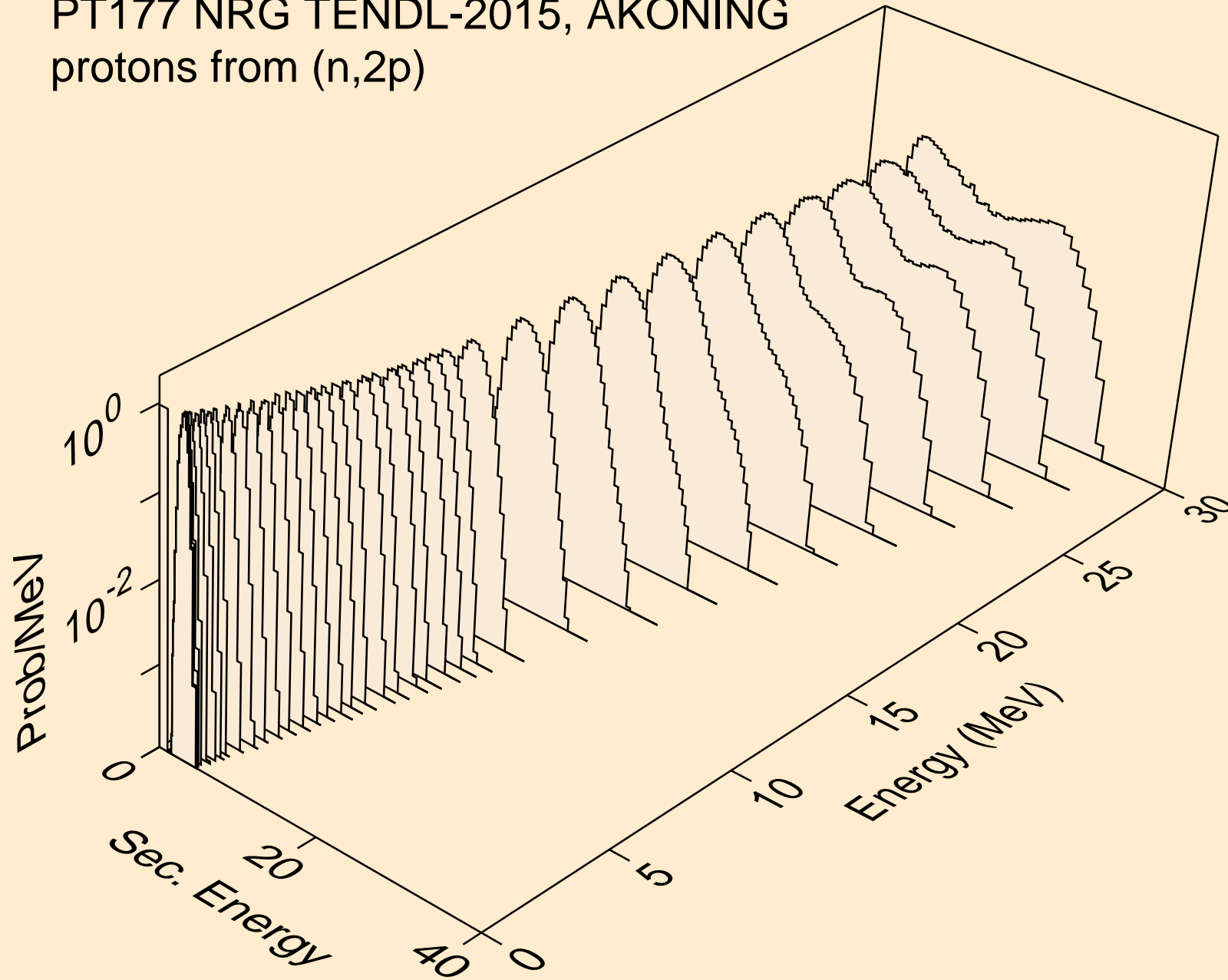

PT177 NRG TENDL-2015, AKONING
protons from (n,pa)

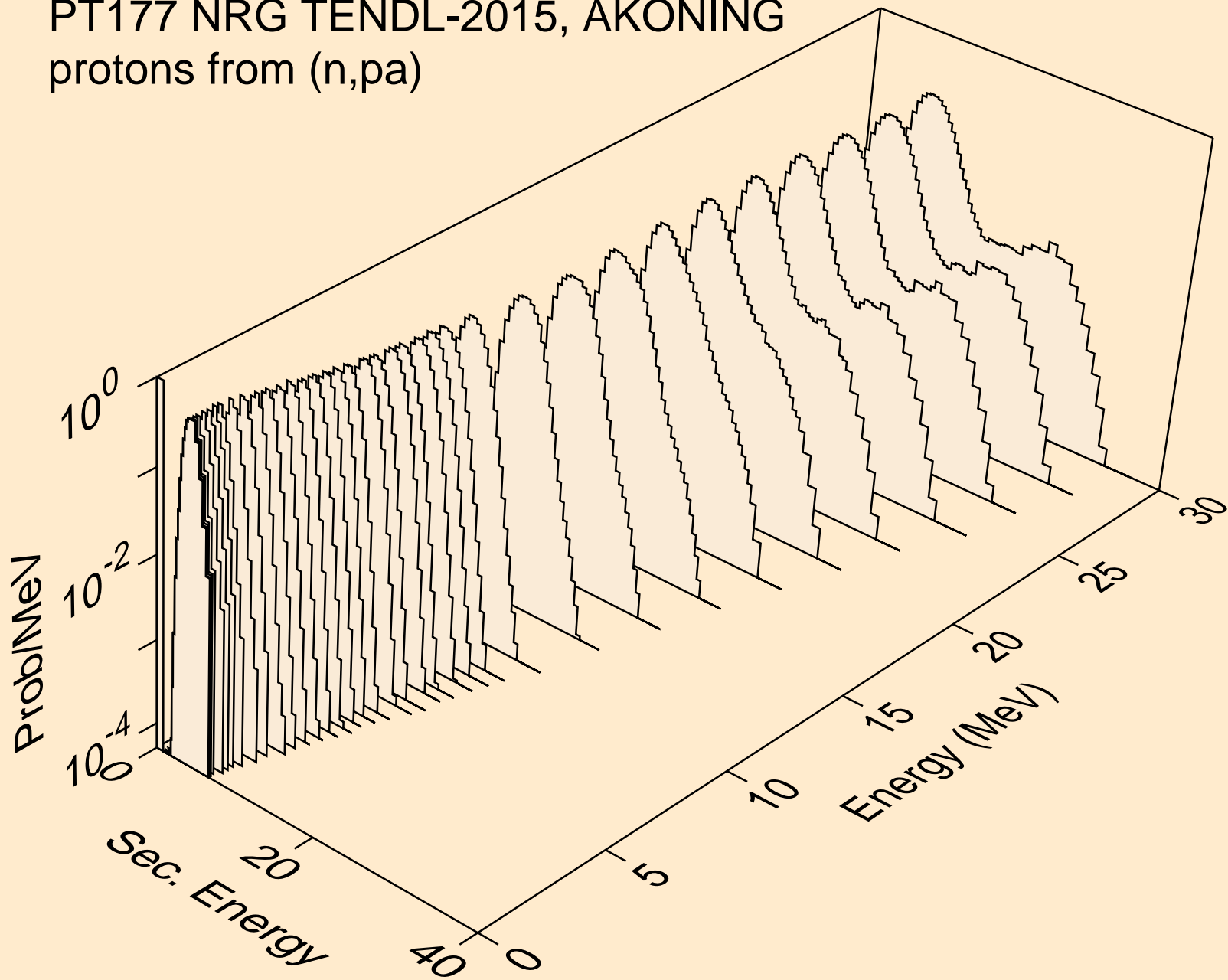

PT177 NRG TENDL-2015, AKONING
protons from (n,pd)

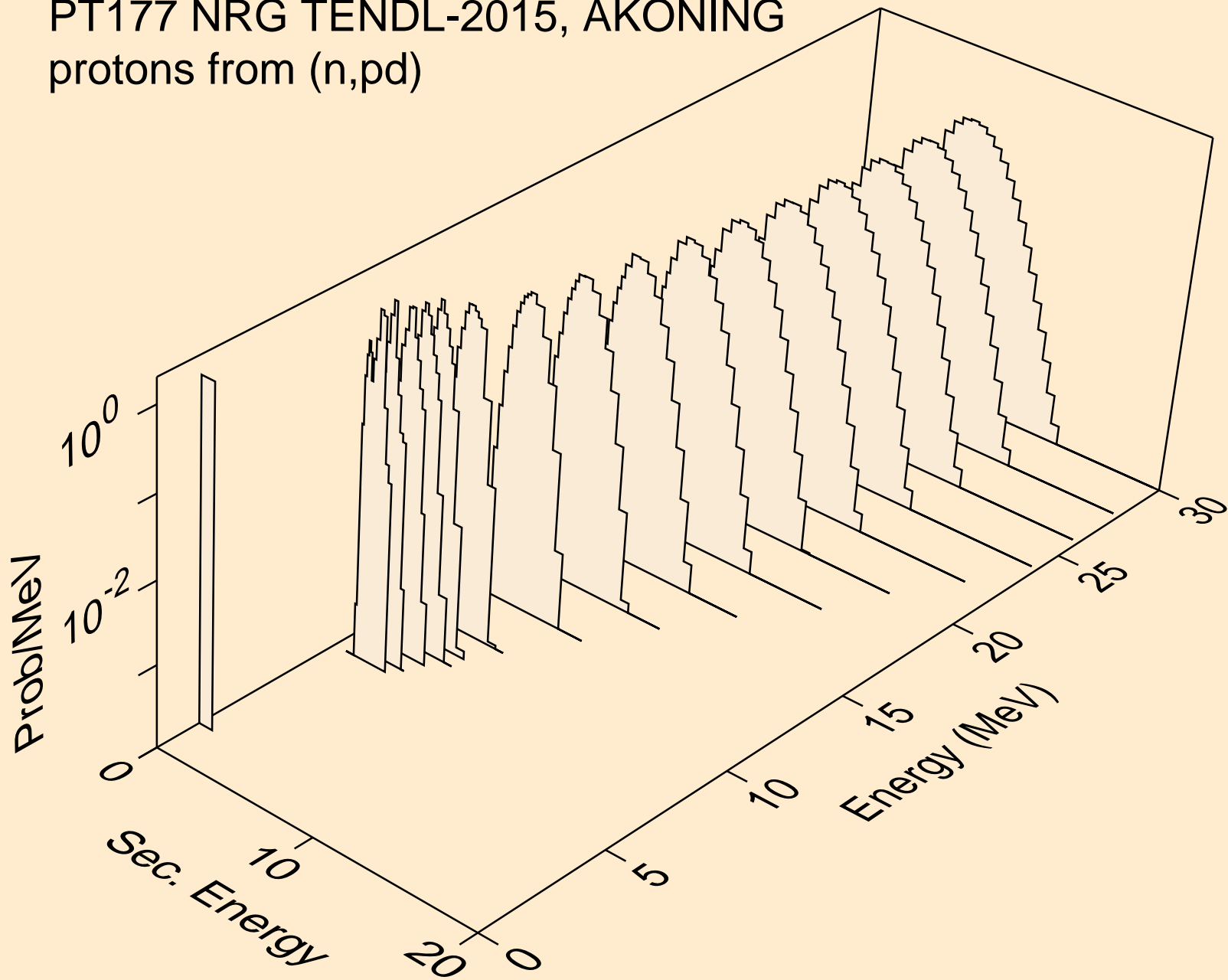

PT177 NRG TENDL-2015, AKONING
protons from (n,pt)

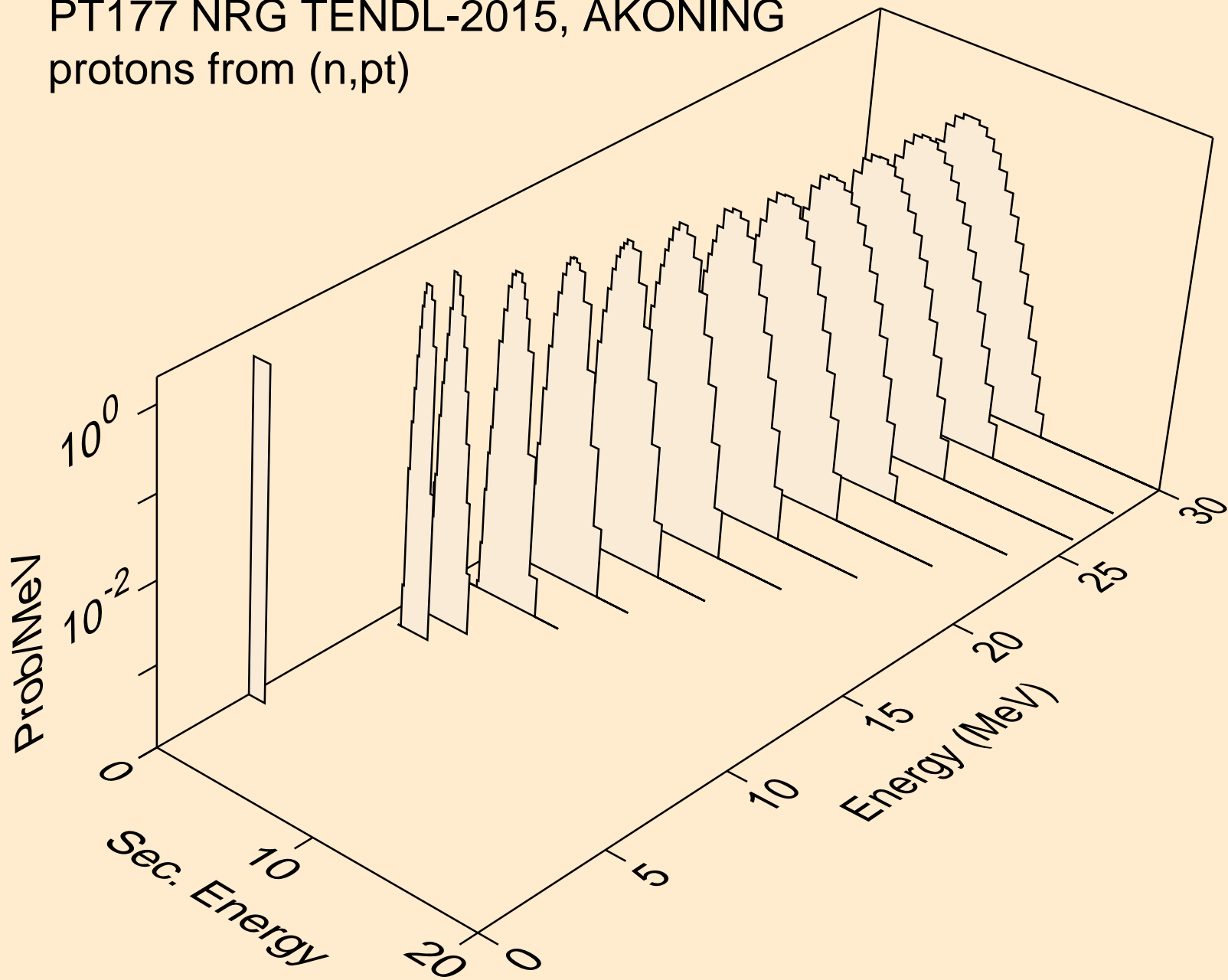

PT177 NRG TENDL-2015, AKONING
deuterons from (n,x)

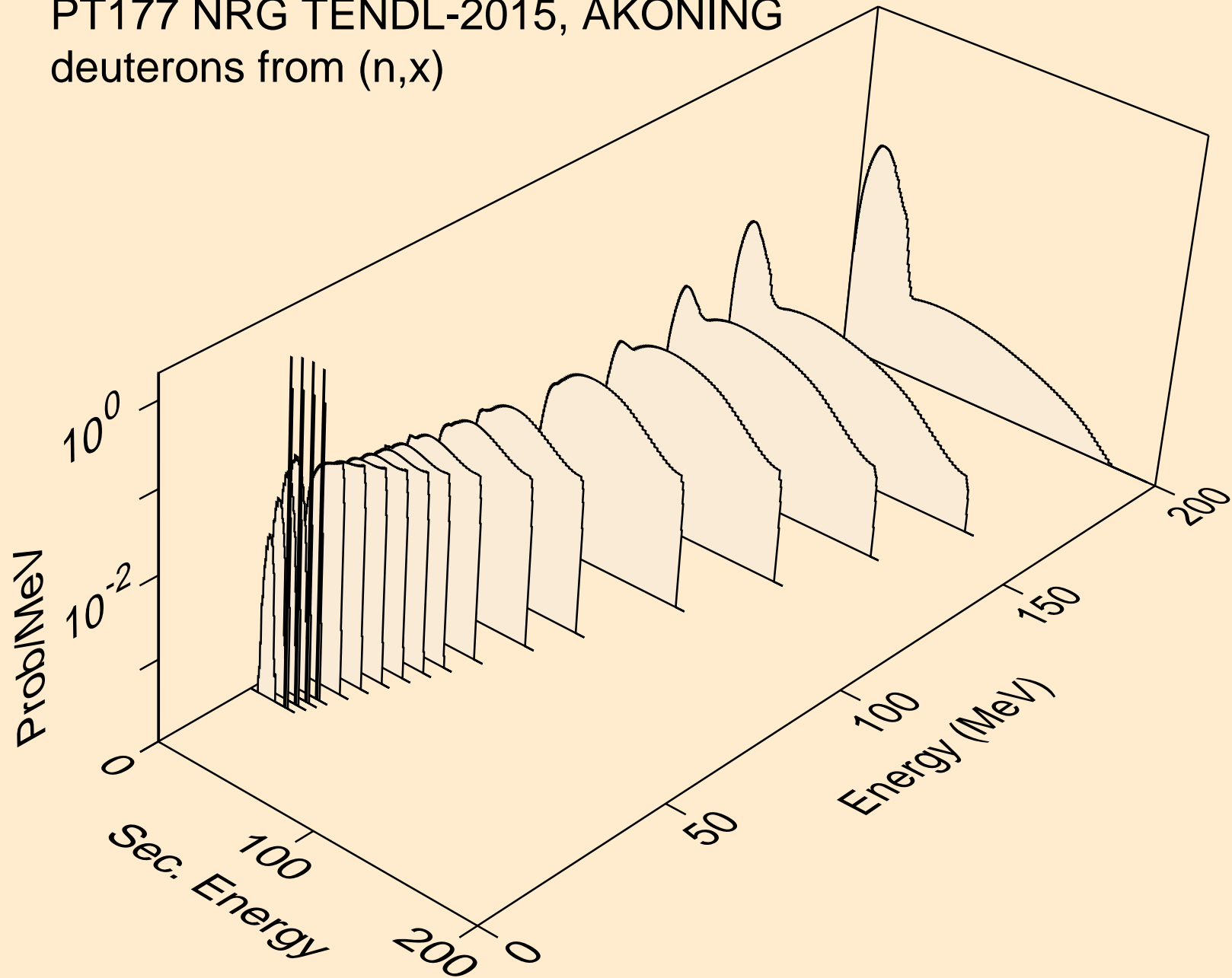

PT177 NRG TENDL-2015, AKONING
deuterons from (n,2nd)

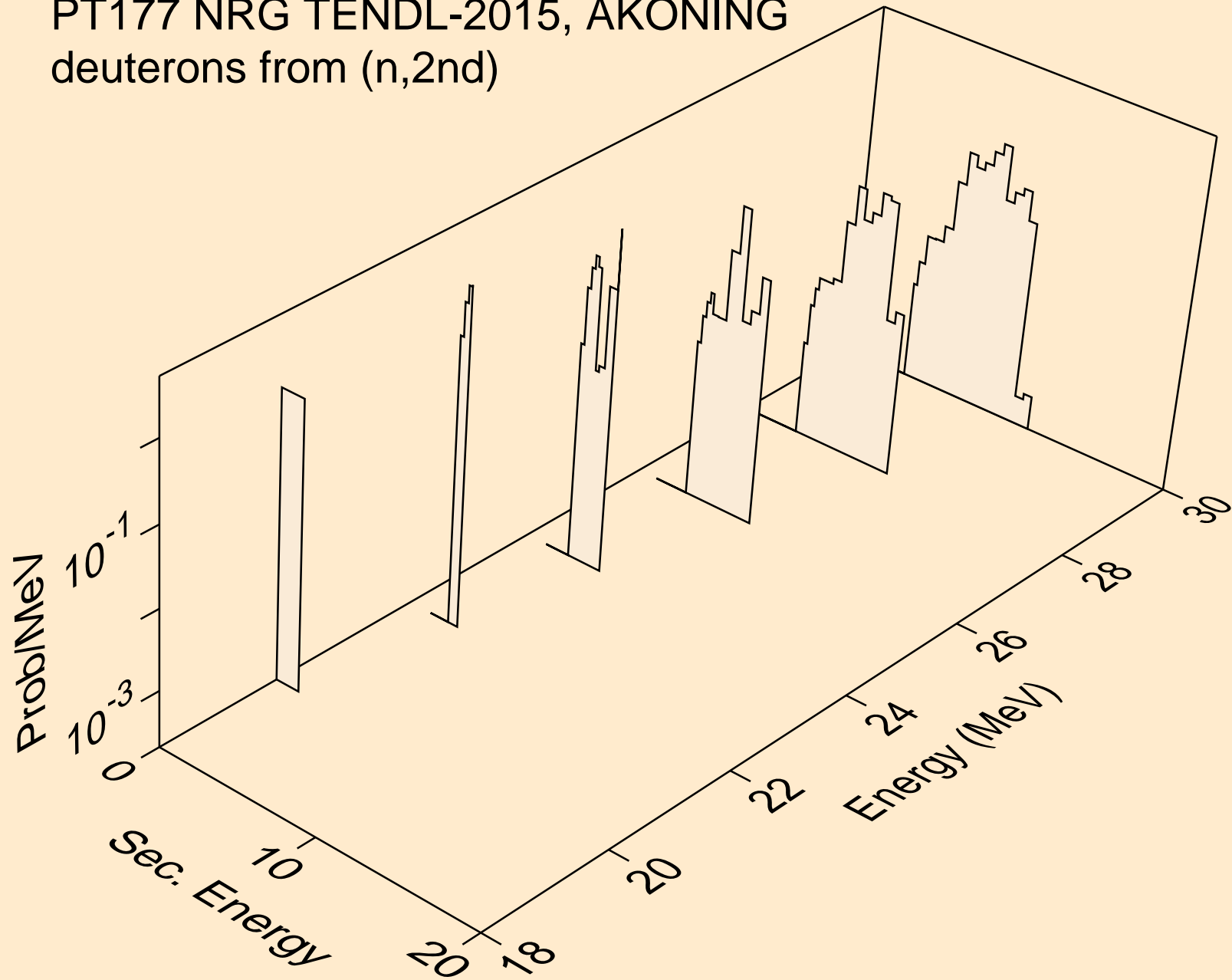

PT177 NRG TENDL-2015, AKONING
deuterons from (n,n*)d

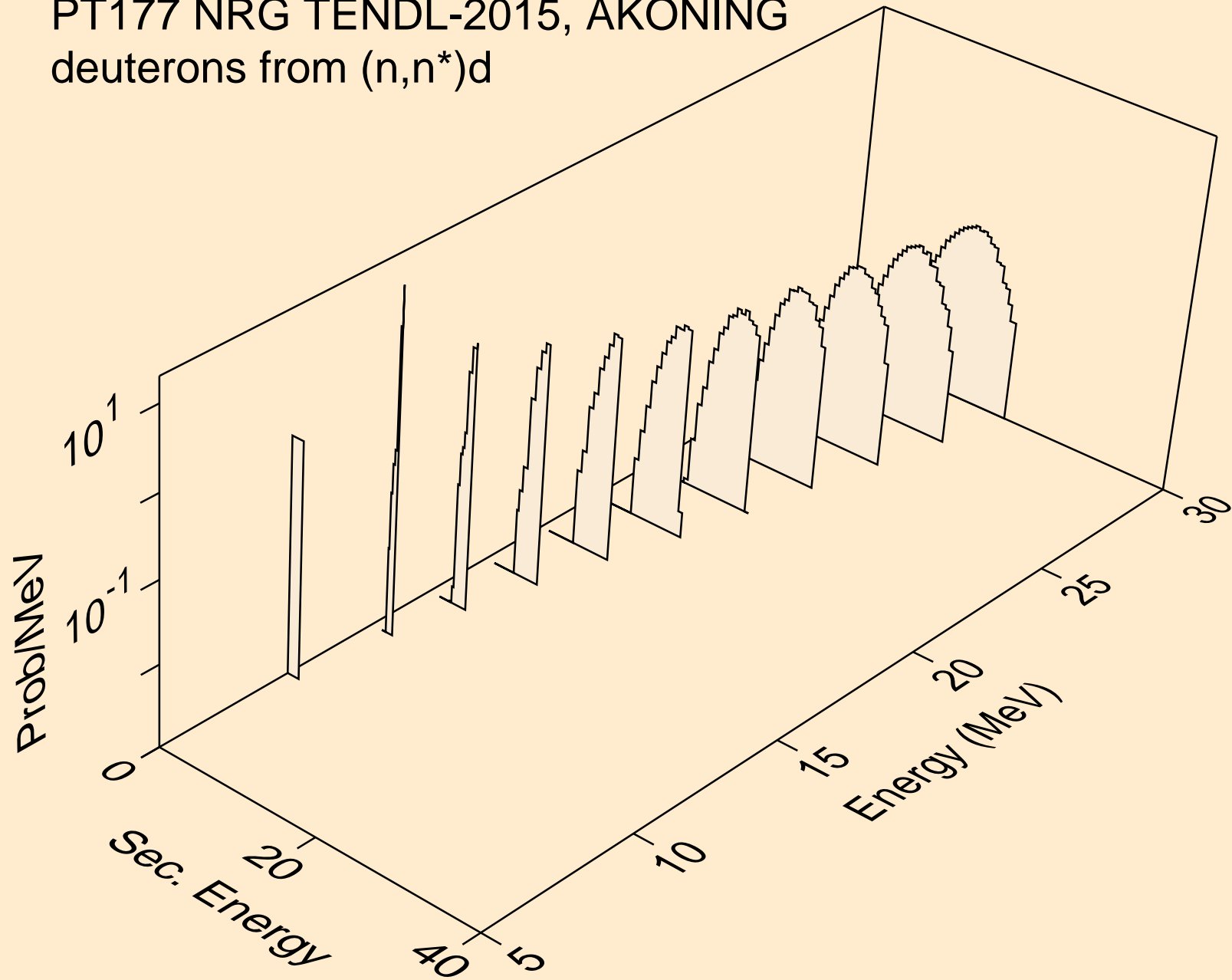

PT177 NRG TENDL-2015, AKONING
deuterons from (n,n*)d2a

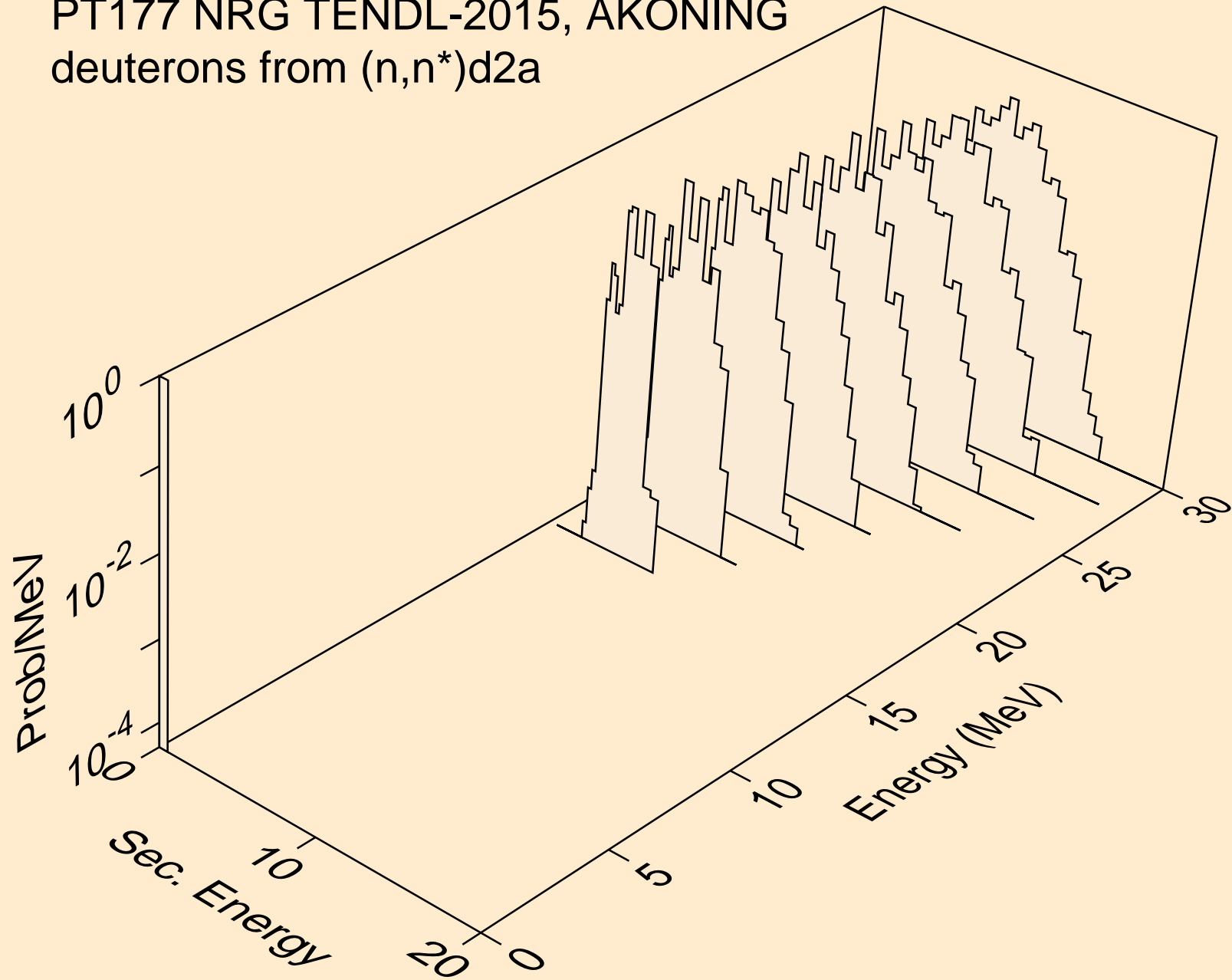

PT177 NRG TENDL-2015, AKONING
deuterons from (n,d)

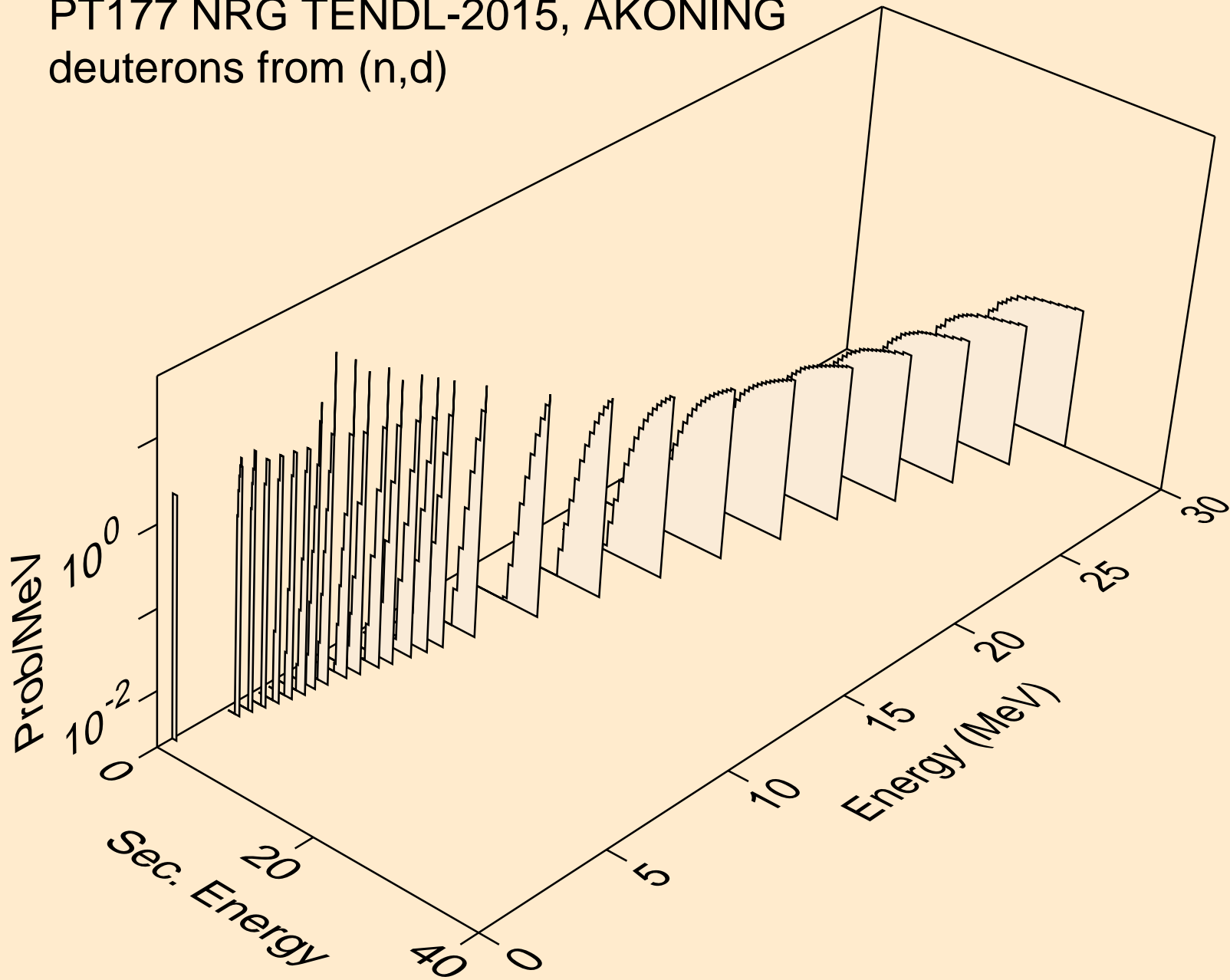

PT177 NRG TENDL-2015, AKONING
deuterons from (n,d2a)

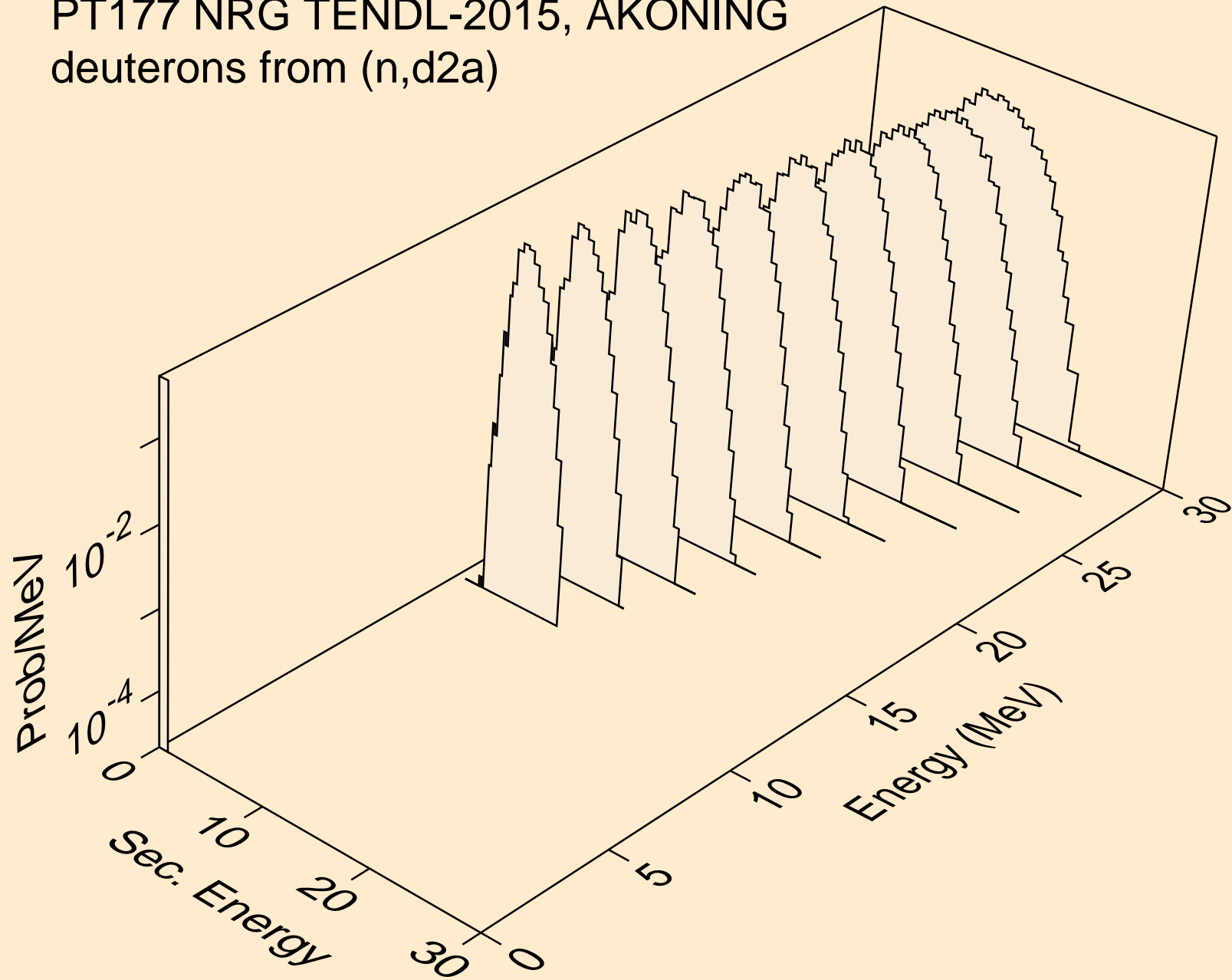

PT177 NRG TENDL-2015, AKONING
deuterons from (n,pd)

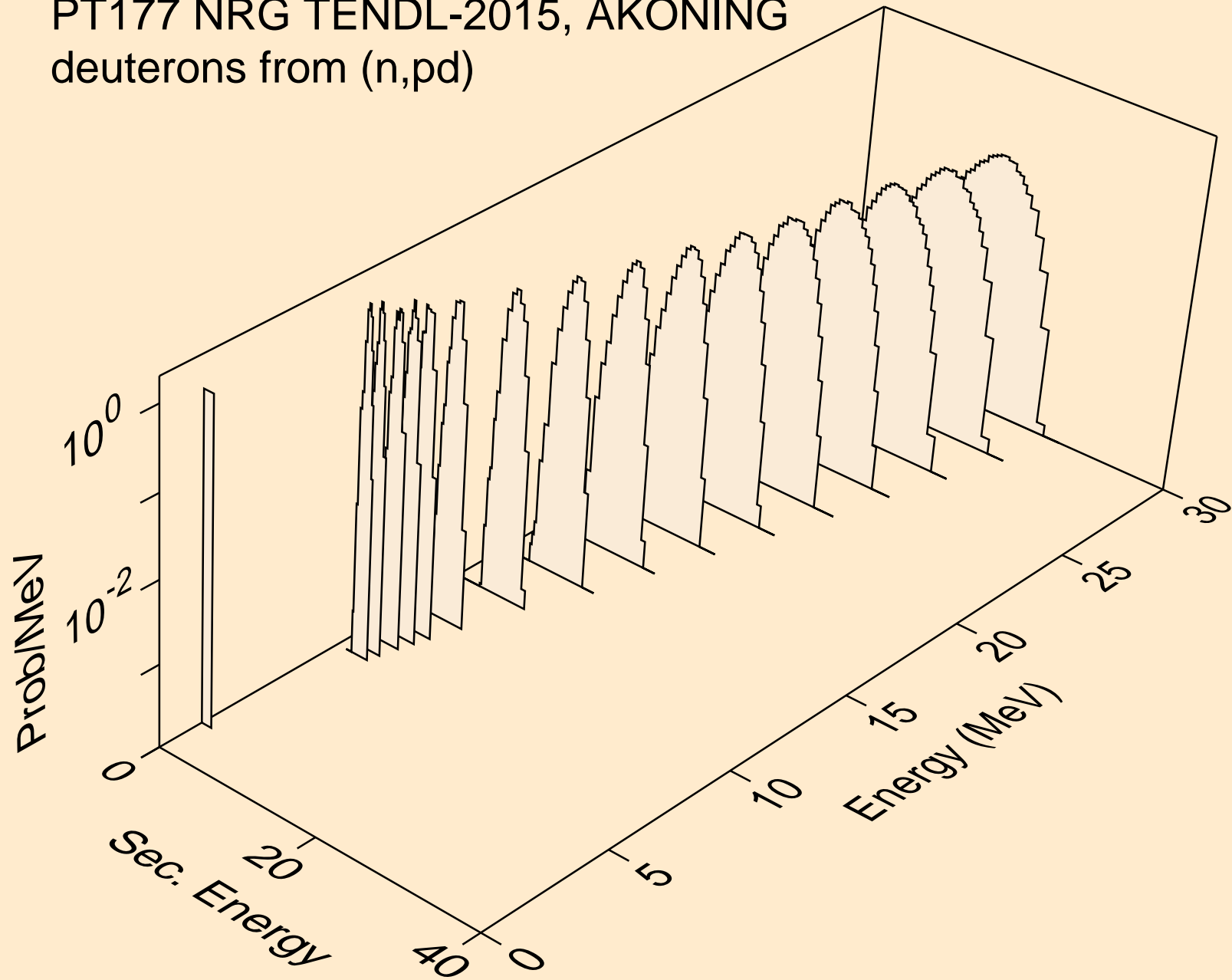

PT177 NRG TENDL-2015, AKONING
deuterons from (n,da)

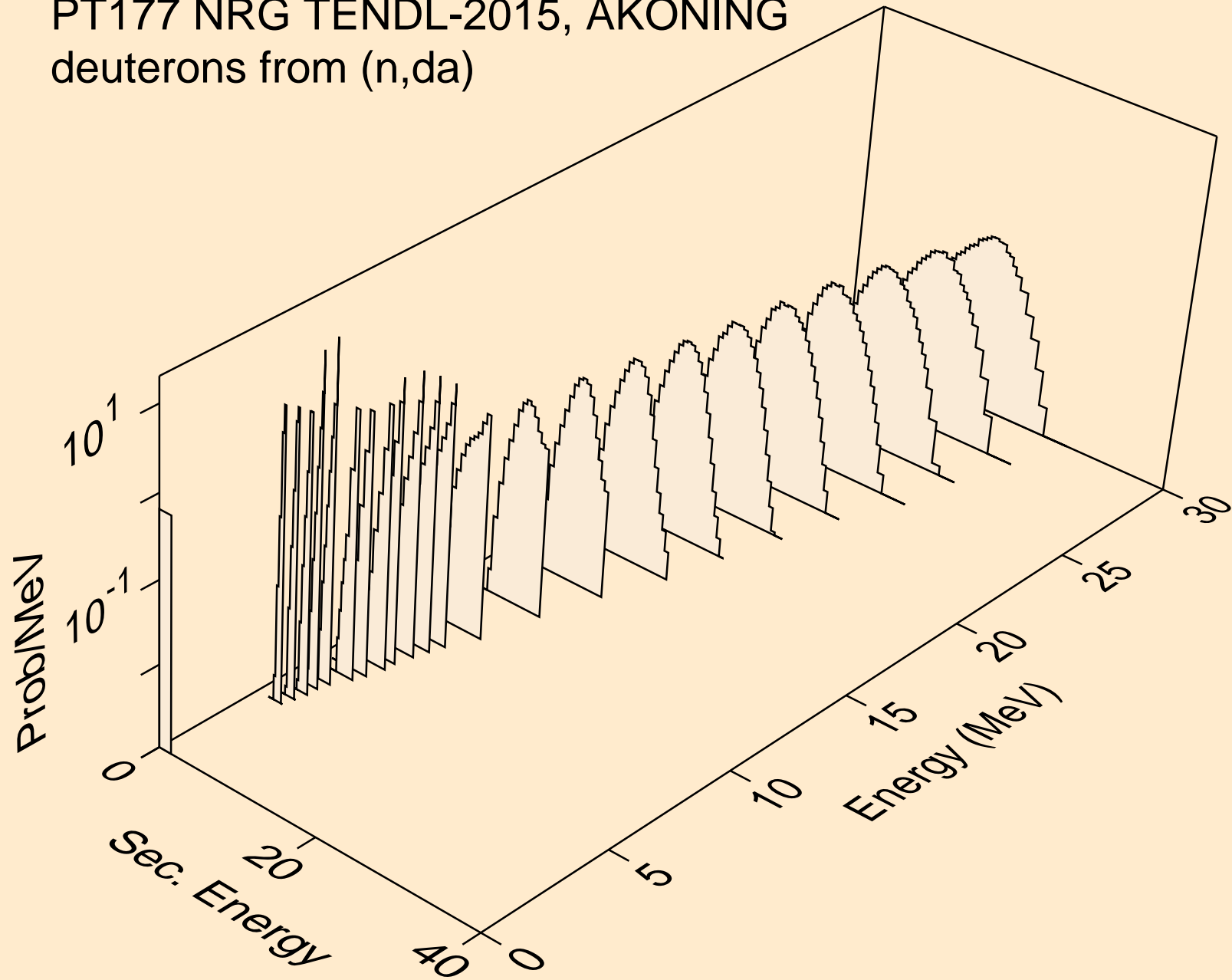

PT177 NRG TENDL-2015, AKONING
tritons from (n,x)

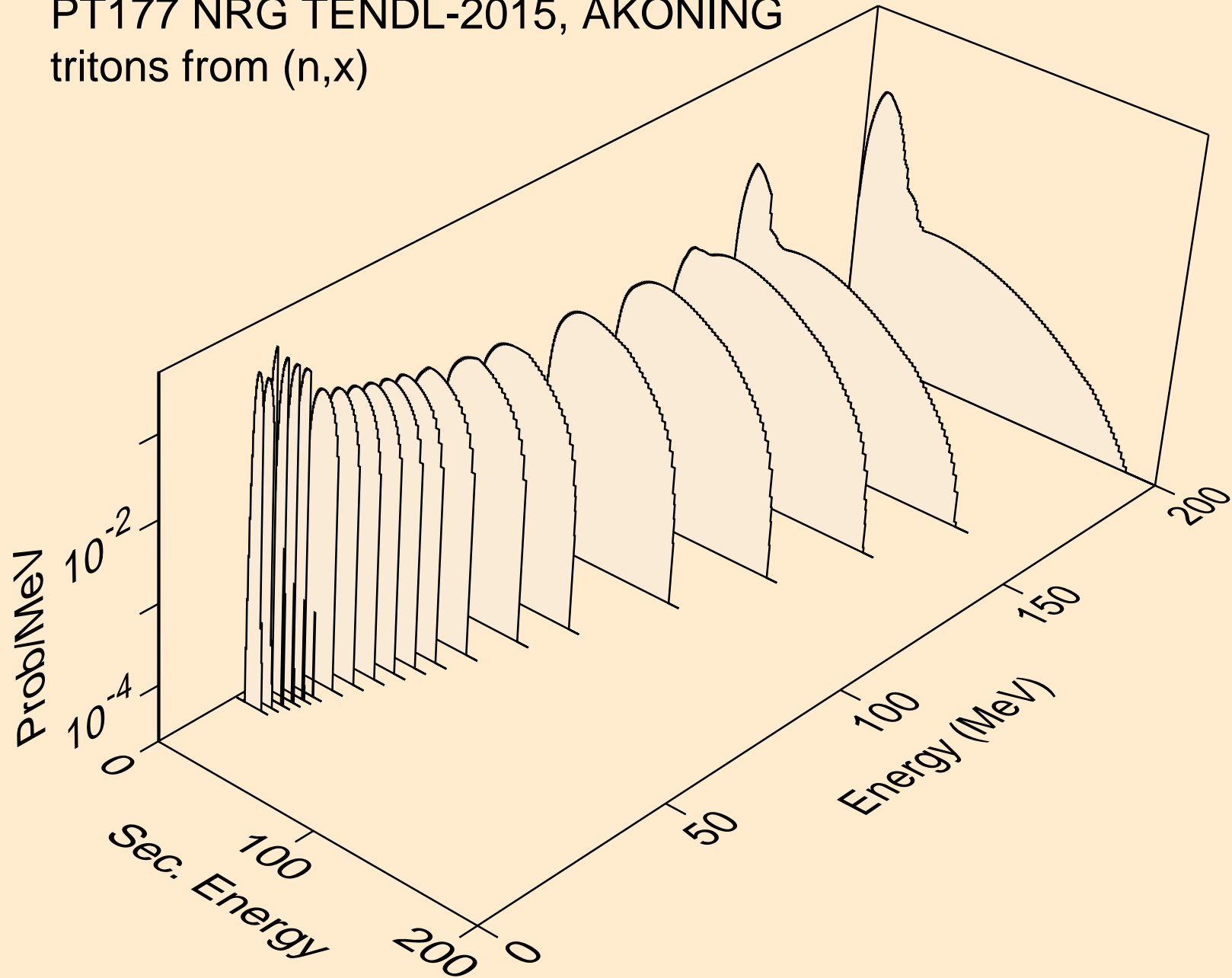

PT177 NRG TENDL-2015, AKONING
tritons from (n,n*)t

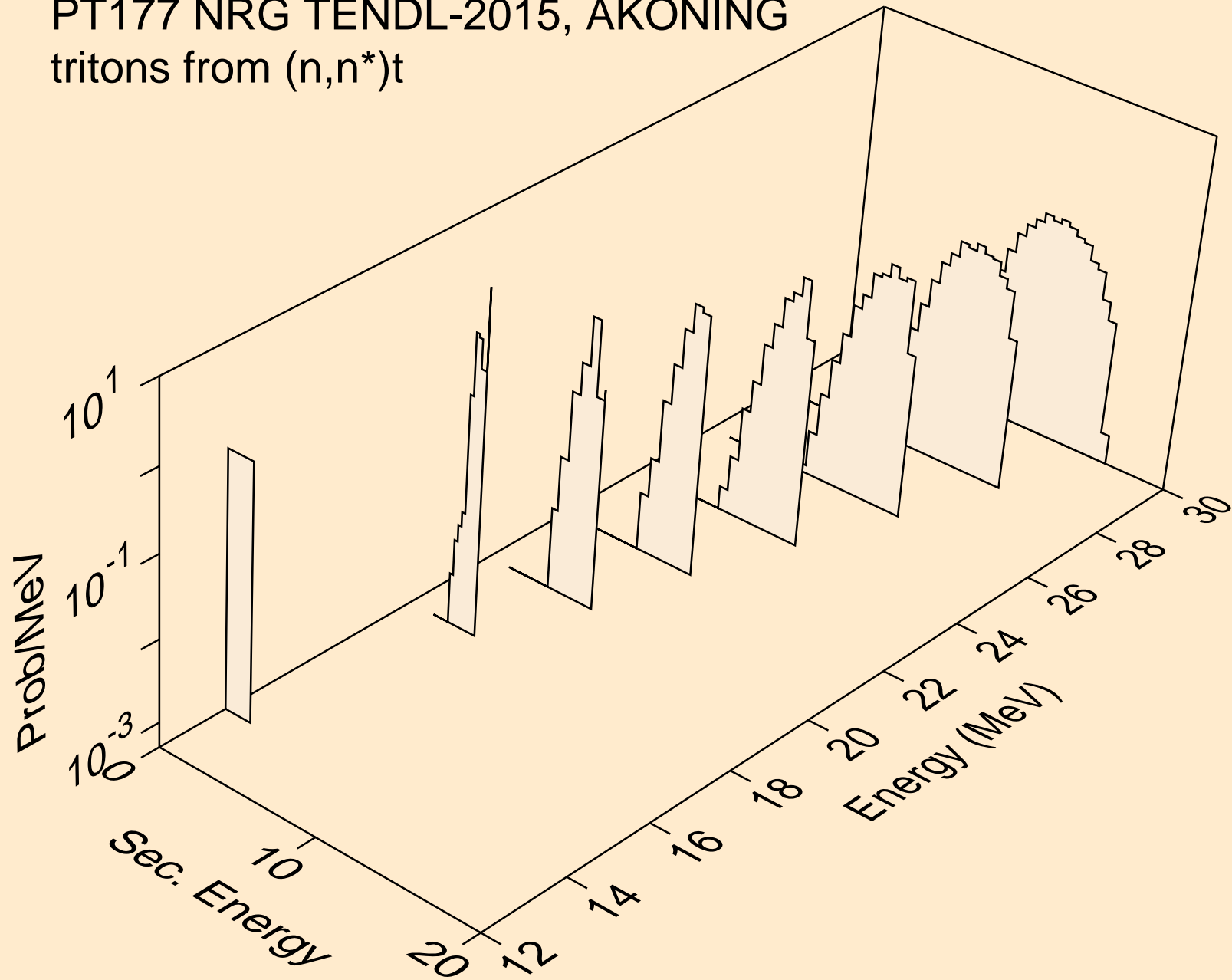

PT177 NRG TENDL-2015, AKONING
tritons from (n,t)

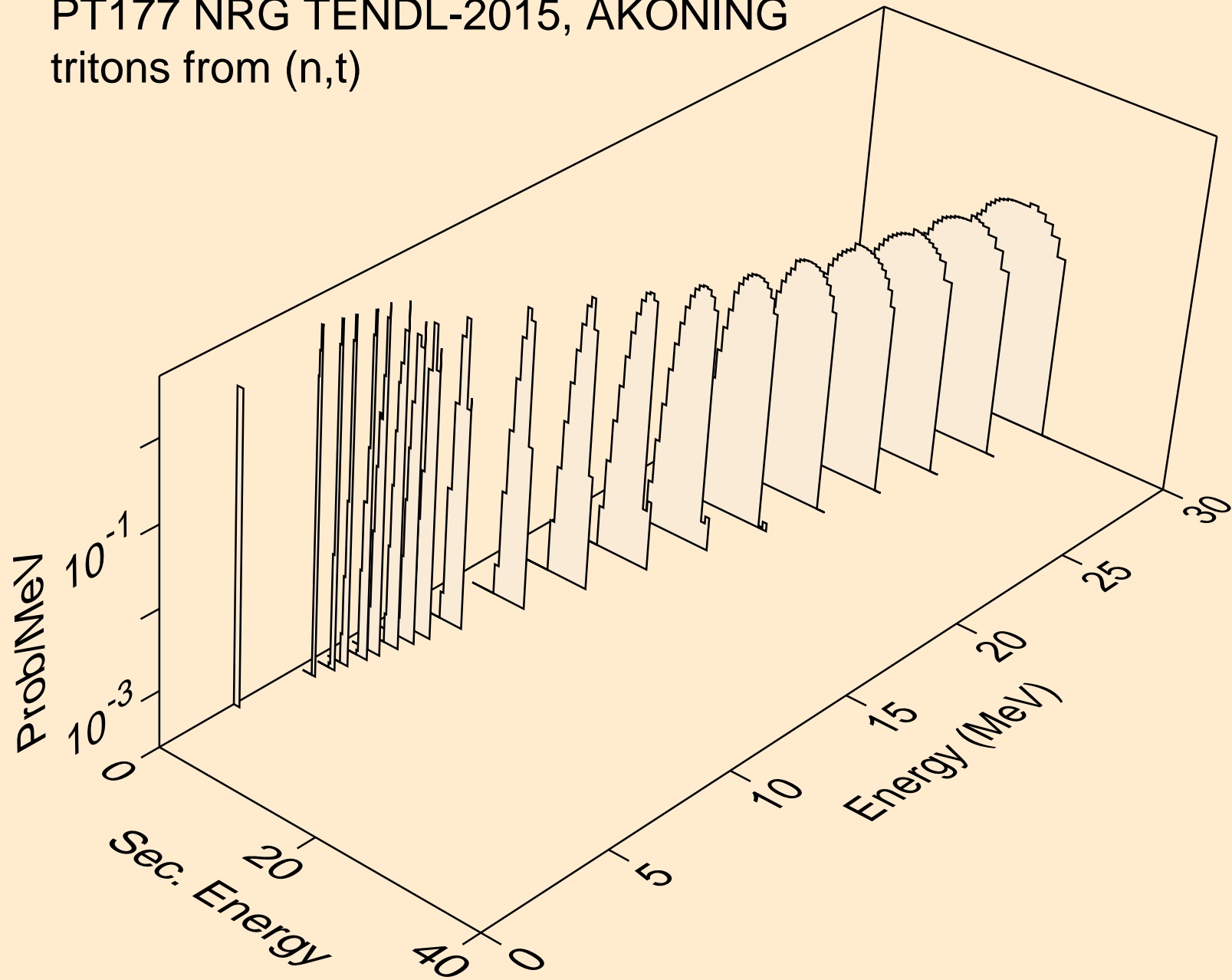

PT177 NRG TENDL-2015, AKONING
tritons from (n,t2a)

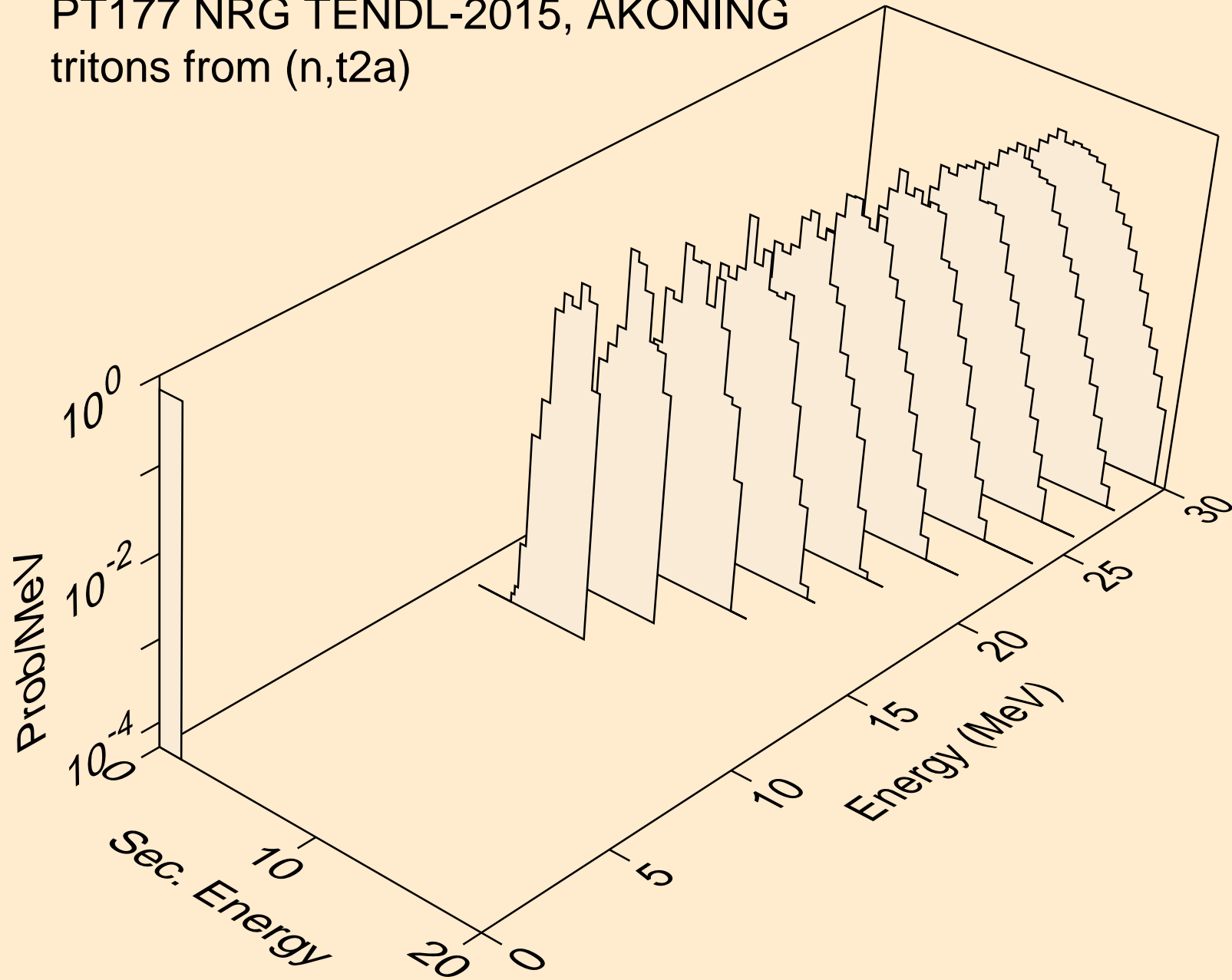

PT177 NRG TENDL-2015, AKONING
tritons from (n,pt)

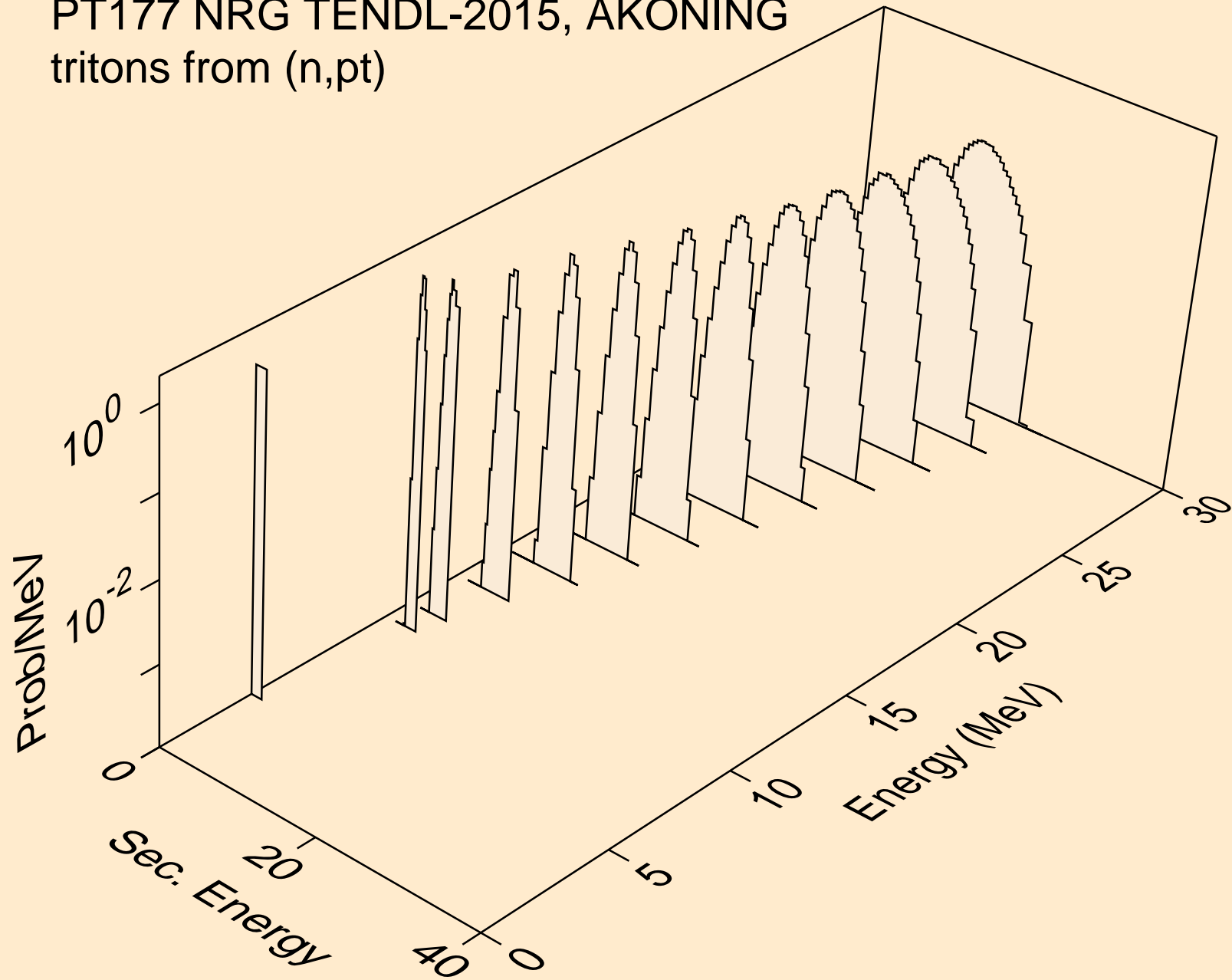

PT177 NRG TENDL-2015, AKONING
he3s from (n,x)

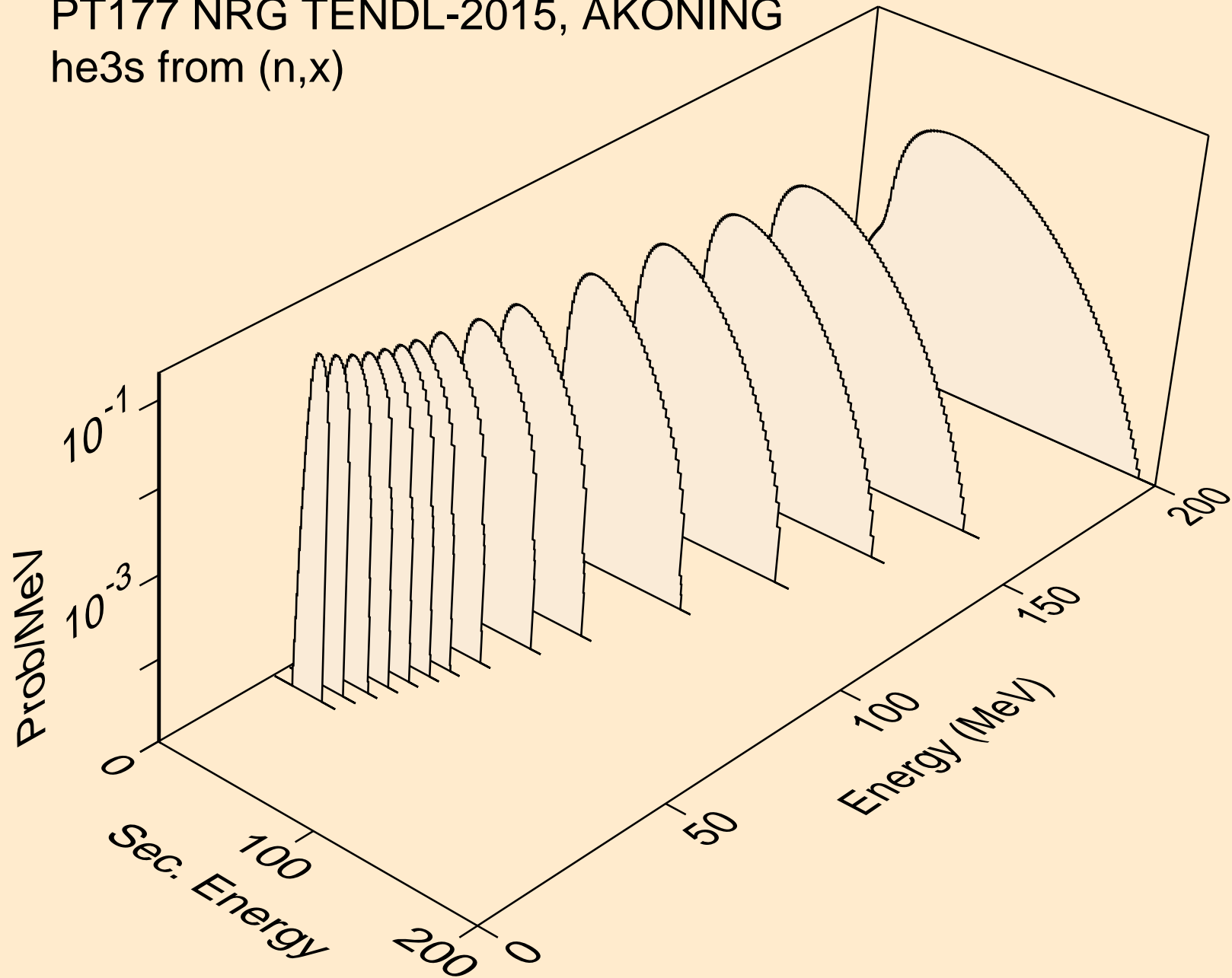

PT177 NRG TENDL-2015, AKONING
he3s from (n,n*)he3

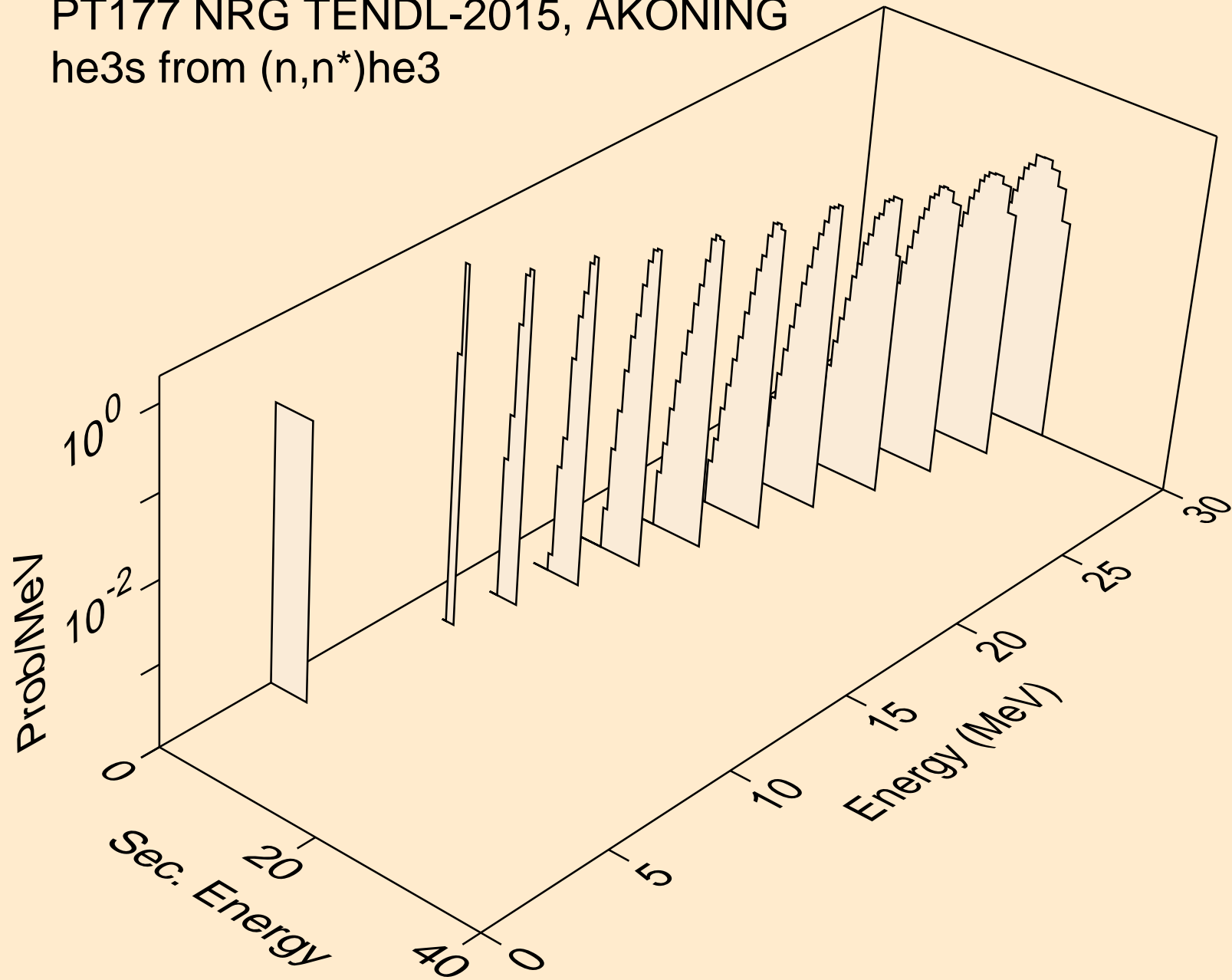

PT177 NRG TENDL-2015, AKONING
he3s from (n,he3)

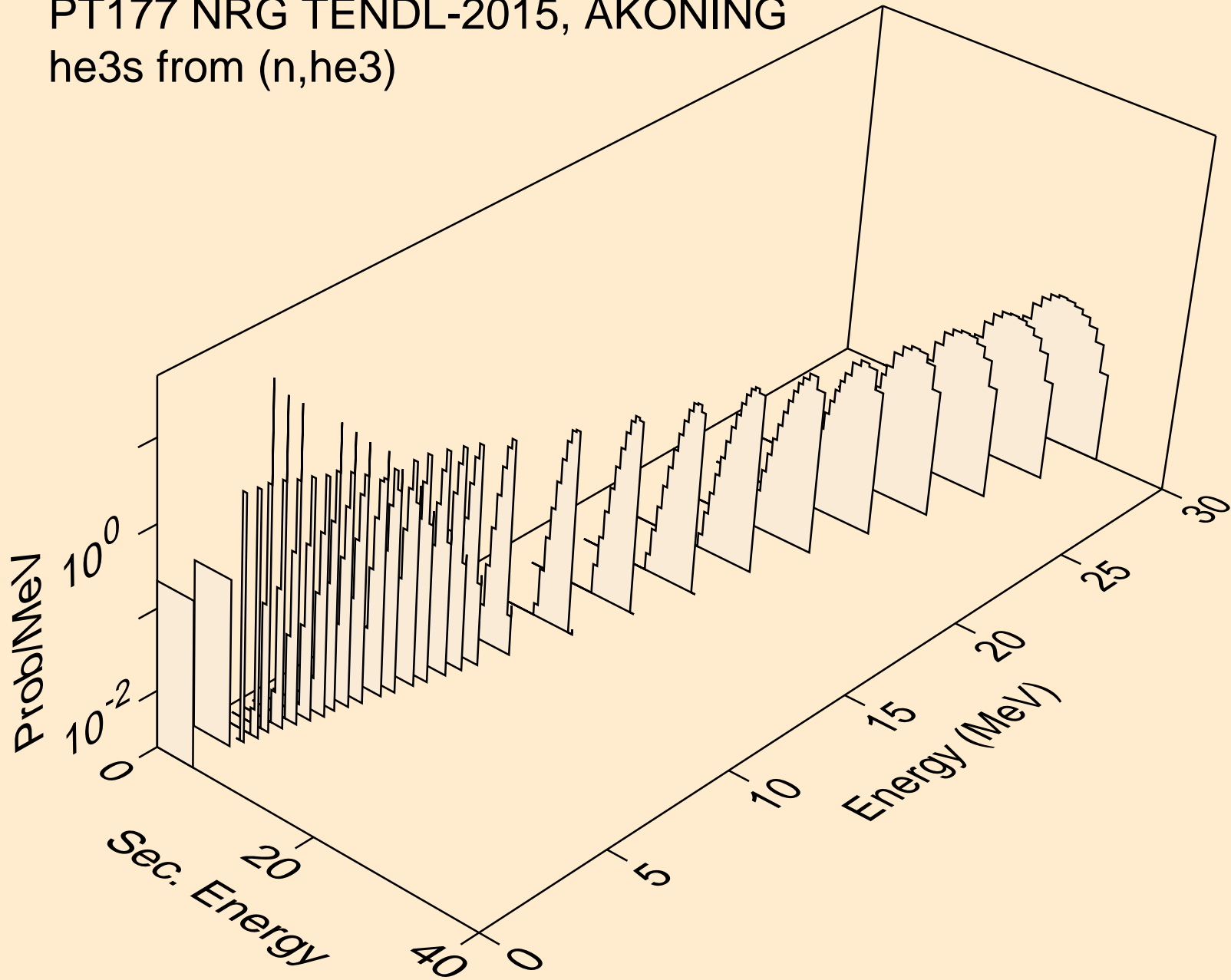

PT177 NRG TENDL-2015, AKONING
alphas from (n,x)

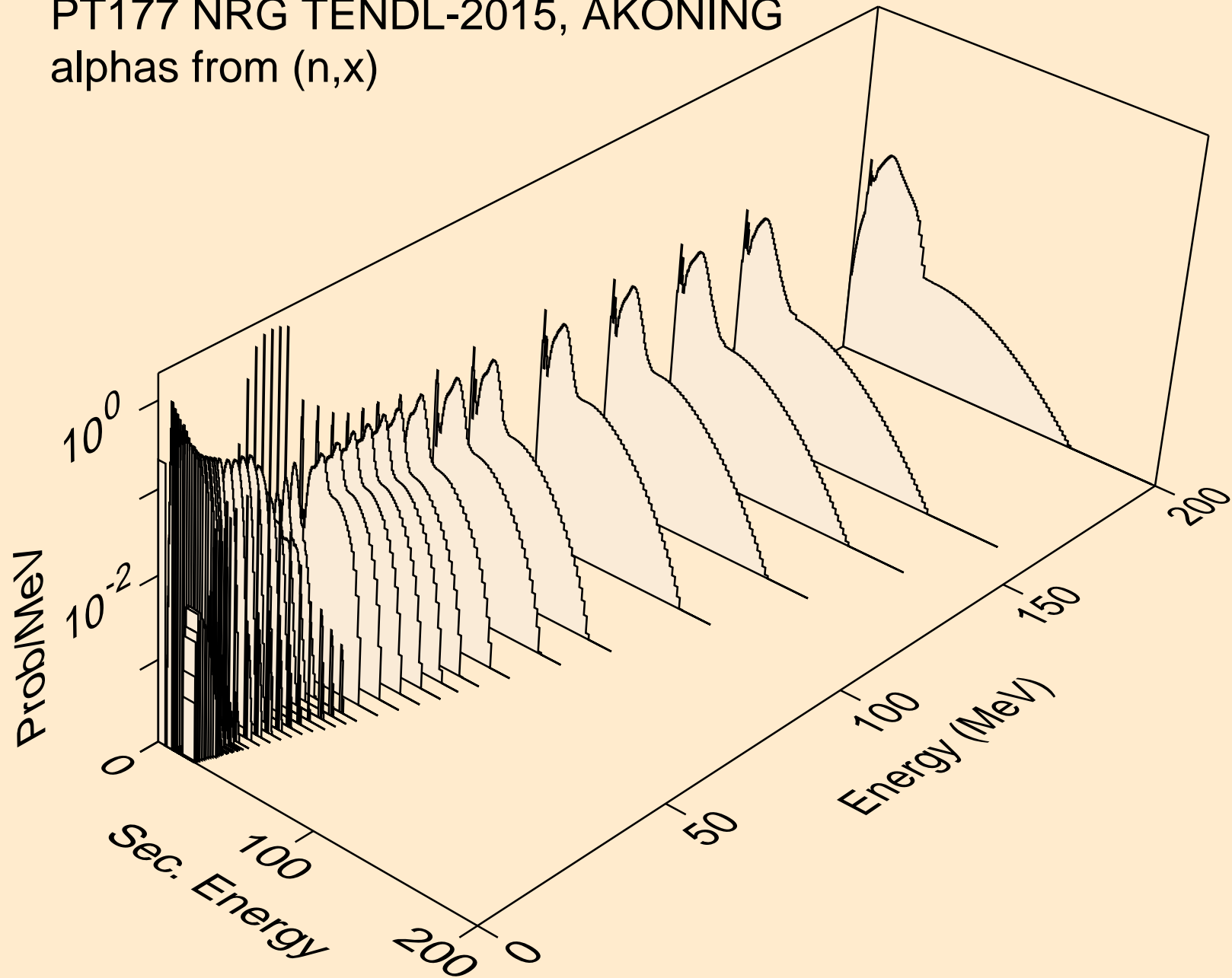

PT177 NRG TENDL-2015, AKONING
alphas from (n,n*)a

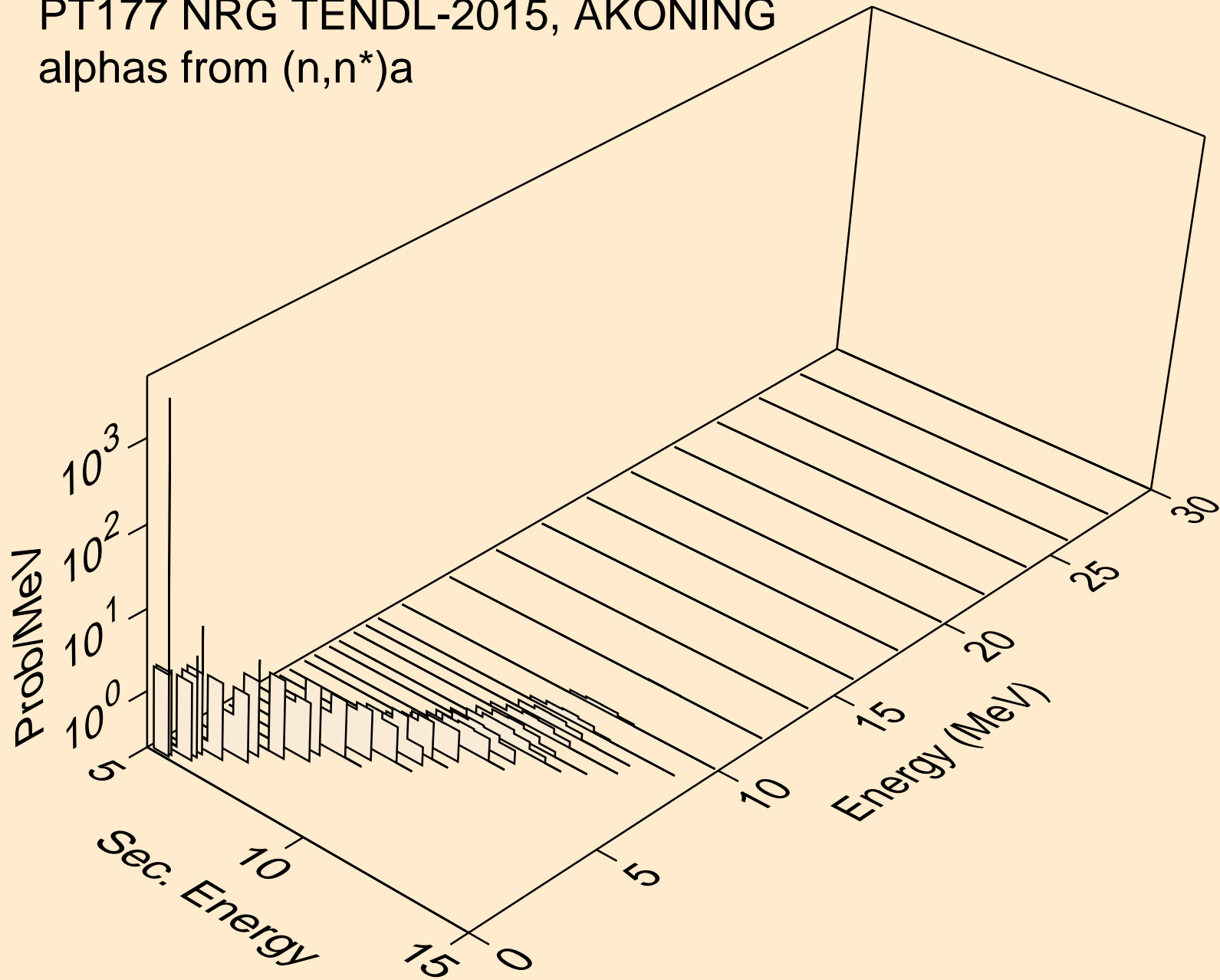

PT177 NRG TENDL-2015, AKONING
alphas from (n,n*)3a

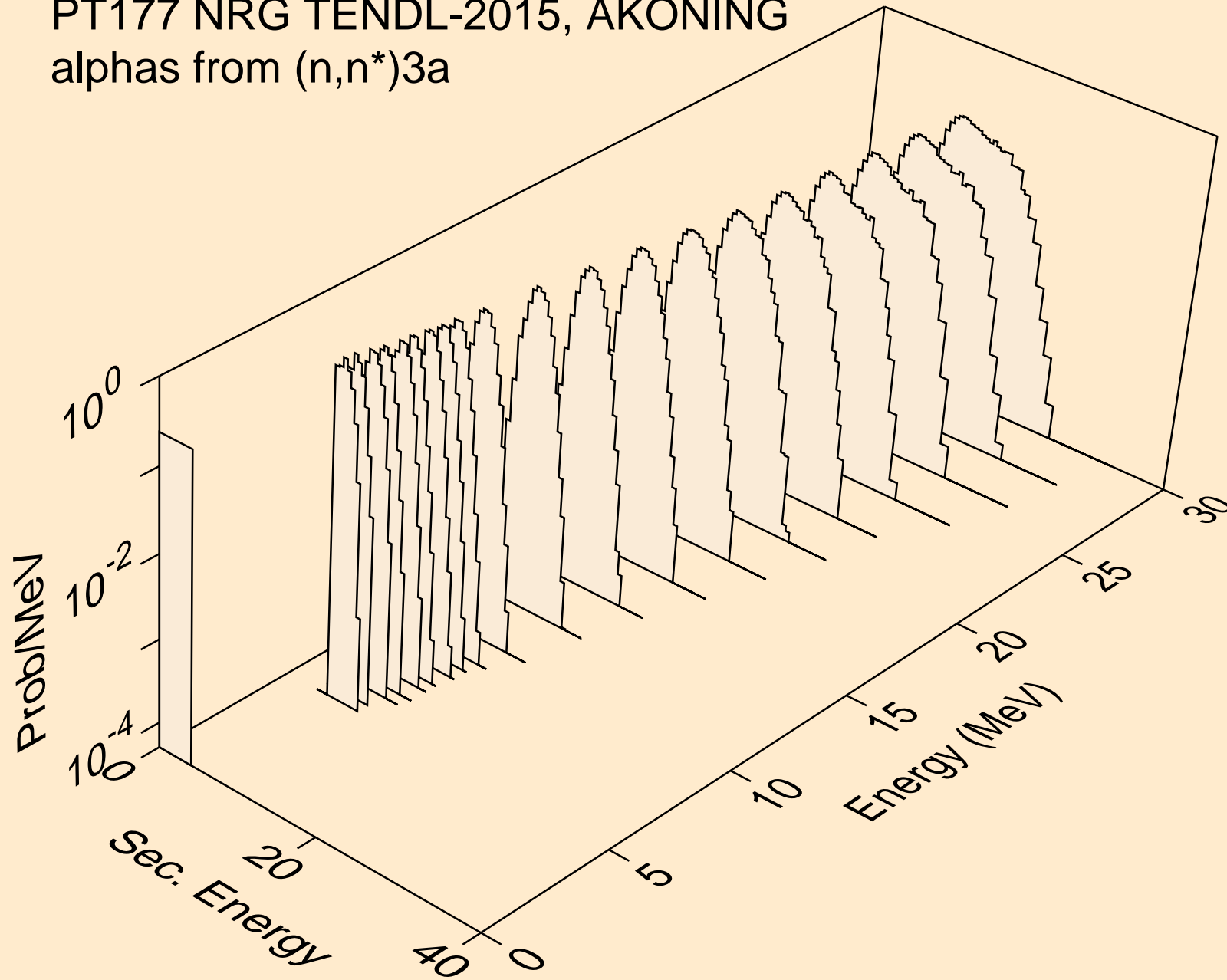

PT177 NRG TENDL-2015, AKONING
alphas from (n,2n)a

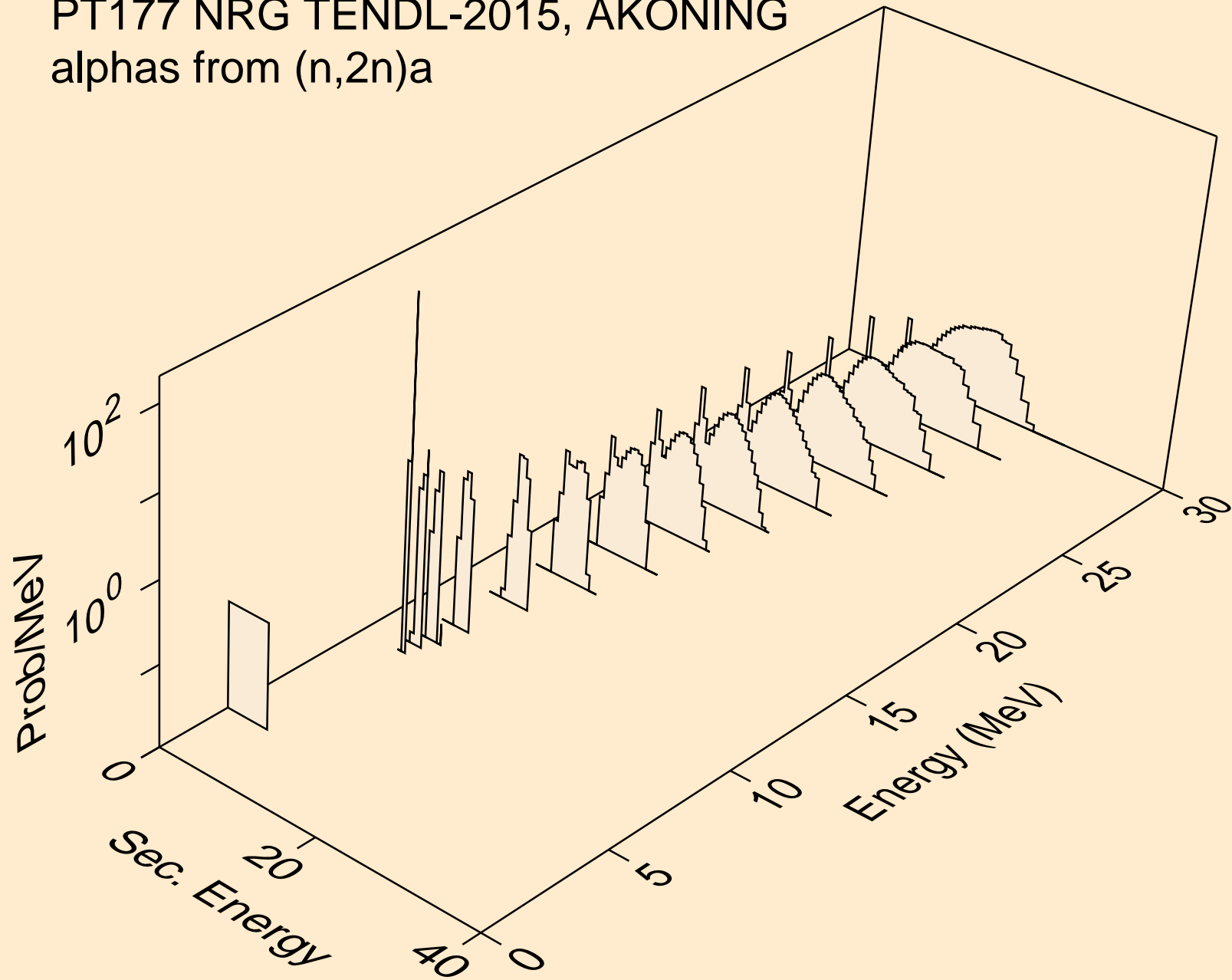

PT177 NRG TENDL-2015, AKONING
alphas from (n,3n)a

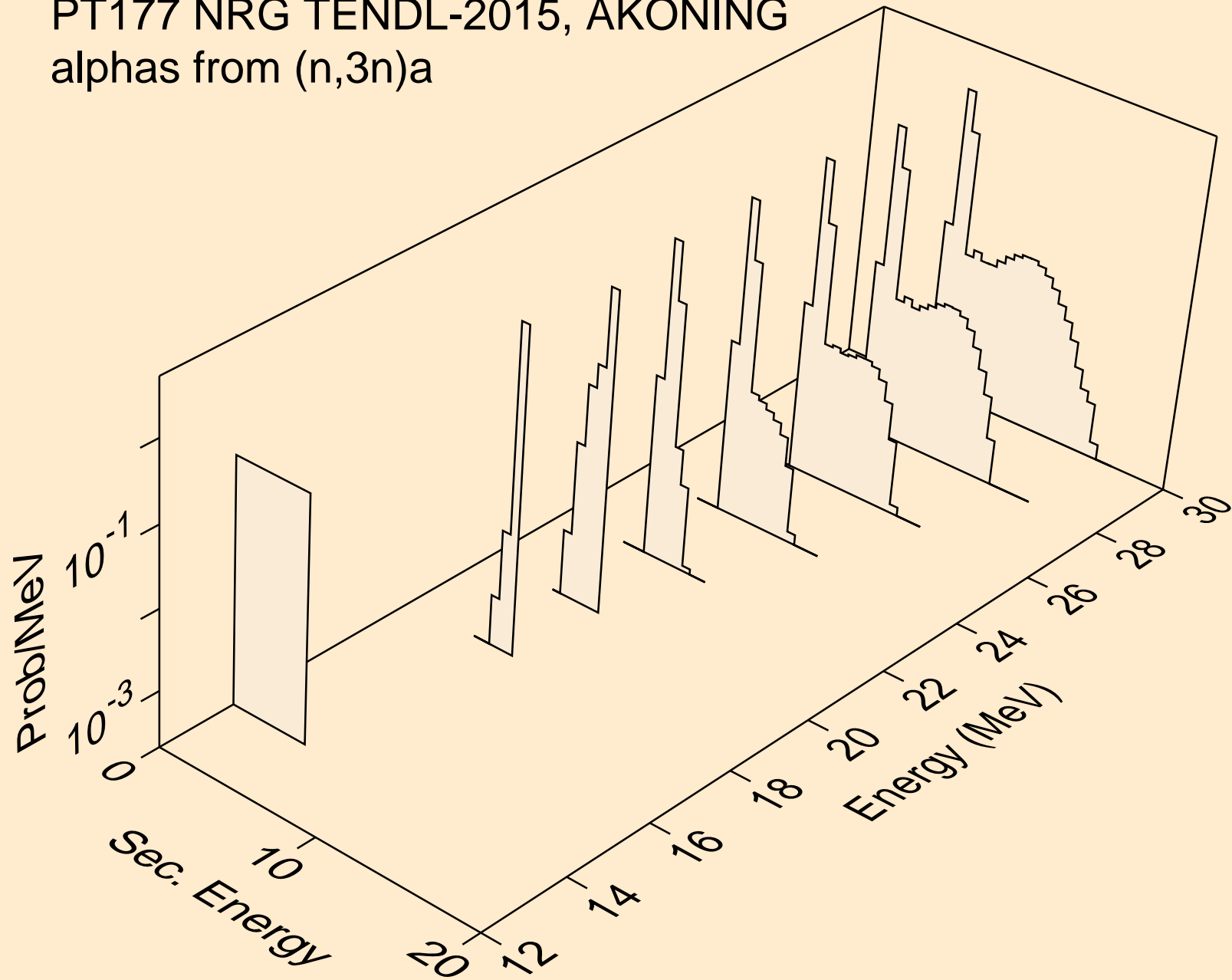

PT177 NRG TENDL-2015, AKONING
alphas from (n,n*)2a

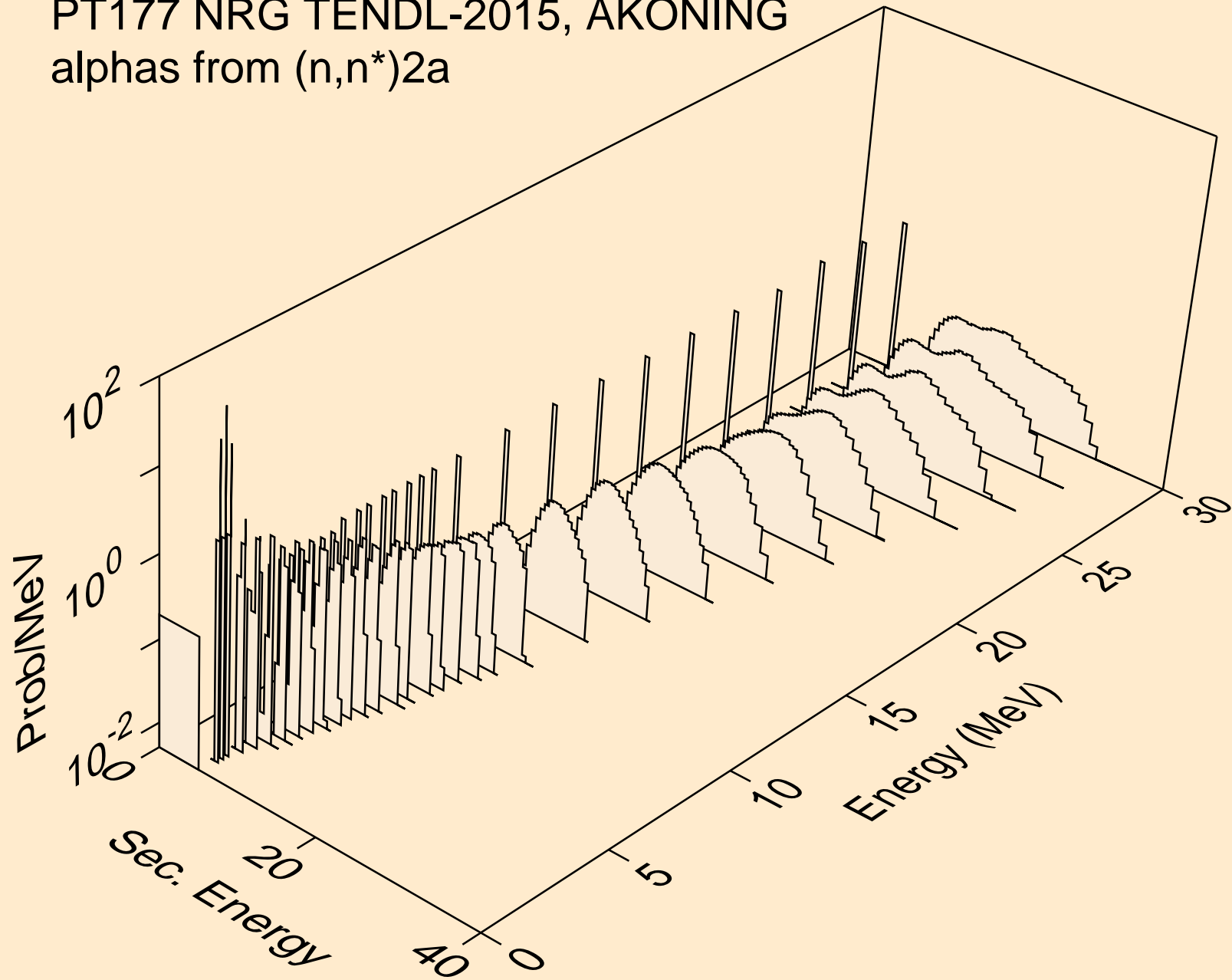

PT177 NRG TENDL-2015, AKONING
alphas from (n,2n)2a

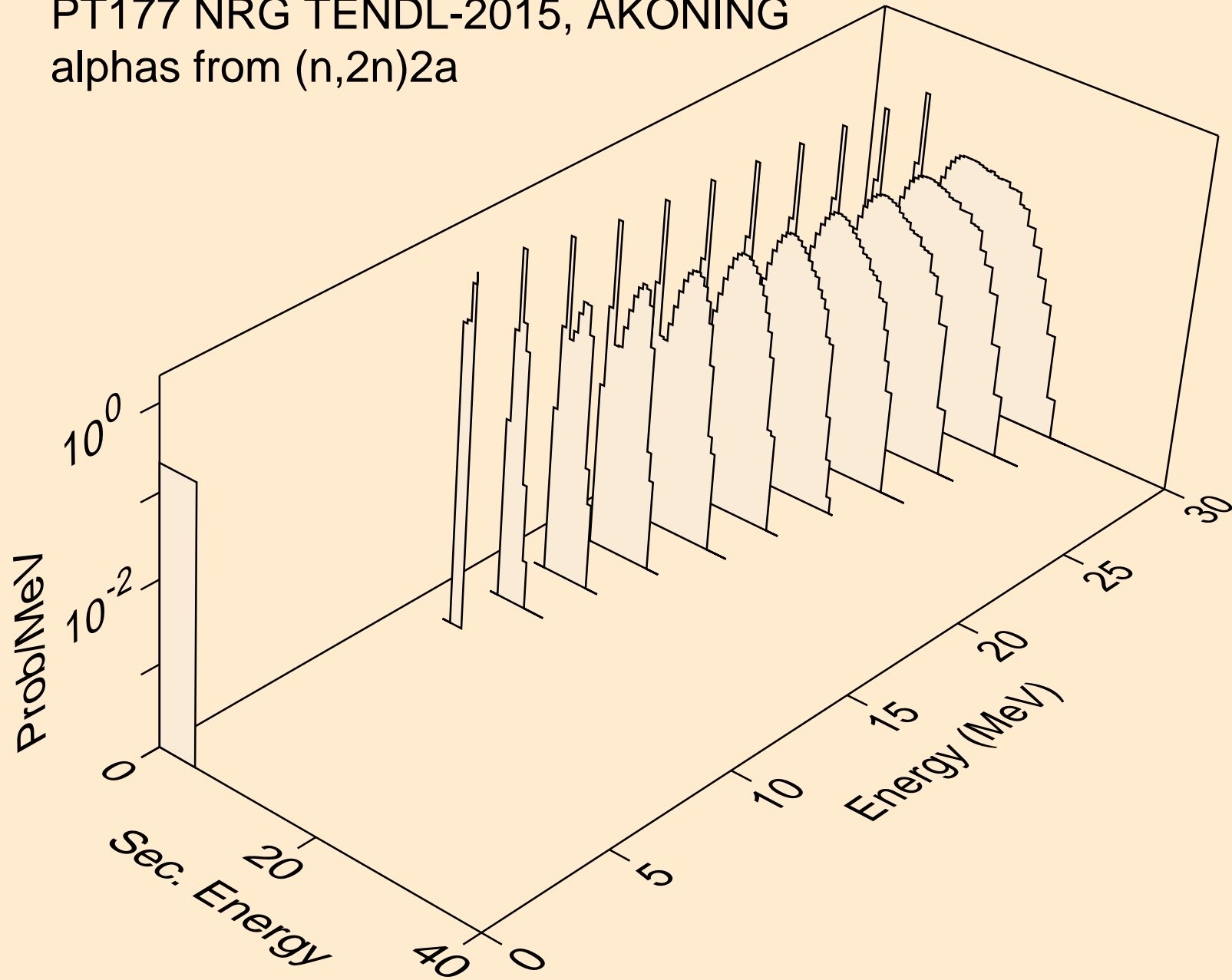

PT177 NRG TENDL-2015, AKONING
alphas from (n,n*)d2a

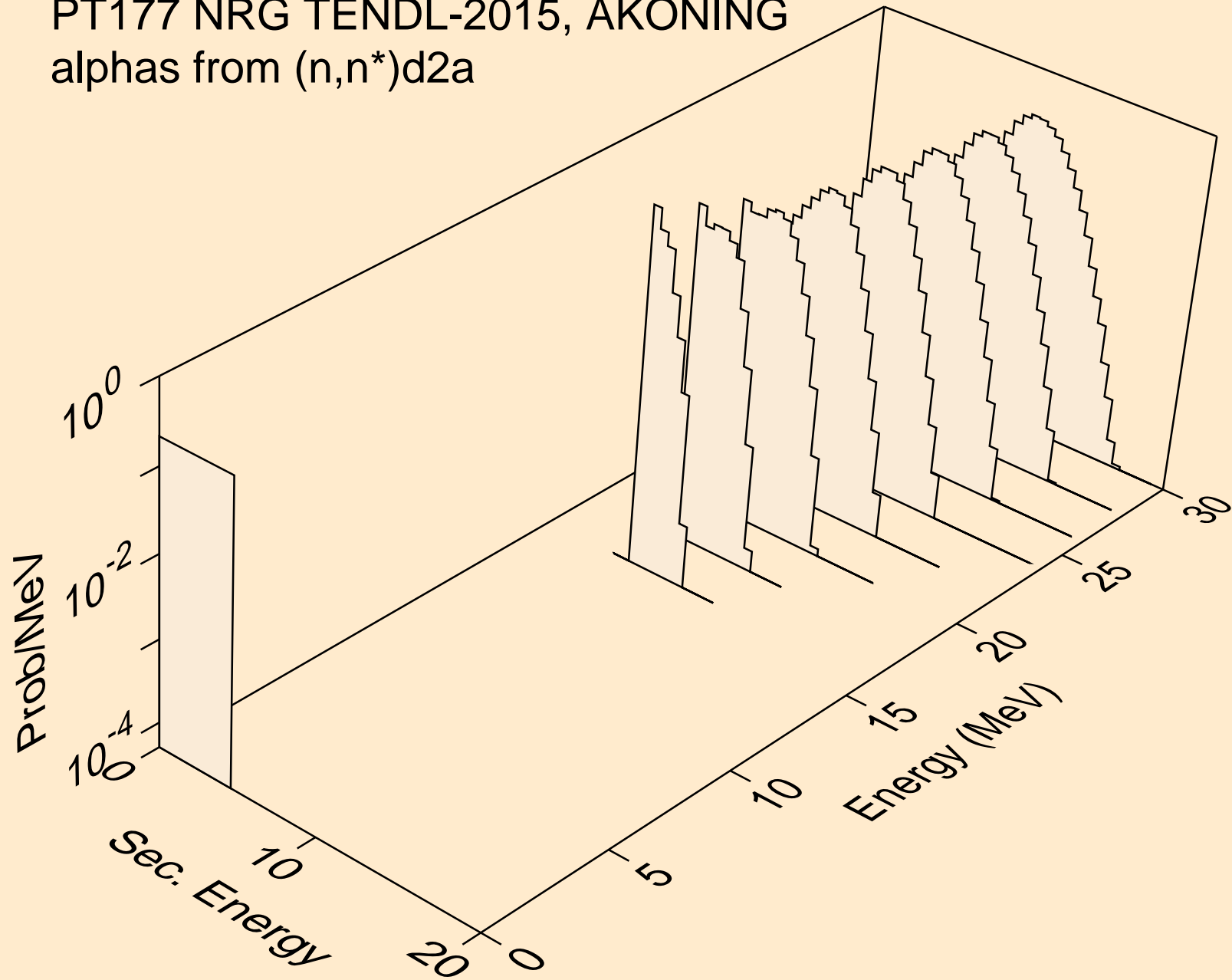

PT177 NRG TENDL-2015, AKONING
alphas from (n,npa)

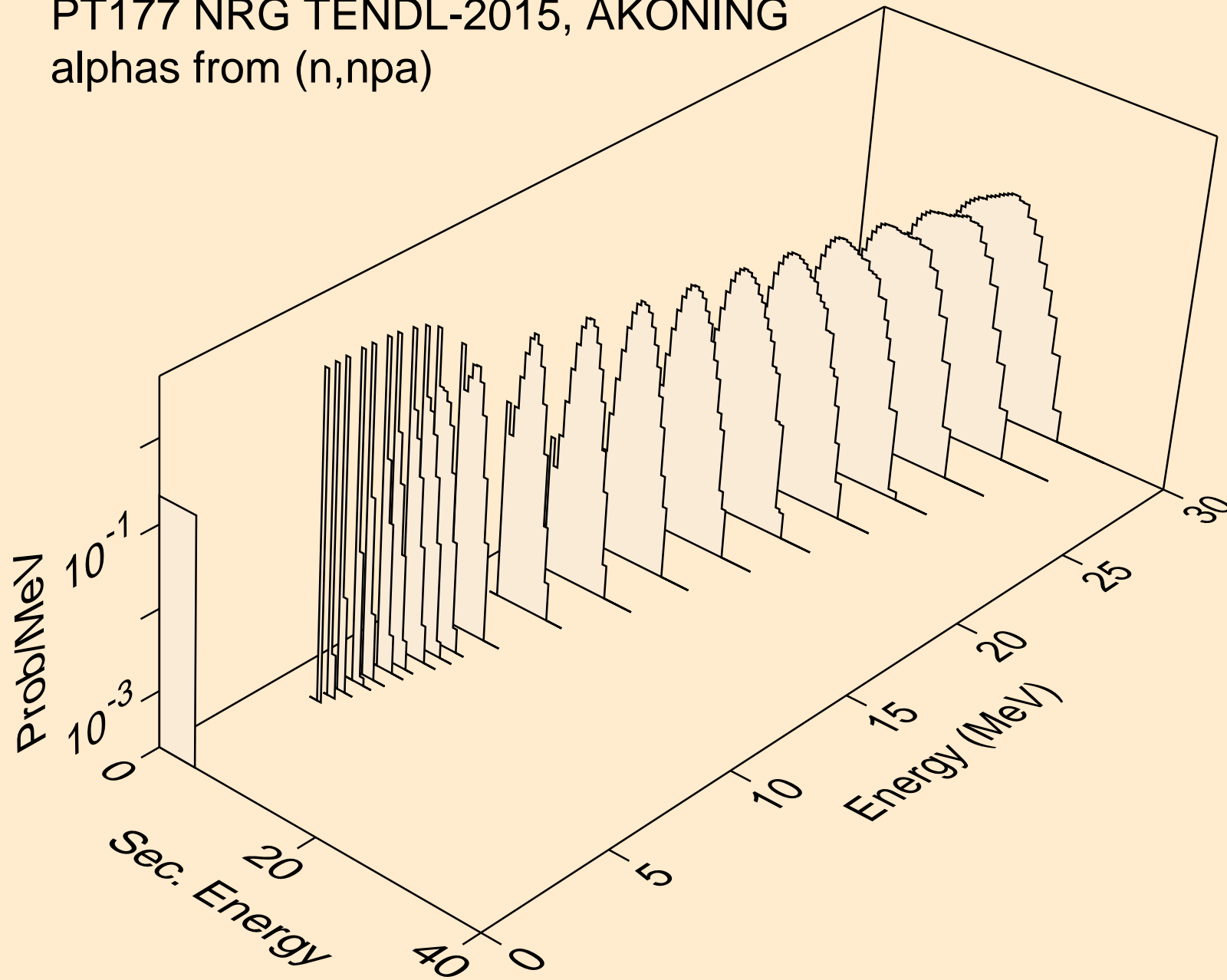

PT177 NRG TENDL-2015, AKONING
alphas from (n,a)

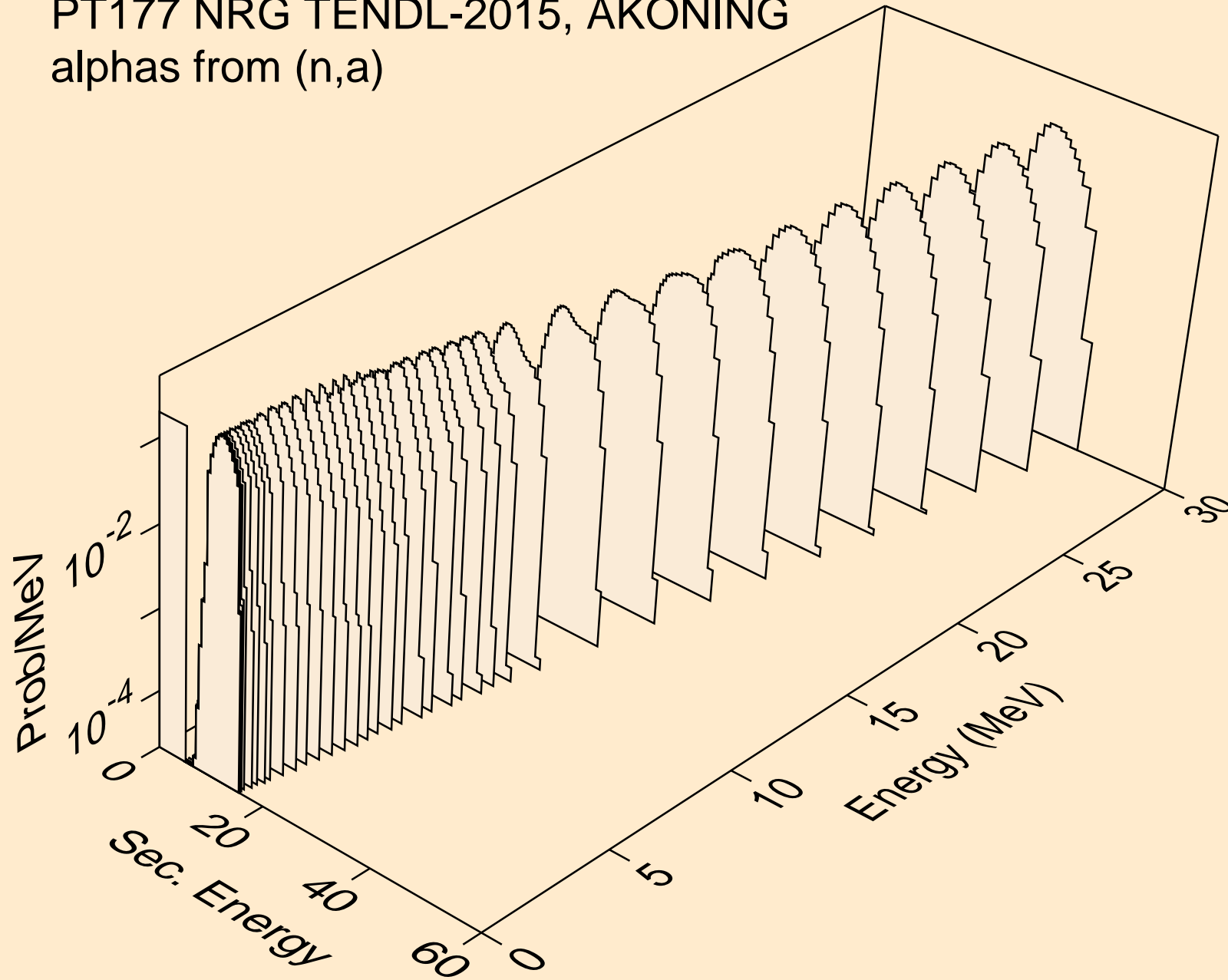

PT177 NRG TENDL-2015, AKONING
alphas from (n,2a)

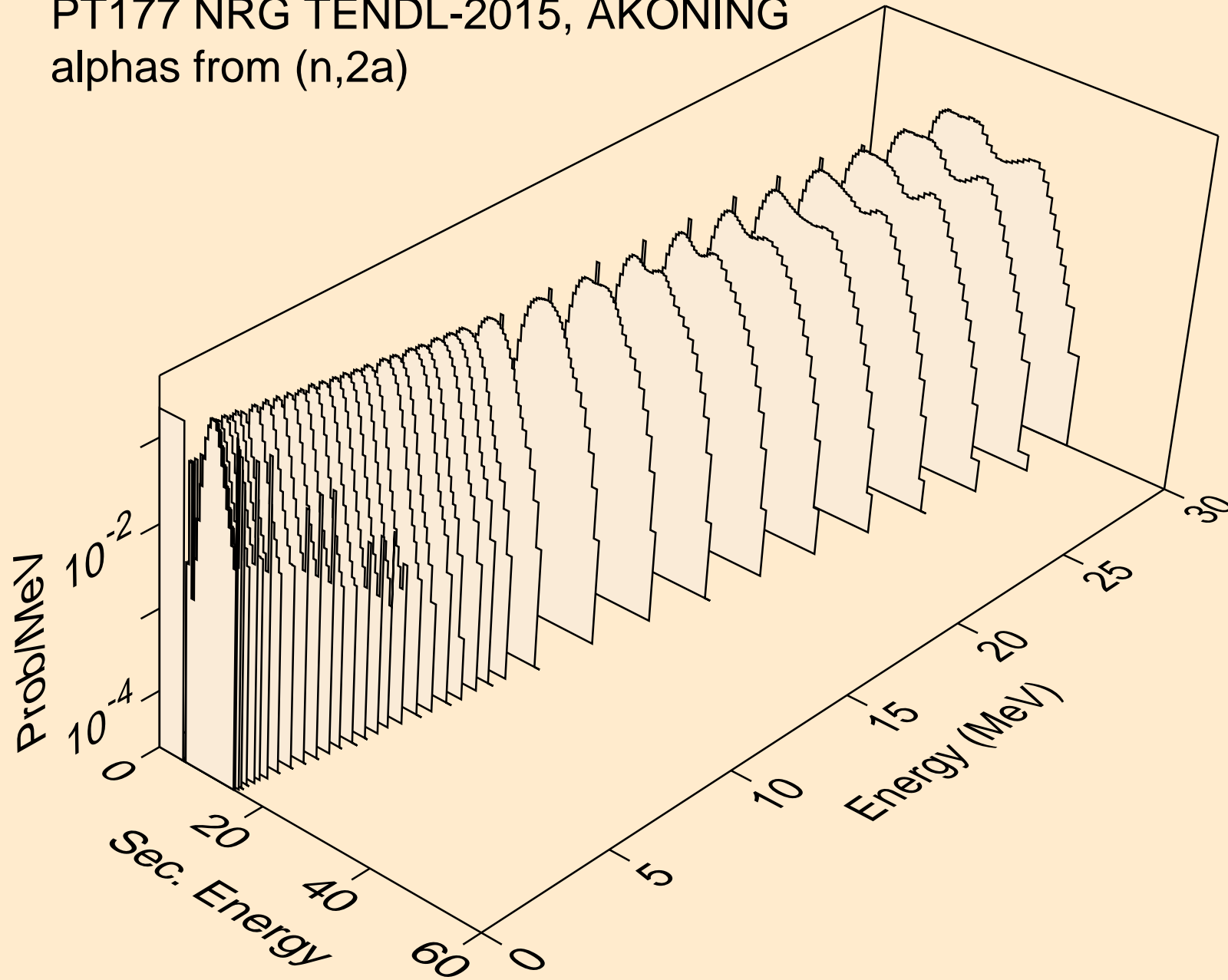

PT177 NRG TENDL-2015, AKONING
alphas from (n,3a)

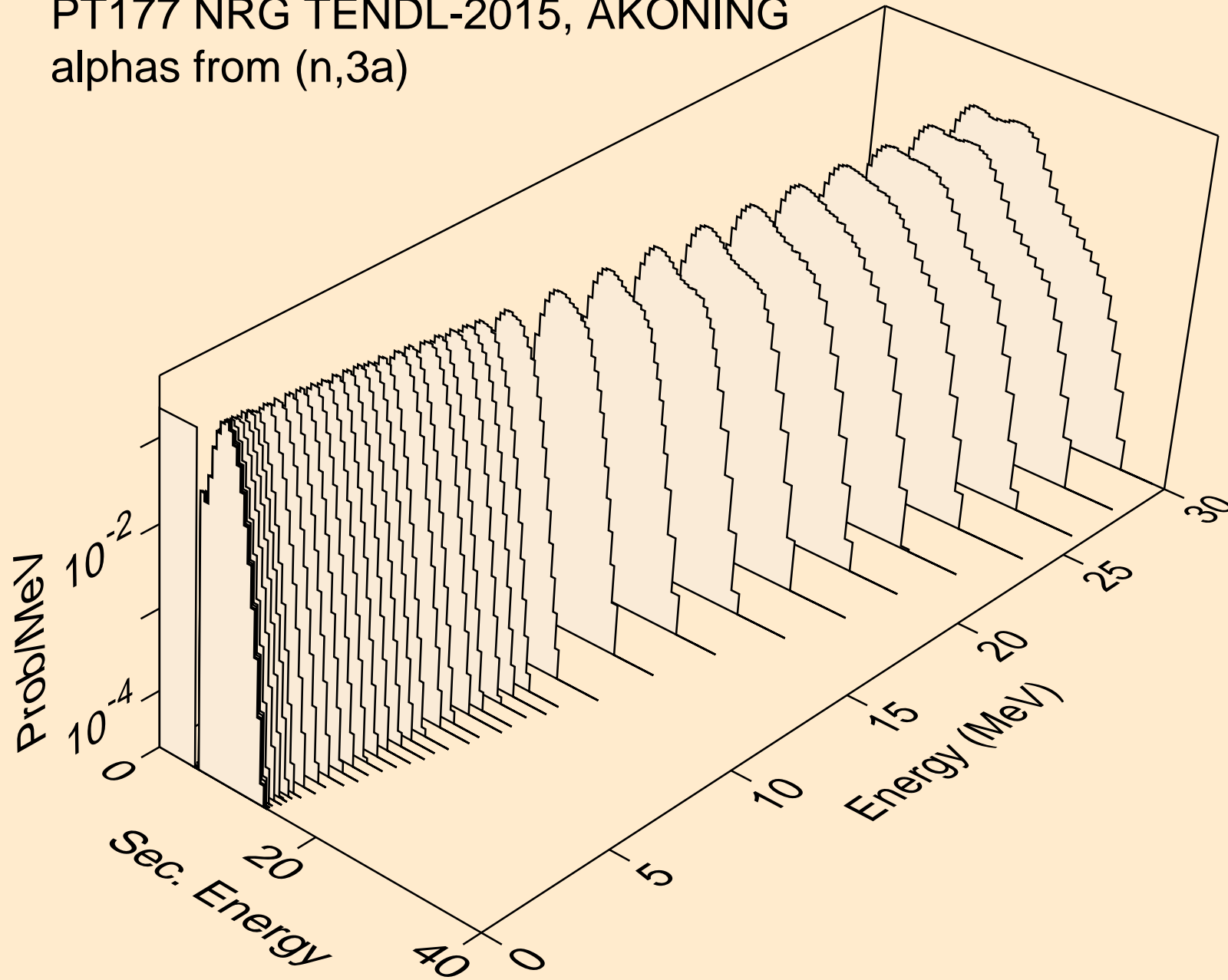

PT177 NRG TENDL-2015, AKONING
alphas from (n,pa)

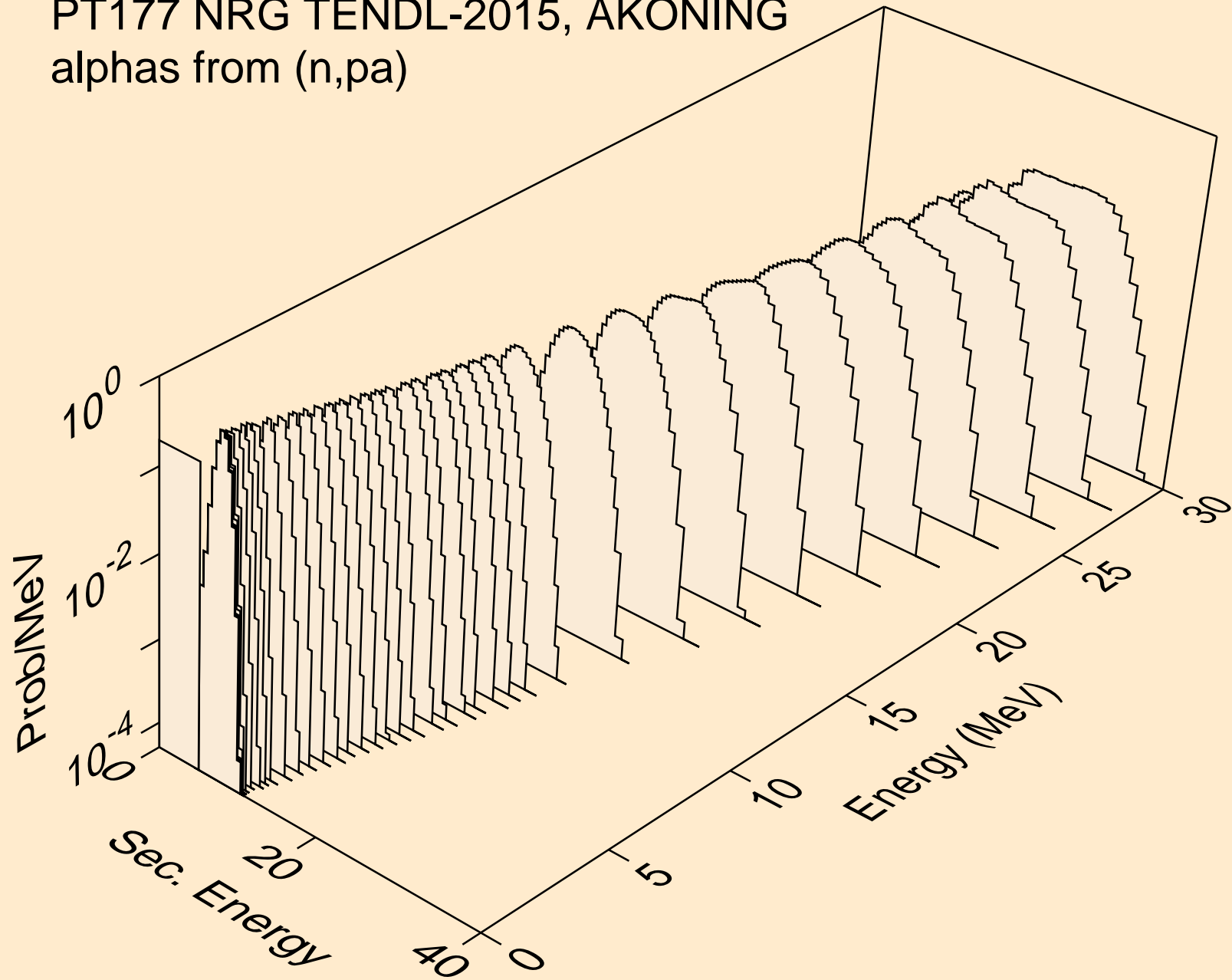

PT177 NRG TENDL-2015, AKONING
alphas from (n,t2a)

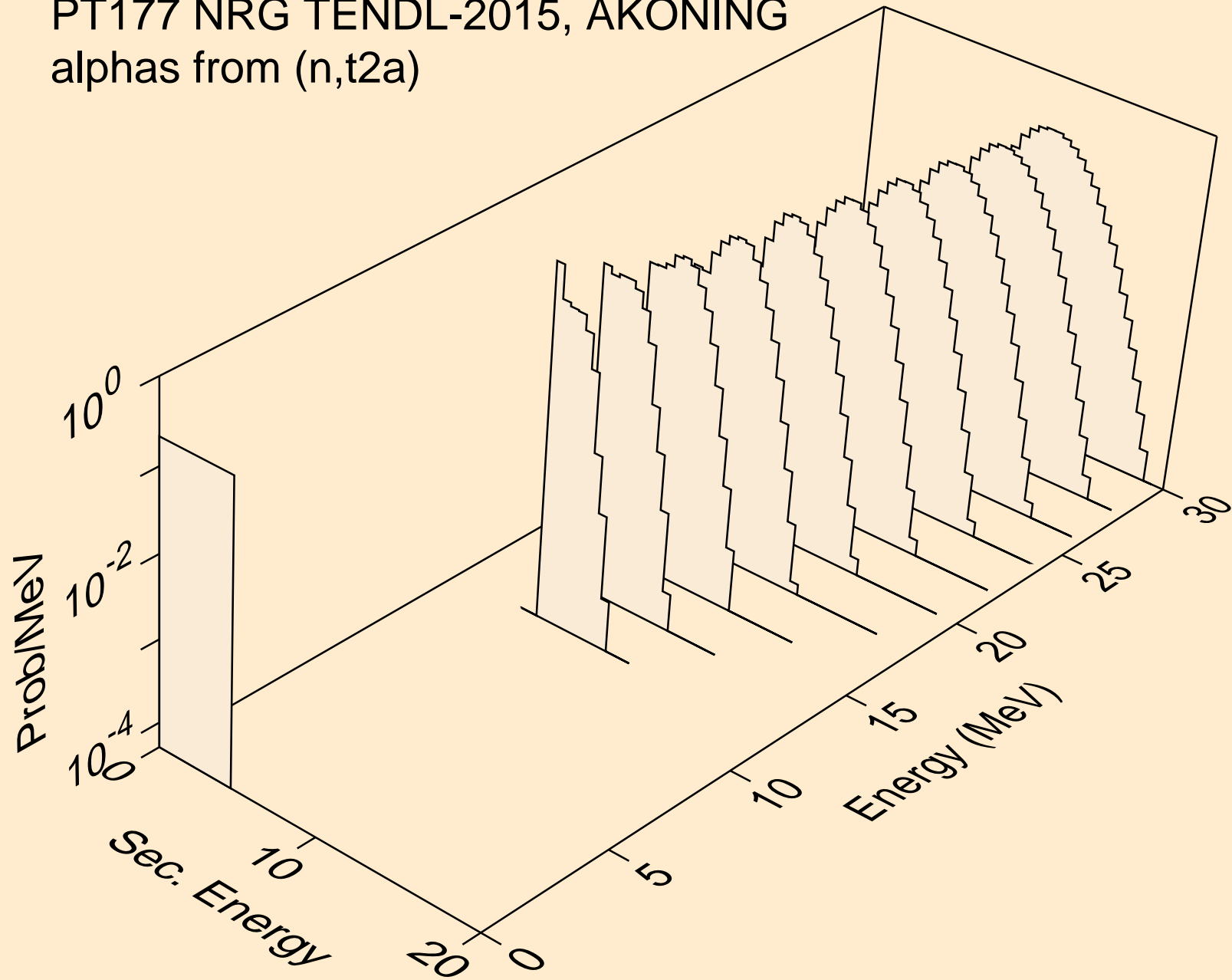

PT177 NRG TENDL-2015, AKONING
alphas from (n,d2a)

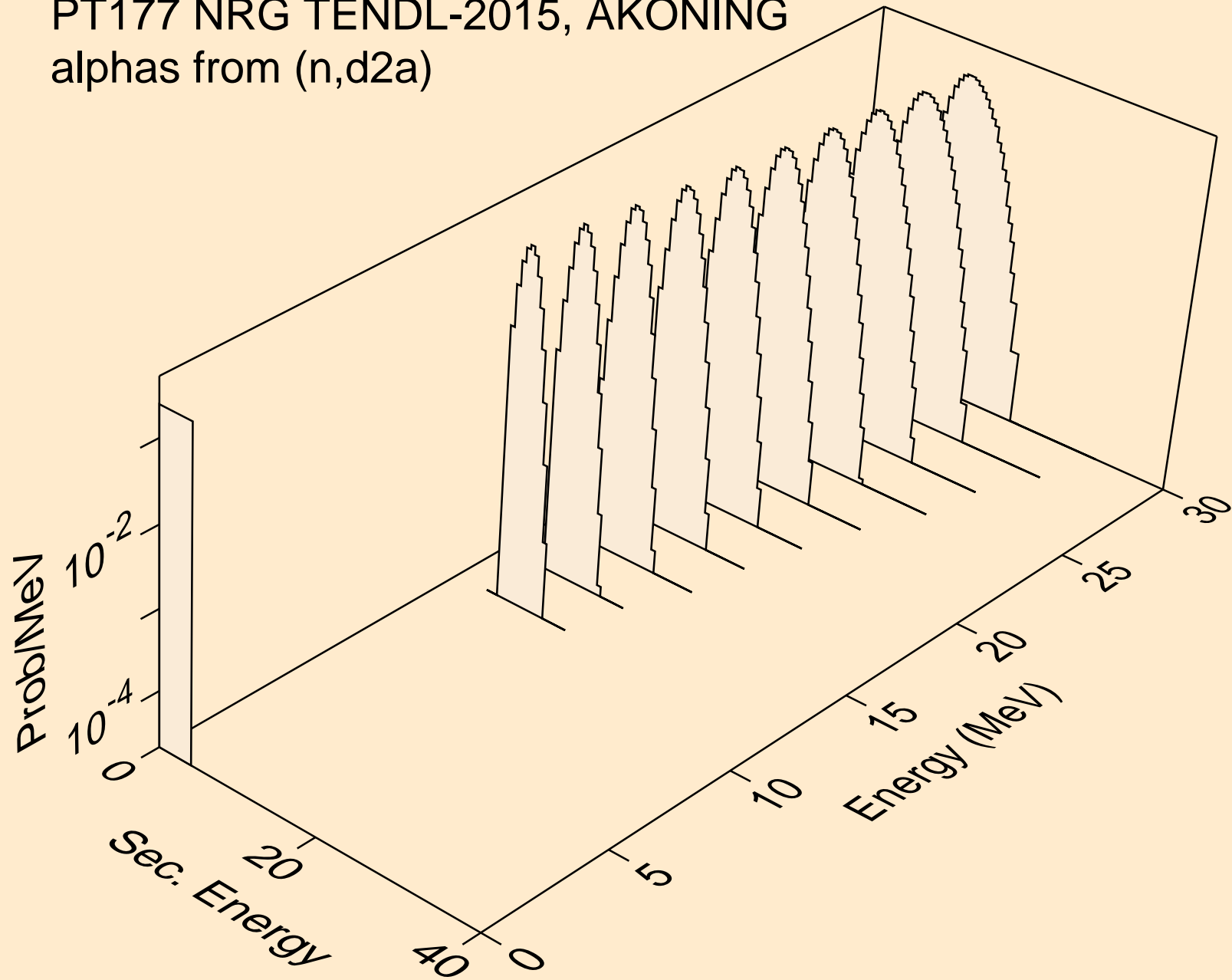

PT177 NRG TENDL-2015, AKONING
alphas from (n,da)

