

PT201 NRG TENDL-2015, AKONING

Principal cross sections

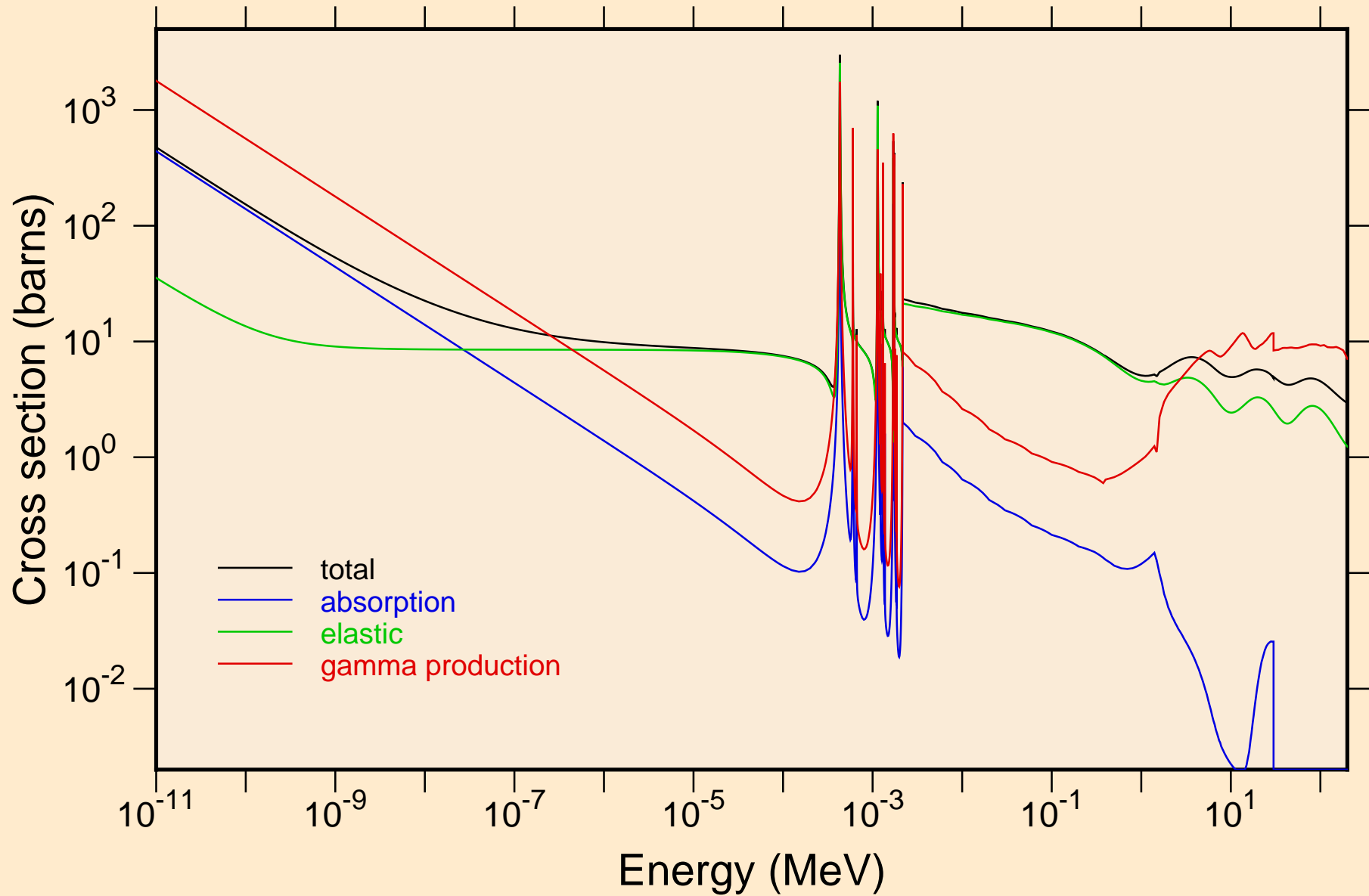

PT201 NRG TENDL-2015, AKONING
Non-threshold reactions

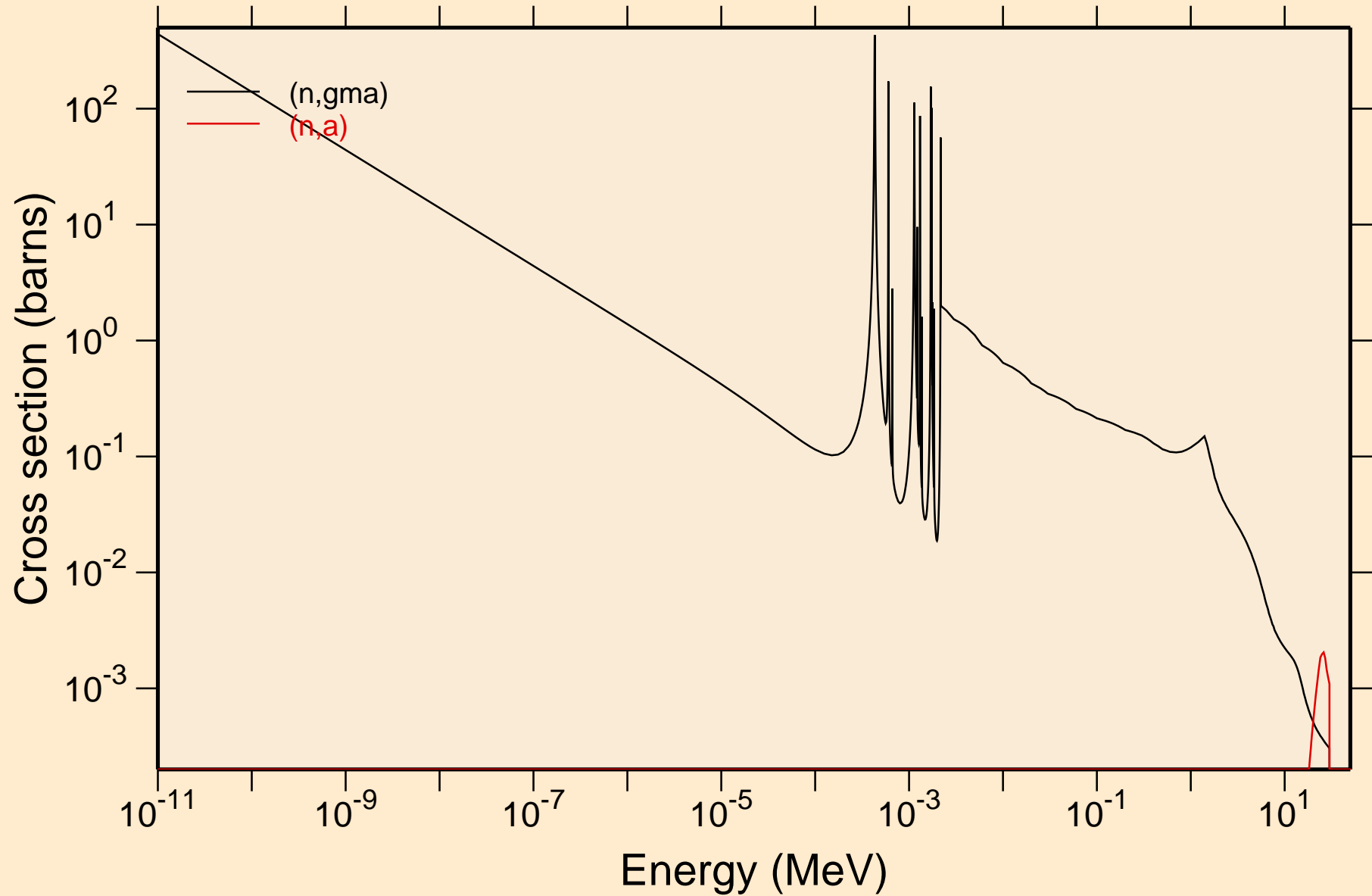

PT201 NRG TENDL-2015, AKONING

Principal cross sections

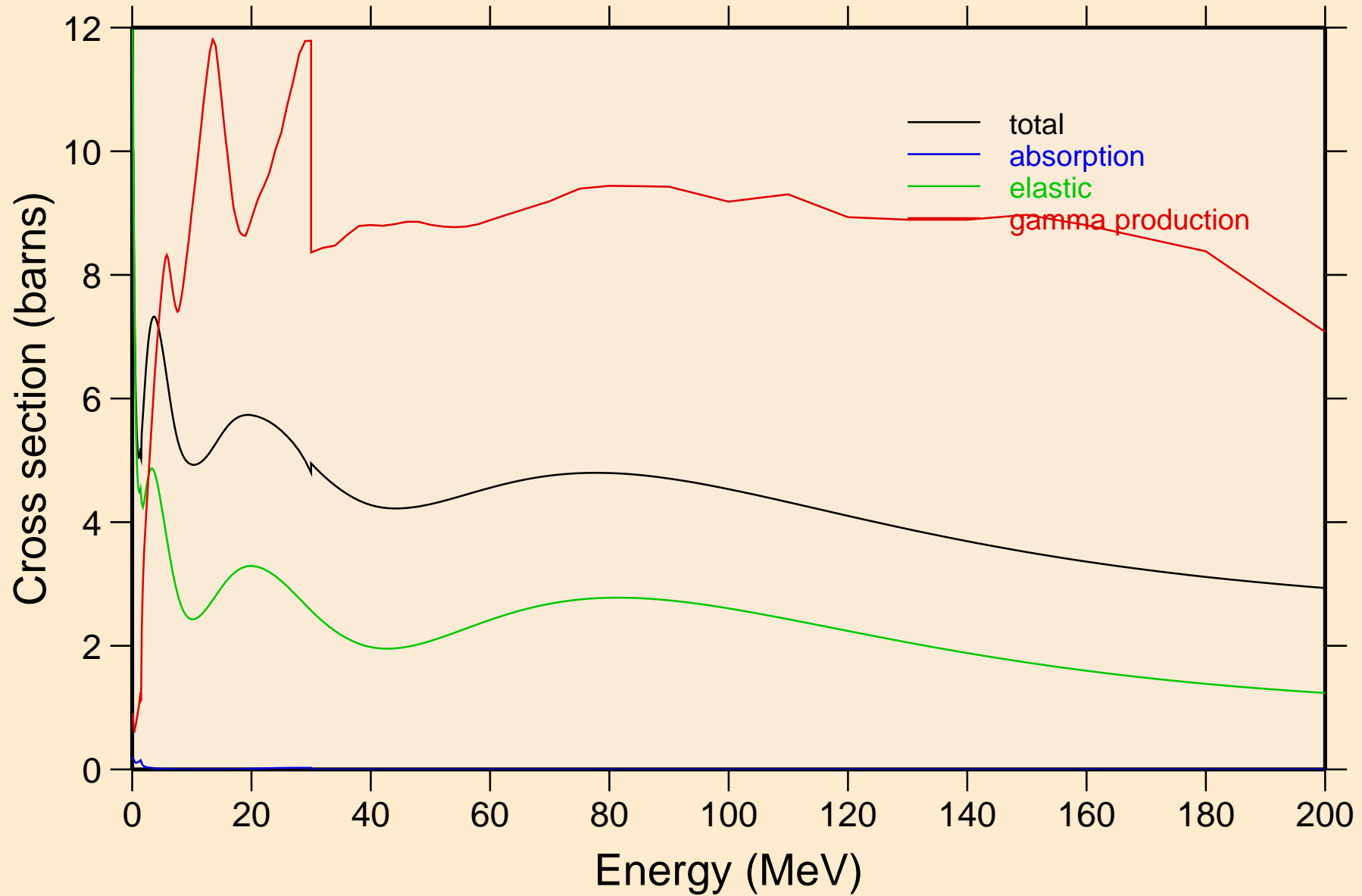

PT201 NRG TENDL-2015, AKONING
Non-threshold reactions

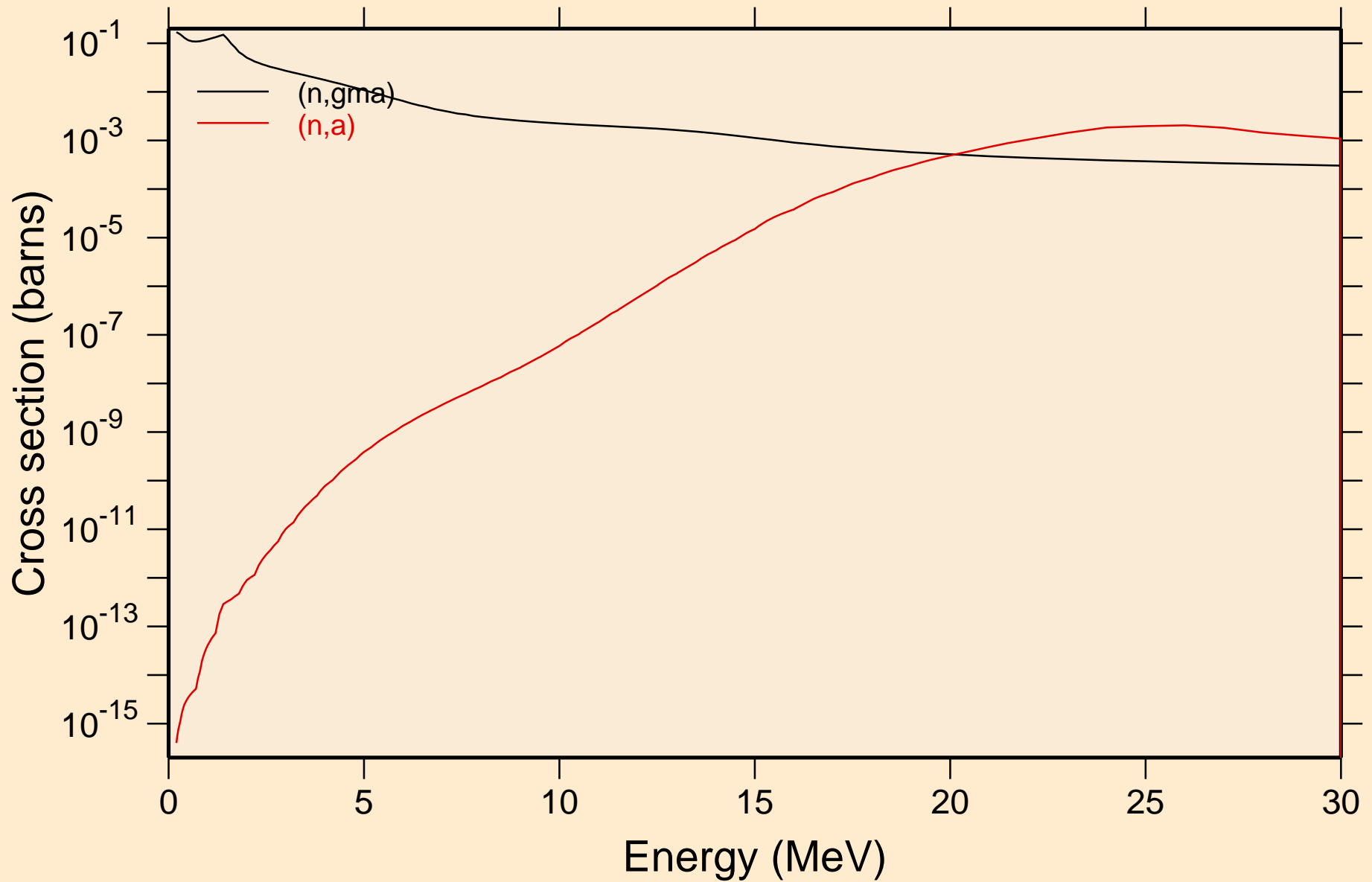

PT201 NRG TENDL-2015, AKONING
Inelastic levels

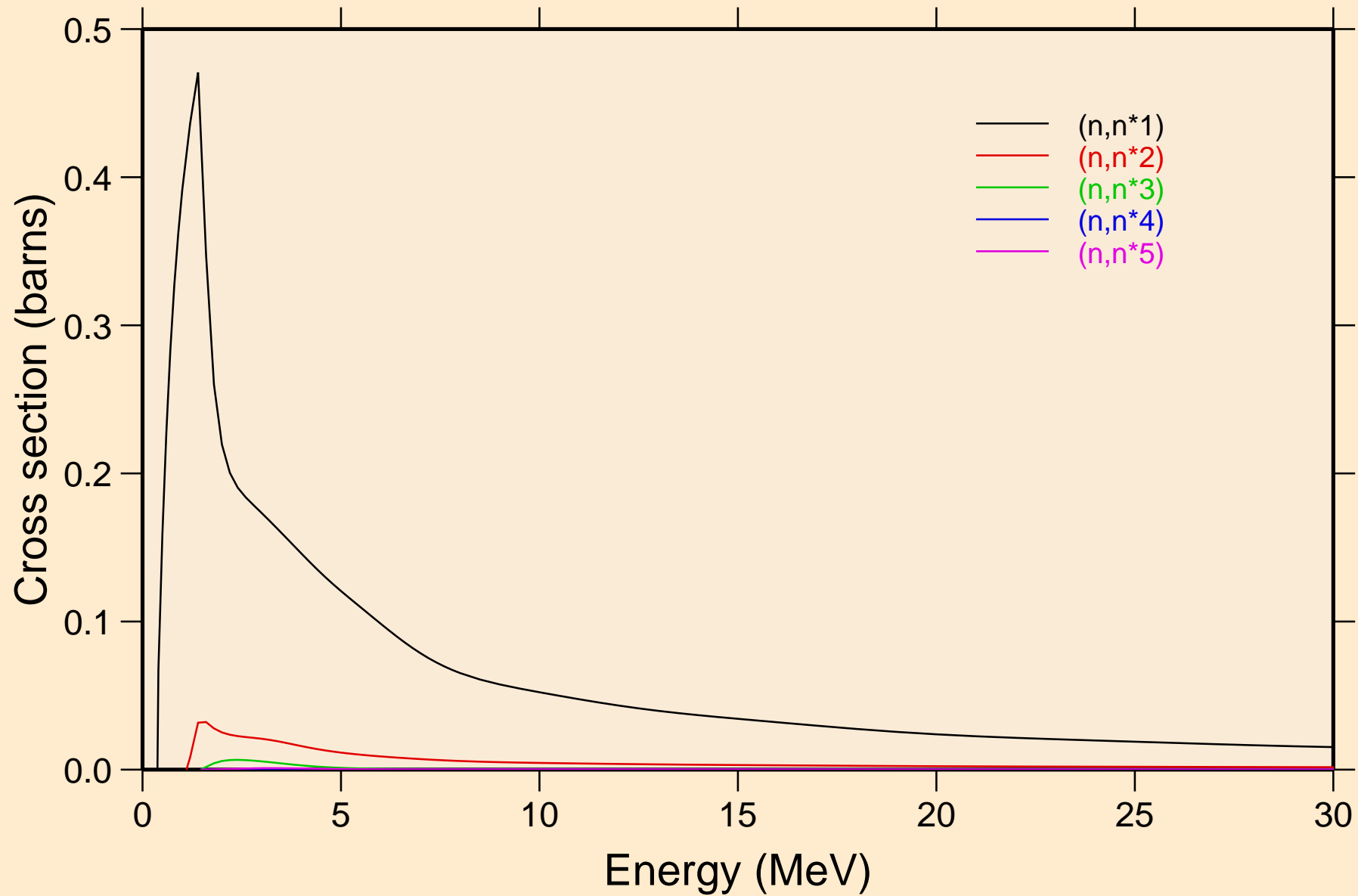

PT201 NRG TENDL-2015, AKONING
Inelastic levels

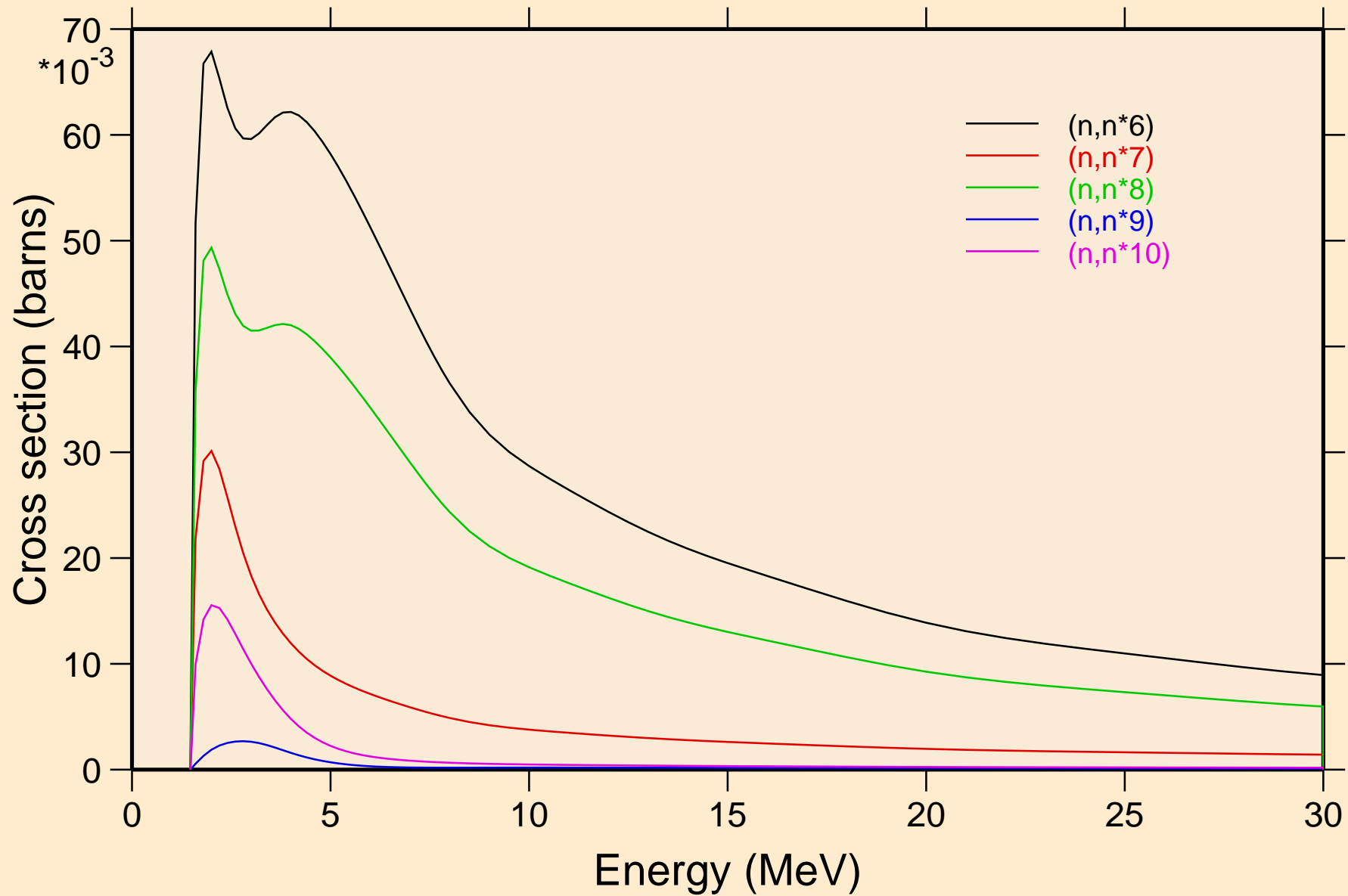

PT201 NRG TENDL-2015, AKONING

Inelastic levels

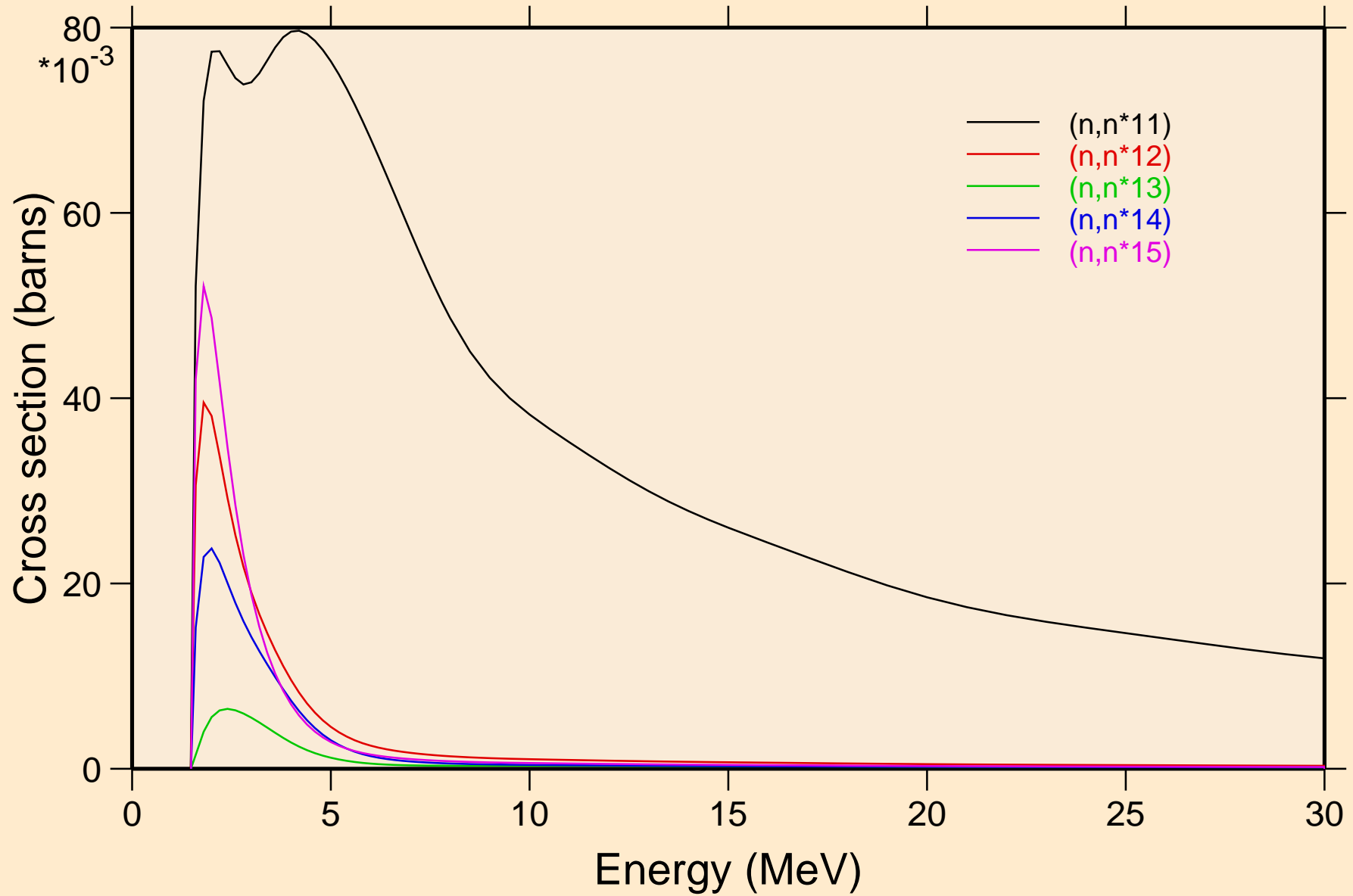

PT201 NRG TENDL-2015, AKONING
Inelastic levels

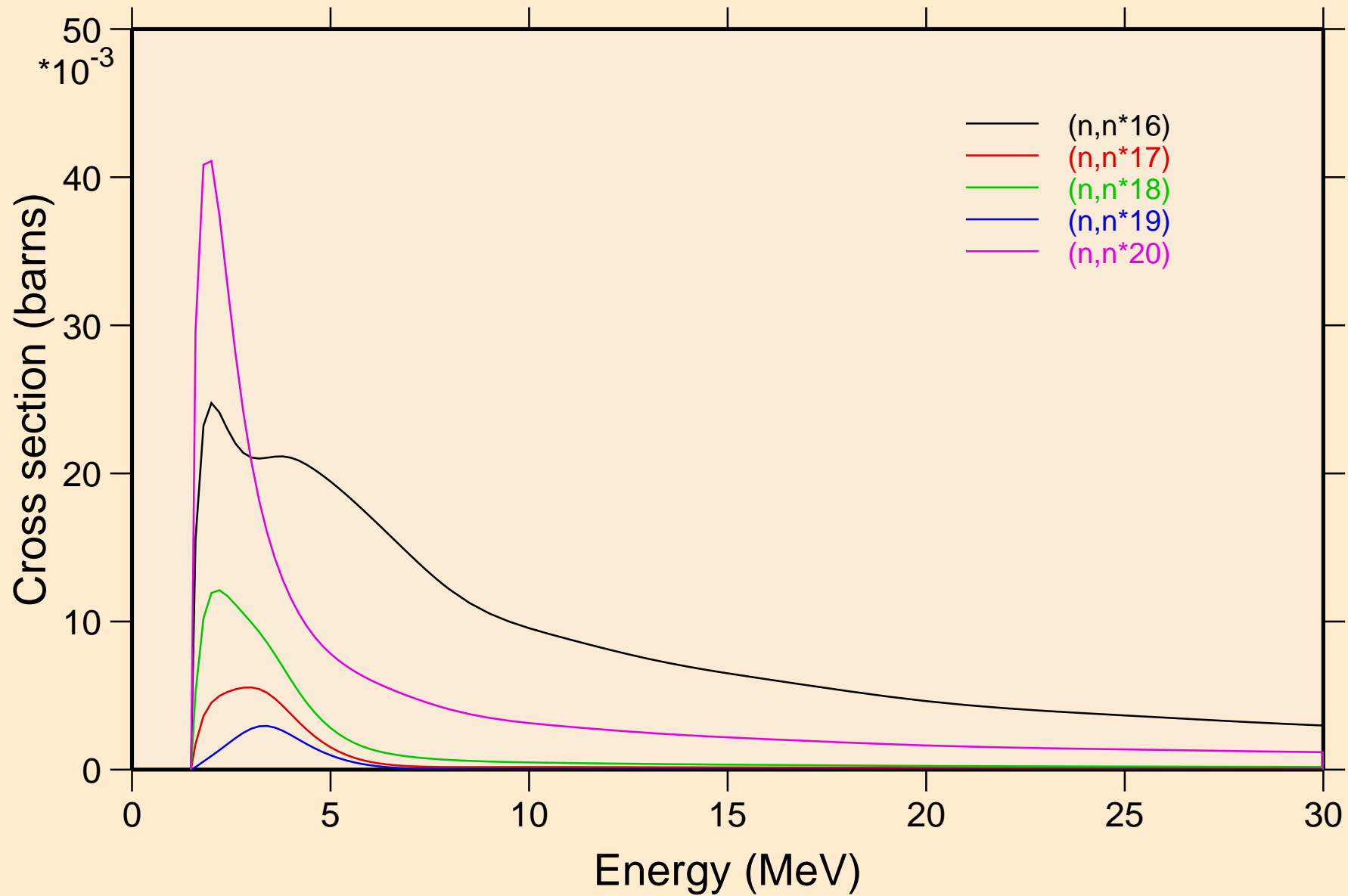

PT201 NRG TENDL-2015, AKONING
Inelastic levels

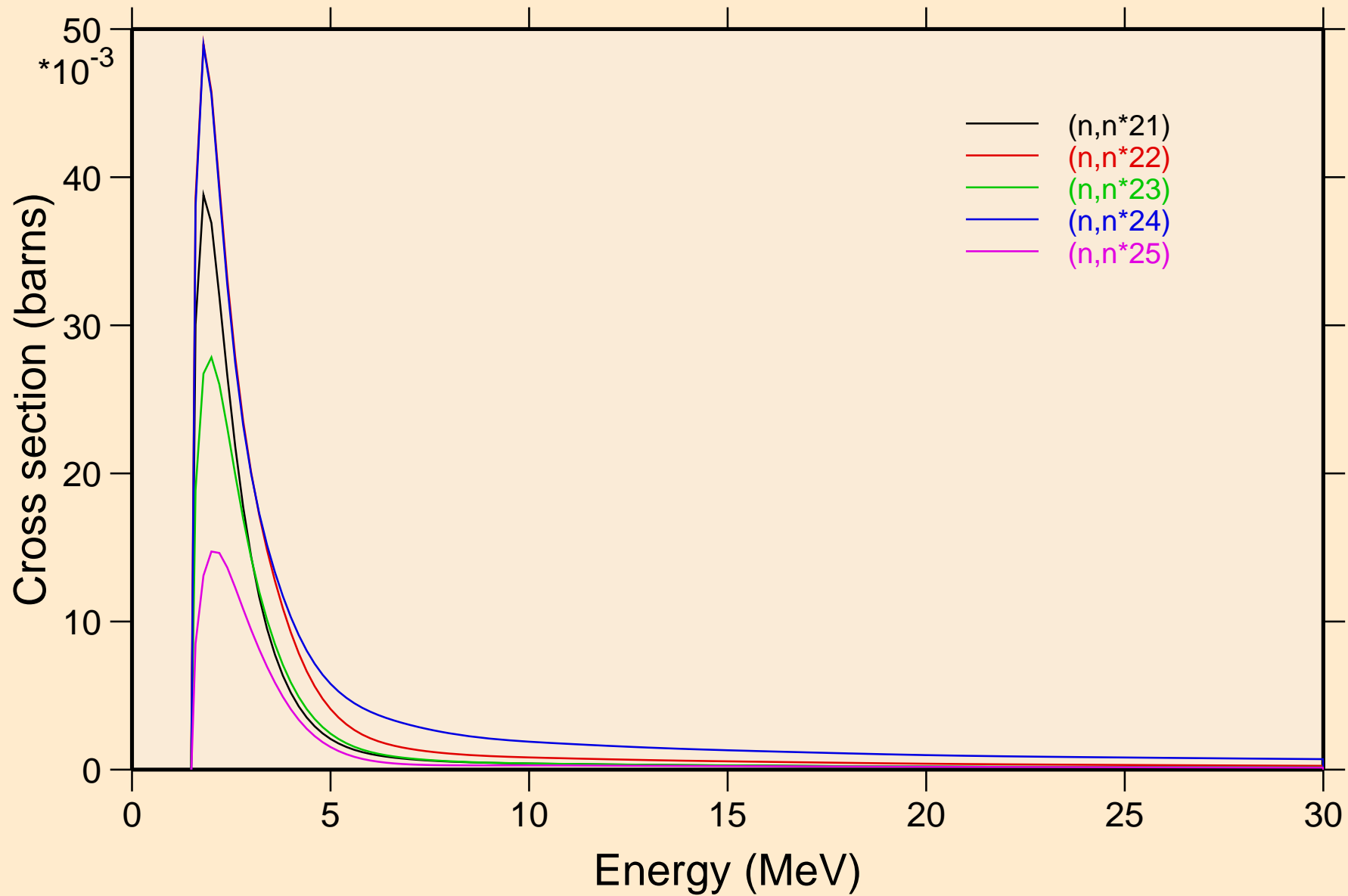

PT201 NRG TENDL-2015, AKONING
Inelastic levels

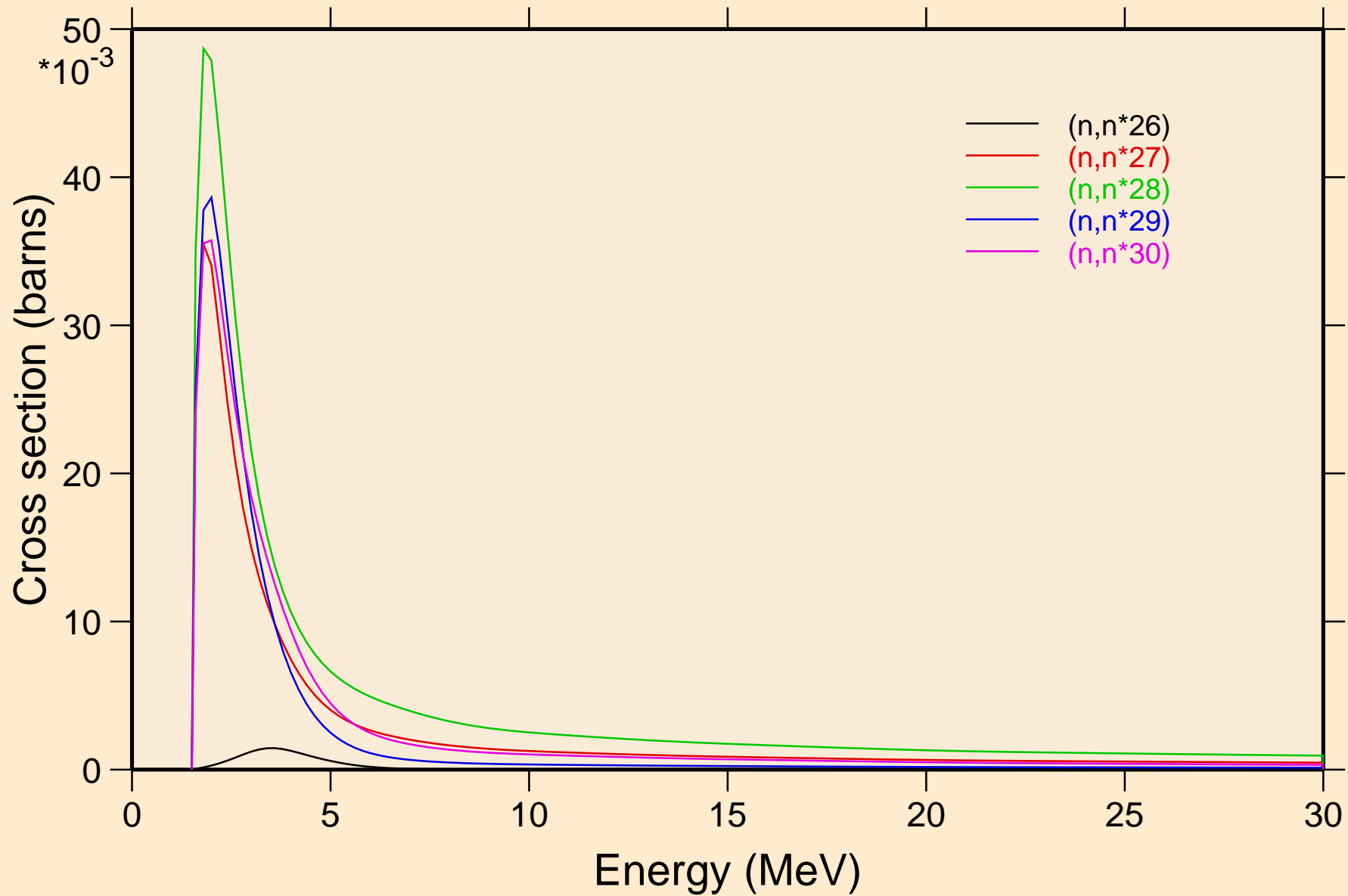

PT201 NRG TENDL-2015, AKONING

Threshold reactions

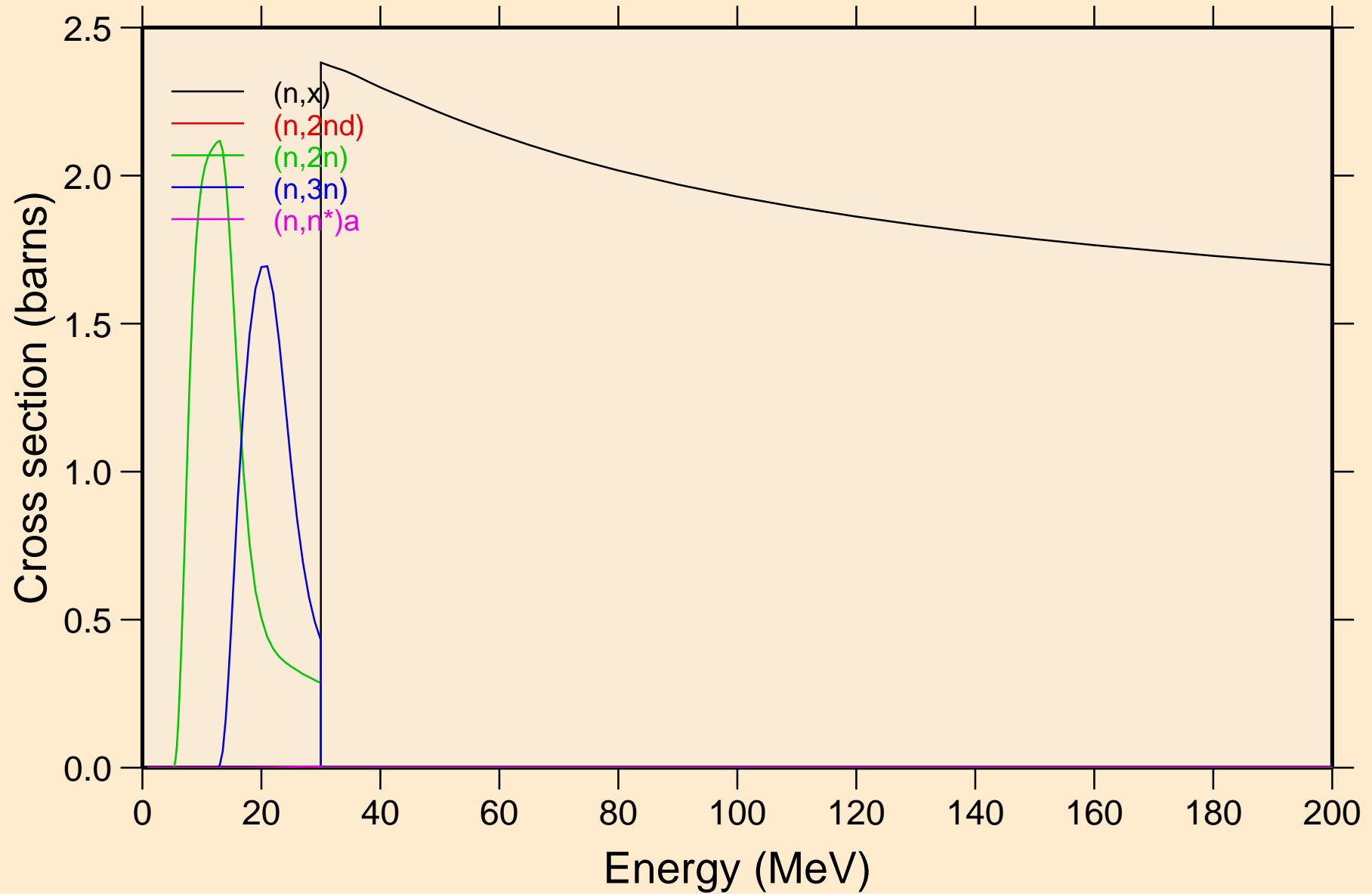

PT201 NRG TENDL-2015, AKONING

Threshold reactions

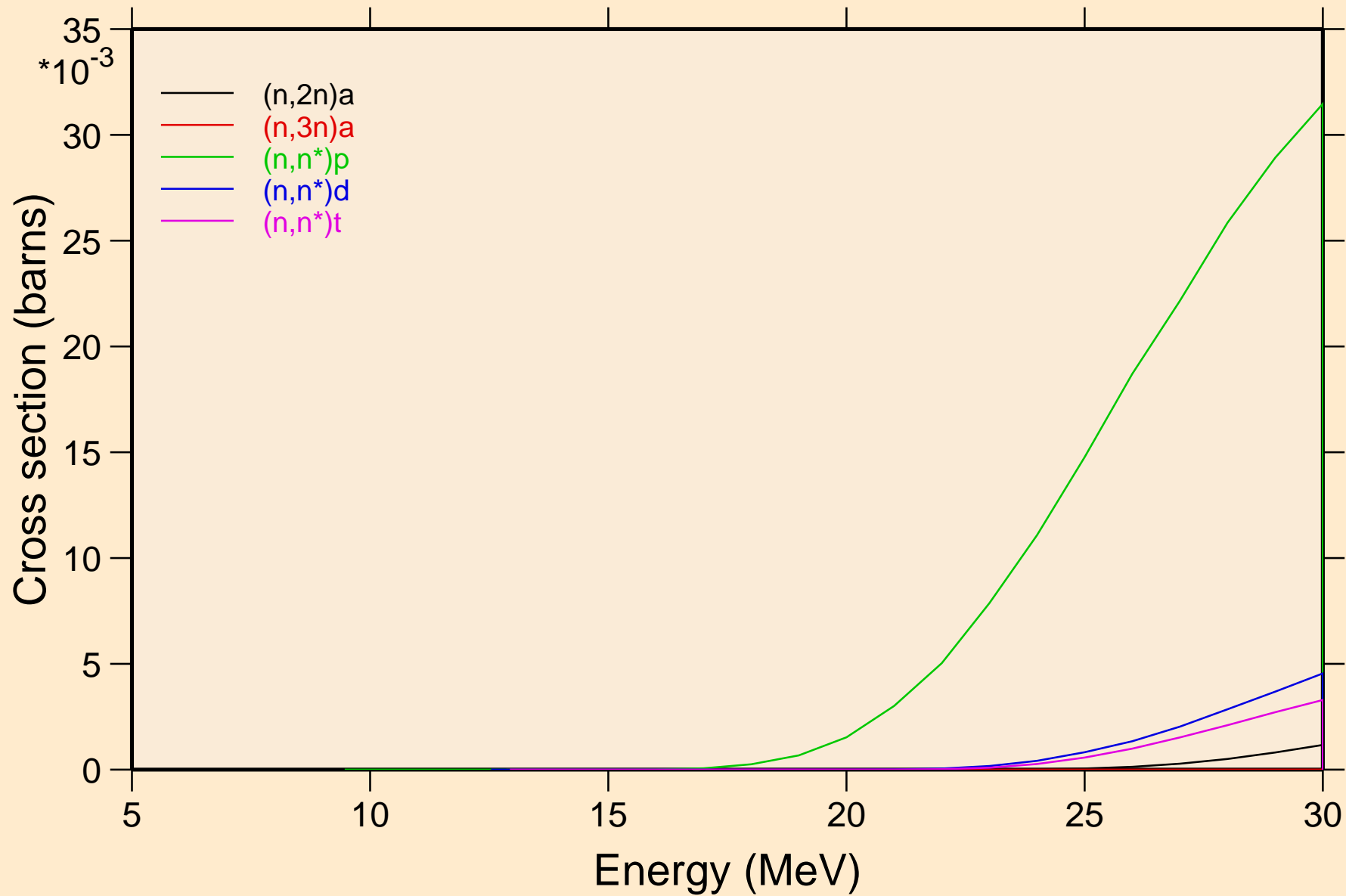

PT201 NRG TENDL-2015, AKONING

Threshold reactions

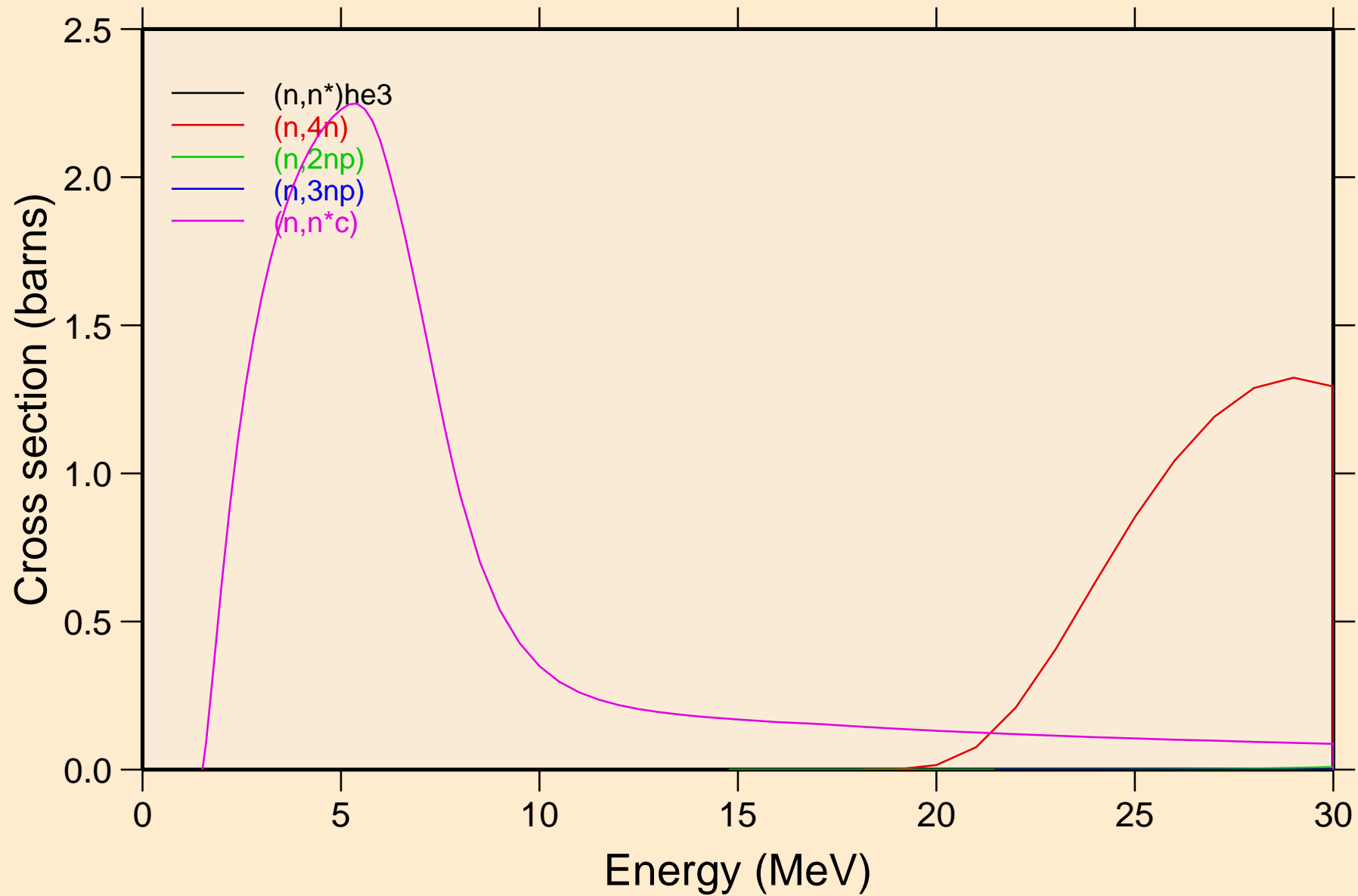

PT201 NRG TENDL-2015, AKONING

Threshold reactions

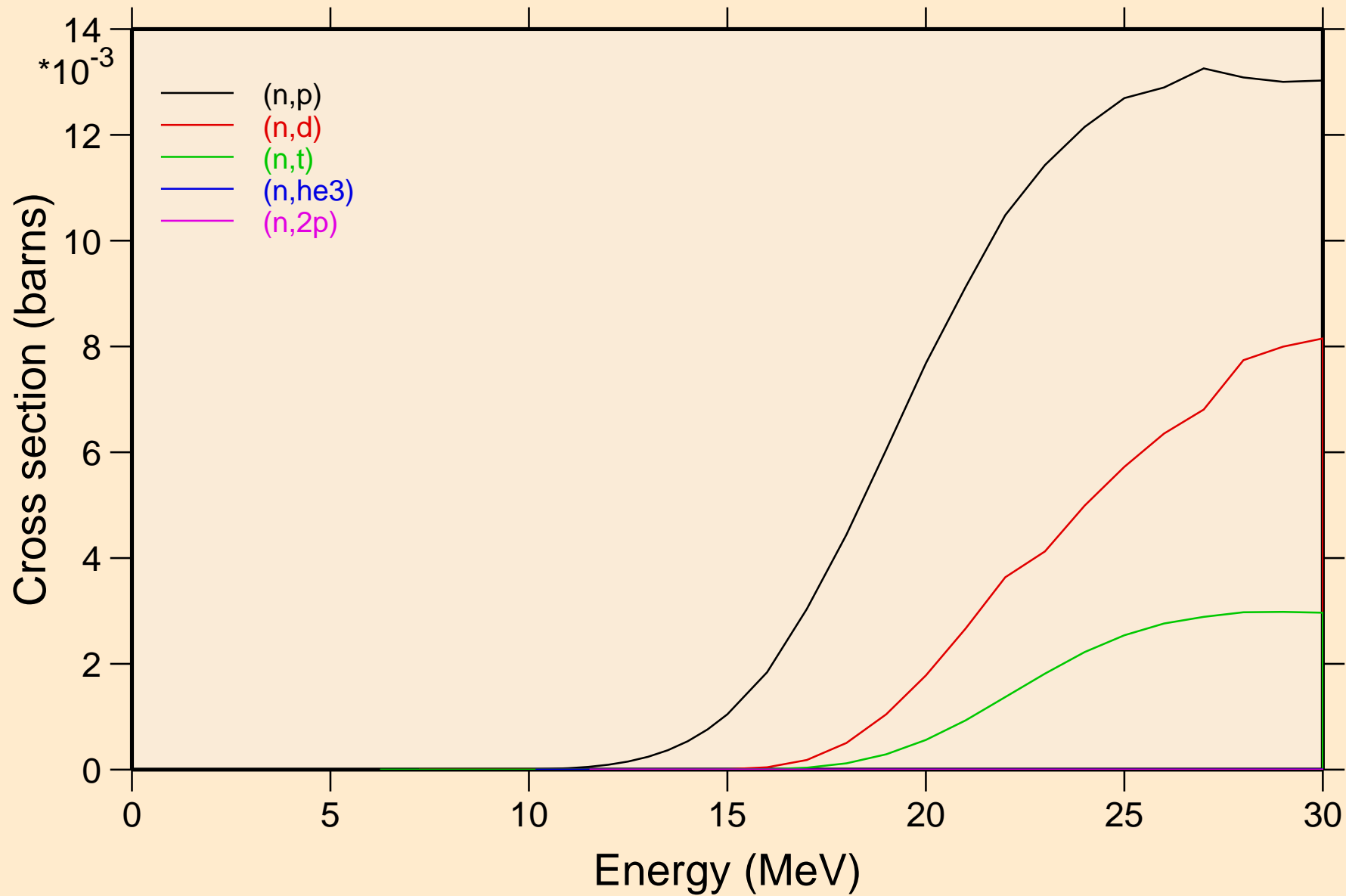

PT201 NRG TENDL-2015, AKONING
angular distribution for elastic

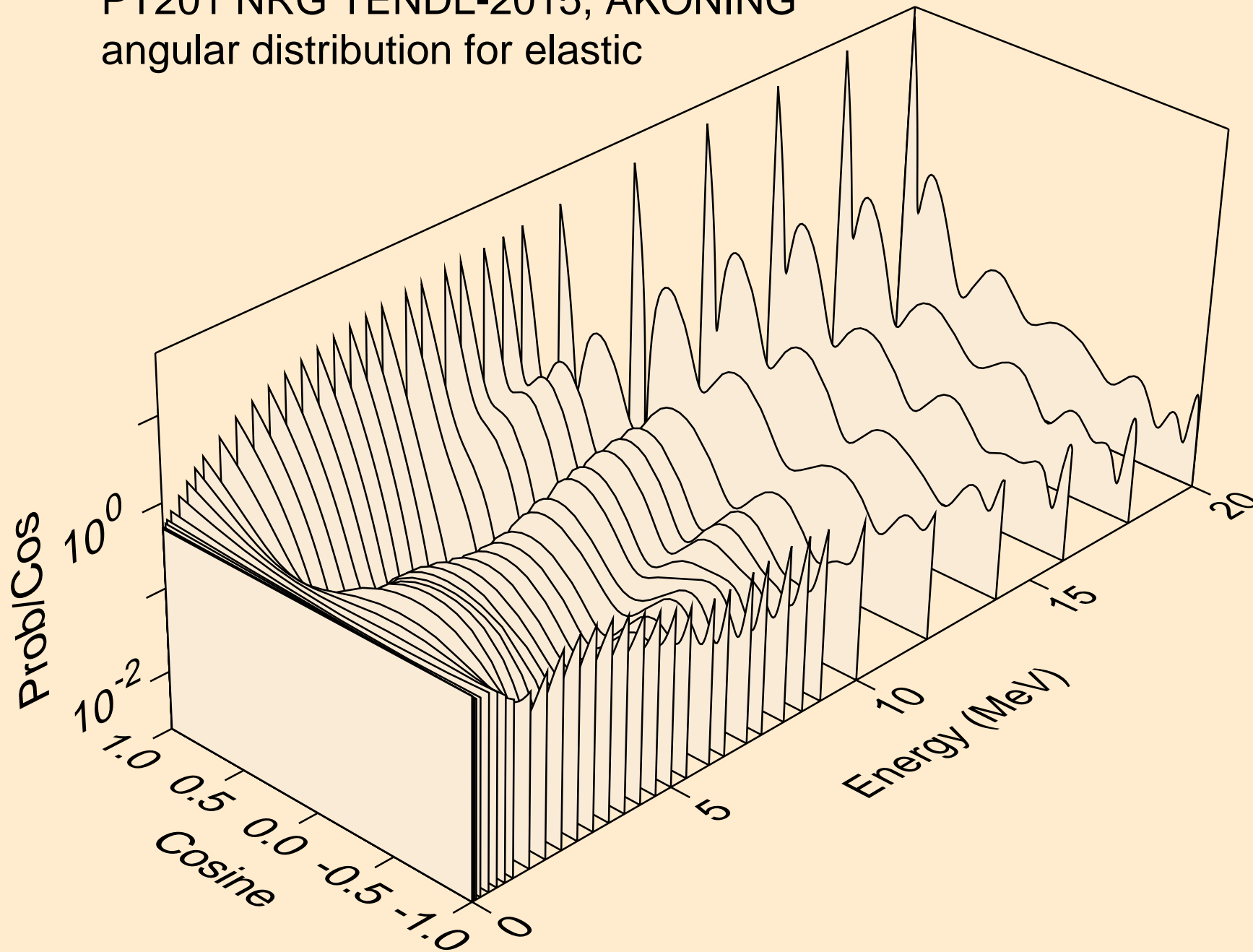

PT201 NRG TENDL-2015, AKONING
angular distribution for elastic

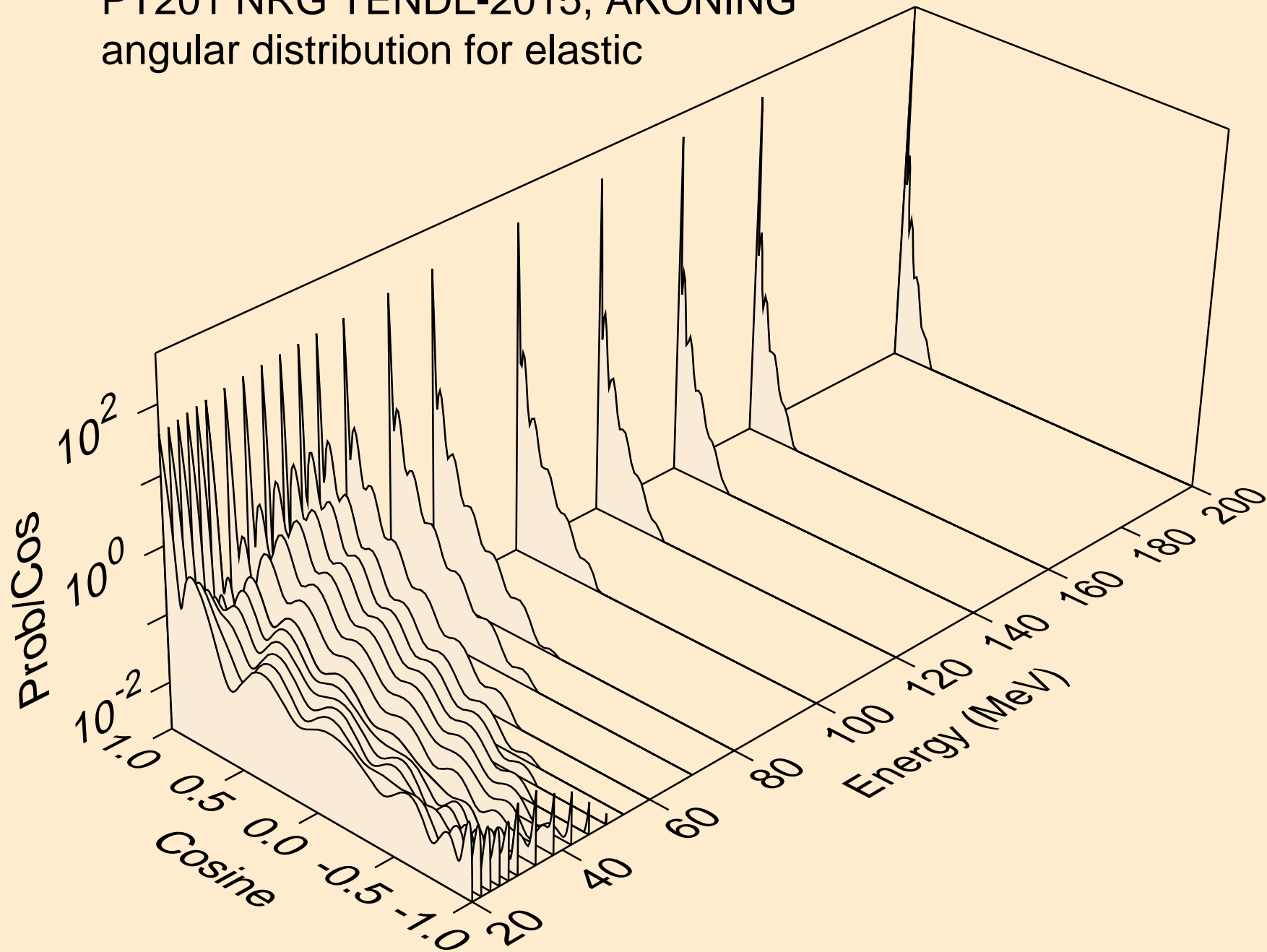

PT201 NRG TENDL-2015, AKONING
angular distribution for (n,n*1)

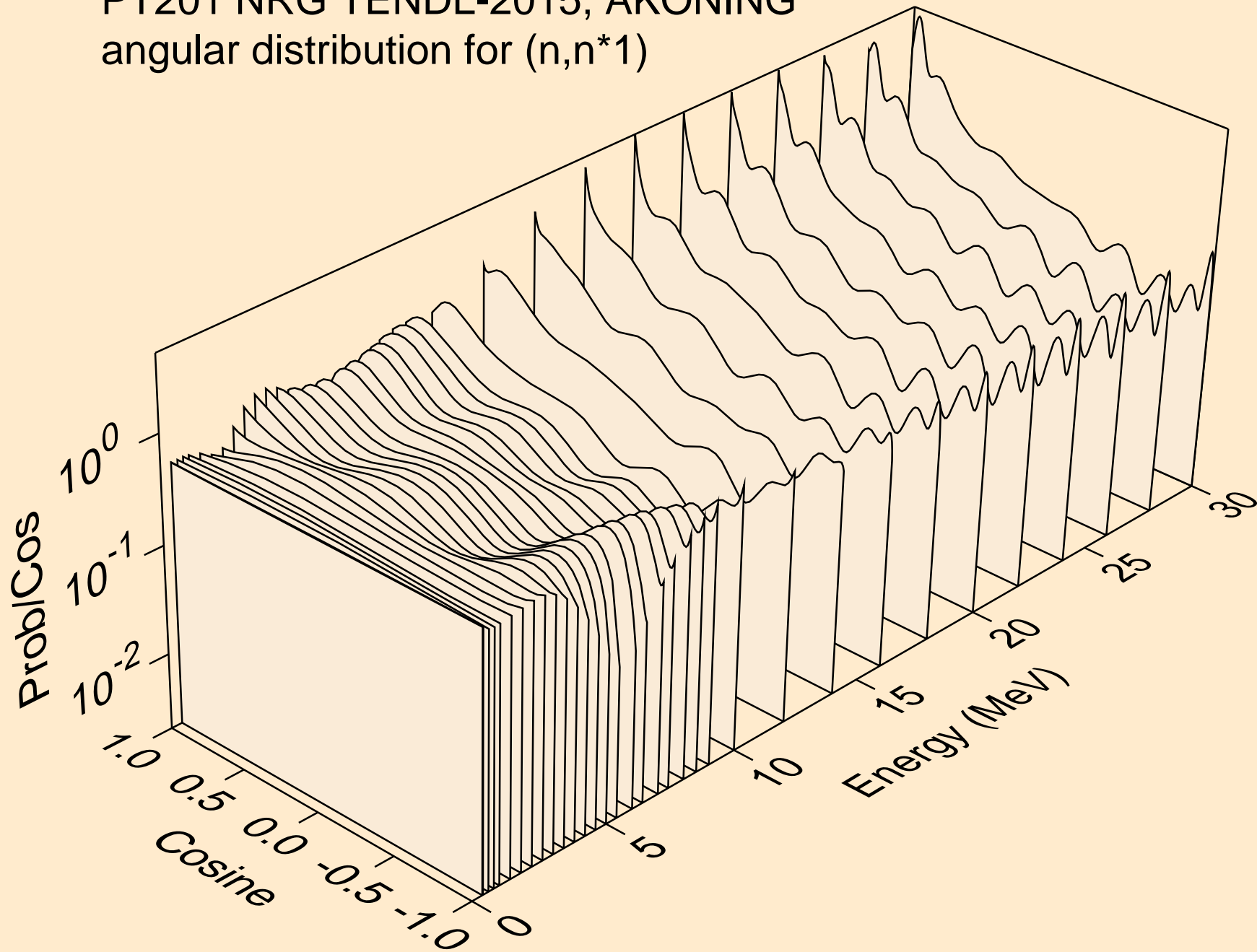

PT201 NRG TENDL-2015, AKONING
angular distribution for (n,n*2)

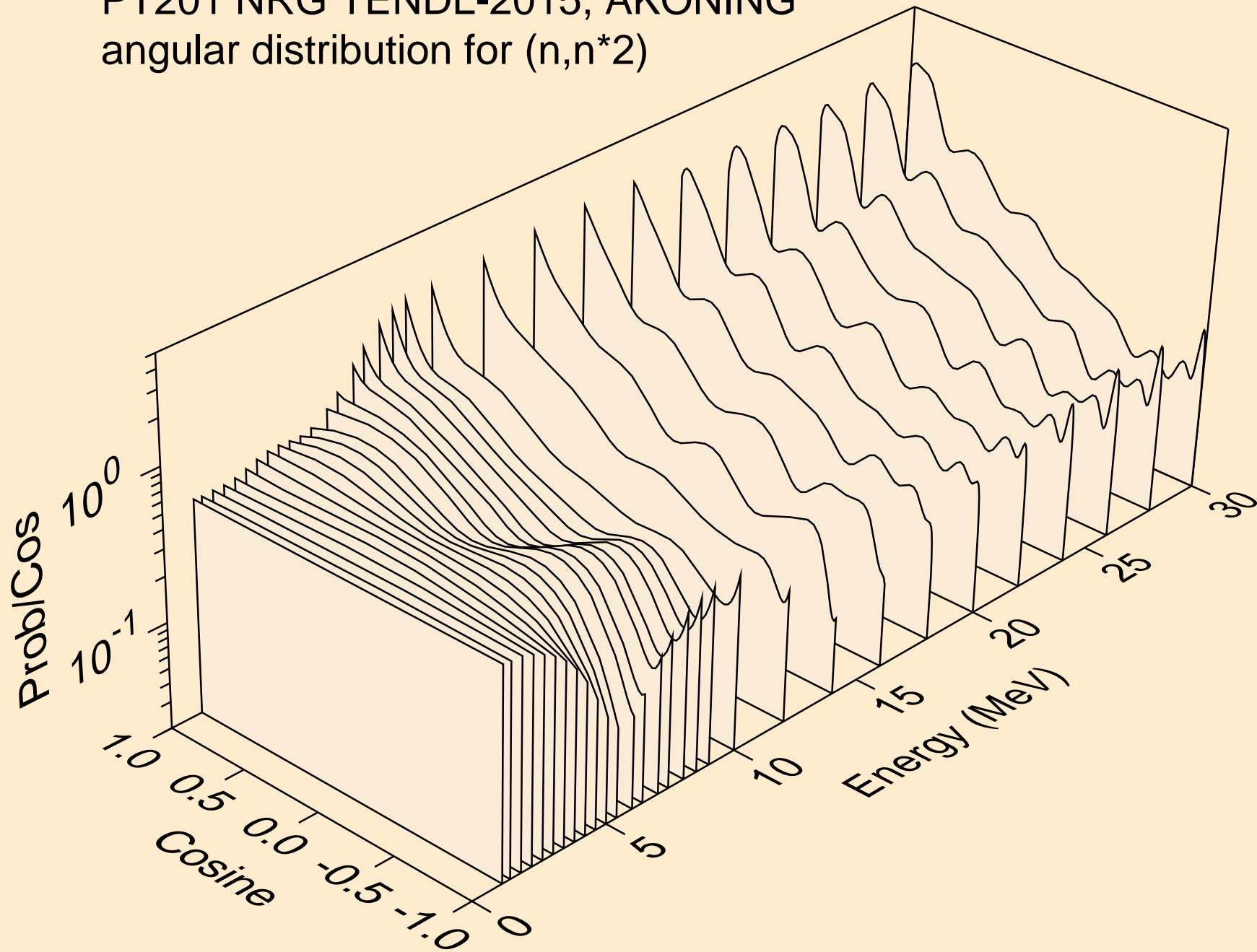

PT201 NRG TENDL-2015, AKONING
angular distribution for (n,n*3)

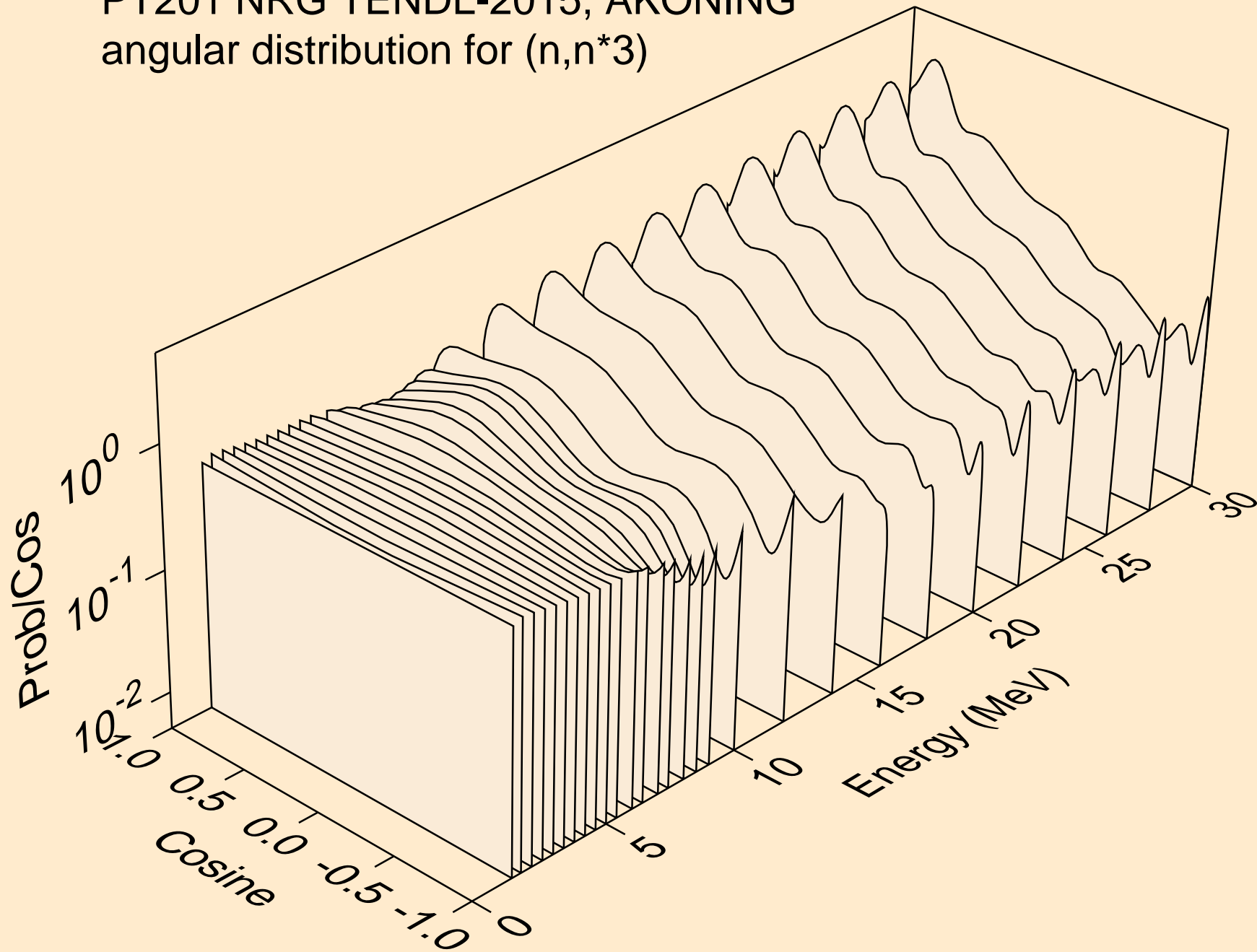

PT201 NRG TENDL-2015, AKONING
angular distribution for (n,n*4)

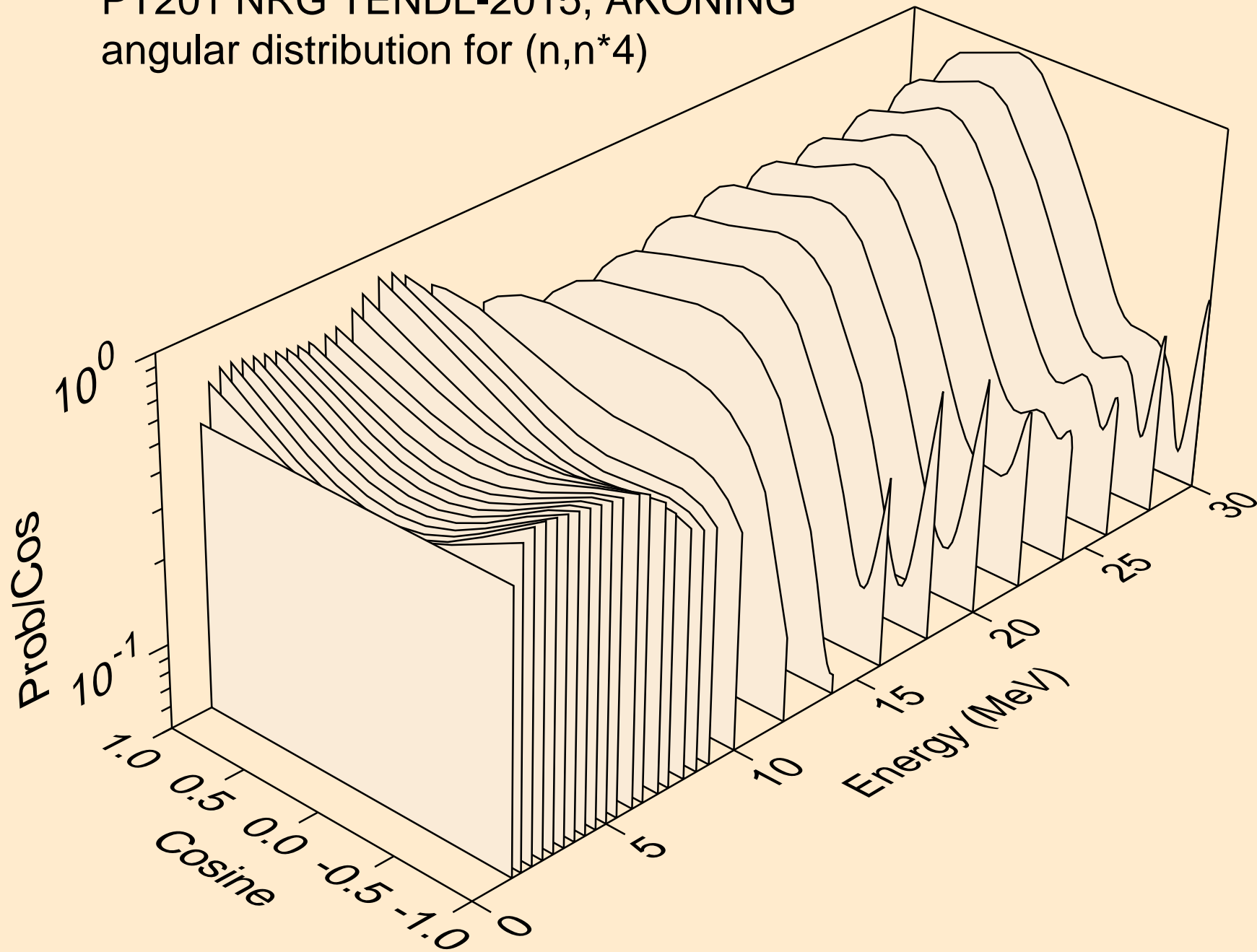

PT201 NRG TENDL-2015, AKONING
angular distribution for (n,n*5)

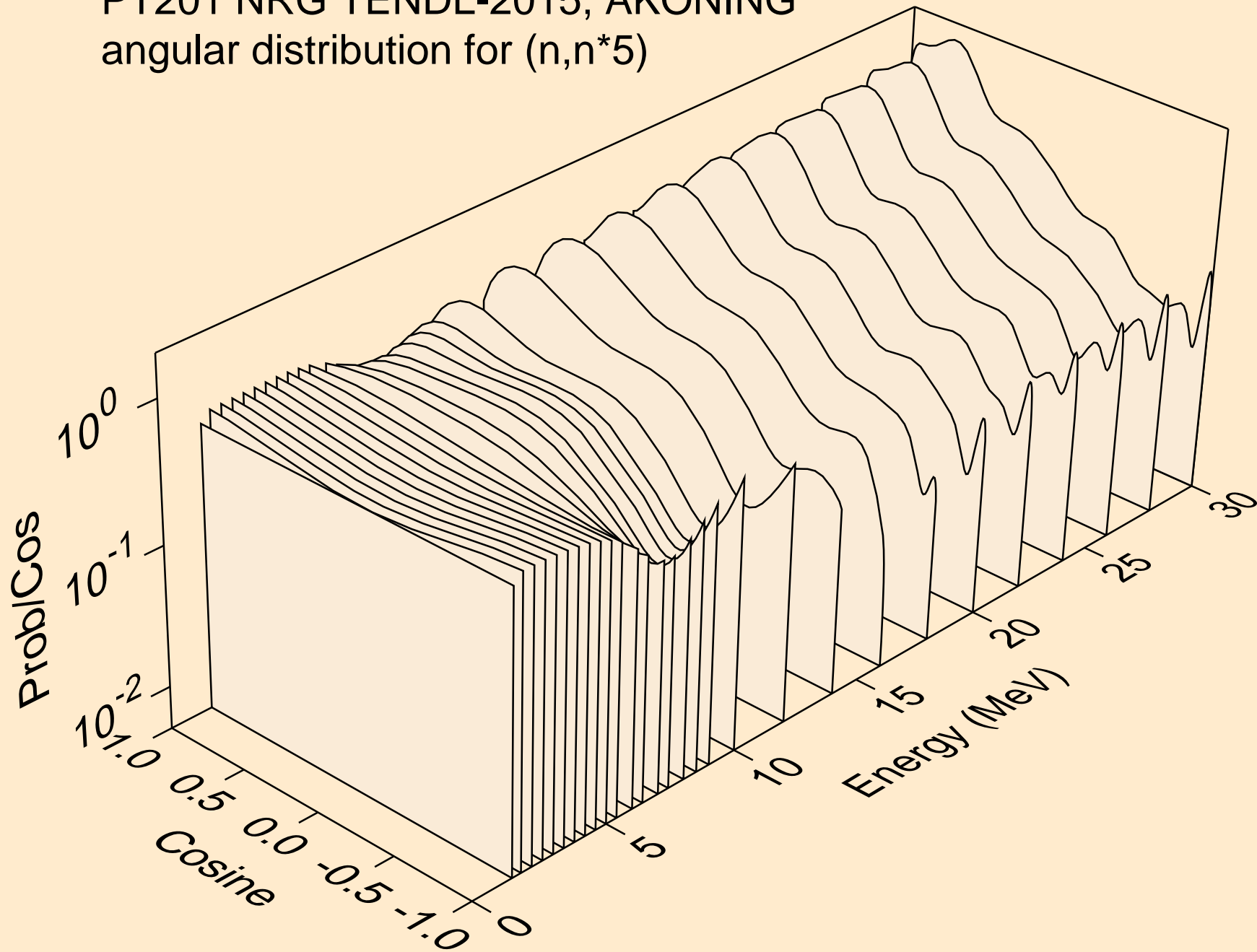

PT201 NRG TENDL-2015, AKONING
angular distribution for (n,n*6)

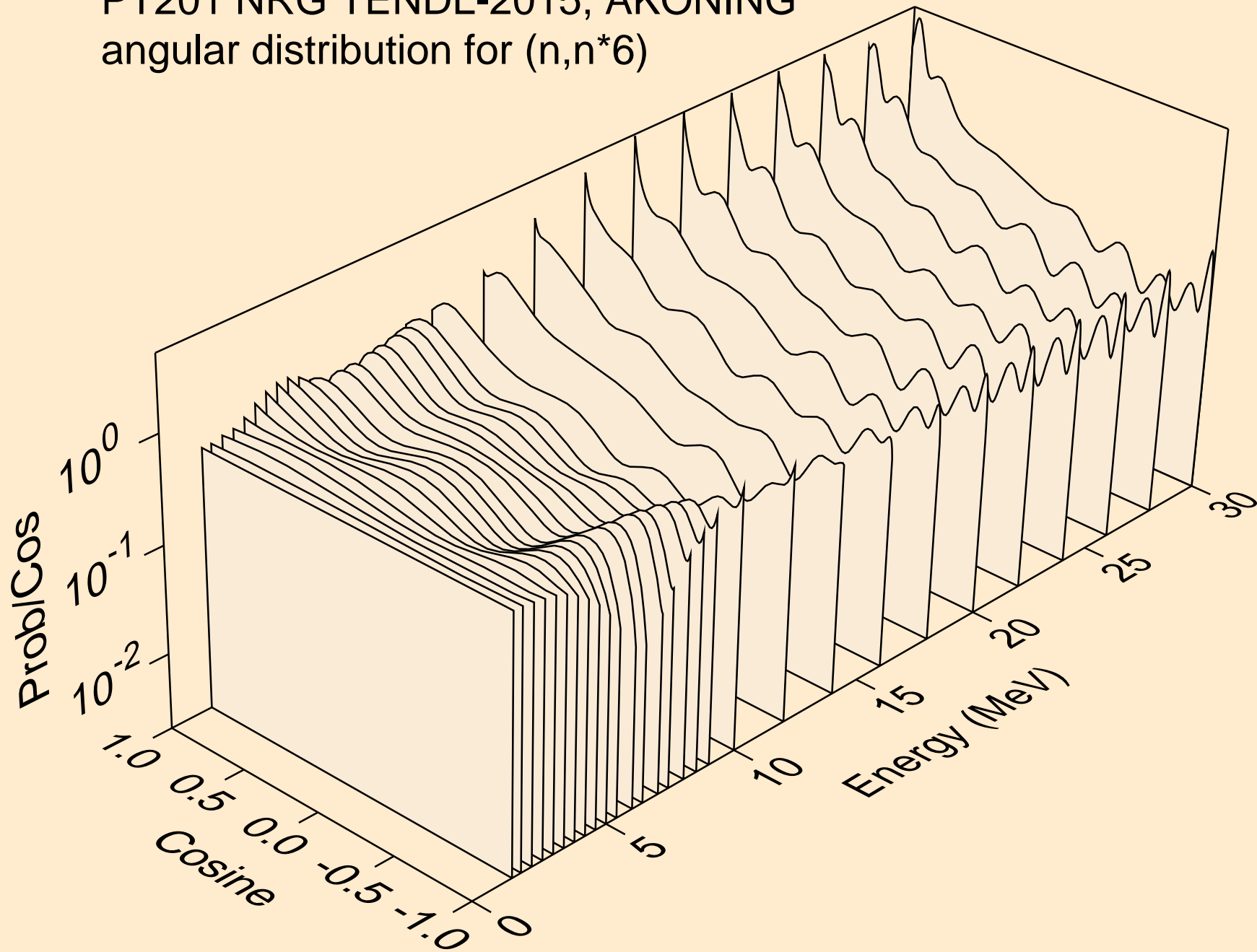

PT201 NRG TENDL-2015, AKONING
angular distribution for (n,n*7)

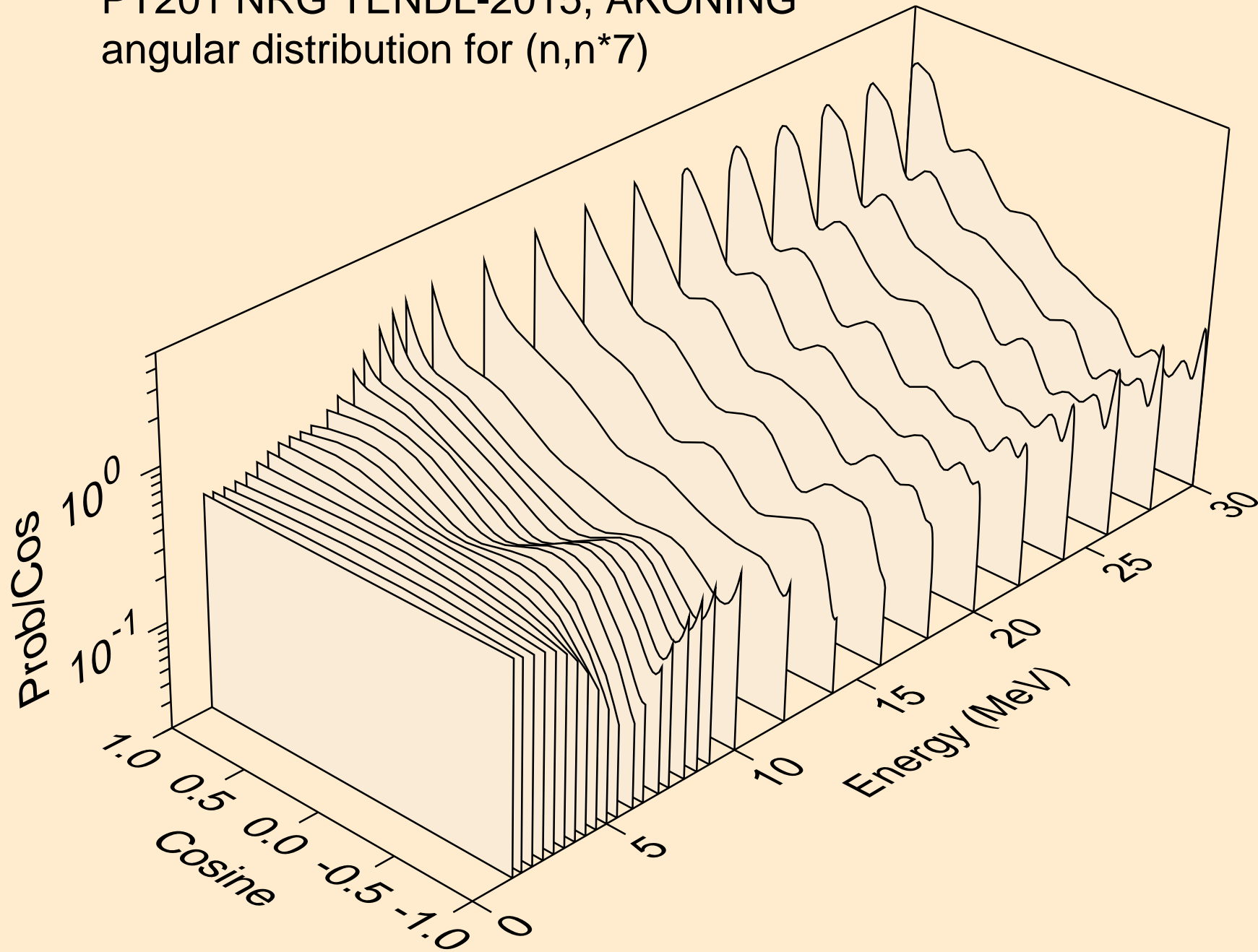

PT201 NRG TENDL-2015, AKONING
angular distribution for (n,n*8)

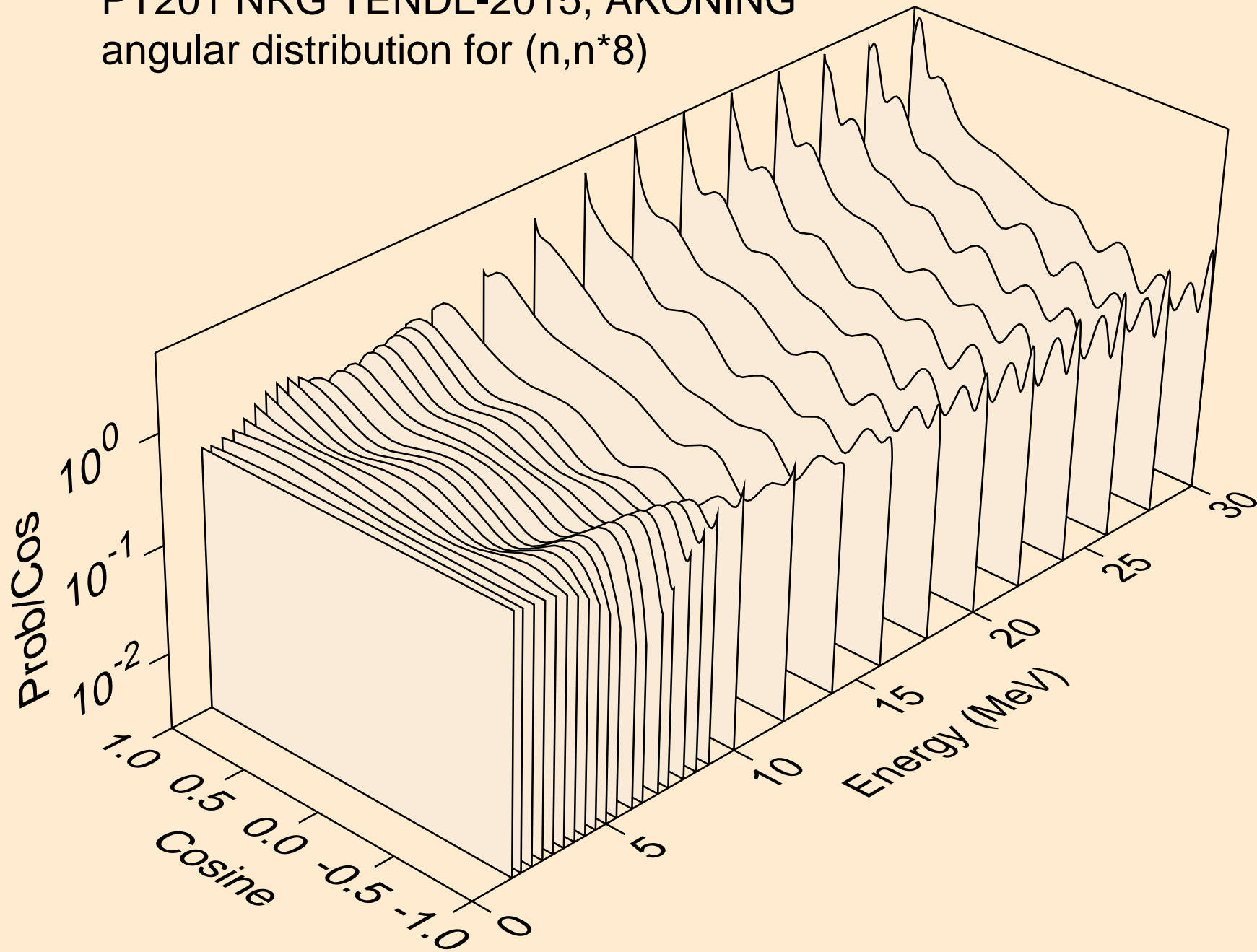

PT201 NRG TENDL-2015, AKONING
angular distribution for (n,n*9)

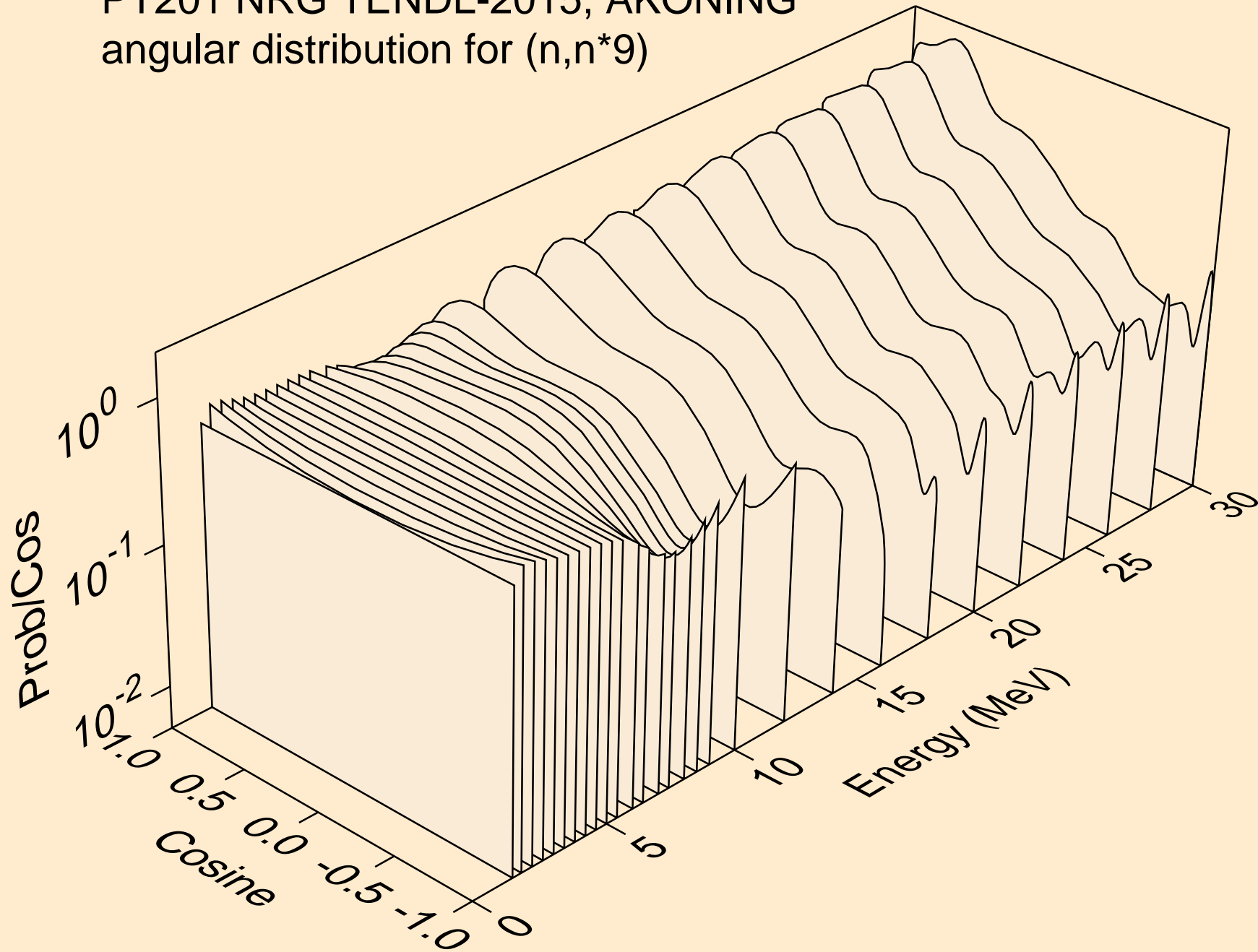

PT201 NRG TENDL-2015, AKONING
angular distribution for (n,n*10)

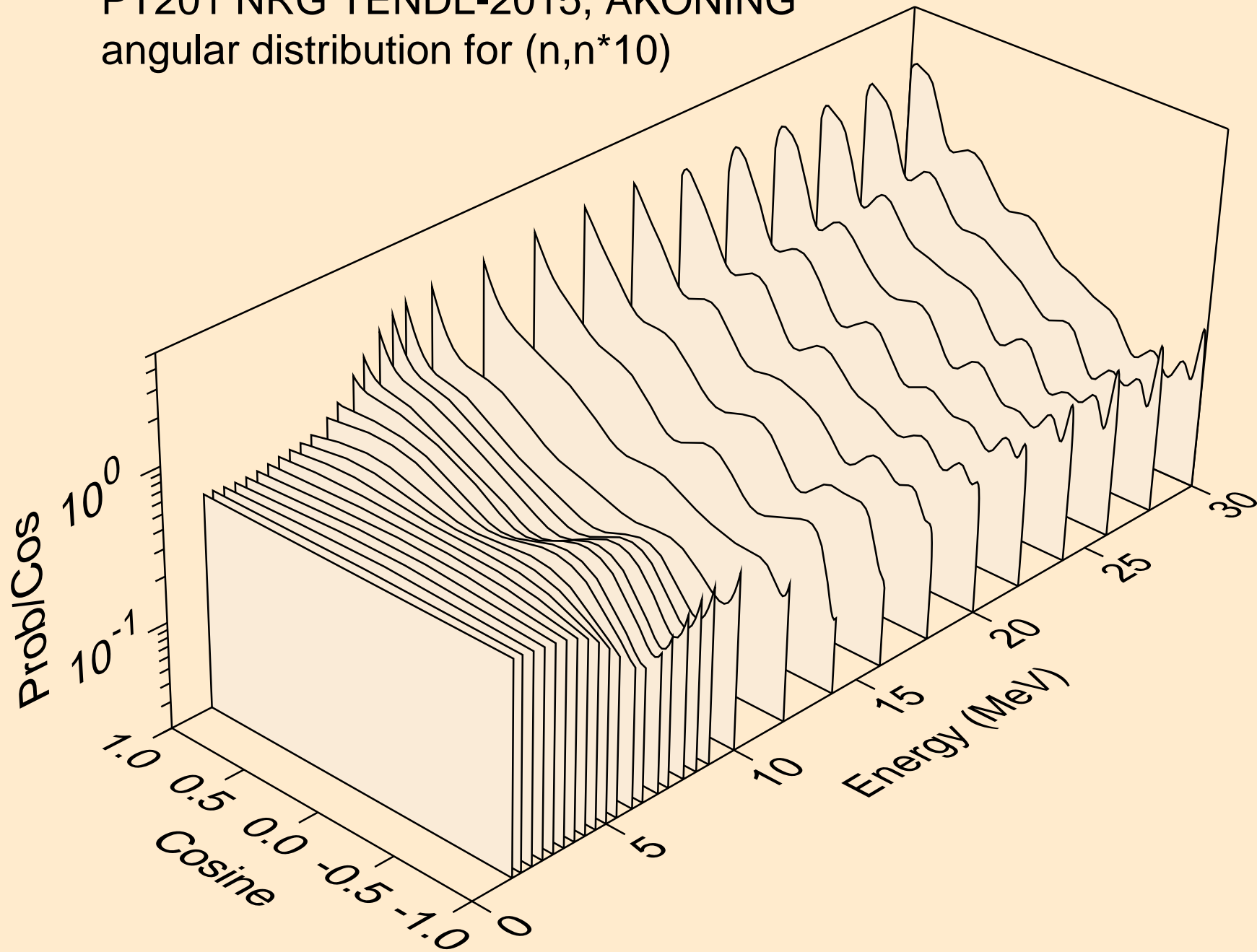

PT201 NRG TENDL-2015, AKONING
angular distribution for (n,n*11)

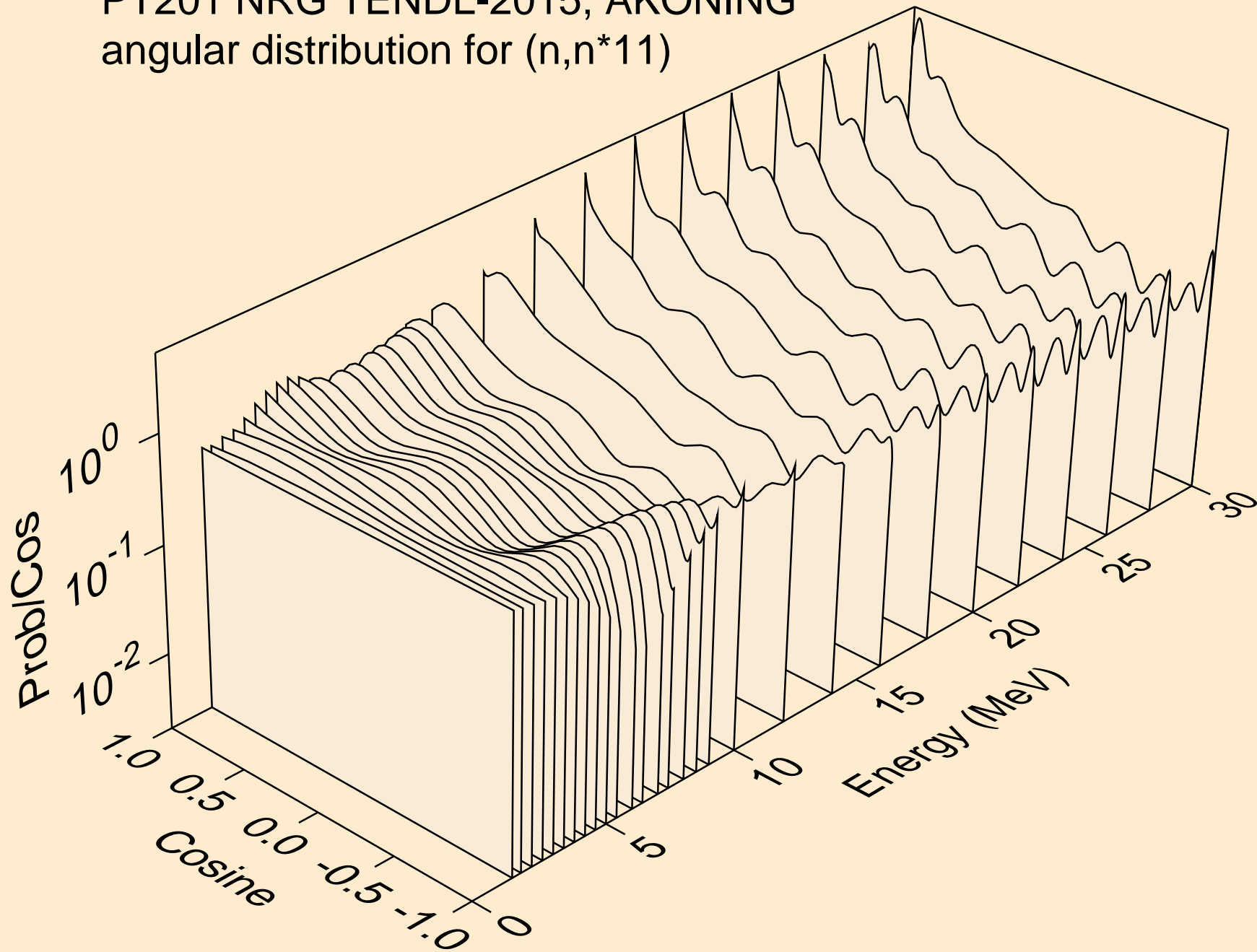

PT201 NRG TENDL-2015, AKONING
angular distribution for (n,n*12)

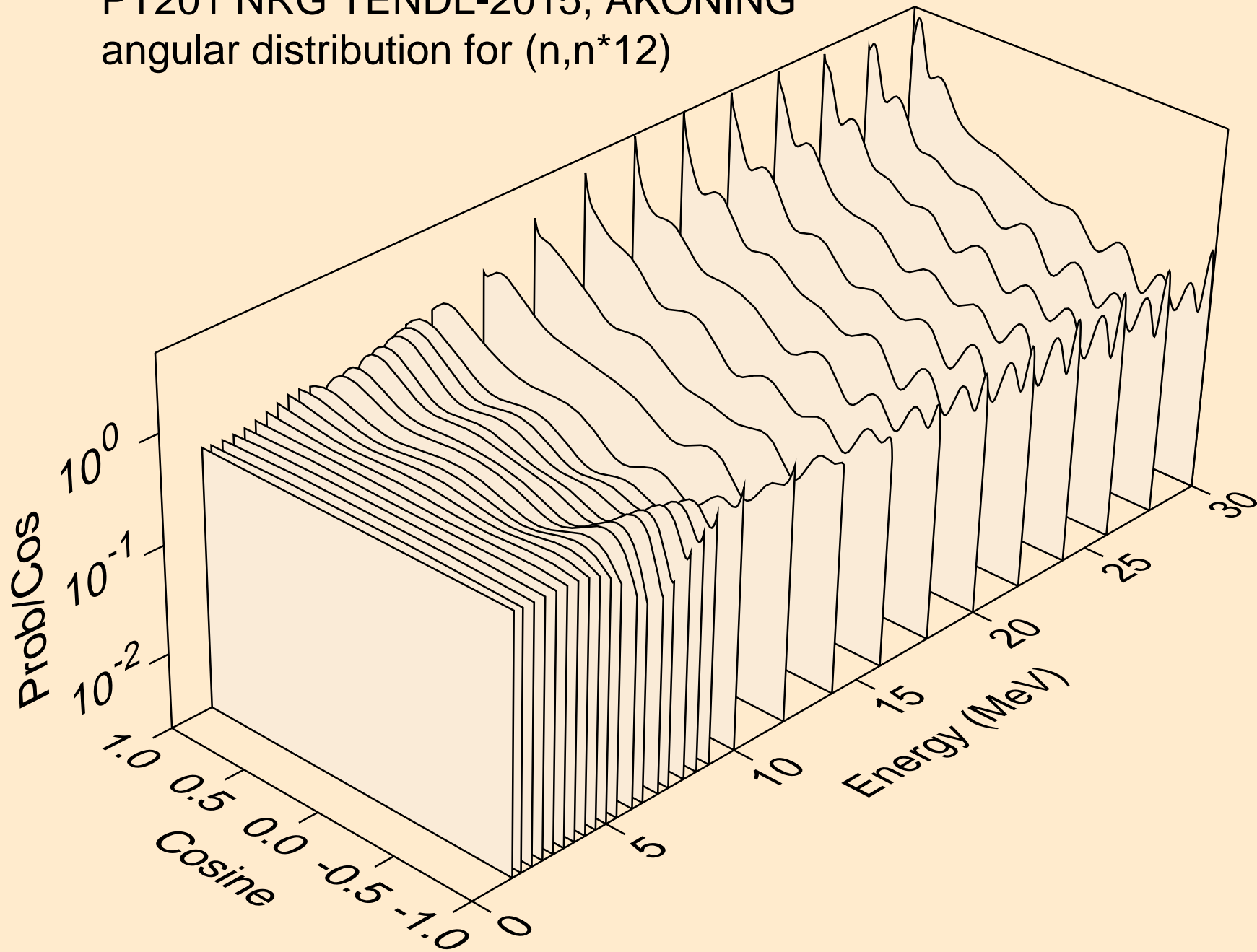

PT201 NRG TENDL-2015, AKONING
angular distribution for (n,n*13)

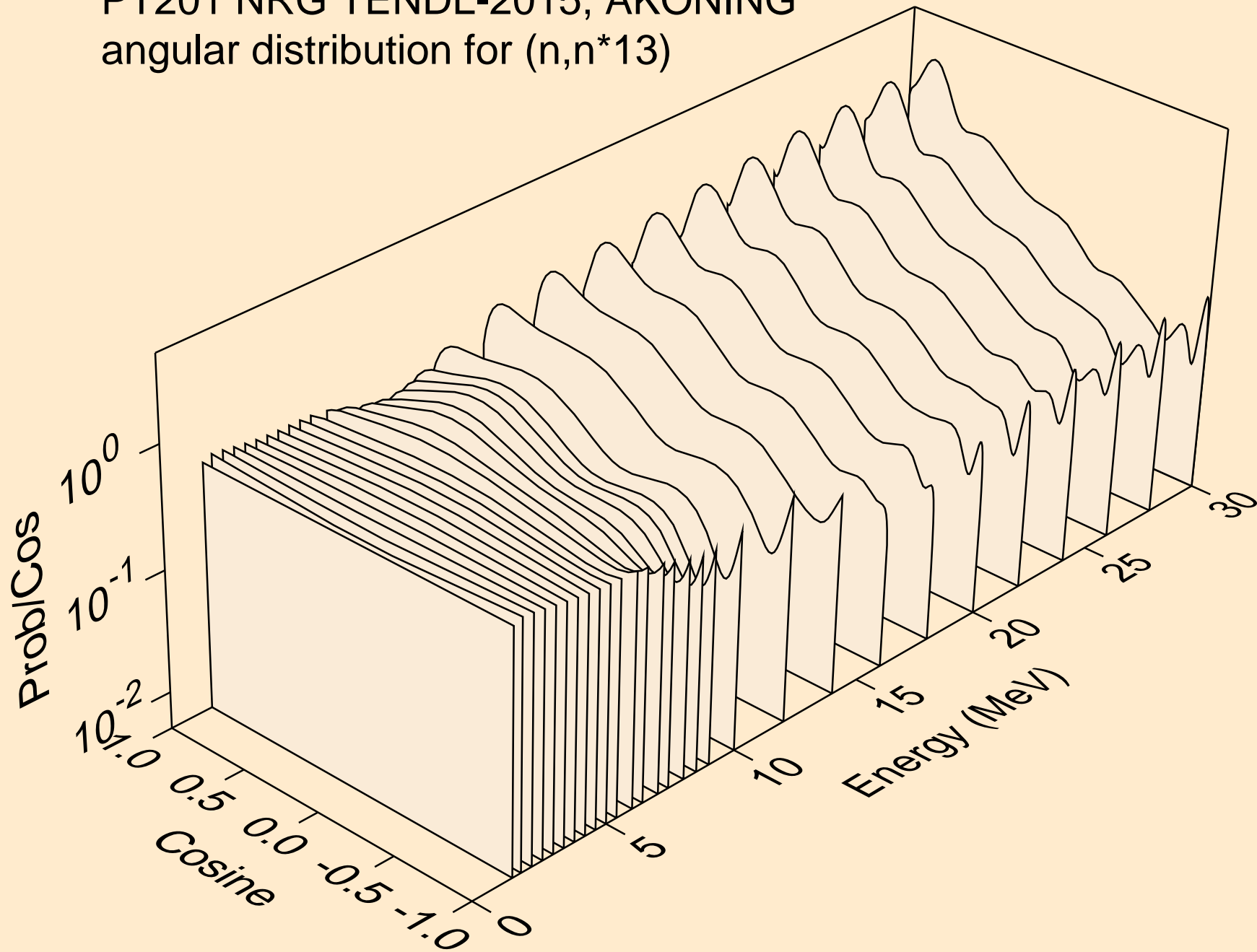

PT201 NRG TENDL-2015, AKONING
angular distribution for (n,n*14)

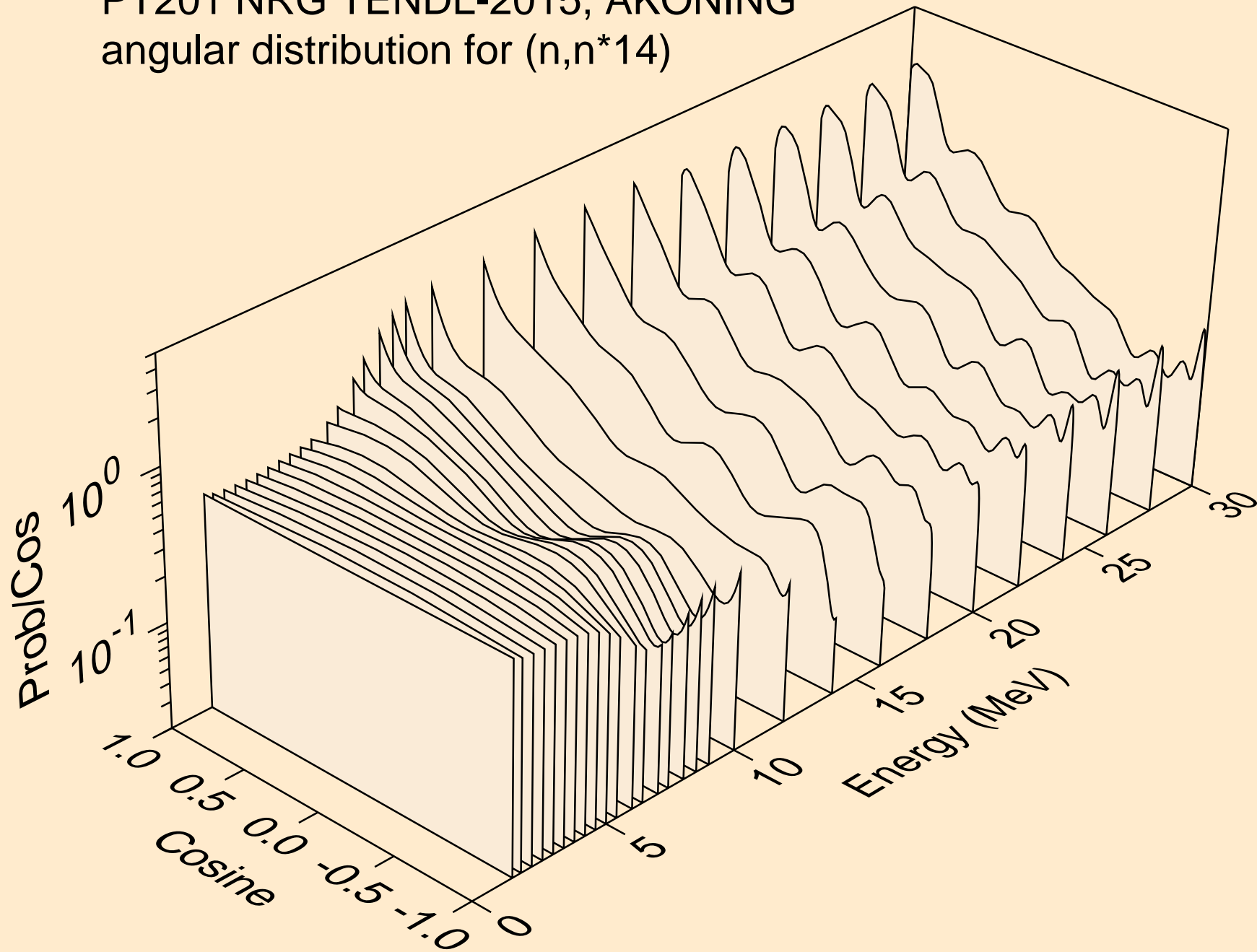

PT201 NRG TENDL-2015, AKONING
angular distribution for (n,n*15)

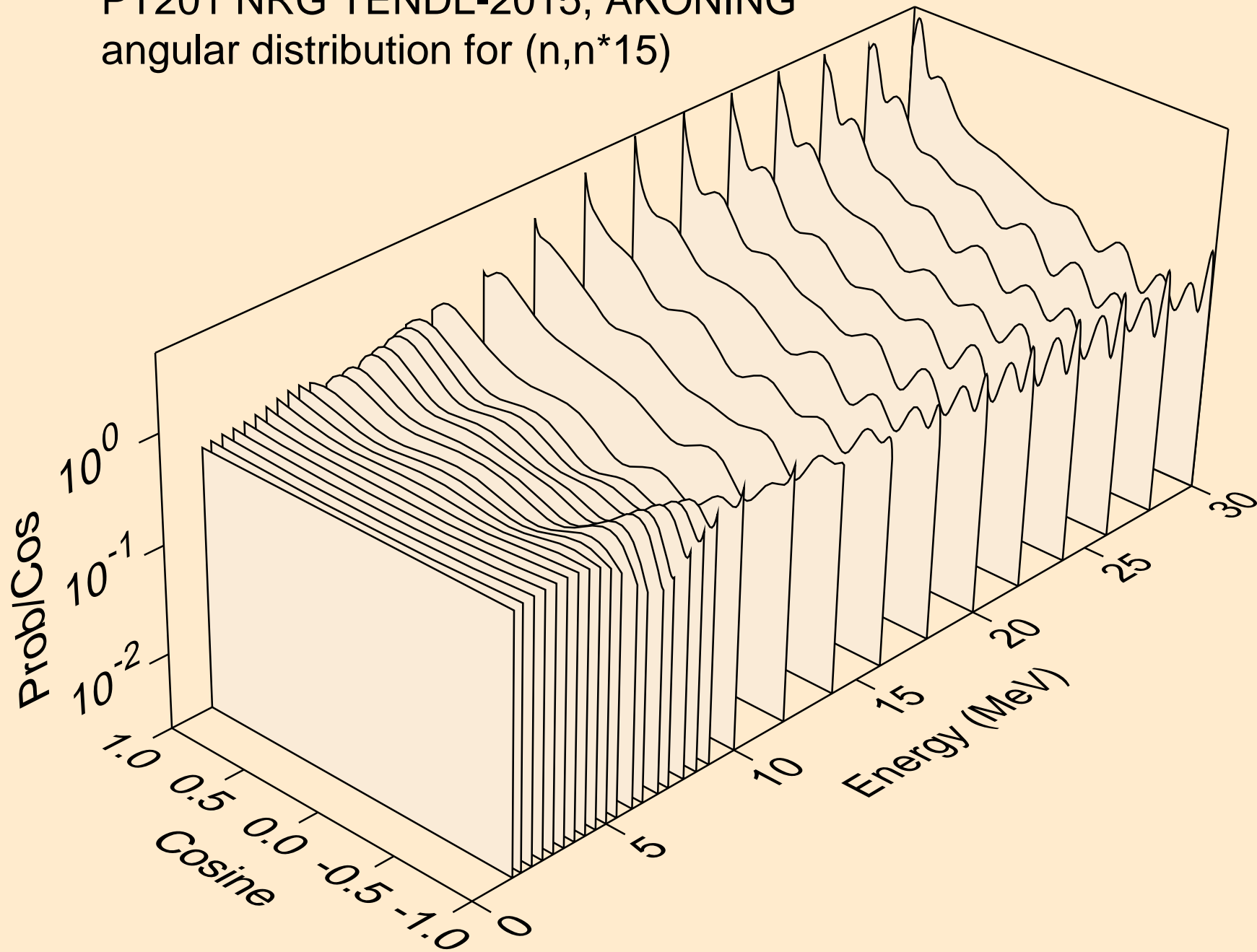

PT201 NRG TENDL-2015, AKONING
angular distribution for (n,n*16)

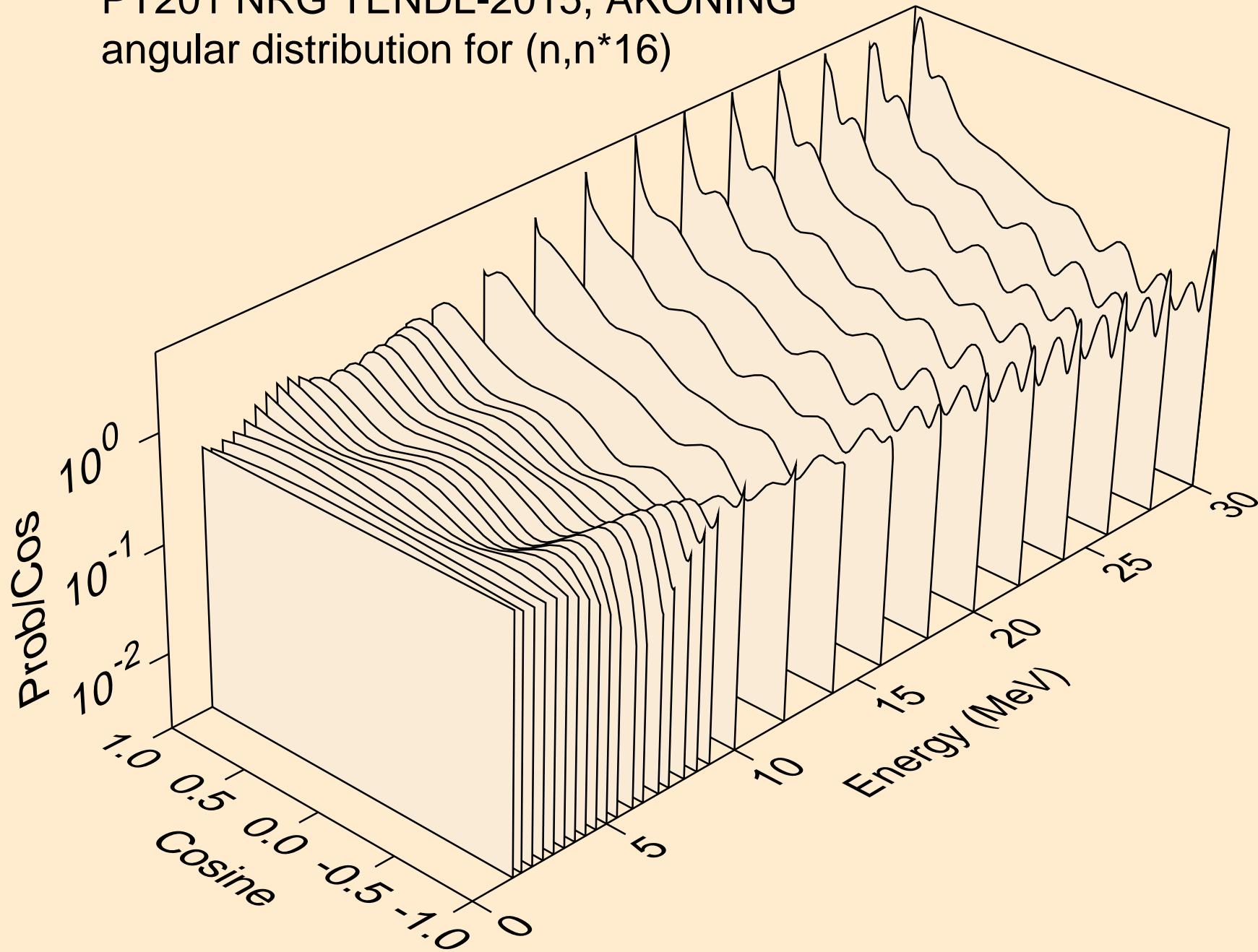

PT201 NRG TENDL-2015, AKONING
angular distribution for (n,n*17)

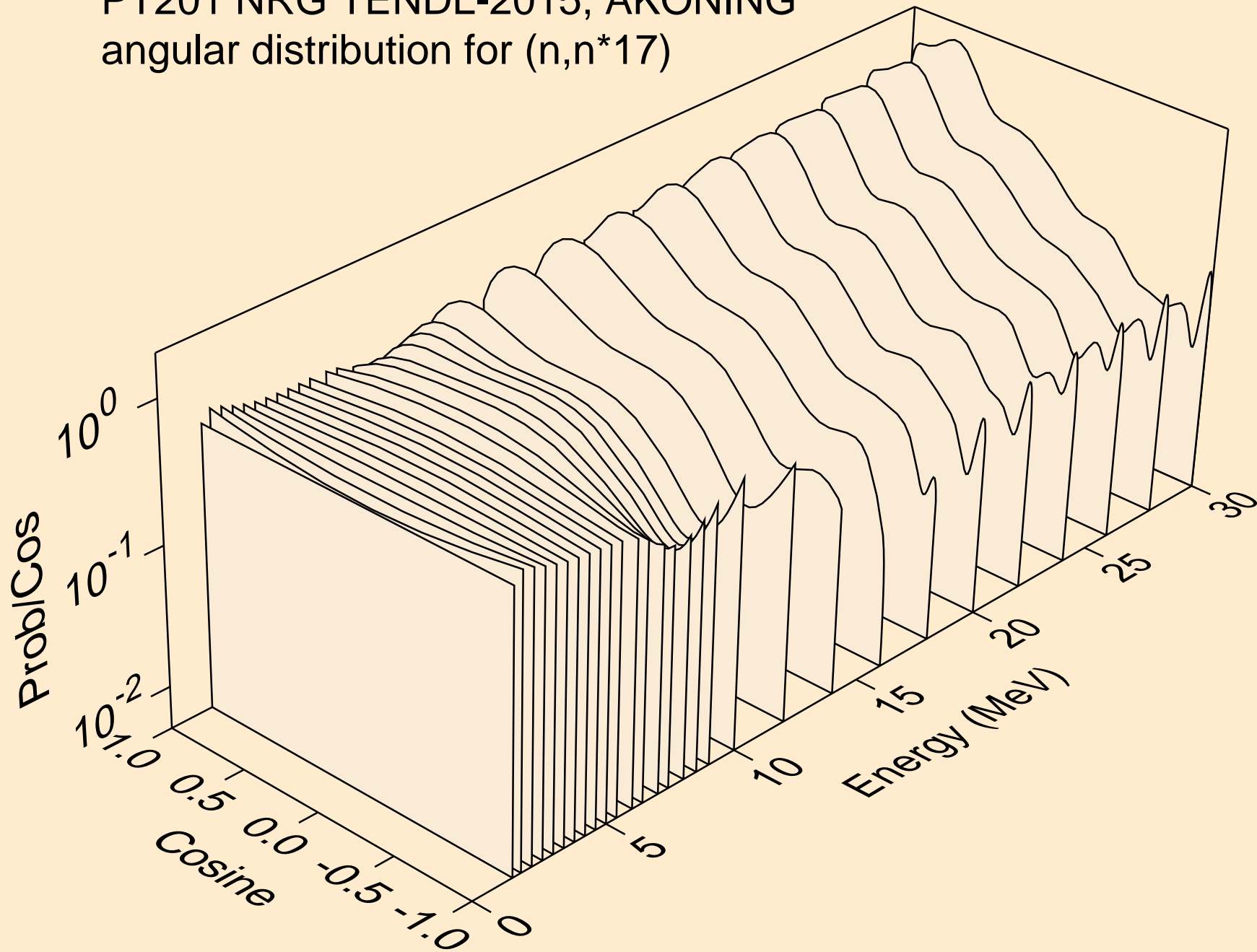

PT201 NRG TENDL-2015, AKONING
angular distribution for (n,n*18)

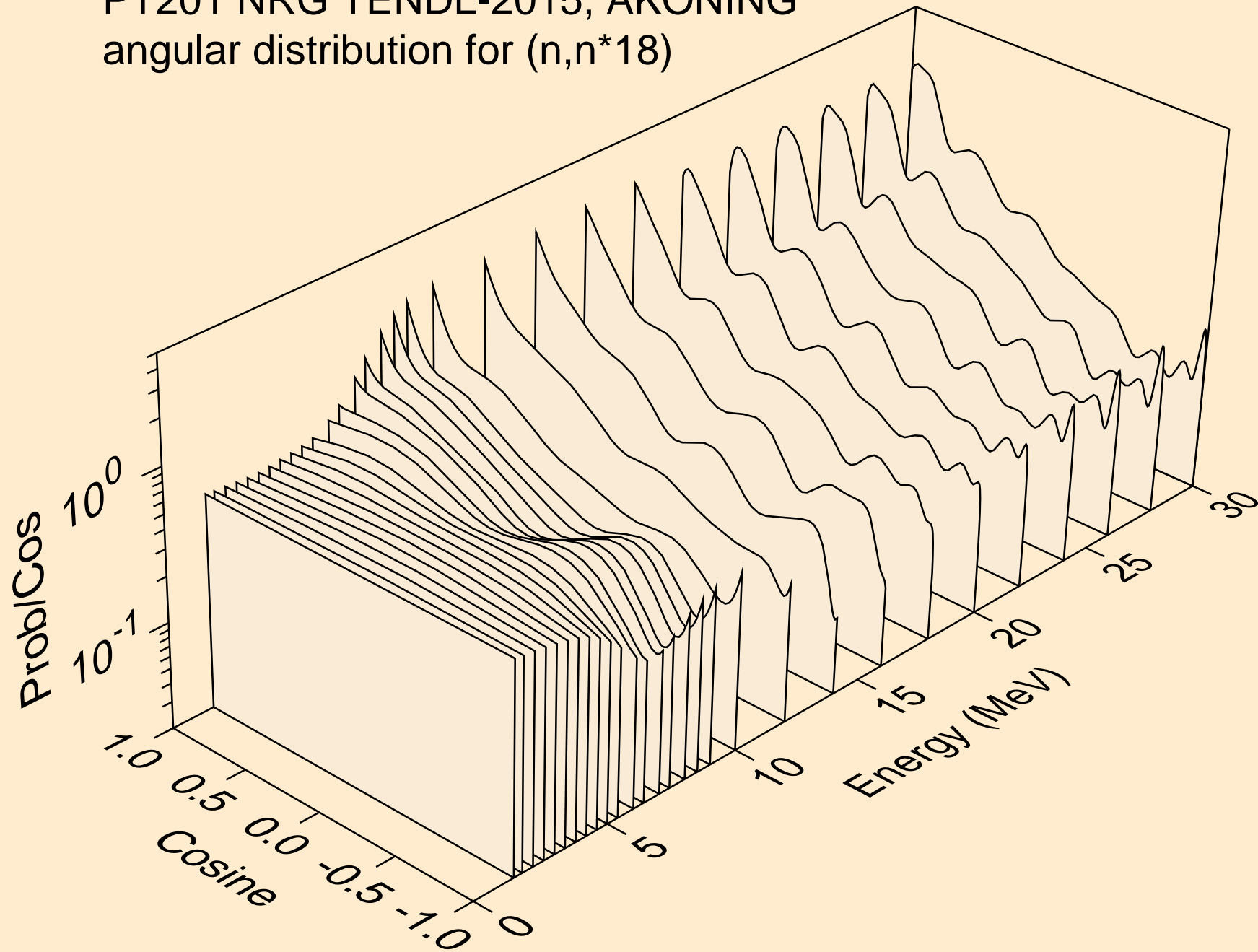

PT201 NRG TENDL-2015, AKONING
angular distribution for (n,n*19)

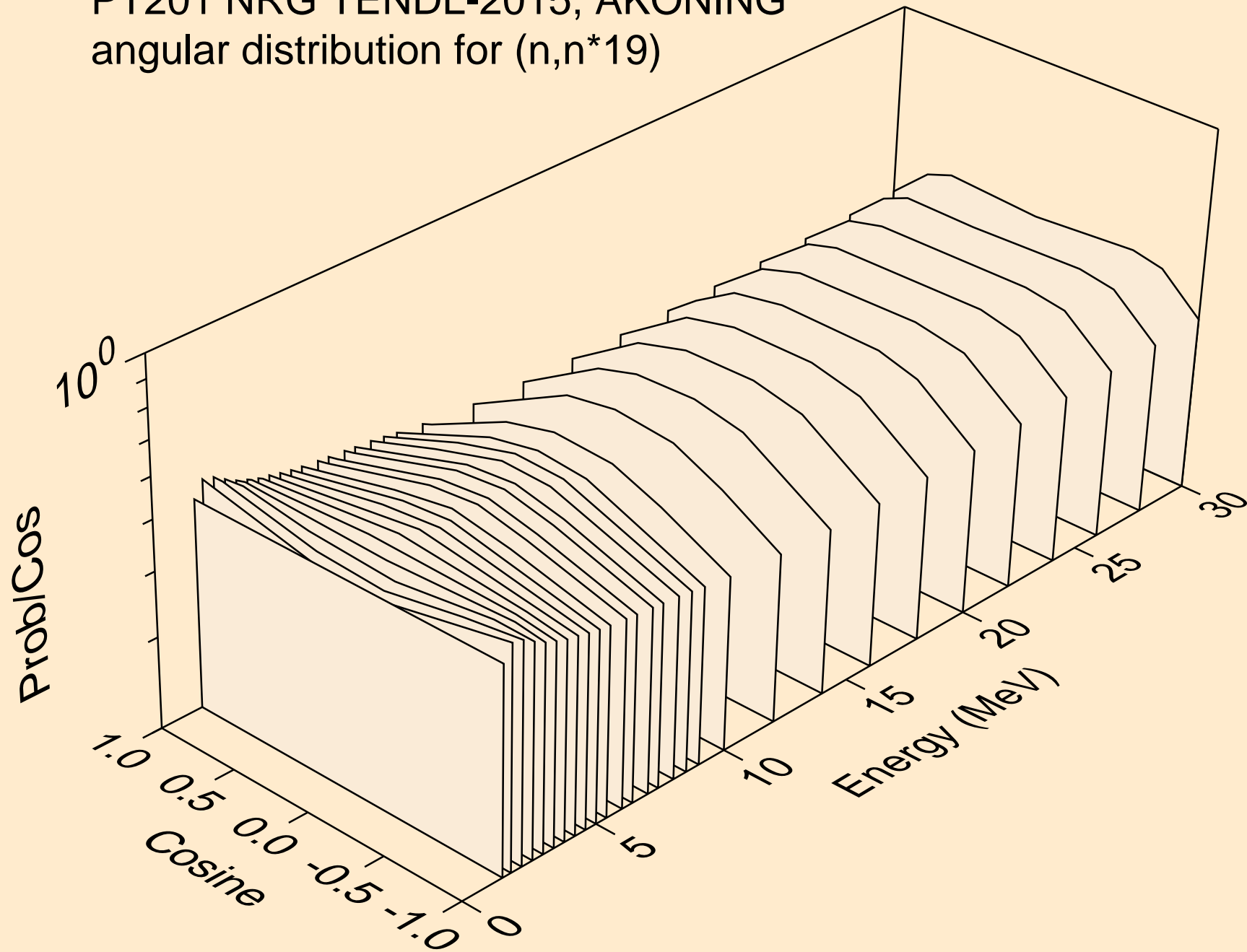

PT201 NRG TENDL-2015, AKONING
angular distribution for (n,n*20)

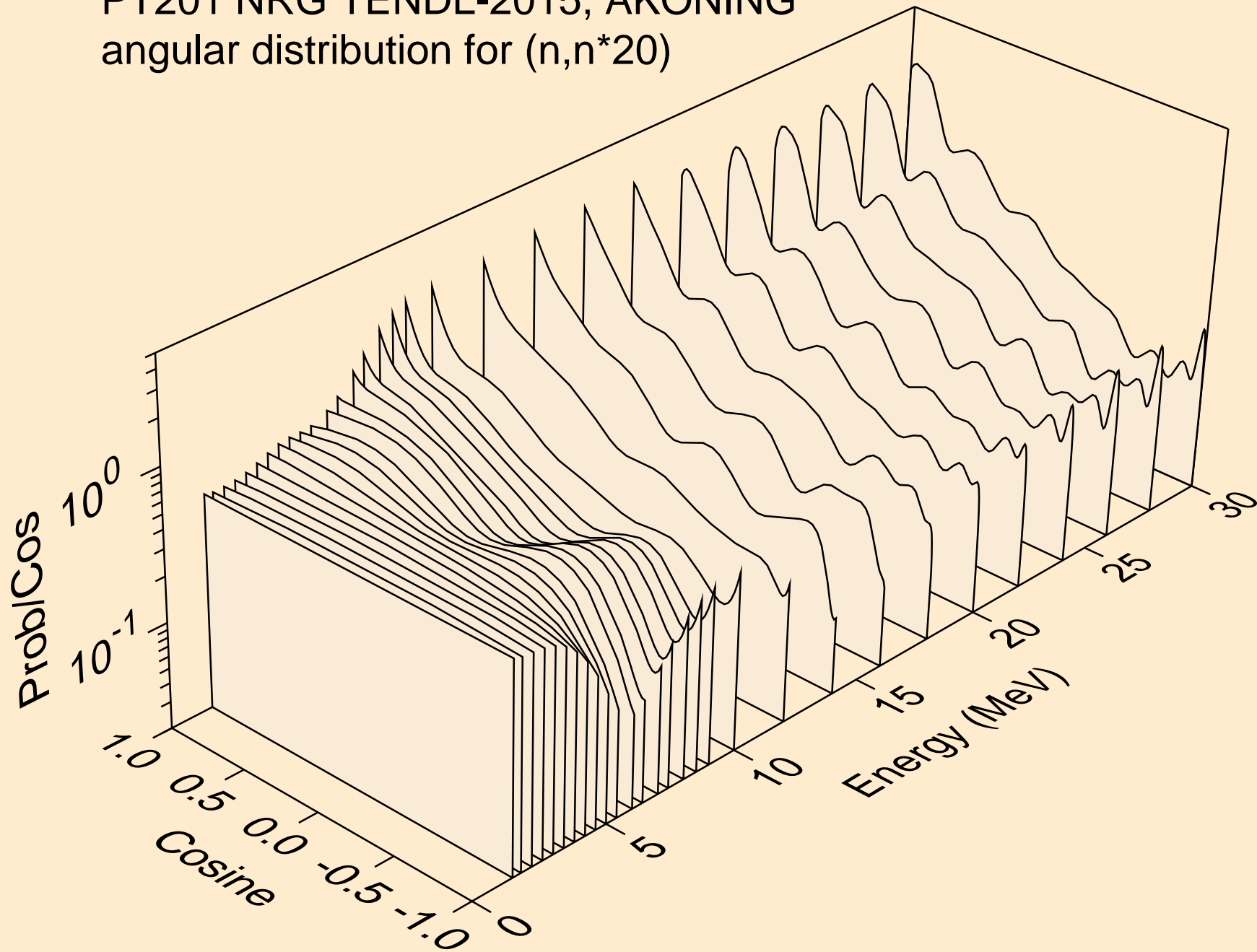

PT201 NRG TENDL-2015, AKONING
angular distribution for (n,n*21)

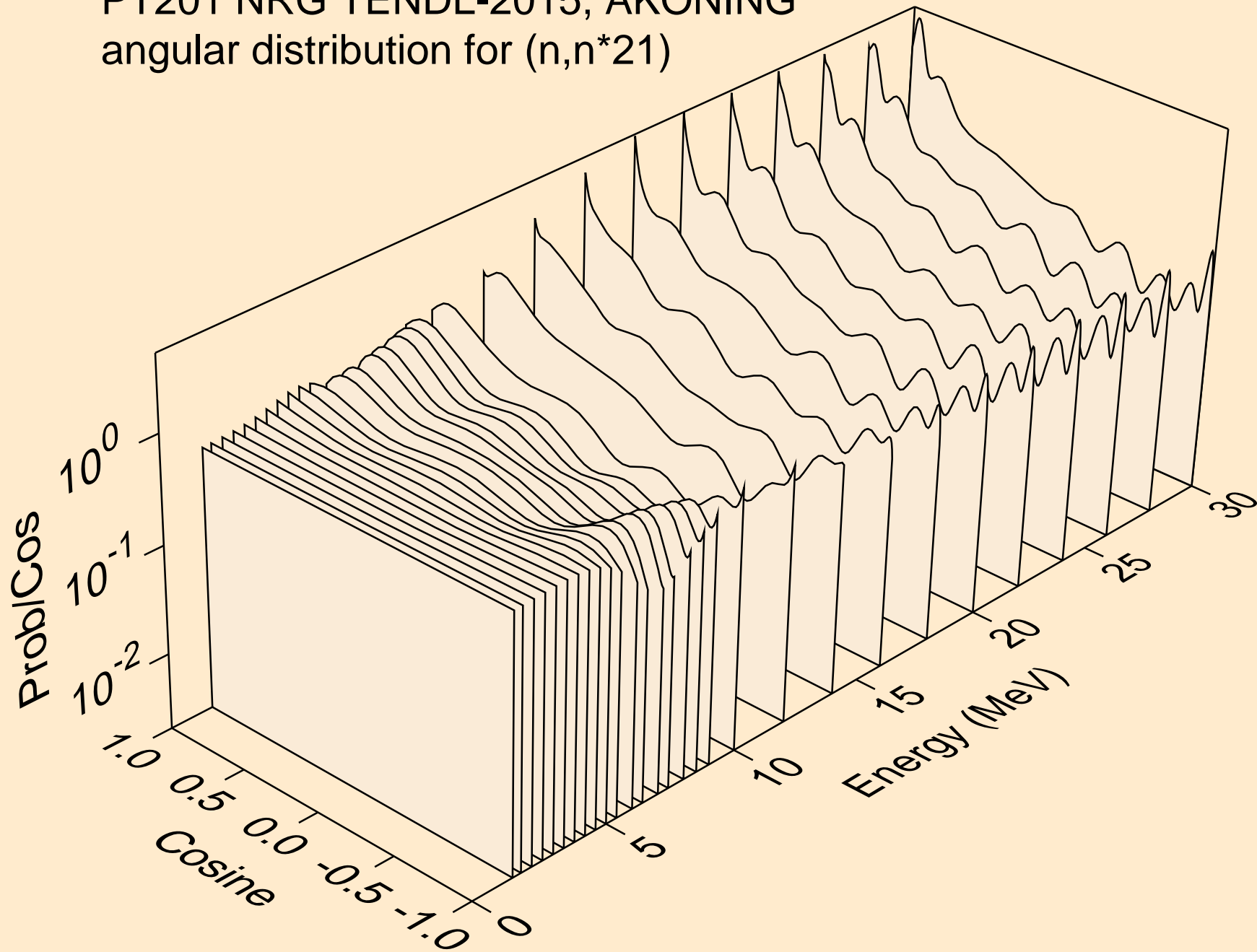

PT201 NRG TENDL-2015, AKONING
angular distribution for (n,n*22)

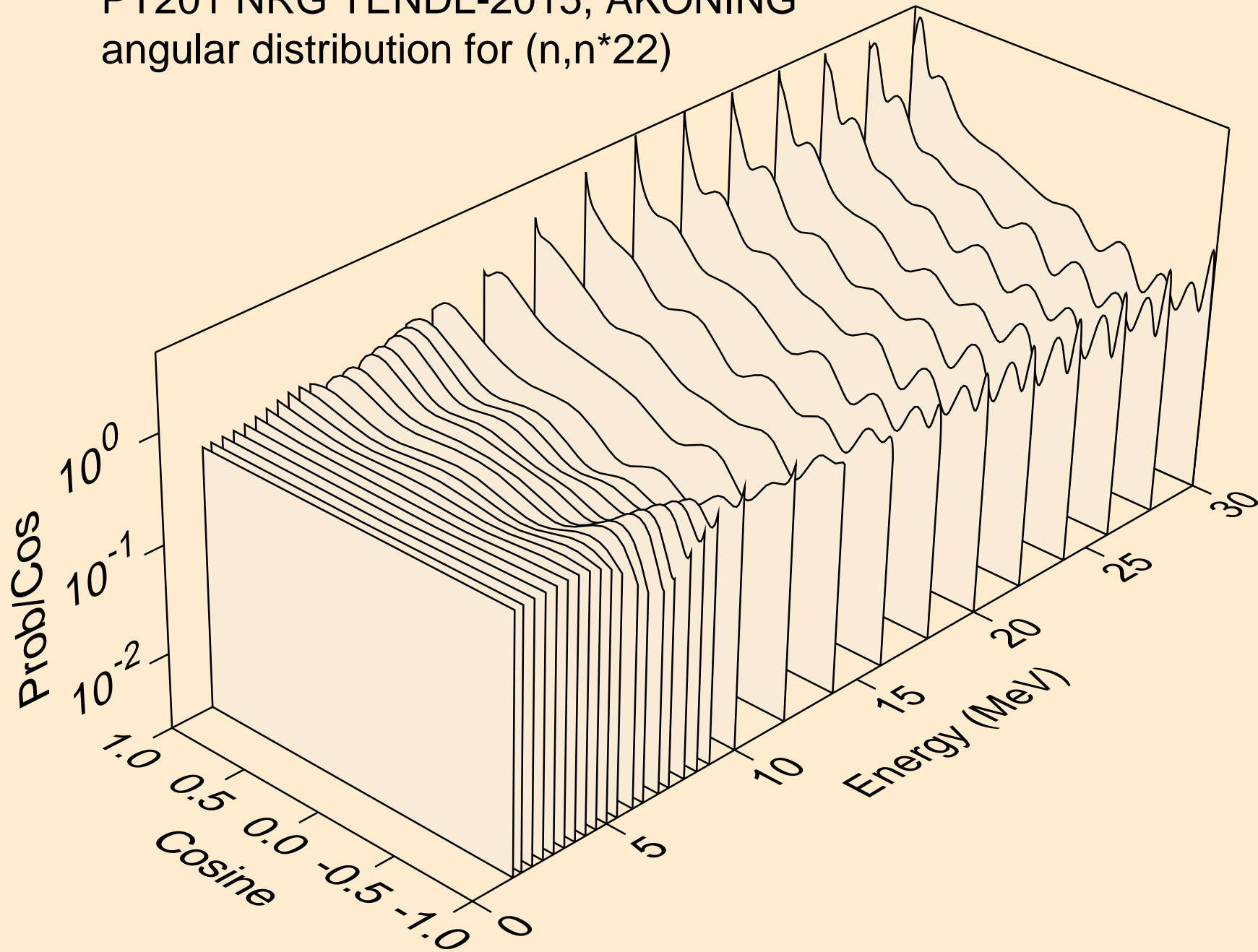

PT201 NRG TENDL-2015, AKONING
angular distribution for (n,n*23)

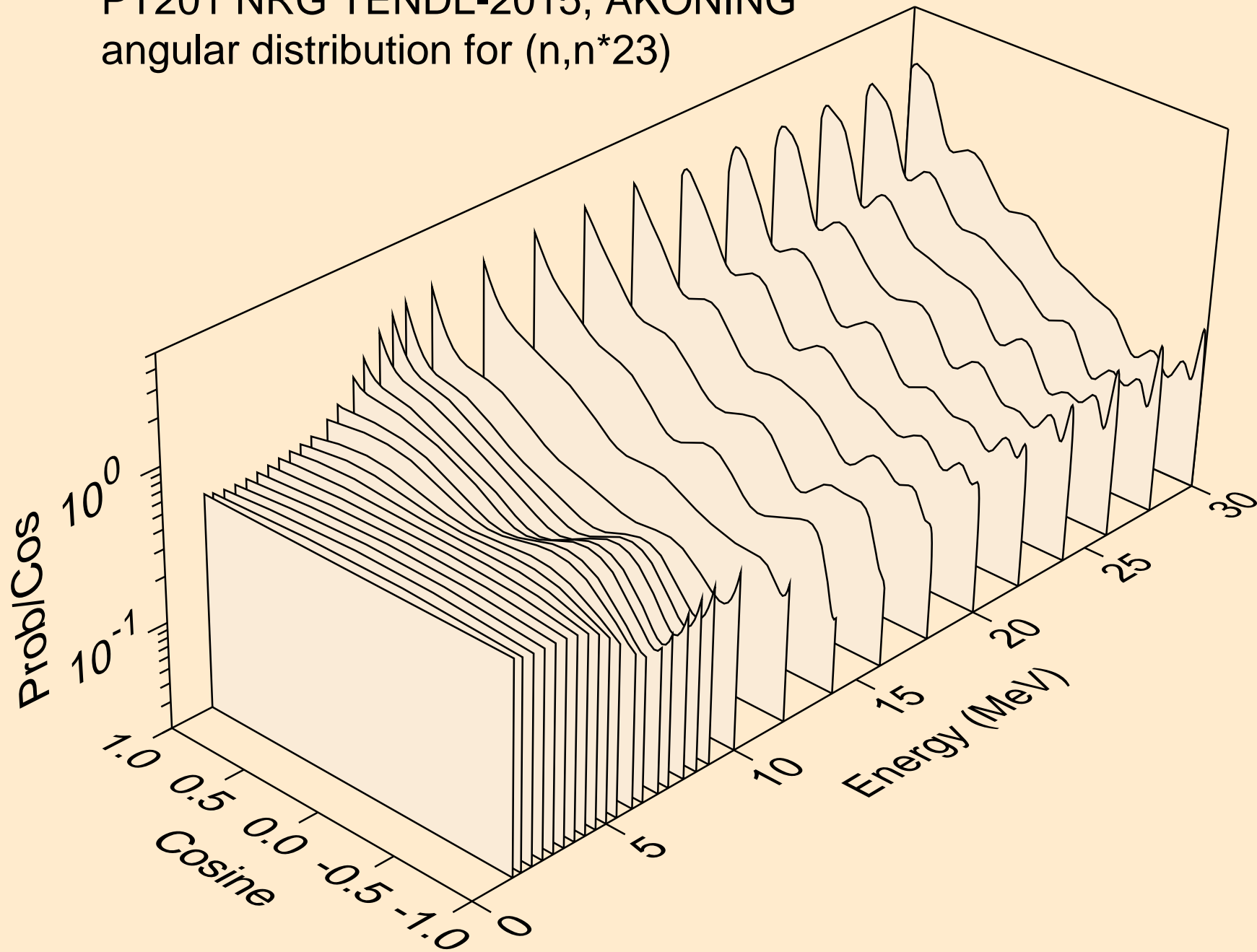

PT201 NRG TENDL-2015, AKONING
angular distribution for (n,n*24)

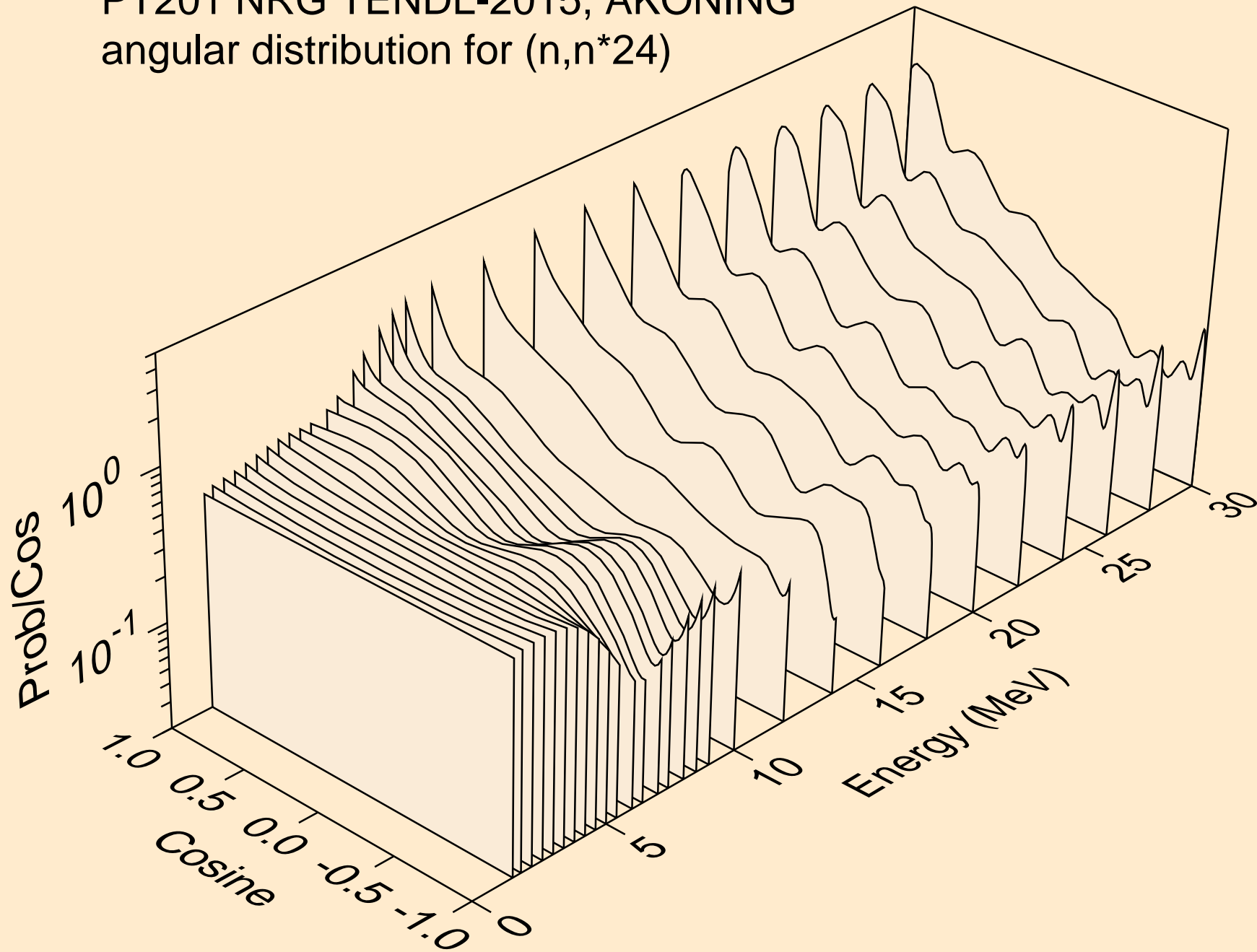

PT201 NRG TENDL-2015, AKONING
angular distribution for (n,n*25)

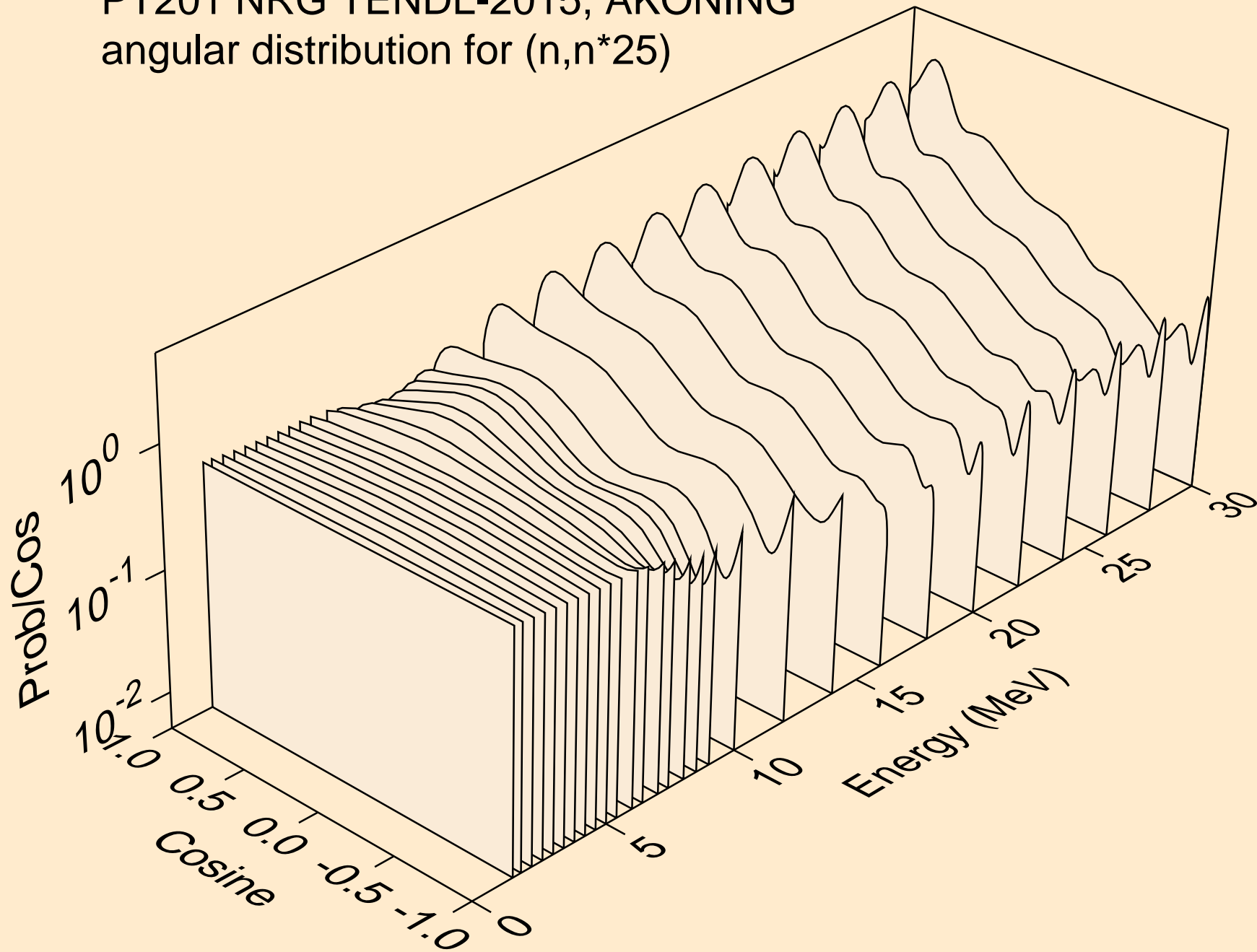

PT201 NRG TENDL-2015, AKONING
angular distribution for (n,n*26)

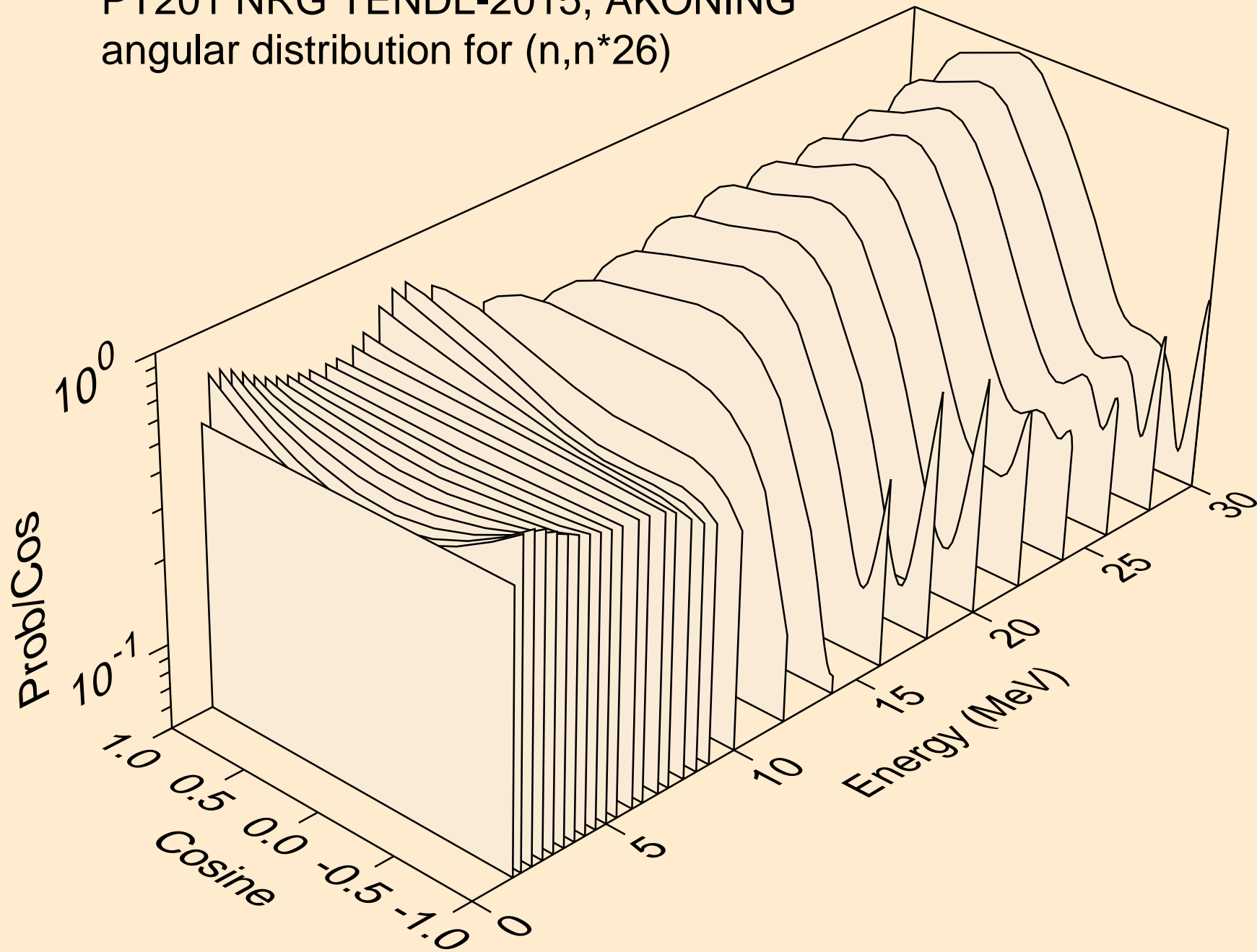

PT201 NRG TENDL-2015, AKONING
angular distribution for (n,n*27)

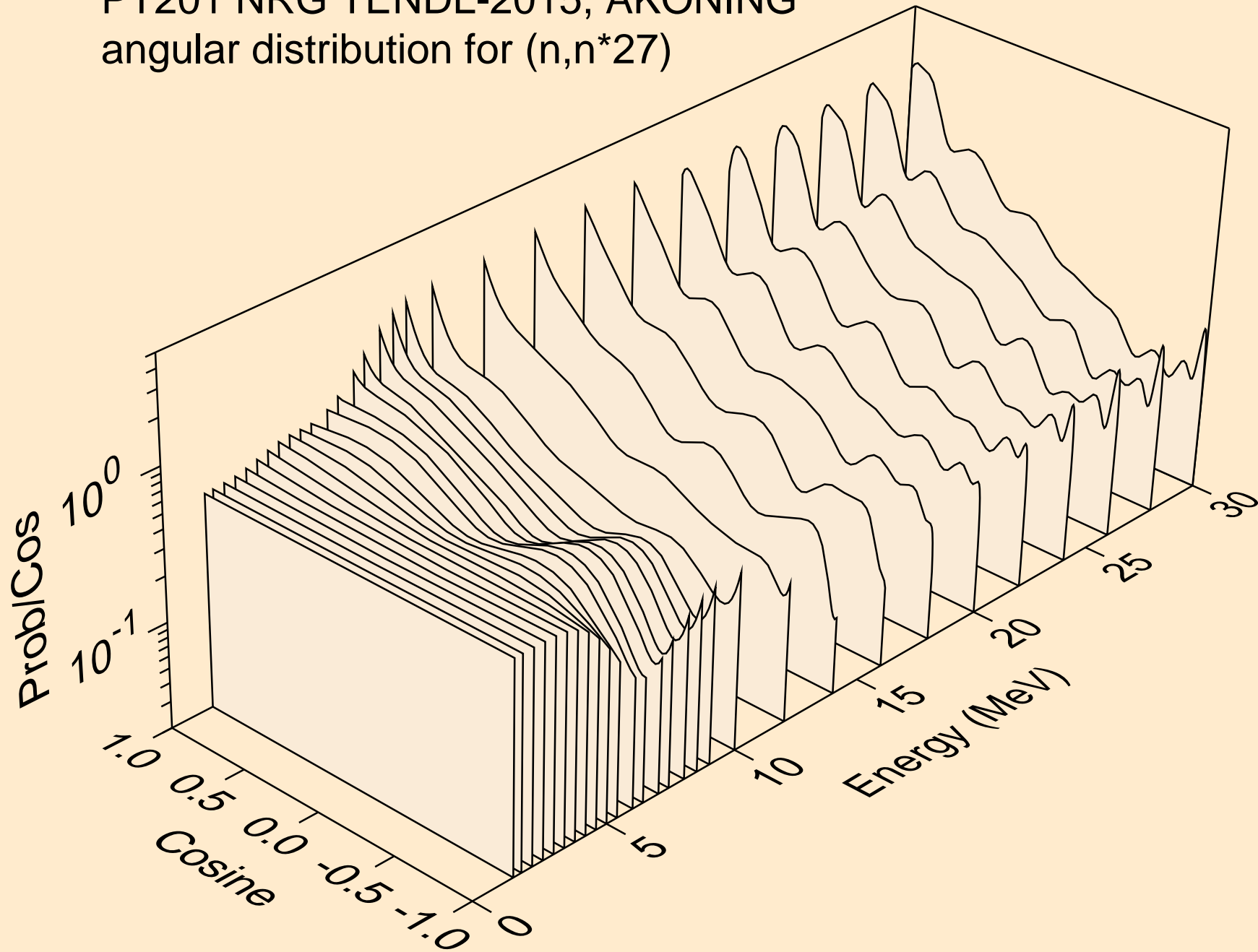

PT201 NRG TENDL-2015, AKONING
angular distribution for (n,n*28)

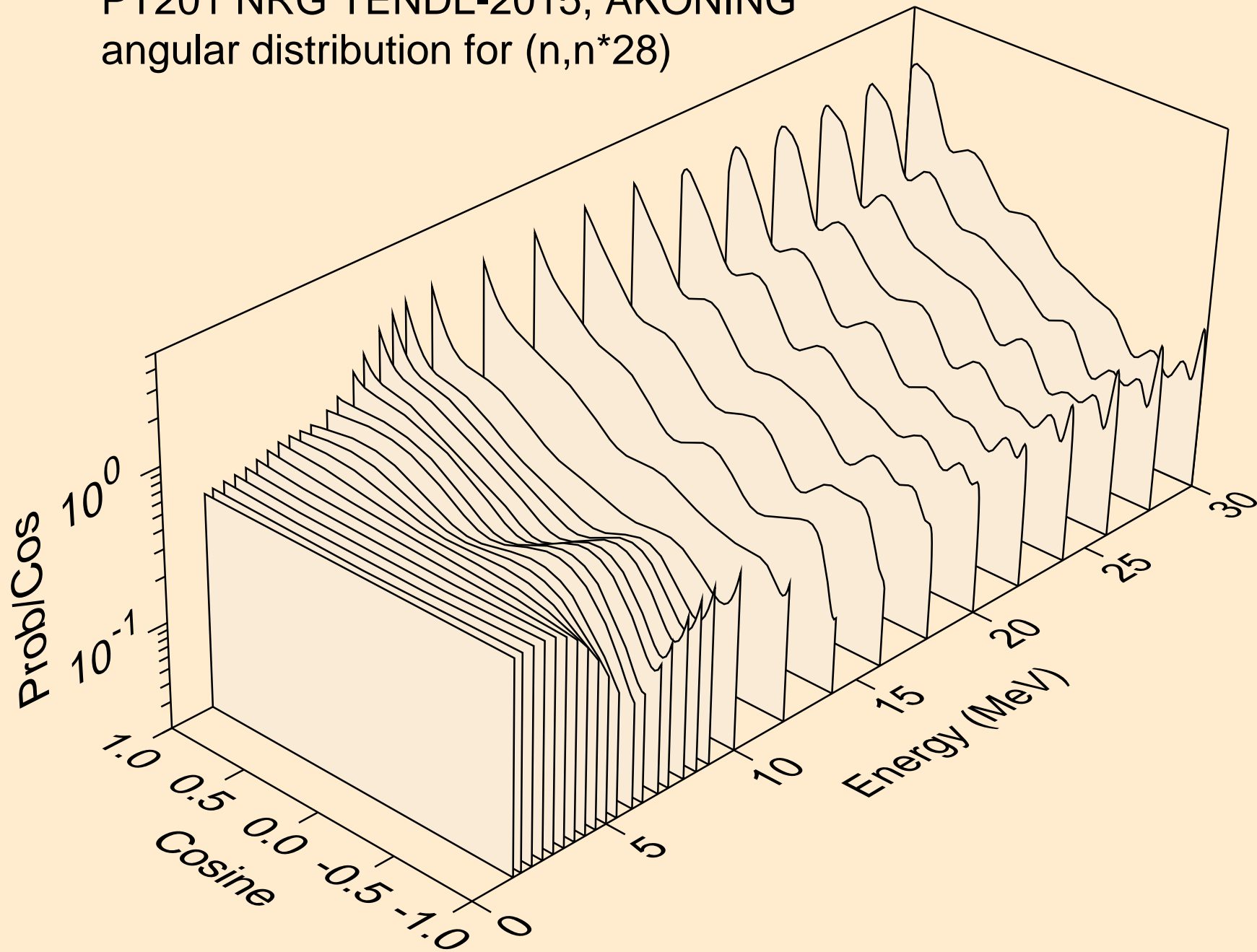

PT201 NRG TENDL-2015, AKONING
angular distribution for (n,n*29)

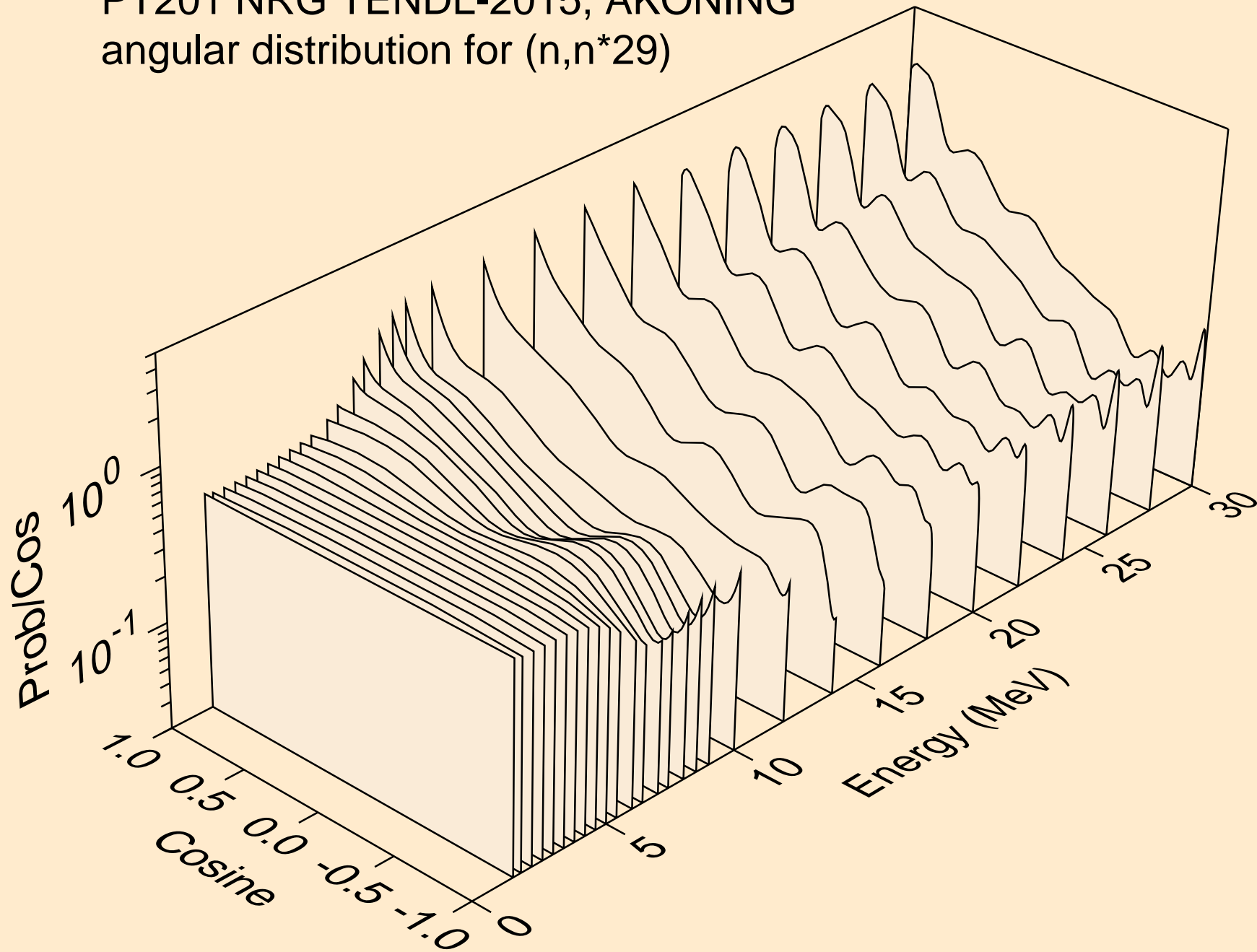

PT201 NRG TENDL-2015, AKONING
angular distribution for (n,n*30)

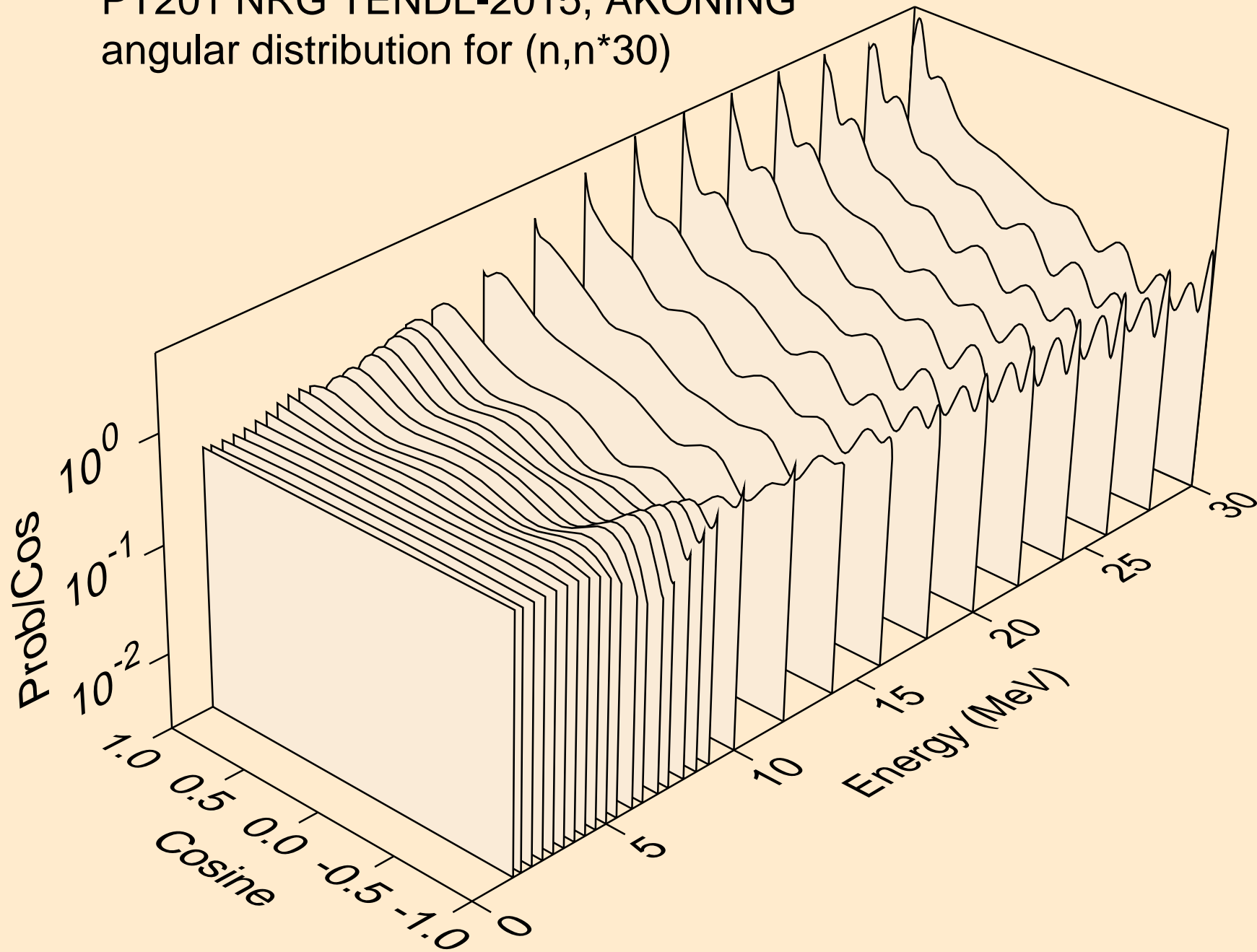

PT201 NRG TENDL-2015, AKONING
Neutron emission for (n,x)

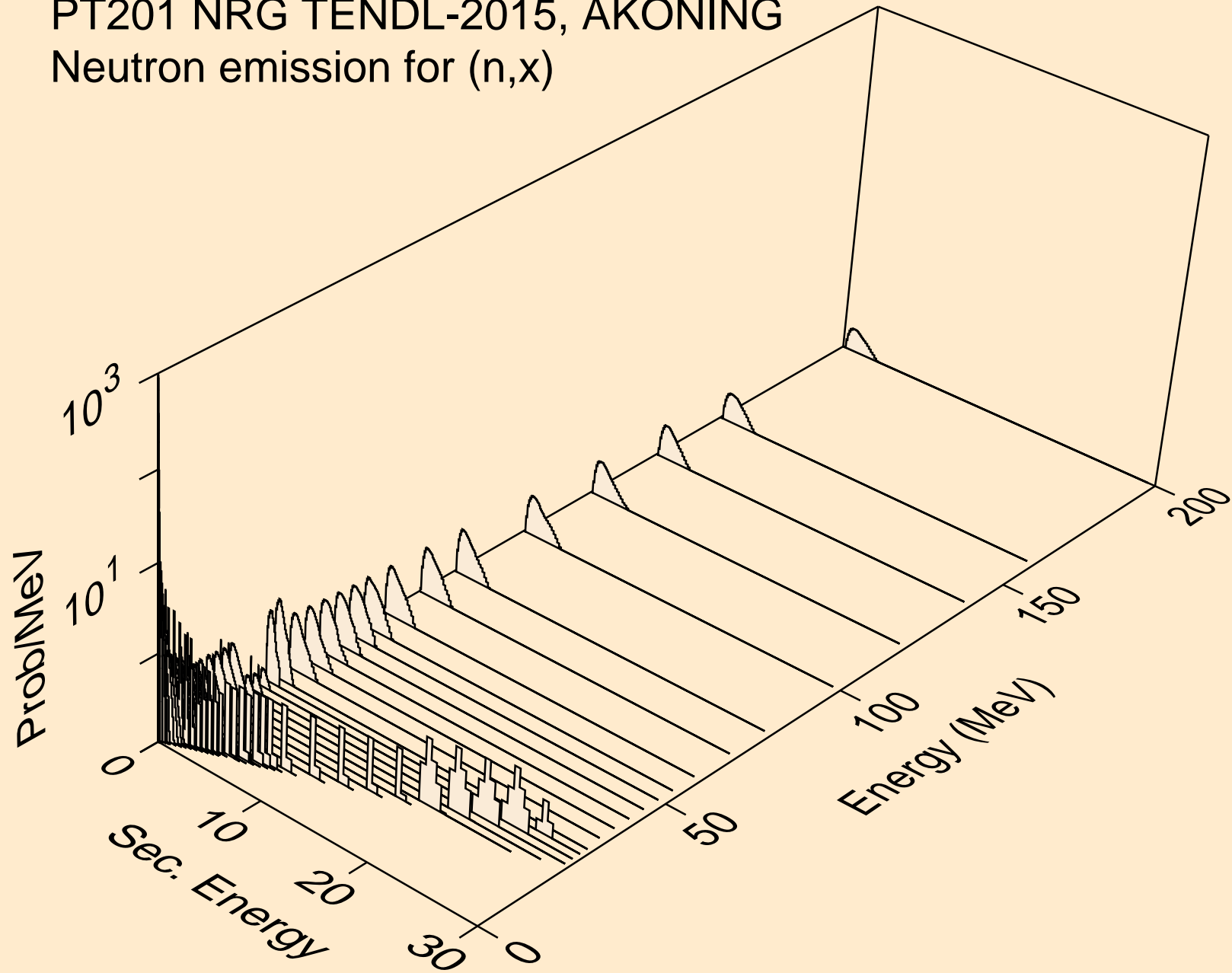

PT201 NRG TENDL-2015, AKONING
Neutron emission for (n,2nd)

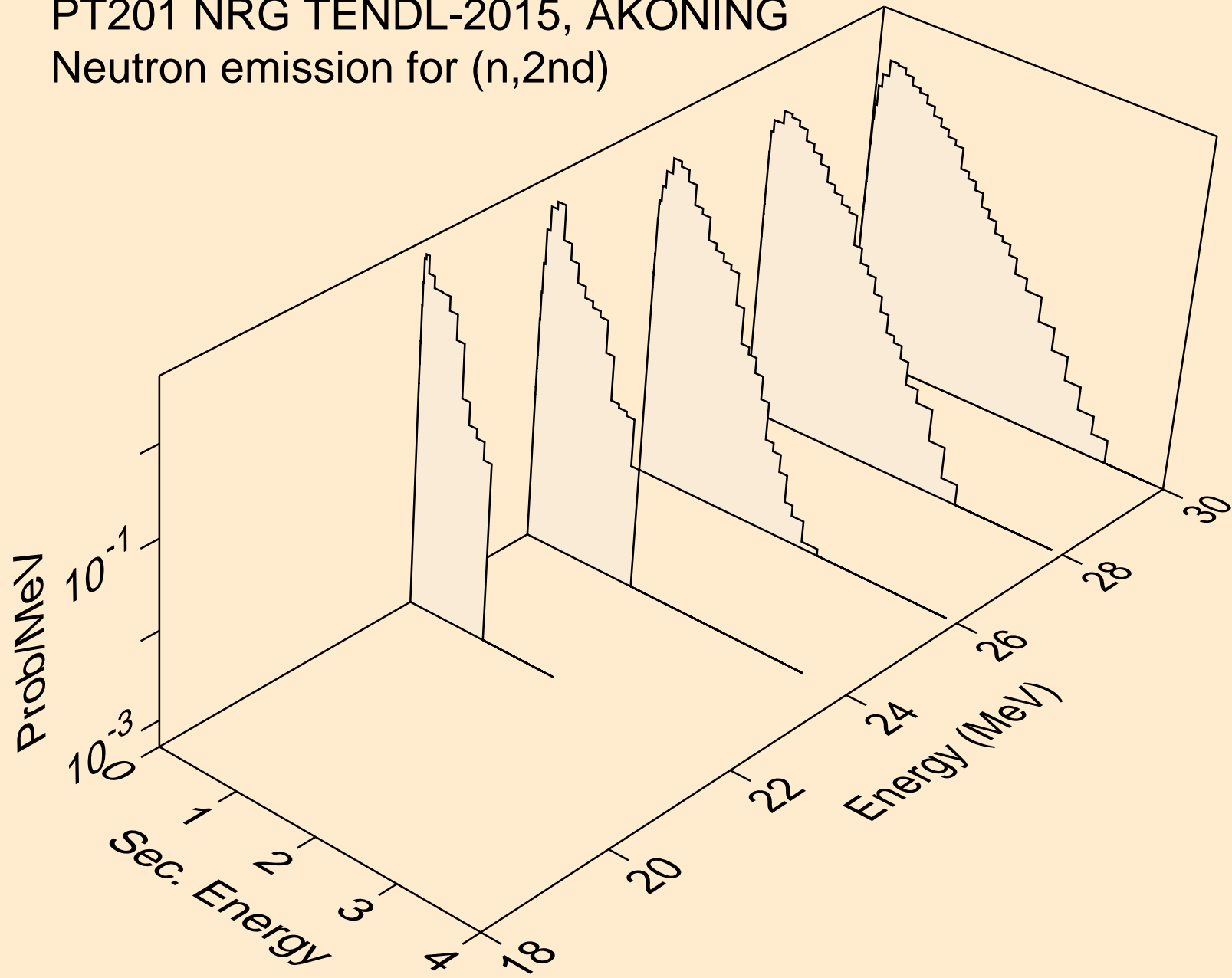

PT201 NRG TENDL-2015, AKONING
Neutron emission for (n,2n)

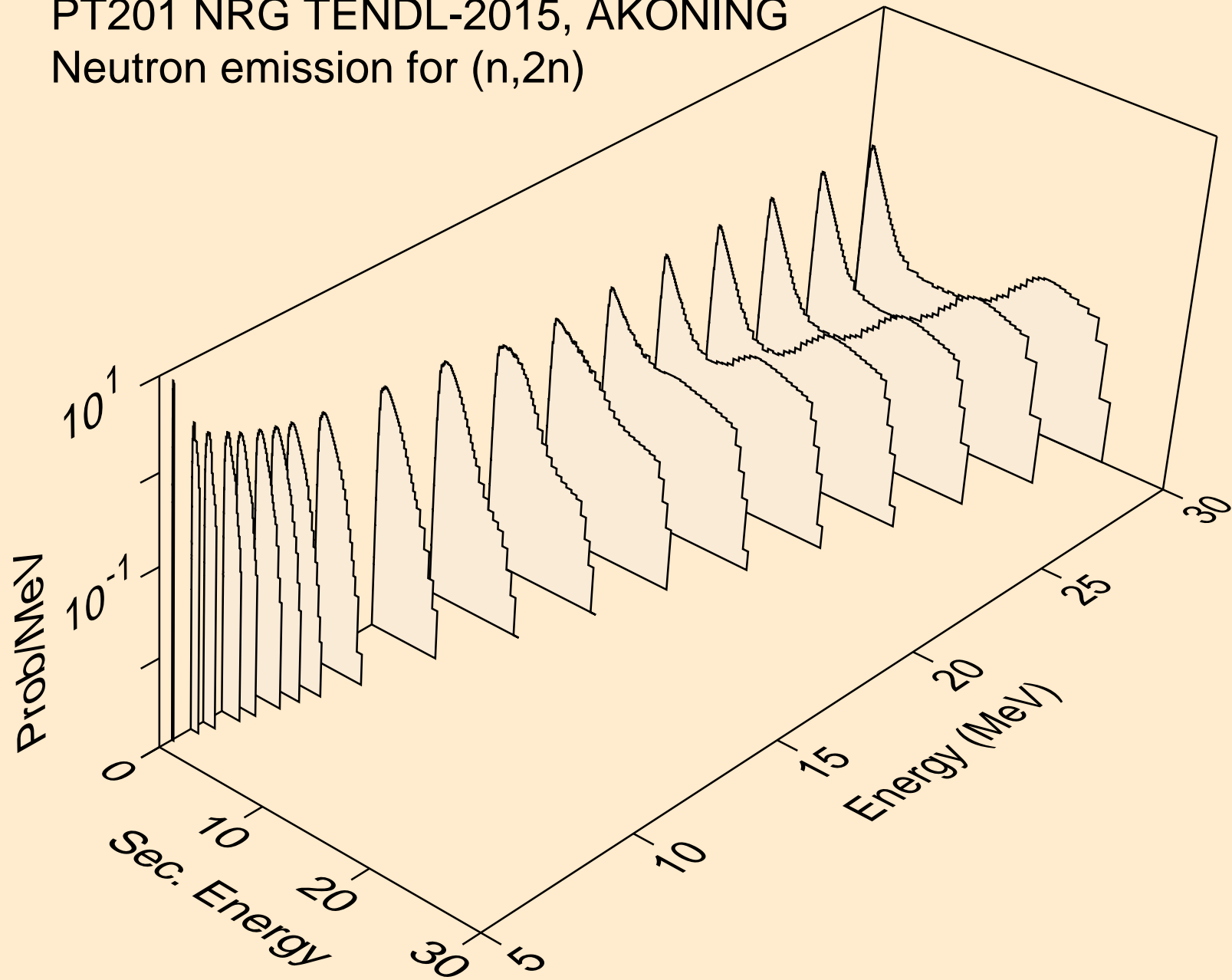

PT201 NRG TENDL-2015, AKONING
Neutron emission for (n,3n)

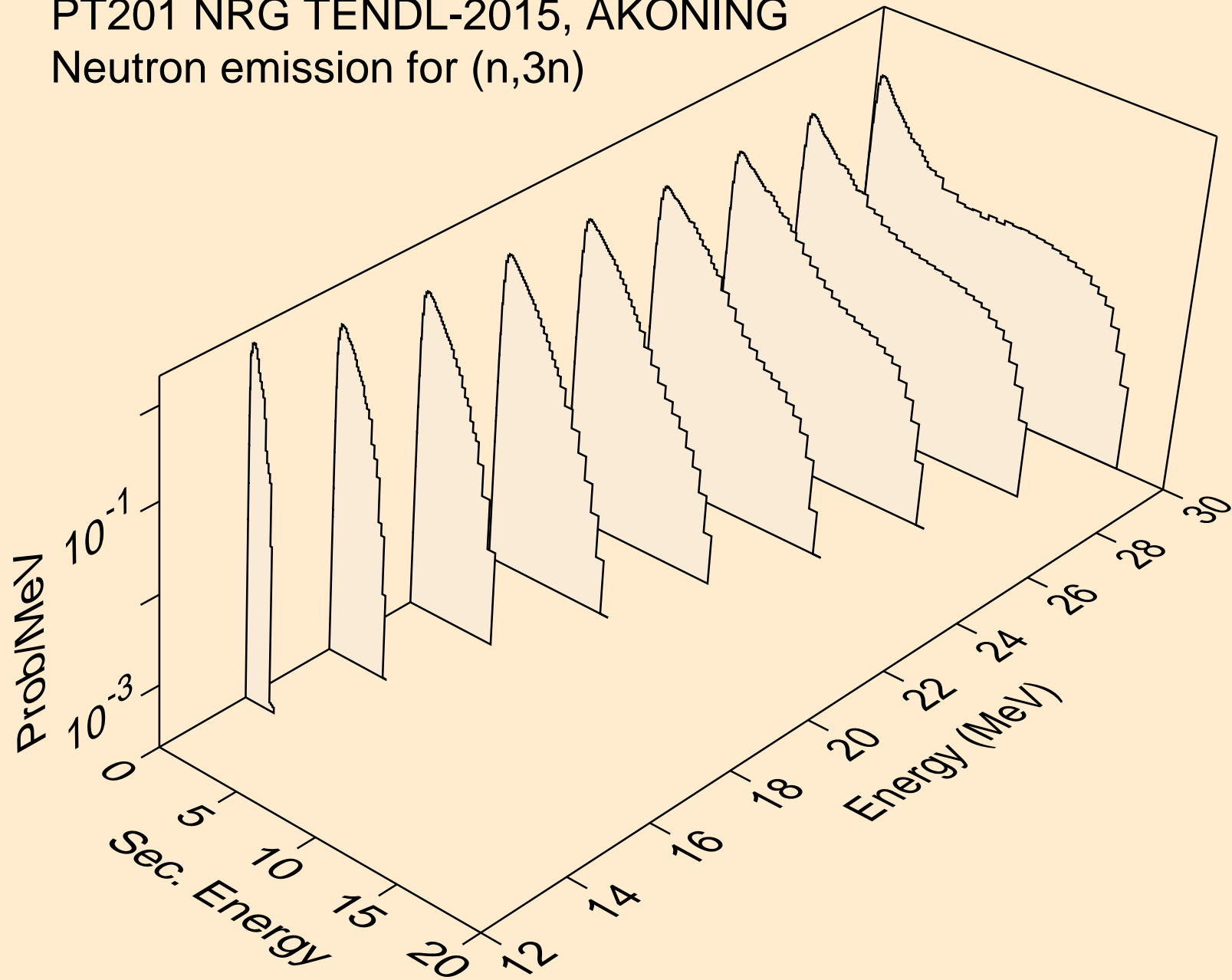

PT201 NRG TENDL-2015, AKONING
Neutron emission for (n,n*)a

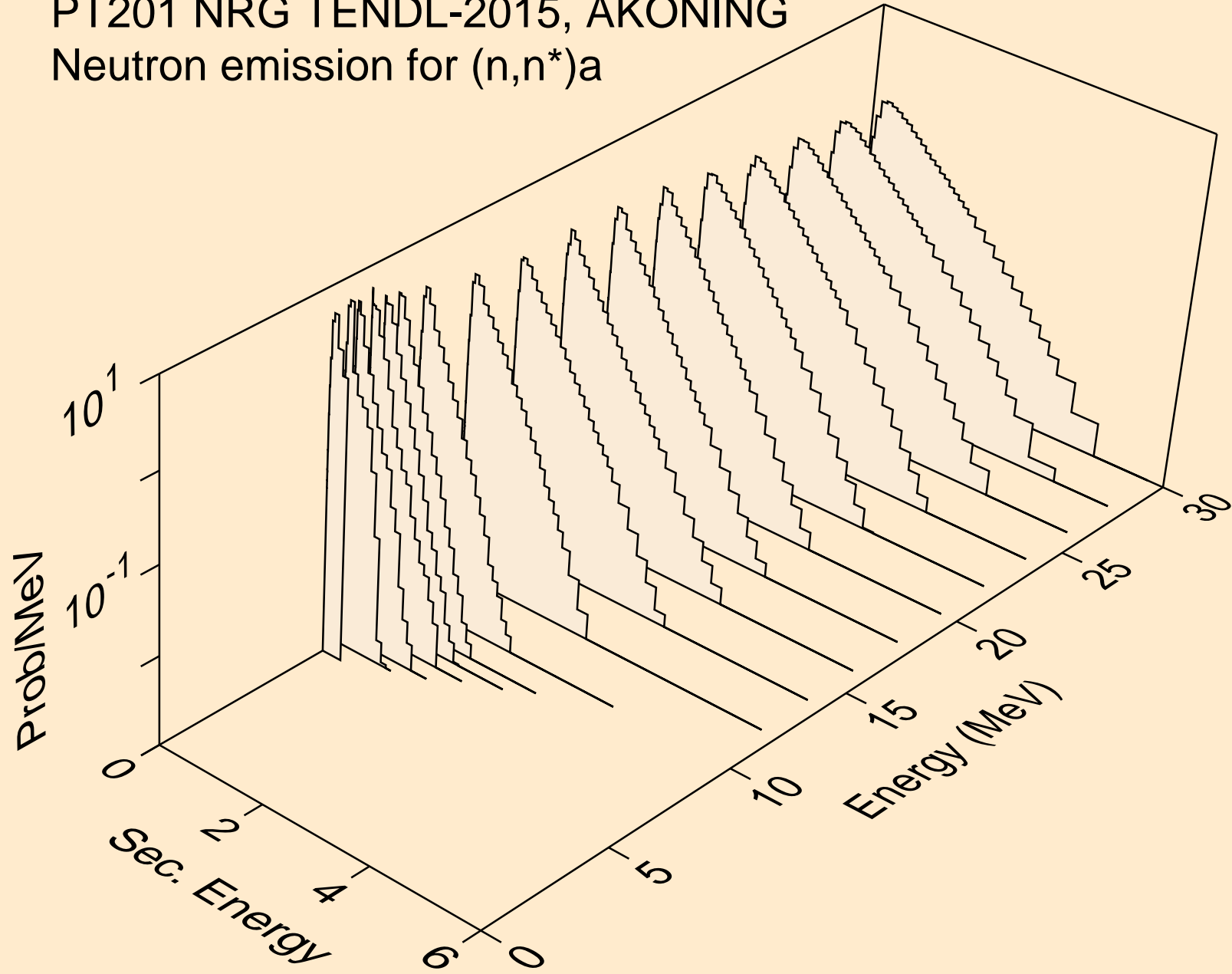

PT201 NRG TENDL-2015, AKONING
Neutron emission for (n,2n)a

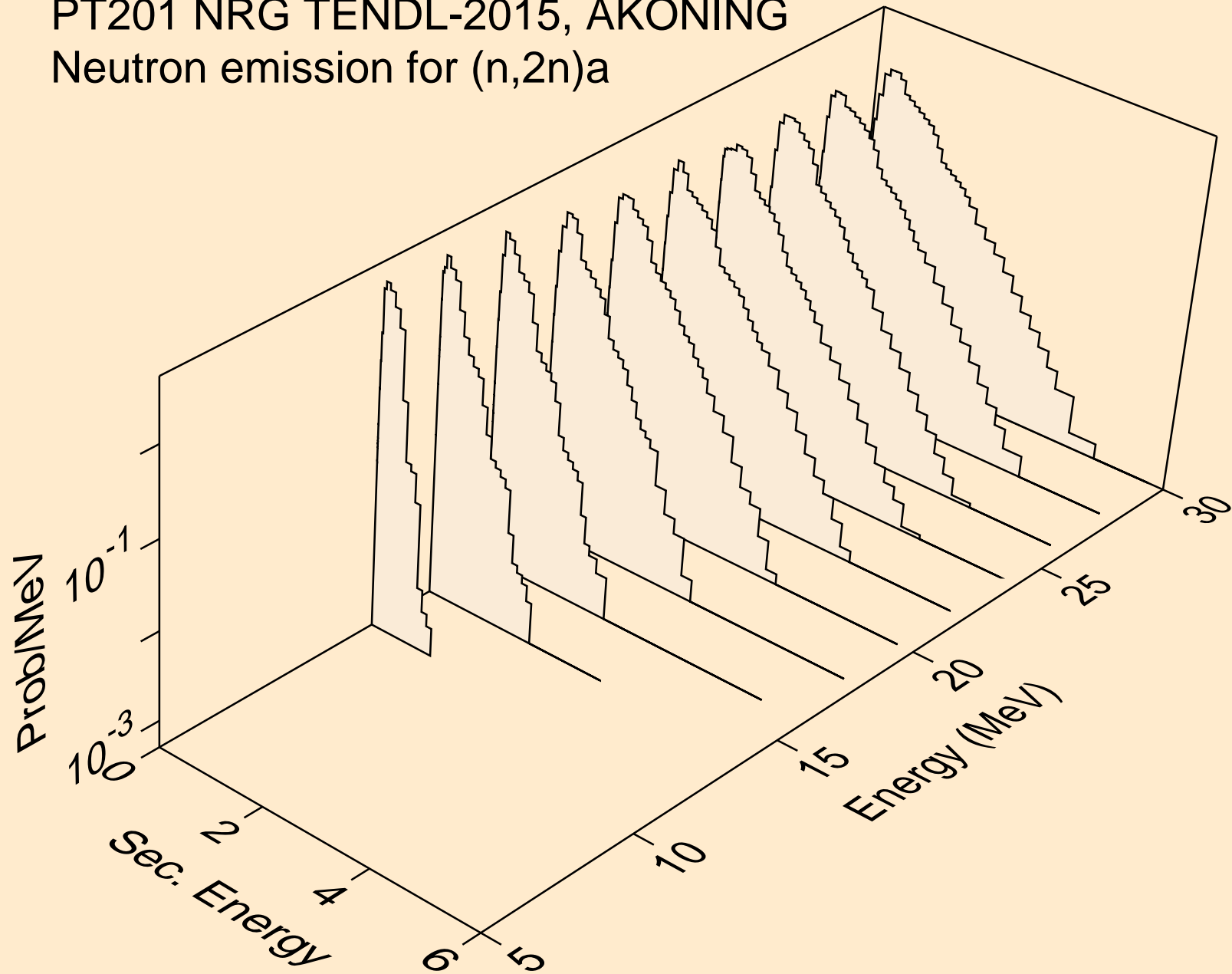

PT201 NRG TENDL-2015, AKONING
Neutron emission for (n,3n)a

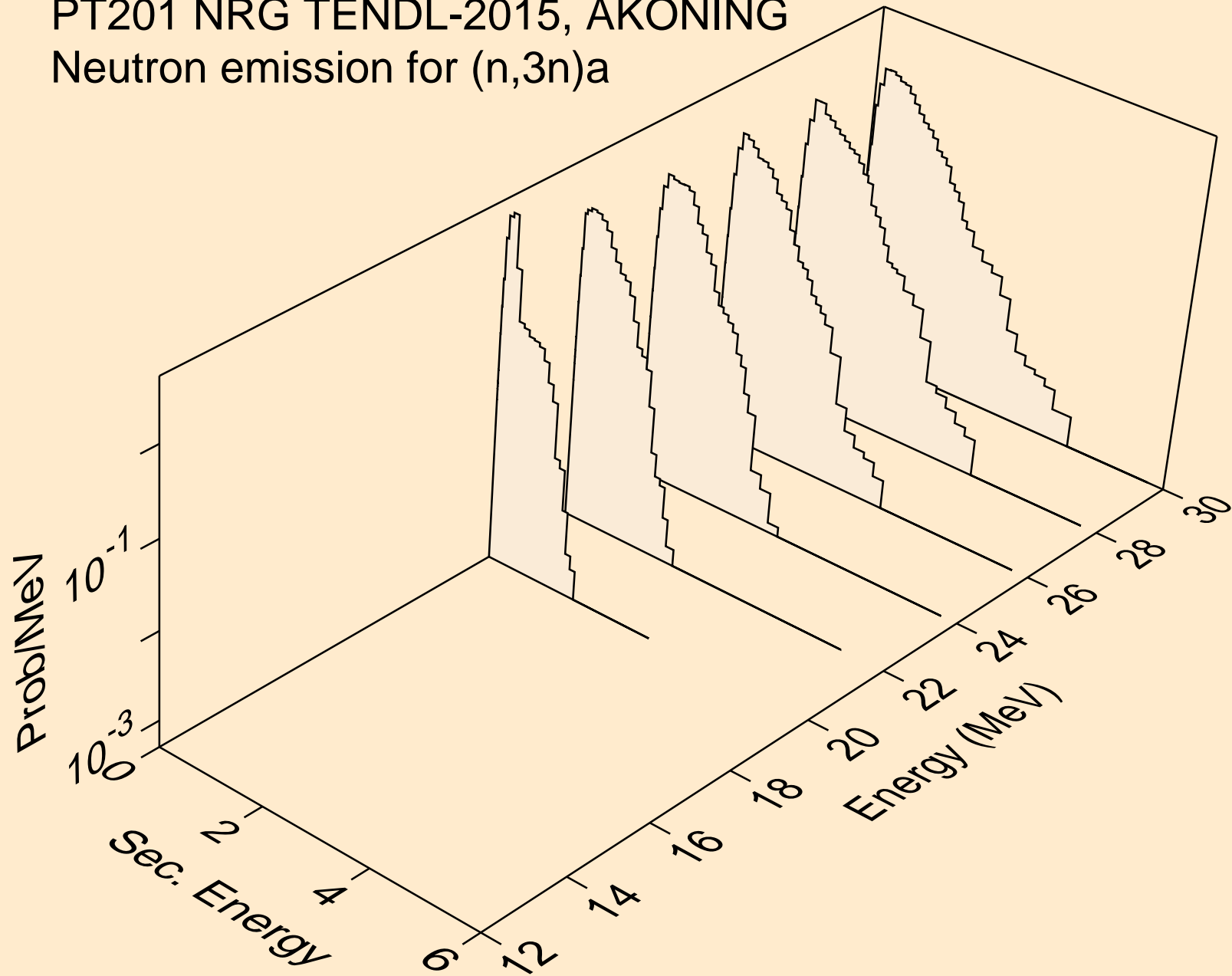

PT201 NRG TENDL-2015, AKONING
Neutron emission for (n,n*)p

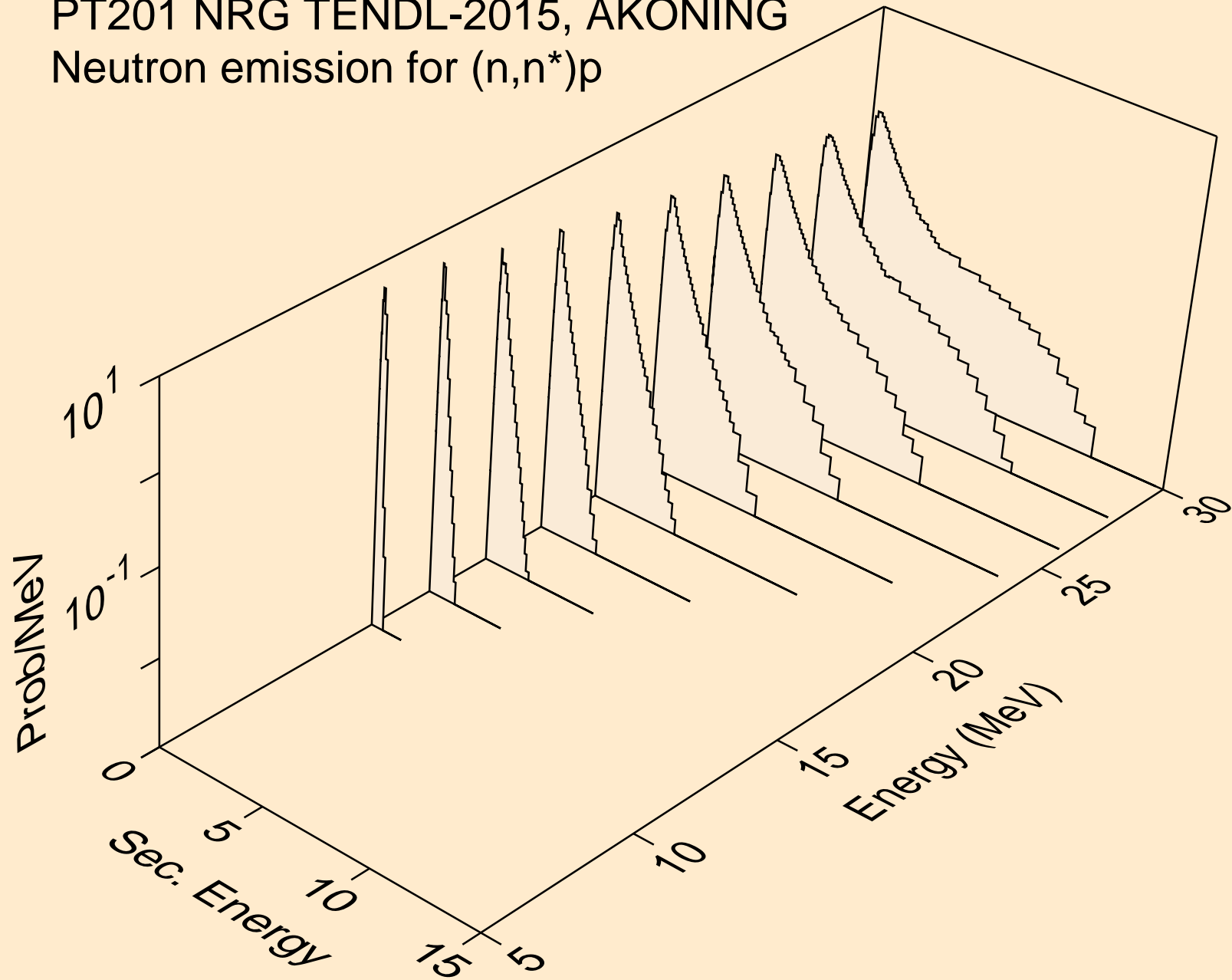

PT201 NRG TENDL-2015, AKONING
Neutron emission for (n,n*)d

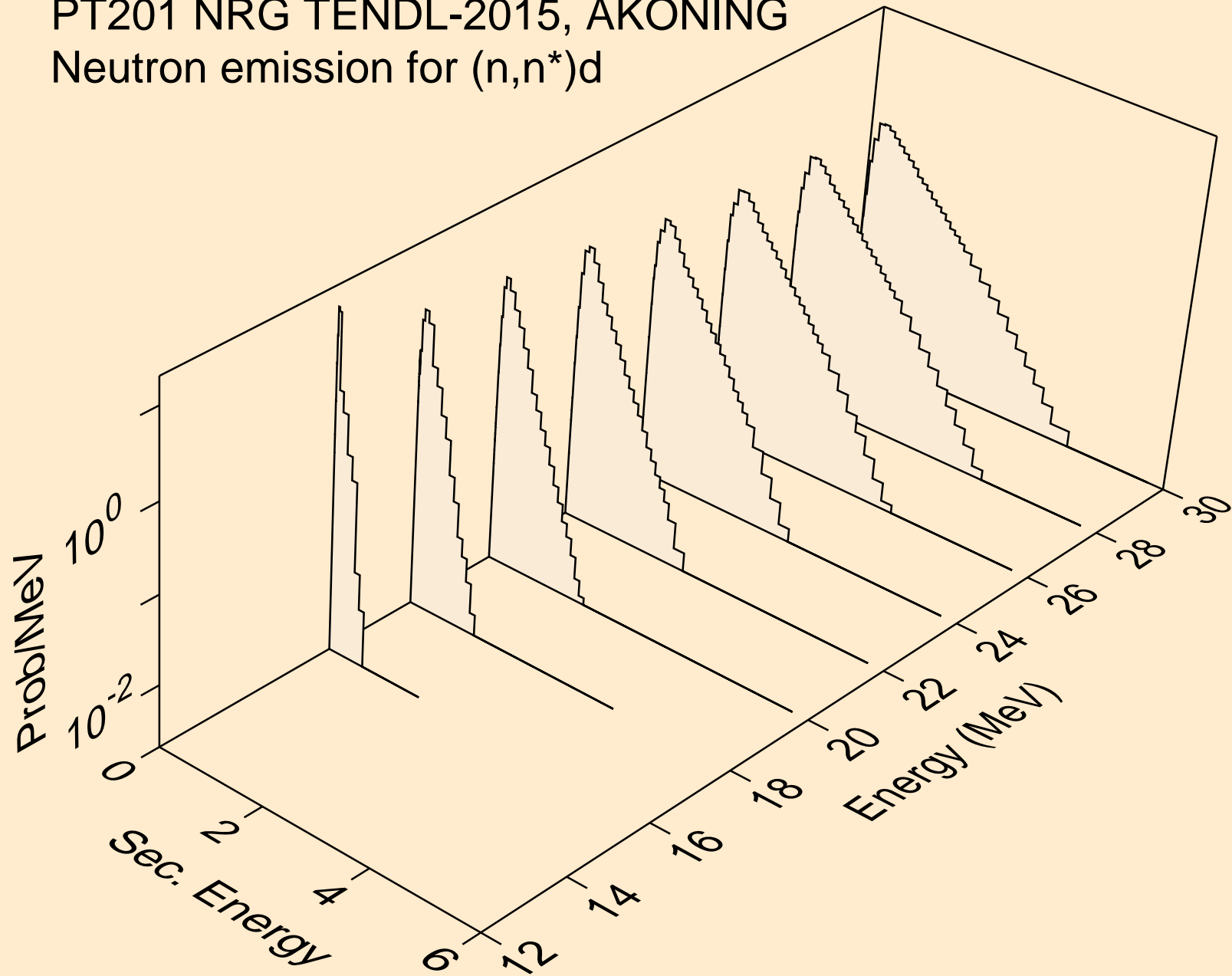

PT201 NRG TENDL-2015, AKONING
Neutron emission for (n,n*)t

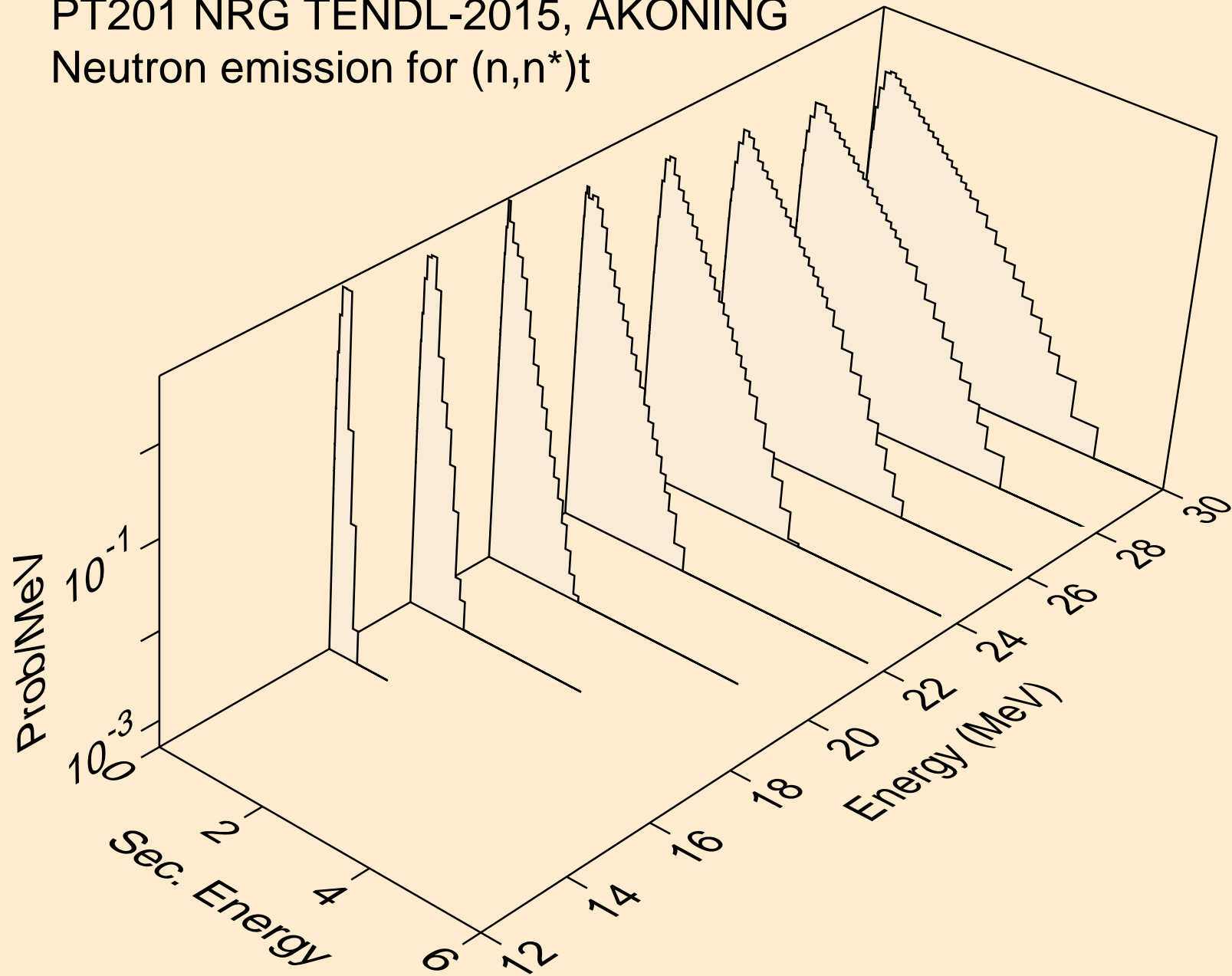

PT201 NRG TENDL-2015, AKONING
Neutron emission for (n,n*)he3

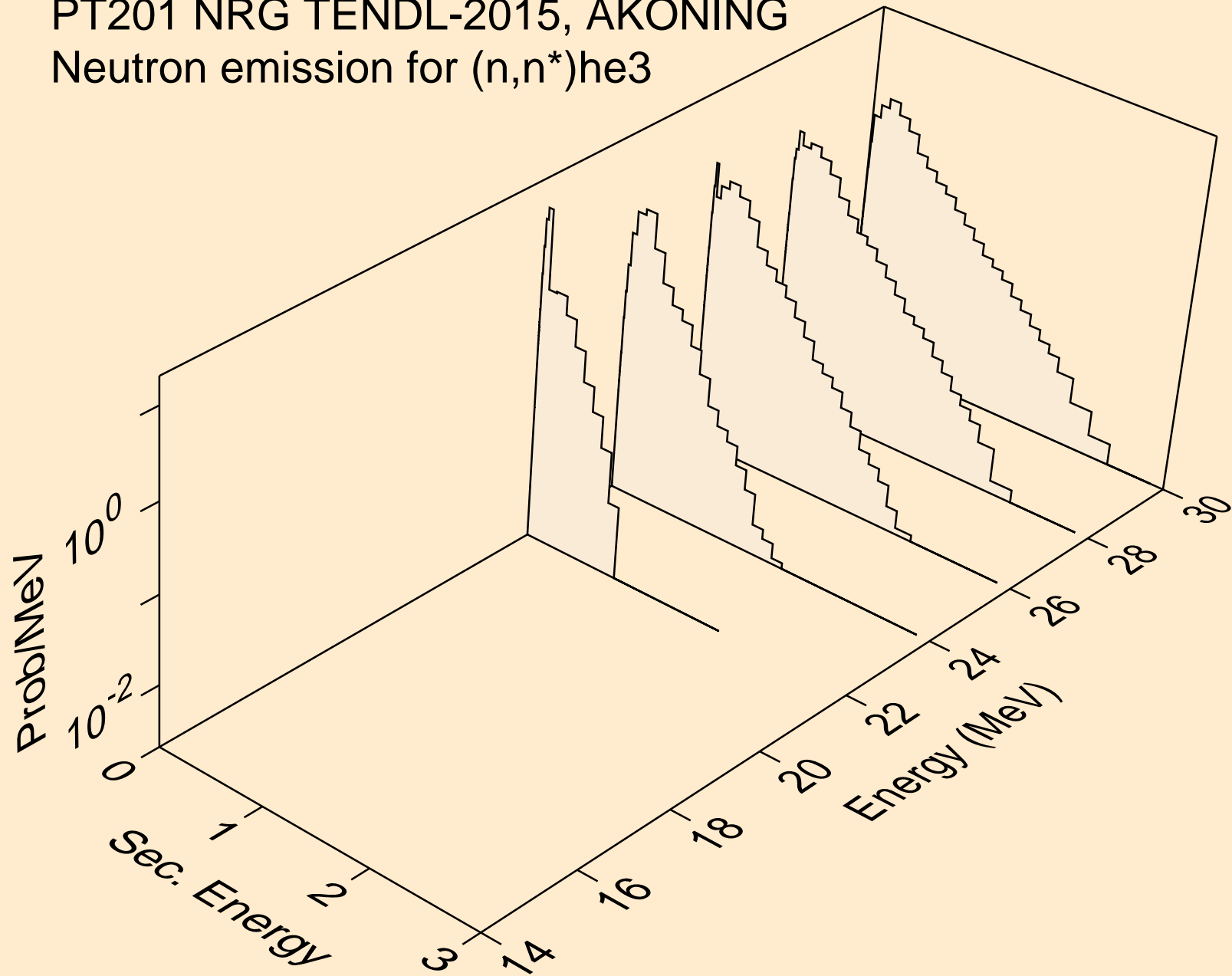

PT201 NRG TENDL-2015, AKONING
Neutron emission for (n,4n)

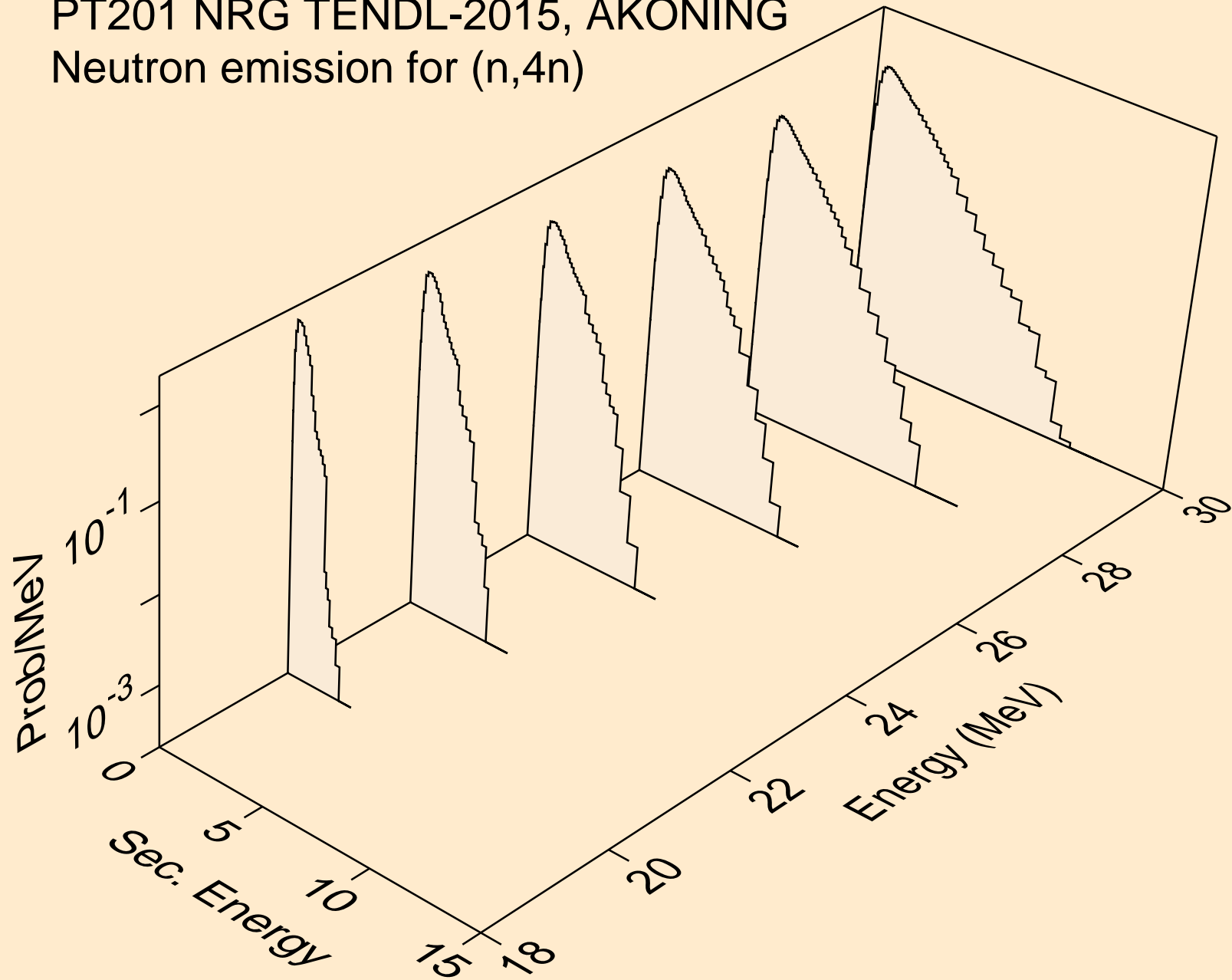

PT201 NRG TENDL-2015, AKONING
Neutron emission for (n,2np)

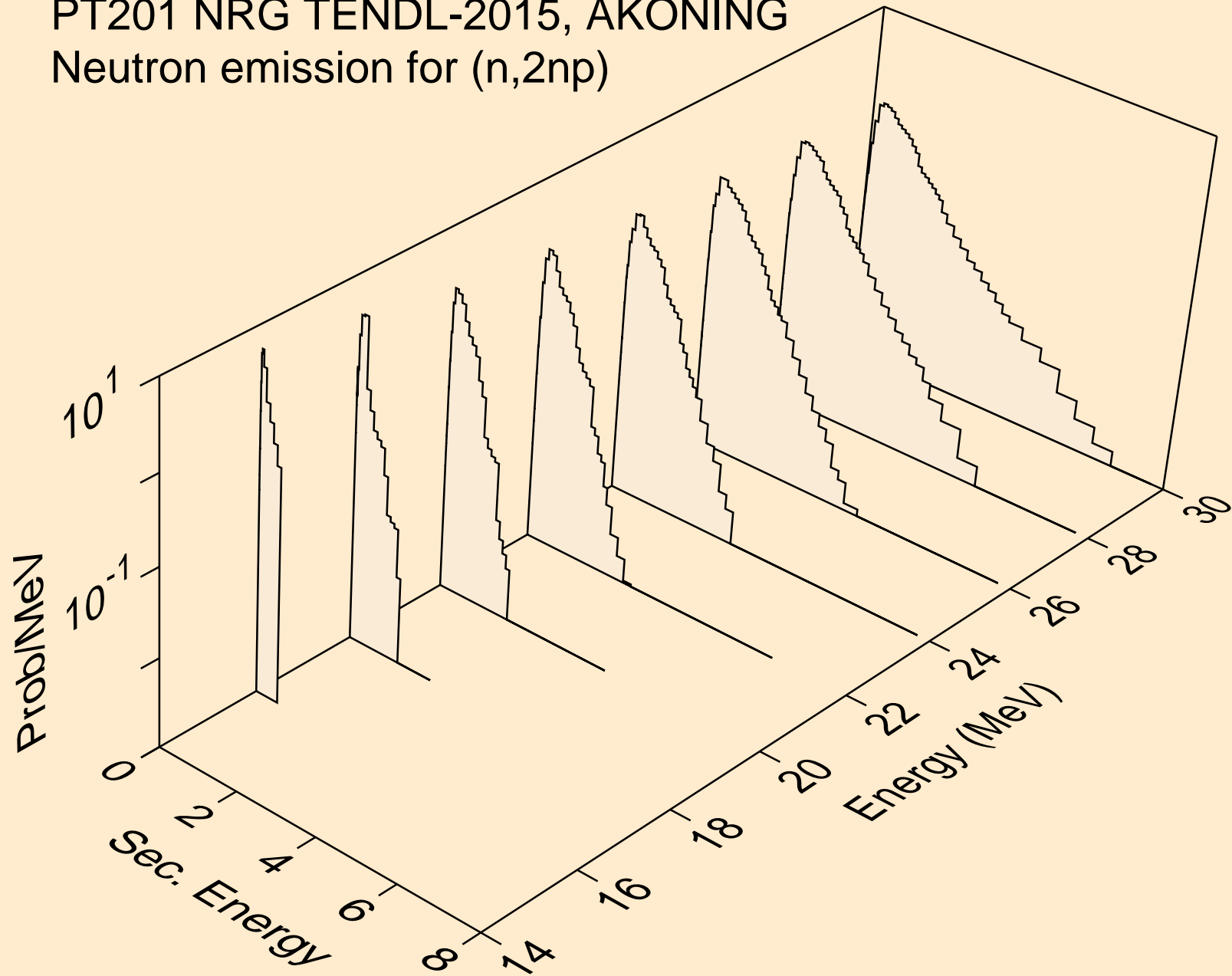

PT201 NRG TENDL-2015, AKONING
Neutron emission for (n,3np)

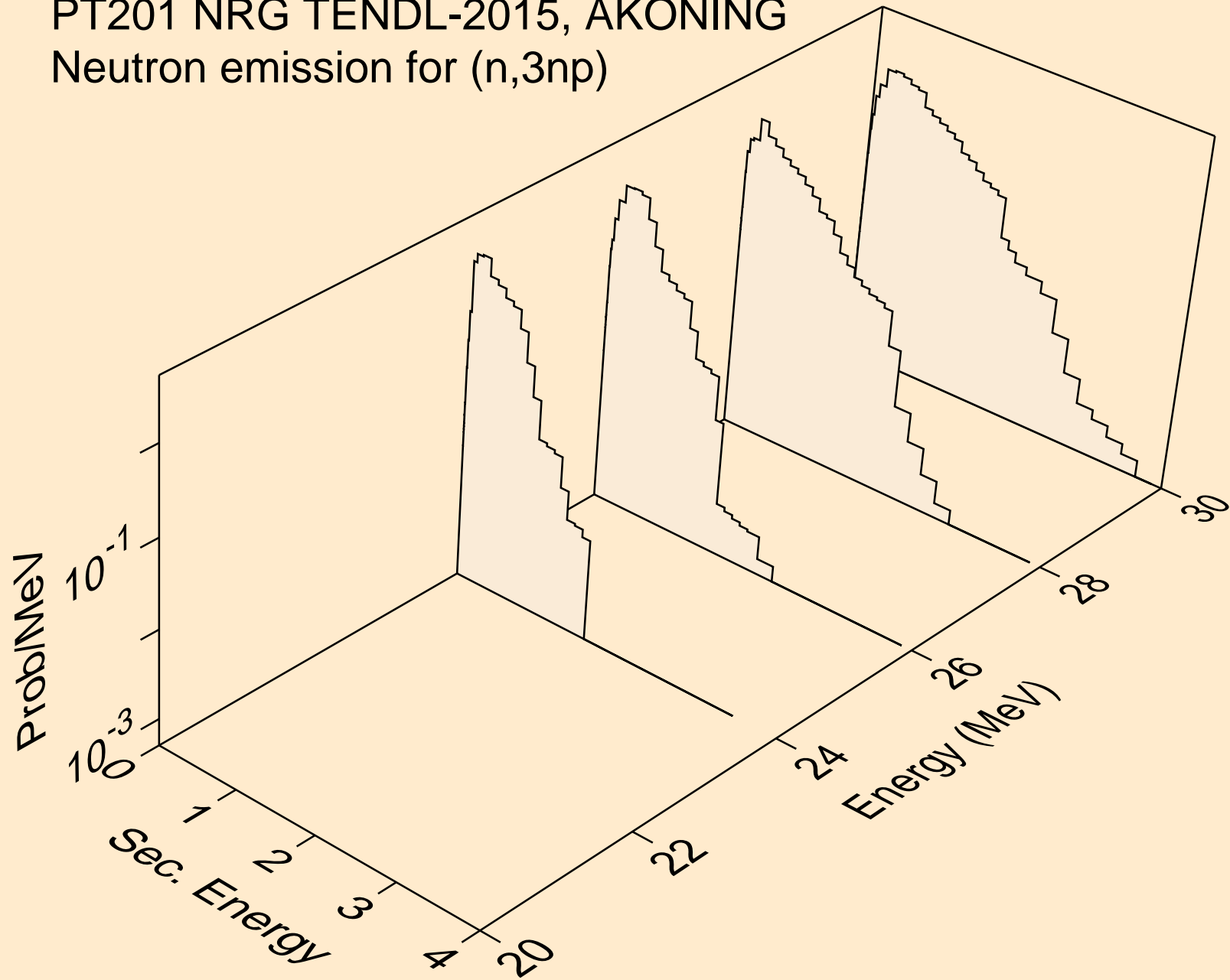

PT201 NRG TENDL-2015, AKONING
Neutron emission for (n,n*c)

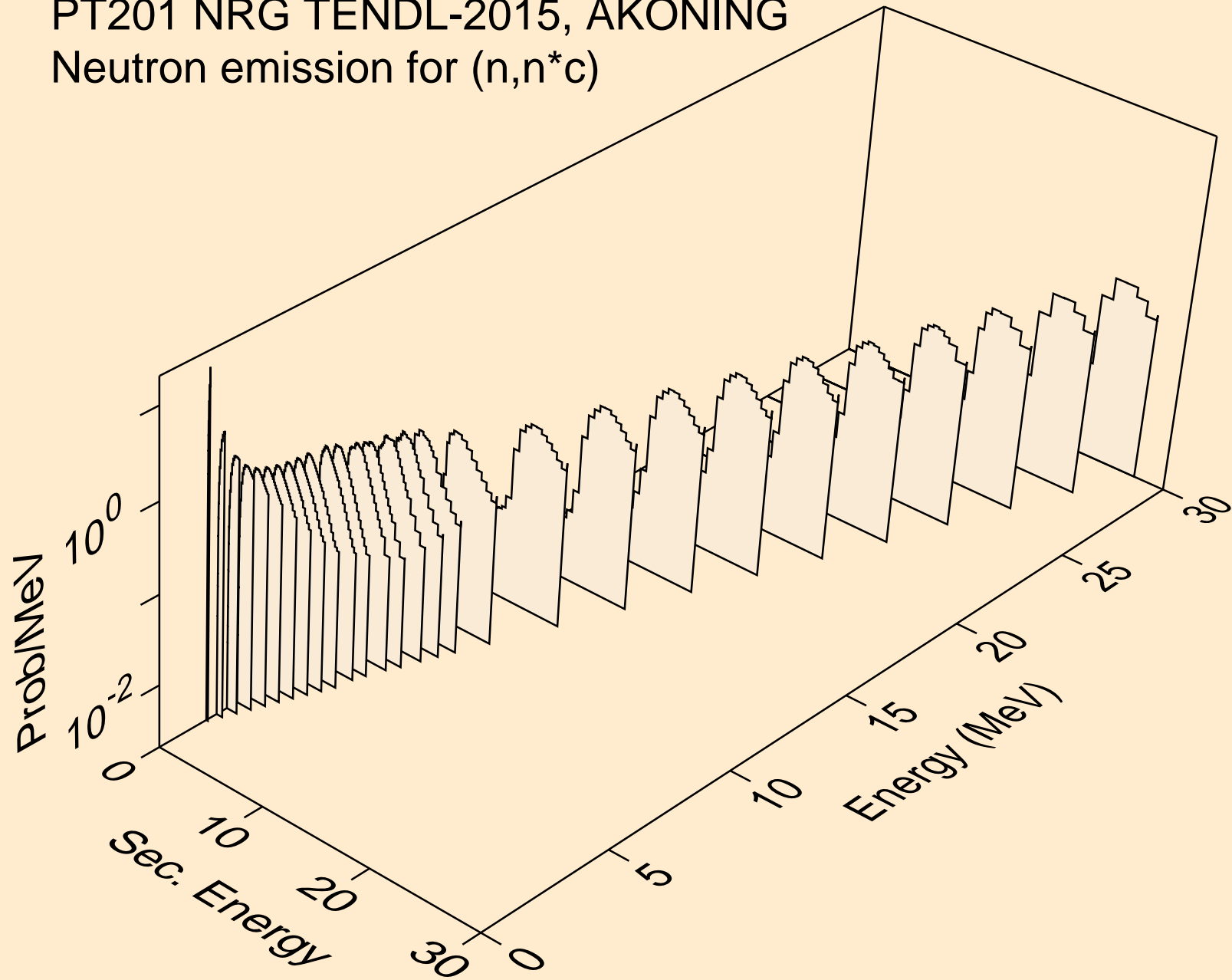

PT201 NRG TENDL-2015, AKONING
Photon emission for (n,x)

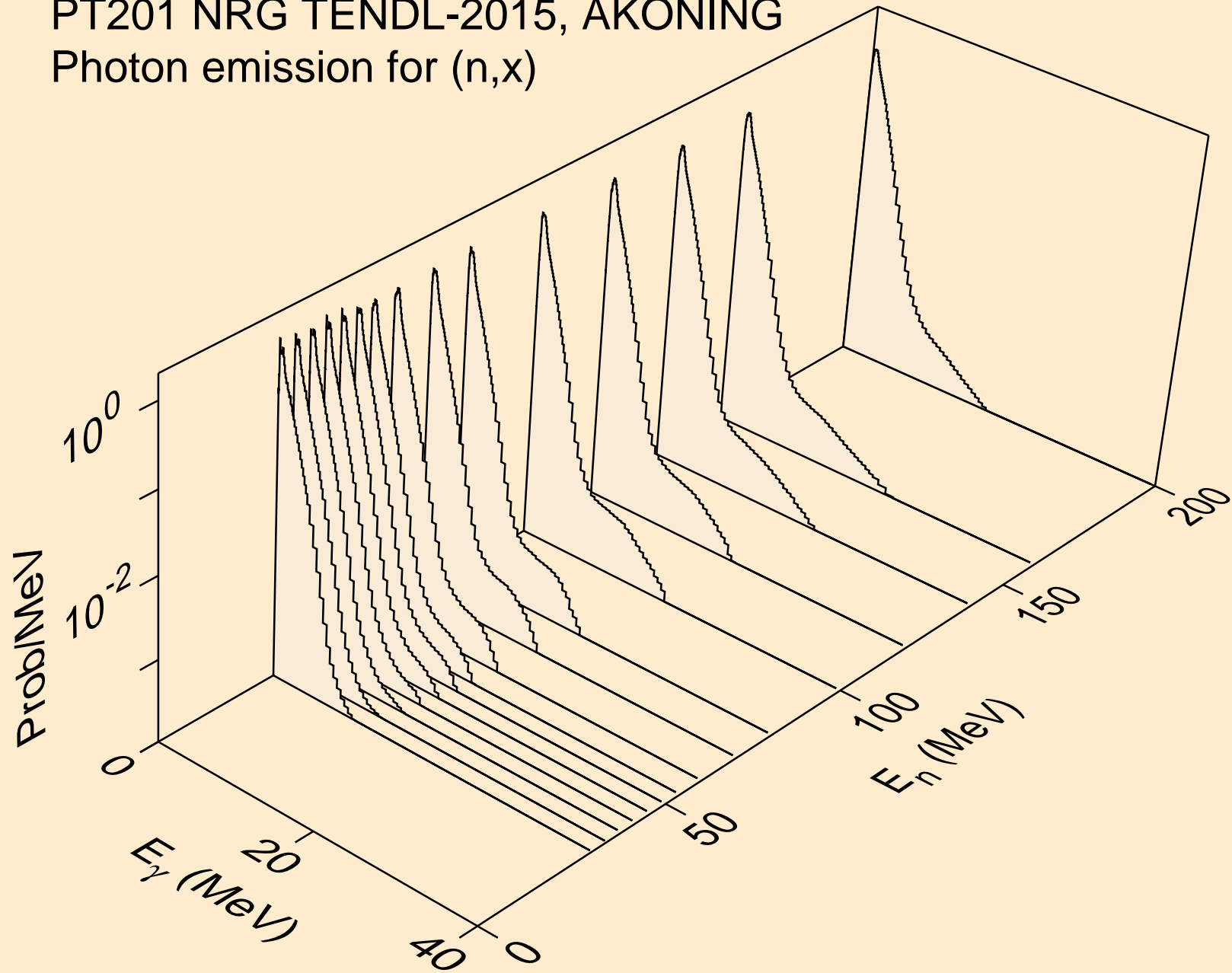

PT201 NRG TENDL-2015, AKONING
Photon emission for (n,2nd)

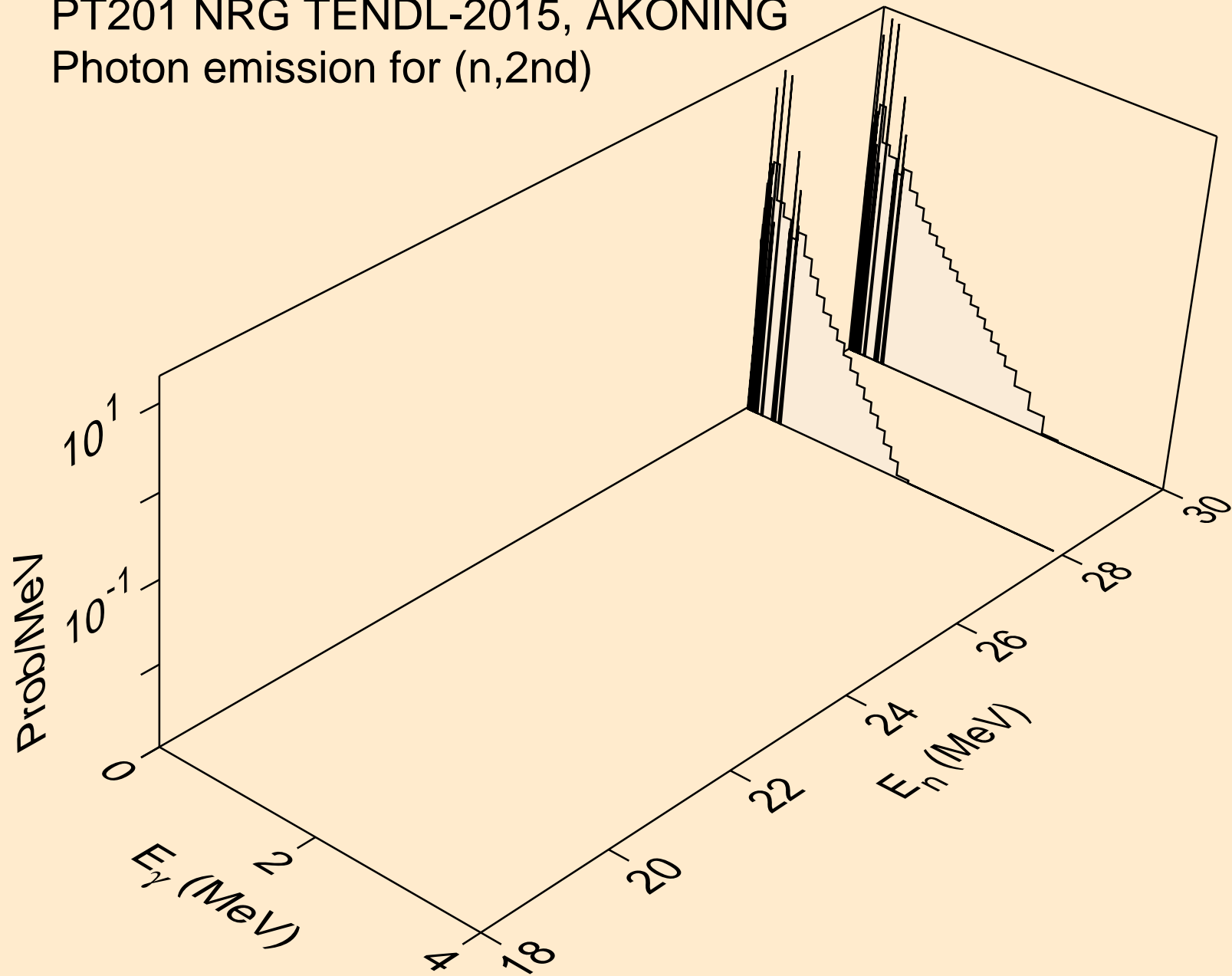

PT201 NRG TENDL-2015, AKONING
Photon emission for (n,2n)

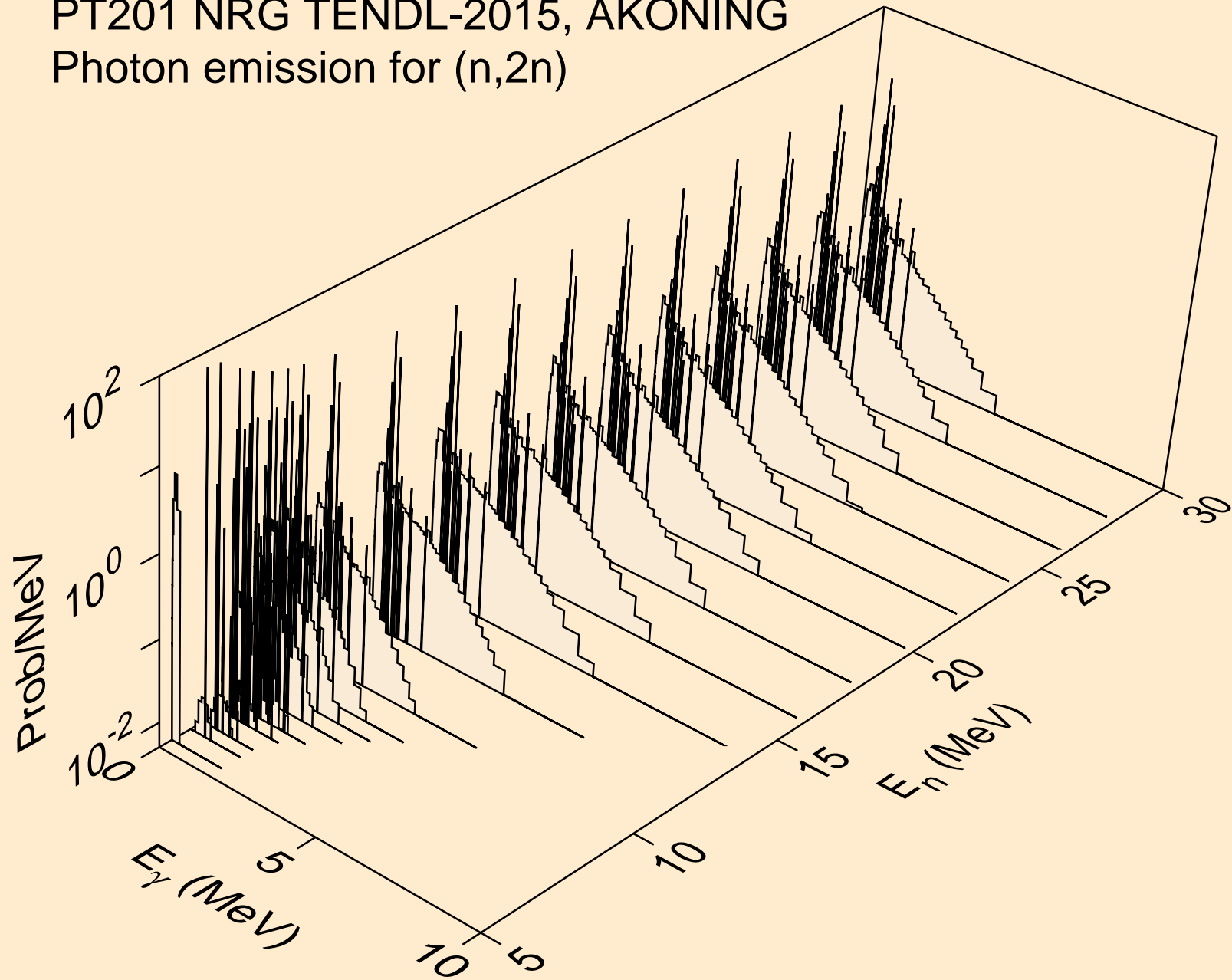

PT201 NRG TENDL-2015, AKONING
Photon emission for (n,3n)

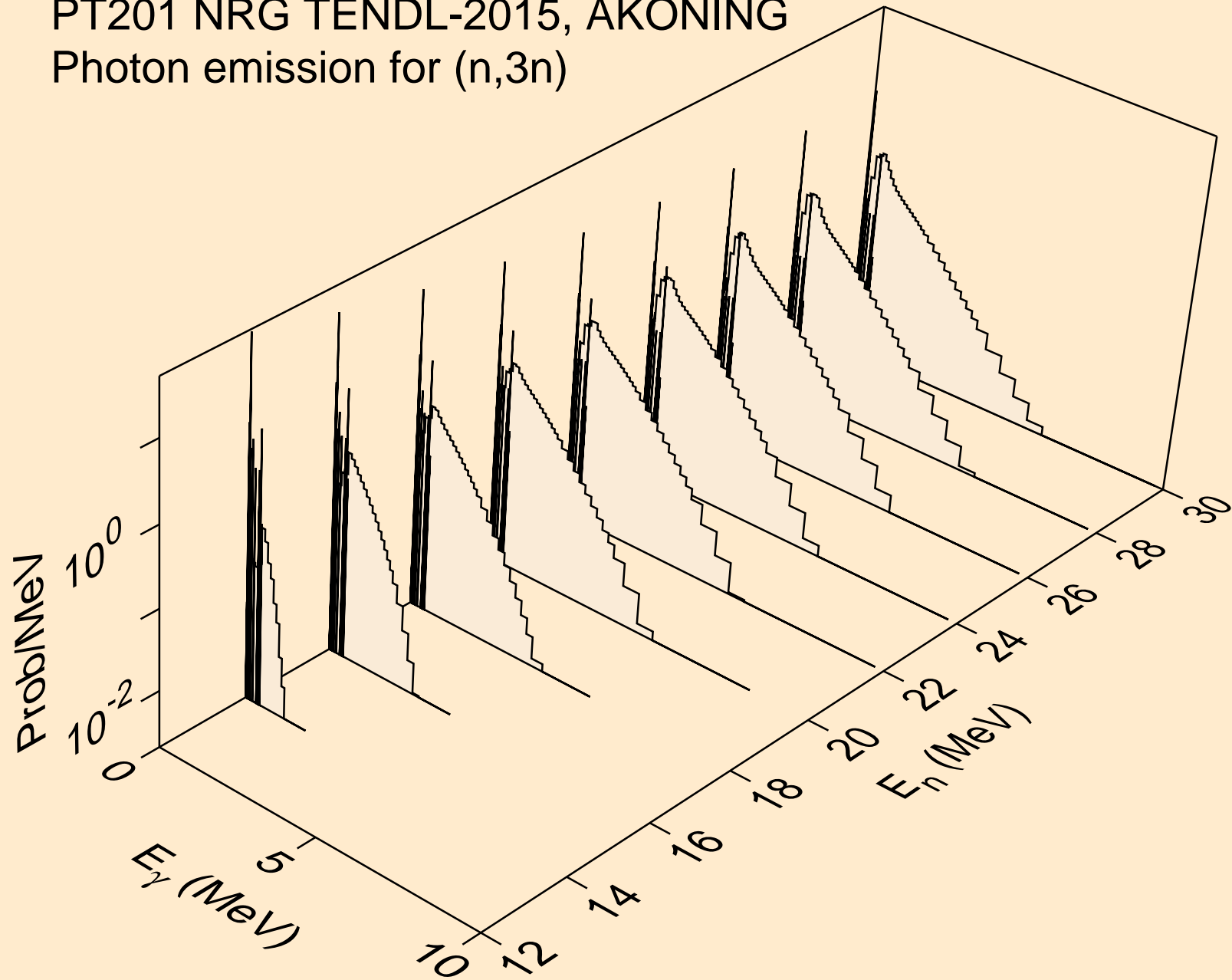

PT201 NRG TENDL-2015, AKONING
Photon emission for (n,n*)a

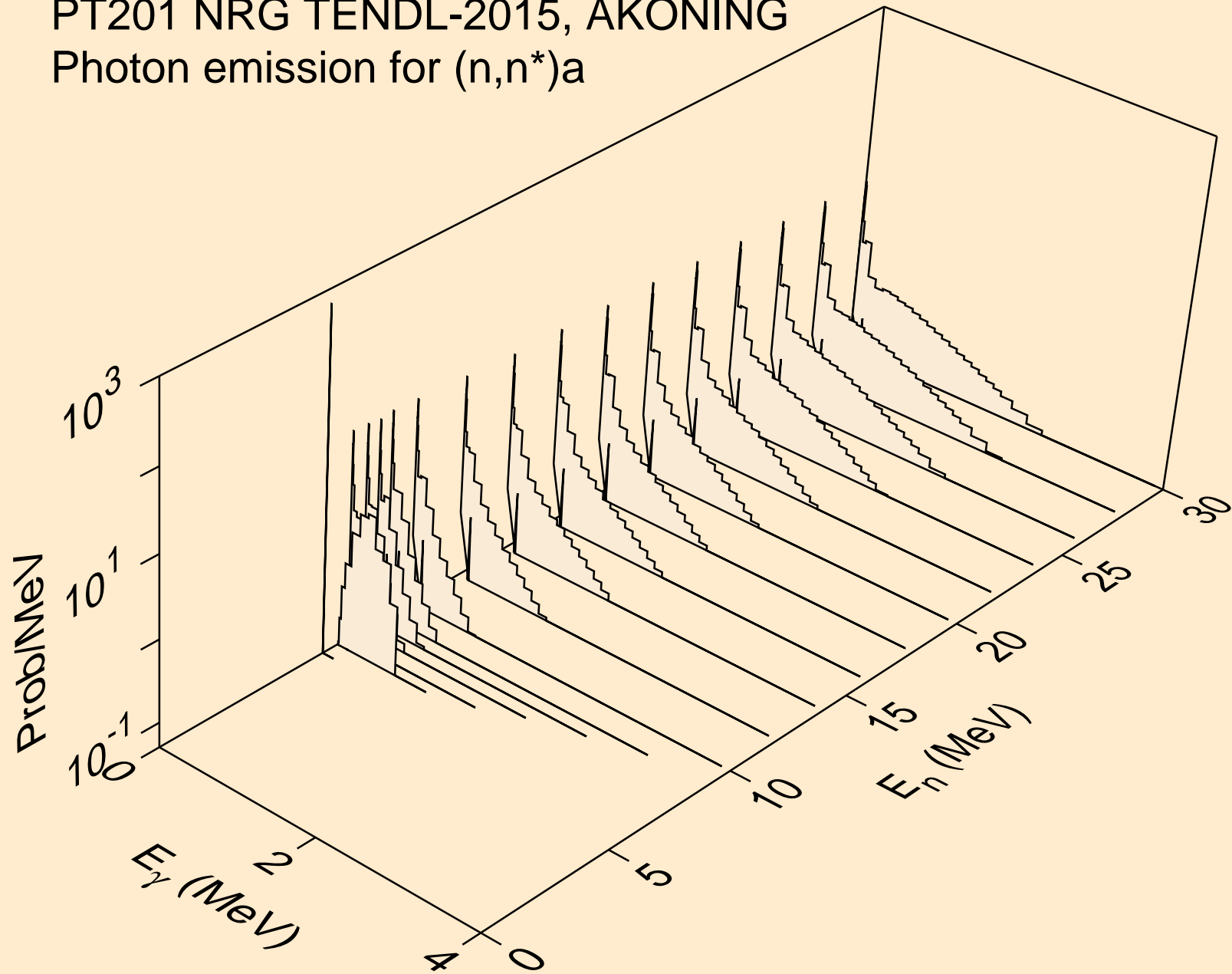

PT201 NRG TENDL-2015, AKONING
Photon emission for (n,2n)a

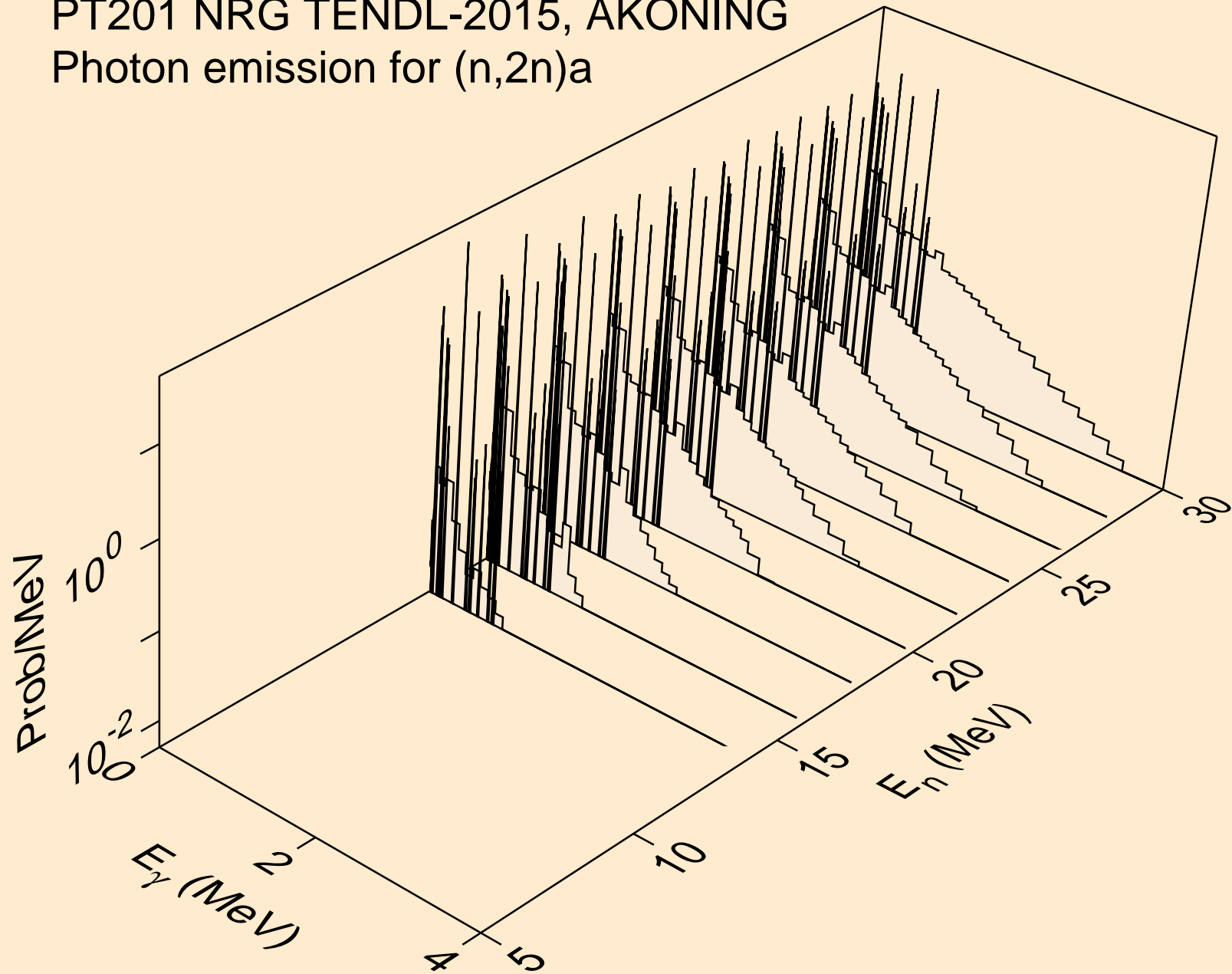

PT201 NRG TENDL-2015, AKONING
Photon emission for (n,3n)a

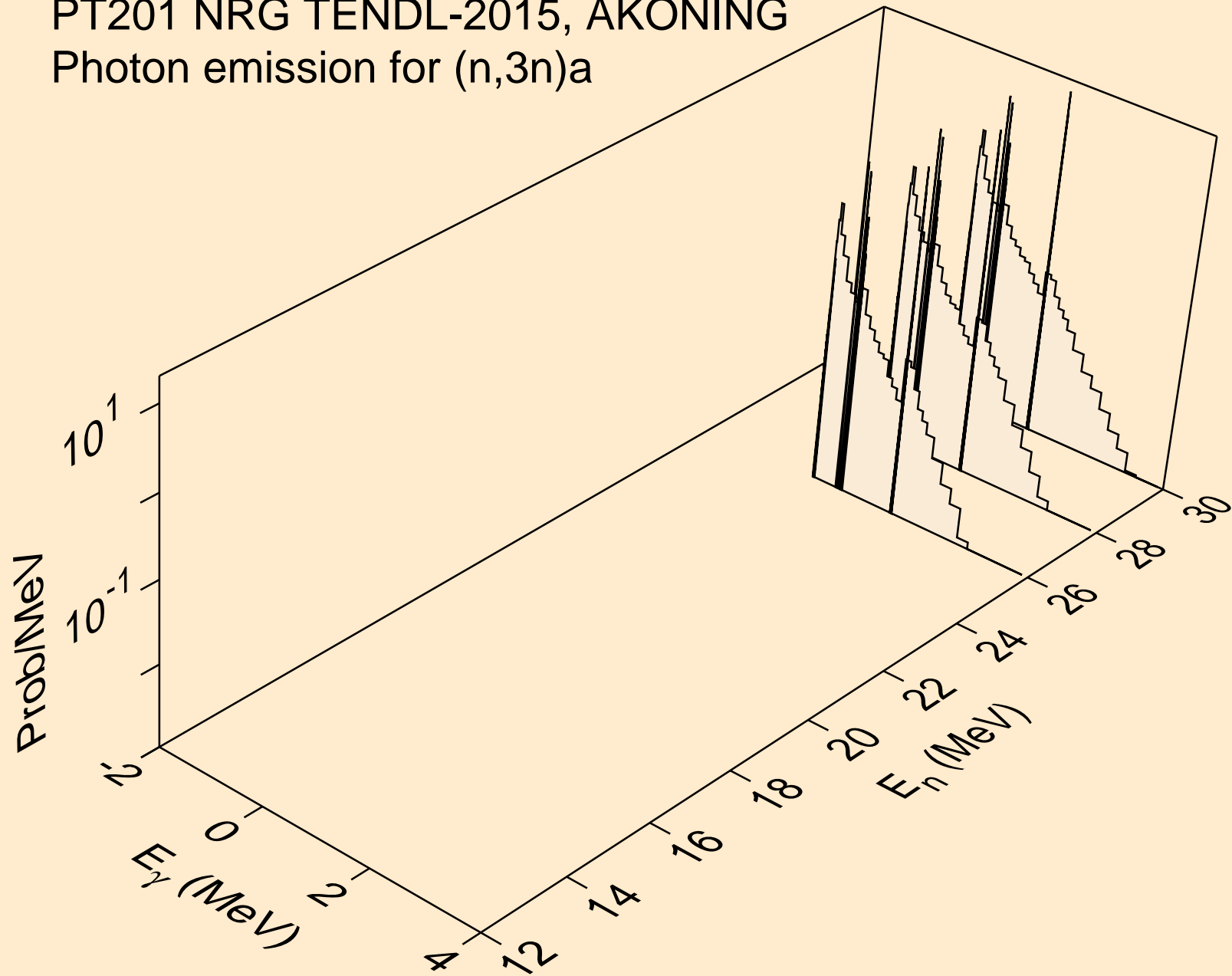

PT201 NRG TENDL-2015, AKONING
Photon emission for (n,n*)p

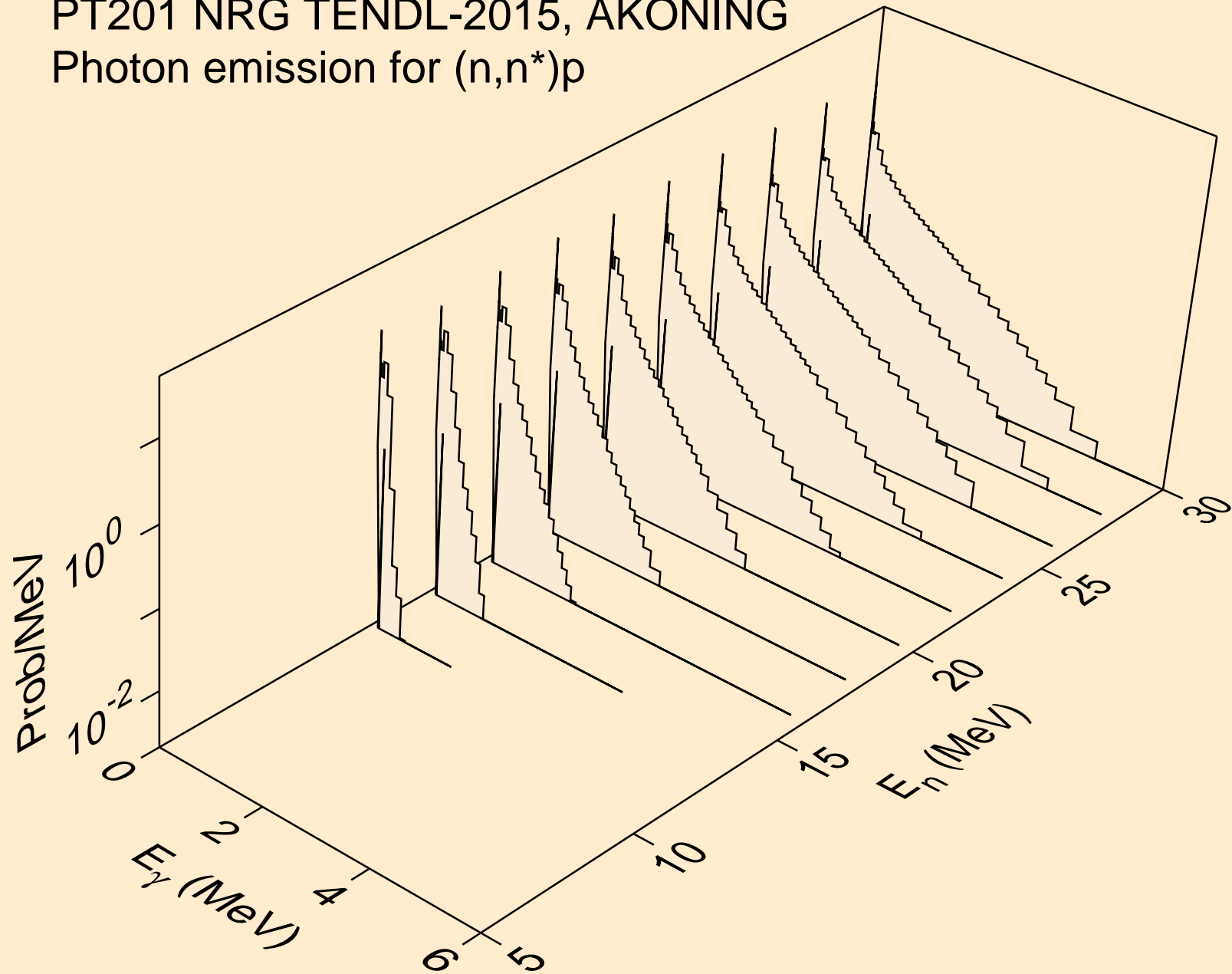

PT201 NRG TENDL-2015, AKONING
Photon emission for (n,n*)d

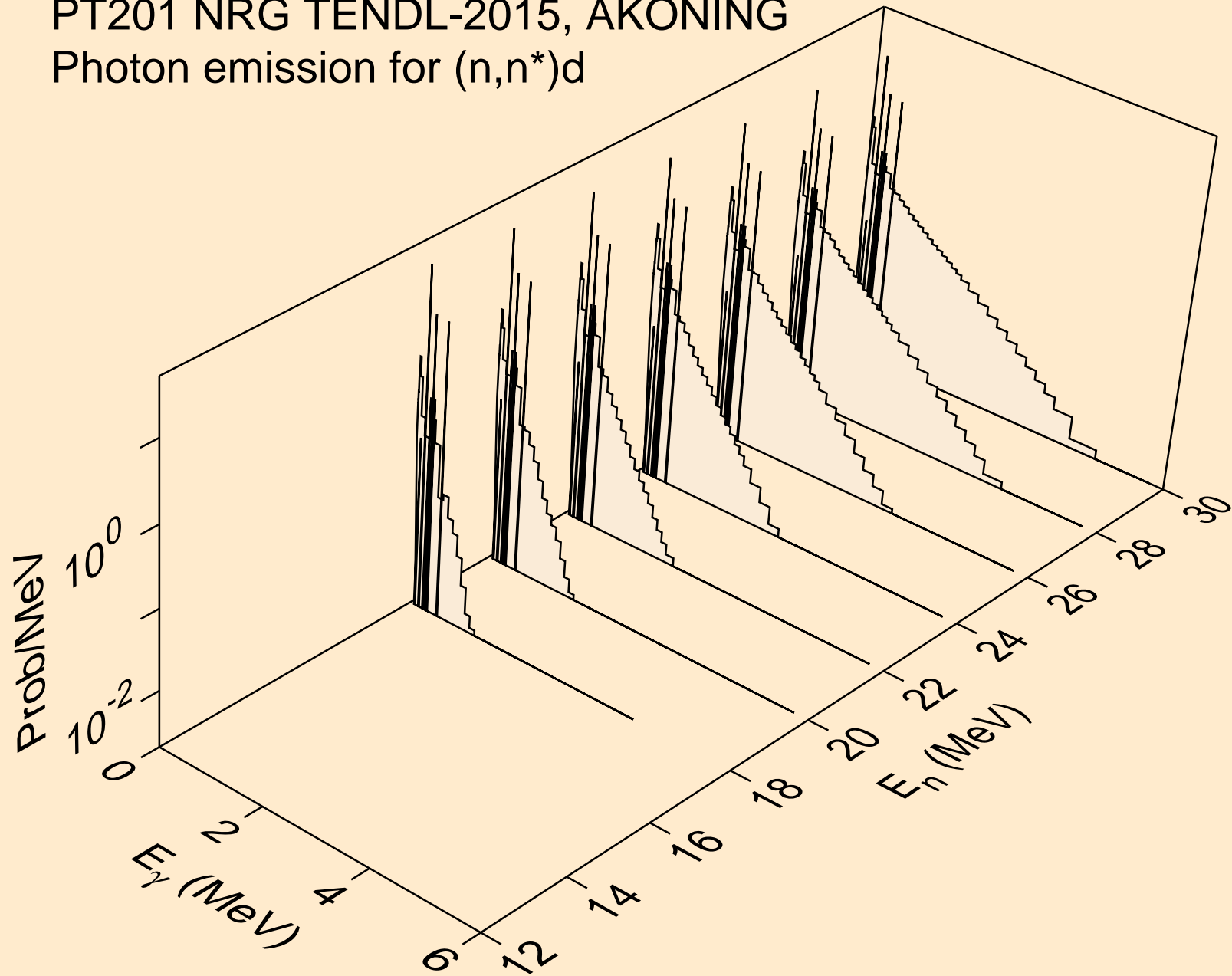

PT201 NRG TENDL-2015, AKONING
Photon emission for (n,n*)t

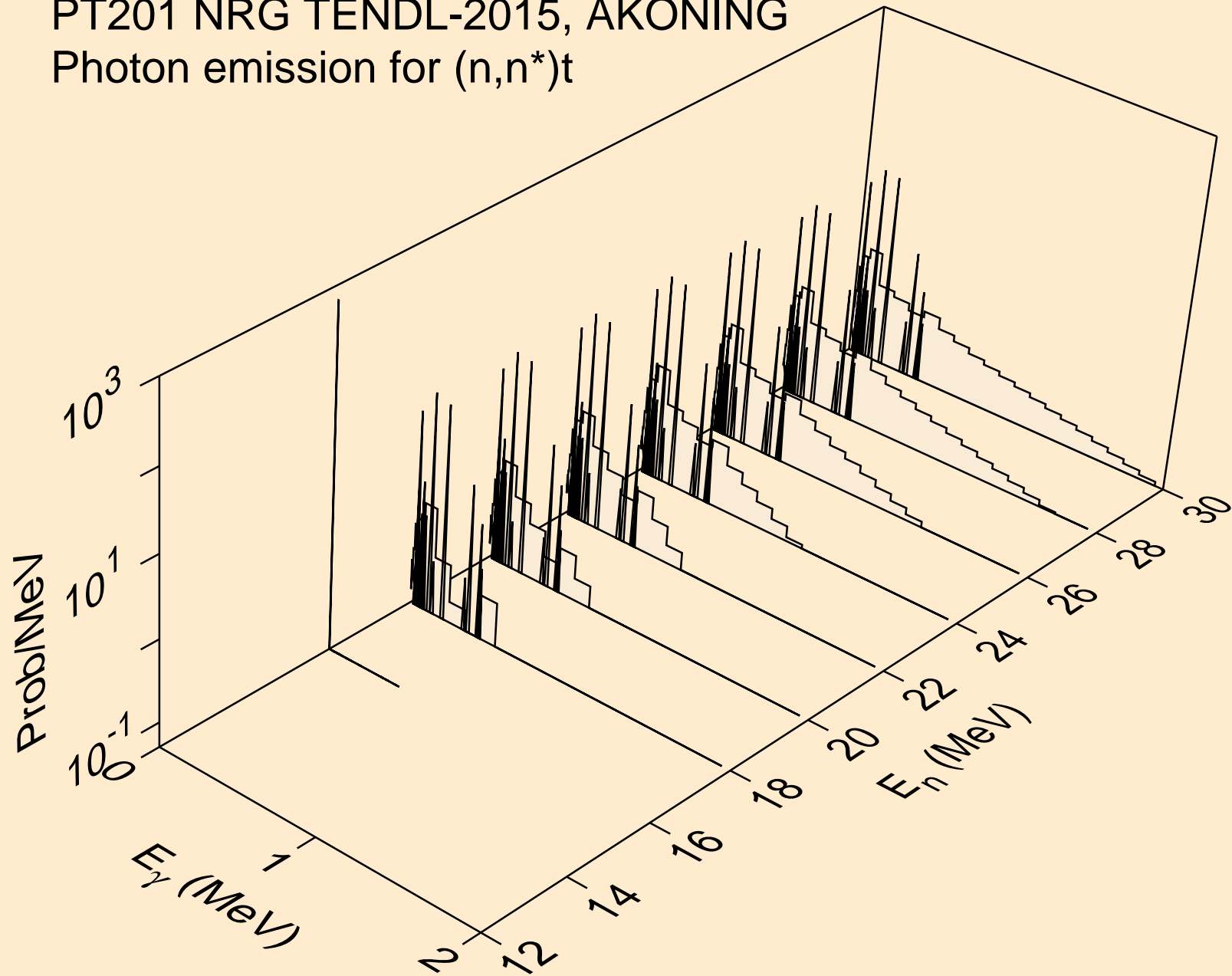

PT201 NRG TENDL-2015, AKONING
Photon emission for (n,n*)he3

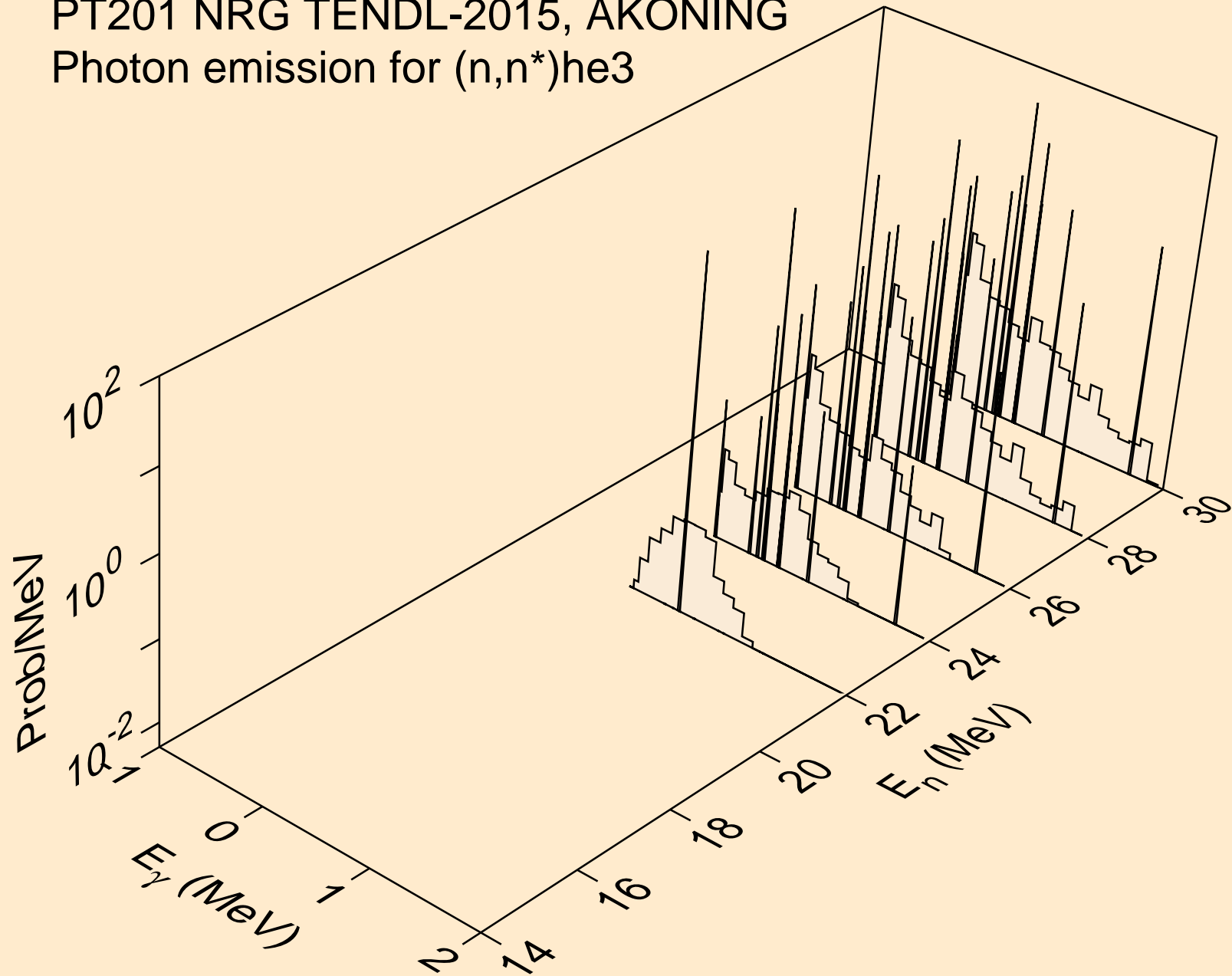

PT201 NRG TENDL-2015, AKONING
Photon emission for (n,4n)

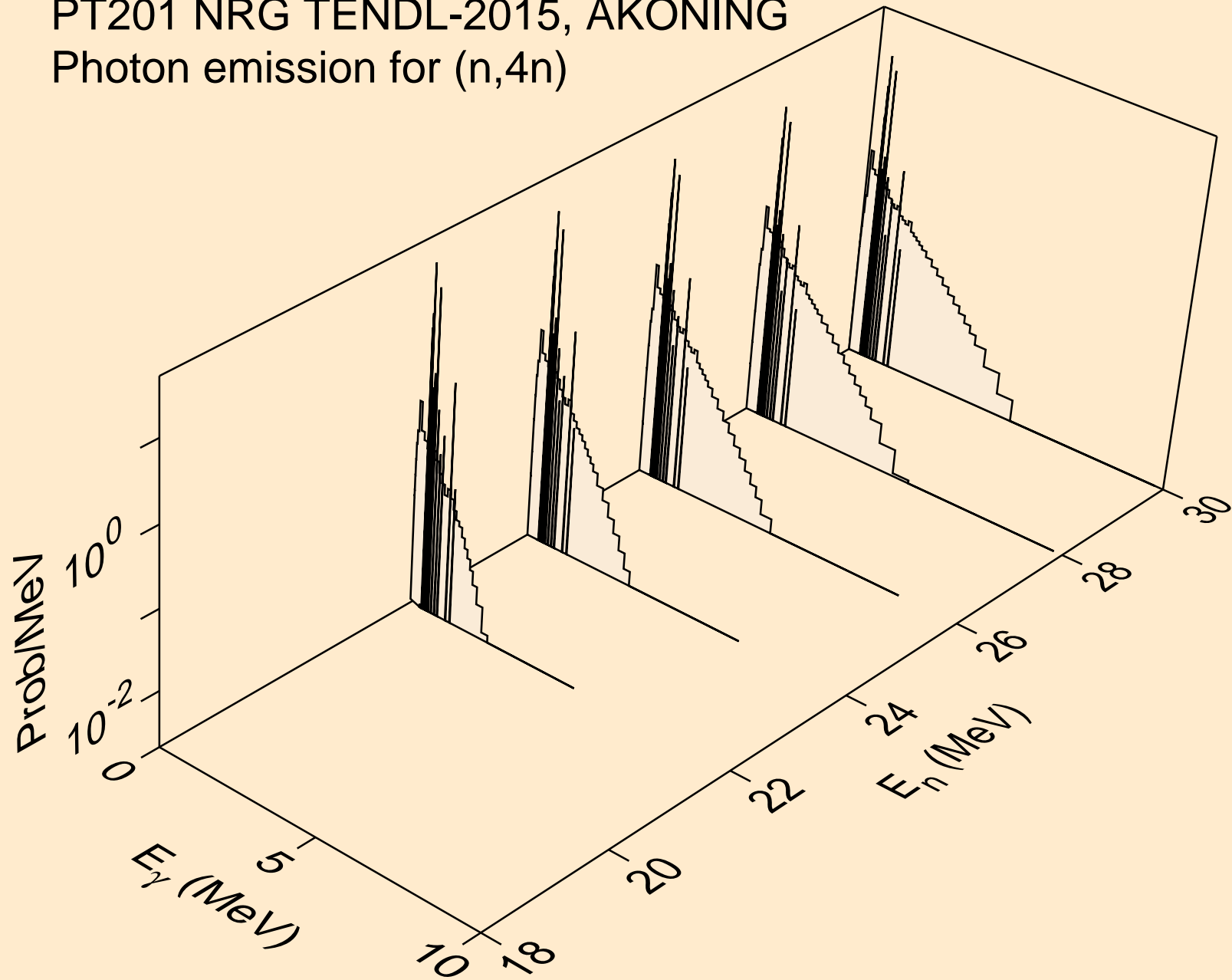

PT201 NRG TENDL-2015, AKONING
Photon emission for (n,2np)

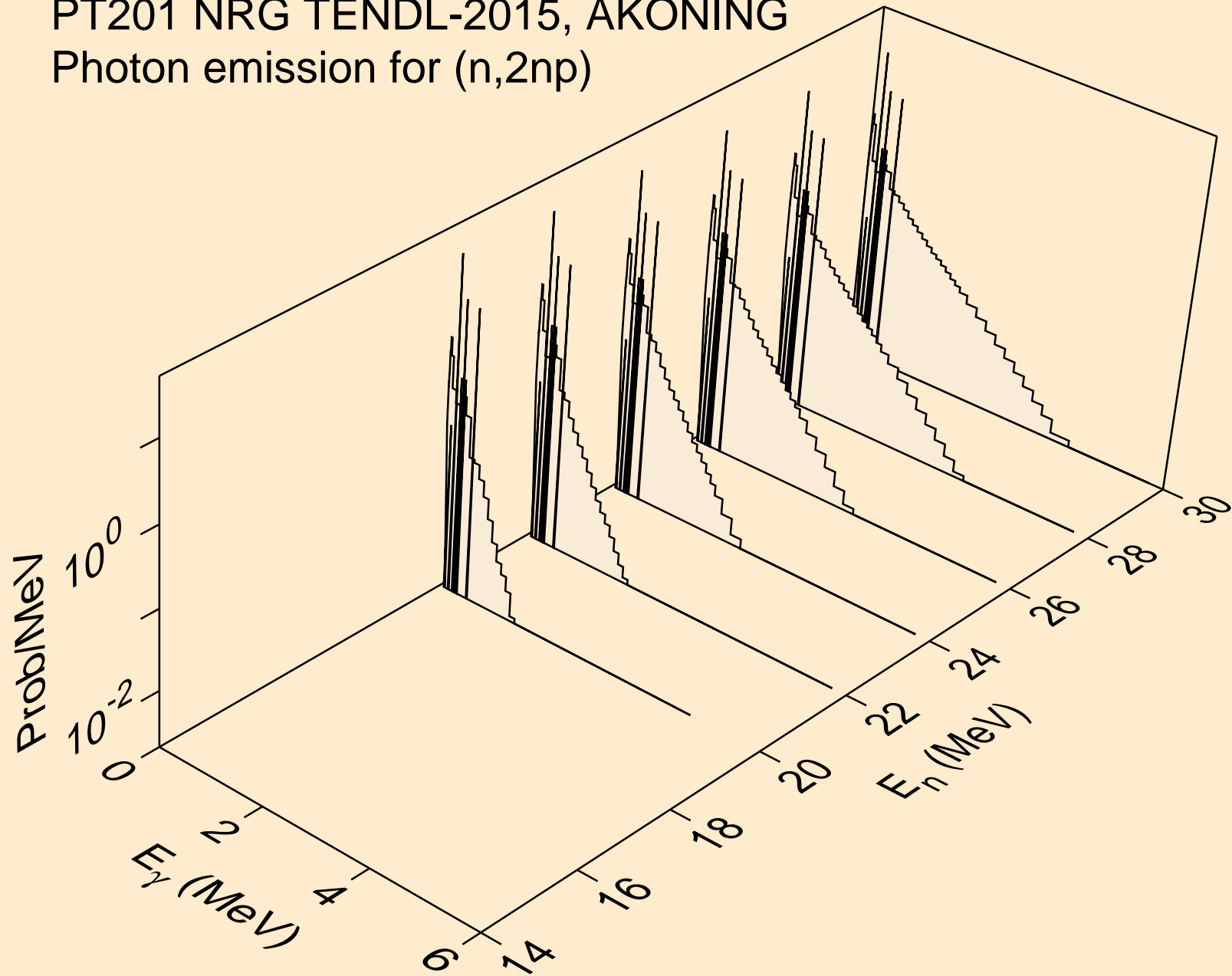

PT201 NRG TENDL-2015, AKONING
Photon emission for (n,3np)

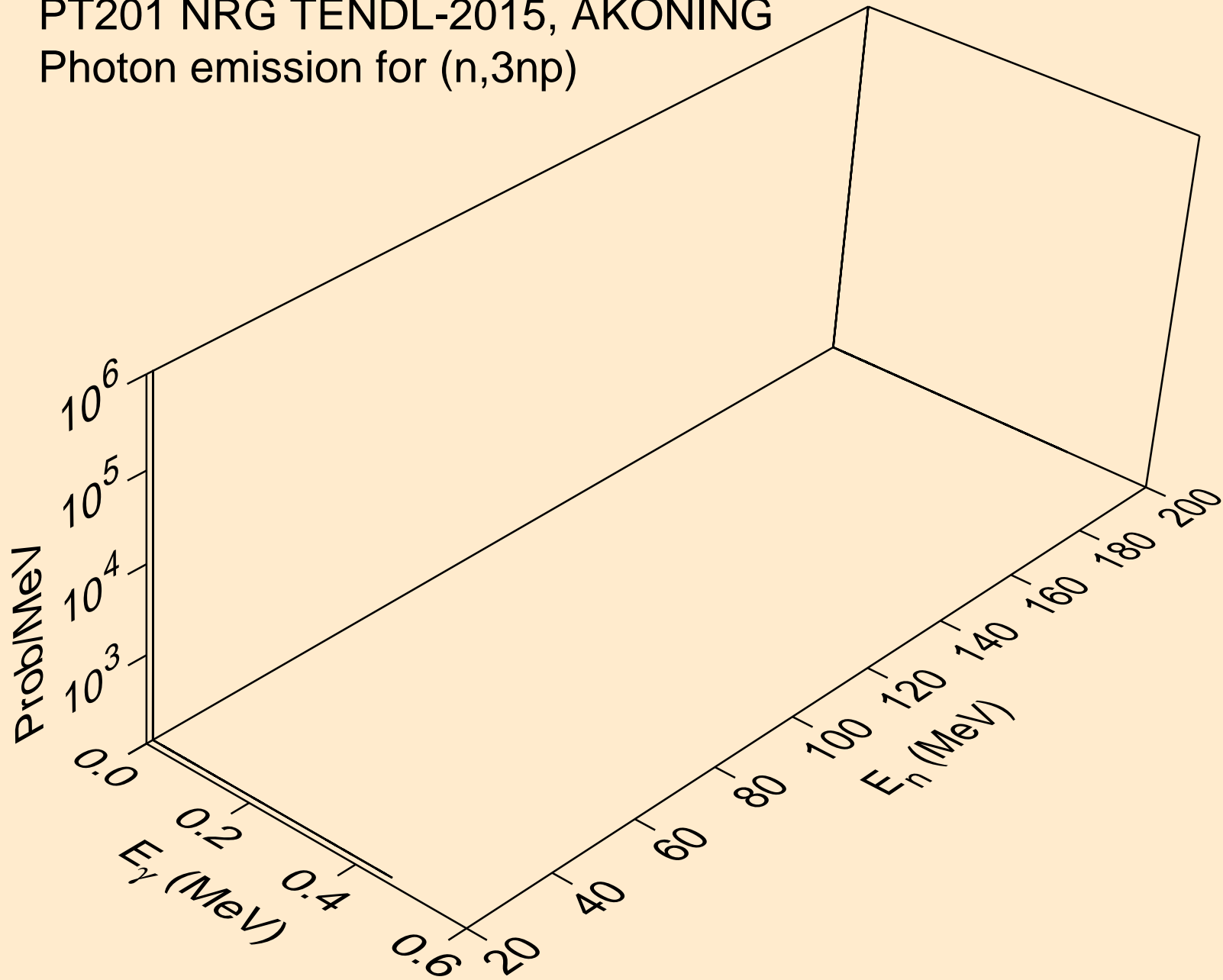

PT201 NRG TENDL-2015, AKONING
Photon emission for (n,n*c)

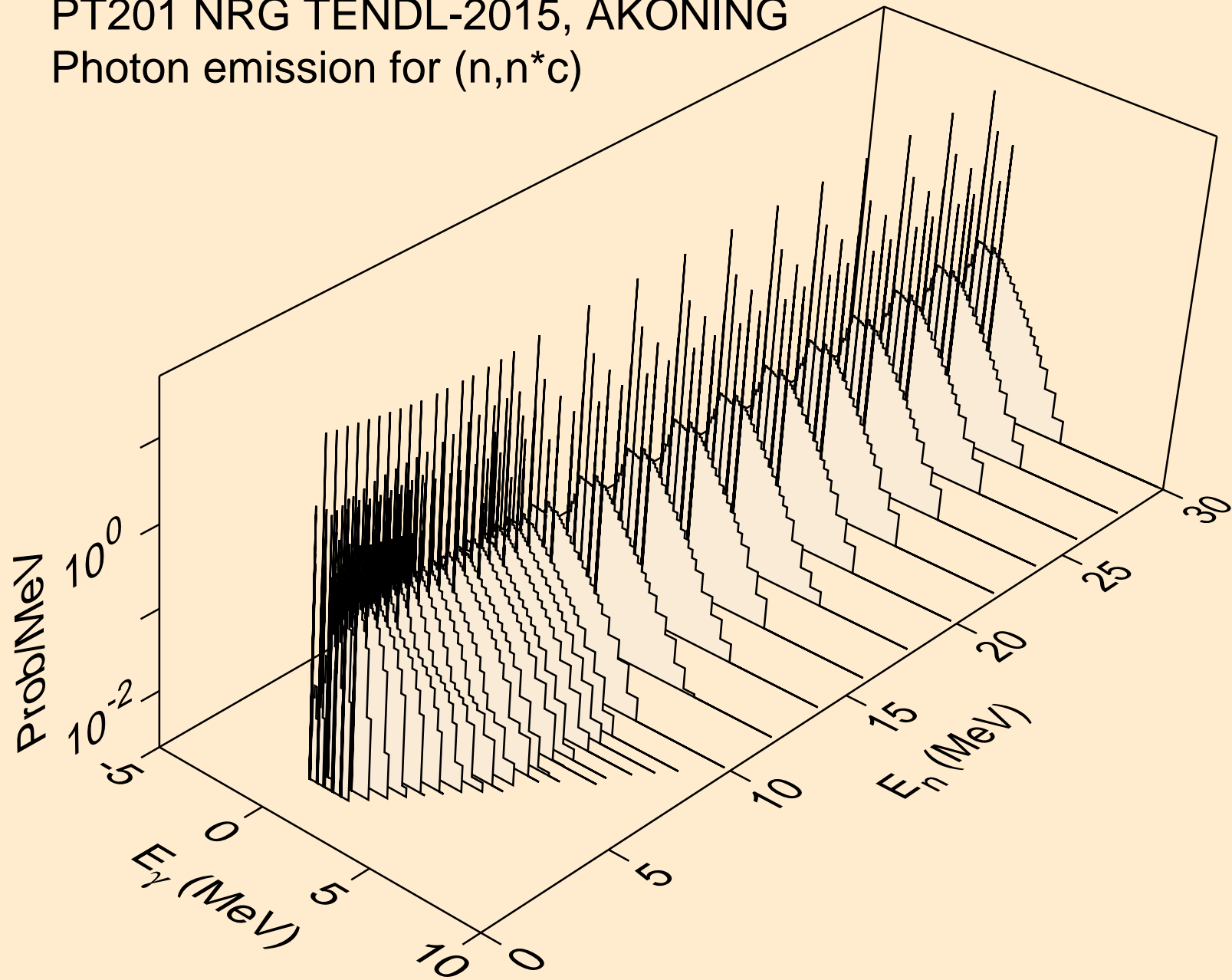

PT201 NRG TENDL-2015, AKONING
Photon emission for (n,gma)

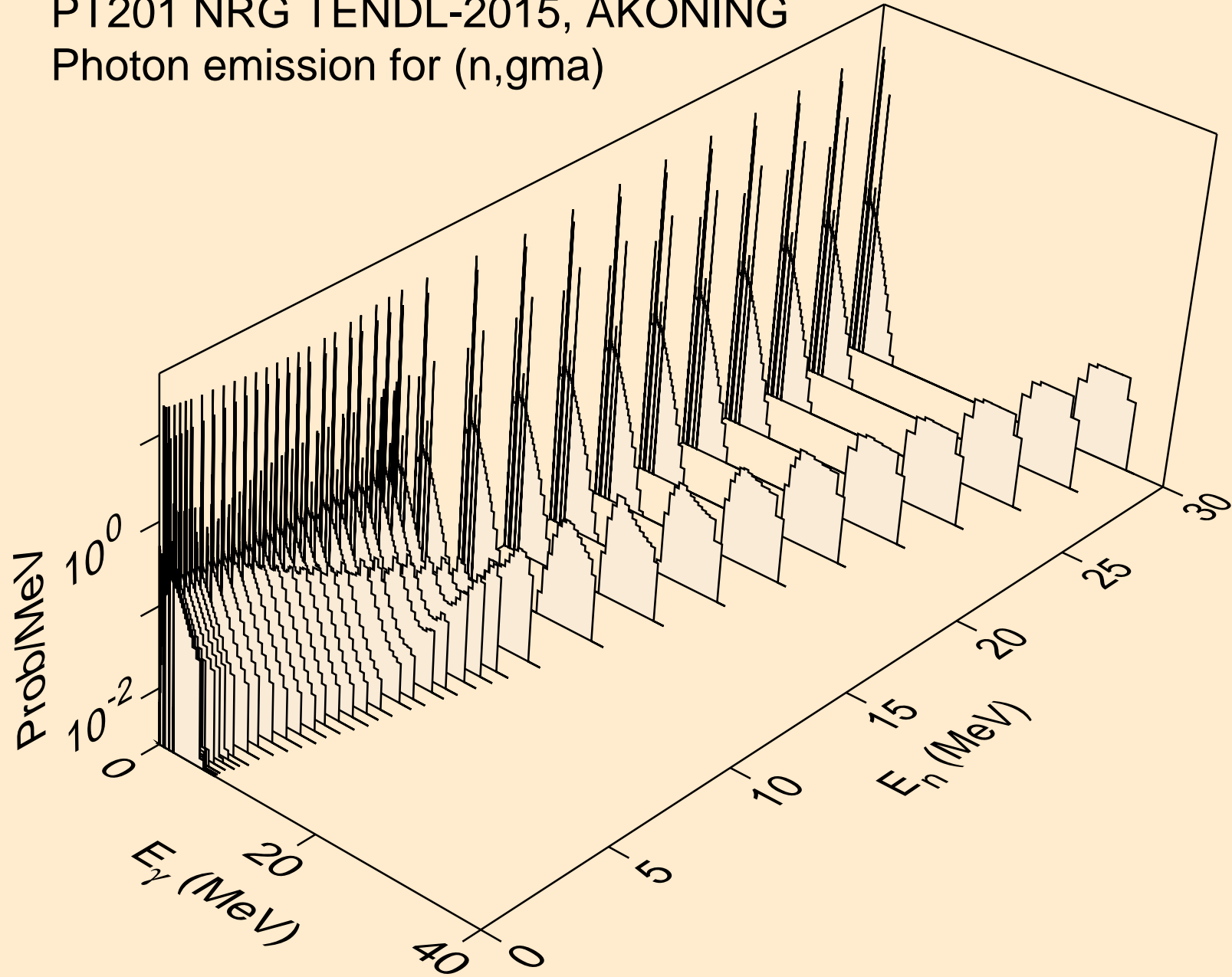

PT201 NRG TENDL-2015, AKONING
Photon emission for (n,p)

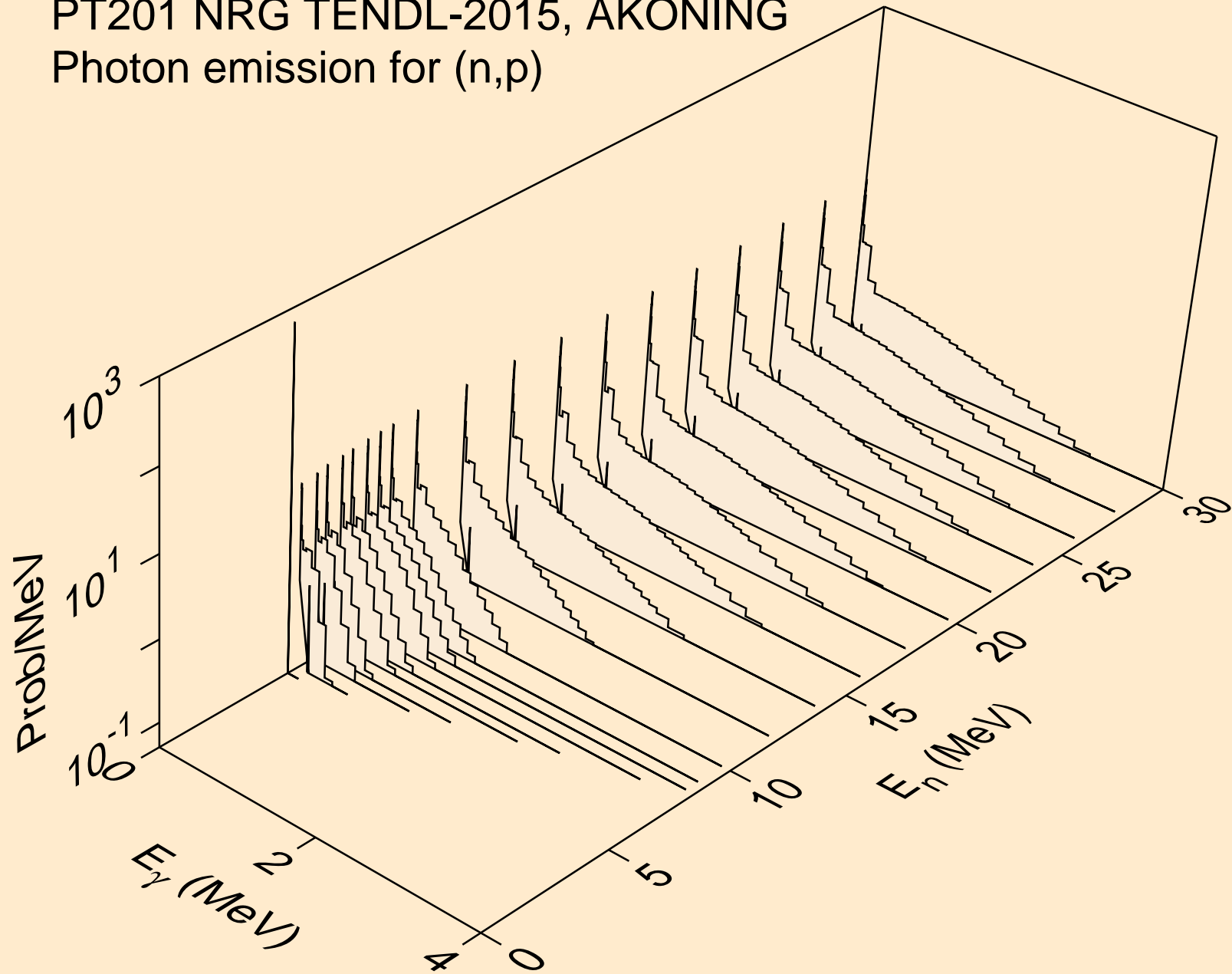

PT201 NRG TENDL-2015, AKONING
Photon emission for (n,d)

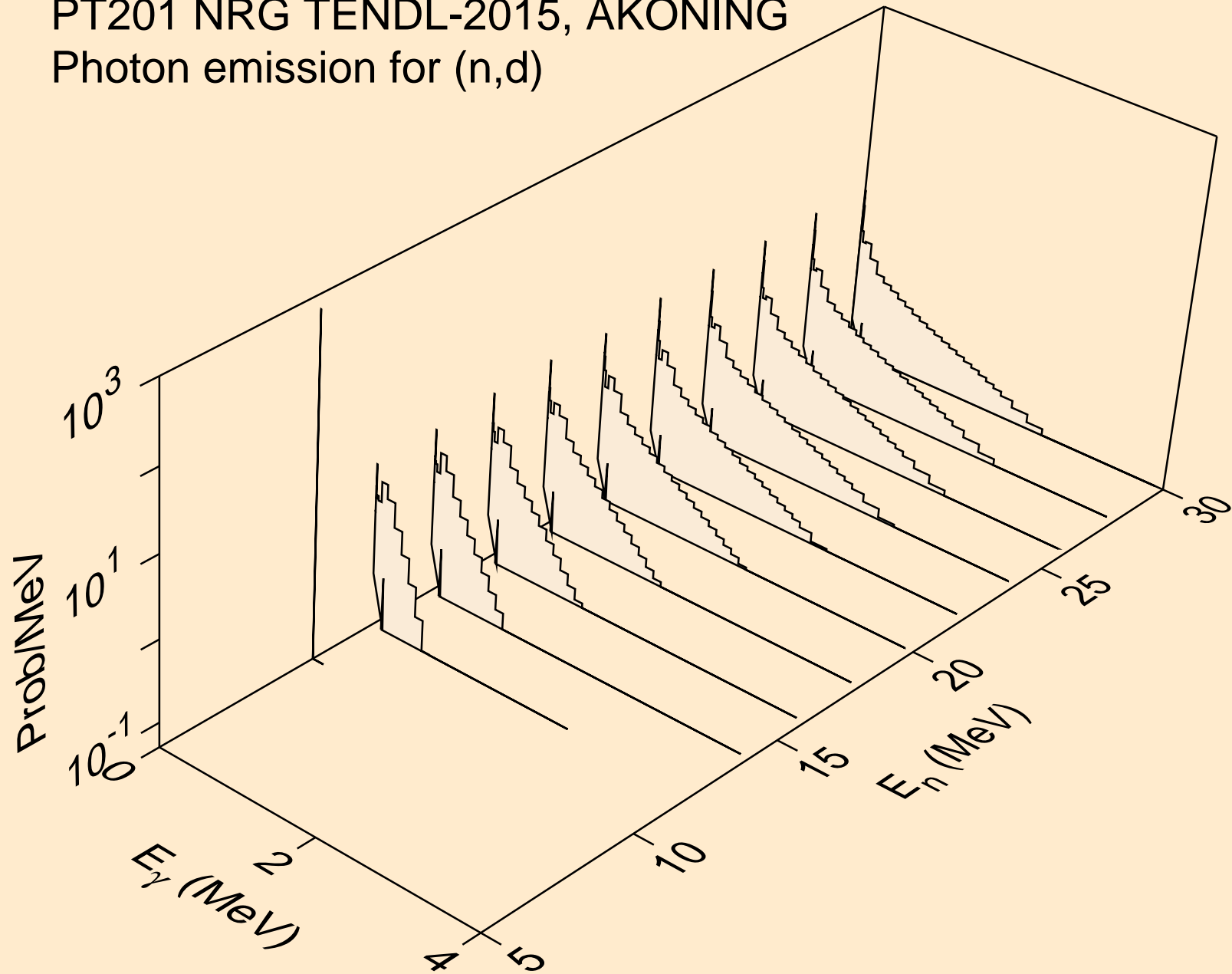

PT201 NRG TENDL-2015, AKONING
Photon emission for (n,t)

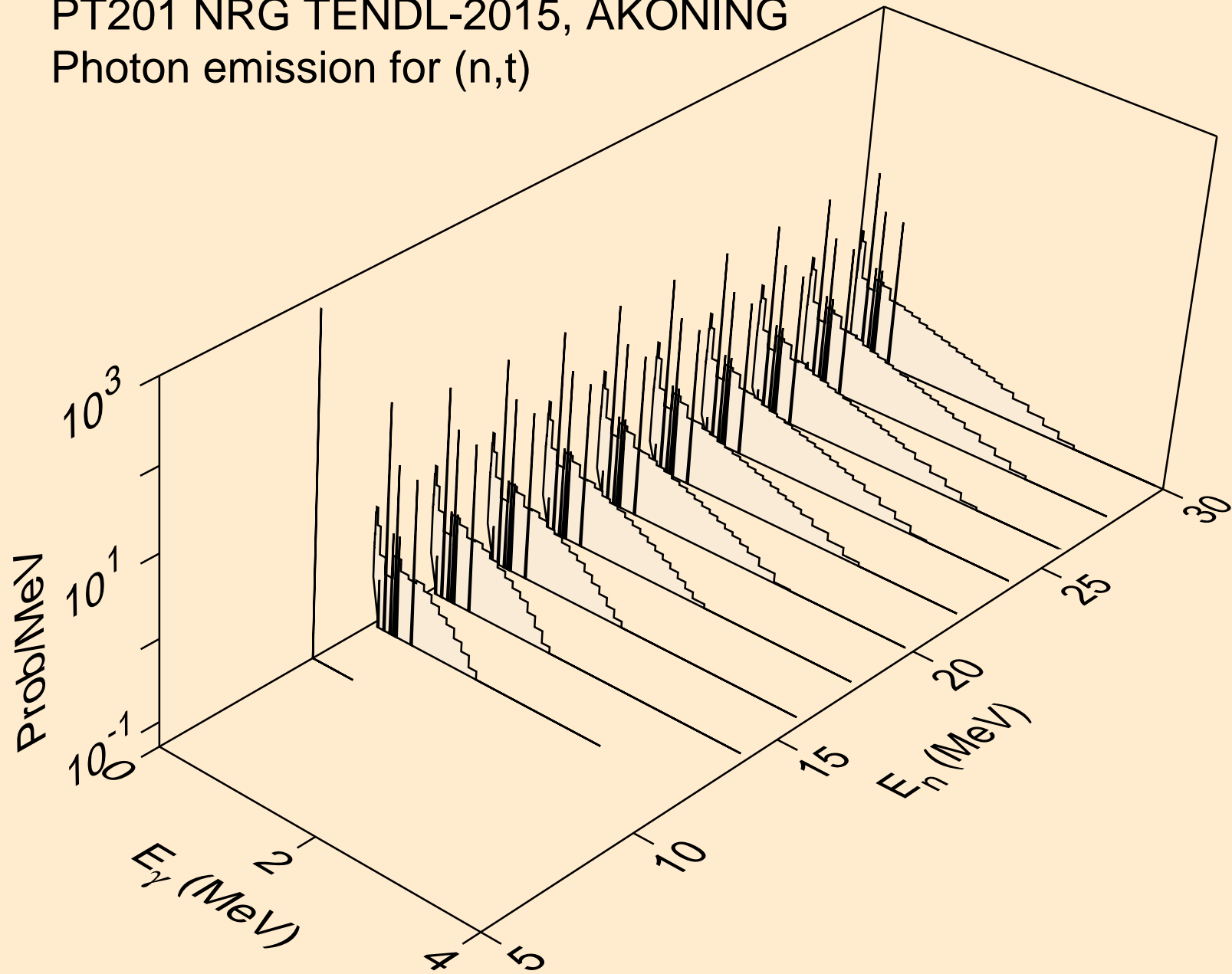

PT201 NRG TENDL-2015, AKONING
Photon emission for (n,he3)

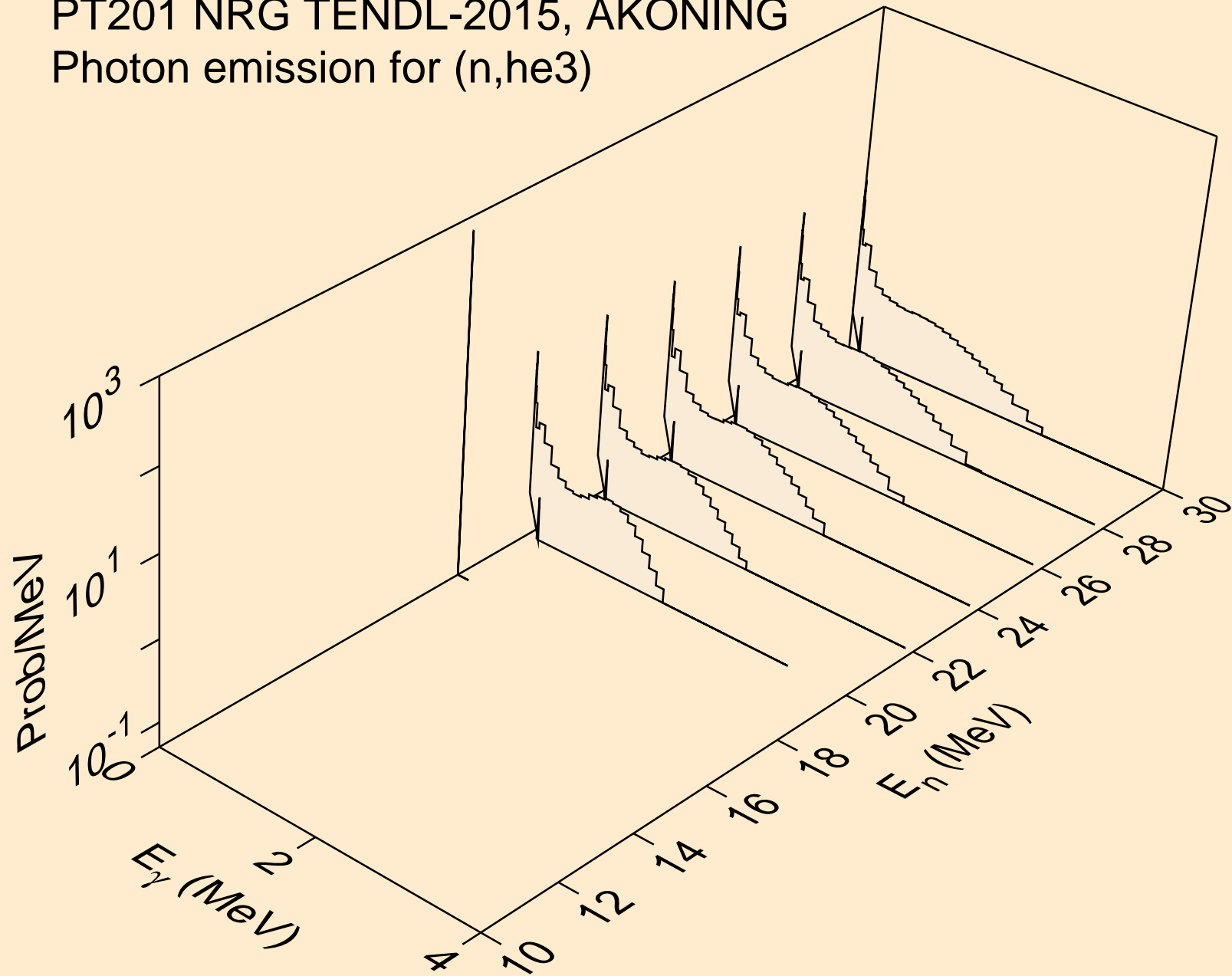

PT201 NRG TENDL-2015, AKONING
Photon emission for (n,a)

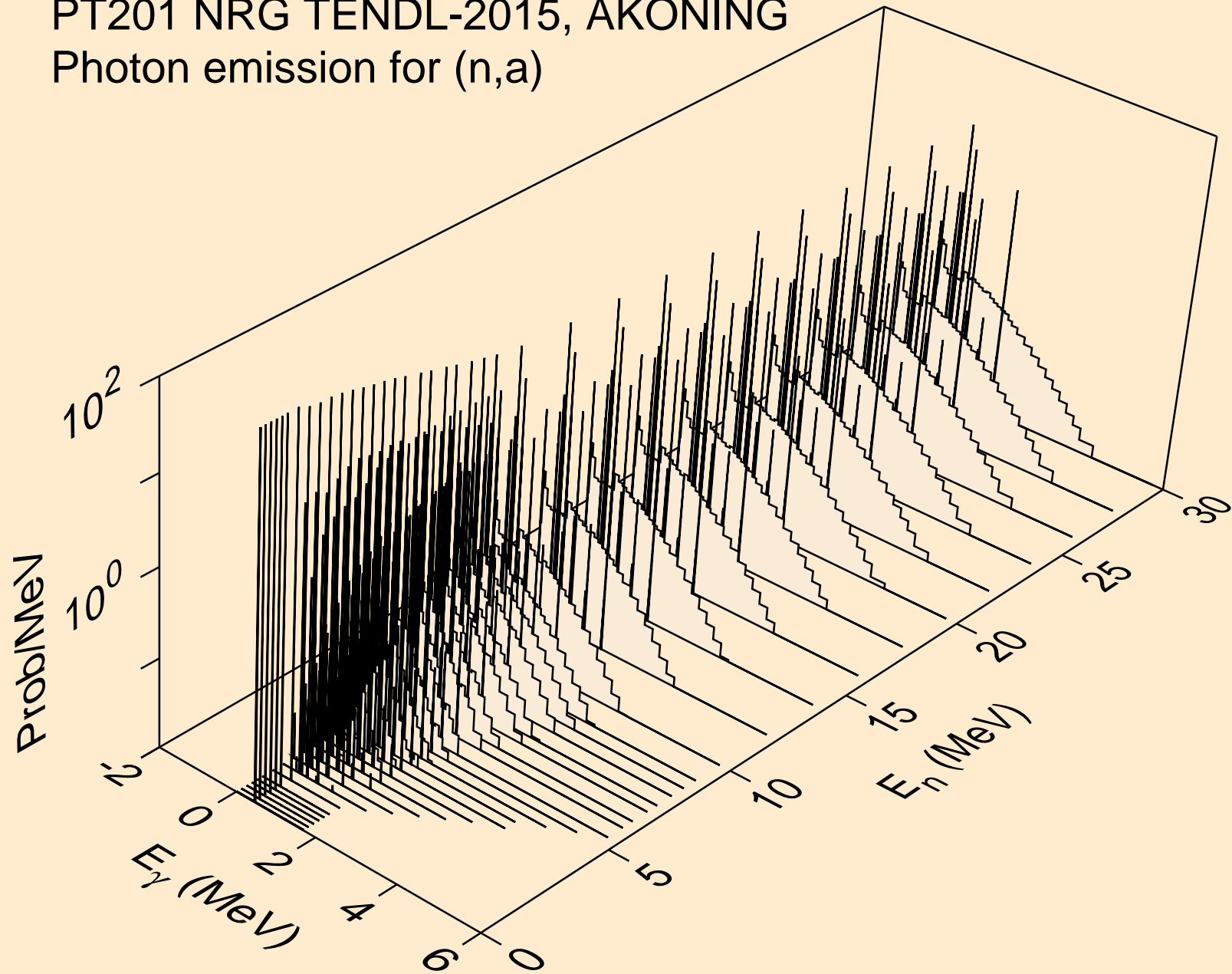

PT201 NRG TENDL-2015, AKONING
Photon emission for (n,2p)

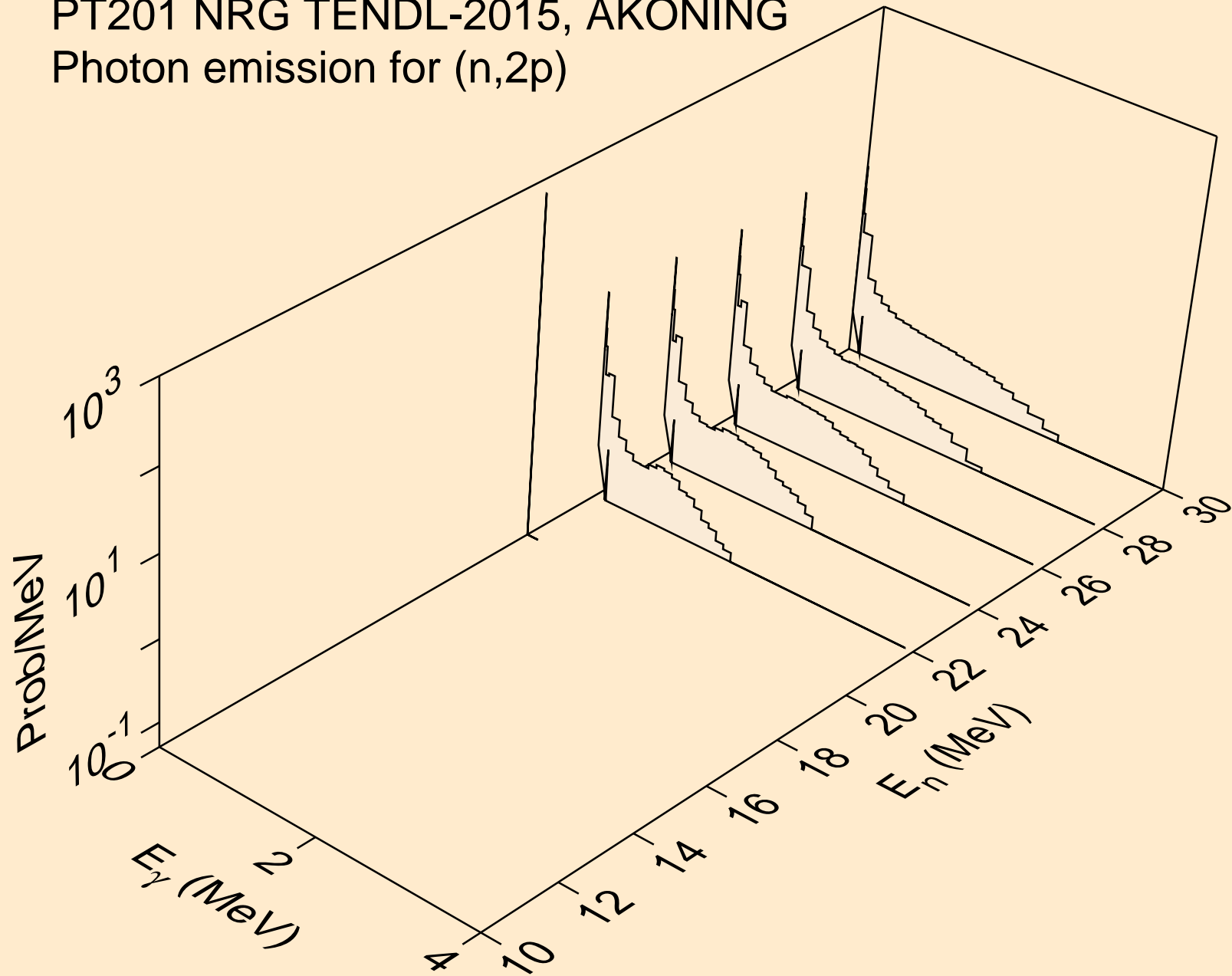

PT201 NRG TENDL-2015, AKONING
thermal capture photon spectrum

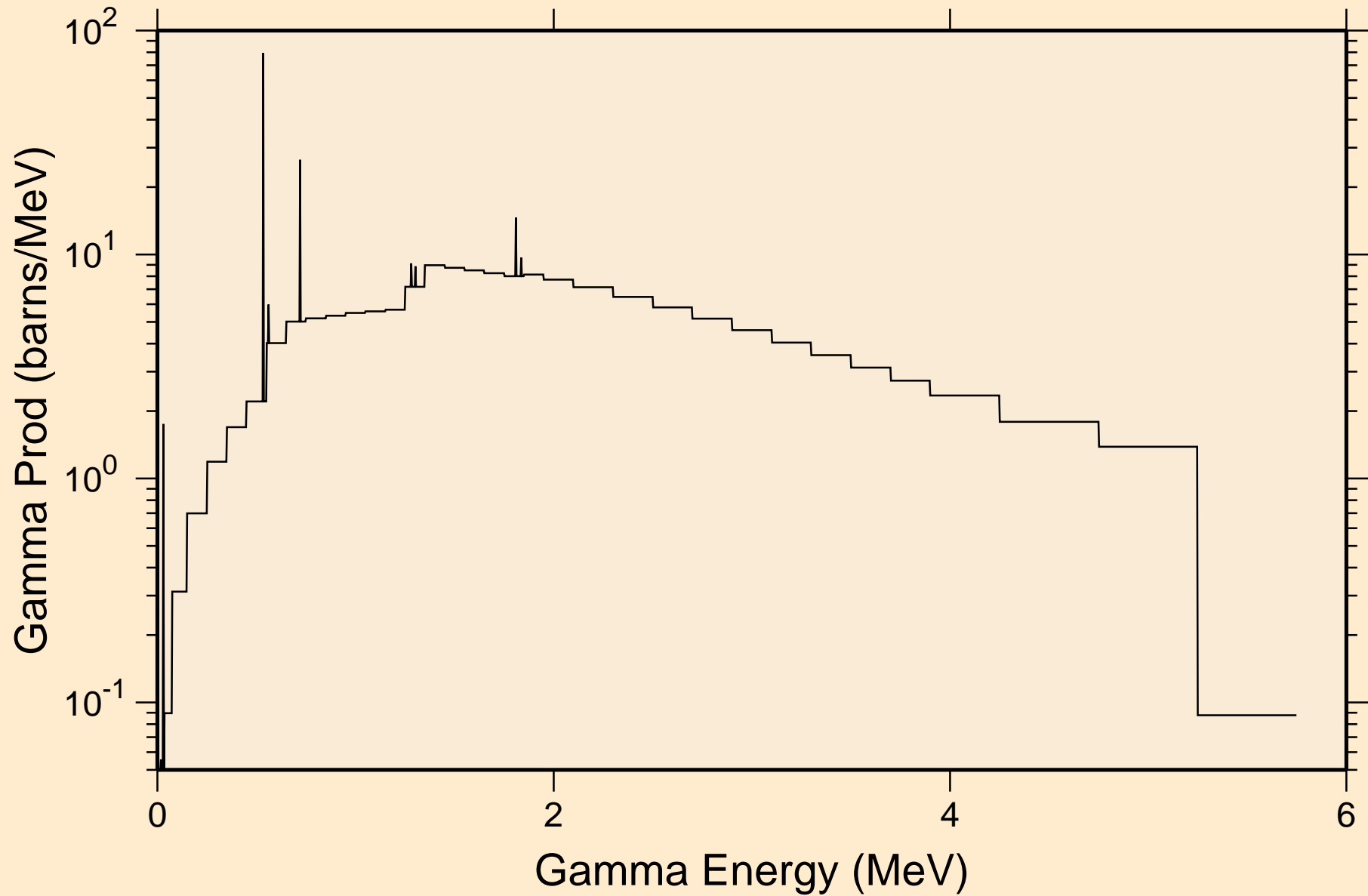

PT201 NRG TENDL-2015, AKONING
14 MeV photon spectrum

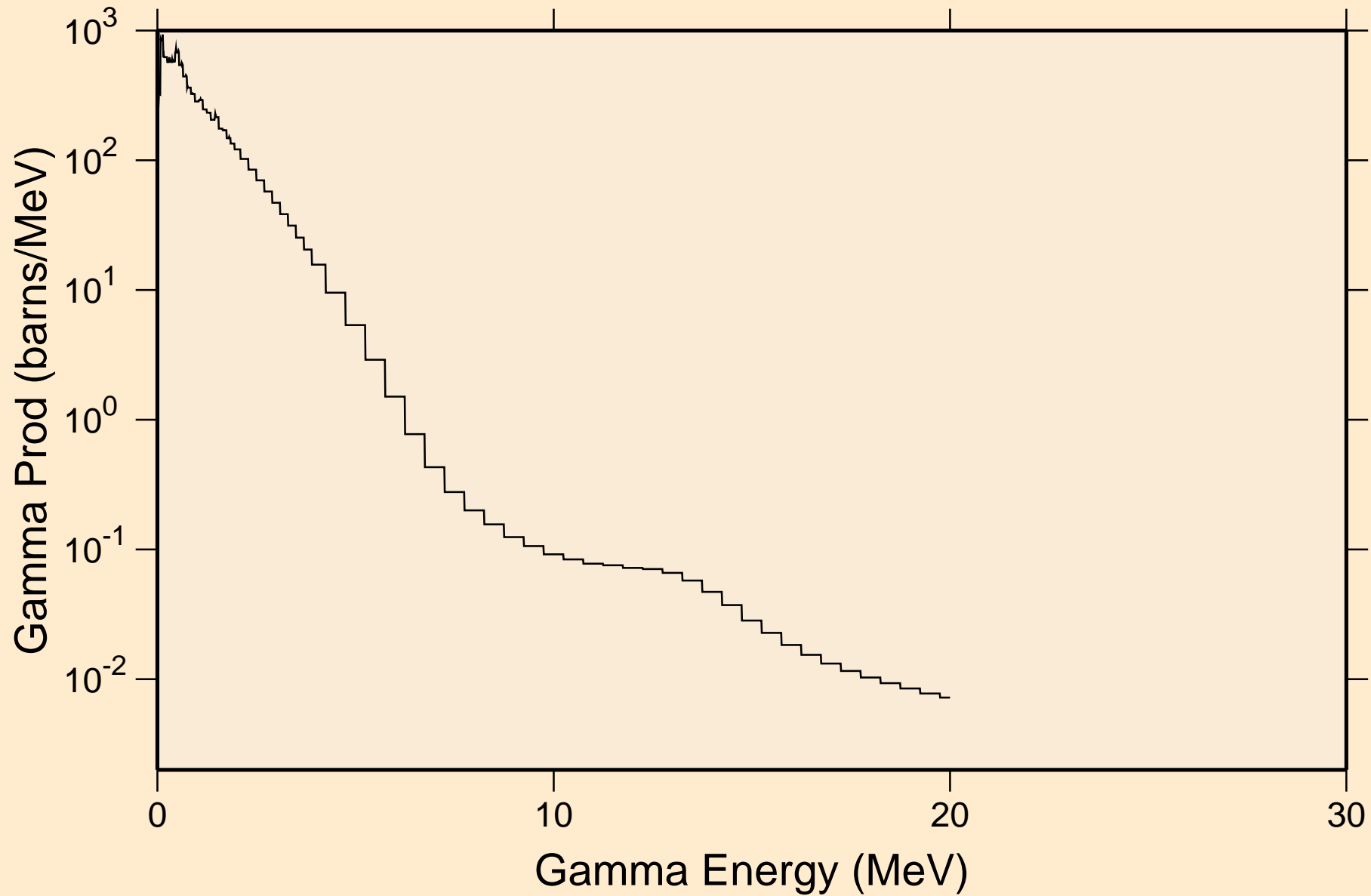

PT201 NRG TENDL-2015, AKONING

Particle heating contributions

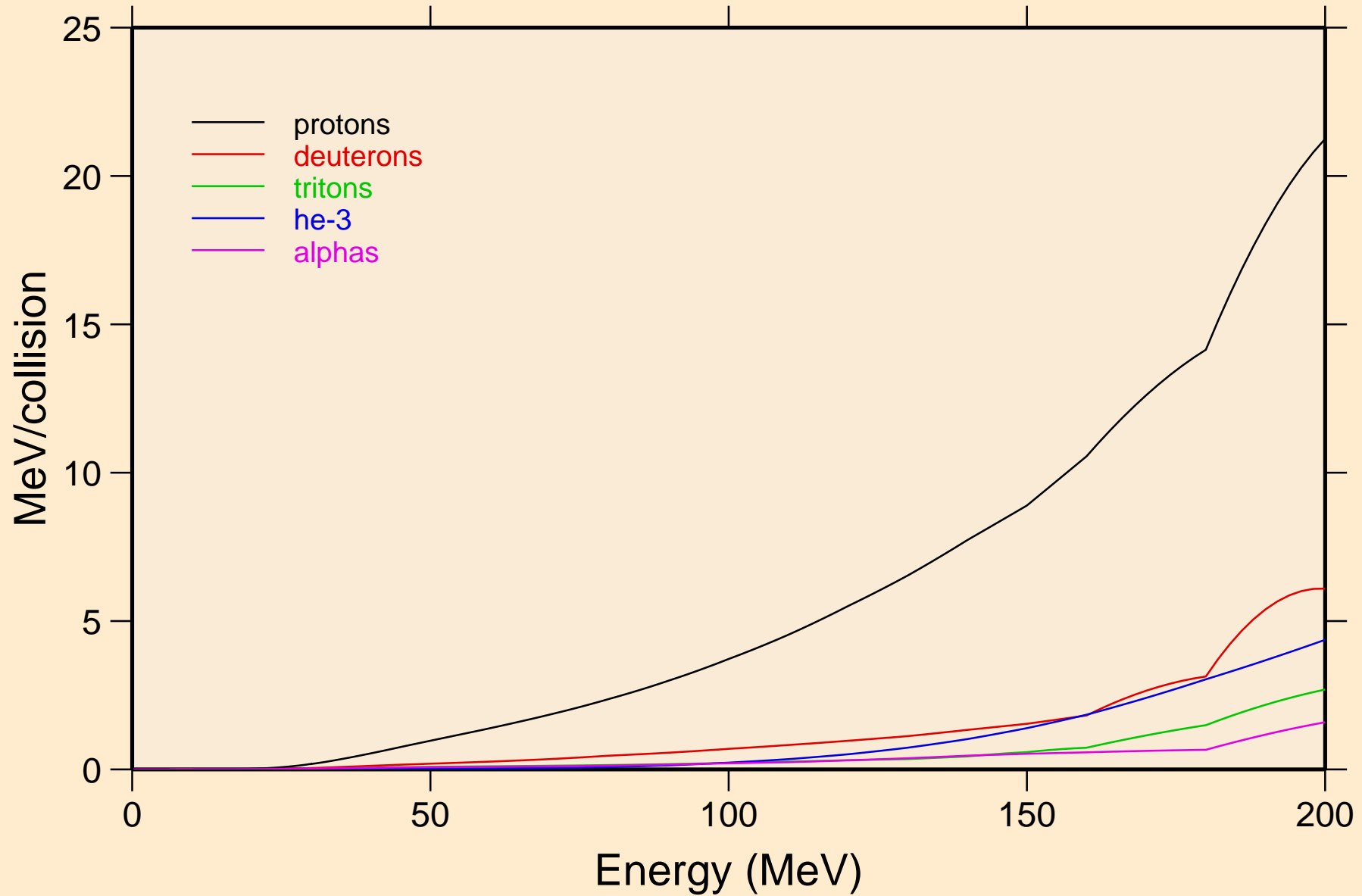

PT201 NRG TENDL-2015, AKONING

Recoil Heating

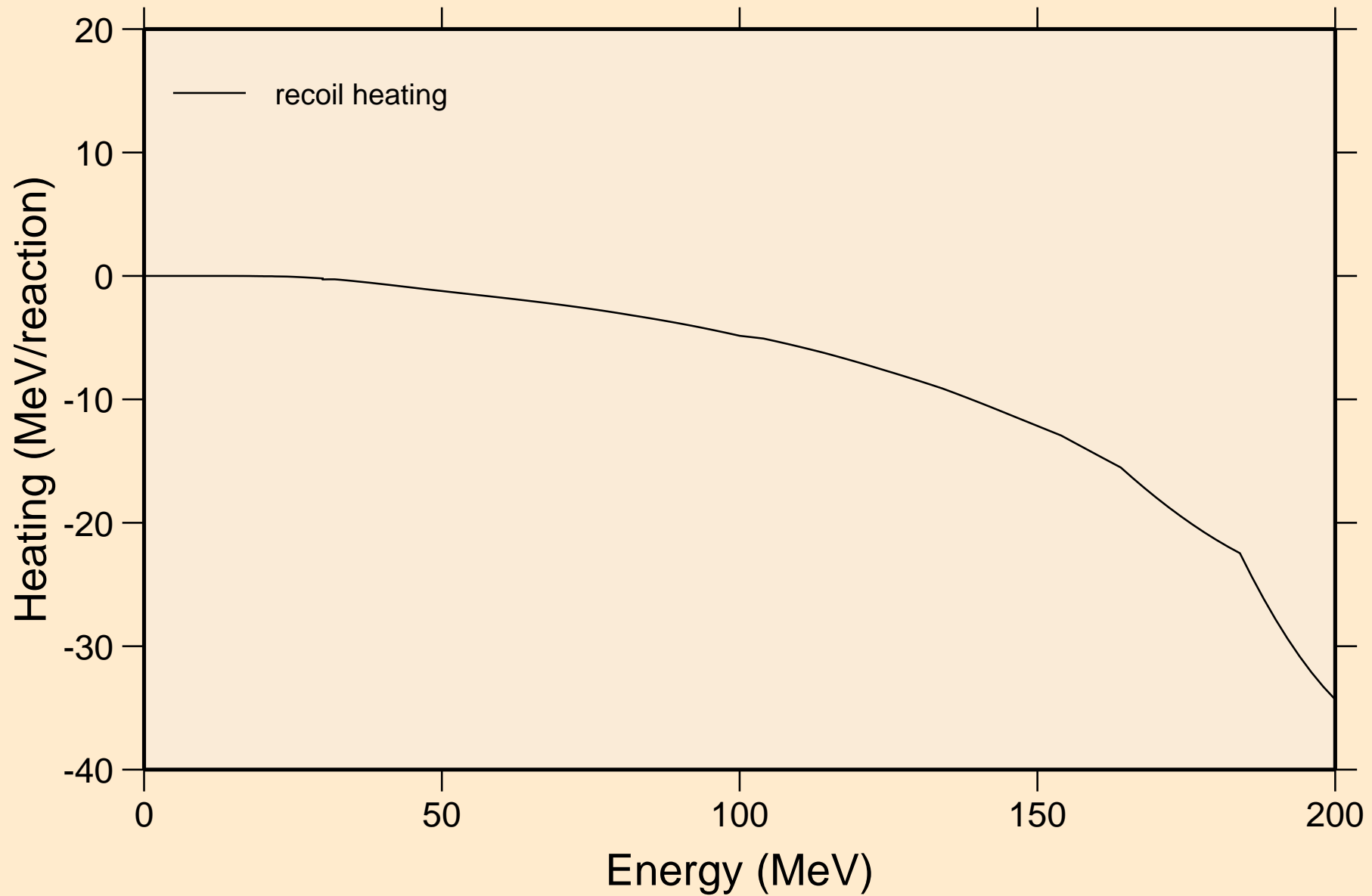

PT201 NRG TENDL-2015, AKONING
Particle production cross sections

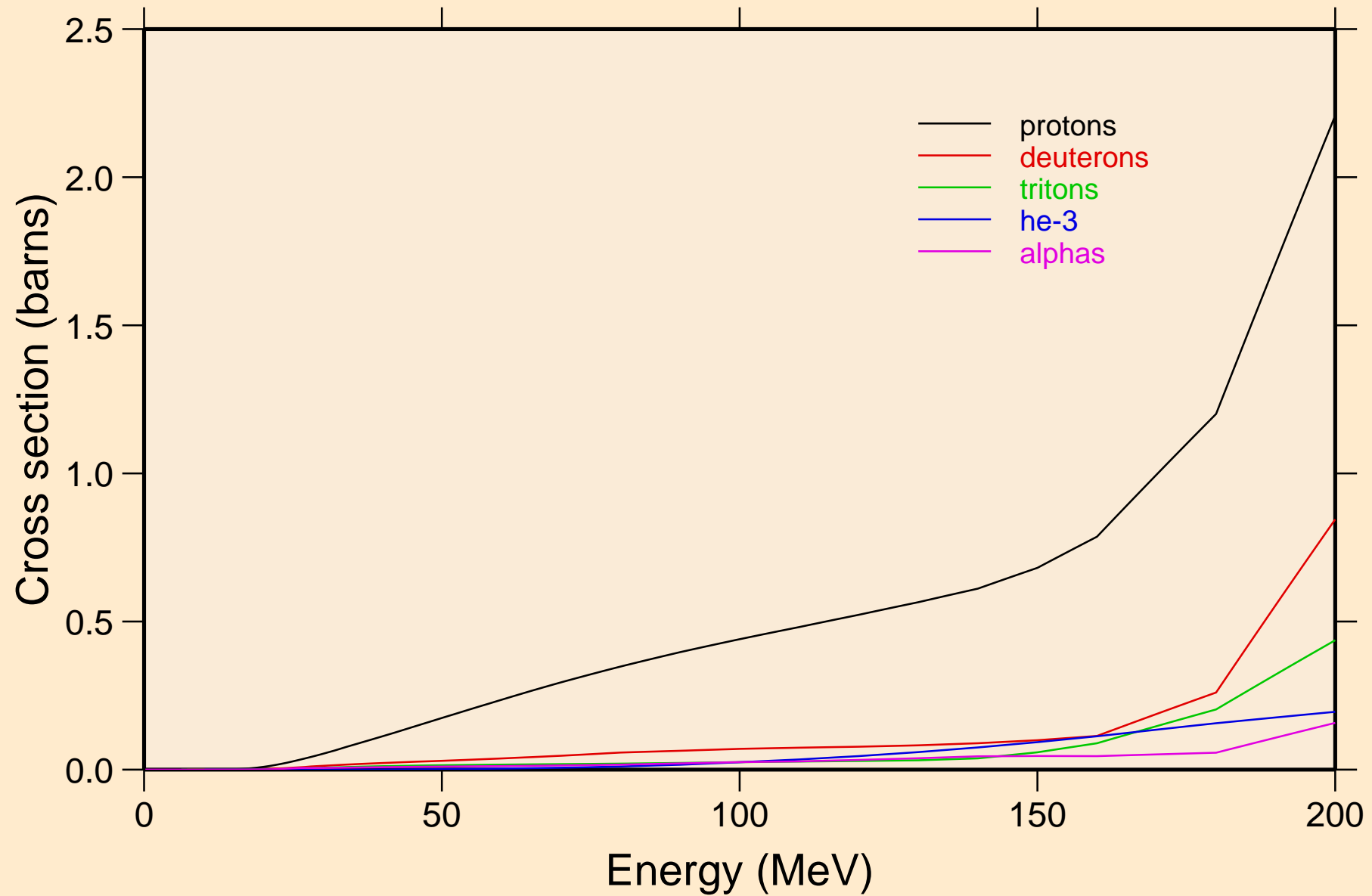

PT201 NRG TENDL-2015, AKONING
protons from (n,x)

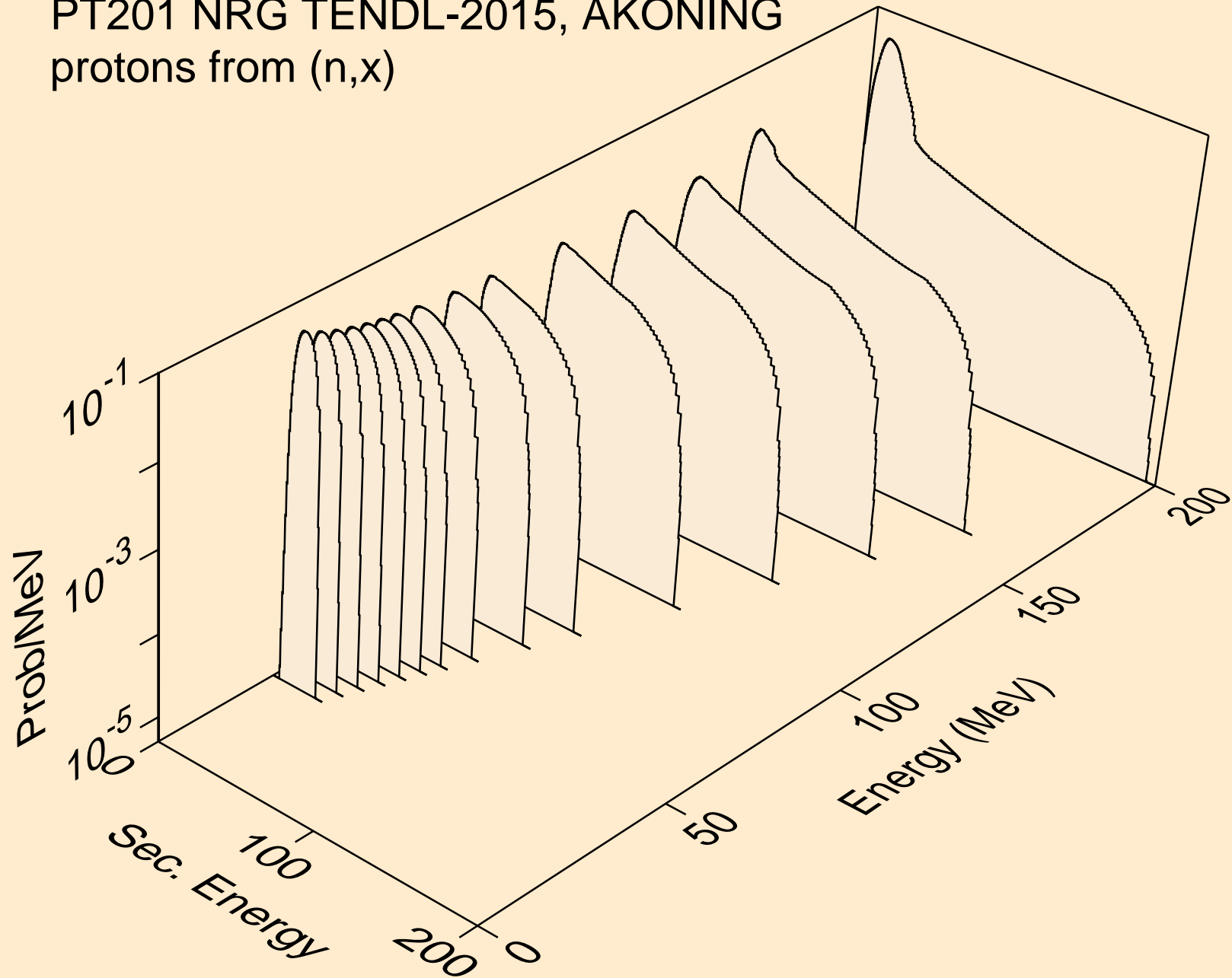

PT201 NRG TENDL-2015, AKONING
protons from (n,n*)p

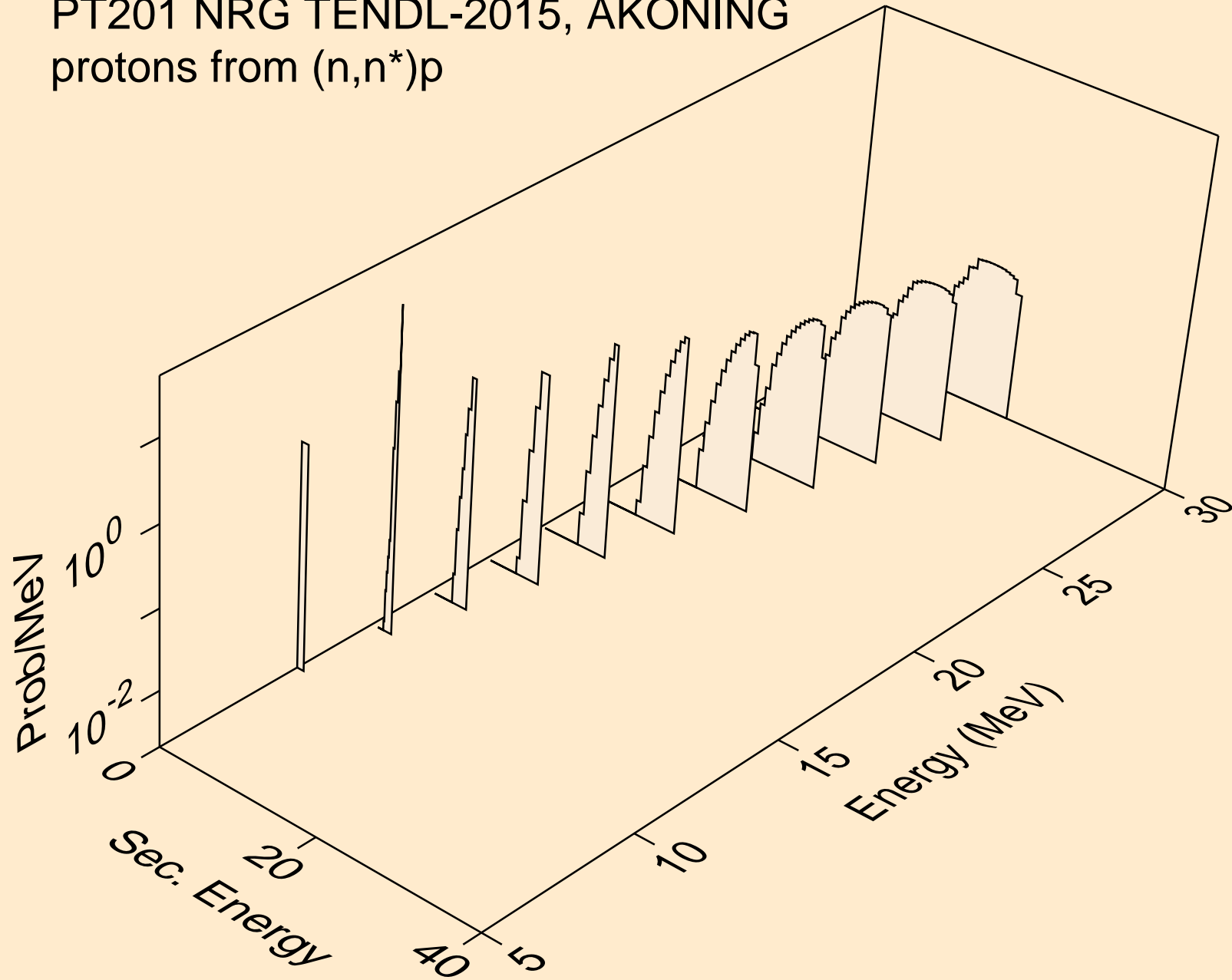

PT201 NRG TENDL-2015, AKONING
protons from (n,2np)

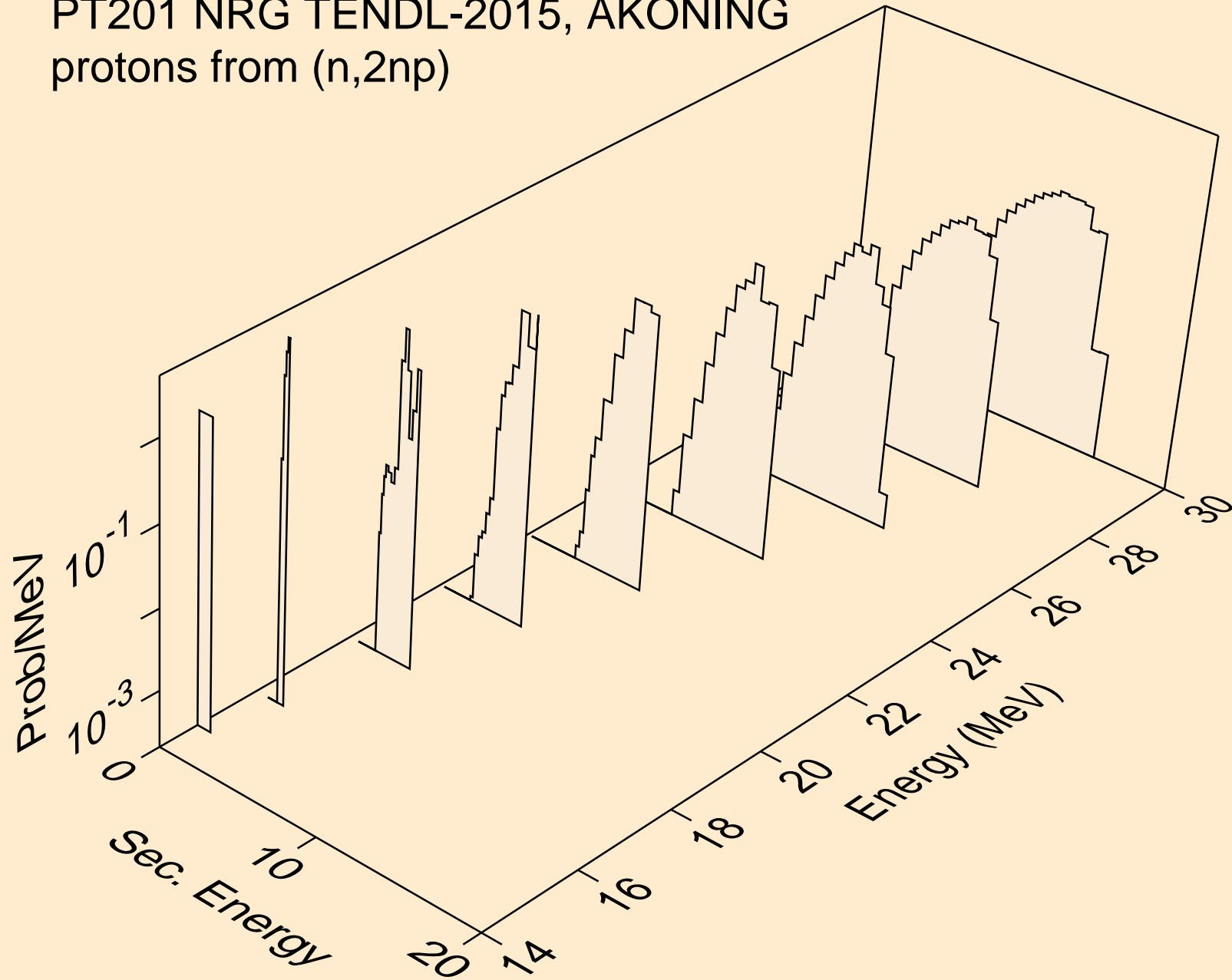

PT201 NRG TENDL-2015, AKONING
protons from (n,3np)

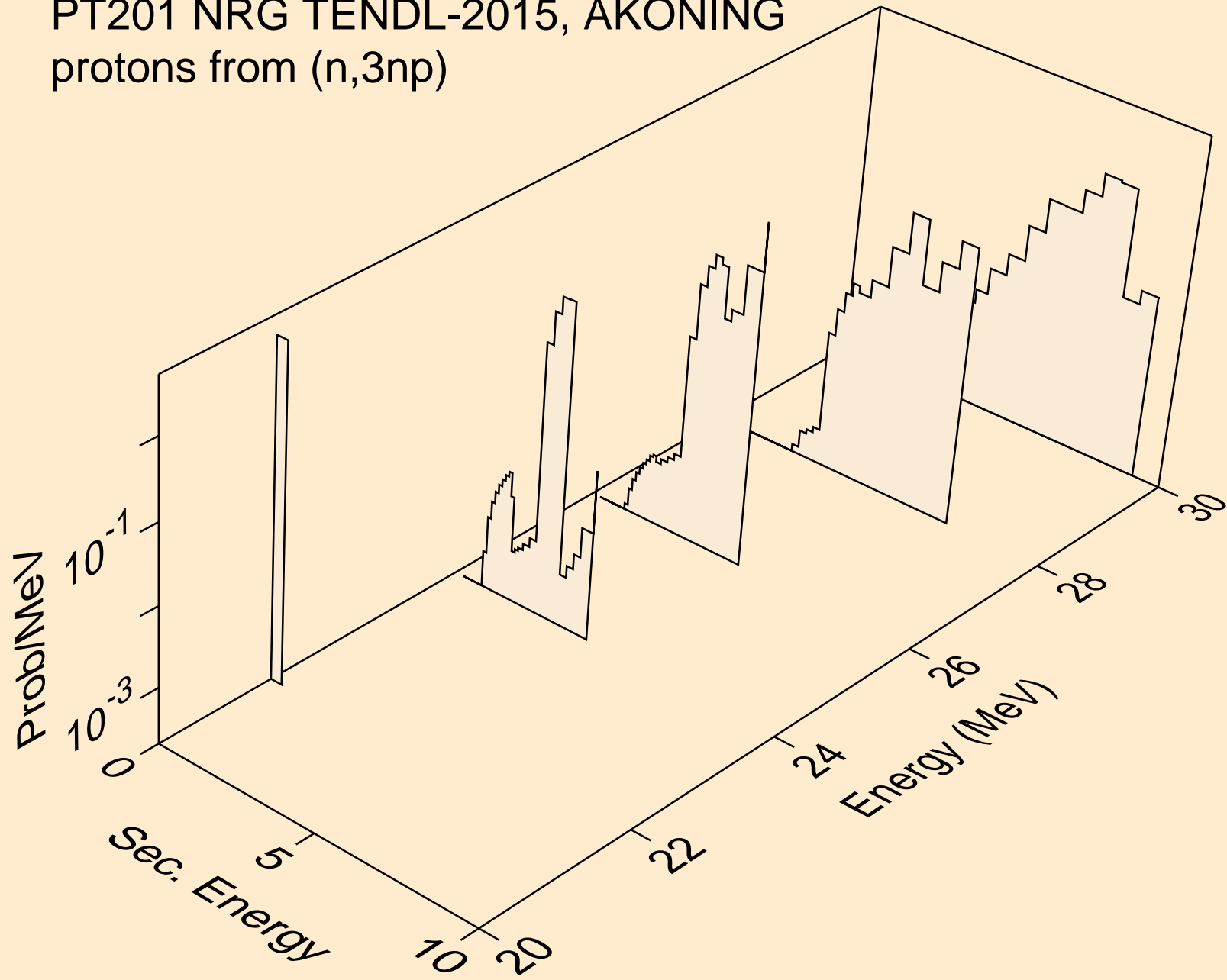

PT201 NRG TENDL-2015, AKONING
protons from (n,p)

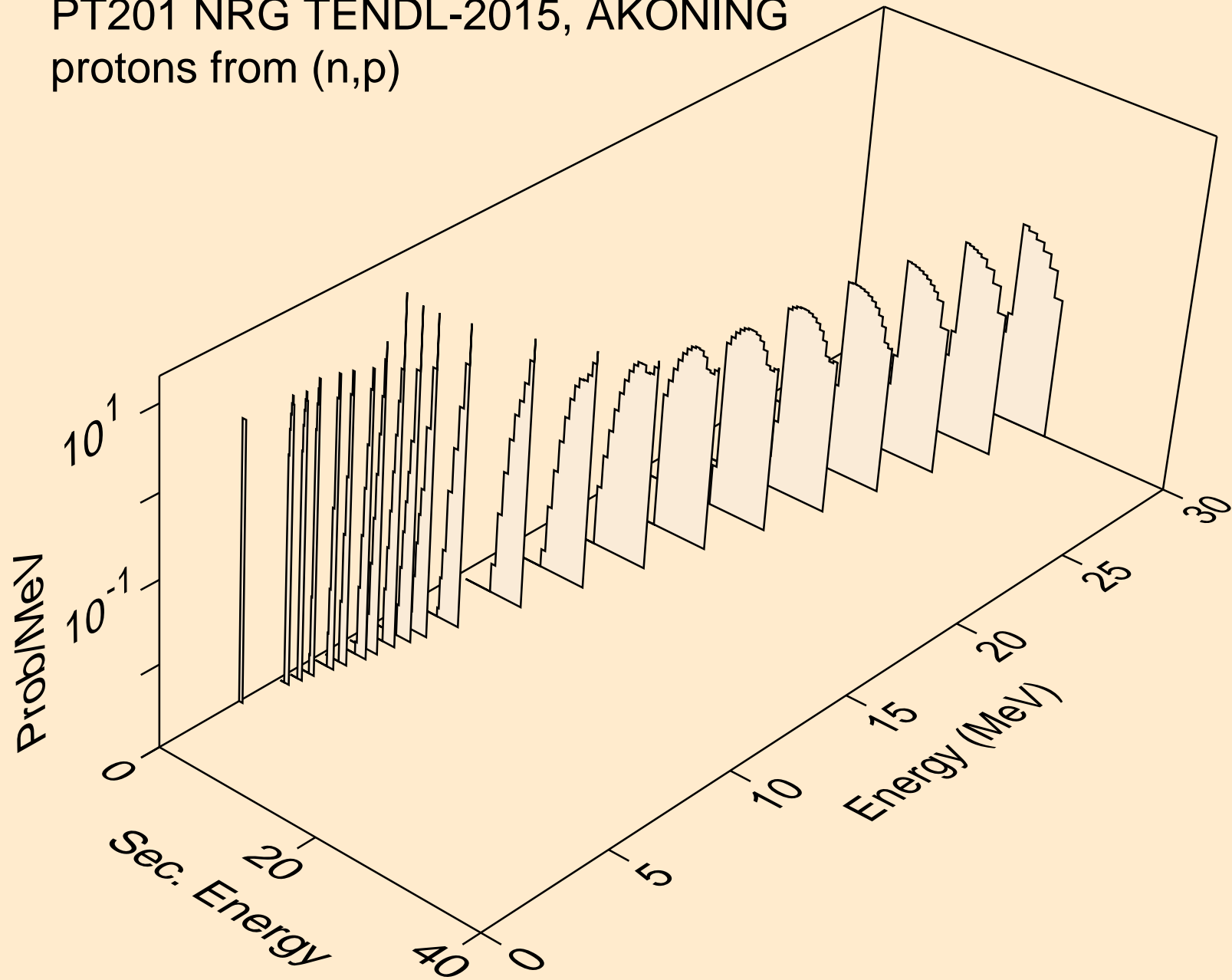

PT201 NRG TENDL-2015, AKONING
protons from (n,2p)

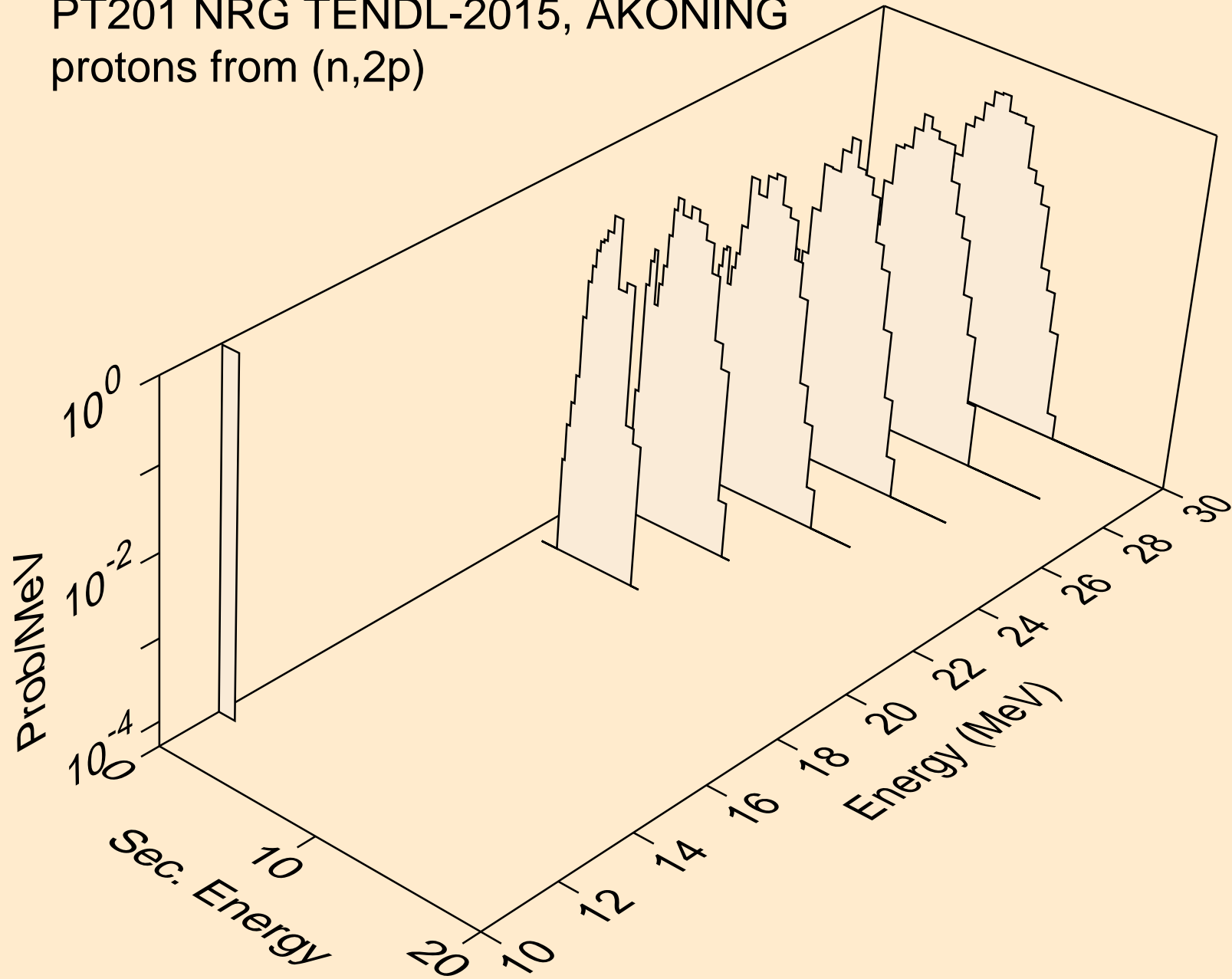

PT201 NRG TENDL-2015, AKONING
deuterons from (n,x)

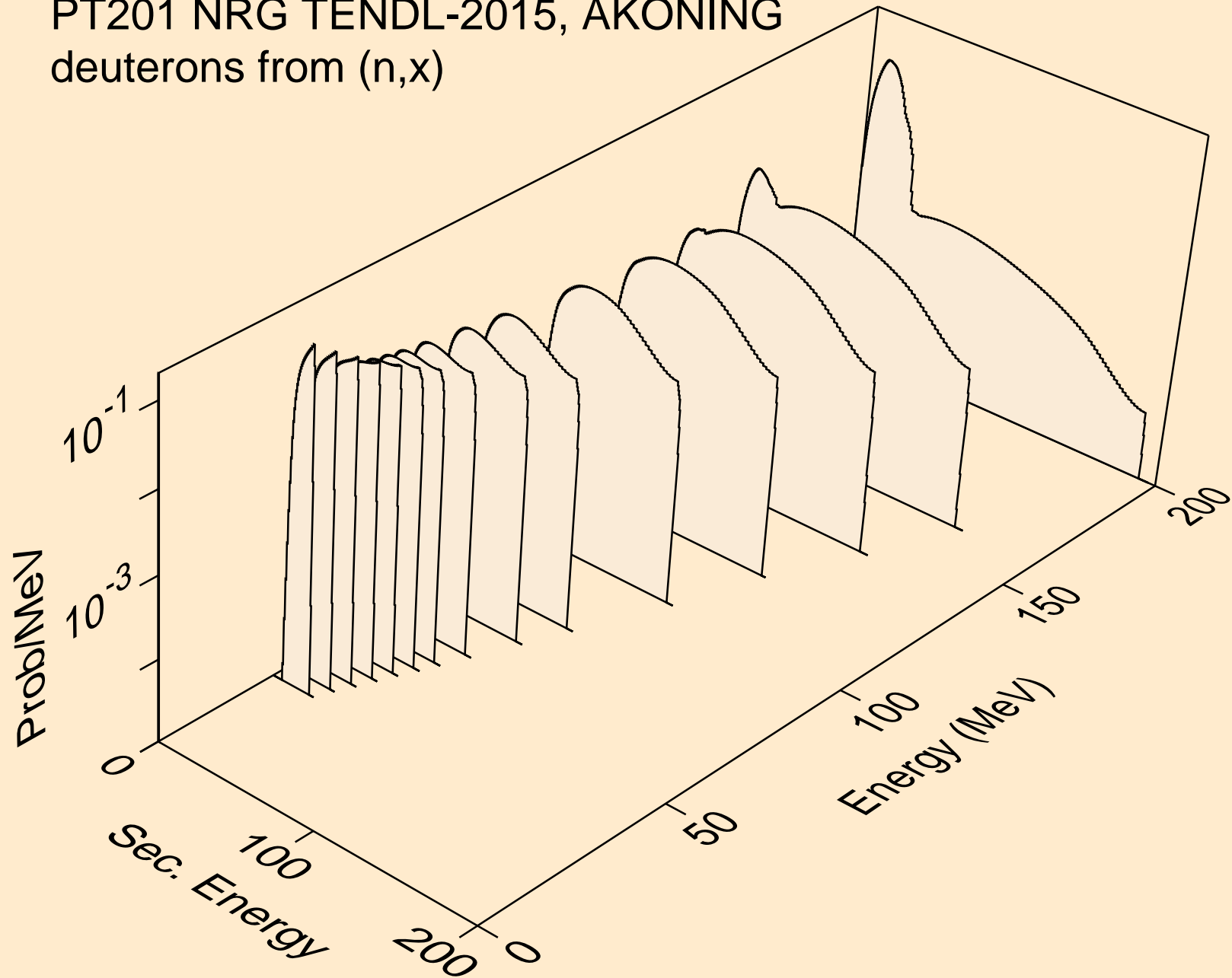

PT201 NRG TENDL-2015, AKONING
deuterons from (n,2nd)

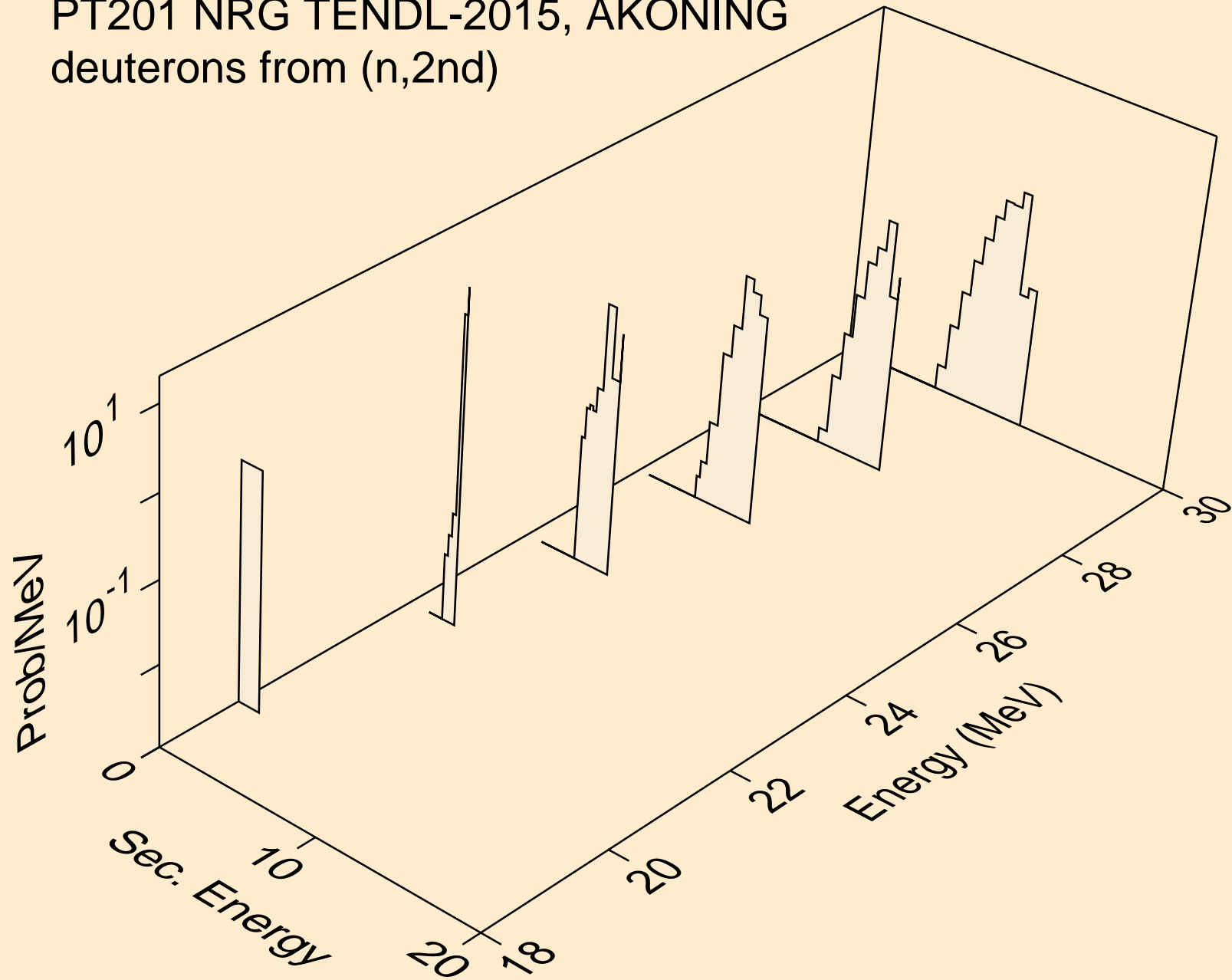

PT201 NRG TENDL-2015, AKONING
deuterons from (n,n*)d

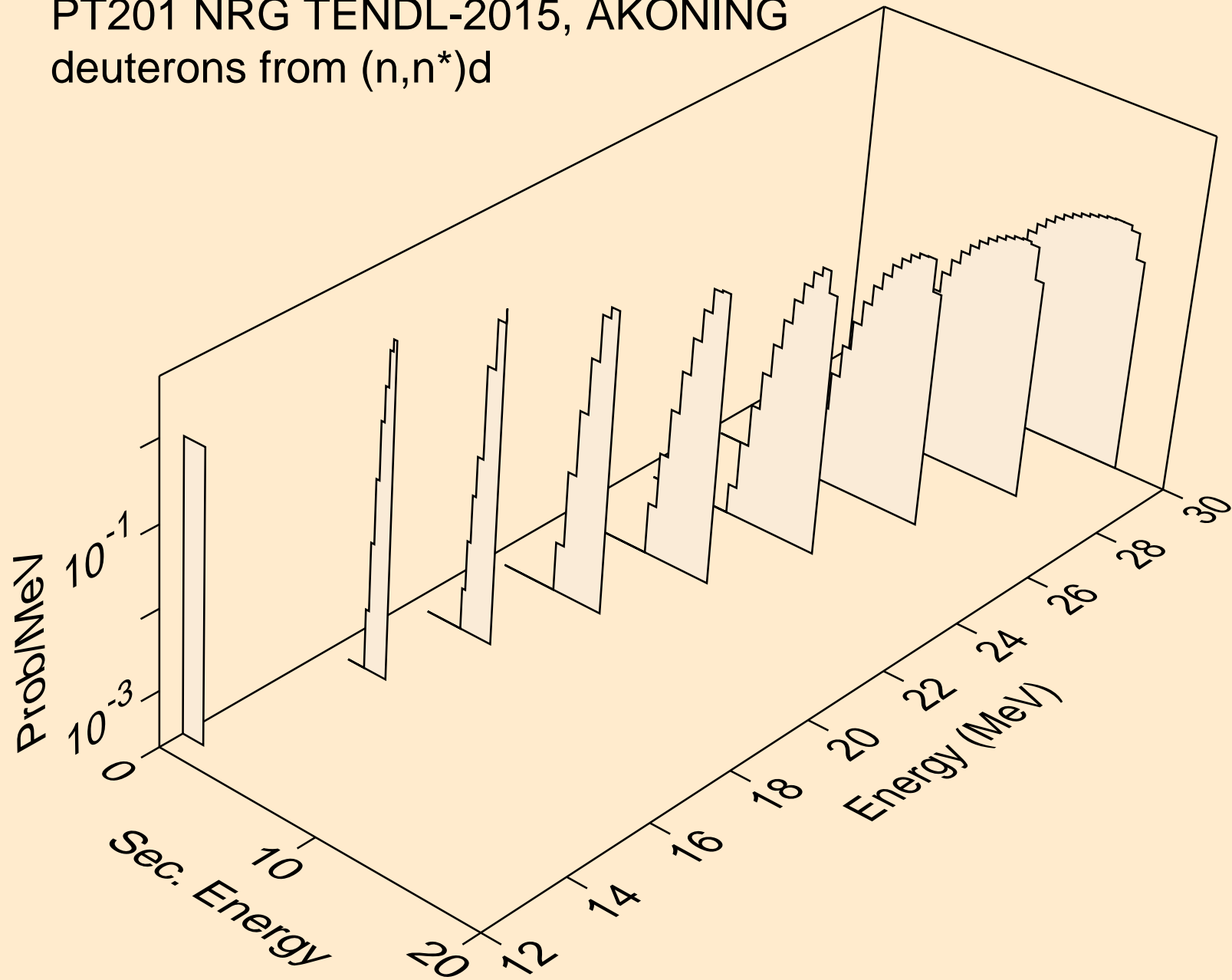

PT201 NRG TENDL-2015, AKONING
deuterons from (n,d)

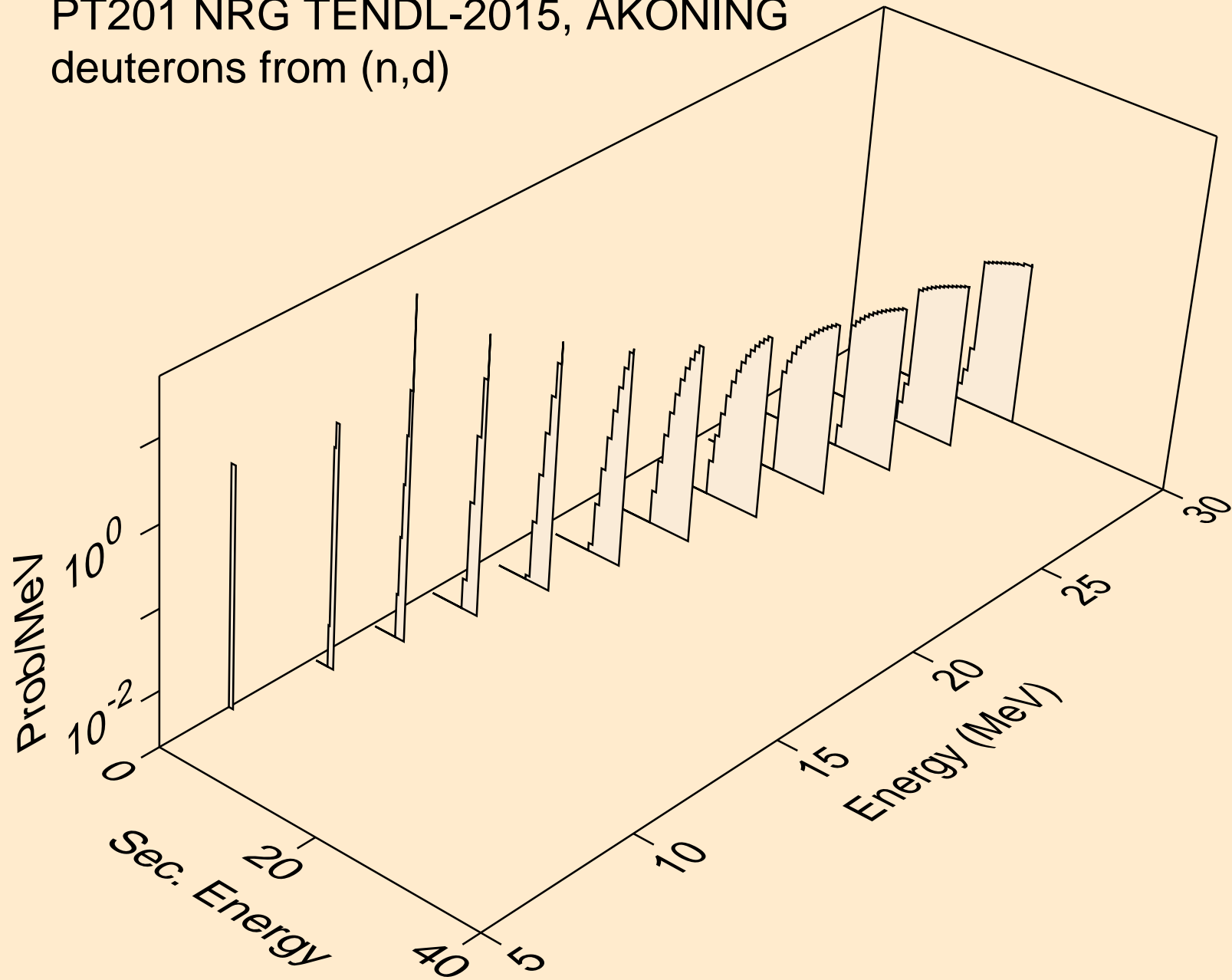

PT201 NRG TENDL-2015, AKONING
tritons from (n,x)

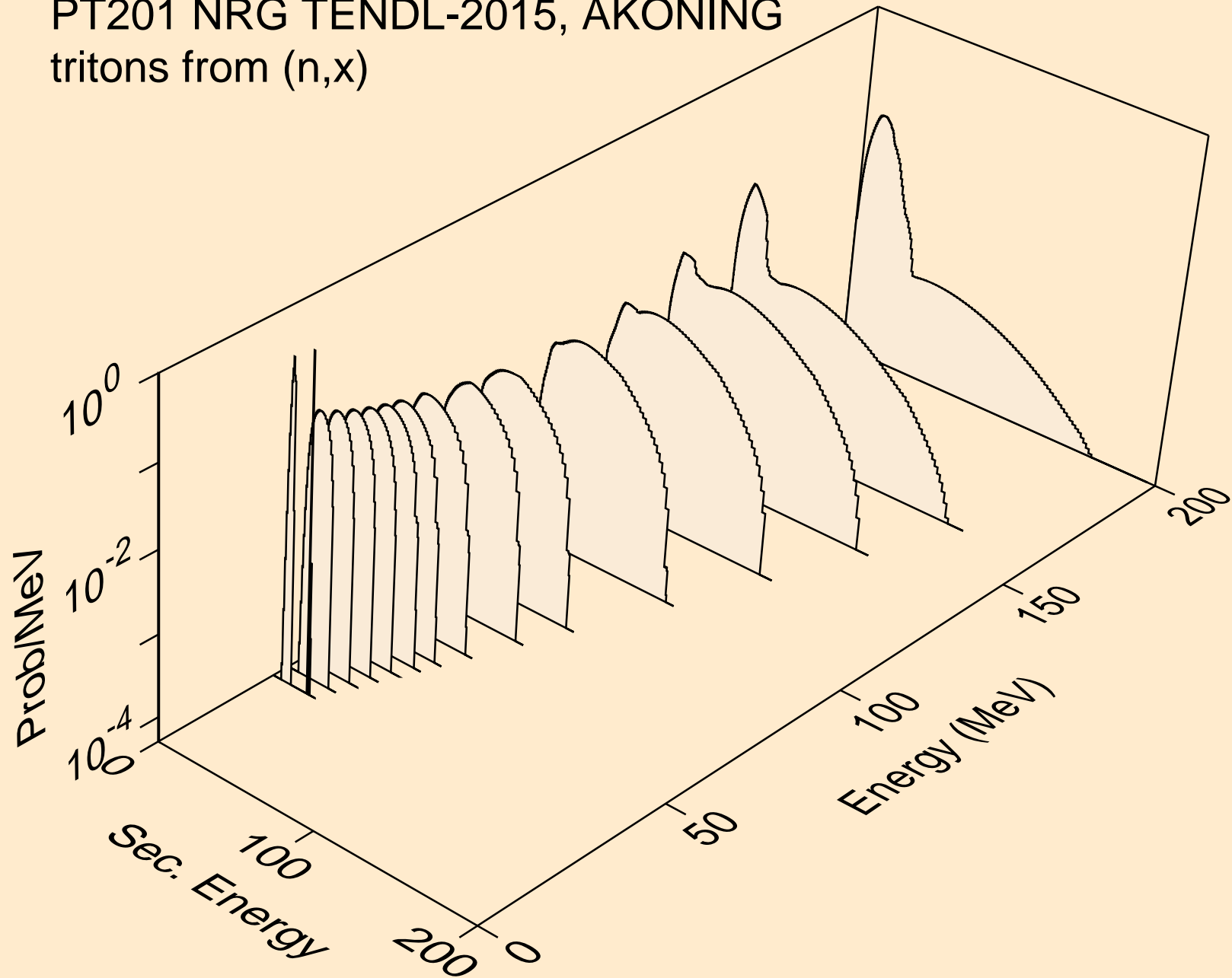

PT201 NRG TENDL-2015, AKONING
tritons from (n,n*)t

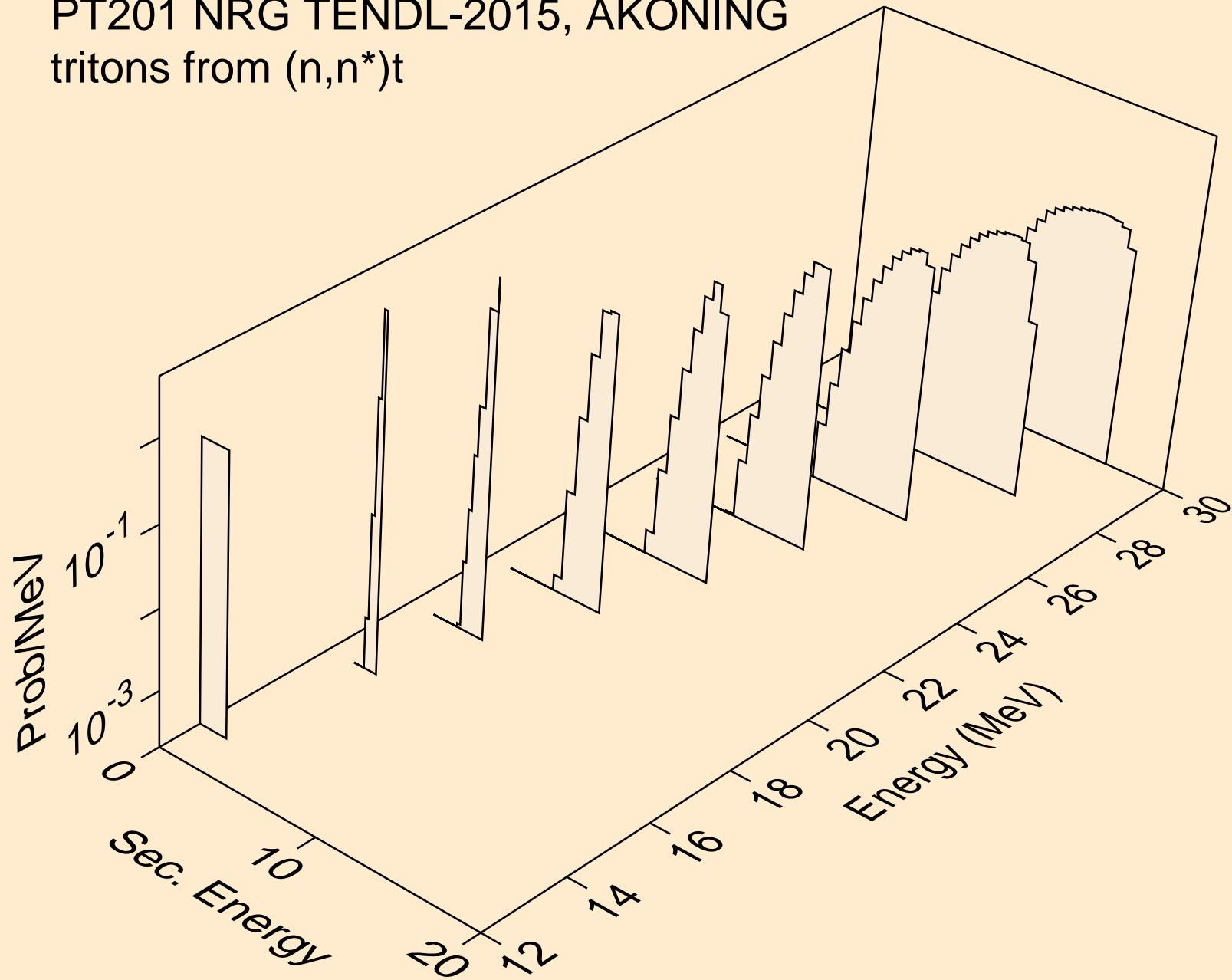

PT201 NRG TENDL-2015, AKONING
tritons from (n,t)

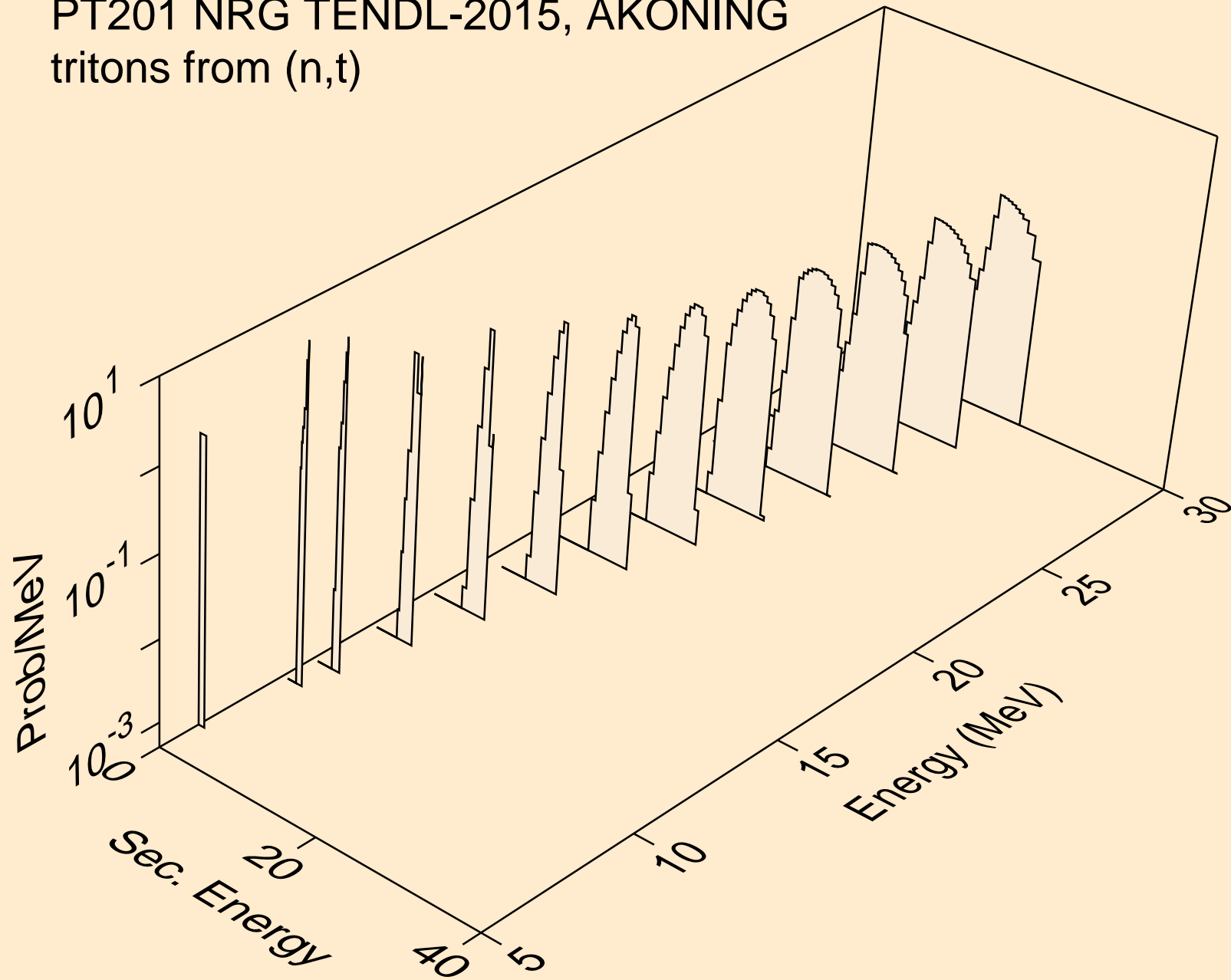

PT201 NRG TENDL-2015, AKONING
he3s from (n,x)

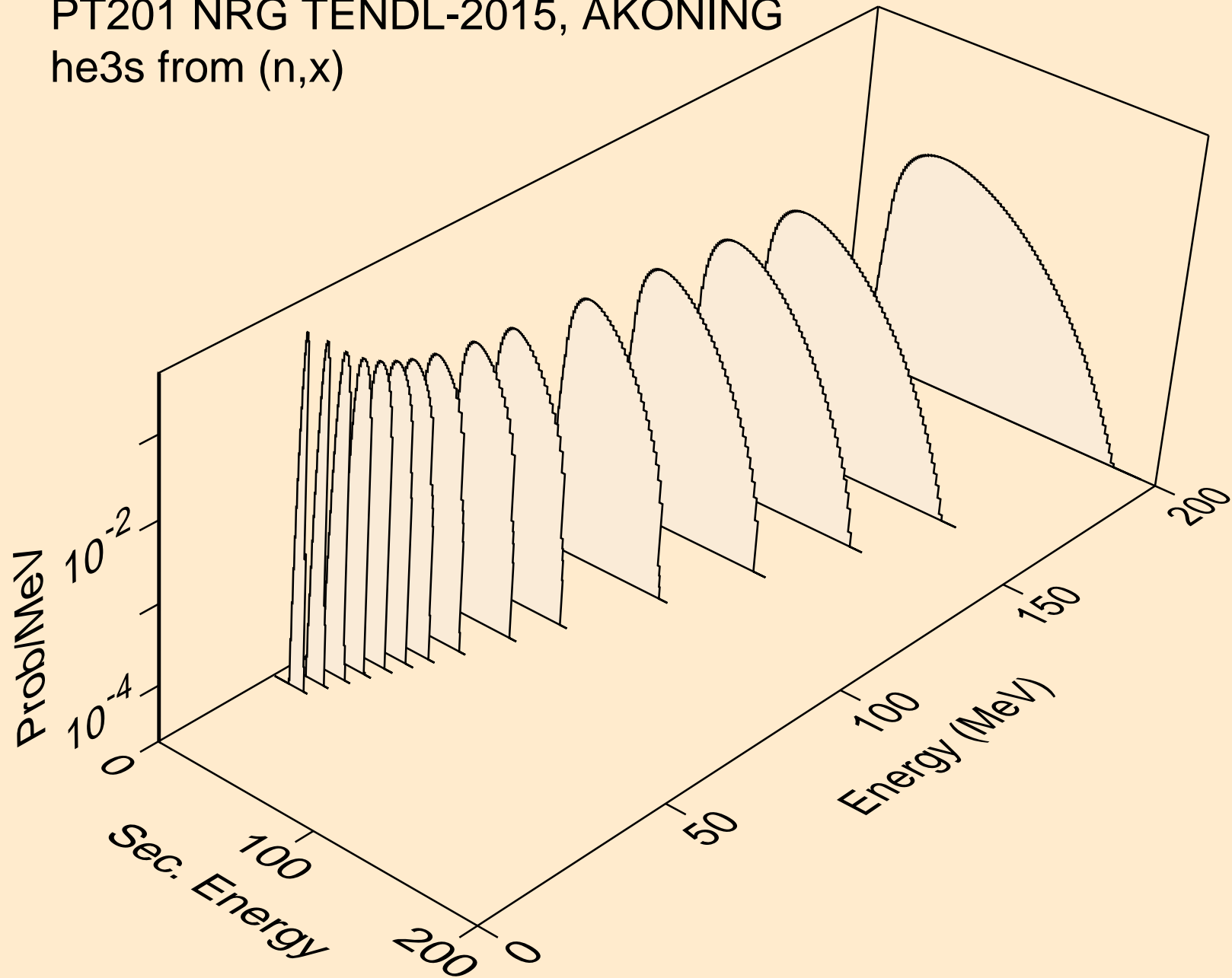

PT201 NRG TENDL-2015, AKONING
he3s from (n,n*)he3

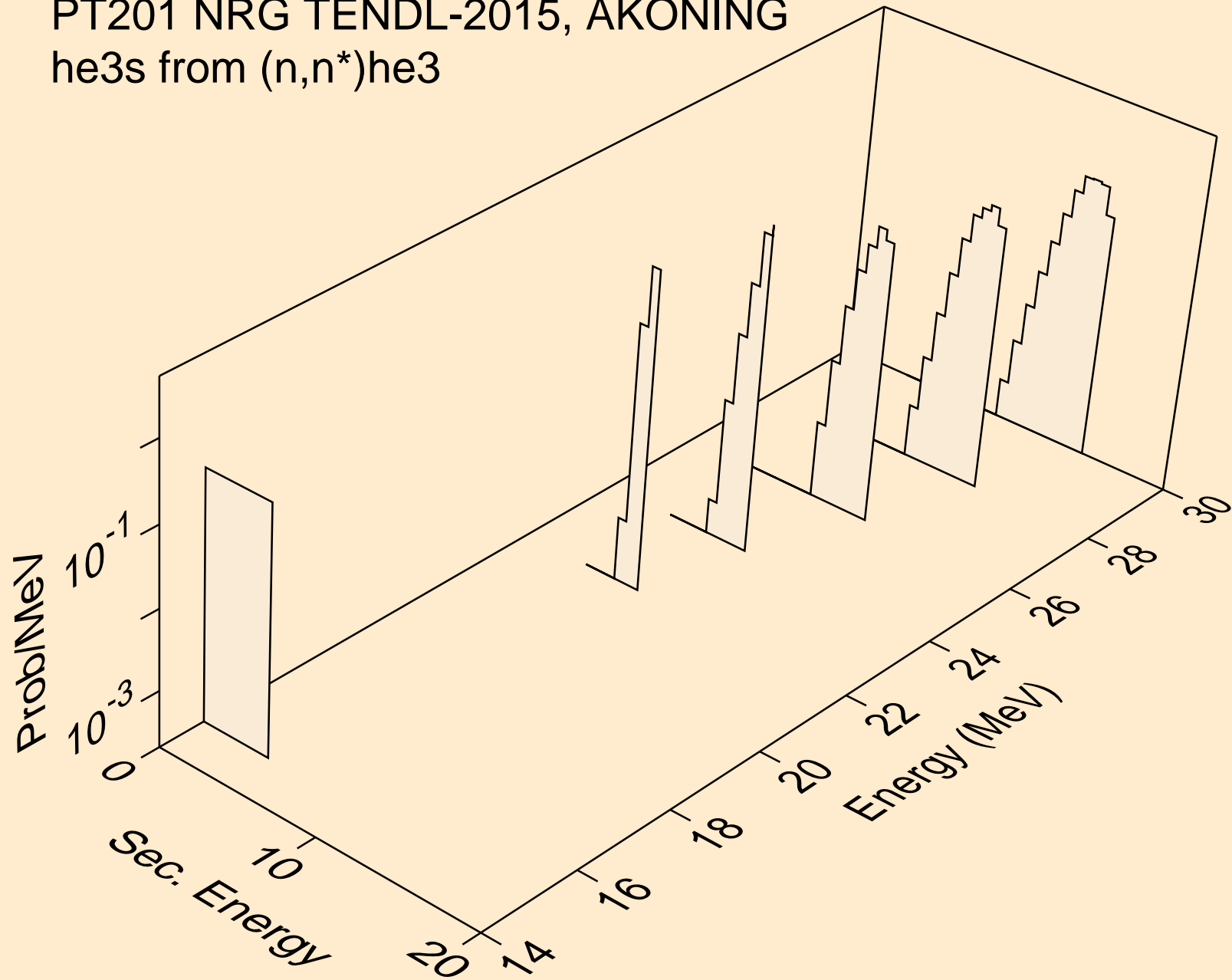

PT201 NRG TENDL-2015, AKONING
he3s from (n,he3)

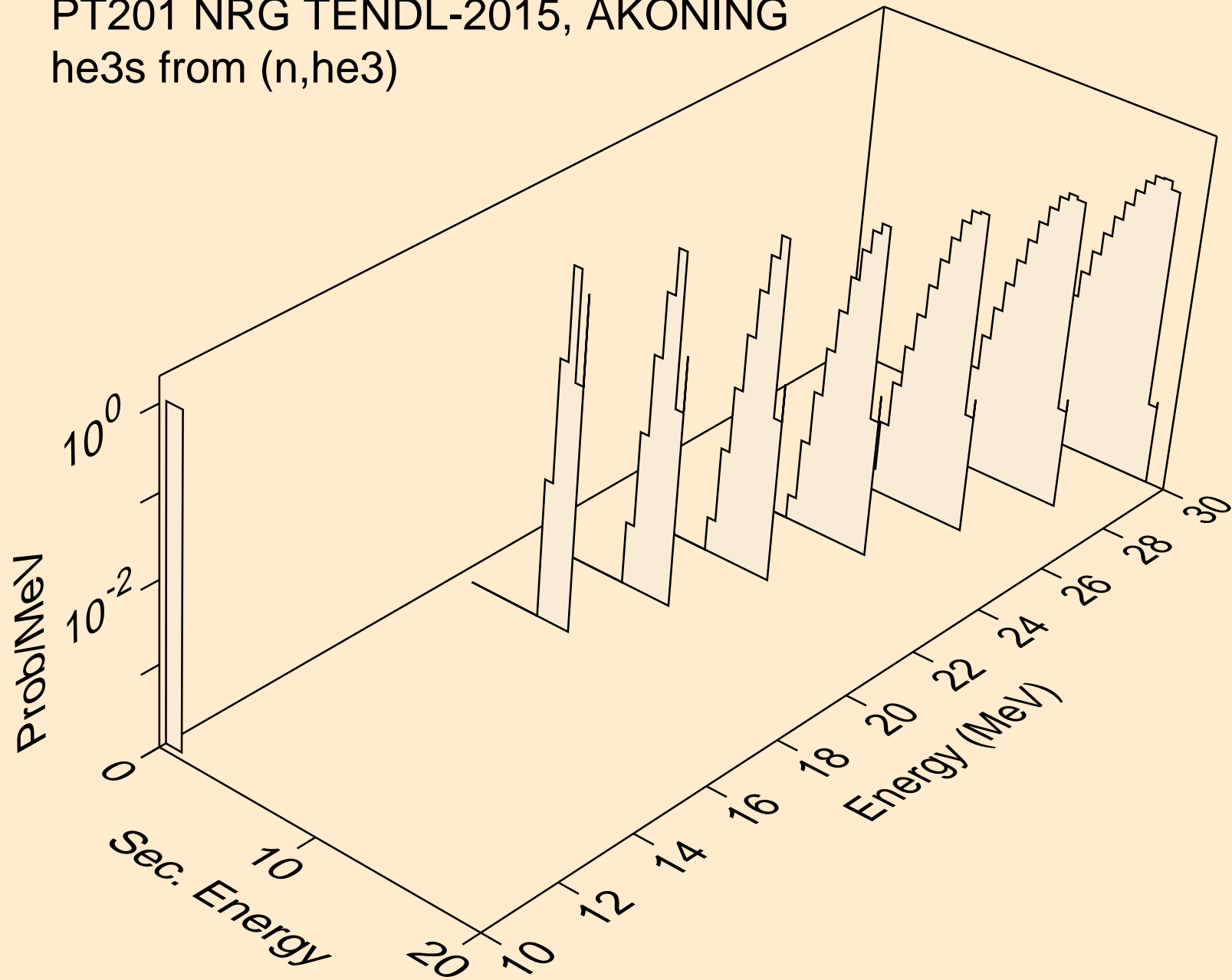

PT201 NRG TENDL-2015, AKONING
alphas from (n,x)

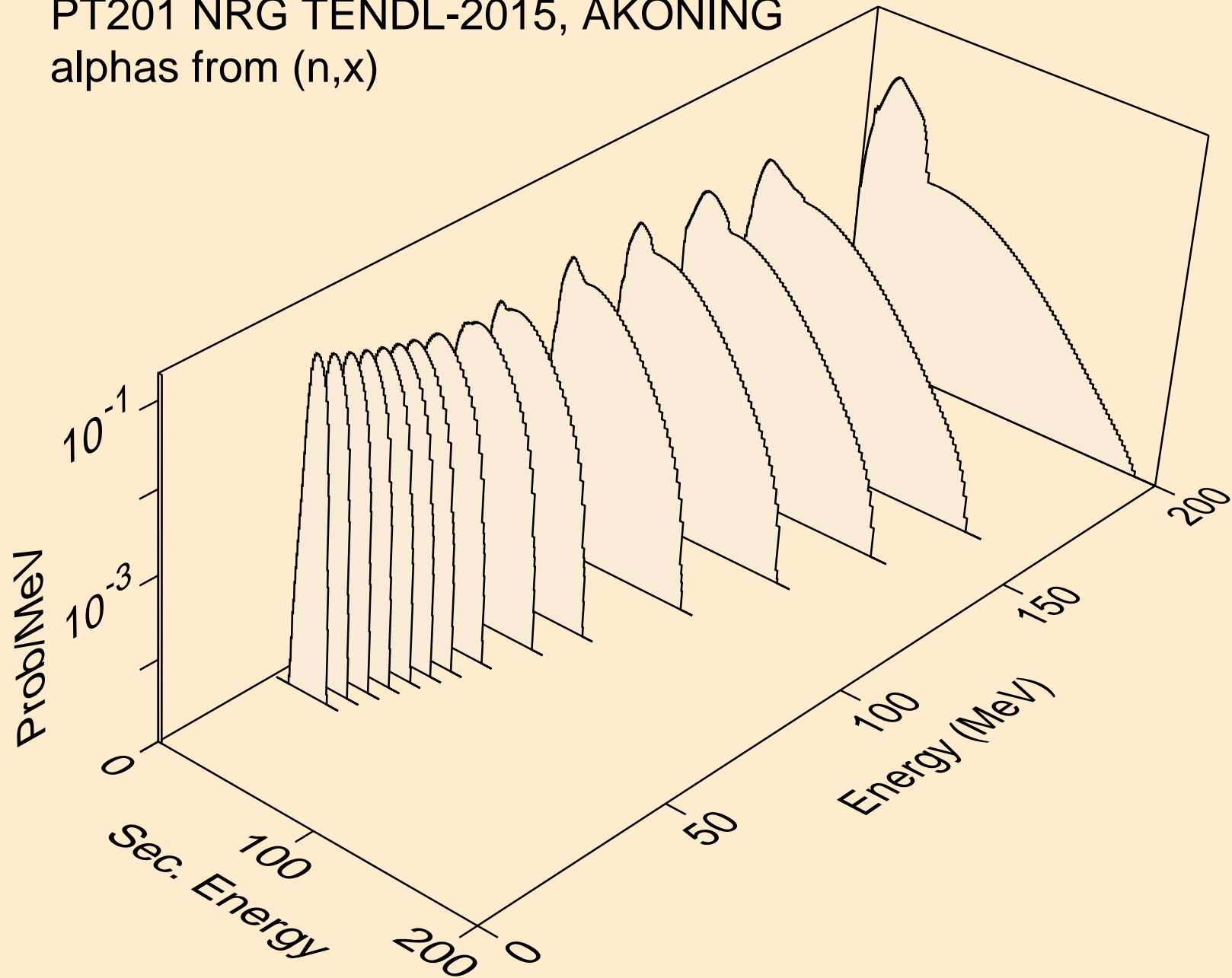

PT201 NRG TENDL-2015, AKONING
alphas from (n,n*)a

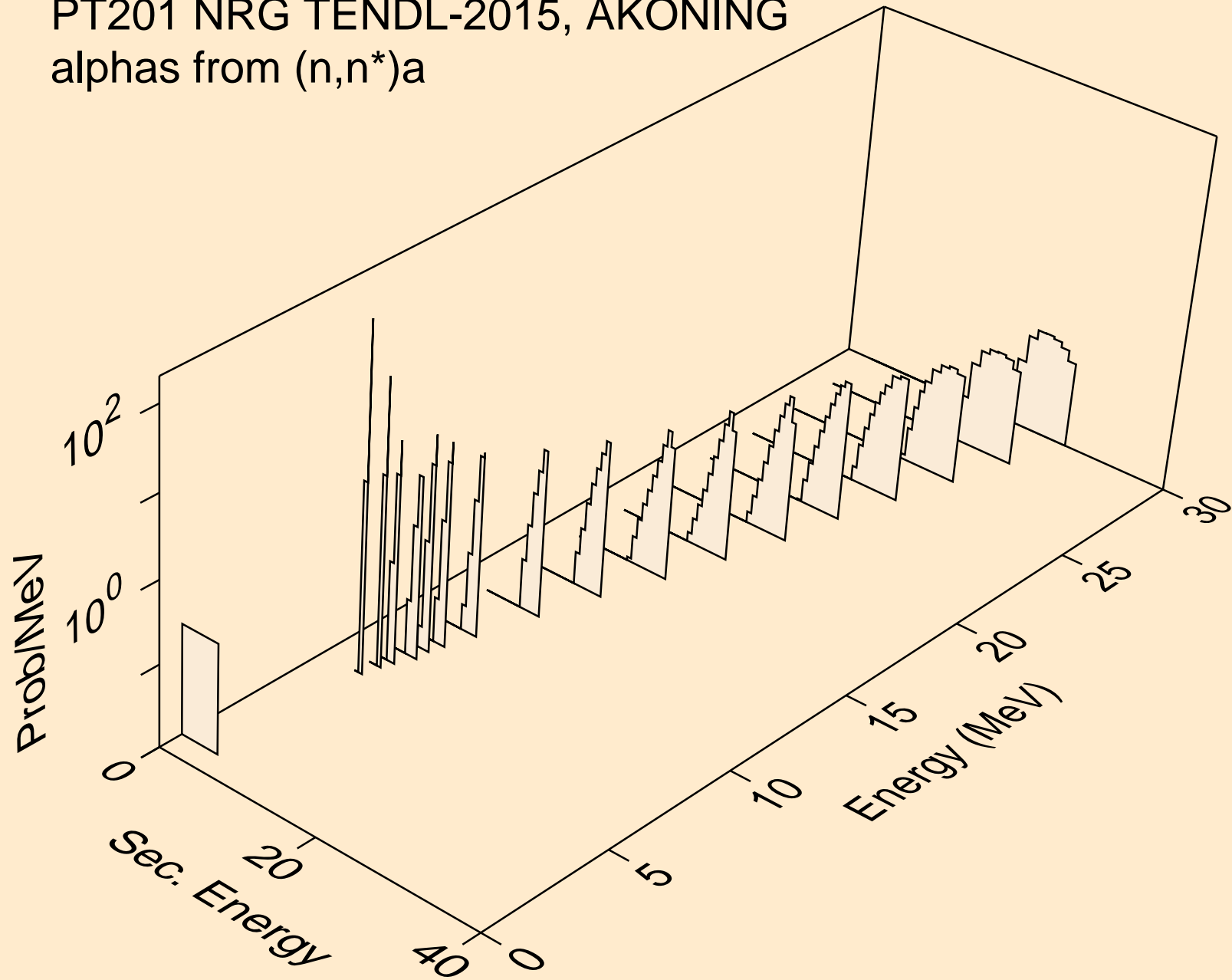

PT201 NRG TENDL-2015, AKONING
alphas from (n,2n)a

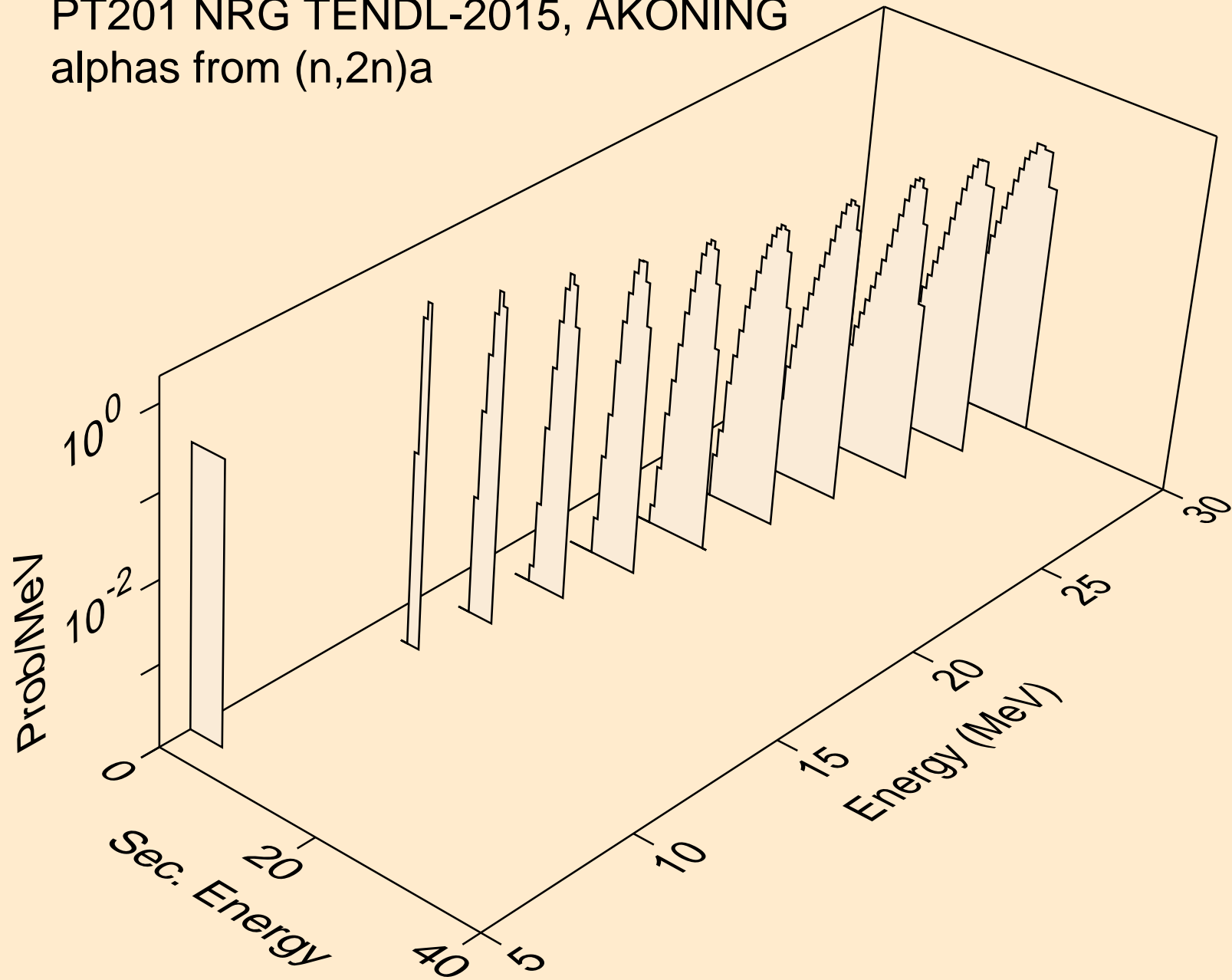

PT201 NRG TENDL-2015, AKONING
alphas from (n,3n)a

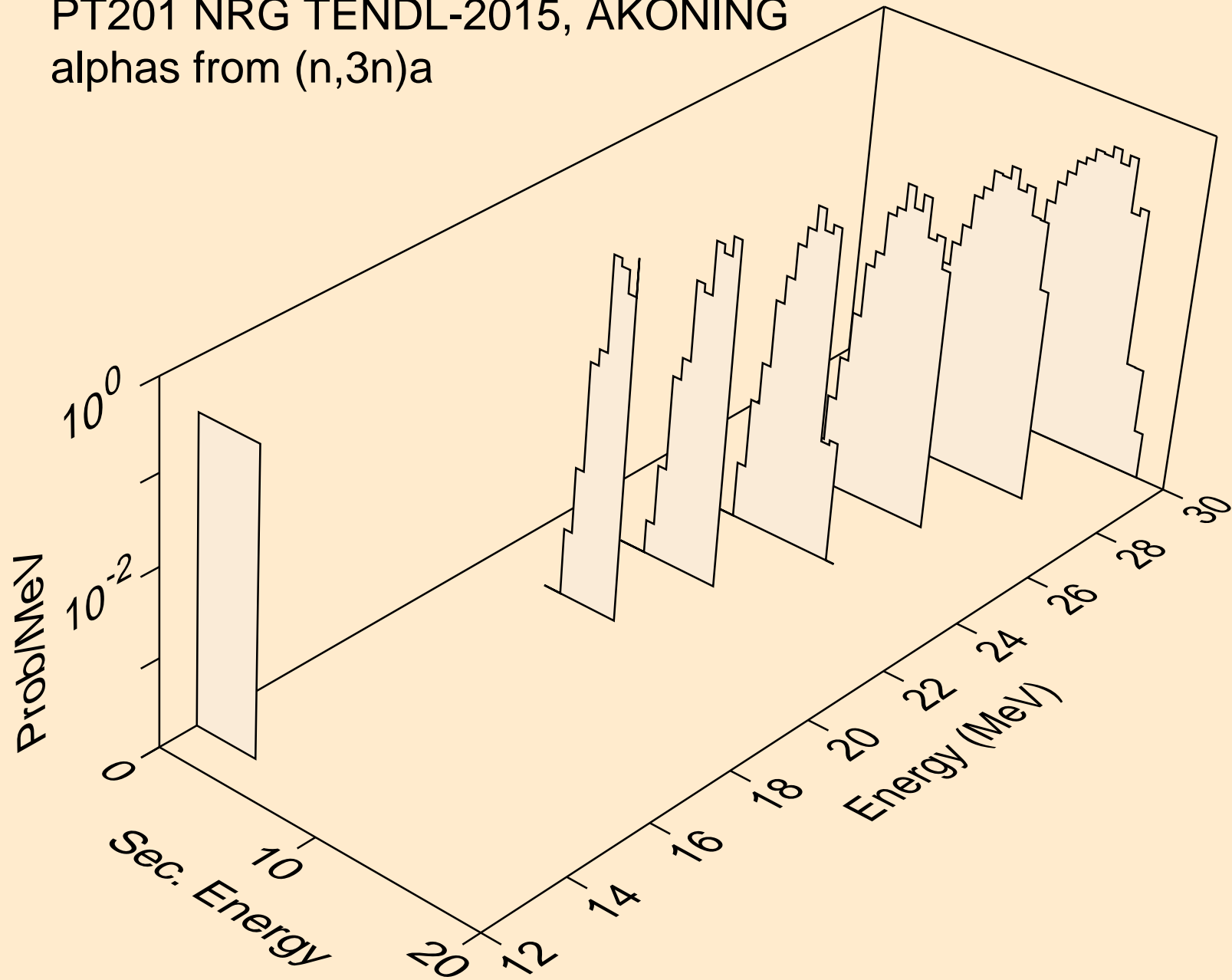

PT201 NRG TENDL-2015, AKONING
alphas from (n,a)

