

PT206 NRG TENDL-2015, AKONING

Principal cross sections

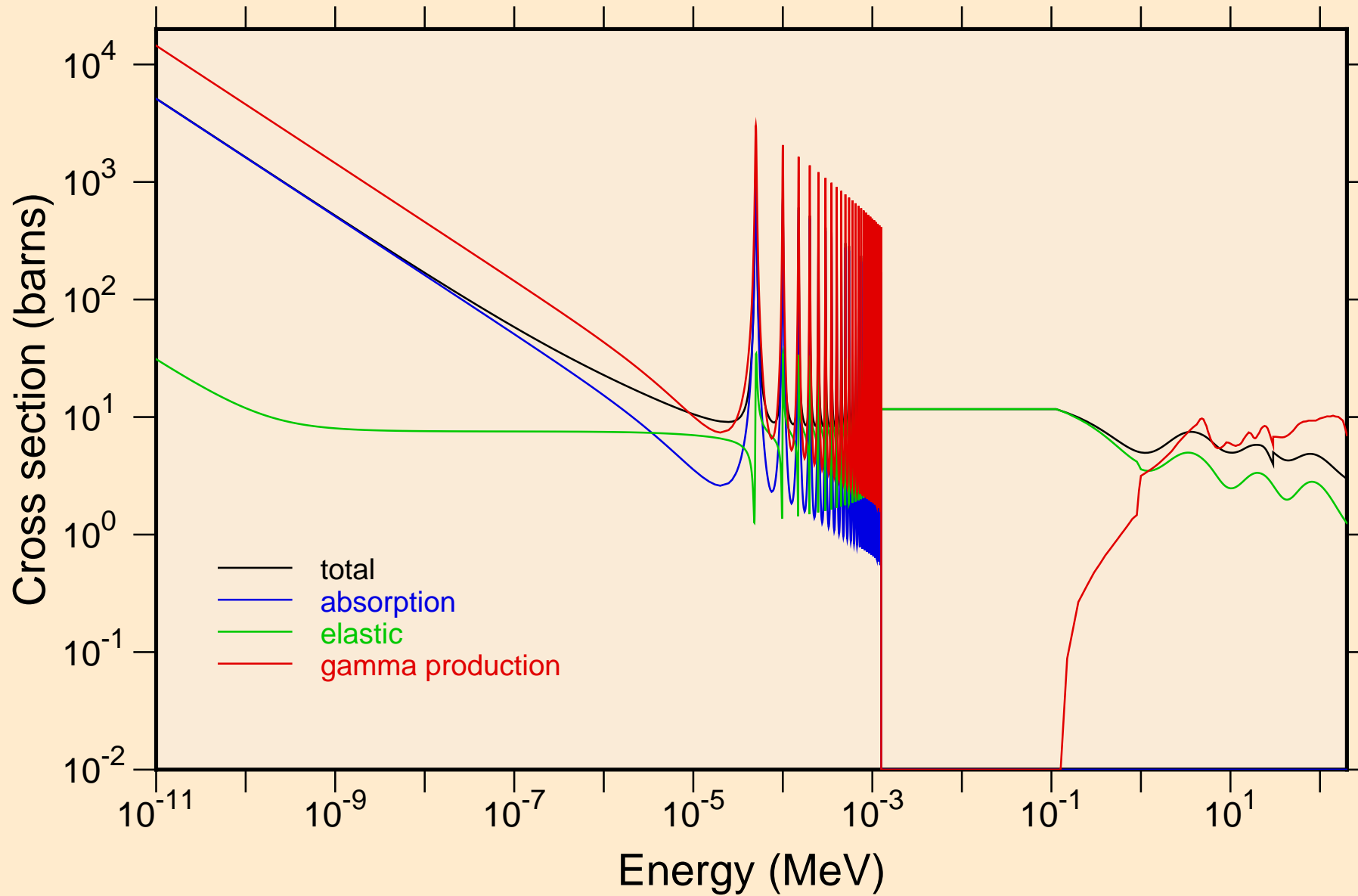

PT206 NRG TENDL-2015, AKONING
resonance total cross section

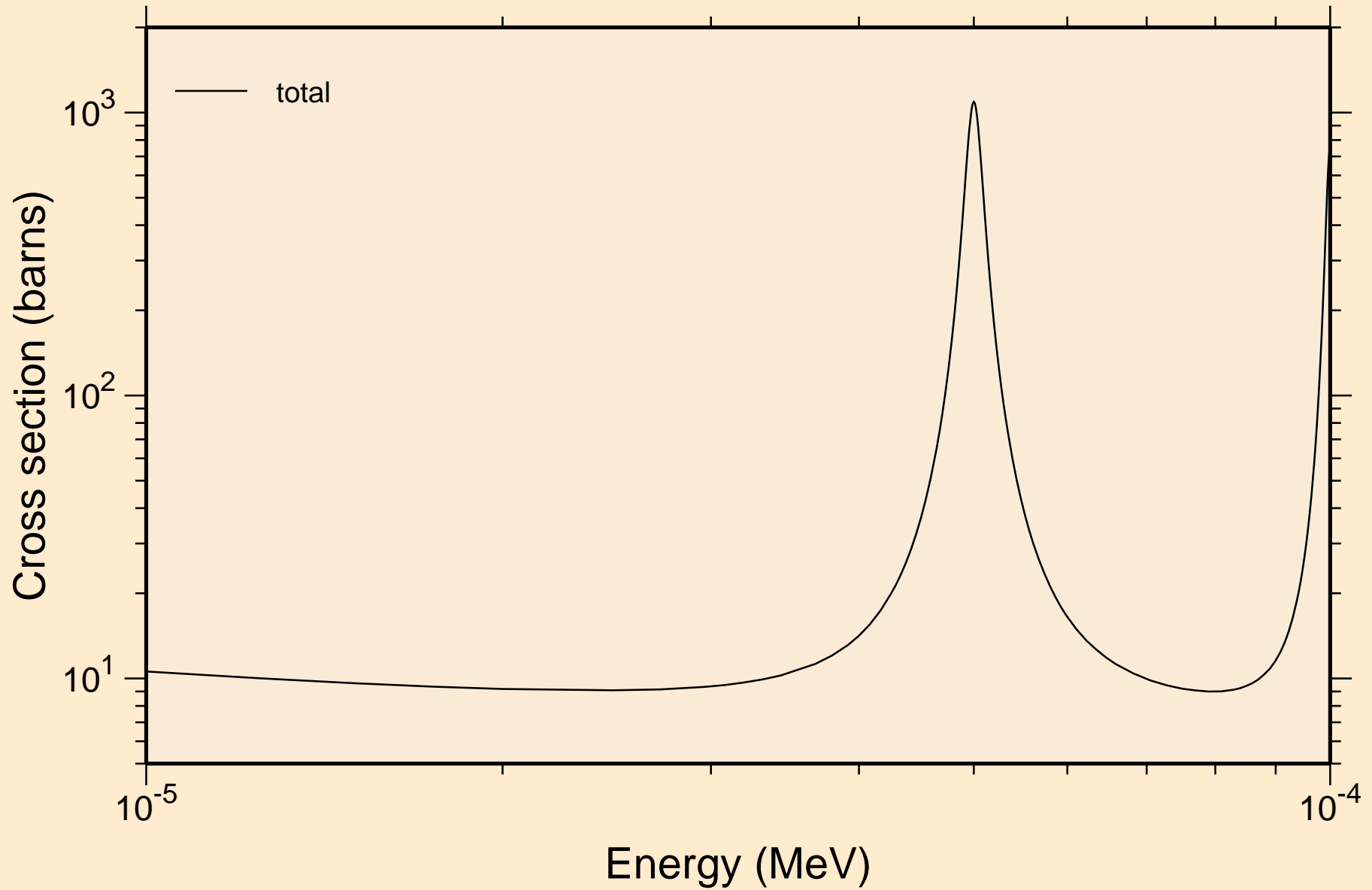

PT206 NRG TENDL-2015, AKONING
resonance total cross section

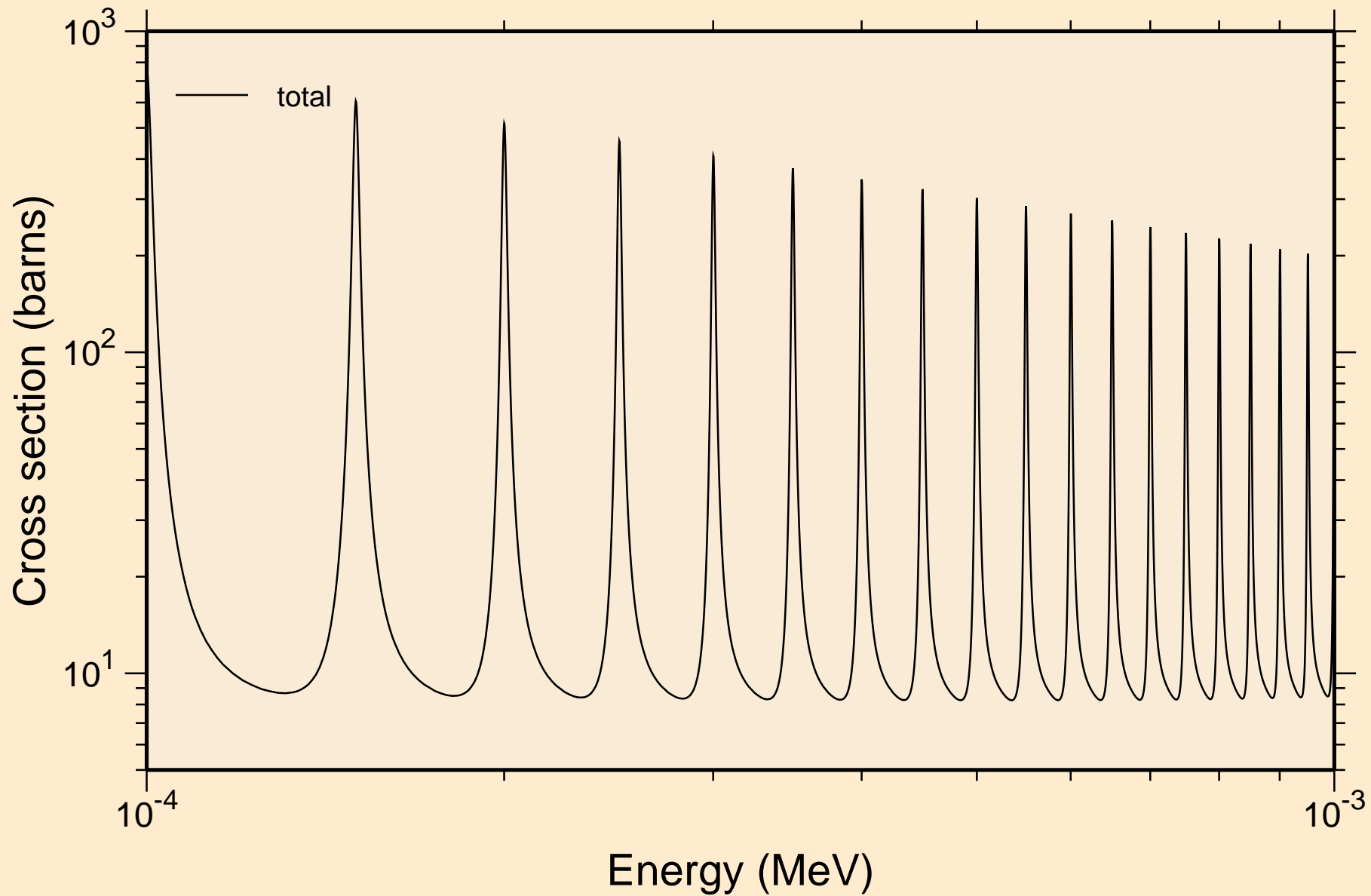

PT206 NRG TENDL-2015, AKONING
resonance total cross section

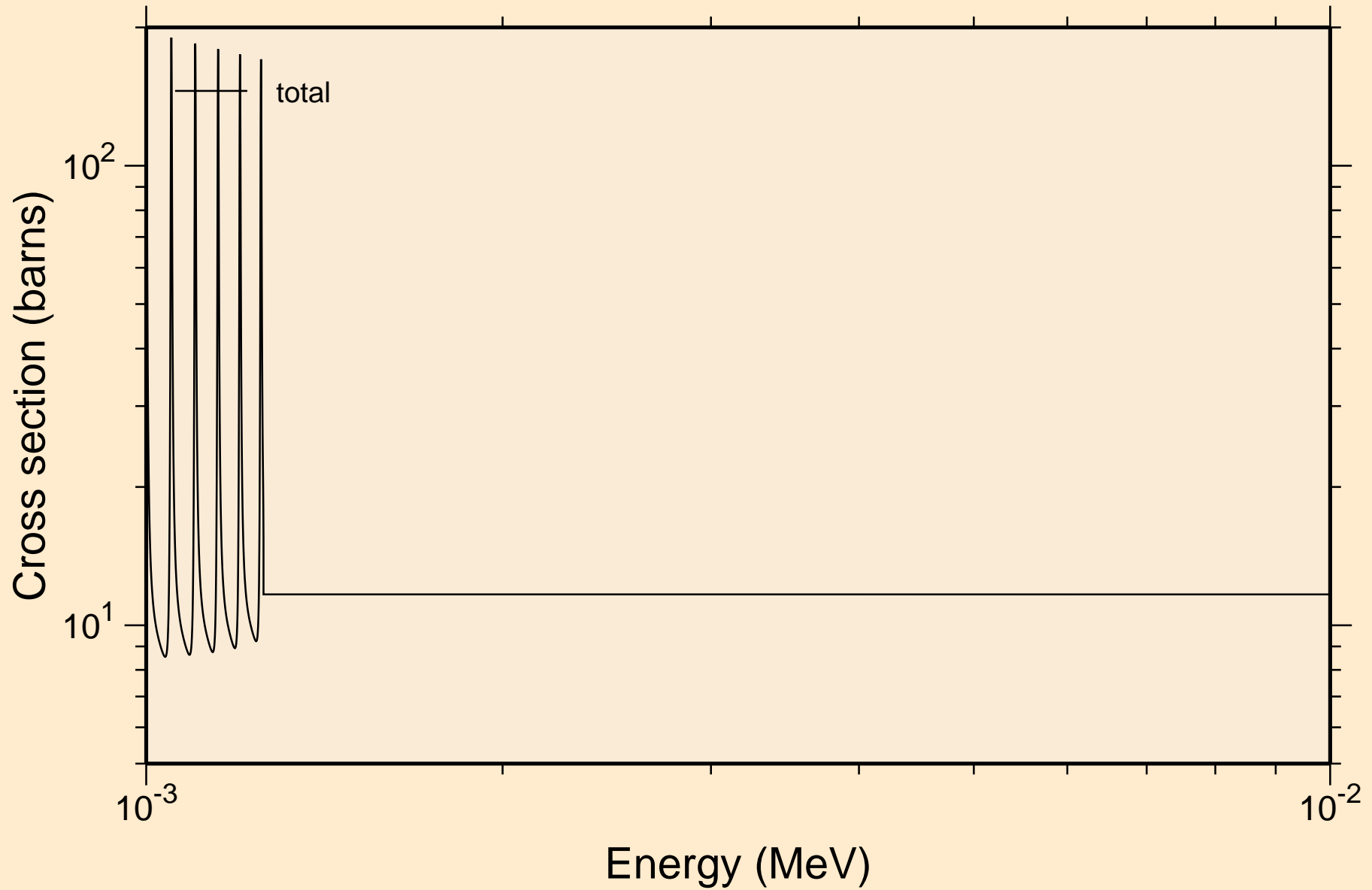

PT206 NRG TENDL-2015, AKONING
resonance total cross section

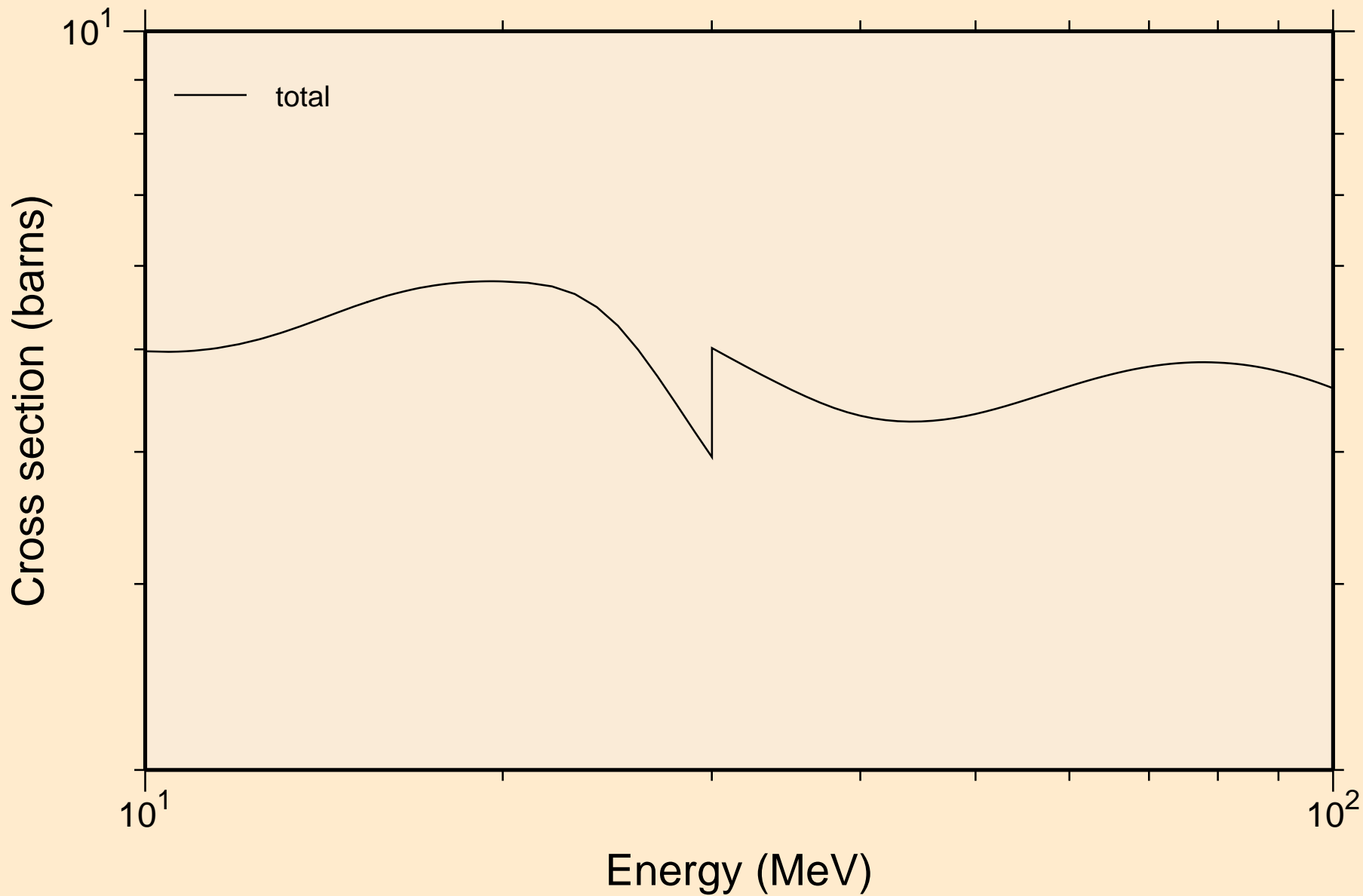

PT206 NRG TENDL-2015, AKONING
resonance absorption cross sections

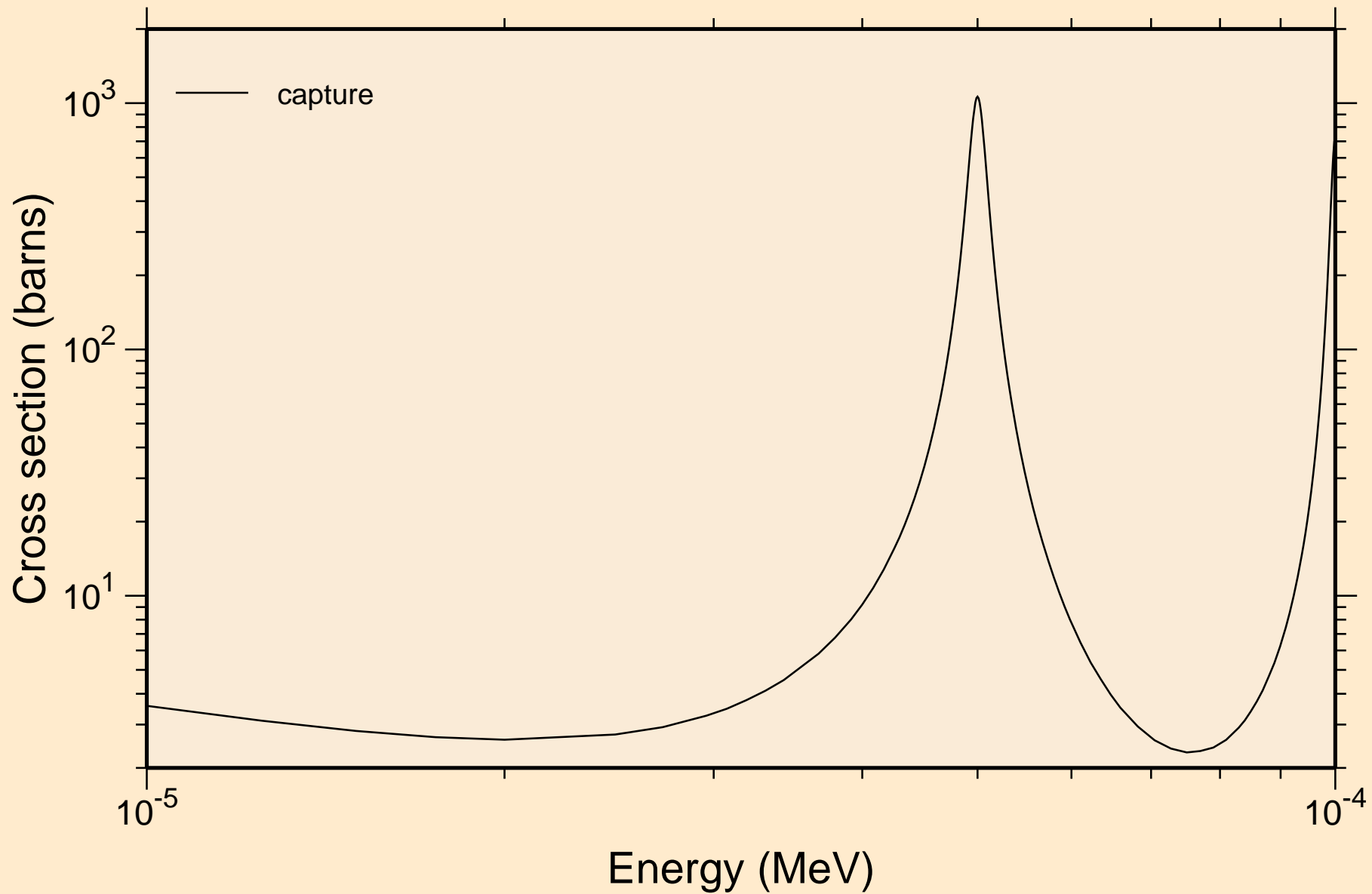

PT206 NRG TENDL-2015, AKONING
resonance absorption cross sections

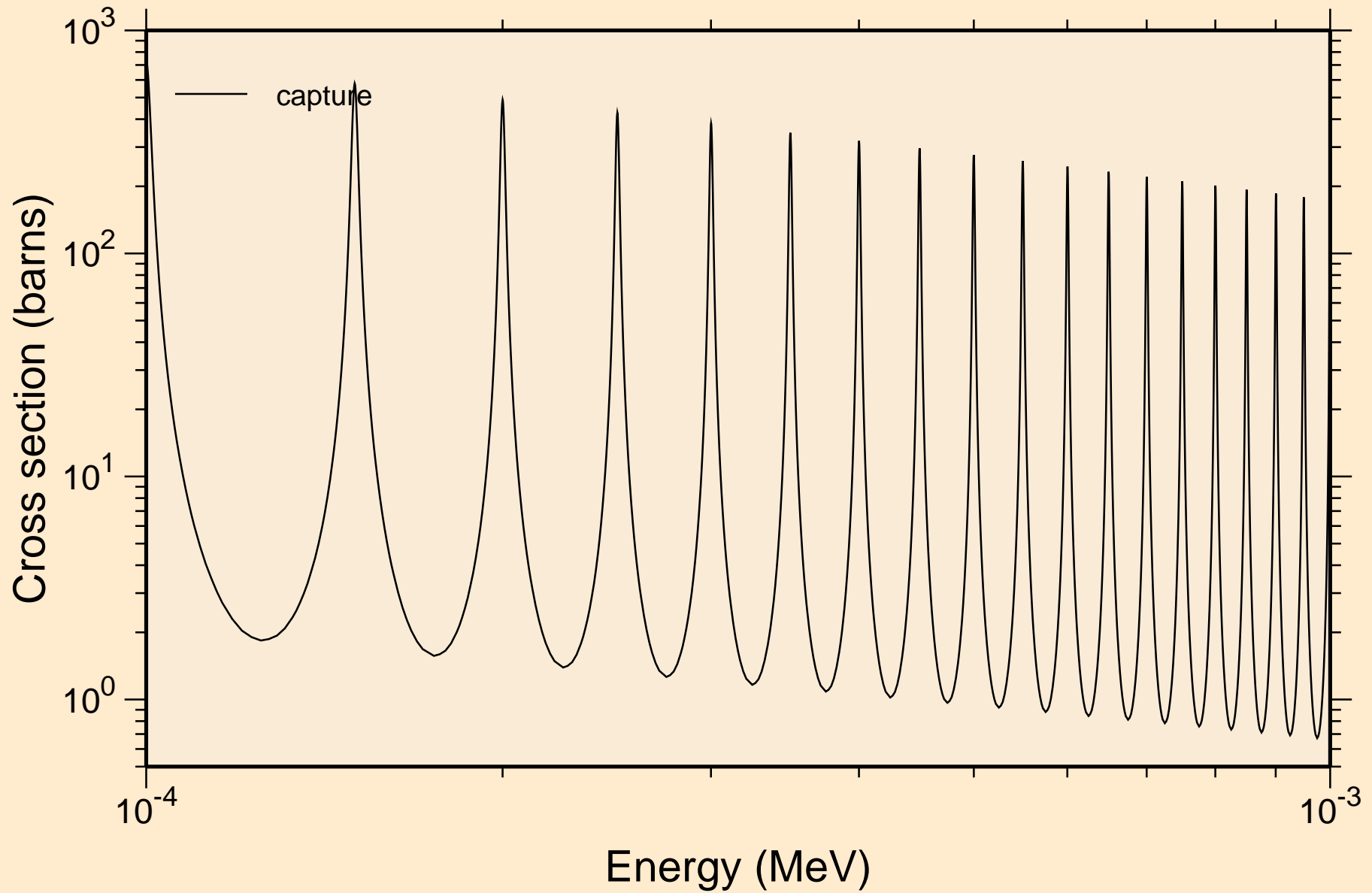

PT206 NRG TENDL-2015, AKONING
resonance absorption cross sections

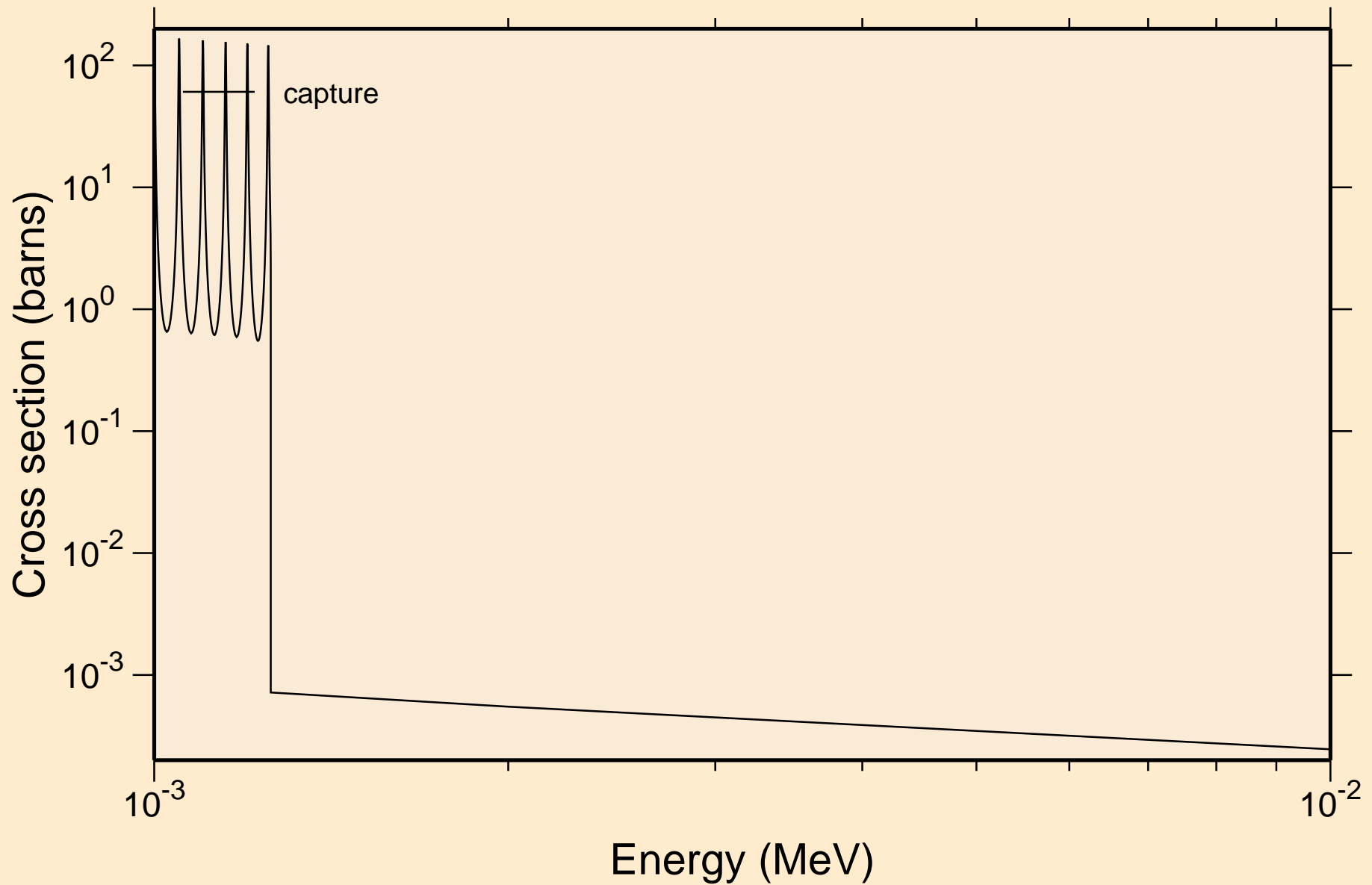

PT206 NRG TENDL-2015, AKONING
resonance absorption cross sections

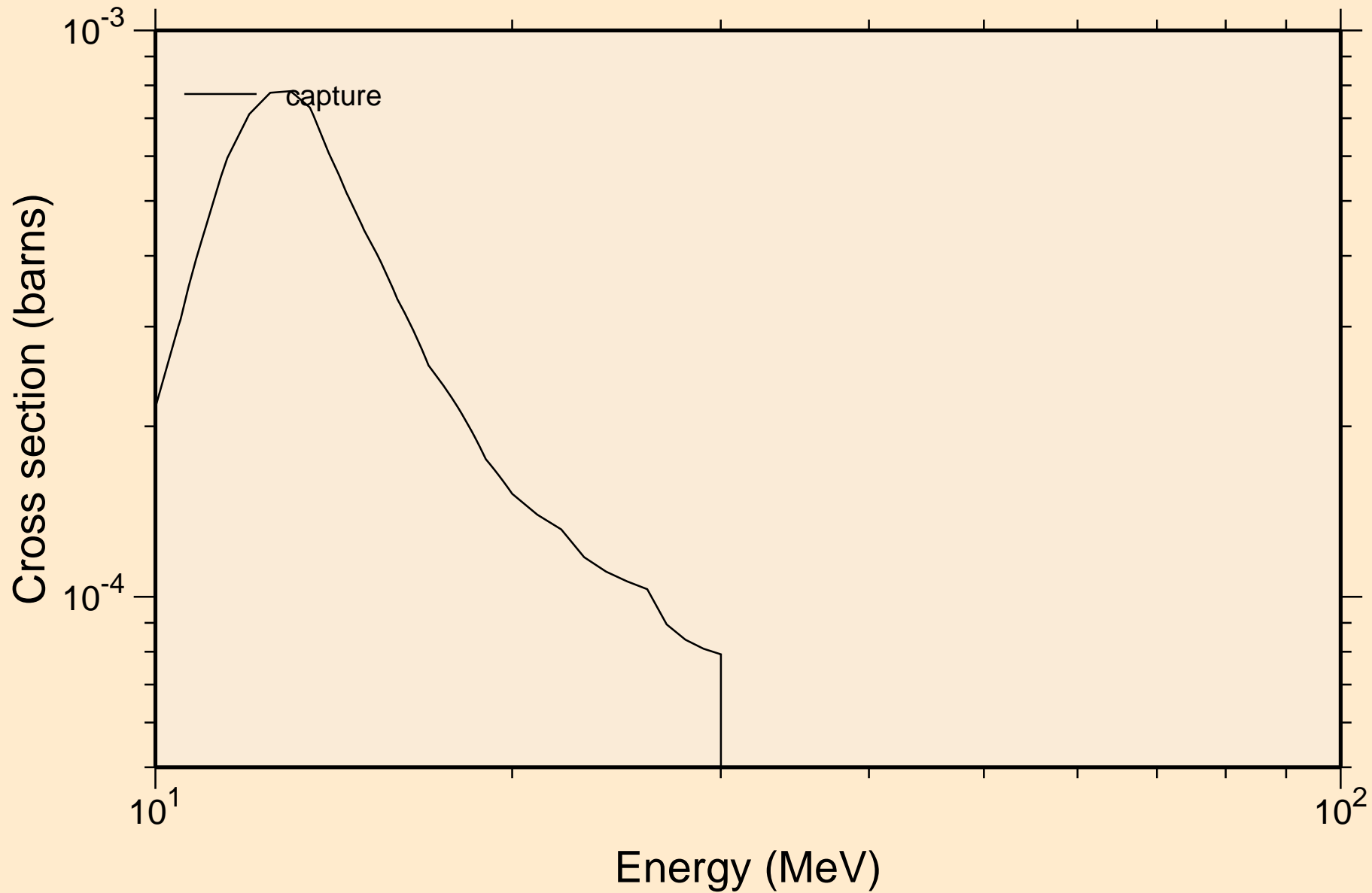

PT206 NRG TENDL-2015, AKONING
Non-threshold reactions

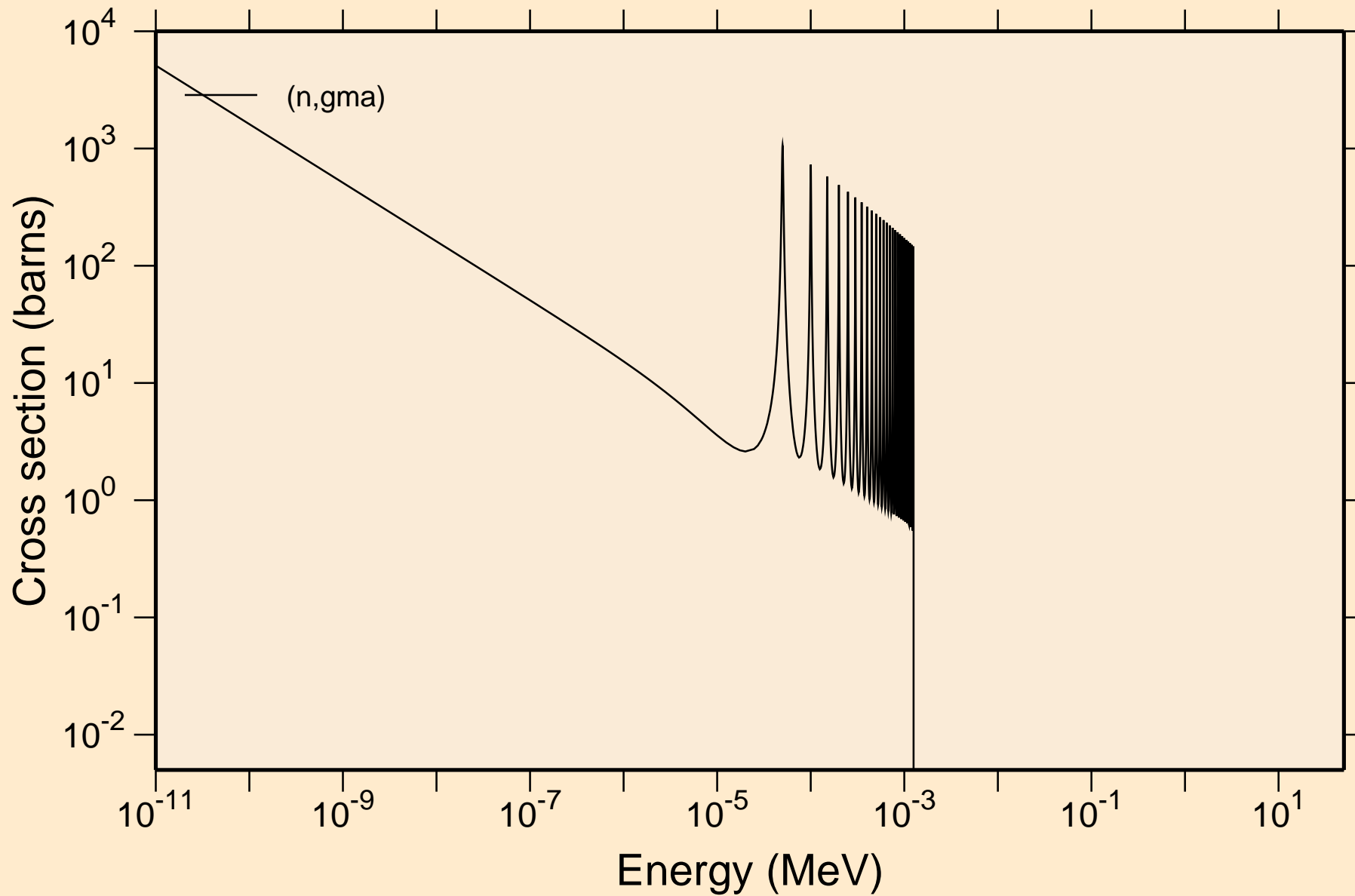

PT206 NRG TENDL-2015, AKONING

Principal cross sections

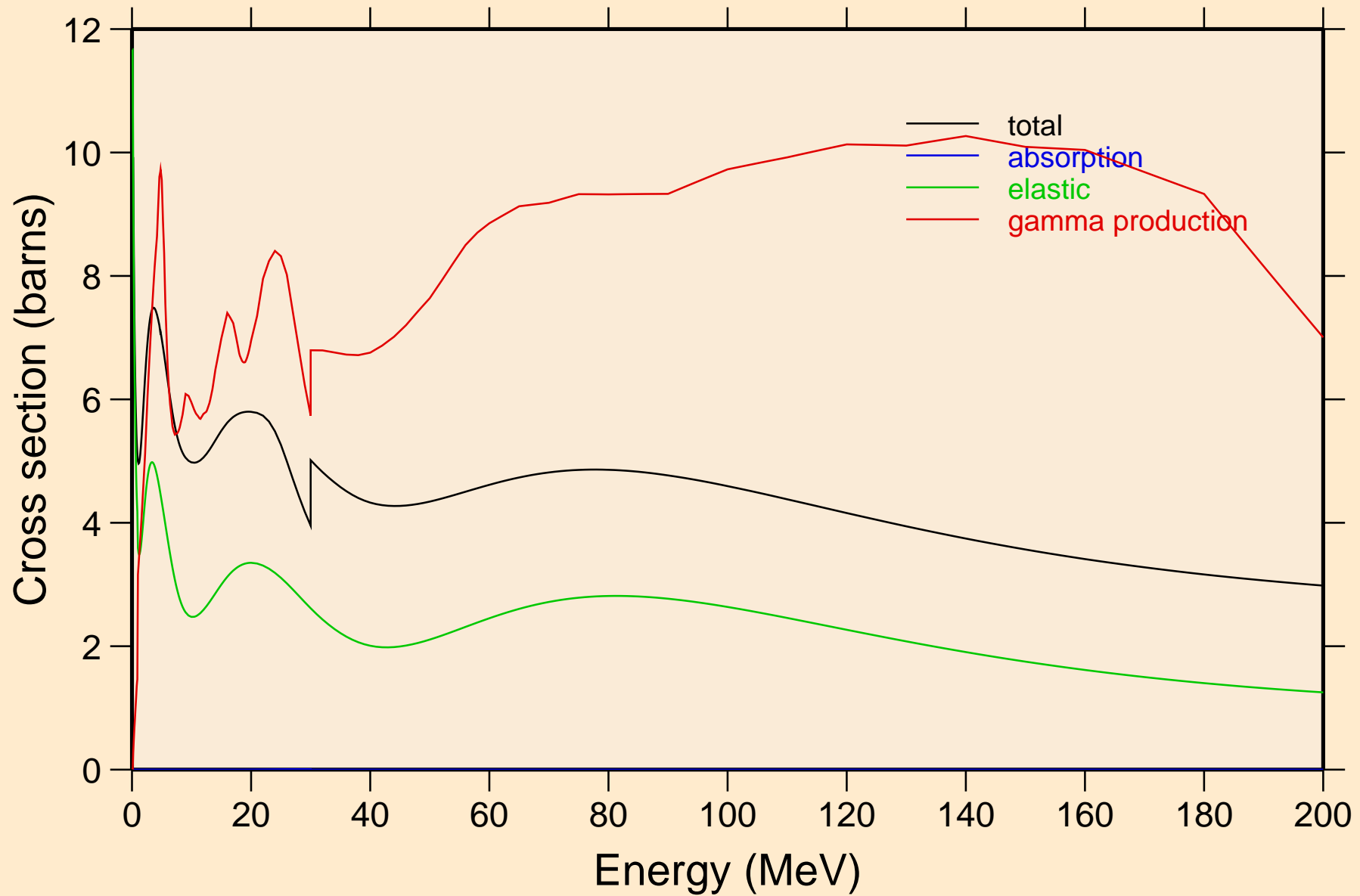

PT206 NRG TENDL-2015, AKONING
Non-threshold reactions

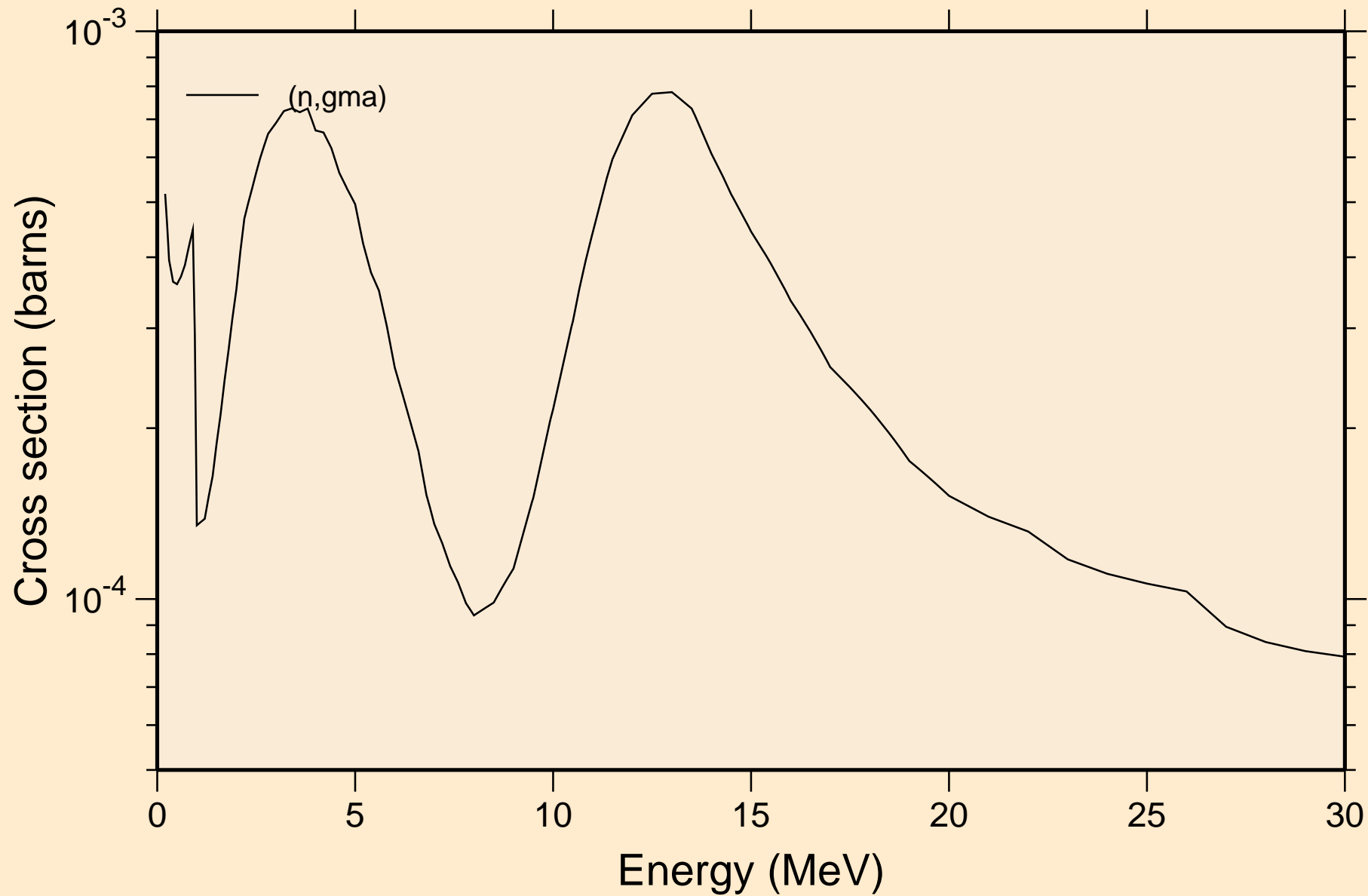

PT206 NRG TENDL-2015, AKONING
Inelastic levels

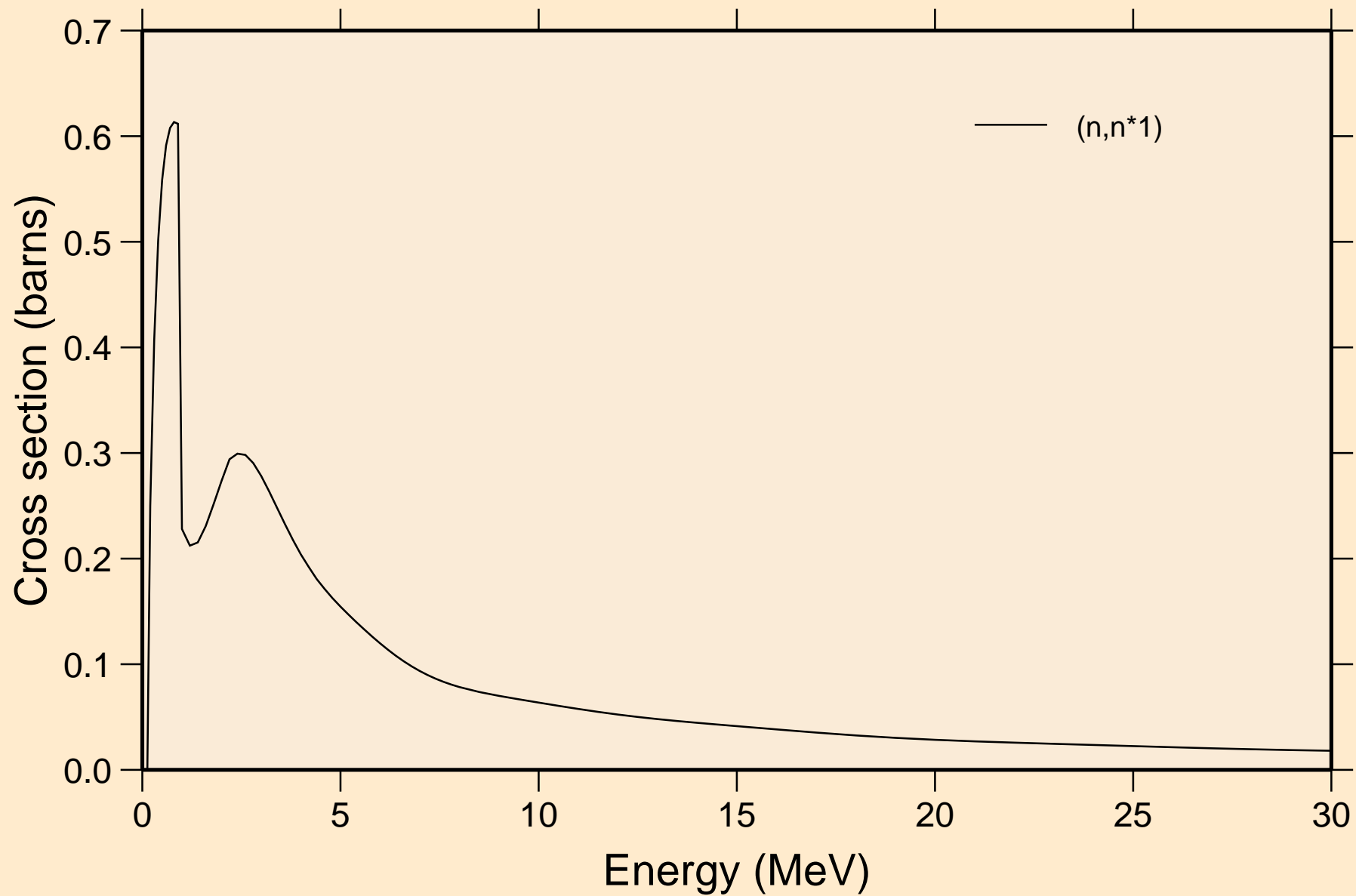

PT206 NRG TENDL-2015, AKONING

Threshold reactions

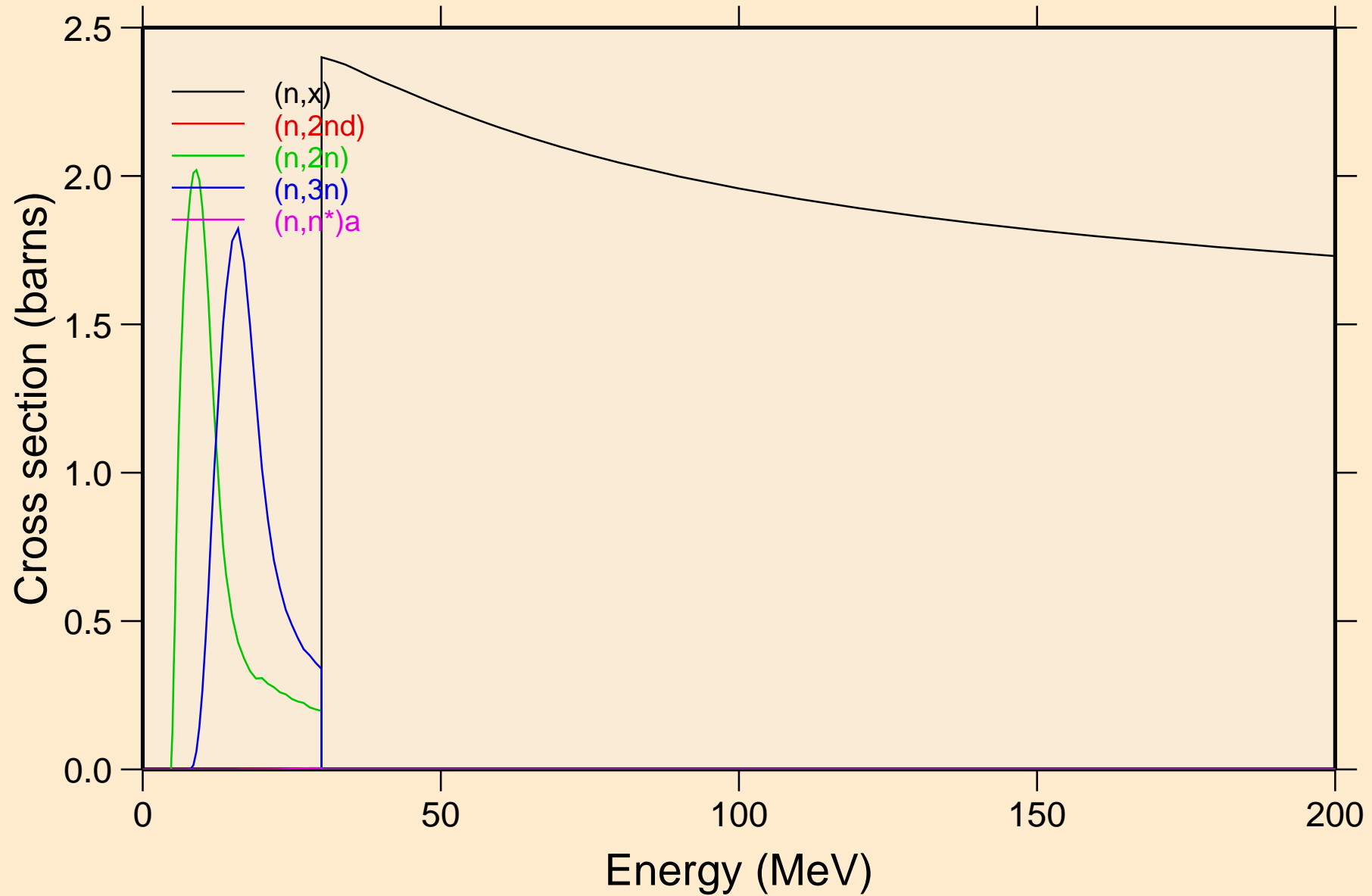

PT206 NRG TENDL-2015, AKONING
Threshold reactions

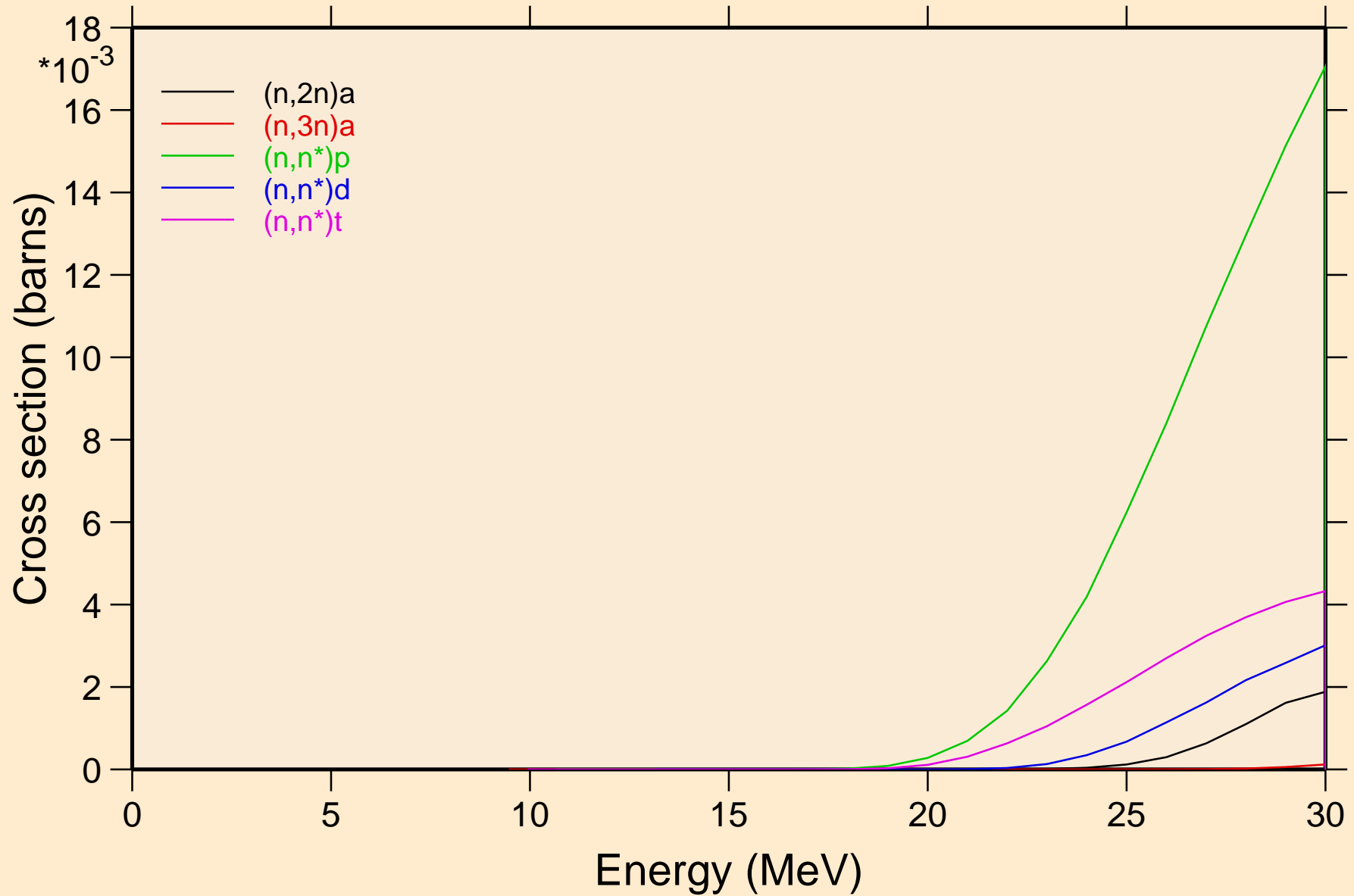

PT206 NRG TENDL-2015, AKONING

Threshold reactions

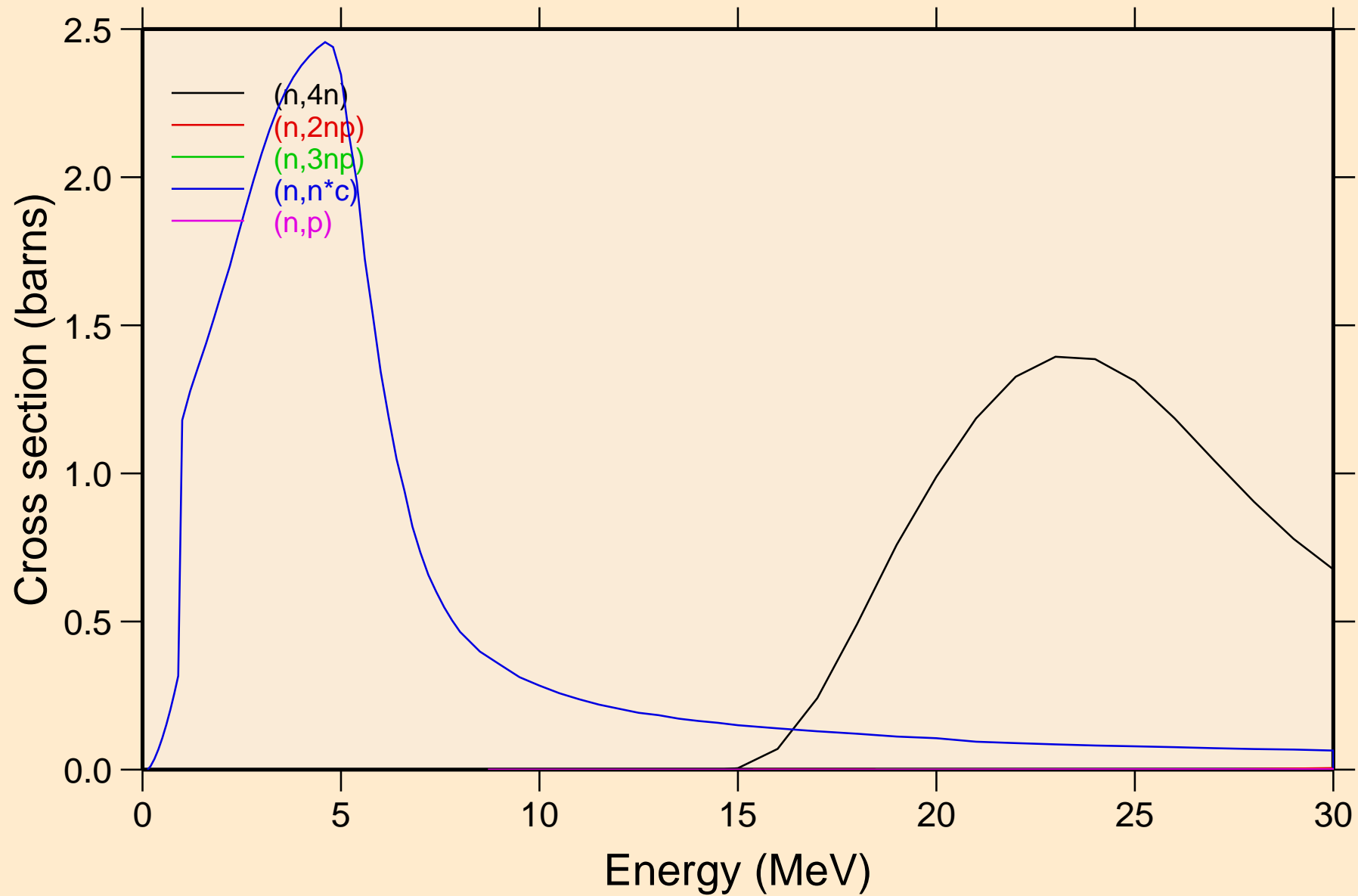

PT206 NRG TENDL-2015, AKONING

Threshold reactions

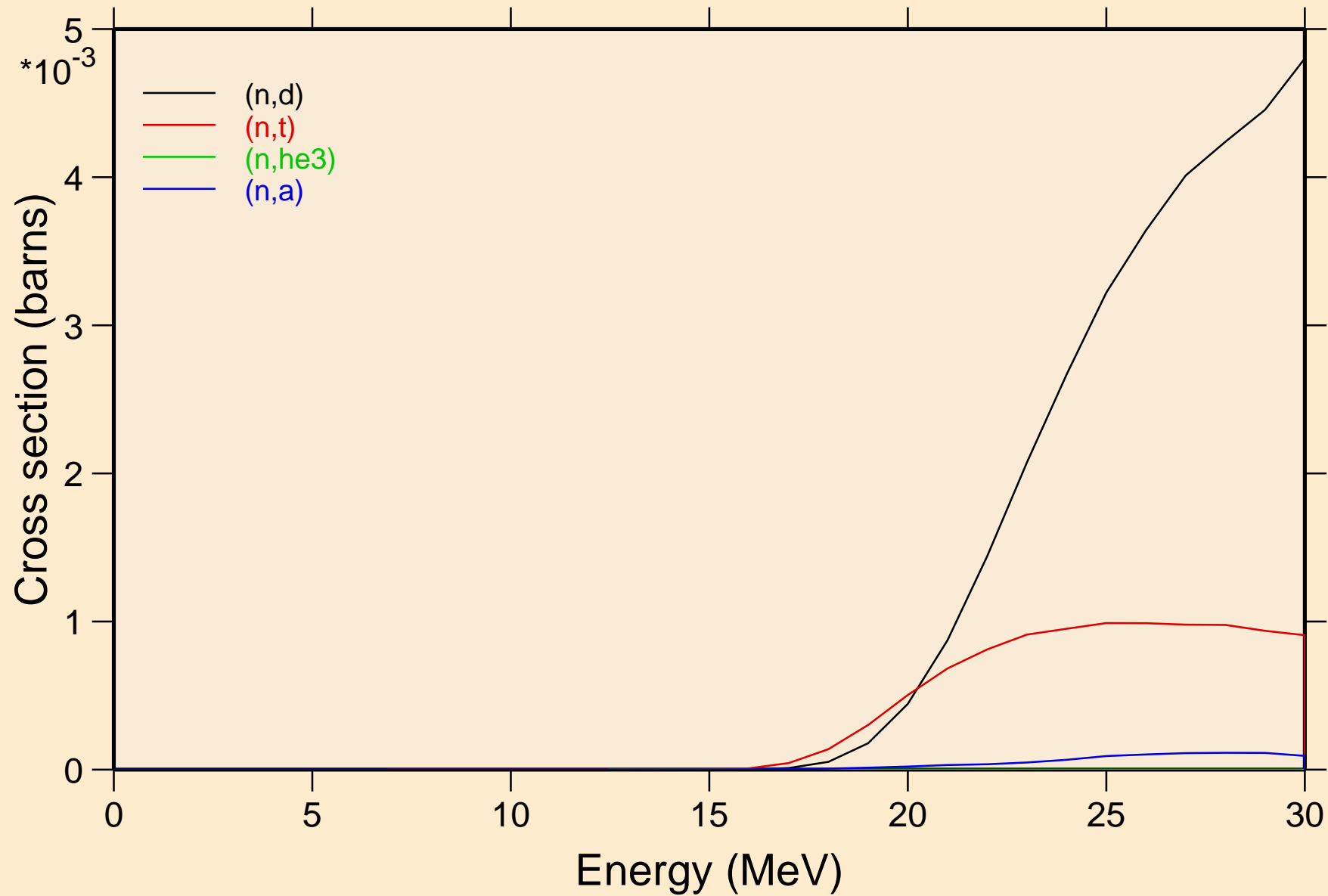

PT206 NRG TENDL-2015, AKONING
angular distribution for elastic

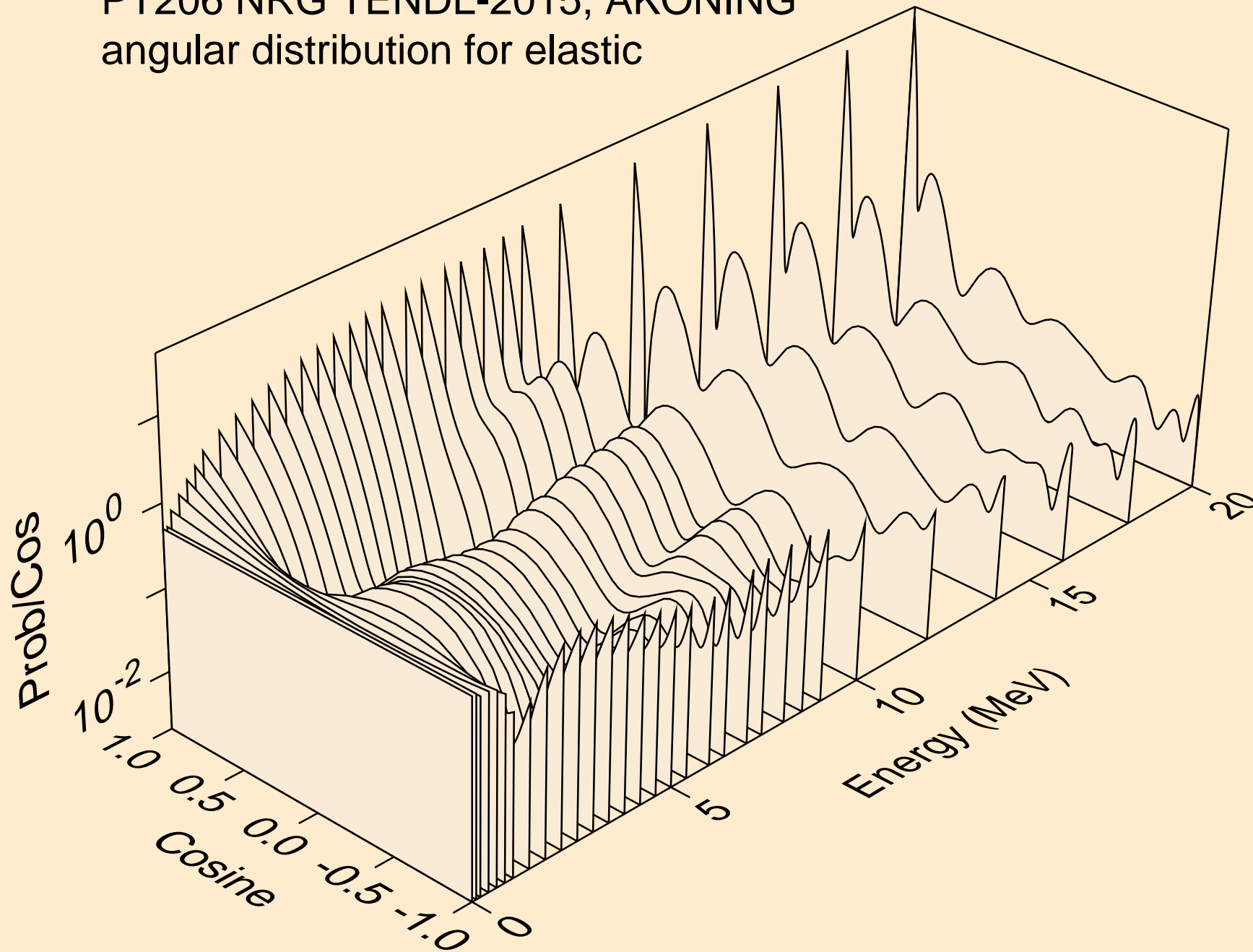

PT206 NRG TENDL-2015, AKONING
angular distribution for elastic

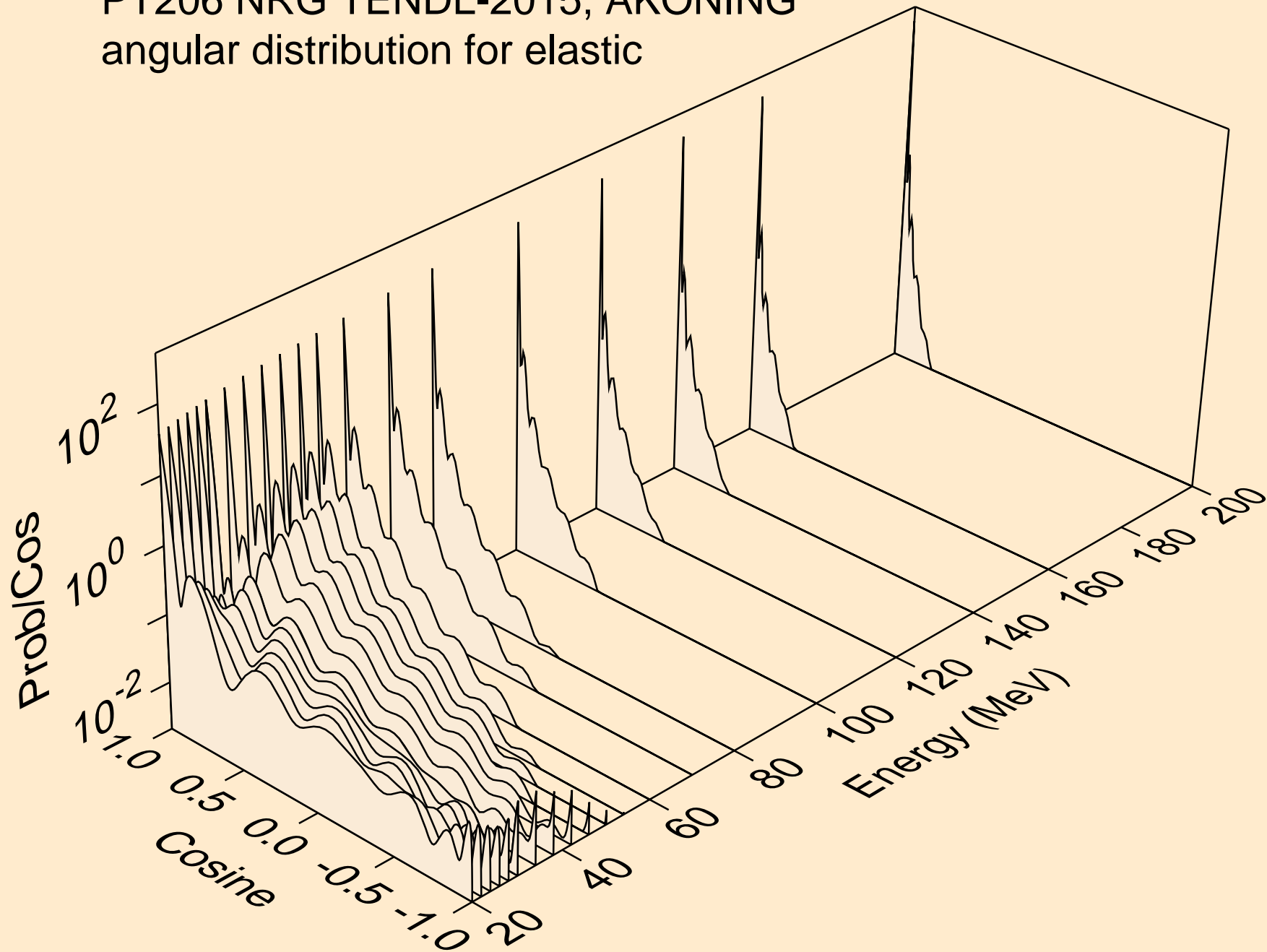

PT206 NRG TENDL-2015, AKONING
angular distribution for (n,n*1)

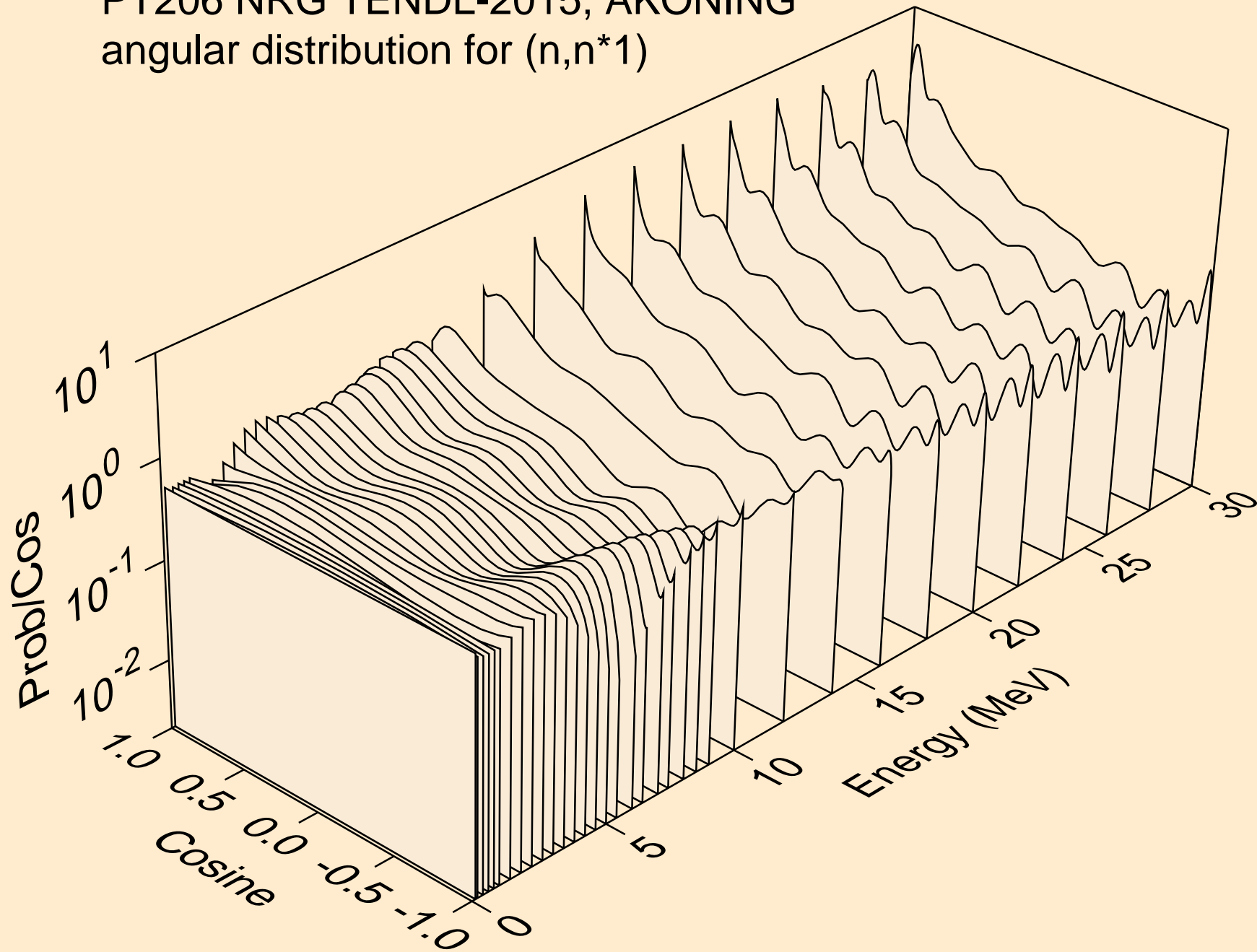

PT206 NRG TENDL-2015, AKONING
Neutron emission for (n,x)

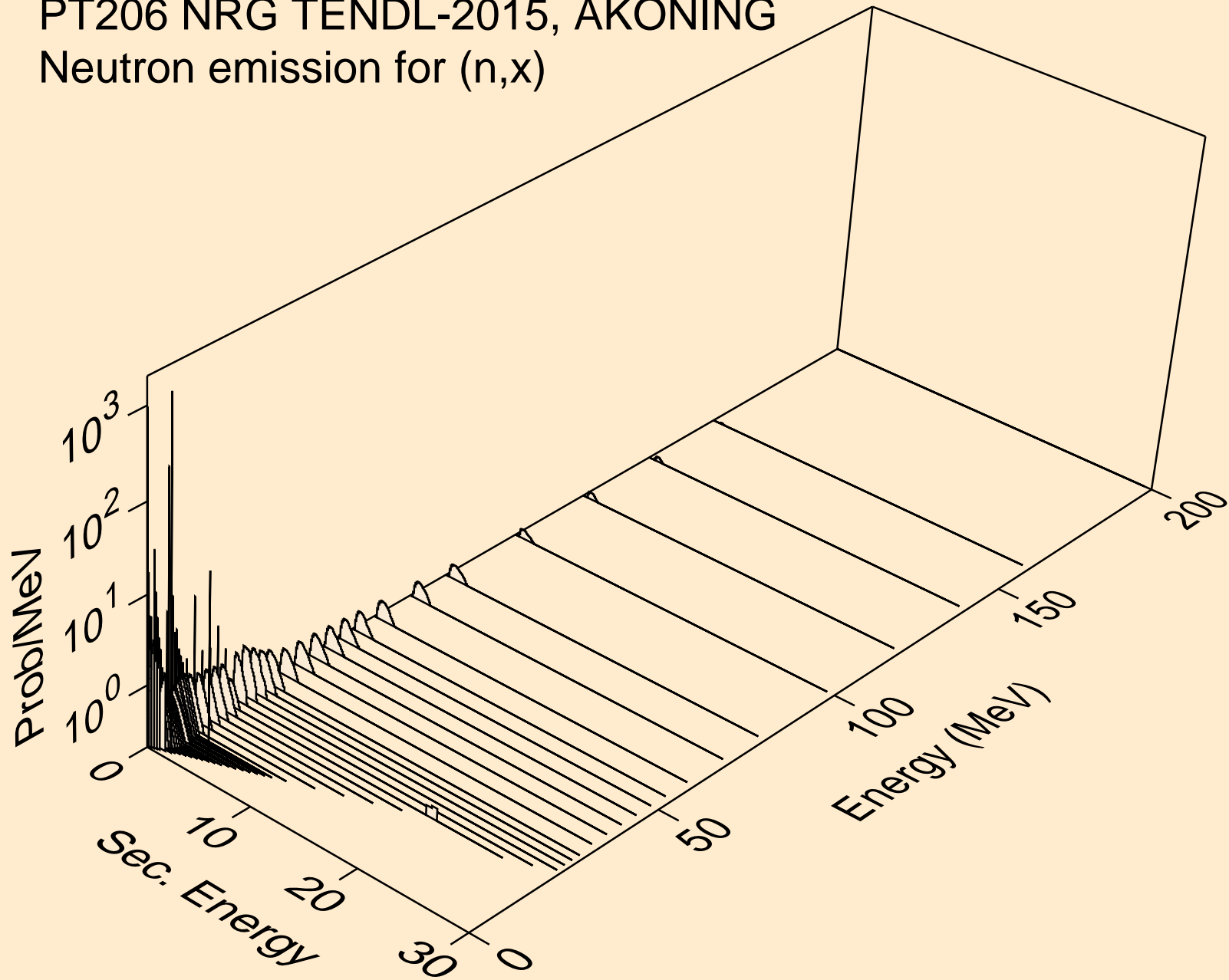

PT206 NRG TENDL-2015, AKONING
Neutron emission for (n,2nd)

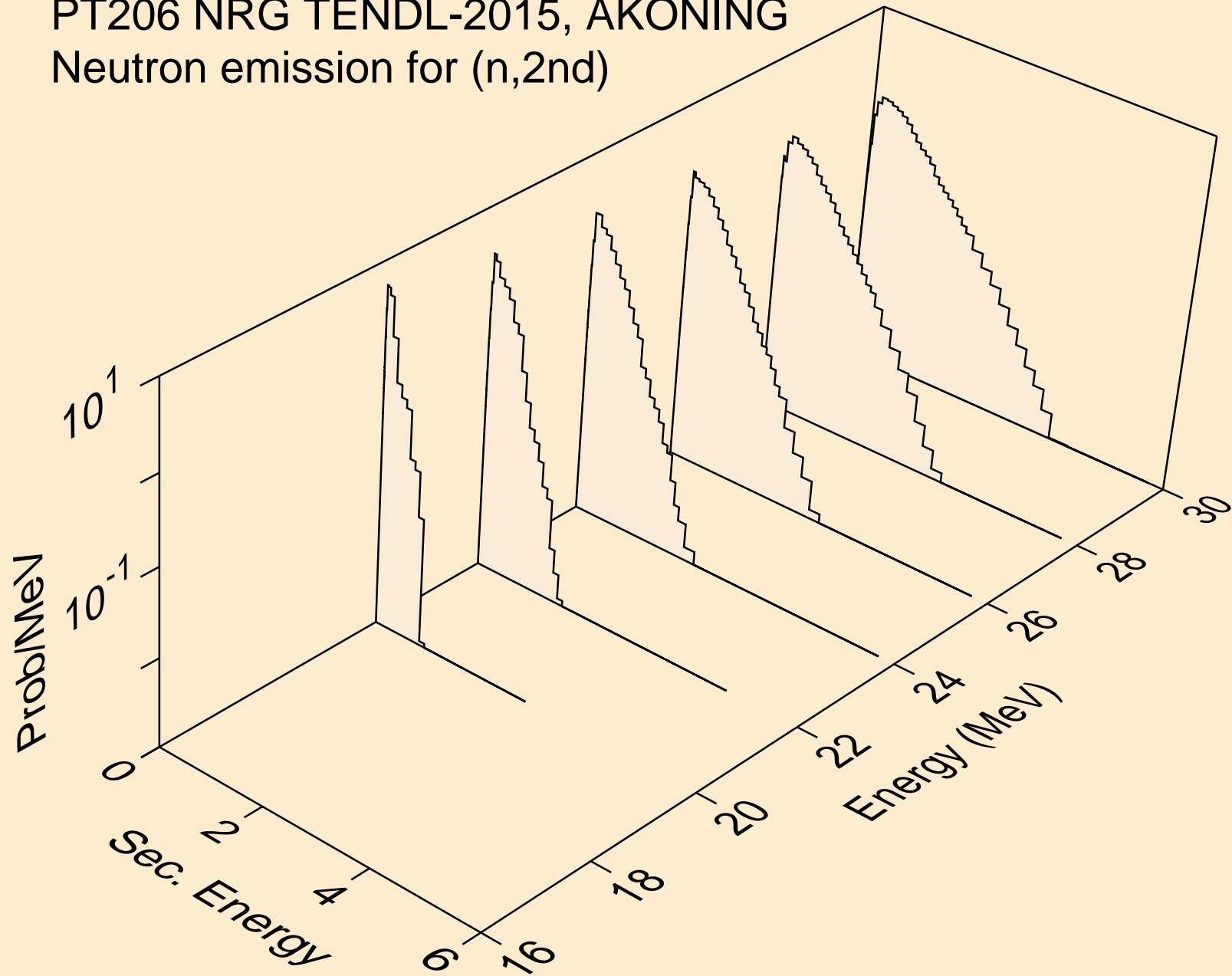

PT206 NRG TENDL-2015, AKONING
Neutron emission for (n,2n)

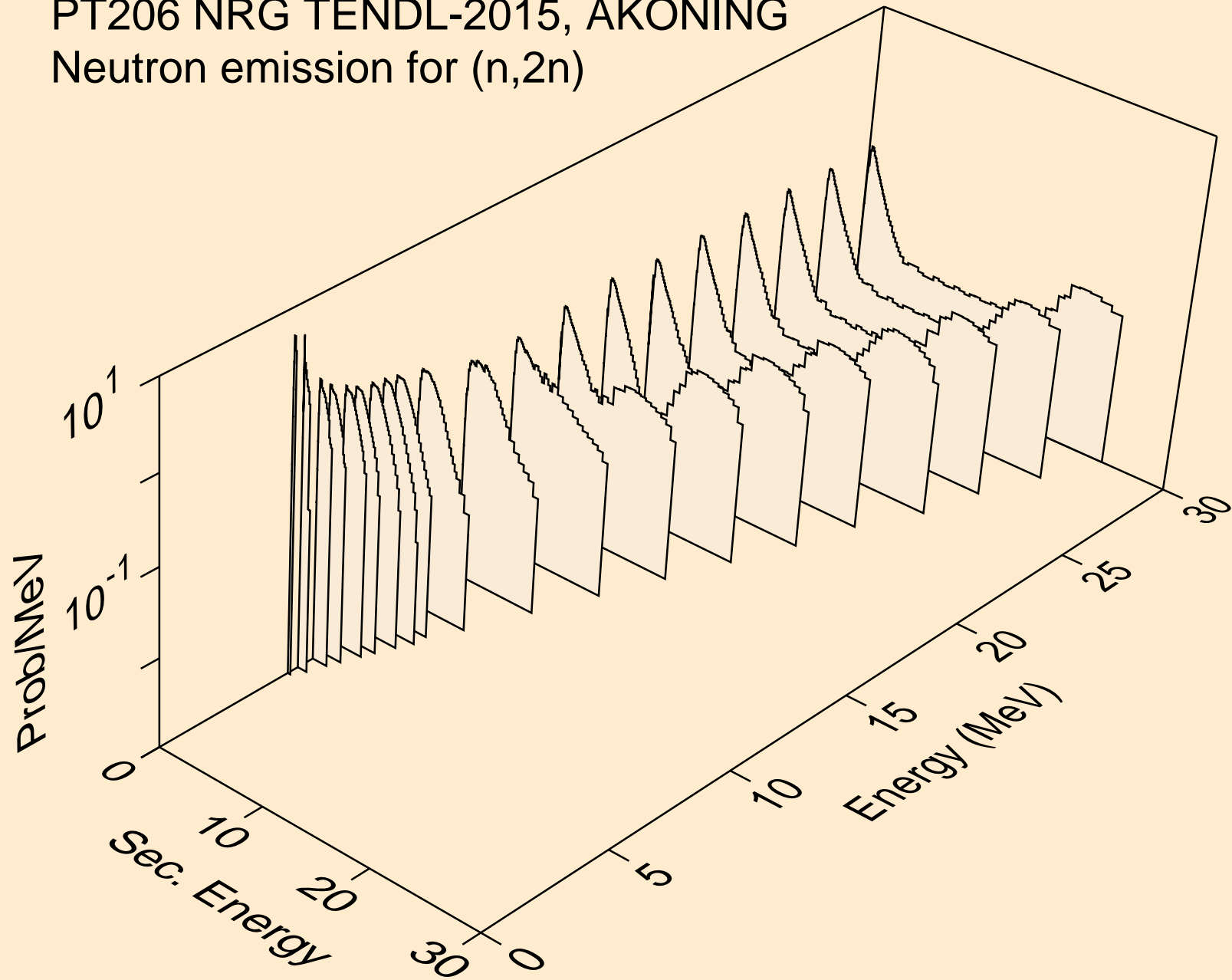

PT206 NRG TENDL-2015, AKONING
Neutron emission for (n,3n)

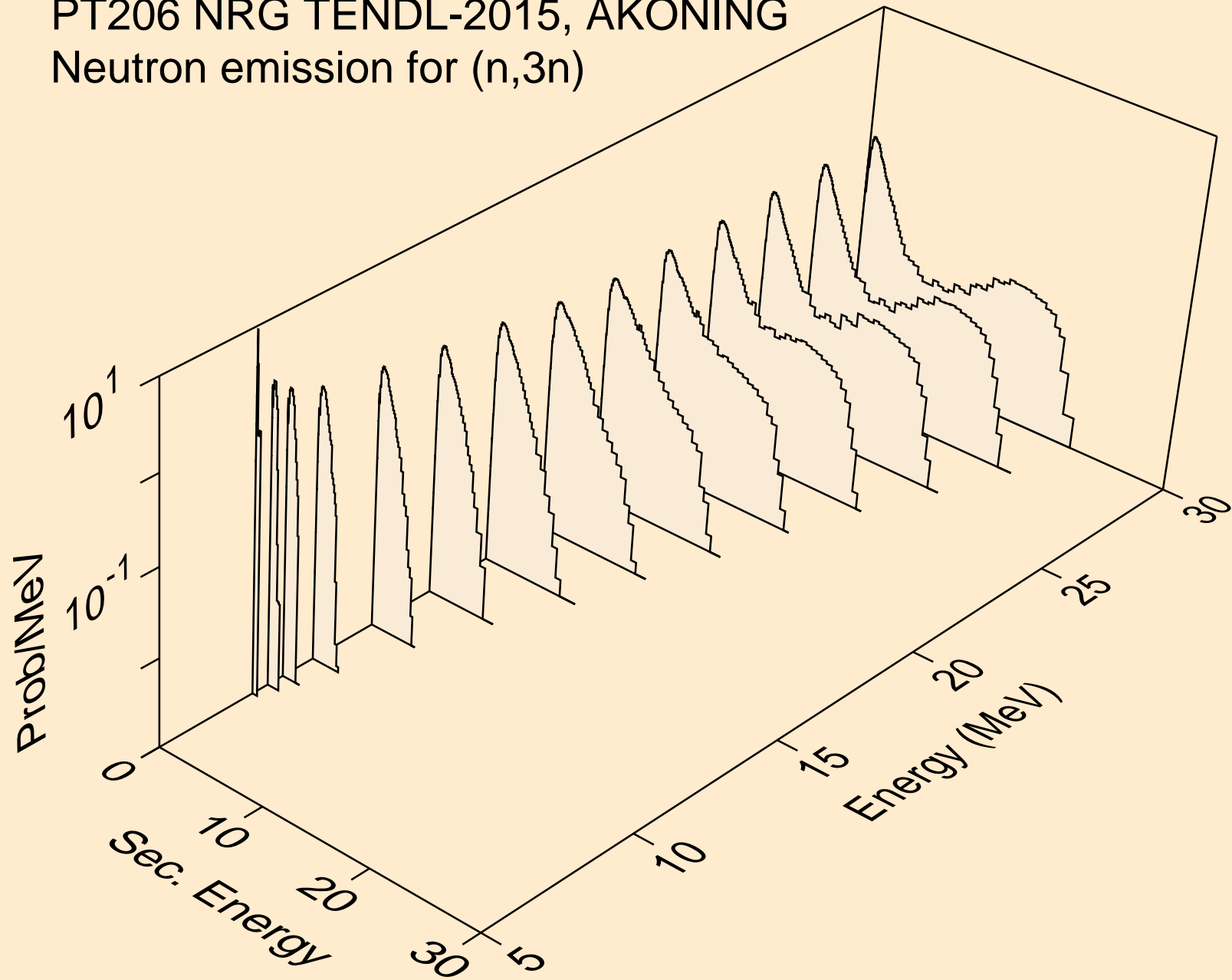

PT206 NRG TENDL-2015, AKONING
Neutron emission for (n,n*)a

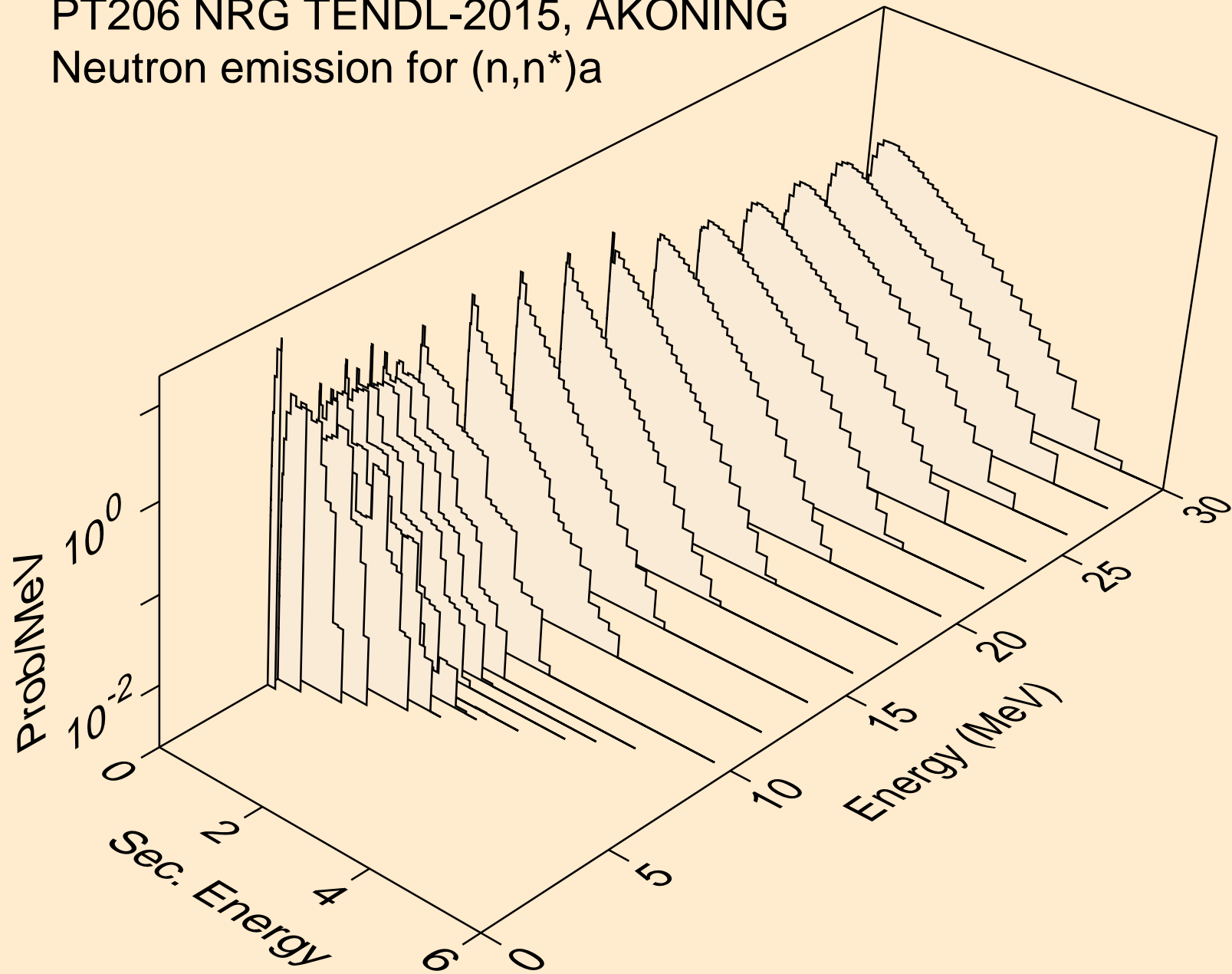

PT206 NRG TENDL-2015, AKONING
Neutron emission for (n,2n)a

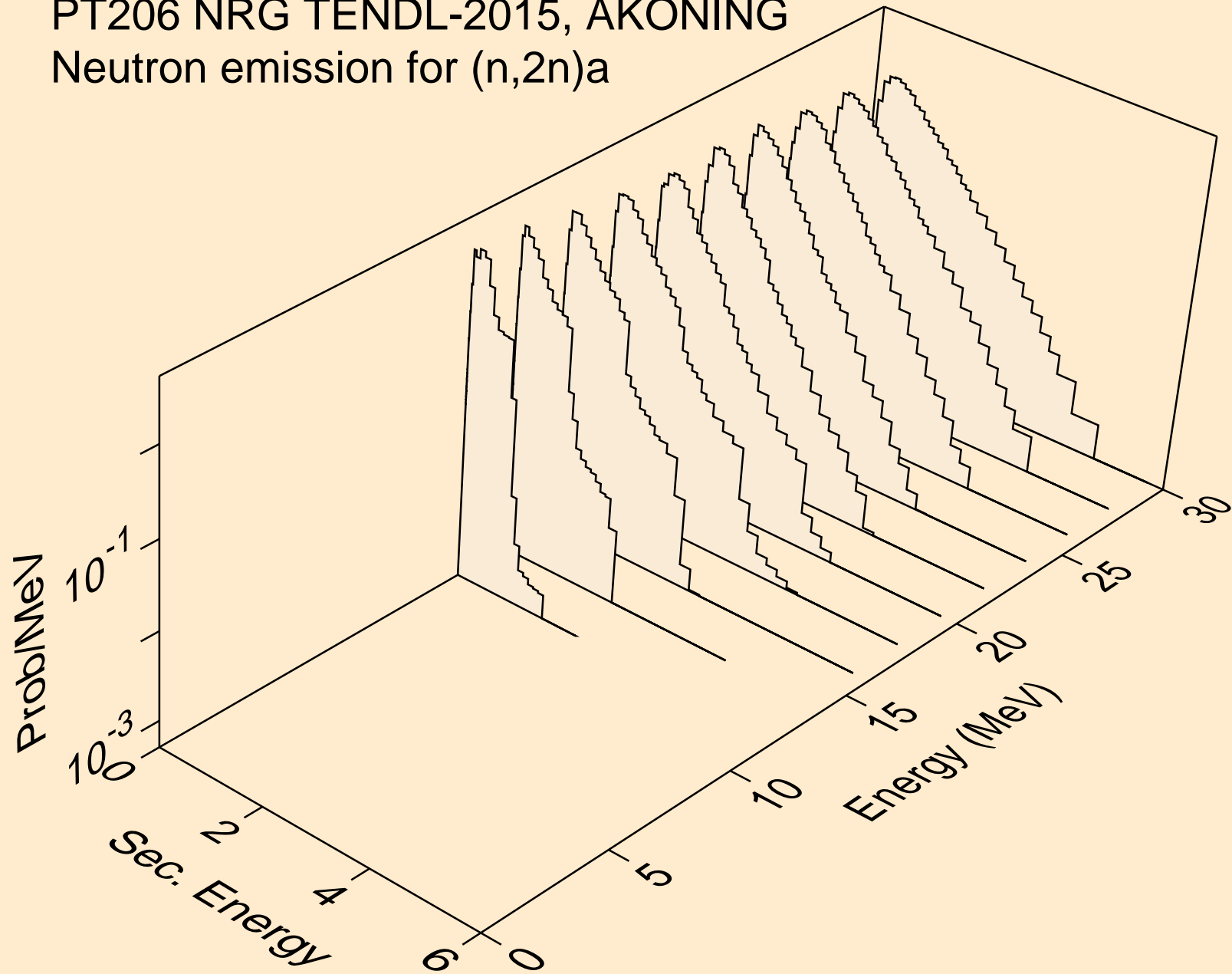

PT206 NRG TENDL-2015, AKONING
Neutron emission for (n,3n)a

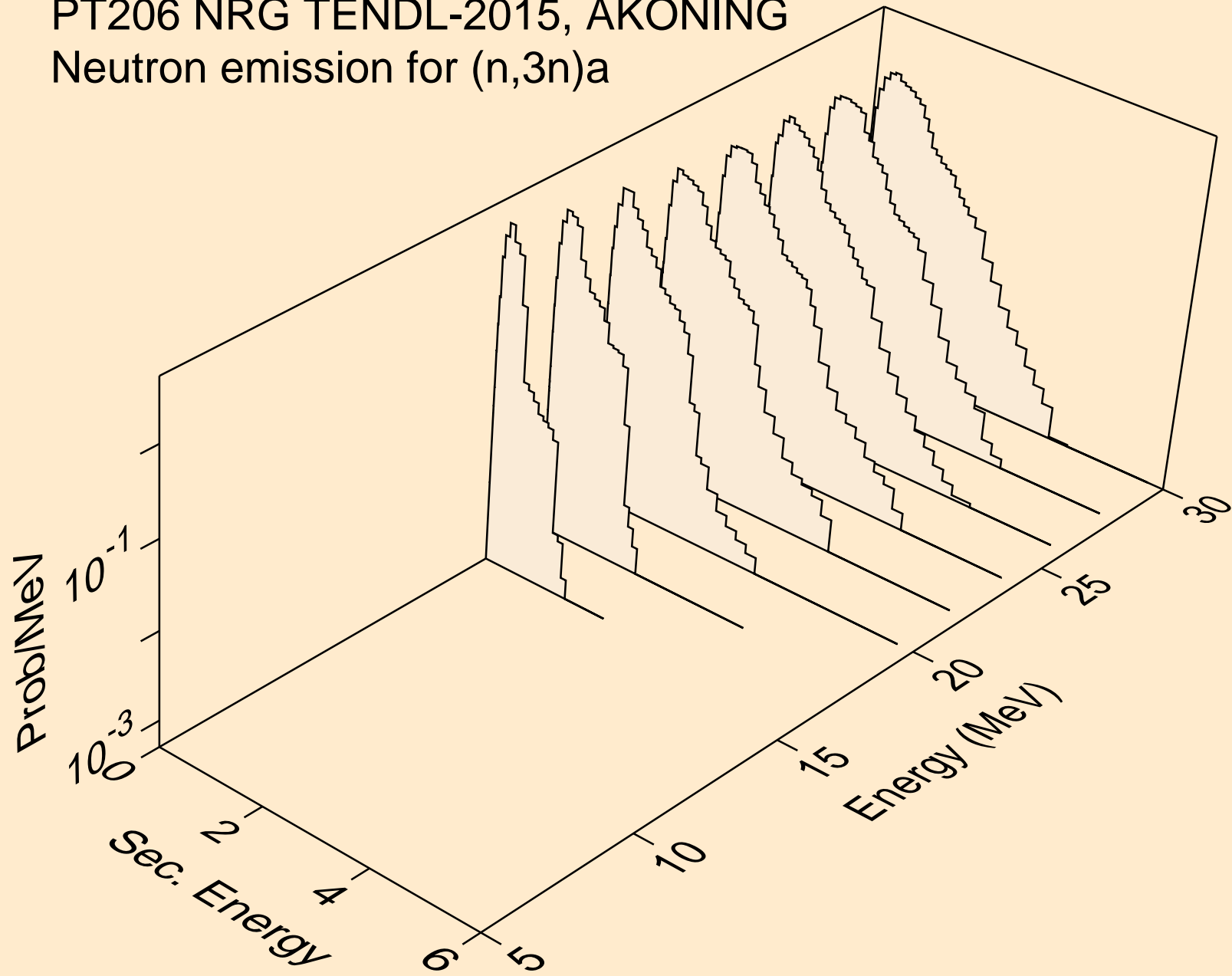

PT206 NRG TENDL-2015, AKONING
Neutron emission for (n,n*)p

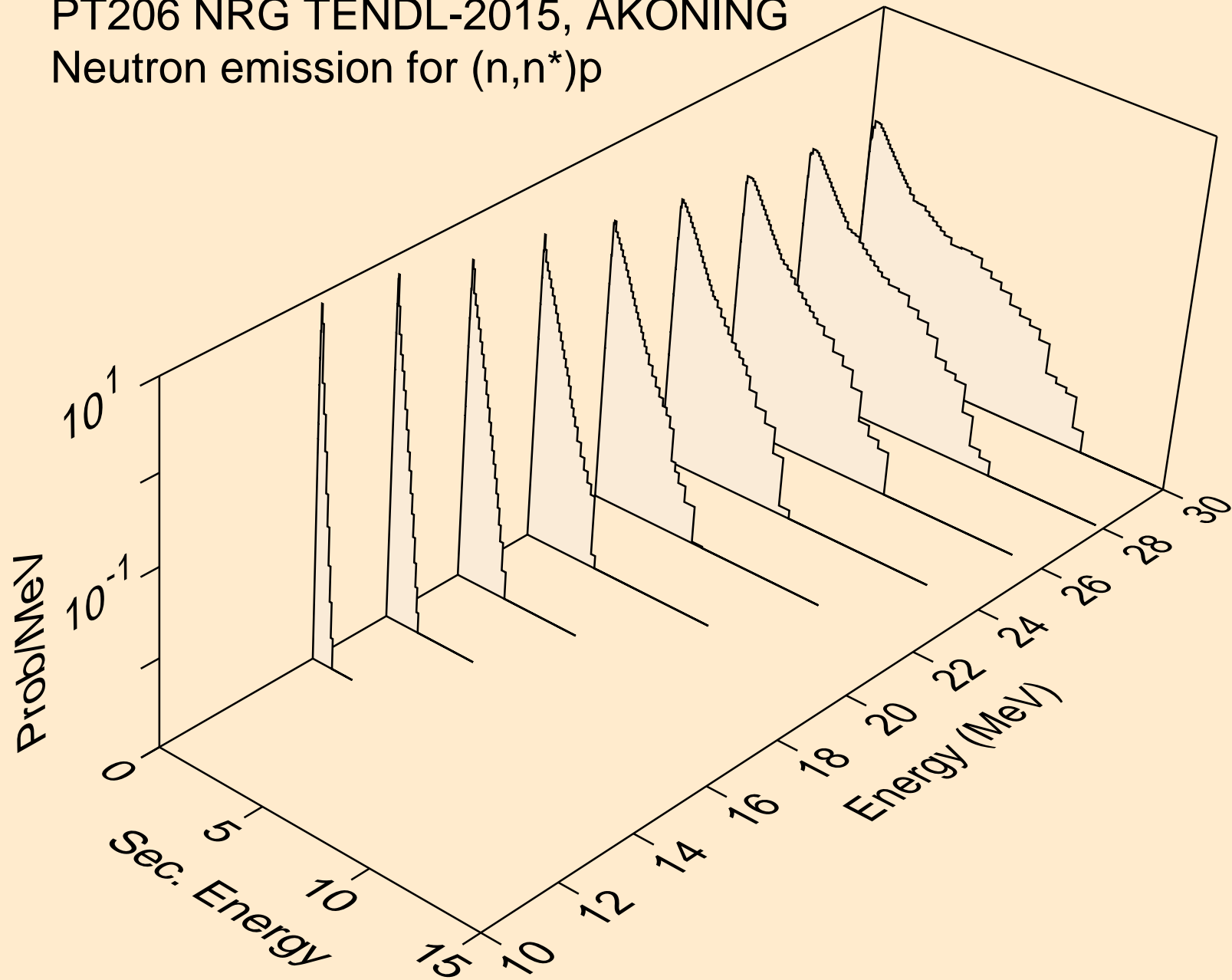

PT206 NRG TENDL-2015, AKONING
Neutron emission for (n,n*)d

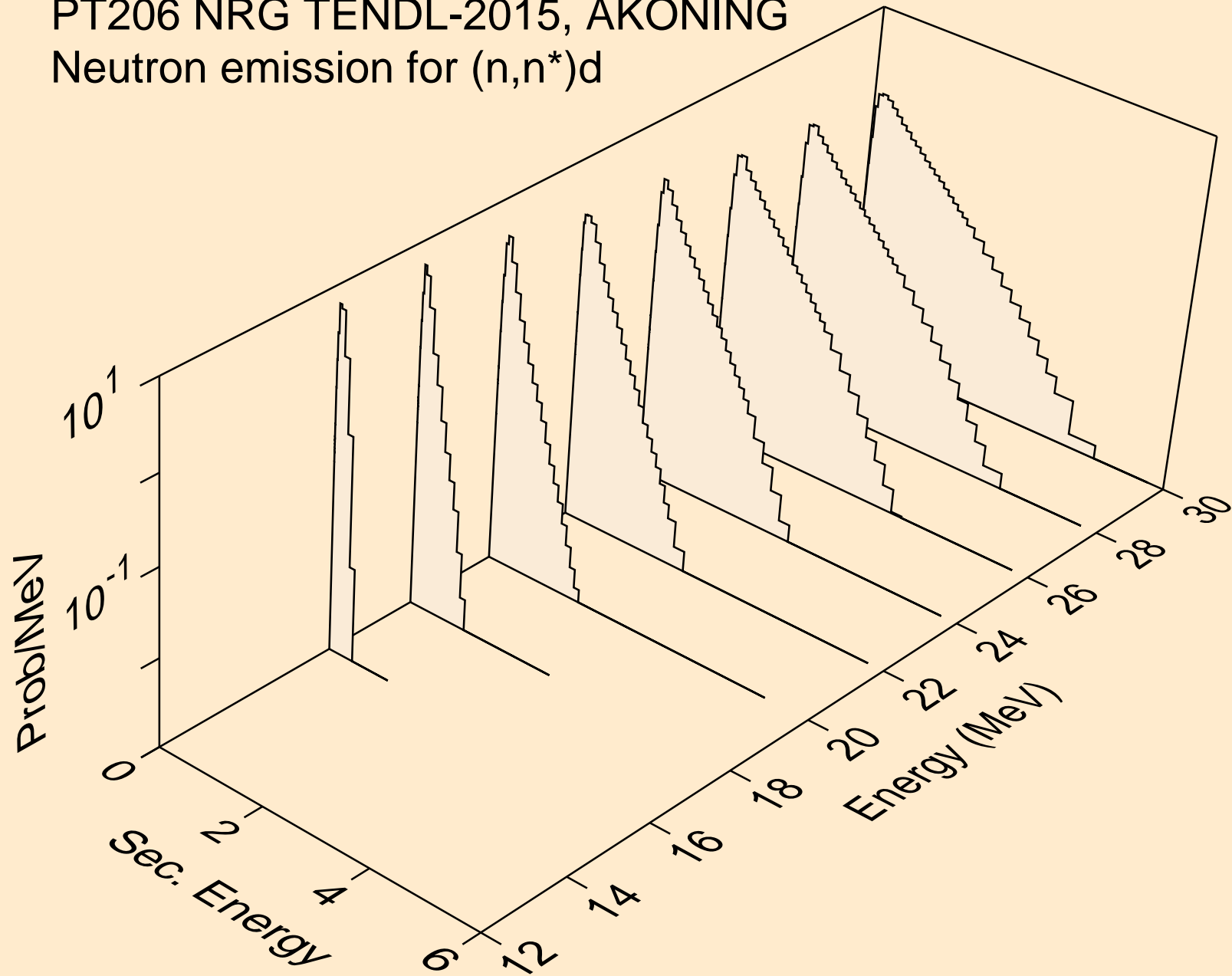

PT206 NRG TENDL-2015, AKONING
Neutron emission for (n,n*)t

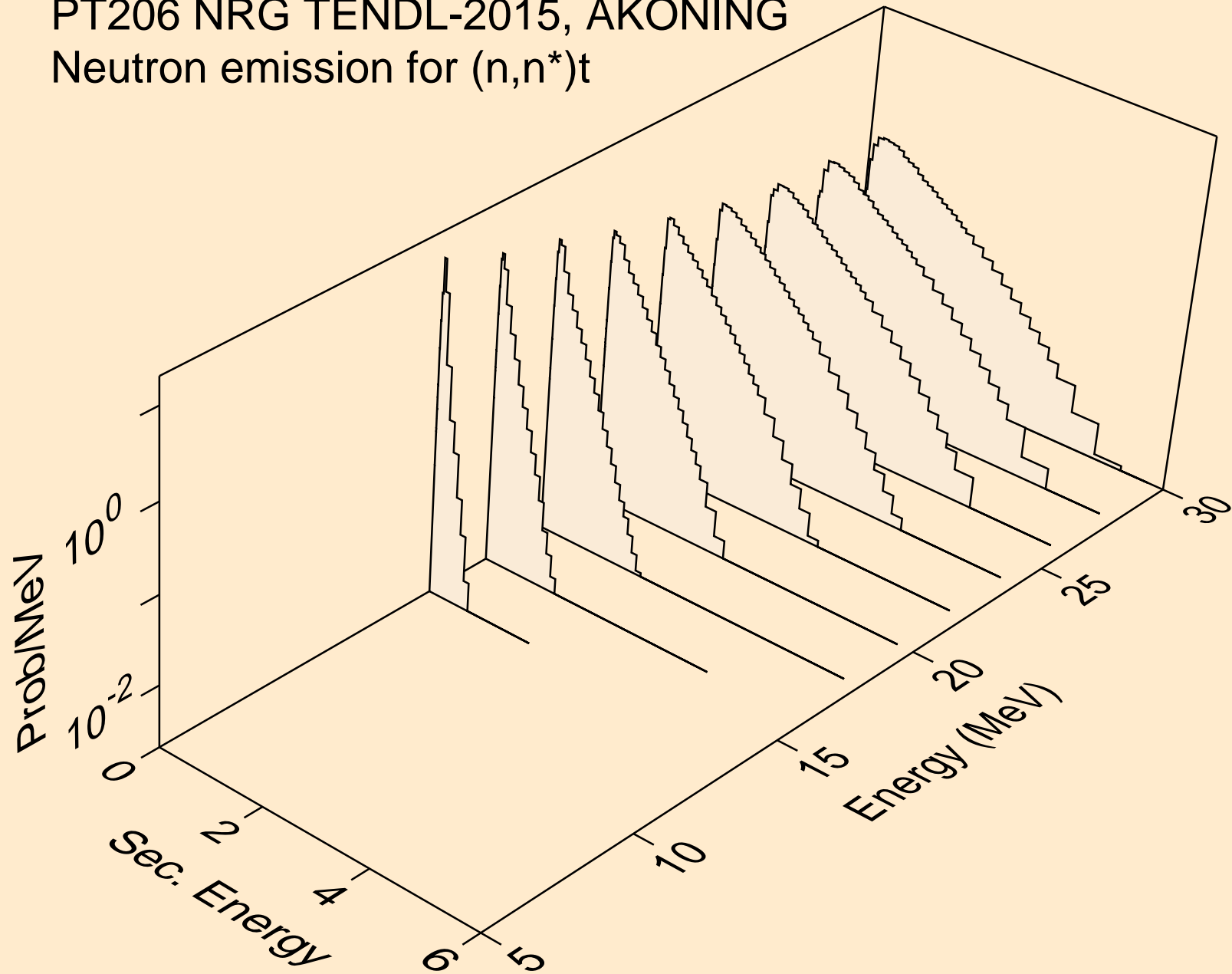

PT206 NRG TENDL-2015, AKONING
Neutron emission for (n,4n)

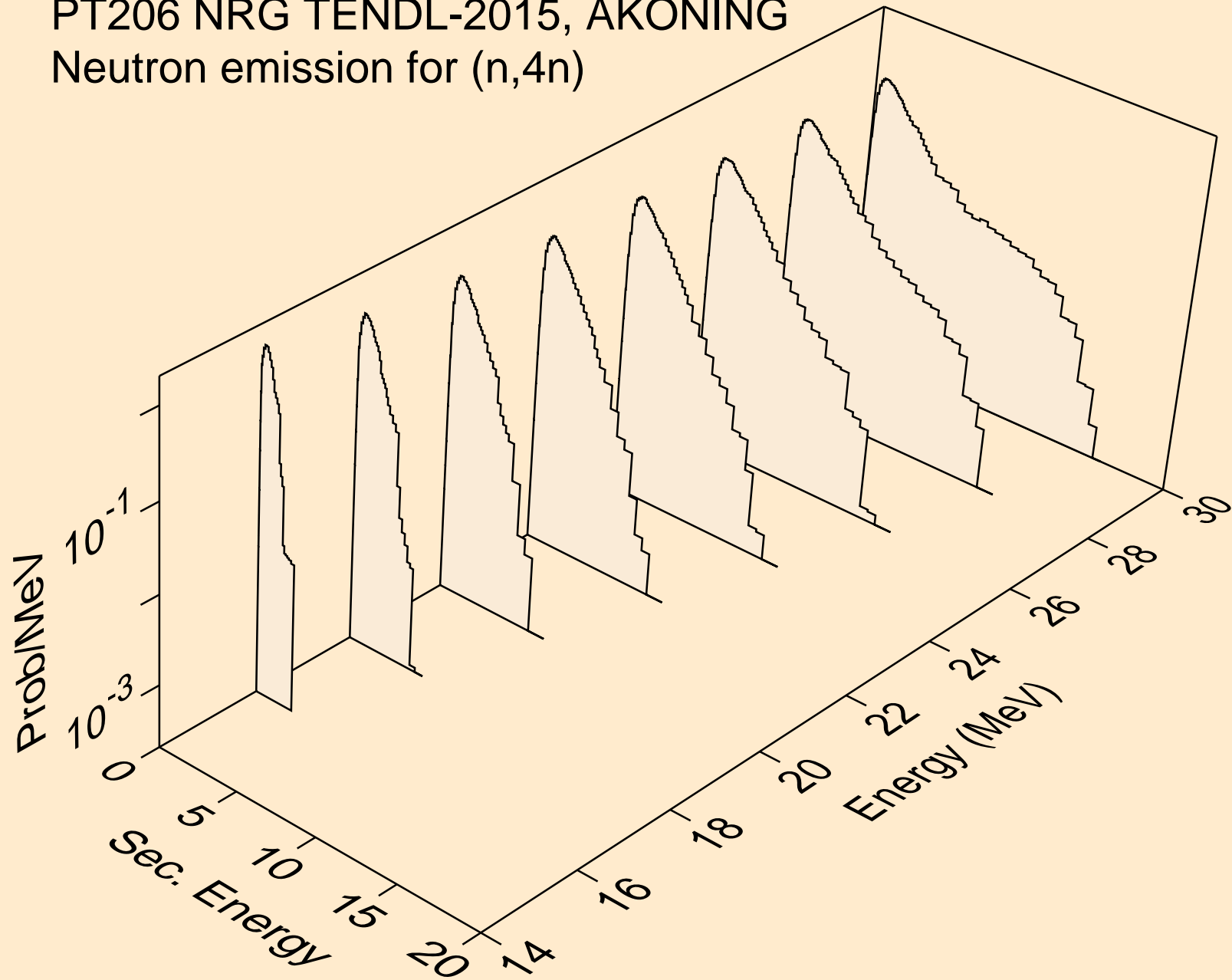

PT206 NRG TENDL-2015, AKONING
Neutron emission for (n,2np)

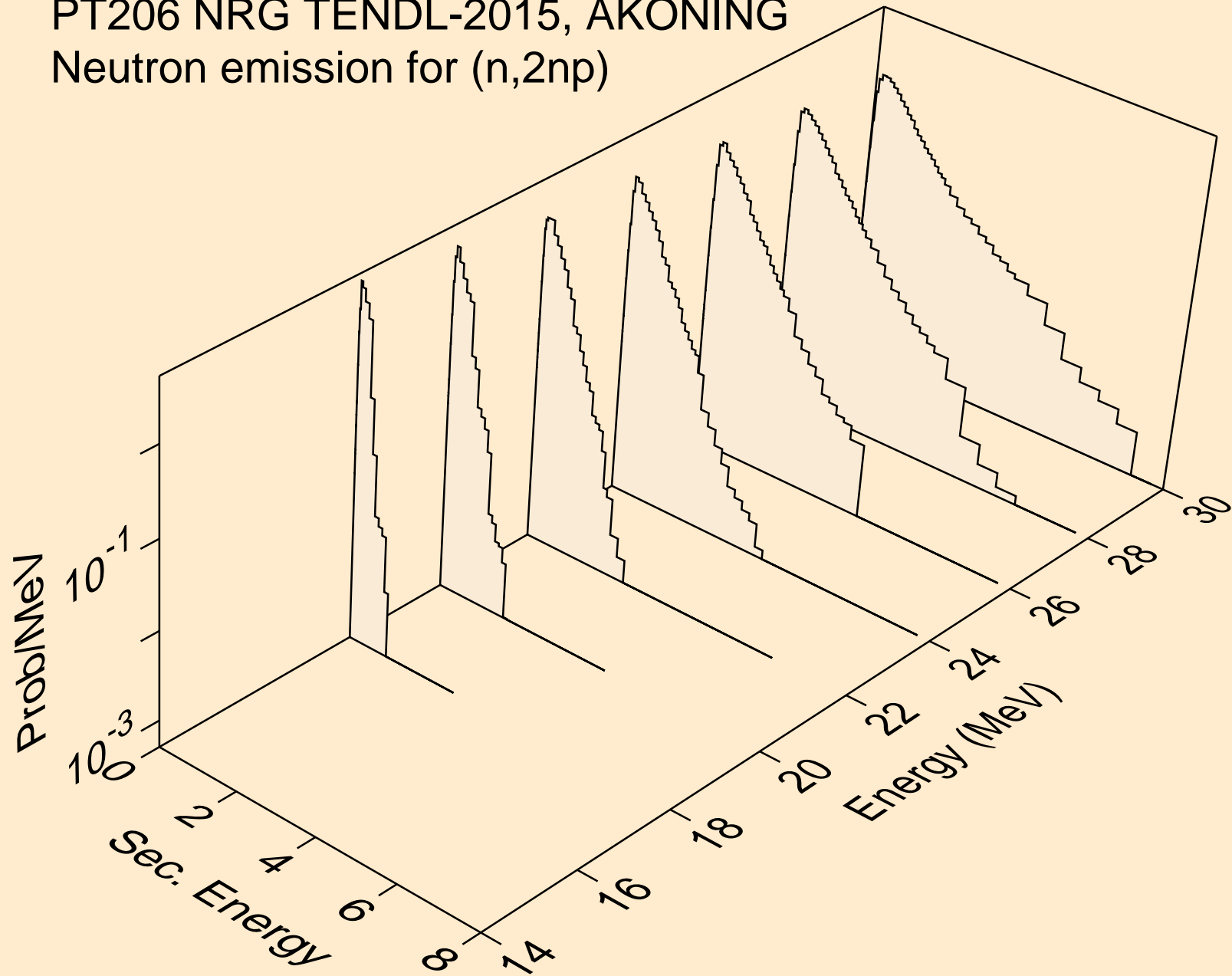

PT206 NRG TENDL-2015, AKONING
Neutron emission for (n,3np)

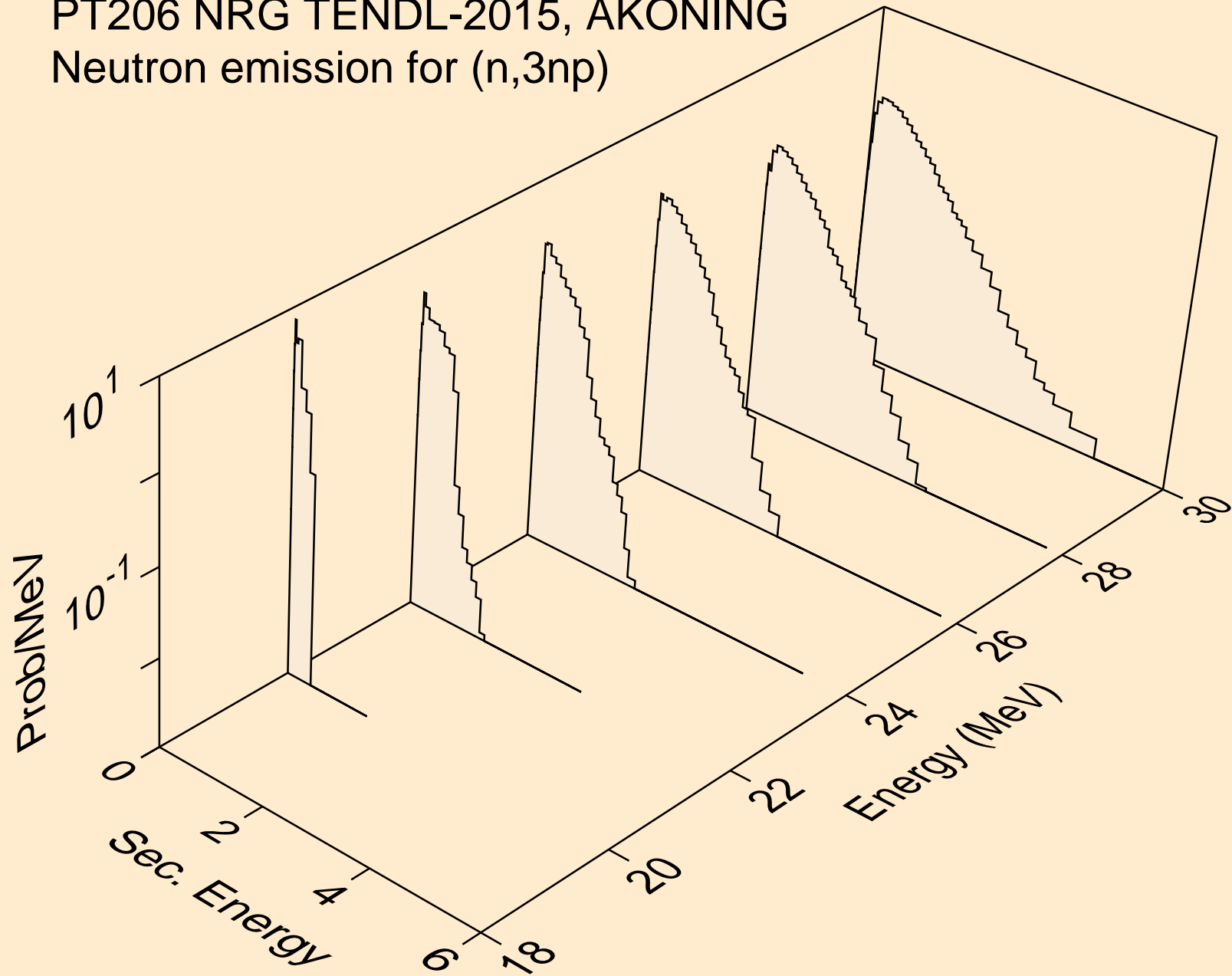

PT206 NRG TENDL-2015, AKONING
Neutron emission for (n,n*c)

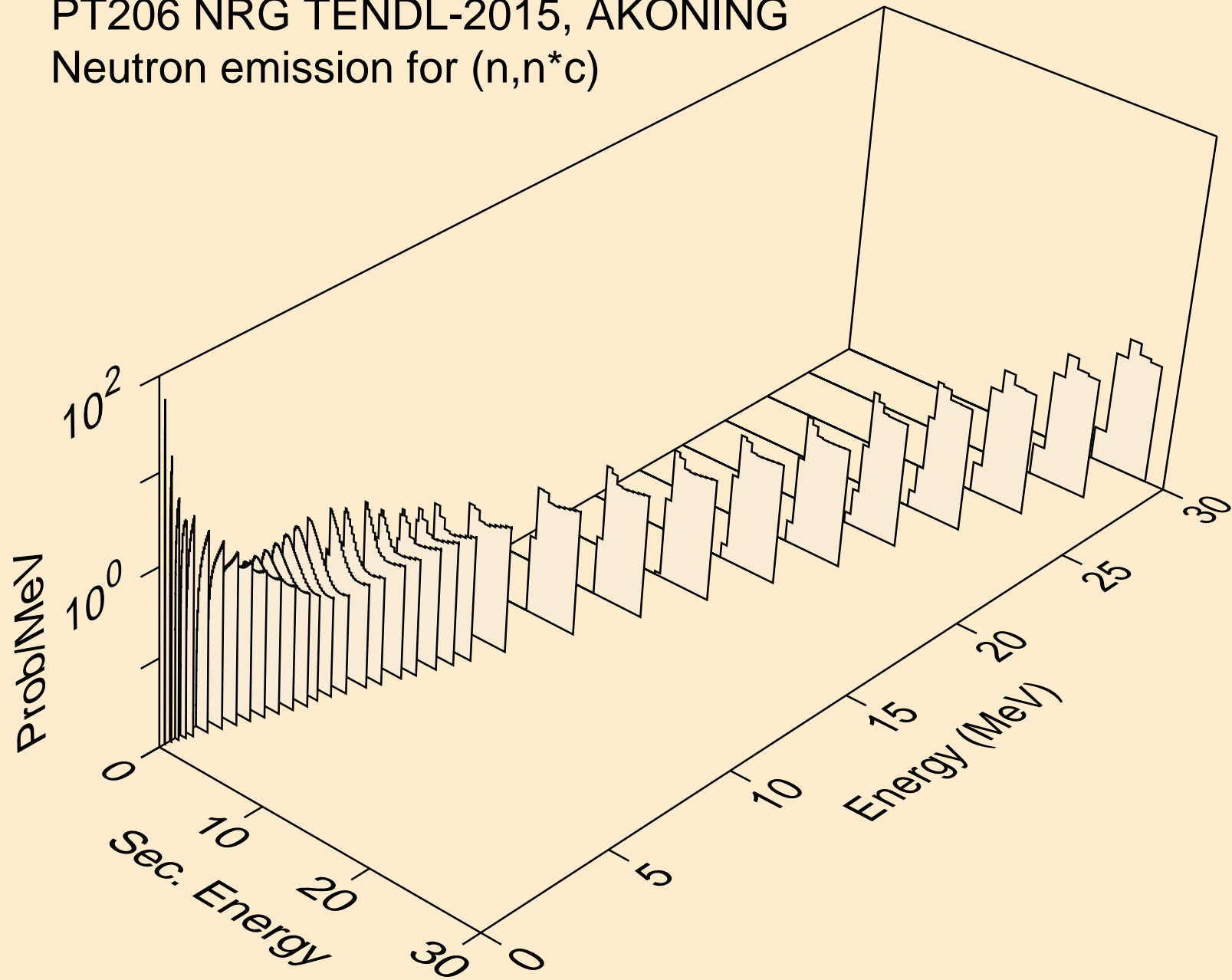

PT206 NRG TENDL-2015, AKONING
Photon emission for (n,x)

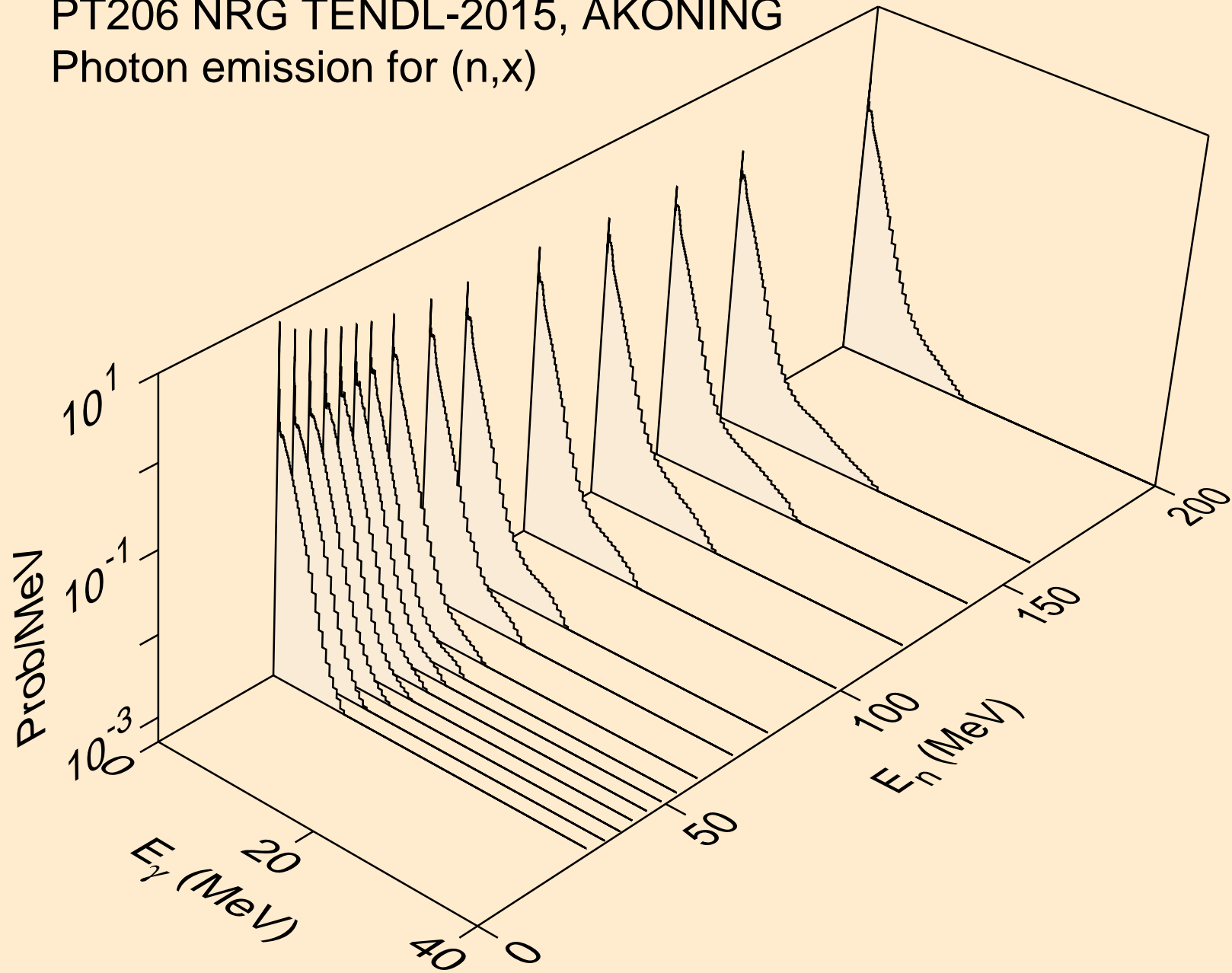

PT206 NRG TENDL-2015, AKONING
Photon emission for (n,2nd)

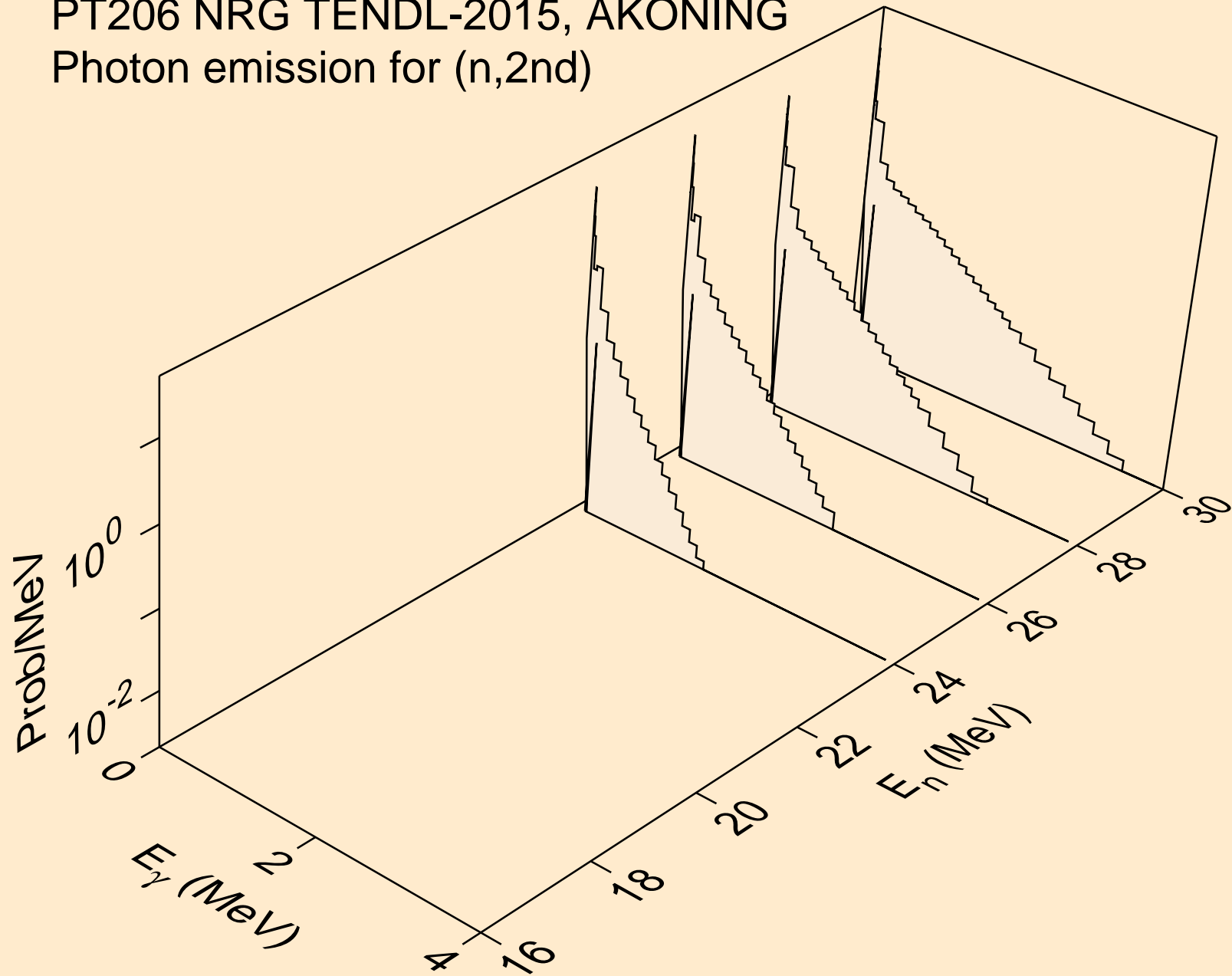

PT206 NRG TENDL-2015, AKONING
Photon emission for (n,2n)

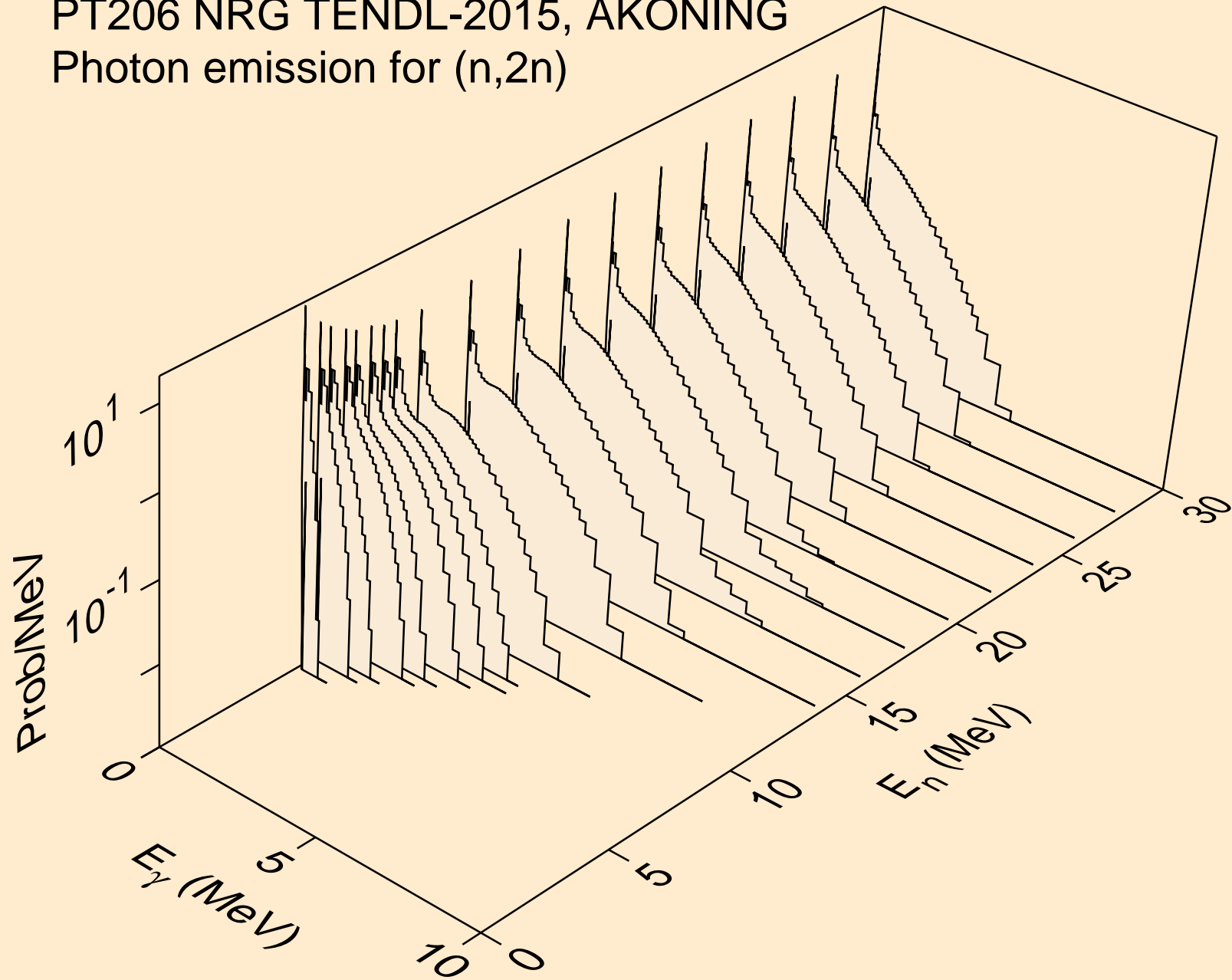

PT206 NRG TENDL-2015, AKONING
Photon emission for (n,3n)

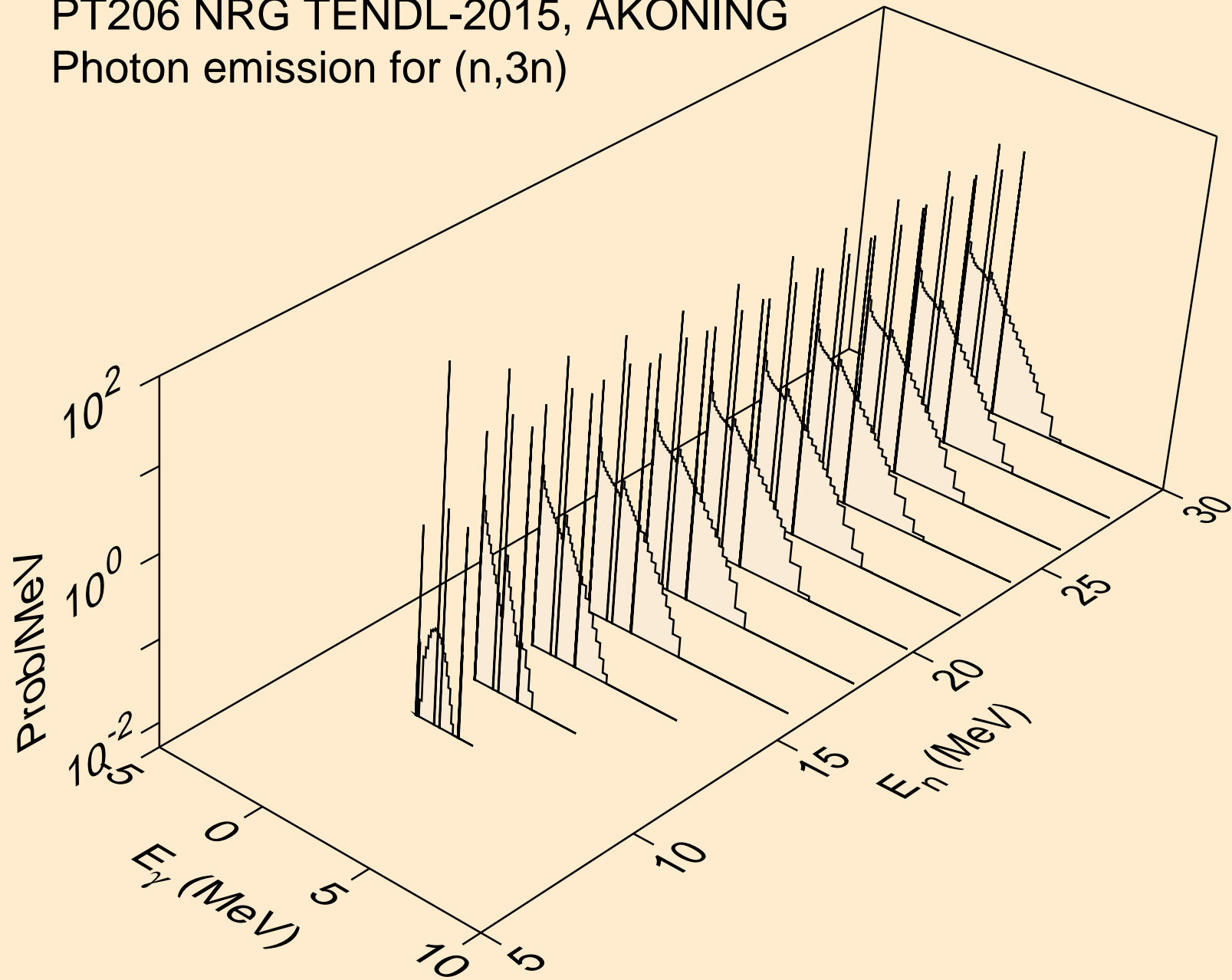

PT206 NRG TENDL-2015, AKONING
Photon emission for (n,n*)a

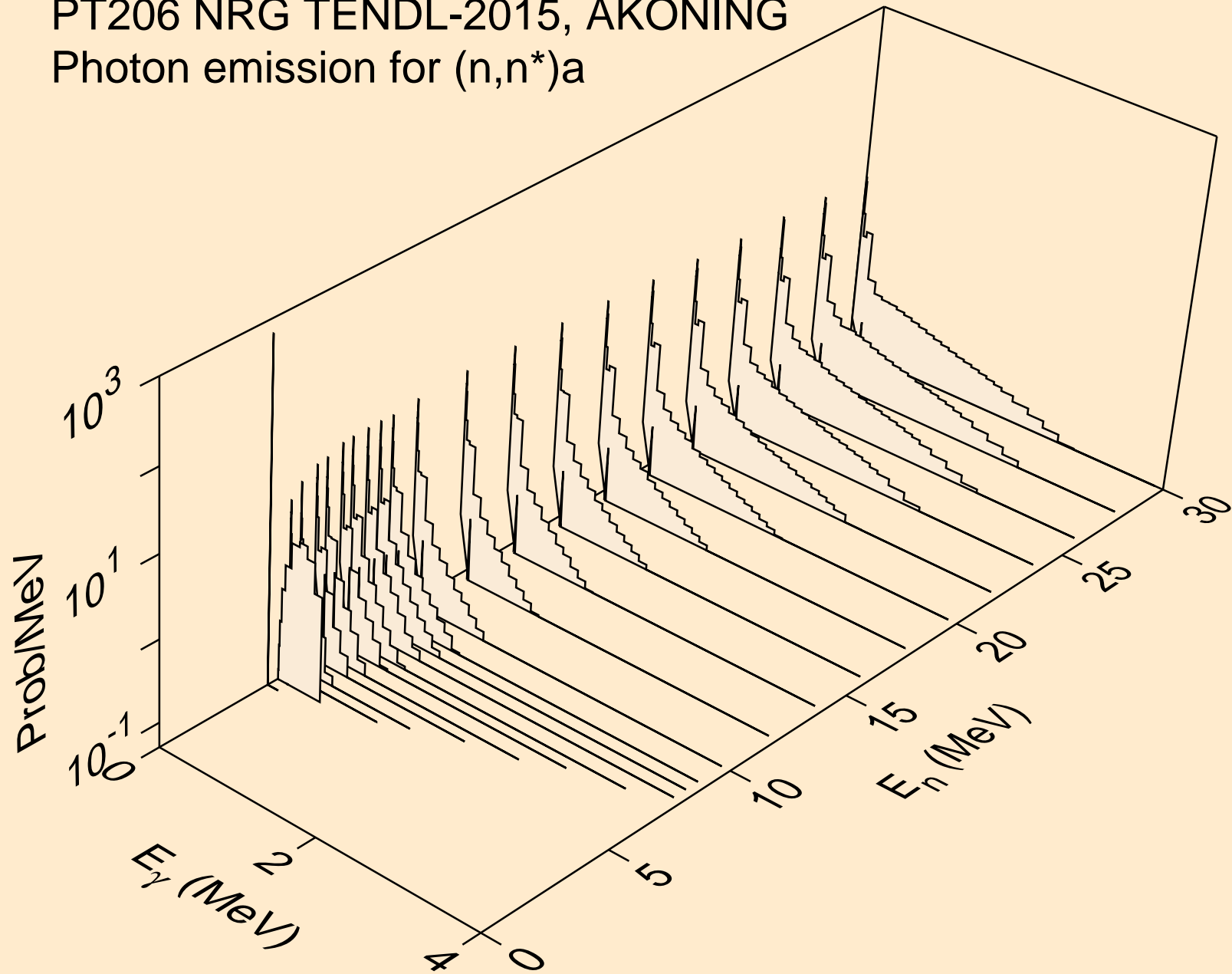

PT206 NRG TENDL-2015, AKONING
Photon emission for (n,2n)a

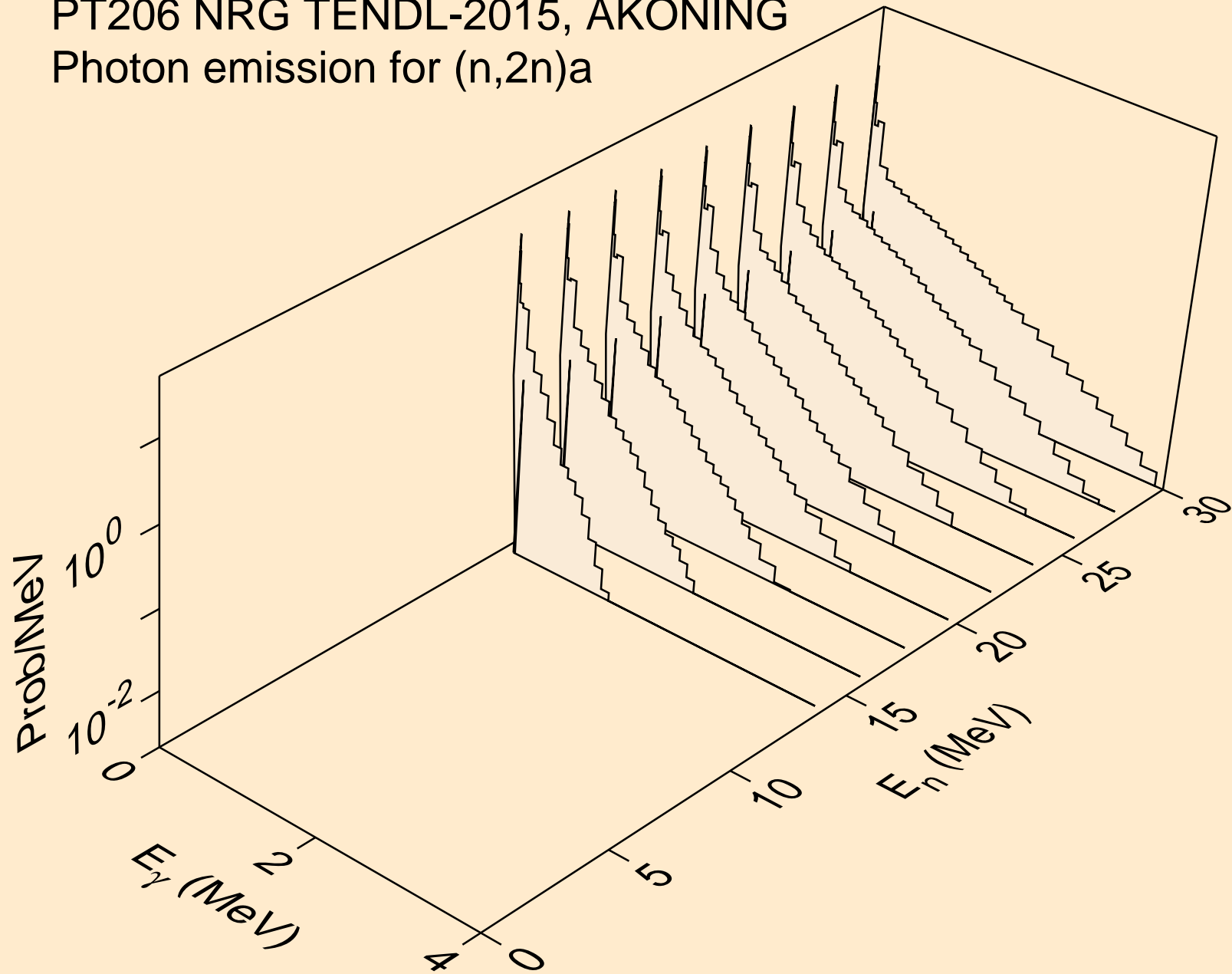

PT206 NRG TENDL-2015, AKONING
Photon emission for (n,3n)a

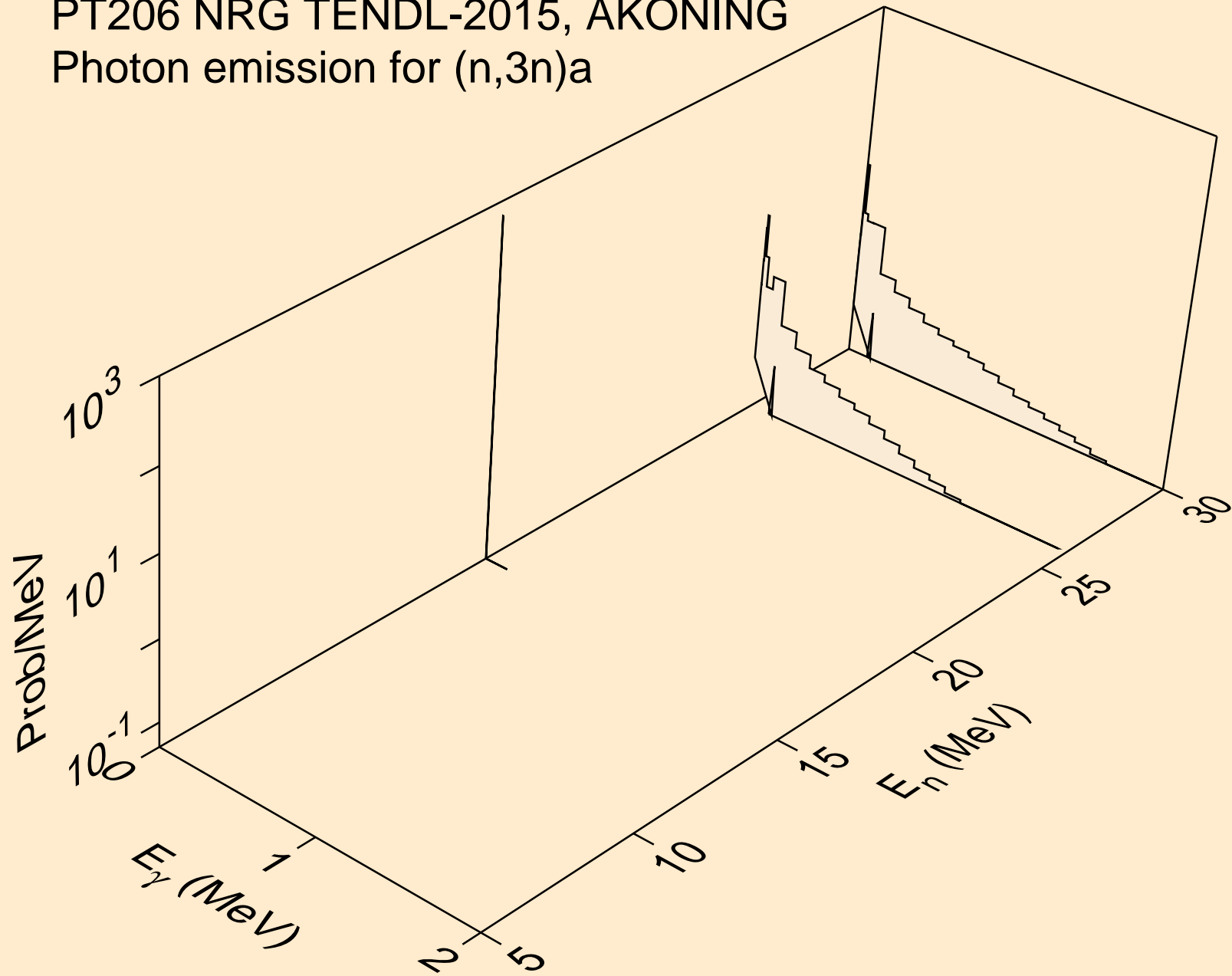

PT206 NRG TENDL-2015, AKONING
Photon emission for (n,n*)p

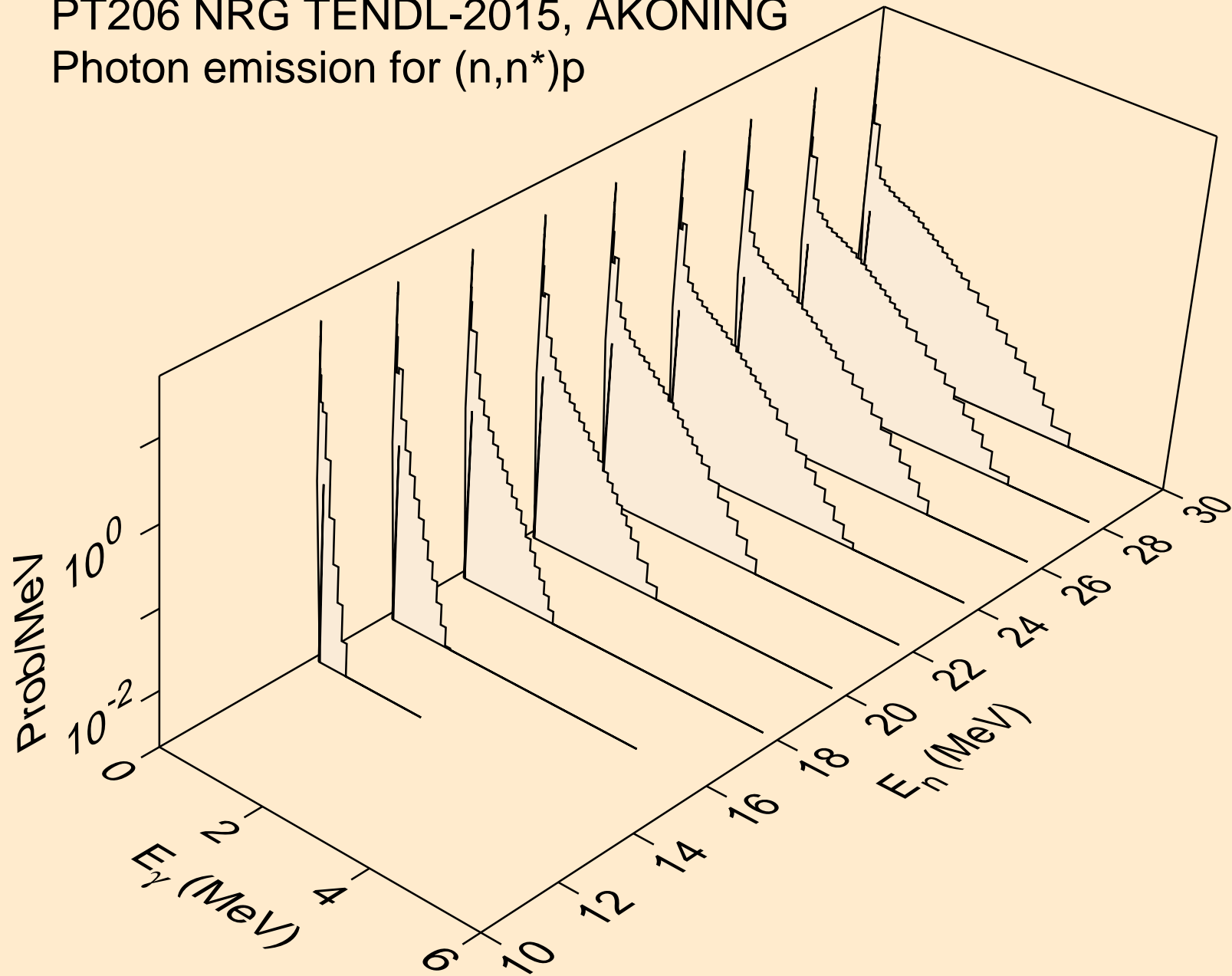

PT206 NRG TENDL-2015, AKONING
Photon emission for (n,n*)d

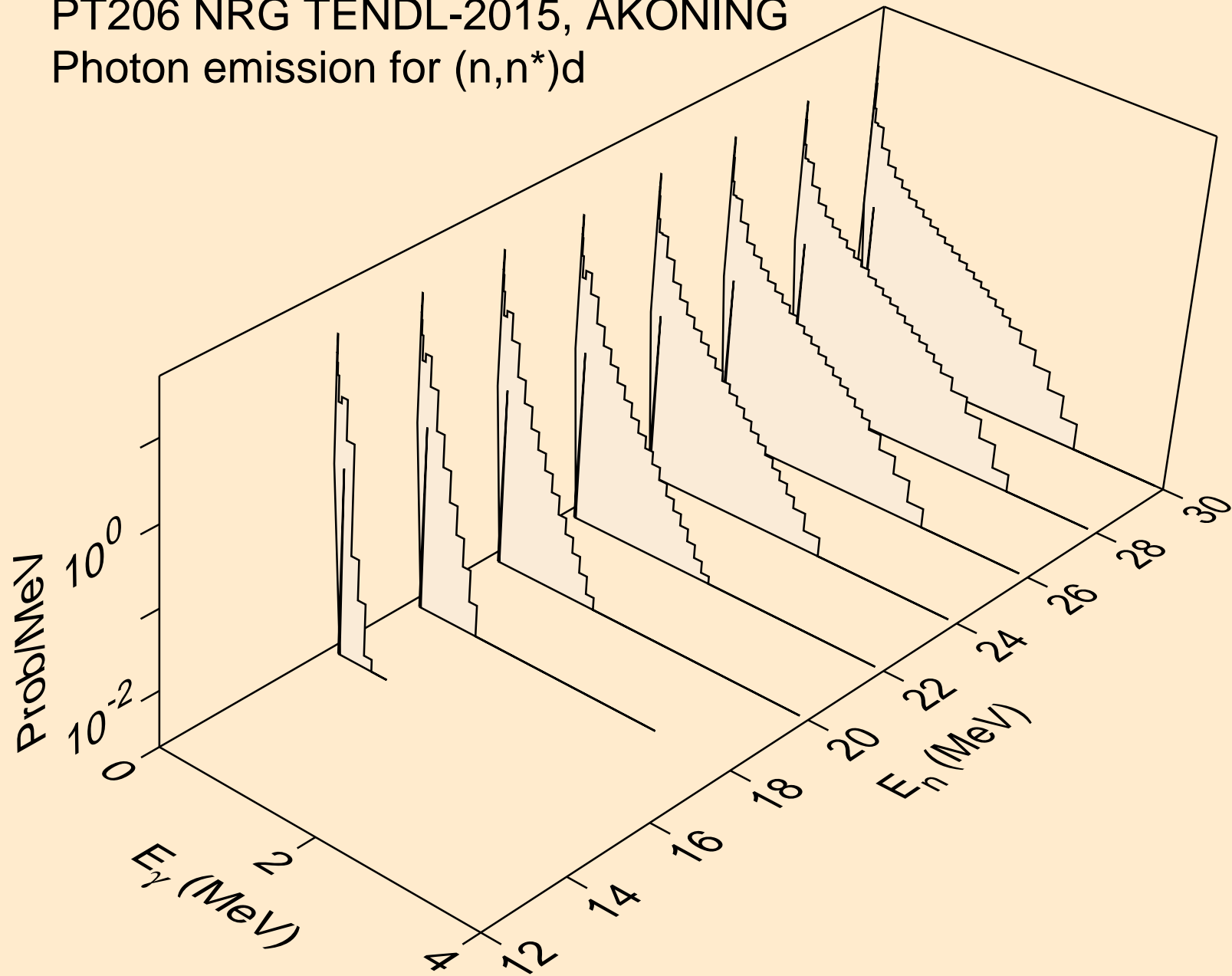

PT206 NRG TENDL-2015, AKONING
Photon emission for (n,n*)t

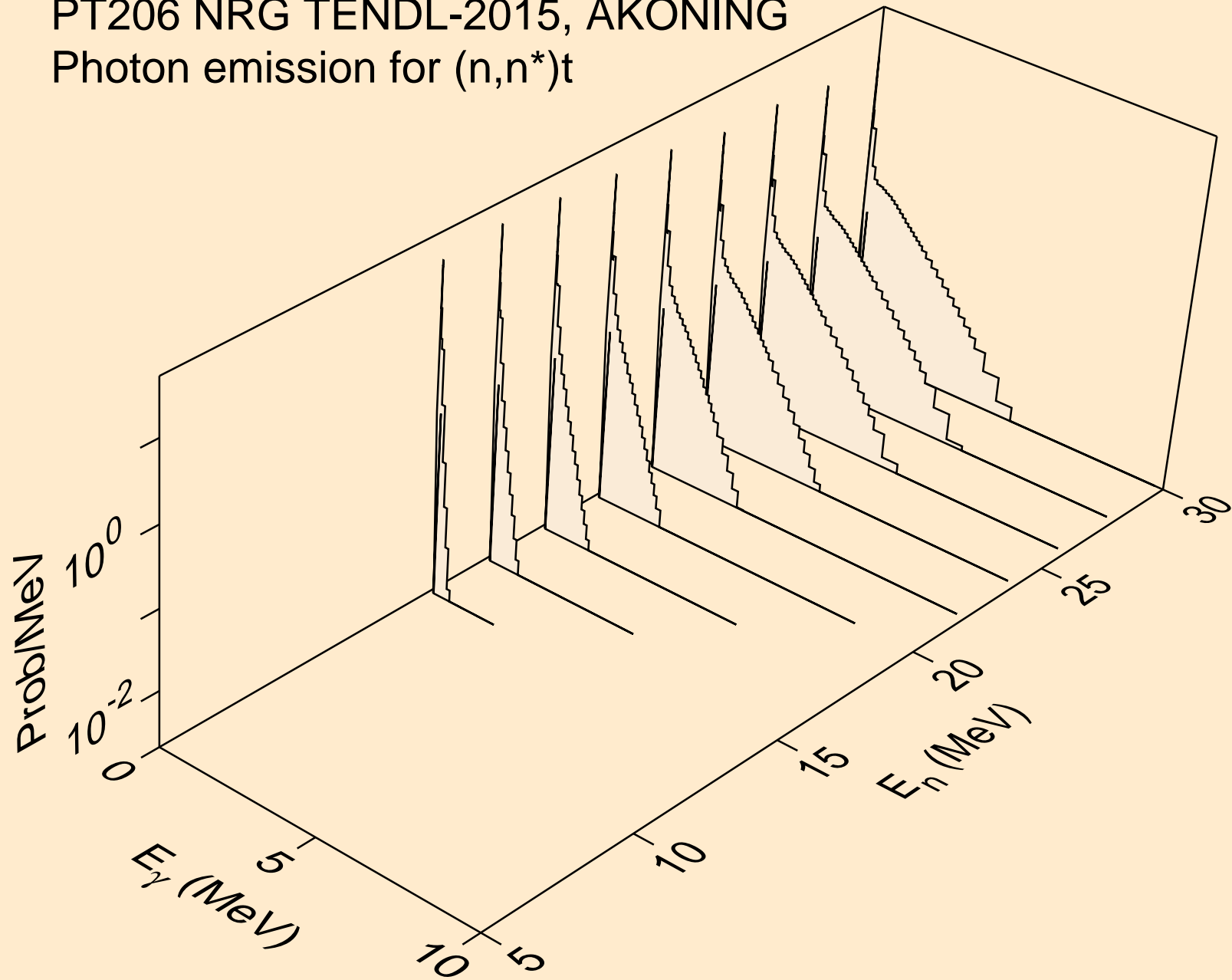

PT206 NRG TENDL-2015, AKONING
Photon emission for (n,4n)

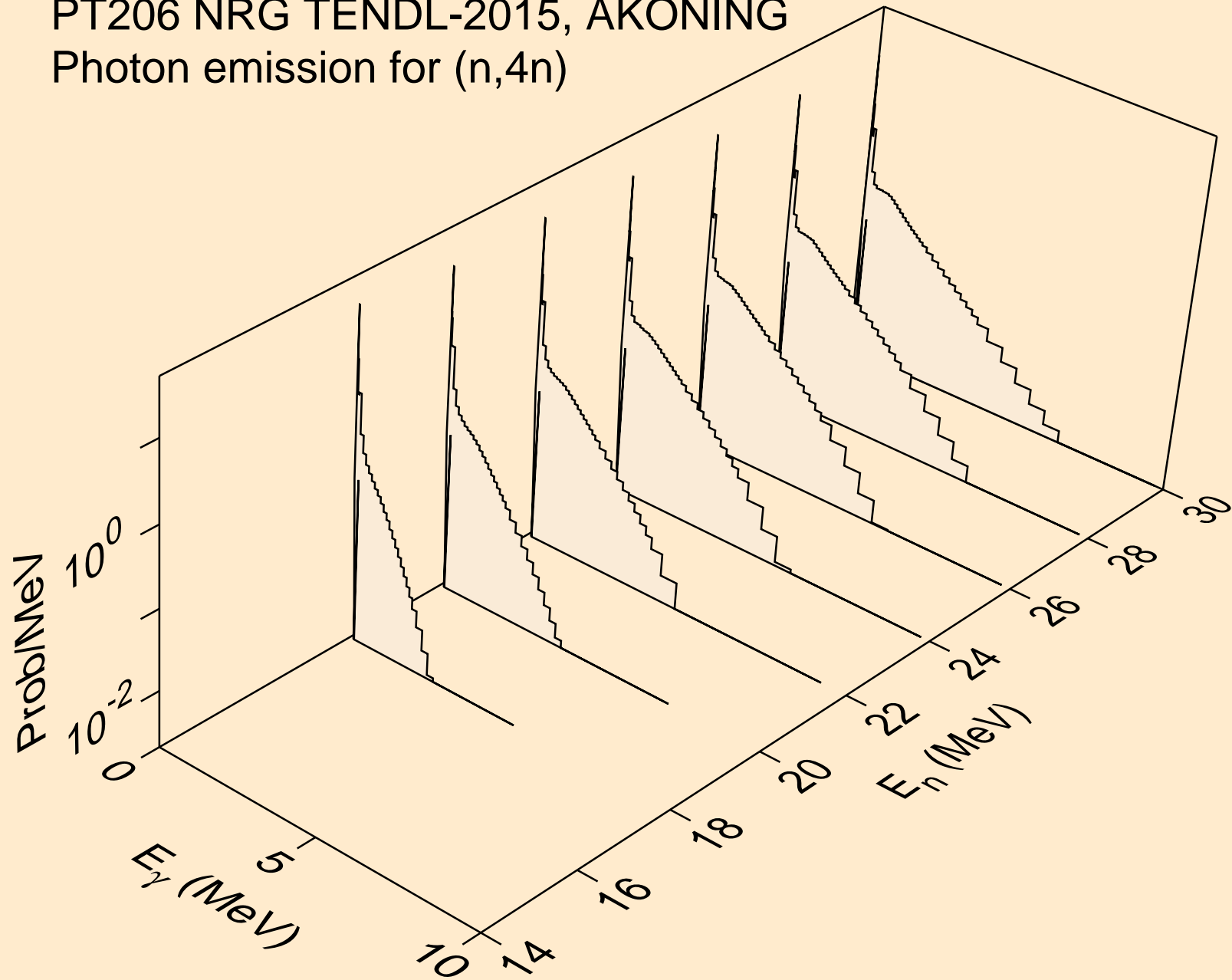

PT206 NRG TENDL-2015, AKONING
Photon emission for (n,2np)

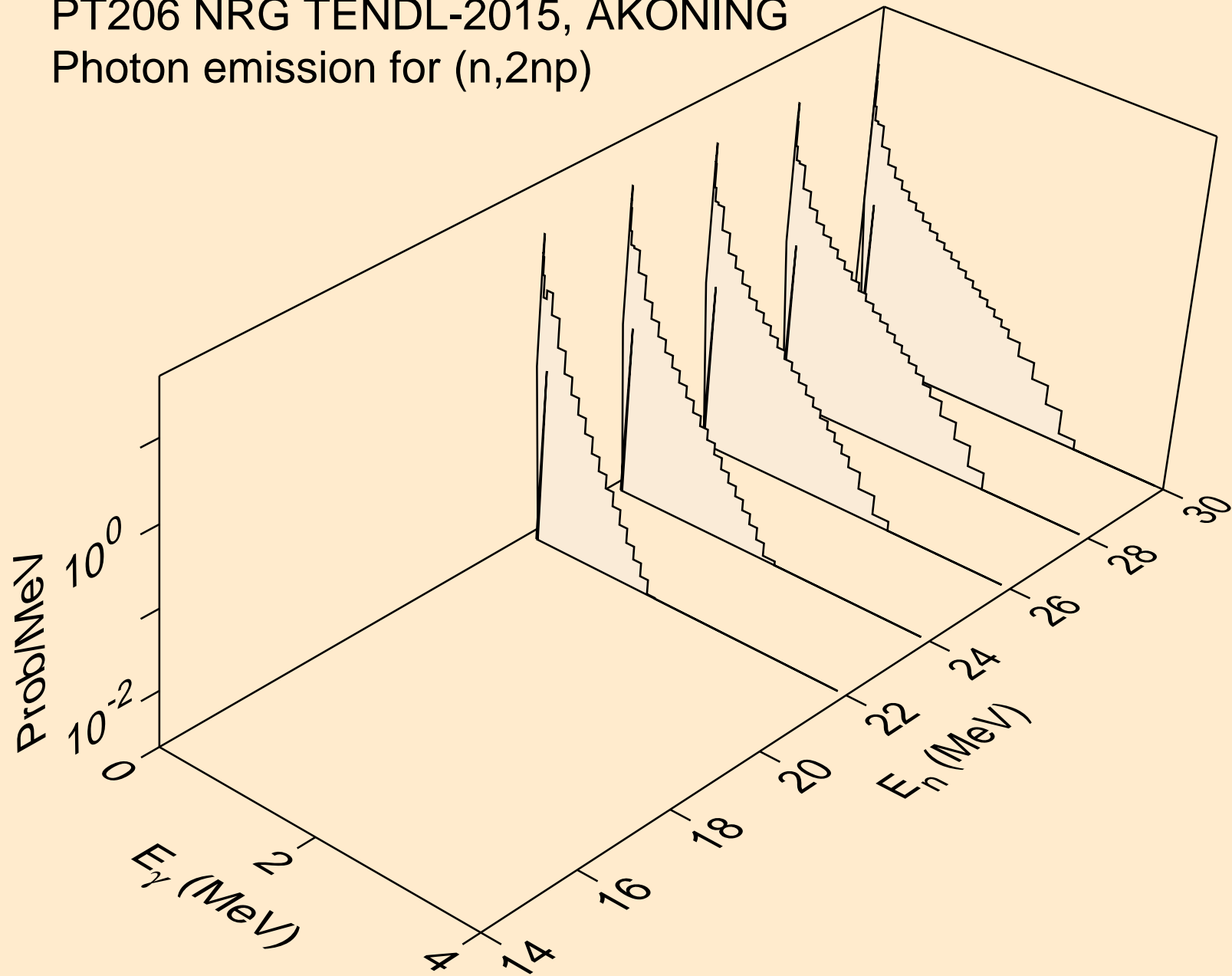

PT206 NRG TENDL-2015, AKONING
Photon emission for (n,3np)

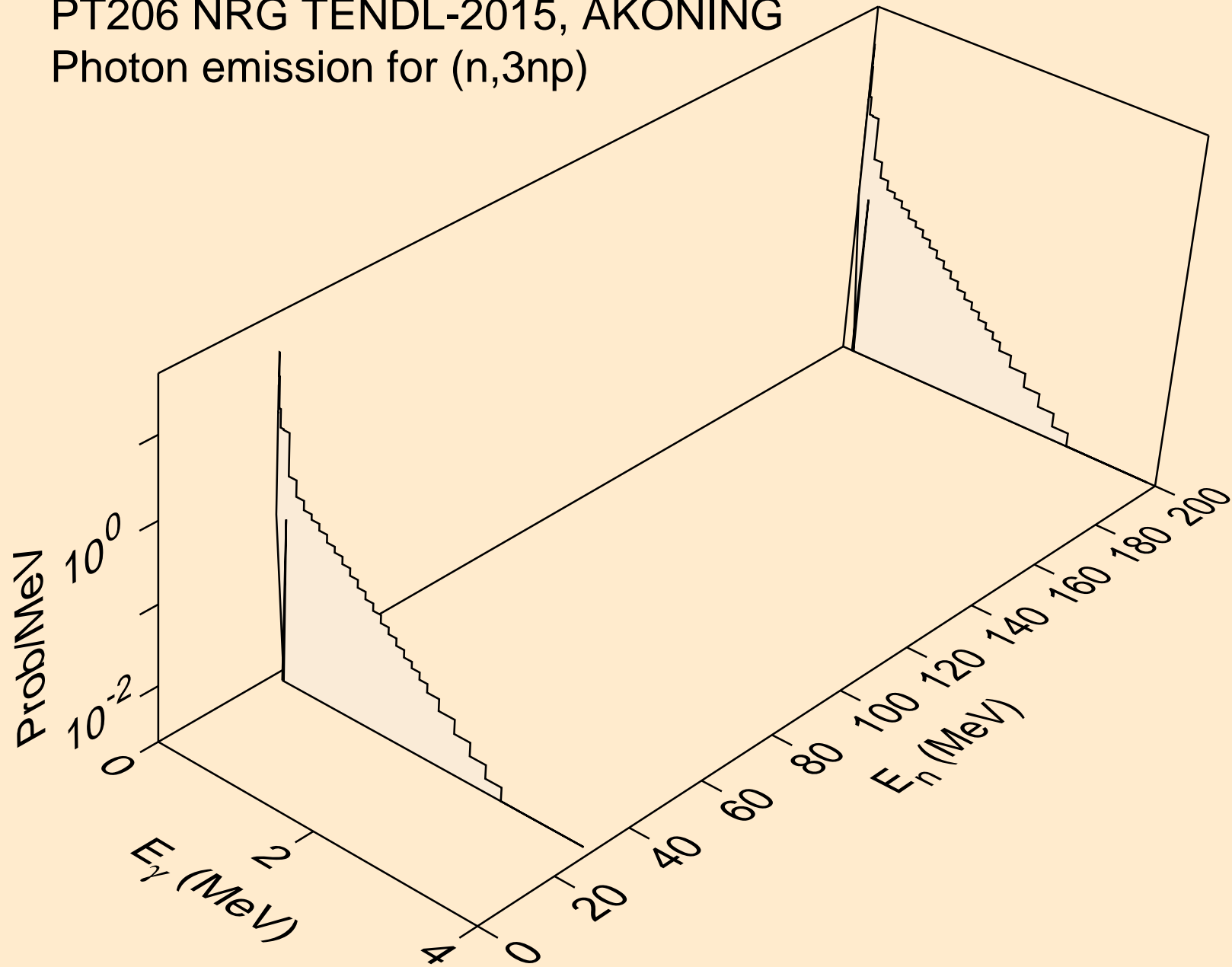

PT206 NRG TENDL-2015, AKONING
Photon emission for (n,n*c)

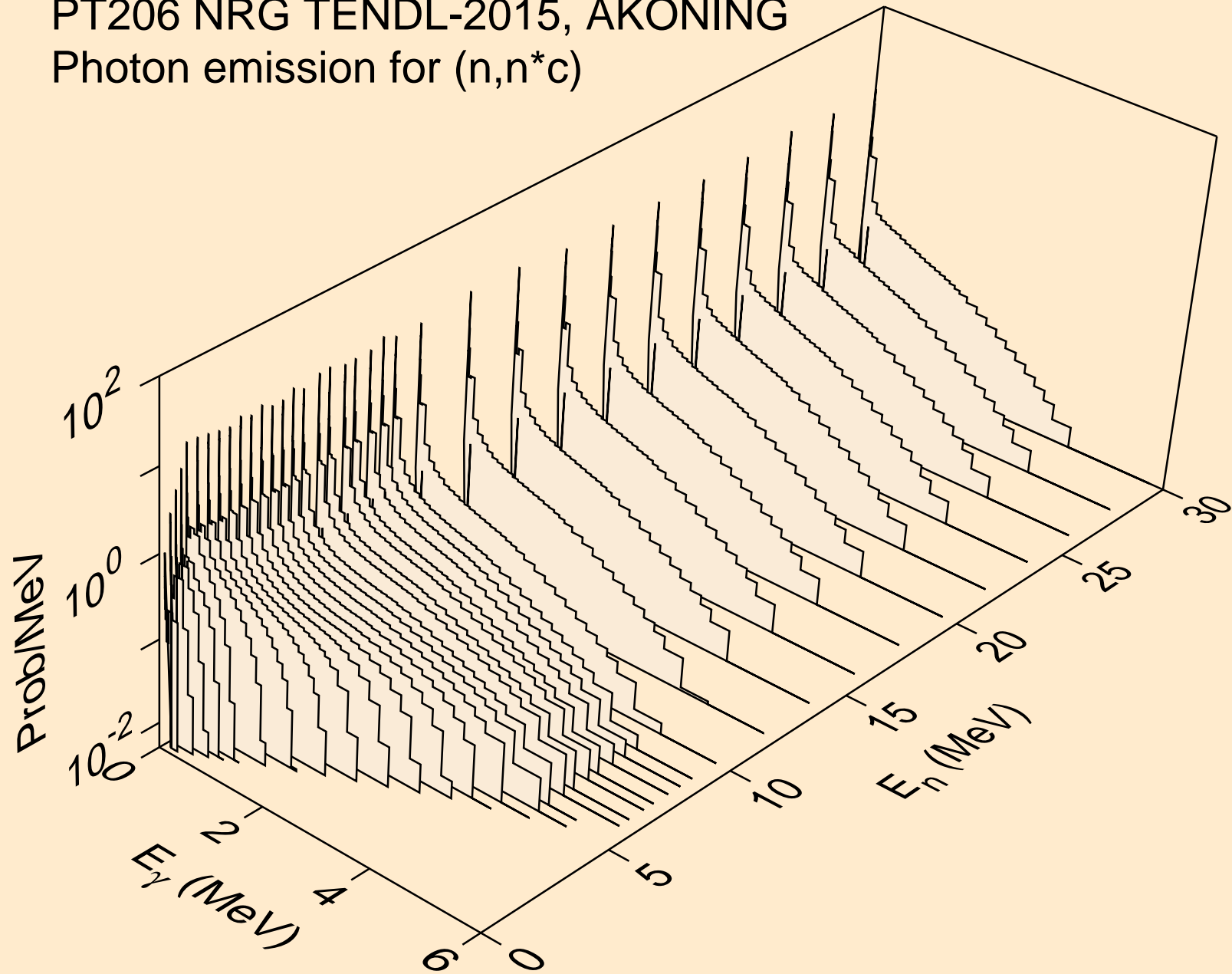

PT206 NRG TENDL-2015, AKONING
Photon emission for (n,gma)

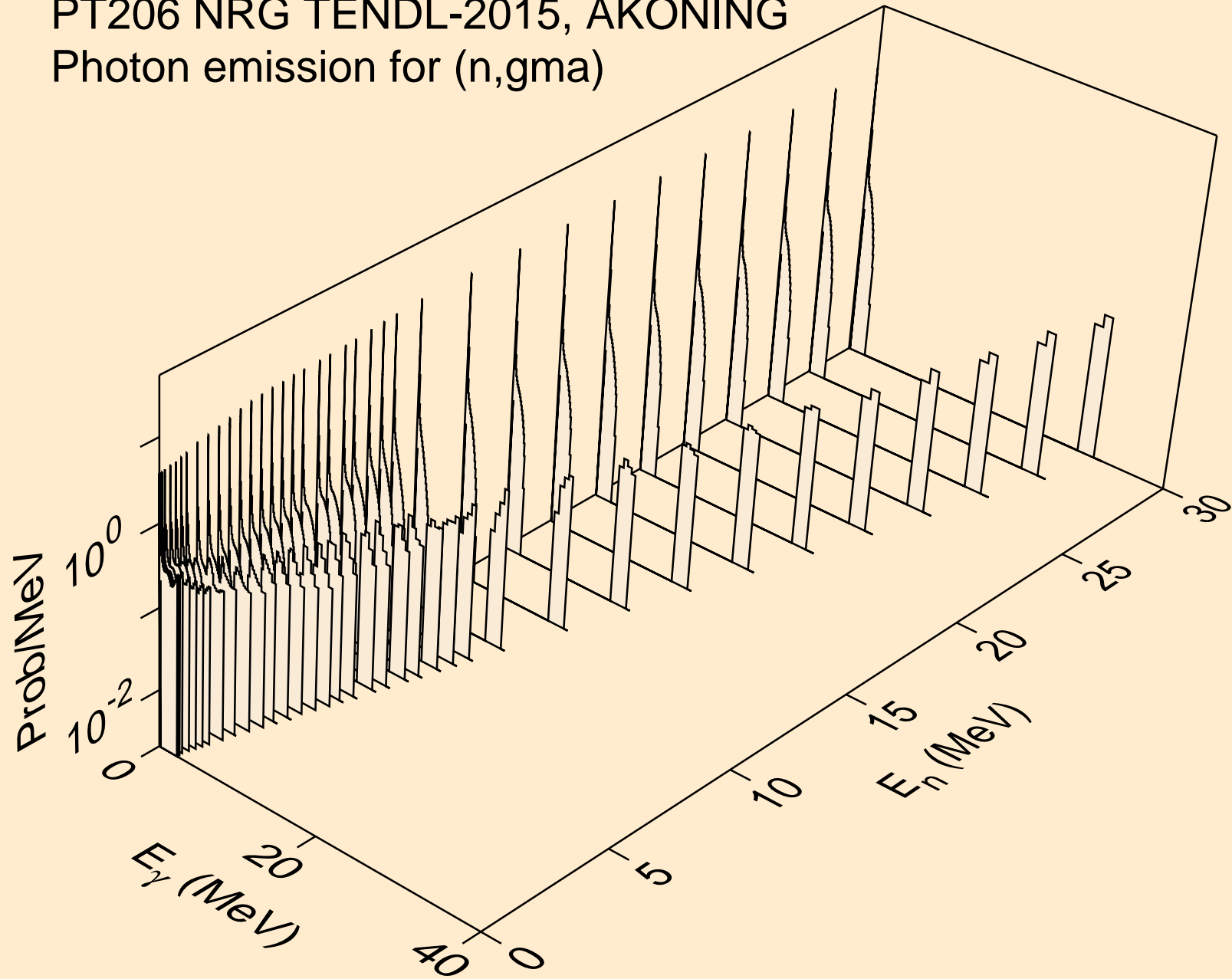

PT206 NRG TENDL-2015, AKONING
Photon emission for (n,p)

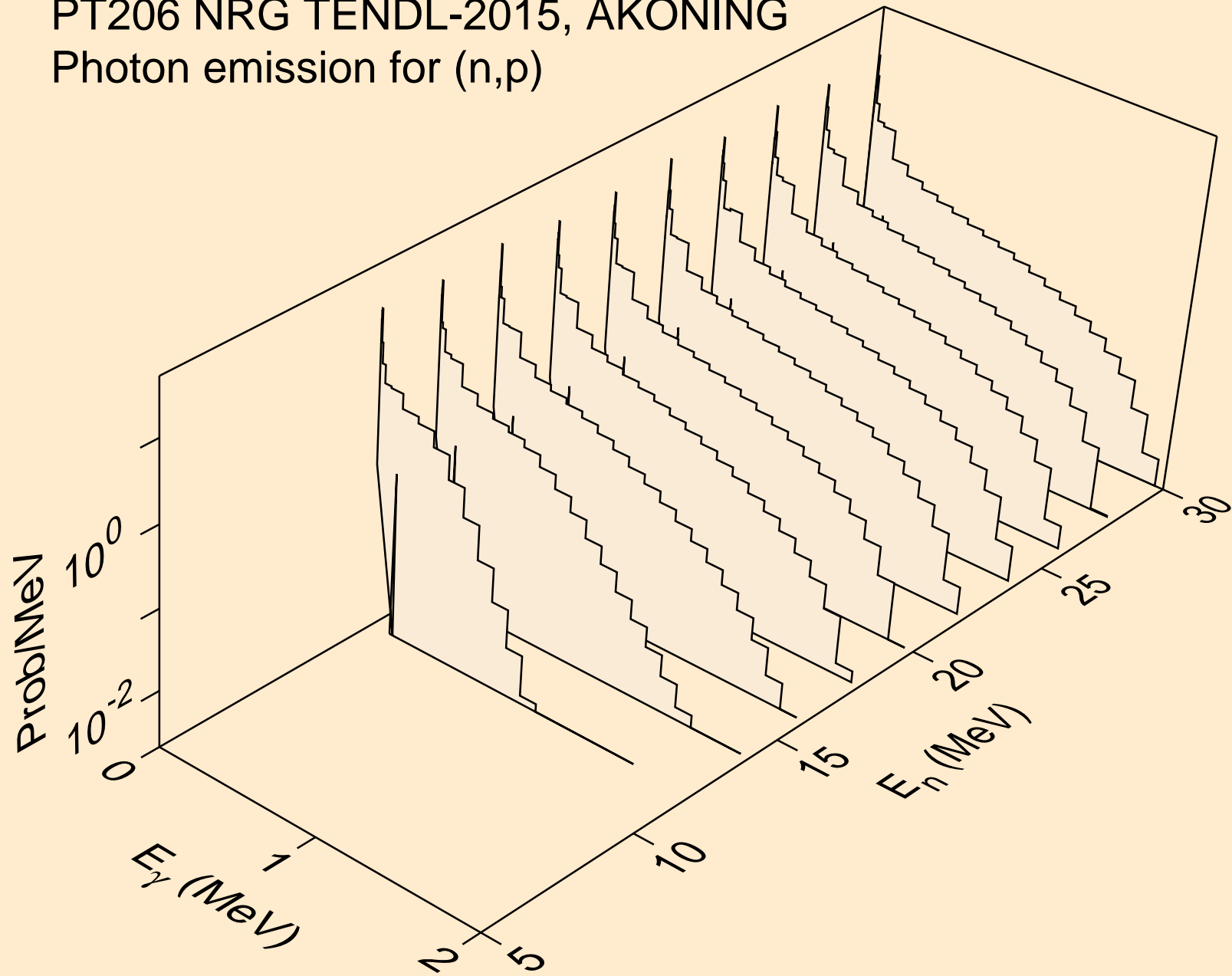

PT206 NRG TENDL-2015, AKONING
Photon emission for (n,d)

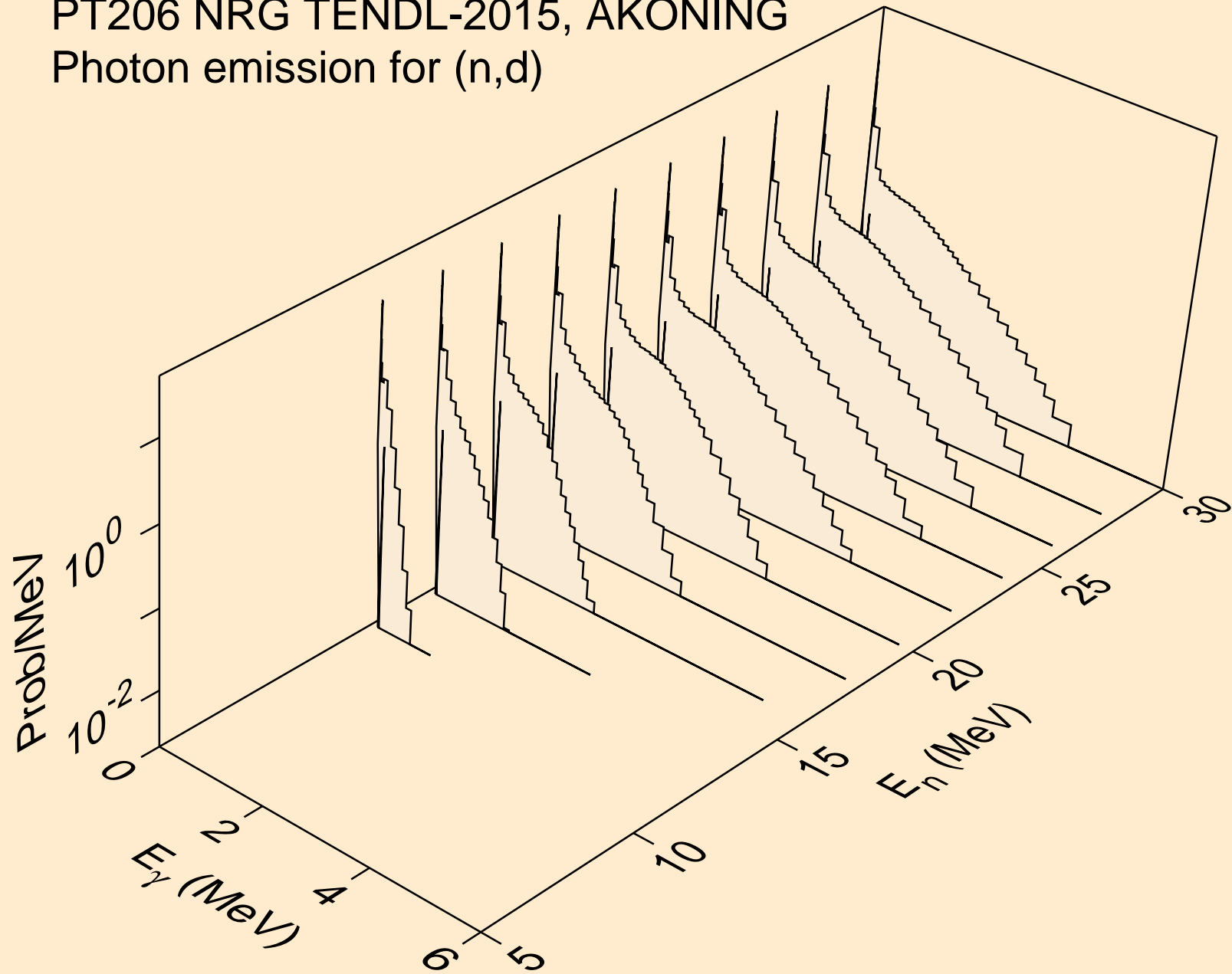

PT206 NRG TENDL-2015, AKONING
Photon emission for (n,t)

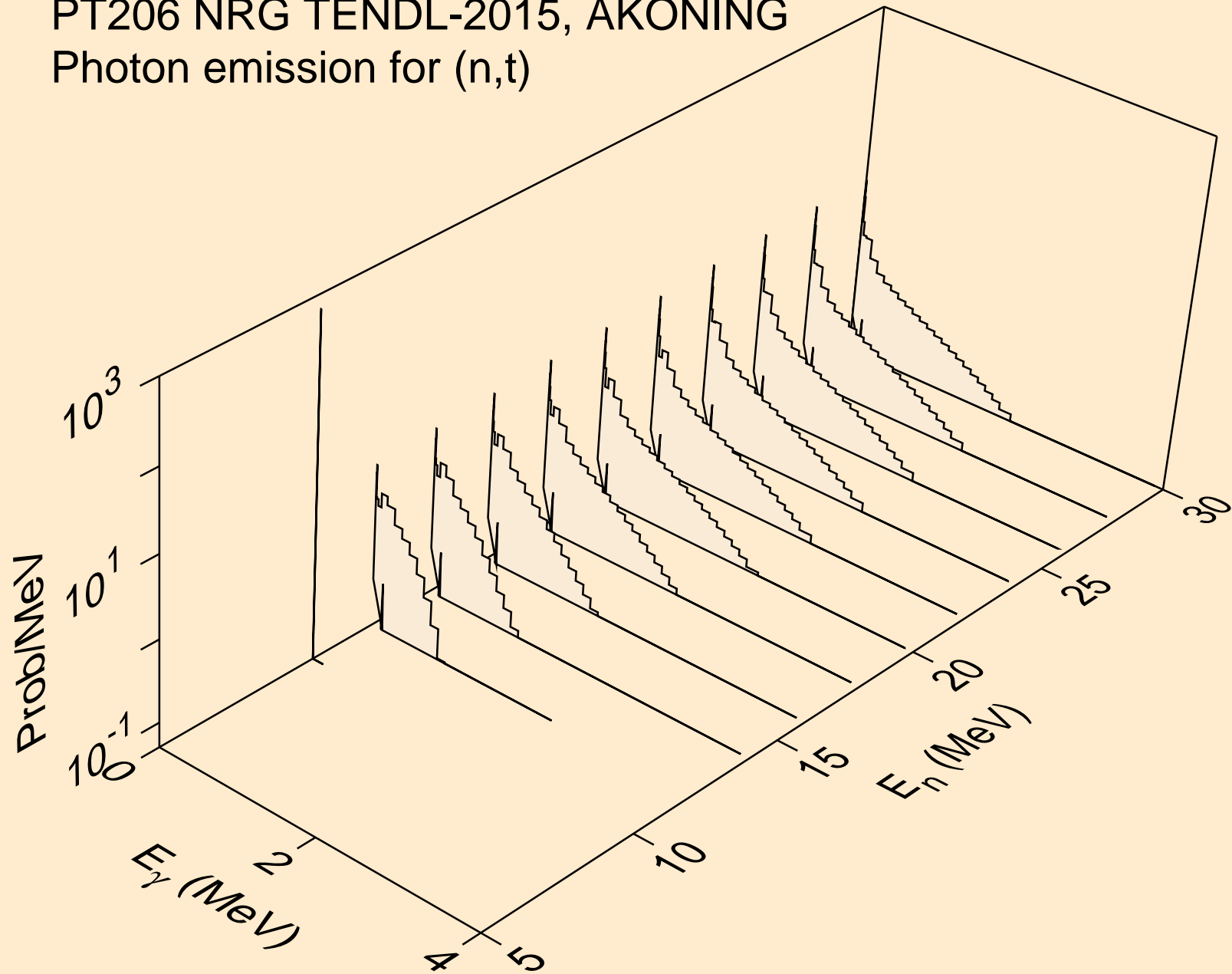

PT206 NRG TENDL-2015, AKONING
Photon emission for (n,he3)

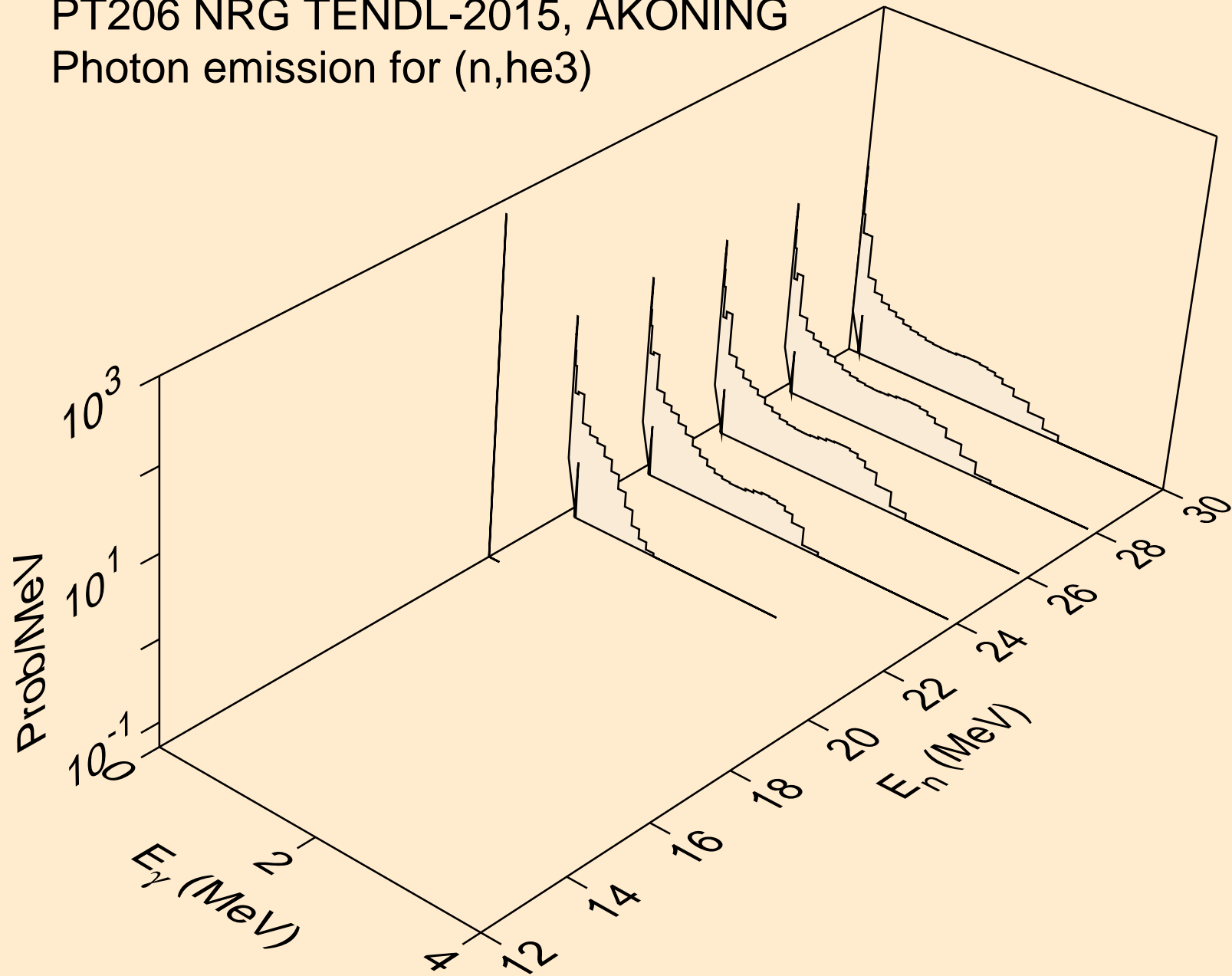

PT206 NRG TENDL-2015, AKONING
Photon emission for (n,a)

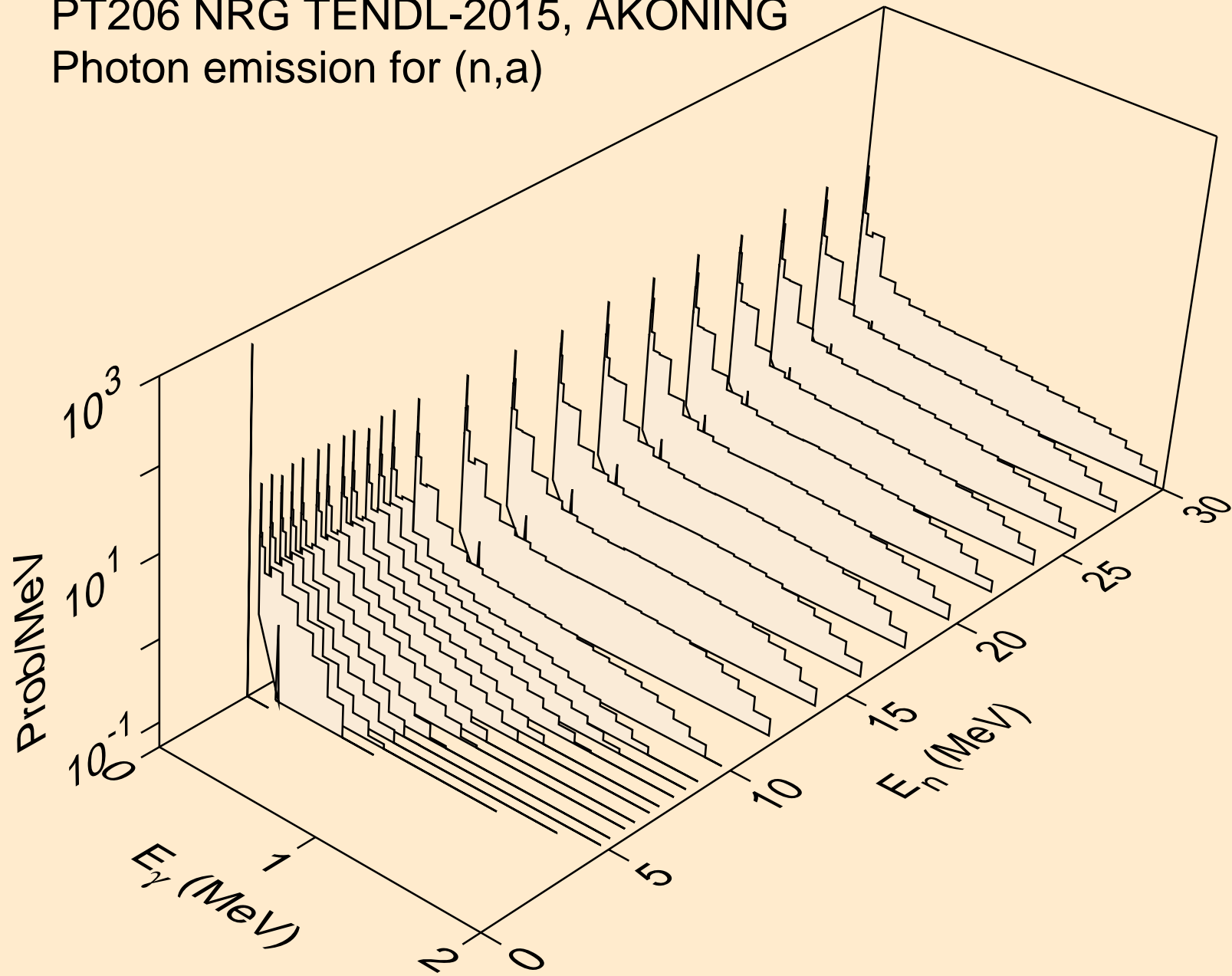

PT206 NRG TENDL-2015, AKONING
thermal capture photon spectrum

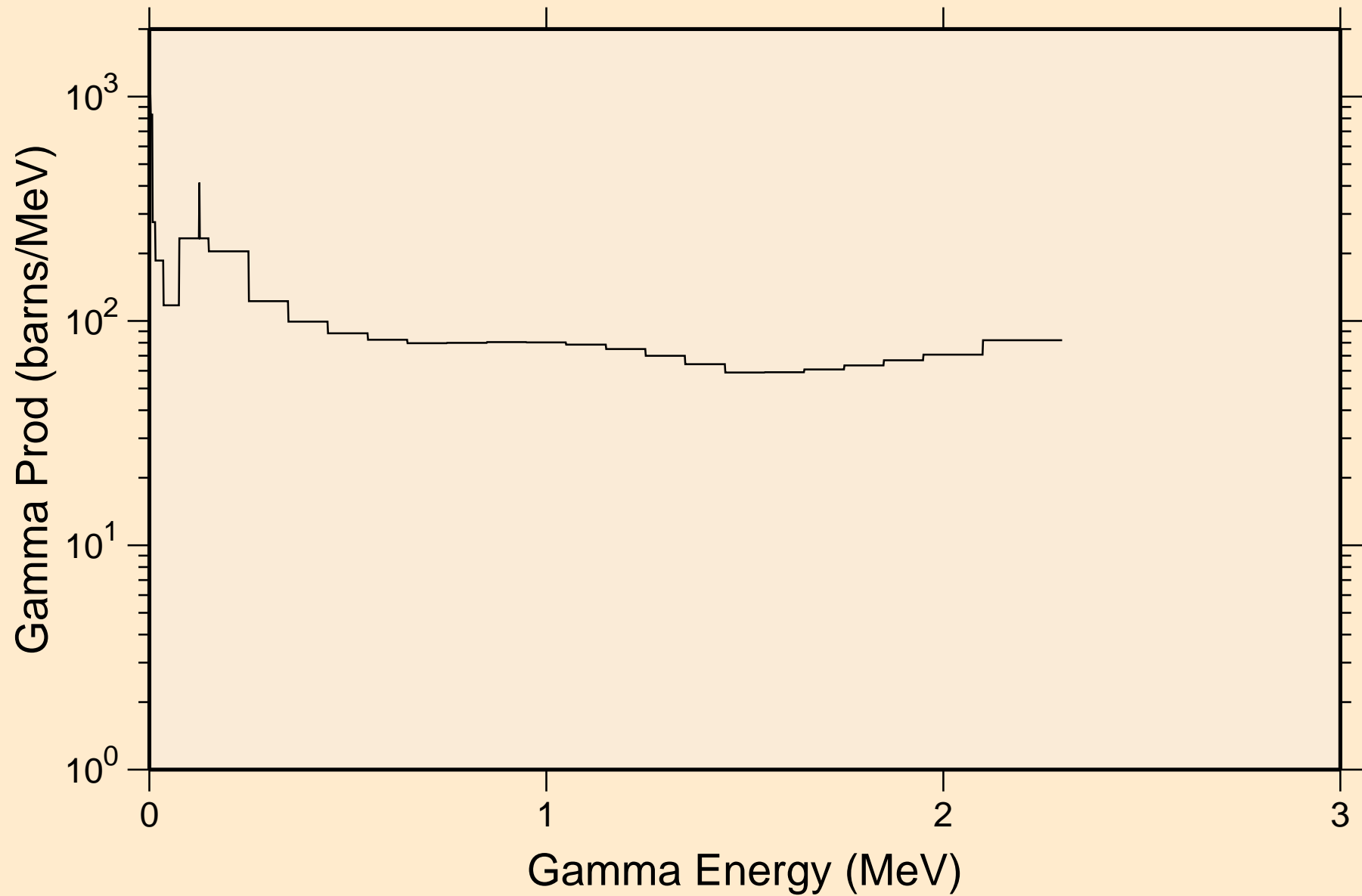

PT206 NRG TENDL-2015, AKONING
14 MeV photon spectrum

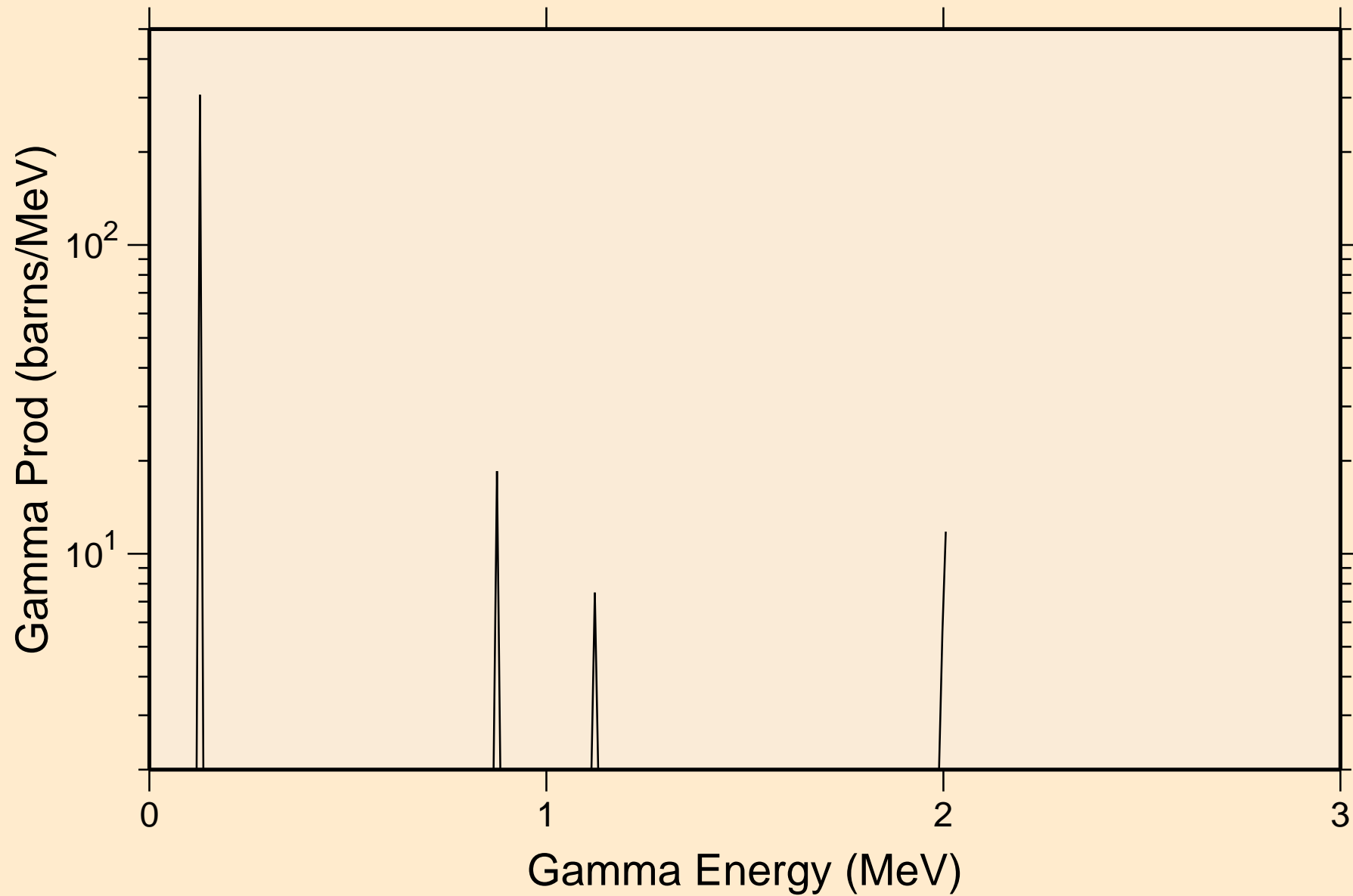

PT206 NRG TENDL-2015, AKONING

Particle heating contributions

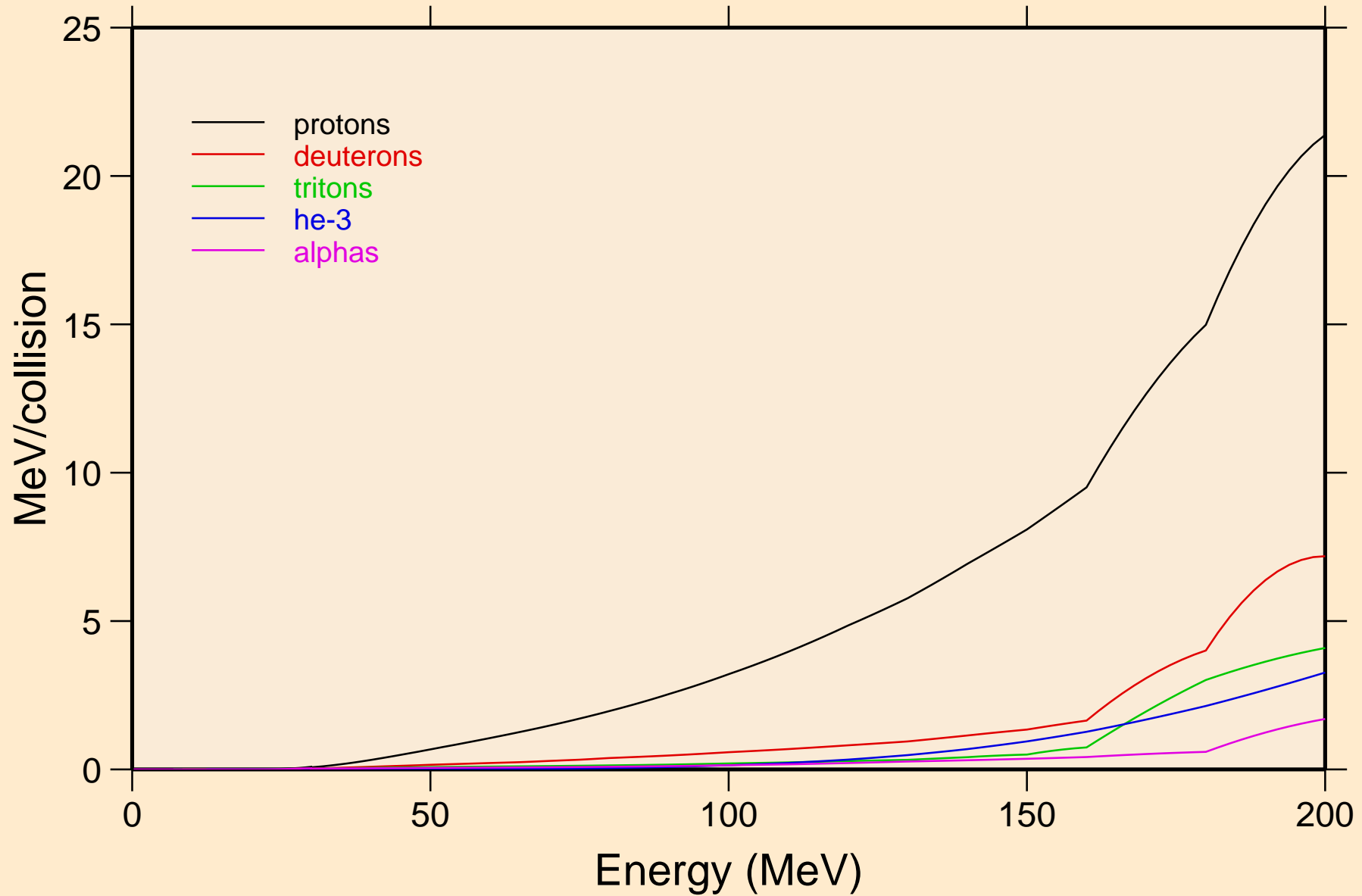

PT206 NRG TENDL-2015, AKONING

Recoil Heating

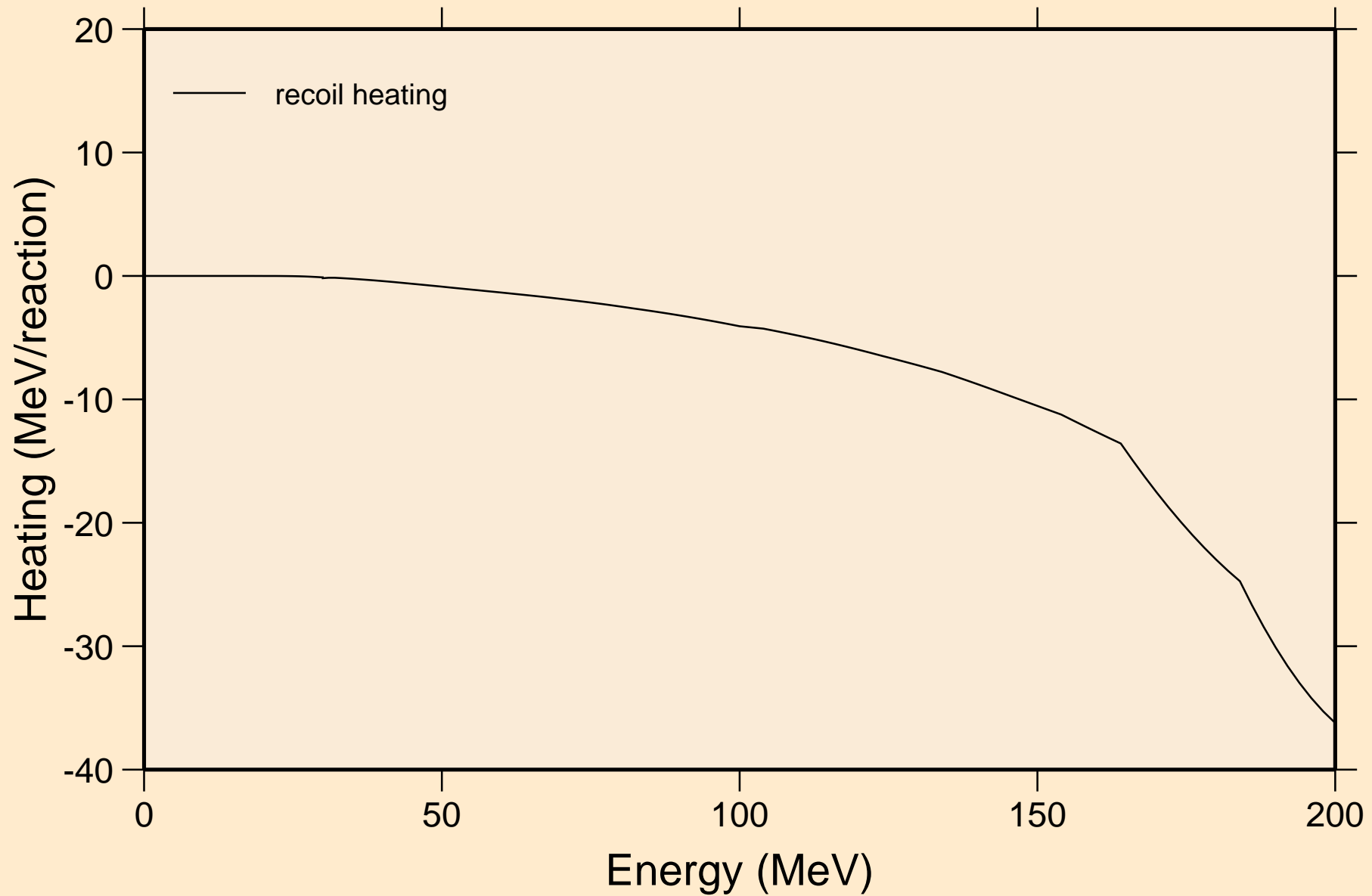

PT206 NRG TENDL-2015, AKONING
Particle production cross sections

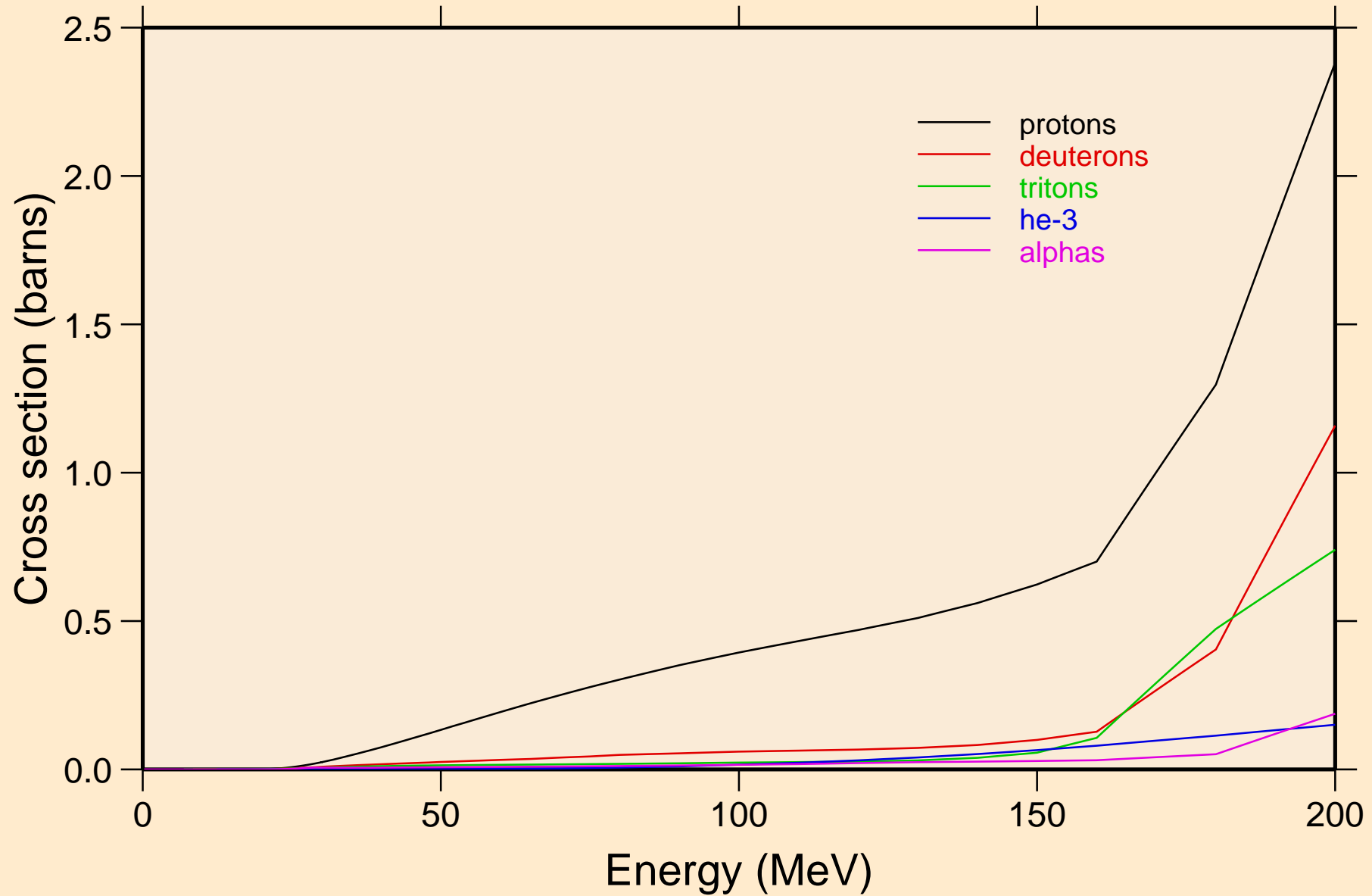

PT206 NRG TENDL-2015, AKONING
protons from (n,x)

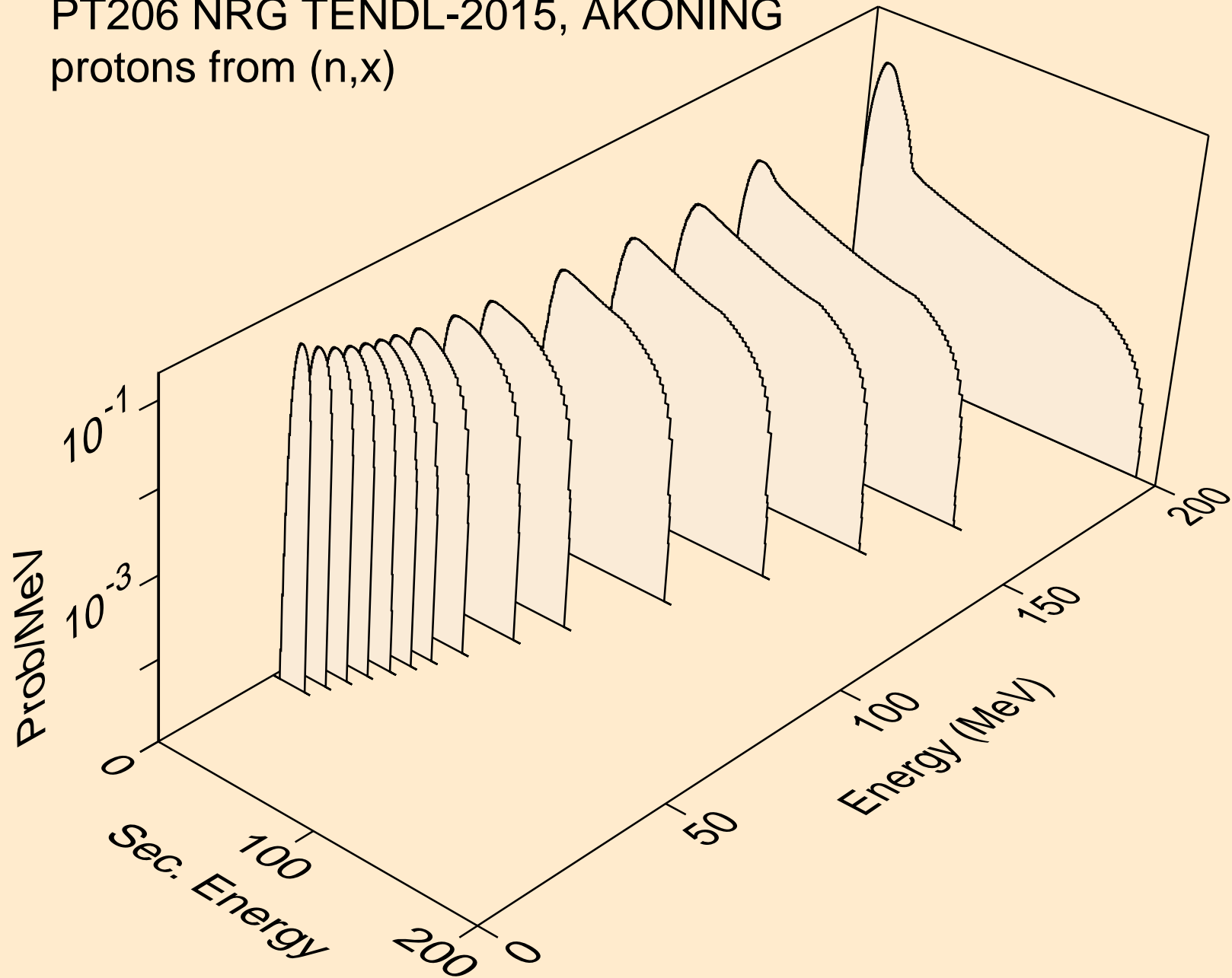

PT206 NRG TENDL-2015, AKONING
protons from (n,n*)p

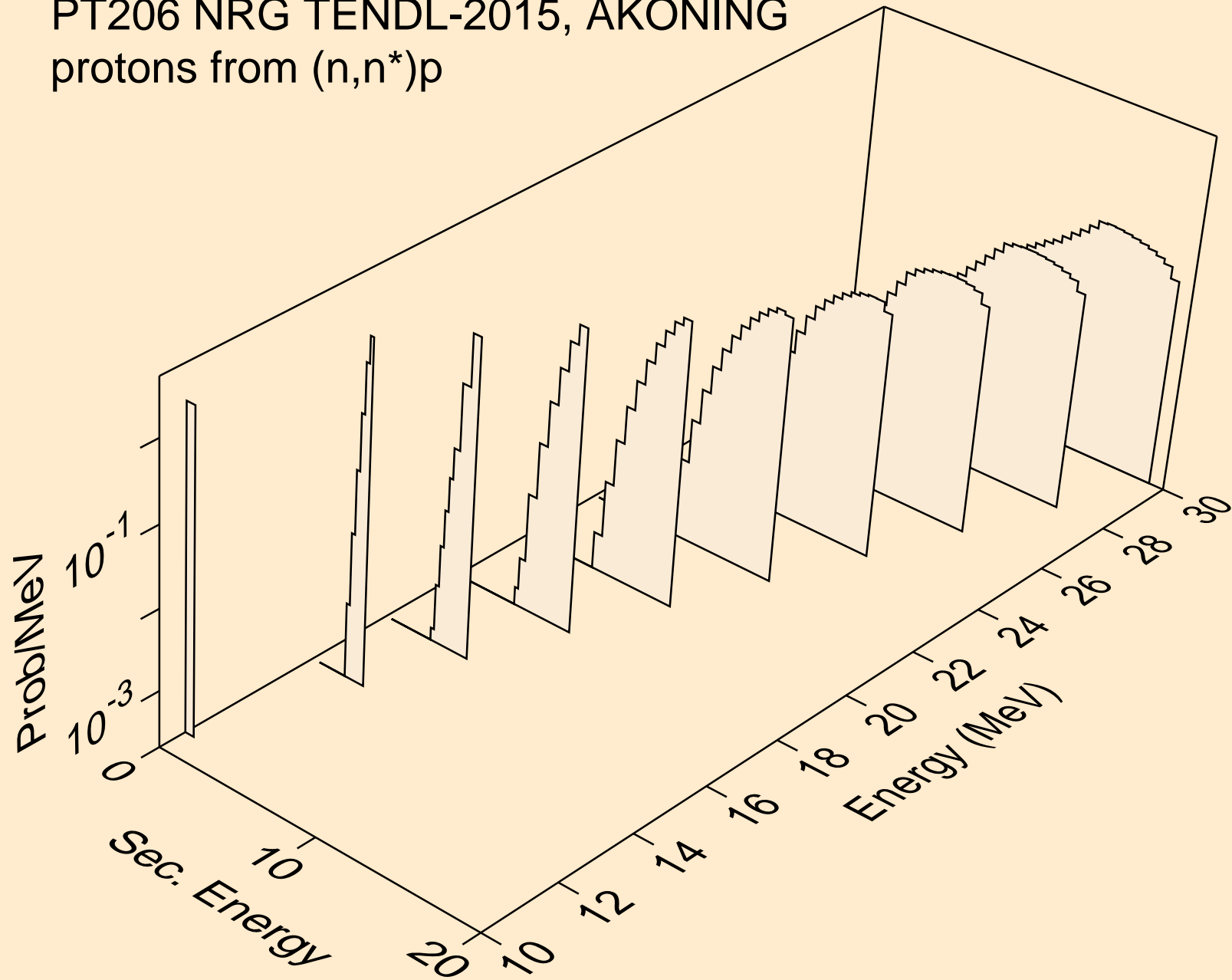

PT206 NRG TENDL-2015, AKONING
protons from (n,2np)

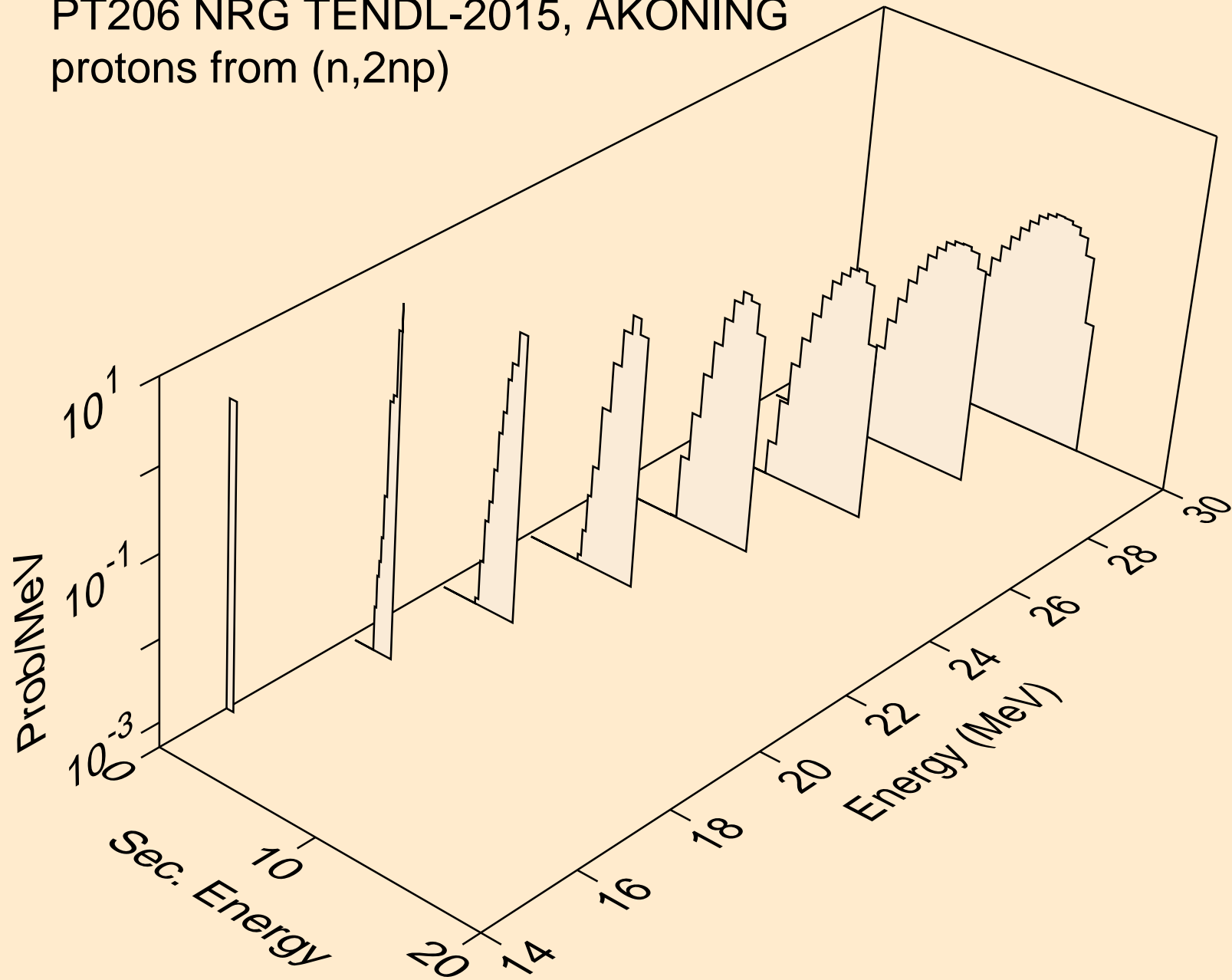

PT206 NRG TENDL-2015, AKONING
protons from (n,3np)

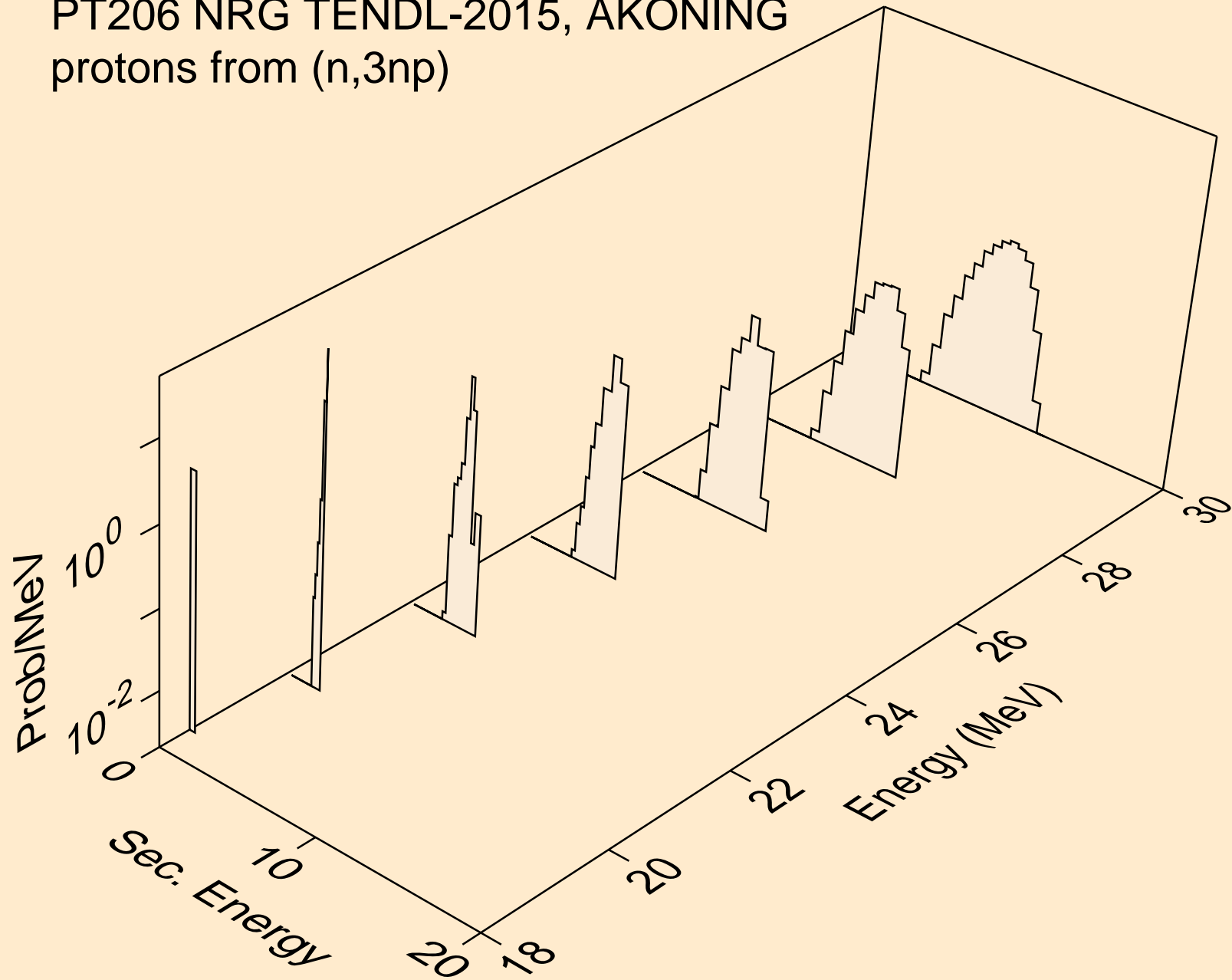

PT206 NRG TENDL-2015, AKONING
protons from (n,p)

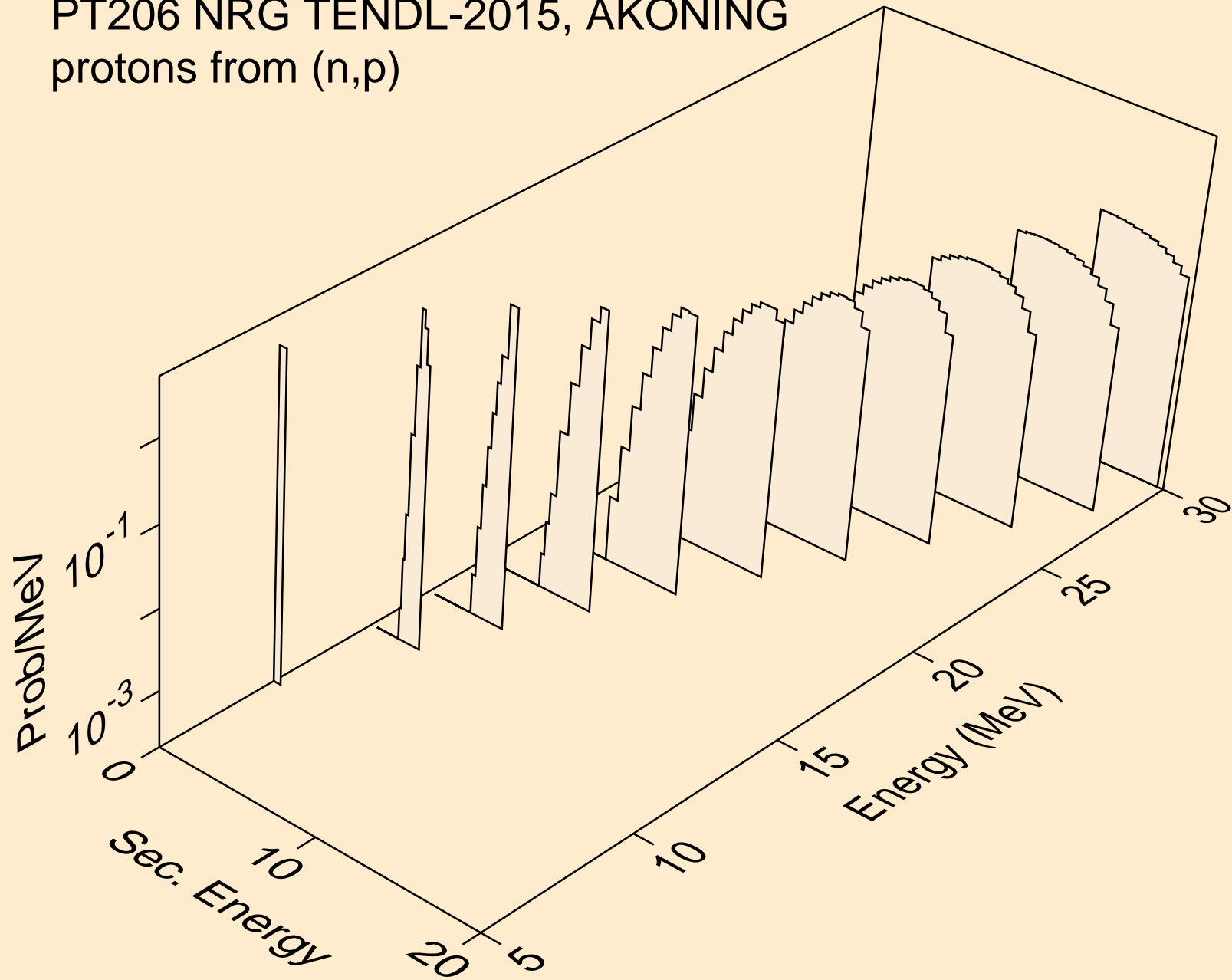

PT206 NRG TENDL-2015, AKONING
deuterons from (n,x)

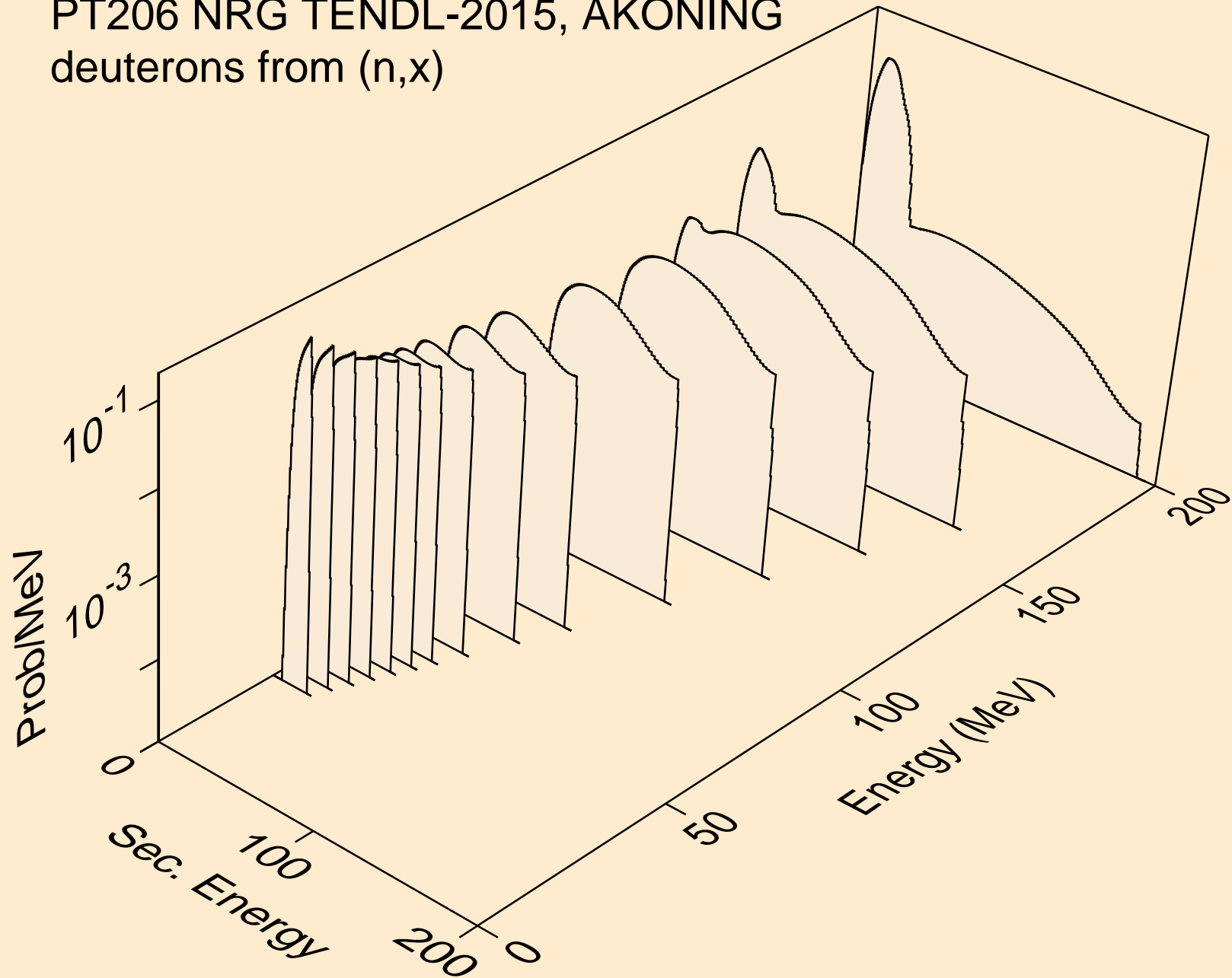

PT206 NRG TENDL-2015, AKONING
deuterons from (n,2nd)

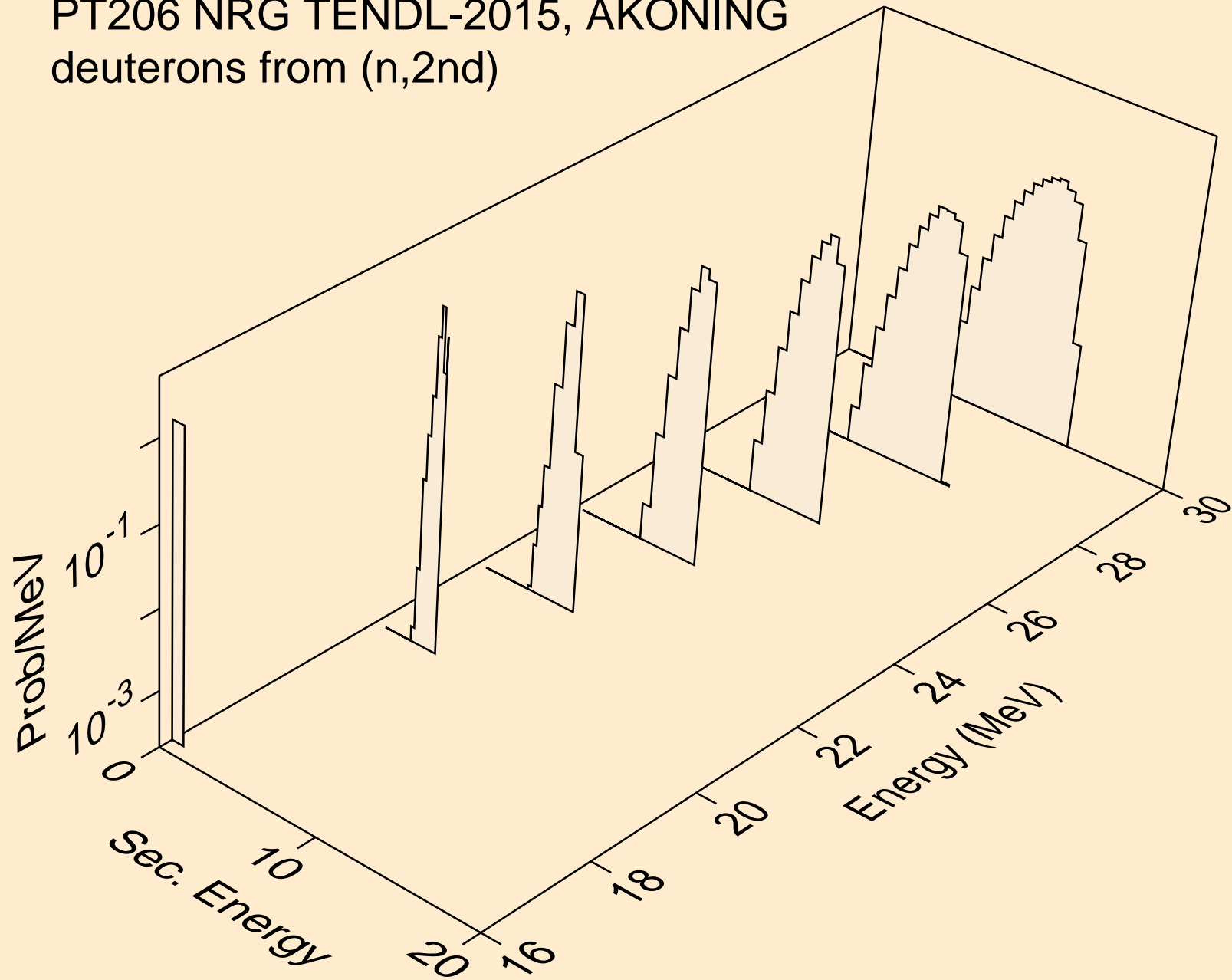

PT206 NRG TENDL-2015, AKONING
deuterons from (n,n*)d

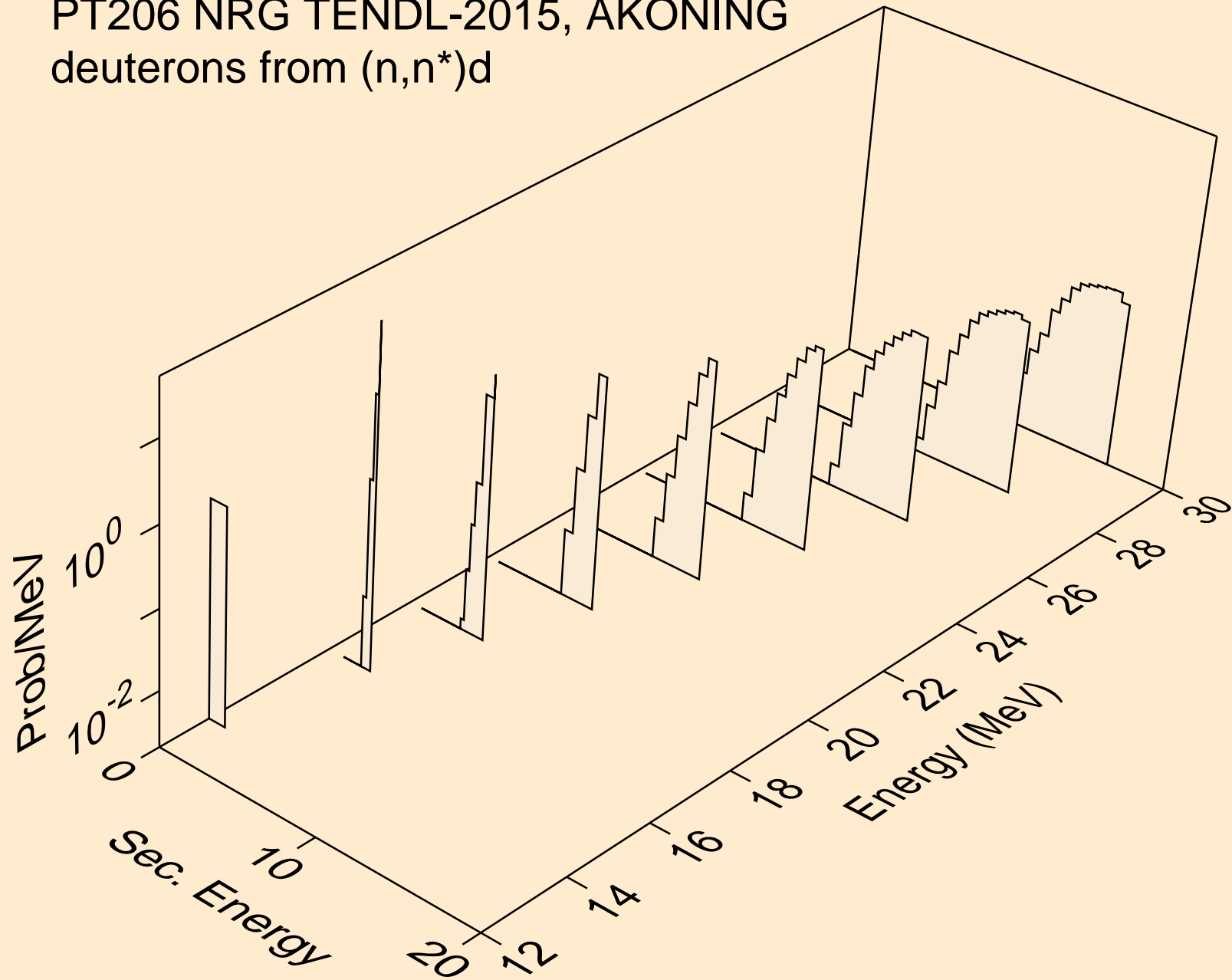

PT206 NRG TENDL-2015, AKONING
deuterons from (n,d)

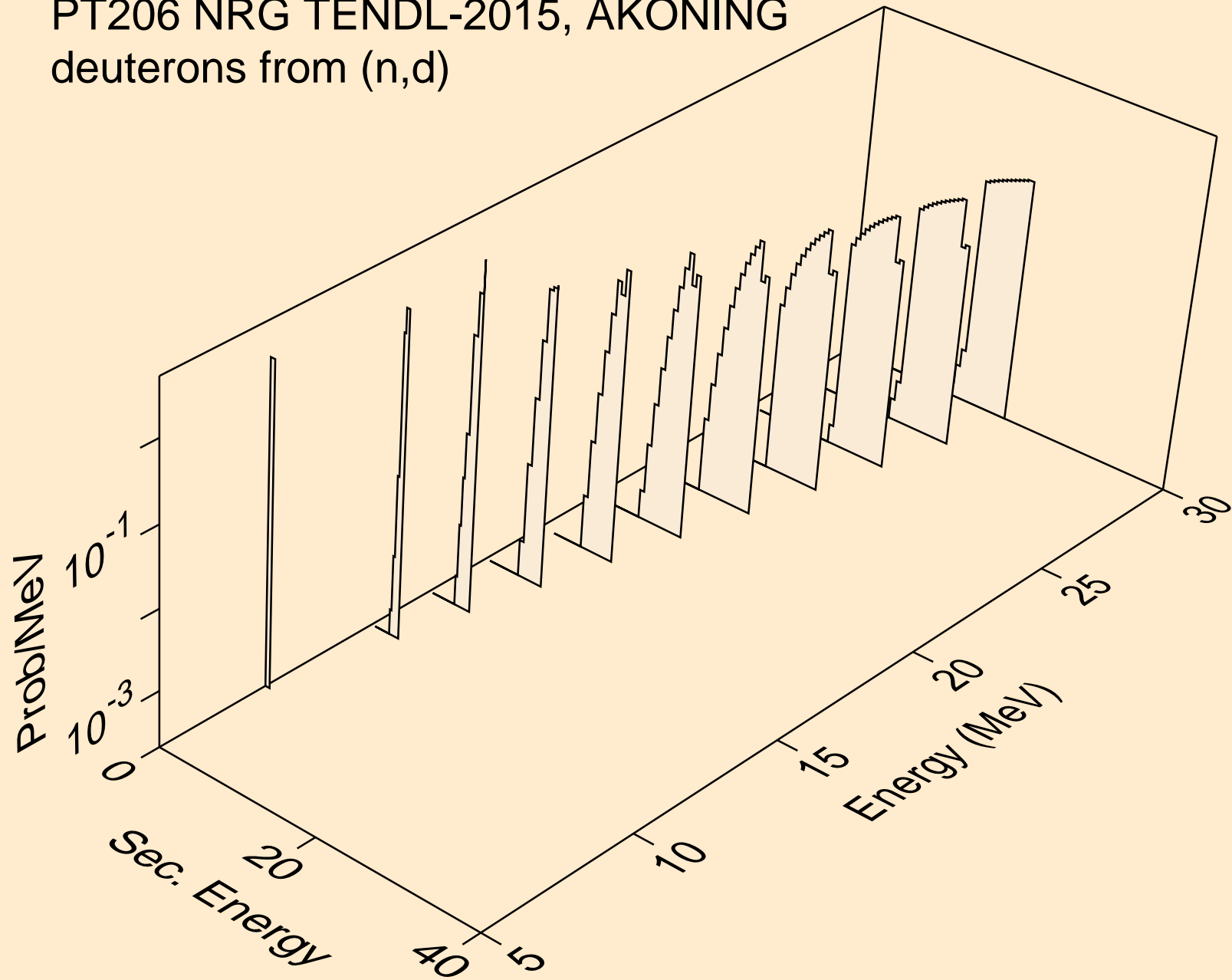

PT206 NRG TENDL-2015, AKONING
tritons from (n,x)

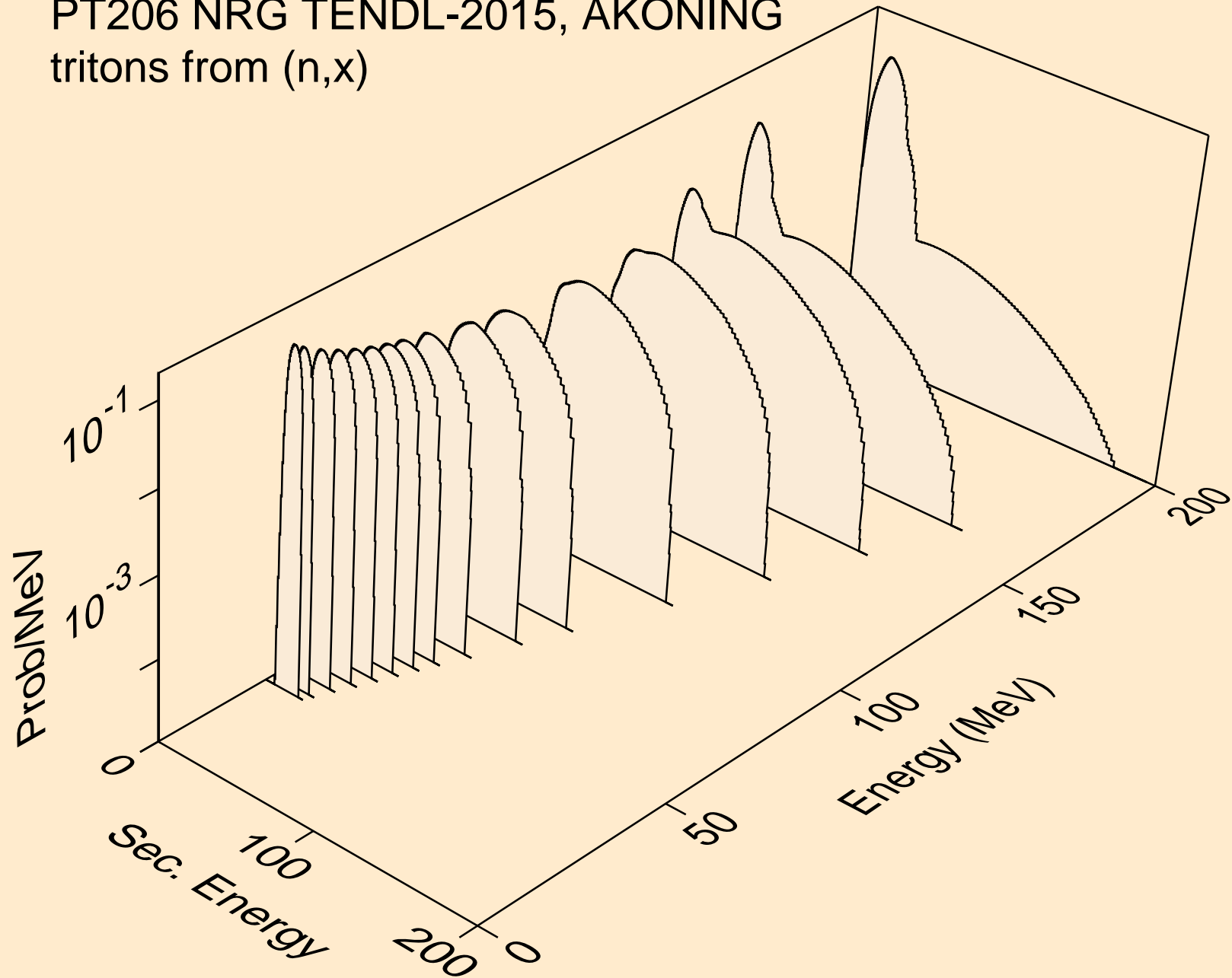

PT206 NRG TENDL-2015, AKONING
tritons from (n,n*)t

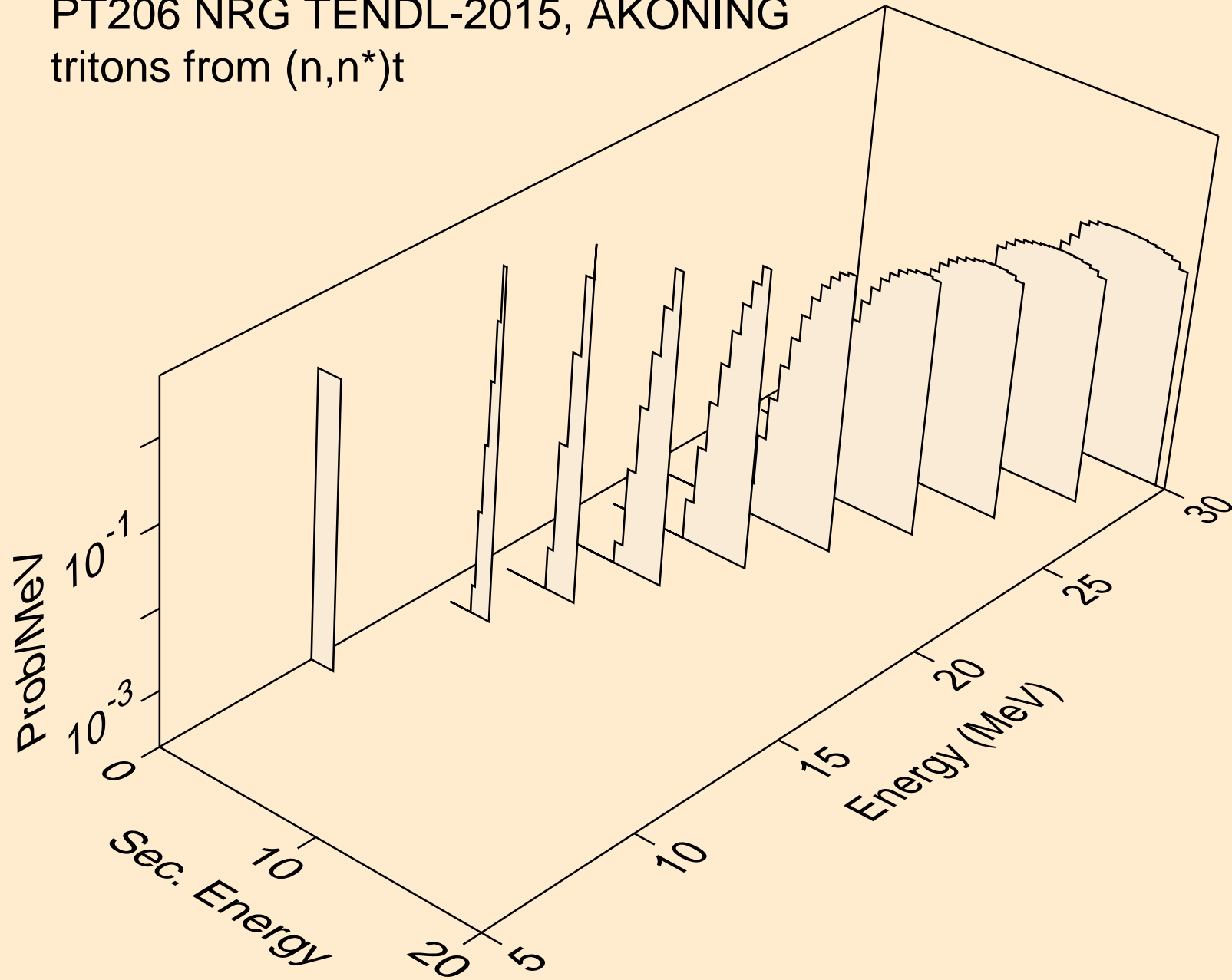

PT206 NRG TENDL-2015, AKONING
tritons from (n,t)

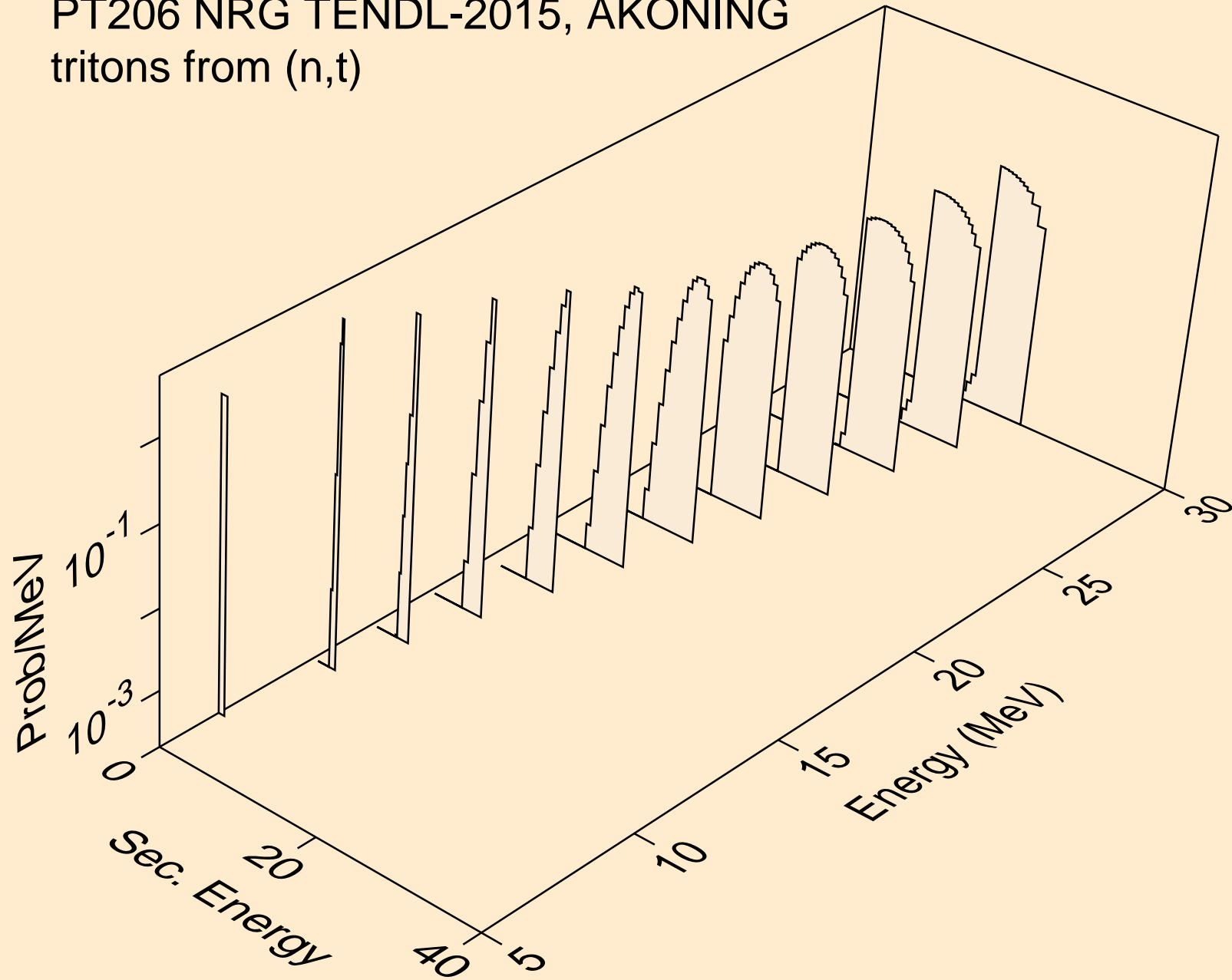

PT206 NRG TENDL-2015, AKONING
he3s from (n,x)

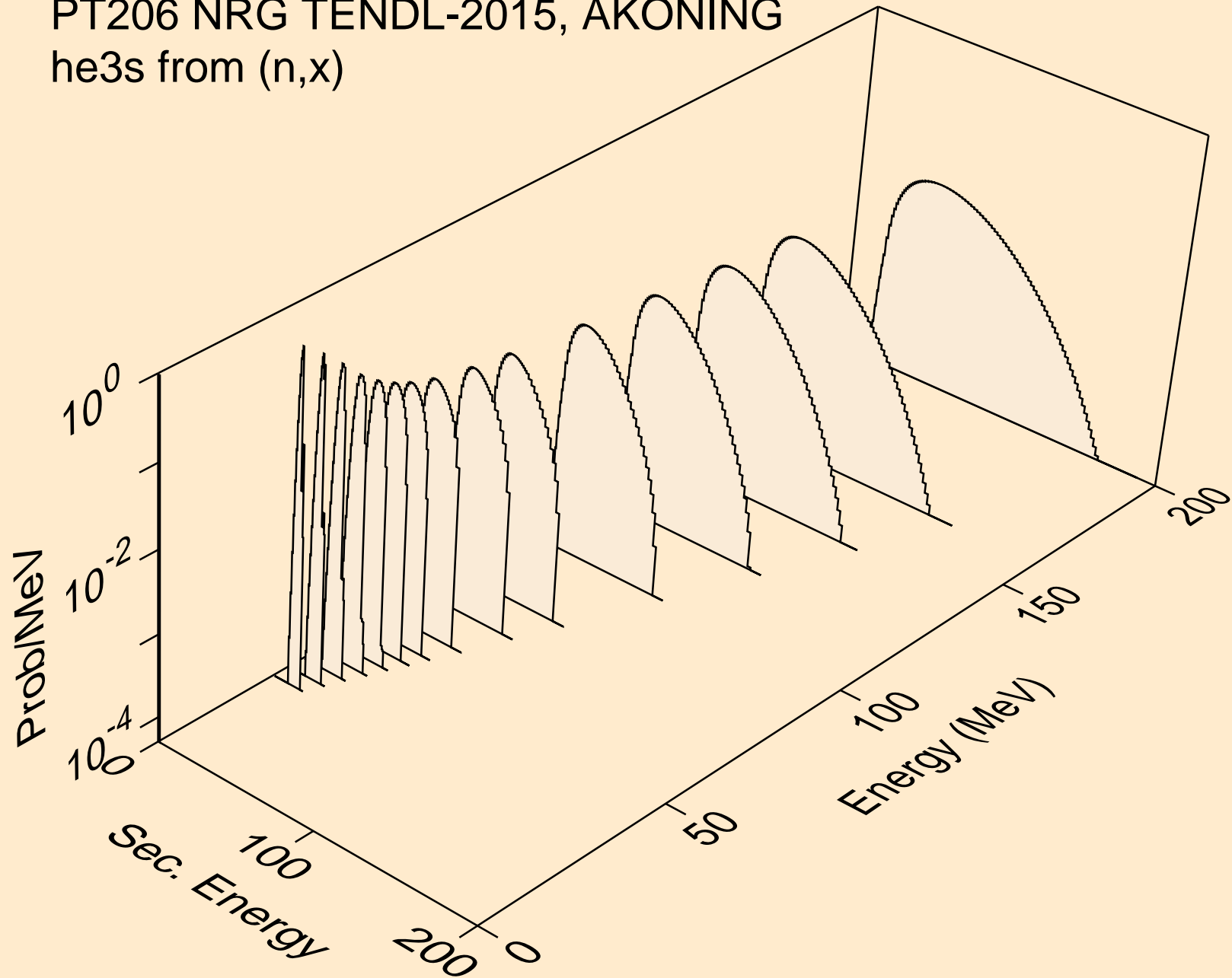

PT206 NRG TENDL-2015, AKONING
he3s from (n,he3)

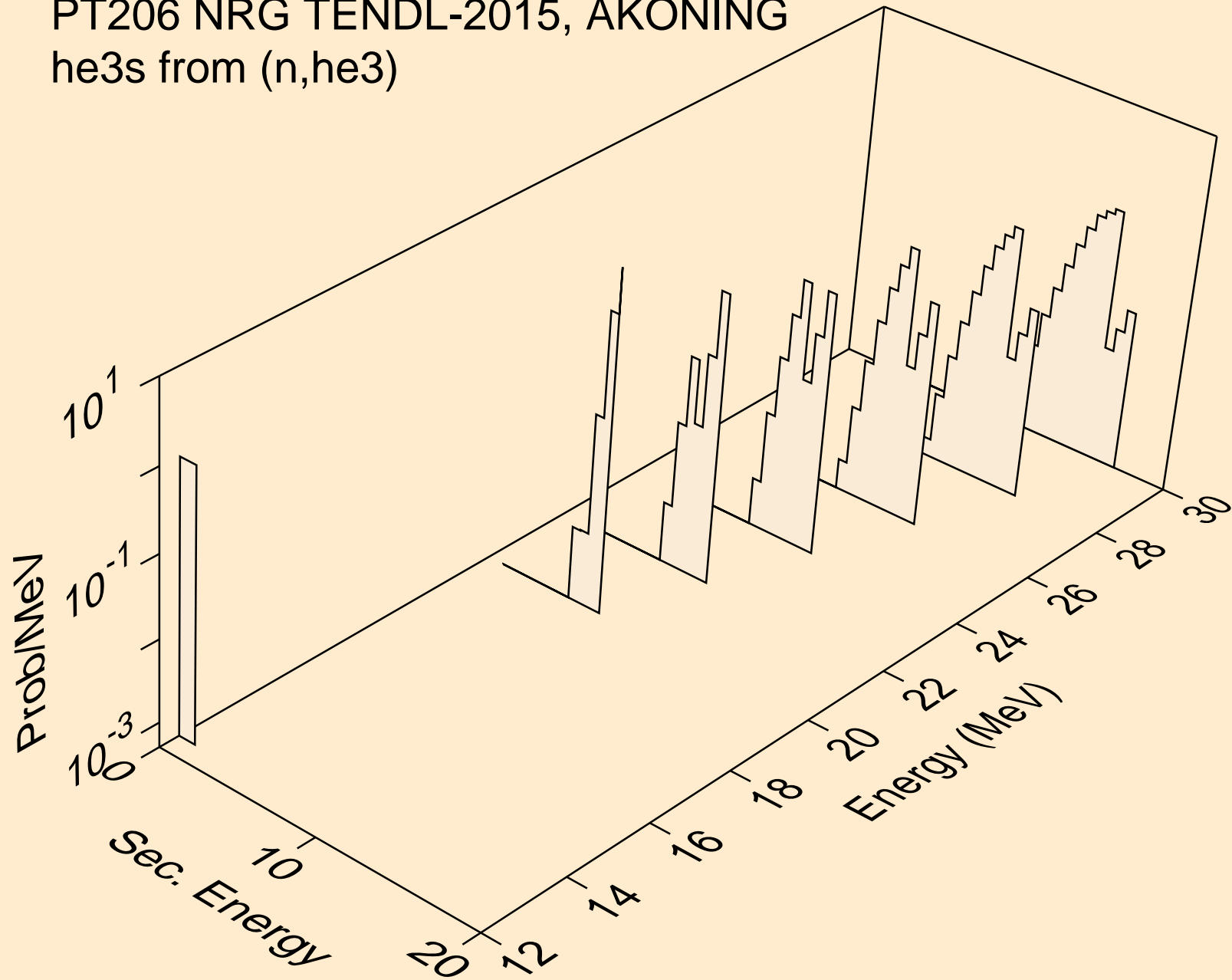

PT206 NRG TENDL-2015, AKONING
alphas from (n,x)

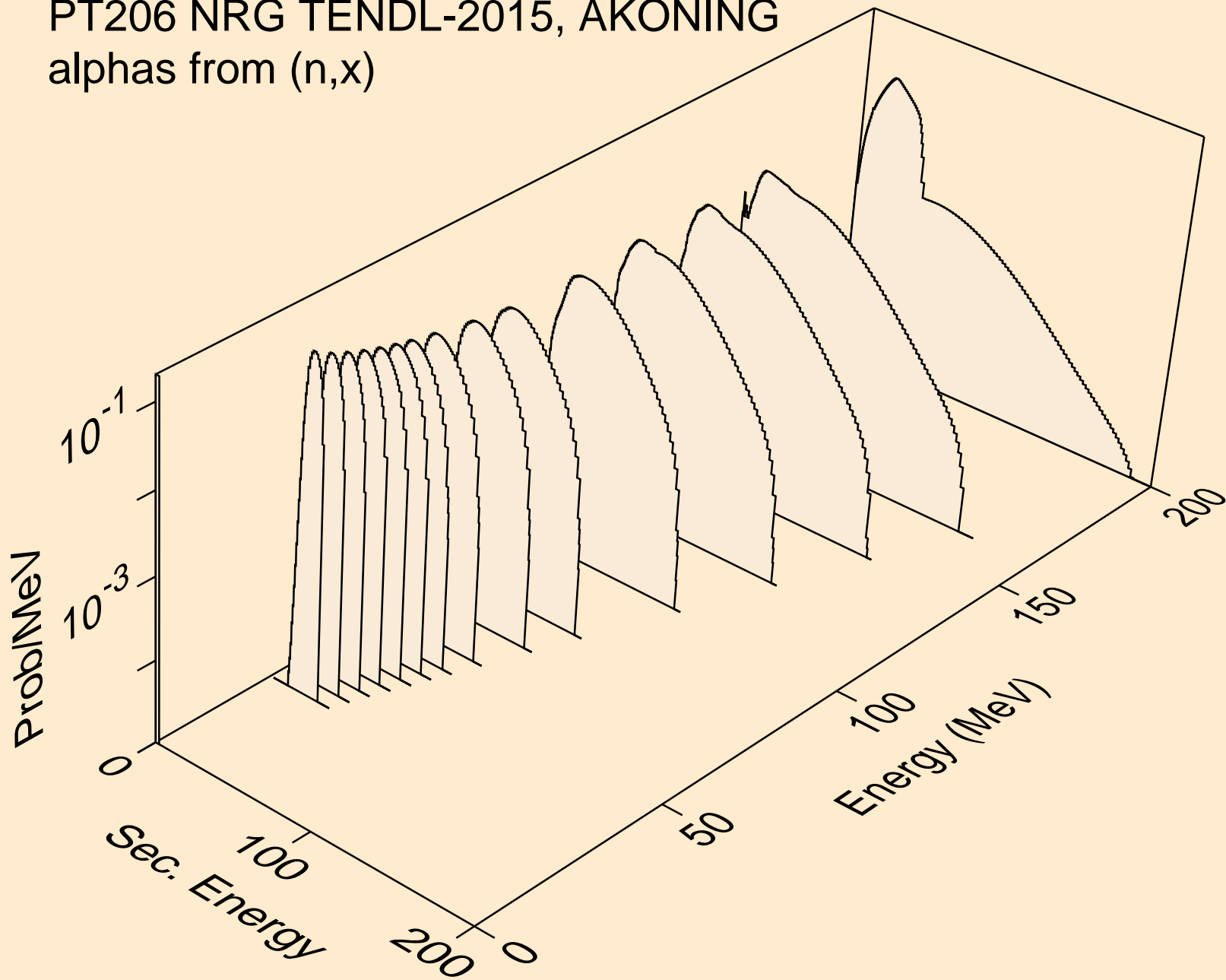

PT206 NRG TENDL-2015, AKONING
alphas from (n,n*)a

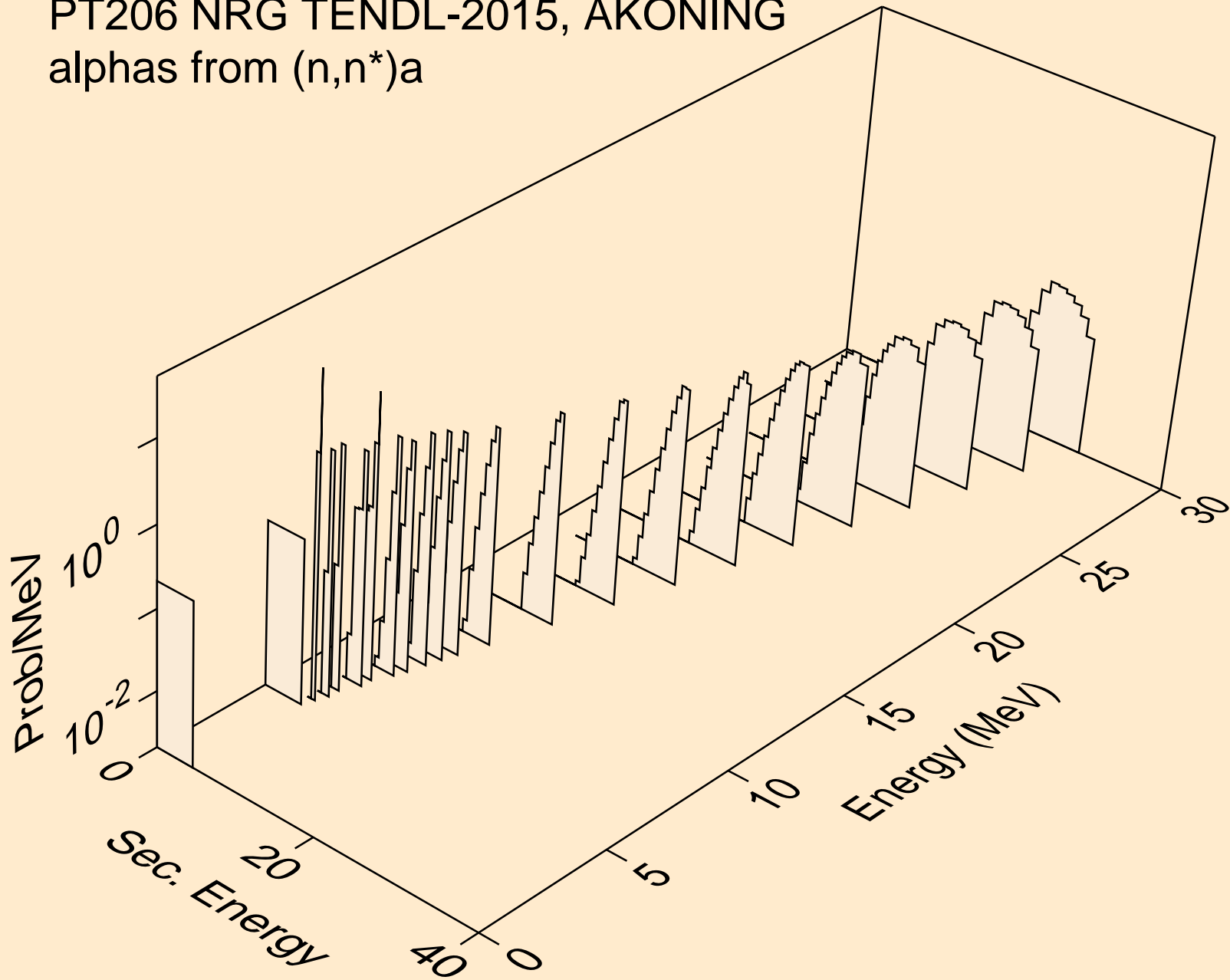

PT206 NRG TENDL-2015, AKONING
alphas from (n,2n)a

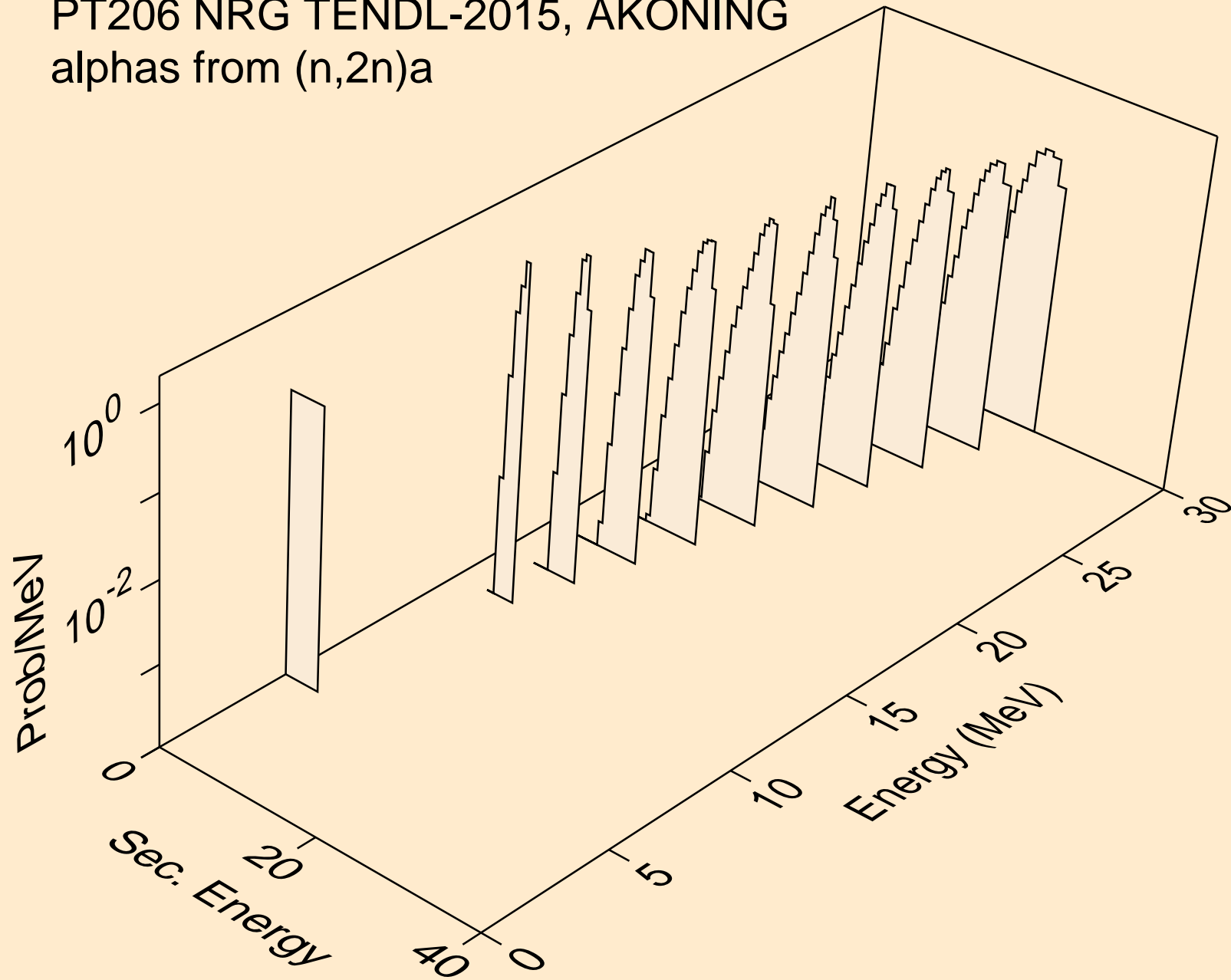

PT206 NRG TENDL-2015, AKONING
alphas from (n,3n)a

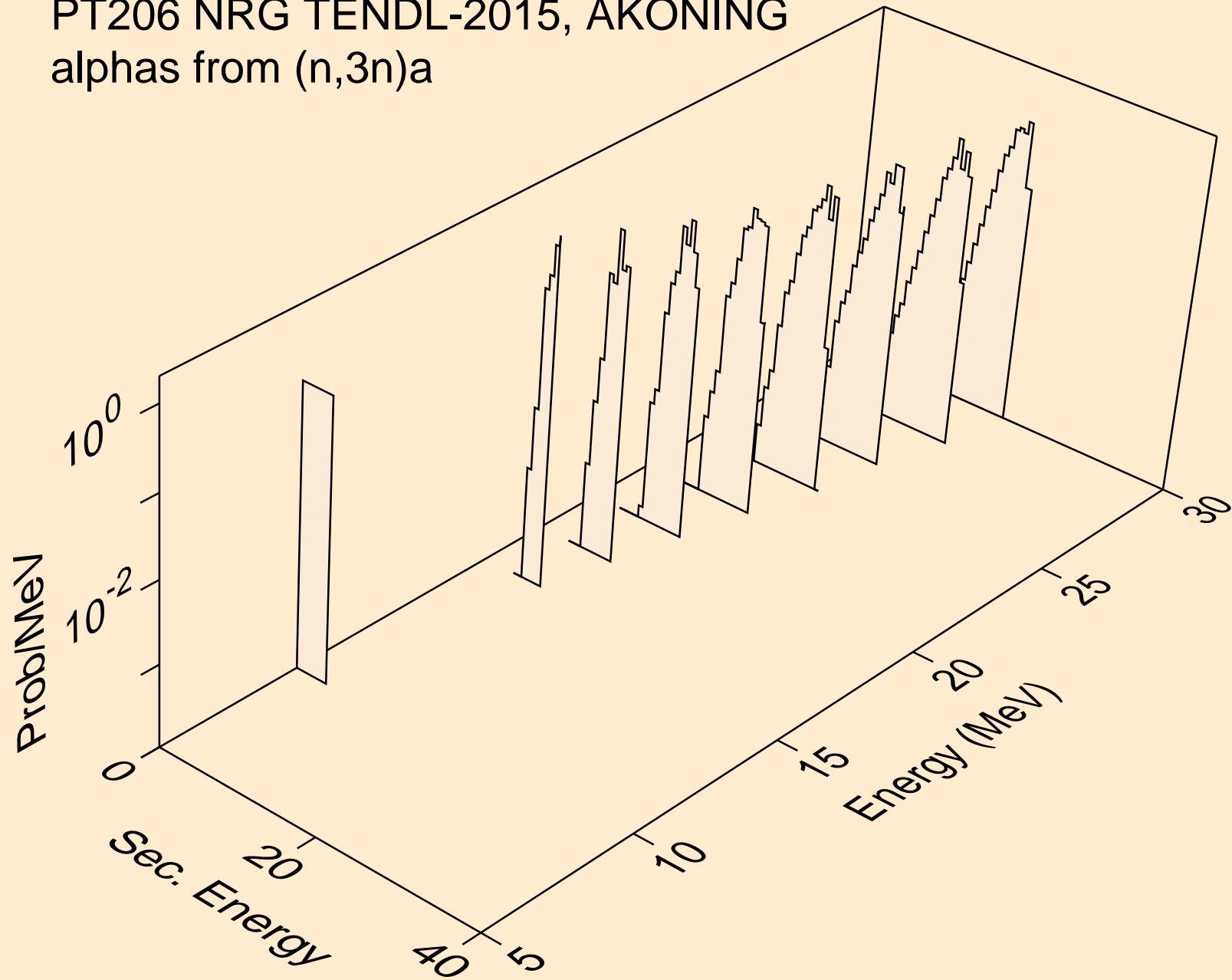

PT206 NRG TENDL-2015, AKONING
alphas from (n,a)

