

PU229 NRG TENDL-2015, AKONING

Principal cross sections

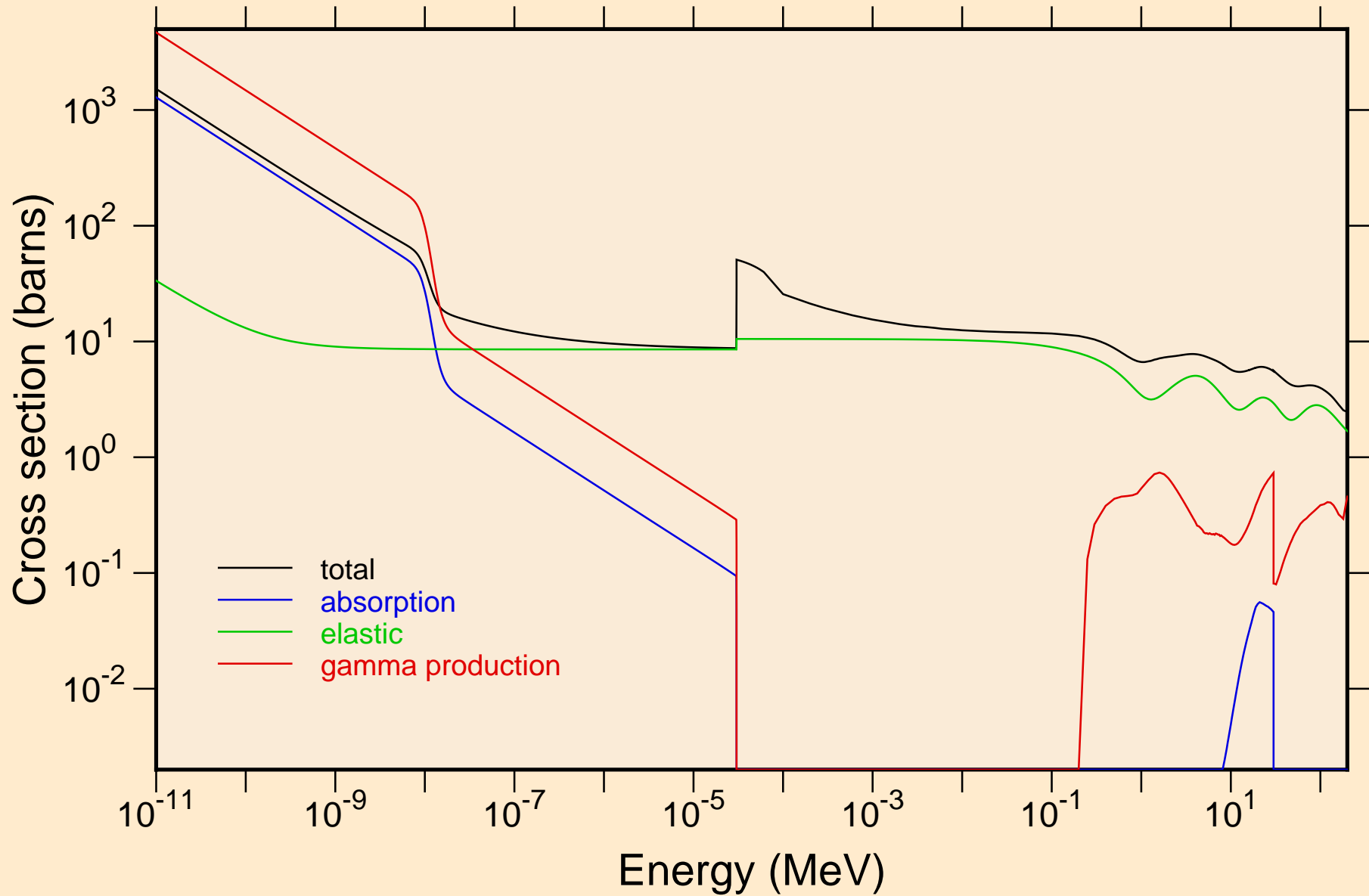

PU229 NRG TENDL-2015, AKONING

Non-threshold reactions

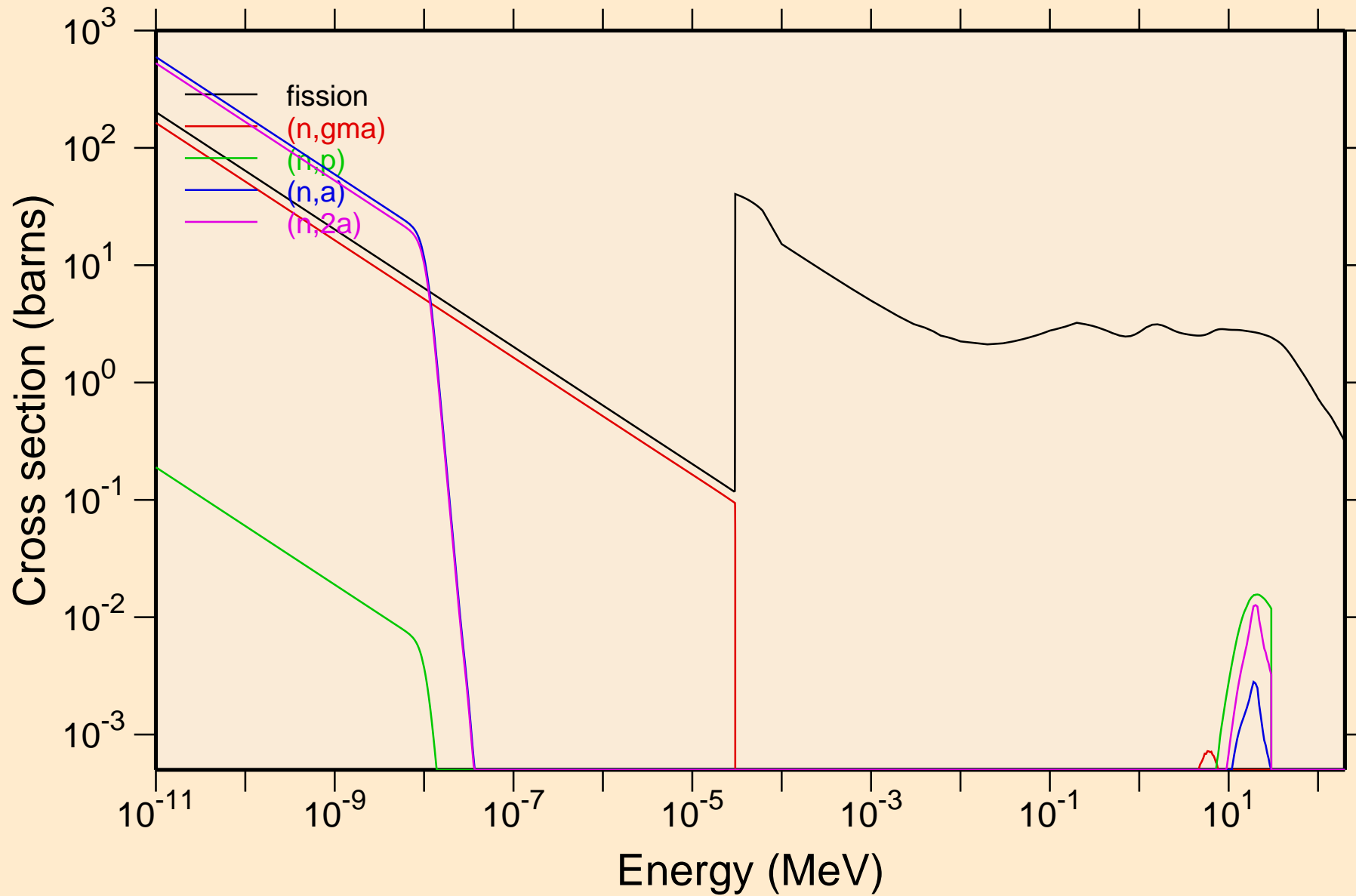

PU229 NRG TENDL-2015, AKONING

Non-threshold reactions

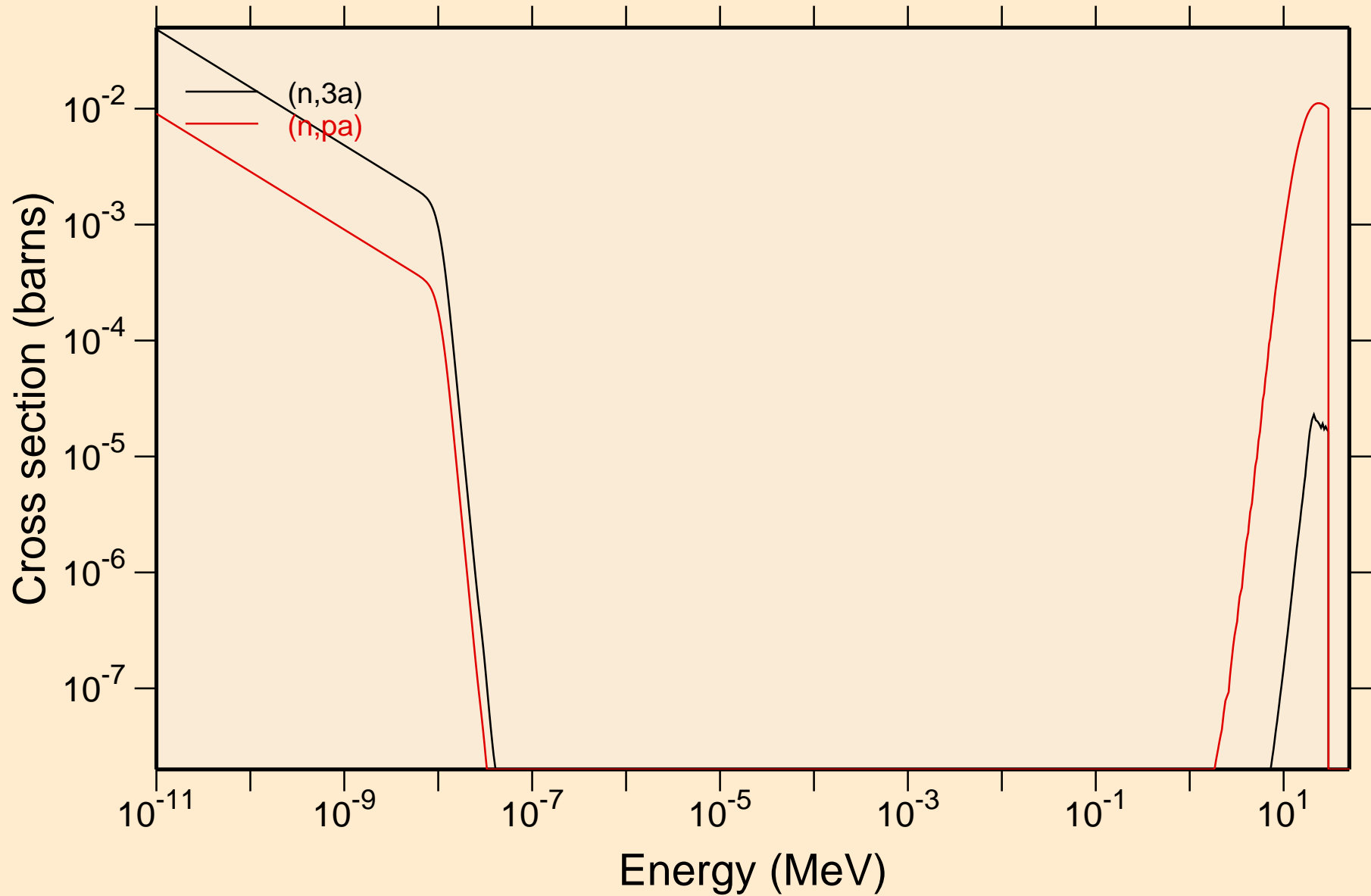

PU229 NRG TENDL-2015, AKONING

Principal cross sections

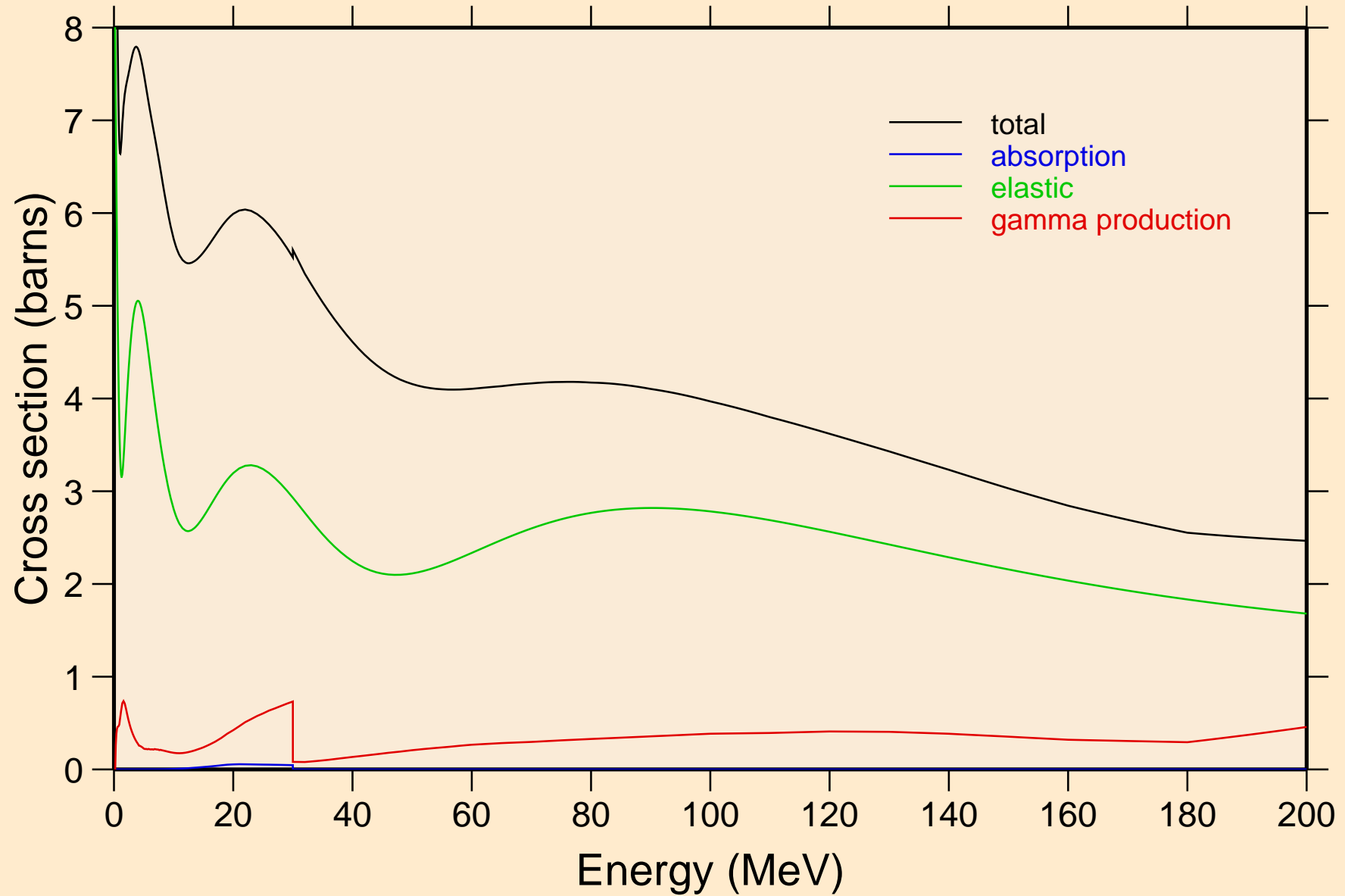

PU229 NRG TENDL-2015, AKONING

Non-threshold reactions

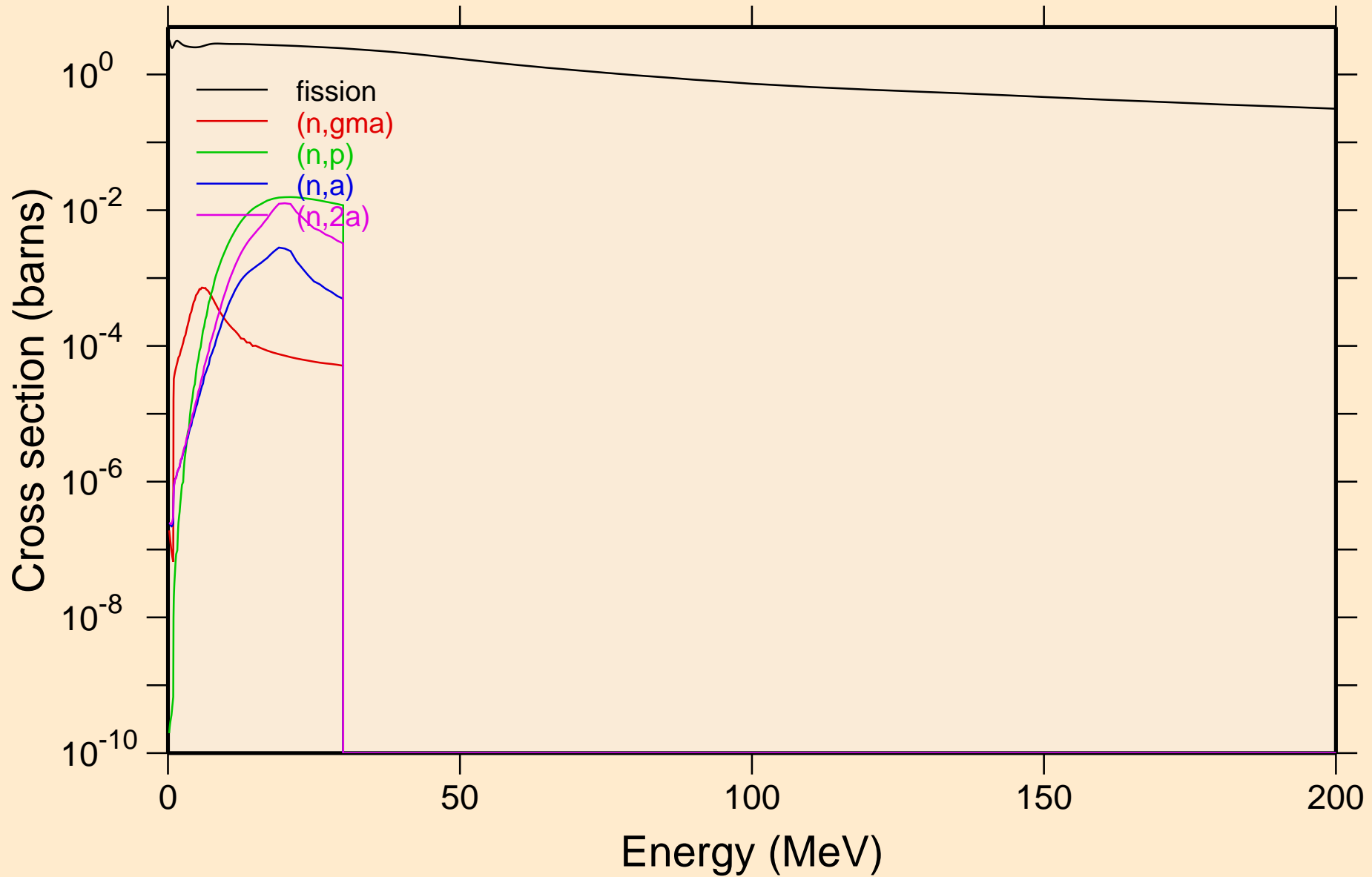

PU229 NRG TENDL-2015, AKONING
Non-threshold reactions

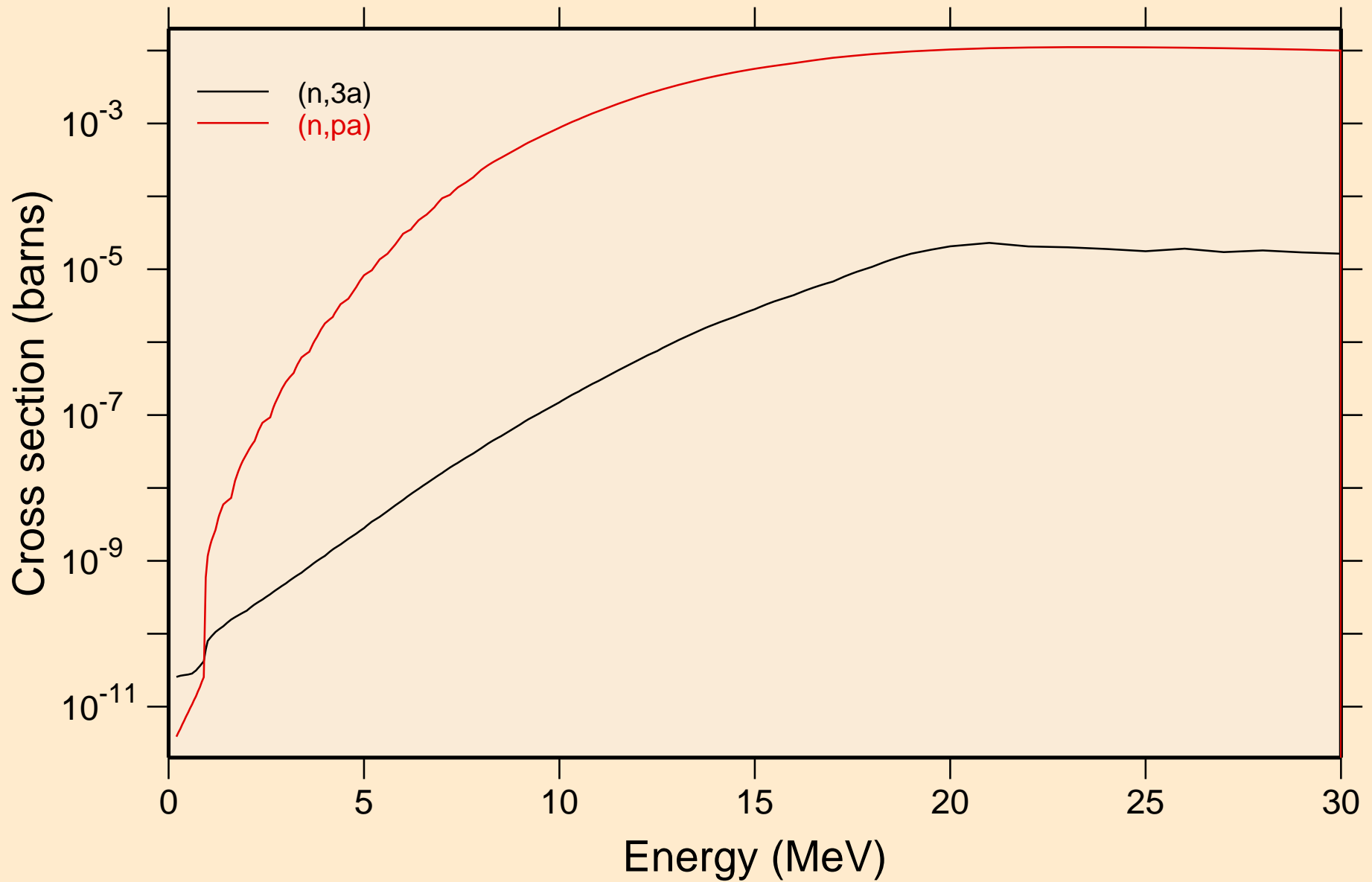

PU229 NRG TENDL-2015, AKONING
Inelastic levels

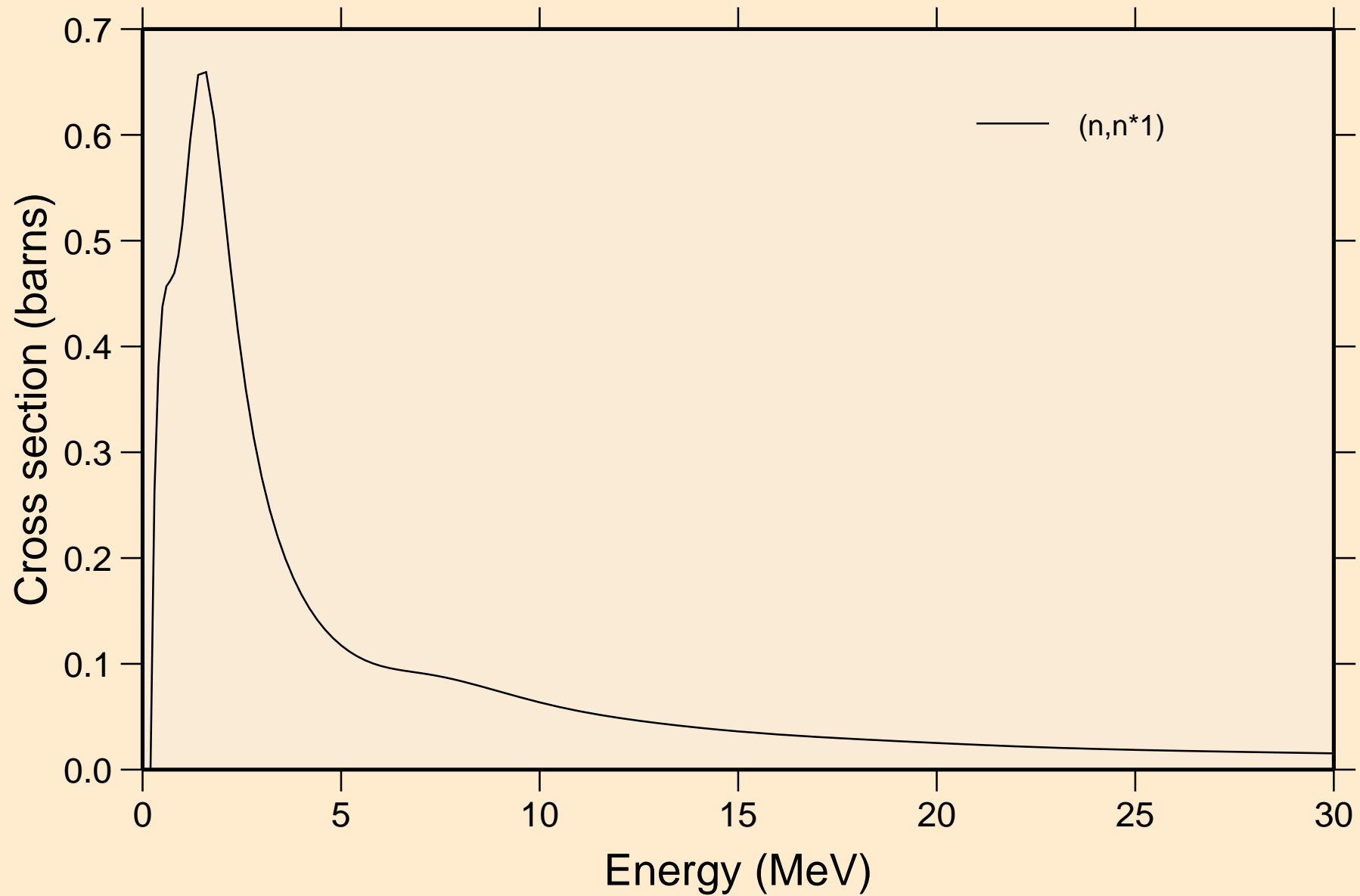

PU229 NRG TENDL-2015, AKONING

Threshold reactions

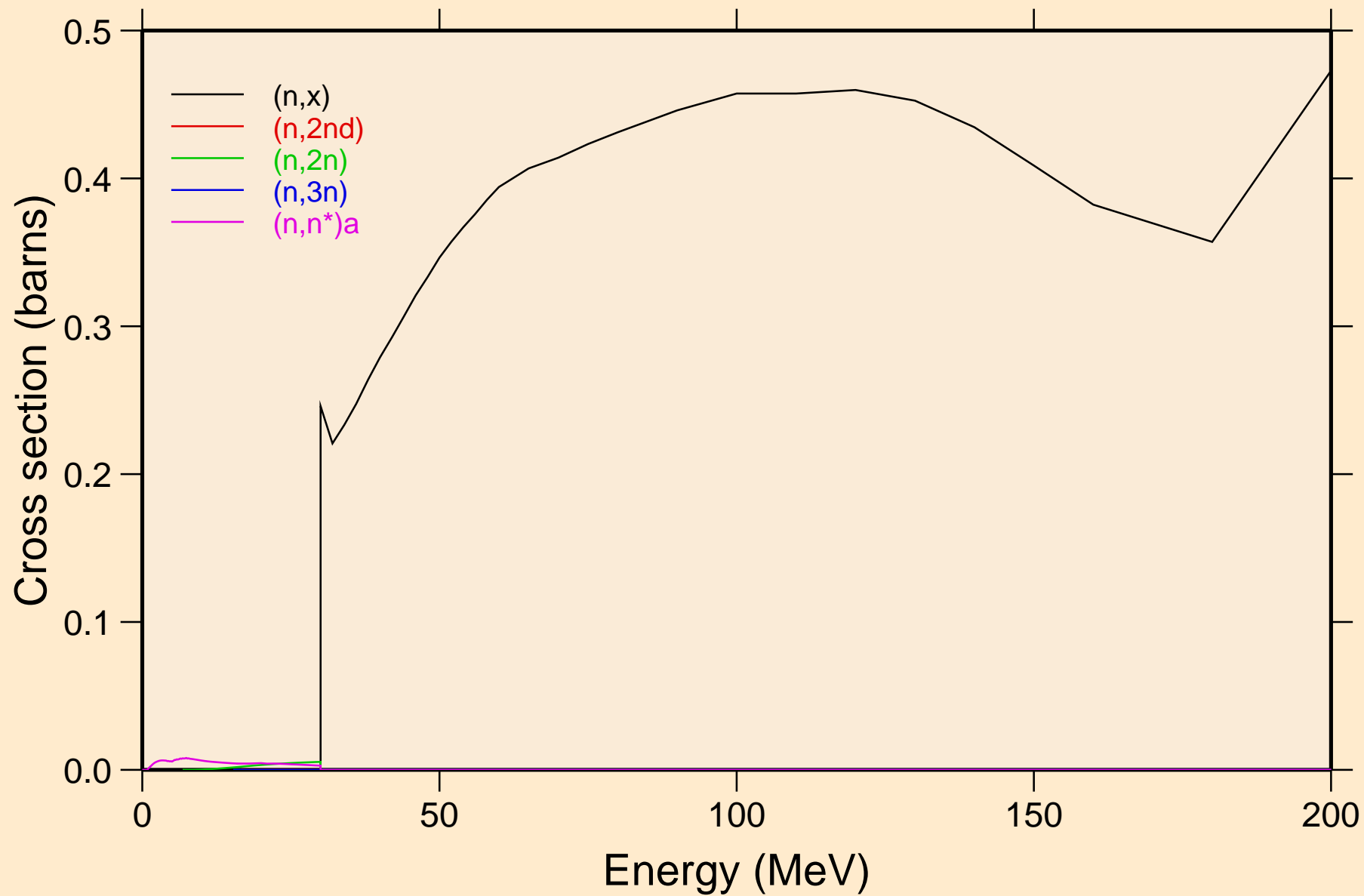

PU229 NRG TENDL-2015, AKONING

Threshold reactions

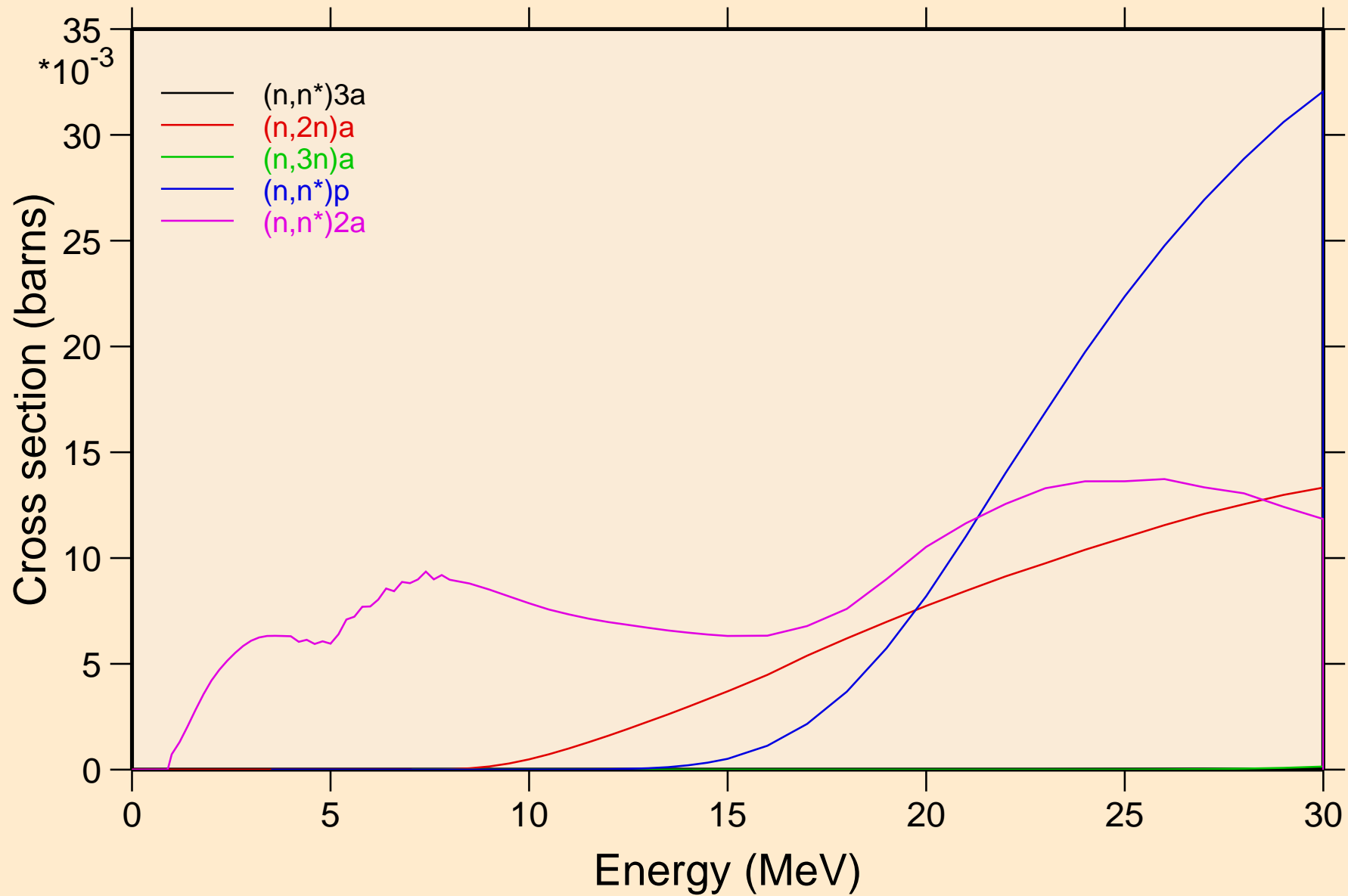

PU229 NRG TENDL-2015, AKONING

Threshold reactions

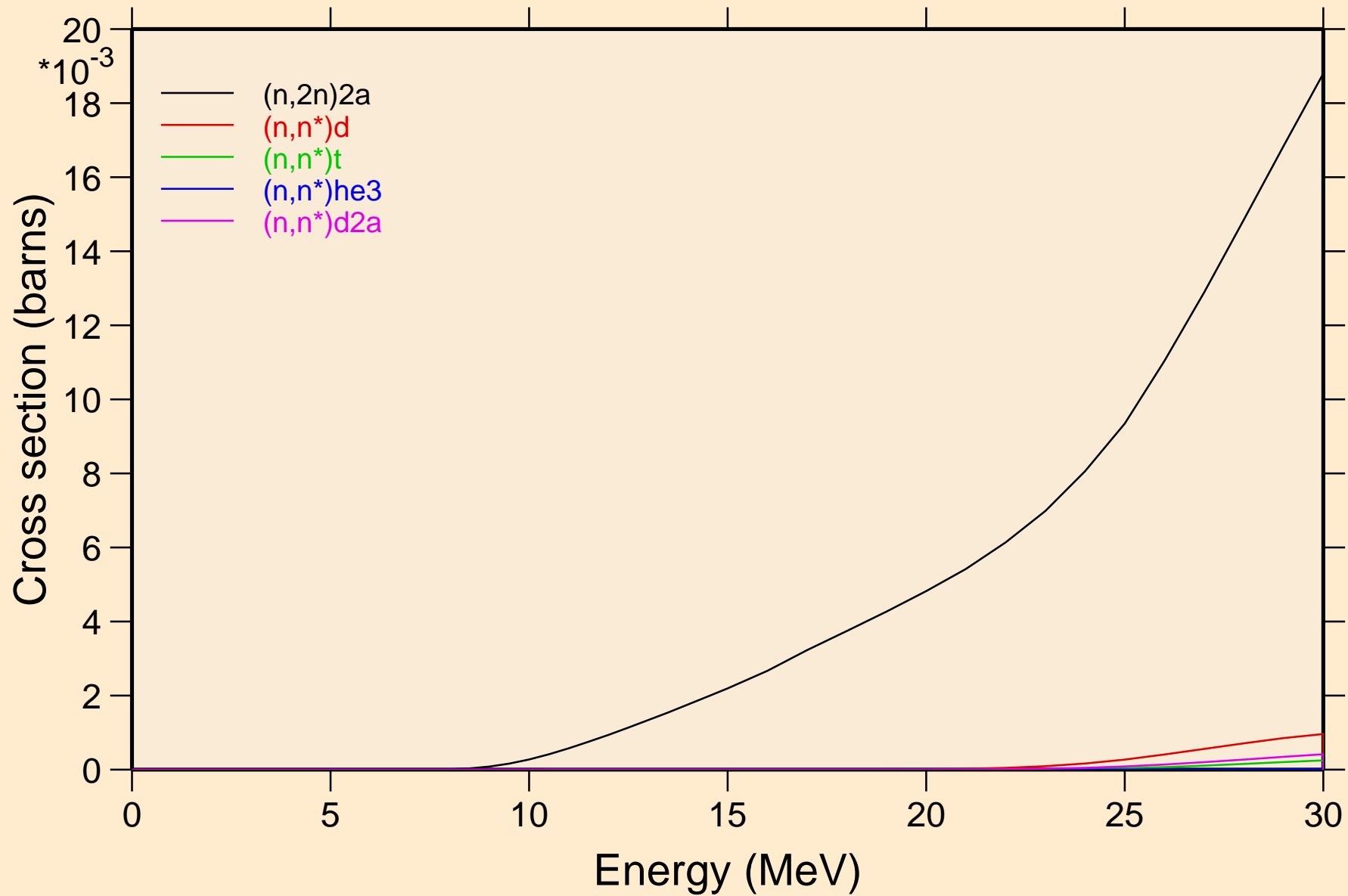

PU229 NRG TENDL-2015, AKONING

Threshold reactions

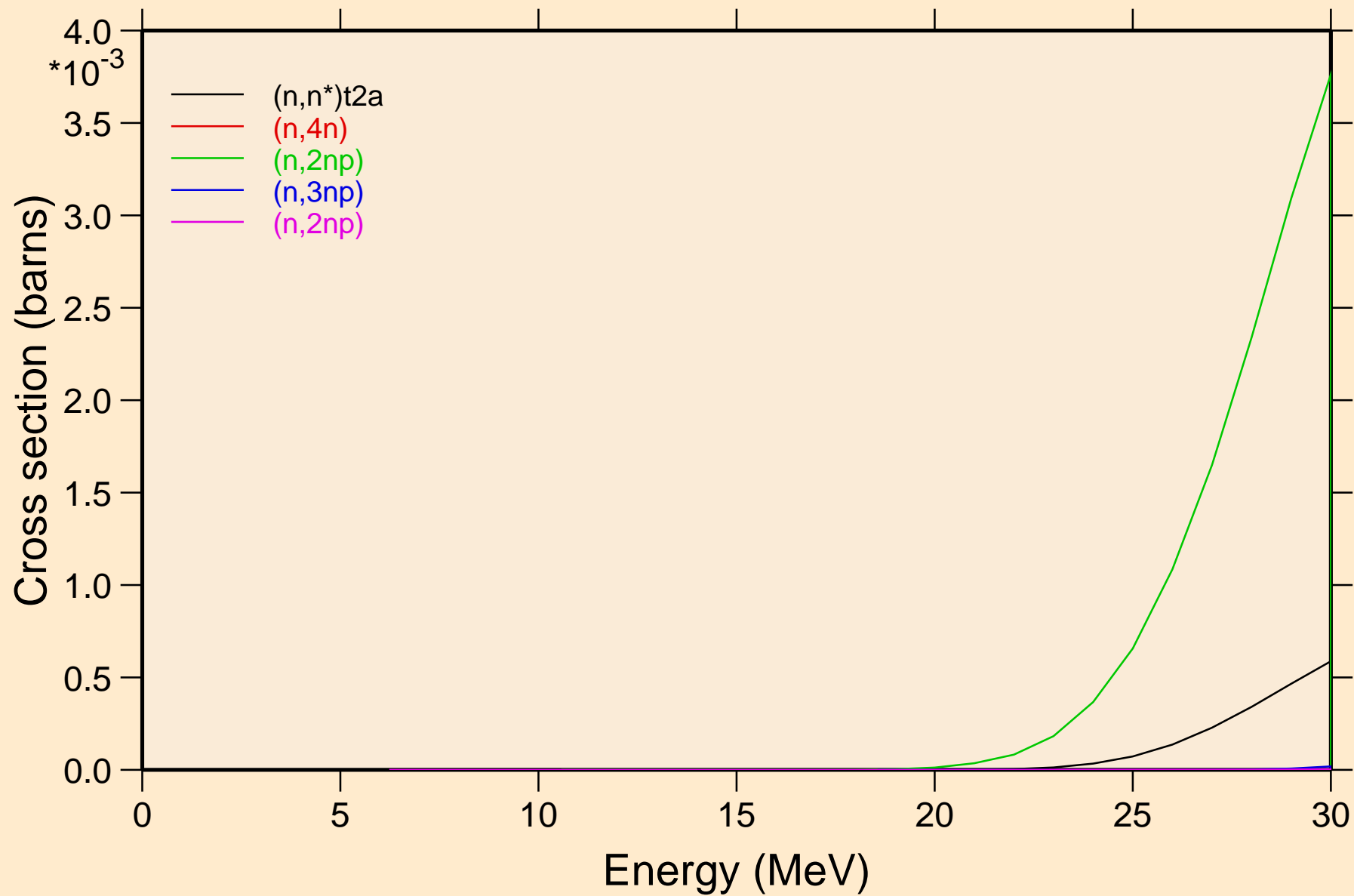

PU229 NRG TENDL-2015, AKONING

Threshold reactions

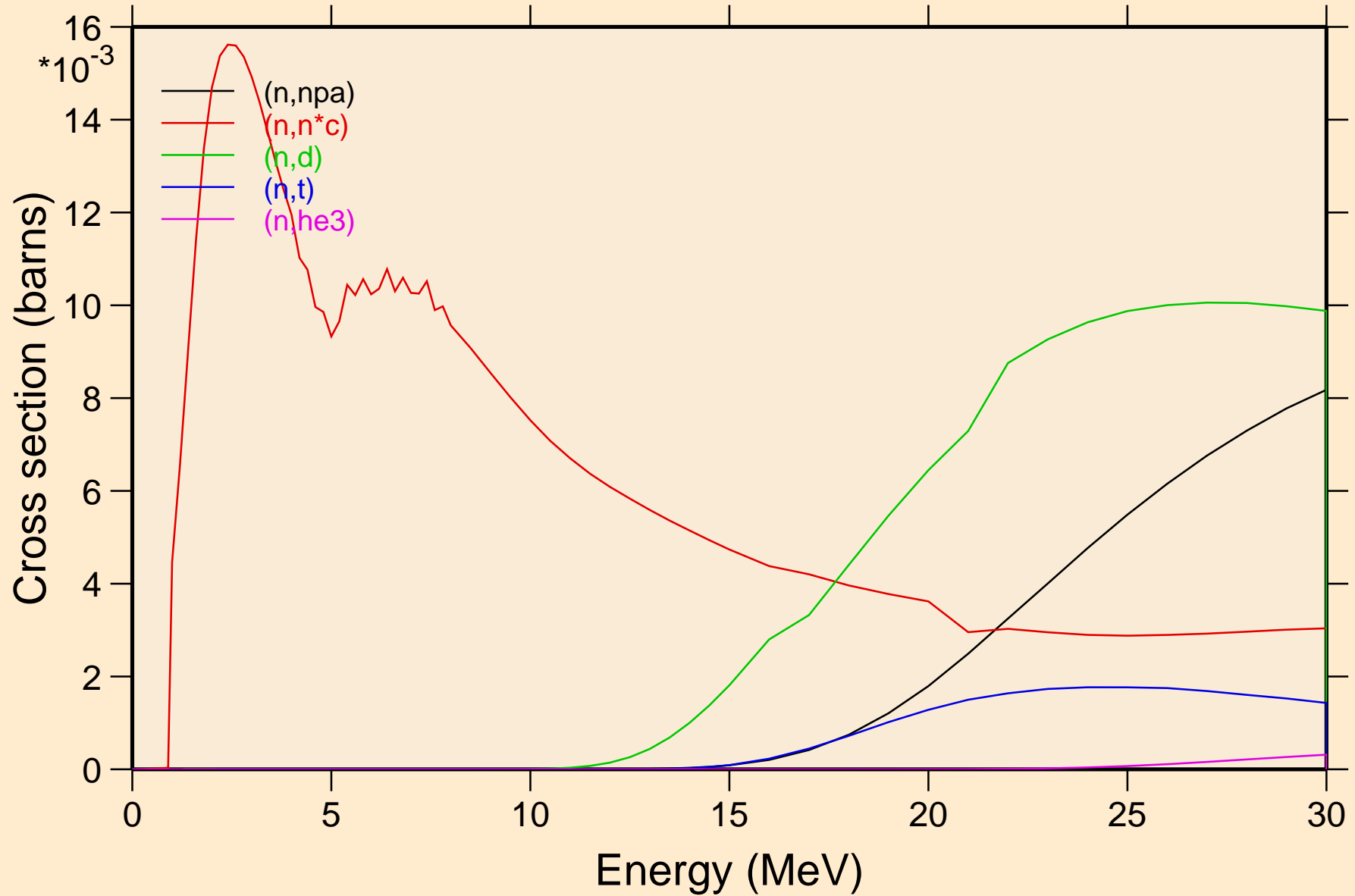

PU229 NRG TENDL-2015, AKONING

Threshold reactions

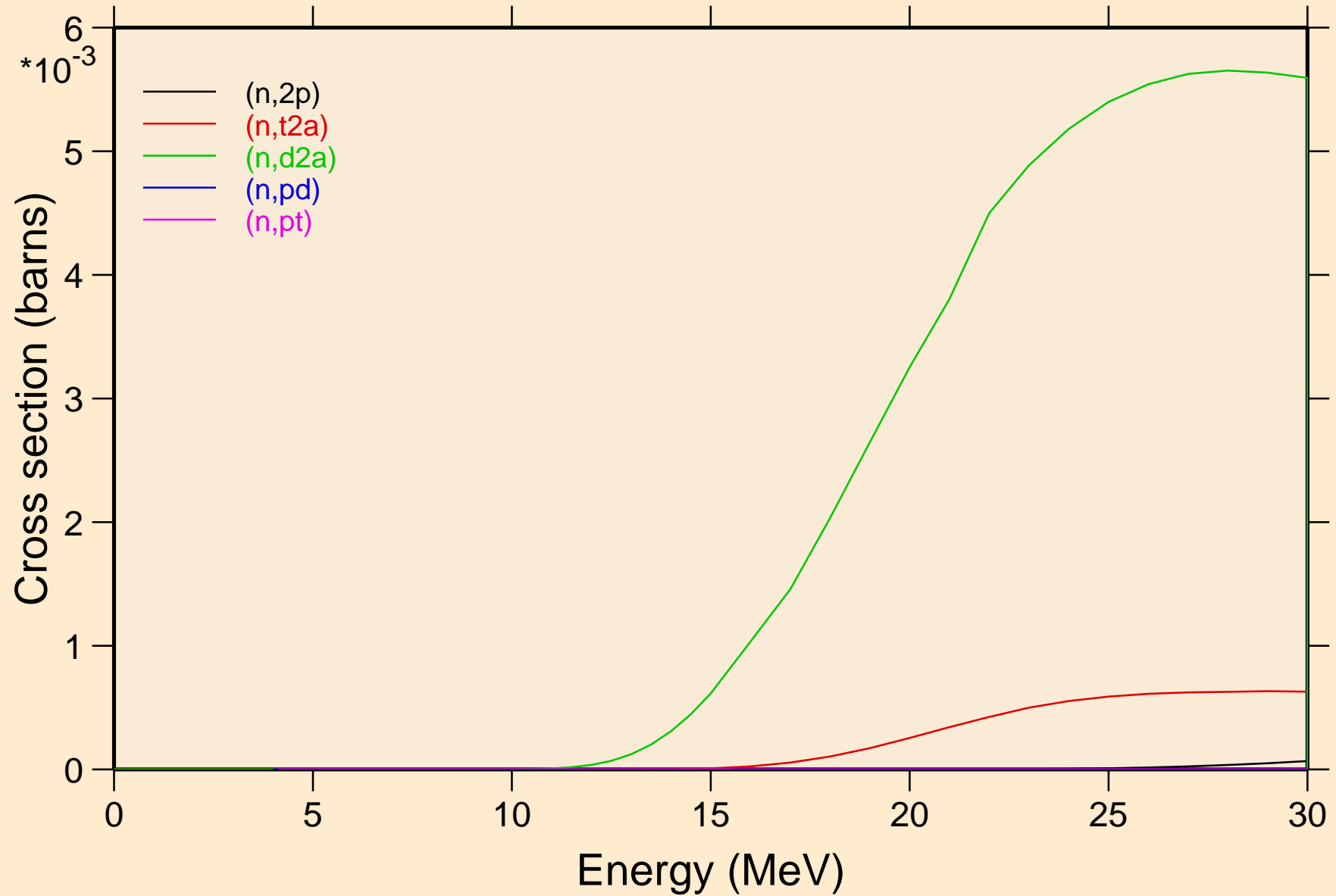

PU229 NRG TENDL-2015, AKONING
Threshold reactions

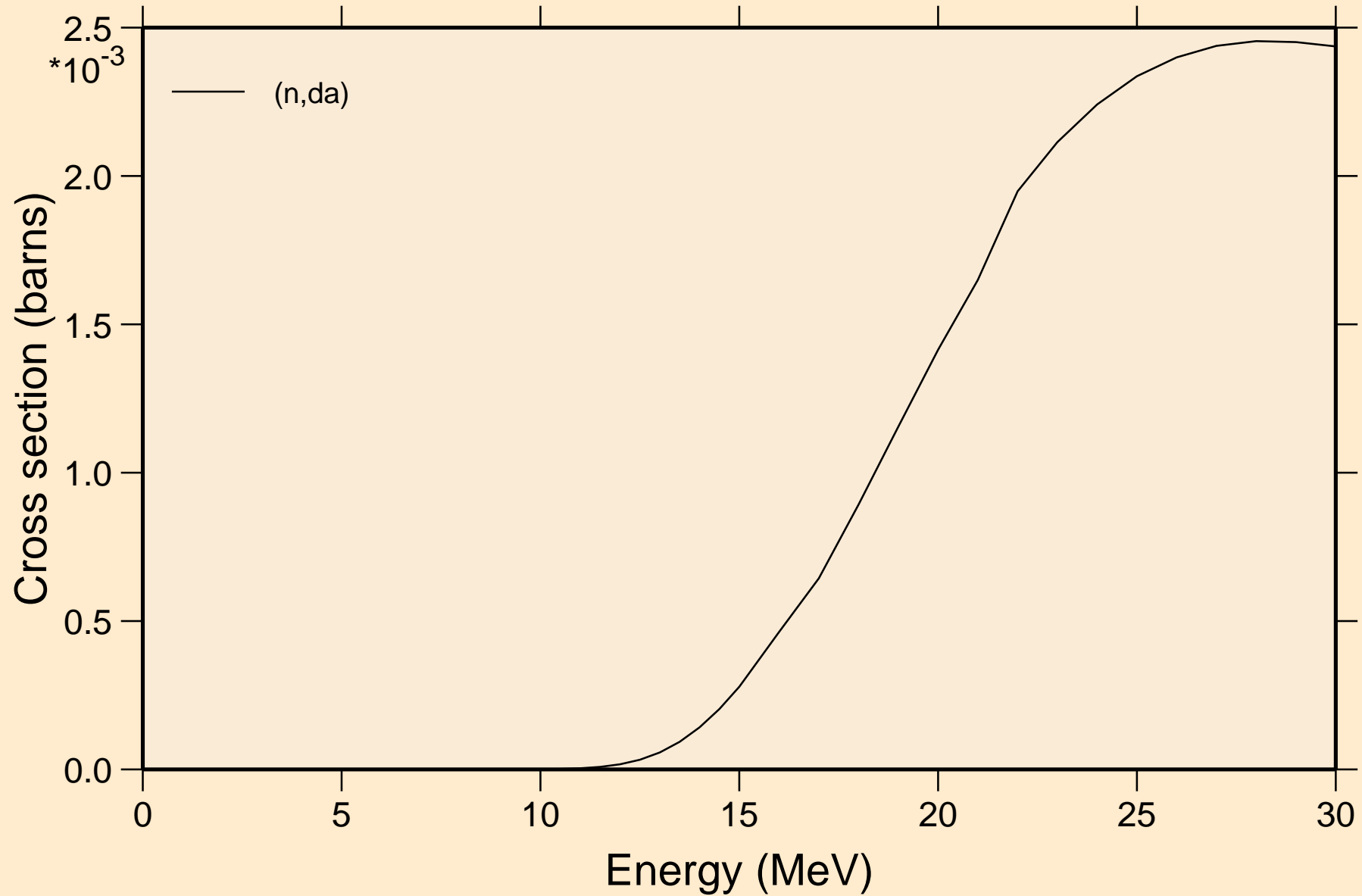

PU229 NRG TENDL-2015, AKONING
angular distribution for elastic

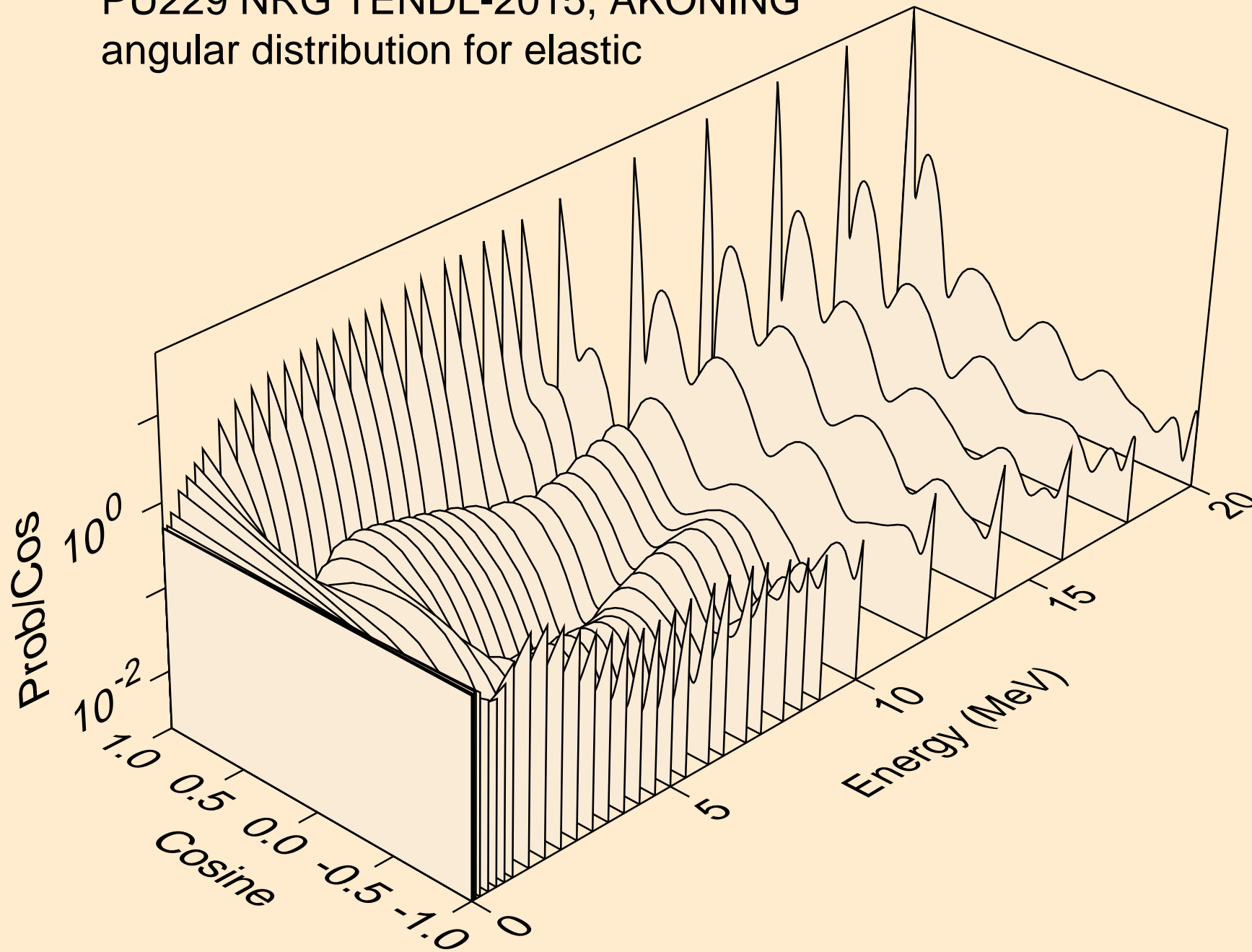

PU229 NRG TENDL-2015, AKONING
angular distribution for elastic

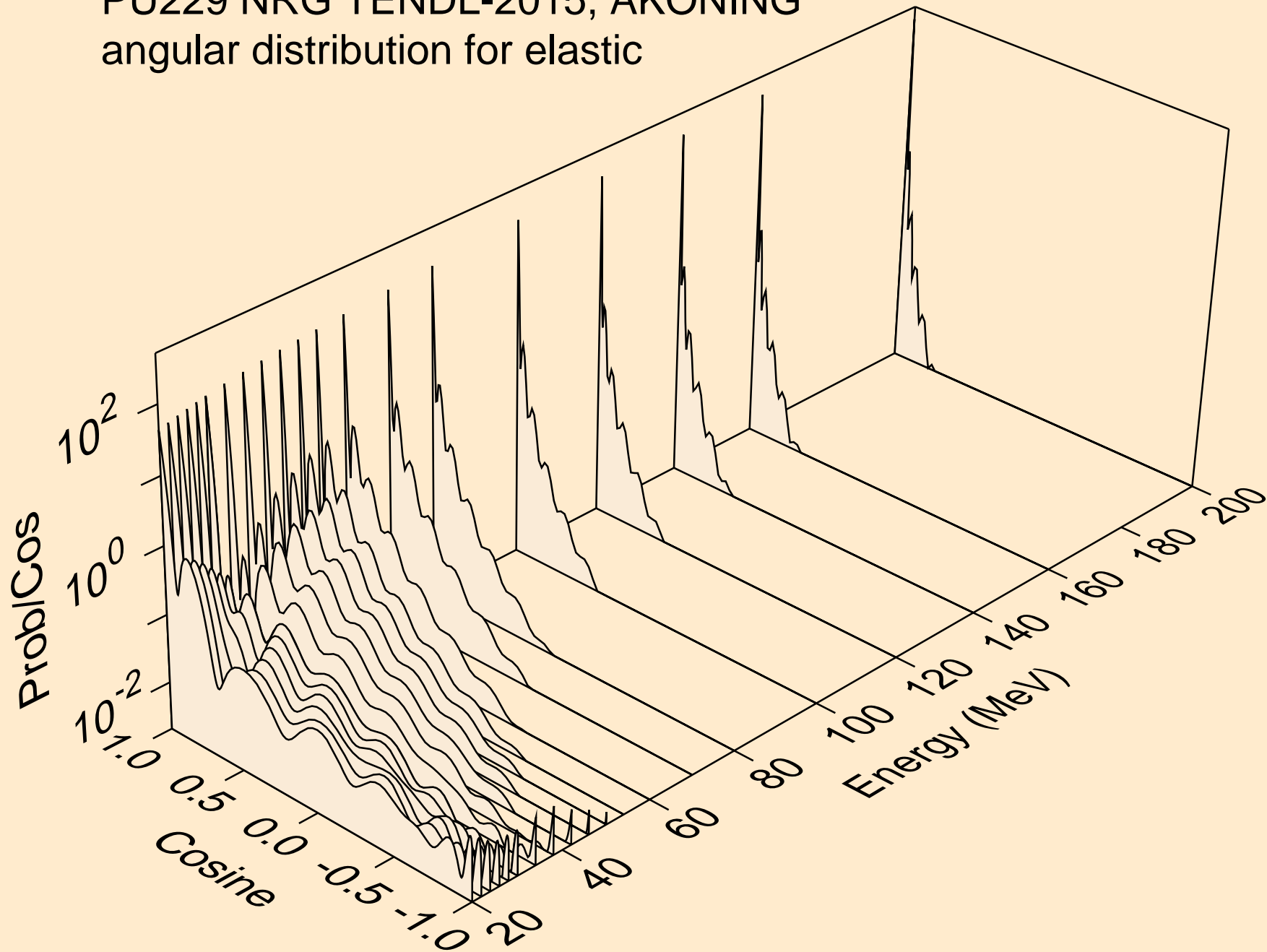

PU229 NRG TENDL-2015, AKONING
angular distribution for (n,n*1)

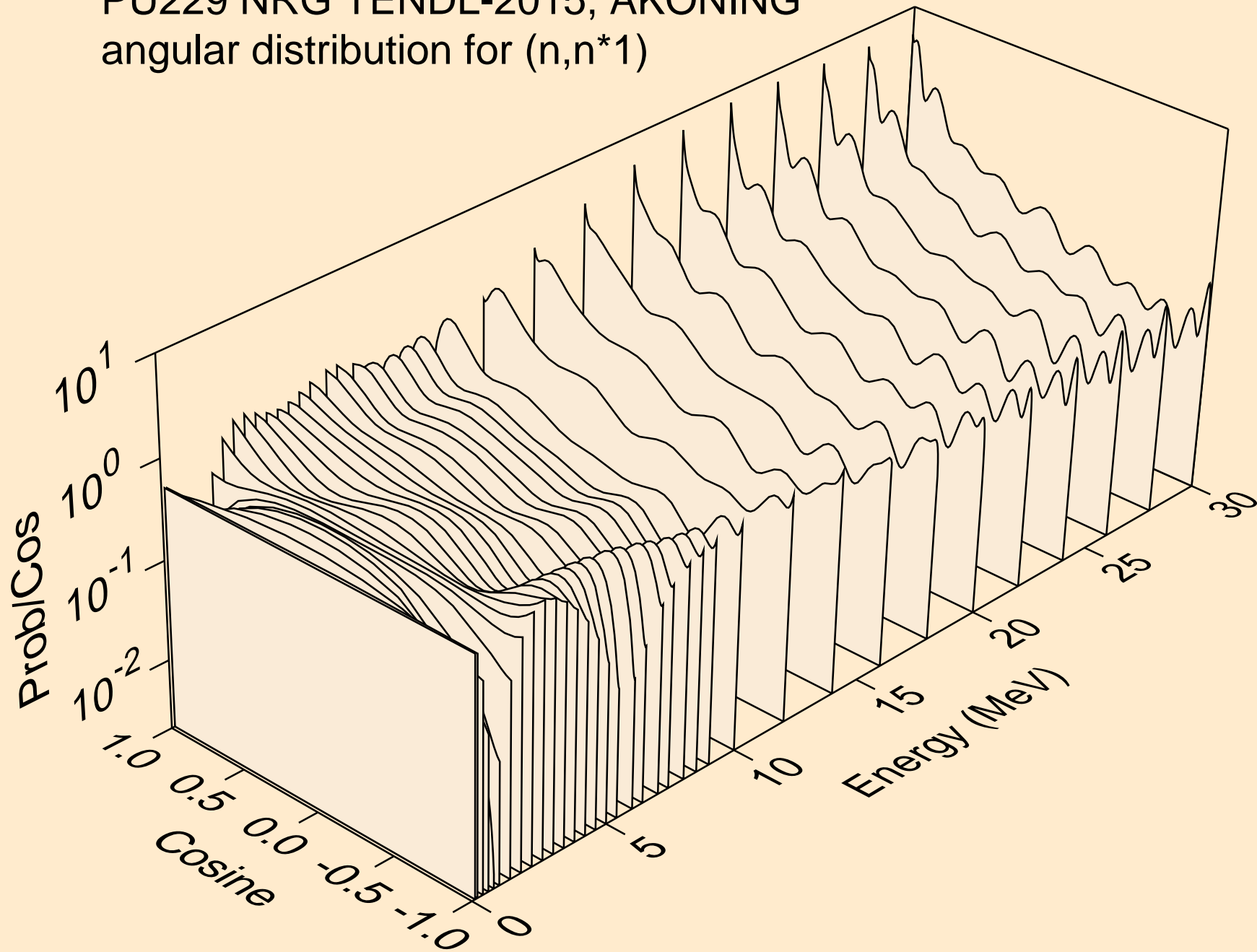

PU229 NRG TENDL-2015, AKONING

Total fission nubar

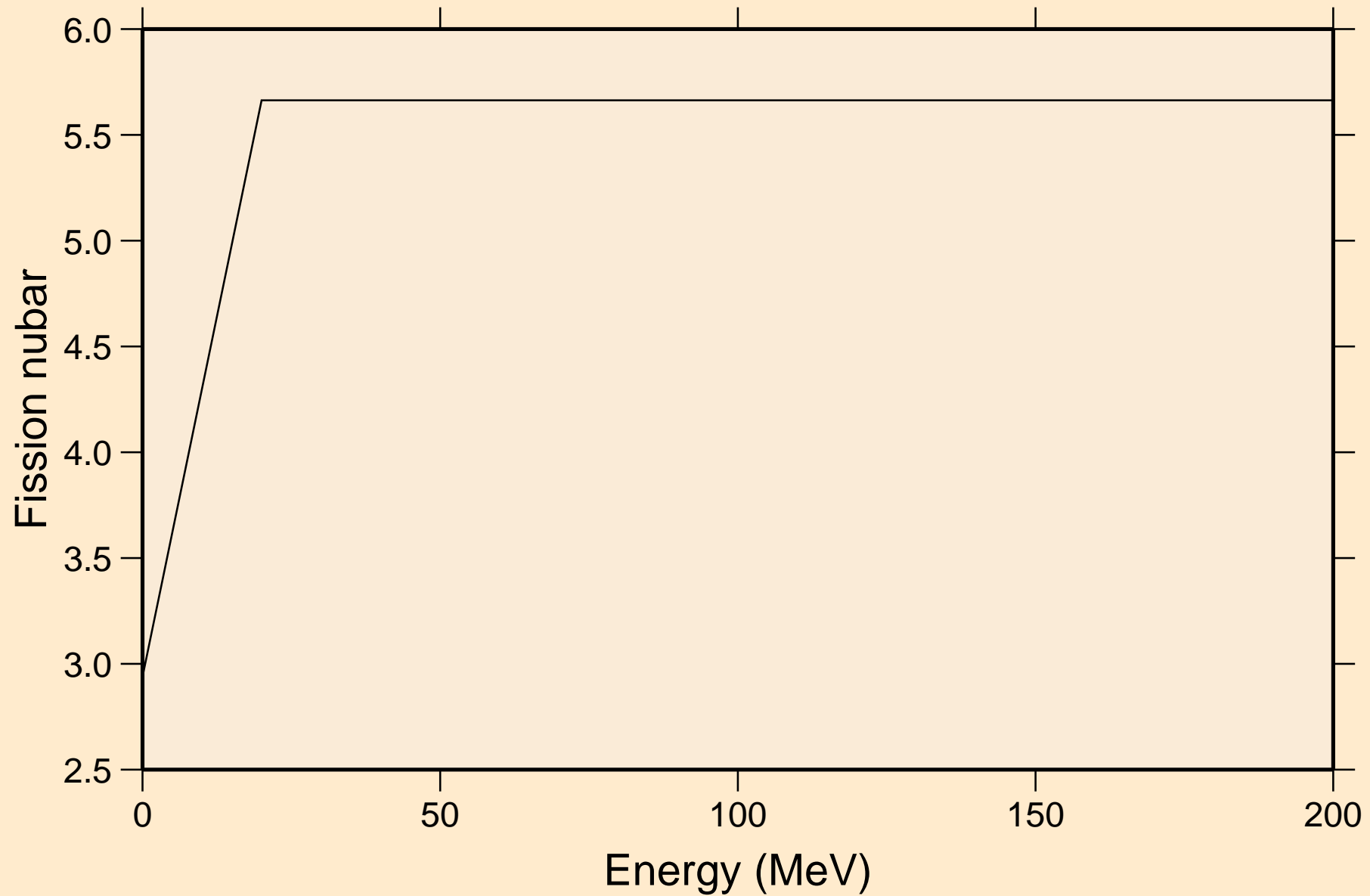

PU229 NRG TENDL-2015, AKONING
Neutron emission for (n,x)

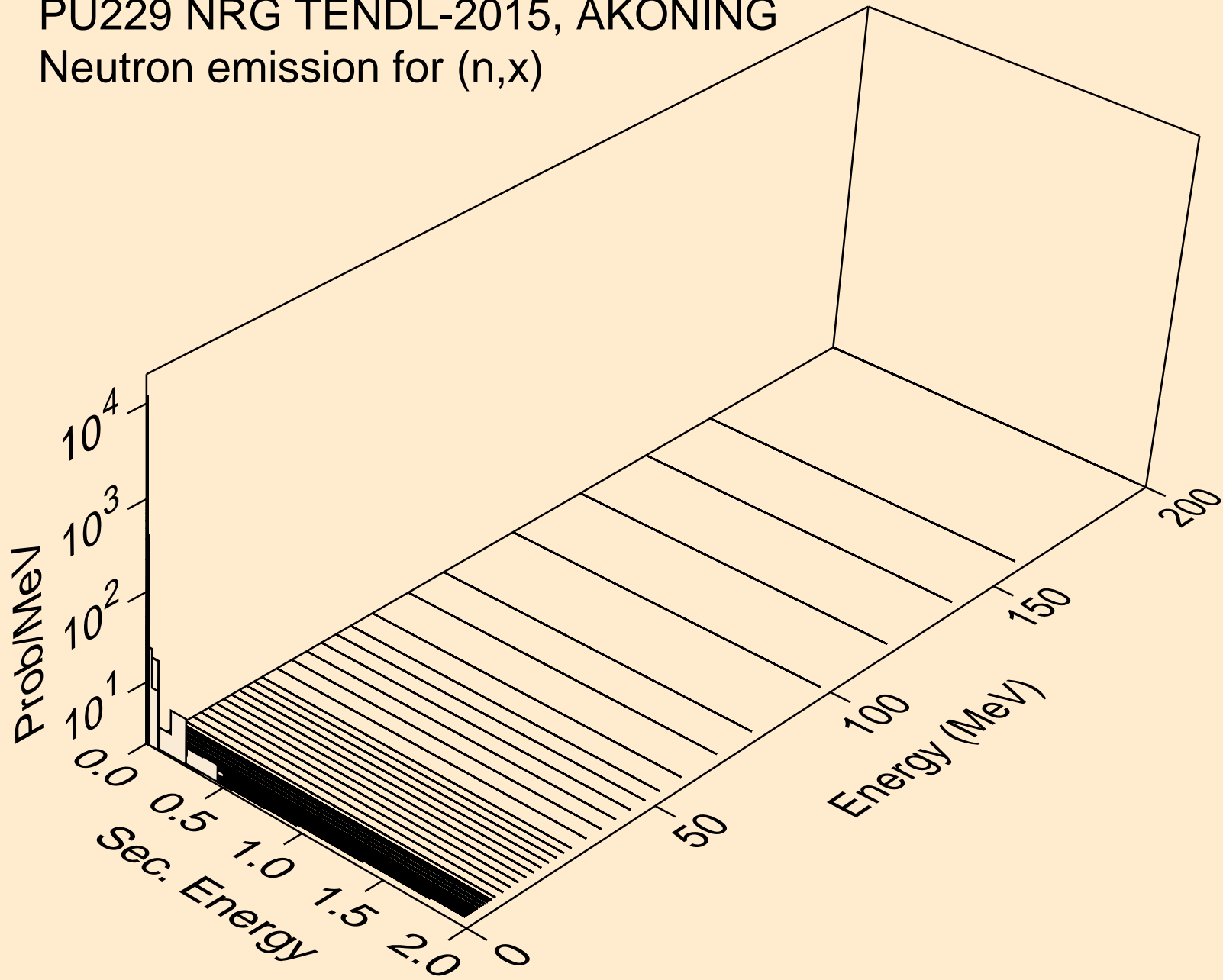

PU229 NRG TENDL-2015, AKONING
Neutron emission for (n,2nd)

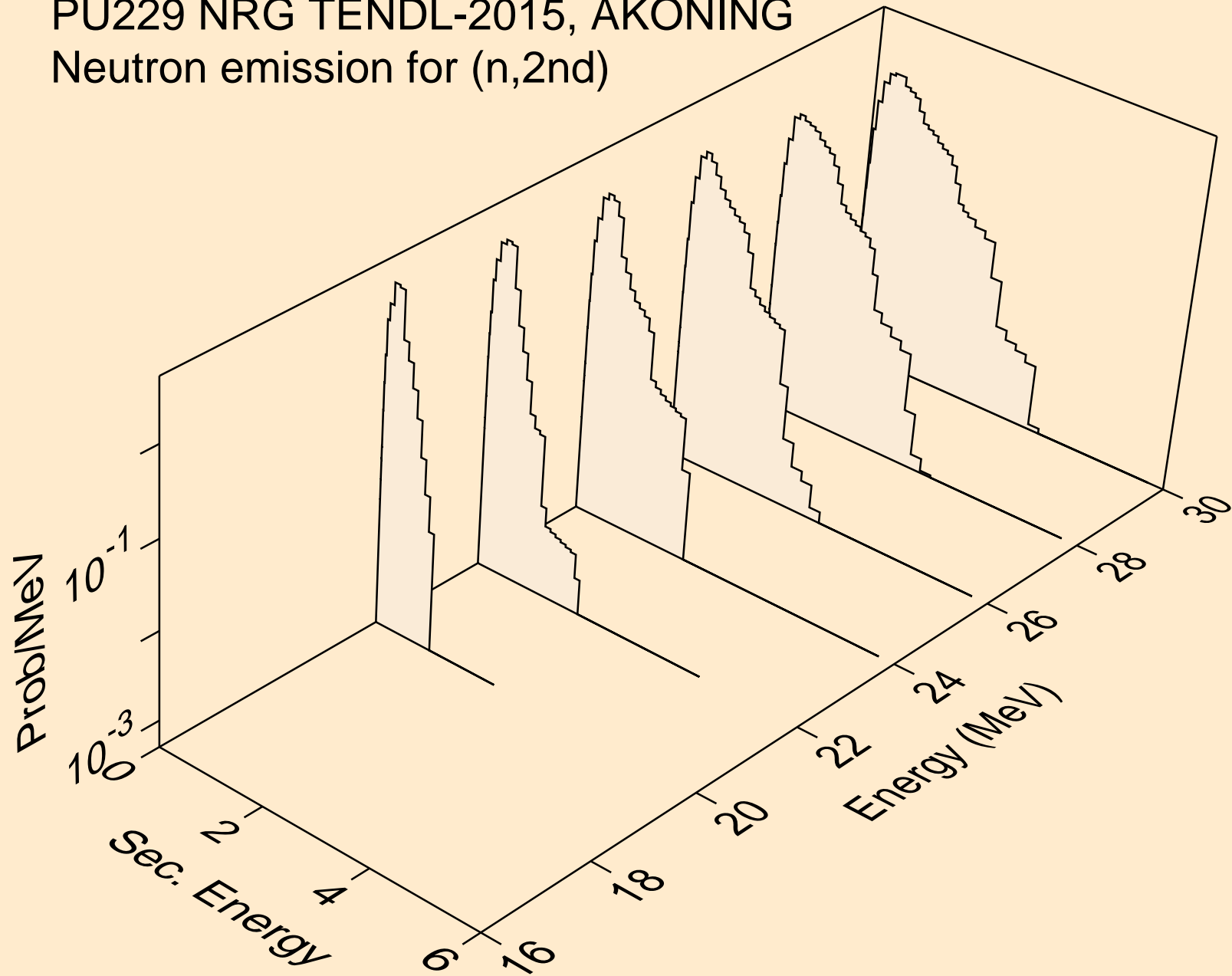

PU229 NRG TENDL-2015, AKONING
Neutron emission for (n,2n)

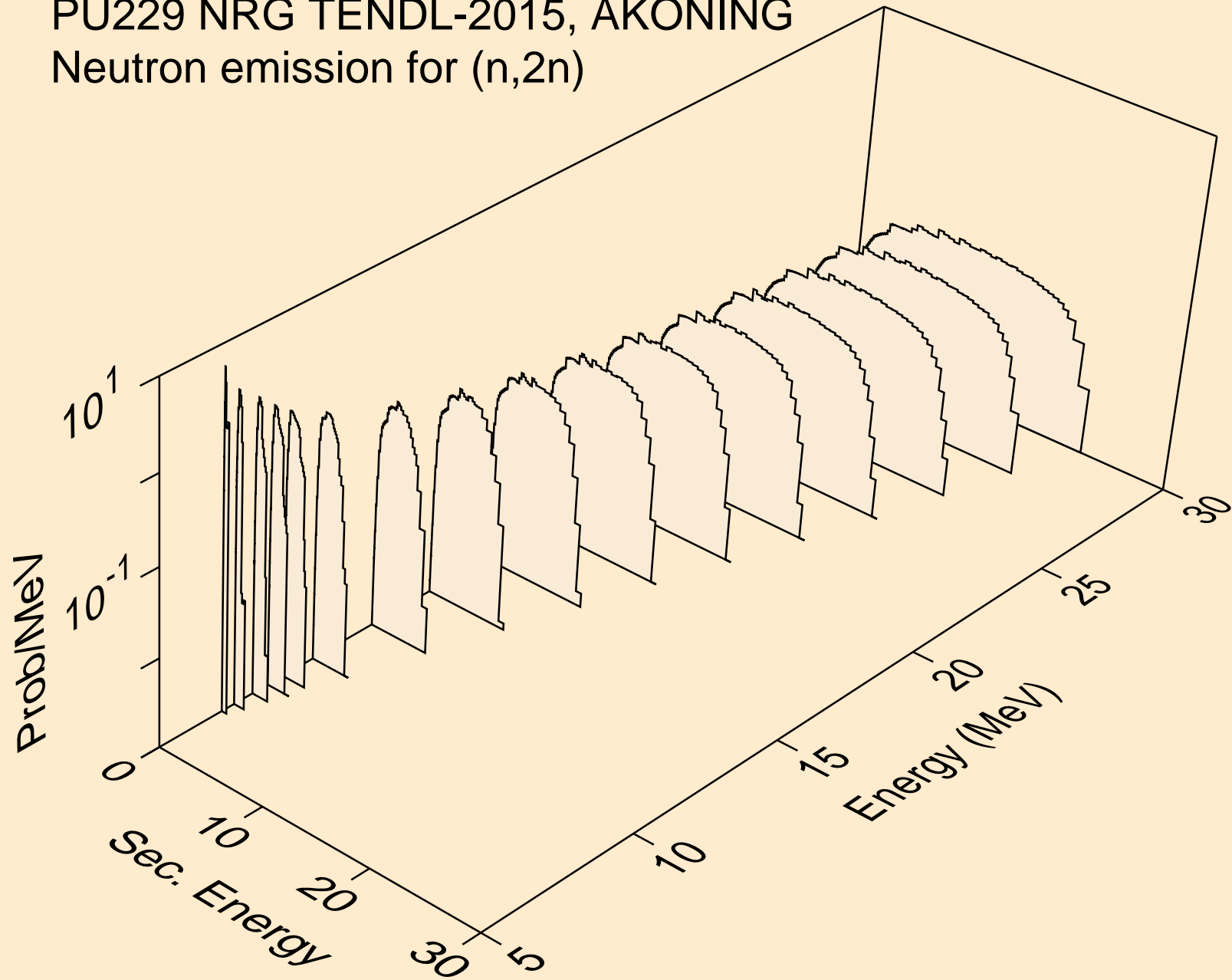

PU229 NRG TENDL-2015, AKONING
Neutron emission for (n,3n)

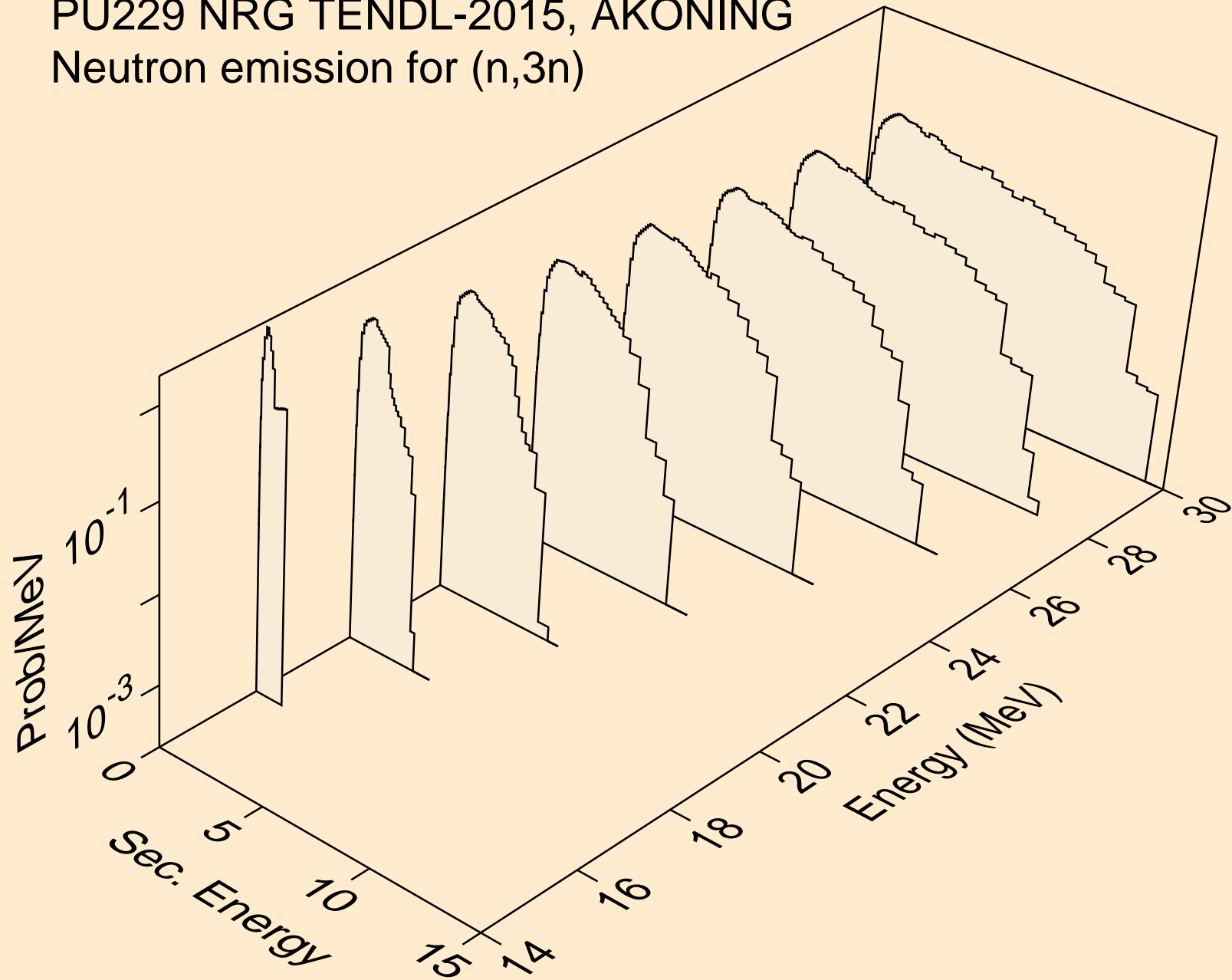

PU229 NRG TENDL-2015, AKONING
Neutron emission for fission

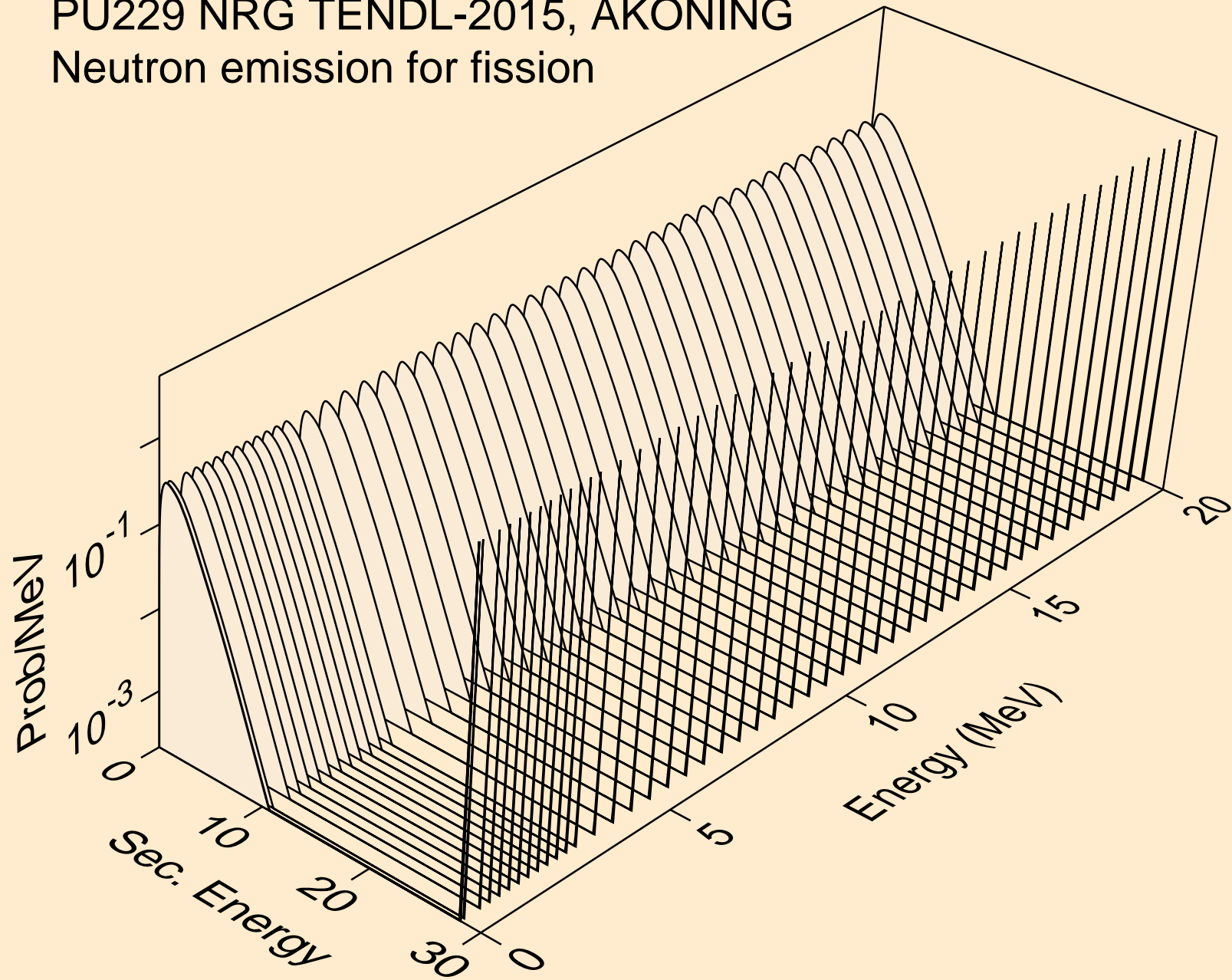

PU229 NRG TENDL-2015, AKONING
Neutron emission for (n,n*)a

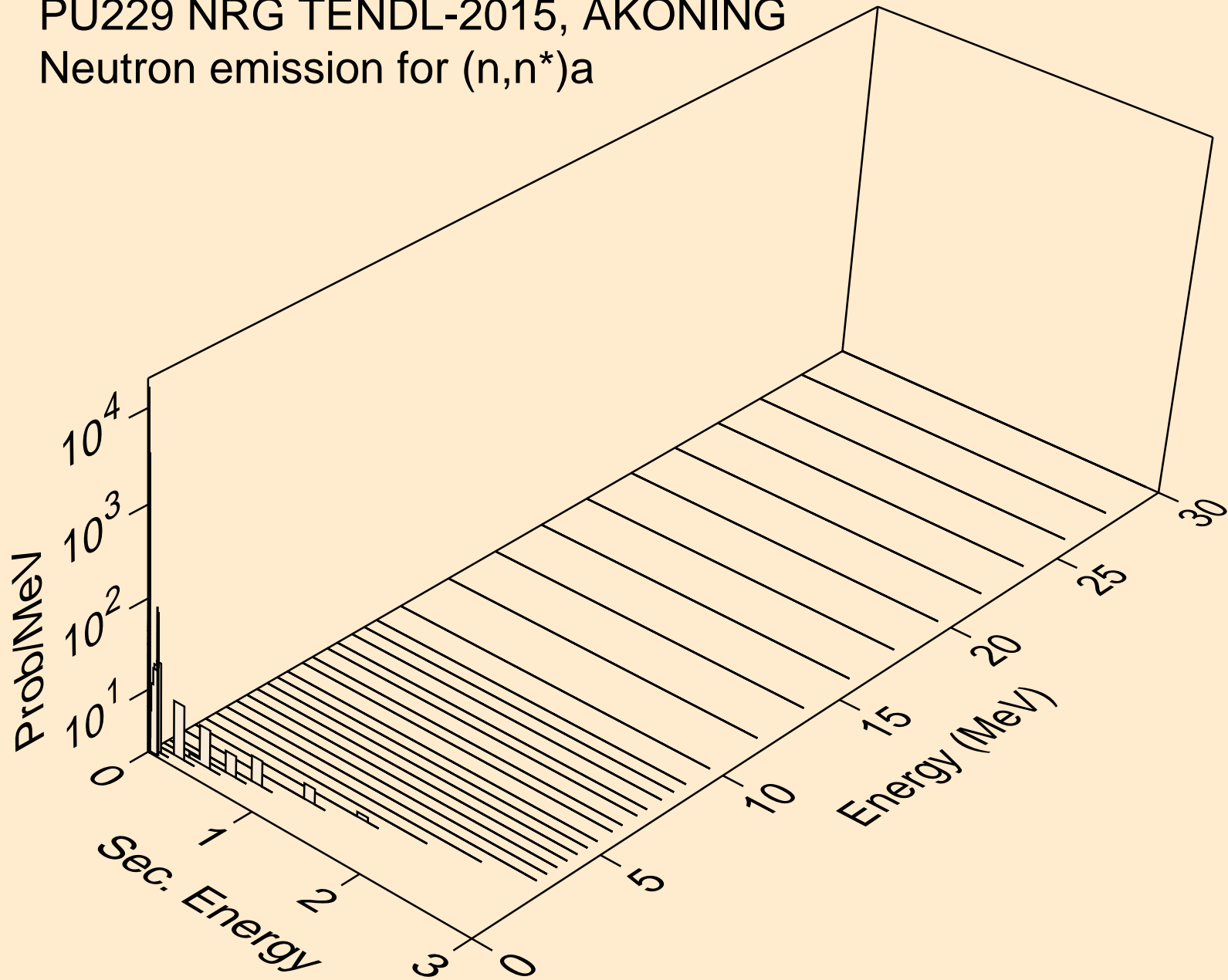

PU229 NRG TENDL-2015, AKONING
Neutron emission for (n,n*)3a

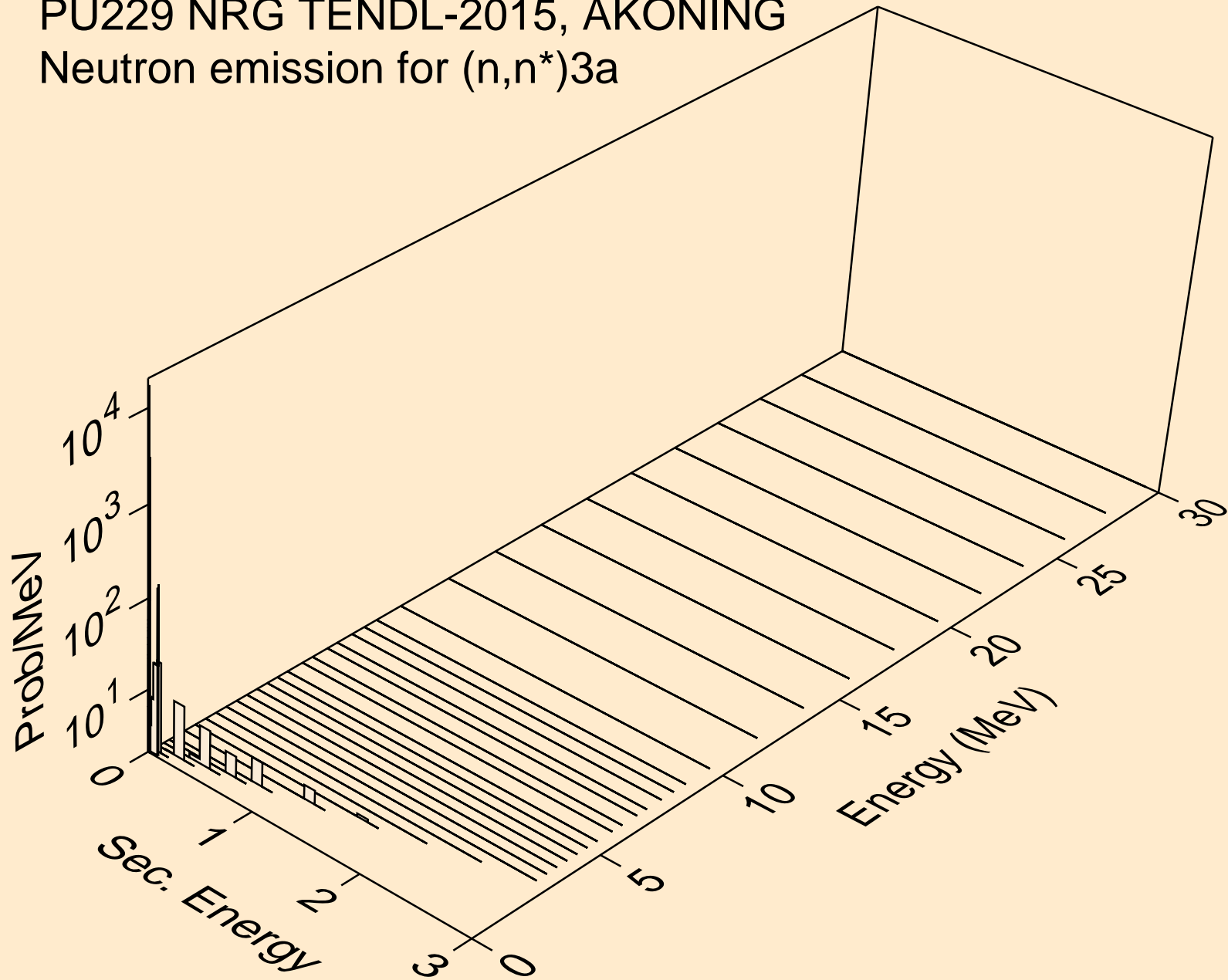

PU229 NRG TENDL-2015, AKONING
Neutron emission for (n,2n)a

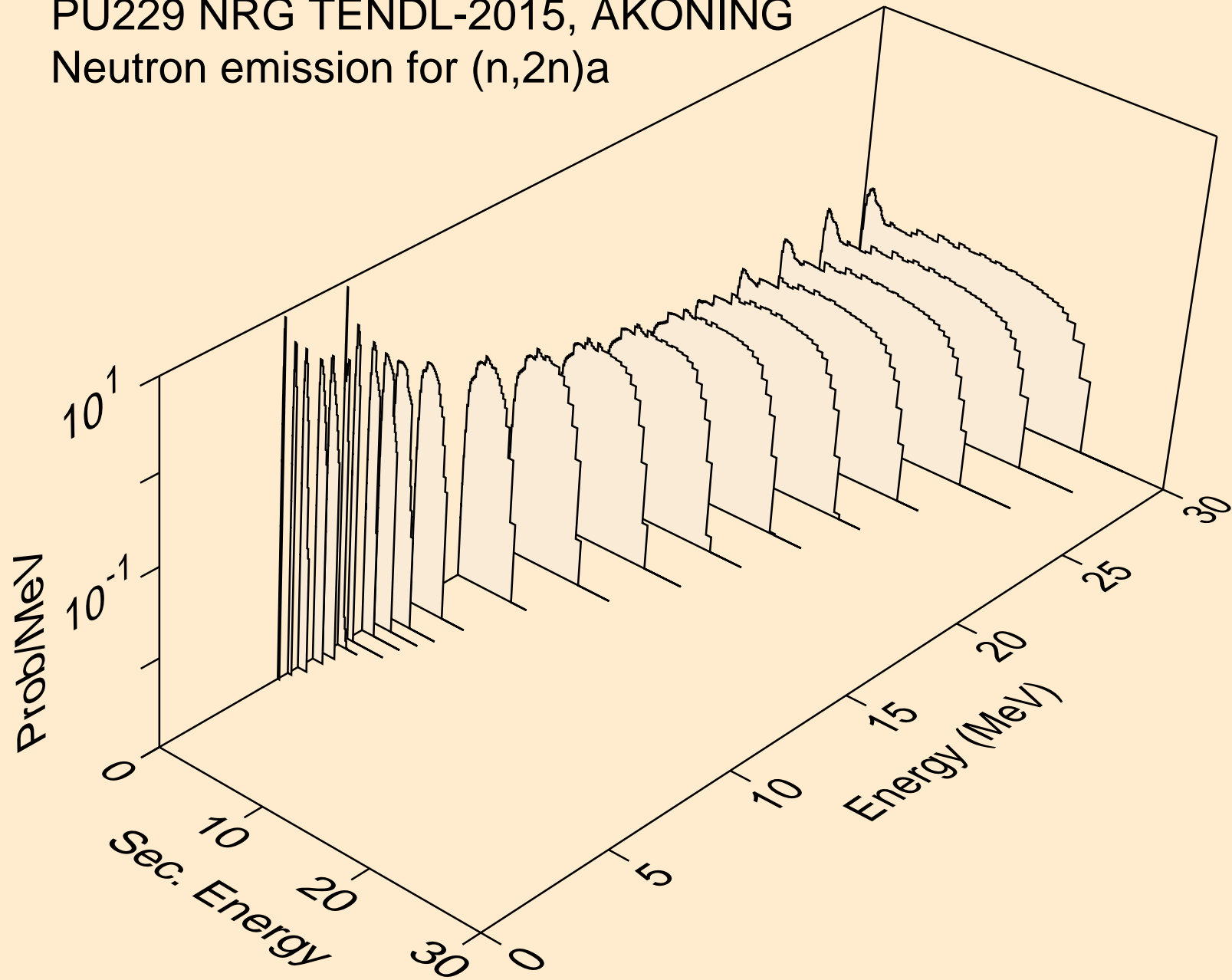

PU229 NRG TENDL-2015, AKONING
Neutron emission for (n,3n)a

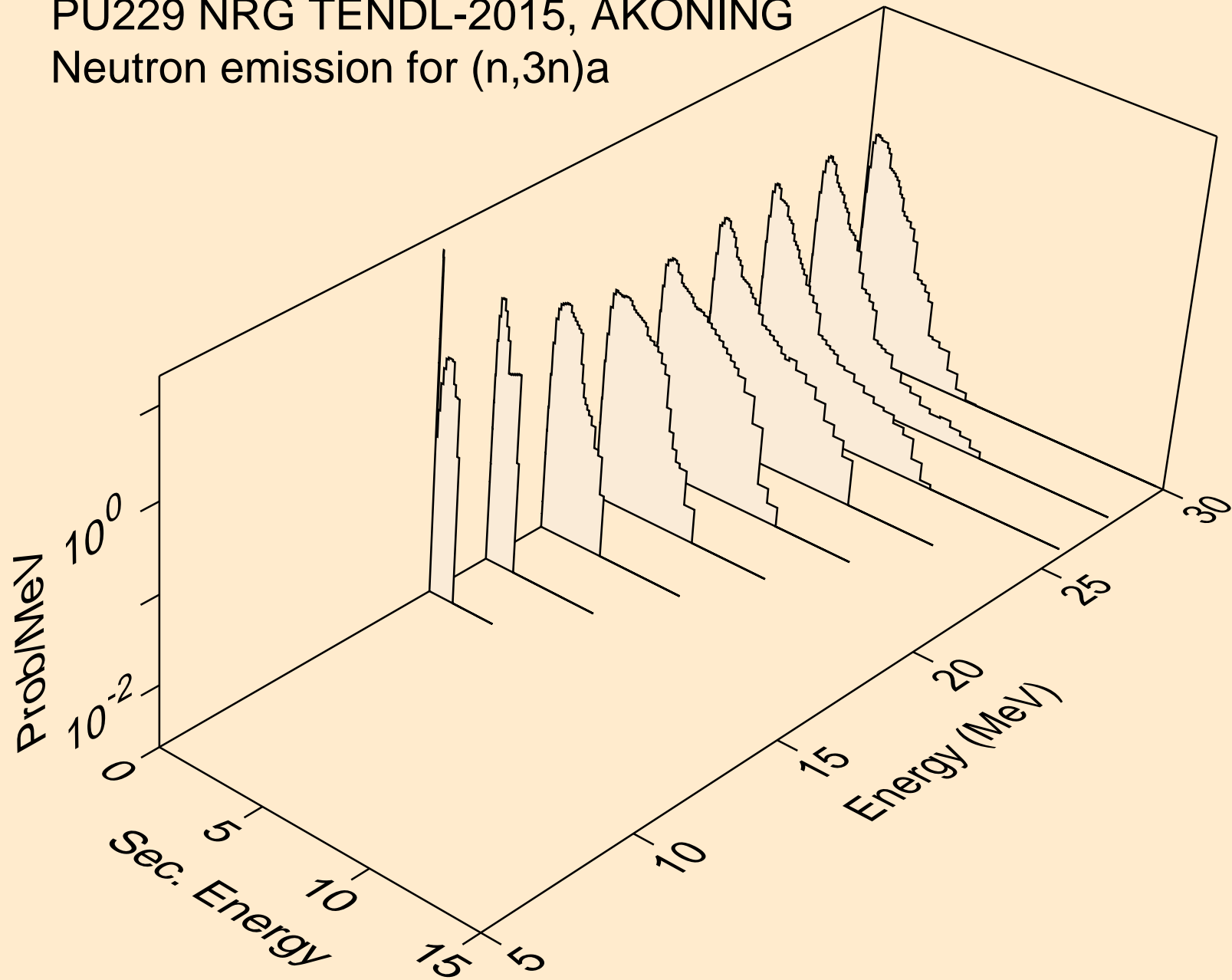

PU229 NRG TENDL-2015, AKONING
Neutron emission for (n,n*)p

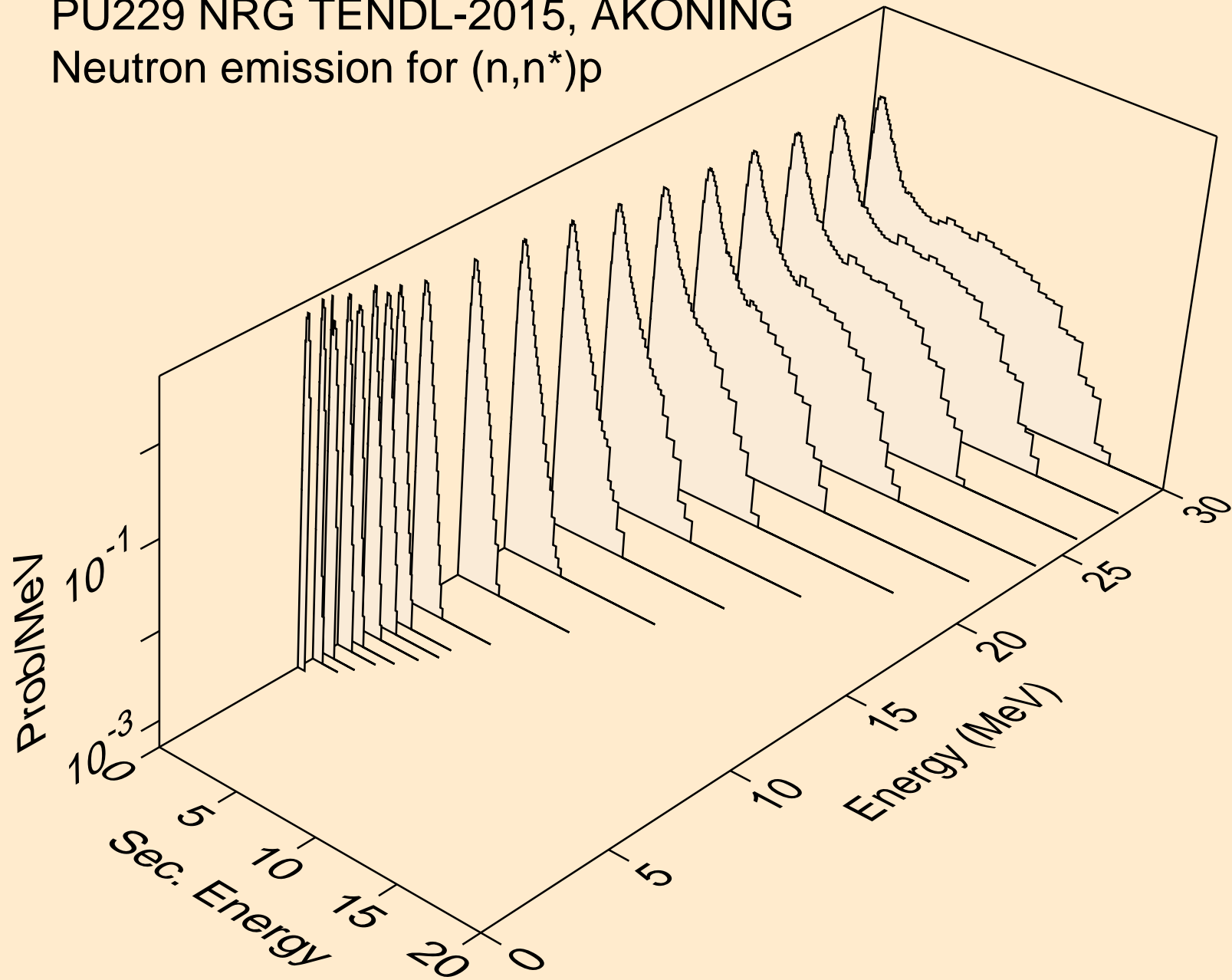

PU229 NRG TENDL-2015, AKONING
Neutron emission for (n,n*)2a

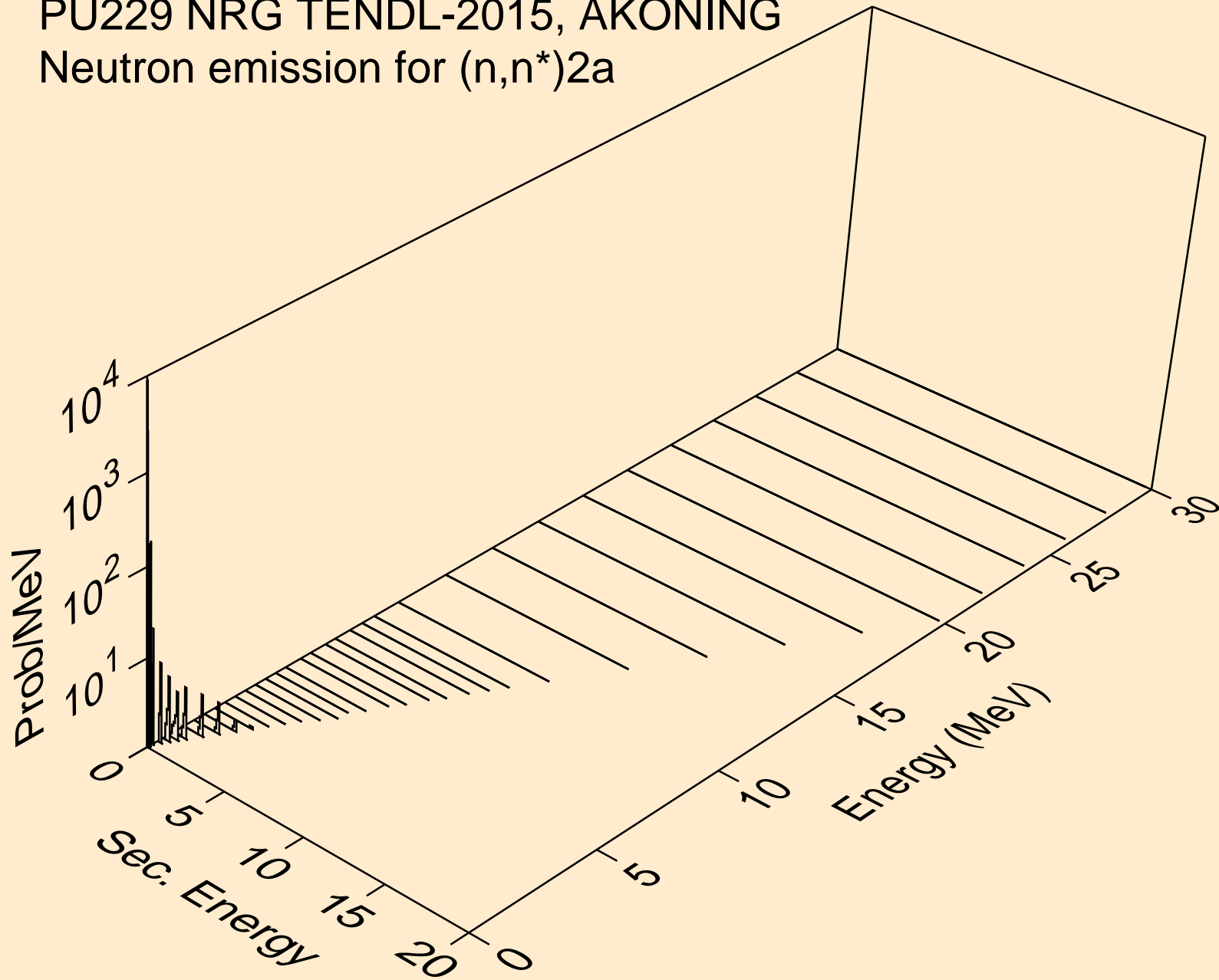

PU229 NRG TENDL-2015, AKONING
Neutron emission for (n,2n)2a

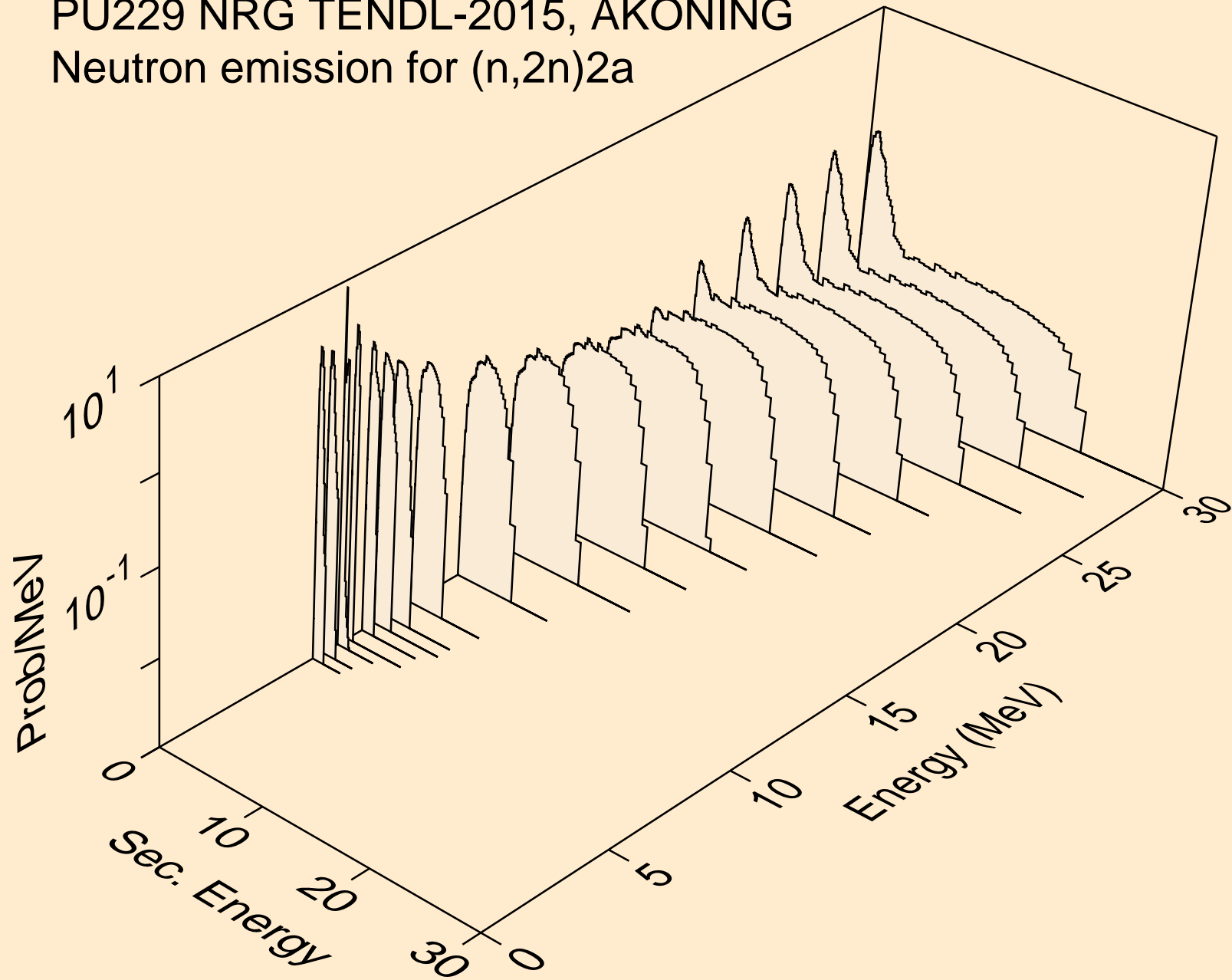

PU229 NRG TENDL-2015, AKONING
Neutron emission for (n,n*)d

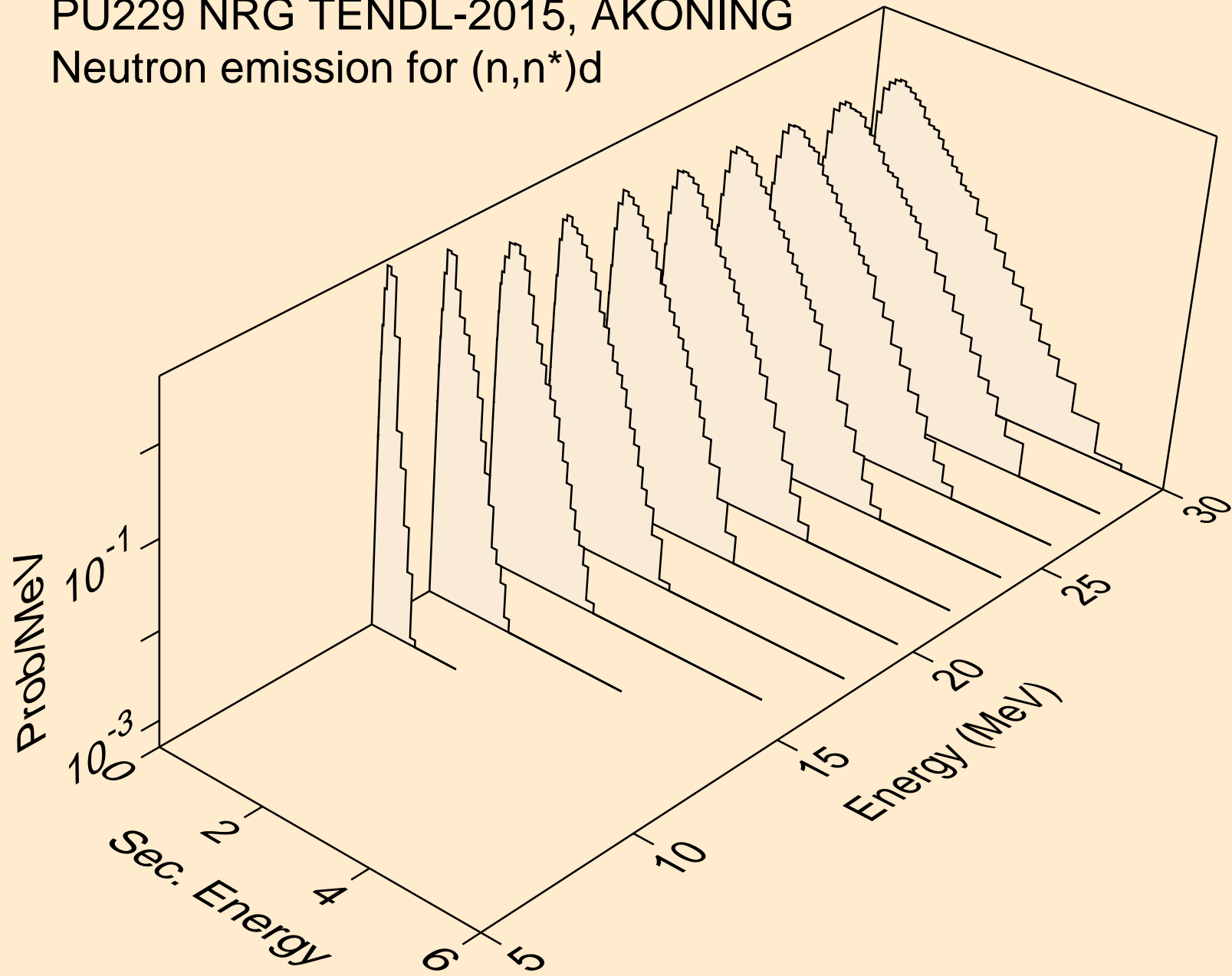

PU229 NRG TENDL-2015, AKONING
Neutron emission for (n,n*)t

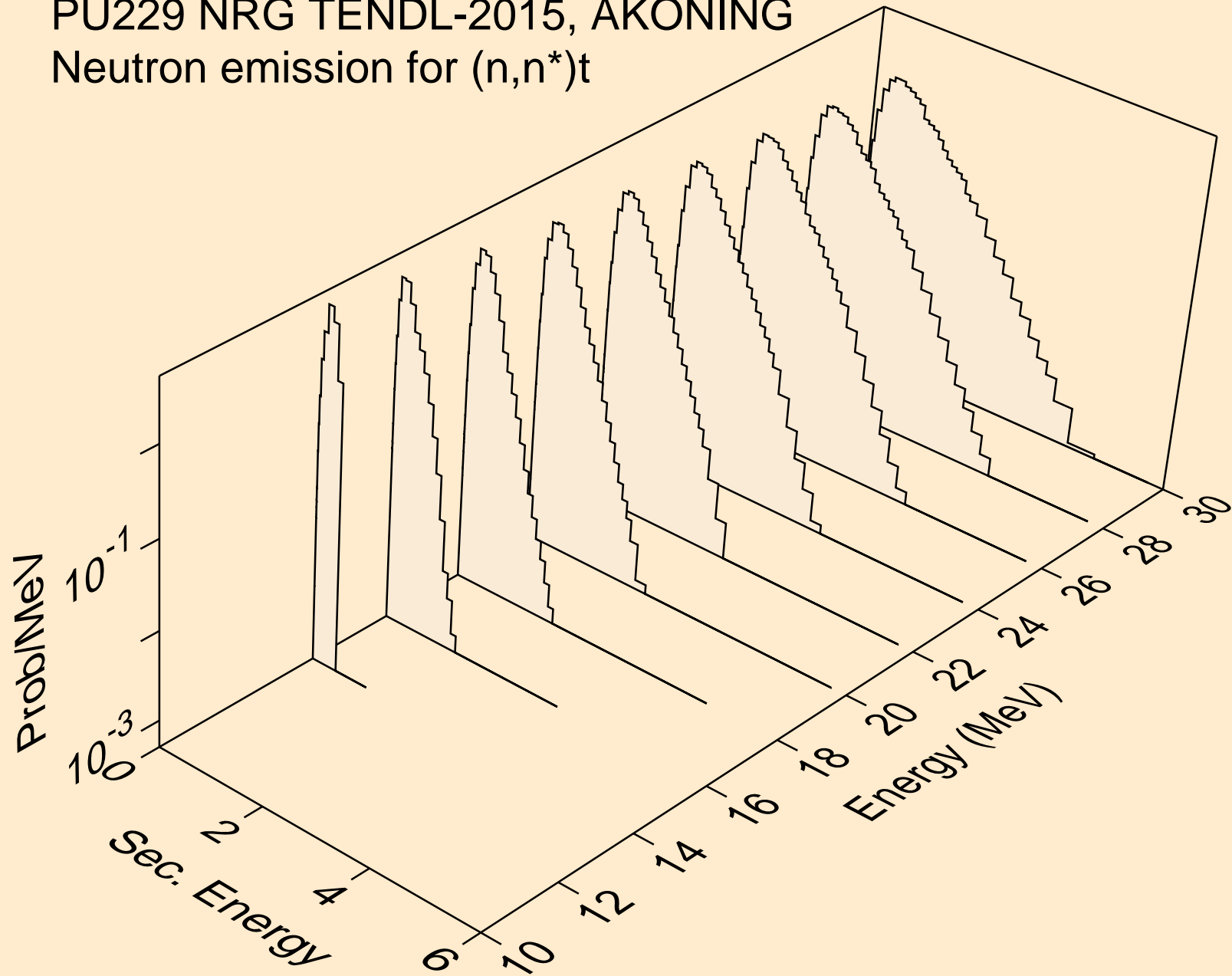

PU229 NRG TENDL-2015, AKONING
Neutron emission for (n,n*)he3

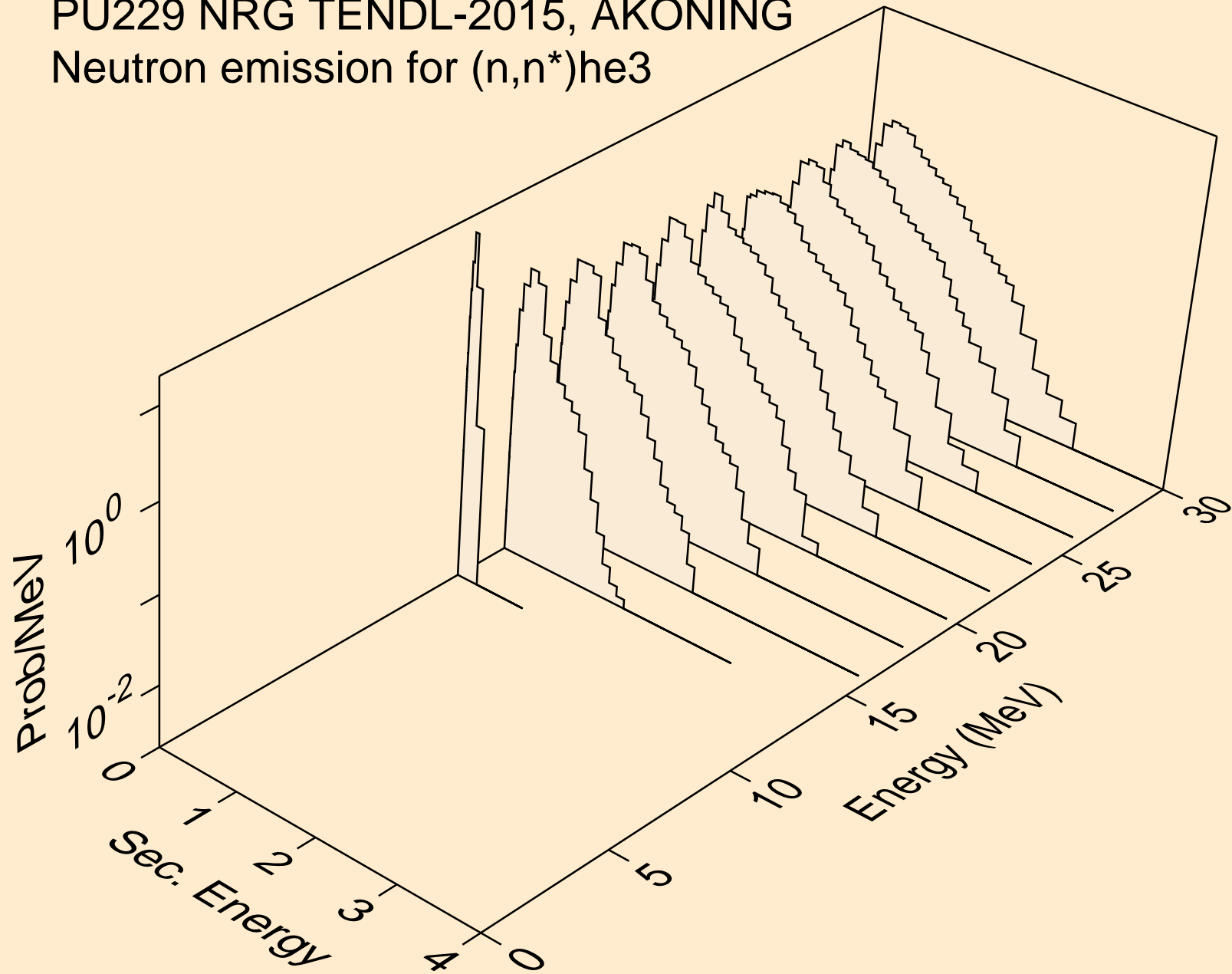

PU229 NRG TENDL-2015, AKONING
Neutron emission for (n,n*)d2a

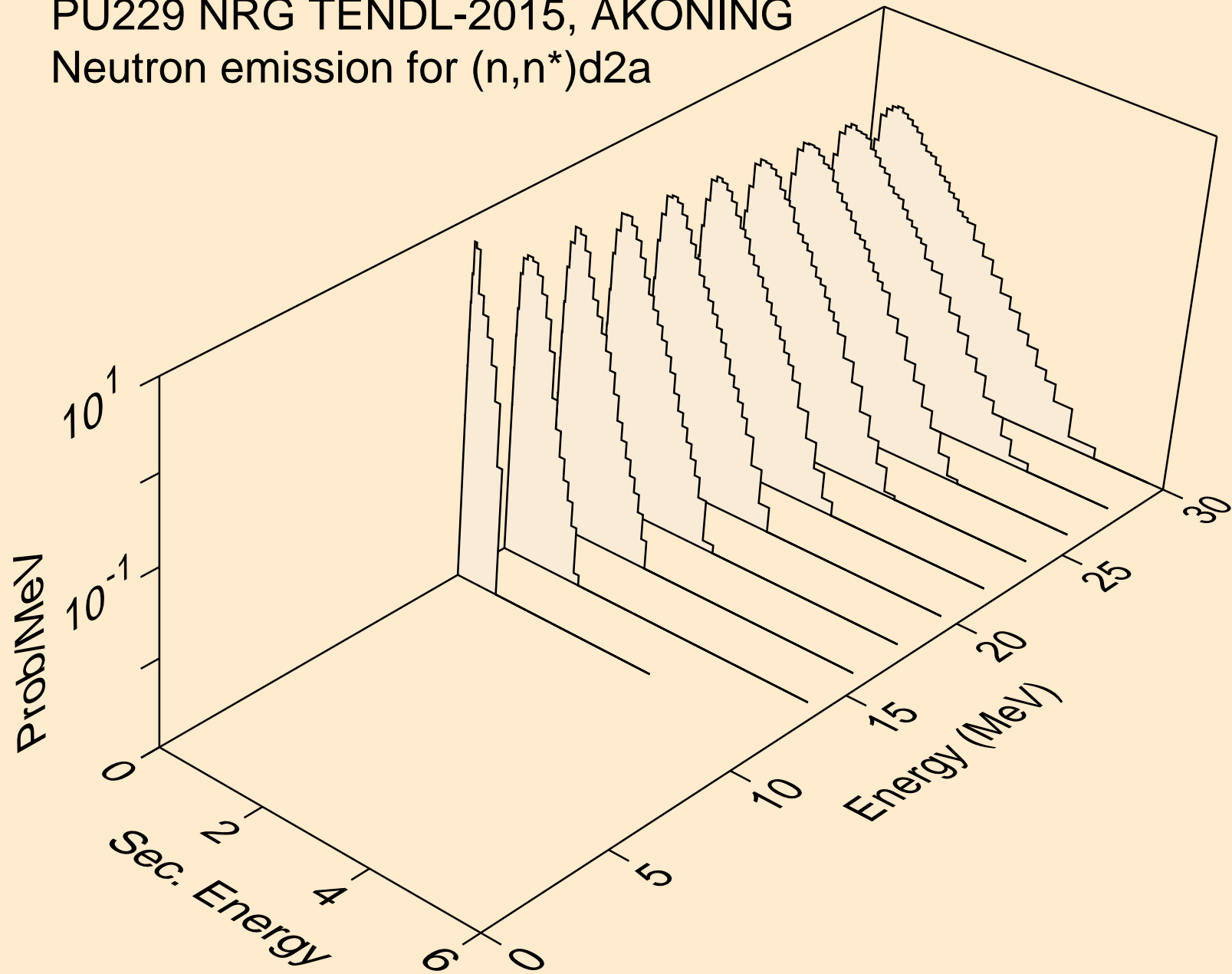

PU229 NRG TENDL-2015, AKONING
Neutron emission for (n,n*)t2a

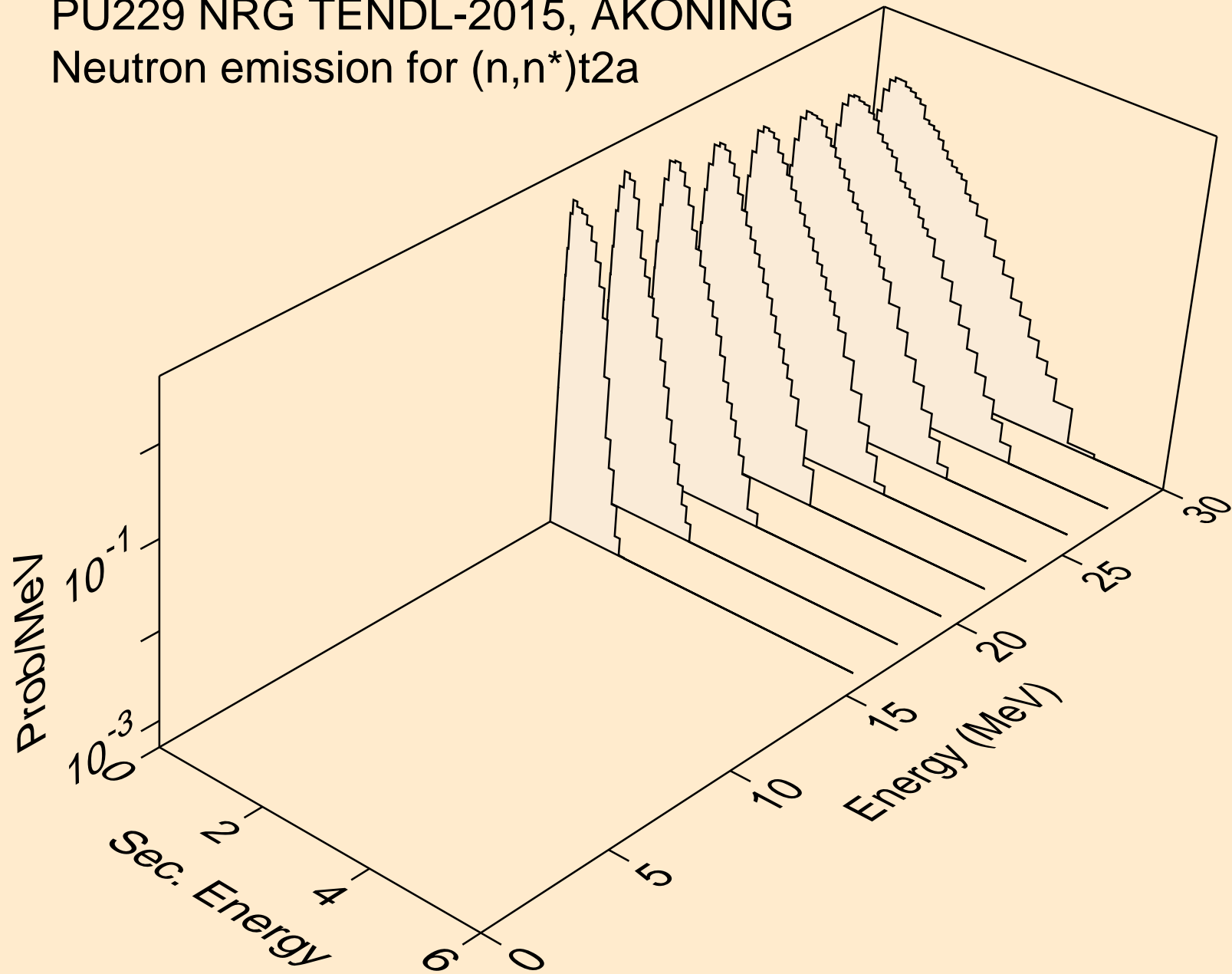

PU229 NRG TENDL-2015, AKONING
Neutron emission for (n,4n)

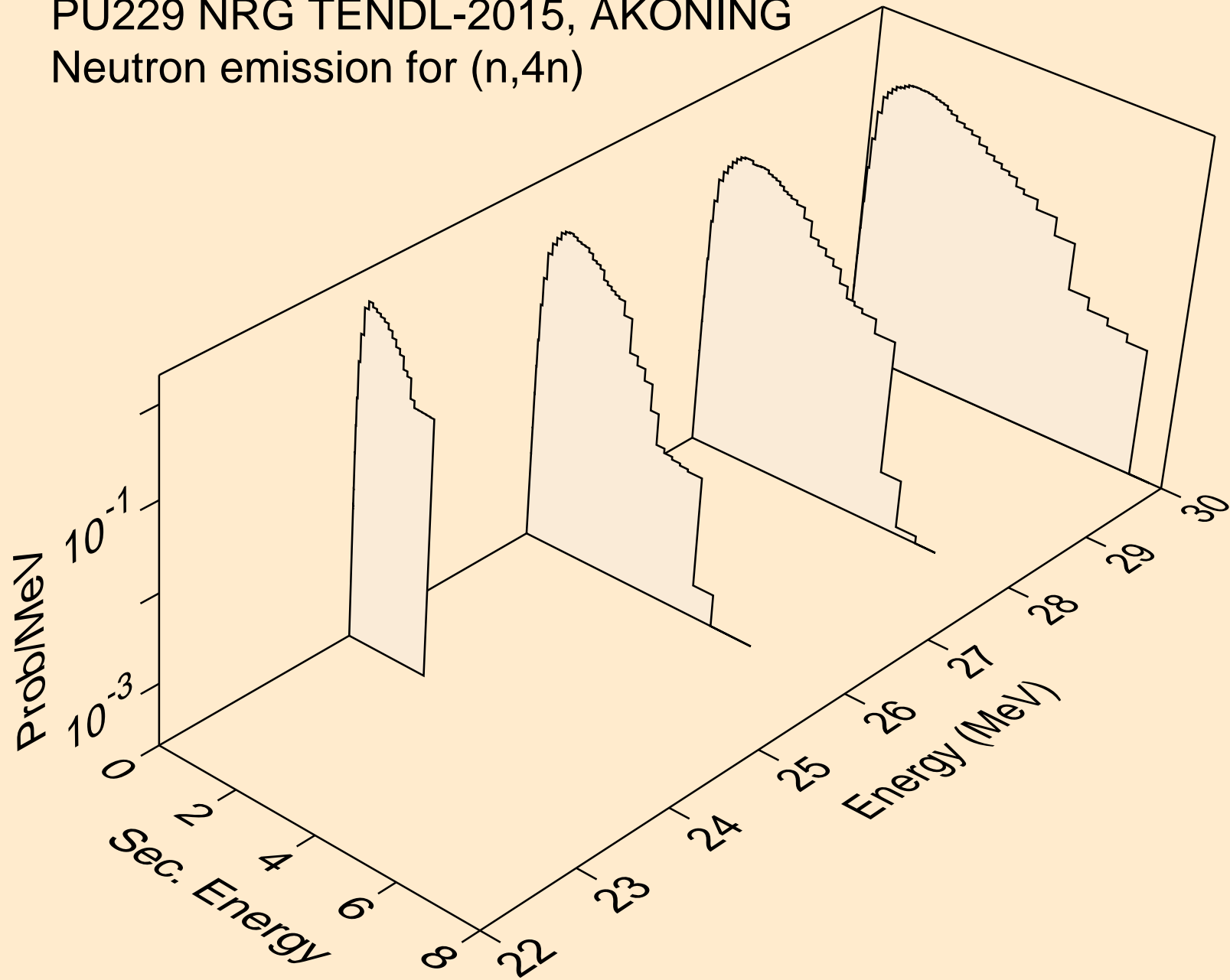

PU229 NRG TENDL-2015, AKONING
Neutron emission for (n,2np)

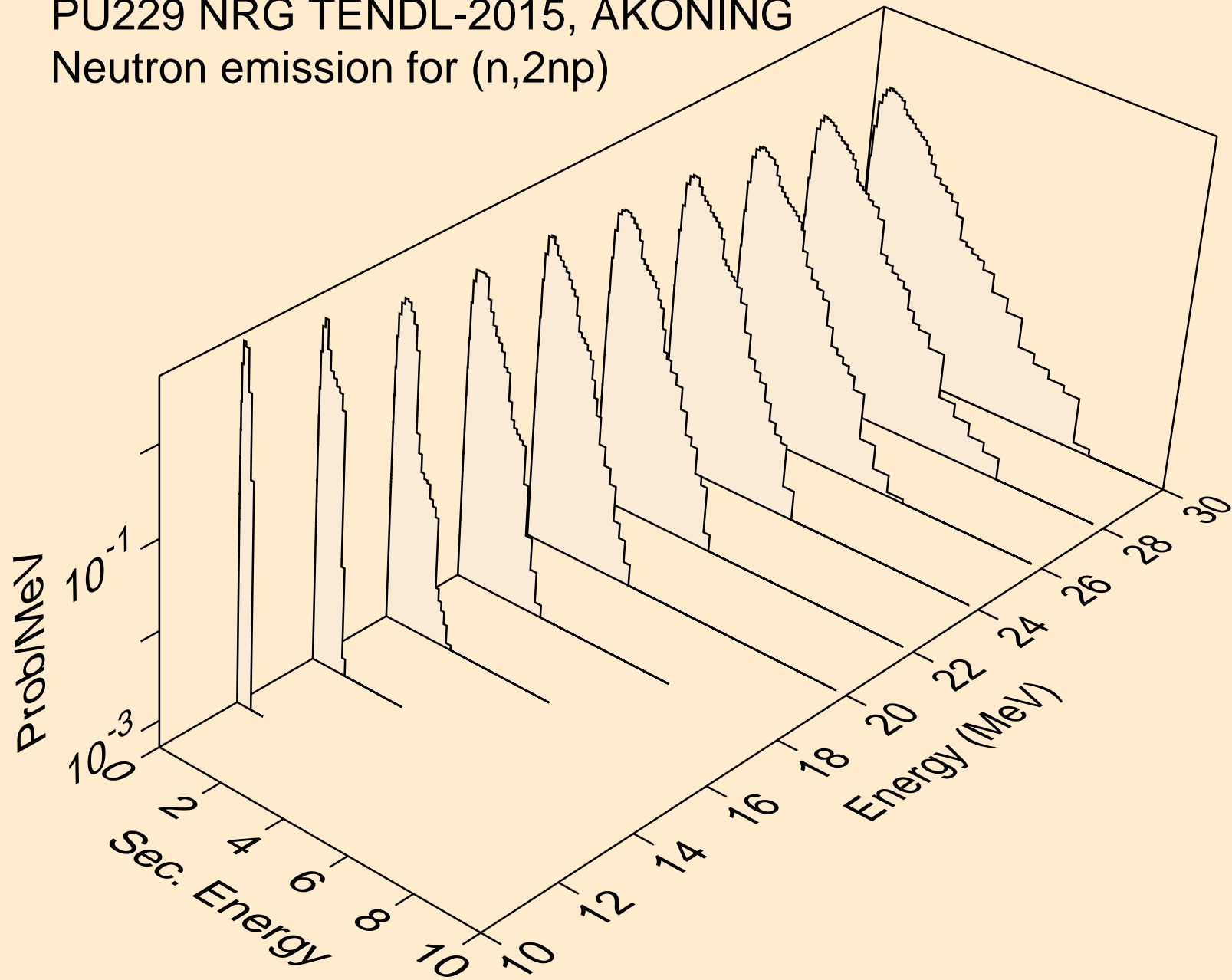

PU229 NRG TENDL-2015, AKONING
Neutron emission for (n,3np)

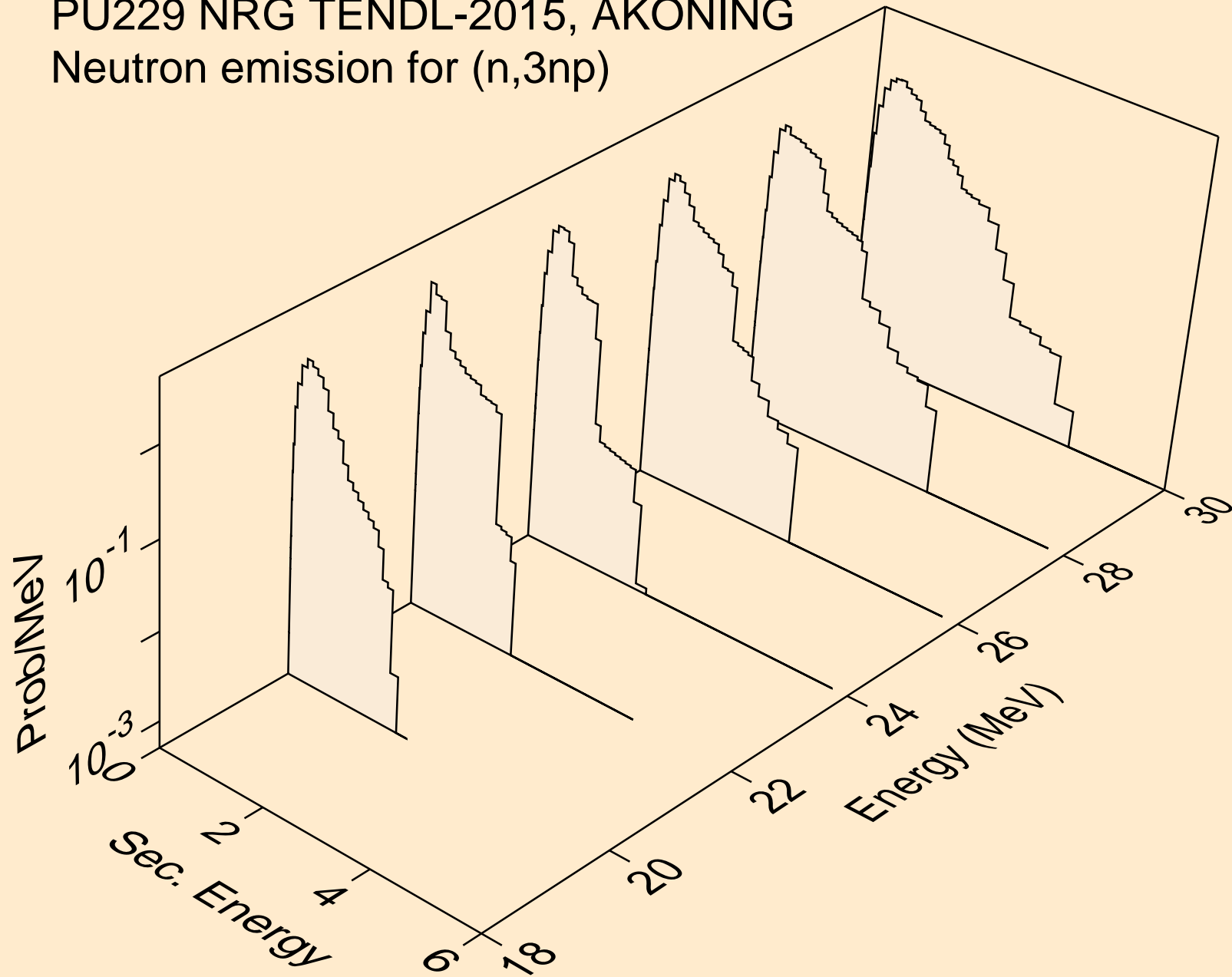

PU229 NRG TENDL-2015, AKONING
Neutron emission for (n,2np)

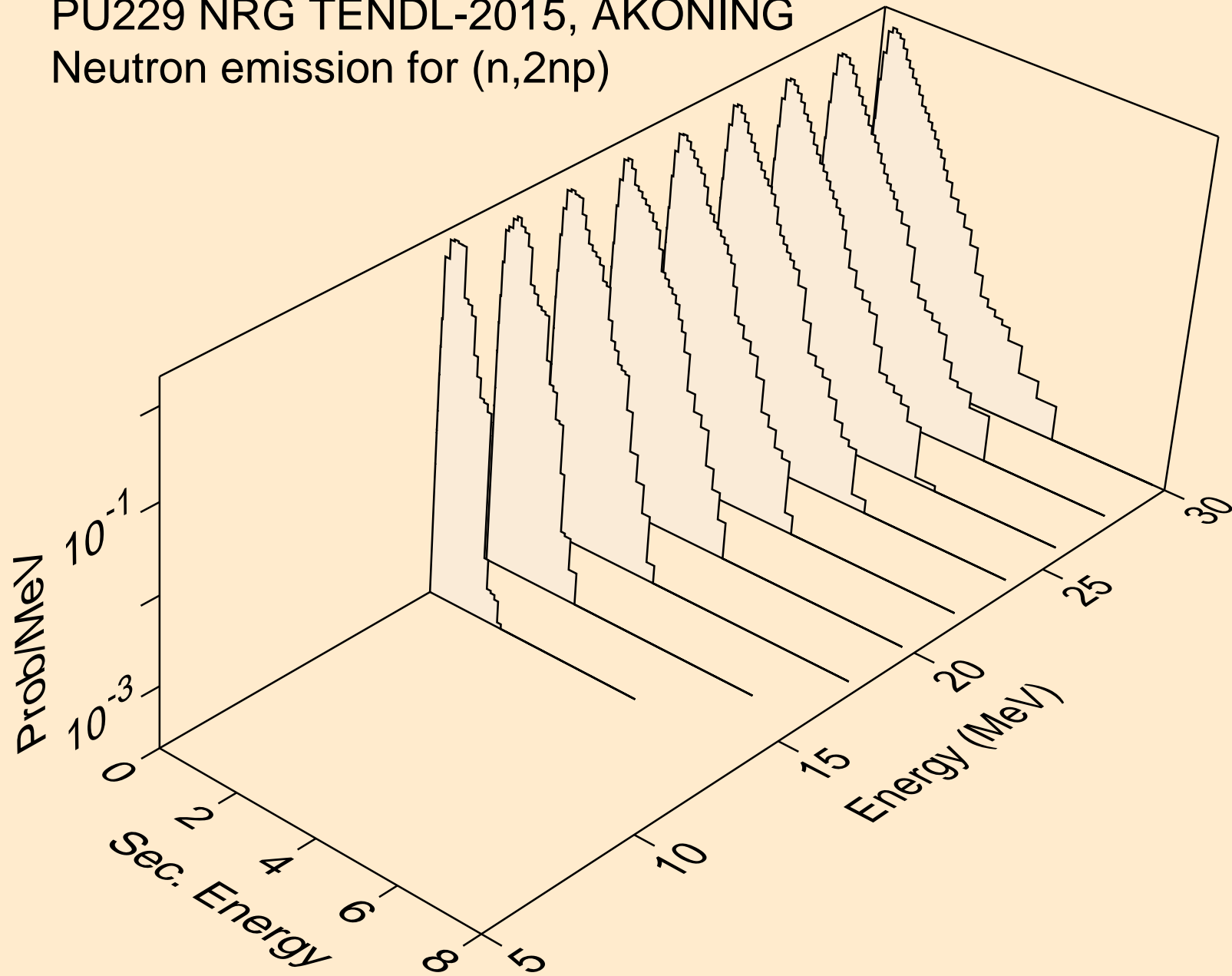

PU229 NRG TENDL-2015, AKONING
Neutron emission for (n,npa)

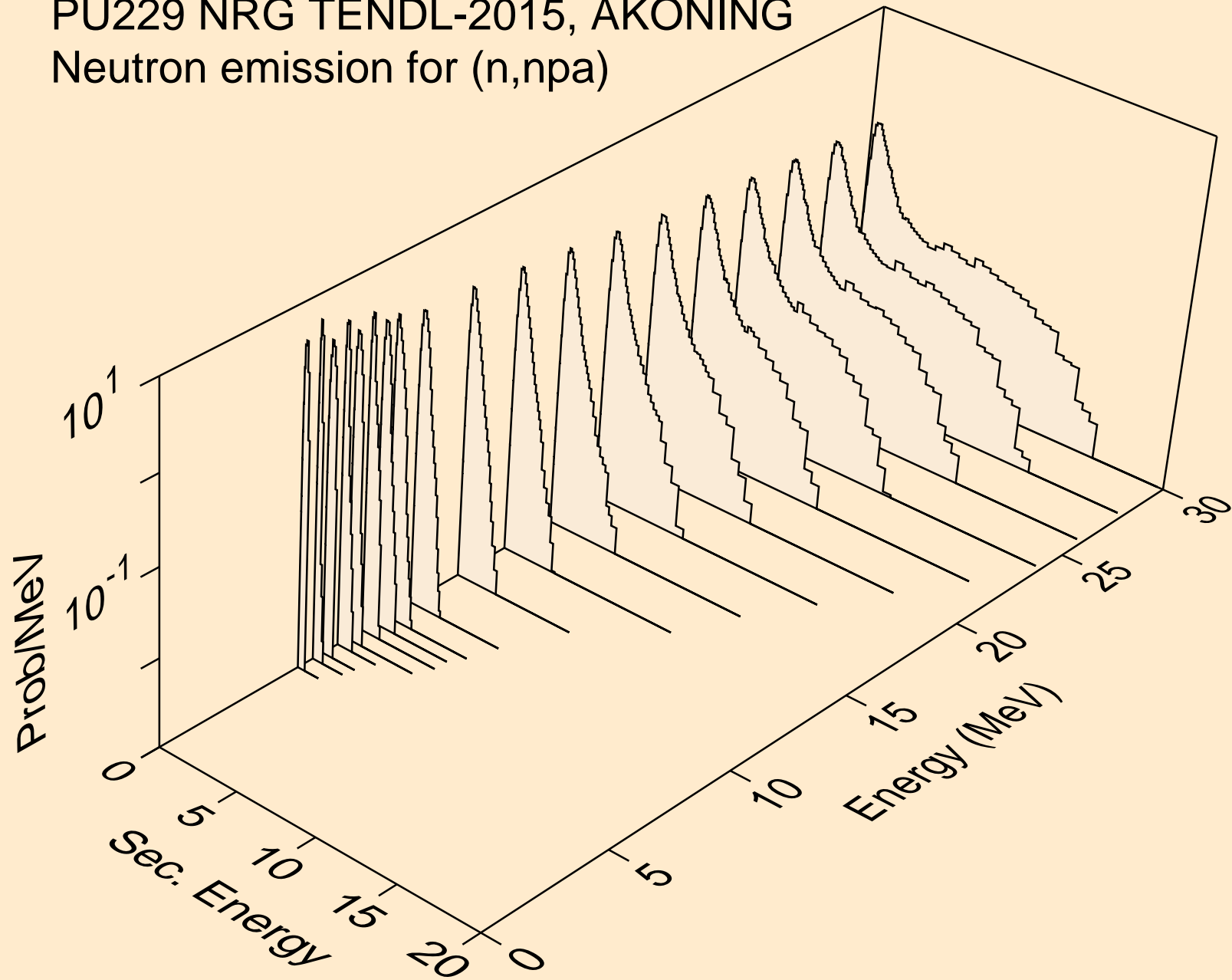

PU229 NRG TENDL-2015, AKONING
Neutron emission for (n,n*c)

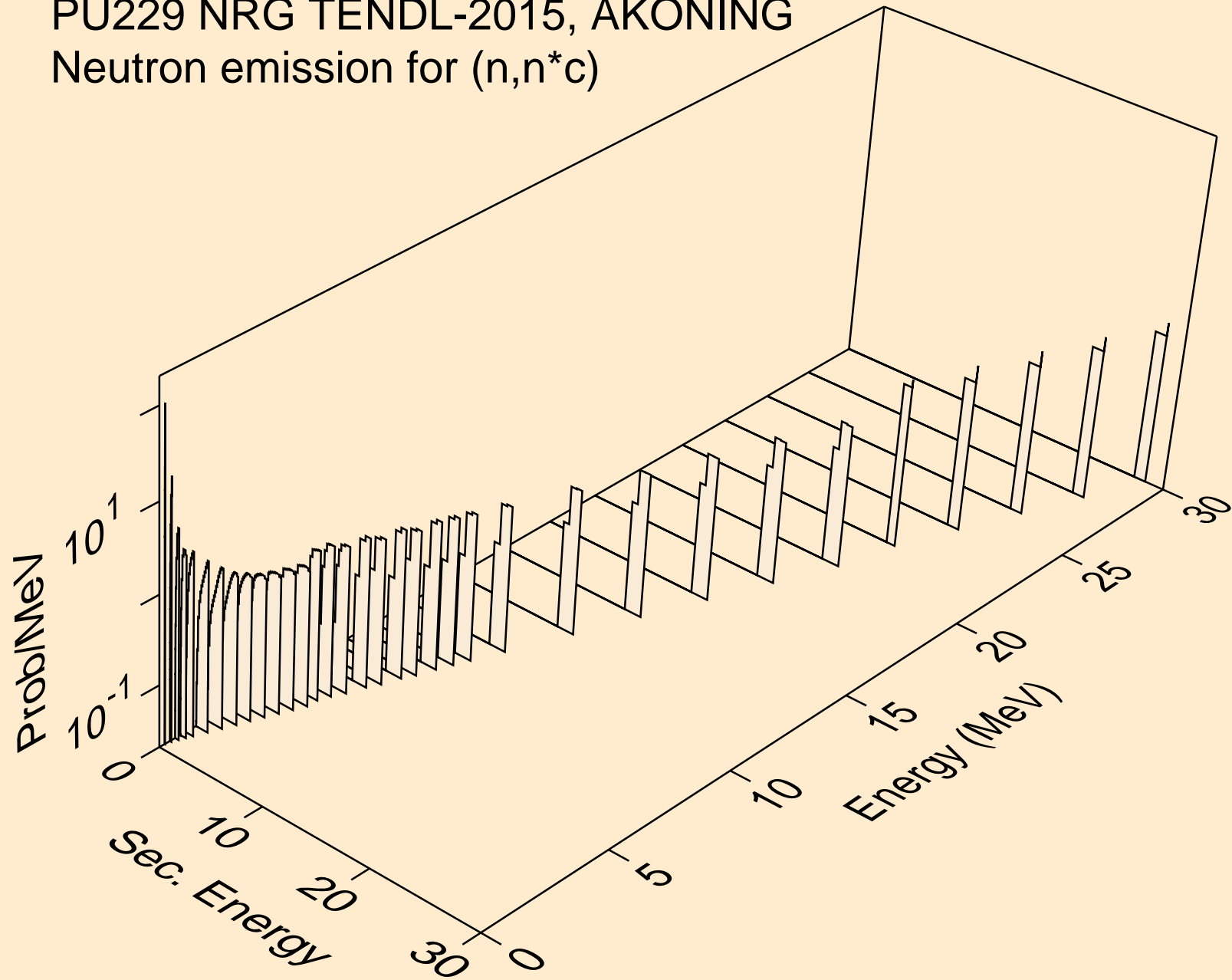

PU229 NRG TENDL-2015, AKONING

Delayed nubar

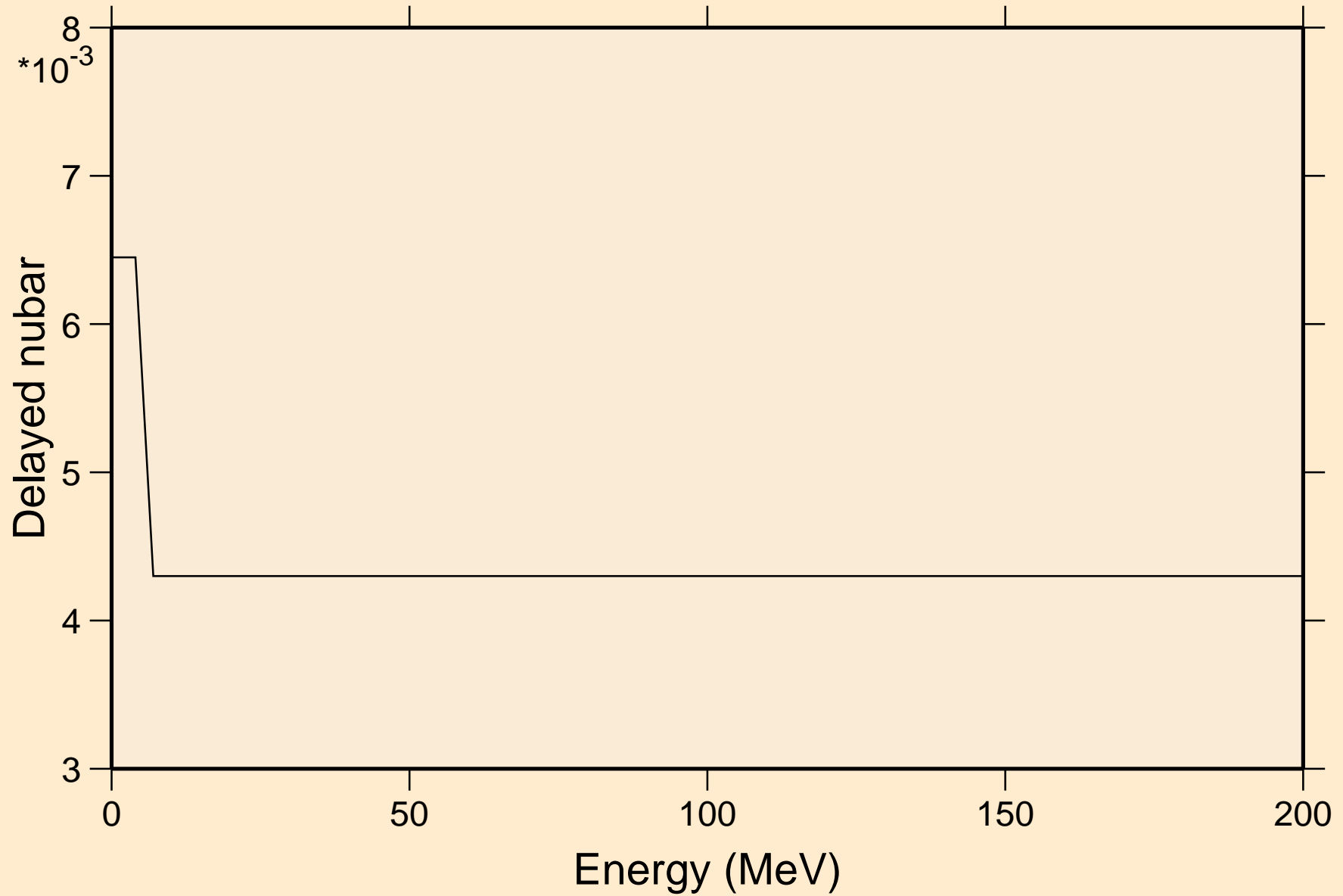

PU229 NRG TENDL-2015, AKONING

Delayed neutron spectra

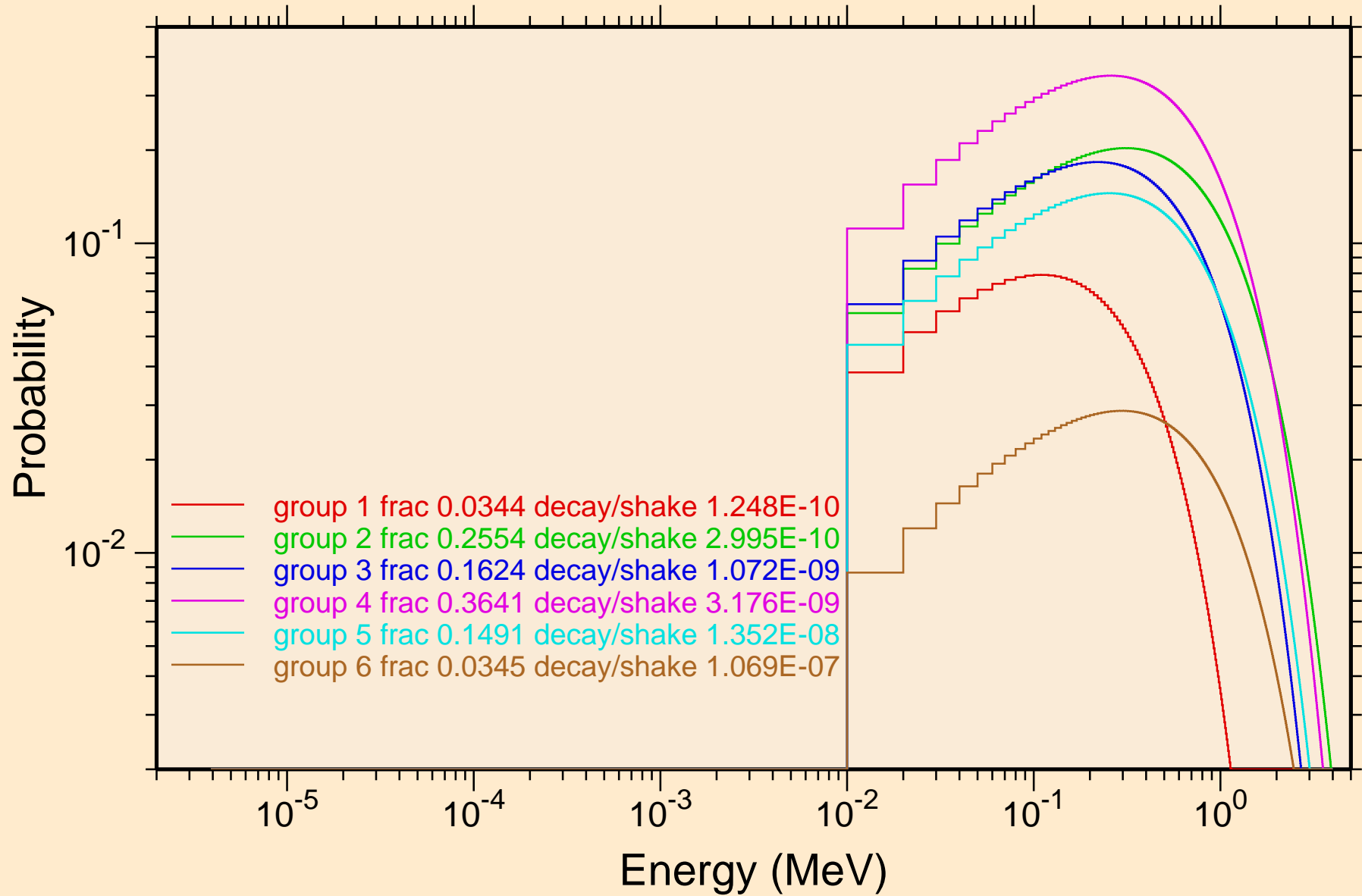

PU229 NRG TENDL-2015, AKONING
Photon emission for (n,x)

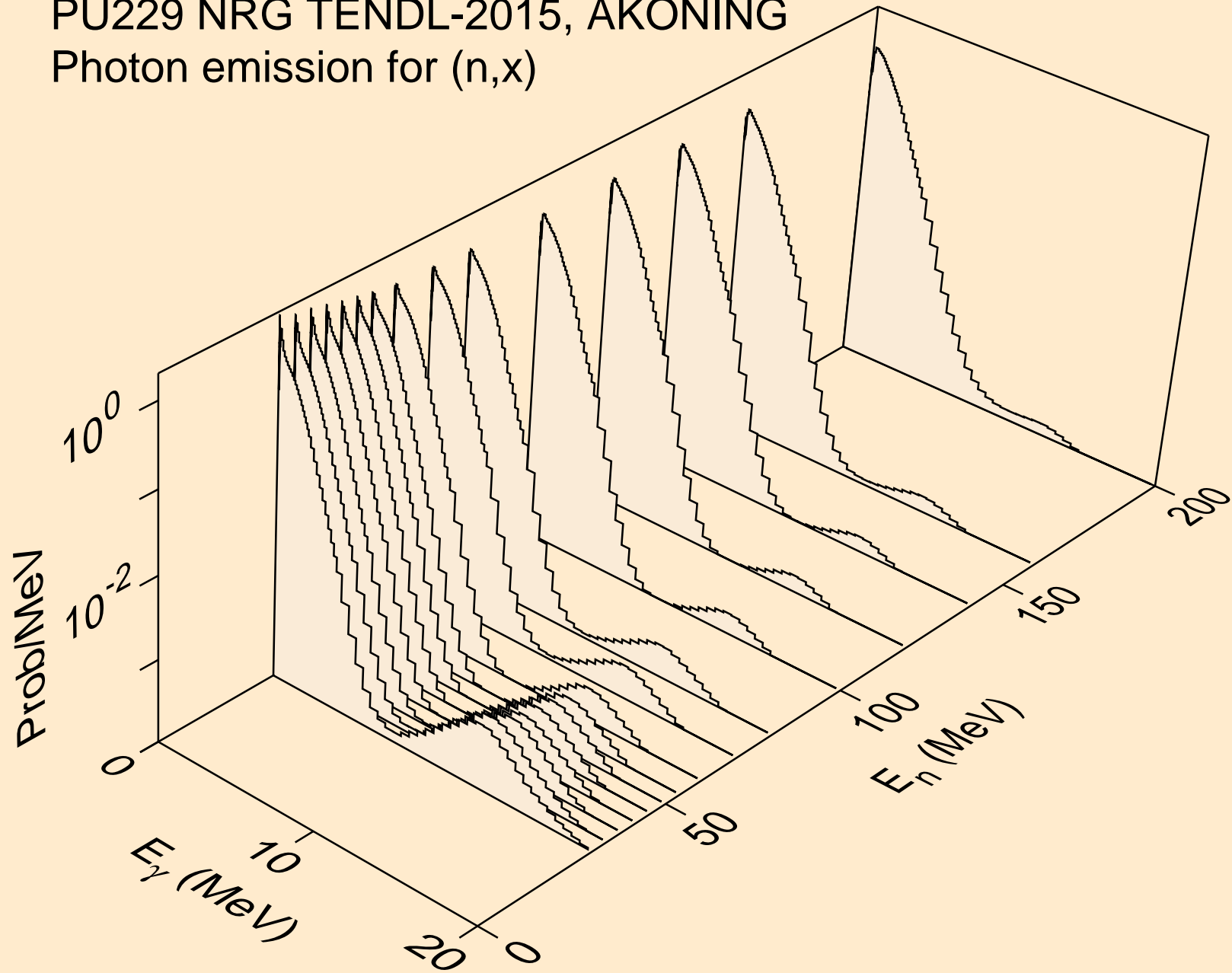

PU229 NRG TENDL-2015, AKONING
Photon emission for (n,2nd)

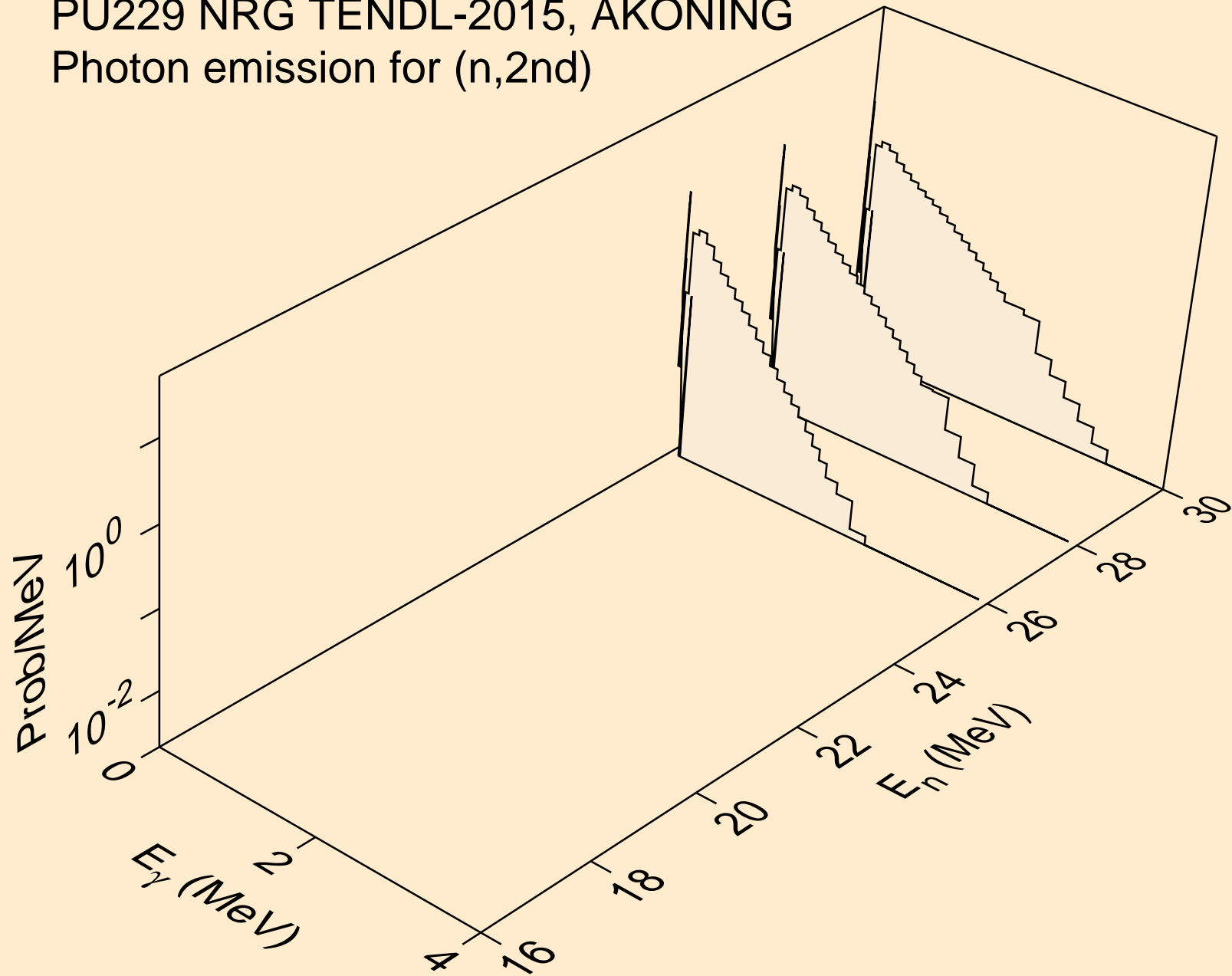

PU229 NRG TENDL-2015, AKONING
Photon emission for (n,2n)

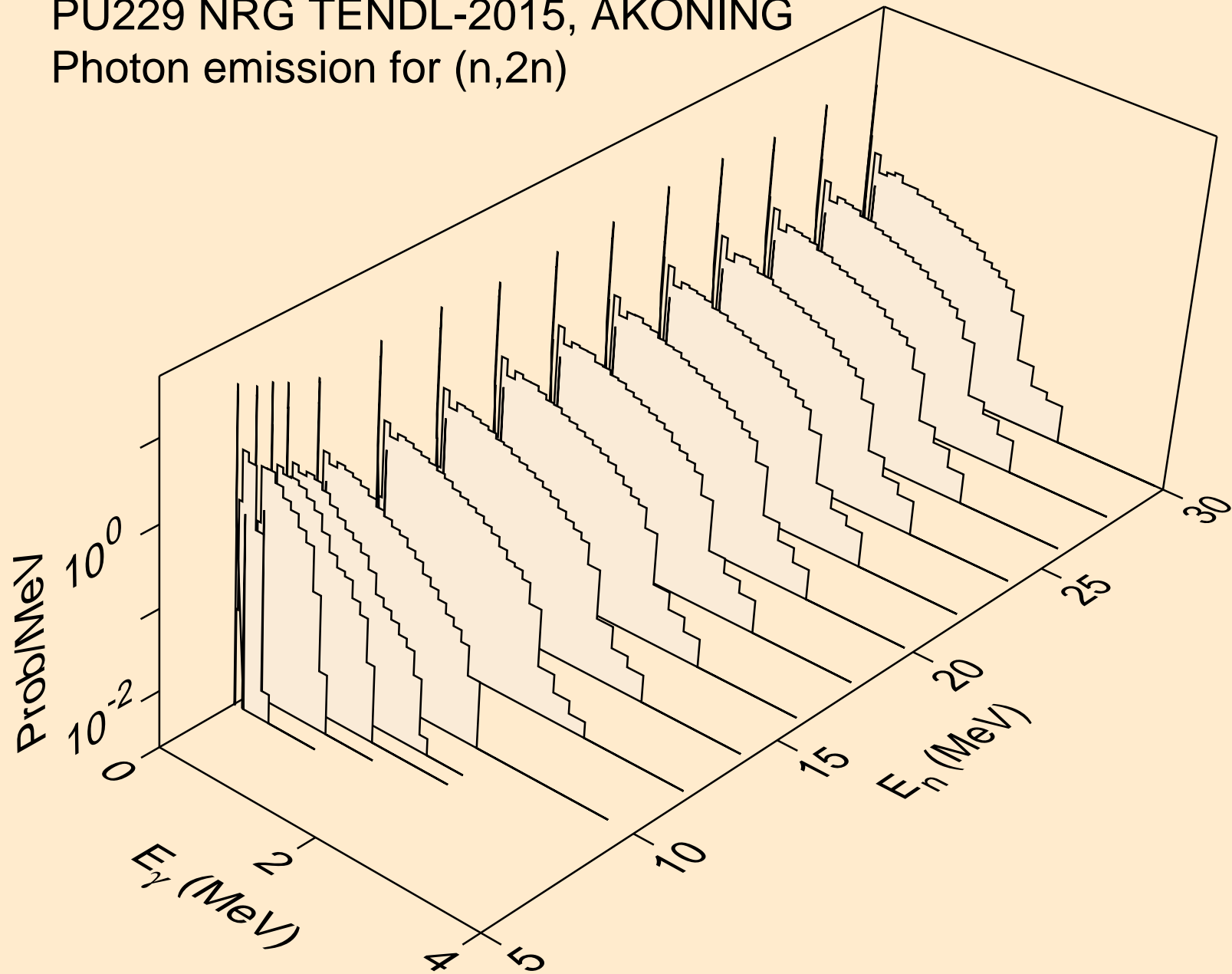

PU229 NRG TENDL-2015, AKONING
Photon emission for (n,3n)

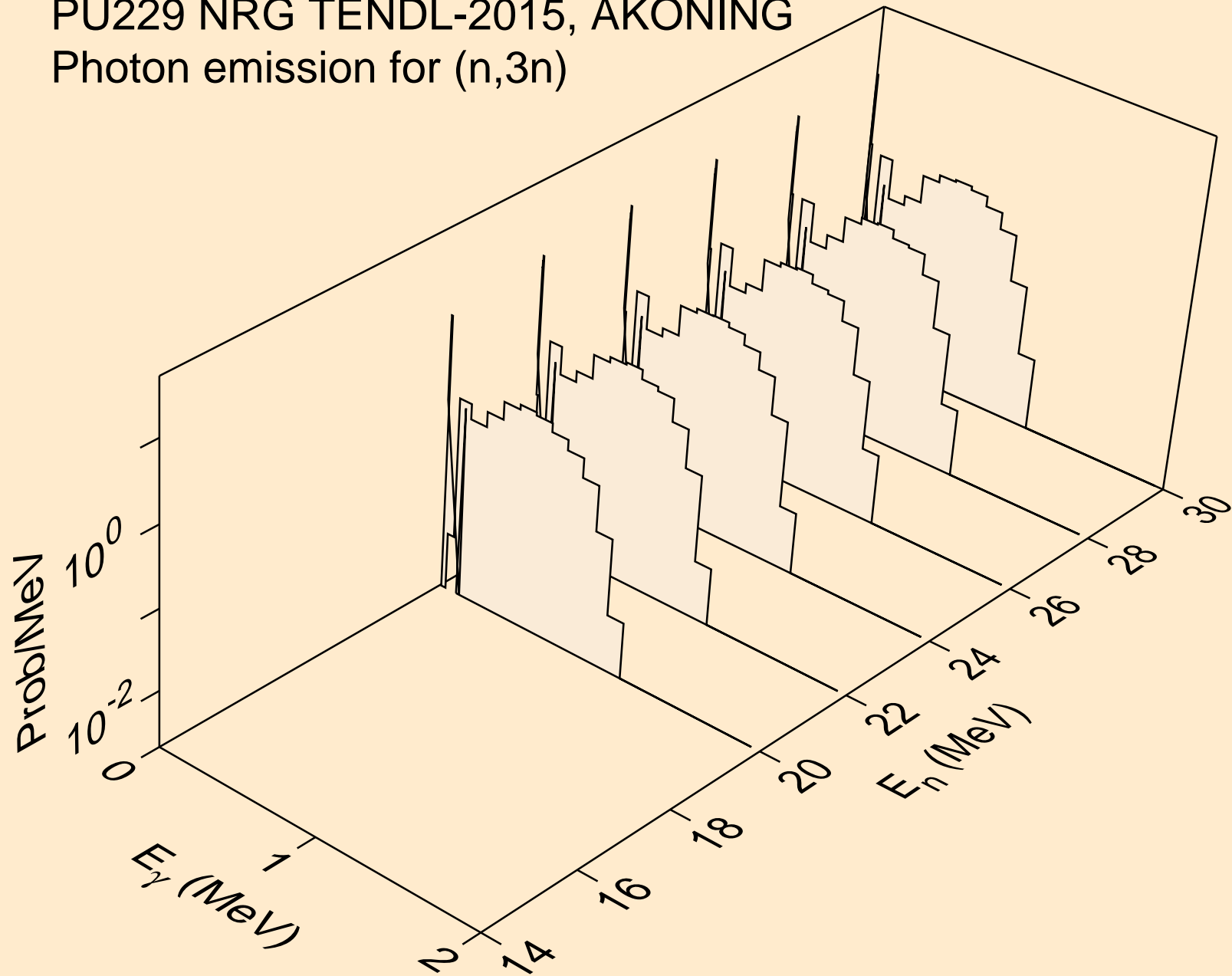

PU229 NRG TENDL-2015, AKONING
Photon emission for (n,n*)a

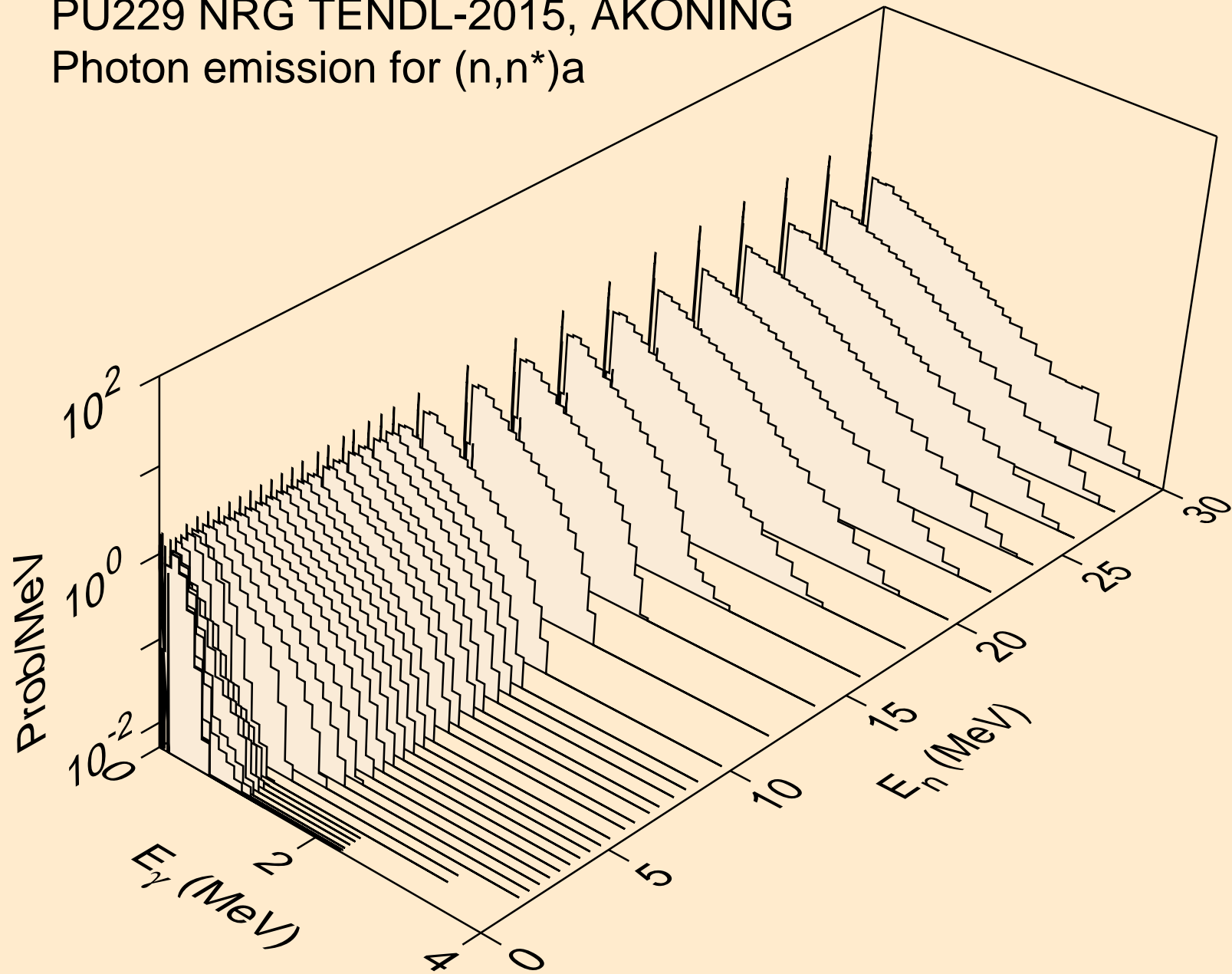

PU229 NRG TENDL-2015, AKONING
Photon emission for (n,n*)3a

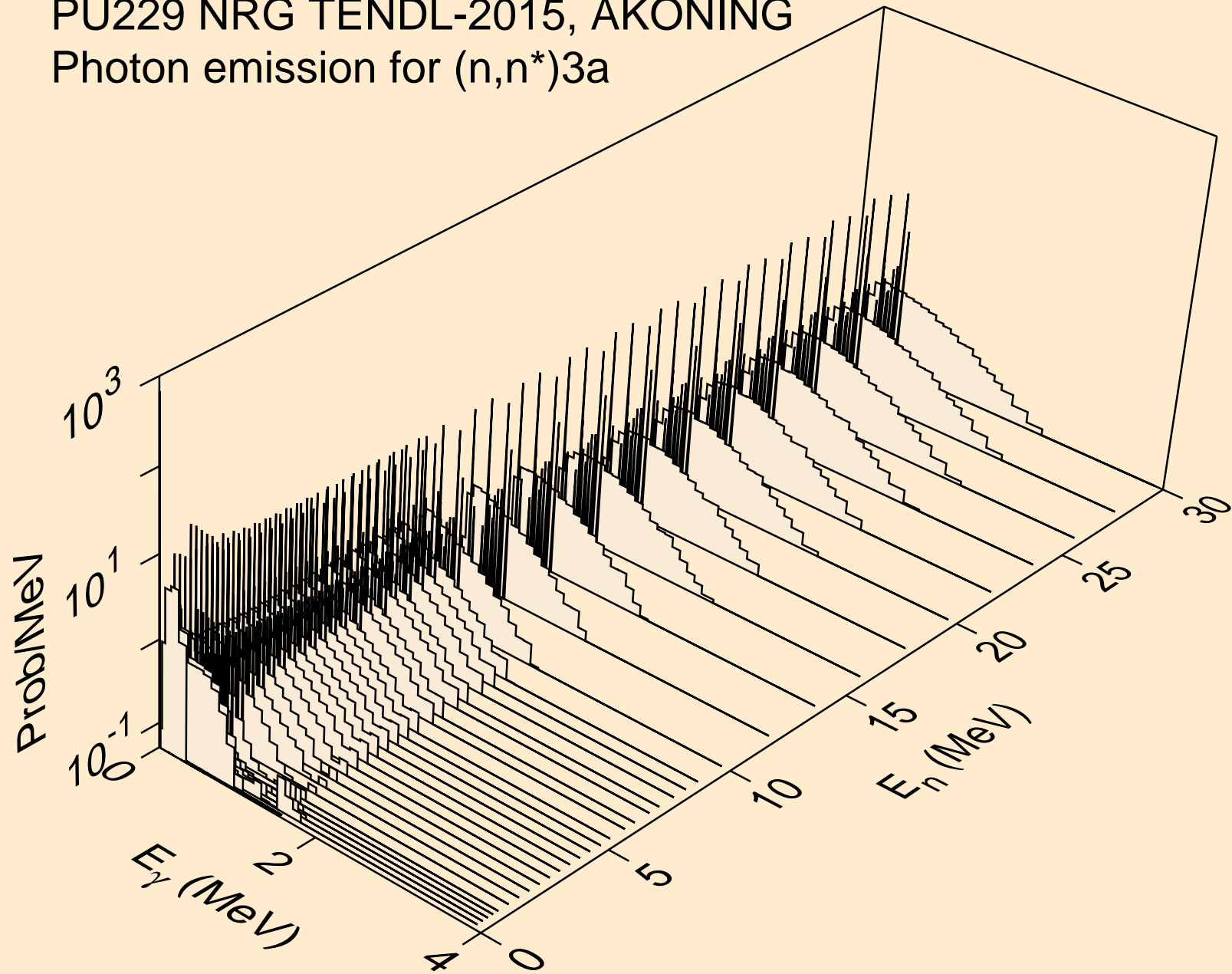

PU229 NRG TENDL-2015, AKONING
Photon emission for (n,2n)a

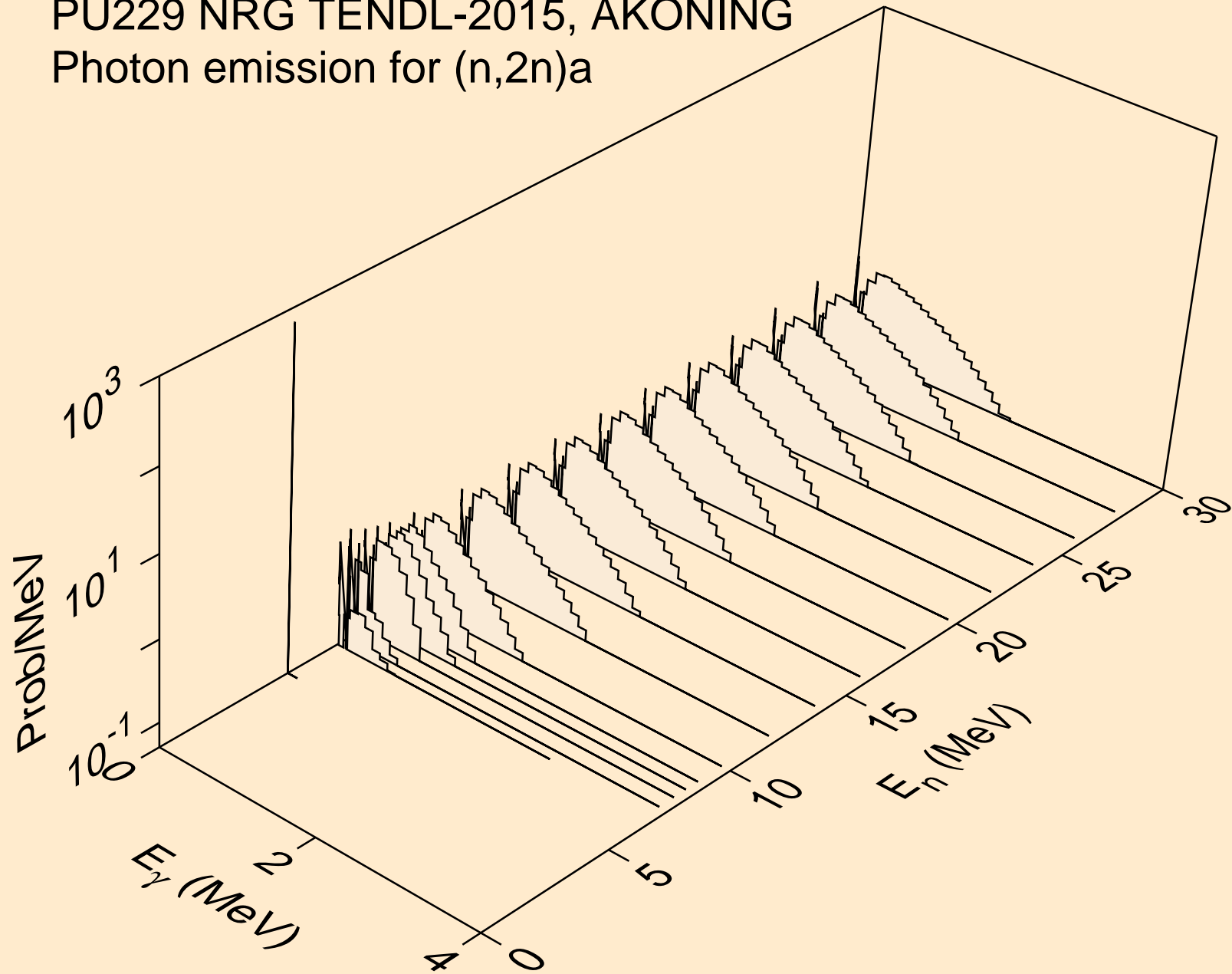

PU229 NRG TENDL-2015, AKONING
Photon emission for (n,3n)a

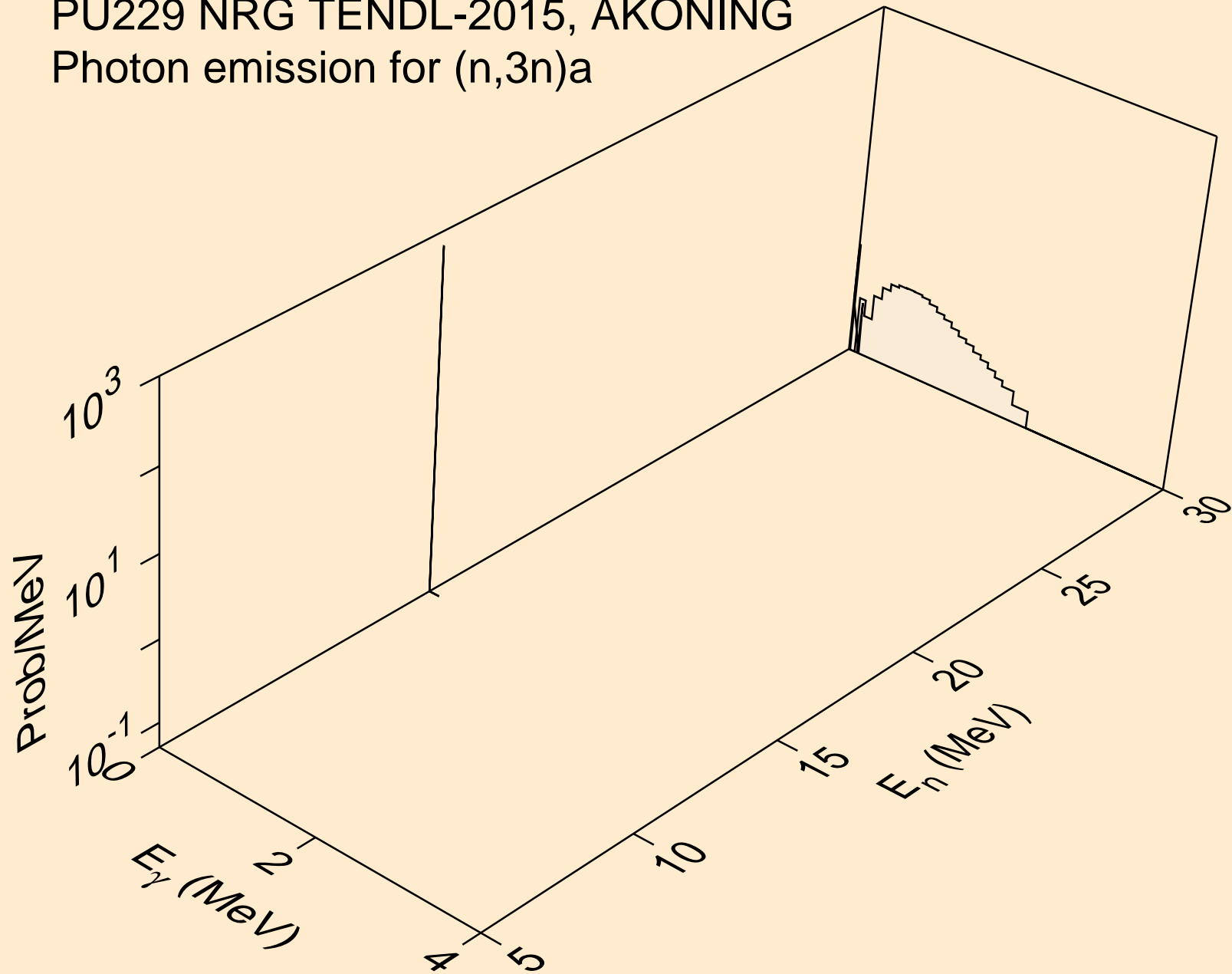

PU229 NRG TENDL-2015, AKONING

Photon emission for (n,n*)p

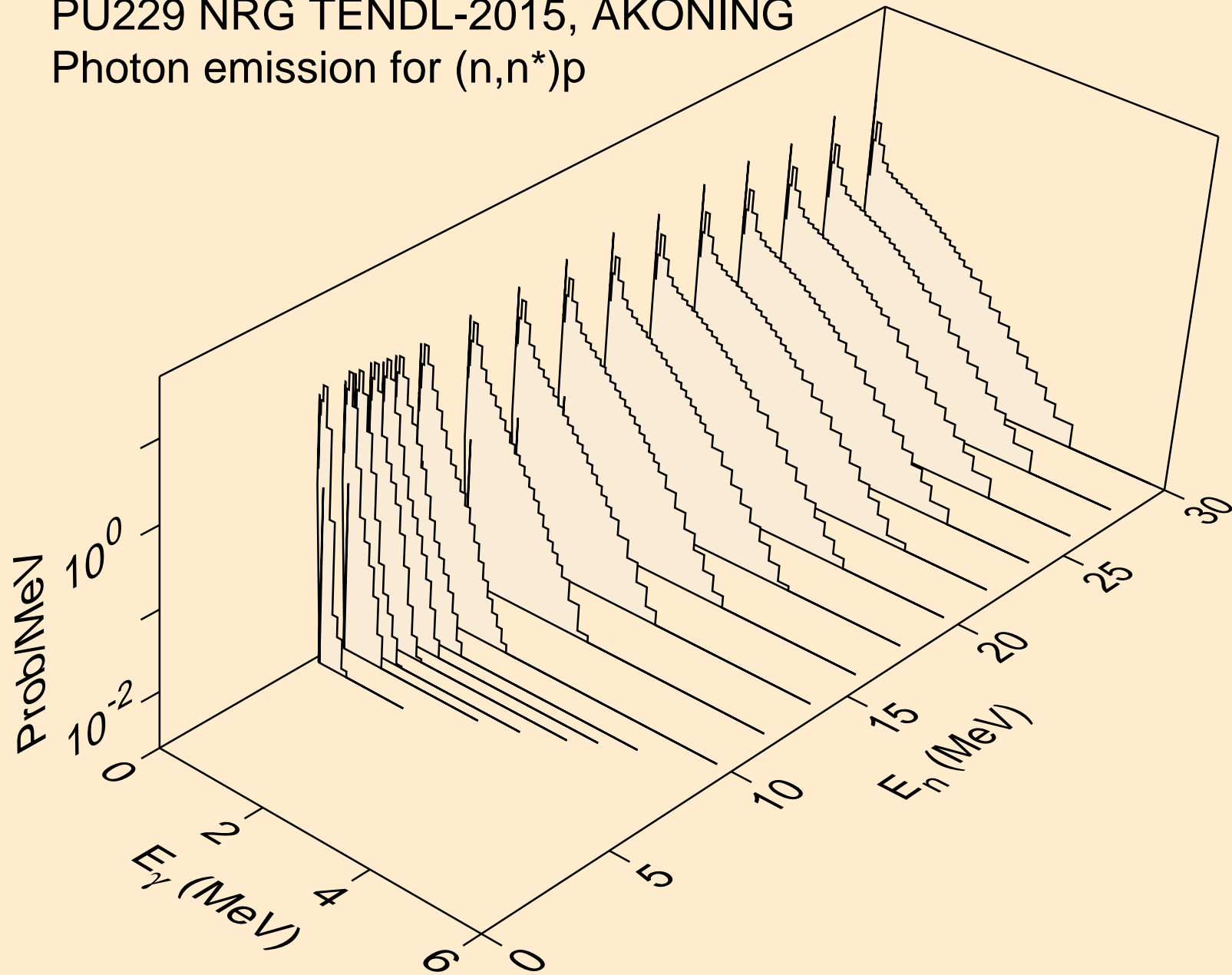

PU229 NRG TENDL-2015, AKONING
Photon emission for (n,n*)2a

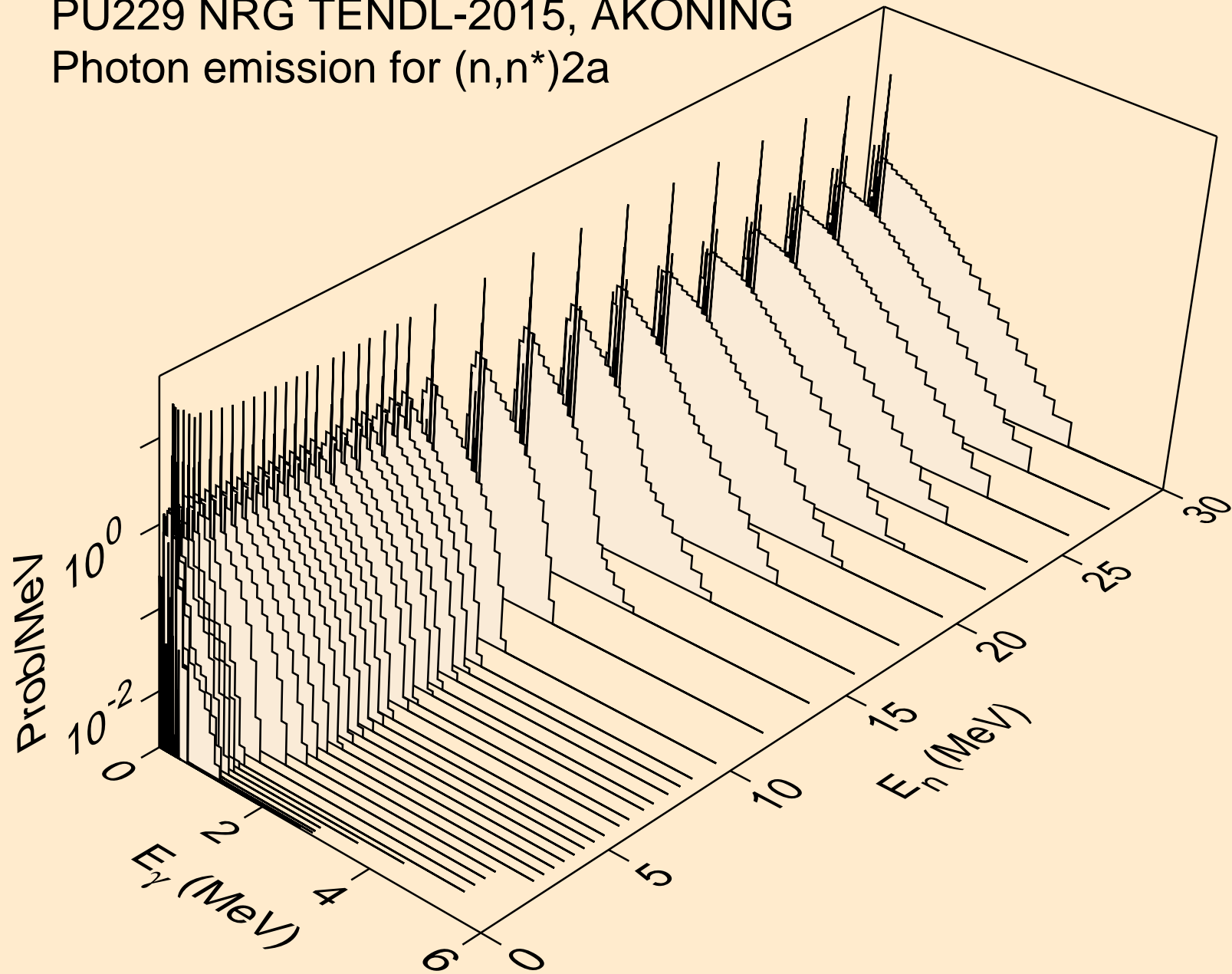

PU229 NRG TENDL-2015, AKONING
Photon emission for (n,2n)2a

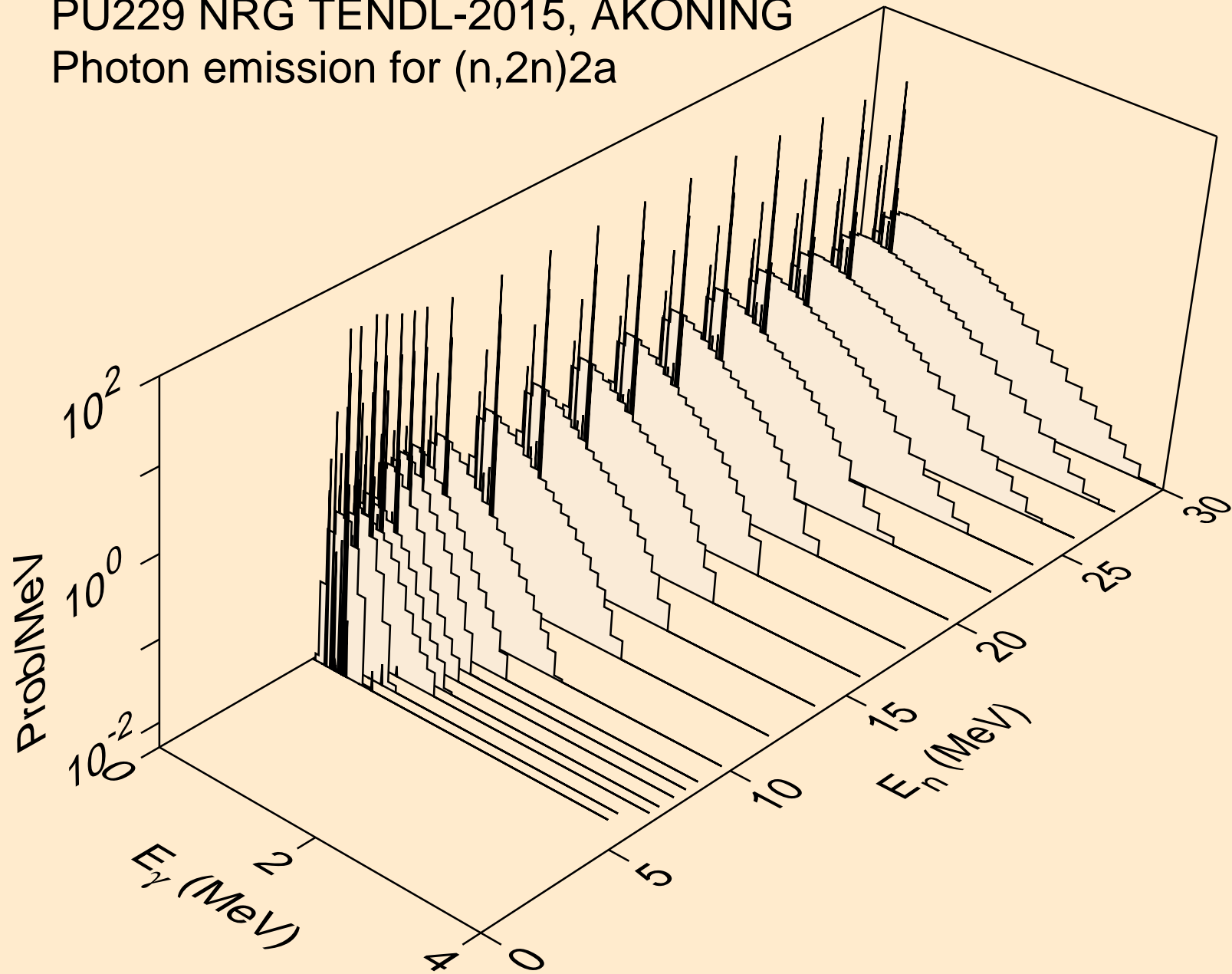

PU229 NRG TENDL-2015, AKONING
Photon emission for (n,n*)d

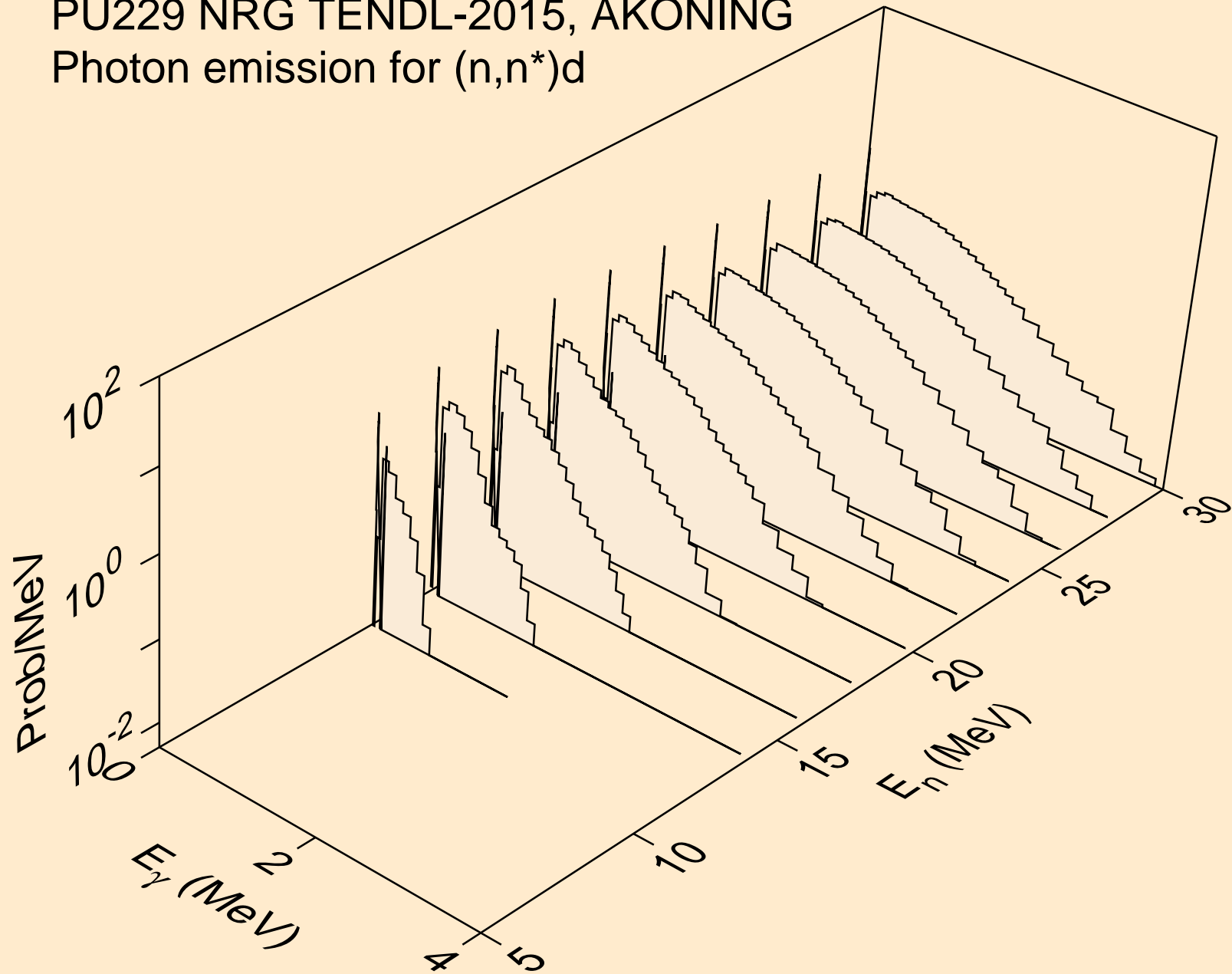

PU229 NRG TENDL-2015, AKONING
Photon emission for (n,n*)t

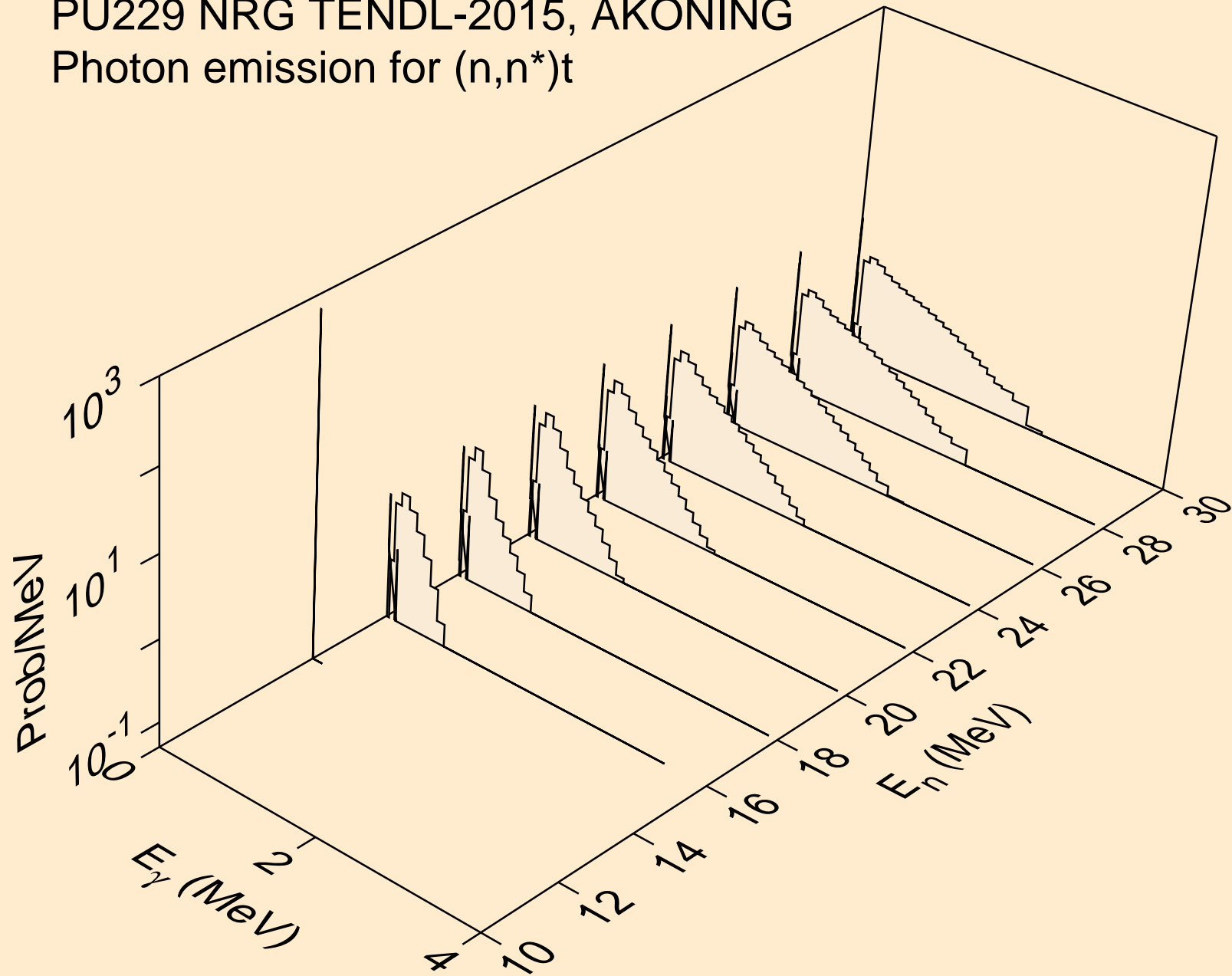

PU229 NRG TENDL-2015, AKONING
Photon emission for (n,n*)he3

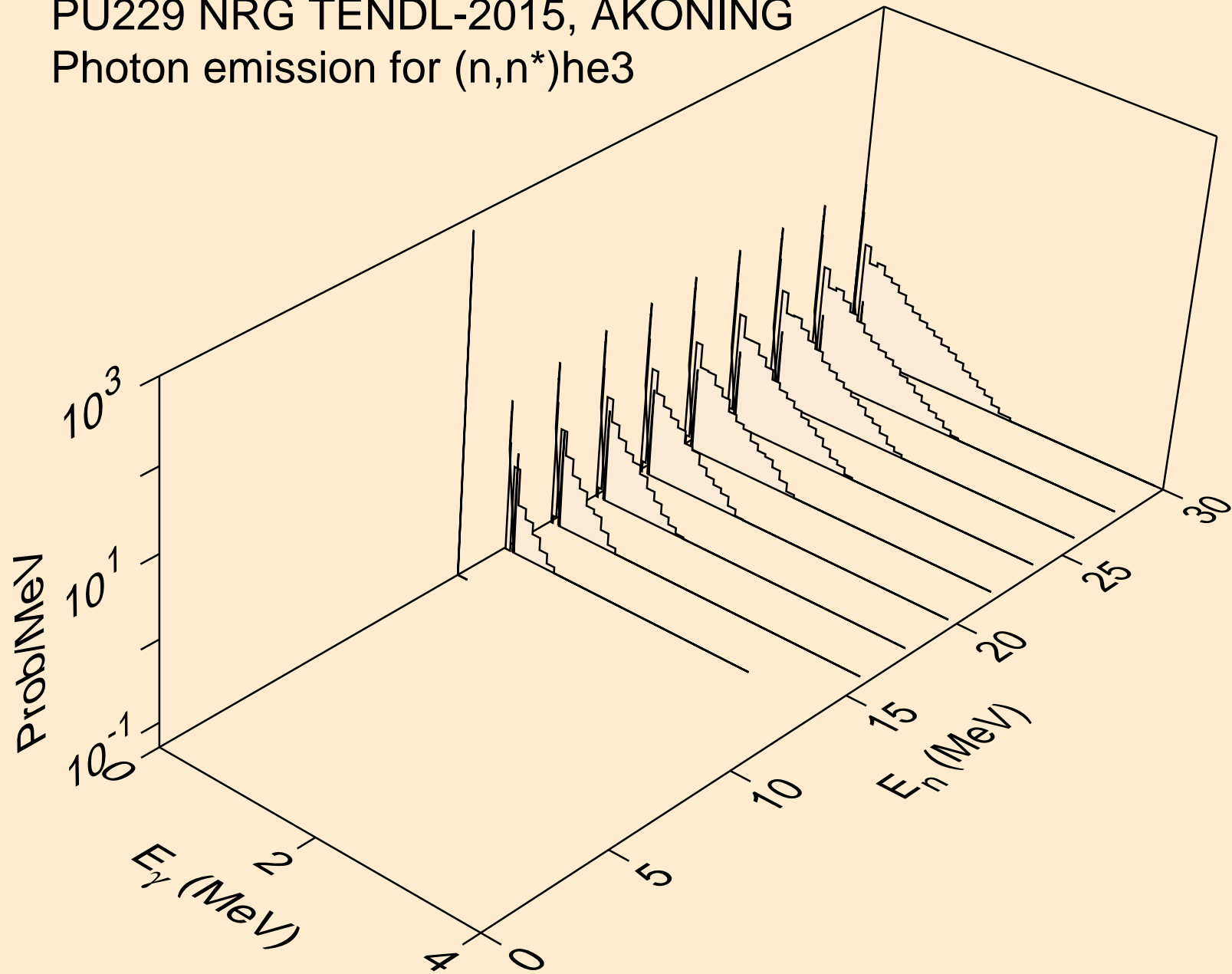

PU229 NRG TENDL-2015, AKONING
Photon emission for (n,n*)d2a

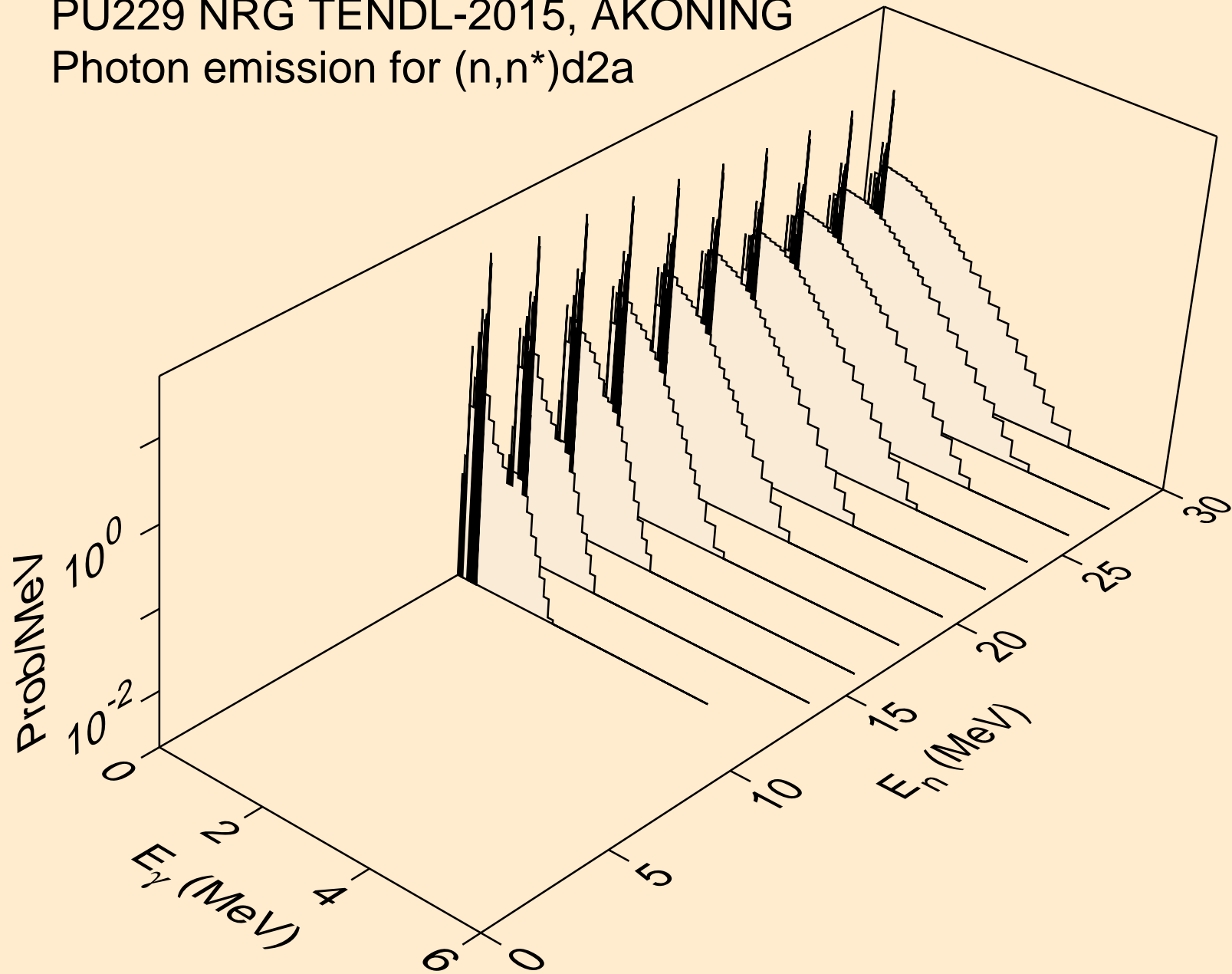

PU229 NRG TENDL-2015, AKONING
Photon emission for (n,n*)t2a

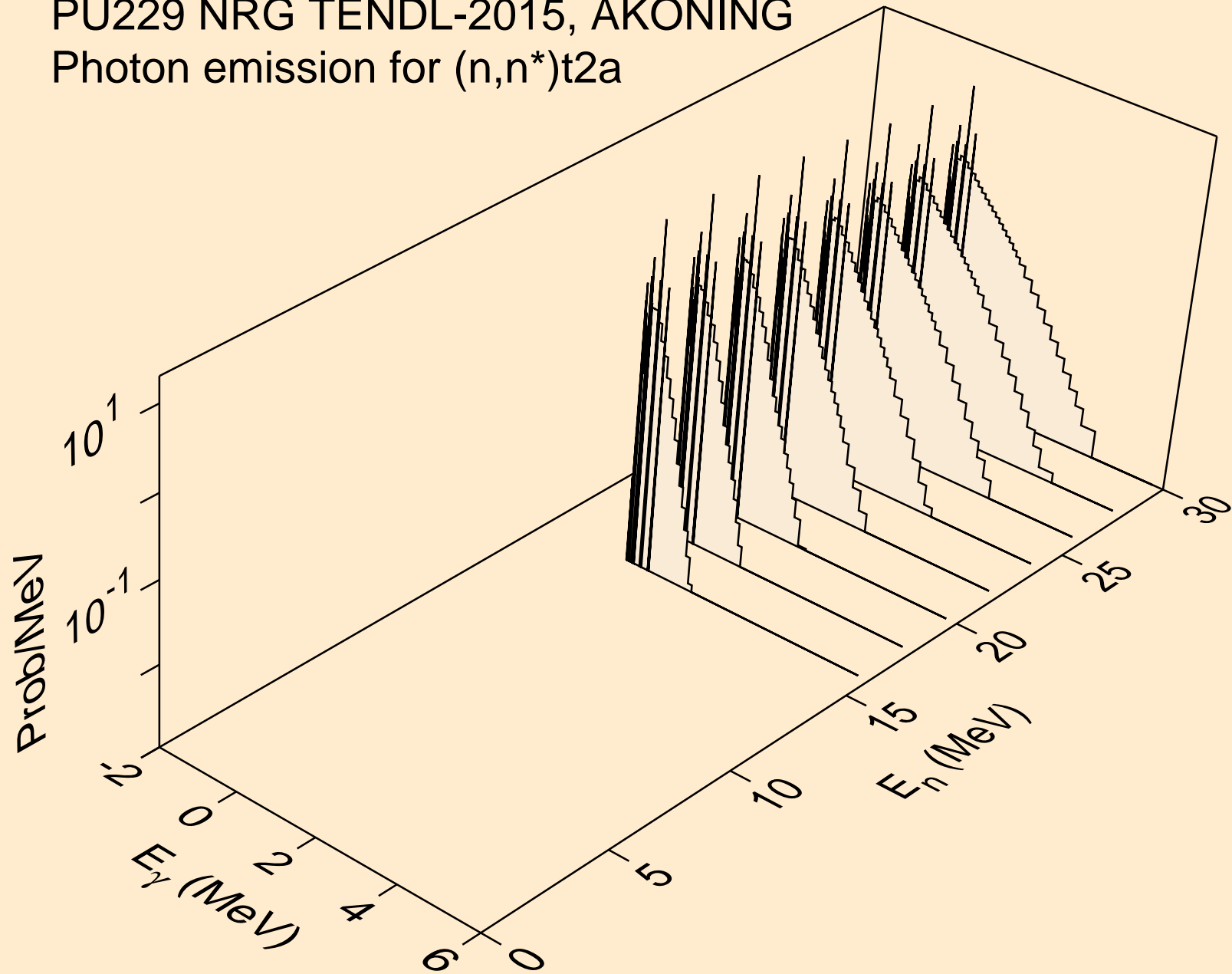

PU229 NRG TENDL-2015, AKONING
Photon emission for (n,4n)

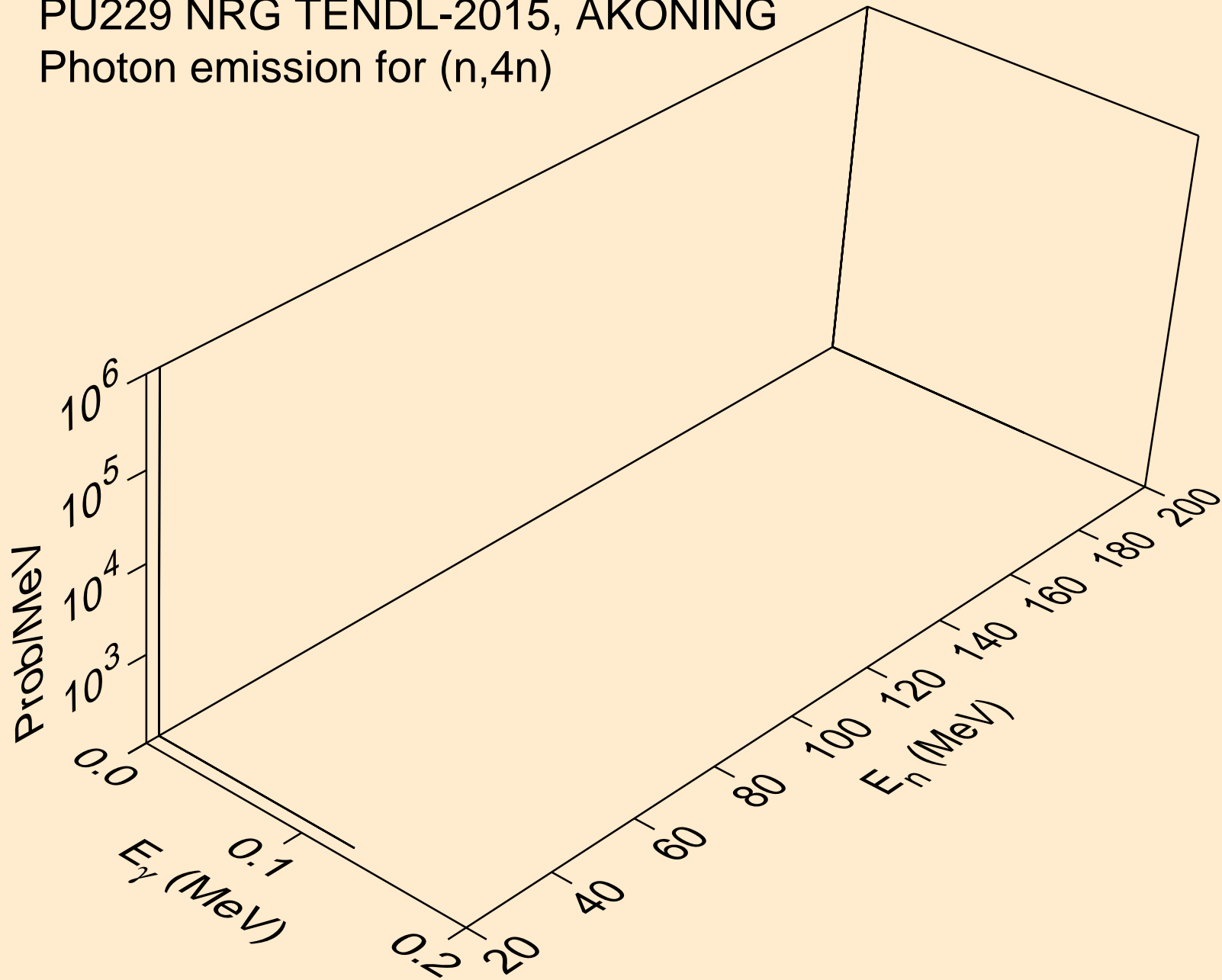

PU229 NRG TENDL-2015, AKONING
Photon emission for (n,2np)

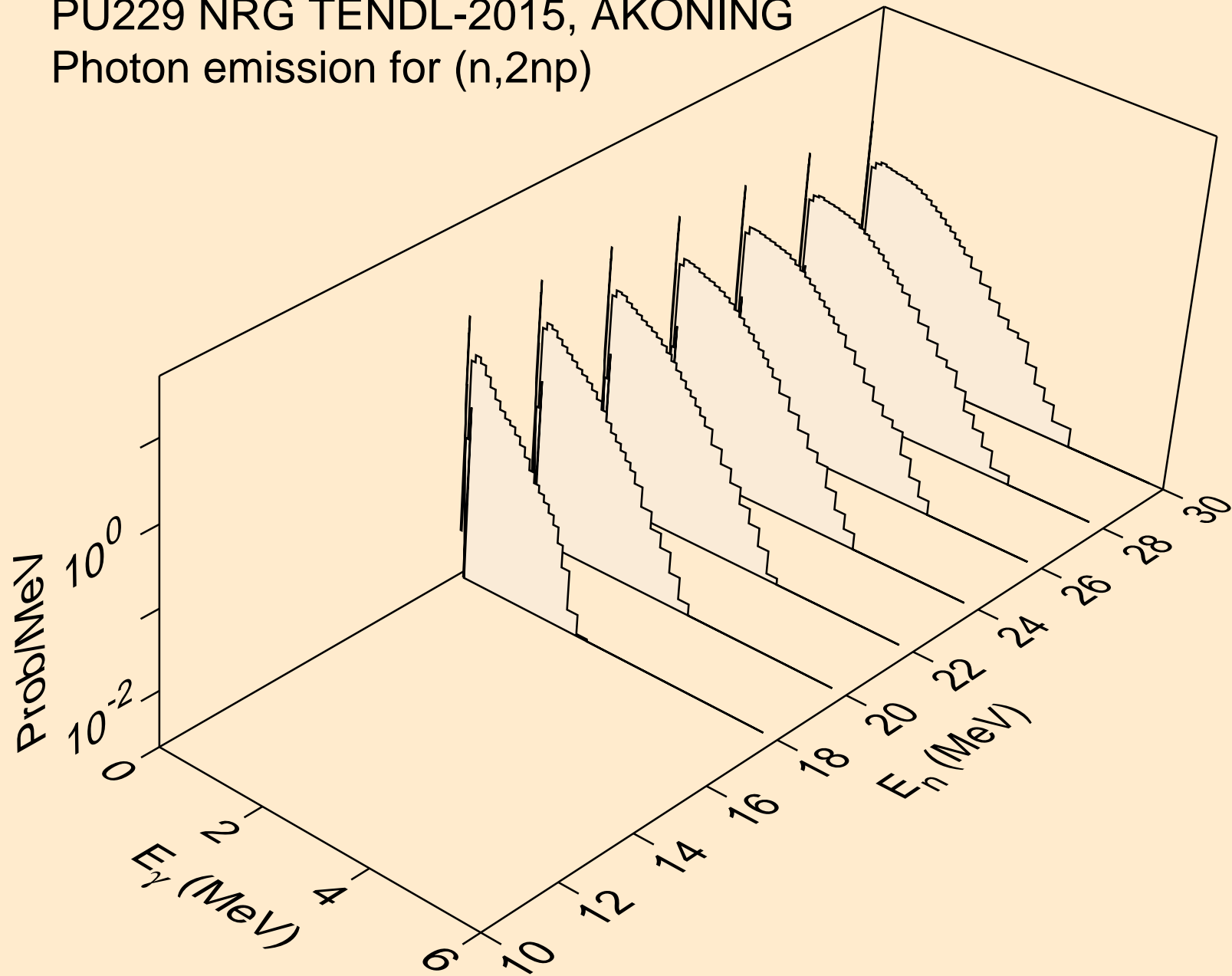

PU229 NRG TENDL-2015, AKONING
Photon emission for (n,3np)

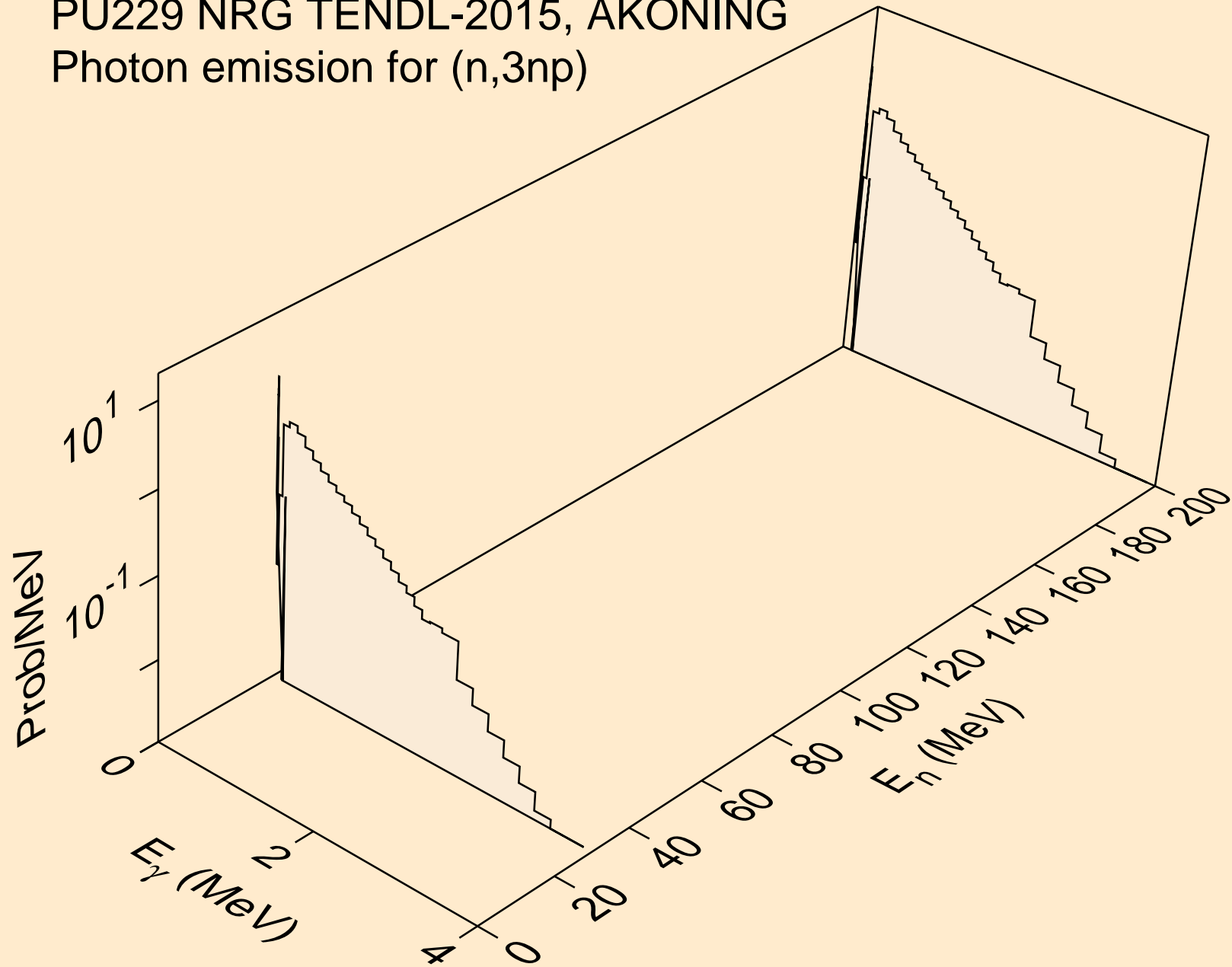

PU229 NRG TENDL-2015, AKONING
Photon emission for (n,2np)

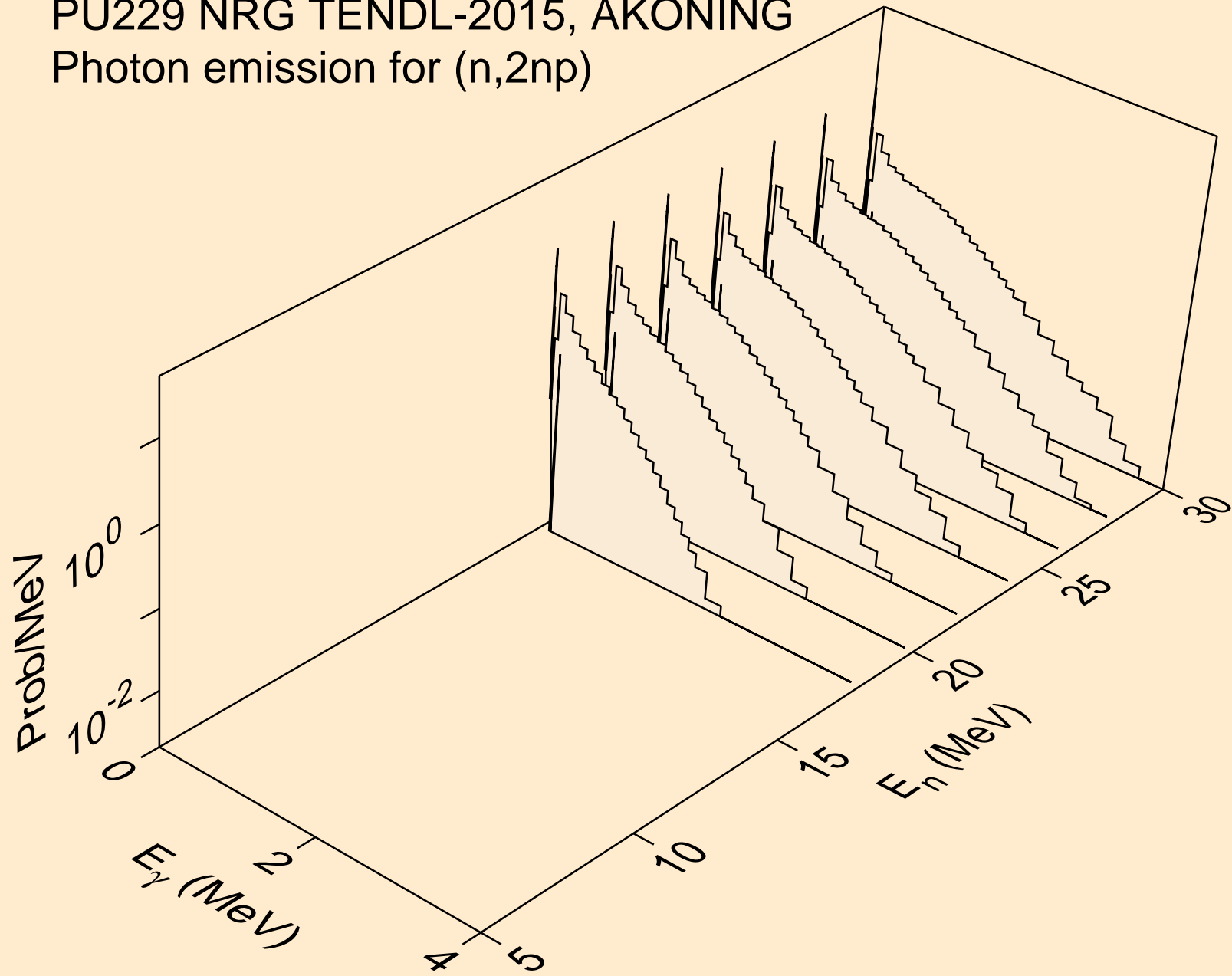

PU229 NRG TENDL-2015, AKONING
Photon emission for (n,npa)

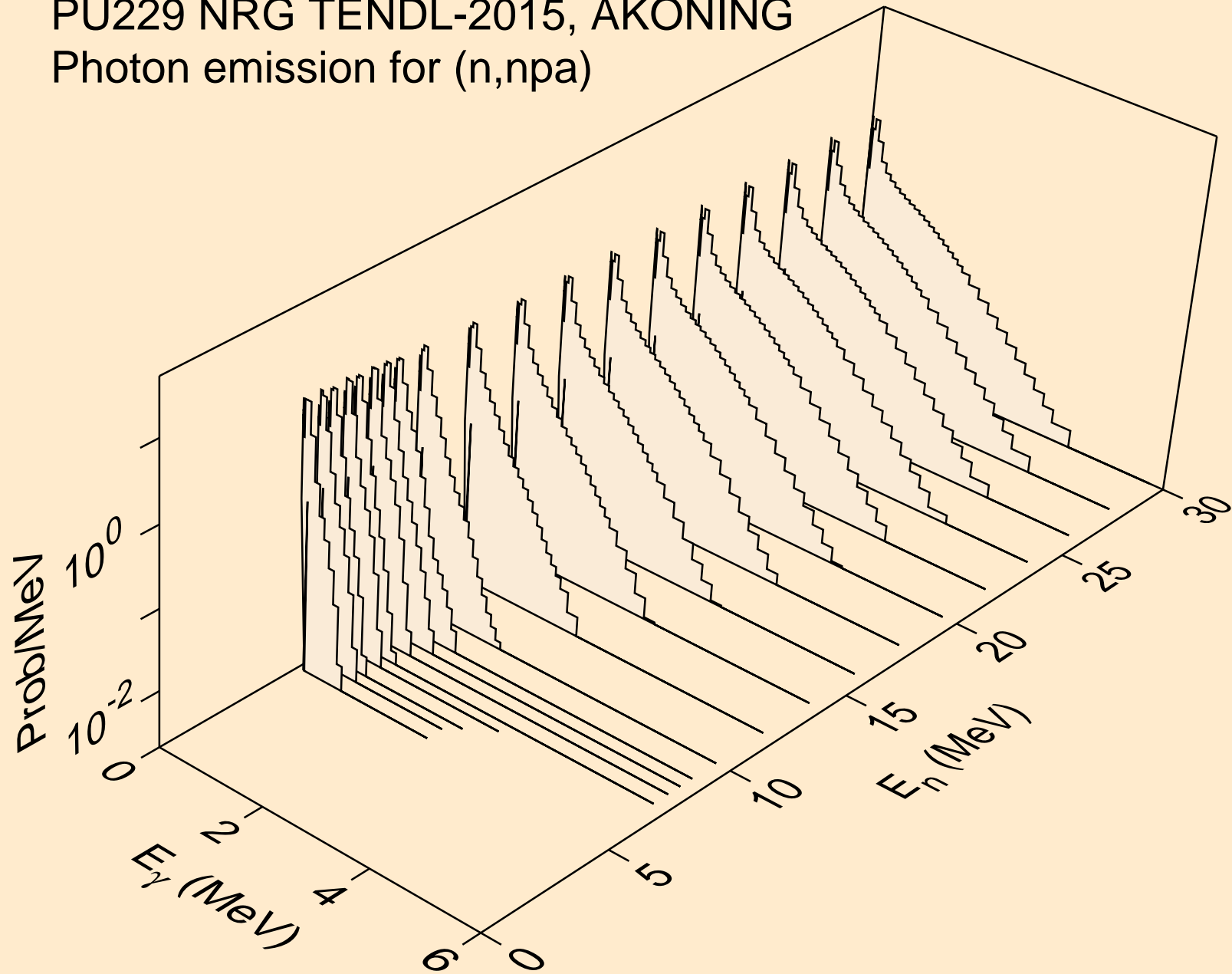

PU229 NRG TENDL-2015, AKONING
Photon emission for (n,n*c)

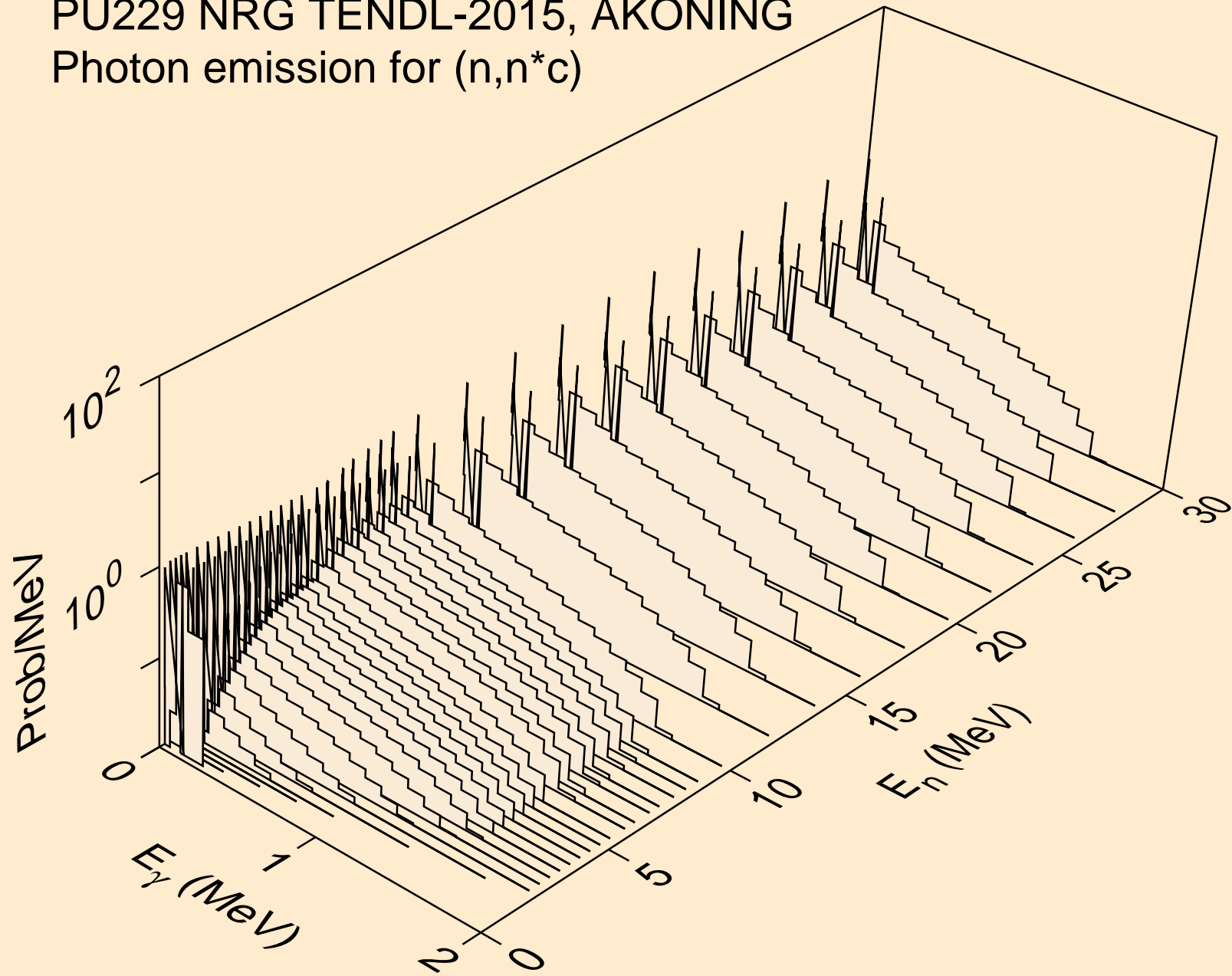

PU229 NRG TENDL-2015, AKONING
Photon emission for (n,gma)

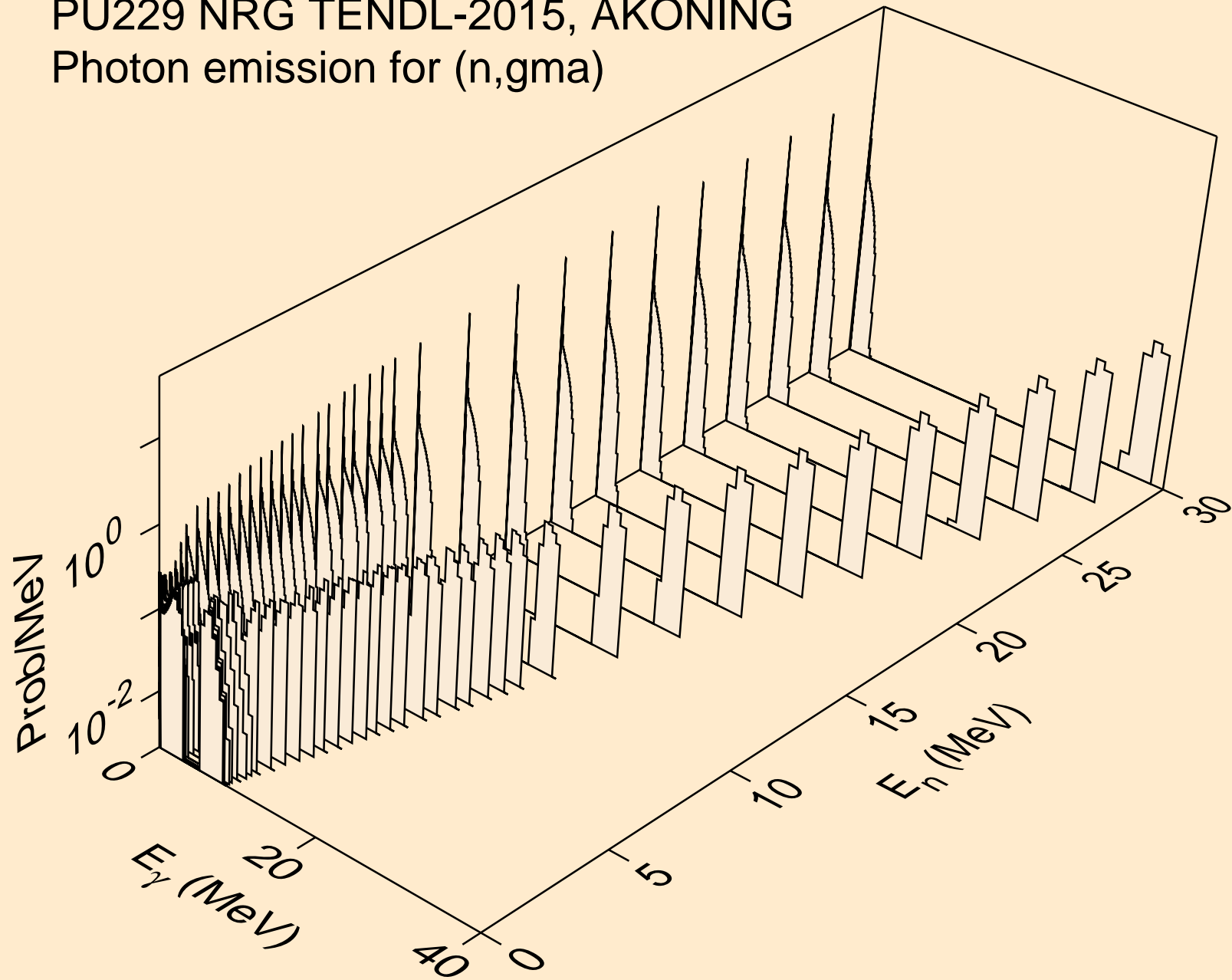

PU229 NRG TENDL-2015, AKONING
Photon emission for (n,p)

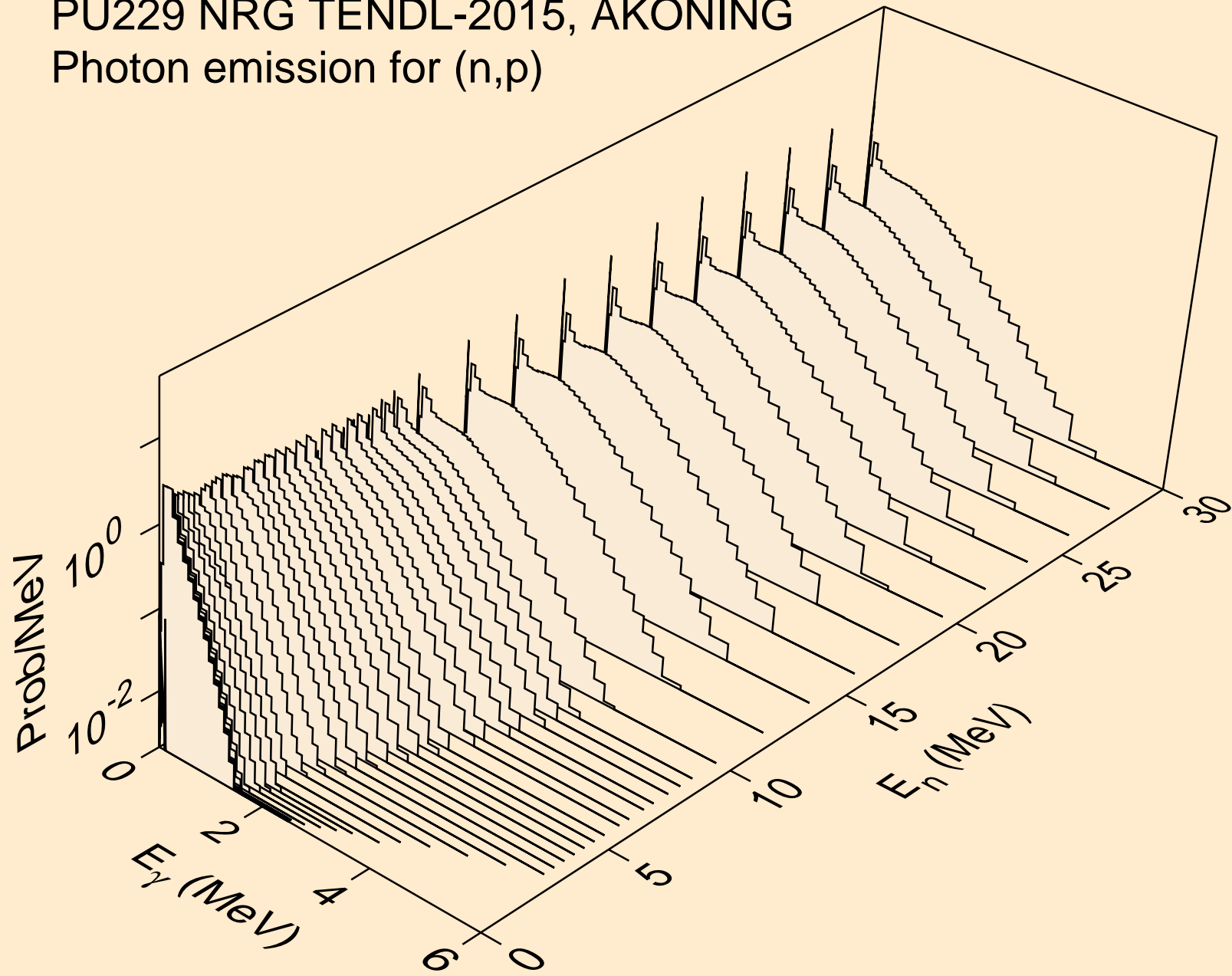

PU229 NRG TENDL-2015, AKONING
Photon emission for (n,d)

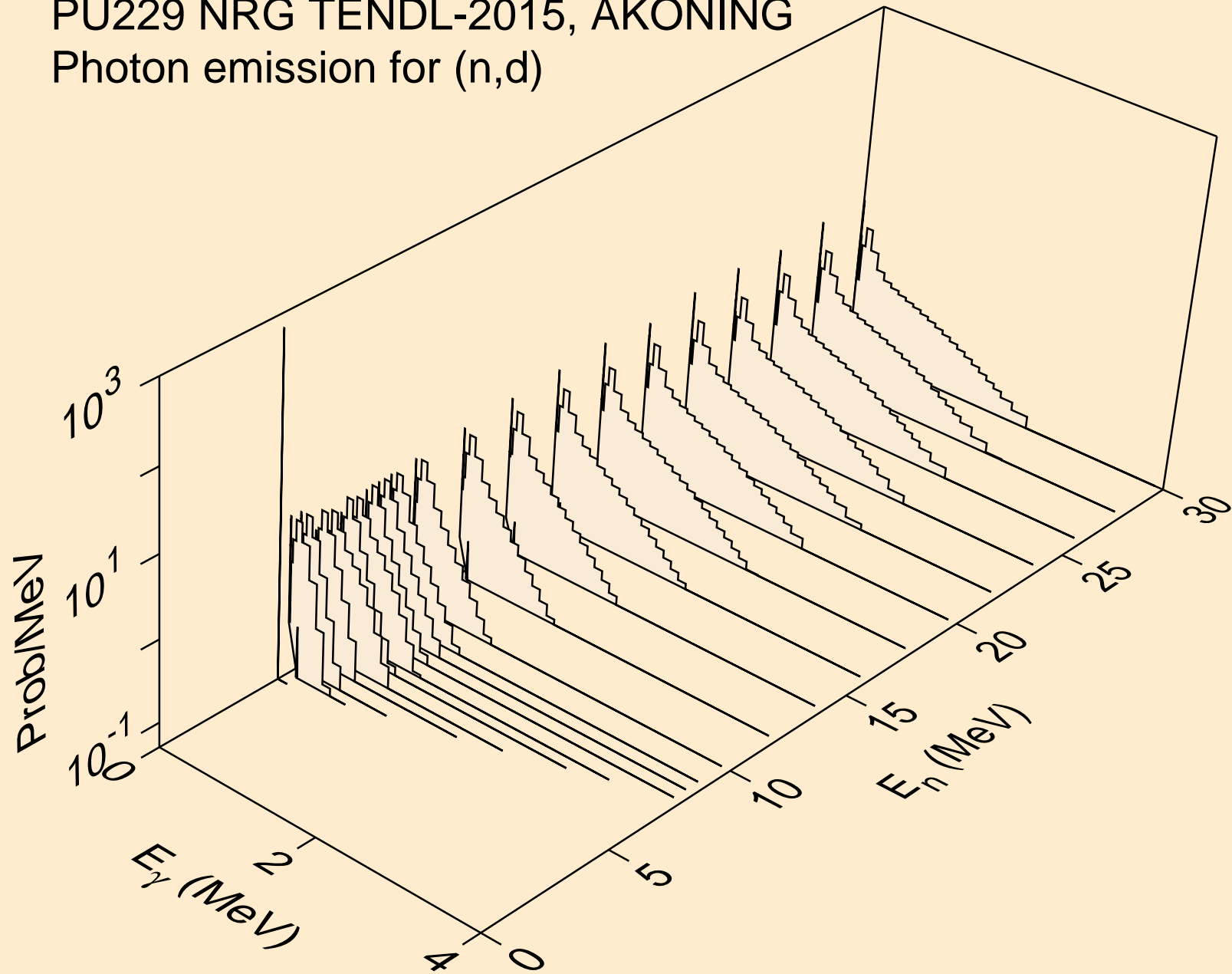

PU229 NRG TENDL-2015, AKONING
Photon emission for (n,t)

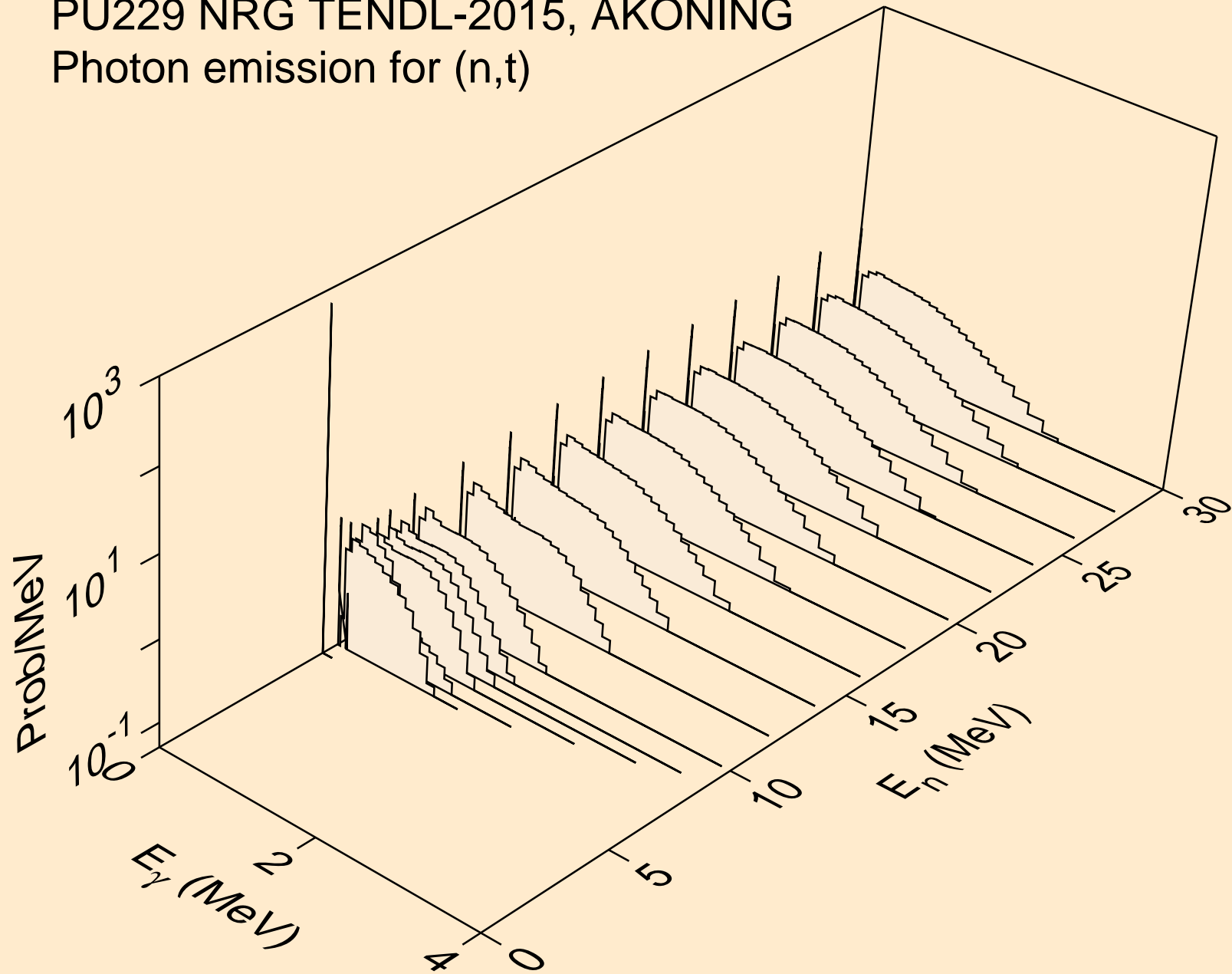

PU229 NRG TENDL-2015, AKONING
Photon emission for (n,he3)

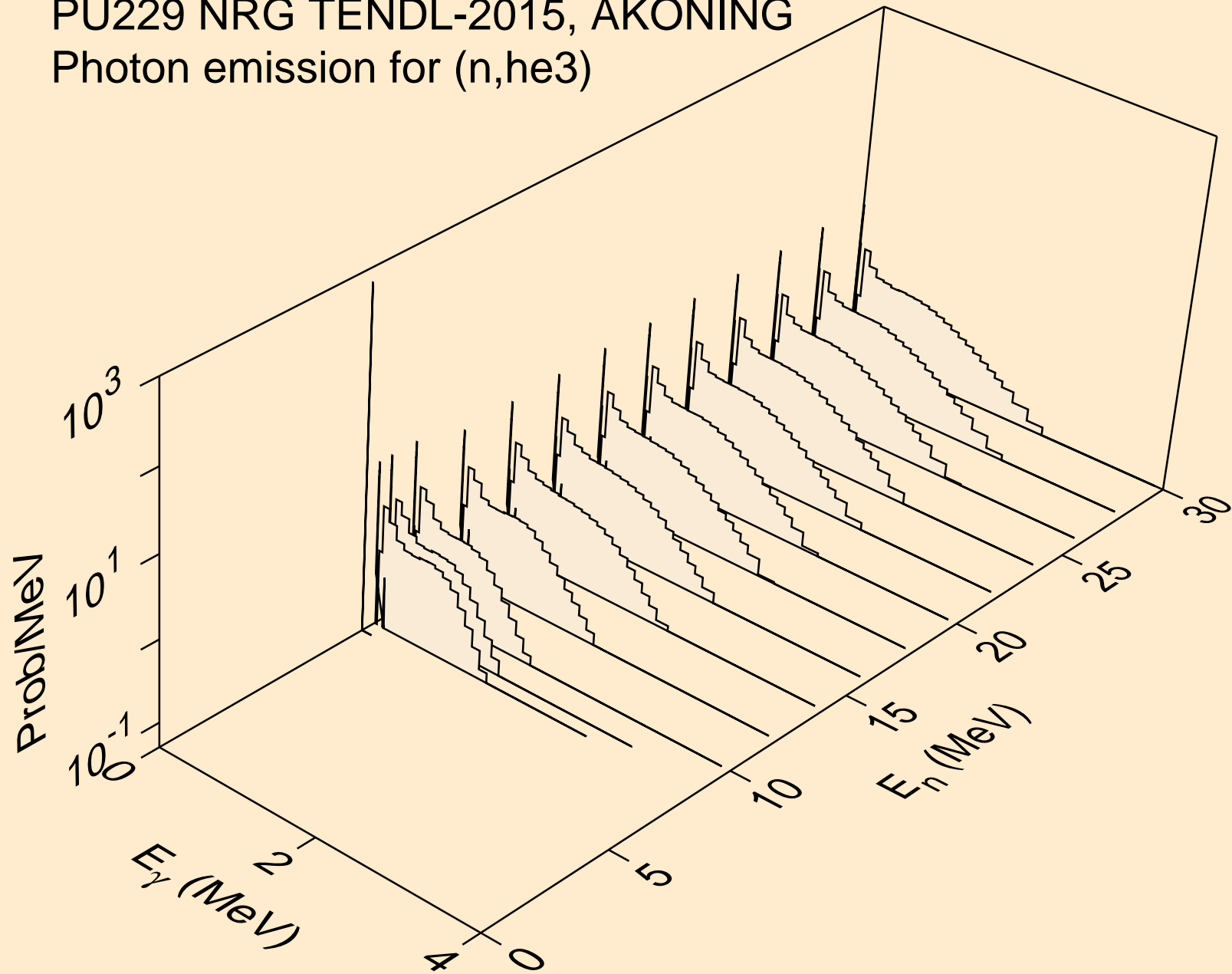

PU229 NRG TENDL-2015, AKONING
Photon emission for (n,a)

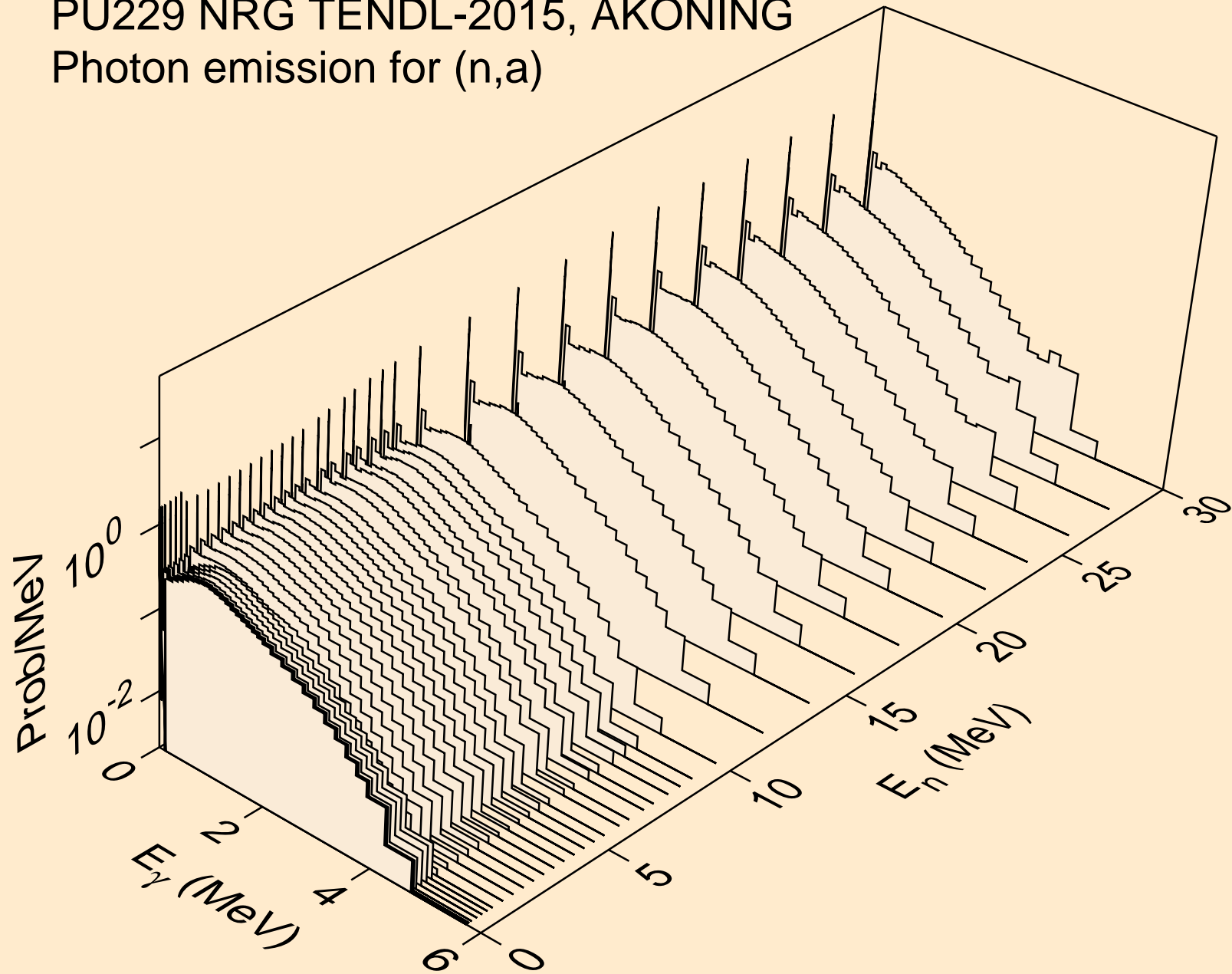

PU229 NRG TENDL-2015, AKONING
Photon emission for (n,2a)

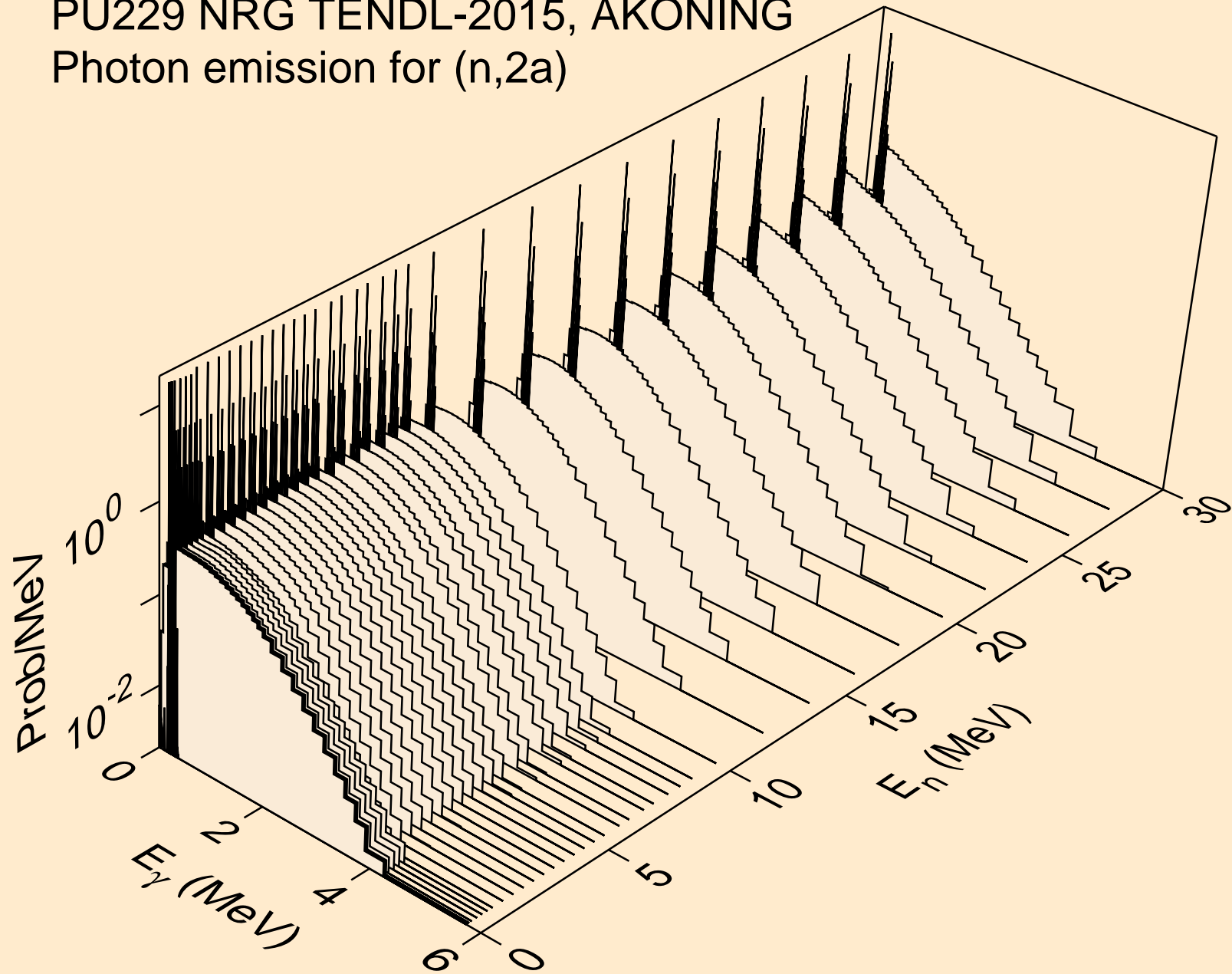

PU229 NRG TENDL-2015, AKONING
Photon emission for (n,3a)

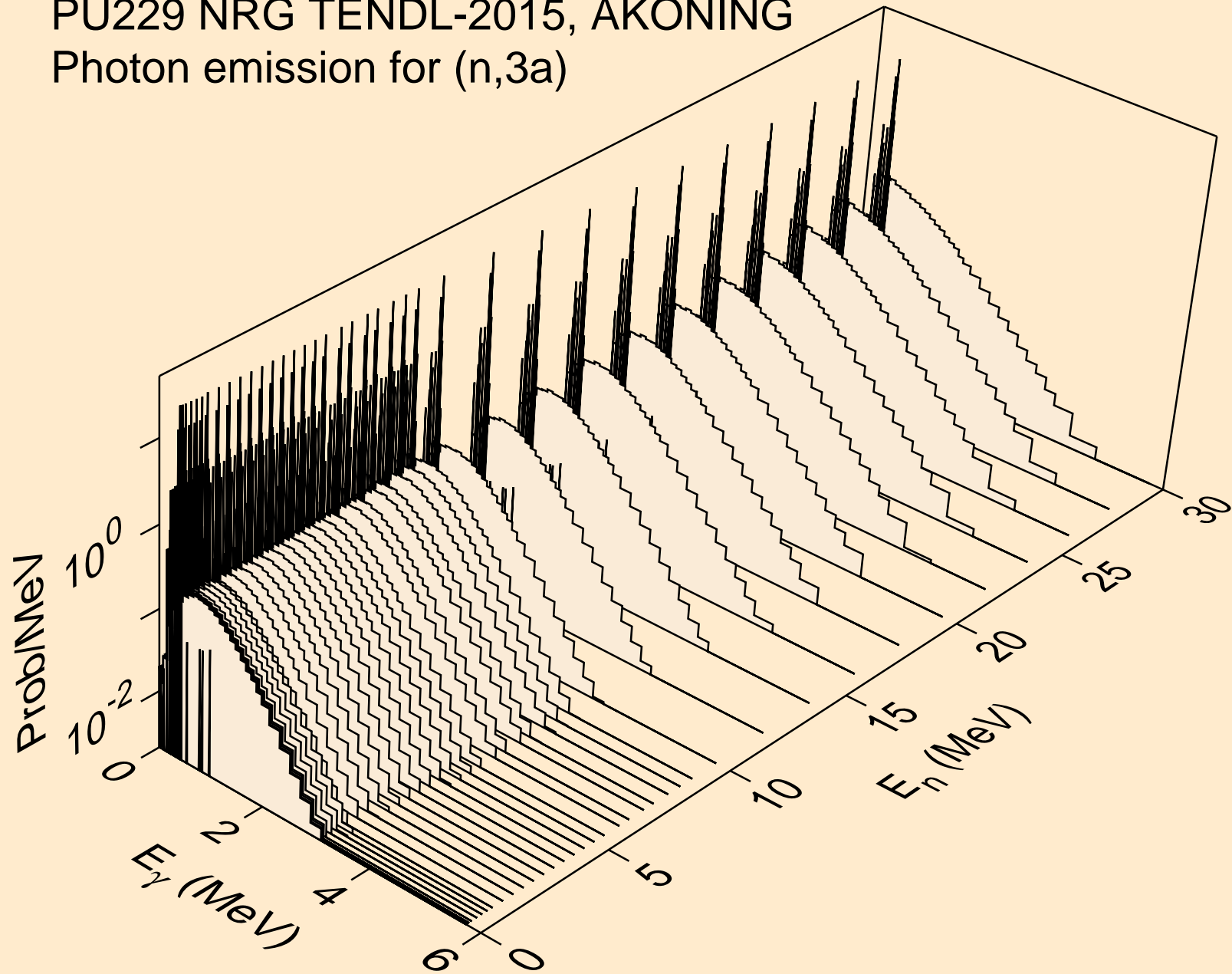

PU229 NRG TENDL-2015, AKONING
Photon emission for (n,2p)

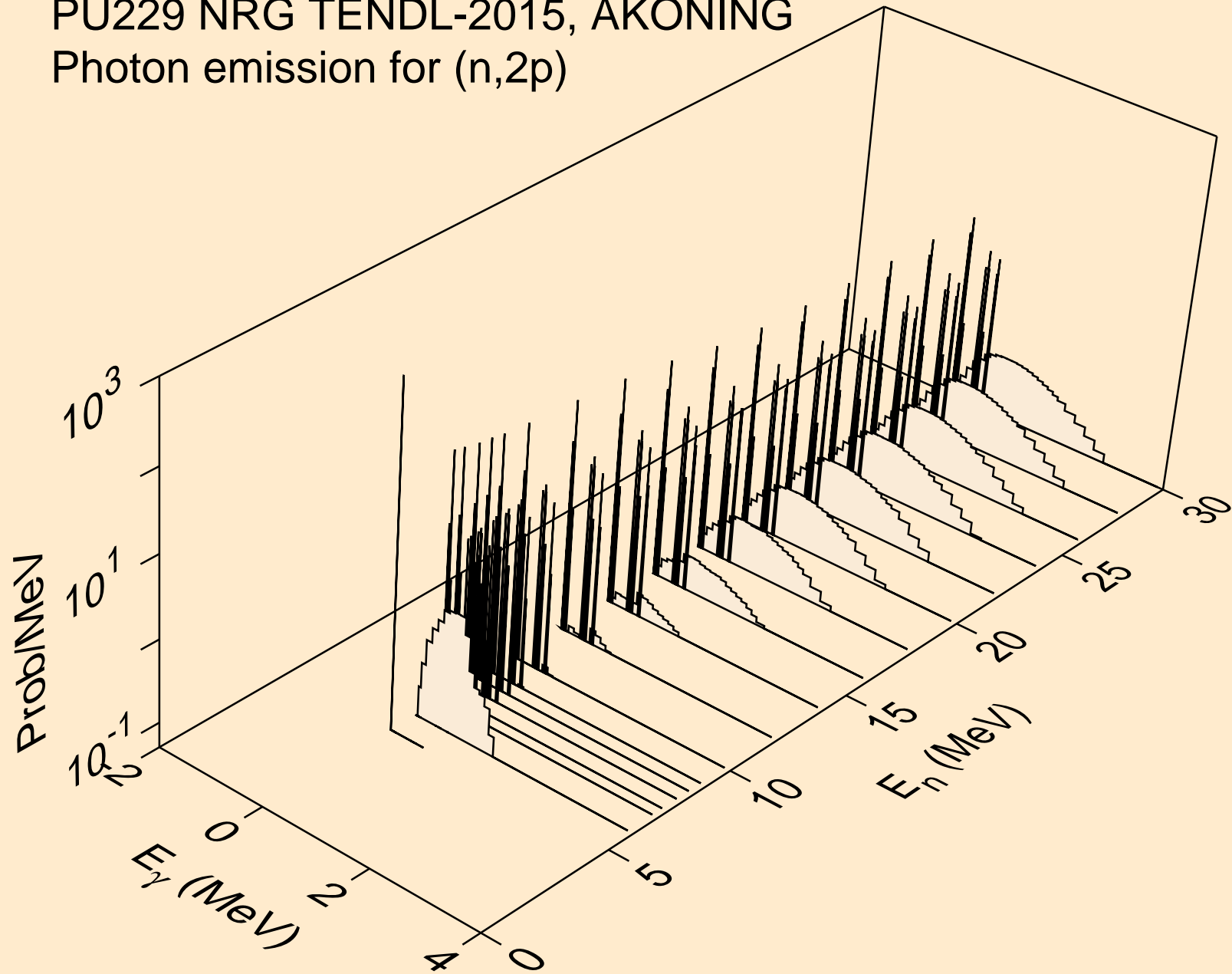

PU229 NRG TENDL-2015, AKONING
Photon emission for (n,pa)

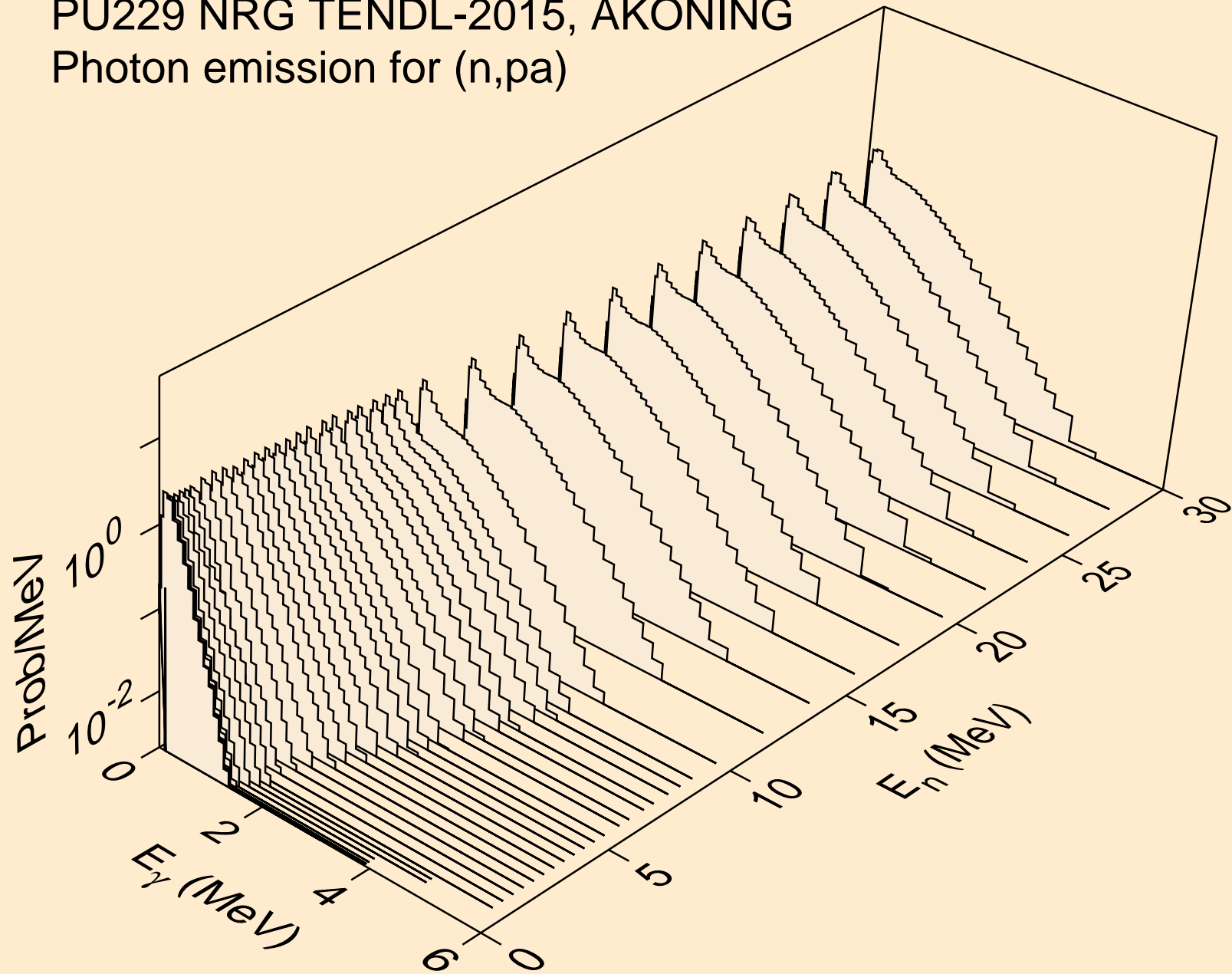

PU229 NRG TENDL-2015, AKONING
Photon emission for (n,t2a)

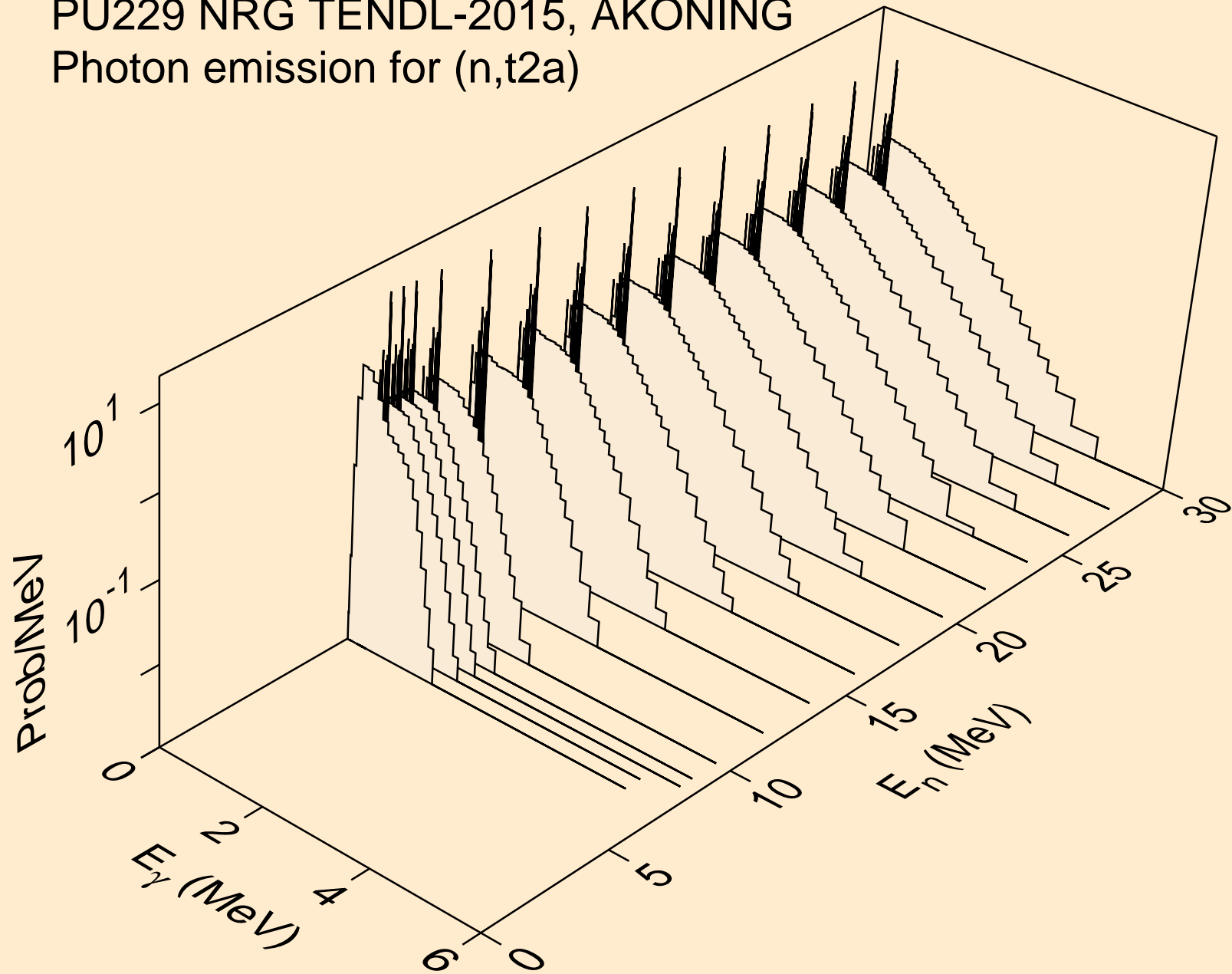

PU229 NRG TENDL-2015, AKONING
Photon emission for (n,d2a)

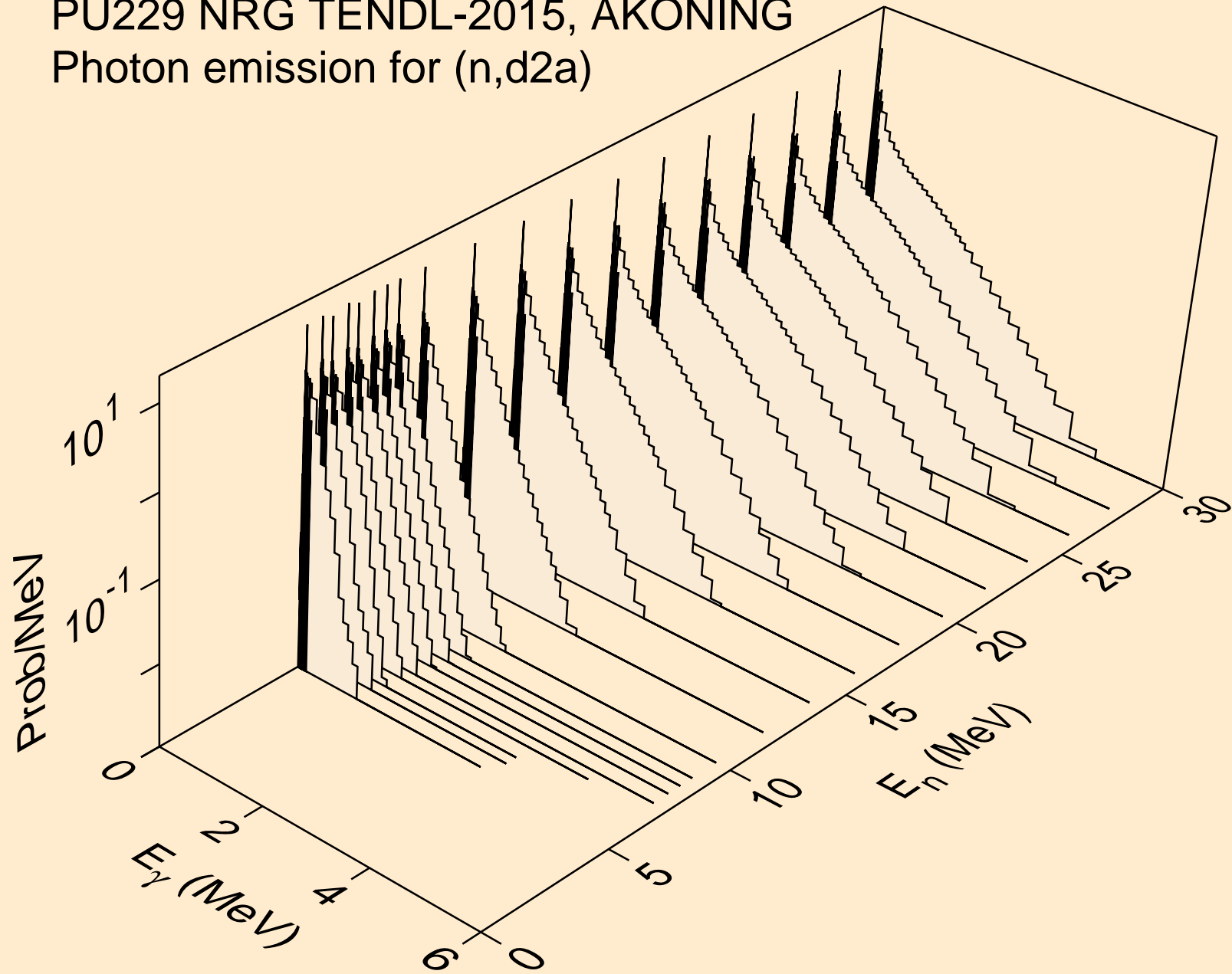

PU229 NRG TENDL-2015, AKONING
Photon emission for (n,pd)

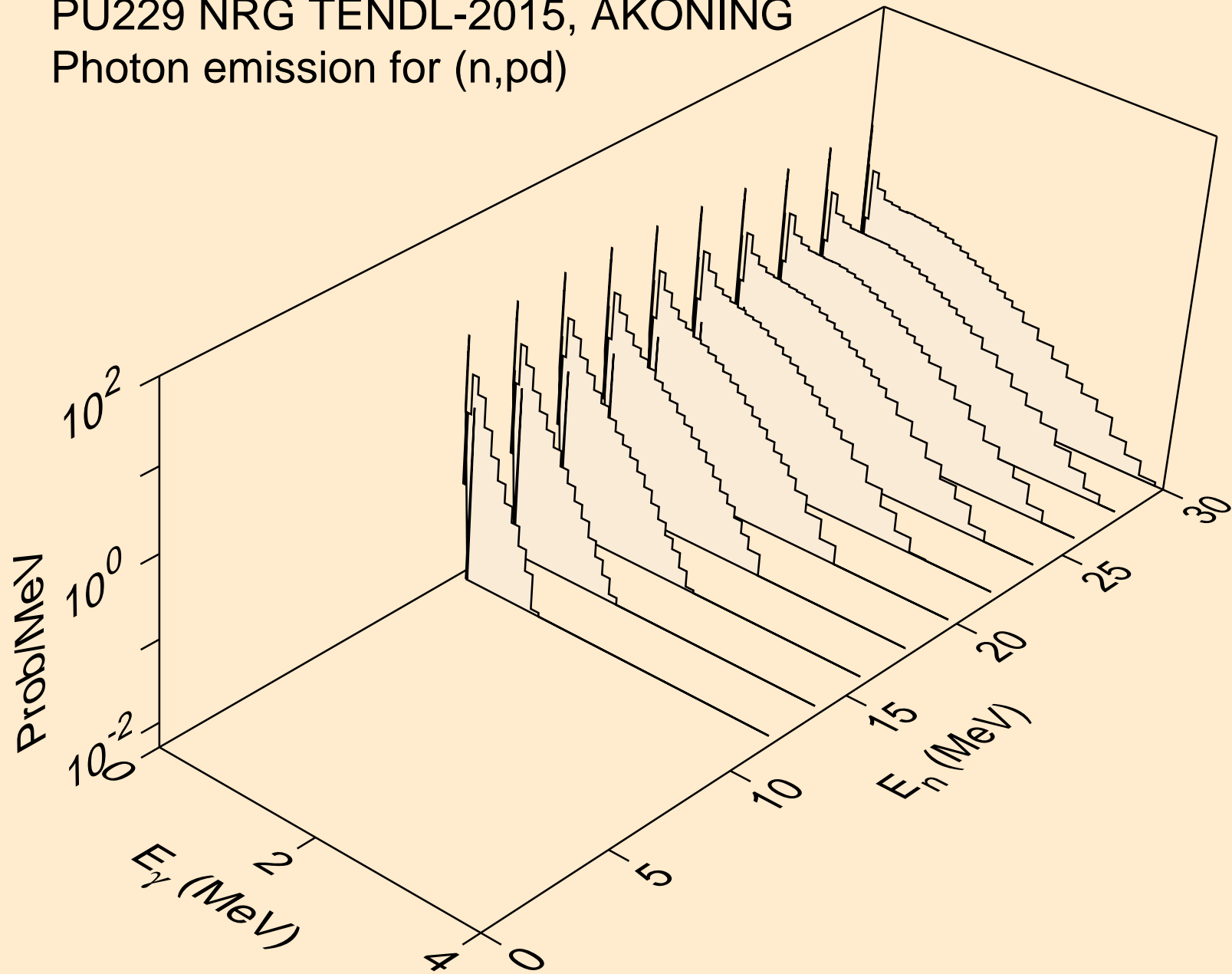

PU229 NRG TENDL-2015, AKONING
Photon emission for (n,pt)

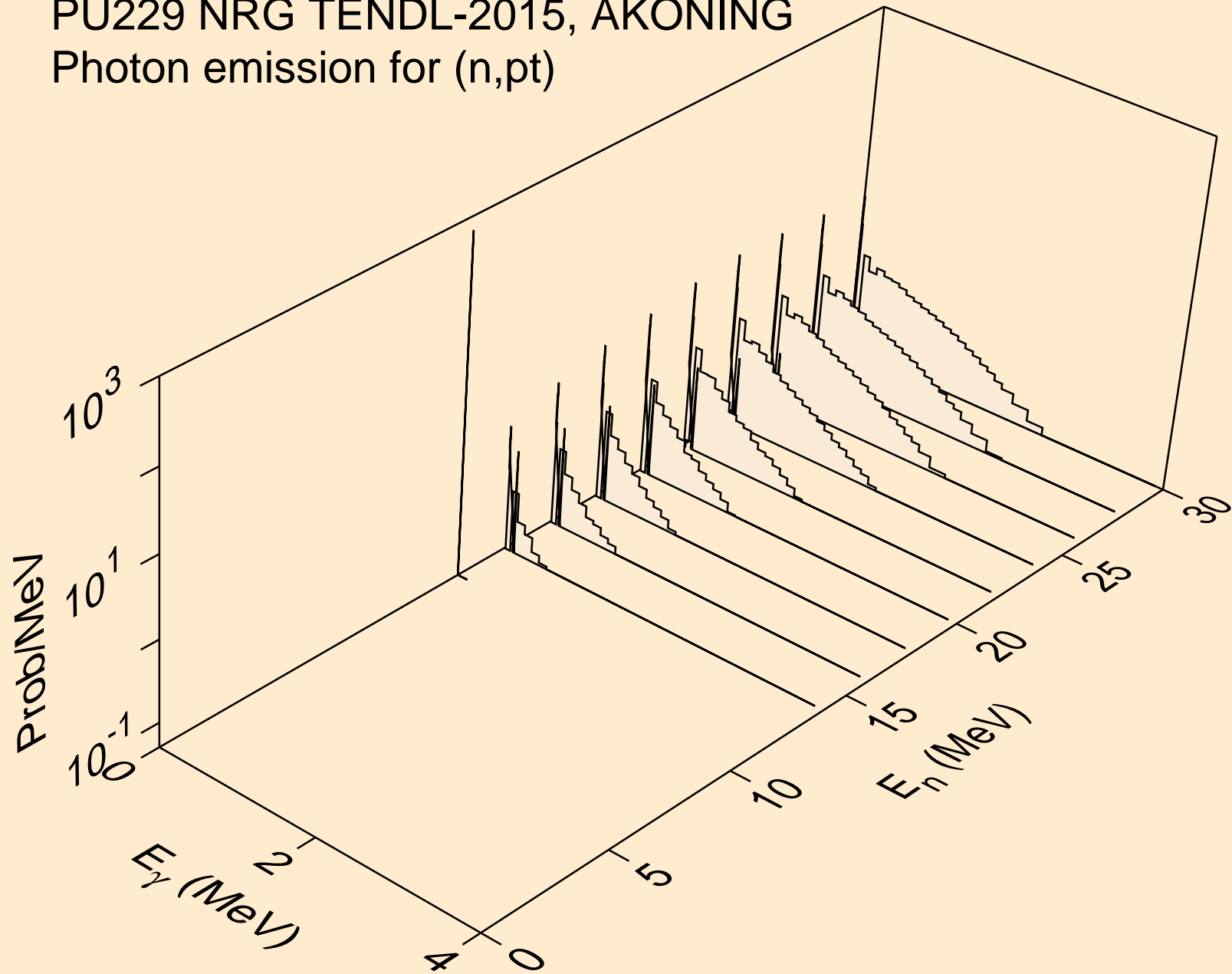

PU229 NRG TENDL-2015, AKONING
Photon emission for (n,da)

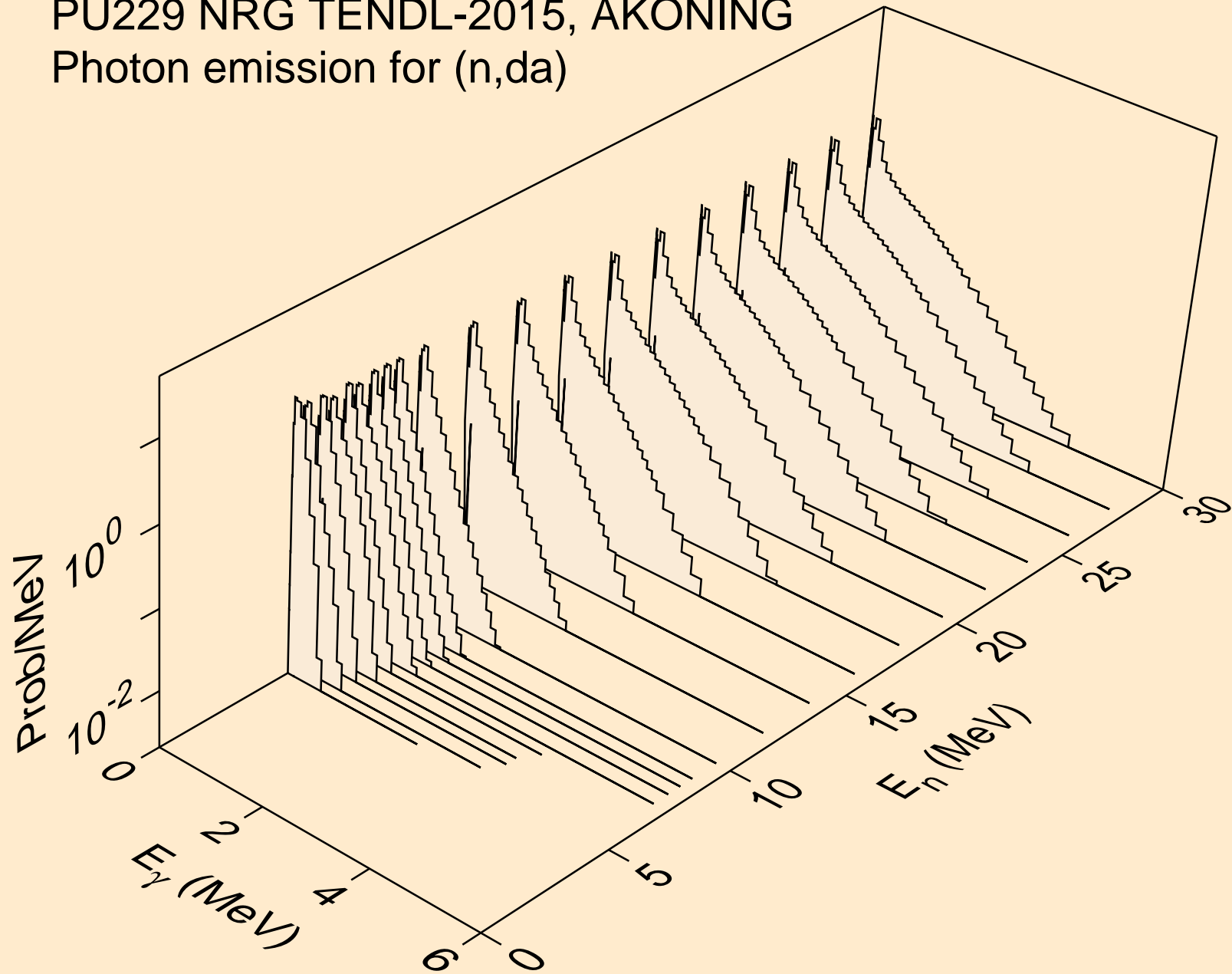

PU229 NRG TENDL-2015, AKONING
thermal capture photon spectrum

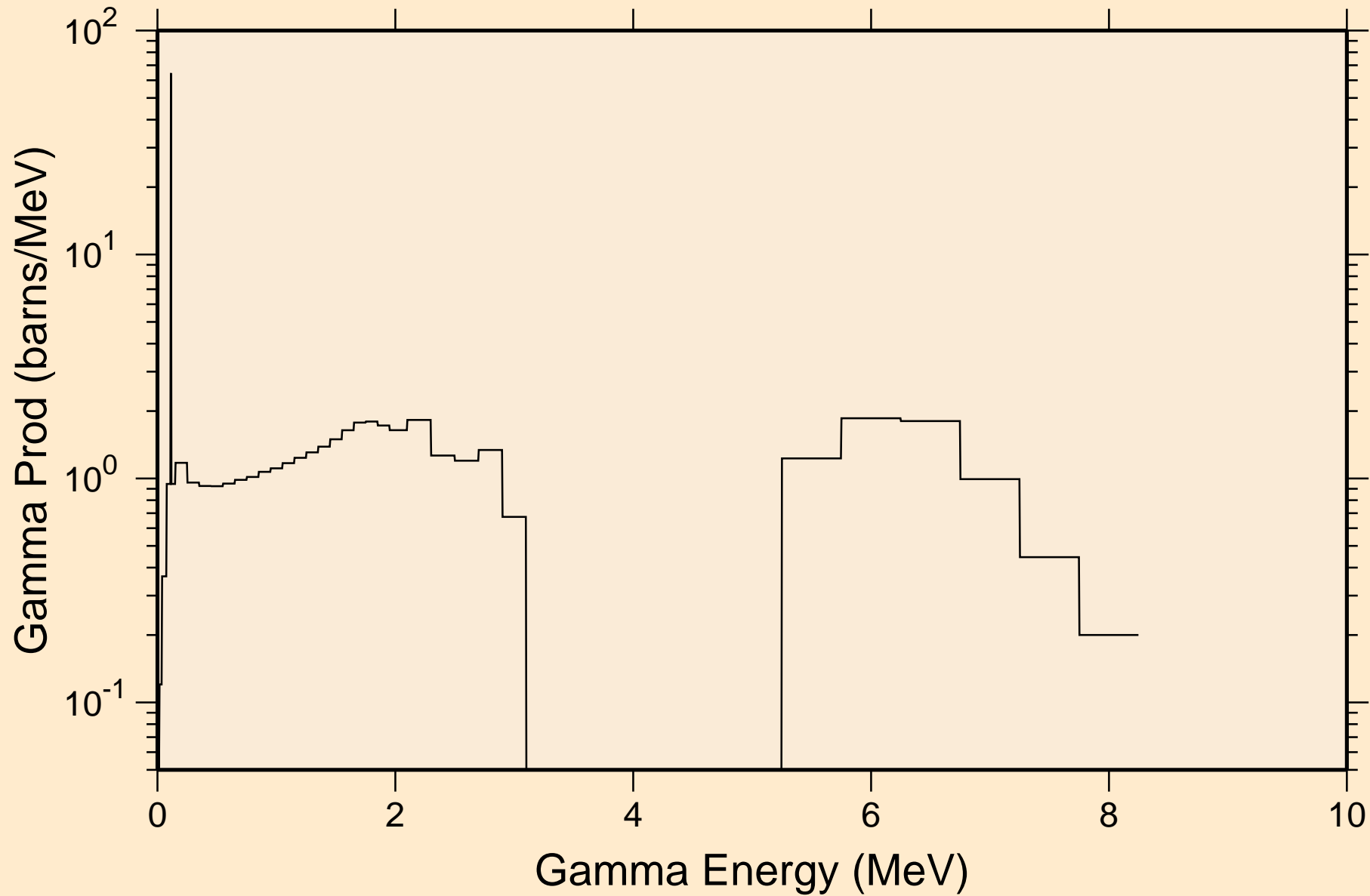

PU229 NRG TENDL-2015, AKONING
14 MeV photon spectrum

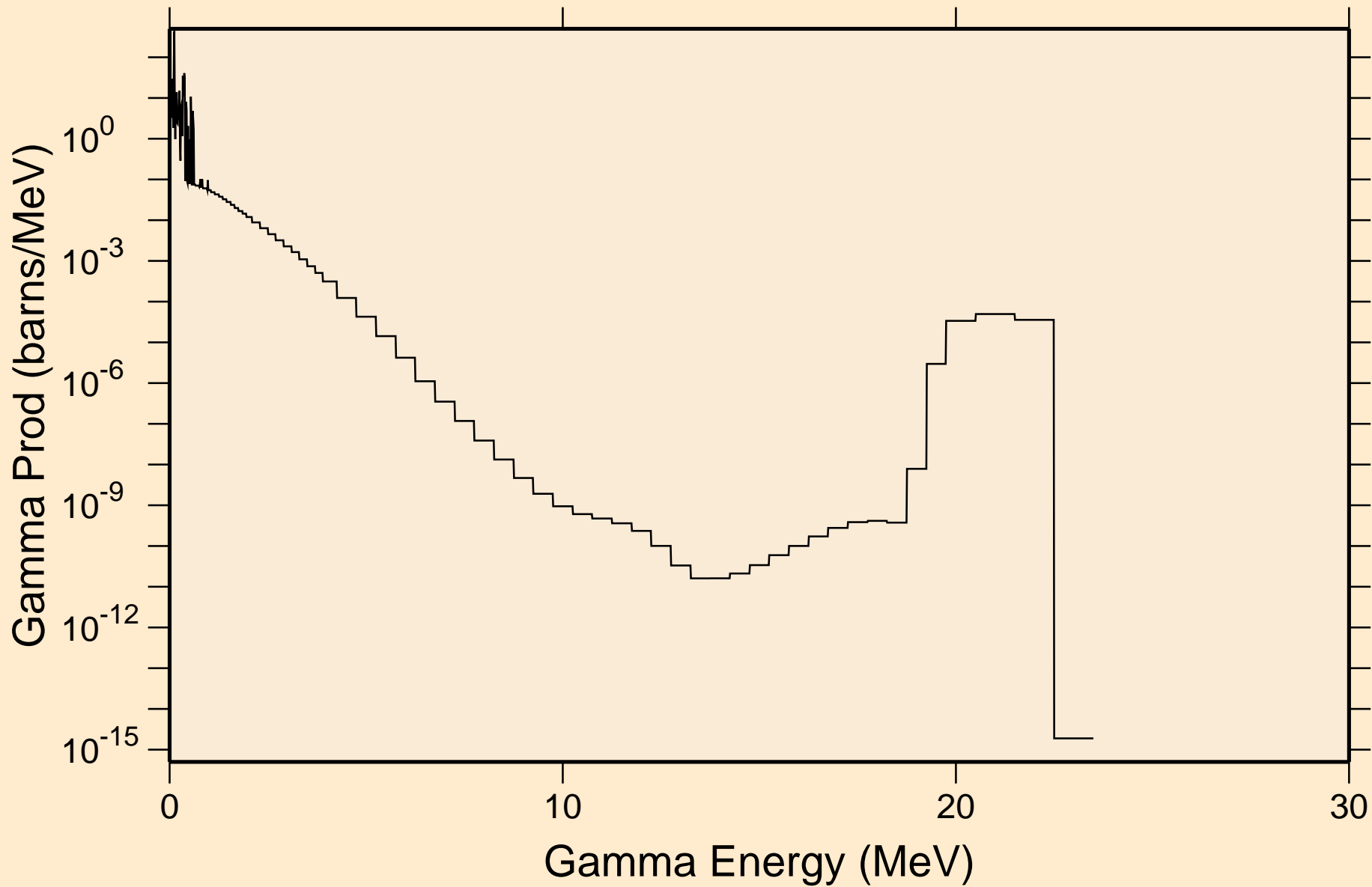

PU229 NRG TENDL-2015, AKONING

Particle heating contributions

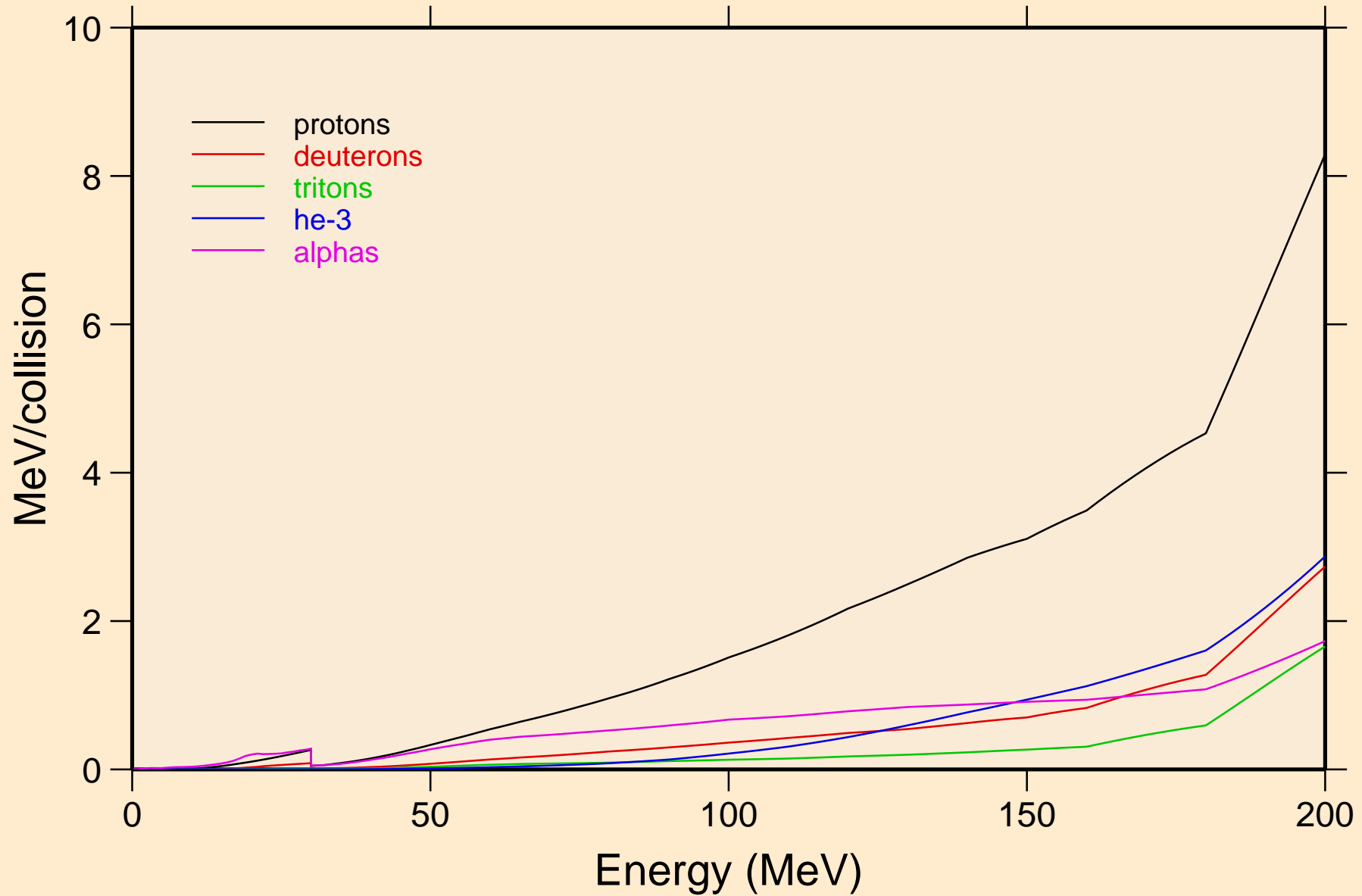

PU229 NRG TENDL-2015, AKONING

Recoil Heating

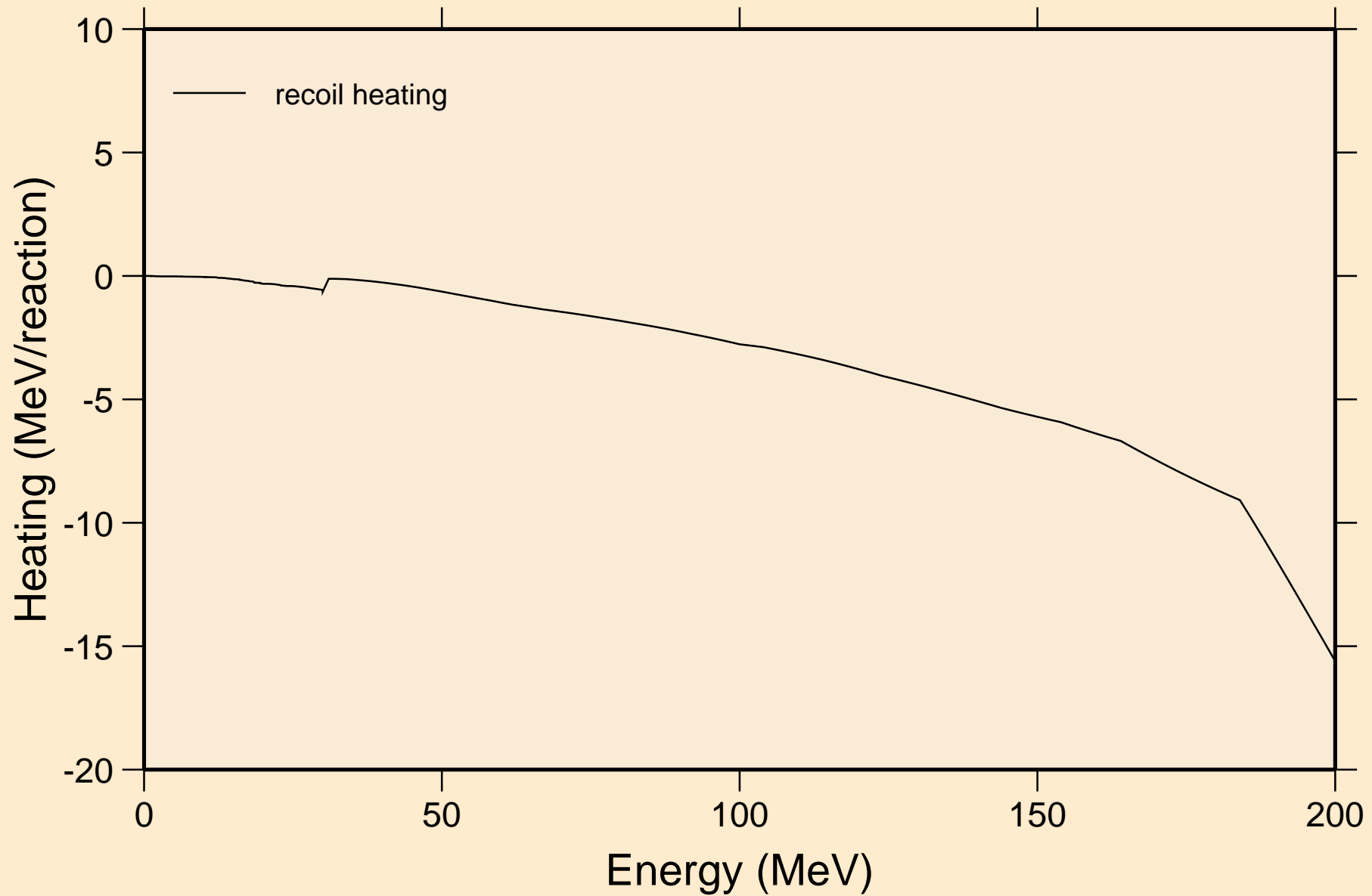

PU229 NRG TENDL-2015, AKONING

Particle production cross sections

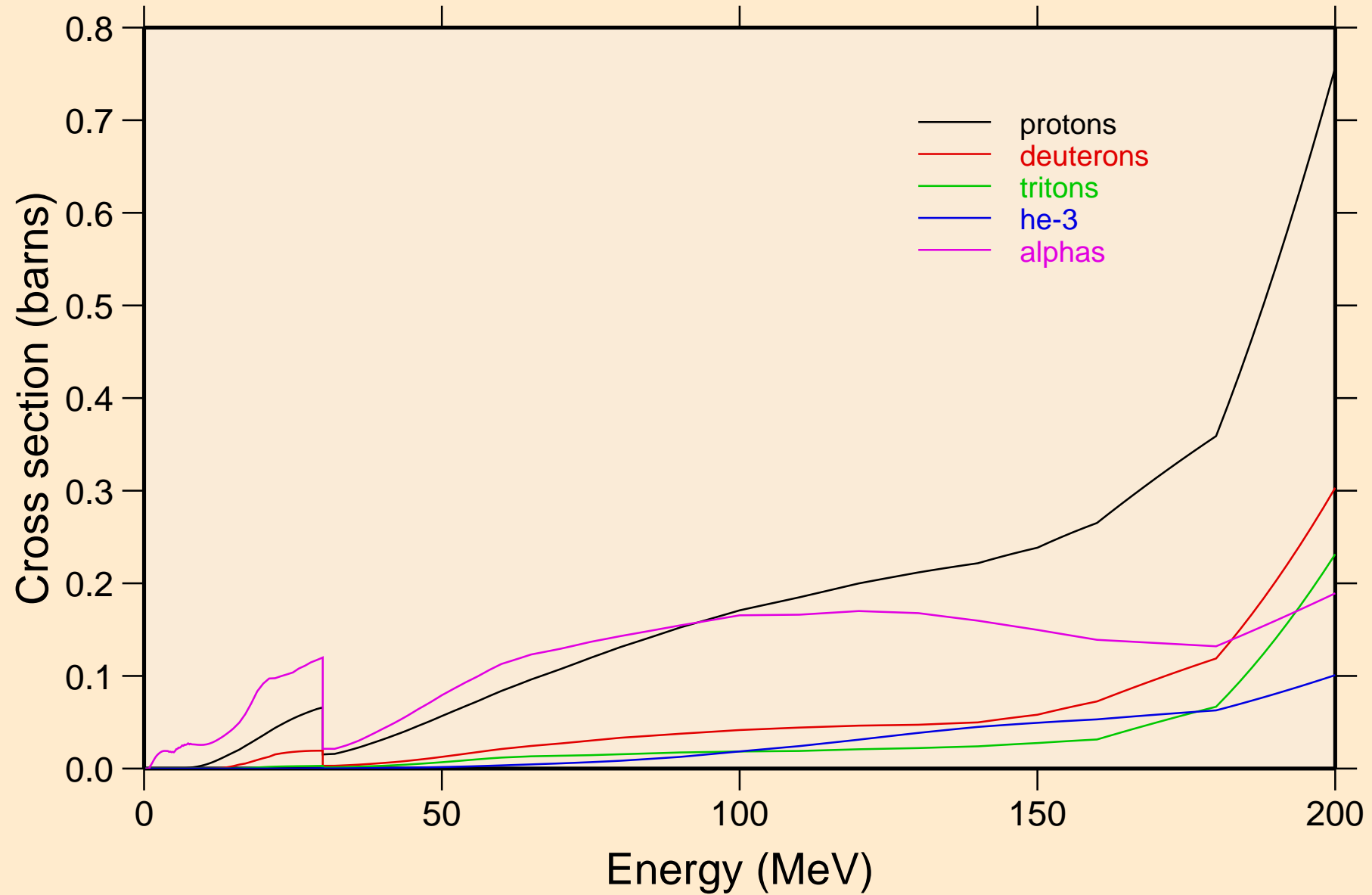

PU229 NRG TENDL-2015, AKONING
protons from (n,x)

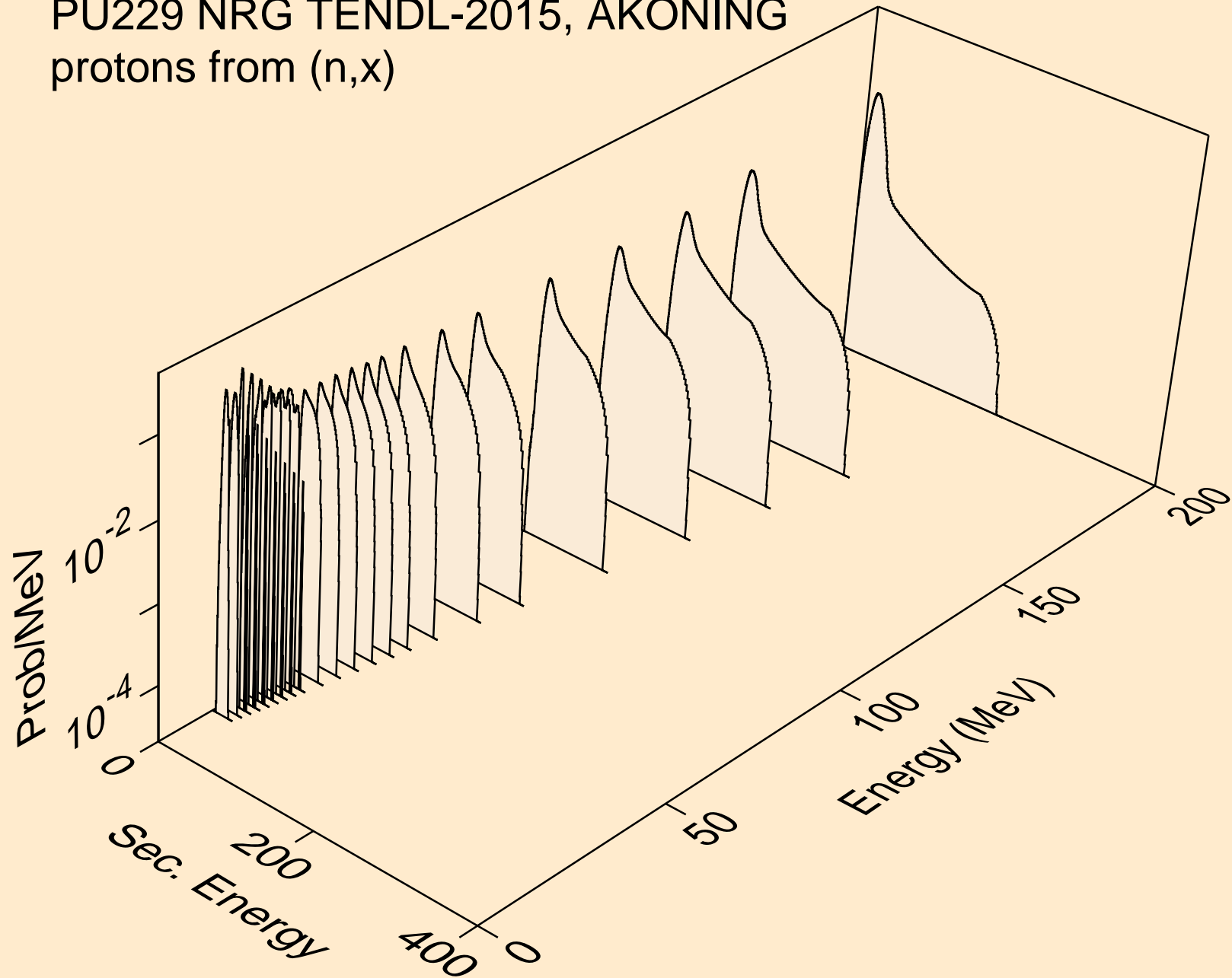

PU229 NRG TENDL-2015, AKONING
protons from (n,n*)p

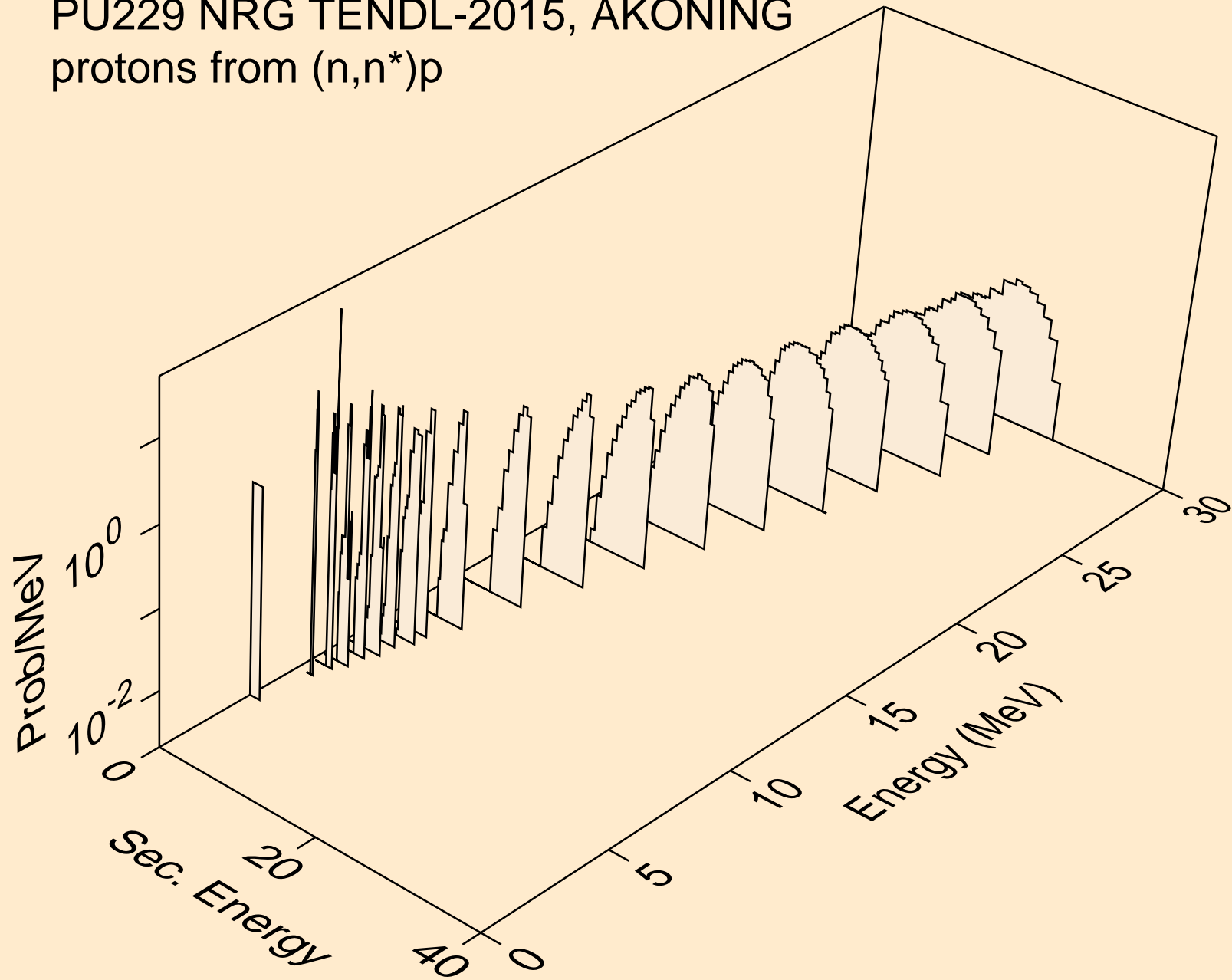

PU229 NRG TENDL-2015, AKONING
protons from (n,2np)

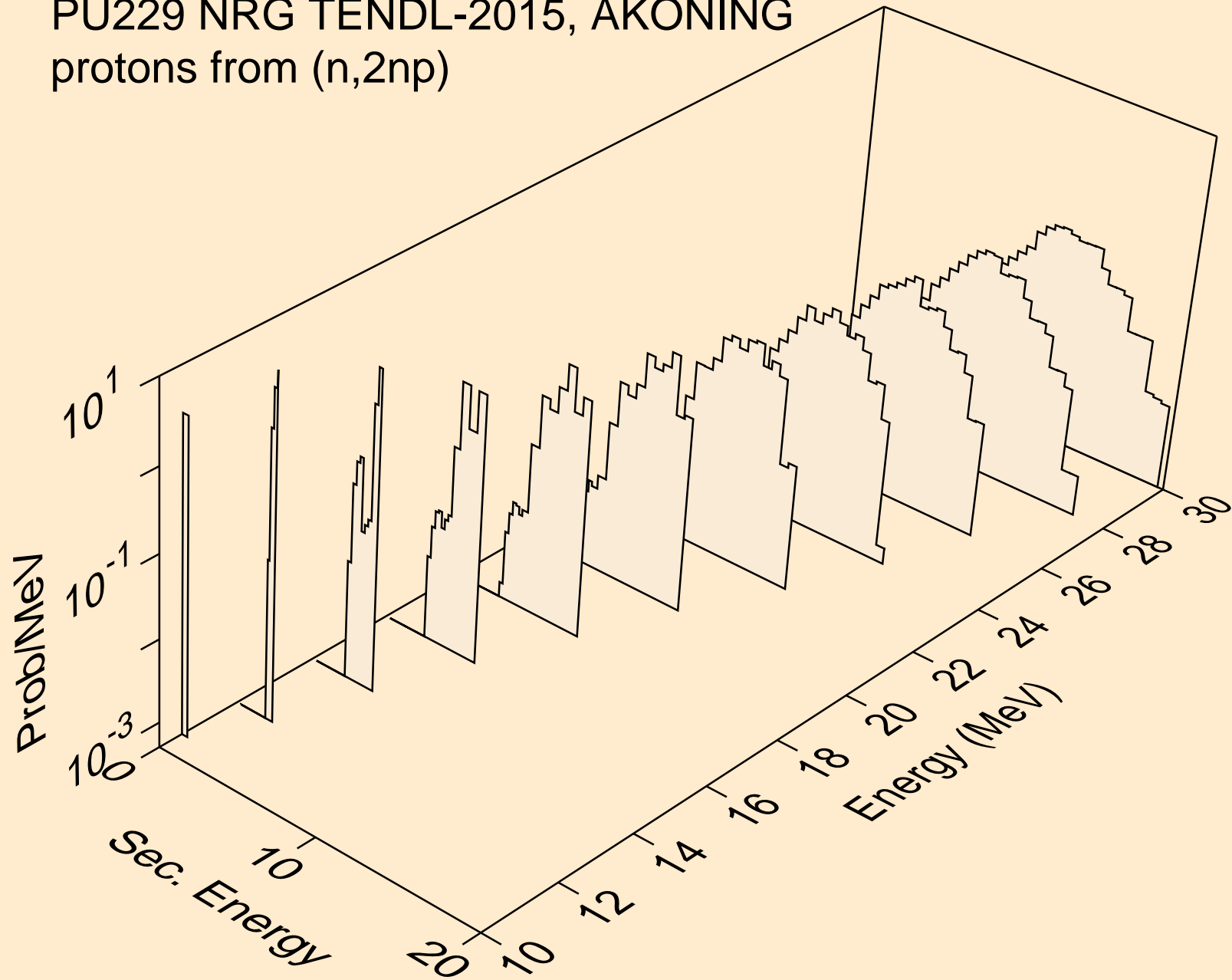

PU229 NRG TENDL-2015, AKONING
protons from (n,3np)

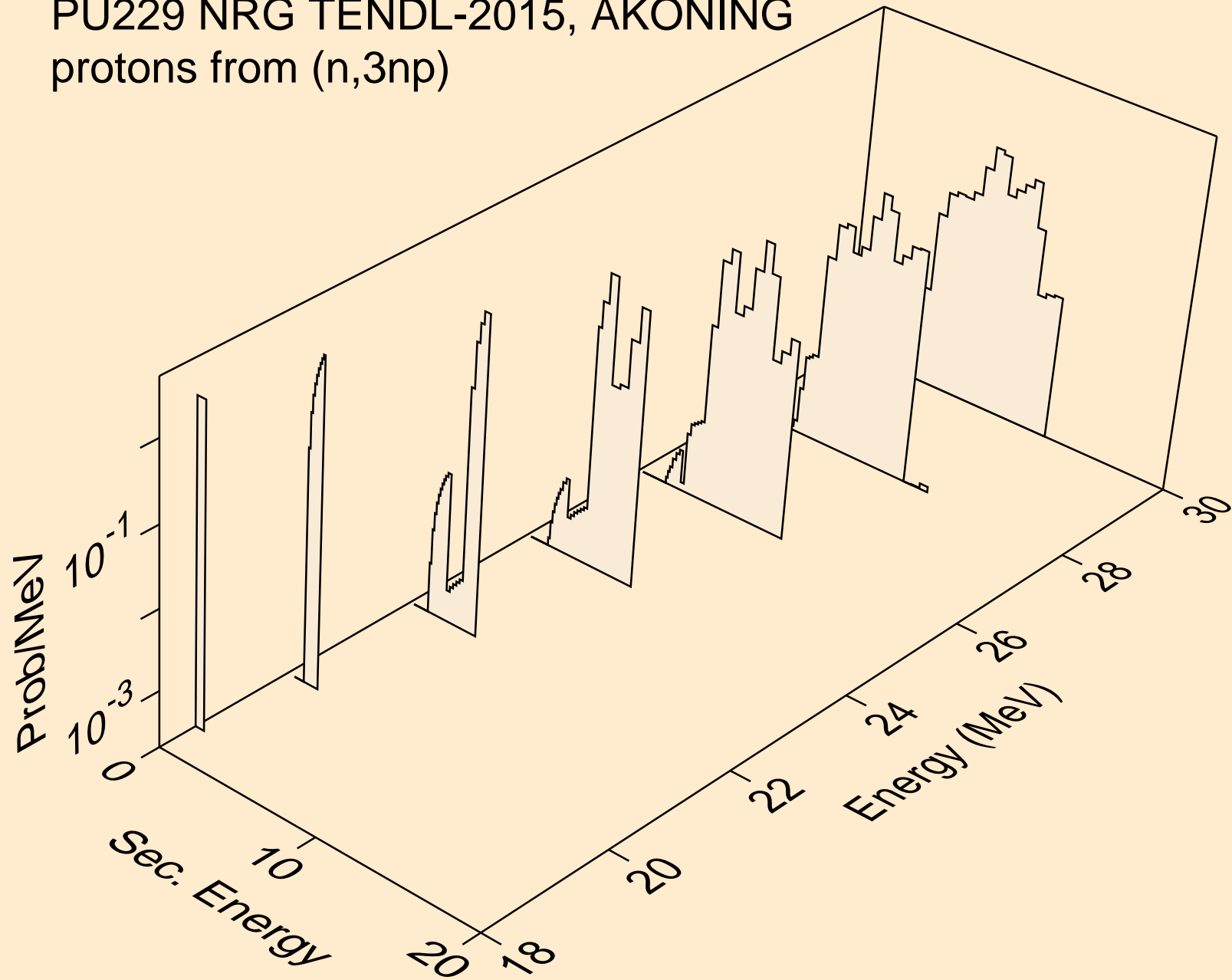

PU229 NRG TENDL-2015, AKONING
protons from (n,2np)

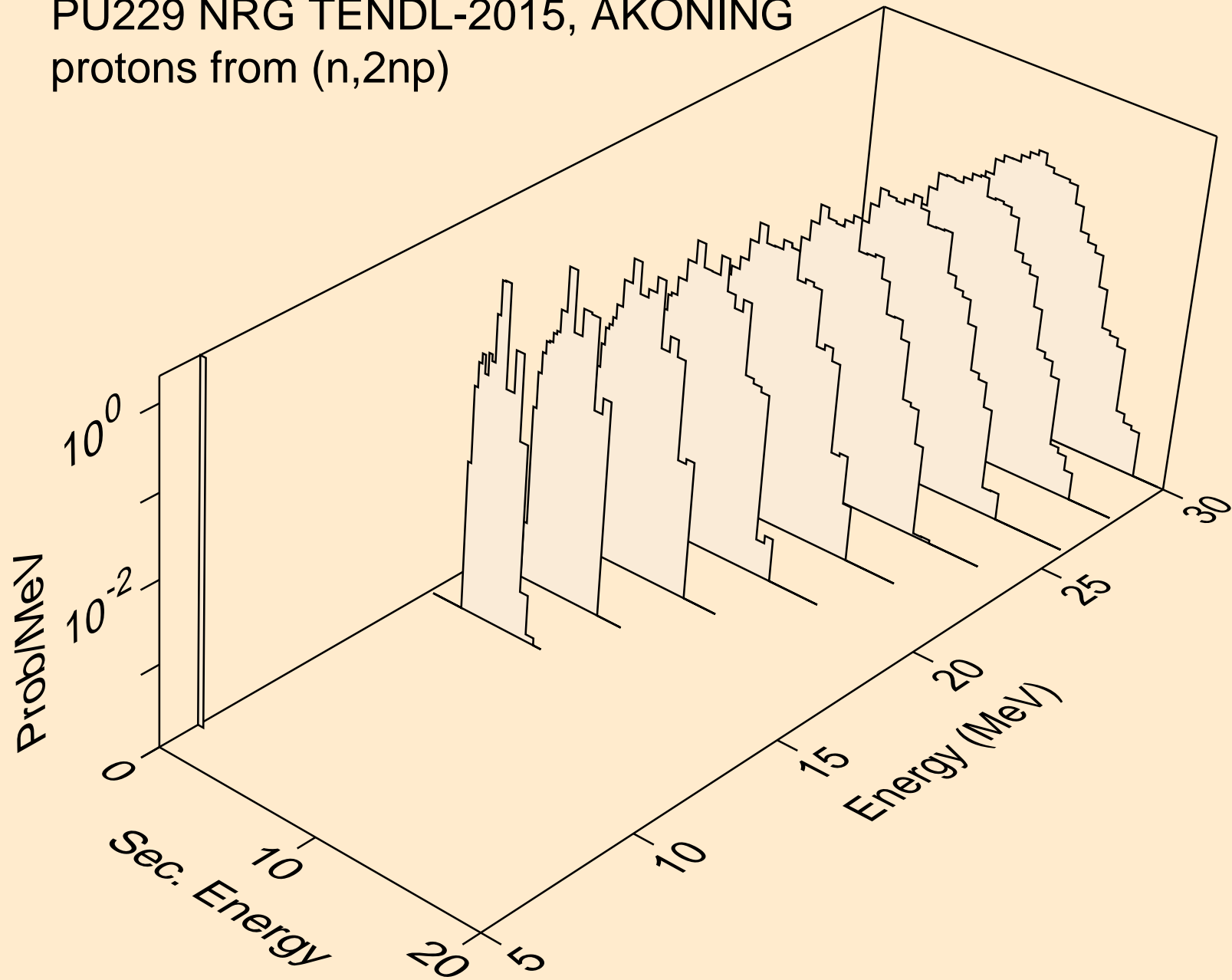

PU229 NRG TENDL-2015, AKONING
protons from (n,npa)

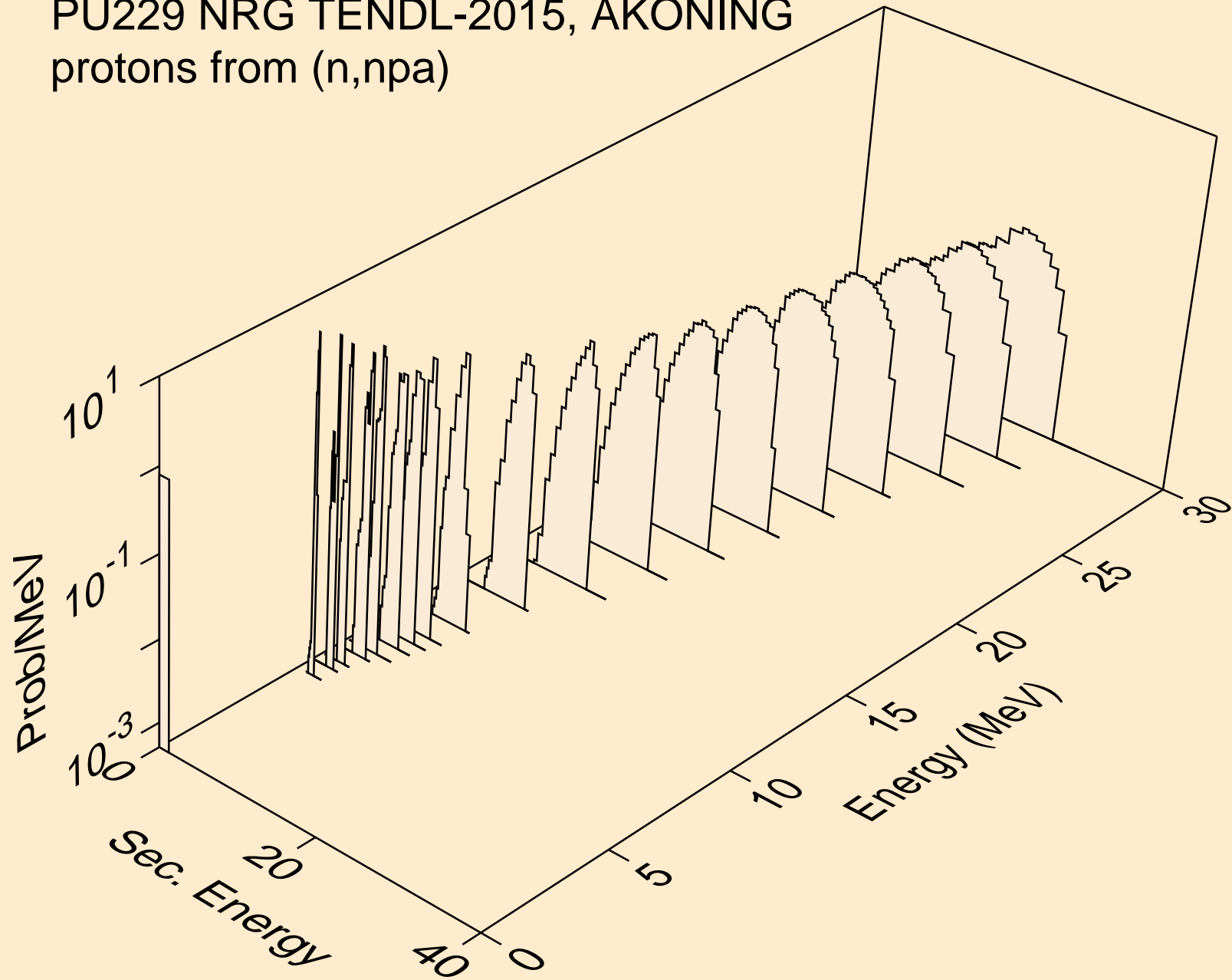

PU229 NRG TENDL-2015, AKONING
protons from (n,p)

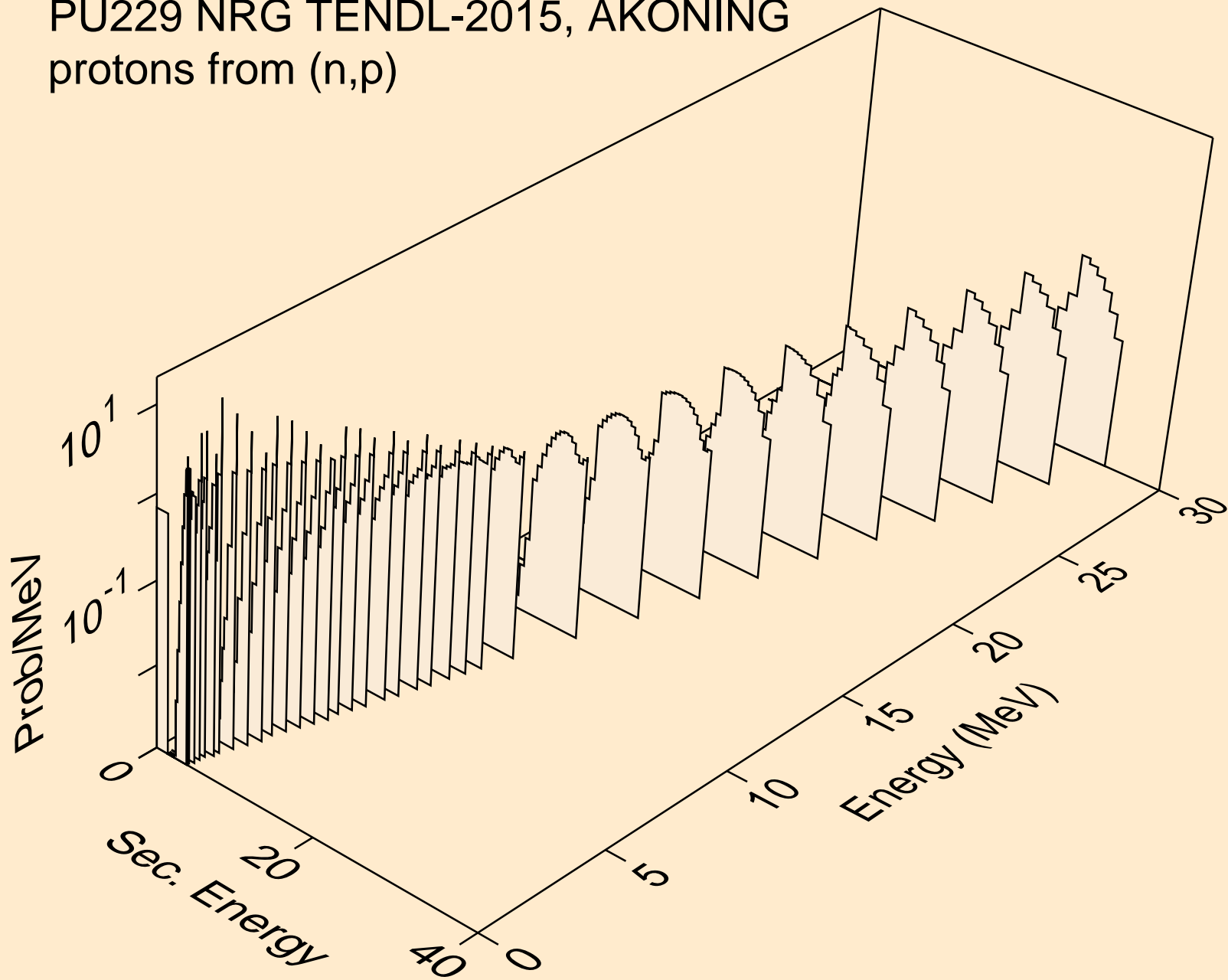

PU229 NRG TENDL-2015, AKONING
protons from (n,2p)

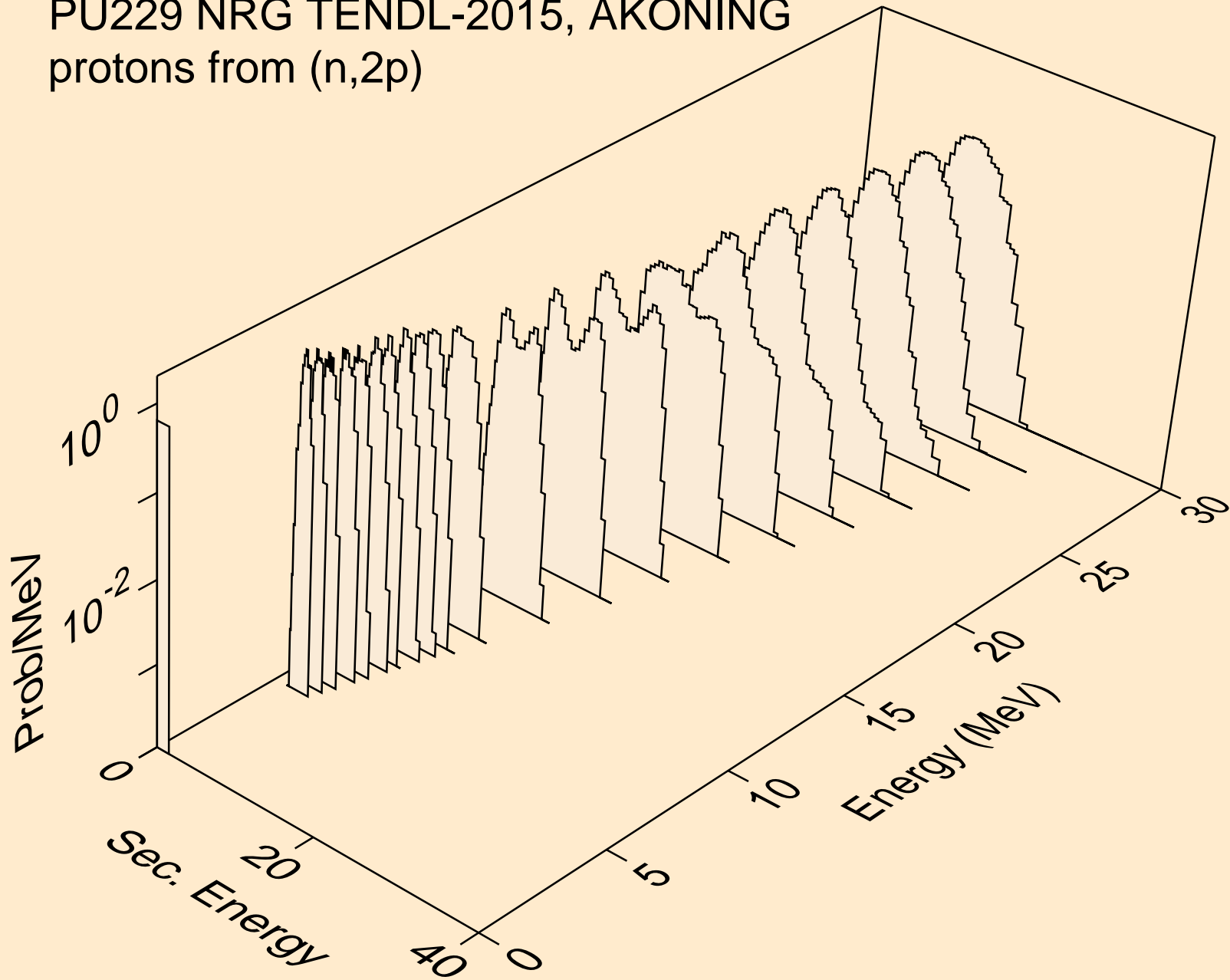

PU229 NRG TENDL-2015, AKONING
protons from (n,pa)

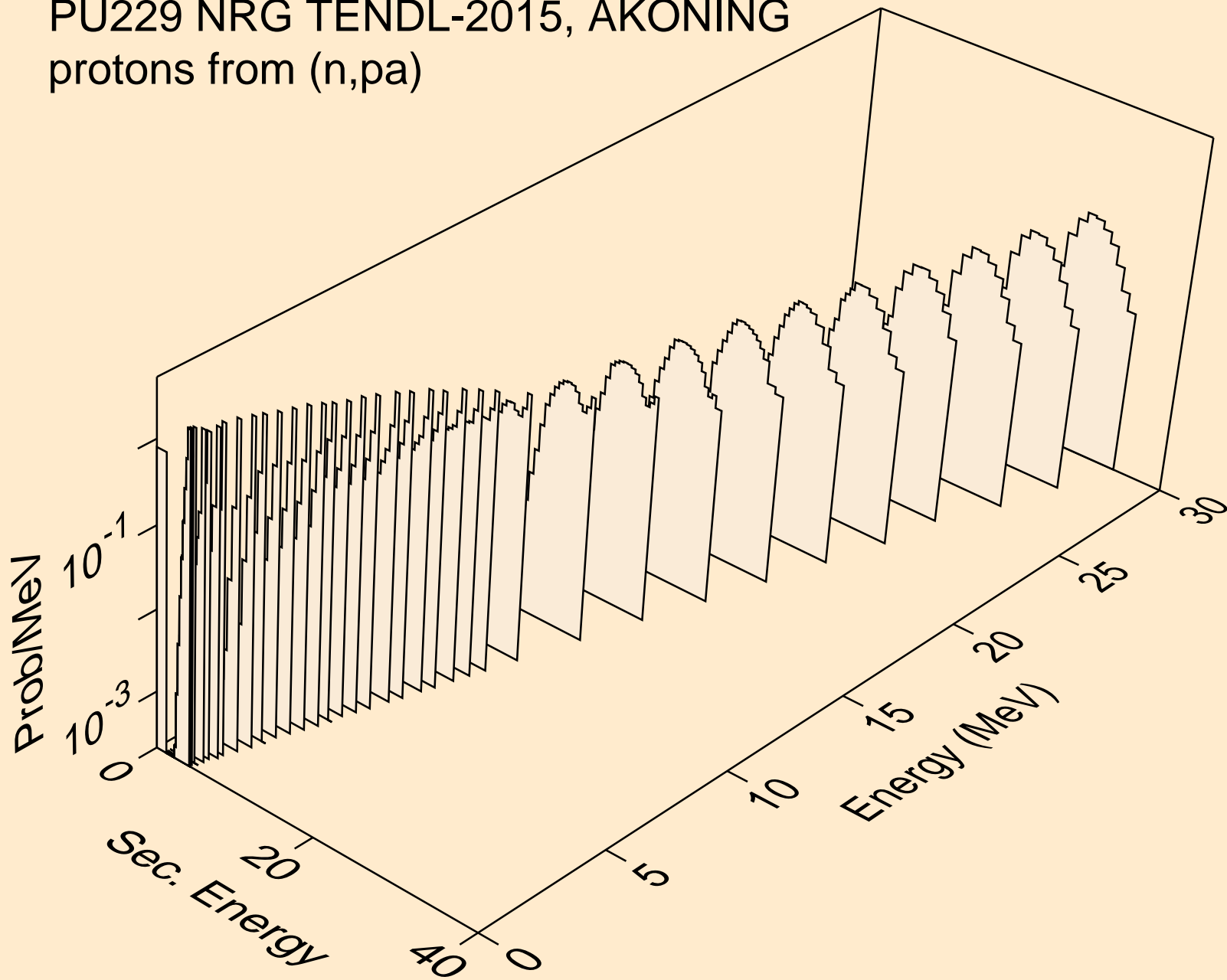

PU229 NRG TENDL-2015, AKONING
protons from (n,pd)

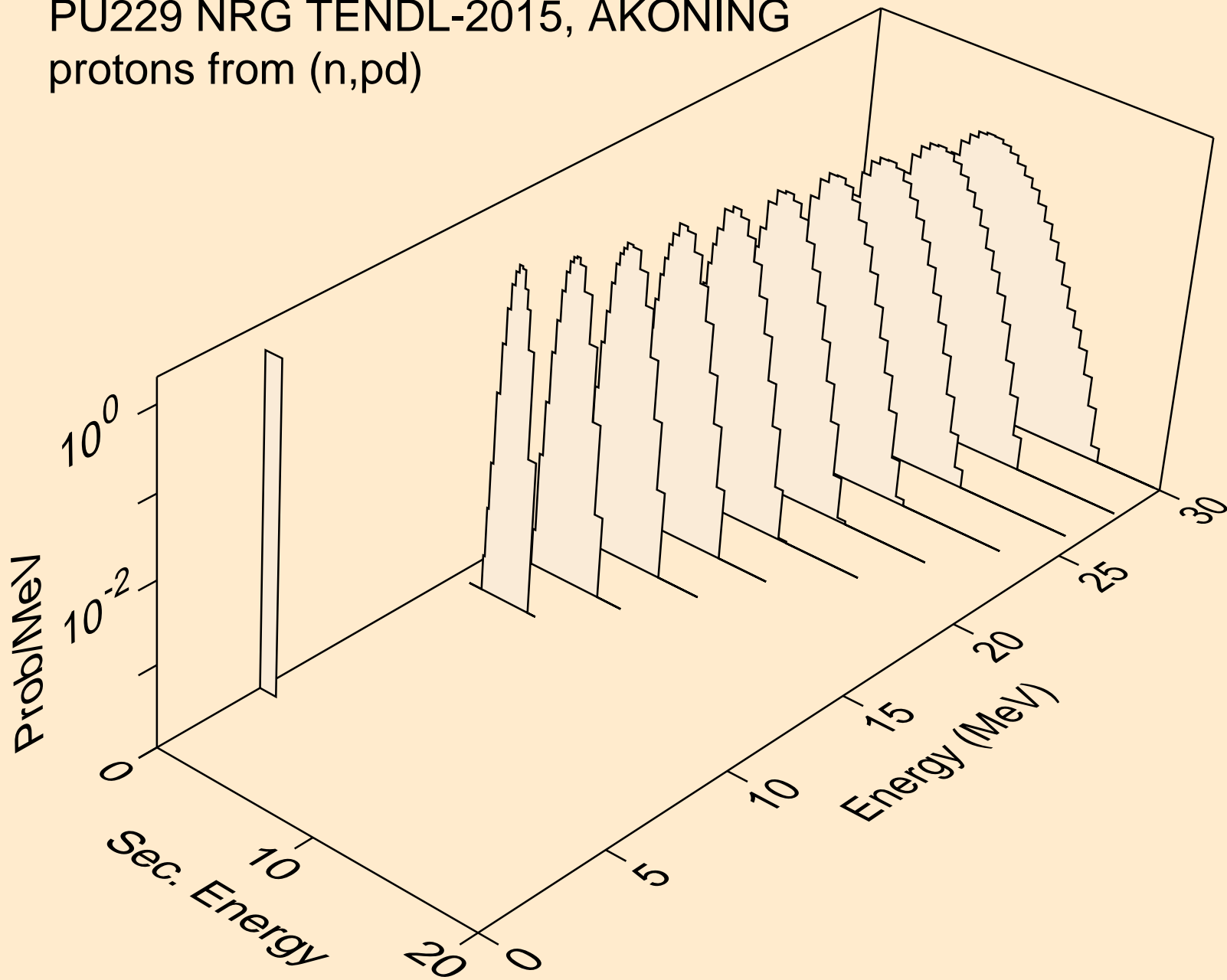

PU229 NRG TENDL-2015, AKONING
protons from (n,pt)

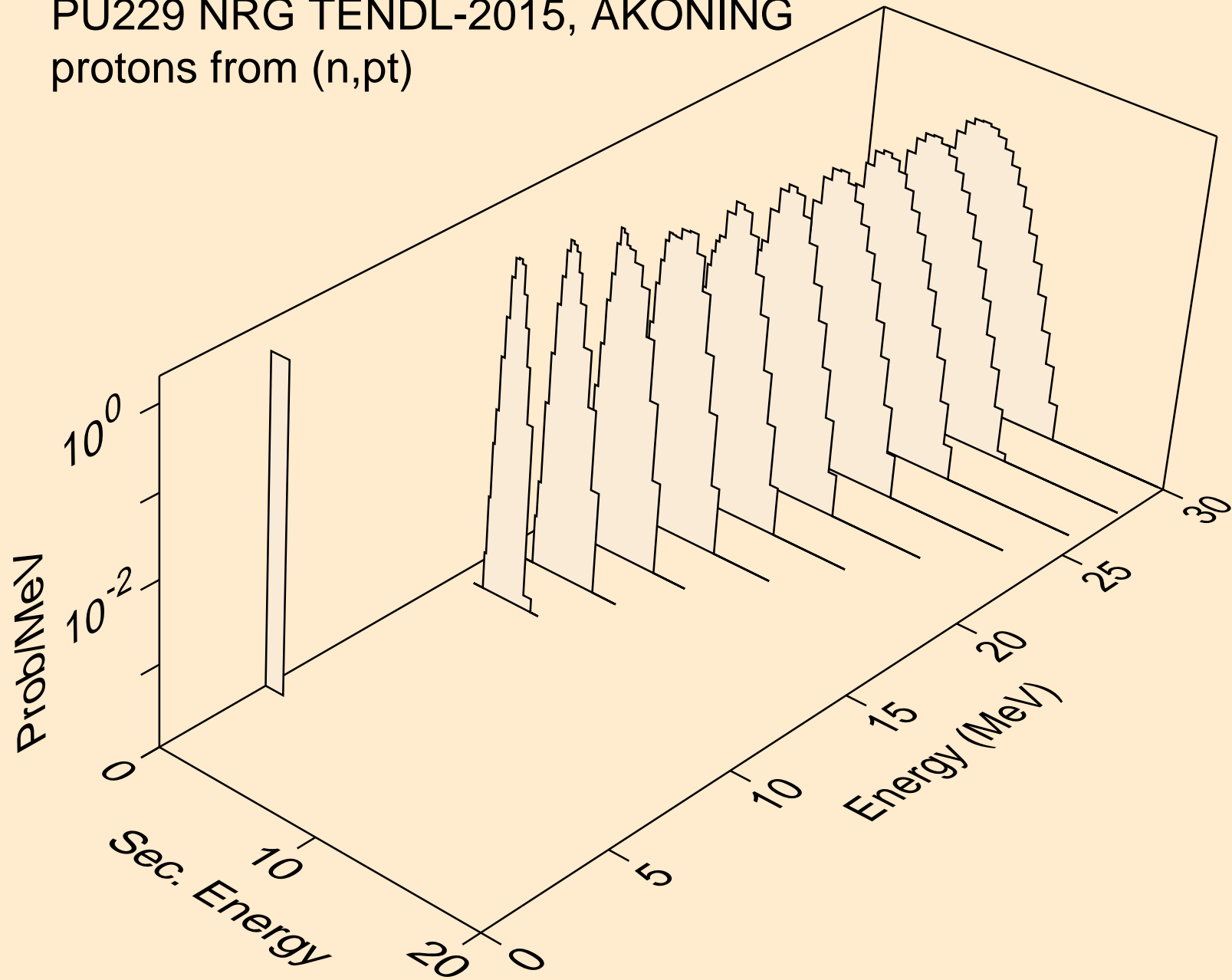

PU229 NRG TENDL-2015, AKONING
deuterons from (n,x)

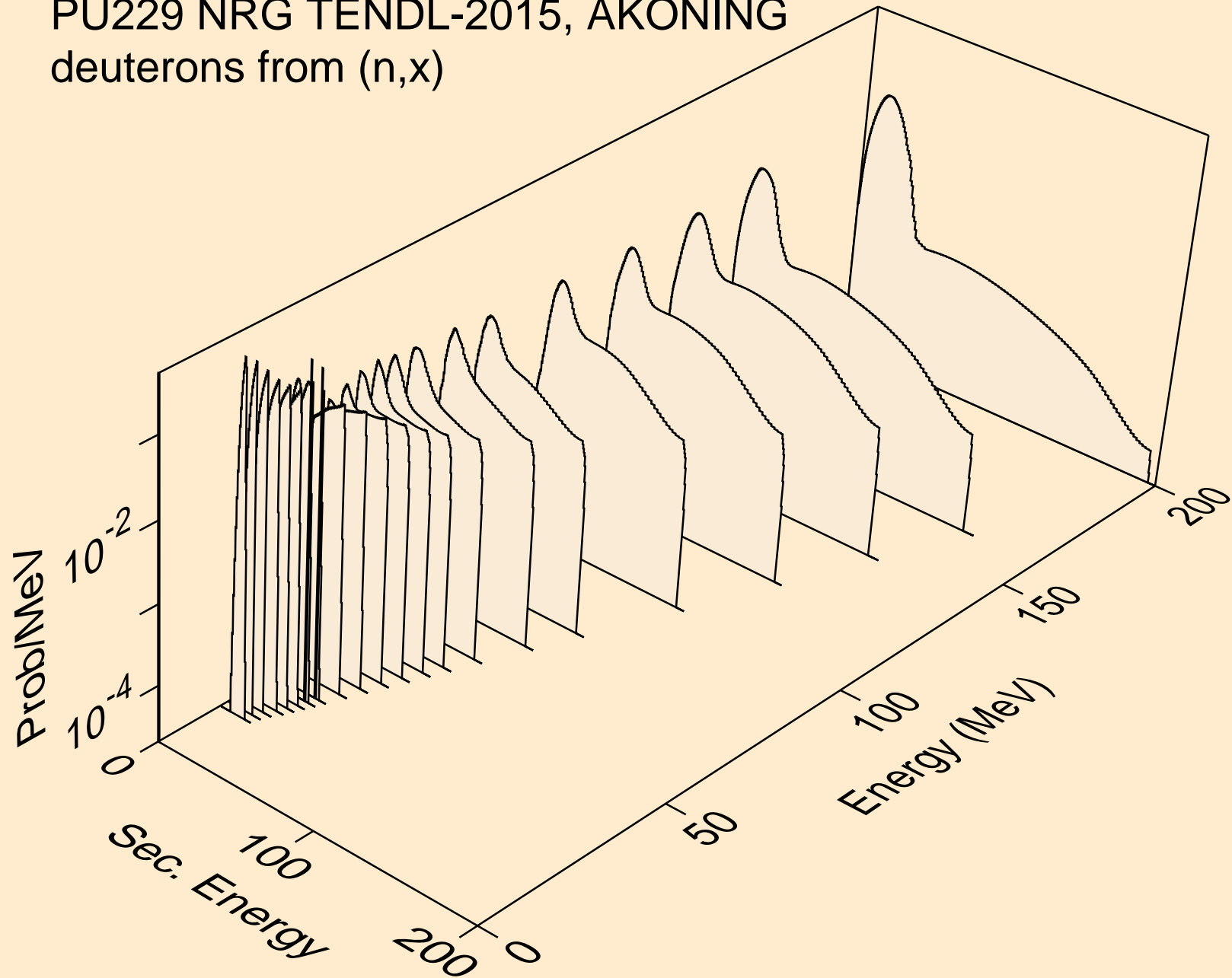

PU229 NRG TENDL-2015, AKONING
deuterons from (n,2nd)

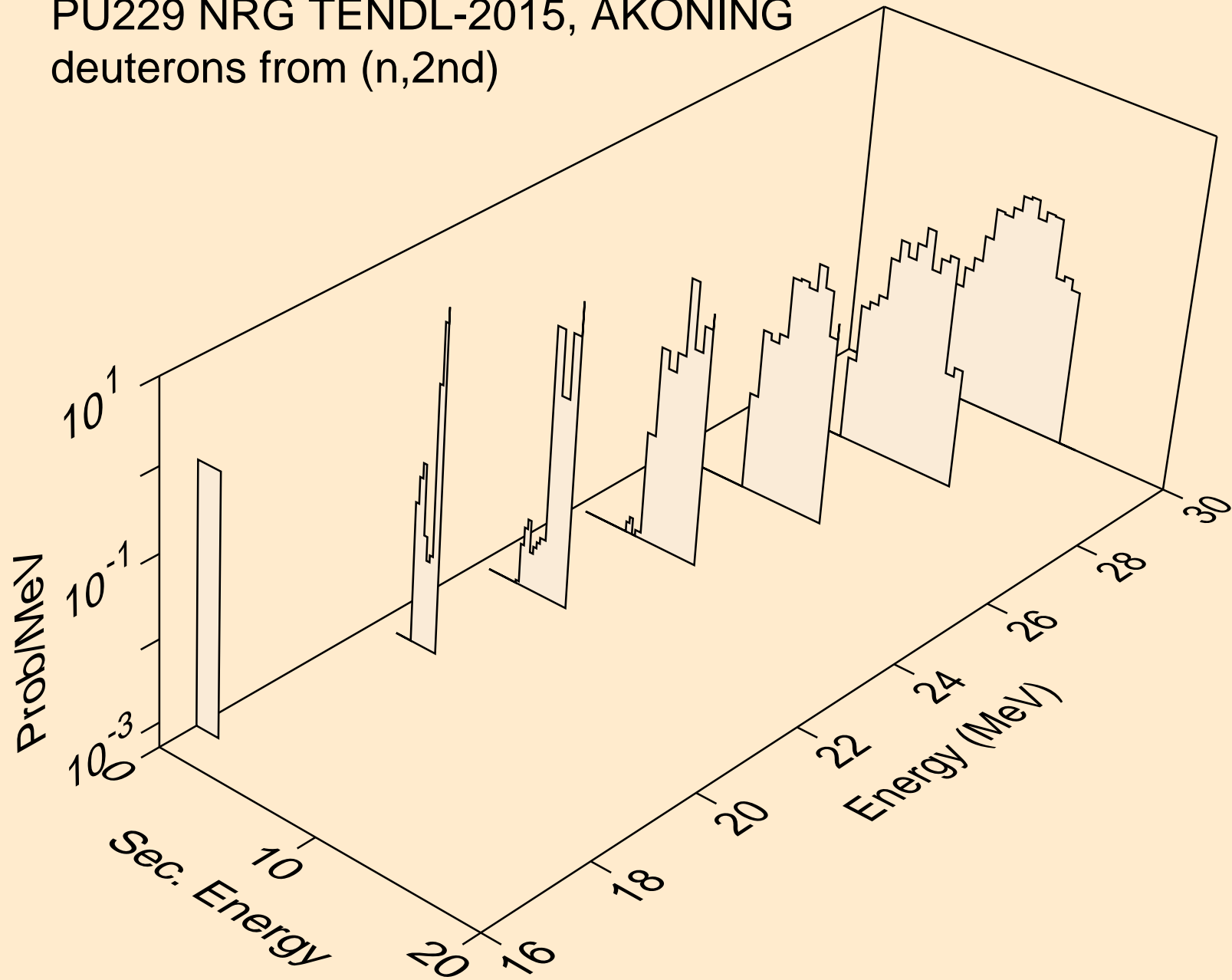

PU229 NRG TENDL-2015, AKONING
deuterons from (n,n*)d

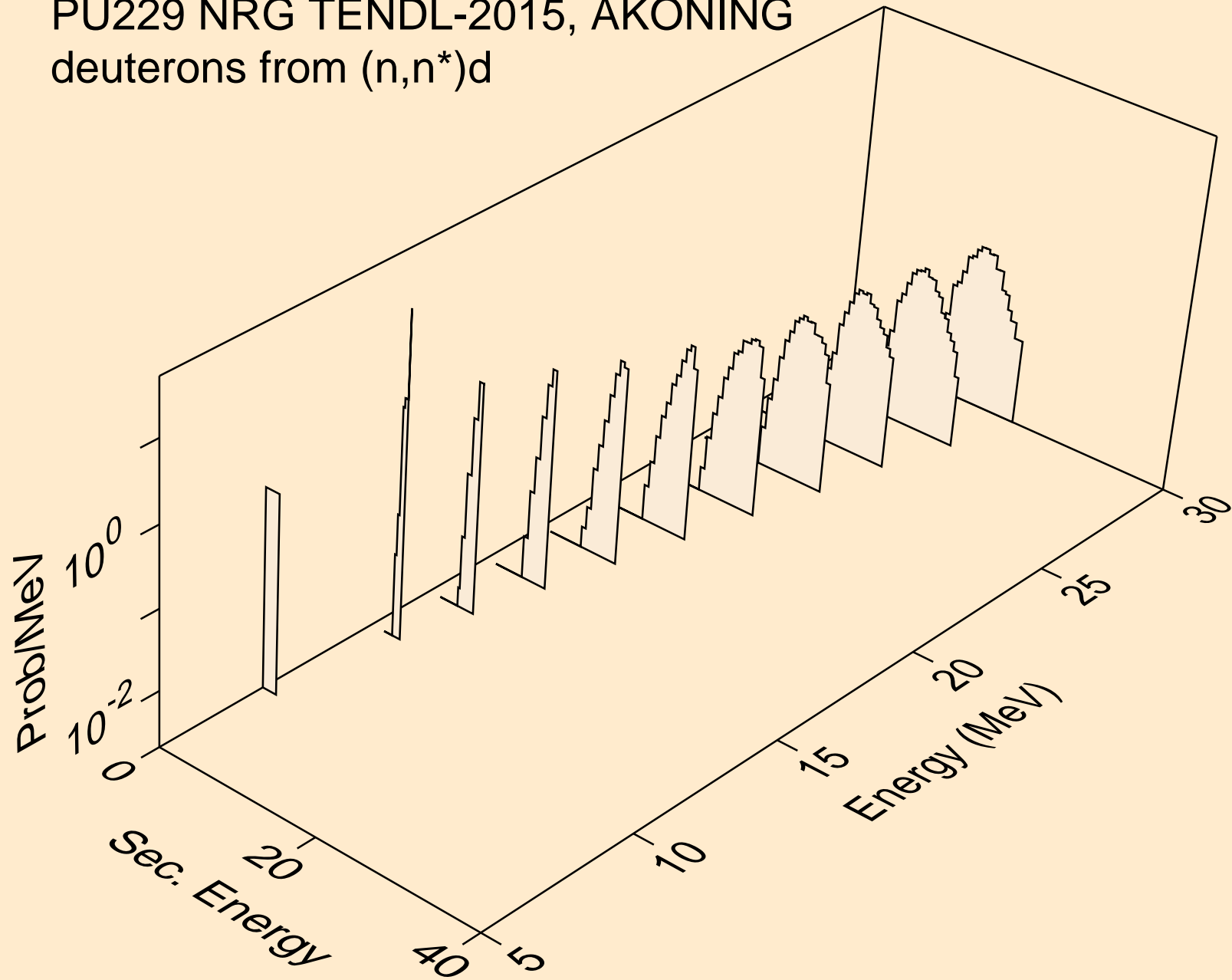

PU229 NRG TENDL-2015, AKONING
deuterons from (n,n*)d2a

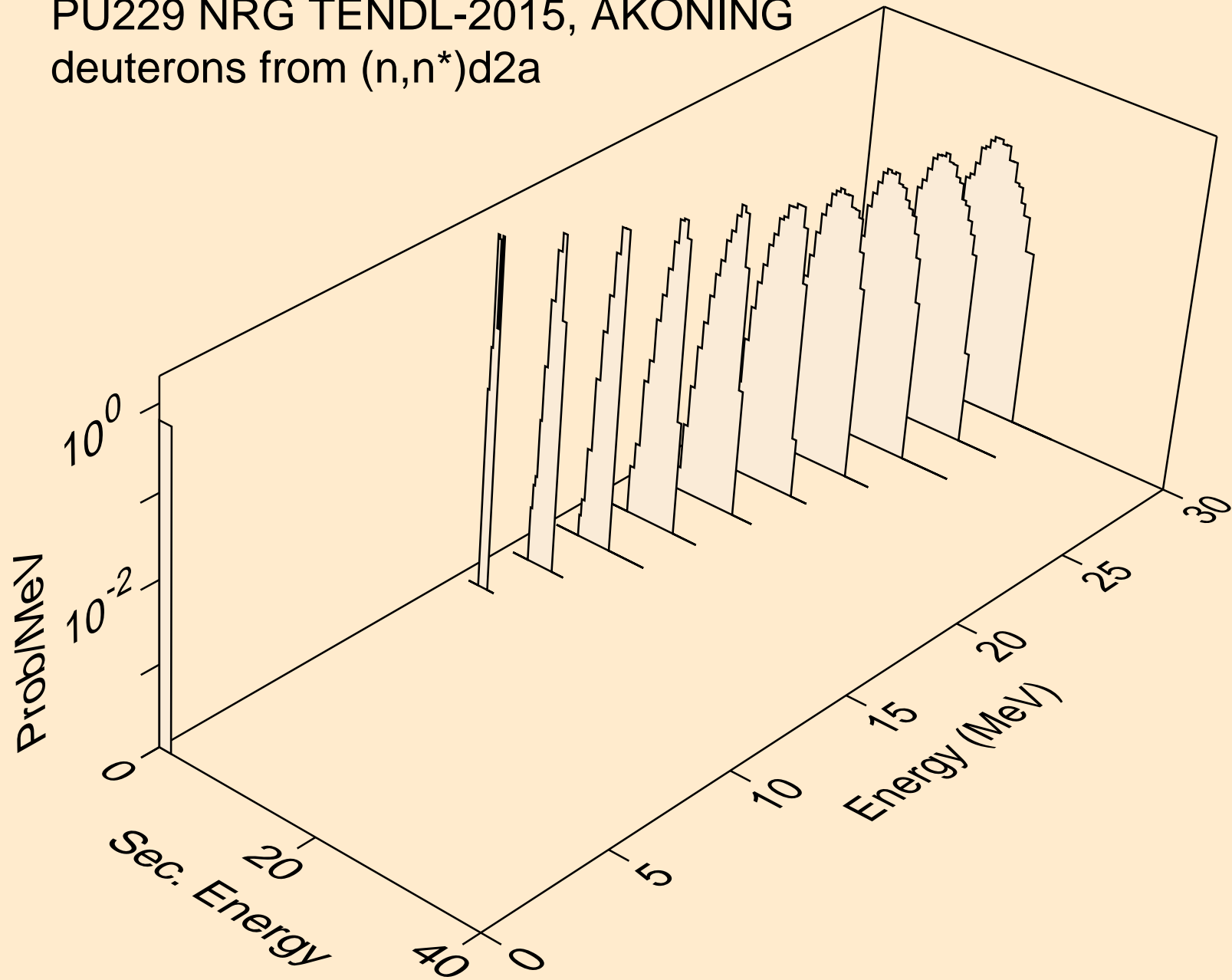

PU229 NRG TENDL-2015, AKONING
deuterons from (n,d)

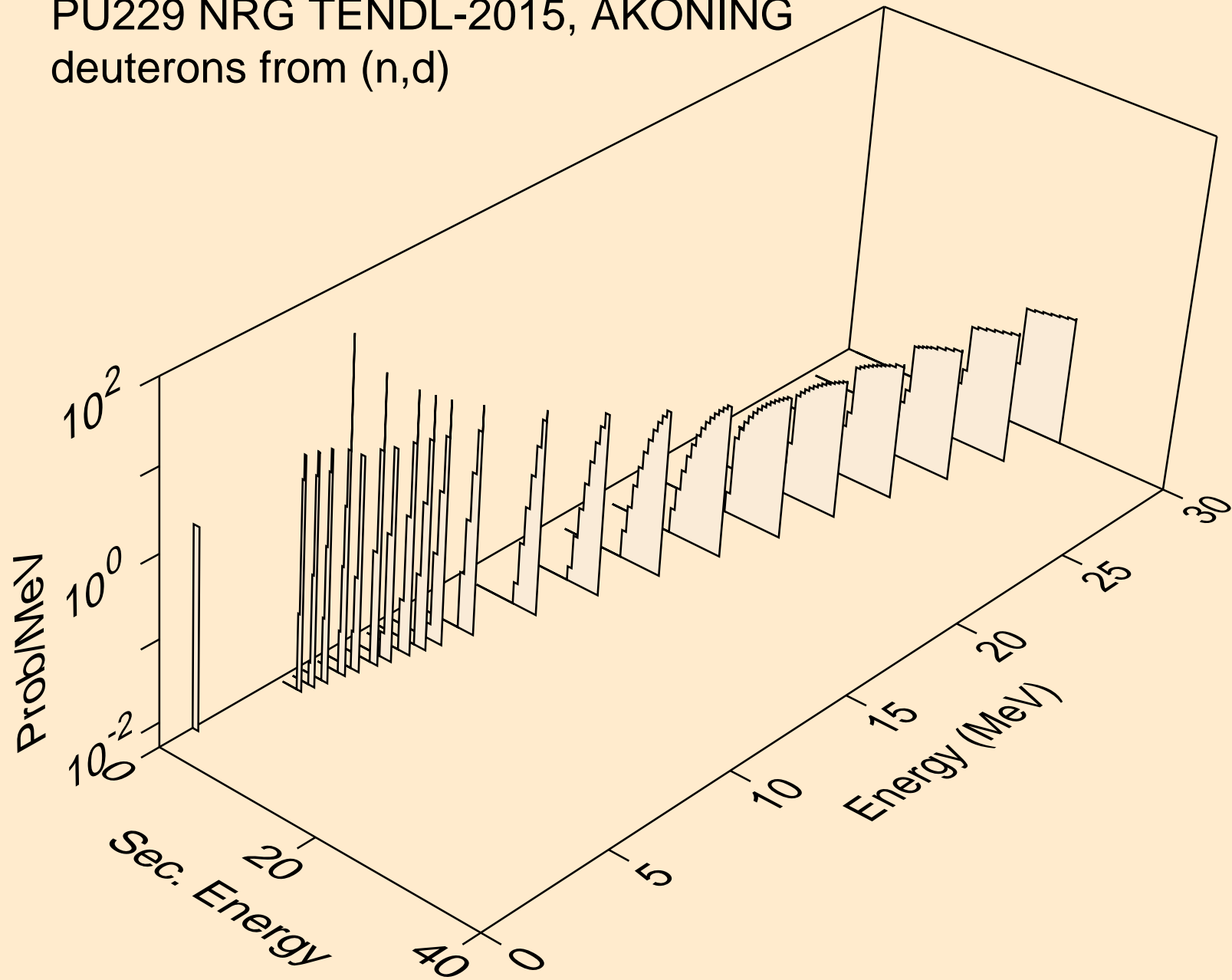

PU229 NRG TENDL-2015, AKONING
deuterons from (n,d2a)

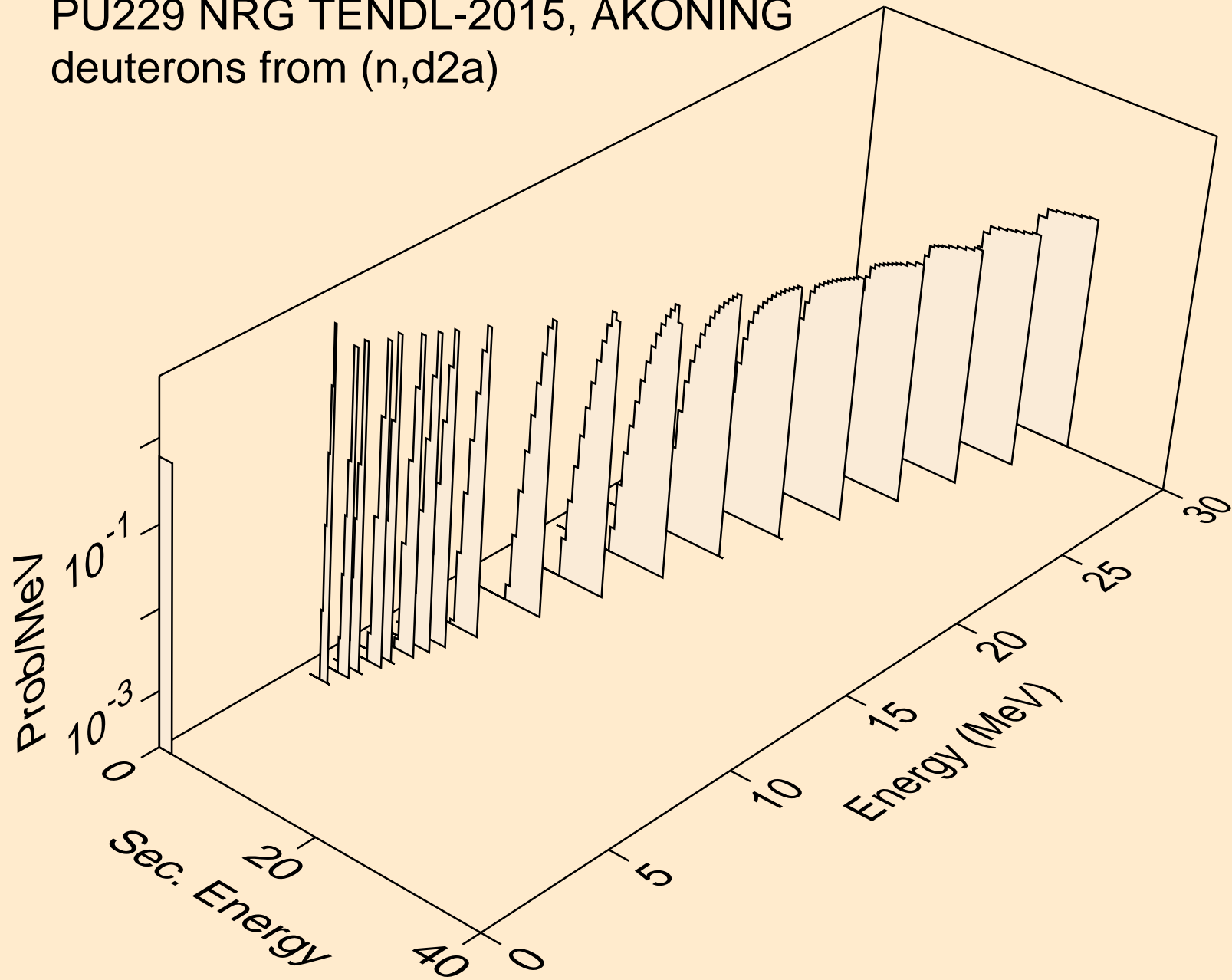

PU229 NRG TENDL-2015, AKONING
deuterons from (n,pd)

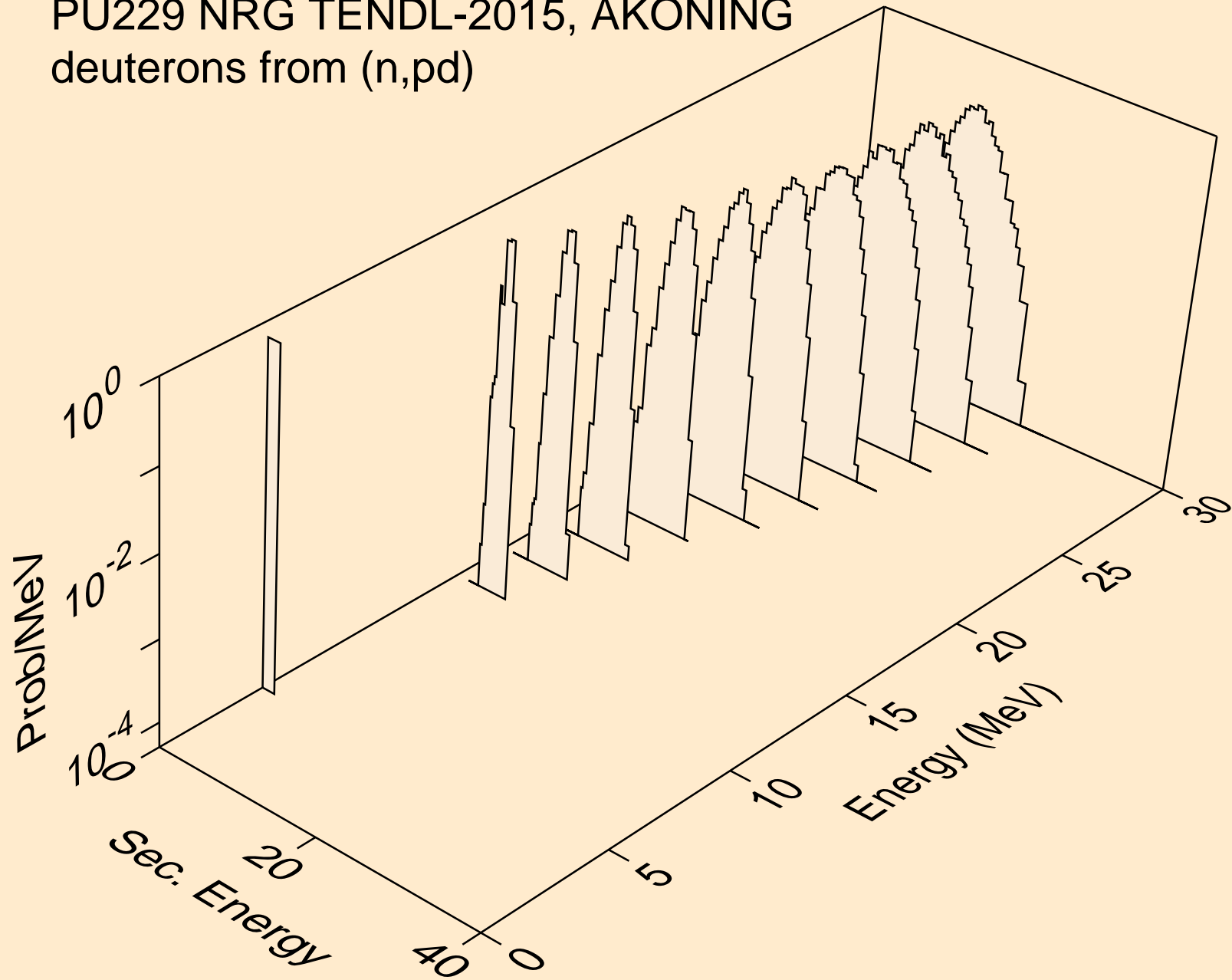

PU229 NRG TENDL-2015, AKONING
deuterons from (n,da)

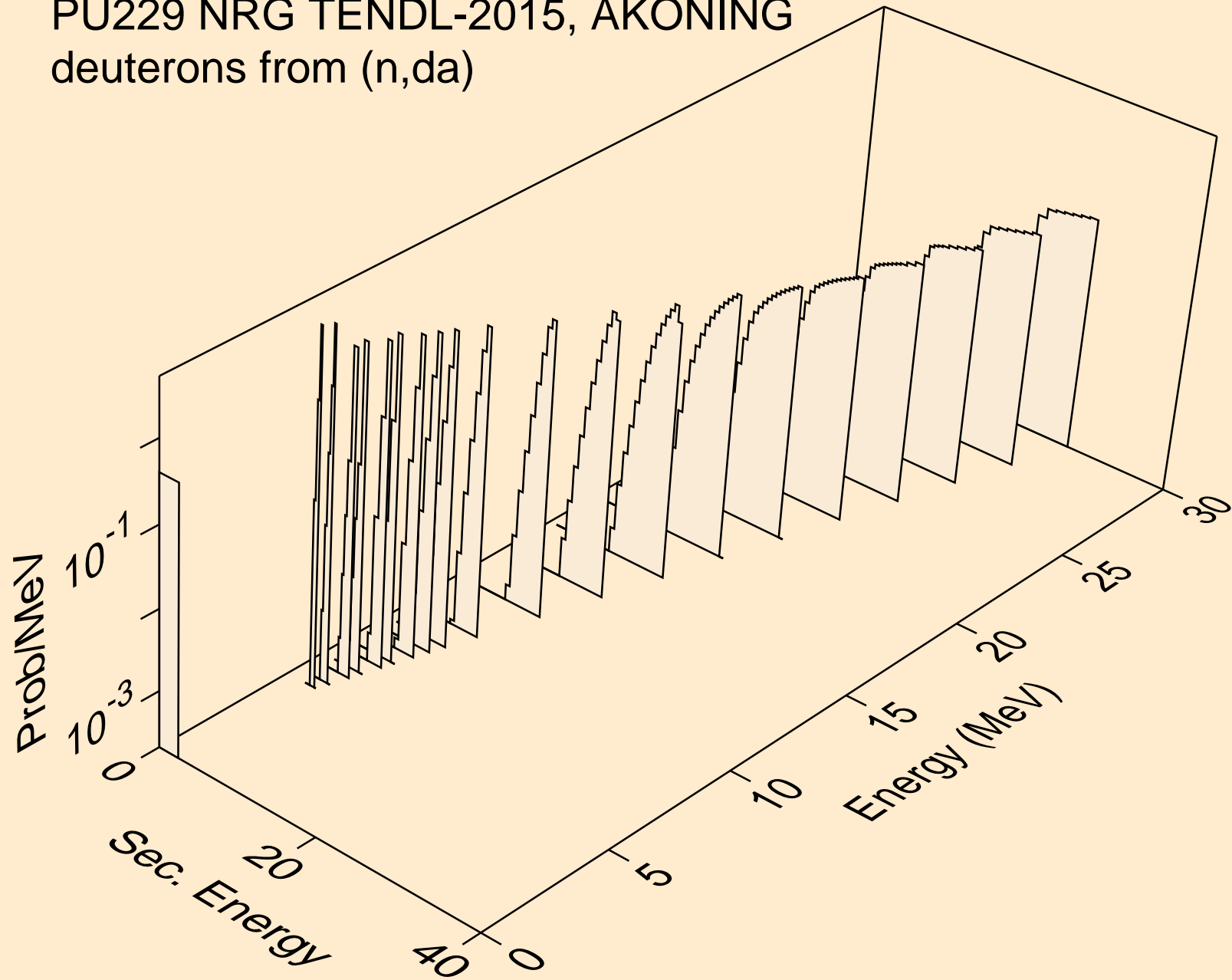

PU229 NRG TENDL-2015, AKONING
tritons from (n,x)

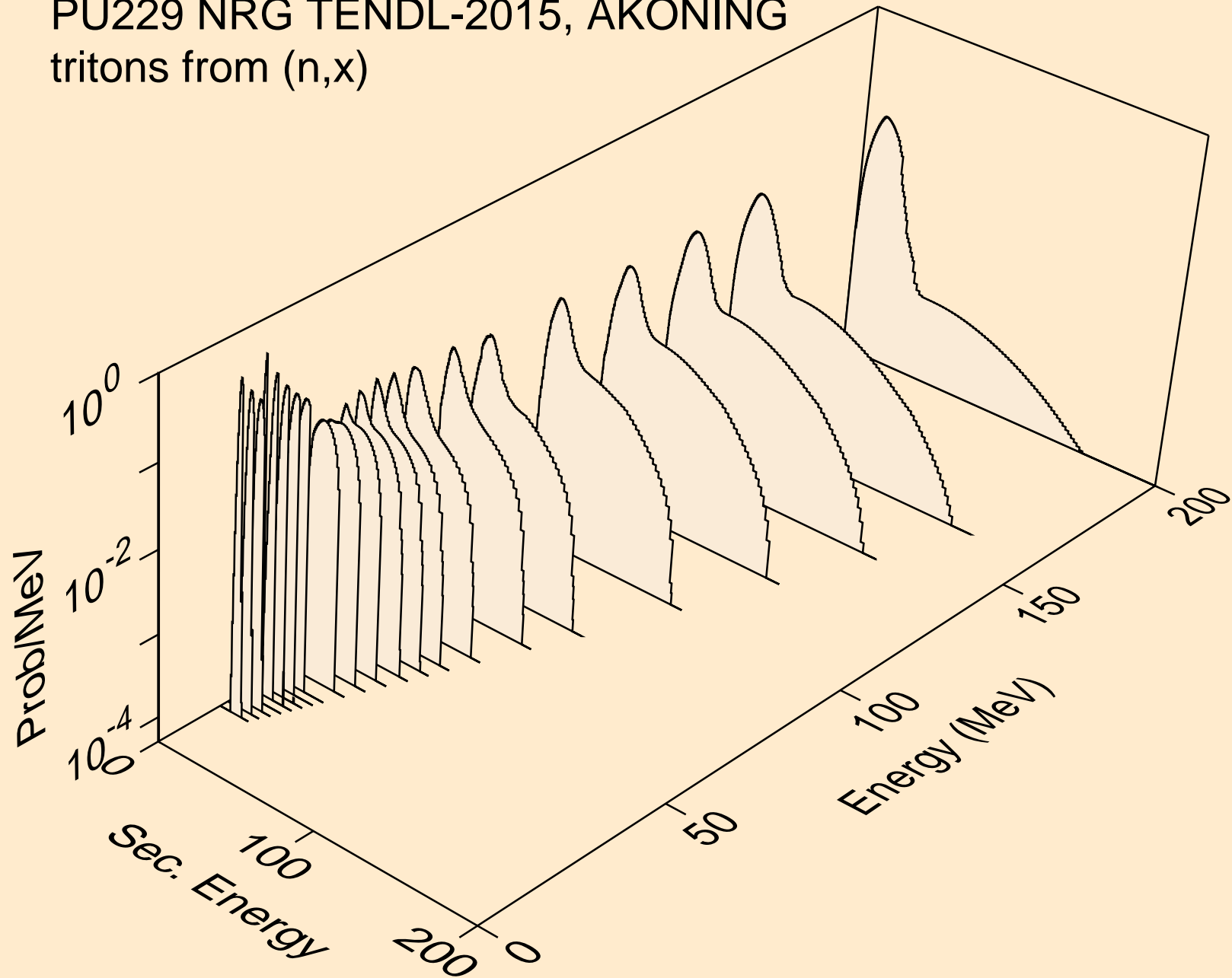

PU229 NRG TENDL-2015, AKONING
tritons from (n,n*)t

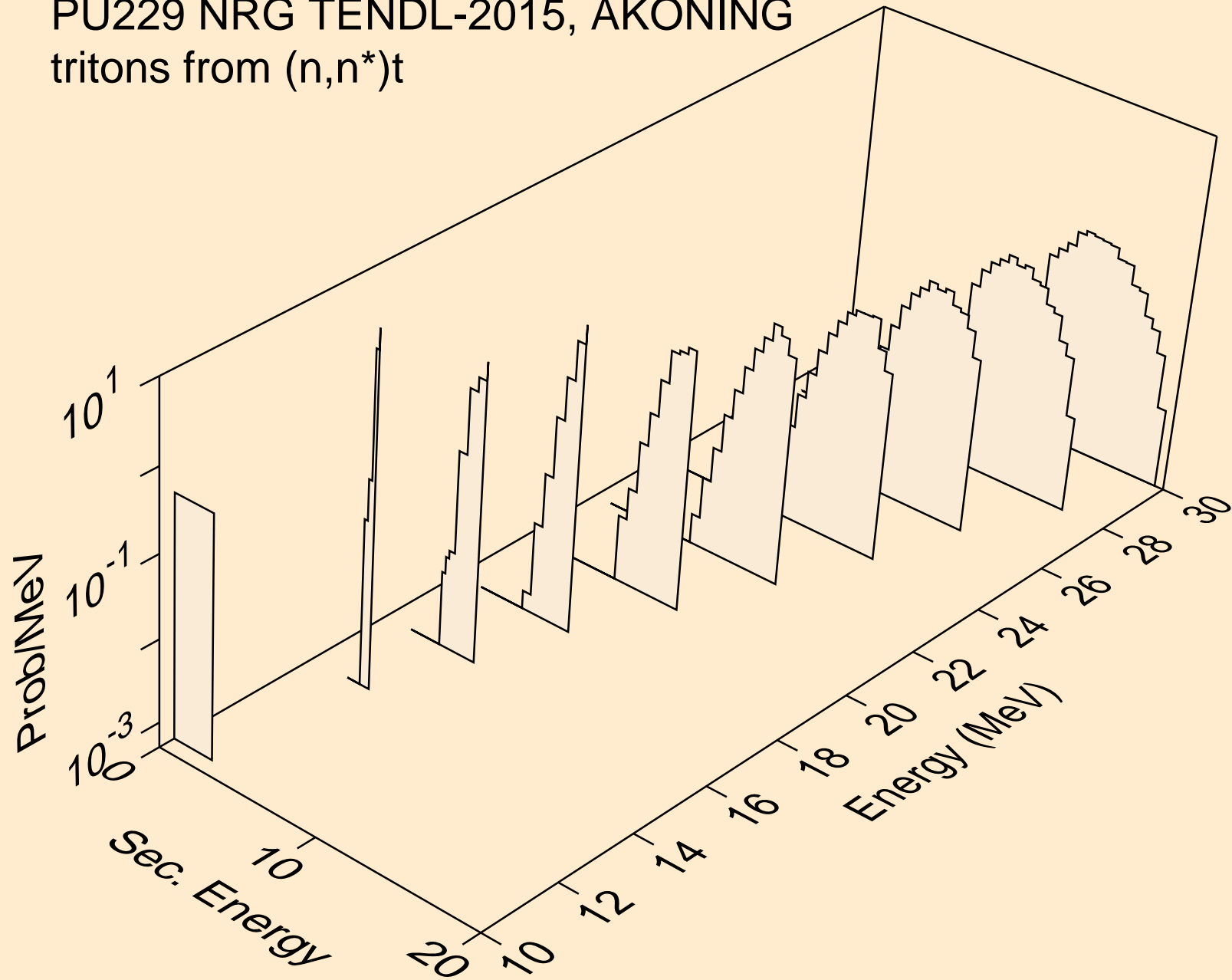

PU229 NRG TENDL-2015, AKONING
tritons from (n,n*)t2a

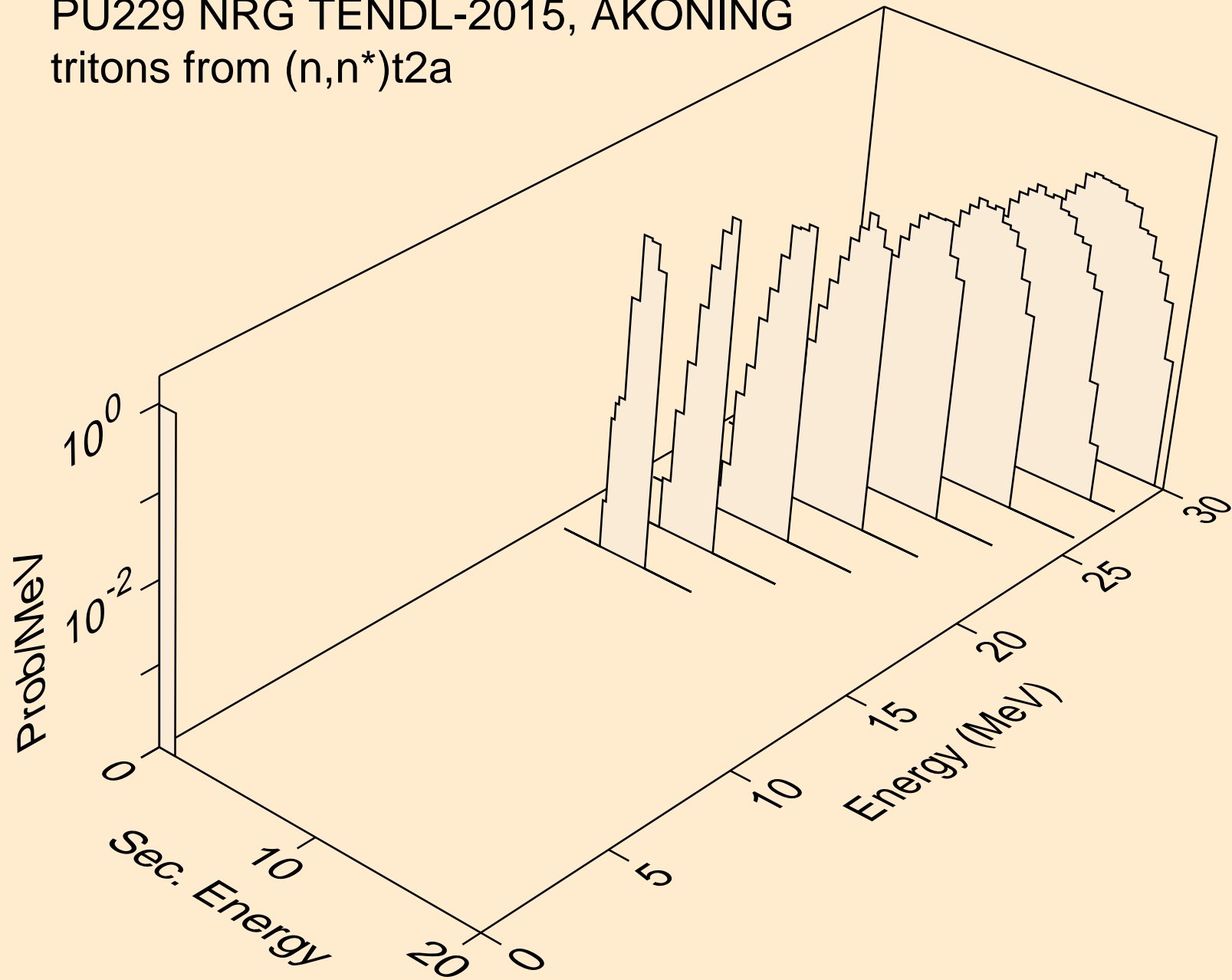

PU229 NRG TENDL-2015, AKONING
tritons from (n,t)

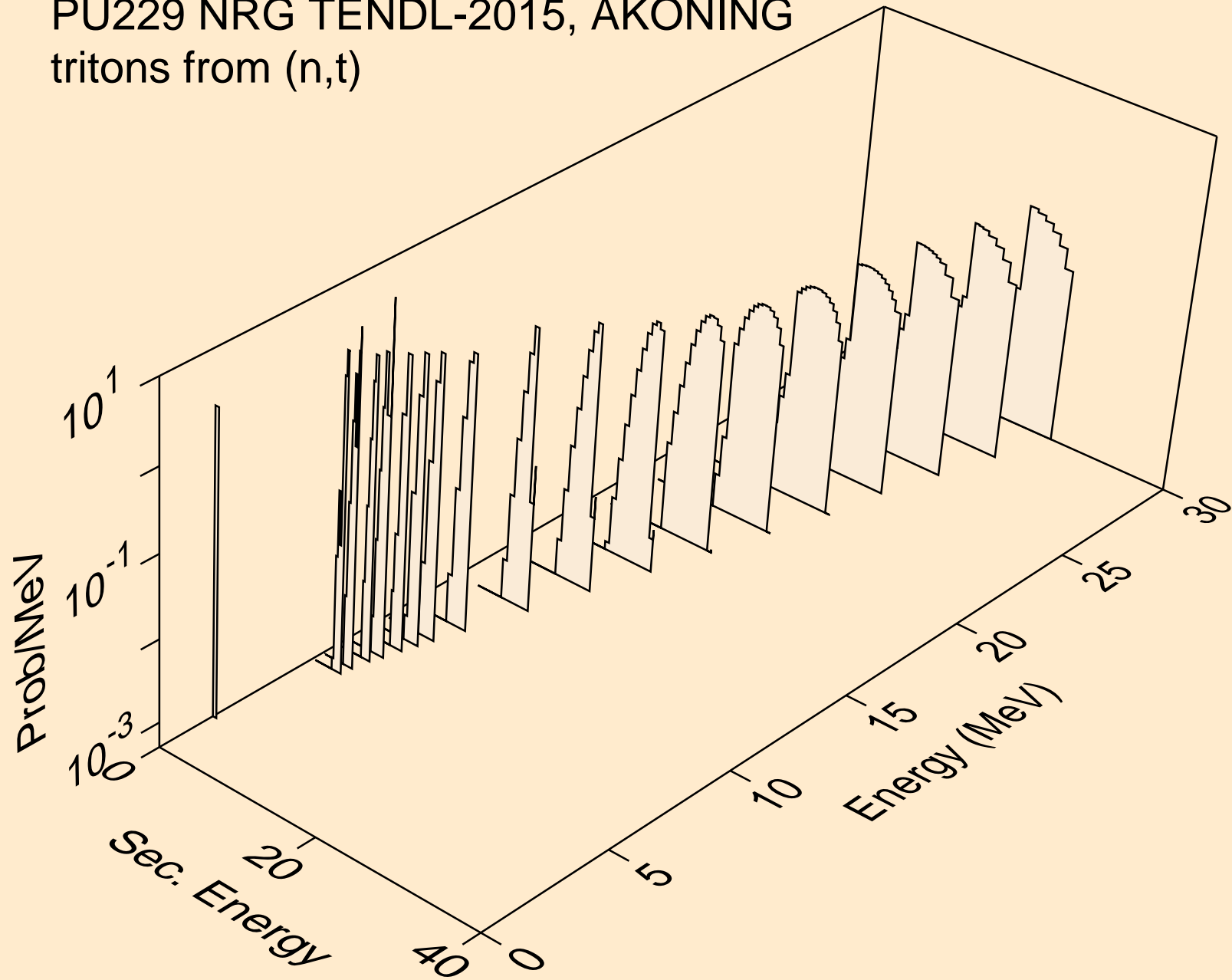

PU229 NRG TENDL-2015, AKONING
tritons from (n,t2a)

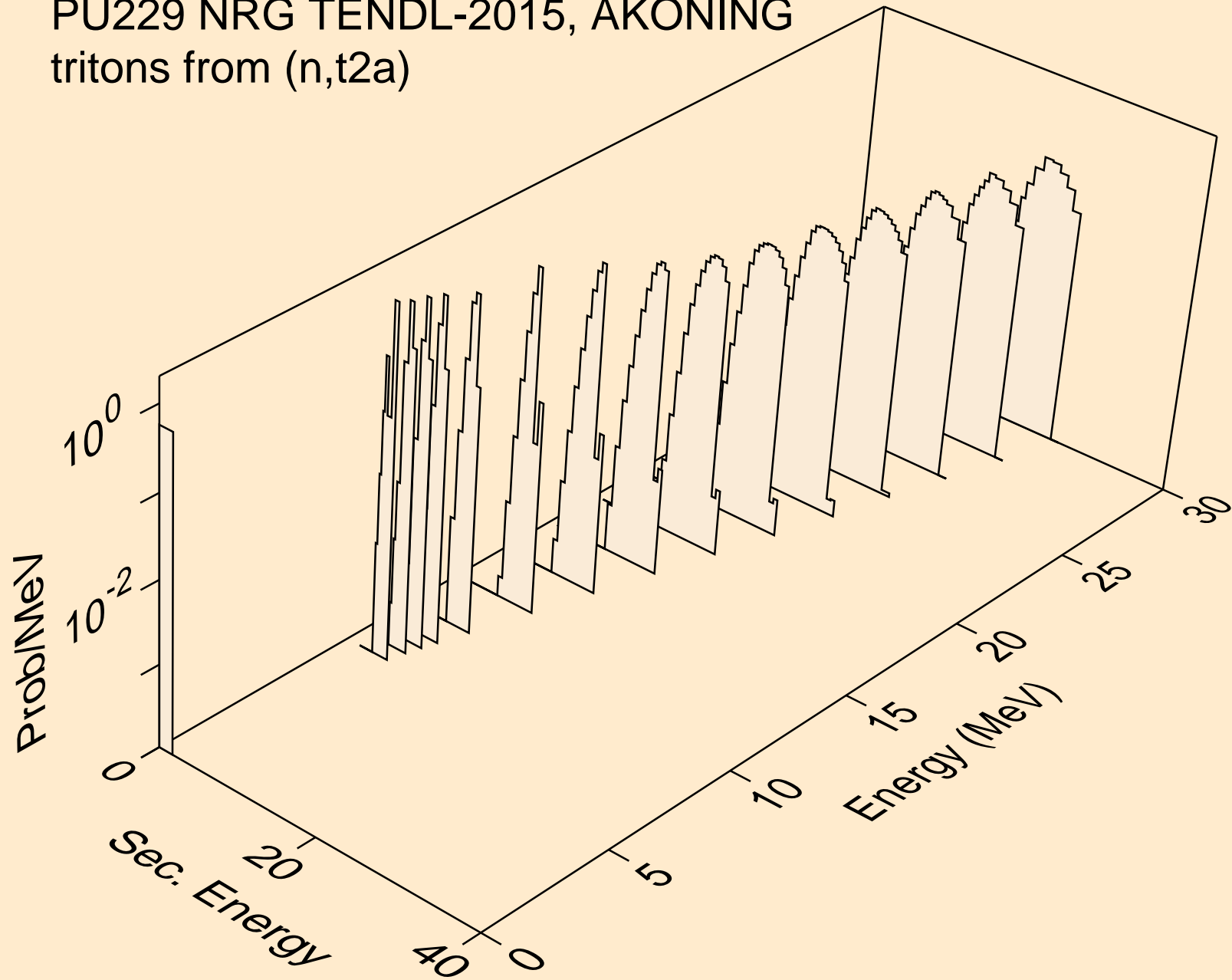

PU229 NRG TENDL-2015, AKONING
tritons from (n,pt)

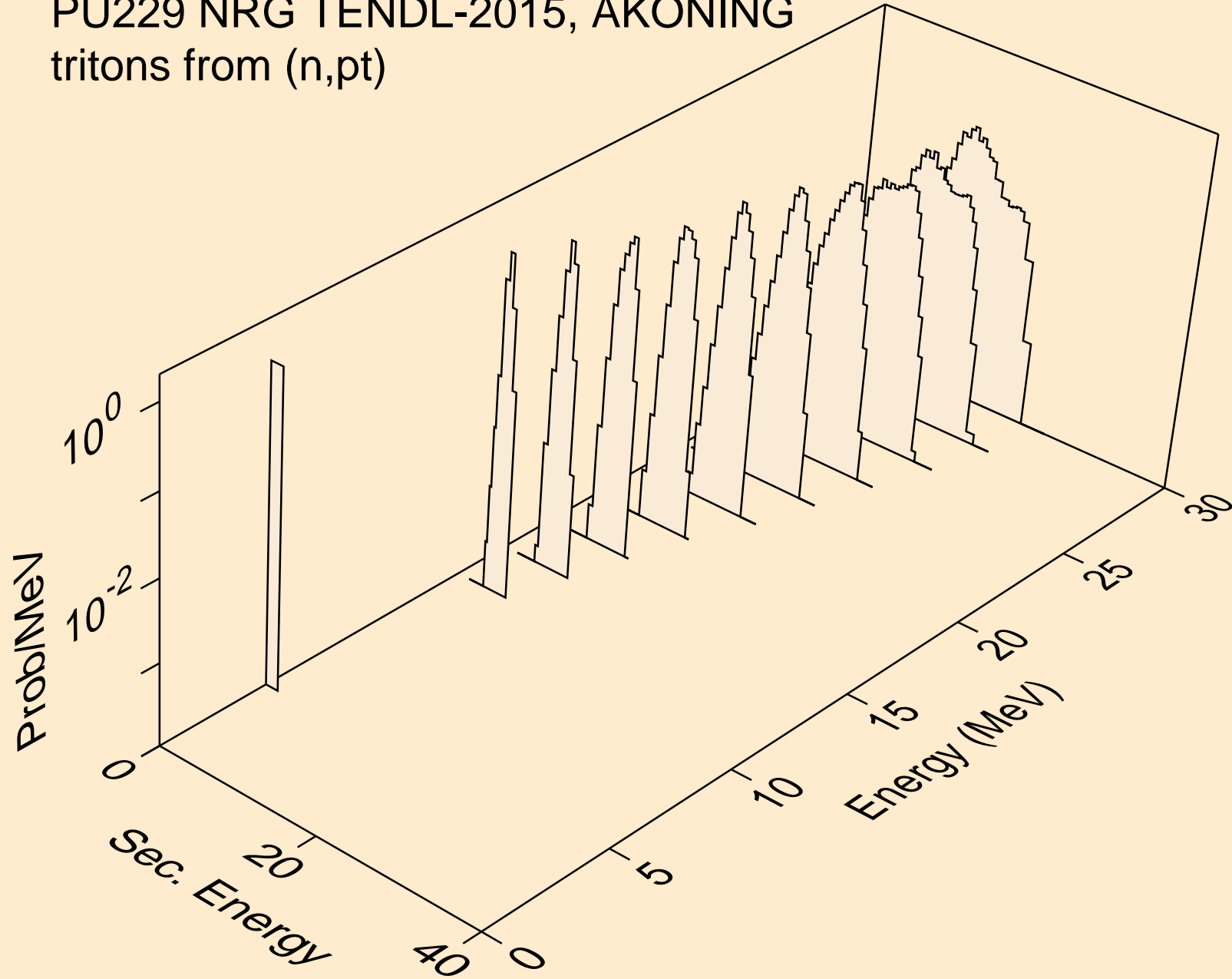

PU229 NRG TENDL-2015, AKONING
he3s from (n,x)

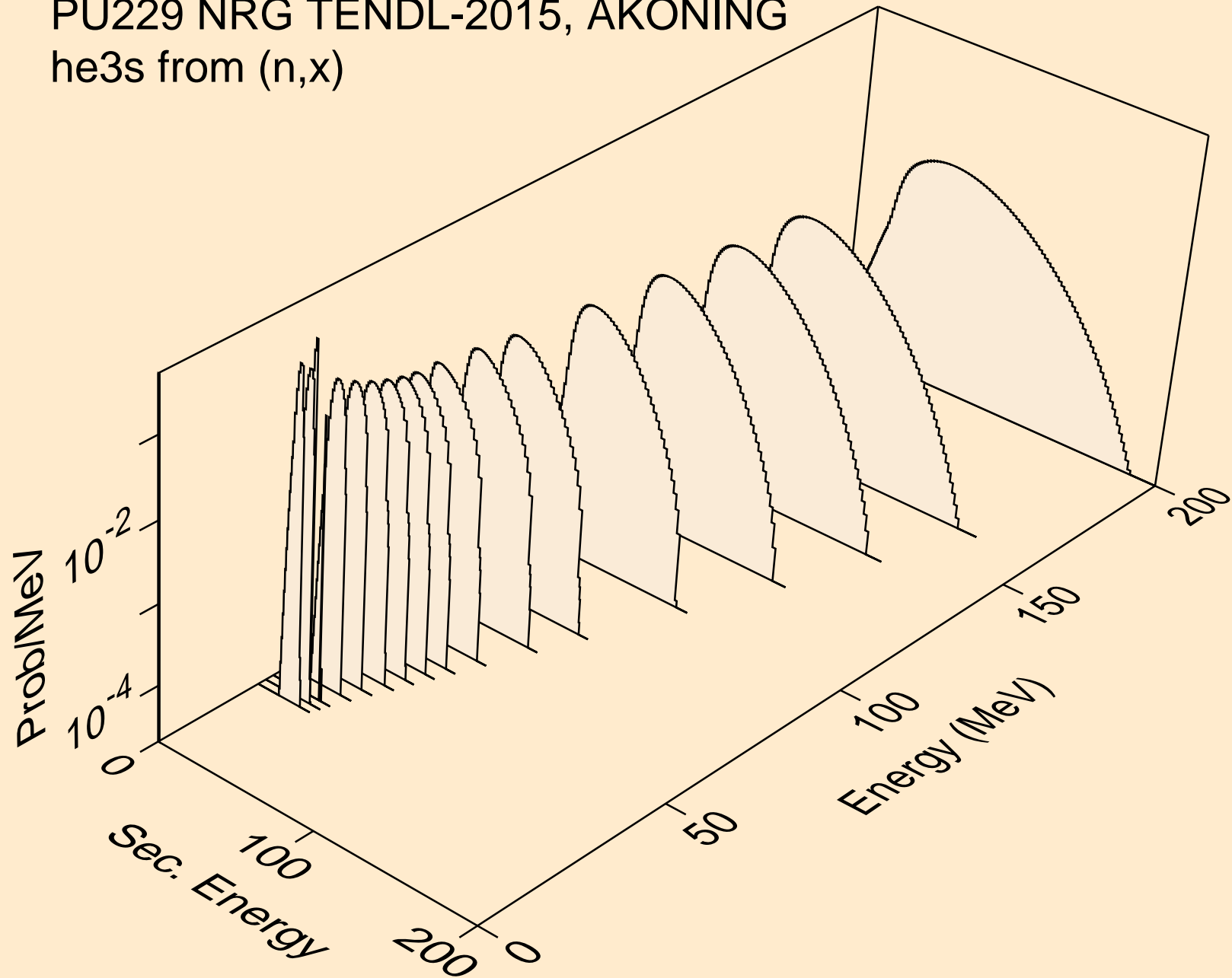

PU229 NRG TENDL-2015, AKONING
he3s from (n,n*)he3

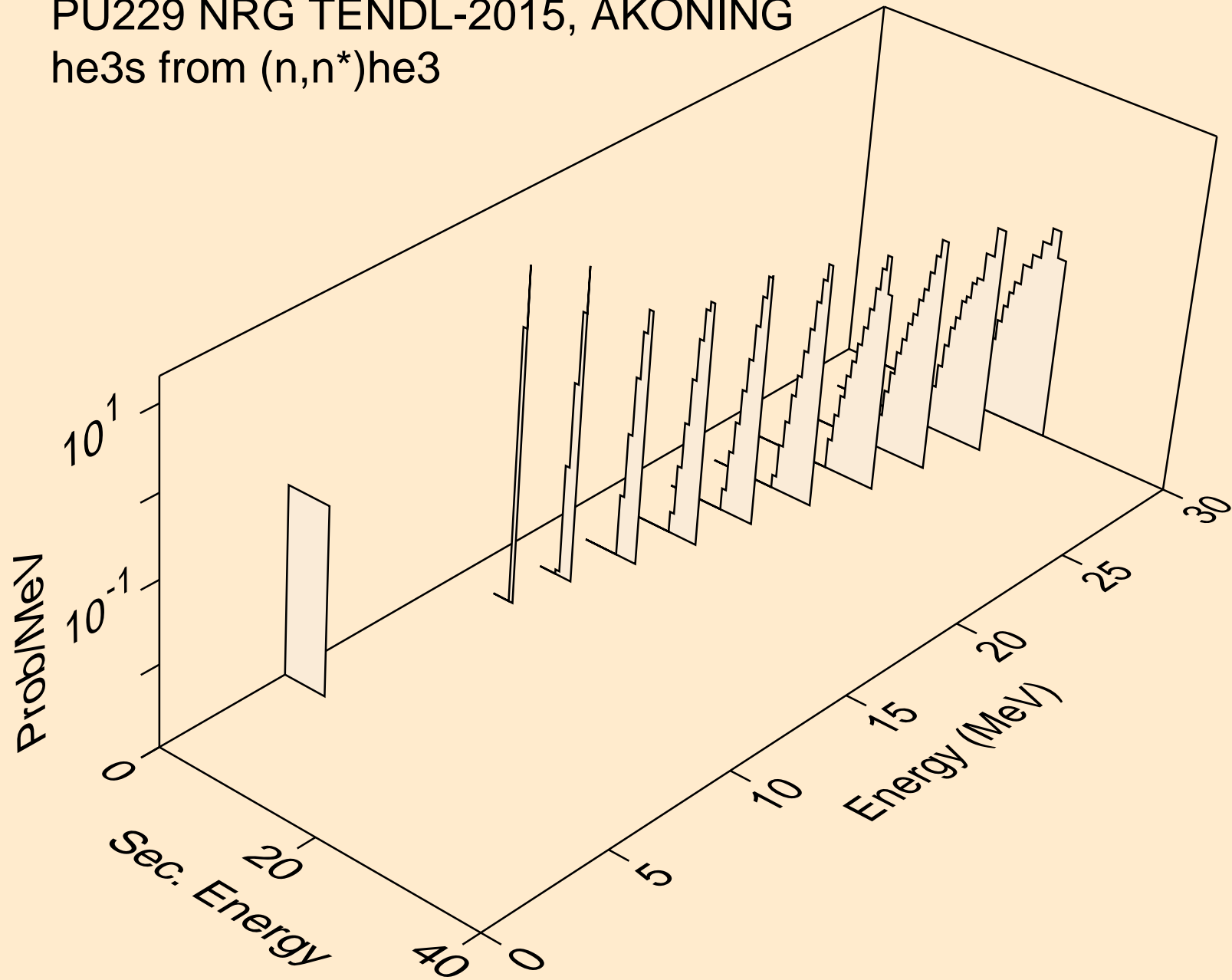

PU229 NRG TENDL-2015, AKONING
he3s from (n,he3)

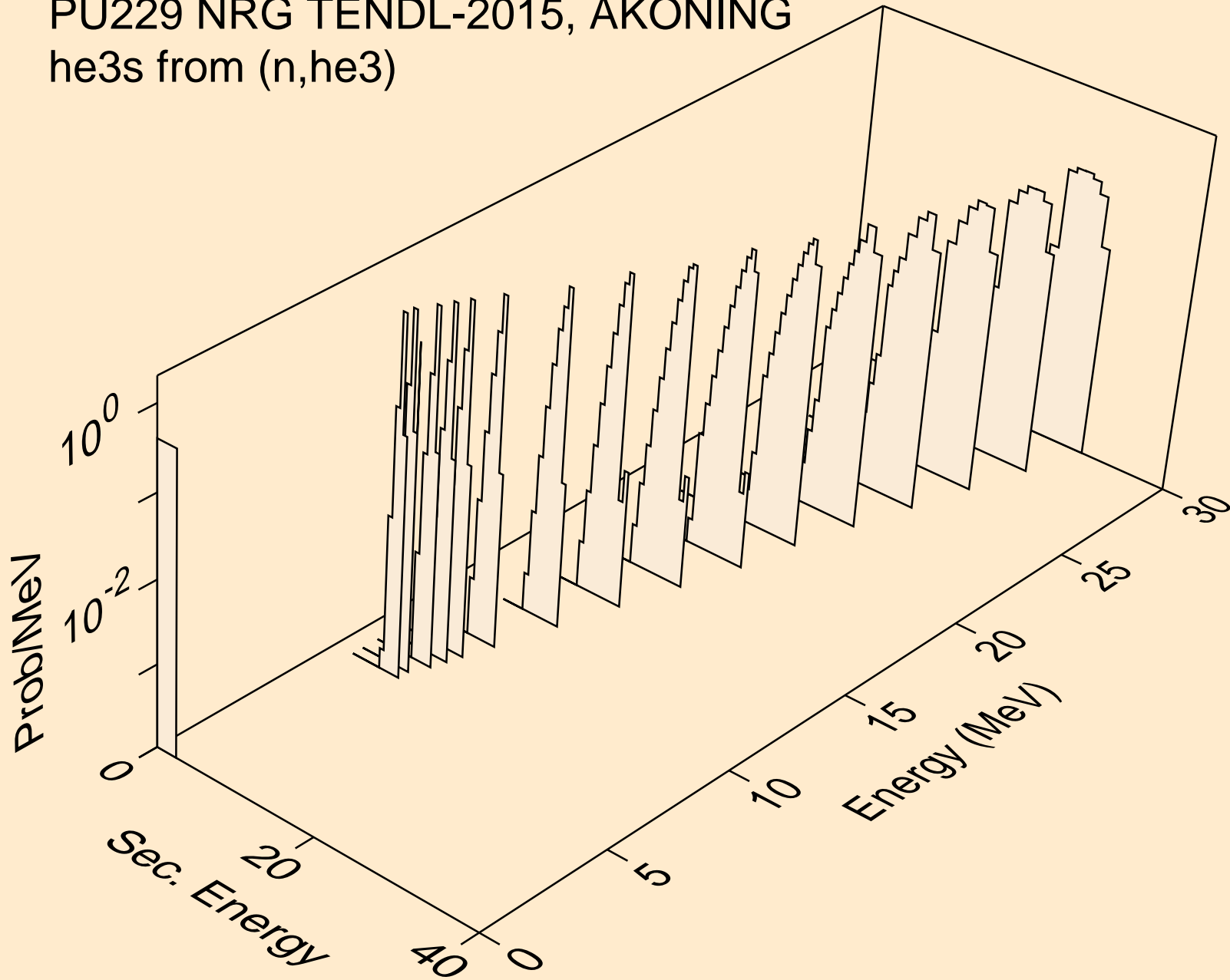

PU229 NRG TENDL-2015, AKONING
alphas from (n,x)

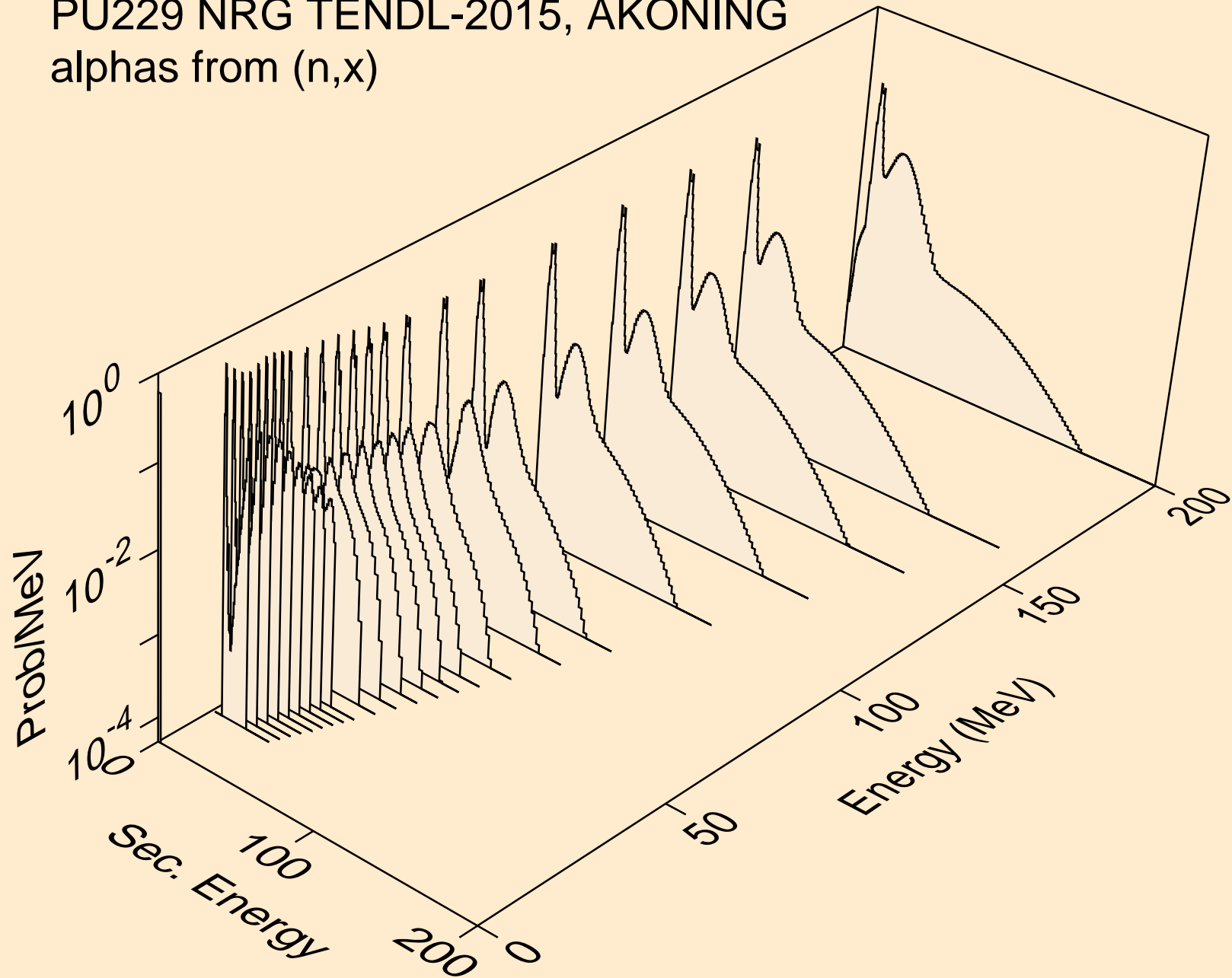

PU229 NRG TENDL-2015, AKONING
alphas from (n,n*)a

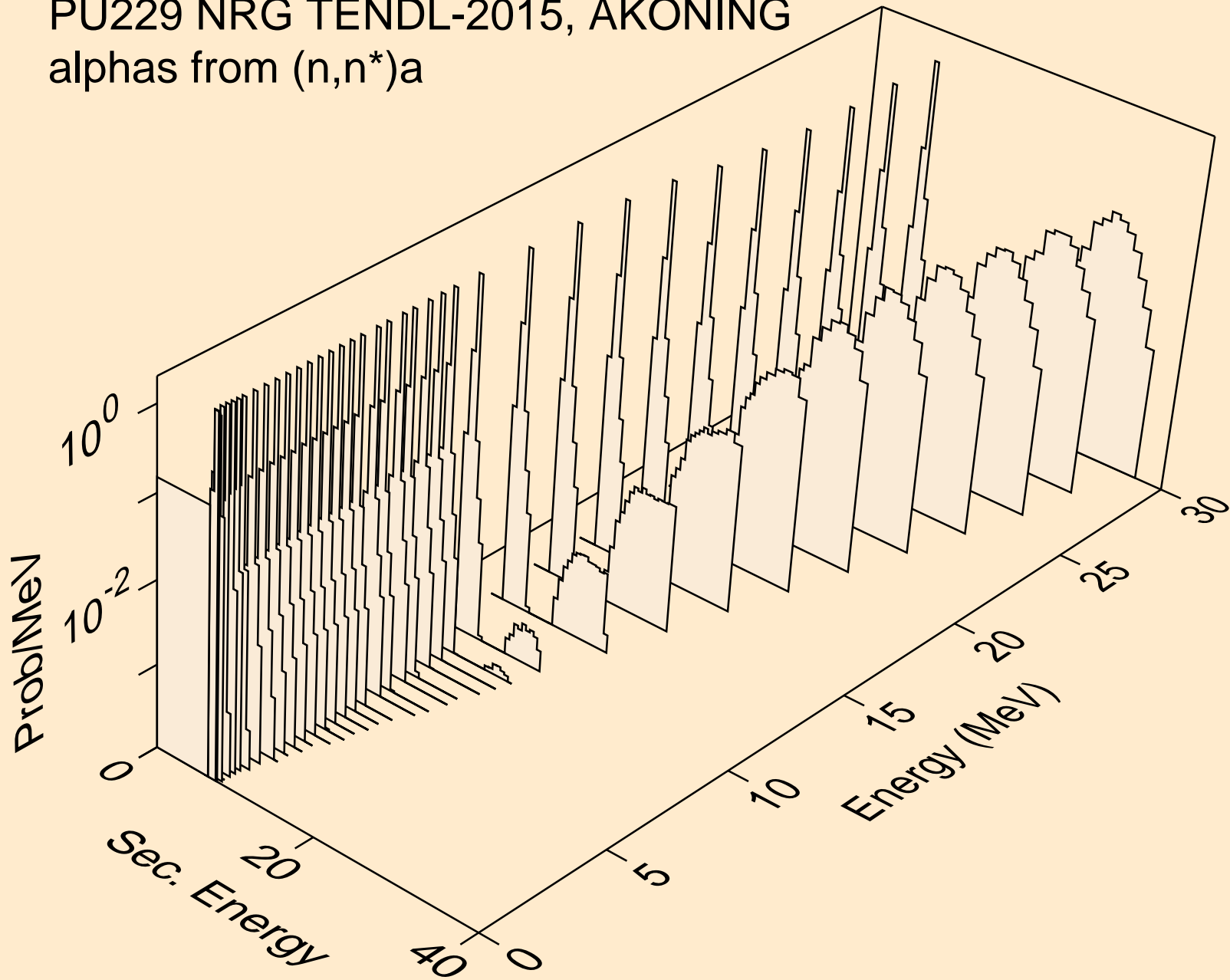

PU229 NRG TENDL-2015, AKONING
alphas from (n,n*)3a

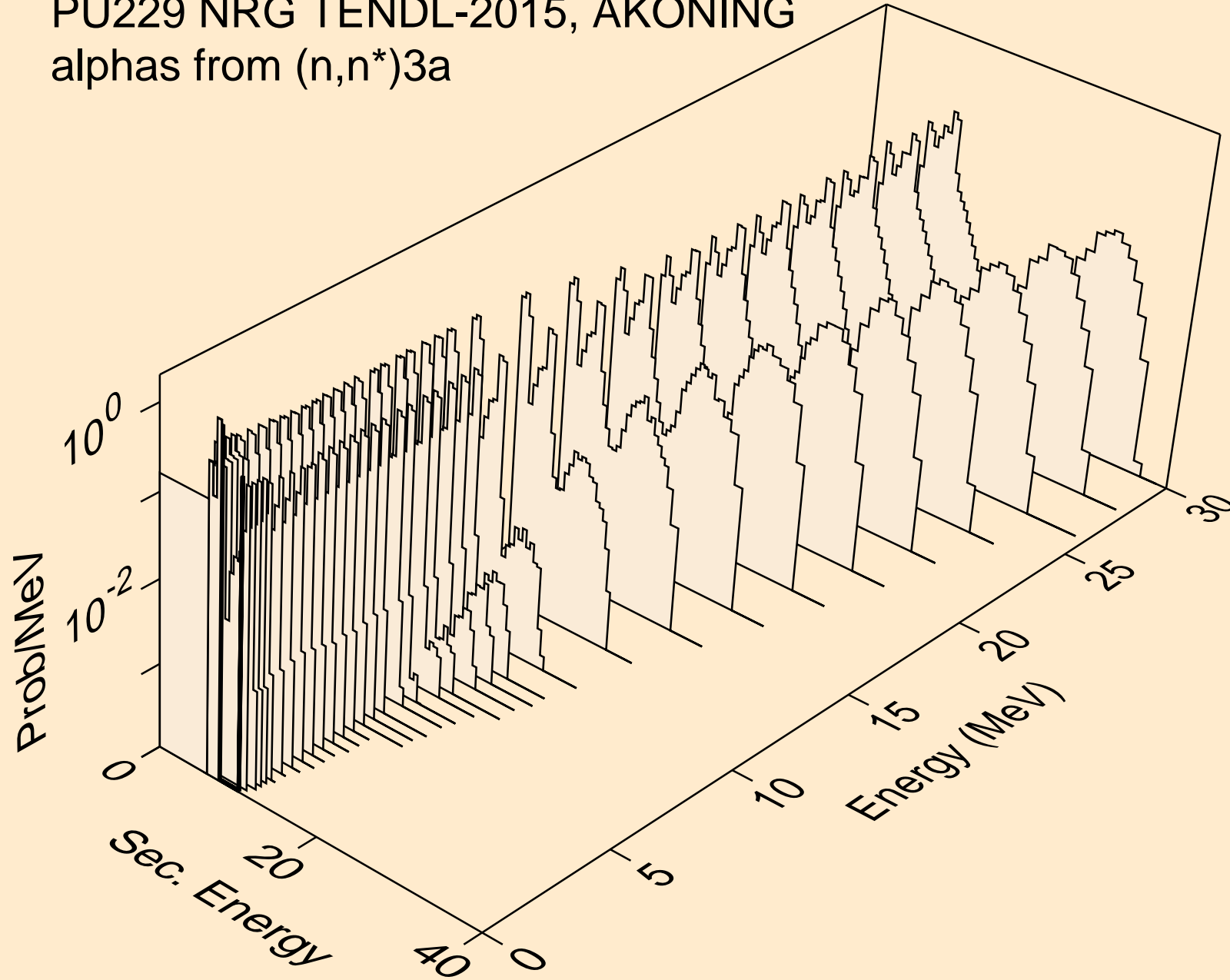

PU229 NRG TENDL-2015, AKONING
alphas from (n,2n)a

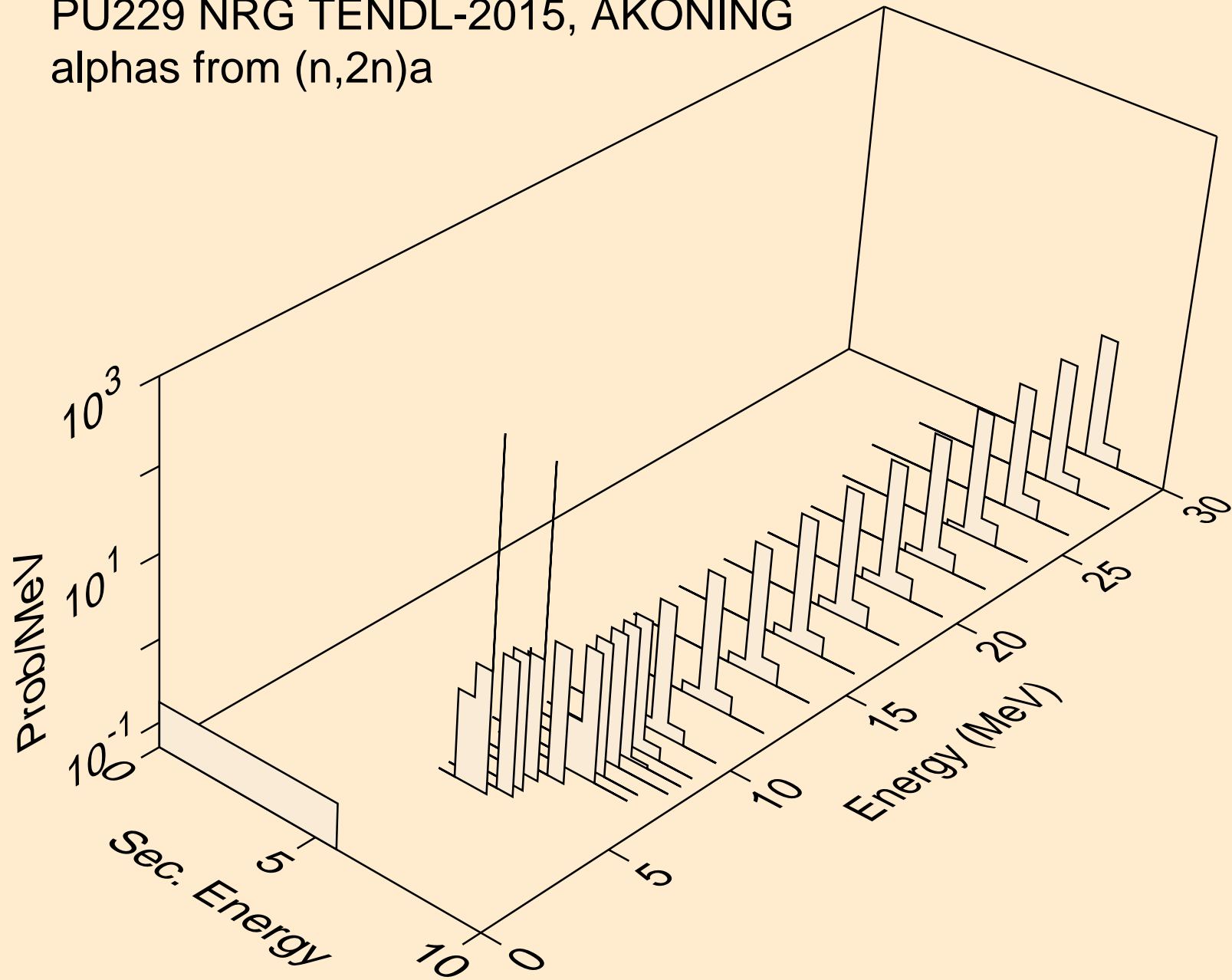

PU229 NRG TENDL-2015, AKONING
alphas from (n,3n)a

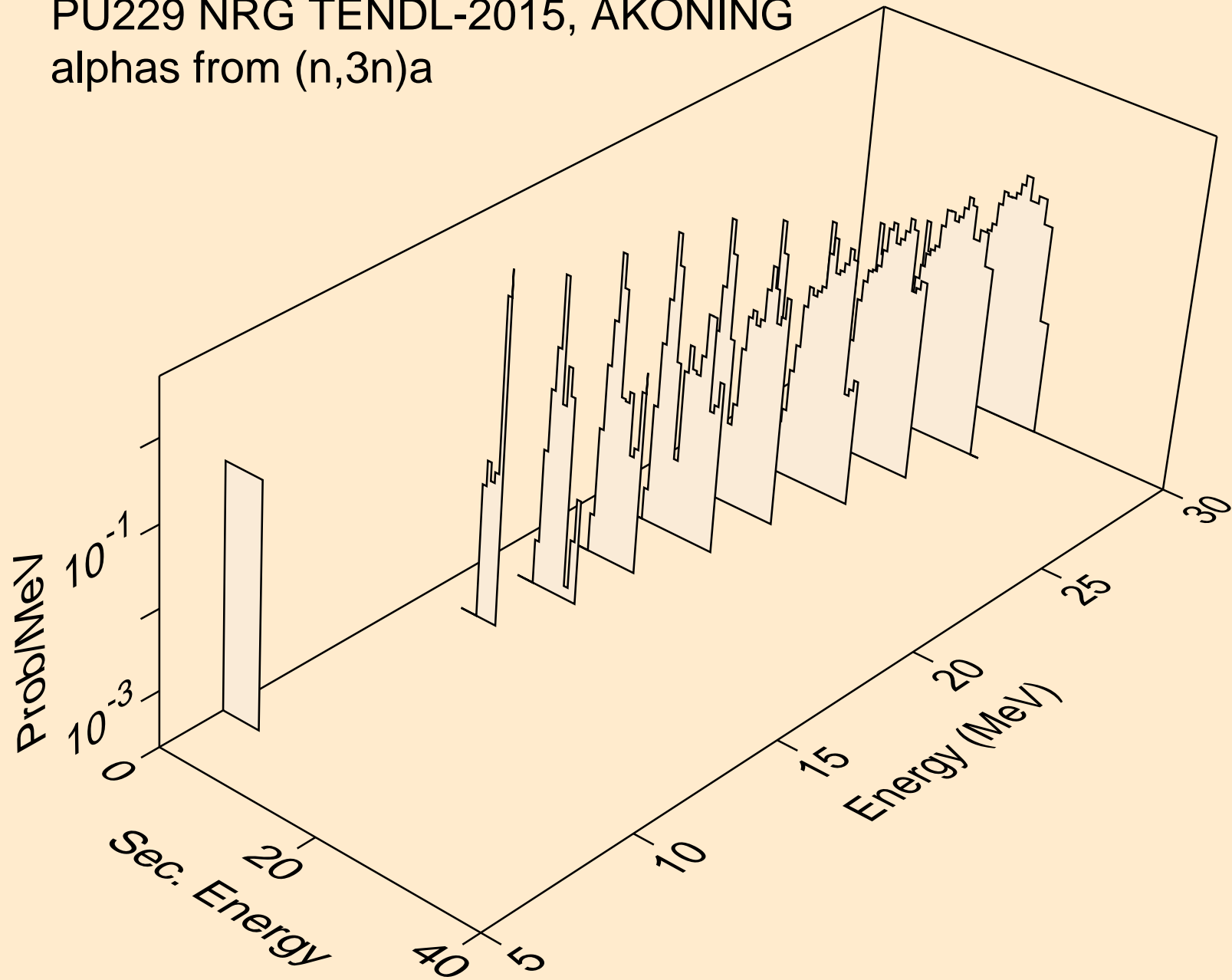

PU229 NRG TENDL-2015, AKONING
alphas from (n,n*)2a

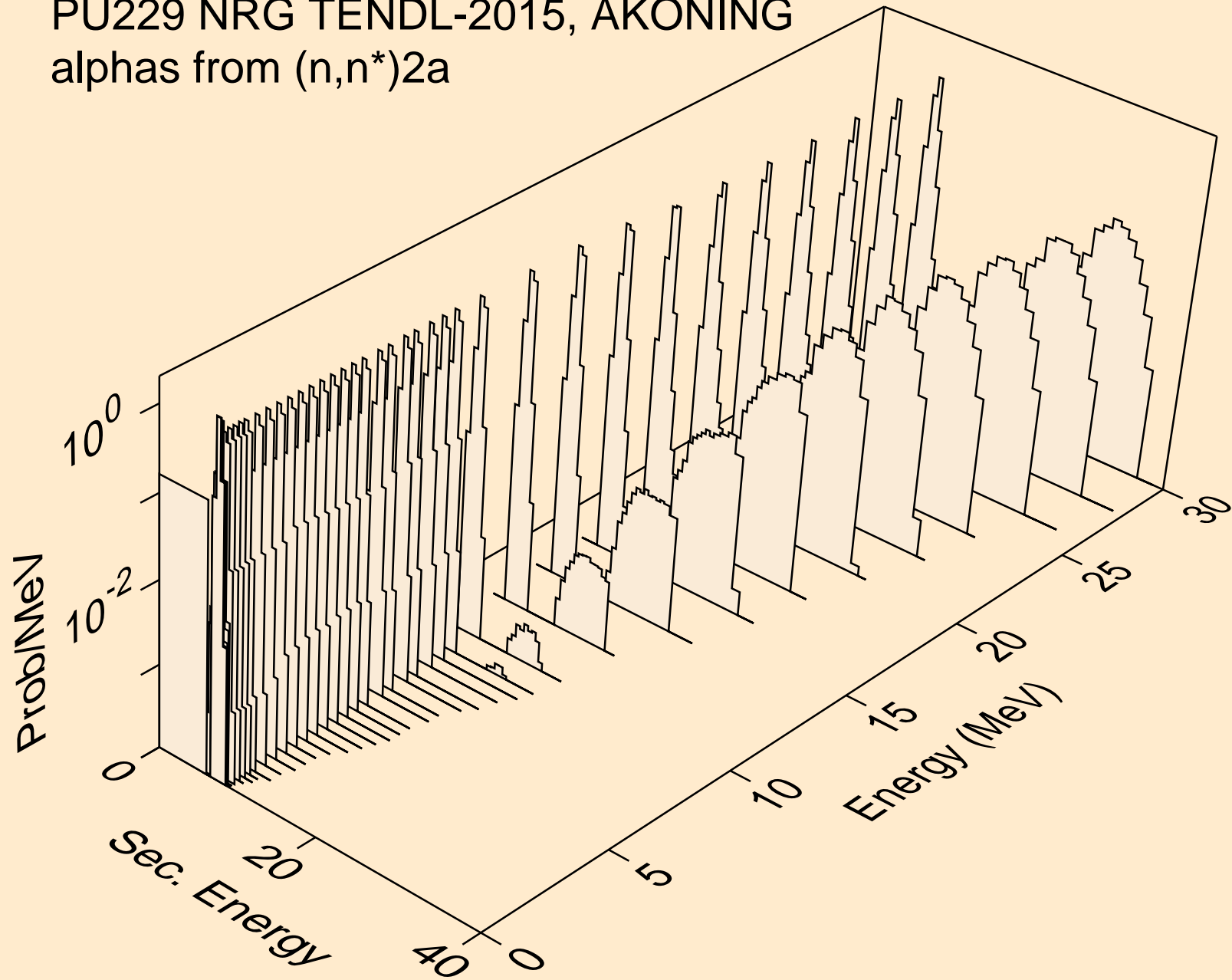

PU229 NRG TENDL-2015, AKONING
alphas from (n,2n)2a

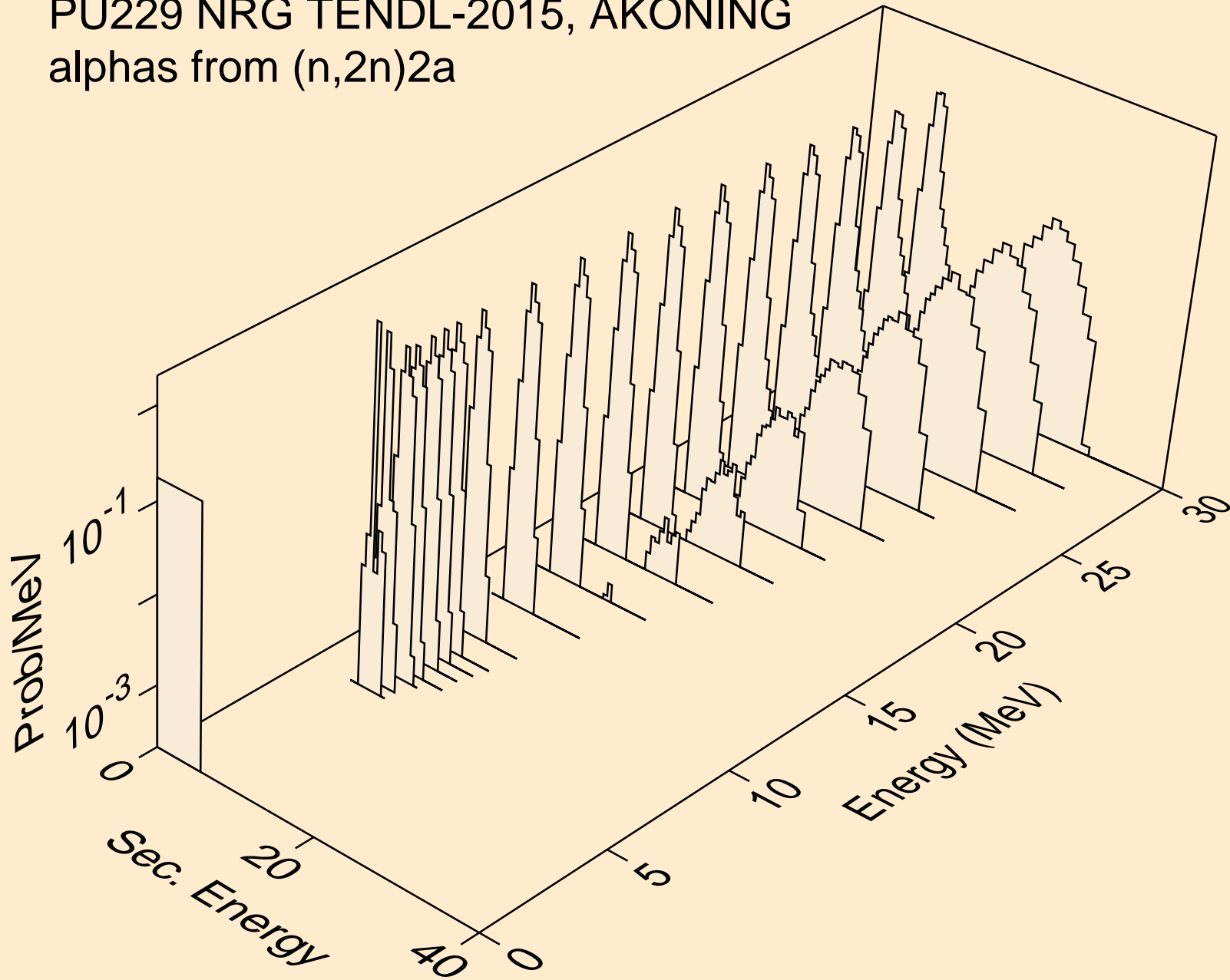

PU229 NRG TENDL-2015, AKONING
alphas from (n,n*)d2a

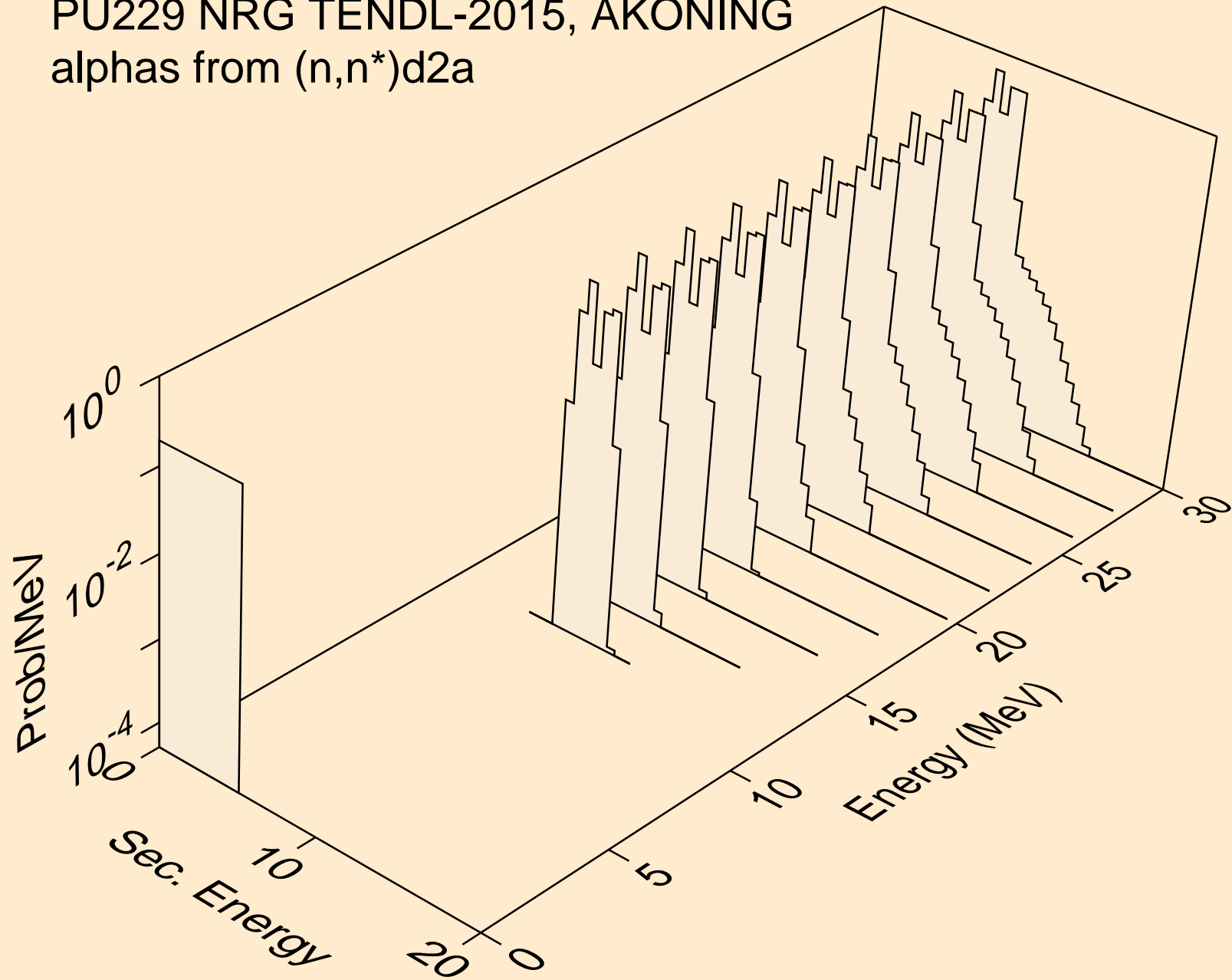

PU229 NRG TENDL-2015, AKONING
alphas from (n,n*)t2a

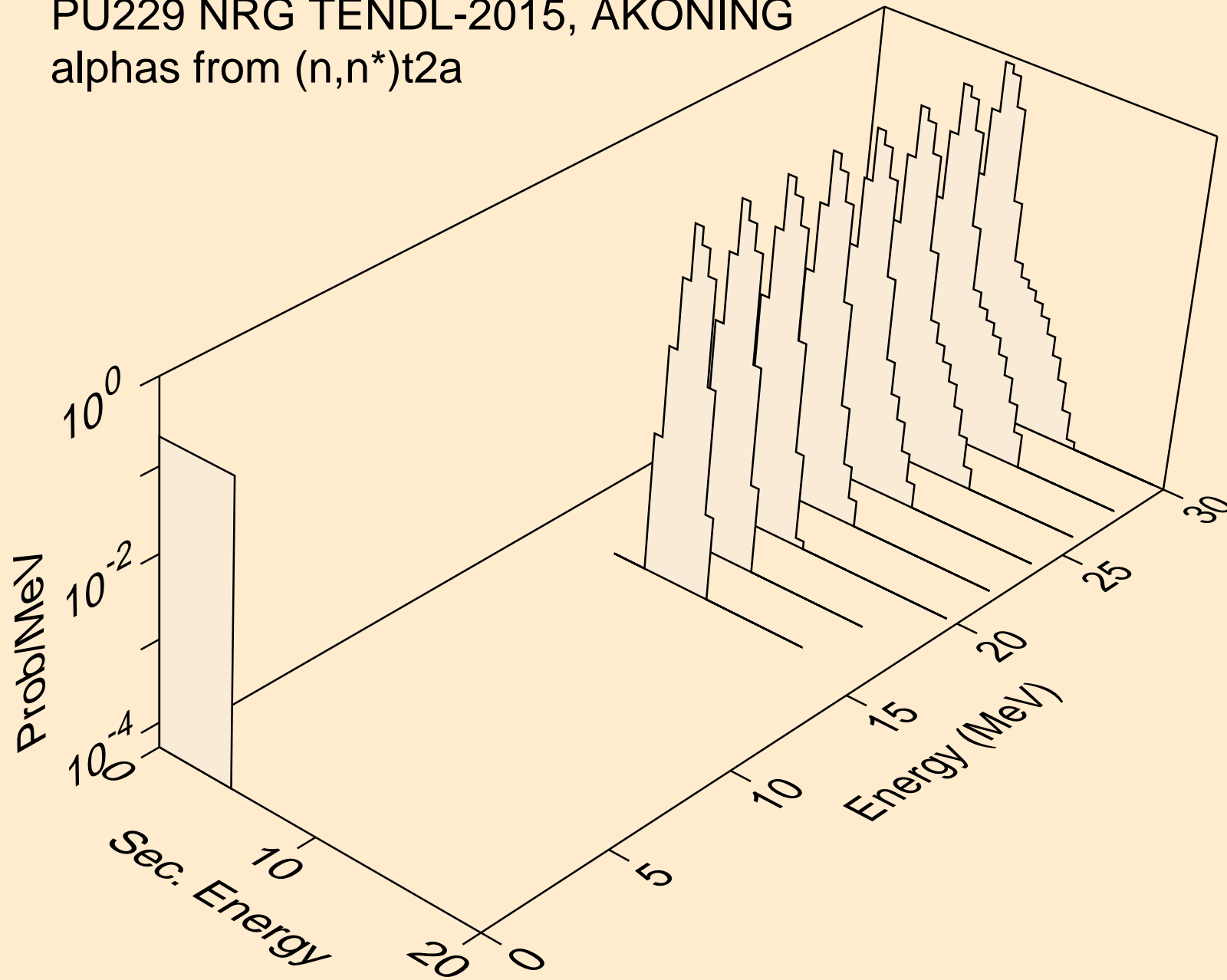

PU229 NRG TENDL-2015, AKONING
alphas from (n,npa)

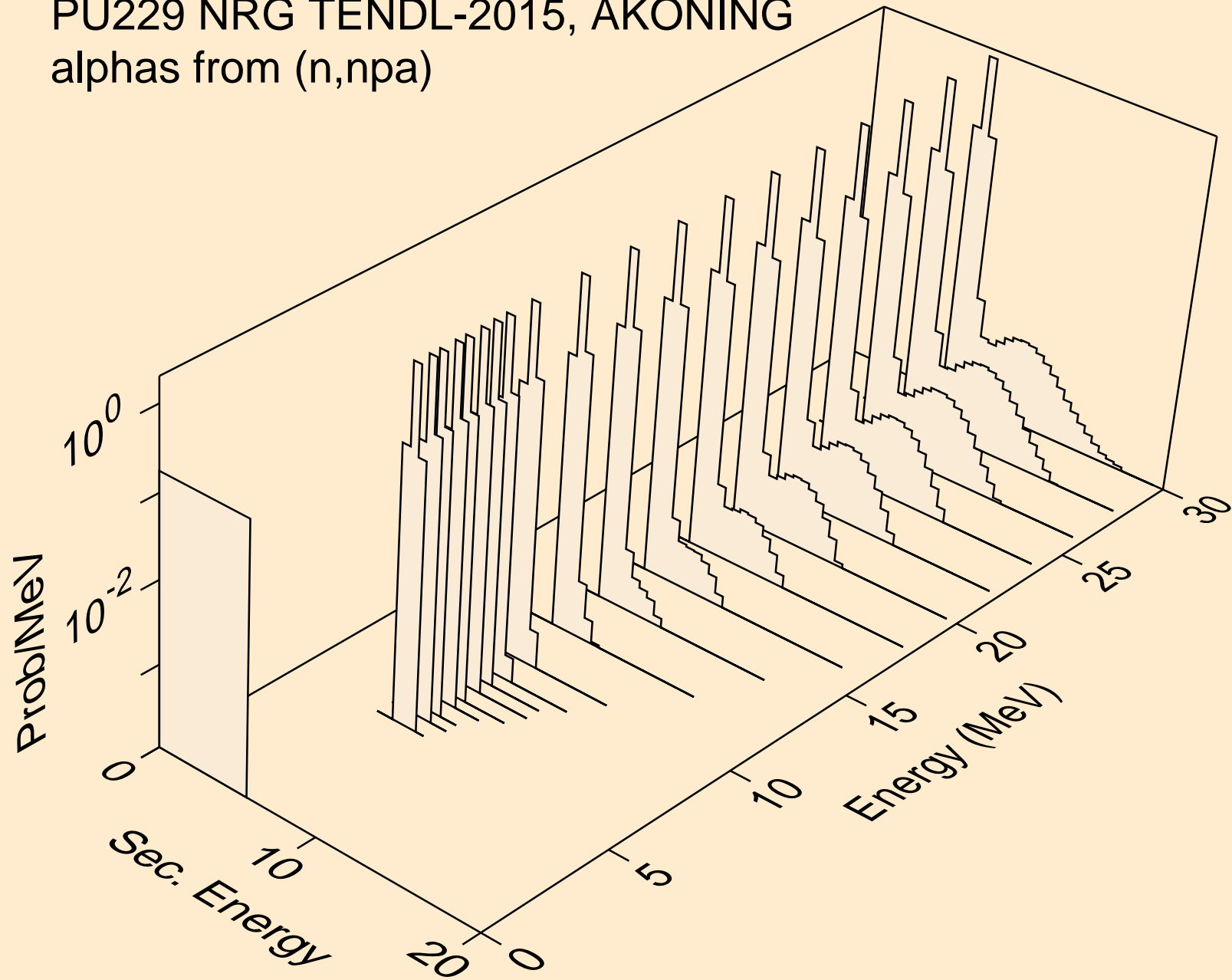

PU229 NRG TENDL-2015, AKONING
alphas from (n,a)

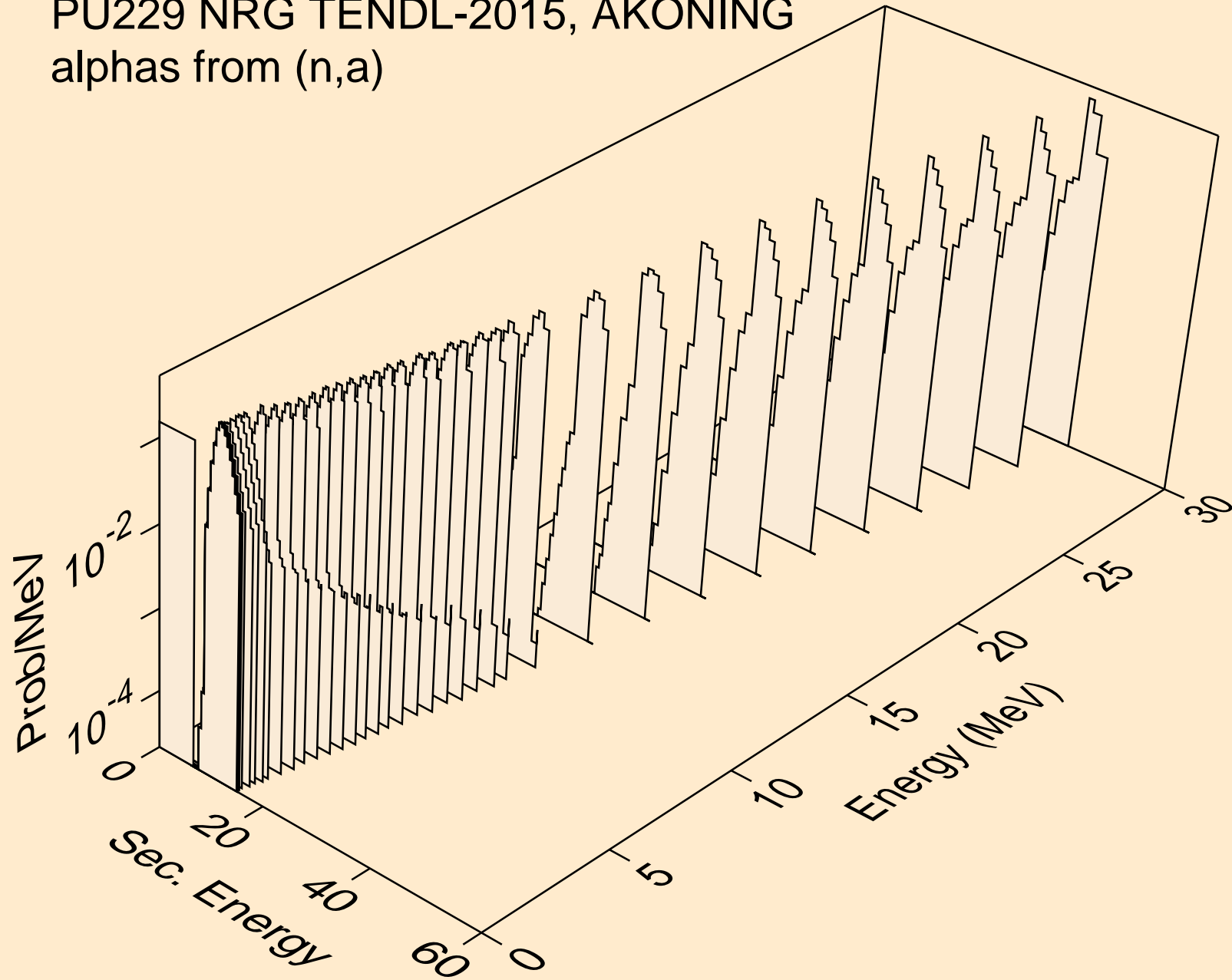

PU229 NRG TENDL-2015, AKONING
alphas from (n,2a)

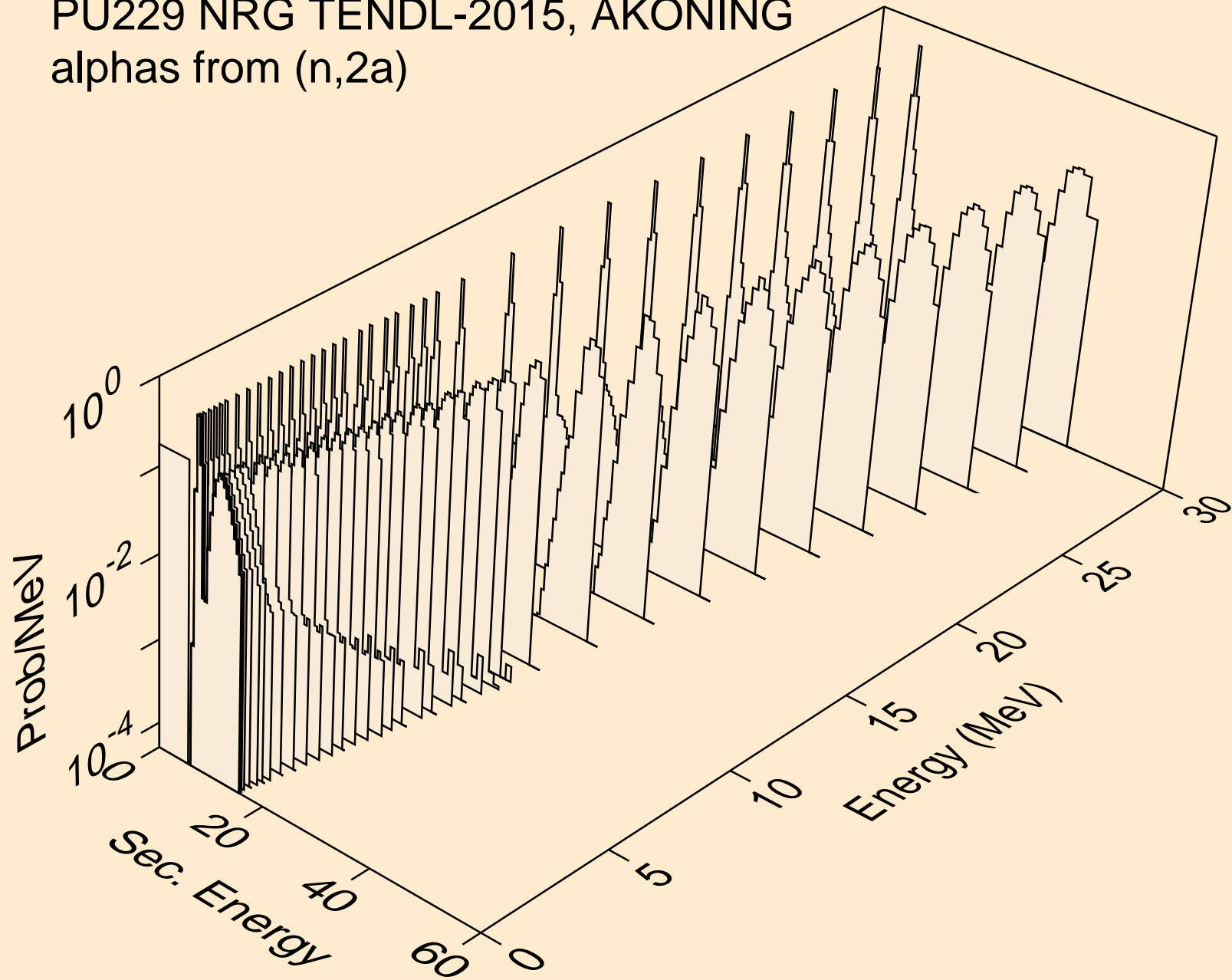

PU229 NRG TENDL-2015, AKONING
alphas from (n,3a)

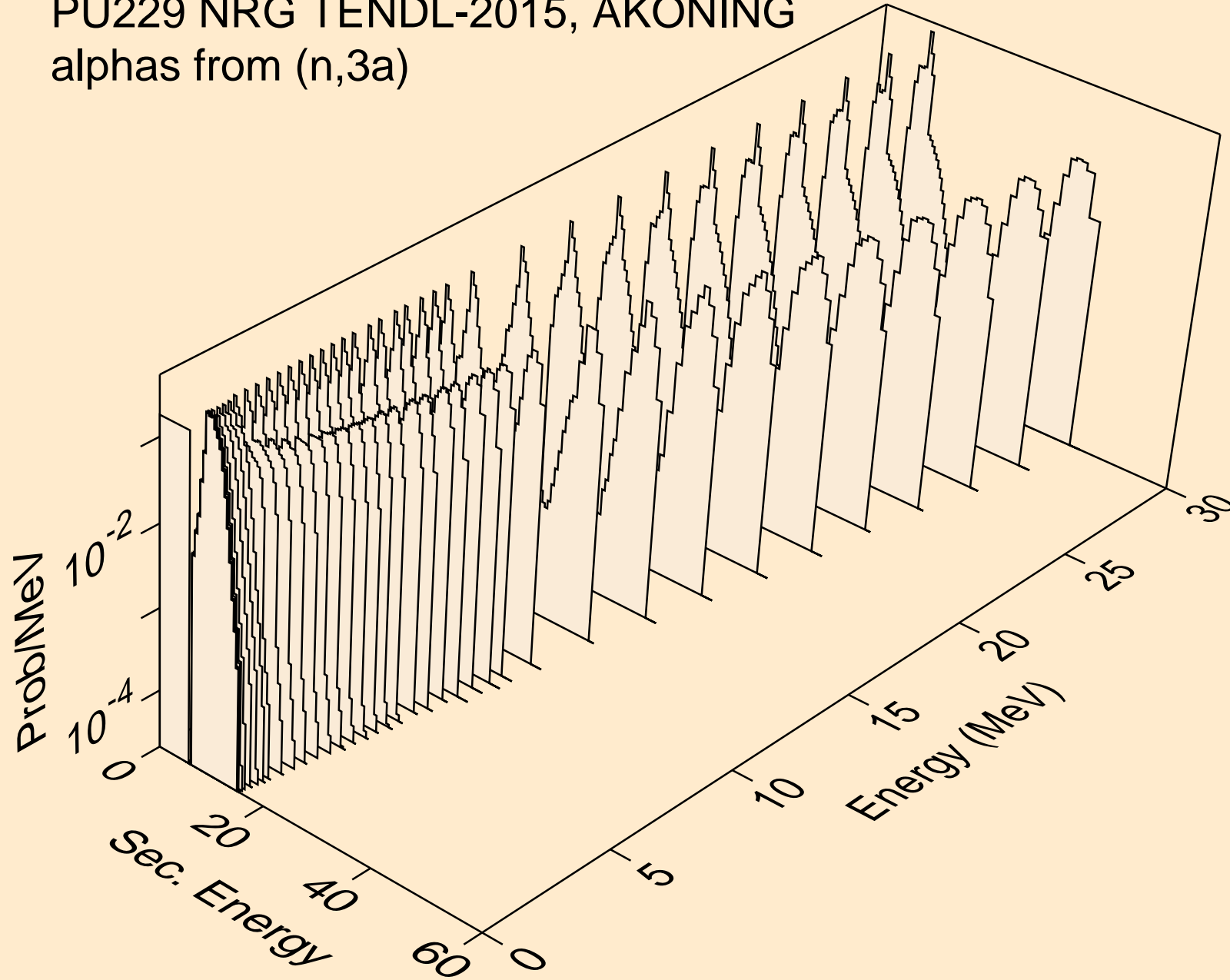

PU229 NRG TENDL-2015, AKONING
alphas from (n,pa)

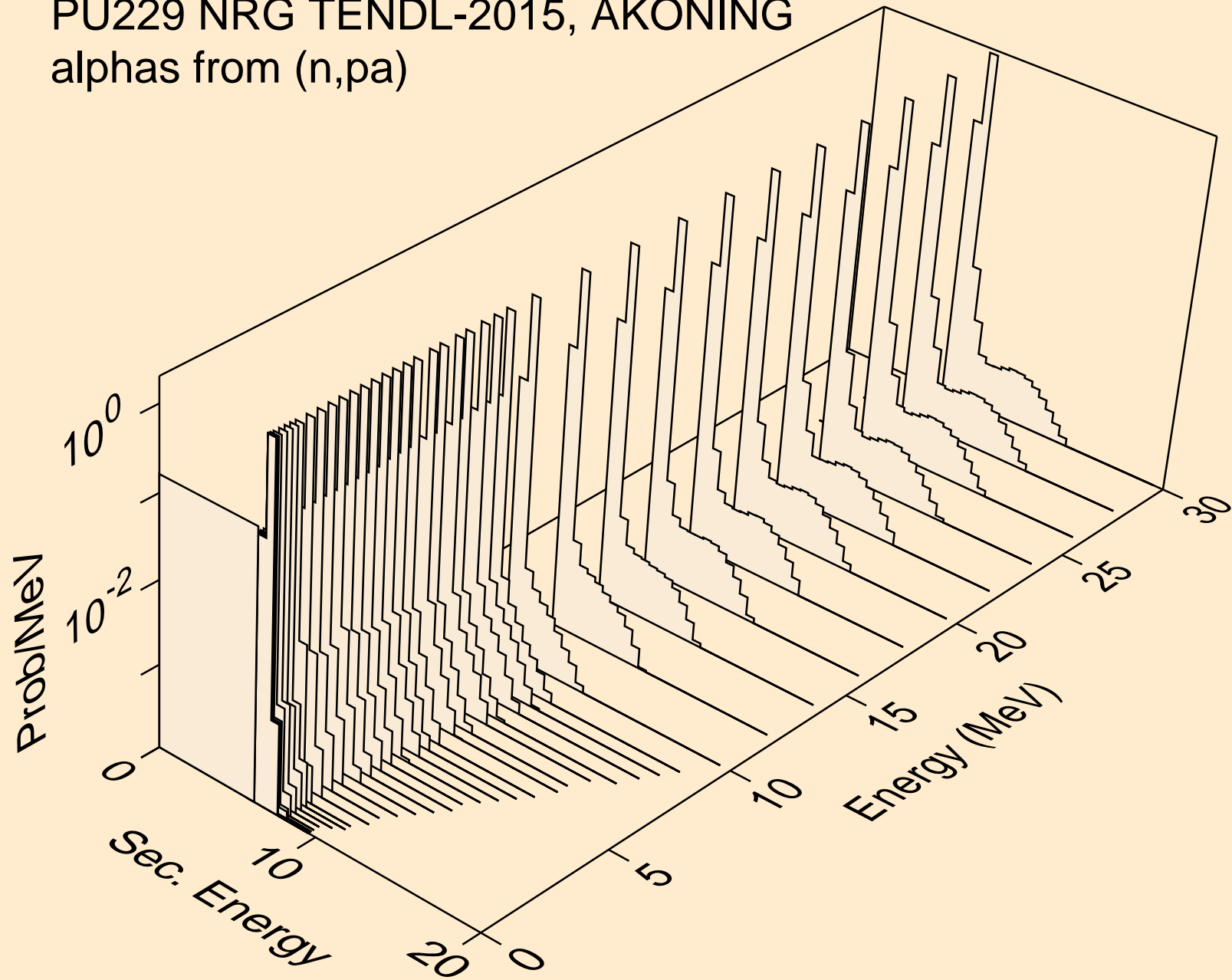

PU229 NRG TENDL-2015, AKONING
alphas from (n,t2a)

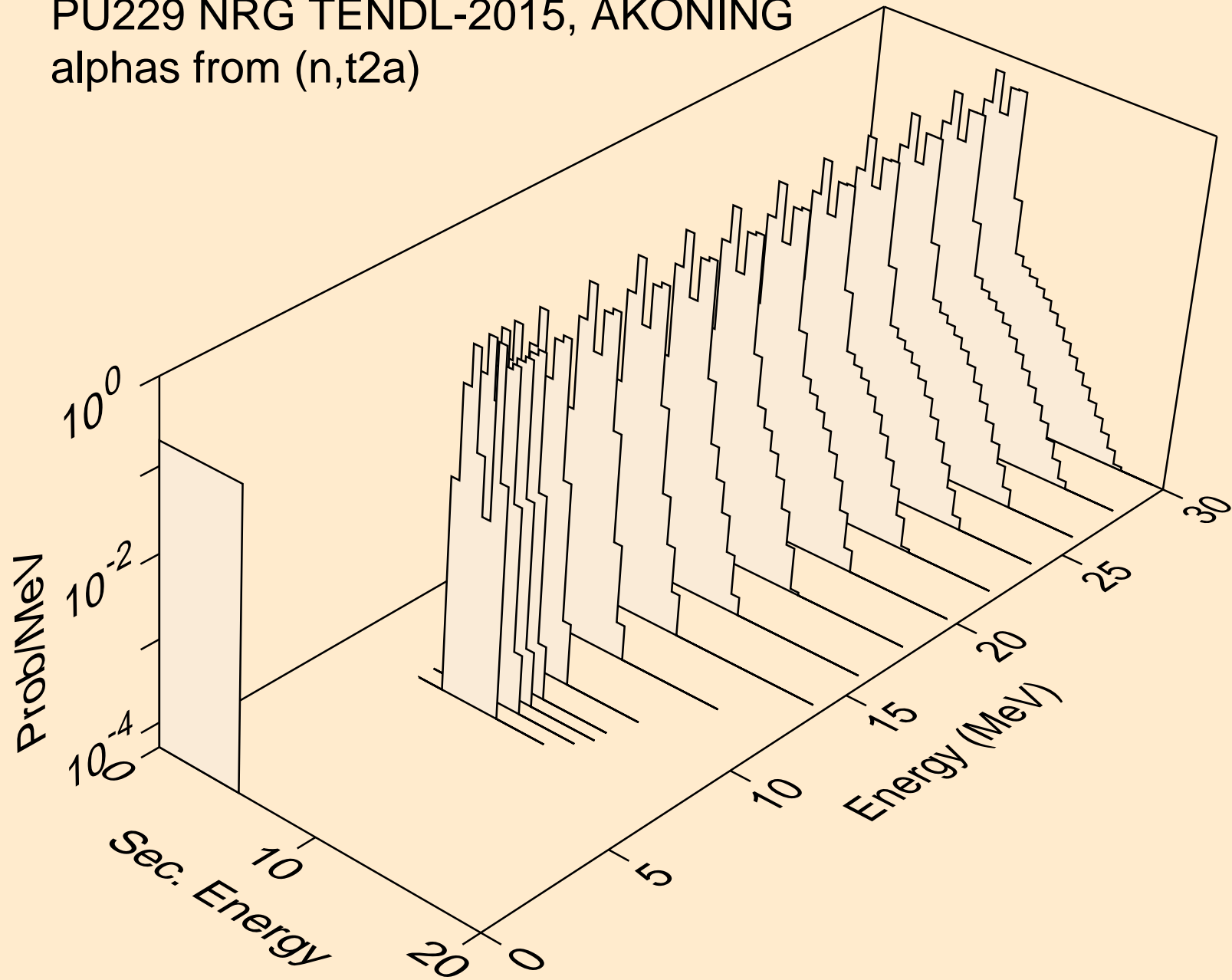

PU229 NRG TENDL-2015, AKONING
alphas from (n,d2a)

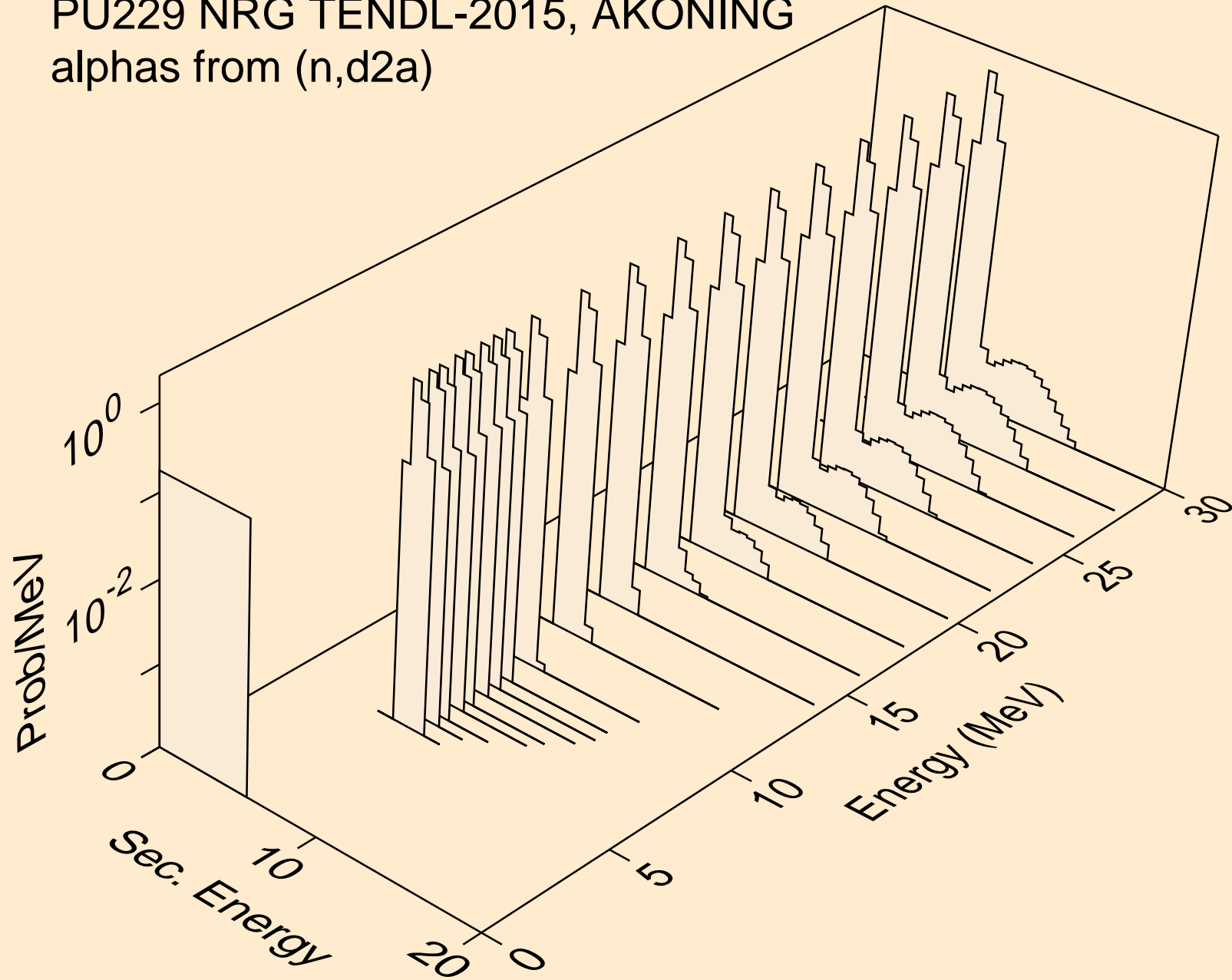

PU229 NRG TENDL-2015, AKONING
alphas from (n,da)

