

# PU231 NRG TENDL-2015, AKONING

## Principal cross sections

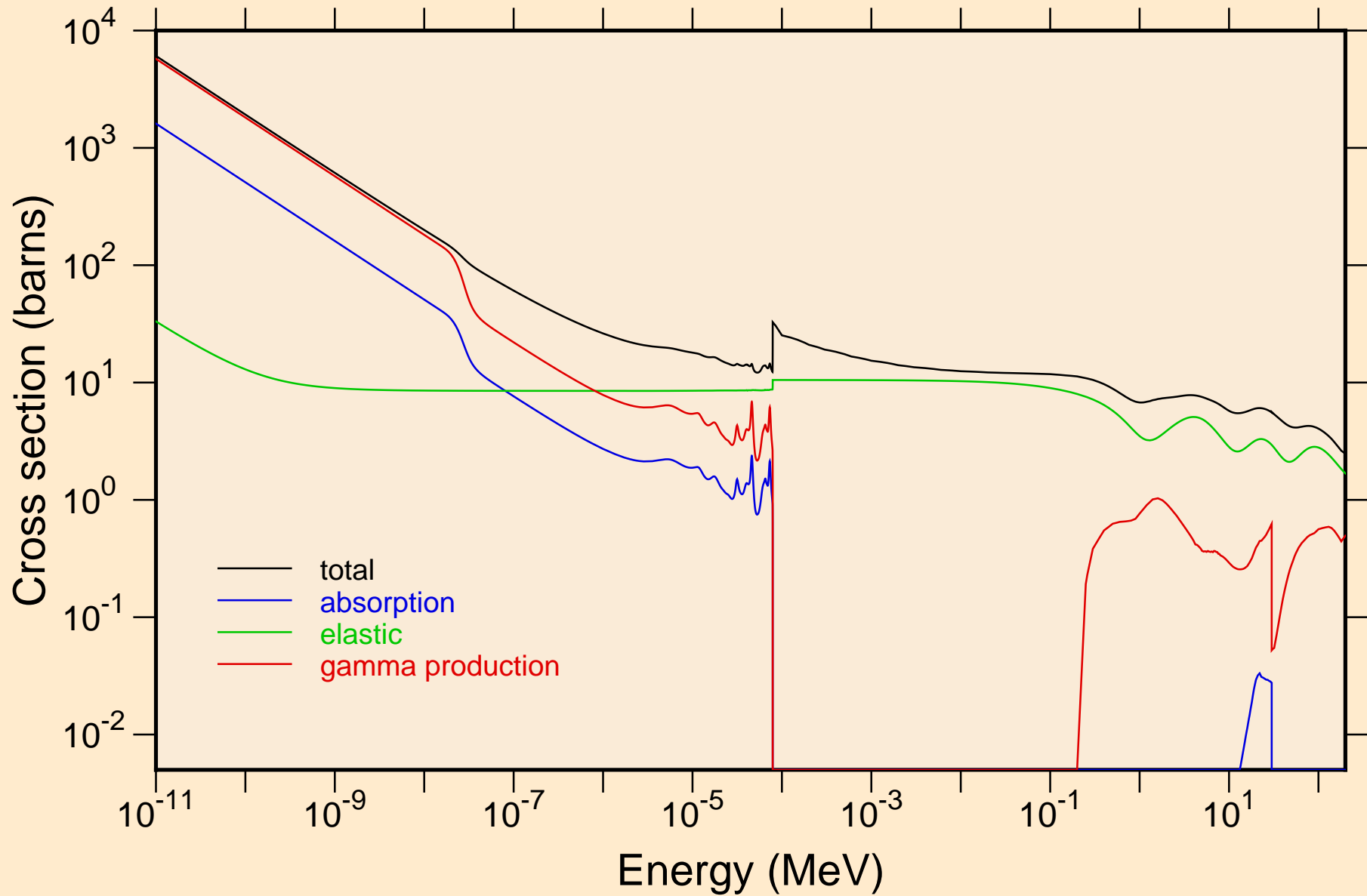

# PU231 NRG TENDL-2015, AKONING

## Non-threshold reactions

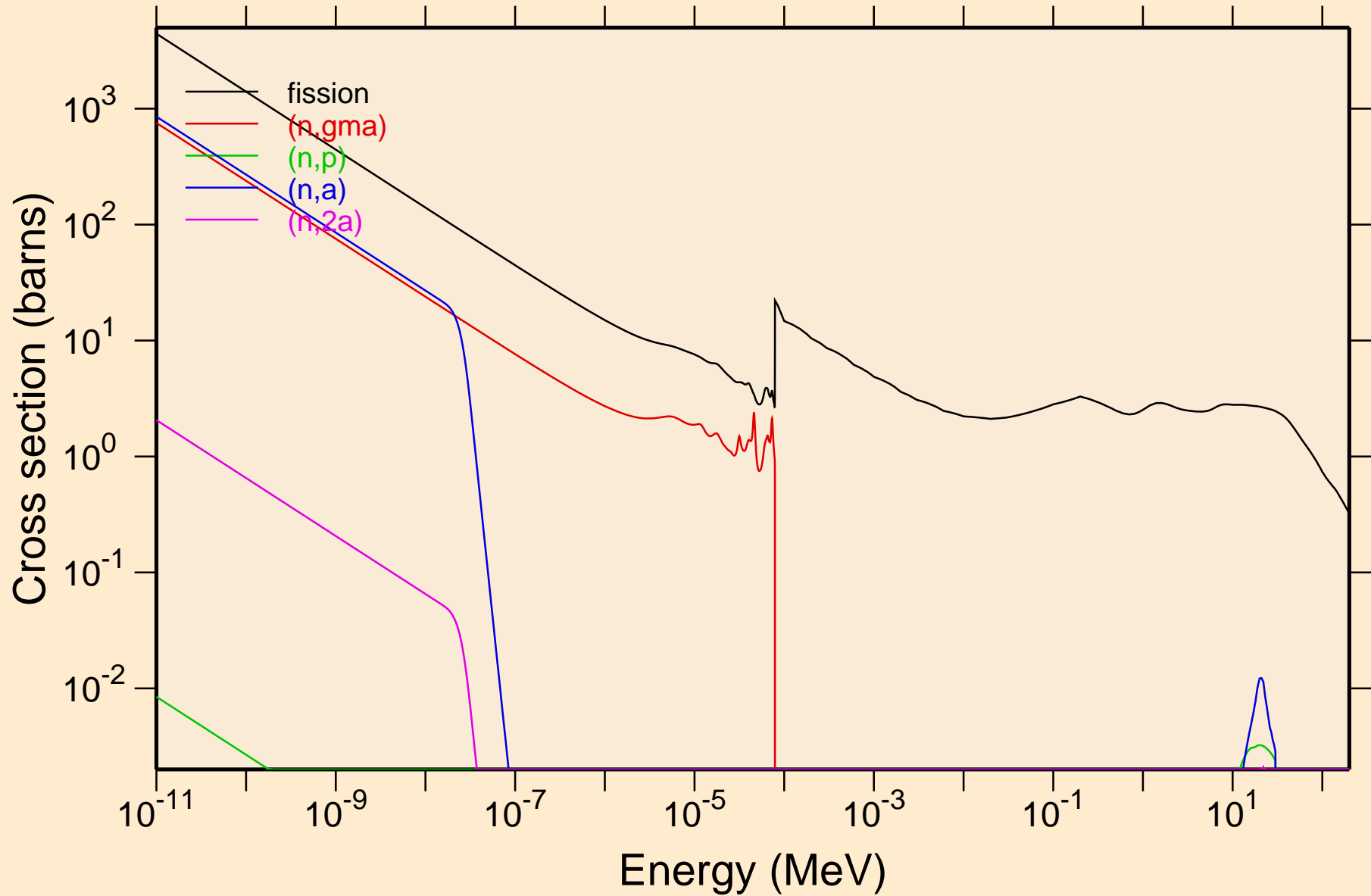

PU231 NRG TENDL-2015, AKONING  
Non-threshold reactions

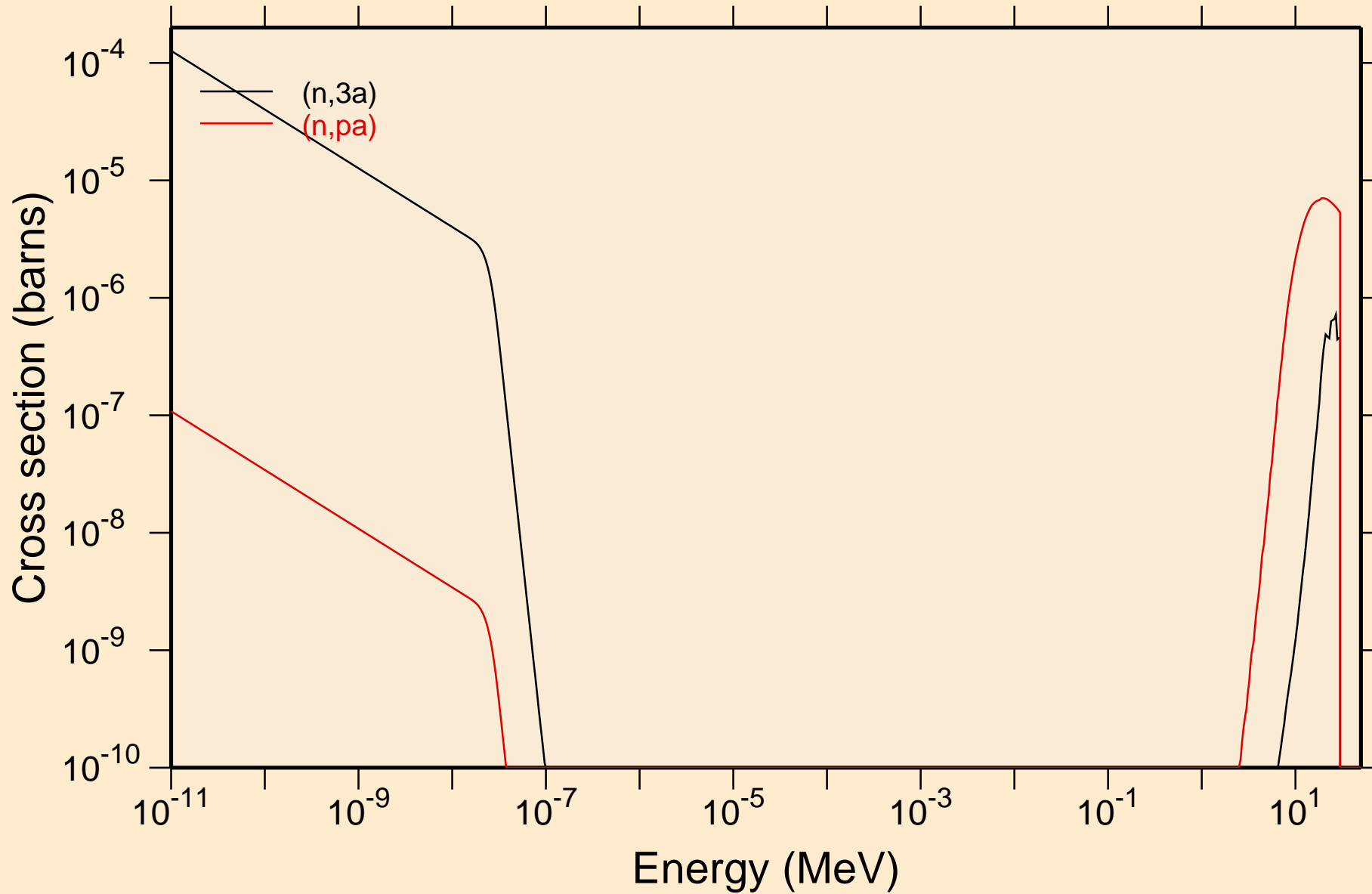

# PU231 NRG TENDL-2015, AKONING

## Principal cross sections

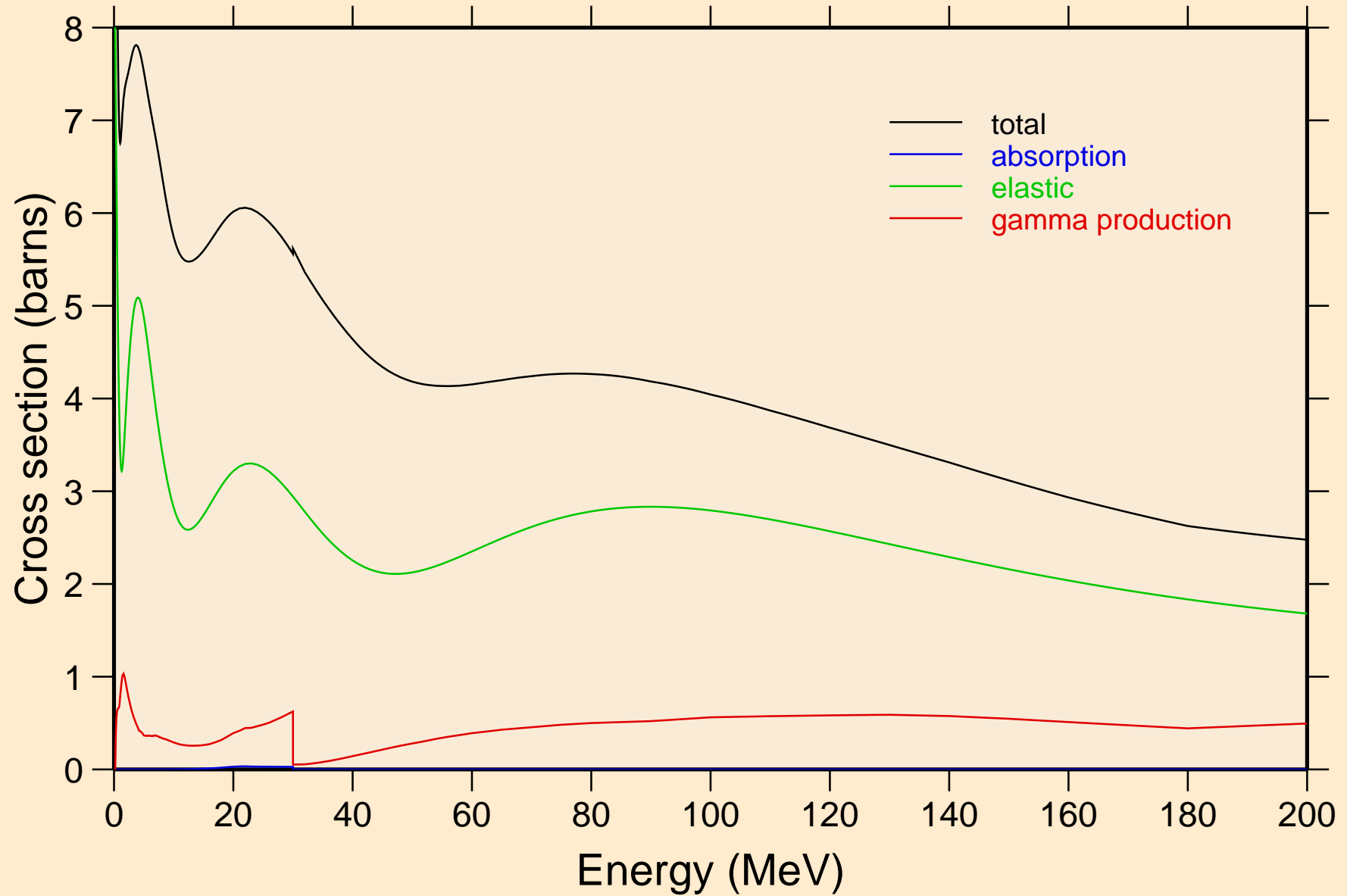

# PU231 NRG TENDL-2015, AKONING

## Non-threshold reactions

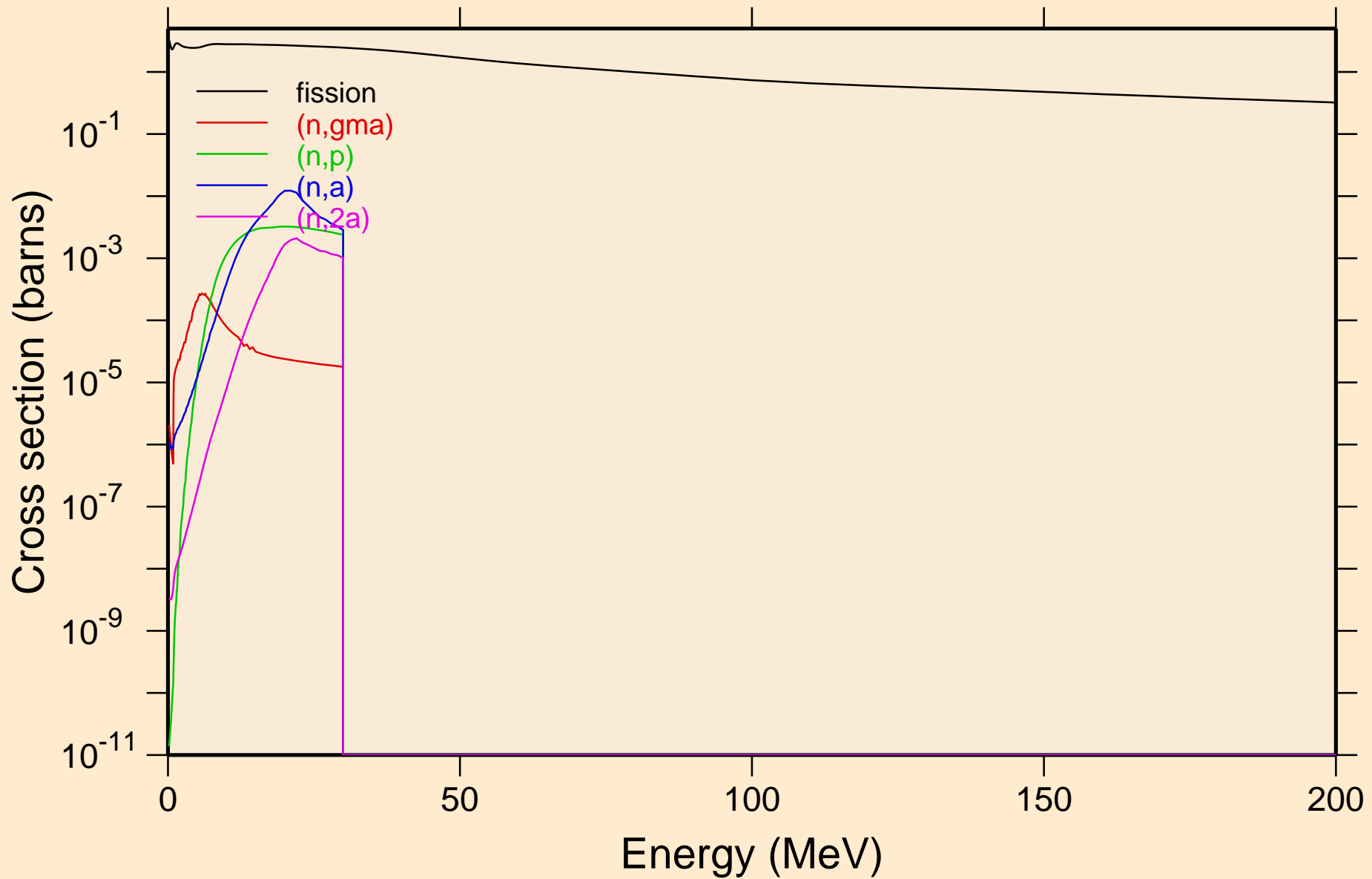

# PU231 NRG TENDL-2015, AKONING

## Non-threshold reactions

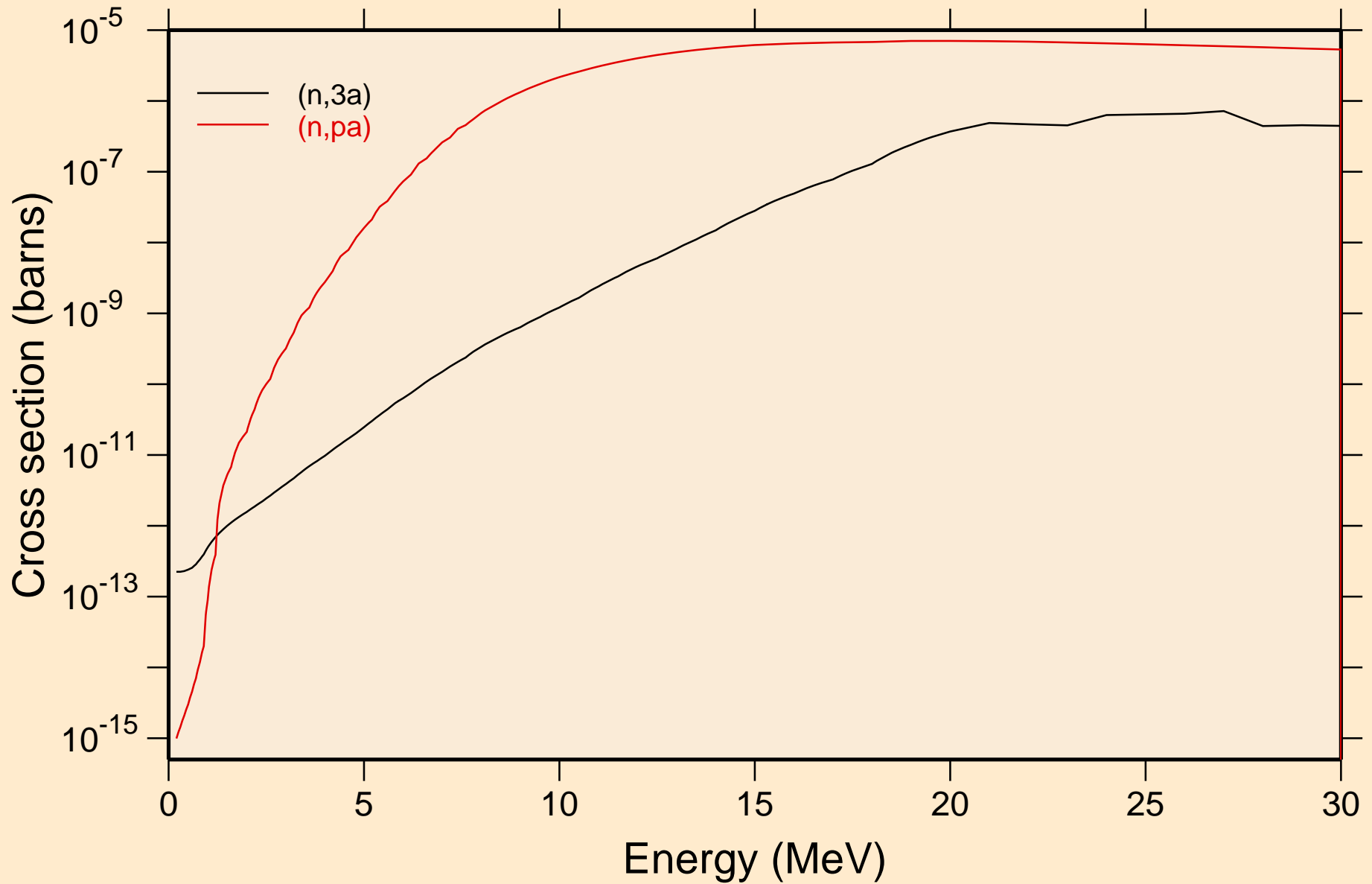

PU231 NRG TENDL-2015, AKONING  
Inelastic levels

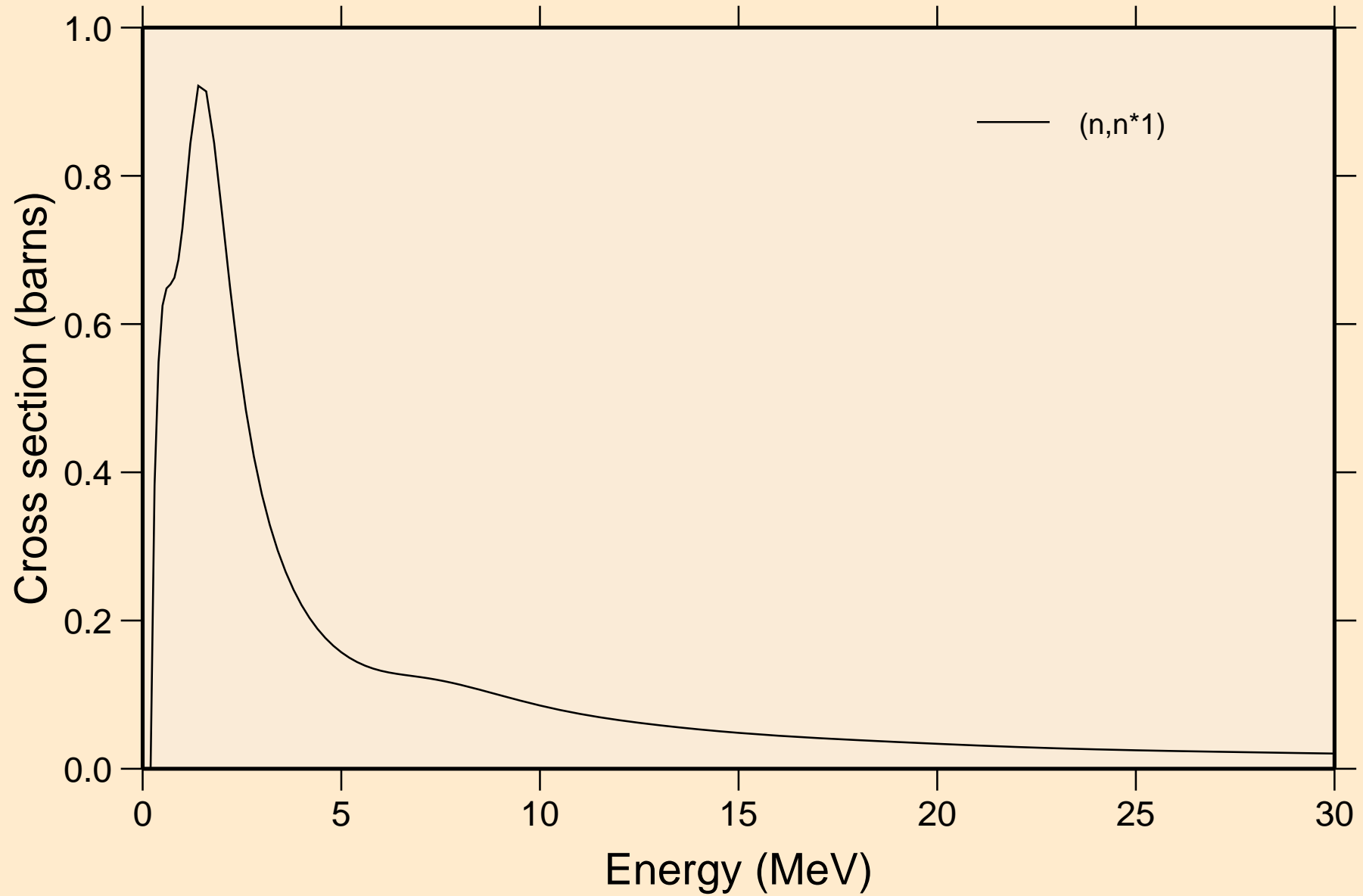

# PU231 NRG TENDL-2015, AKONING

## Threshold reactions

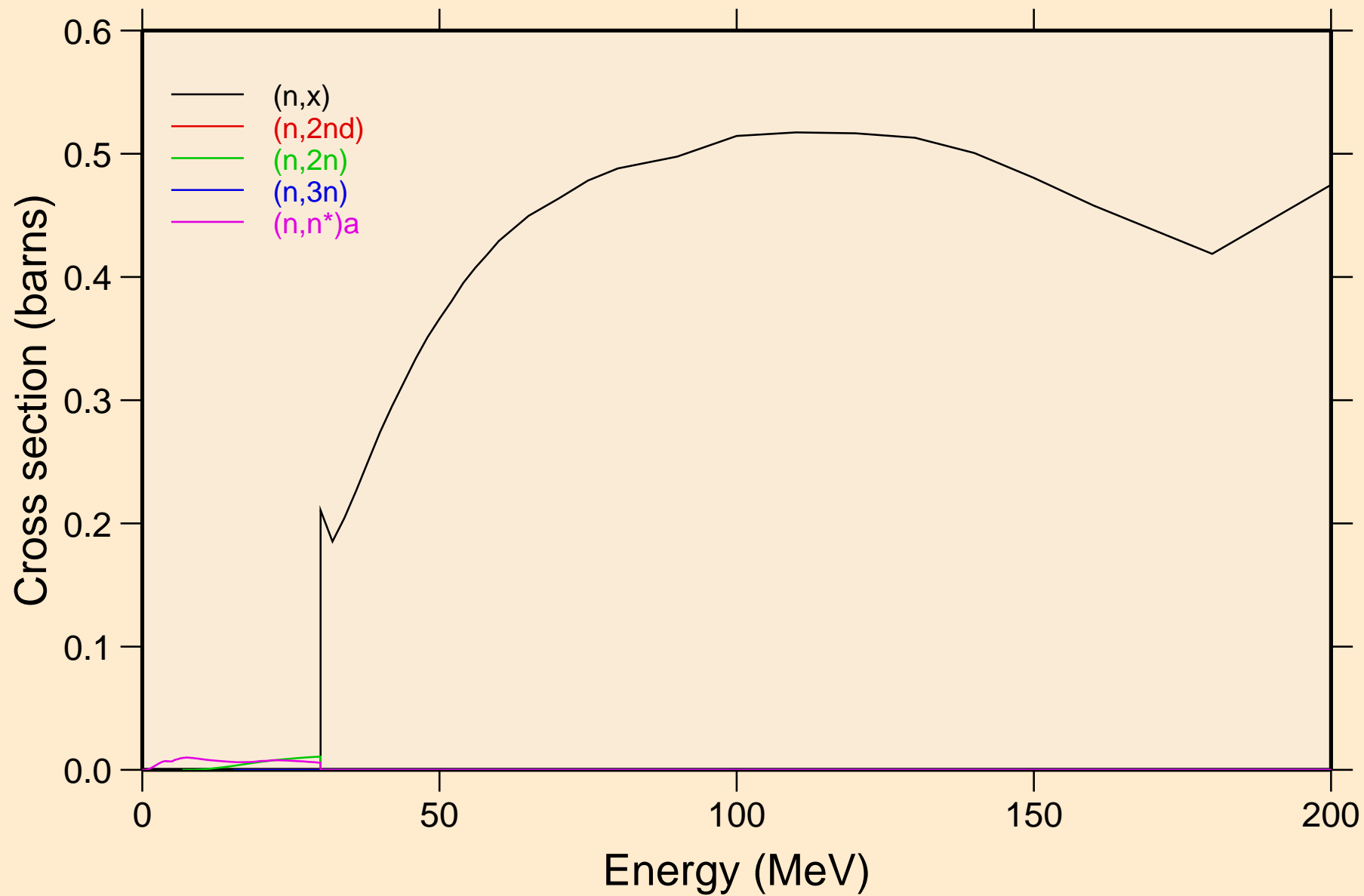



# PU231 NRG TENDL-2015, AKONING

## Threshold reactions

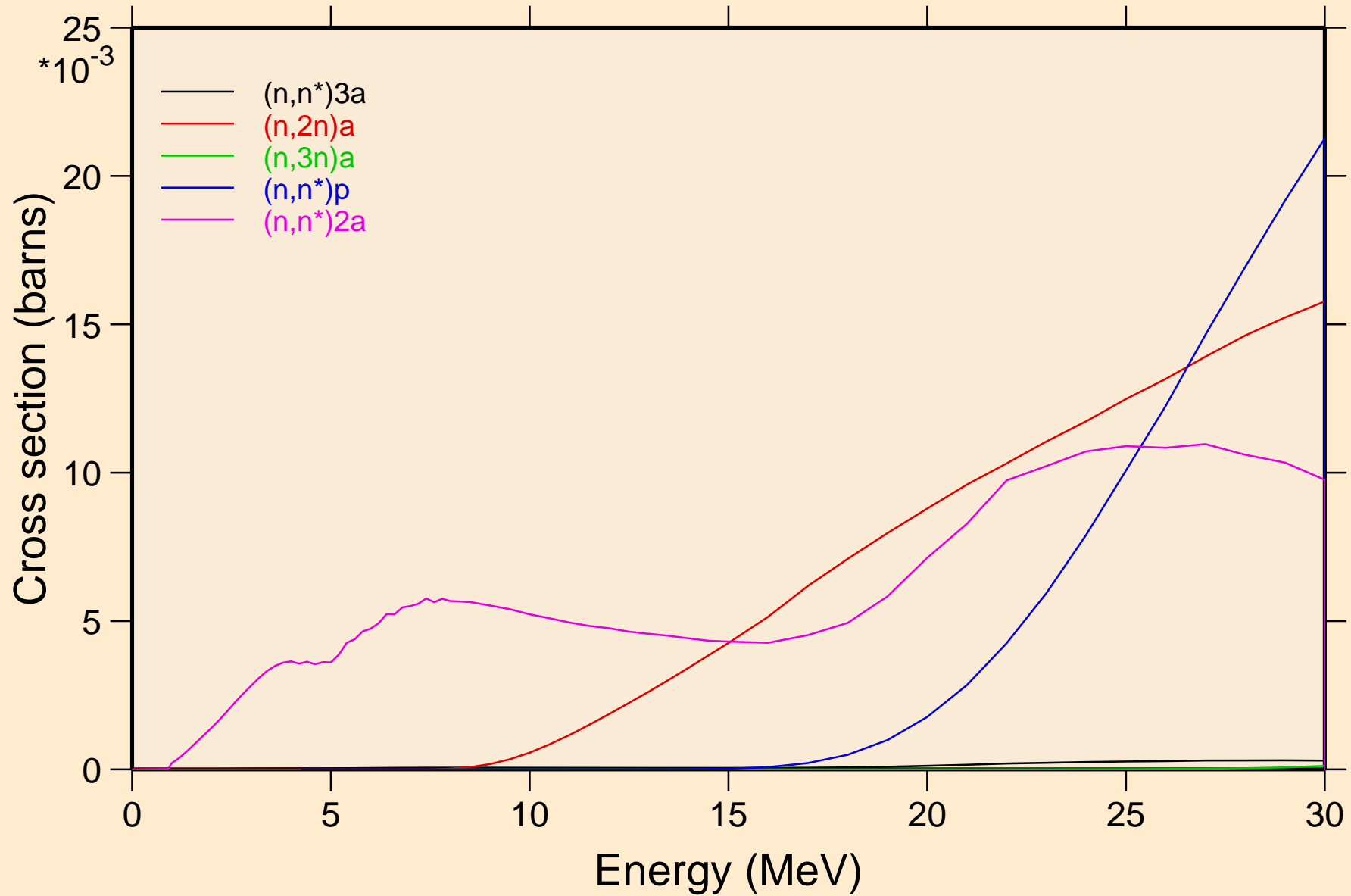

# PU231 NRG TENDL-2015, AKONING

## Threshold reactions

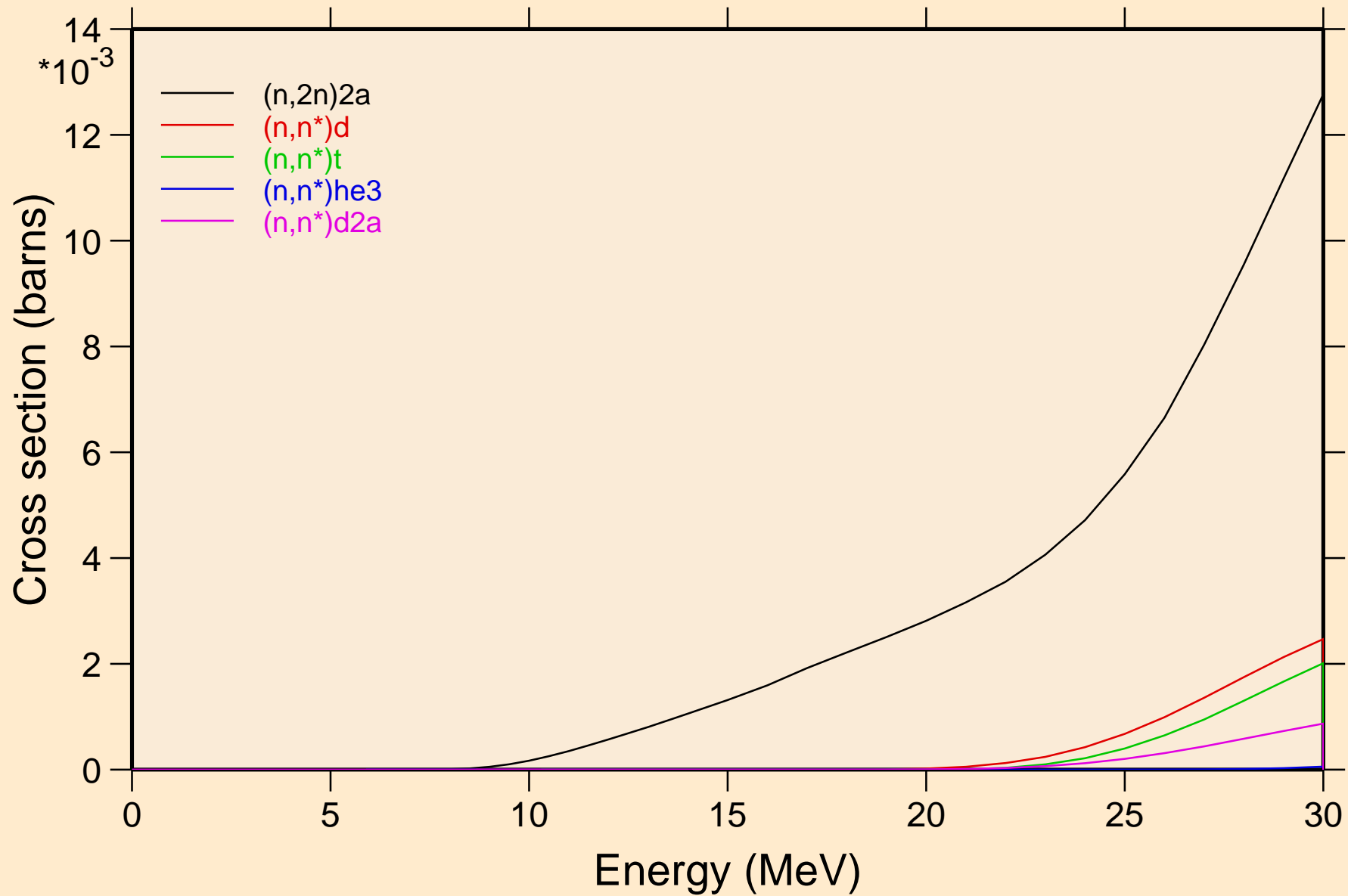

# PU231 NRG TENDL-2015, AKONING

## Threshold reactions

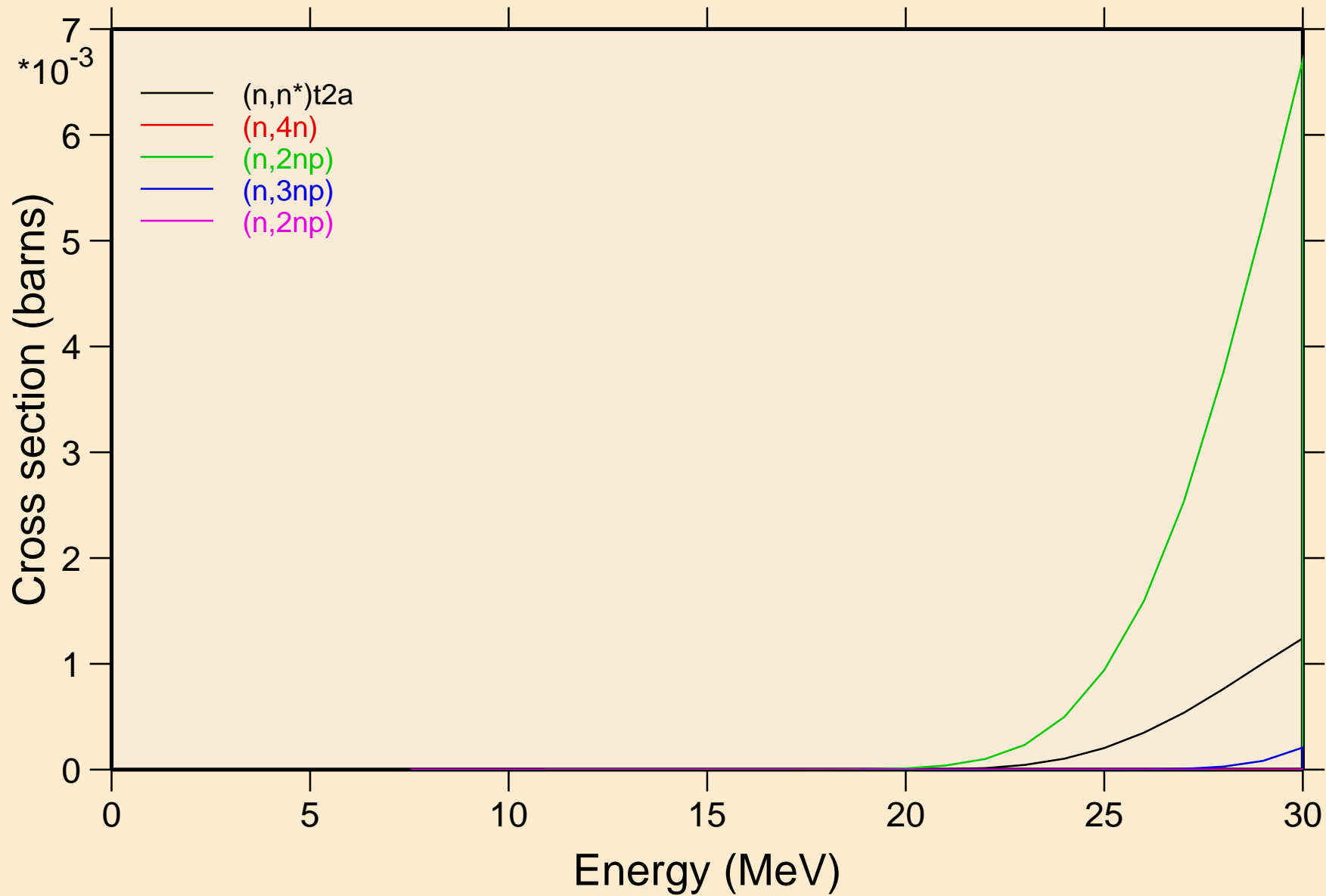

# PU231 NRG TENDL-2015, AKONING

## Threshold reactions

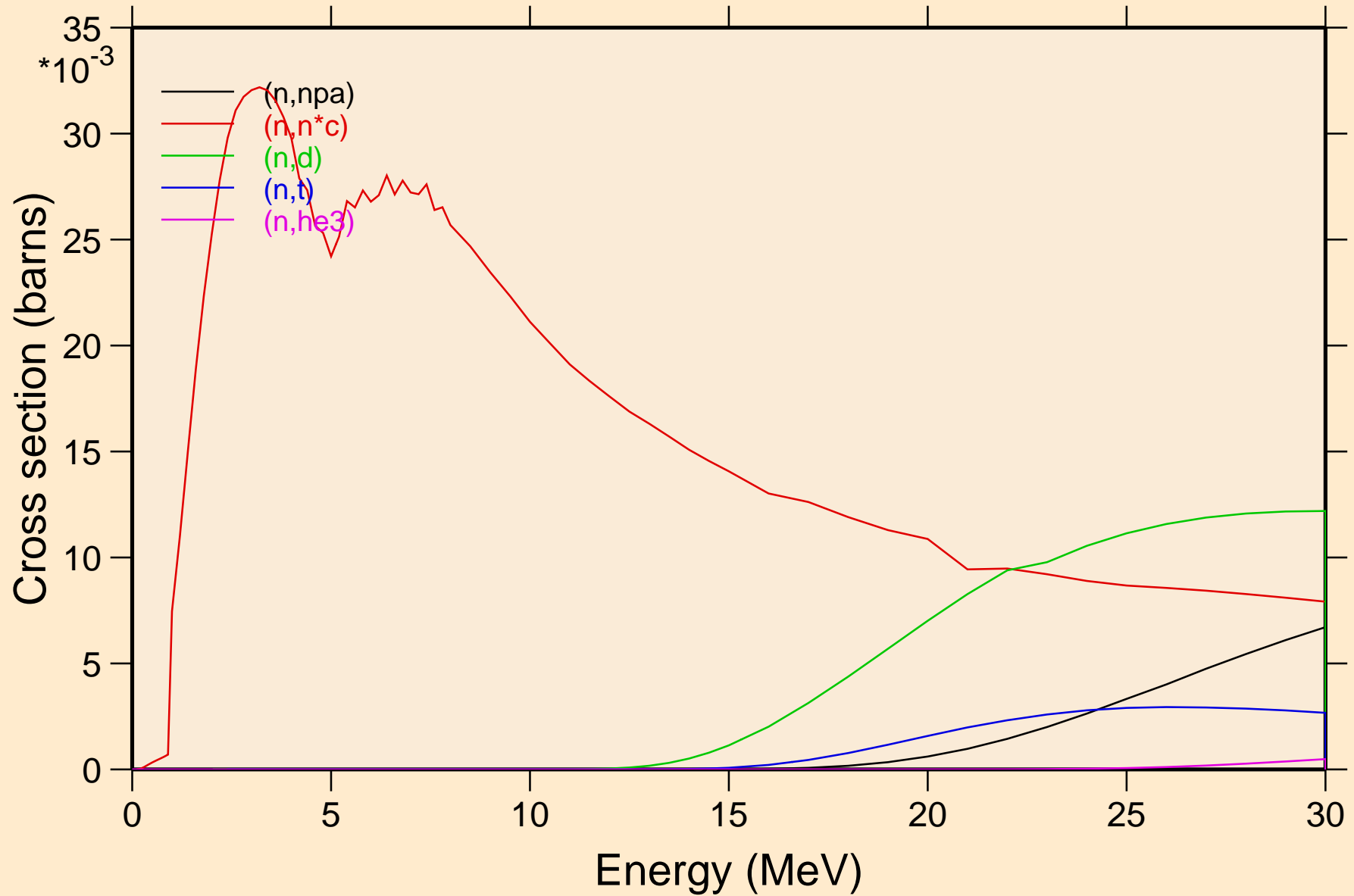

# PU231 NRG TENDL-2015, AKONING

## Threshold reactions

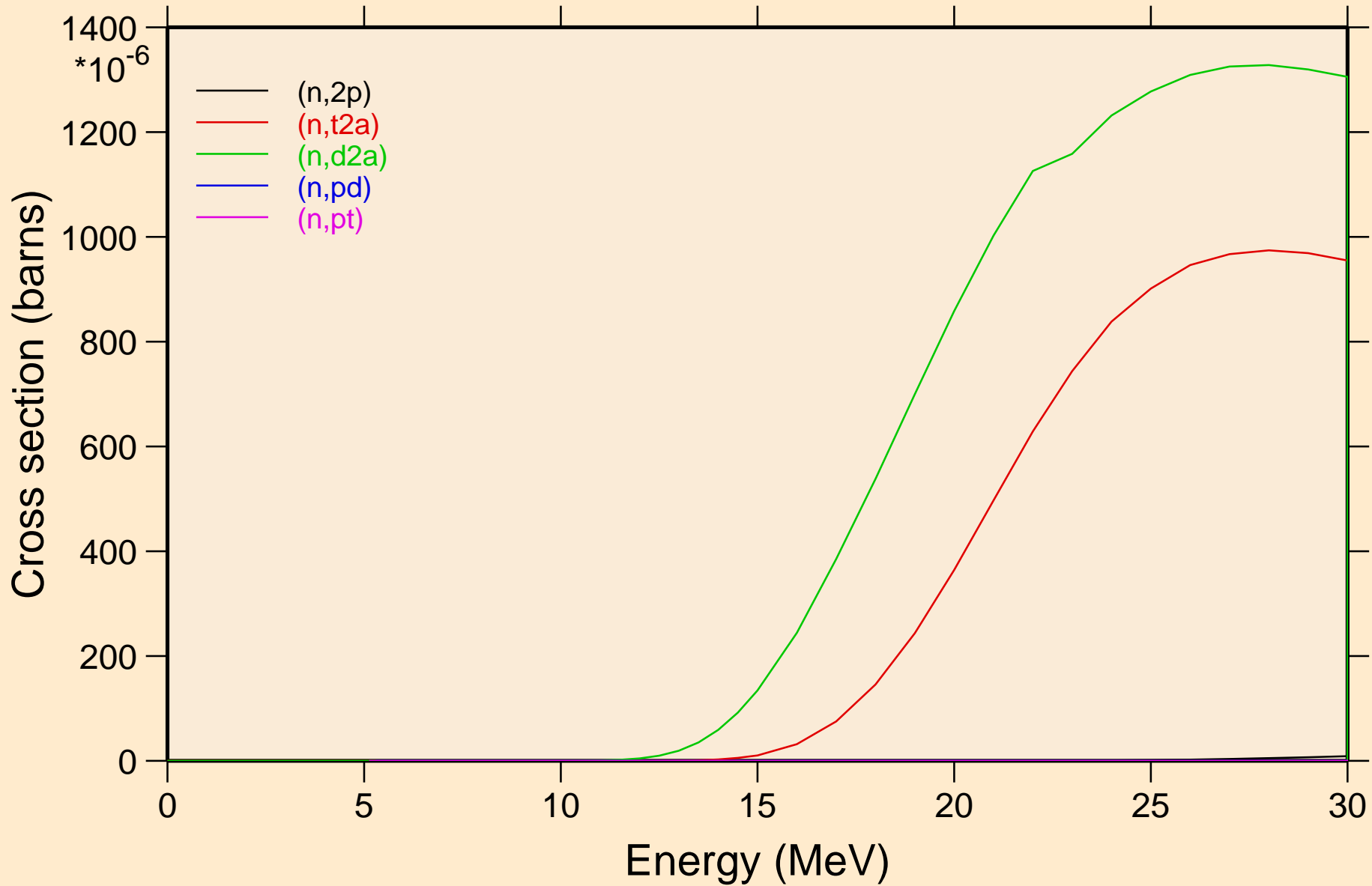

# PU231 NRG TENDL-2015, AKONING

## Threshold reactions

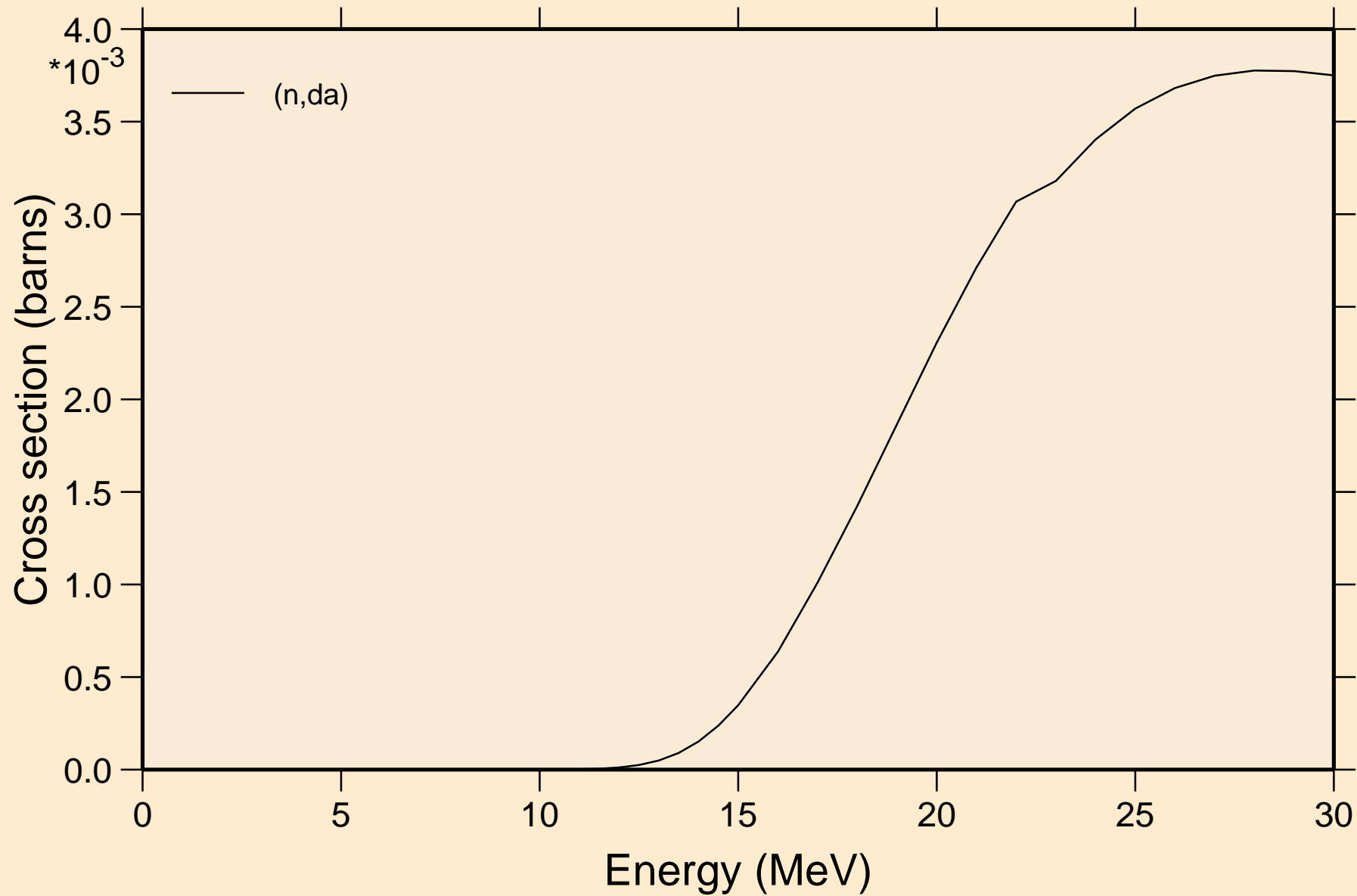

PU231 NRG TENDL-2015, AKONING  
angular distribution for elastic

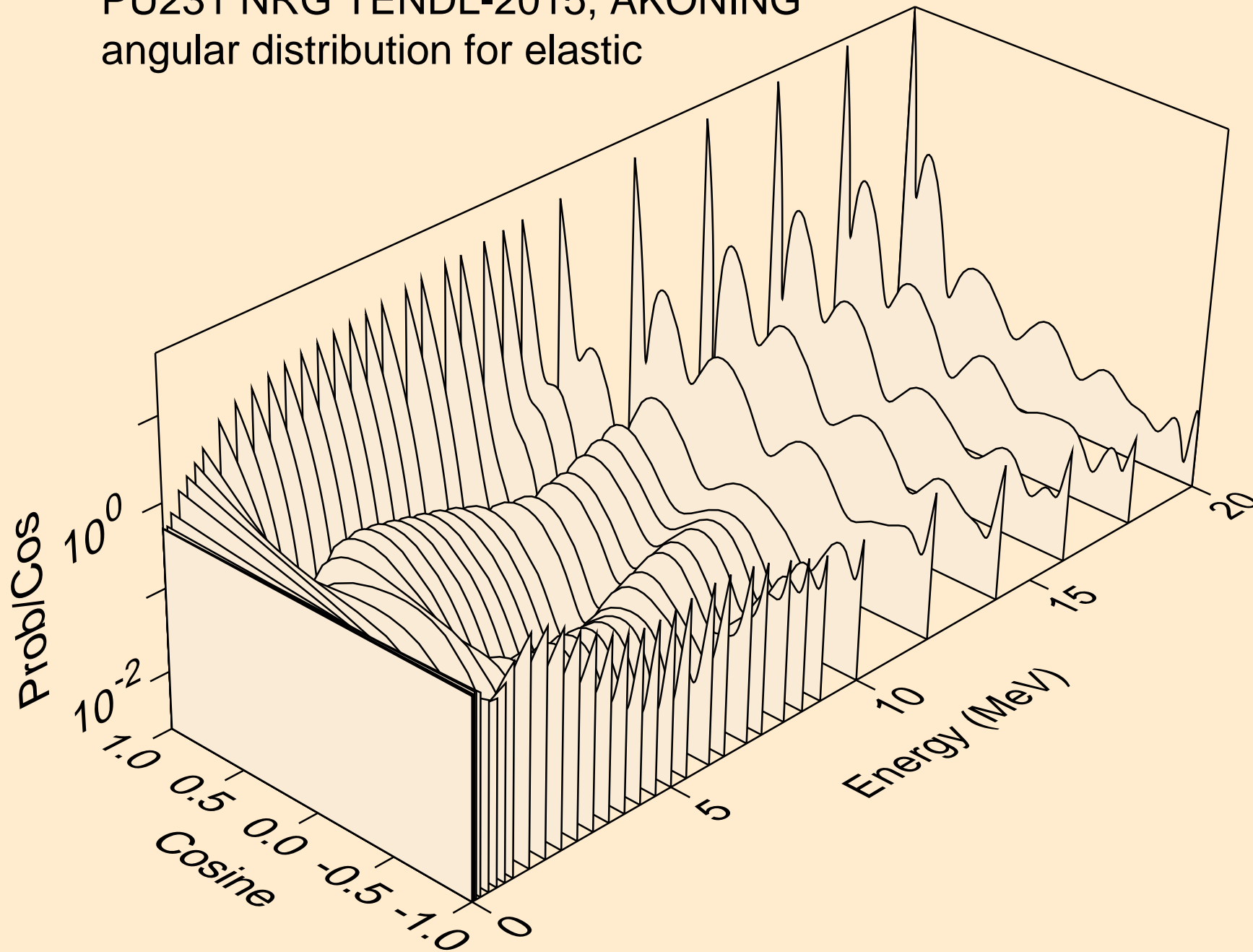

PU231 NRG TENDL-2015, AKONING  
angular distribution for elastic

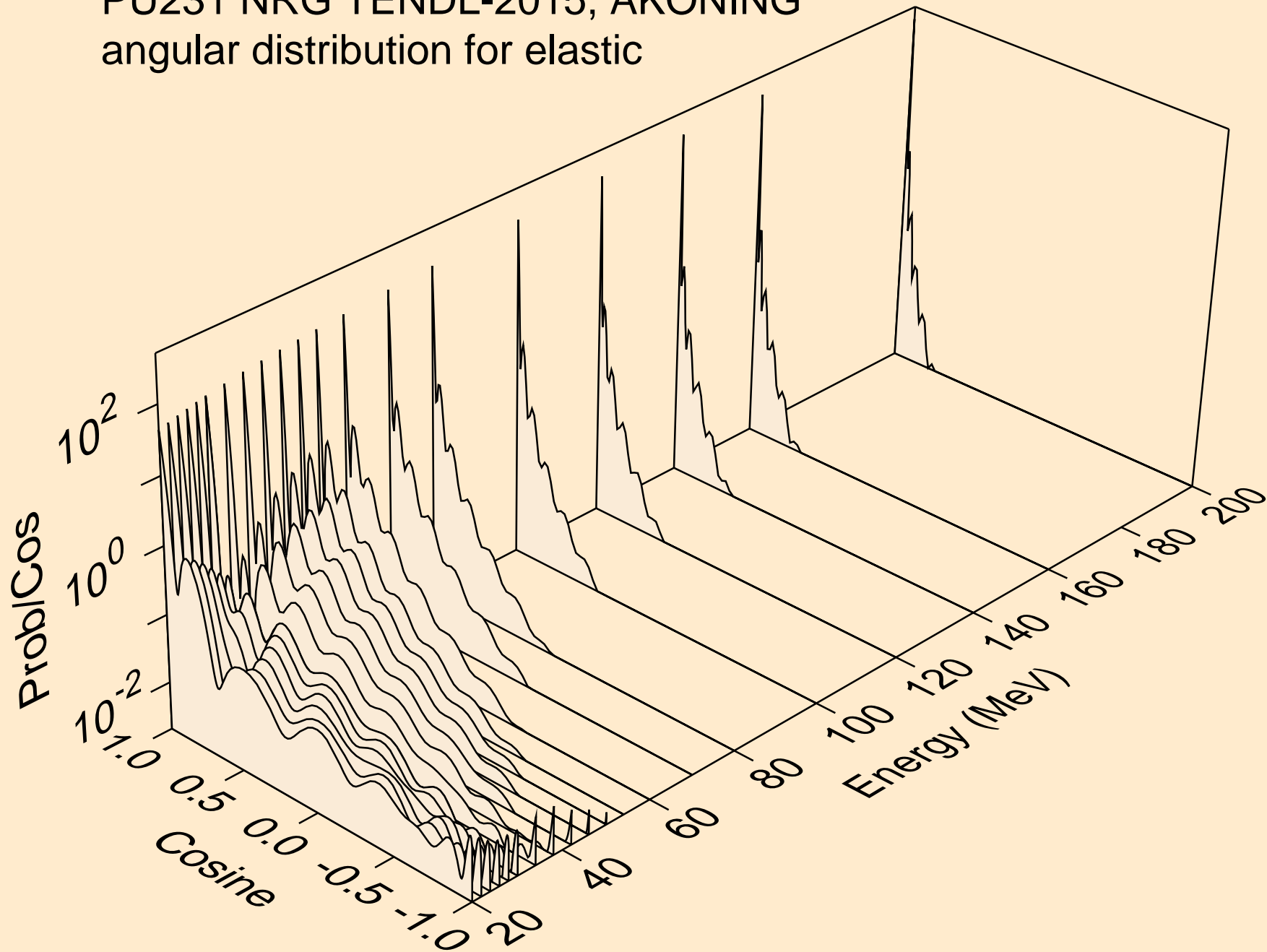



PU231 NRG TENDL-2015, AKONING  
angular distribution for (n,n\*1)

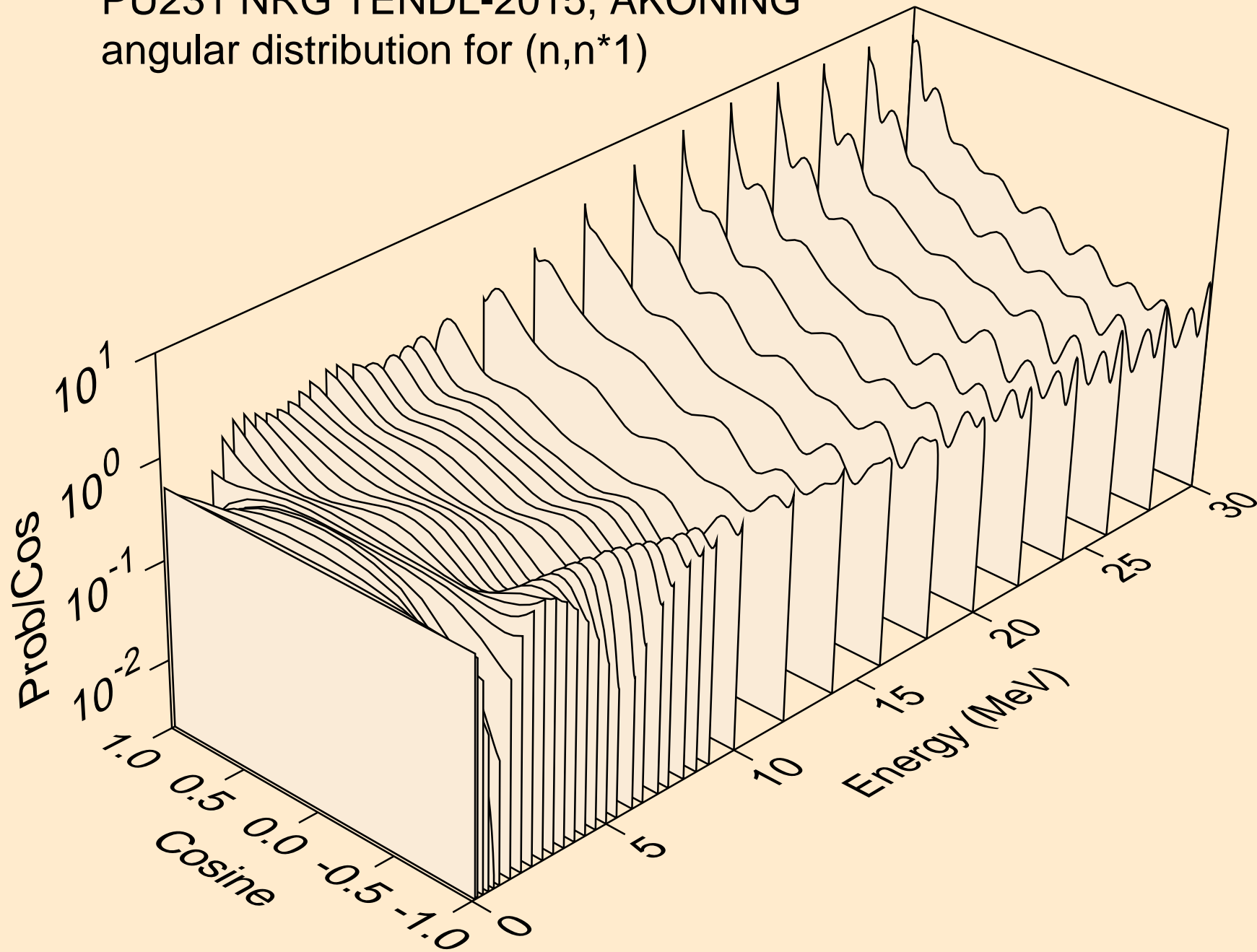

# PU231 NRG TENDL-2015, AKONING

Total fission nubar

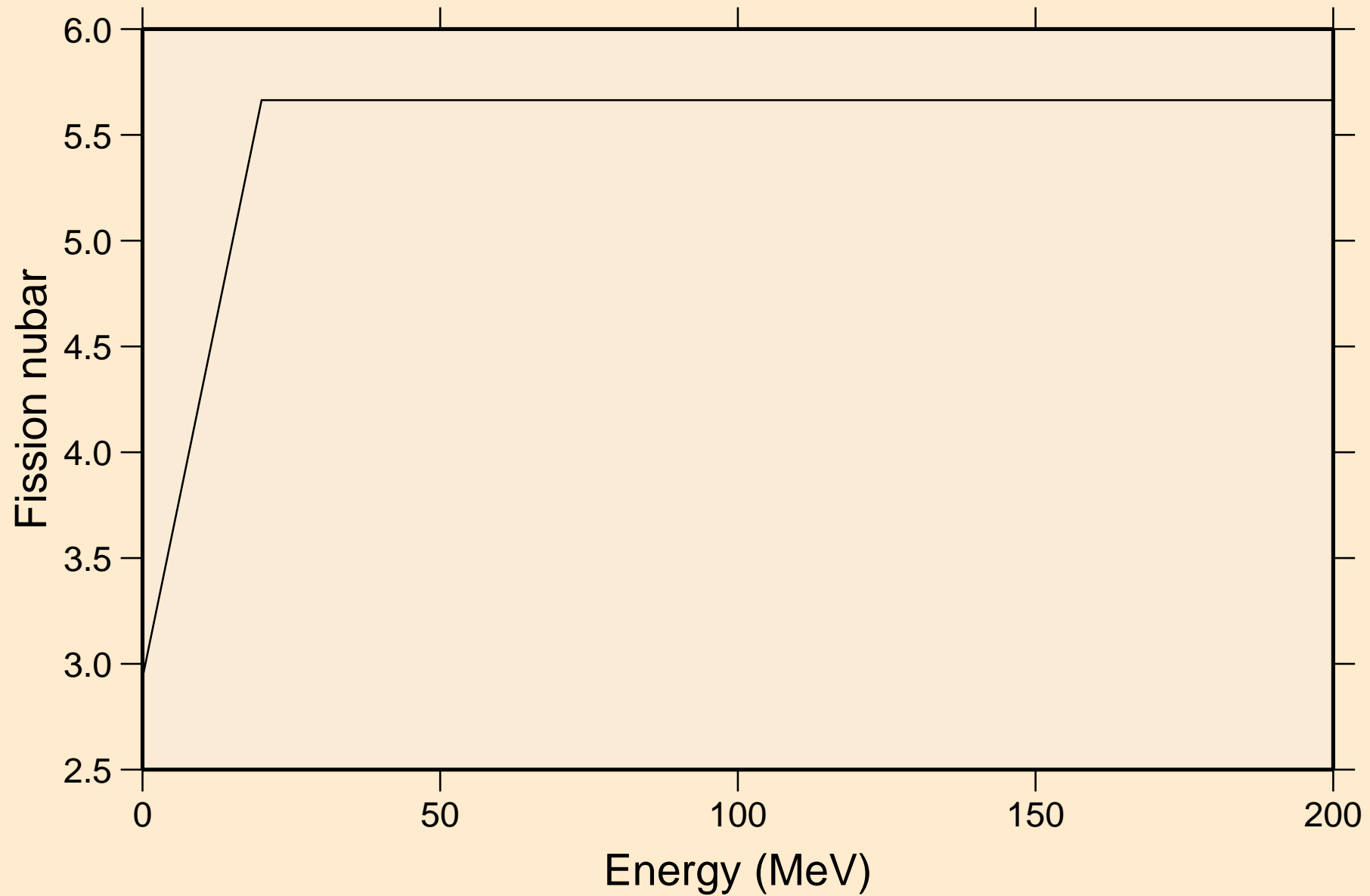

PU231 NRG TENDL-2015, AKONING  
Neutron emission for (n,x)

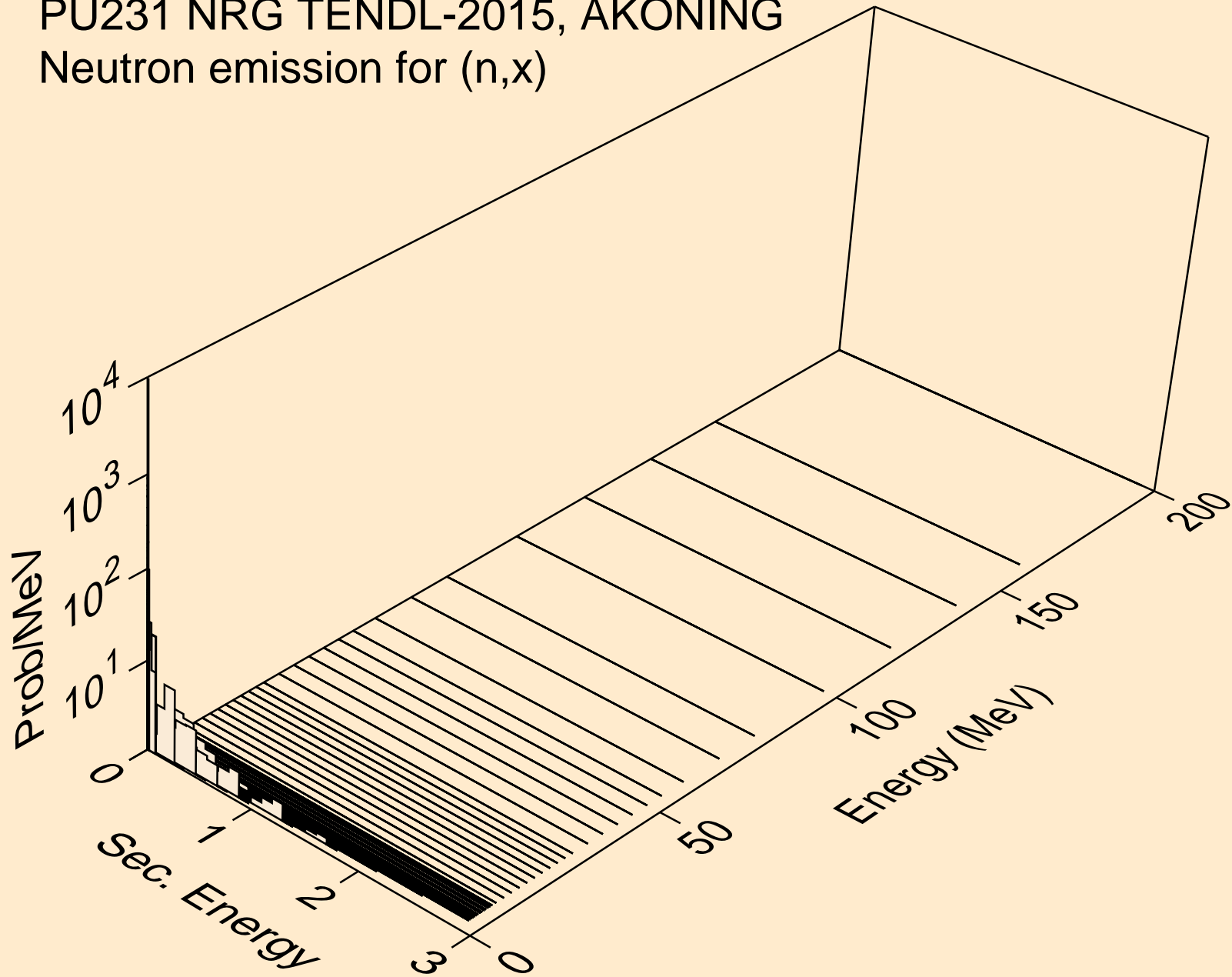

PU231 NRG TENDL-2015, AKONING  
Neutron emission for (n,2nd)

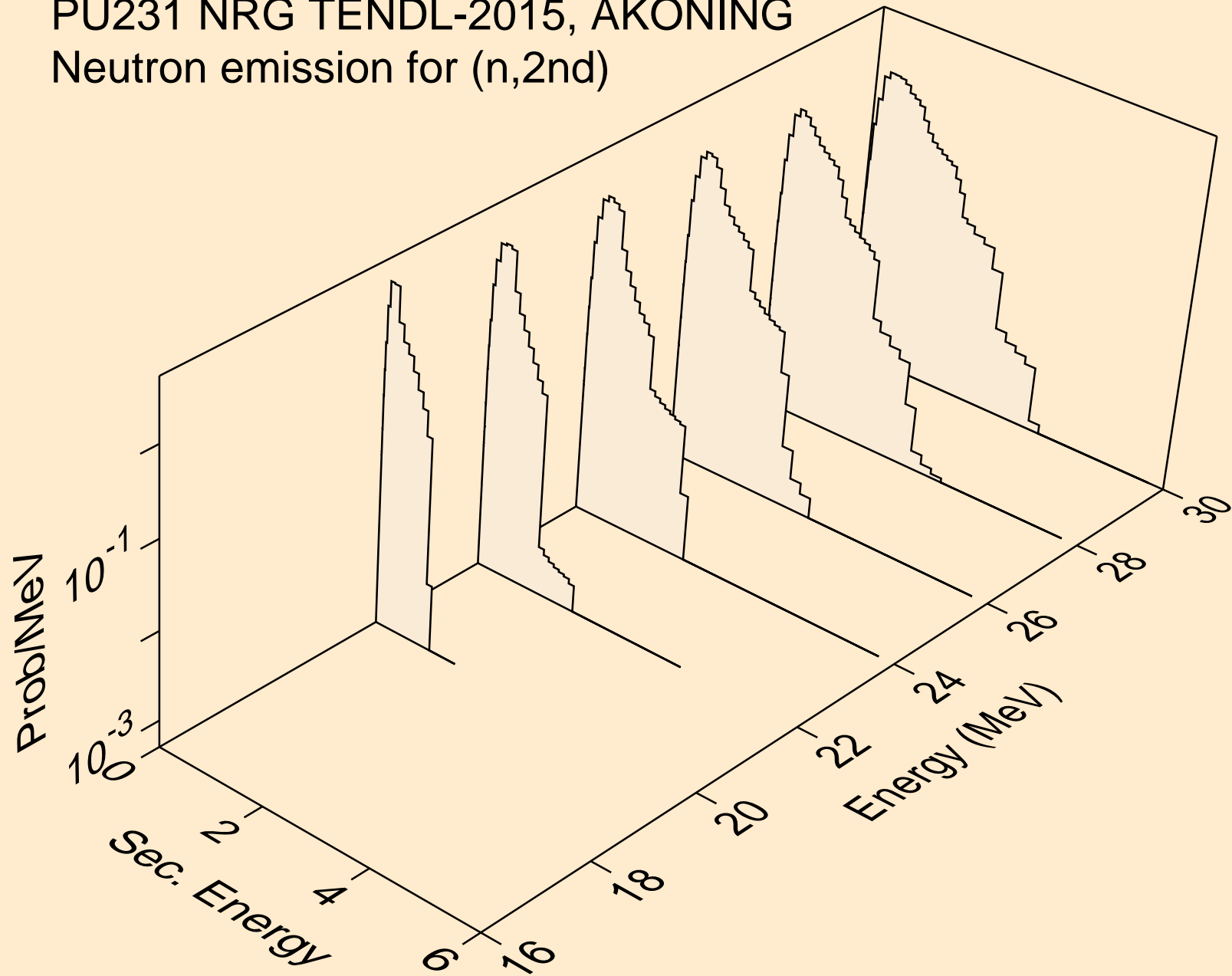

PU231 NRG TENDL-2015, AKONING  
Neutron emission for (n,2n)

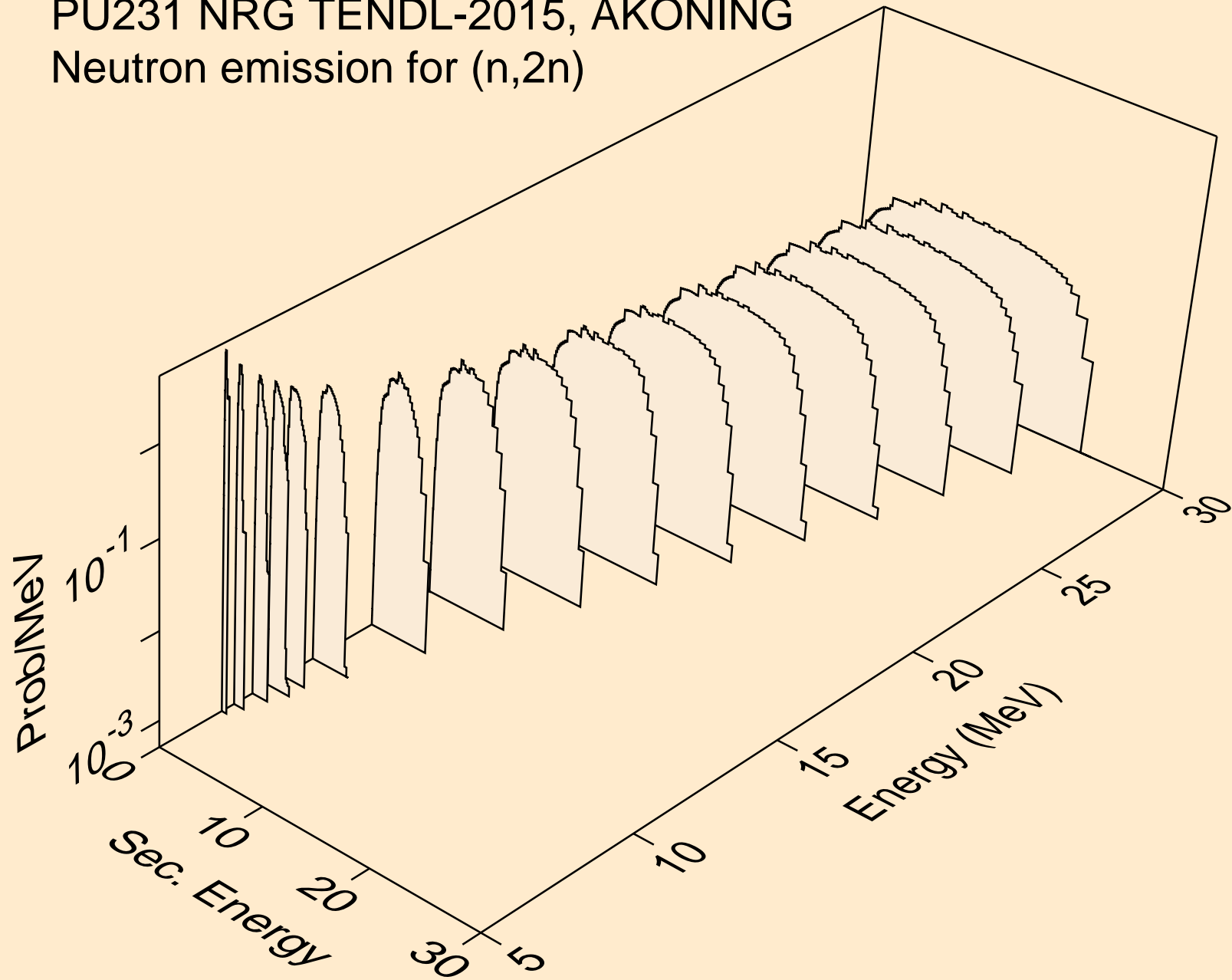

PU231 NRG TENDL-2015, AKONING  
Neutron emission for (n,3n)

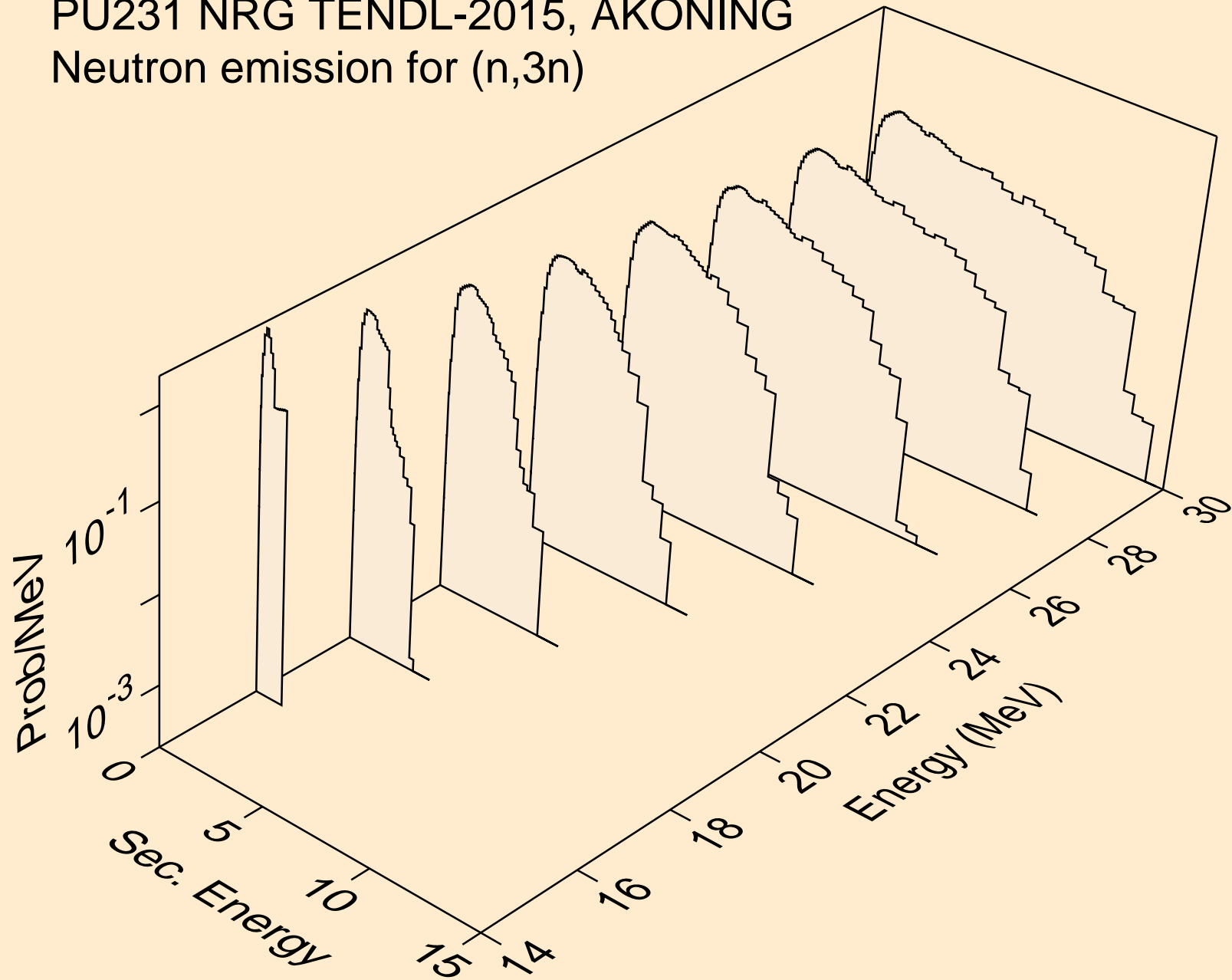

PU231 NRG TENDL-2015, AKONING  
Neutron emission for fission

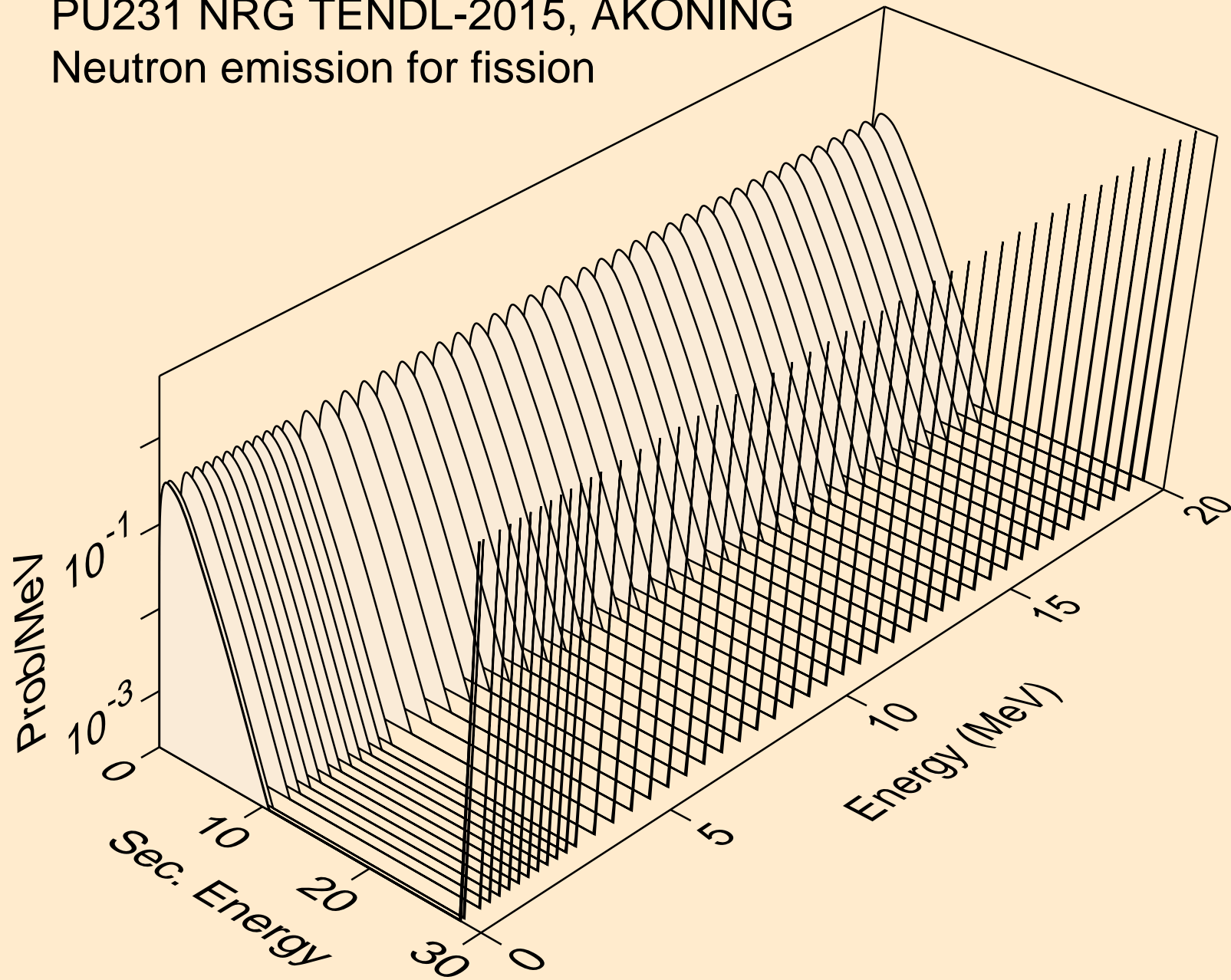

PU231 NRG TENDL-2015, AKONING  
Neutron emission for (n,n\*)a

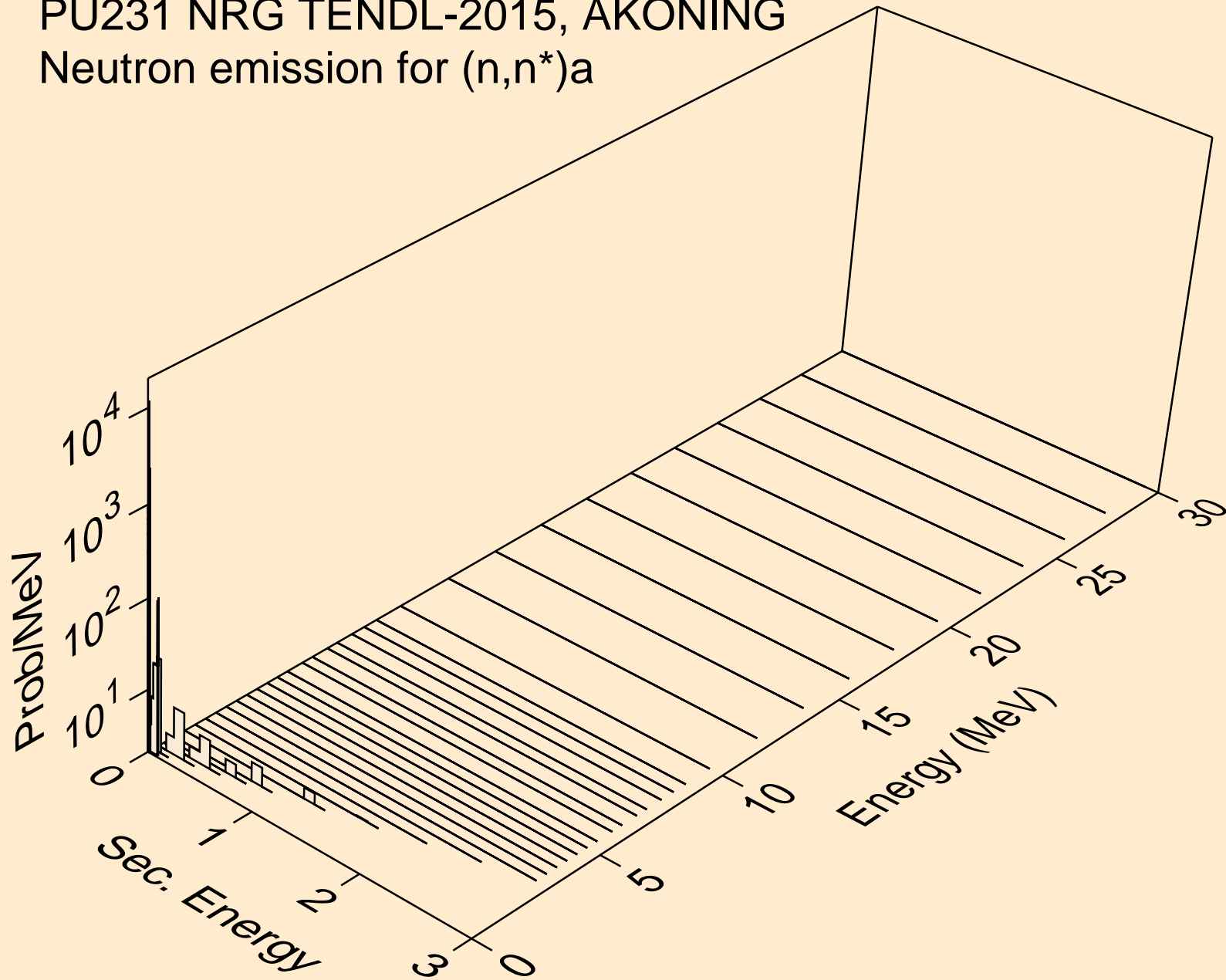



PU231 NRG TENDL-2015, AKONING  
Neutron emission for (n,n\*)3a

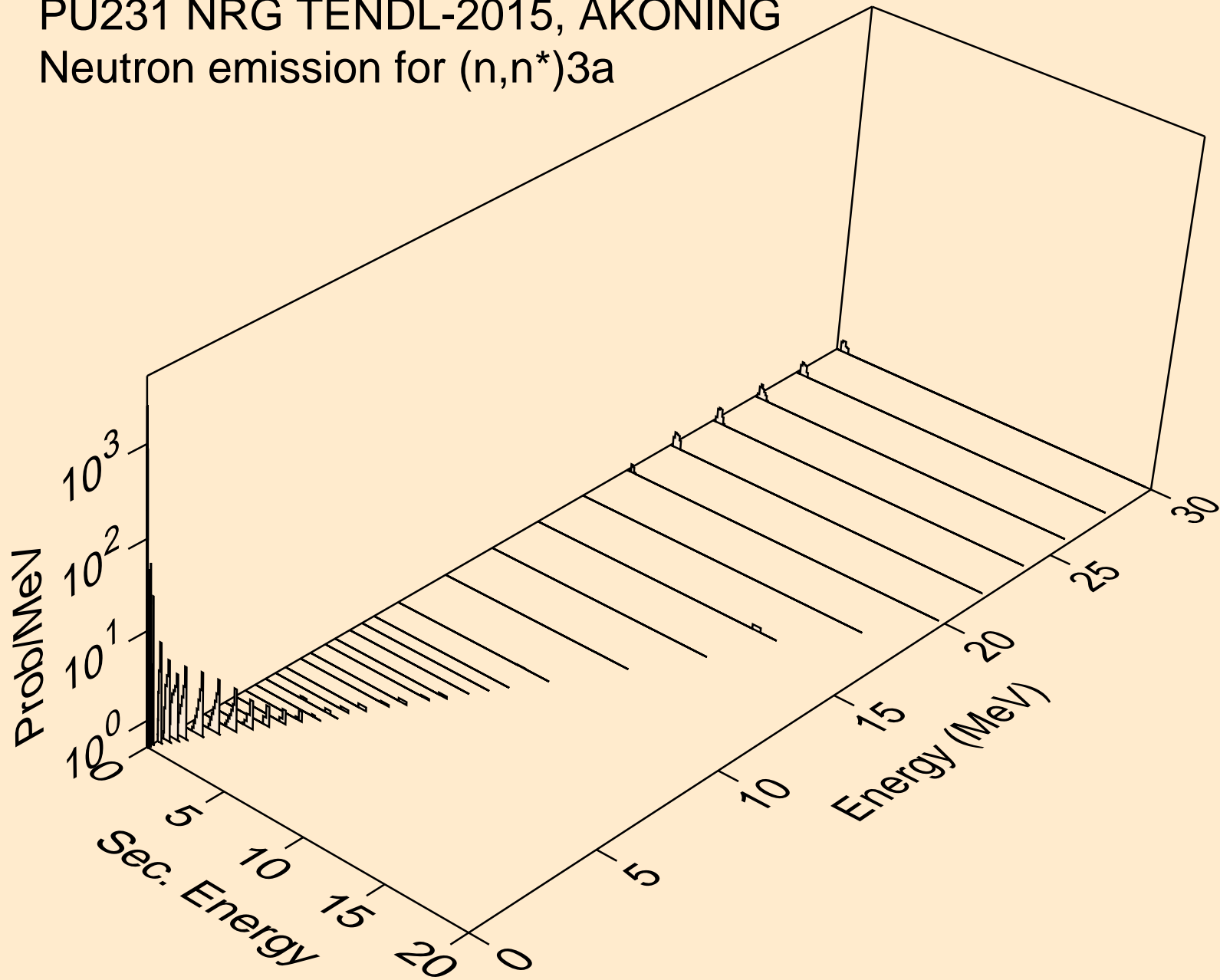

PU231 NRG TENDL-2015, AKONING  
Neutron emission for (n,2n)a

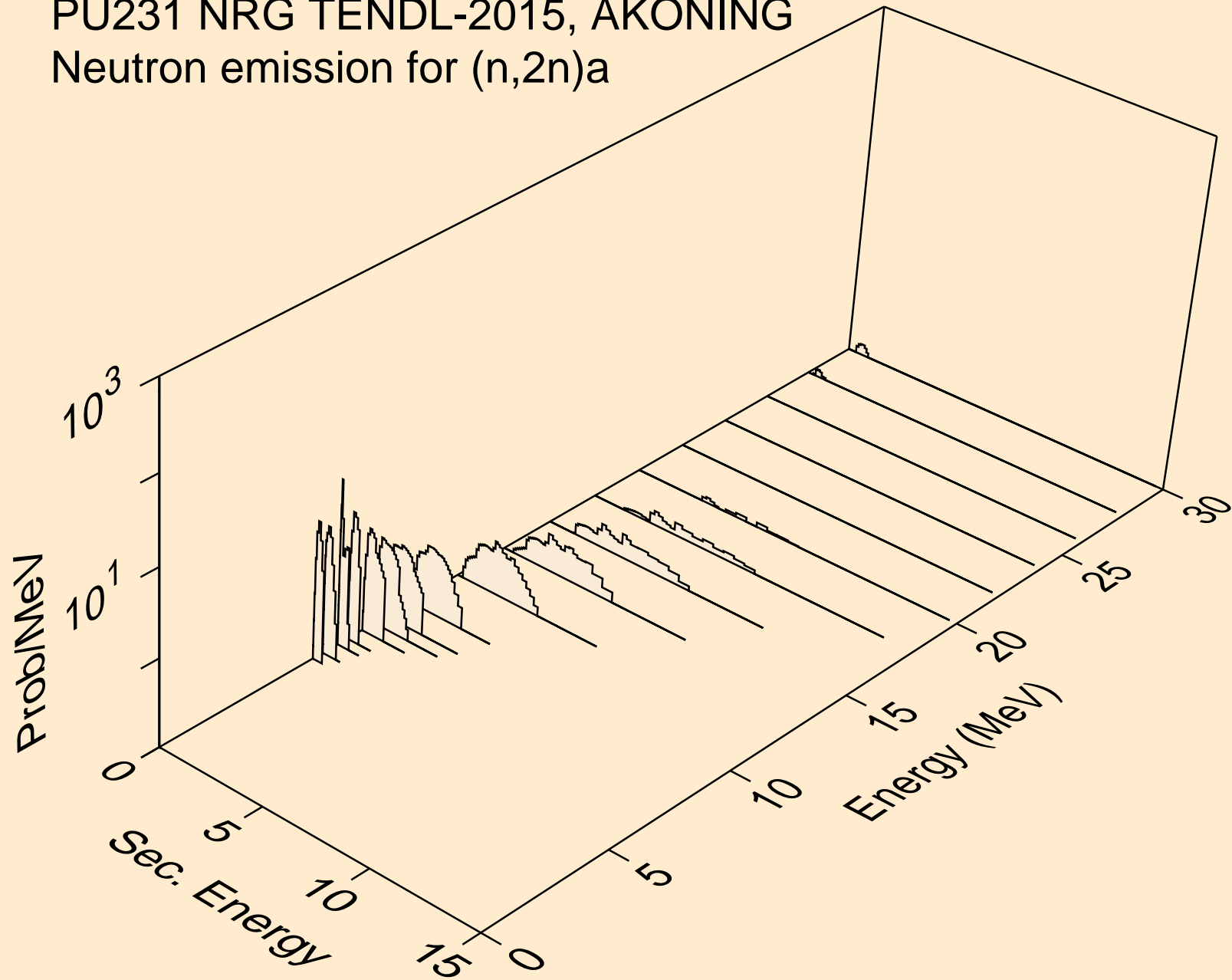

PU231 NRG TENDL-2015, AKONING  
Neutron emission for (n,3n)a

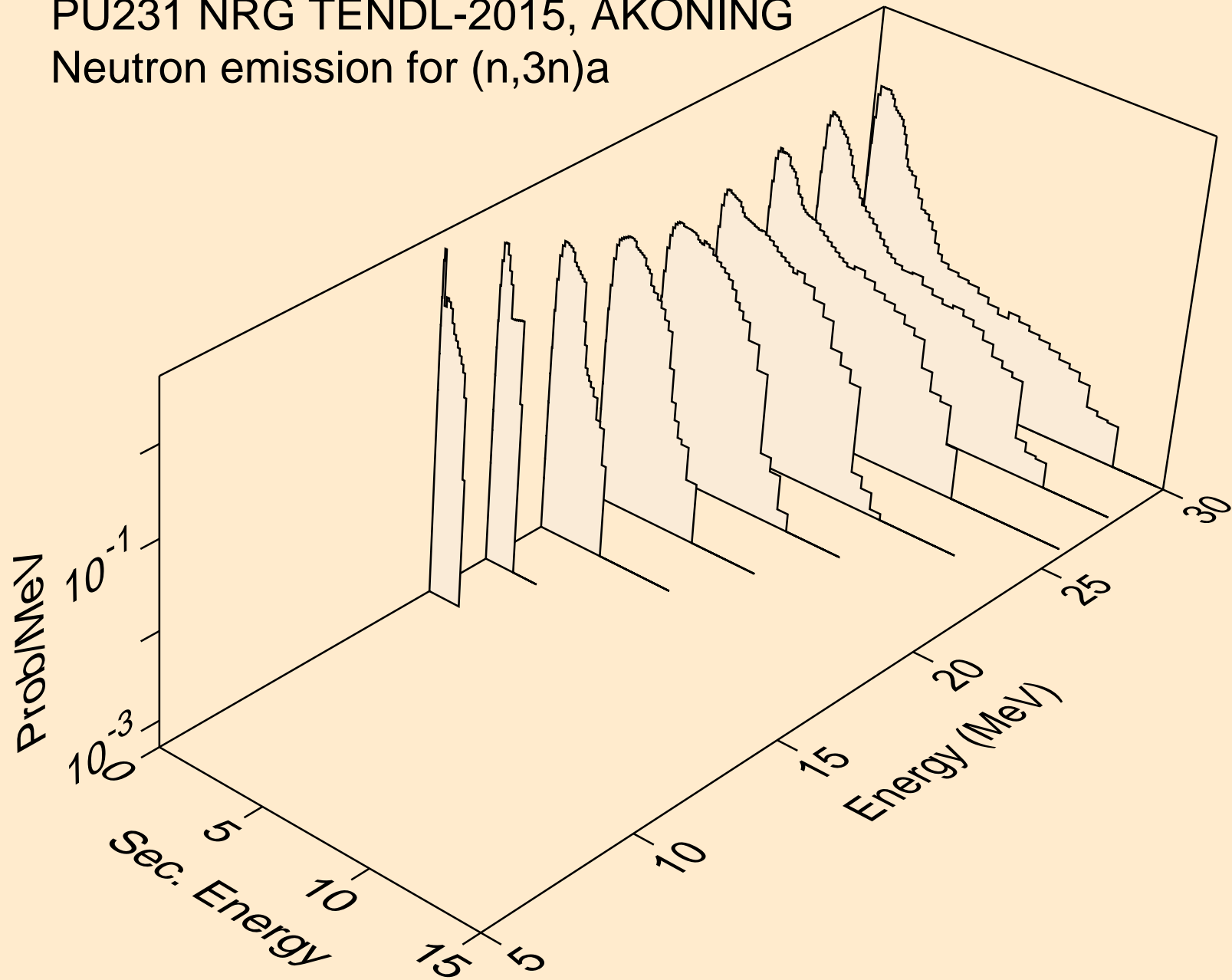

PU231 NRG TENDL-2015, AKONING  
Neutron emission for (n,n\*)p

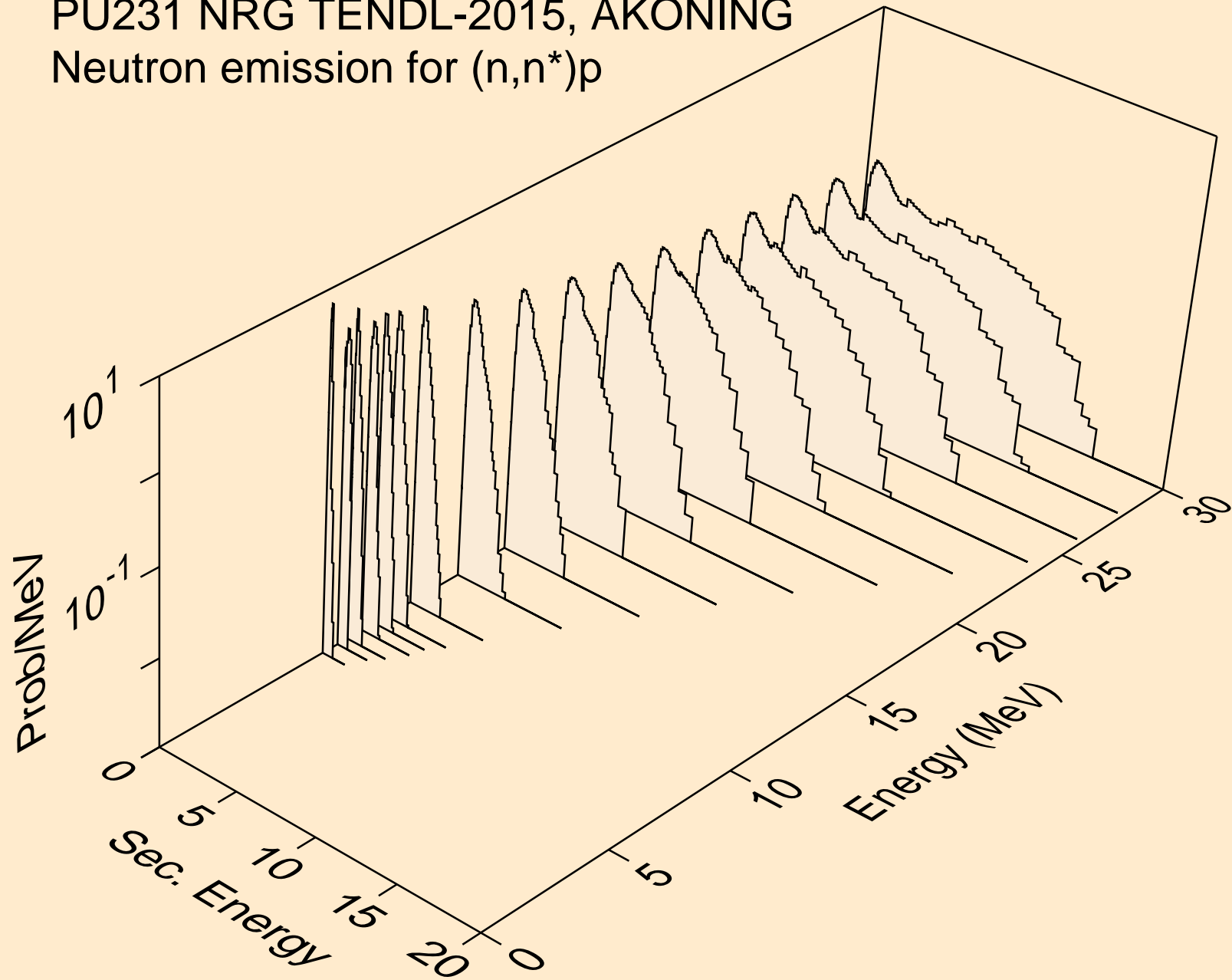

PU231 NRG TENDL-2015, AKONING  
Neutron emission for (n,n\*)2a

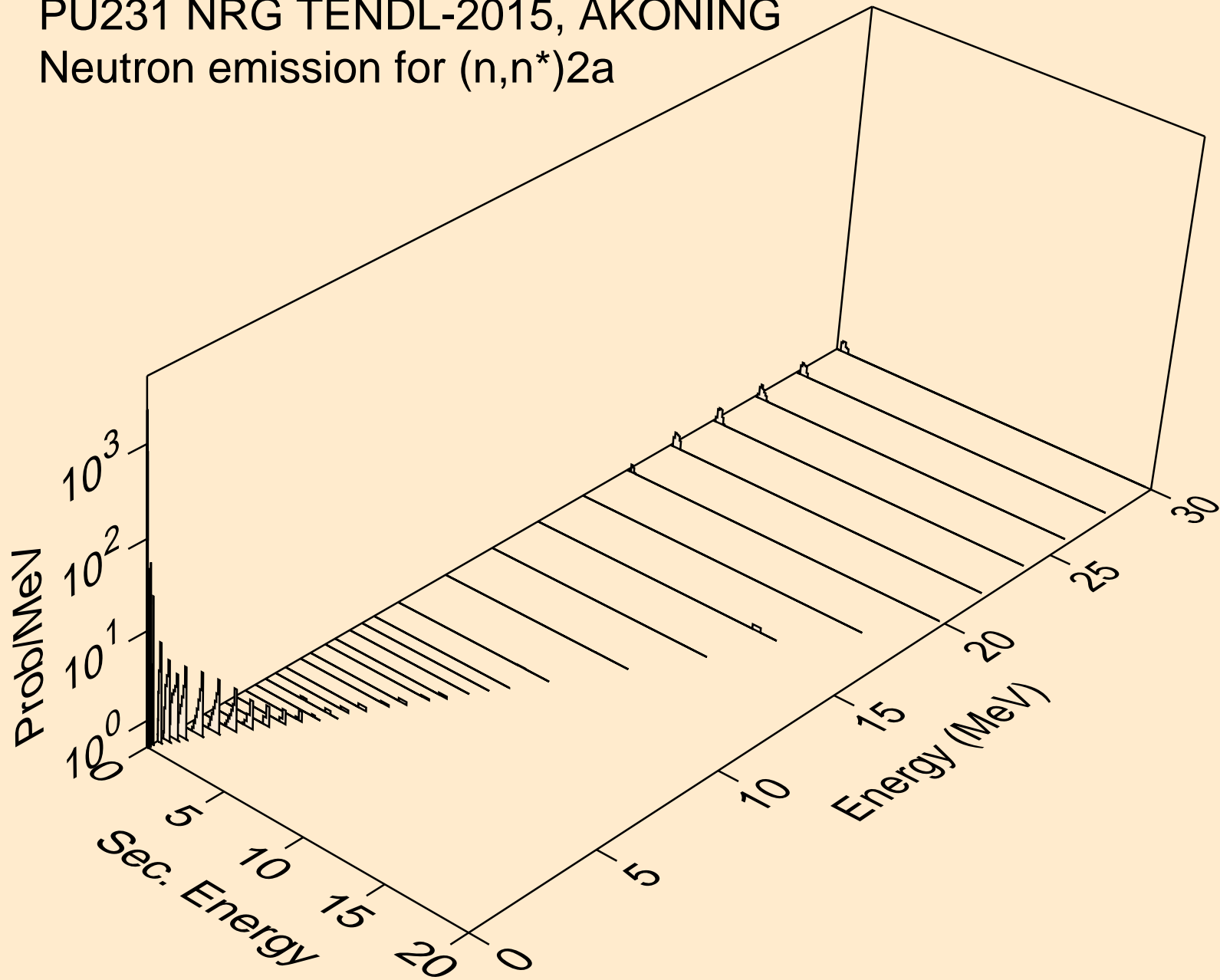

PU231 NRG TENDL-2015, AKONING  
Neutron emission for (n,2n)2a

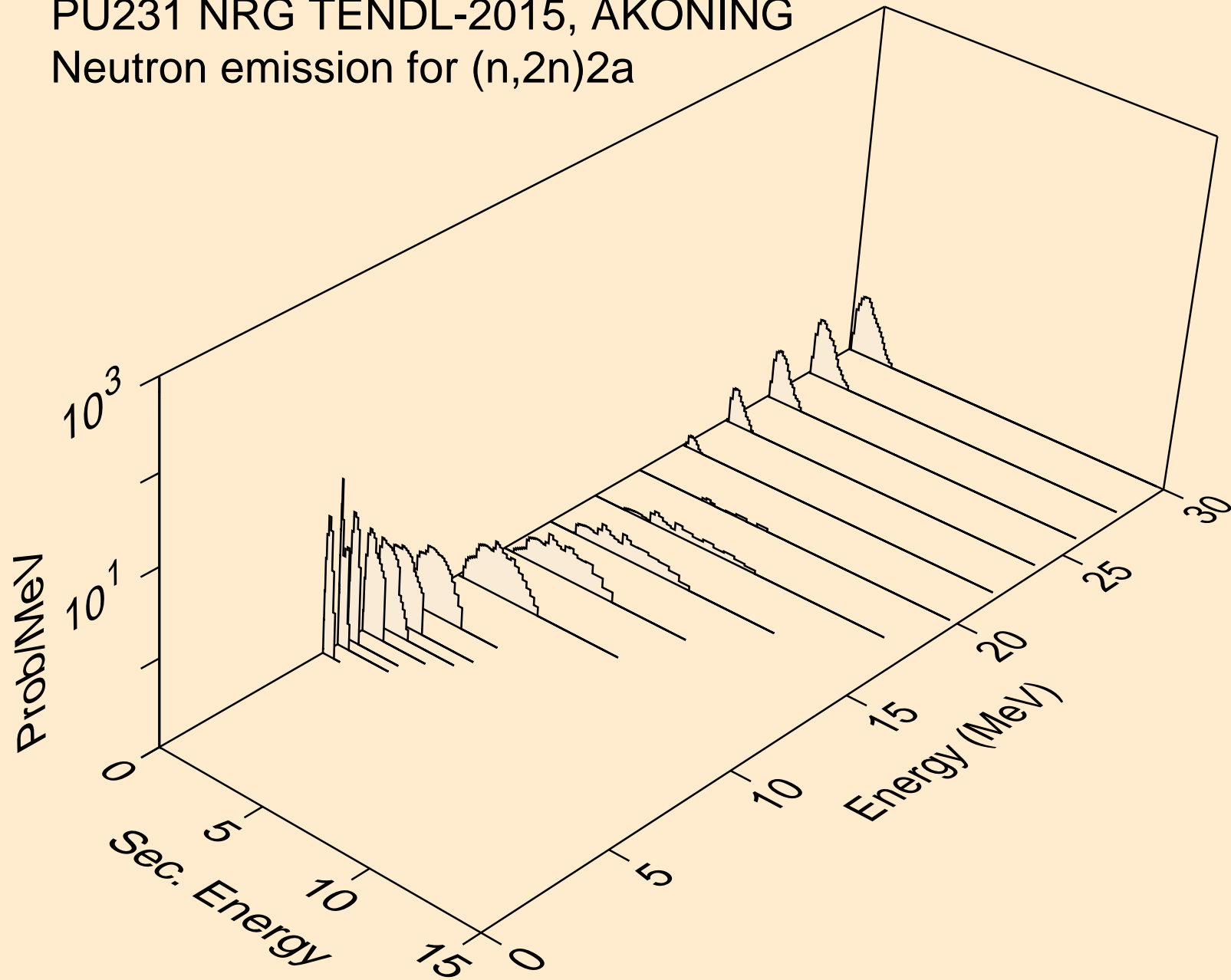

PU231 NRG TENDL-2015, AKONING  
Neutron emission for (n,n\*)d

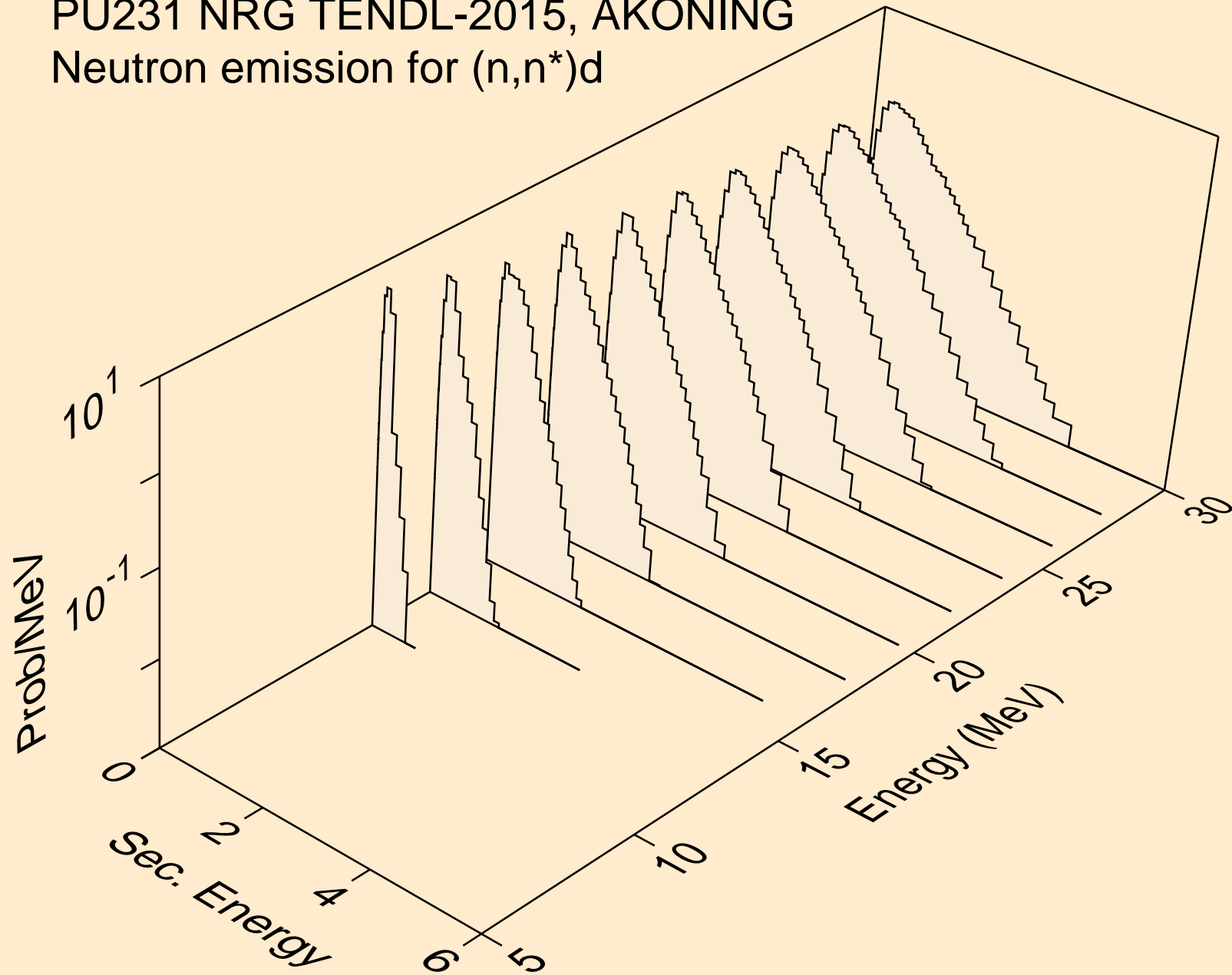

PU231 NRG TENDL-2015, AKONING  
Neutron emission for (n,n\*)t

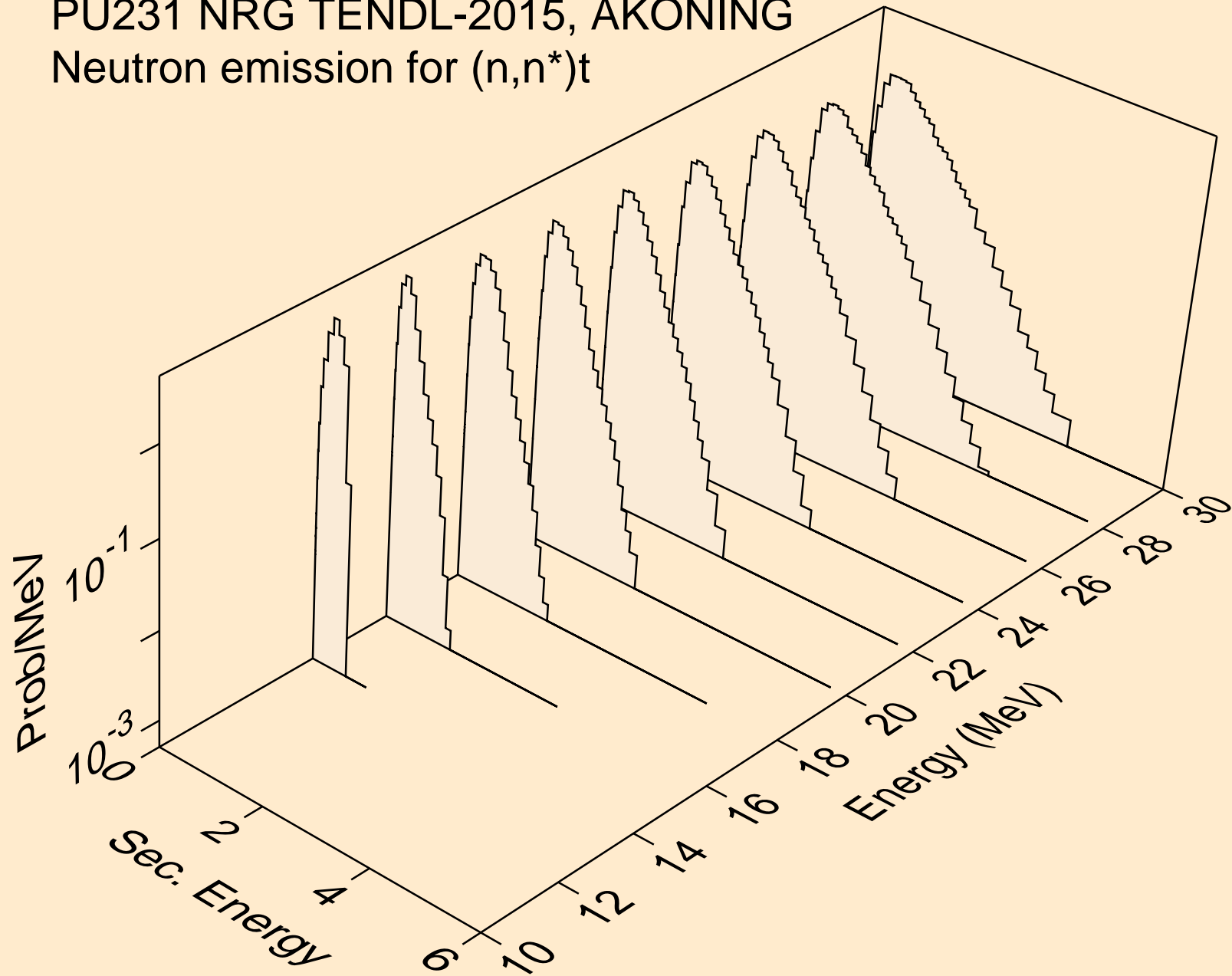



PU231 NRG TENDL-2015, AKONING  
Neutron emission for (n,n\*)he3

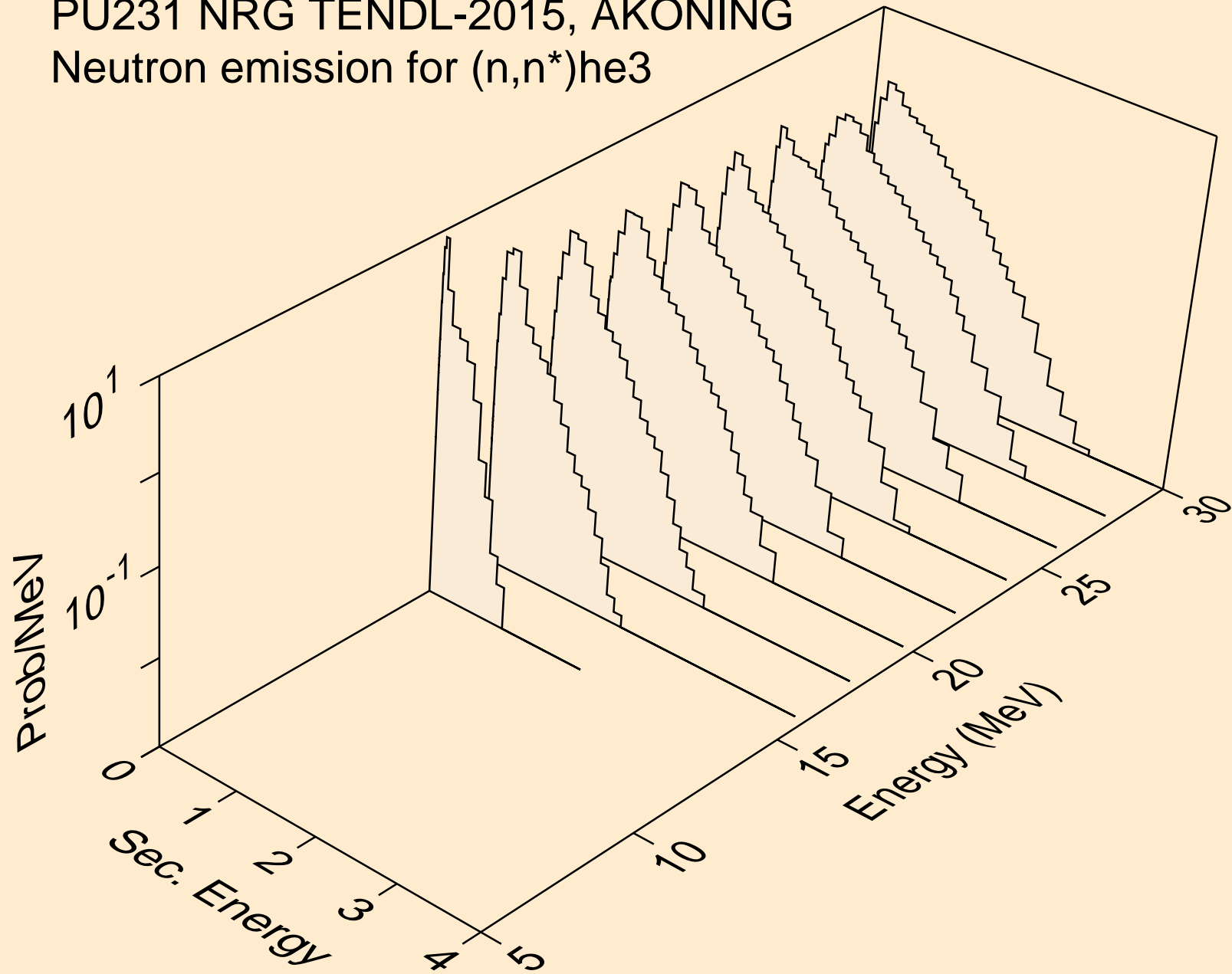

PU231 NRG TENDL-2015, AKONING  
Neutron emission for (n,n\*)d2a

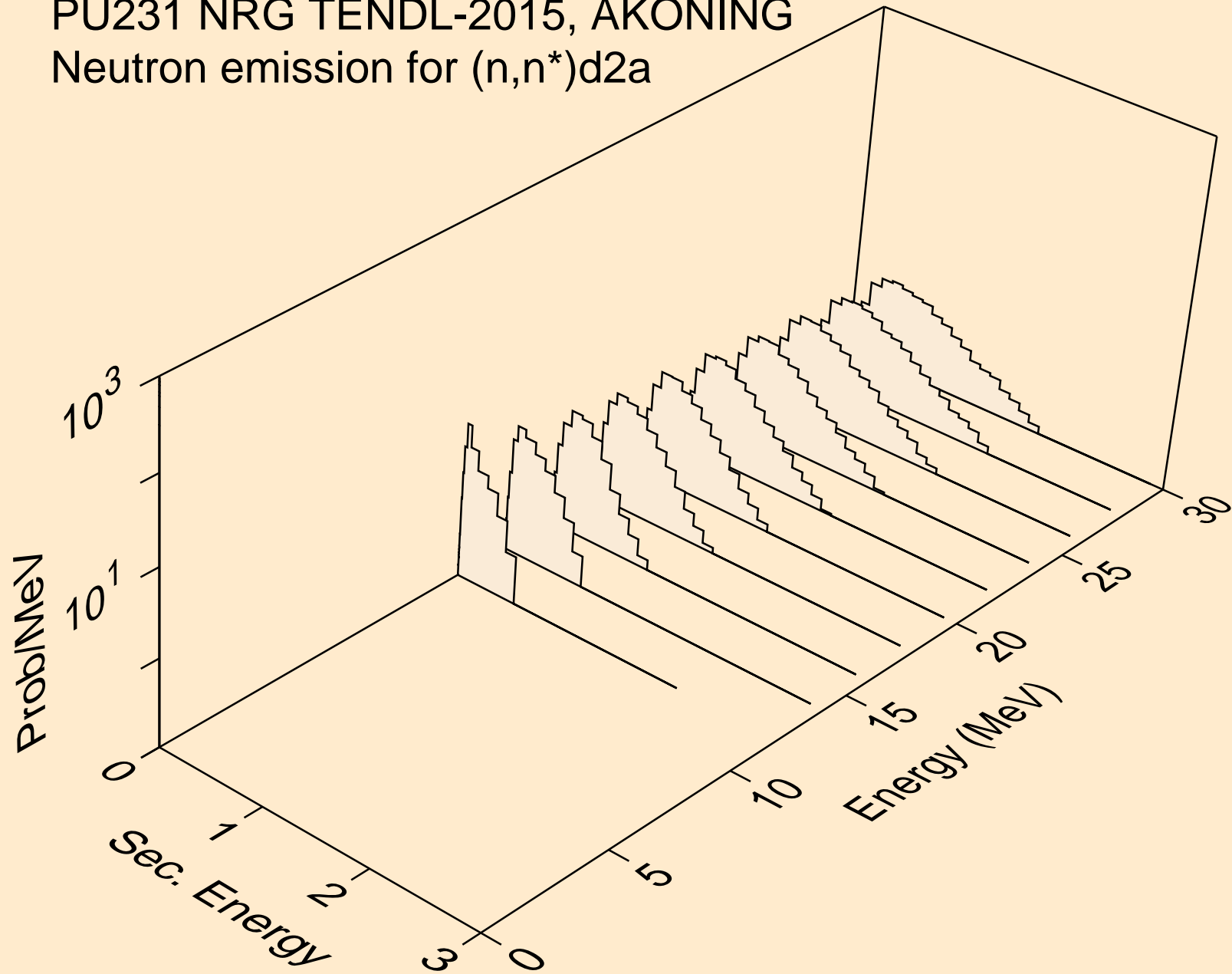

PU231 NRG TENDL-2015, AKONING  
Neutron emission for (n,n\*)t2a

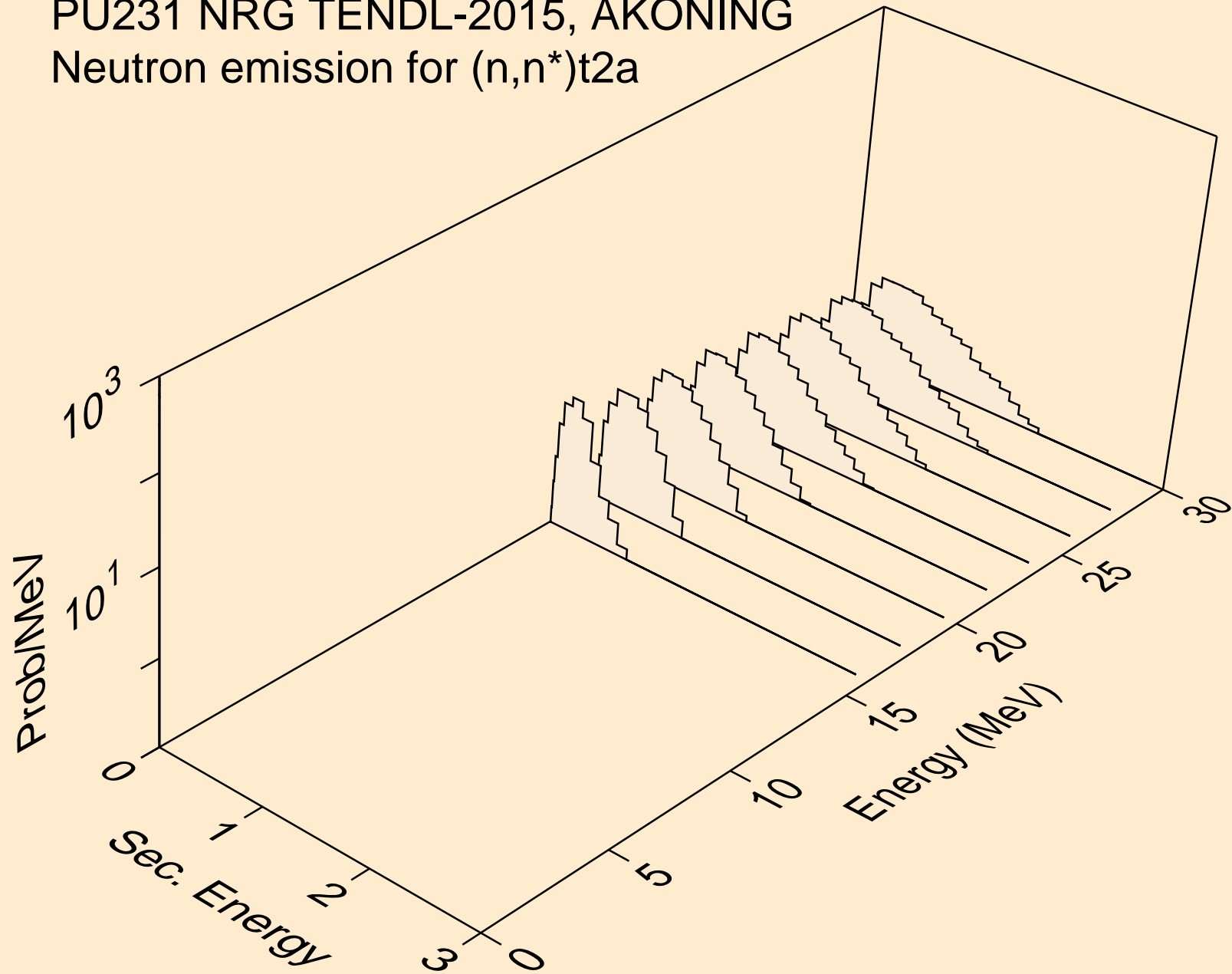

PU231 NRG TENDL-2015, AKONING  
Neutron emission for (n,4n)

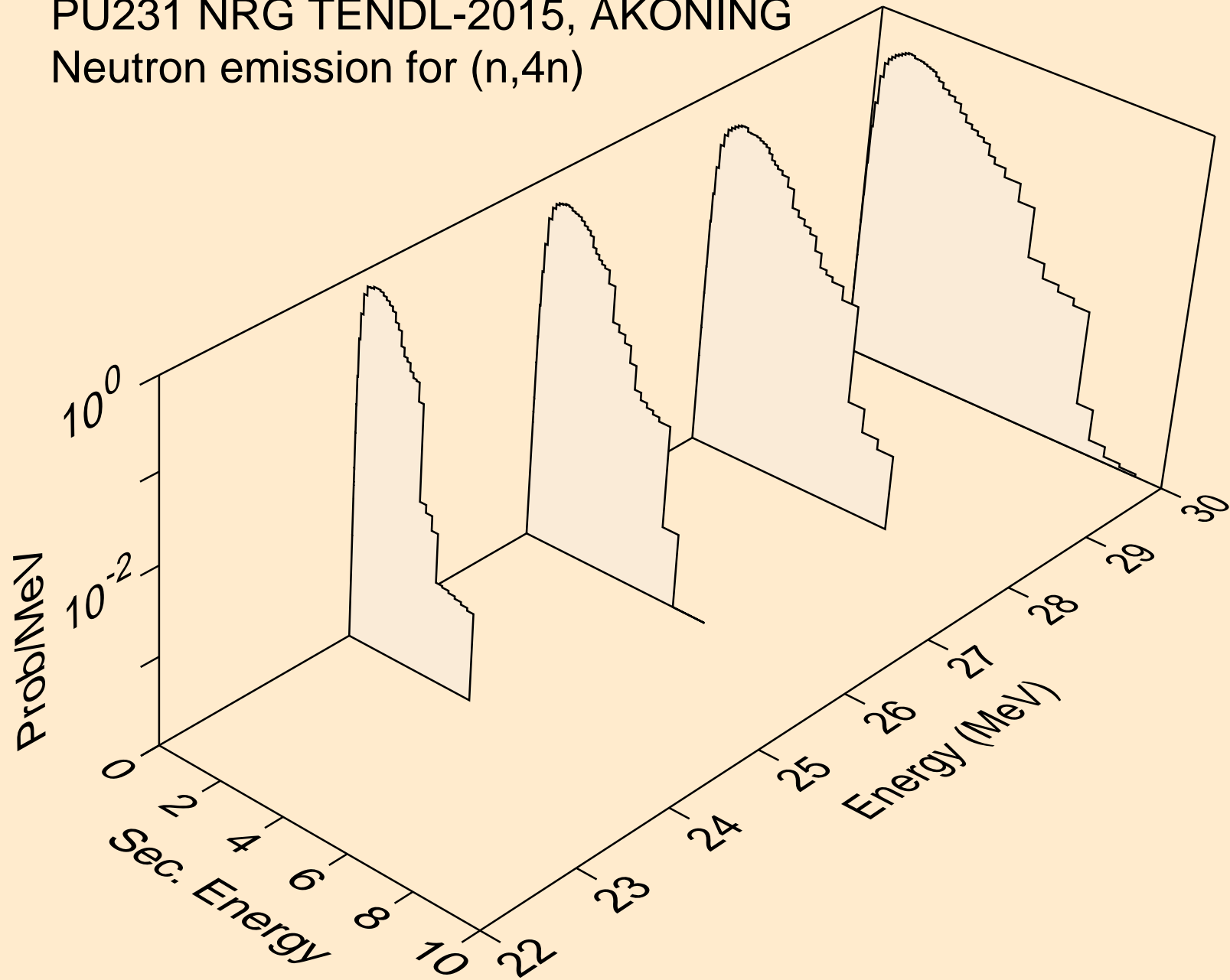

PU231 NRG TENDL-2015, AKONING  
Neutron emission for (n,2np)

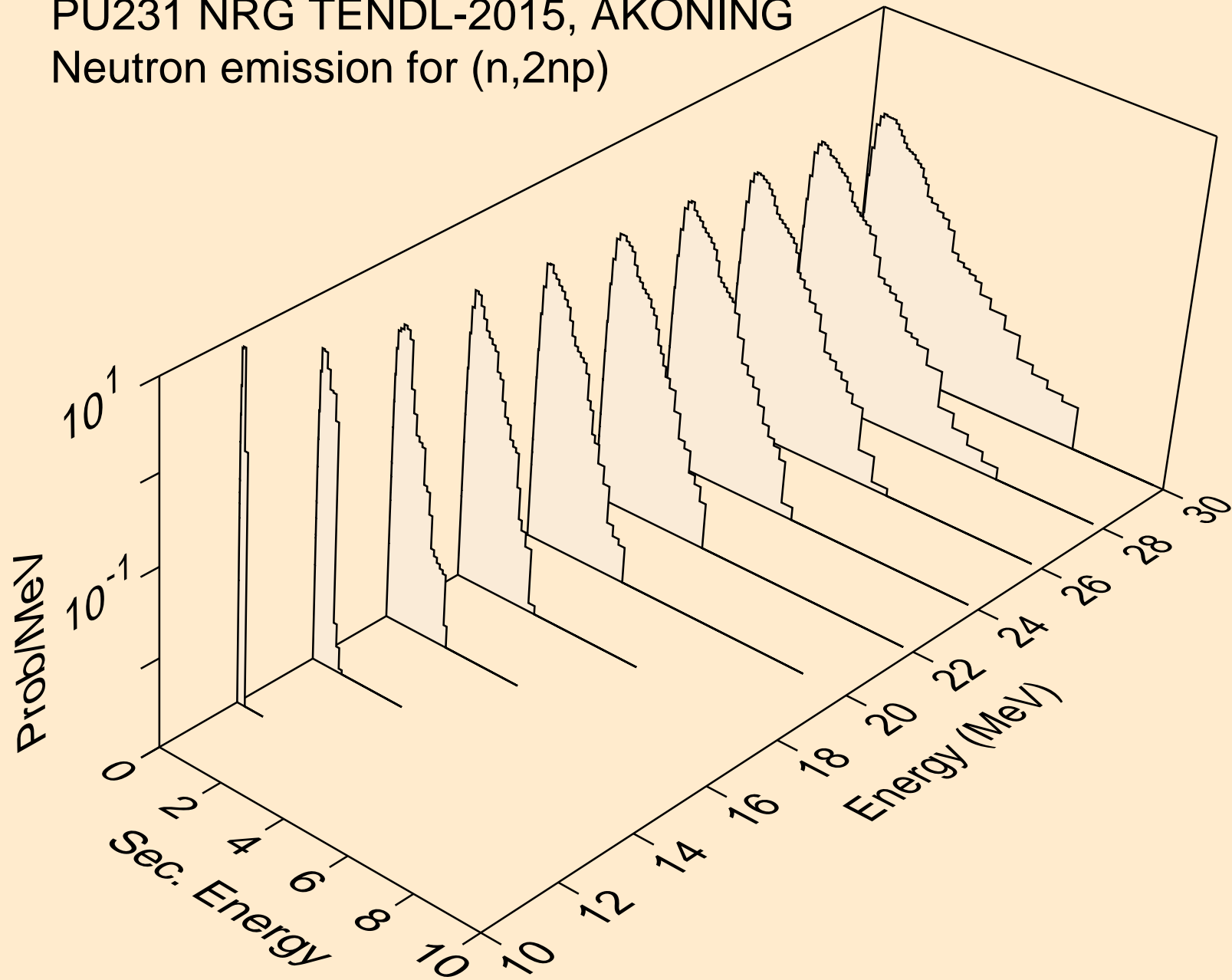

PU231 NRG TENDL-2015, AKONING  
Neutron emission for (n,3np)

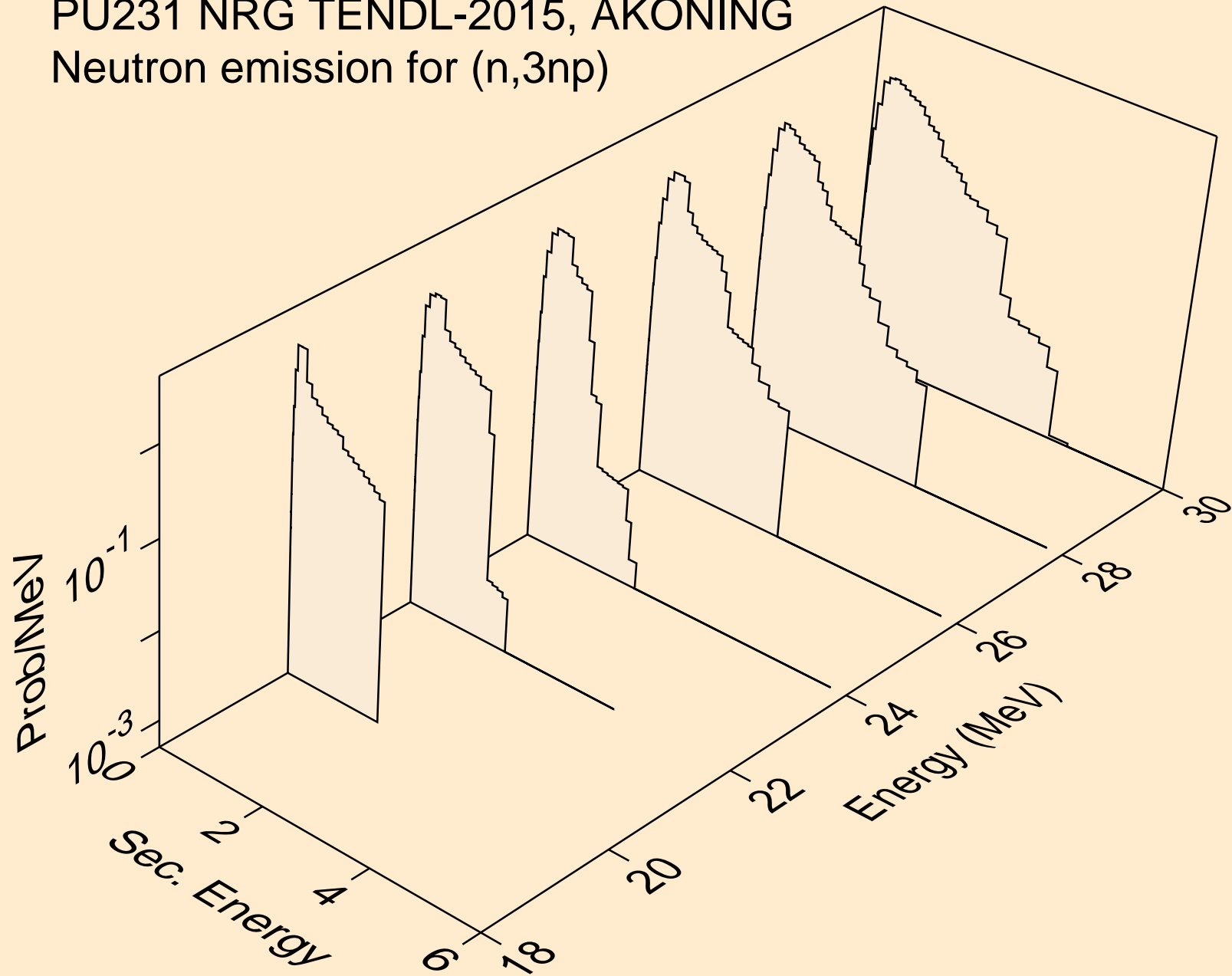

PU231 NRG TENDL-2015, AKONING  
Neutron emission for (n,2np)

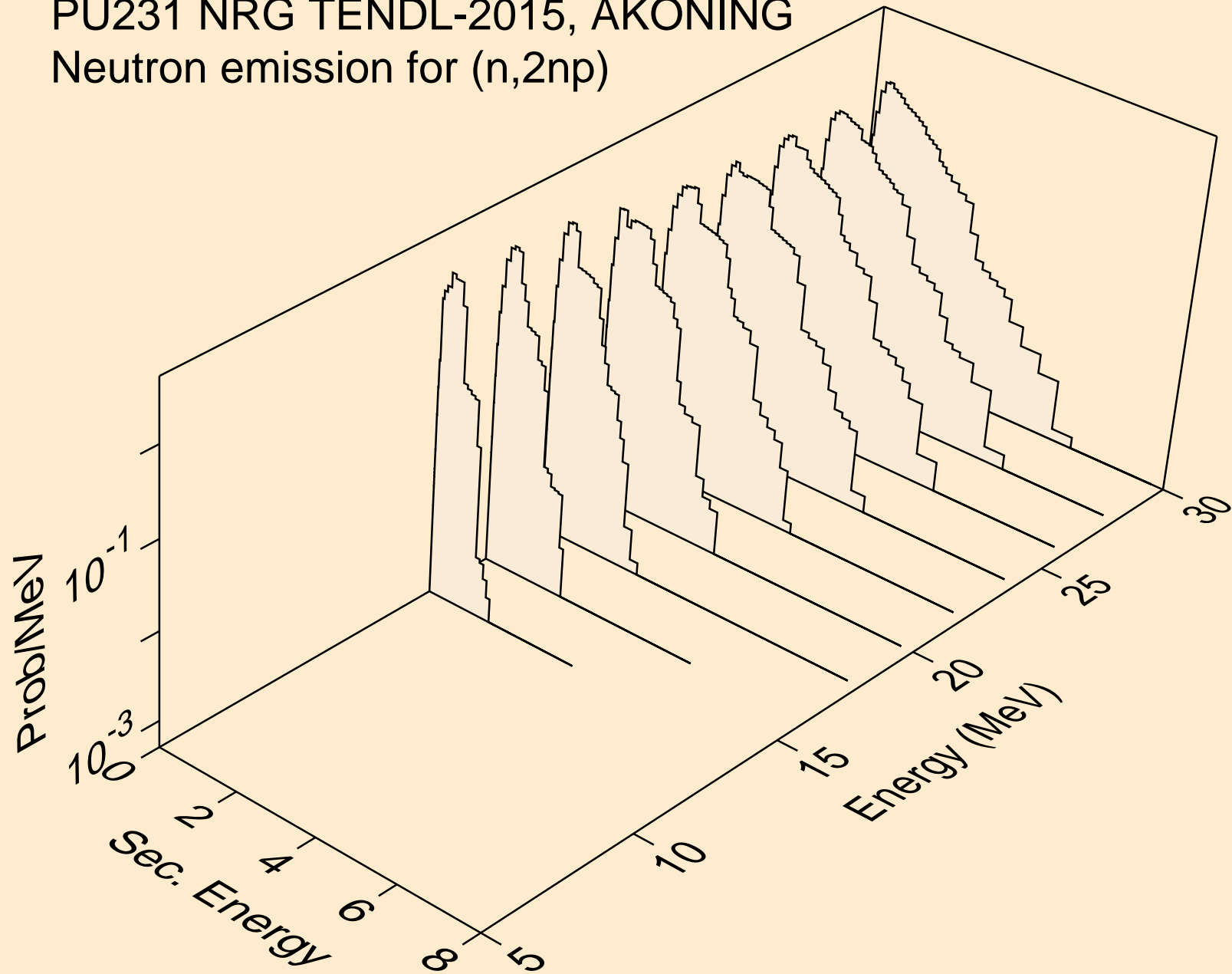

PU231 NRG TENDL-2015, AKONING  
Neutron emission for (n,npa)

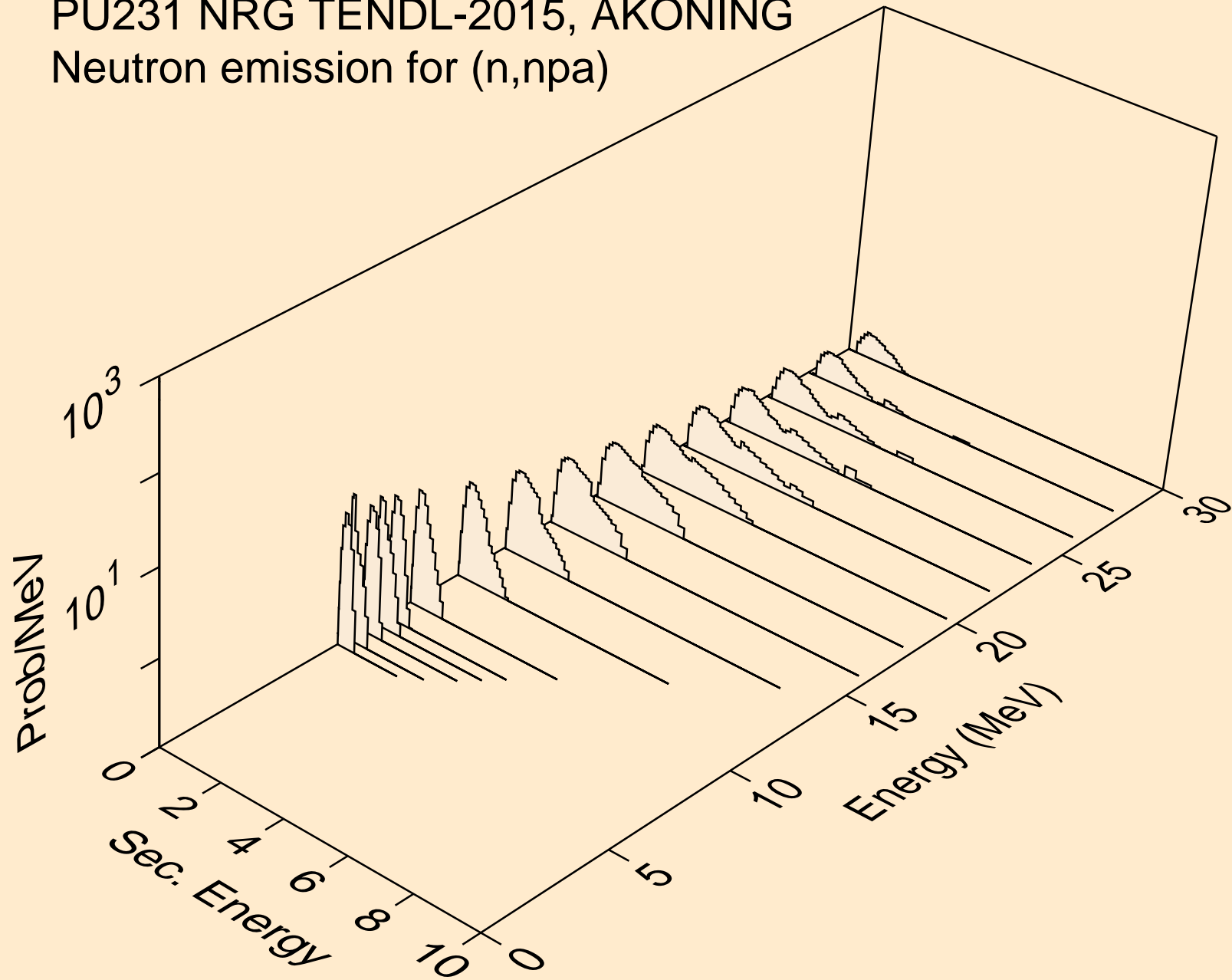



PU231 NRG TENDL-2015, AKONING  
Neutron emission for (n,n\*c)

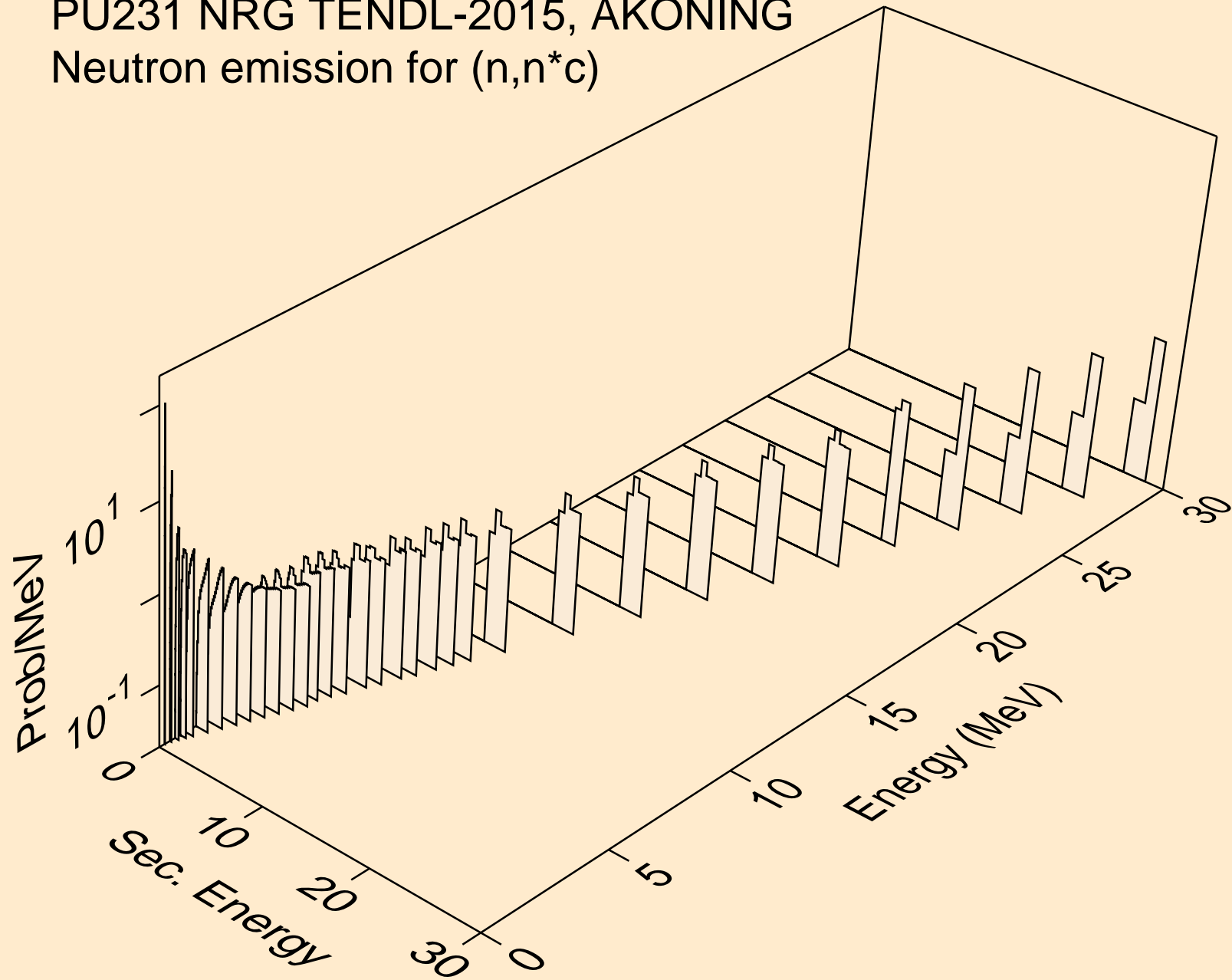

# PU231 NRG TENDL-2015, AKONING

## Delayed nubar

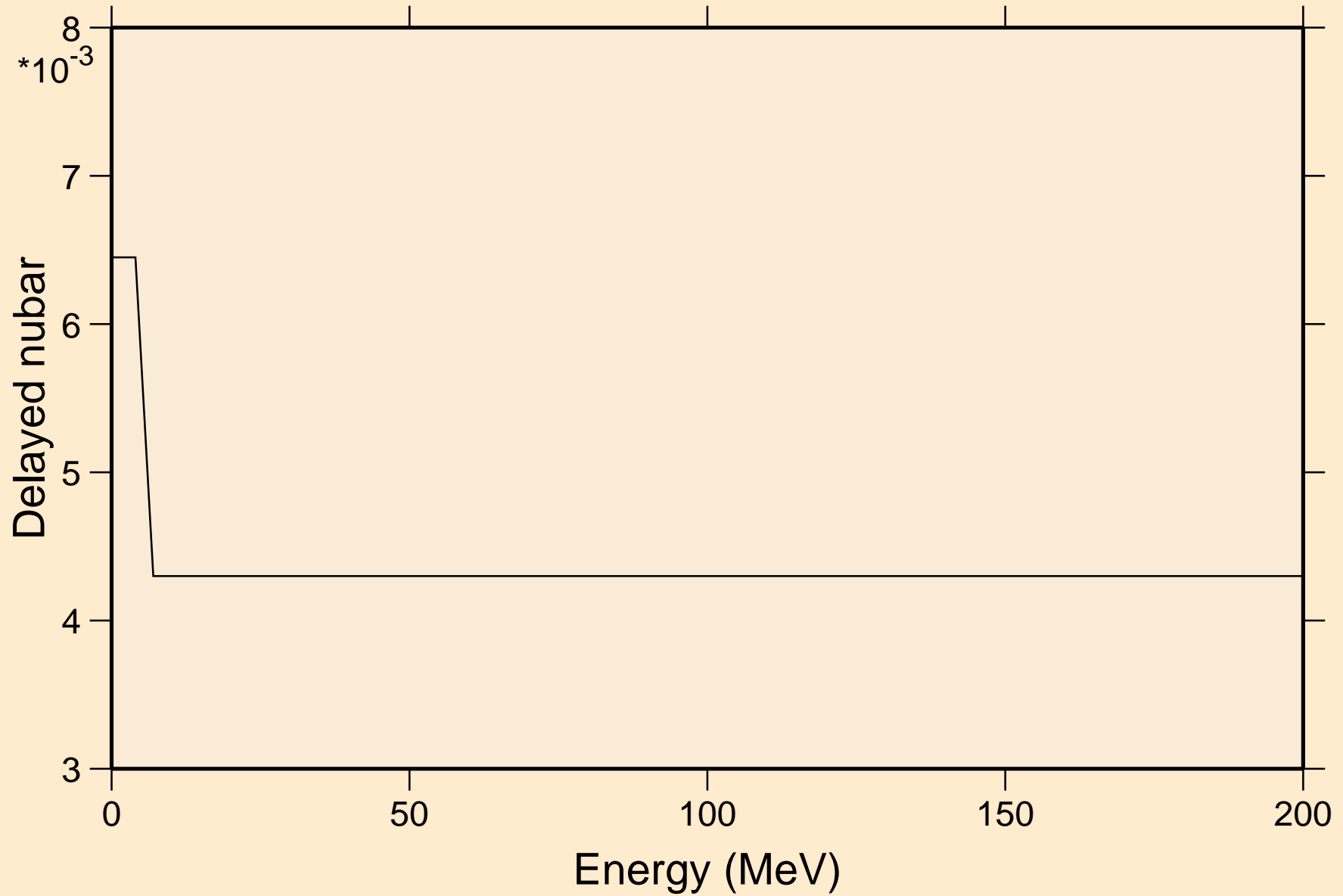

# PU231 NRG TENDL-2015, AKONING

## Delayed neutron spectra

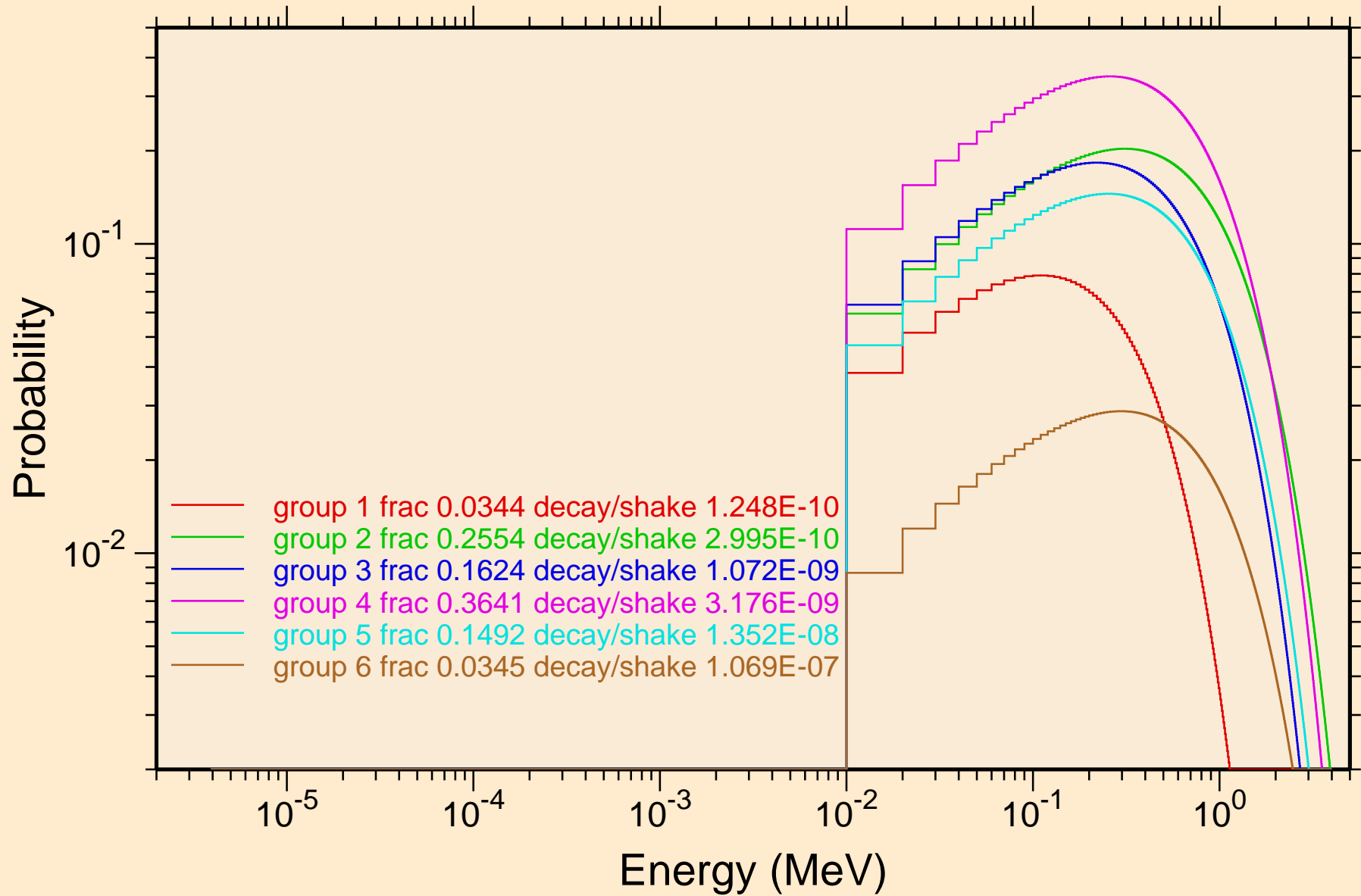

PU231 NRG TENDL-2015, AKONING  
Photon emission for (n,x)

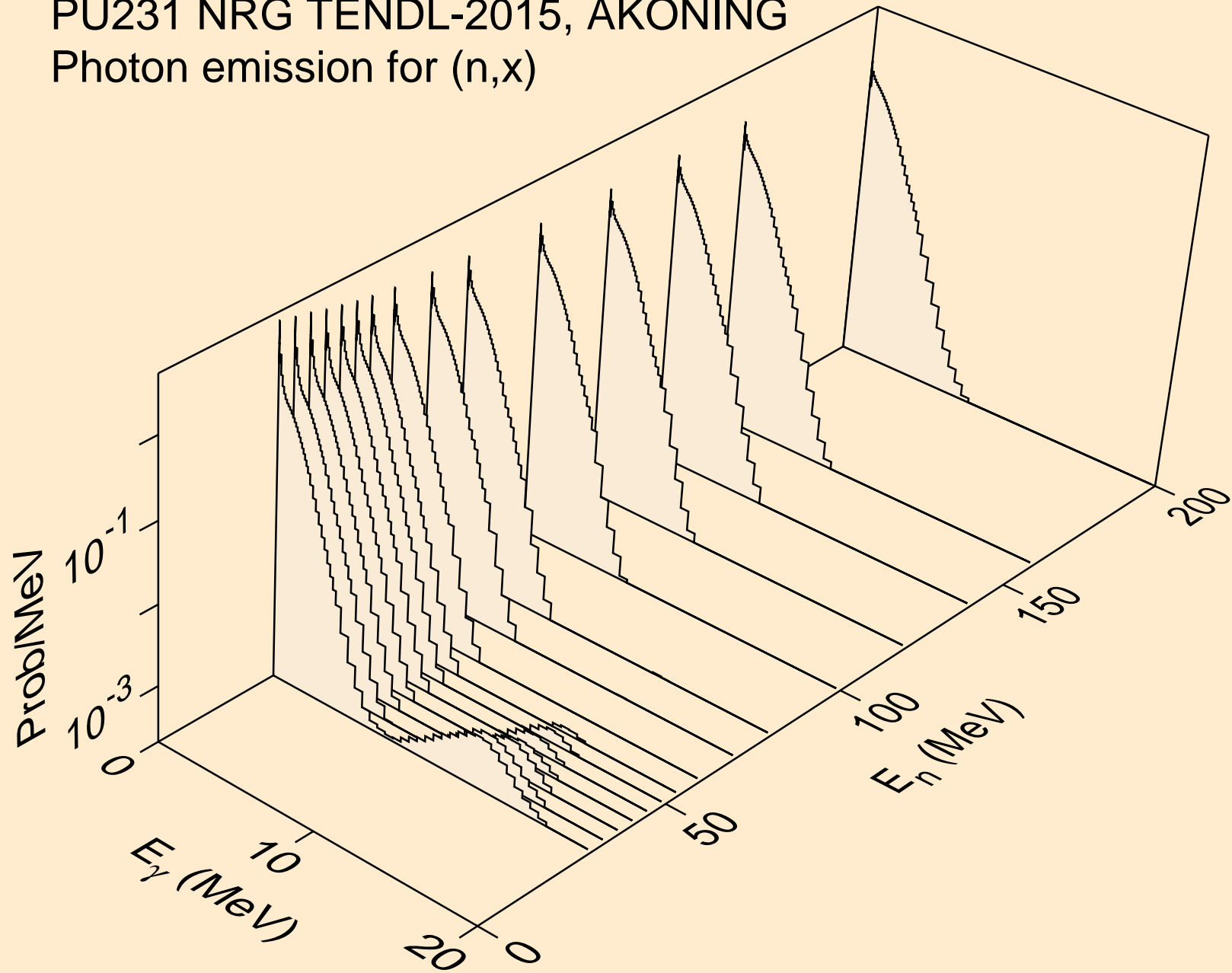

PU231 NRG TENDL-2015, AKONING  
Photon emission for (n,2nd)

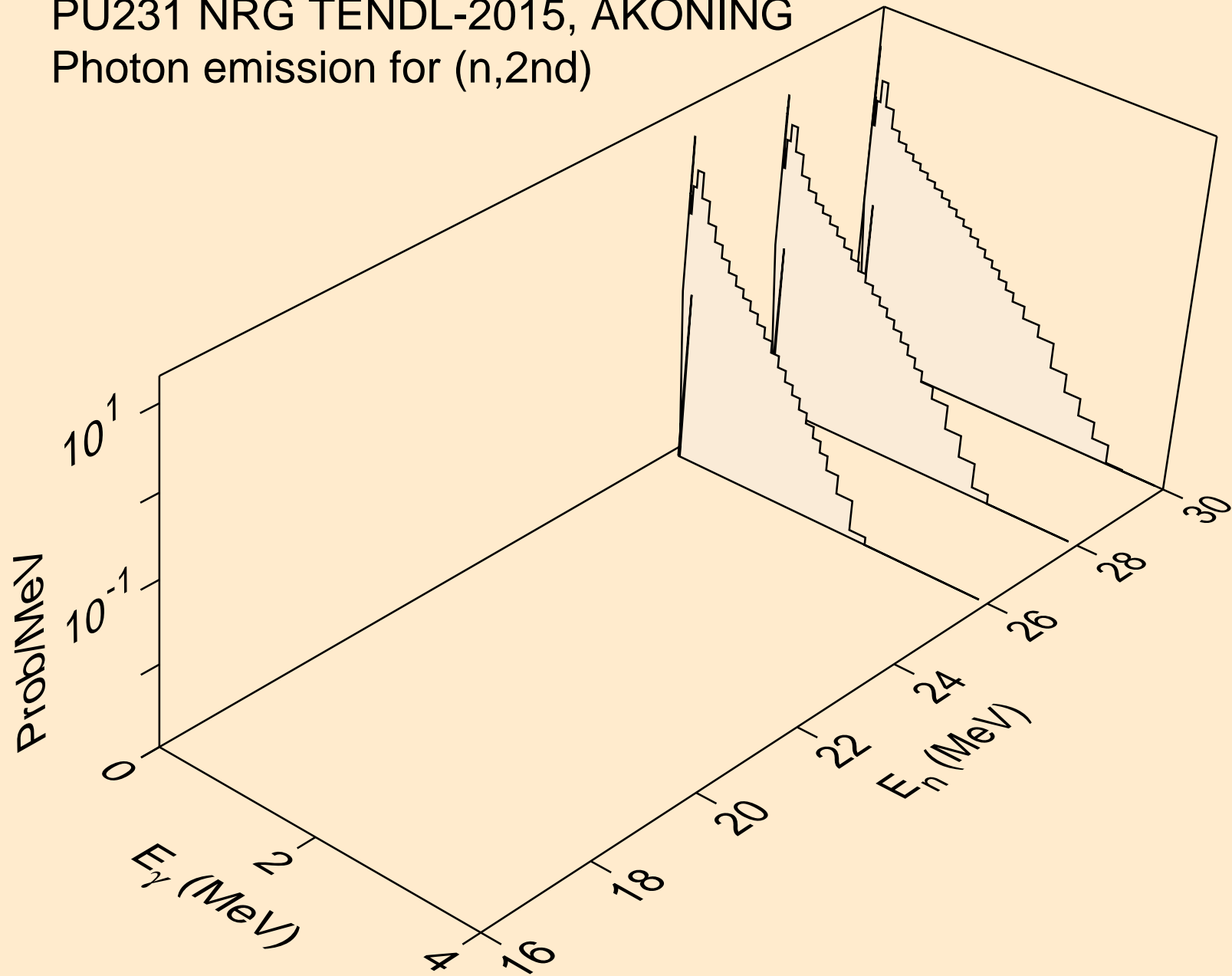

PU231 NRG TENDL-2015, AKONING  
Photon emission for (n,2n)

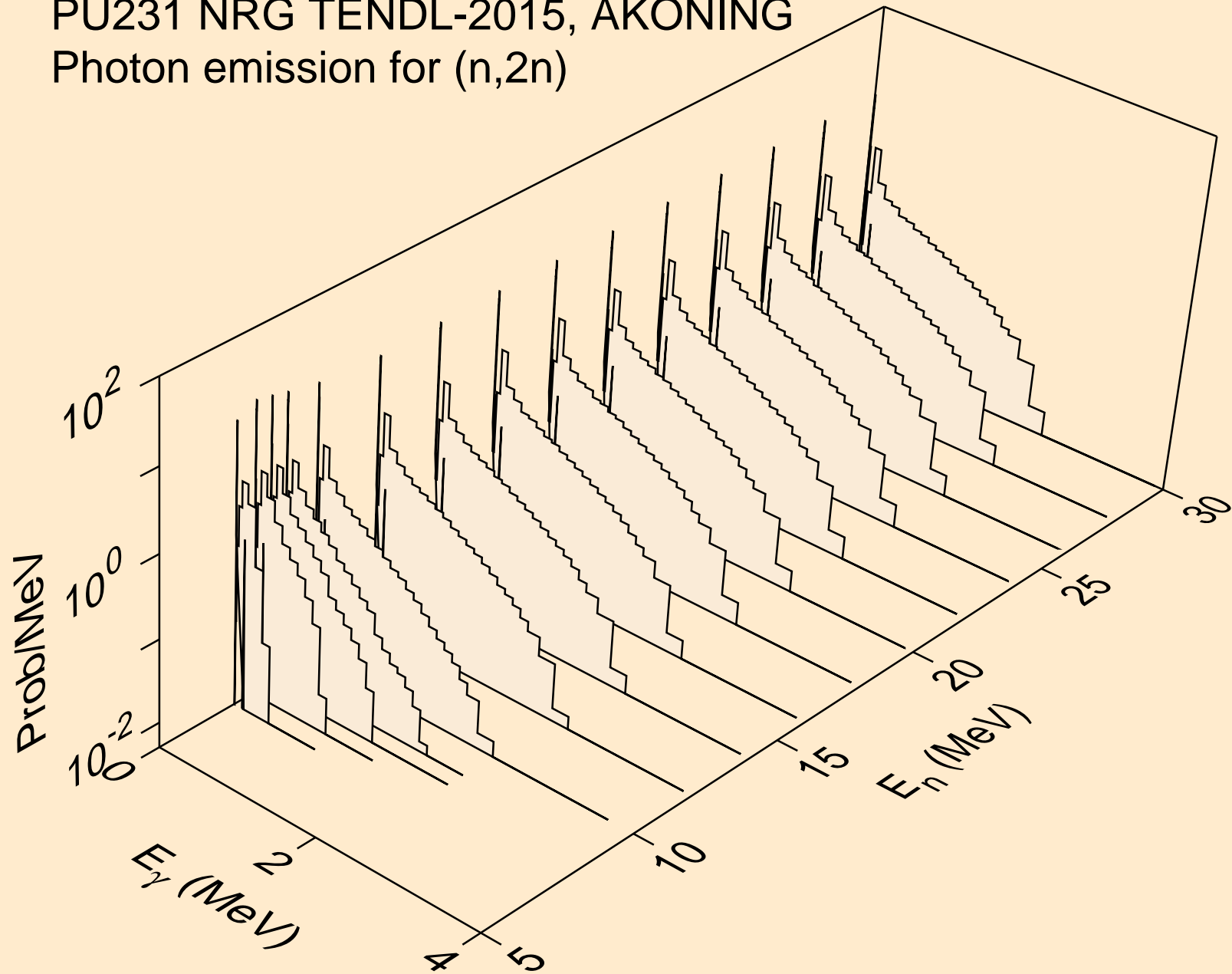

PU231 NRG TENDL-2015, AKONING  
Photon emission for (n,3n)

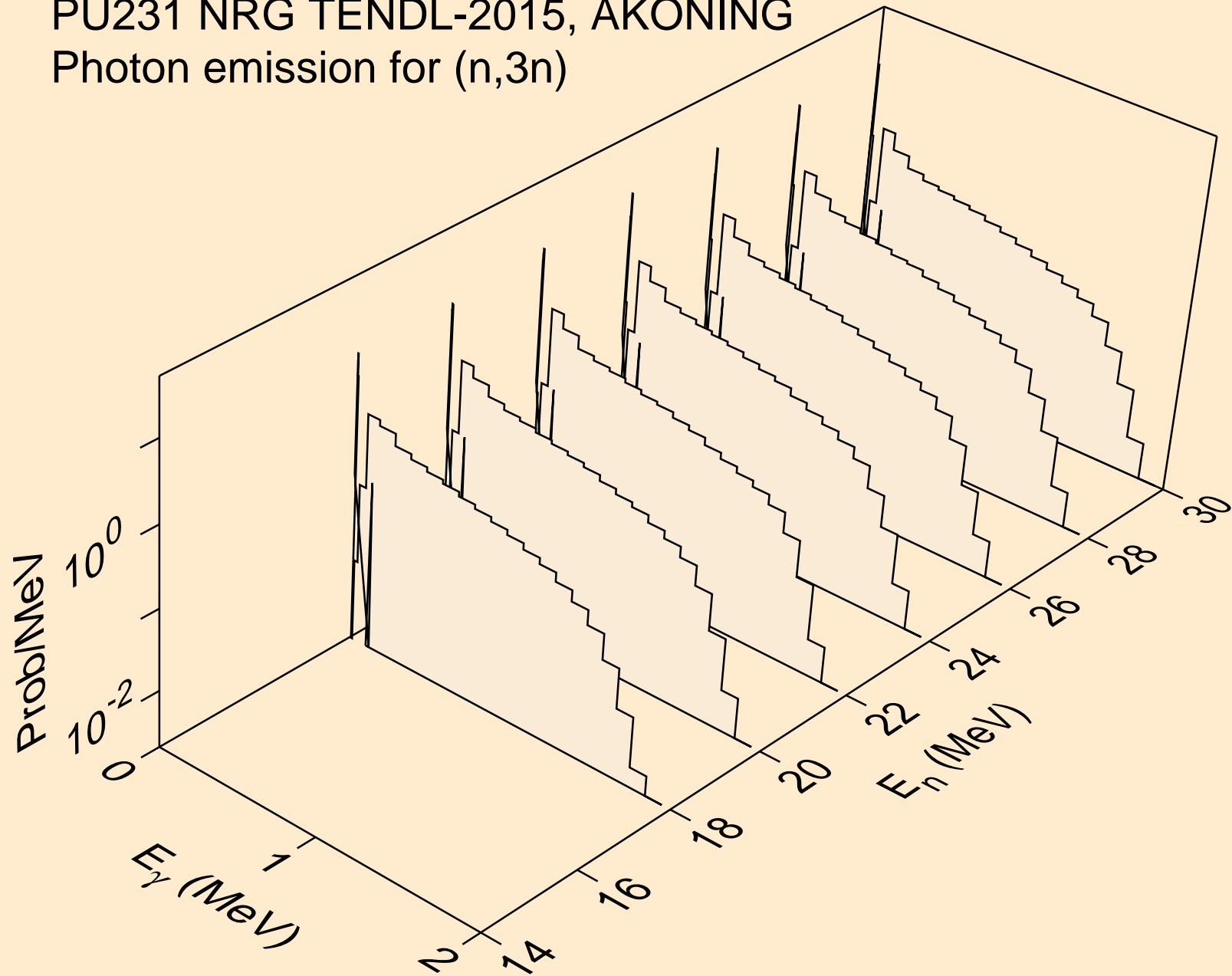

PU231 NRG TENDL-2015, AKONING  
Photon emission for (n,n\*)a

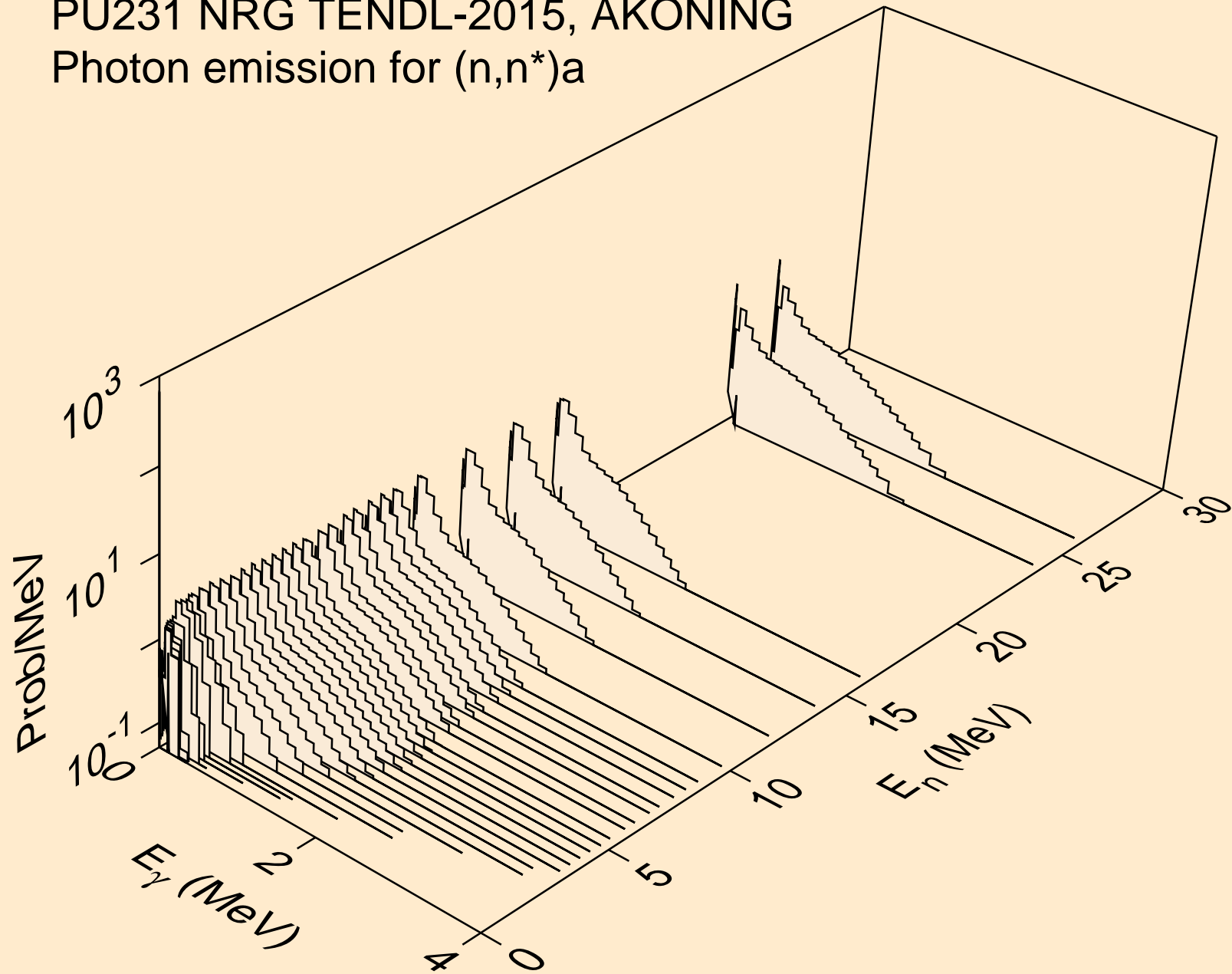



PU231 NRG TENDL-2015, AKONING  
Photon emission for (n,n\*)3a

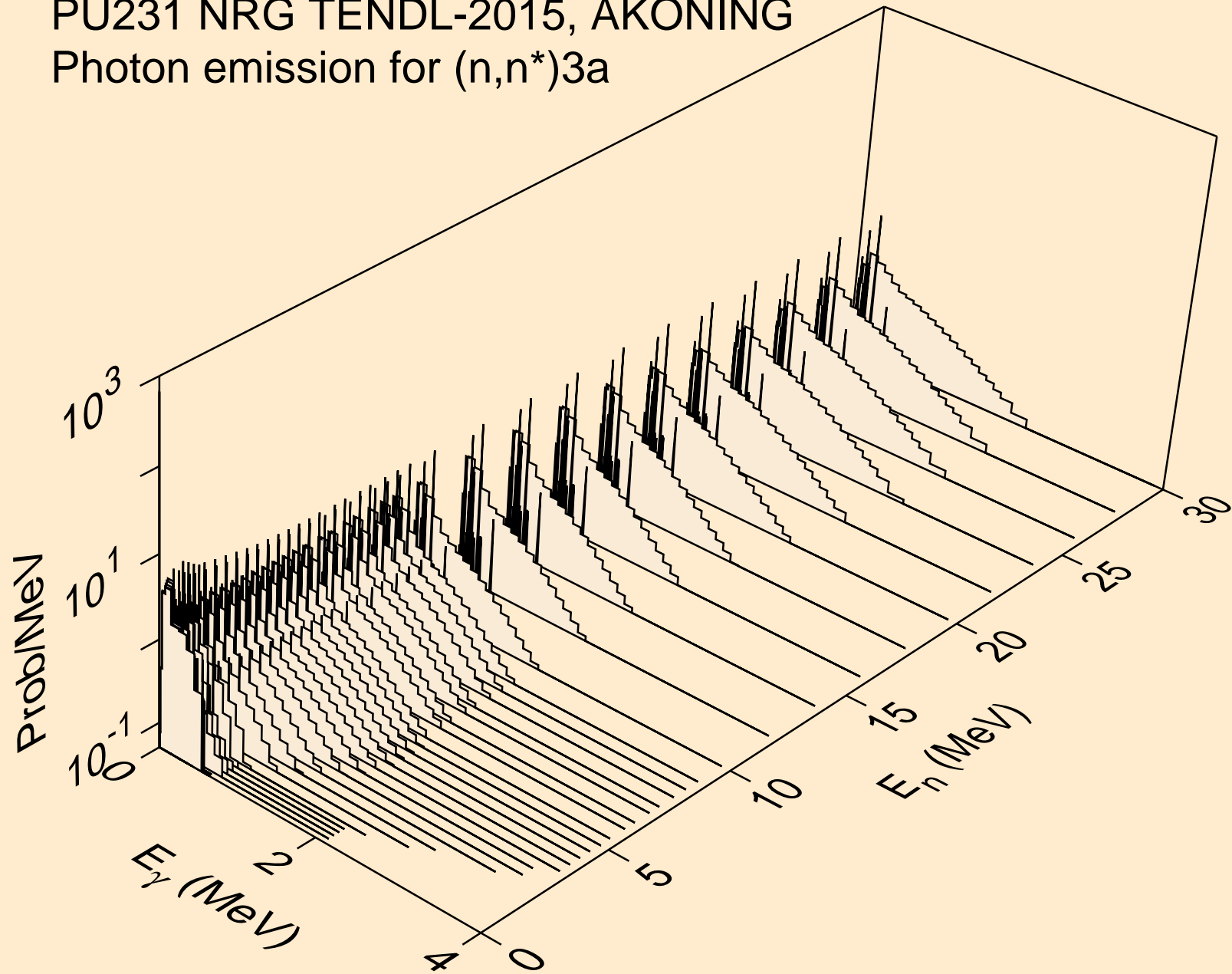

PU231 NRG TENDL-2015, AKONING  
Photon emission for (n,2n)<sub>a</sub>

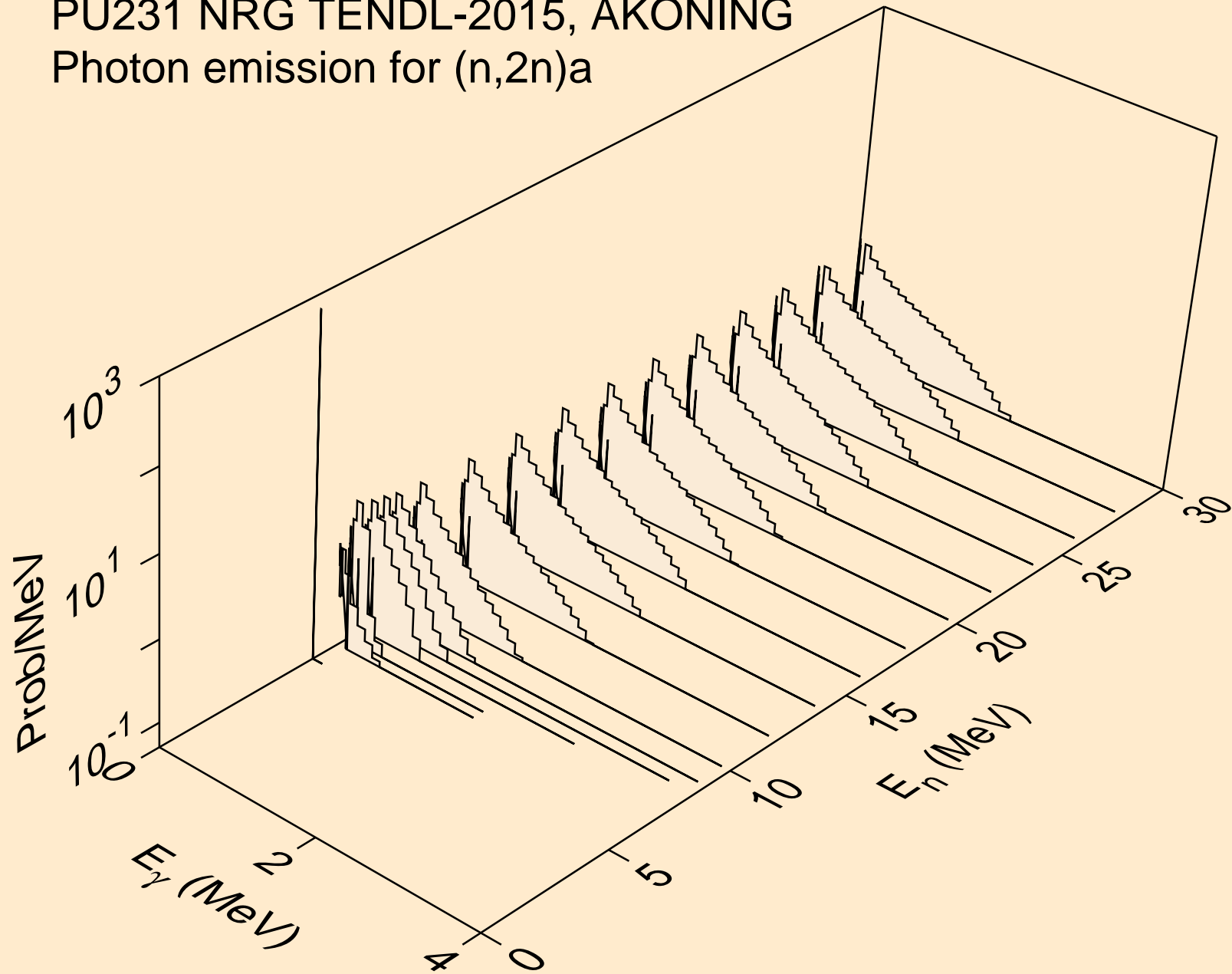

PU231 NRG TENDL-2015, AKONING  
Photon emission for (n,3n)a

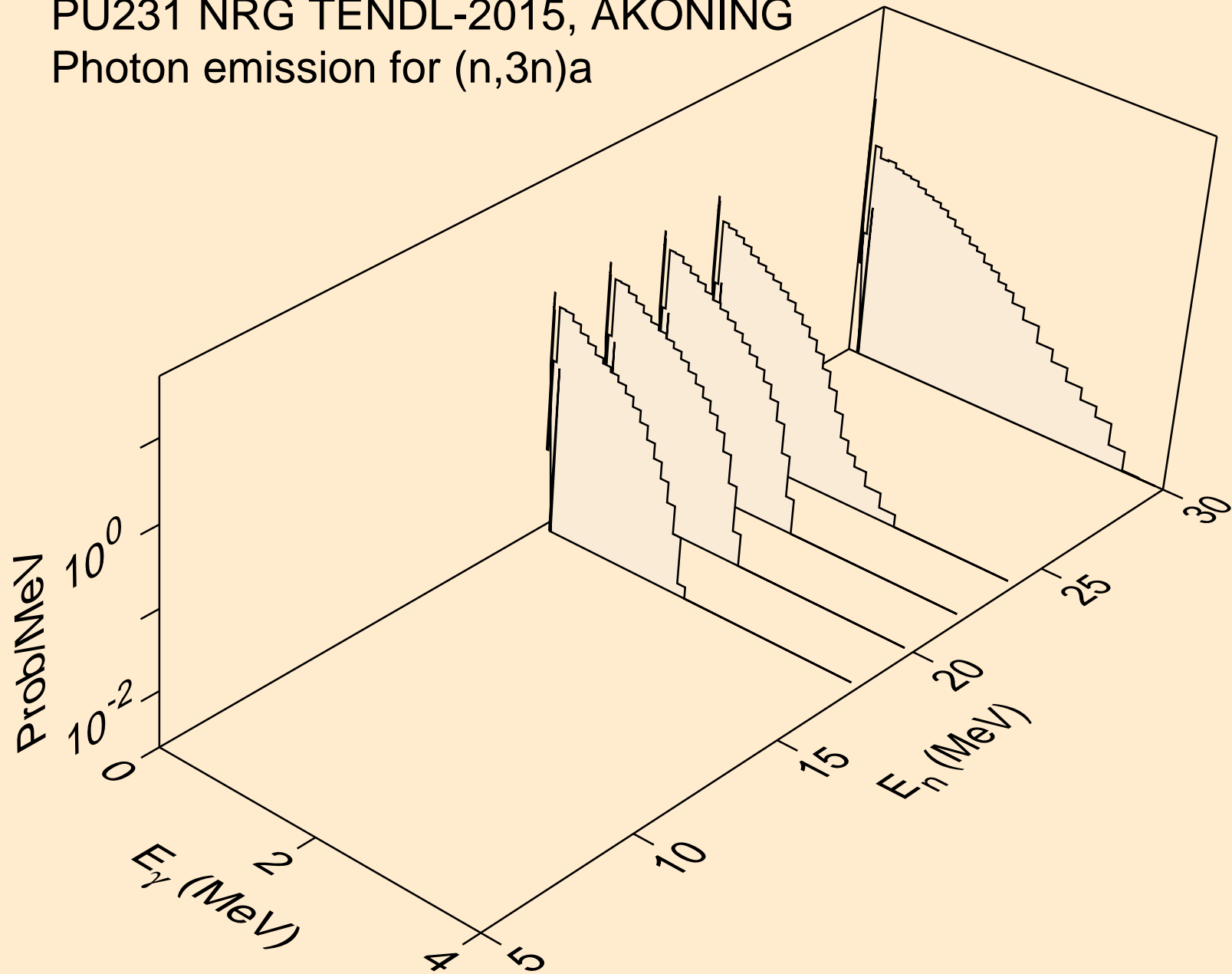

PU231 NRG TENDL-2015, AKONING  
Photon emission for (n,n\*)p

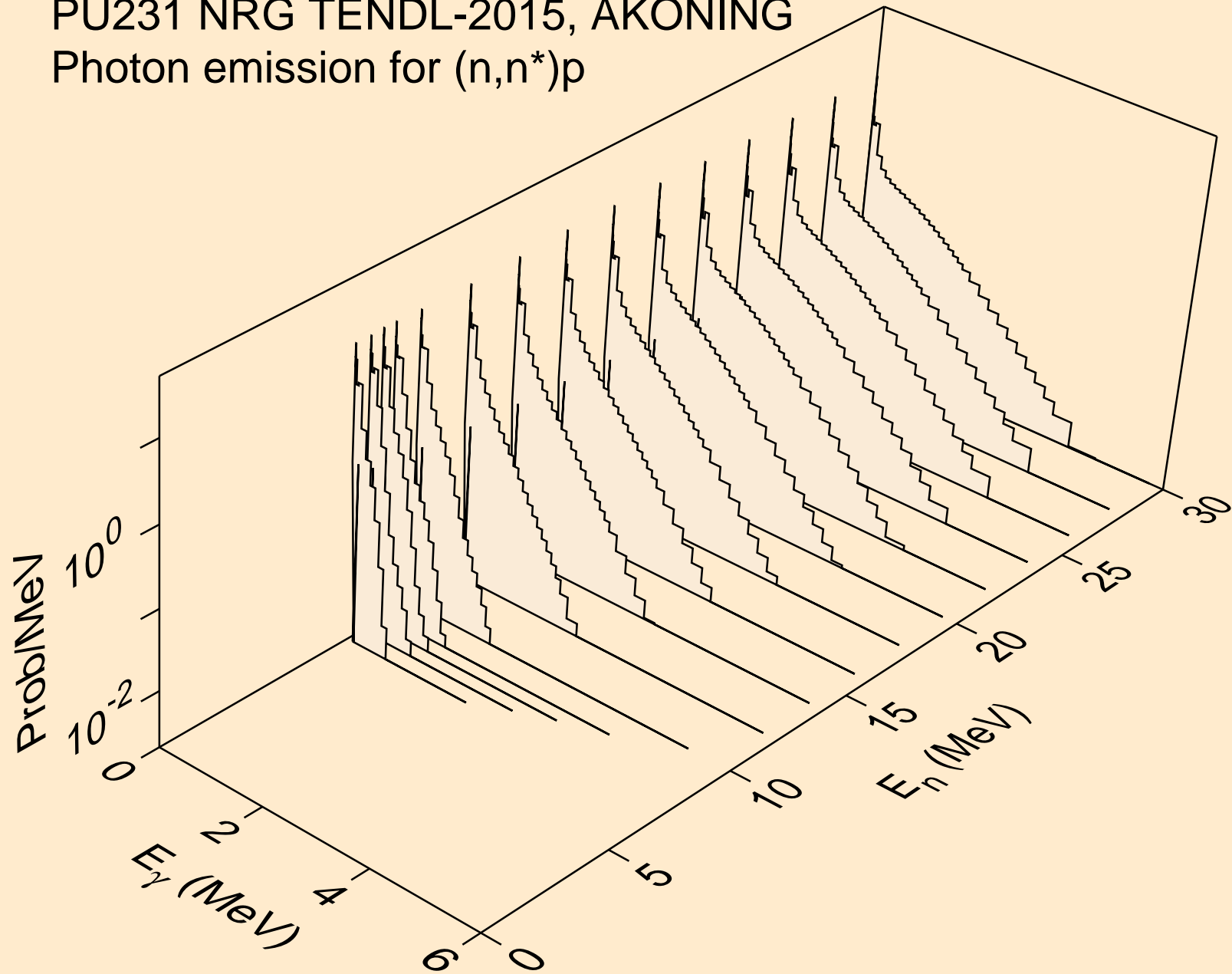

PU231 NRG TENDL-2015, AKONING  
Photon emission for (n,n\*)2a

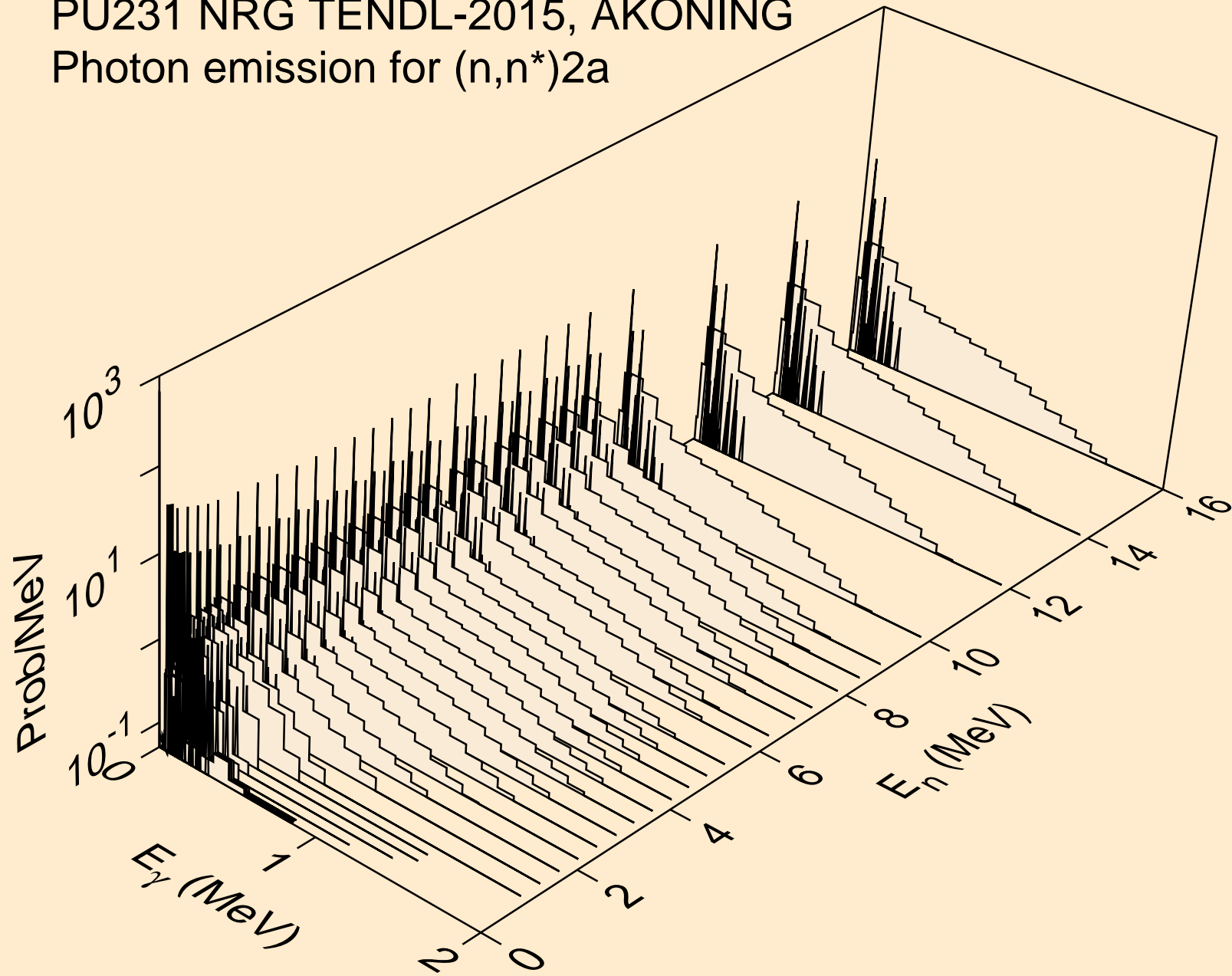

PU231 NRG TENDL-2015, AKONING  
Photon emission for (n,2n)2a

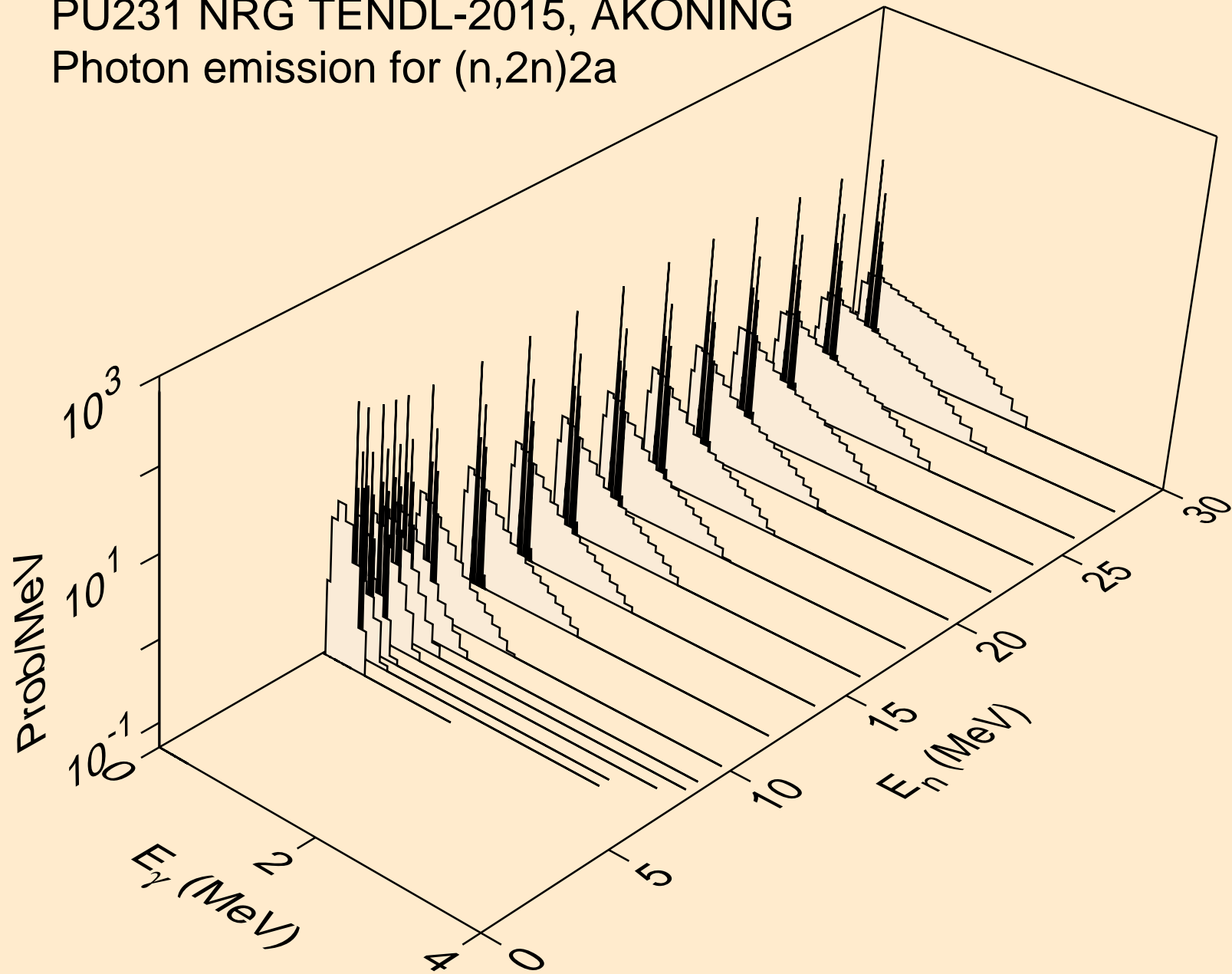

PU231 NRG TENDL-2015, AKONING  
Photon emission for (n,n\*)d

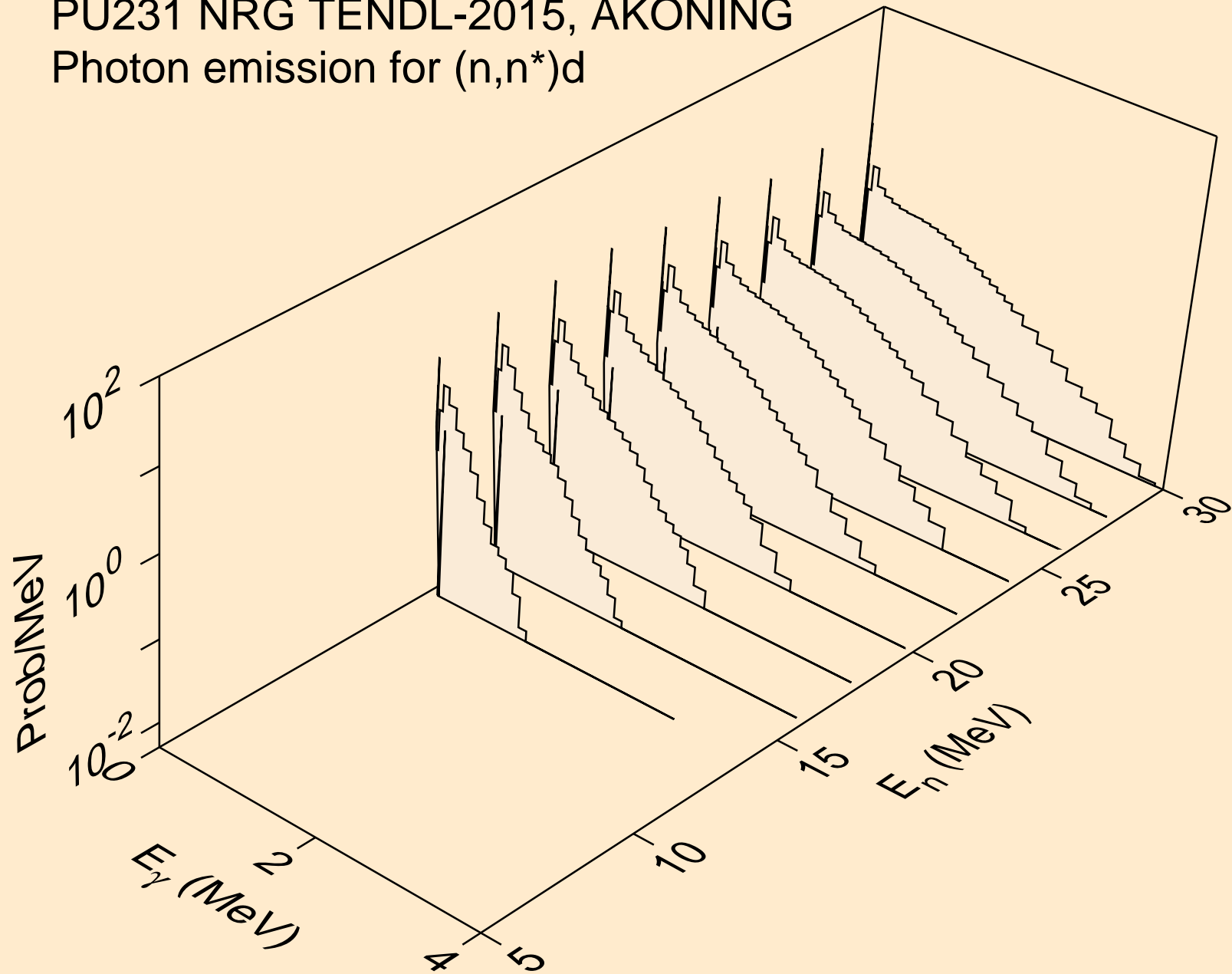

PU231 NRG TENDL-2015, AKONING  
Photon emission for (n,n\*)t

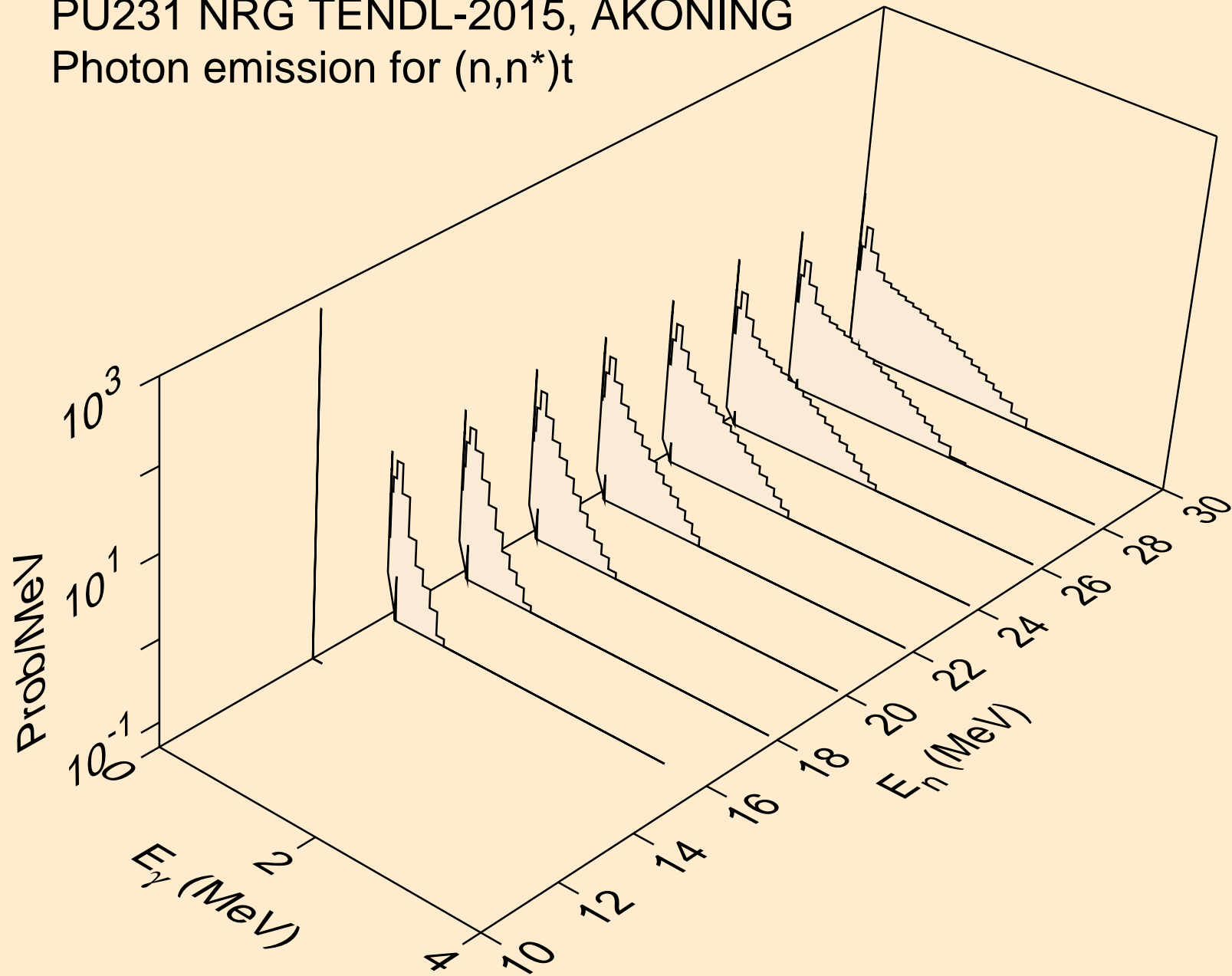



PU231 NRG TENDL-2015, AKONING  
Photon emission for (n,n\*)he3

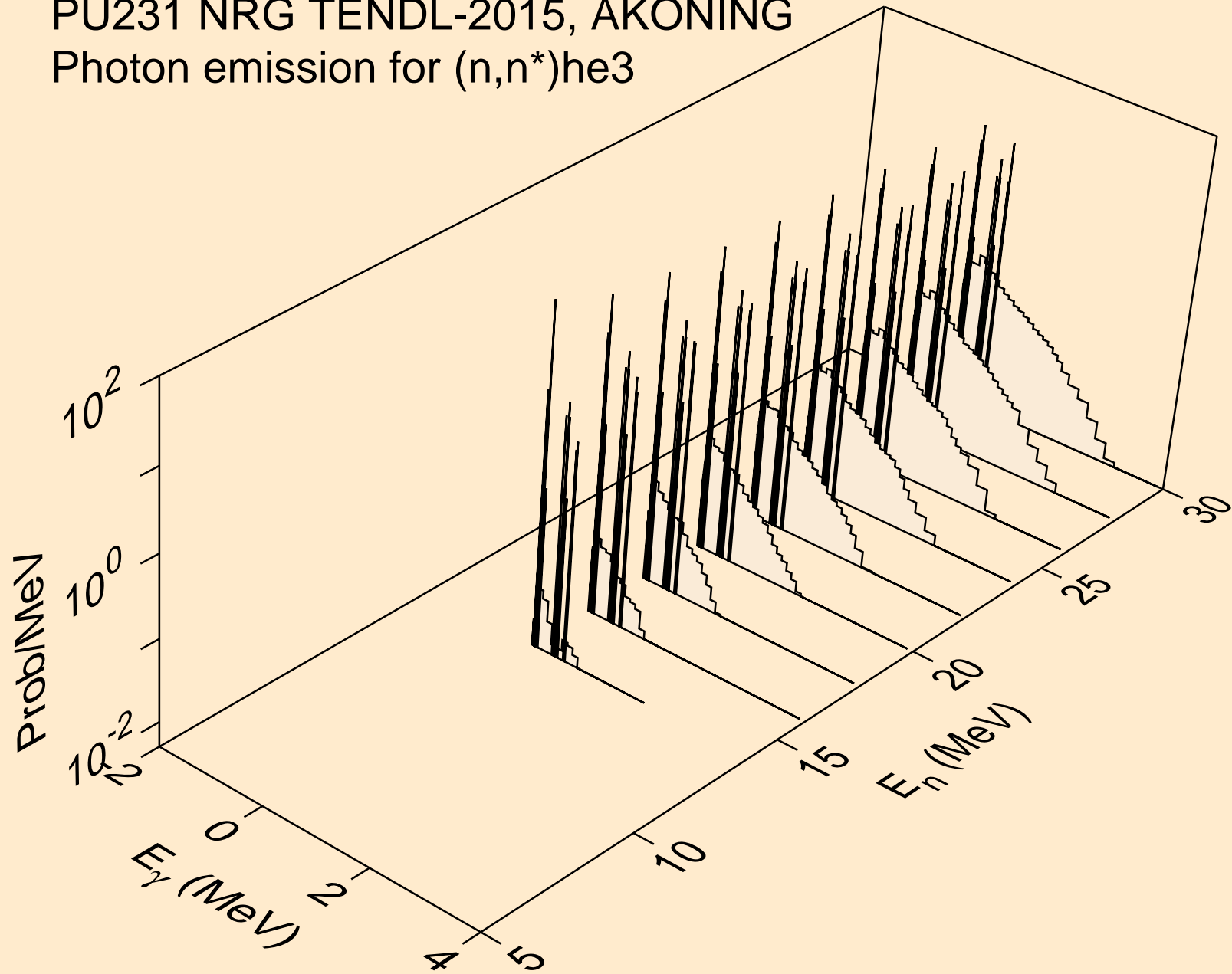

PU231 NRG TENDL-2015, AKONING  
Photon emission for (n,n\*)d2a

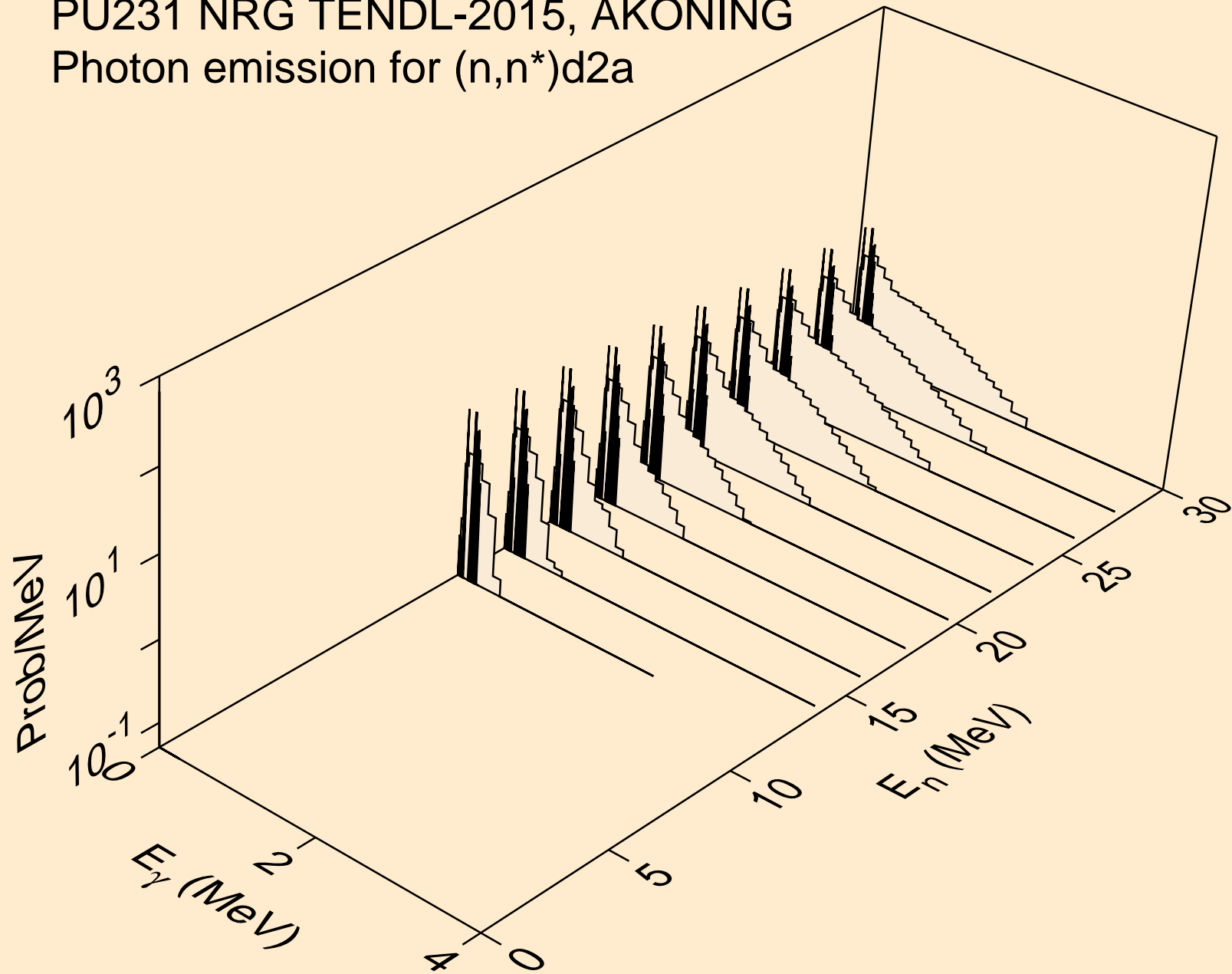

PU231 NRG TENDL-2015, AKONING  
Photon emission for (n,n\*)t2a

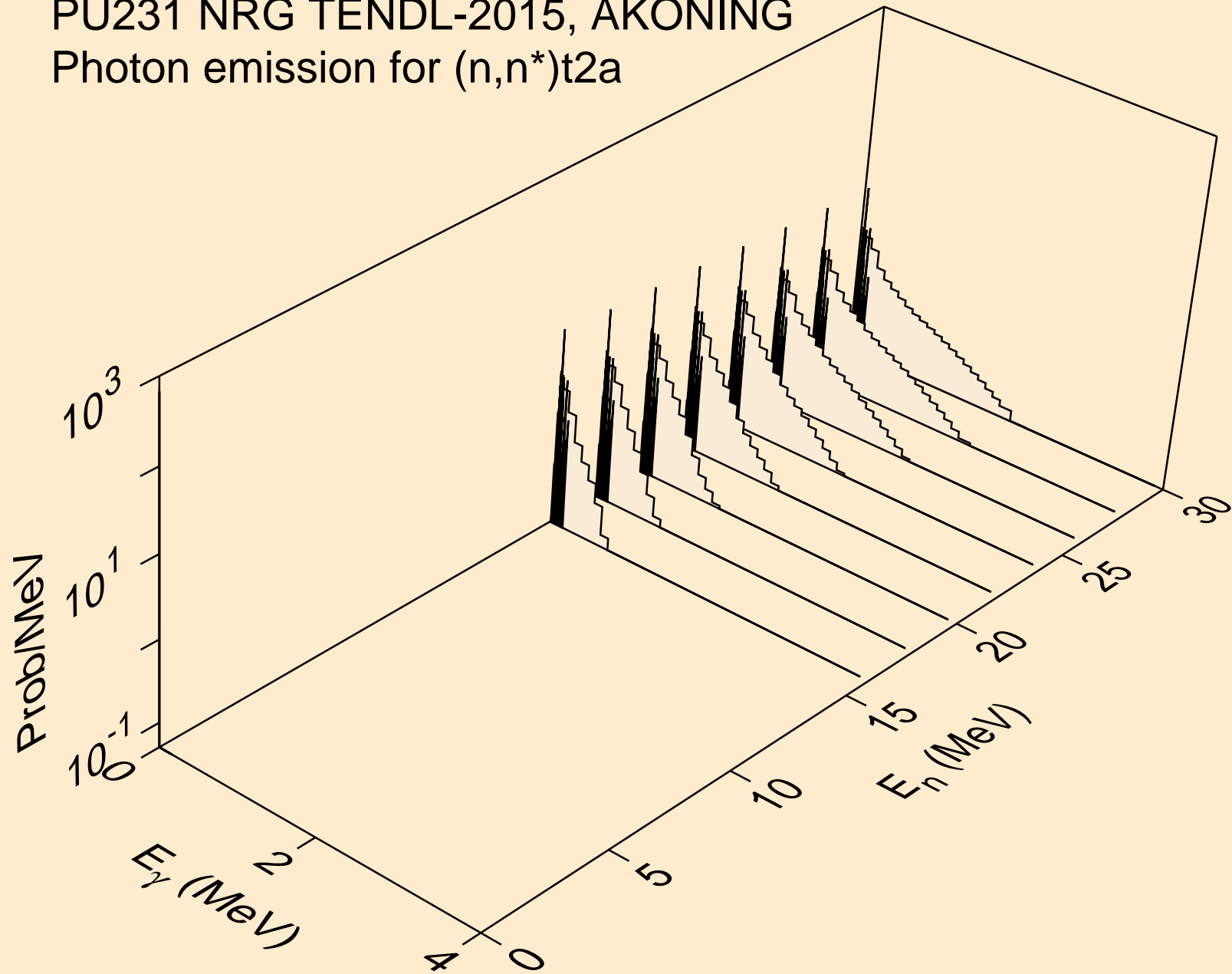

PU231 NRG TENDL-2015, AKONING  
Photon emission for (n,4n)

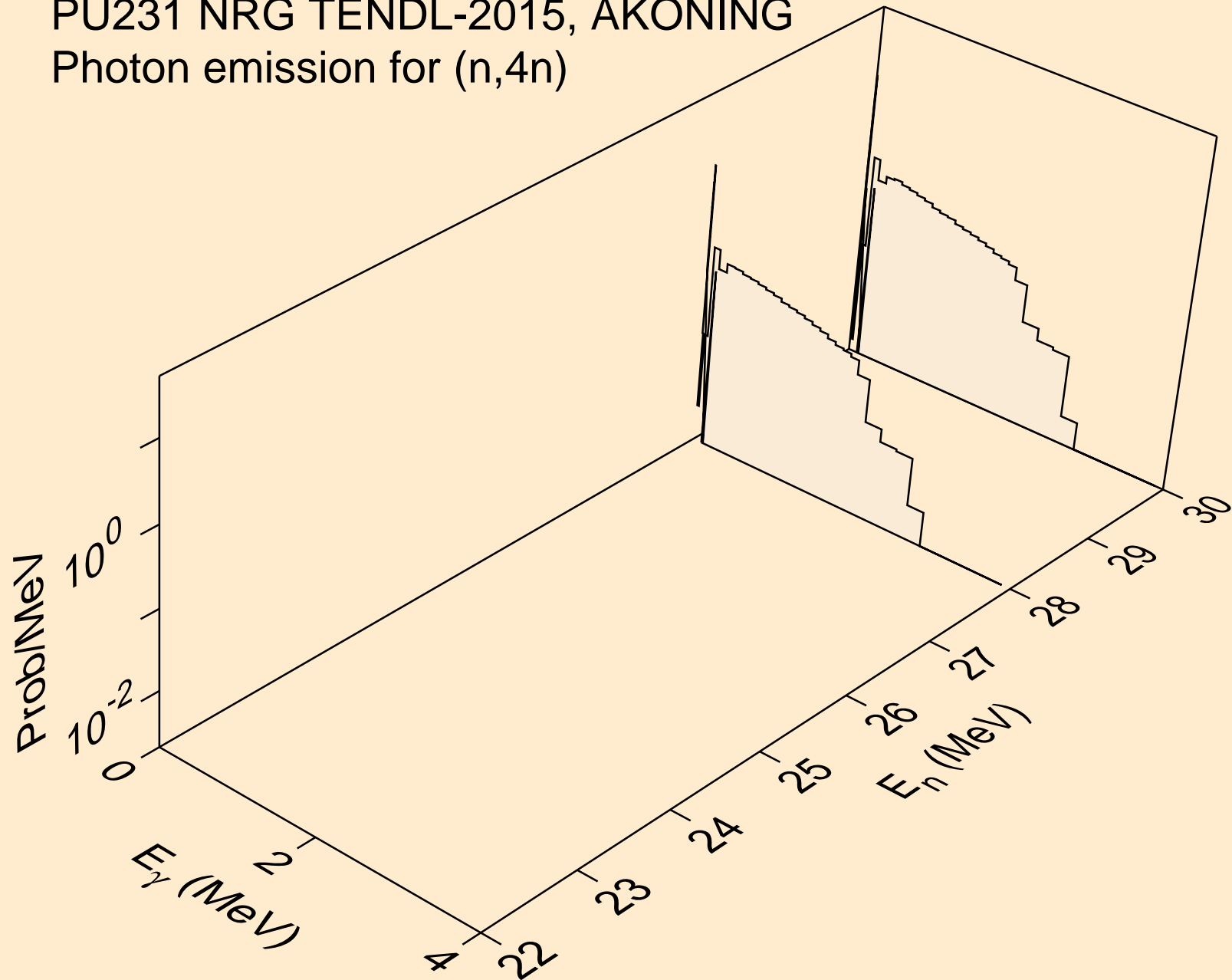

PU231 NRG TENDL-2015, AKONING  
Photon emission for (n,2np)

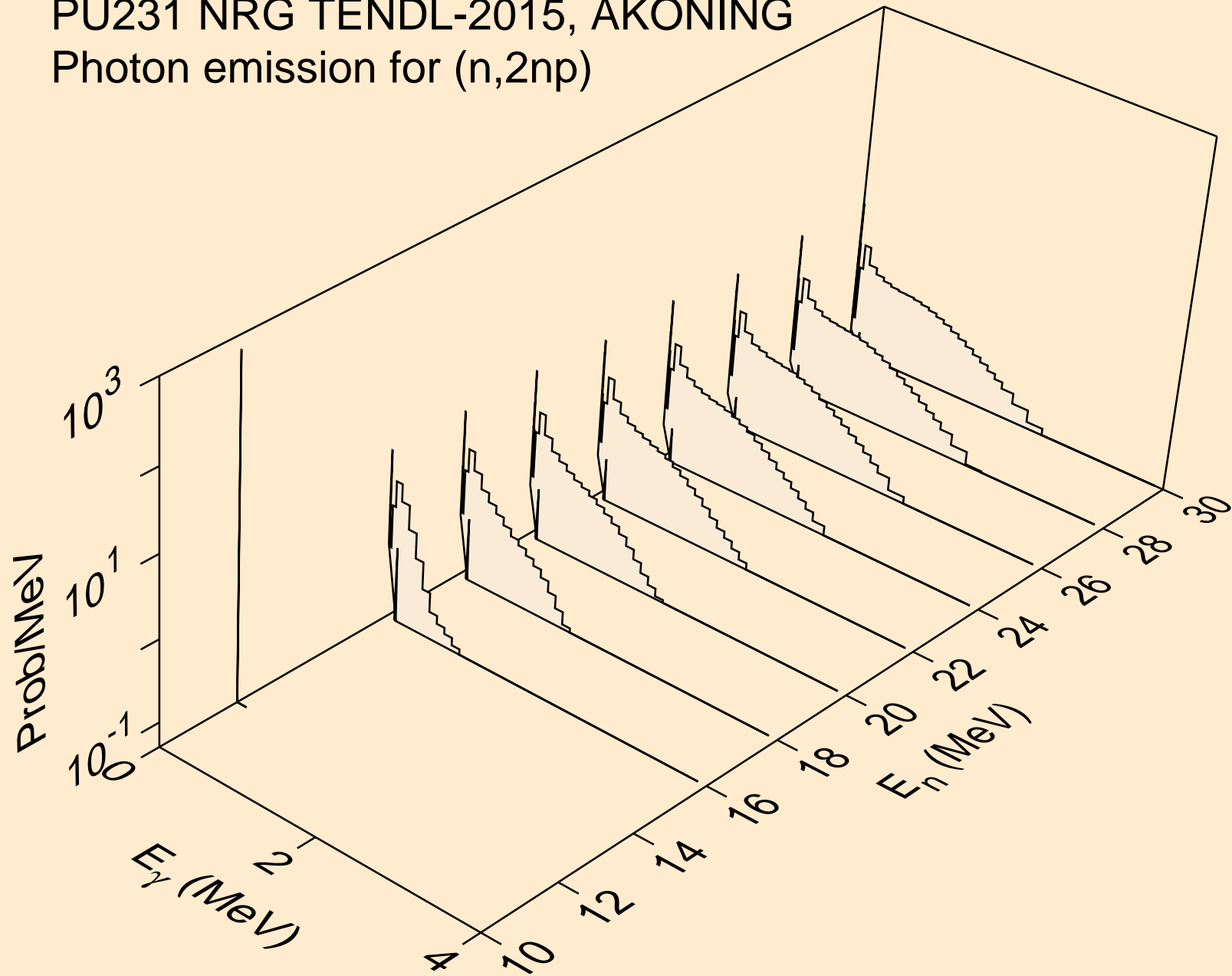

PU231 NRG TENDL-2015, AKONING  
Photon emission for (n,3np)

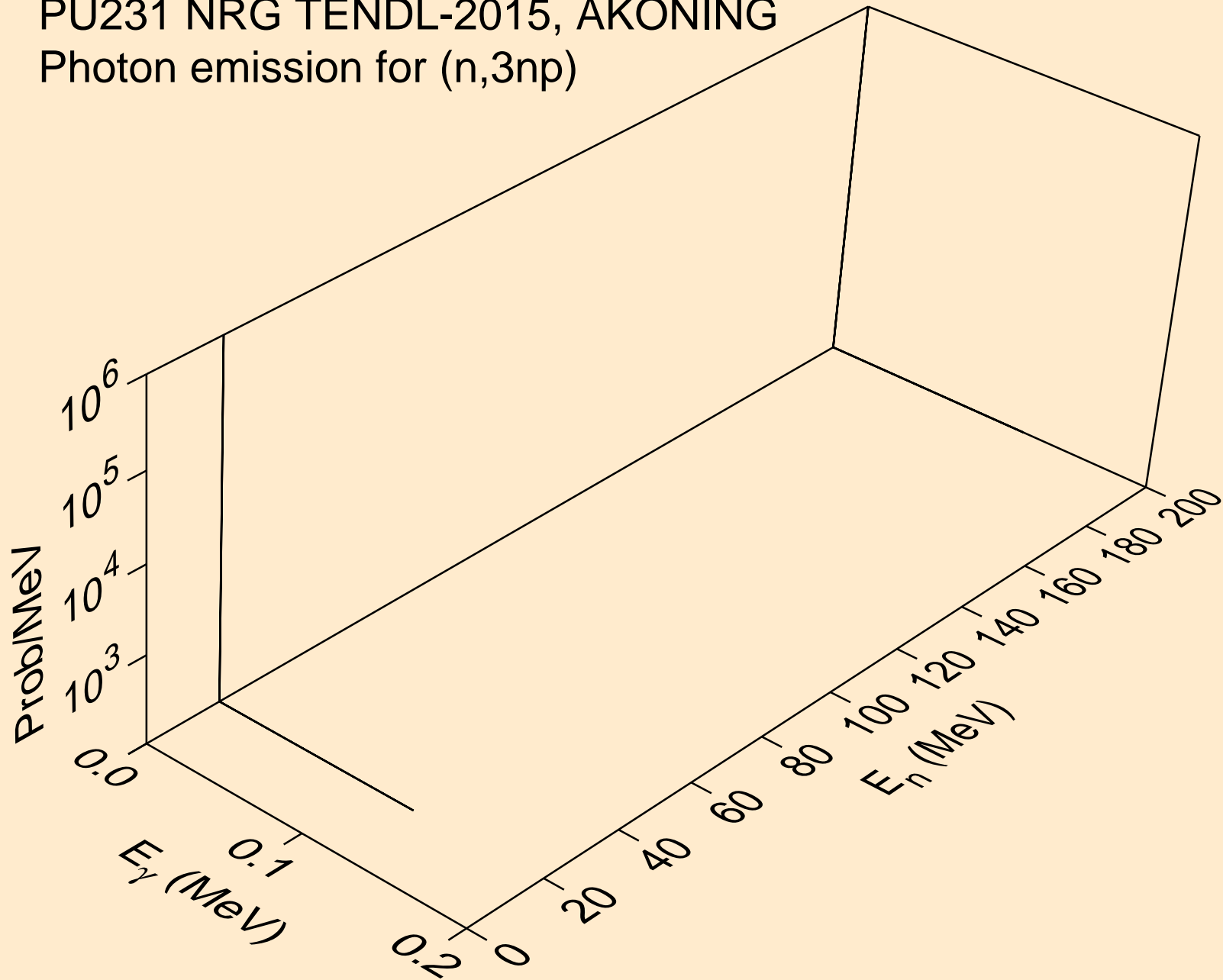

PU231 NRG TENDL-2015, AKONING  
Photon emission for (n,2np)

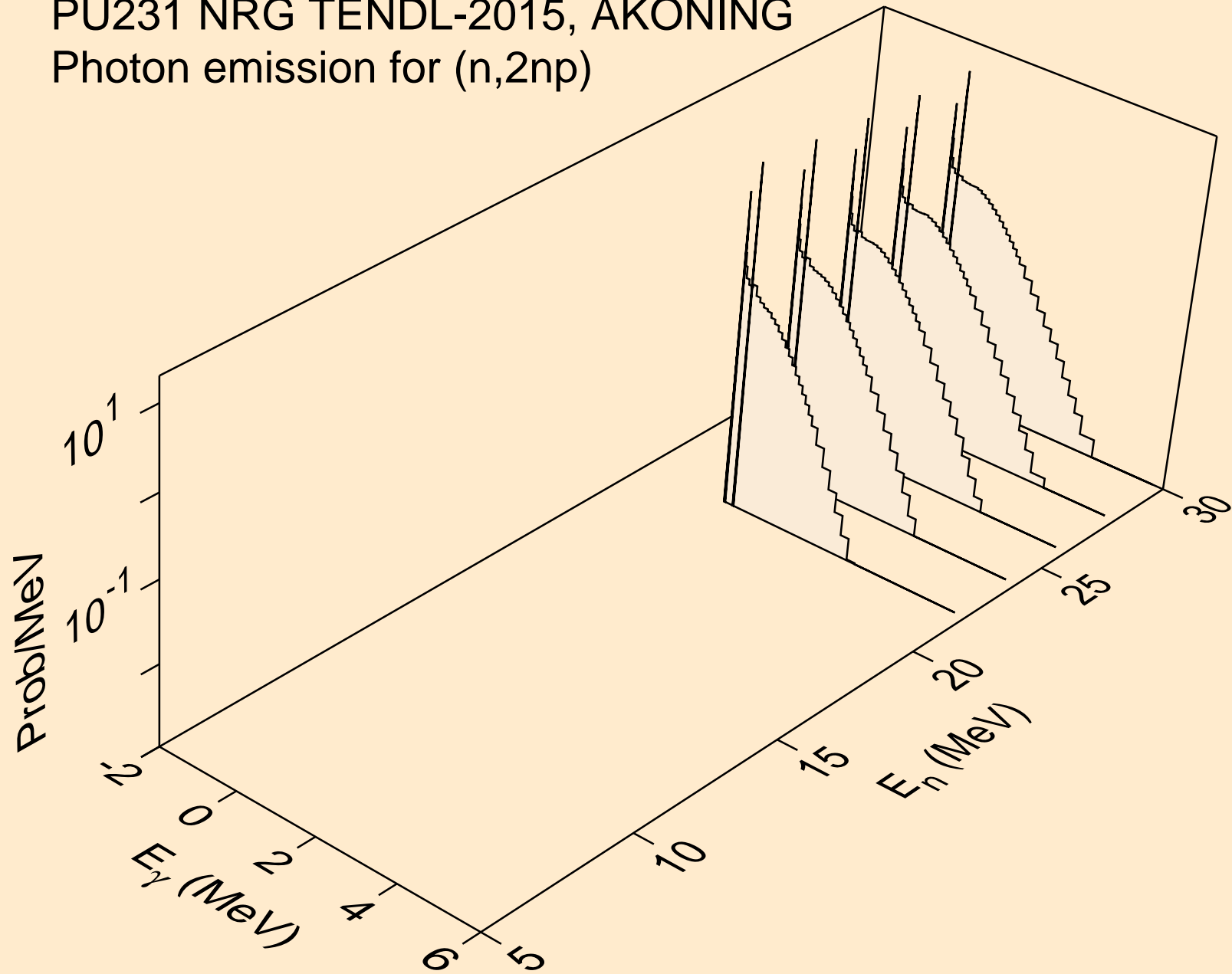

PU231 NRG TENDL-2015, AKONING  
Photon emission for (n,npa)

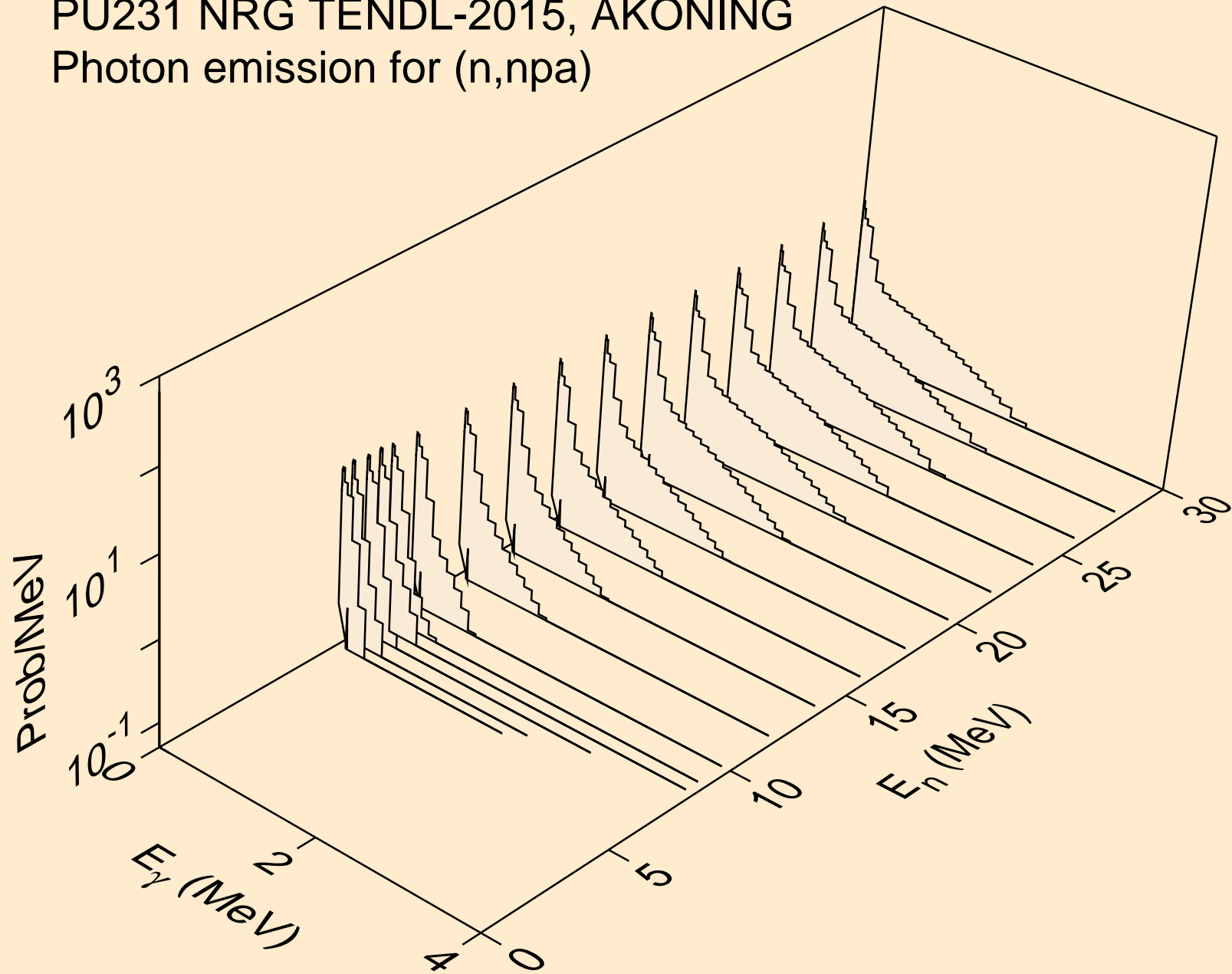



PU231 NRG TENDL-2015, AKONING  
Photon emission for (n,n\*c)

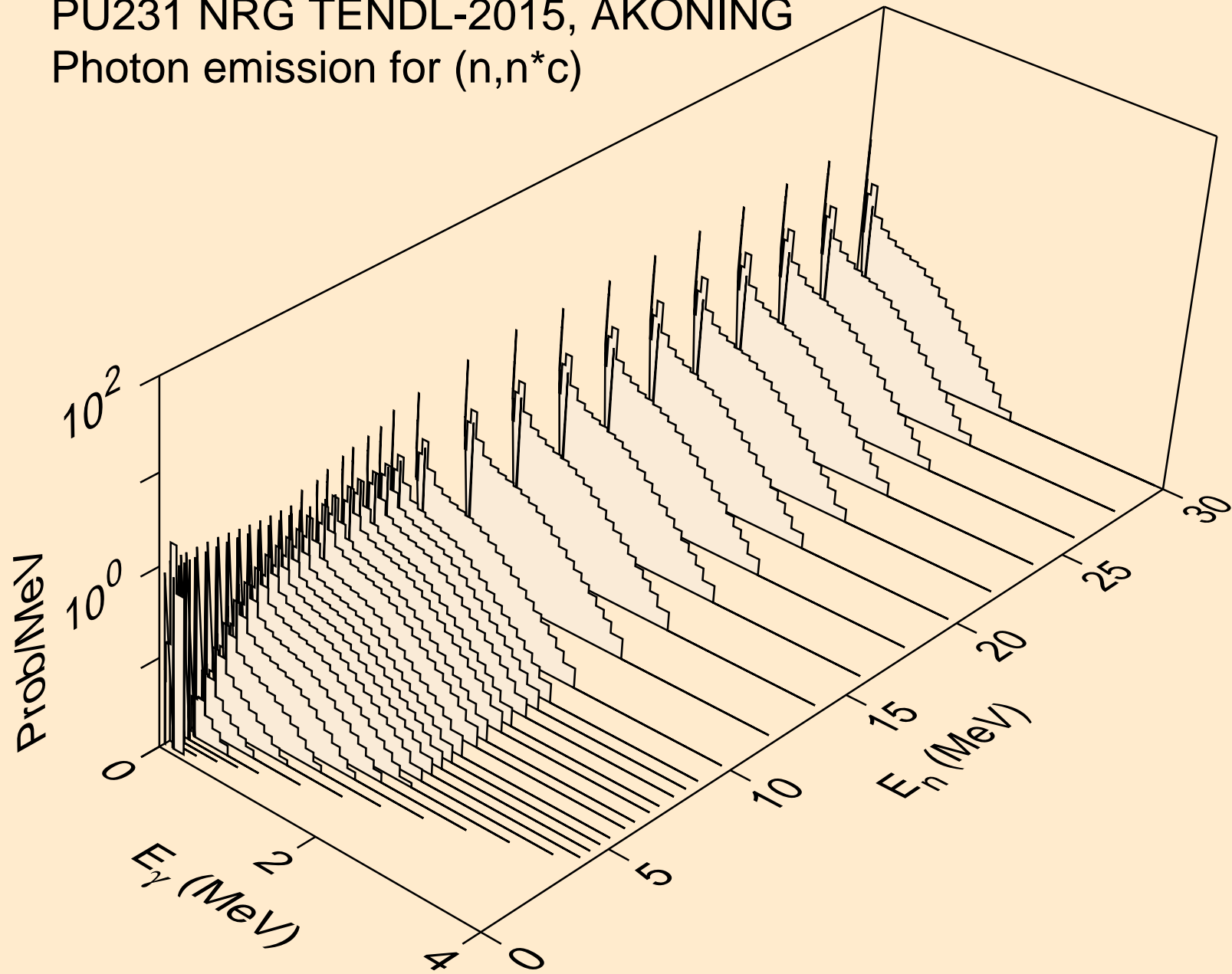

PU231 NRG TENDL-2015, AKONING  
Photon emission for (n,gma)

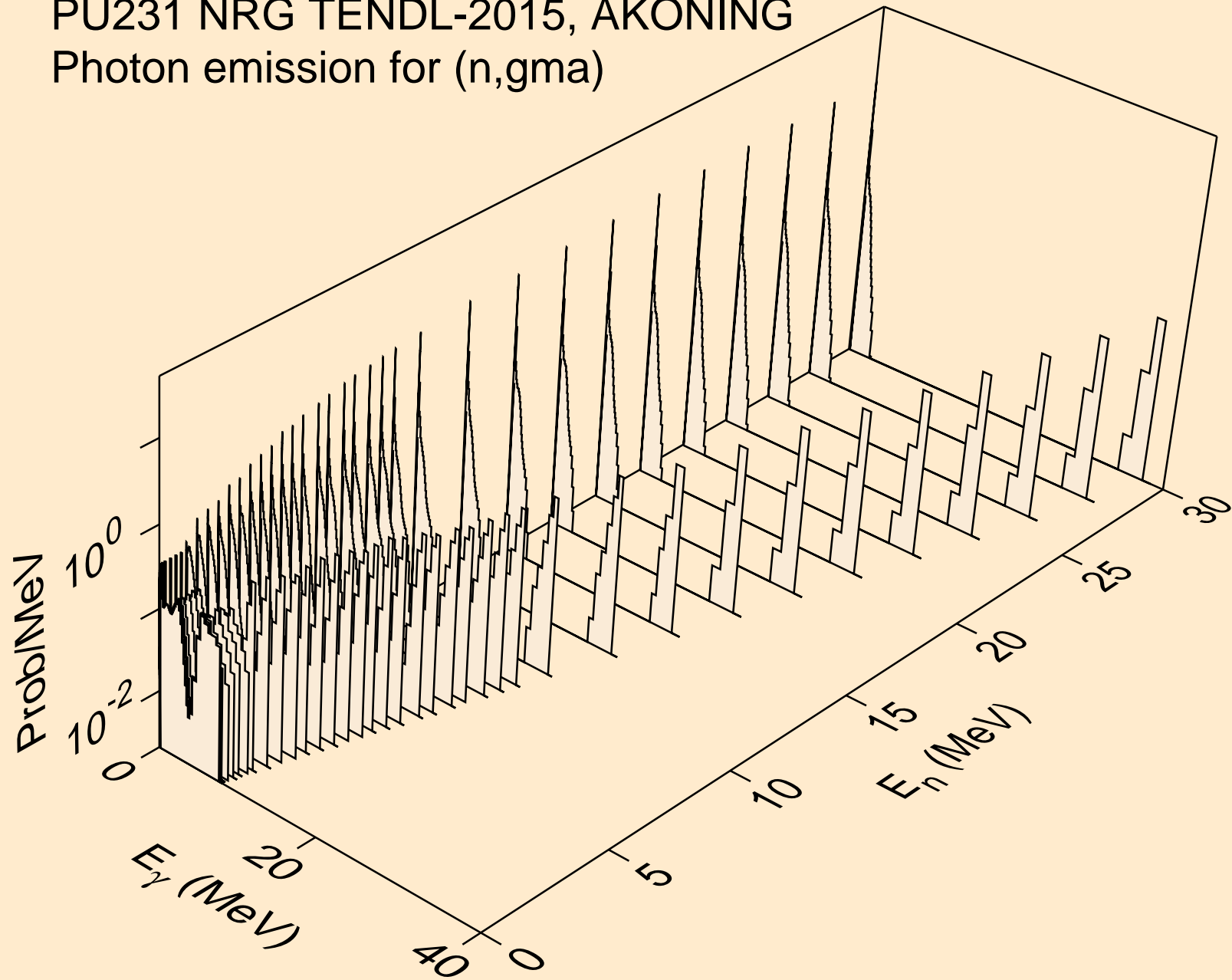

PU231 NRG TENDL-2015, AKONING  
Photon emission for (n,p)

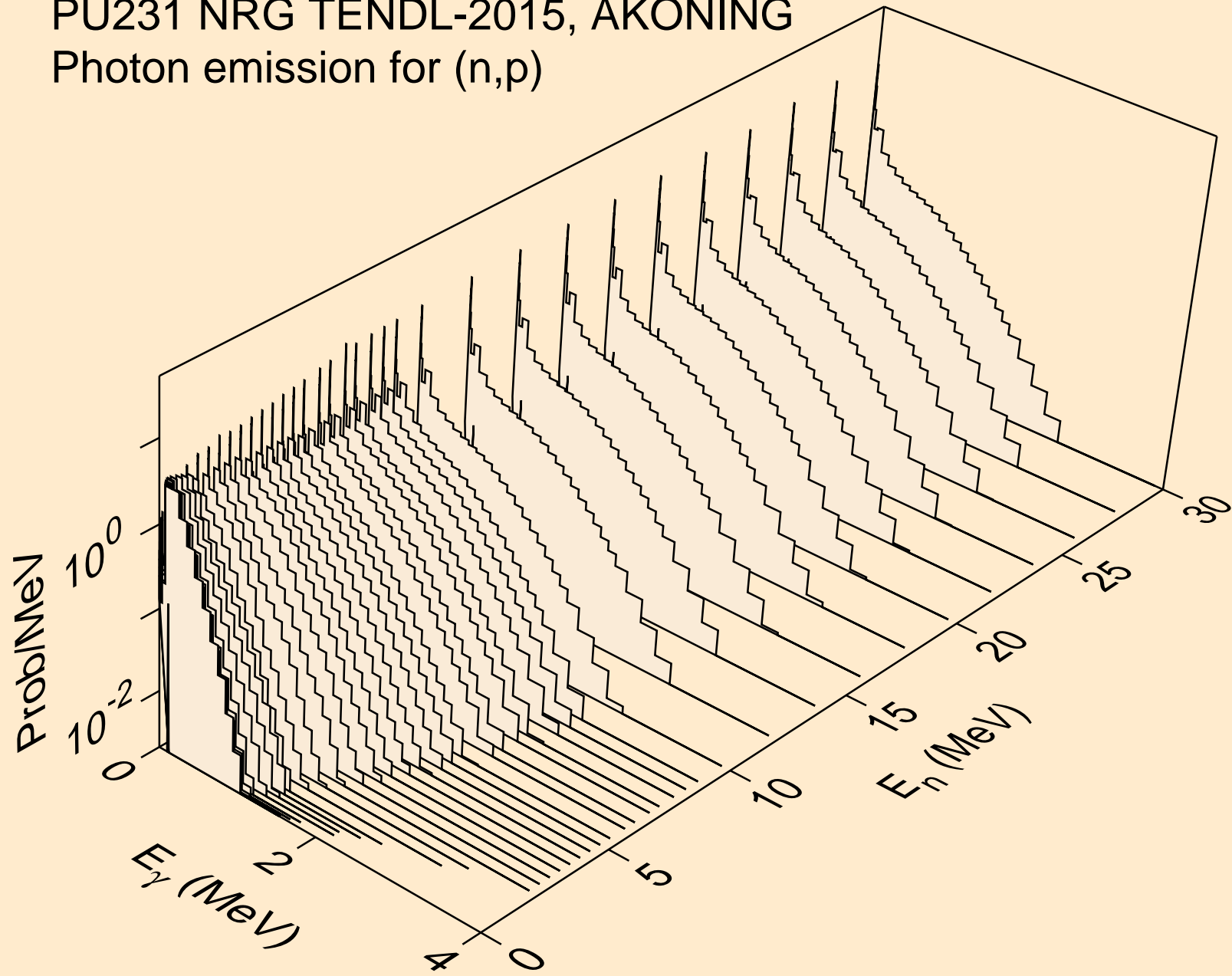

PU231 NRG TENDL-2015, AKONING  
Photon emission for (n,d)

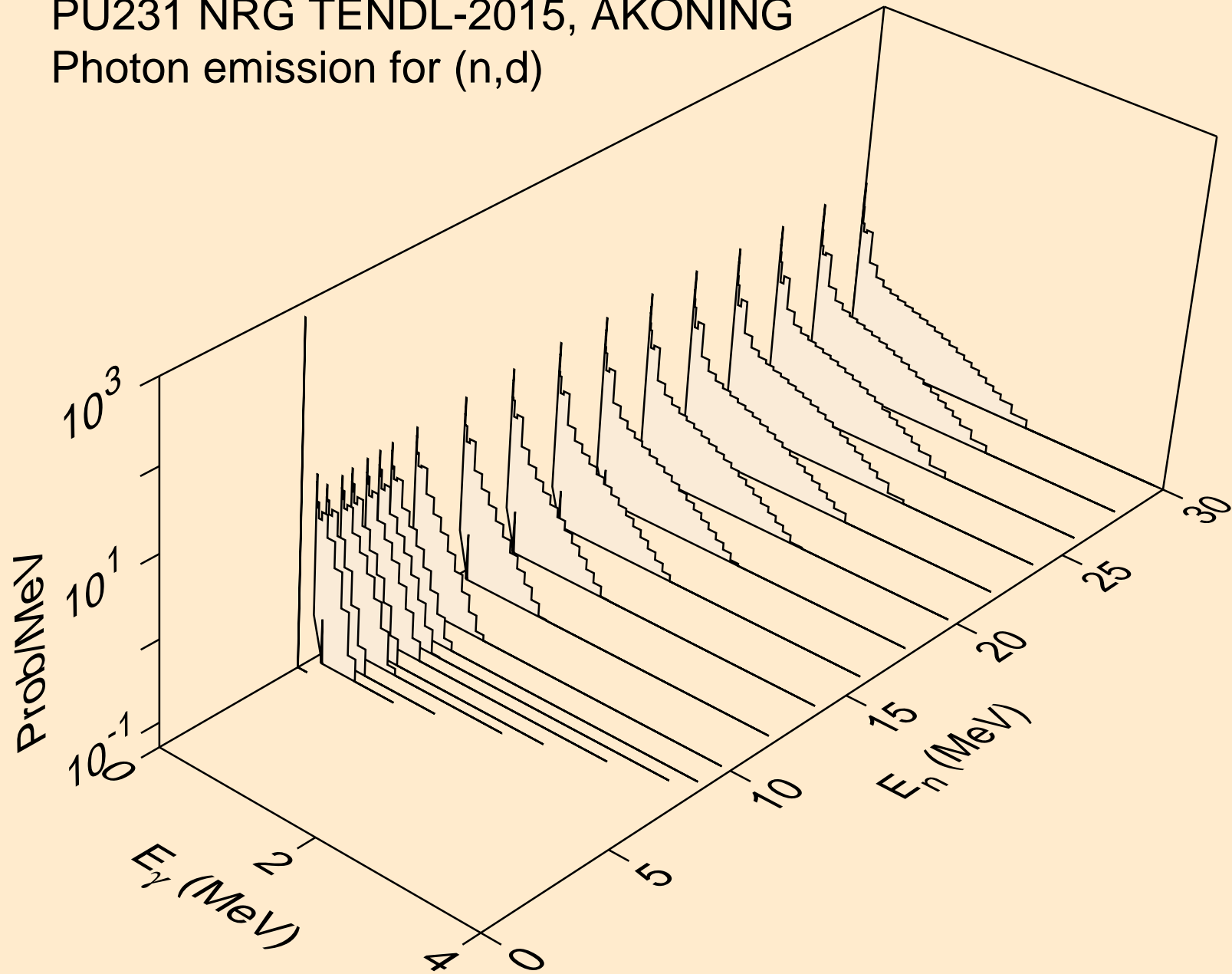

PU231 NRG TENDL-2015, AKONING  
Photon emission for (n,t)

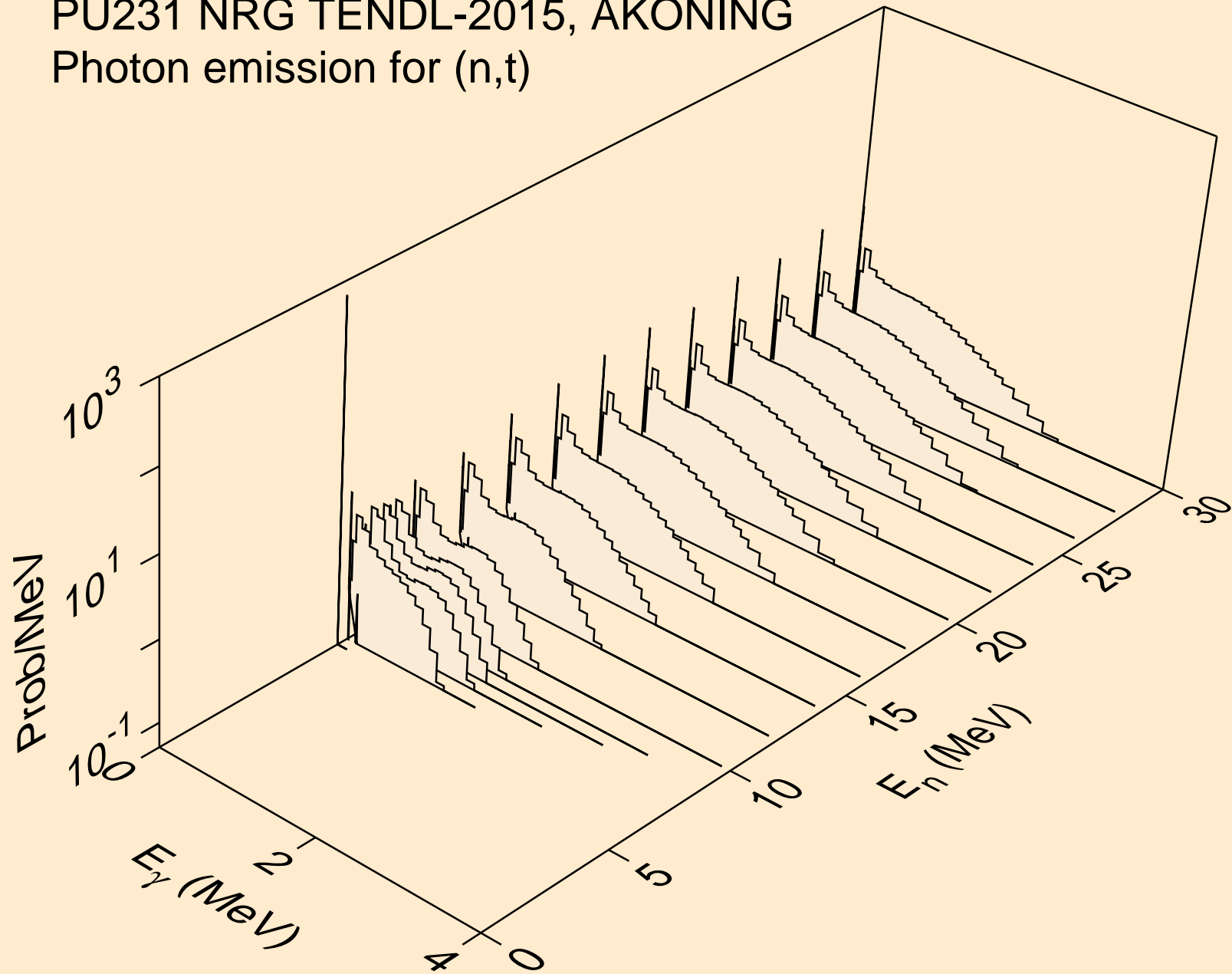

PU231 NRG TENDL-2015, AKONING  
Photon emission for (n,he3)

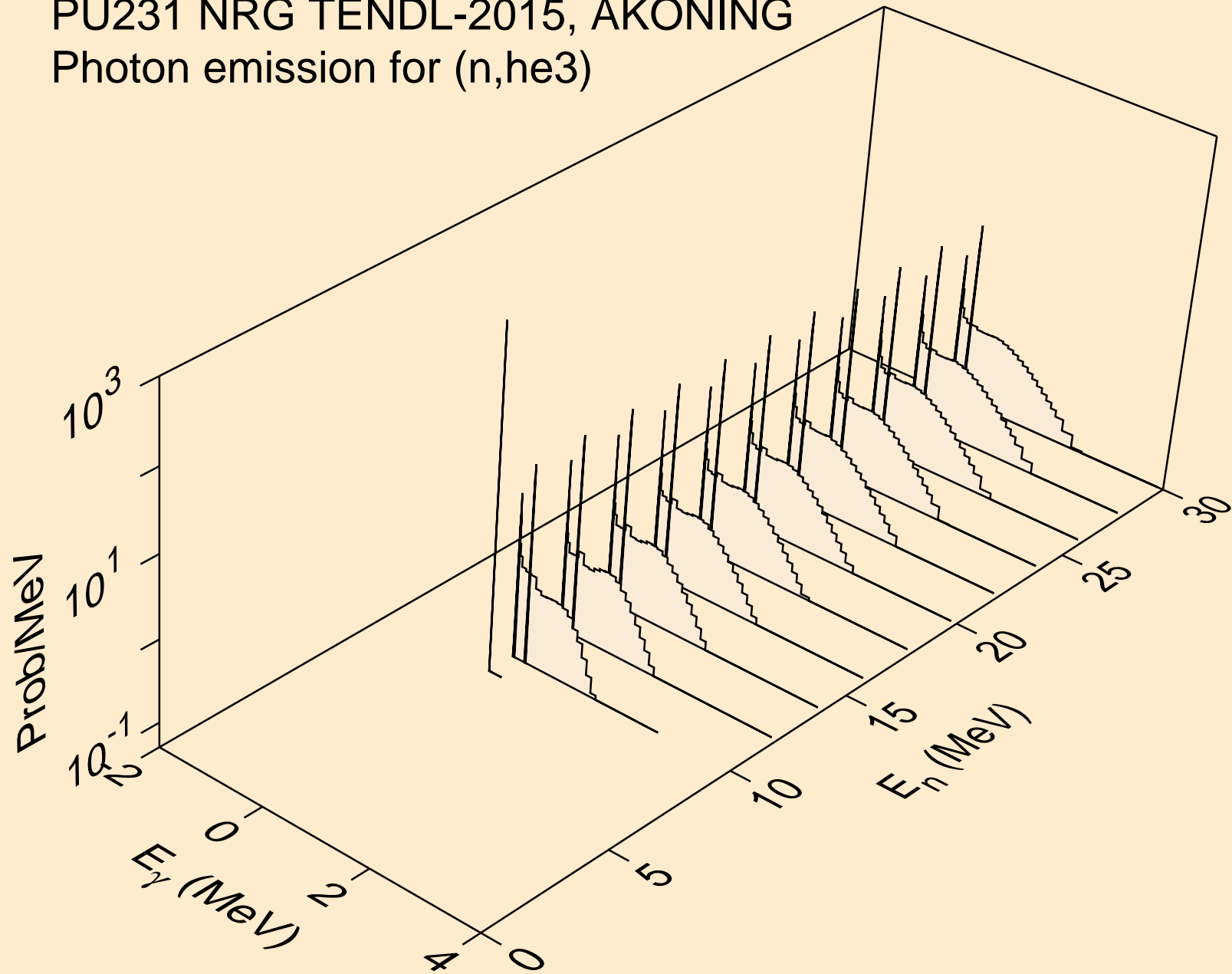

PU231 NRG TENDL-2015, AKONING  
Photon emission for (n,a)

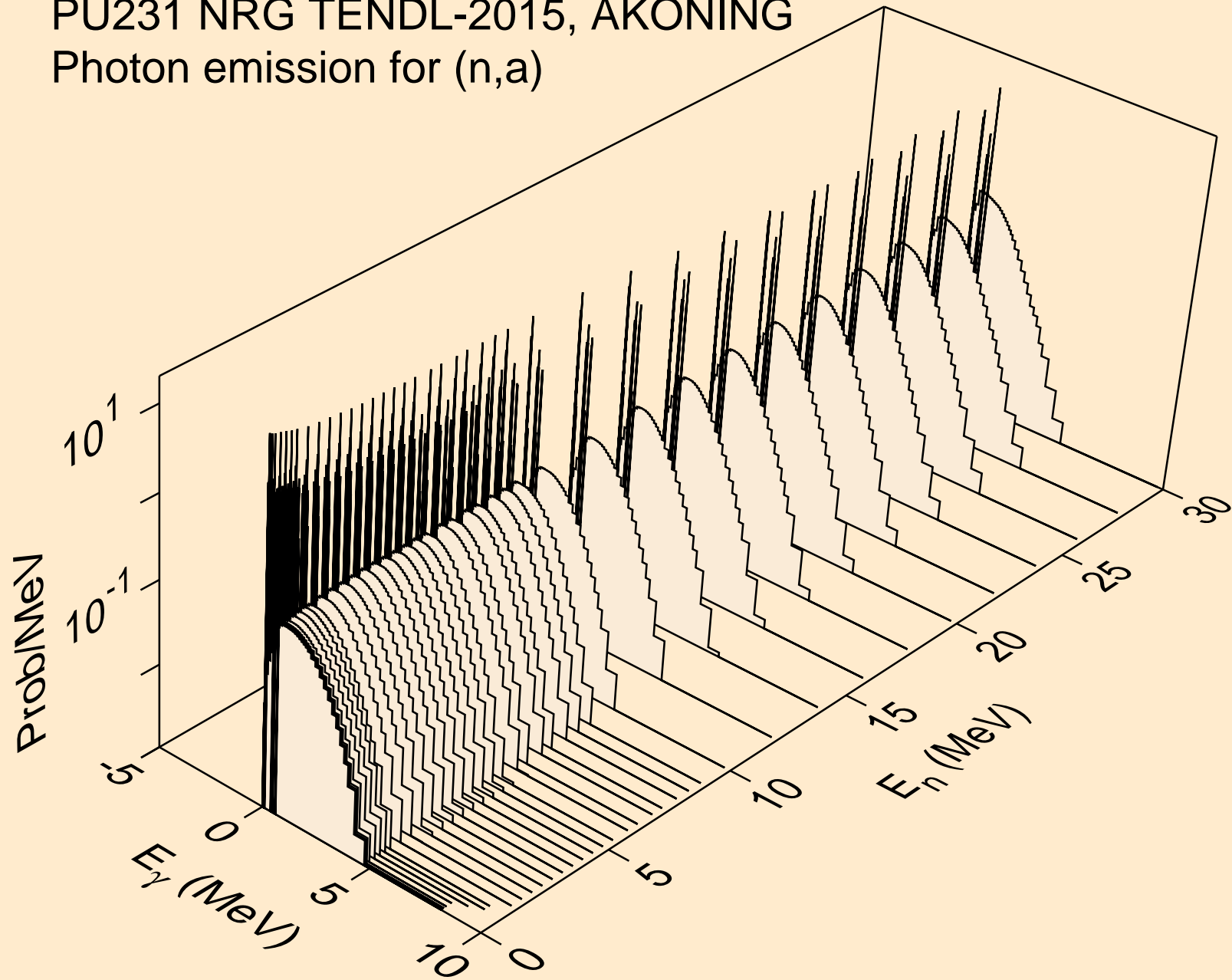

PU231 NRG TENDL-2015, AKONING  
Photon emission for (n,2a)

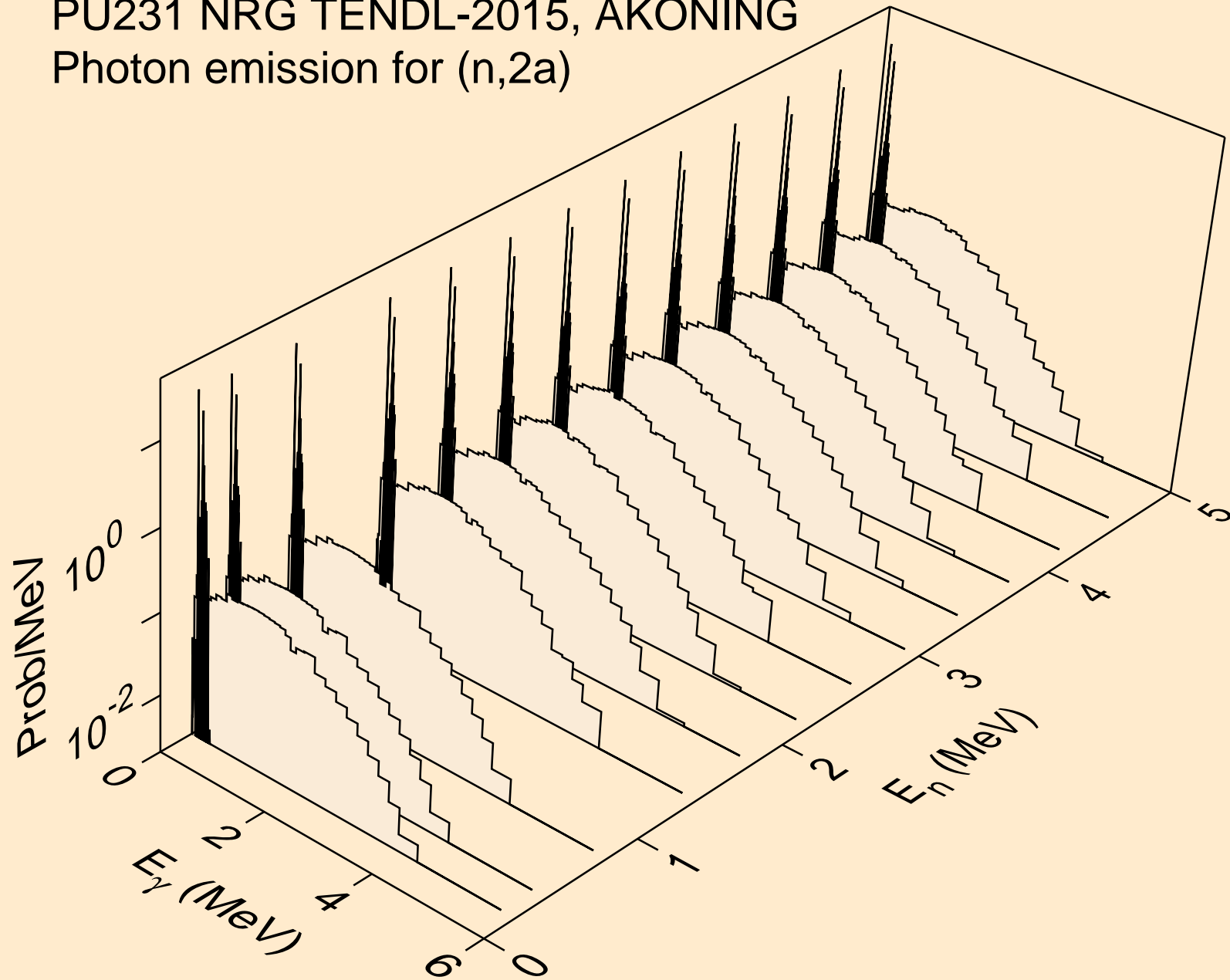



PU231 NRG TENDL-2015, AKONING  
Photon emission for (n,3a)

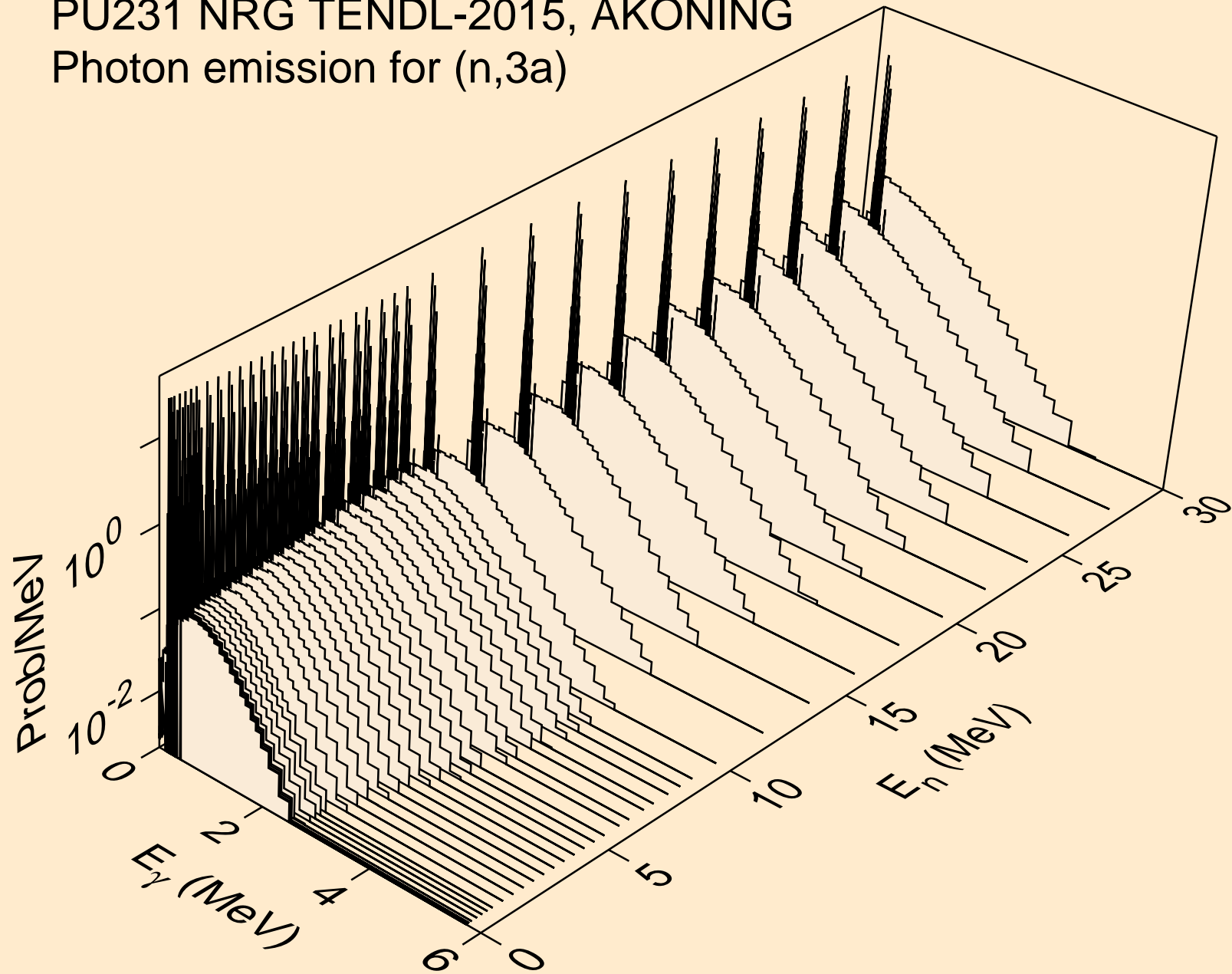

PU231 NRG TENDL-2015, AKONING  
Photon emission for (n,2p)

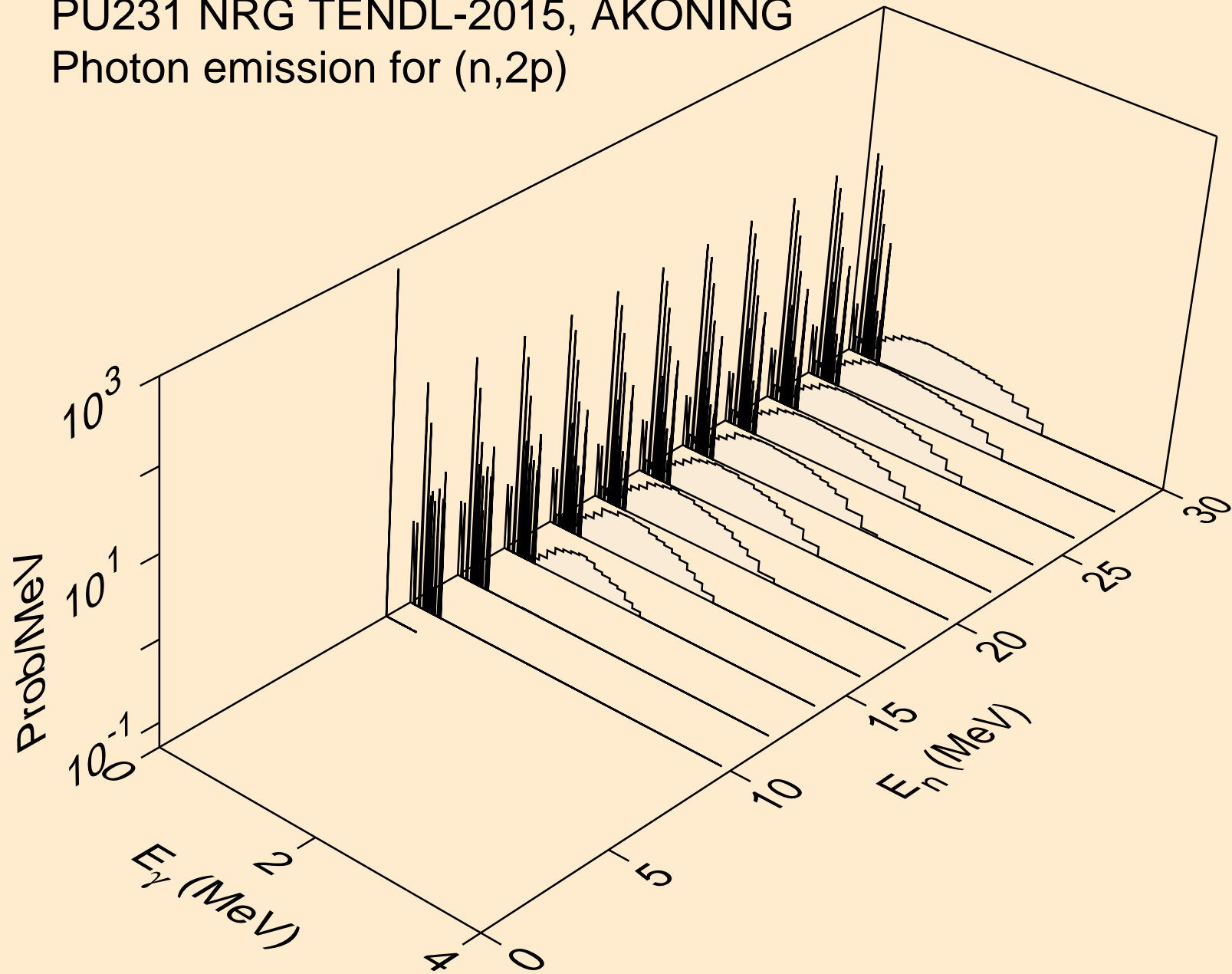

PU231 NRG TENDL-2015, AKONING  
Photon emission for (n,pa)

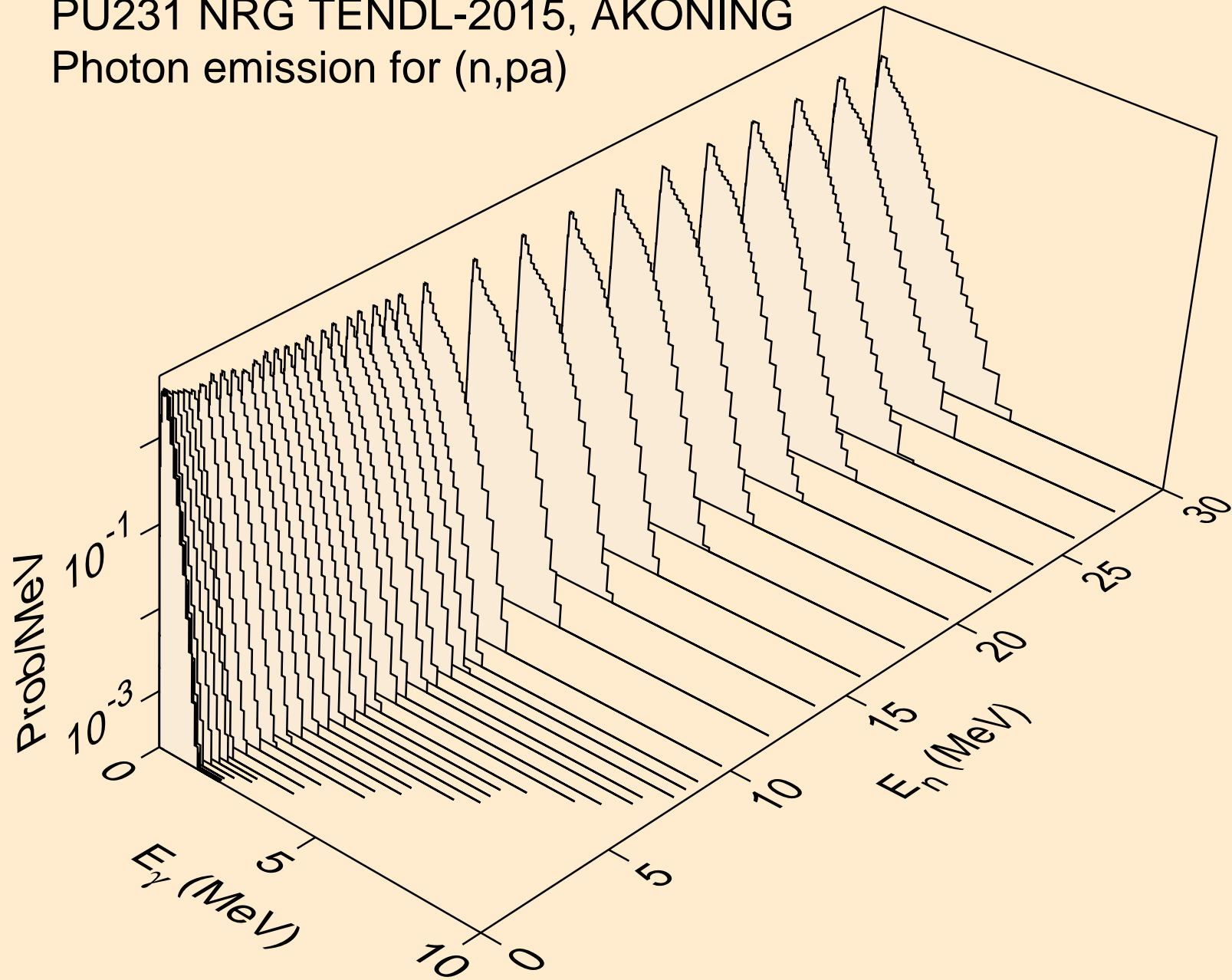

PU231 NRG TENDL-2015, AKONING  
Photon emission for (n,t2a)

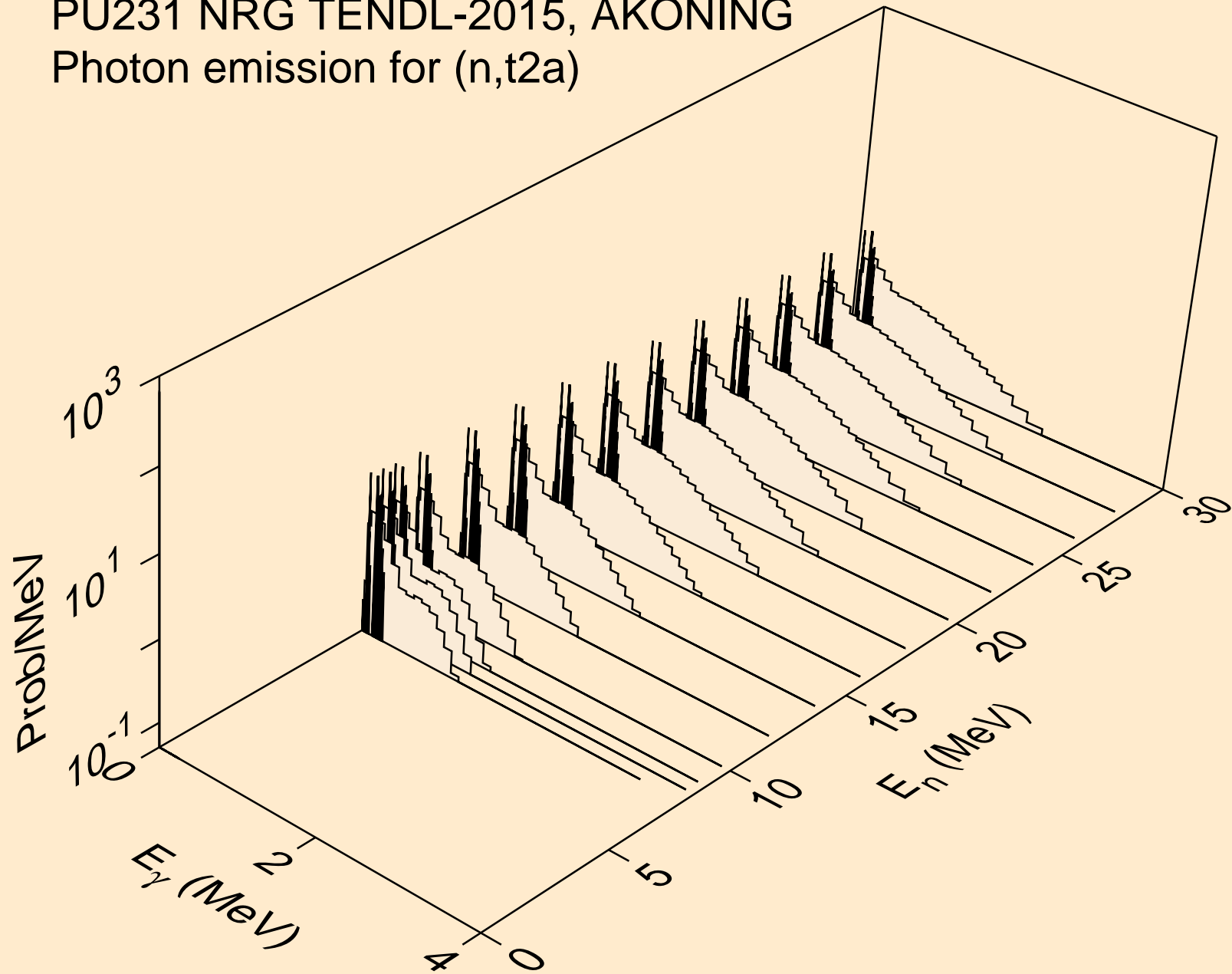

PU231 NRG TENDL-2015, AKONING  
Photon emission for (n,d2a)

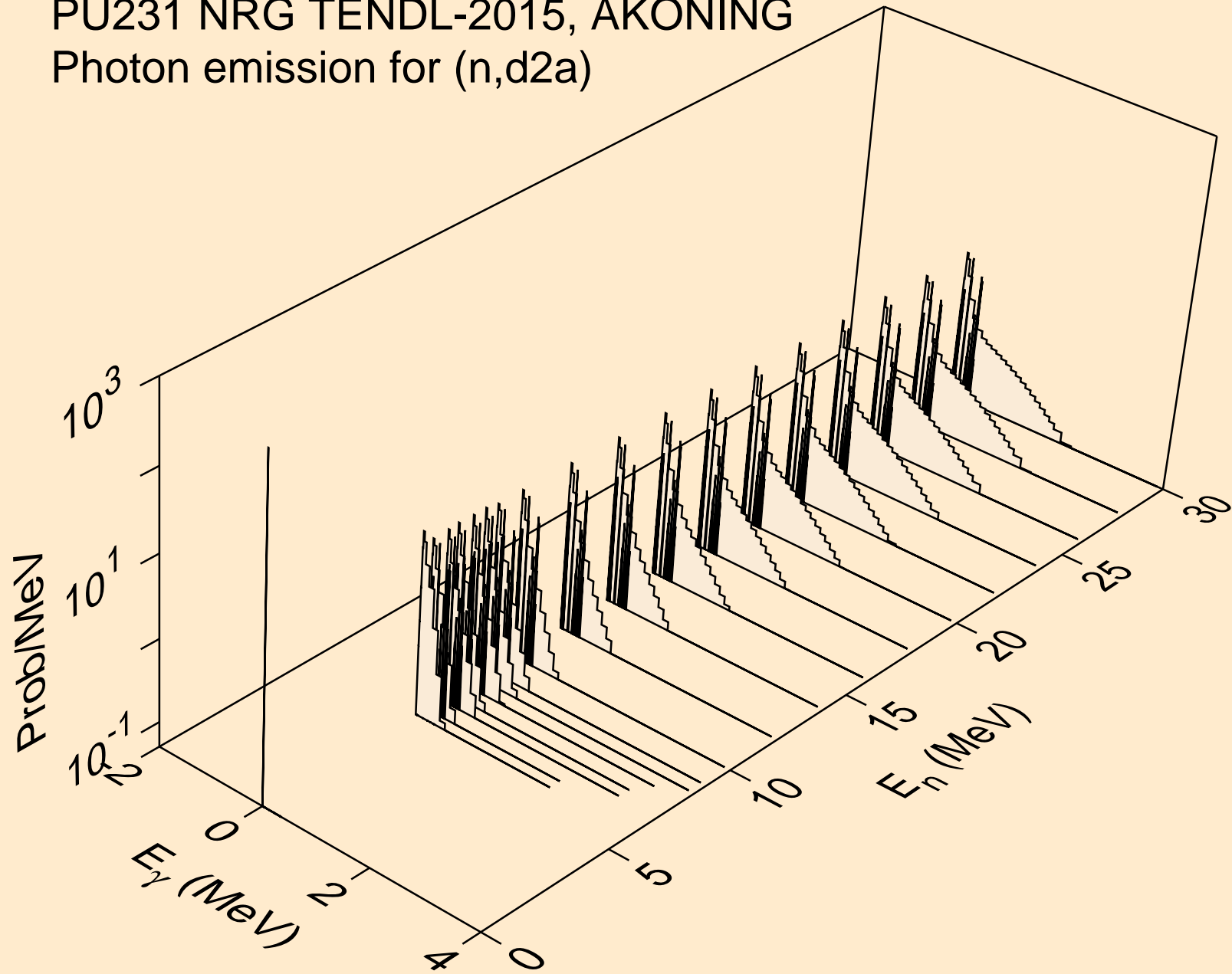

PU231 NRG TENDL-2015, AKONING  
Photon emission for (n,pd)

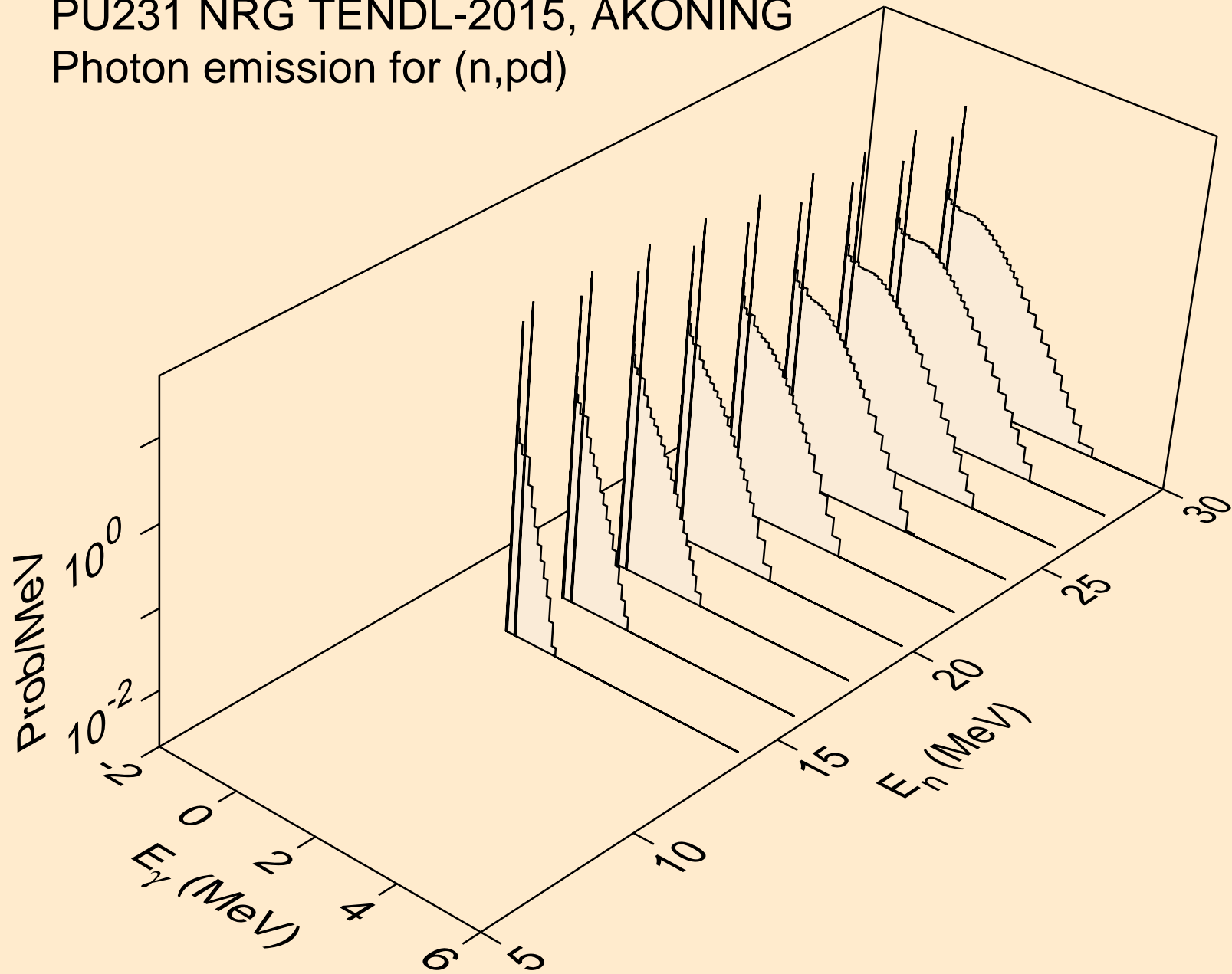

PU231 NRG TENDL-2015, AKONING  
Photon emission for (n,pt)

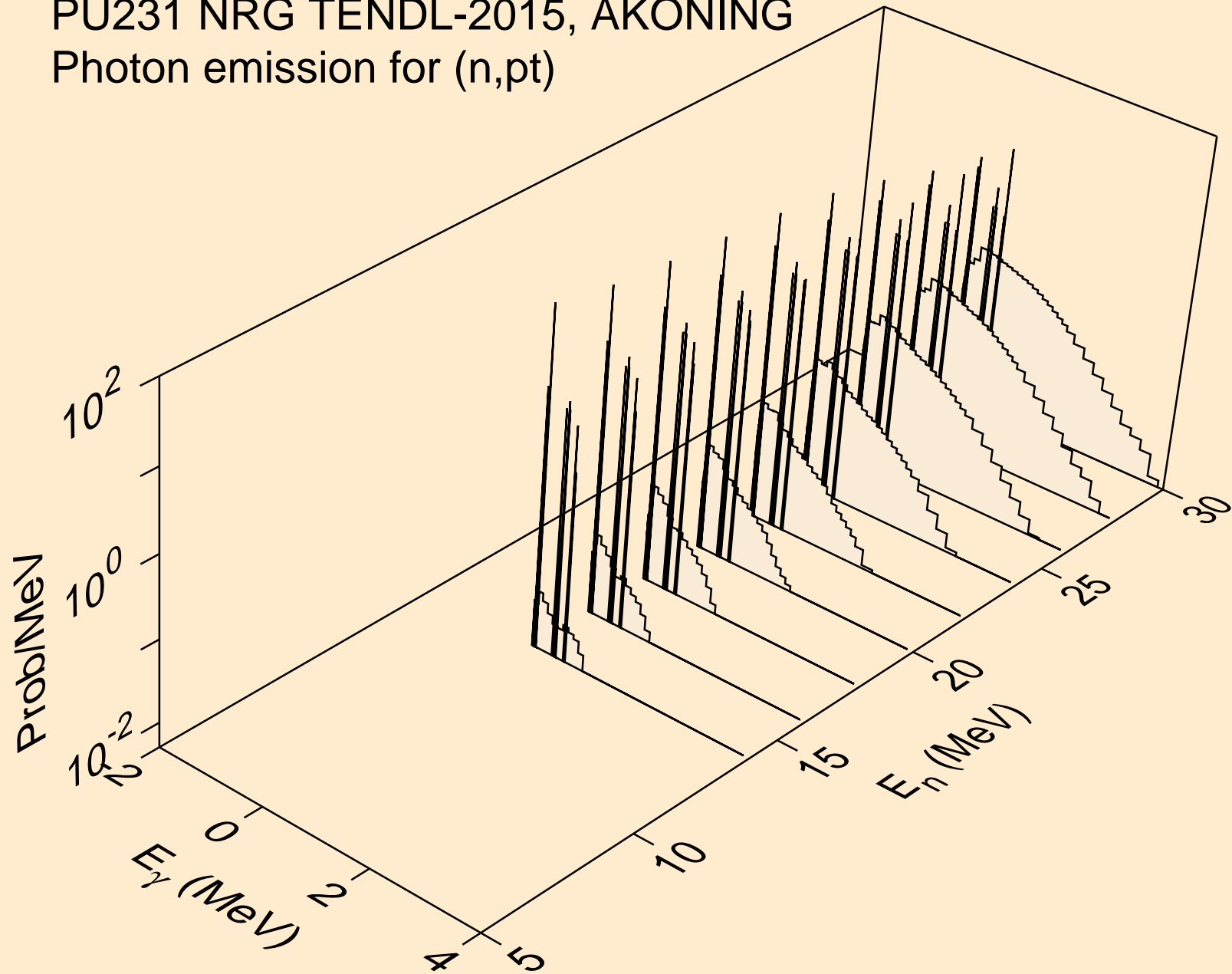

PU231 NRG TENDL-2015, AKONING  
Photon emission for (n,da)

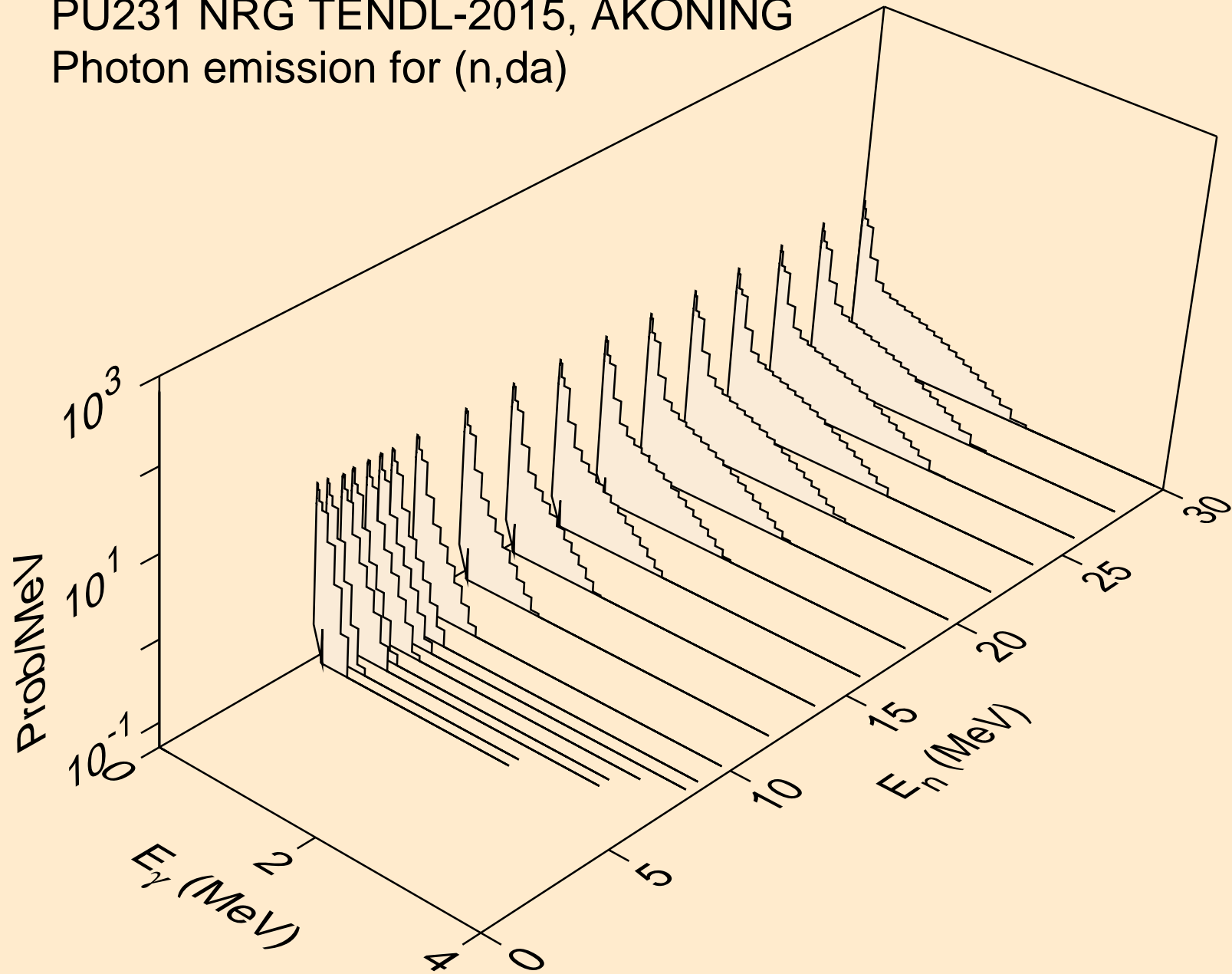



PU231 NRG TENDL-2015, AKONING  
thermal capture photon spectrum

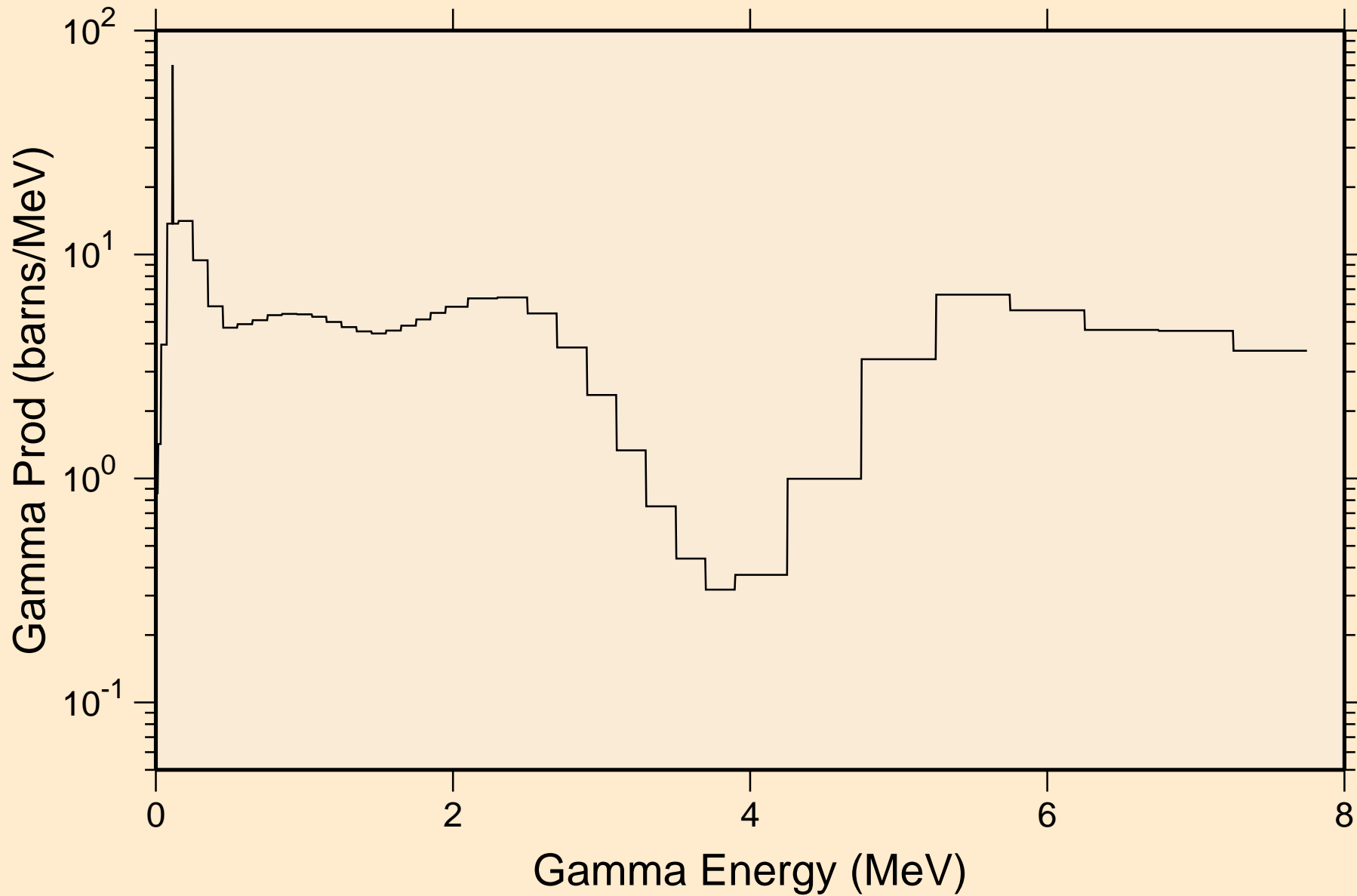

PU231 NRG TENDL-2015, AKONING  
14 MeV photon spectrum

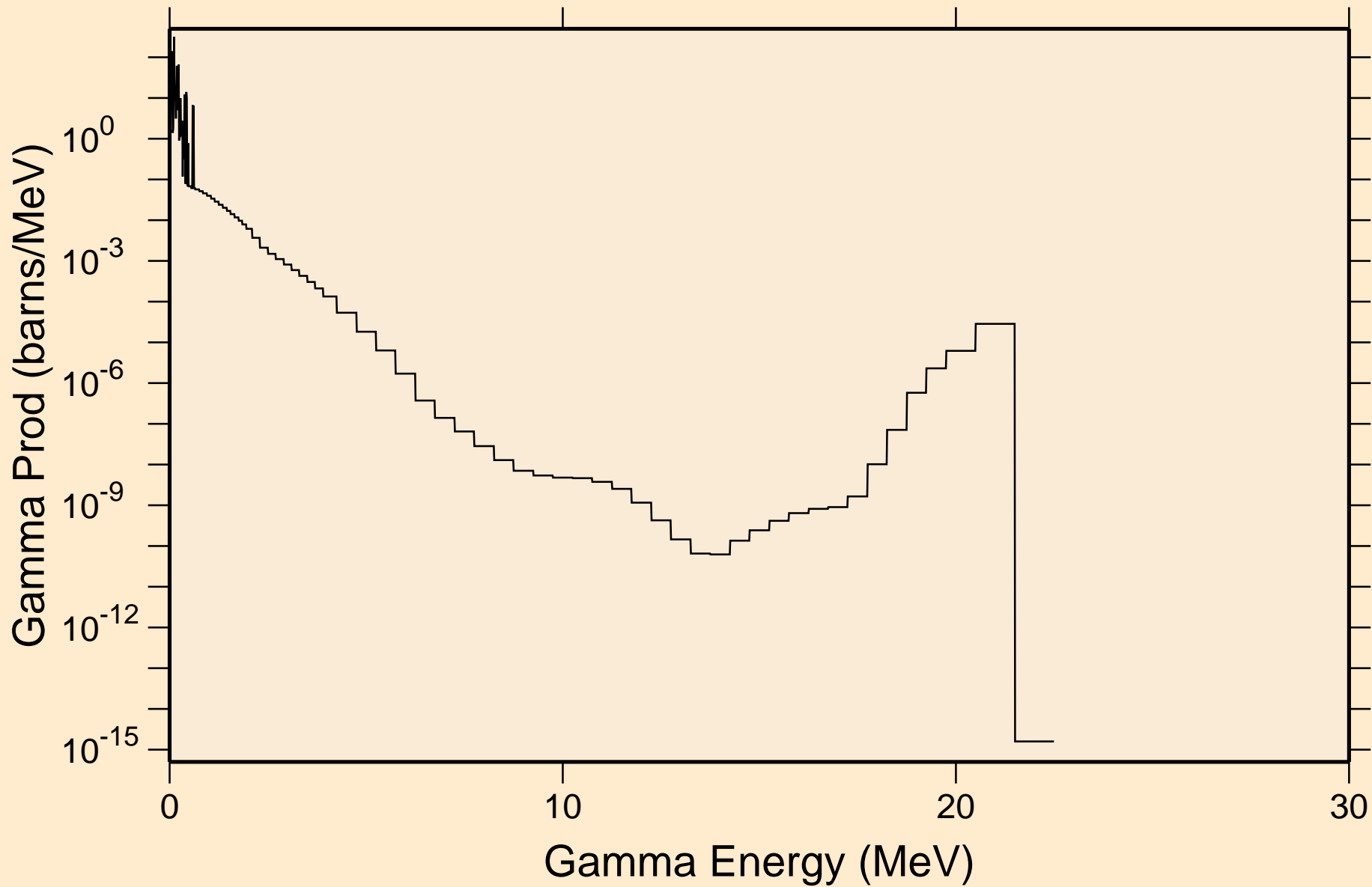

# PU231 NRG TENDL-2015, AKONING

## Particle heating contributions

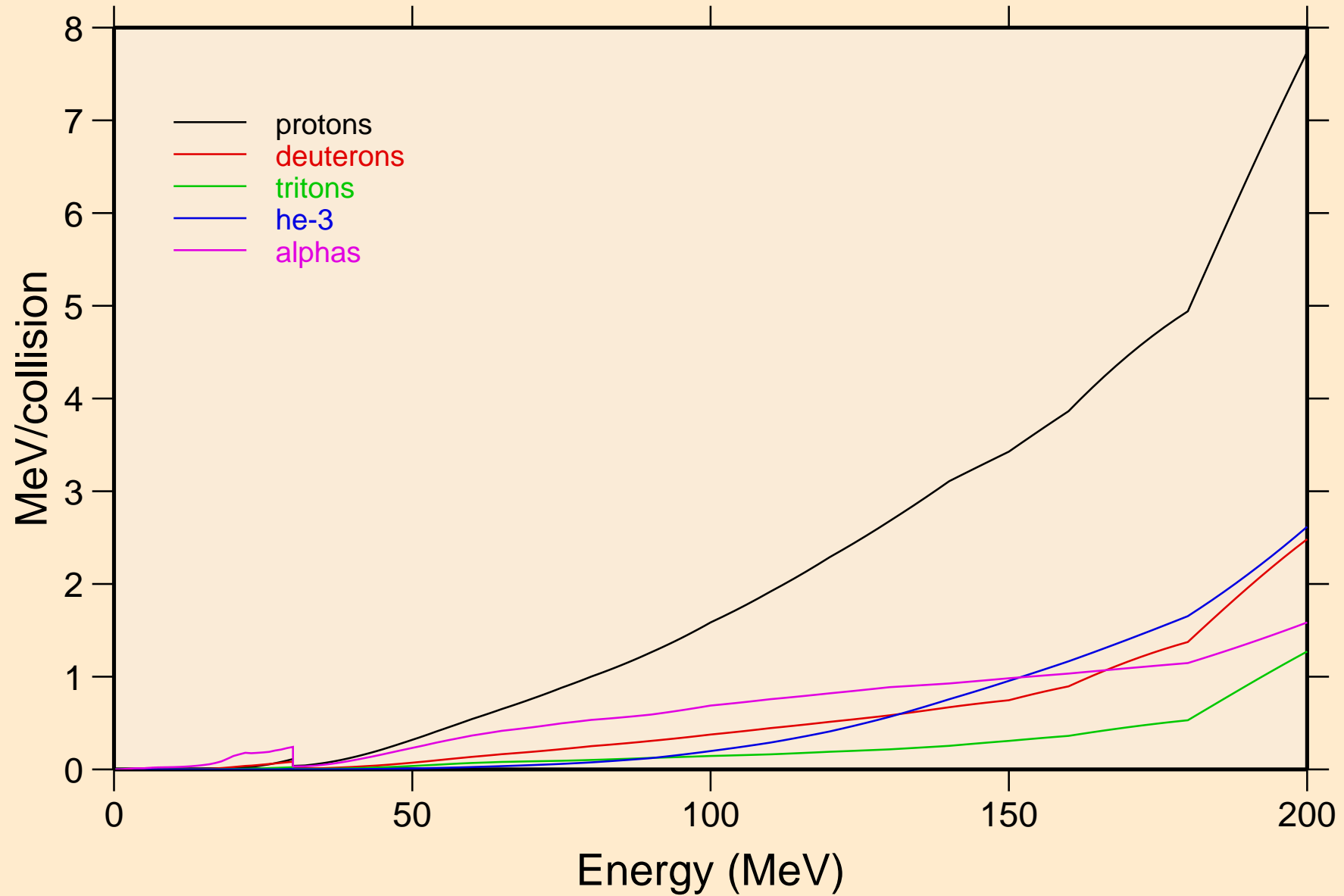

# PU231 NRG TENDL-2015, AKONING

## Recoil Heating

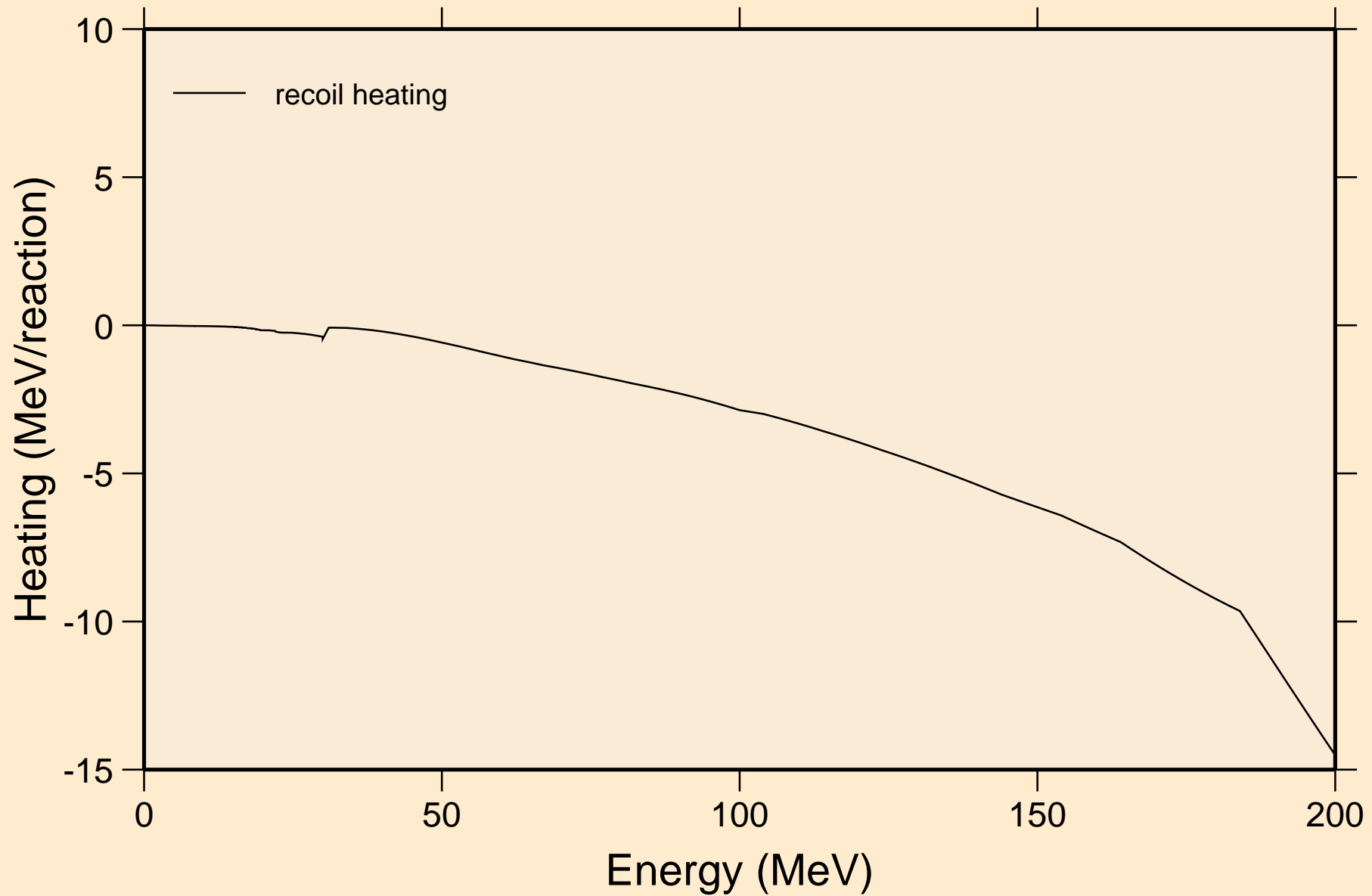

# PU231 NRG TENDL-2015, AKONING

## Particle production cross sections

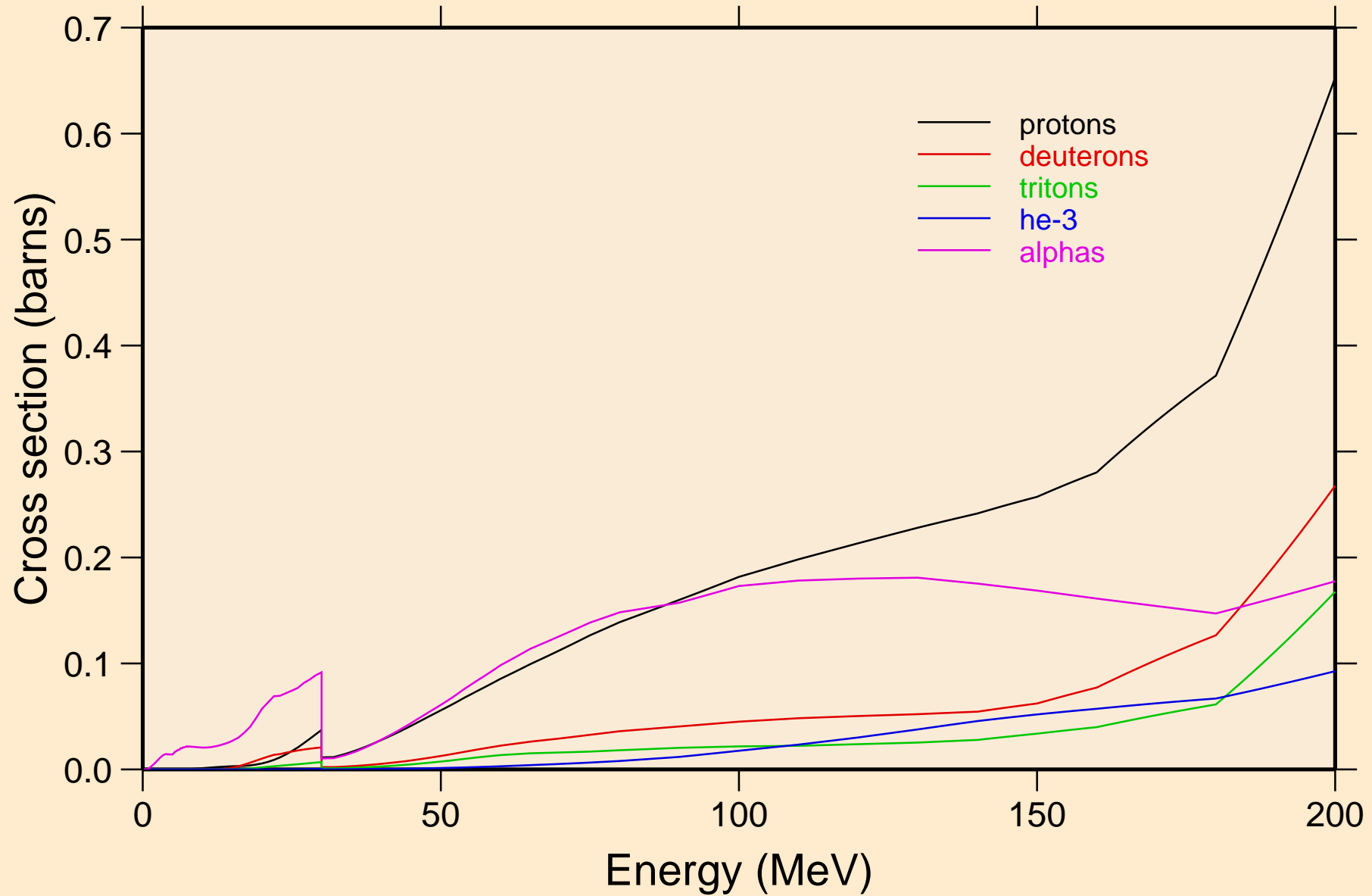

PU231 NRG TENDL-2015, AKONING  
protons from (n,x)

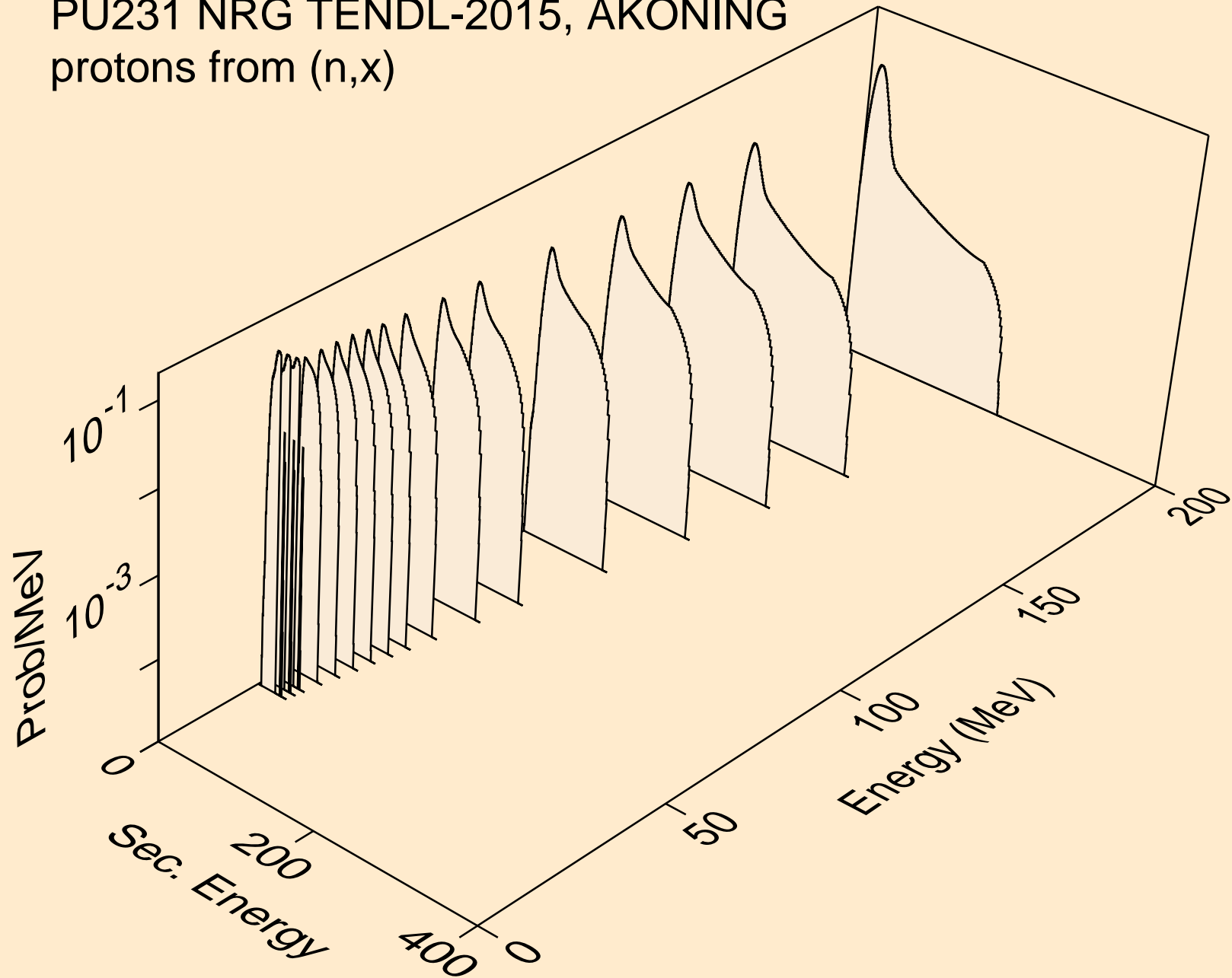

PU231 NRG TENDL-2015, AKONING  
protons from (n,n\*)p

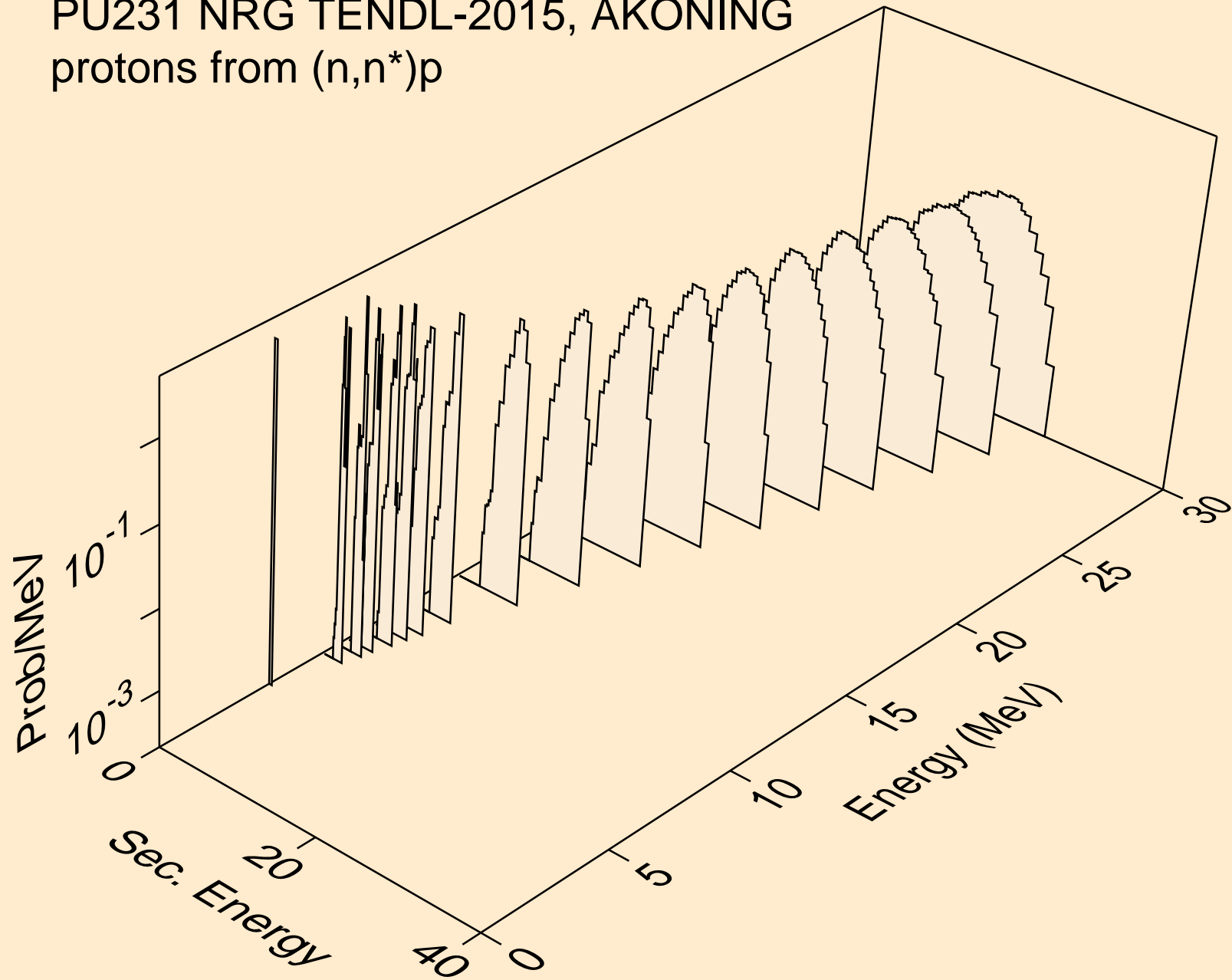

PU231 NRG TENDL-2015, AKONING  
protons from (n,2np)

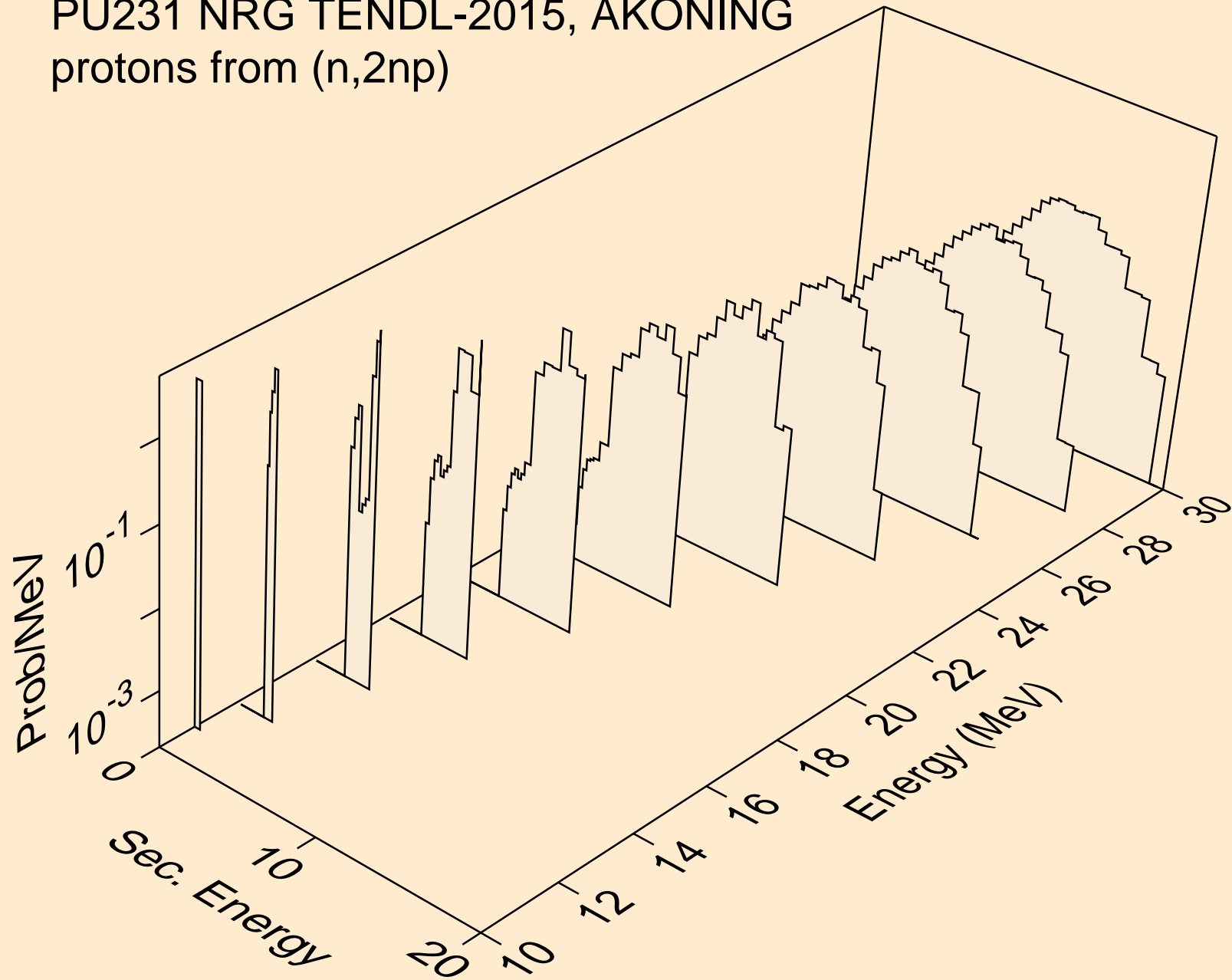



PU231 NRG TENDL-2015, AKONING  
protons from (n,3np)

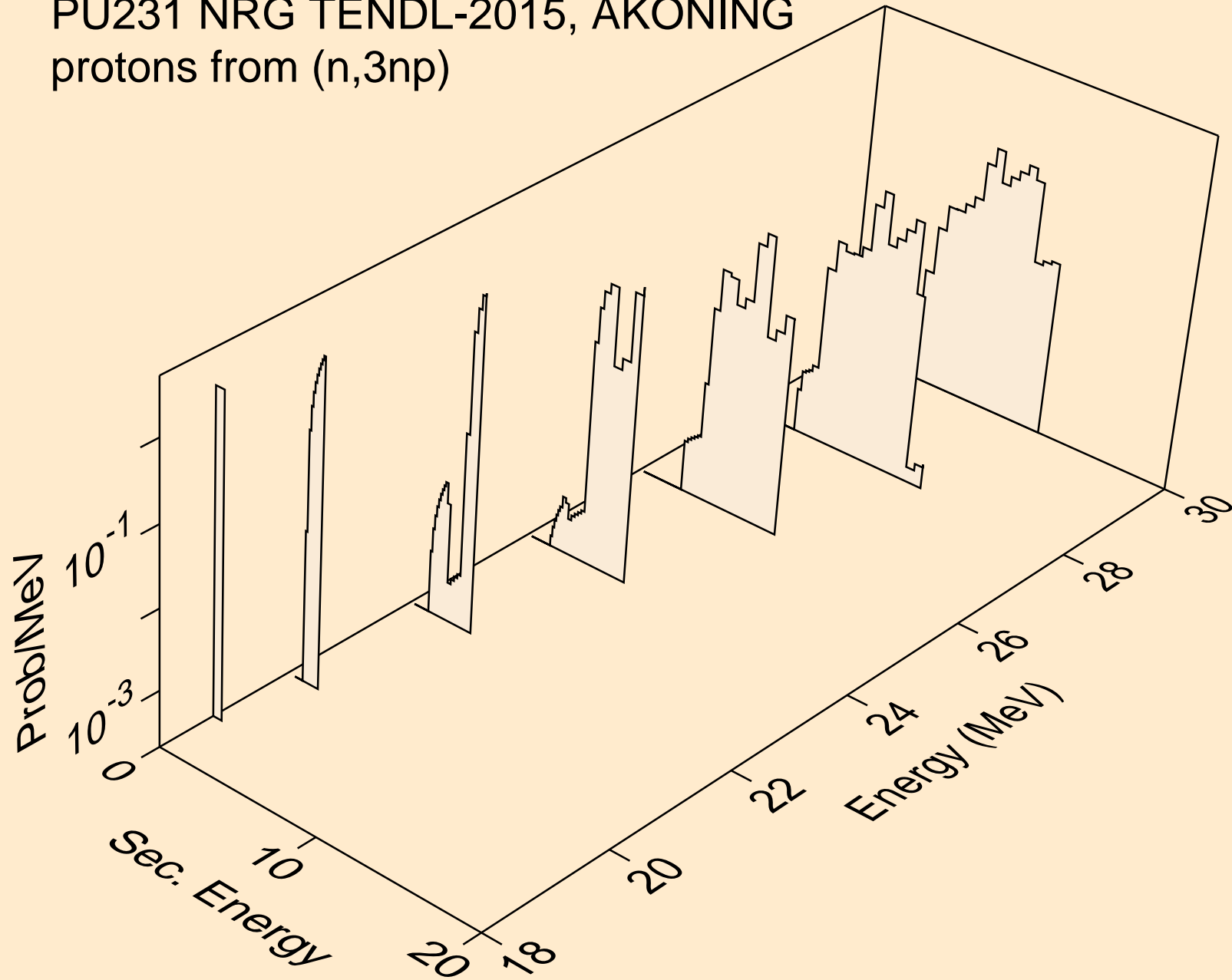

PU231 NRG TENDL-2015, AKONING  
protons from (n,2np)

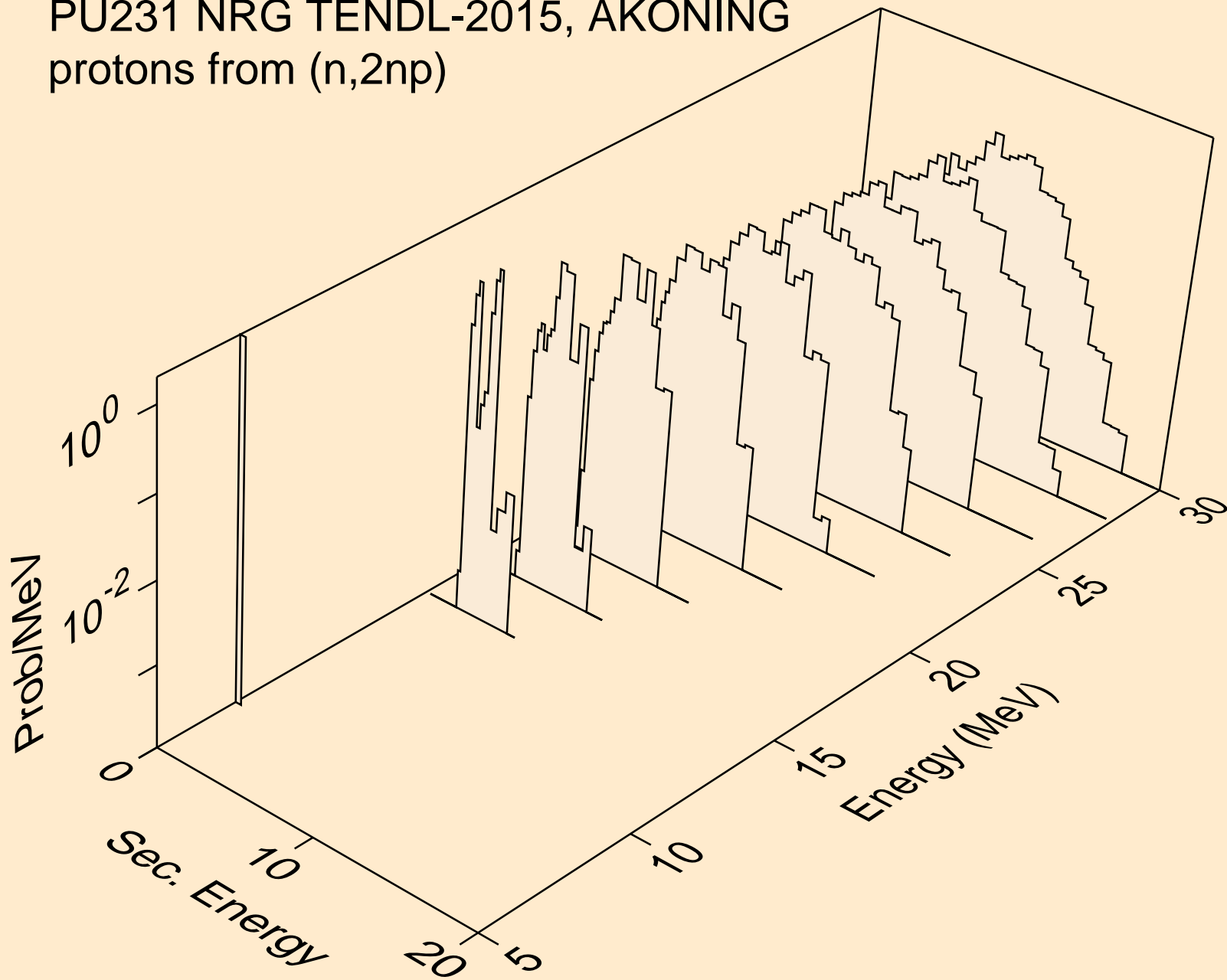

PU231 NRG TENDL-2015, AKONING  
protons from (n,npa)

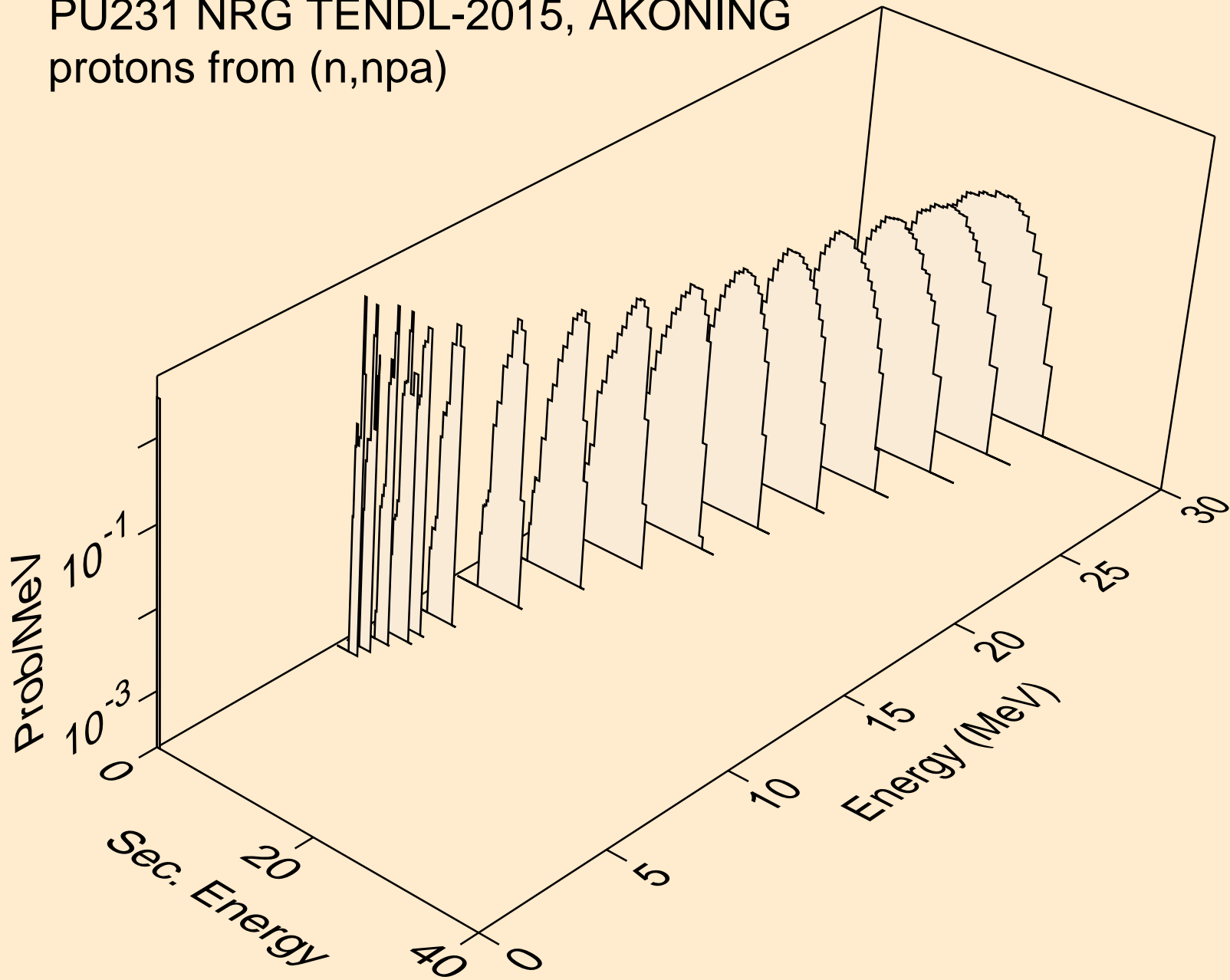

PU231 NRG TENDL-2015, AKONING  
protons from (n,p)

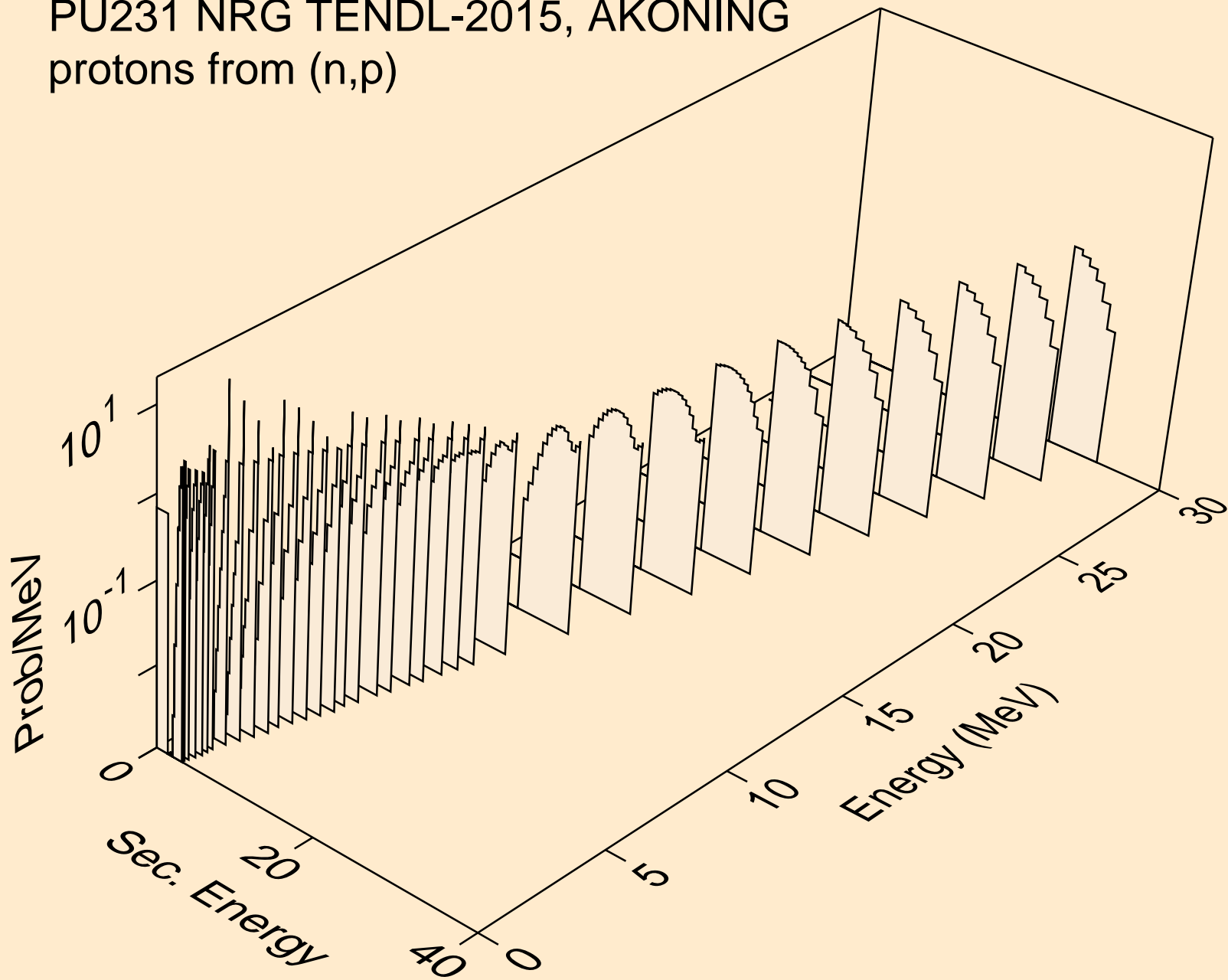

PU231 NRG TENDL-2015, AKONING  
protons from (n,2p)

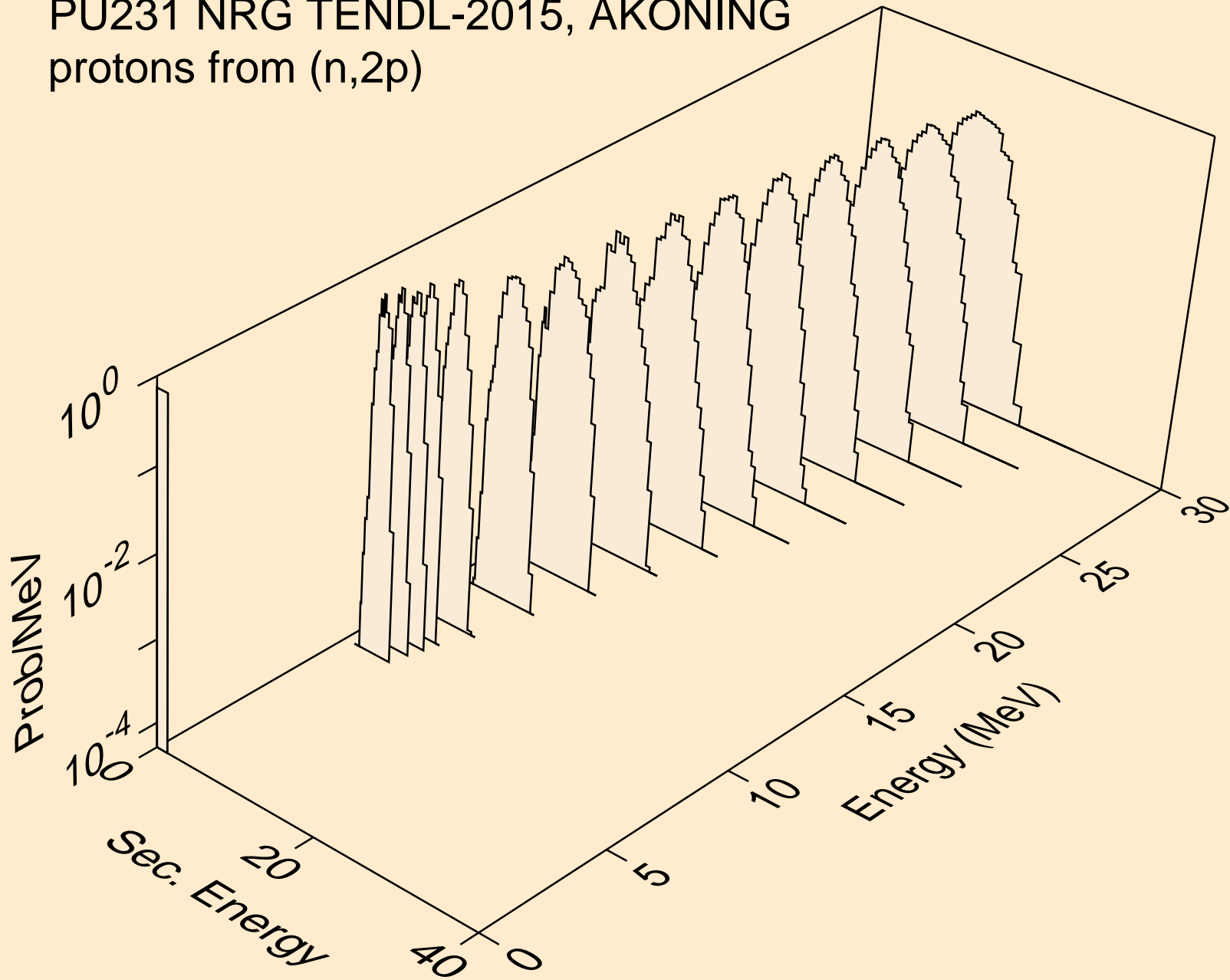

PU231 NRG TENDL-2015, AKONING  
protons from (n,pa)

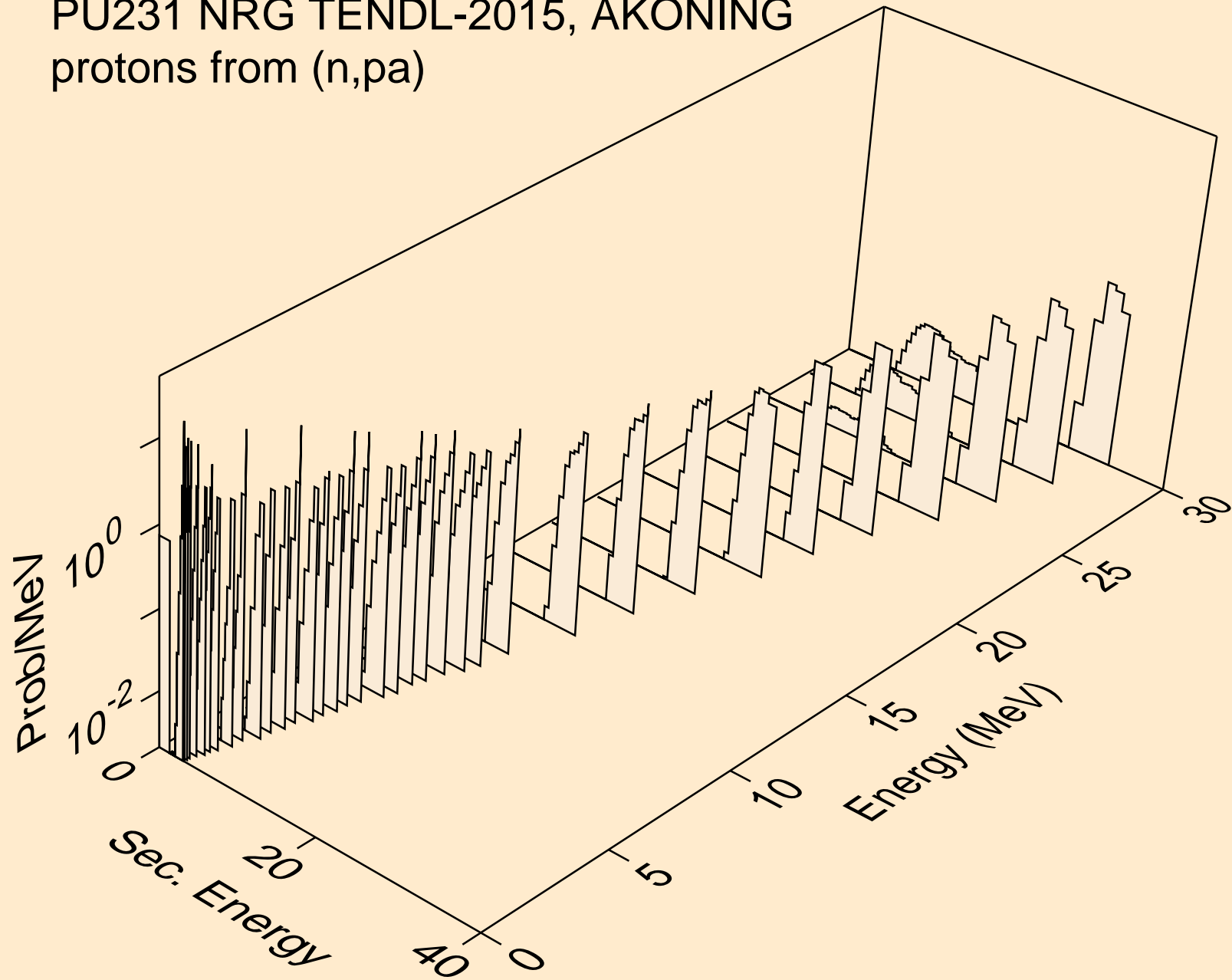

PU231 NRG TENDL-2015, AKONING  
protons from (n,pd)

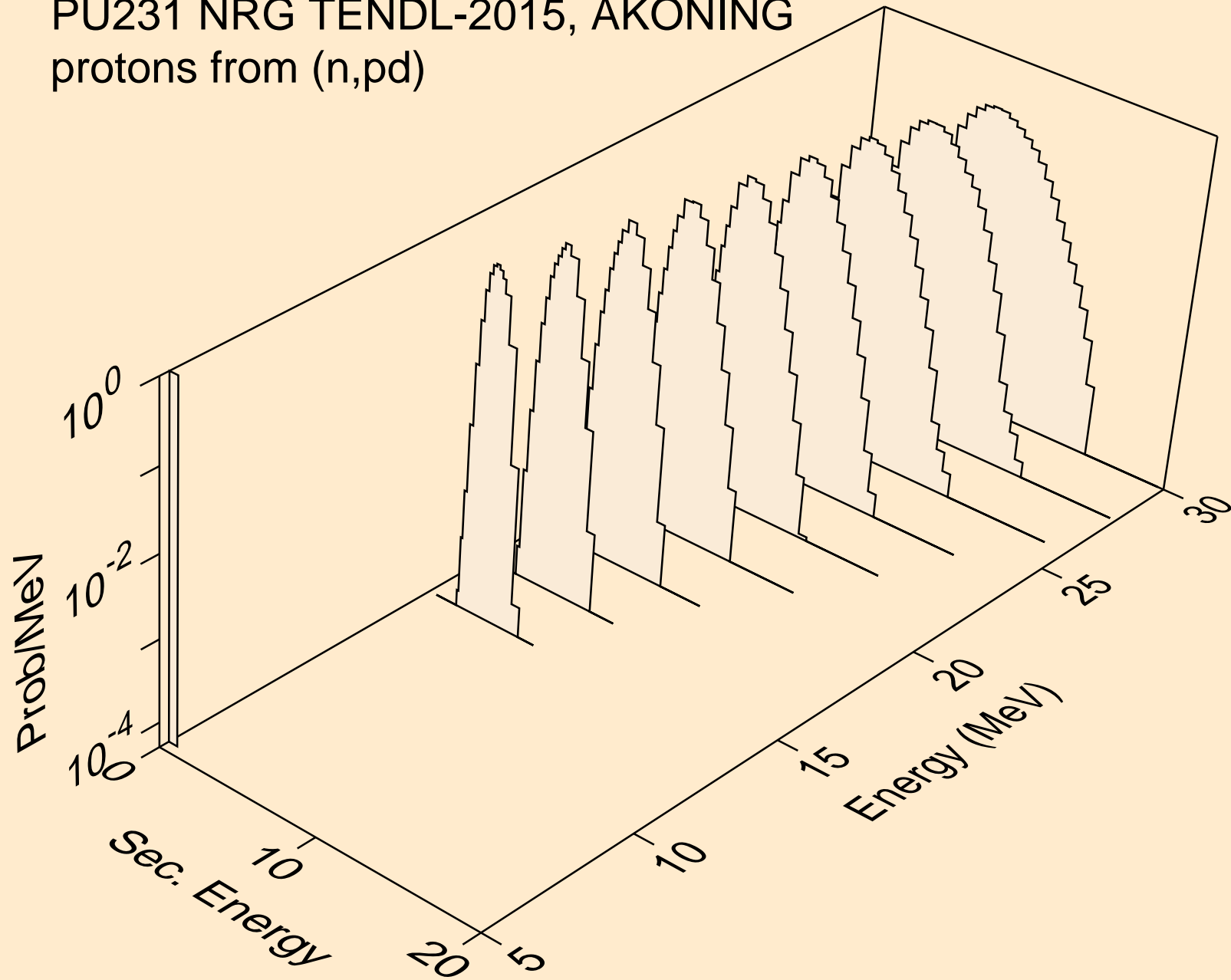

PU231 NRG TENDL-2015, AKONING  
protons from (n,pt)

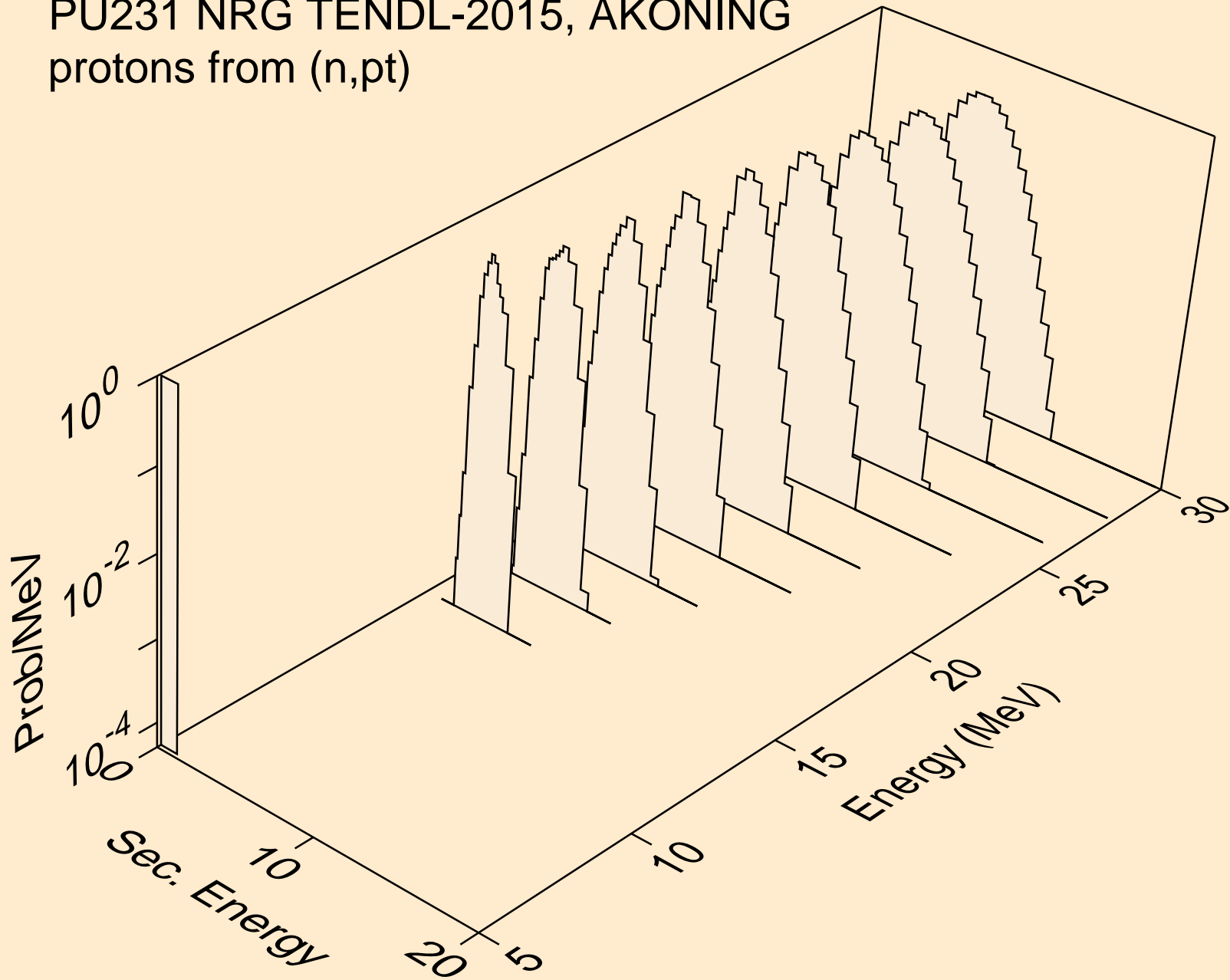



PU231 NRG TENDL-2015, AKONING  
deuterons from (n,x)

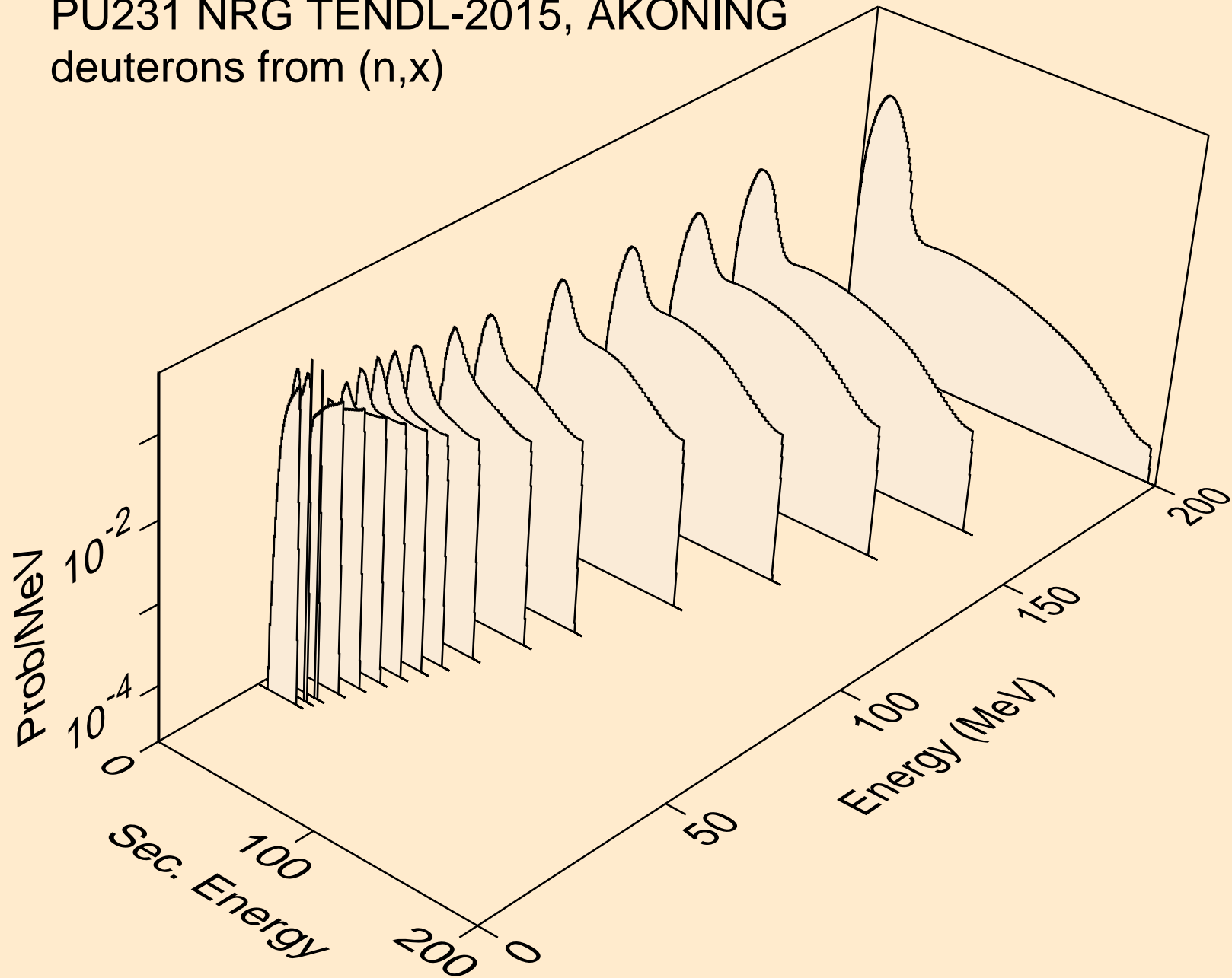

PU231 NRG TENDL-2015, AKONING  
deuterons from (n,2nd)

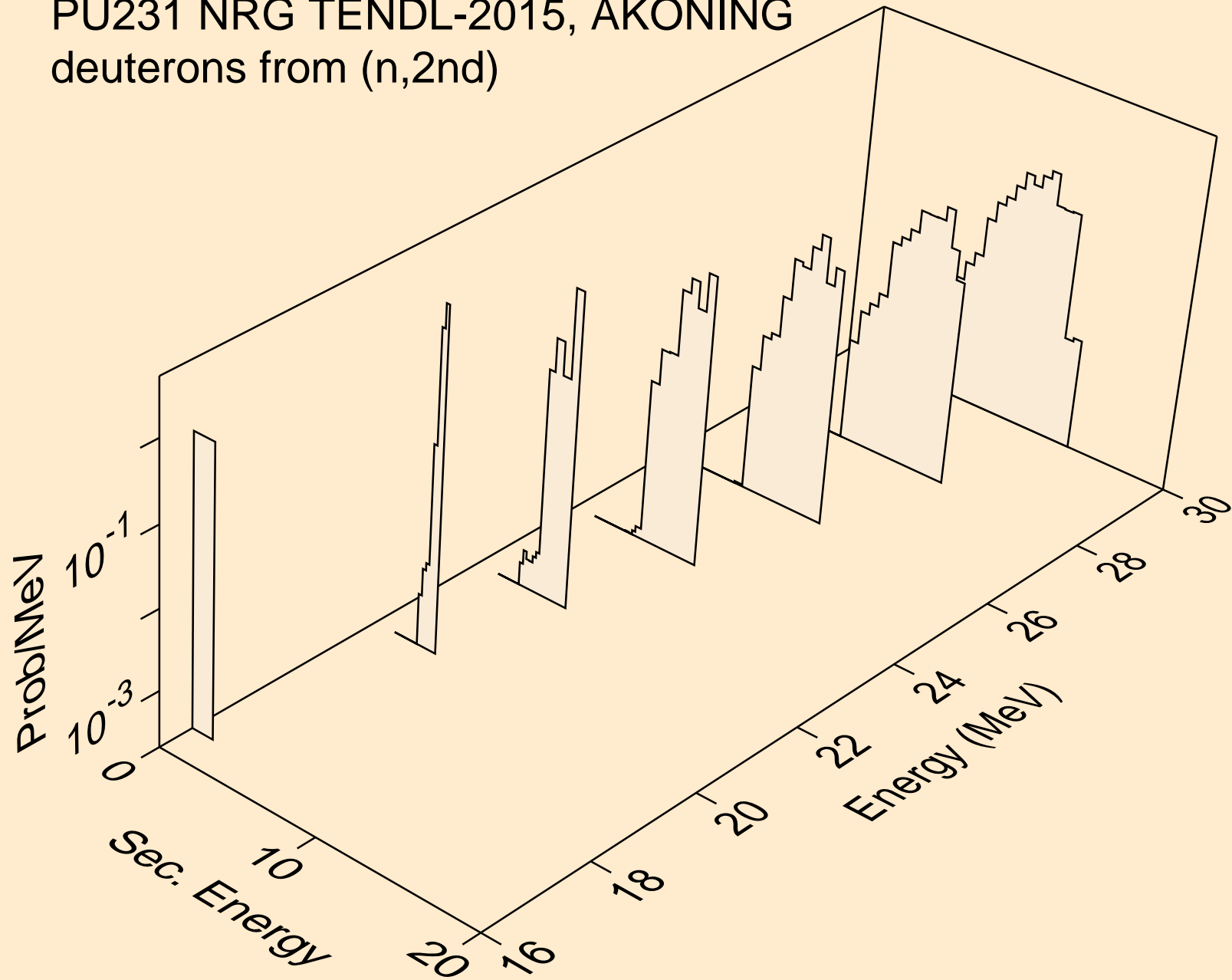

PU231 NRG TENDL-2015, AKONING  
deuterons from (n,n\*)d

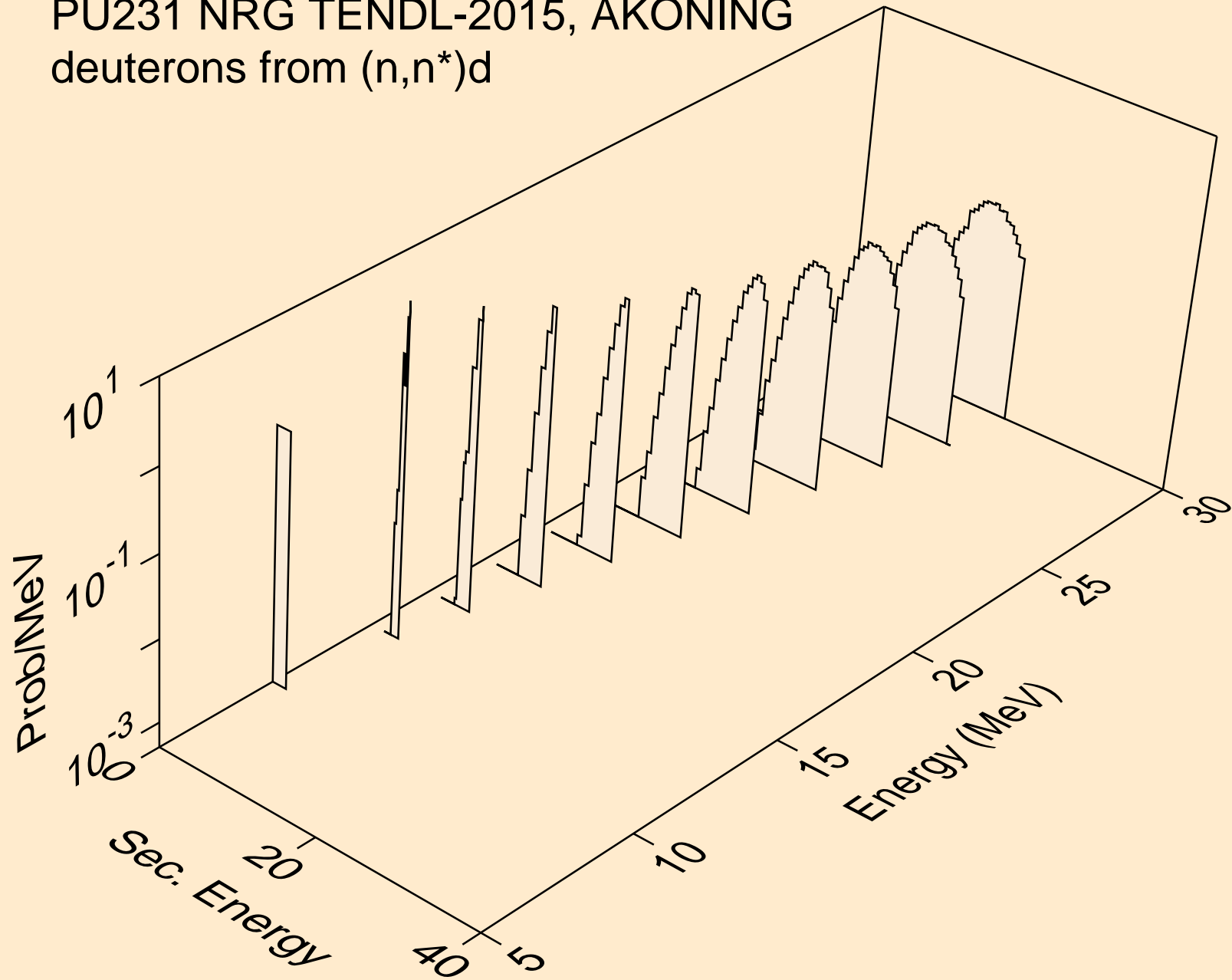

PU231 NRG TENDL-2015, AKONING  
deuterons from (n,n\*)d2a

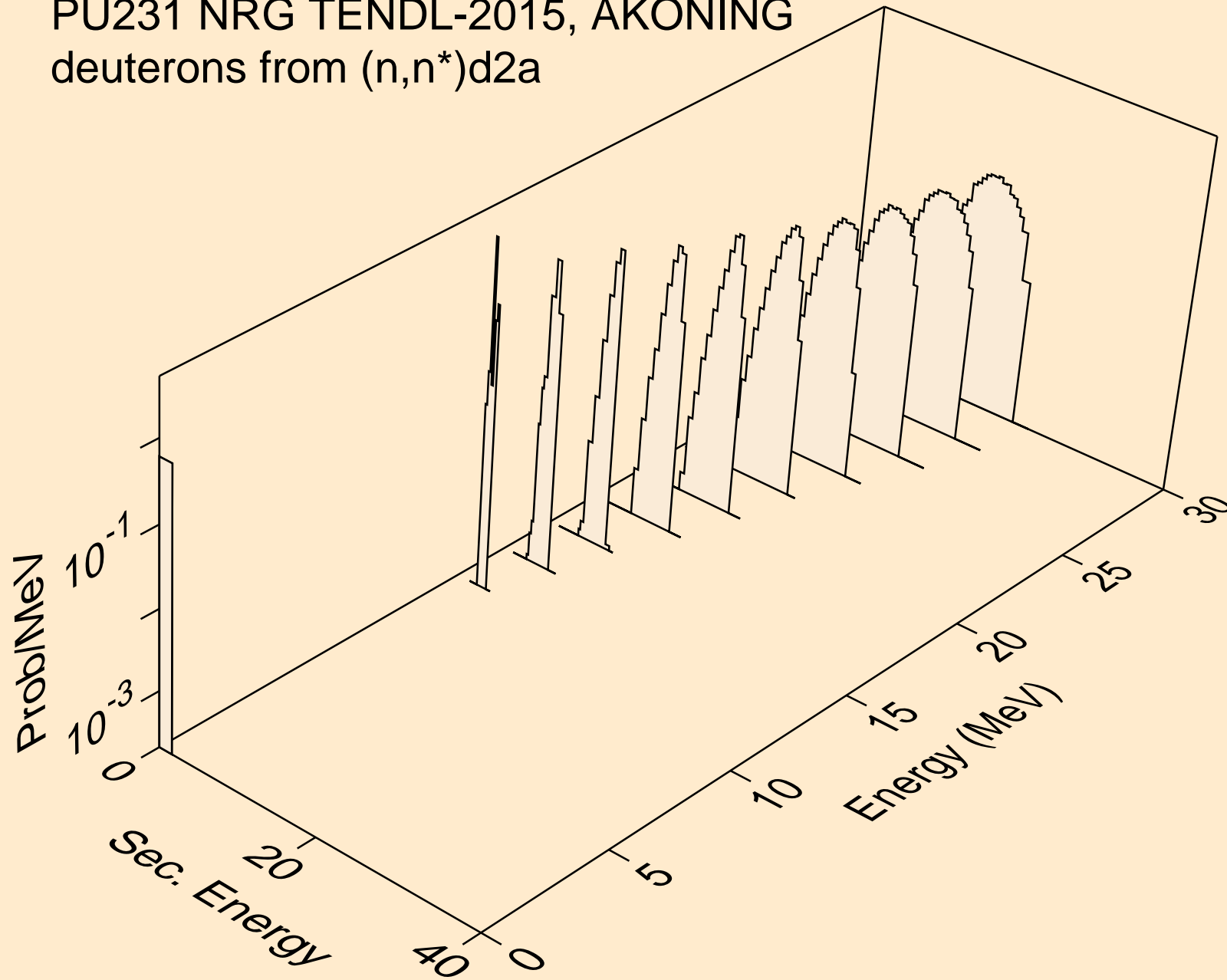

PU231 NRG TENDL-2015, AKONING  
deuterons from (n,d)

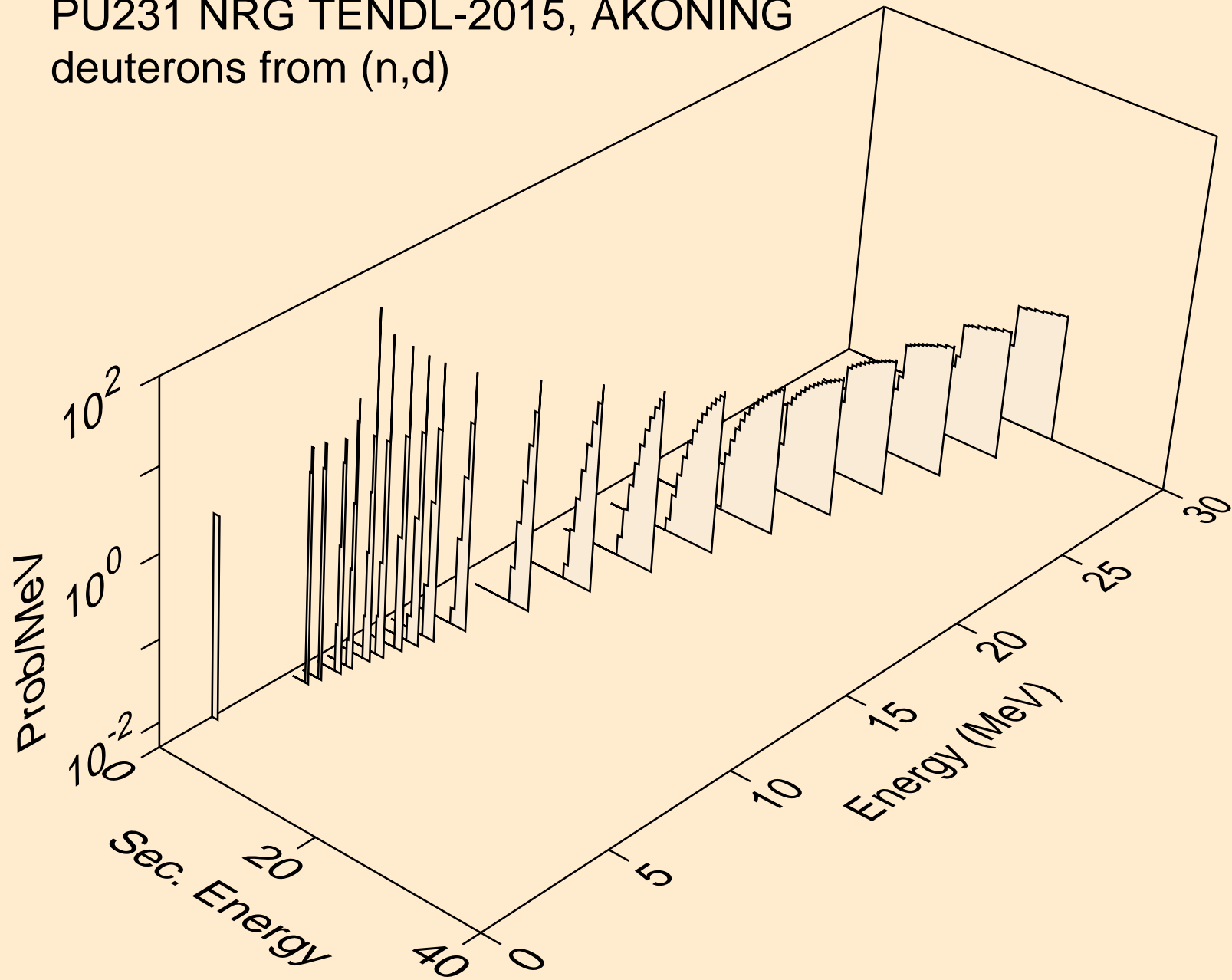

PU231 NRG TENDL-2015, AKONING  
deuterons from (n,d2a)

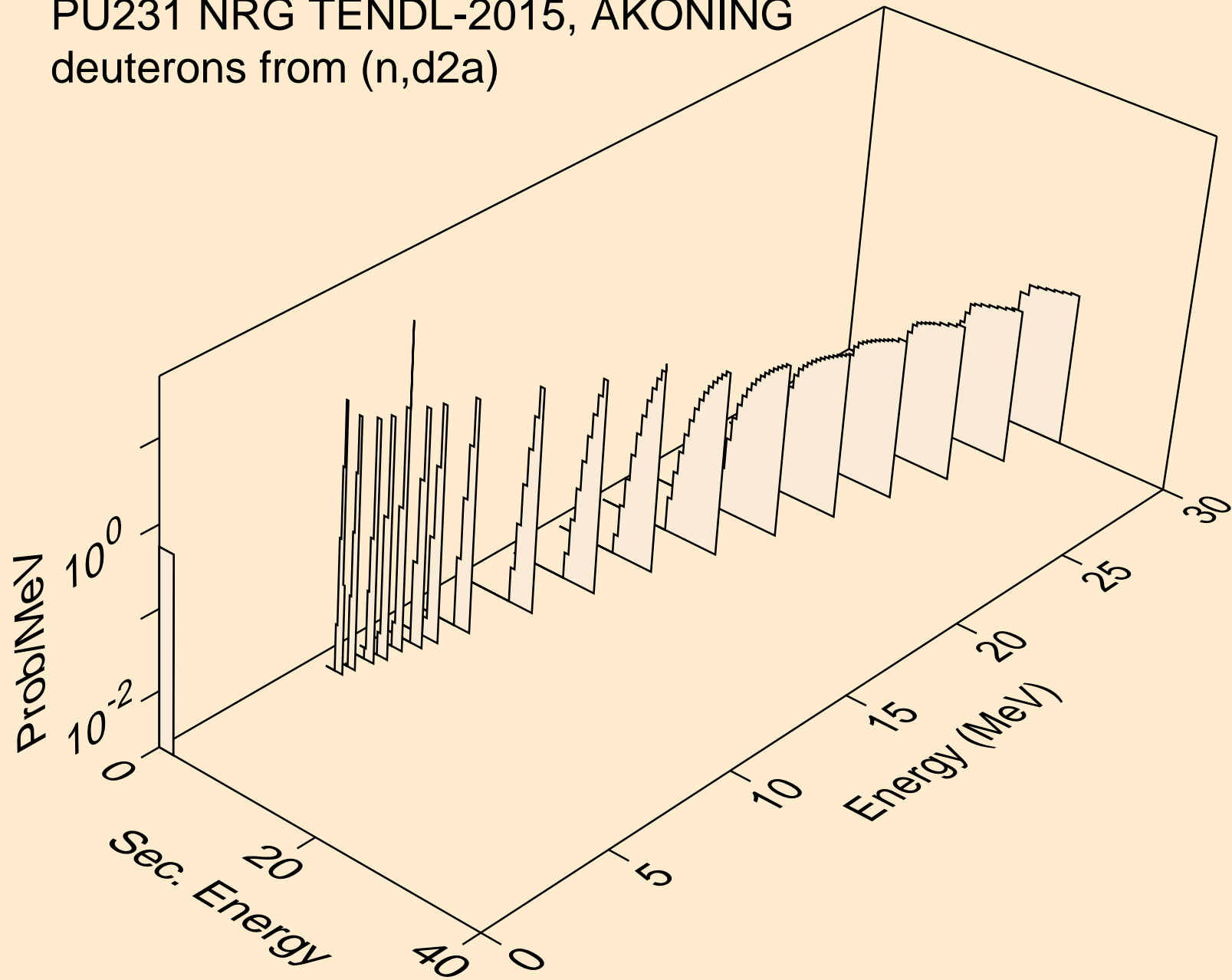

PU231 NRG TENDL-2015, AKONING  
deuterons from (n,pd)

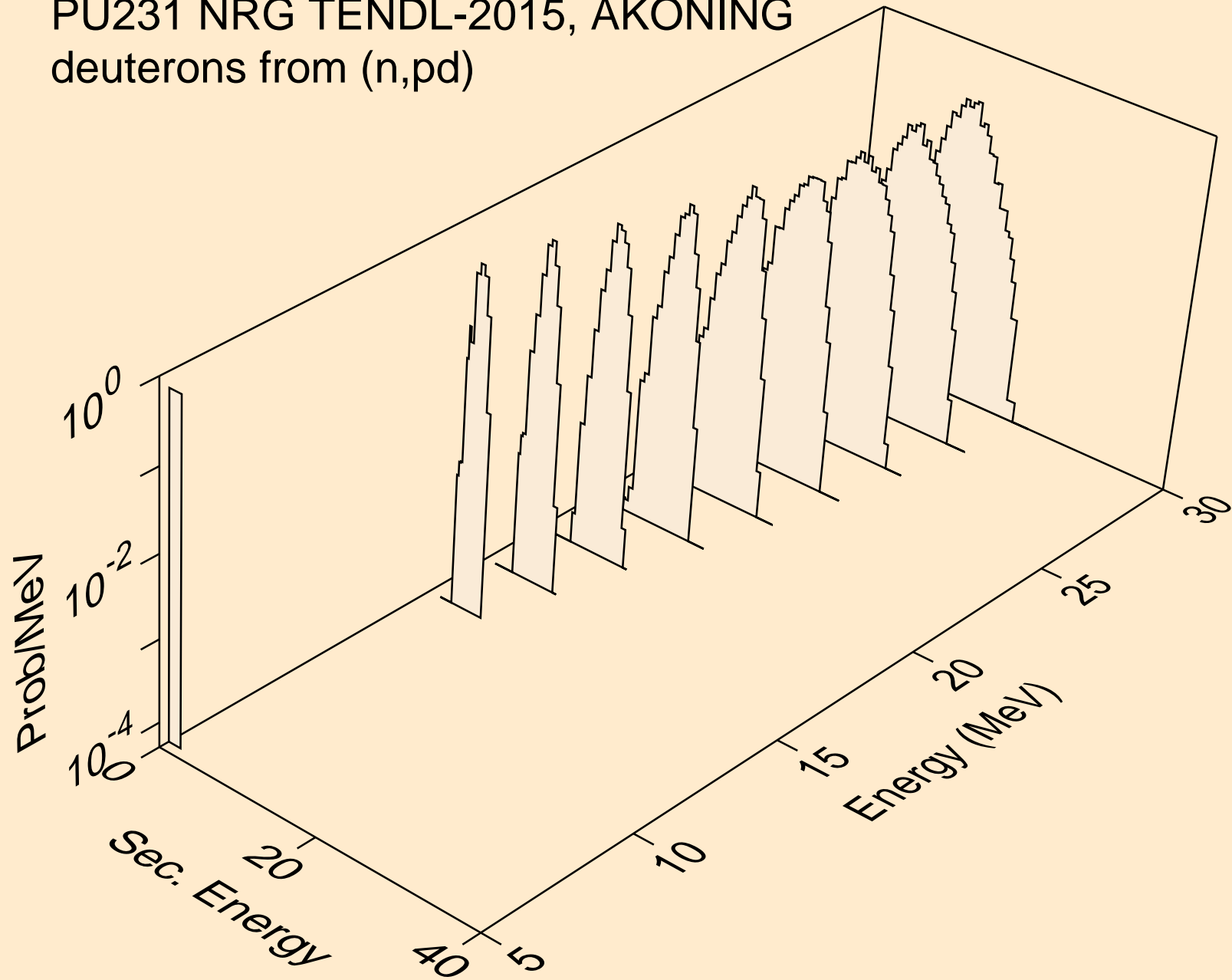

PU231 NRG TENDL-2015, AKONING  
deuterons from (n,da)

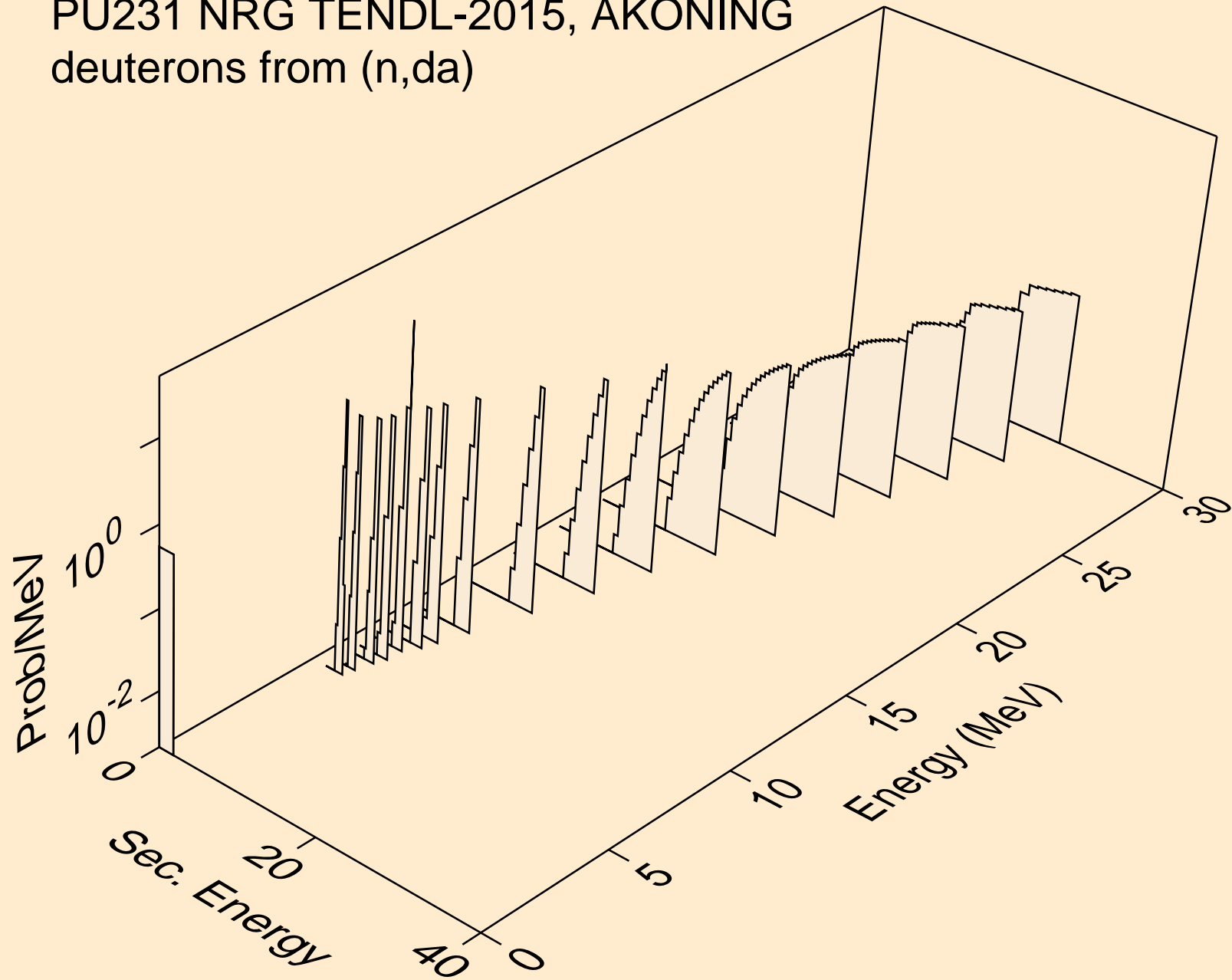



PU231 NRG TENDL-2015, AKONING  
tritons from (n,x)

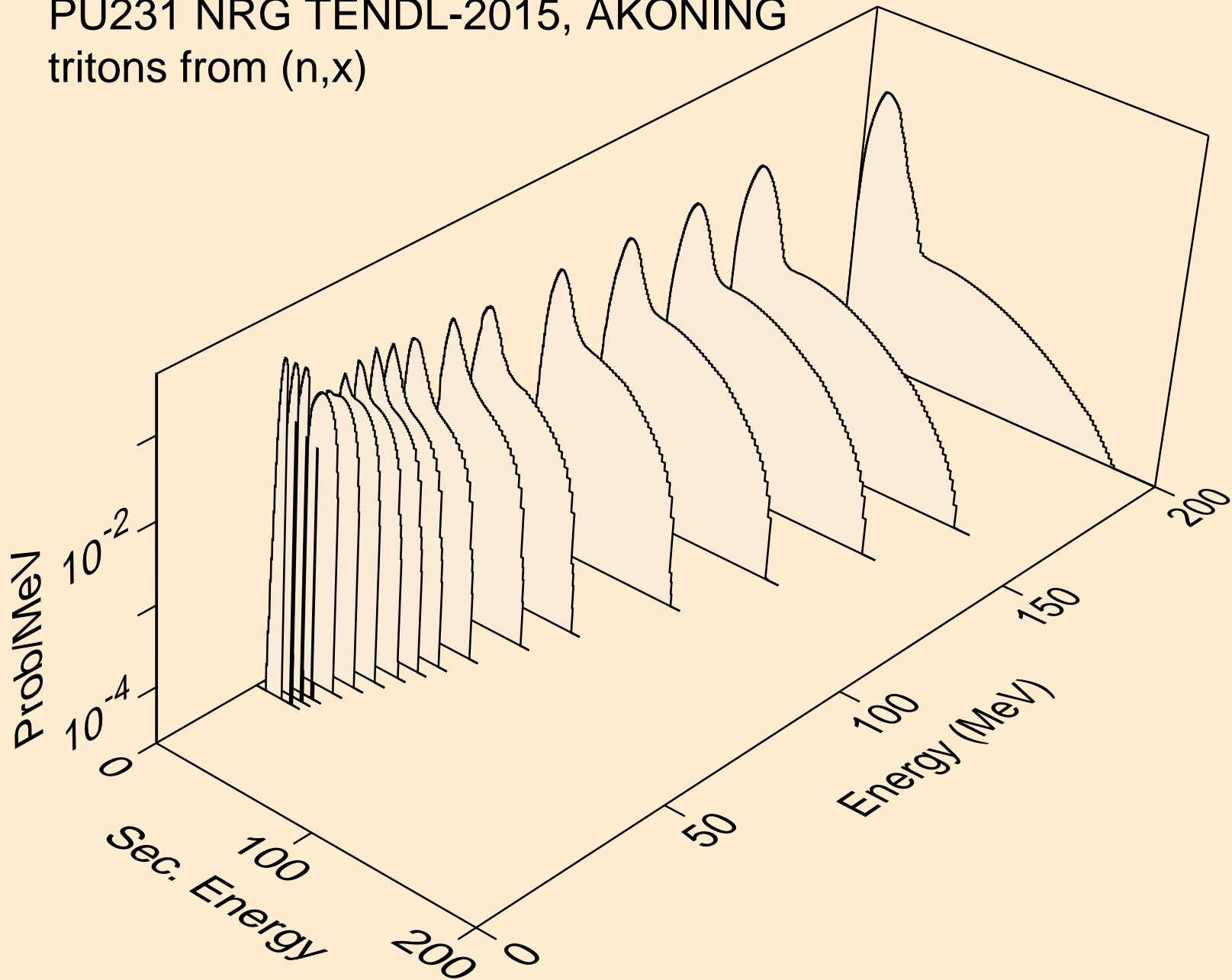

PU231 NRG TENDL-2015, AKONING  
tritons from (n,n\*)t

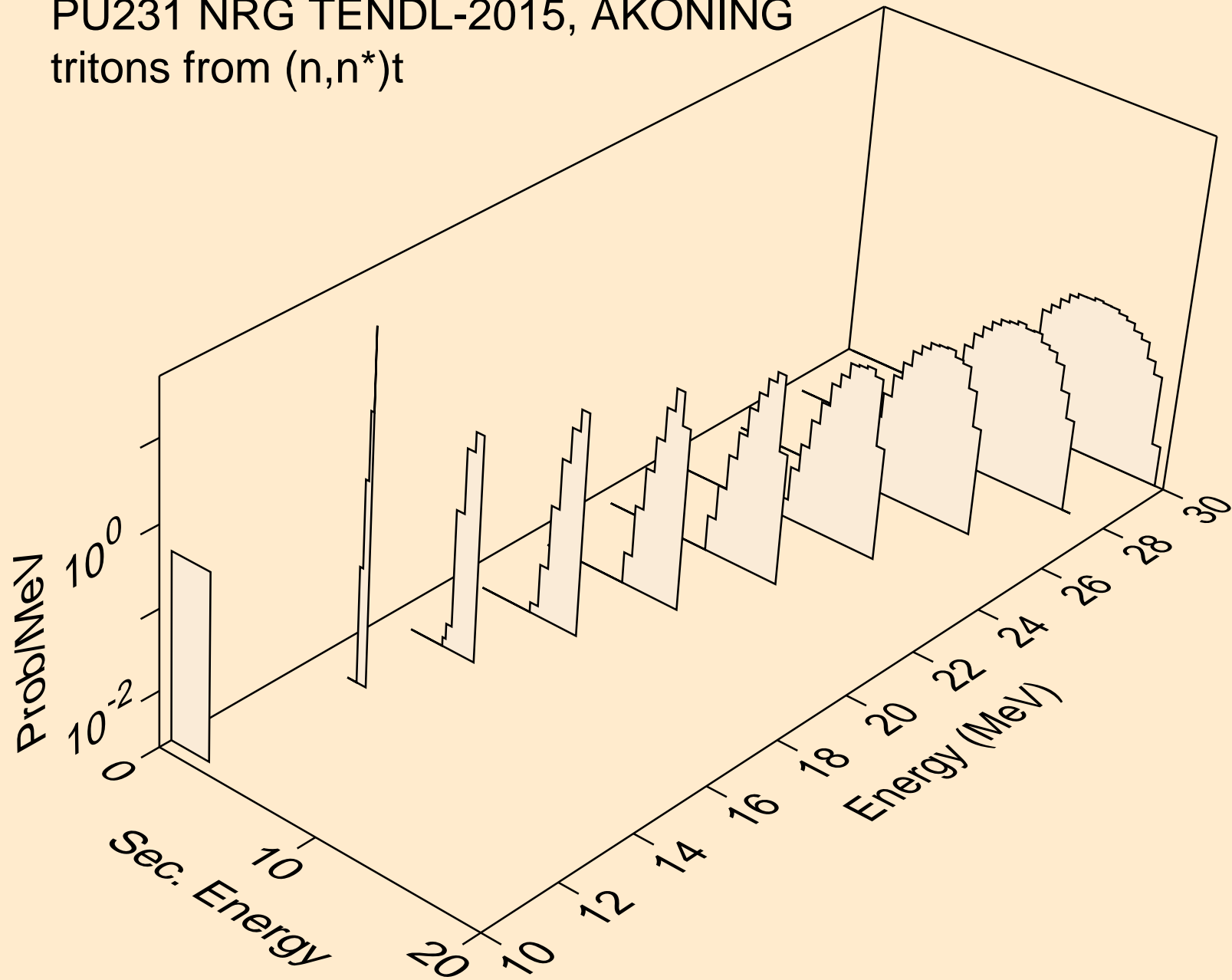

PU231 NRG TENDL-2015, AKONING  
tritons from (n,n\*)t2a

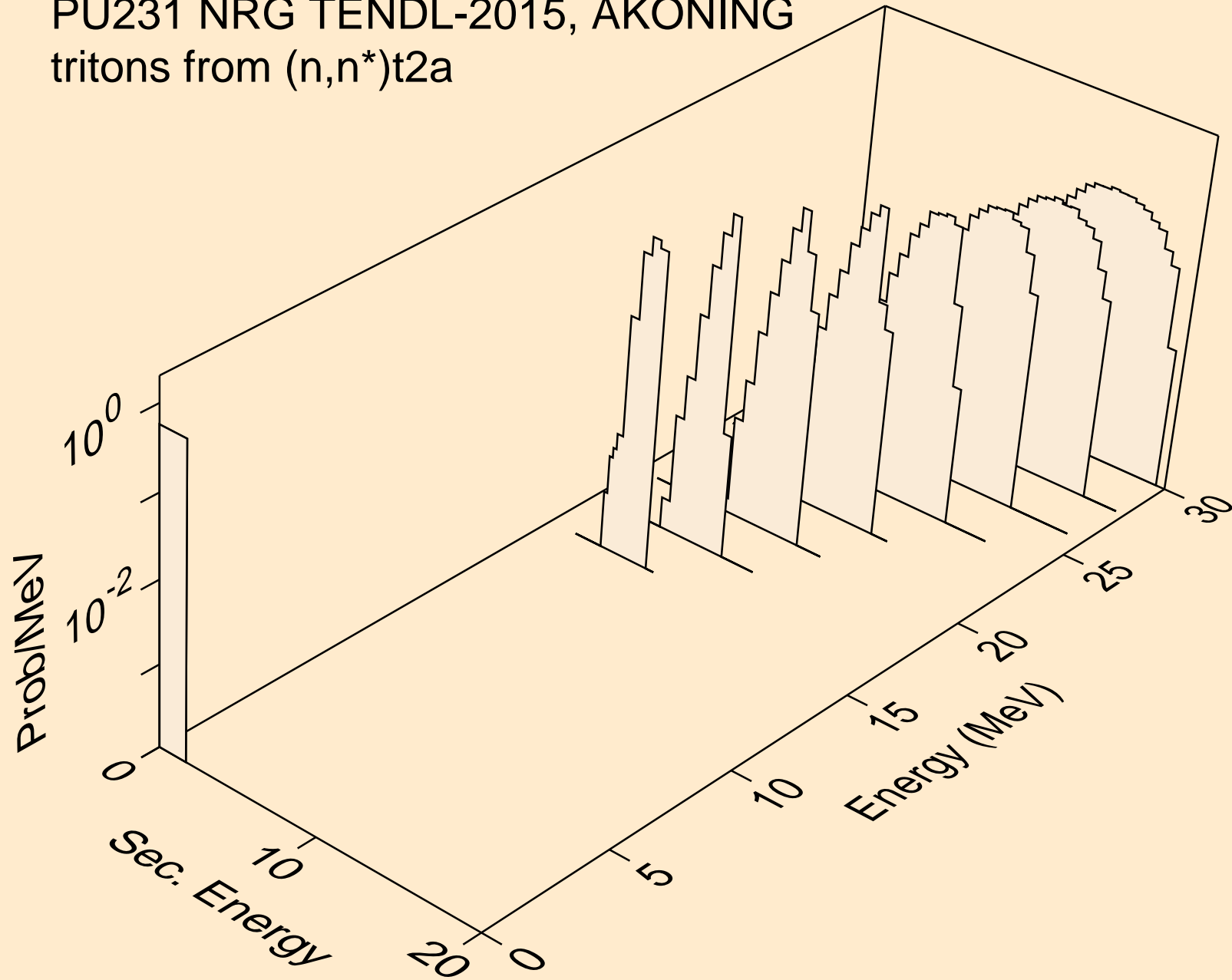

PU231 NRG TENDL-2015, AKONING  
tritons from (n,t)

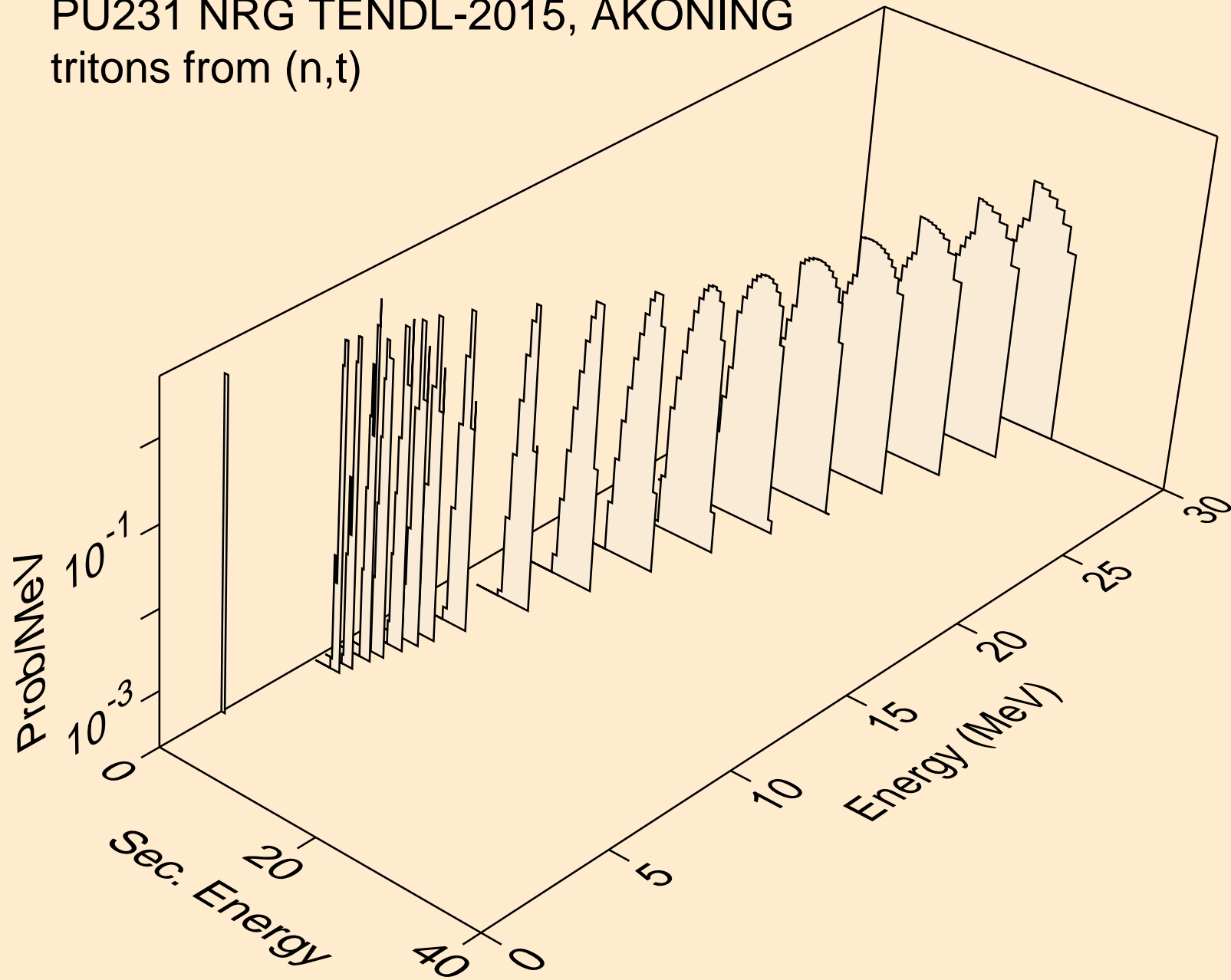

PU231 NRG TENDL-2015, AKONING  
tritons from (n,t2a)

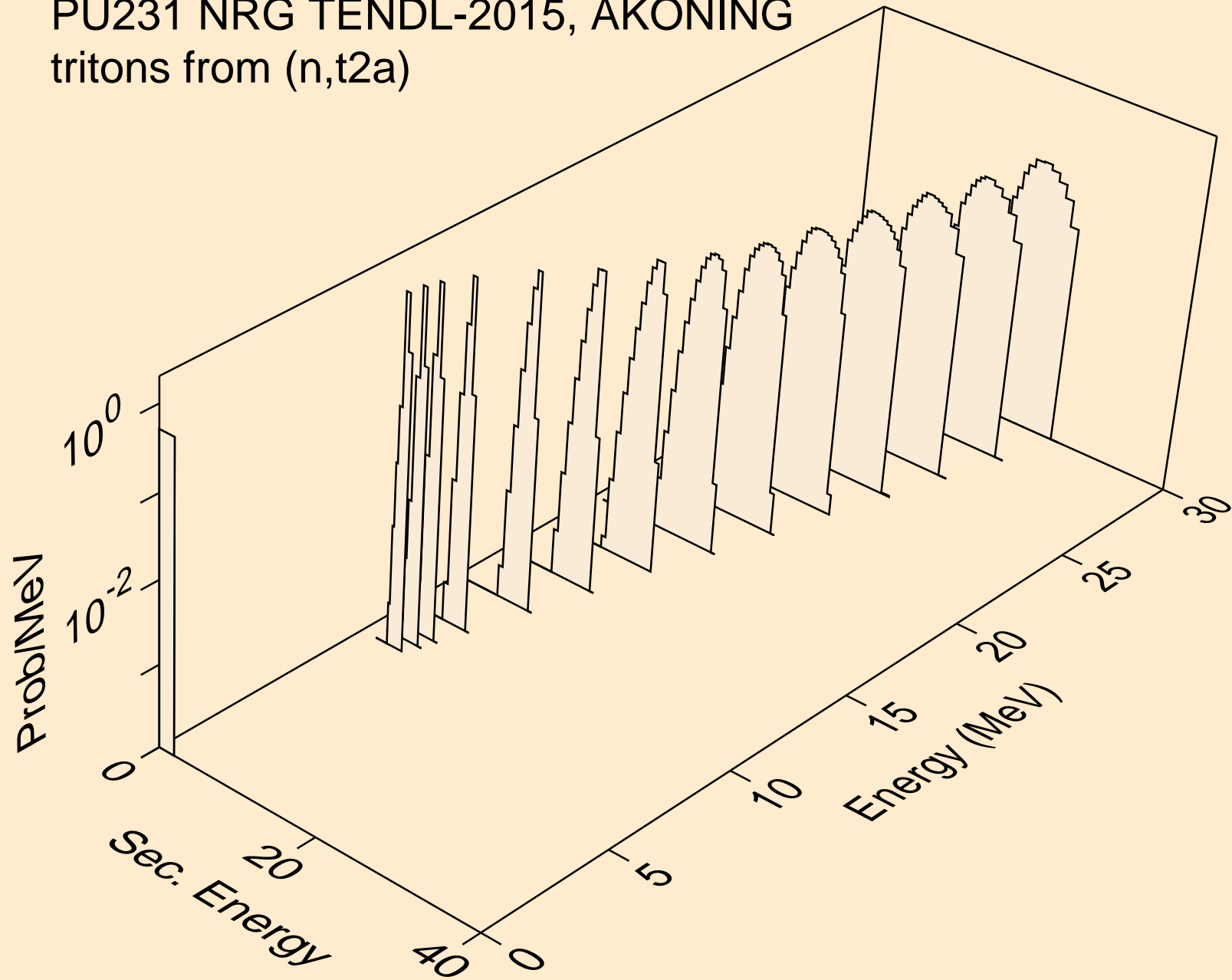

PU231 NRG TENDL-2015, AKONING  
tritons from (n,pt)

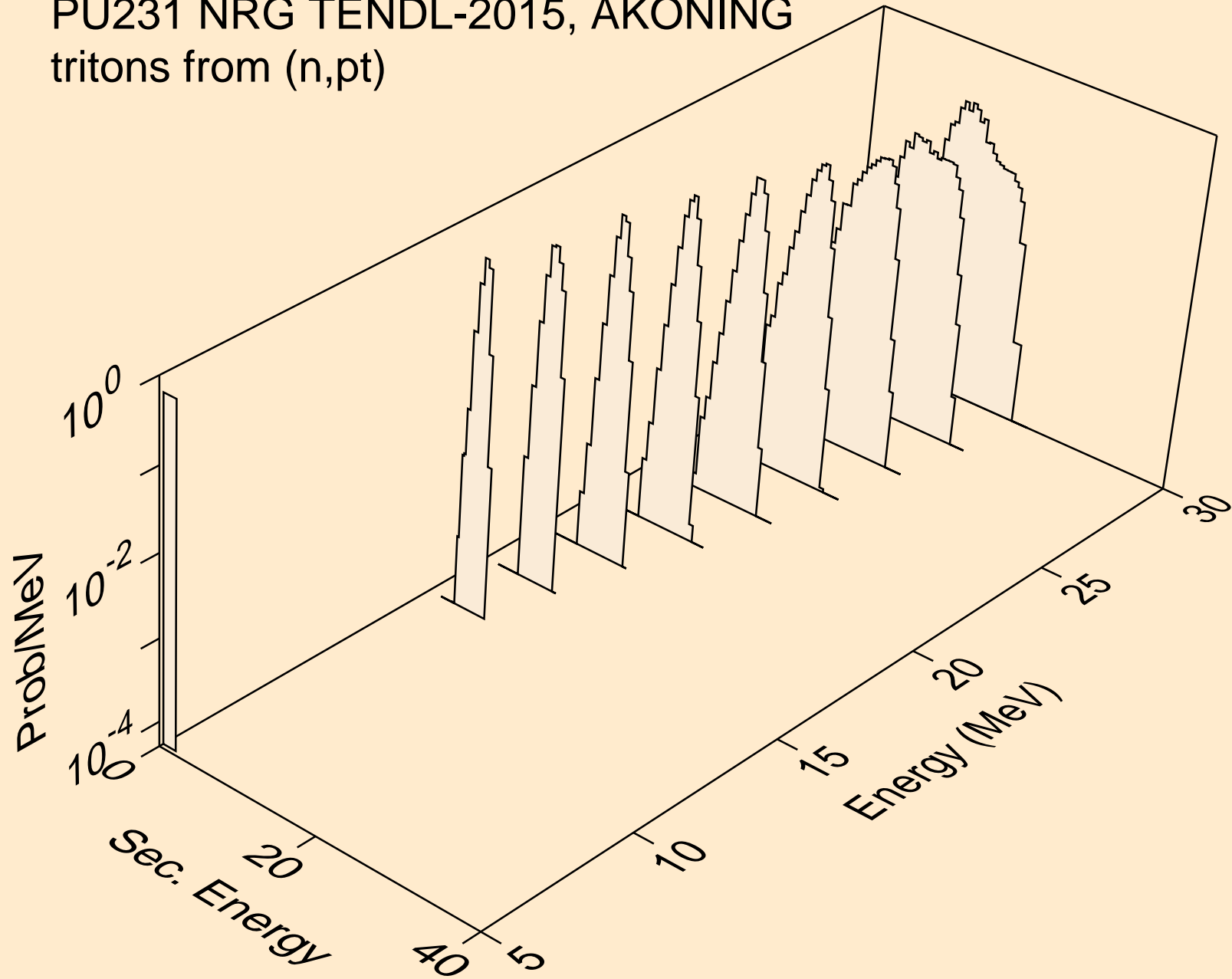

PU231 NRG TENDL-2015, AKONING  
he3s from (n,x)

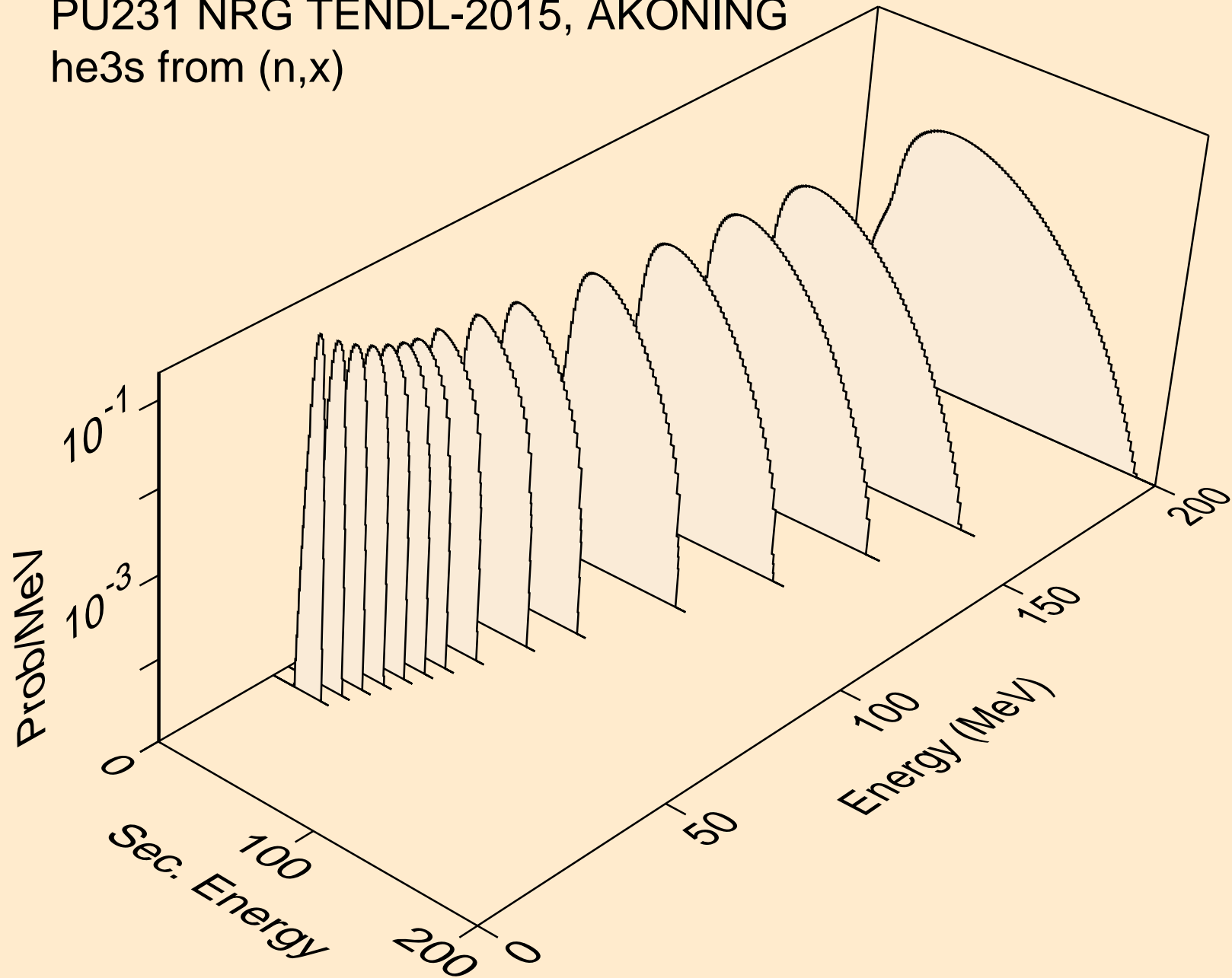

PU231 NRG TENDL-2015, AKONING  
he3s from (n,n\*)he3

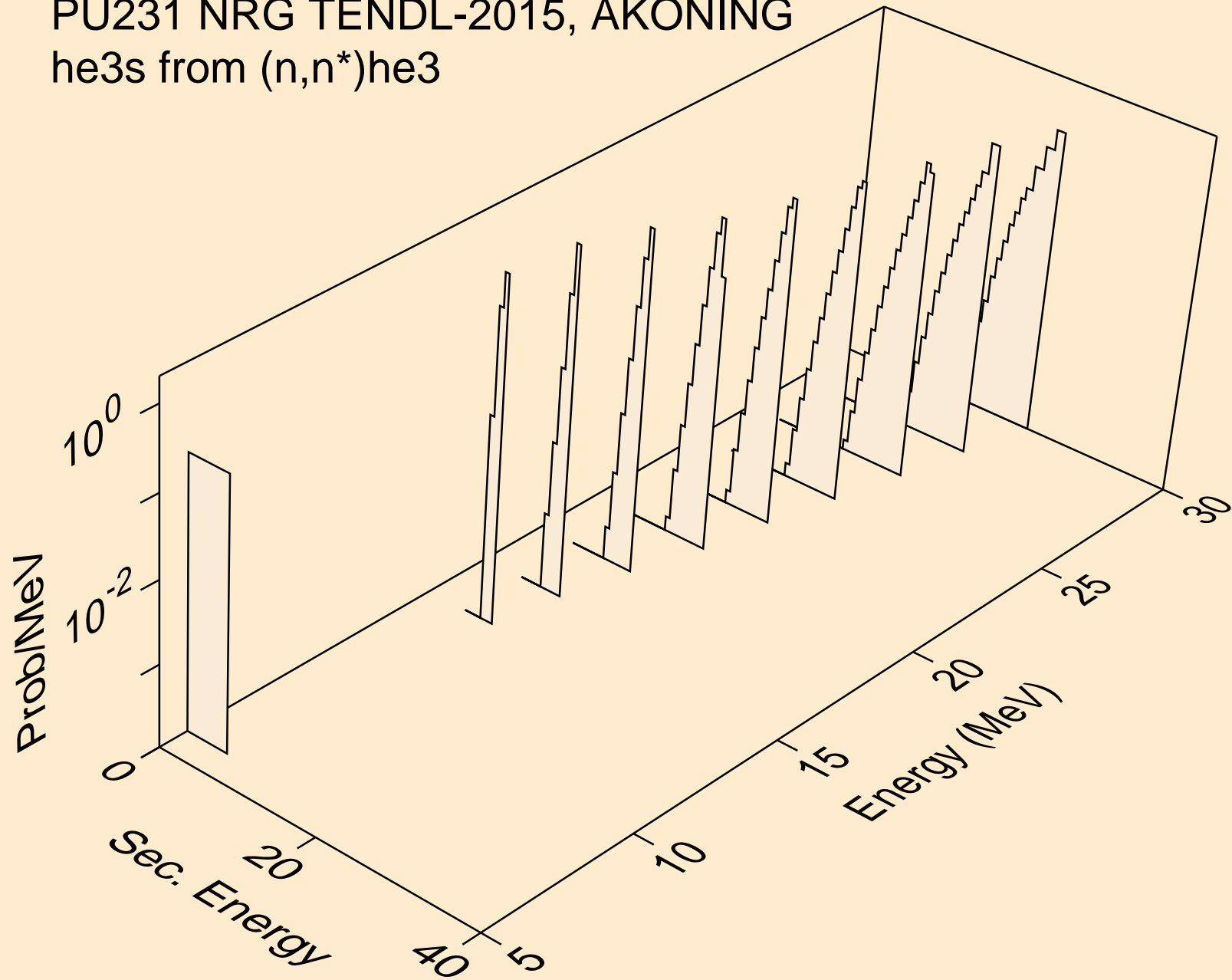



PU231 NRG TENDL-2015, AKONING  
he3s from (n,he3)

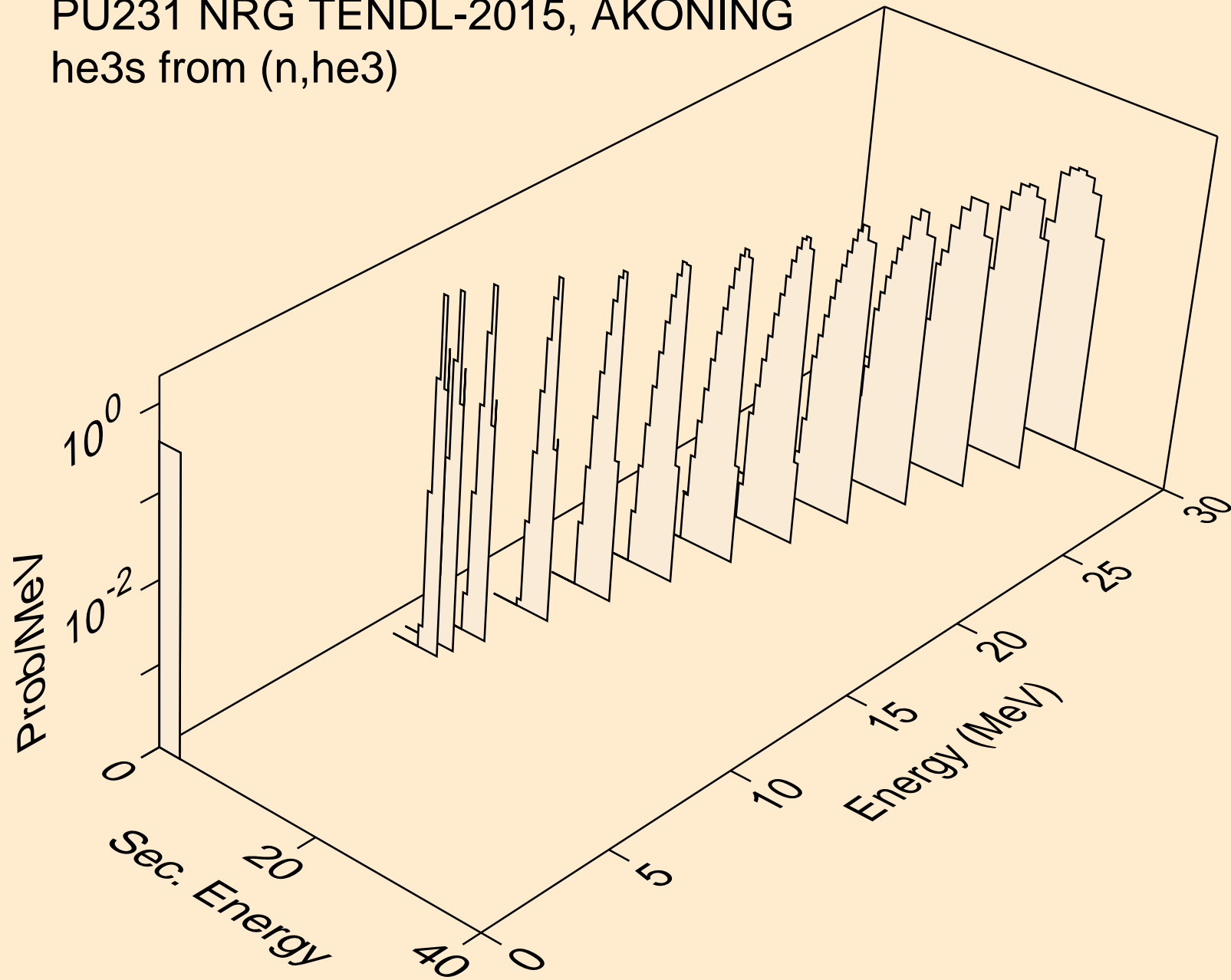

PU231 NRG TENDL-2015, AKONING  
alphas from (n,x)

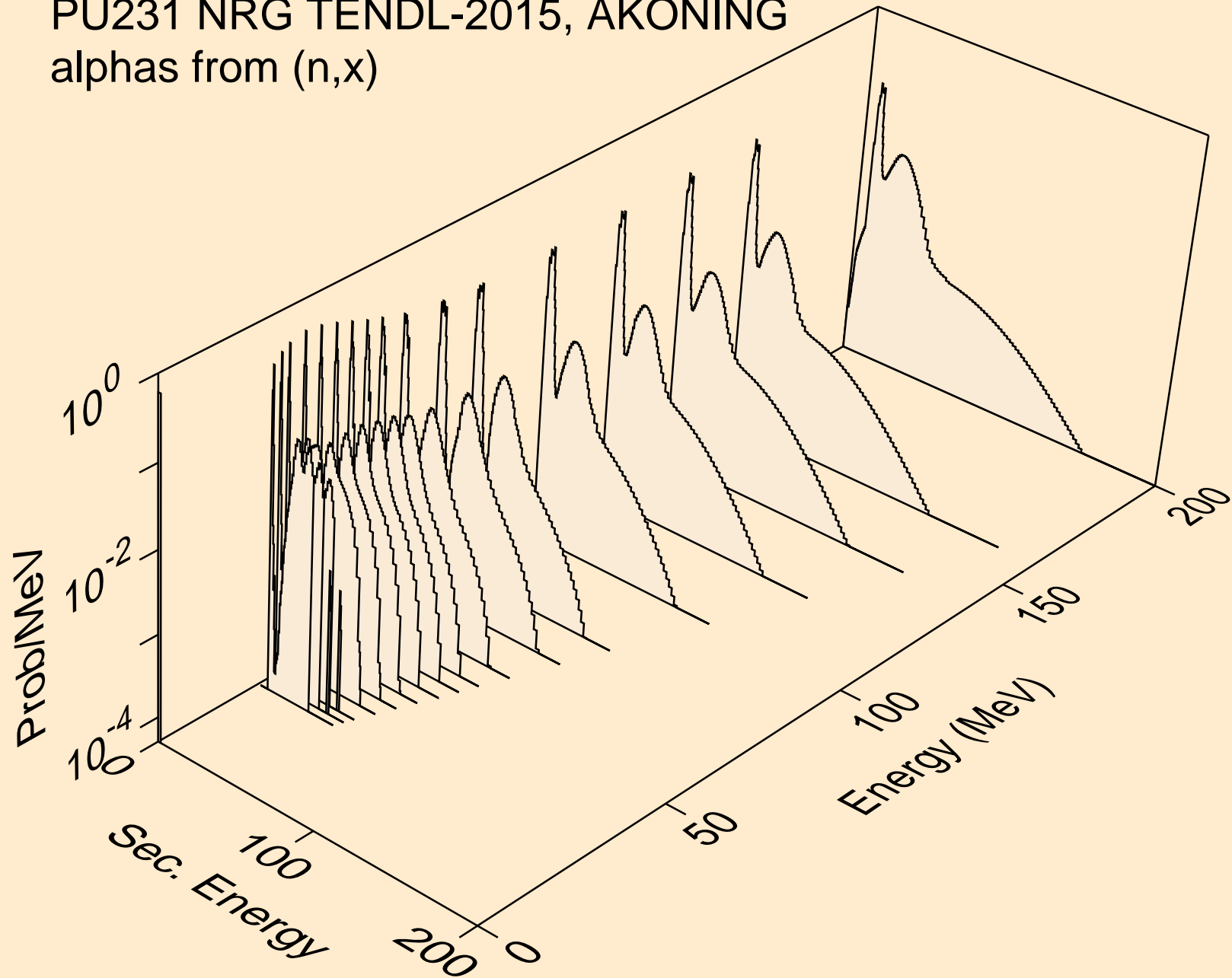

PU231 NRG TENDL-2015, AKONING  
alphas from (n,n\*)a

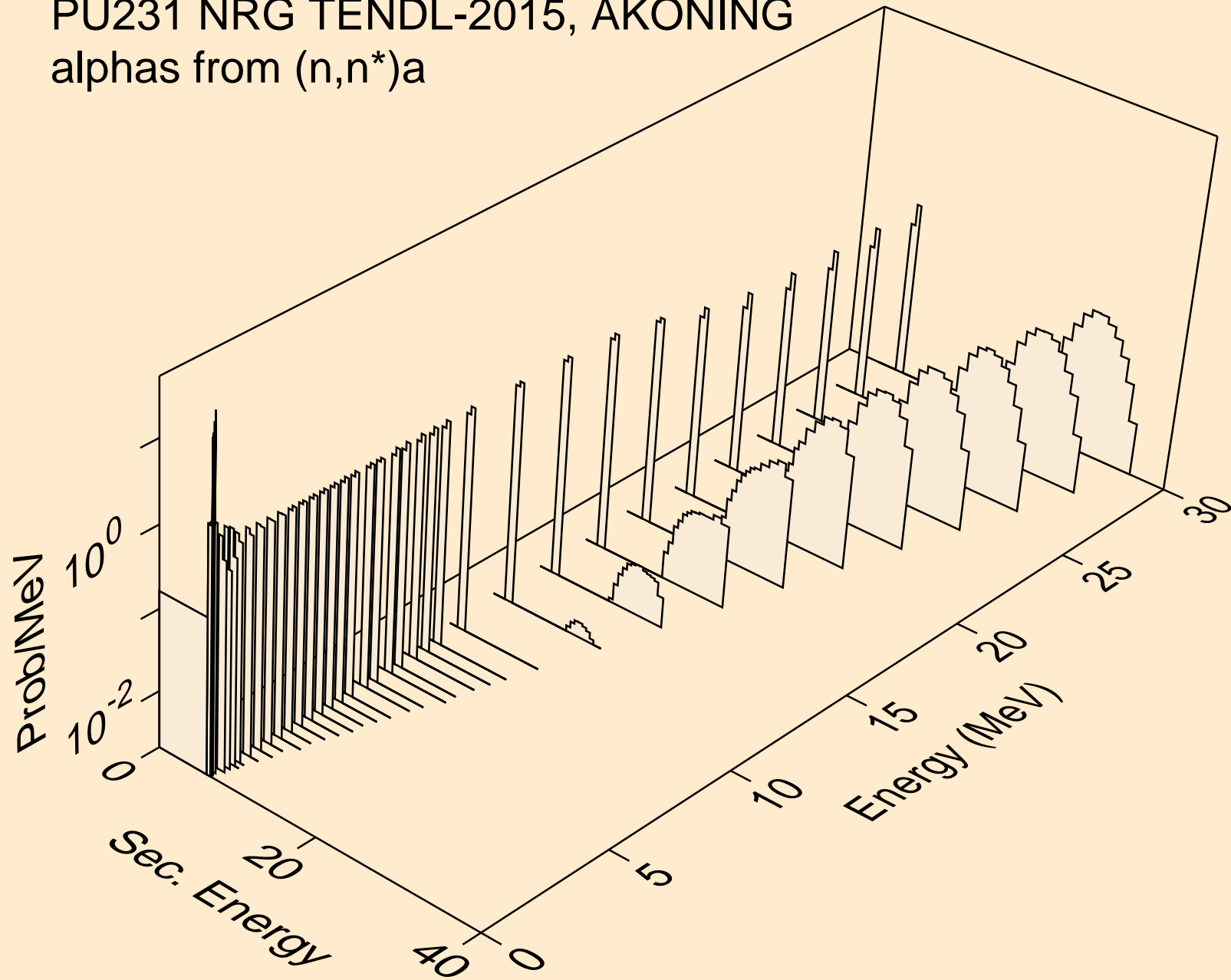

PU231 NRG TENDL-2015, AKONING  
alphas from (n,n\*)3a

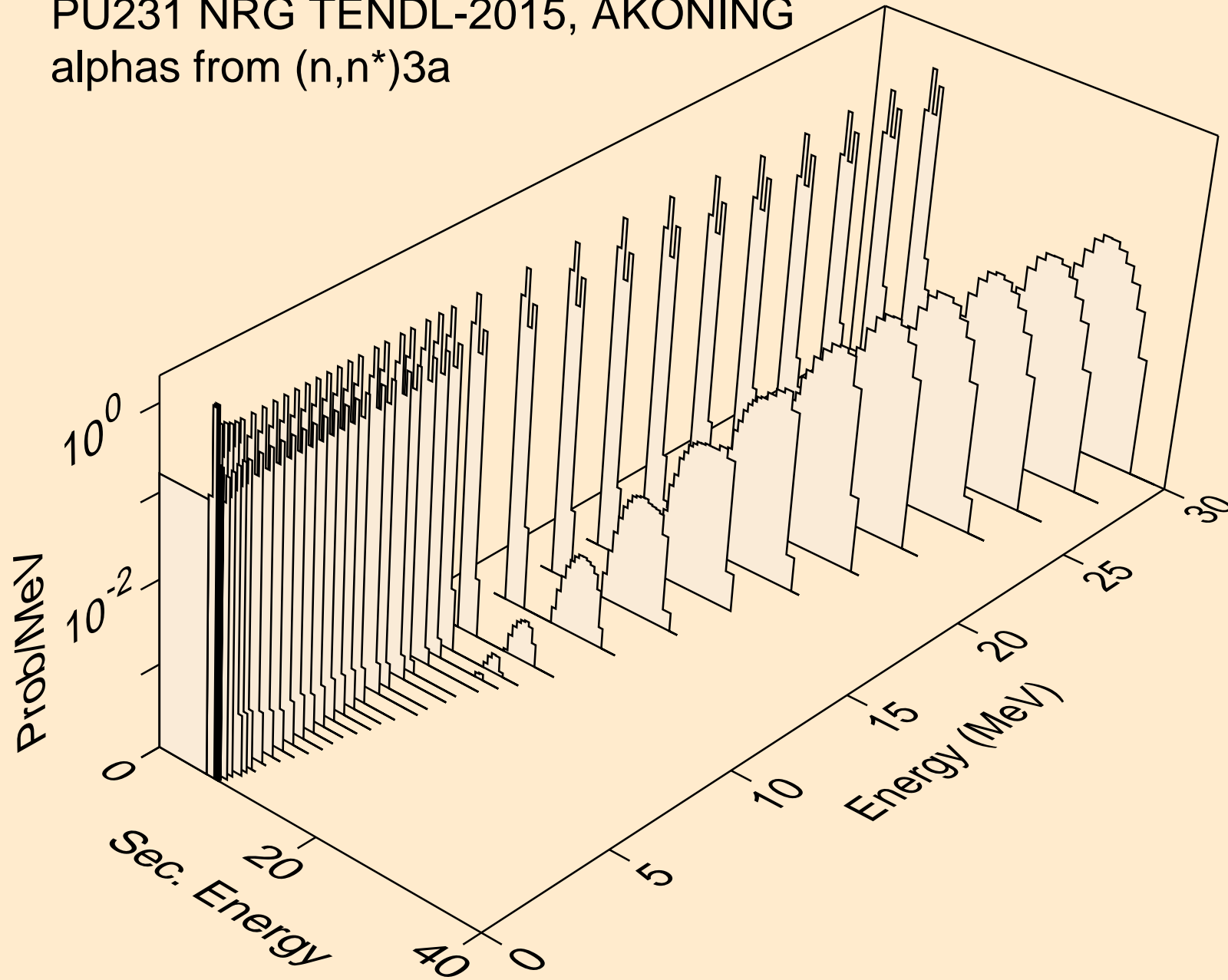

PU231 NRG TENDL-2015, AKONING  
alphas from (n,2n)a

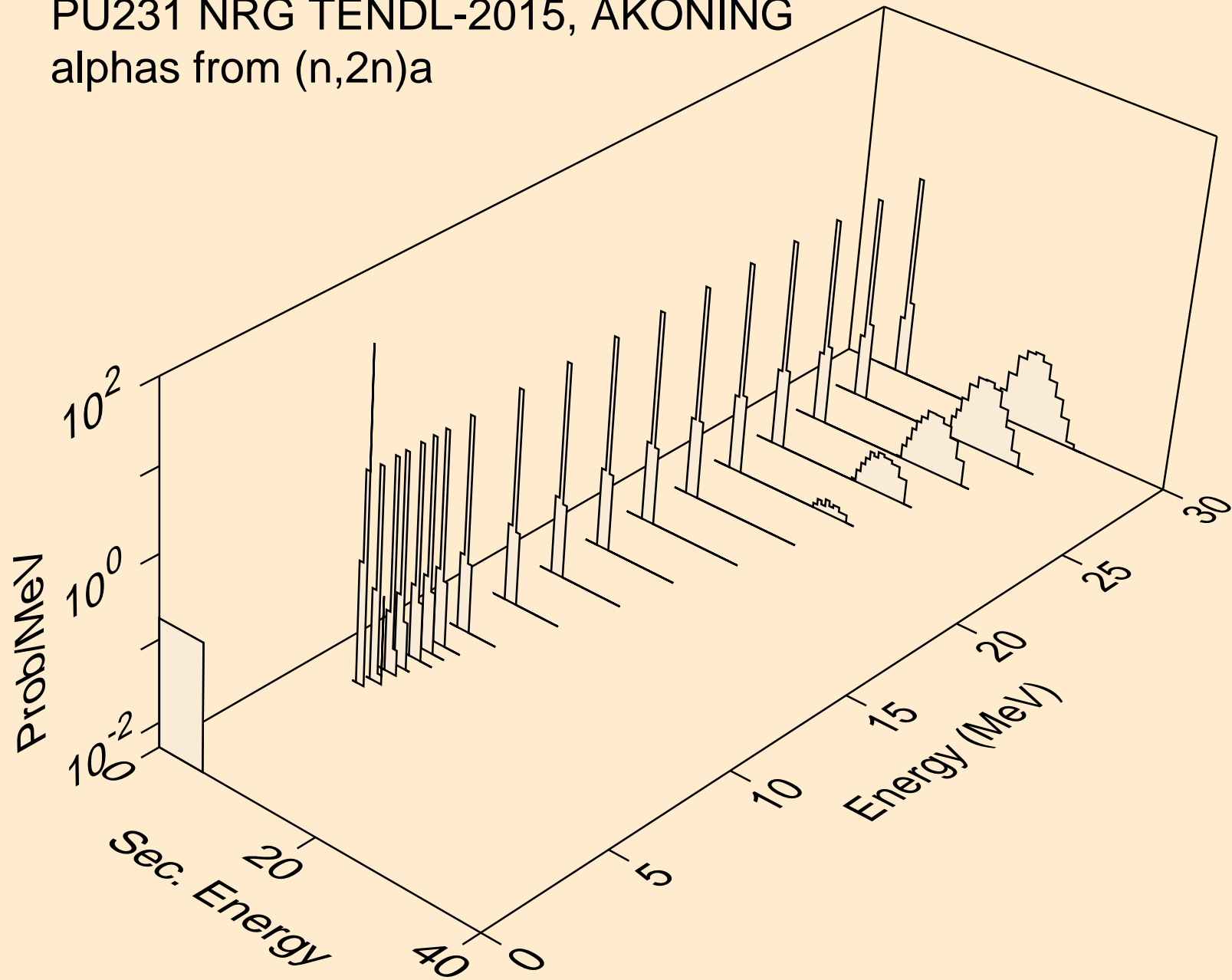

PU231 NRG TENDL-2015, AKONING  
alphas from (n,3n)a

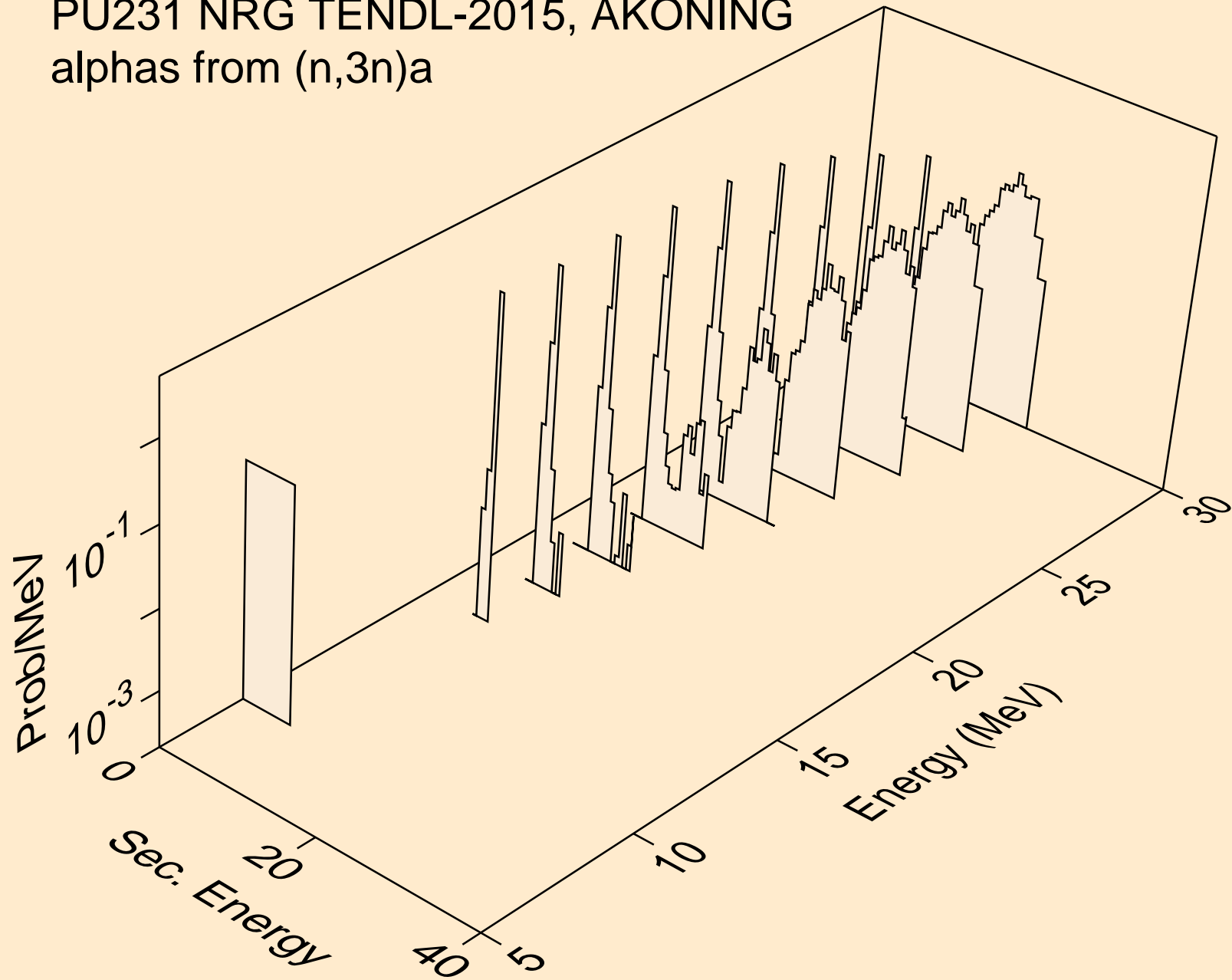

PU231 NRG TENDL-2015, AKONING  
alphas from (n,n\*)2a

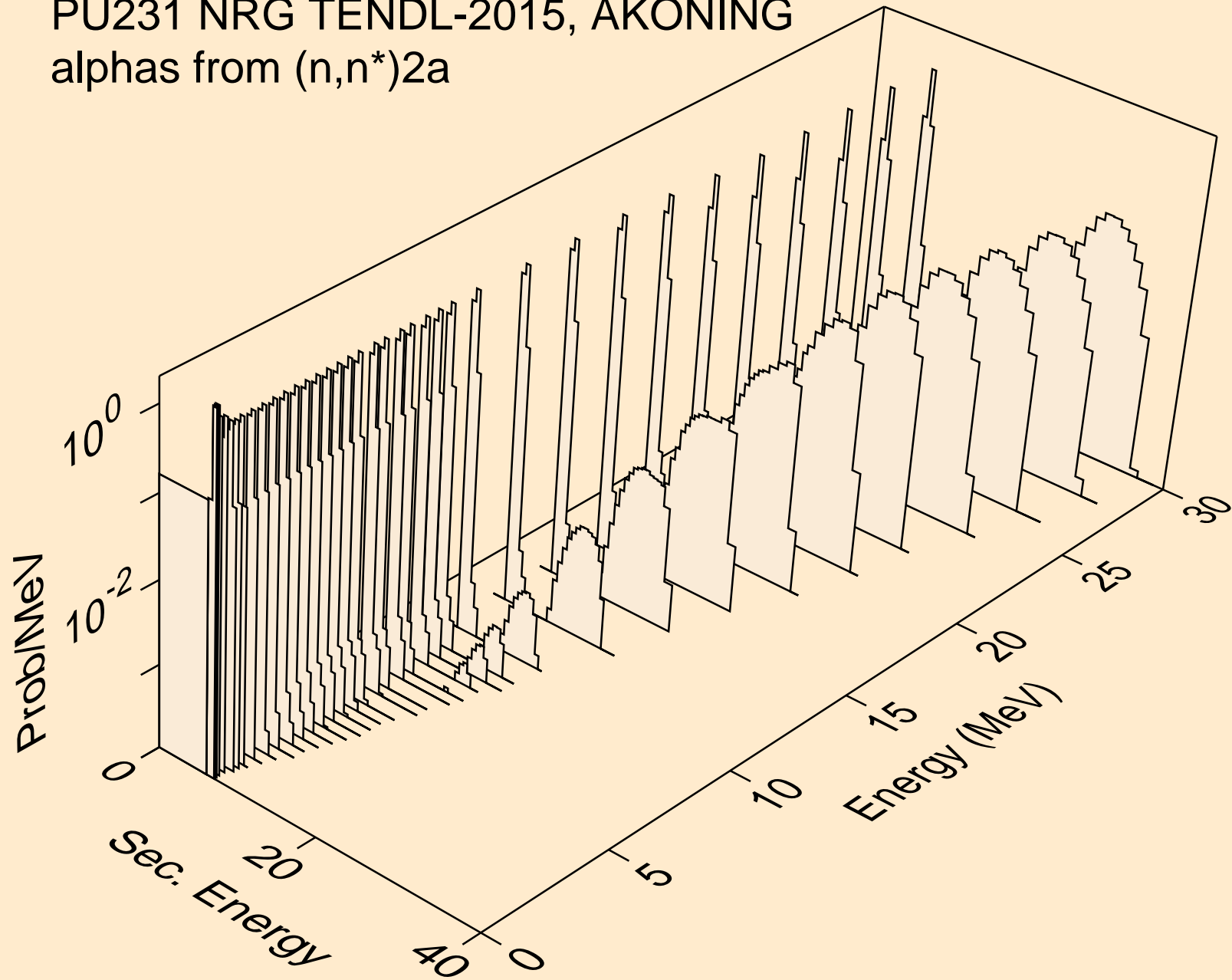

PU231 NRG TENDL-2015, AKONING  
alphas from (n,2n)2a

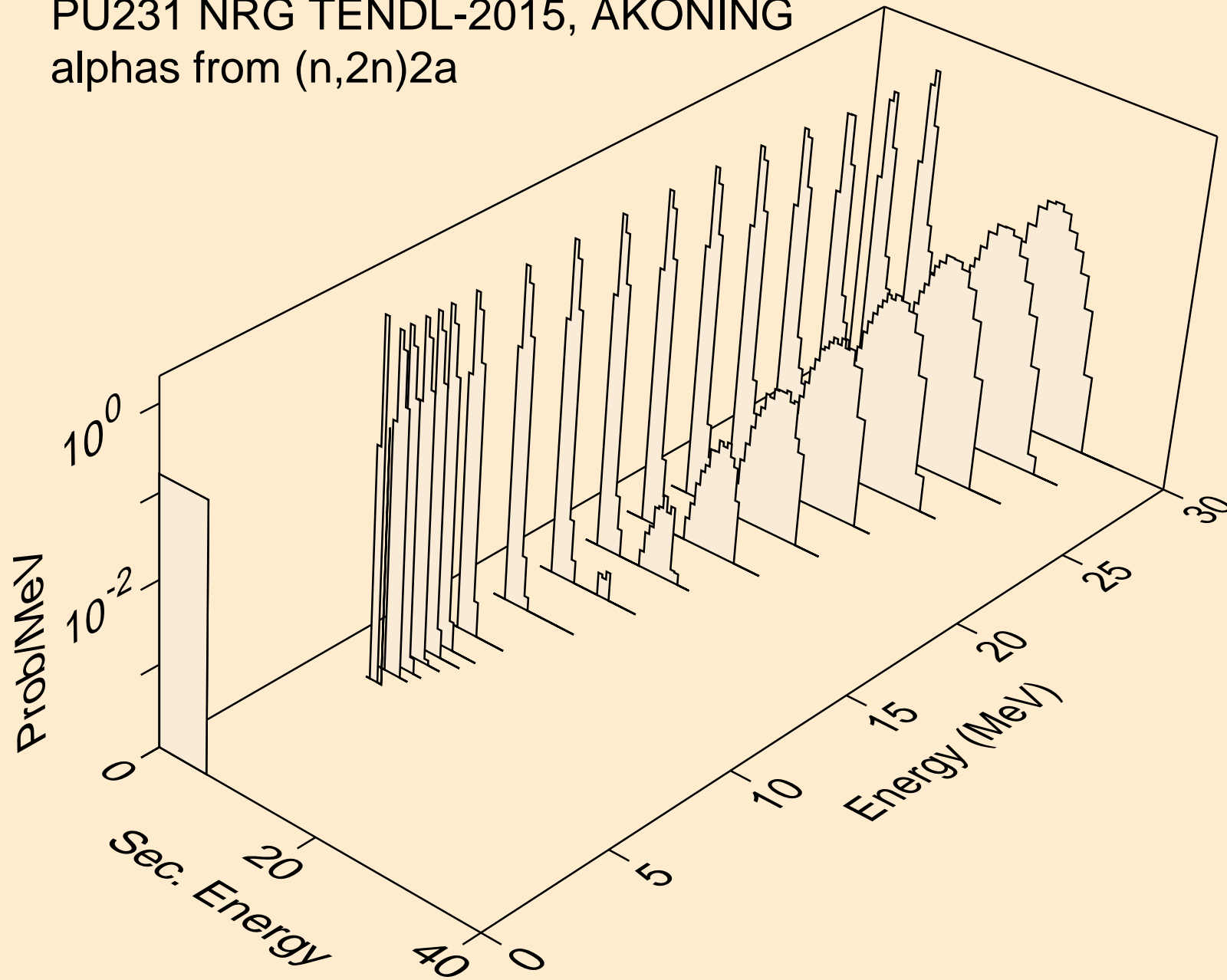



PU231 NRG TENDL-2015, AKONING  
alphas from (n,n\*)d2a

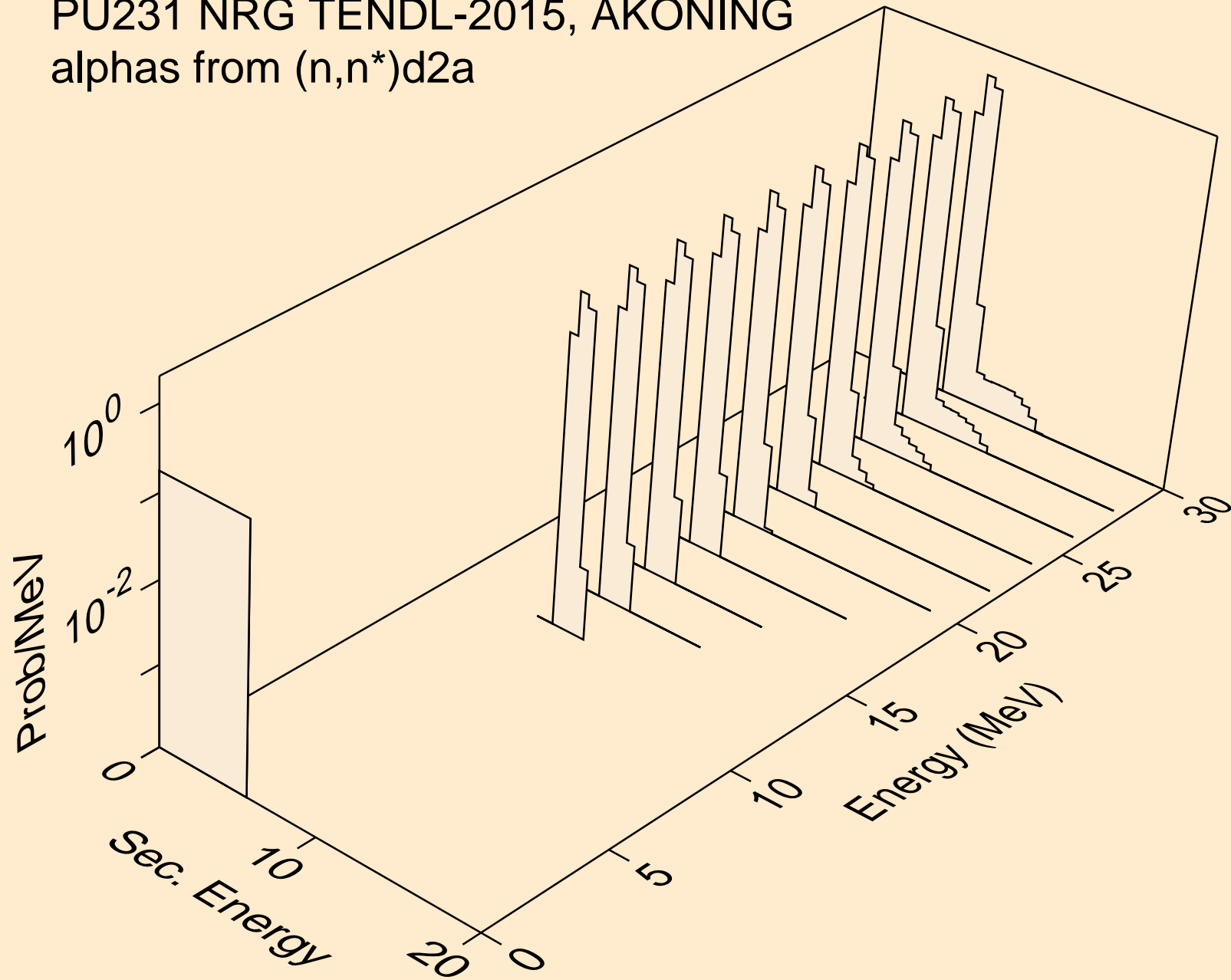

PU231 NRG TENDL-2015, AKONING  
alphas from (n,n\*)t2a

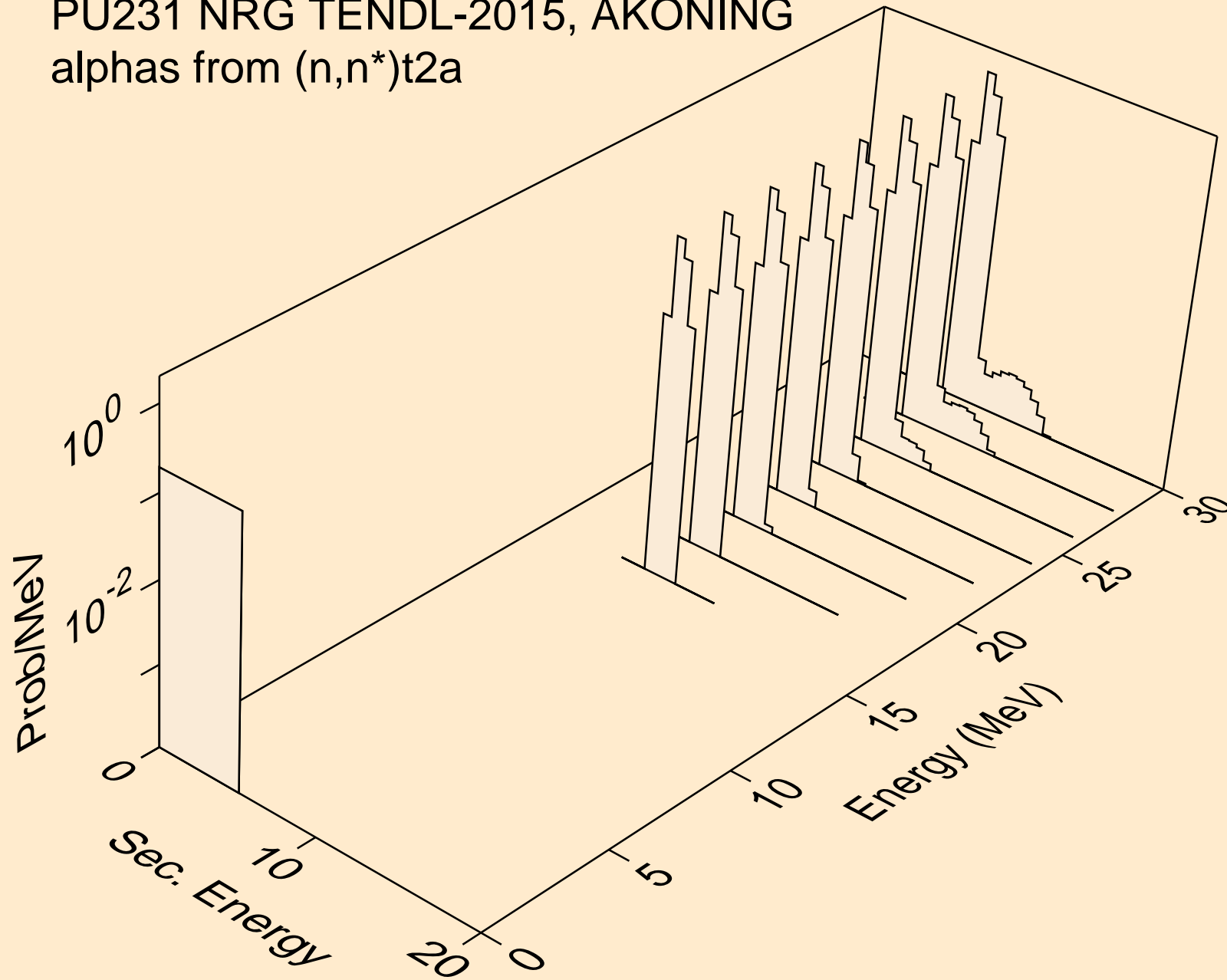

PU231 NRG TENDL-2015, AKONING  
alphas from (n,npa)

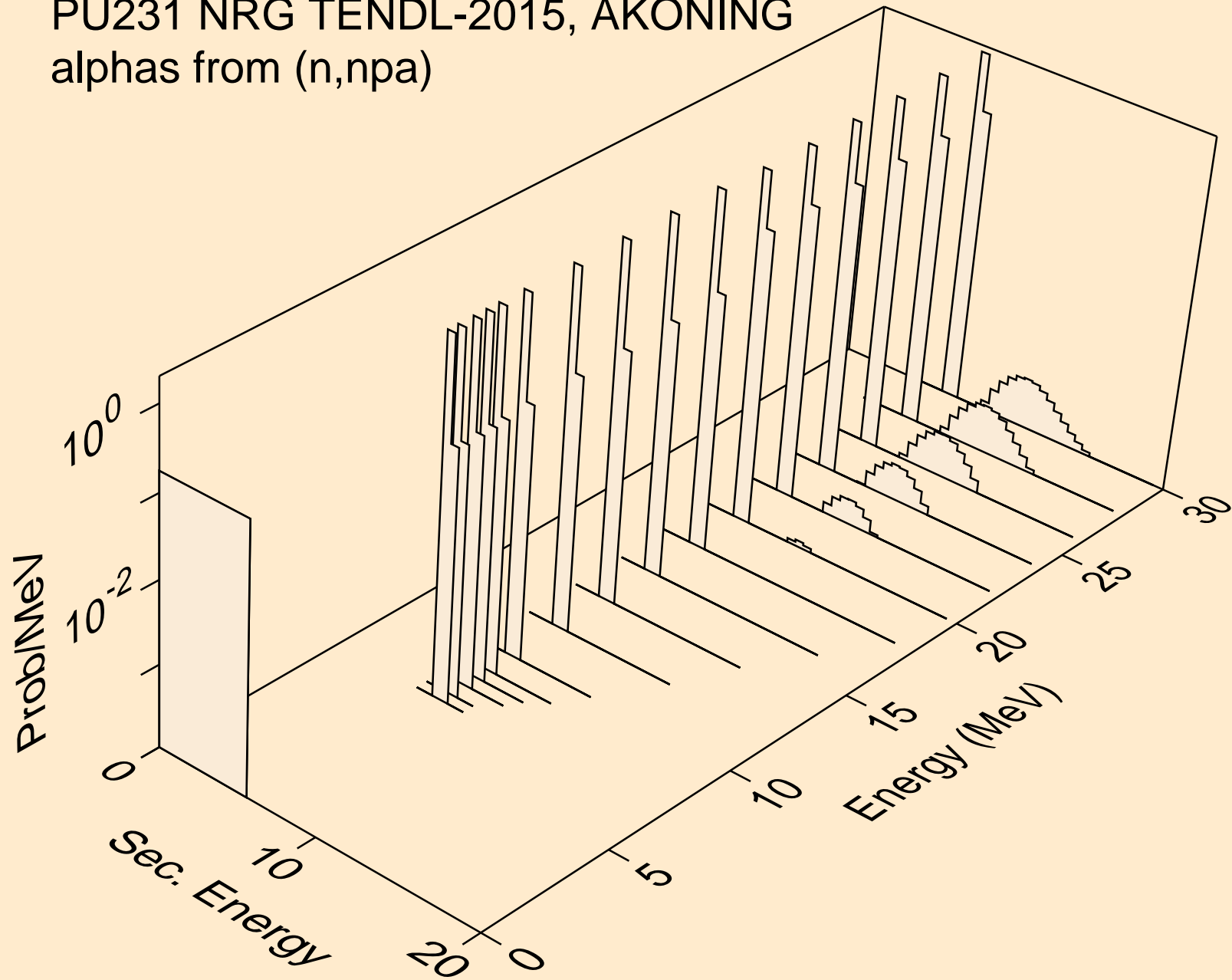

PU231 NRG TENDL-2015, AKONING  
alphas from (n,a)

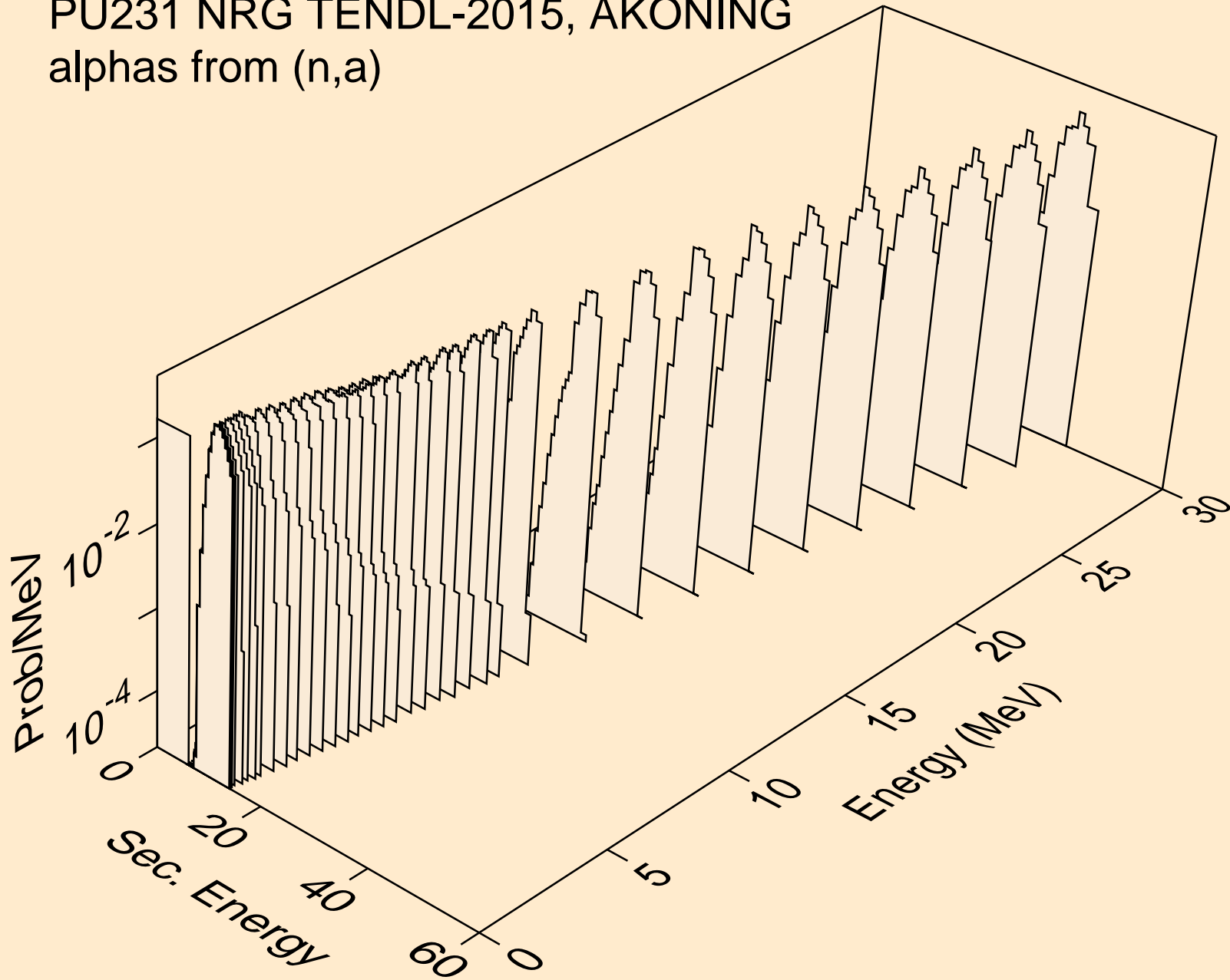

PU231 NRG TENDL-2015, AKONING  
alphas from (n,2a)

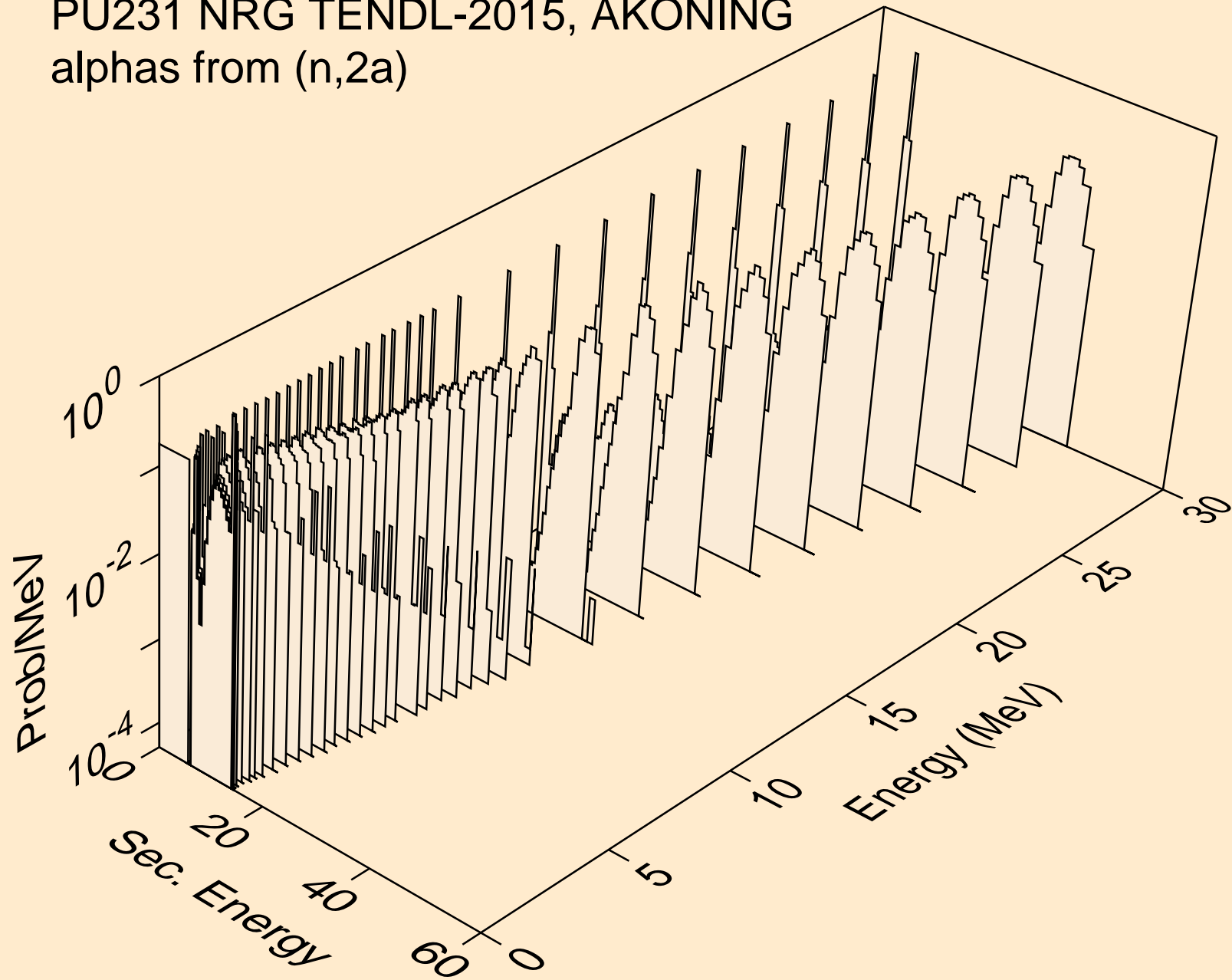

PU231 NRG TENDL-2015, AKONING  
alphas from (n,3a)

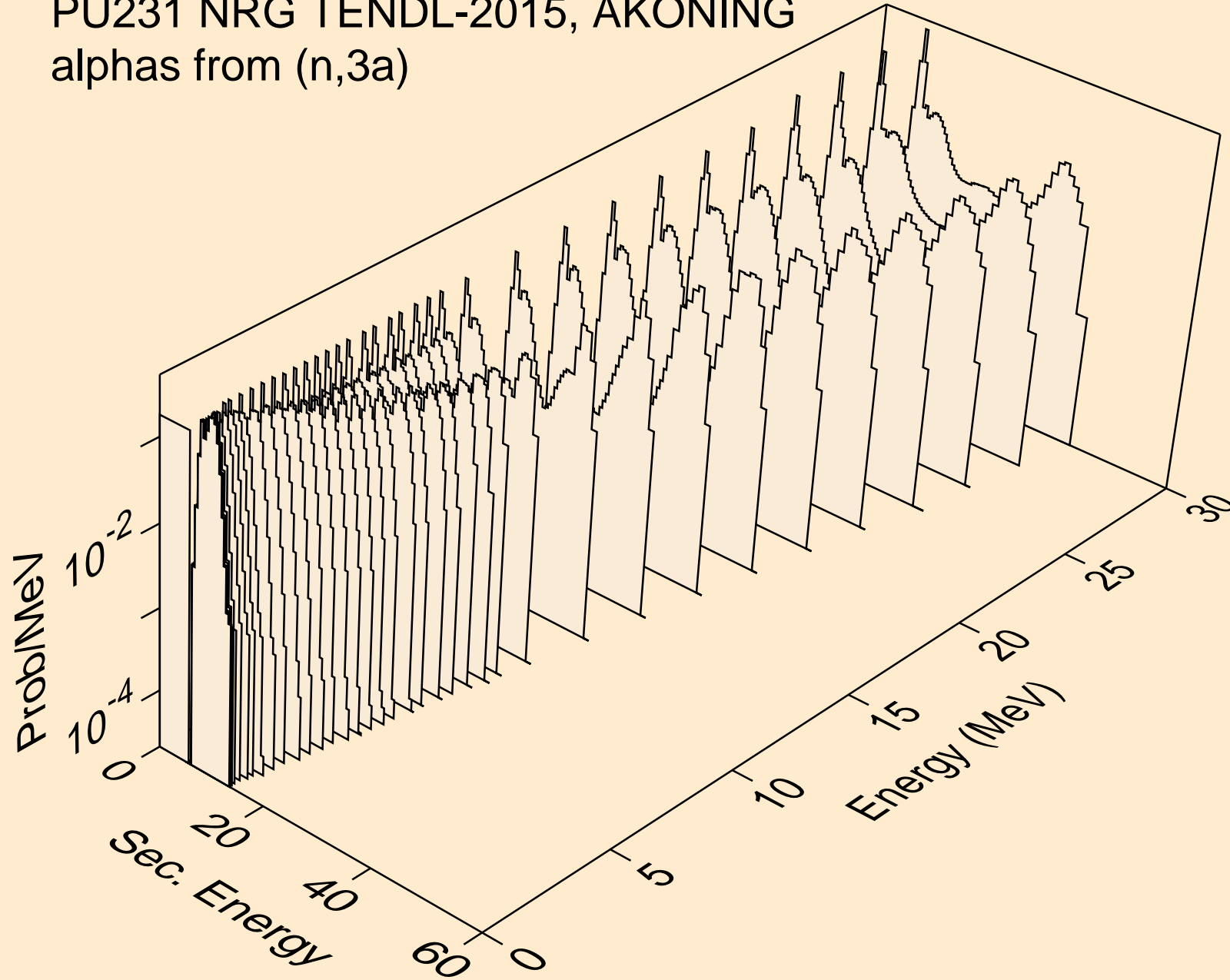

PU231 NRG TENDL-2015, AKONING  
alphas from (n,pa)

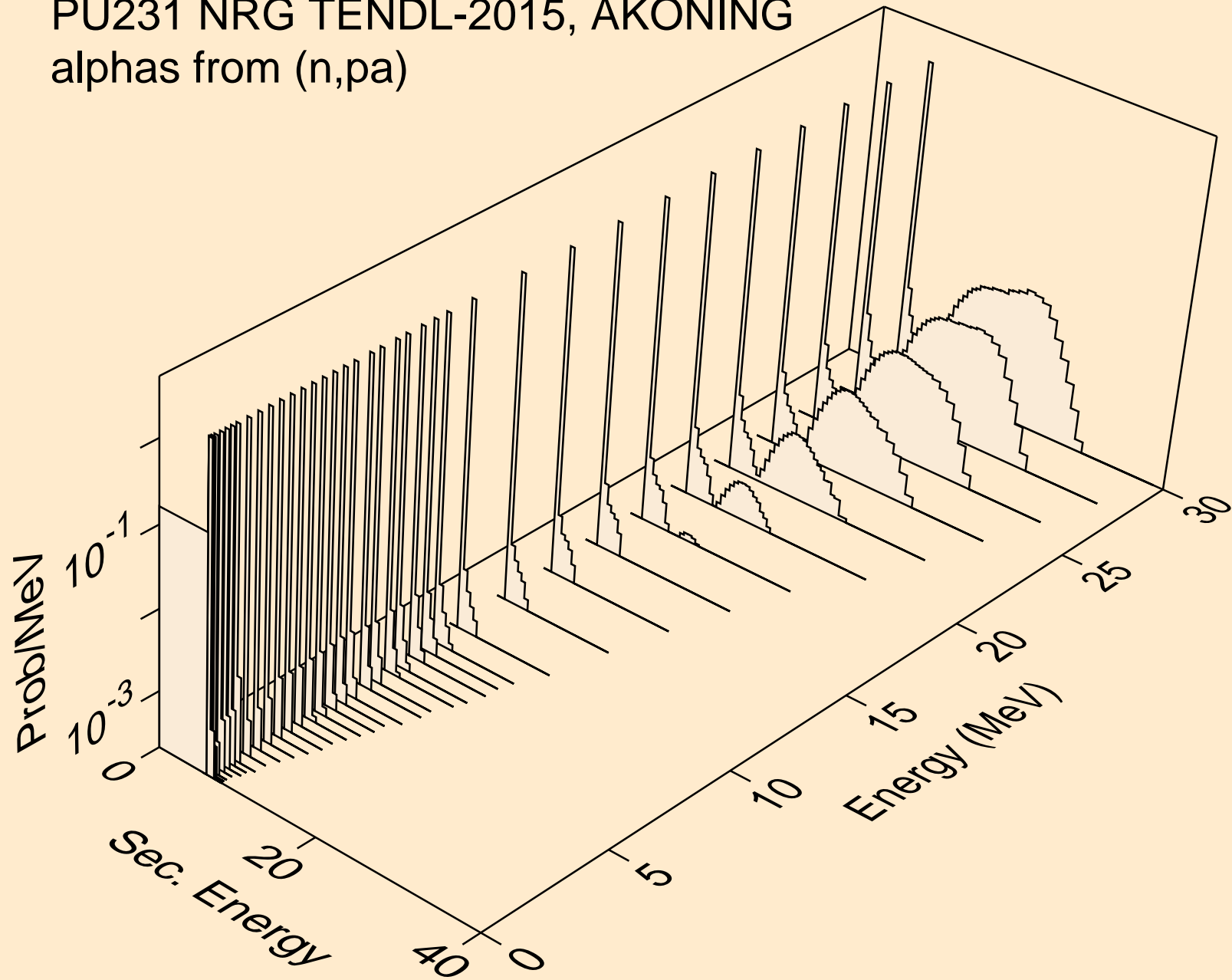

PU231 NRG TENDL-2015, AKONING  
alphas from (n,t2a)

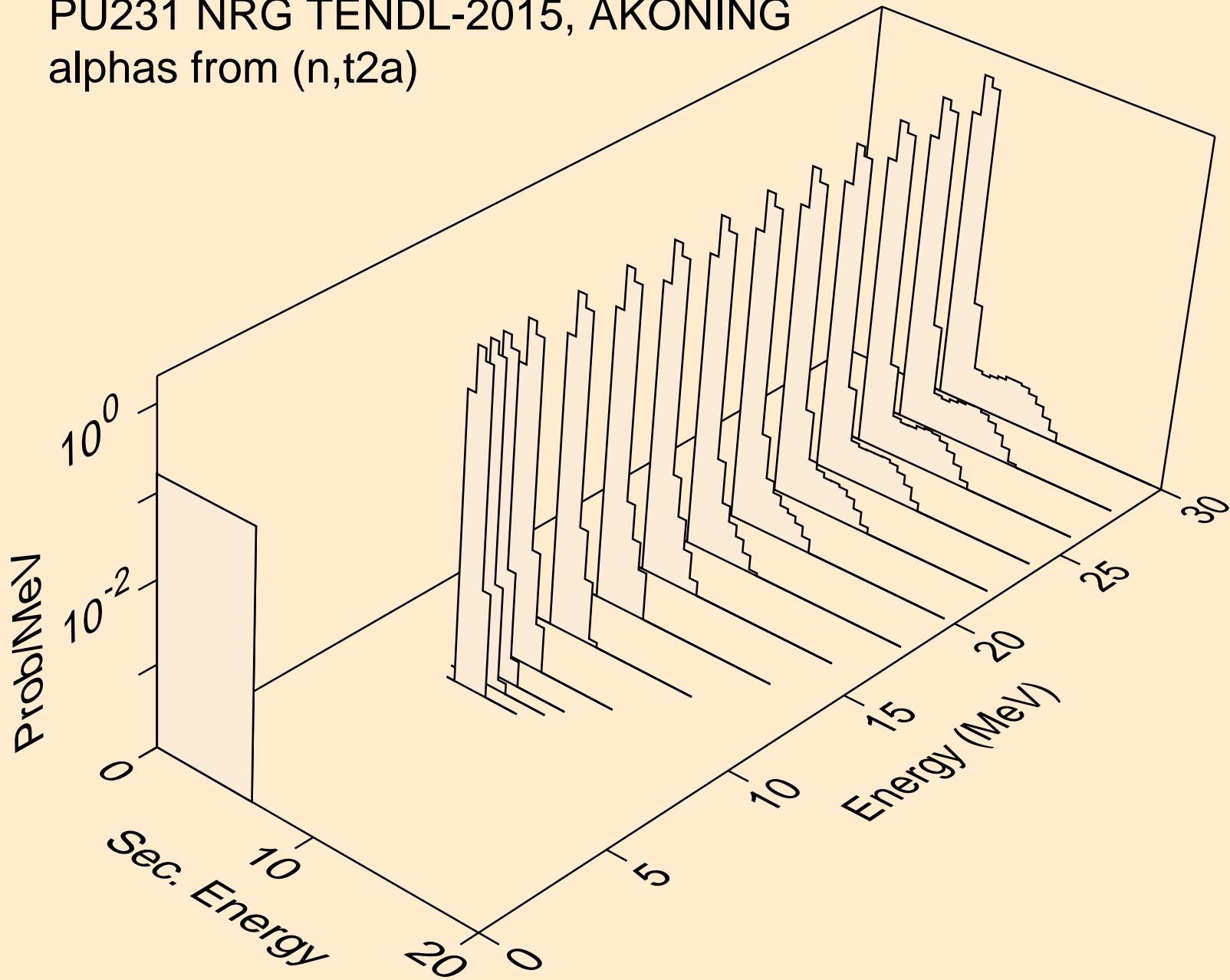



PU231 NRG TENDL-2015, AKONING  
alphas from (n,d2a)

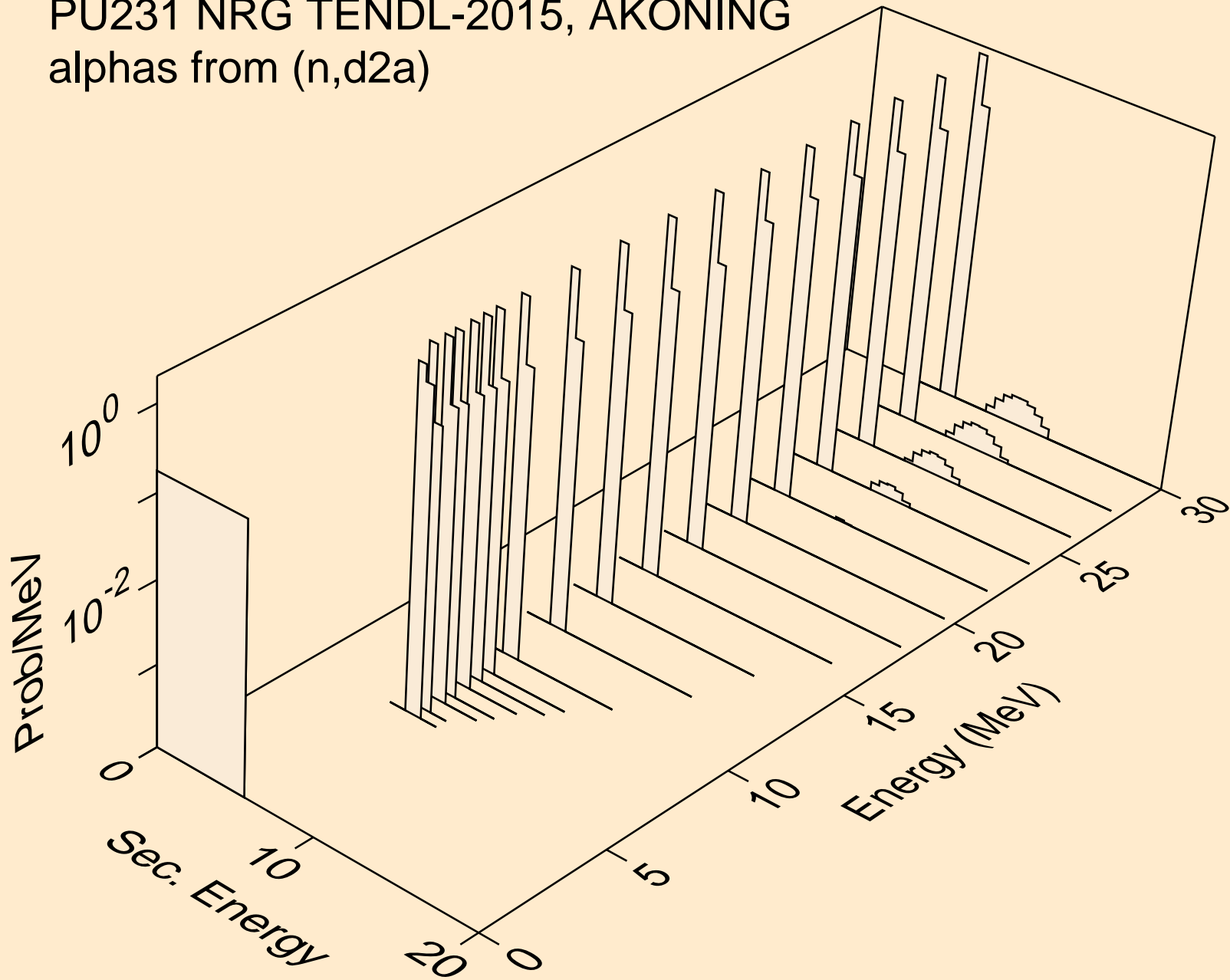

PU231 NRG TENDL-2015, AKONING  
alphas from (n,da)

