

# PU243 NRG TENDL-2015, AKONING

## Principal cross sections

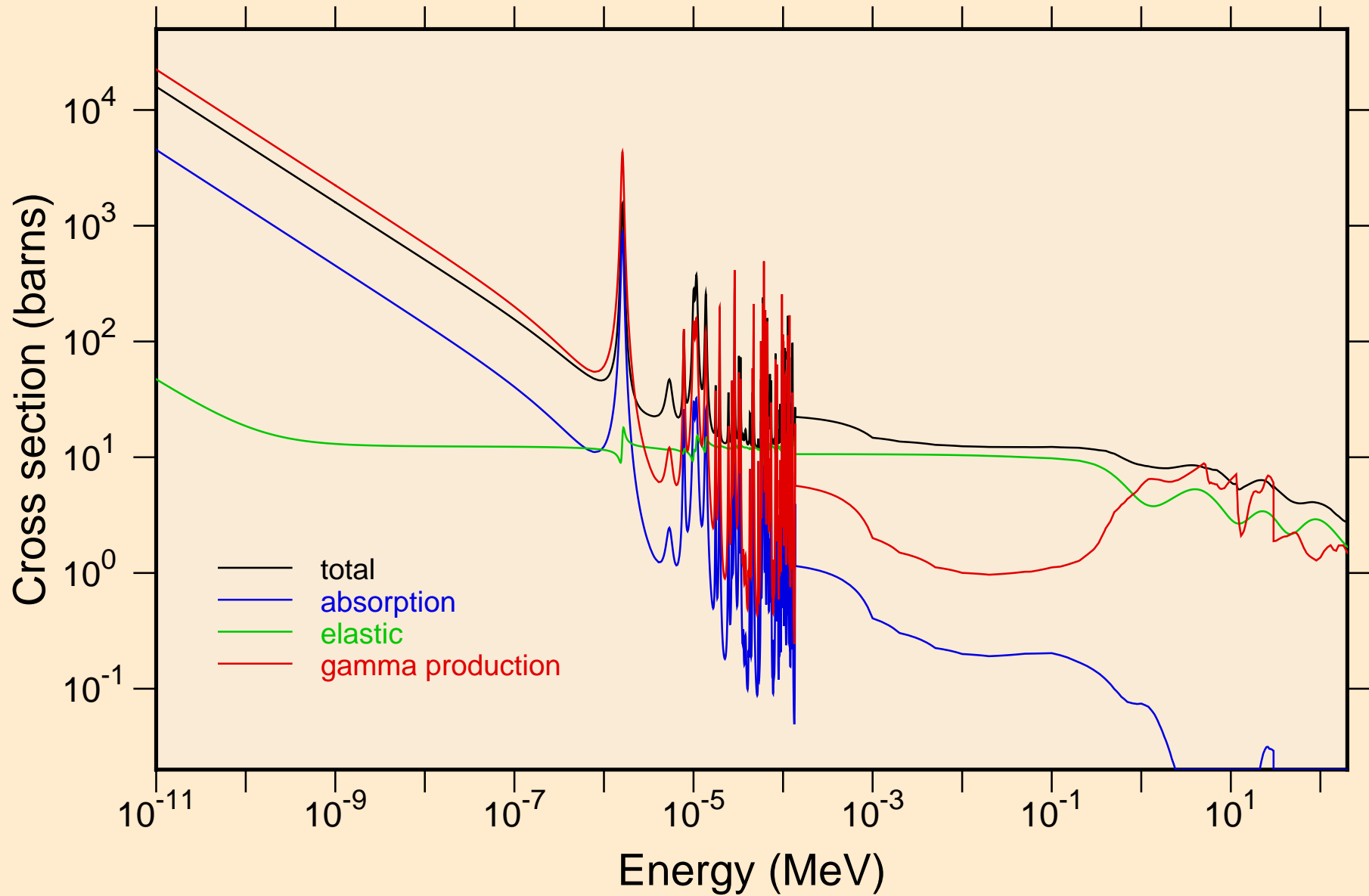

PU243 NRG TENDL-2015, AKONING  
resonance total cross section

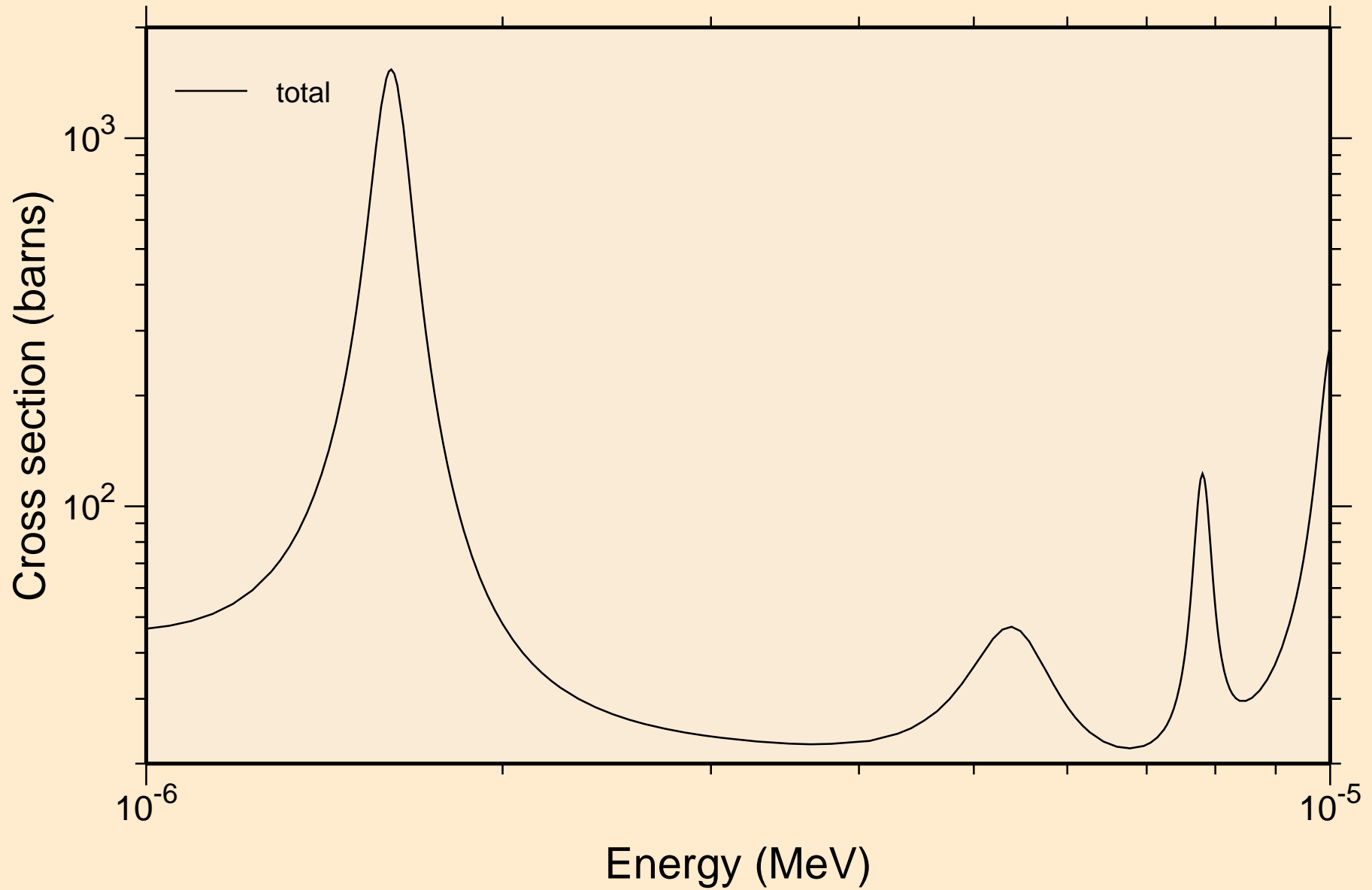

PU243 NRG TENDL-2015, AKONING  
resonance total cross section

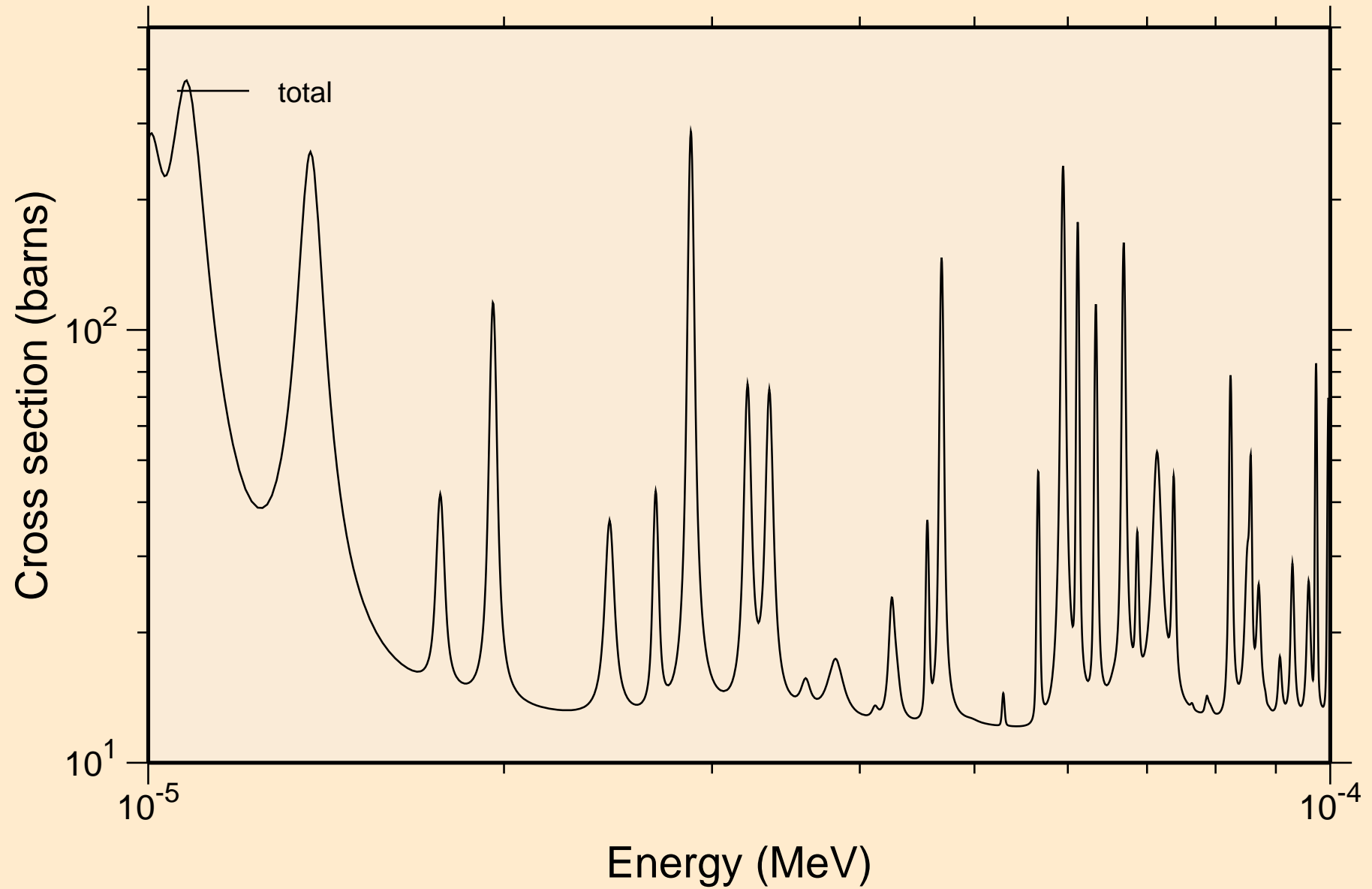

PU243 NRG TENDL-2015, AKONING  
resonance total cross section

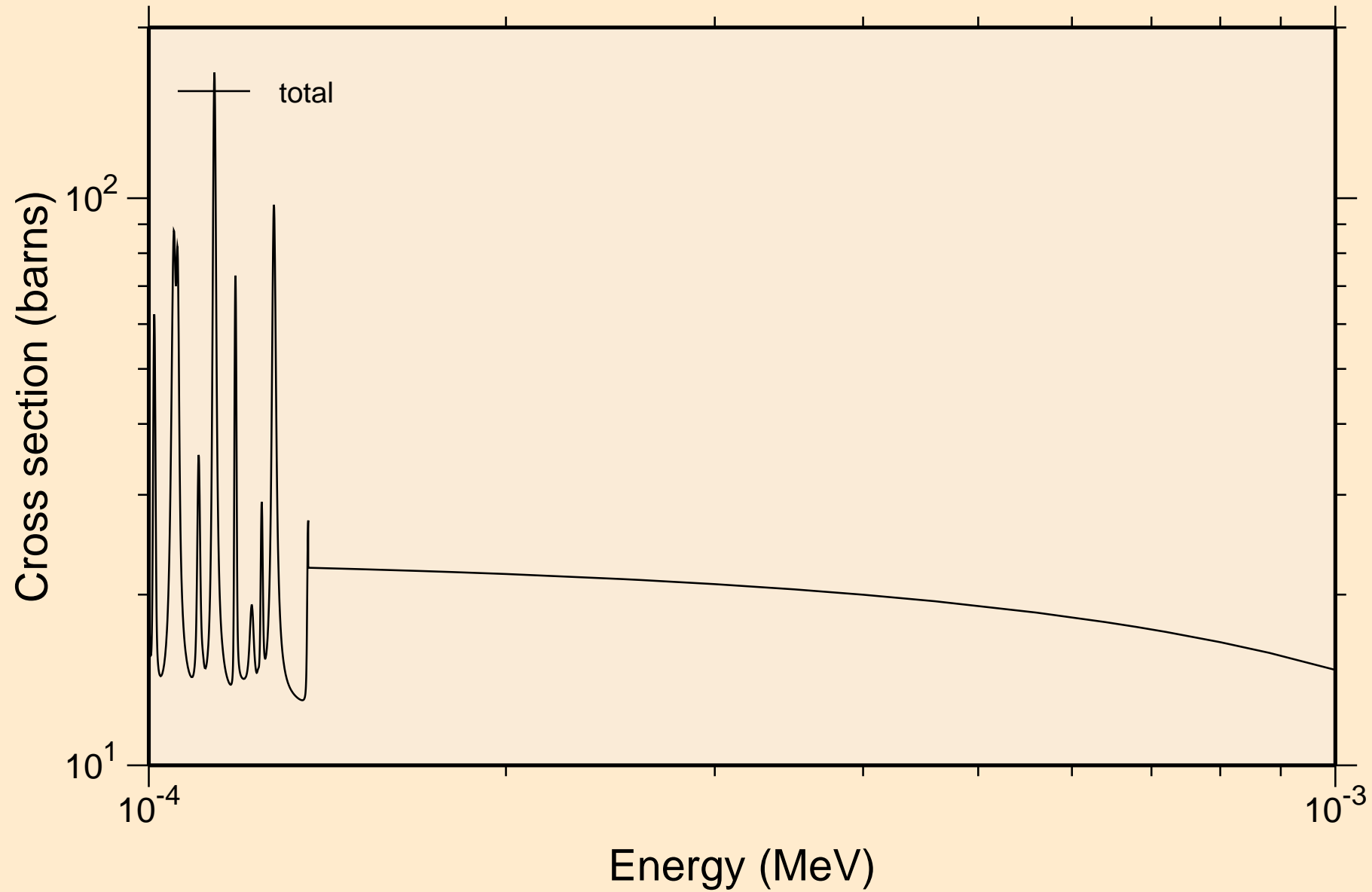

PU243 NRG TENDL-2015, AKONING  
resonance total cross section

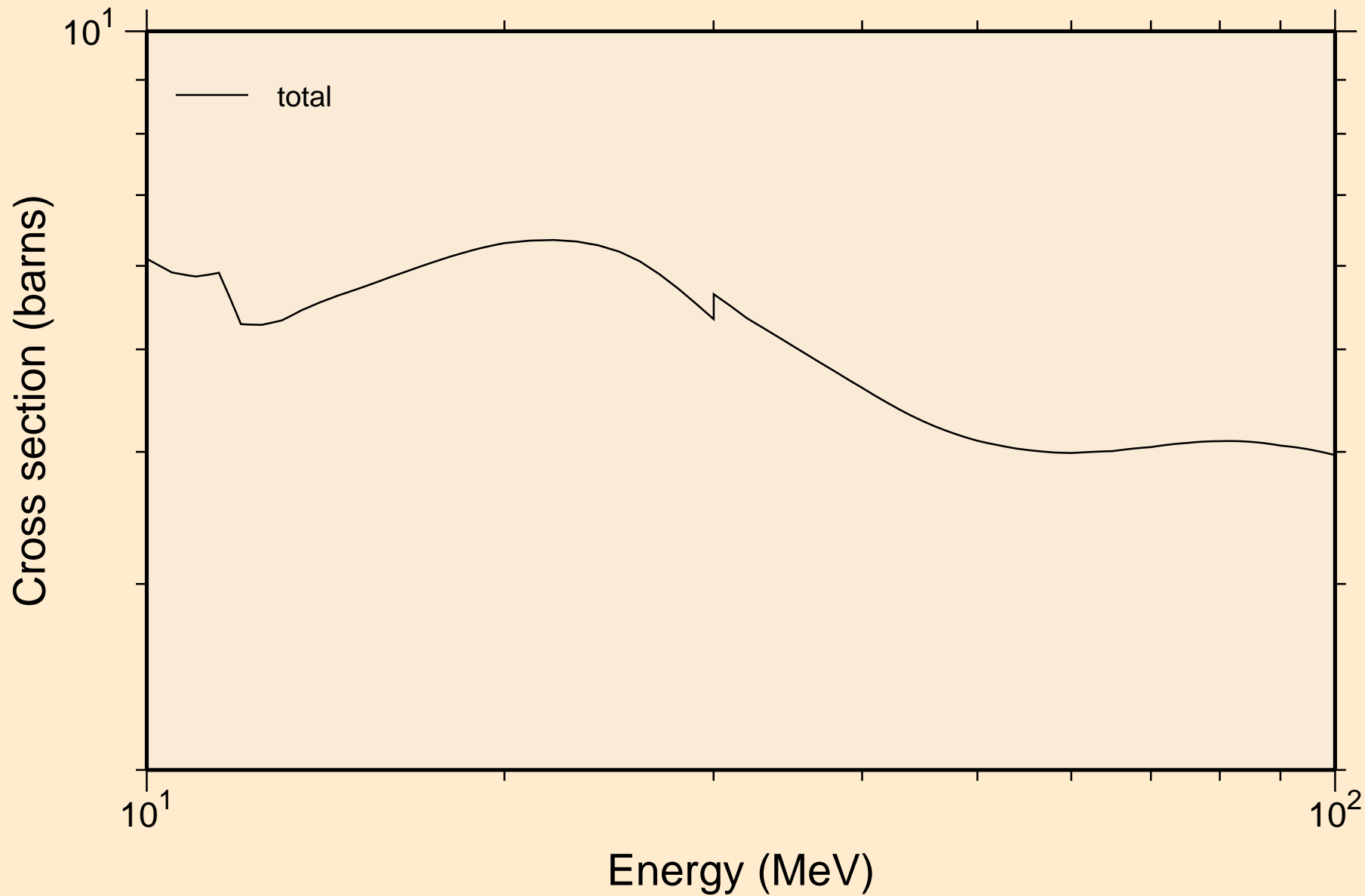

PU243 NRG TENDL-2015, AKONING  
resonance absorption cross sections

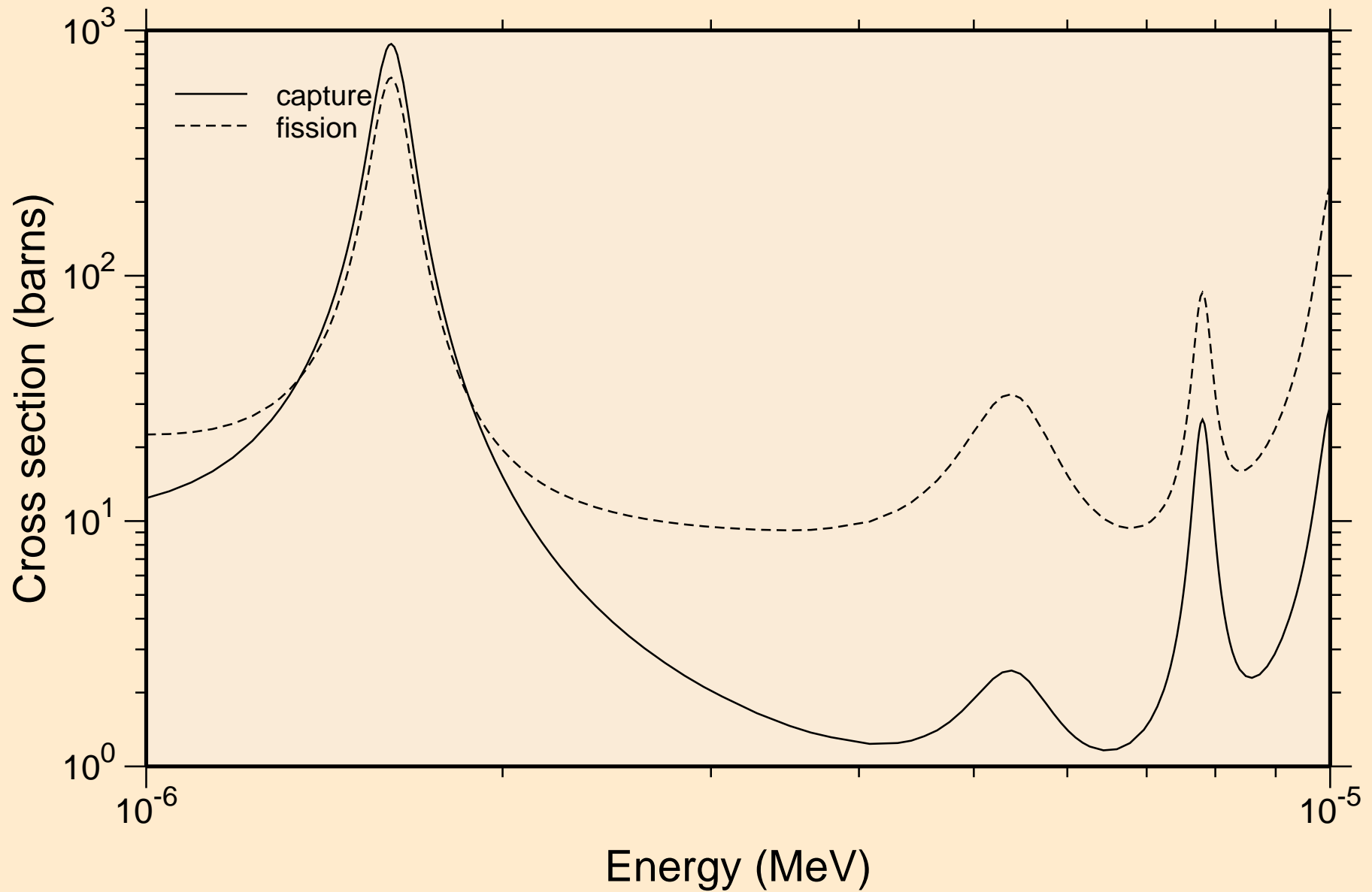

PU243 NRG TENDL-2015, AKONING  
resonance absorption cross sections

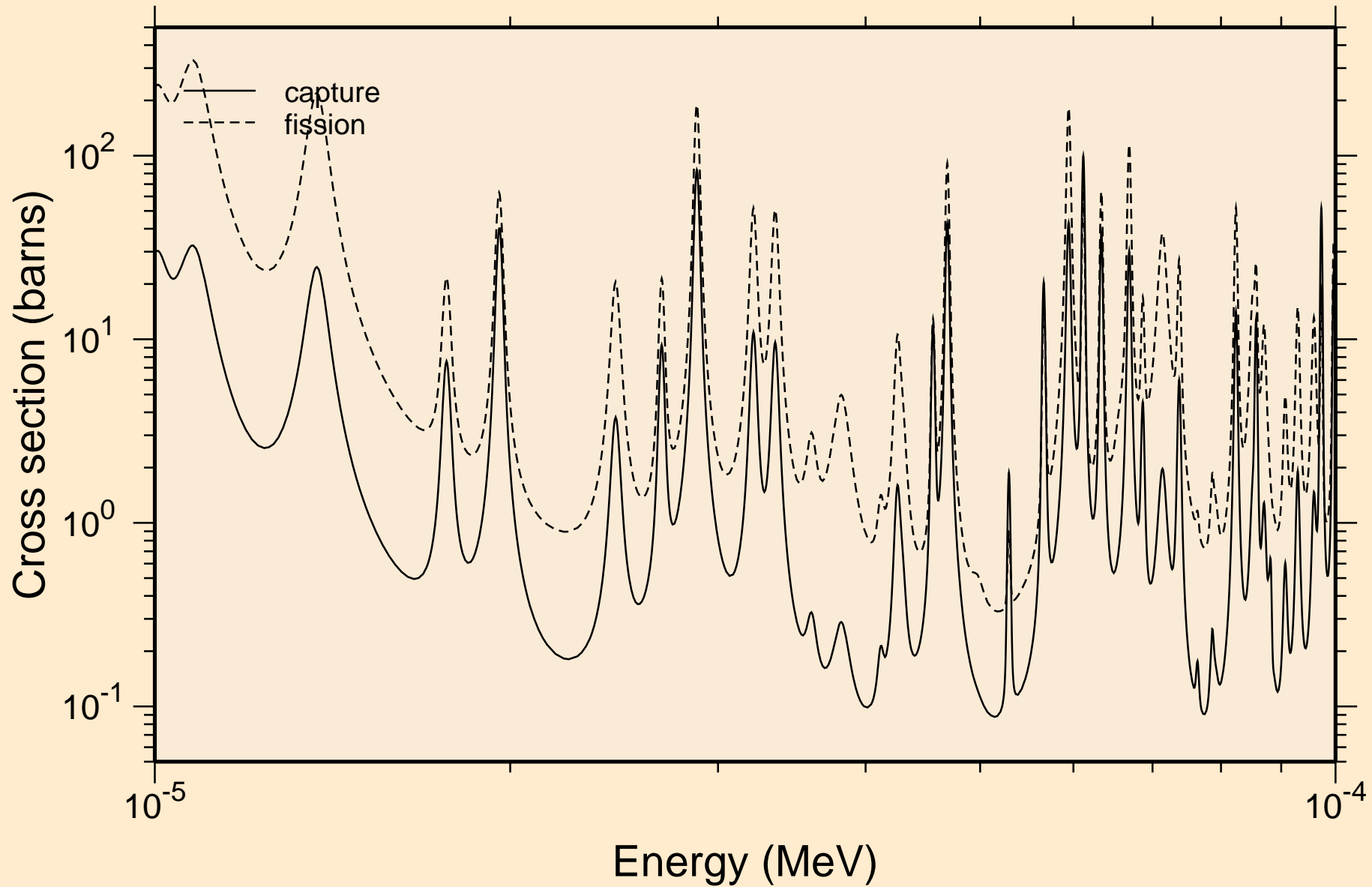

PU243 NRG TENDL-2015, AKONING  
resonance absorption cross sections

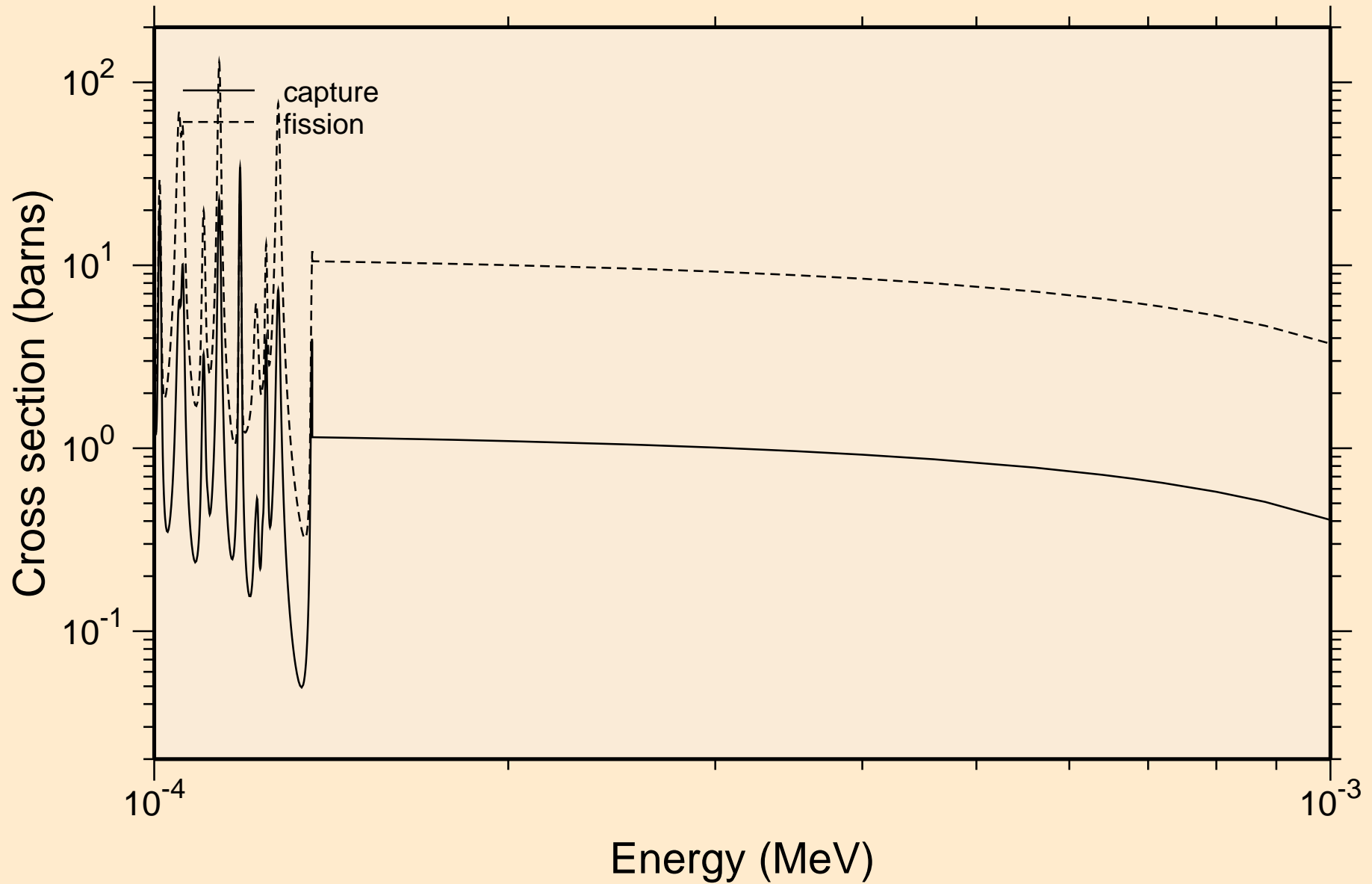



PU243 NRG TENDL-2015, AKONING  
resonance absorption cross sections

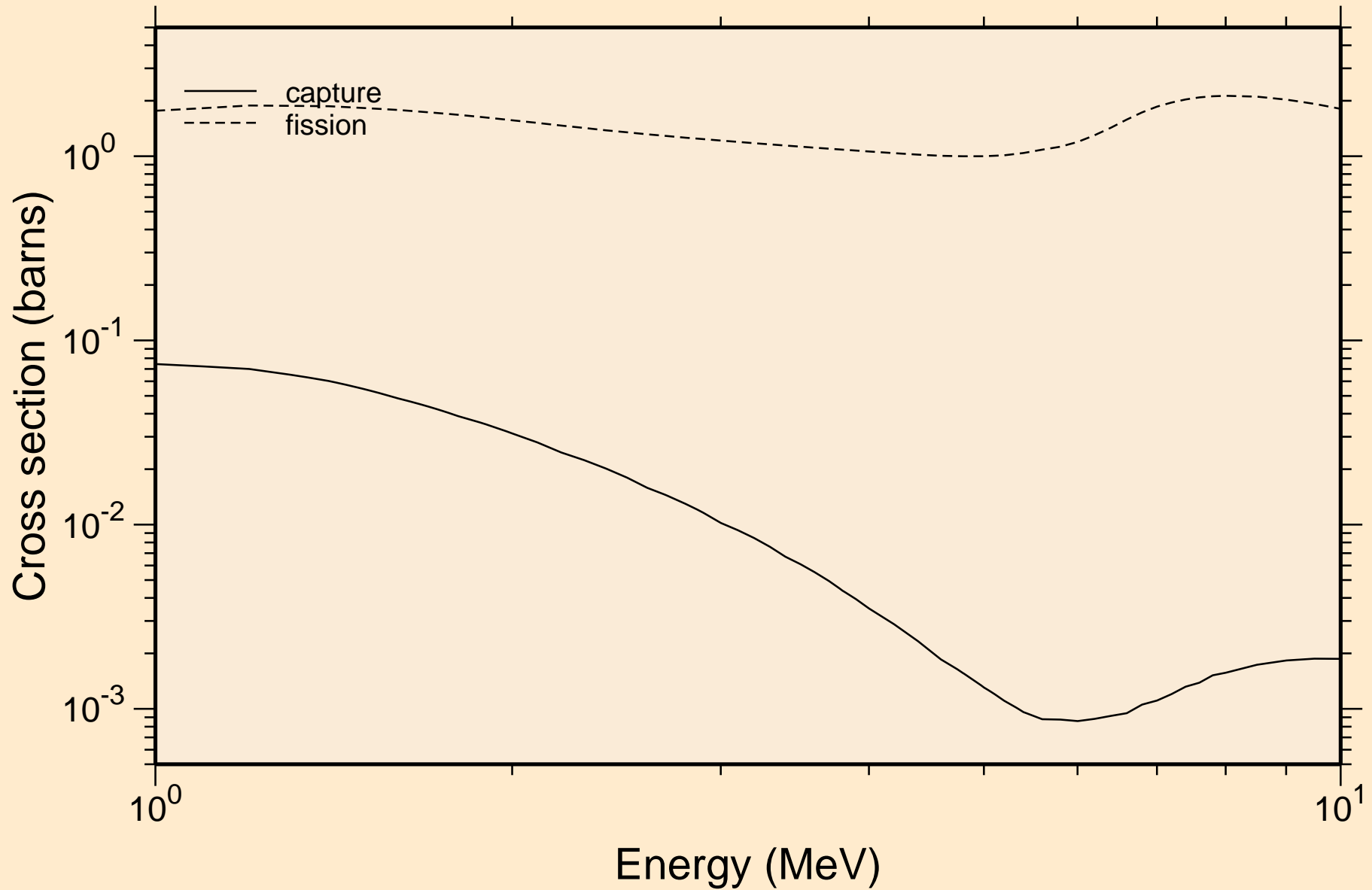

# PU243 NRG TENDL-2015, AKONING

## Non-threshold reactions

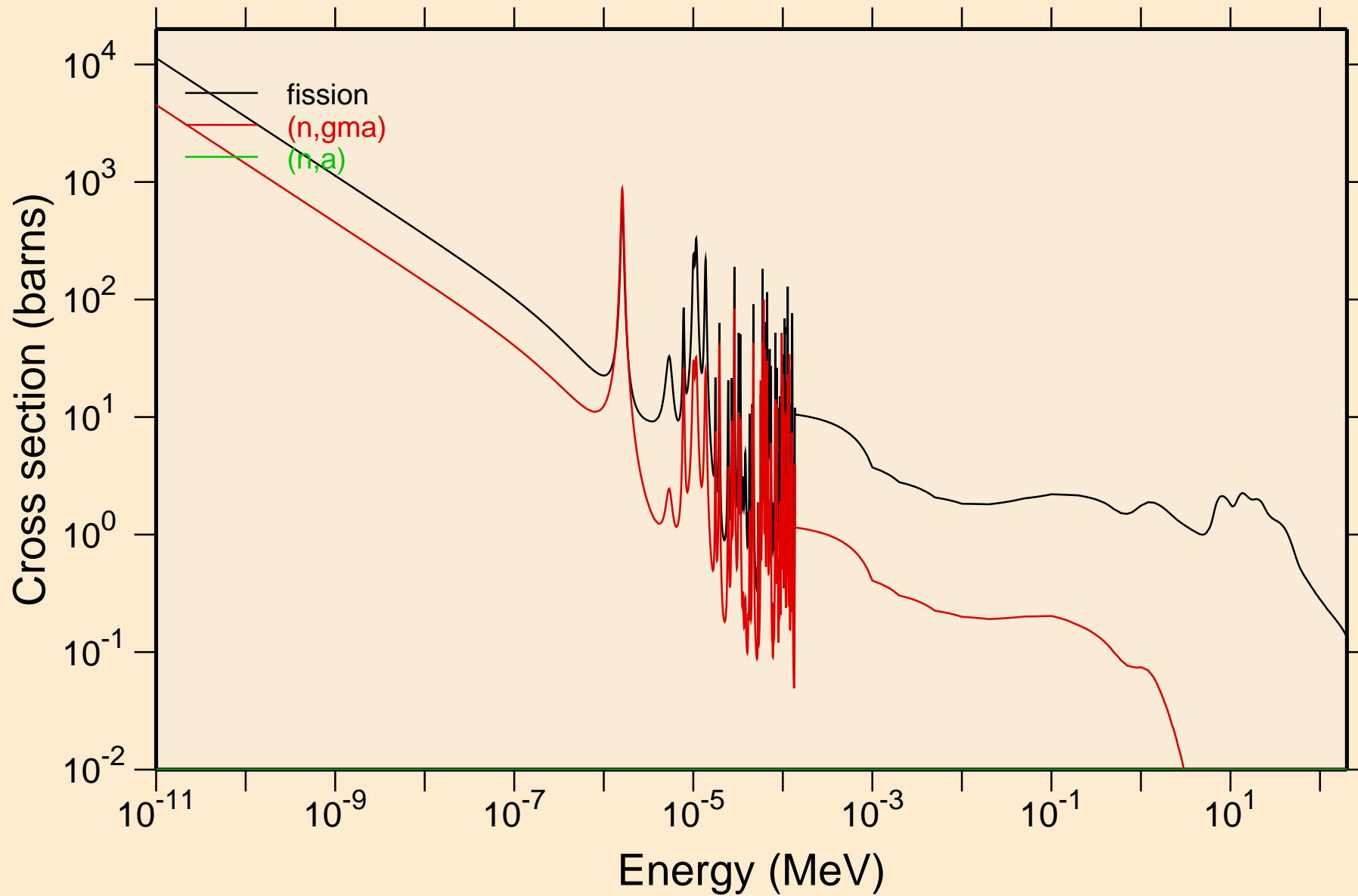

# PU243 NRG TENDL-2015, AKONING

## Principal cross sections

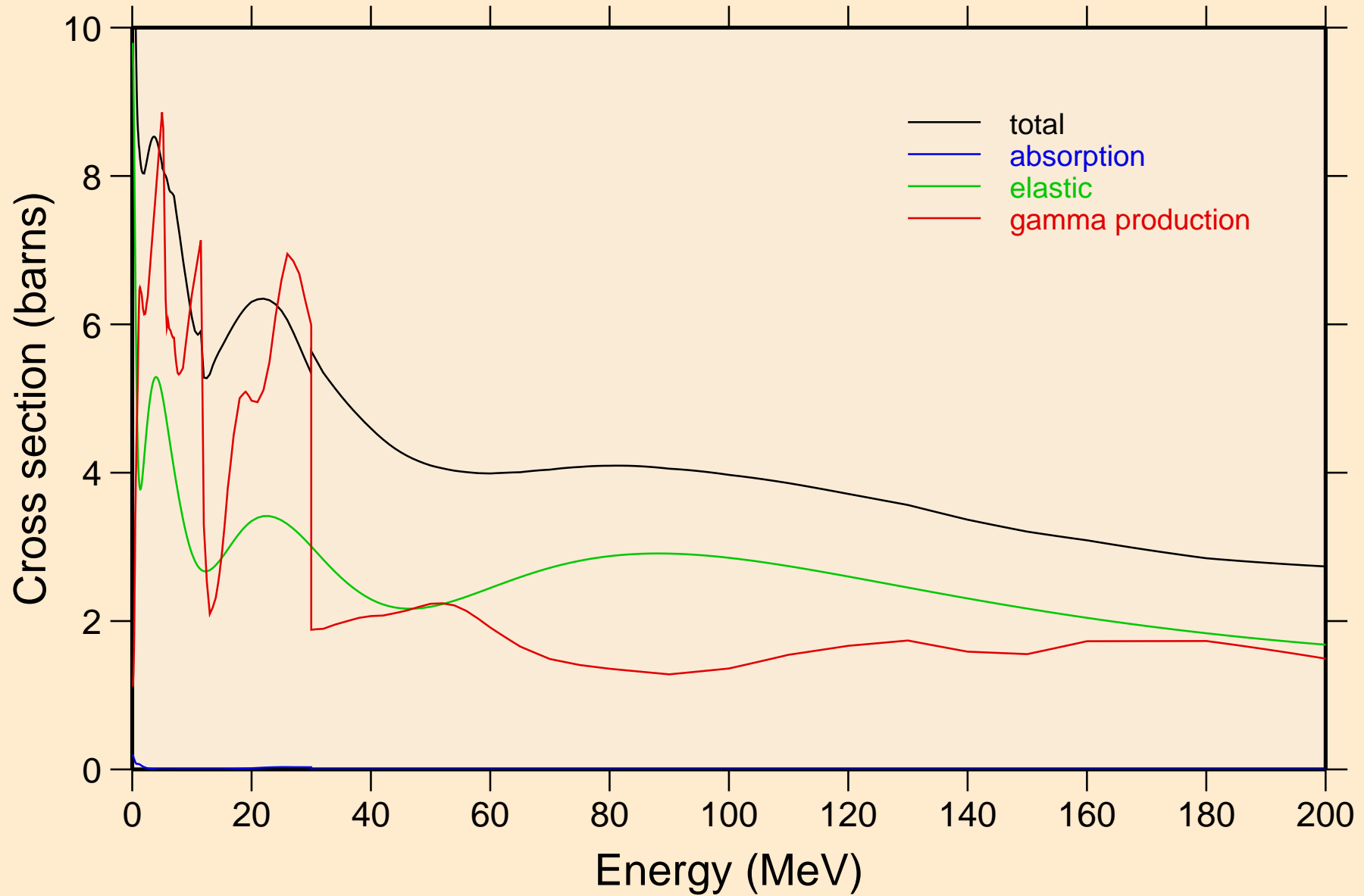

# PU243 NRG TENDL-2015, AKONING

## Non-threshold reactions

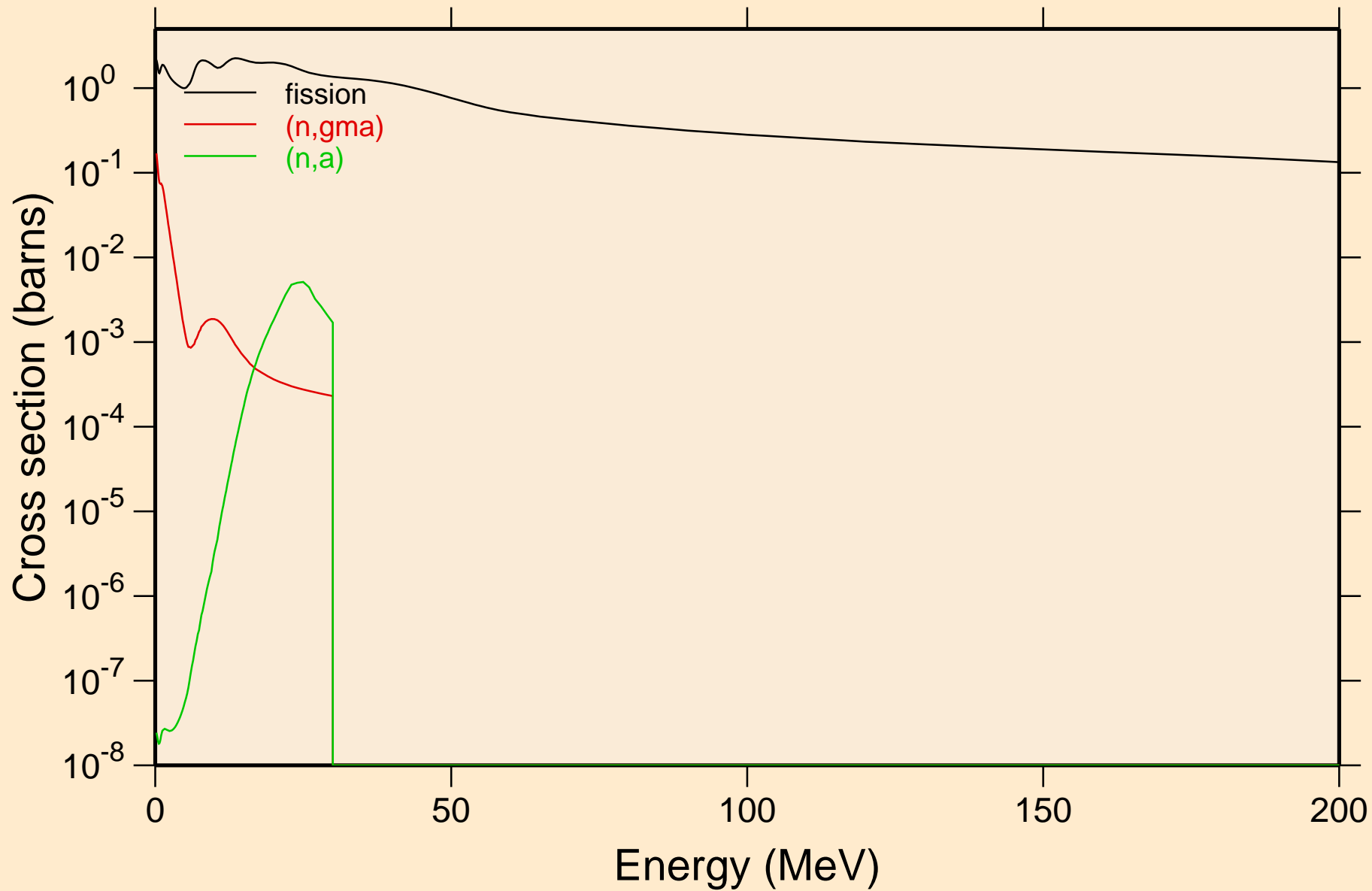

# PU243 NRG TENDL-2015, AKONING

## Inelastic levels

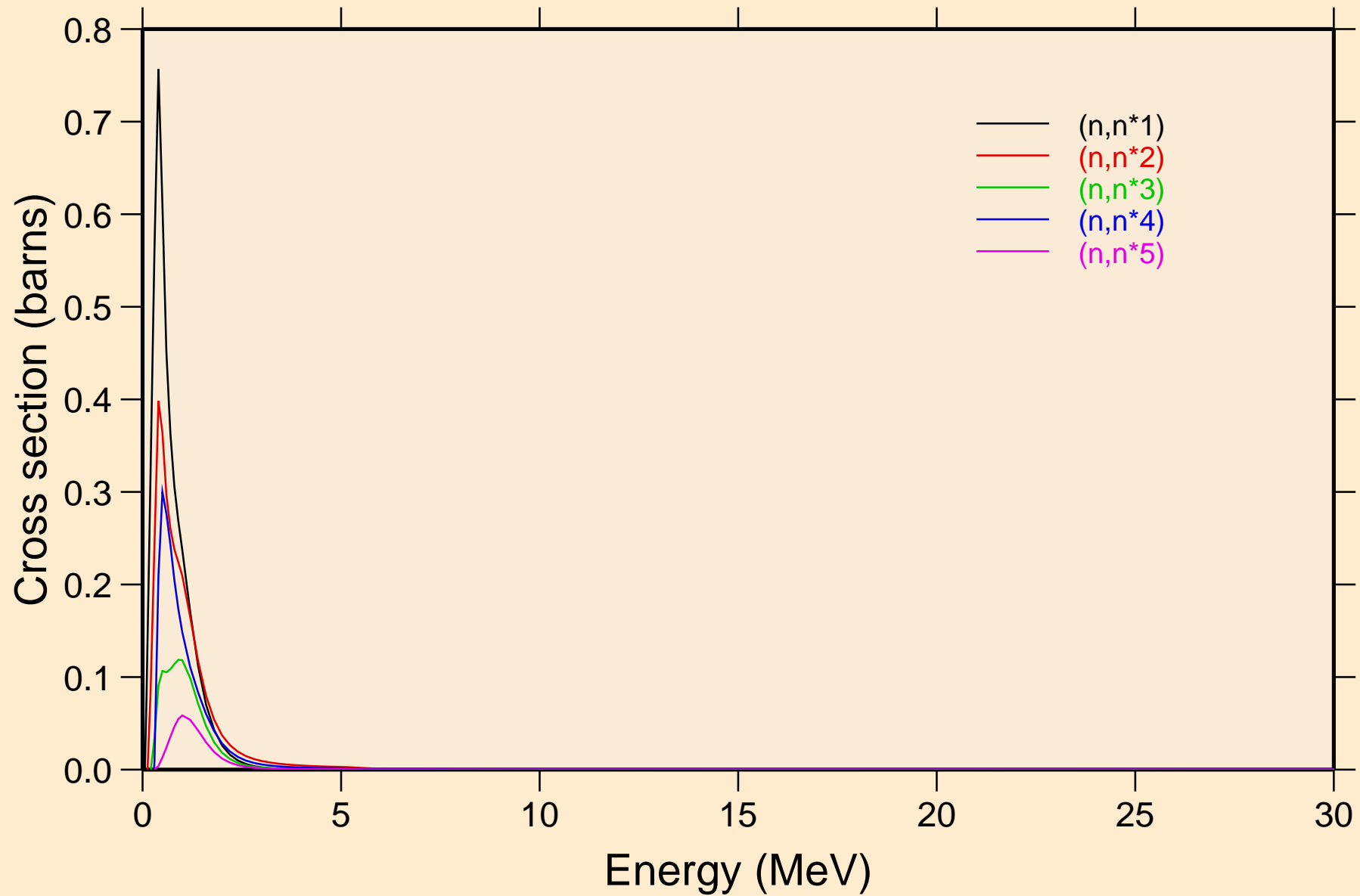

# PU243 NRG TENDL-2015, AKONING

## Inelastic levels

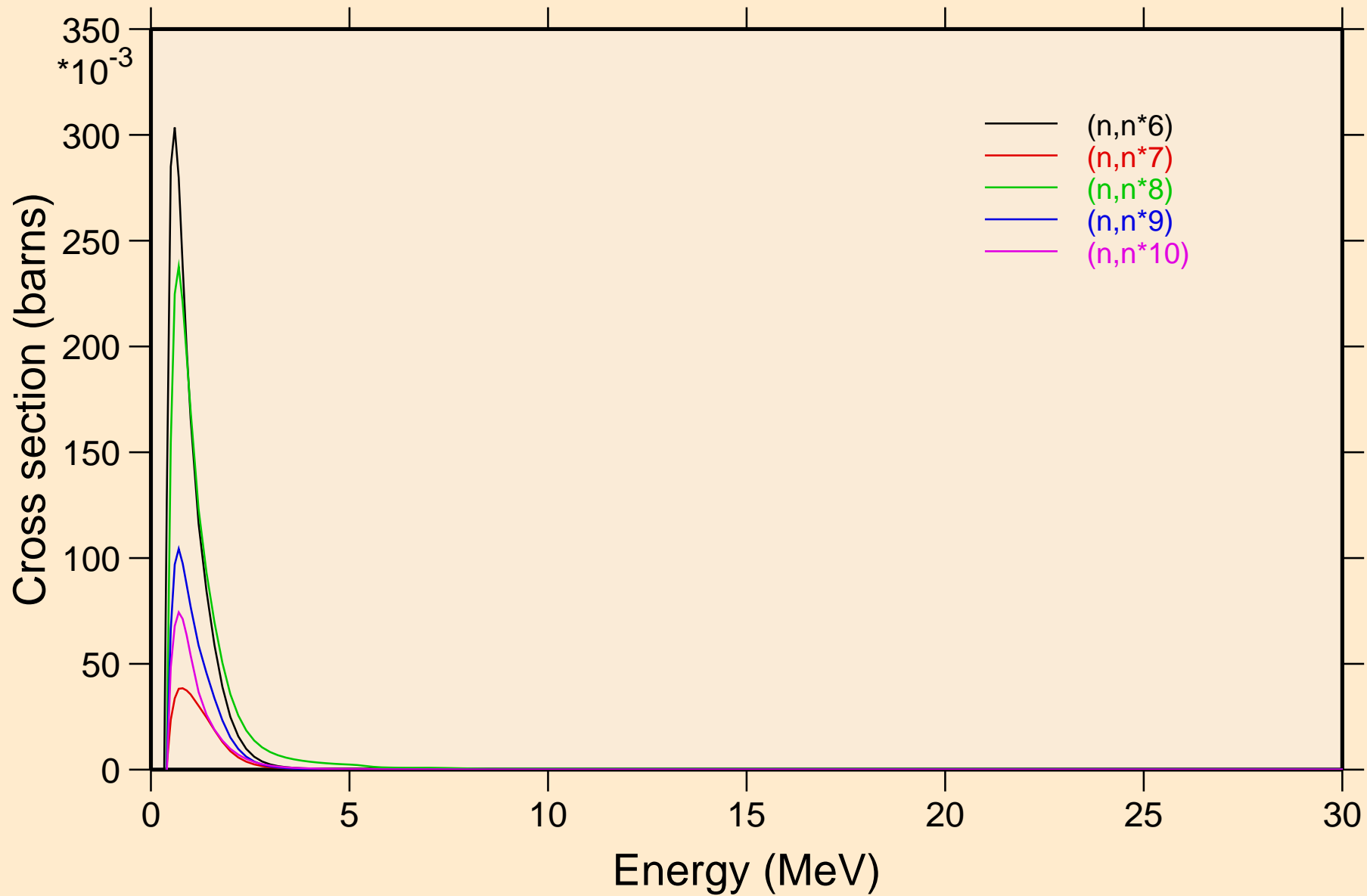

# PU243 NRG TENDL-2015, AKONING

## Inelastic levels

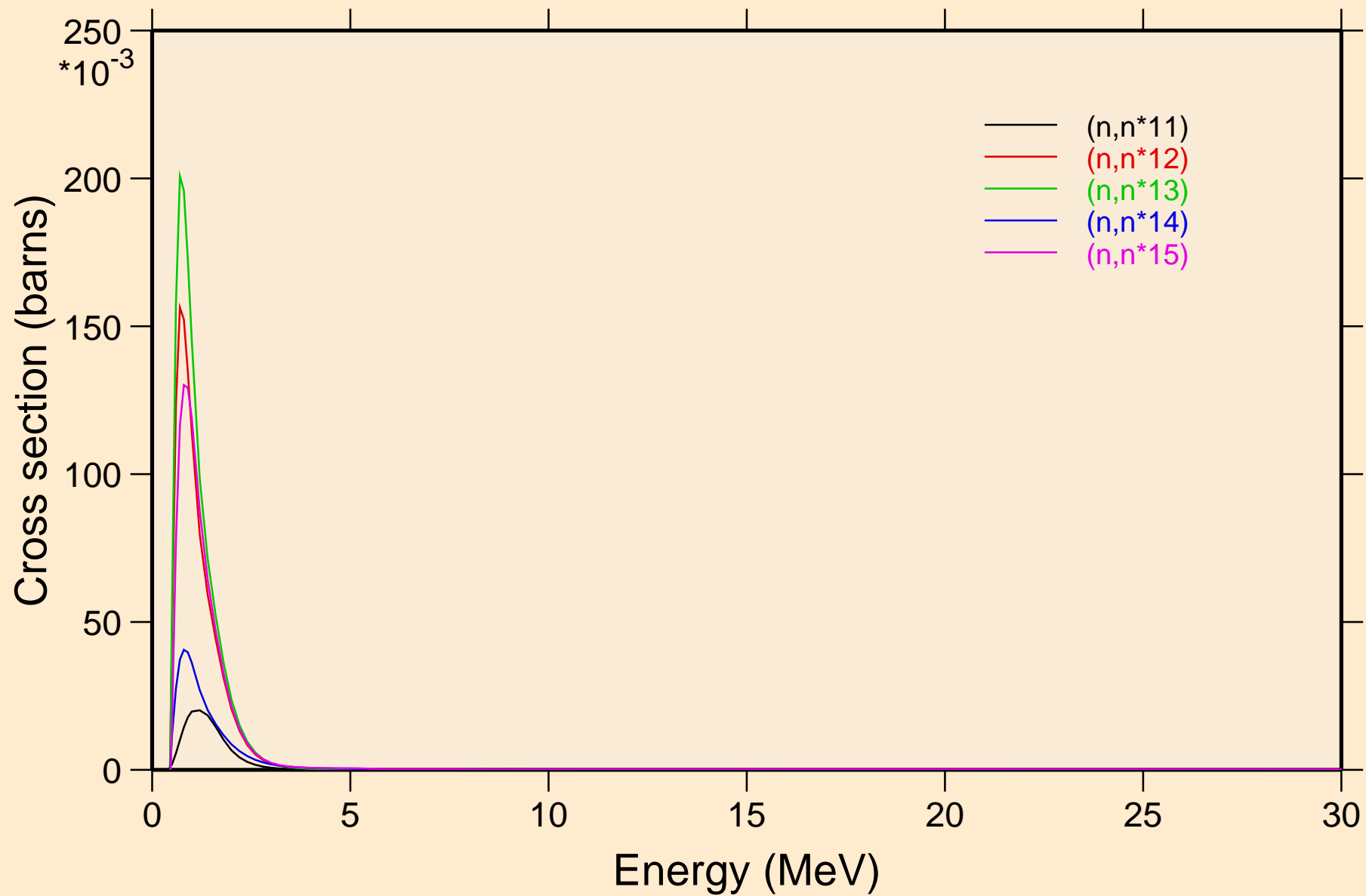

# PU243 NRG TENDL-2015, AKONING

## Inelastic levels

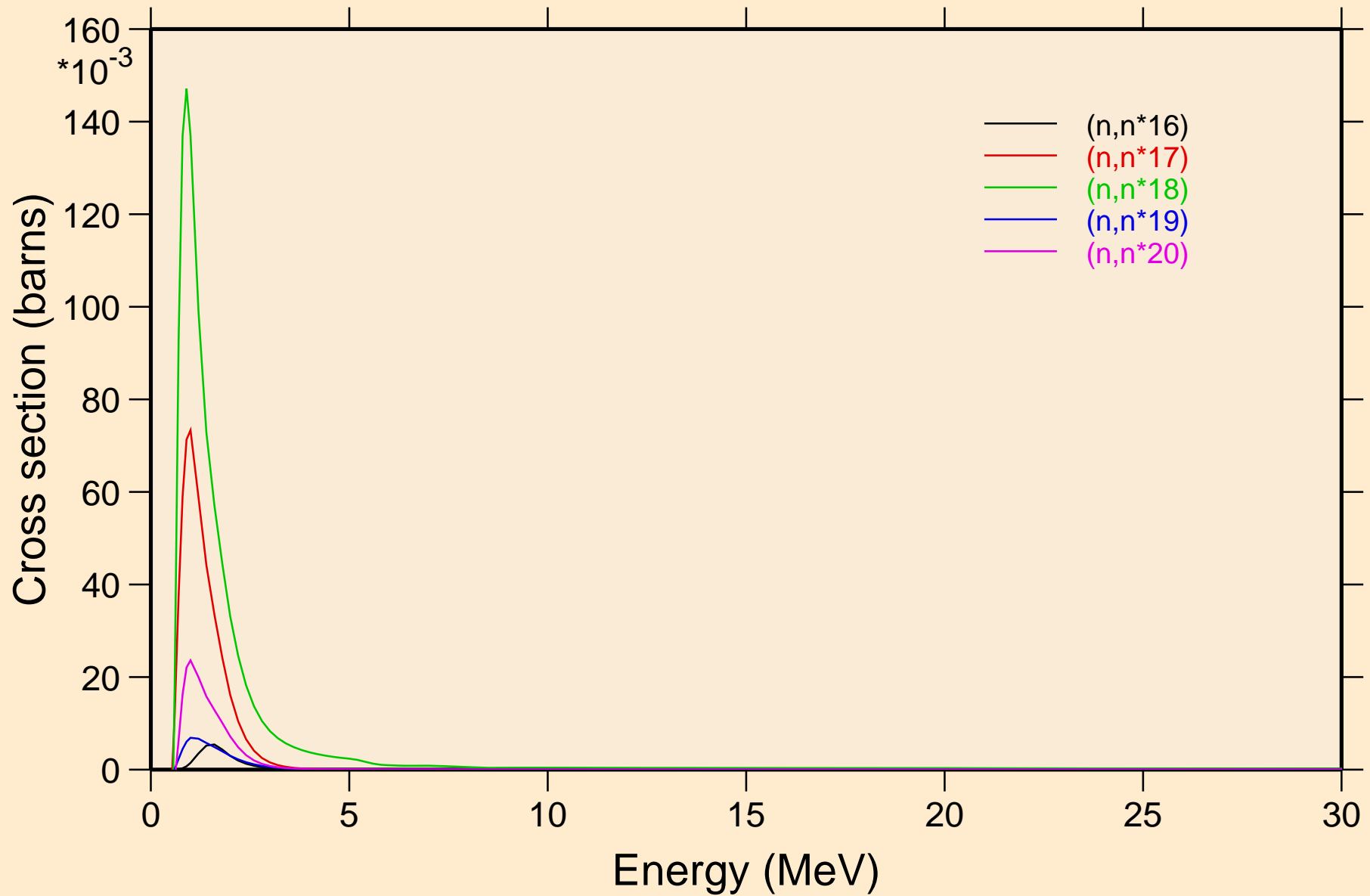



# PU243 NRG TENDL-2015, AKONING

## Inelastic levels

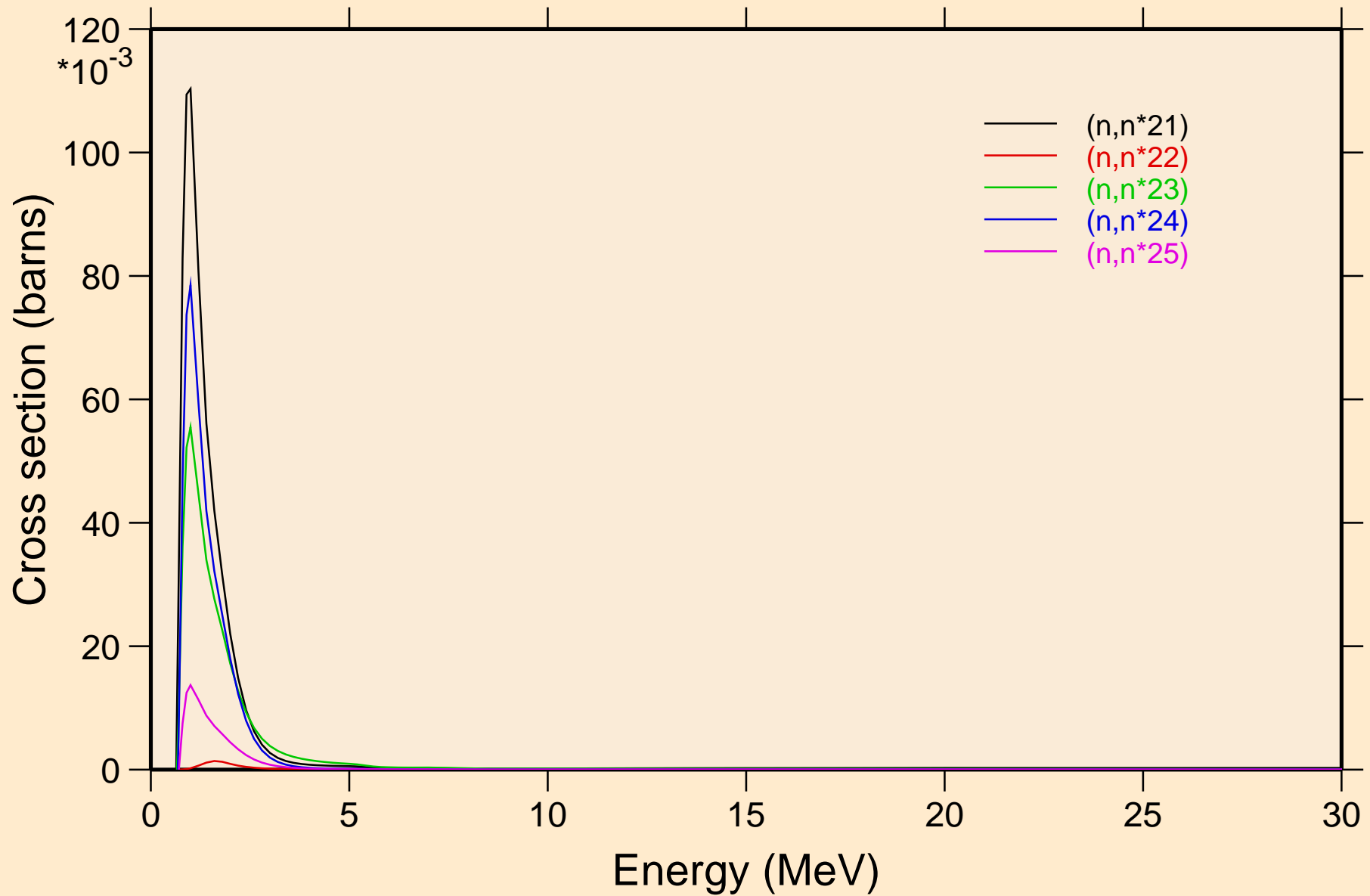

# PU243 NRG TENDL-2015, AKONING

## Inelastic levels

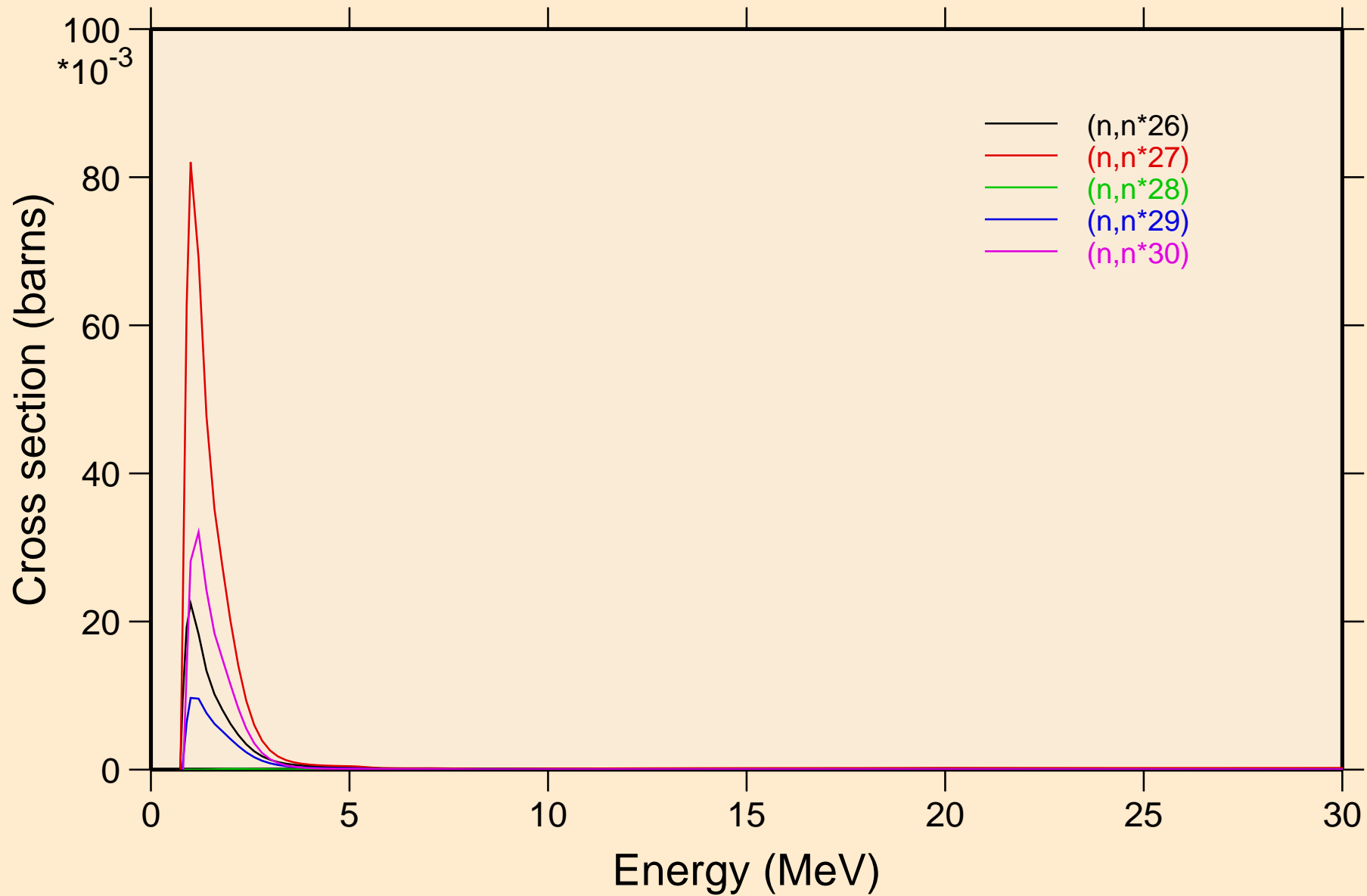

# PU243 NRG TENDL-2015, AKONING

## Threshold reactions

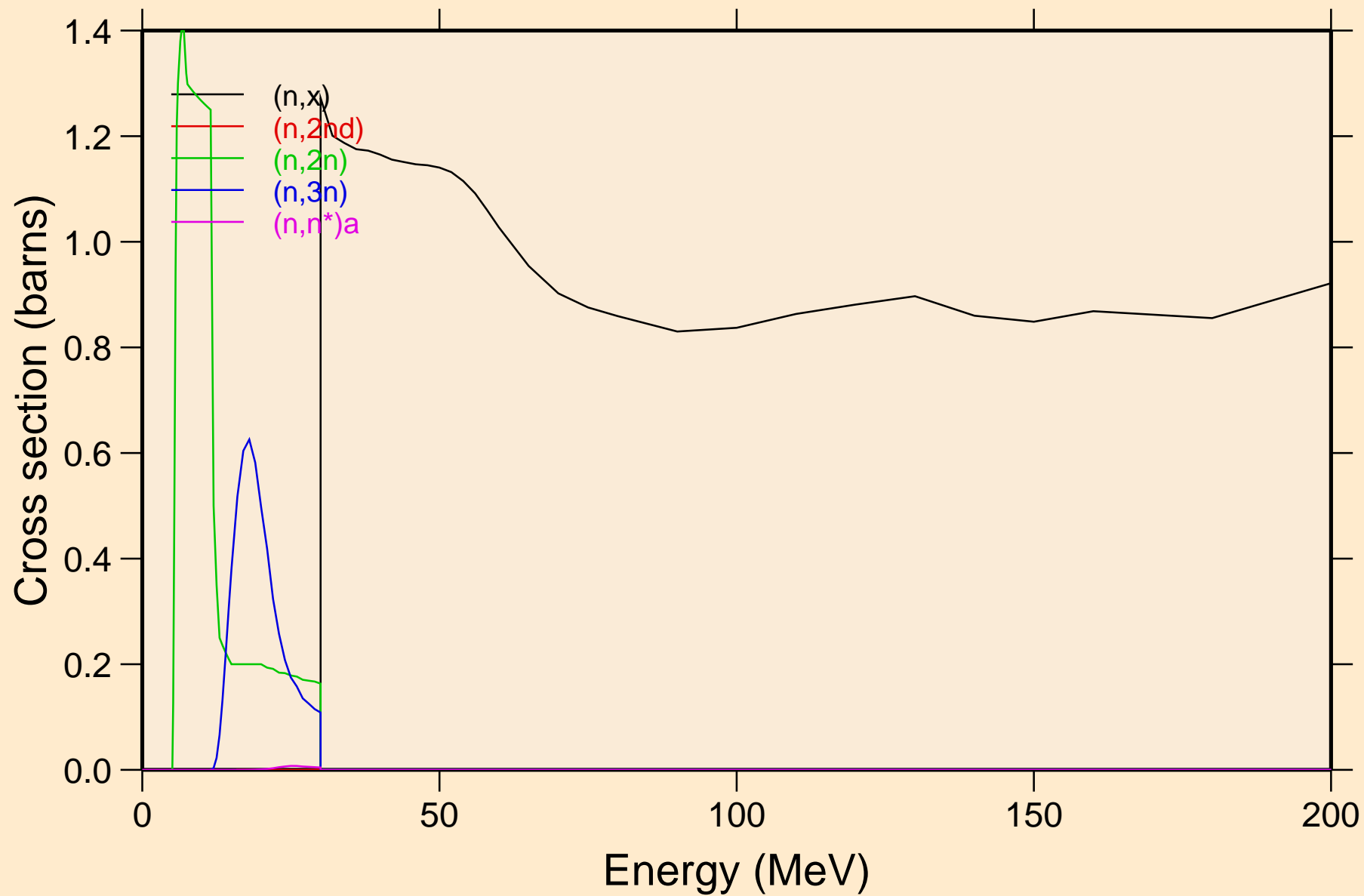

# PU243 NRG TENDL-2015, AKONING

## Threshold reactions

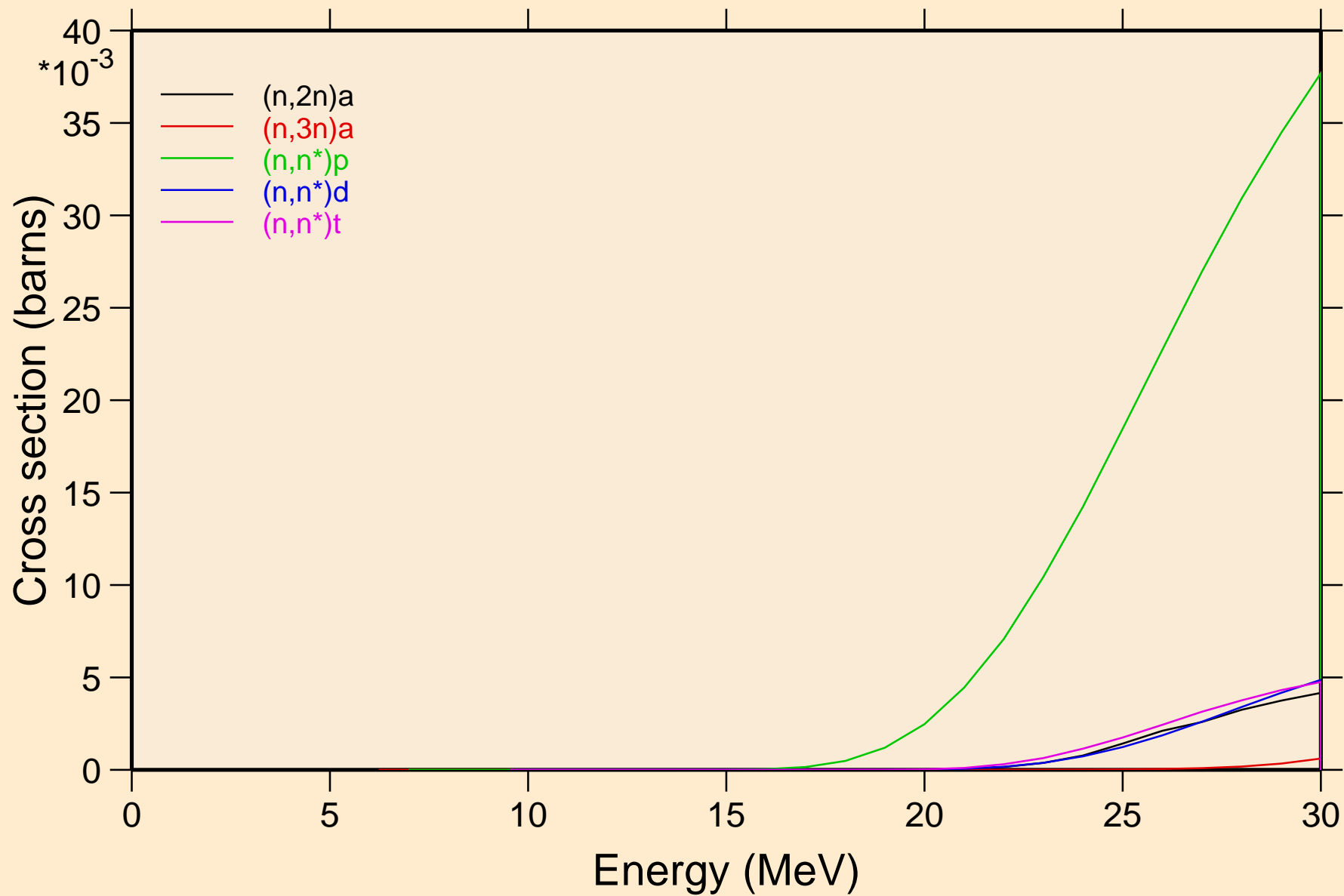

# PU243 NRG TENDL-2015, AKONING

## Threshold reactions

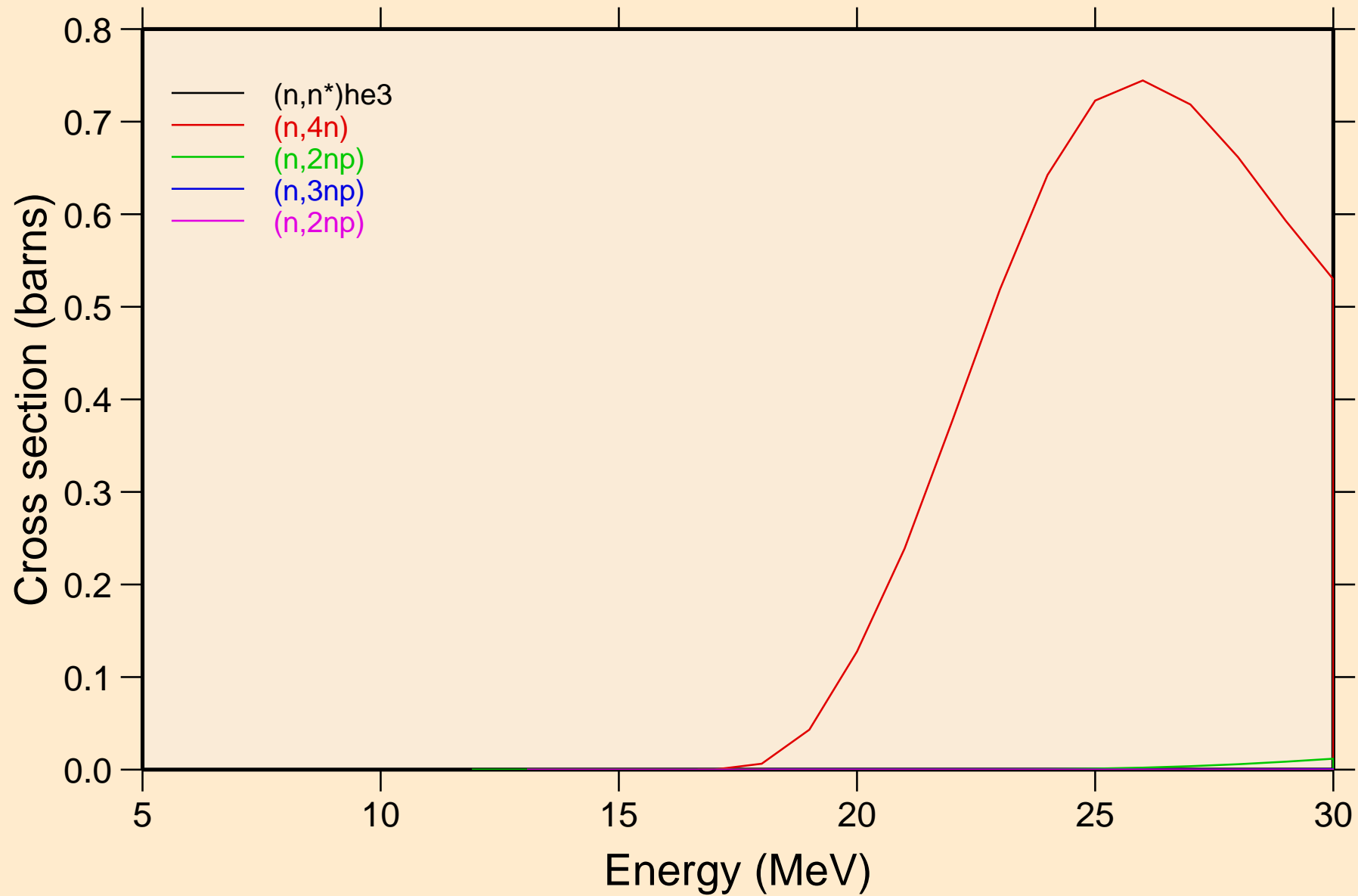

# PU243 NRG TENDL-2015, AKONING

## Threshold reactions

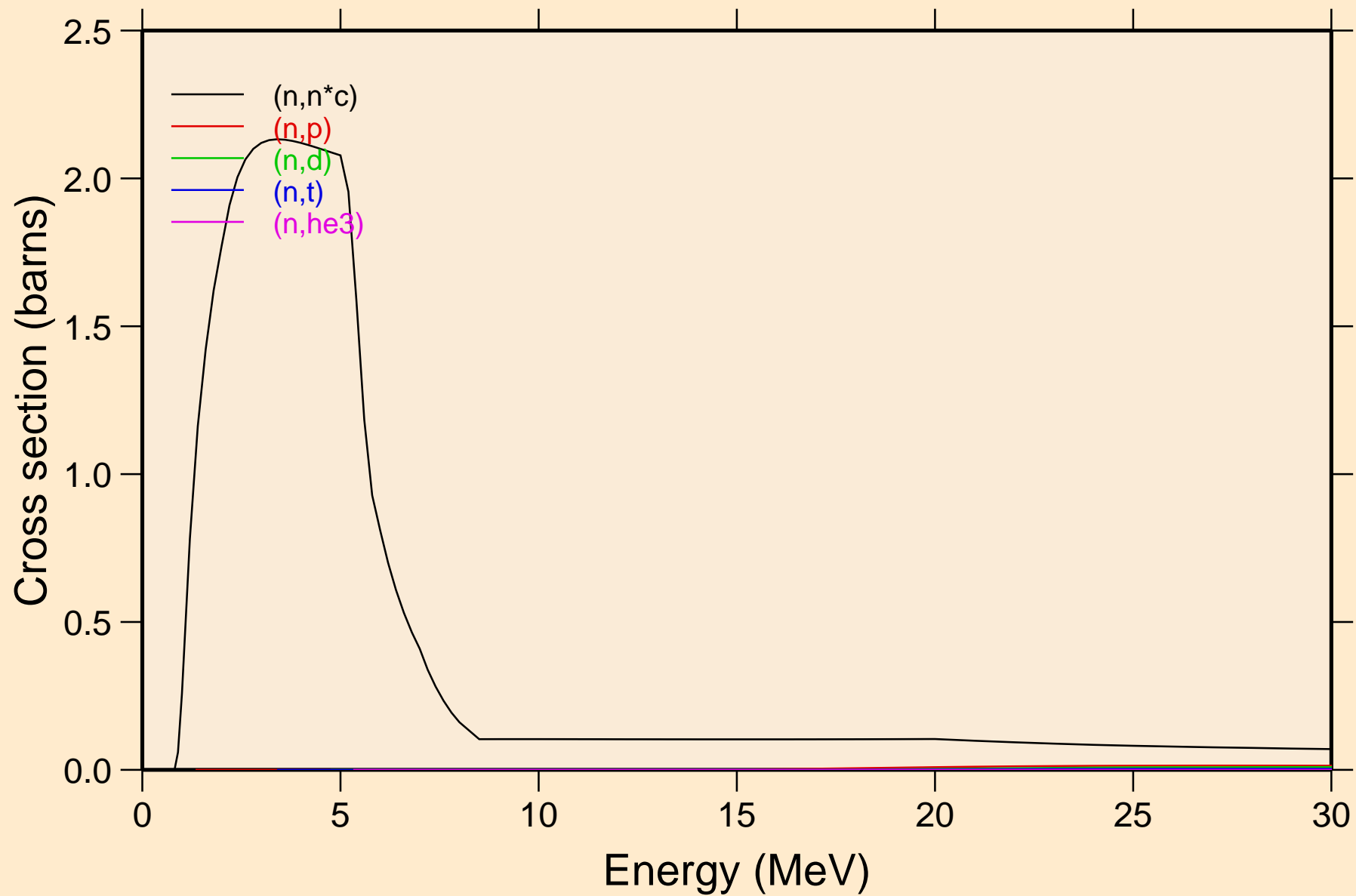

# PU243 NRG TENDL-2015, AKONING

## Threshold reactions

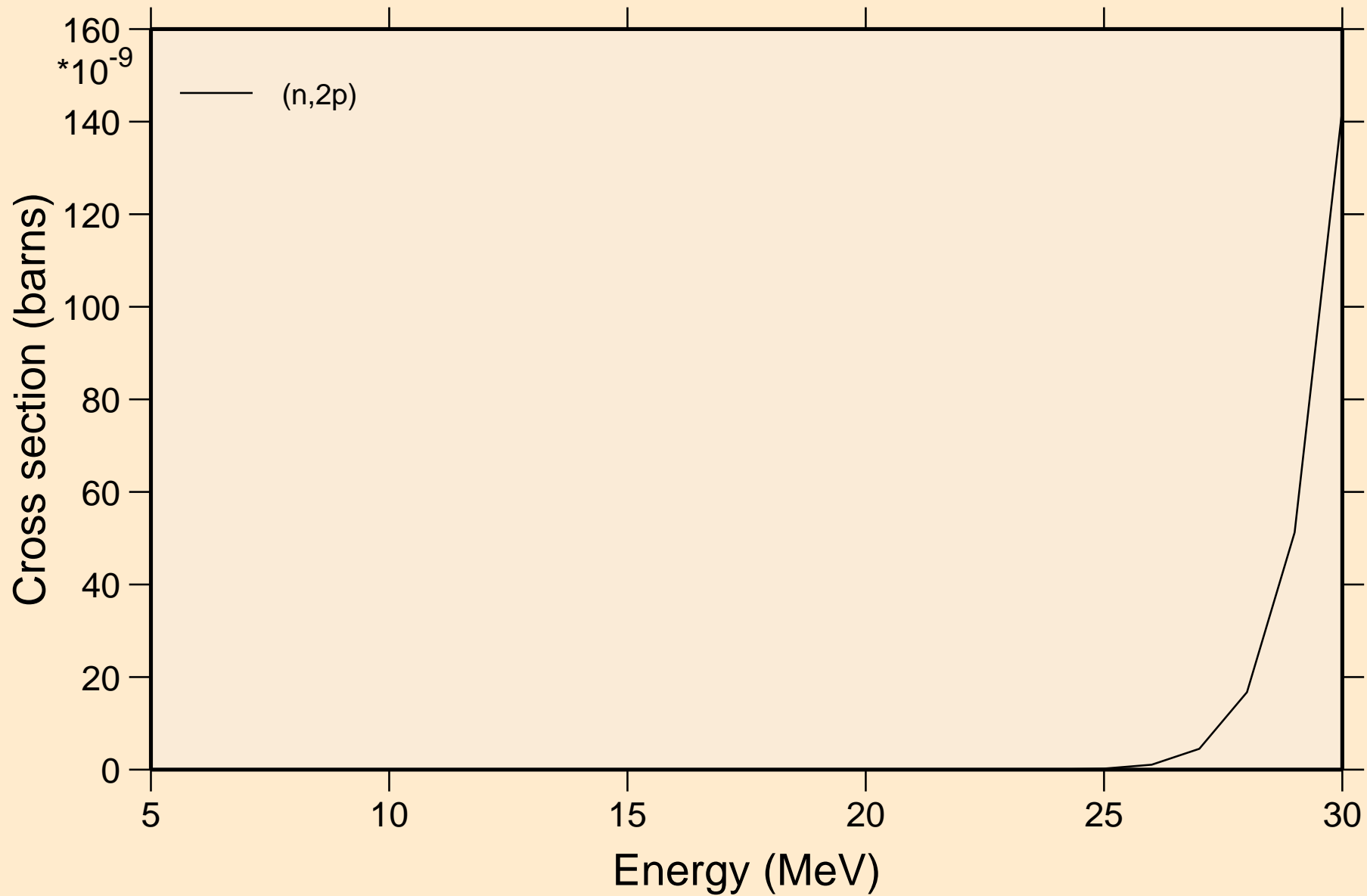

PU243 NRG TENDL-2015, AKONING  
angular distribution for elastic

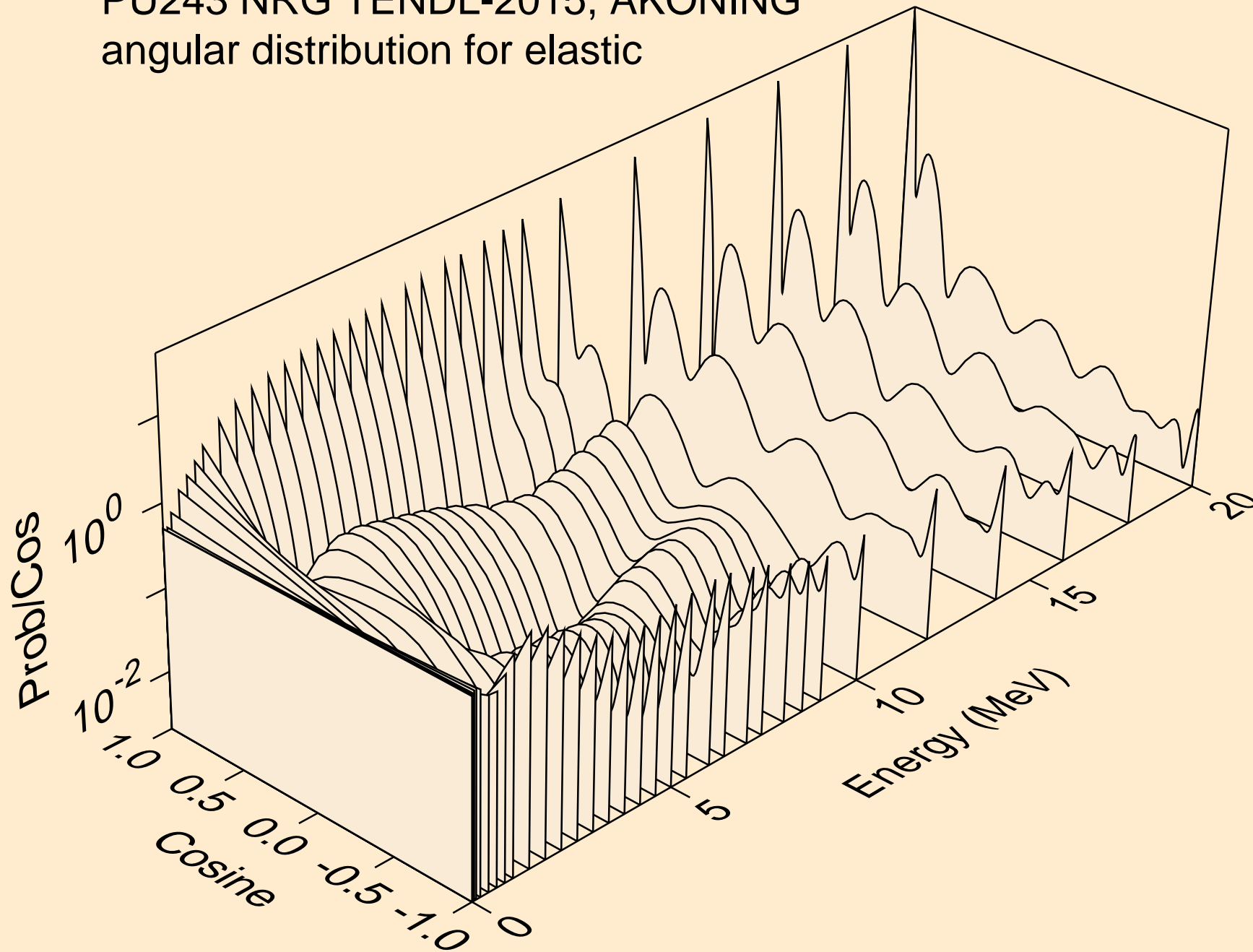



PU243 NRG TENDL-2015, AKONING  
angular distribution for elastic

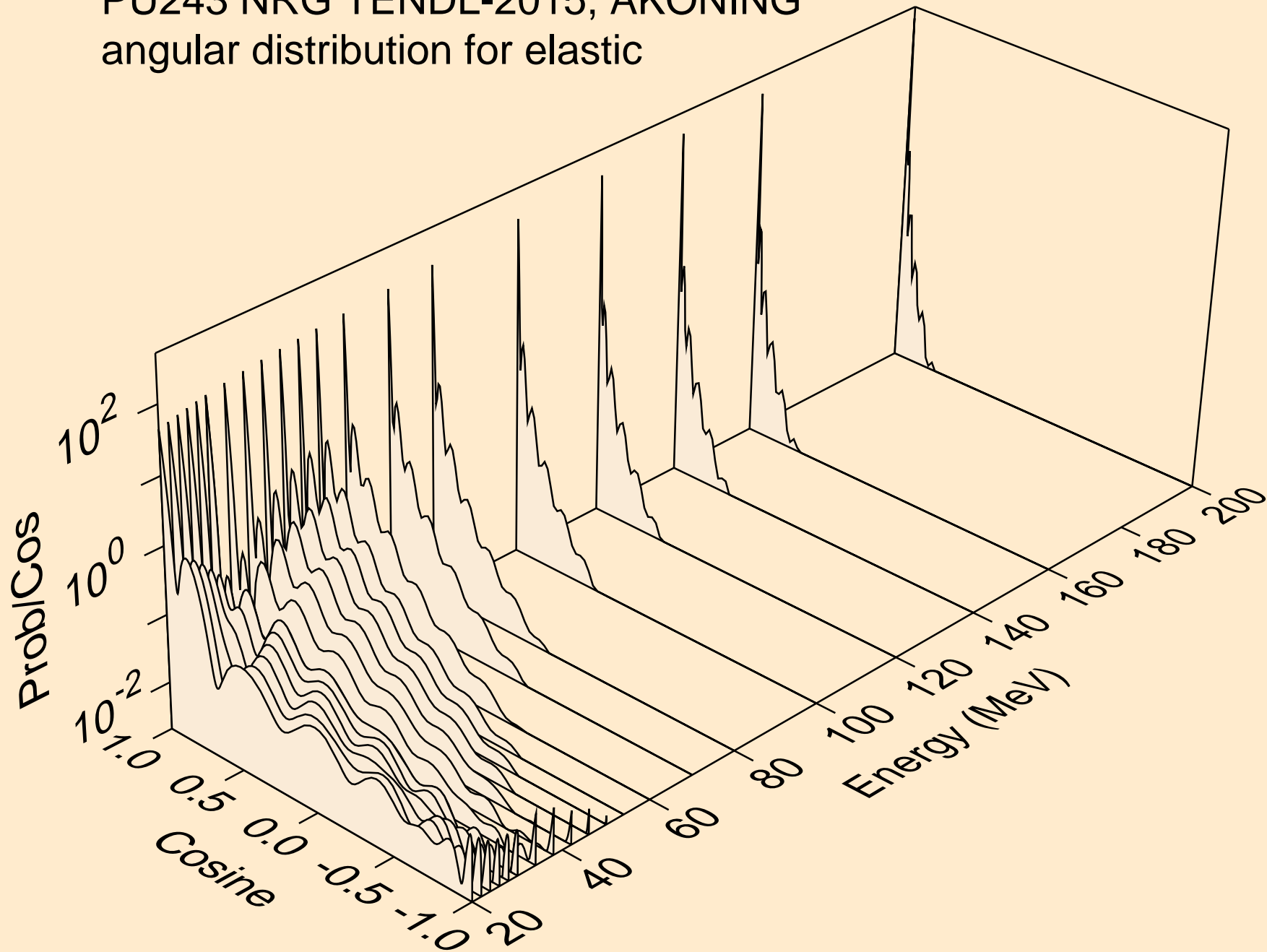

PU243 NRG TENDL-2015, AKONING  
angular distribution for (n,n\*1)

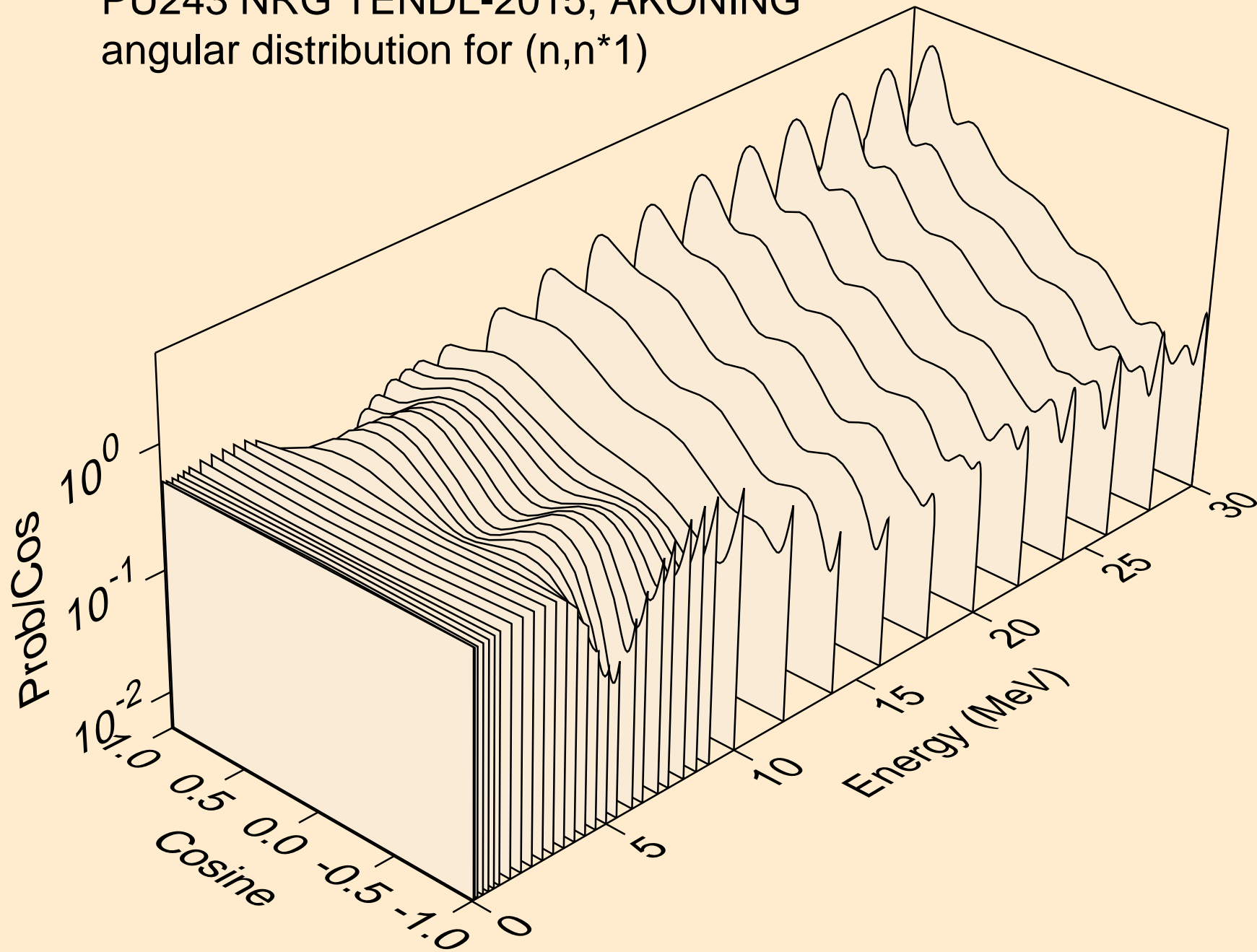

PU243 NRG TENDL-2015, AKONING  
angular distribution for (n,n\*2)

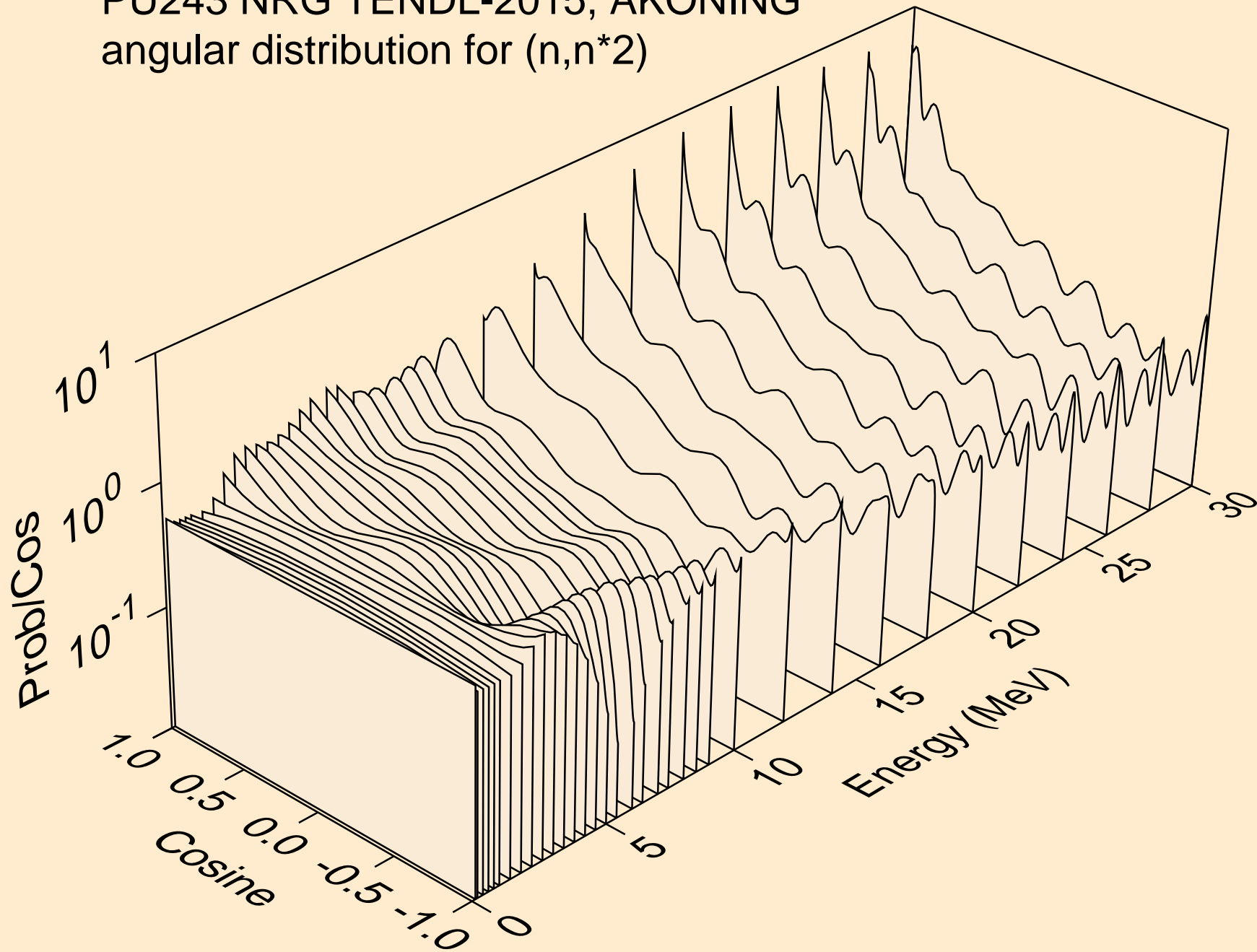

PU243 NRG TENDL-2015, AKONING  
angular distribution for (n,n\*3)

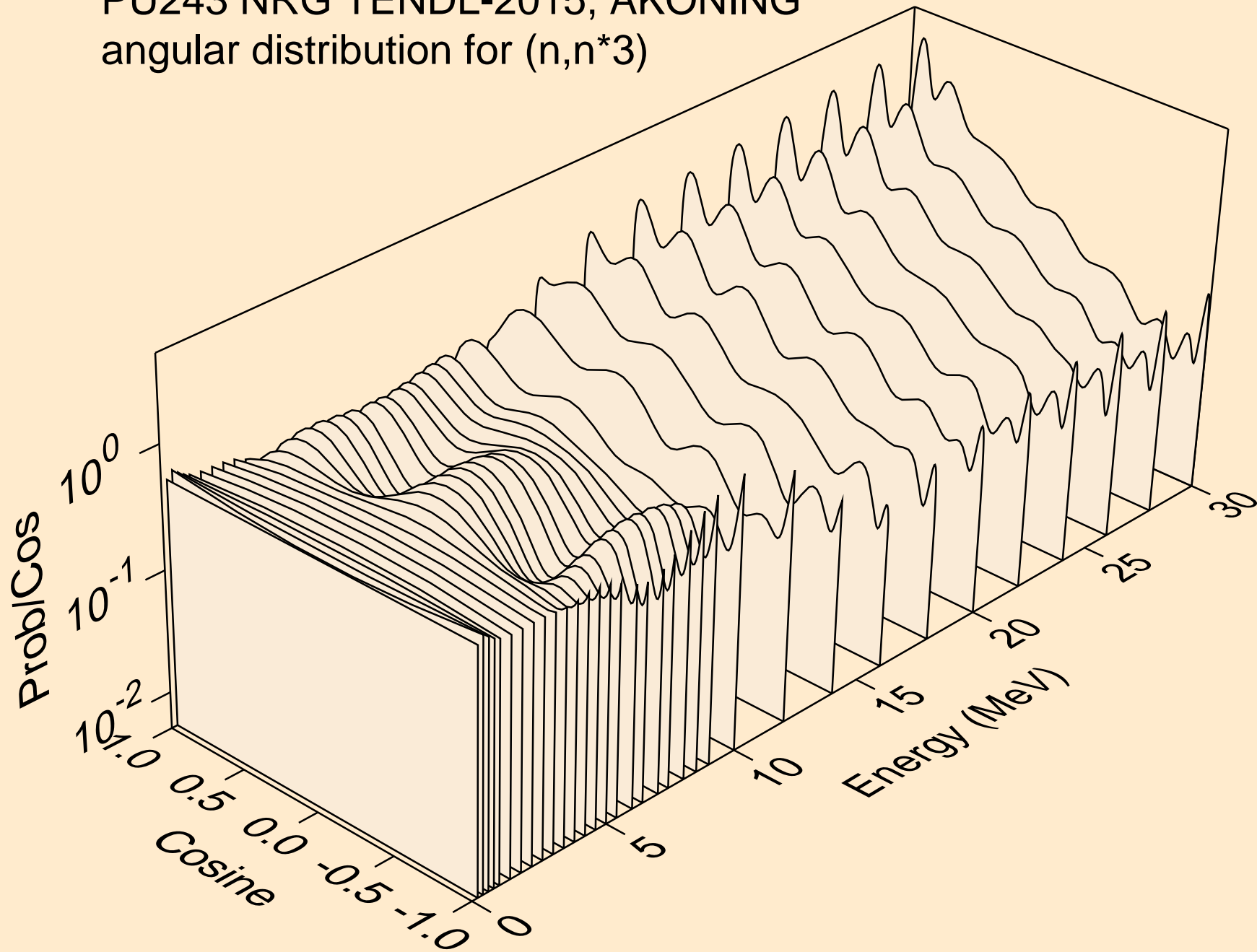

PU243 NRG TENDL-2015, AKONING  
angular distribution for (n,n\*4)

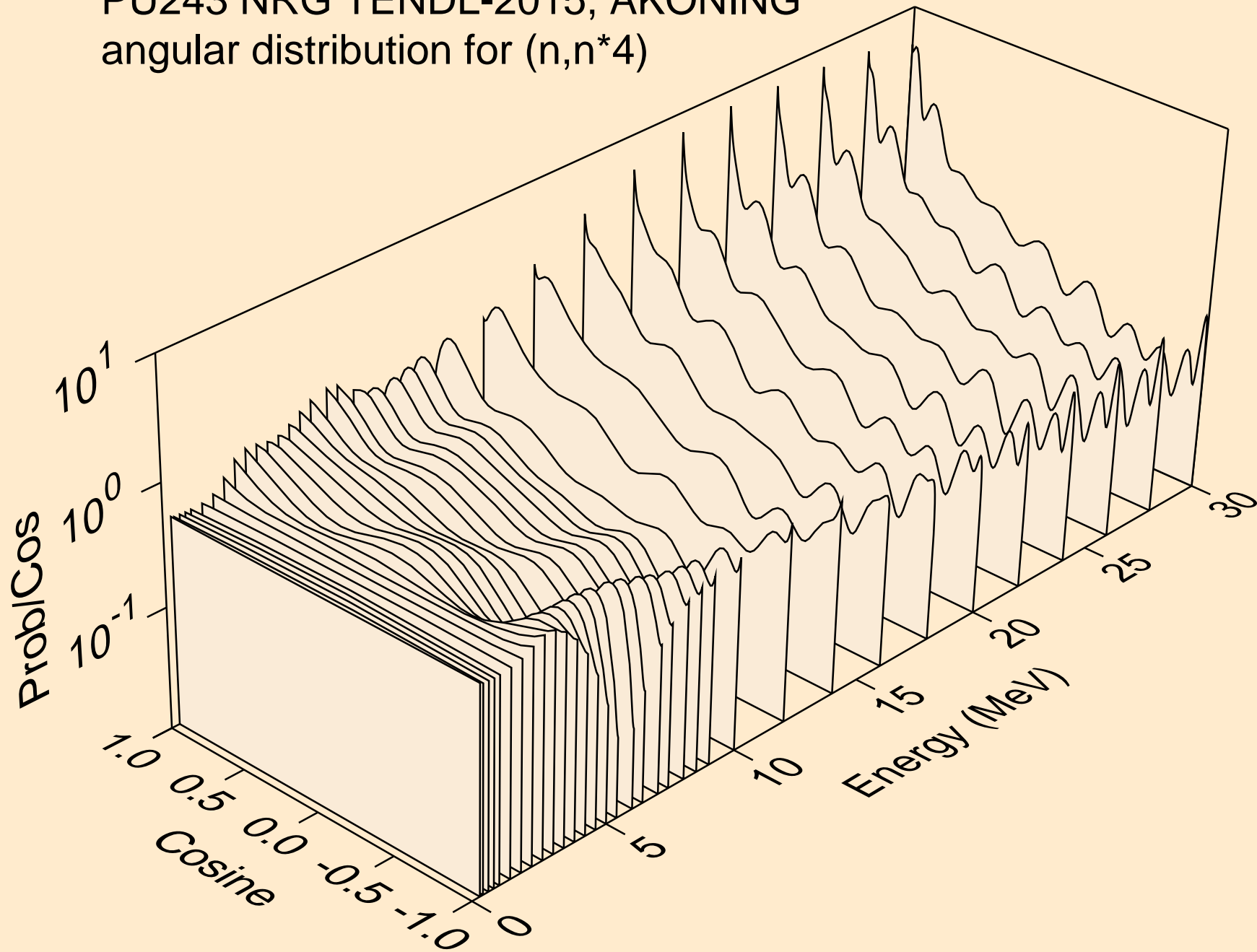

PU243 NRG TENDL-2015, AKONING  
angular distribution for (n,n\*5)

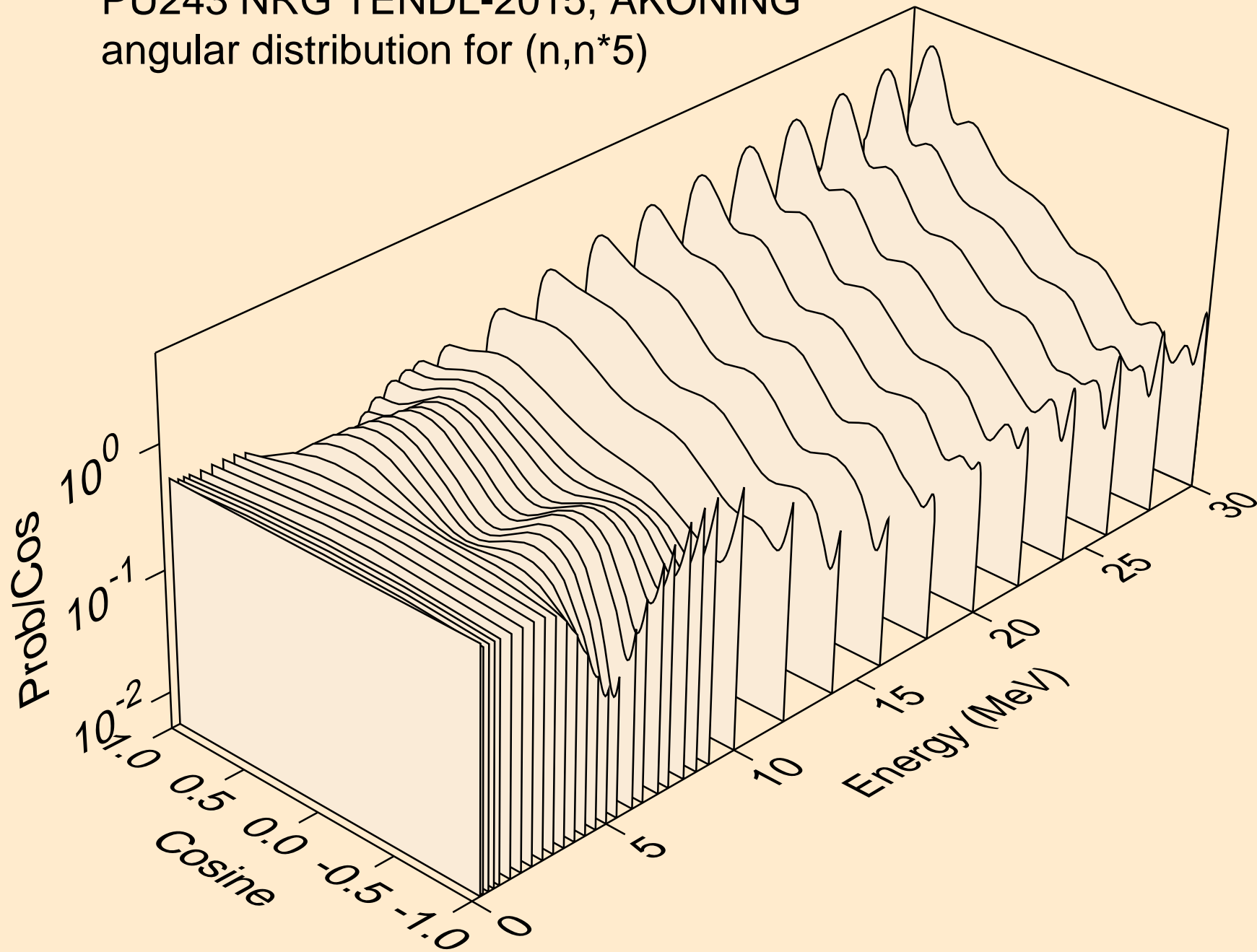

PU243 NRG TENDL-2015, AKONING  
angular distribution for (n,n\*6)

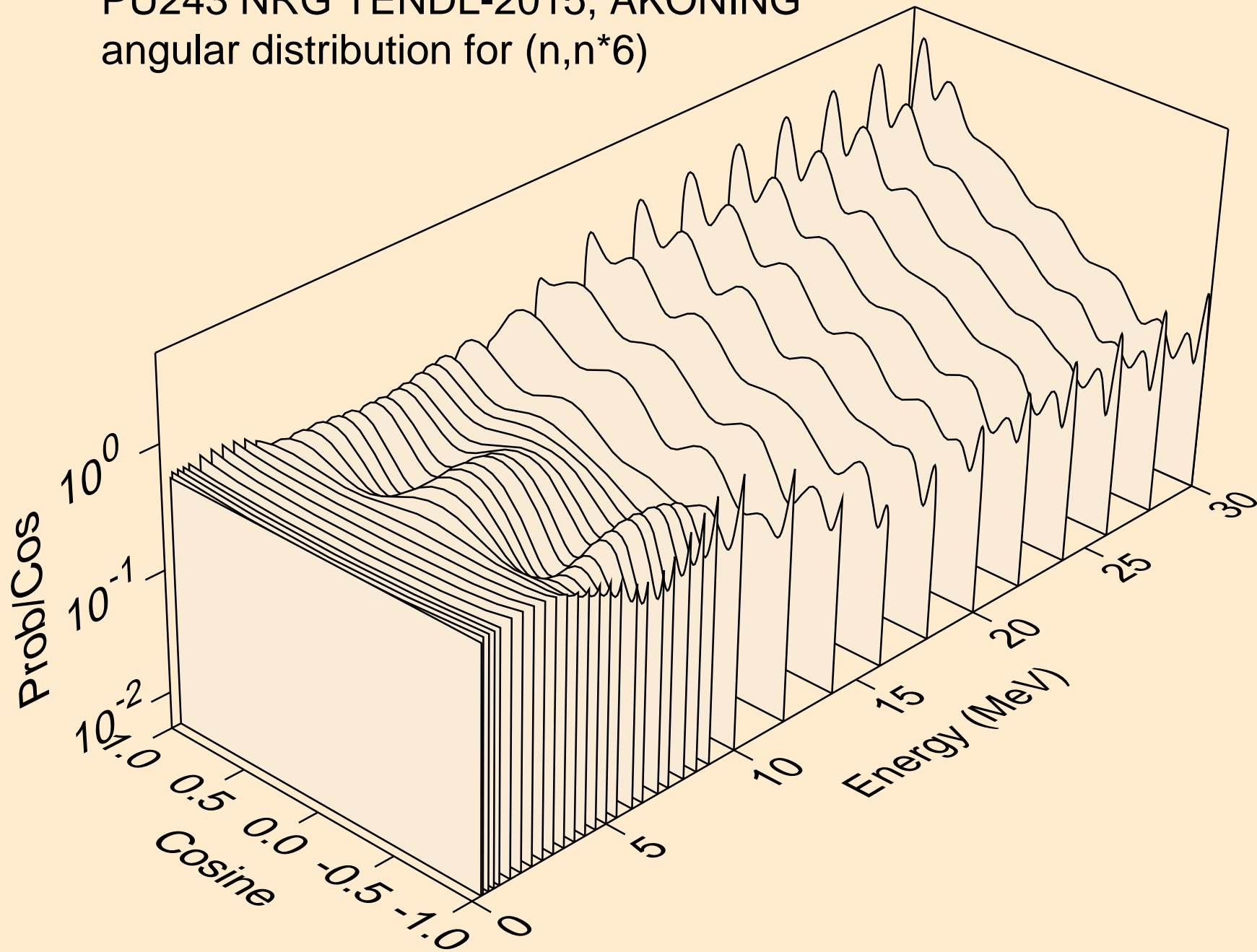

PU243 NRG TENDL-2015, AKONING  
angular distribution for (n,n\*7)

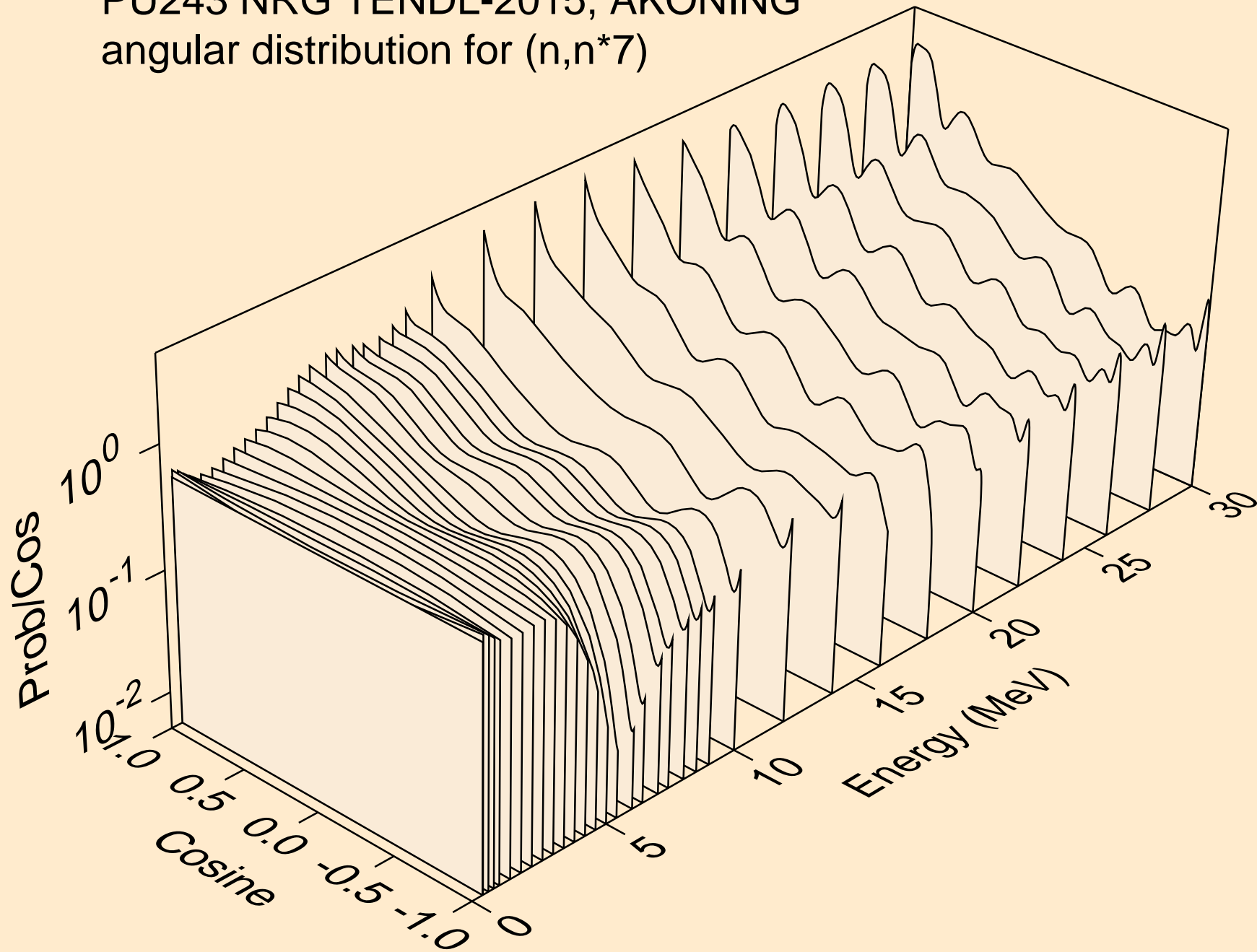



PU243 NRG TENDL-2015, AKONING  
angular distribution for (n,n\*8)

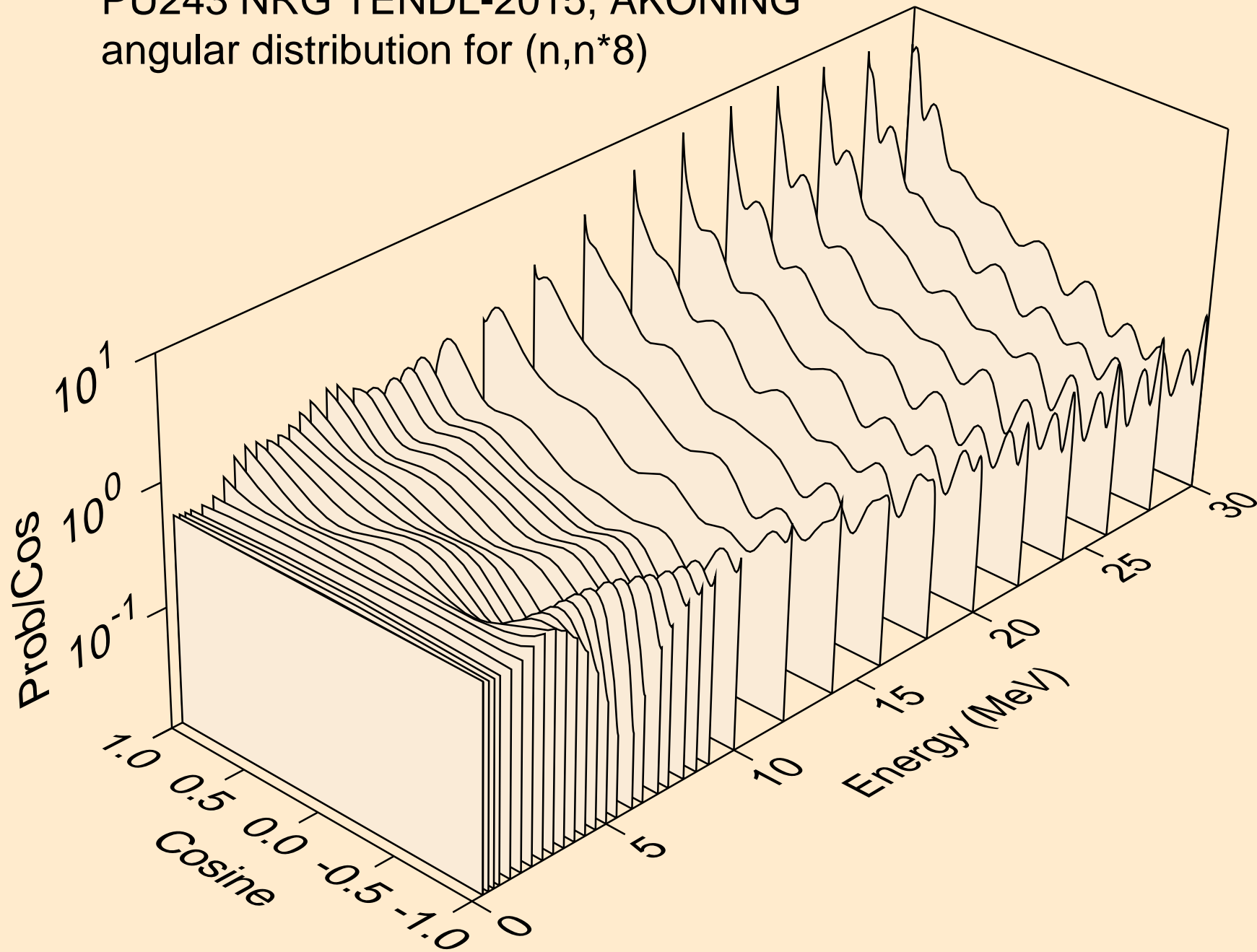

PU243 NRG TENDL-2015, AKONING  
angular distribution for (n,n\*9)

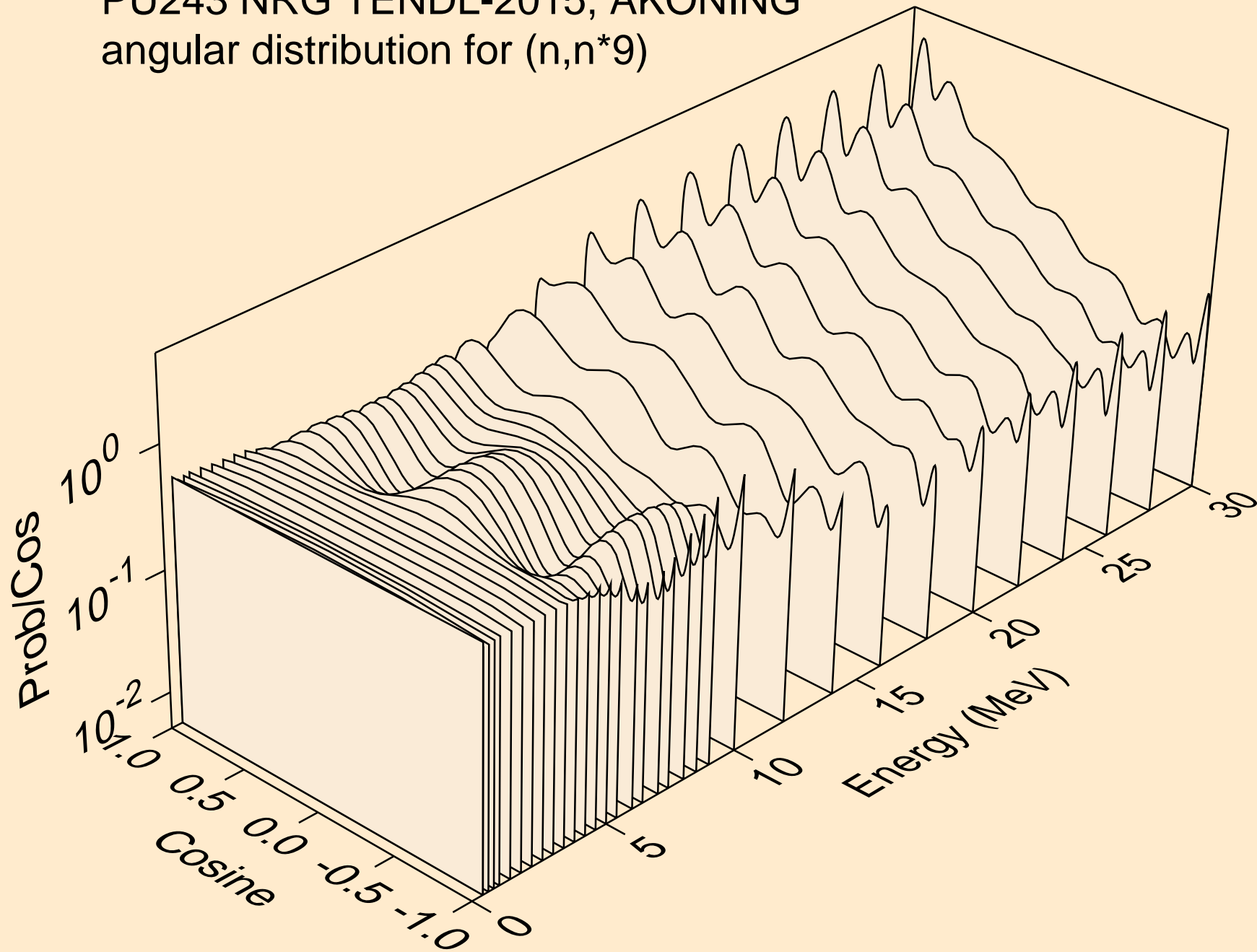

PU243 NRG TENDL-2015, AKONING  
angular distribution for (n,n\*10)

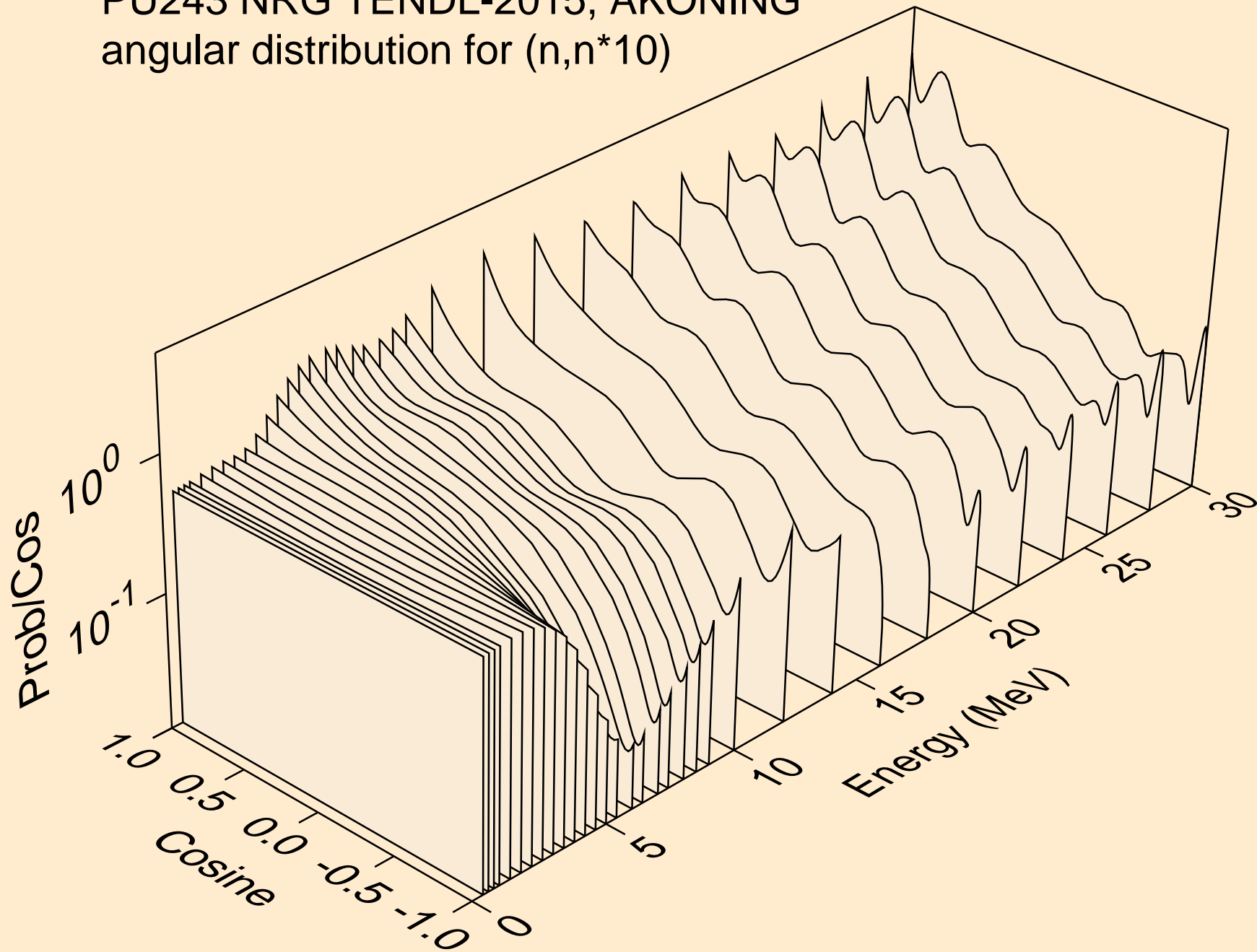

PU243 NRG TENDL-2015, AKONING  
angular distribution for (n,n\*11)

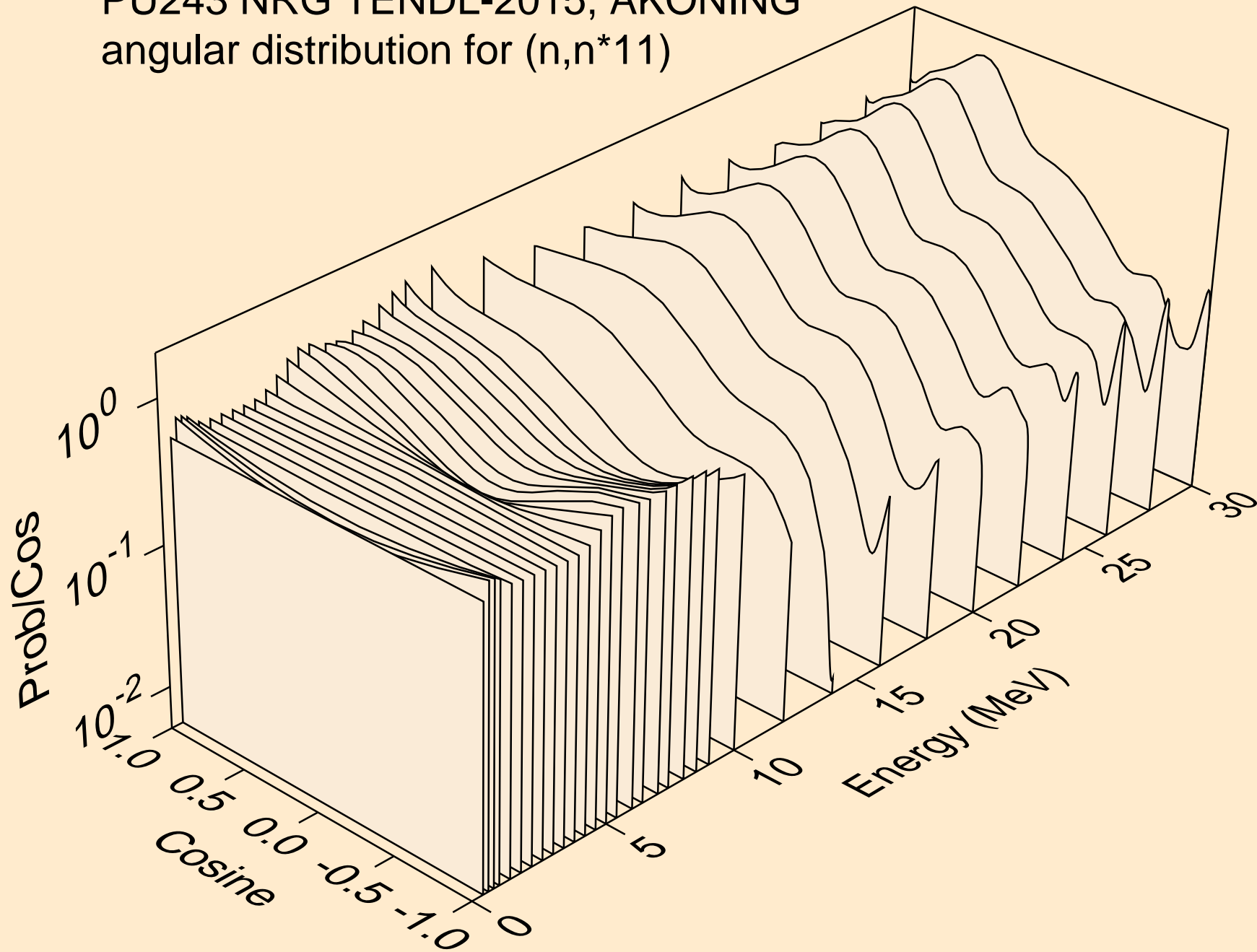

PU243 NRG TENDL-2015, AKONING  
angular distribution for (n,n\*12)

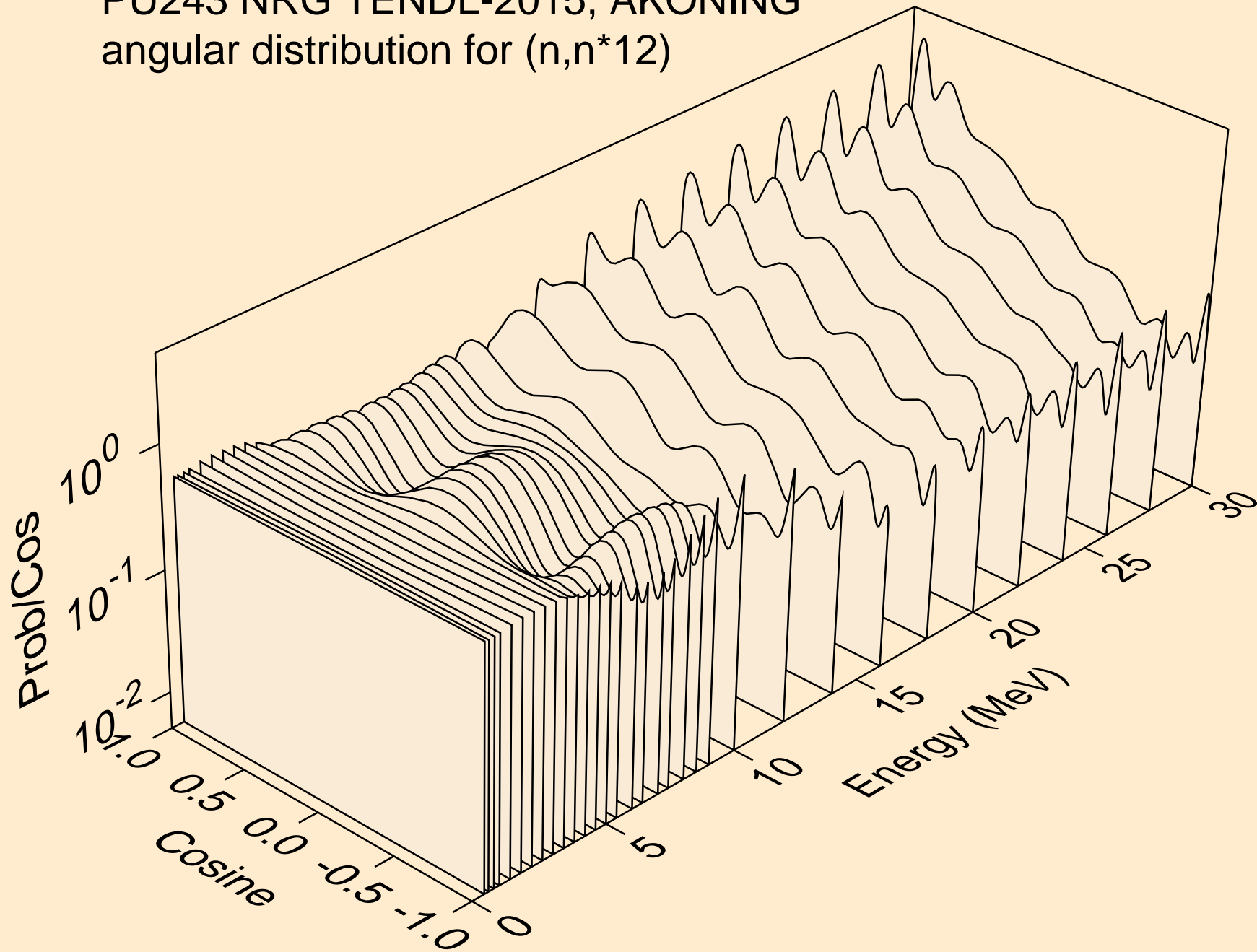

PU243 NRG TENDL-2015, AKONING  
angular distribution for (n,n\*13)

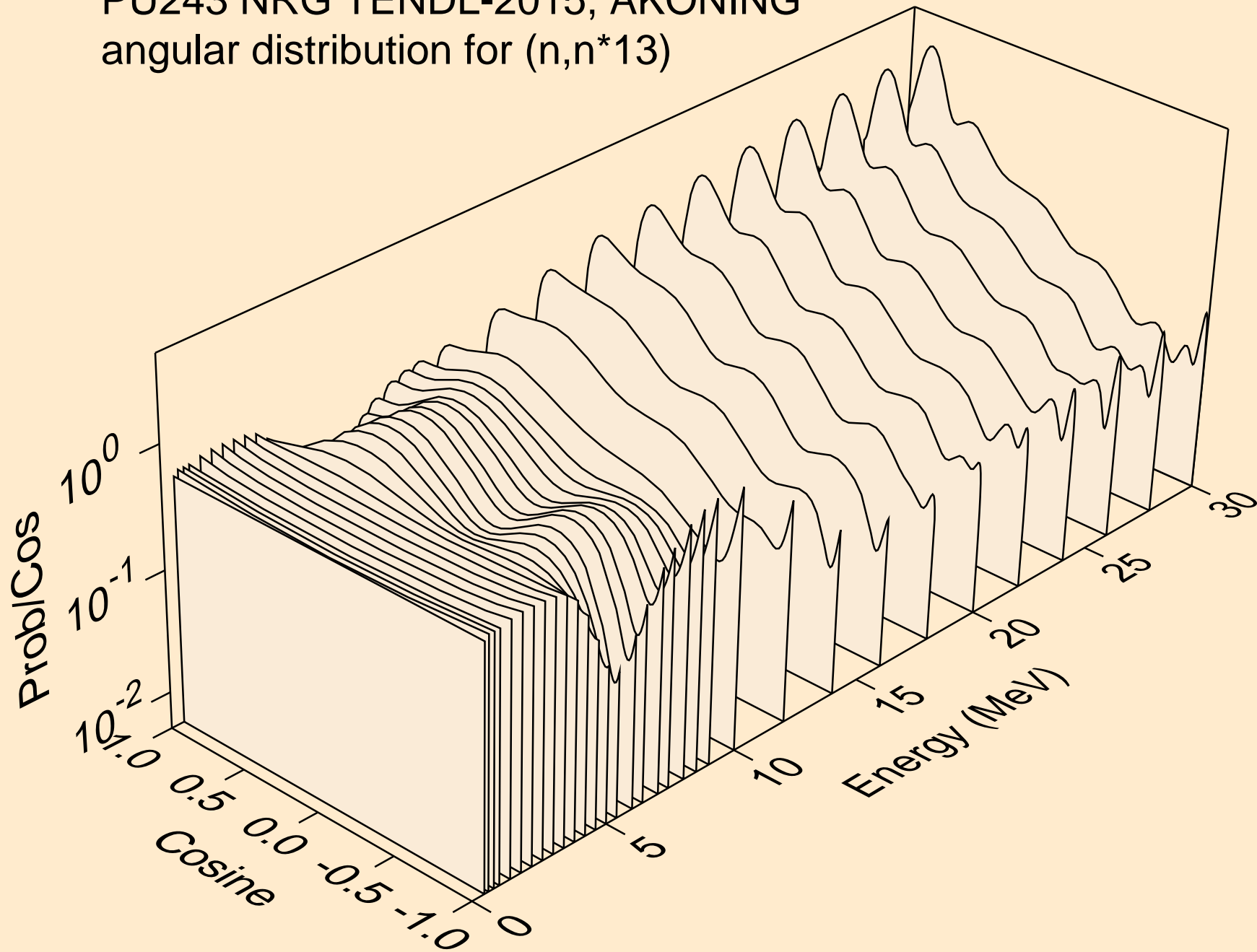

PU243 NRG TENDL-2015, AKONING  
angular distribution for (n,n\*14)

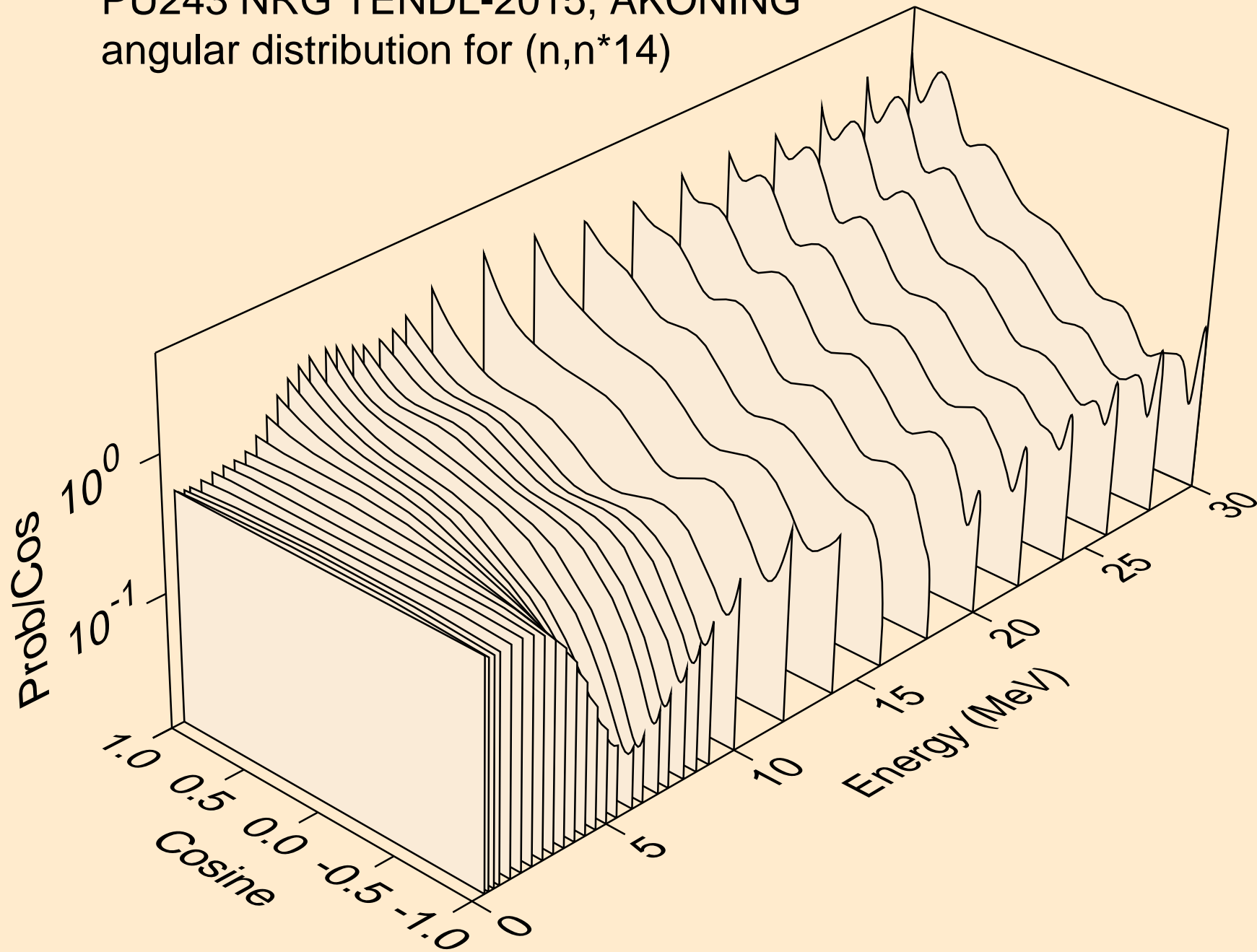

PU243 NRG TENDL-2015, AKONING  
angular distribution for (n,n\*15)

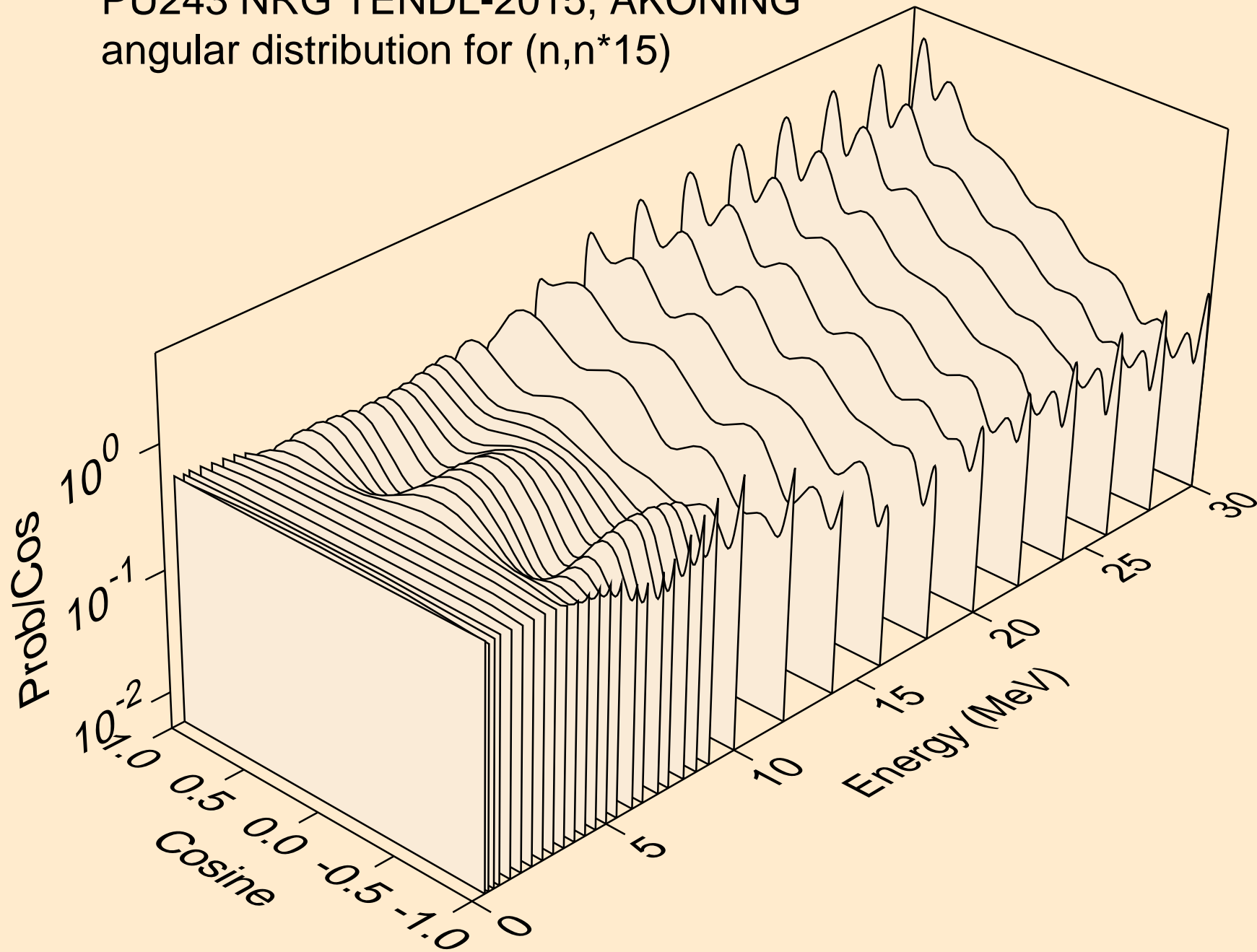



PU243 NRG TENDL-2015, AKONING  
angular distribution for (n,n\*16)

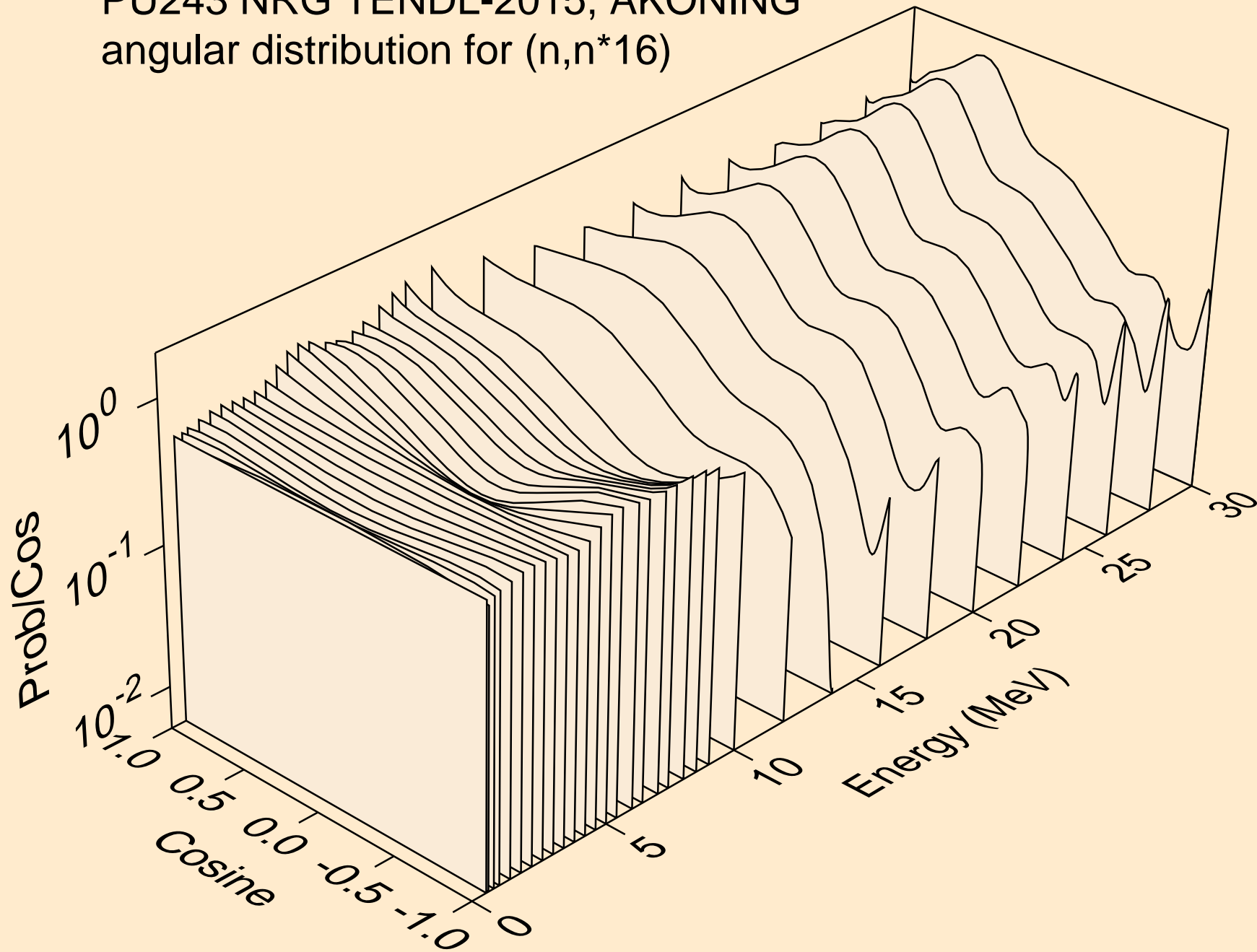

PU243 NRG TENDL-2015, AKONING  
angular distribution for (n,n\*17)

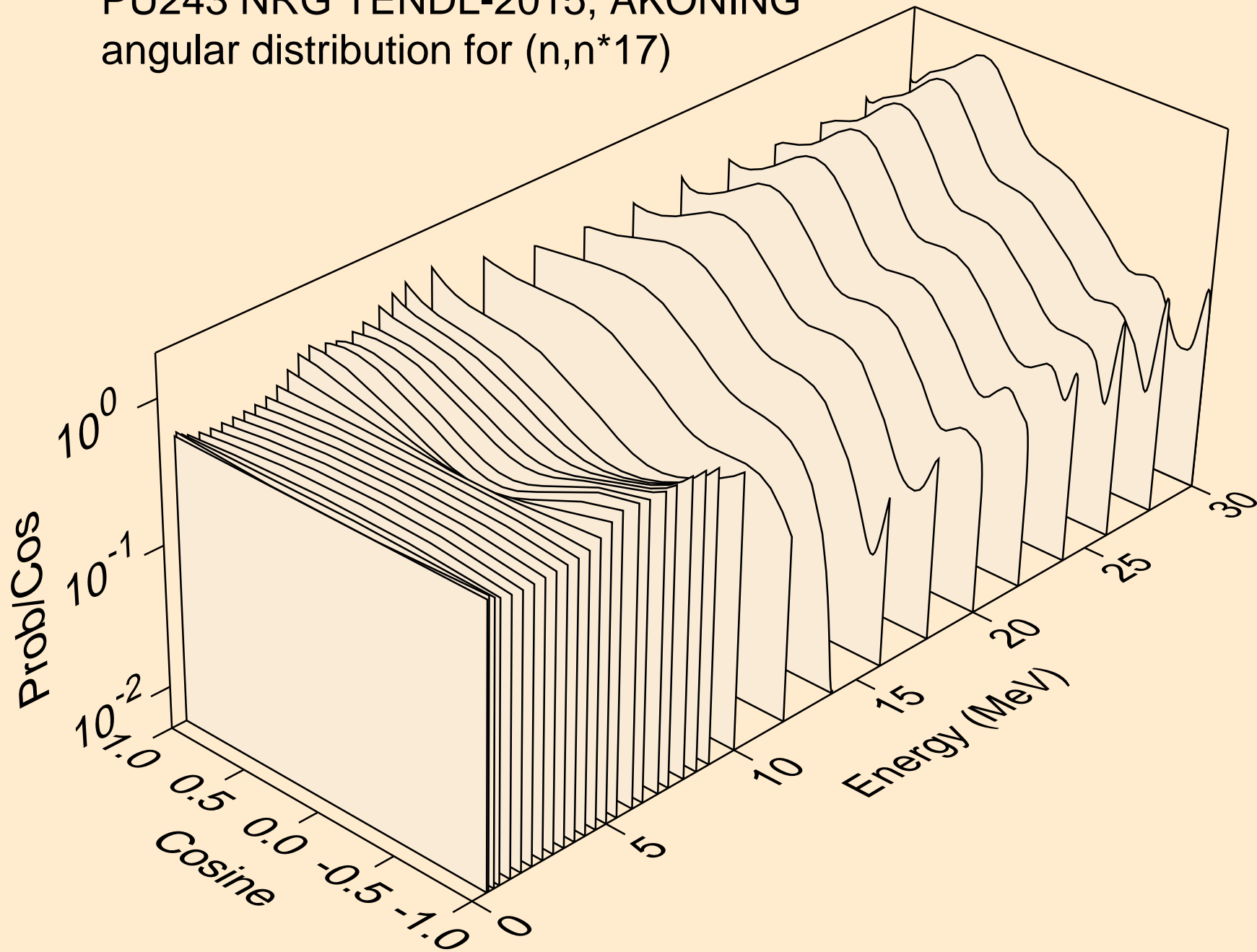

PU243 NRG TENDL-2015, AKONING  
angular distribution for (n,n\*18)

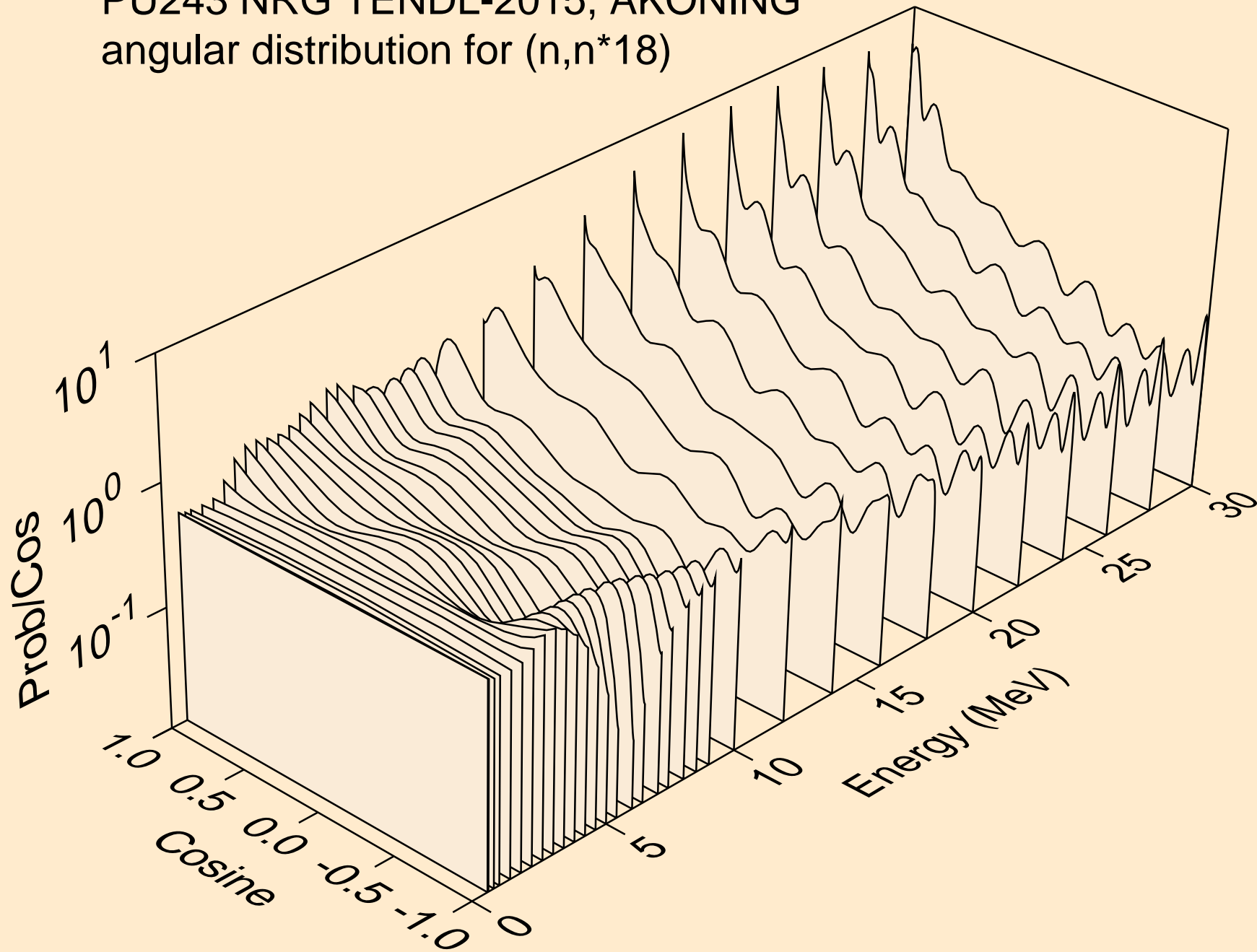

PU243 NRG TENDL-2015, AKONING  
angular distribution for (n,n\*19)

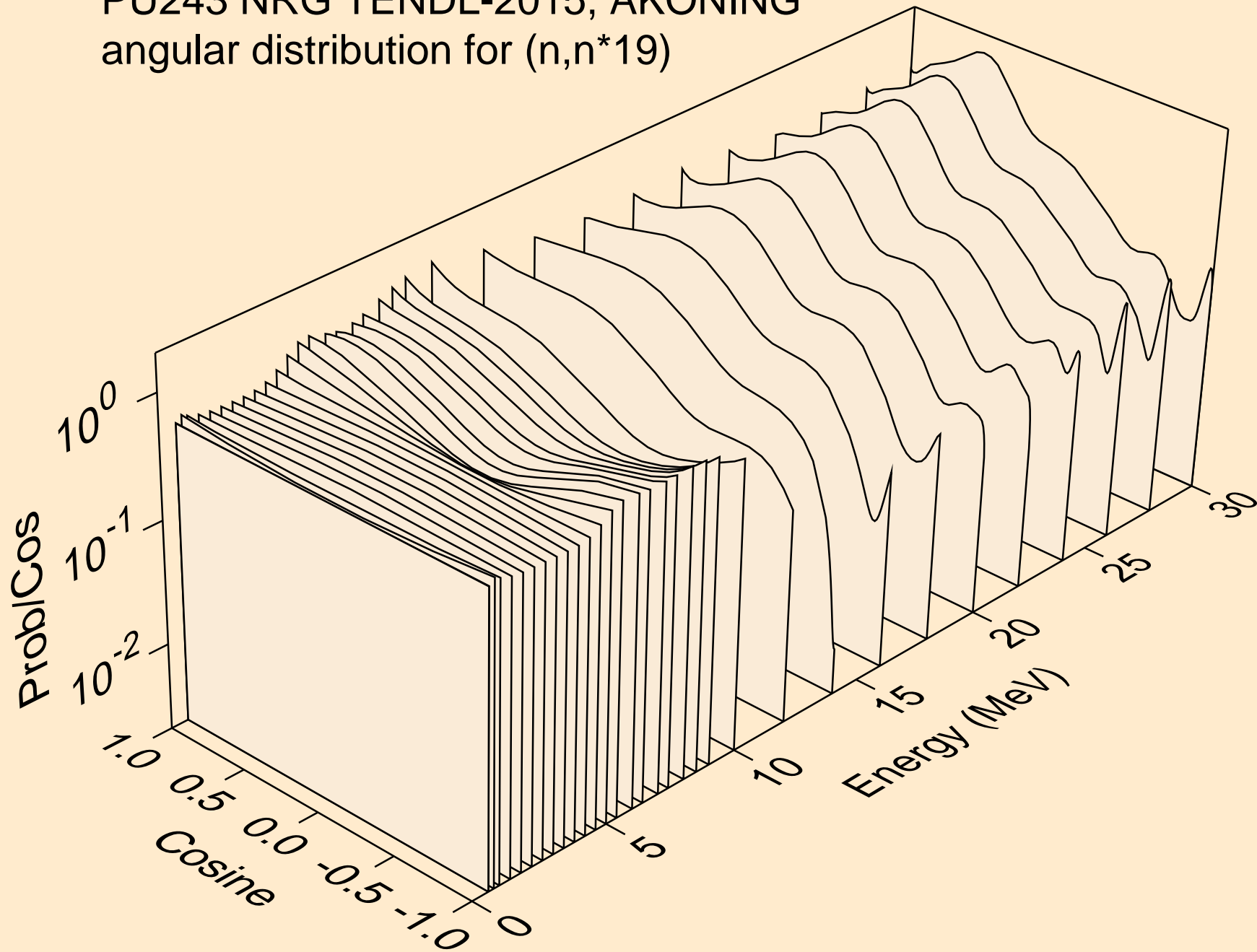

PU243 NRG TENDL-2015, AKONING  
angular distribution for (n,n\*20)

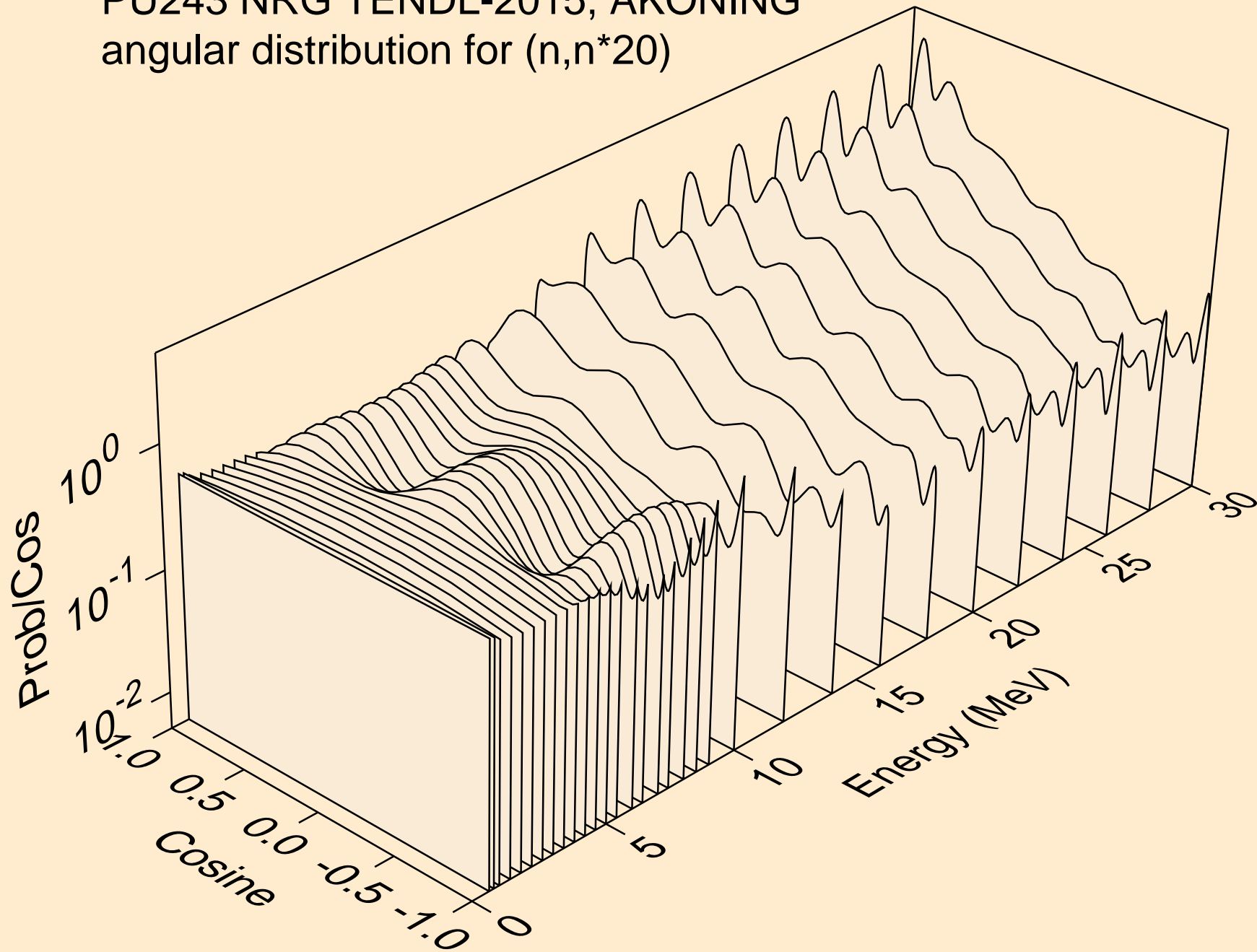

PU243 NRG TENDL-2015, AKONING  
angular distribution for (n,n\*21)

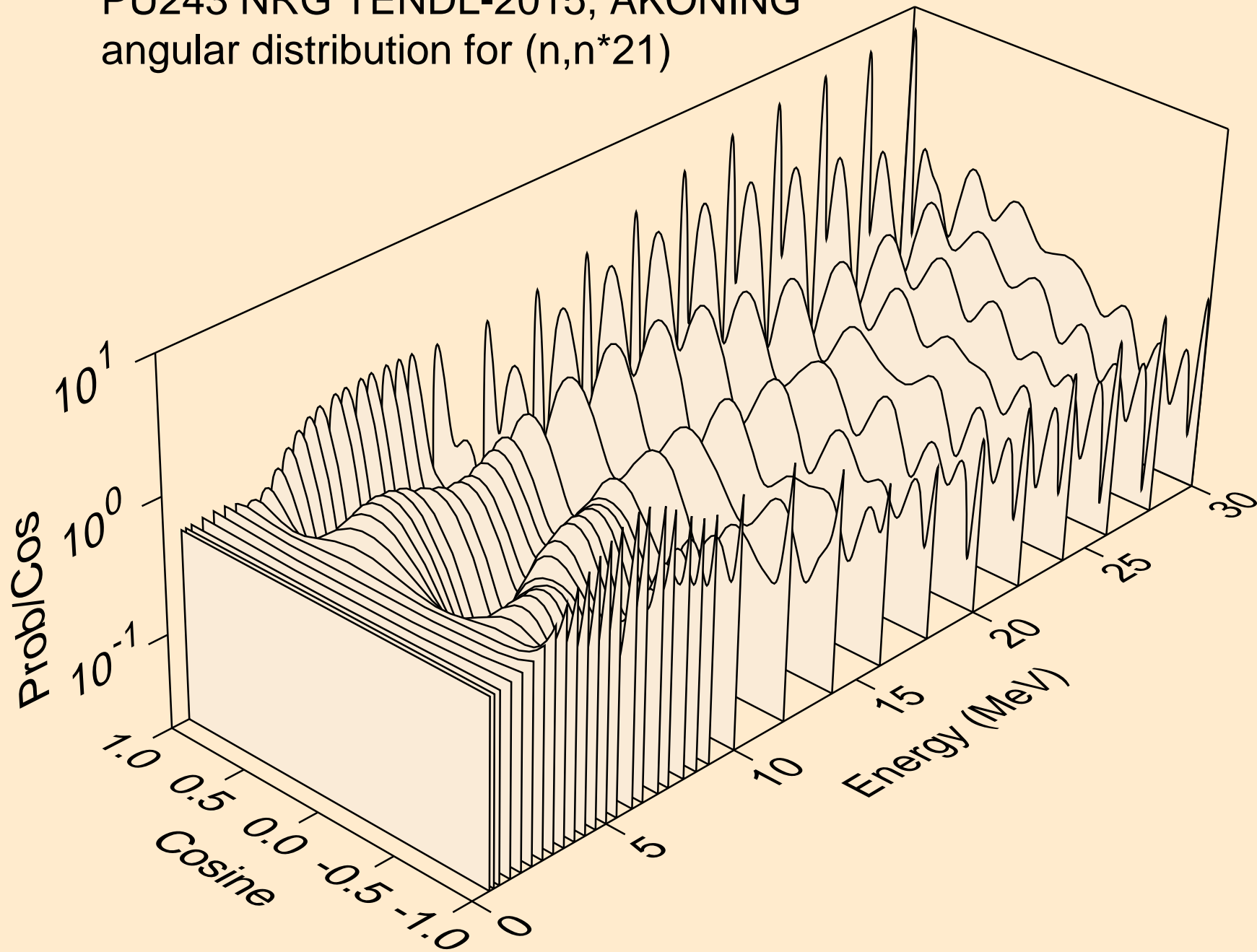

PU243 NRG TENDL-2015, AKONING  
angular distribution for (n,n\*22)

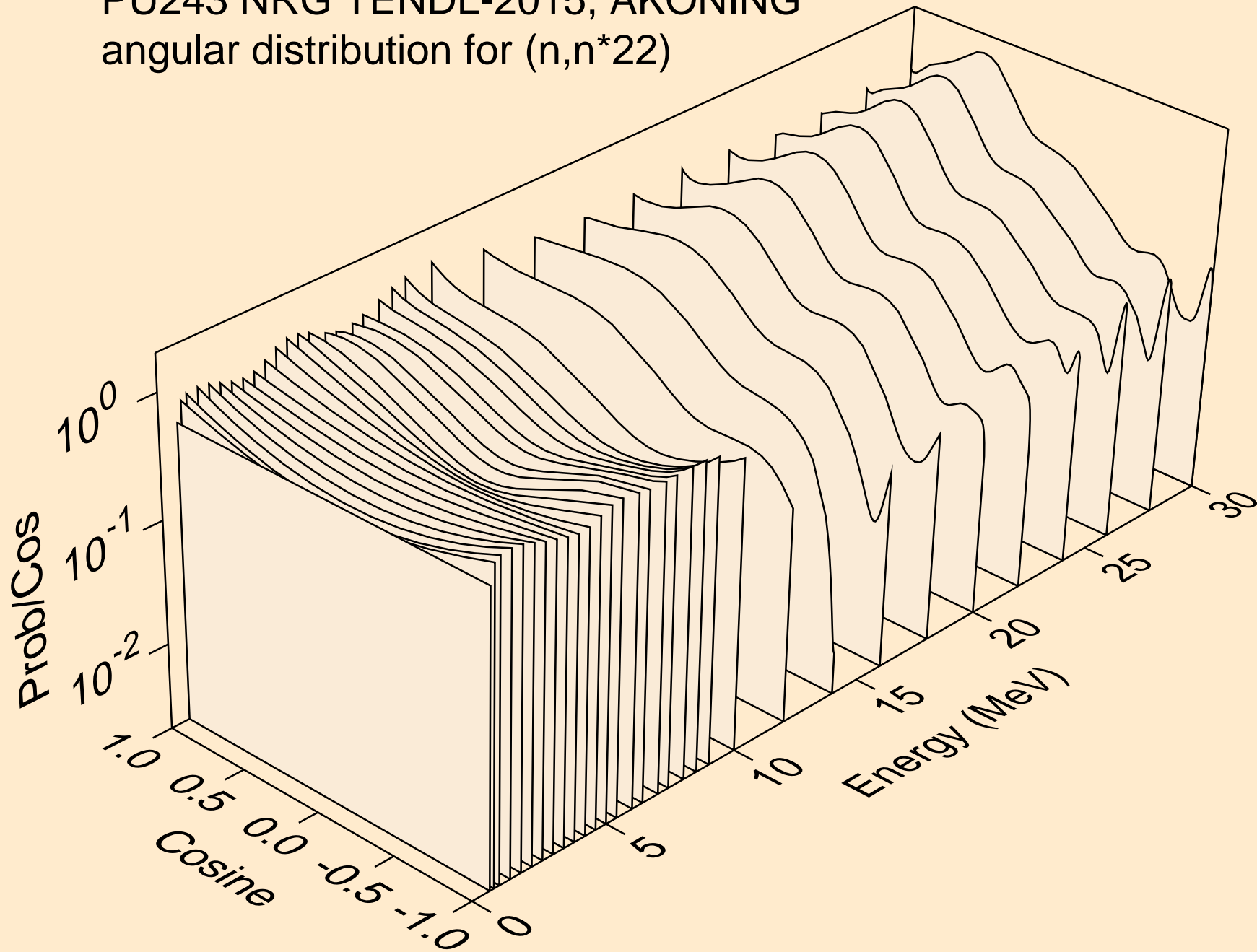

PU243 NRG TENDL-2015, AKONING  
angular distribution for (n,n\*23)

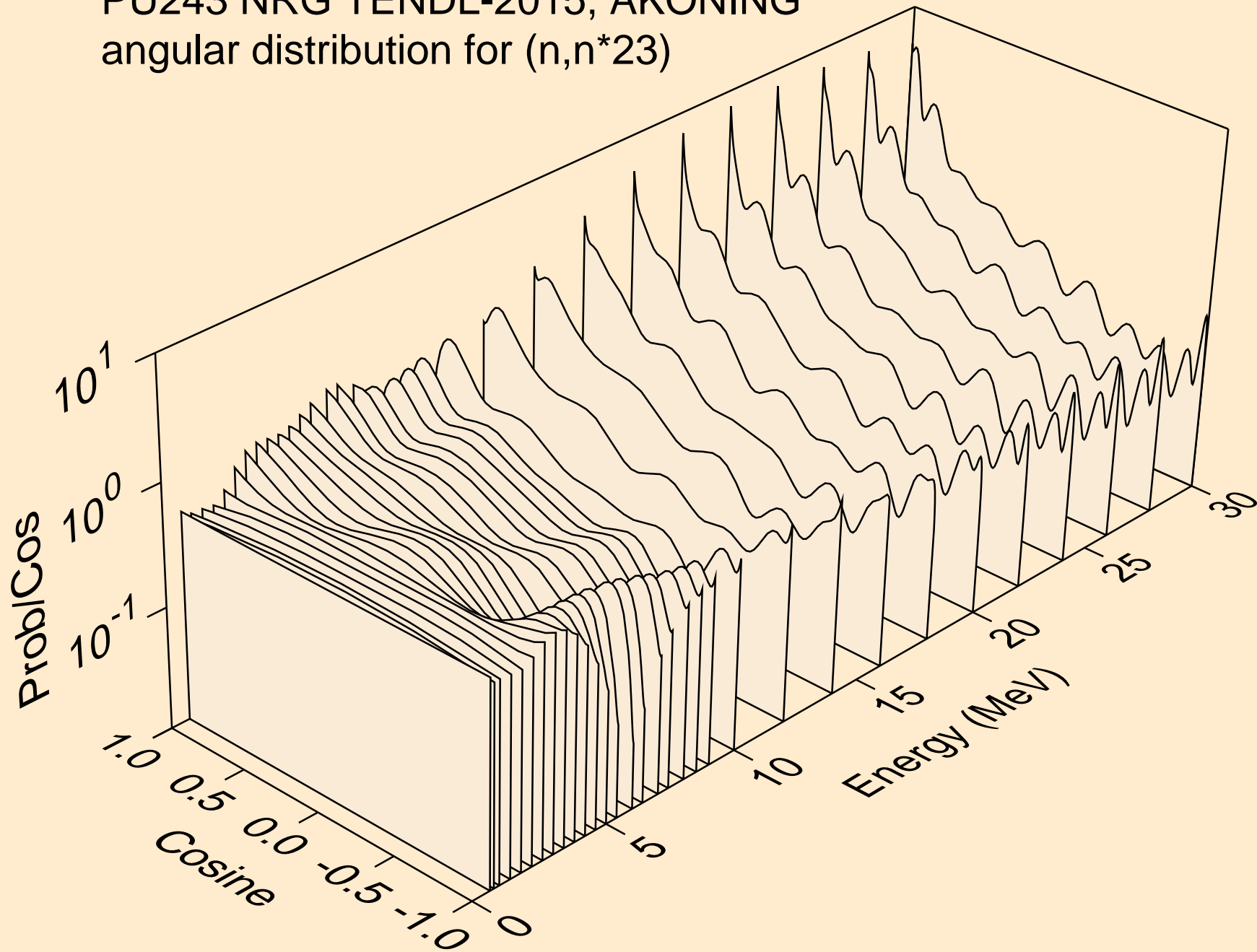



PU243 NRG TENDL-2015, AKONING  
angular distribution for (n,n\*24)

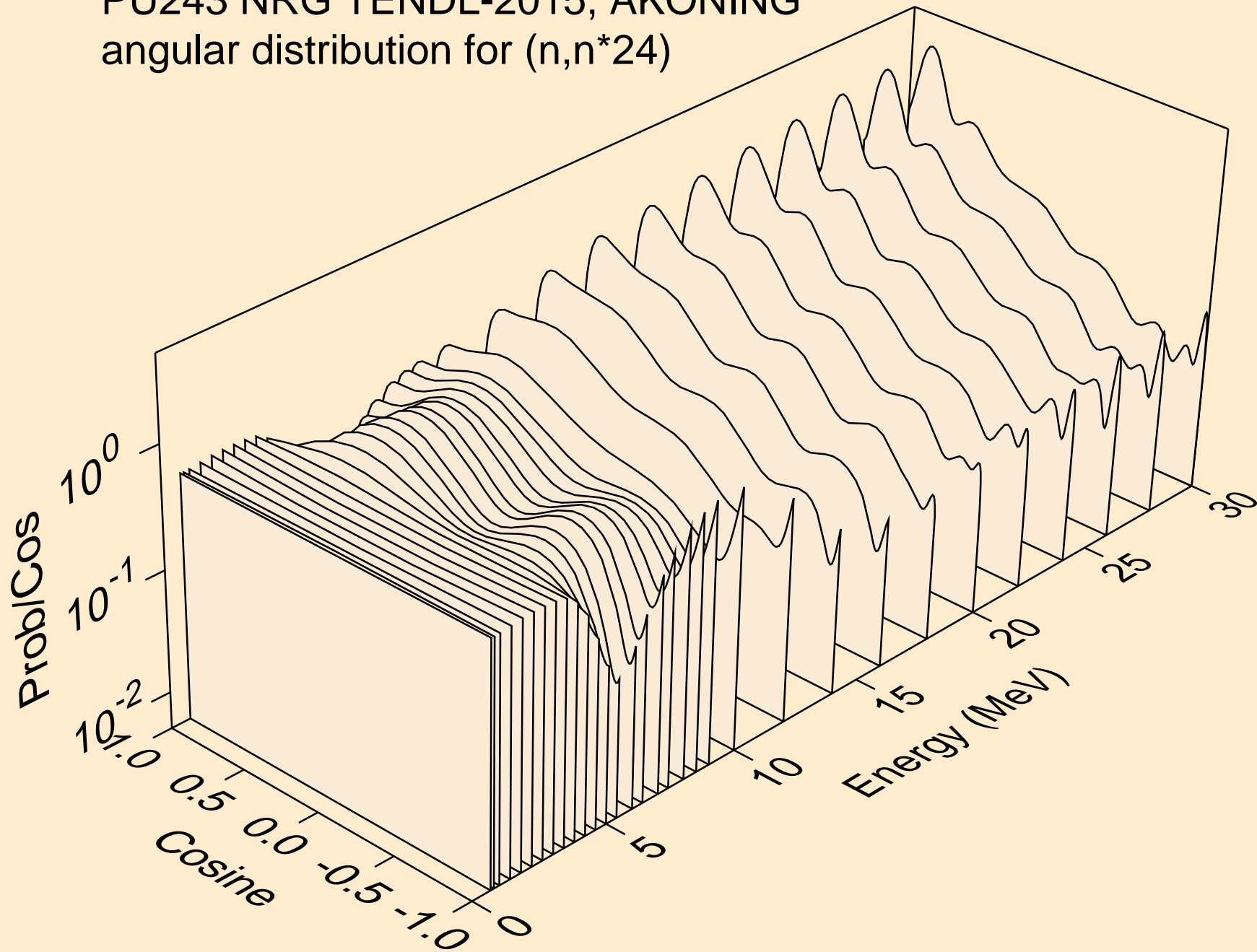

PU243 NRG TENDL-2015, AKONING  
angular distribution for (n,n\*25)

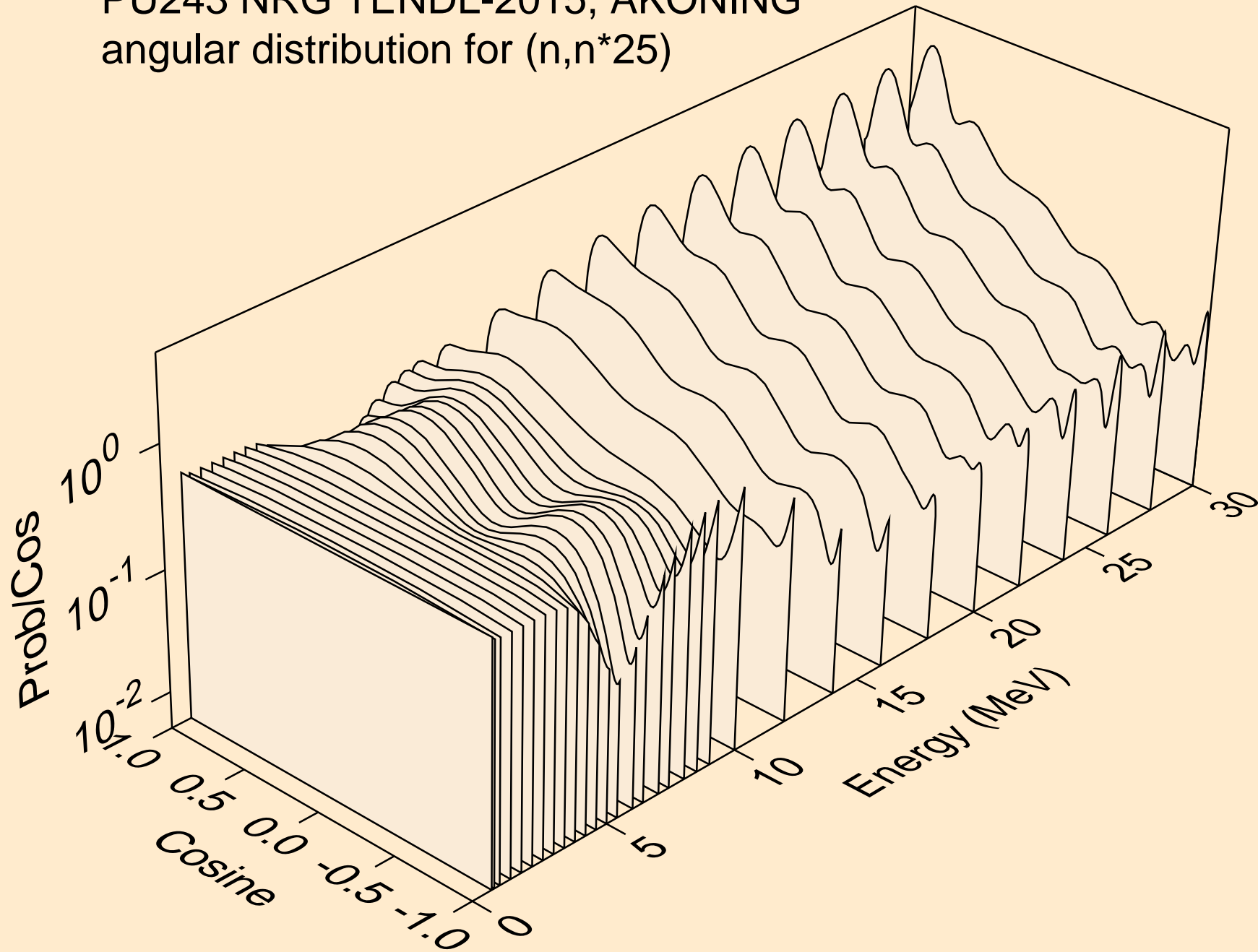

PU243 NRG TENDL-2015, AKONING  
angular distribution for (n,n\*26)

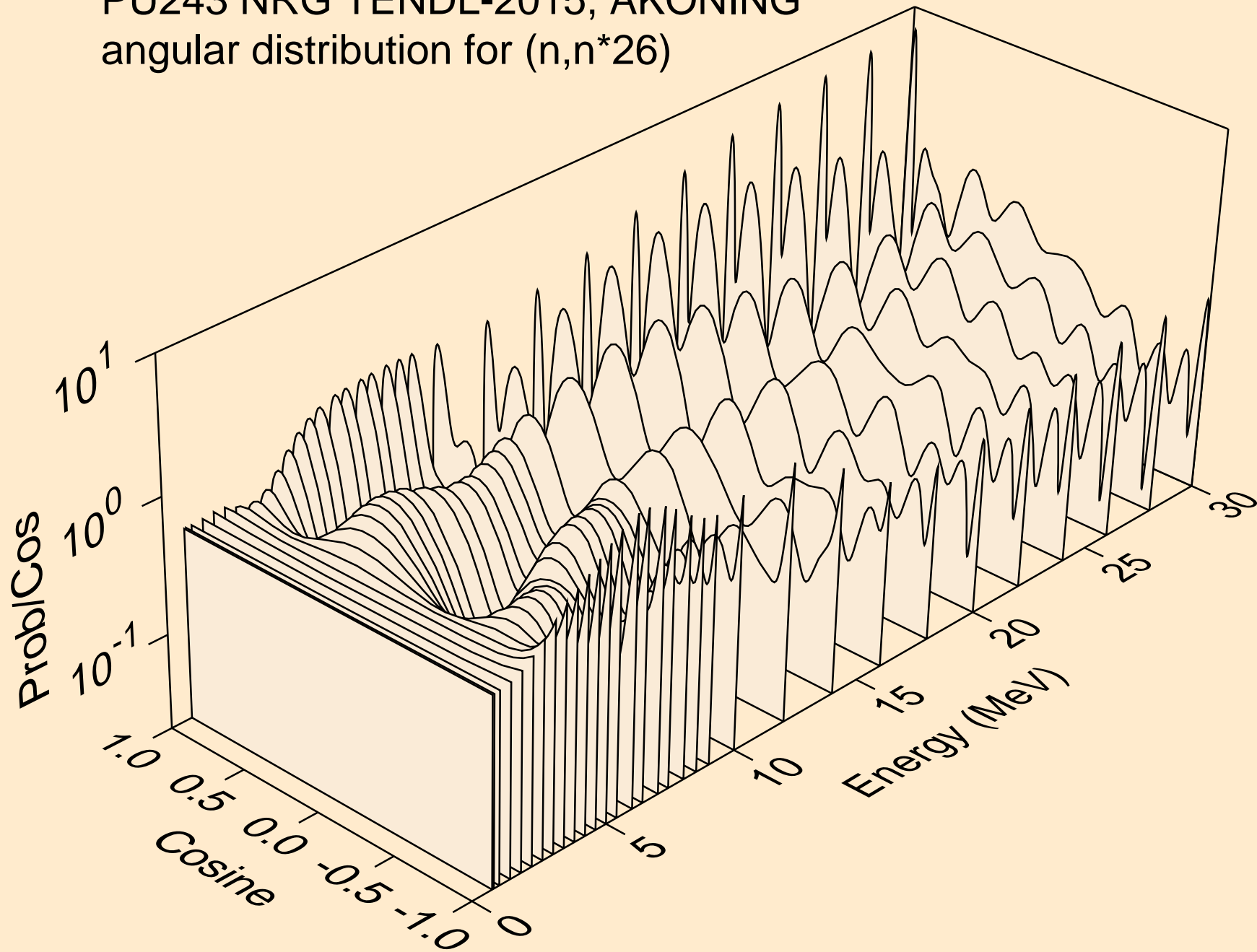

PU243 NRG TENDL-2015, AKONING  
angular distribution for (n,n\*27)

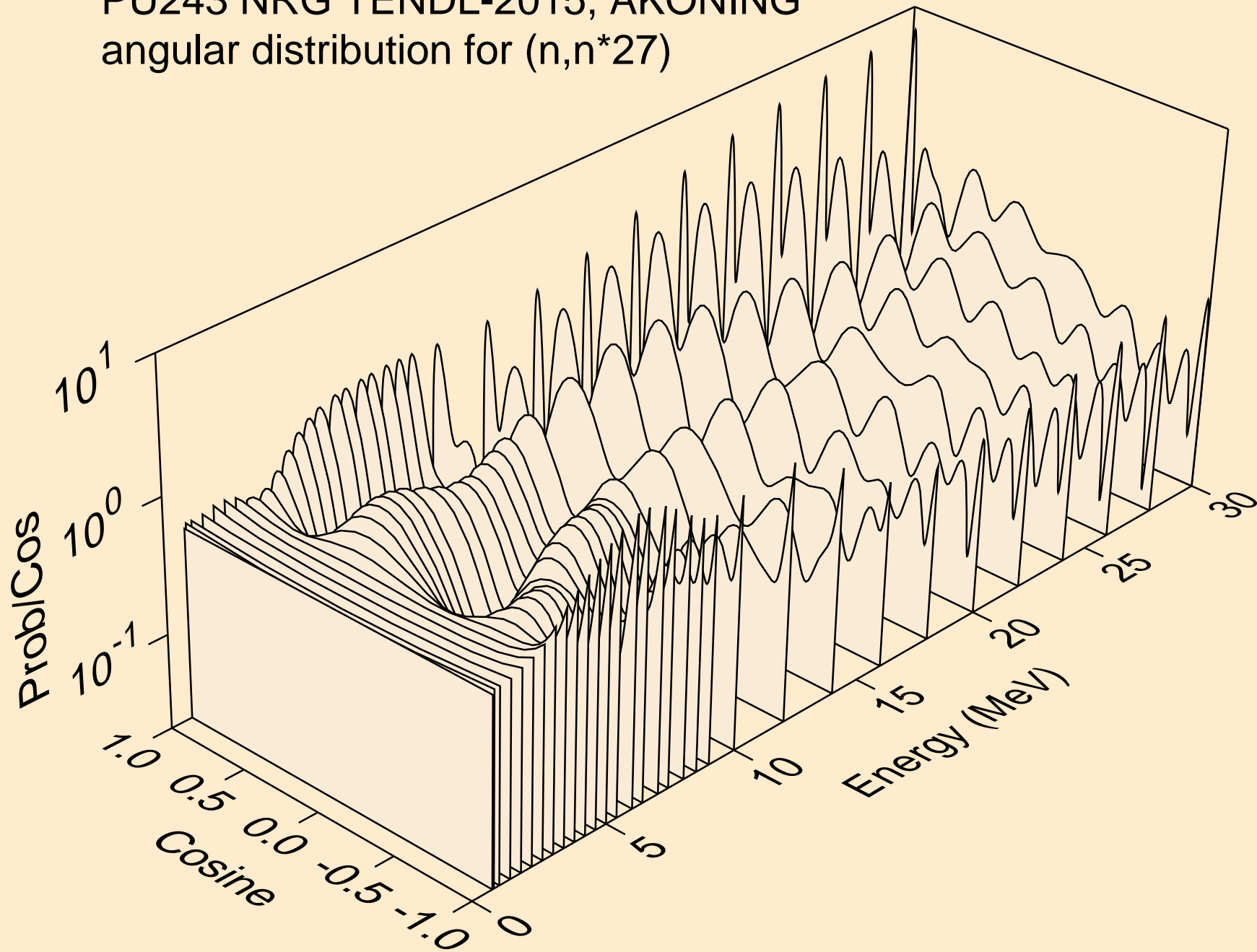

PU243 NRG TENDL-2015, AKONING  
angular distribution for (n,n\*28)

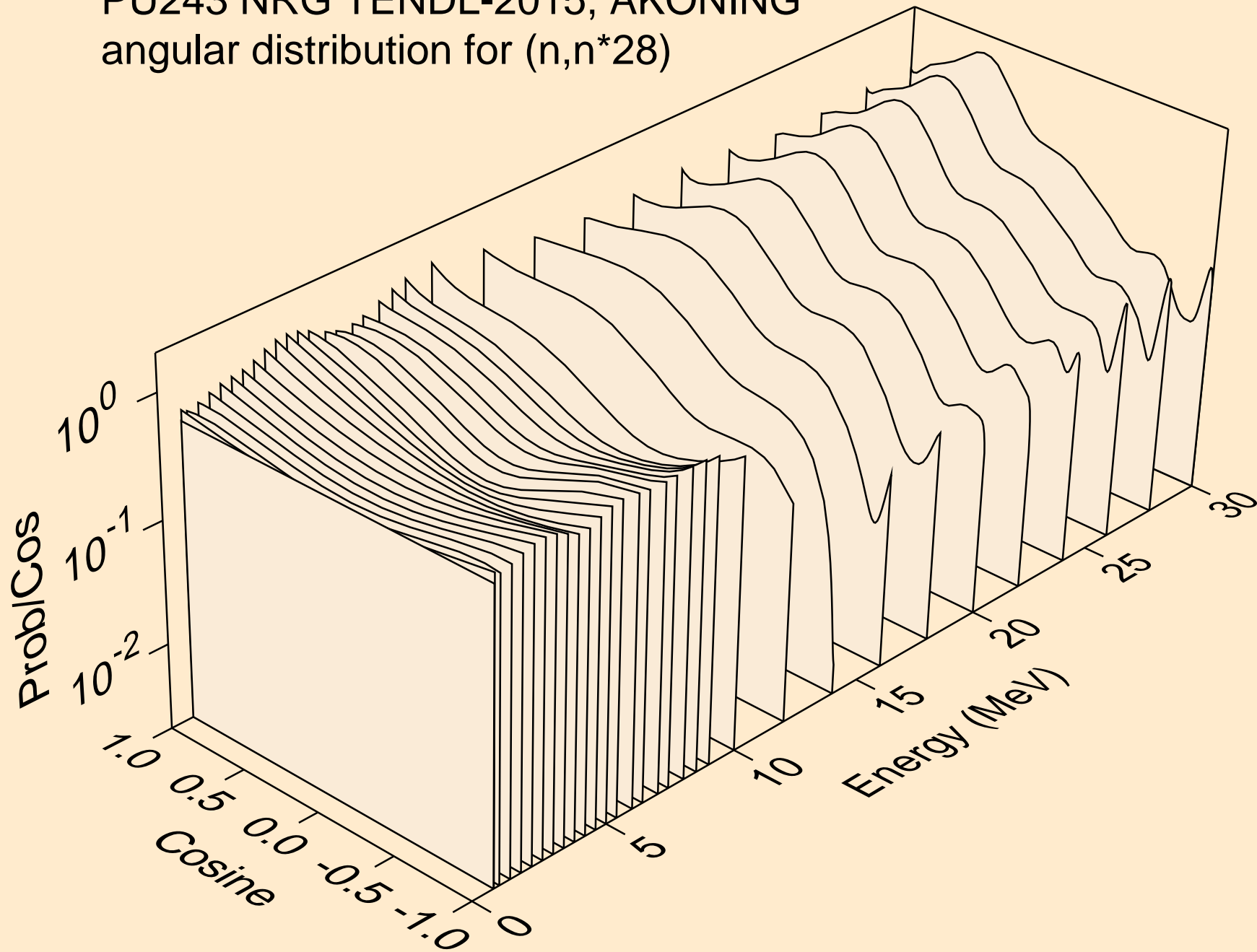

PU243 NRG TENDL-2015, AKONING  
angular distribution for (n,n\*29)

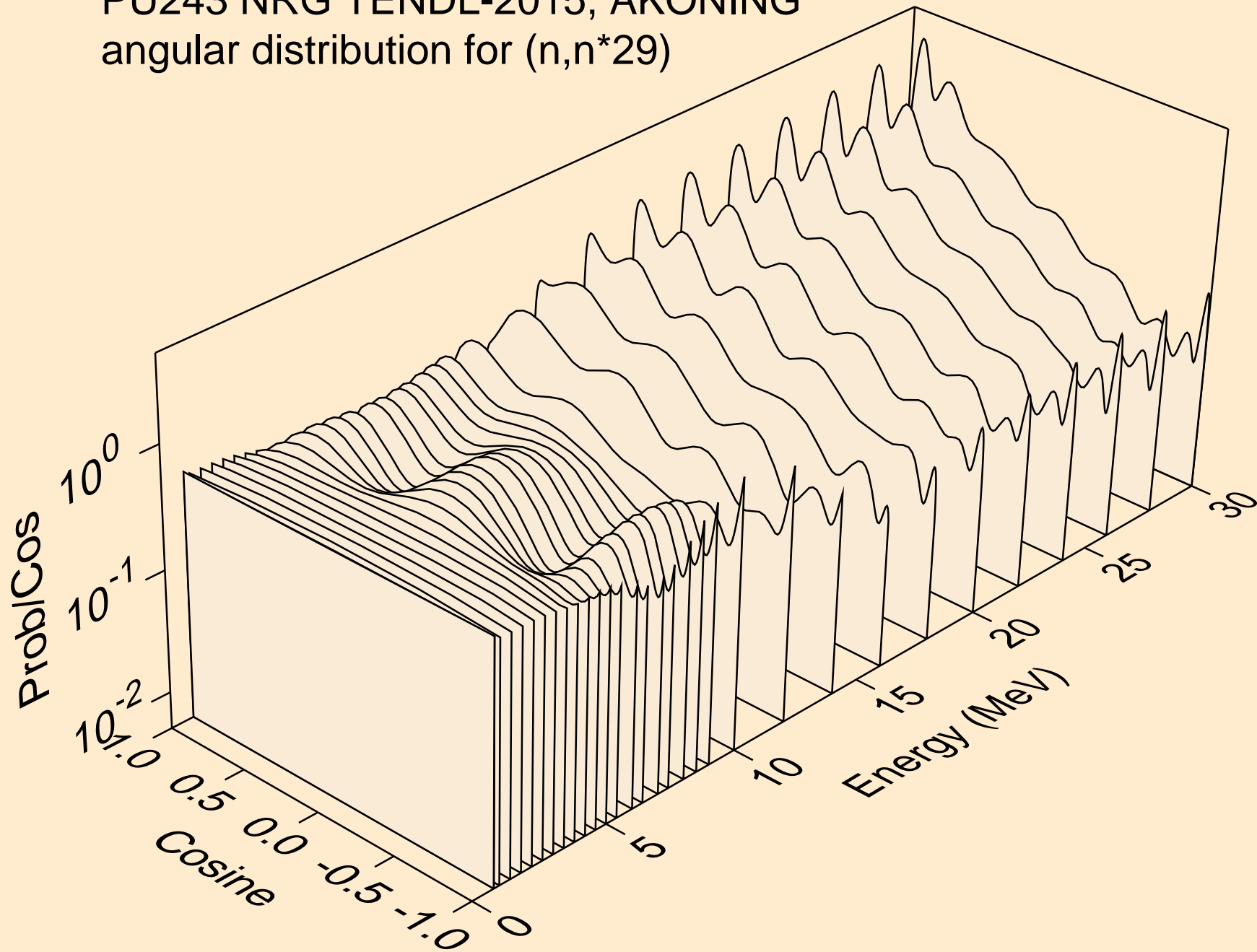

PU243 NRG TENDL-2015, AKONING  
angular distribution for (n,n\*30)

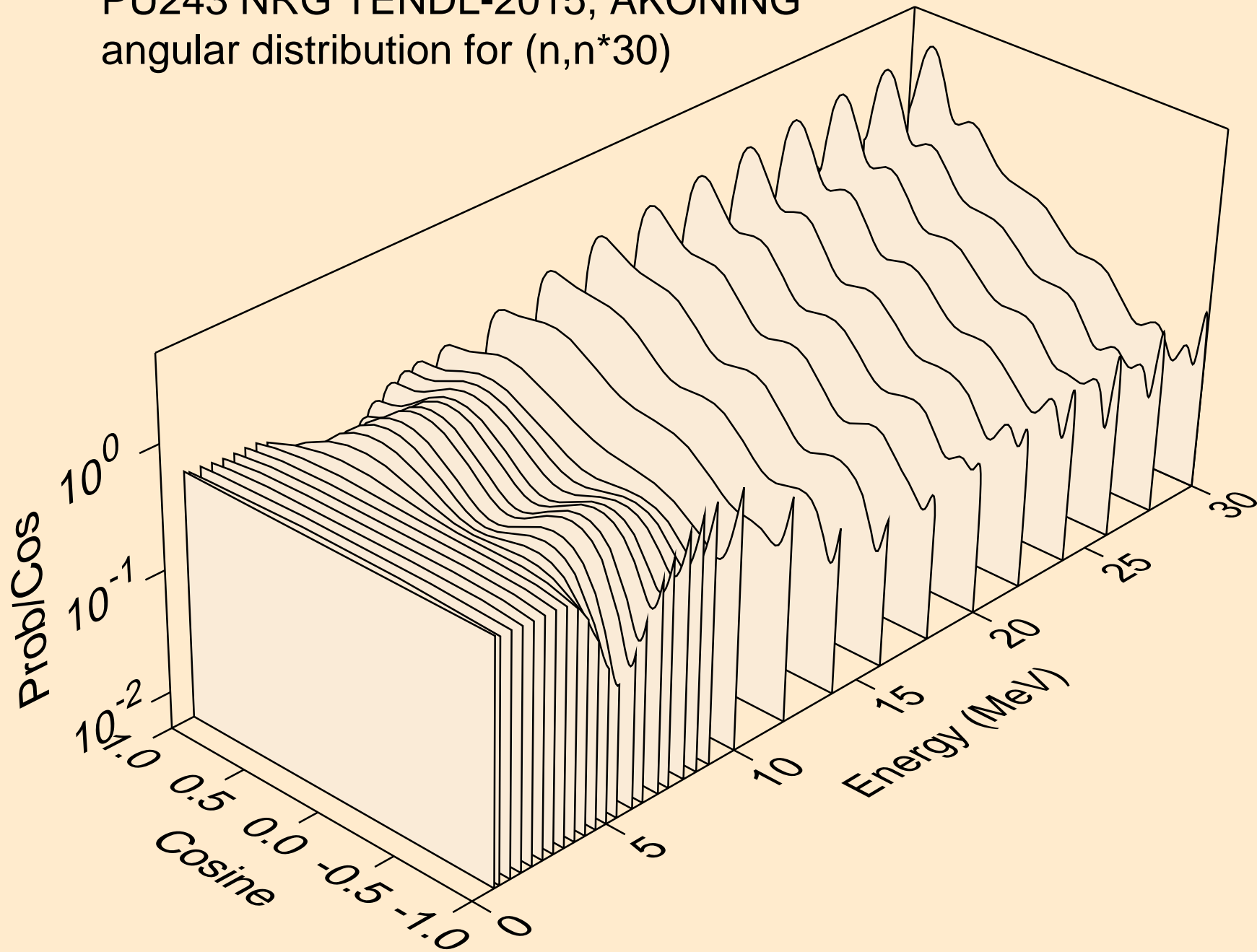

# PU243 NRG TENDL-2015, AKONING

Total fission nubar

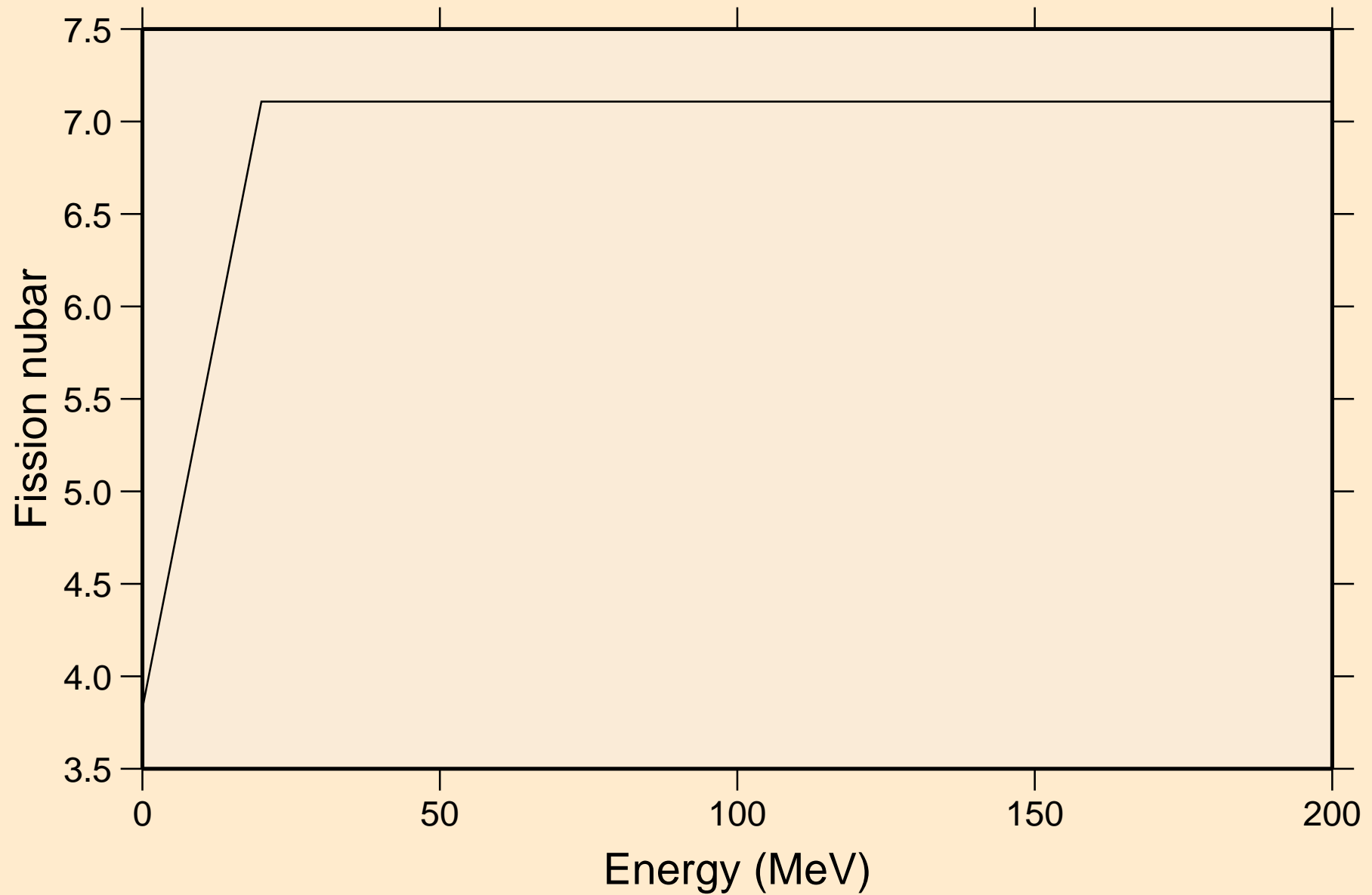



PU243 NRG TENDL-2015, AKONING  
Neutron emission for (n,x)

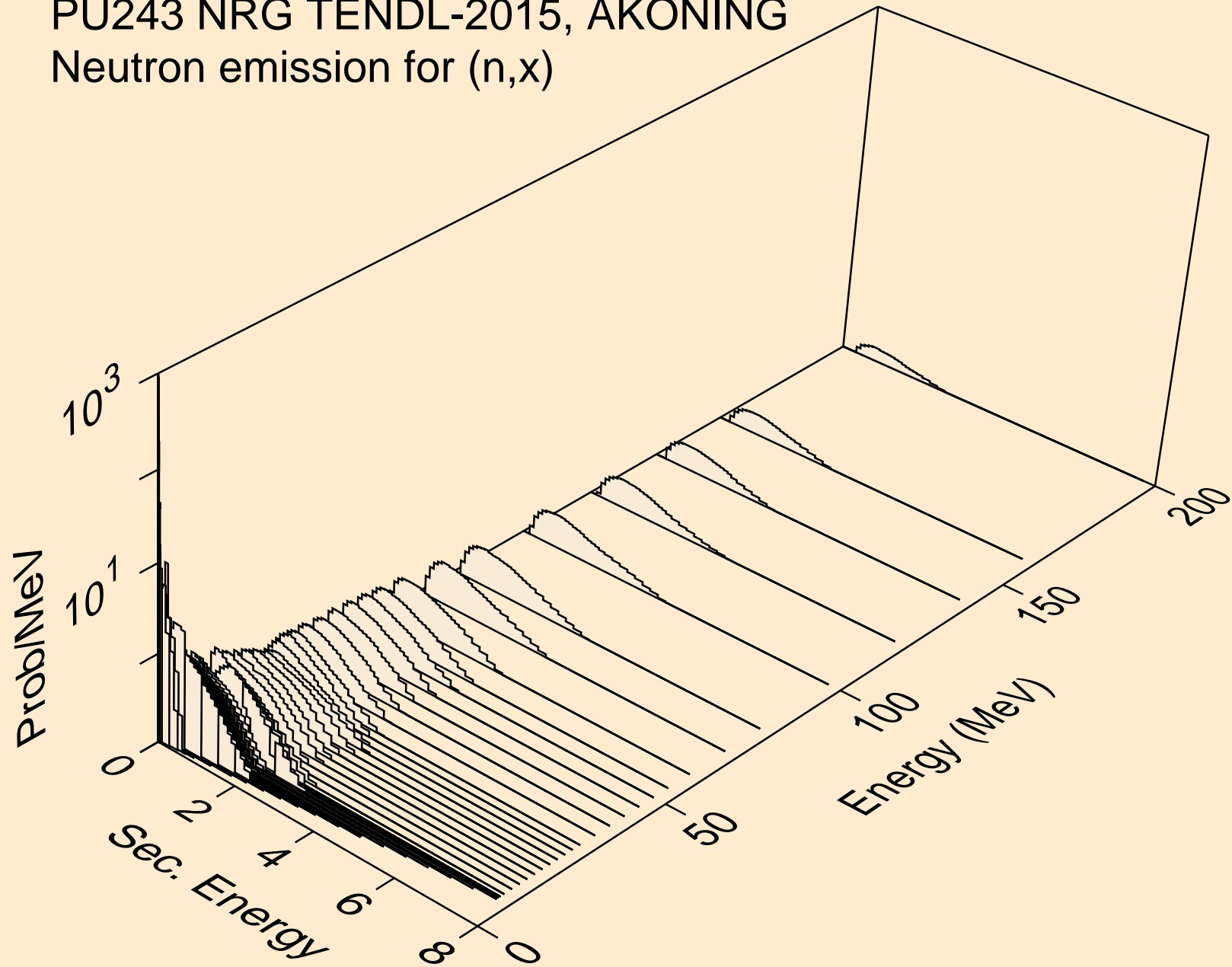

PU243 NRG TENDL-2015, AKONING  
Neutron emission for (n,2nd)

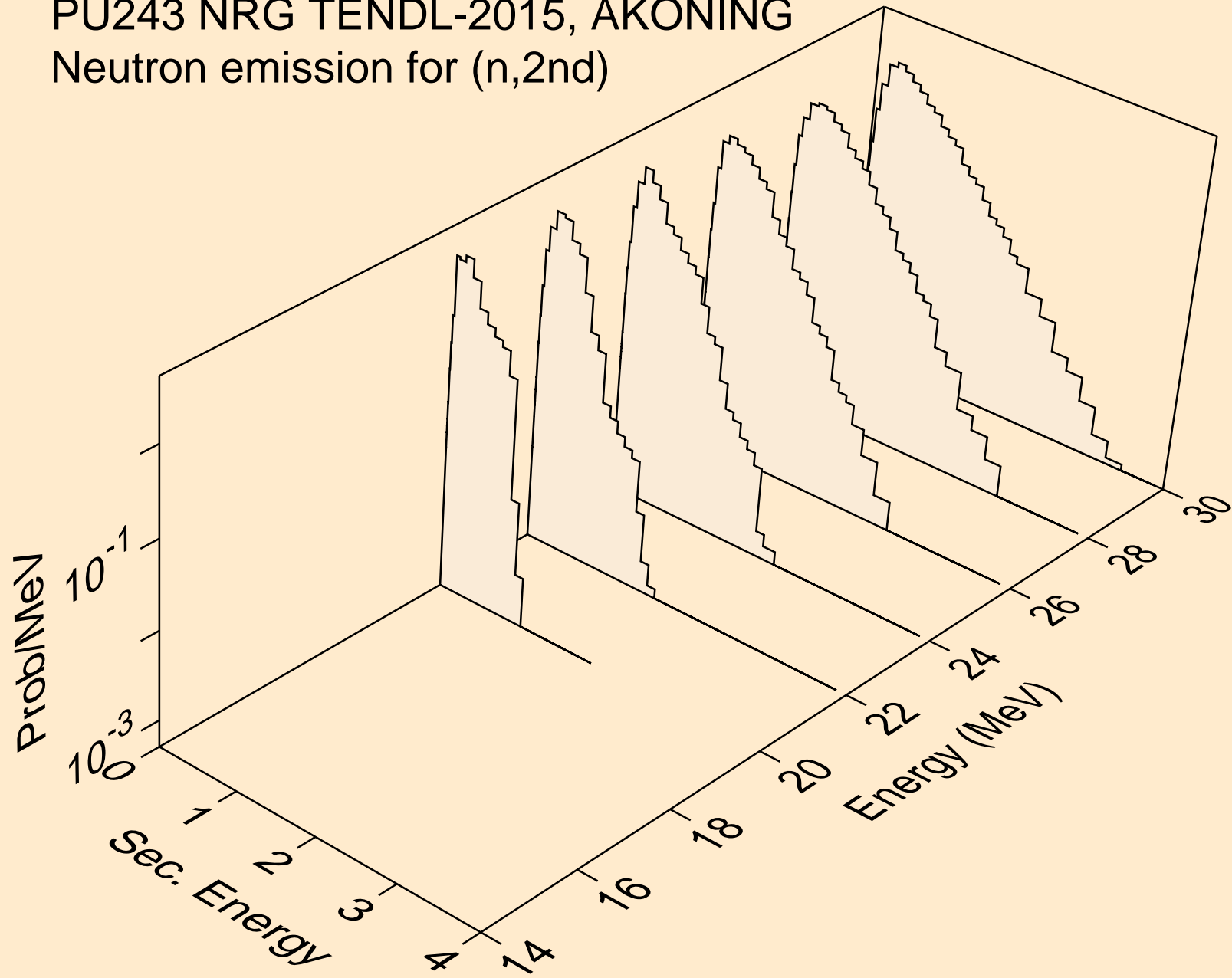

PU243 NRG TENDL-2015, AKONING  
Neutron emission for (n,2n)

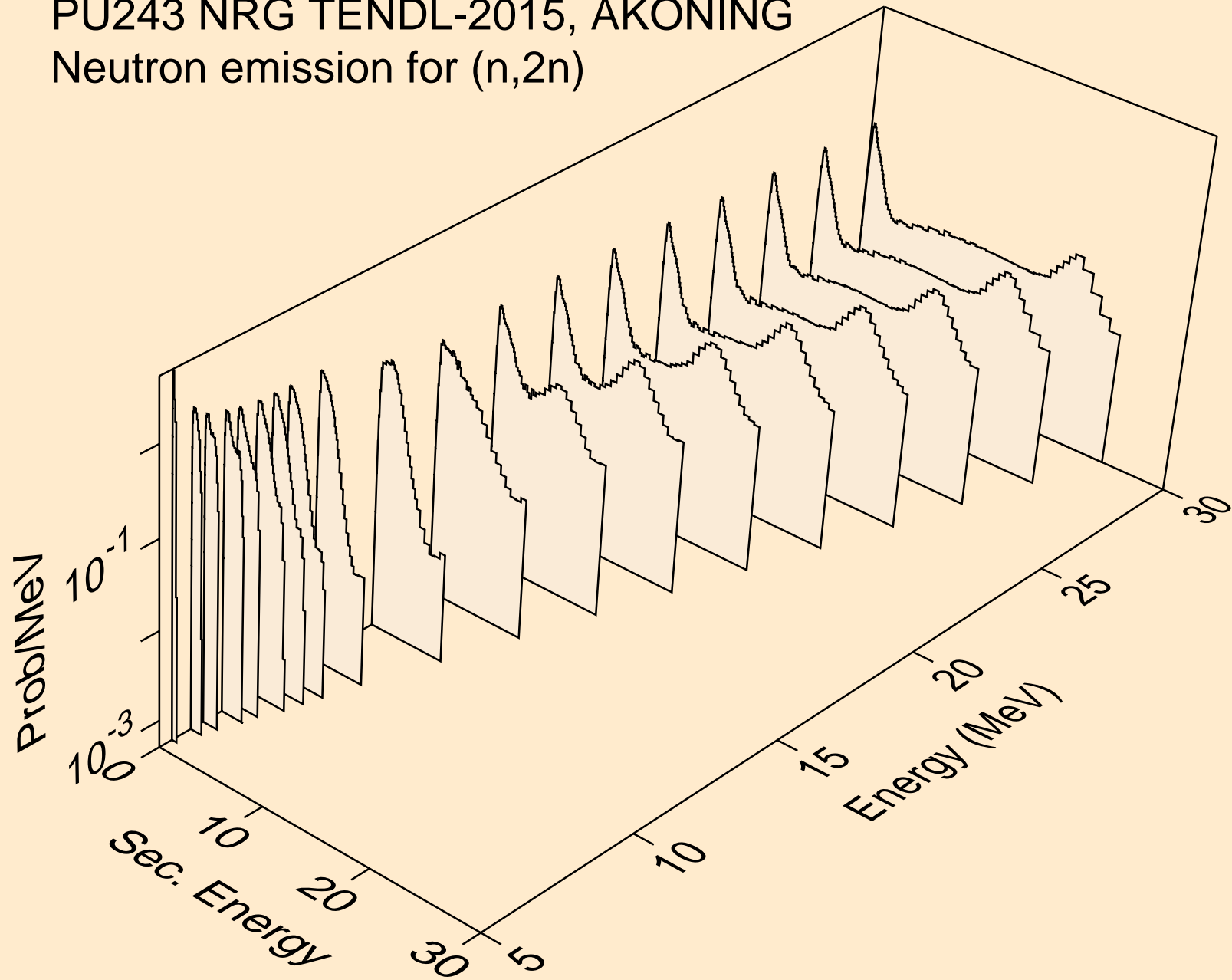

PU243 NRG TENDL-2015, AKONING  
Neutron emission for (n,3n)

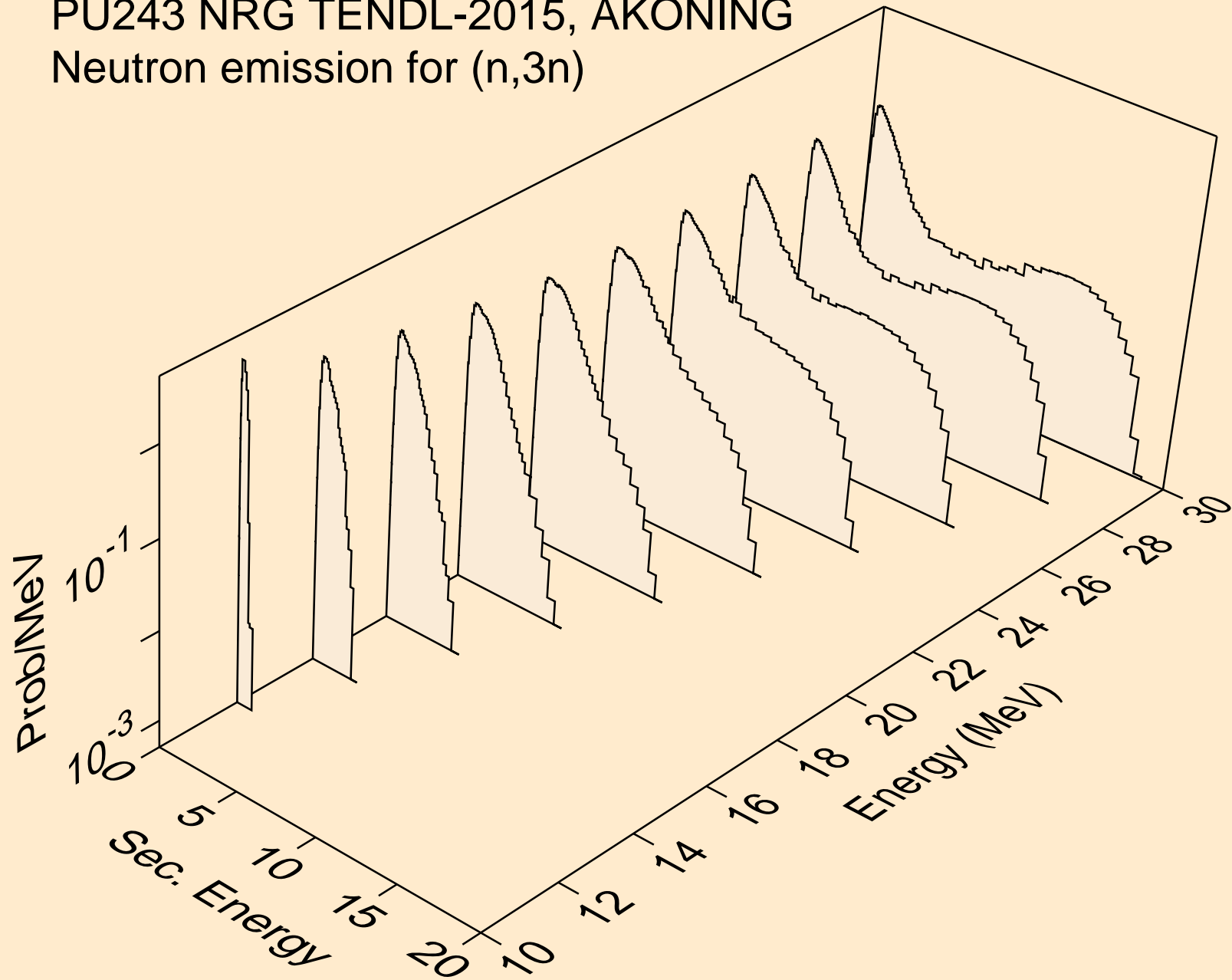

PU243 NRG TENDL-2015, AKONING  
Neutron emission for fission

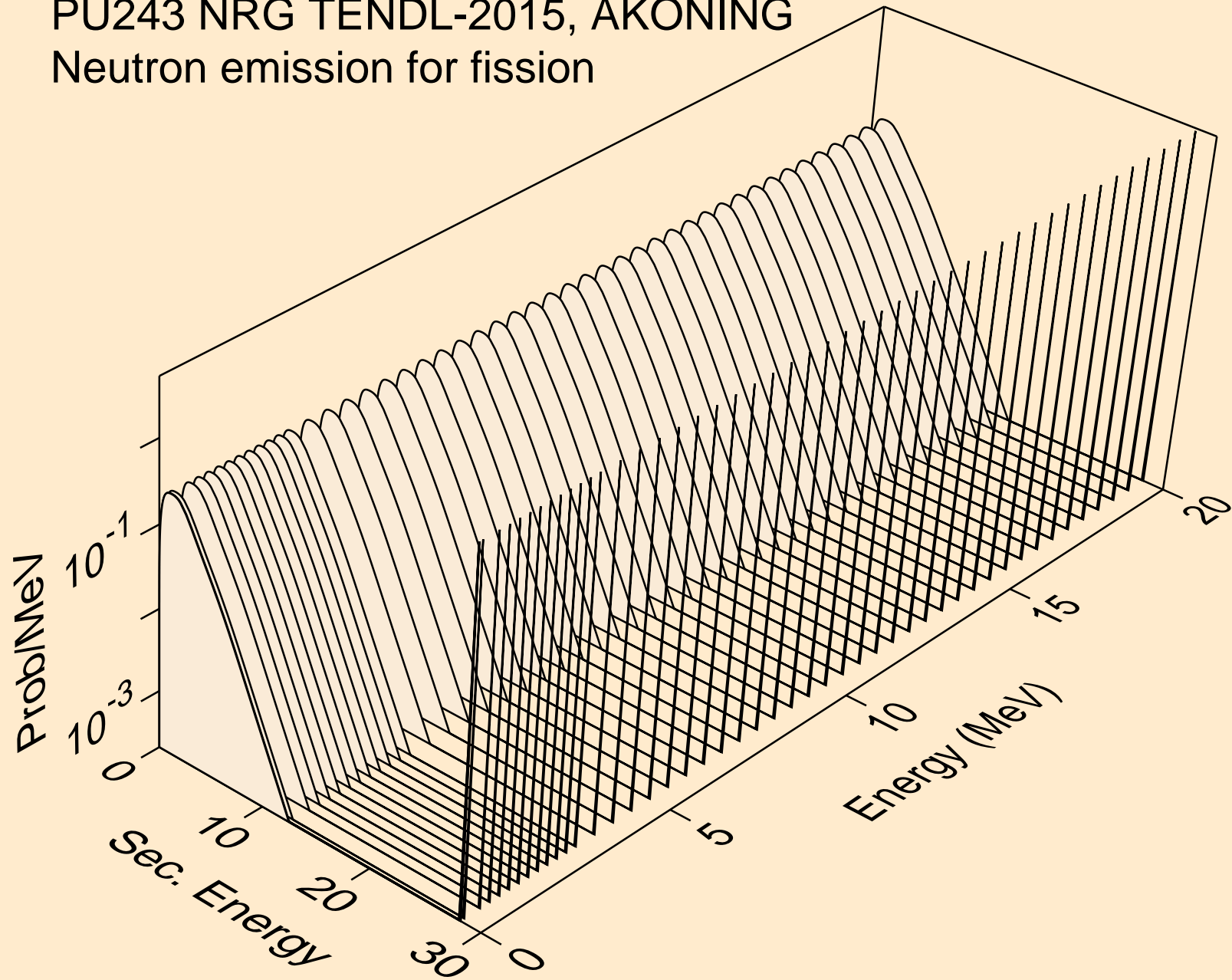

PU243 NRG TENDL-2015, AKONING  
Neutron emission for (n,n\*)a

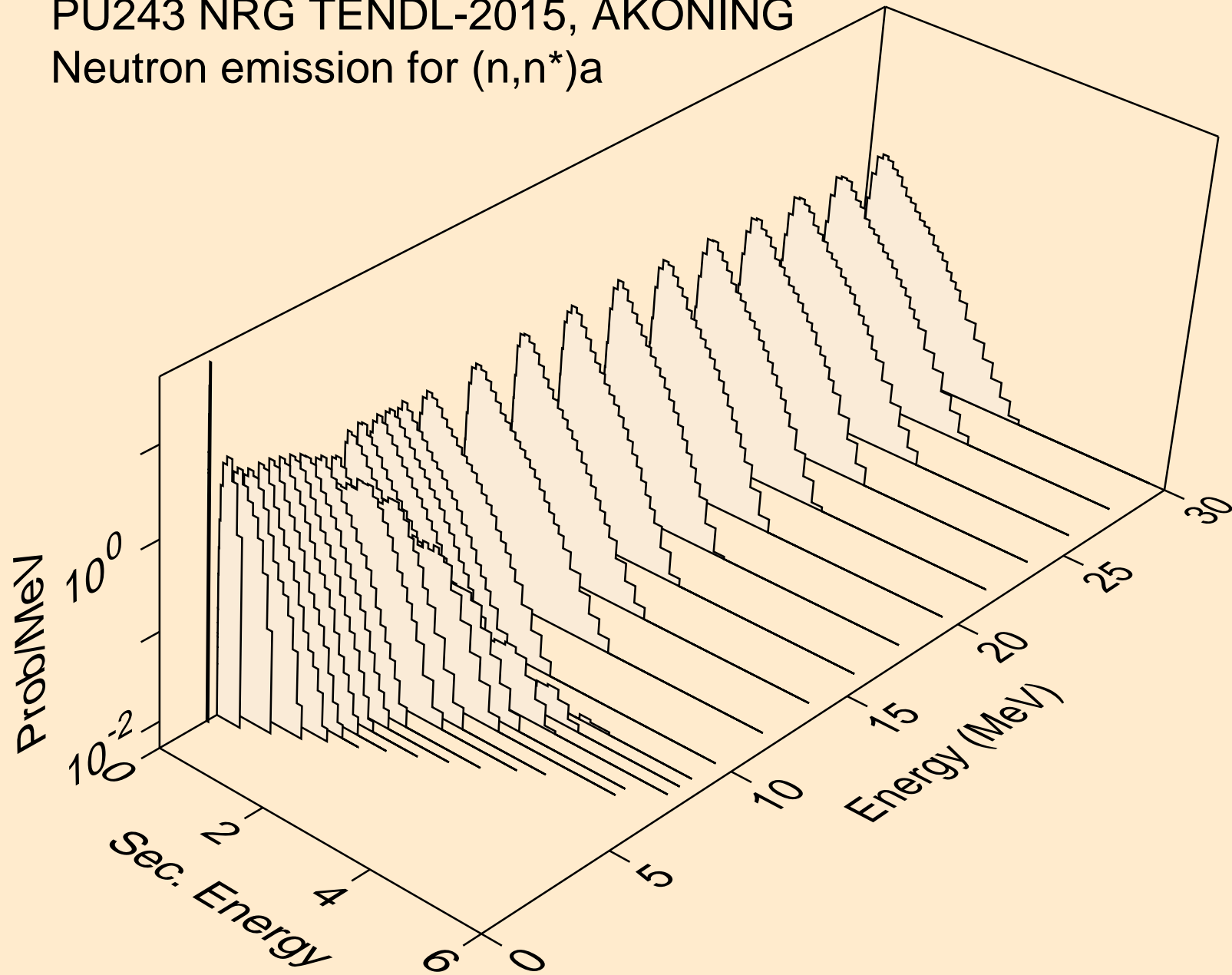

PU243 NRG TENDL-2015, AKONING  
Neutron emission for (n,2n)a

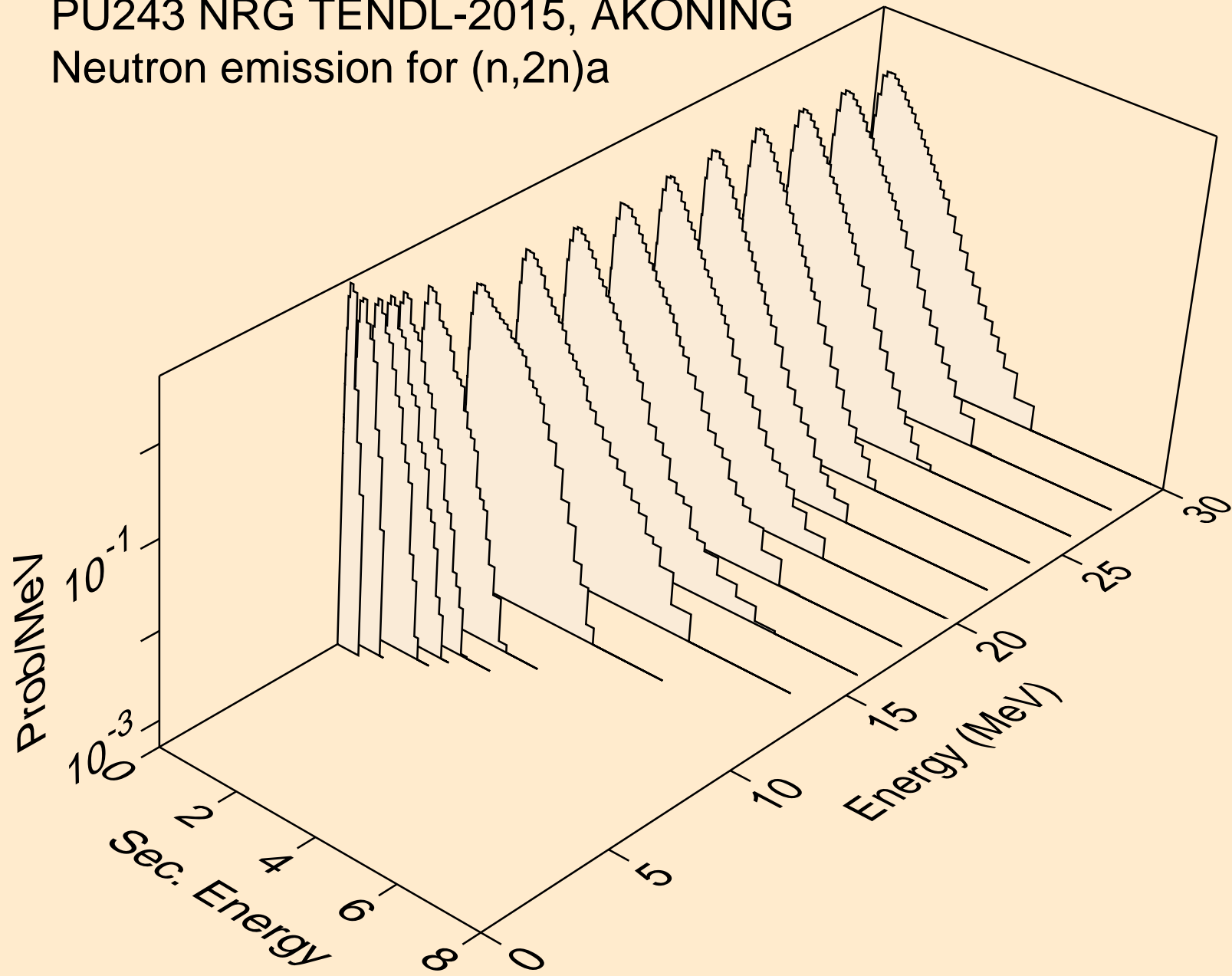

PU243 NRG TENDL-2015, AKONING  
Neutron emission for (n,3n)a

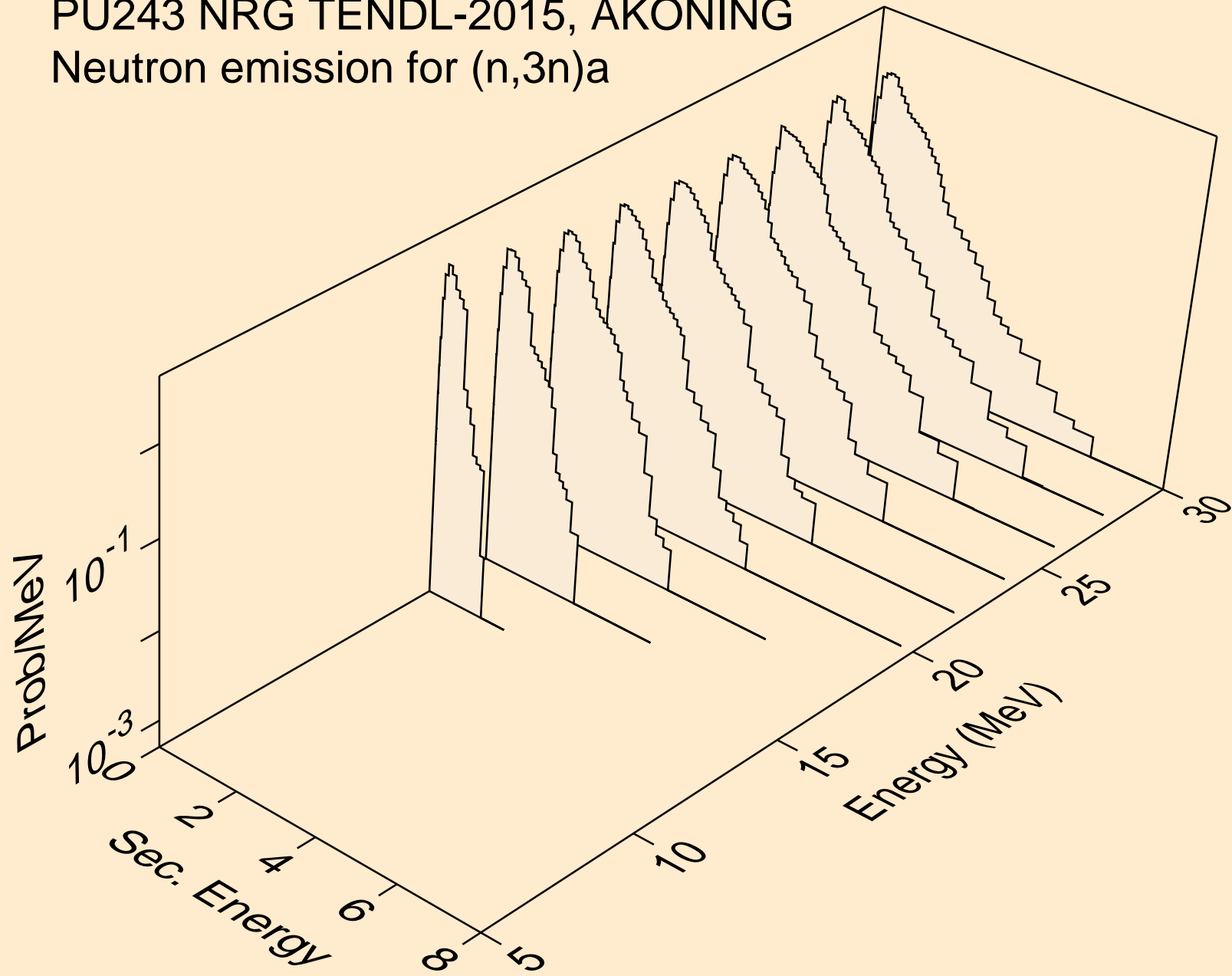



PU243 NRG TENDL-2015, AKONING  
Neutron emission for (n,n\*)p

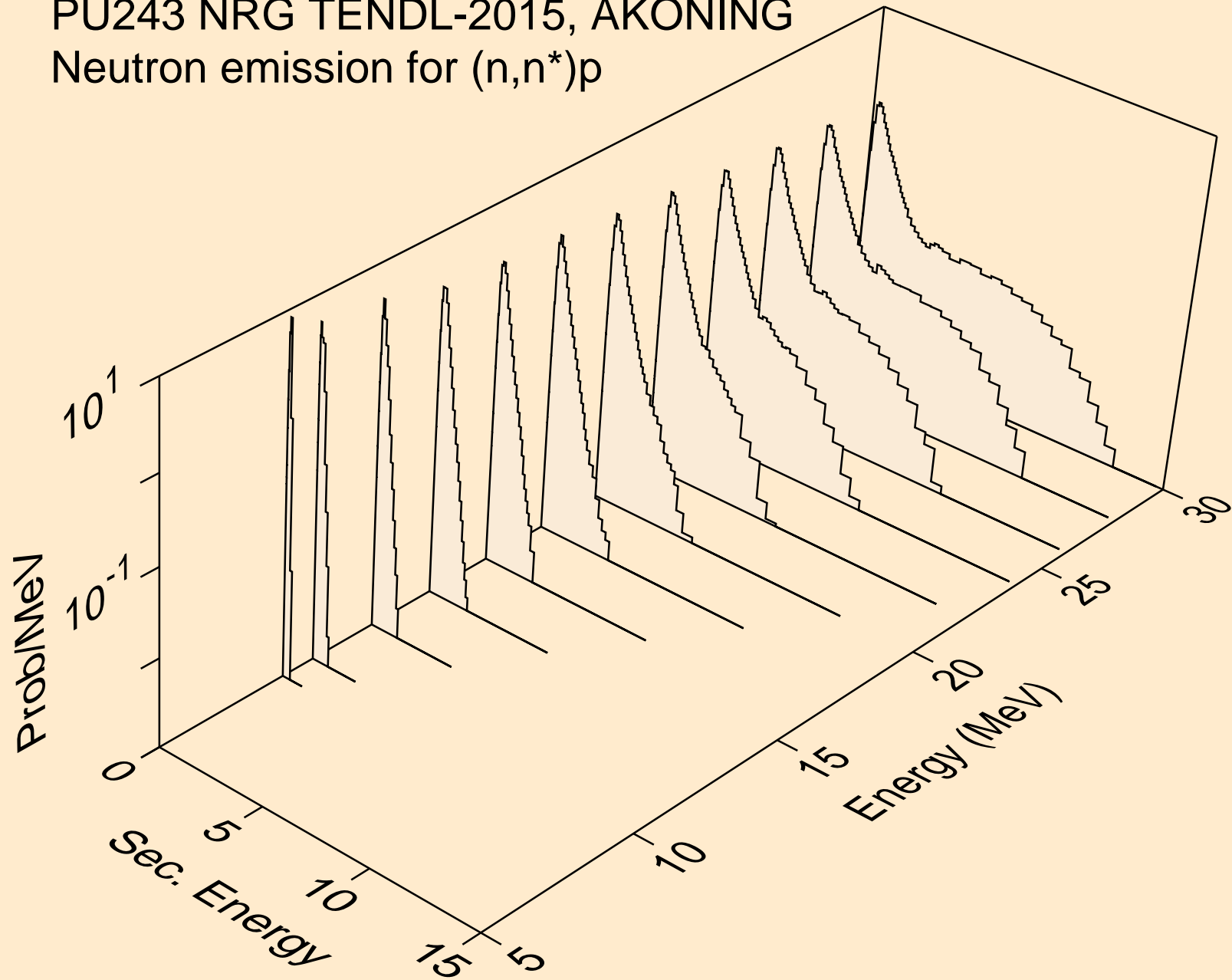

PU243 NRG TENDL-2015, AKONING  
Neutron emission for (n,n\*)d

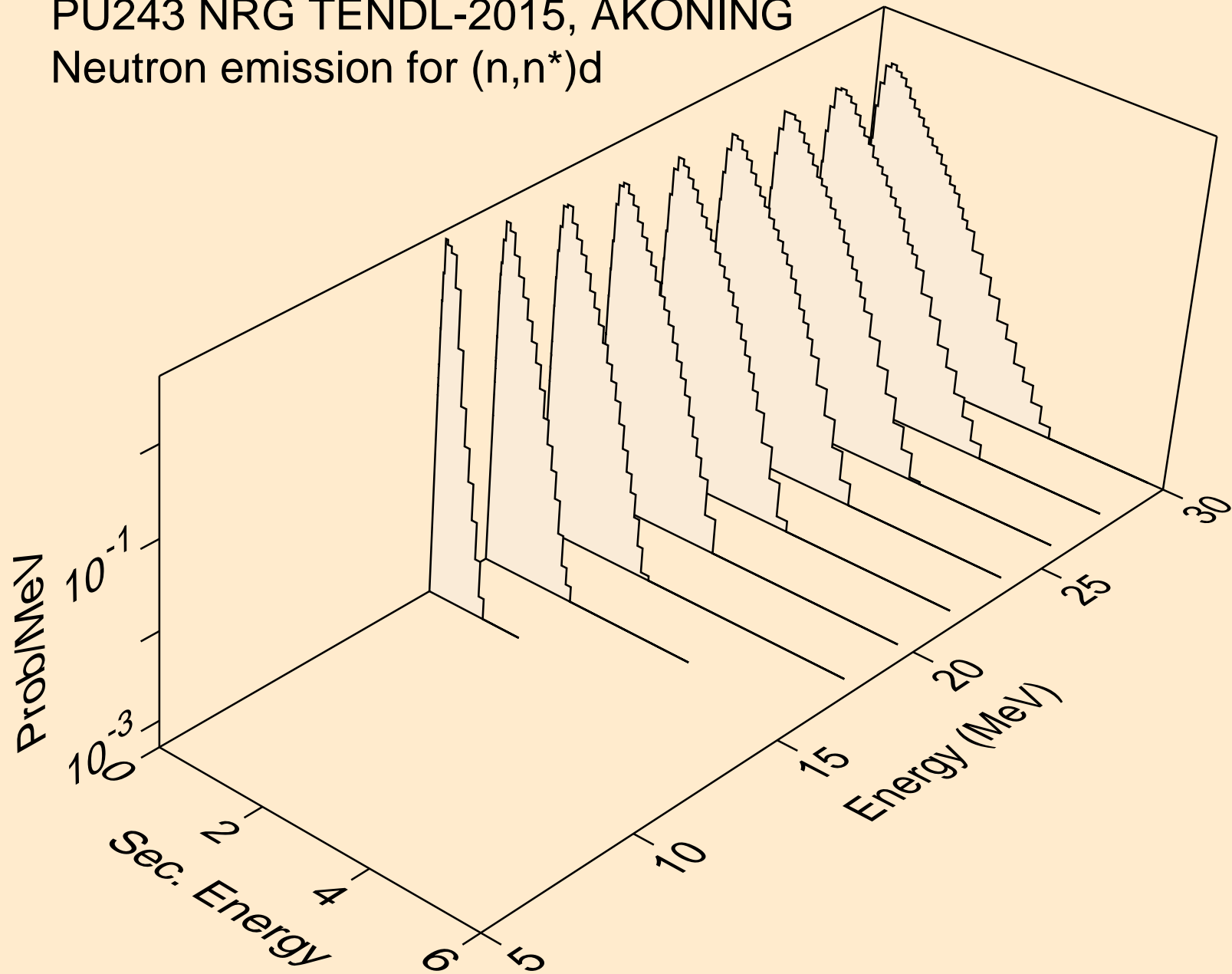

PU243 NRG TENDL-2015, AKONING  
Neutron emission for (n,n\*)t

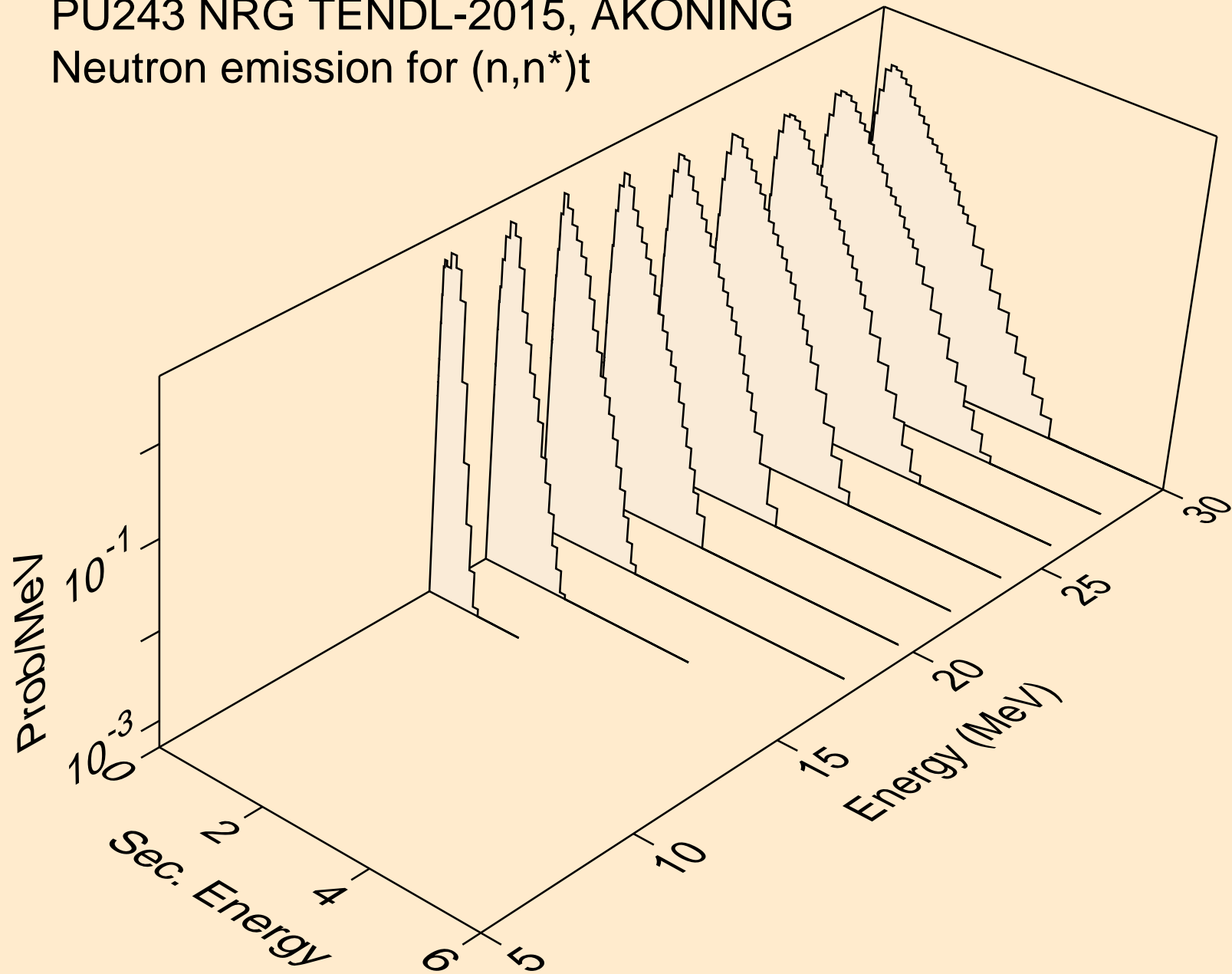

PU243 NRG TENDL-2015, AKONING  
Neutron emission for (n,n\*)he3

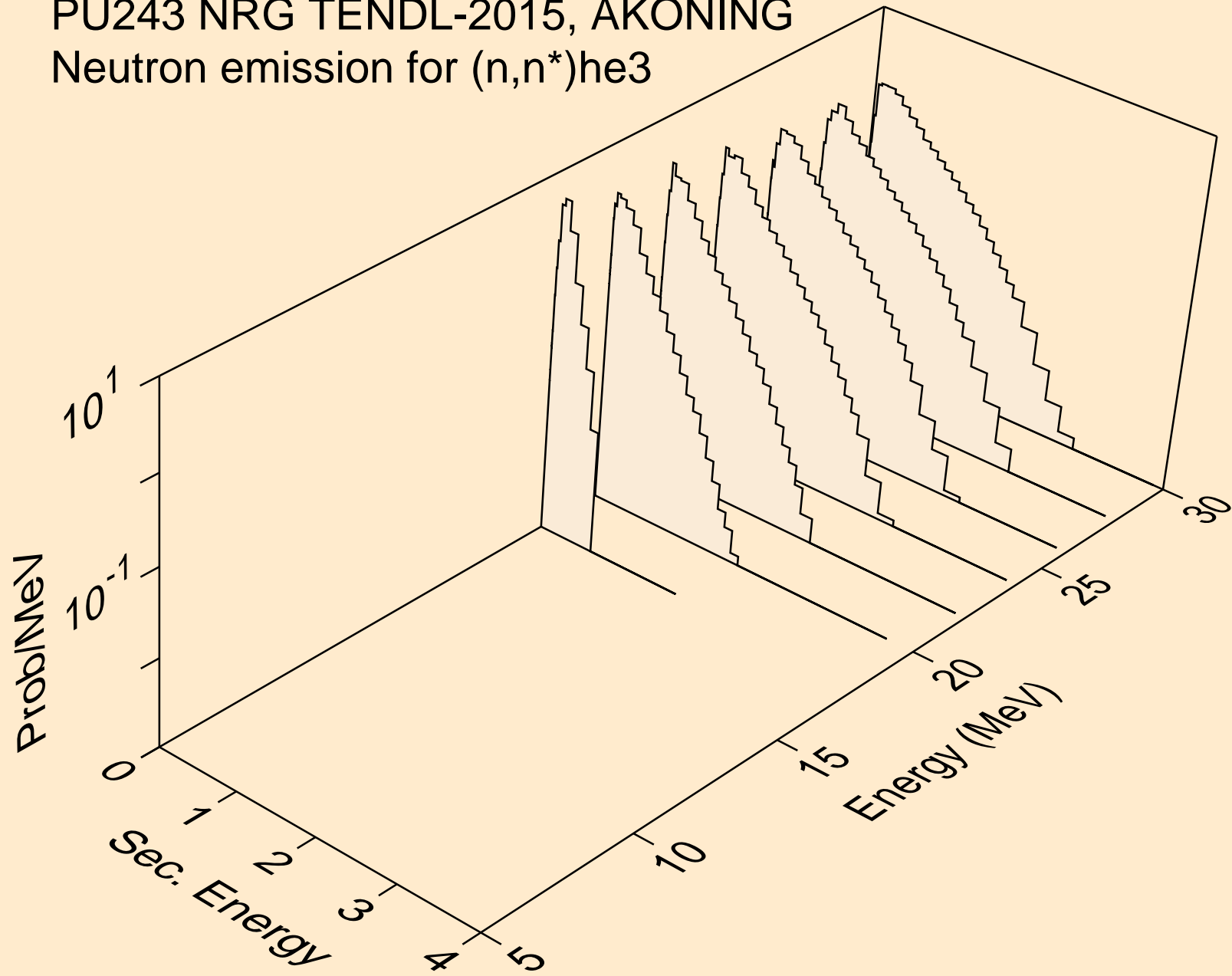

PU243 NRG TENDL-2015, AKONING  
Neutron emission for (n,4n)

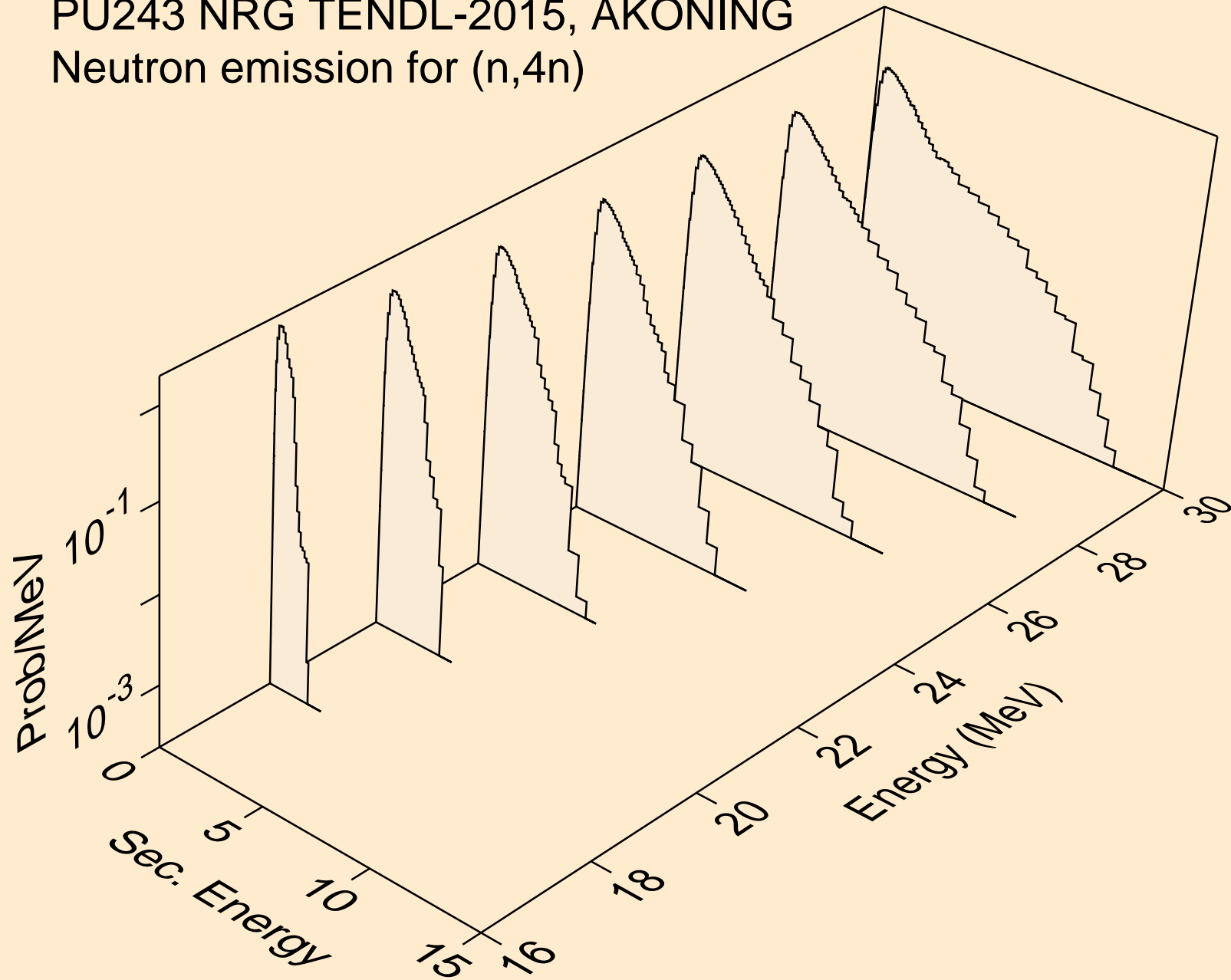

PU243 NRG TENDL-2015, AKONING  
Neutron emission for (n,2np)

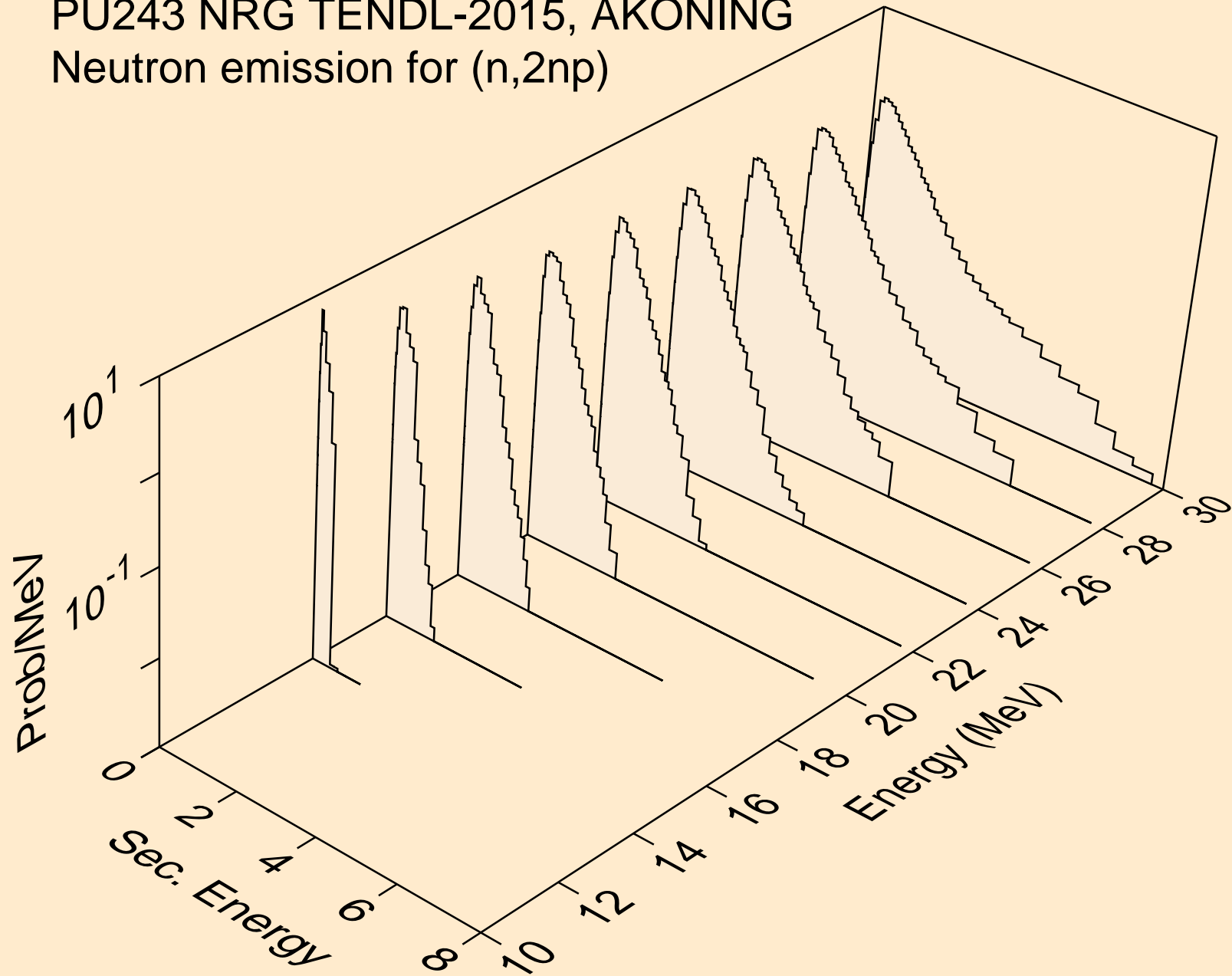

PU243 NRG TENDL-2015, AKONING  
Neutron emission for (n,3np)

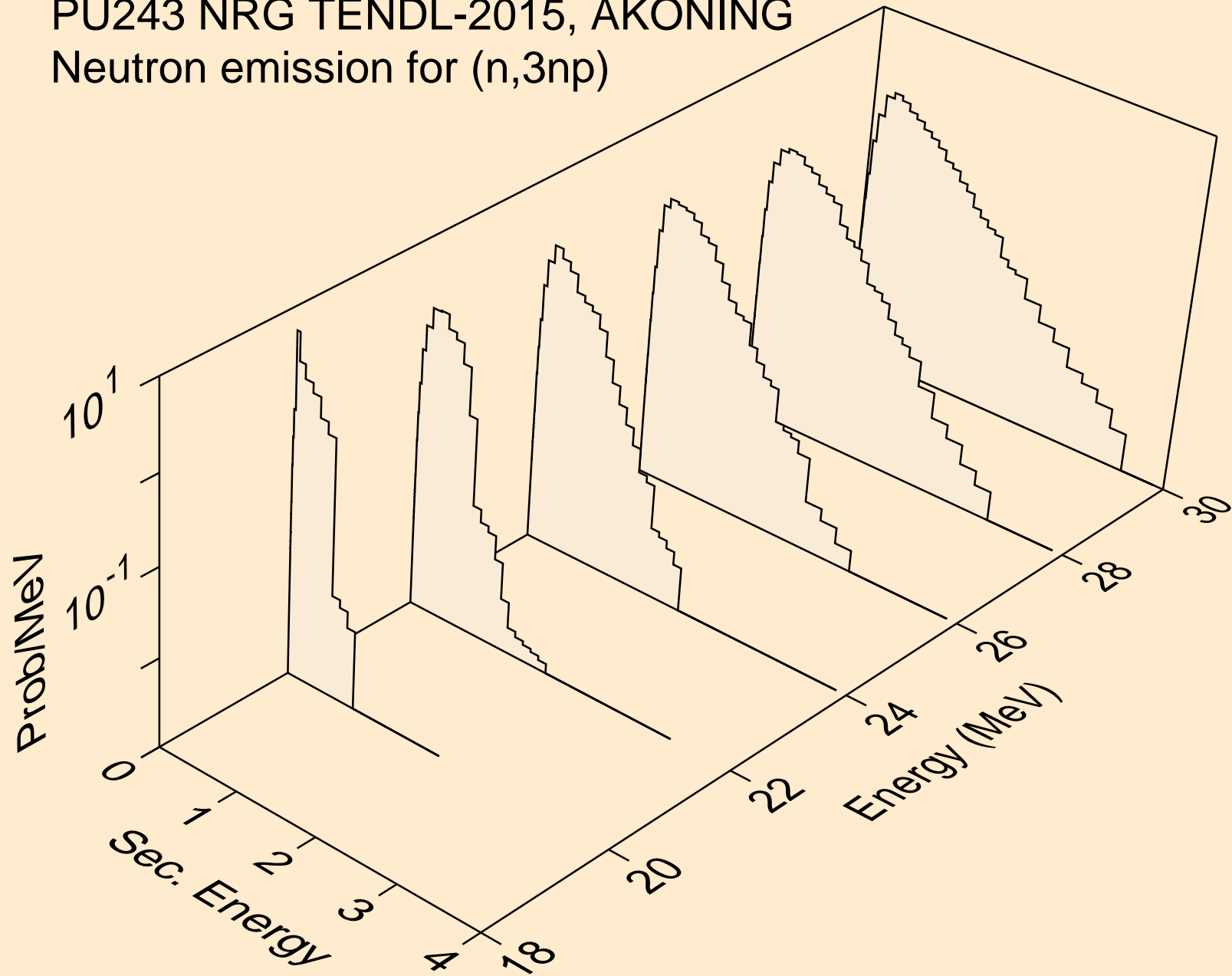

PU243 NRG TENDL-2015, AKONING  
Neutron emission for (n,2np)

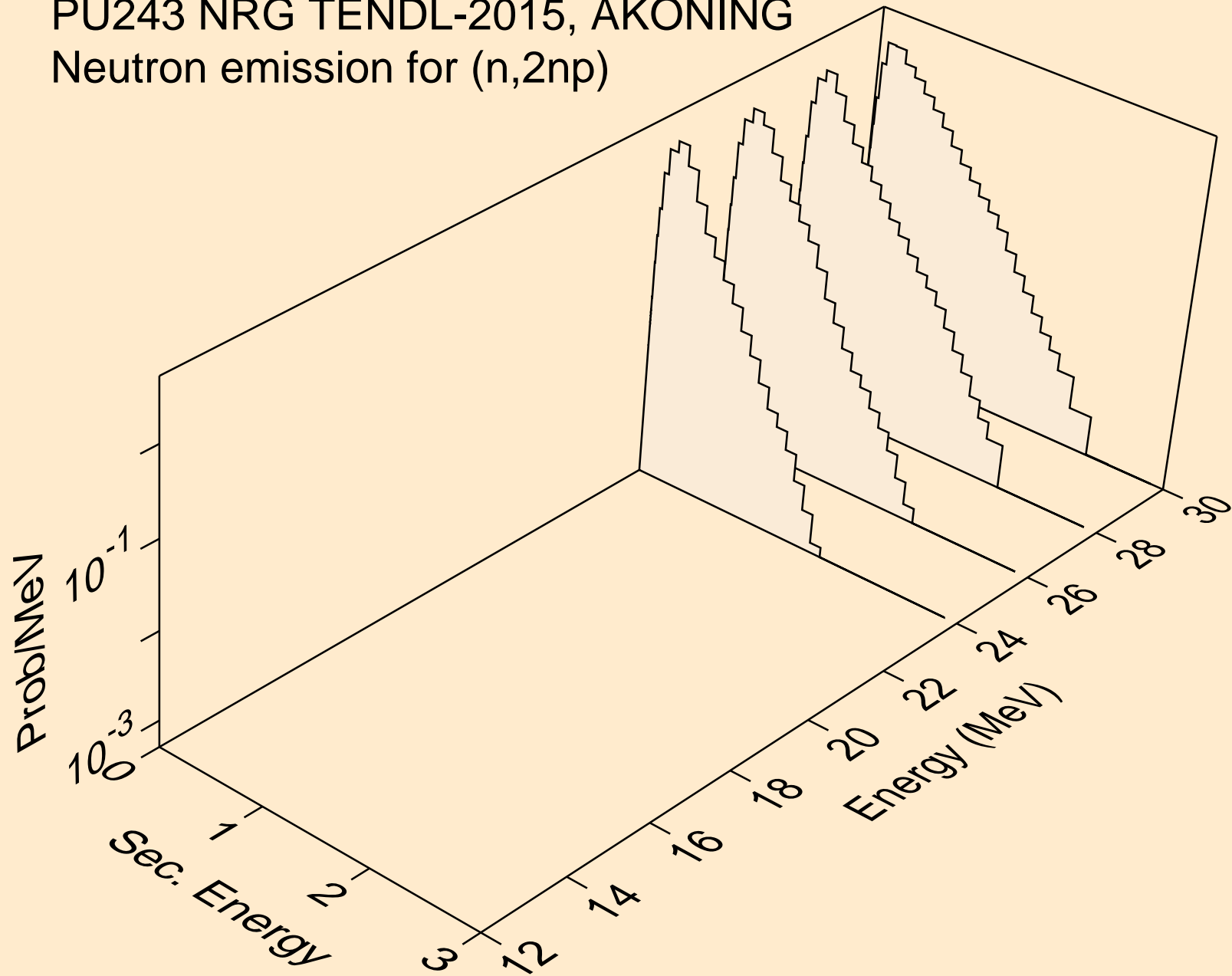



PU243 NRG TENDL-2015, AKONING  
Neutron emission for (n,n\*c)

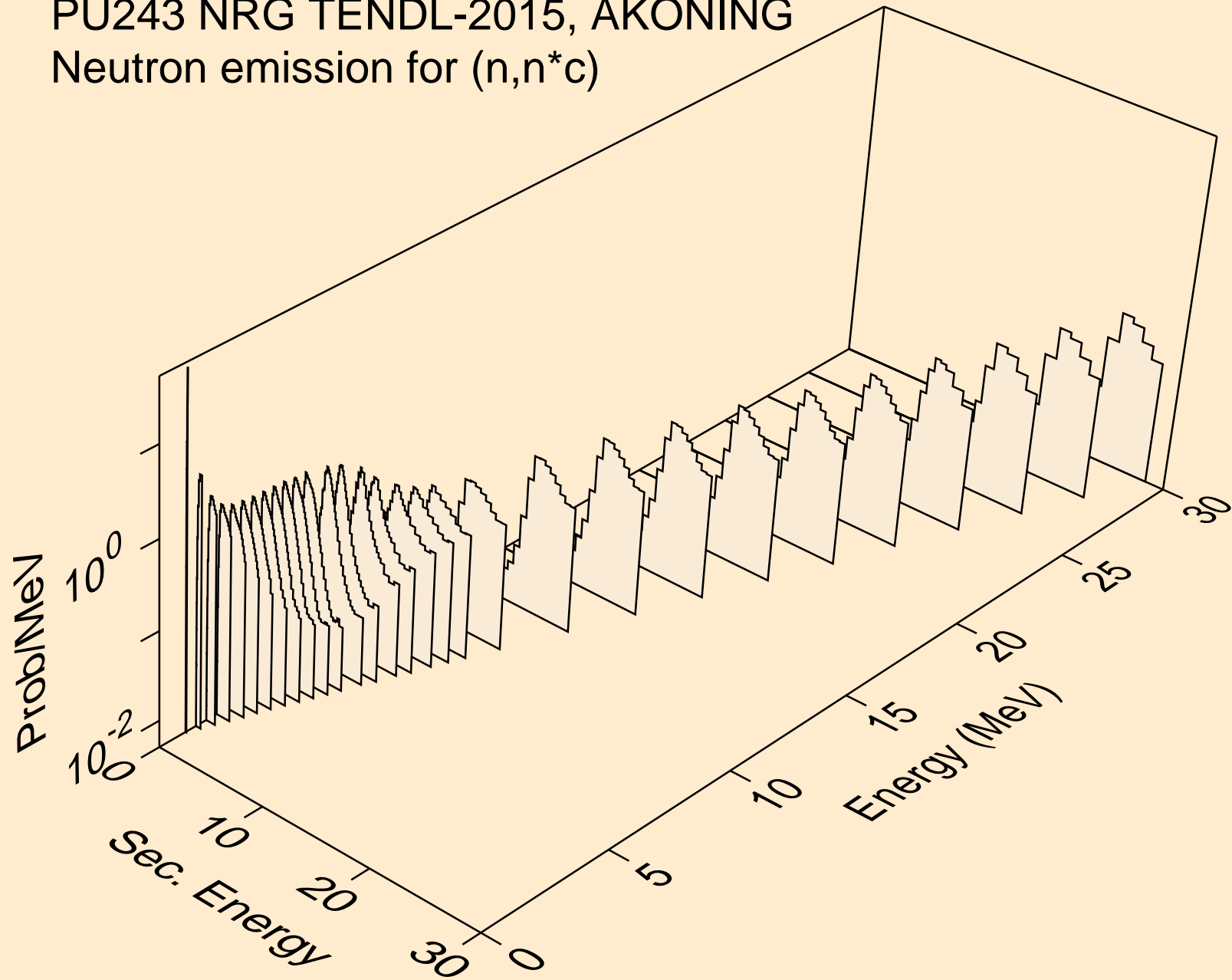

# PU243 NRG TENDL-2015, AKONING

Delayed nubar

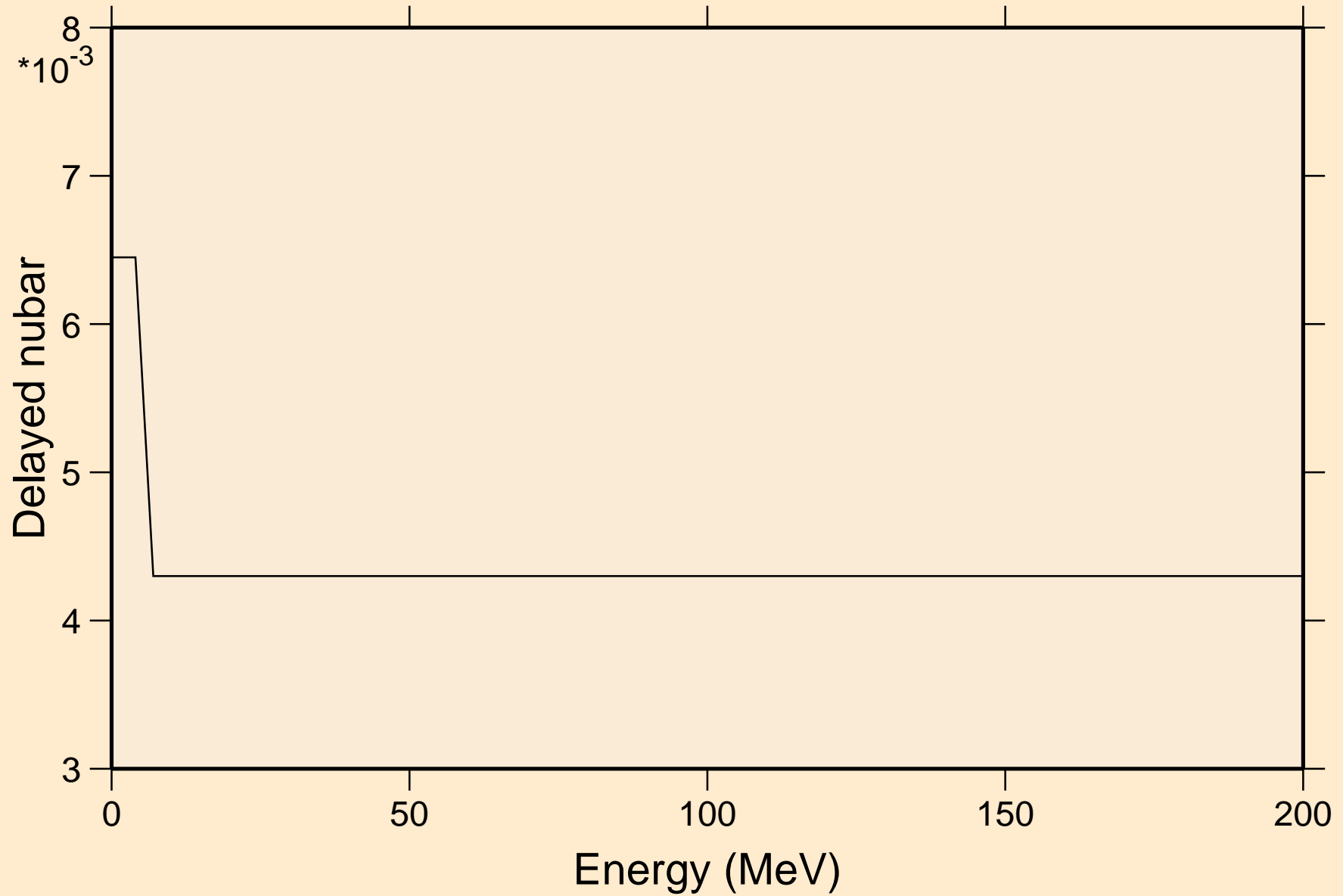

# PU243 NRG TENDL-2015, AKONING

## Delayed neutron spectra

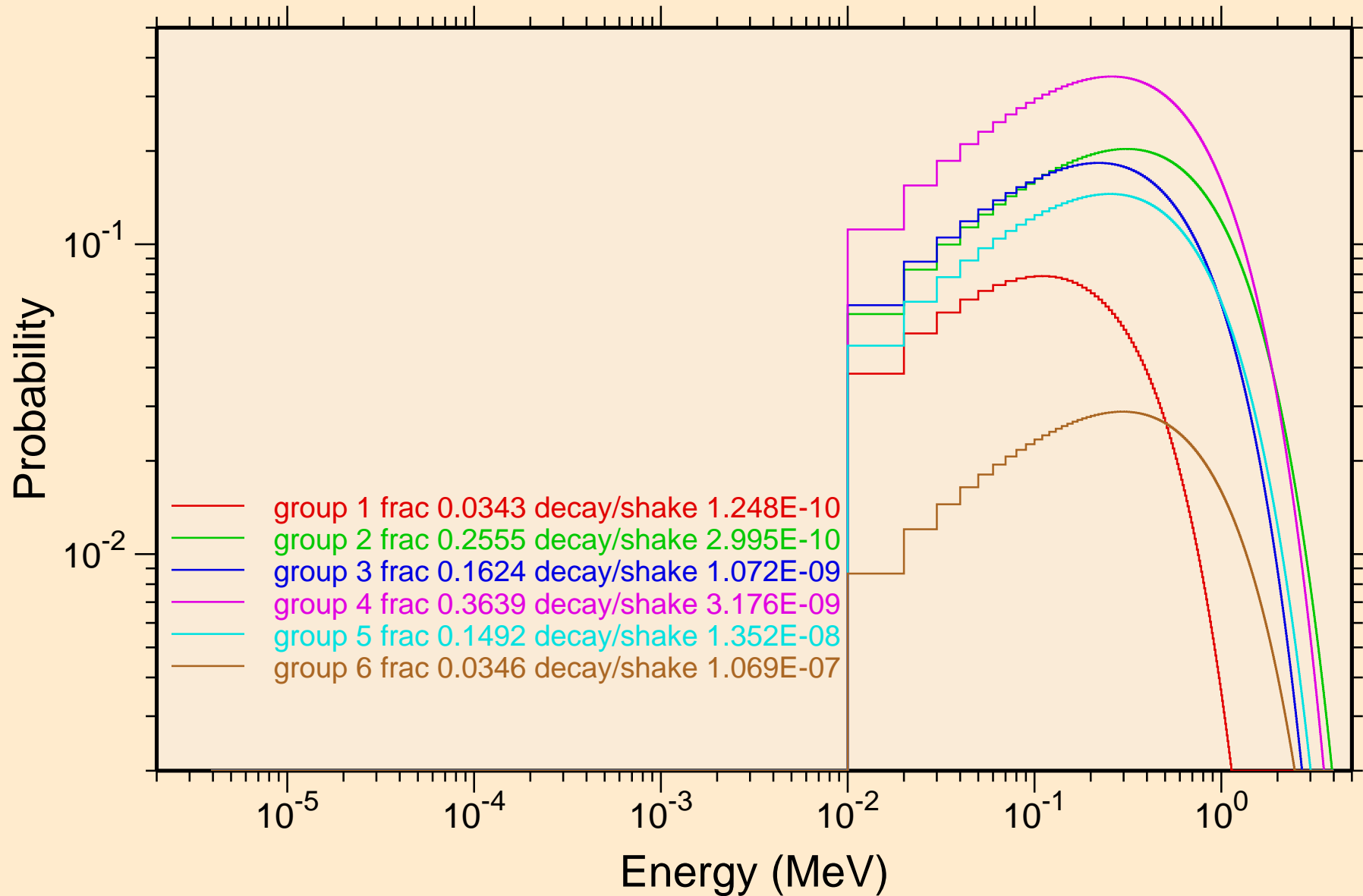

PU243 NRG TENDL-2015, AKONING  
Photon emission for (n,x)

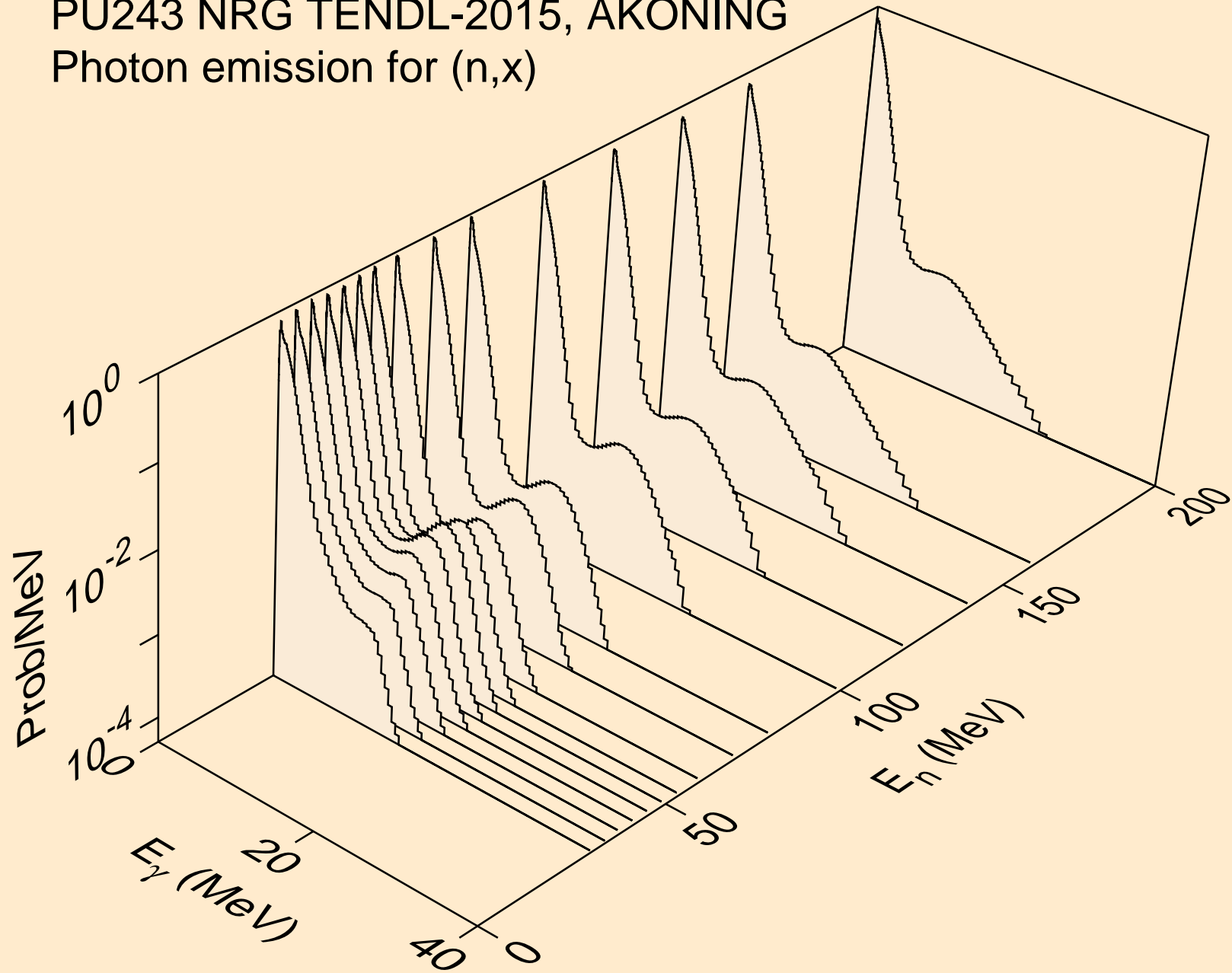

PU243 NRG TENDL-2015, AKONING  
Photon emission for (n,2nd)

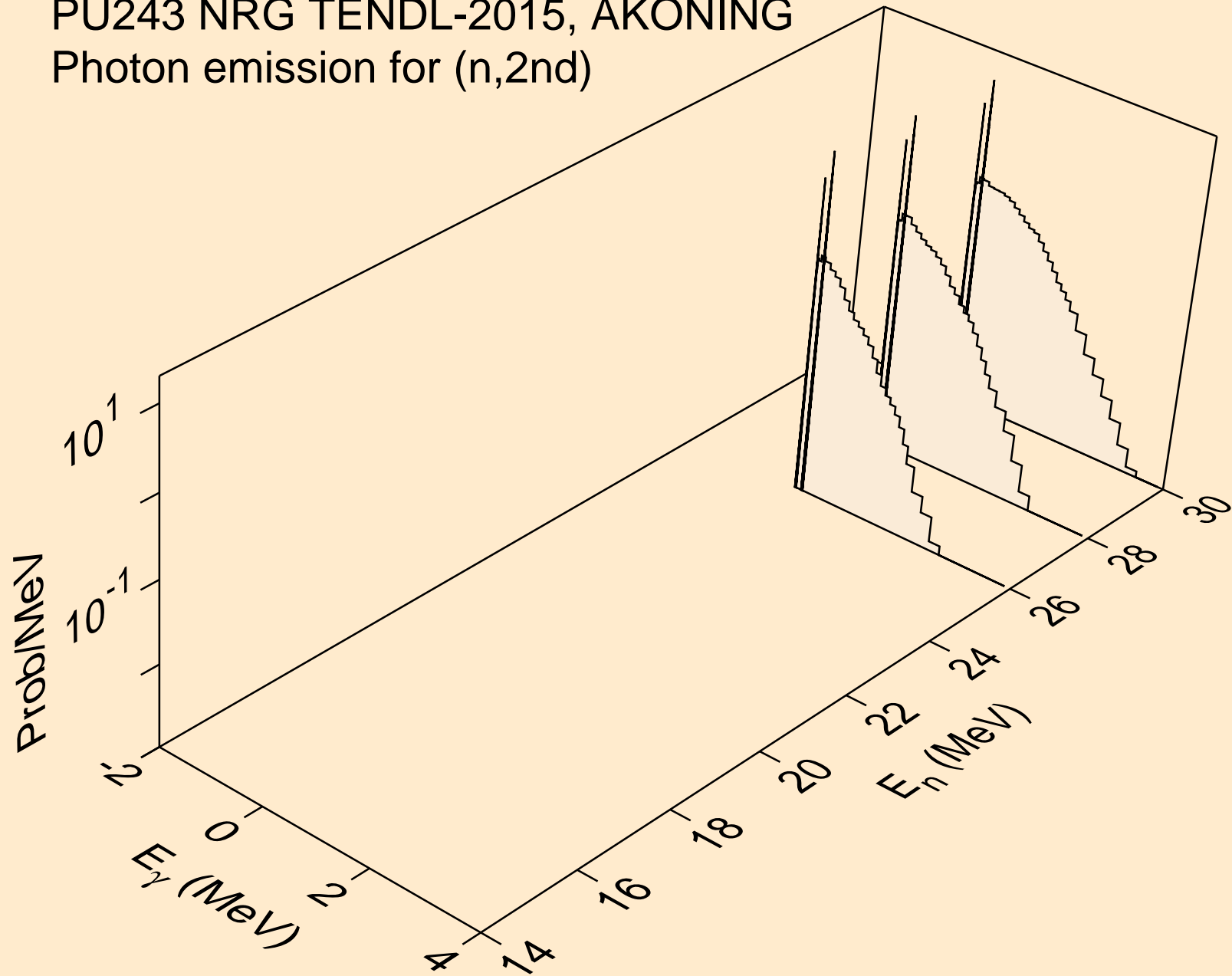

PU243 NRG TENDL-2015, AKONING  
Photon emission for (n,2n)

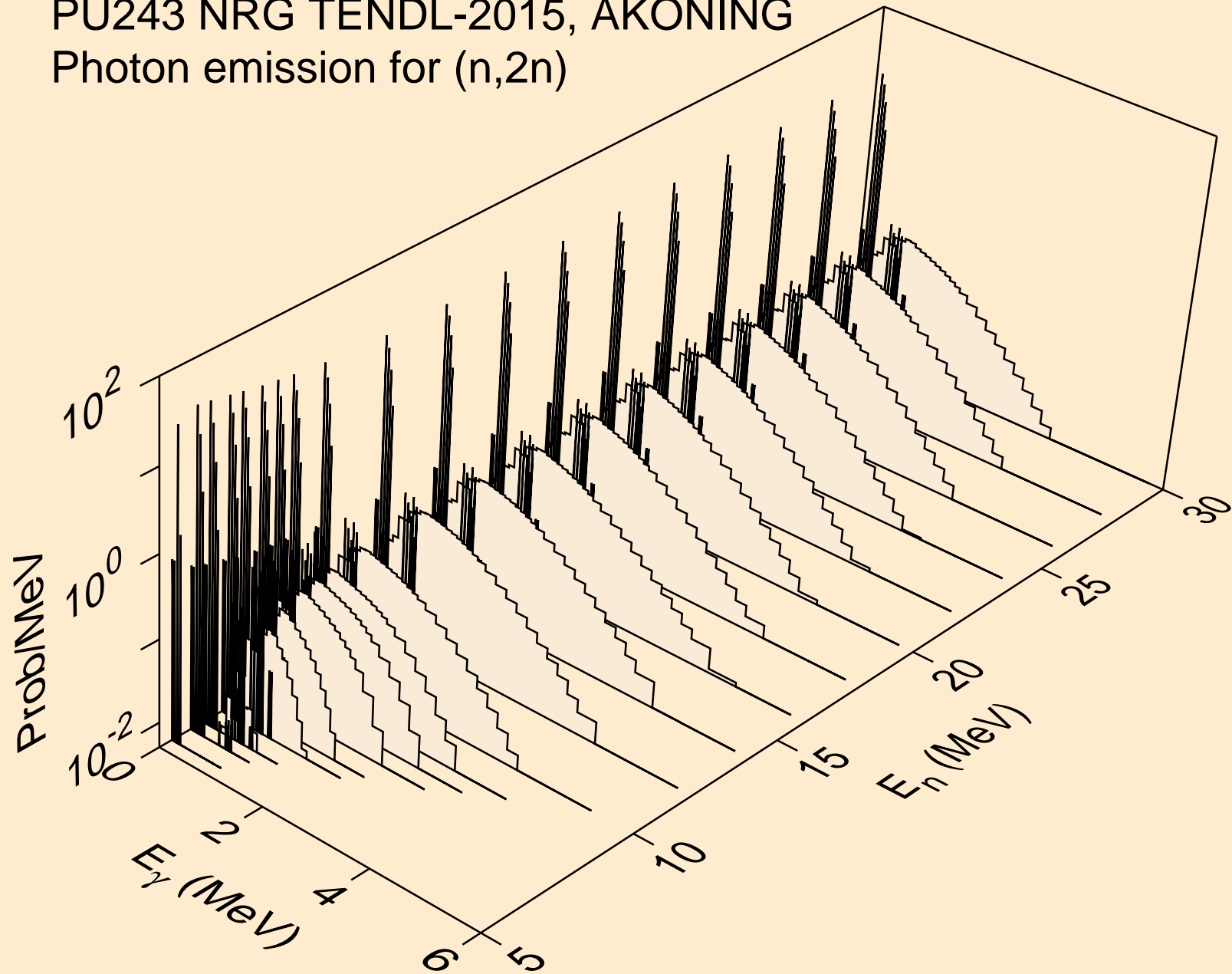

PU243 NRG TENDL-2015, AKONING  
Photon emission for (n,3n)

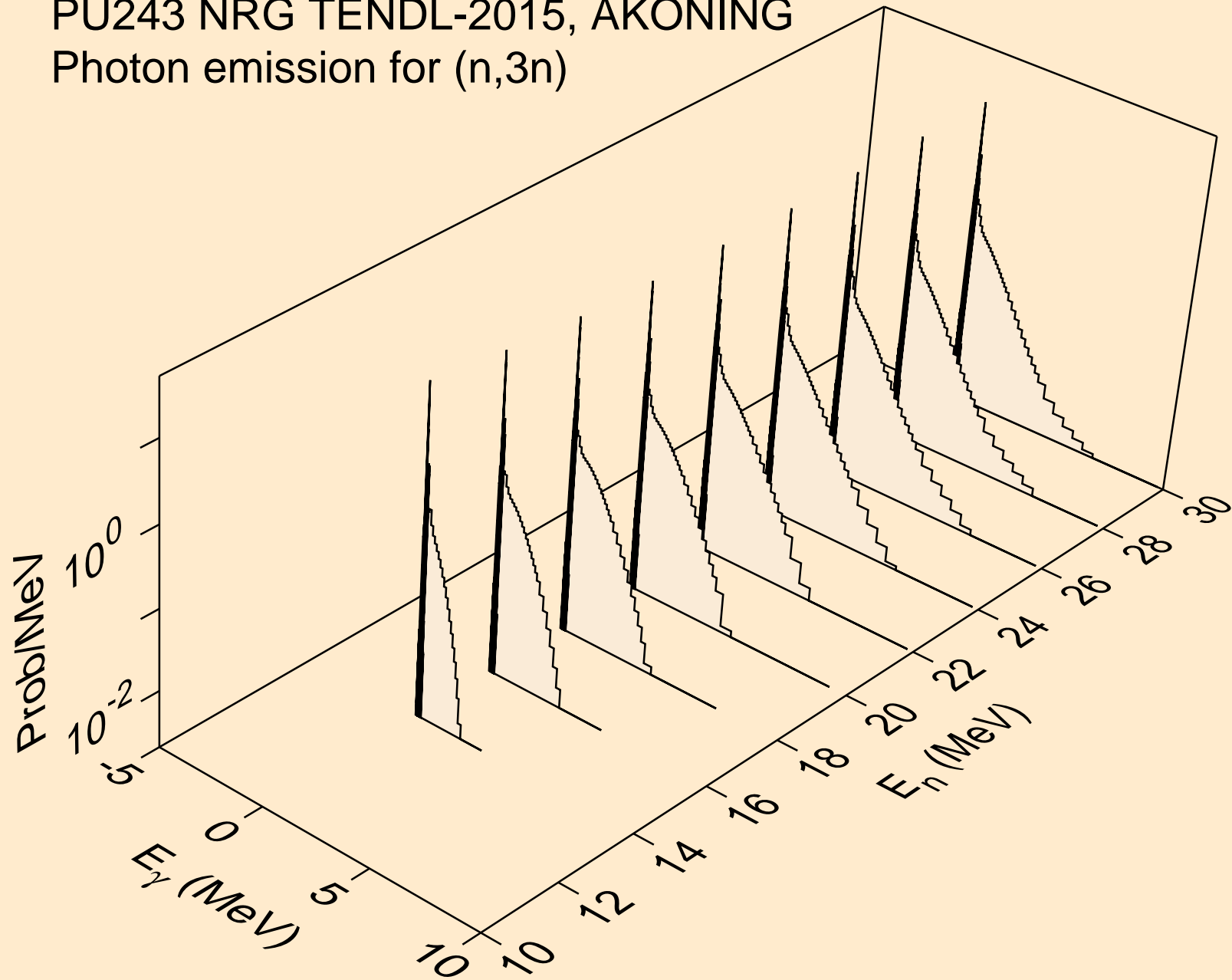

PU243 NRG TENDL-2015, AKONING  
Photon emission for (n,n\*)a

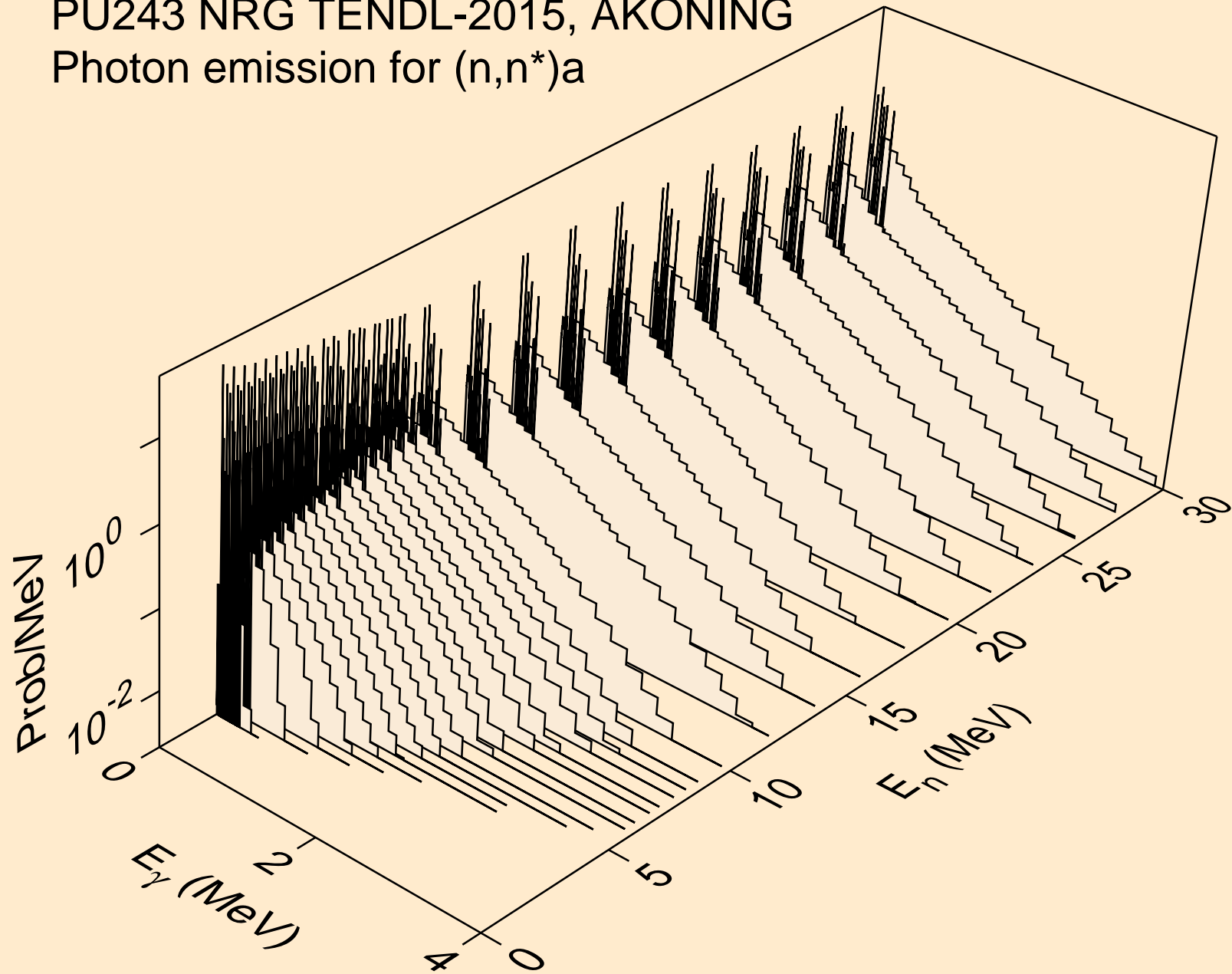



PU243 NRG TENDL-2015, AKONING  
Photon emission for (n,2n)a

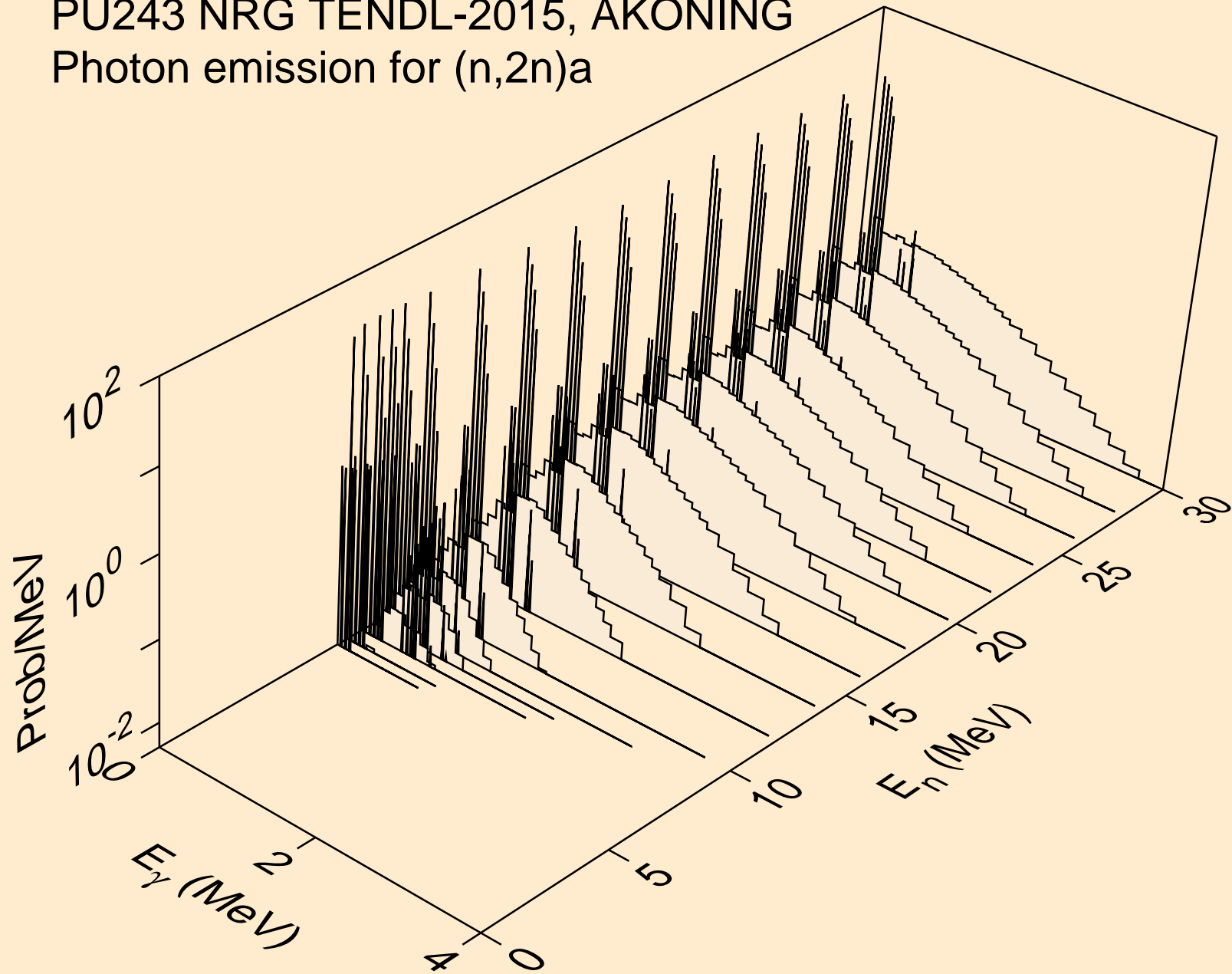

PU243 NRG TENDL-2015, AKONING  
Photon emission for (n,3n)a

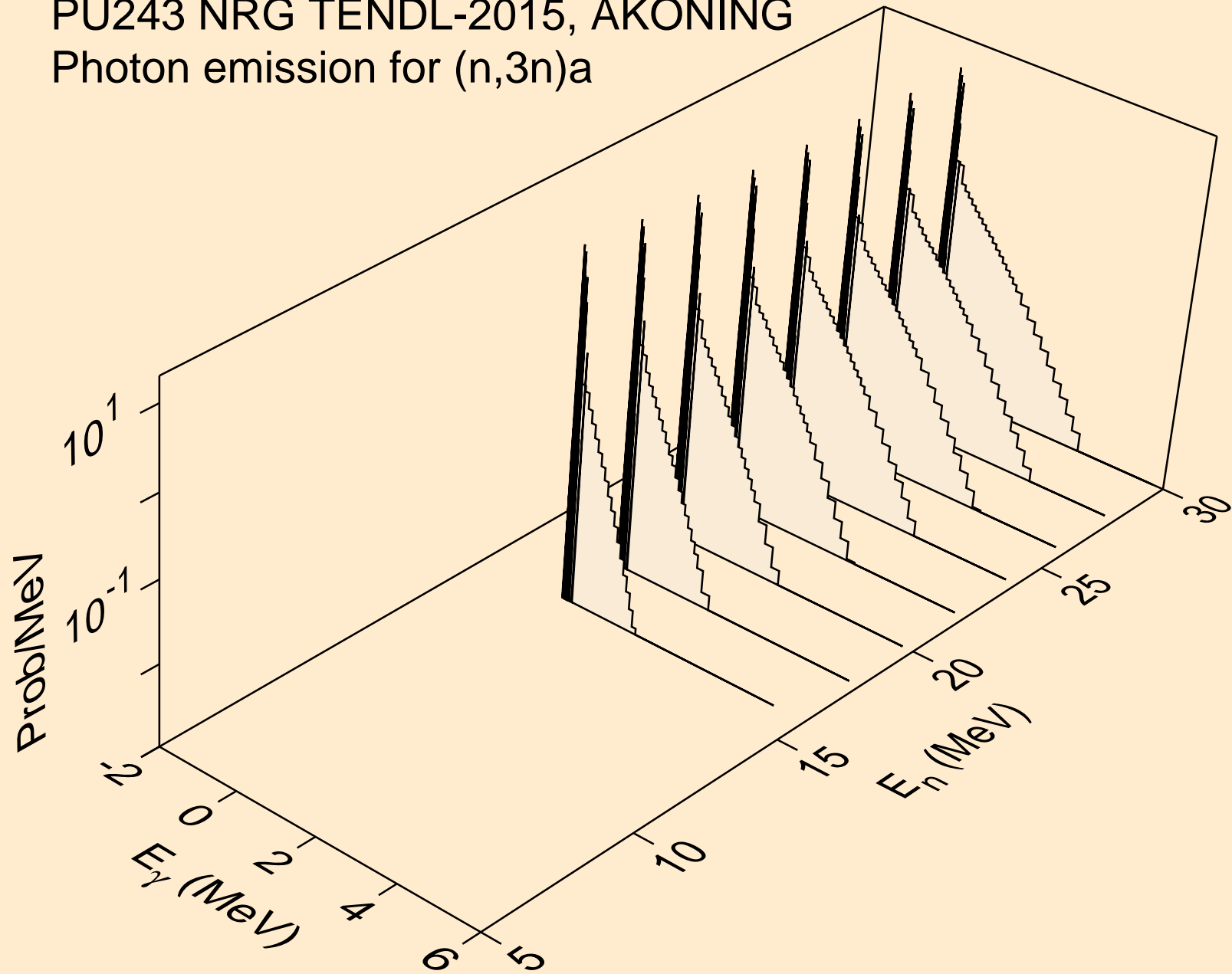

PU243 NRG TENDL-2015, AKONING  
Photon emission for (n,n\*)p

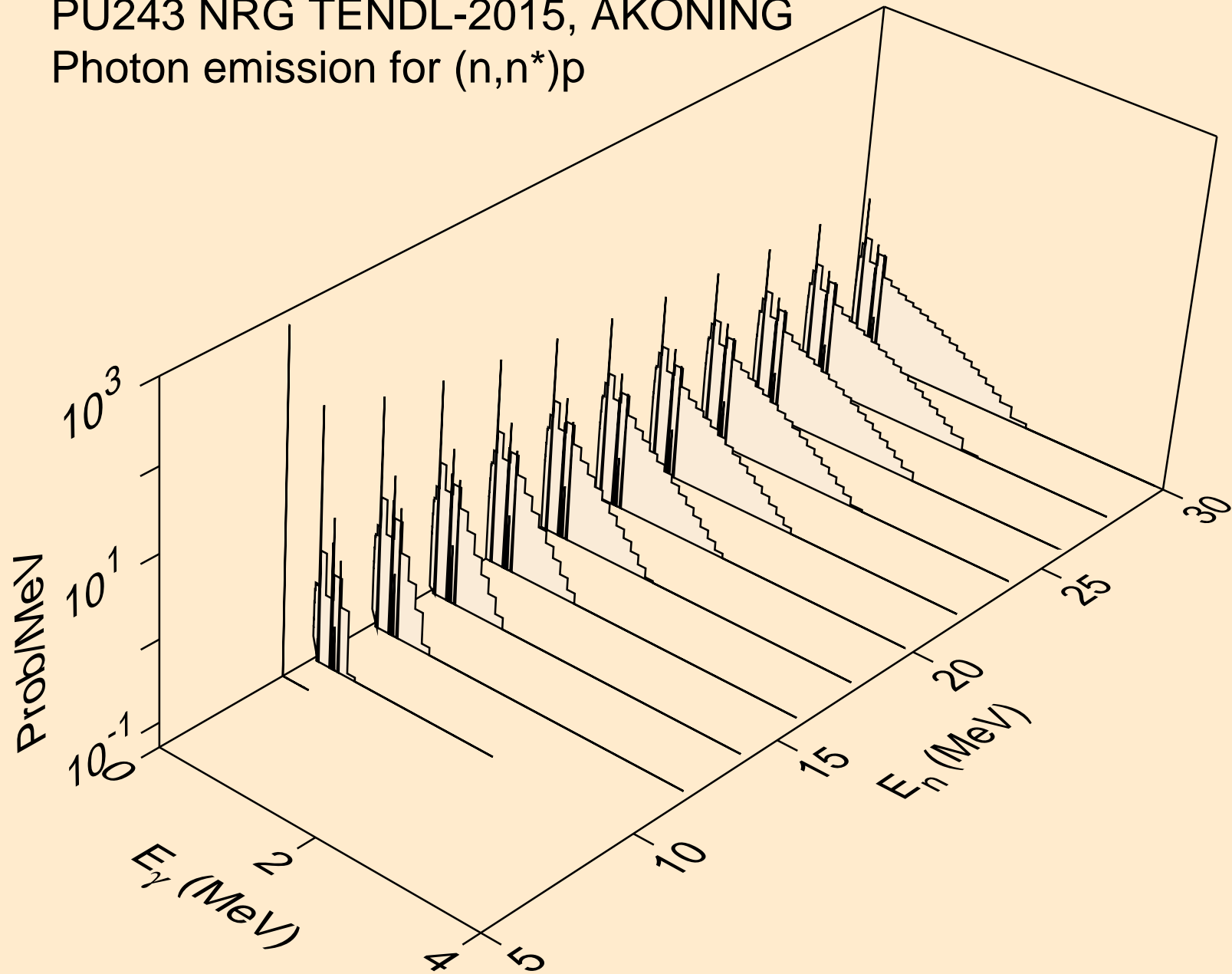

PU243 NRG TENDL-2015, AKONING  
Photon emission for (n,n\*)d

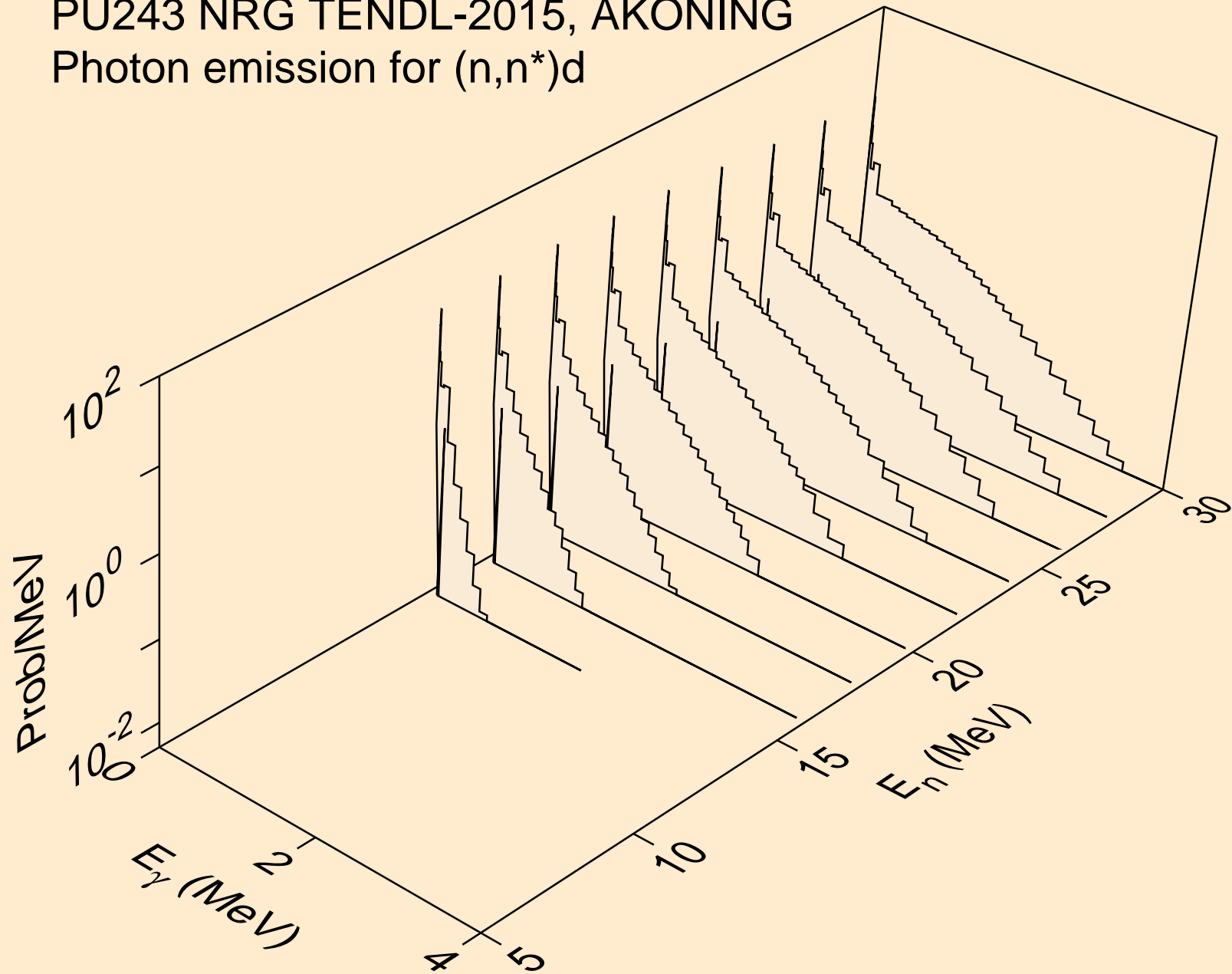

PU243 NRG TENDL-2015, AKONING  
Photon emission for (n,n\*)t

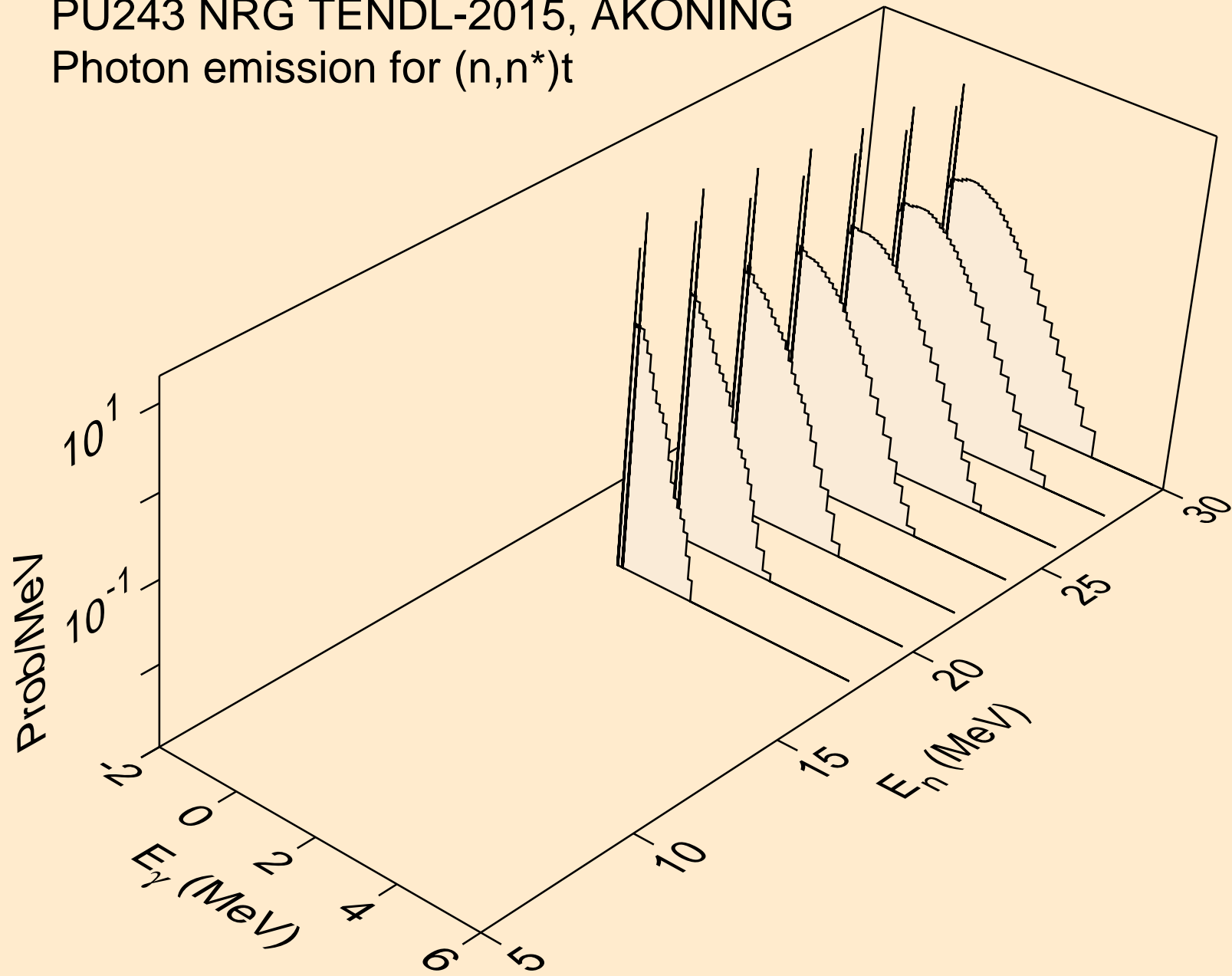

PU243 NRG TENDL-2015, AKONING  
Photon emission for (n,n\*)he3

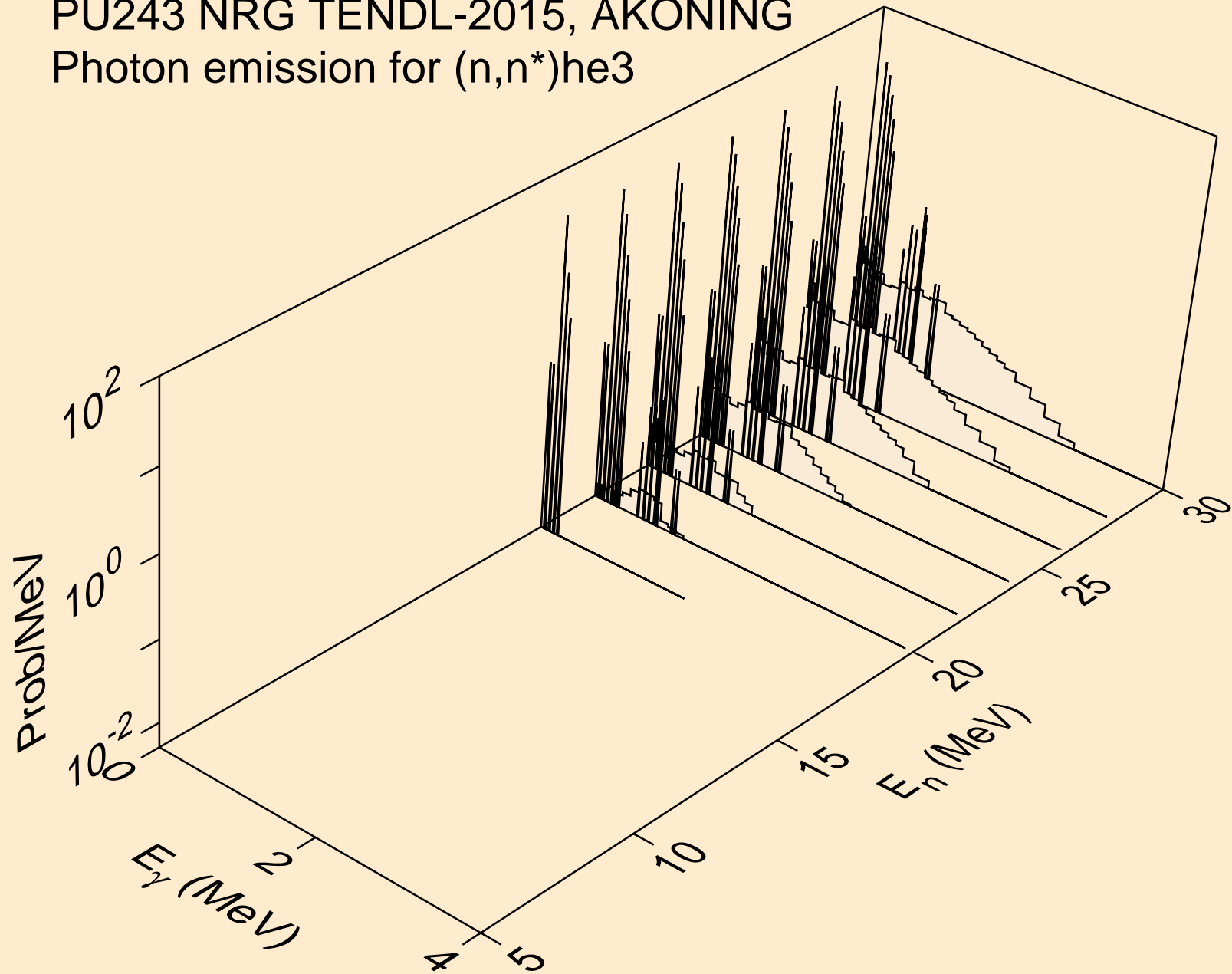

PU243 NRG TENDL-2015, AKONING  
Photon emission for (n,4n)

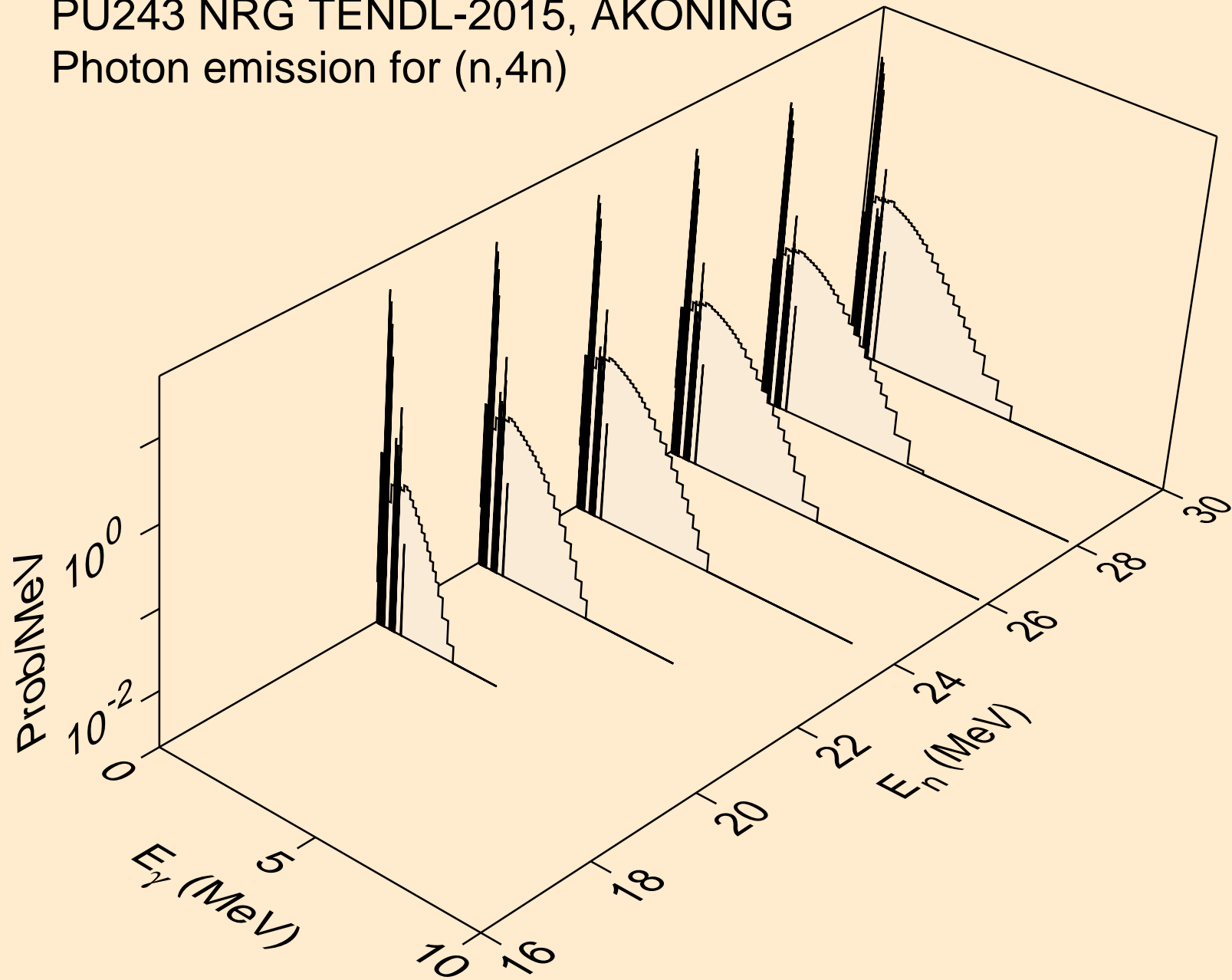

PU243 NRG TENDL-2015, AKONING  
Photon emission for (n,2np)

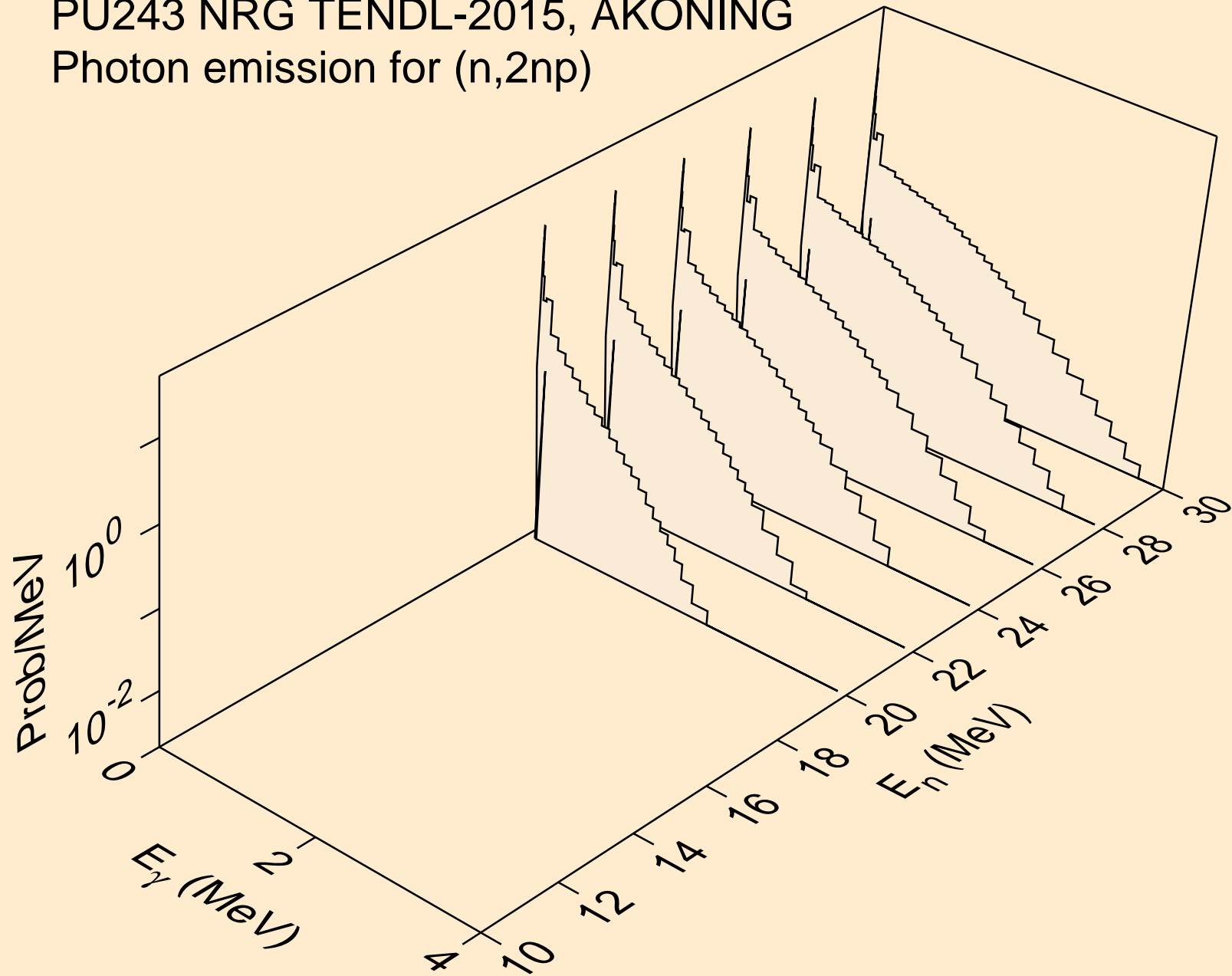



PU243 NRG TENDL-2015, AKONING  
Photon emission for (n,3np)

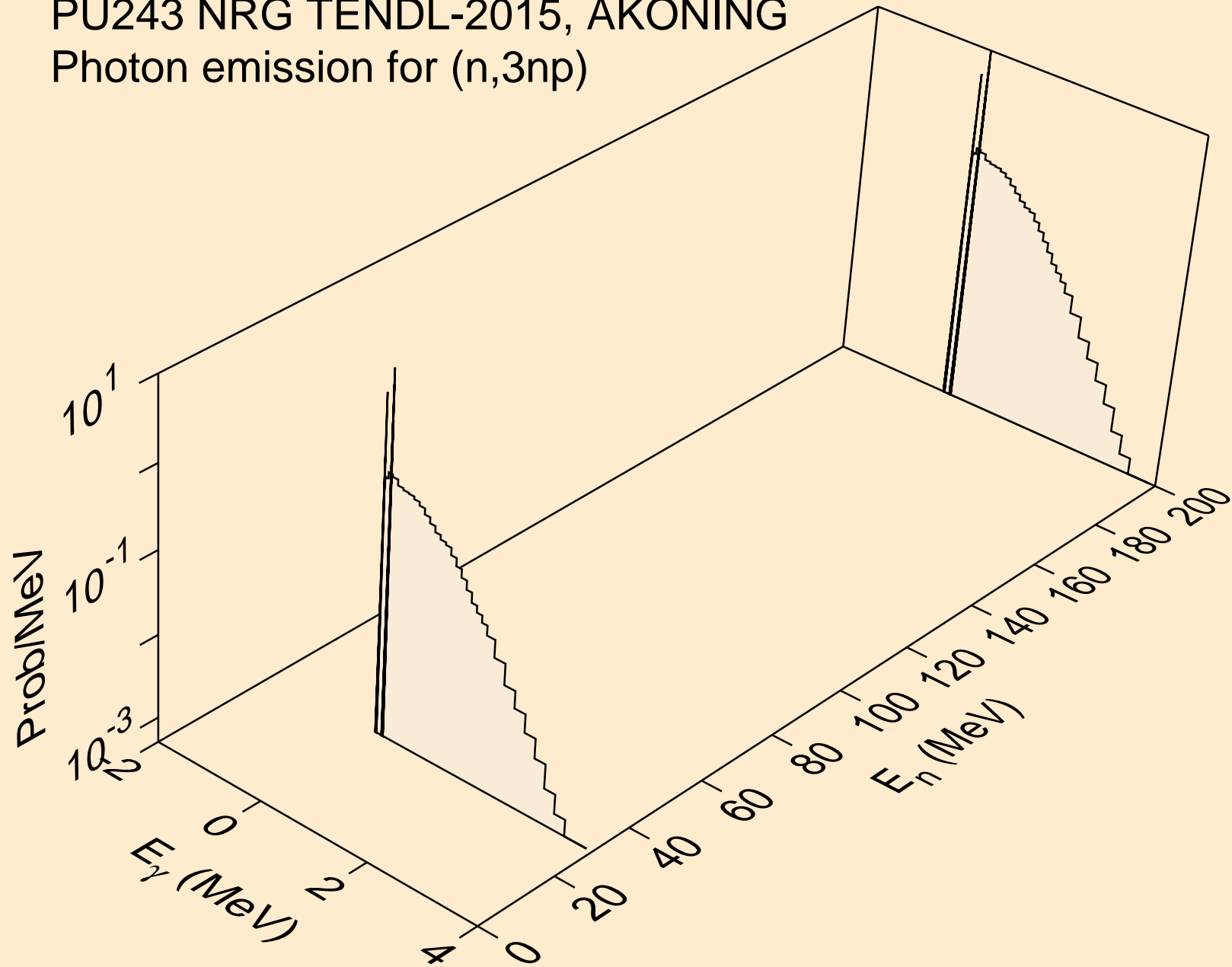

PU243 NRG TENDL-2015, AKONING  
Photon emission for (n,2np)

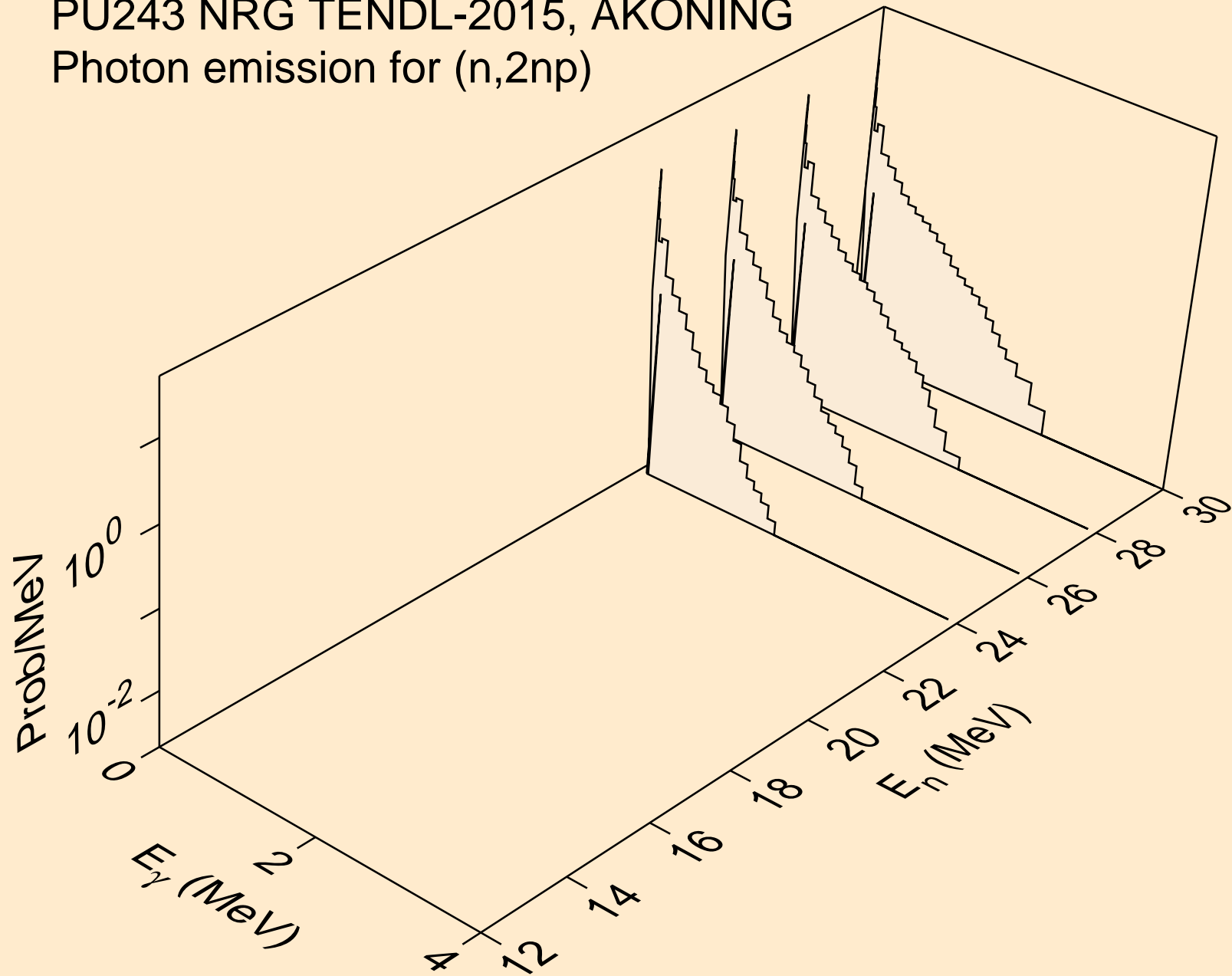

PU243 NRG TENDL-2015, AKONING  
Photon emission for (n,n\*c)

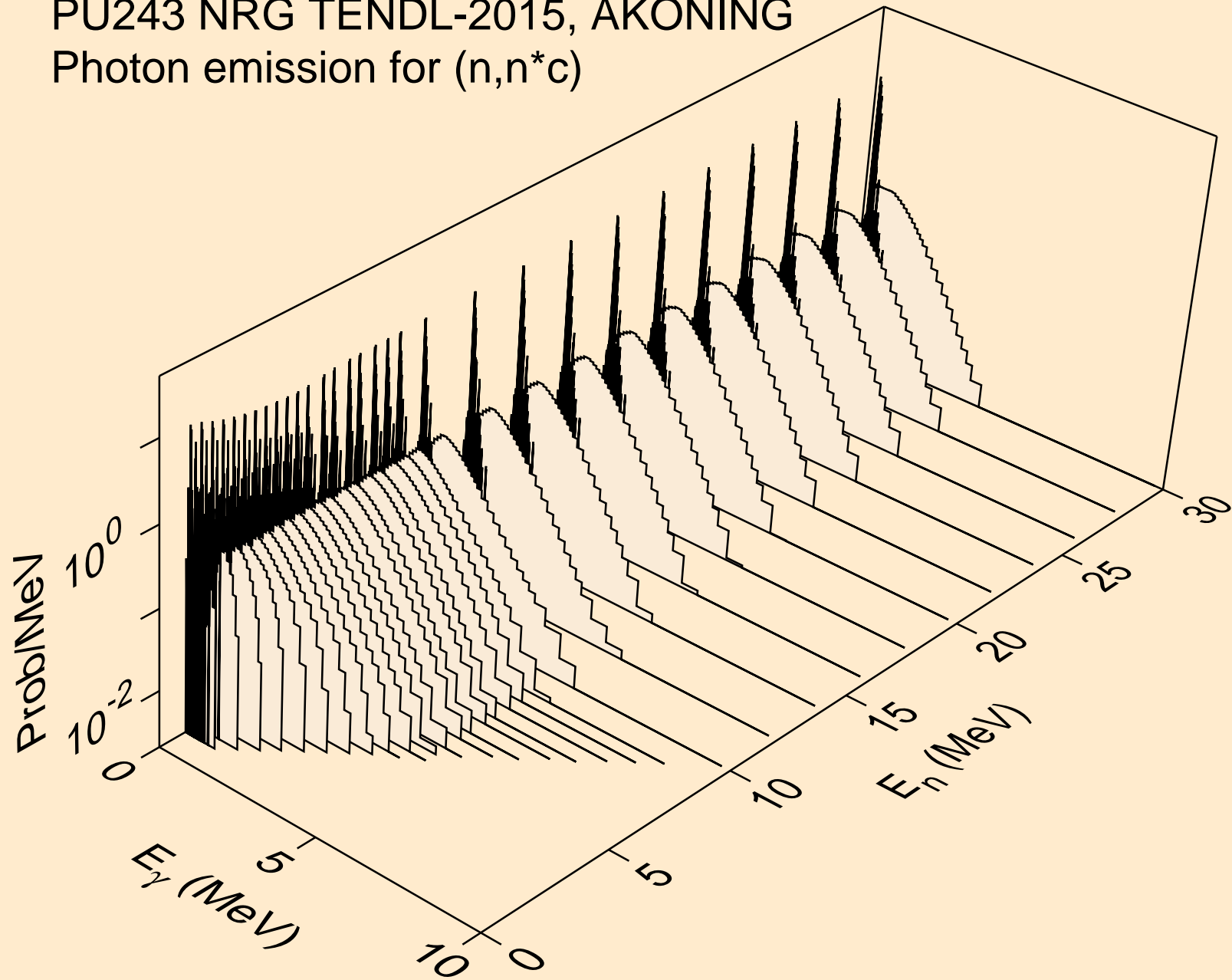

PU243 NRG TENDL-2015, AKONING  
Photon emission for (n,gma)

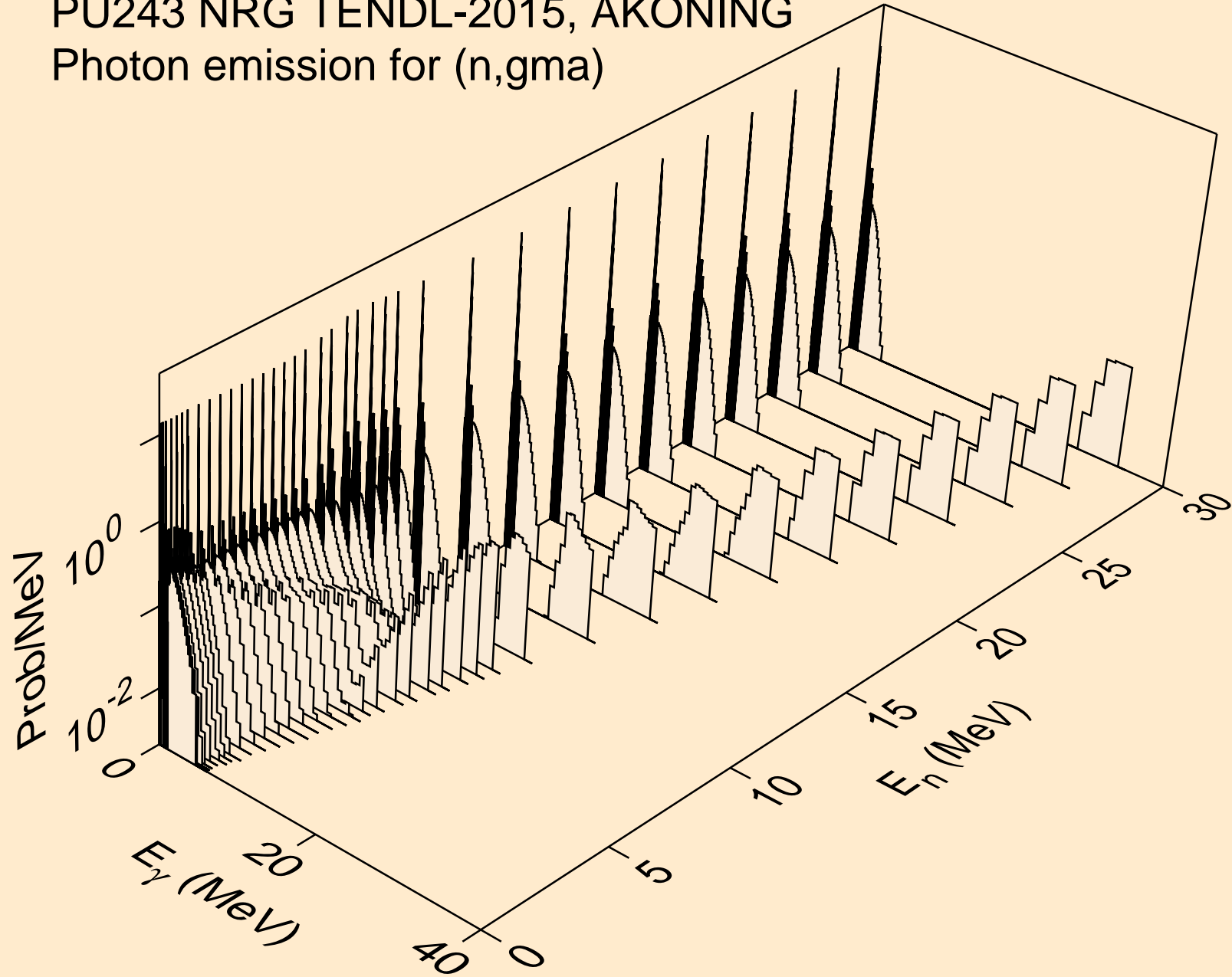

PU243 NRG TENDL-2015, AKONING  
Photon emission for (n,p)

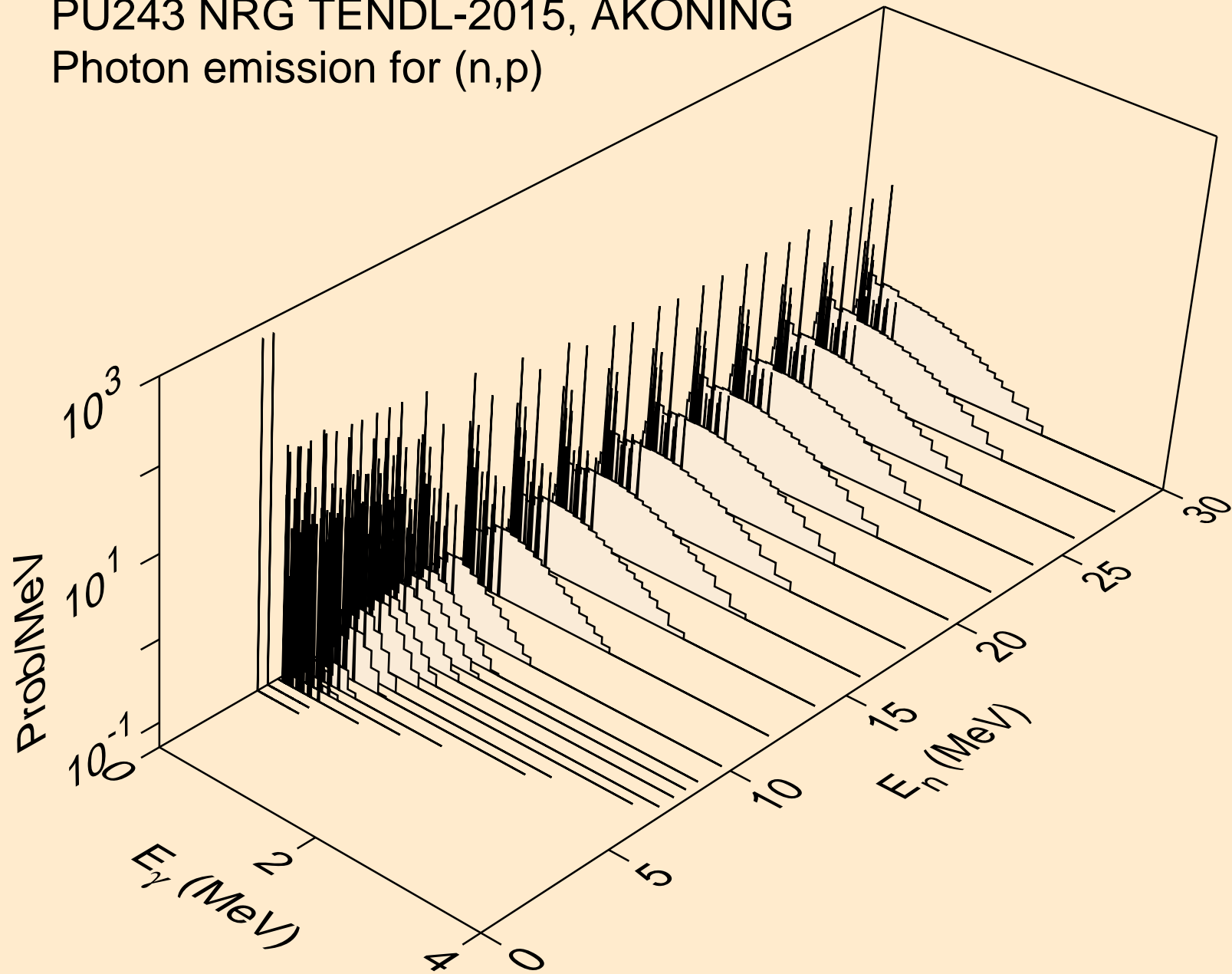

PU243 NRG TENDL-2015, AKONING  
Photon emission for (n,d)

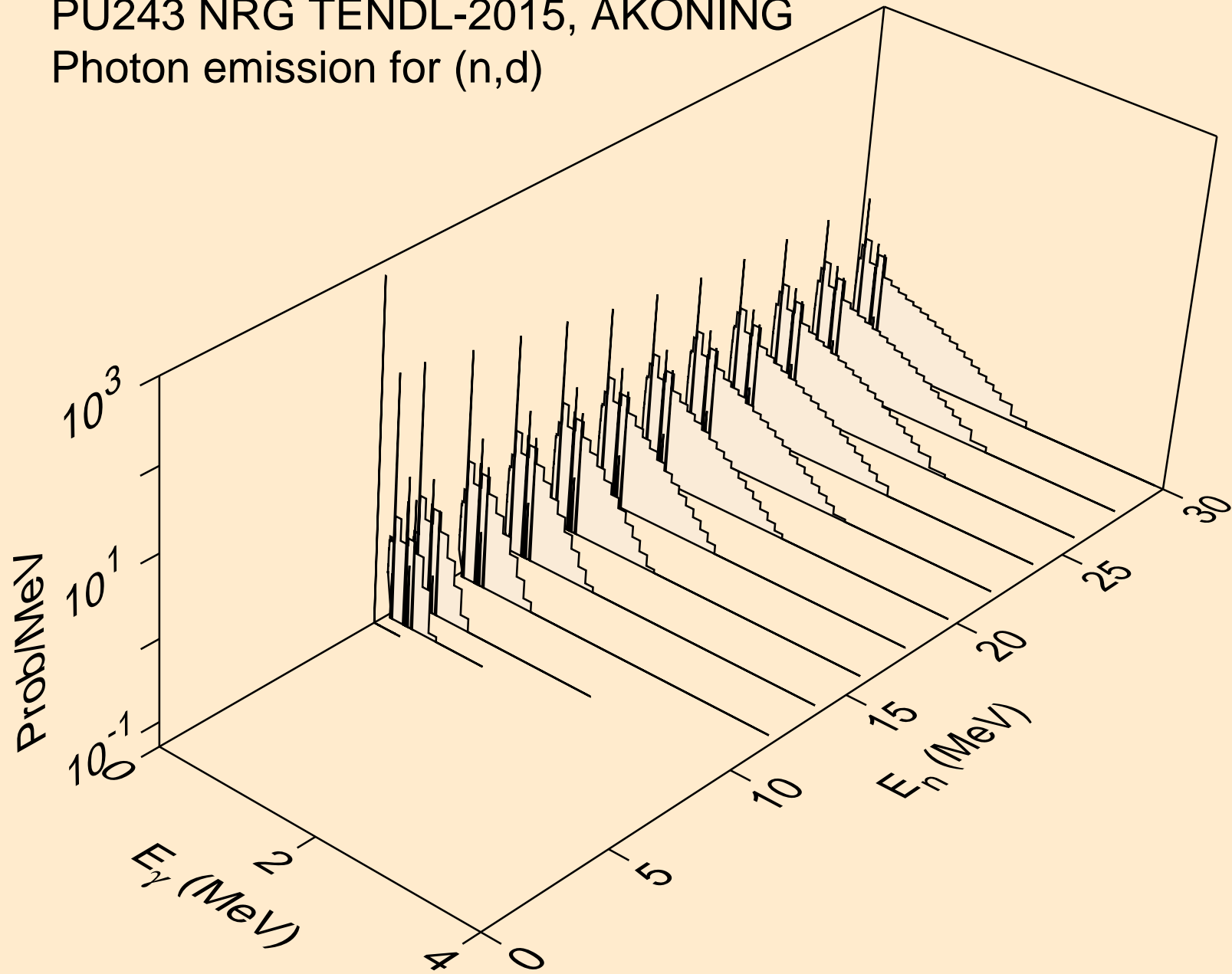

PU243 NRG TENDL-2015, AKONING  
Photon emission for (n,t)

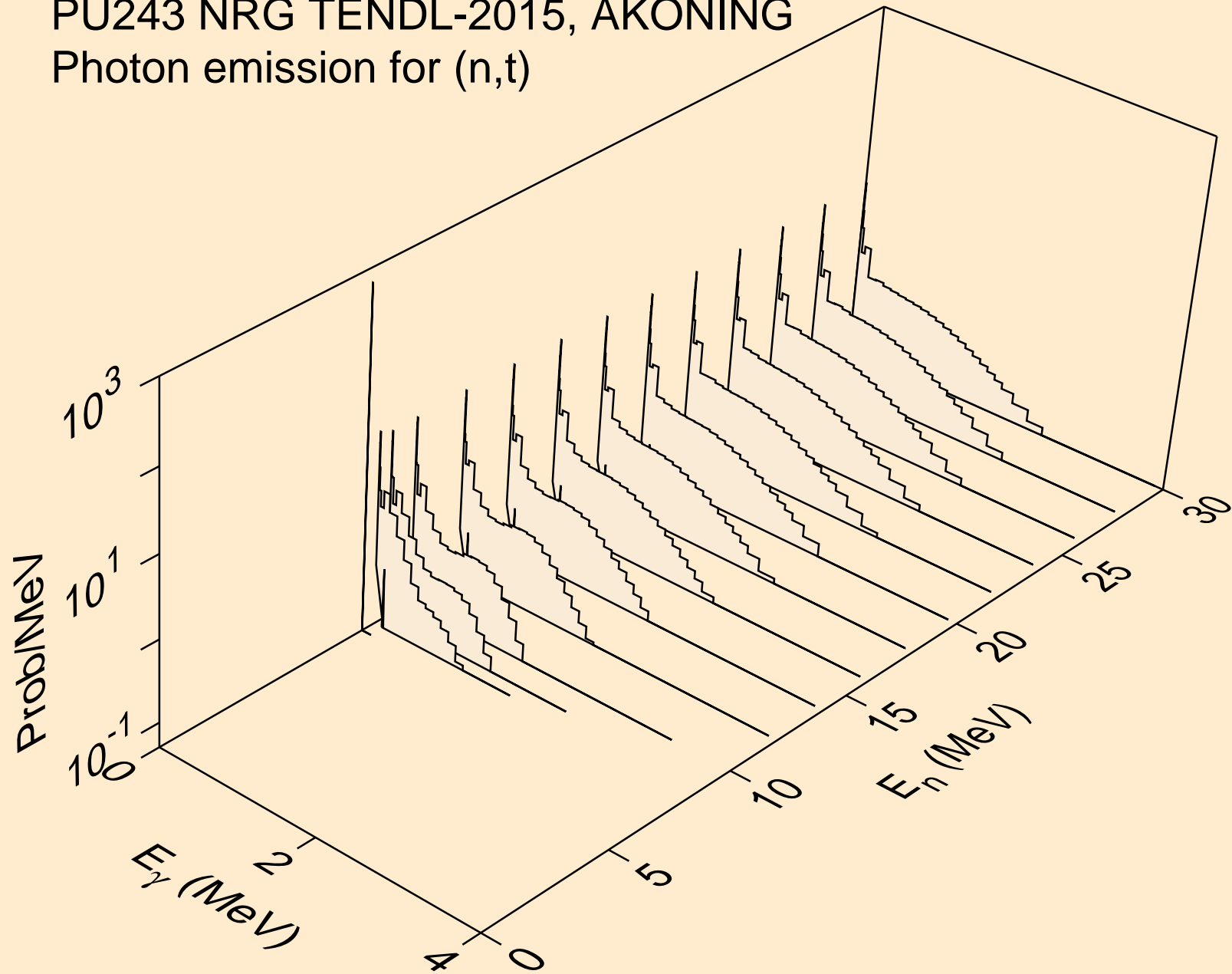

PU243 NRG TENDL-2015, AKONING  
Photon emission for (n,he3)

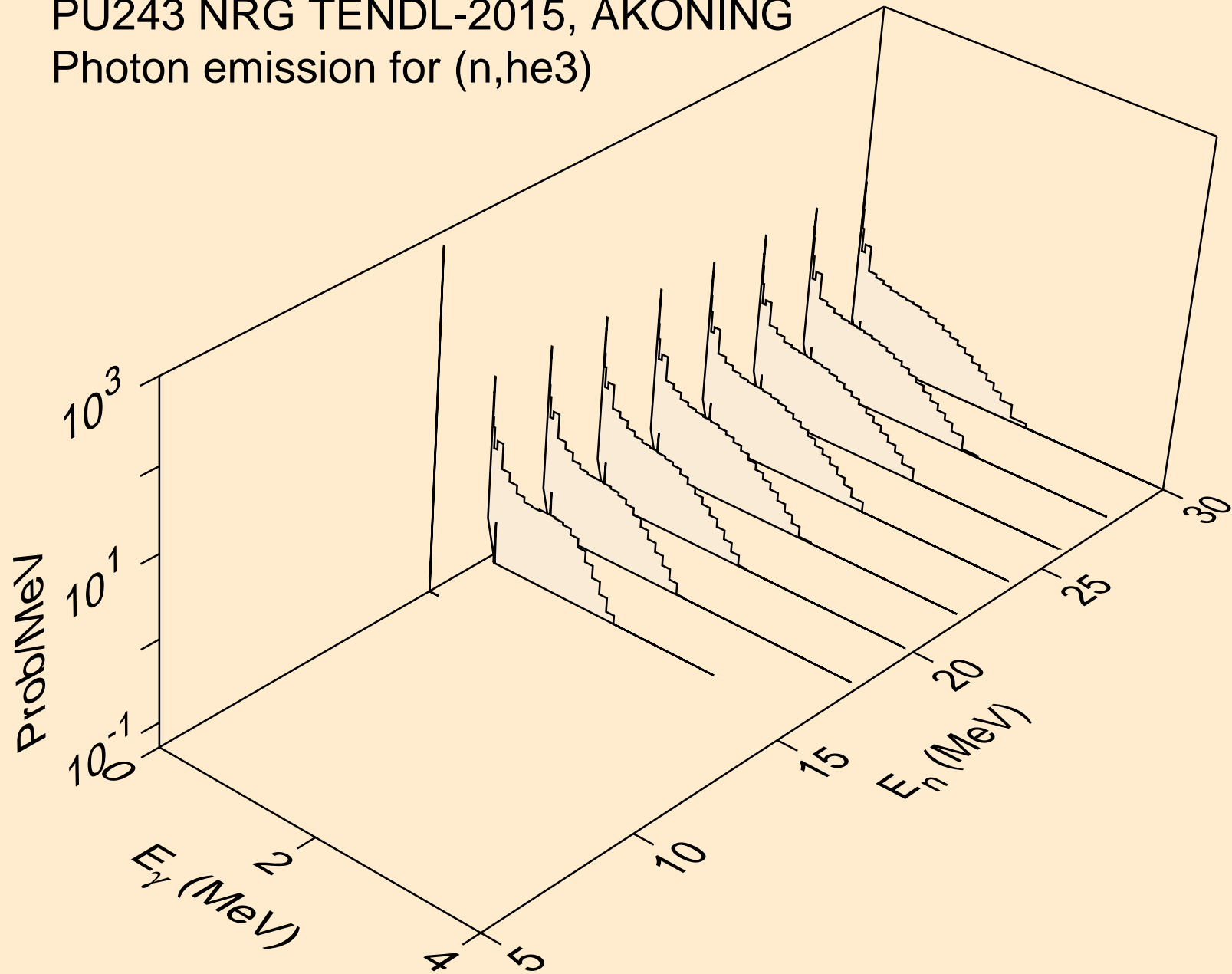



PU243 NRG TENDL-2015, AKONING  
Photon emission for (n,a)

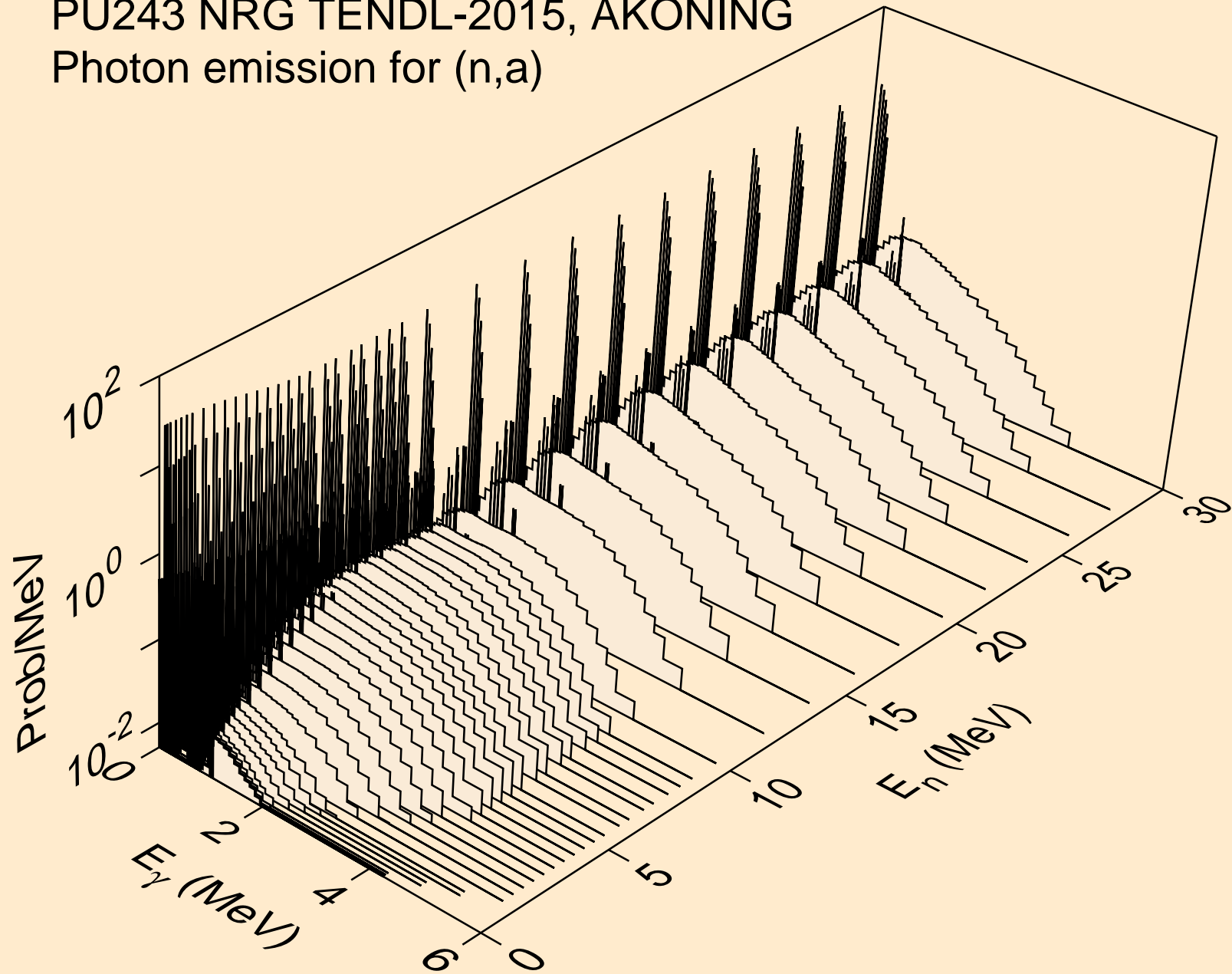

PU243 NRG TENDL-2015, AKONING  
Photon emission for (n,2p)

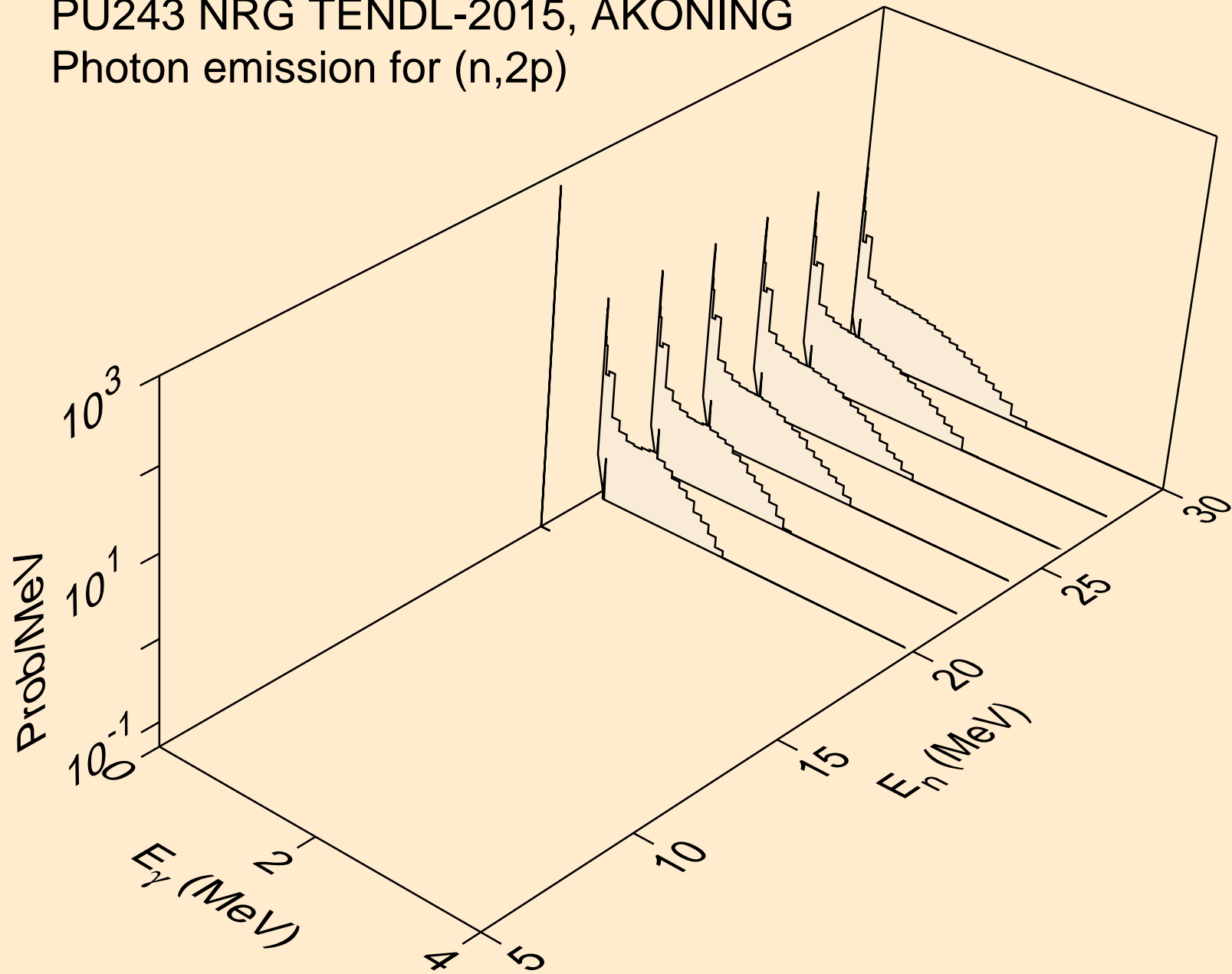

PU243 NRG TENDL-2015, AKONING  
thermal capture photon spectrum

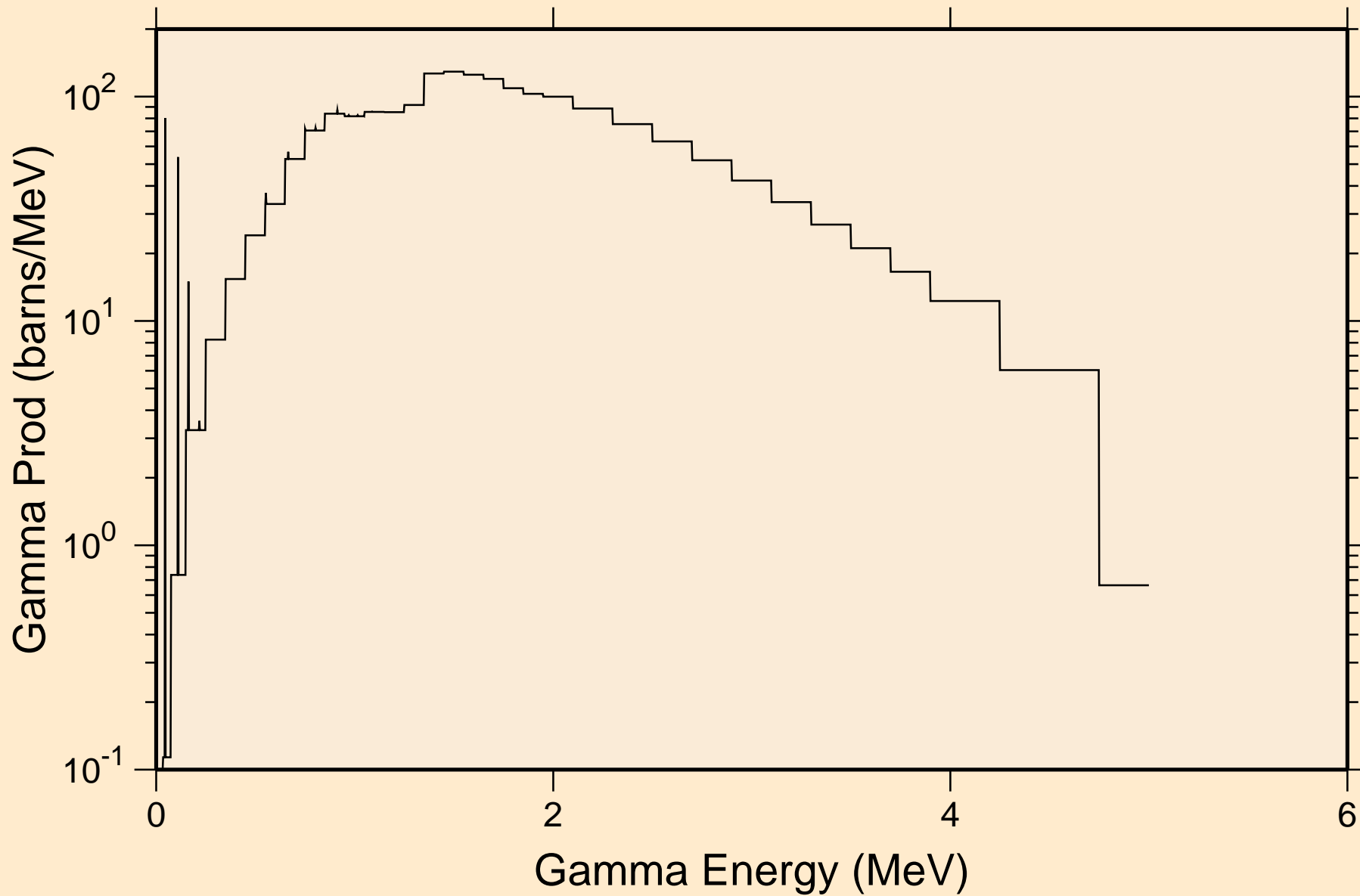

PU243 NRG TENDL-2015, AKONING  
14 MeV photon spectrum

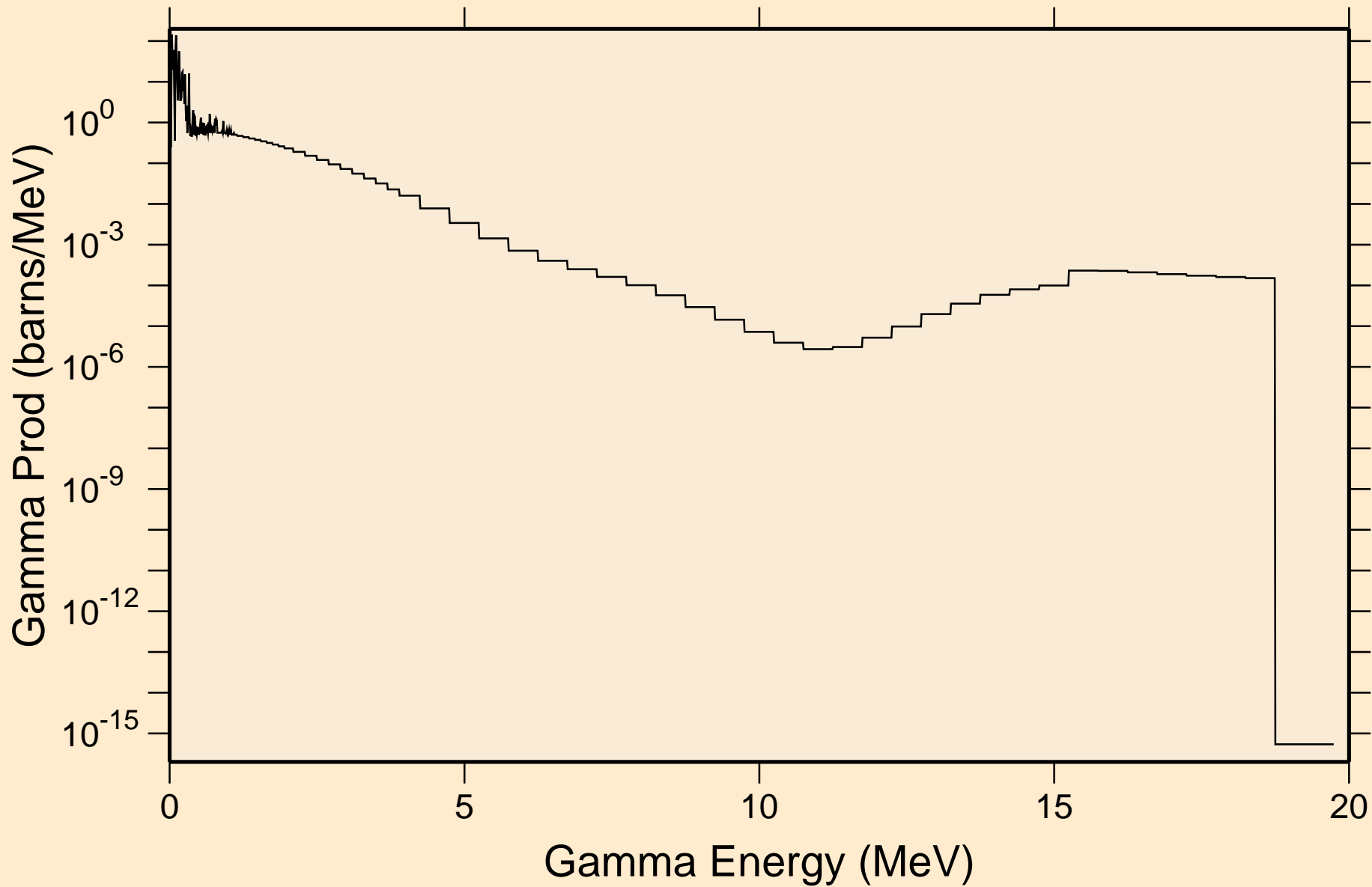

# PU243 NRG TENDL-2015, AKONING

## Particle heating contributions

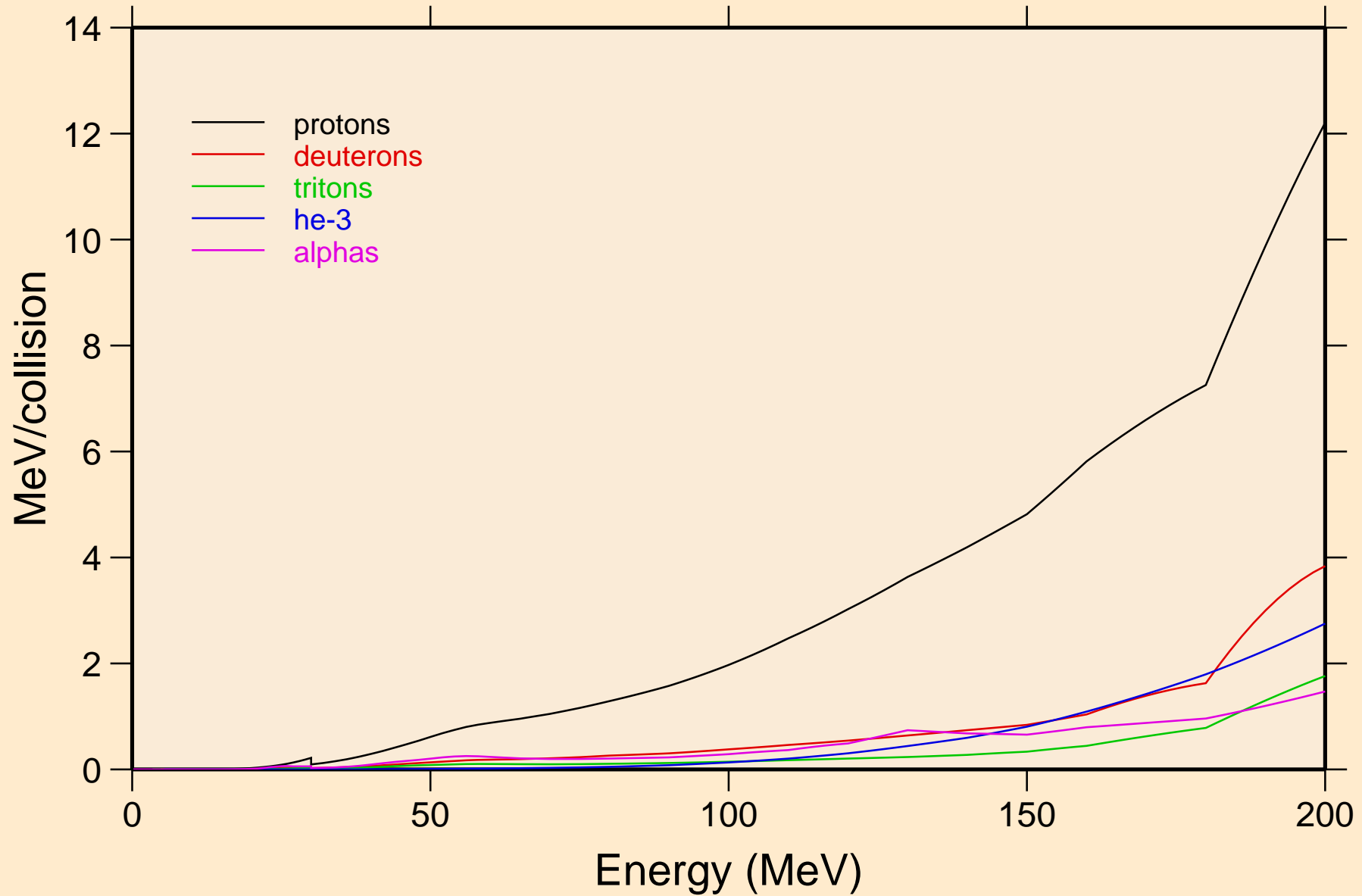

# PU243 NRG TENDL-2015, AKONING

## Recoil Heating

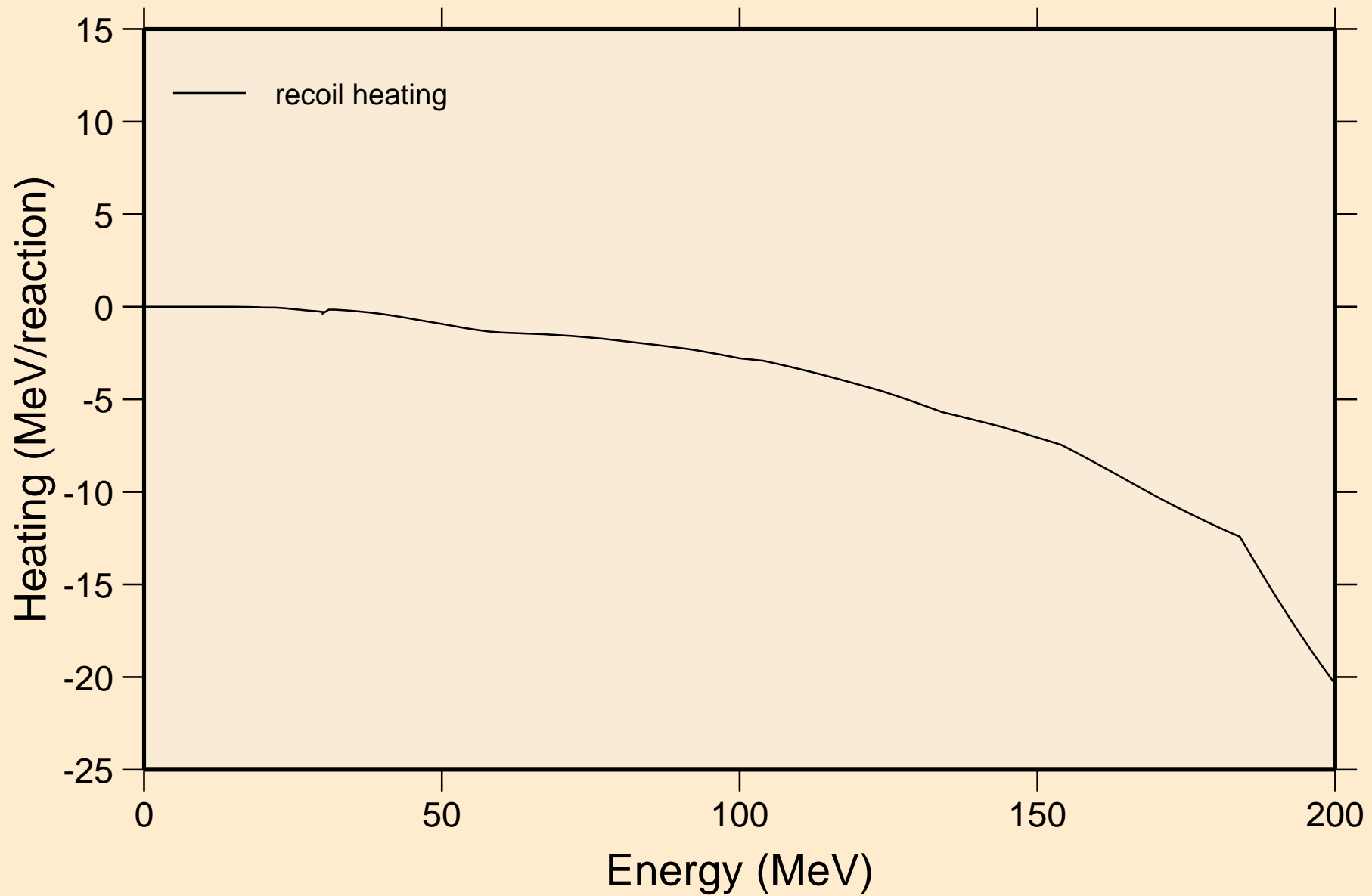

# PU243 NRG TENDL-2015, AKONING

## Particle production cross sections

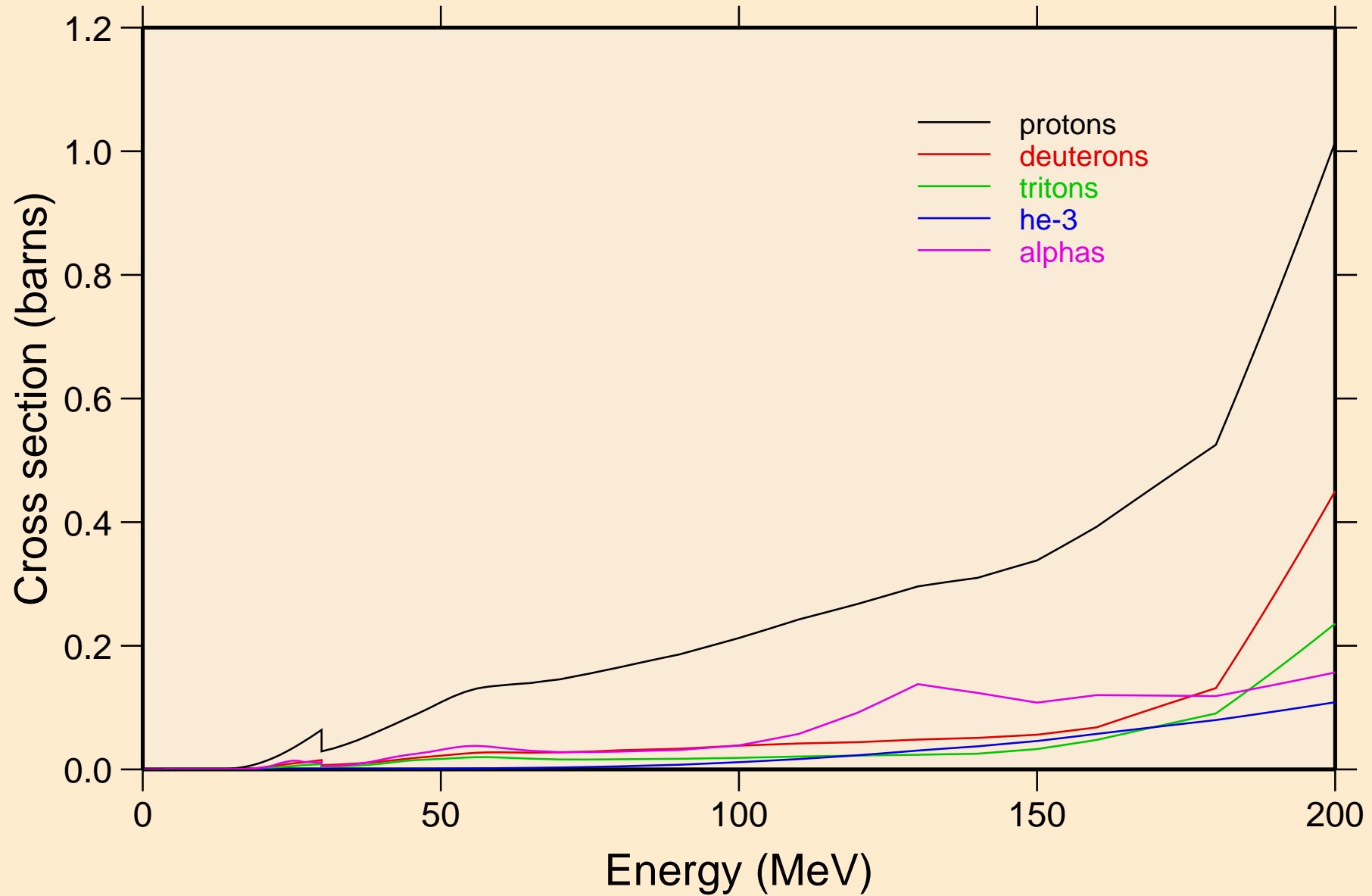

PU243 NRG TENDL-2015, AKONING  
protons from (n,x)

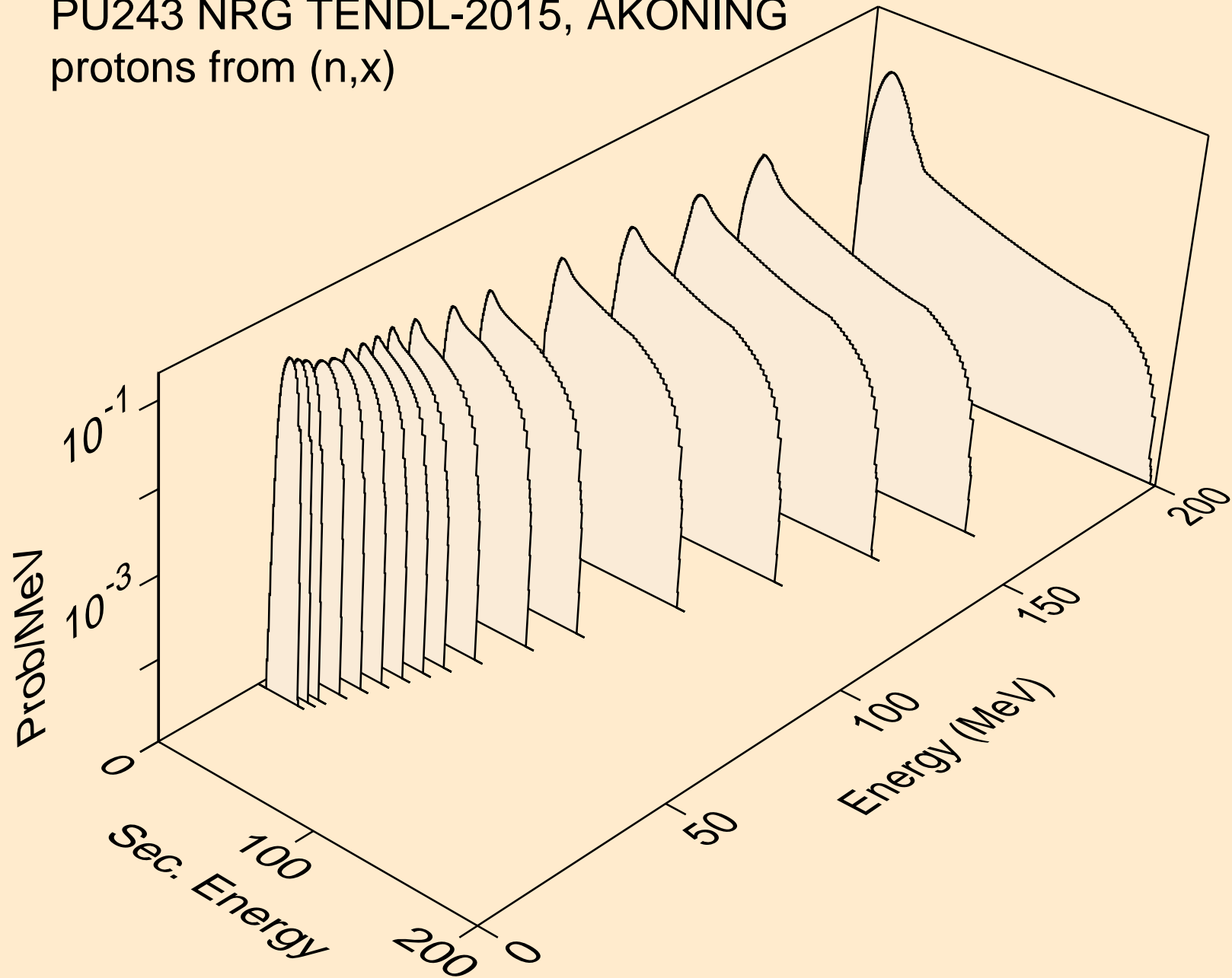



PU243 NRG TENDL-2015, AKONING  
protons from (n,n\*)p

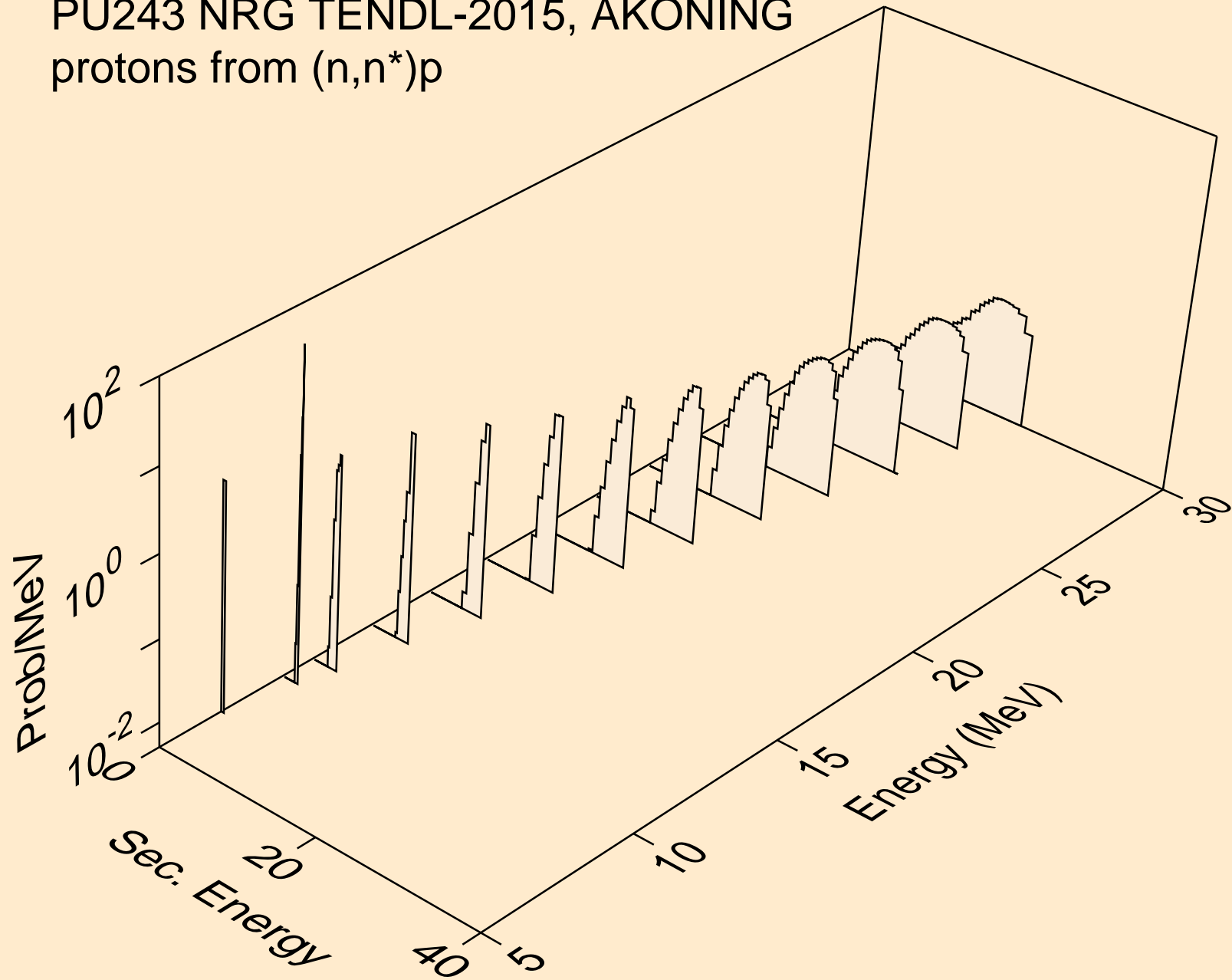

PU243 NRG TENDL-2015, AKONING  
protons from (n,2np)

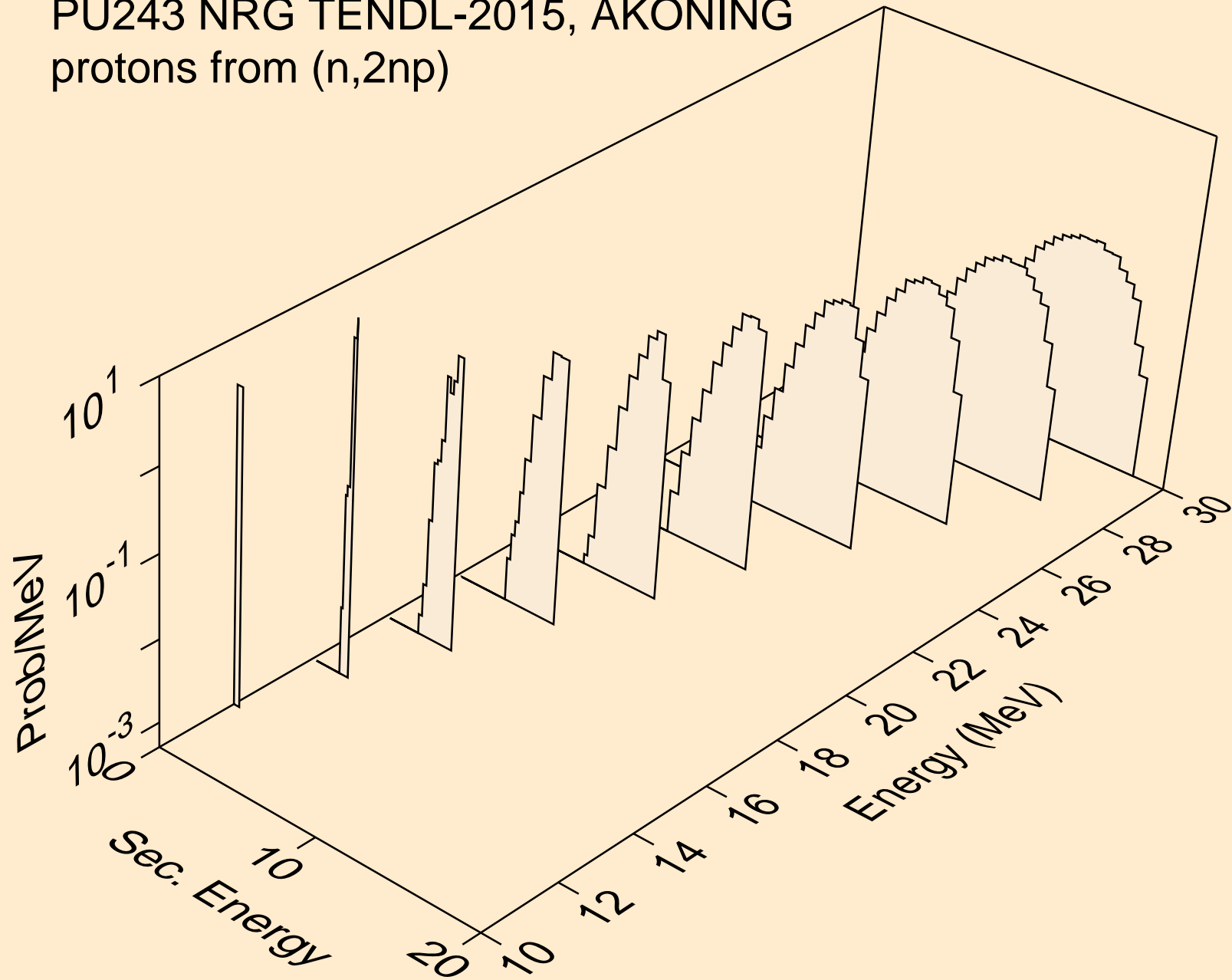

PU243 NRG TENDL-2015, AKONING  
protons from (n,3np)

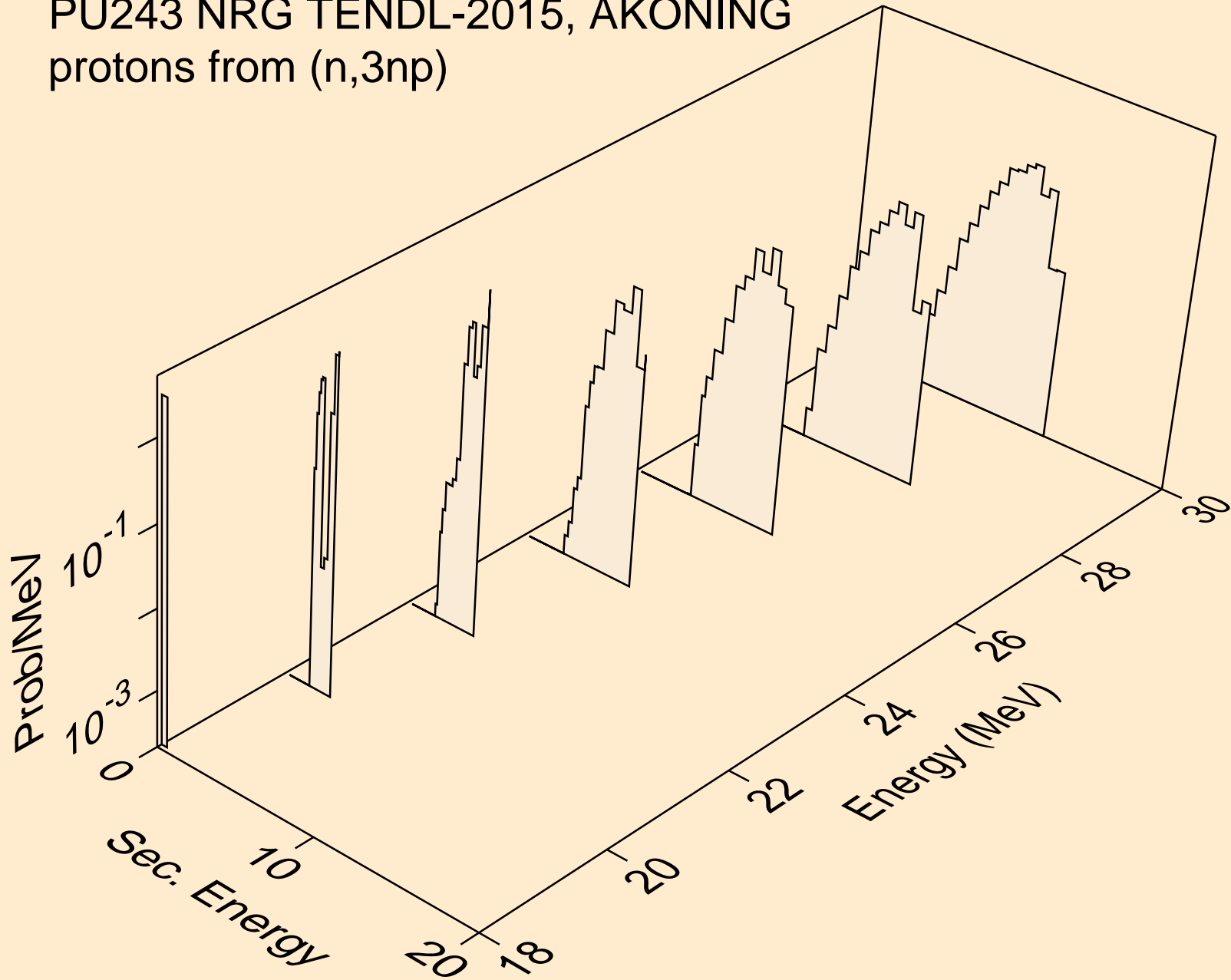

PU243 NRG TENDL-2015, AKONING  
protons from (n,2np)

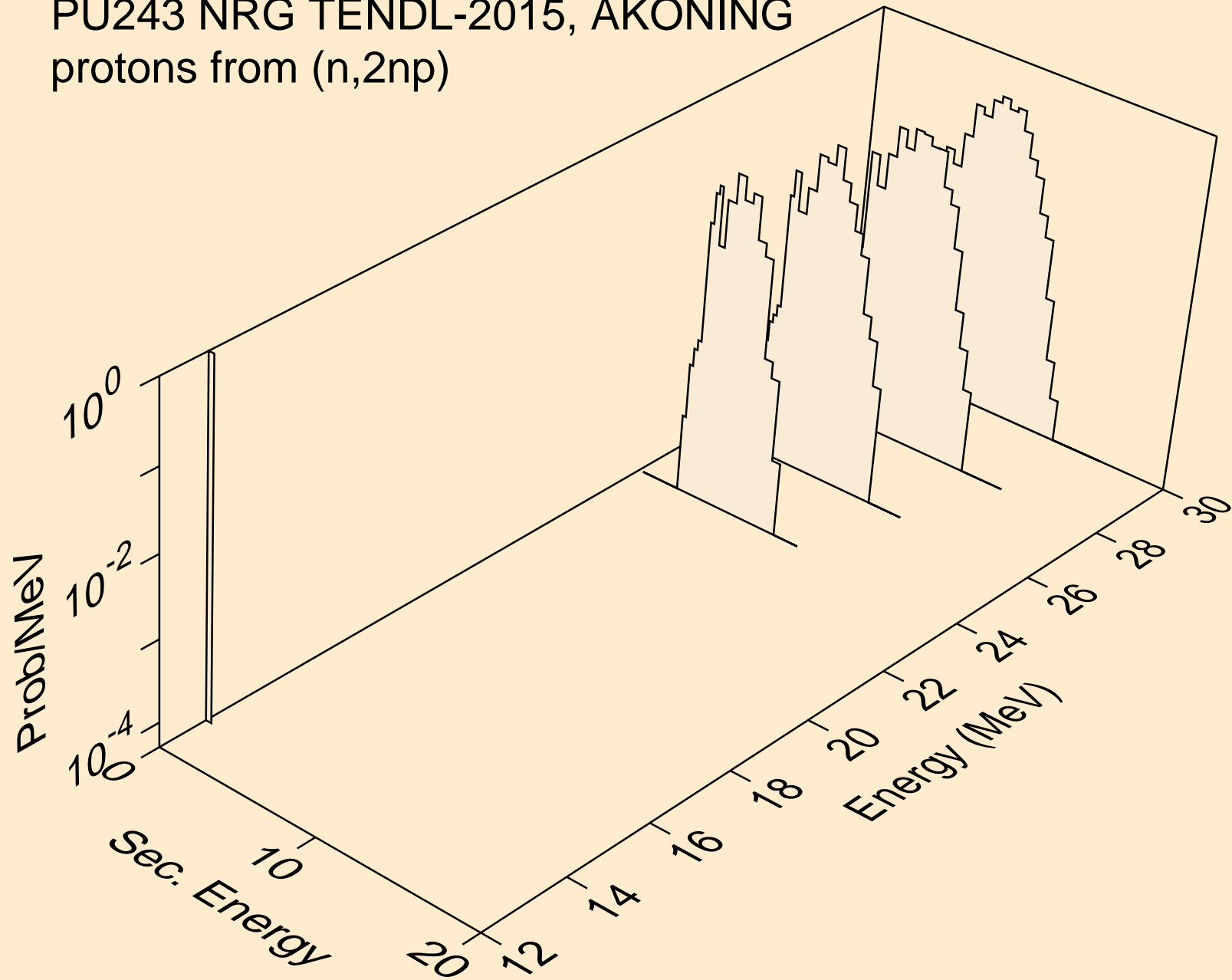

PU243 NRG TENDL-2015, AKONING  
protons from (n,p)

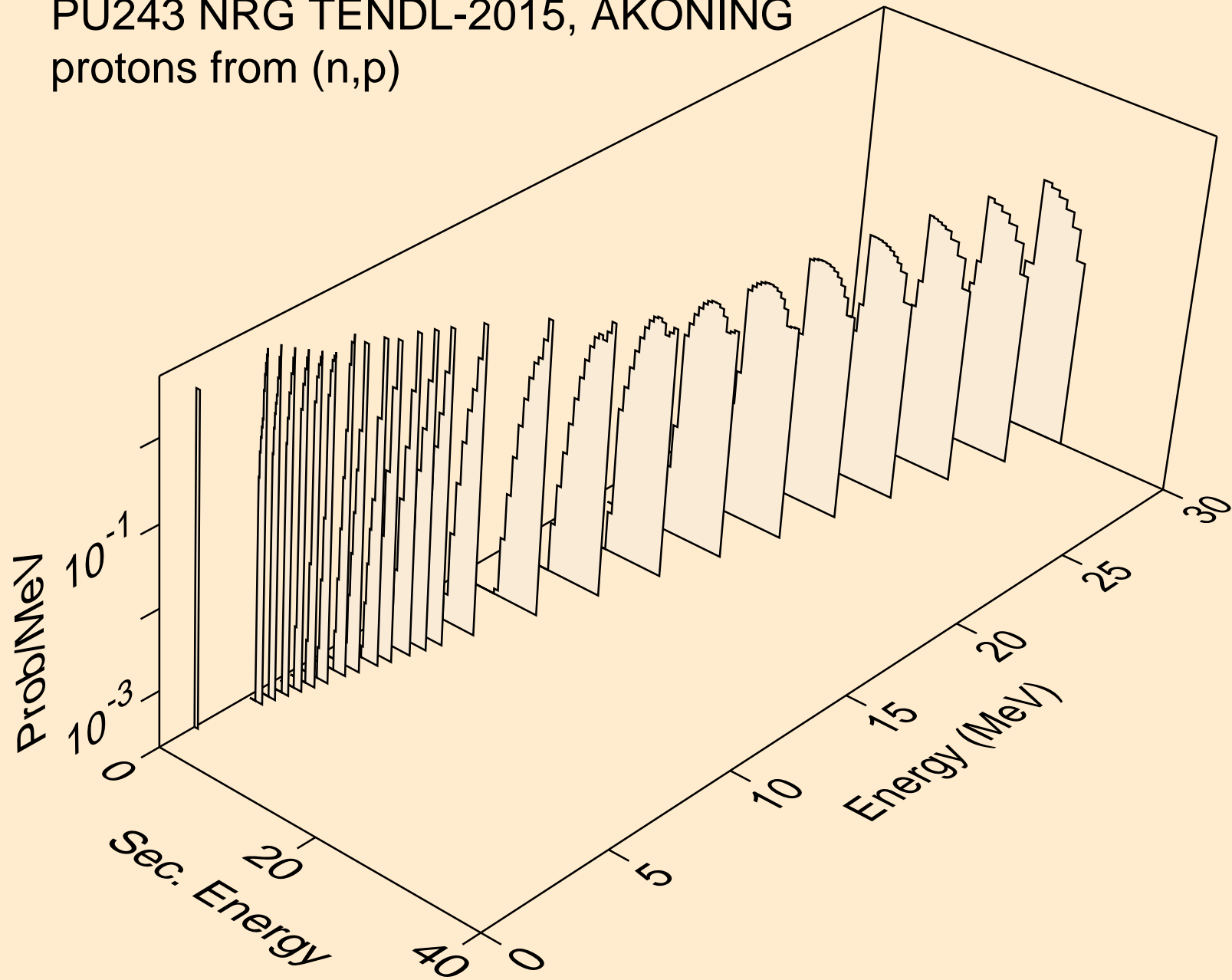

PU243 NRG TENDL-2015, AKONING  
protons from (n,2p)

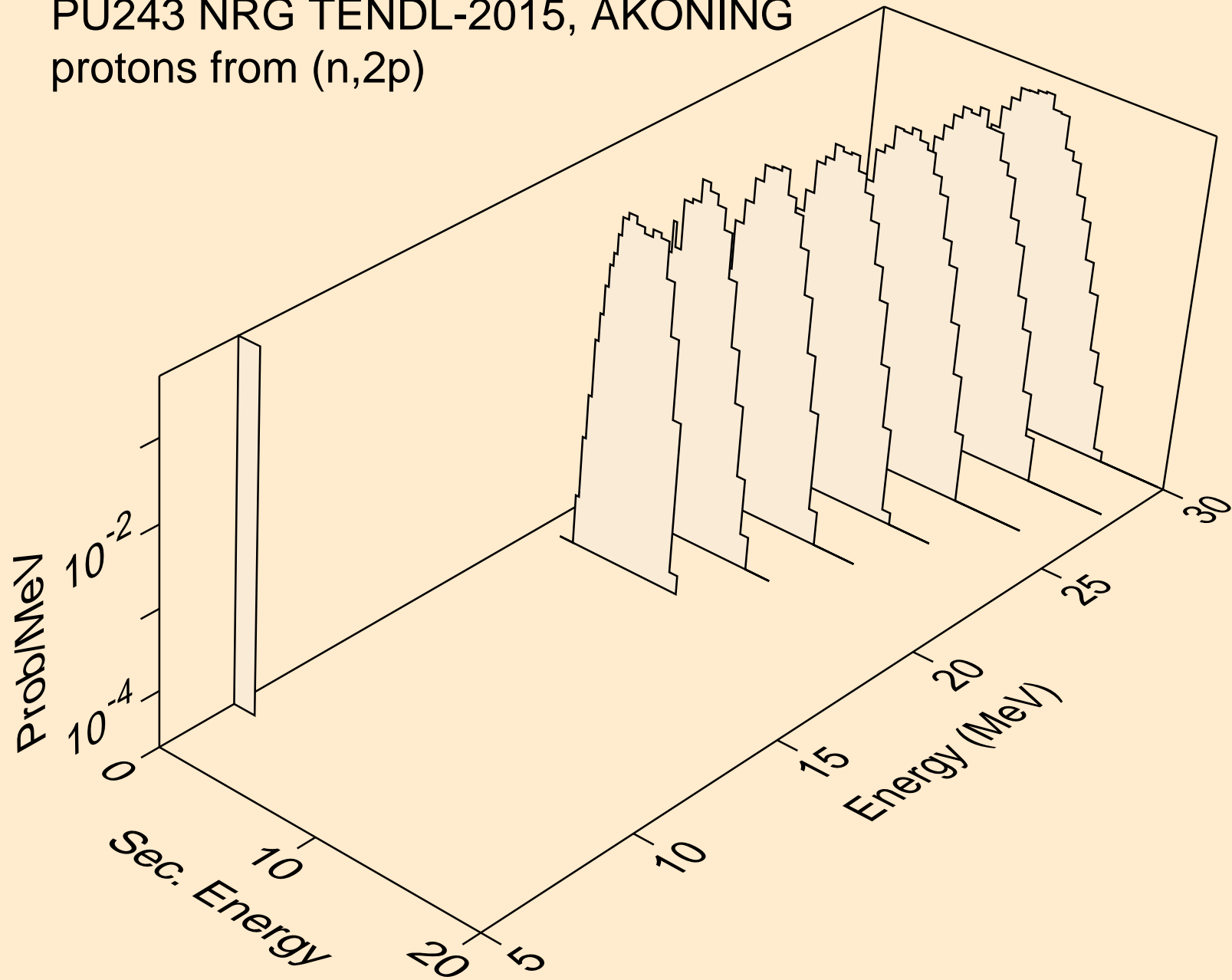

PU243 NRG TENDL-2015, AKONING  
deuterons from (n,x)

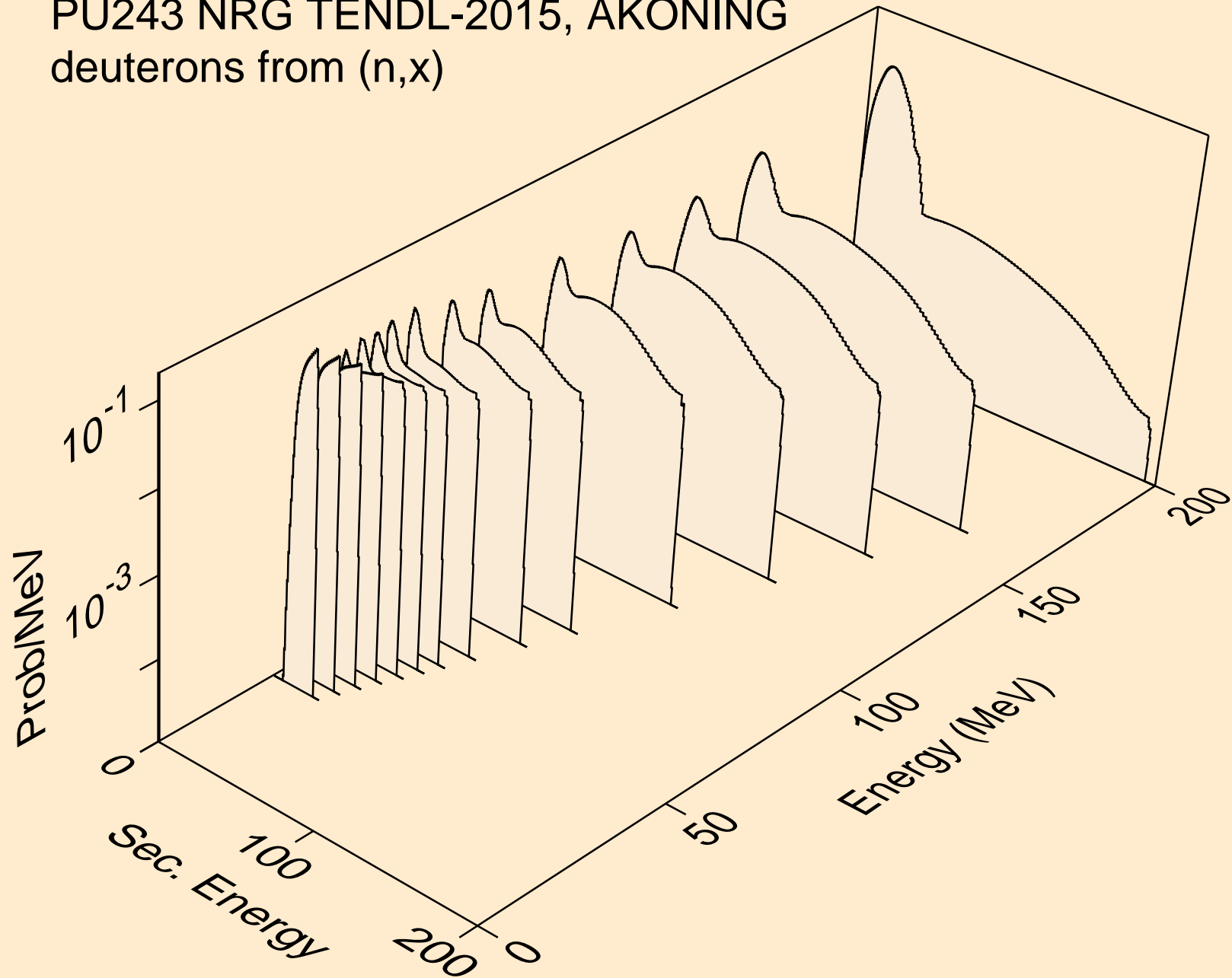

PU243 NRG TENDL-2015, AKONING  
deuterons from (n,2nd)

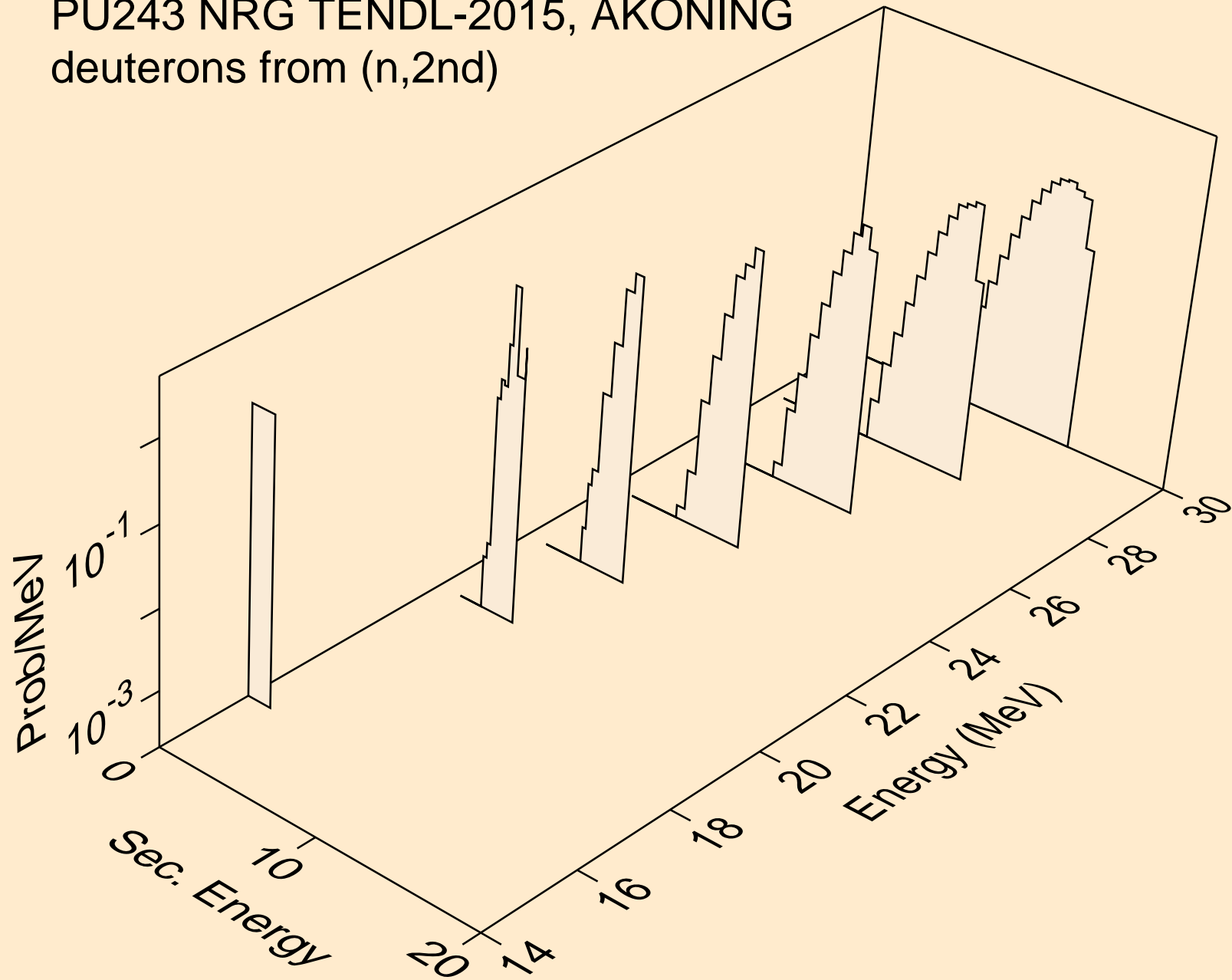



PU243 NRG TENDL-2015, AKONING  
deuterons from (n,n\*)d

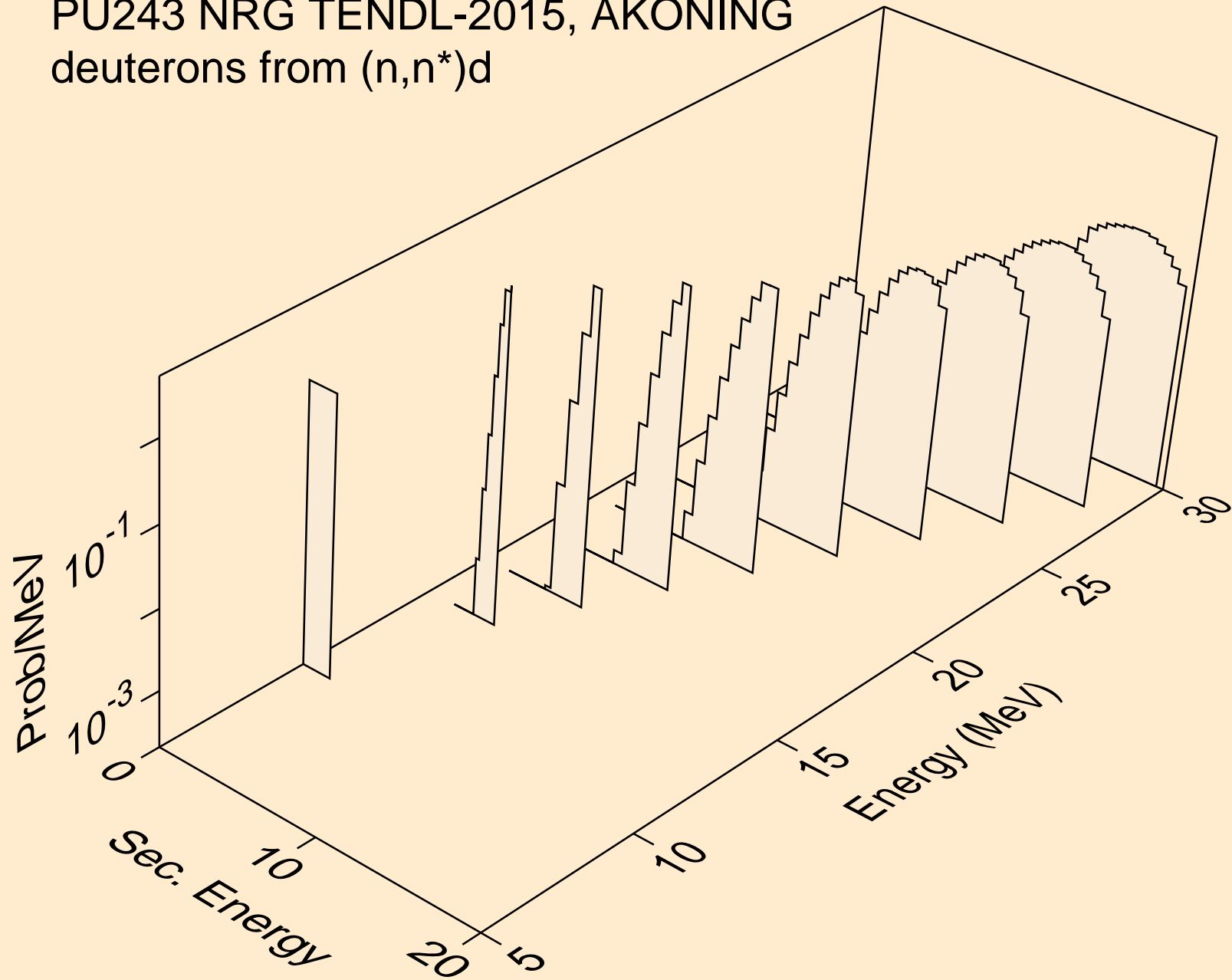

PU243 NRG TENDL-2015, AKONING  
deuterons from (n,d)

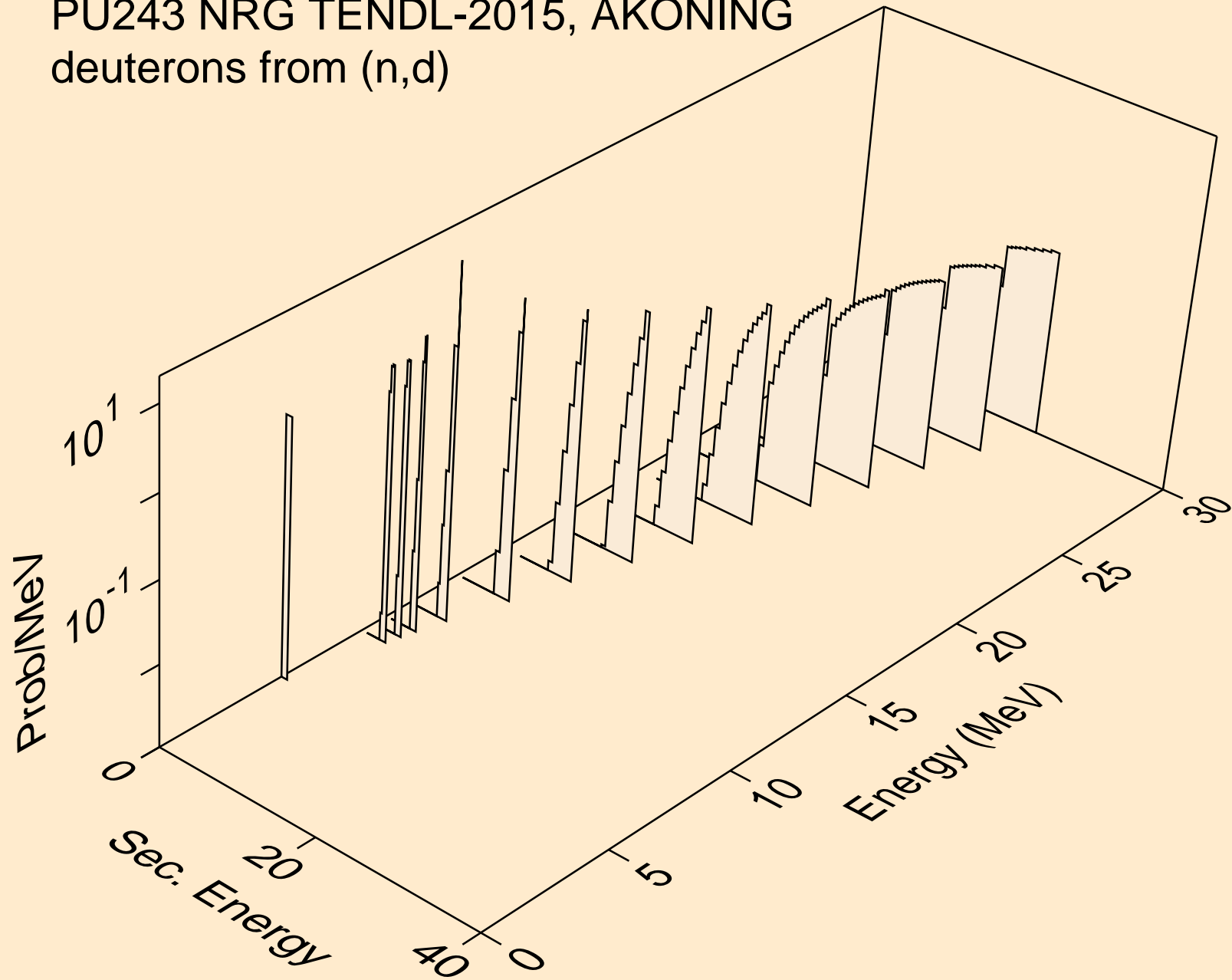

PU243 NRG TENDL-2015, AKONING  
tritons from (n,x)

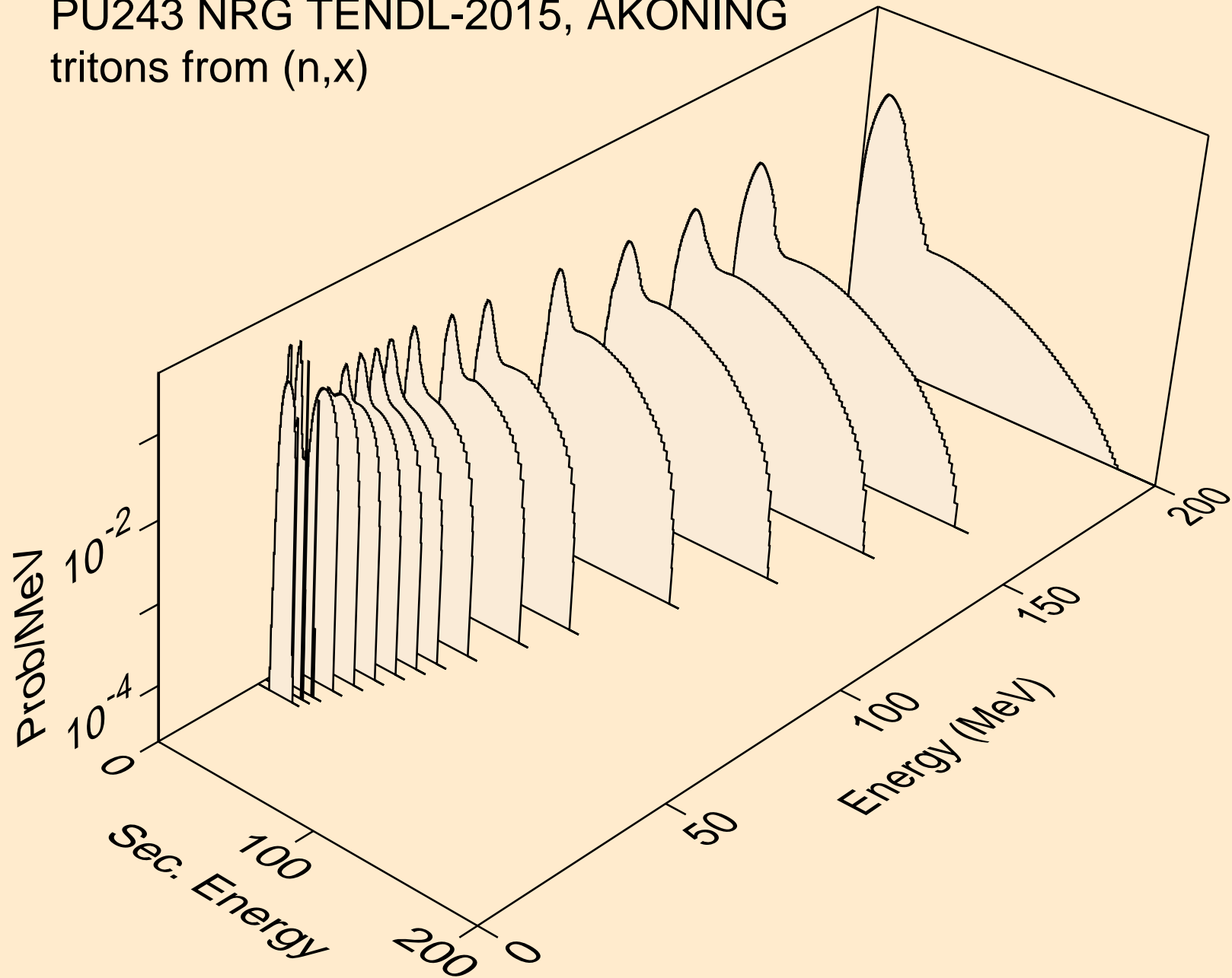

PU243 NRG TENDL-2015, AKONING  
tritons from (n,n\*)t

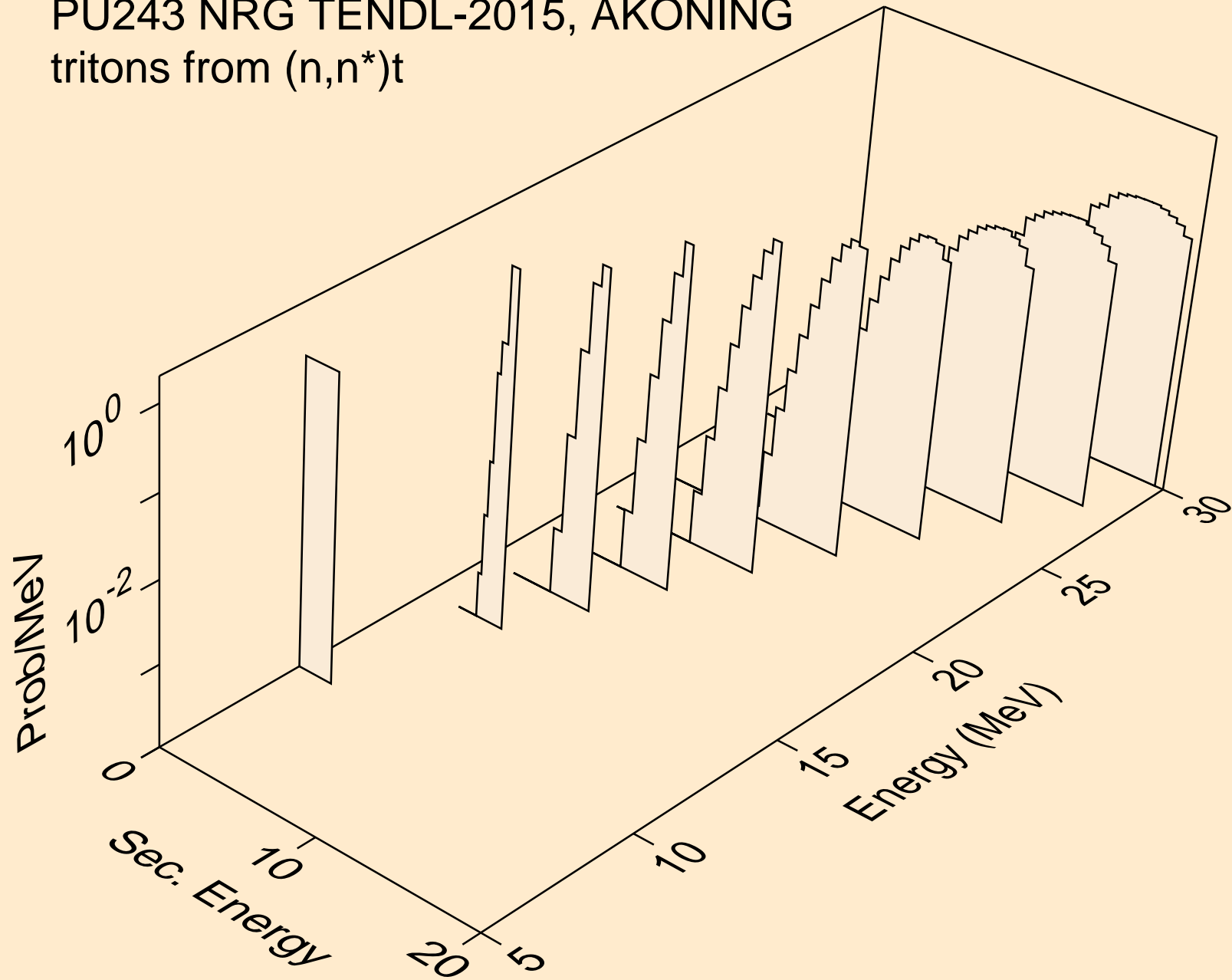

PU243 NRG TENDL-2015, AKONING  
tritons from (n,t)

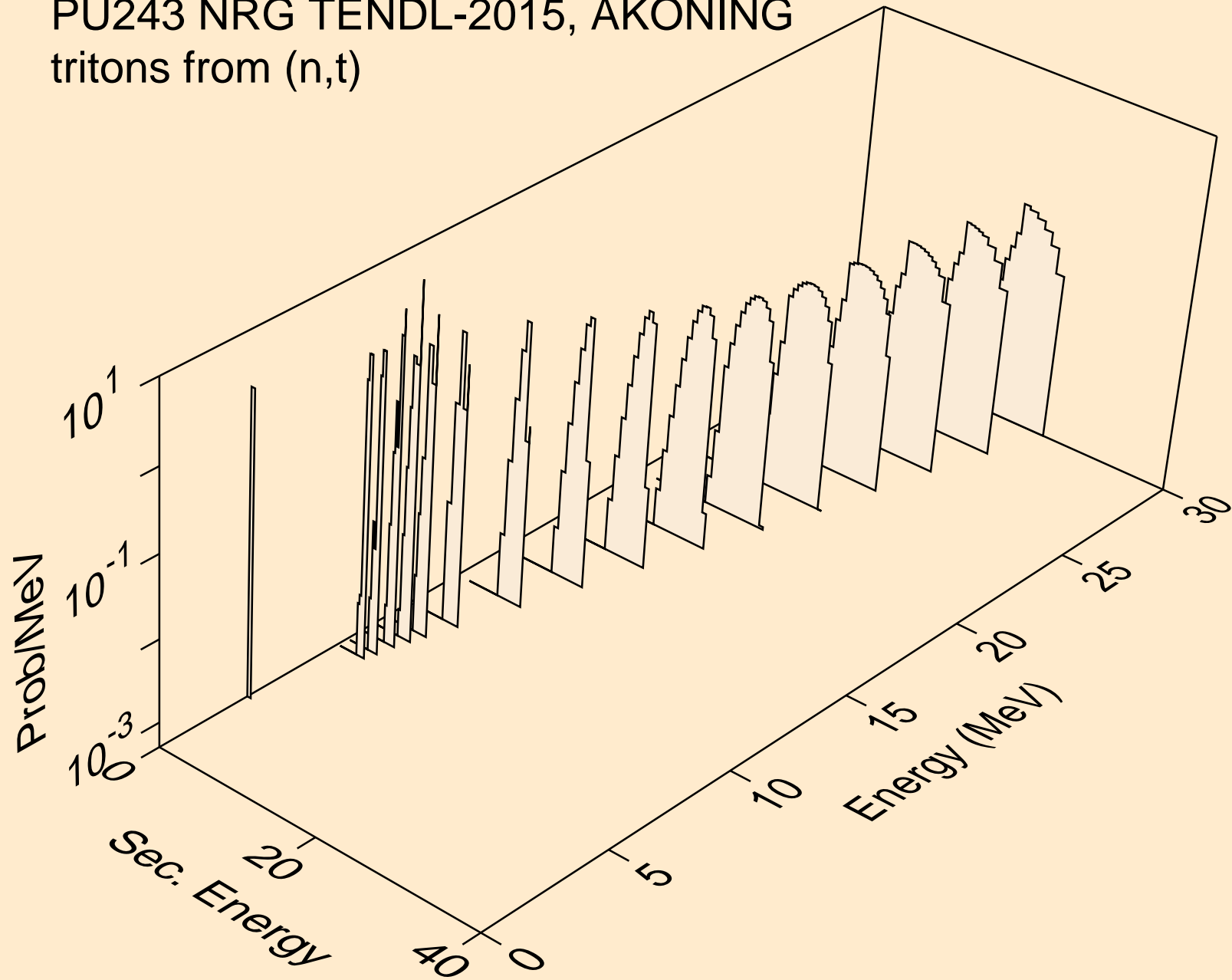

PU243 NRG TENDL-2015, AKONING  
he3s from (n,x)

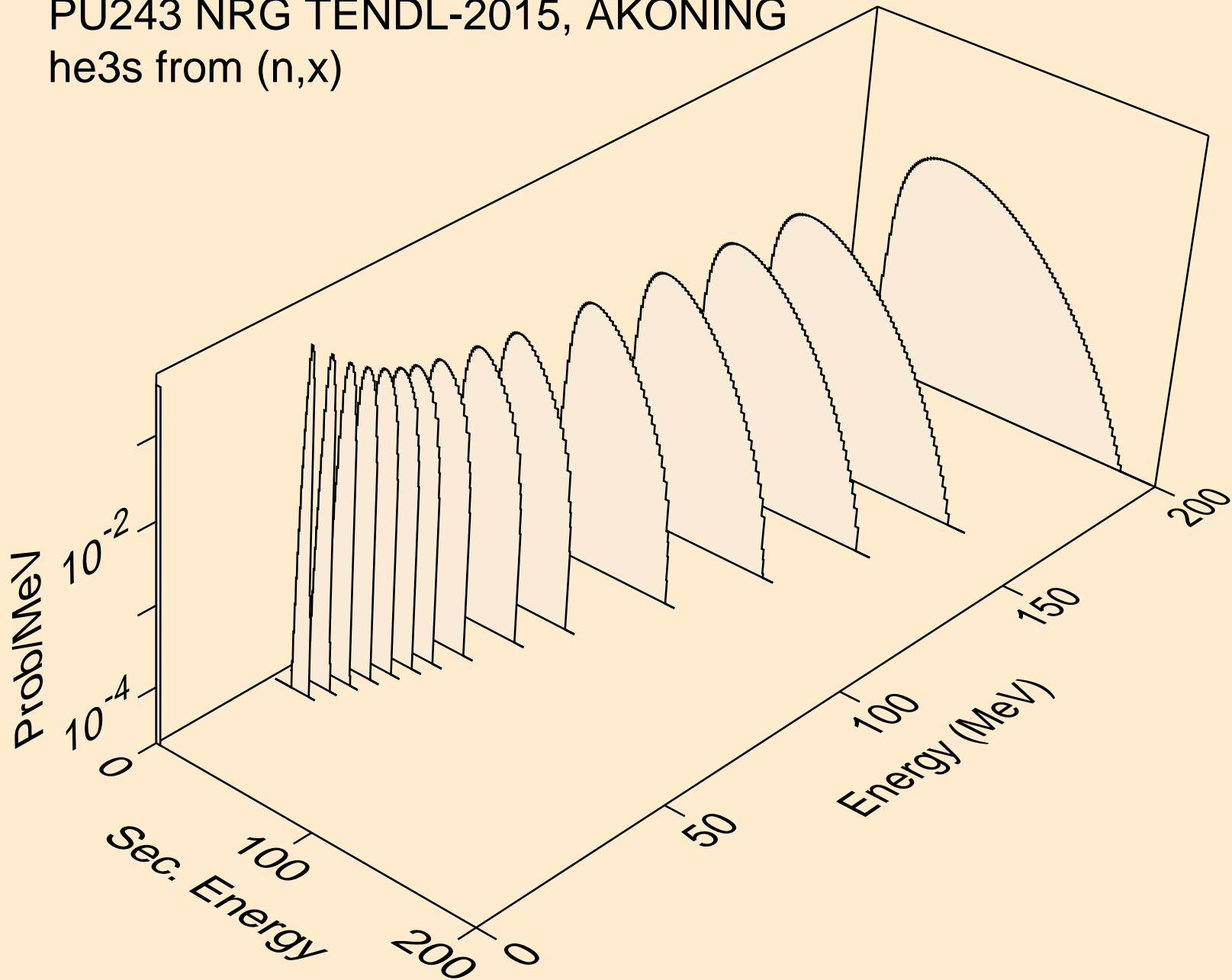

PU243 NRG TENDL-2015, AKONING  
he3s from (n,n\*)he3

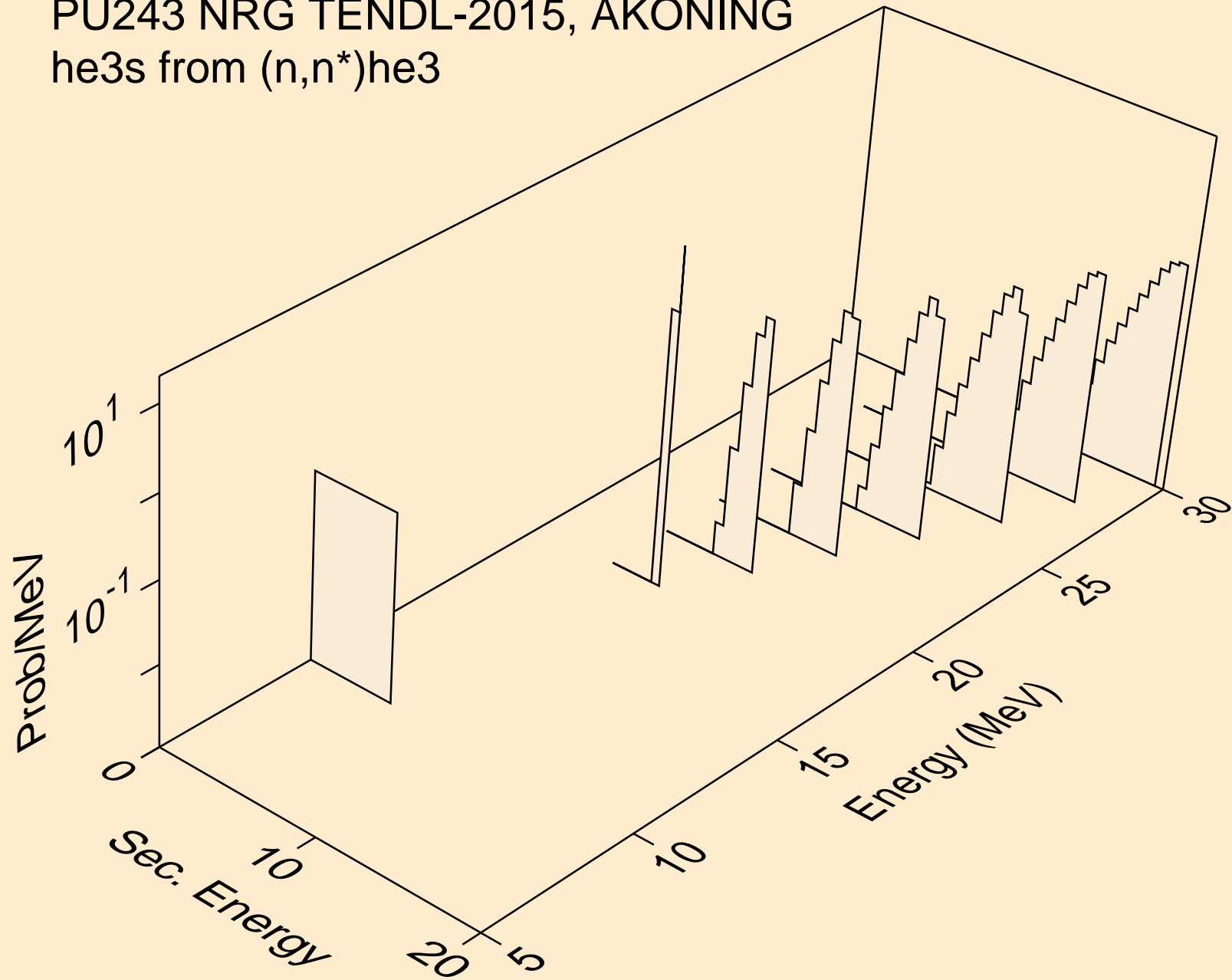

PU243 NRG TENDL-2015, AKONING  
he3s from (n,he3)

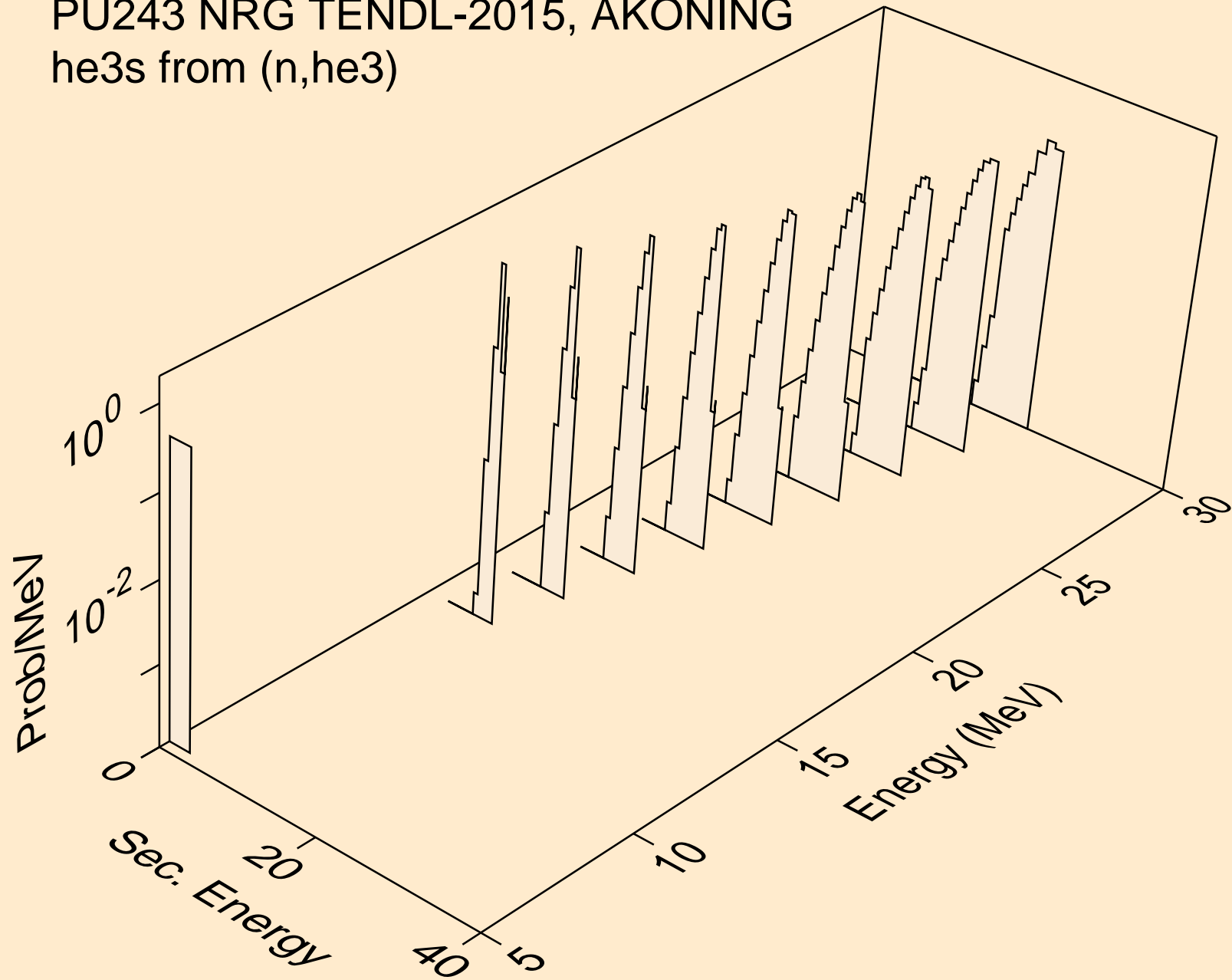



PU243 NRG TENDL-2015, AKONING  
alphas from (n,x)

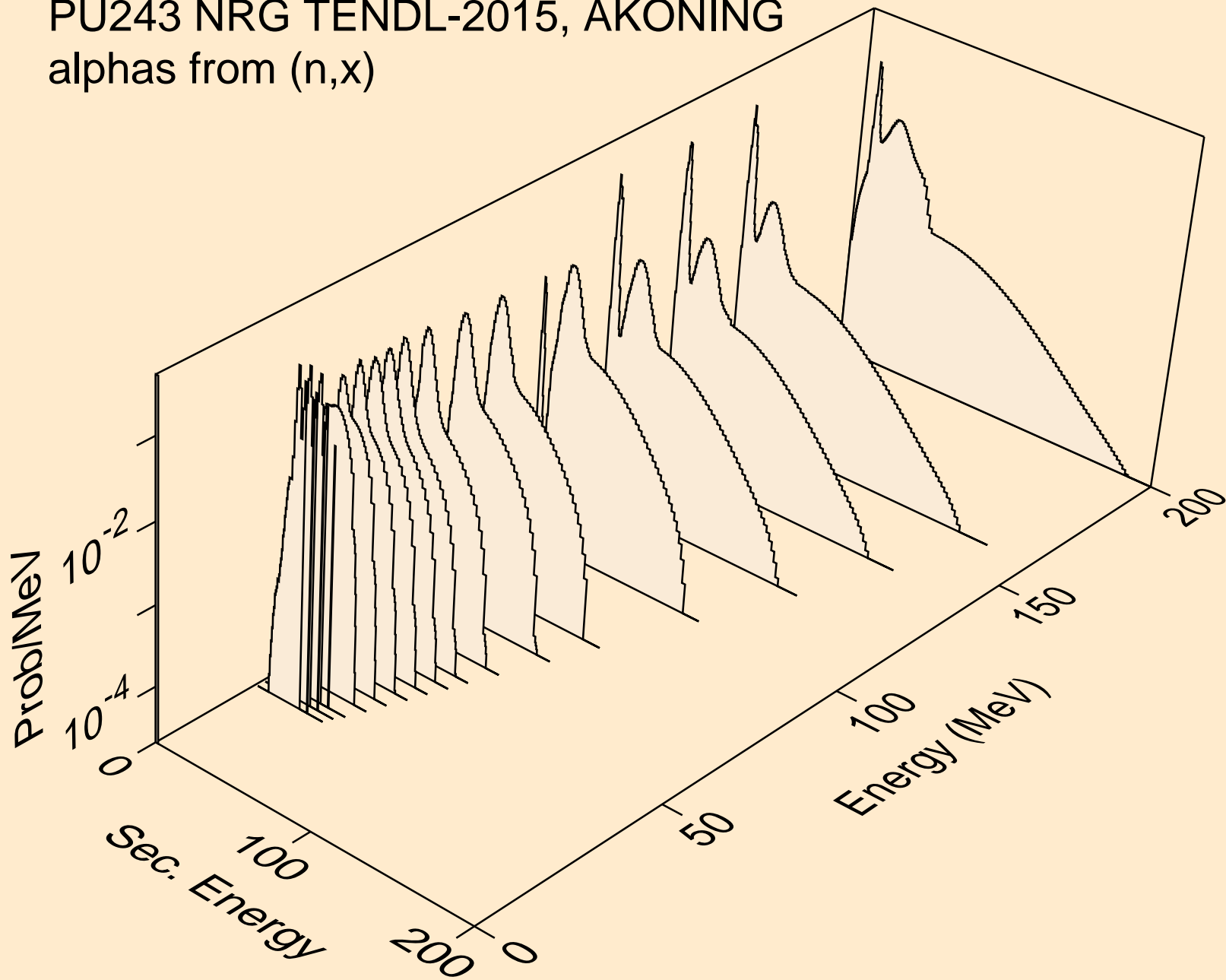

PU243 NRG TENDL-2015, AKONING  
alphas from (n,n\*)a

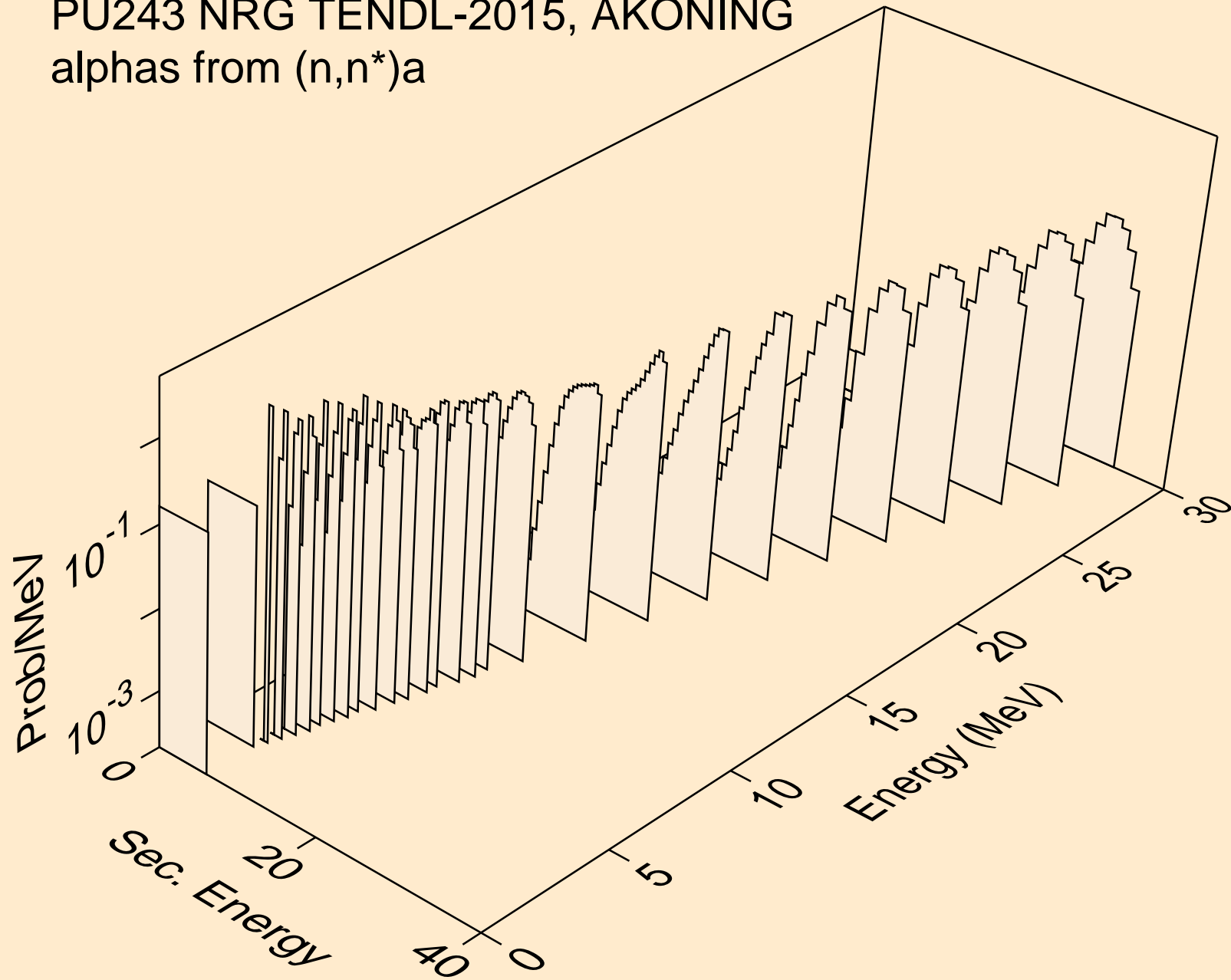

PU243 NRG TENDL-2015, AKONING  
alphas from (n,2n)a

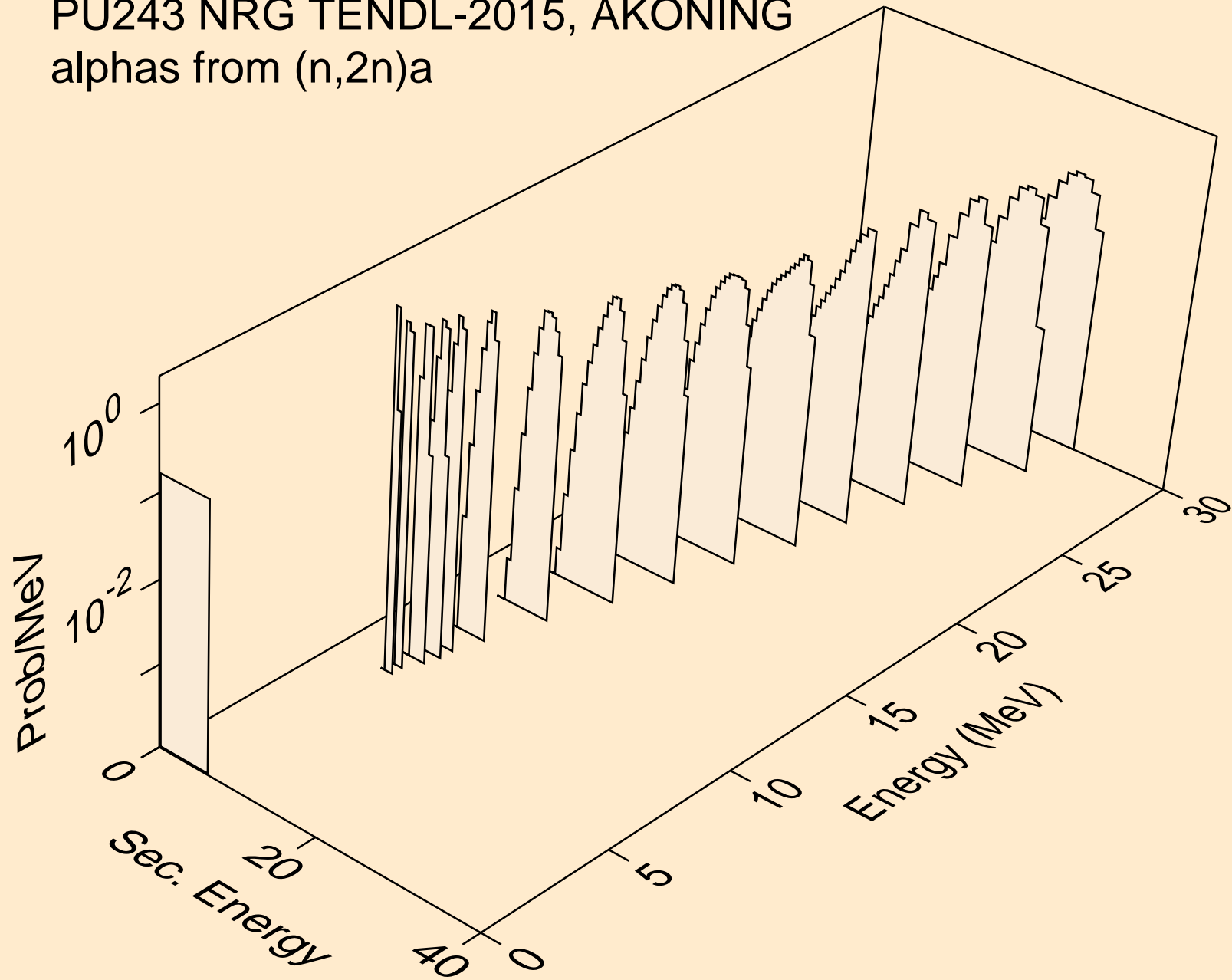

PU243 NRG TENDL-2015, AKONING  
alphas from (n,3n)a

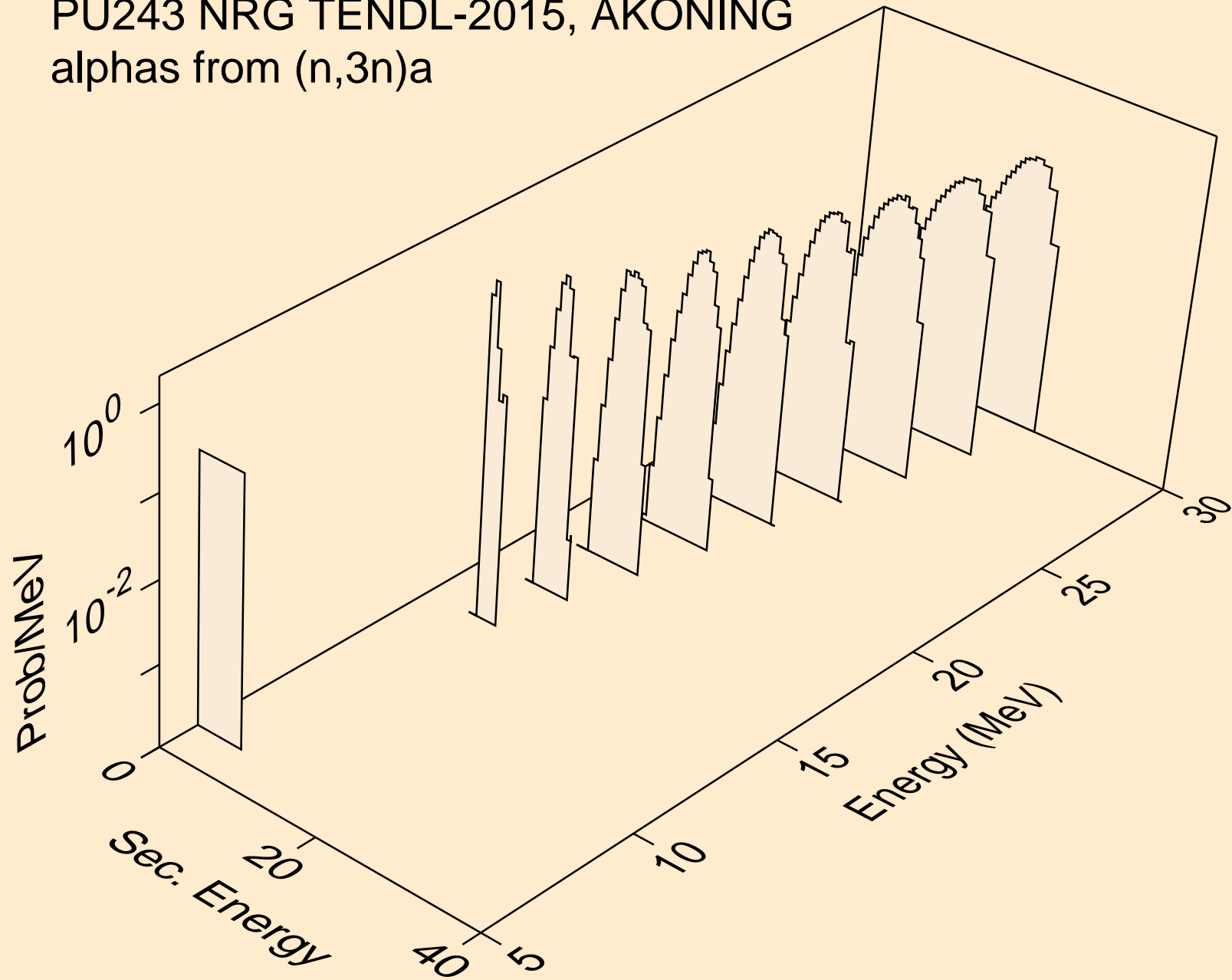

PU243 NRG TENDL-2015, AKONING  
alphas from (n,a)

