

RA211 NRG TENDL-2015, AKONING

Principal cross sections

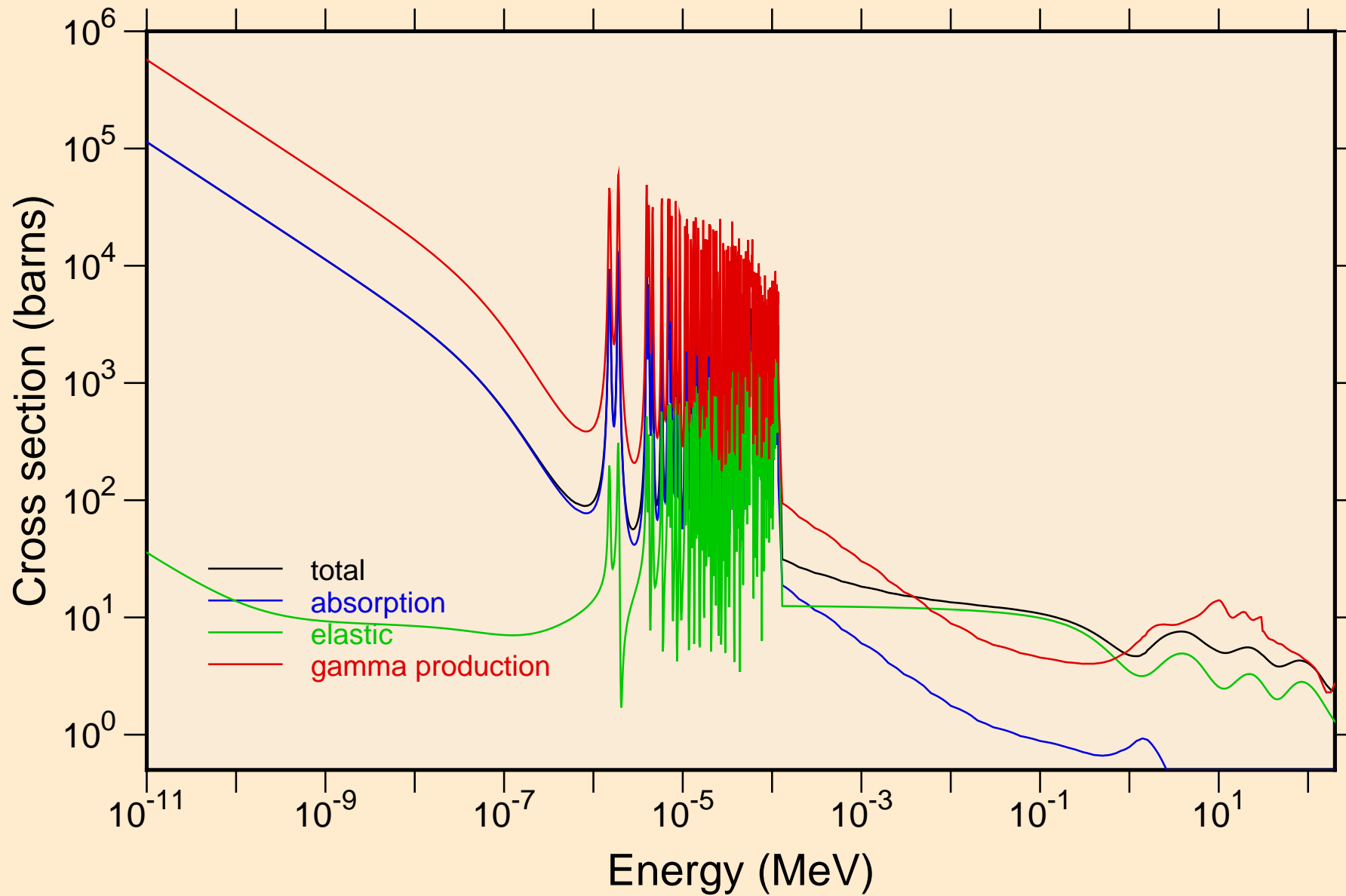

RA211 NRG TENDL-2015, AKONING
resonance total cross section

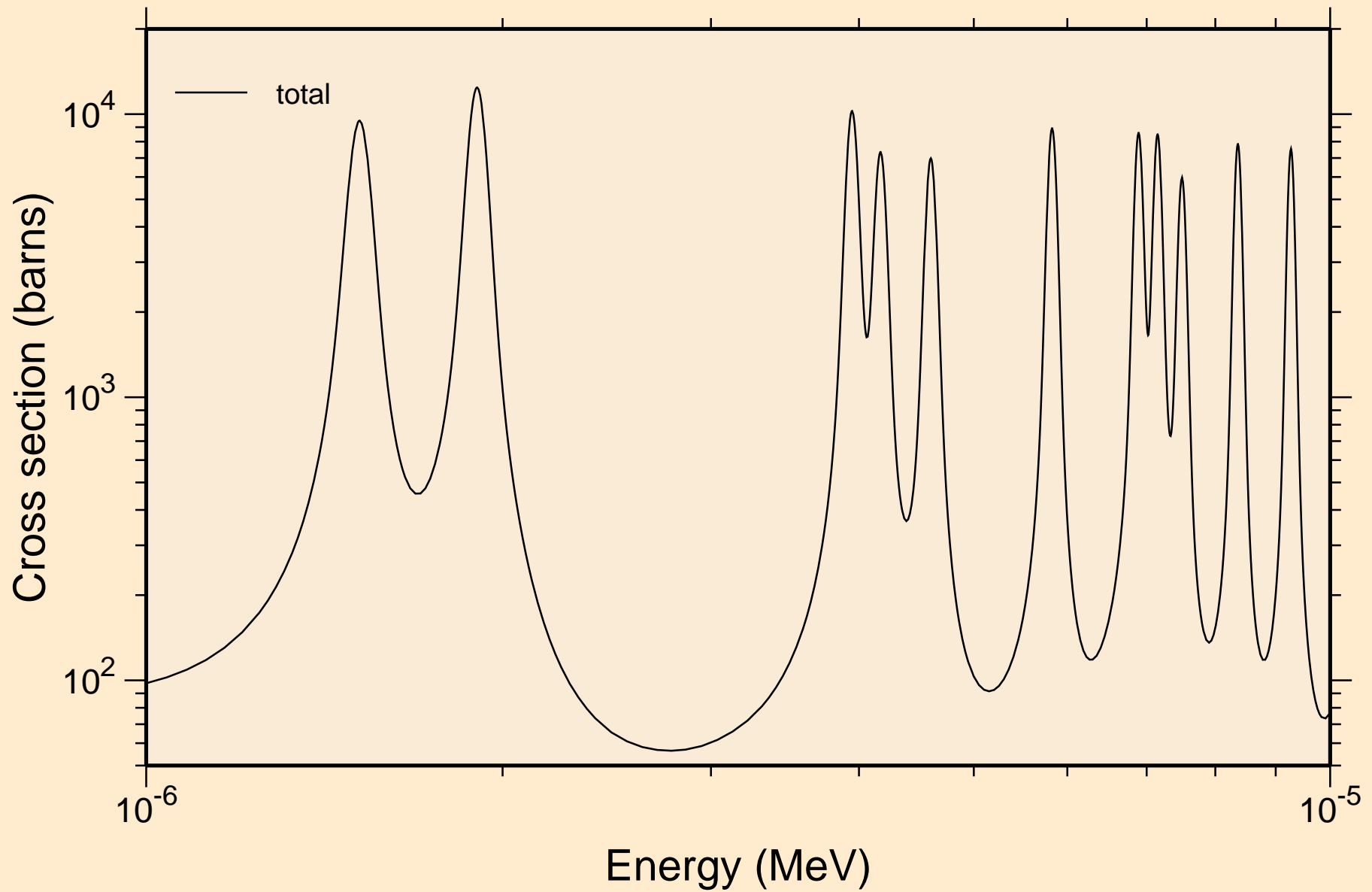

RA211 NRG TENDL-2015, AKONING
resonance total cross section

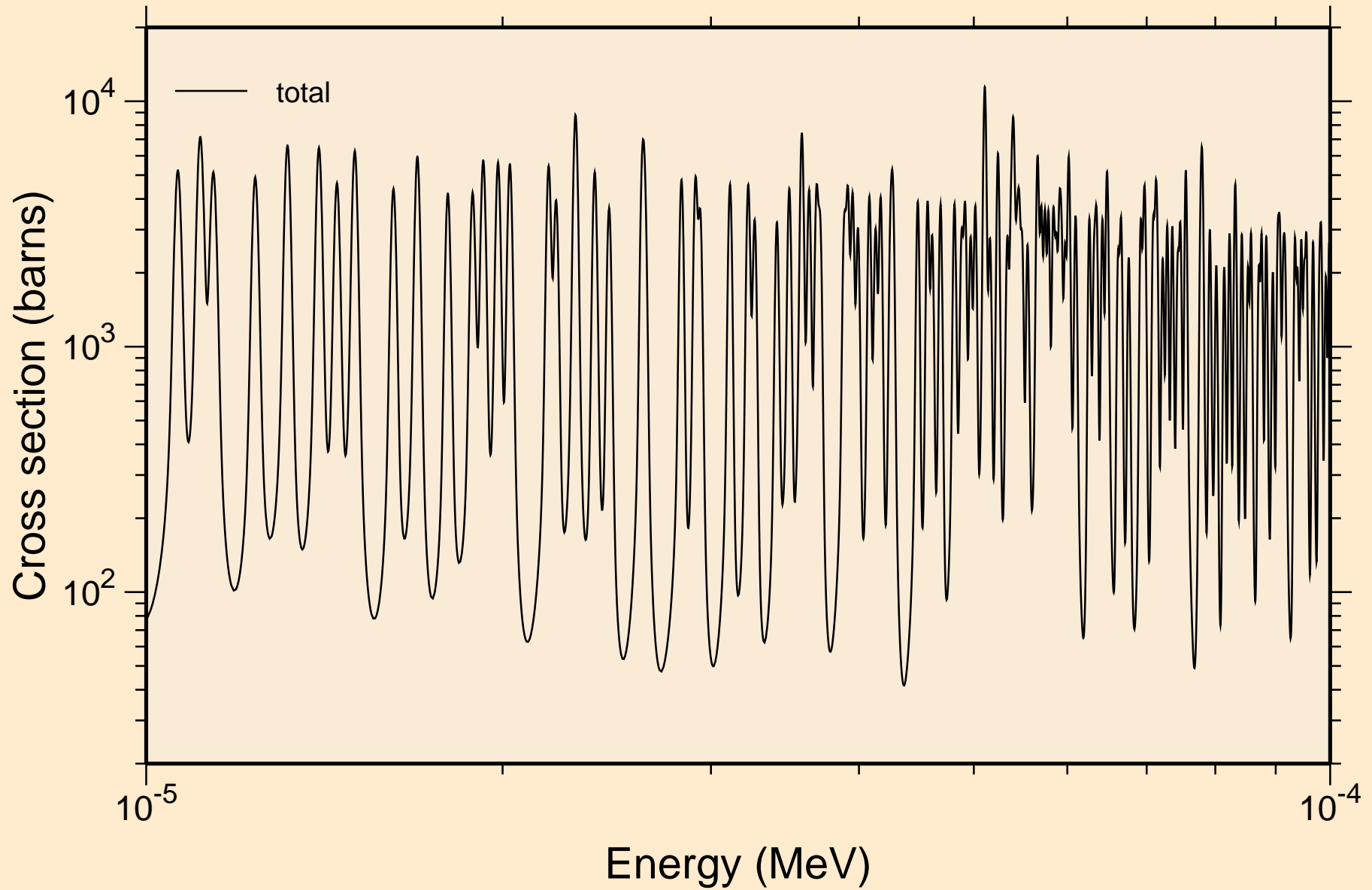

RA211 NRG TENDL-2015, AKONING
resonance total cross section

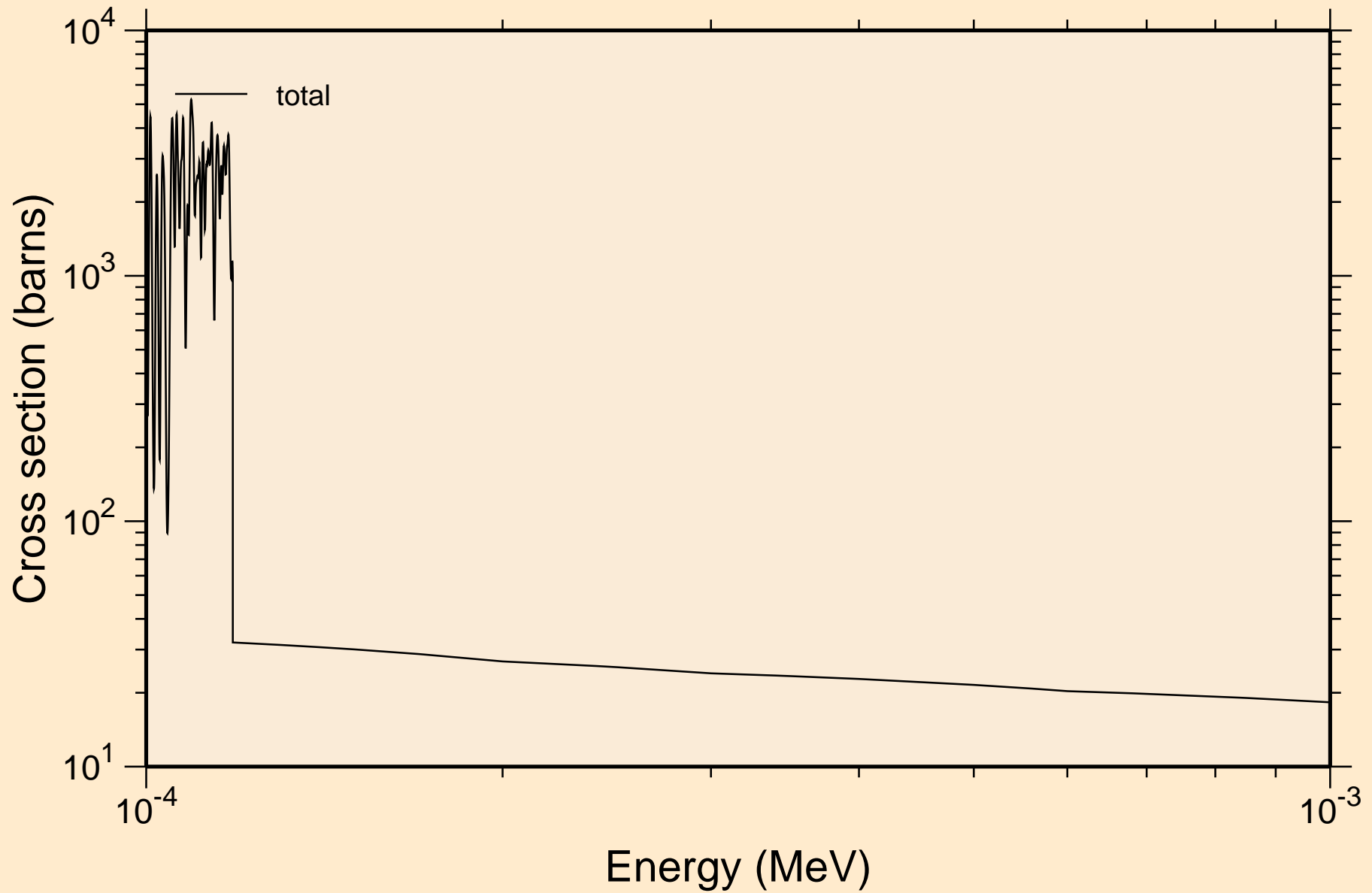

RA211 NRG TENDL-2015, AKONING
resonance total cross section

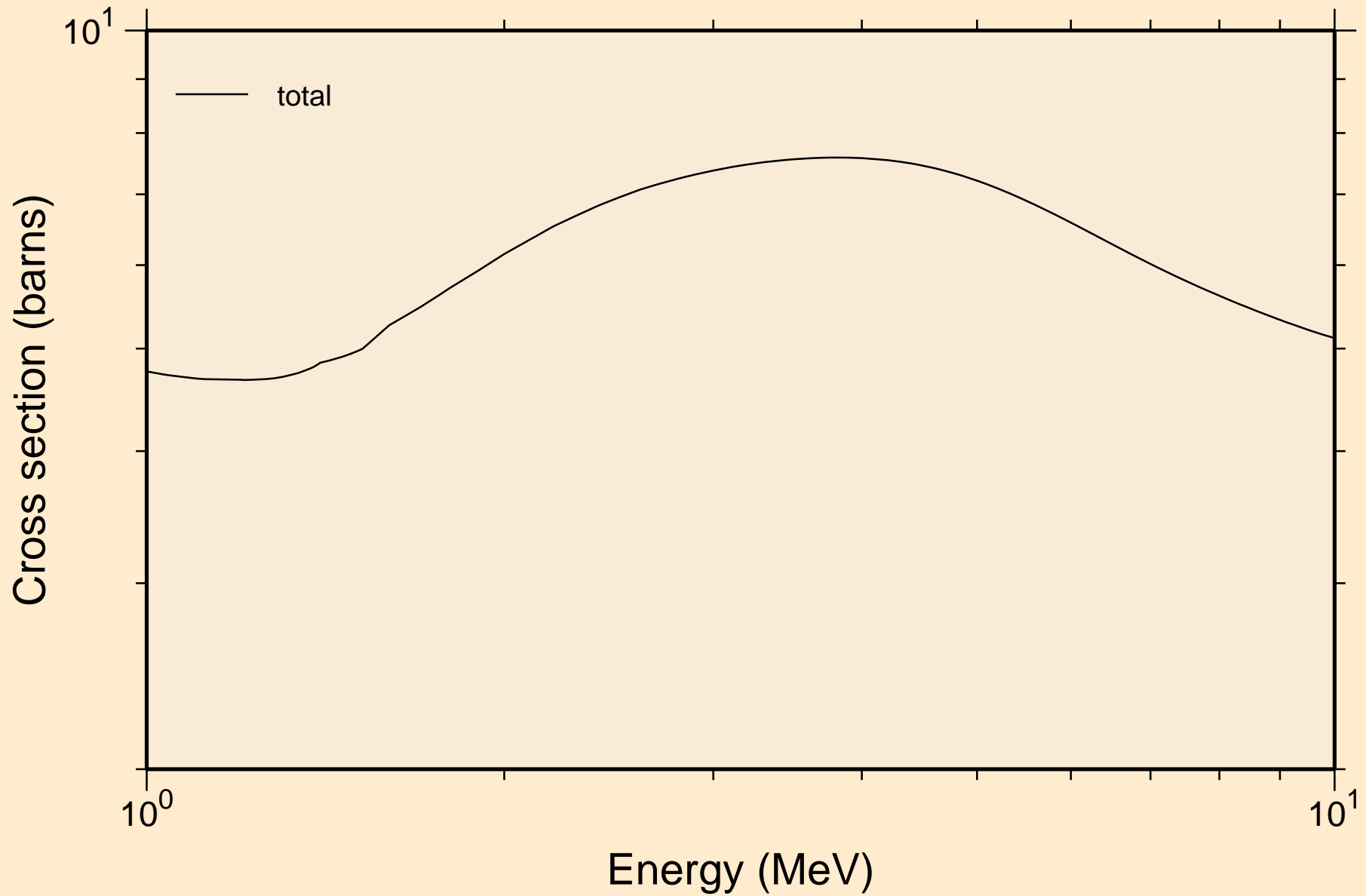

RA211 NRG TENDL-2015, AKONING
resonance absorption cross sections

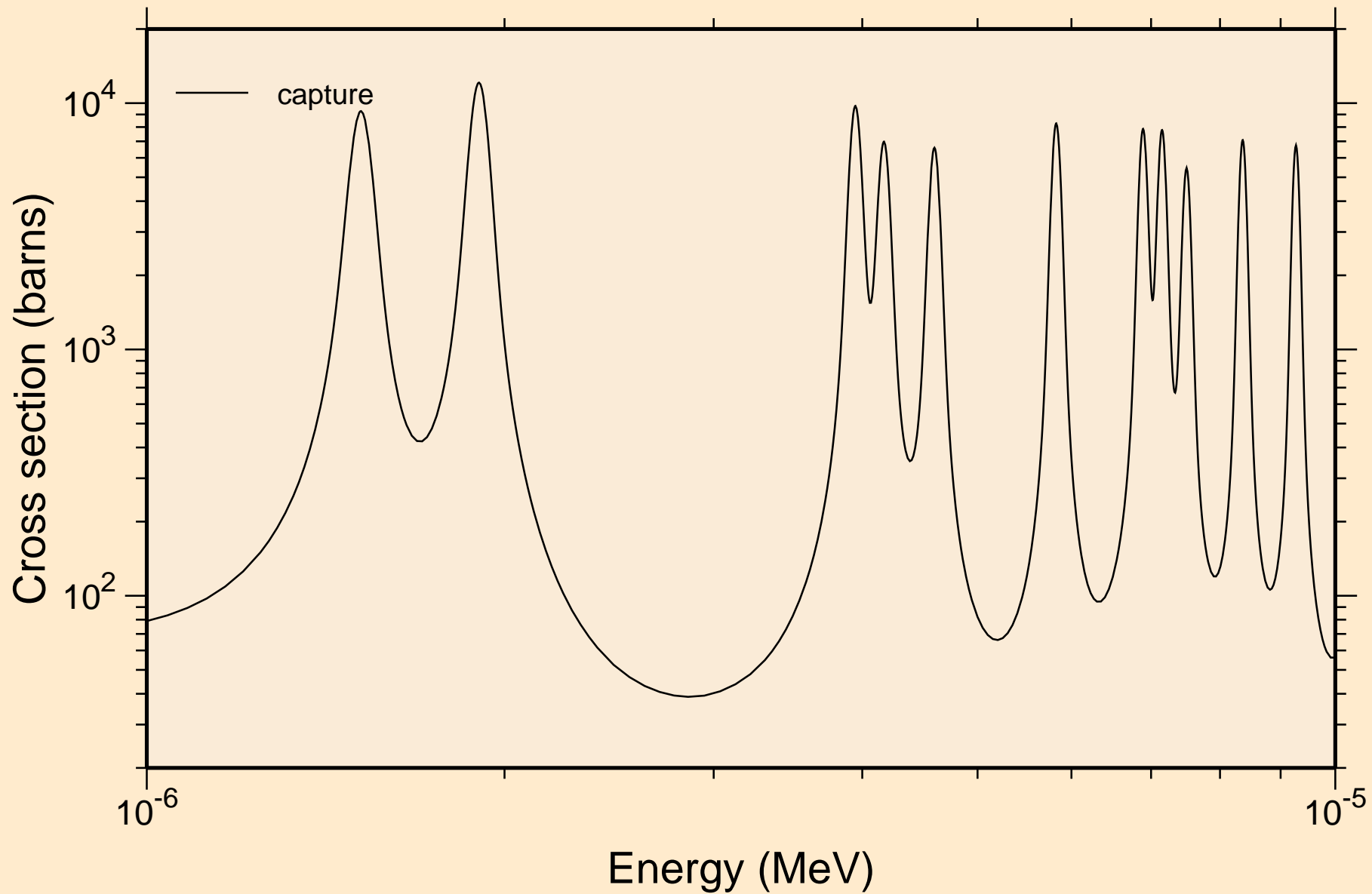

RA211 NRG TENDL-2015, AKONING
resonance absorption cross sections

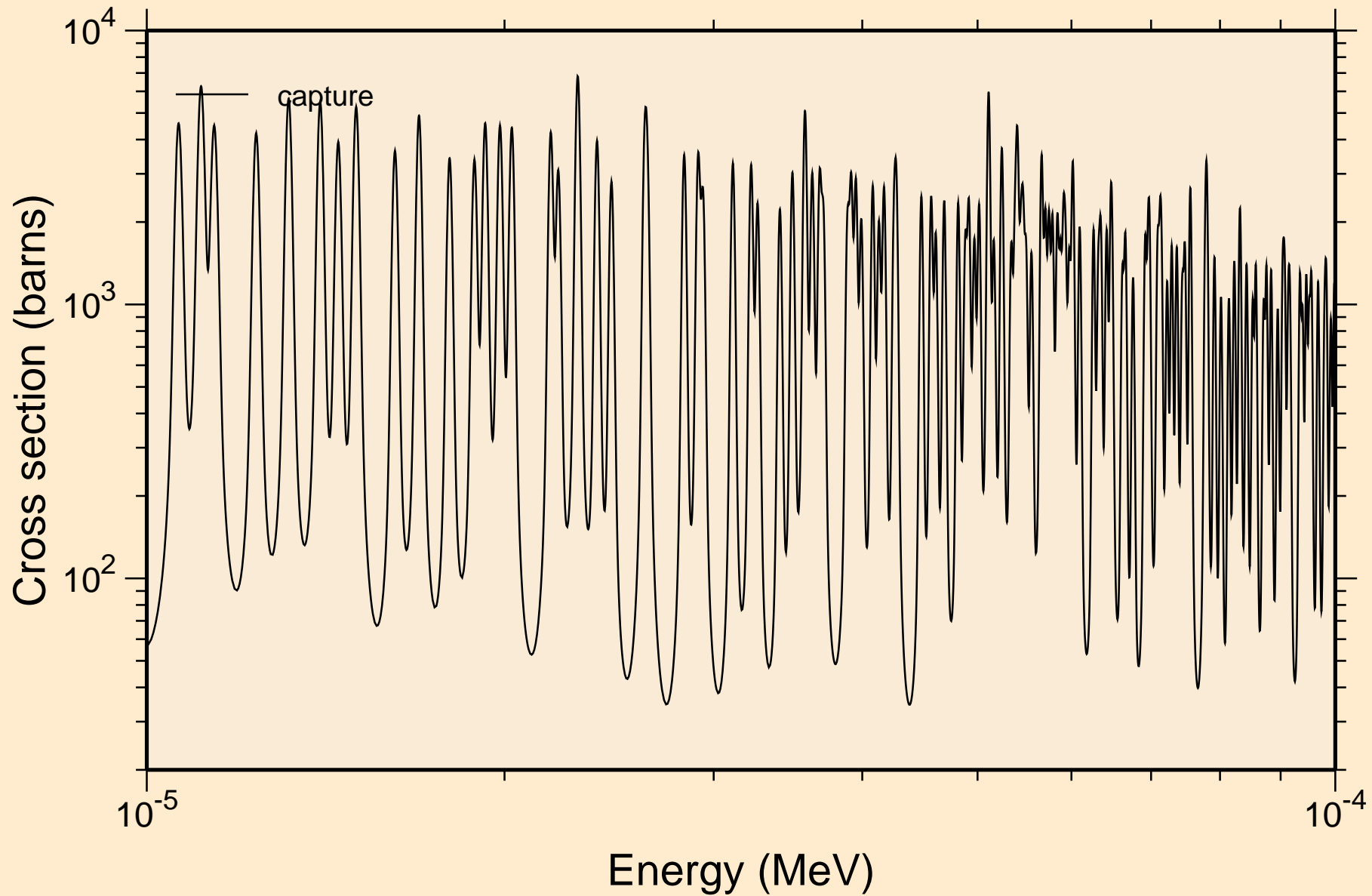

RA211 NRG TENDL-2015, AKONING
resonance absorption cross sections

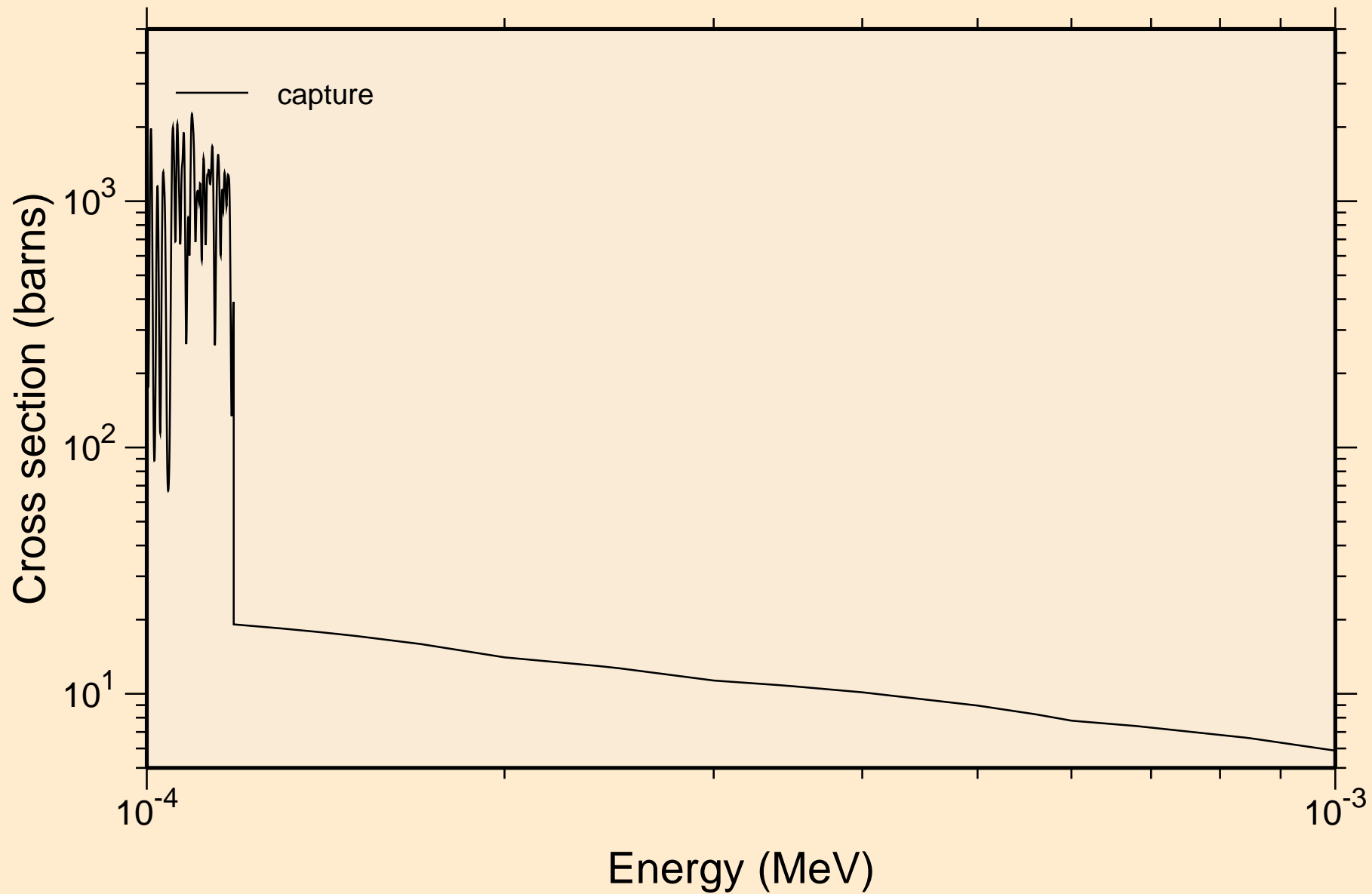

RA211 NRG TENDL-2015, AKONING
resonance absorption cross sections

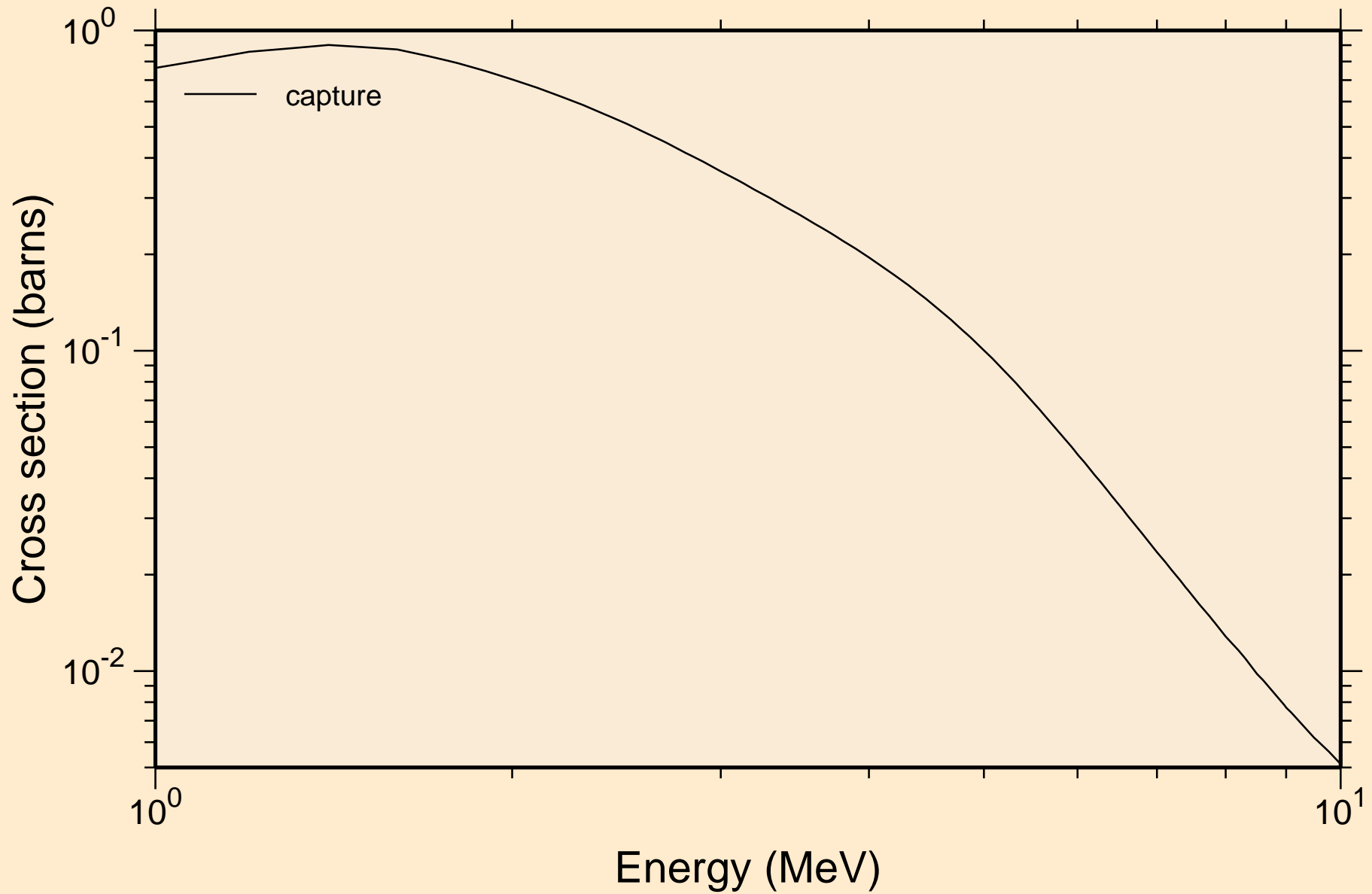

RA211 NRG TENDL-2015, AKONING

Non-threshold reactions

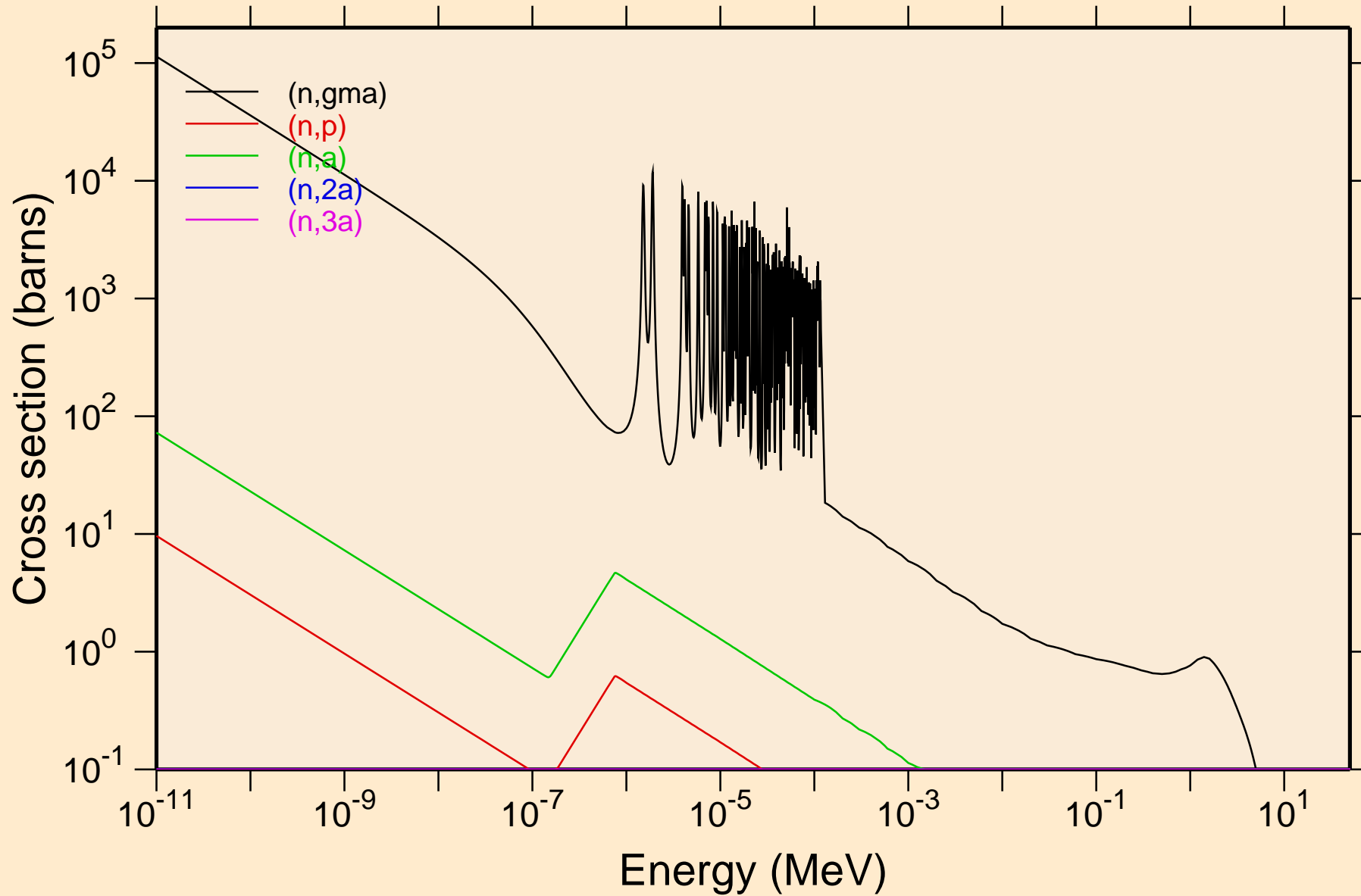

RA211 NRG TENDL-2015, AKONING

Non-threshold reactions

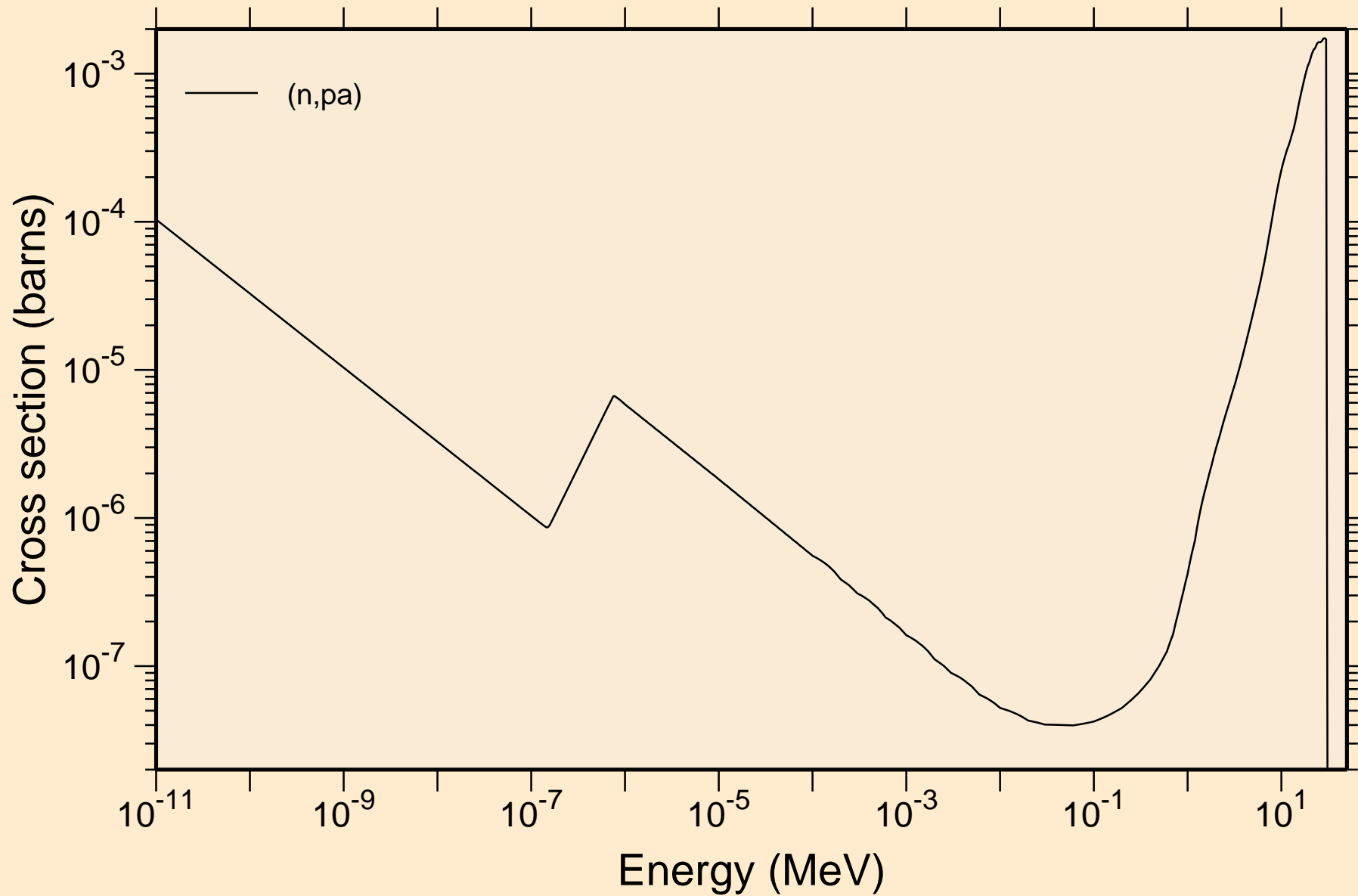

RA211 NRG TENDL-2015, AKONING

Principal cross sections

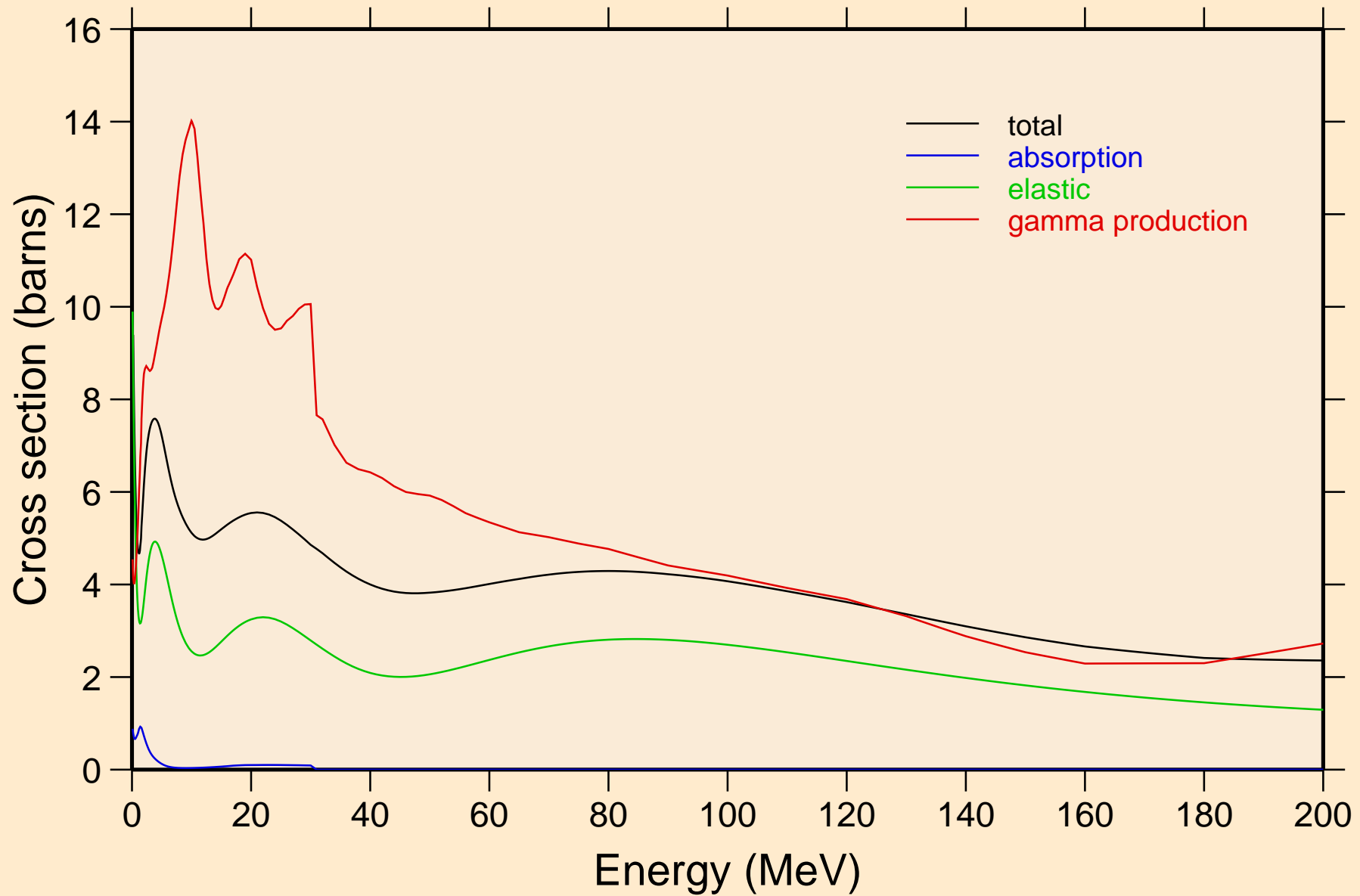

RA211 NRG TENDL-2015, AKONING

Non-threshold reactions

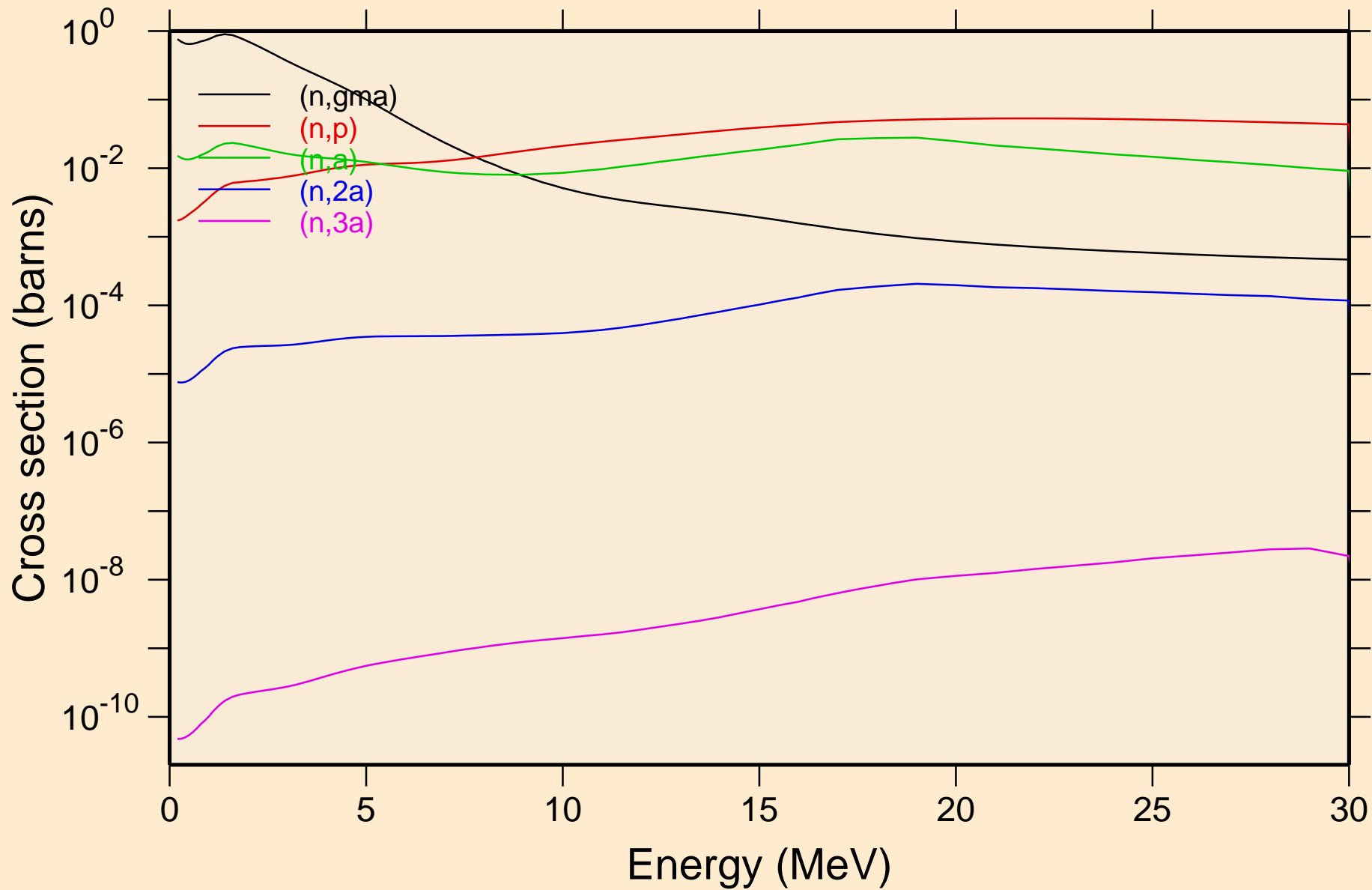

RA211 NRG TENDL-2015, AKONING
Non-threshold reactions

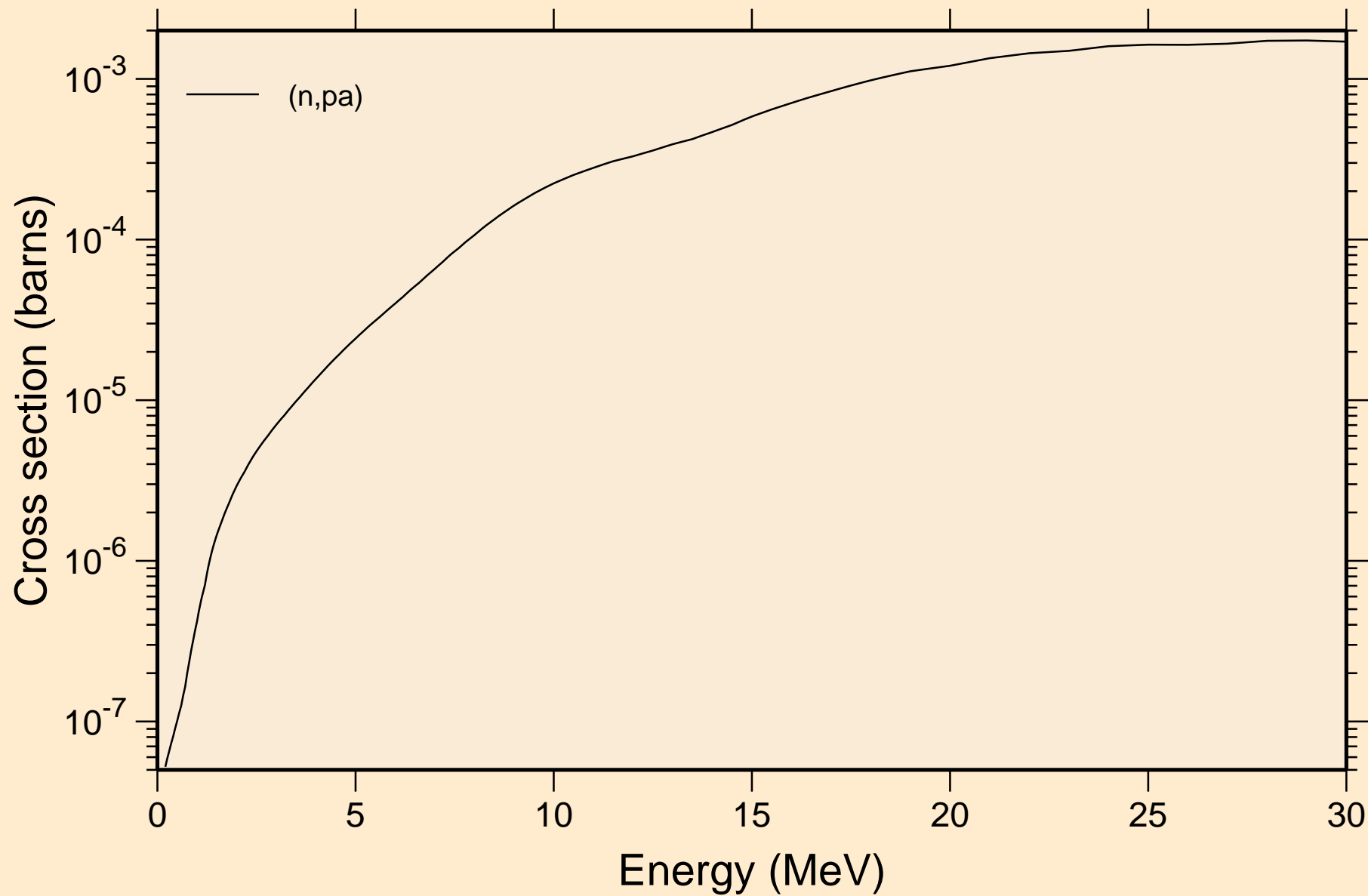

RA211 NRG TENDL-2015, AKONING

Inelastic levels

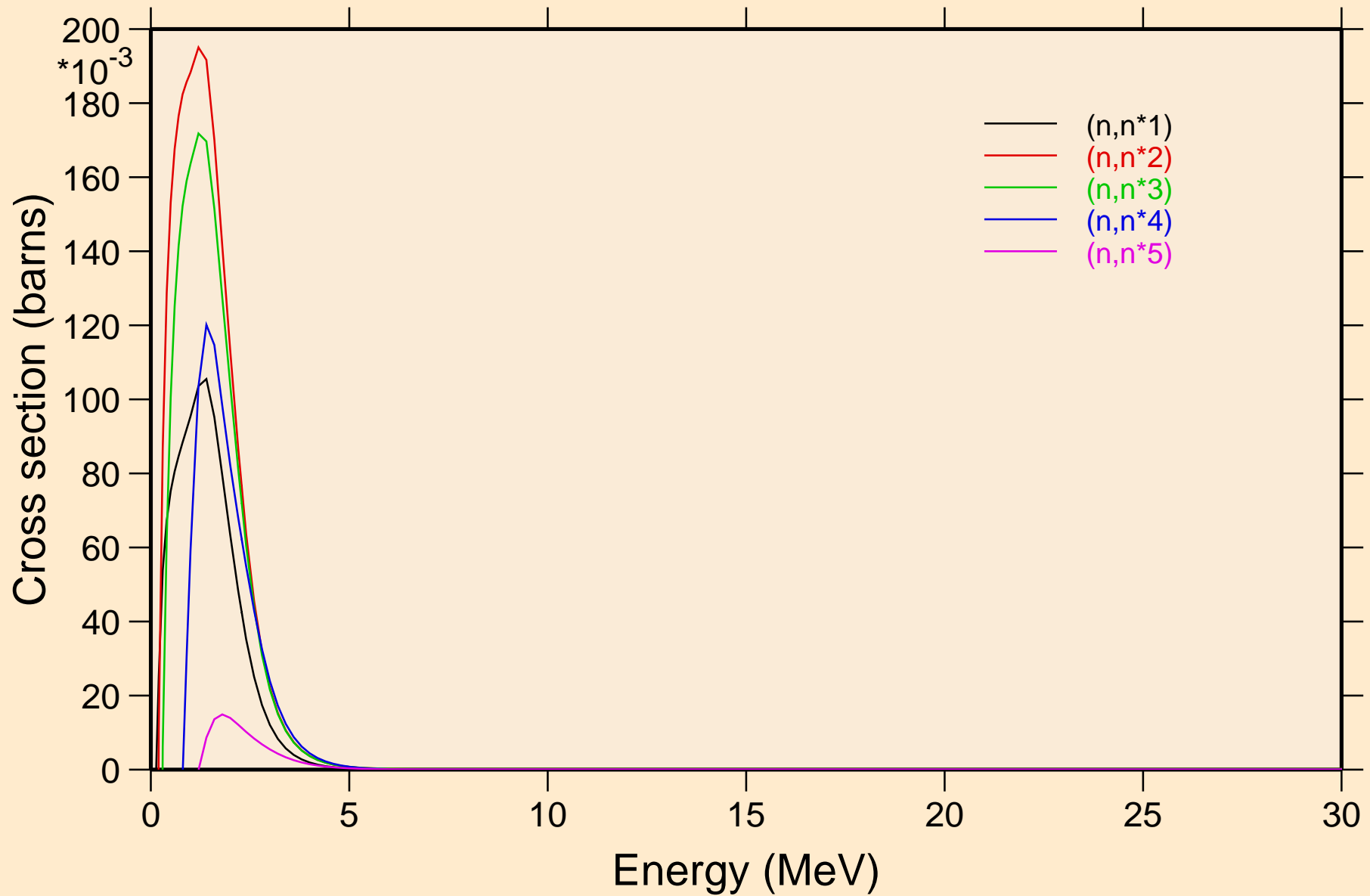

RA211 NRG TENDL-2015, AKONING

Inelastic levels

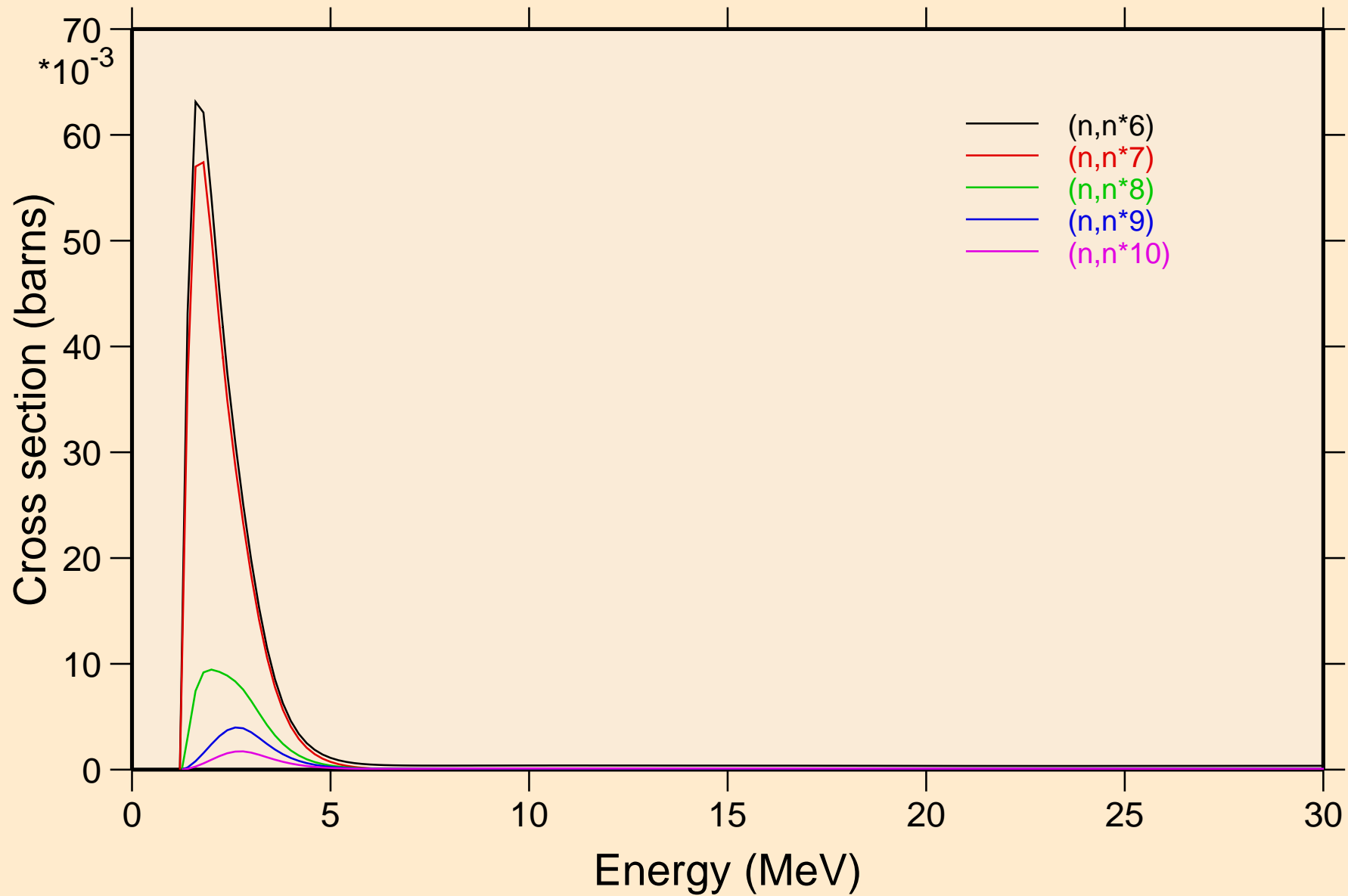

RA211 NRG TENDL-2015, AKONING

Inelastic levels

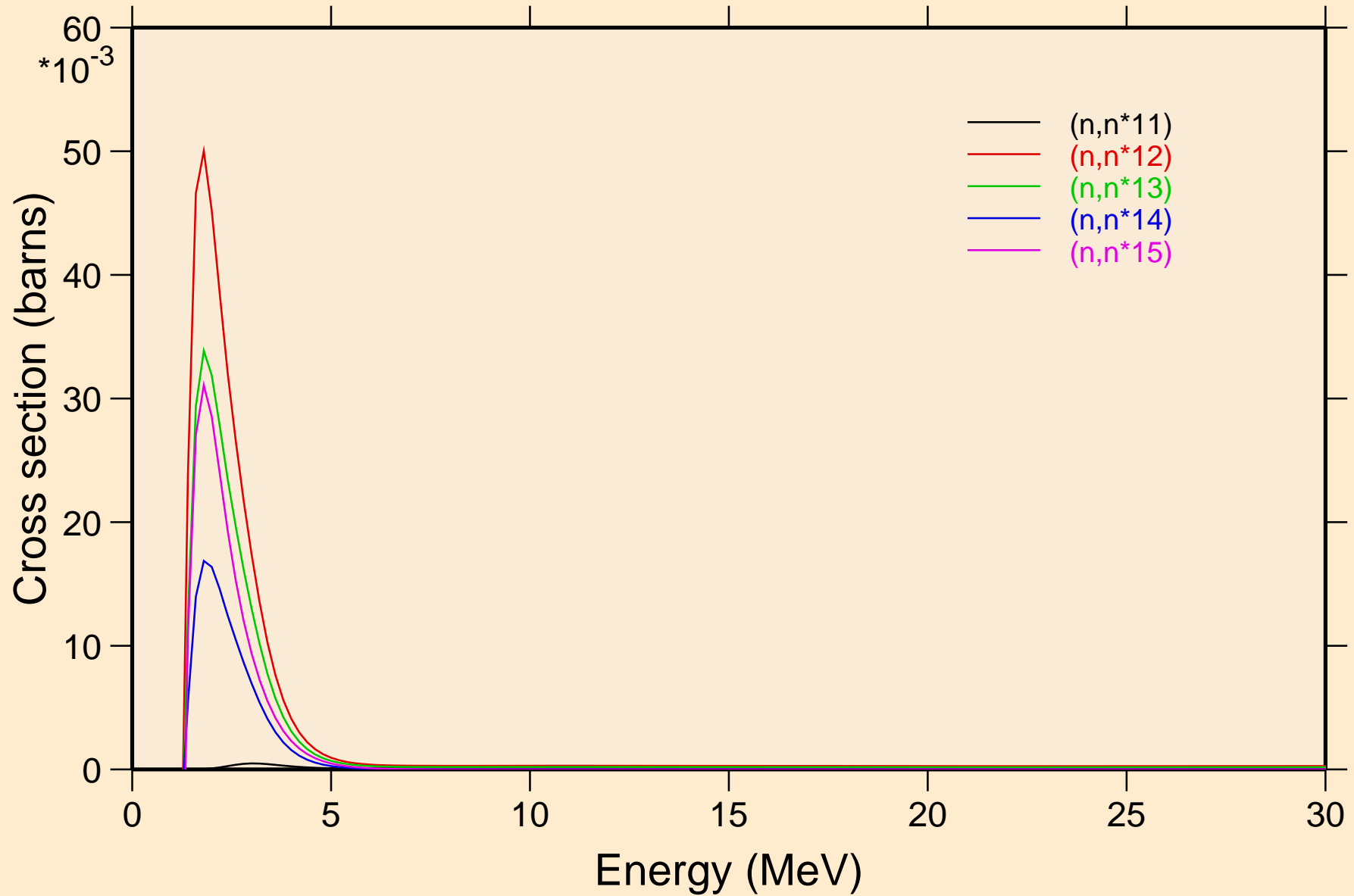

RA211 NRG TENDL-2015, AKONING

Inelastic levels

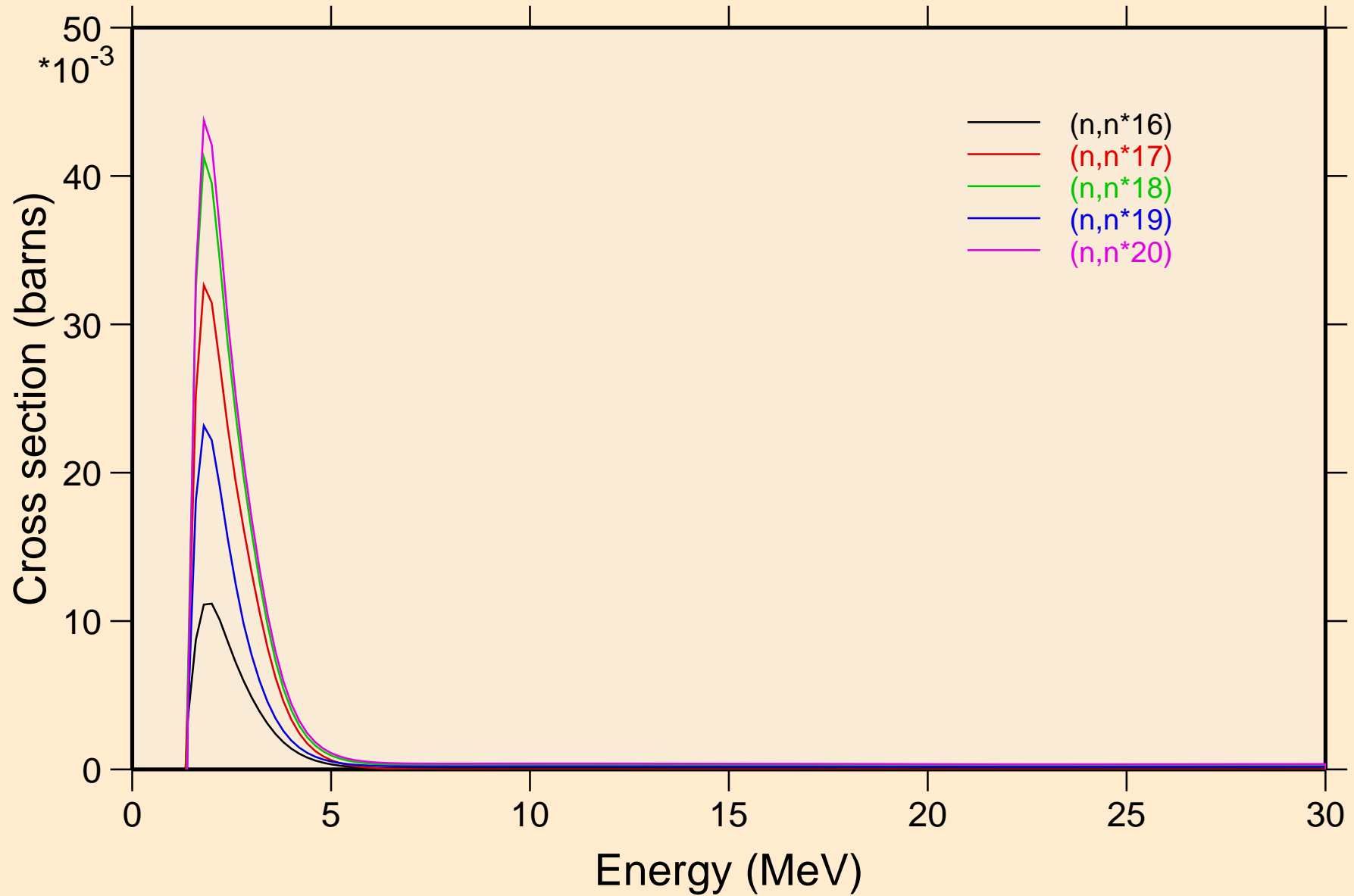

RA211 NRG TENDL-2015, AKONING

Inelastic levels

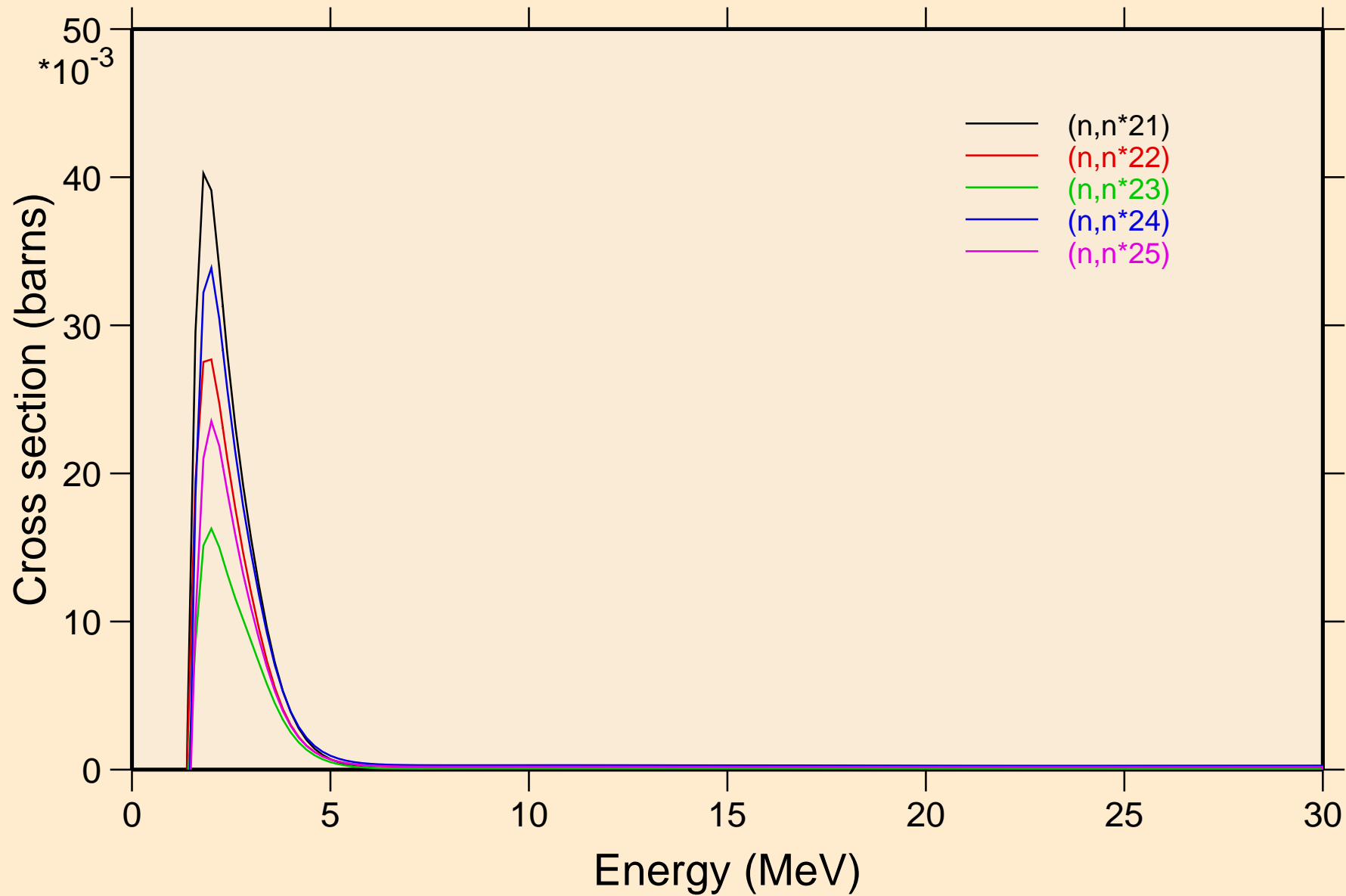

RA211 NRG TENDL-2015, AKONING

Inelastic levels

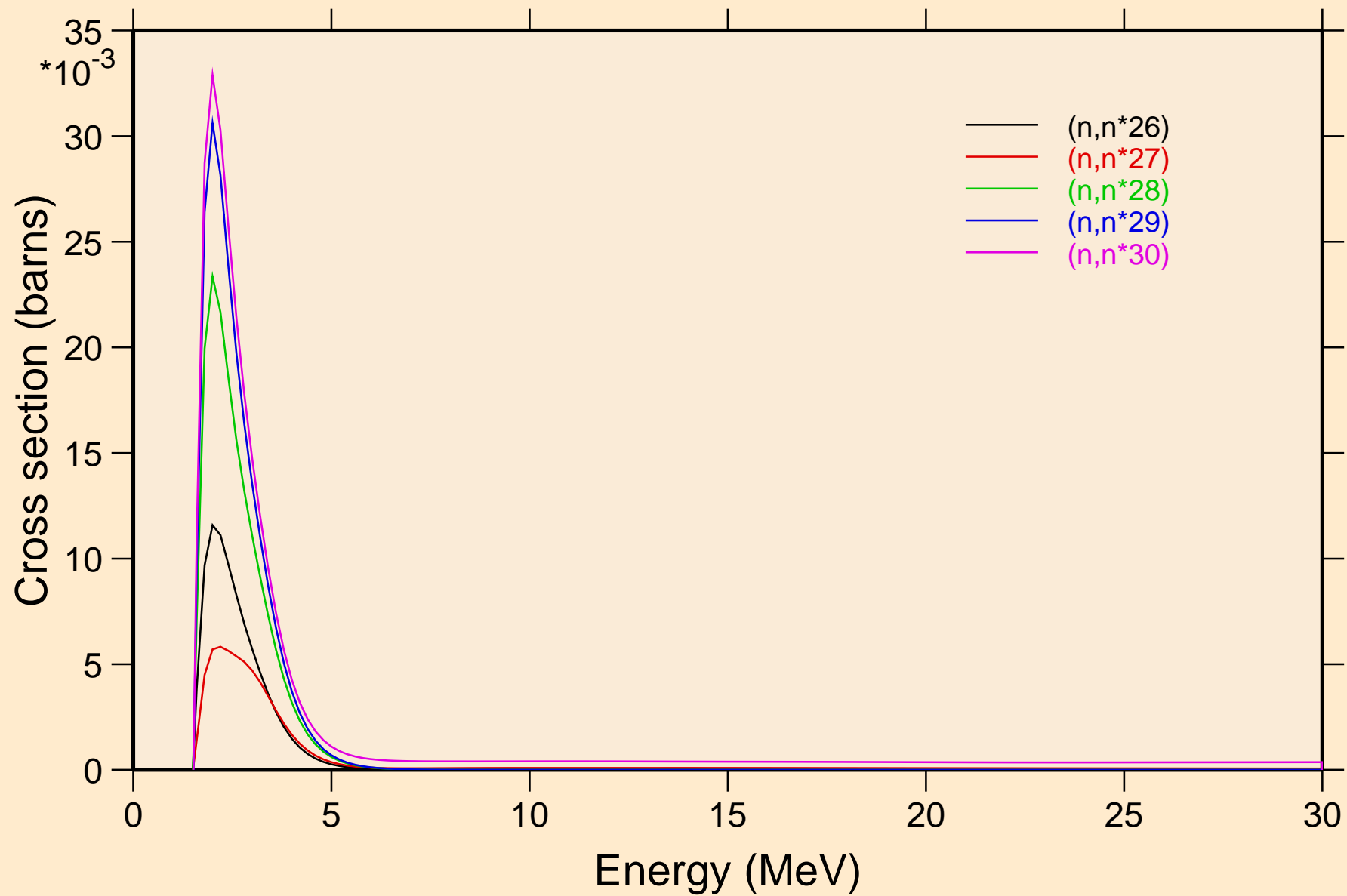

RA211 NRG TENDL-2015, AKONING

Threshold reactions

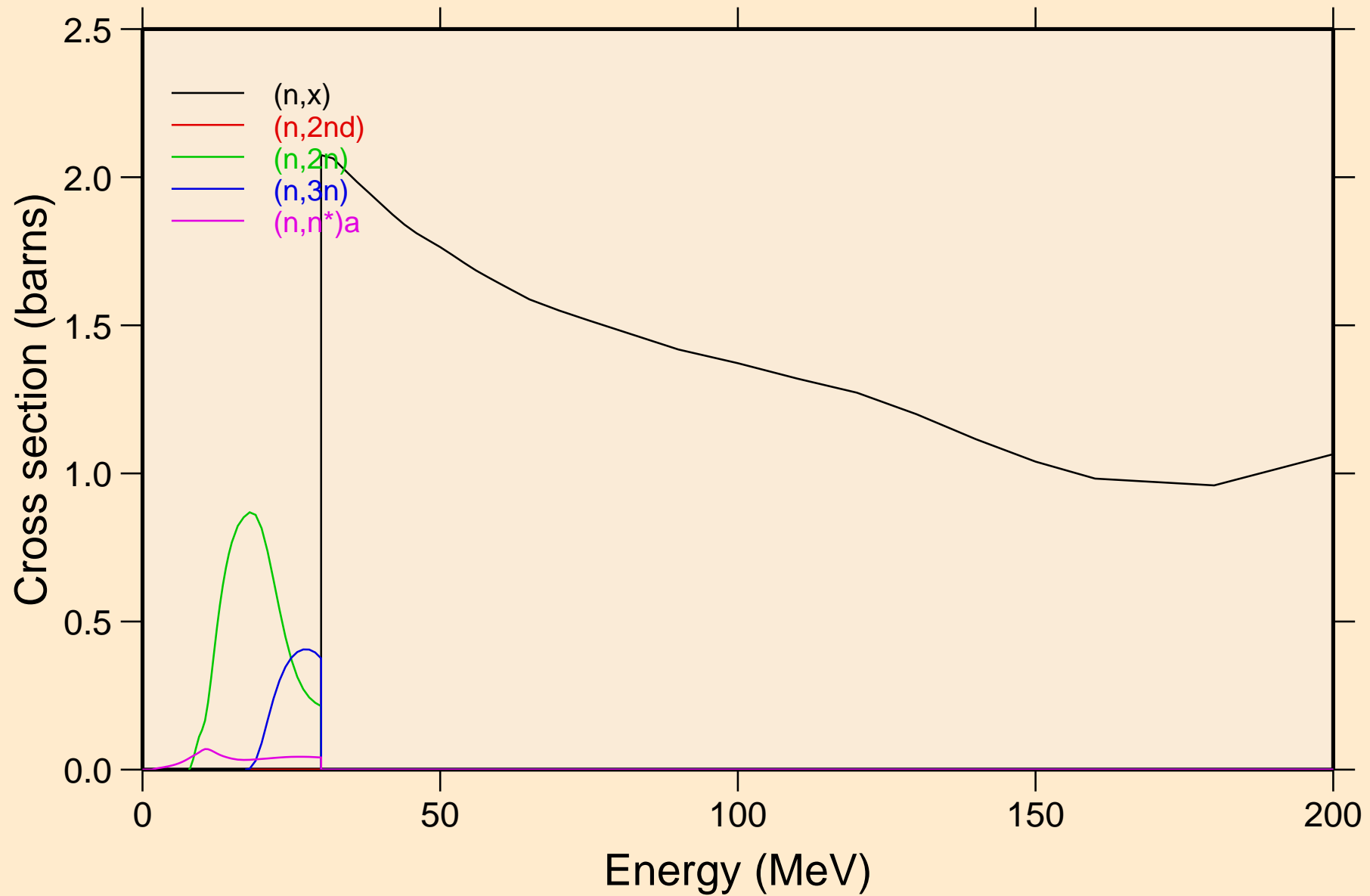

RA211 NRG TENDL-2015, AKONING

Threshold reactions

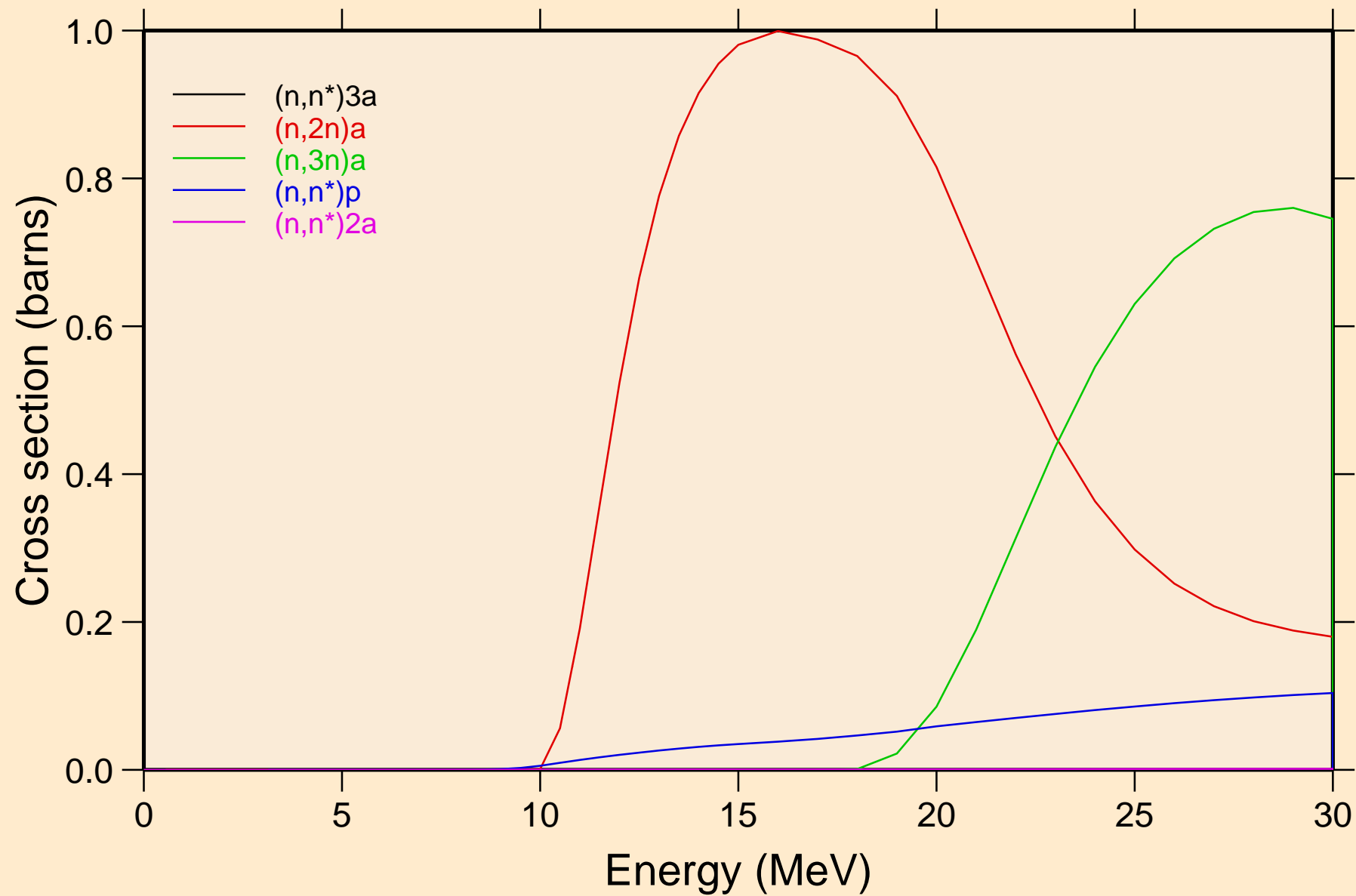

RA211 NRG TENDL-2015, AKONING

Threshold reactions

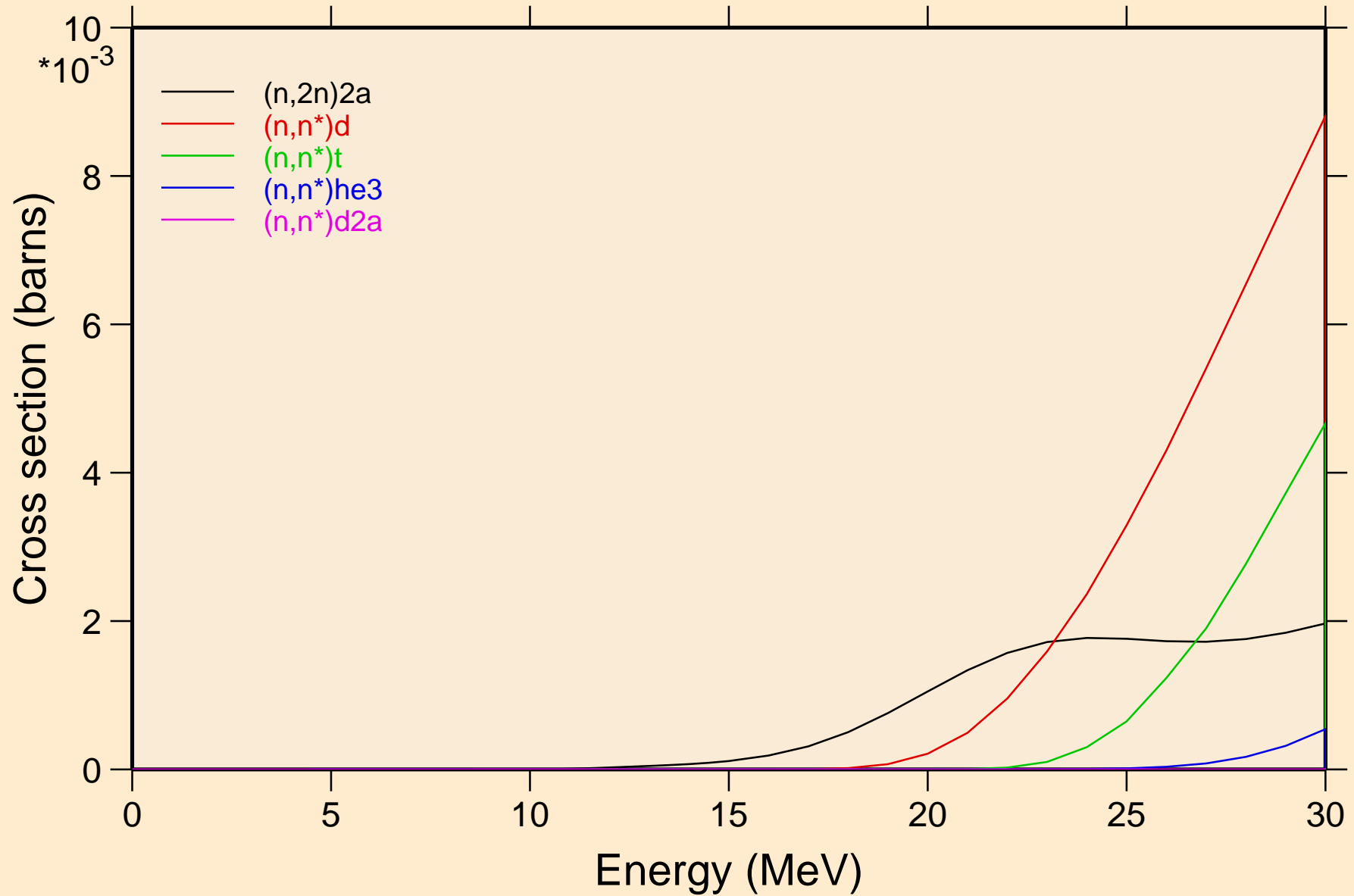

RA211 NRG TENDL-2015, AKONING

Threshold reactions

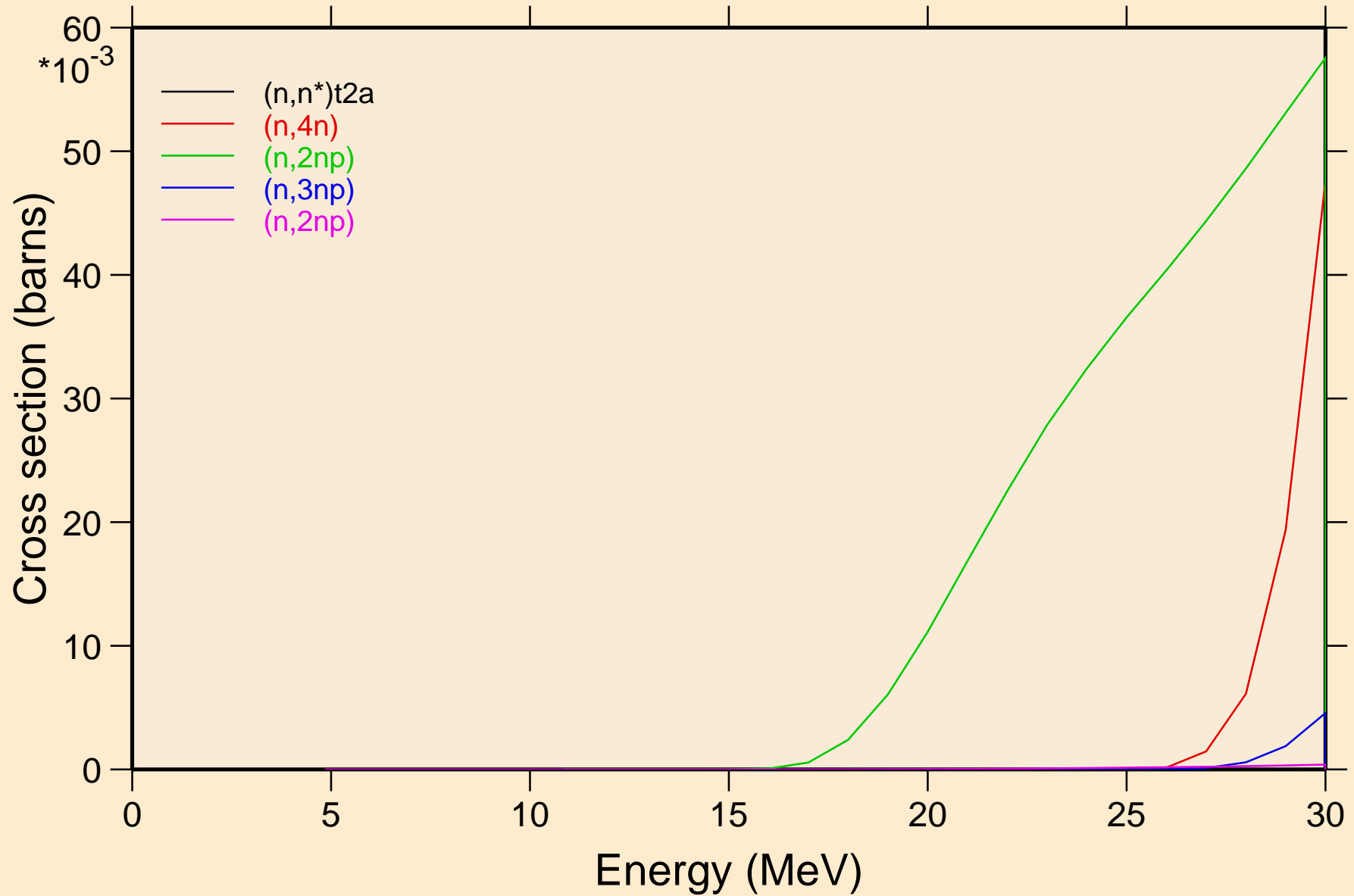

RA211 NRG TENDL-2015, AKONING

Threshold reactions

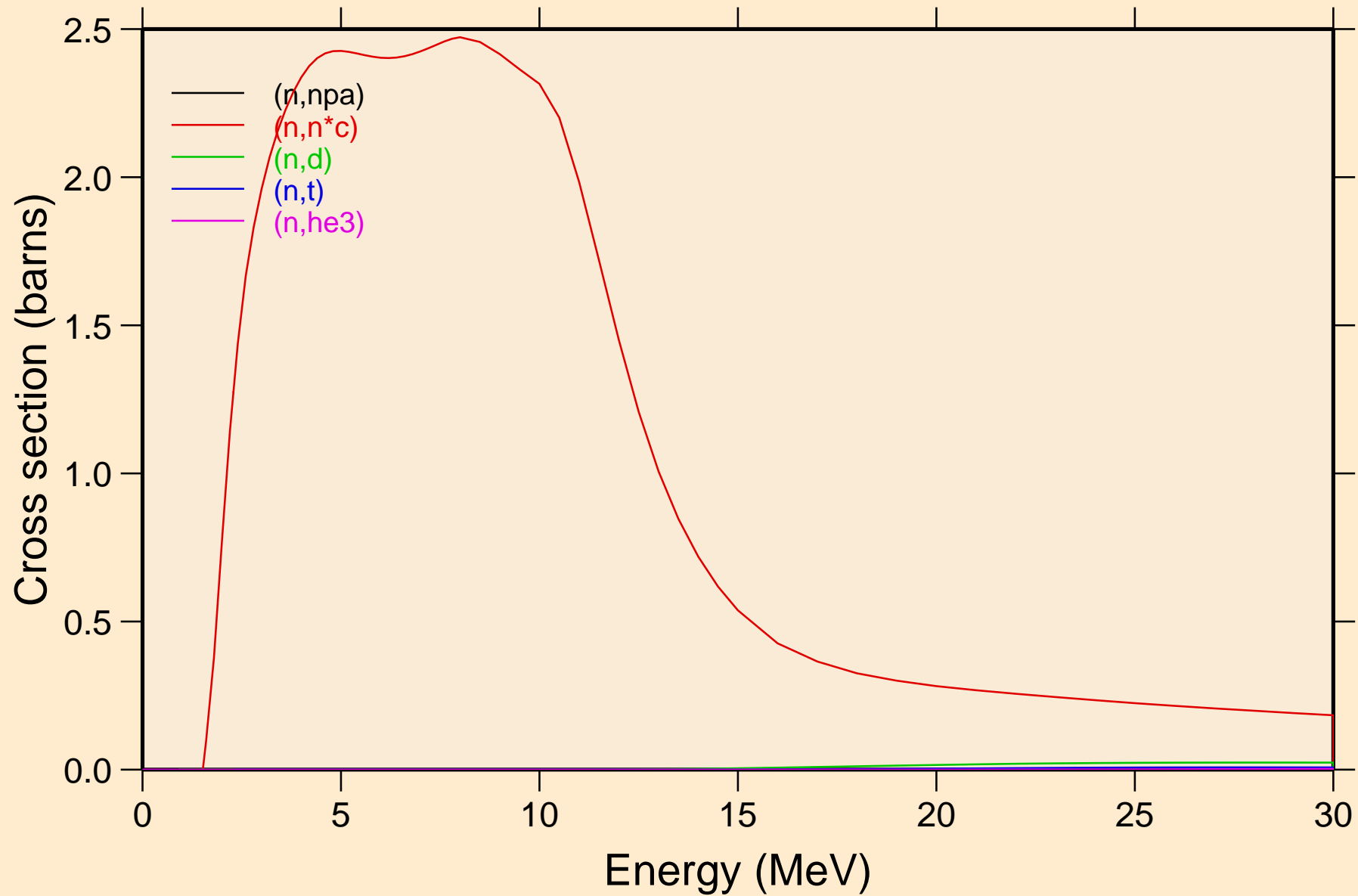

RA211 NRG TENDL-2015, AKONING

Threshold reactions

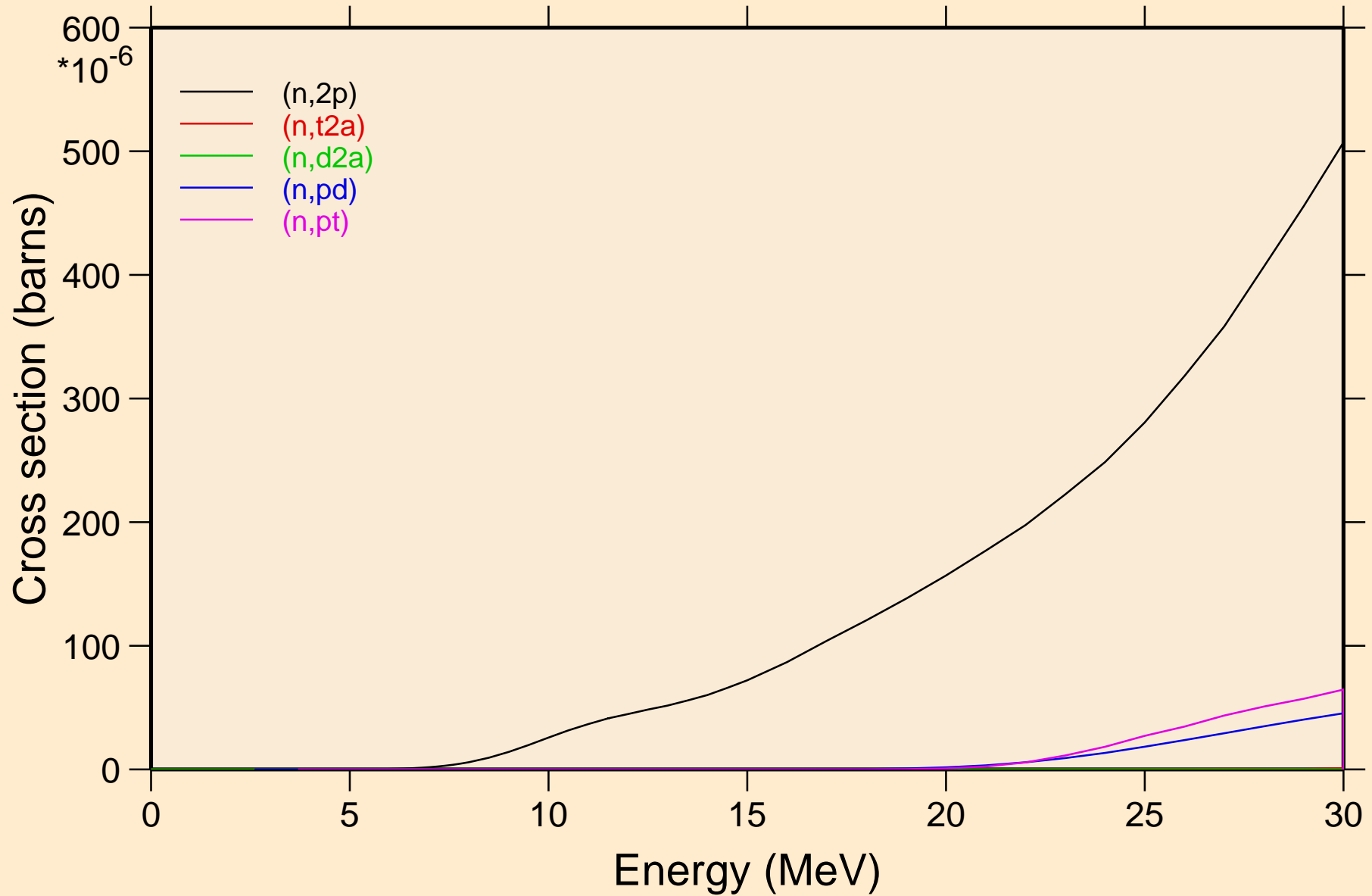

RA211 NRG TENDL-2015, AKONING

Threshold reactions

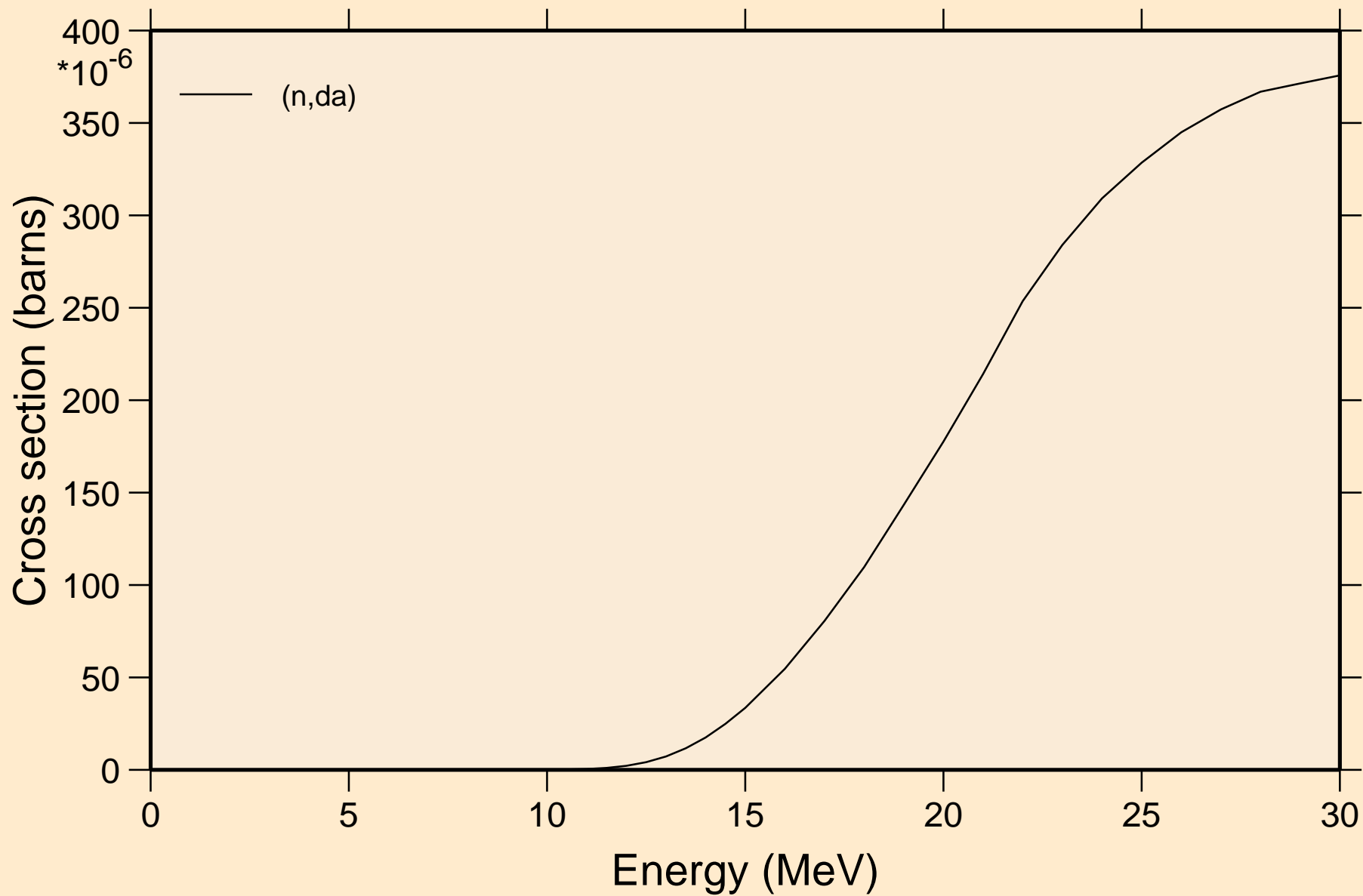

RA211 NRG TENDL-2015, AKONING
angular distribution for elastic

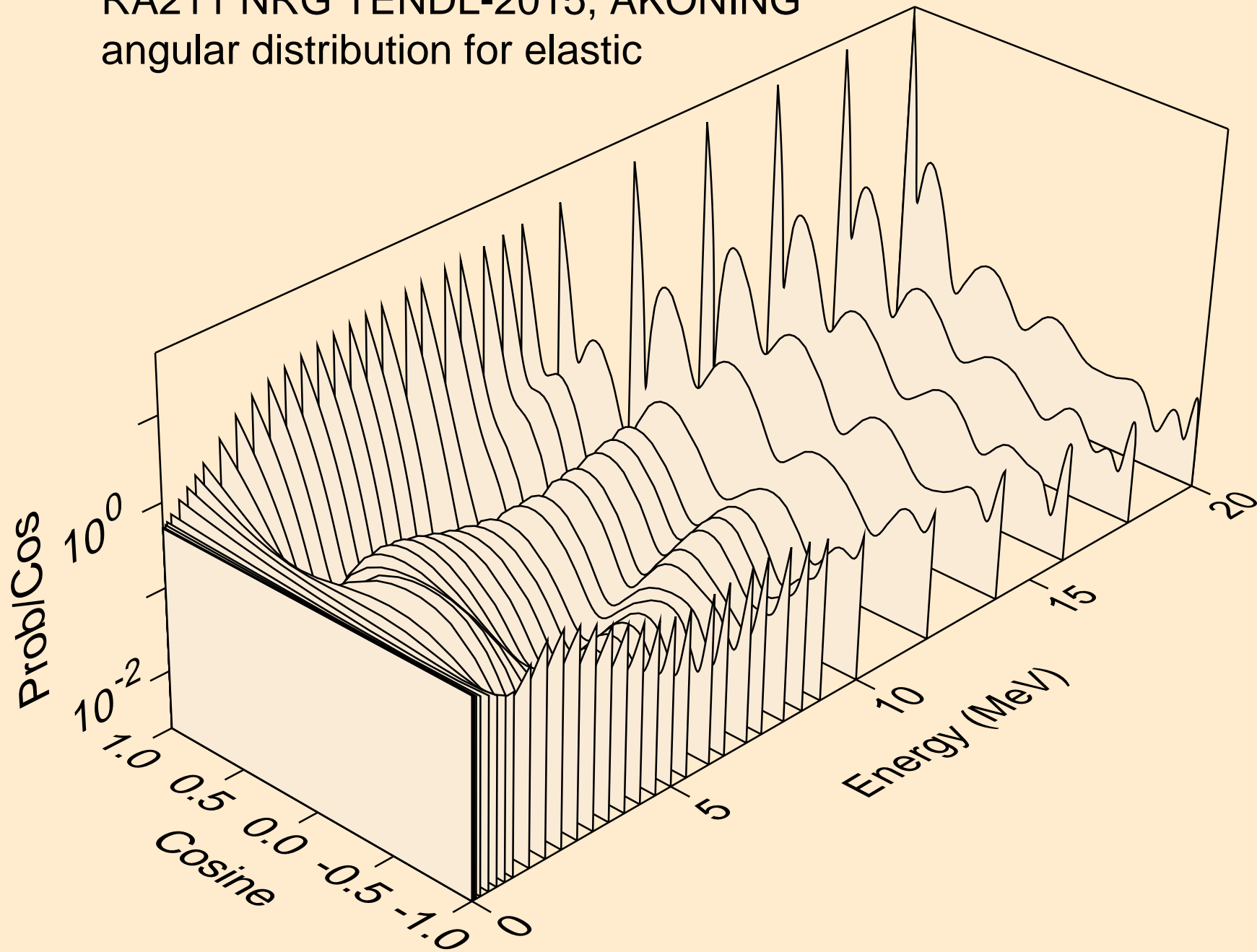

RA211 NRG TENDL-2015, AKONING
angular distribution for elastic

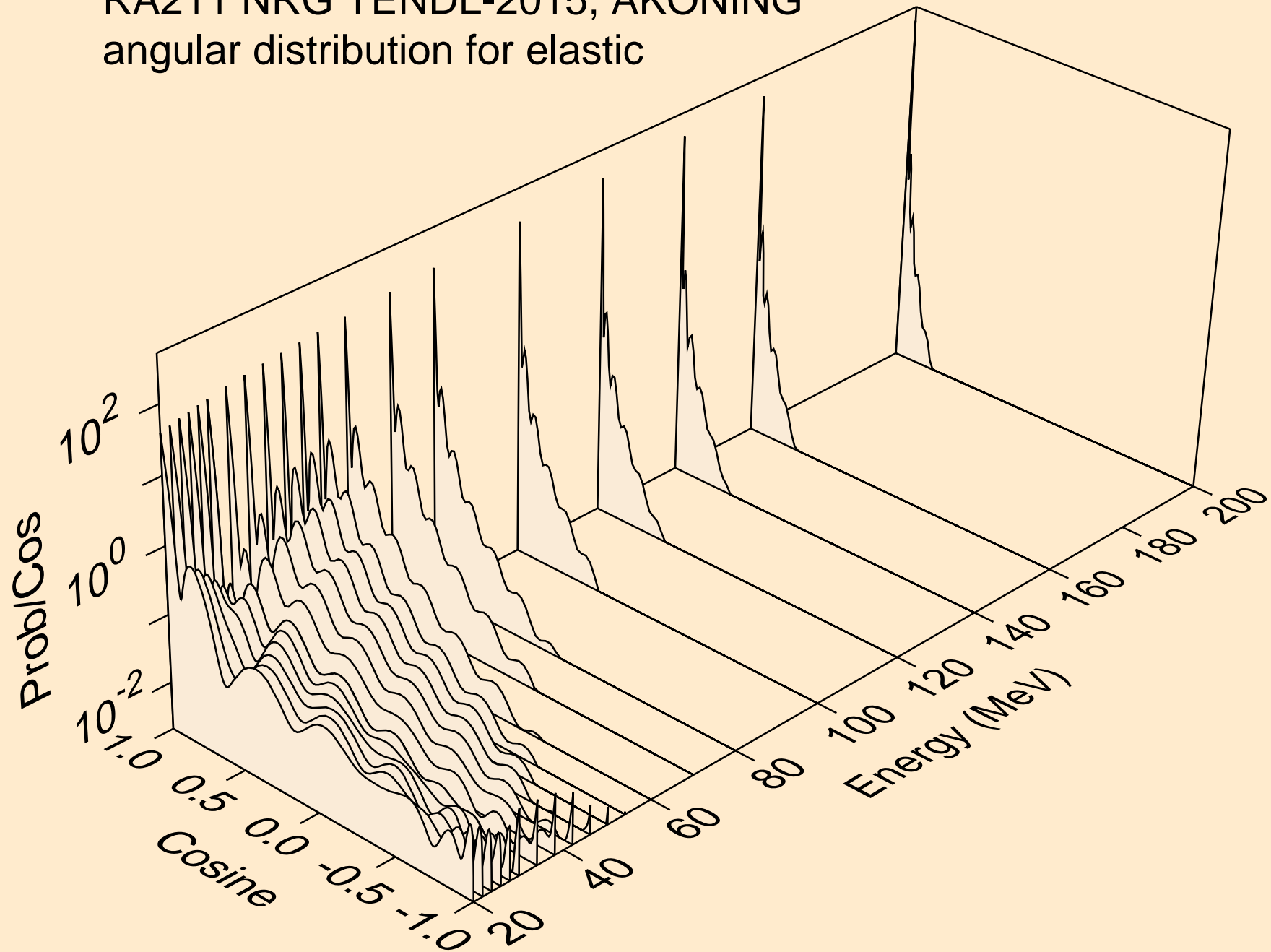

RA211 NRG TENDL-2015, AKONING
angular distribution for (n,n*1)

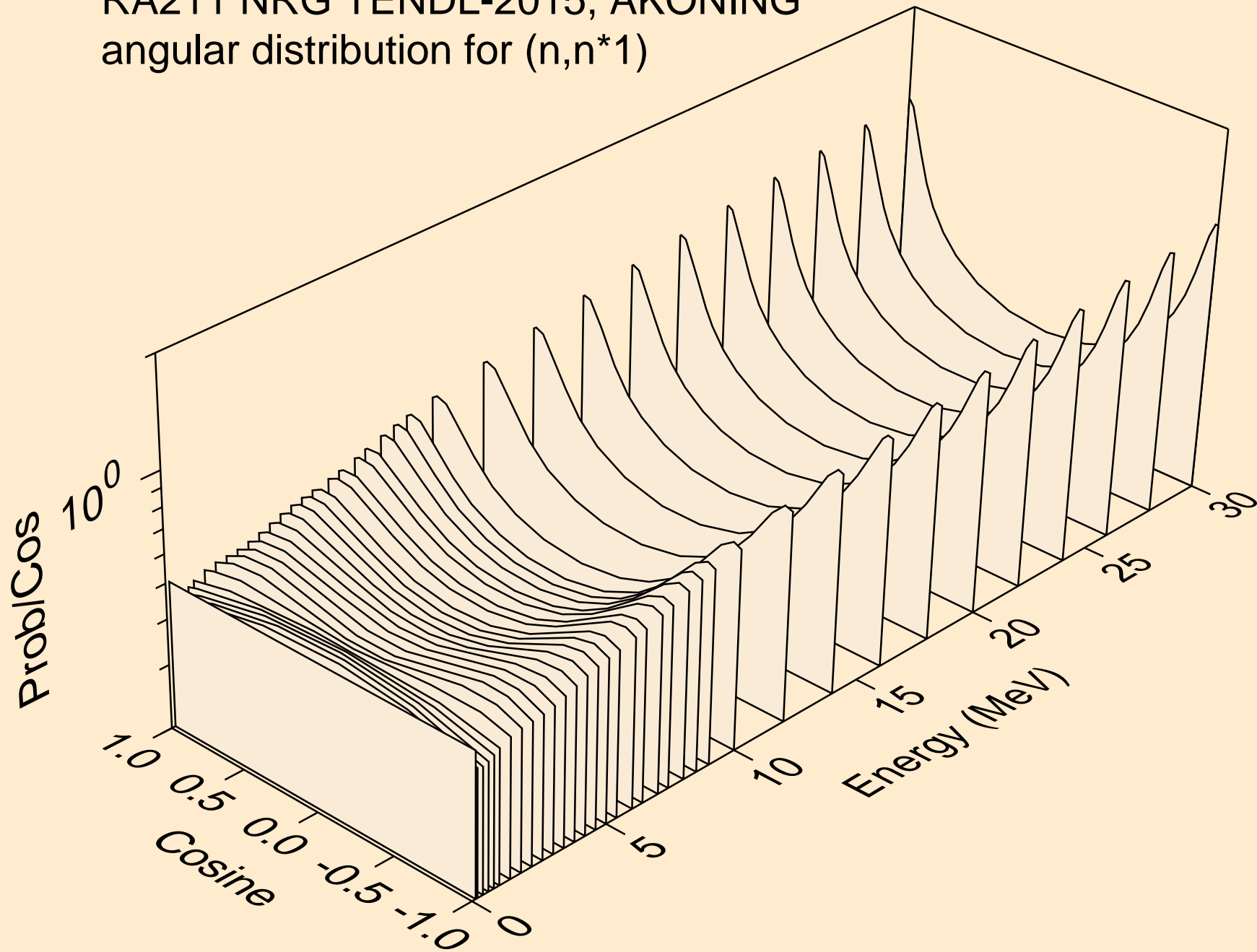

RA211 NRG TENDL-2015, AKONING
angular distribution for (n,n*2)

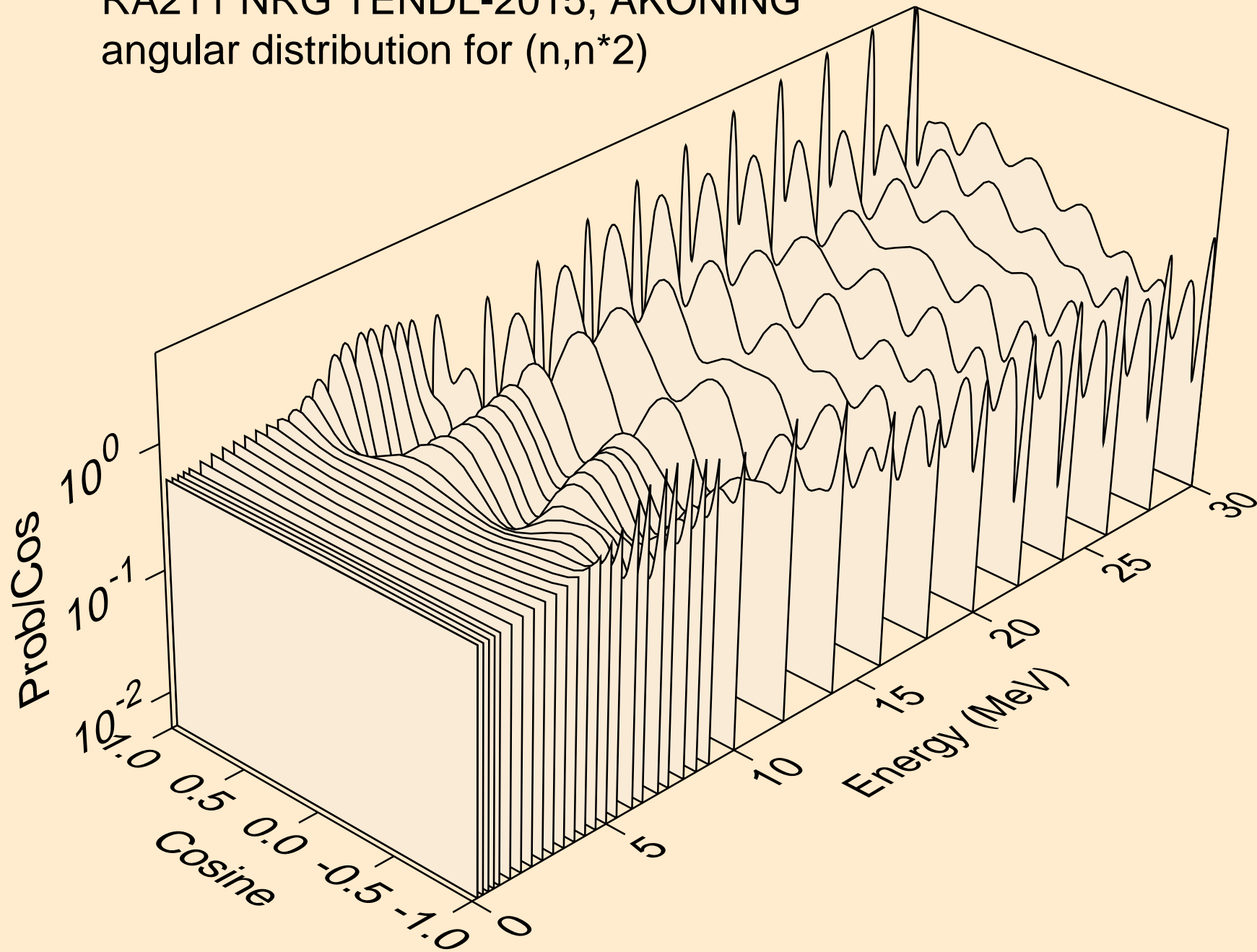

RA211 NRG TENDL-2015, AKONING
angular distribution for (n,n*3)

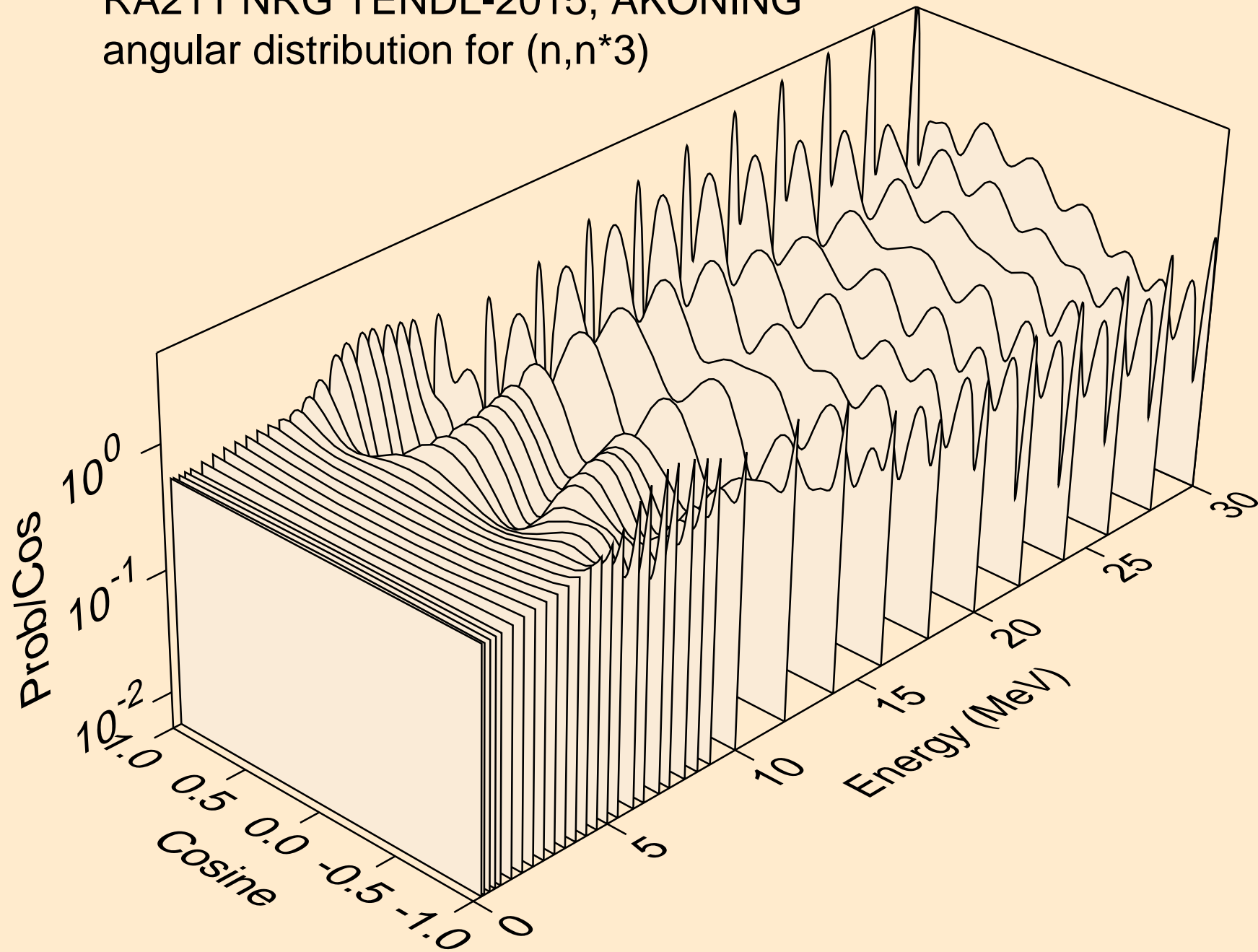

RA211 NRG TENDL-2015, AKONING
angular distribution for (n,n*4)

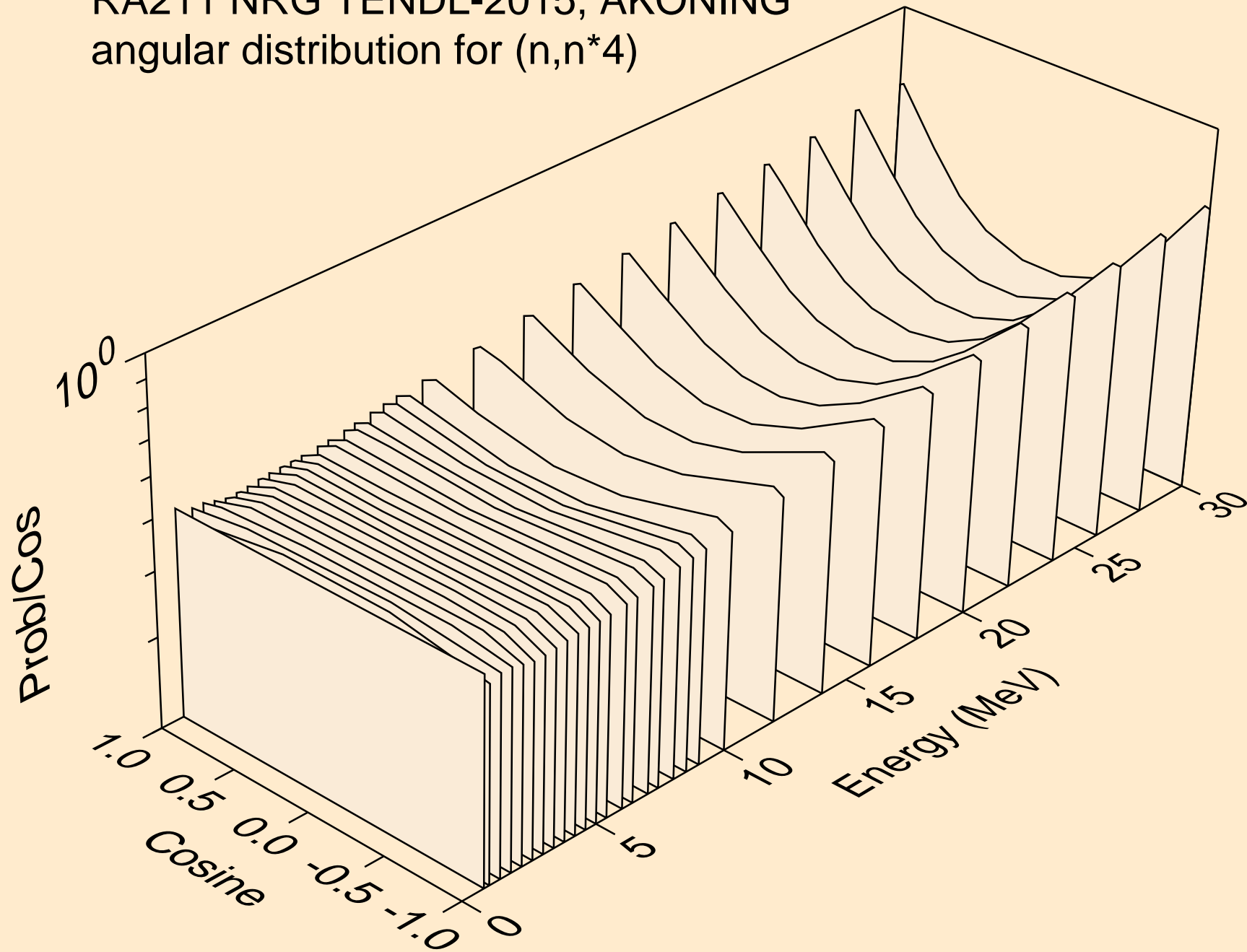

RA211 NRG TENDL-2015, AKONING
angular distribution for (n,n*5)

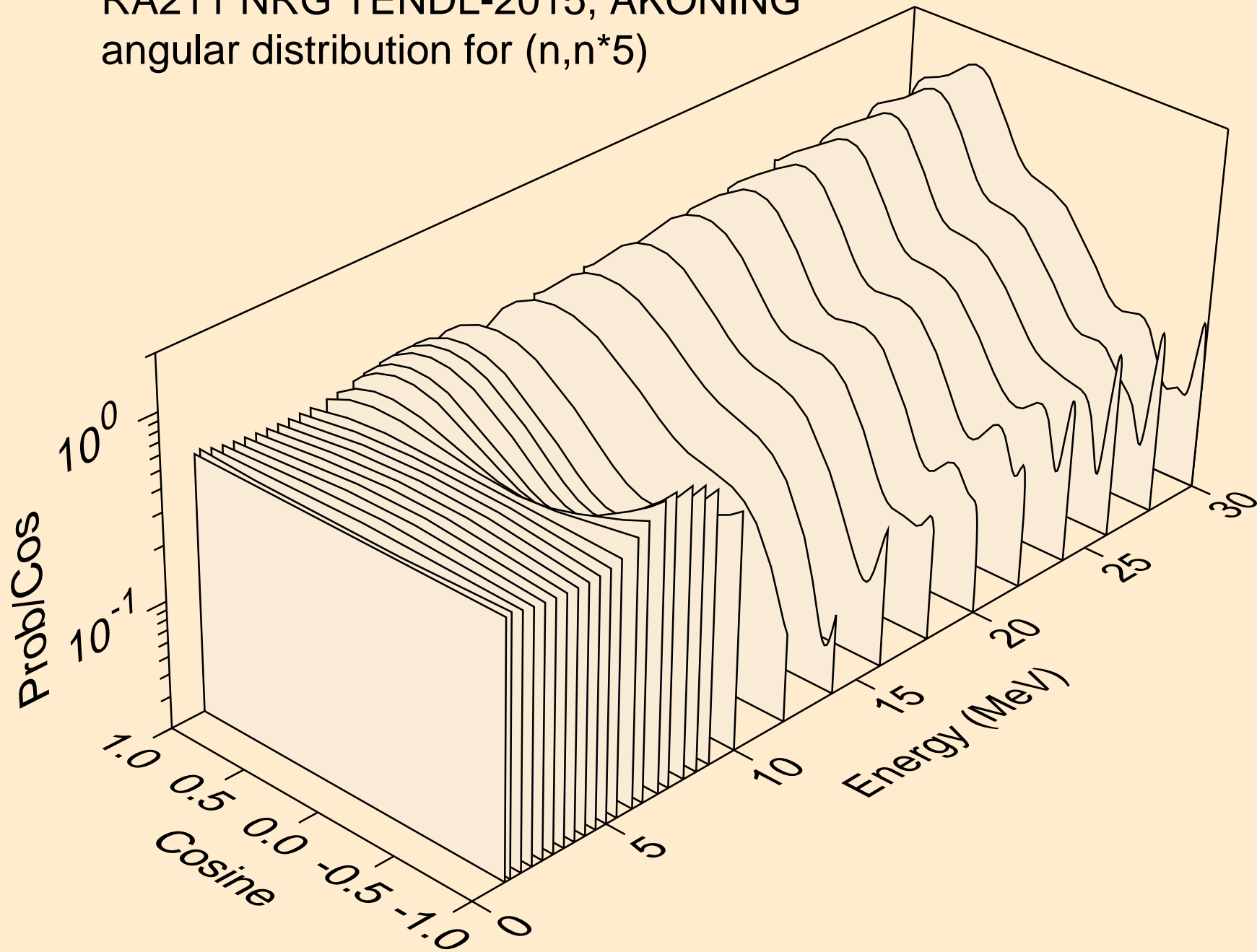

RA211 NRG TENDL-2015, AKONING
angular distribution for (n,n*6)

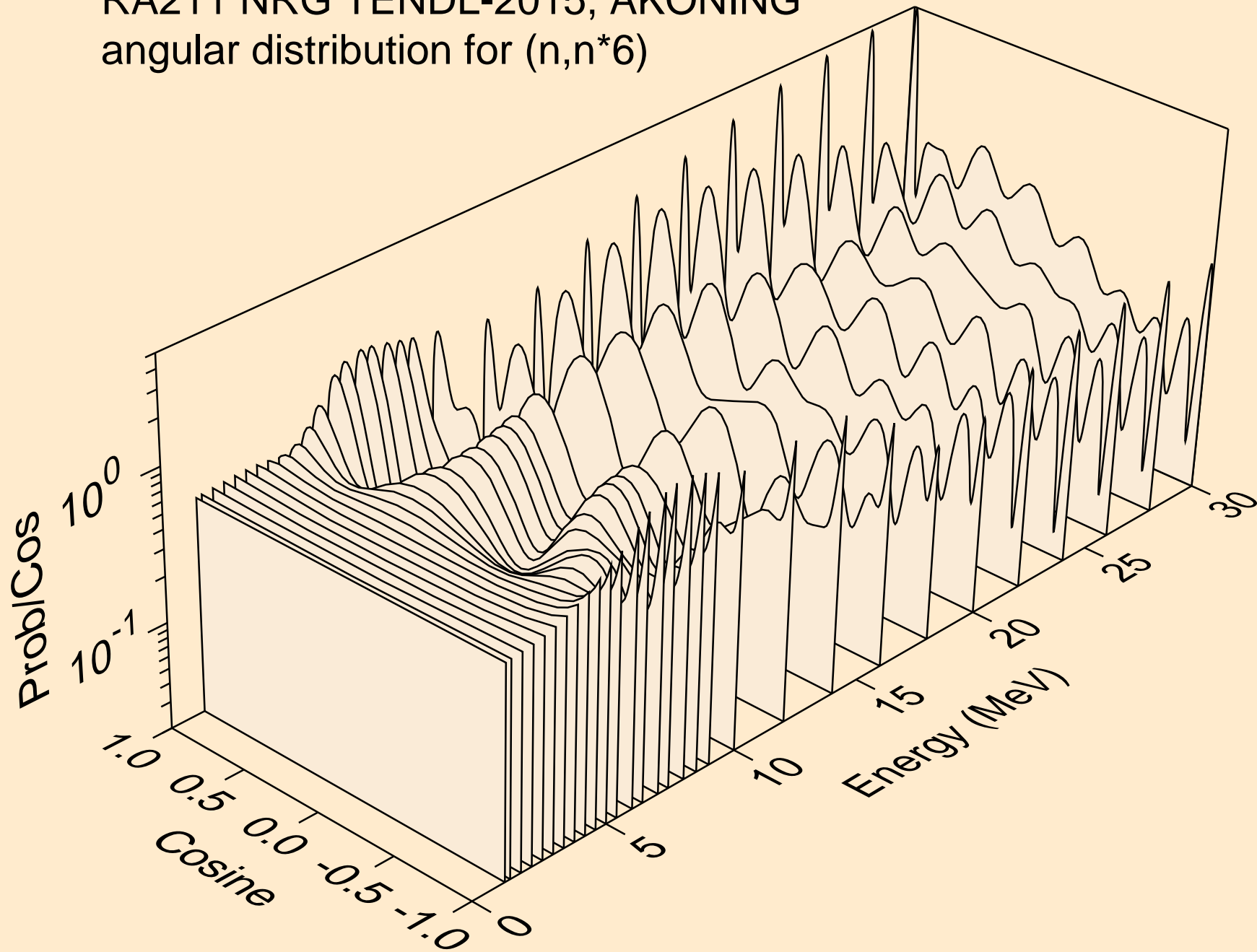

RA211 NRG TENDL-2015, AKONING
angular distribution for (n,n*7)

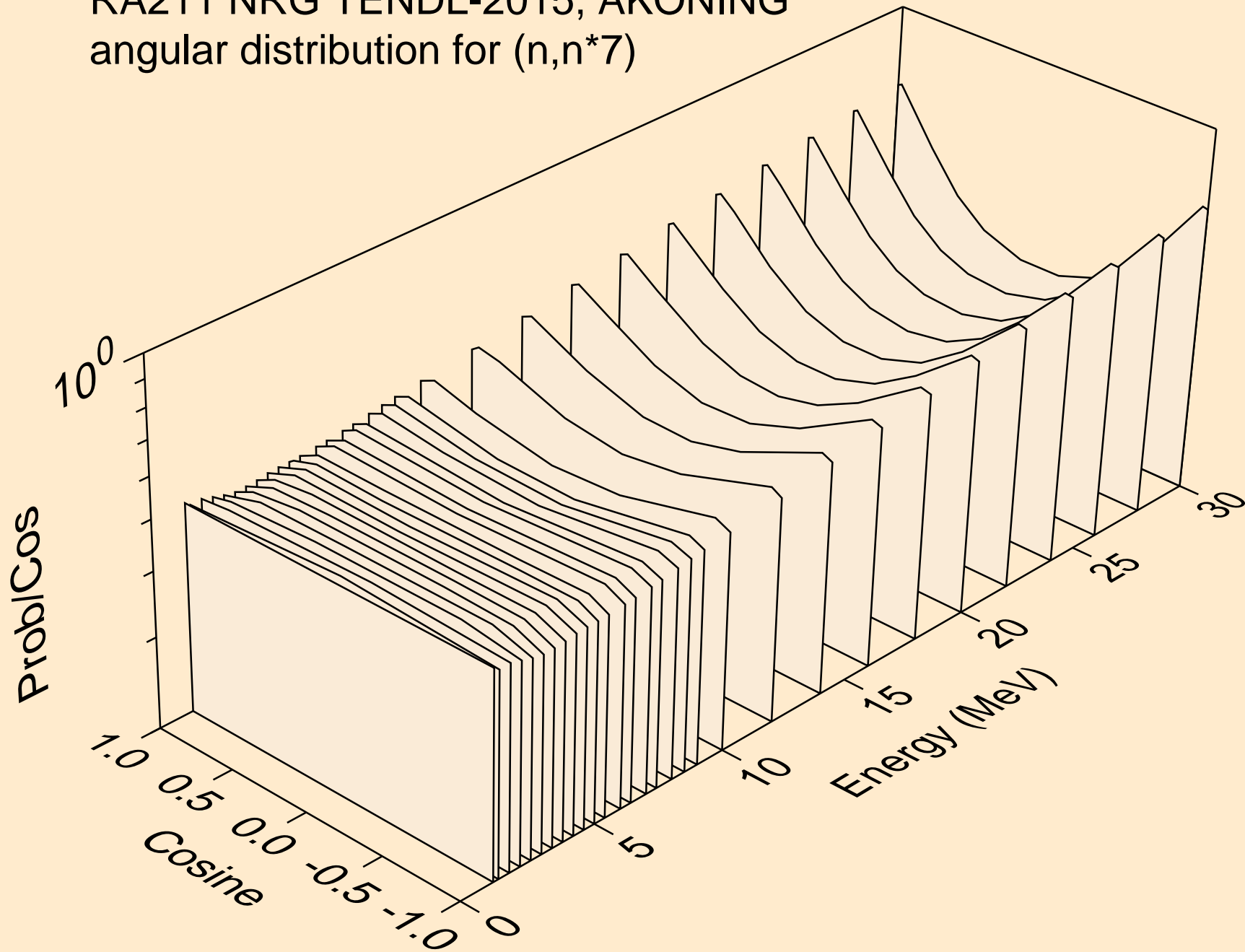

RA211 NRG TENDL-2015, AKONING
angular distribution for (n,n*8)

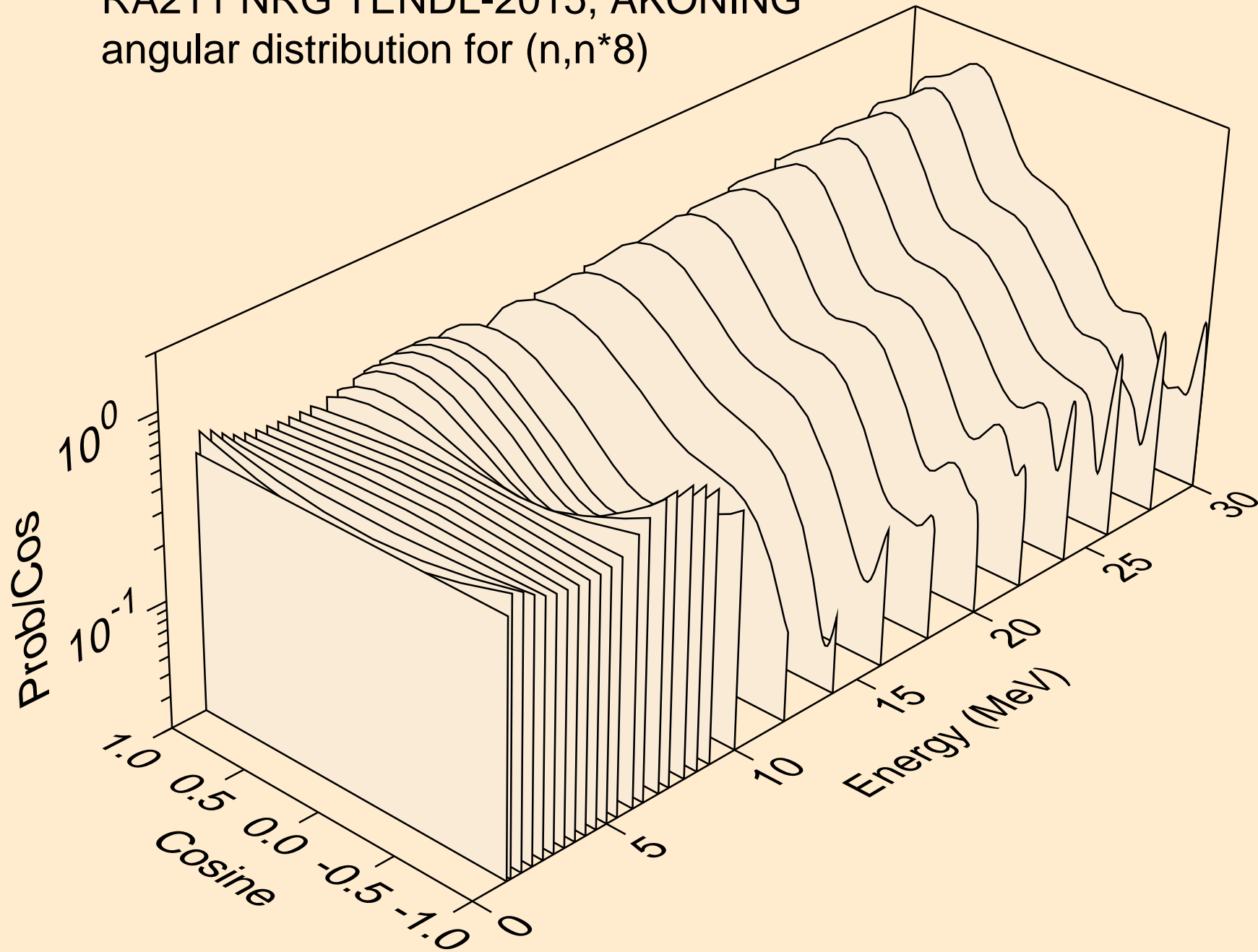

RA211 NRG TENDL-2015, AKONING
angular distribution for (n,n*9)

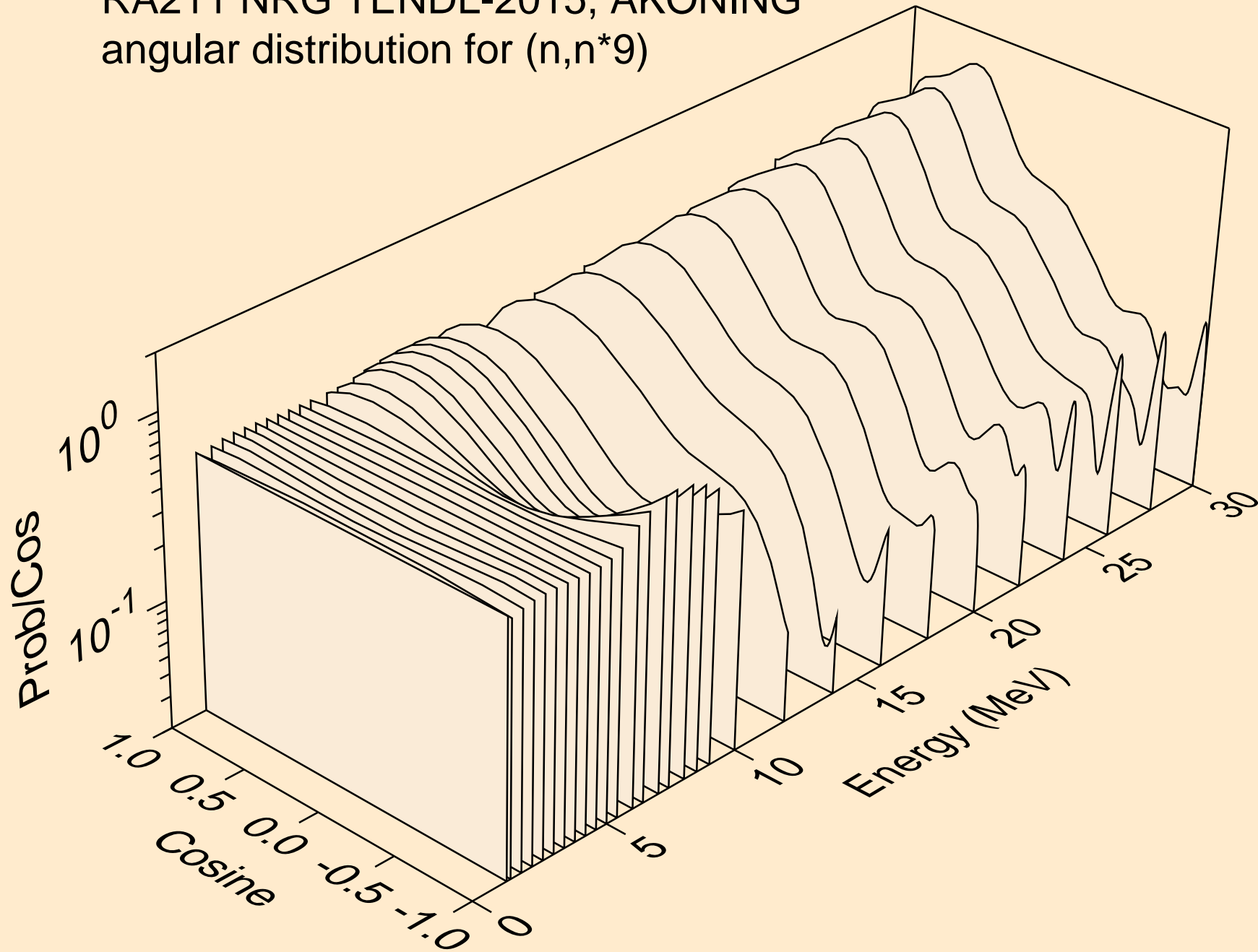

RA211 NRG TENDL-2015, AKONING
angular distribution for (n,n*10)

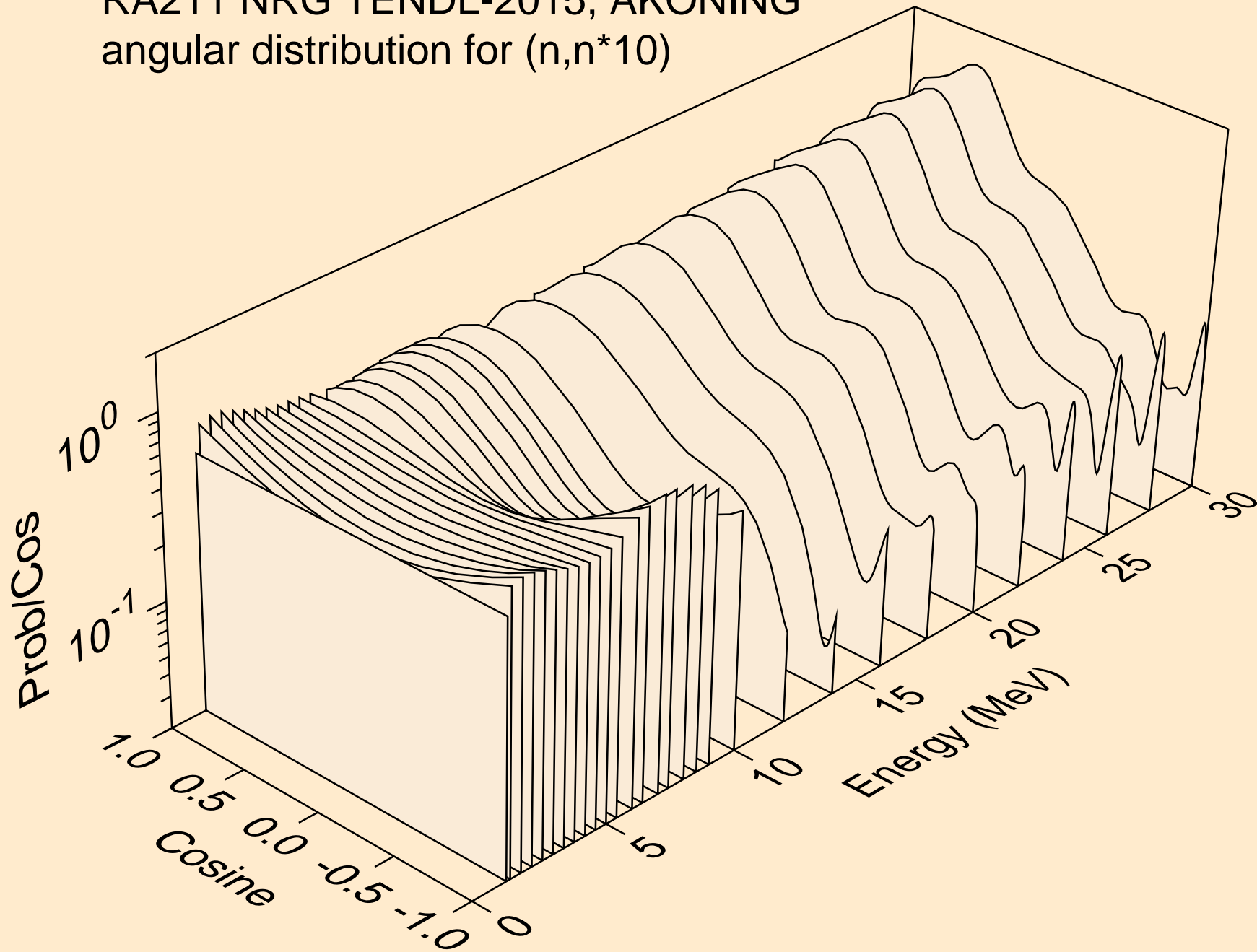

RA211 NRG TENDL-2015, AKONING
angular distribution for (n,n*11)

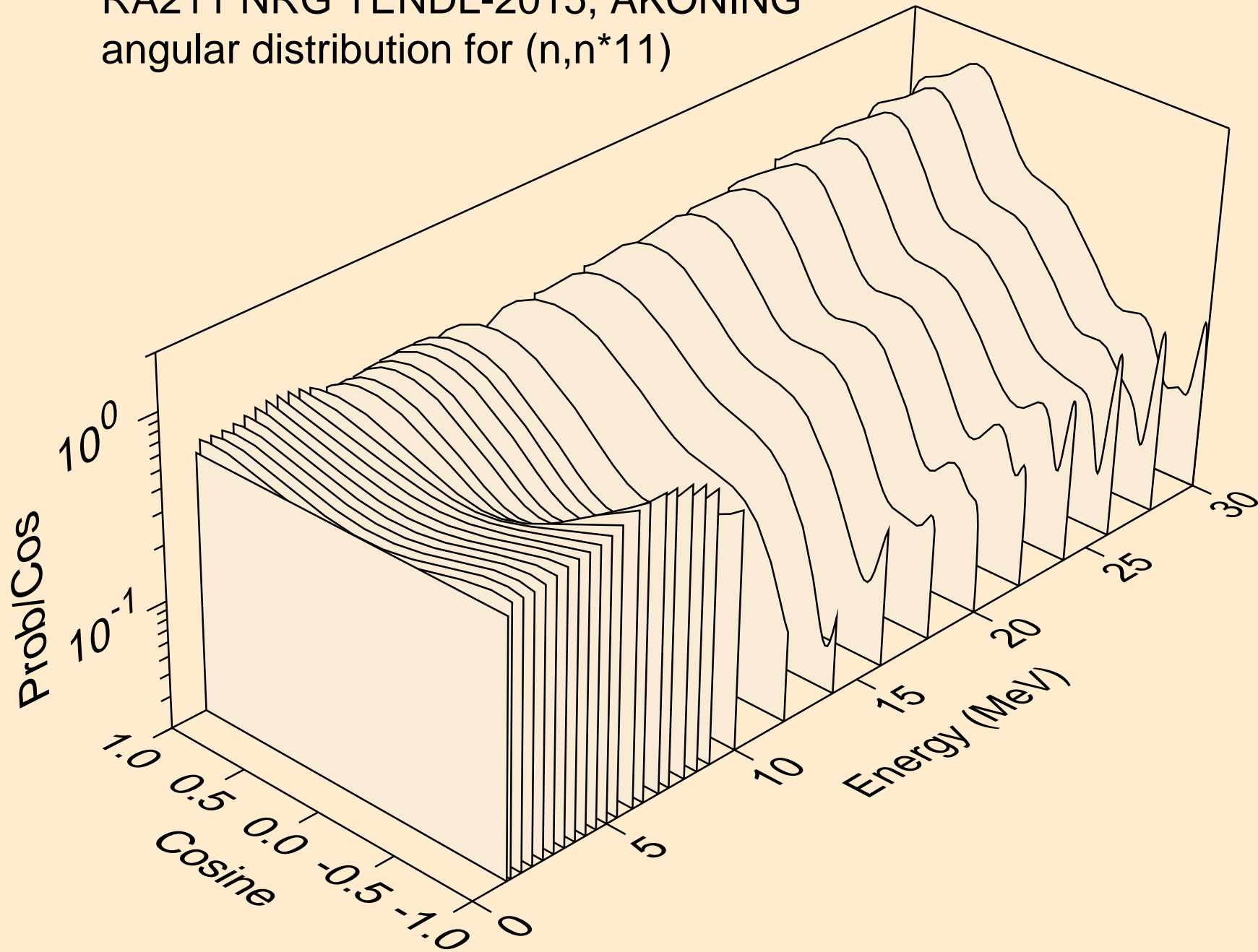

RA211 NRG TENDL-2015, AKONING
angular distribution for (n,n*12)

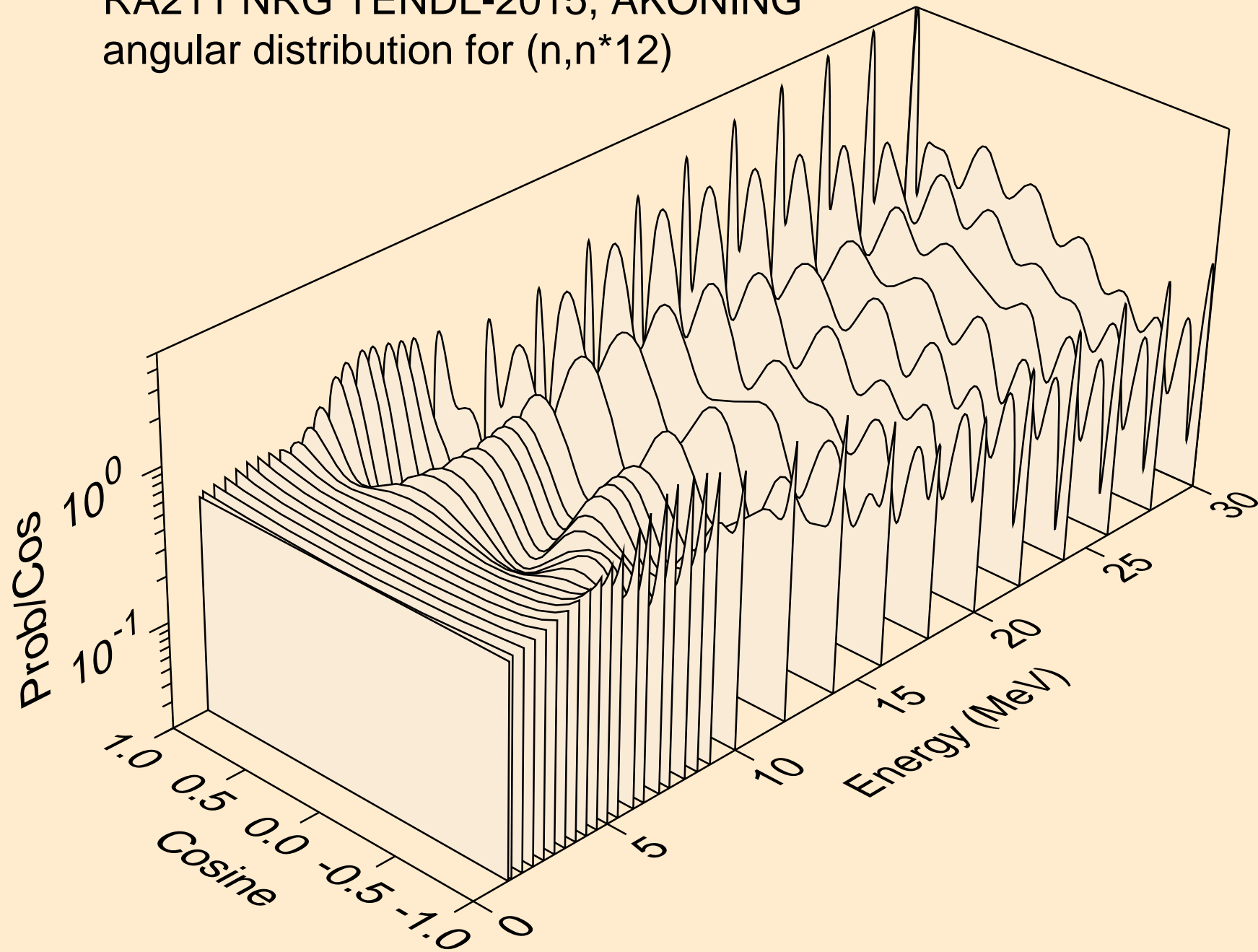

RA211 NRG TENDL-2015, AKONING
angular distribution for (n,n*13)

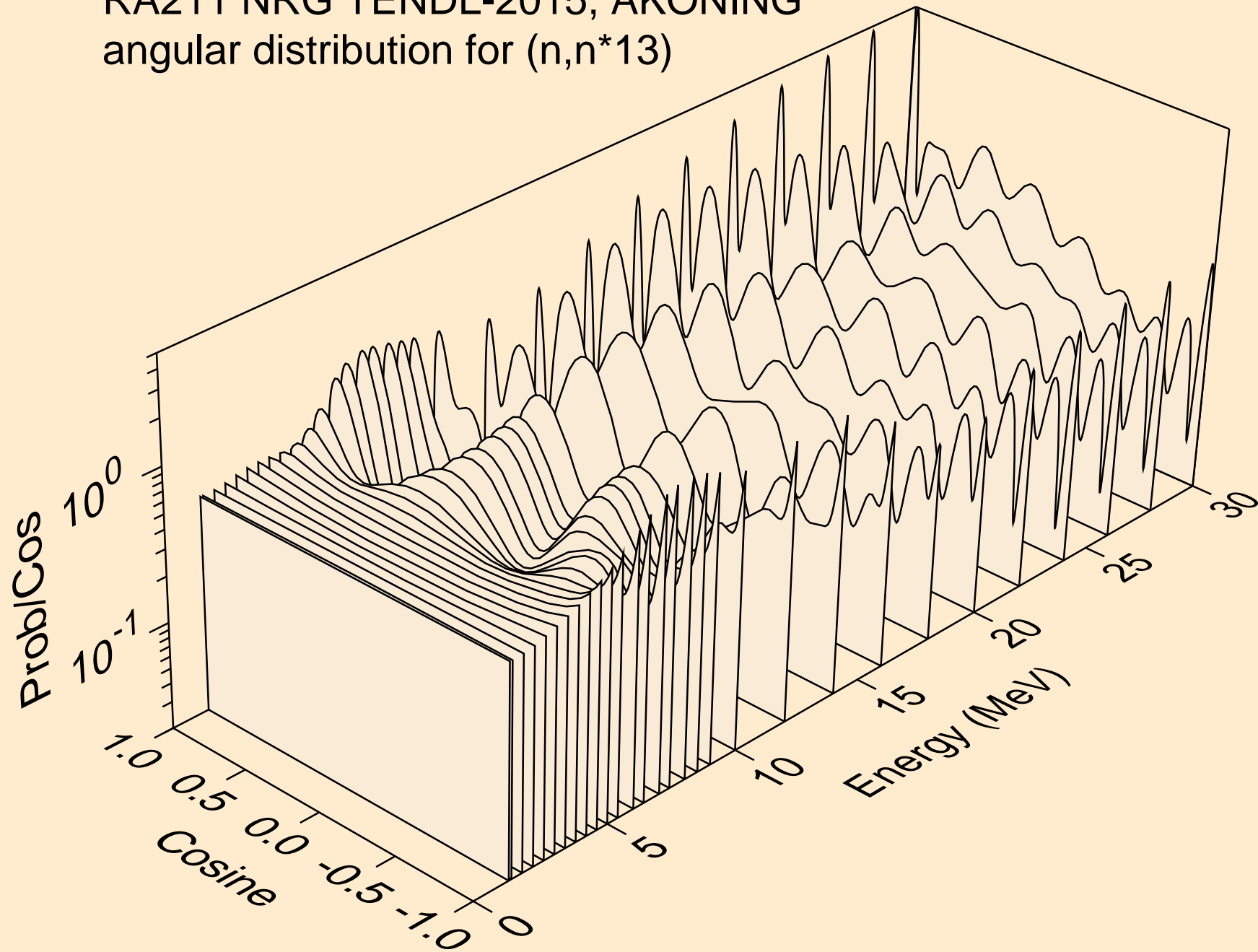

RA211 NRG TENDL-2015, AKONING
angular distribution for (n,n*14)

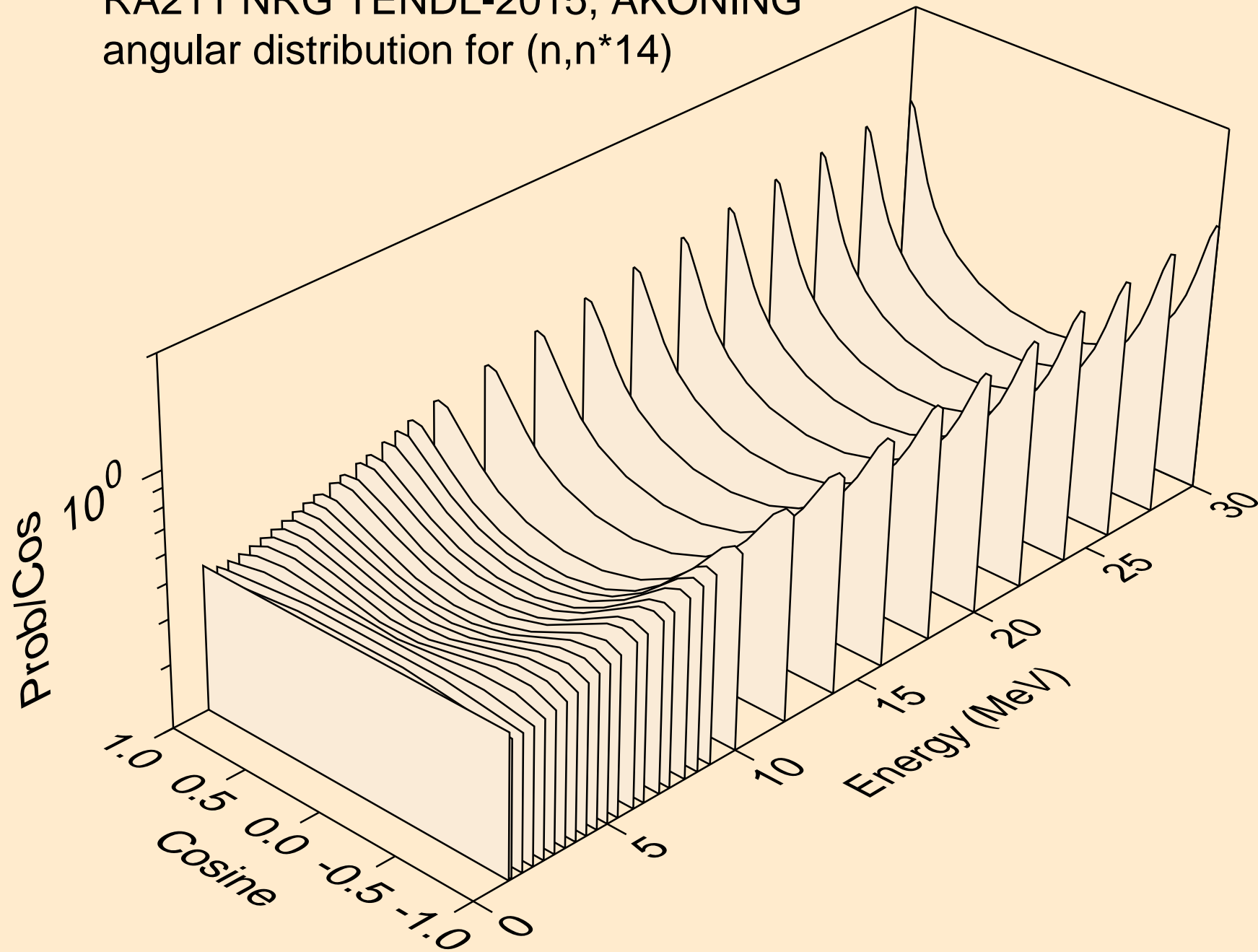

RA211 NRG TENDL-2015, AKONING
angular distribution for (n,n*15)

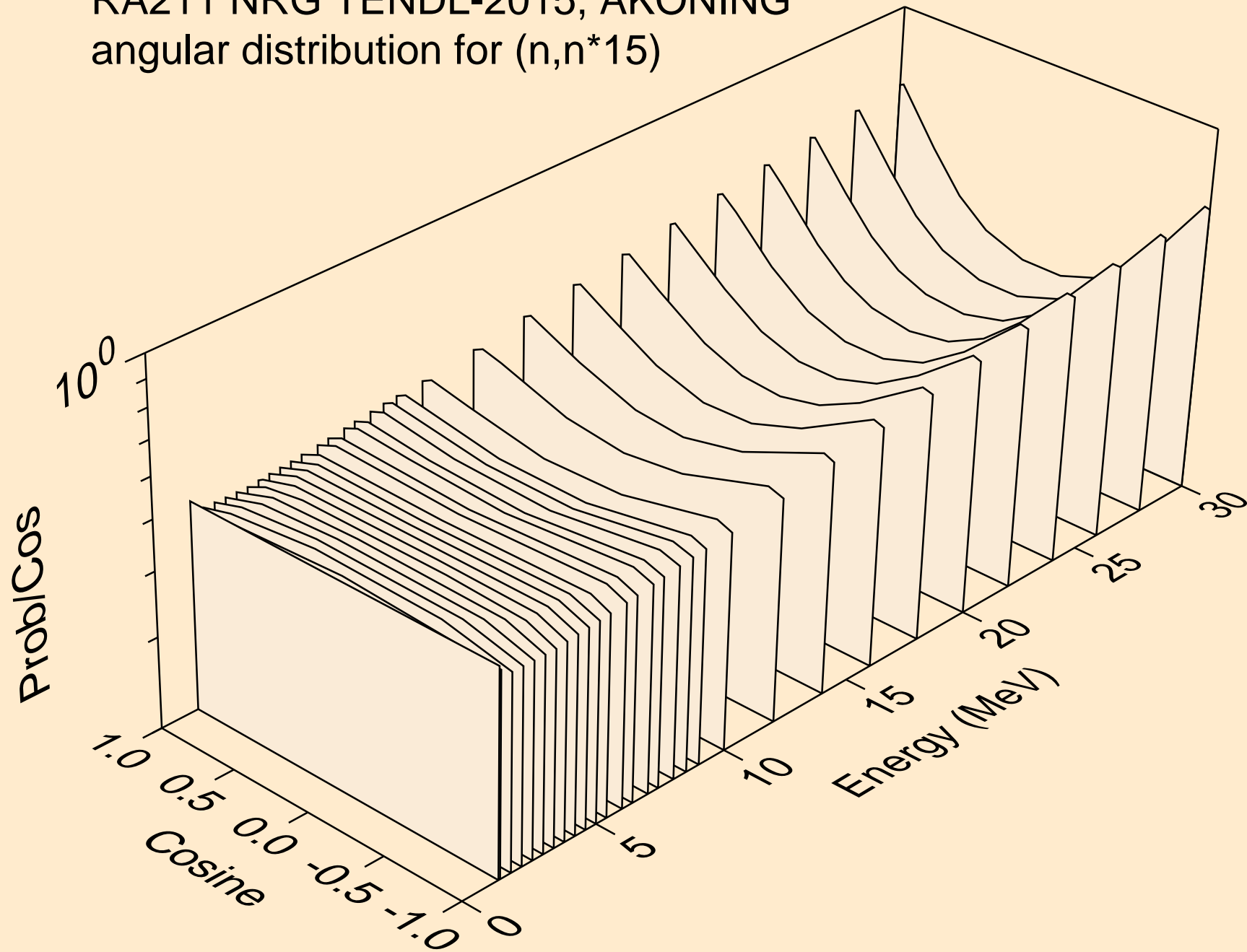

RA211 NRG TENDL-2015, AKONING
angular distribution for (n,n*16)

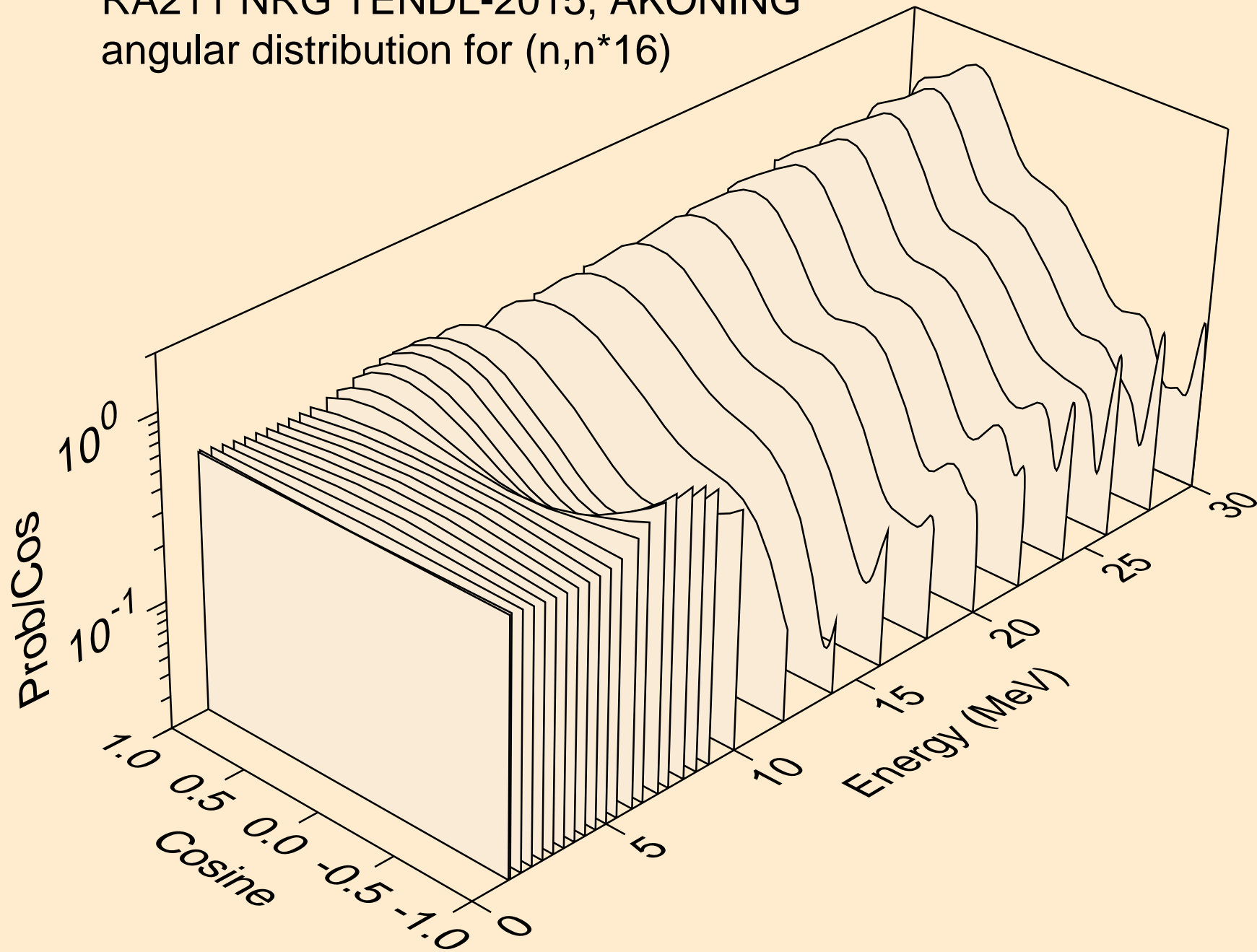

RA211 NRG TENDL-2015, AKONING
angular distribution for (n,n*17)

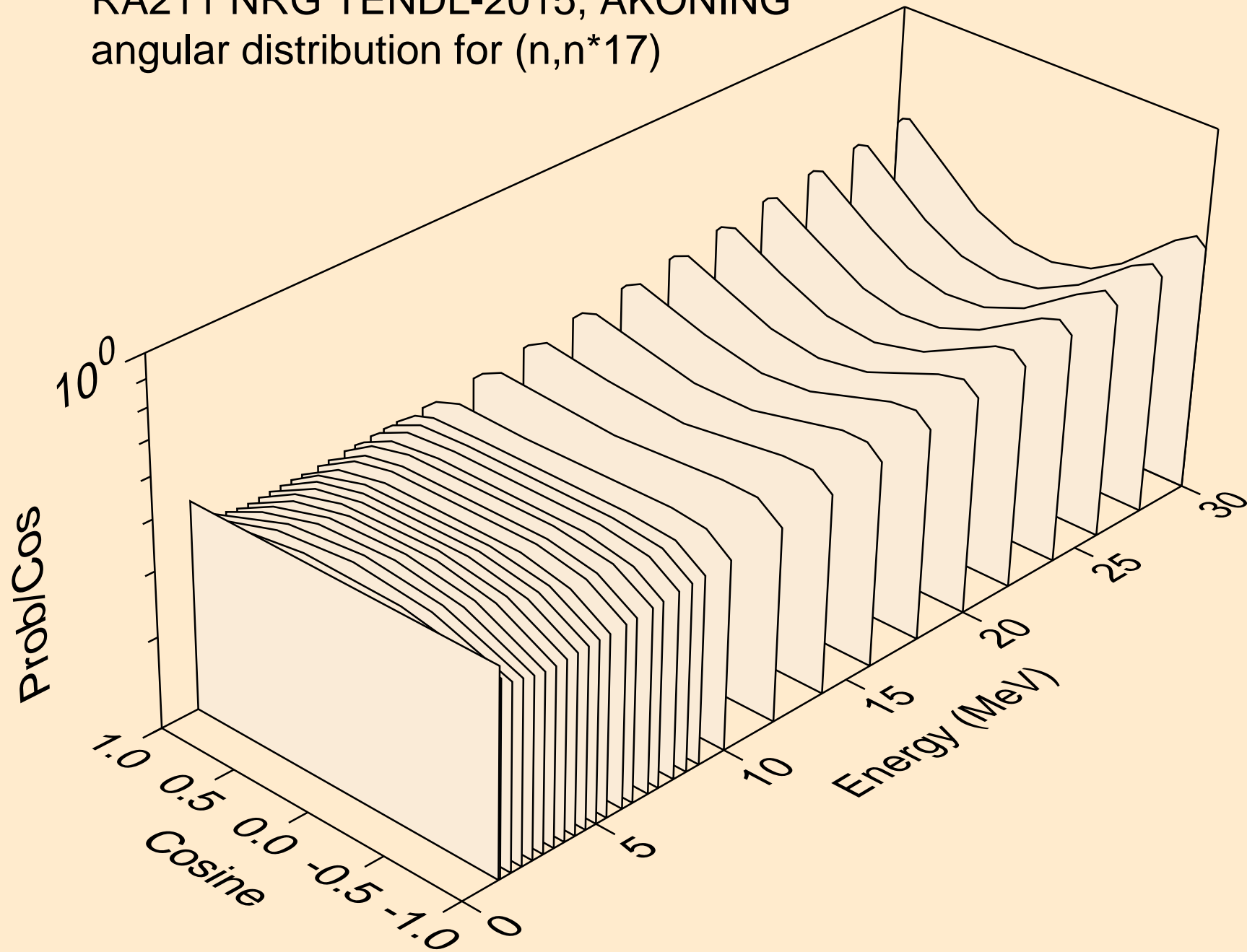

RA211 NRG TENDL-2015, AKONING
angular distribution for (n,n*18)

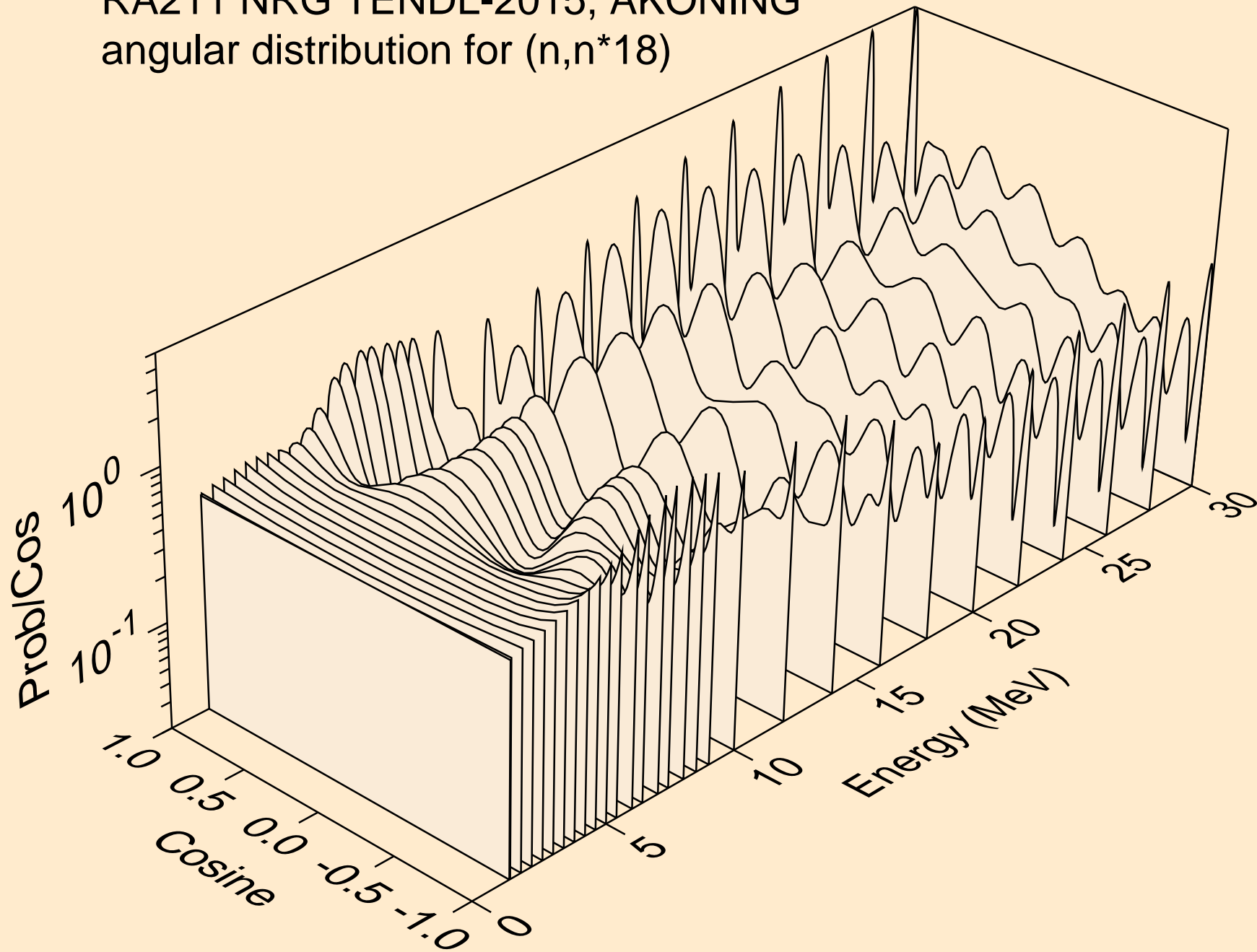

RA211 NRG TENDL-2015, AKONING
angular distribution for (n,n*19)

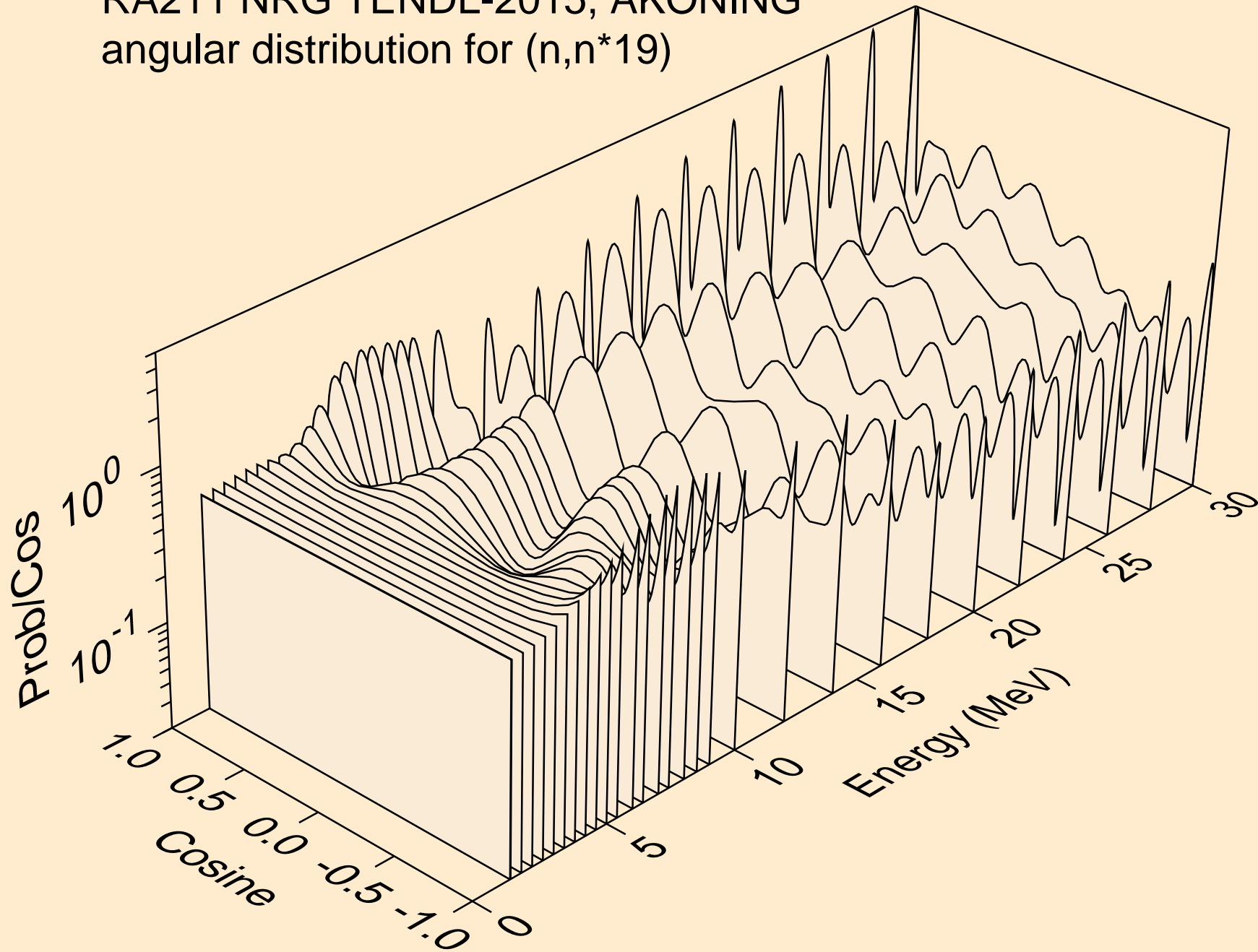

RA211 NRG TENDL-2015, AKONING
angular distribution for (n,n*20)

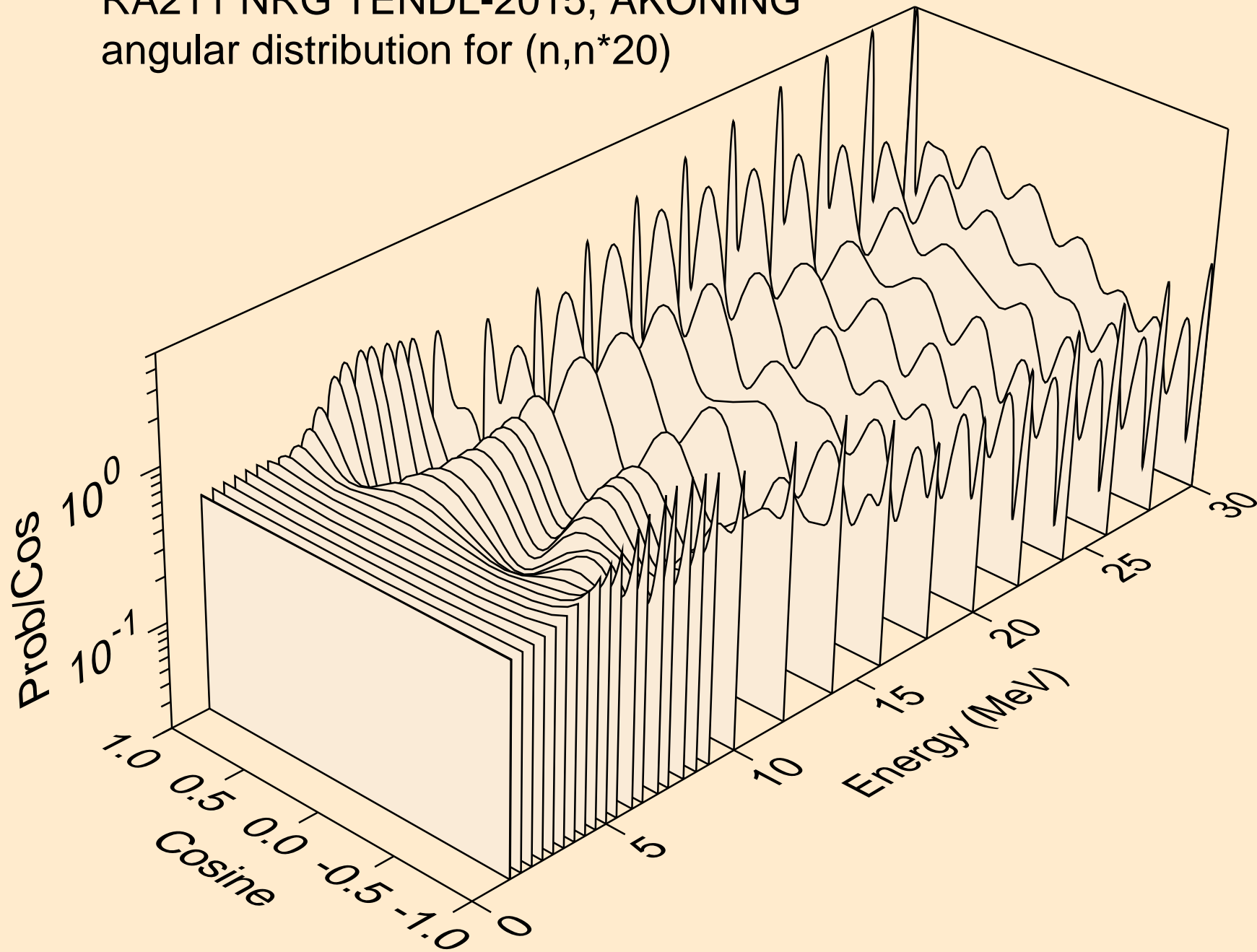

RA211 NRG TENDL-2015, AKONING
angular distribution for (n,n*21)

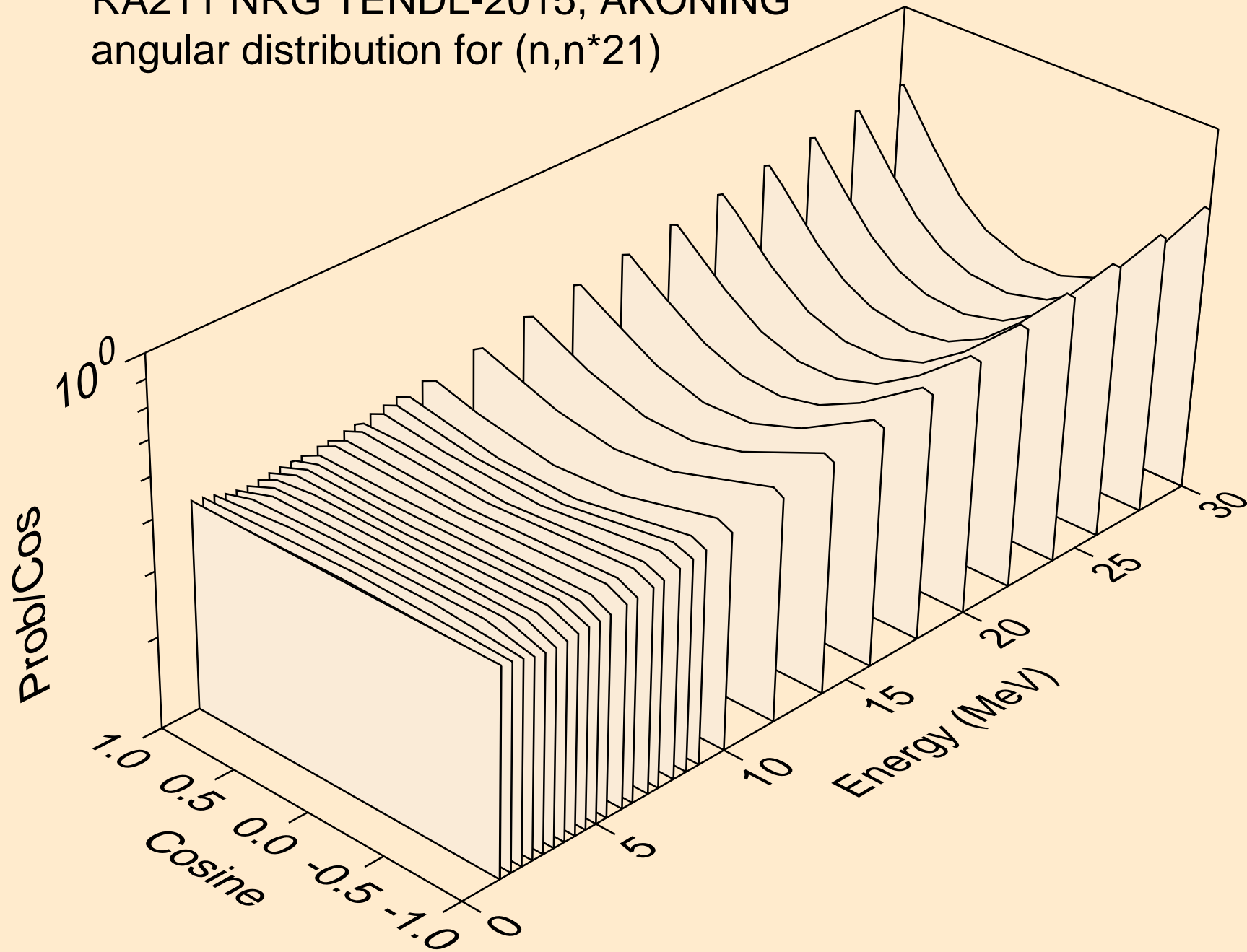

RA211 NRG TENDL-2015, AKONING
angular distribution for (n,n*22)

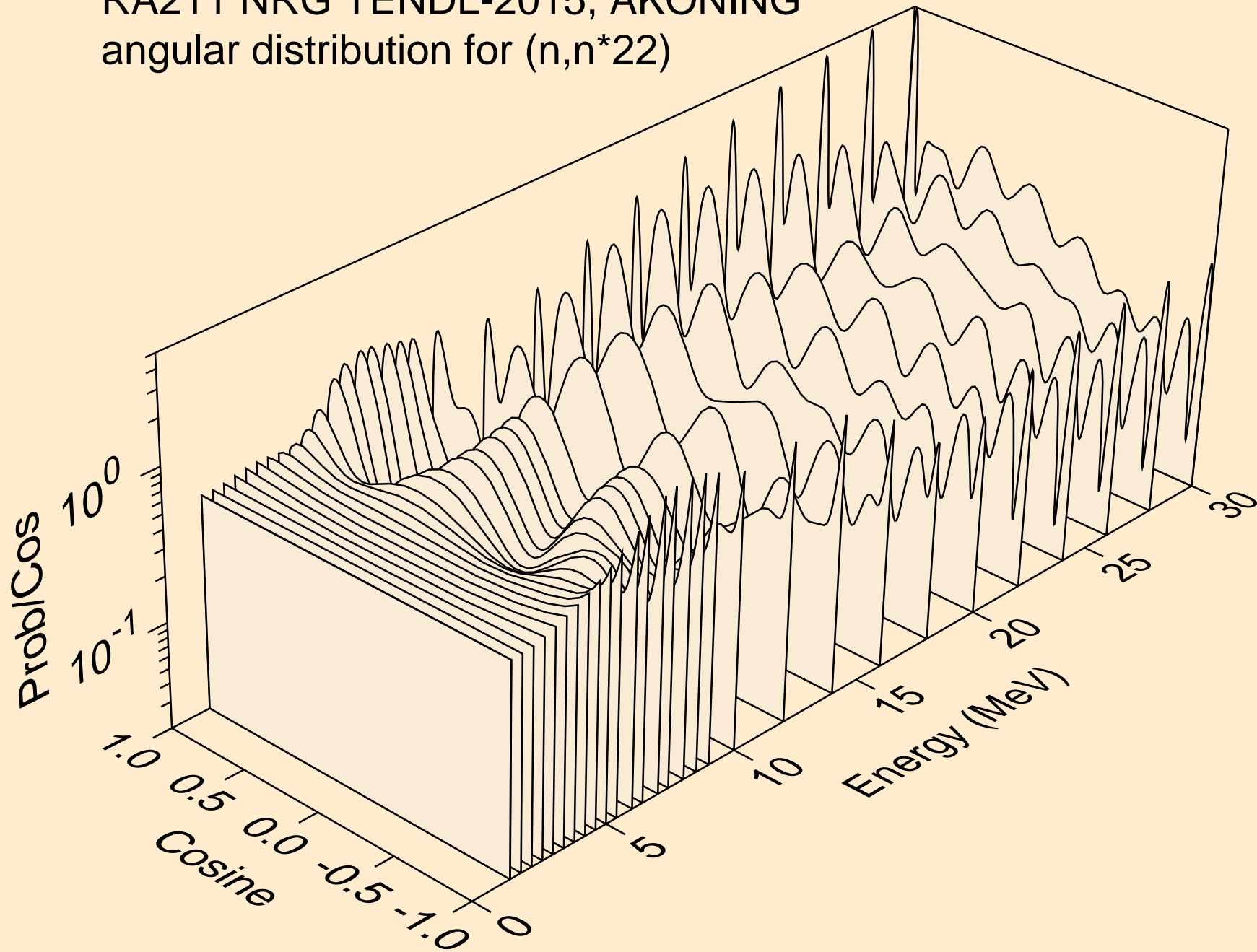

RA211 NRG TENDL-2015, AKONING
angular distribution for (n,n*23)

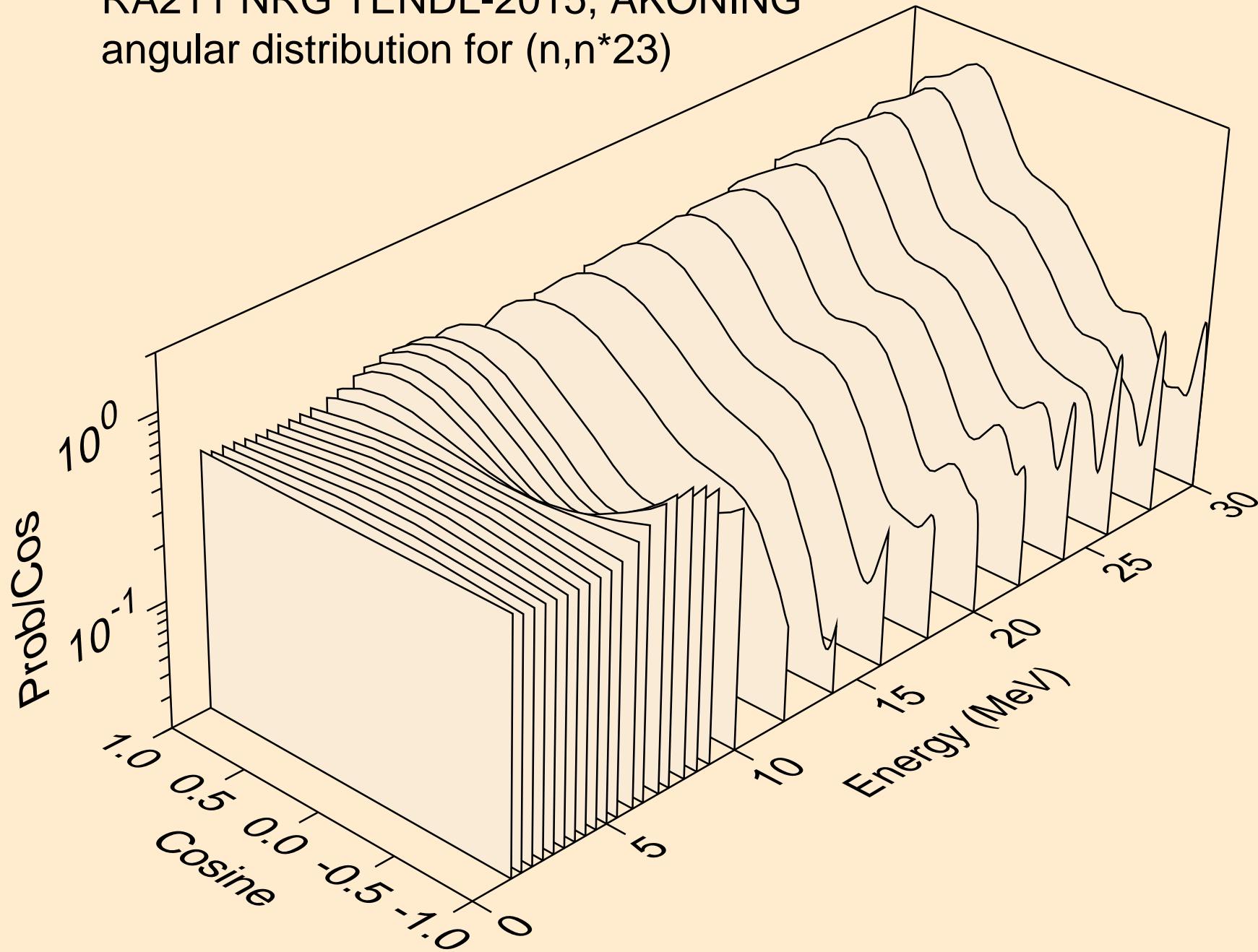

RA211 NRG TENDL-2015, AKONING
angular distribution for (n,n*24)

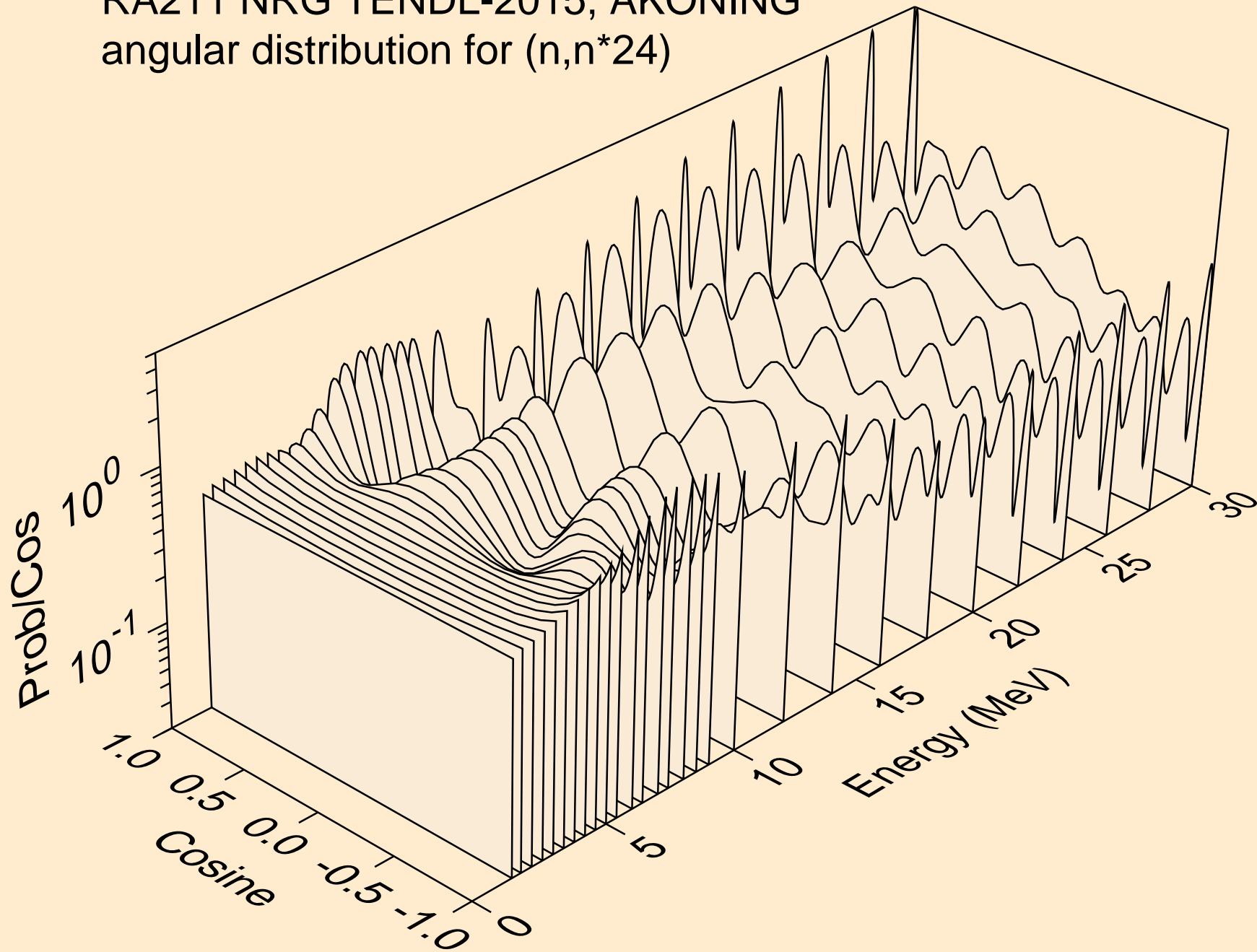

RA211 NRG TENDL-2015, AKONING
angular distribution for (n,n*25)

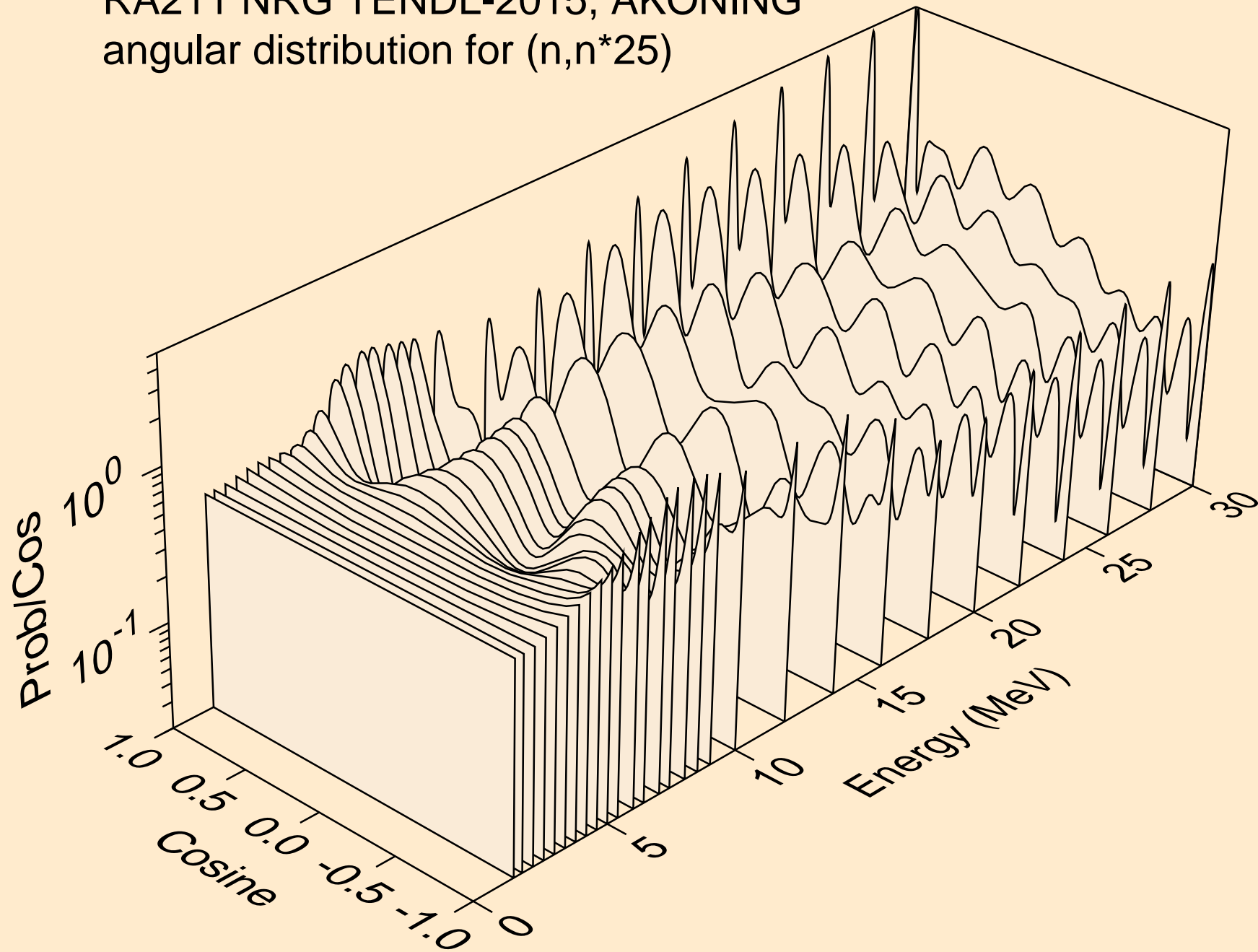

RA211 NRG TENDL-2015, AKONING
angular distribution for (n,n*26)

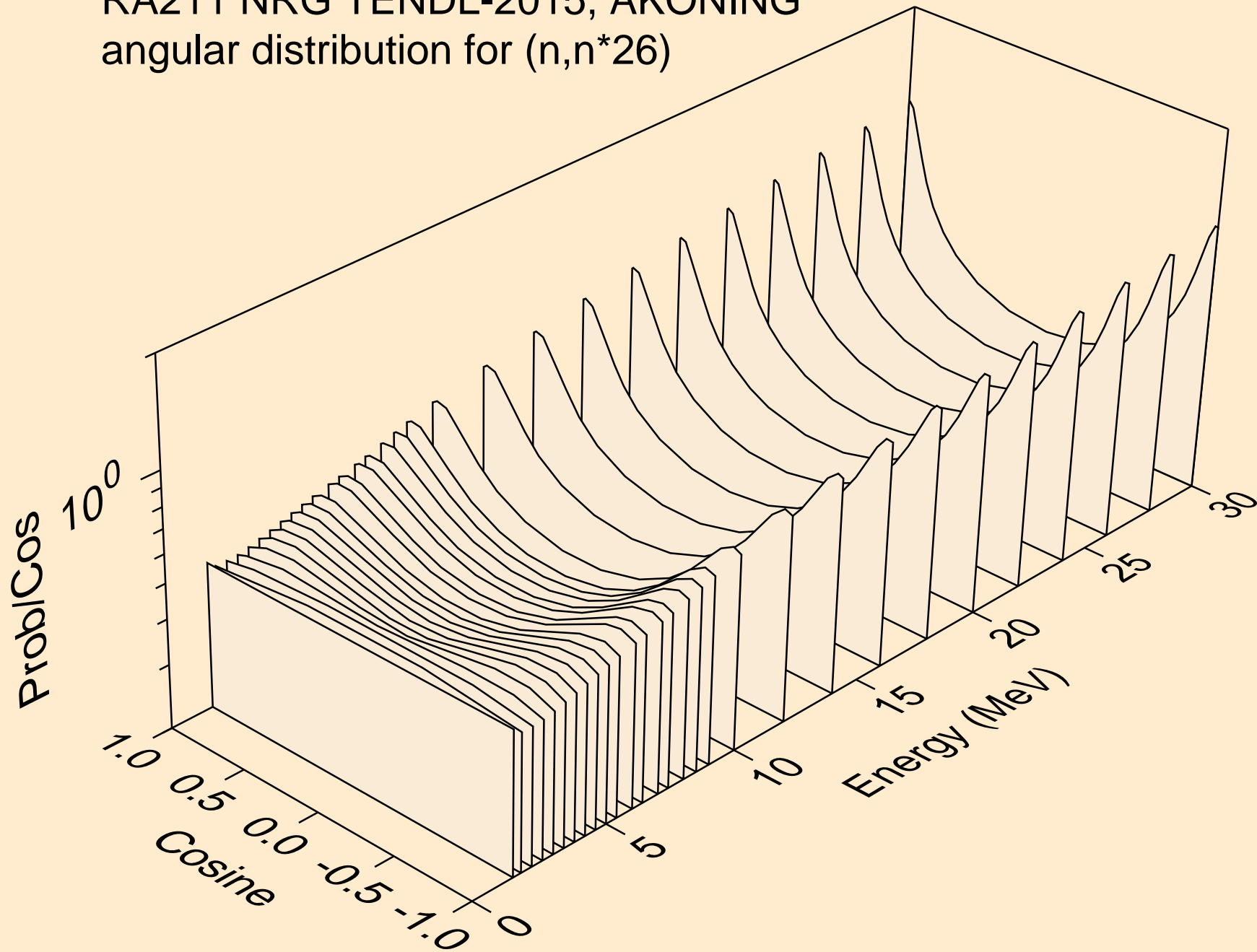

RA211 NRG TENDL-2015, AKONING
angular distribution for (n,n*27)

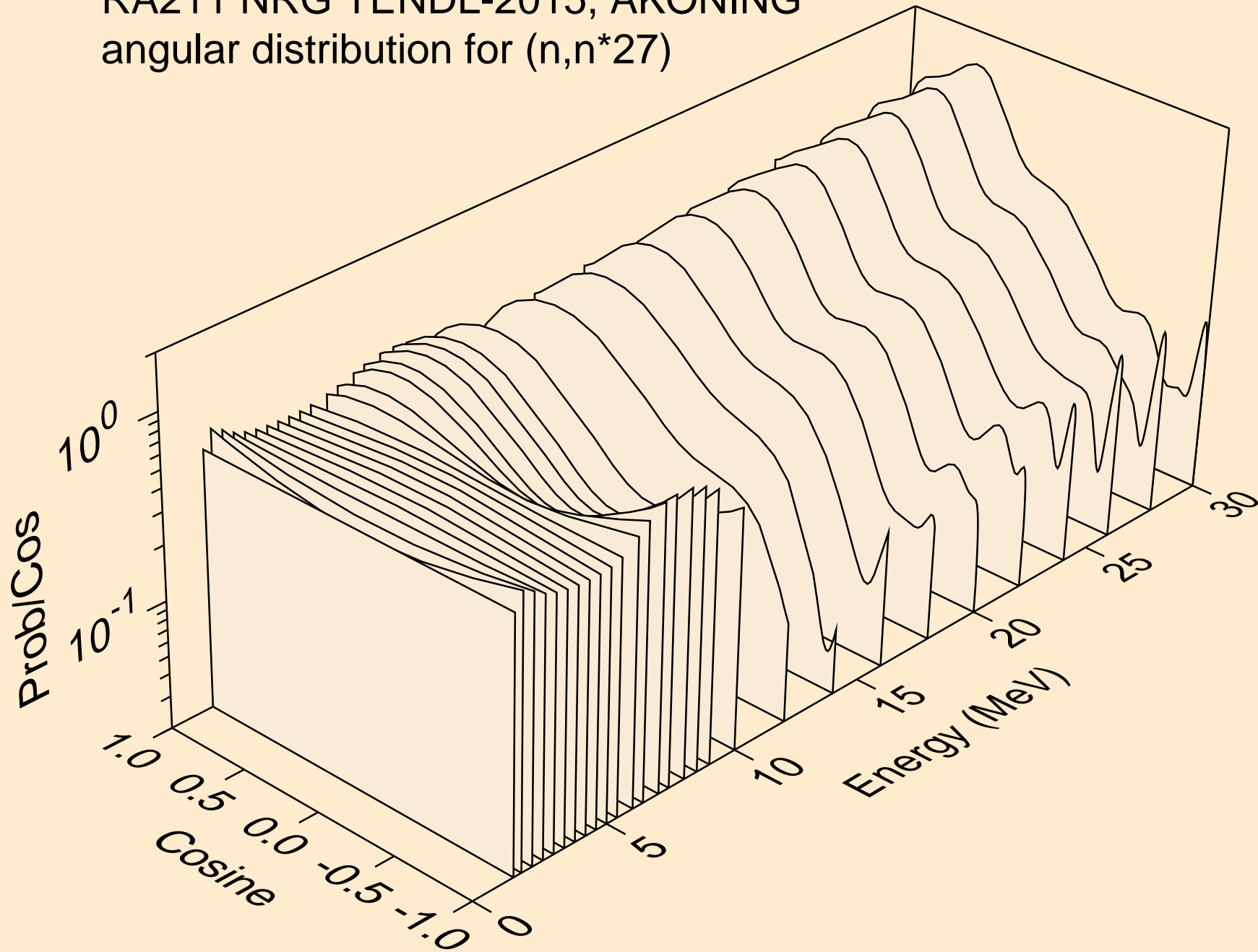

RA211 NRG TENDL-2015, AKONING
angular distribution for (n,n*28)

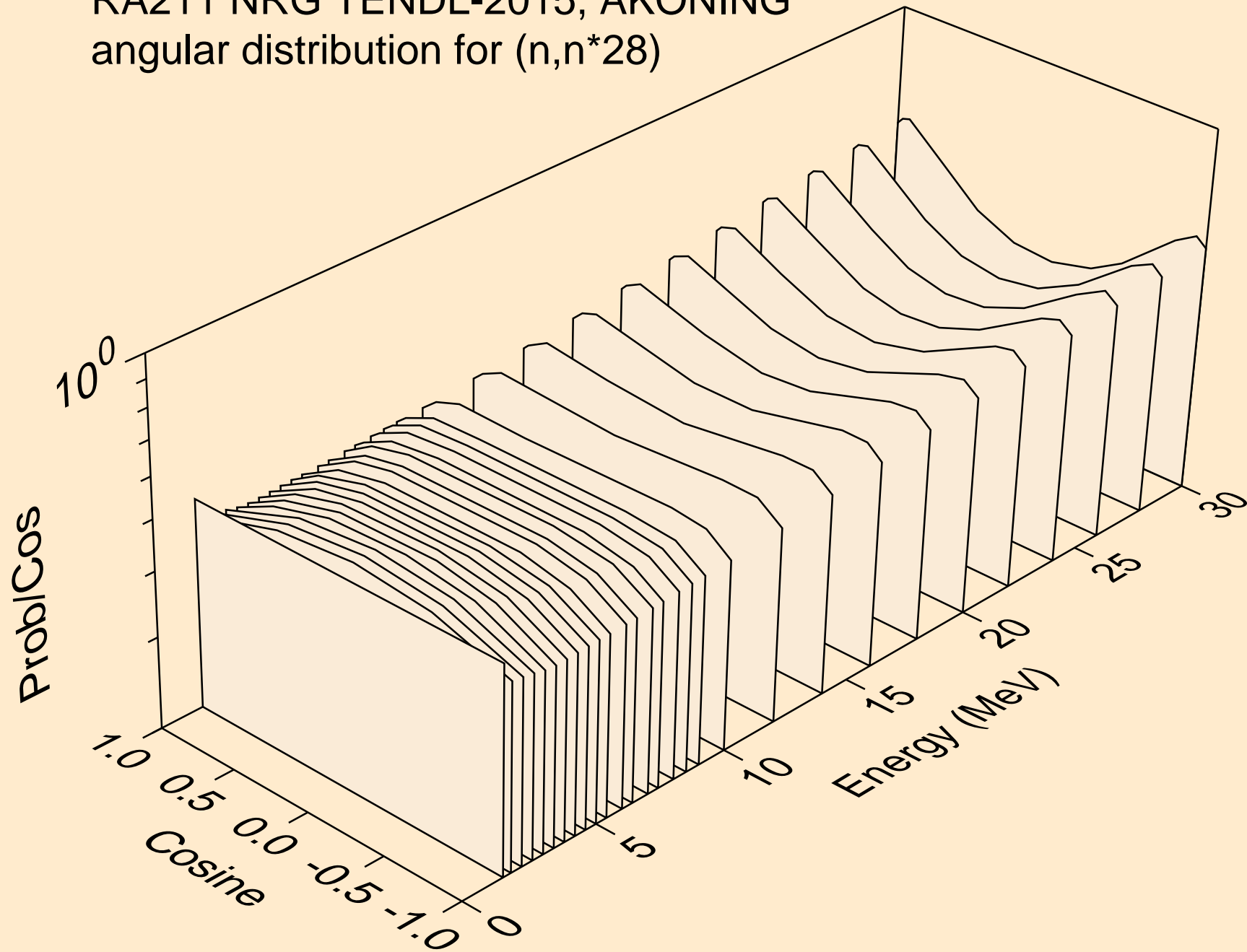

RA211 NRG TENDL-2015, AKONING
angular distribution for (n,n*29)

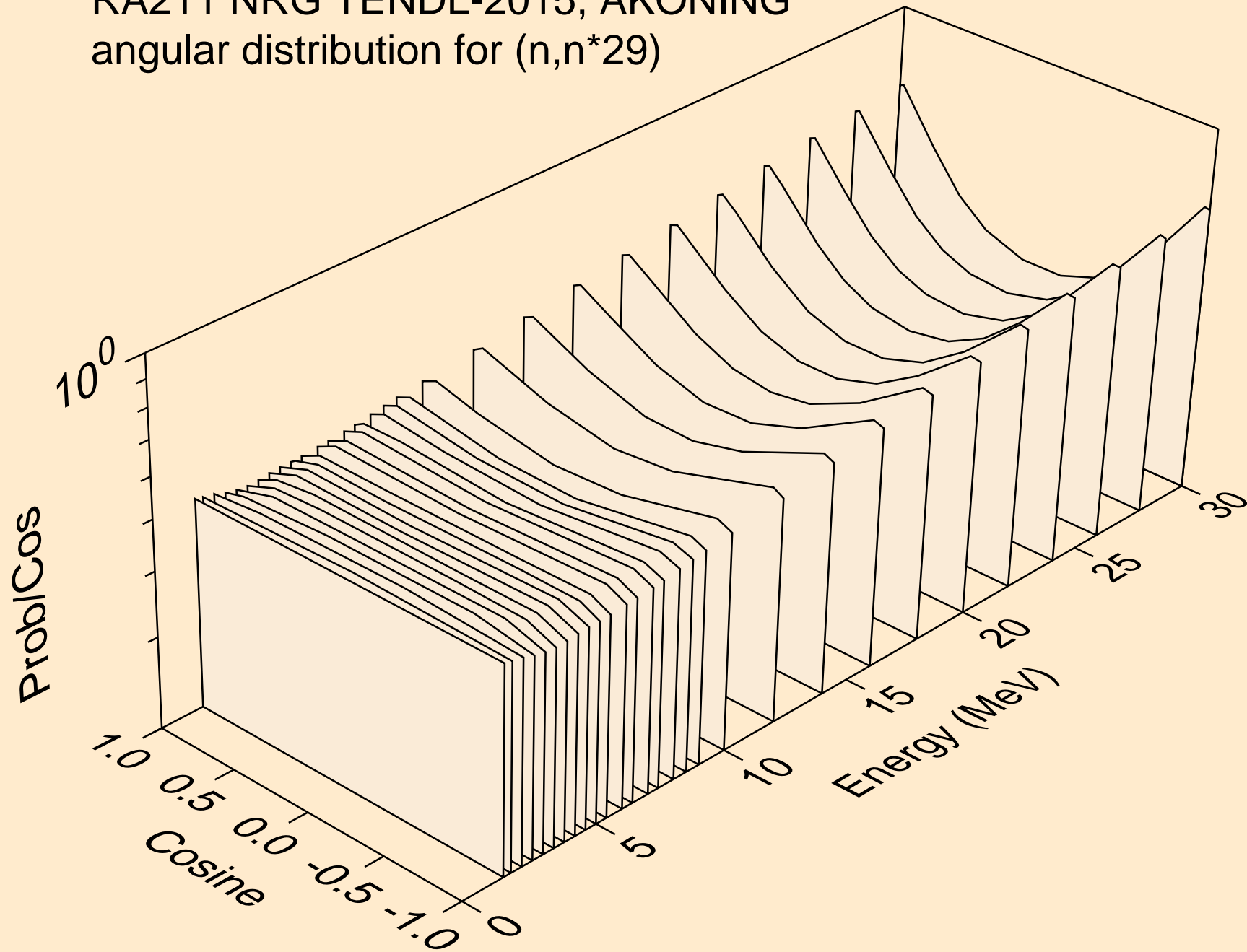

RA211 NRG TENDL-2015, AKONING
angular distribution for (n,n*30)

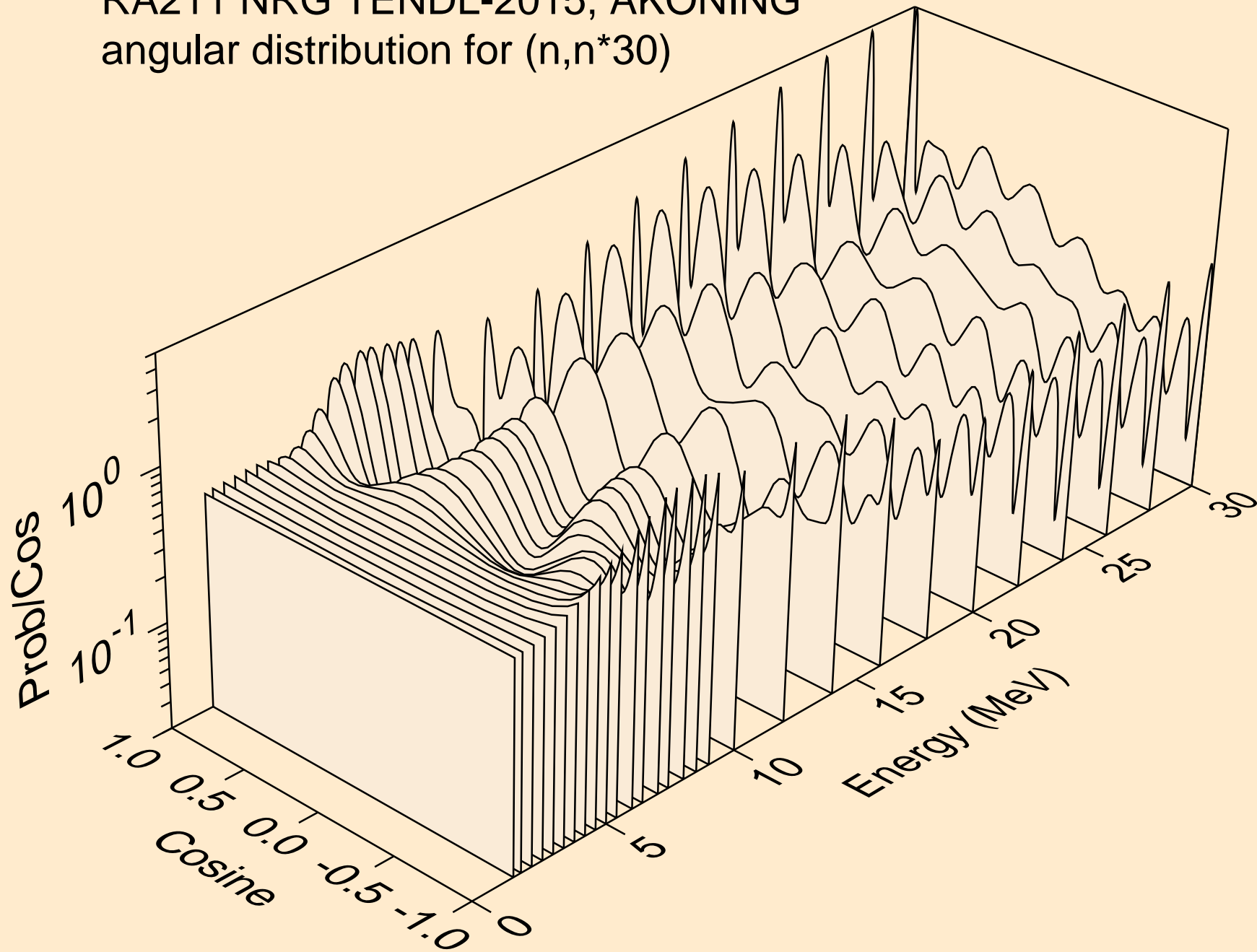

RA211 NRG TENDL-2015, AKONING
Neutron emission for (n,x)

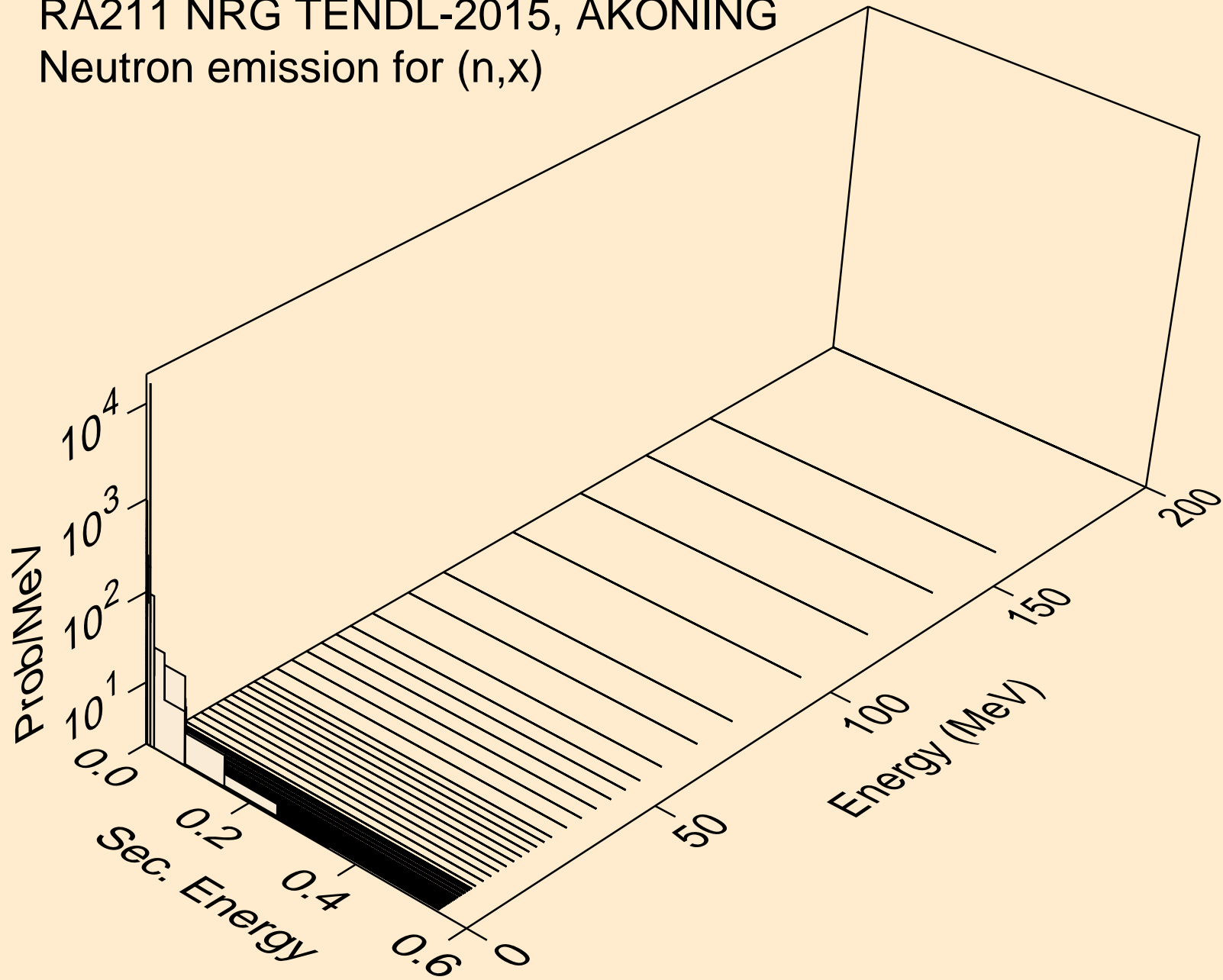

RA211 NRG TENDL-2015, AKONING
Neutron emission for (n,2nd)

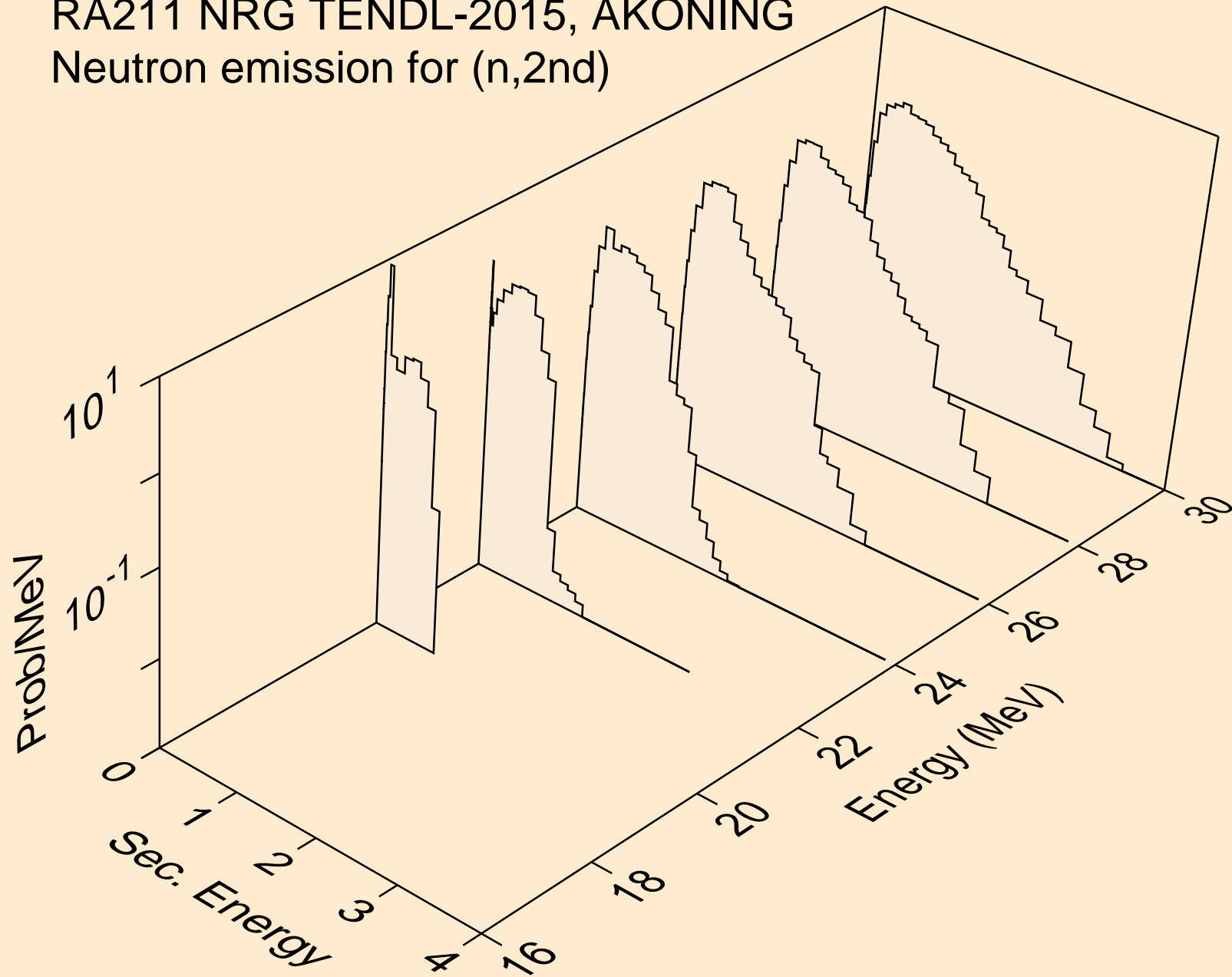

RA211 NRG TENDL-2015, AKONING
Neutron emission for (n,2n)

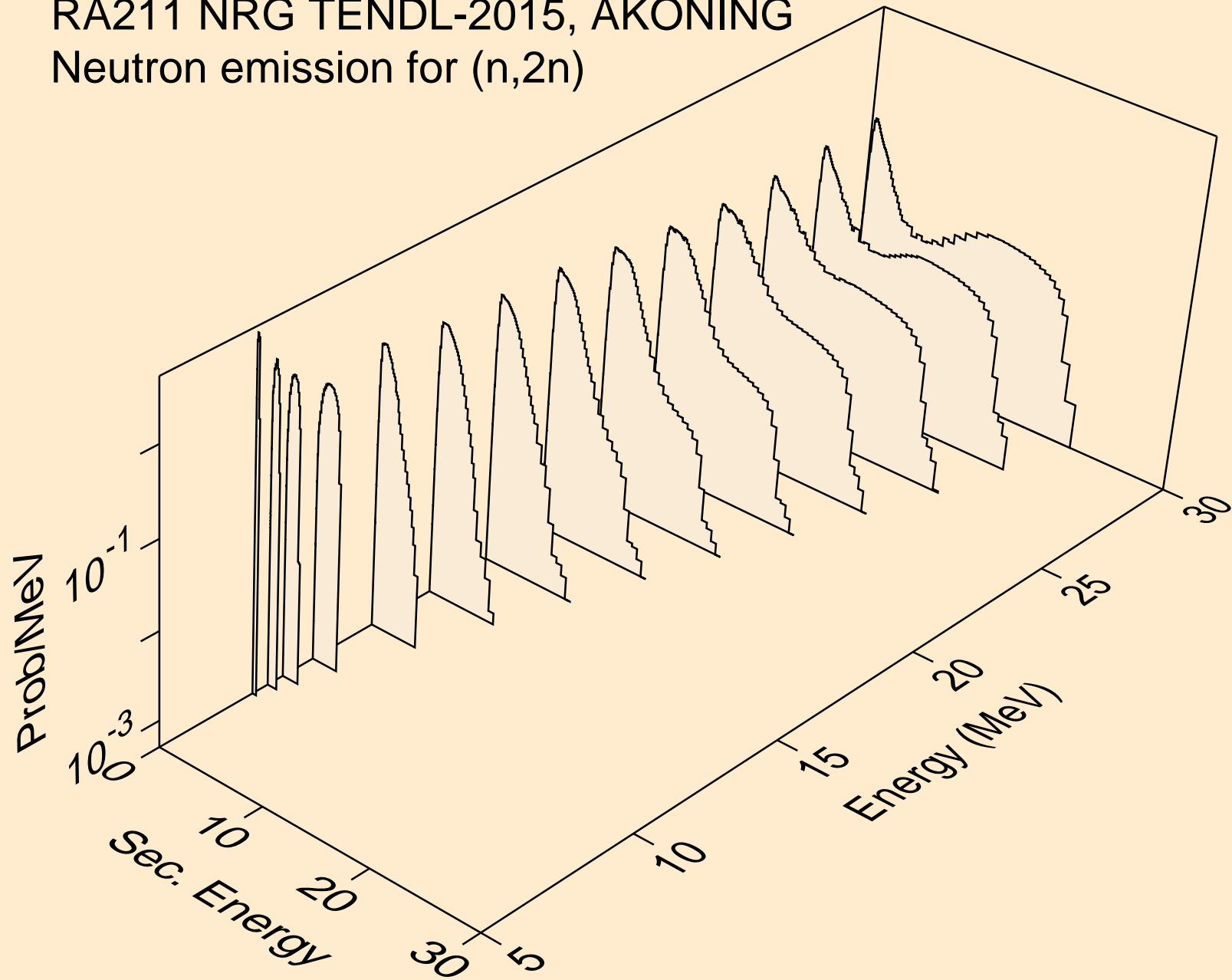

RA211 NRG TENDL-2015, AKONING
Neutron emission for (n,3n)

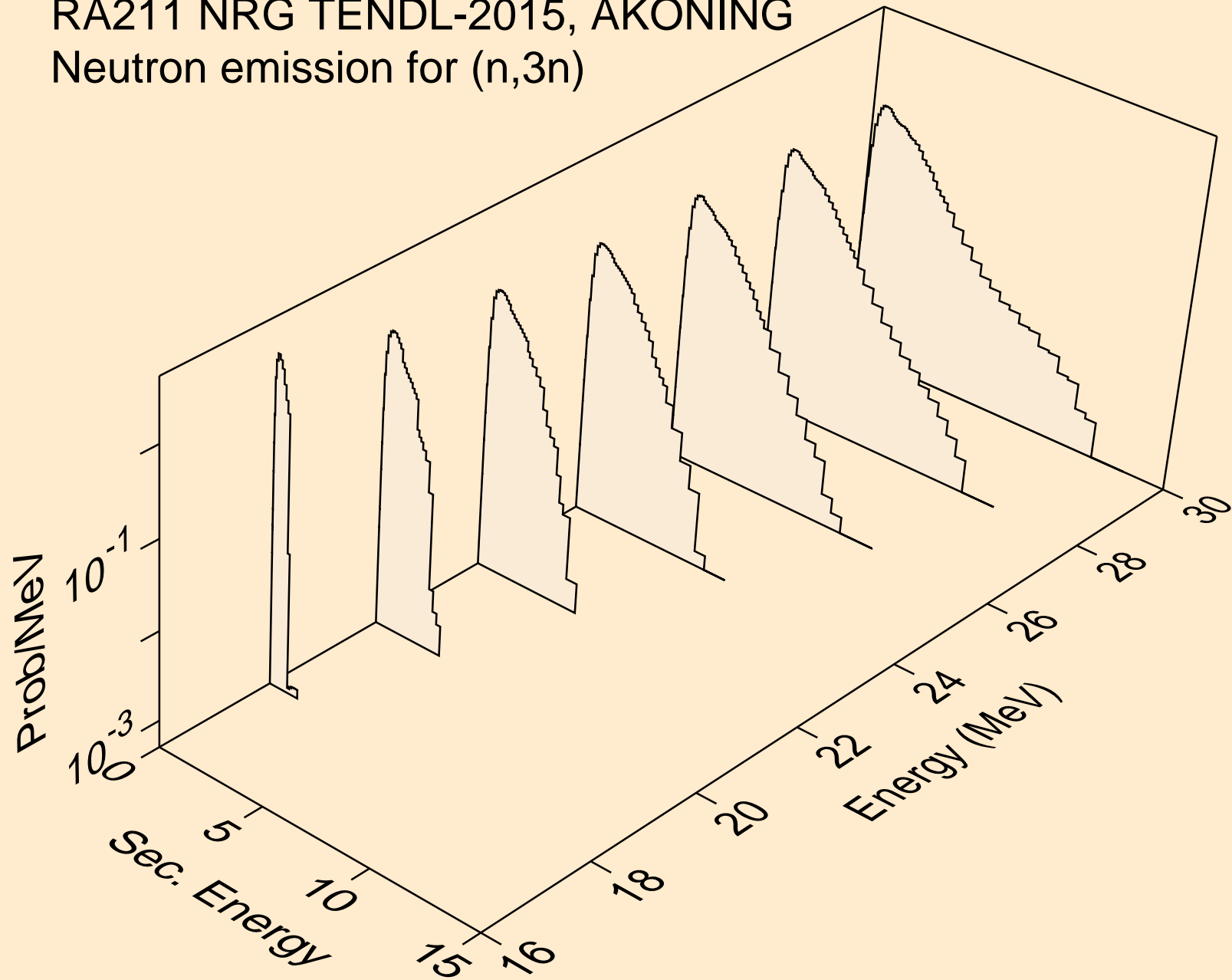

RA211 NRG TENDL-2015, AKONING
Neutron emission for (n,n*)a

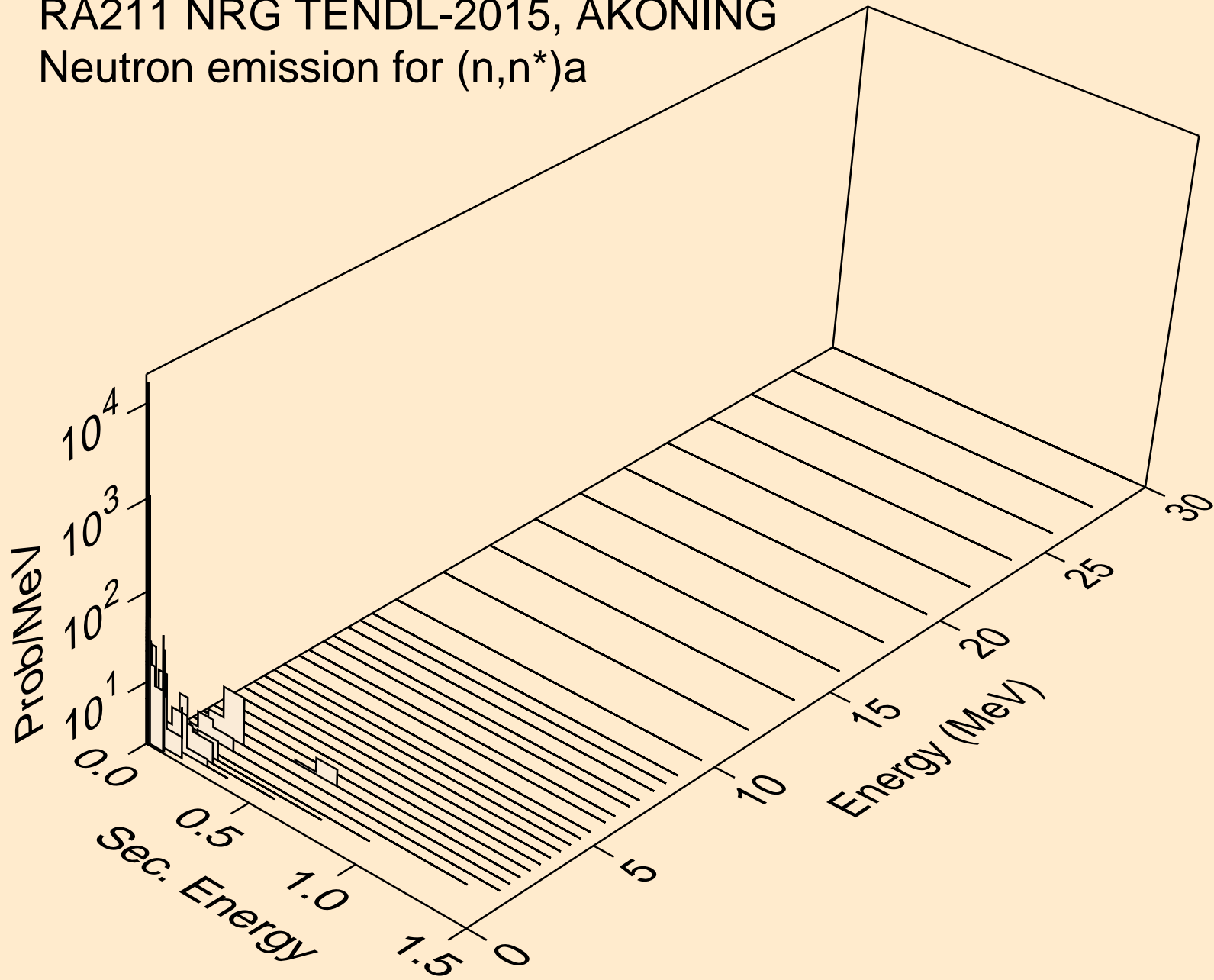

RA211 NRG TENDL-2015, AKONING
Neutron emission for (n,n*)3a

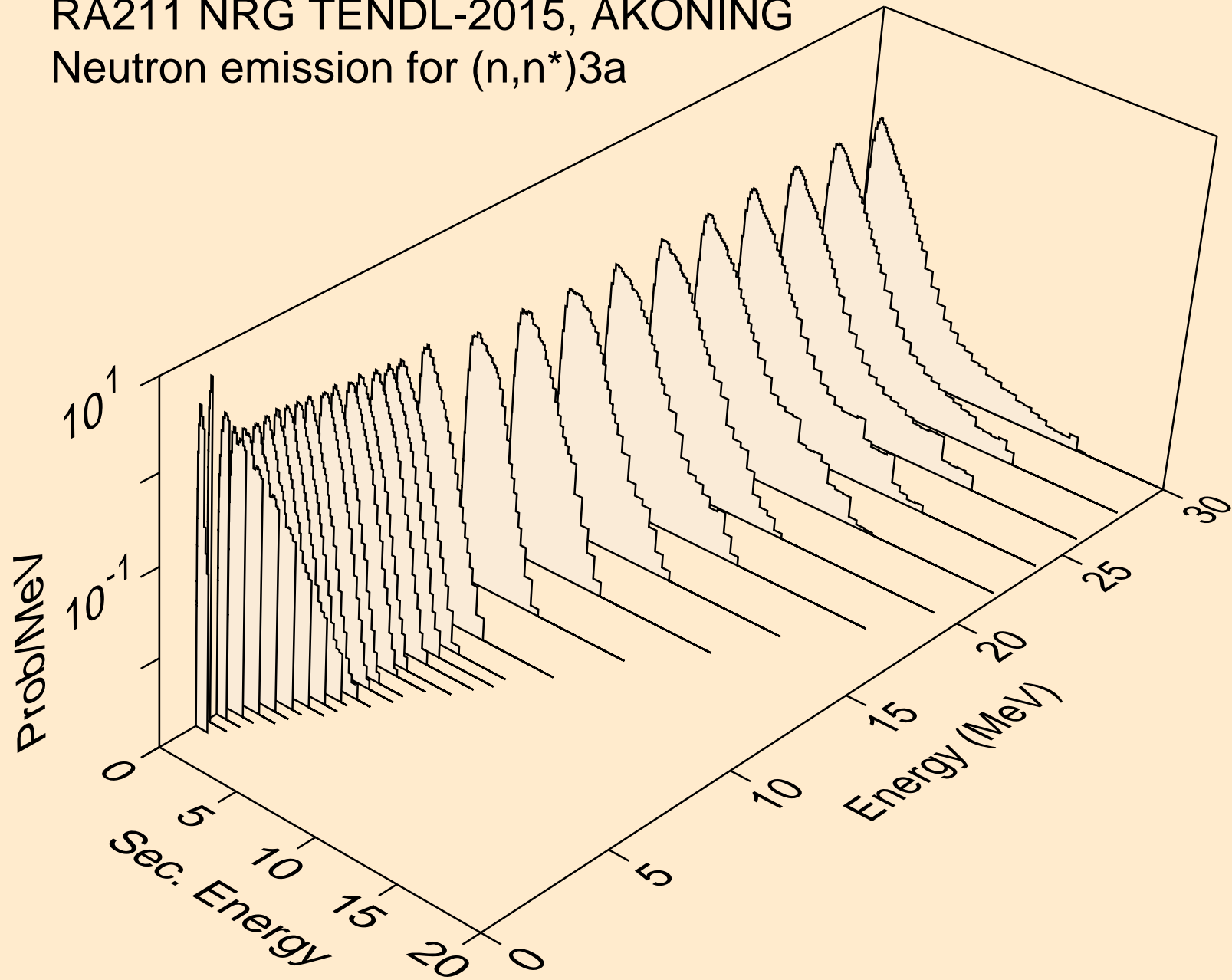

RA211 NRG TENDL-2015, AKONING
Neutron emission for (n,2n)a

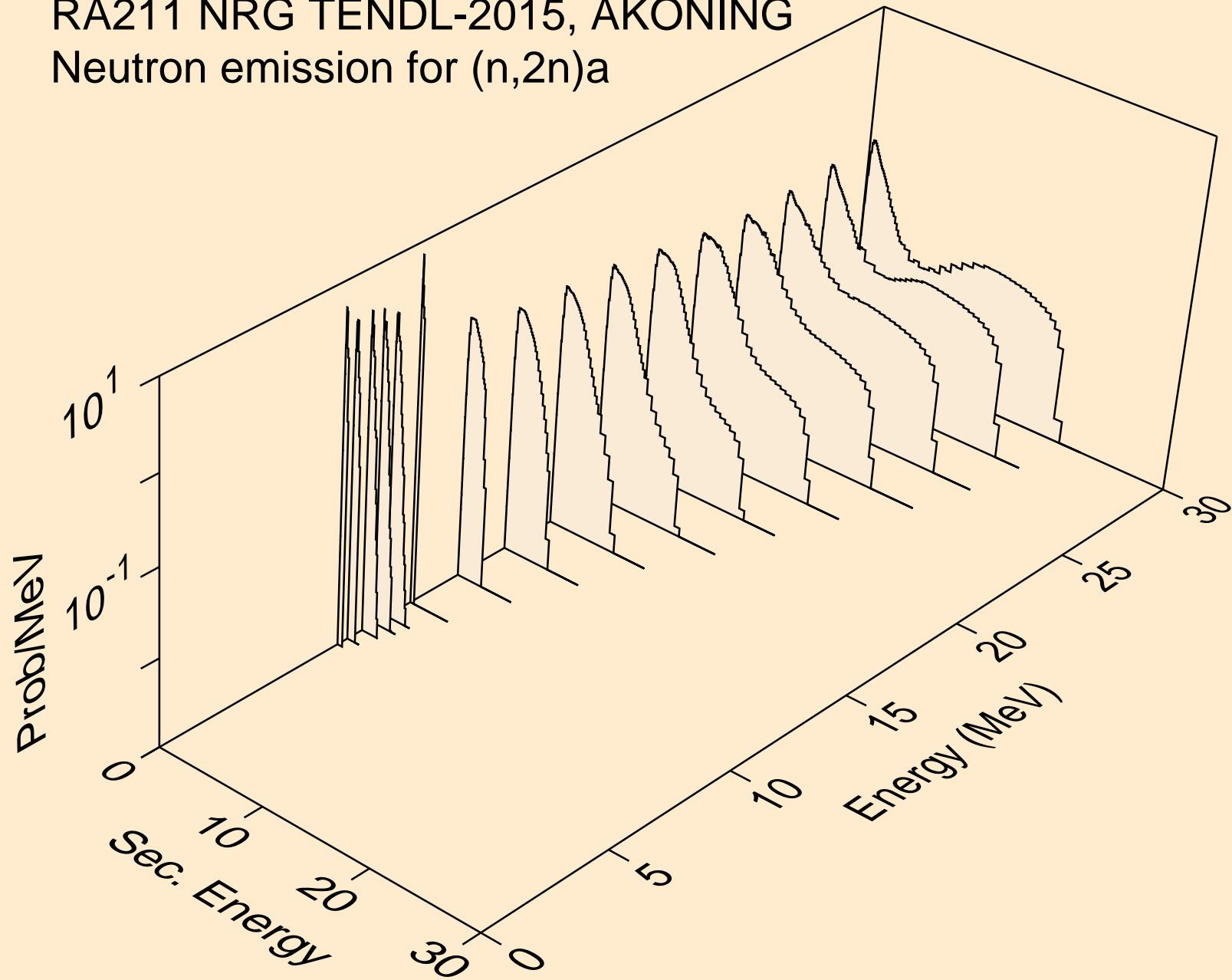

RA211 NRG TENDL-2015, AKONING
Neutron emission for (n,3n)a

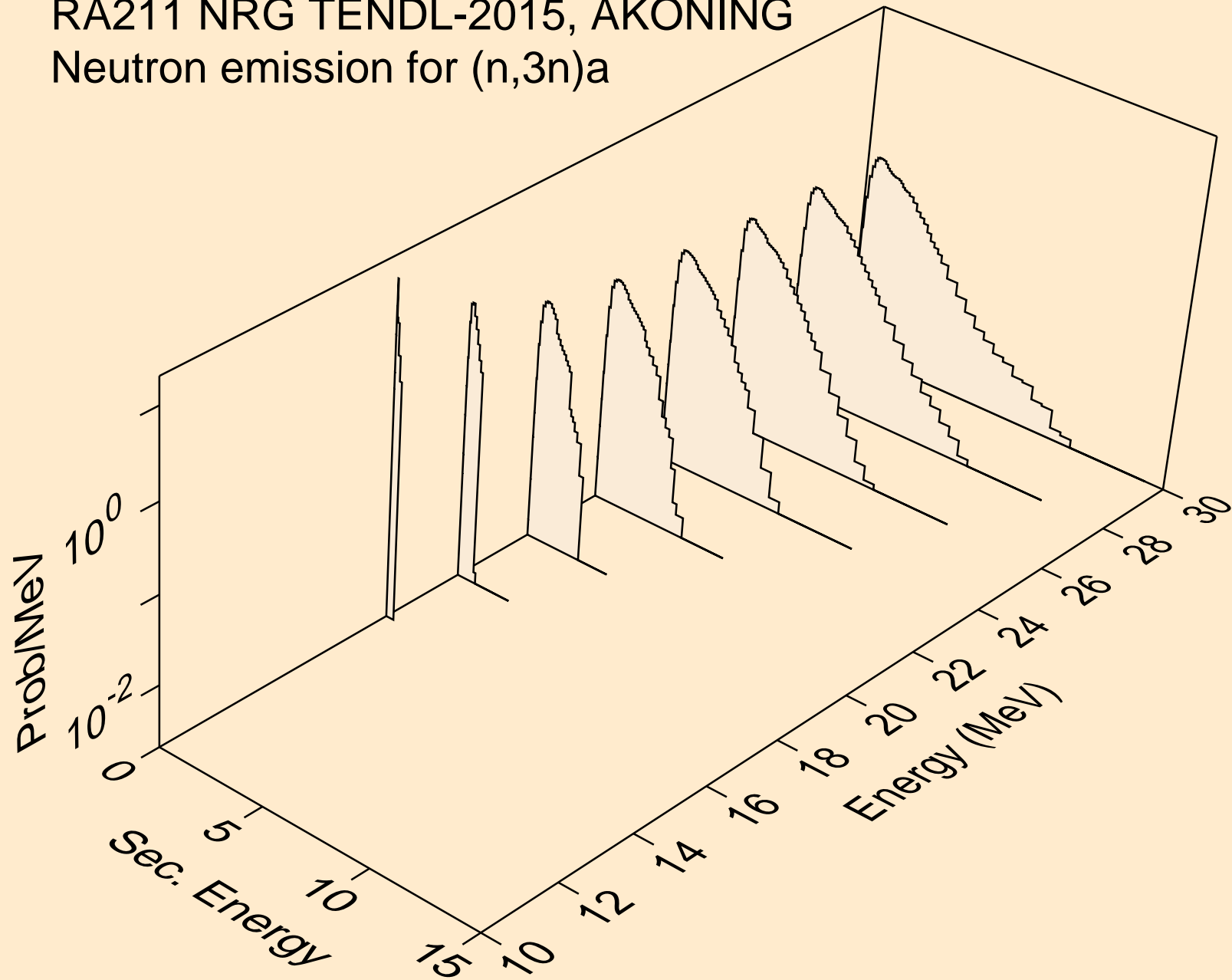

RA211 NRG TENDL-2015, AKONING
Neutron emission for (n,n*)p

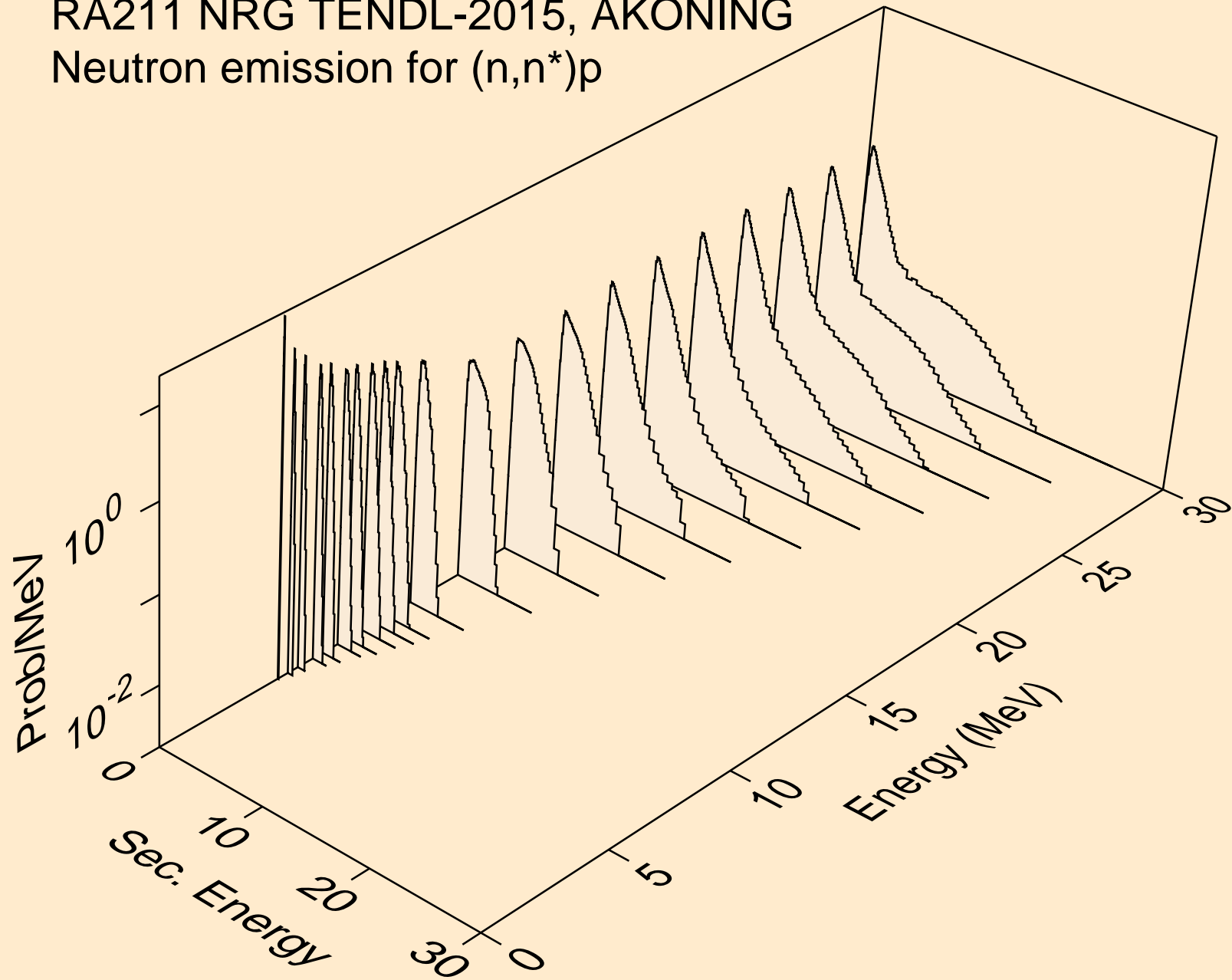

RA211 NRG TENDL-2015, AKONING
Neutron emission for (n,n*)2a

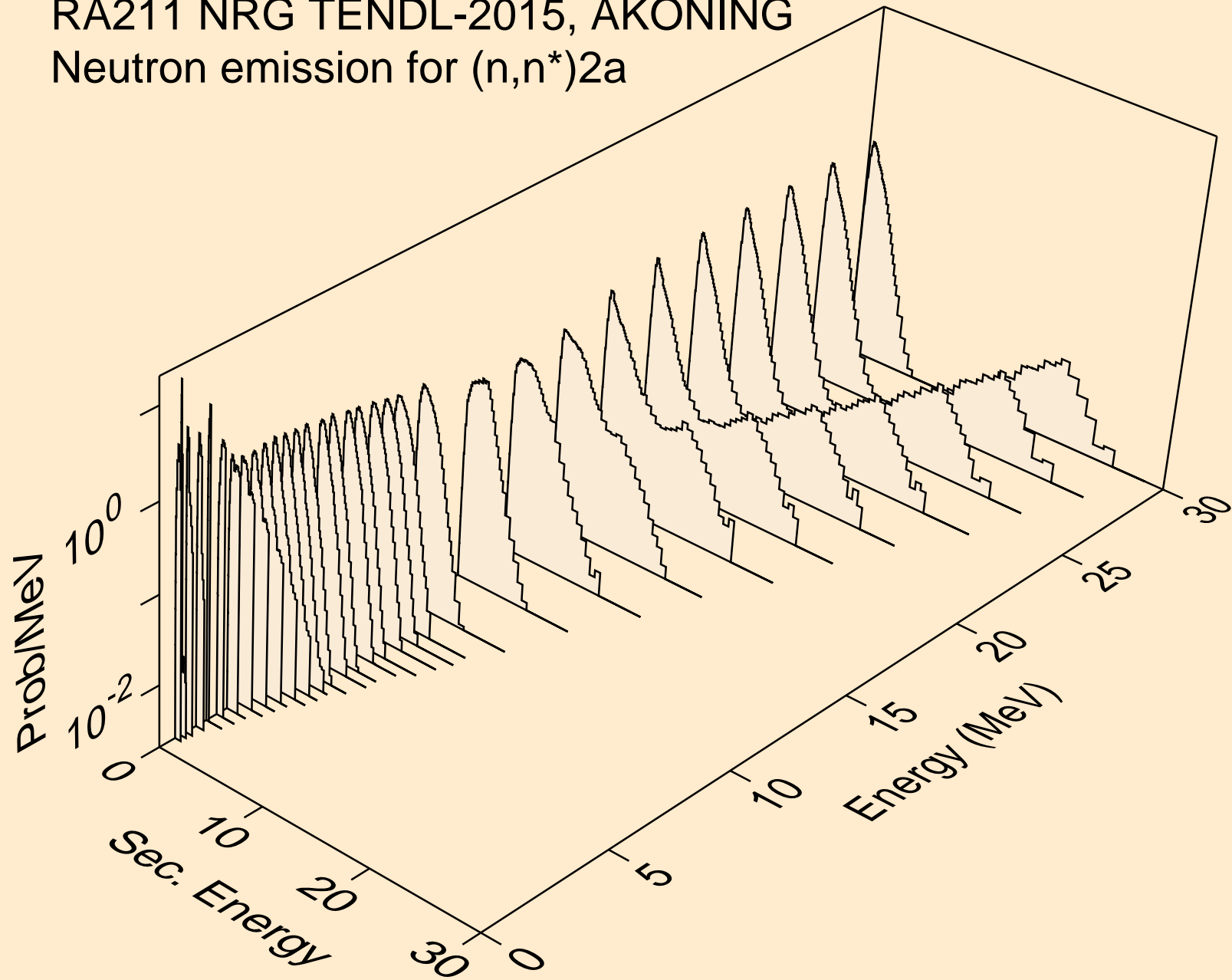

RA211 NRG TENDL-2015, AKONING
Neutron emission for (n,2n)2a

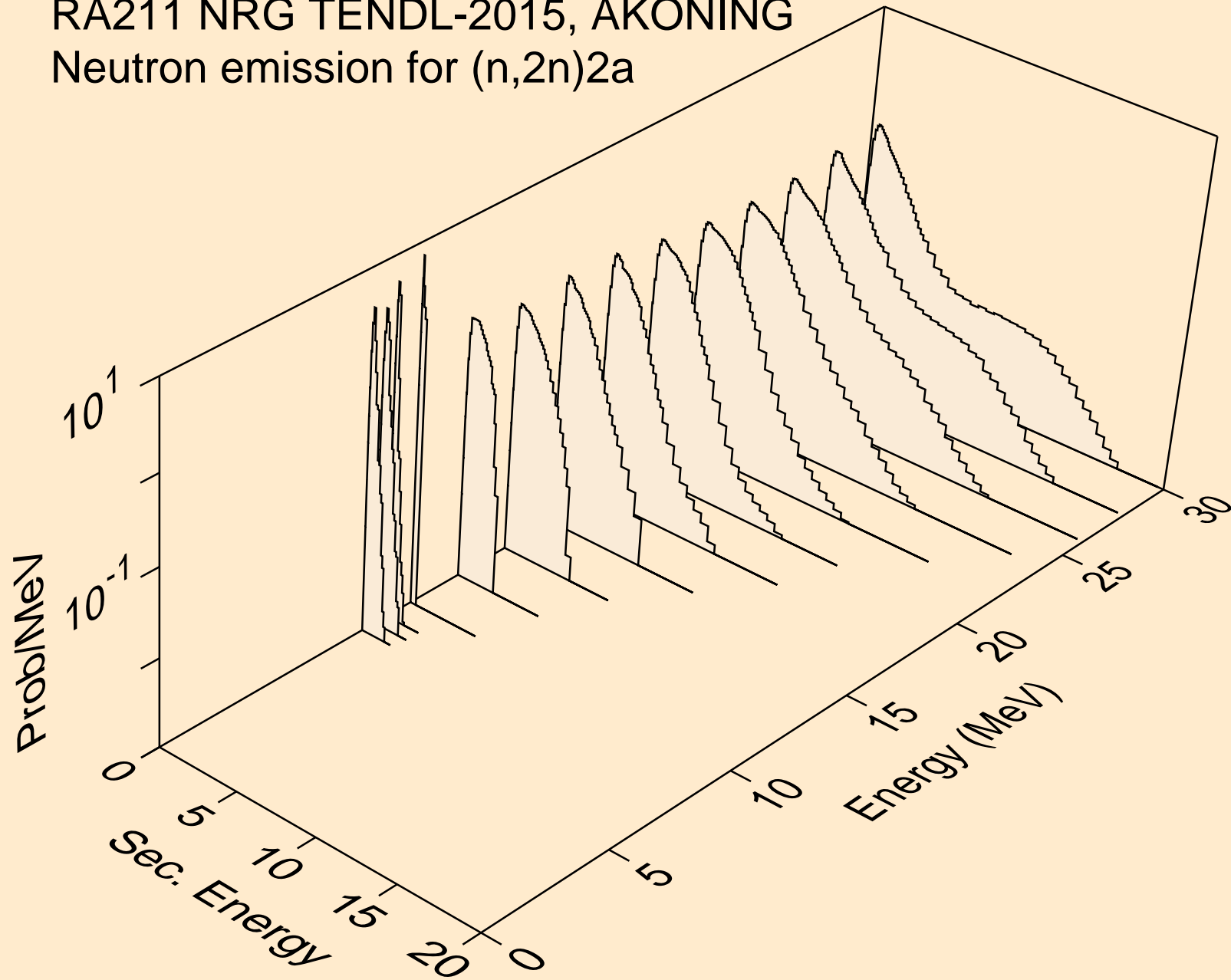

RA211 NRG TENDL-2015, AKONING
Neutron emission for (n,n*)d

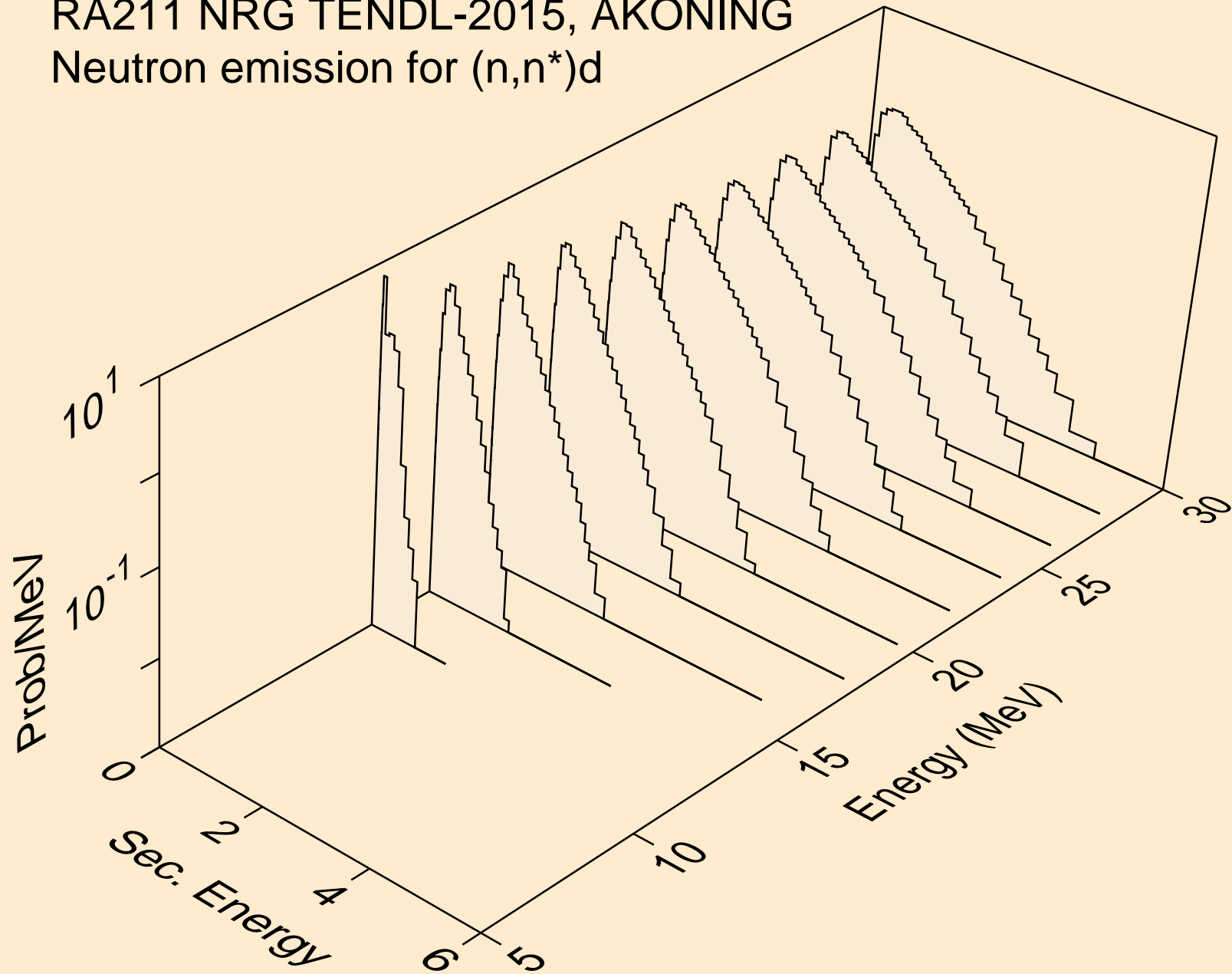

RA211 NRG TENDL-2015, AKONING
Neutron emission for (n,n*)t

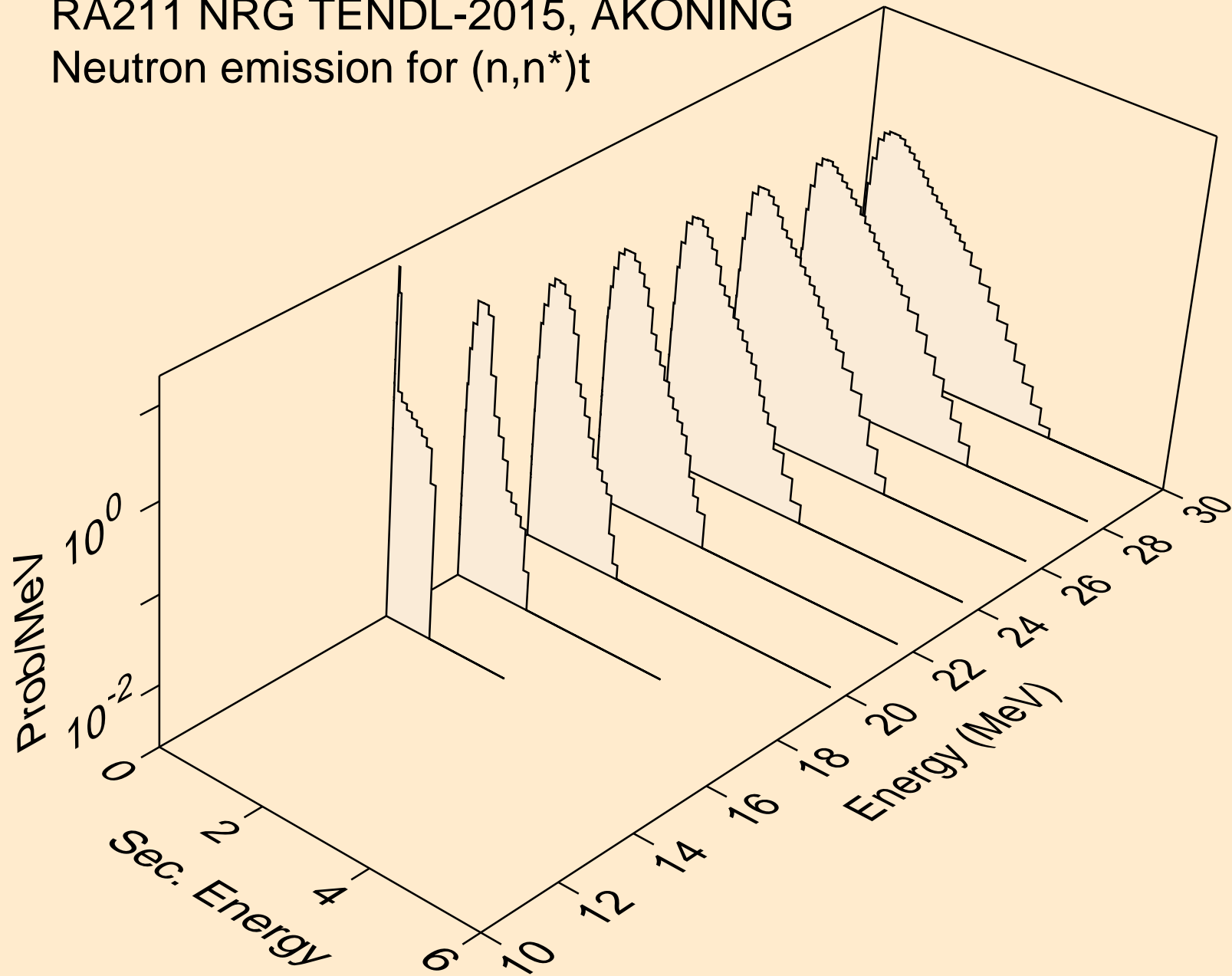

RA211 NRG TENDL-2015, AKONING
Neutron emission for (n,n*)he3

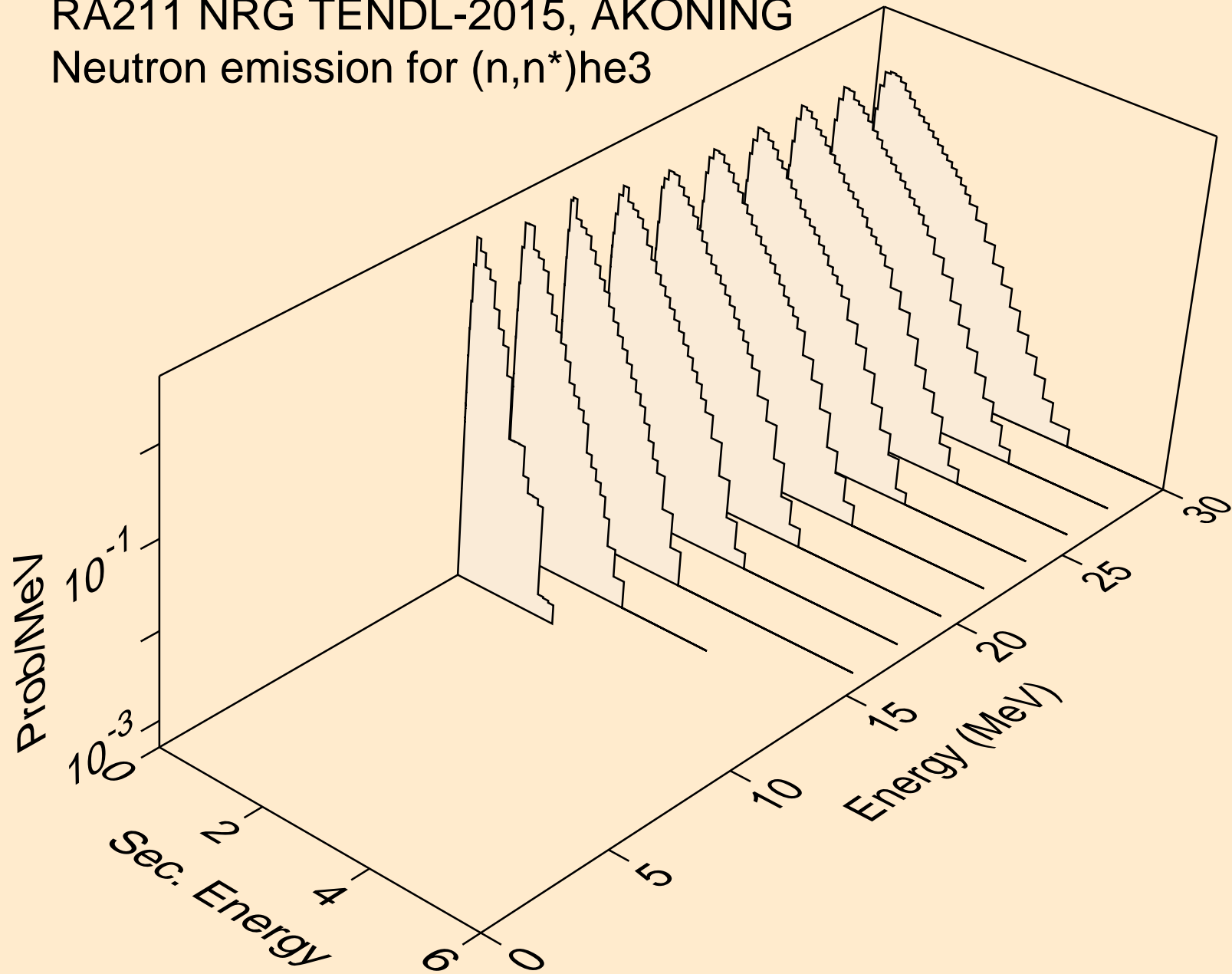

RA211 NRG TENDL-2015, AKONING
Neutron emission for (n,n*)d2a

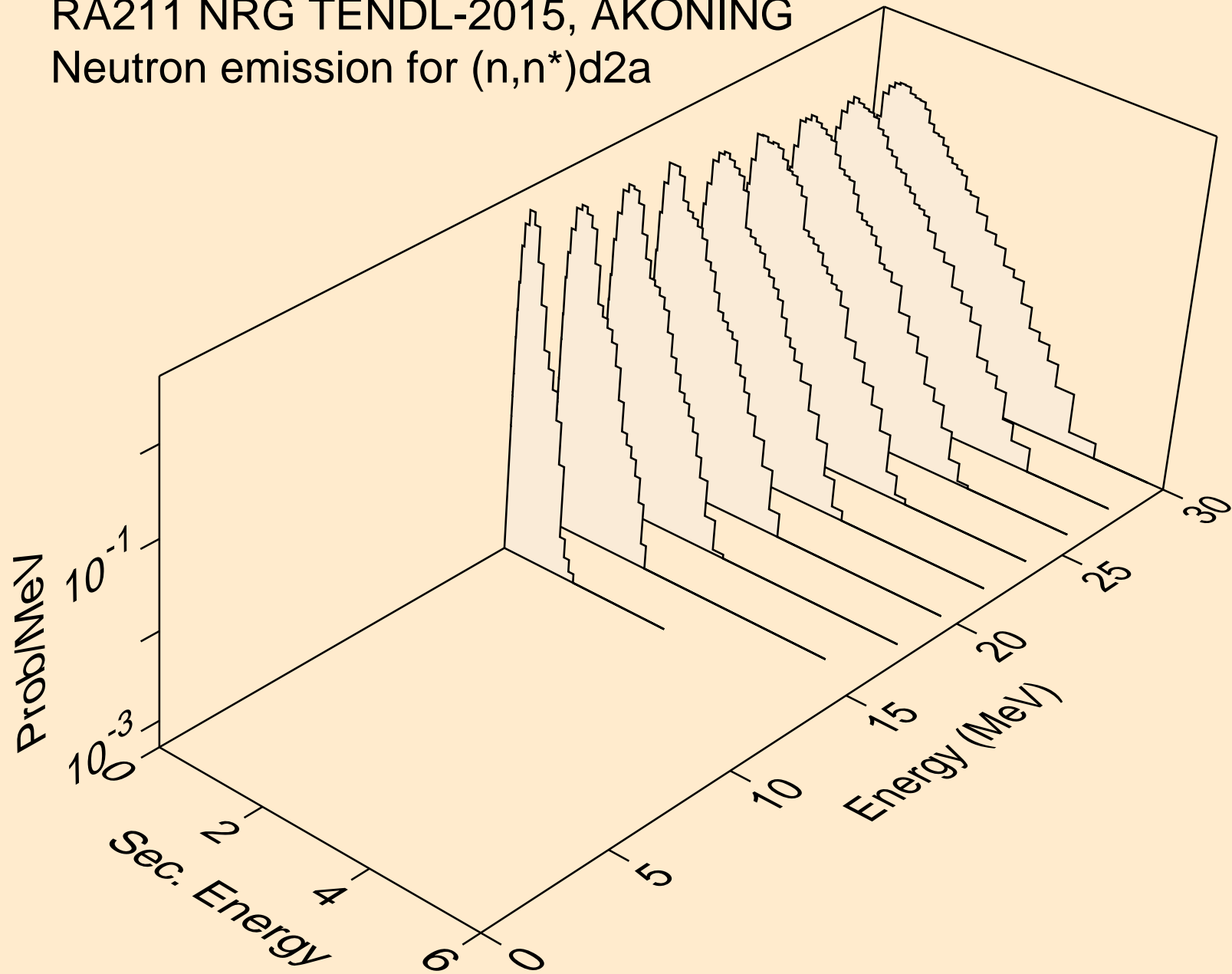

RA211 NRG TENDL-2015, AKONING
Neutron emission for (n,n*)t2a

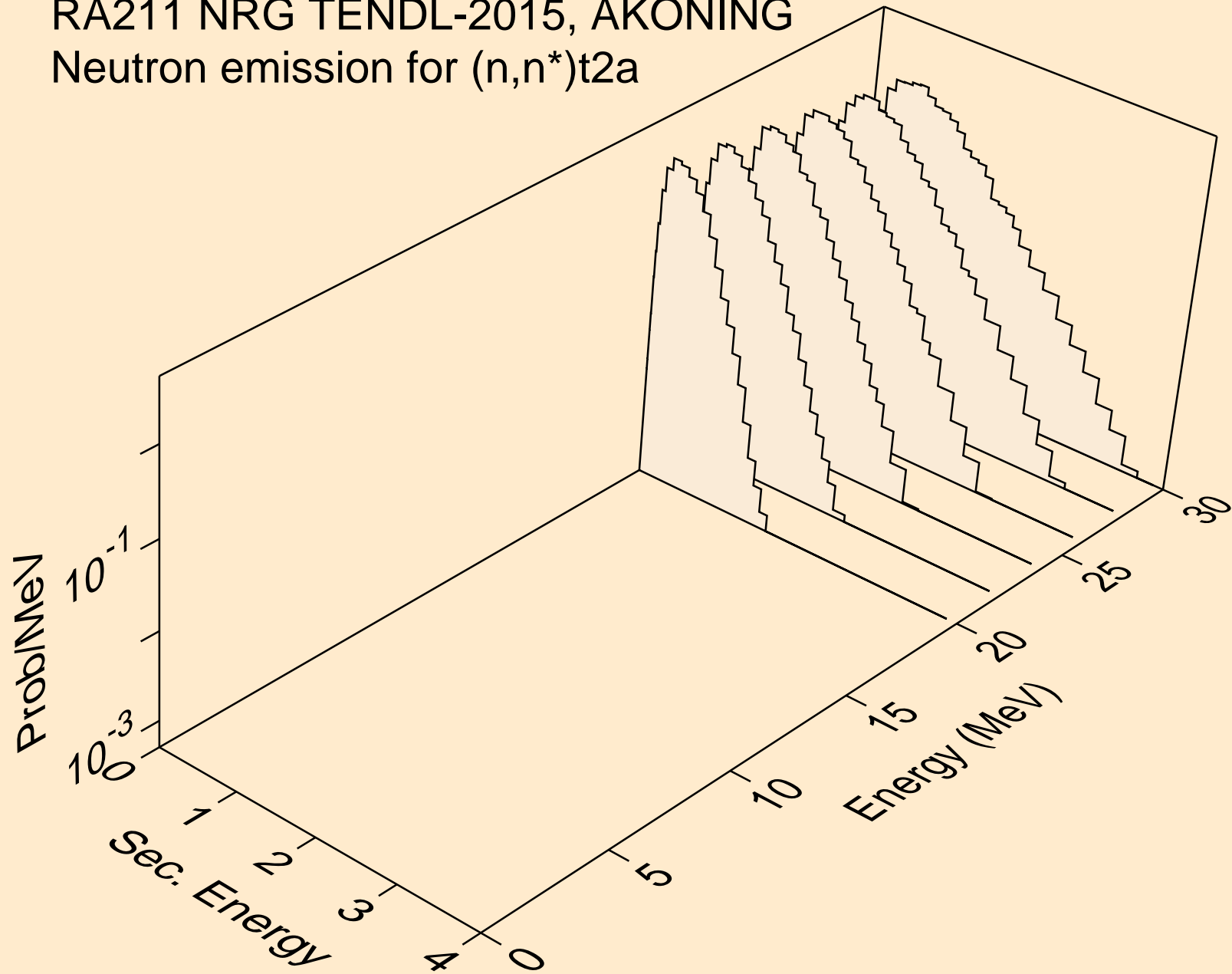

RA211 NRG TENDL-2015, AKONING
Neutron emission for (n,4n)

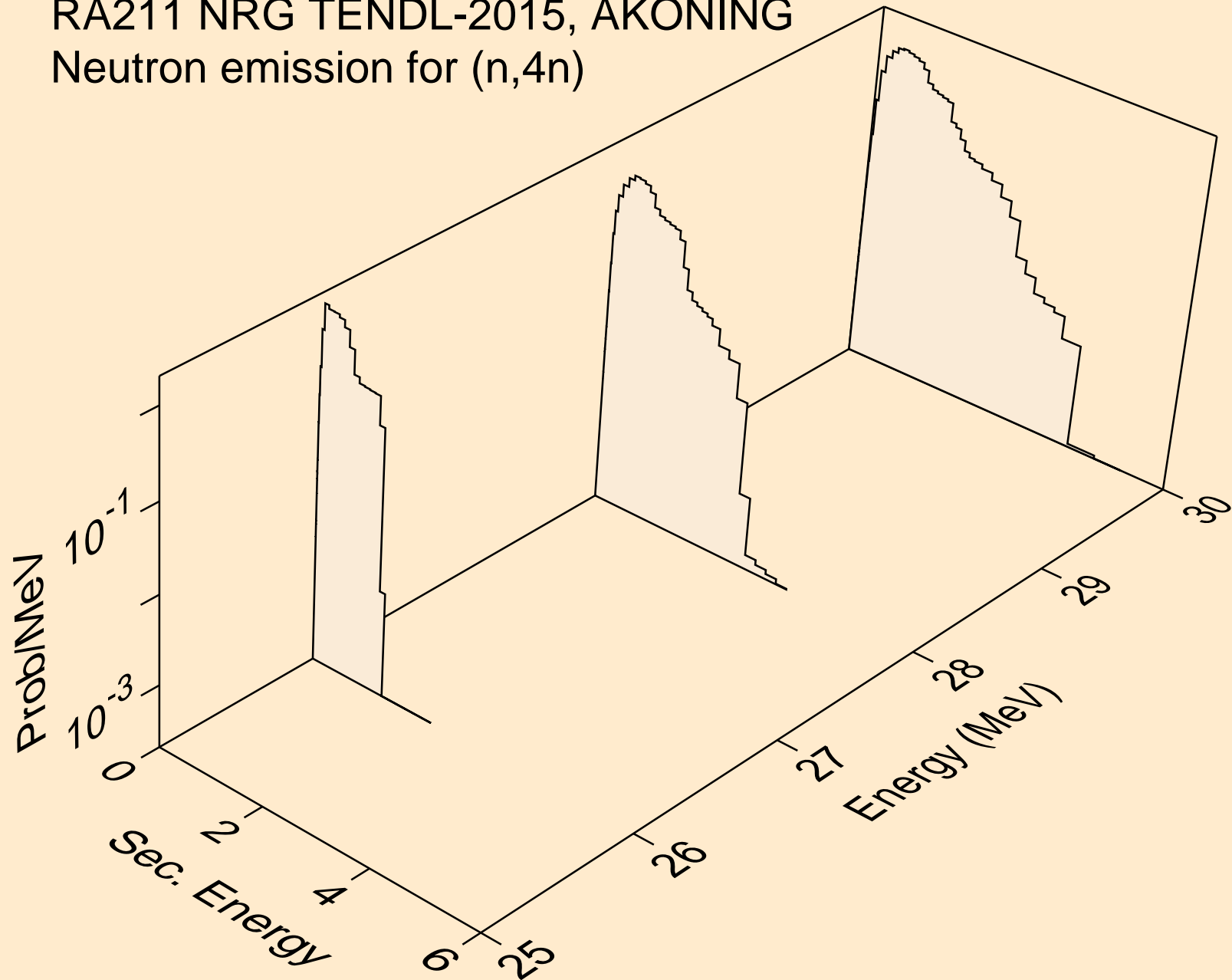

RA211 NRG TENDL-2015, AKONING
Neutron emission for (n,2np)

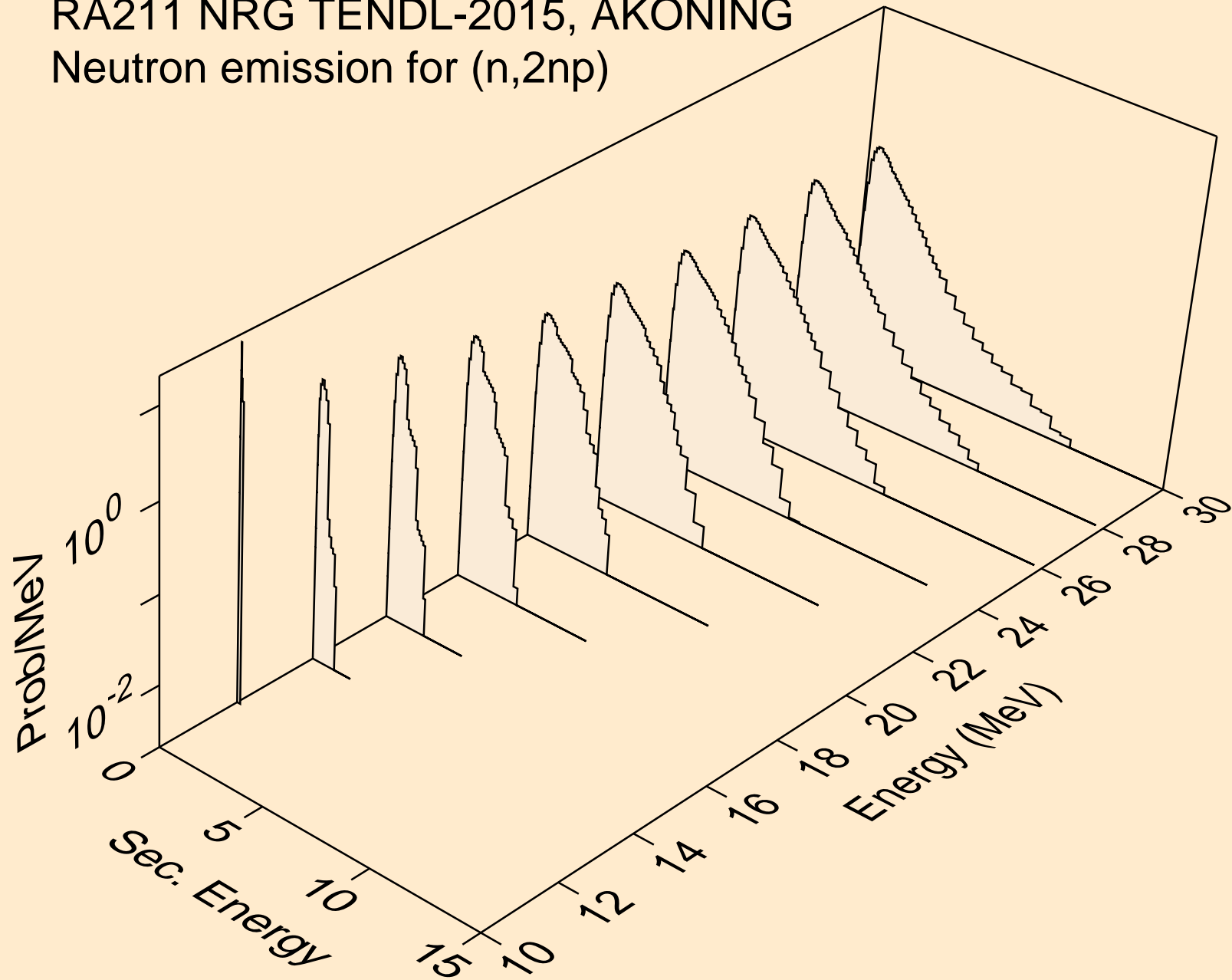

RA211 NRG TENDL-2015, AKONING
Neutron emission for (n,3np)

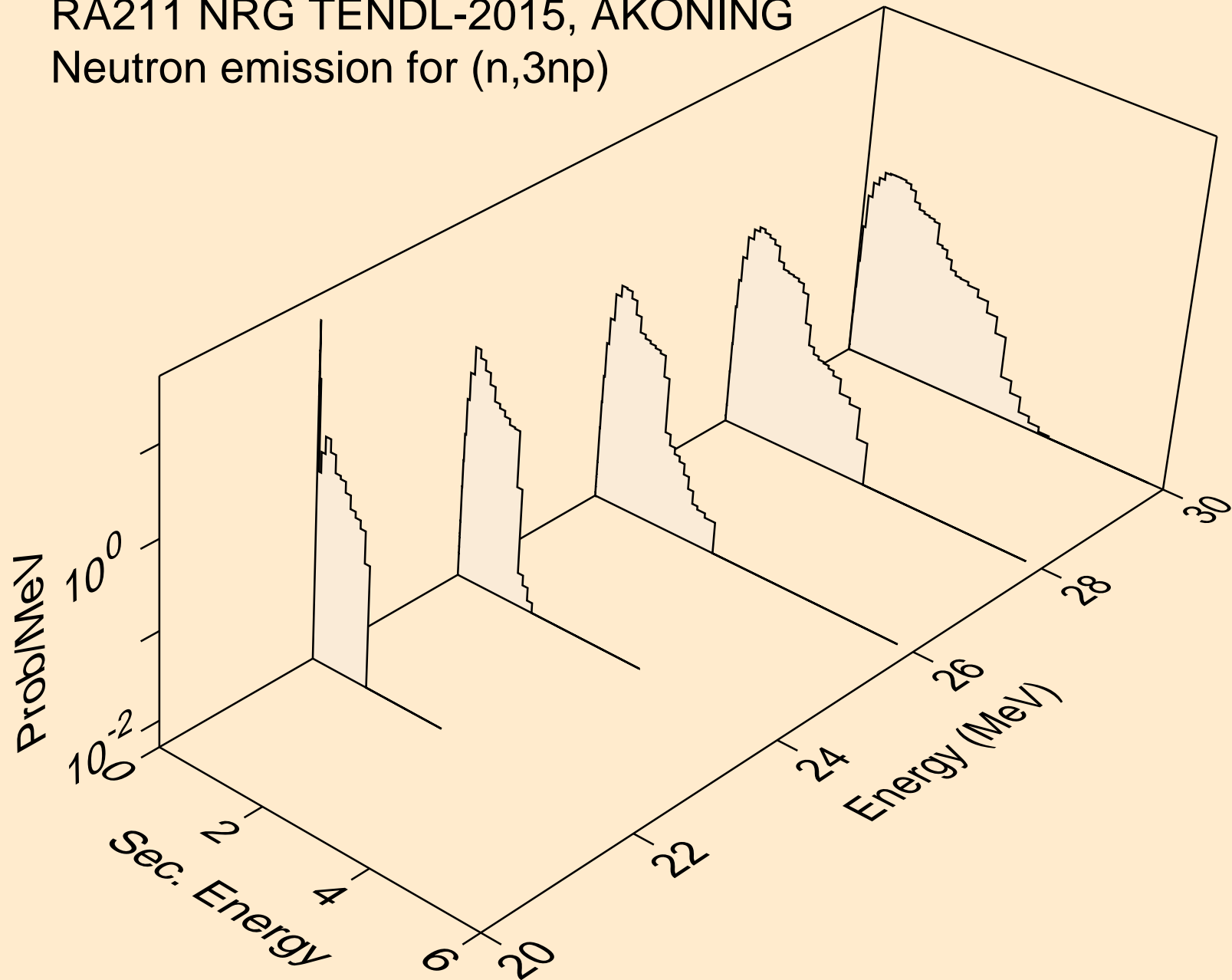

RA211 NRG TENDL-2015, AKONING
Neutron emission for (n,2np)

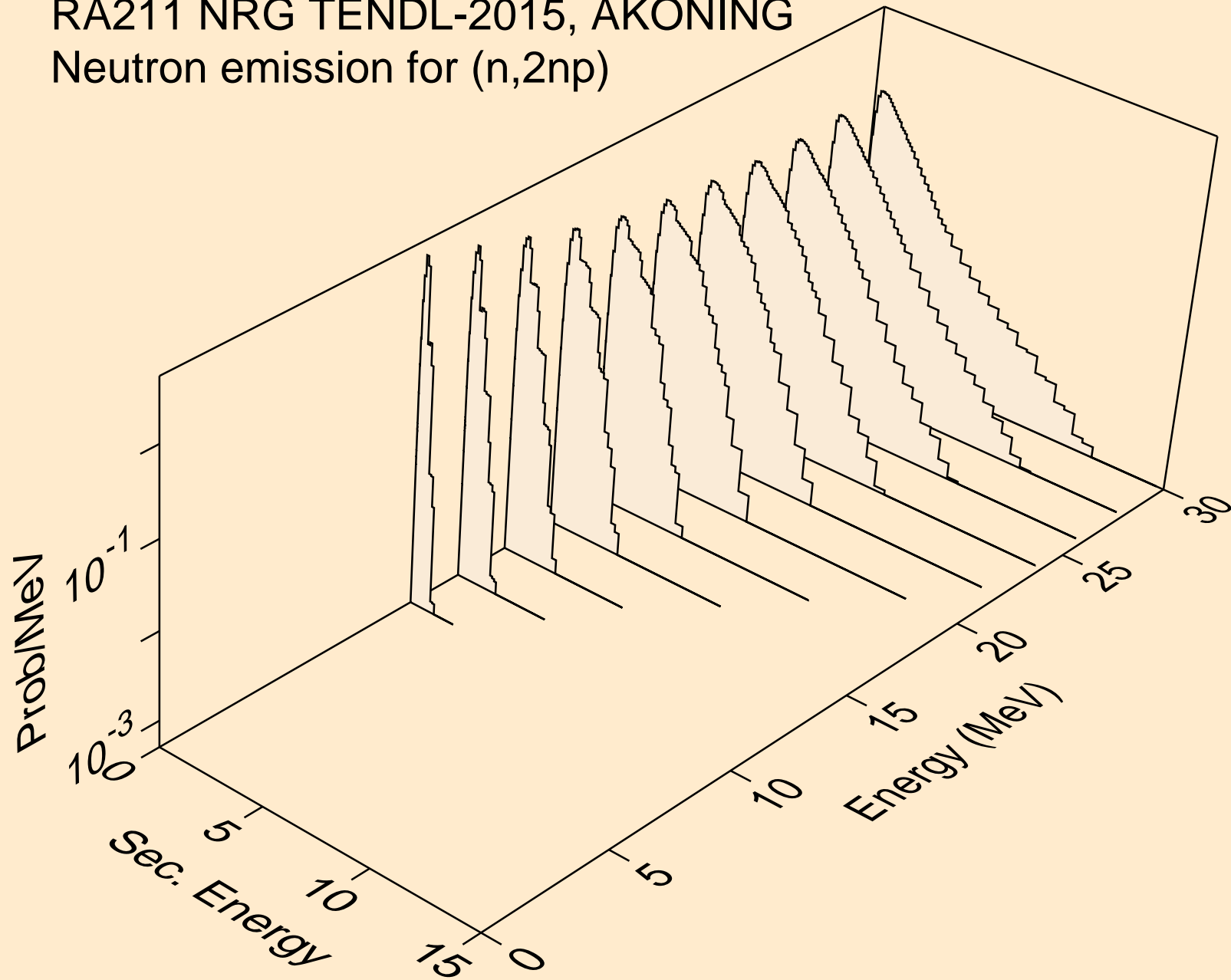

RA211 NRG TENDL-2015, AKONING
Neutron emission for (n,npa)

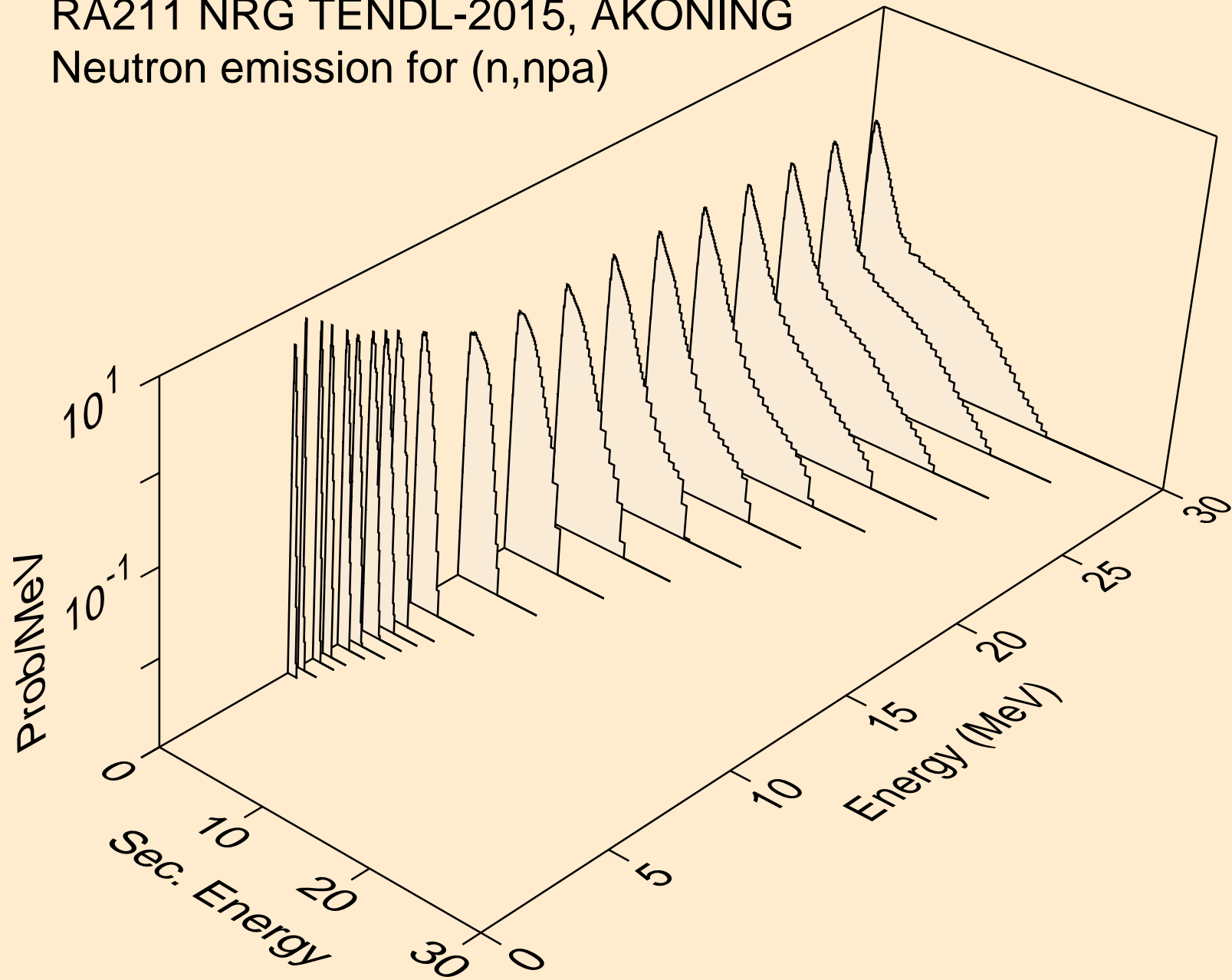

RA211 NRG TENDL-2015, AKONING
Neutron emission for (n,n*c)

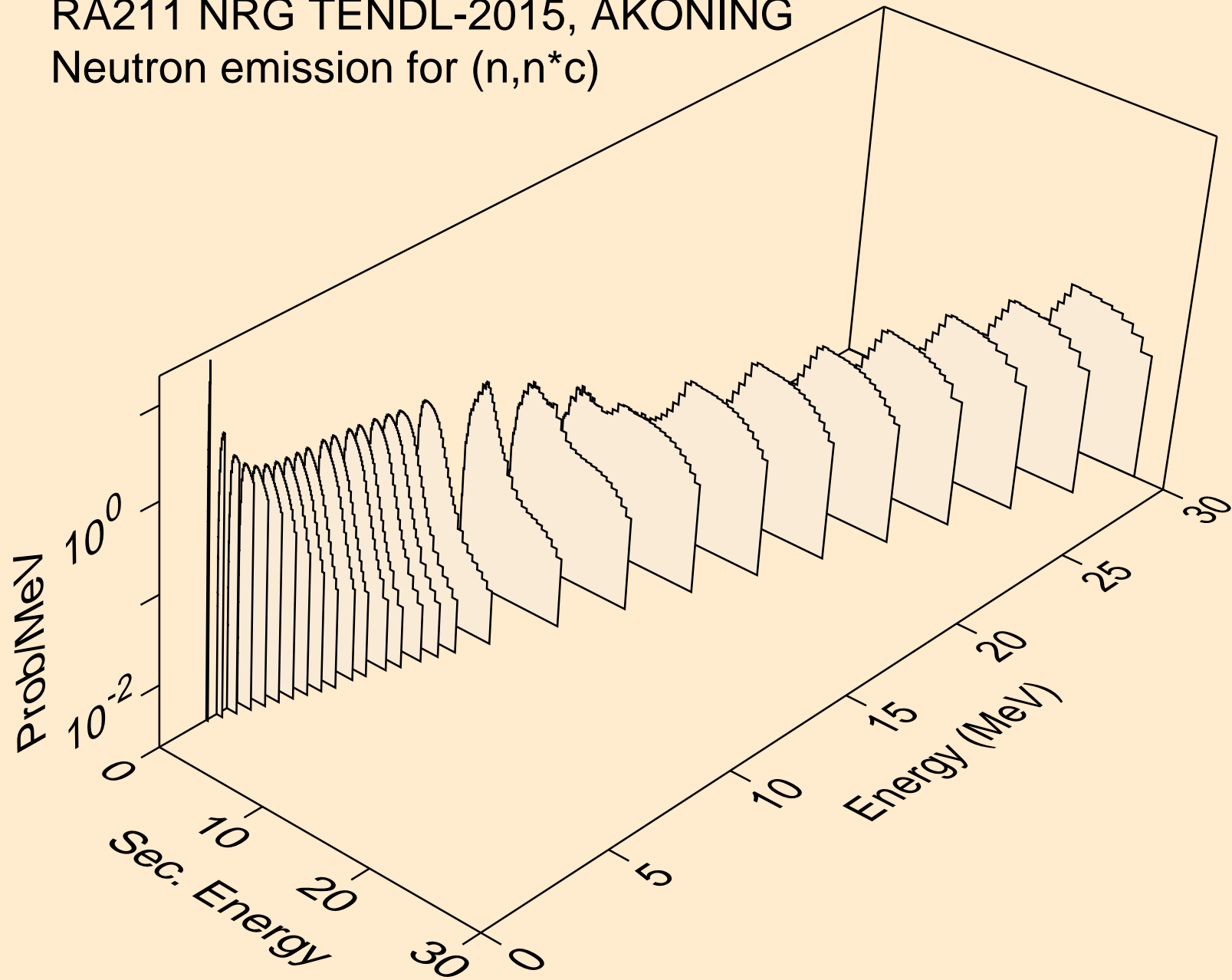

RA211 NRG TENDL-2015, AKONING
Photon emission for (n,x)

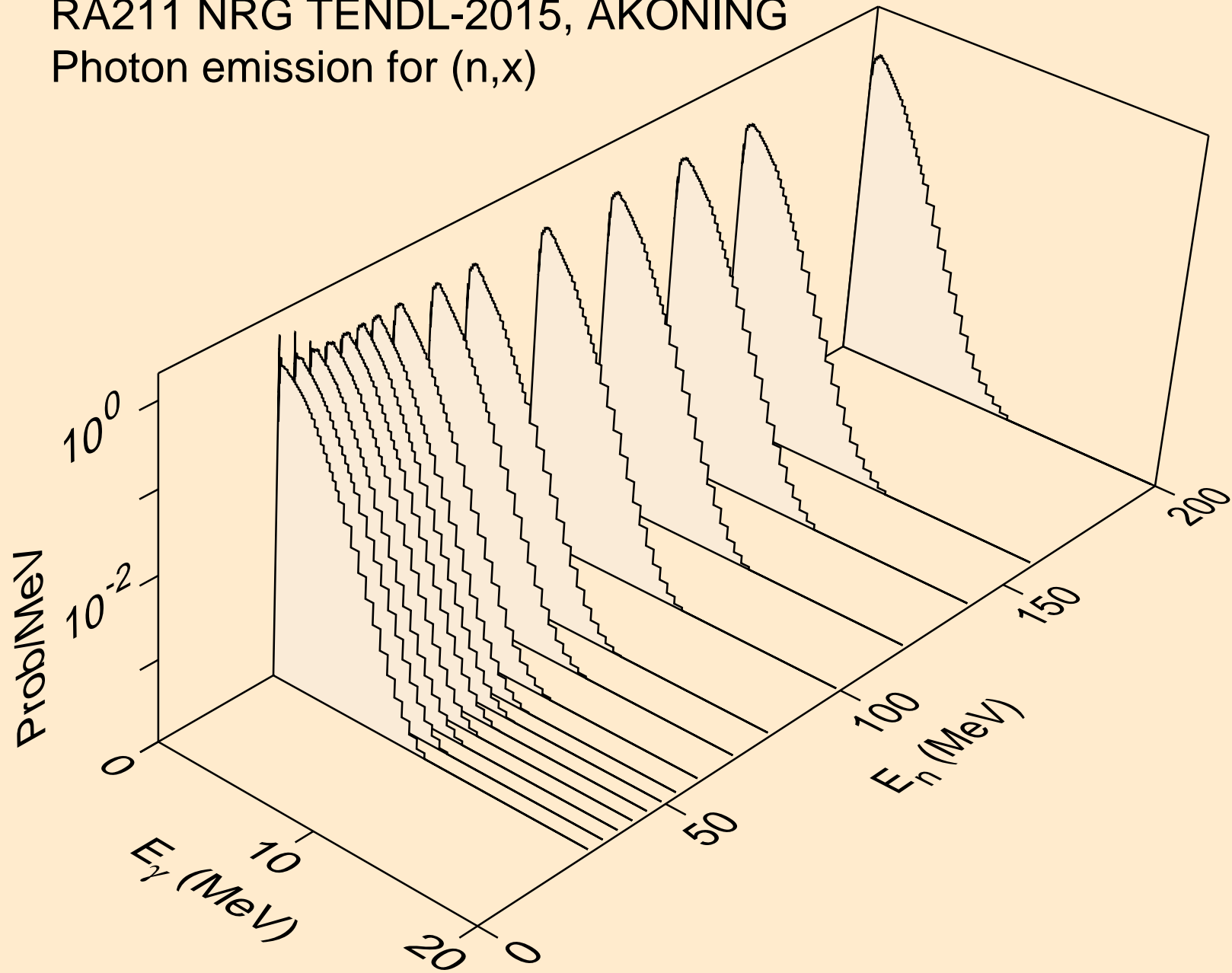

RA211 NRG TENDL-2015, AKONING
Photon emission for (n,2nd)

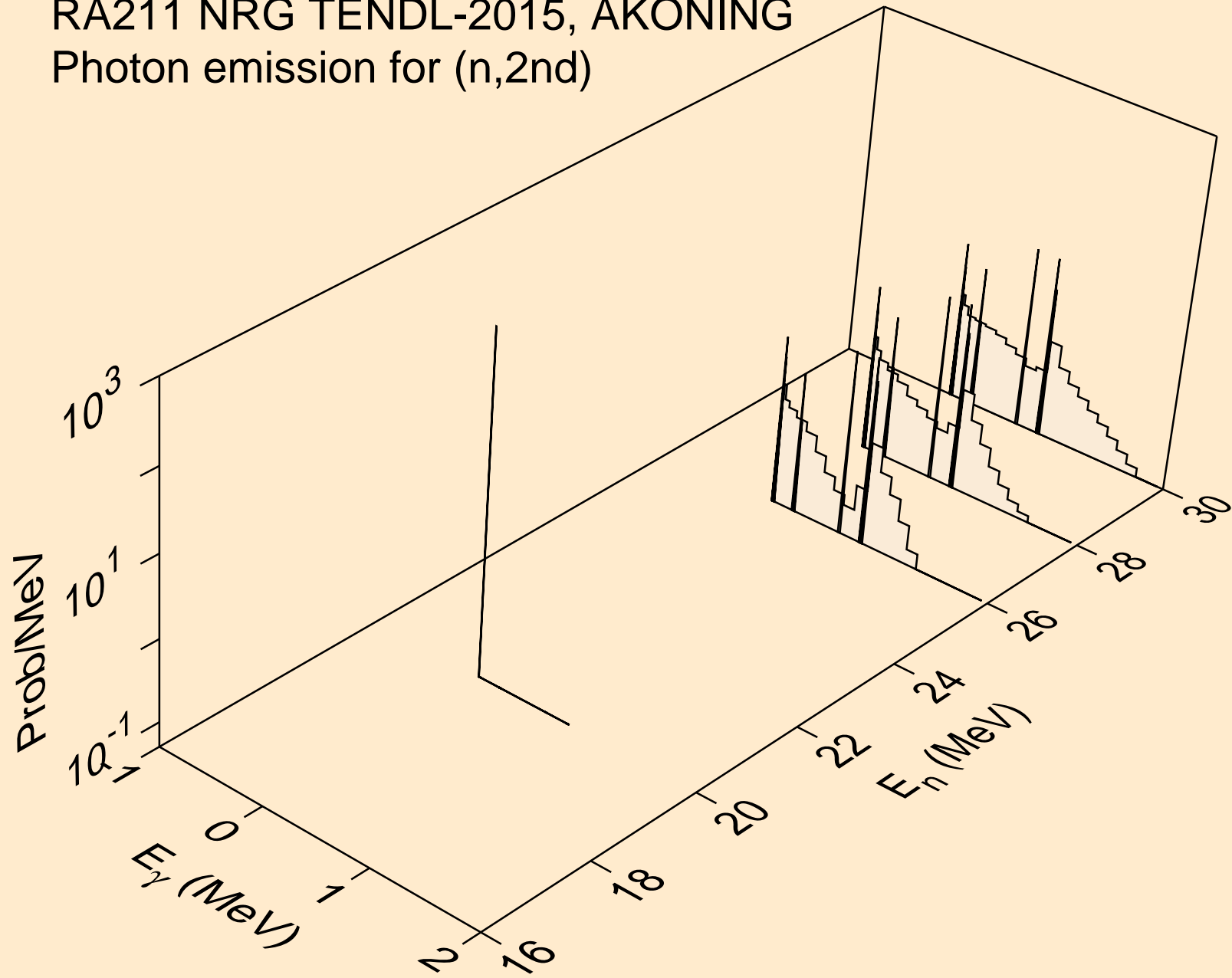

RA211 NRG TENDL-2015, AKONING
Photon emission for (n,2n)

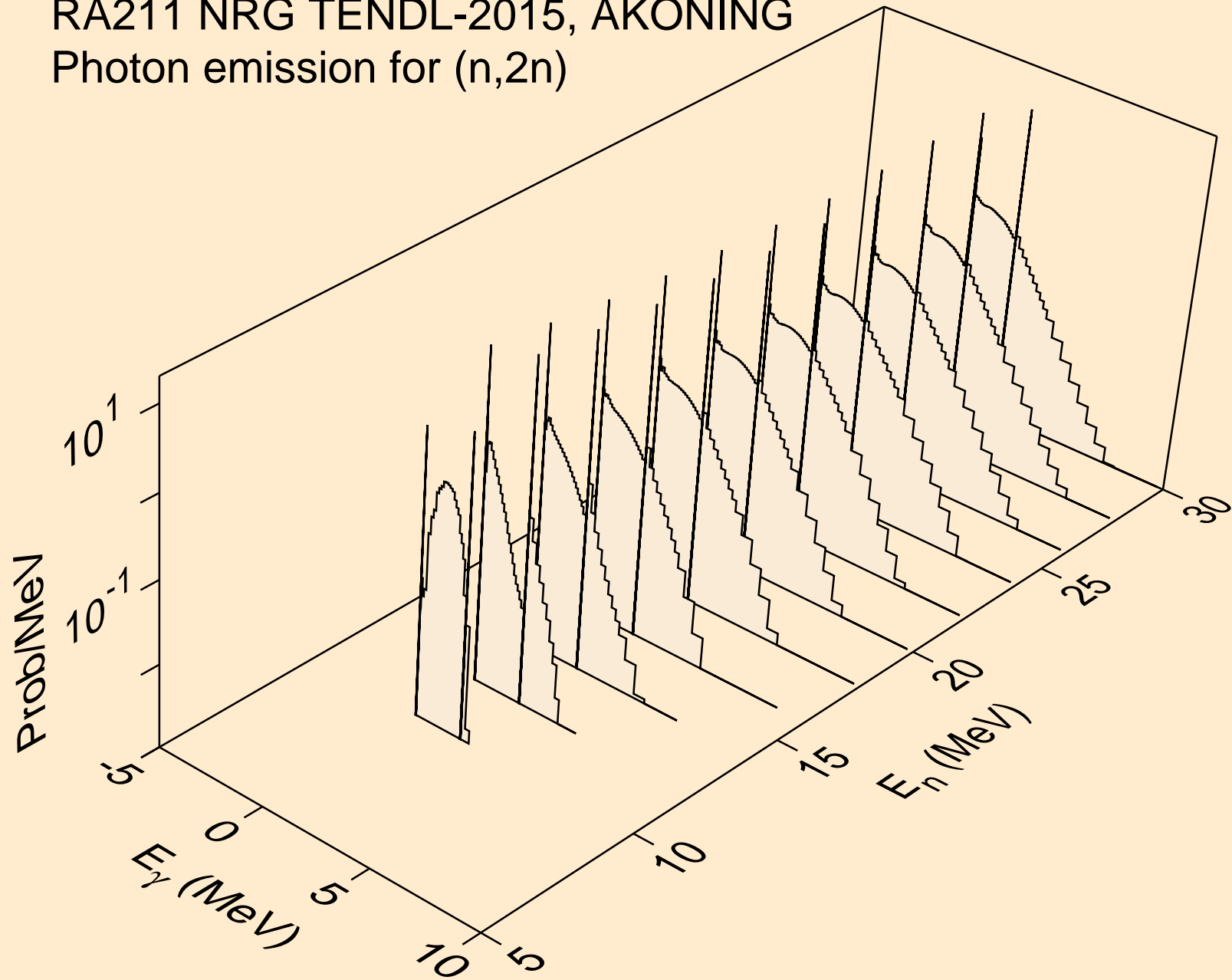

RA211 NRG TENDL-2015, AKONING
Photon emission for (n,3n)

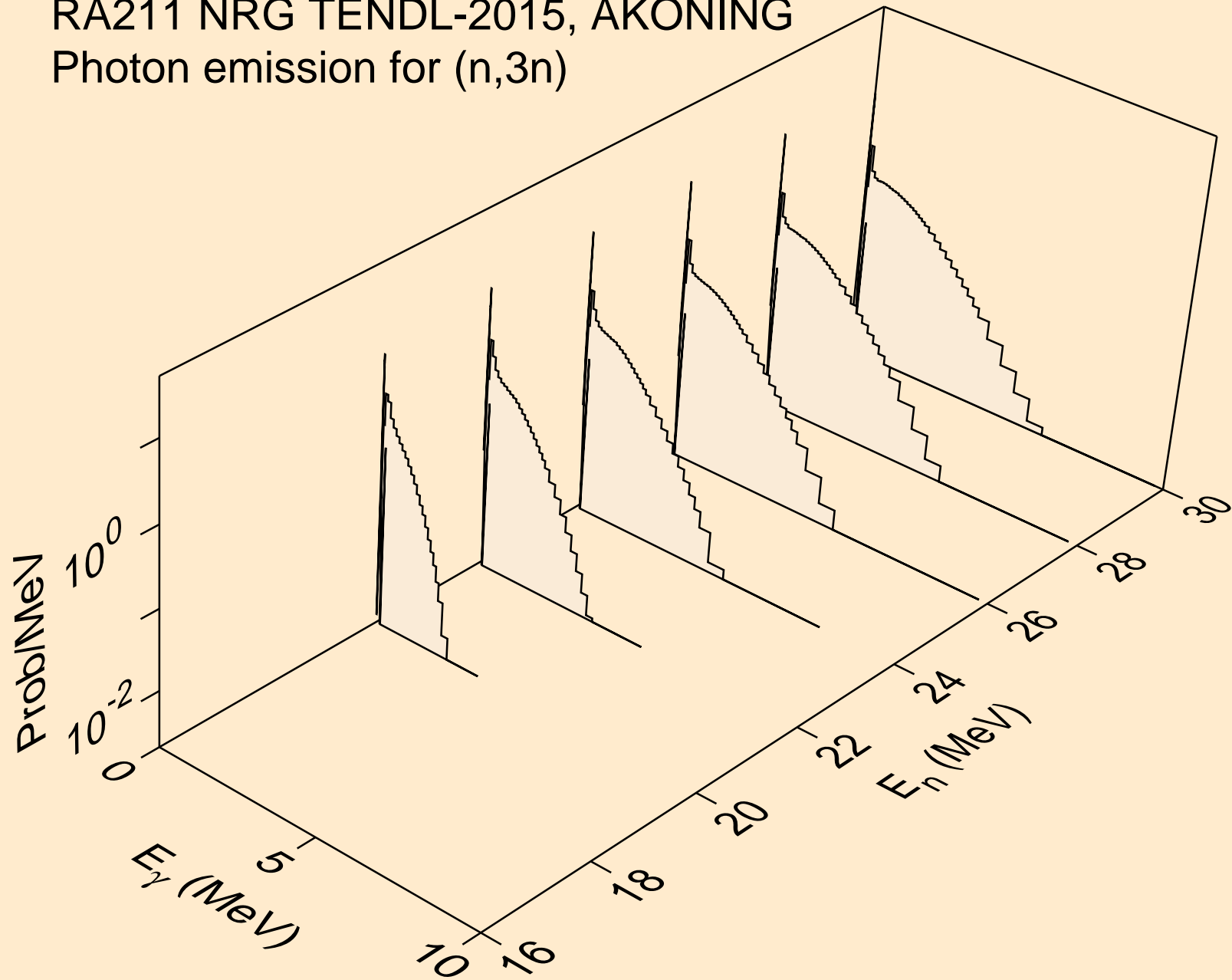

RA211 NRG TENDL-2015, AKONING
Photon emission for (n,n*)a

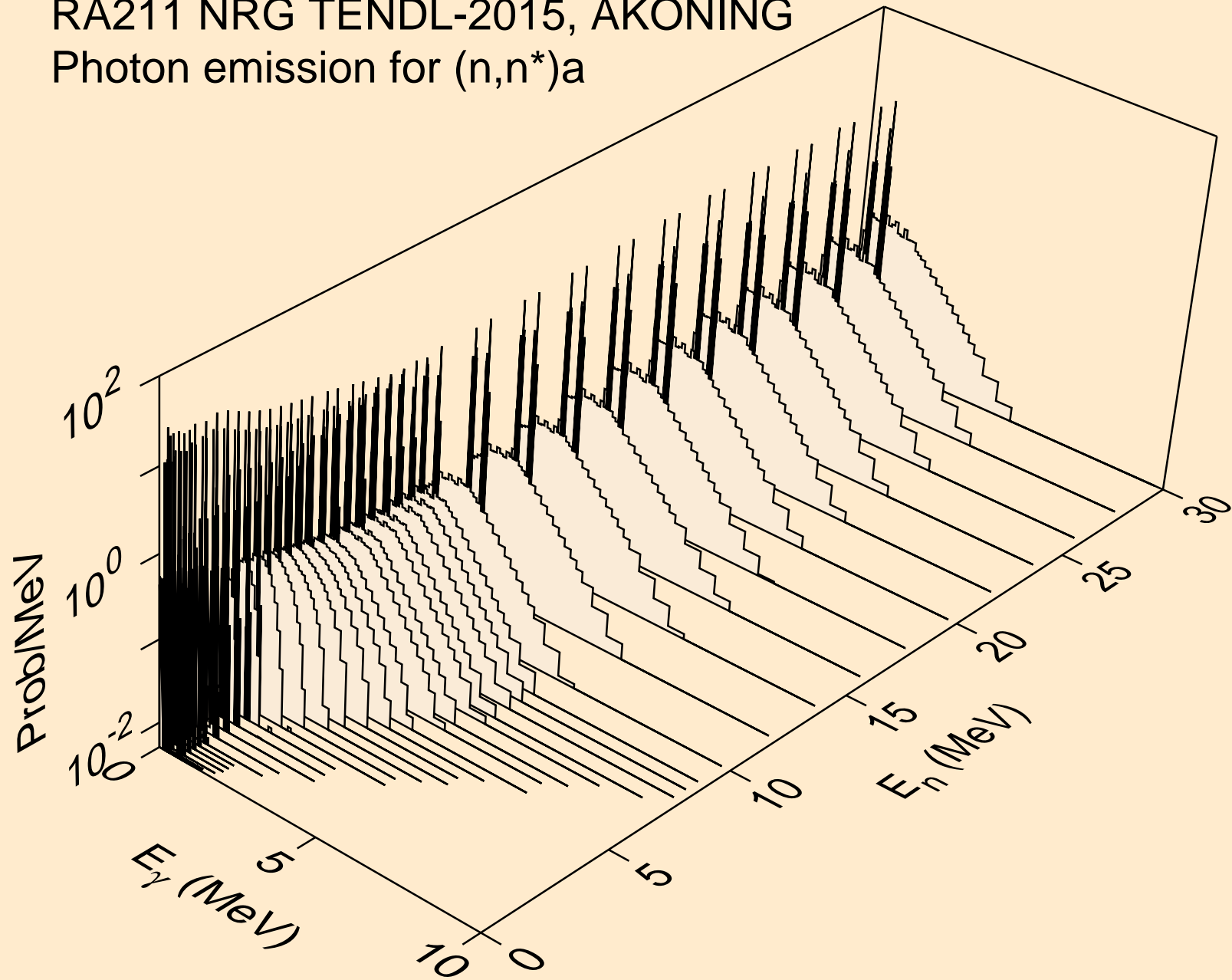

RA211 NRG TENDL-2015, AKONING
Photon emission for (n,n*)3a

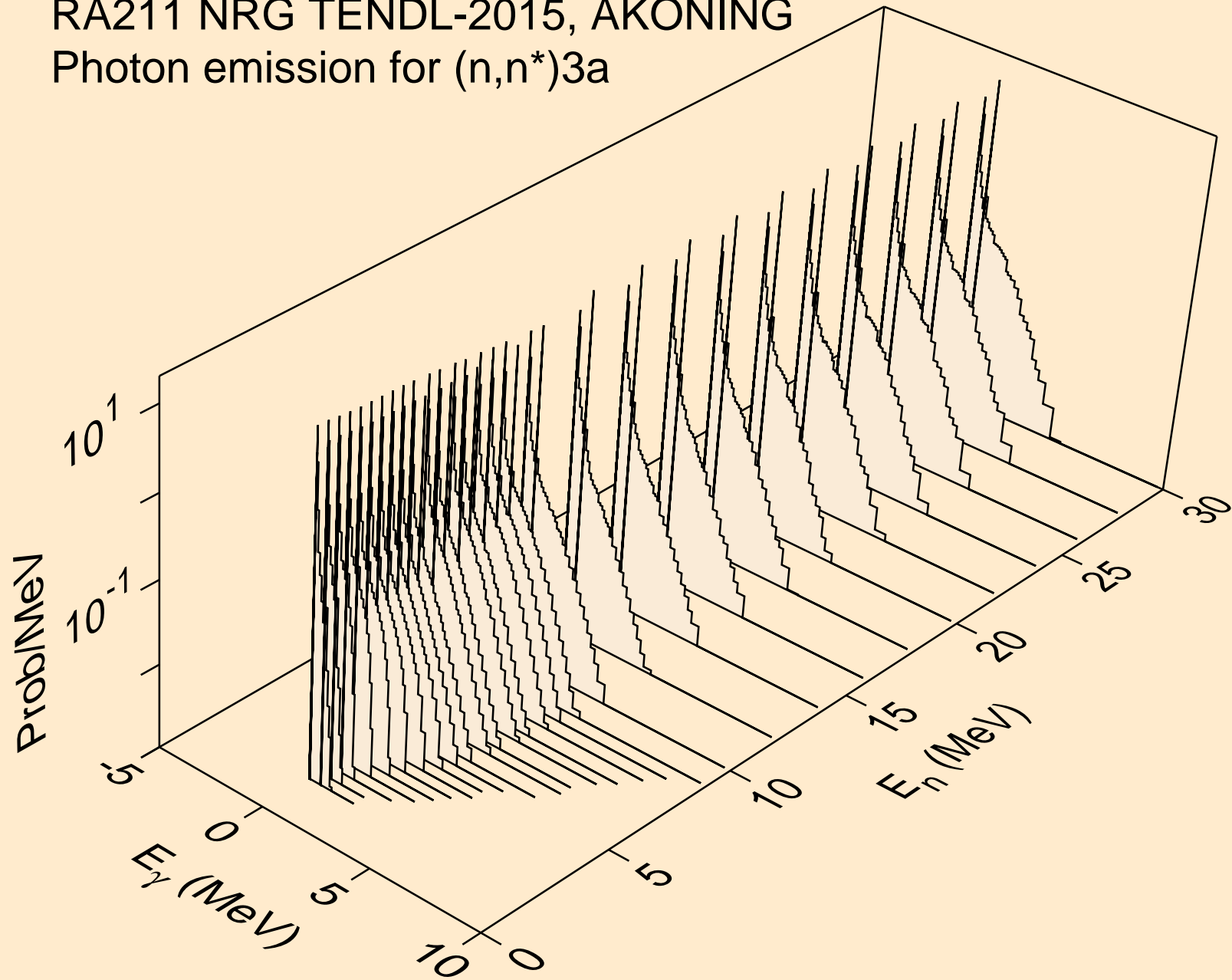

RA211 NRG TENDL-2015, AKONING
Photon emission for (n,2n)a

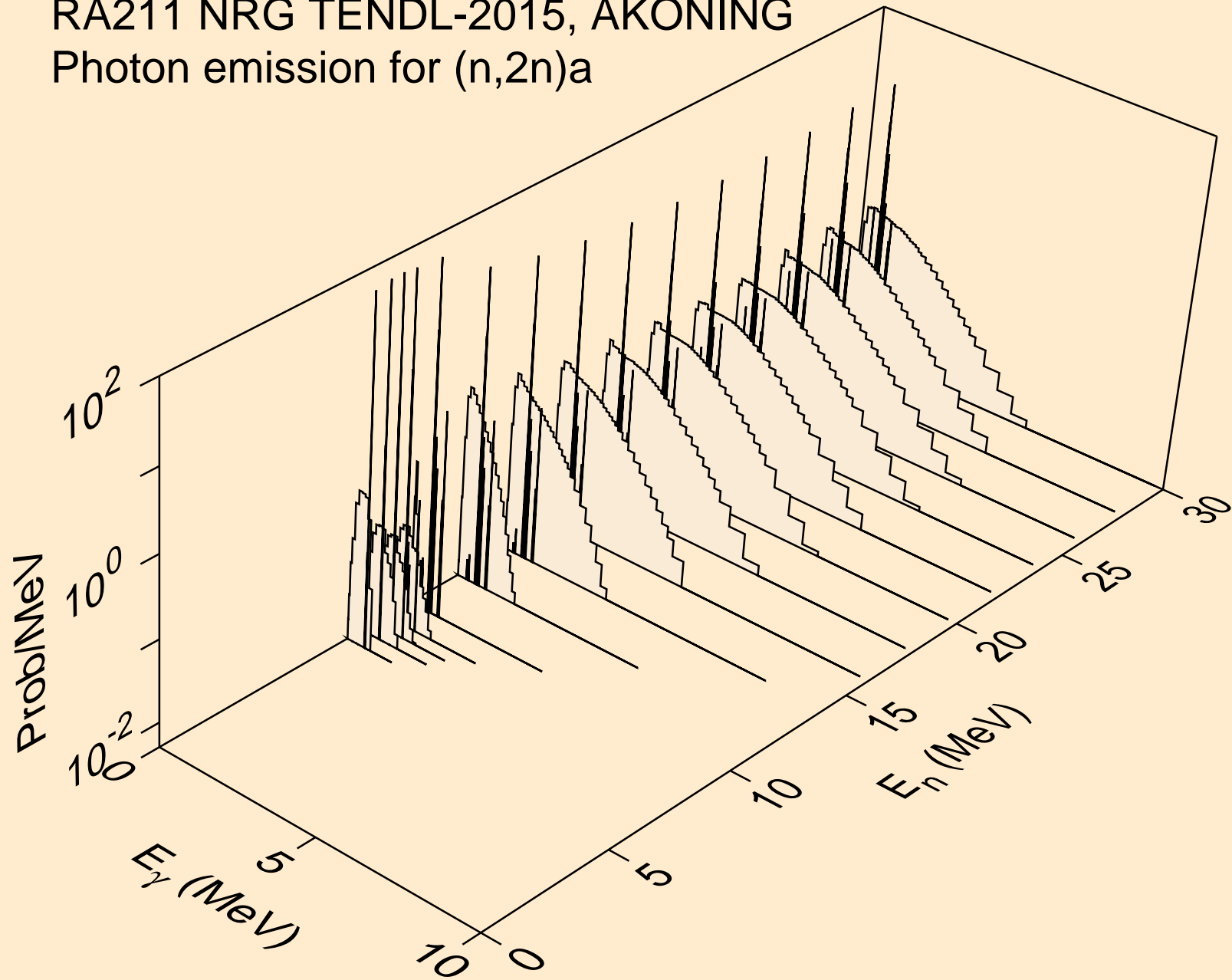

RA211 NRG TENDL-2015, AKONING
Photon emission for (n,3n)a

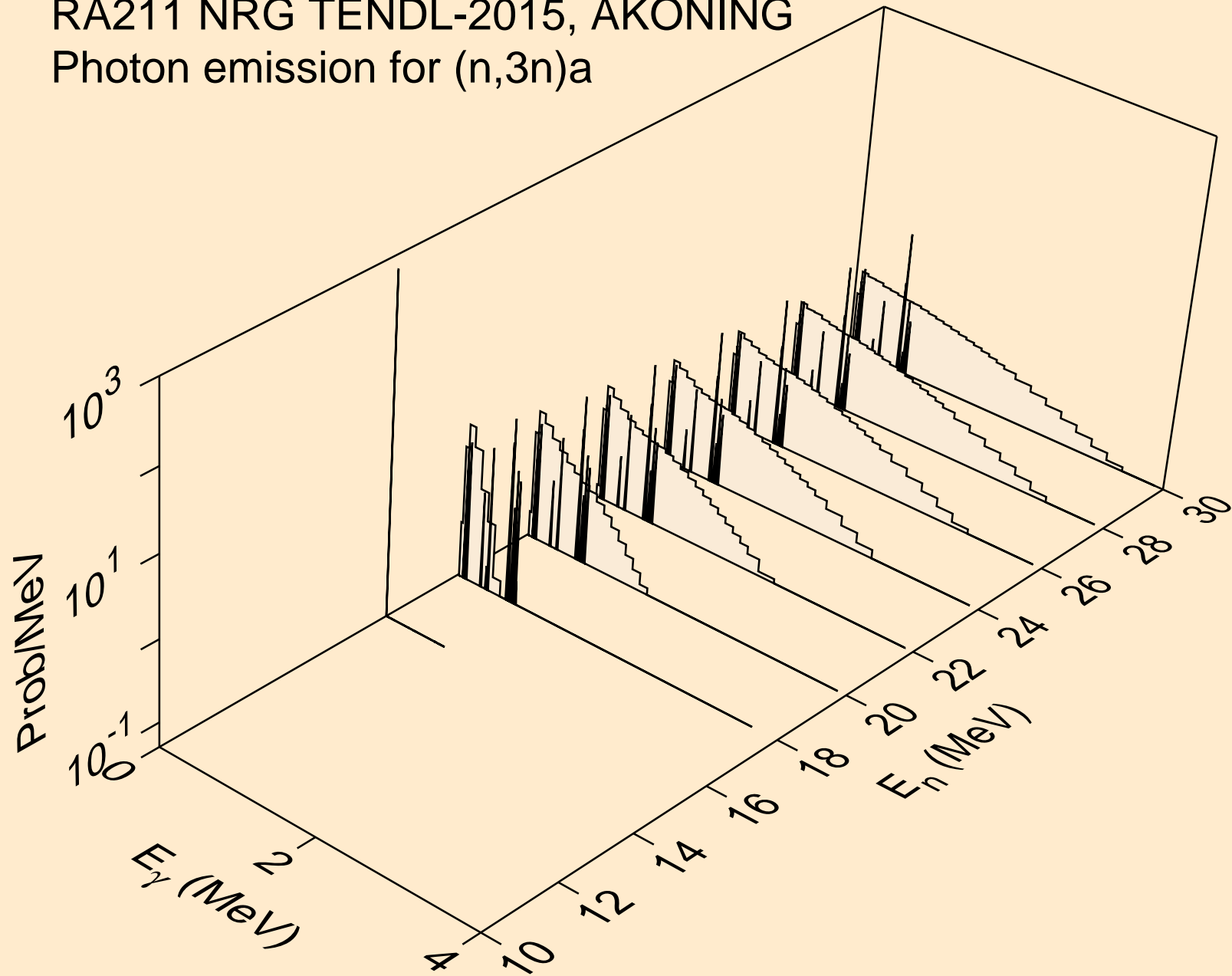

RA211 NRG TENDL-2015, AKONING
Photon emission for (n,n*)p

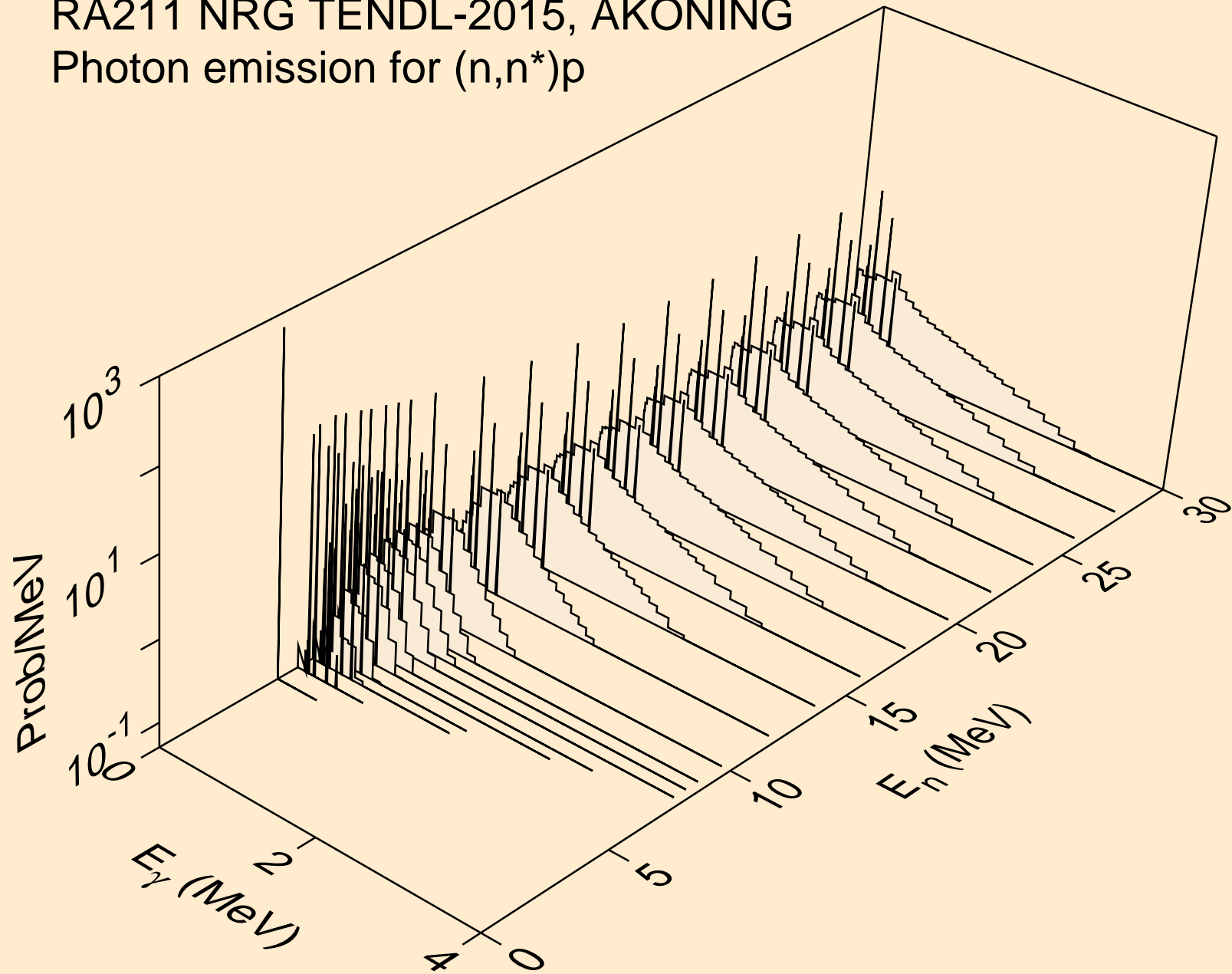

RA211 NRG TENDL-2015, AKONING
Photon emission for (n,n*)2a

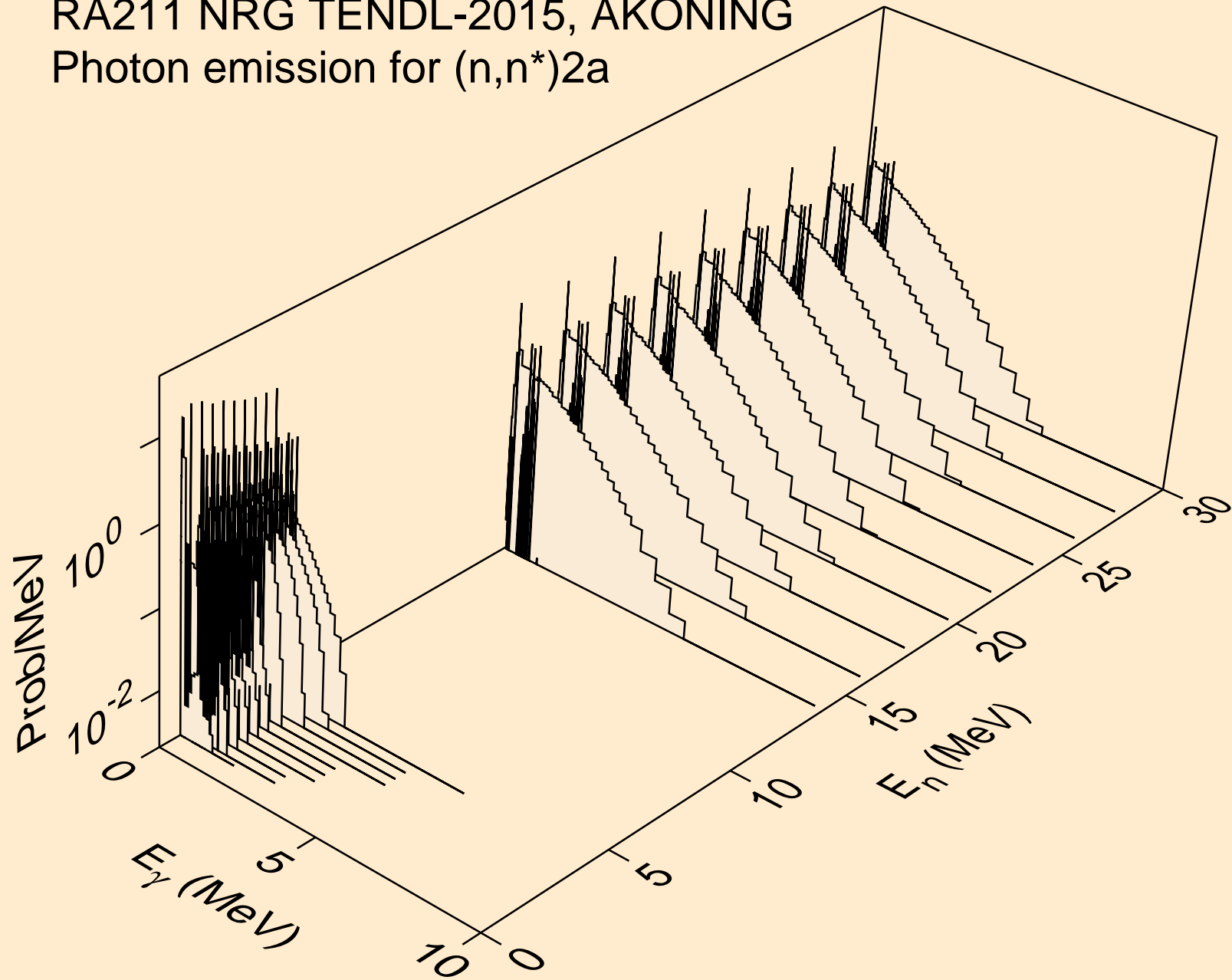

RA211 NRG TENDL-2015, AKONING
Photon emission for (n,2n)2a

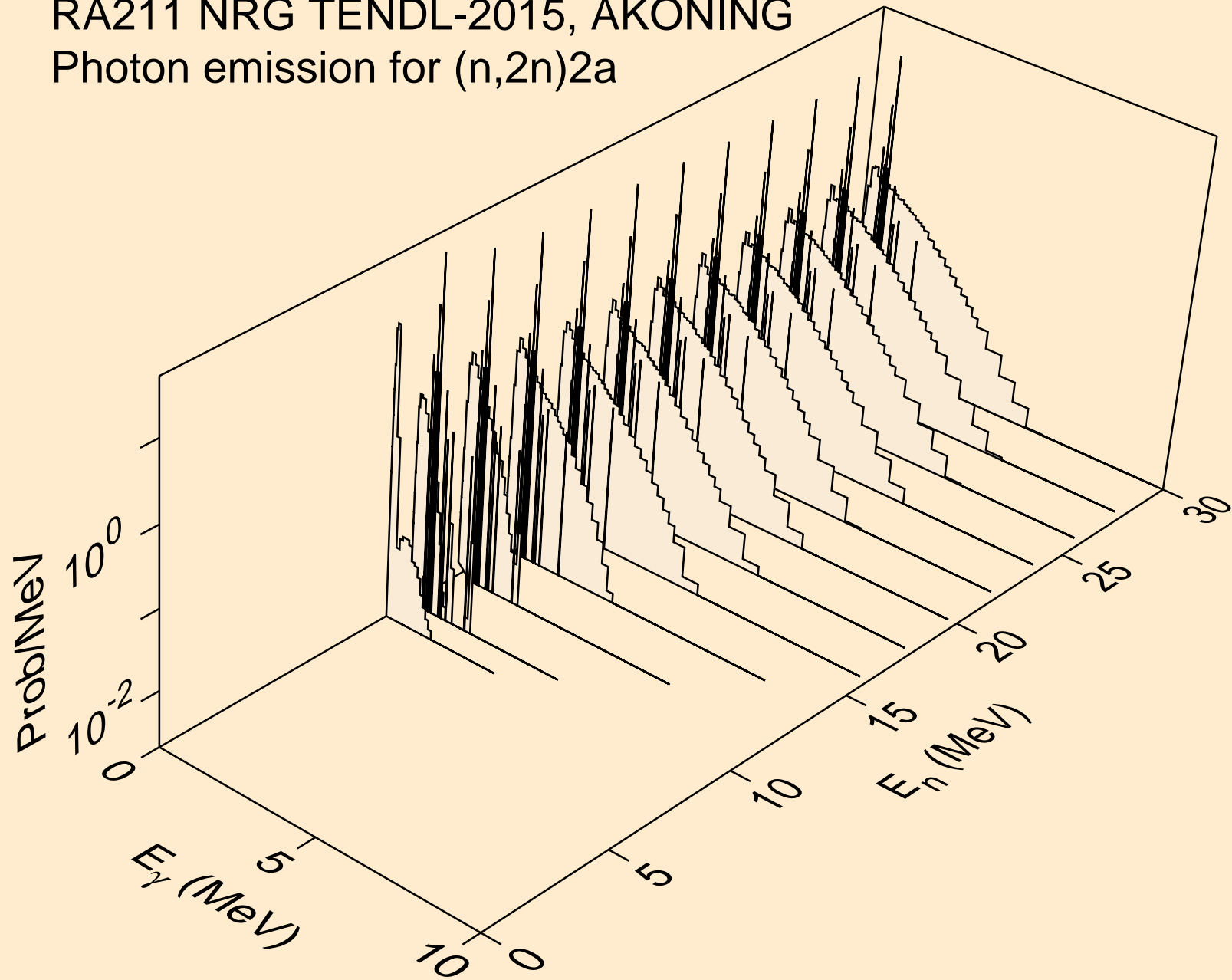

RA211 NRG TENDL-2015, AKONING
Photon emission for (n,n*)d

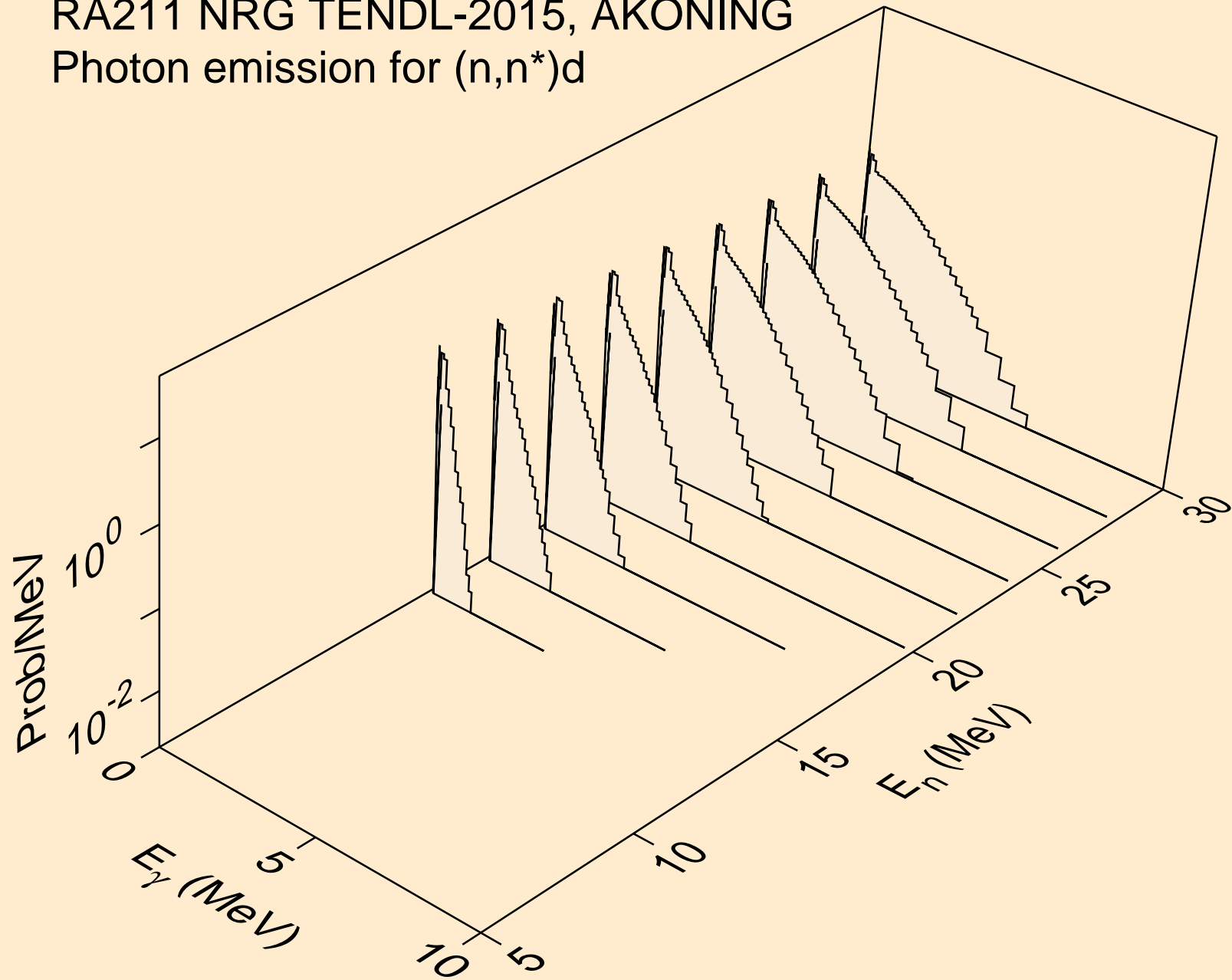

RA211 NRG TENDL-2015, AKONING
Photon emission for (n,n*)t

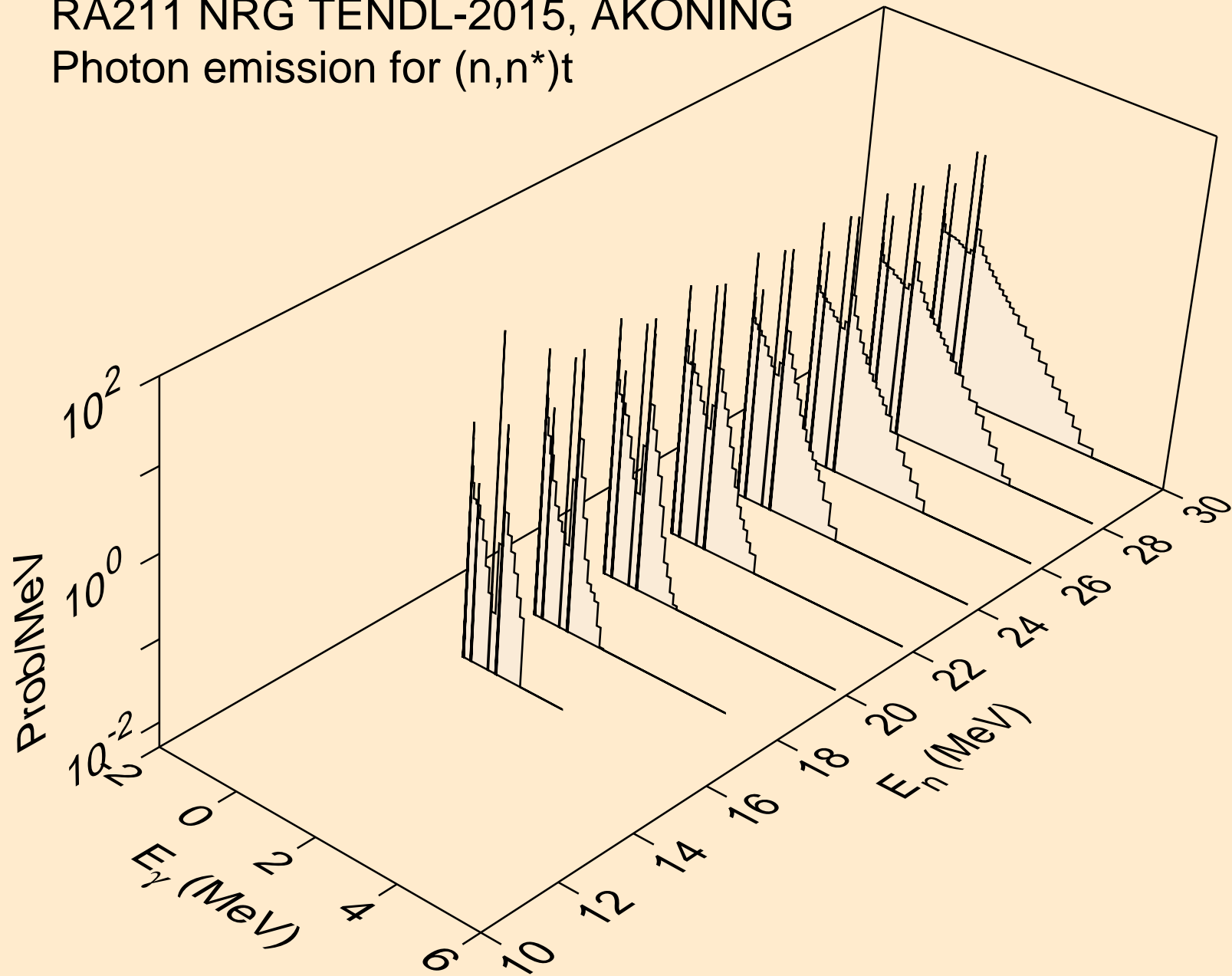

RA211 NRG TENDL-2015, AKONING
Photon emission for (n,n*)he3

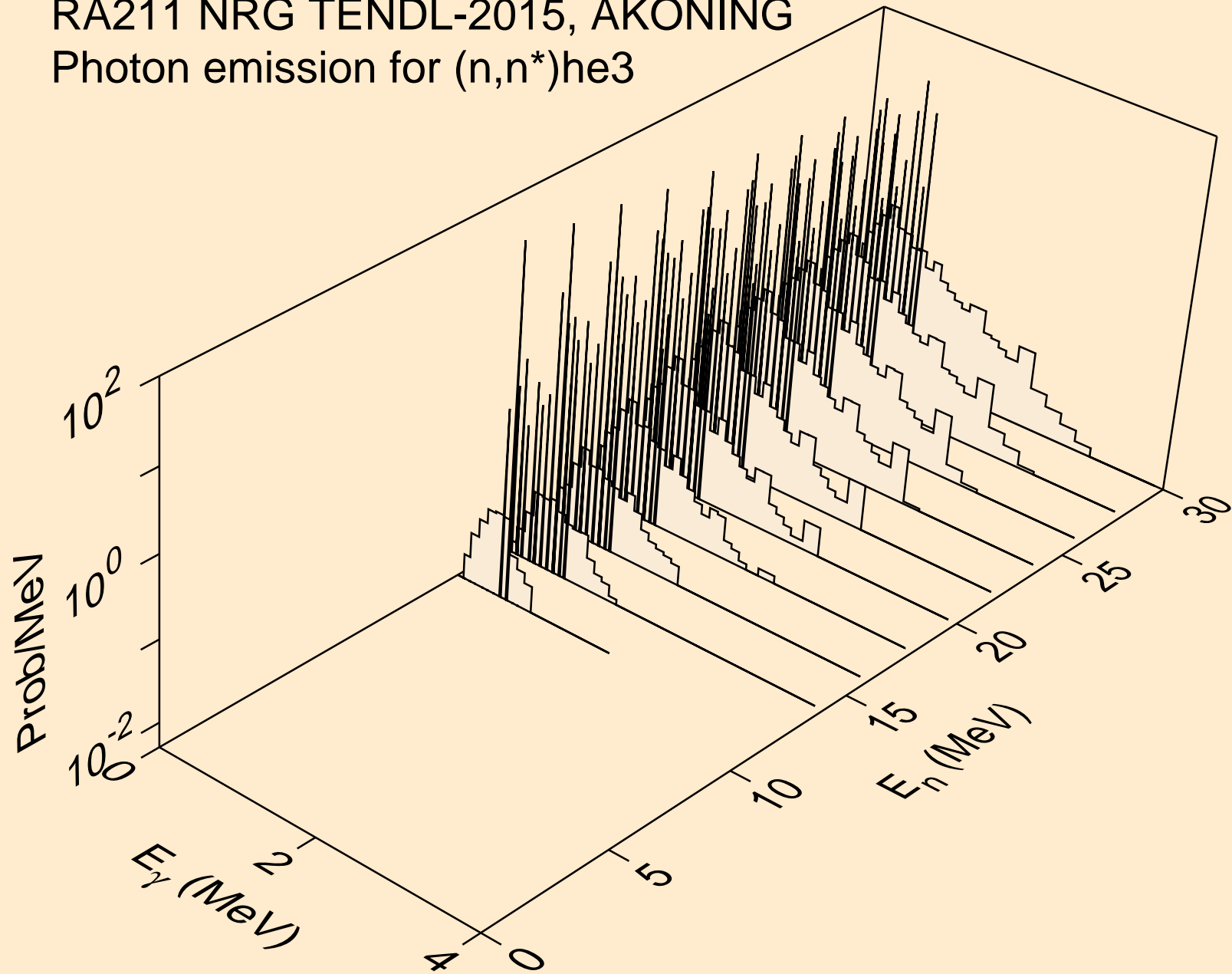

RA211 NRG TENDL-2015, AKONING
Photon emission for (n,n*)d2a

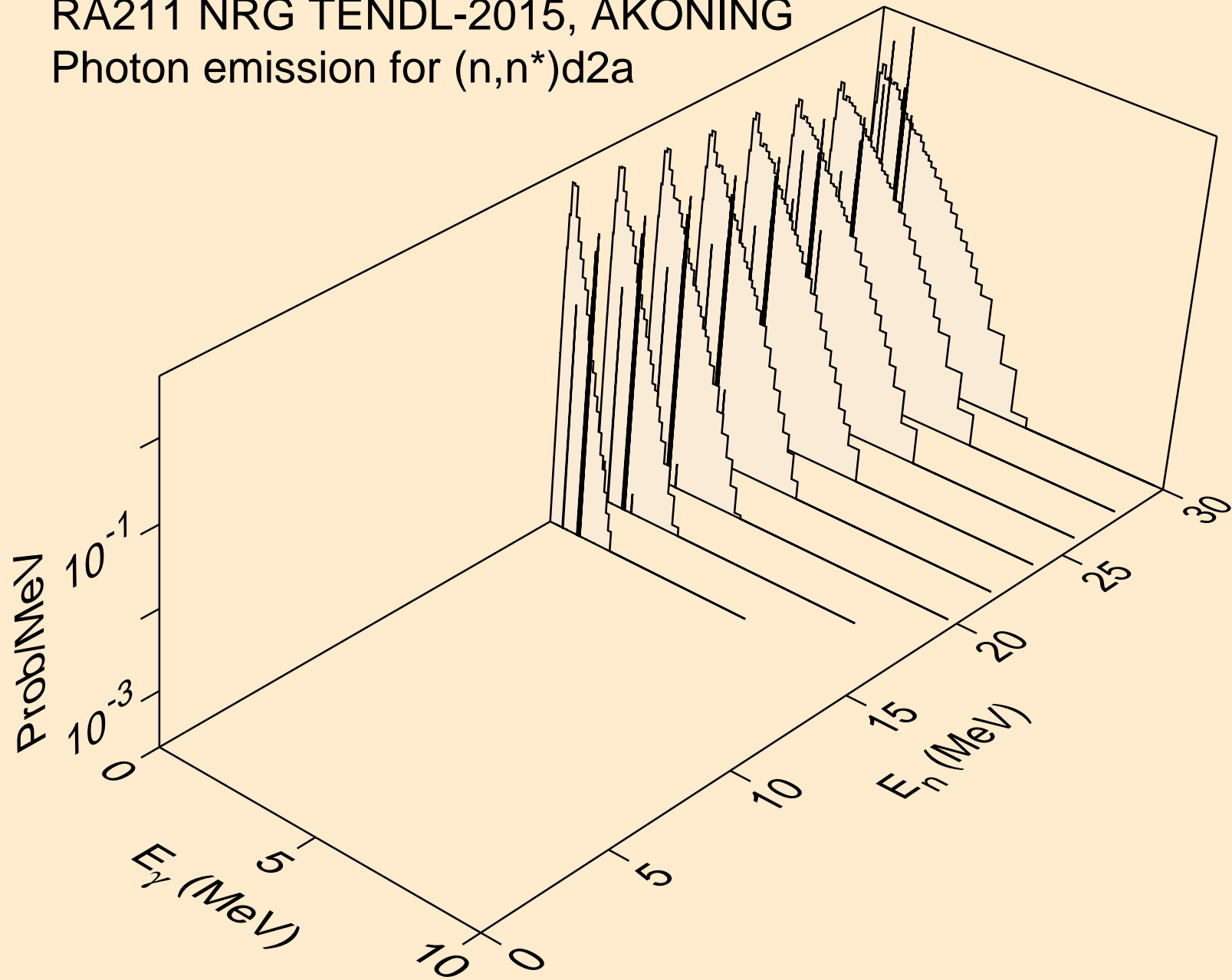

RA211 NRG TENDL-2015, AKONING
Photon emission for (n,n*)t2a

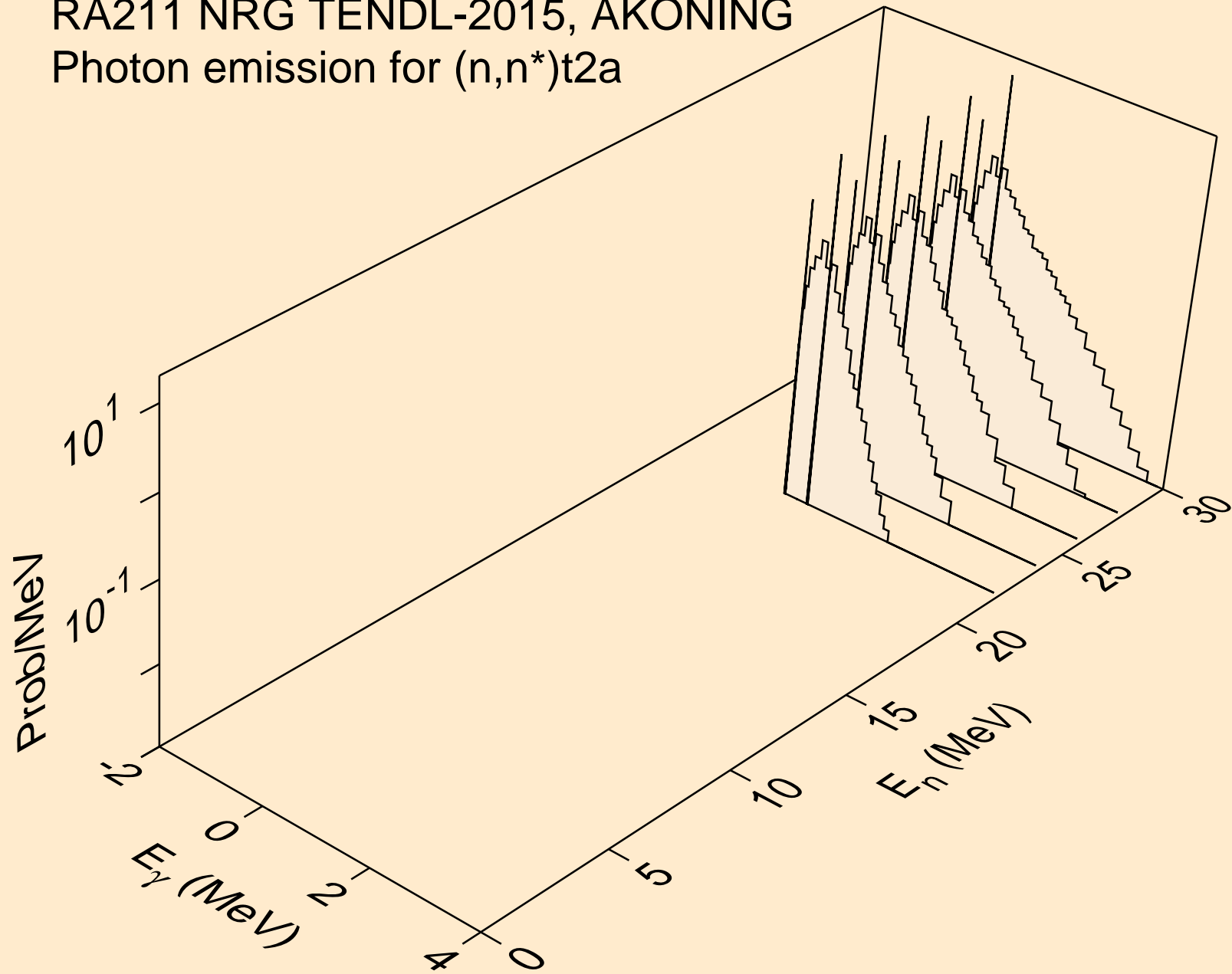

RA211 NRG TENDL-2015, AKONING
Photon emission for (n,4n)

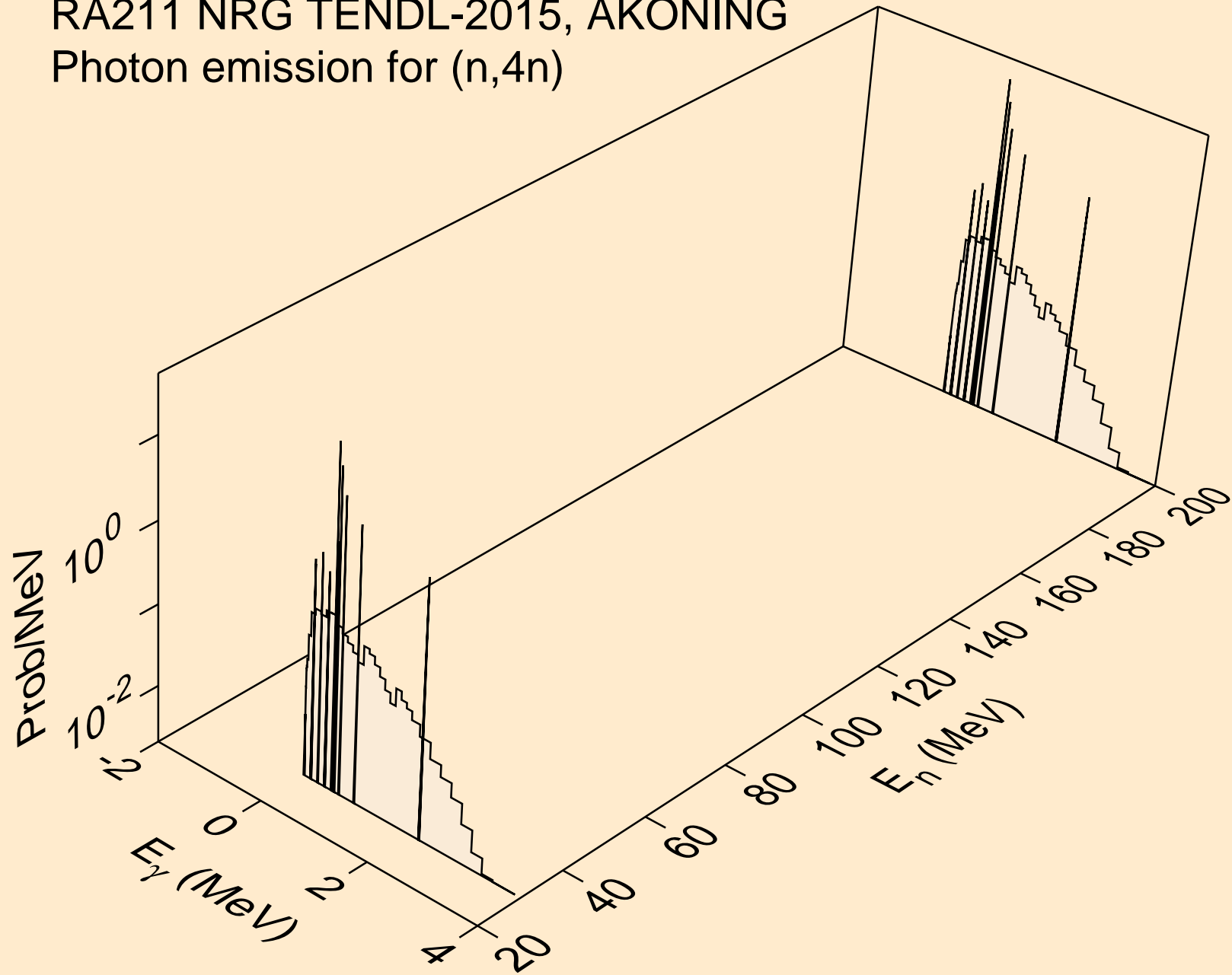

RA211 NRG TENDL-2015, AKONING
Photon emission for (n,2np)

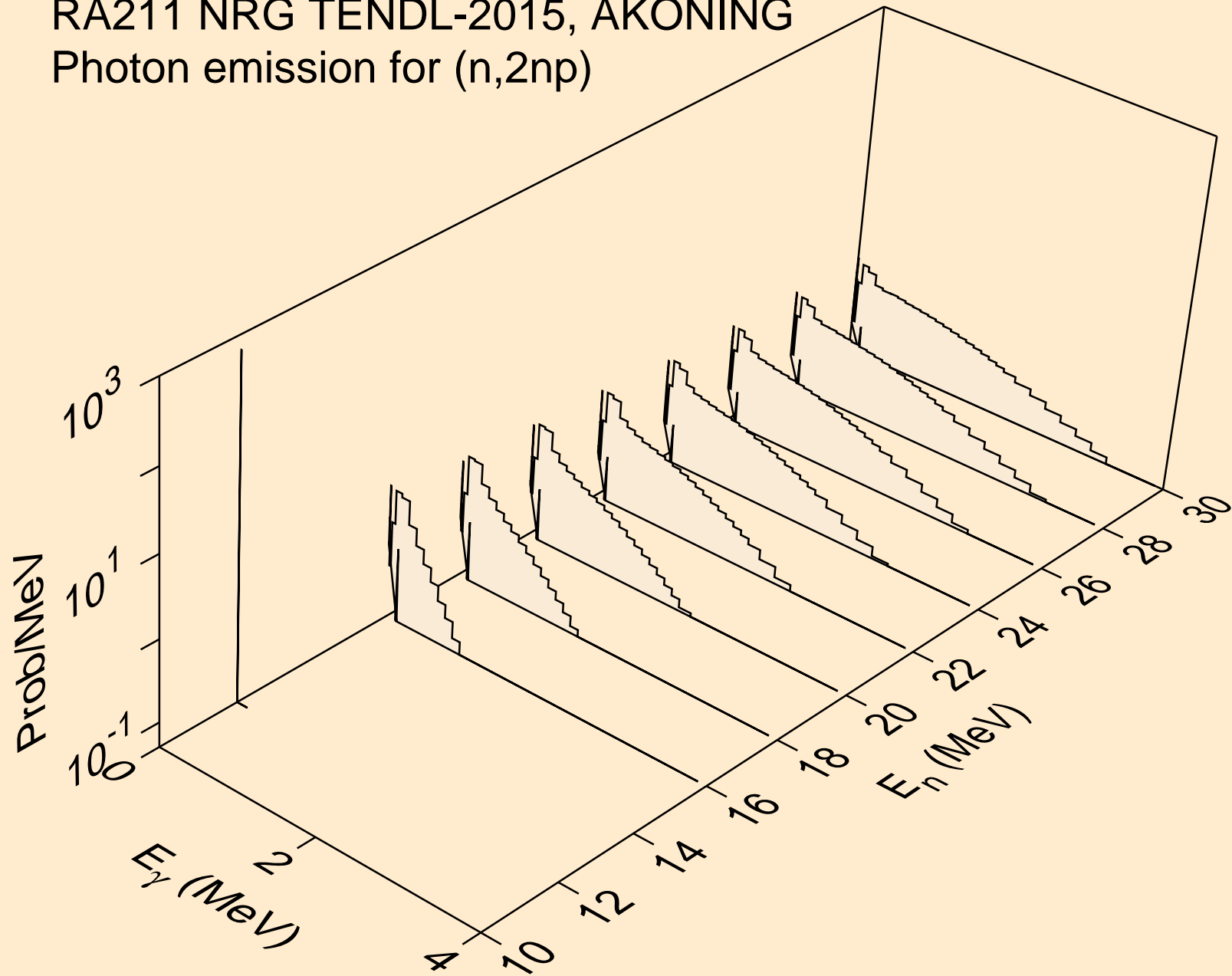

RA211 NRG TENDL-2015, AKONING
Photon emission for (n,3np)

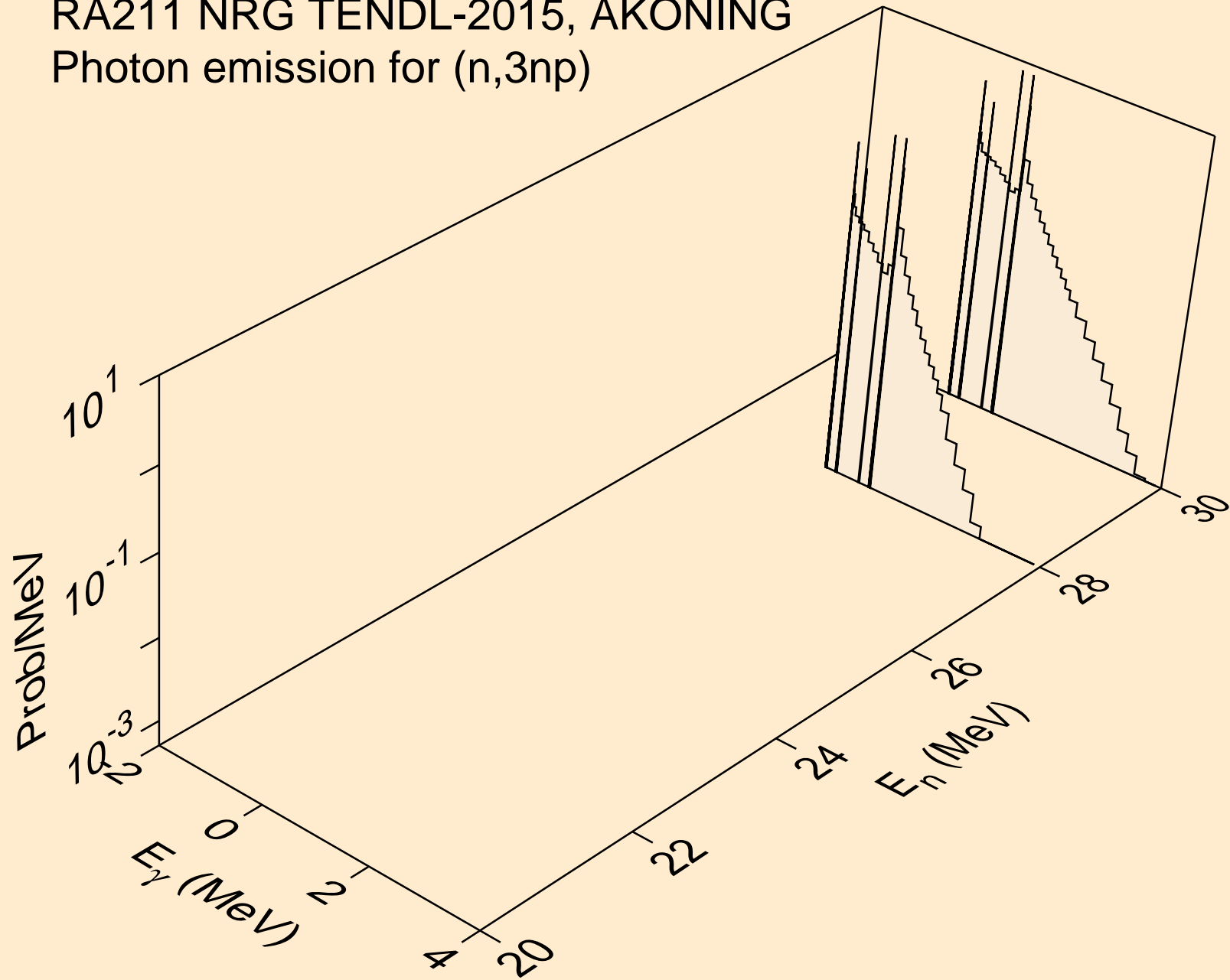

RA211 NRG TENDL-2015, AKONING
Photon emission for (n,2np)

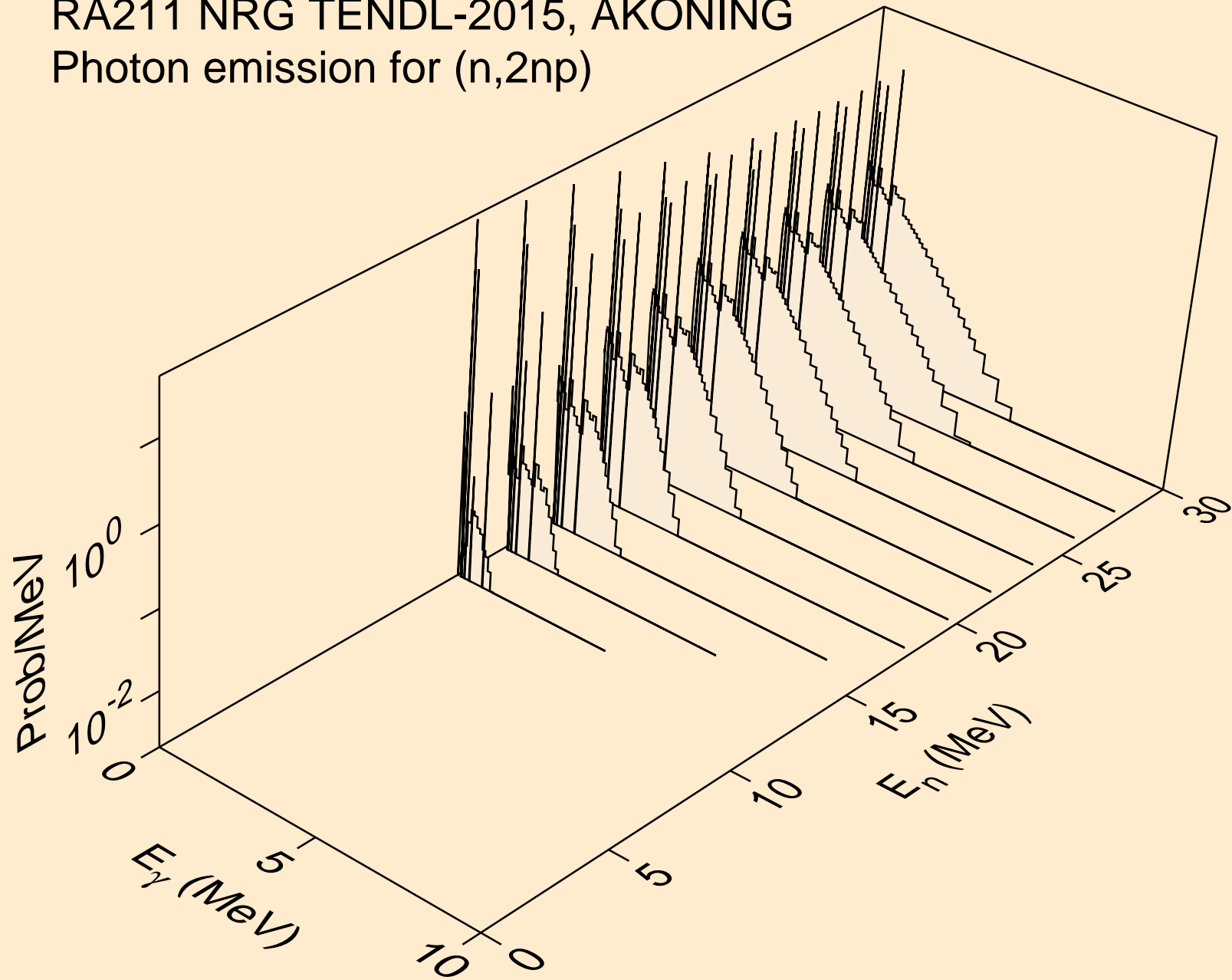

RA211 NRG TENDL-2015, AKONING
Photon emission for (n,npa)

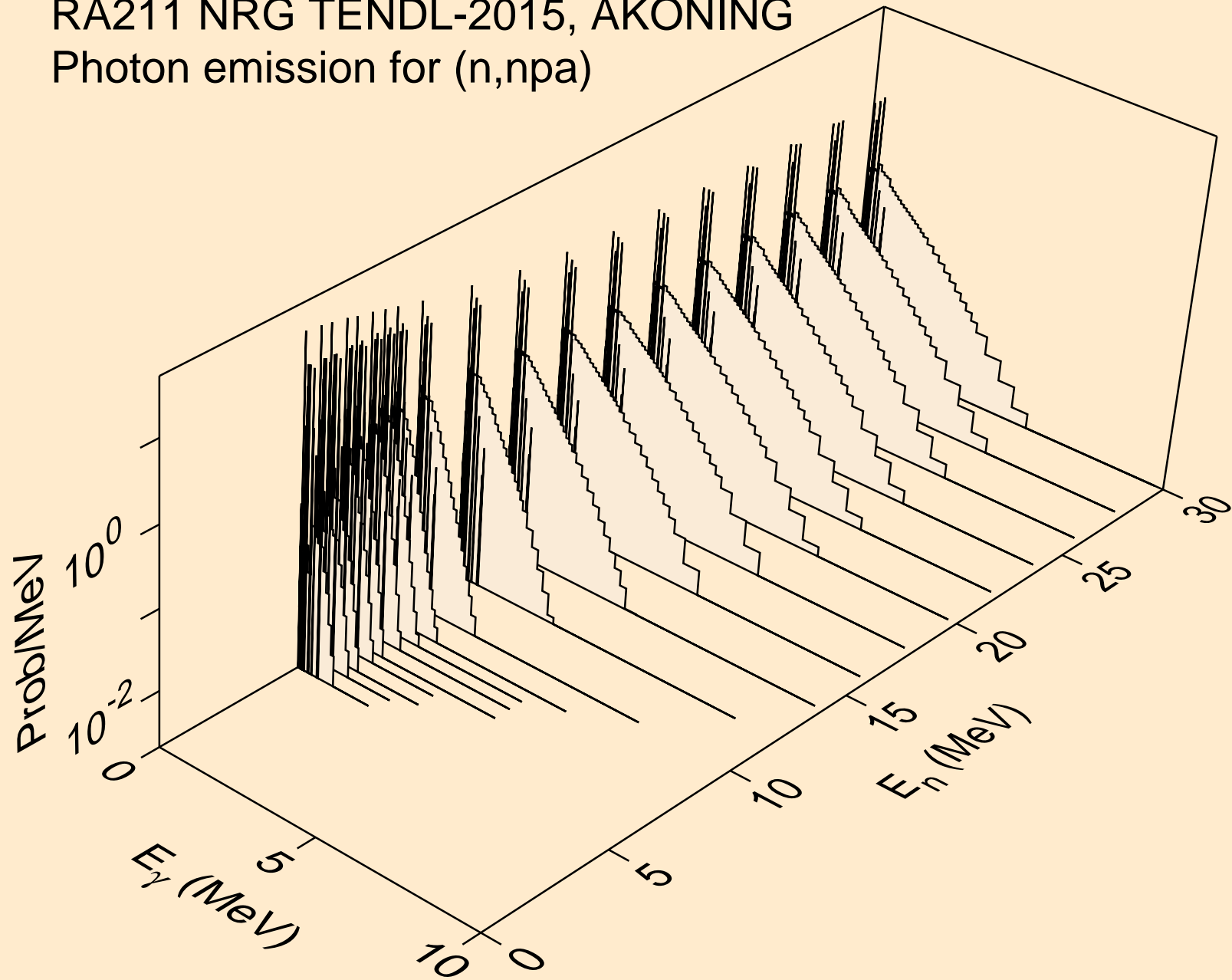

RA211 NRG TENDL-2015, AKONING
Photon emission for (n,n*c)

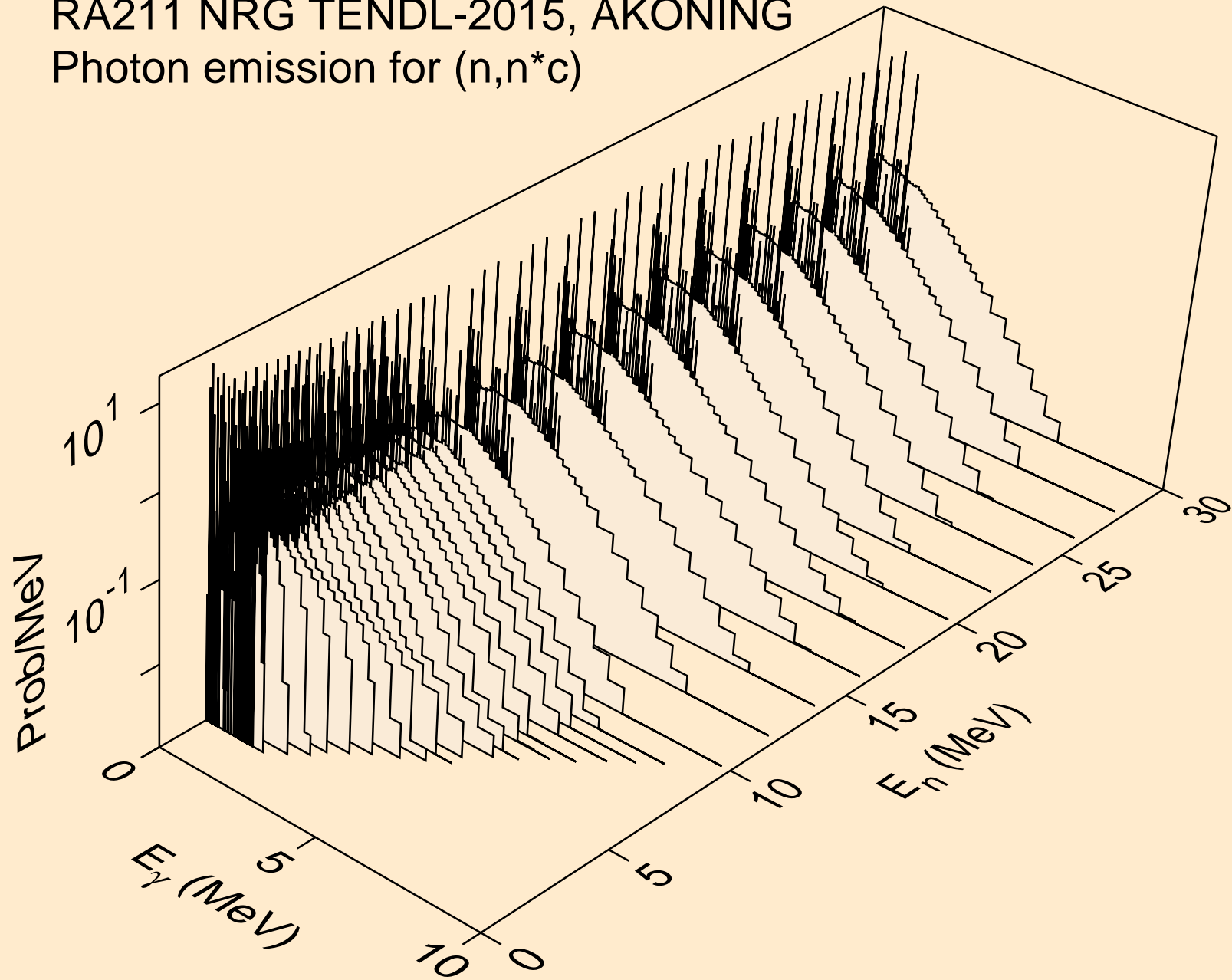

RA211 NRG TENDL-2015, AKONING
Photon emission for (n,gma)

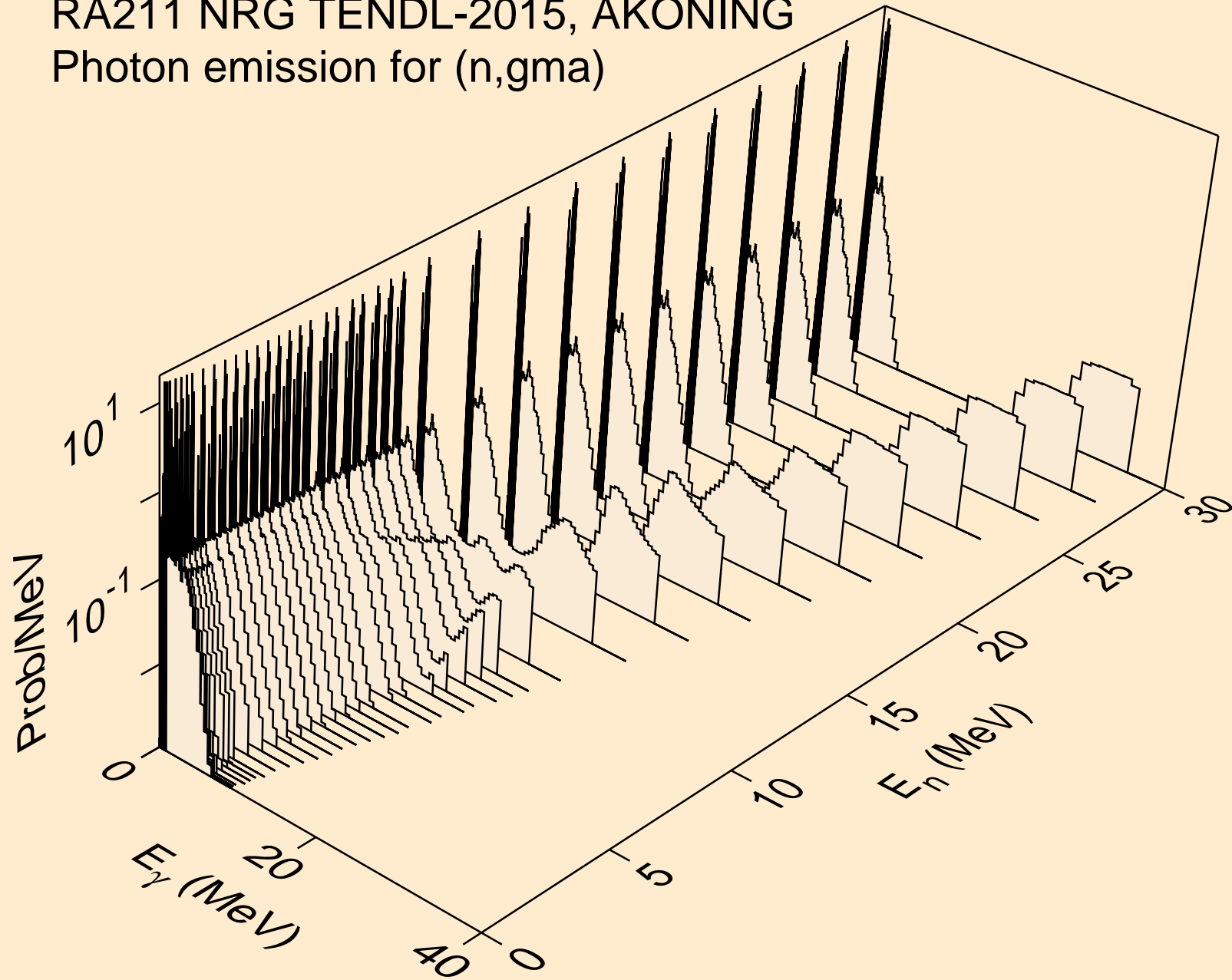

RA211 NRG TENDL-2015, AKONING
Photon emission for (n,p)

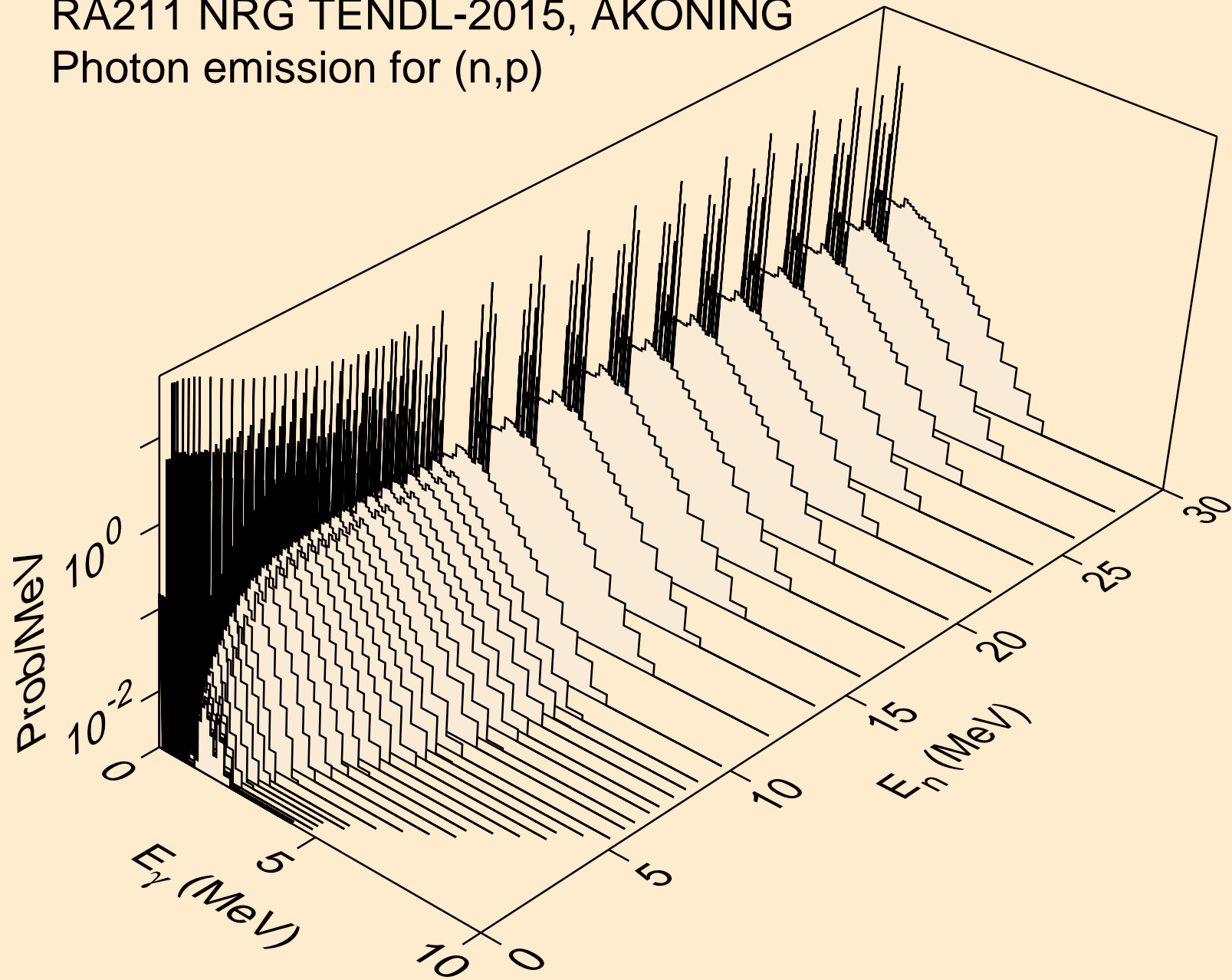

RA211 NRG TENDL-2015, AKONING
Photon emission for (n,d)

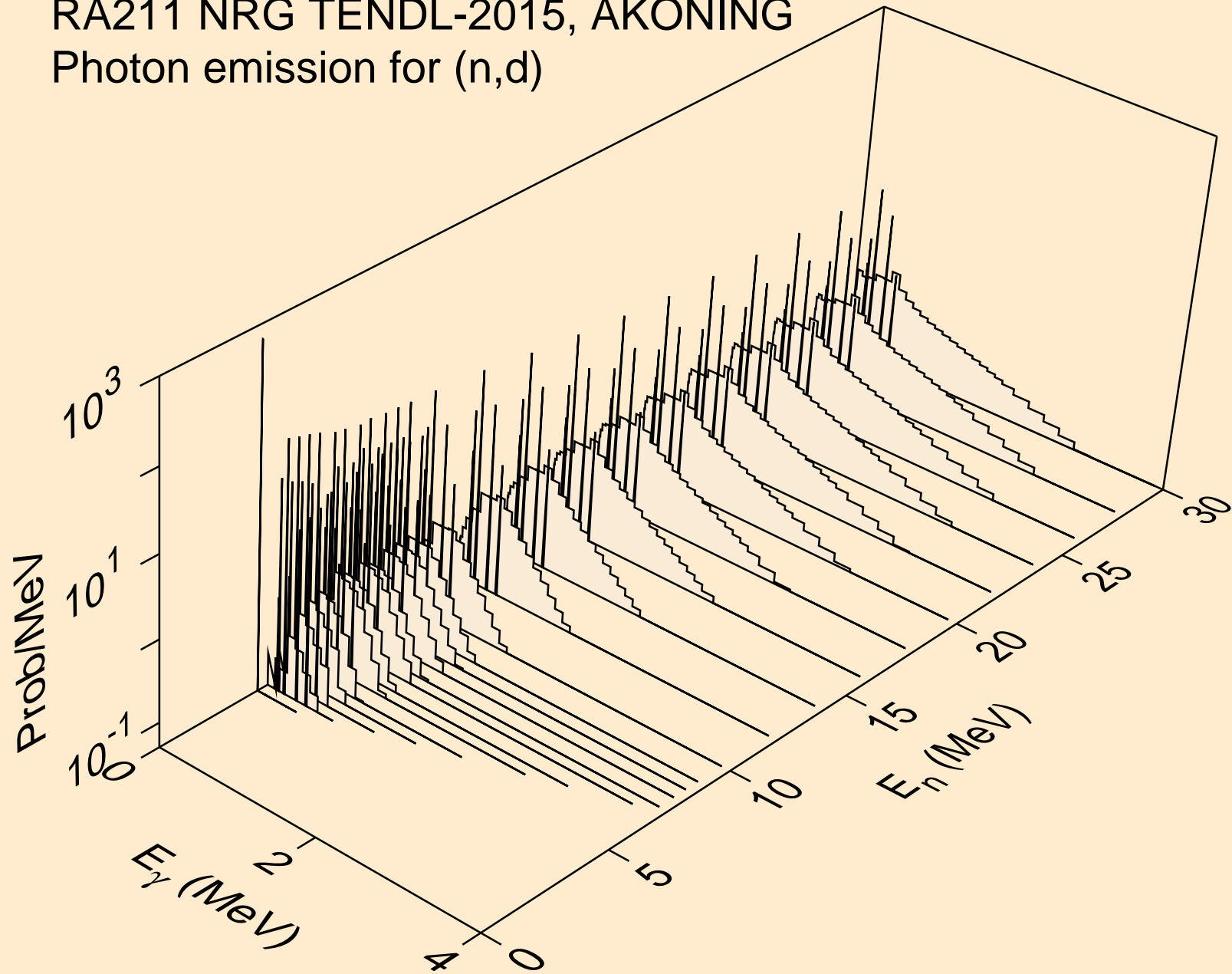

RA211 NRG TENDL-2015, AKONING
Photon emission for (n,t)

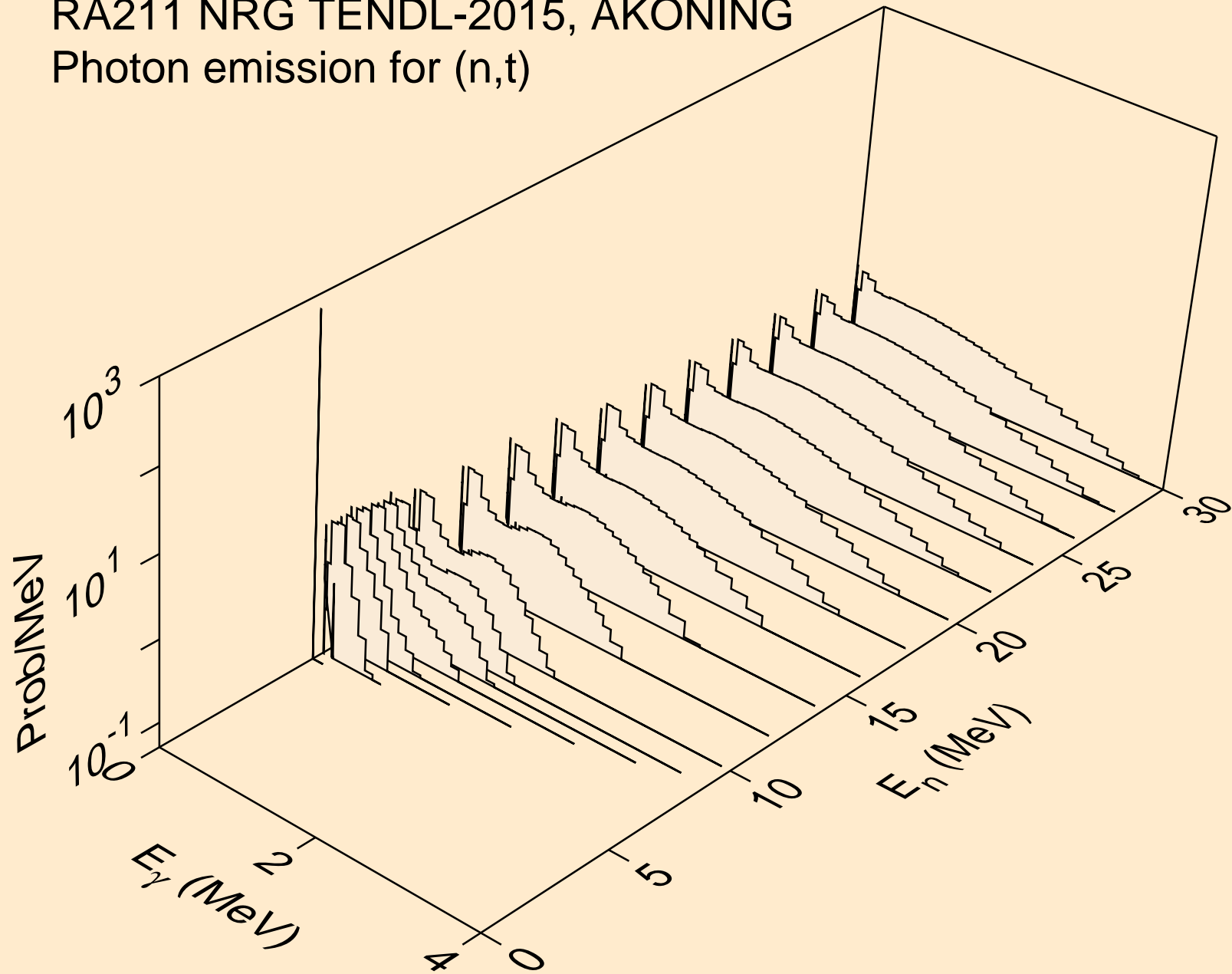

RA211 NRG TENDL-2015, AKONING
Photon emission for (n,he3)

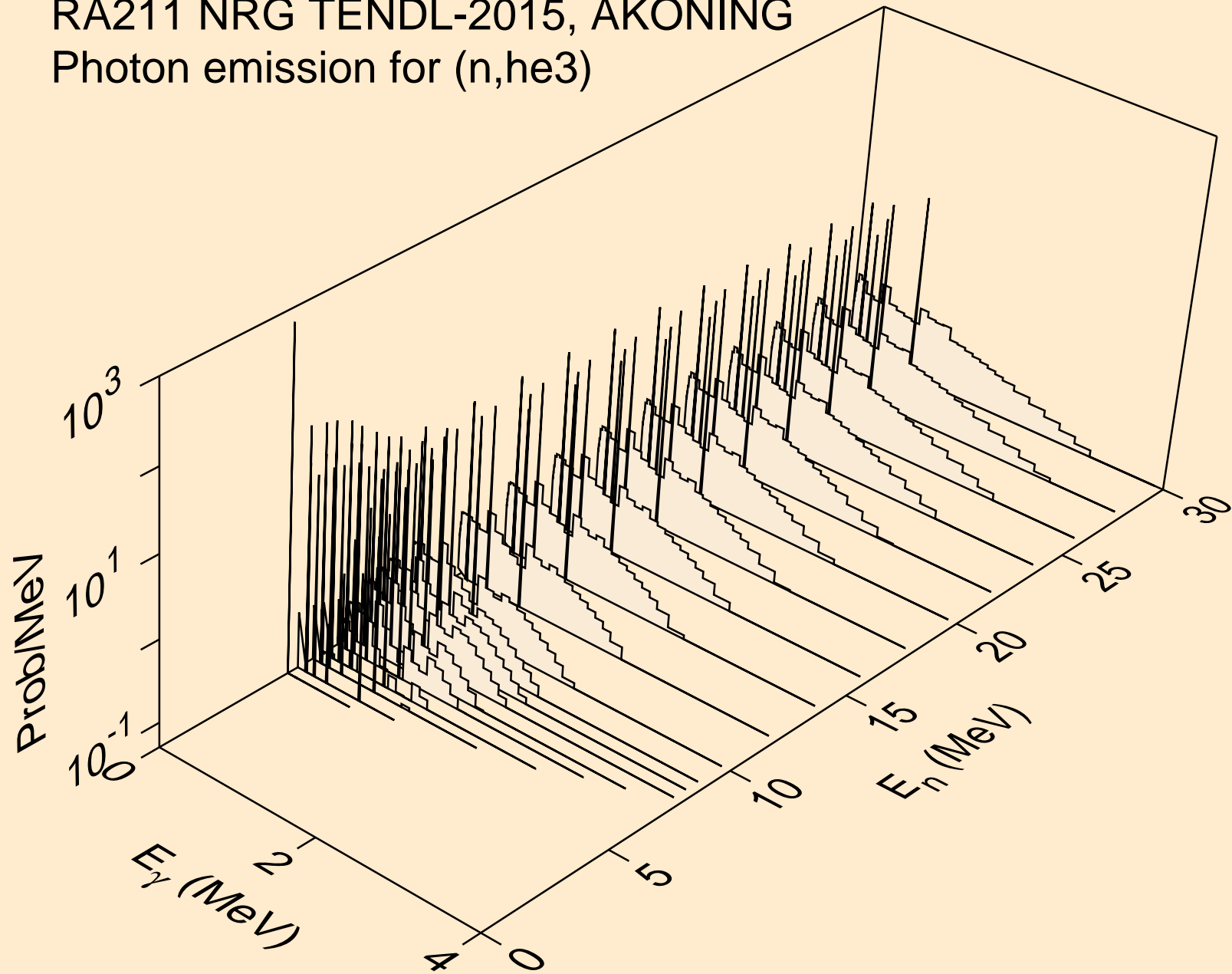

RA211 NRG TENDL-2015, AKONING
Photon emission for (n,a)

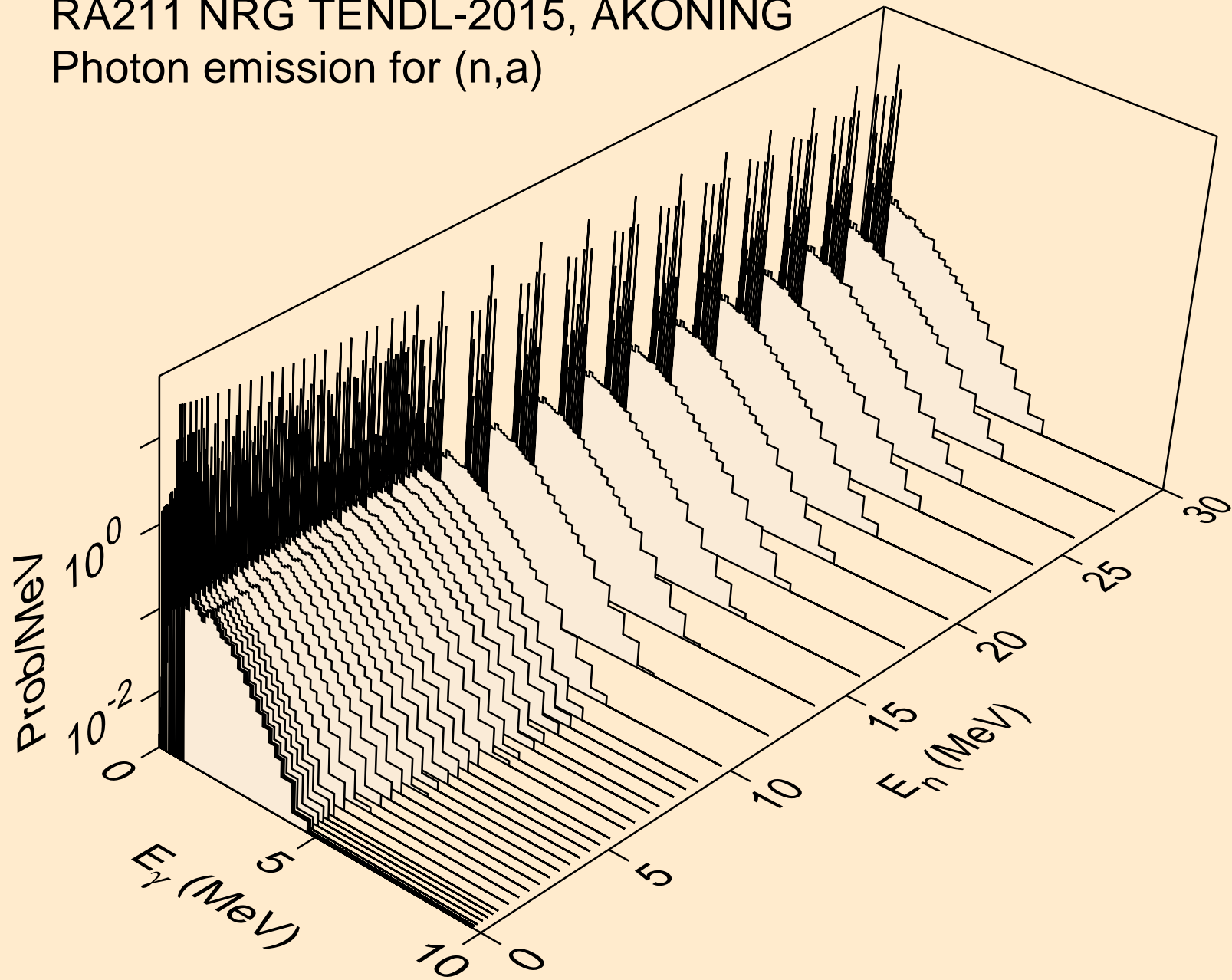

RA211 NRG TENDL-2015, AKONING
Photon emission for (n,2a)

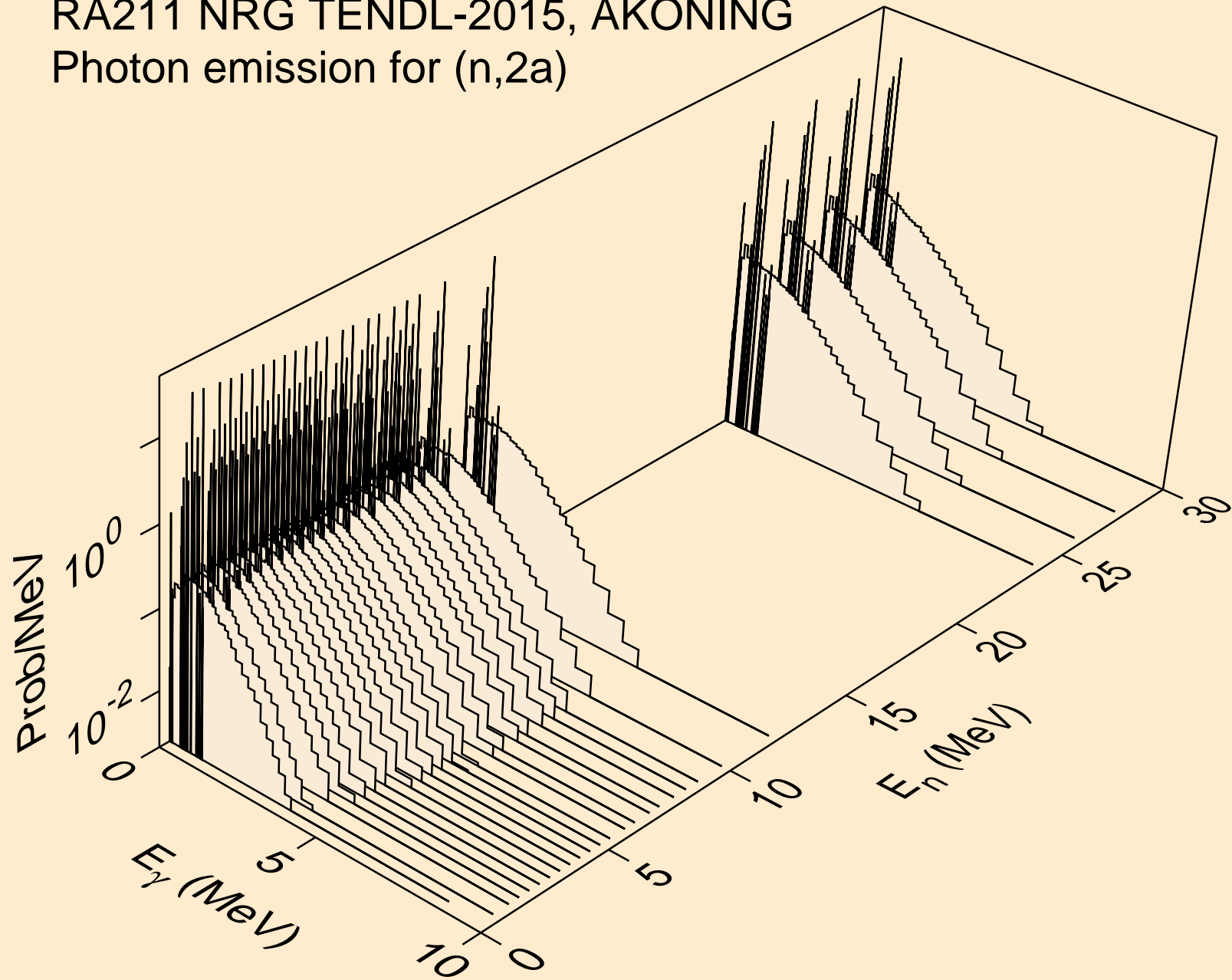

RA211 NRG TENDL-2015, AKONING
Photon emission for (n,3a)

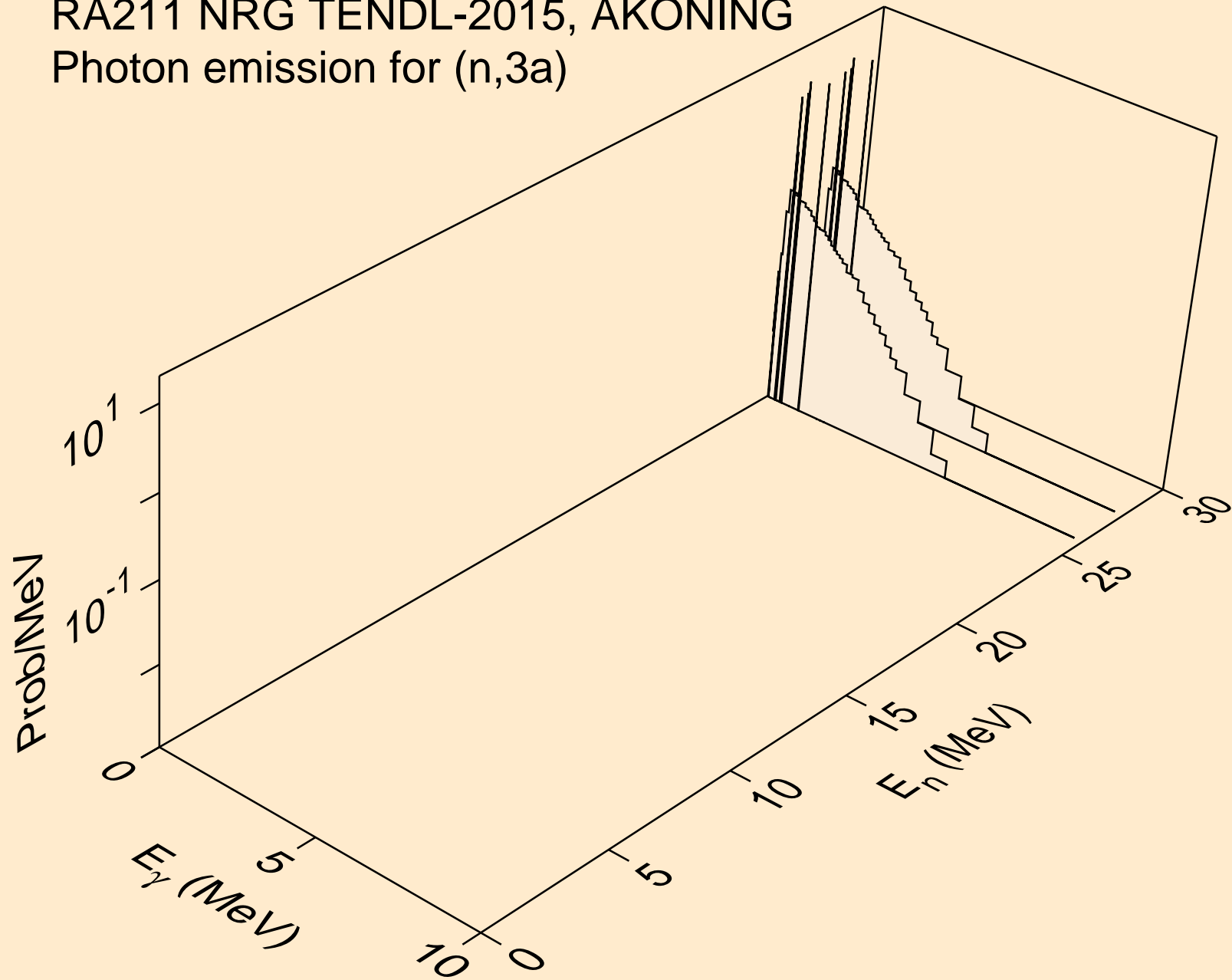

RA211 NRG TENDL-2015, AKONING
Photon emission for (n,2p)

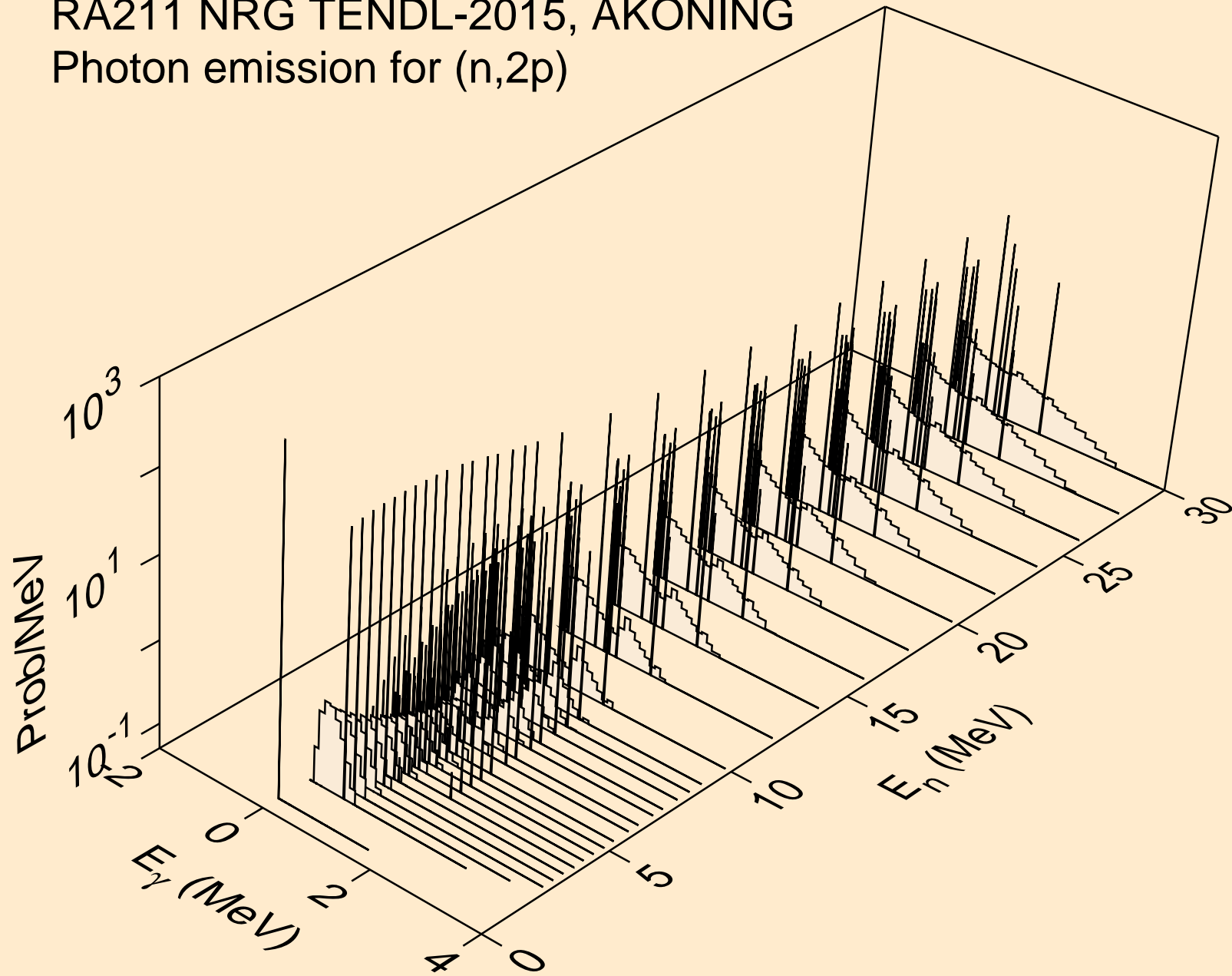

RA211 NRG TENDL-2015, AKONING
Photon emission for (n,p α)

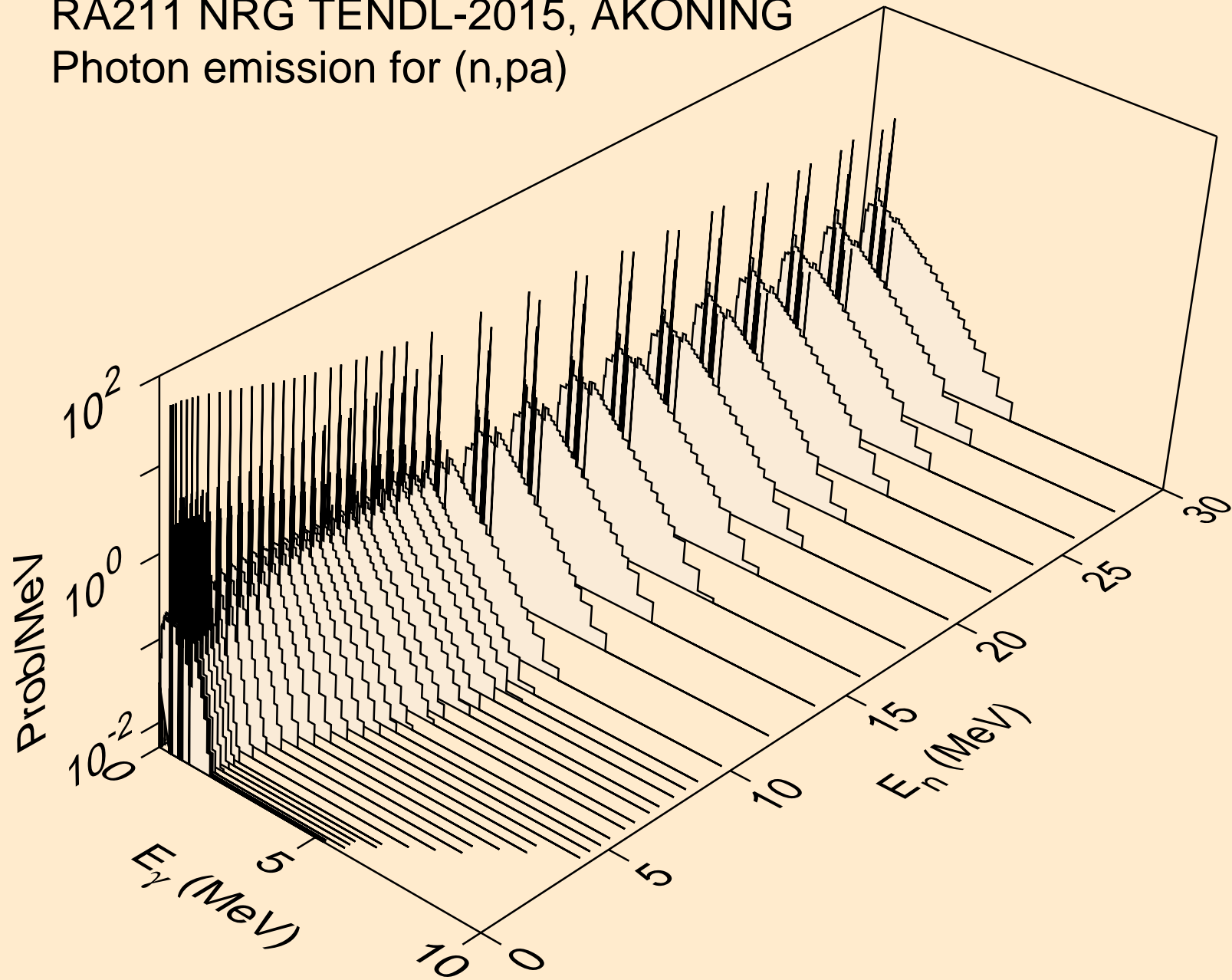

RA211 NRG TENDL-2015, AKONING
Photon emission for (n,t2a)

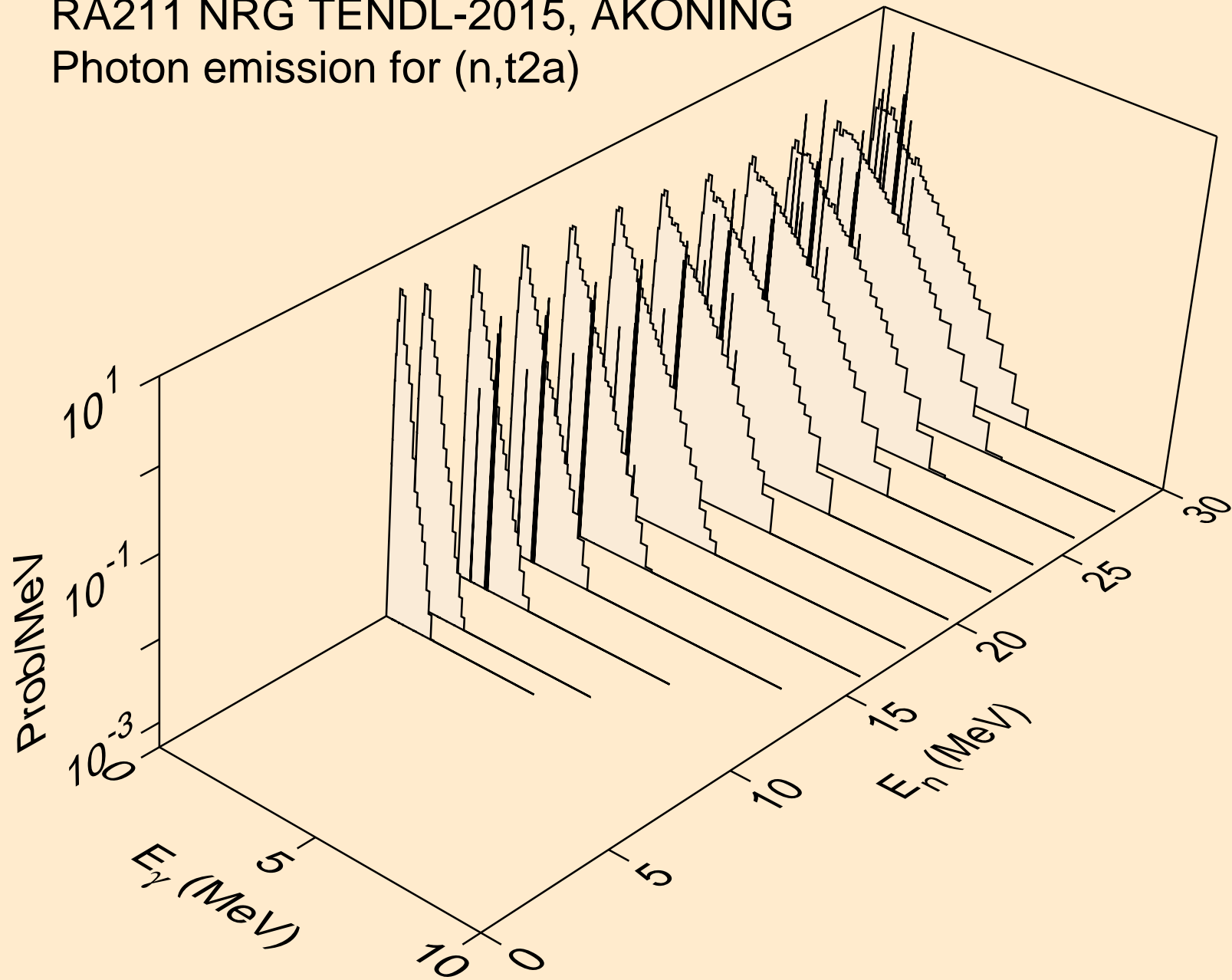

RA211 NRG TENDL-2015, AKONING
Photon emission for (n,d2a)

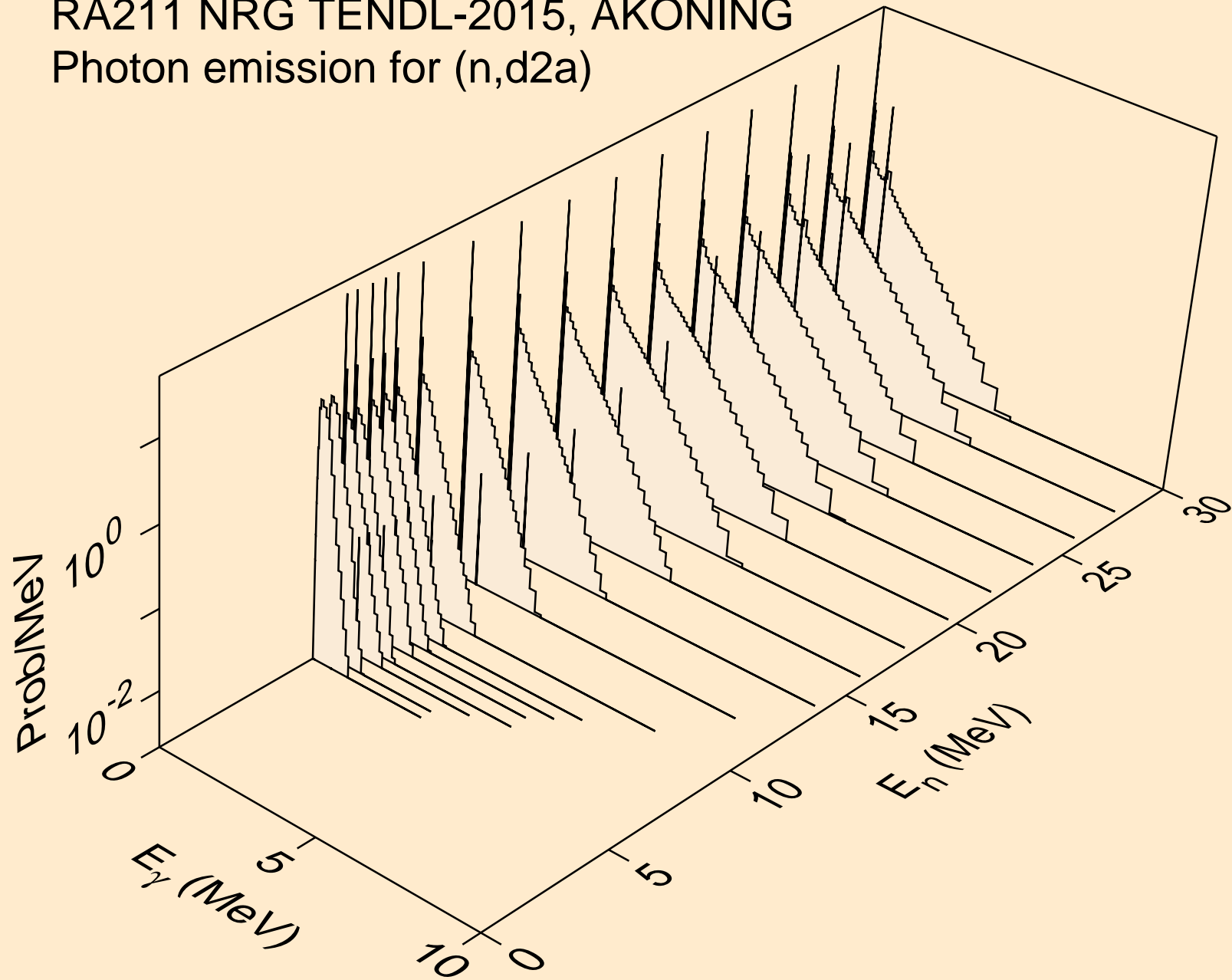

RA211 NRG TENDL-2015, AKONING
Photon emission for (n,pd)

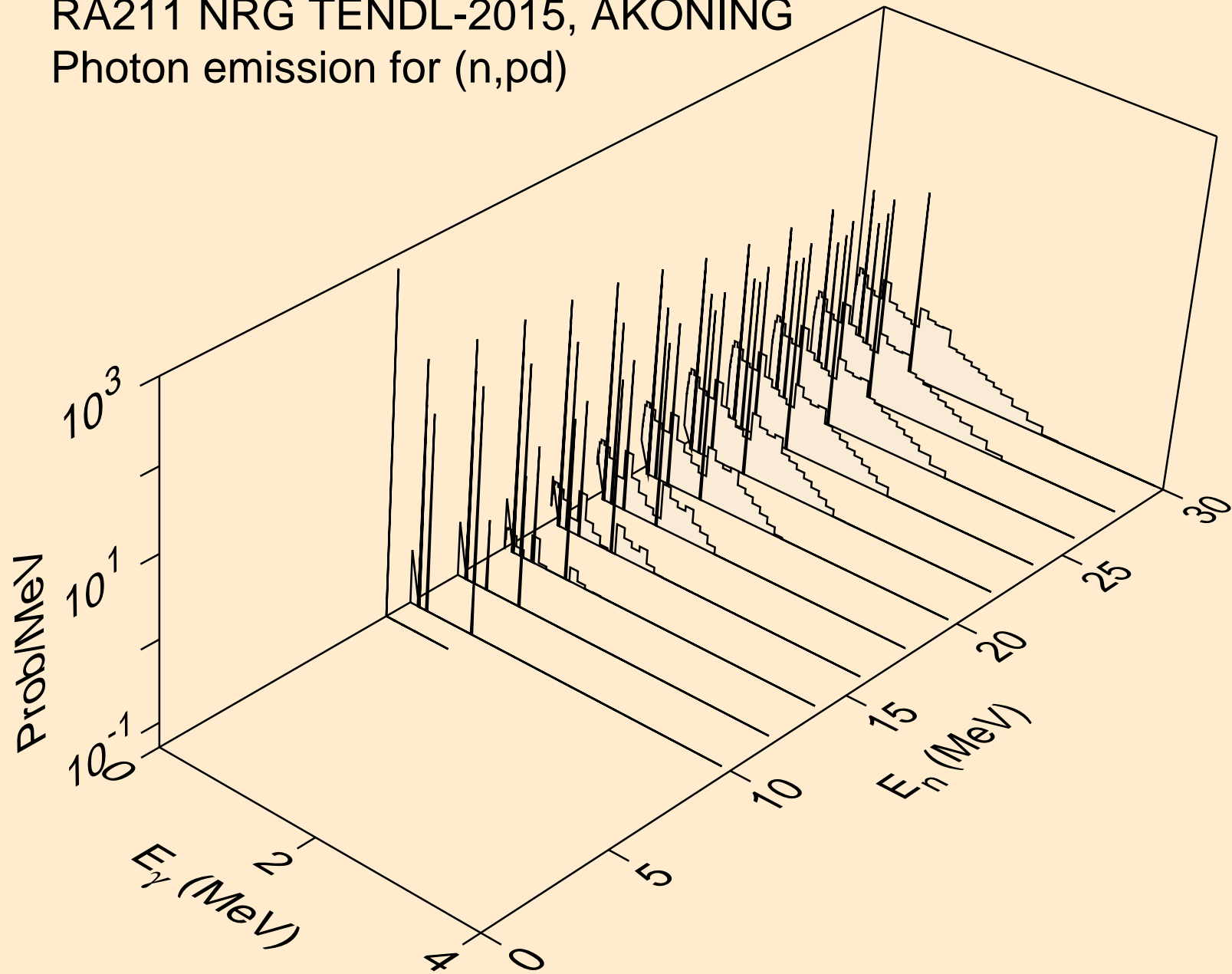

RA211 NRG TENDL-2015, AKONING
Photon emission for (n,pt)

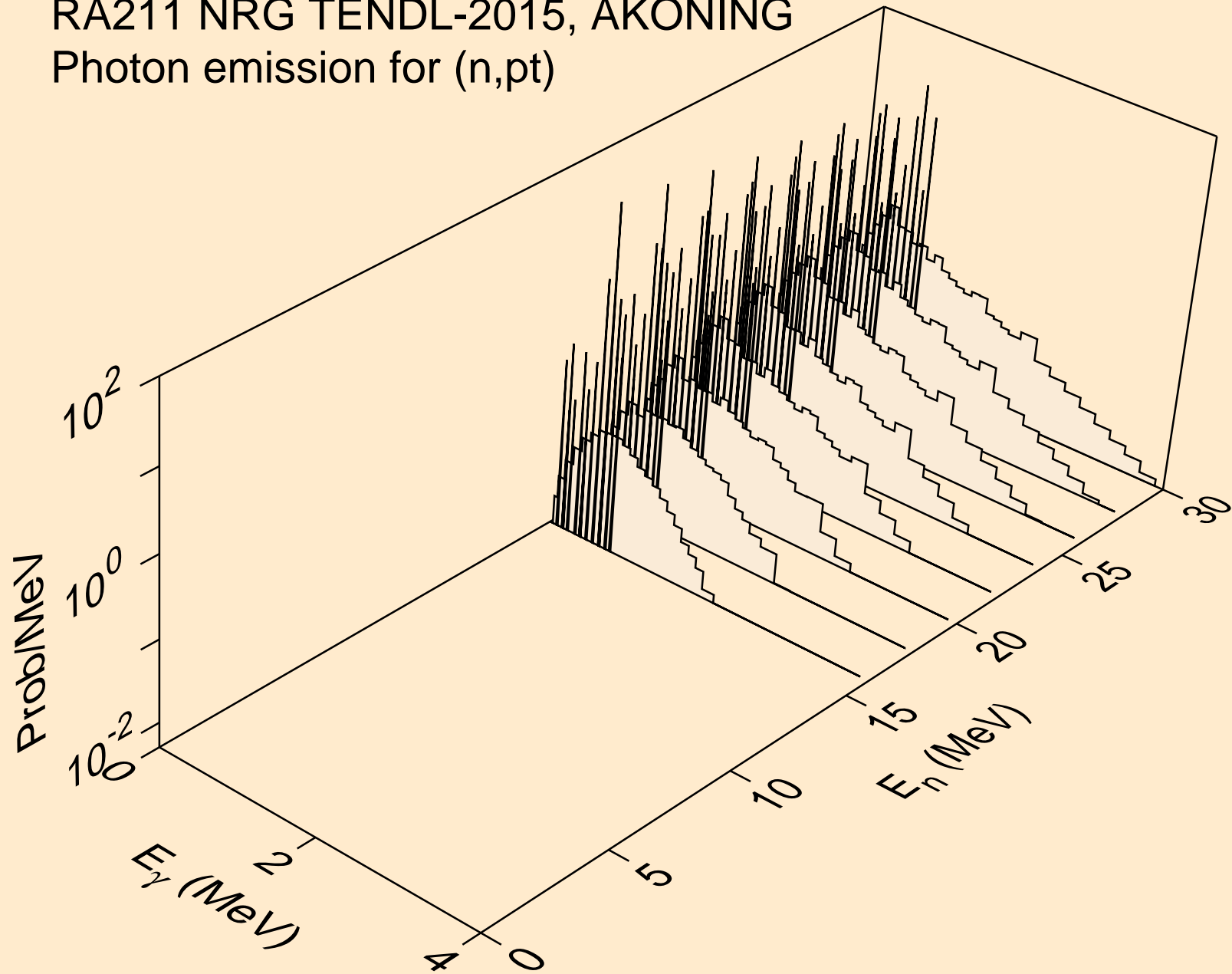

RA211 NRG TENDL-2015, AKONING
Photon emission for (n,da)

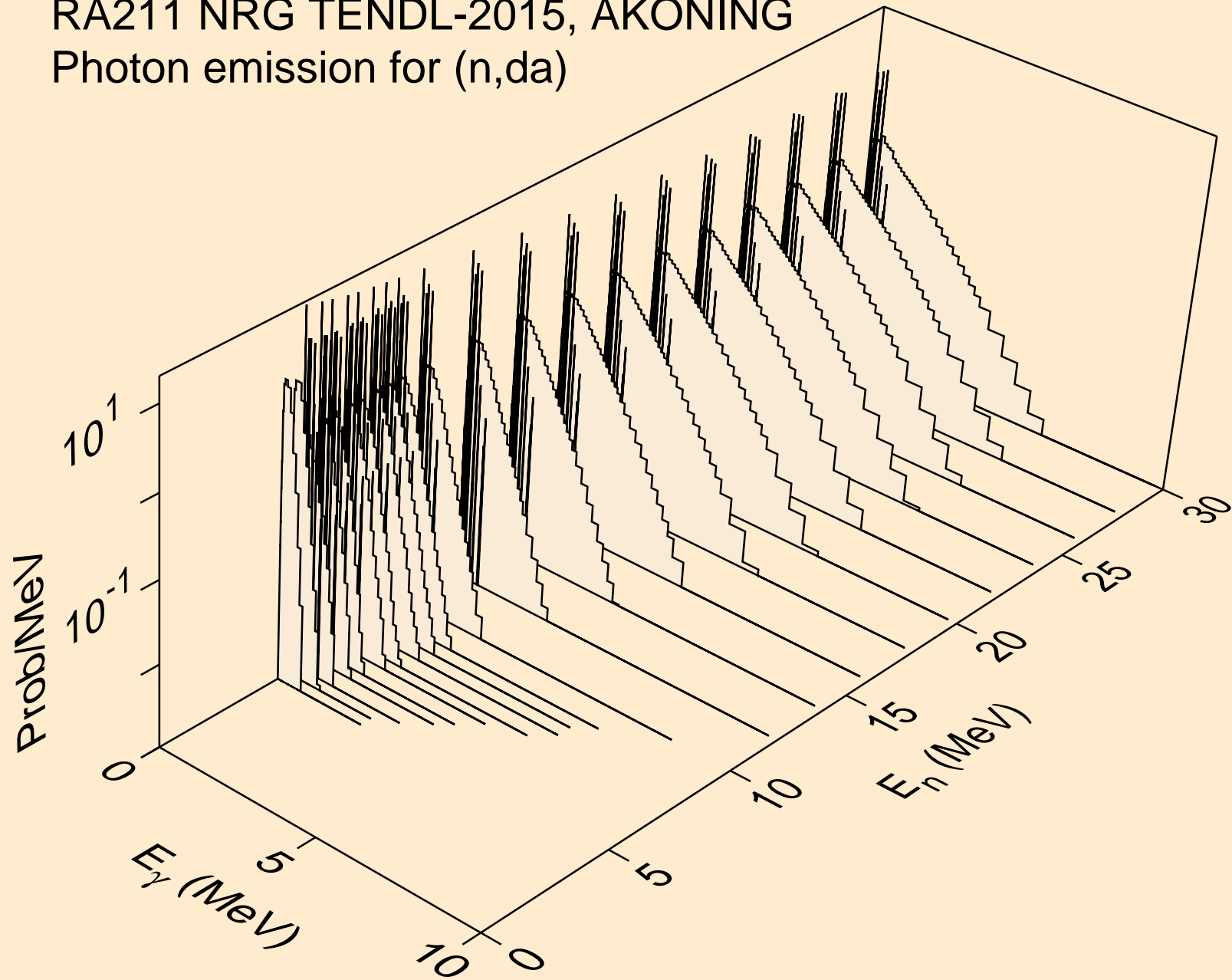

RA211 NRG TENDL-2015, AKONING
thermal capture photon spectrum

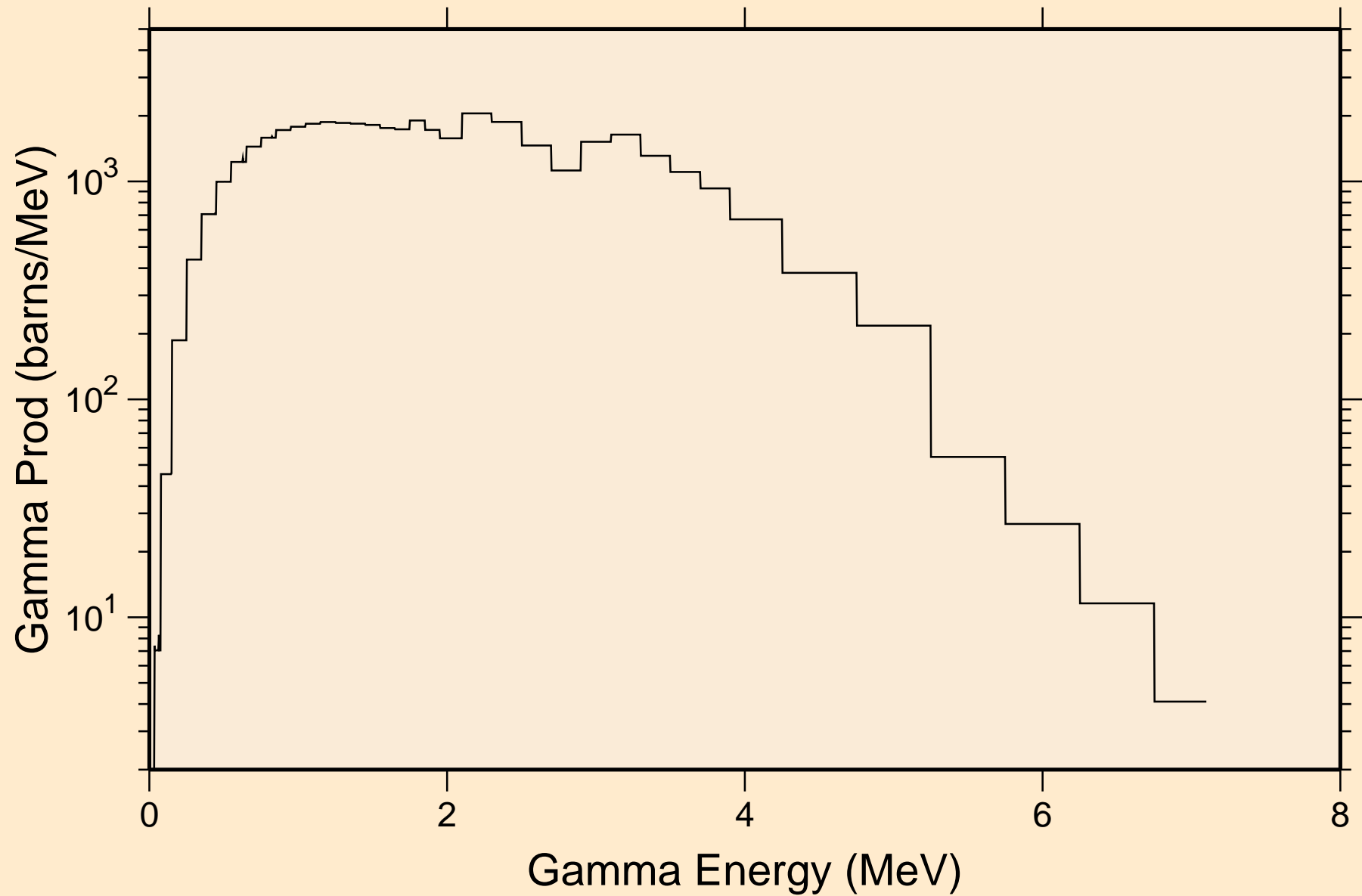

RA211 NRG TENDL-2015, AKONING
14 MeV photon spectrum

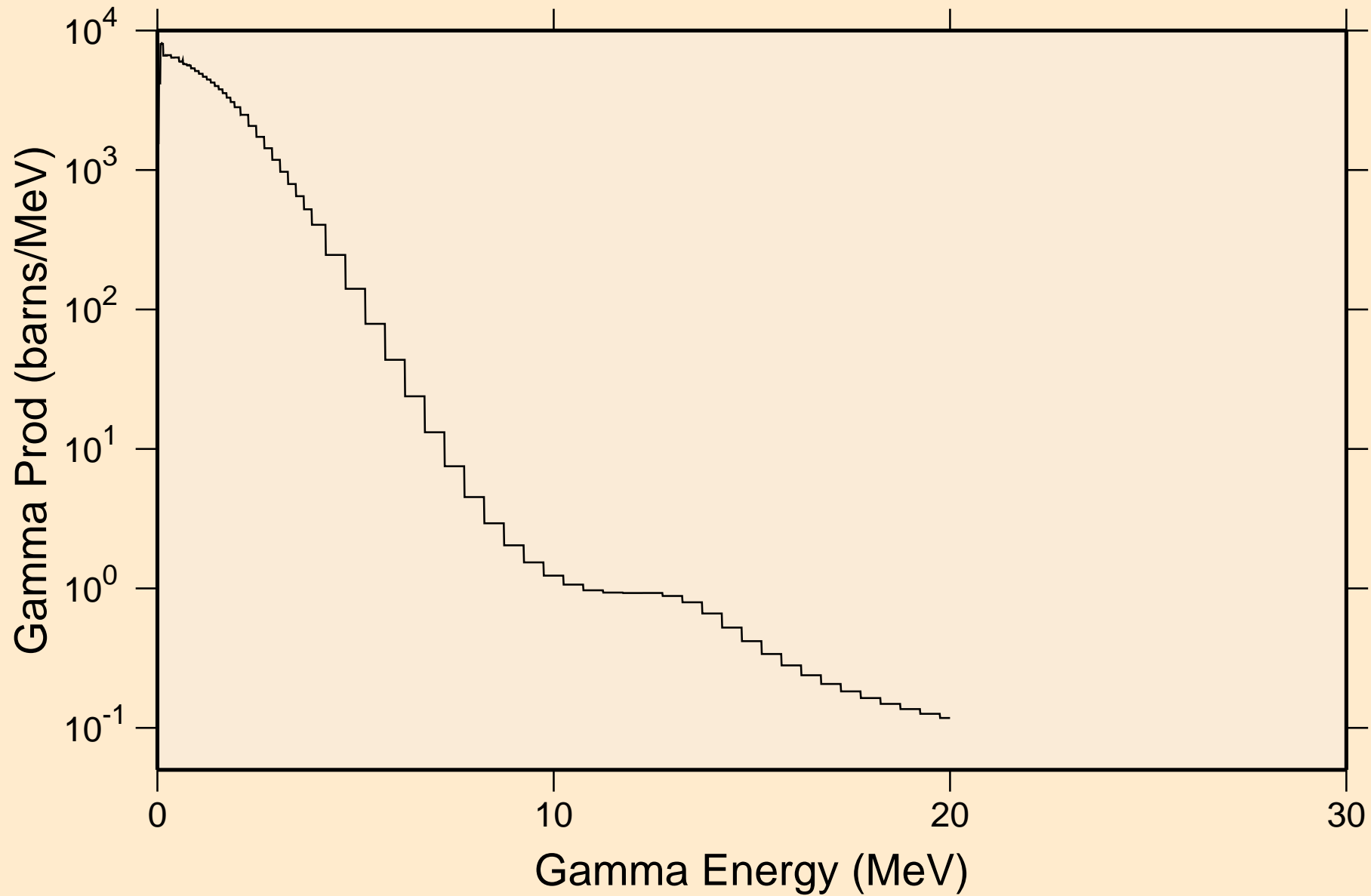

RA211 NRG TENDL-2015, AKONING

Particle heating contributions

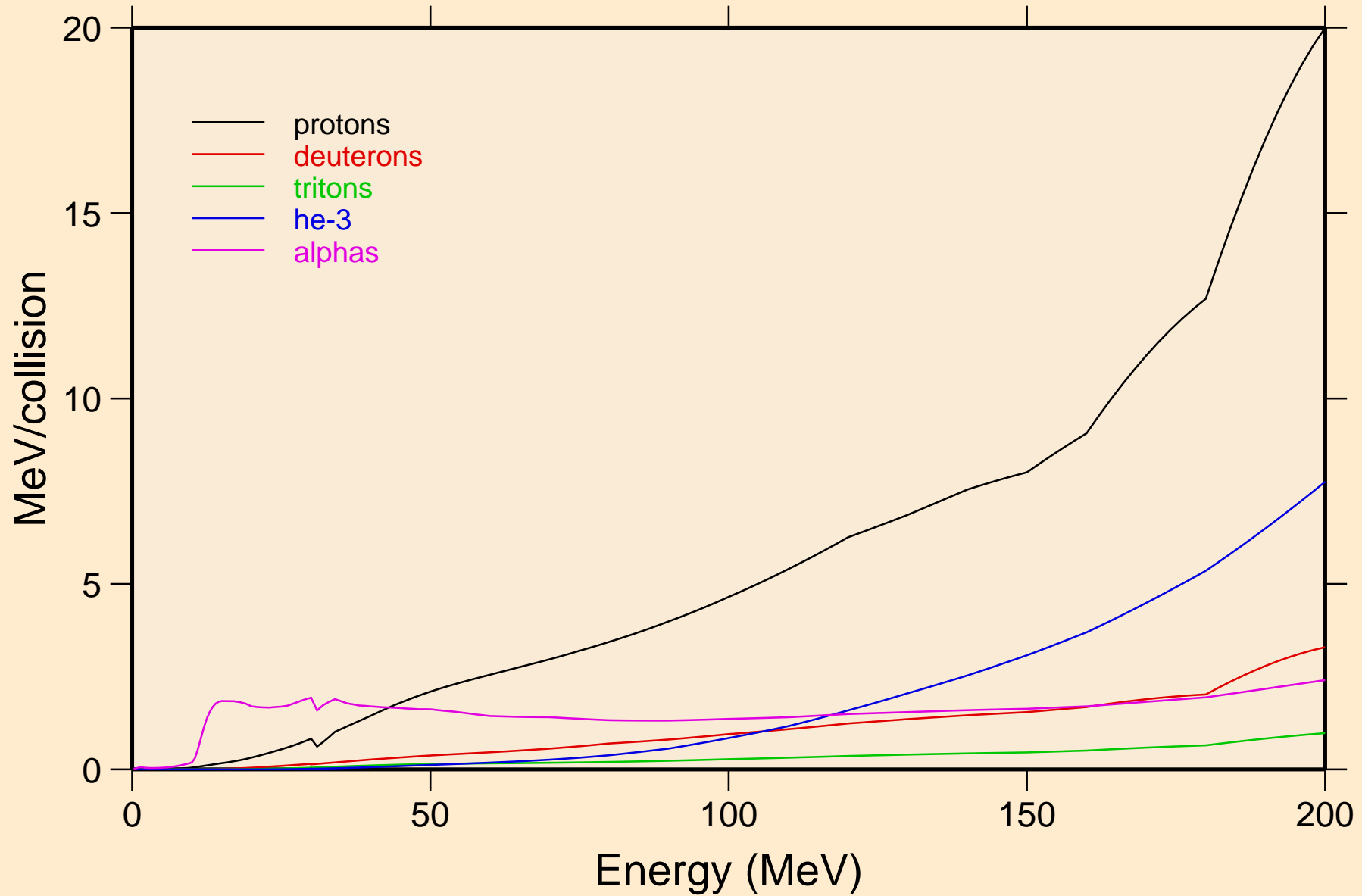

RA211 NRG TENDL-2015, AKONING

Recoil Heating

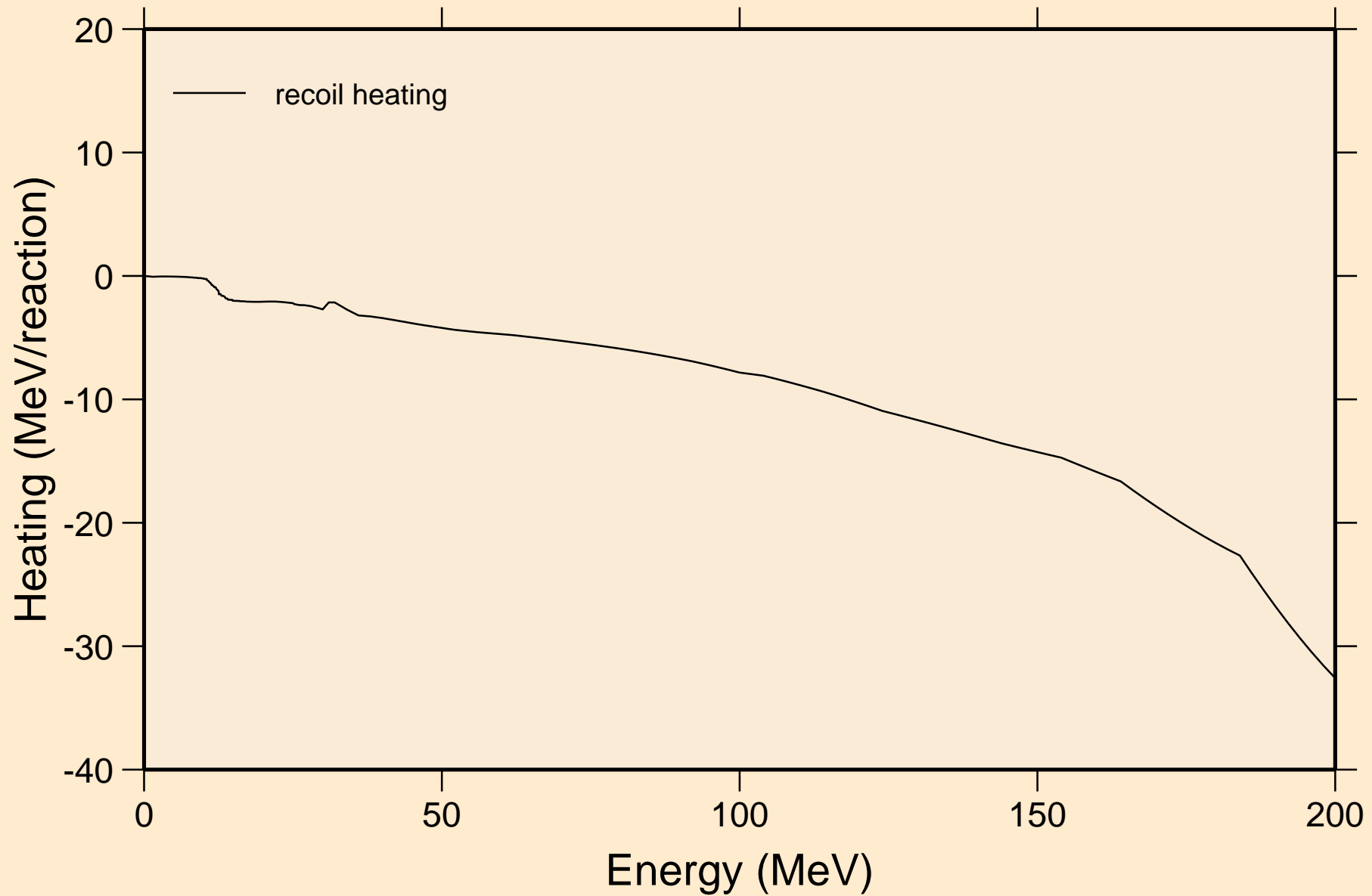

RA211 NRG TENDL-2015, AKONING

Particle production cross sections

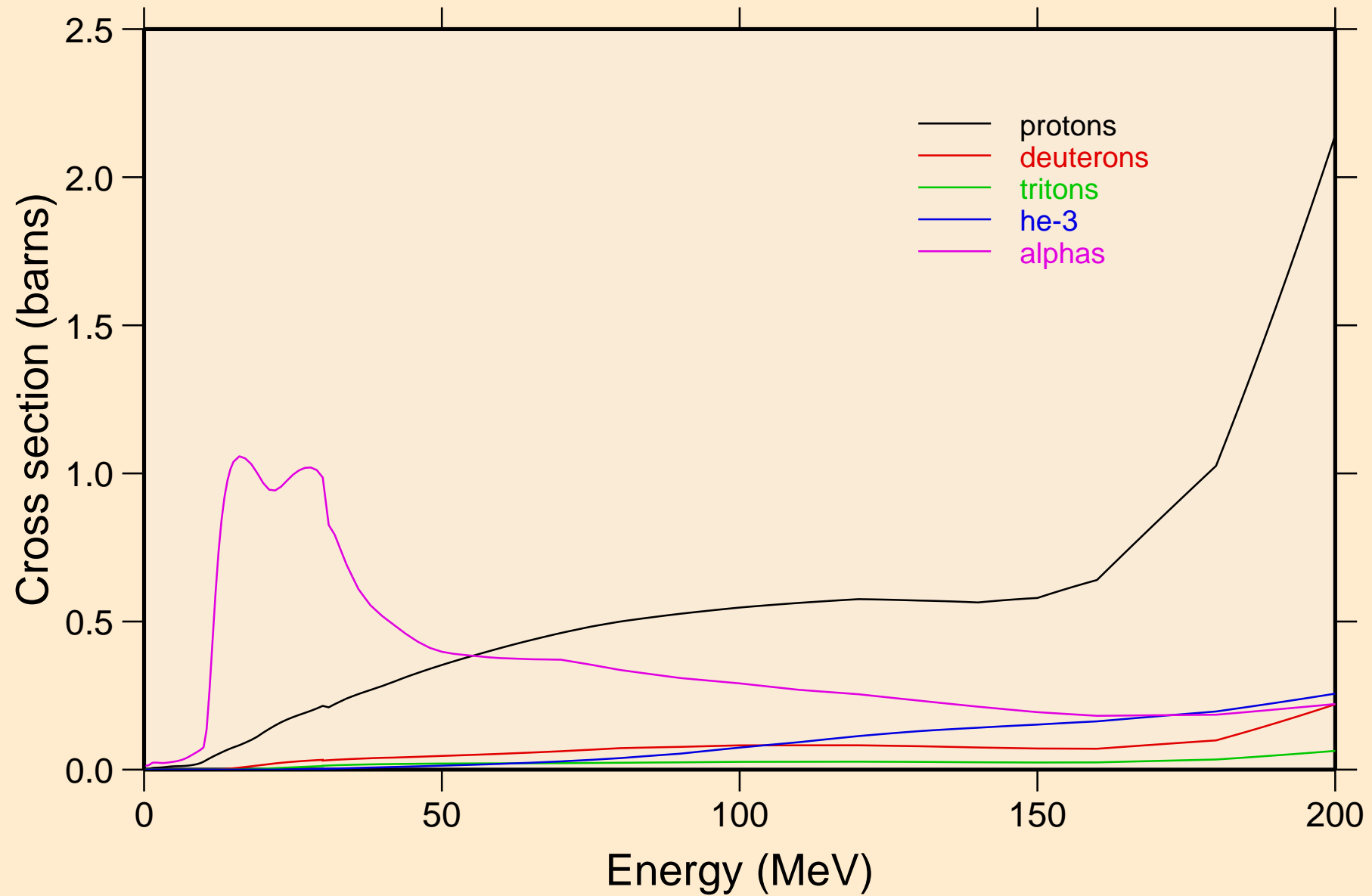

RA211 NRG TENDL-2015, AKONING
protons from (n,x)

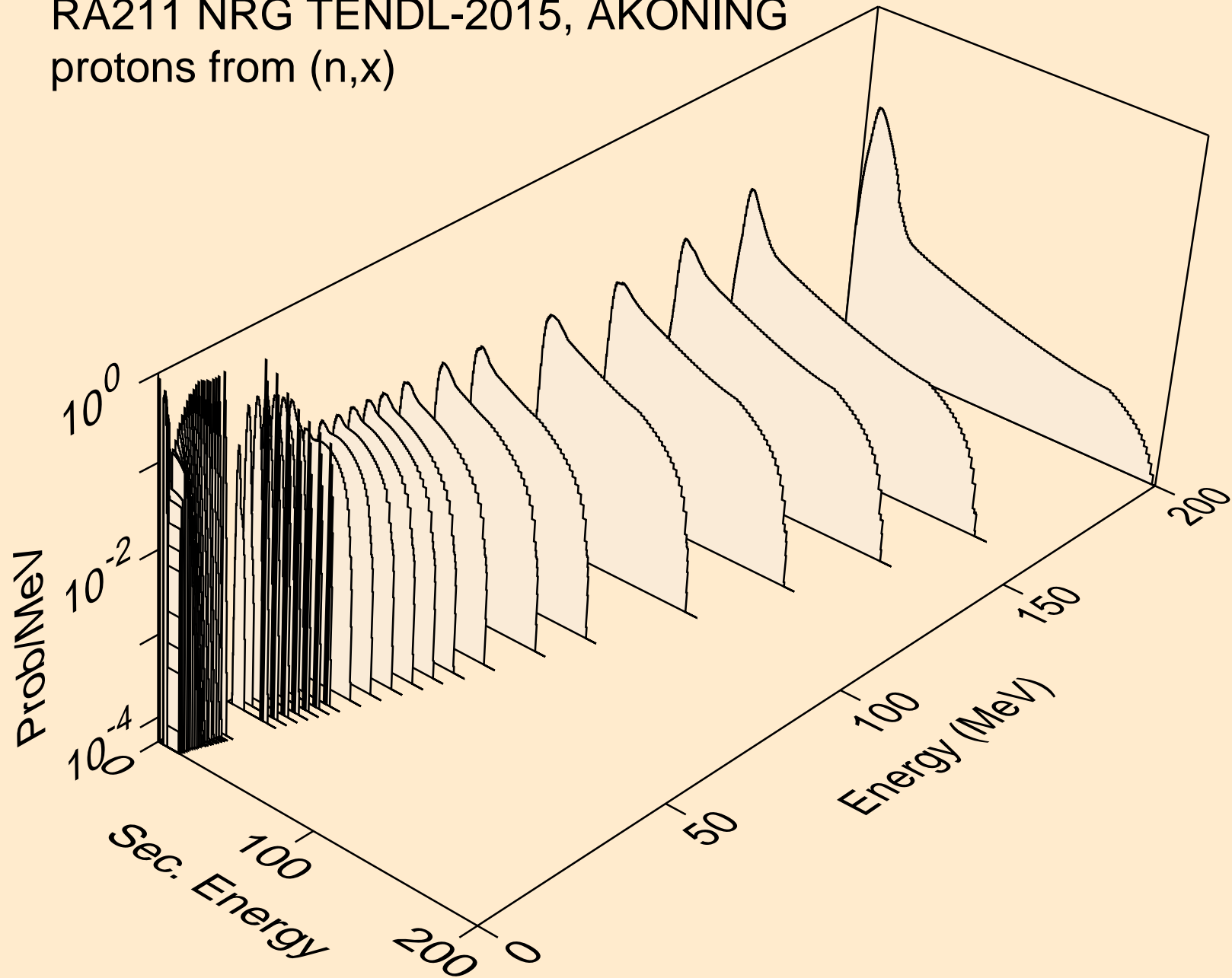

RA211 NRG TENDL-2015, AKONING
protons from (n,n*)p

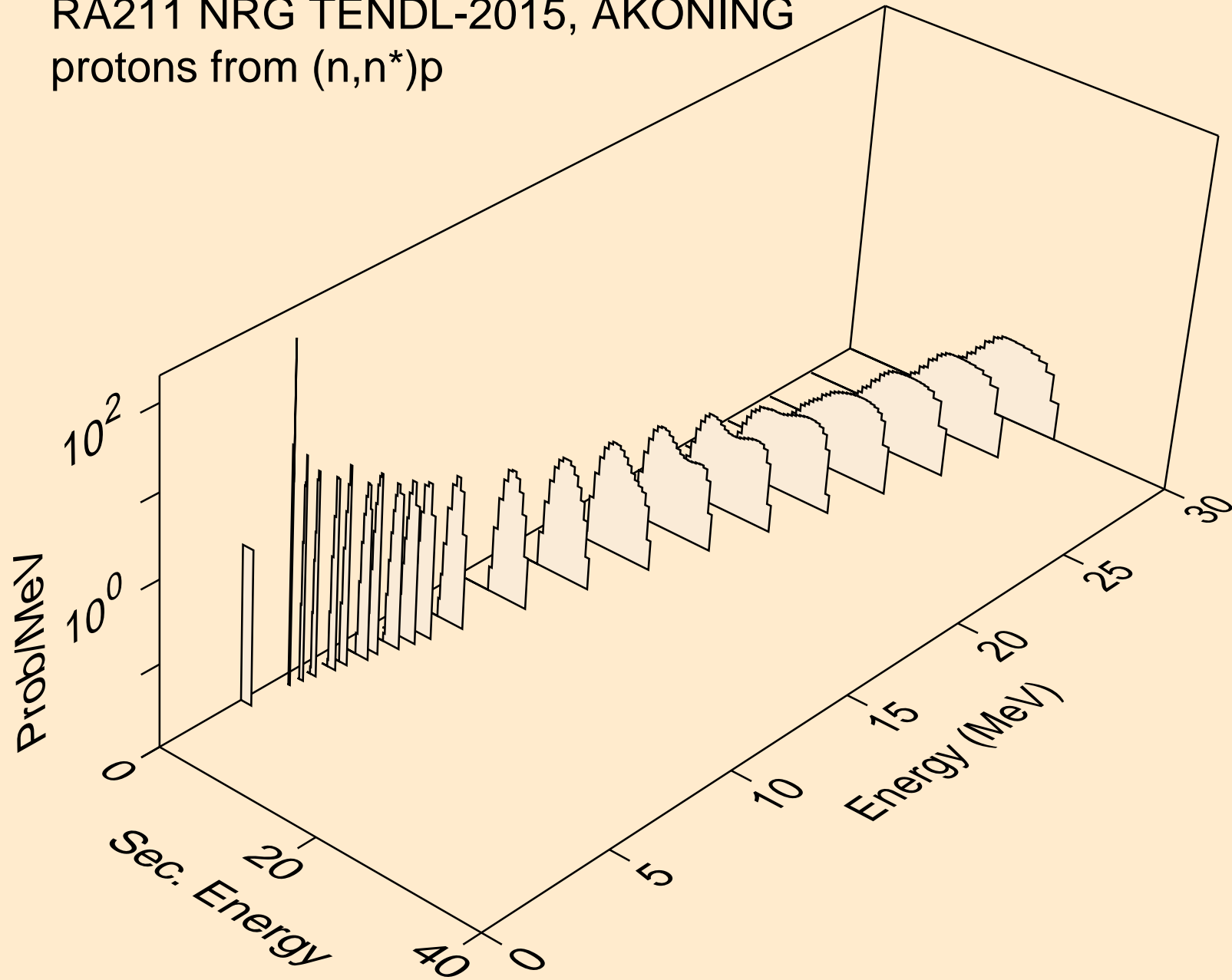

RA211 NRG TENDL-2015, AKONING
protons from (n,2np)

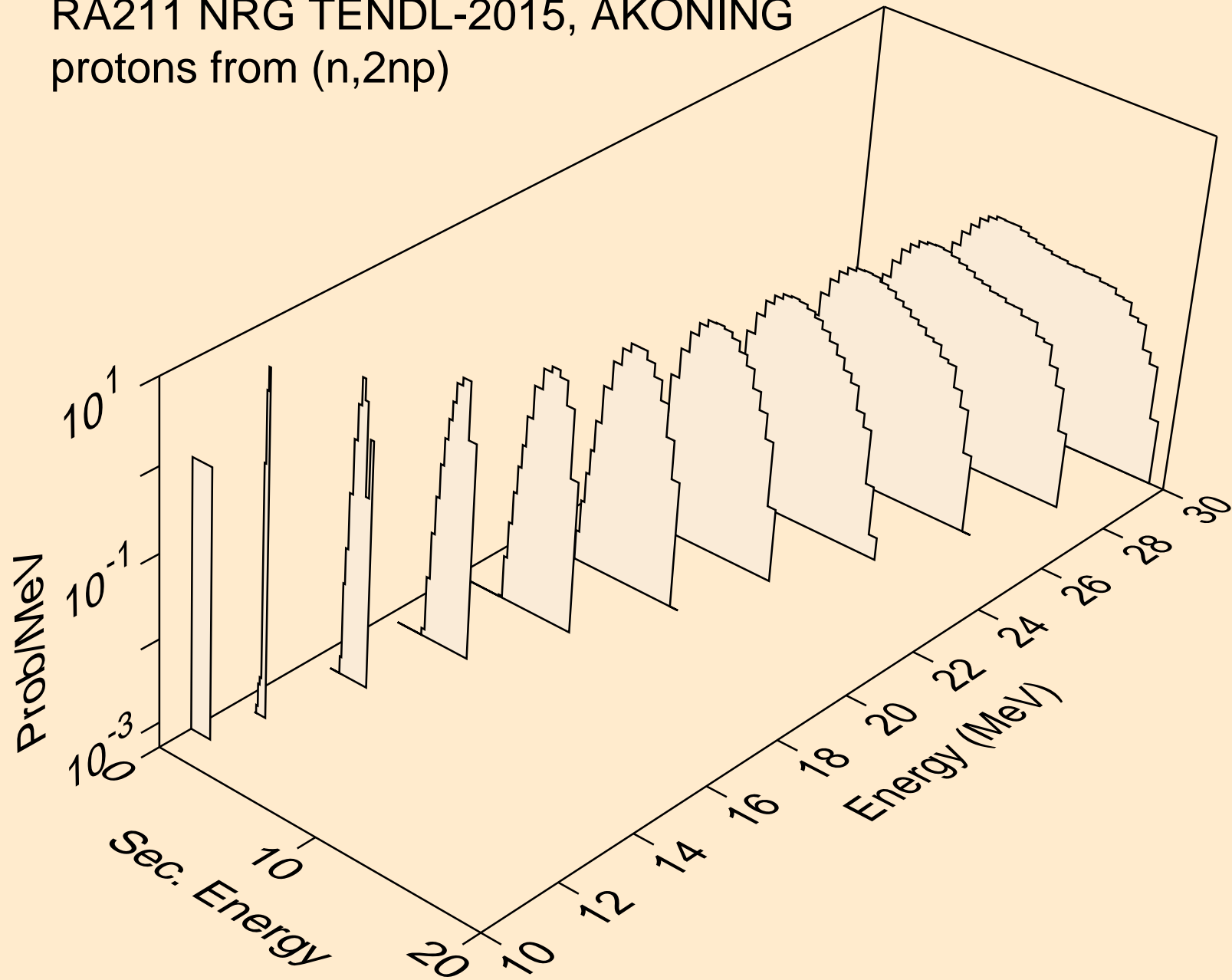

RA211 NRG TENDL-2015, AKONING
protons from (n,3np)

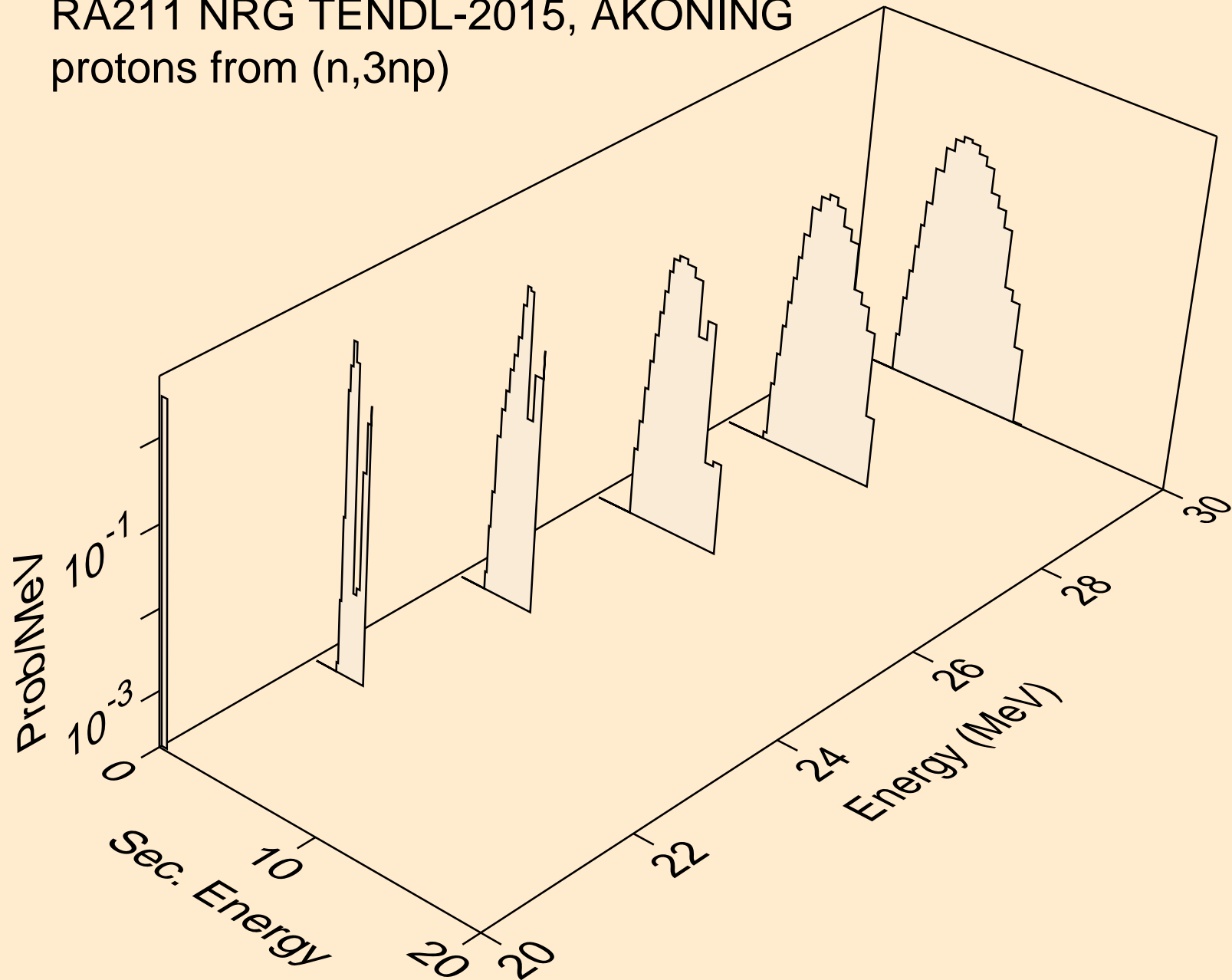

RA211 NRG TENDL-2015, AKONING
protons from (n,2np)

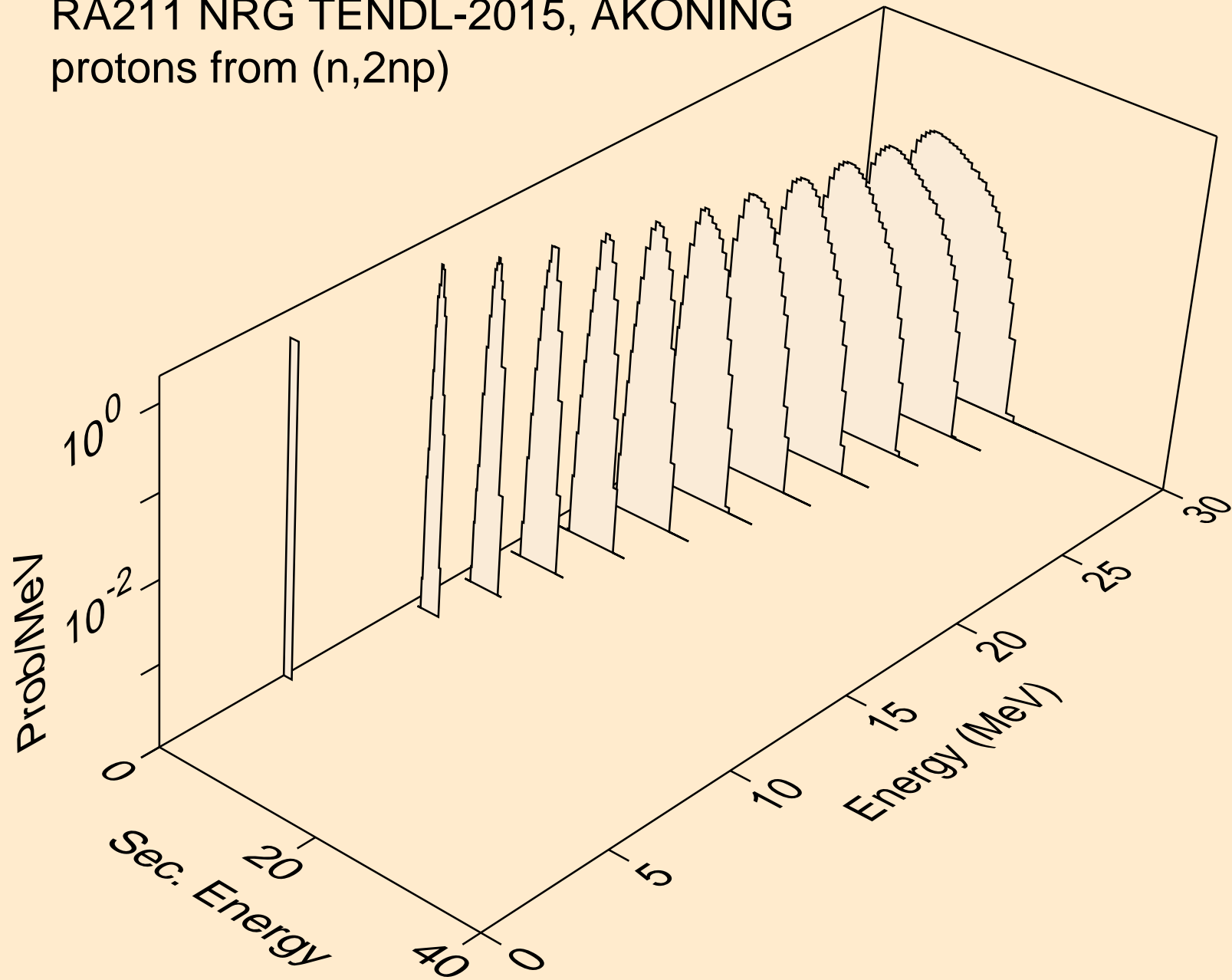

RA211 NRG TENDL-2015, AKONING
protons from (n,npa)

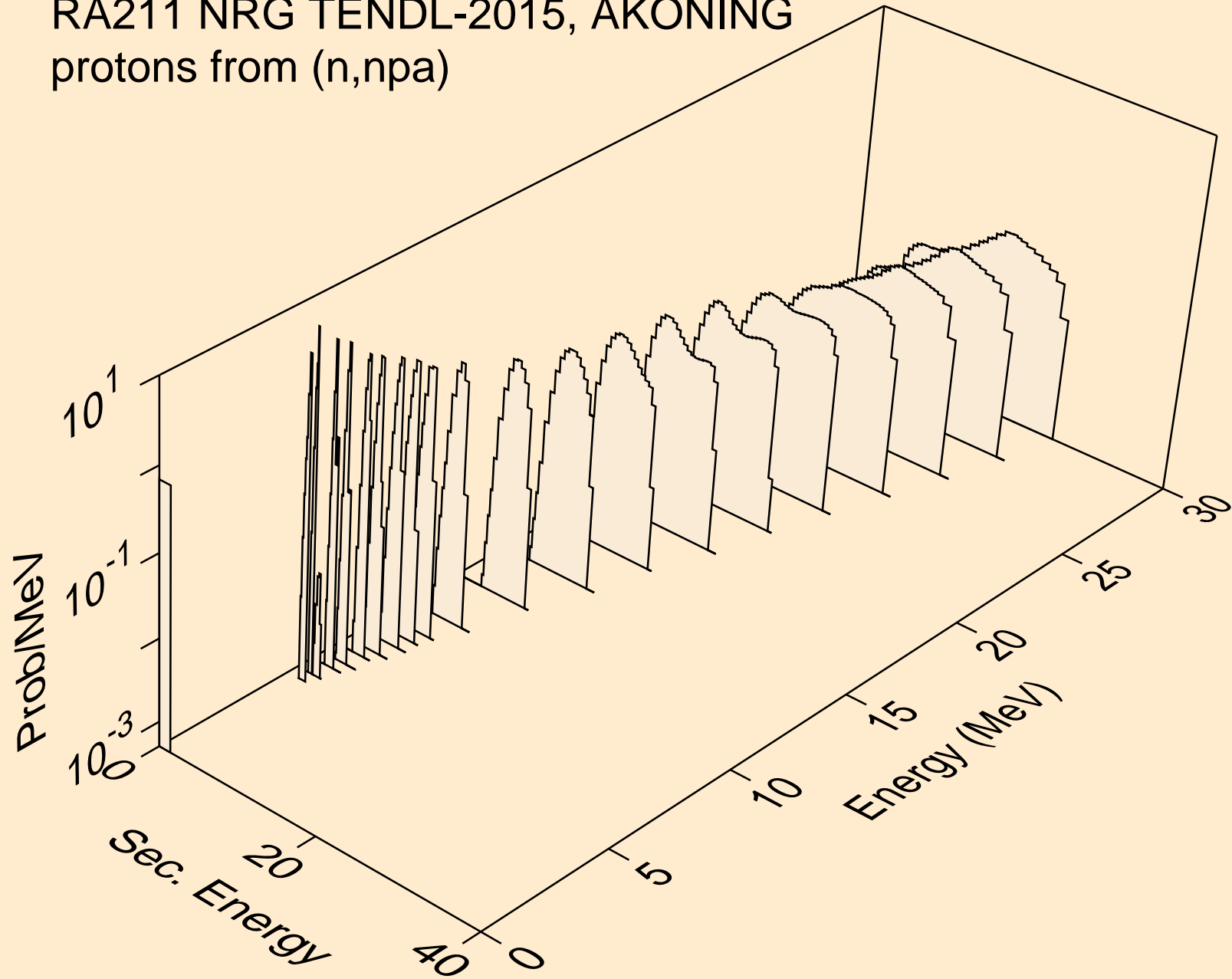

RA211 NRG TENDL-2015, AKONING
protons from (n,p)

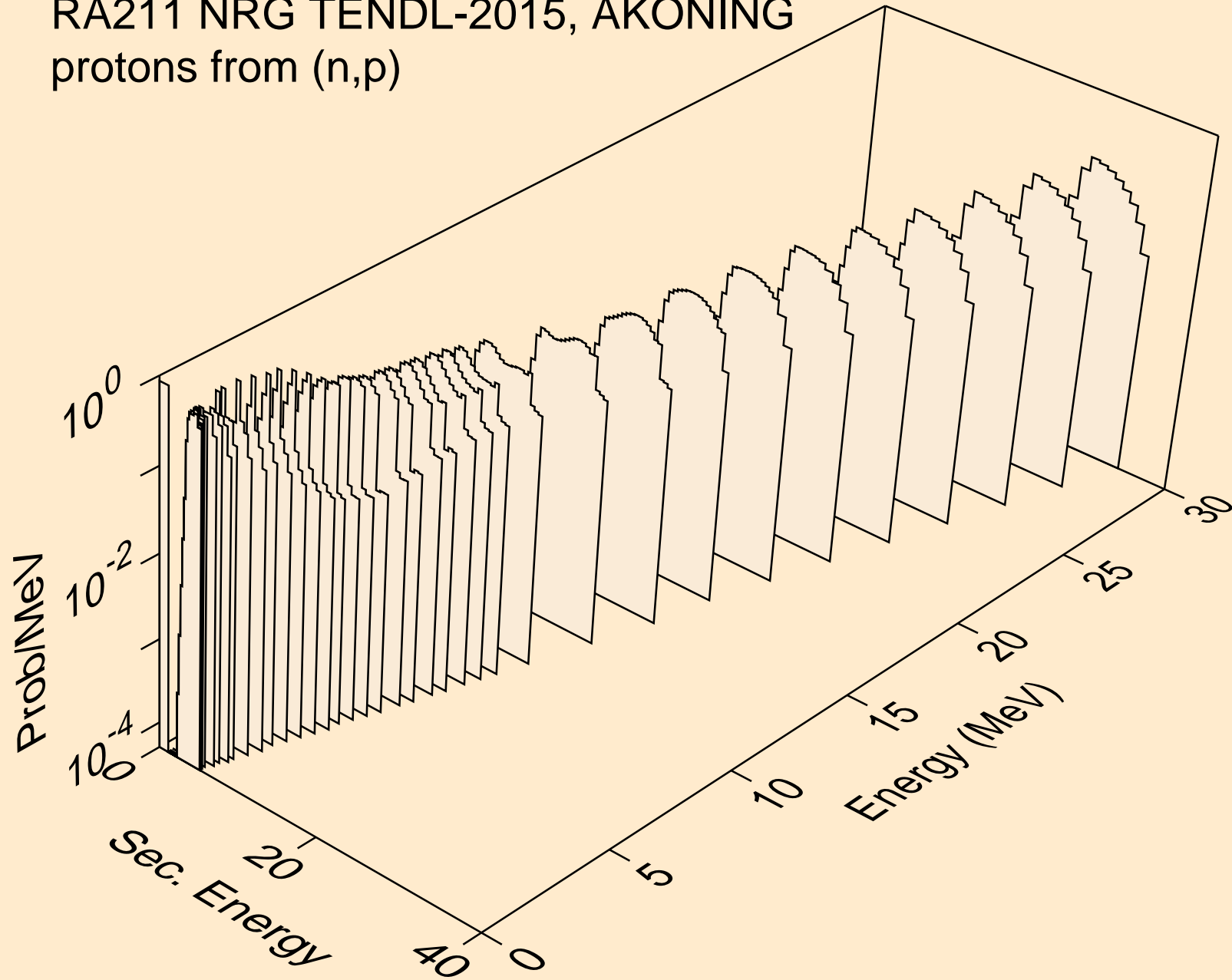

RA211 NRG TENDL-2015, AKONING
protons from (n,2p)

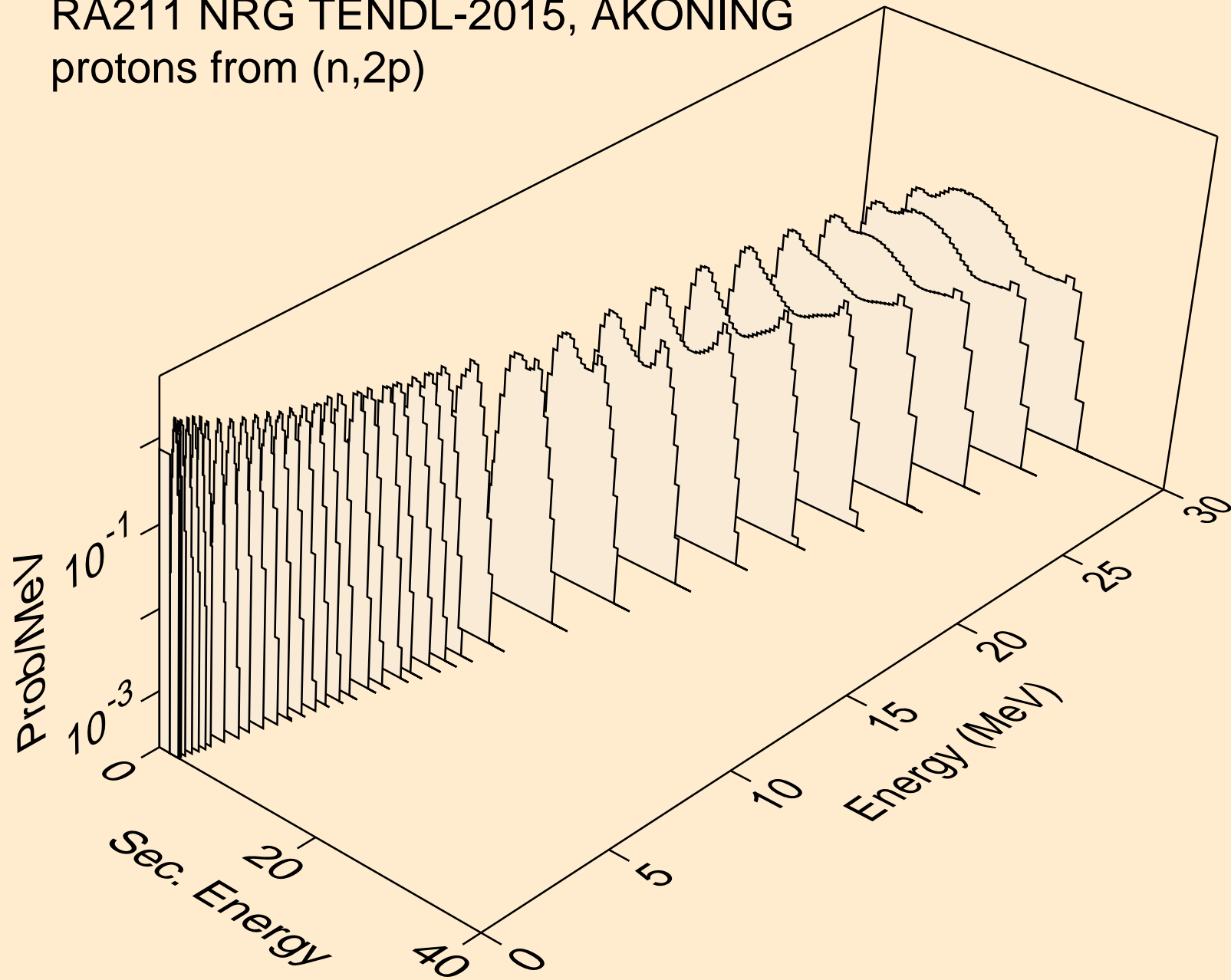

RA211 NRG TENDL-2015, AKONING
protons from (n,pa)

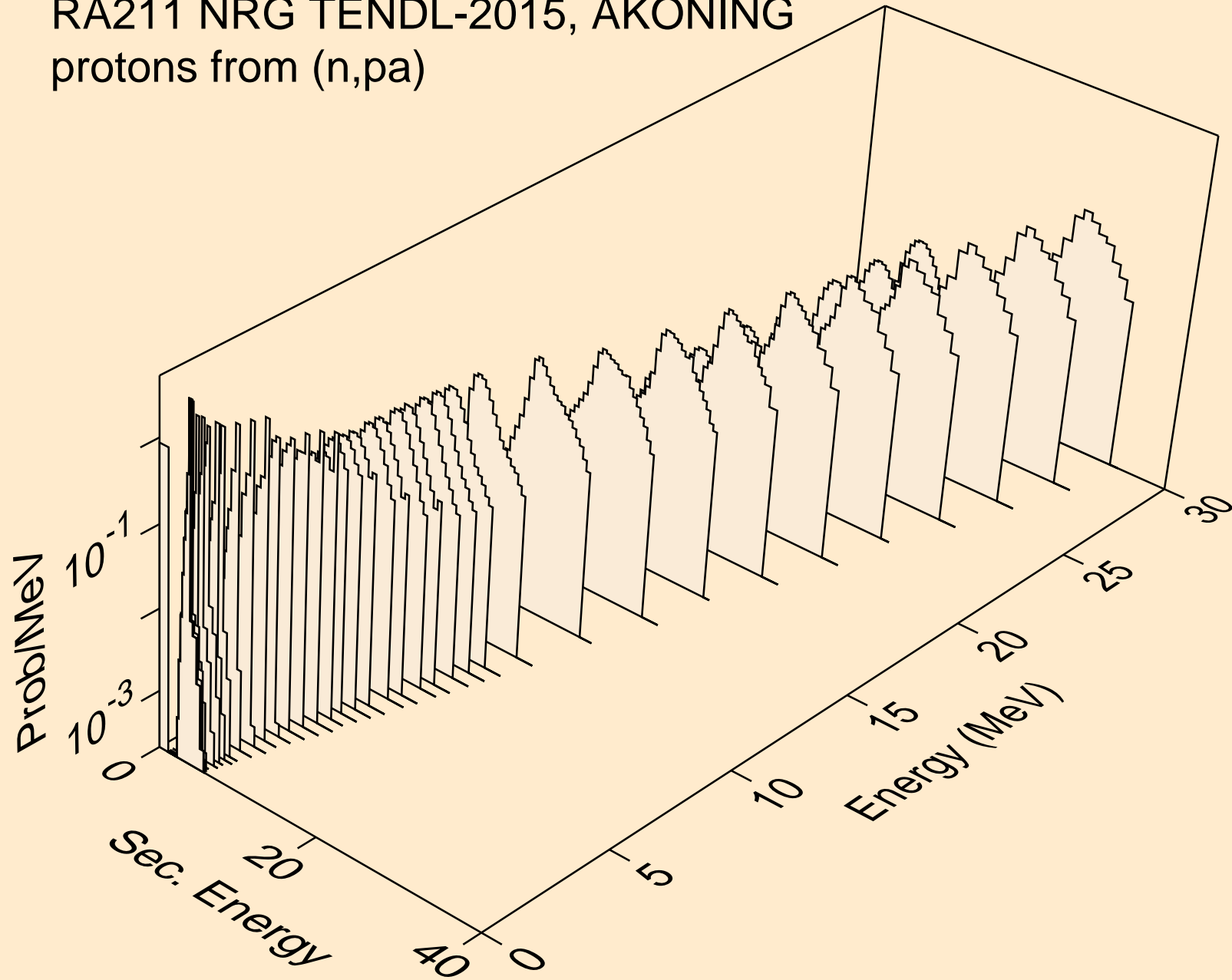

RA211 NRG TENDL-2015, AKONING
protons from (n,pd)

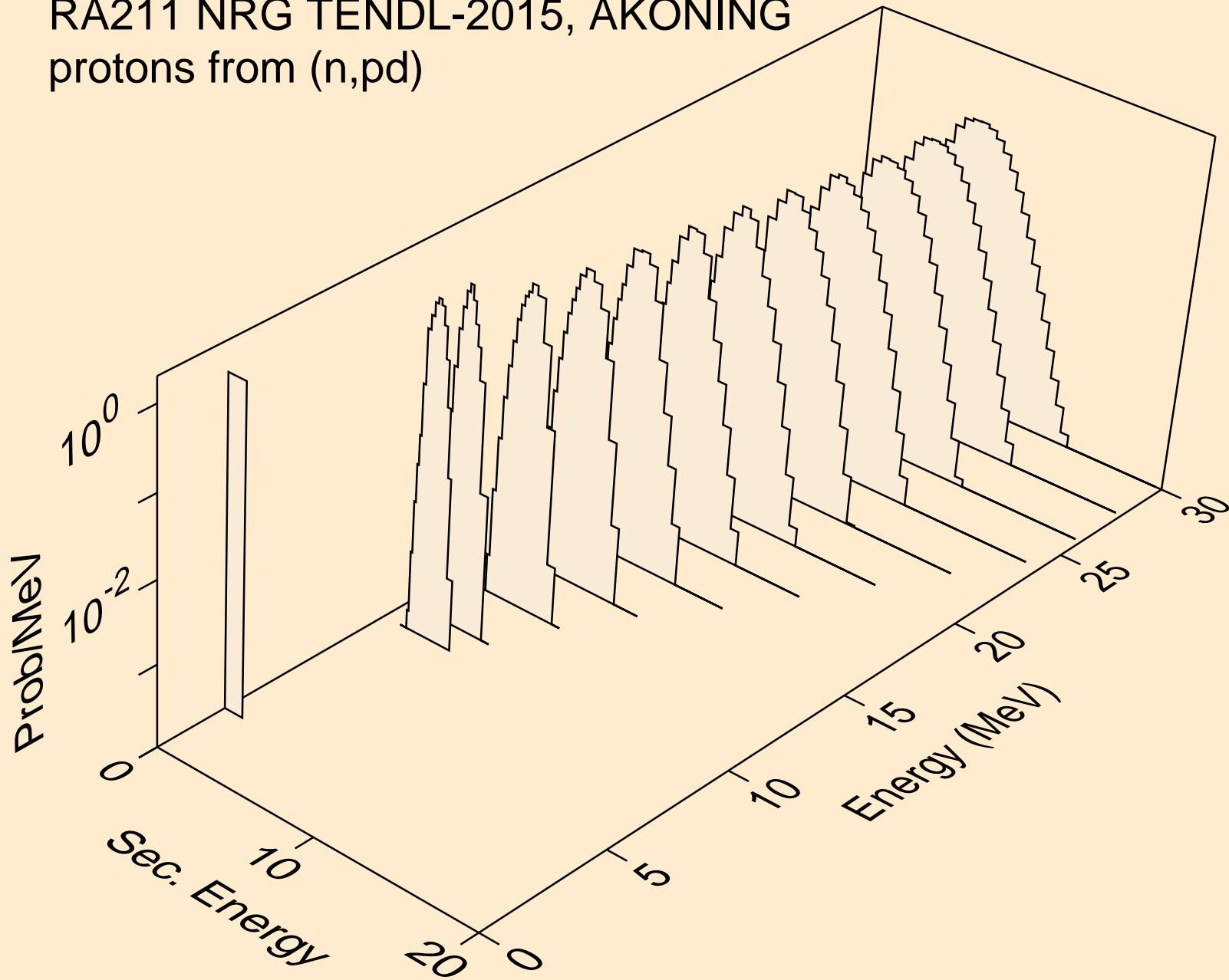

RA211 NRG TENDL-2015, AKONING
protons from (n,pt)

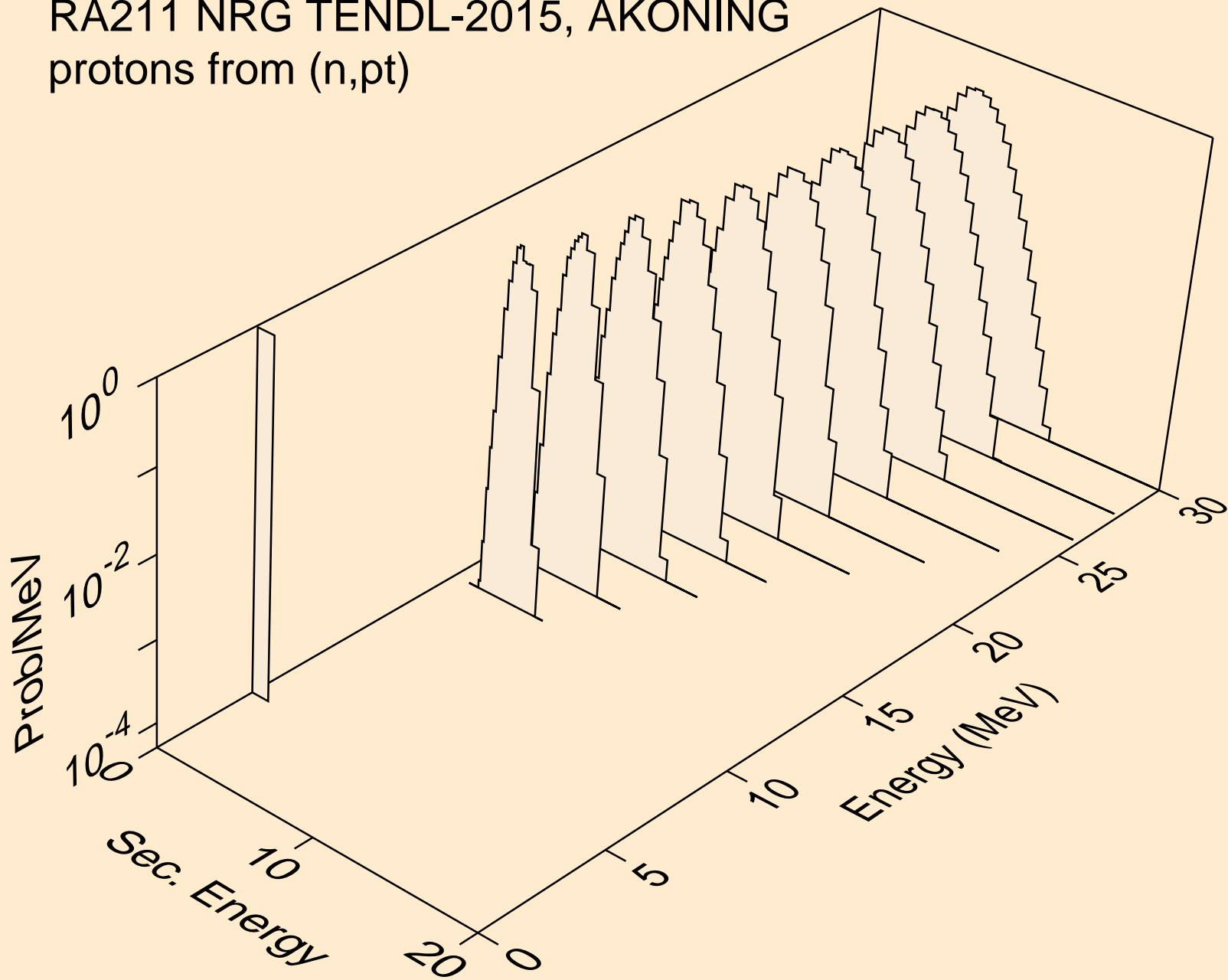

RA211 NRG TENDL-2015, AKONING
deuterons from (n,x)

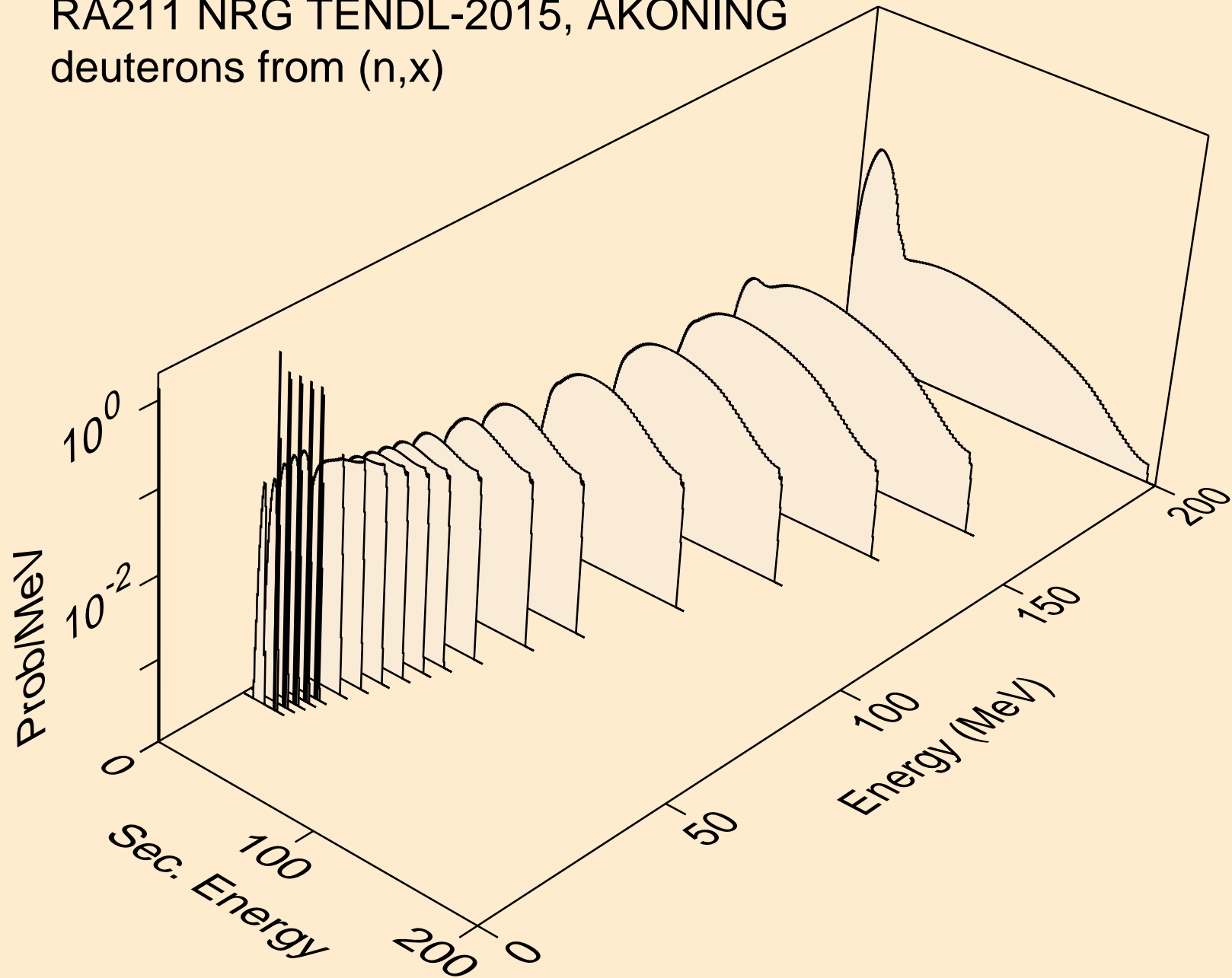

RA211 NRG TENDL-2015, AKONING
deuterons from (n,2nd)

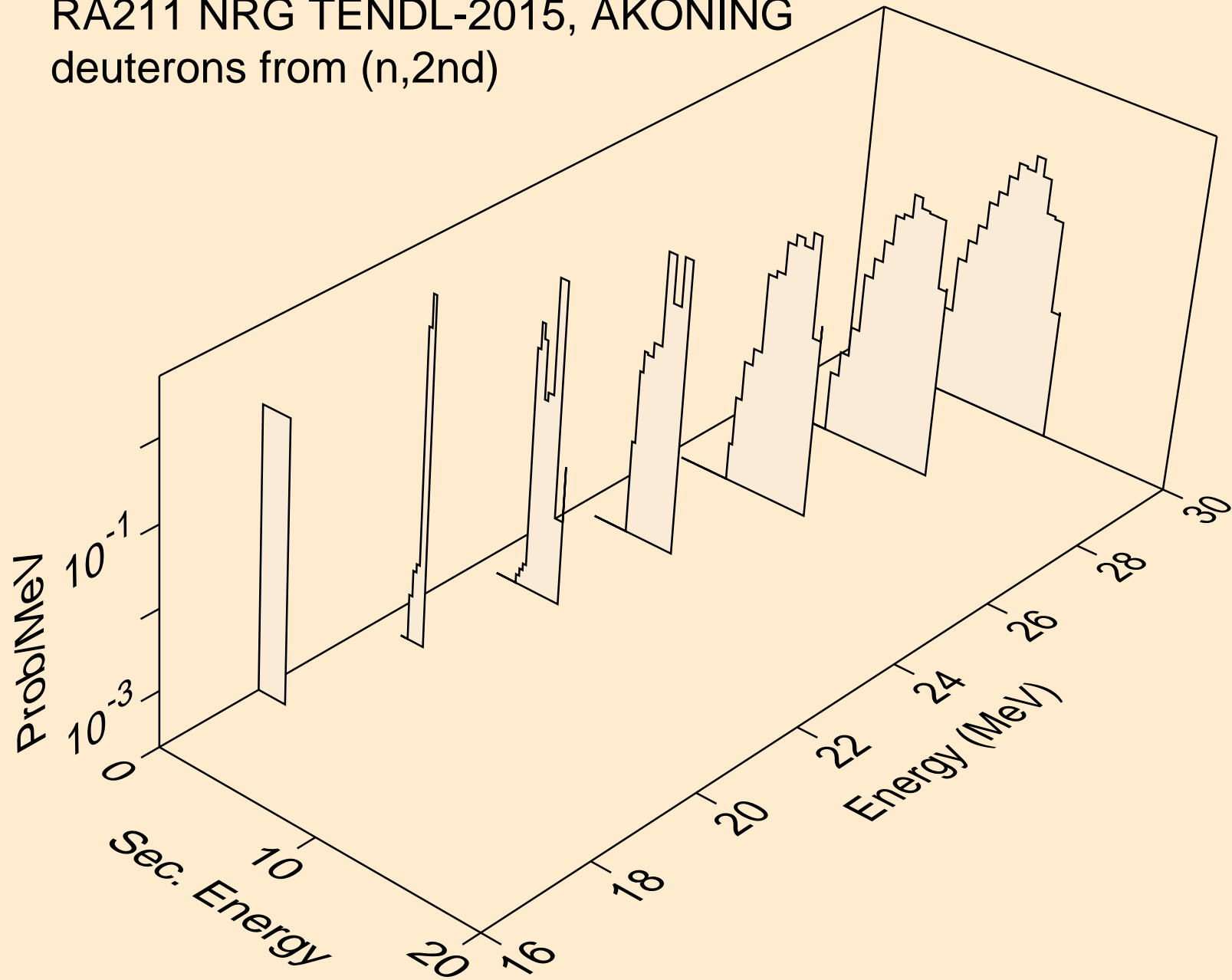

RA211 NRG TENDL-2015, AKONING
deuterons from (n,n*)d

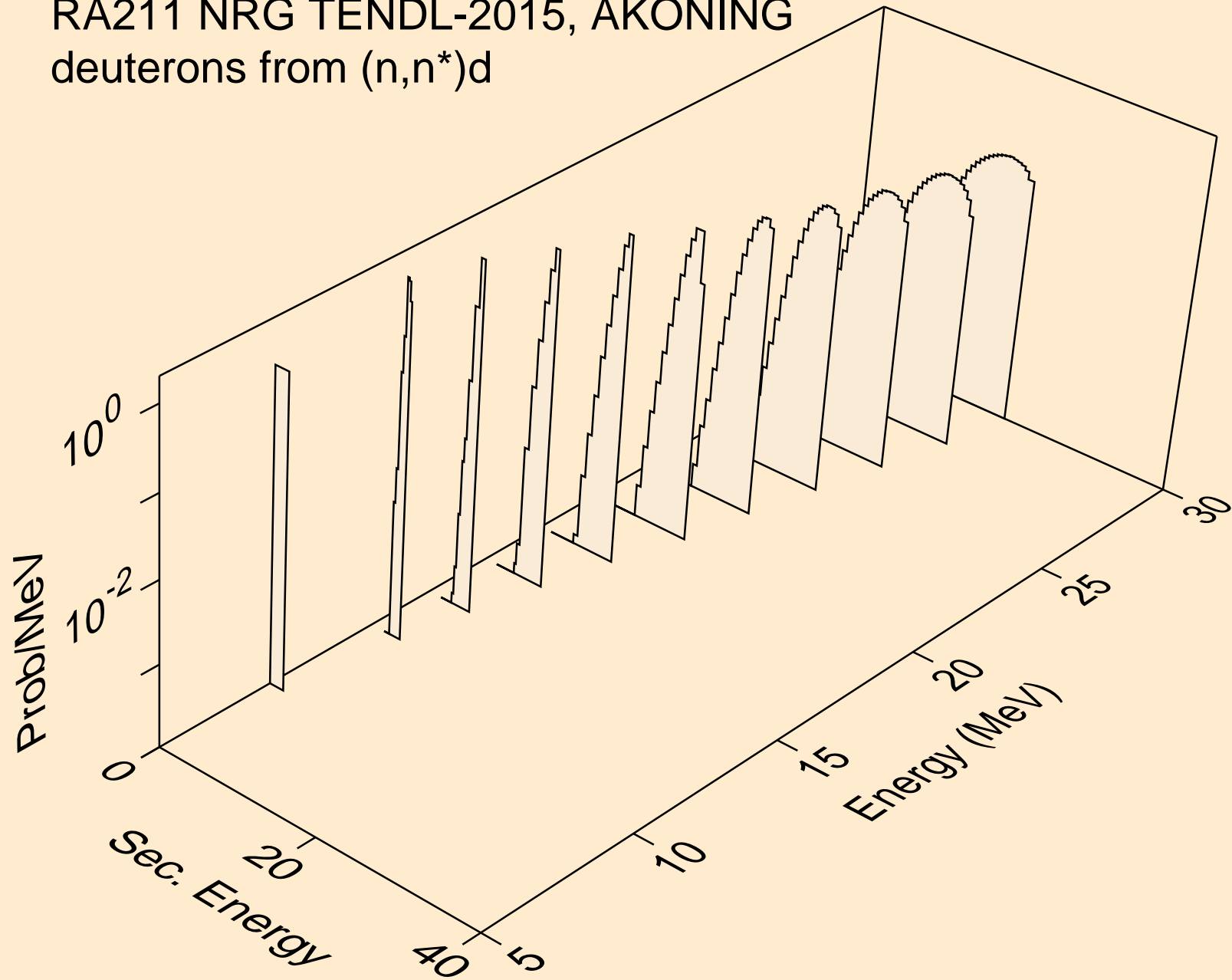

RA211 NRG TENDL-2015, AKONING
deuterons from (n,n*)d2a

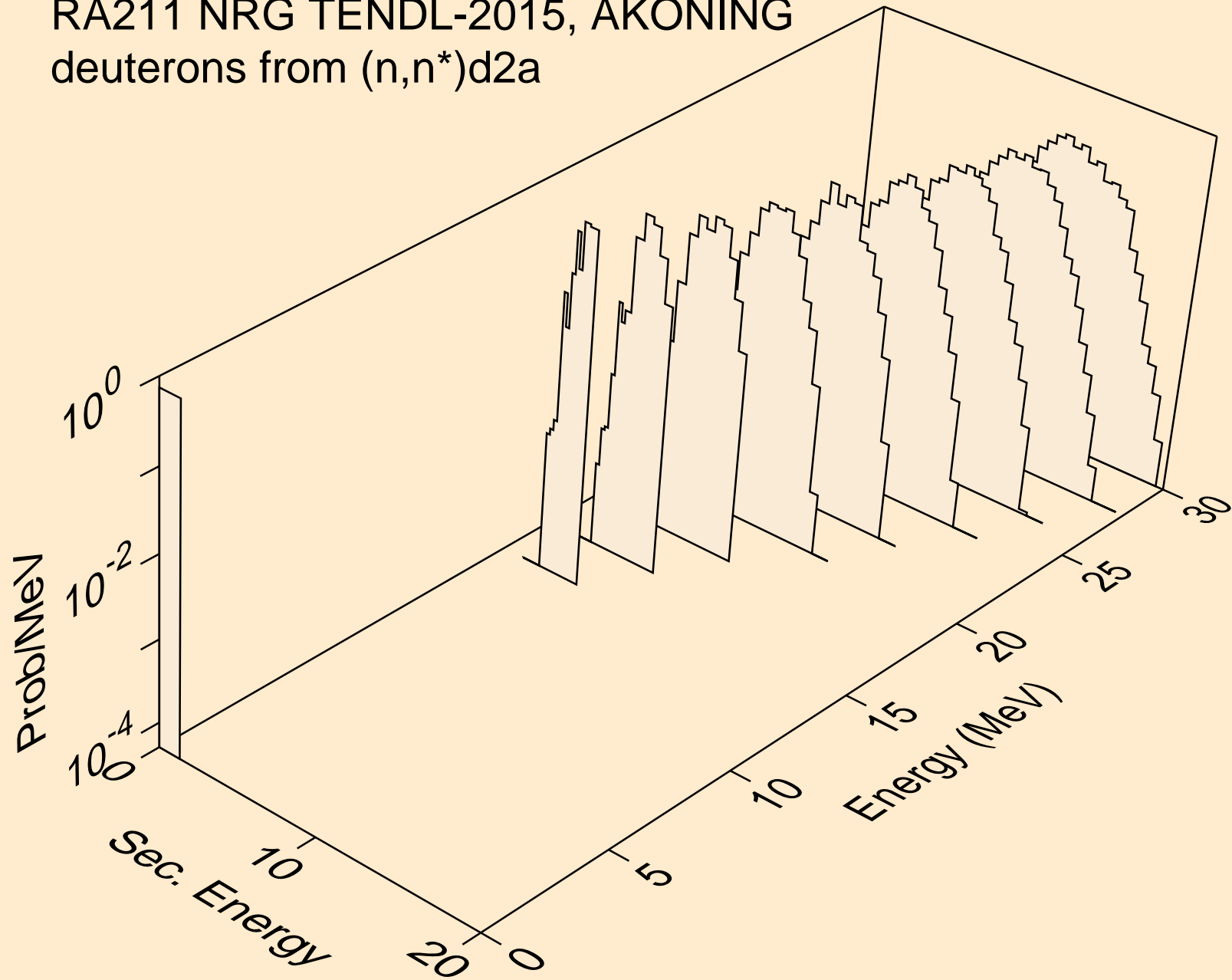

RA211 NRG TENDL-2015, AKONING
deuterons from (n,d)

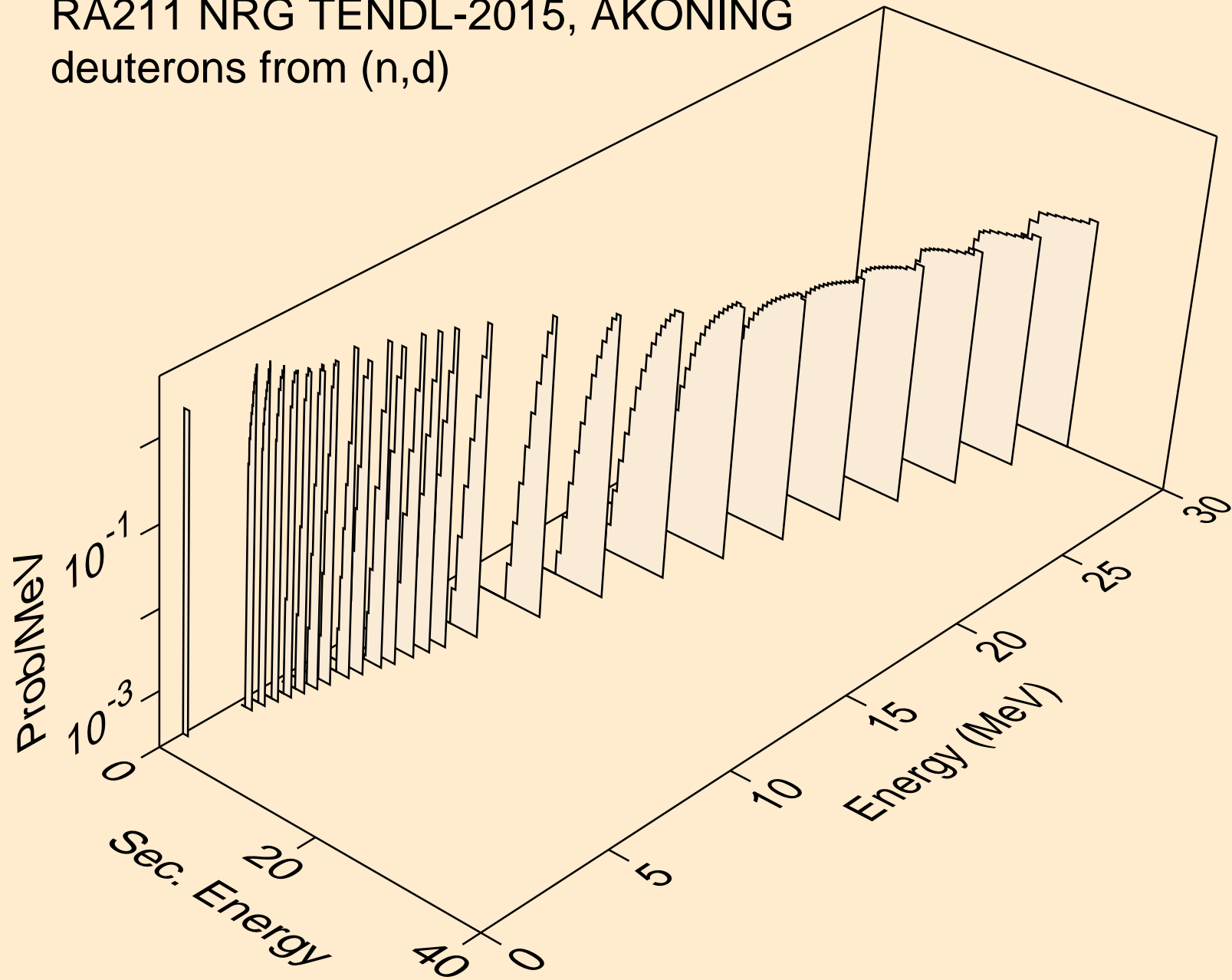

RA211 NRG TENDL-2015, AKONING
deuterons from (n,d2a)

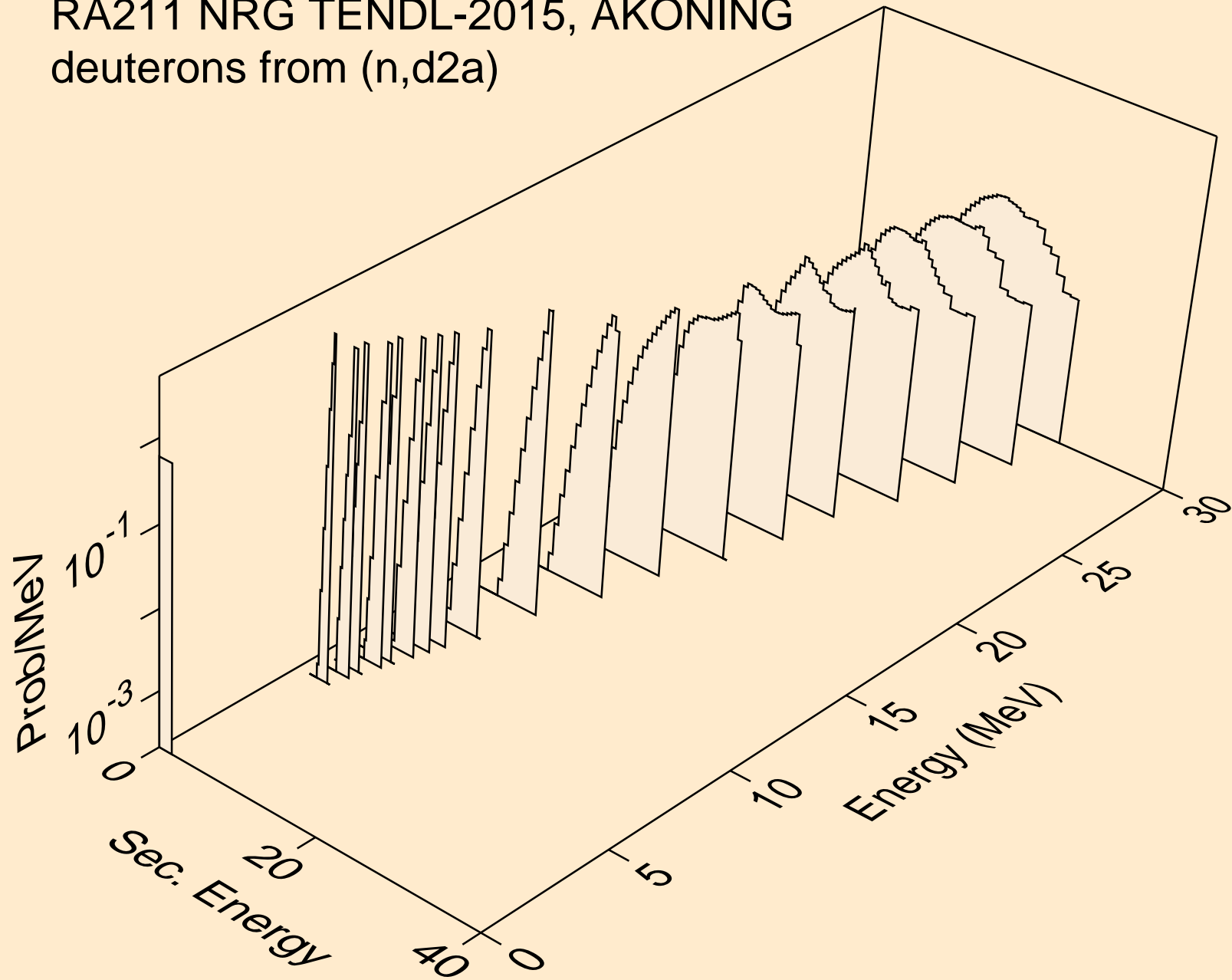

RA211 NRG TENDL-2015, AKONING
deuterons from (n,pd)

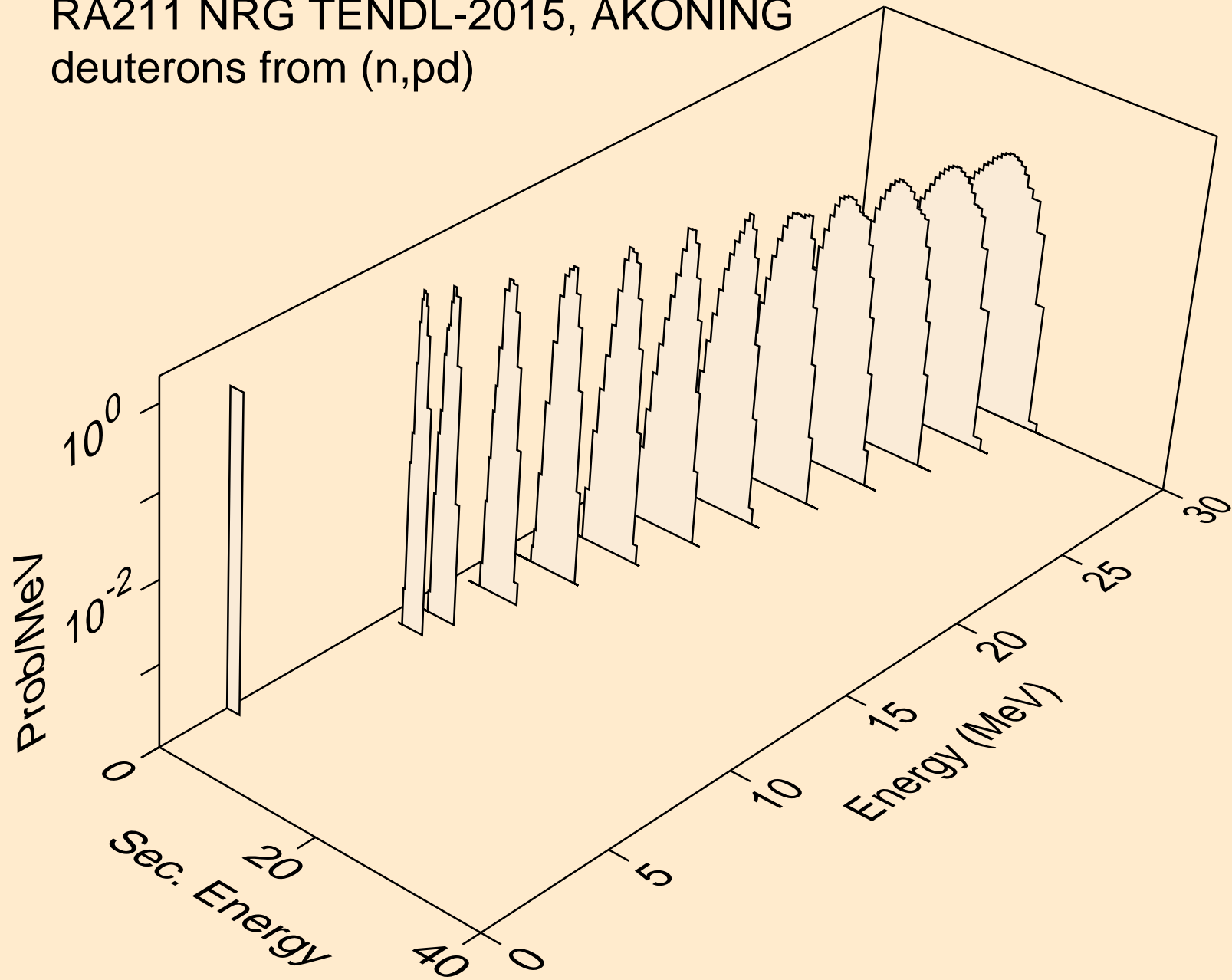

RA211 NRG TENDL-2015, AKONING
deuterons from (n,da)

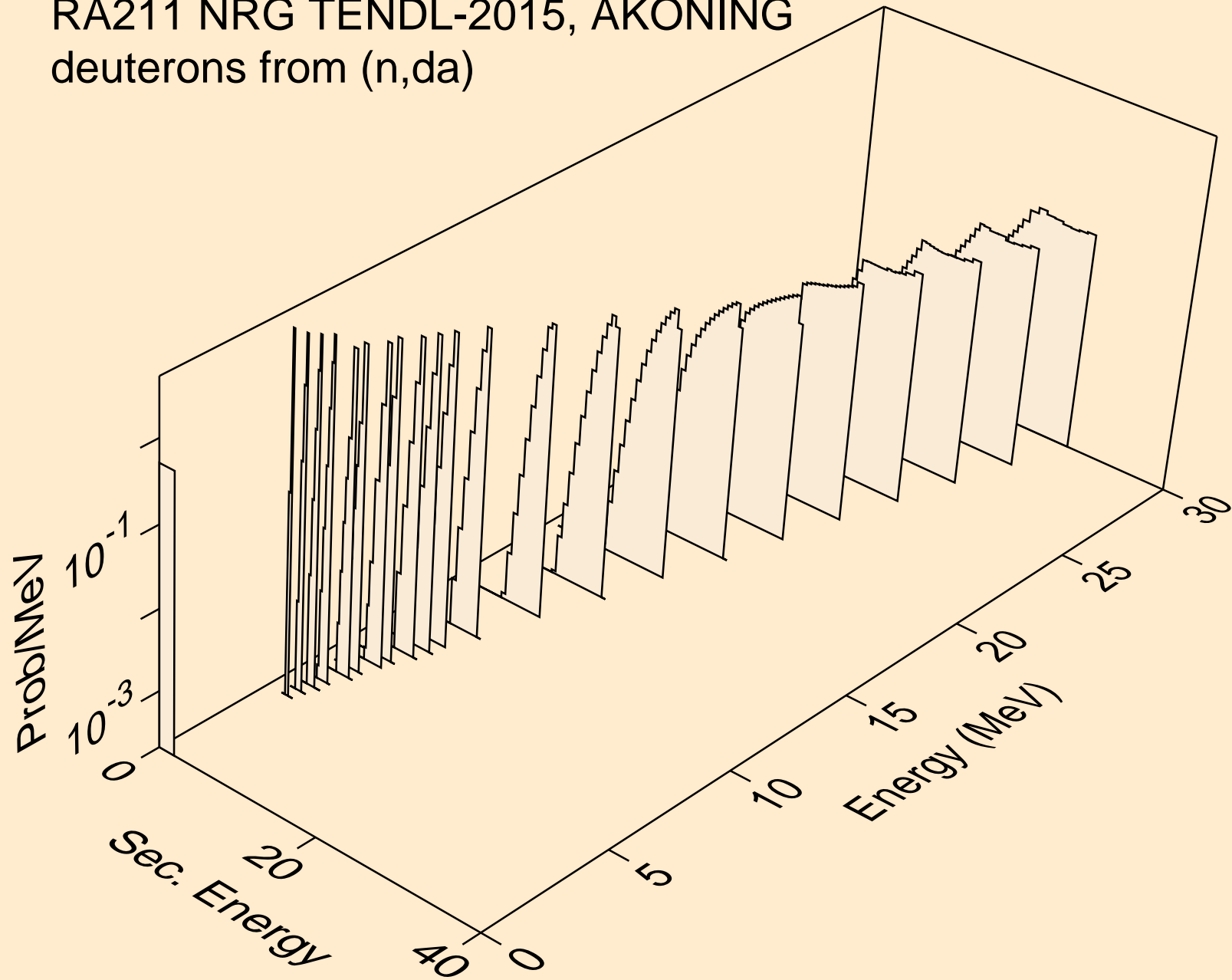

RA211 NRG TENDL-2015, AKONING
tritons from (n,x)

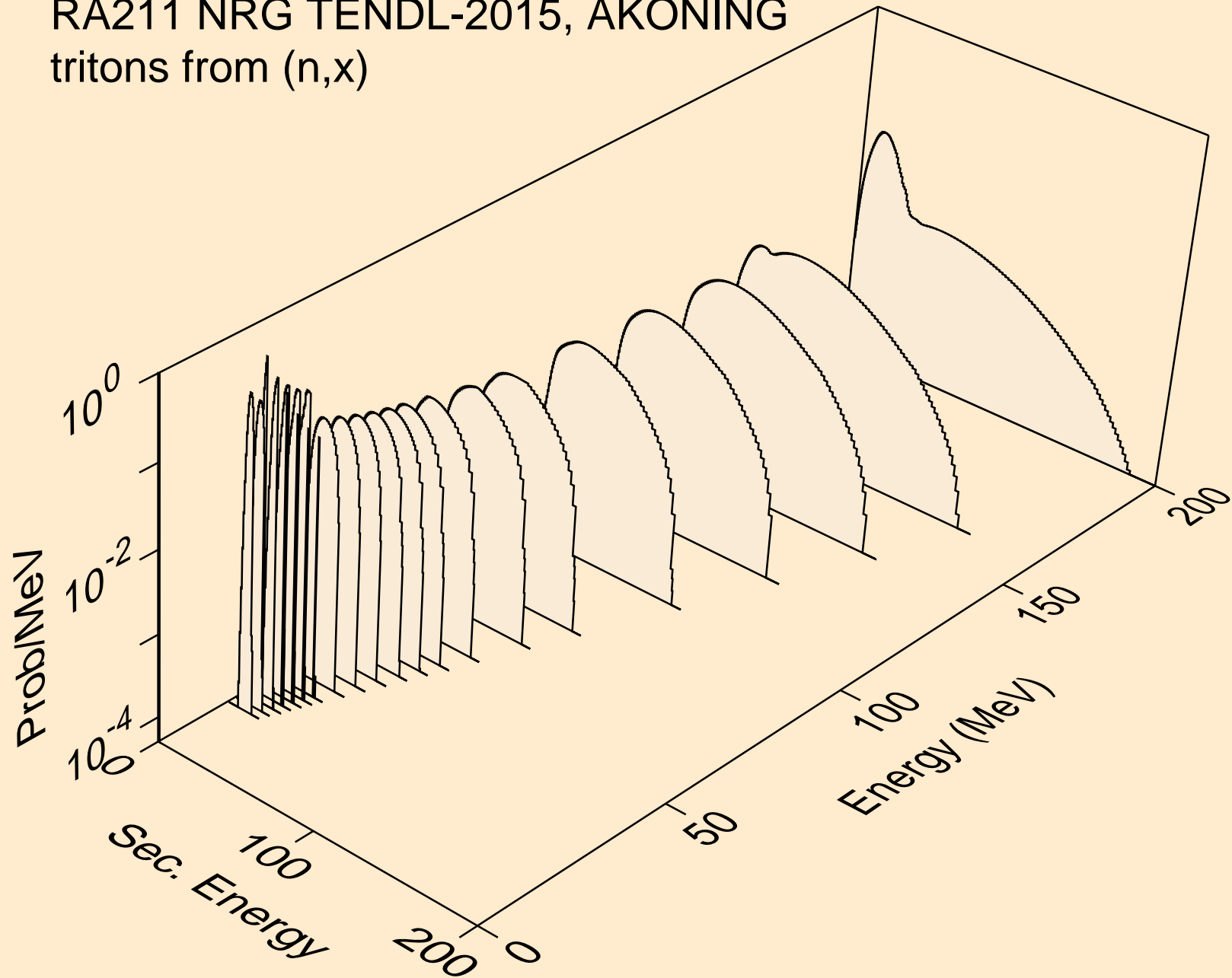

RA211 NRG TENDL-2015, AKONING
tritons from (n,n*)t

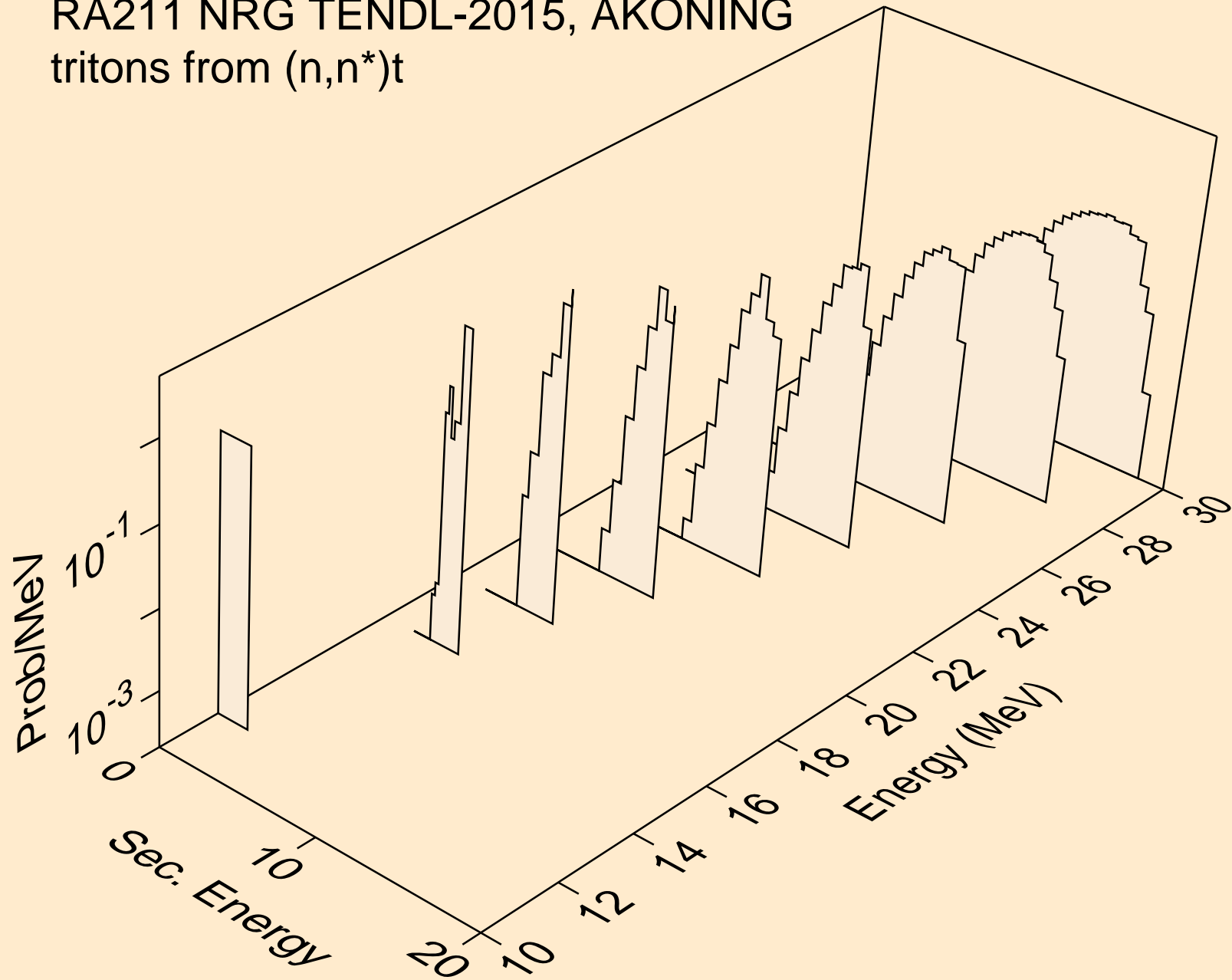

RA211 NRG TENDL-2015, AKONING
tritons from (n,n*)t2a

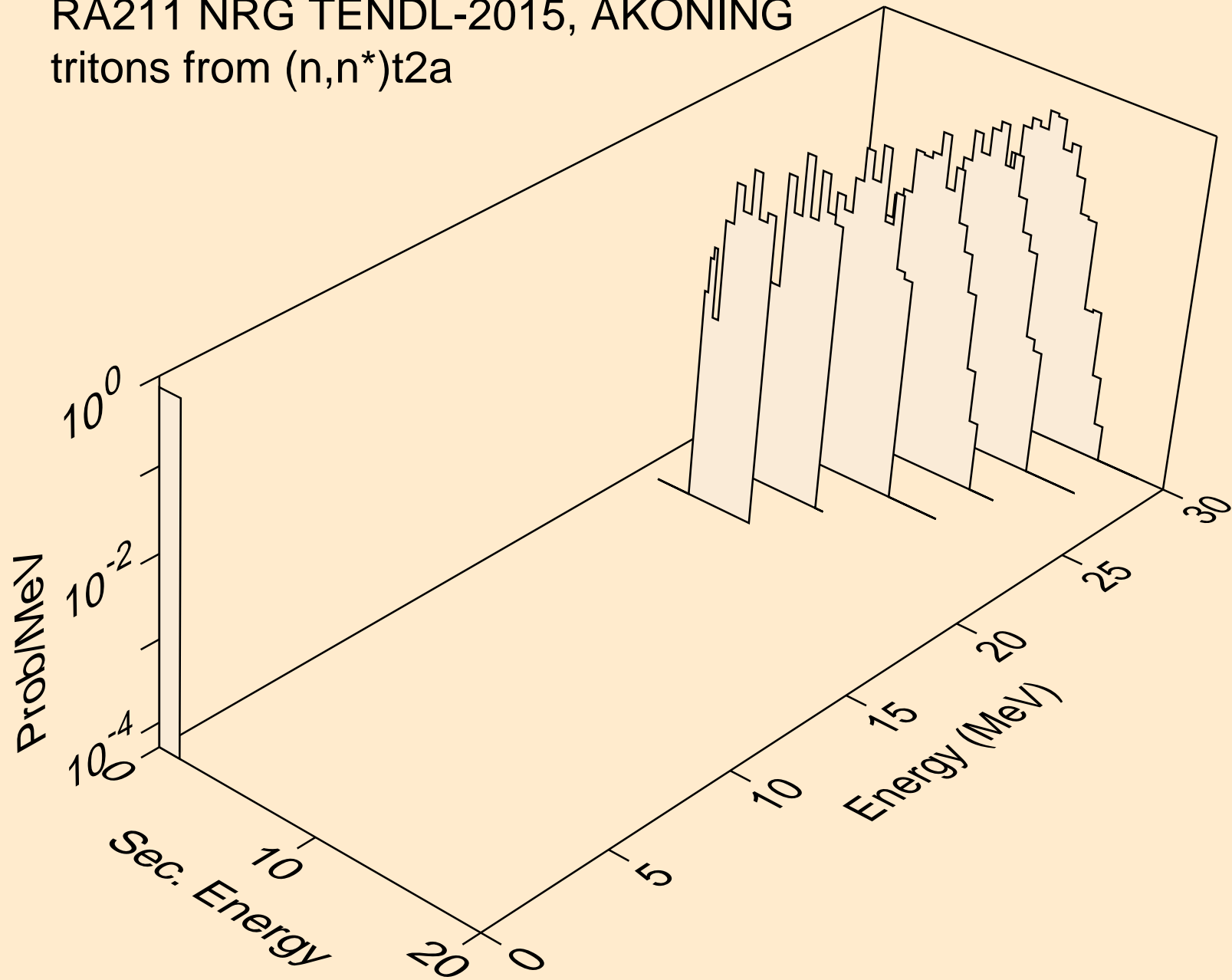

RA211 NRG TENDL-2015, AKONING
tritons from (n,t)

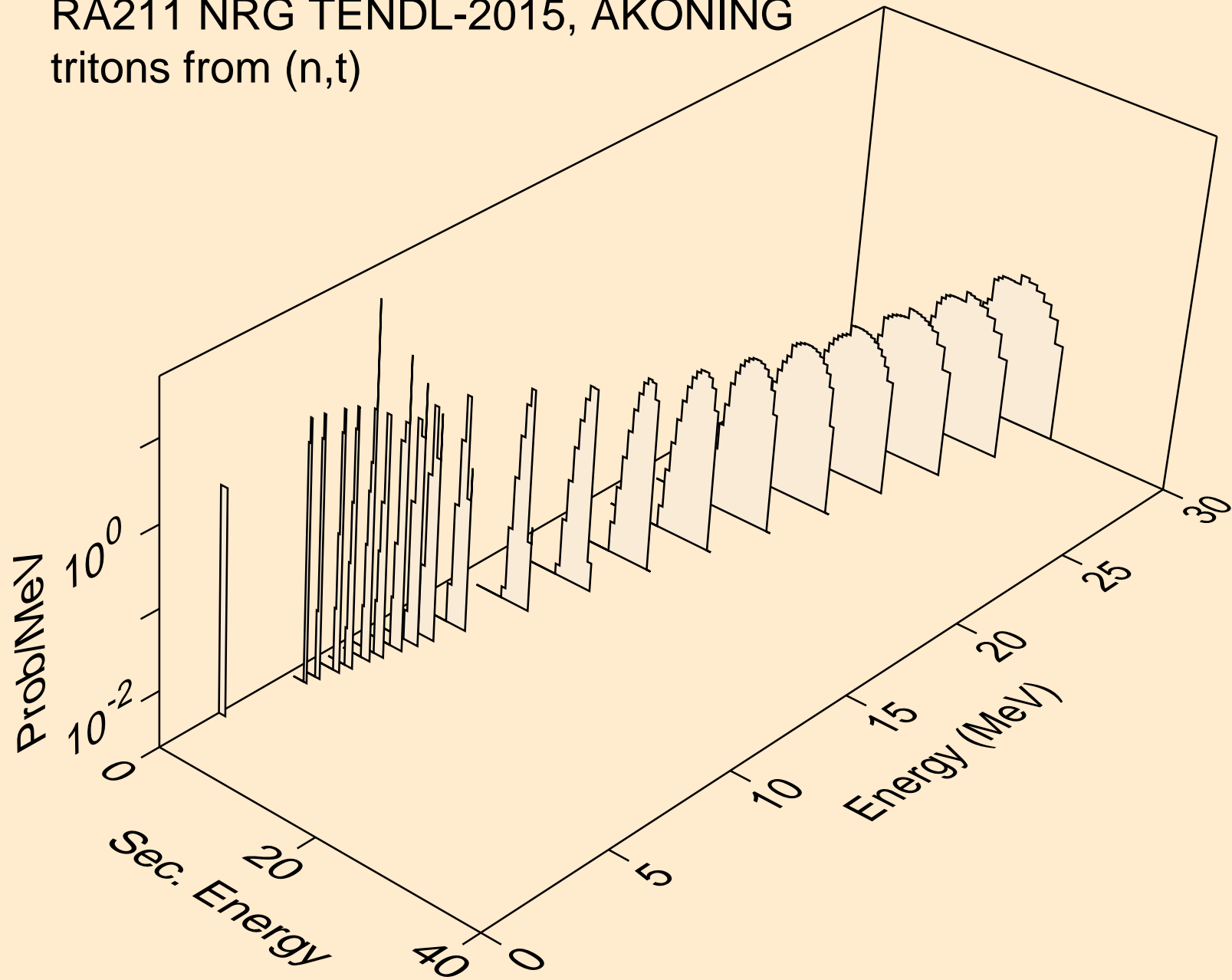

RA211 NRG TENDL-2015, AKONING
tritons from (n,t2a)

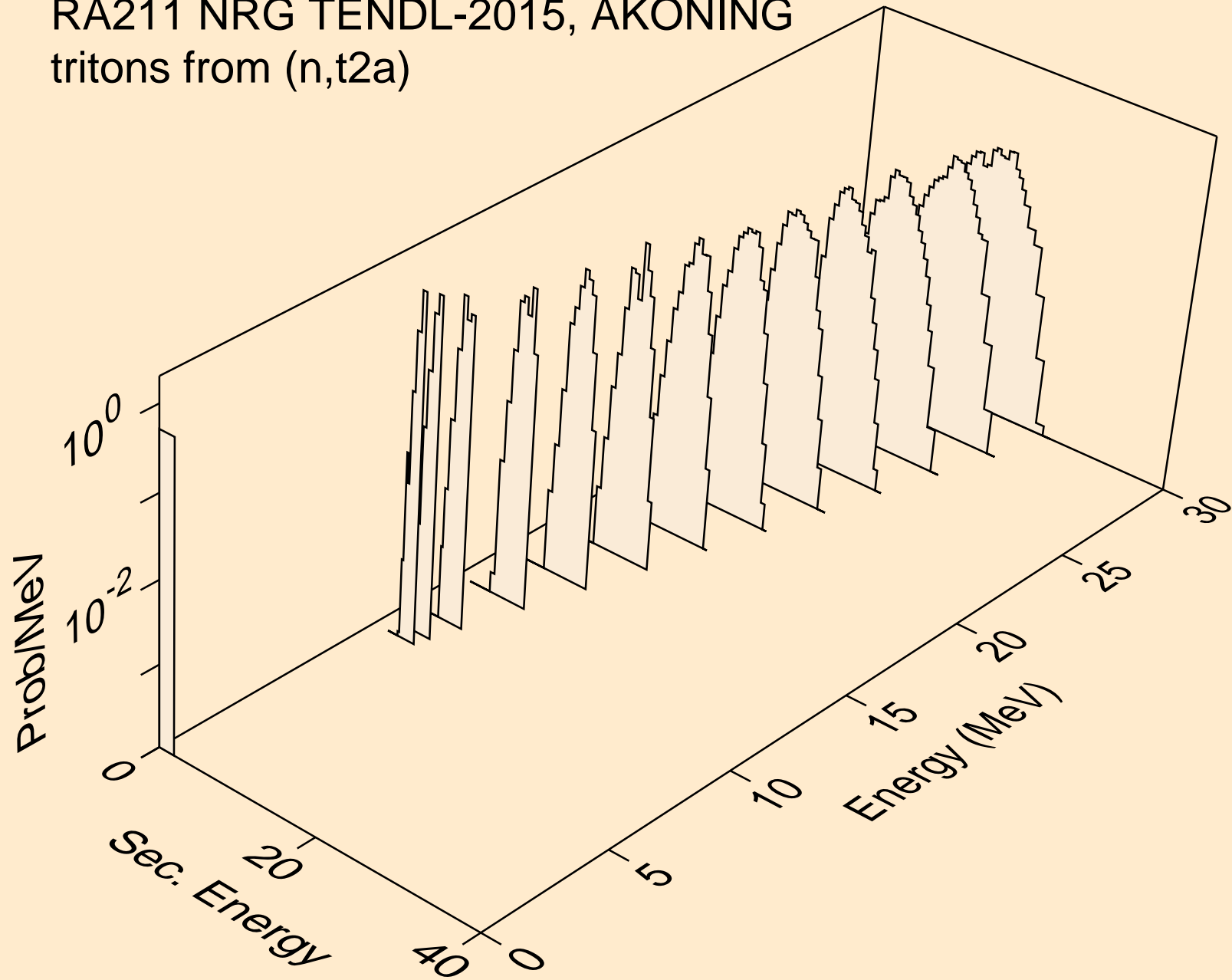

RA211 NRG TENDL-2015, AKONING
tritons from (n,pt)

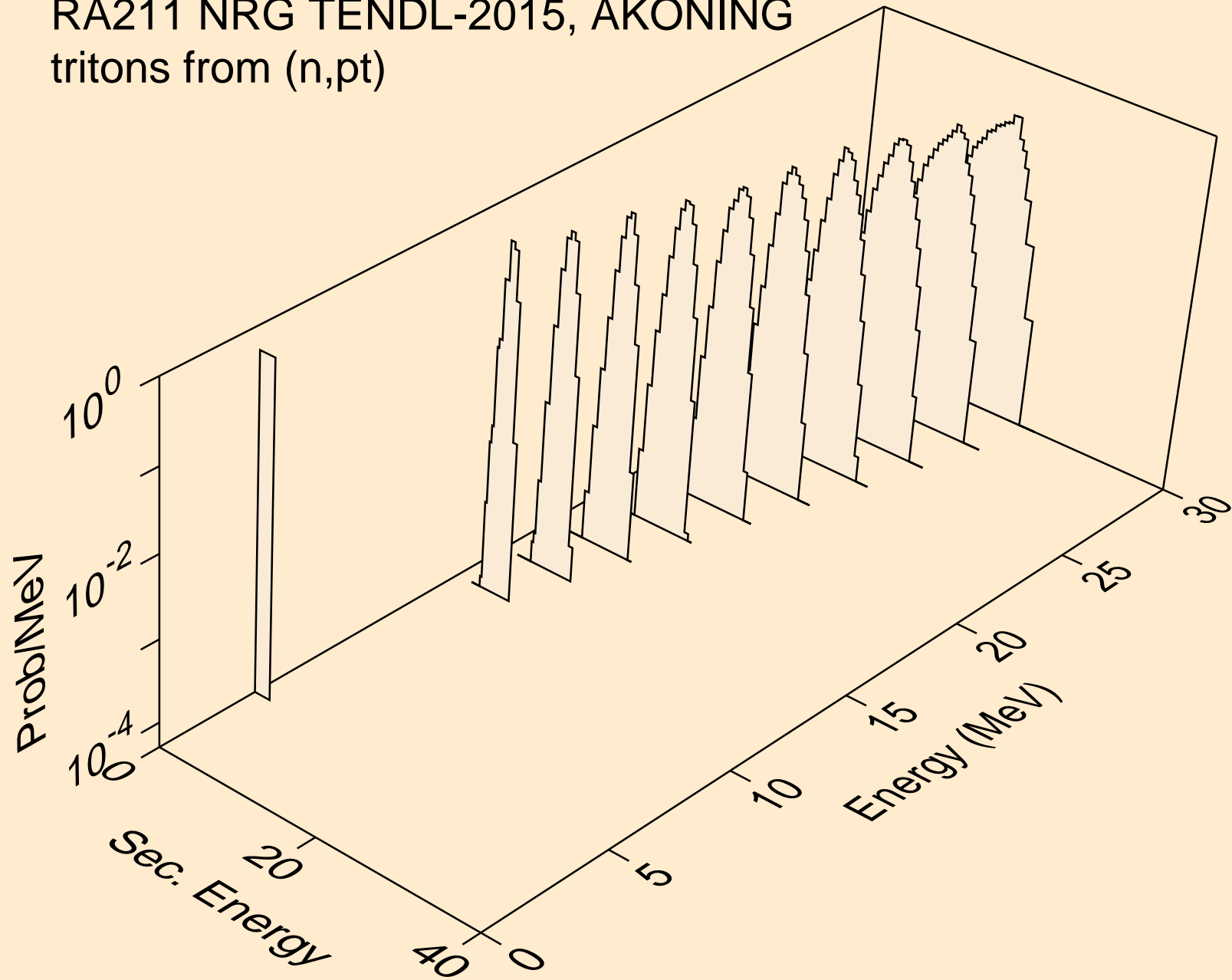

RA211 NRG TENDL-2015, AKONING
he3s from (n,x)

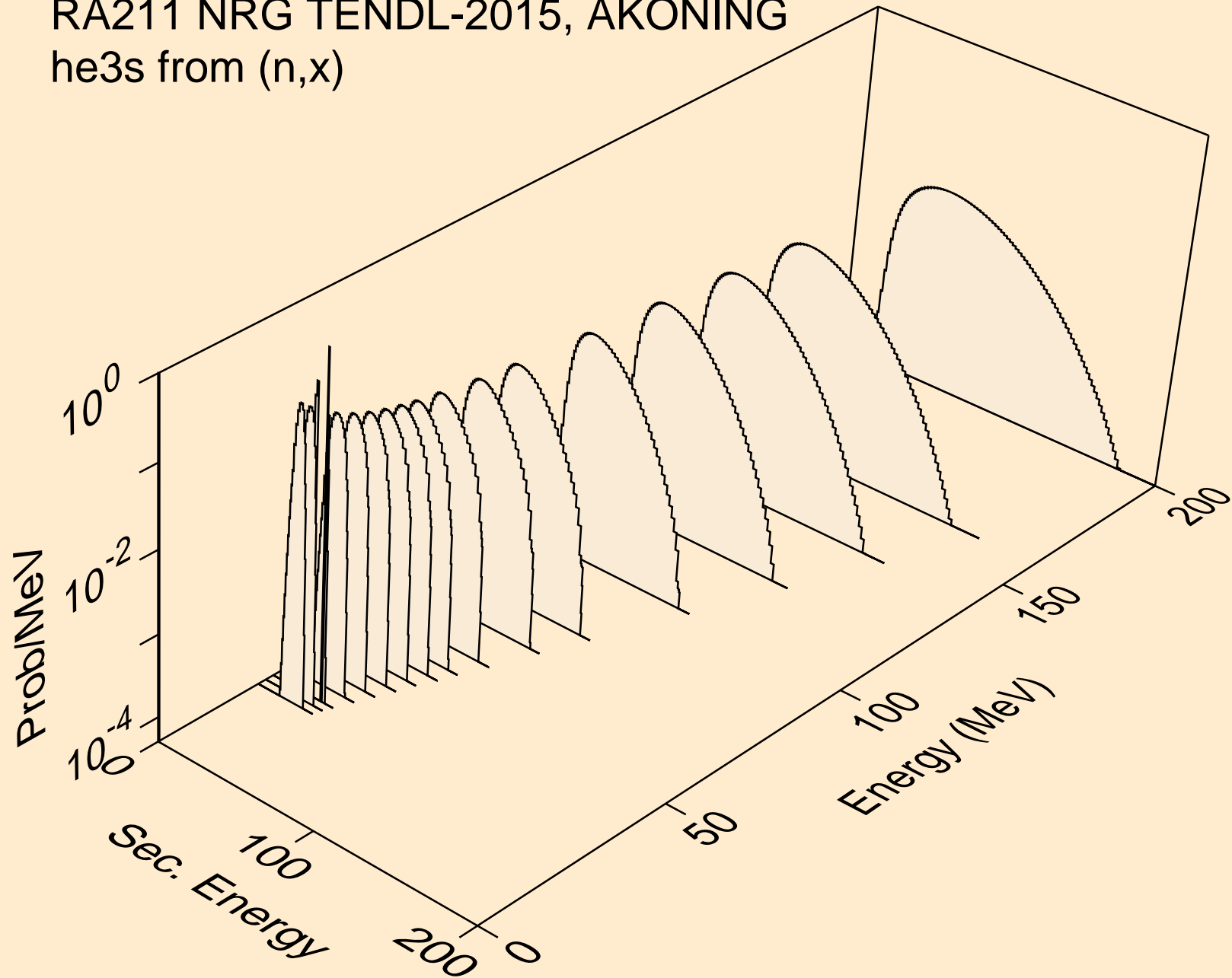

RA211 NRG TENDL-2015, AKONING
he3s from (n,n*)he3

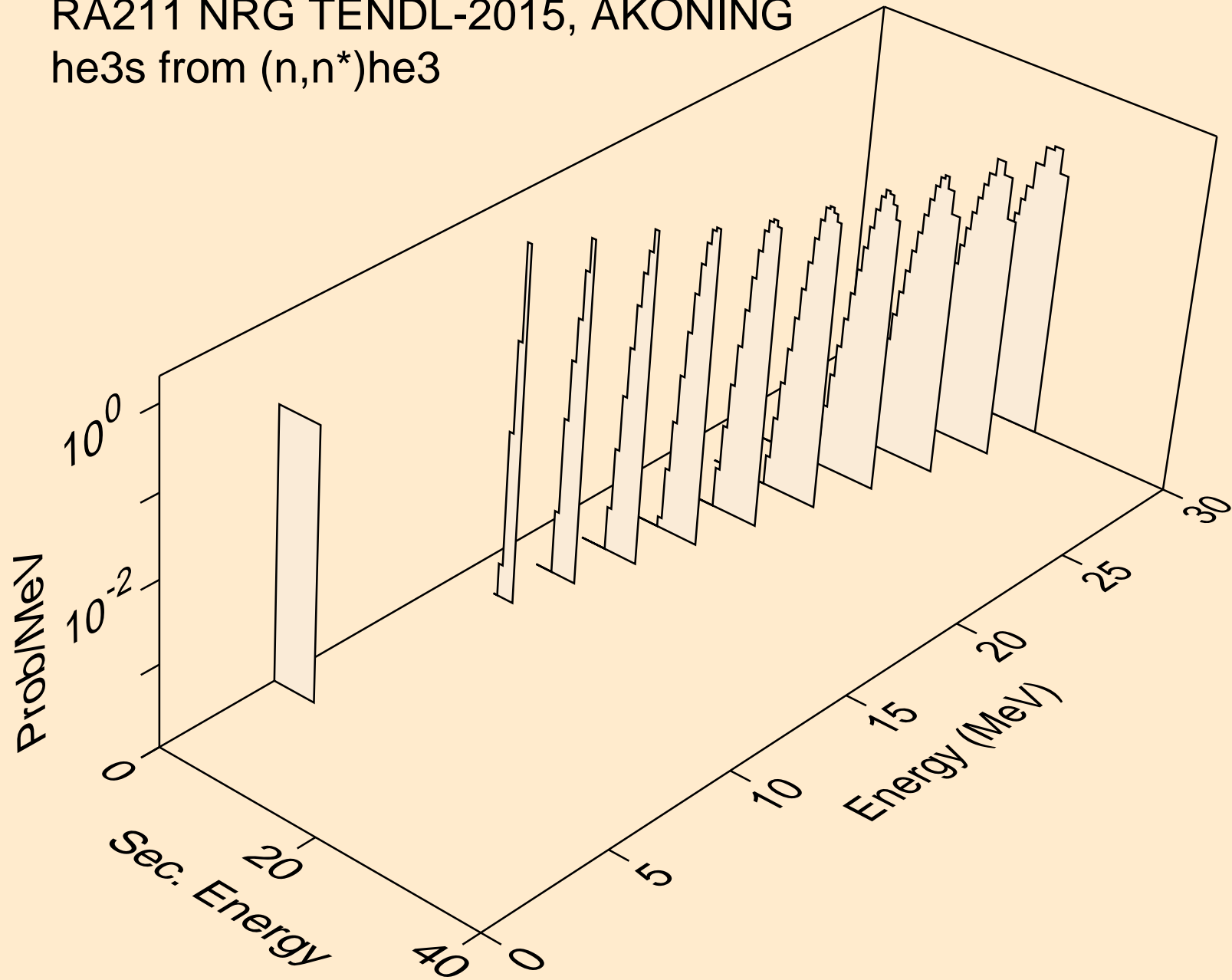

RA211 NRG TENDL-2015, AKONING
he3s from (n,he3)

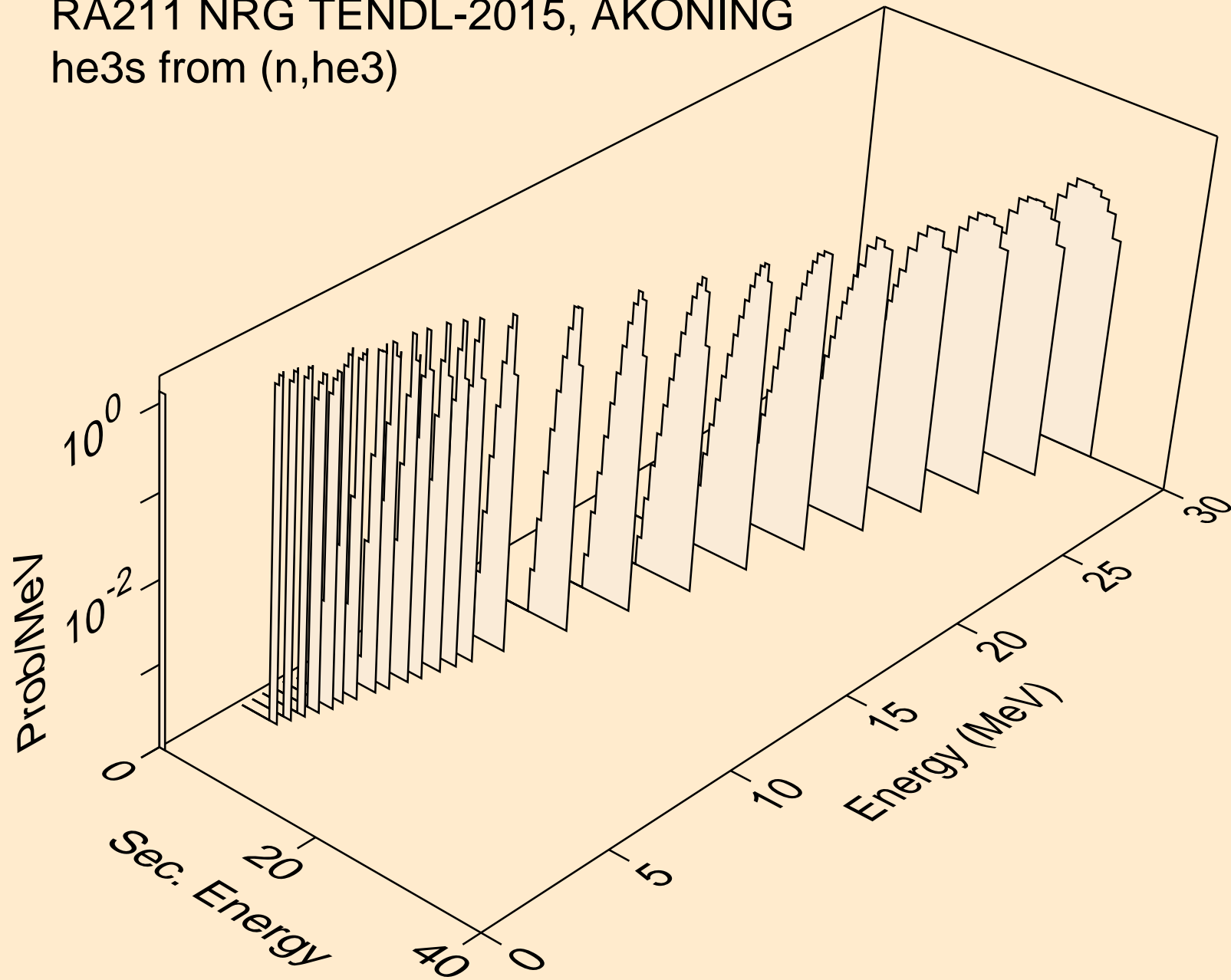

RA211 NRG TENDL-2015, AKONING
alphas from (n,x)

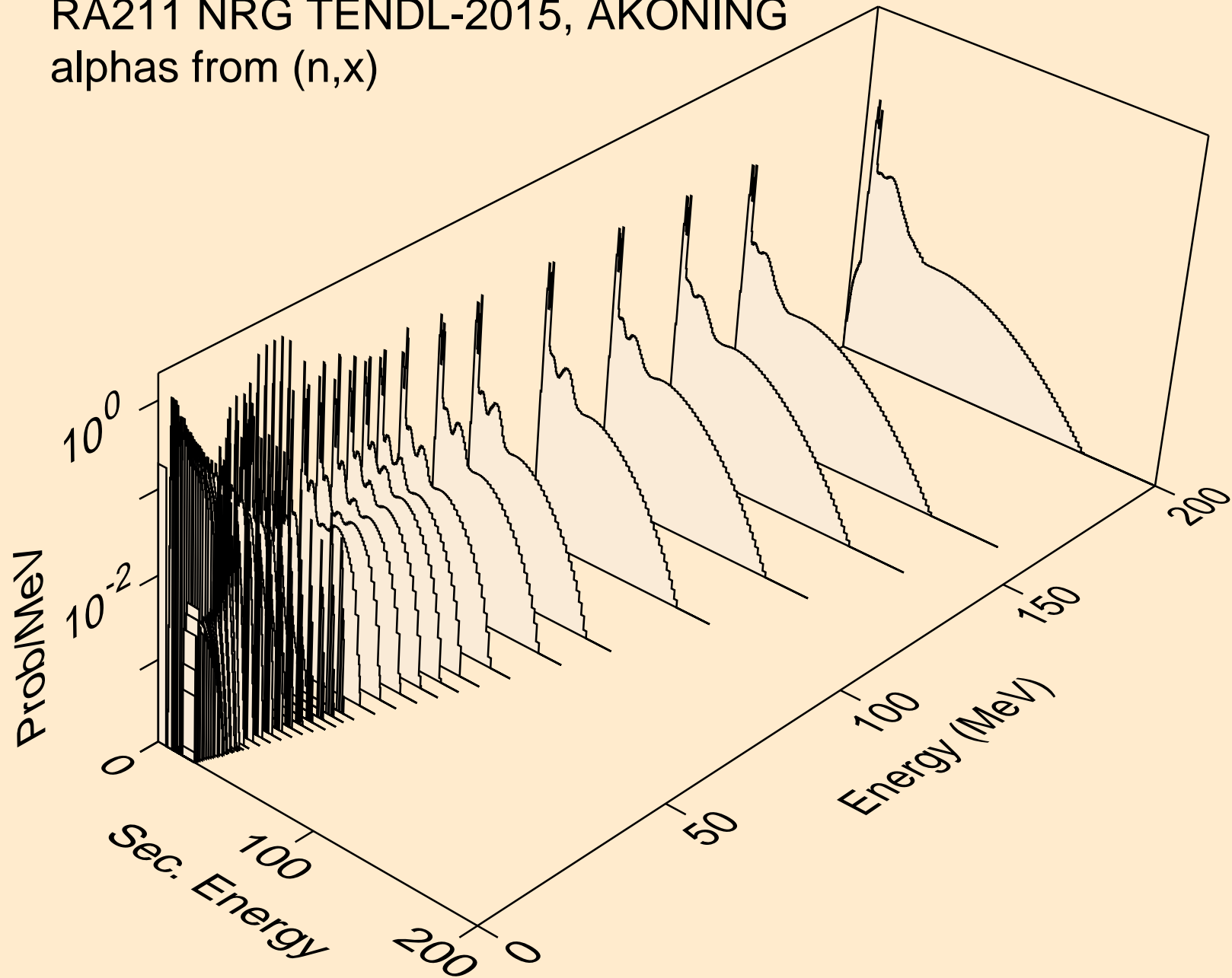

RA211 NRG TENDL-2015, AKONING
alphas from (n,n*)a

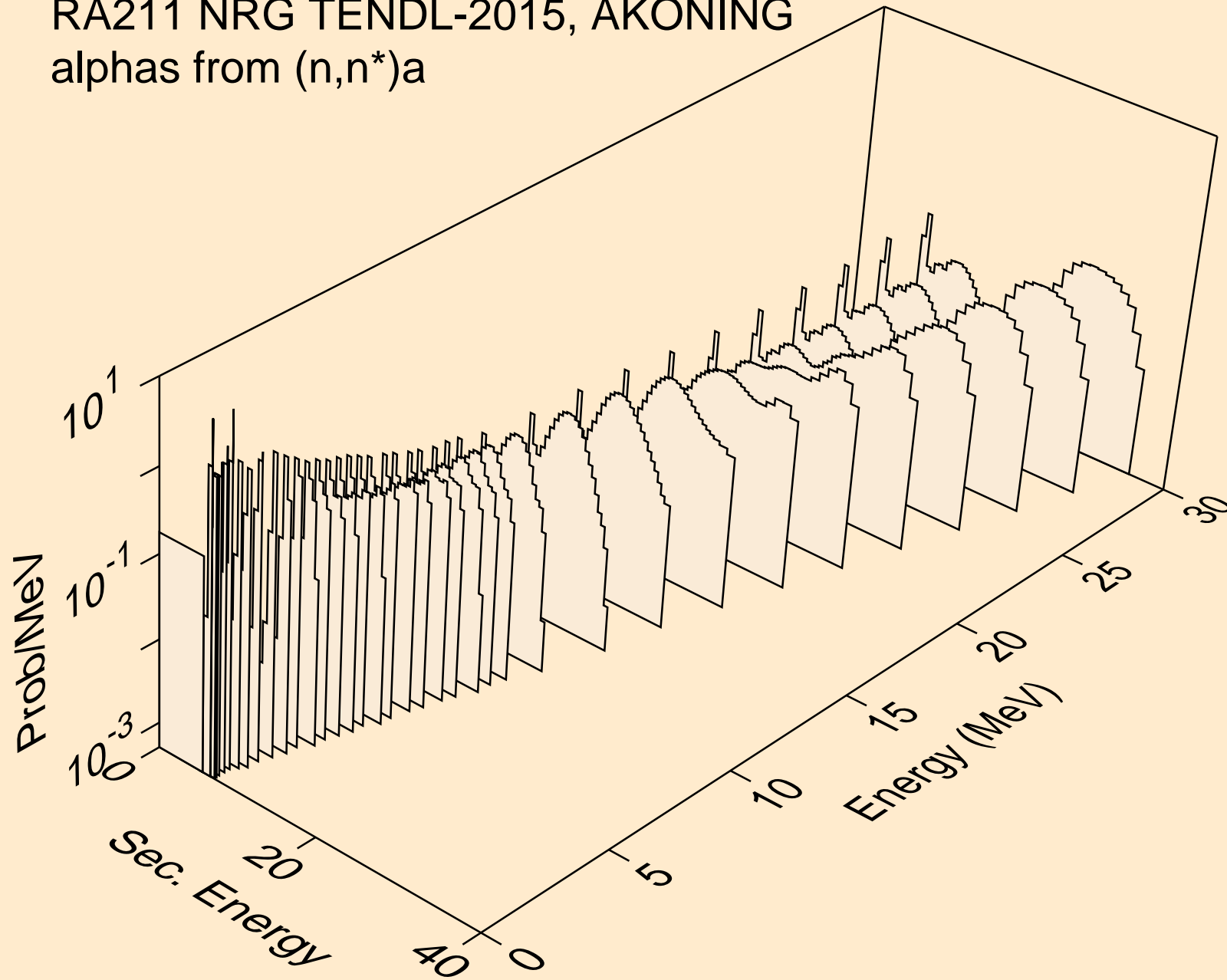

RA211 NRG TENDL-2015, AKONING
alphas from (n,n*)3a

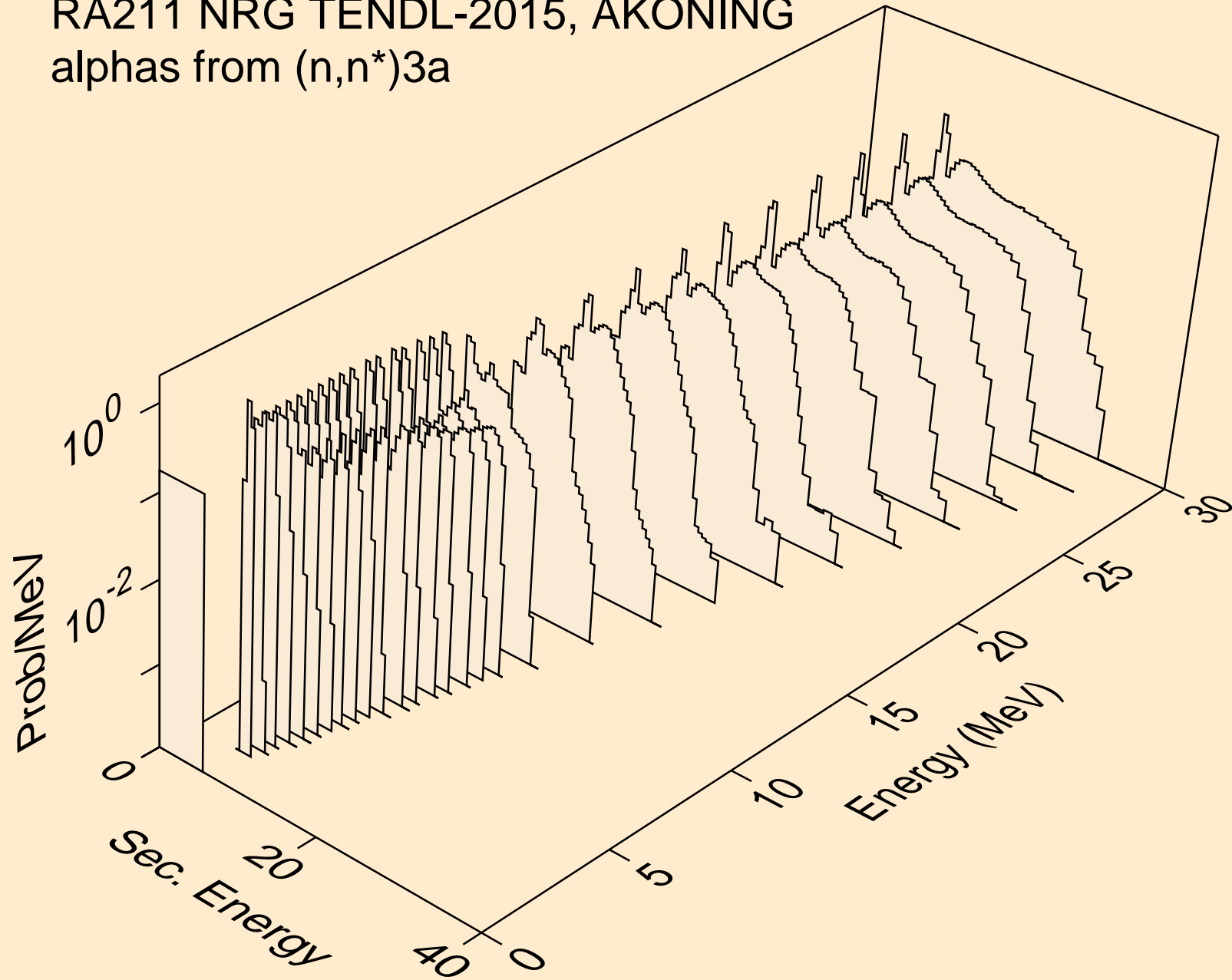

RA211 NRG TENDL-2015, AKONING
alphas from (n,2n)a

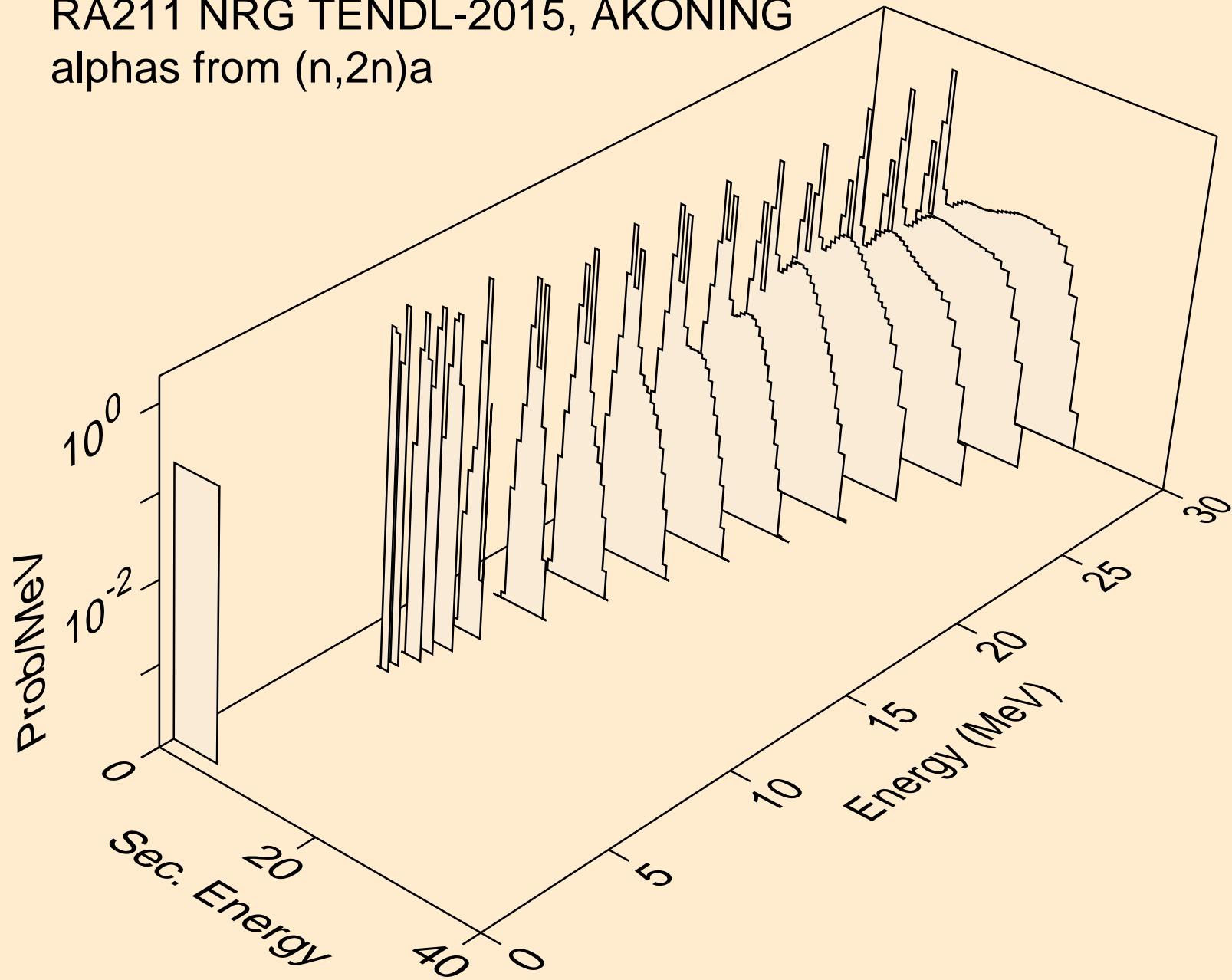

RA211 NRG TENDL-2015, AKONING
alphas from (n,3n)a

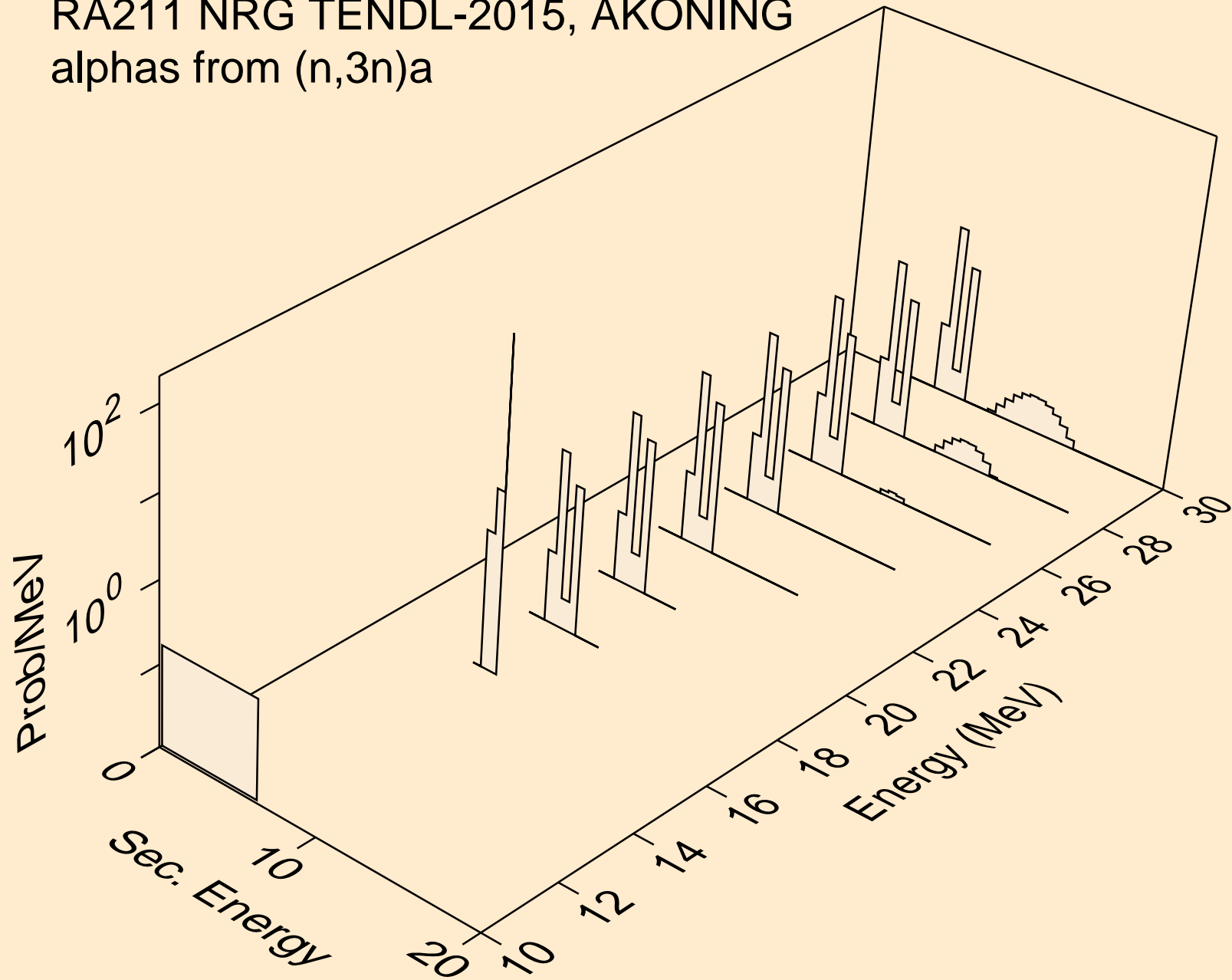

RA211 NRG TENDL-2015, AKONING
alphas from (n,n*)2a

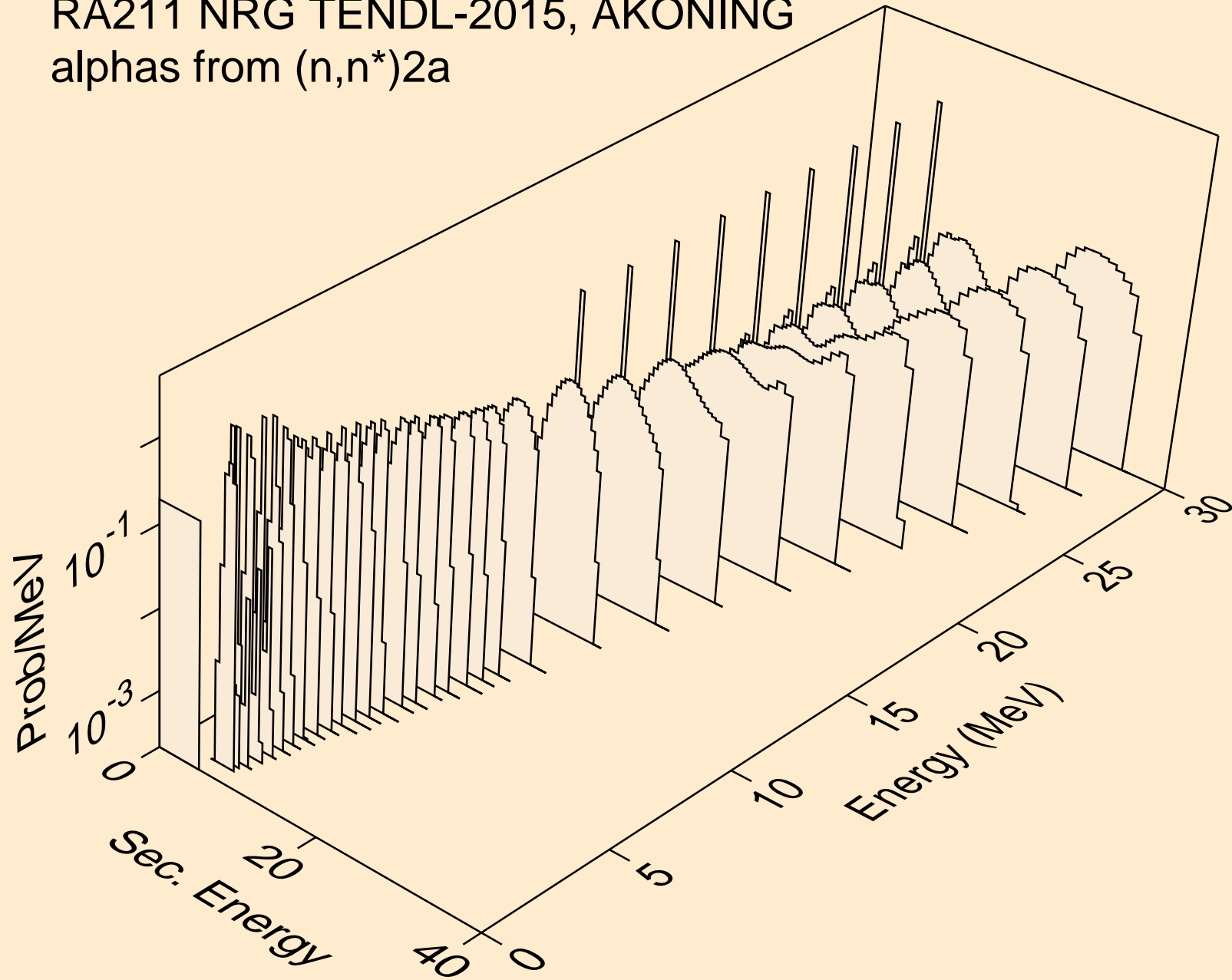

RA211 NRG TENDL-2015, AKONING
alphas from (n,2n)2a

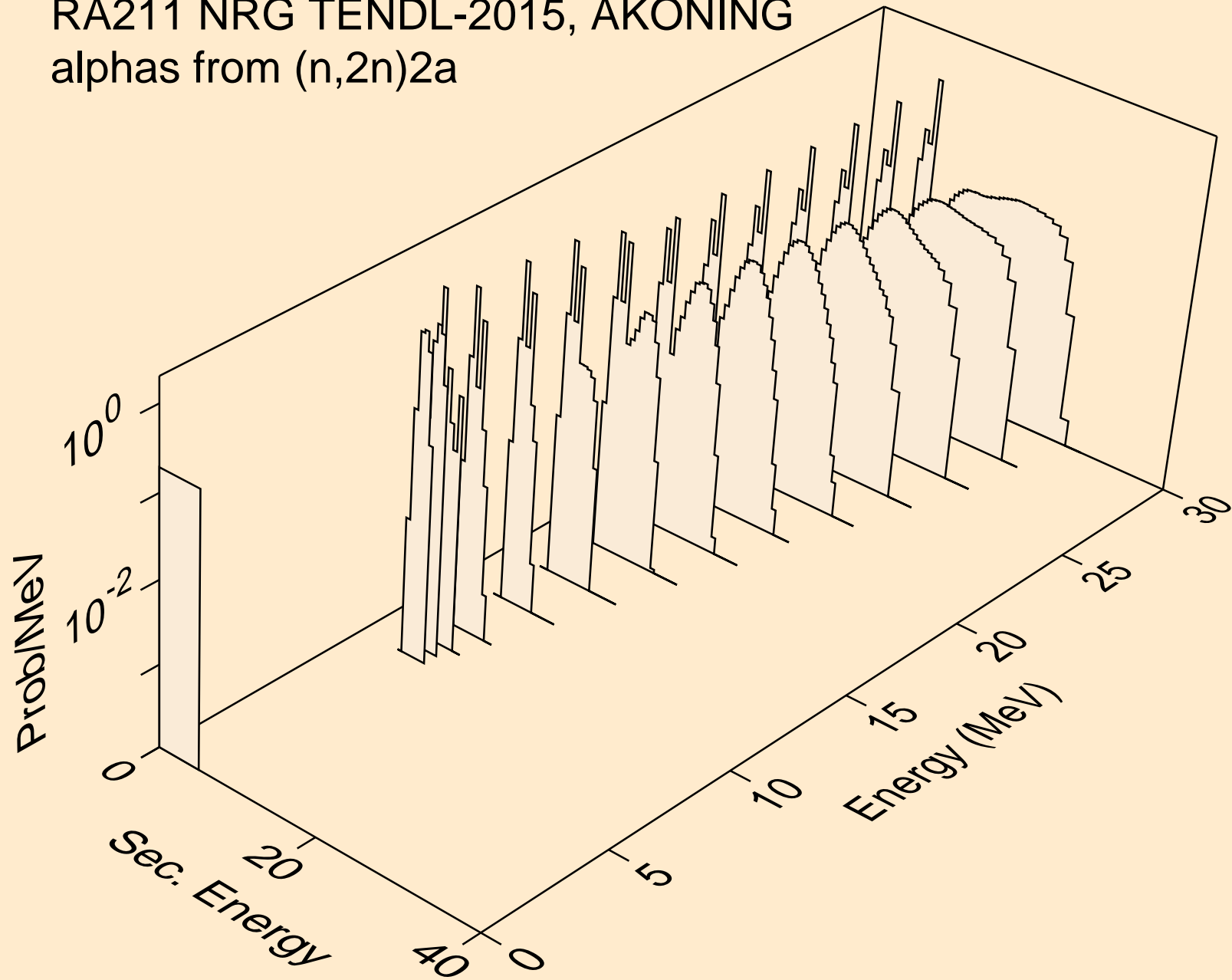

RA211 NRG TENDL-2015, AKONING
alphas from (n,n*)d2a

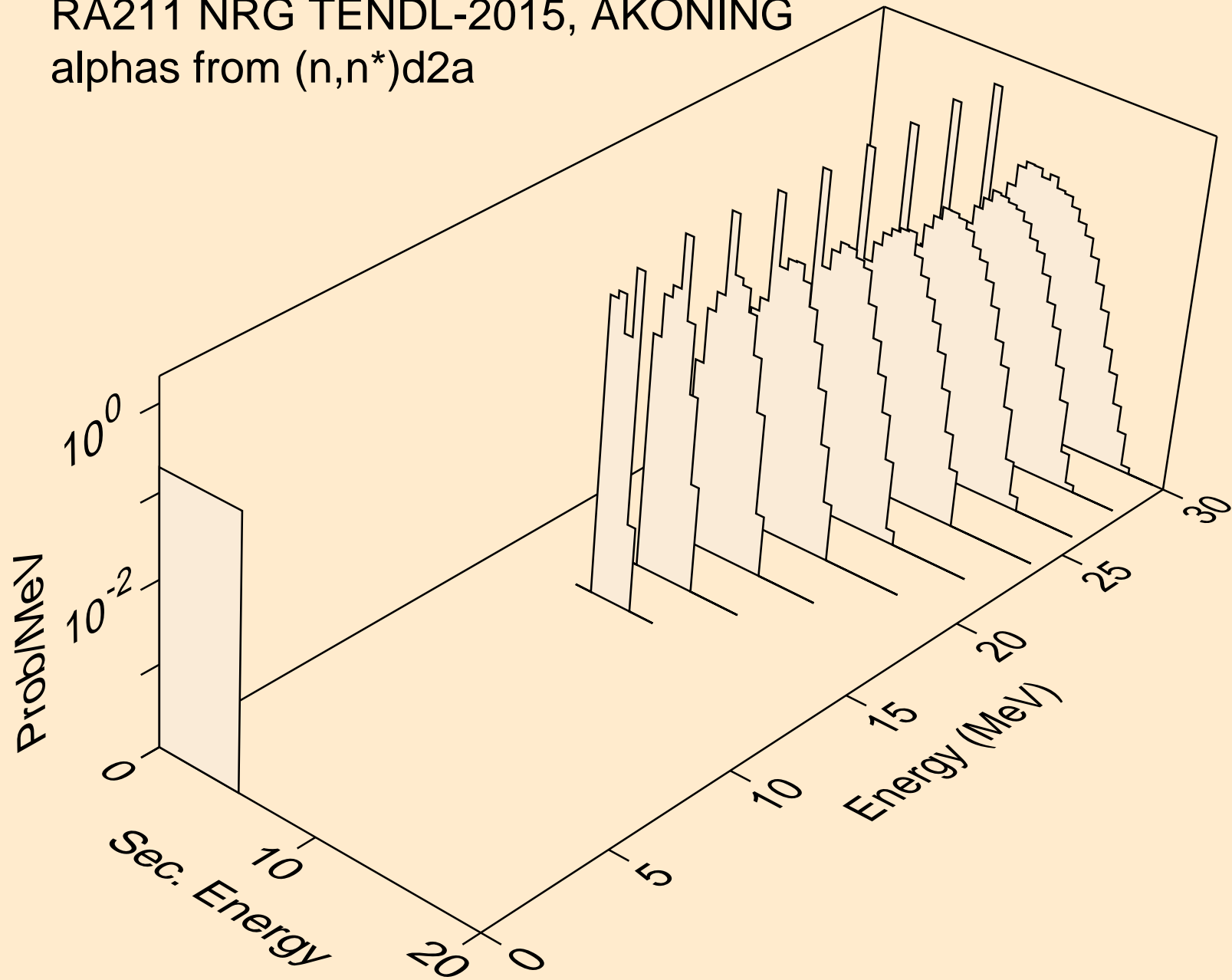

RA211 NRG TENDL-2015, AKONING
alphas from (n,n*)t2a

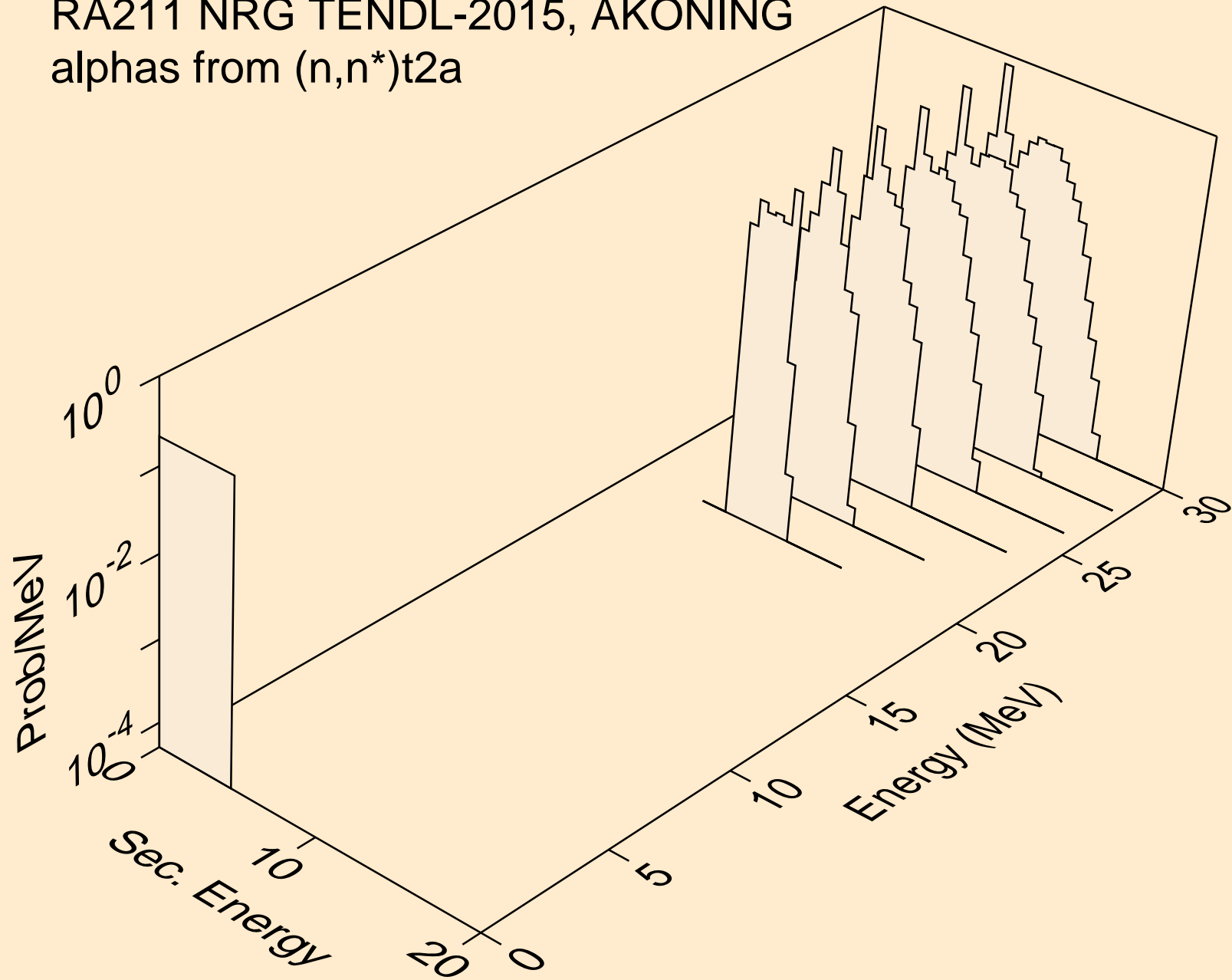

RA211 NRG TENDL-2015, AKONING
alphas from (n,npa)

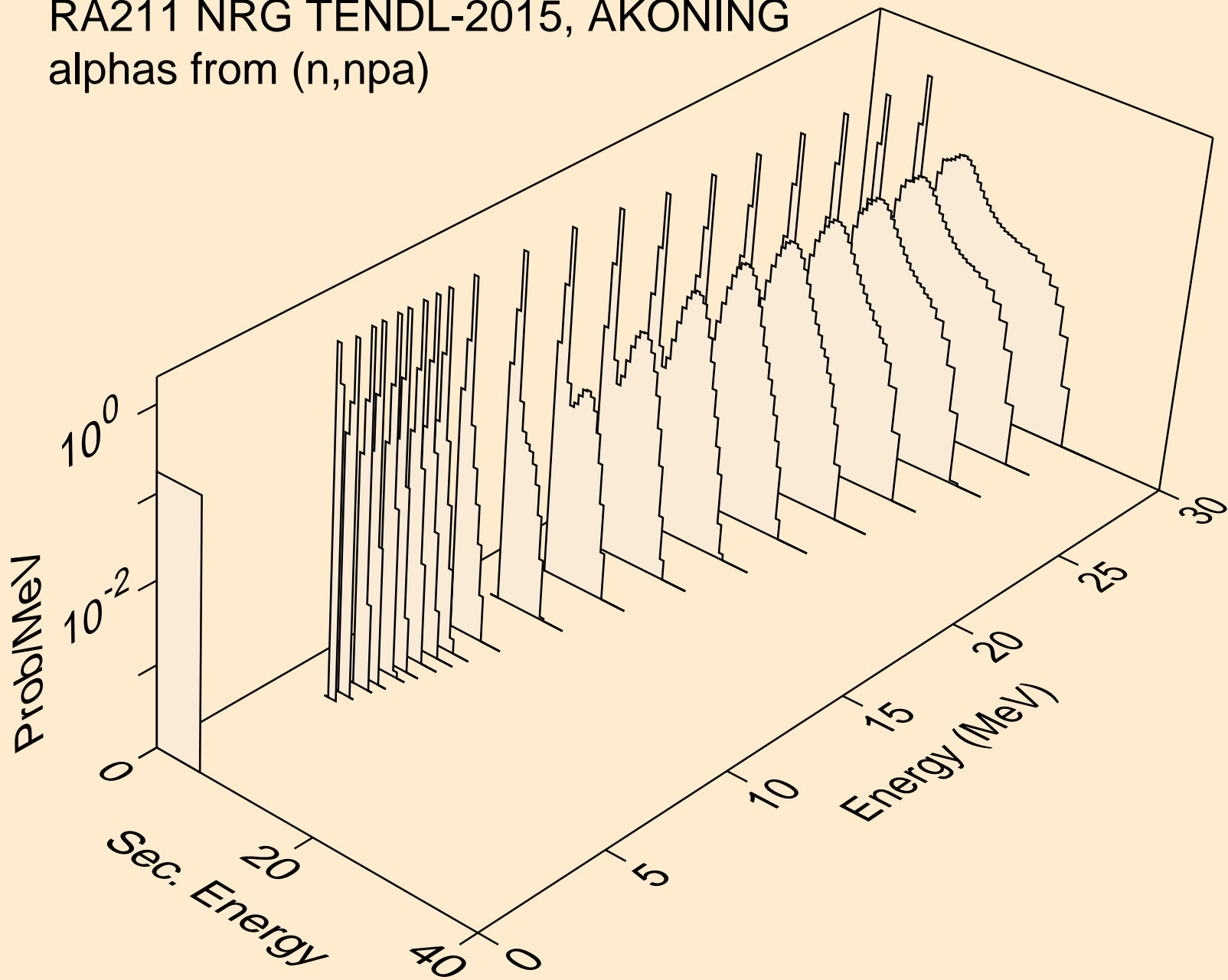

RA211 NRG TENDL-2015, AKONING
alphas from (n,a)

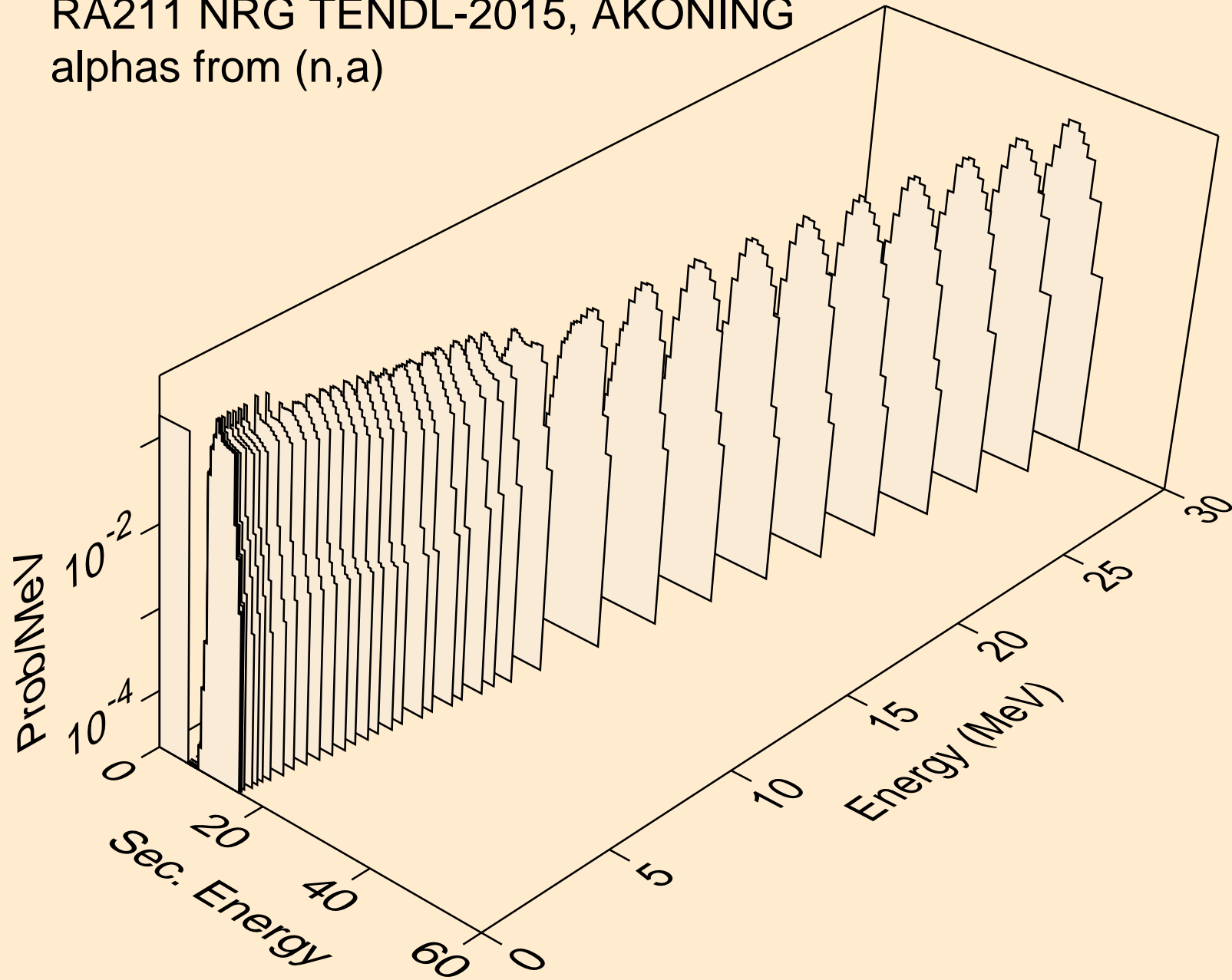

RA211 NRG TENDL-2015, AKONING
alphas from (n,2a)

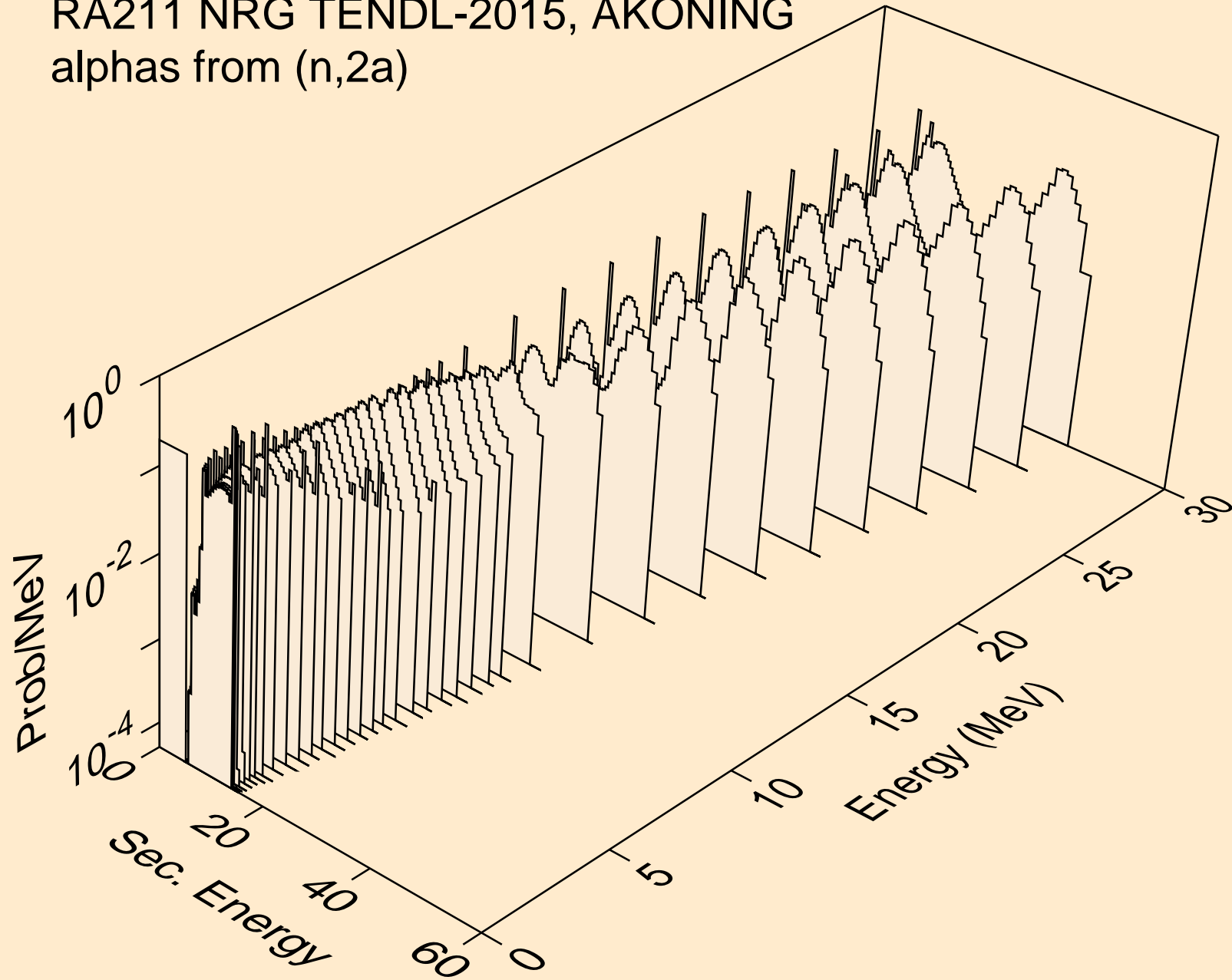

RA211 NRG TENDL-2015, AKONING
alphas from (n,3a)

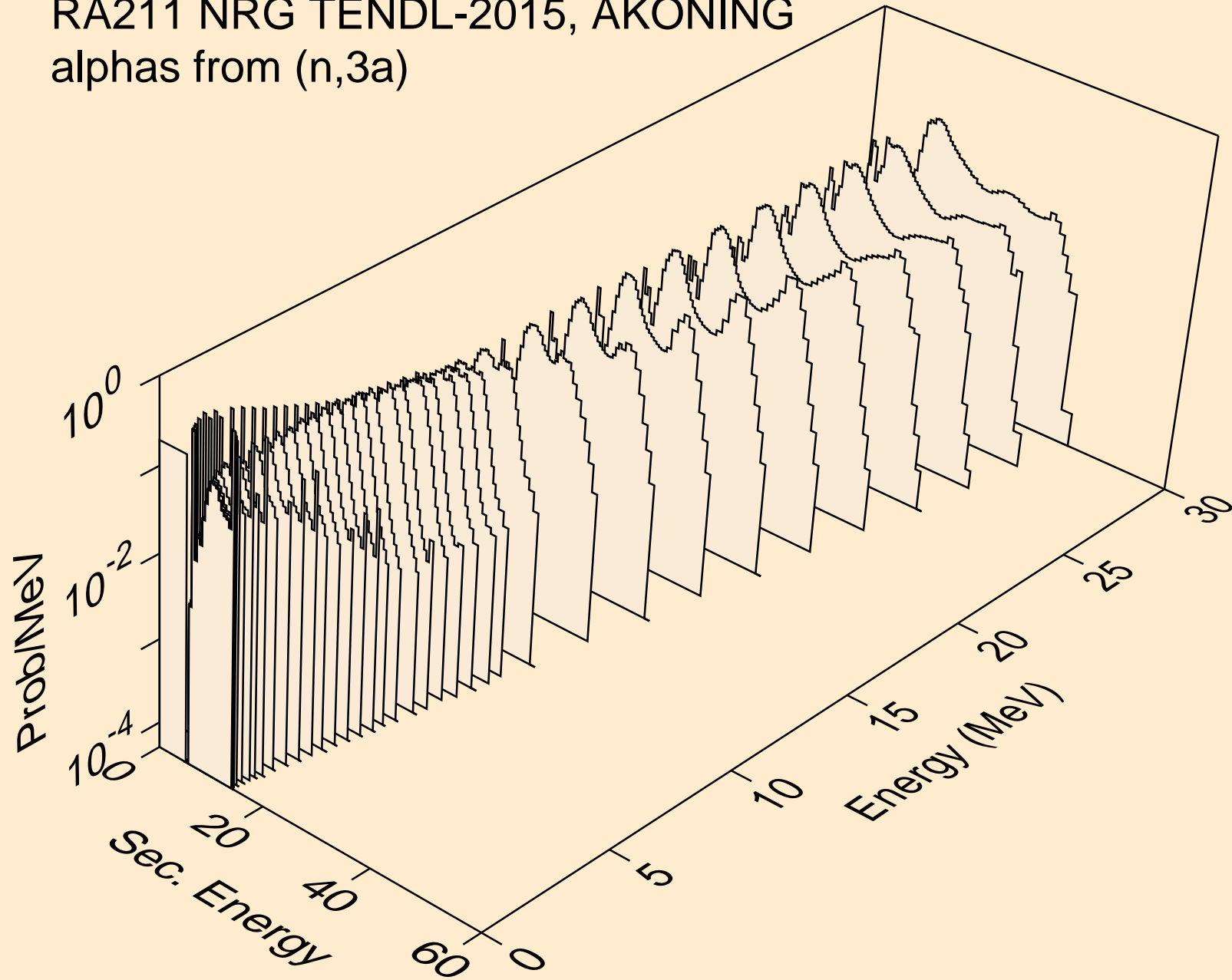

RA211 NRG TENDL-2015, AKONING
alphas from (n,pa)

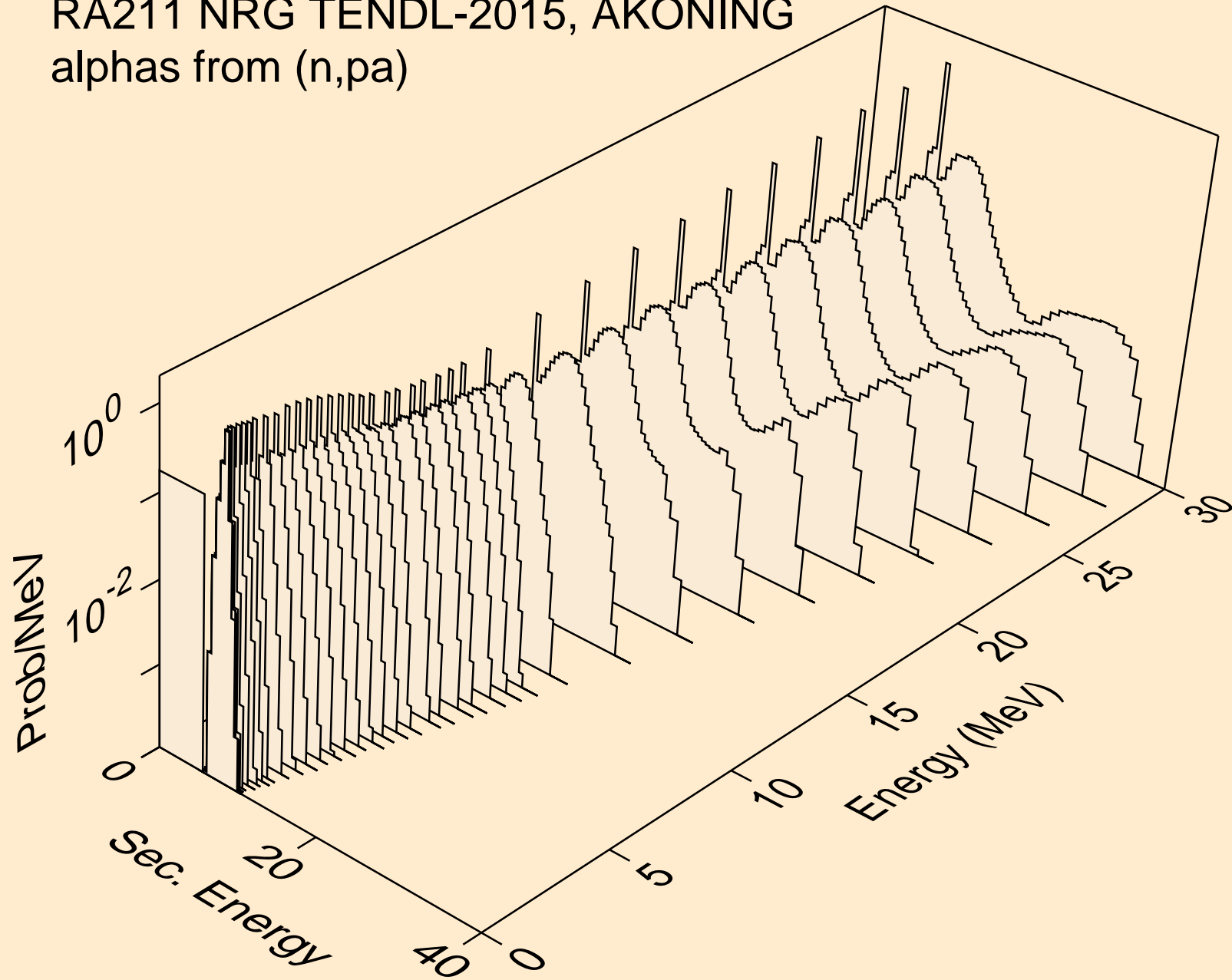

RA211 NRG TENDL-2015, AKONING
alphas from (n,t2a)

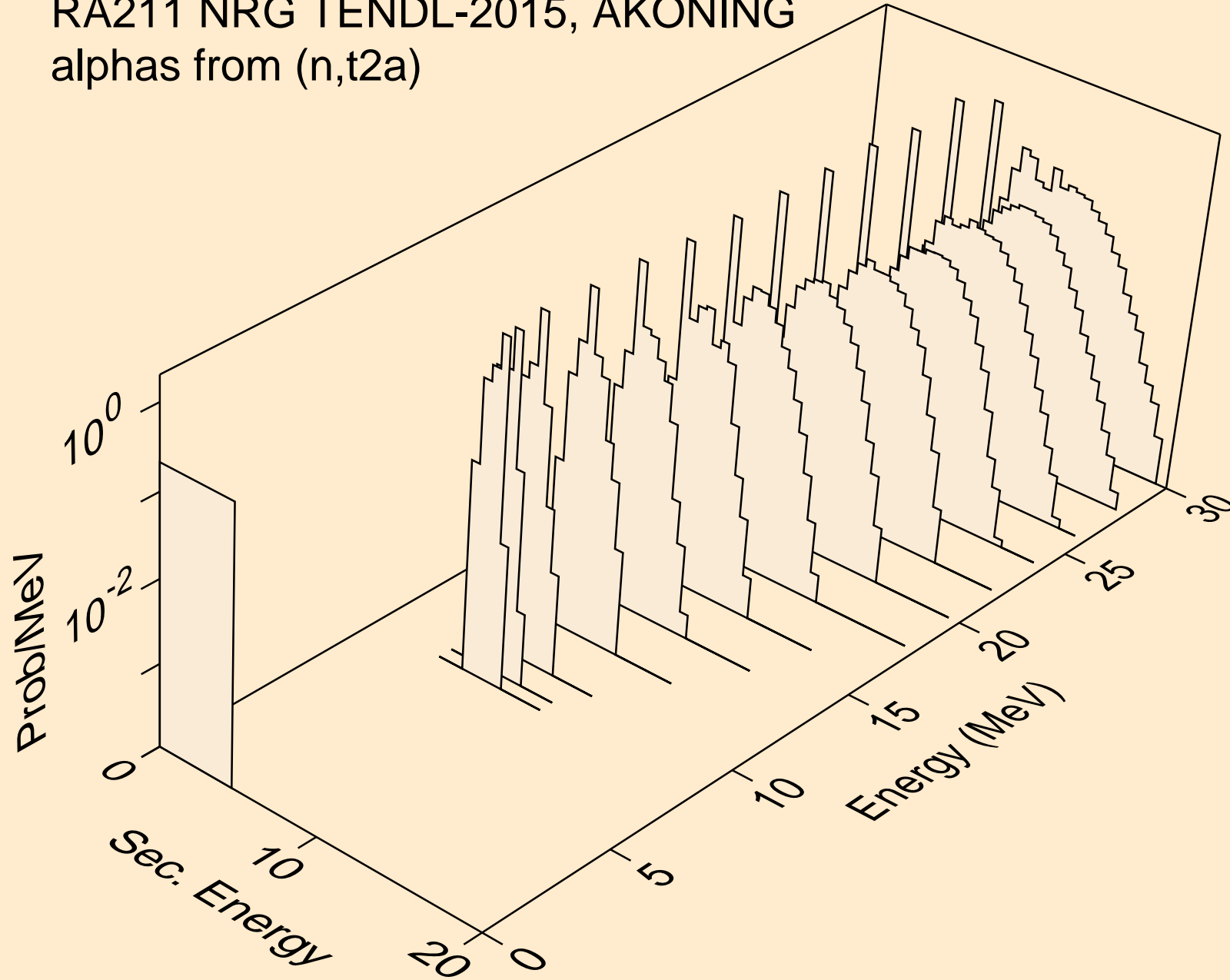

RA211 NRG TENDL-2015, AKONING
alphas from (n,d2a)

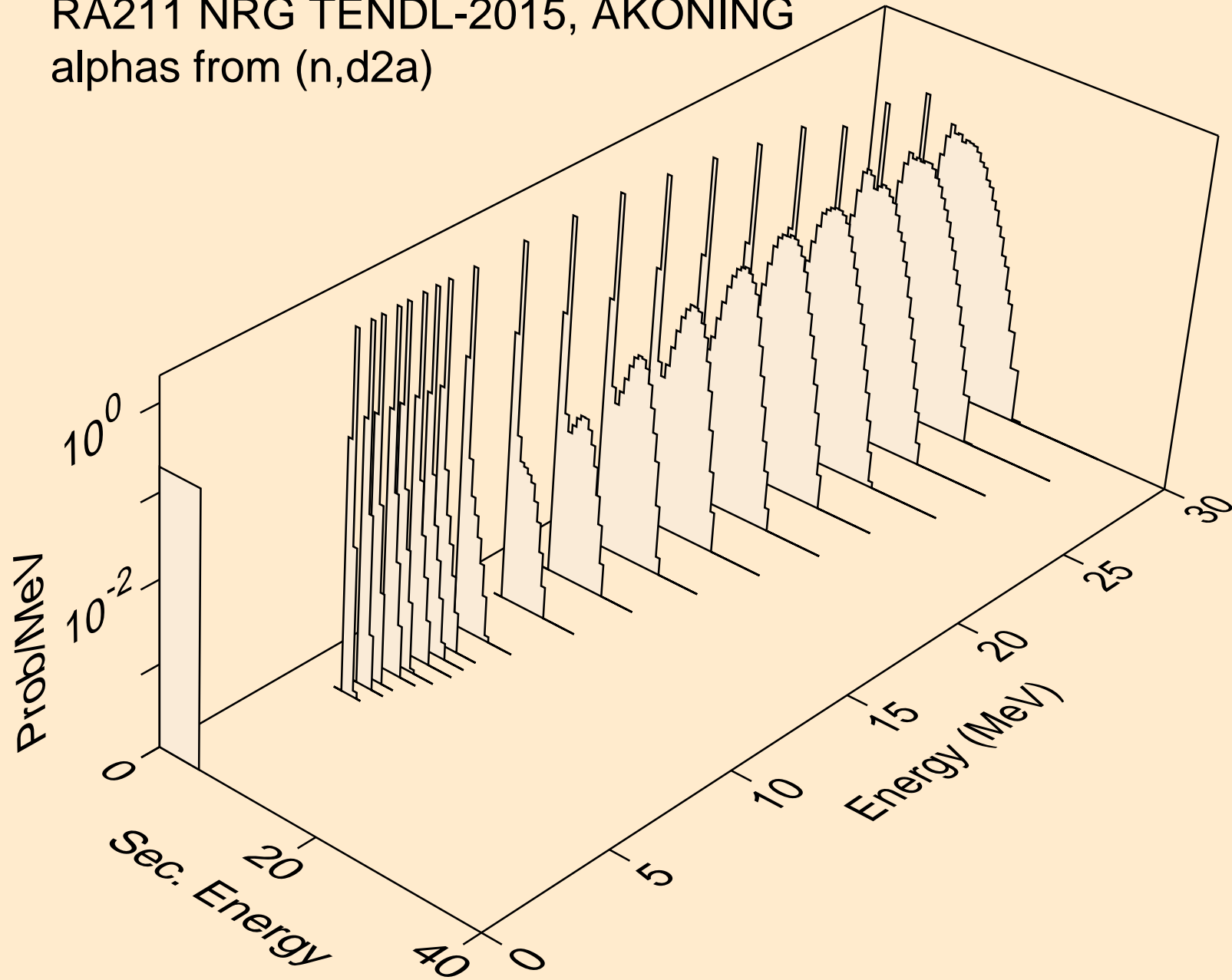

RA211 NRG TENDL-2015, AKONING
alphas from (n,da)

