

RE165M NRG TENDL-2015, AKONING

Principal cross sections

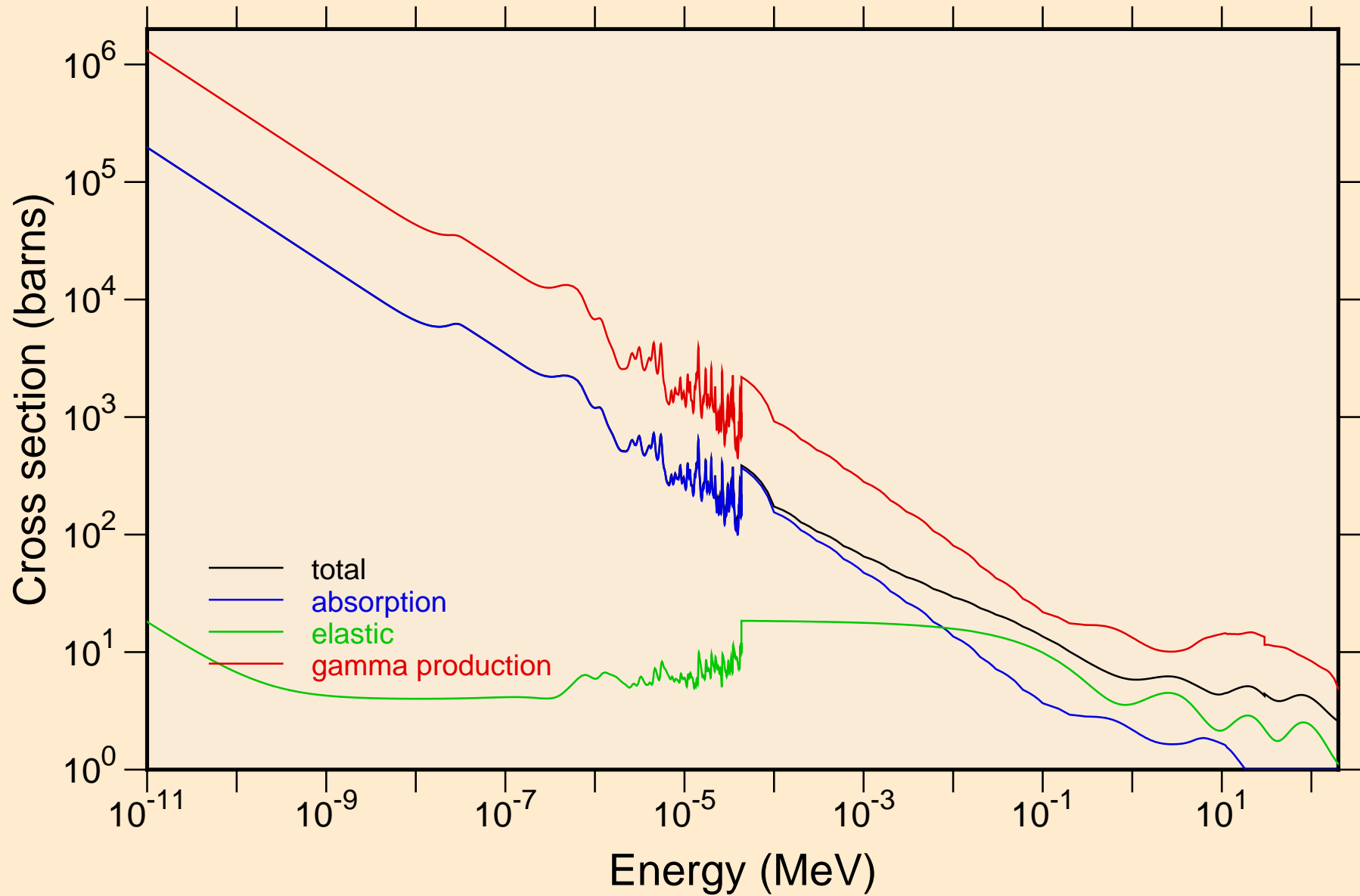

RE165M NRG TENDL-2015, AKONING

Non-threshold reactions

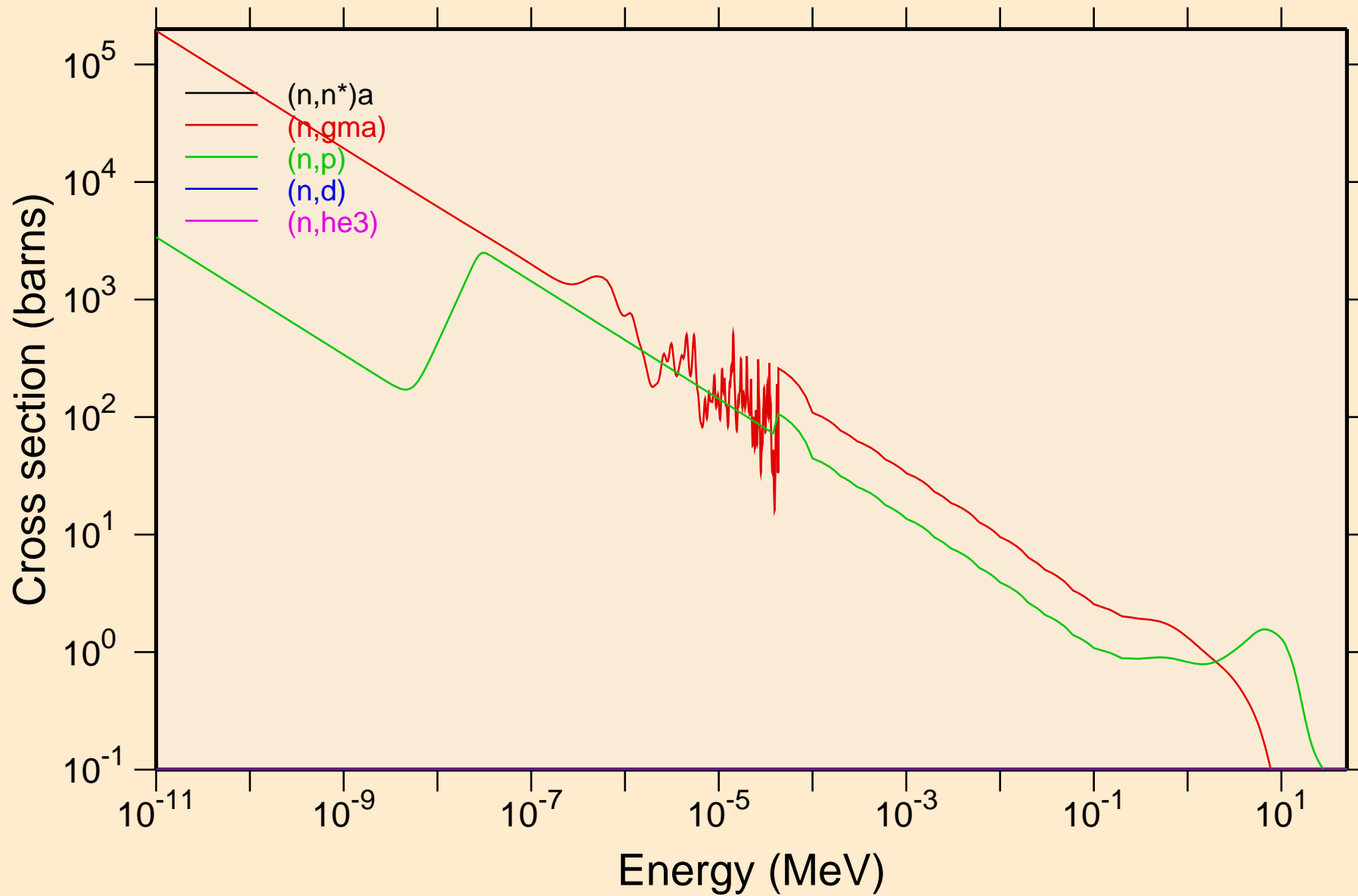

RE165M NRG TENDL-2015, AKONING

Non-threshold reactions

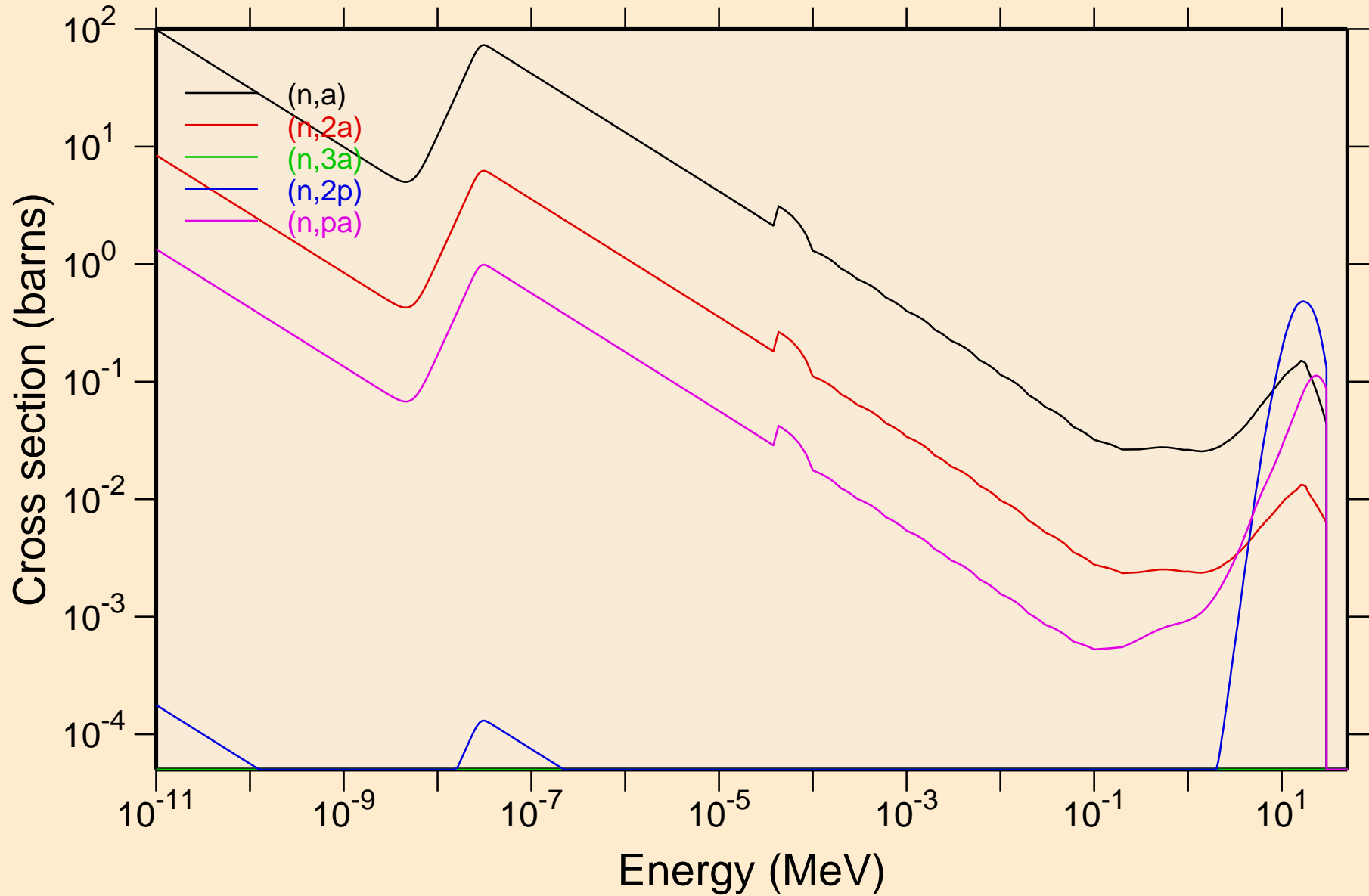

RE165M NRG TENDL-2015, AKONING

Principal cross sections

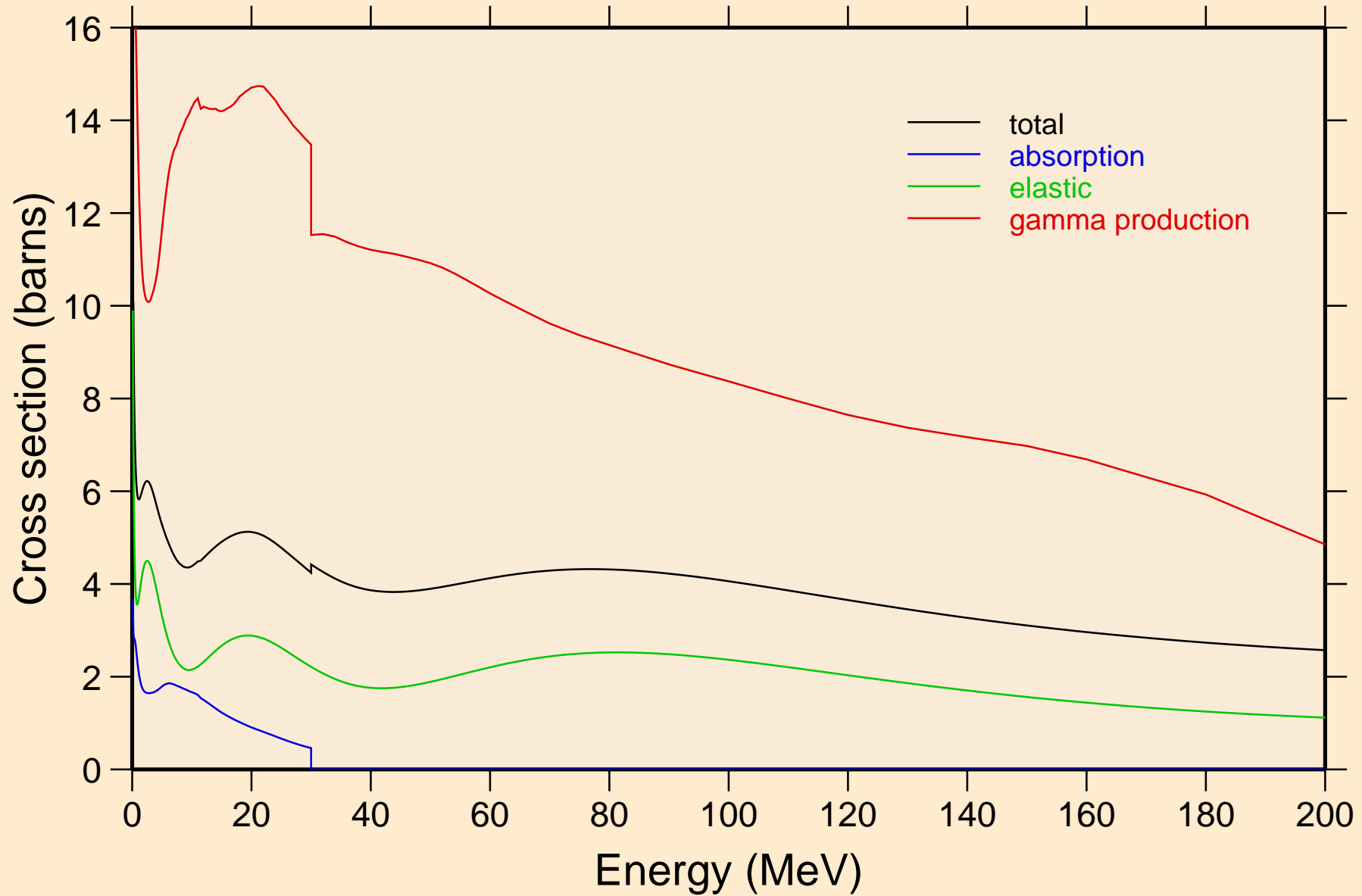

RE165M NRG TENDL-2015, AKONING

Non-threshold reactions

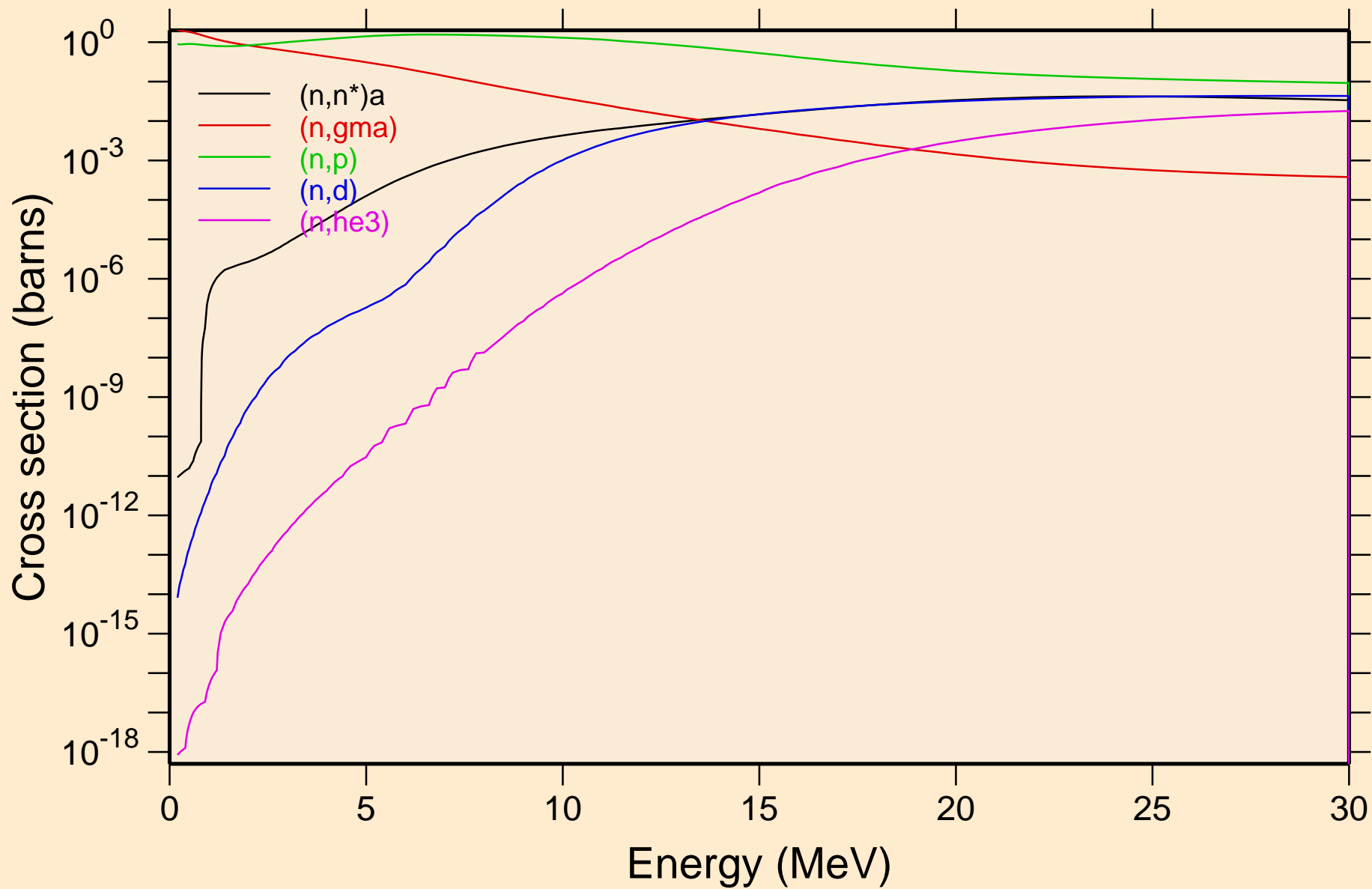

RE165M NRG TENDL-2015, AKONING

Non-threshold reactions

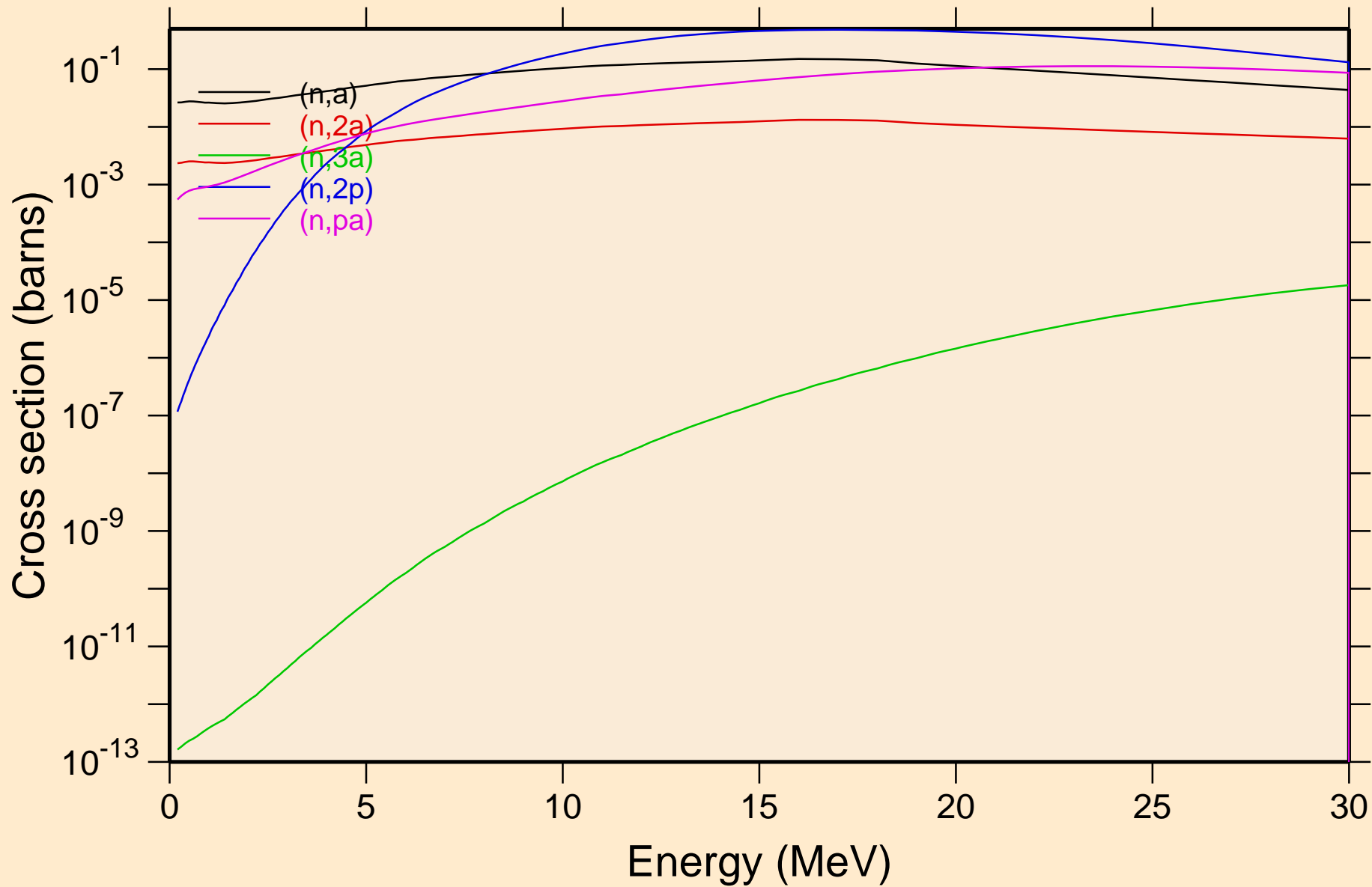

RE165M NRG TENDL-2015, AKONING
Inelastic levels

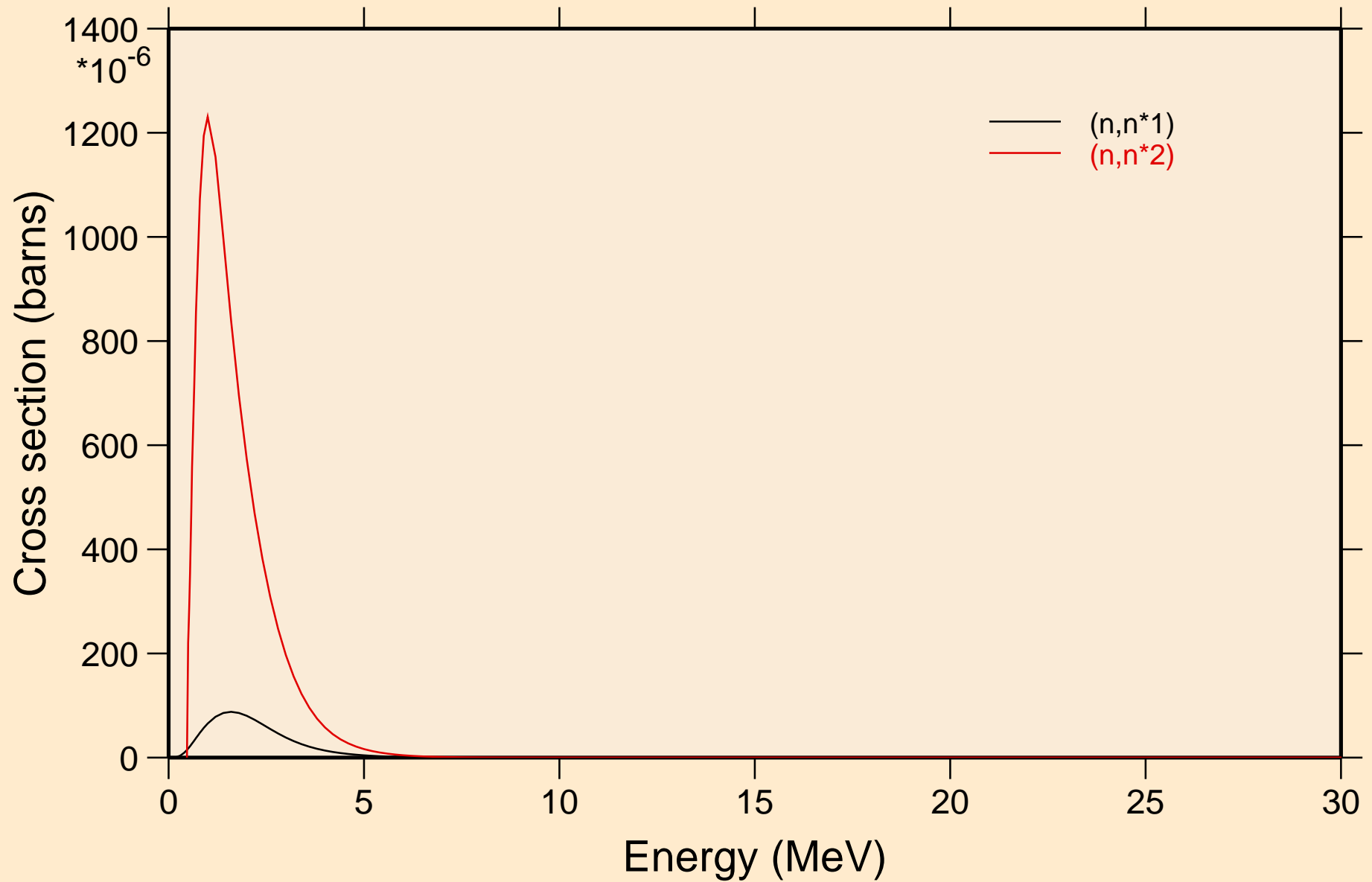

RE165M NRG TENDL-2015, AKONING

Threshold reactions

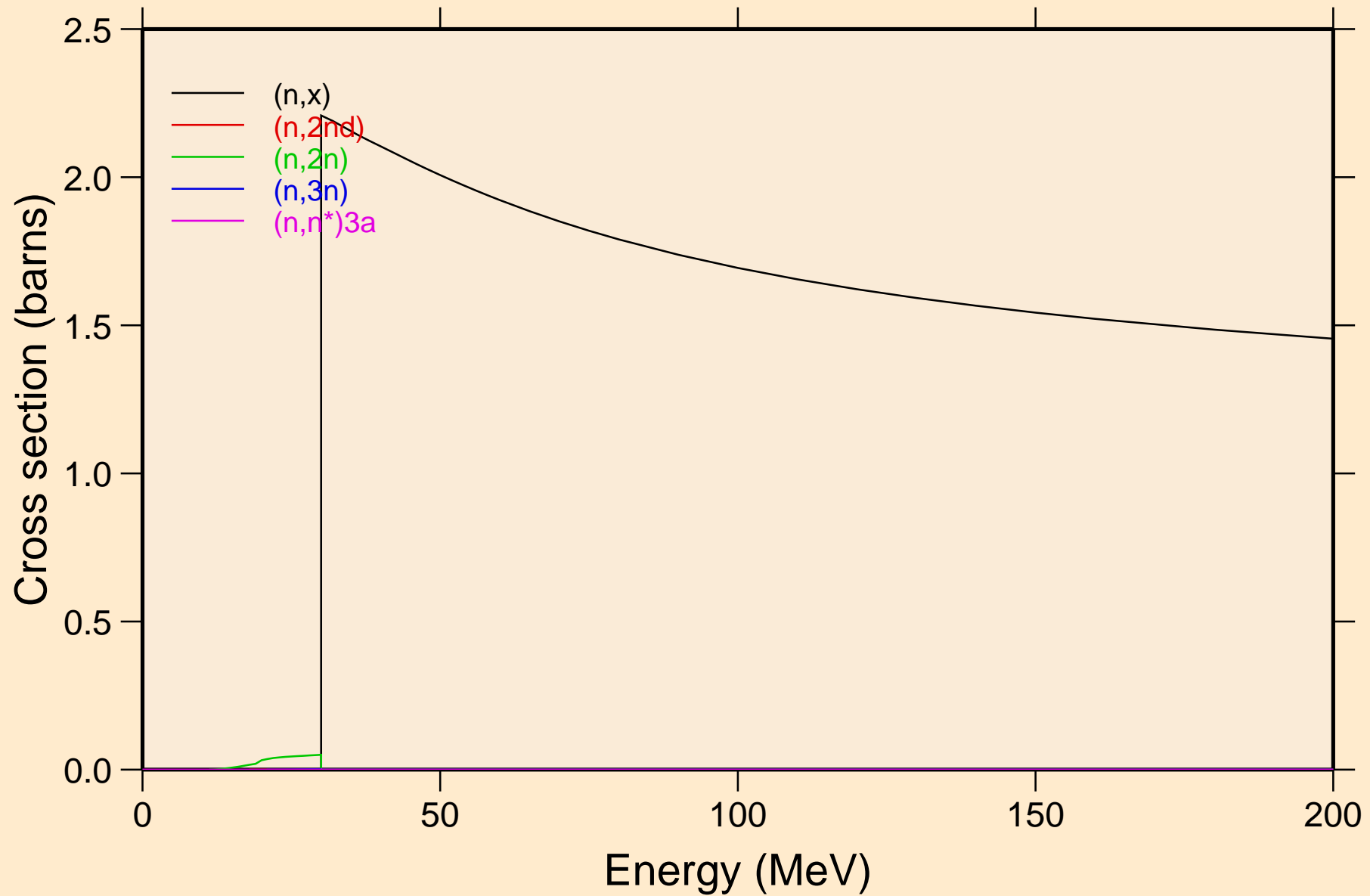

RE165M NRG TENDL-2015, AKONING

Threshold reactions

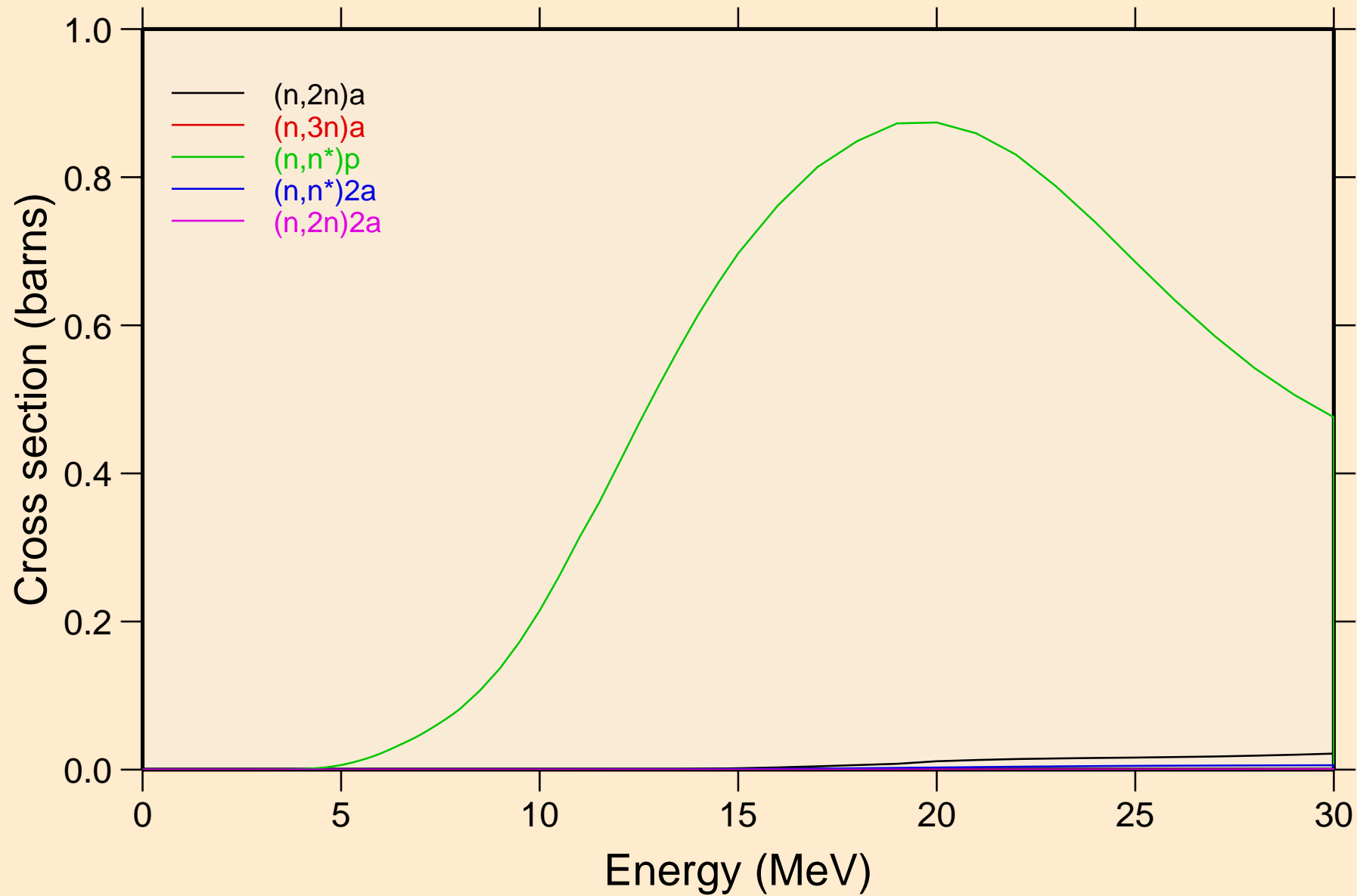

RE165M NRG TENDL-2015, AKONING

Threshold reactions

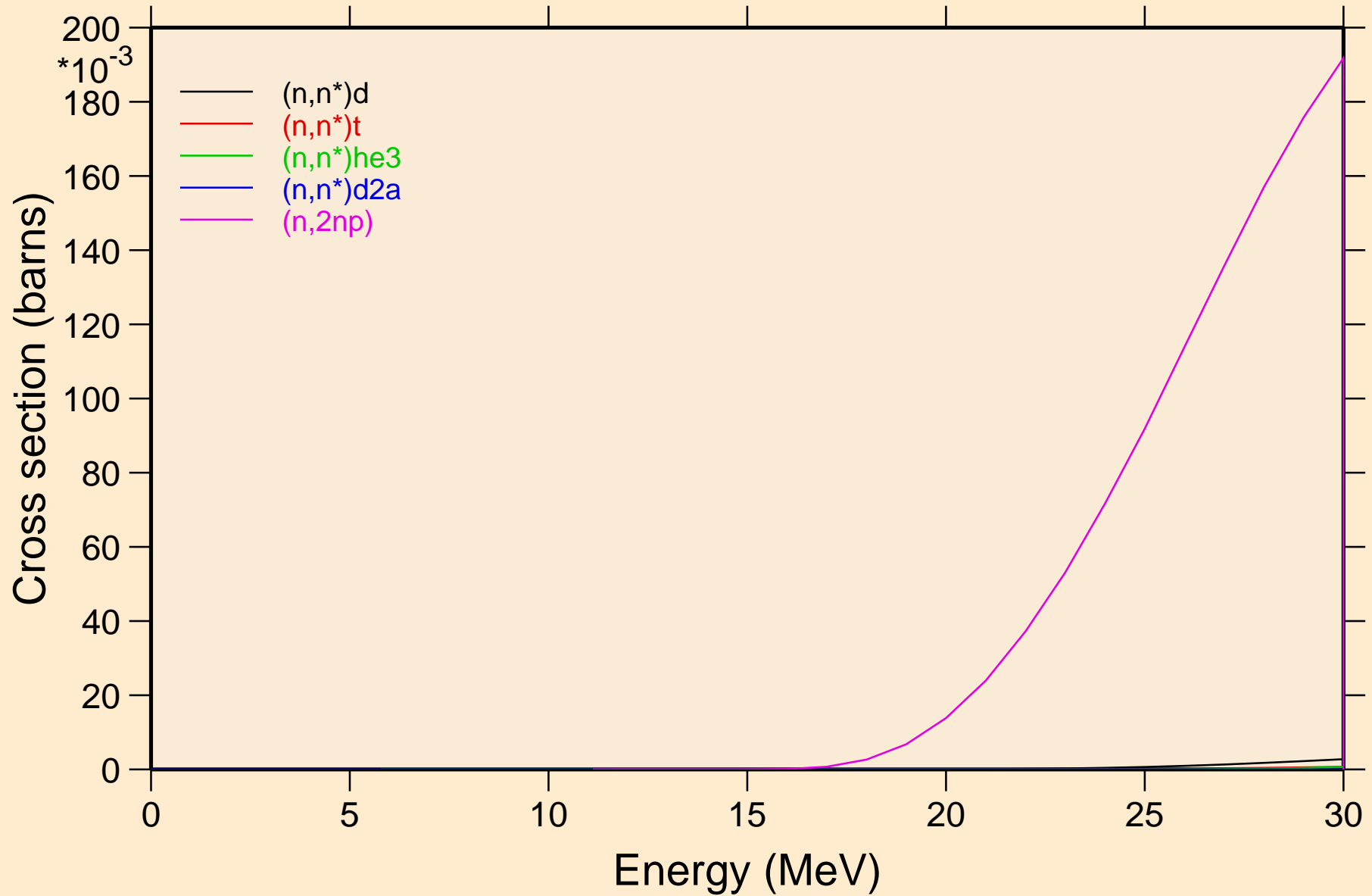

RE165M NRG TENDL-2015, AKONING

Threshold reactions

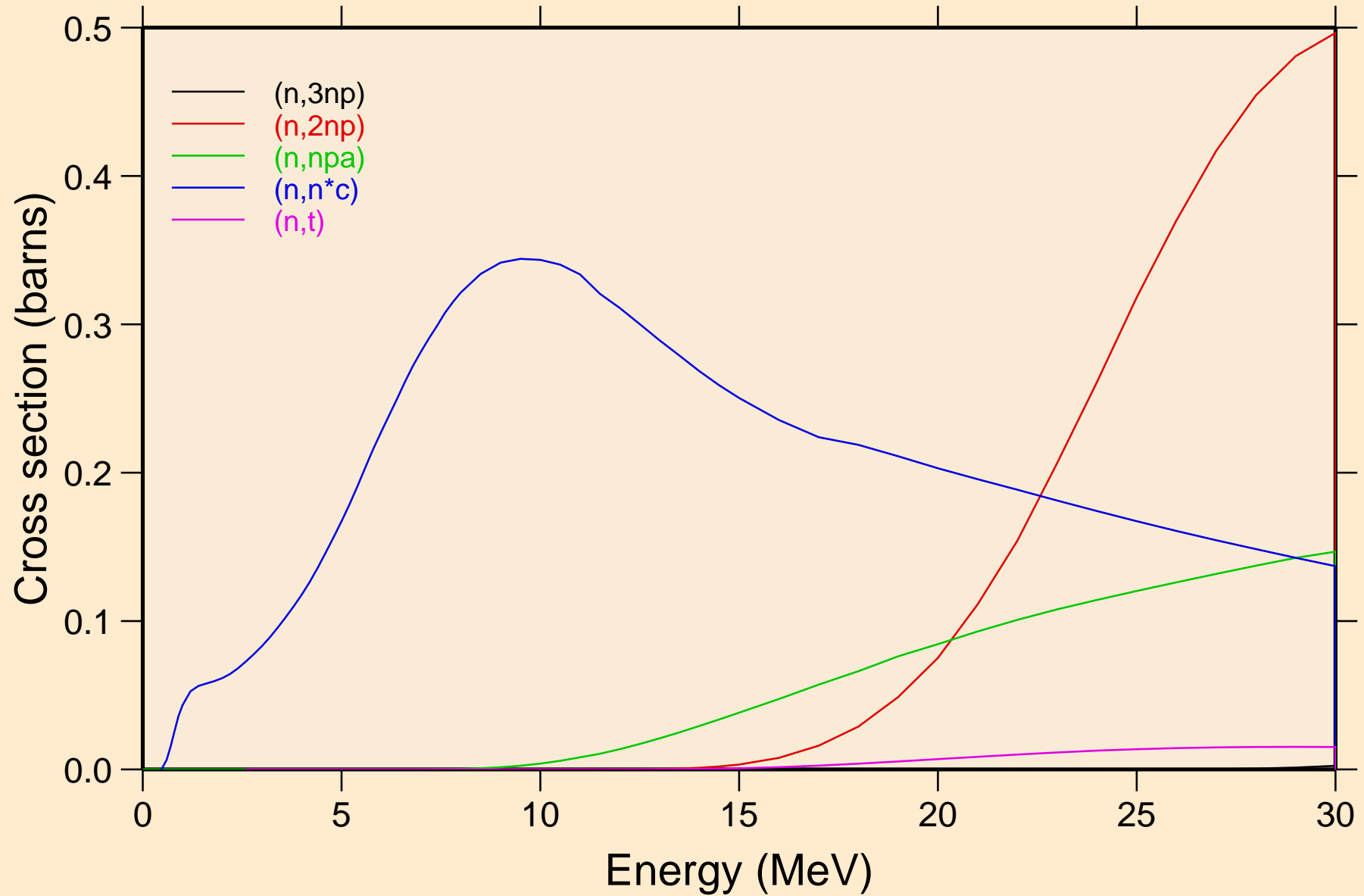

RE165M NRG TENDL-2015, AKONING

Threshold reactions

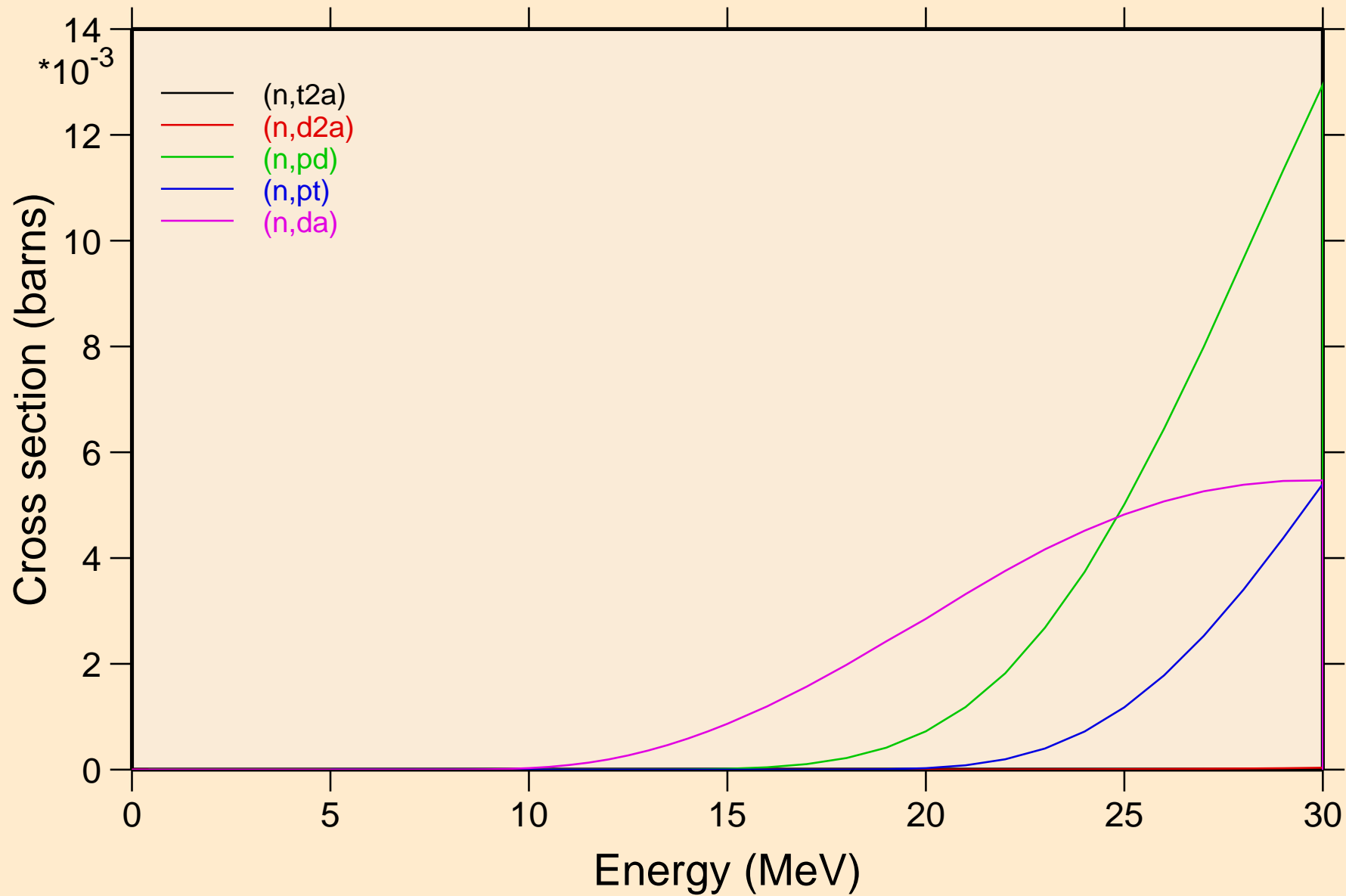

RE165M NRG TENDL-2015, AKONING
angular distribution for elastic

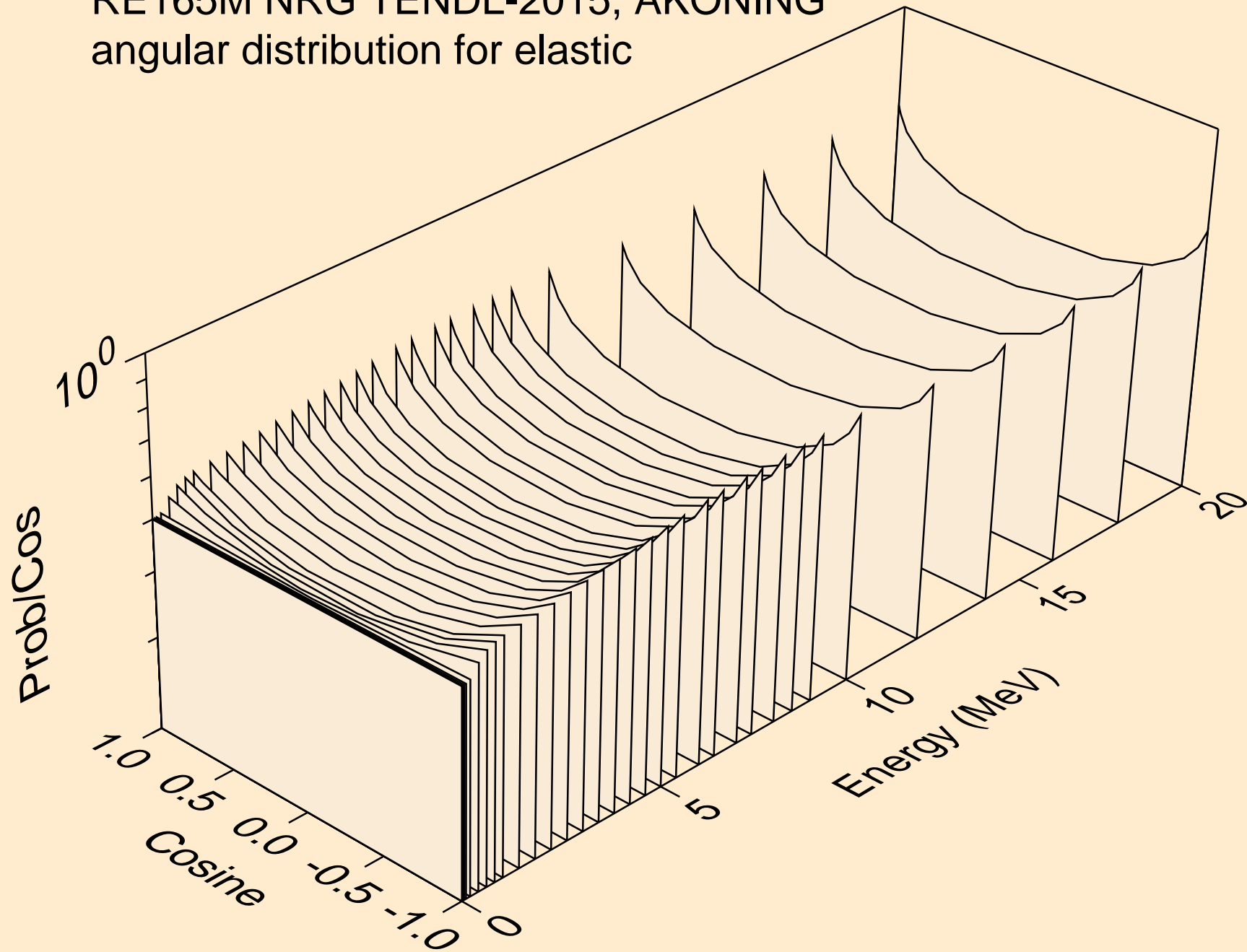

RE165M NRG TENDL-2015, AKONING
angular distribution for elastic

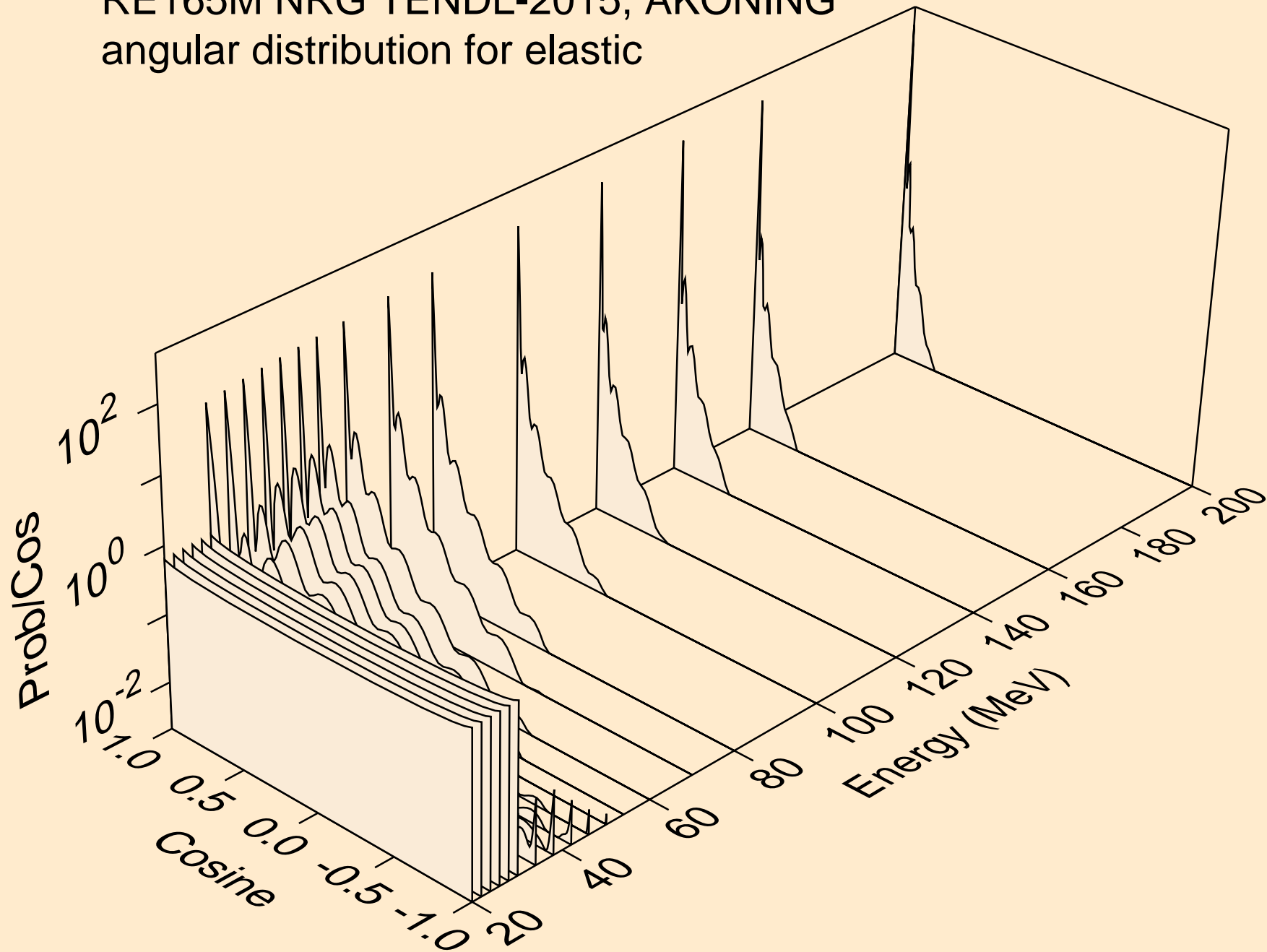

RE165M NRG TENDL-2015, AKONING
angular distribution for (n,n*1)

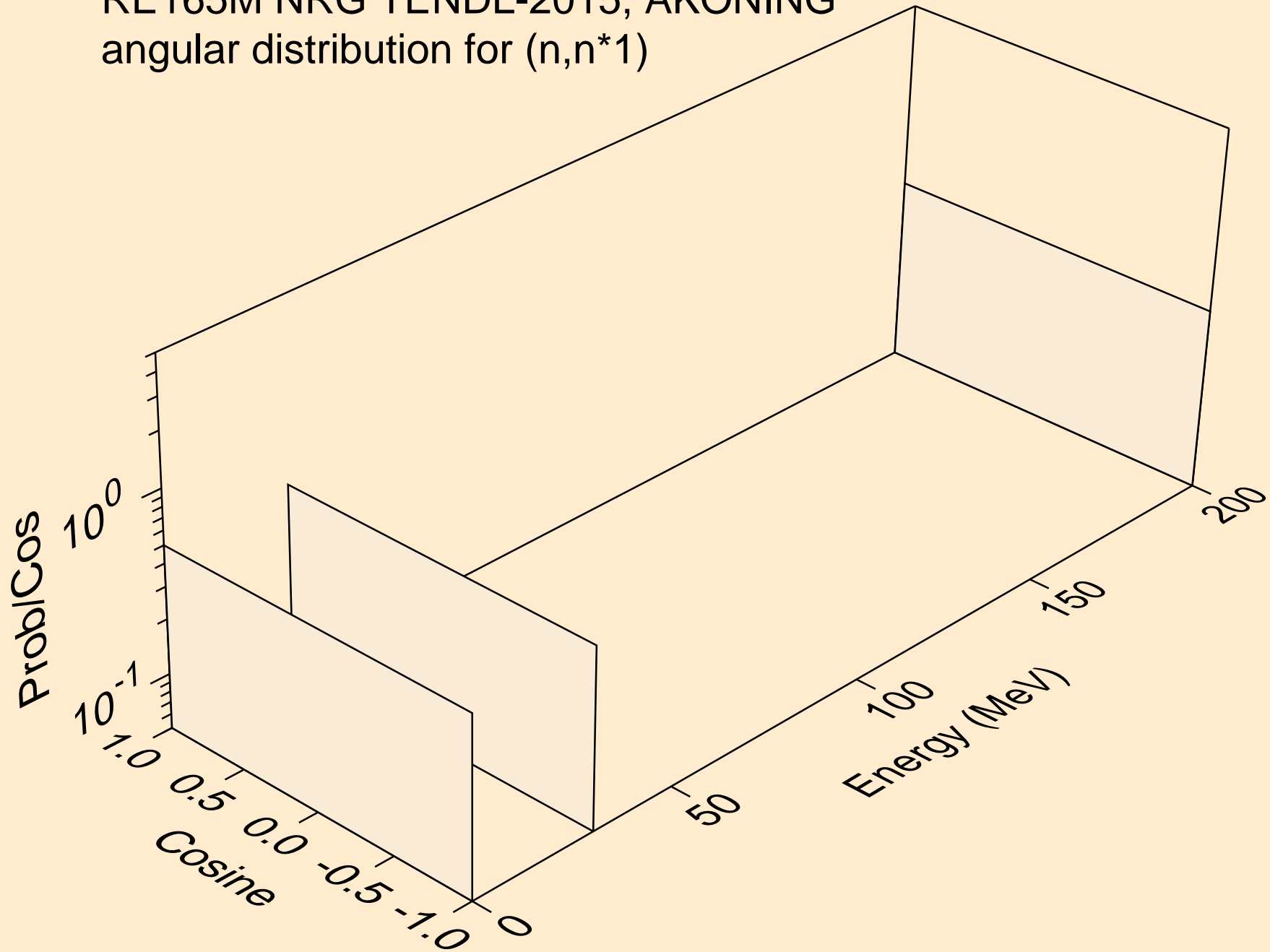

RE165M NRG TENDL-2015, AKONING
angular distribution for (n,n*2)

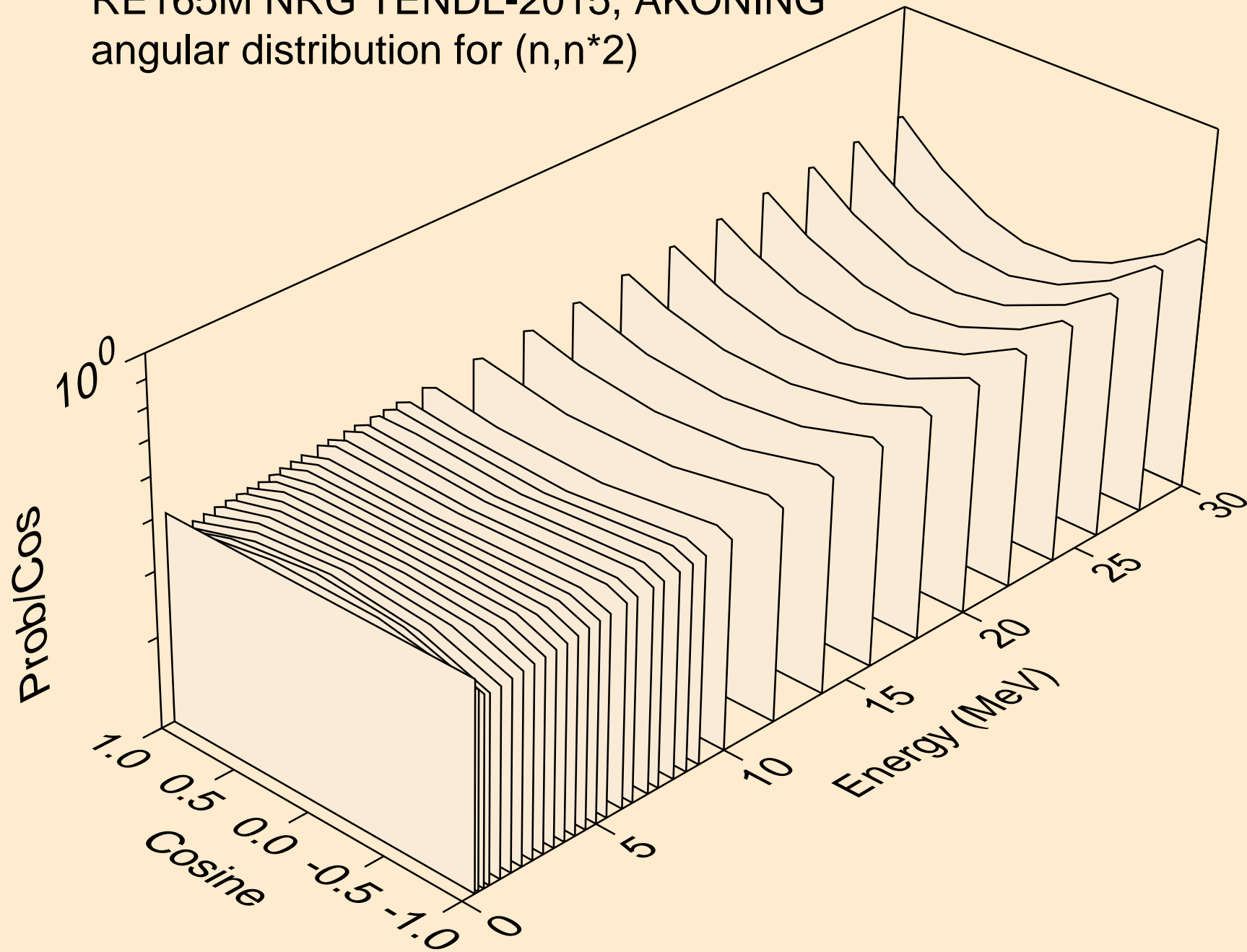

RE165M NRG TENDL-2015, AKONING
Neutron emission for (n,x)

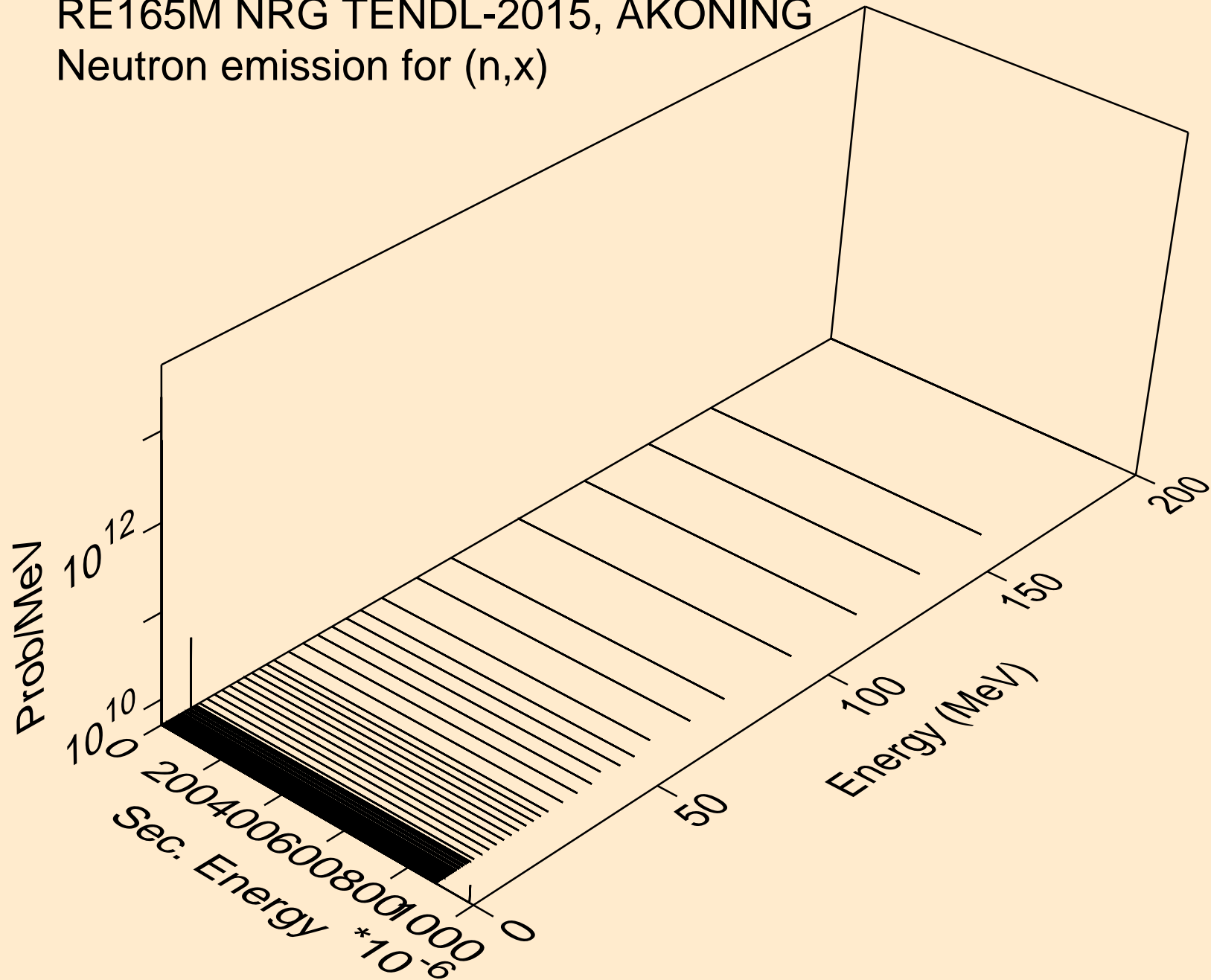

RE165M NRG TENDL-2015, AKONING
Neutron emission for (n,2nd)

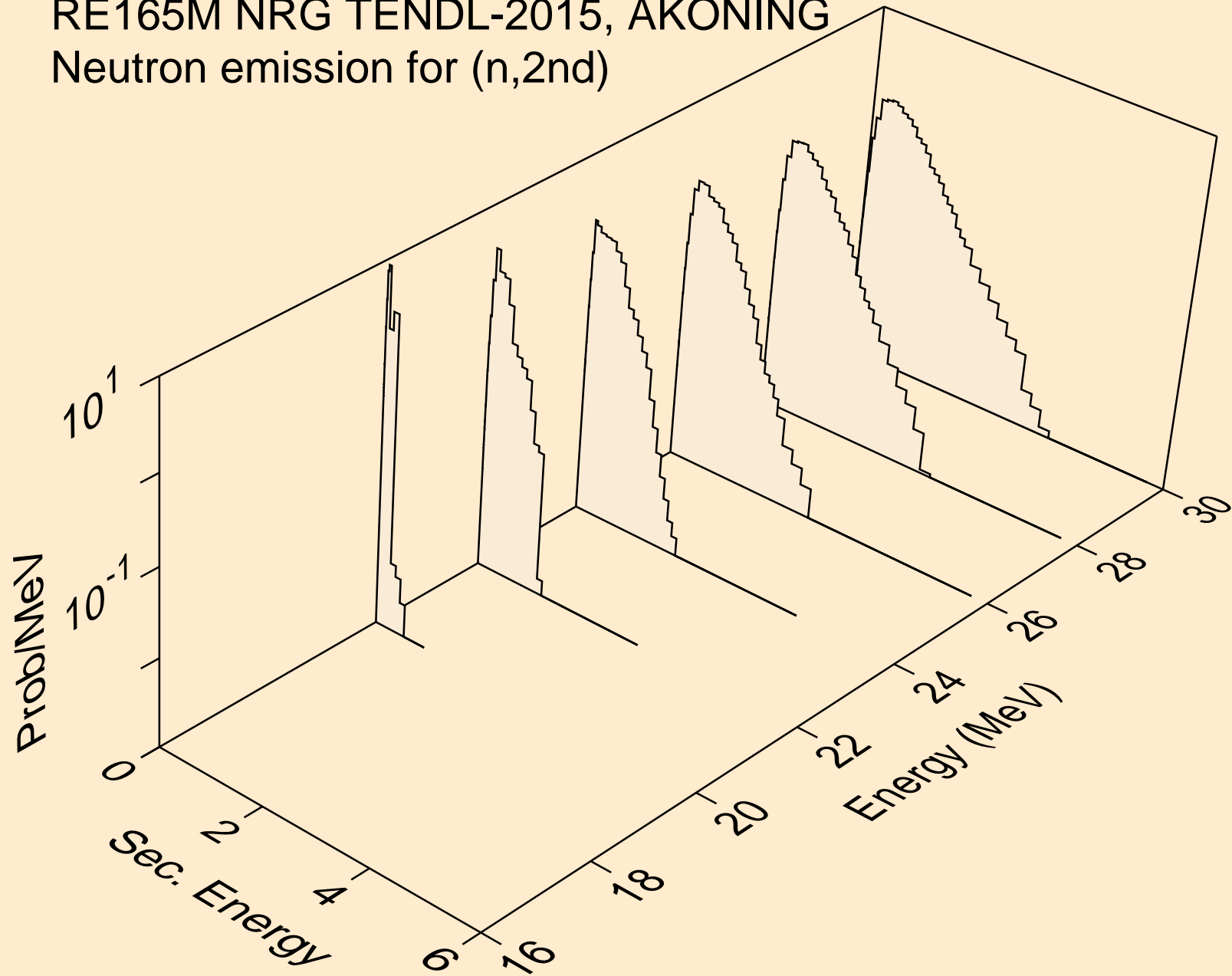

RE165M NRG TENDL-2015, AKONING
Neutron emission for (n,2n)

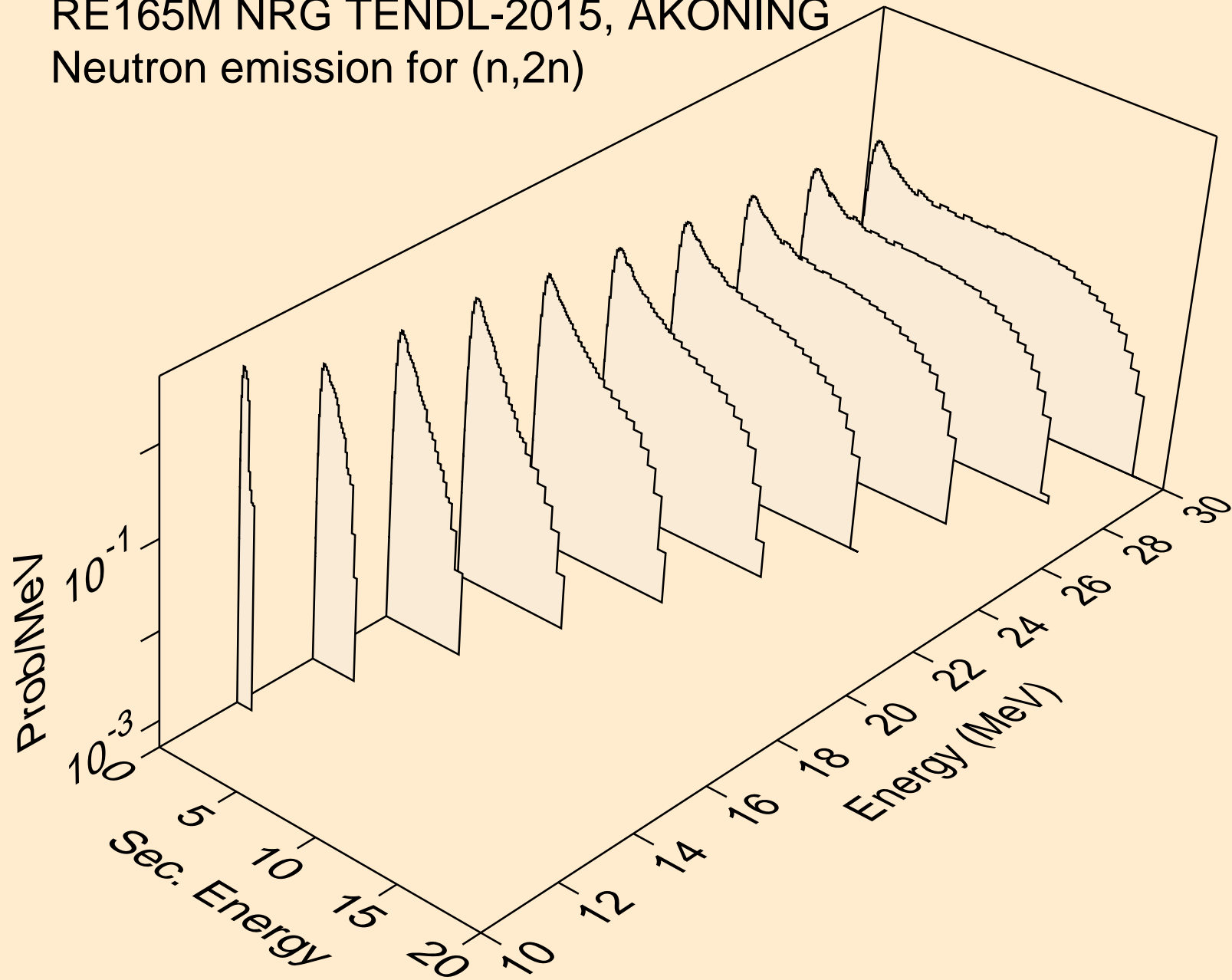

RE165M NRG TENDL-2015, AKONING
Neutron emission for (n,3n)

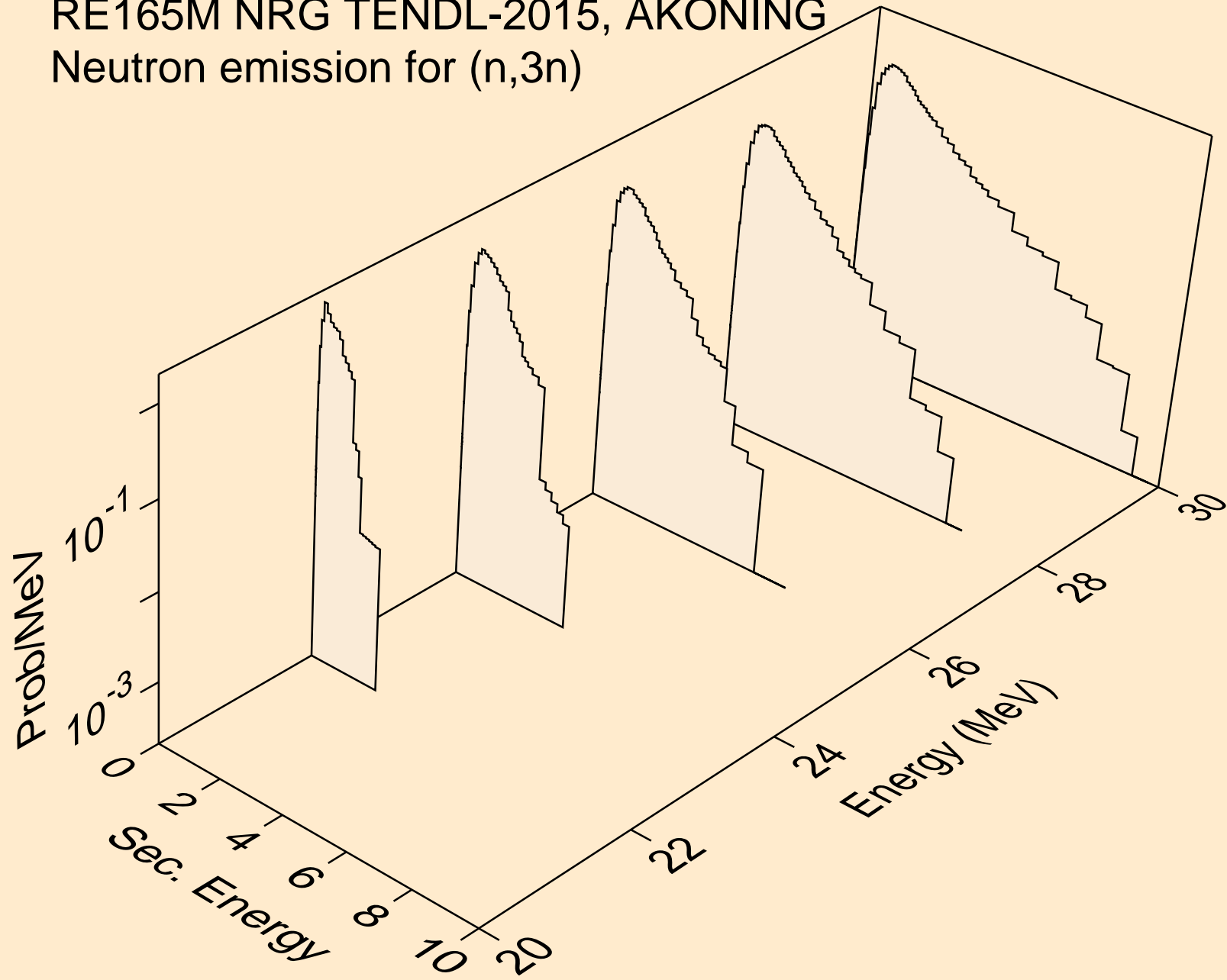

RE165M NRG TENDL-2015, AKONING
Neutron emission for (n,n*)a

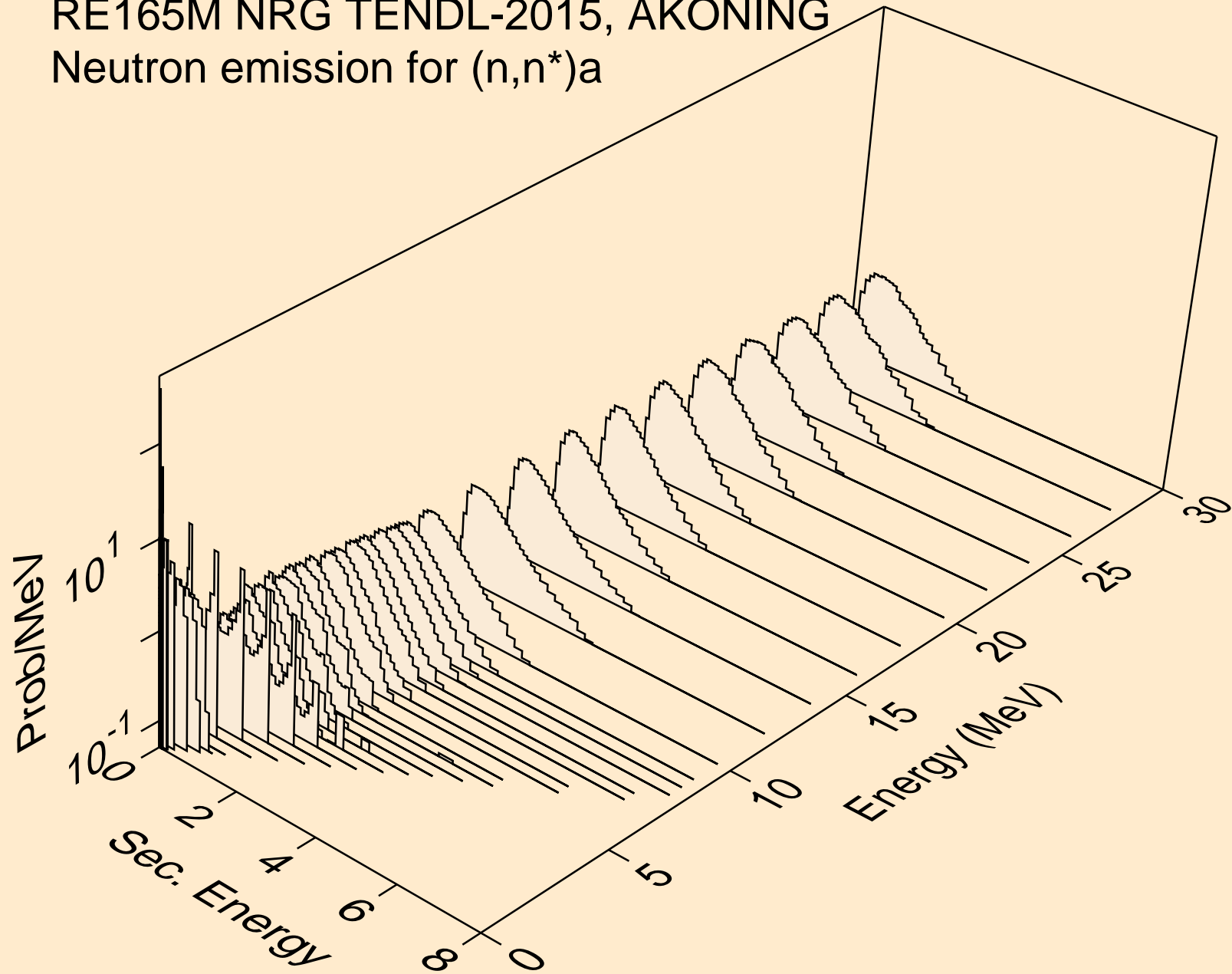

RE165M NRG TENDL-2015, AKONING
Neutron emission for (n,n*)3a

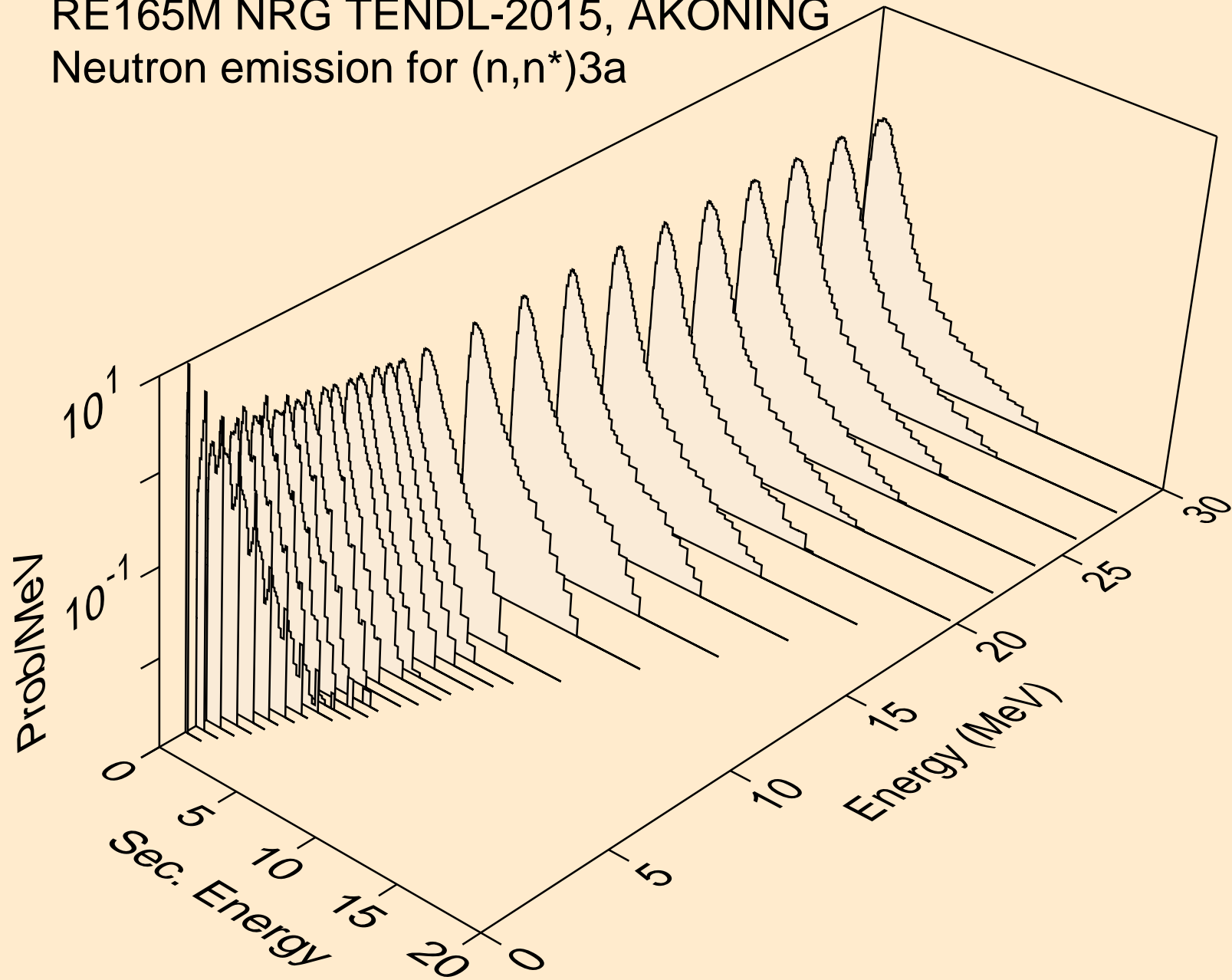

RE165M NRG TENDL-2015, AKONING
Neutron emission for (n,2n)a

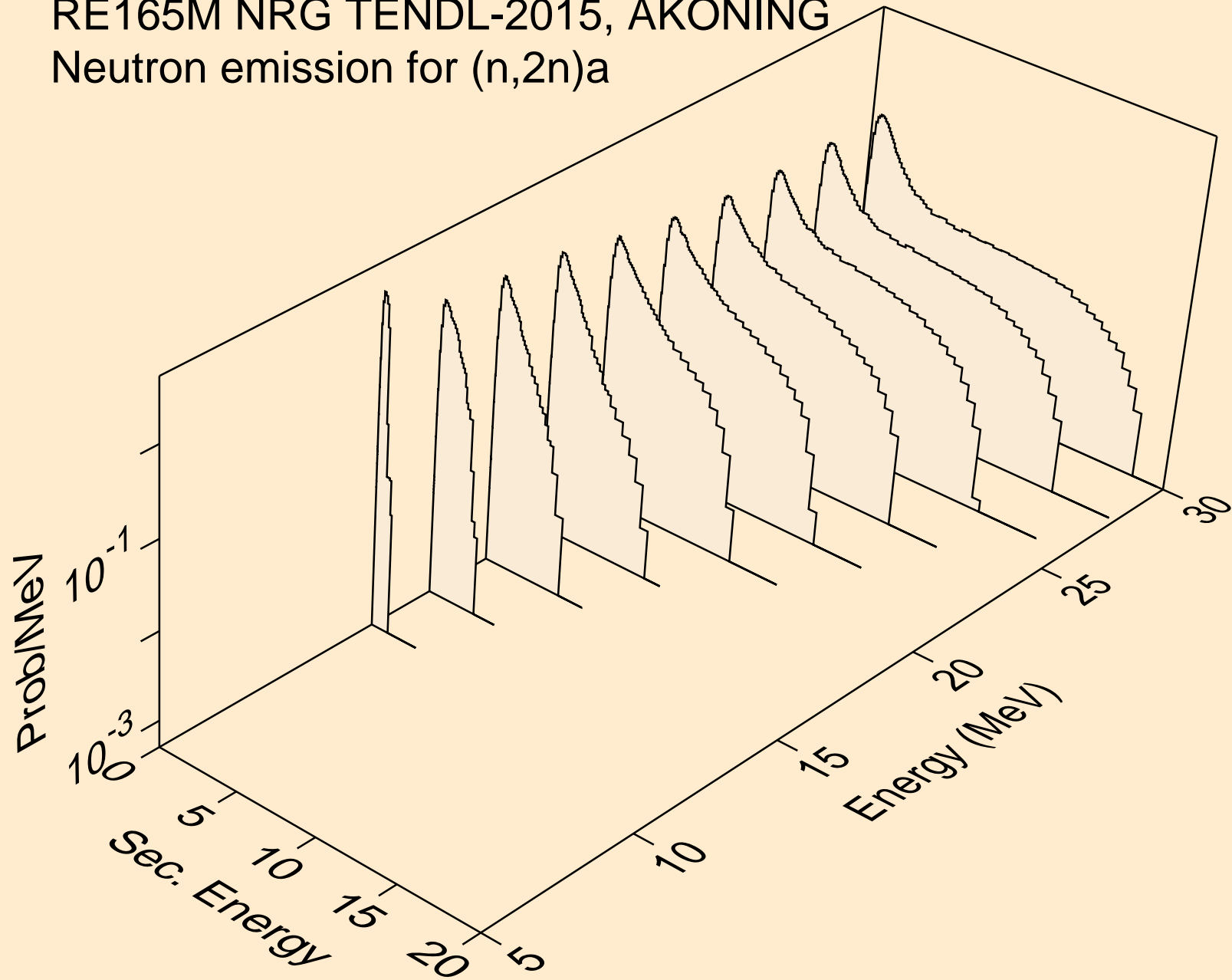

RE165M NRG TENDL-2015, AKONING
Neutron emission for (n,3n)a

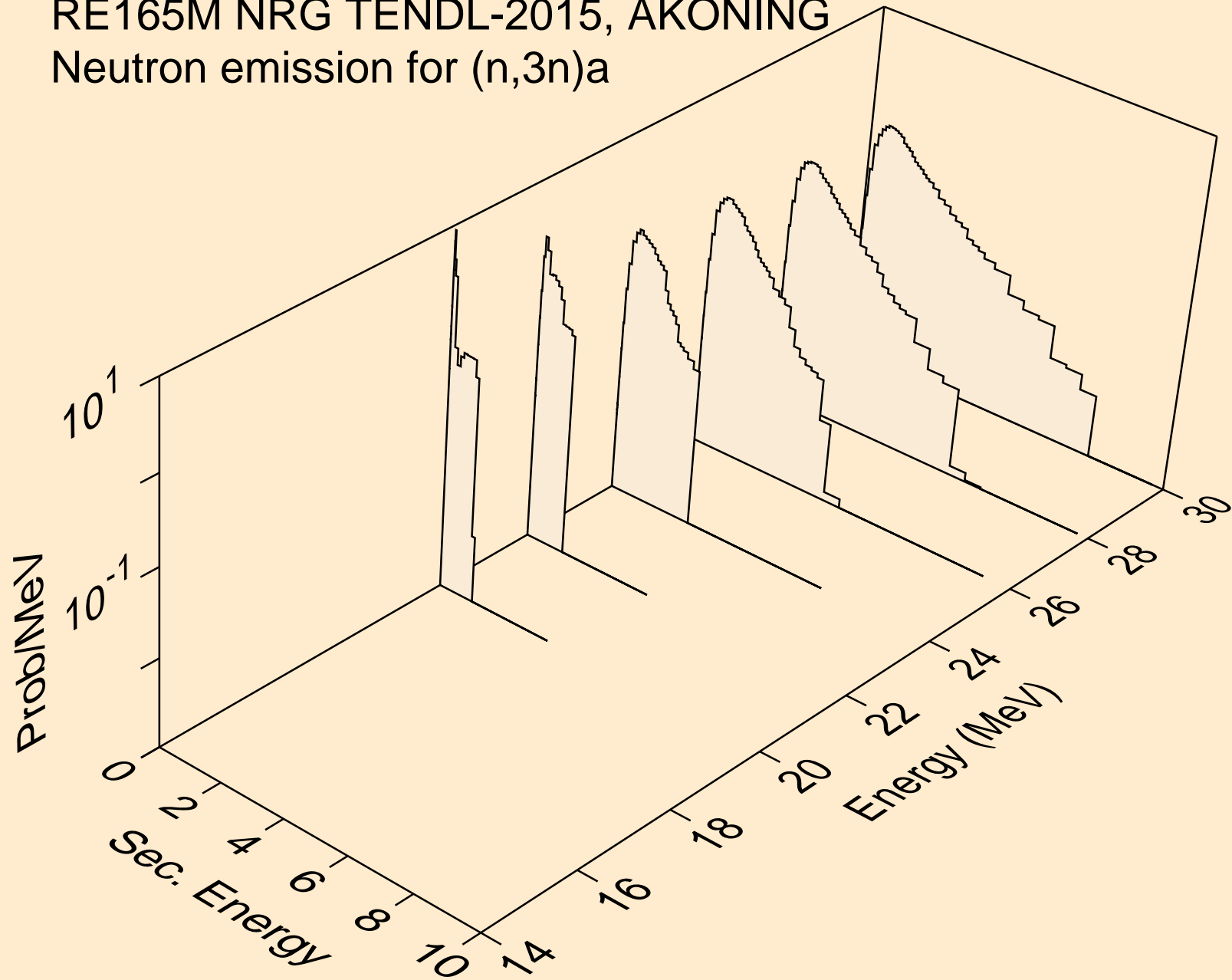

RE165M NRG TENDL-2015, AKONING
Neutron emission for (n,n*)p

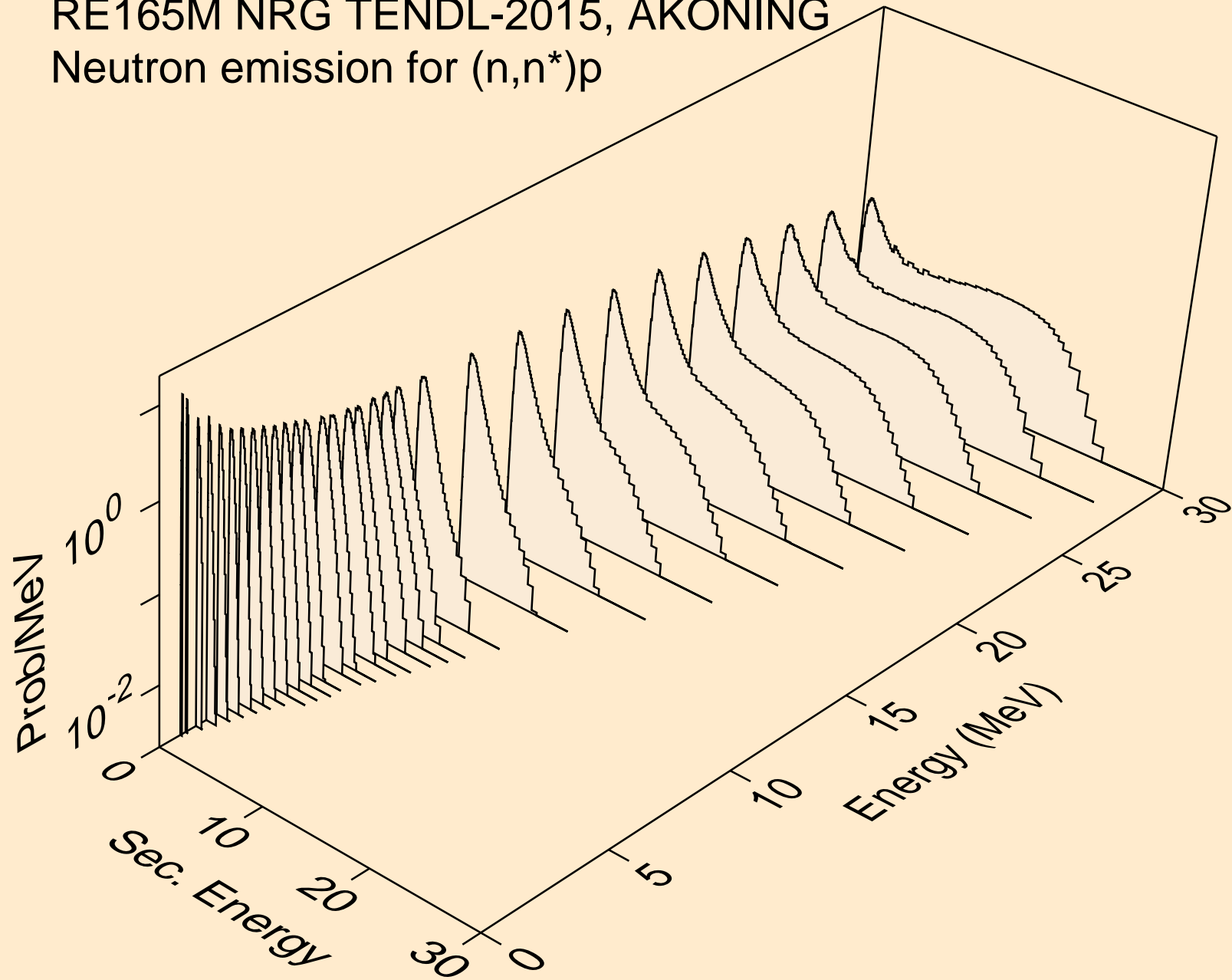

RE165M NRG TENDL-2015, AKONING
Neutron emission for (n,n*)2a

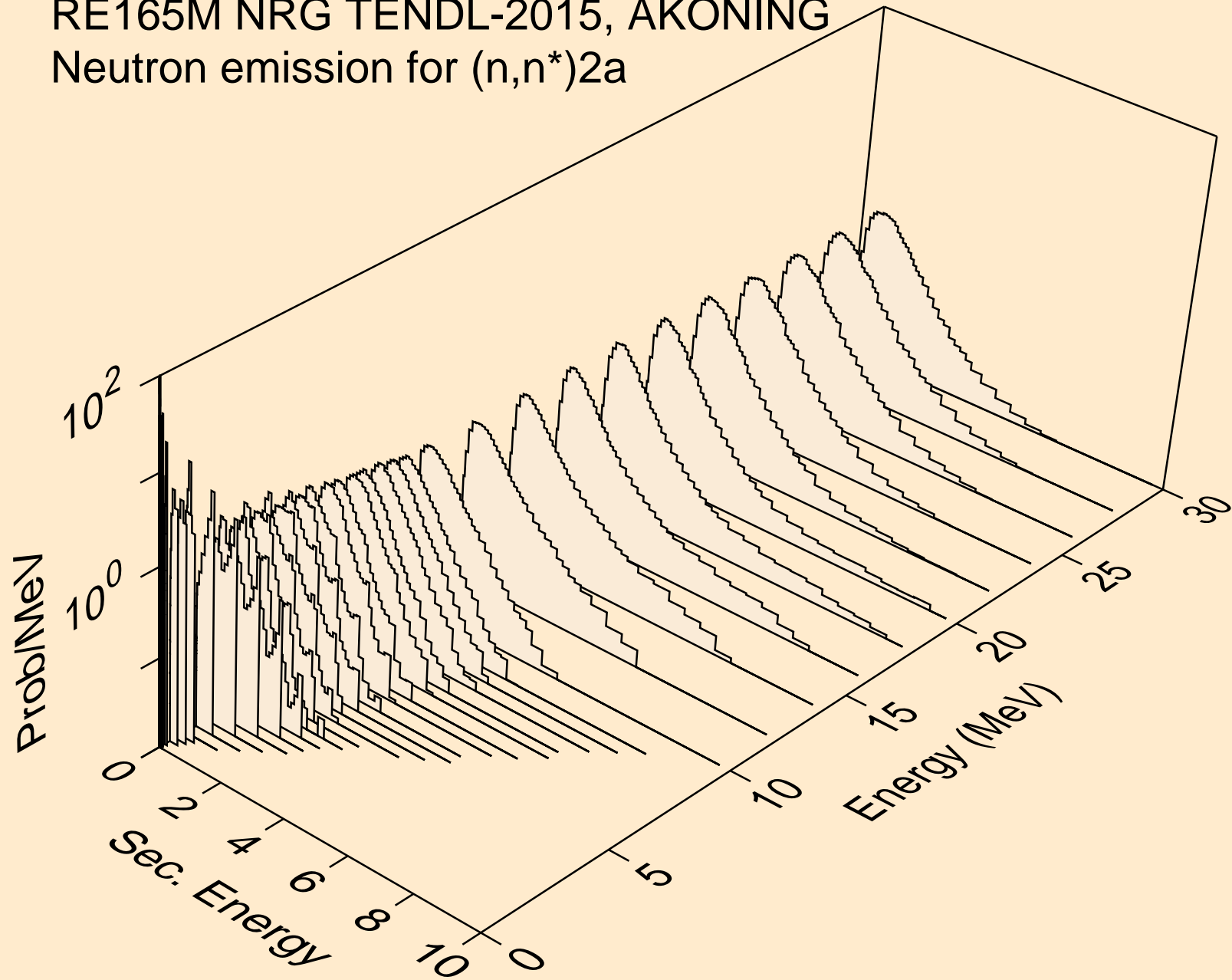

RE165M NRG TENDL-2015, AKONING
Neutron emission for (n,2n)_{2a}

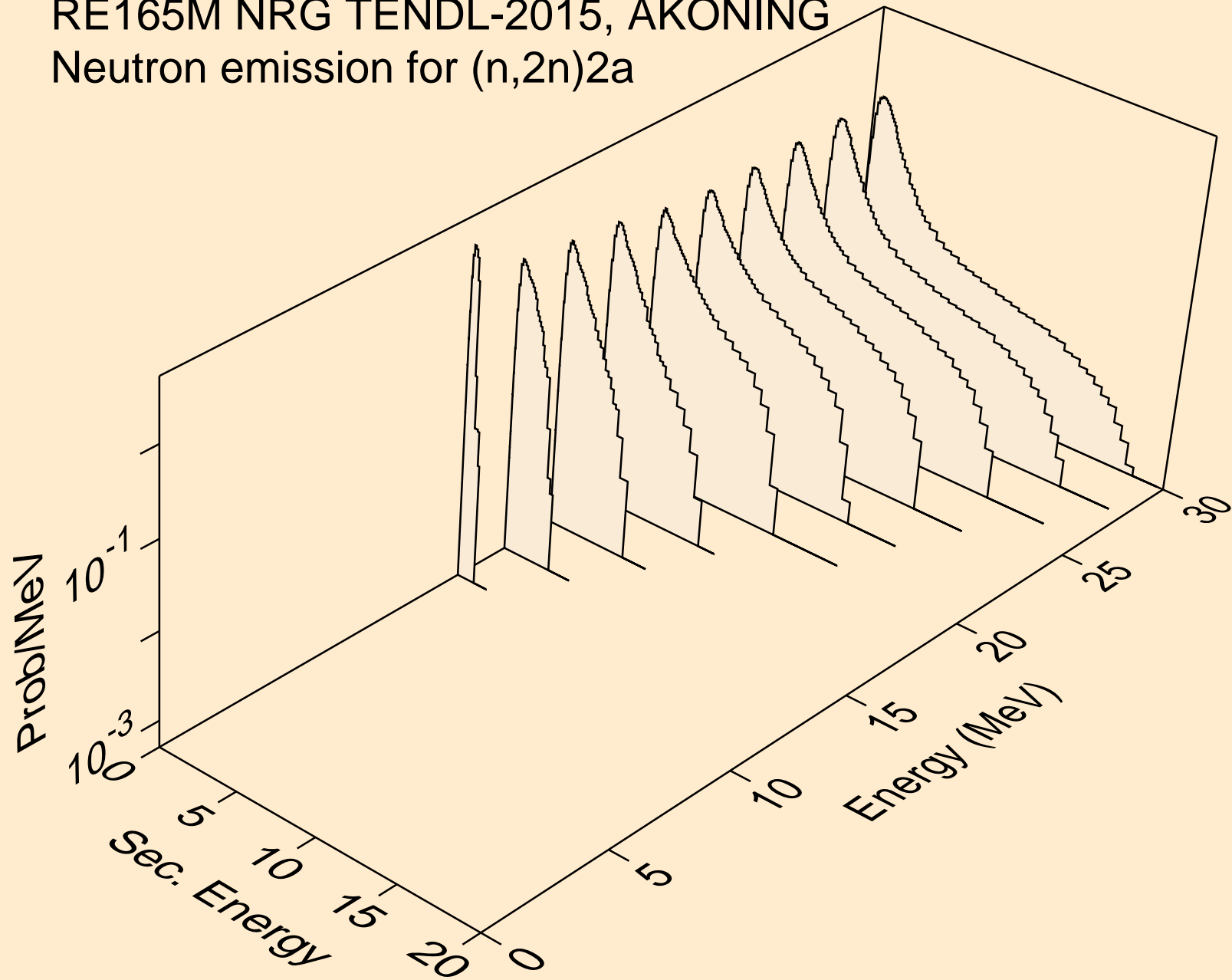

RE165M NRG TENDL-2015, AKONING
Neutron emission for (n,n*)d

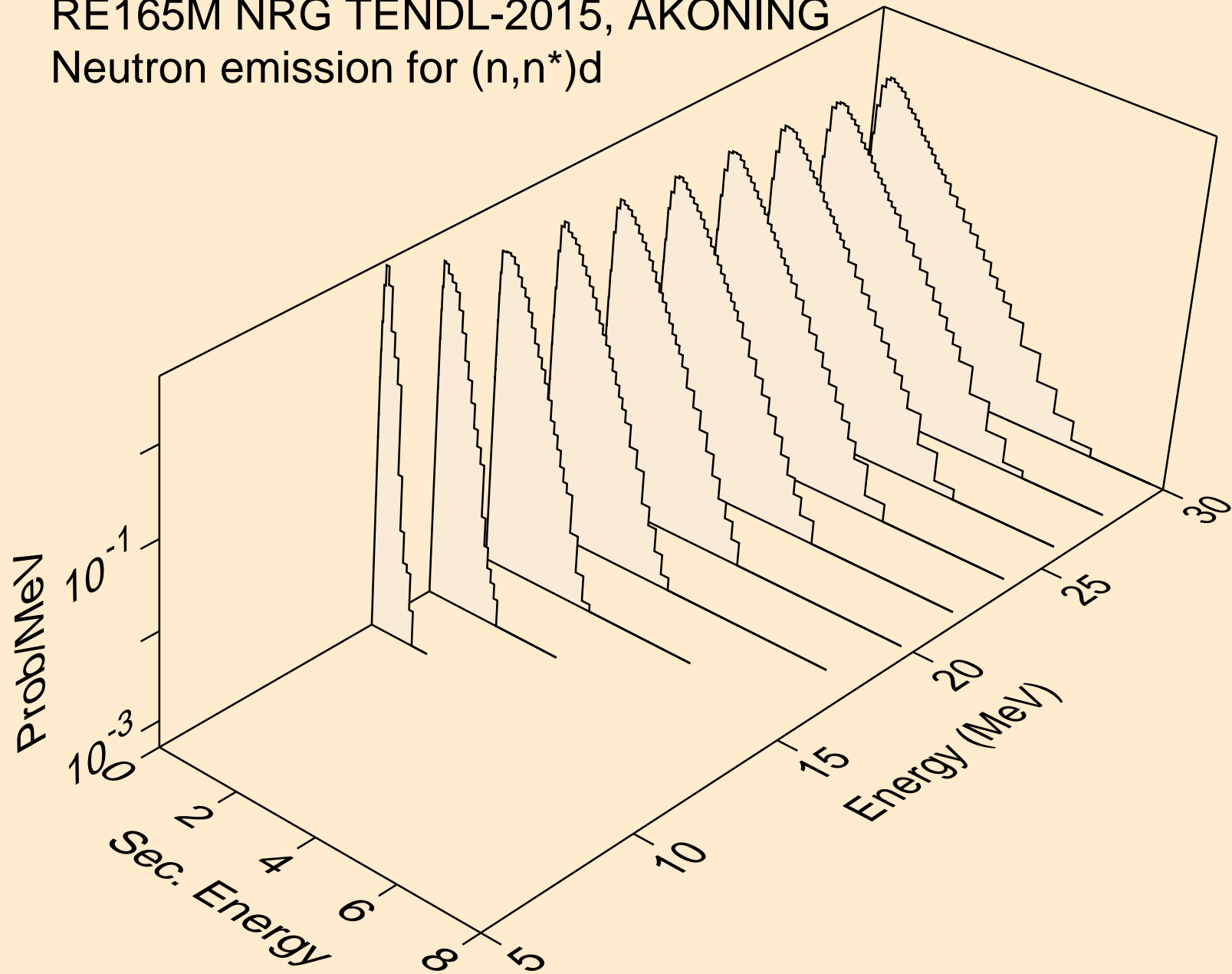

RE165M NRG TENDL-2015, AKONING
Neutron emission for (n,n*)t

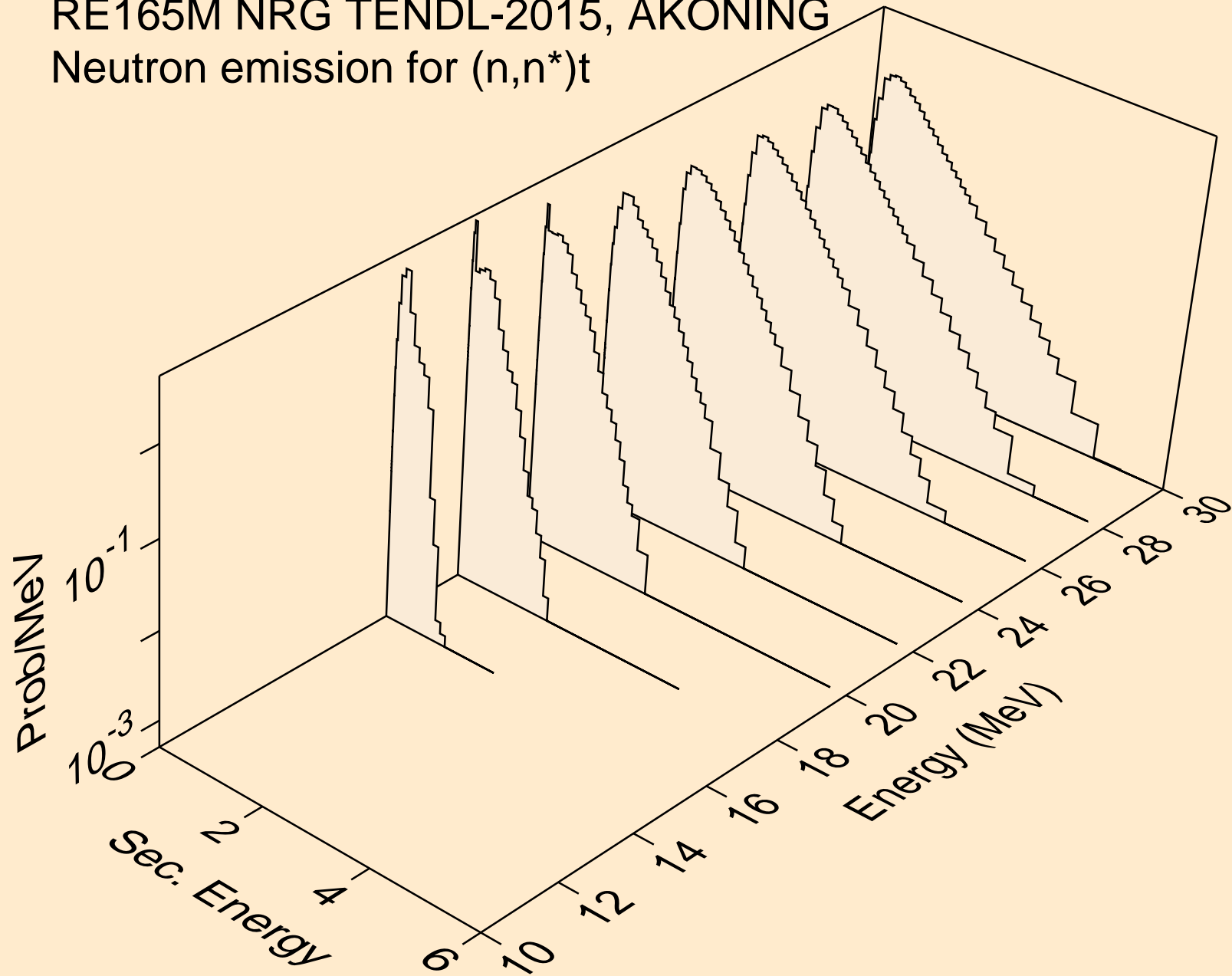

RE165M NRG TENDL-2015, AKONING
Neutron emission for (n,n*)he3

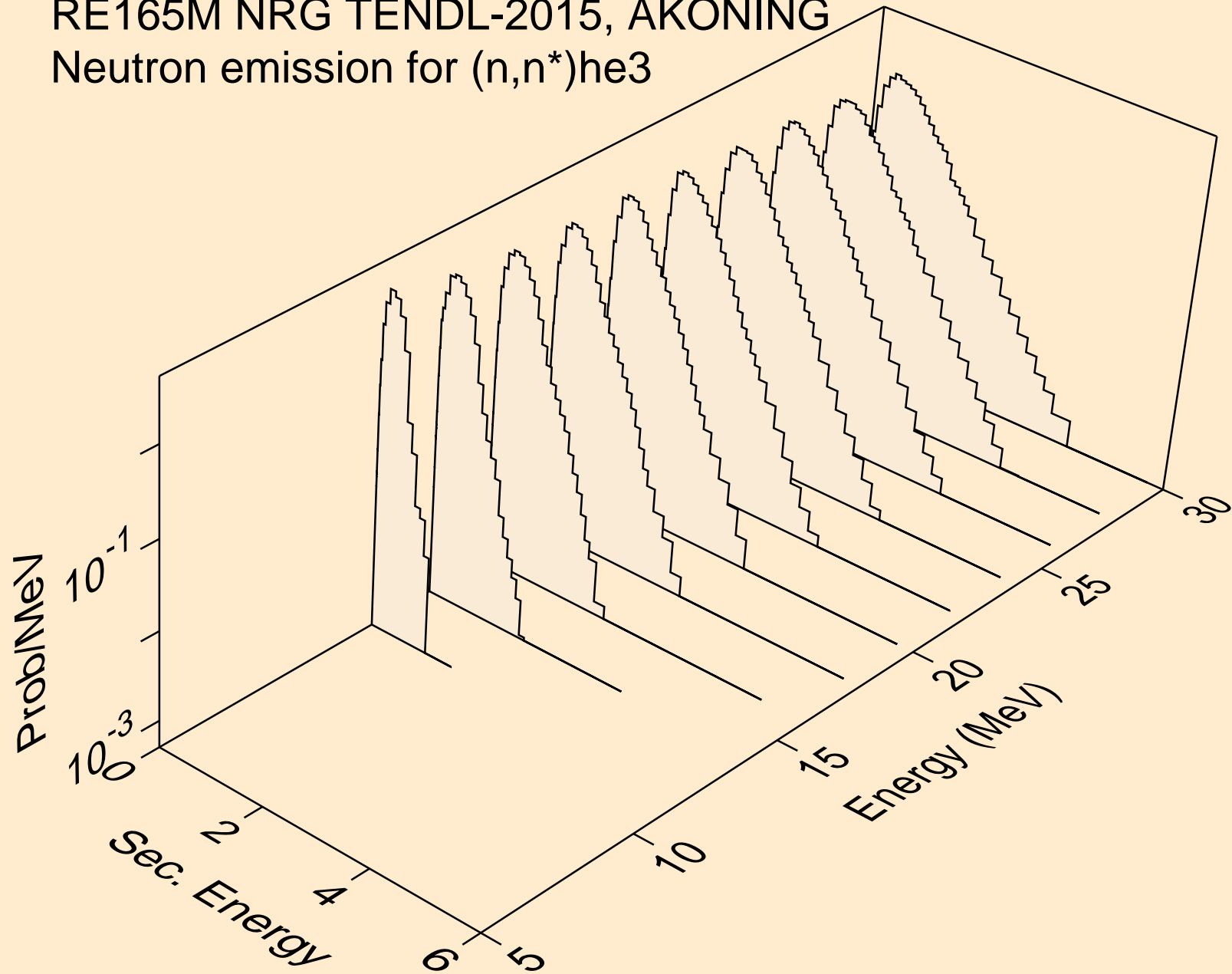

RE165M NRG TENDL-2015, AKONING
Neutron emission for (n,n*)d2a

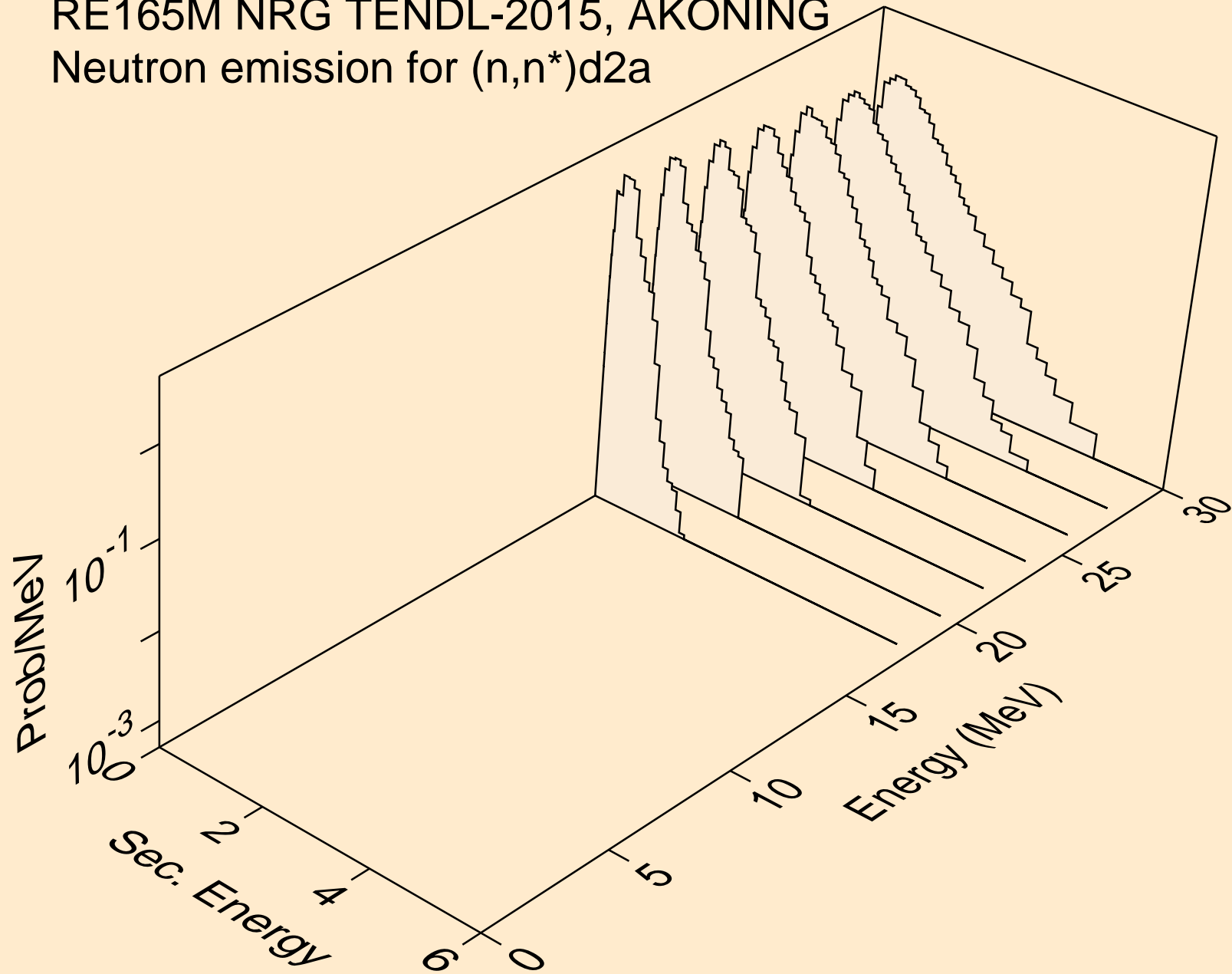

RE165M NRG TENDL-2015, AKONING
Neutron emission for (n,2np)

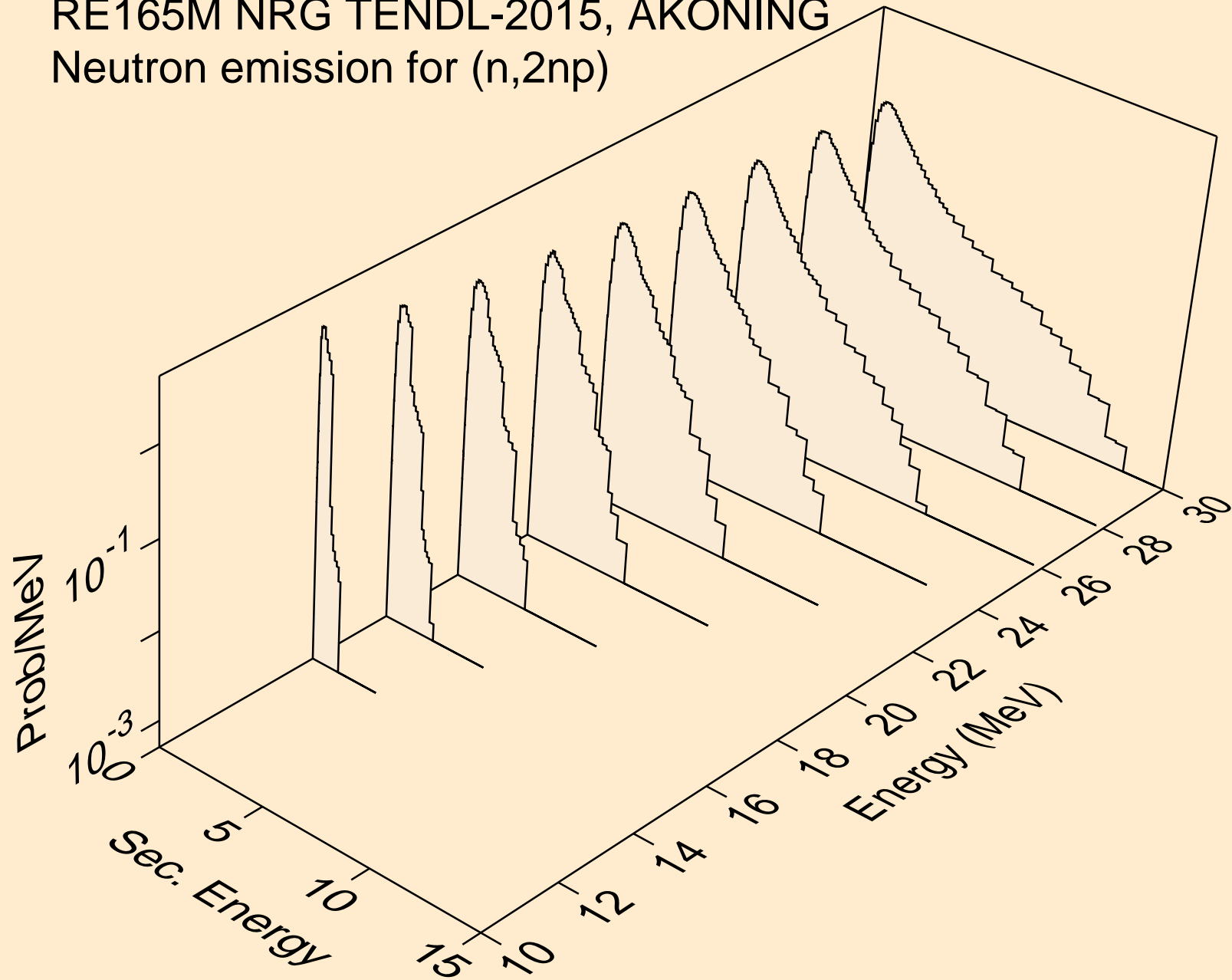

RE165M NRG TENDL-2015, AKONING
Neutron emission for (n,3np)

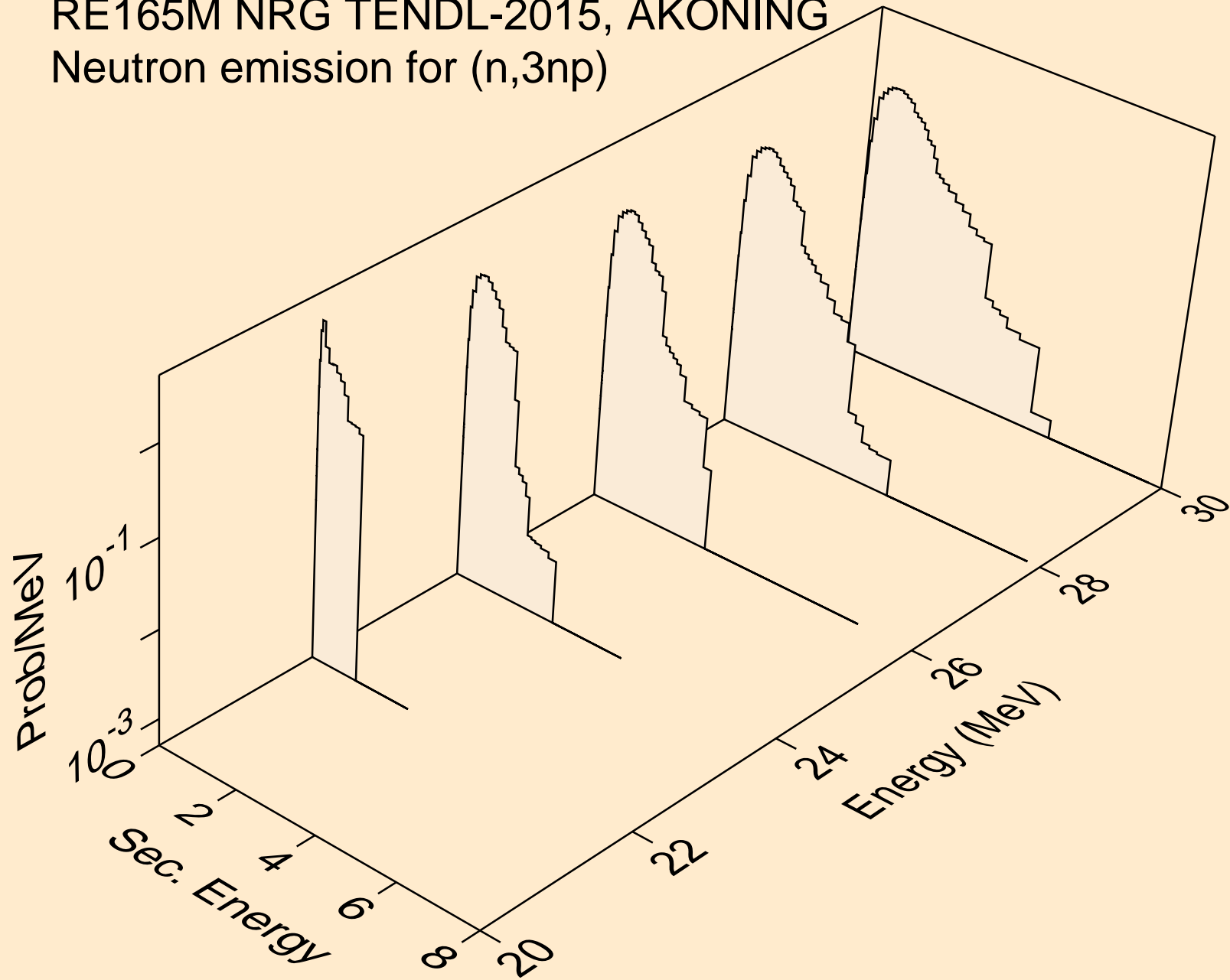

RE165M NRG TENDL-2015, AKONING
Neutron emission for (n,2np)

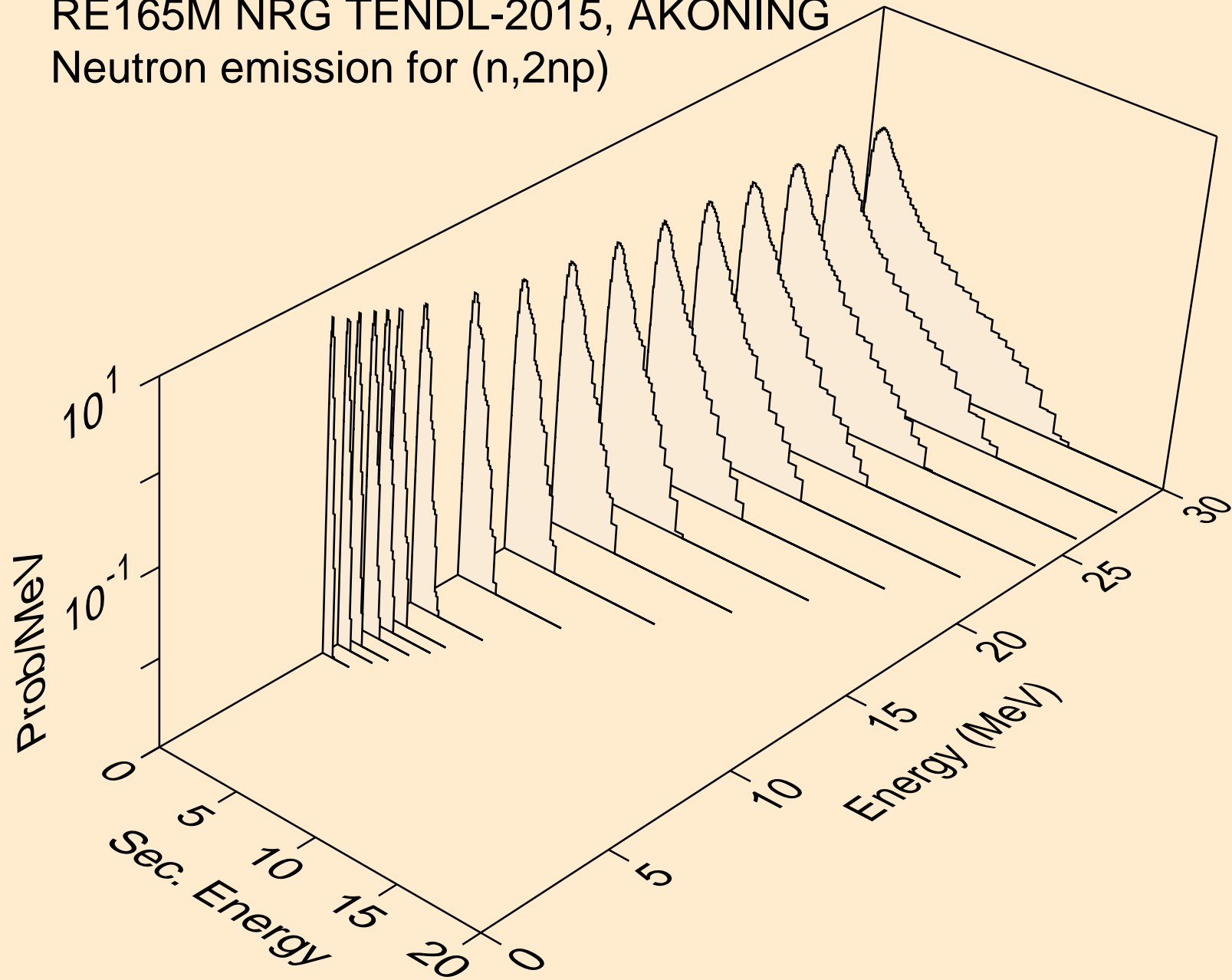

RE165M NRG TENDL-2015, AKONING
Neutron emission for (n,npa)

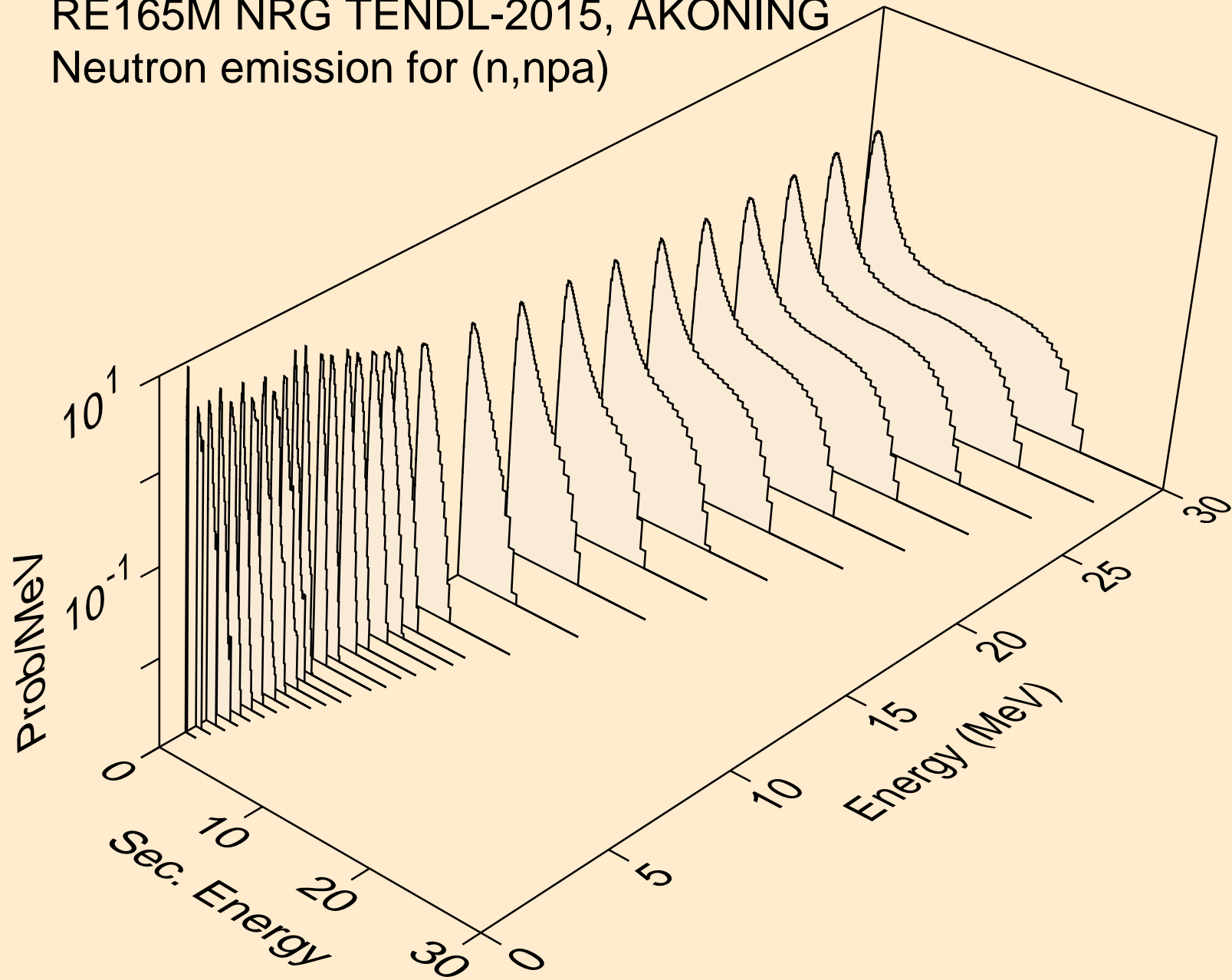

RE165M NRG TENDL-2015, AKONING
Neutron emission for (n,n*c)

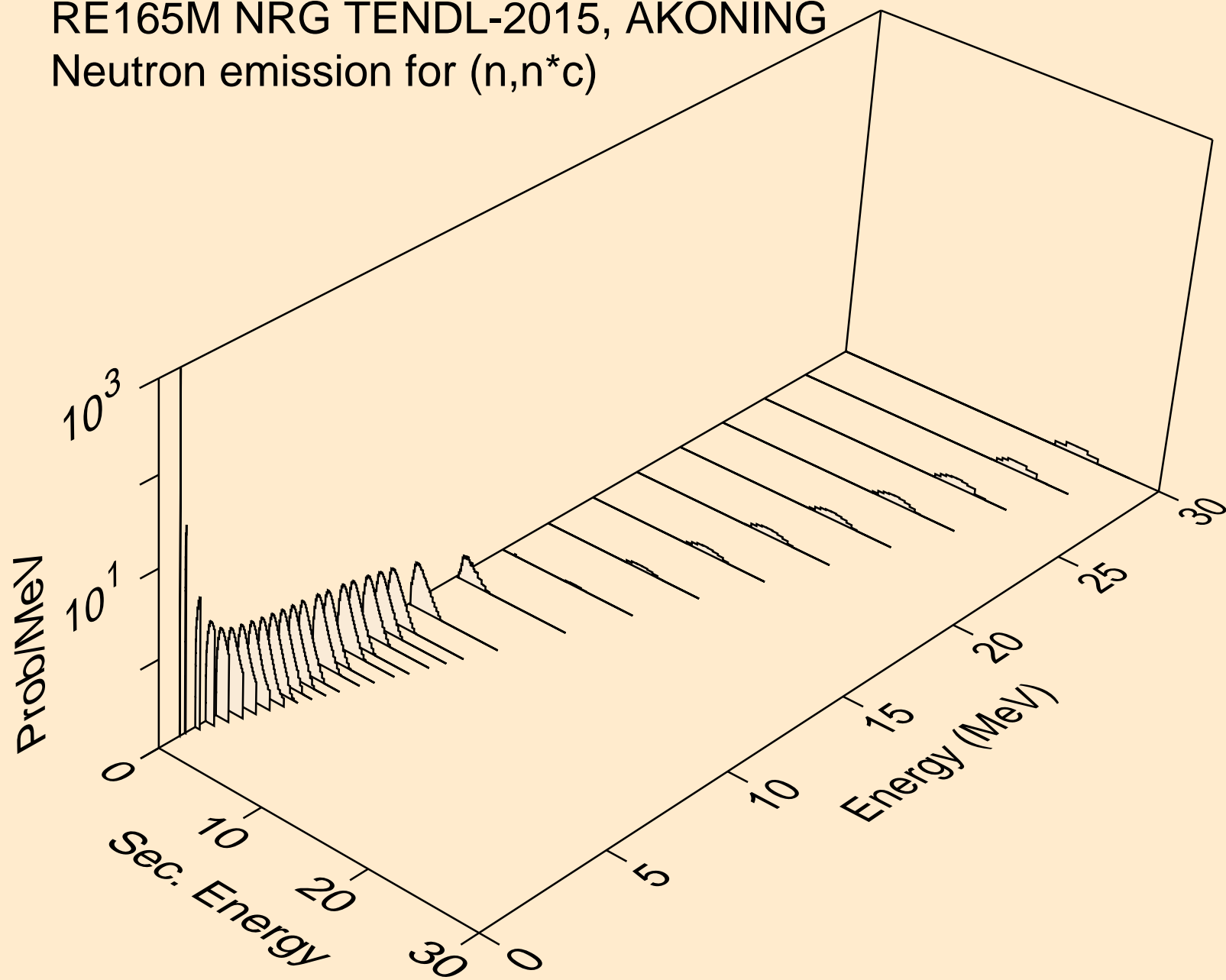

RE165M NRG TENDL-2015, AKONING
Photon emission for (n,x)

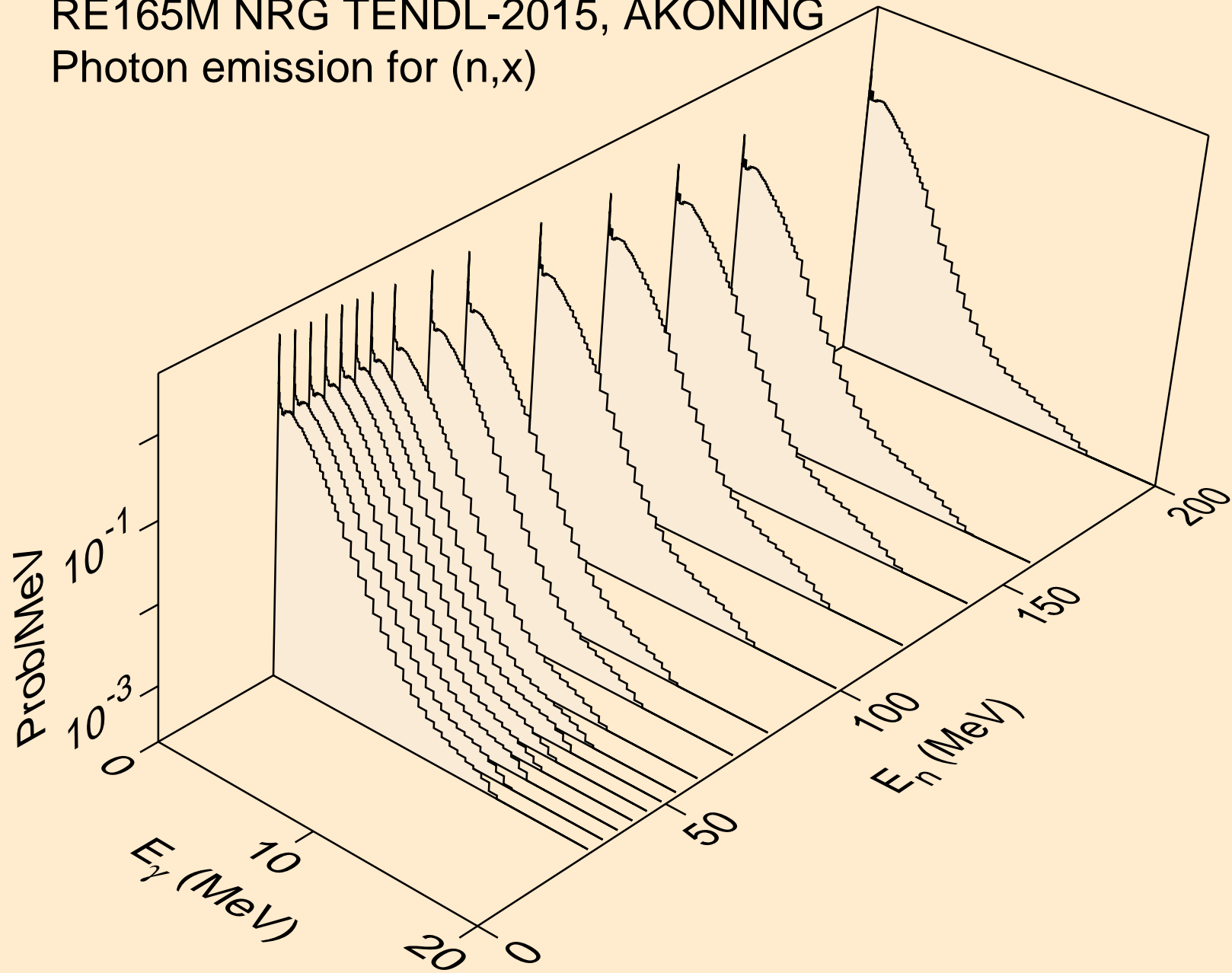

RE165M NRG TENDL-2015, AKONING
Photon emission for (n,2nd)

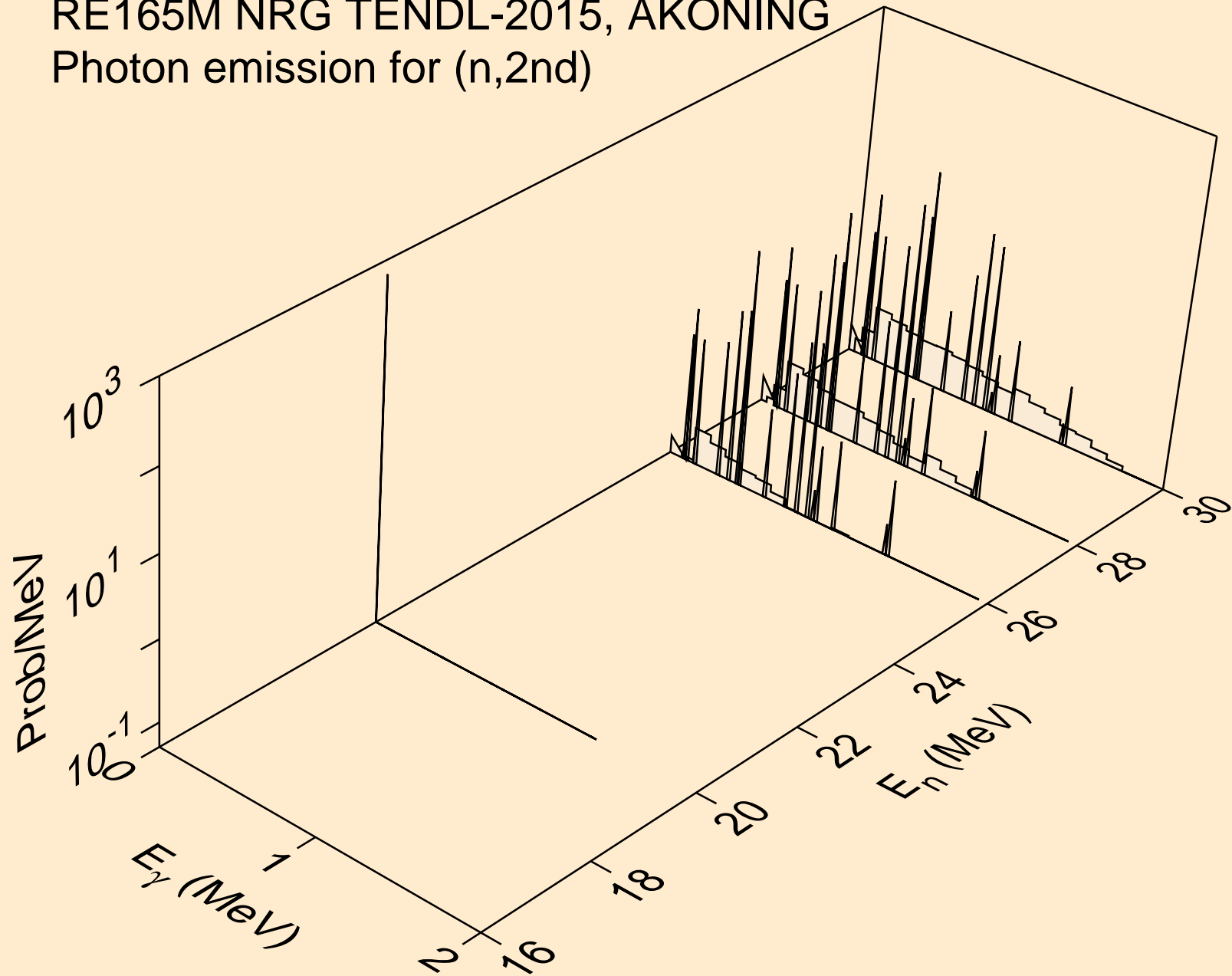

RE165M NRG TENDL-2015, AKONING
Photon emission for (n,2n)

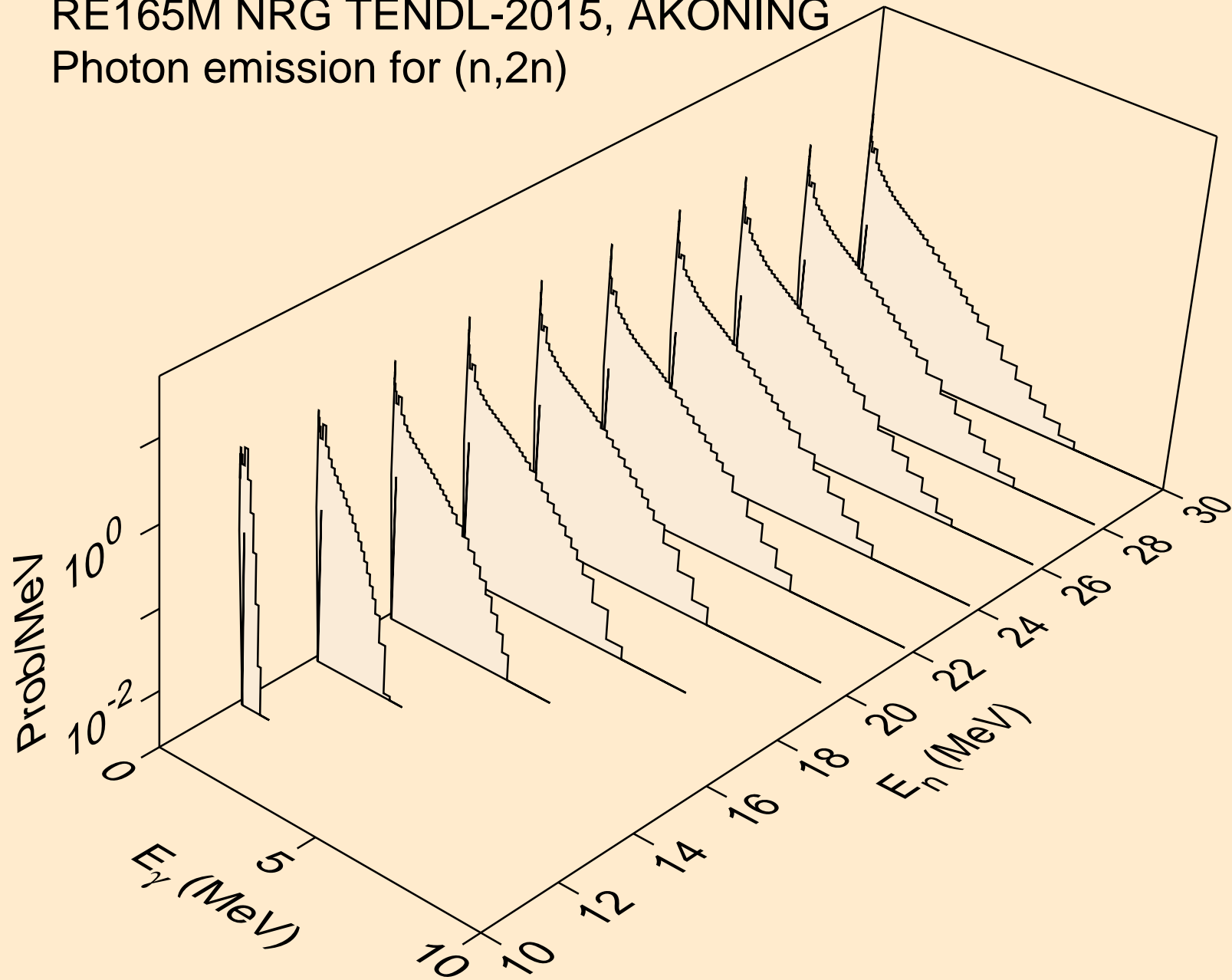

RE165M NRG TENDL-2015, AKONING
Photon emission for (n,3n)

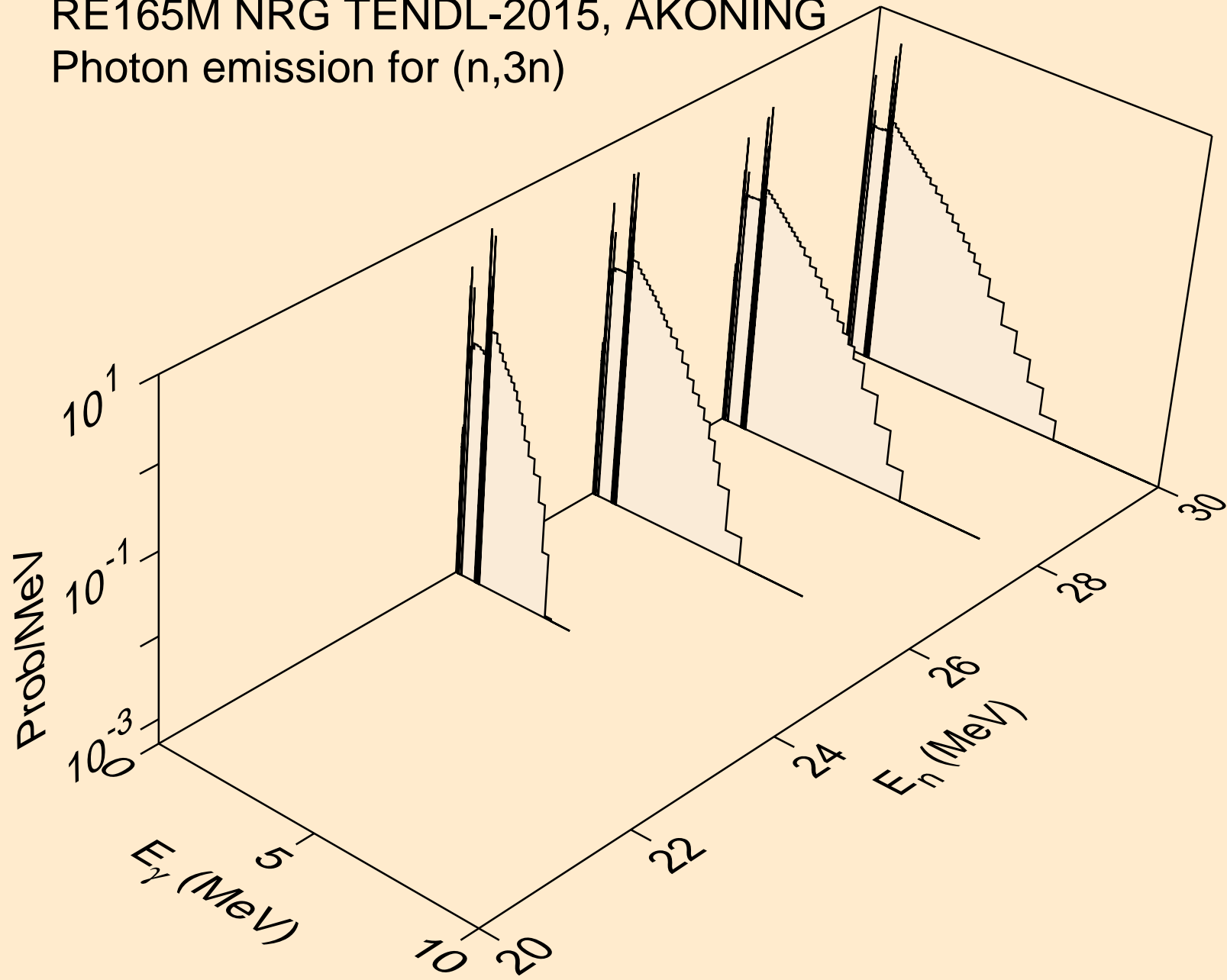

RE165M NRG TENDL-2015, AKONING
Photon emission for (n,n*)a

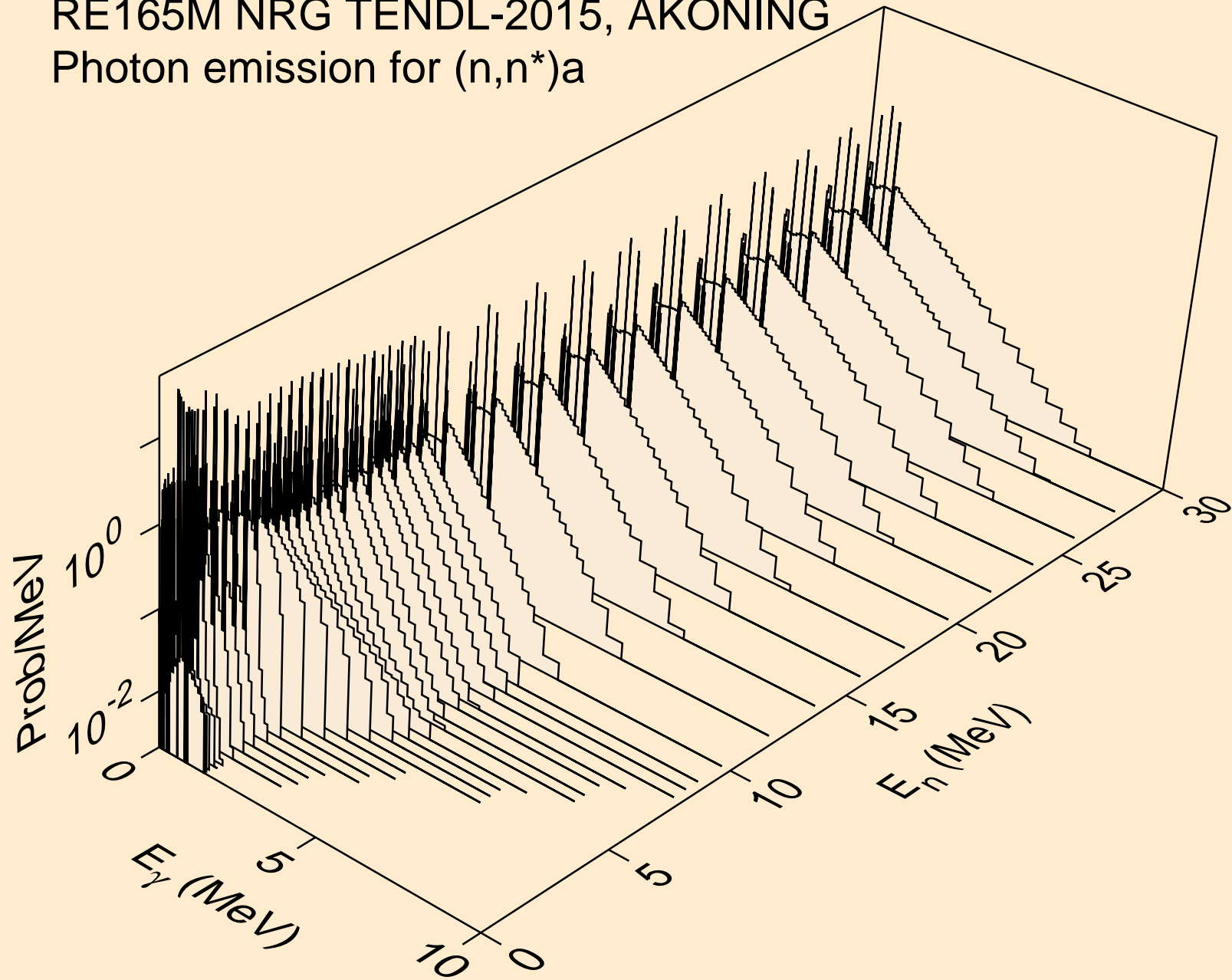

RE165M NRG TENDL-2015, AKONING
Photon emission for (n,n*)3a

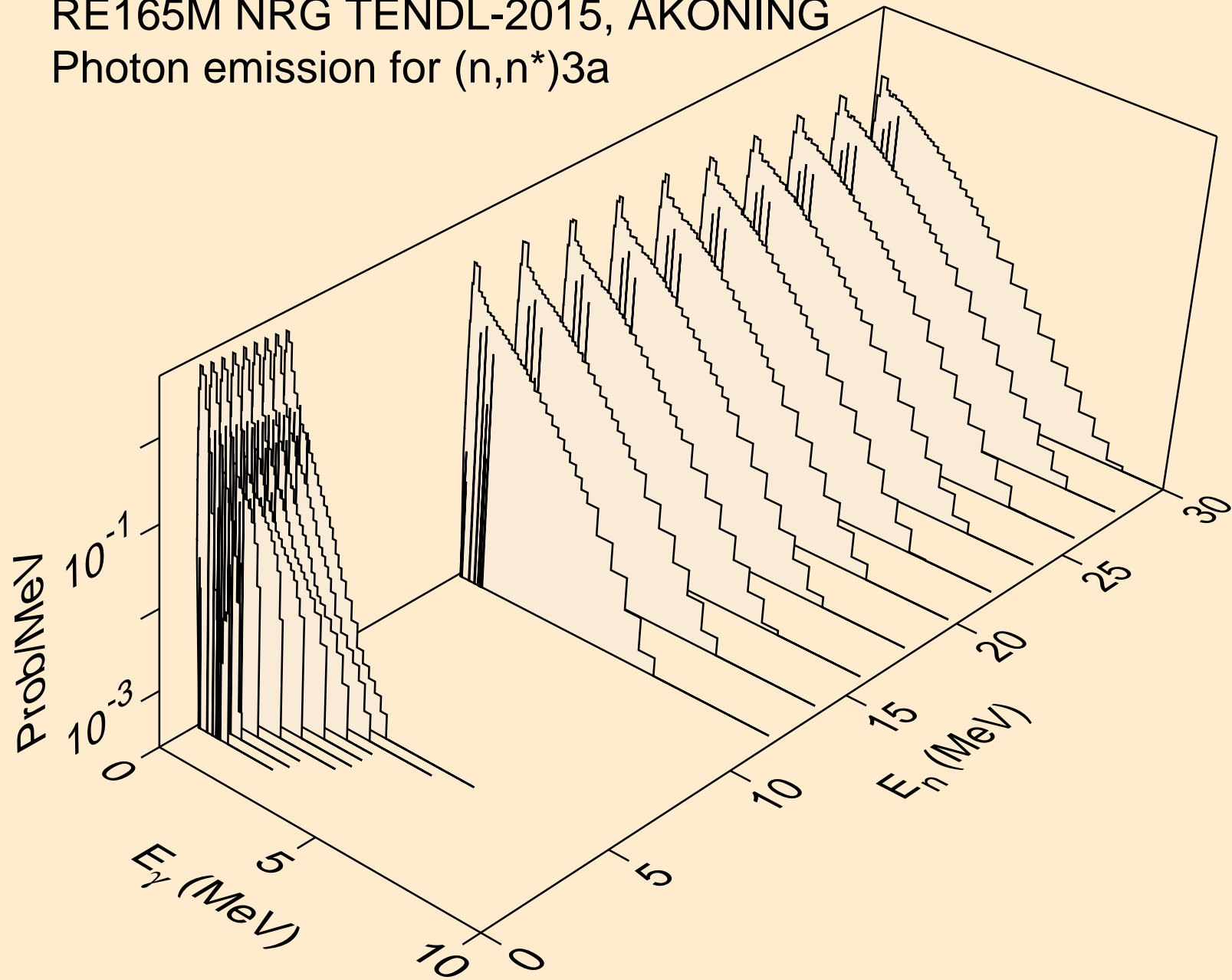

RE165M NRG TENDL-2015, AKONING
Photon emission for (n,2n)a

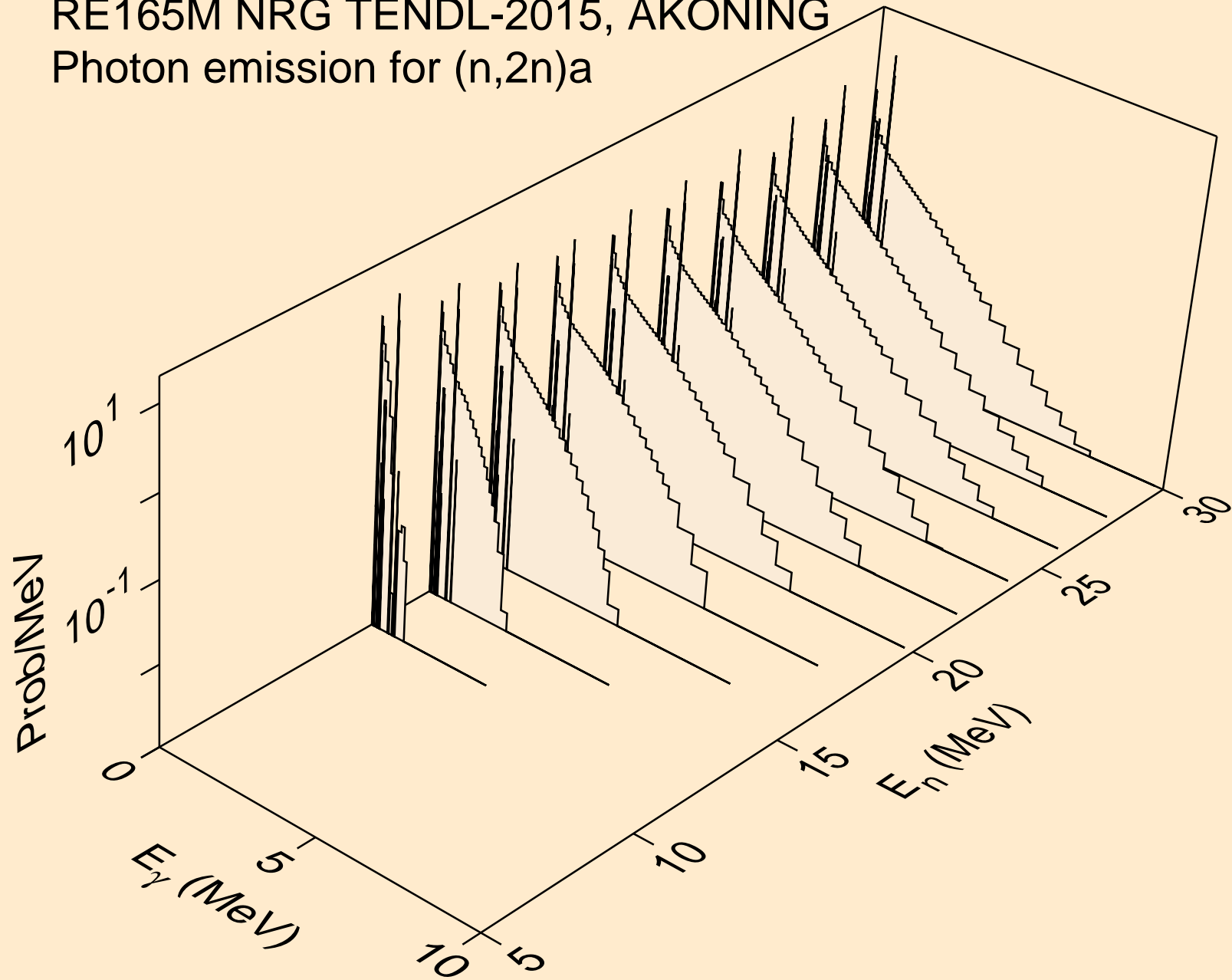

RE165M NRG TENDL-2015, AKONING
Photon emission for (n,3n)a

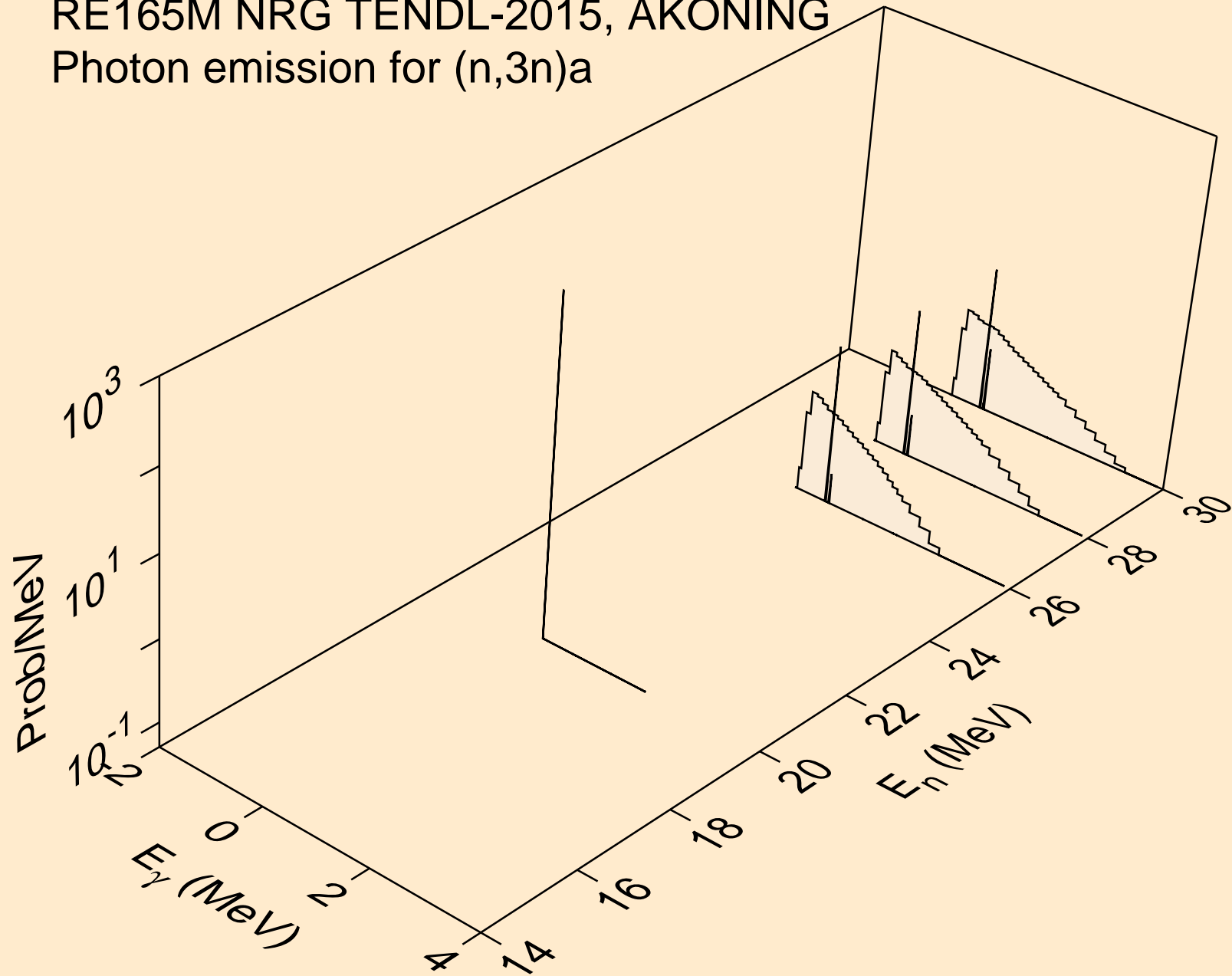

RE165M NRG TENDL-2015, AKONING
Photon emission for (n,n*)p

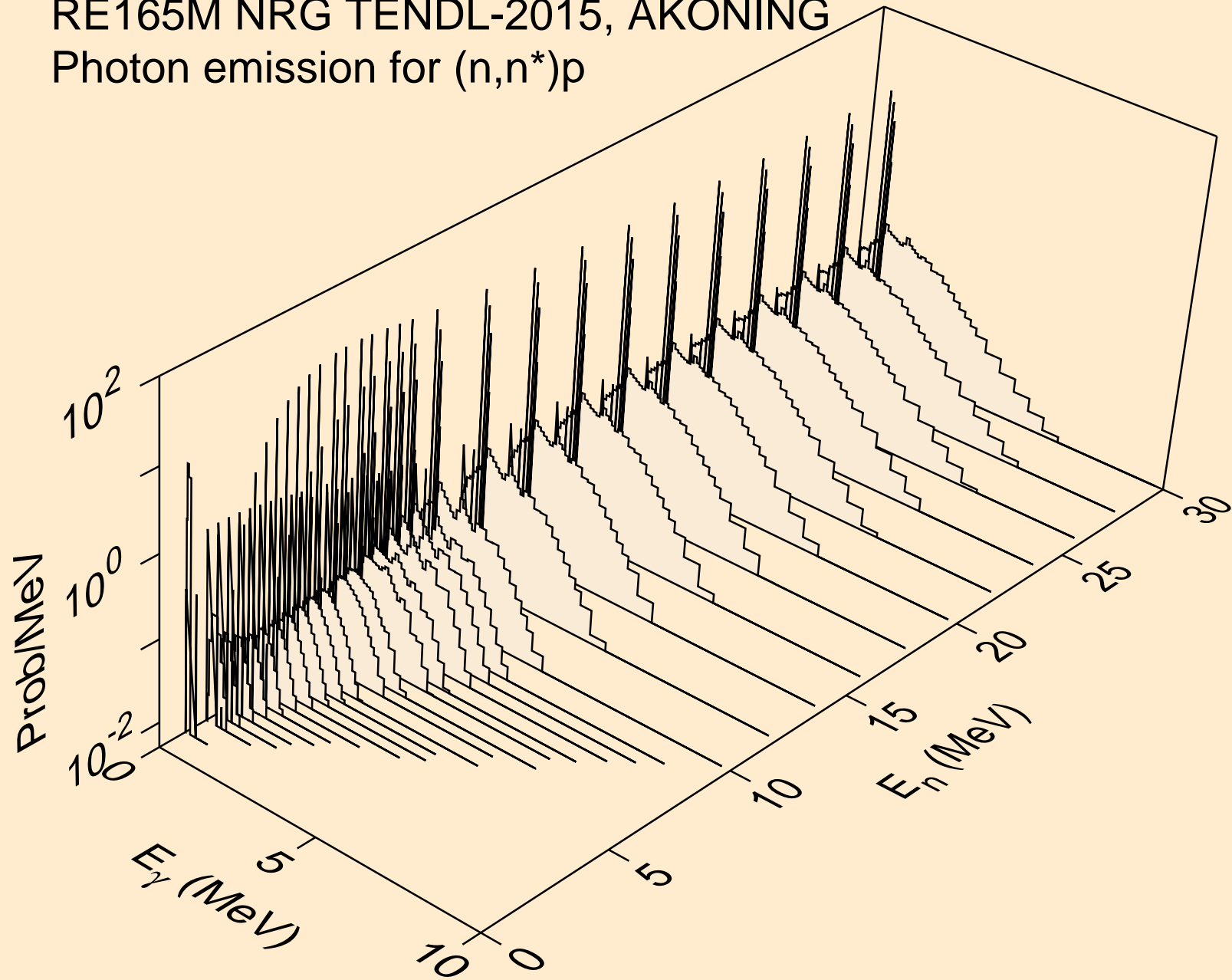

RE165M NRG TENDL-2015, AKONING
Photon emission for (n,n*)2a

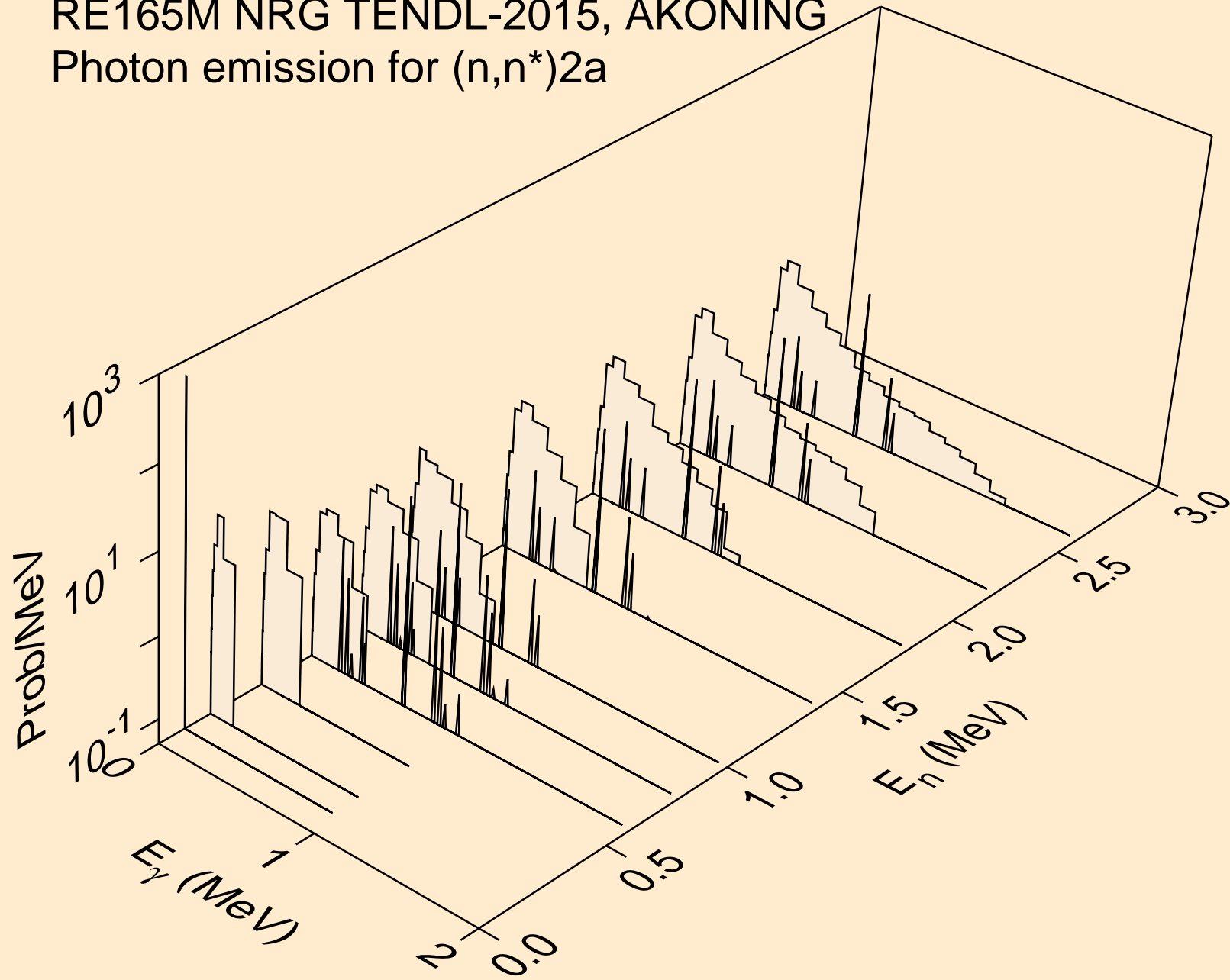

RE165M NRG TENDL-2015, AKONING
Photon emission for (n,2n)2a

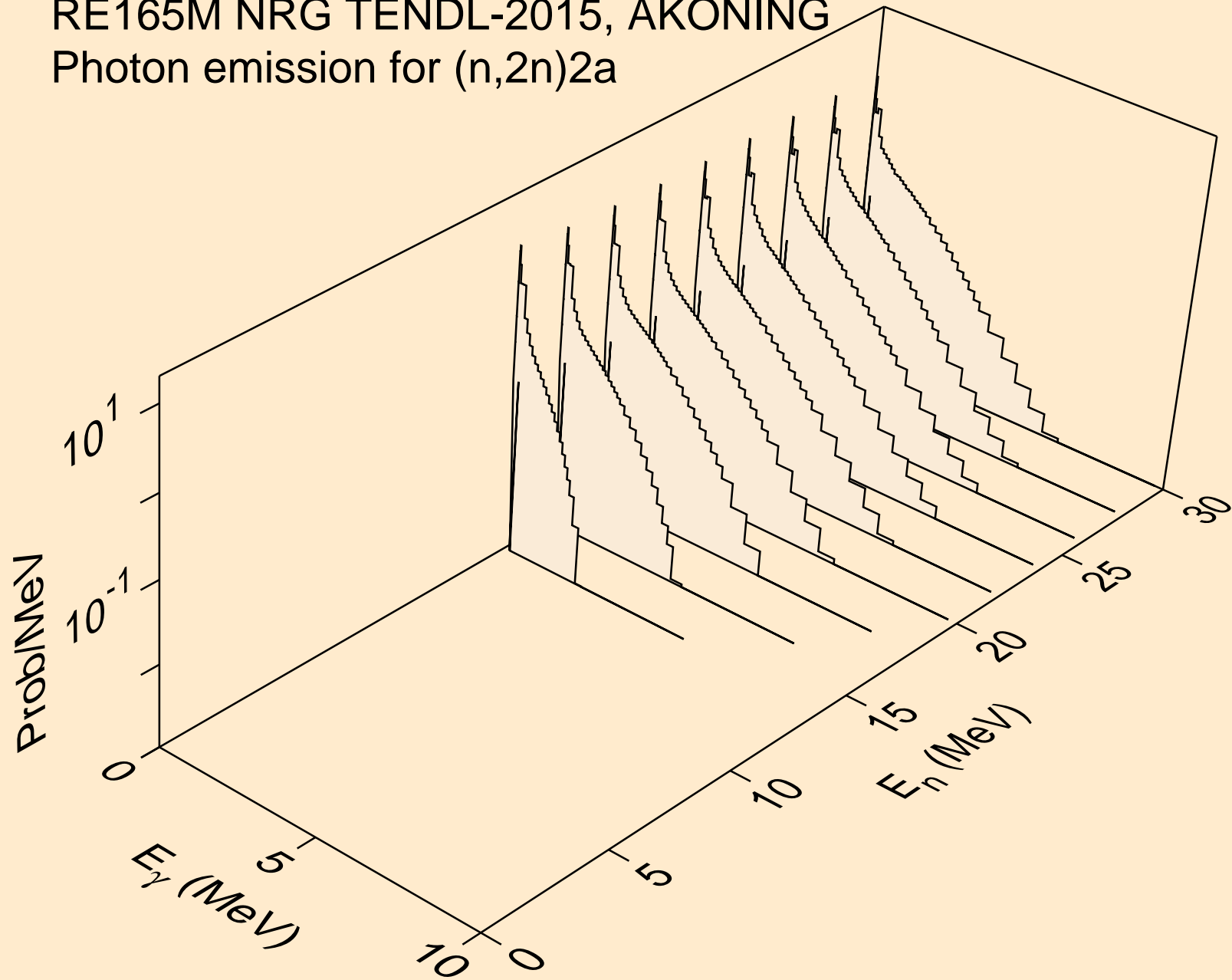

RE165M NRG TENDL-2015, AKONING
Photon emission for (n,n*)d

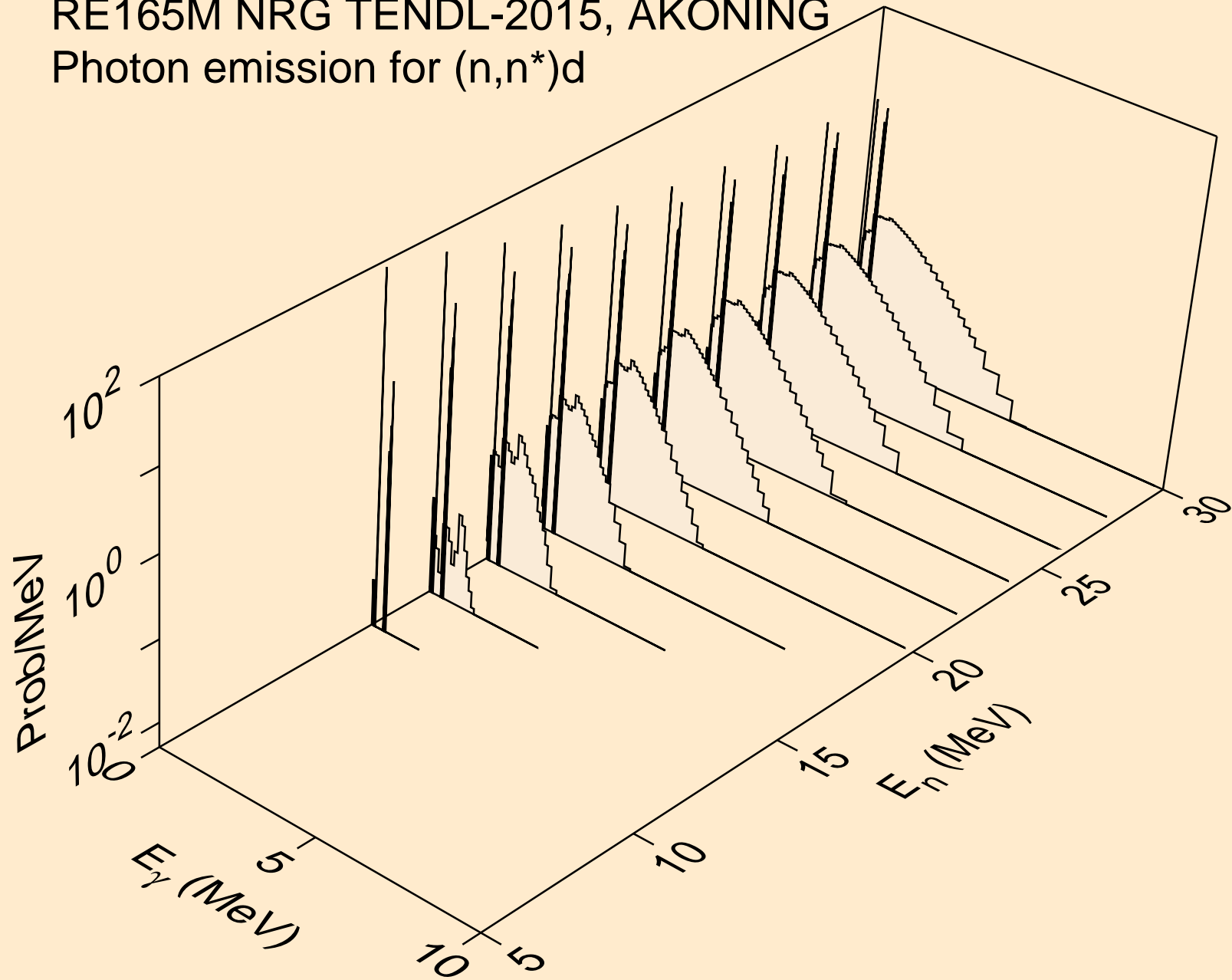

RE165M NRG TENDL-2015, AKONING
Photon emission for (n,n*)t

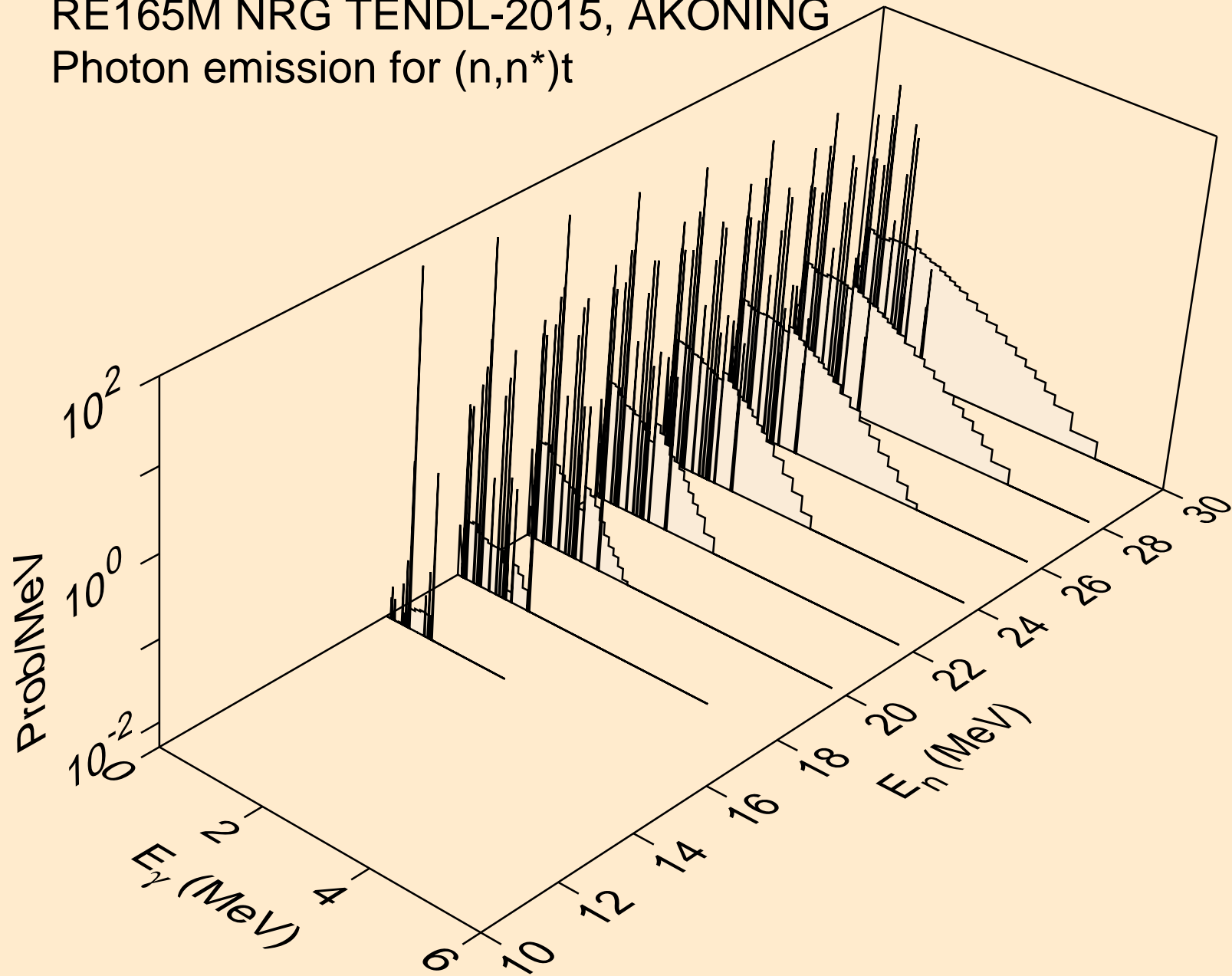

RE165M NRG TENDL-2015, AKONING
Photon emission for (n,n*)he3

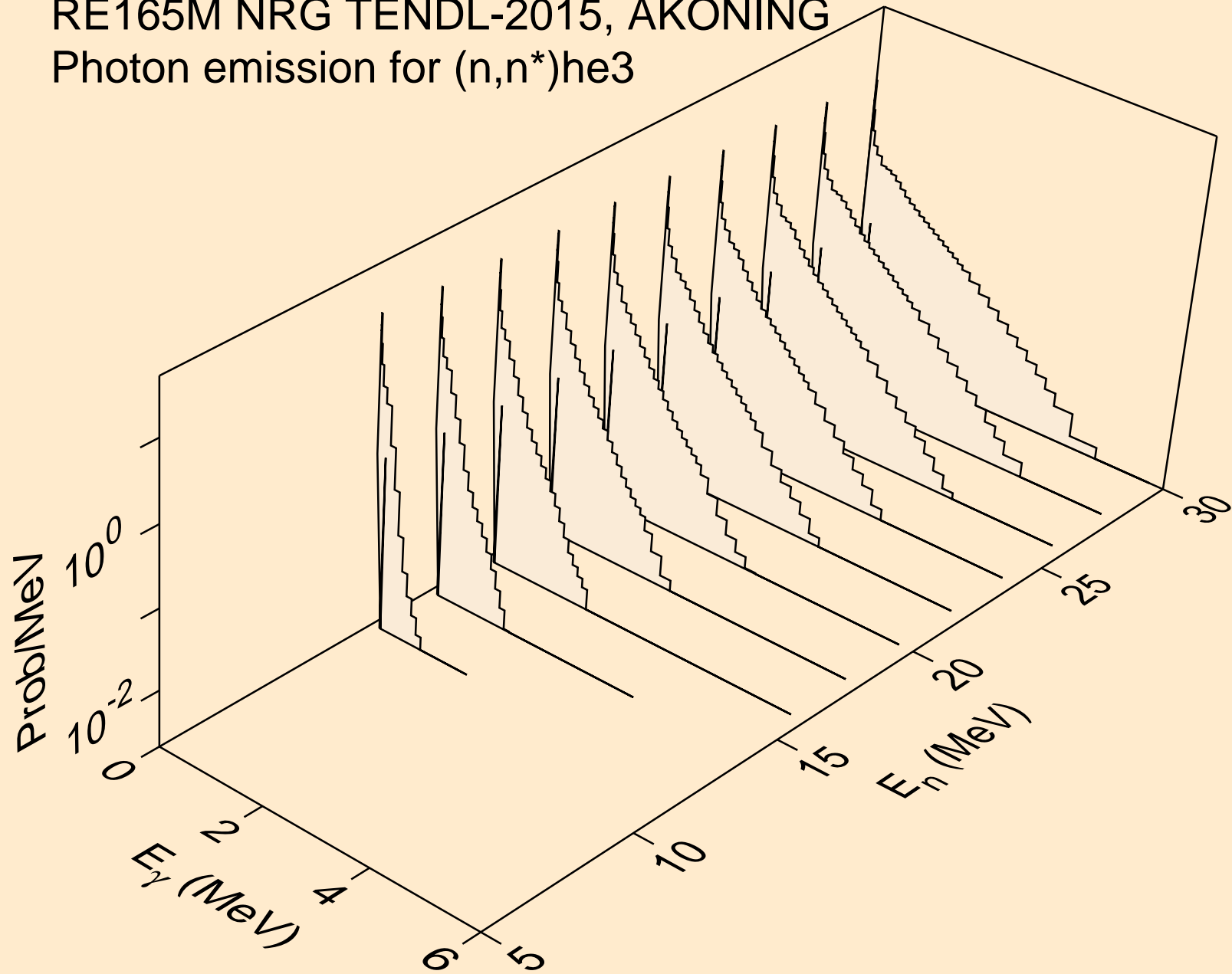

RE165M NRG TENDL-2015, AKONING
Photon emission for (n,n*)d2a

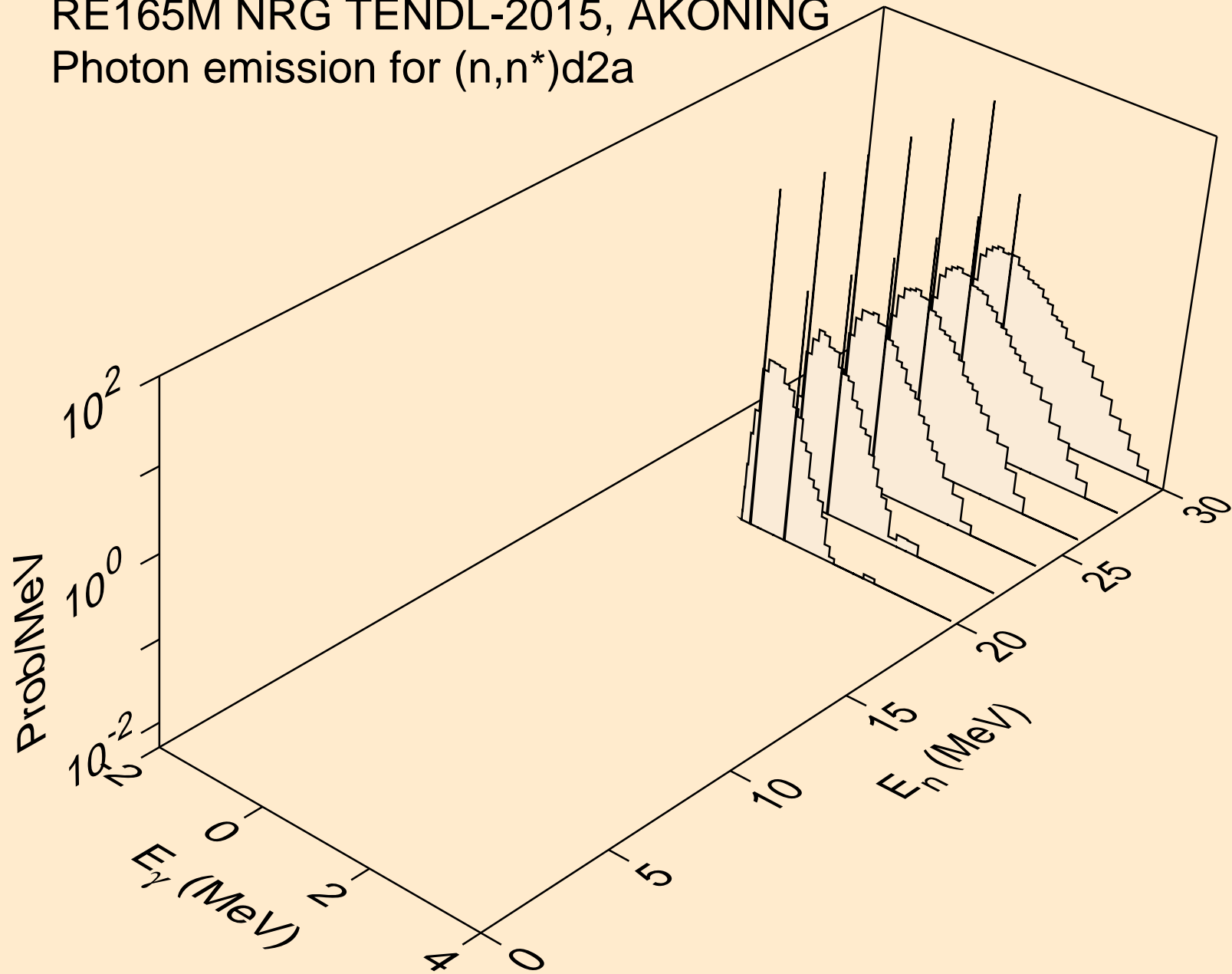

RE165M NRG TENDL-2015, AKONING
Photon emission for (n,2np)

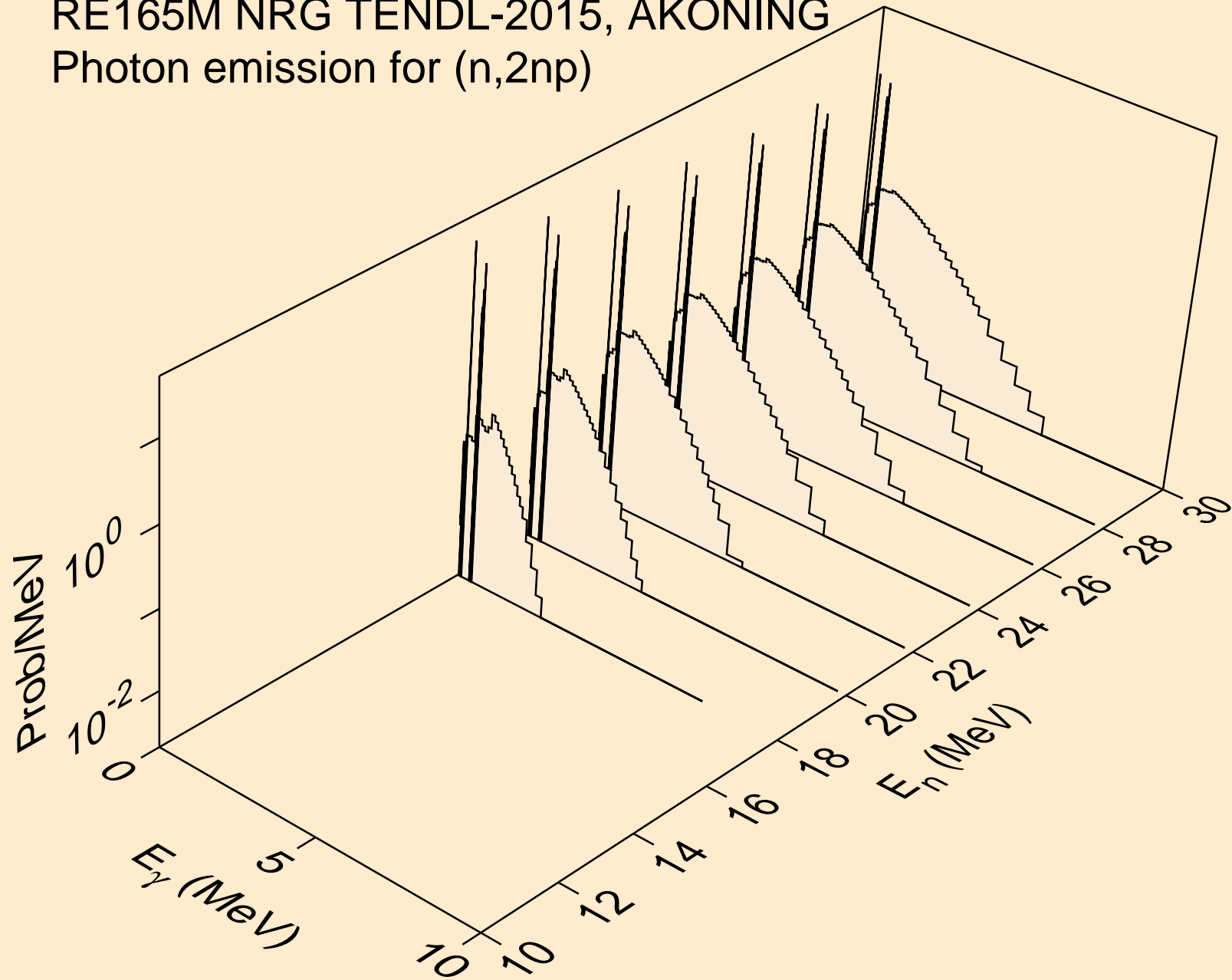

RE165M NRG TENDL-2015, AKONING
Photon emission for (n,3np)

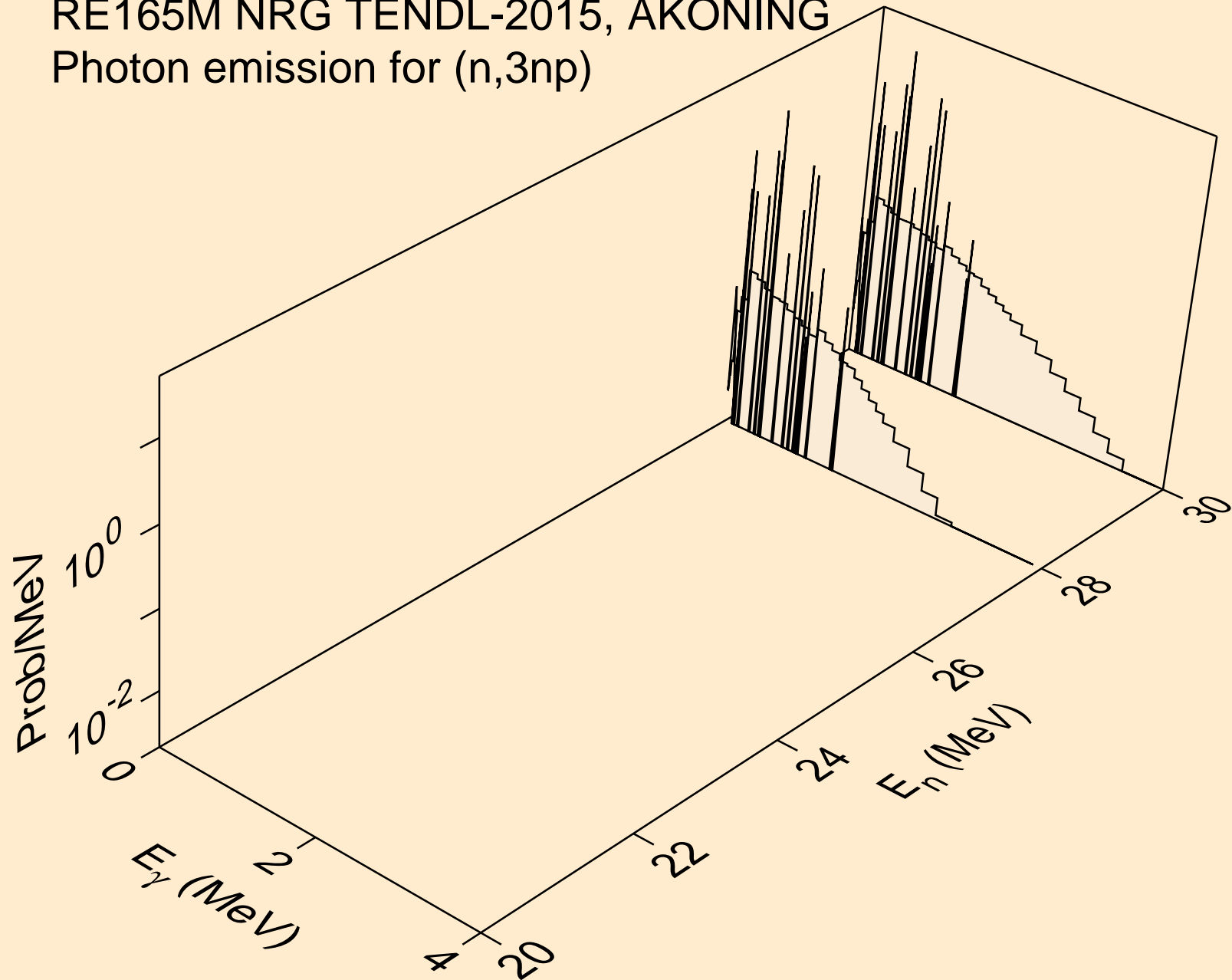

RE165M NRG TENDL-2015, AKONING
Photon emission for (n,2np)

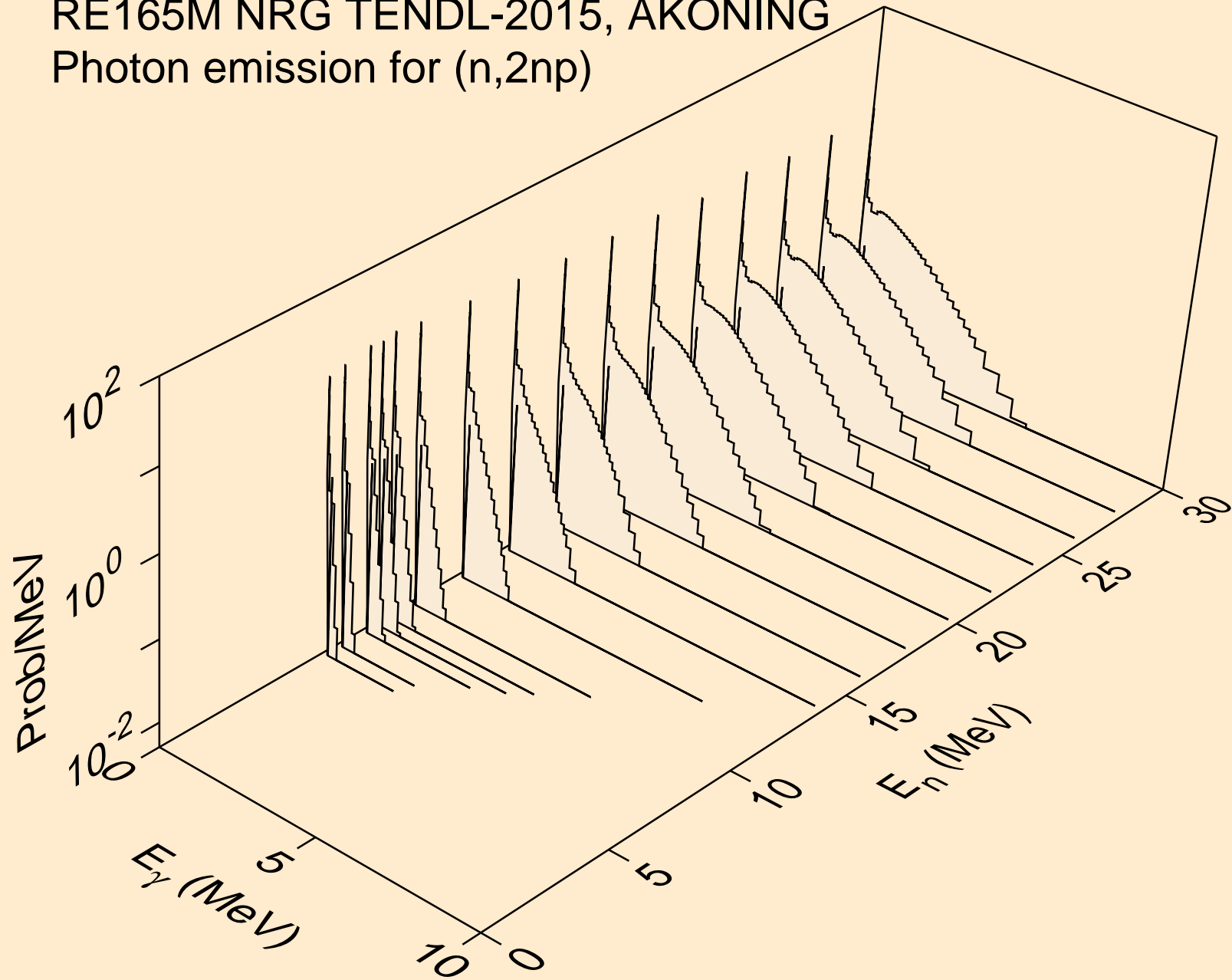

RE165M NRG TENDL-2015, AKONING
Photon emission for (n,npa)

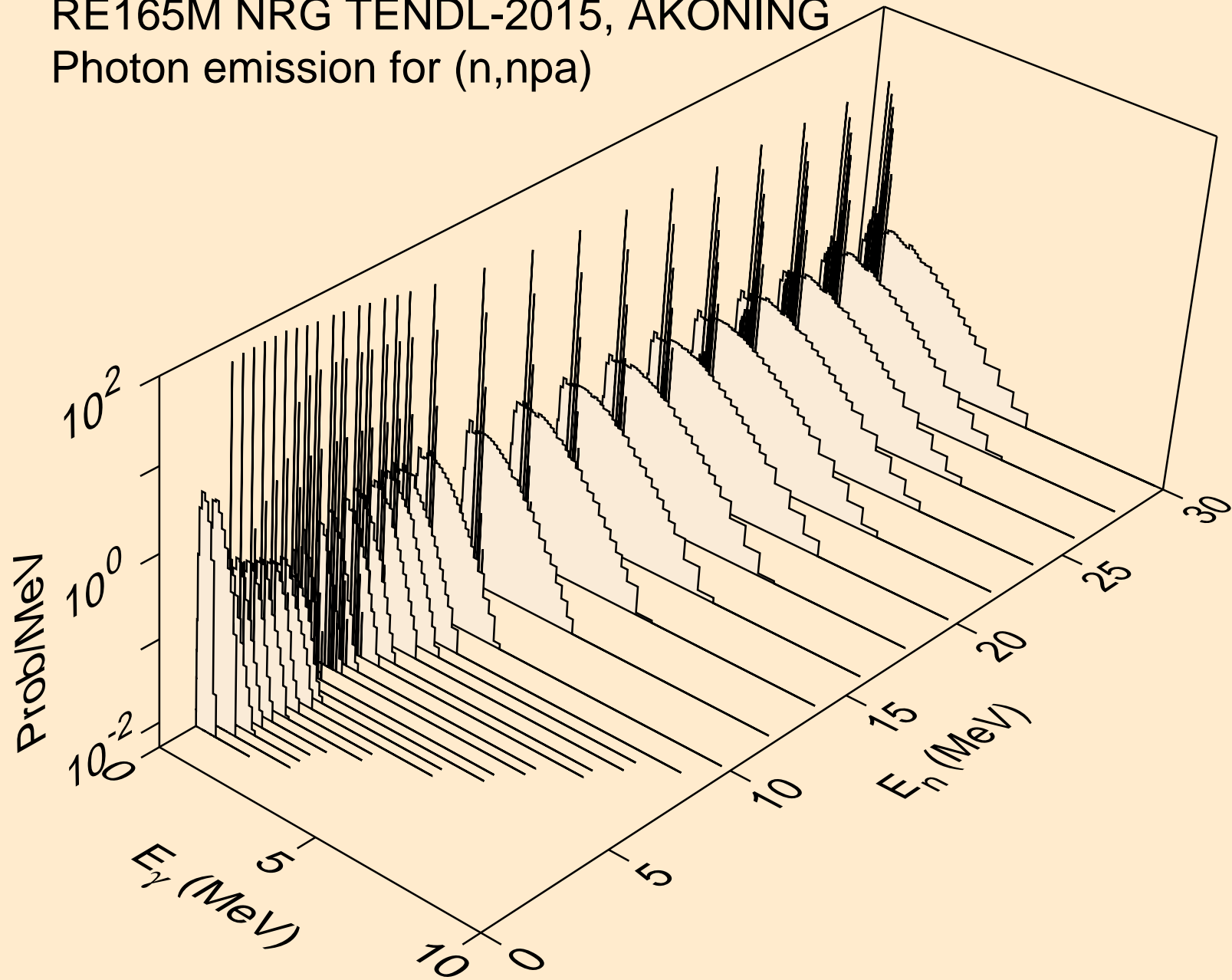

RE165M NRG TENDL-2015, AKONING
Photon emission for (n,n*2)

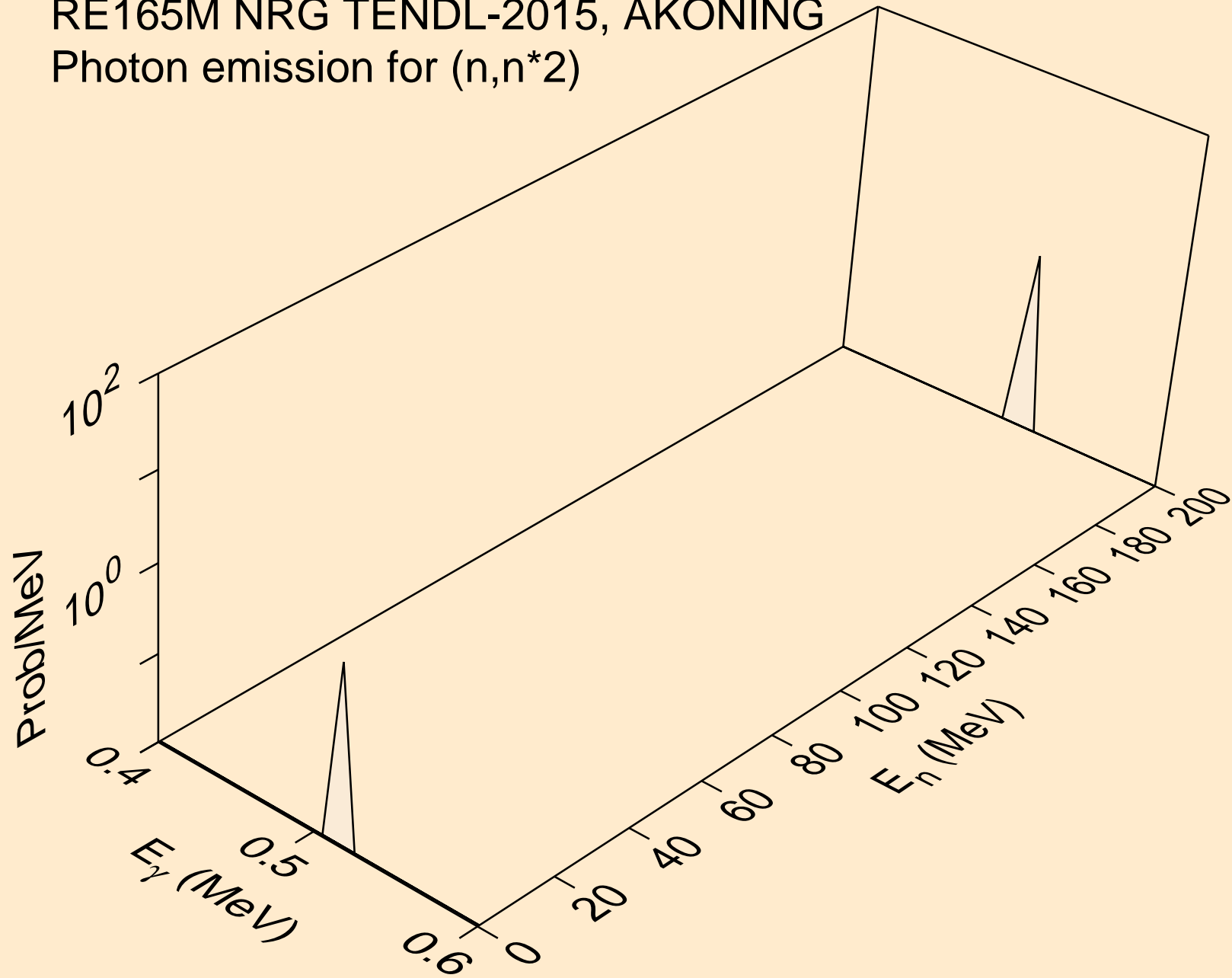

RE165M NRG TENDL-2015, AKONING
Photon emission for (n,n*c)

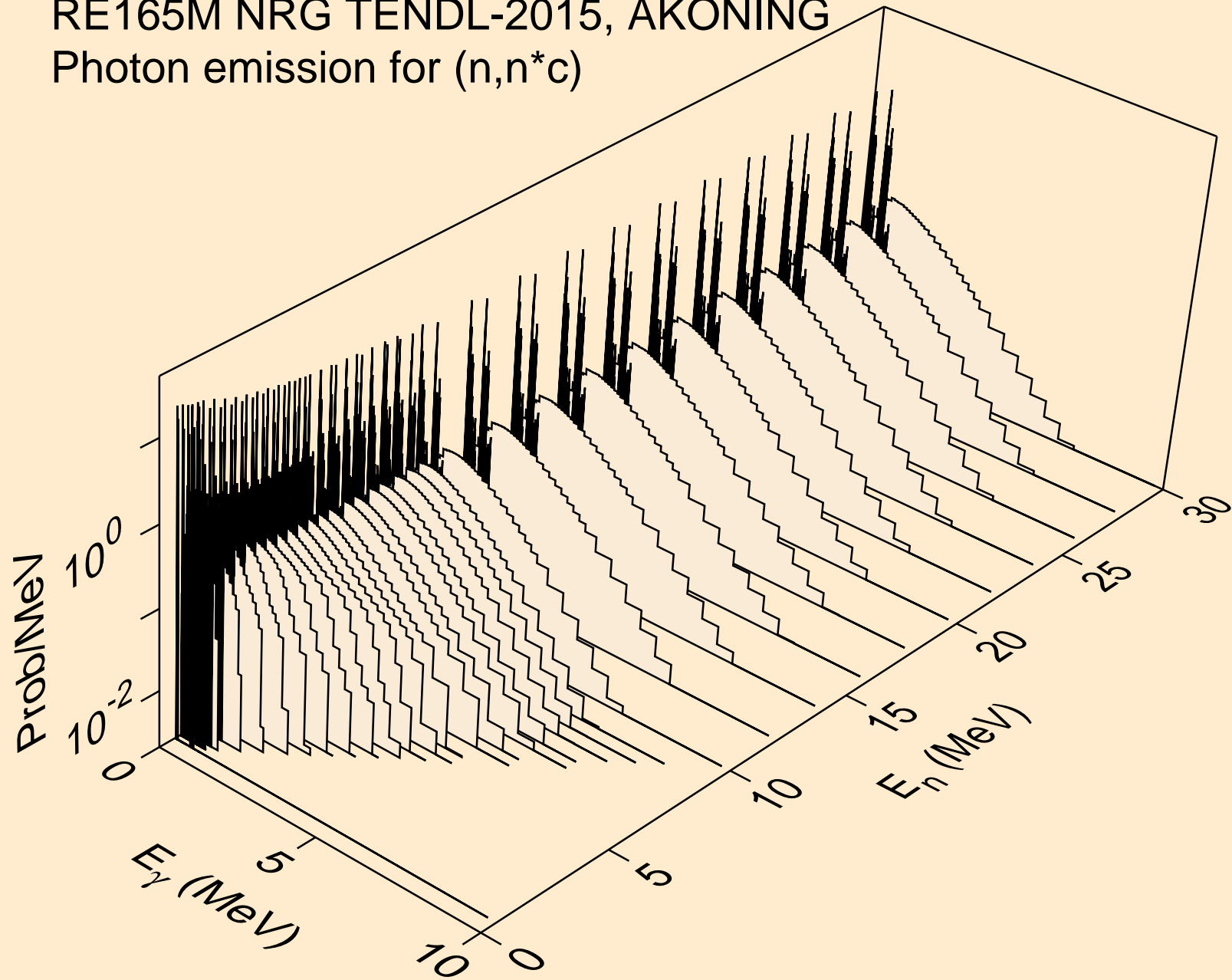

RE165M NRG TENDL-2015, AKONING
Photon emission for (n,gma)

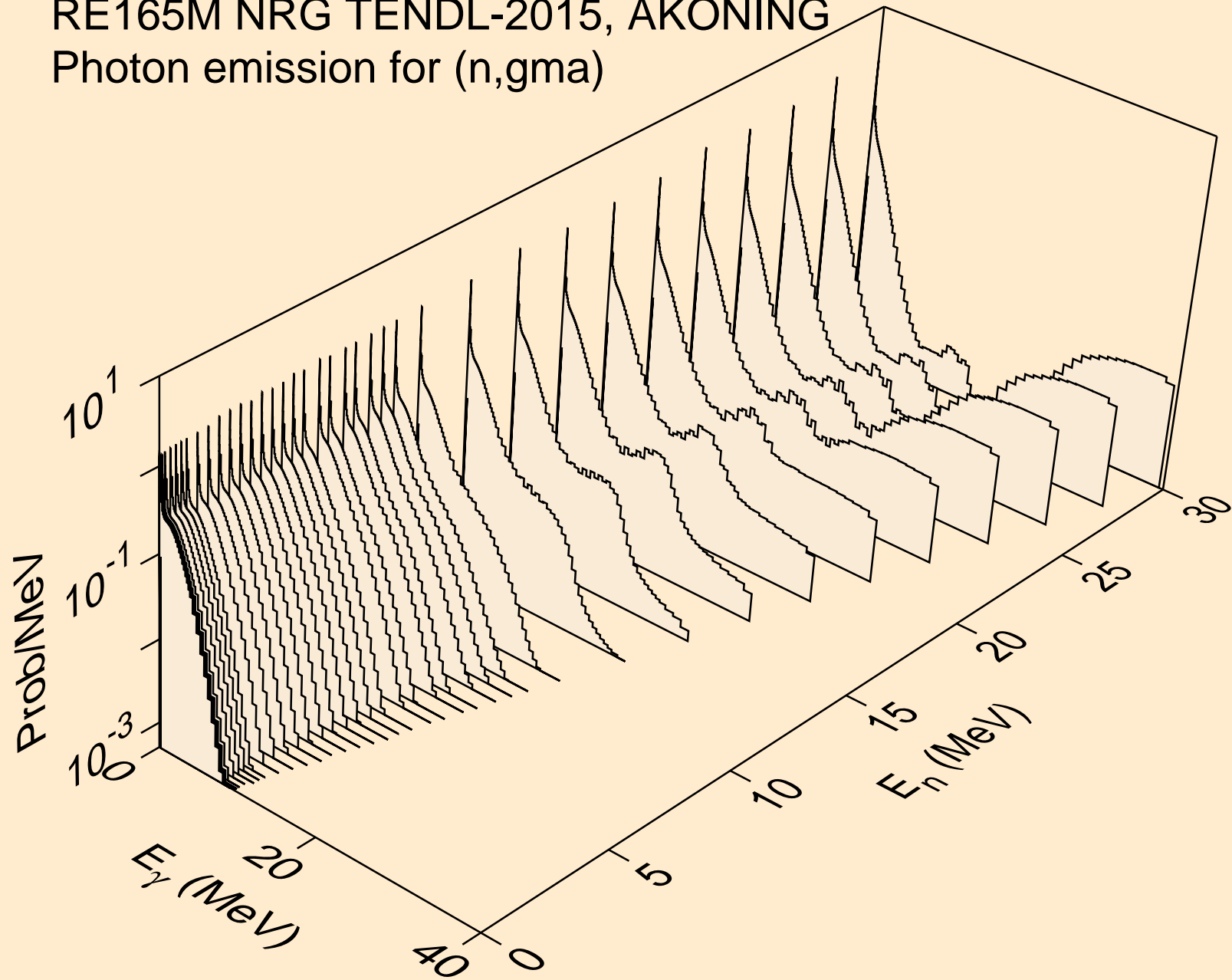

RE165M NRG TENDL-2015, AKONING
Photon emission for (n,p)

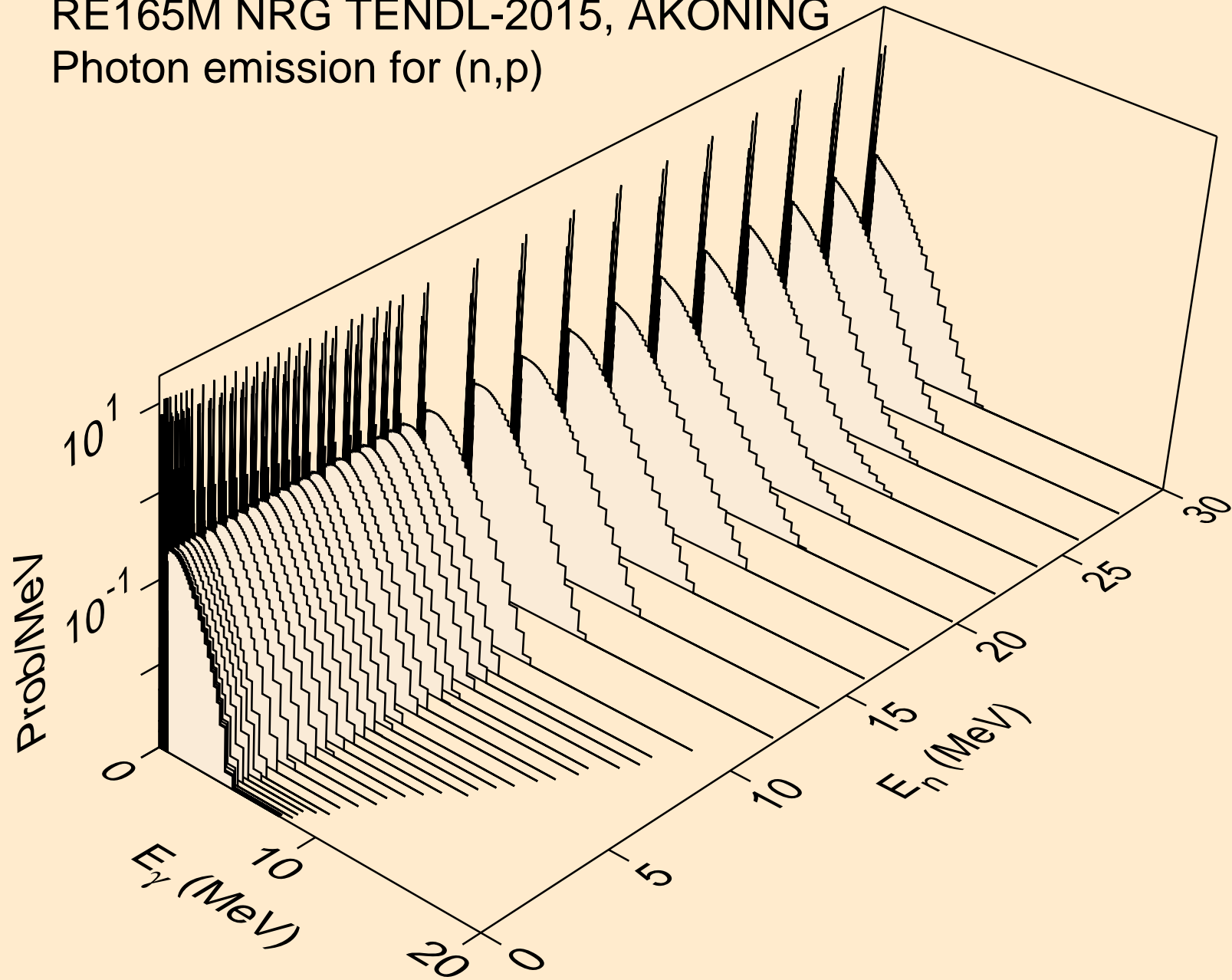

RE165M NRG TENDL-2015, AKONING
Photon emission for (n,d)

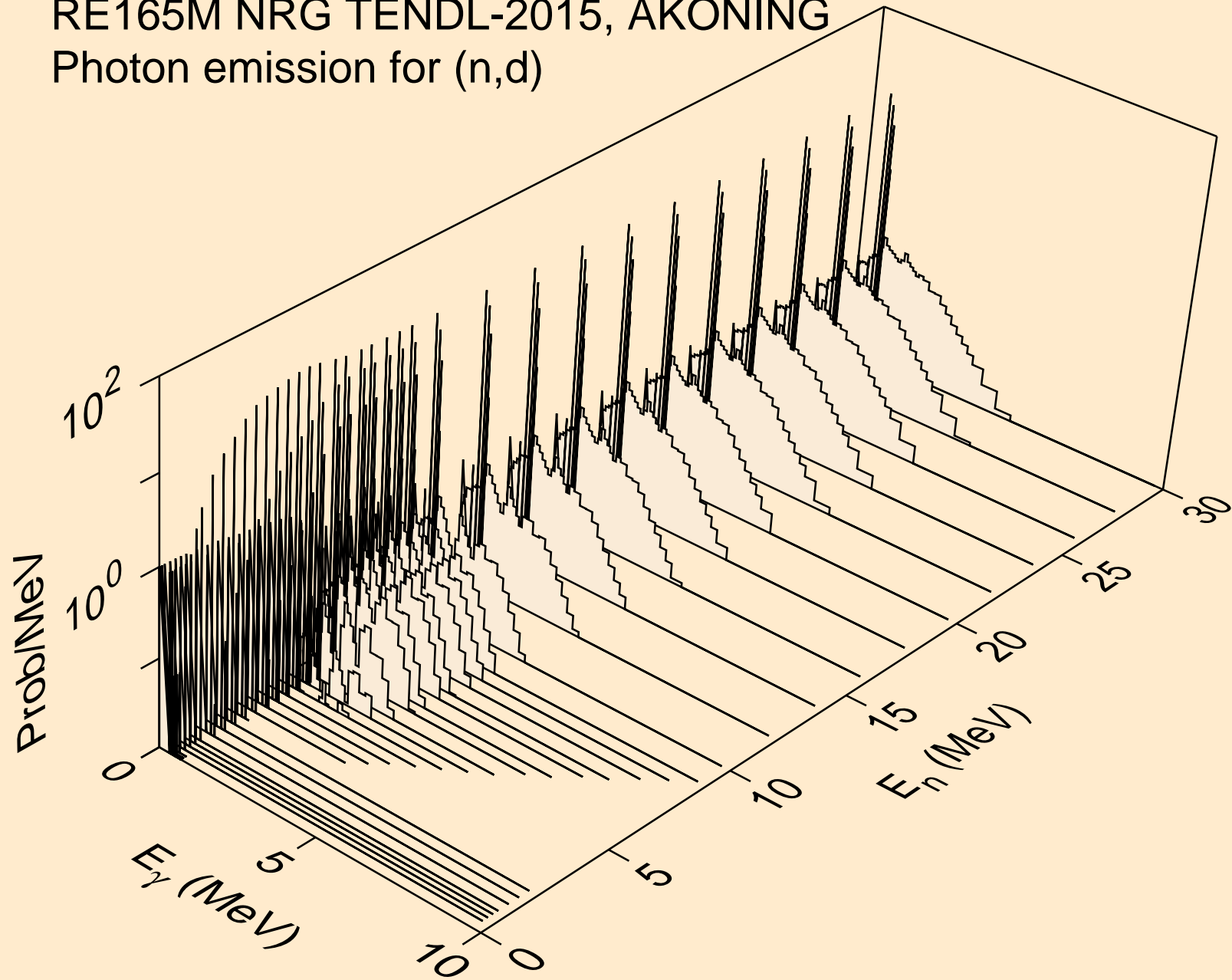

RE165M NRG TENDL-2015, AKONING
Photon emission for (n,t)

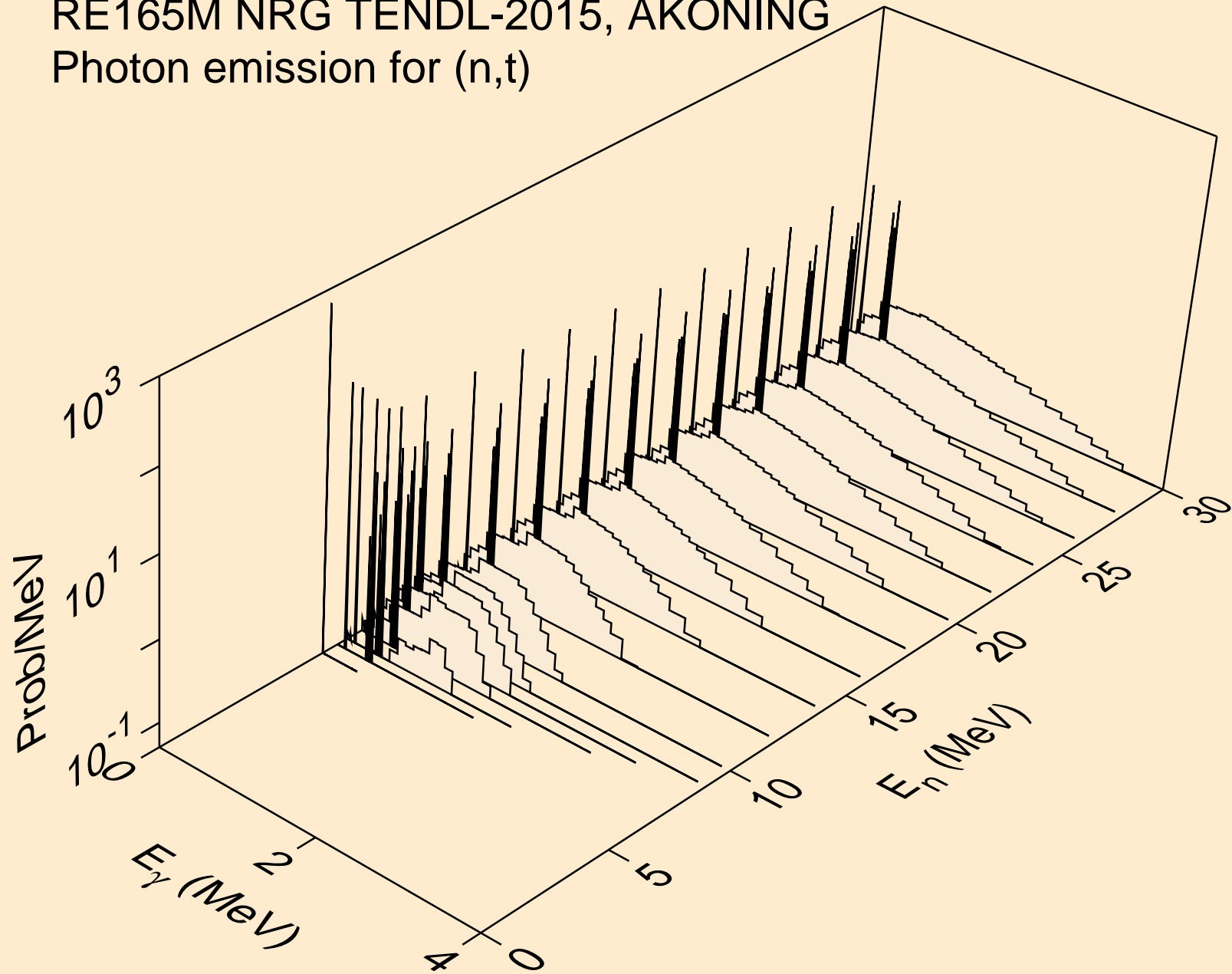

RE165M NRG TENDL-2015, AKONING
Photon emission for (n,he3)

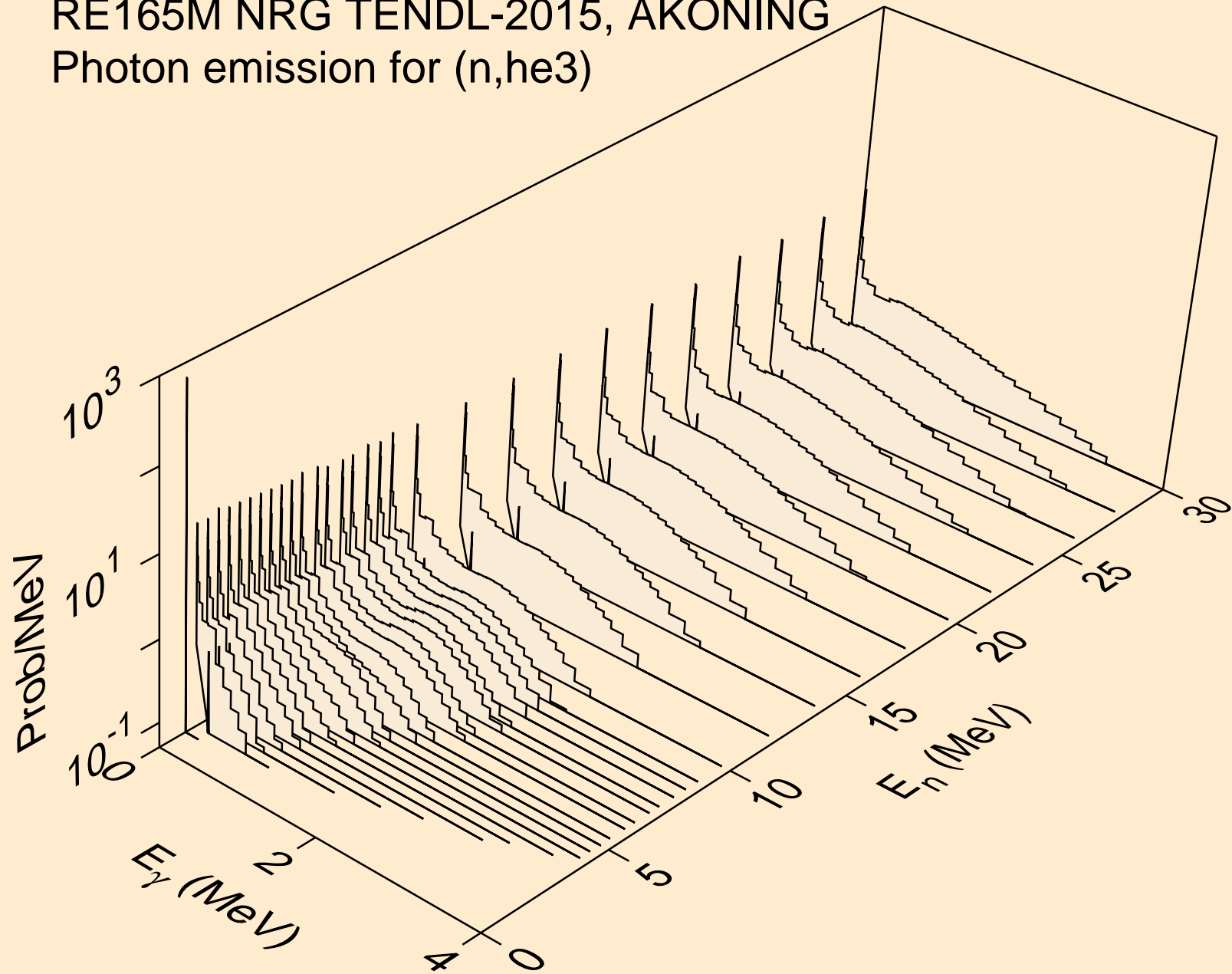

RE165M NRG TENDL-2015, AKONING
Photon emission for (n,a)

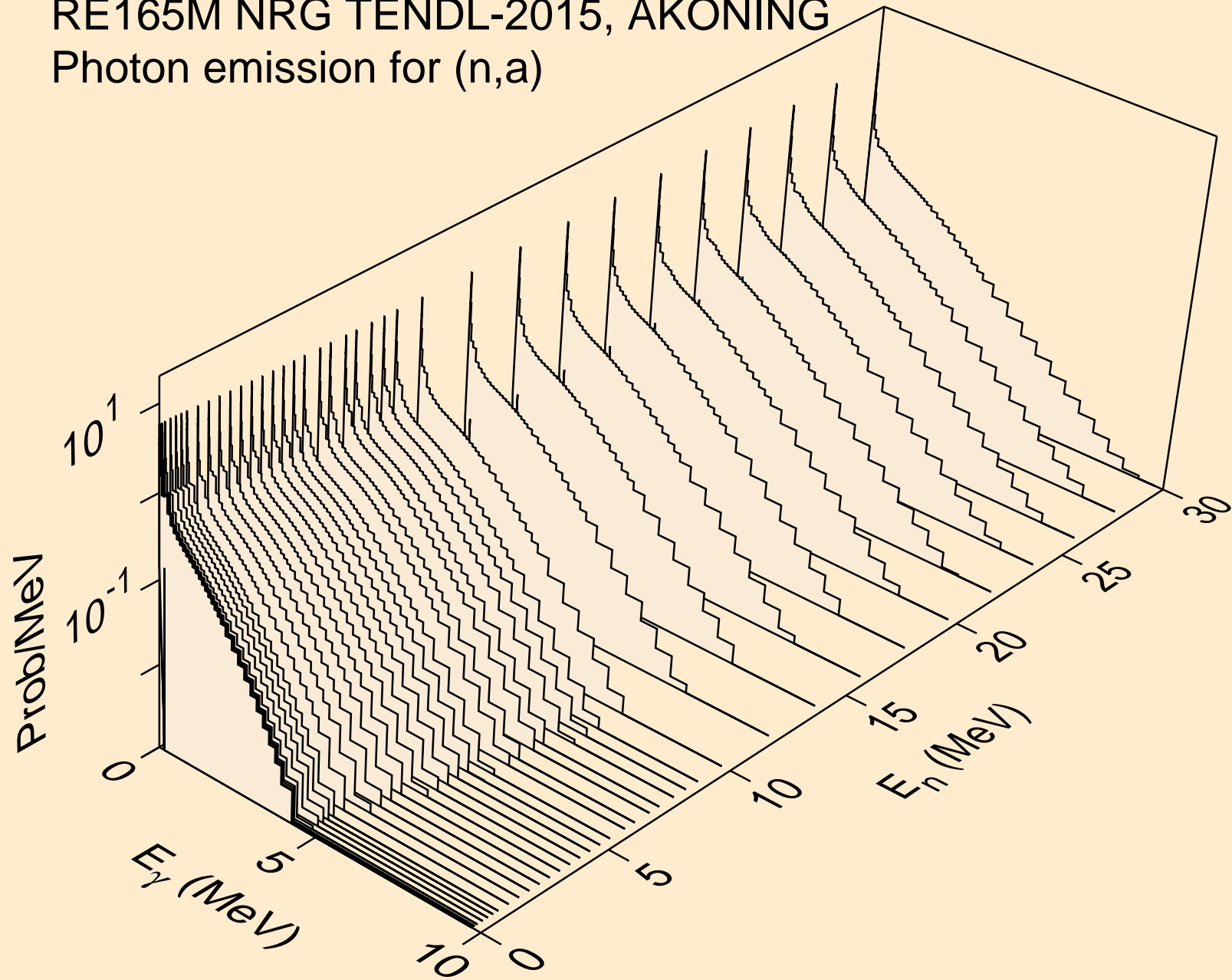

RE165M NRG TENDL-2015, AKONING

Photon emission for (n,2a)

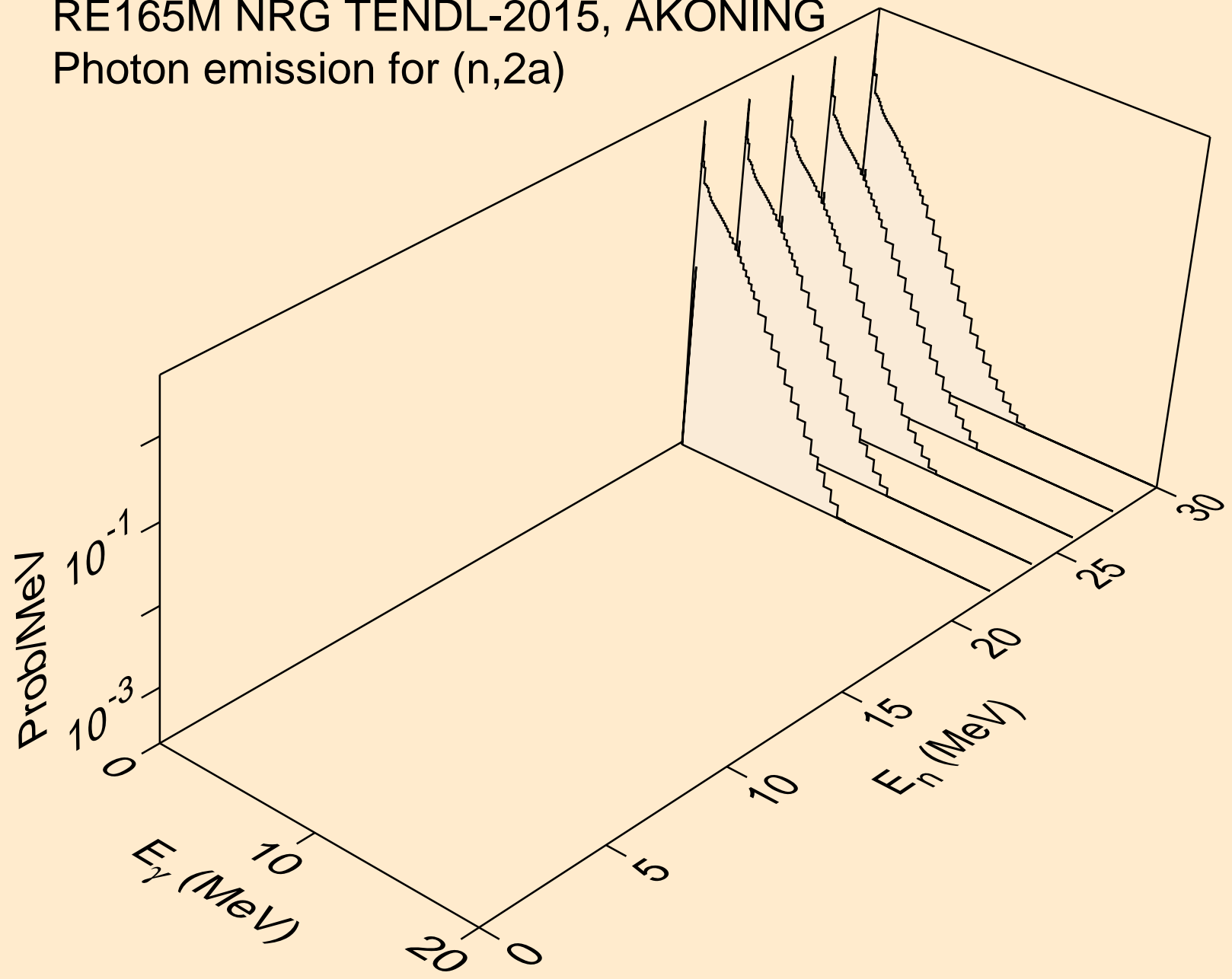

RE165M NRG TENDL-2015, AKONING
Photon emission for (n,3a)

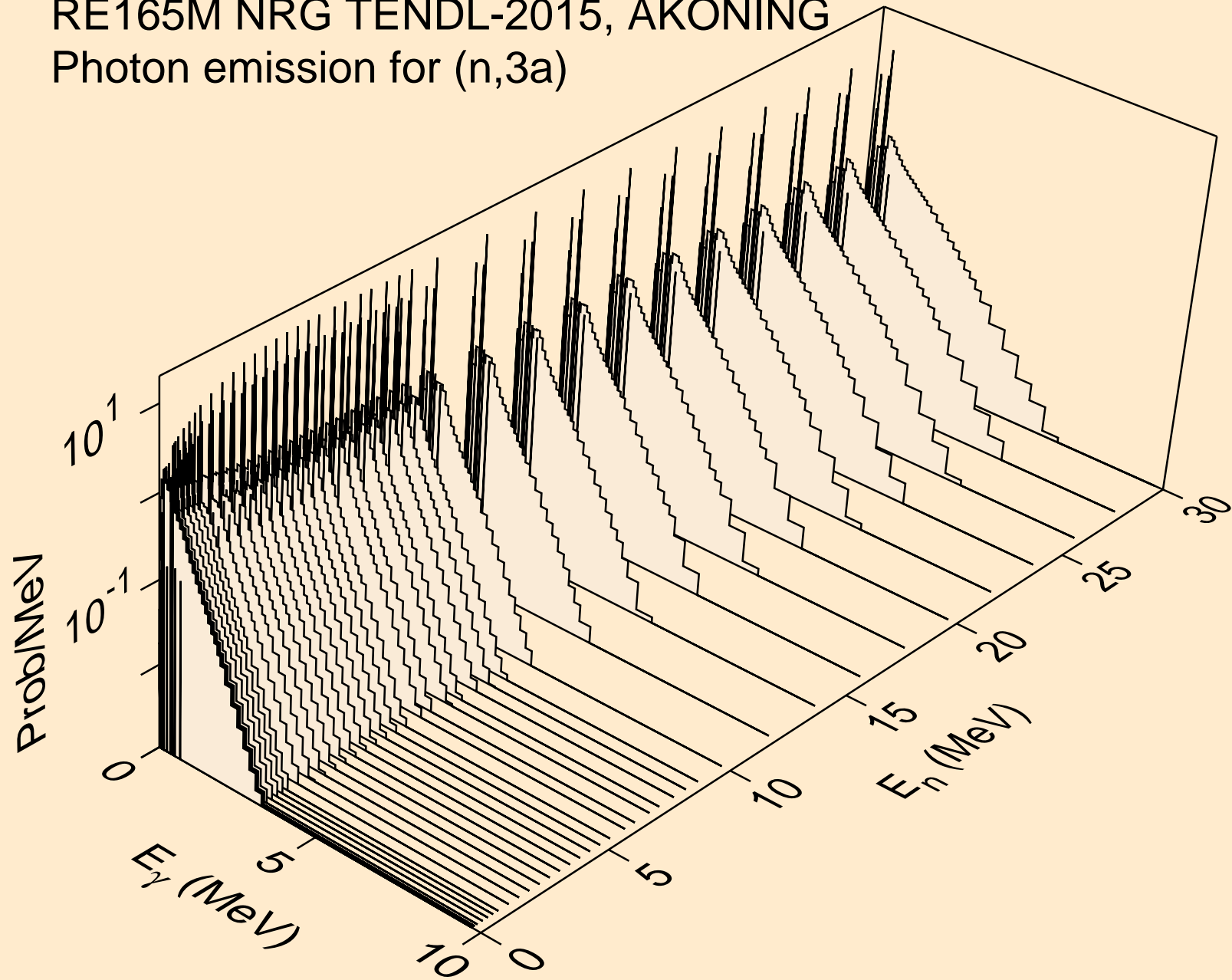

RE165M NRG TENDL-2015, AKONING
Photon emission for (n,2p)

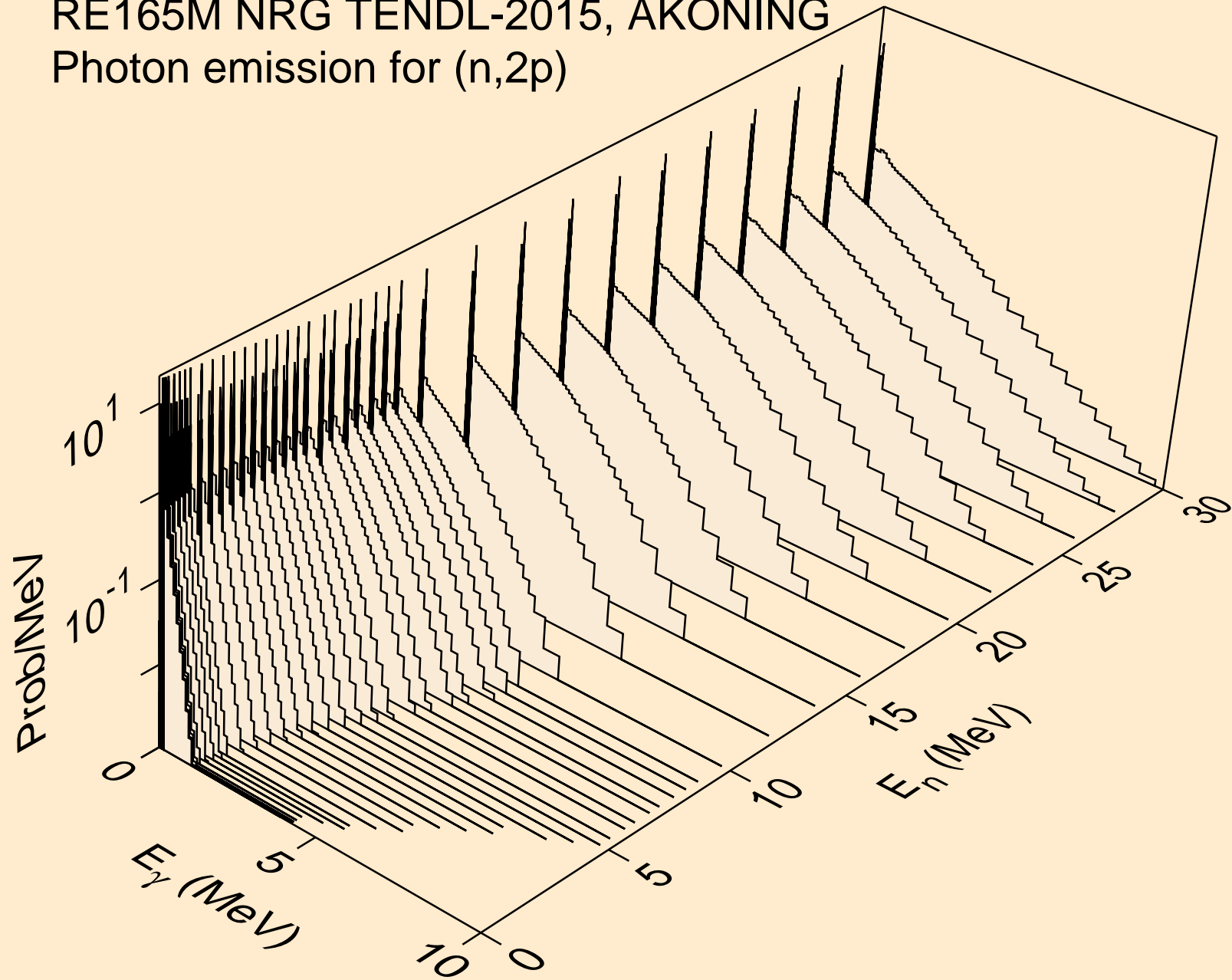

RE165M NRG TENDL-2015, AKONING
Photon emission for (n,pa)

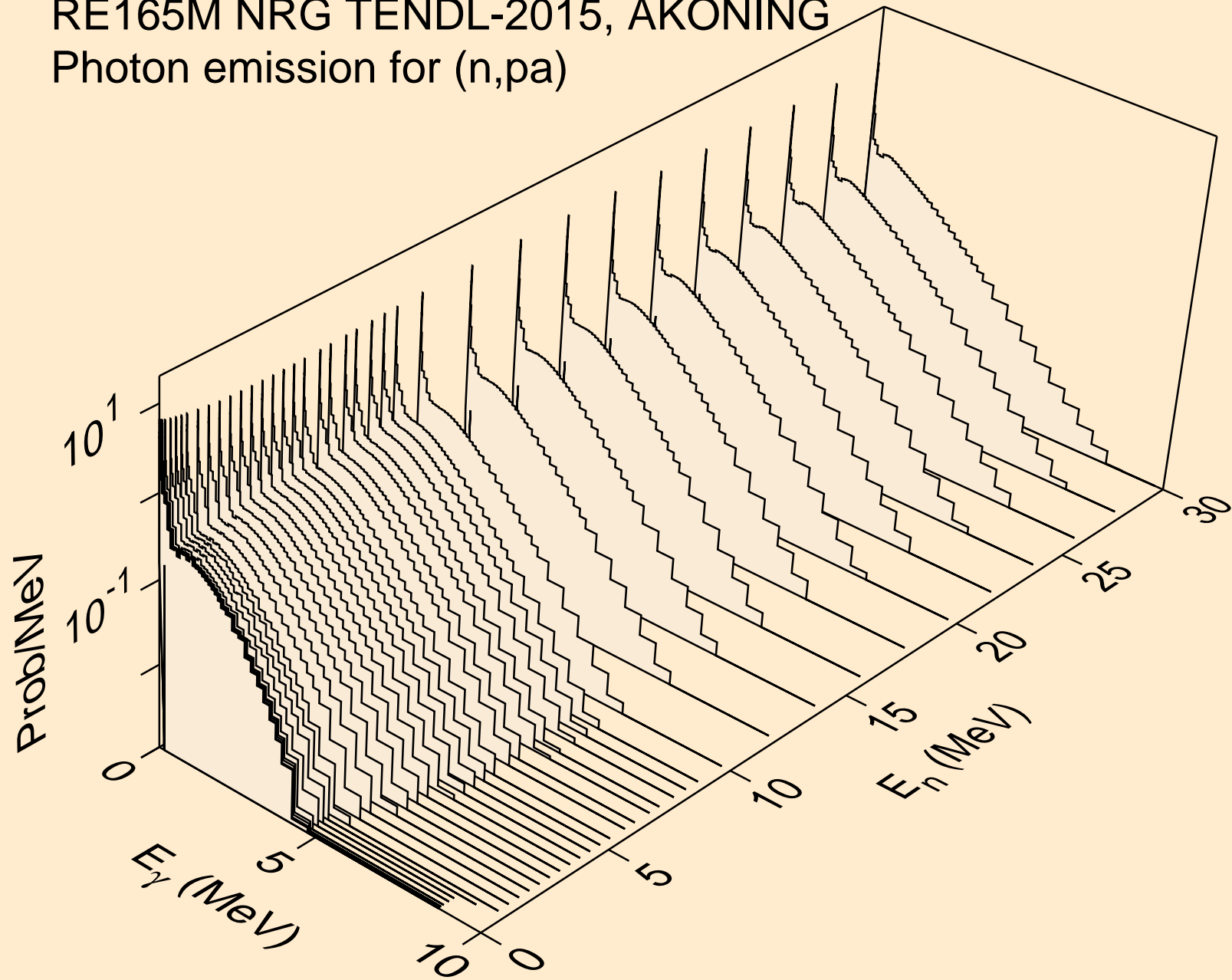

RE165M NRG TENDL-2015, AKONING
Photon emission for (n,t2a)

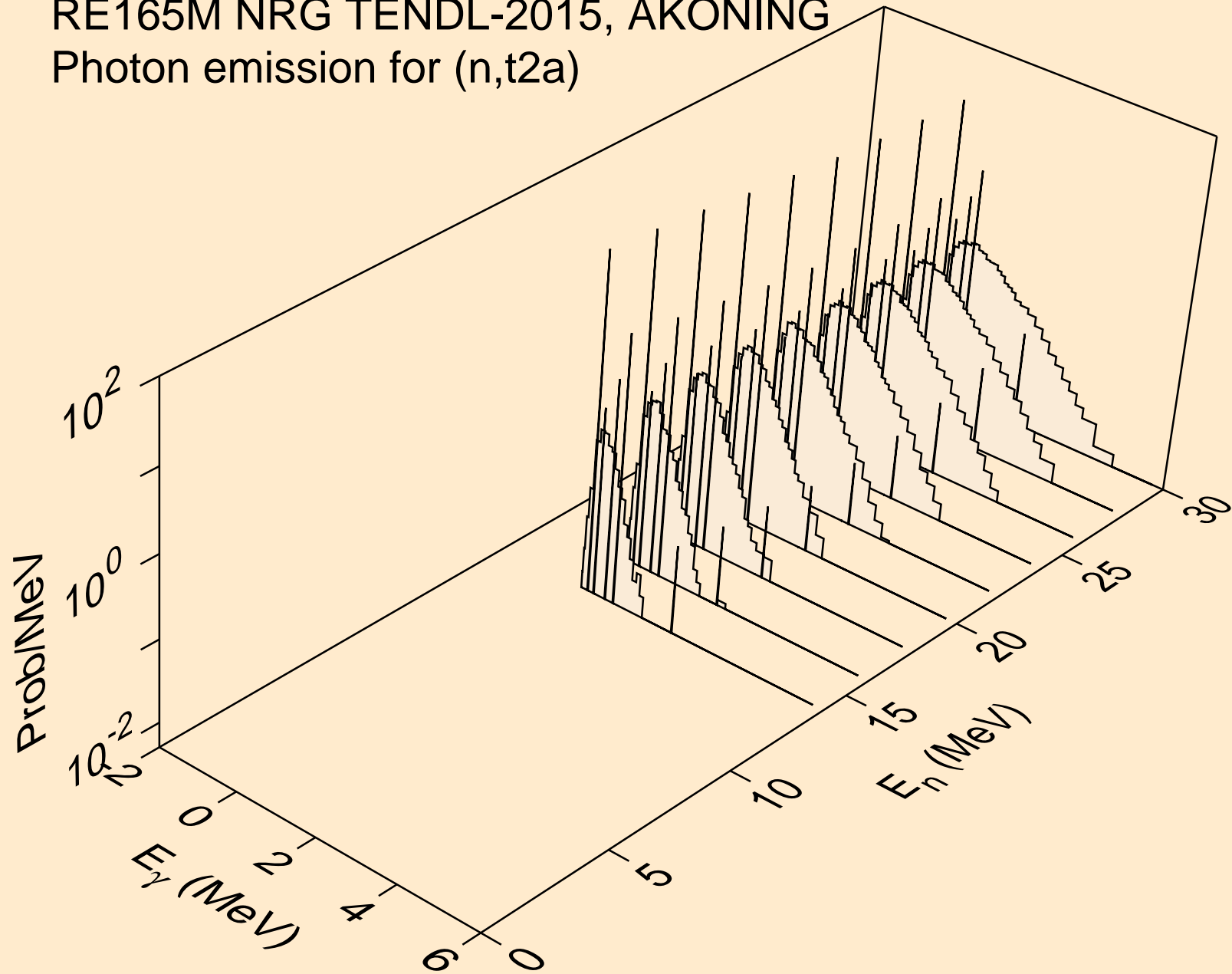

RE165M NRG TENDL-2015, AKONING
Photon emission for (n,d2a)

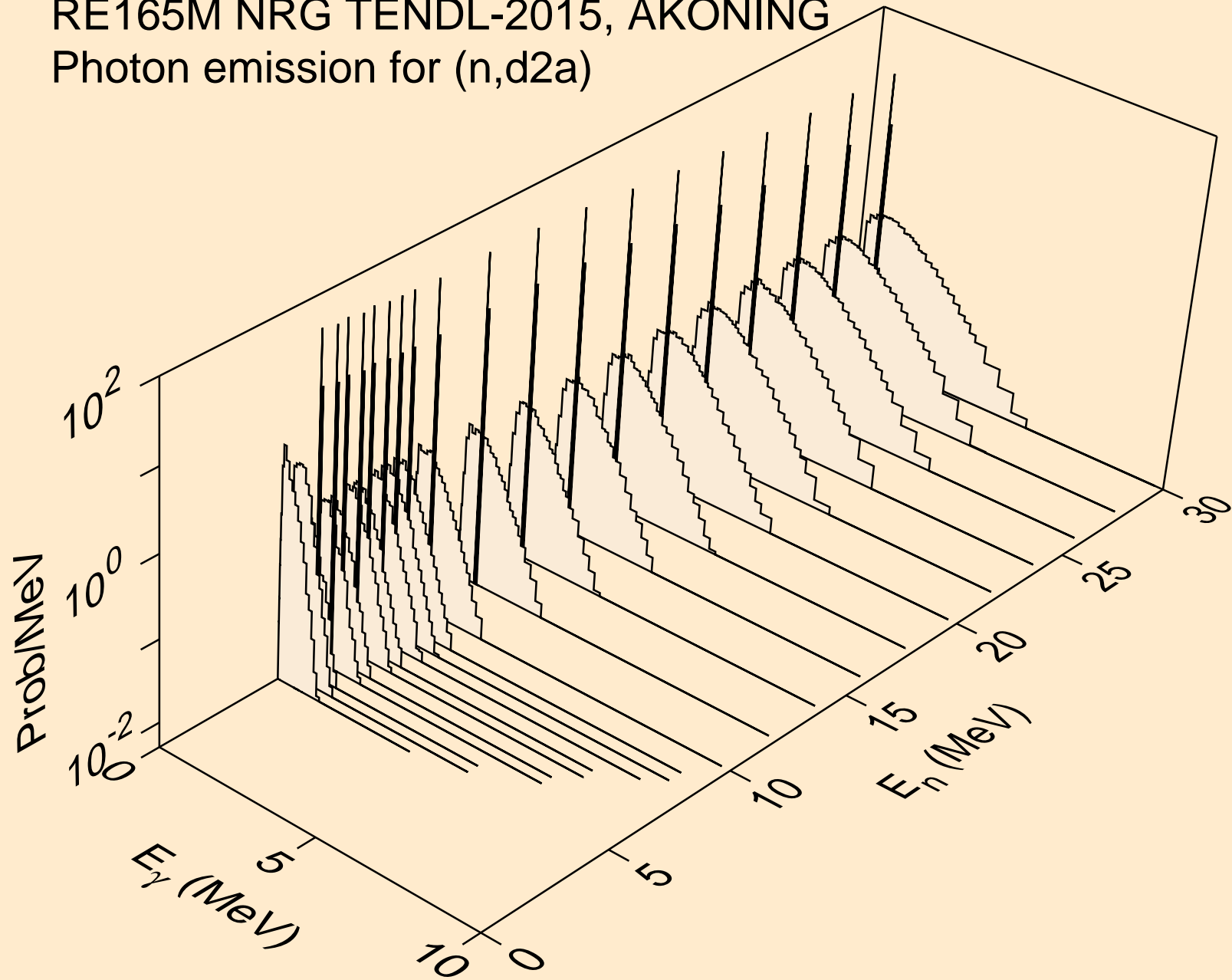

RE165M NRG TENDL-2015, AKONING
Photon emission for (n,pd)

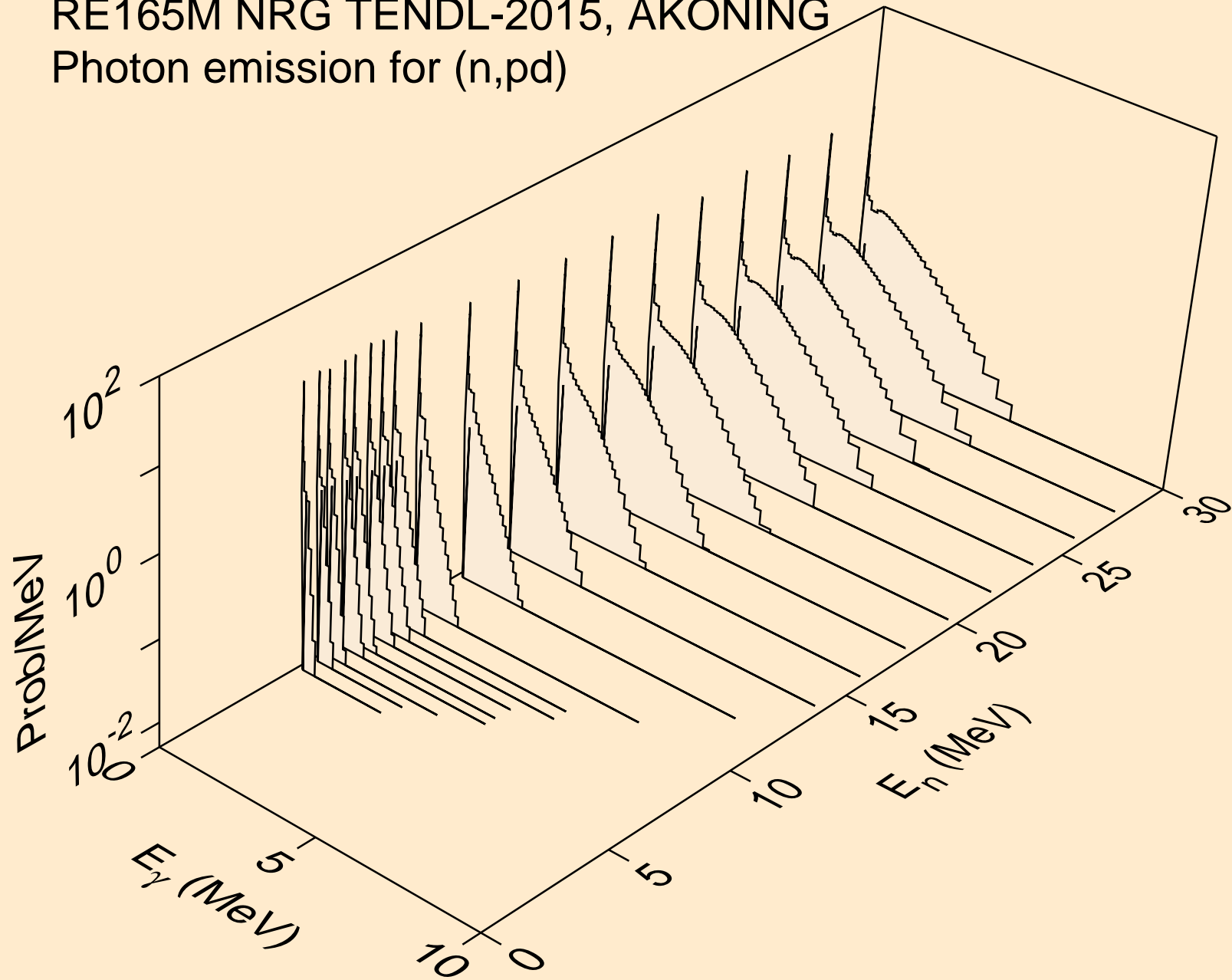

RE165M NRG TENDL-2015, AKONING
Photon emission for (n,pt)

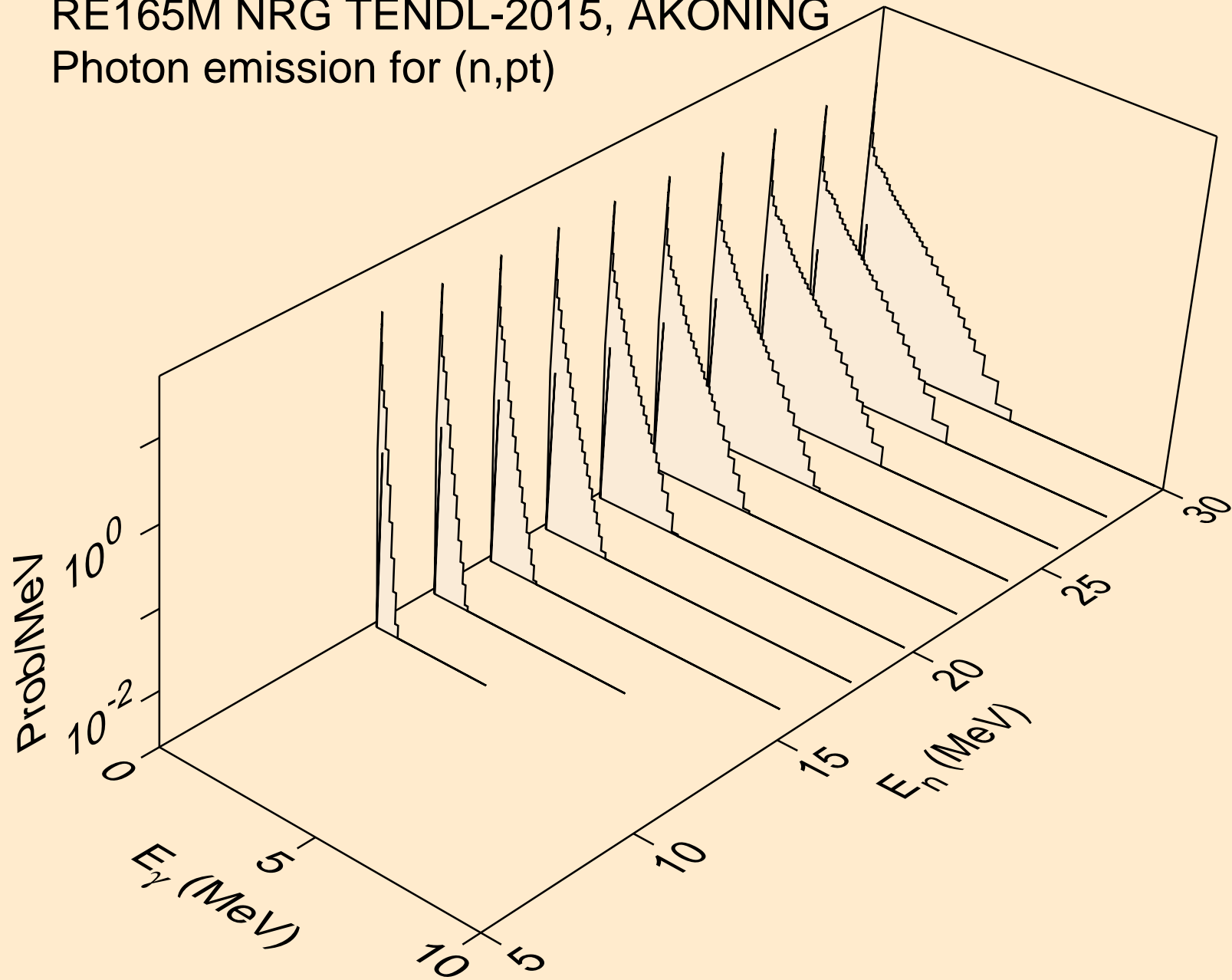

RE165M NRG TENDL-2015, AKONING
Photon emission for (n,da)

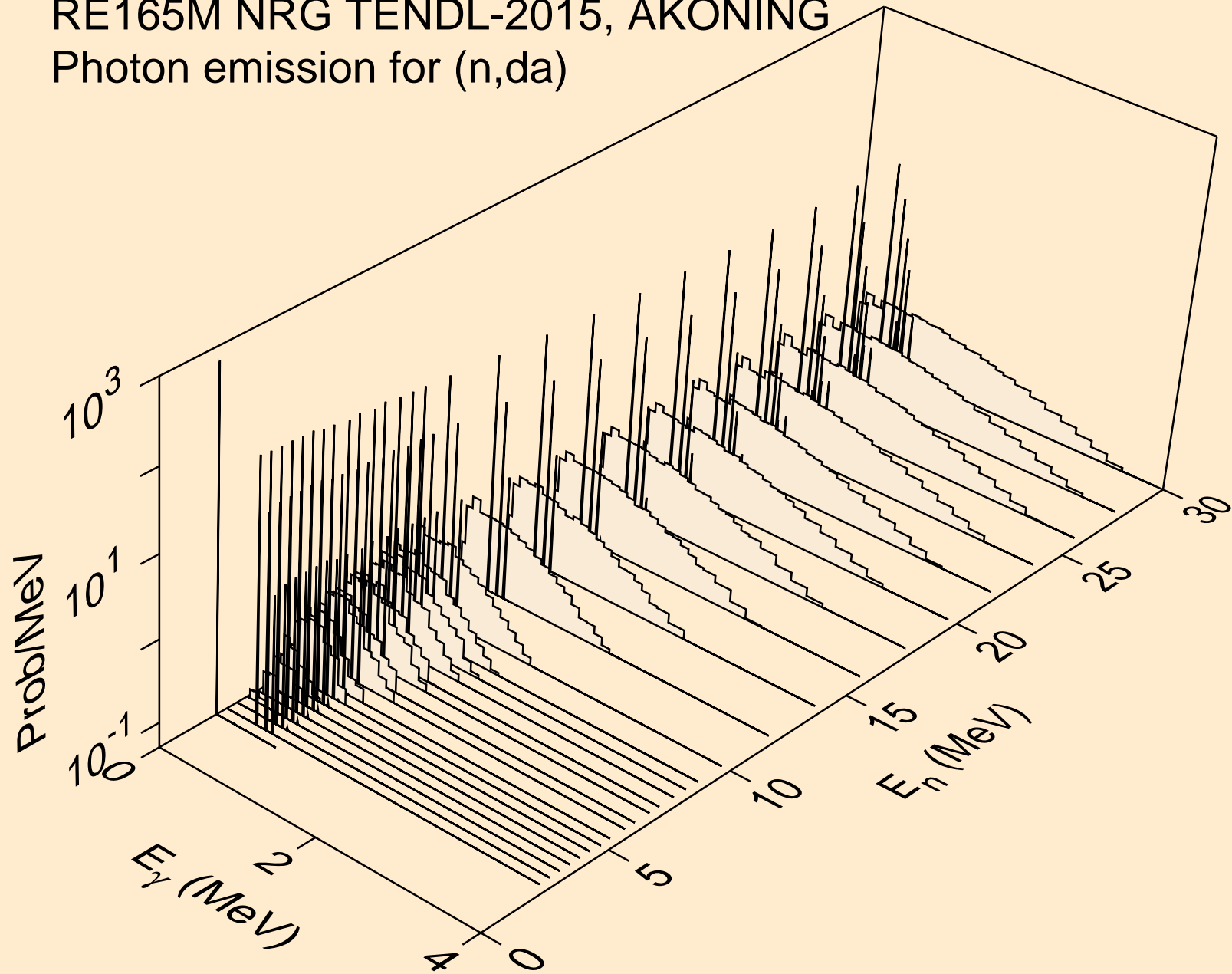

RE165M NRG TENDL-2015, AKONING
thermal capture photon spectrum

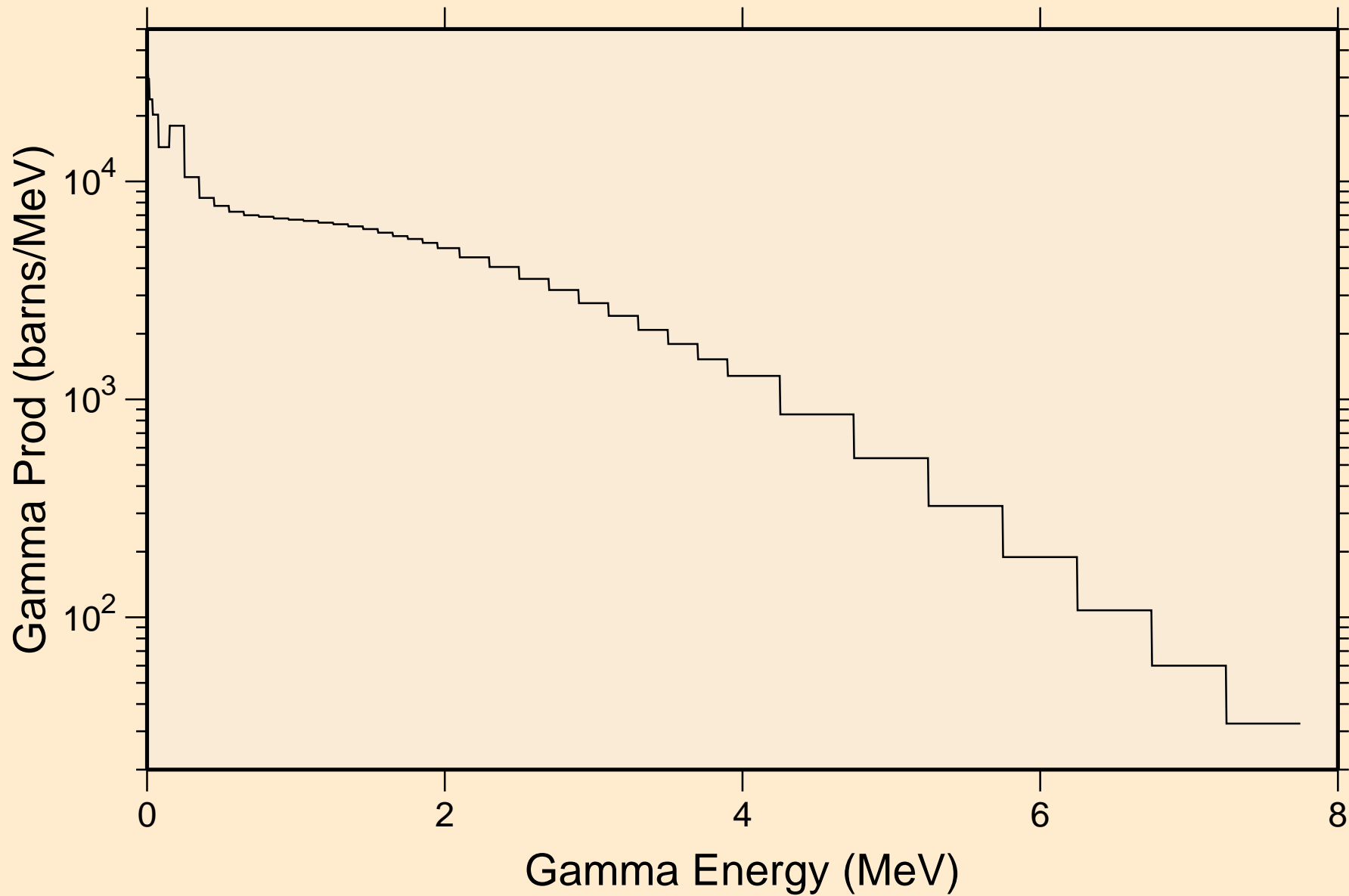

RE165M NRG TENDL-2015, AKONING
14 MeV photon spectrum

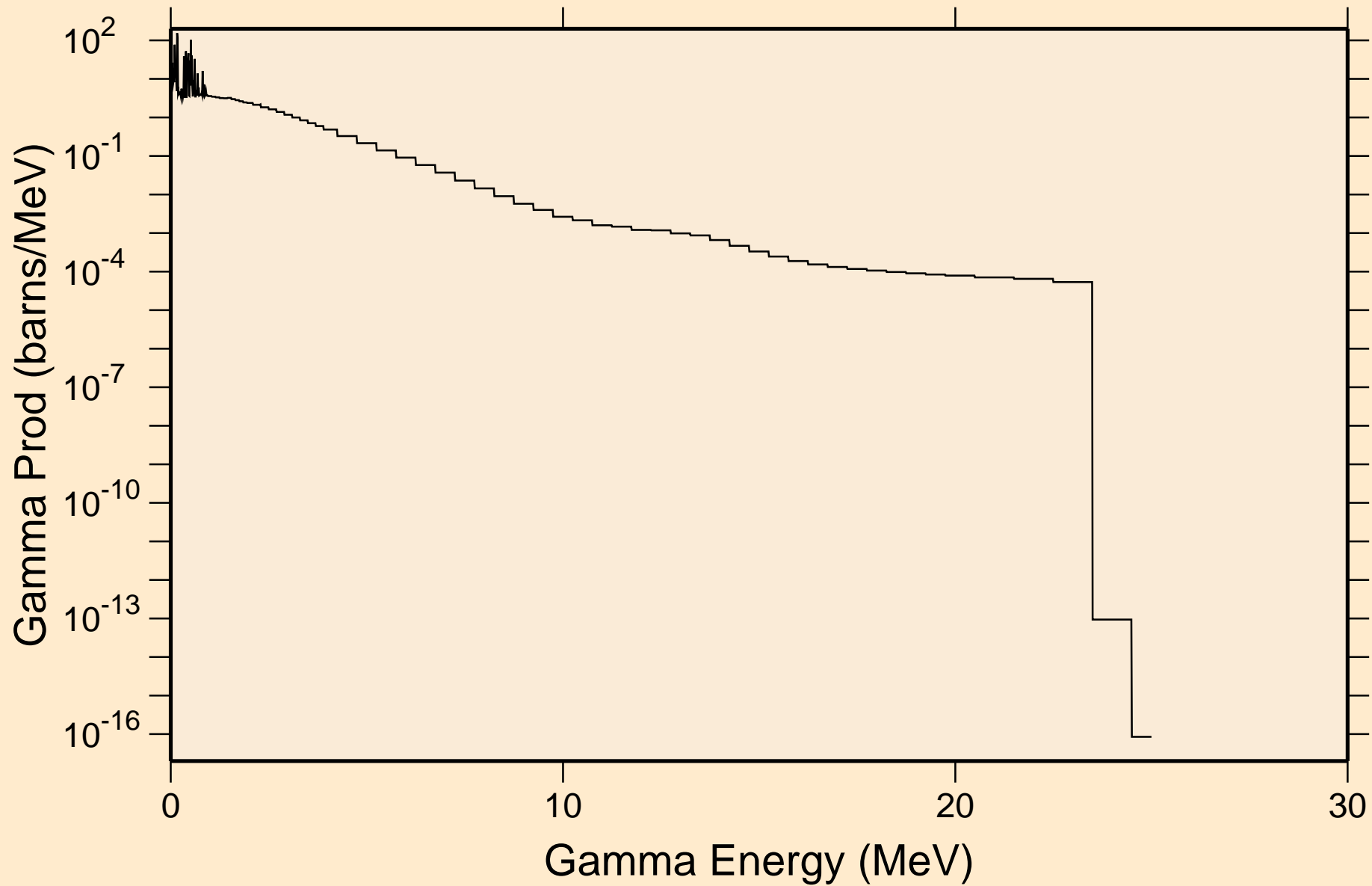

RE165M NRG TENDL-2015, AKONING

Particle heating contributions

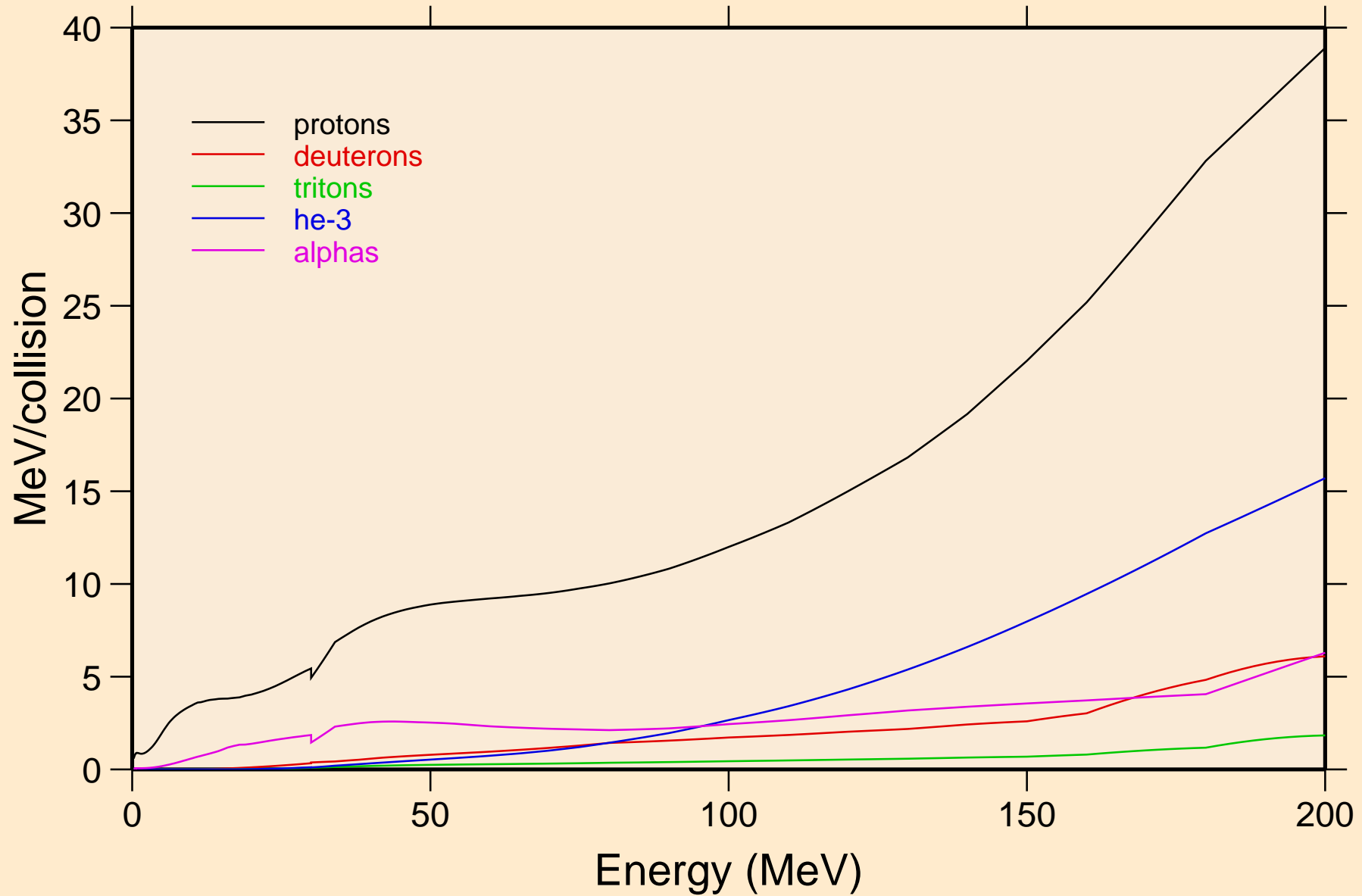

RE165M NRG TENDL-2015, AKONING

Recoil Heating

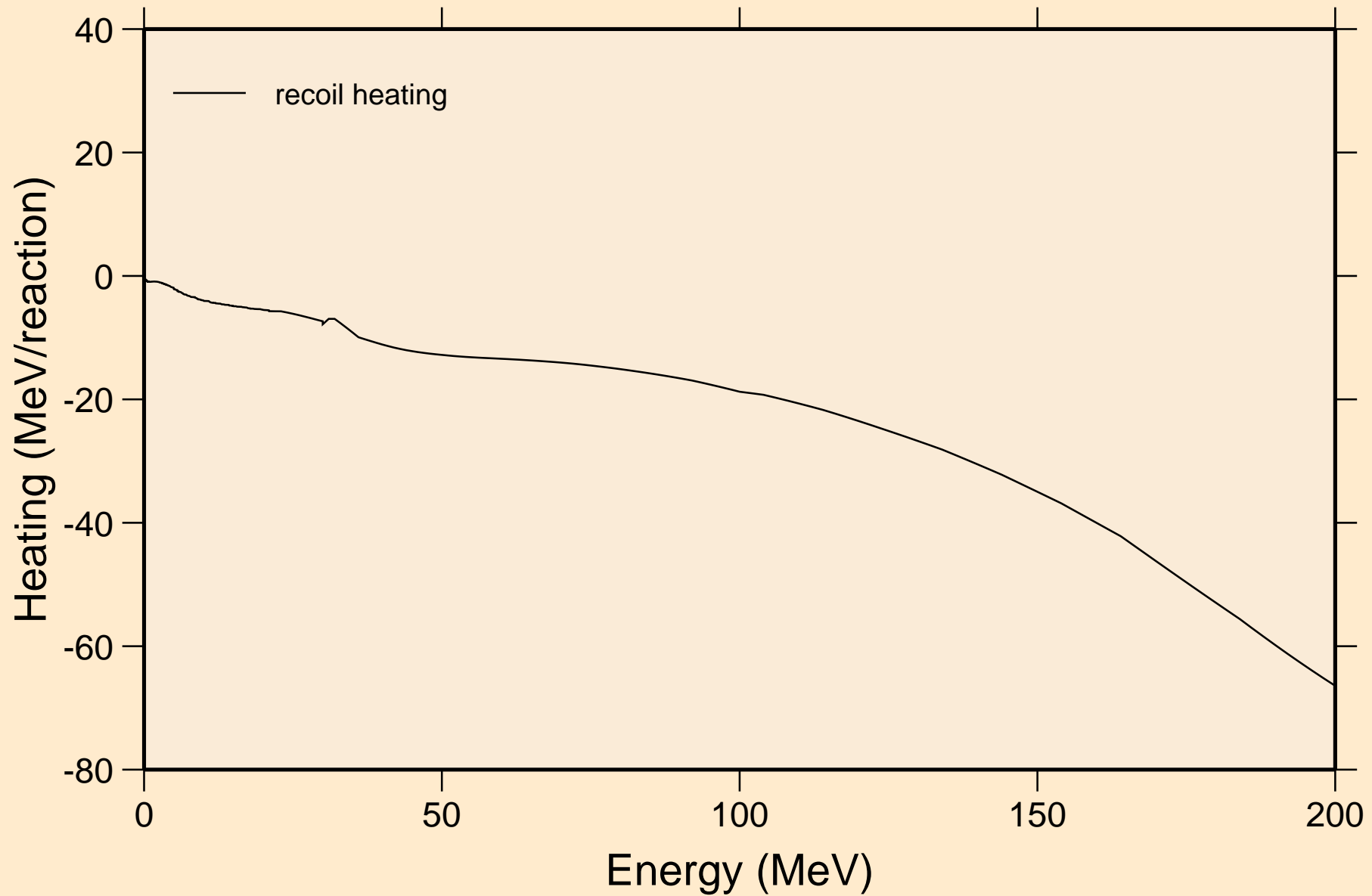

RE165M NRG TENDL-2015, AKONING

Particle production cross sections

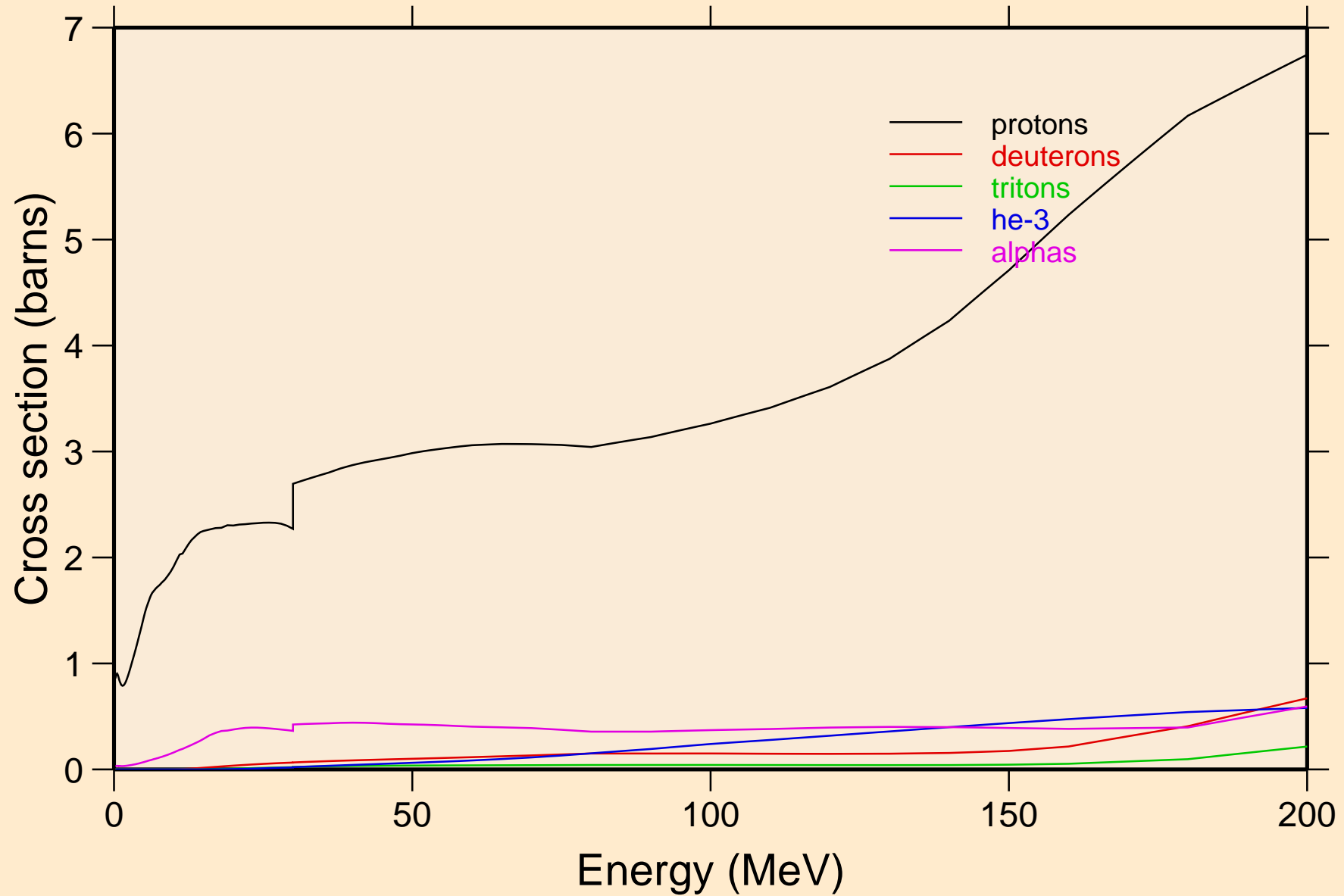

RE165M NRG TENDL-2015, AKONING
protons from (n,x)

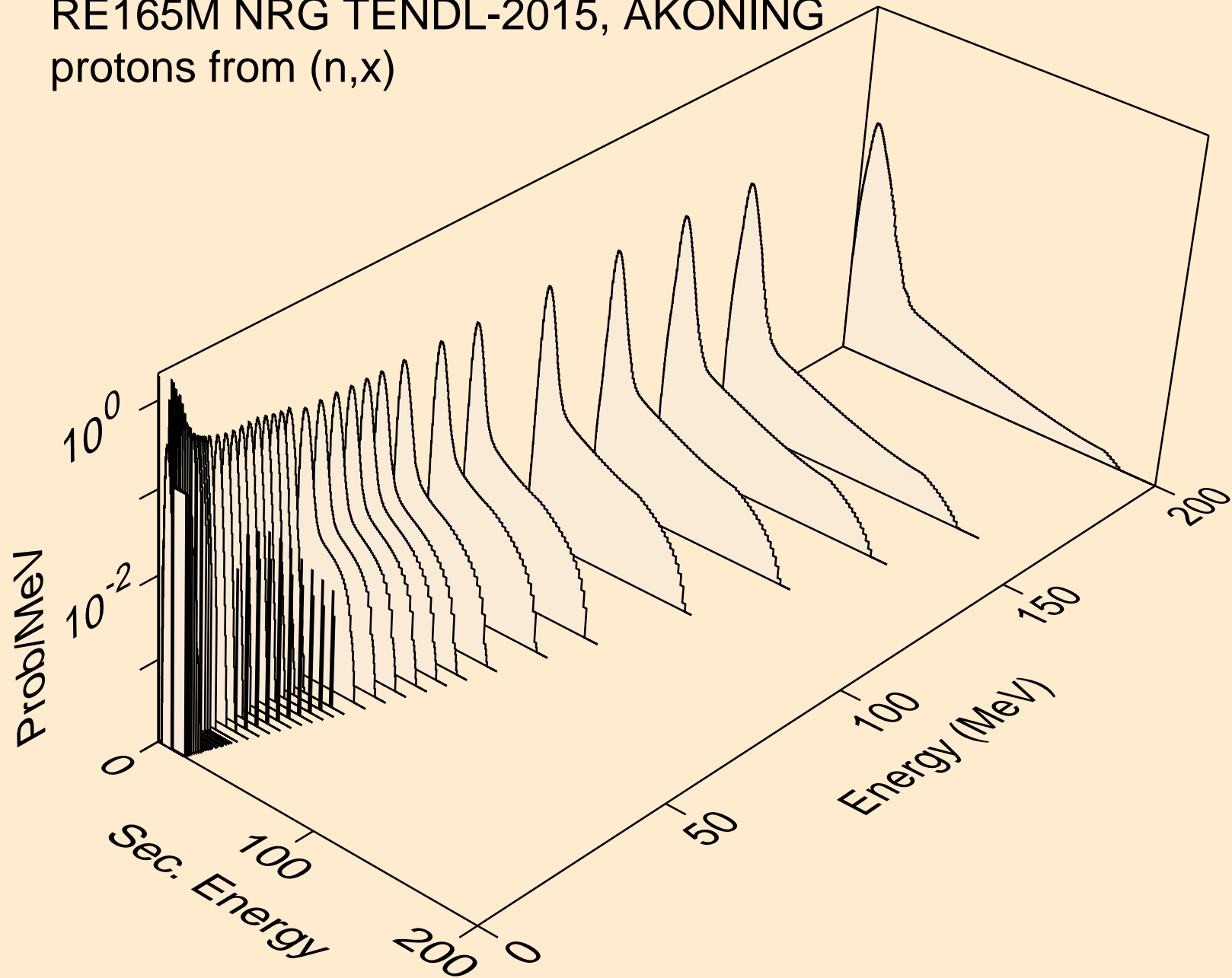

RE165M NRG TENDL-2015, AKONING
protons from (n,n*)p

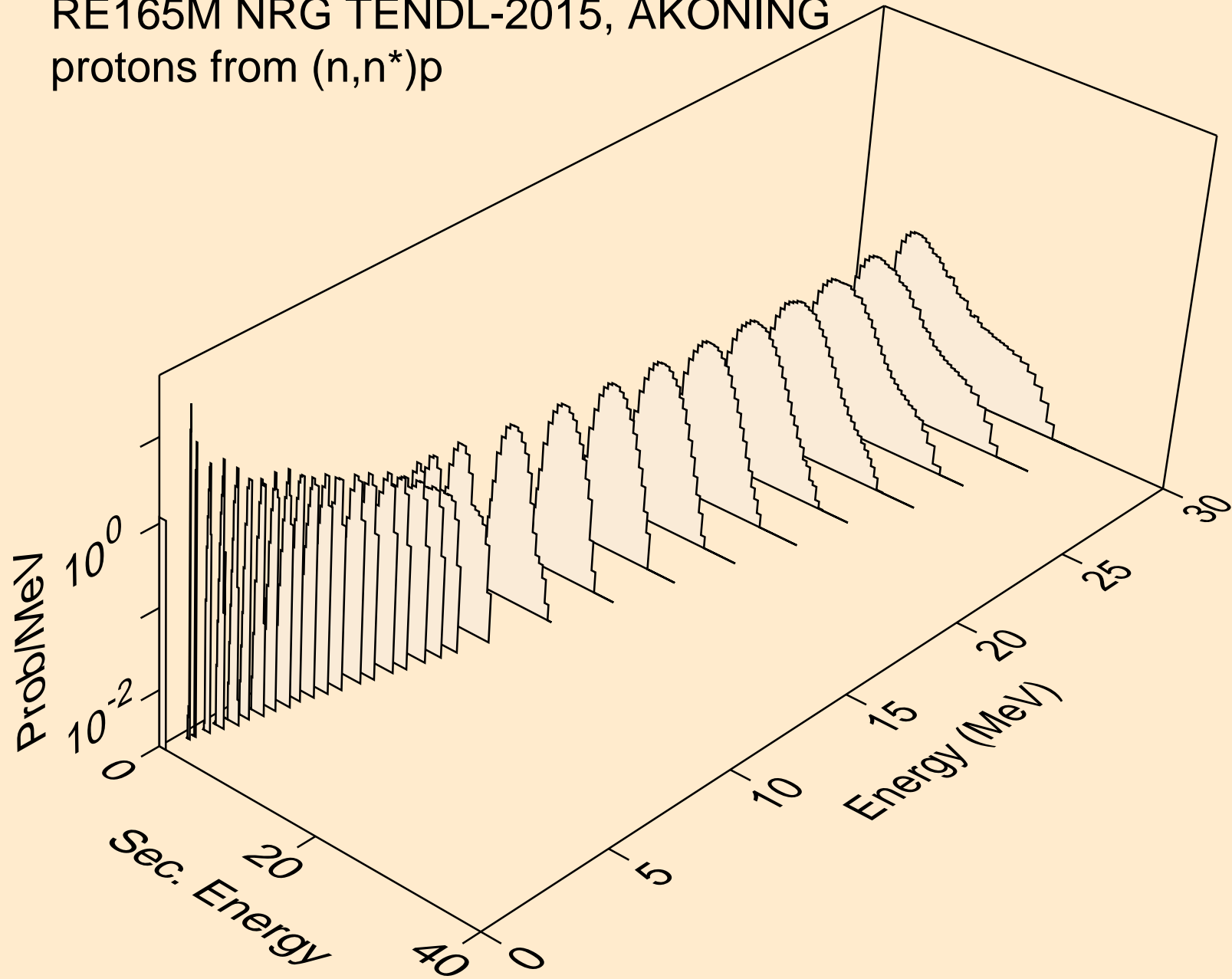

RE165M NRG TENDL-2015, AKONING
protons from (n,2np)

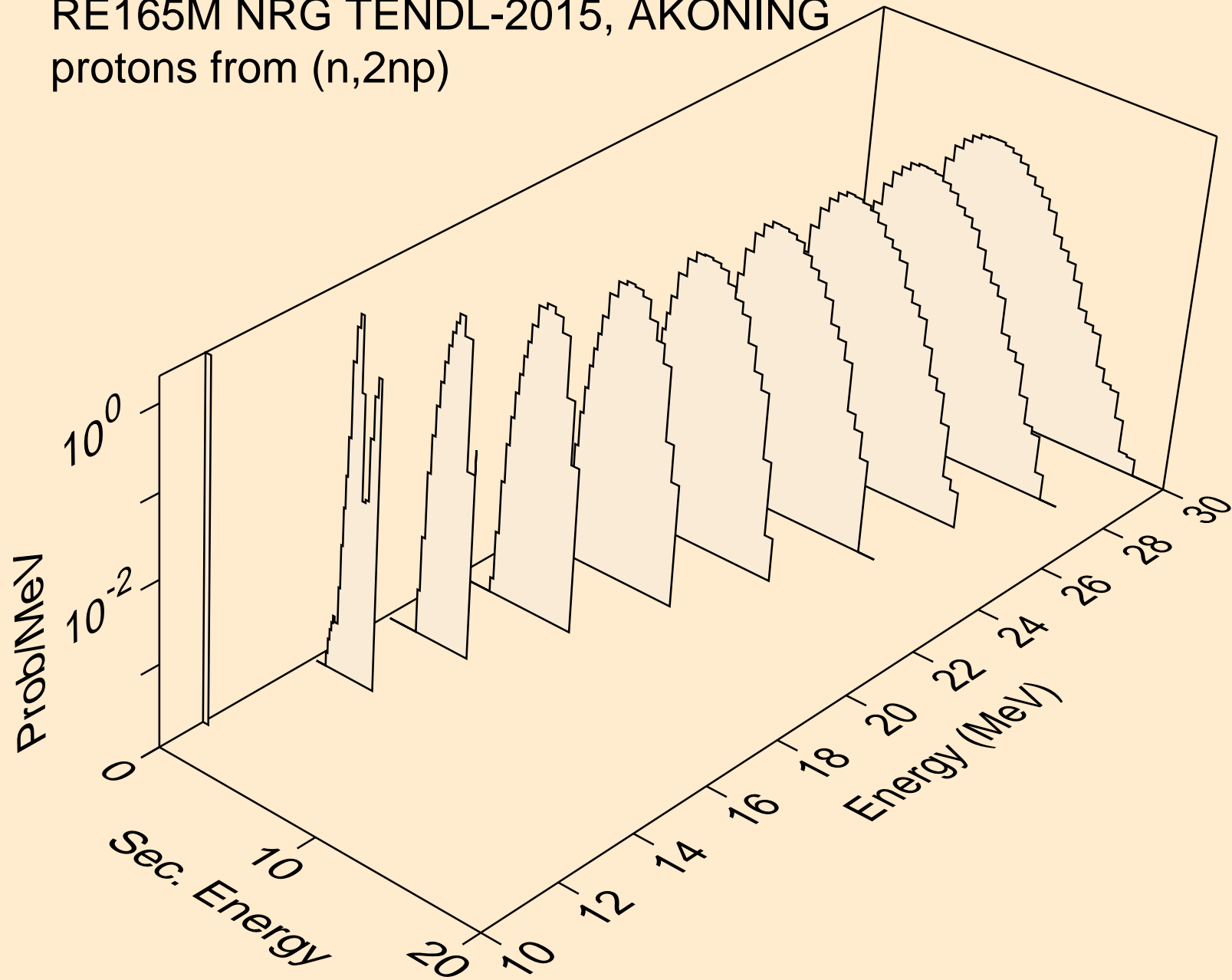

RE165M NRG TENDL-2015, AKONING
protons from (n,3np)

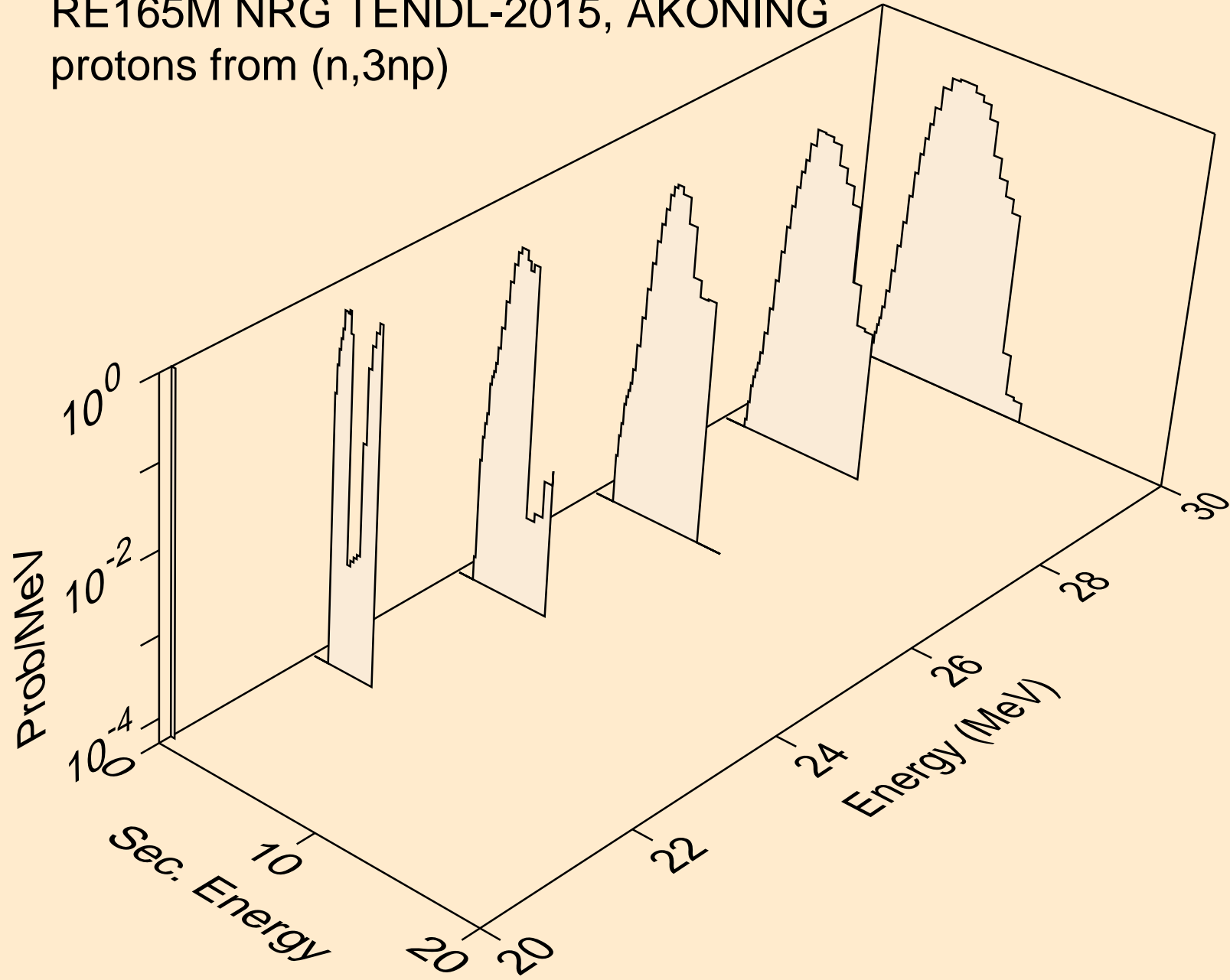

RE165M NRG TENDL-2015, AKONING
protons from (n,2np)

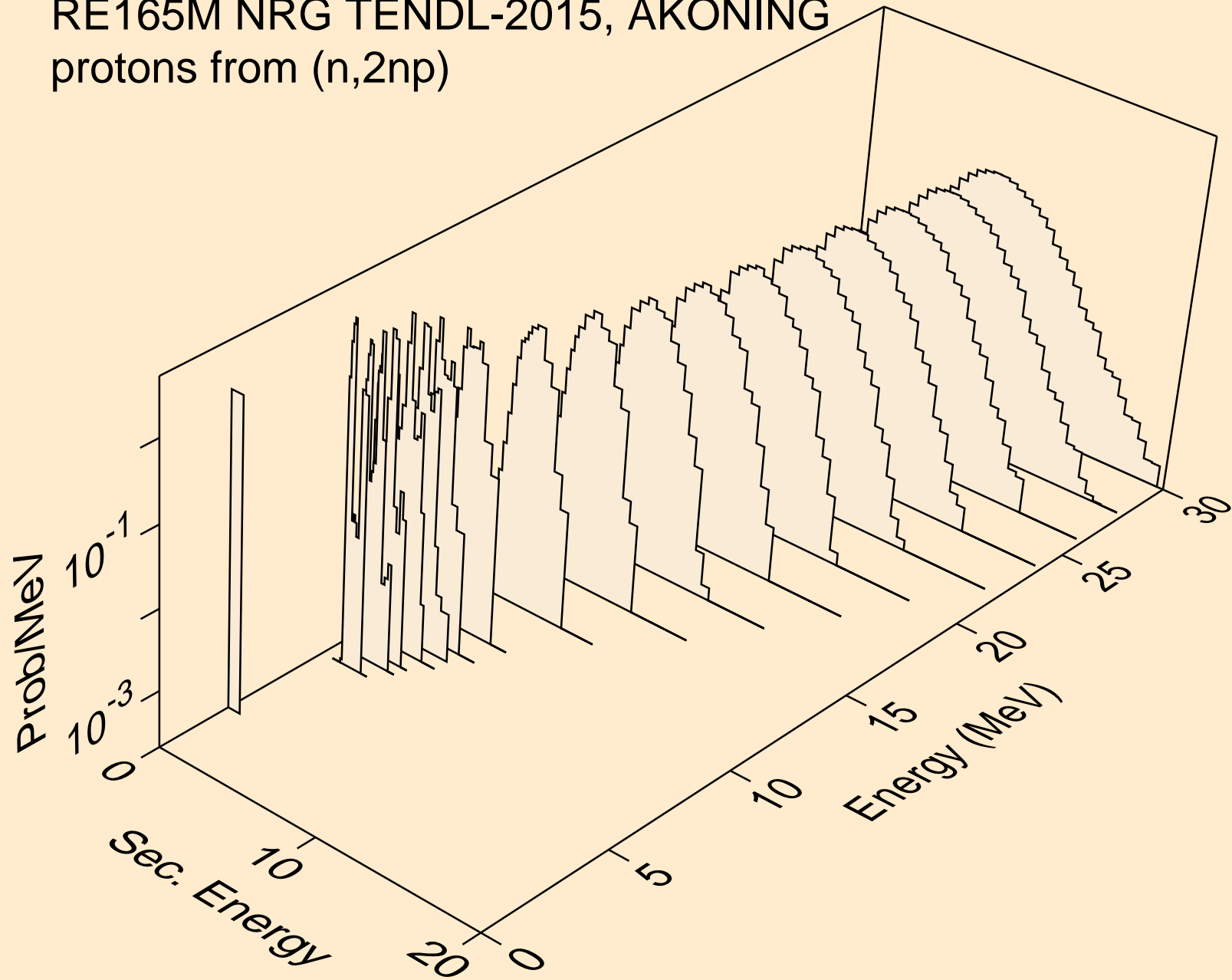

RE165M NRG TENDL-2015, AKONING
protons from (n,npa)

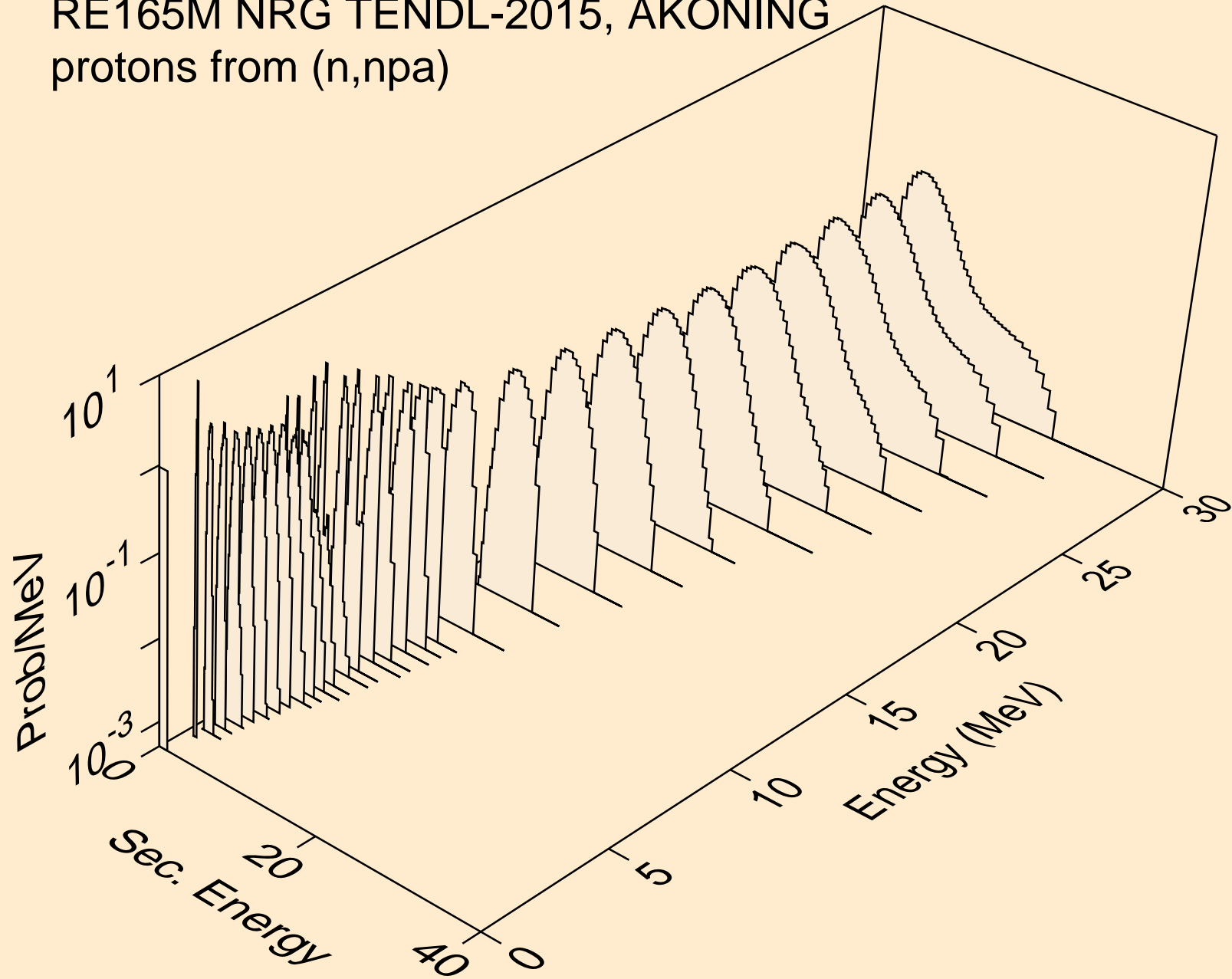

RE165M NRG TENDL-2015, AKONING
protons from (n,p)

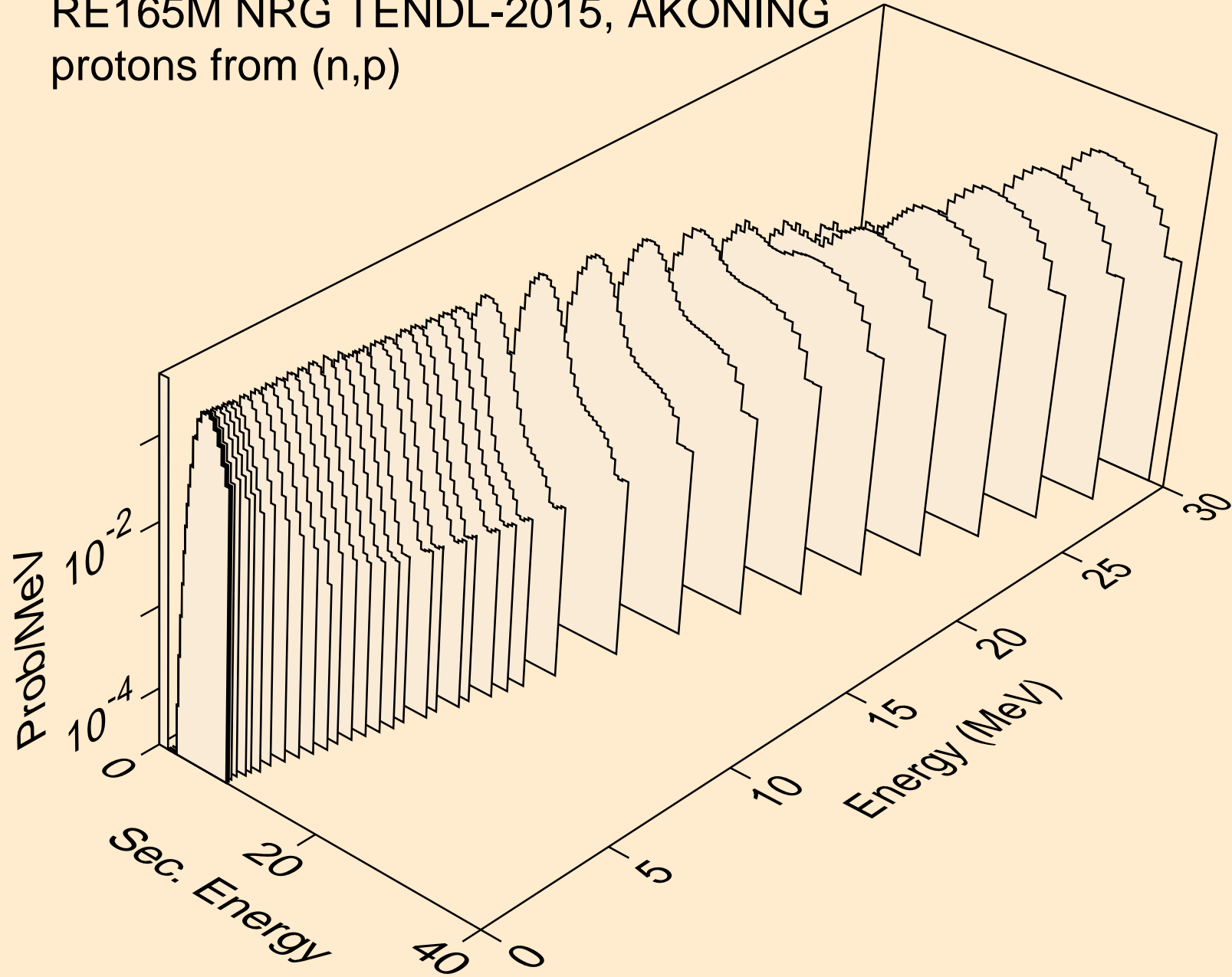

RE165M NRG TENDL-2015, AKONING
protons from (n,2p)

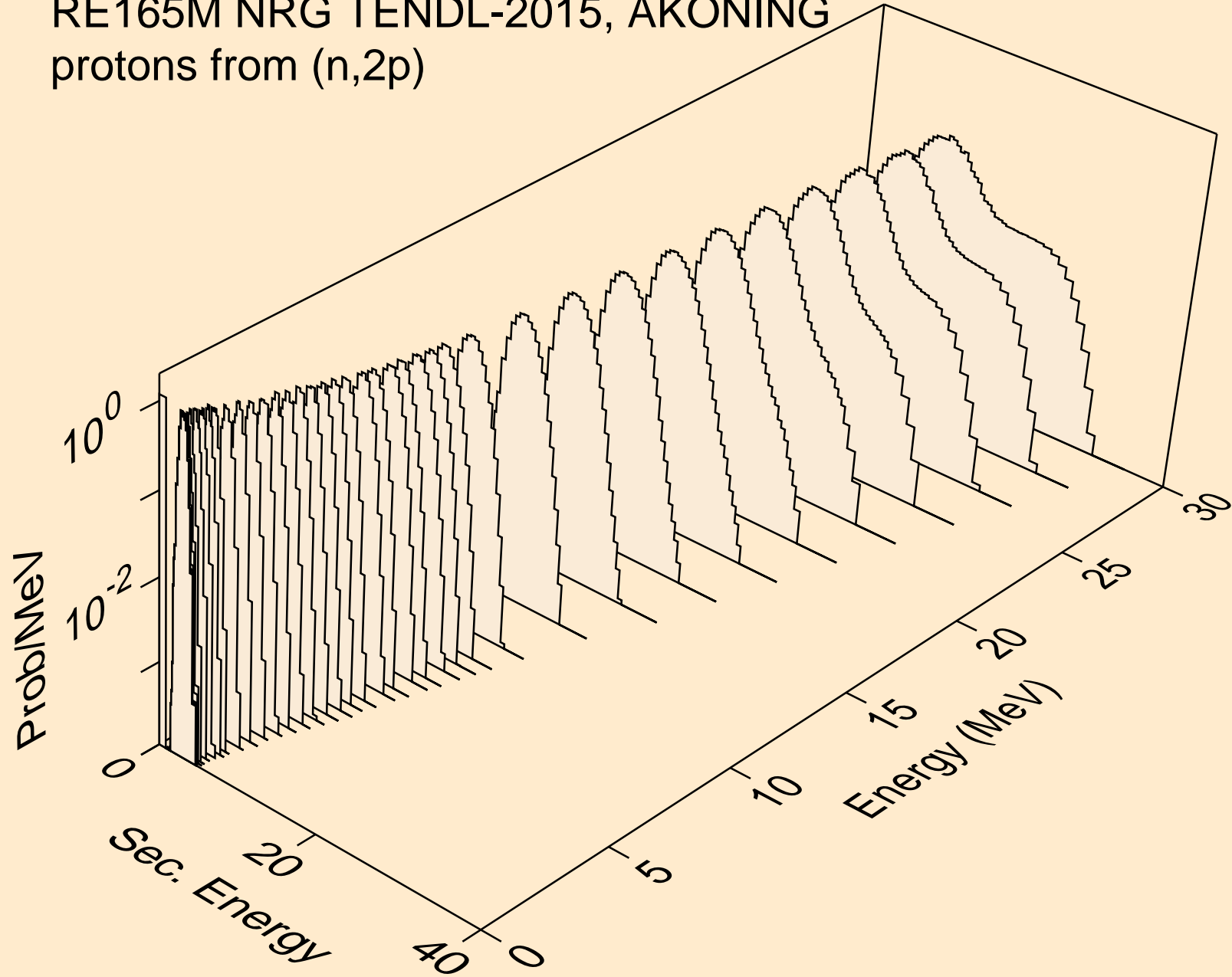

RE165M NRG TENDL-2015, AKONING
protons from (n,pa)

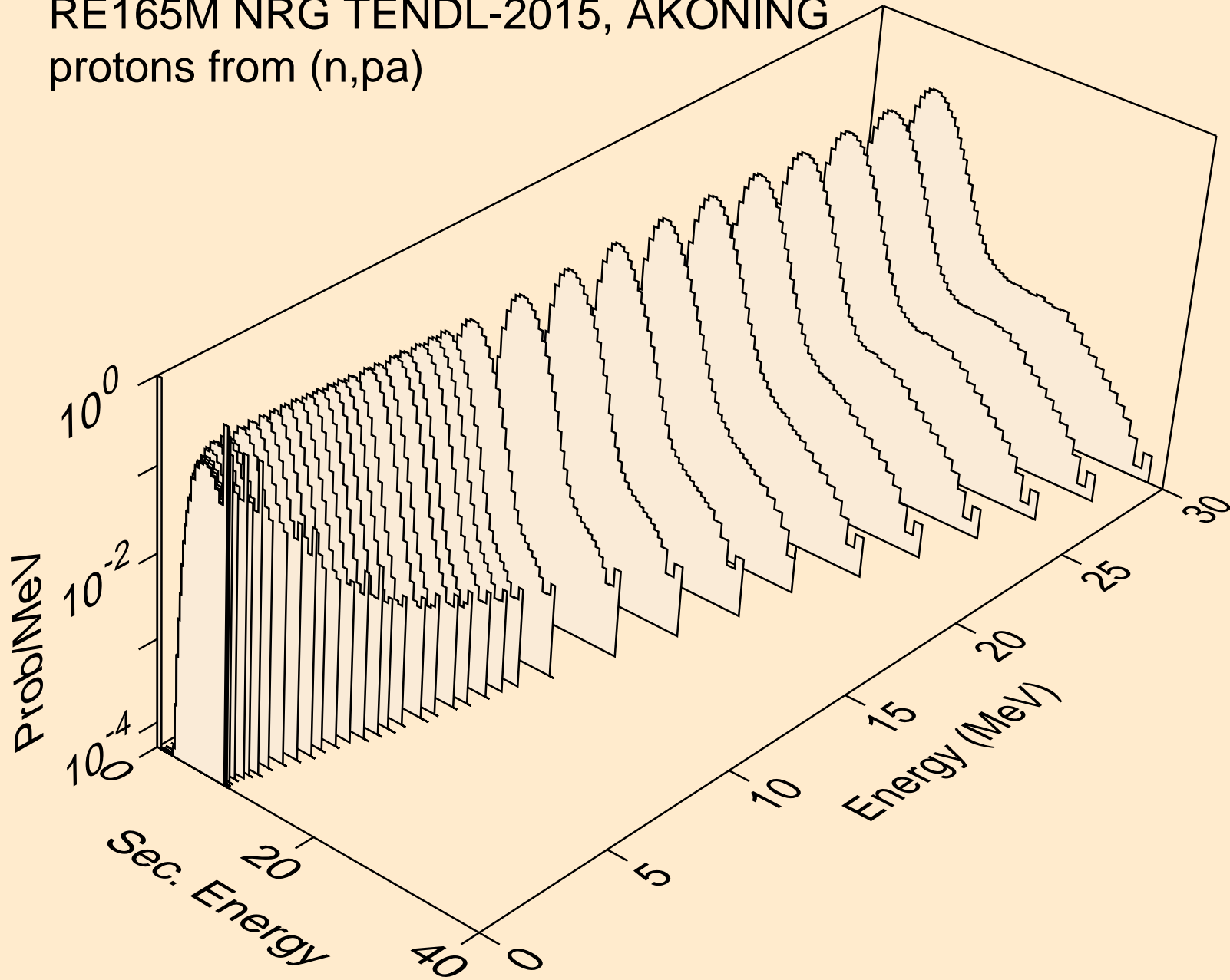

RE165M NRG TENDL-2015, AKONING
protons from (n,pd)

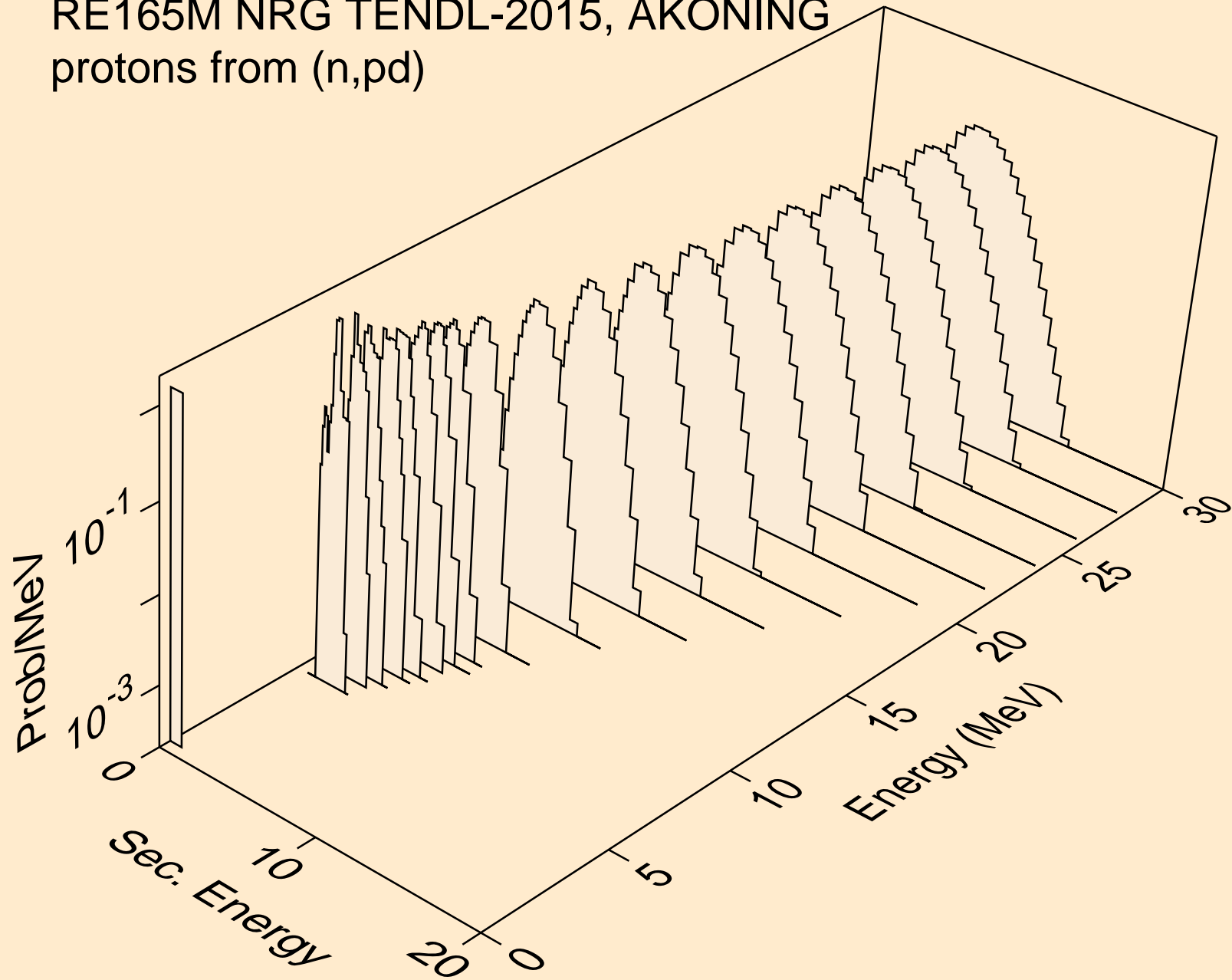

RE165M NRG TENDL-2015, AKONING
protons from (n,pt)

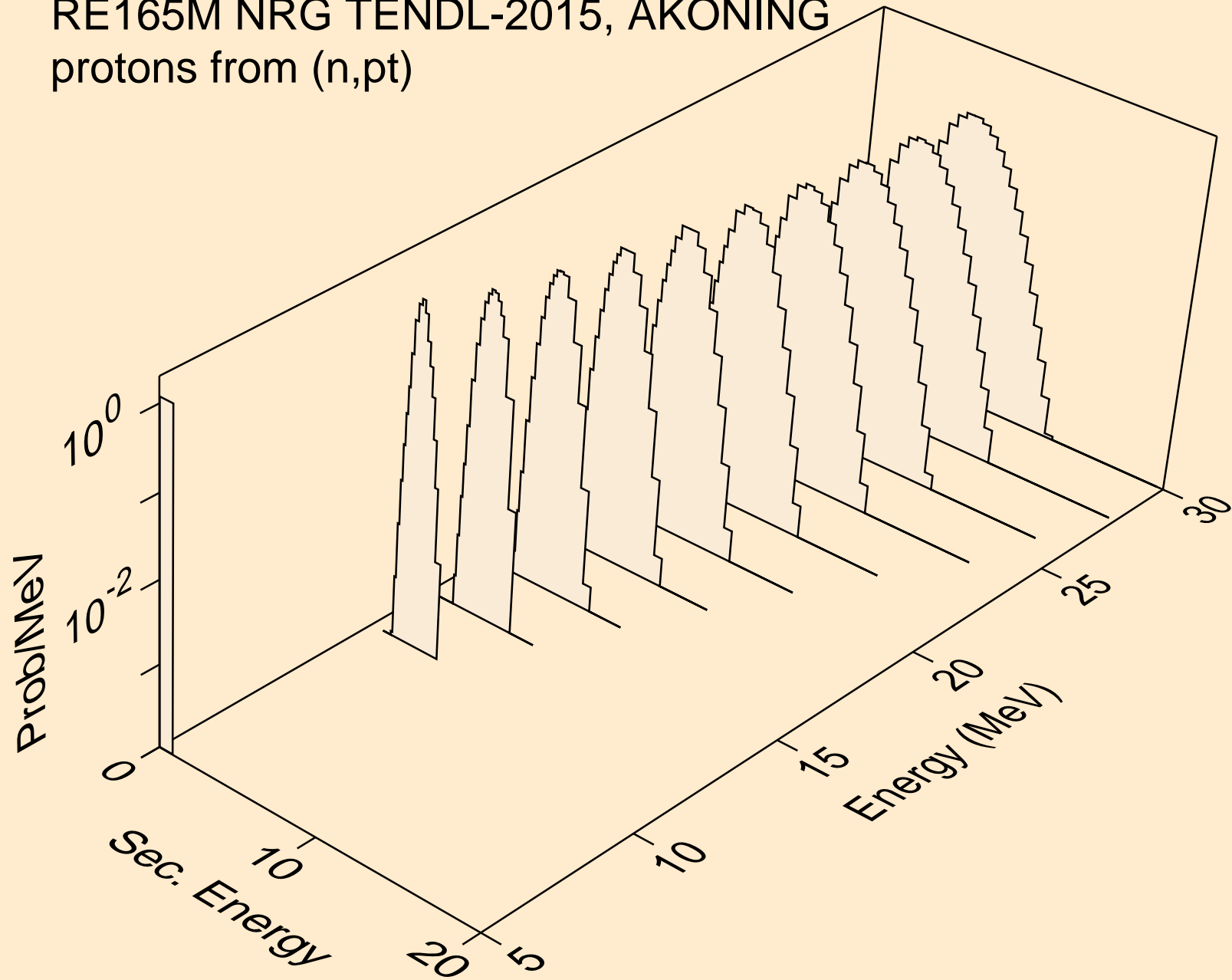

RE165M NRG TENDL-2015, AKONING
deuterons from (n,x)

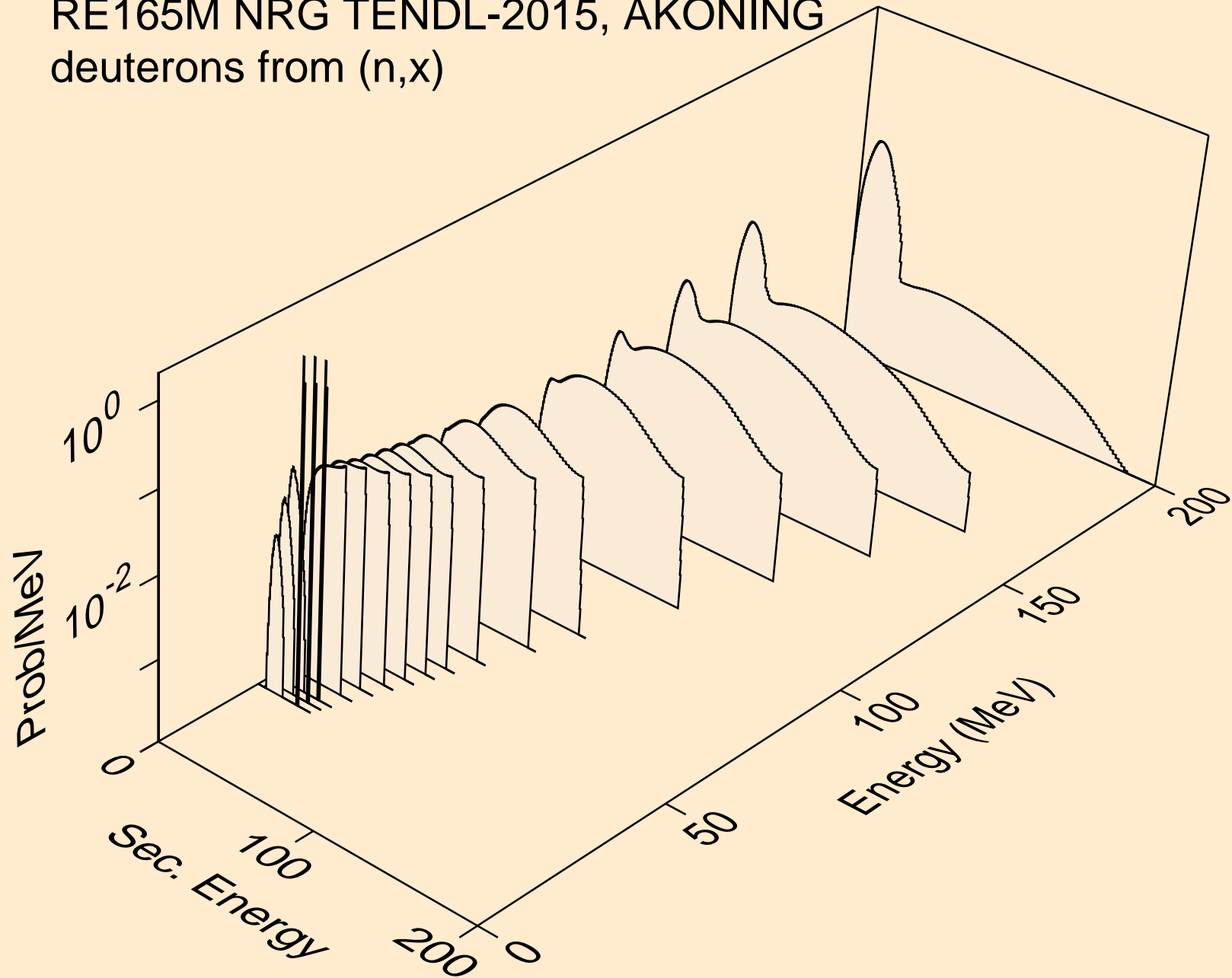

RE165M NRG TENDL-2015, AKONING
deuterons from (n,2nd)

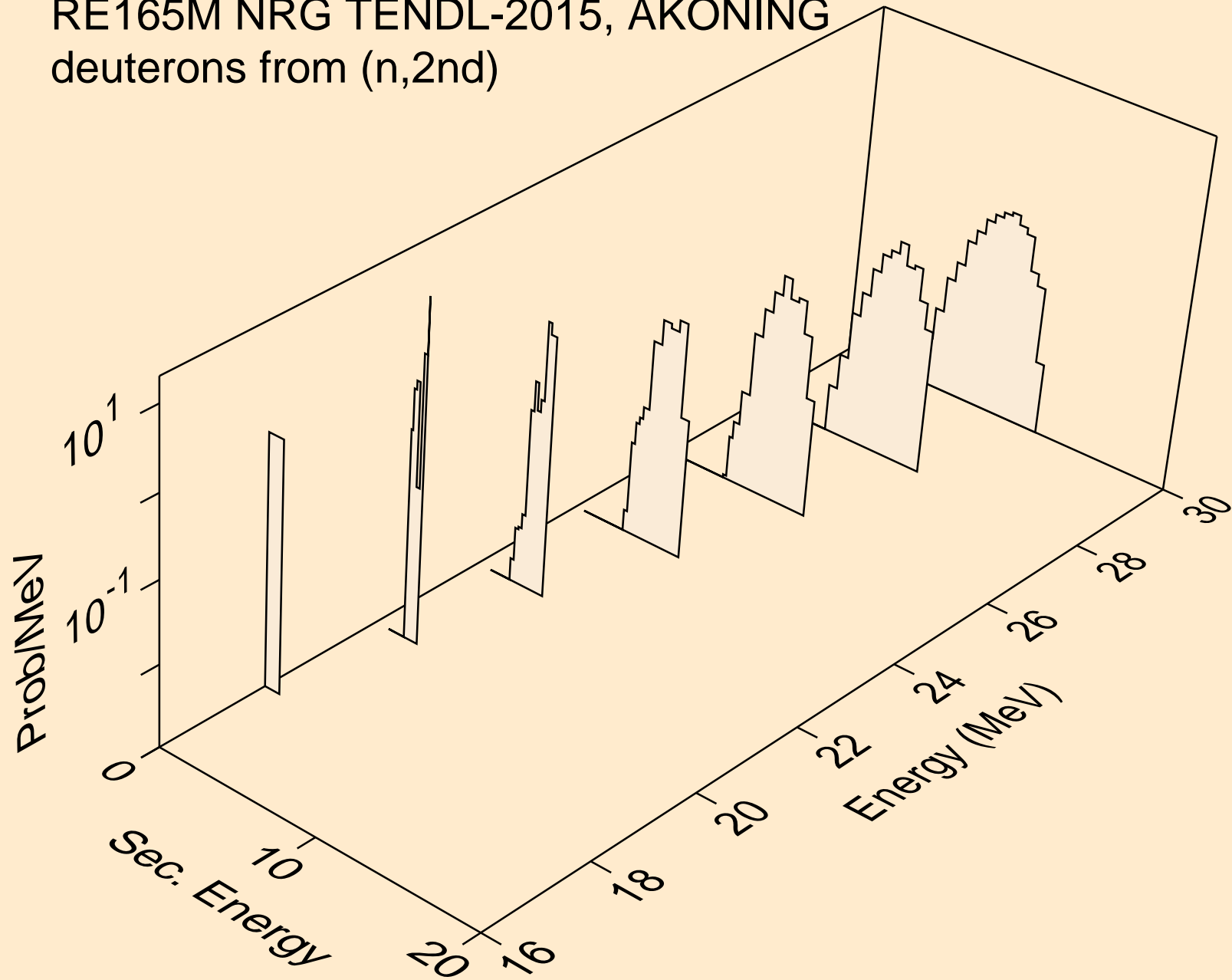

RE165M NRG TENDL-2015, AKONING
deuterons from (n,n*)d

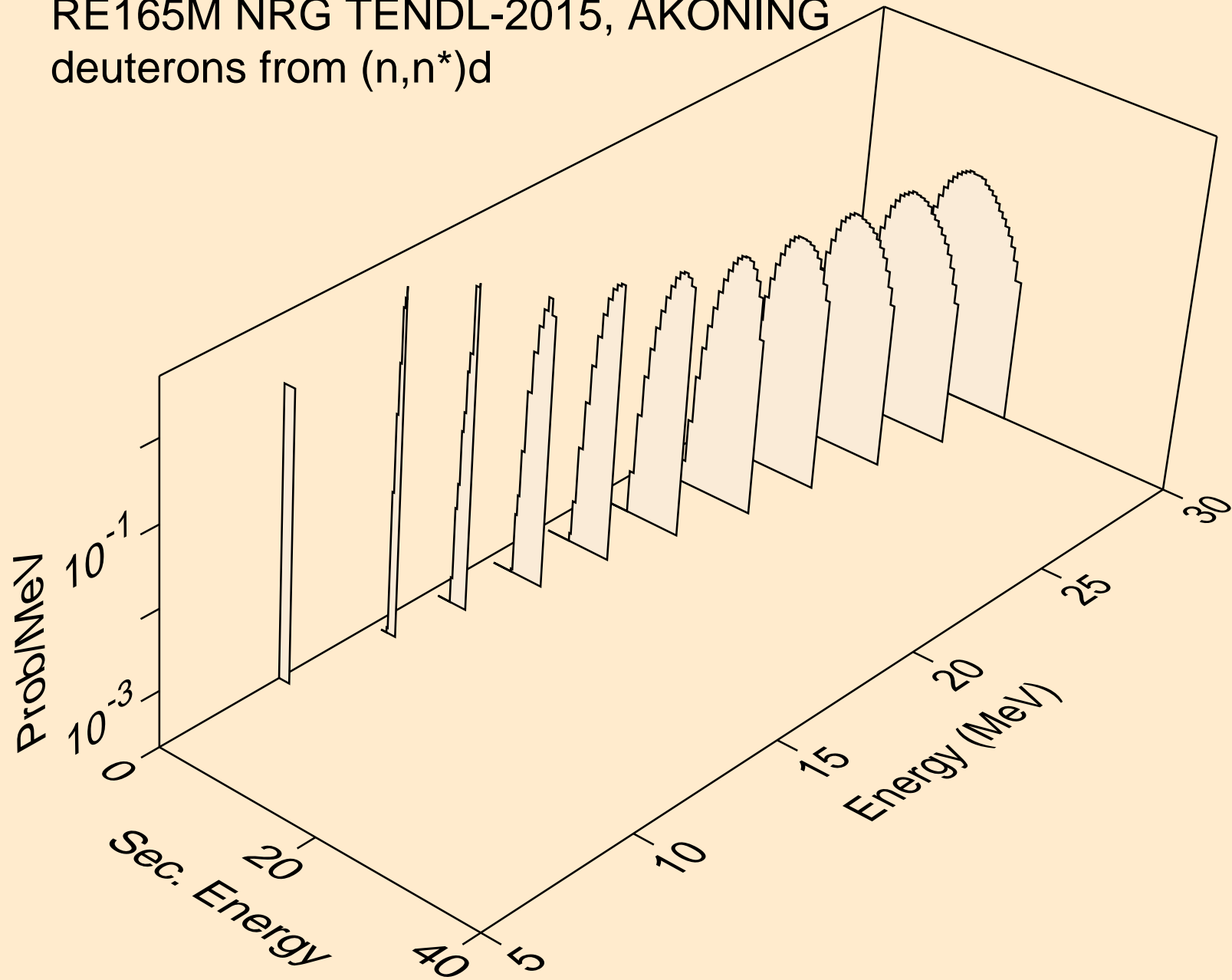

RE165M NRG TENDL-2015, AKONING
deuterons from (n,n*)d2a

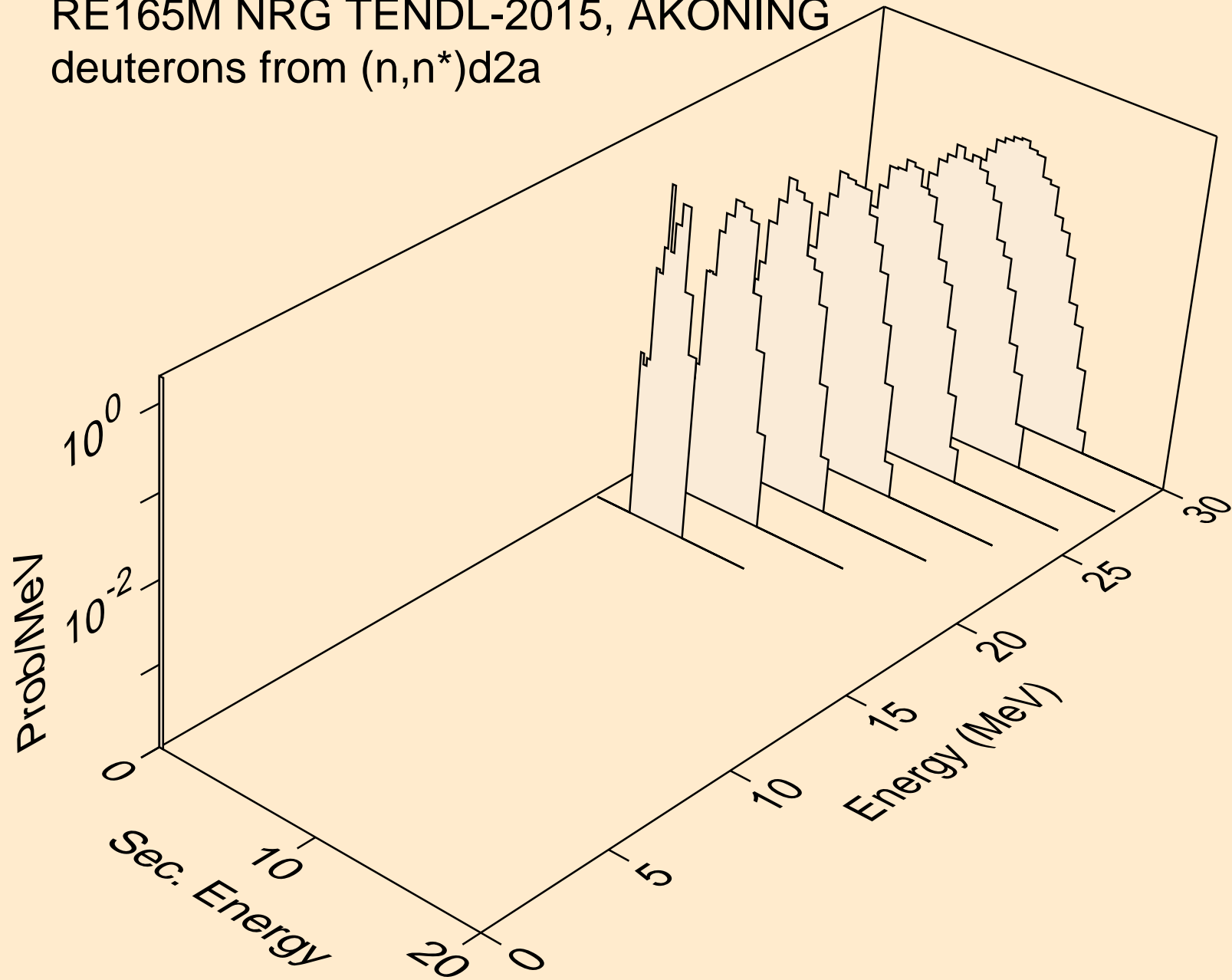

RE165M NRG TENDL-2015, AKONING
deuterons from (n,d)

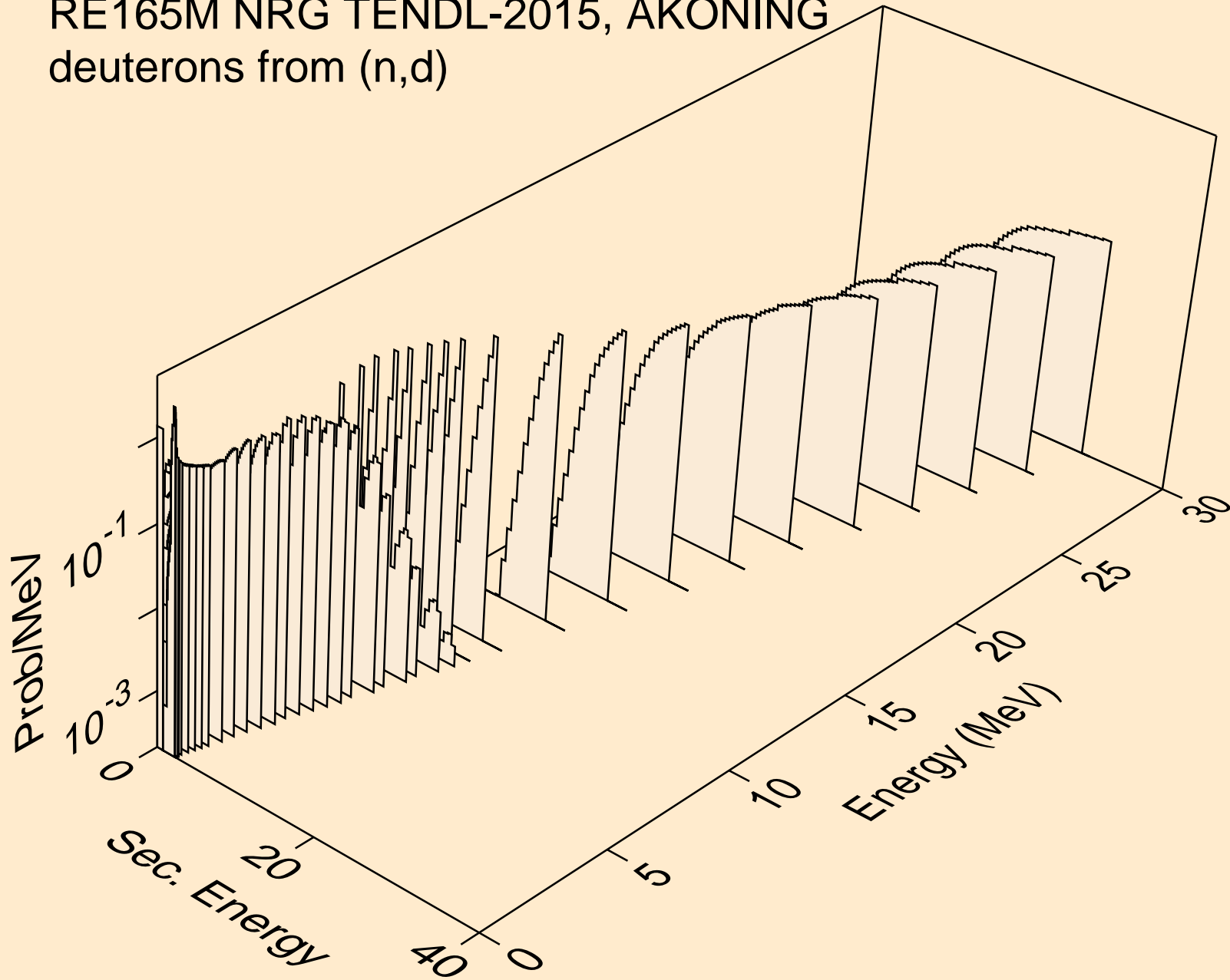

RE165M NRG TENDL-2015, AKONING
deuterons from (n,d2a)

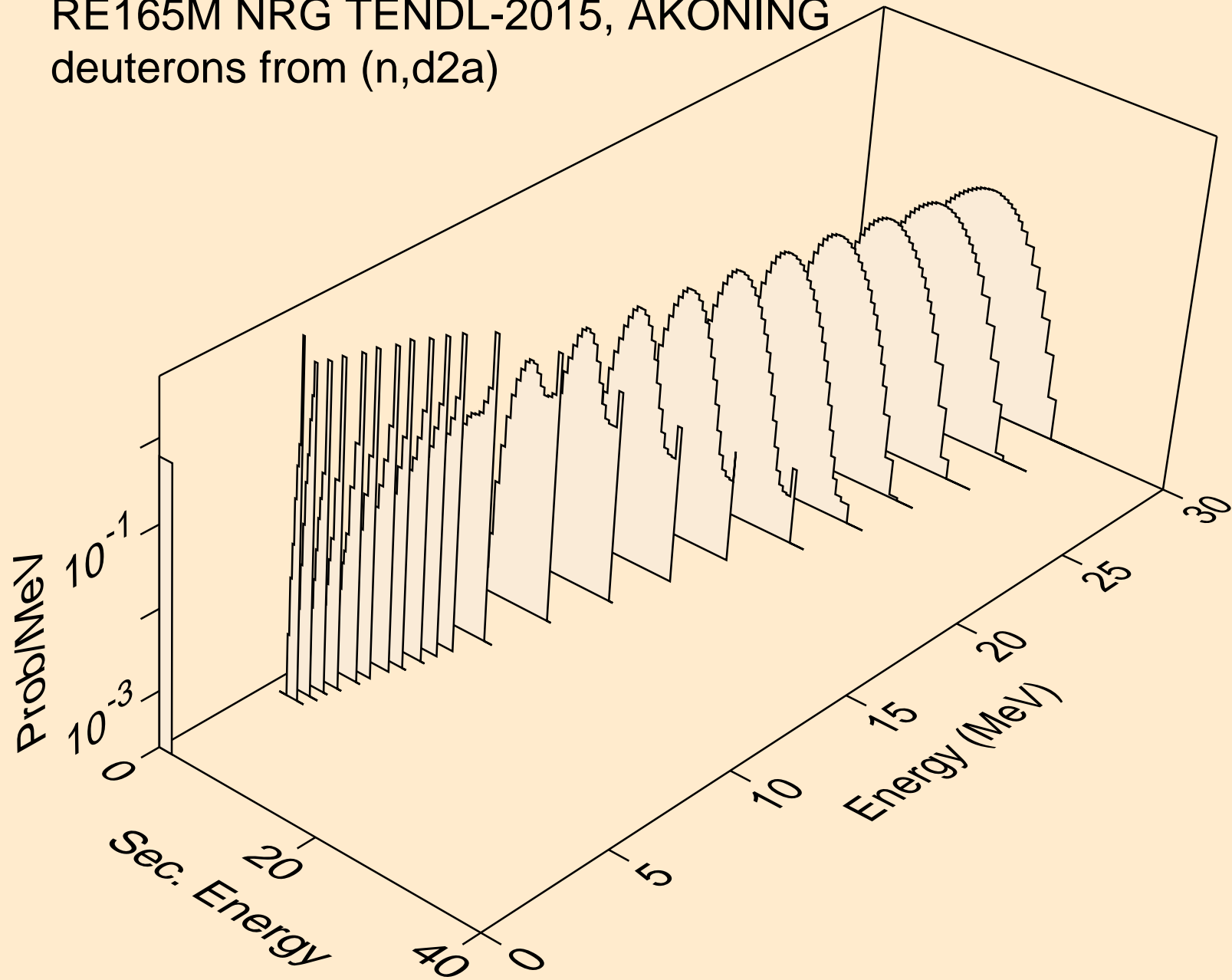

RE165M NRG TENDL-2015, AKONING
deuterons from (n,pd)

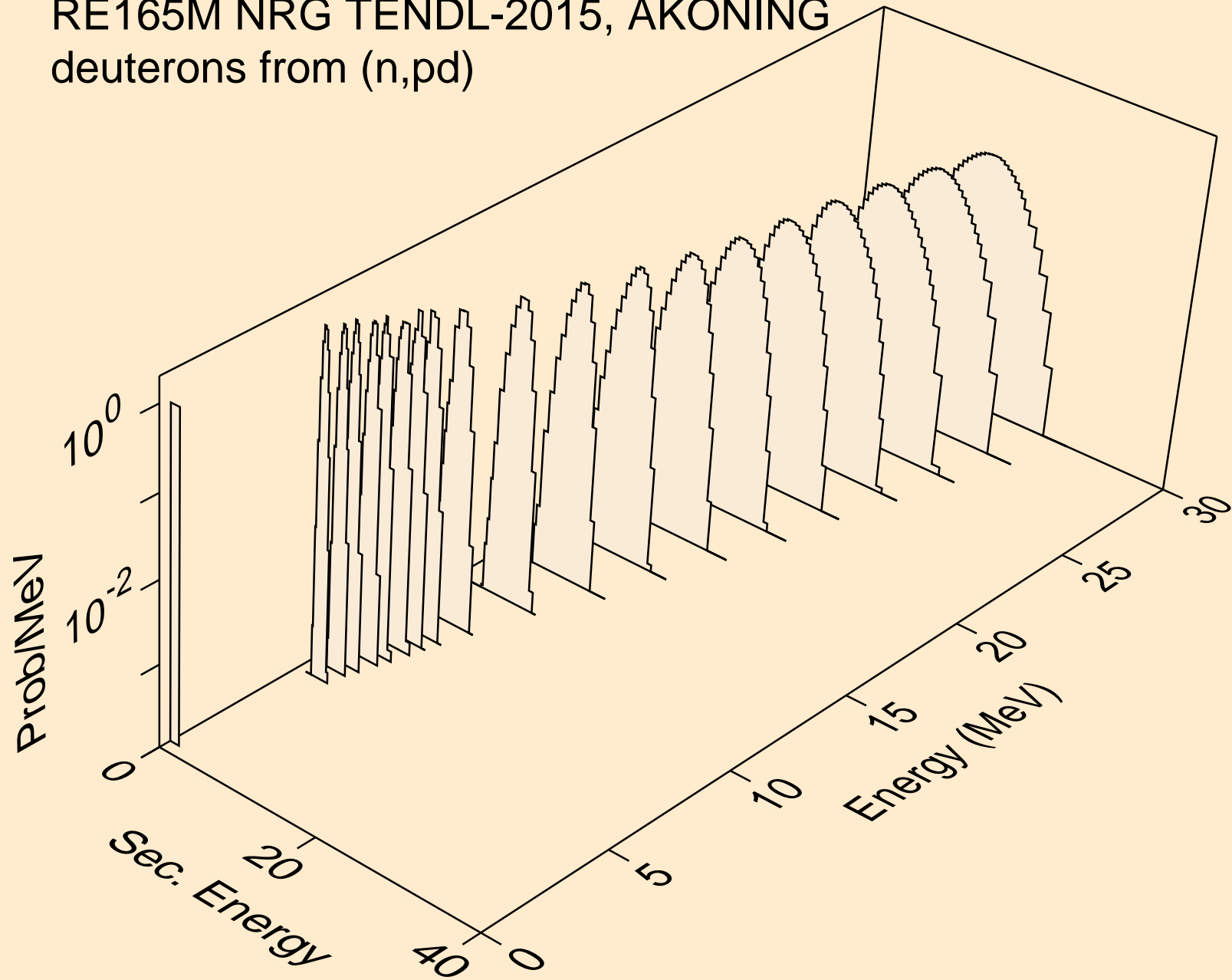

RE165M NRG TENDL-2015, AKONING
deuterons from (n,da)

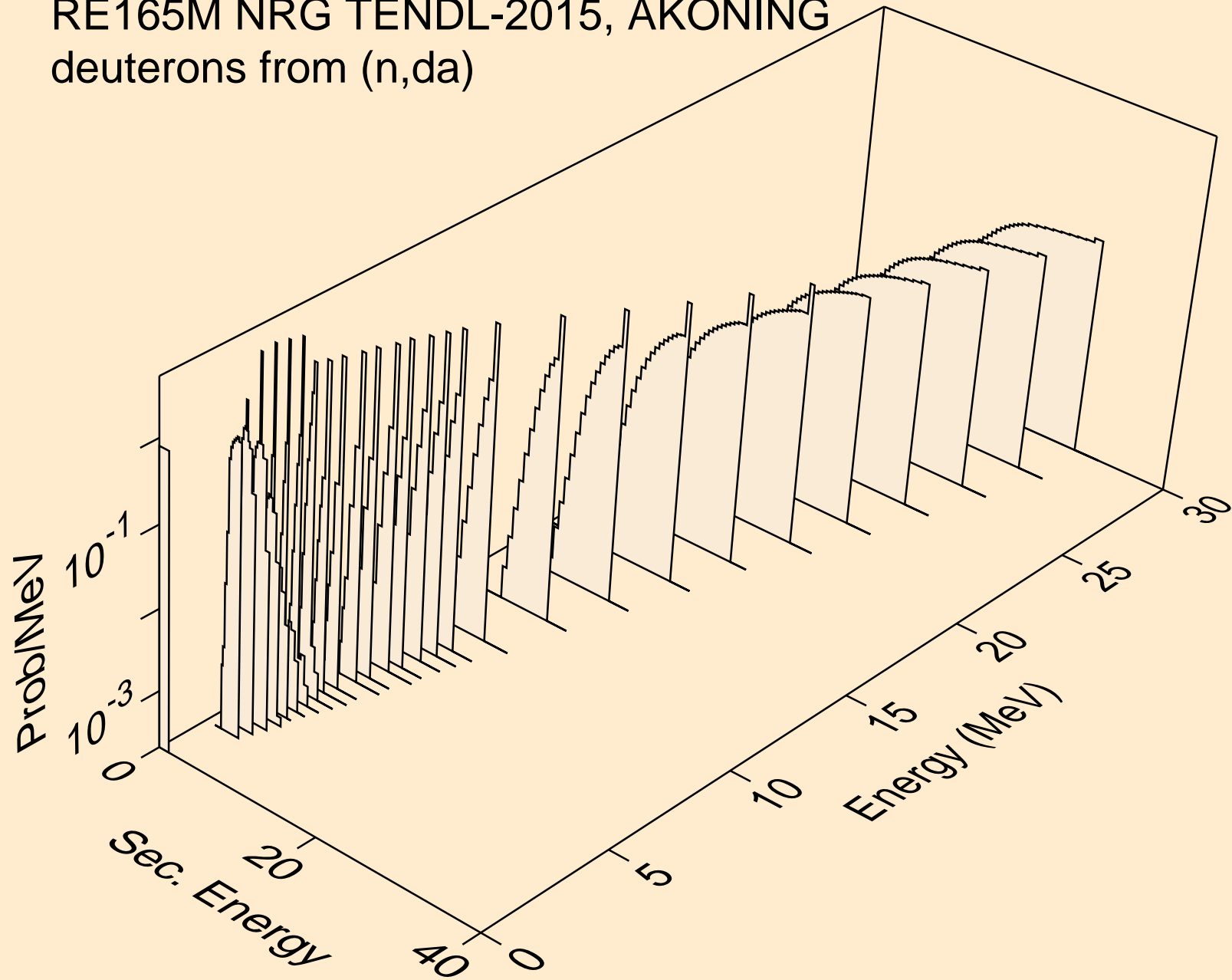

RE165M NRG TENDL-2015, AKONING
tritons from (n,x)

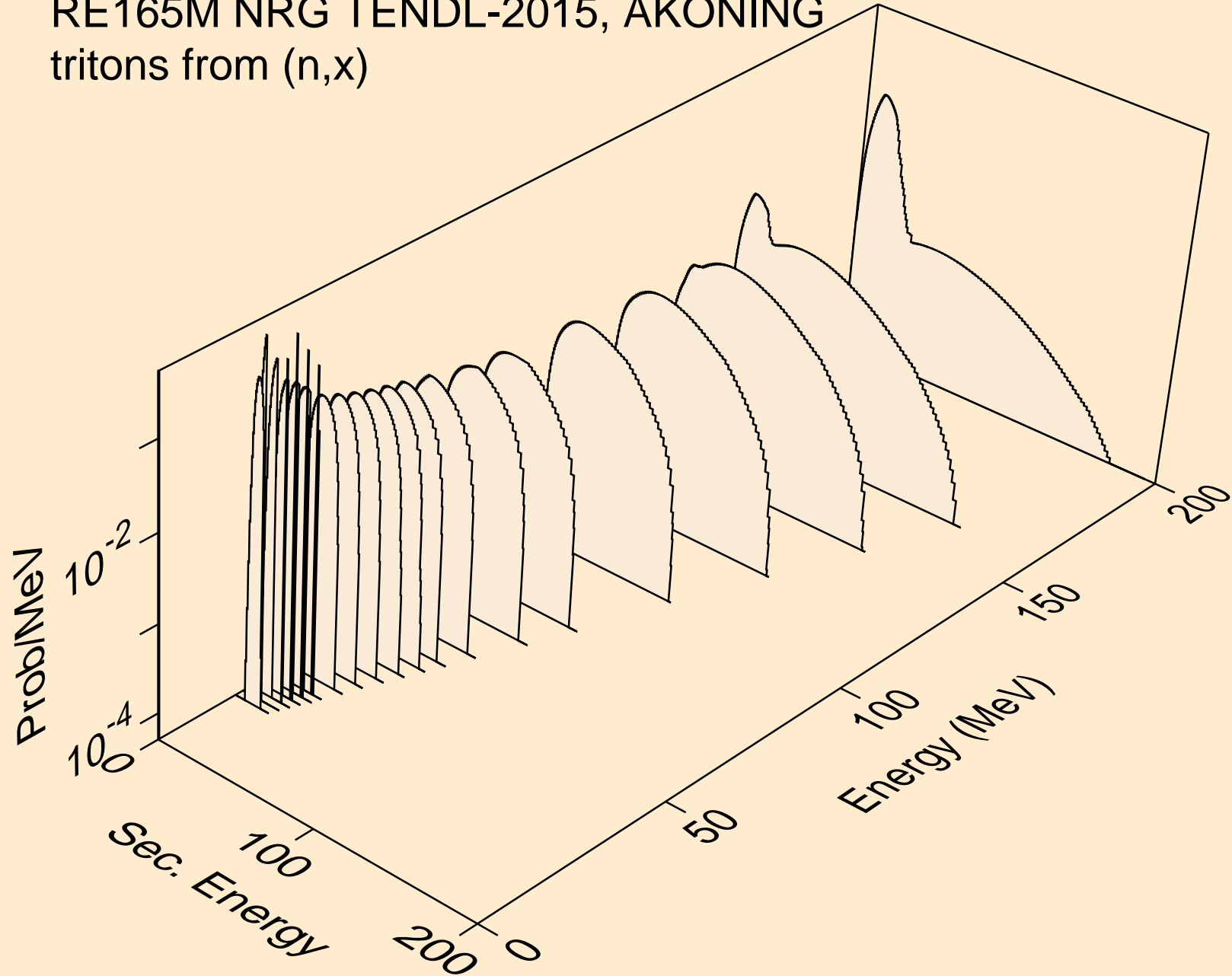

RE165M NRG TENDL-2015, AKONING
tritons from (n,n*)t

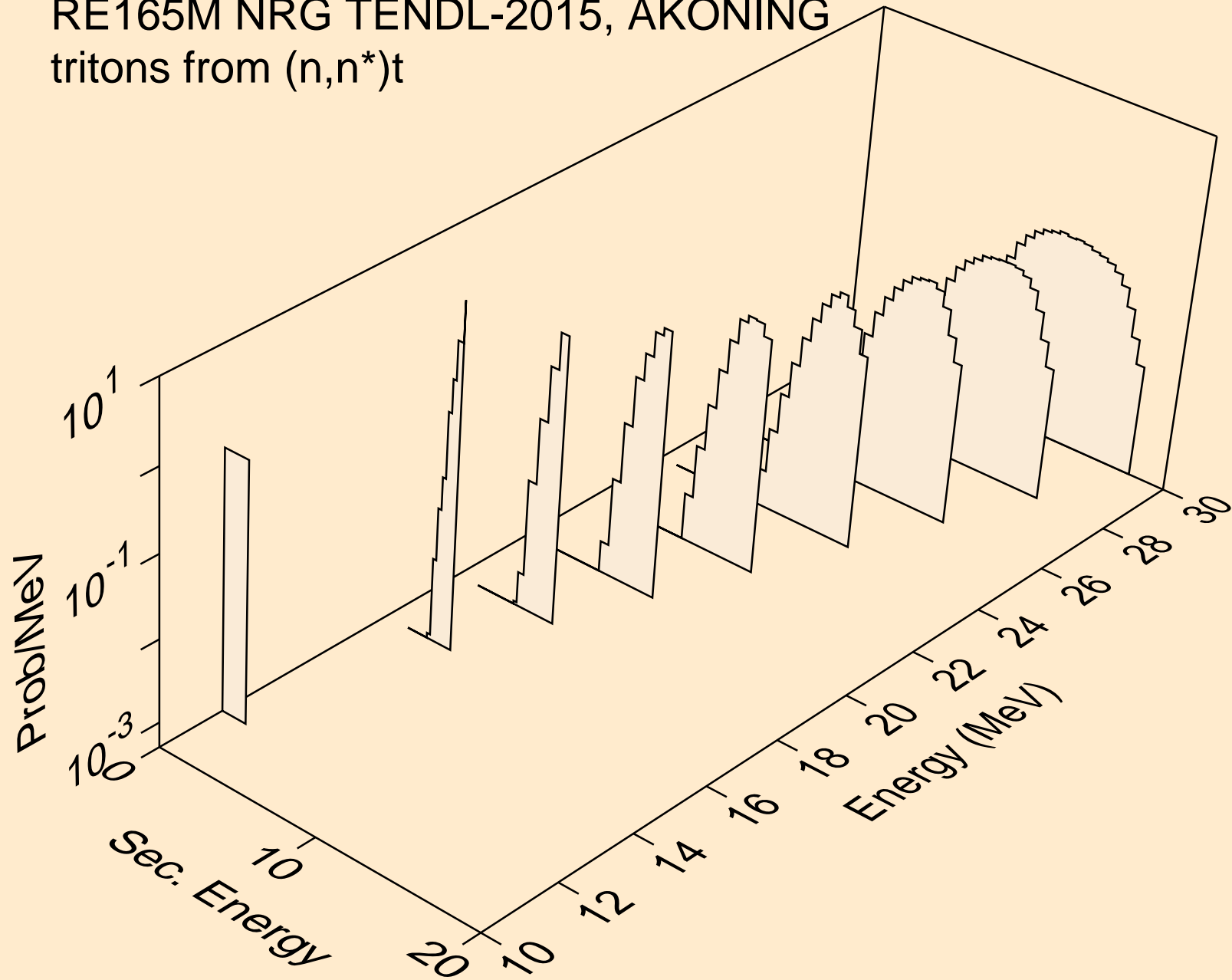

RE165M NRG TENDL-2015, AKONING
tritons from (n,t)

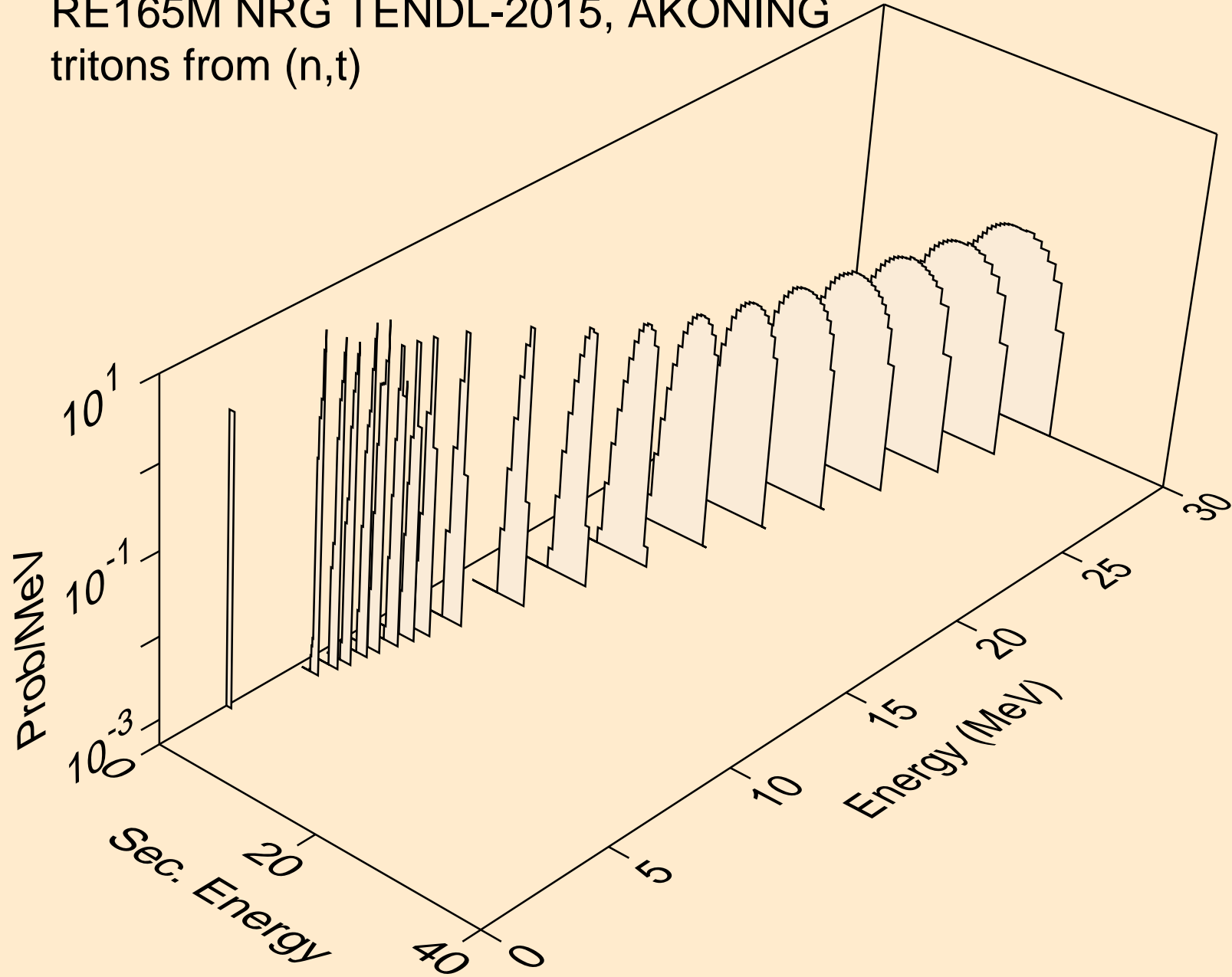

RE165M NRG TENDL-2015, AKONING
tritons from (n,t2a)

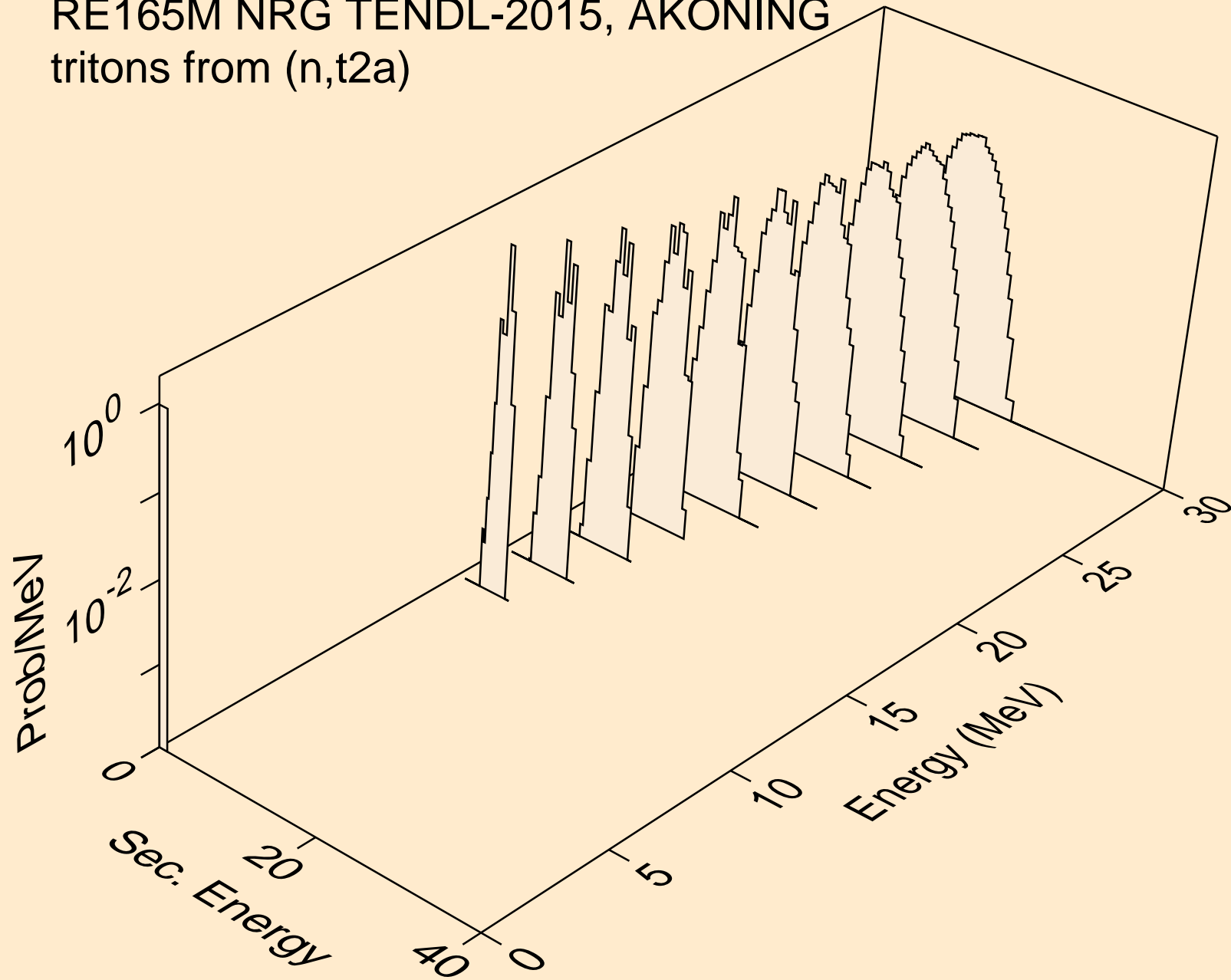

RE165M NRG TENDL-2015, AKONING
tritons from (n,pt)

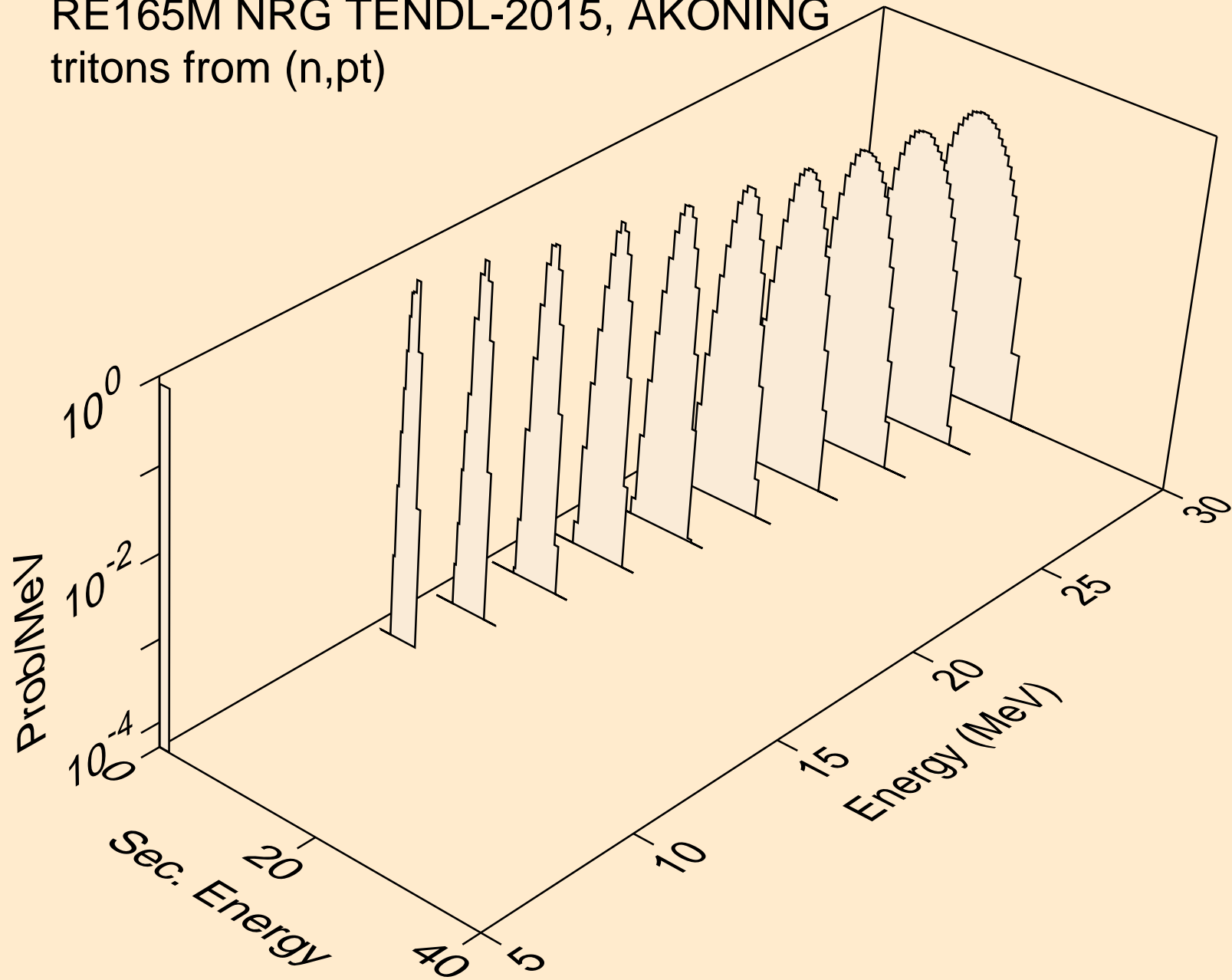

RE165M NRG TENDL-2015, AKONING
he3s from (n,x)

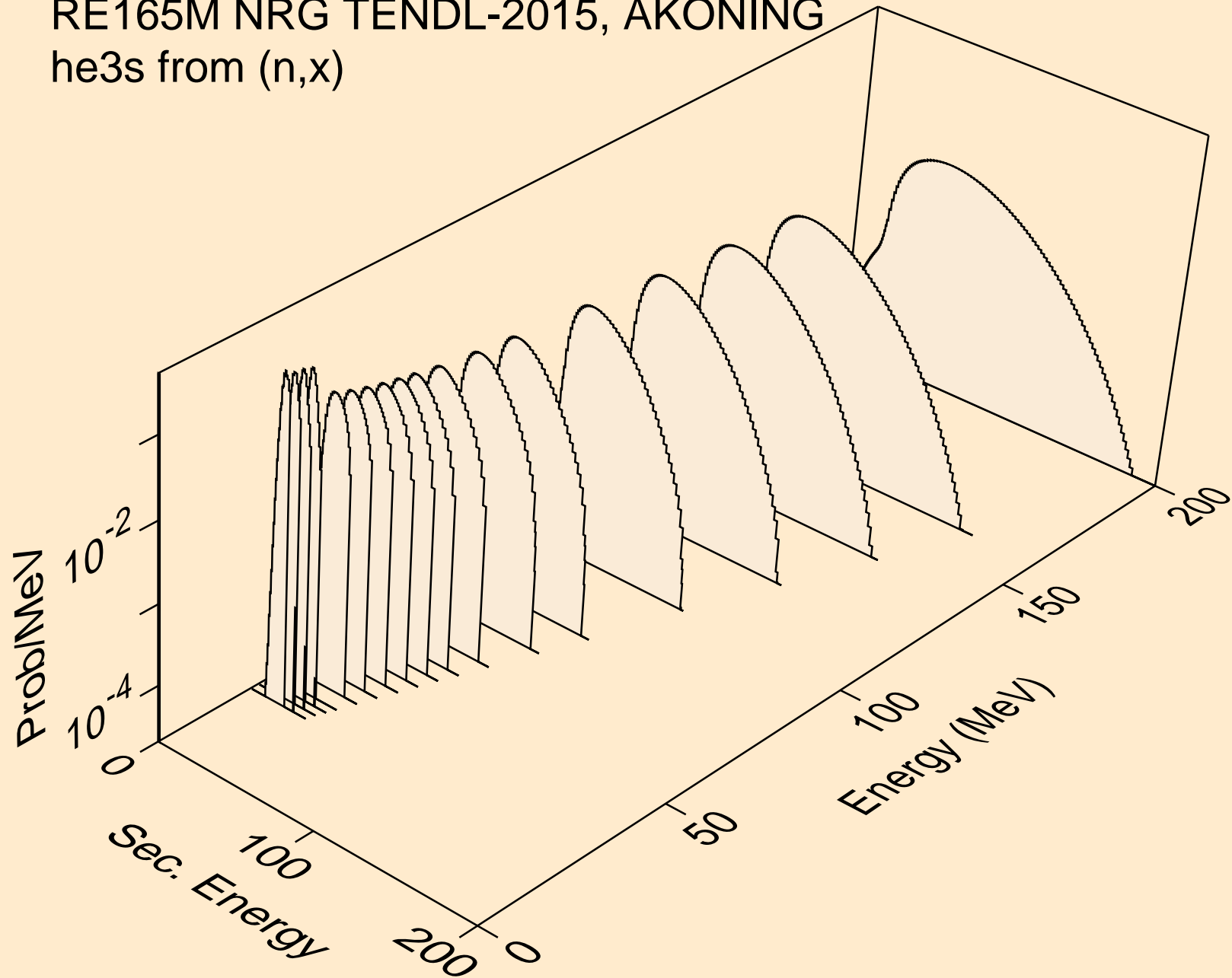

RE165M NRG TENDL-2015, AKONING
he3s from (n,n*)he3

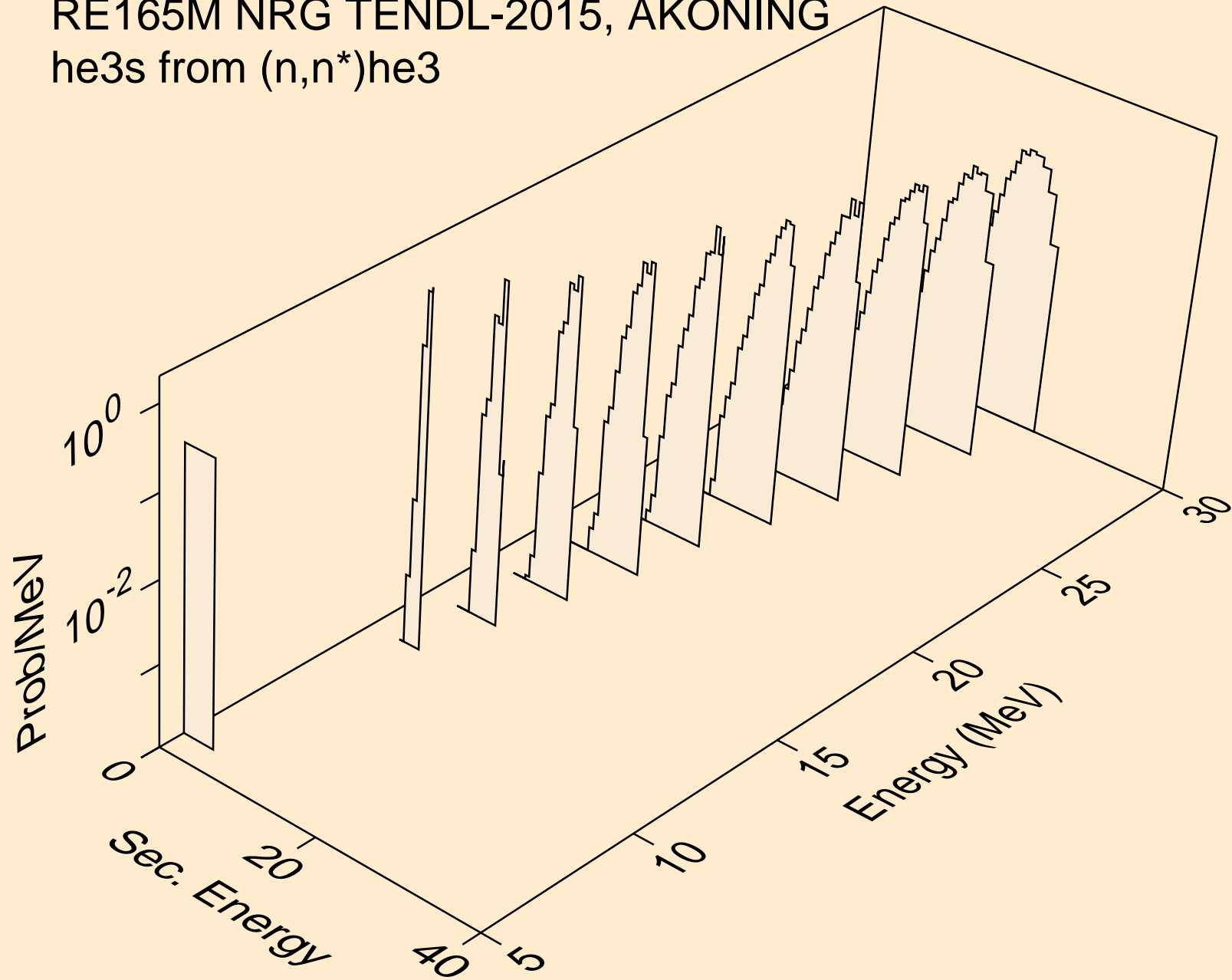

RE165M NRG TENDL-2015, AKONING
he3s from (n,he3)

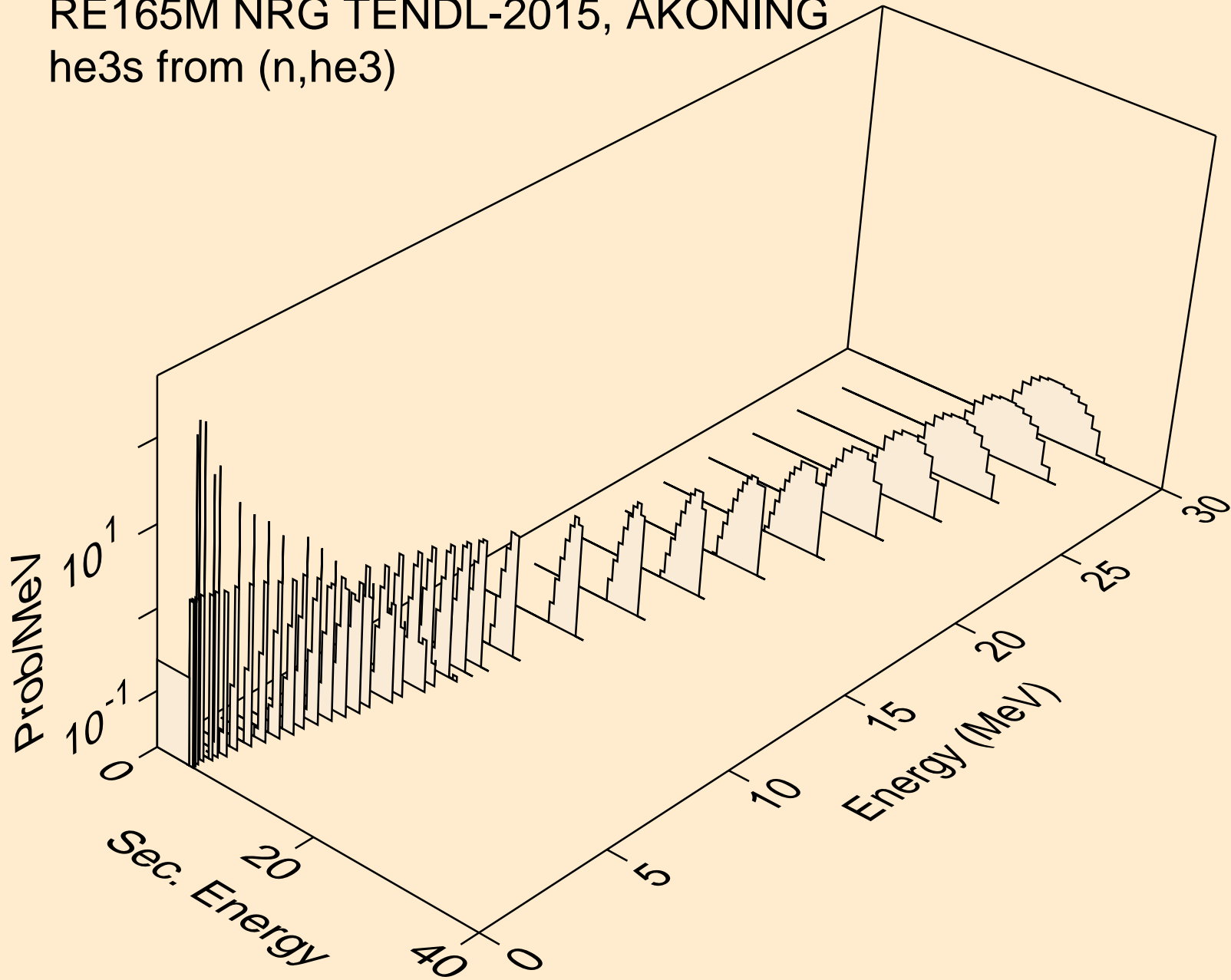

RE165M NRG TENDL-2015, AKONING
alphas from (n,x)

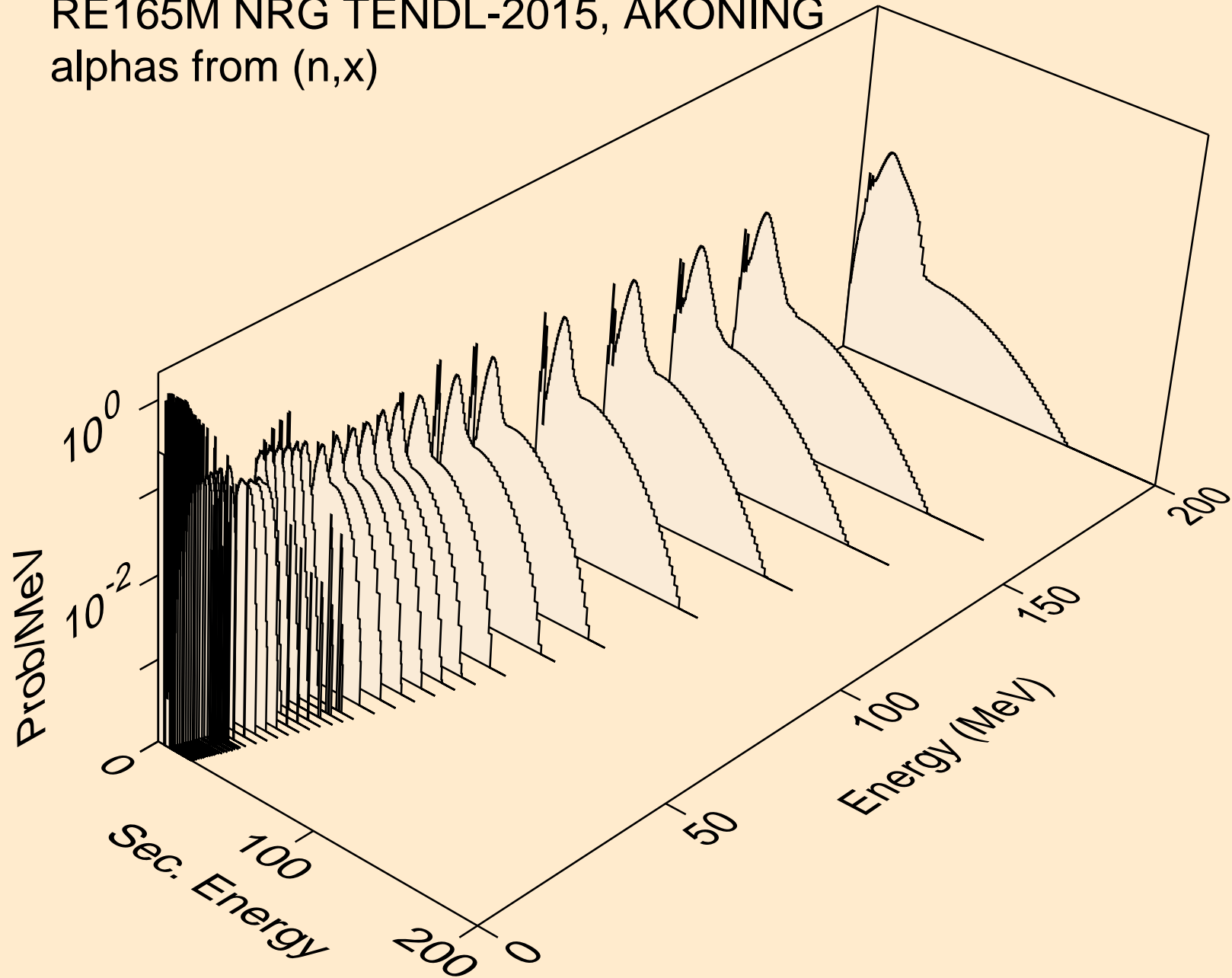

RE165M NRG TENDL-2015, AKONING
alphas from (n,n*)a

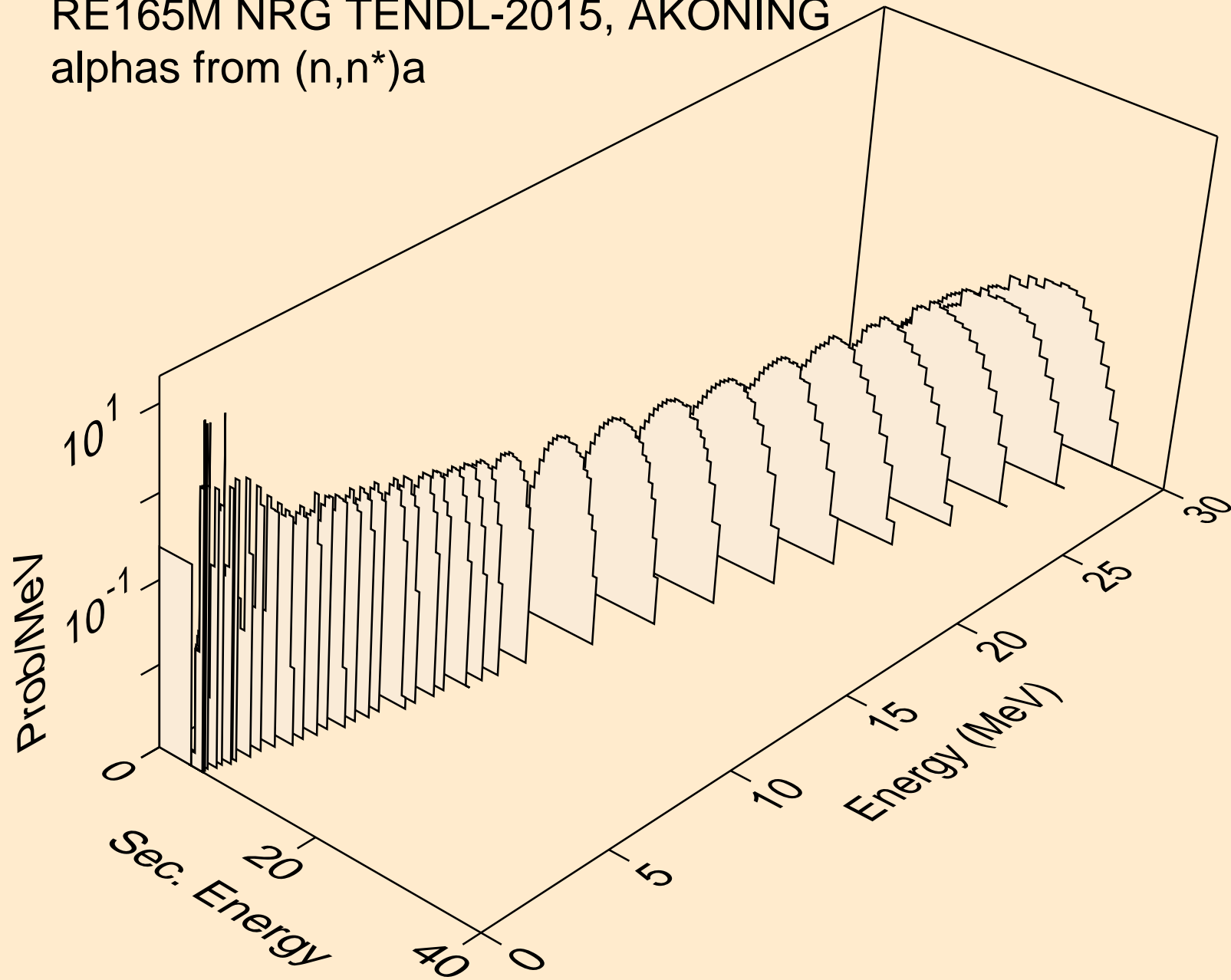

RE165M NRG TENDL-2015, AKONING
alphas from (n,n*)3a

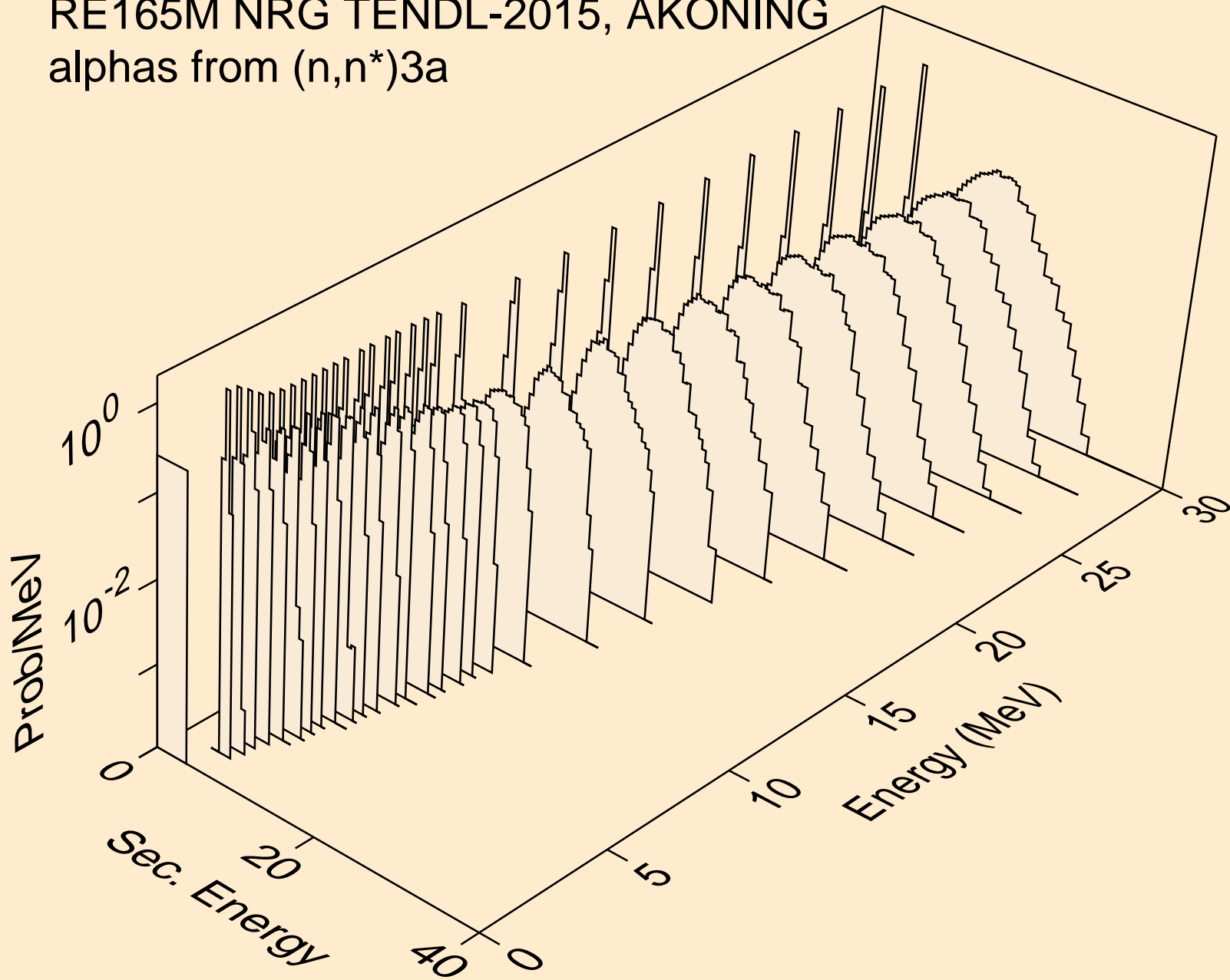

RE165M NRG TENDL-2015, AKONING
alphas from (n,2n)a

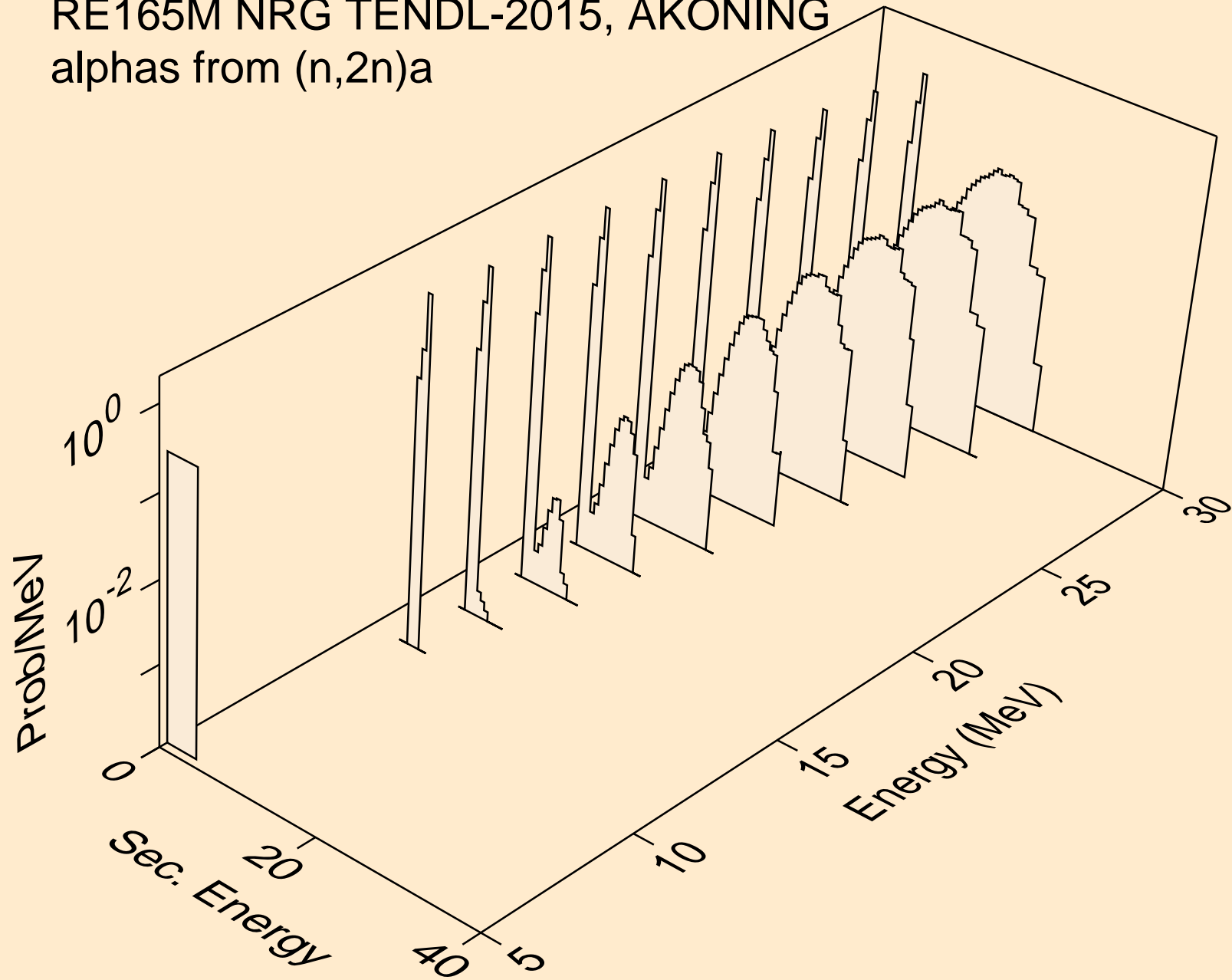

RE165M NRG TENDL-2015, AKONING
alphas from (n,3n)a

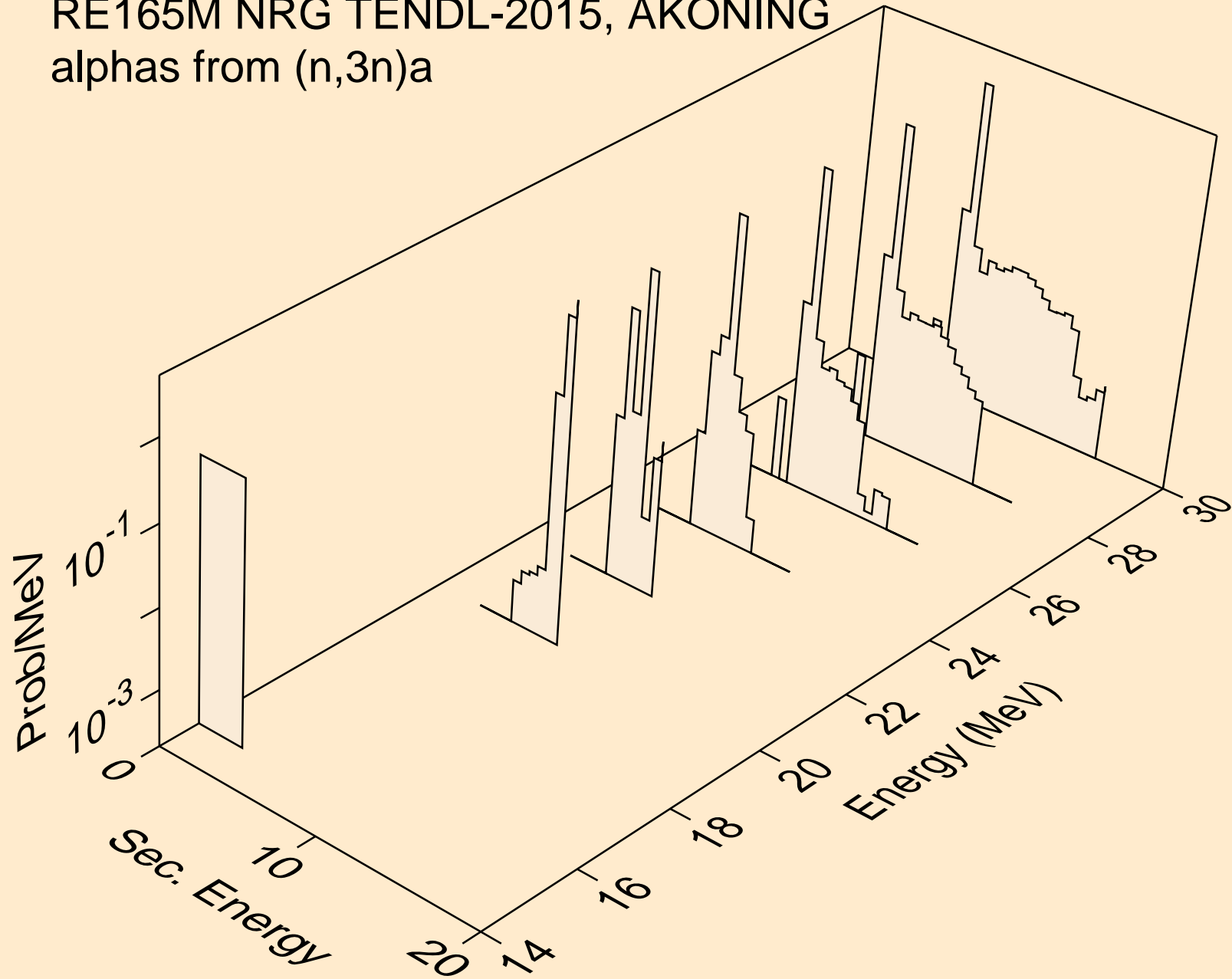

RE165M NRG TENDL-2015, AKONING
alphas from (n,n*)2a

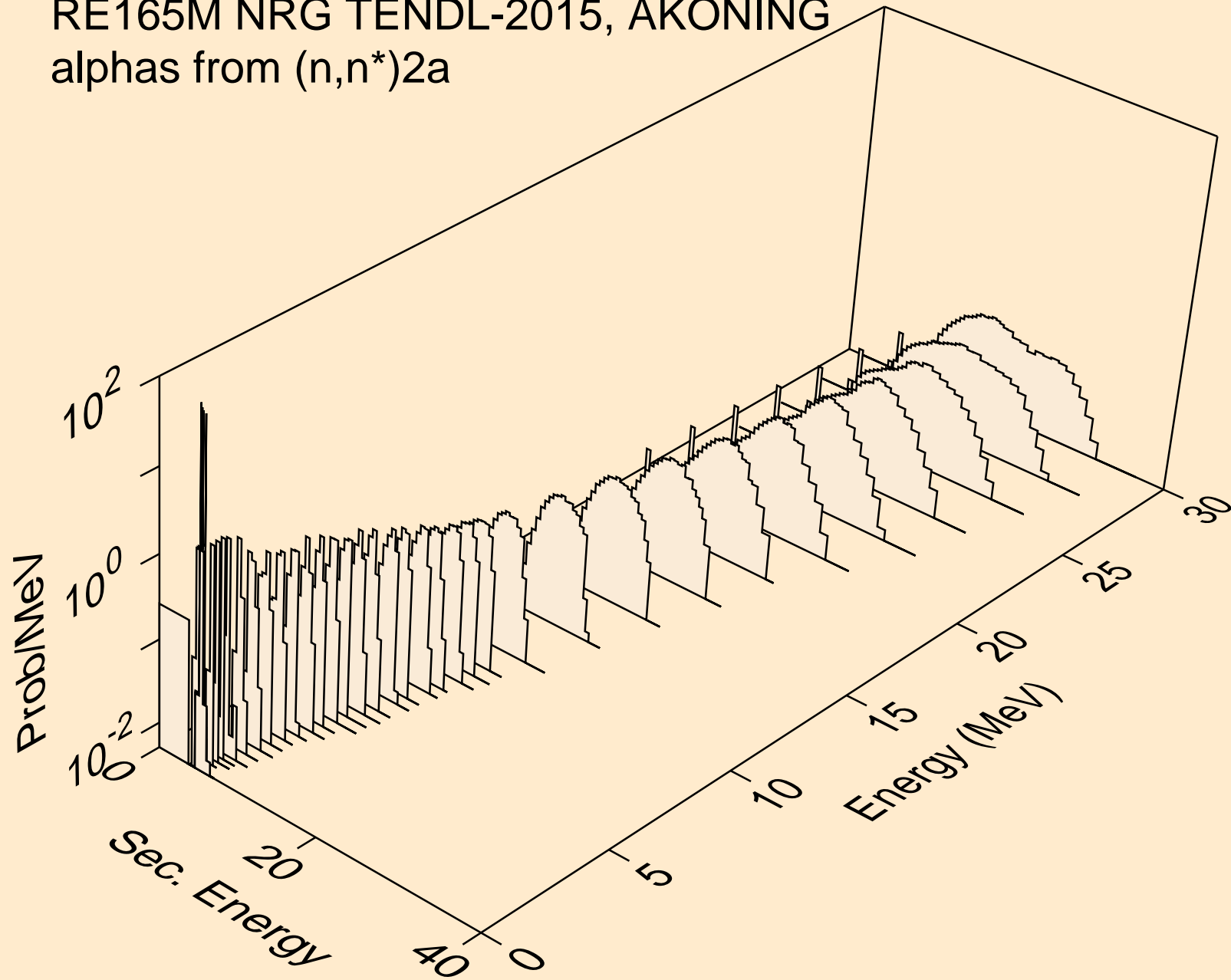

RE165M NRG TENDL-2015, AKONING
alphas from (n,2n)2a

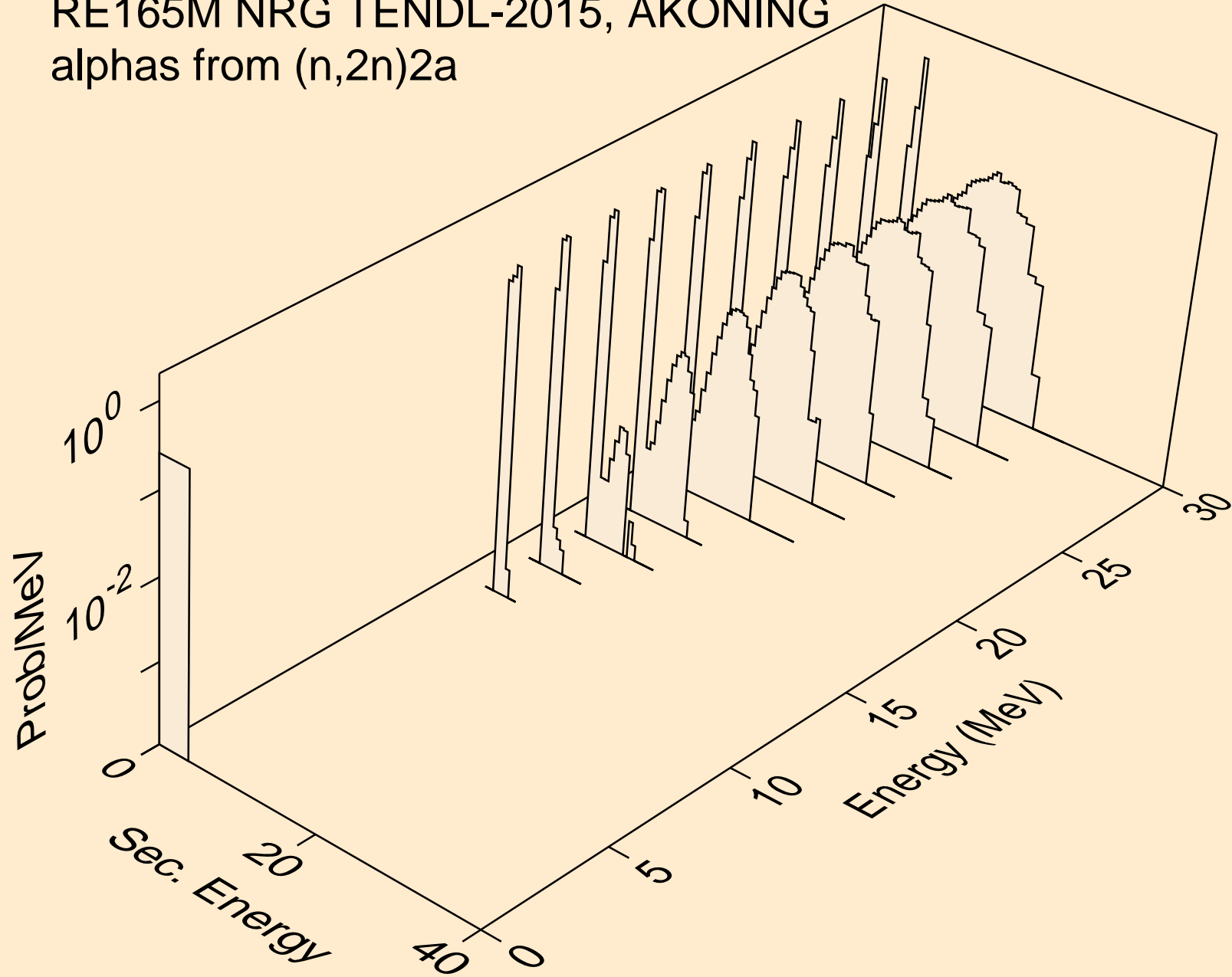

RE165M NRG TENDL-2015, AKONING
alphas from (n,n*)d2a

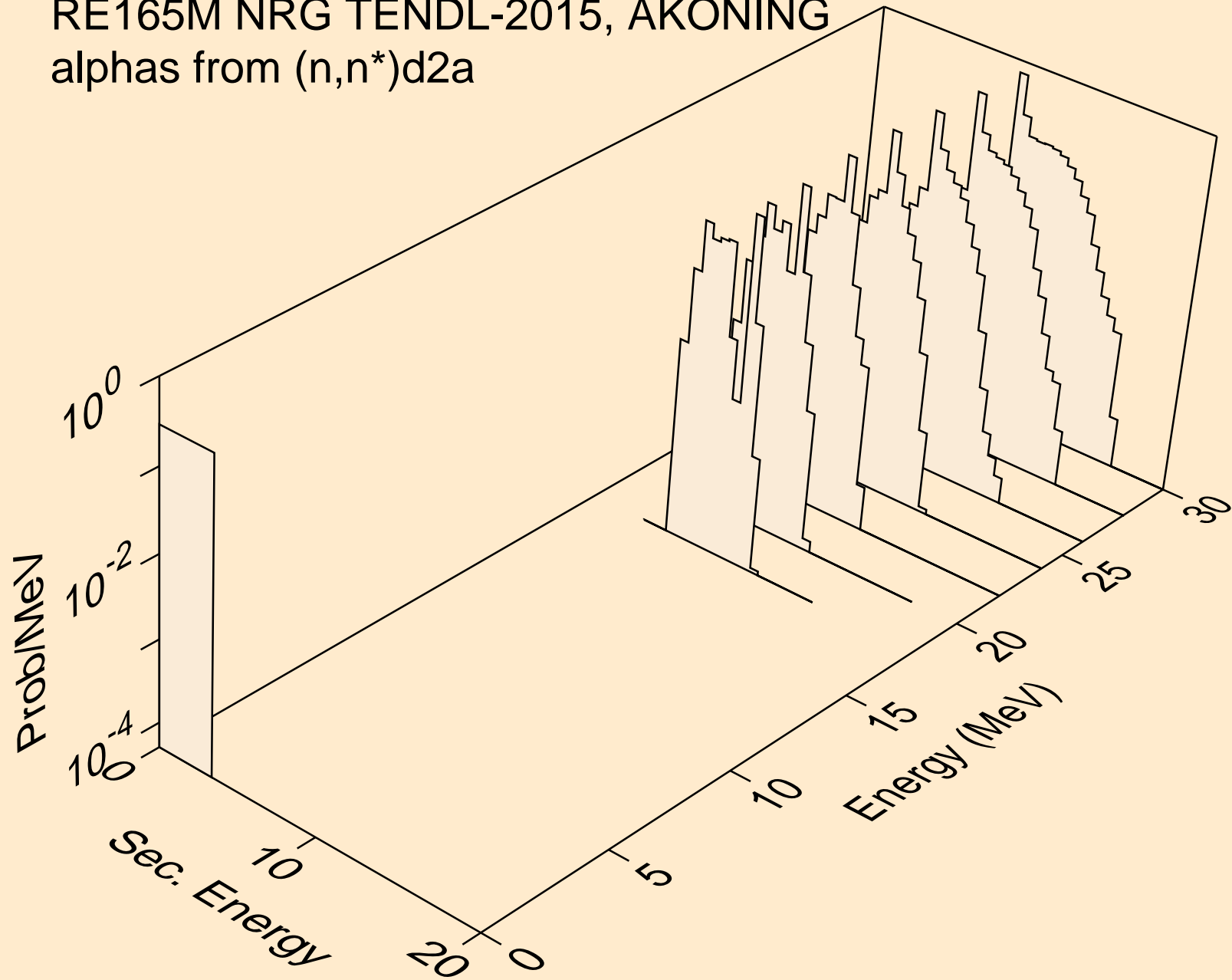

RE165M NRG TENDL-2015, AKONING
alphas from (n,npa)

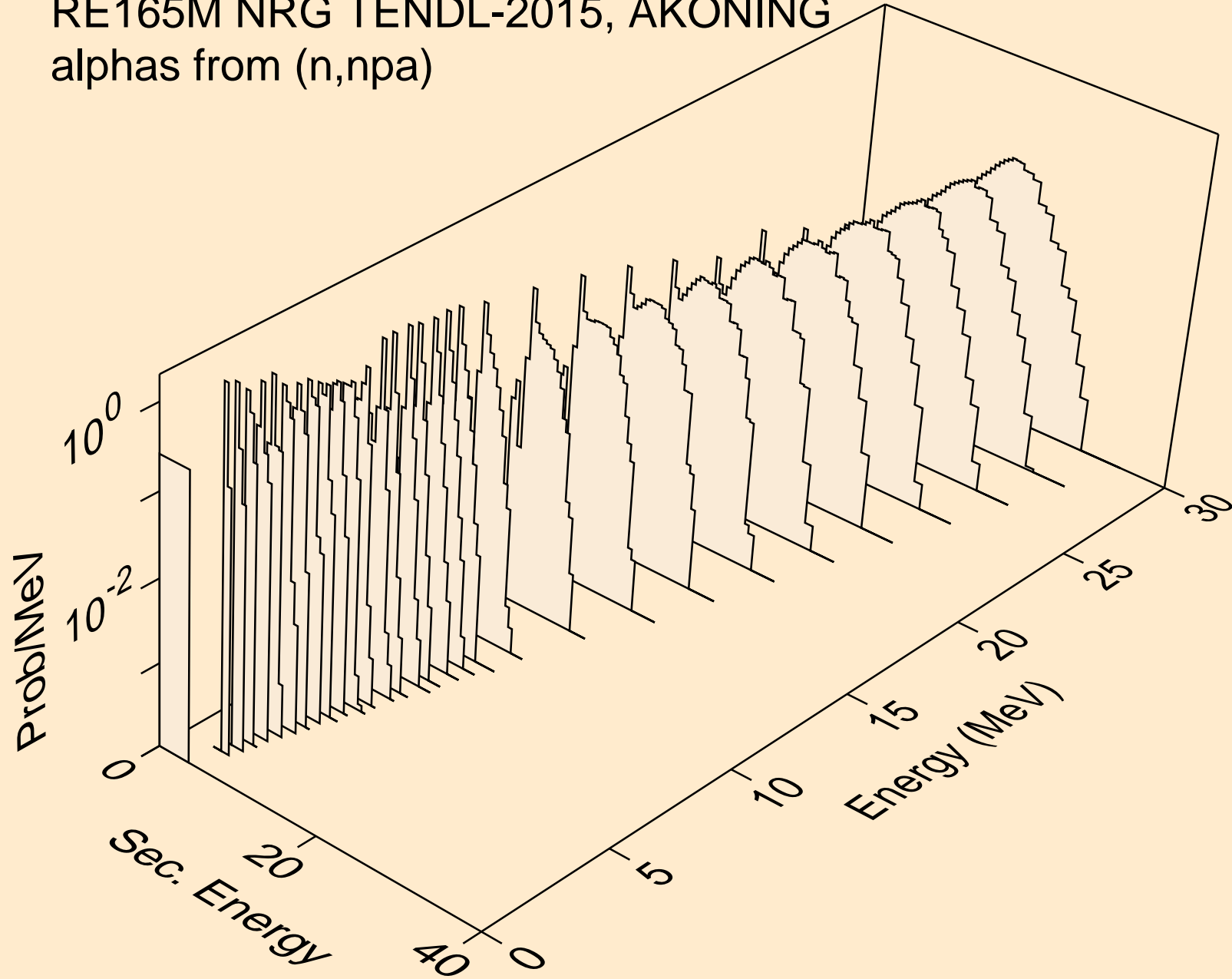

RE165M NRG TENDL-2015, AKONING
alphas from (n,a)

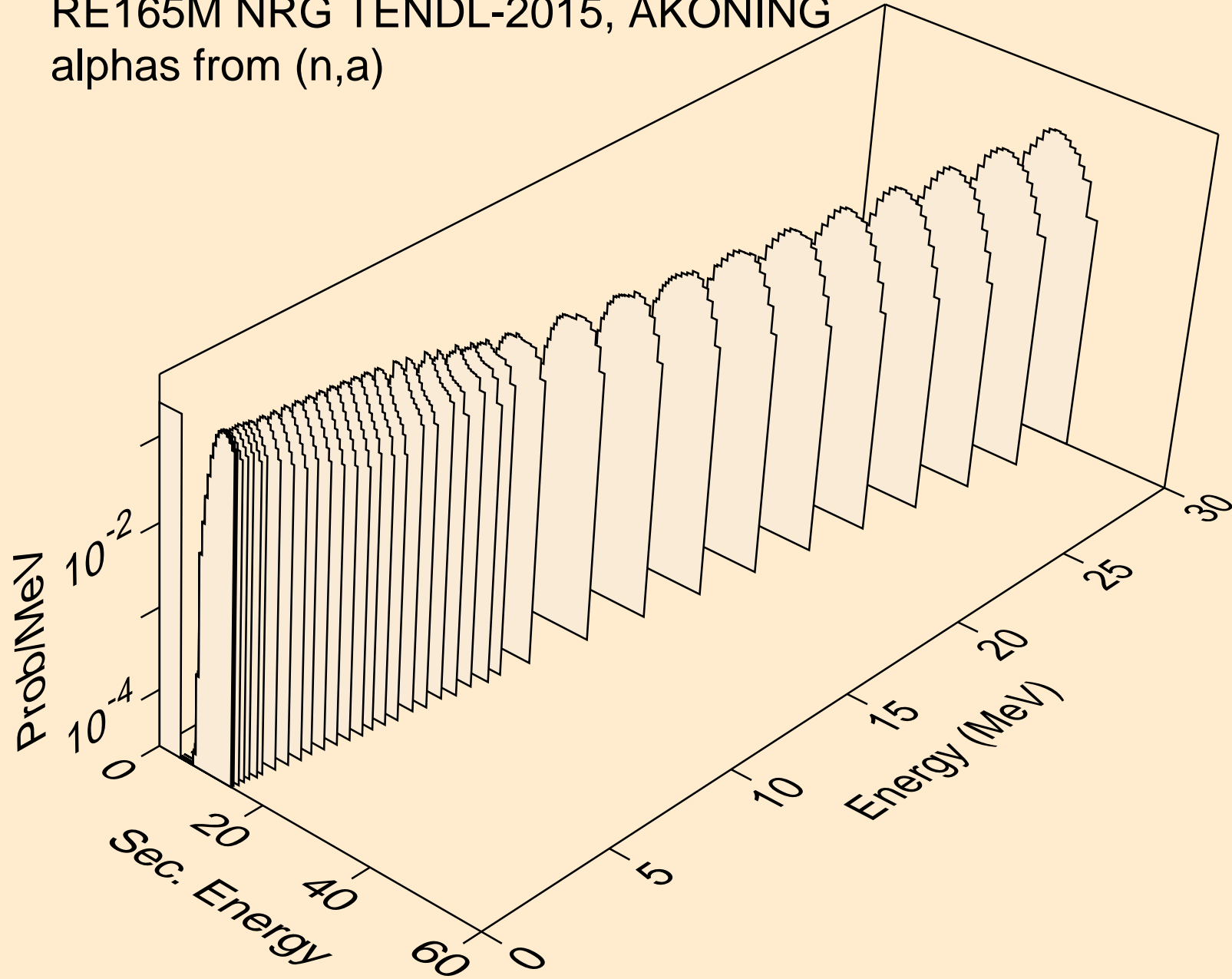

RE165M NRG TENDL-2015, AKONING
alphas from (n,2a)

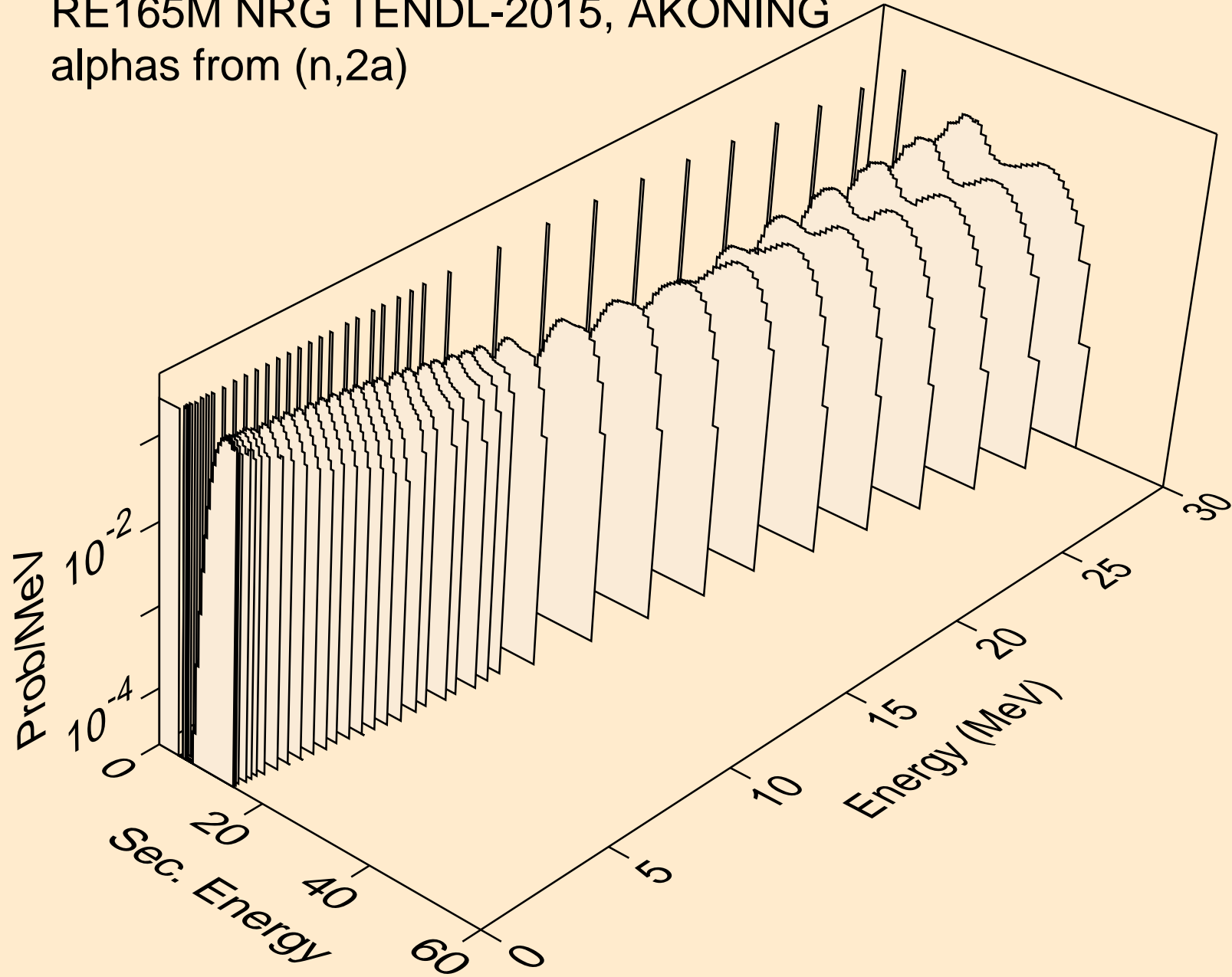

RE165M NRG TENDL-2015, AKONING
alphas from (n,3a)

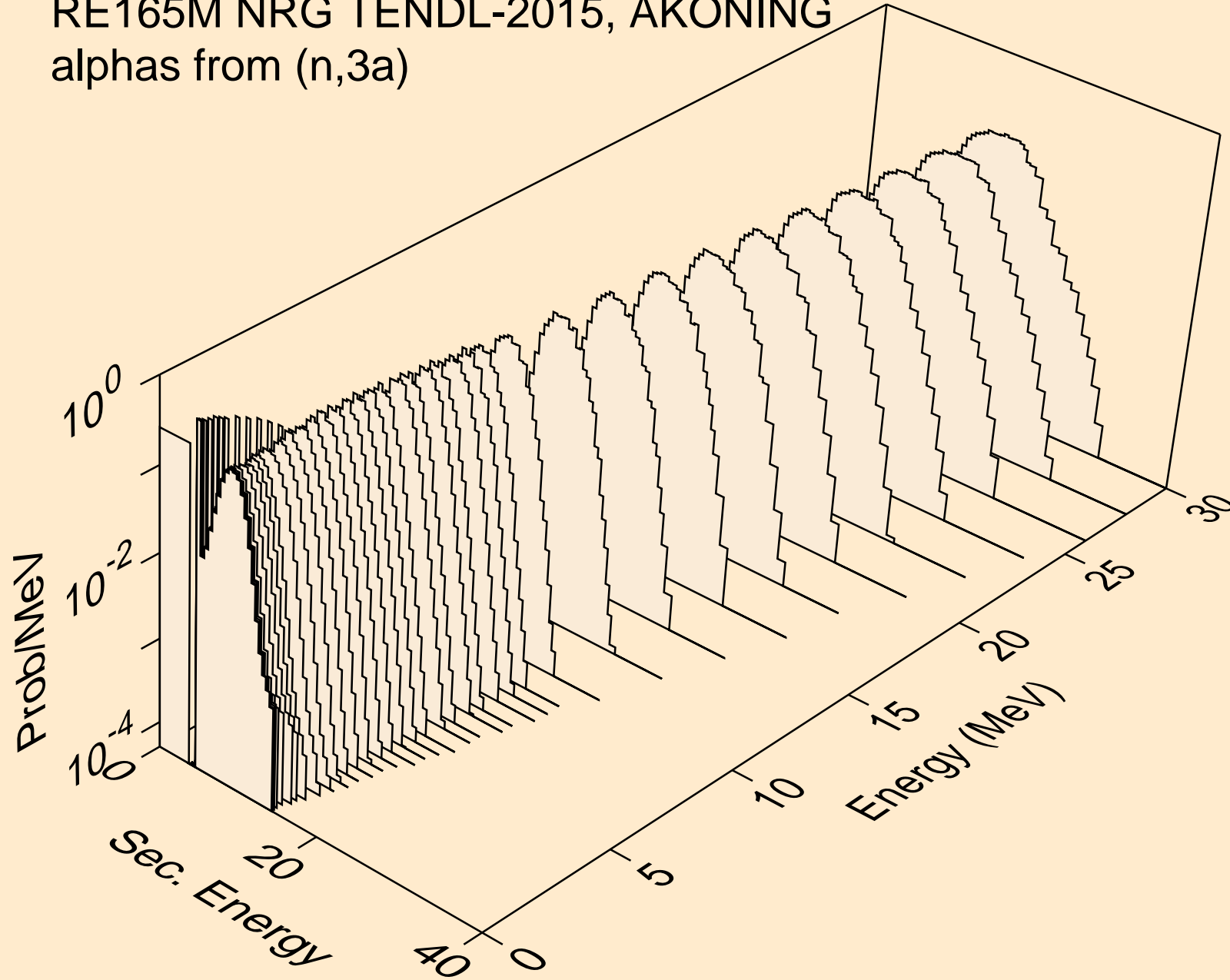

RE165M NRG TENDL-2015, AKONING
alphas from (n,pa)

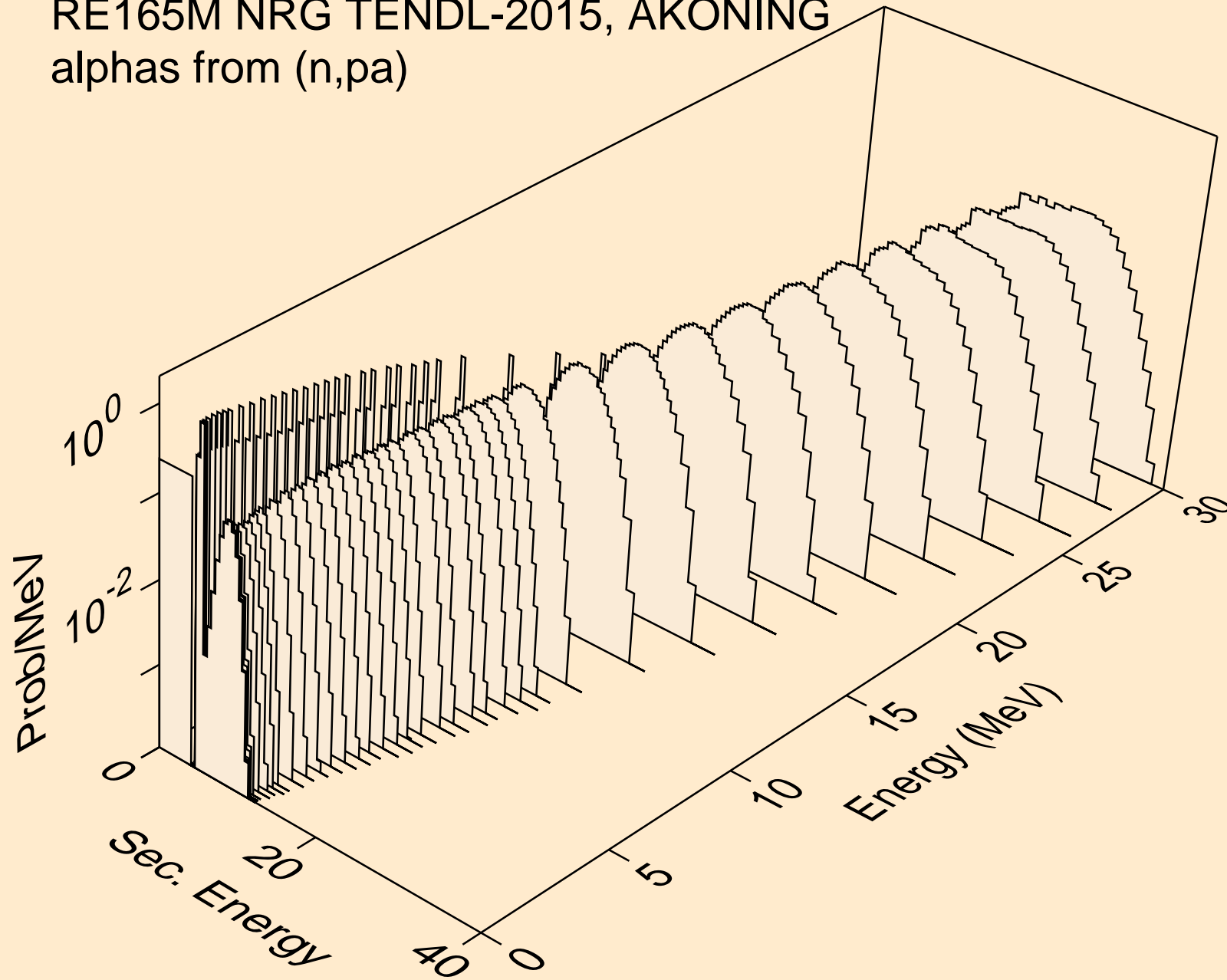

RE165M NRG TENDL-2015, AKONING
alphas from (n,t2a)

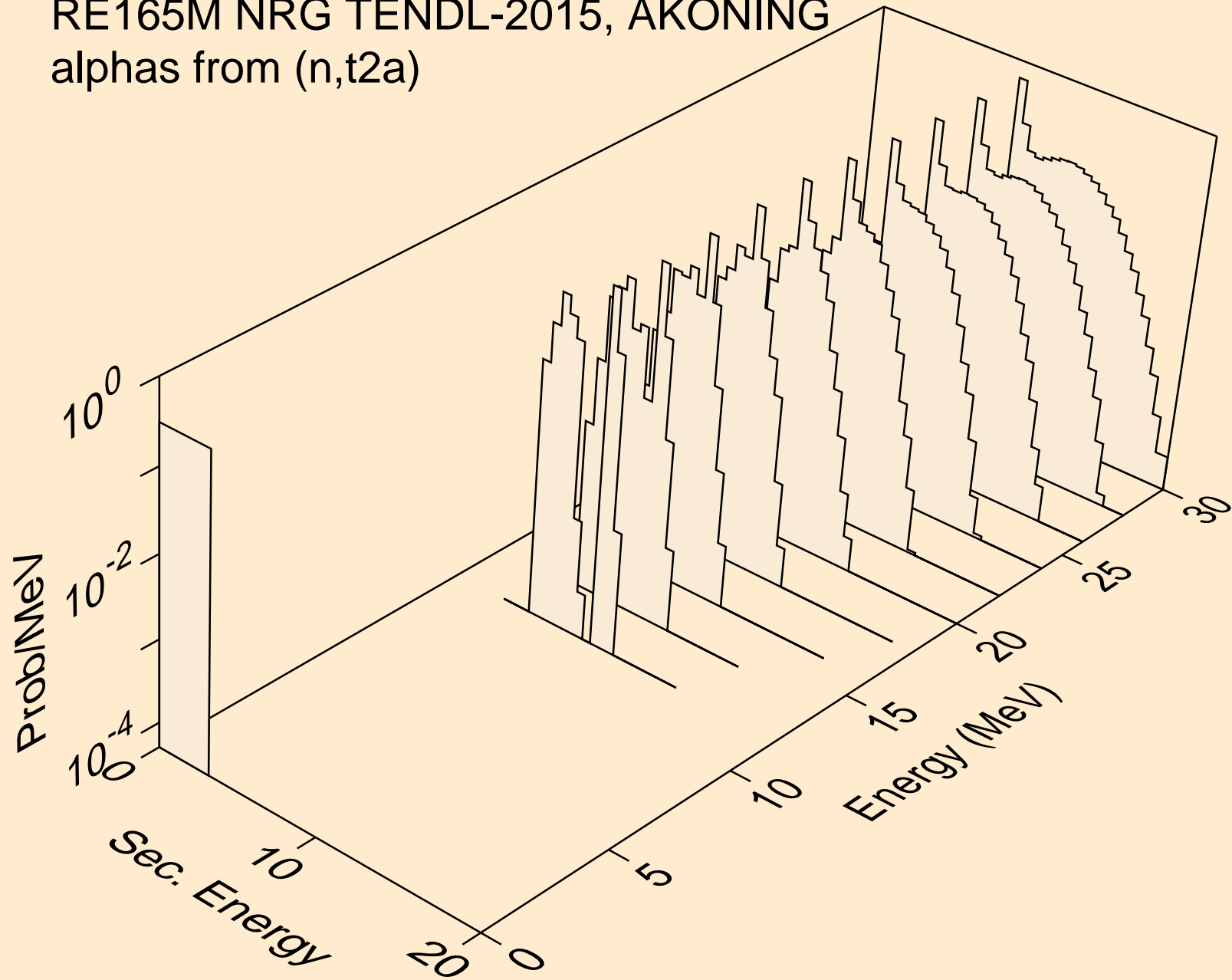

RE165M NRG TENDL-2015, AKONING
alphas from (n,d2a)

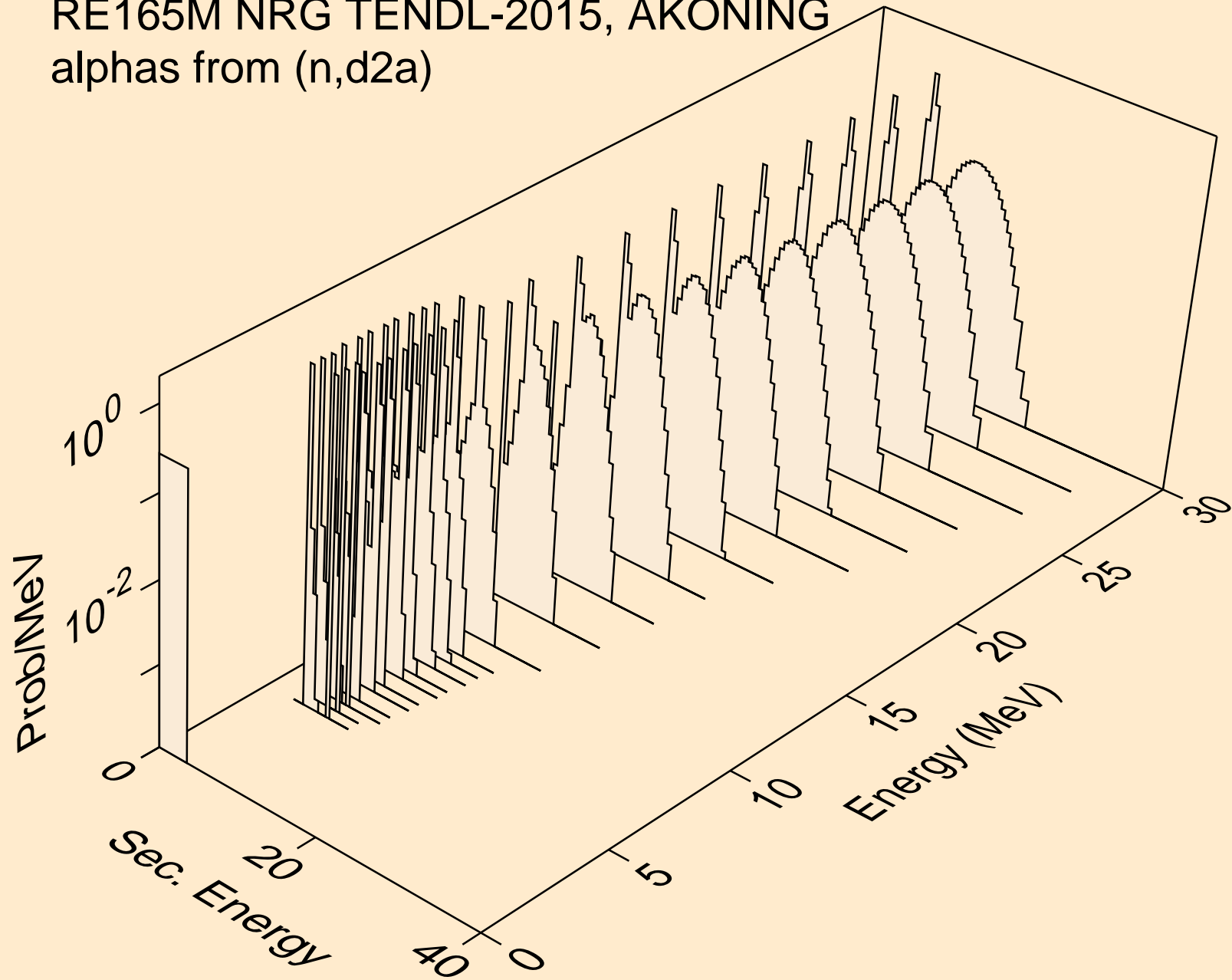

RE165M NRG TENDL-2015, AKONING
alphas from (n,da)

