

RE172M NRG TENDL-2015, AKONING

Principal cross sections

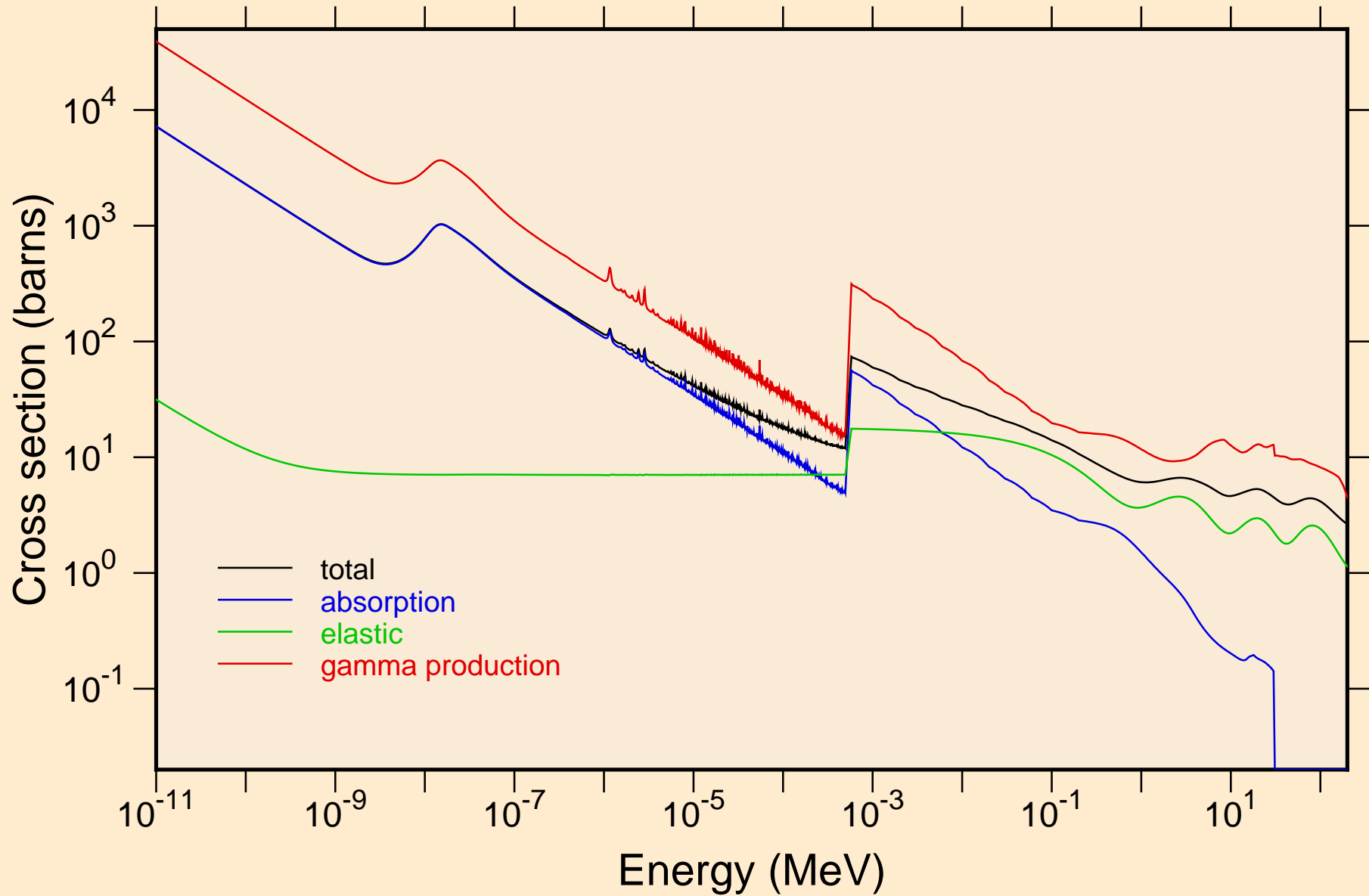

RE172M NRG TENDL-2015, AKONING
resonance total cross section

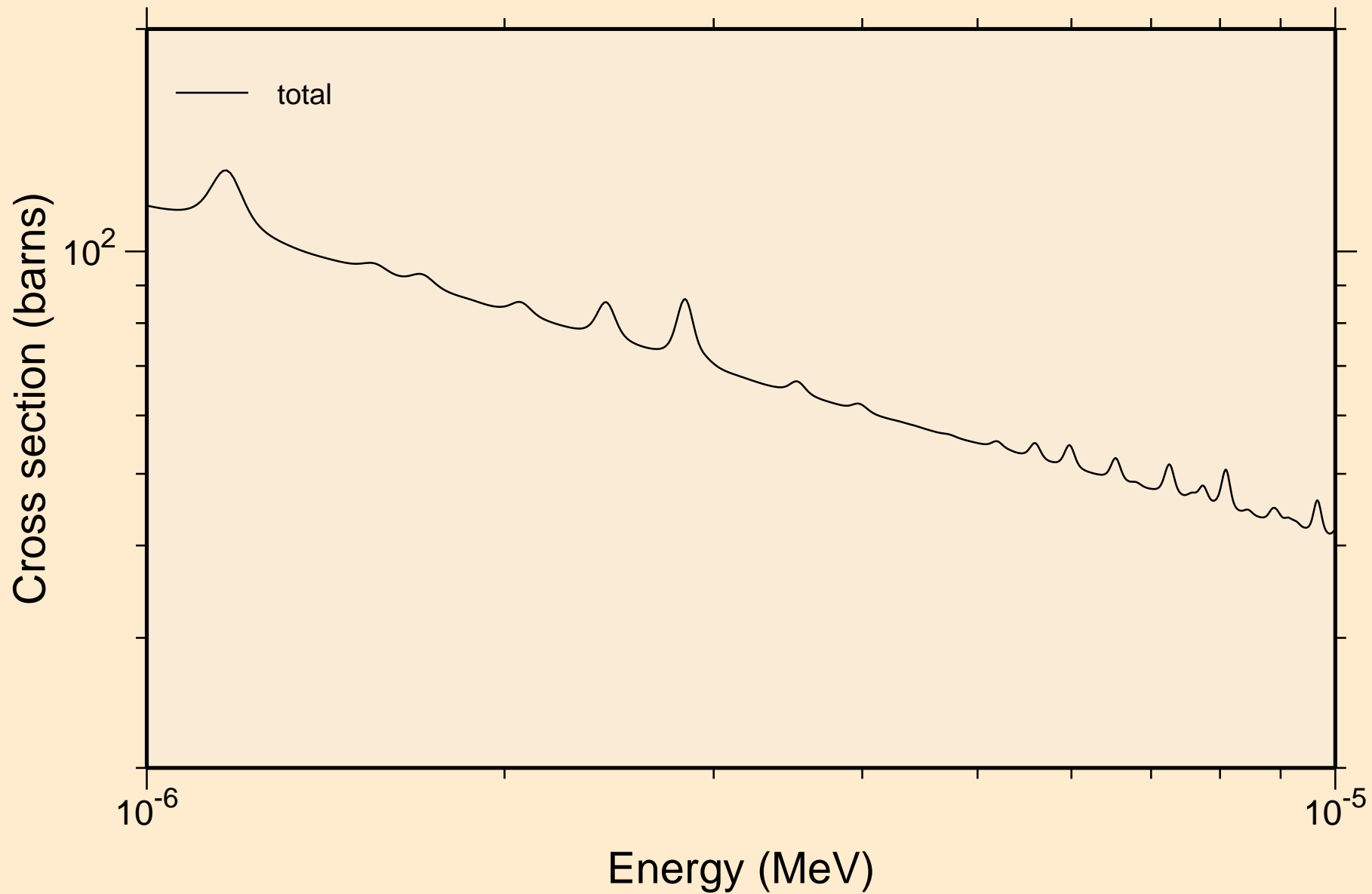

RE172M NRG TENDL-2015, AKONING
resonance total cross section

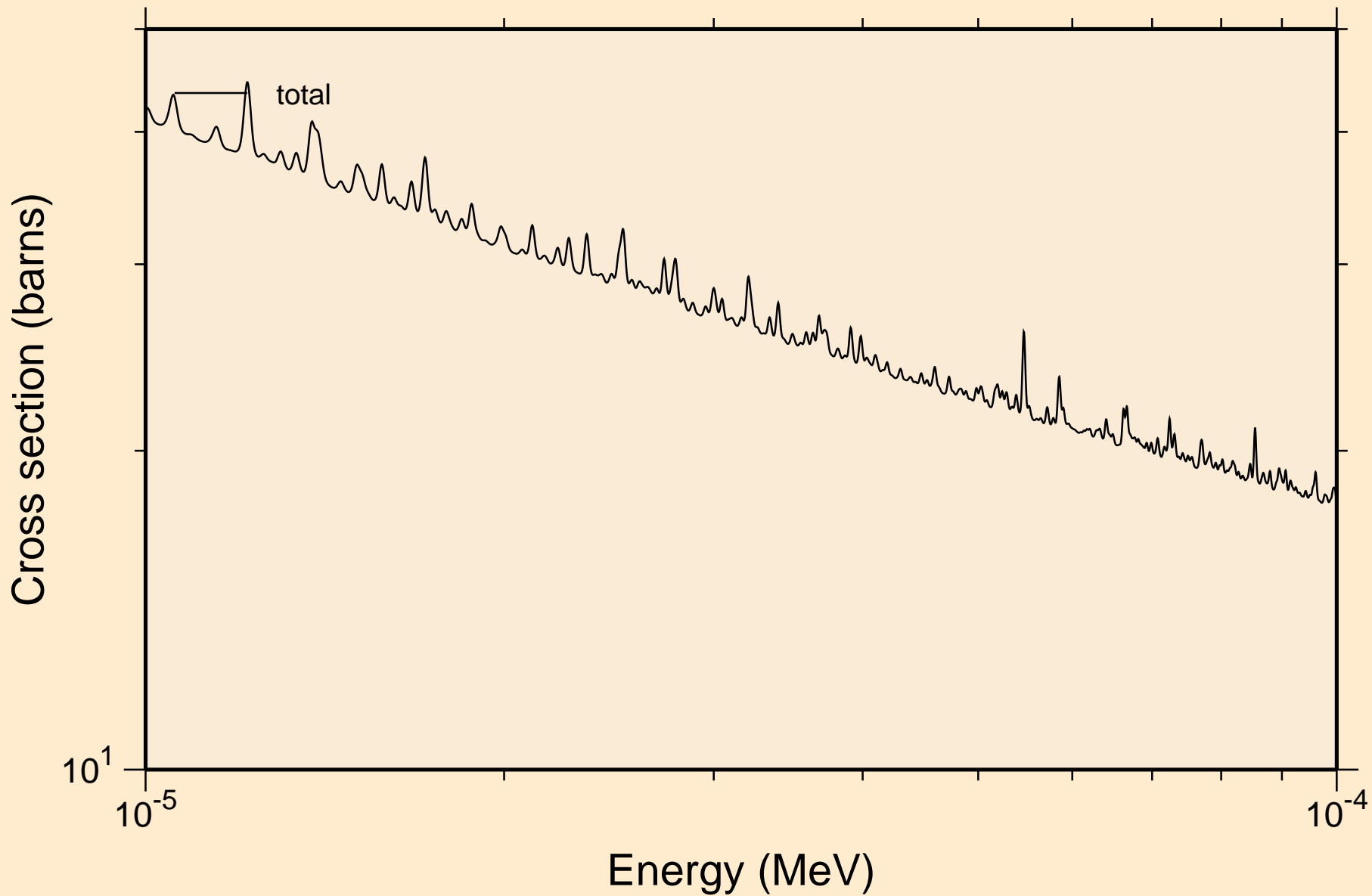

RE172M NRG TENDL-2015, AKONING
resonance total cross section

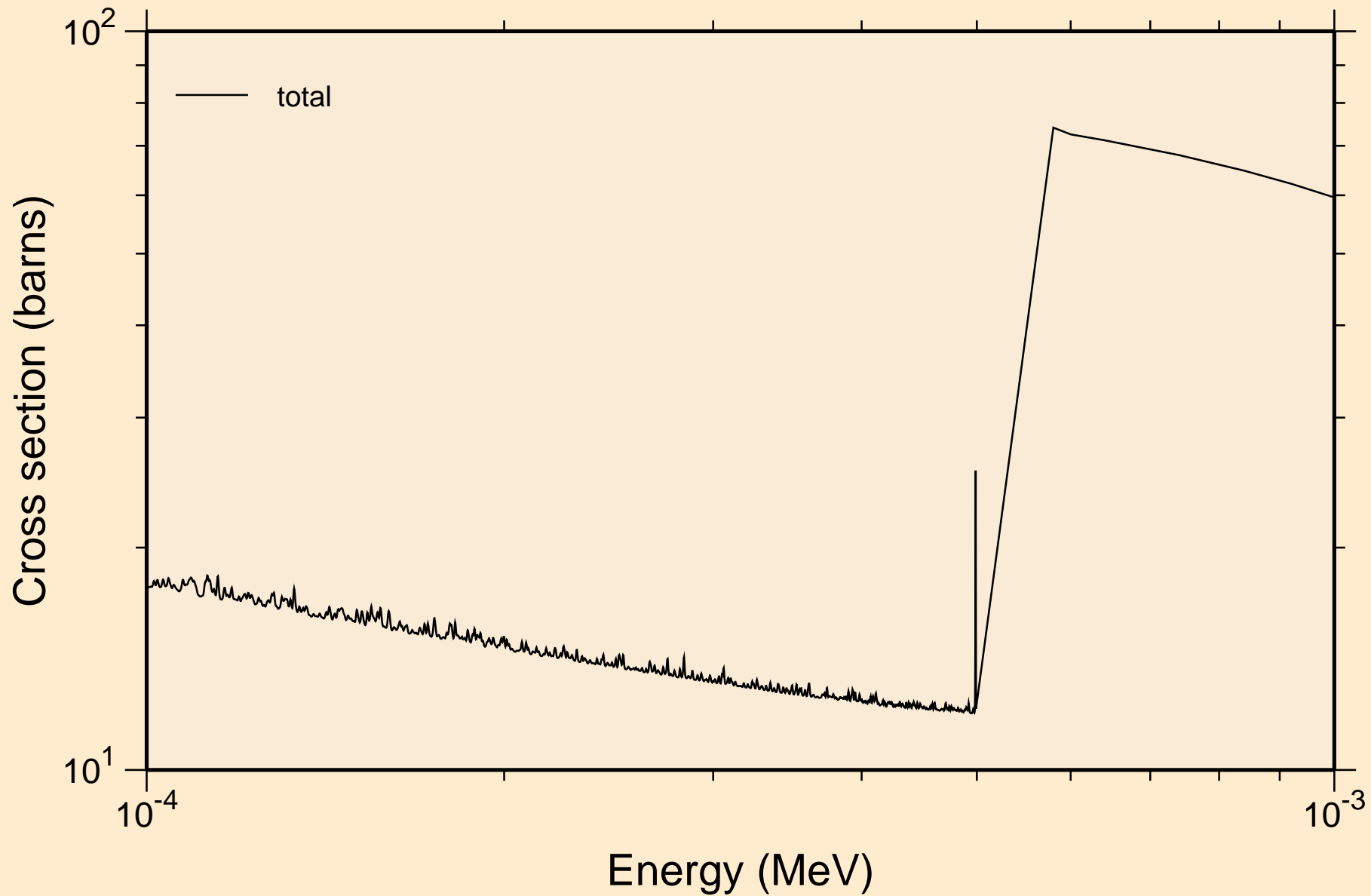

RE172M NRG TENDL-2015, AKONING
resonance total cross section

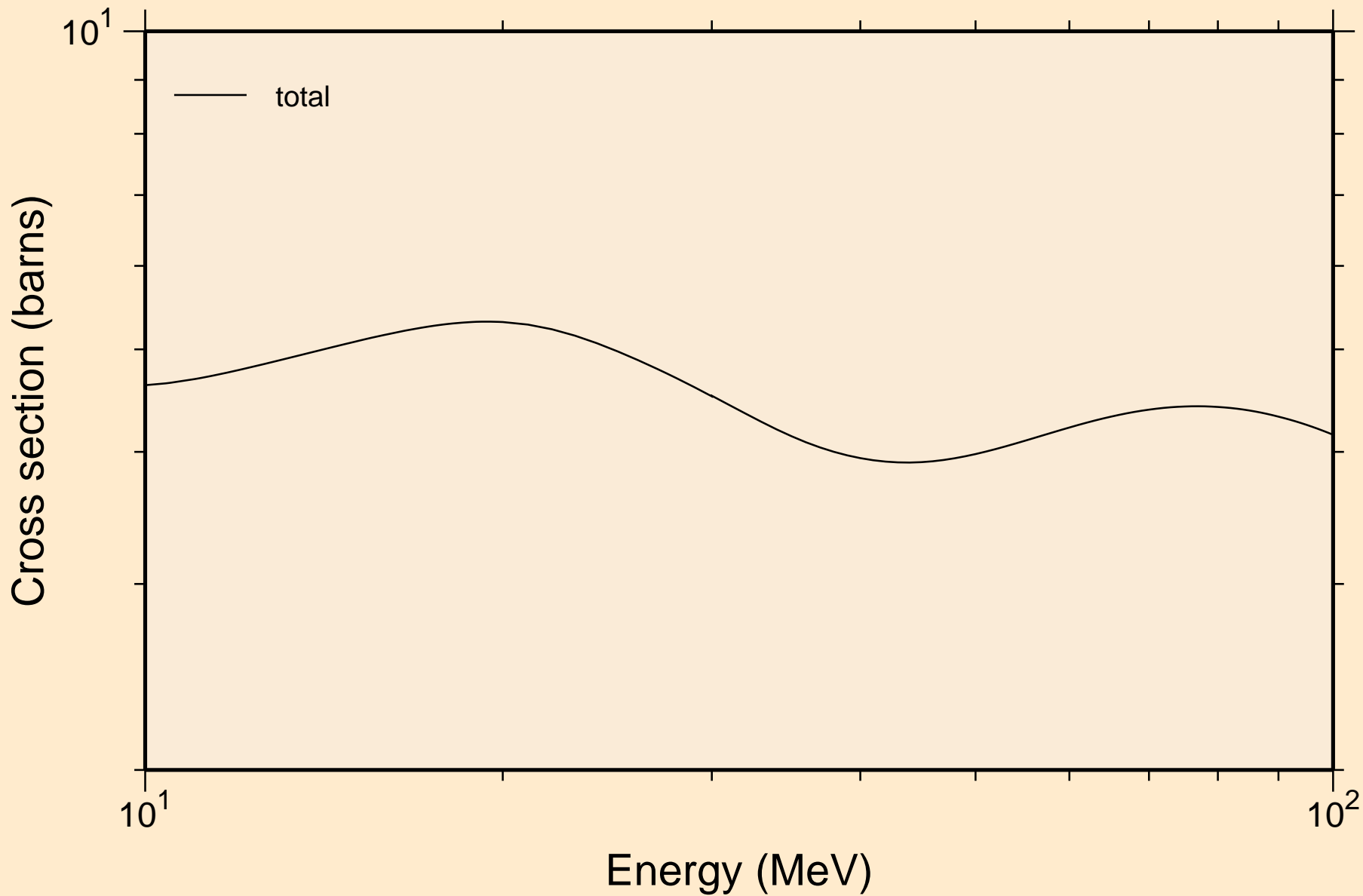

RE172M NRG TENDL-2015, AKONING
resonance absorption cross sections

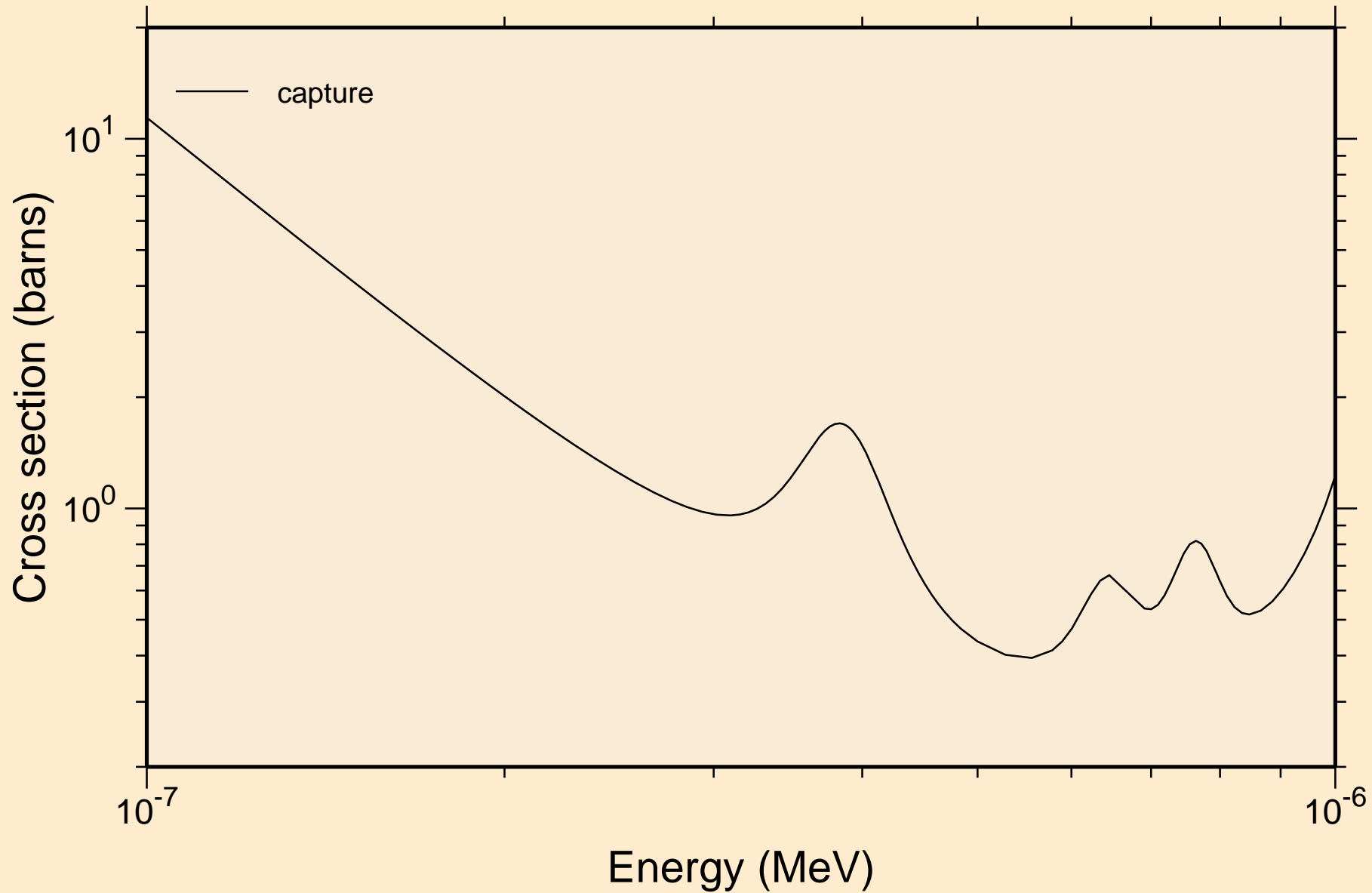

RE172M NRG TENDL-2015, AKONING
resonance absorption cross sections

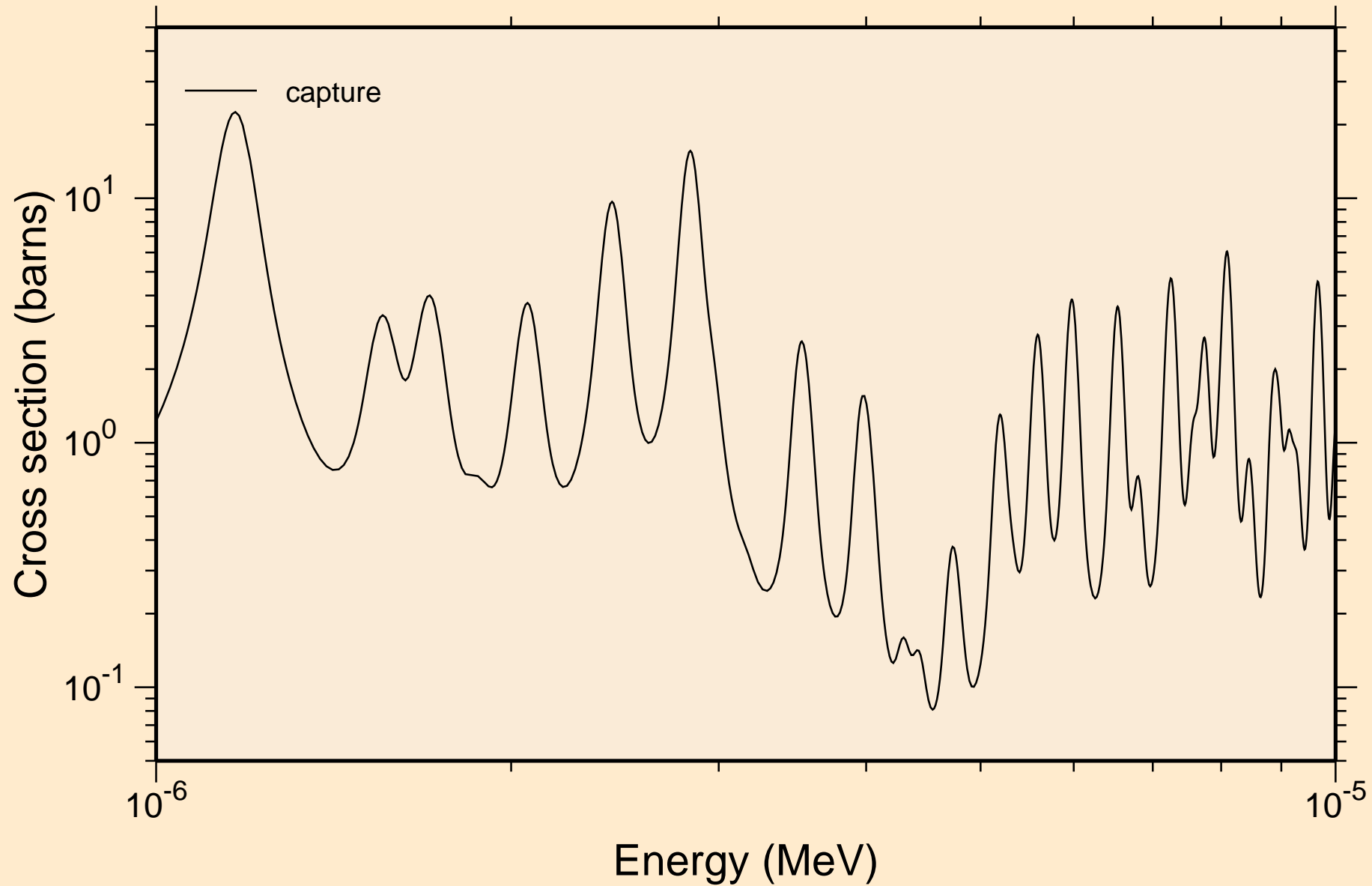

RE172M NRG TENDL-2015, AKONING
resonance absorption cross sections

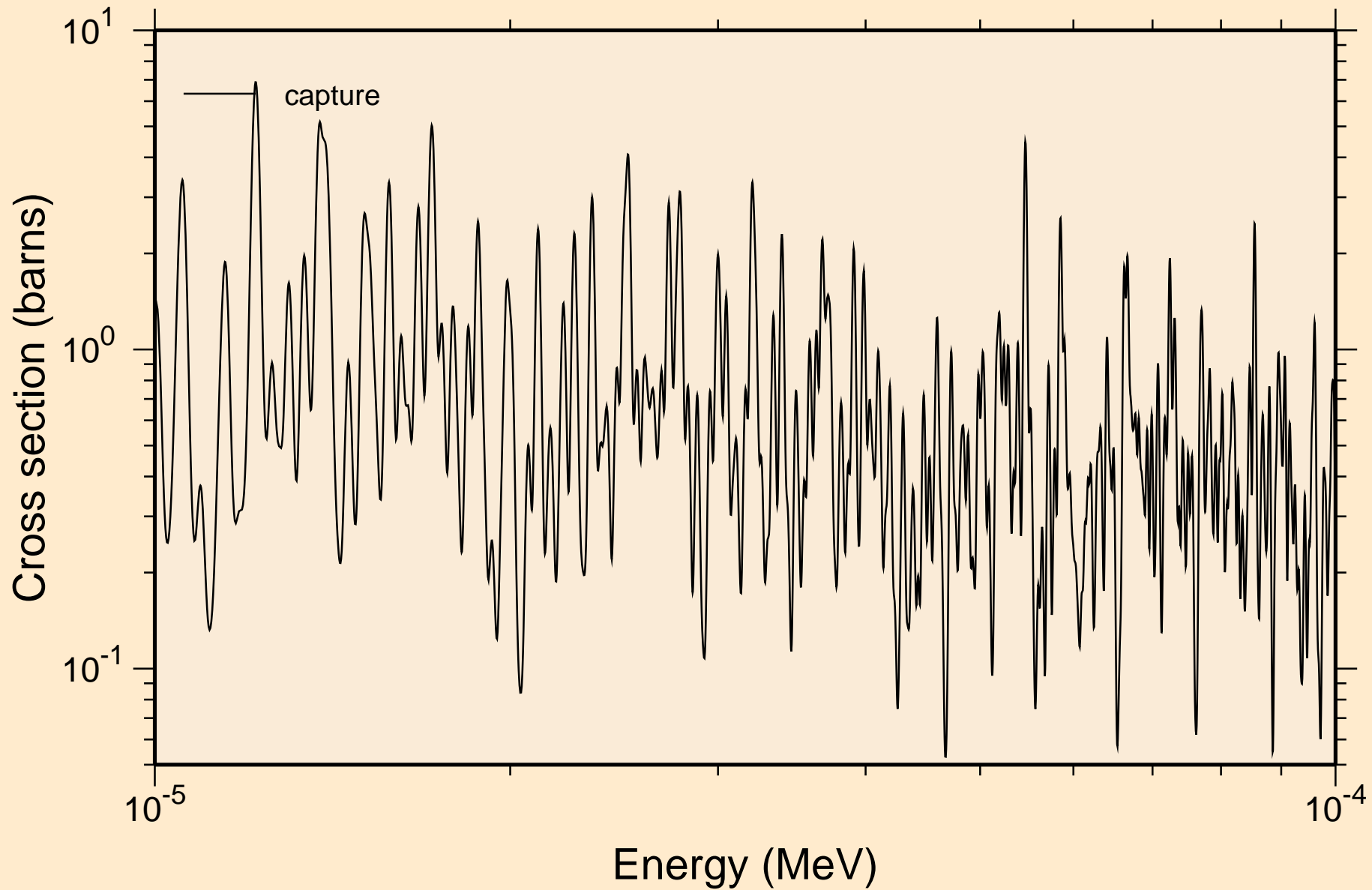

RE172M NRG TENDL-2015, AKONING
resonance absorption cross sections

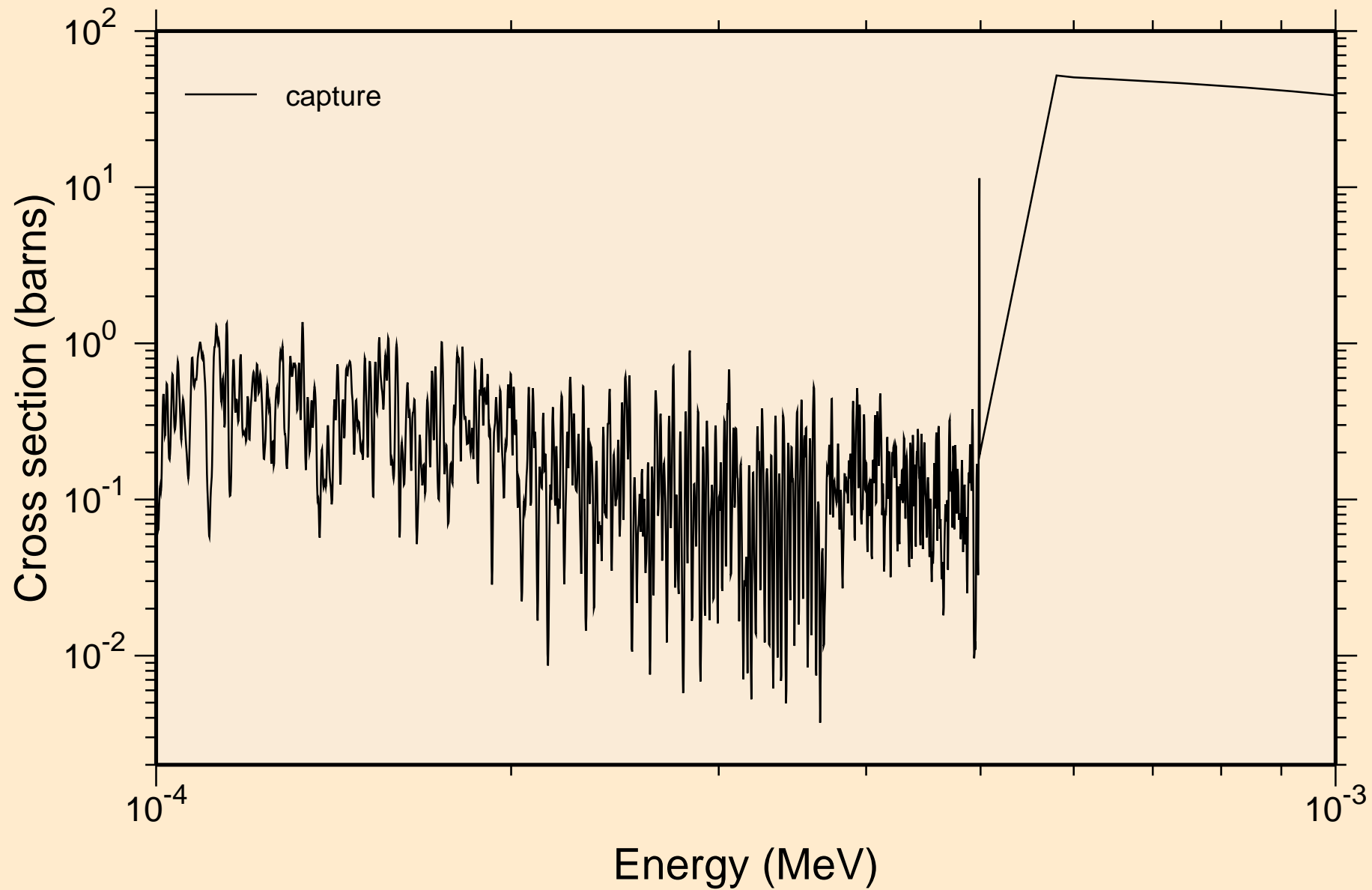

RE172M NRG TENDL-2015, AKONING
resonance absorption cross sections

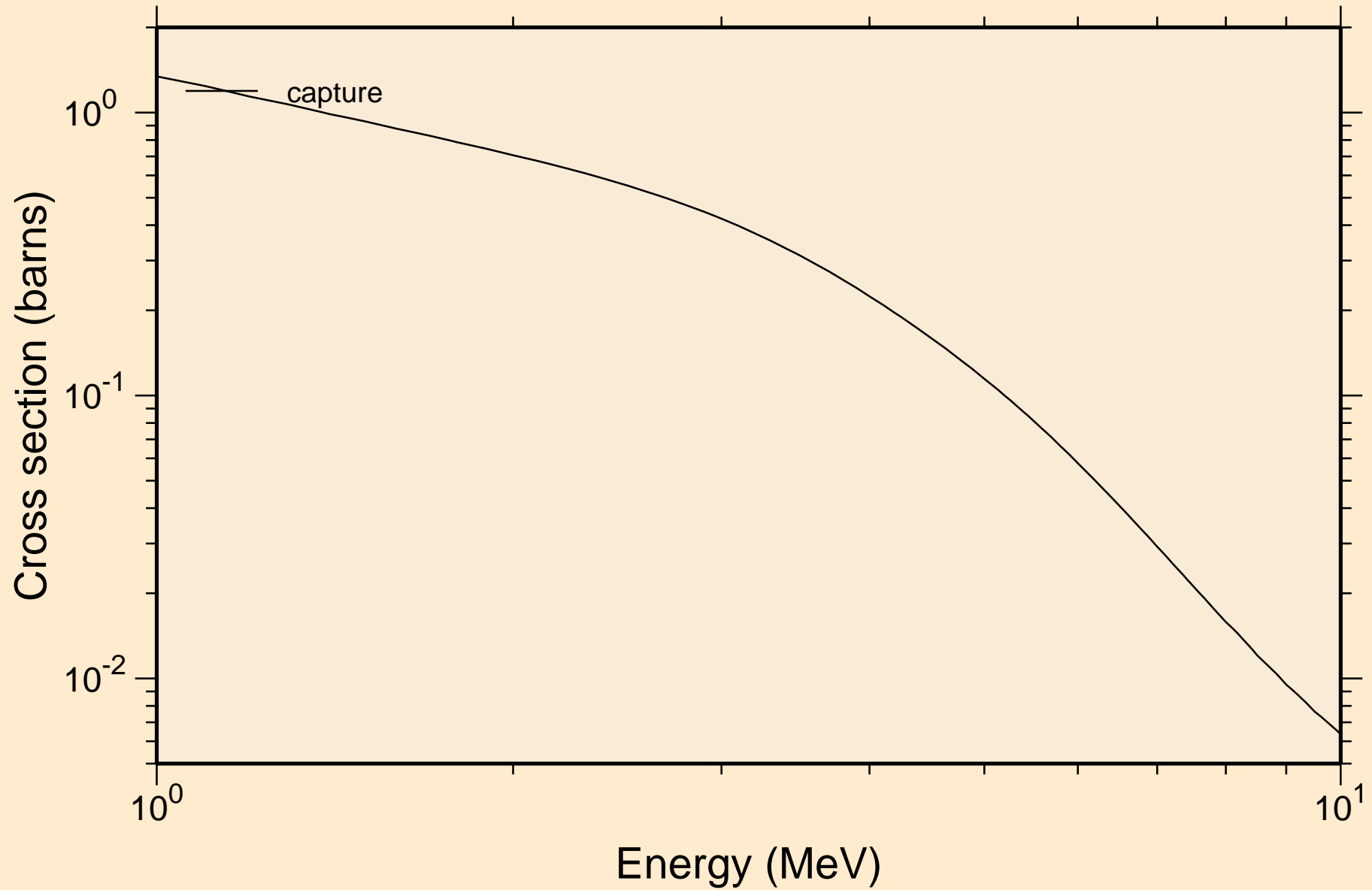

RE172M NRG TENDL-2015, AKONING

Non-threshold reactions

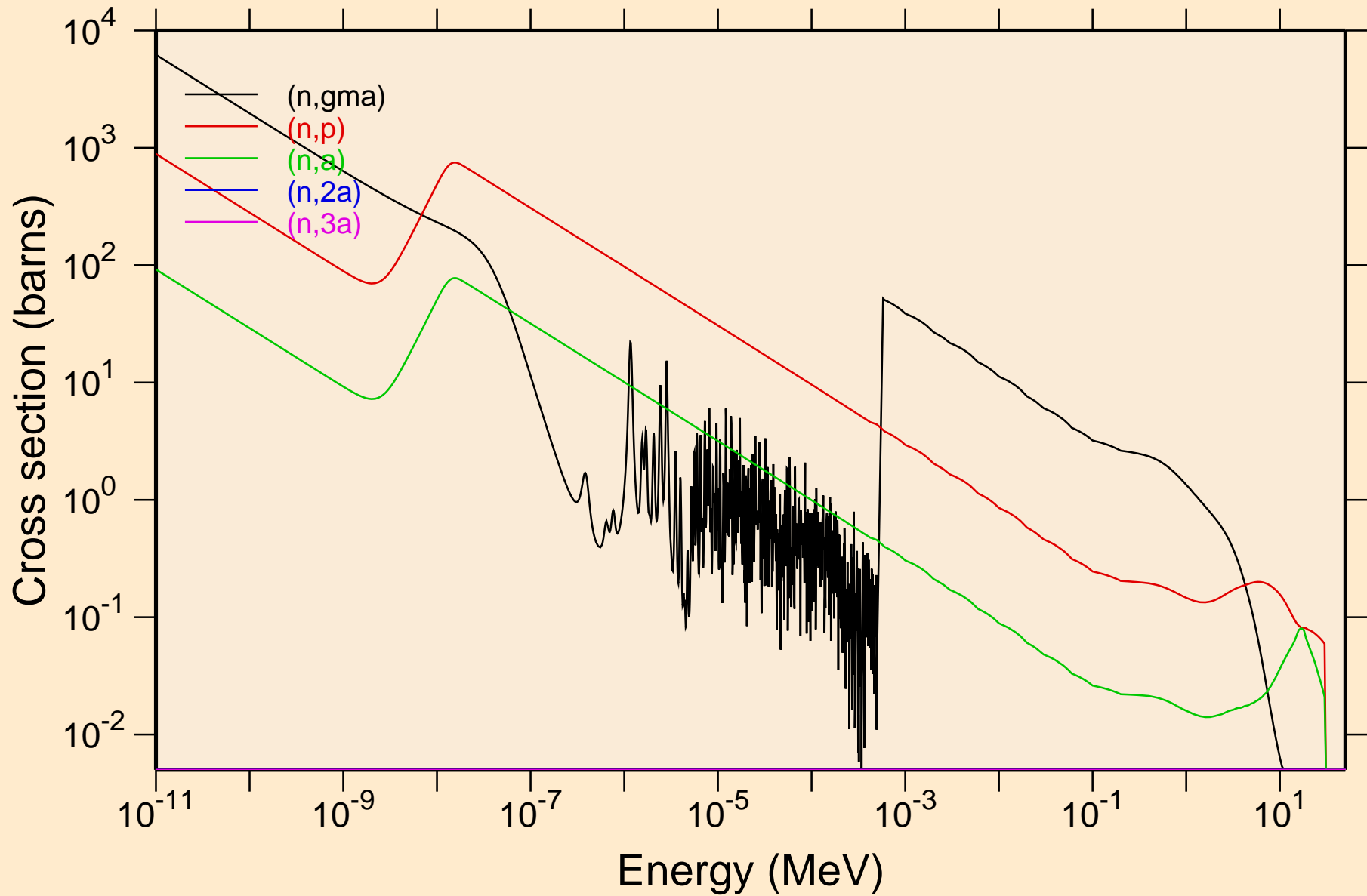

RE172M NRG TENDL-2015, AKONING
Non-threshold reactions

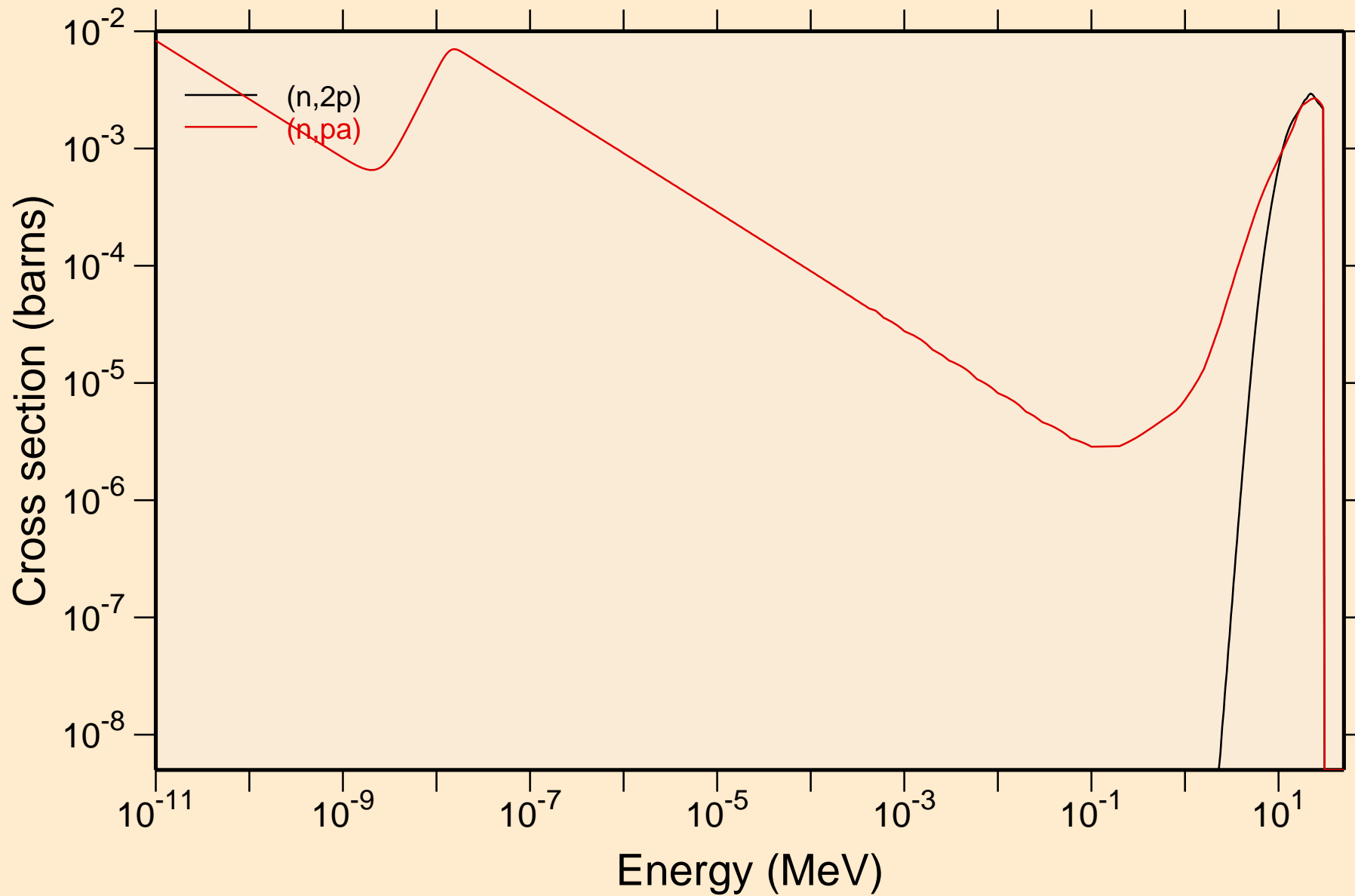

RE172M NRG TENDL-2015, AKONING

Principal cross sections

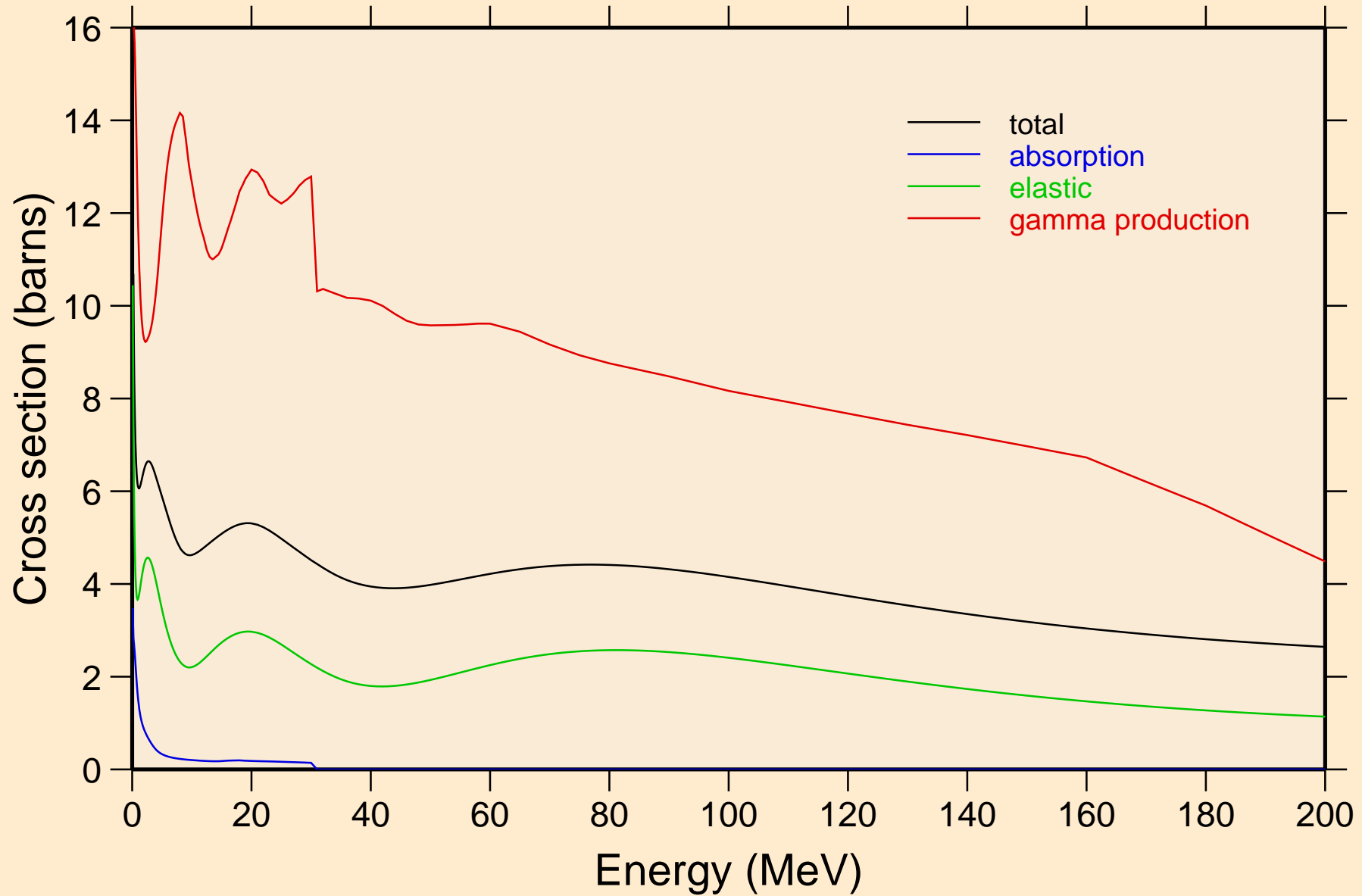

RE172M NRG TENDL-2015, AKONING

Non-threshold reactions

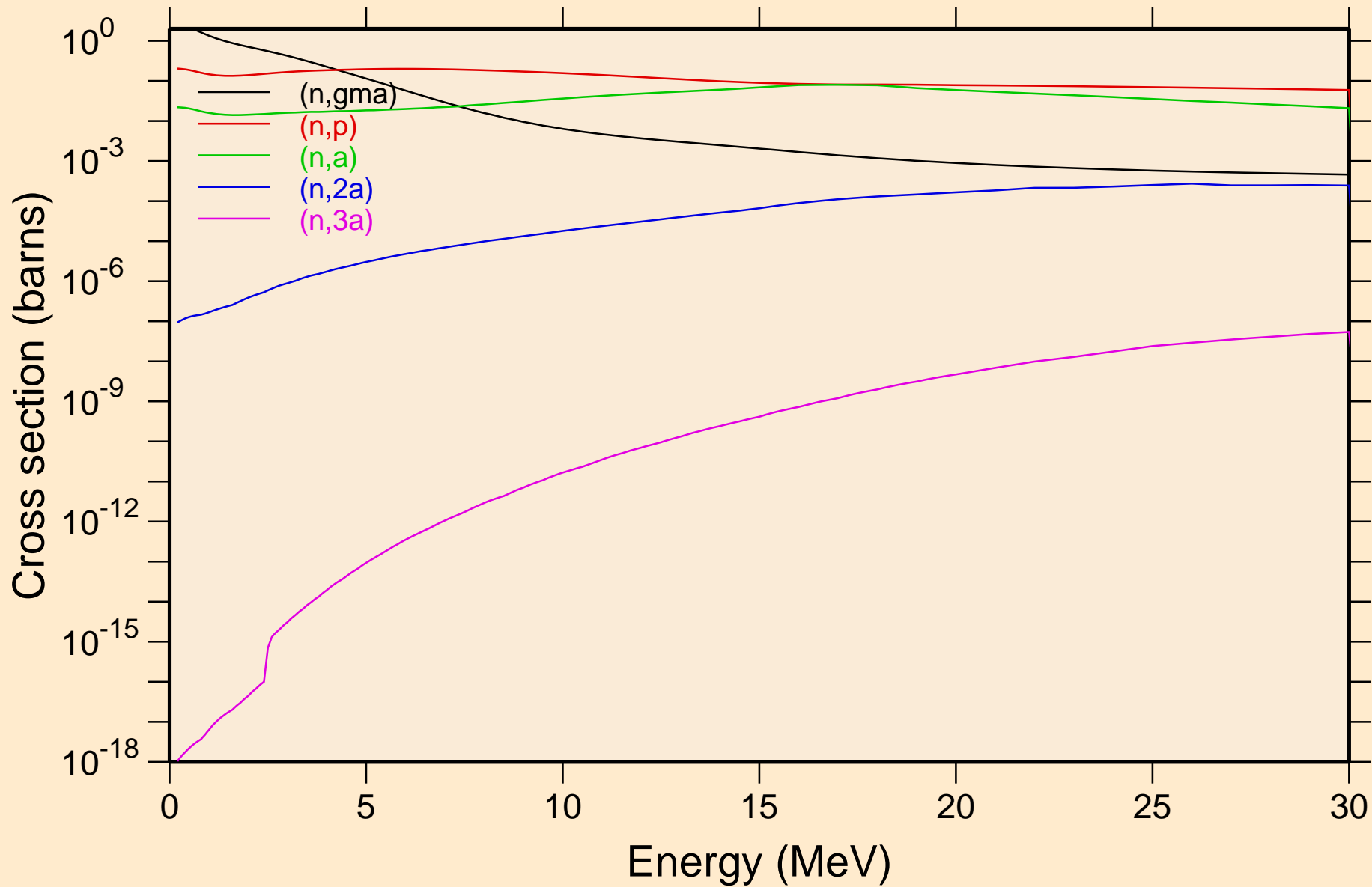

RE172M NRG TENDL-2015, AKONING
Non-threshold reactions

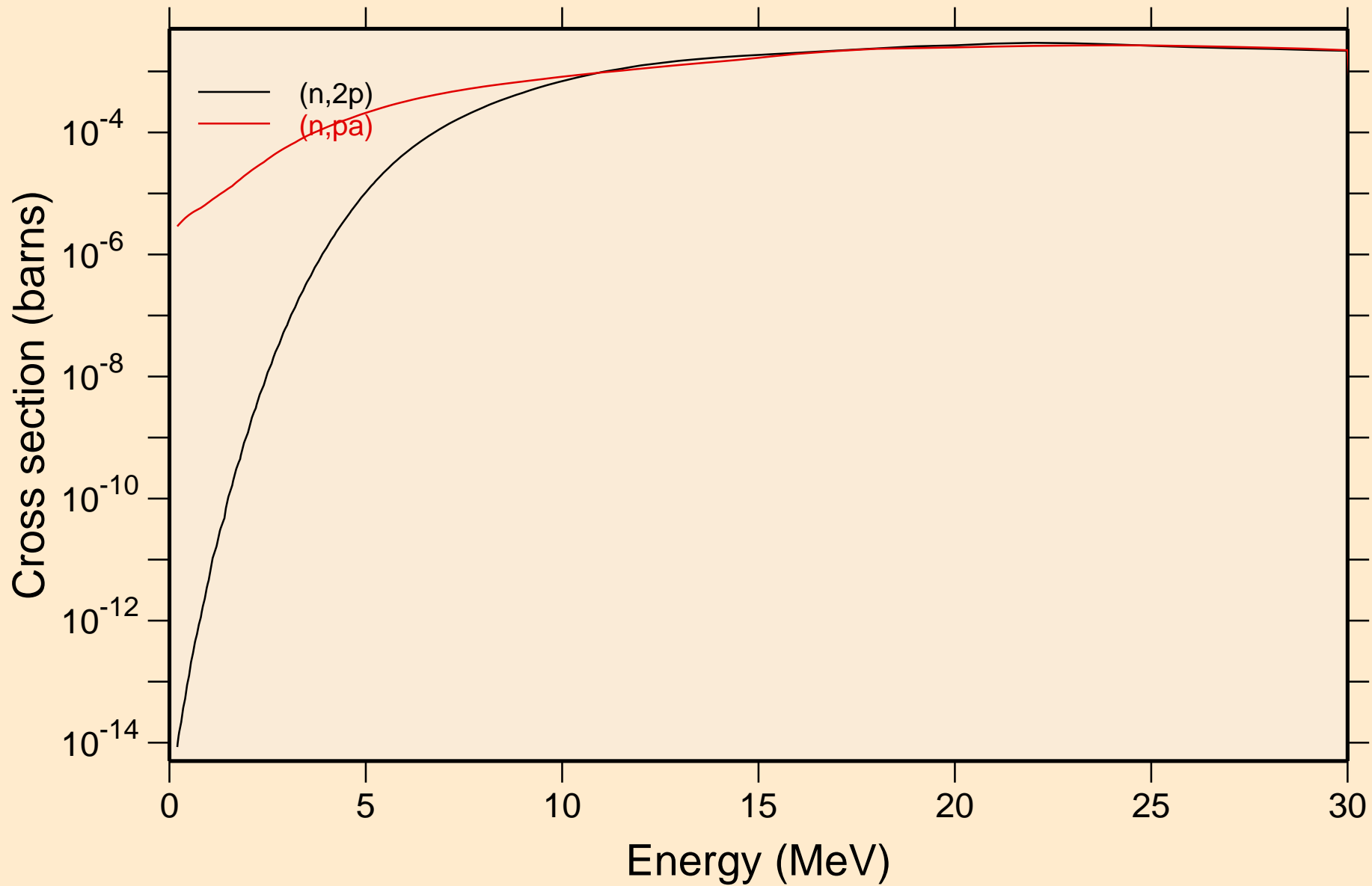

RE172M NRG TENDL-2015, AKONING

Inelastic levels

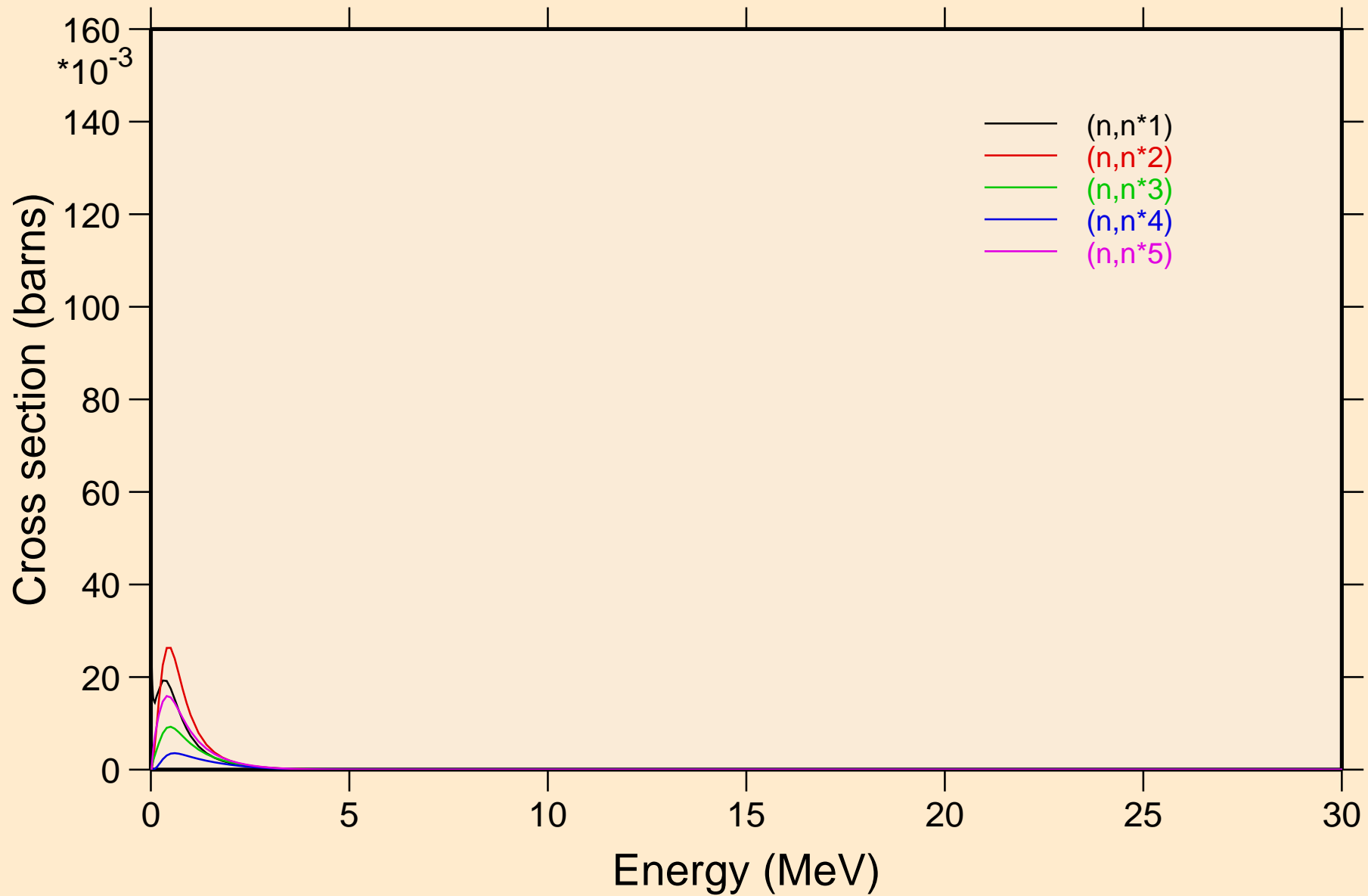

RE172M NRG TENDL-2015, AKONING

Inelastic levels

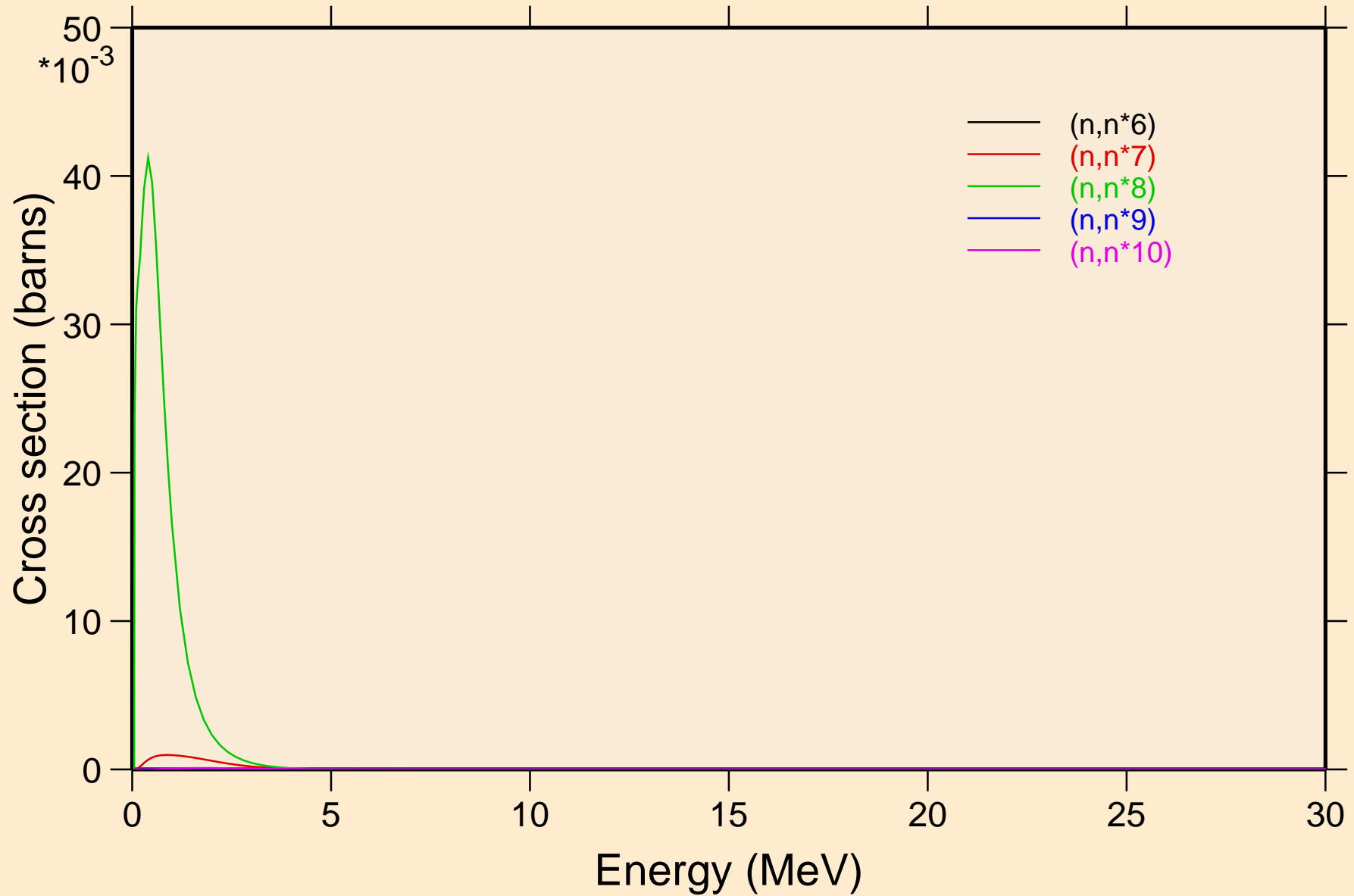

RE172M NRG TENDL-2015, AKONING

Inelastic levels

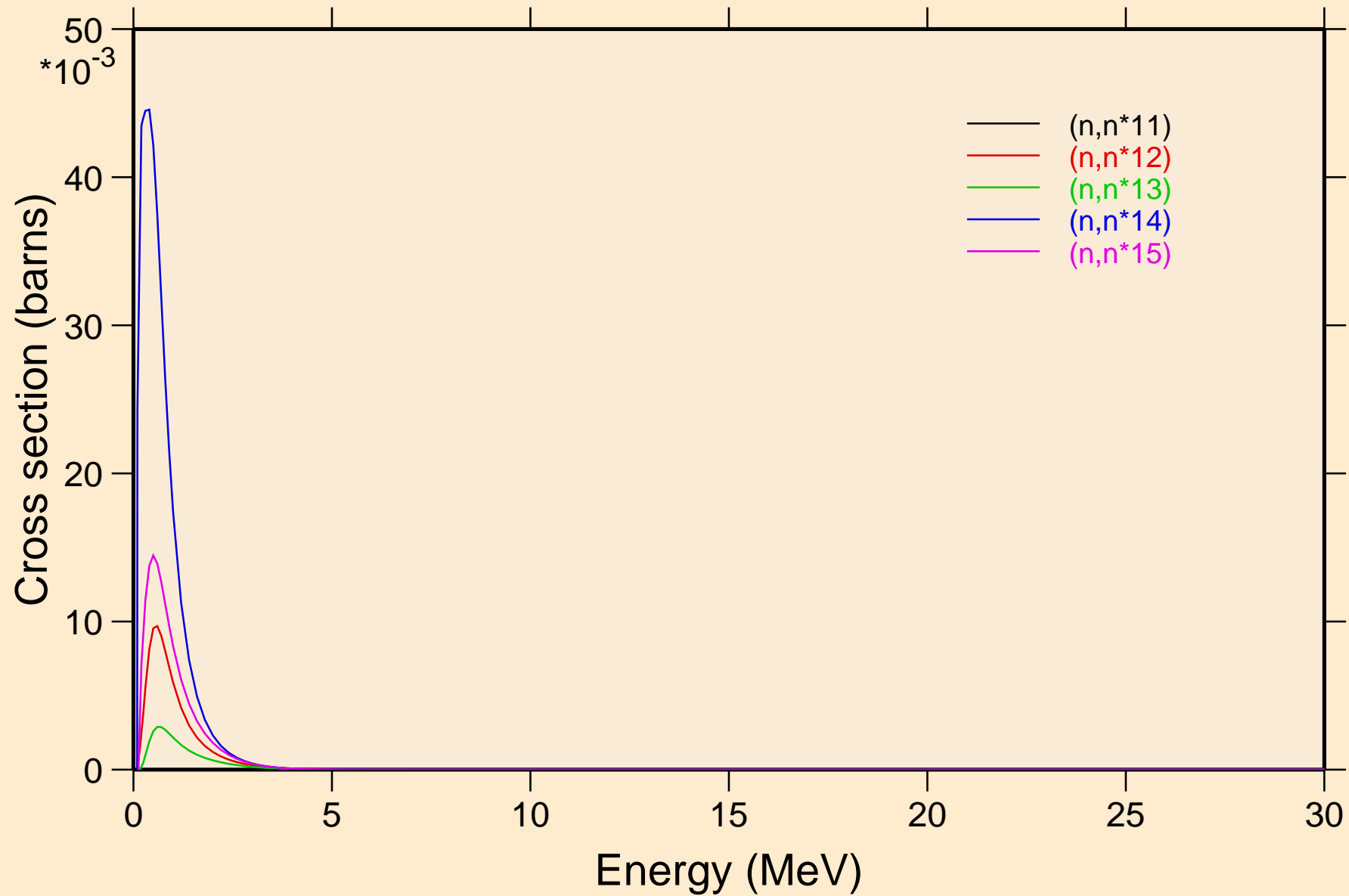

RE172M NRG TENDL-2015, AKONING

Inelastic levels

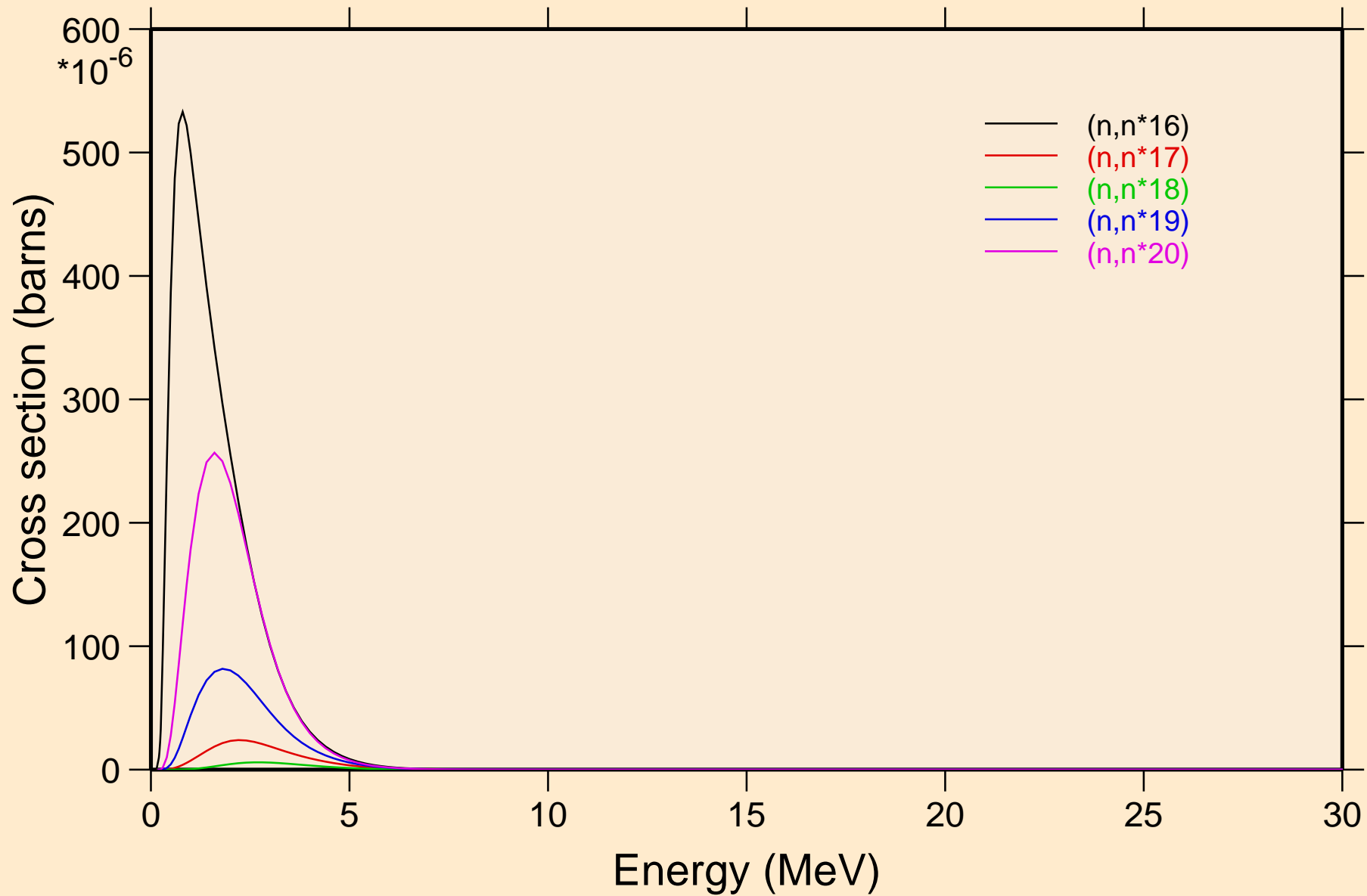

RE172M NRG TENDL-2015, AKONING
Inelastic levels

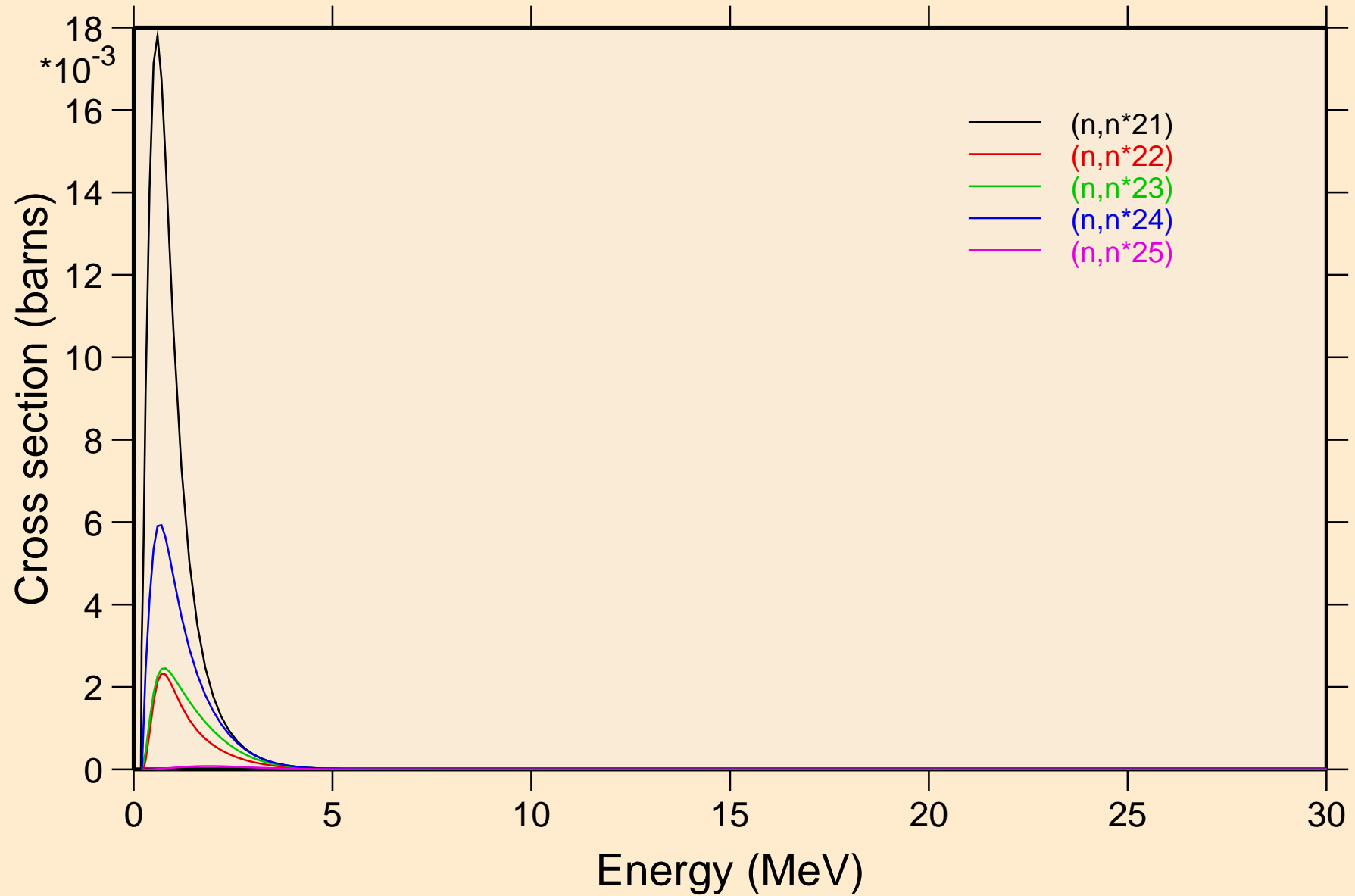

RE172M NRG TENDL-2015, AKONING
Inelastic levels

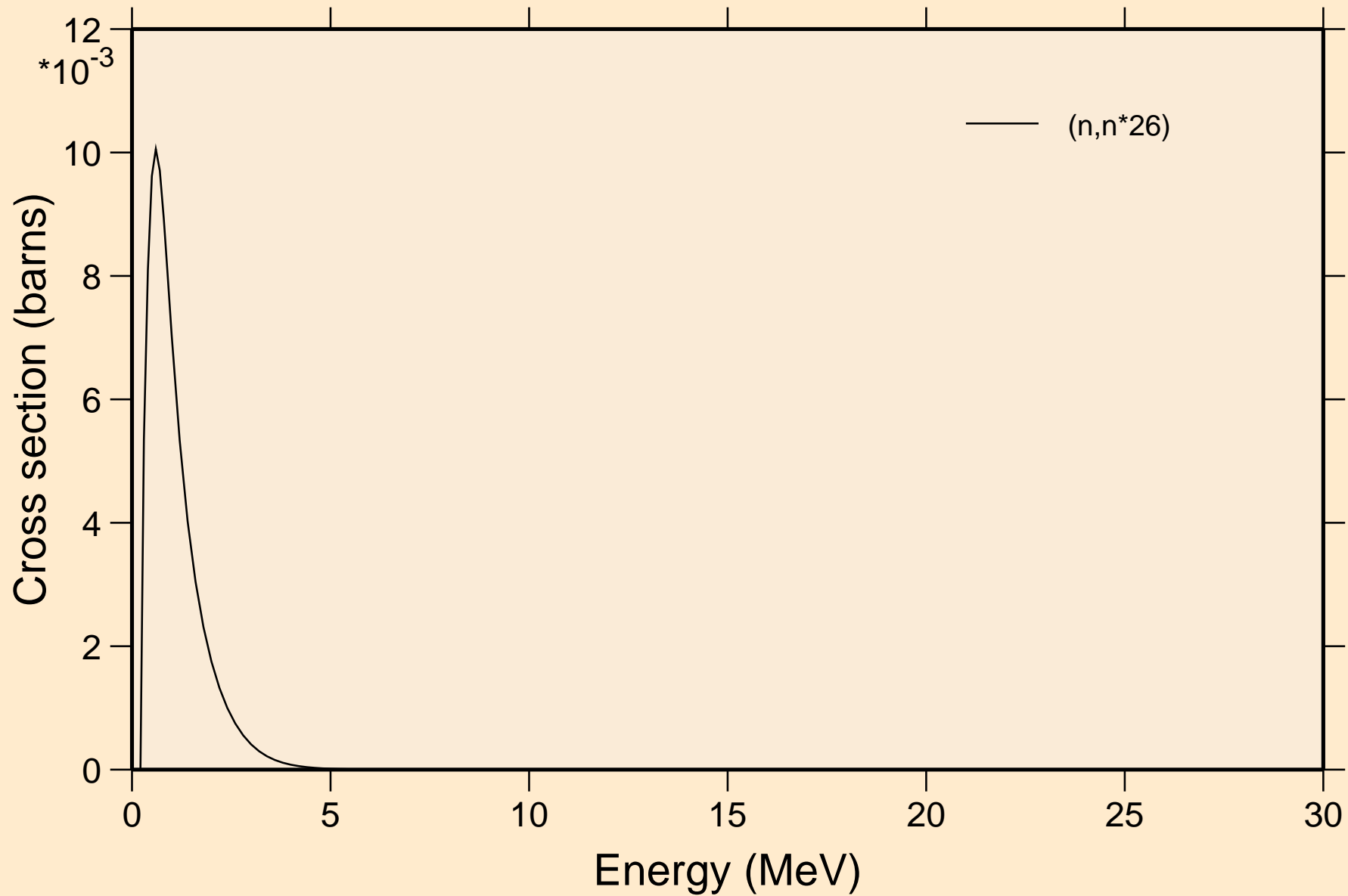

RE172M NRG TENDL-2015, AKONING

Threshold reactions

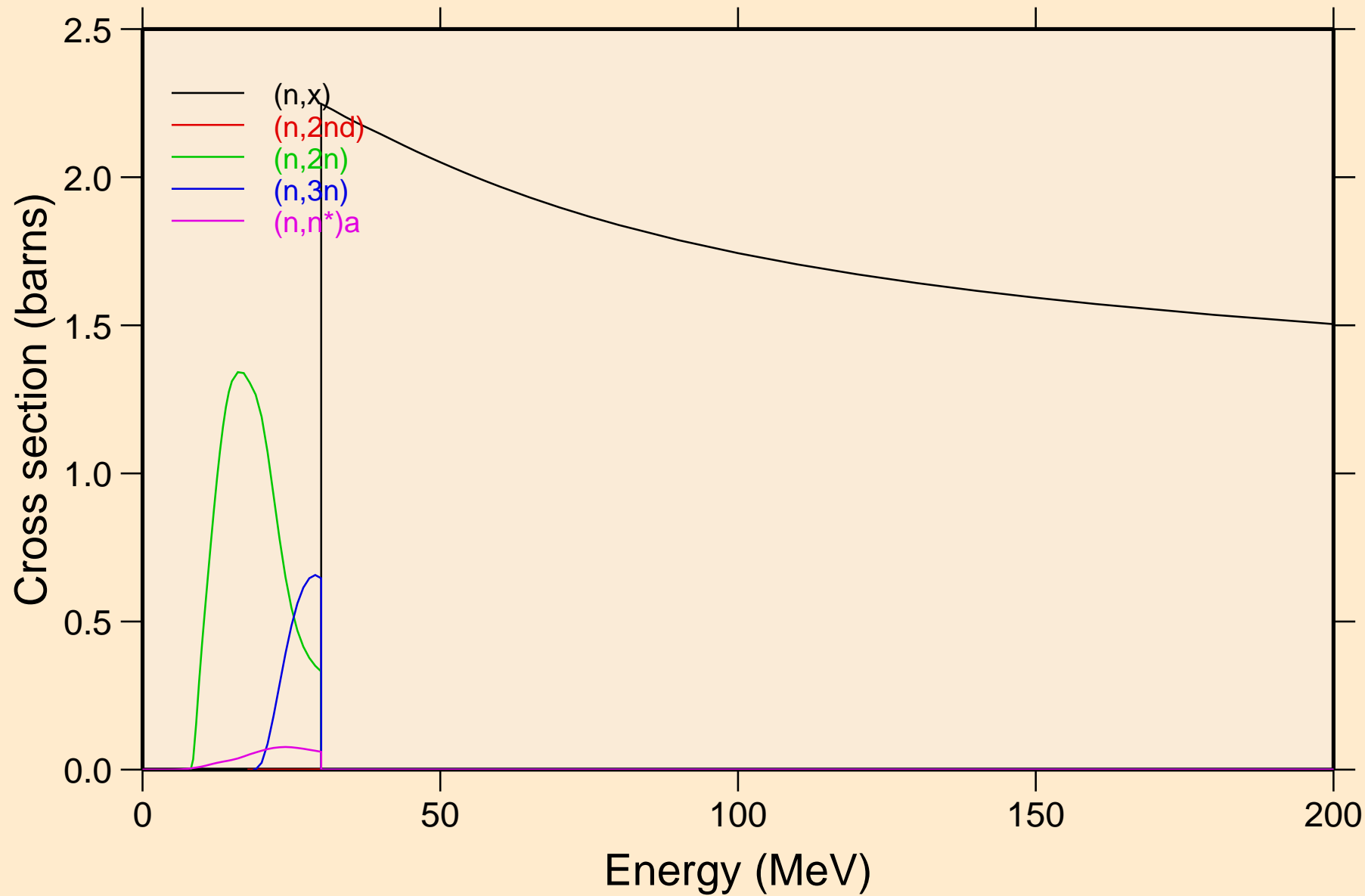

RE172M NRG TENDL-2015, AKONING

Threshold reactions

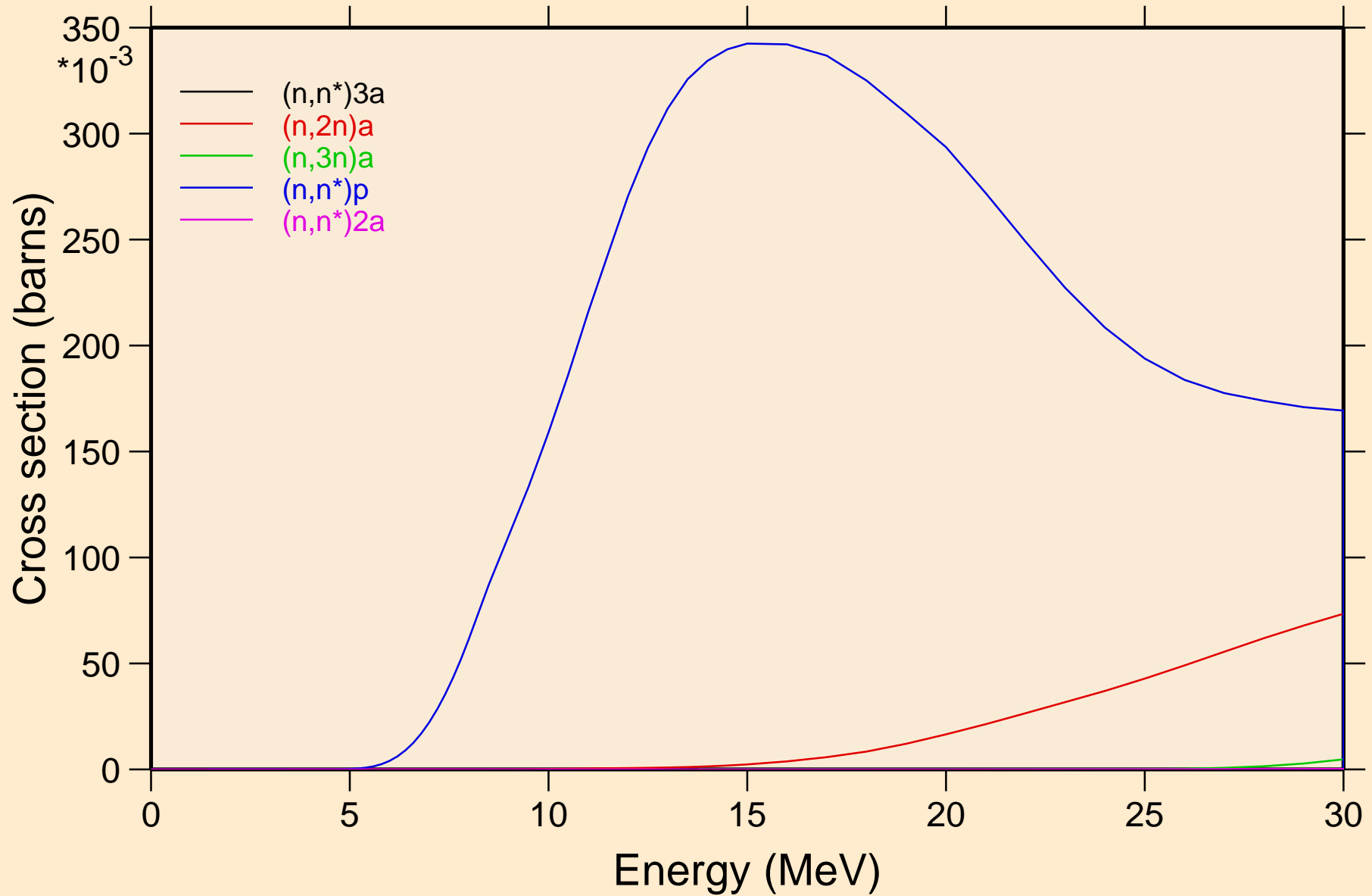

RE172M NRG TENDL-2015, AKONING

Threshold reactions

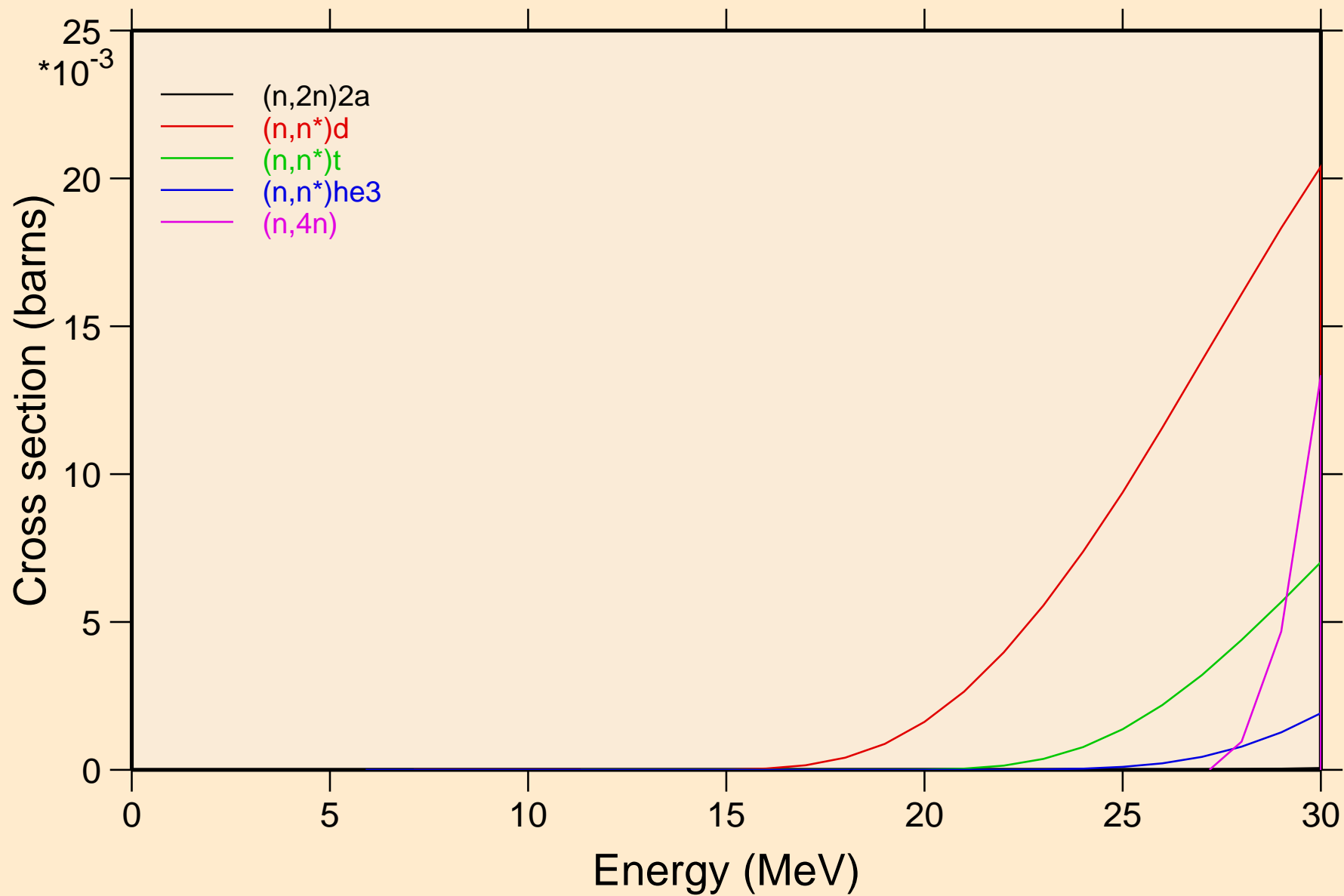

RE172M NRG TENDL-2015, AKONING

Threshold reactions

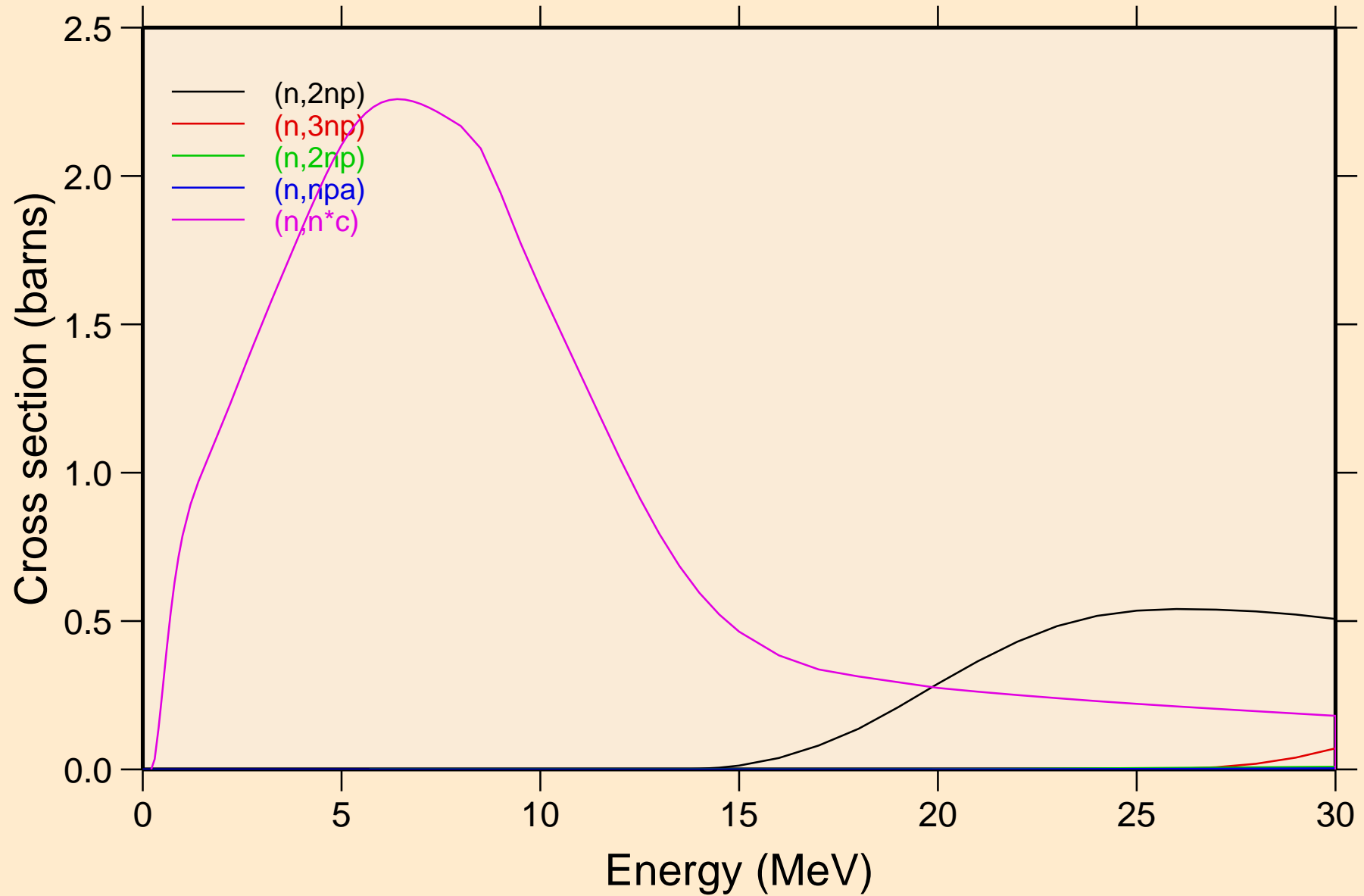

RE172M NRG TENDL-2015, AKONING

Threshold reactions

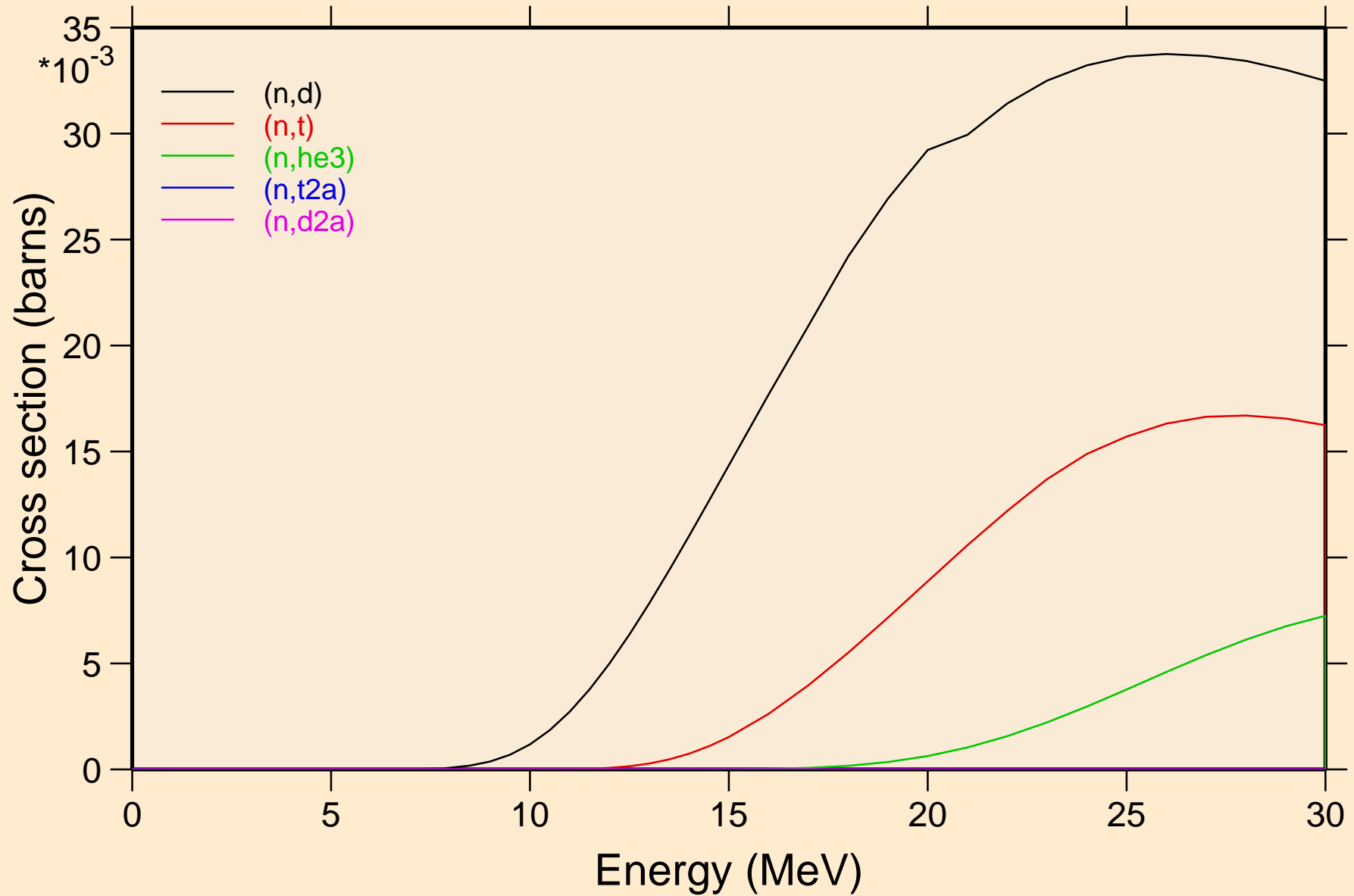

RE172M NRG TENDL-2015, AKONING

Threshold reactions

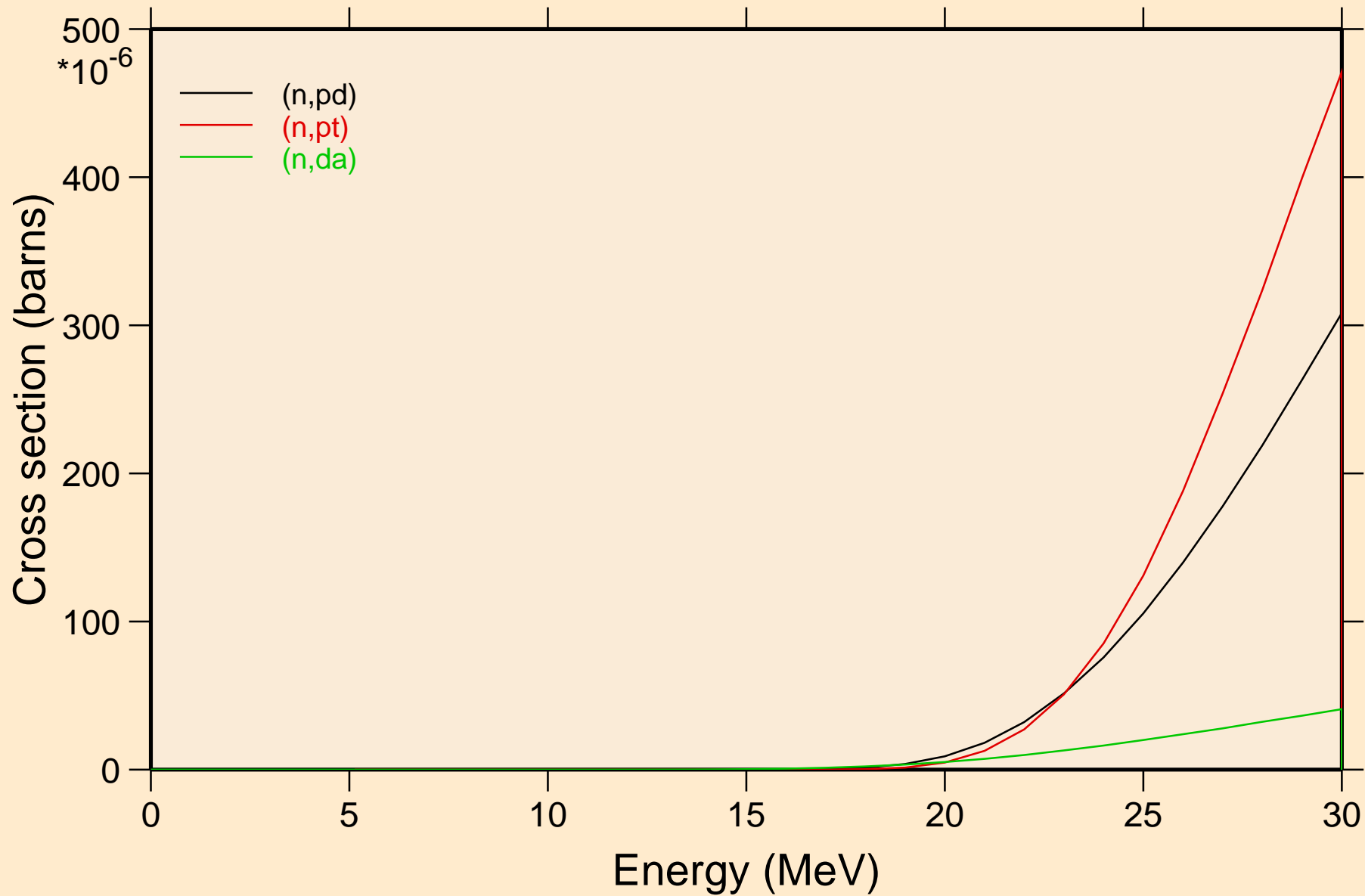

RE172M NRG TENDL-2015, AKONING
angular distribution for elastic

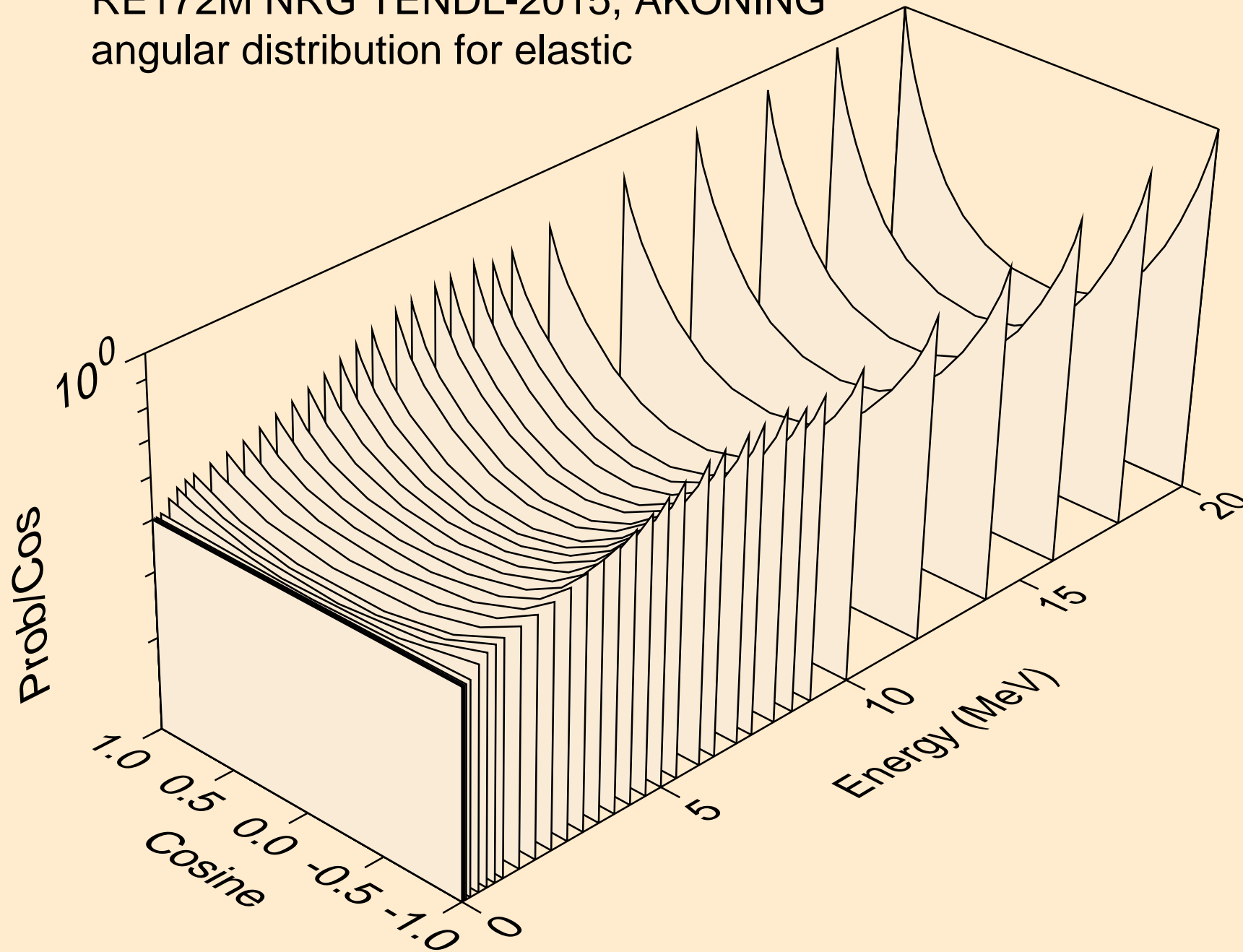

RE172M NRG TENDL-2015, AKONING
angular distribution for elastic

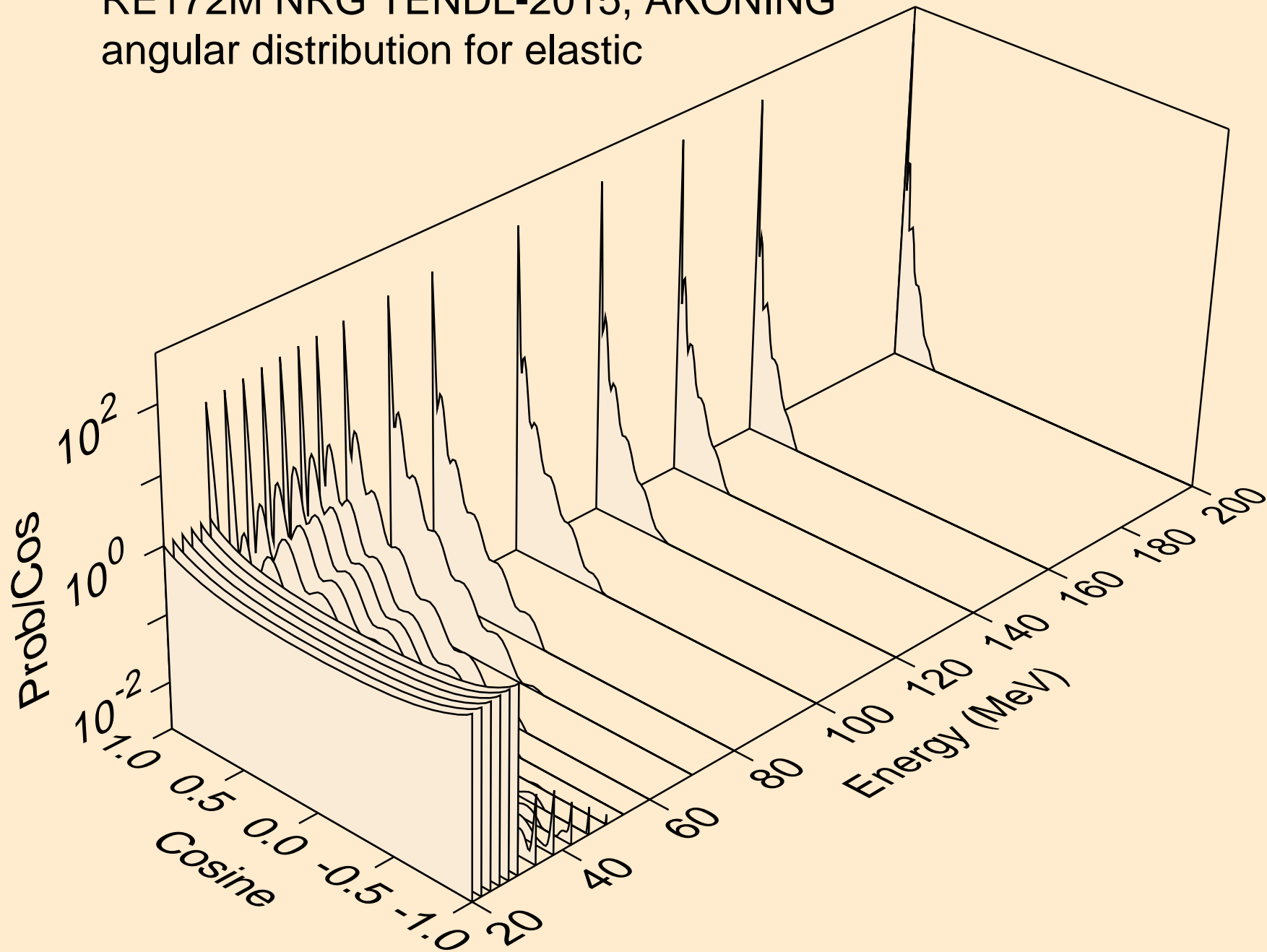

RE172M NRG TENDL-2015, AKONING
angular distribution for (n,n*1)

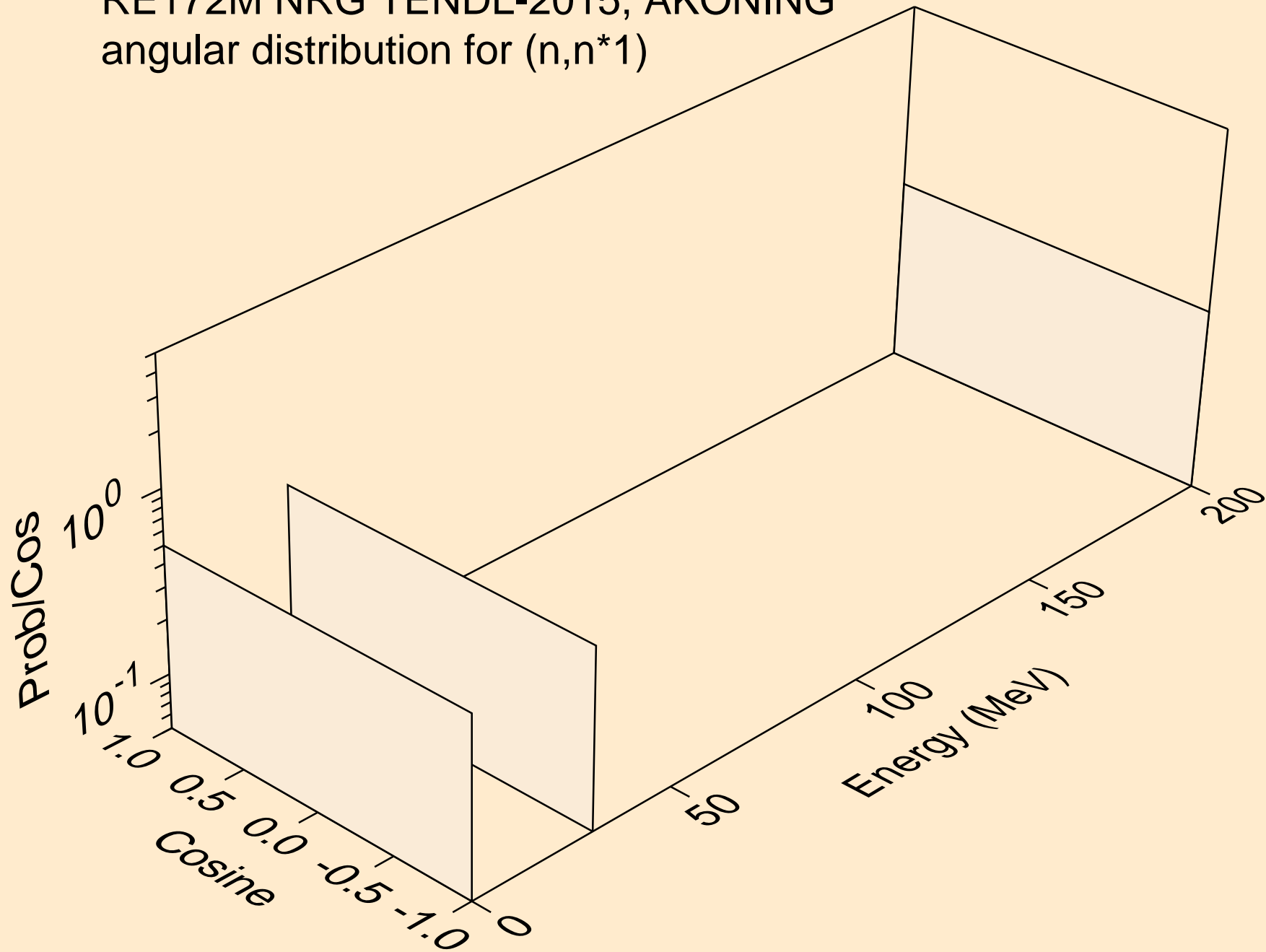

RE172M NRG TENDL-2015, AKONING
angular distribution for (n,n*2)

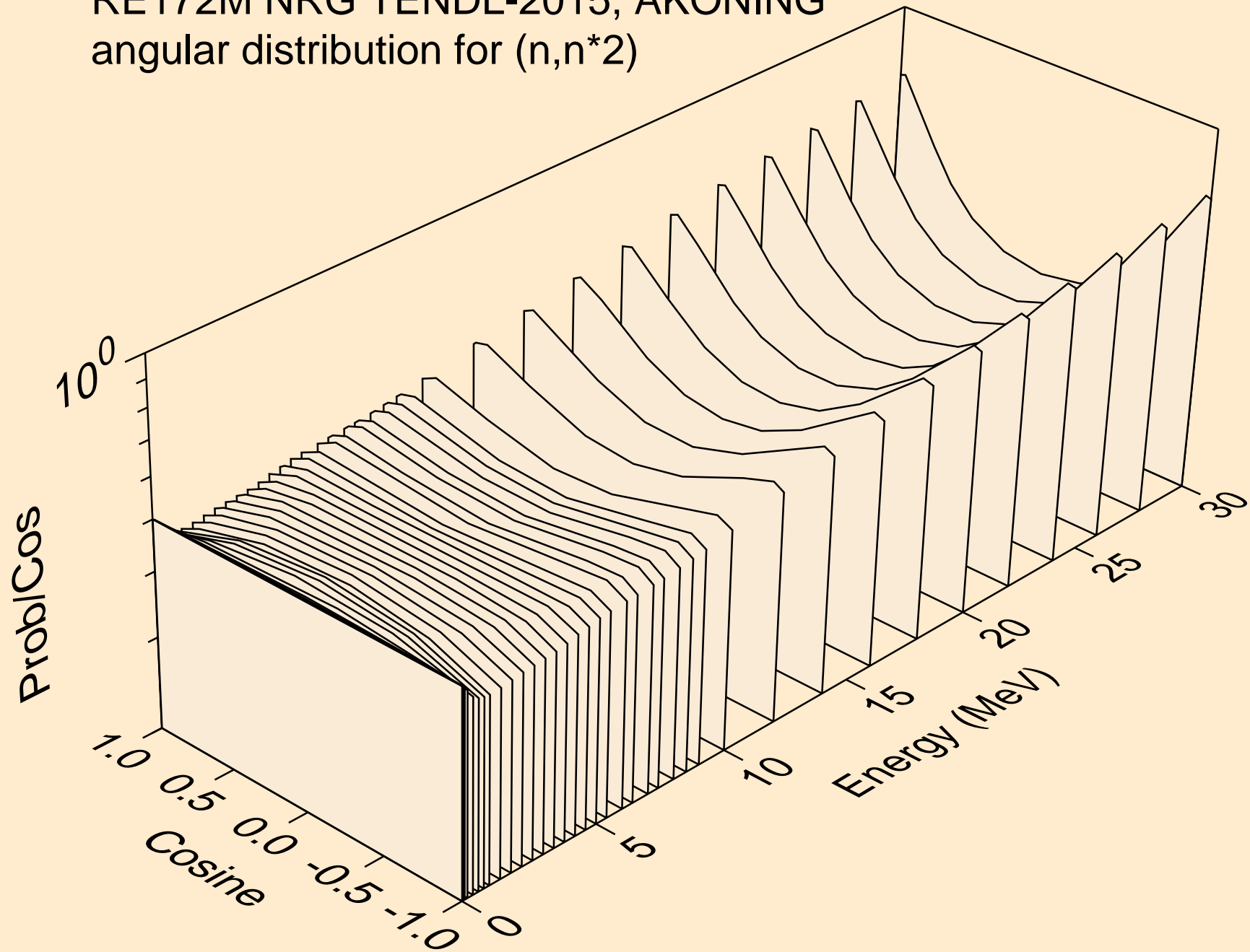

RE172M NRG TENDL-2015, AKONING
angular distribution for (n,n*3)

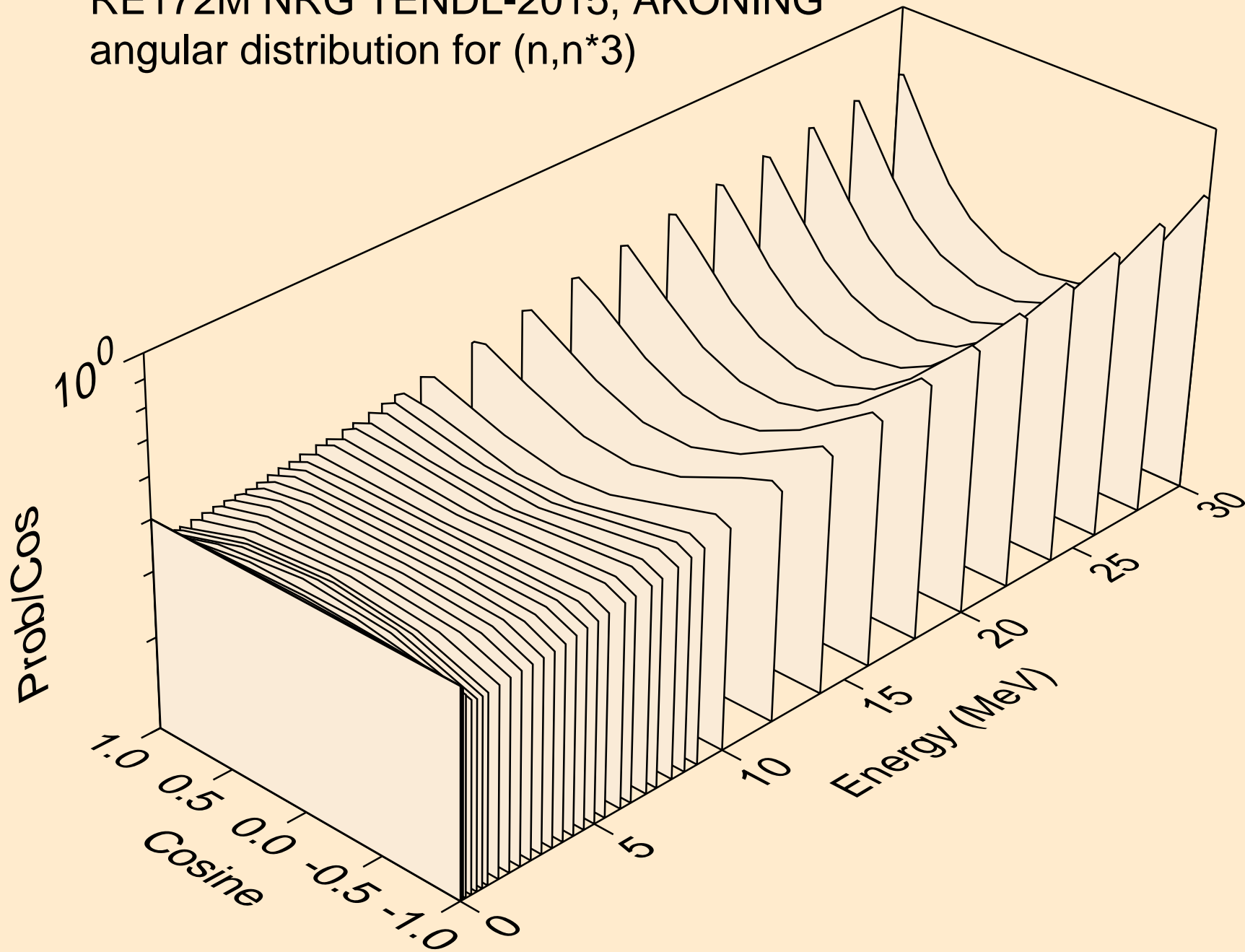

RE172M NRG TENDL-2015, AKONING
angular distribution for (n,n*4)

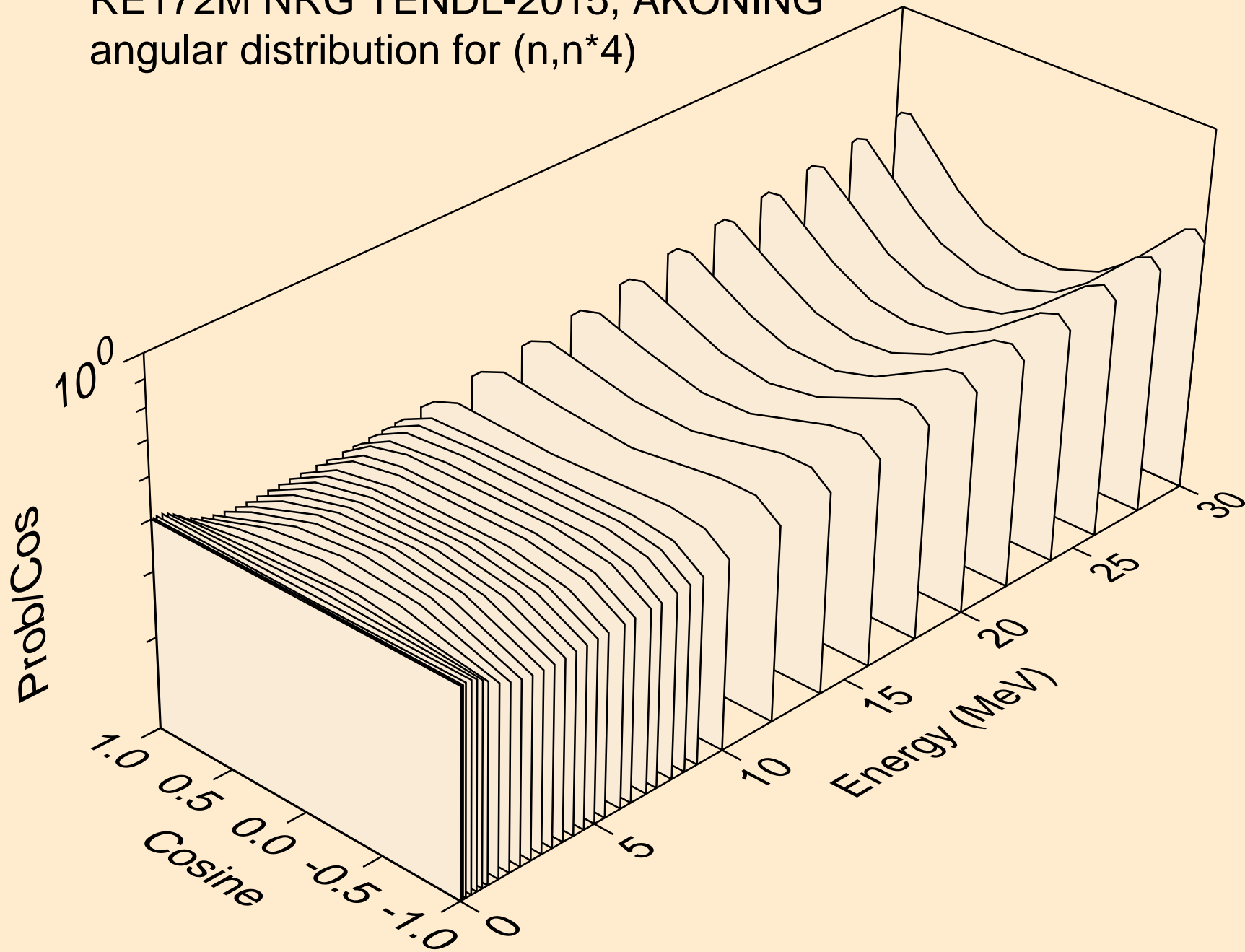

RE172M NRG TENDL-2015, AKONING
angular distribution for (n,n*5)

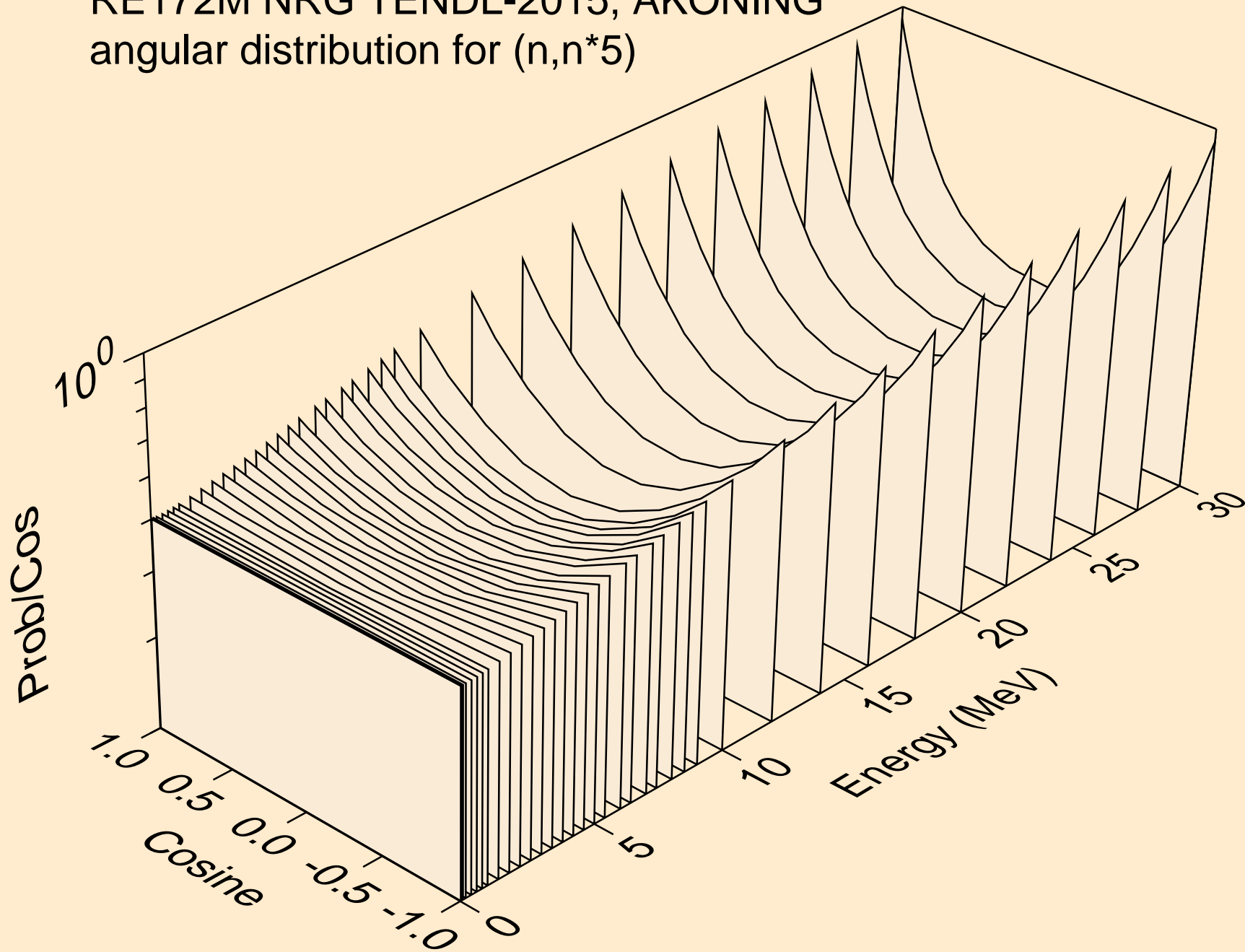

RE172M NRG TENDL-2015, AKONING
angular distribution for (n,n*6)

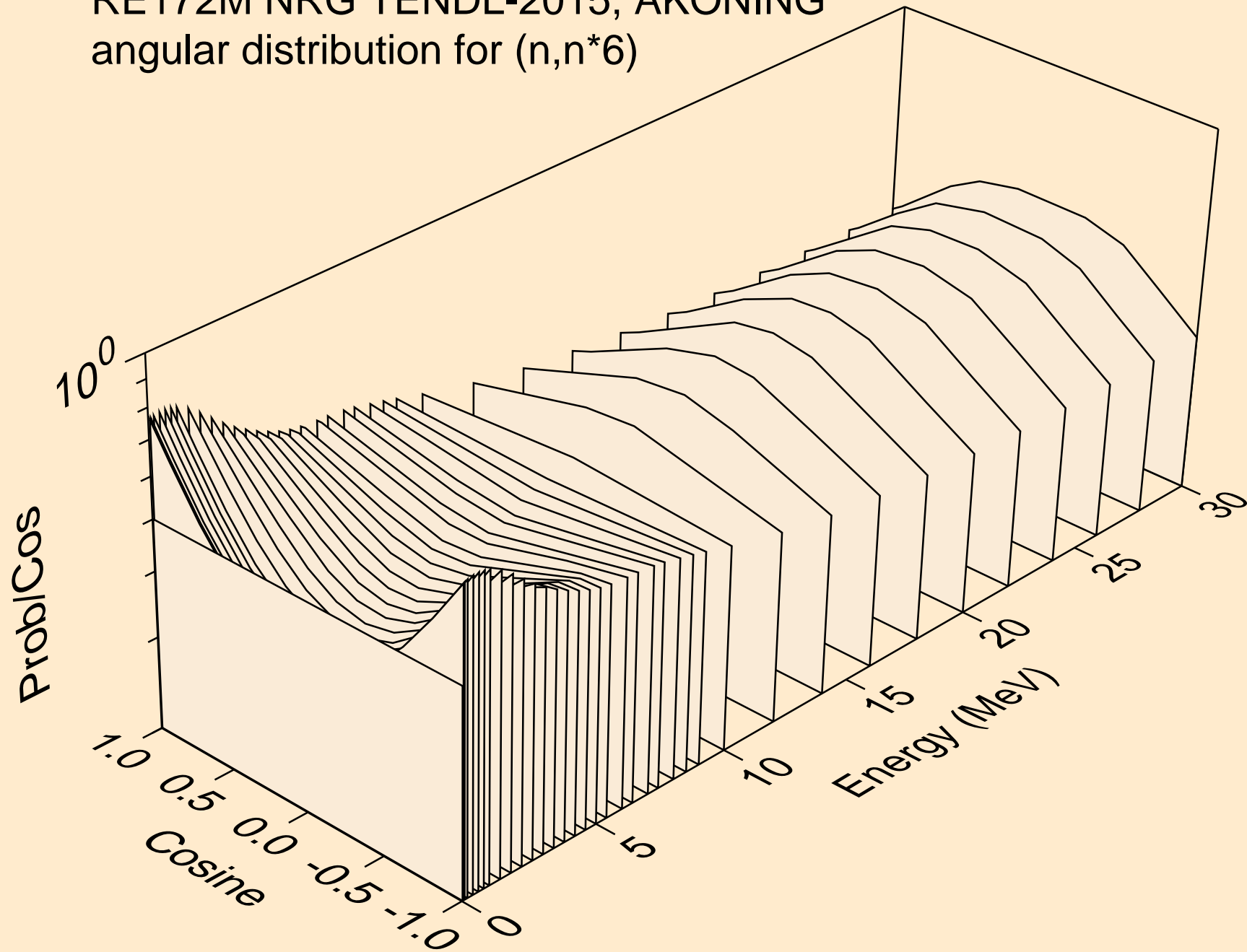

RE172M NRG TENDL-2015, AKONING
angular distribution for (n,n*7)

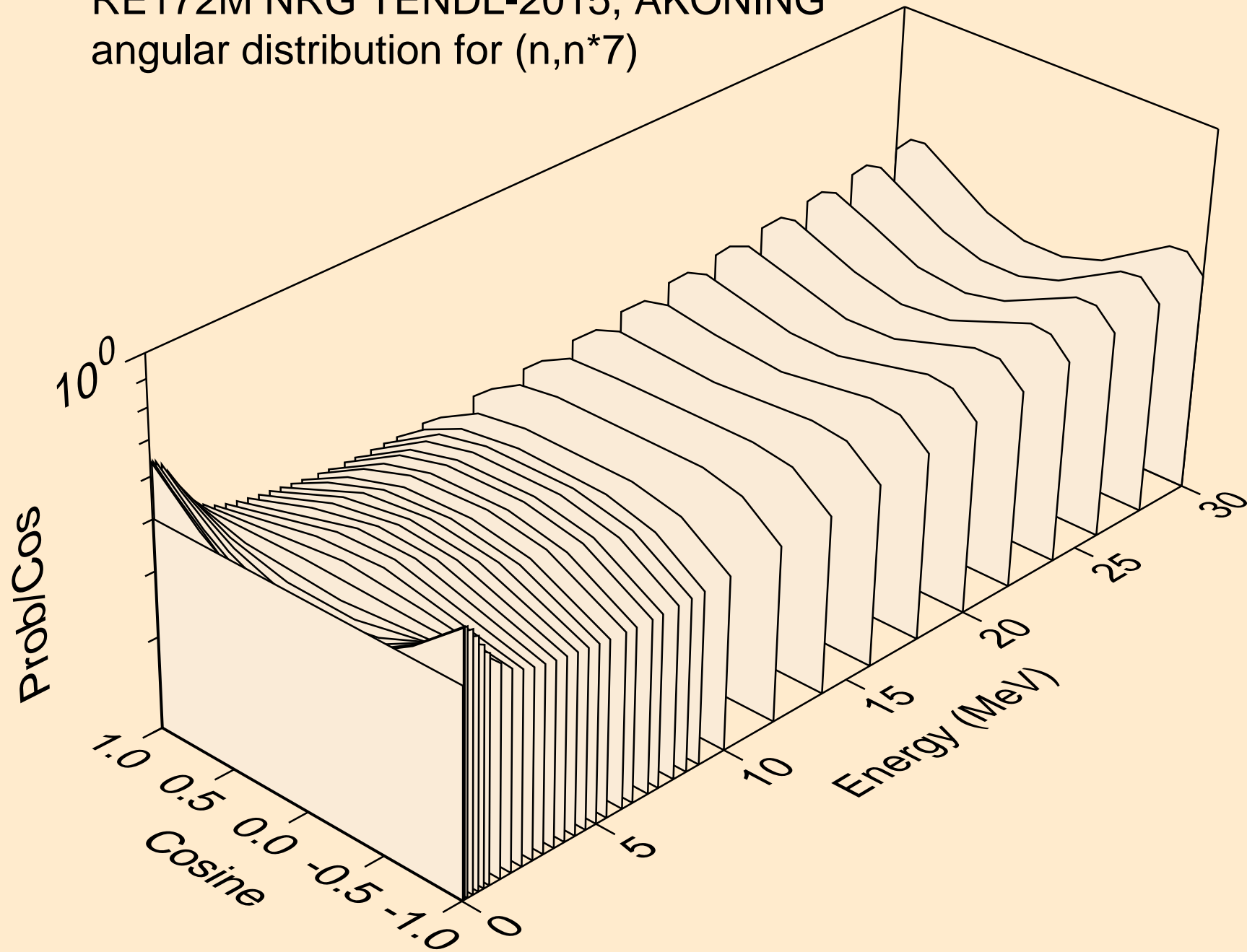

RE172M NRG TENDL-2015, AKONING
angular distribution for (n,n*8)

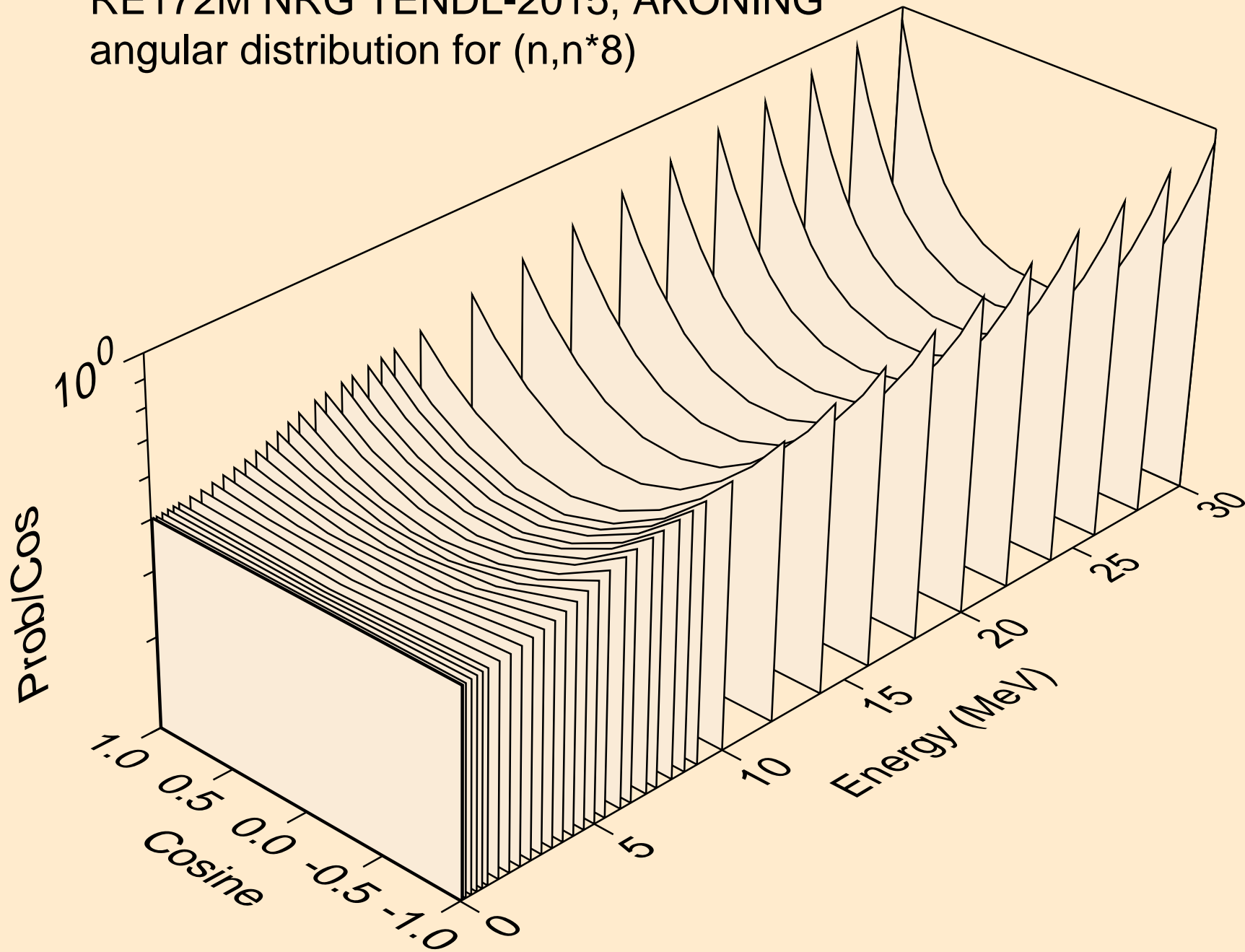

RE172M NRG TENDL-2015, AKONING
angular distribution for (n,n*9)

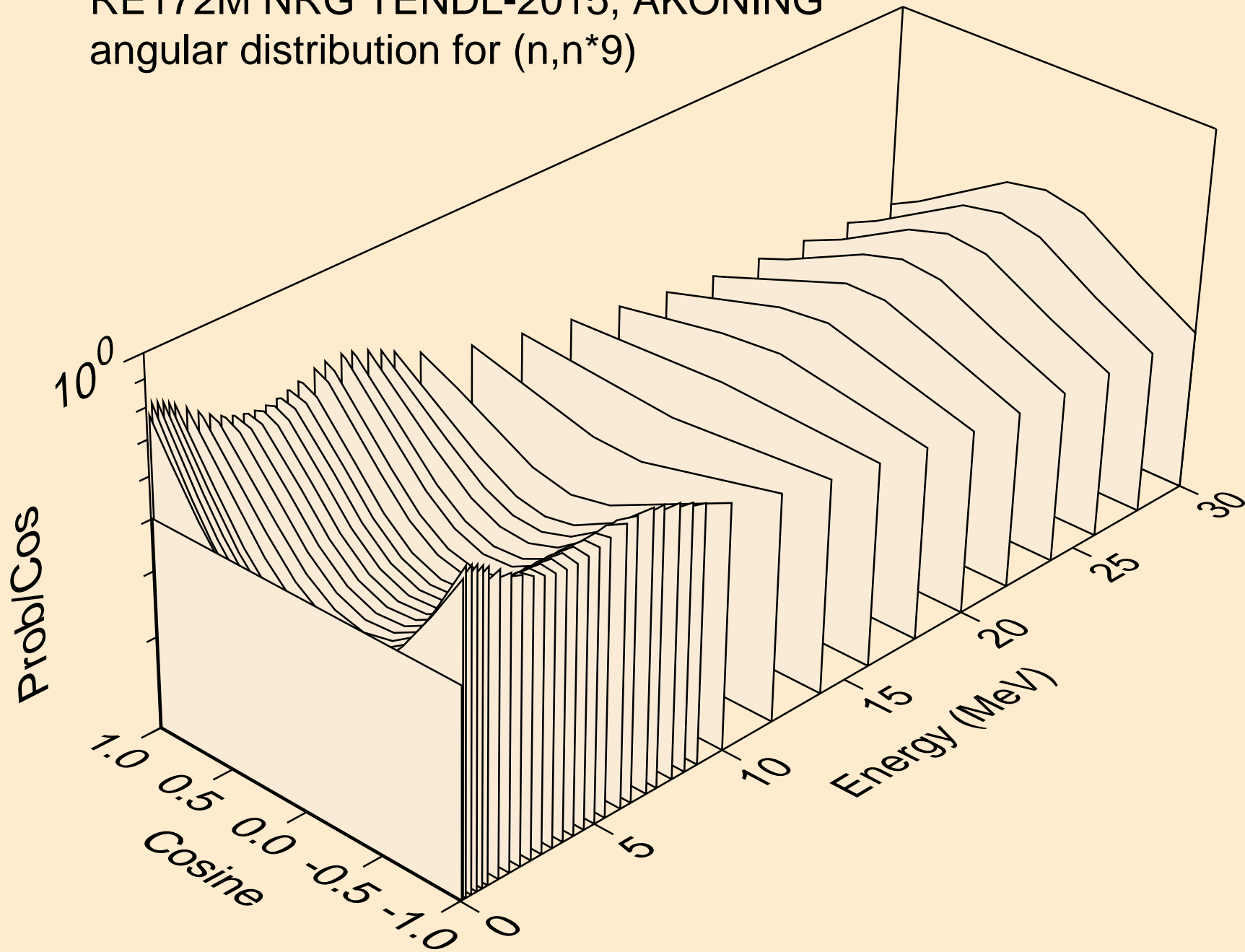

RE172M NRG TENDL-2015, AKONING
angular distribution for (n,n*10)

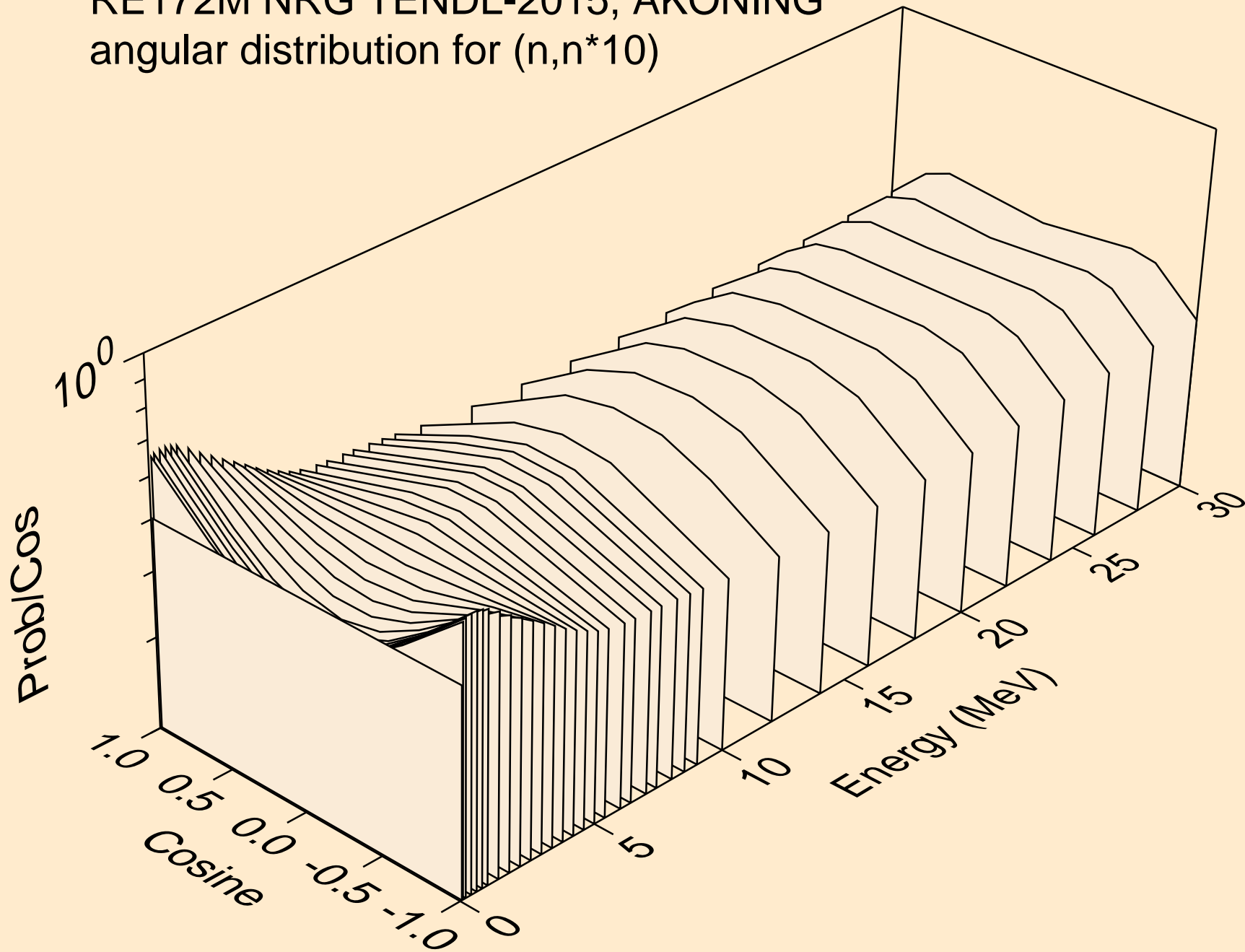

RE172M NRG TENDL-2015, AKONING
angular distribution for (n,n*11)

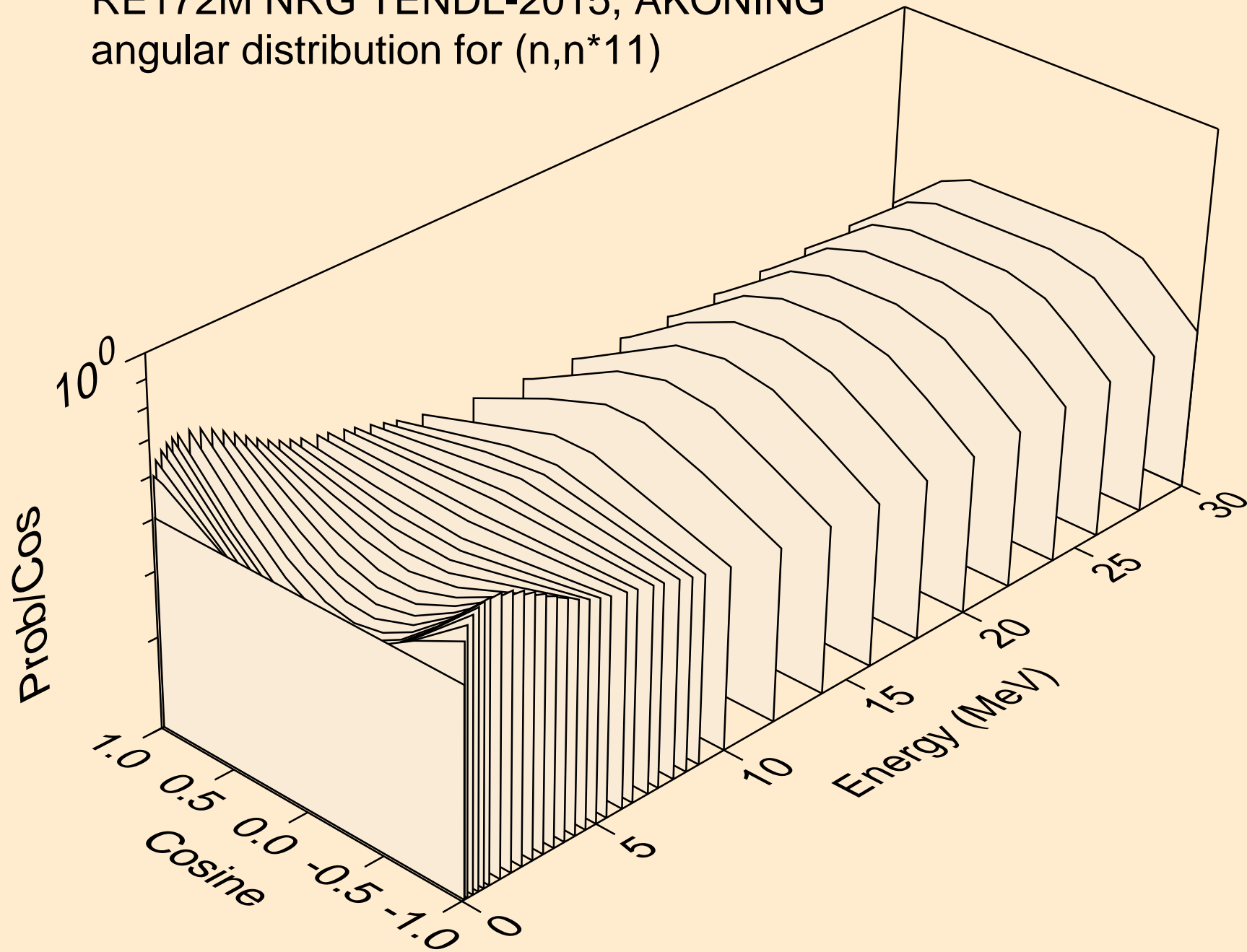

RE172M NRG TENDL-2015, AKONING
angular distribution for (n,n*12)

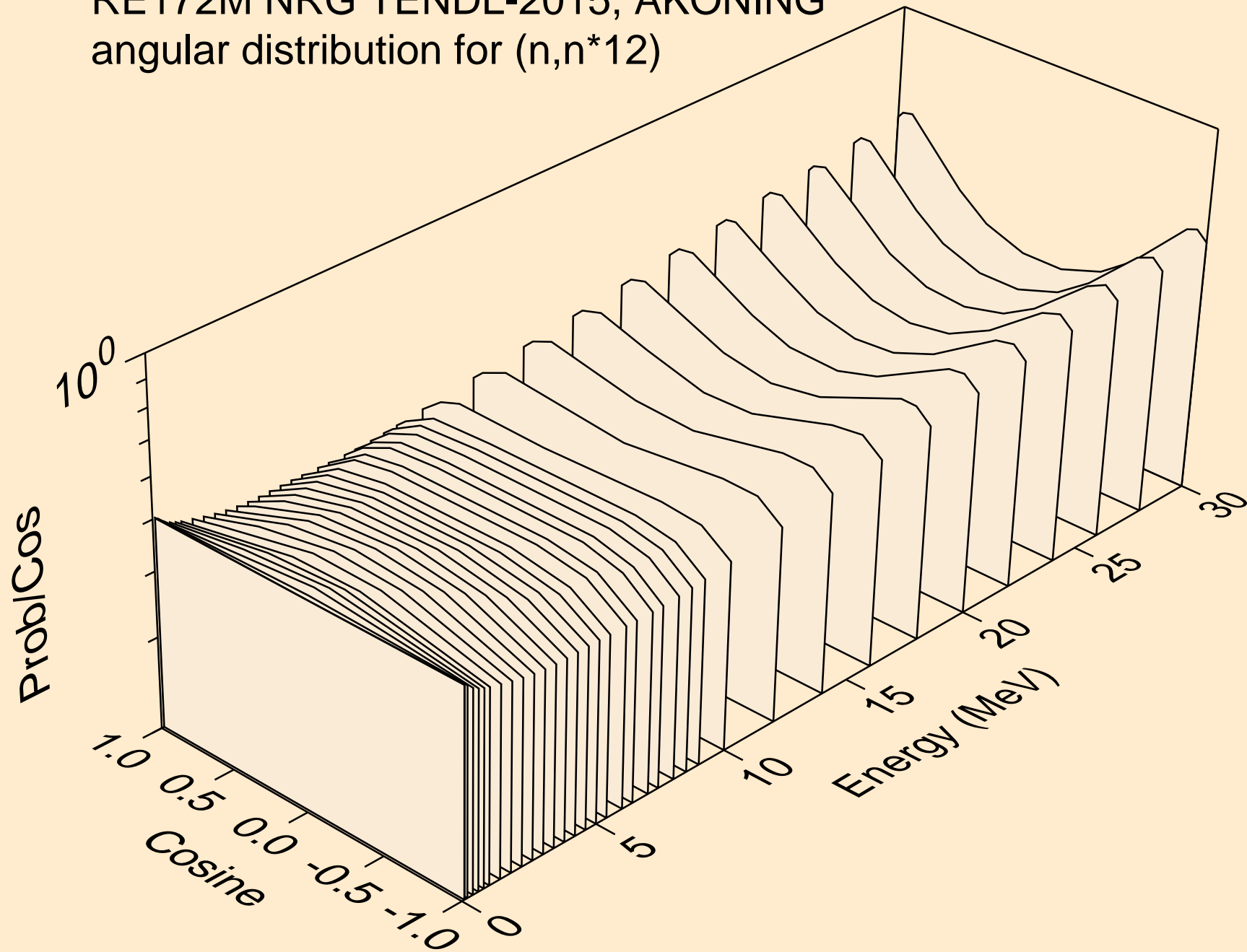

RE172M NRG TENDL-2015, AKONING
angular distribution for (n,n*13)

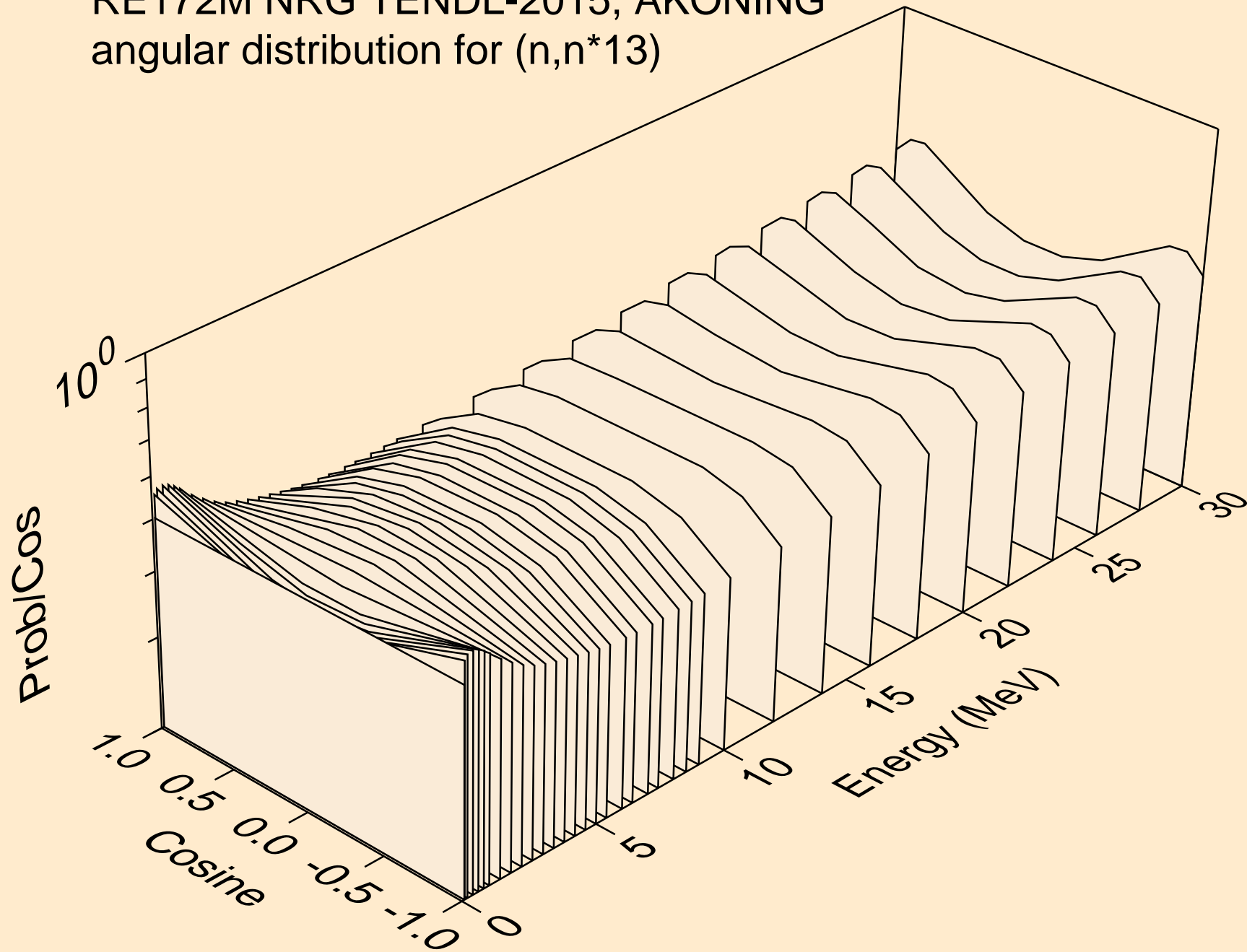

RE172M NRG TENDL-2015, AKONING
angular distribution for (n,n*14)

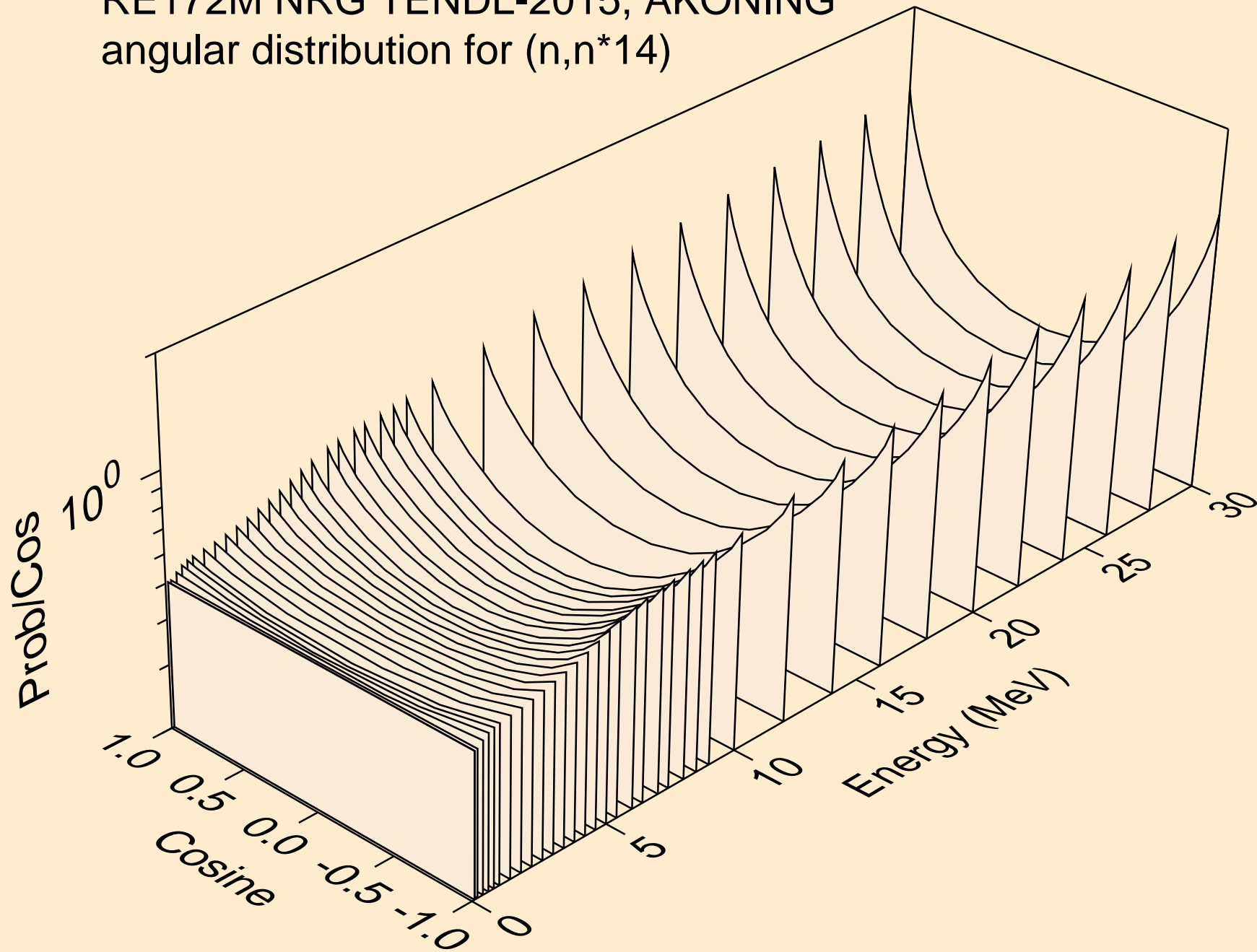

RE172M NRG TENDL-2015, AKONING
angular distribution for (n,n*15)

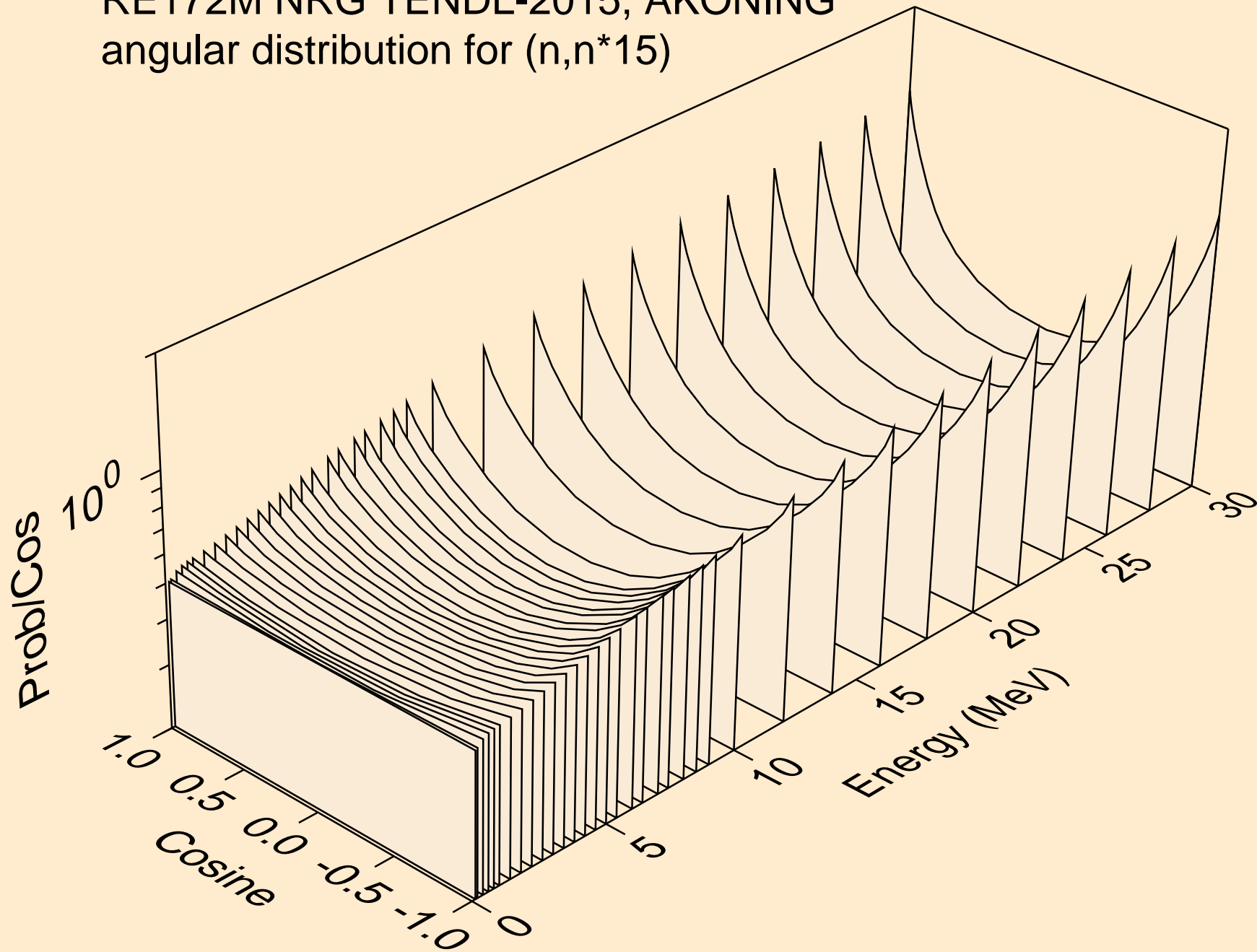

RE172M NRG TENDL-2015, AKONING
angular distribution for (n,n*16)

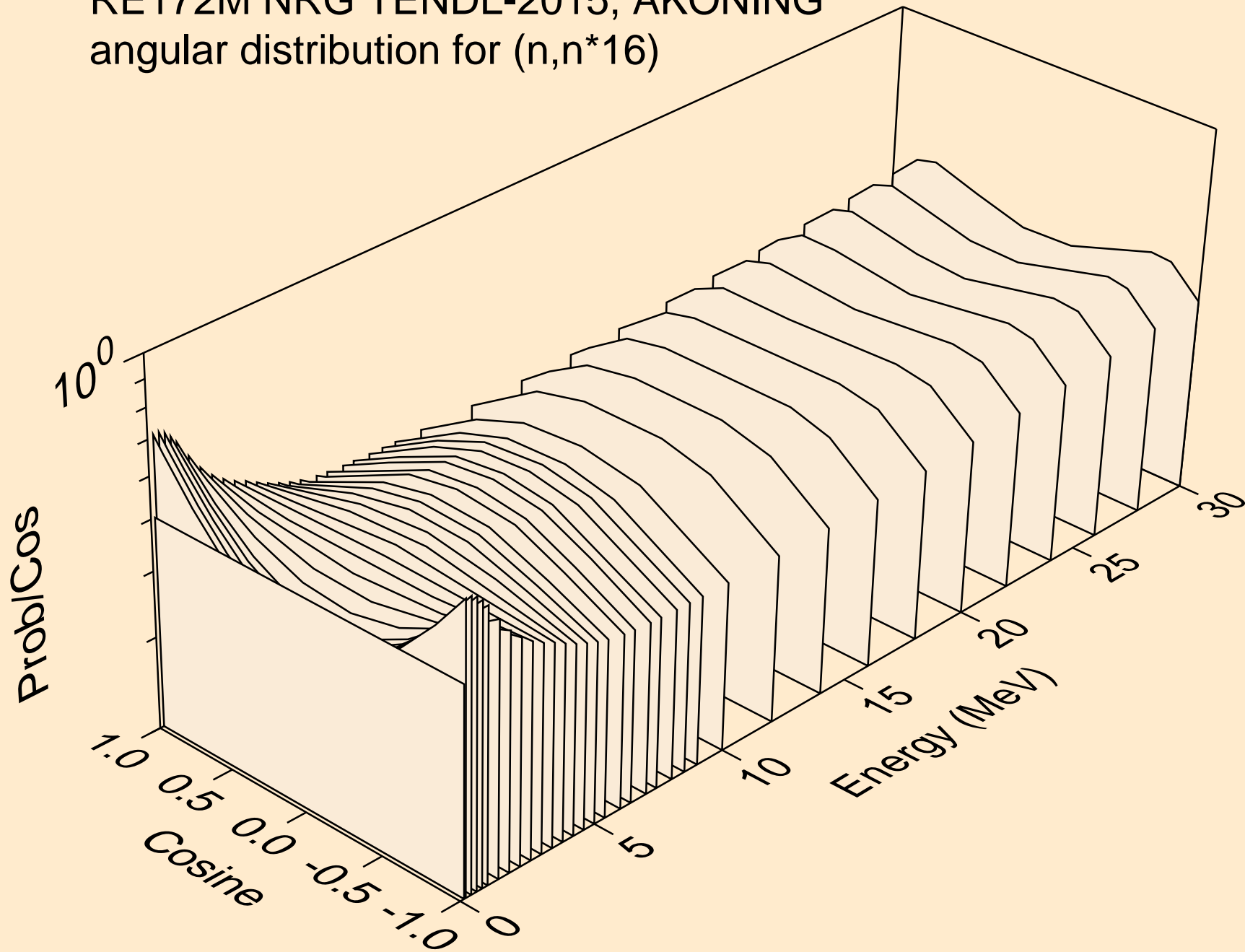

RE172M NRG TENDL-2015, AKONING
angular distribution for (n,n*17)

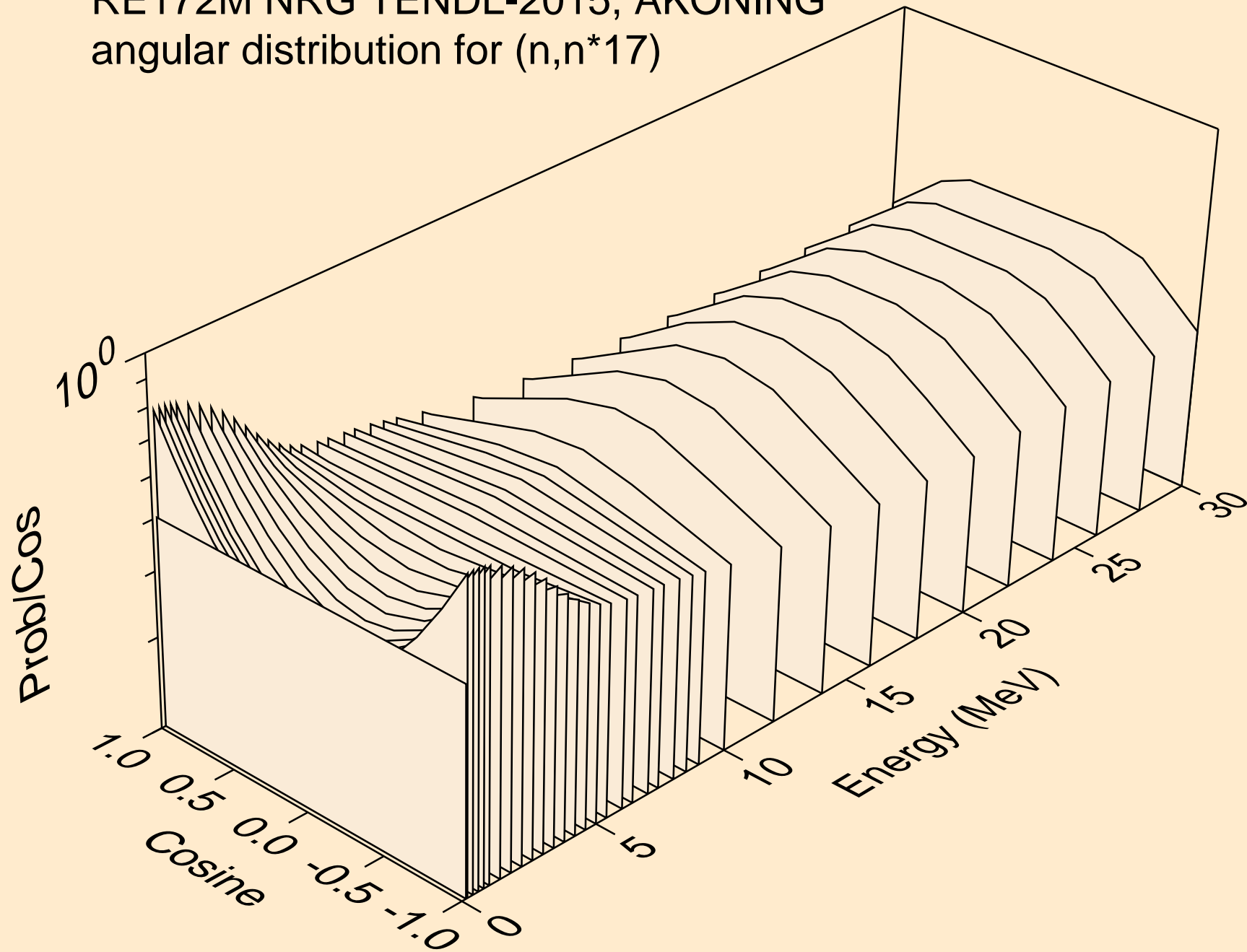

RE172M NRG TENDL-2015, AKONING
angular distribution for (n,n*18)

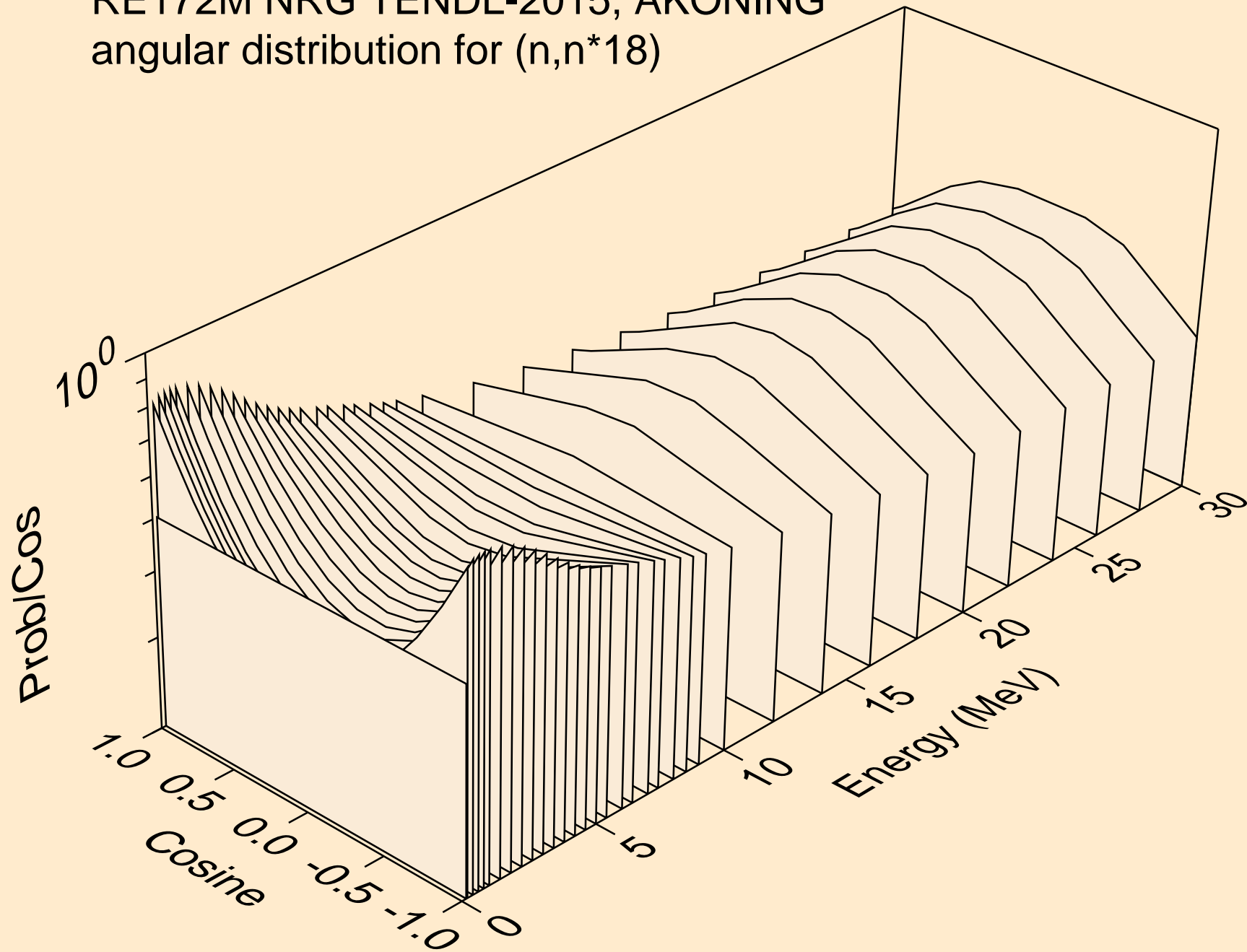

RE172M NRG TENDL-2015, AKONING
angular distribution for (n,n*19)

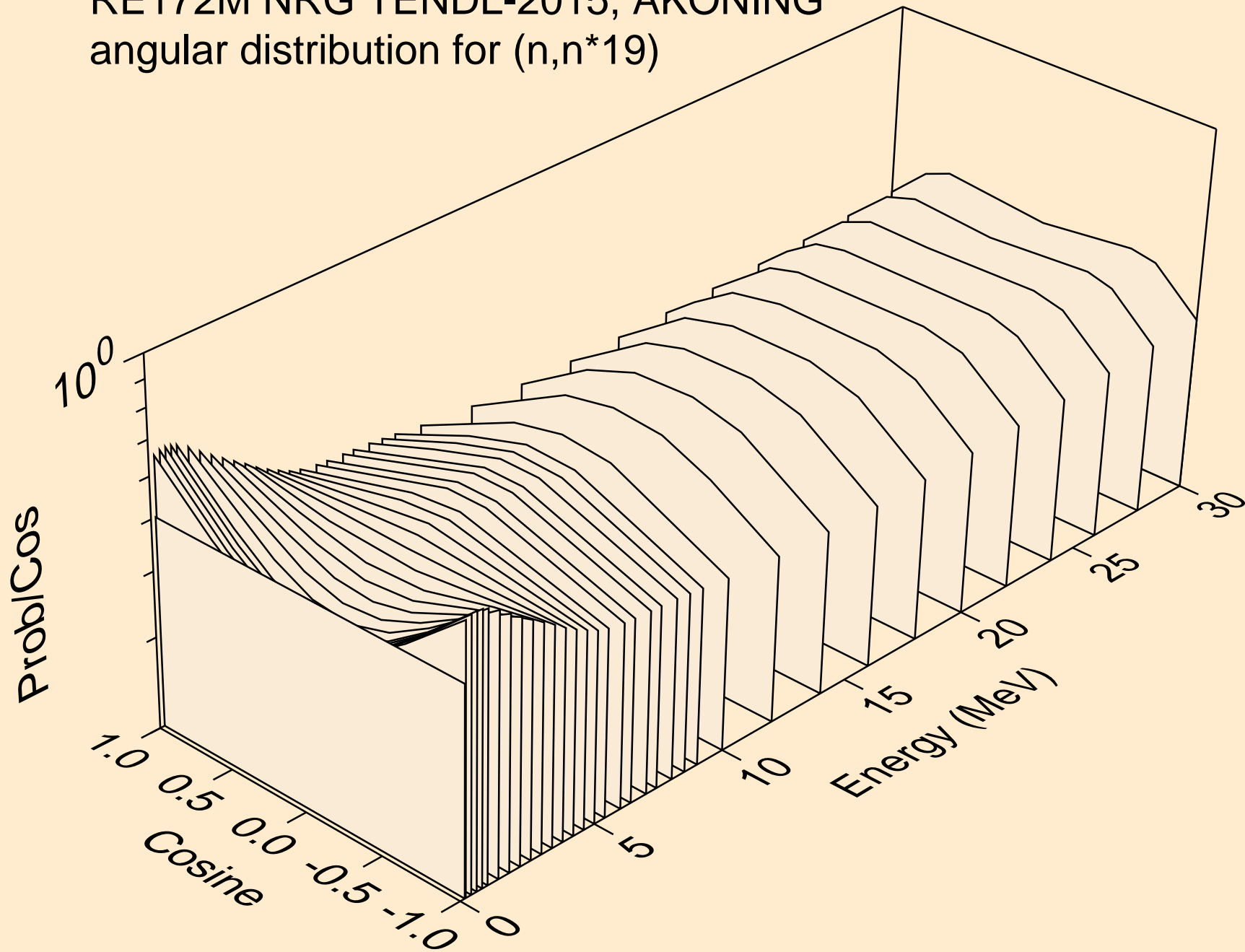

RE172M NRG TENDL-2015, AKONING
angular distribution for (n,n*20)

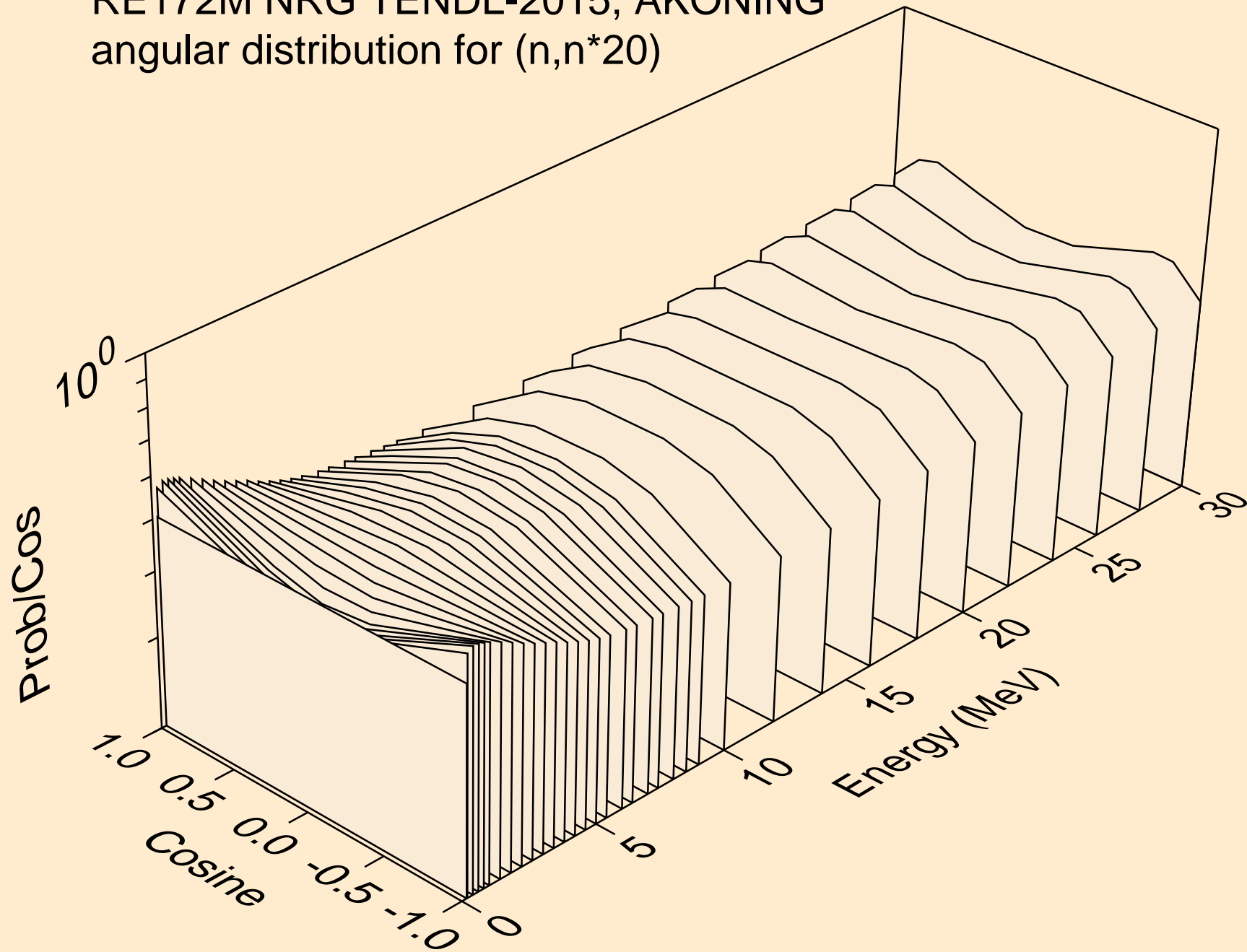

RE172M NRG TENDL-2015, AKONING
angular distribution for (n,n*21)

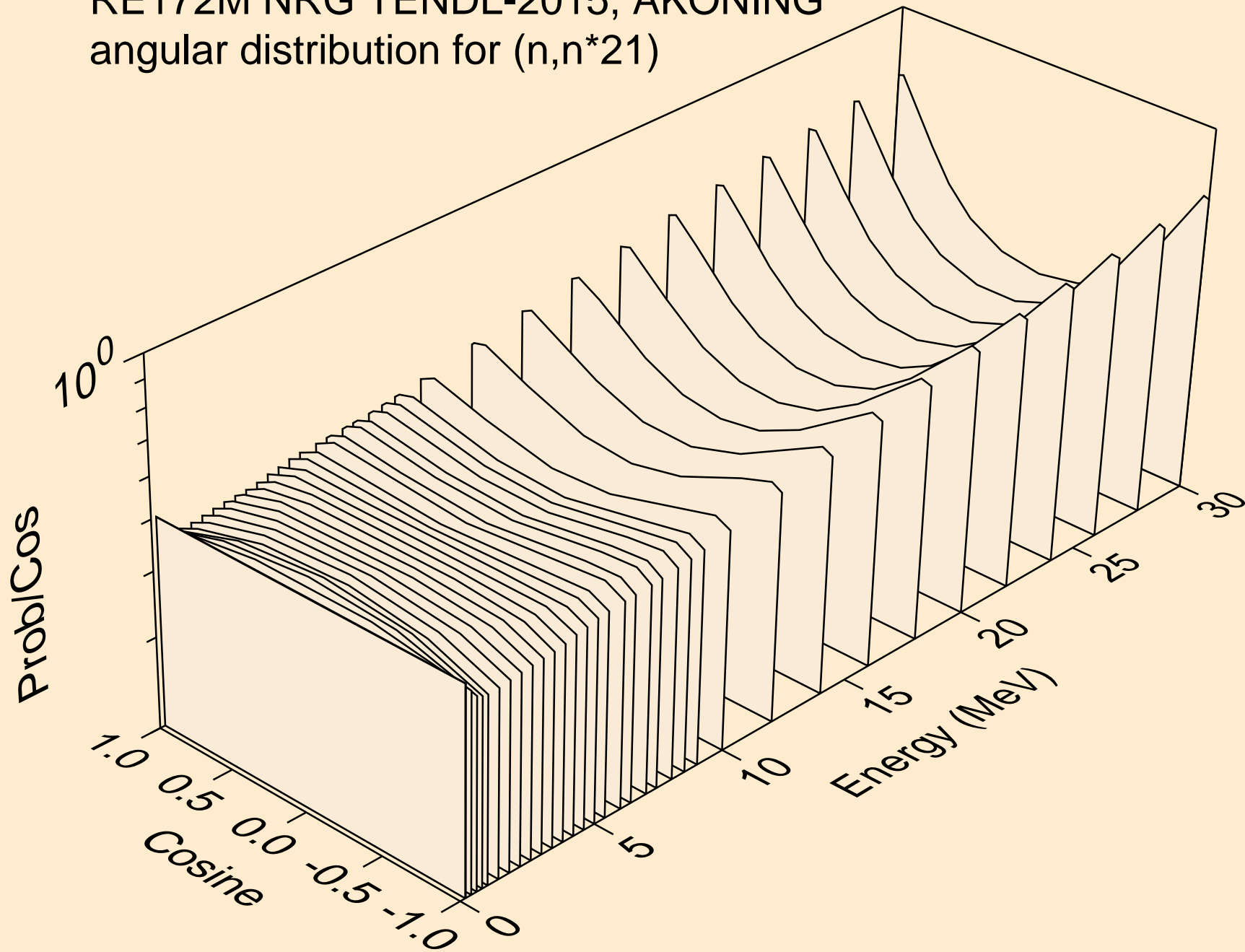

RE172M NRG TENDL-2015, AKONING
angular distribution for (n,n*22)

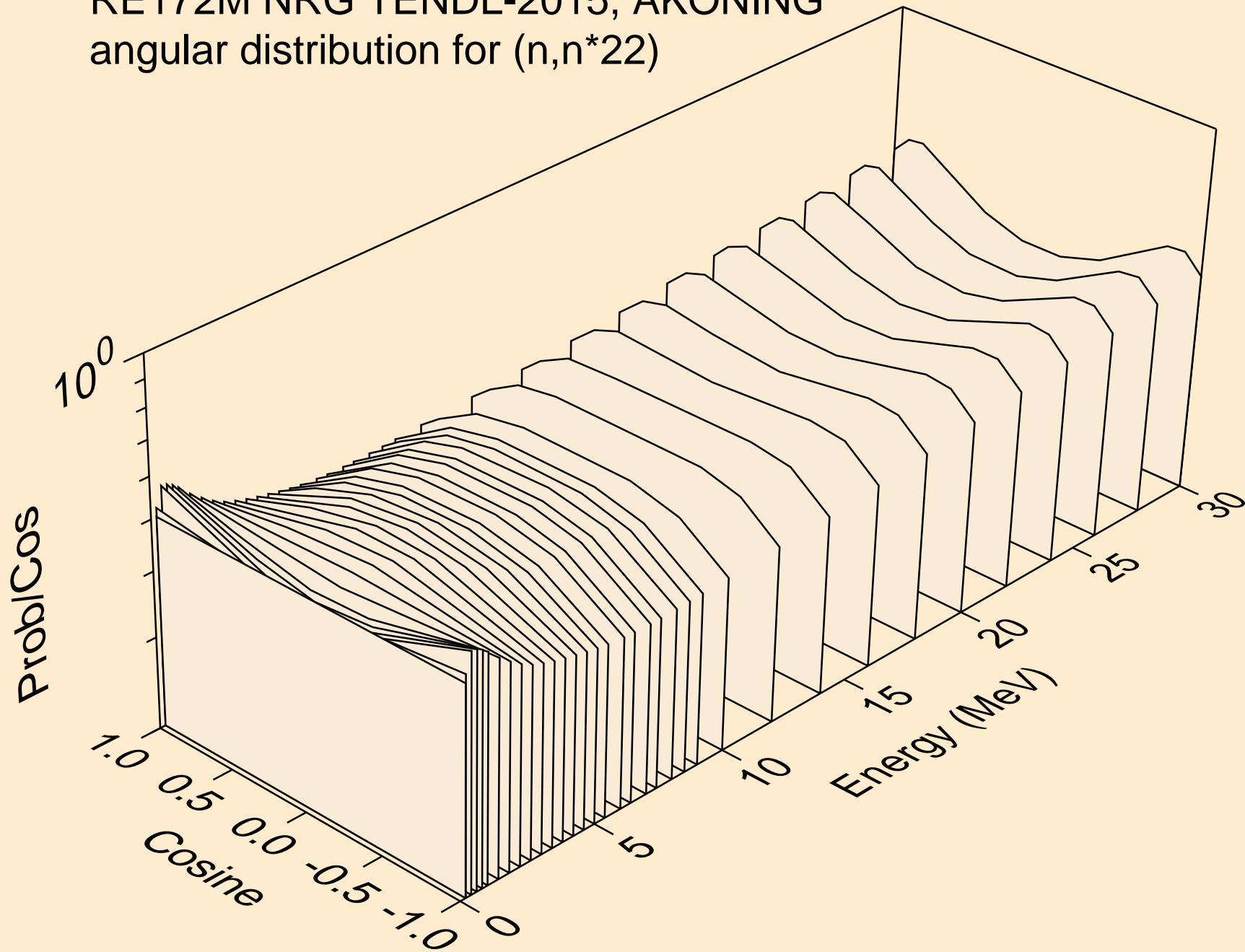

RE172M NRG TENDL-2015, AKONING
angular distribution for (n,n*23)

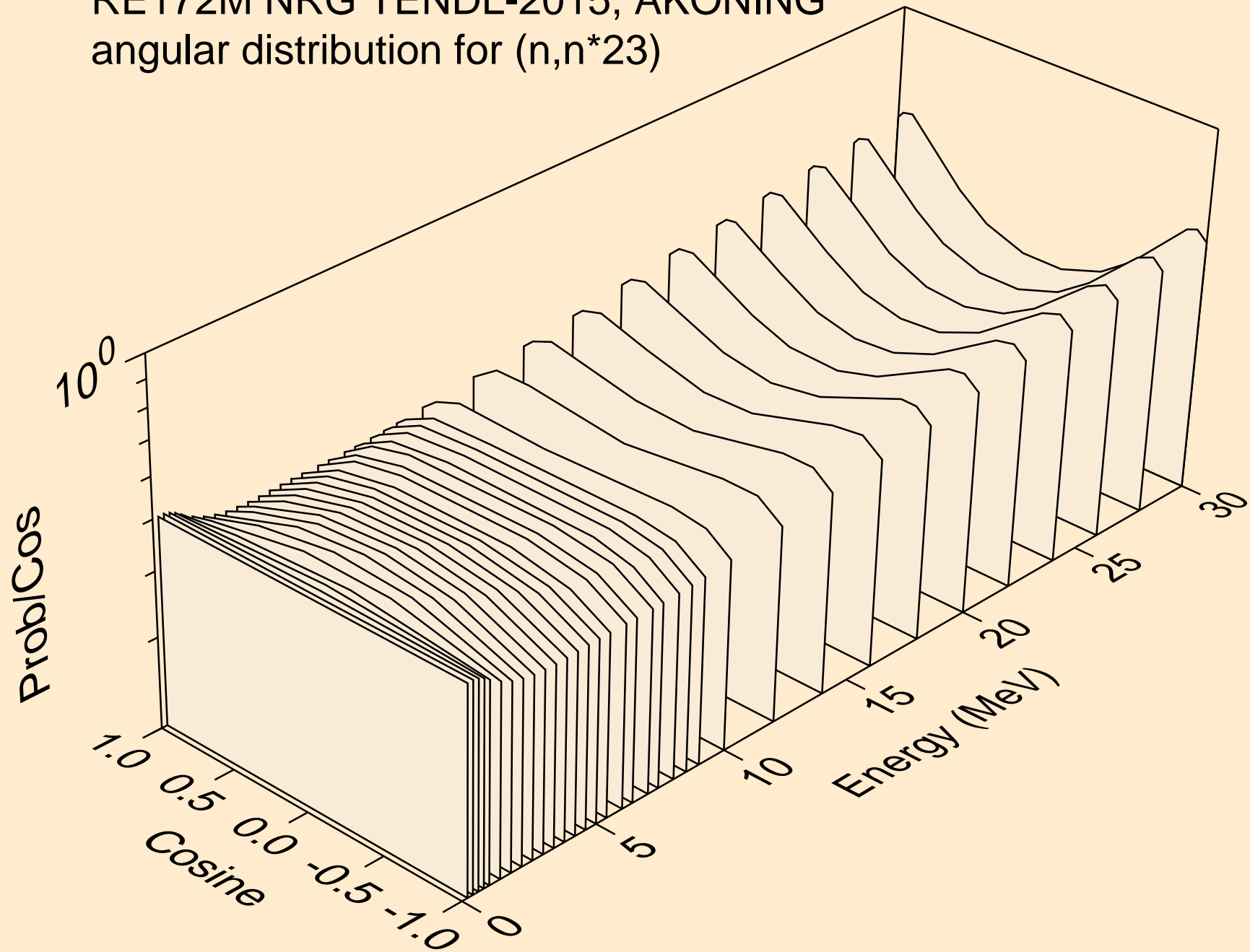

RE172M NRG TENDL-2015, AKONING
angular distribution for (n,n*24)

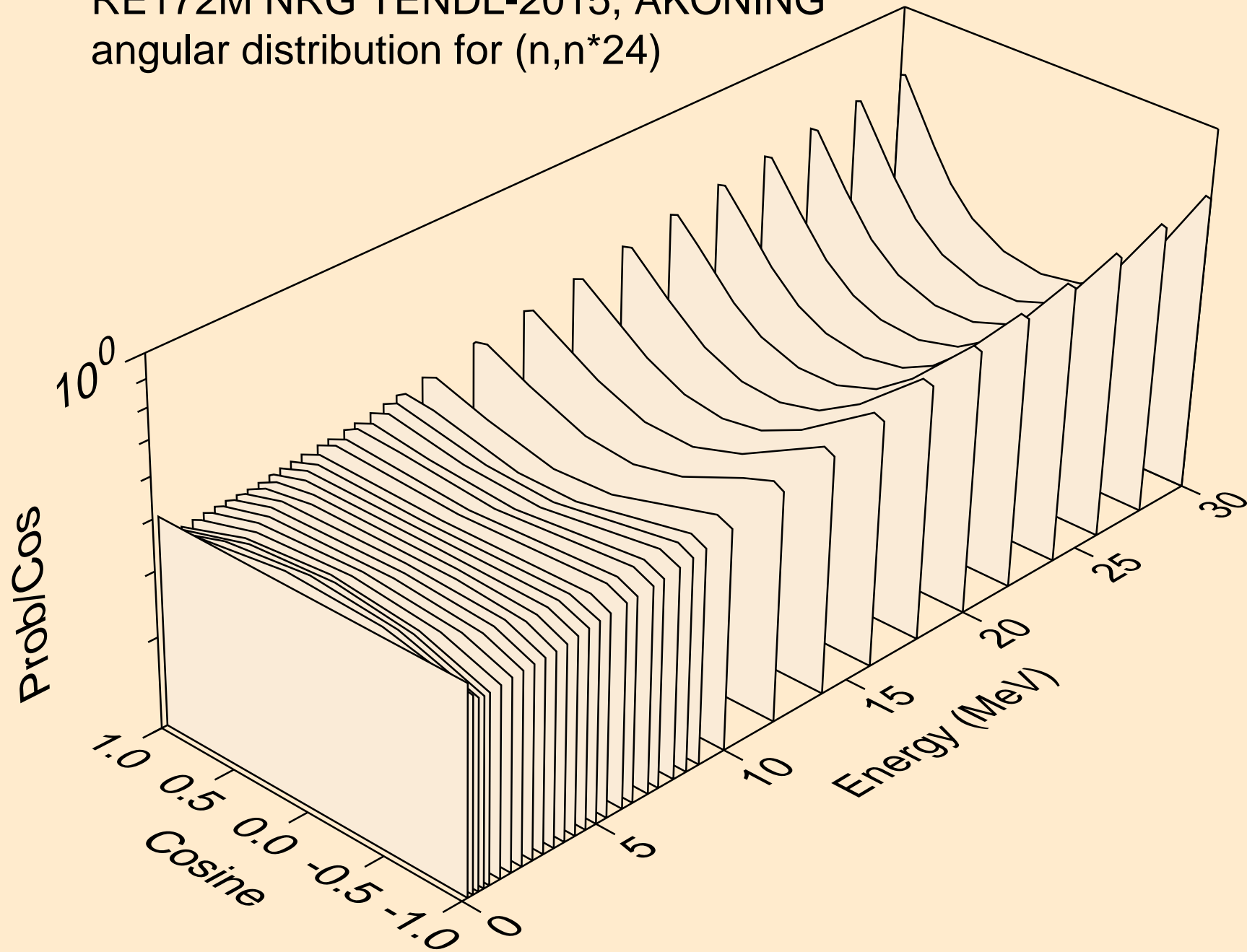

RE172M NRG TENDL-2015, AKONING
angular distribution for (n,n*25)

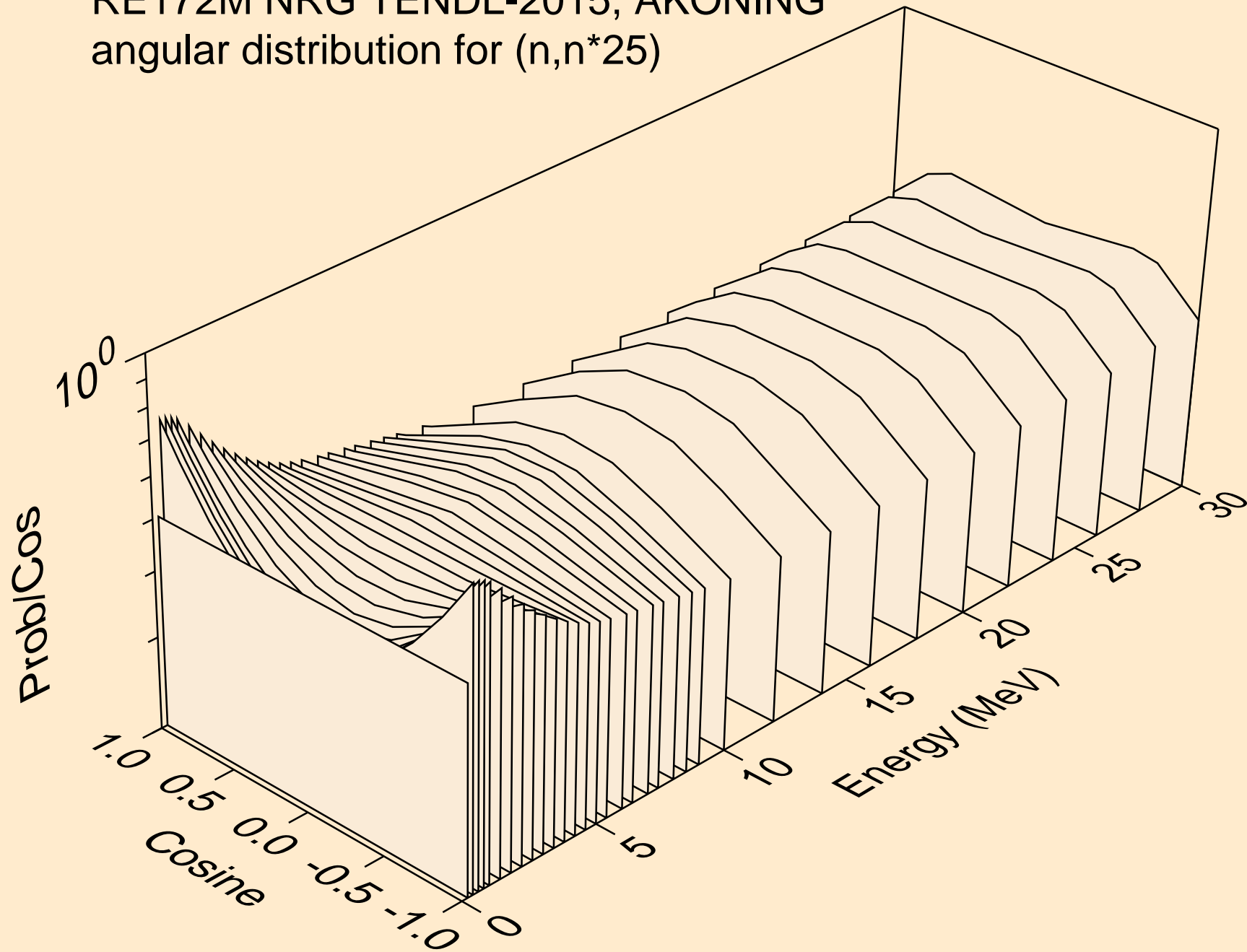

RE172M NRG TENDL-2015, AKONING
angular distribution for (n,n*26)

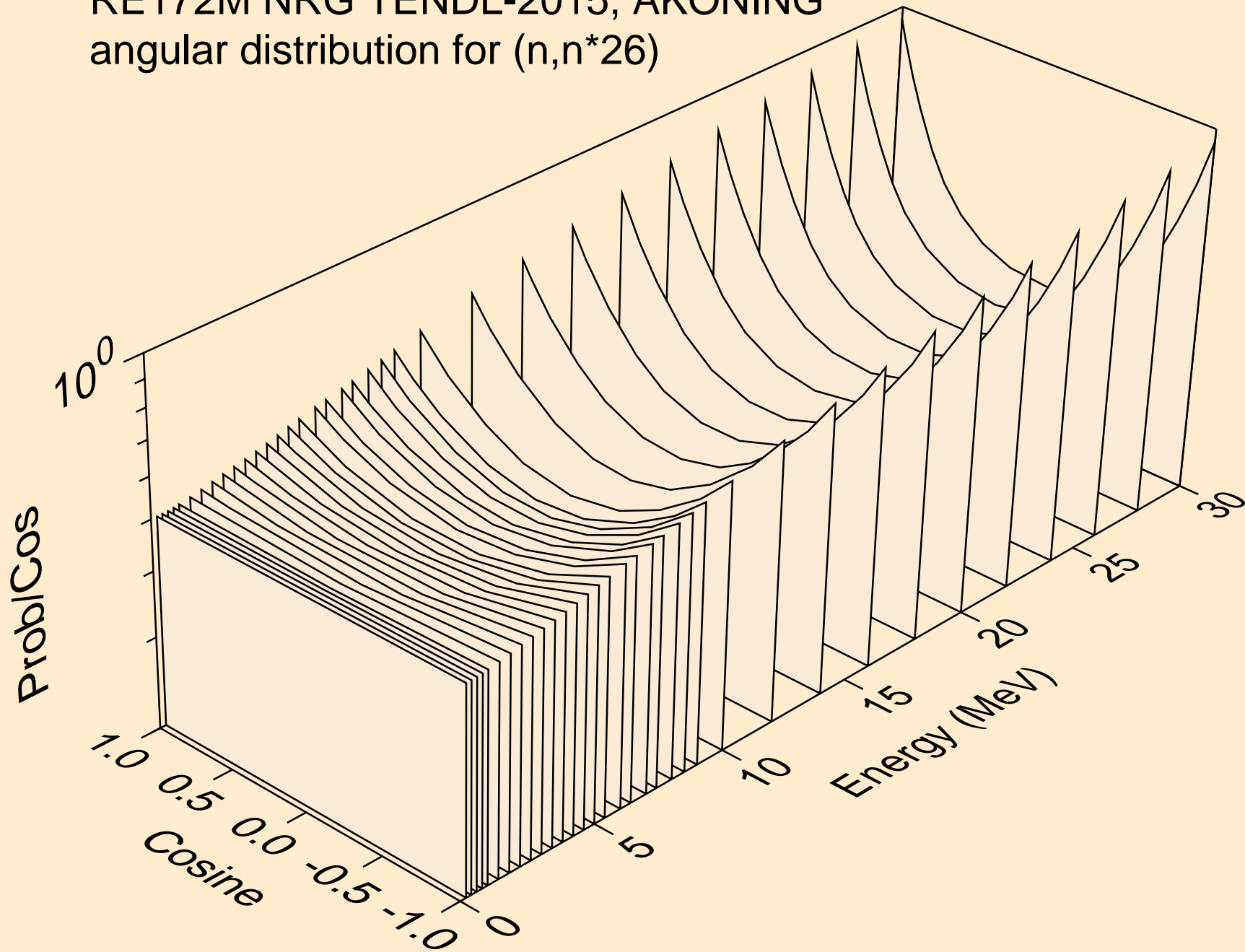

RE172M NRG TENDL-2015, AKONING
Neutron emission for (n,x)

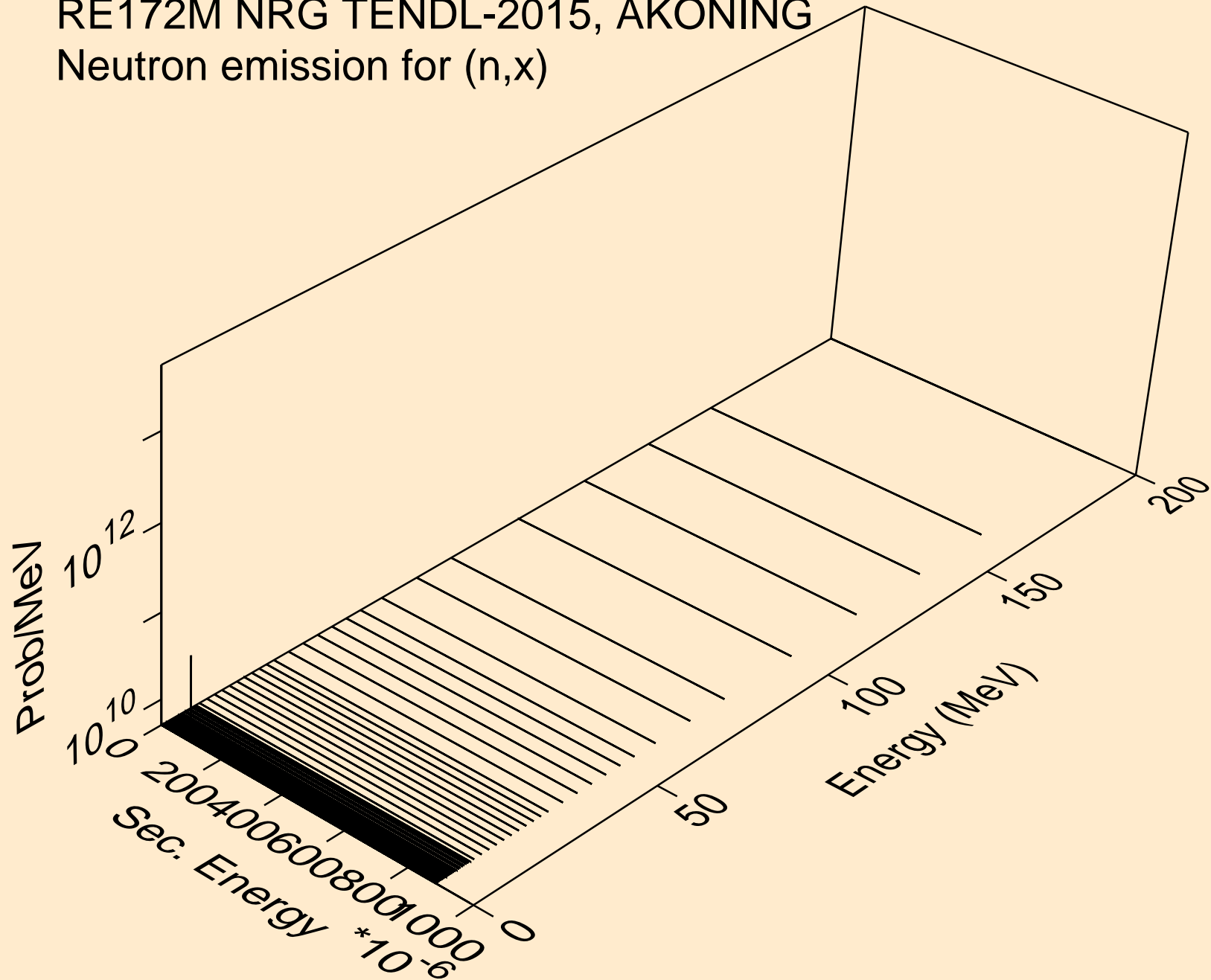

RE172M NRG TENDL-2015, AKONING
Neutron emission for (n,2nd)

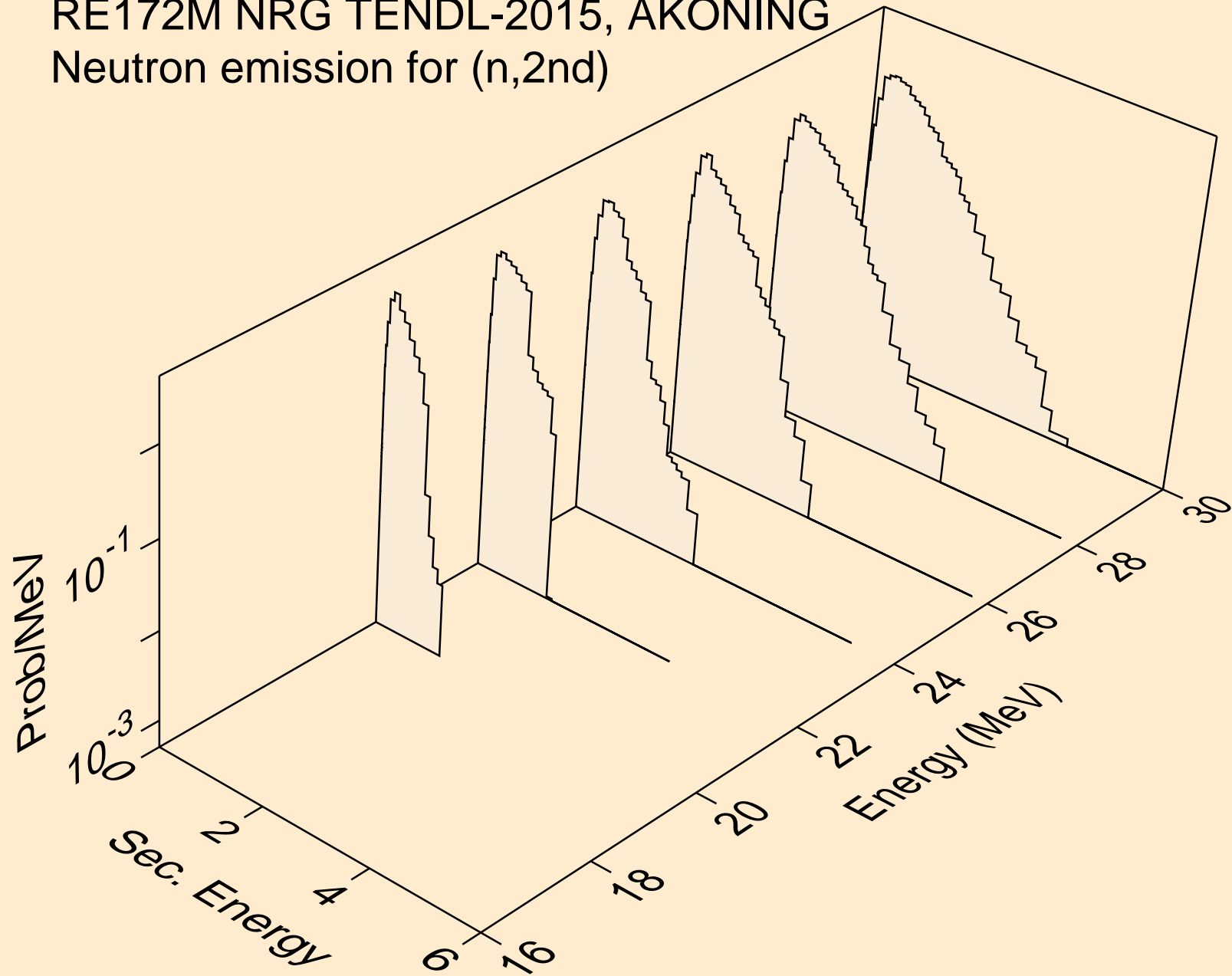

RE172M NRG TENDL-2015, AKONING
Neutron emission for (n,2n)

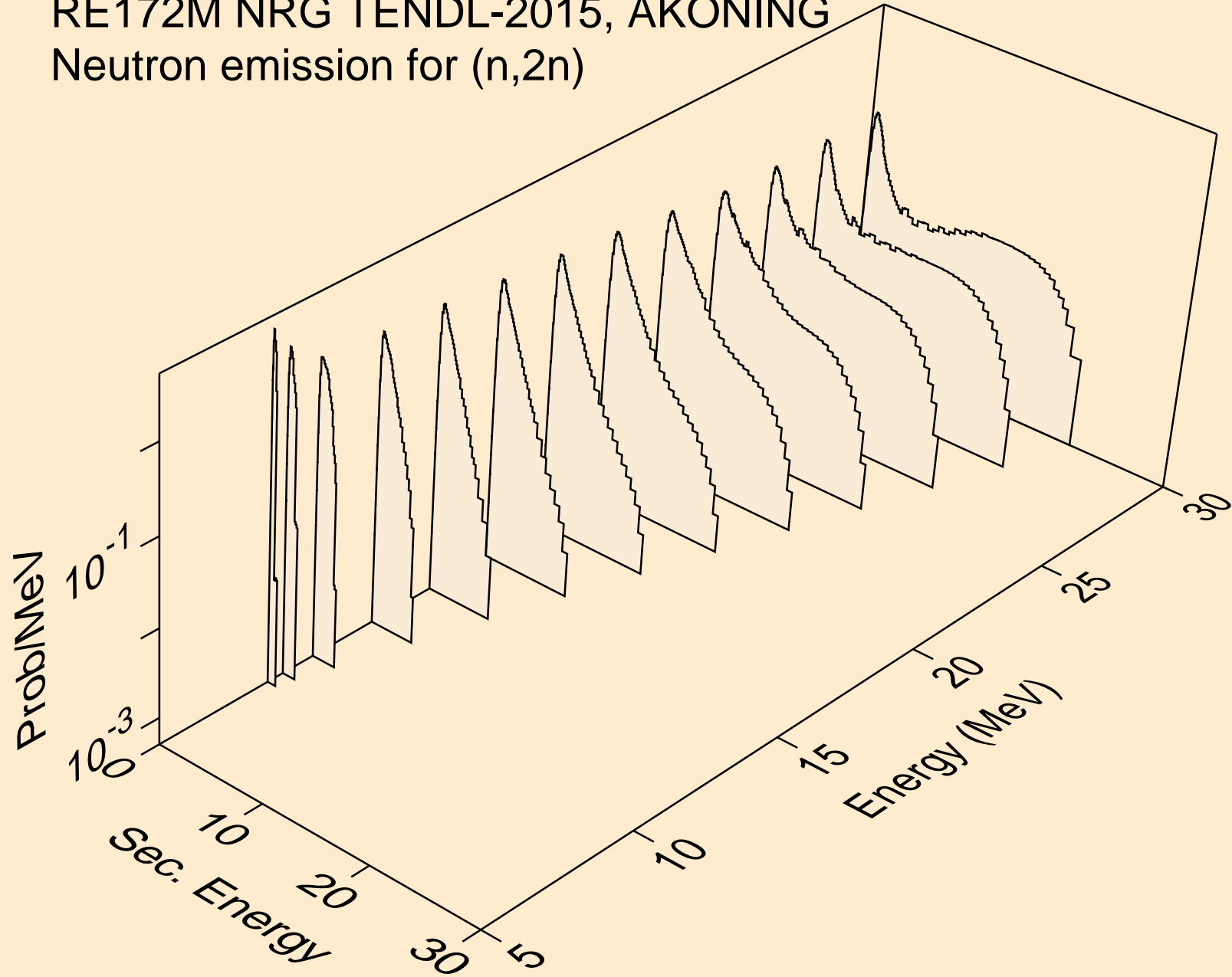

RE172M NRG TENDL-2015, AKONING
Neutron emission for (n,3n)

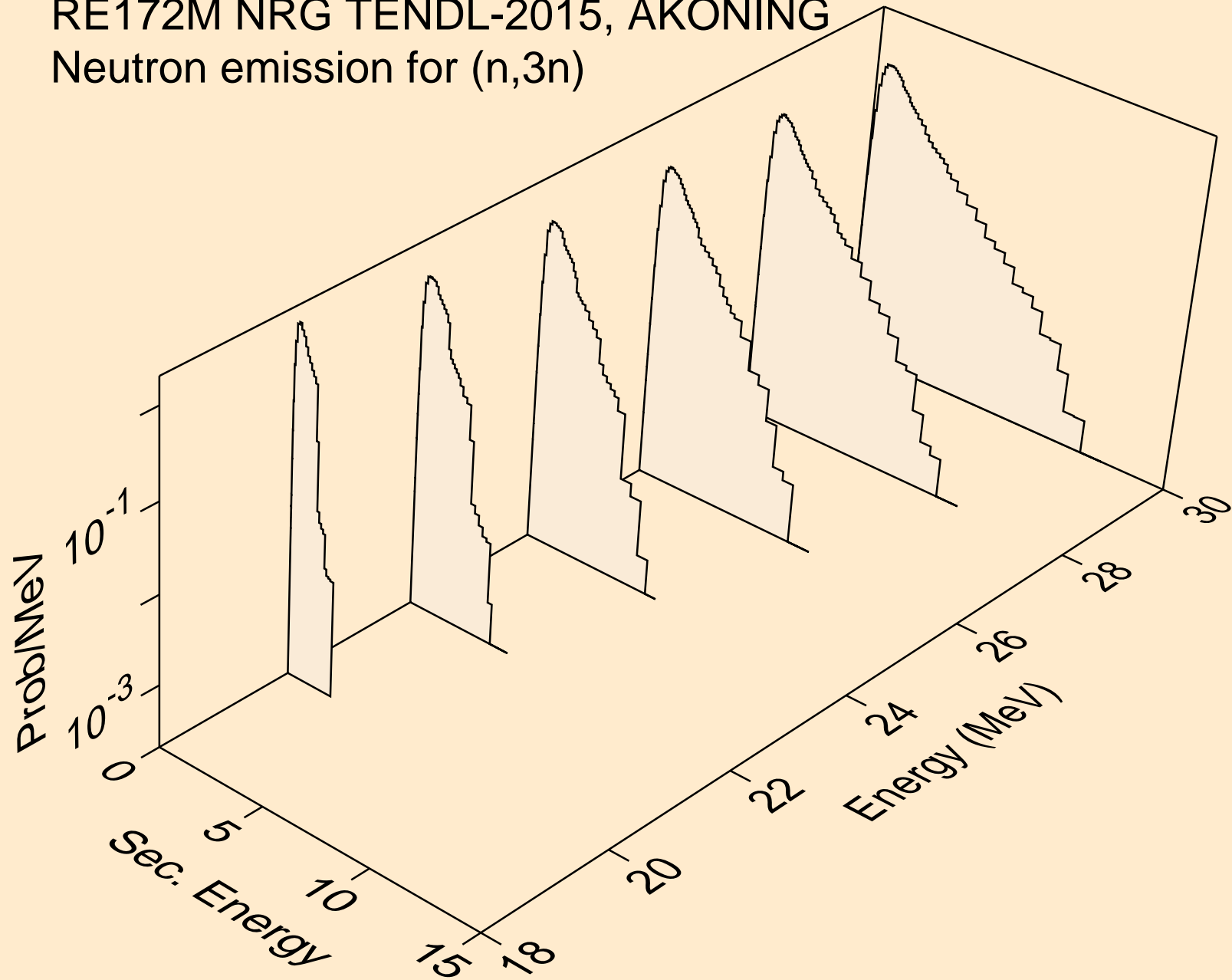

RE172M NRG TENDL-2015, AKONING
Neutron emission for (n,n*)a

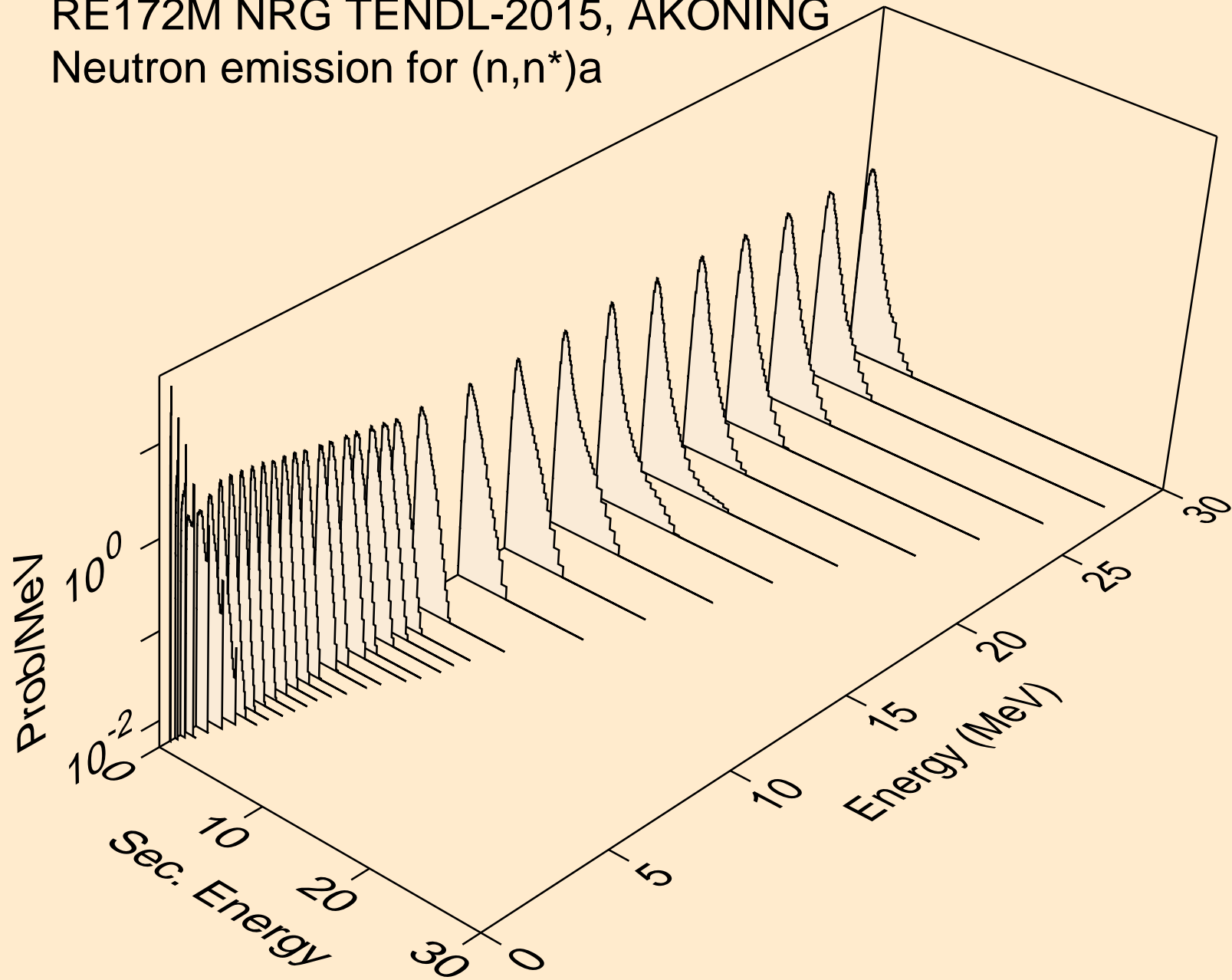

RE172M NRG TENDL-2015, AKONING
Neutron emission for (n,n*)3a

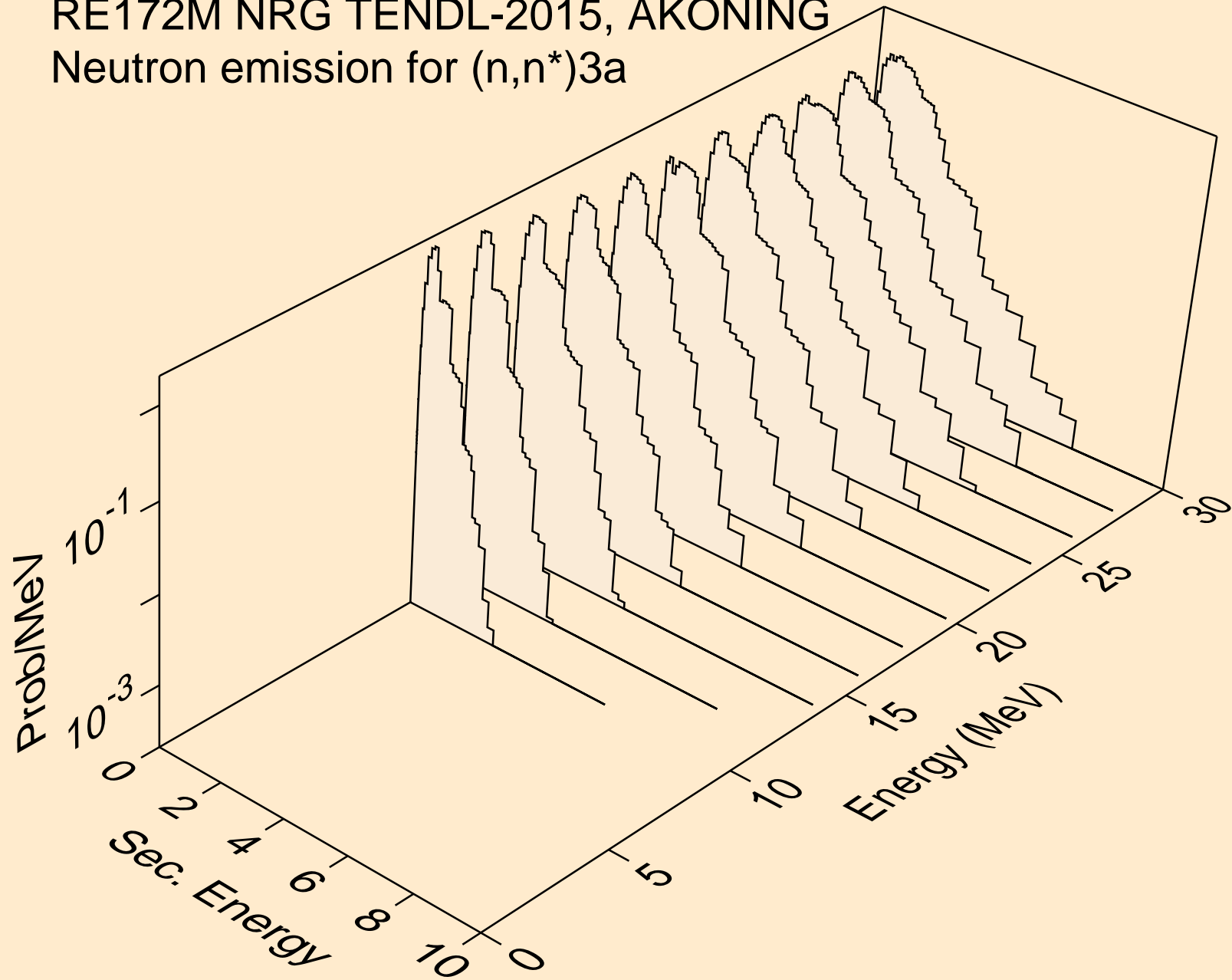

RE172M NRG TENDL-2015, AKONING
Neutron emission for (n,2n)a

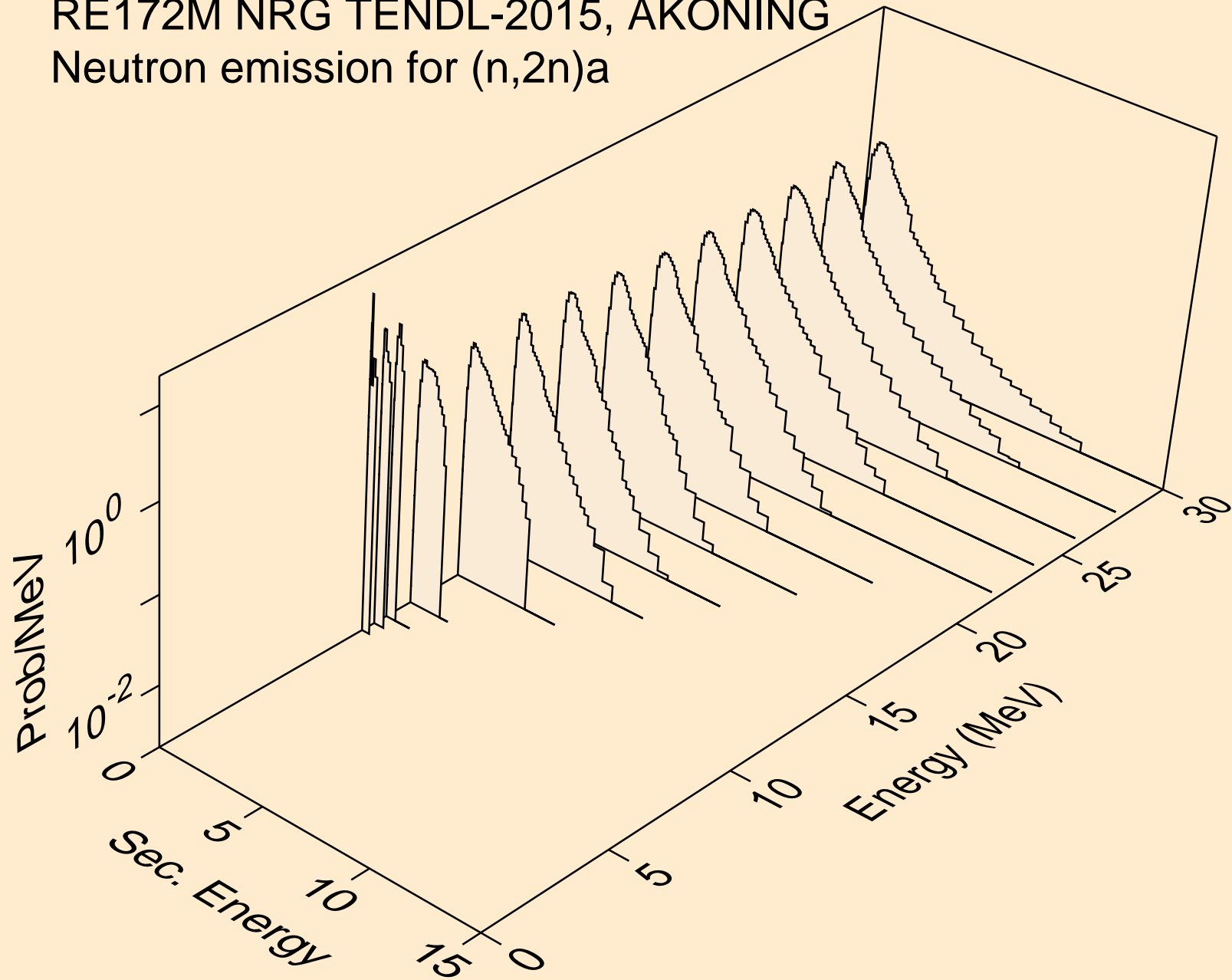

RE172M NRG TENDL-2015, AKONING
Neutron emission for (n,3n)a

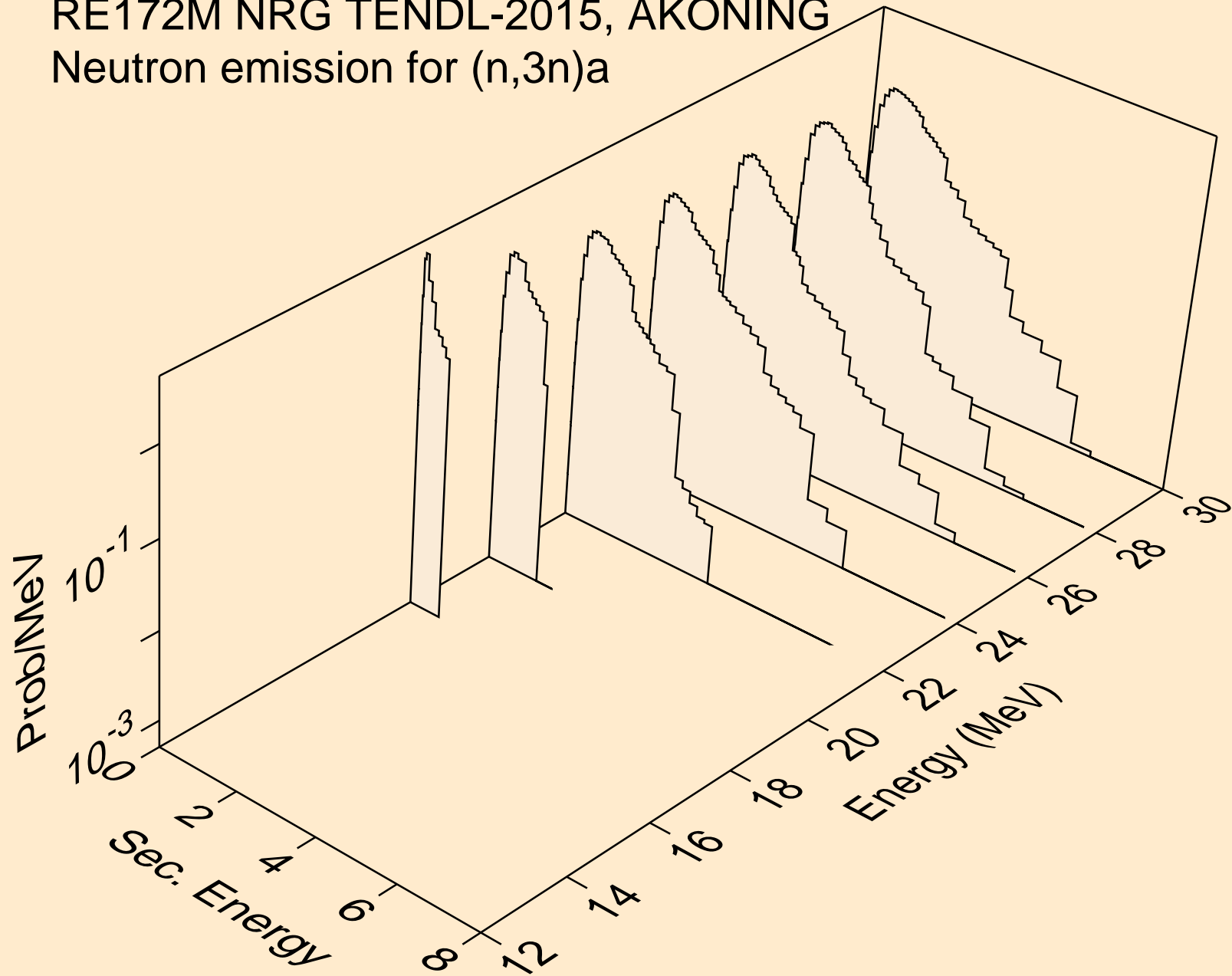

RE172M NRG TENDL-2015, AKONING
Neutron emission for (n,n*)p

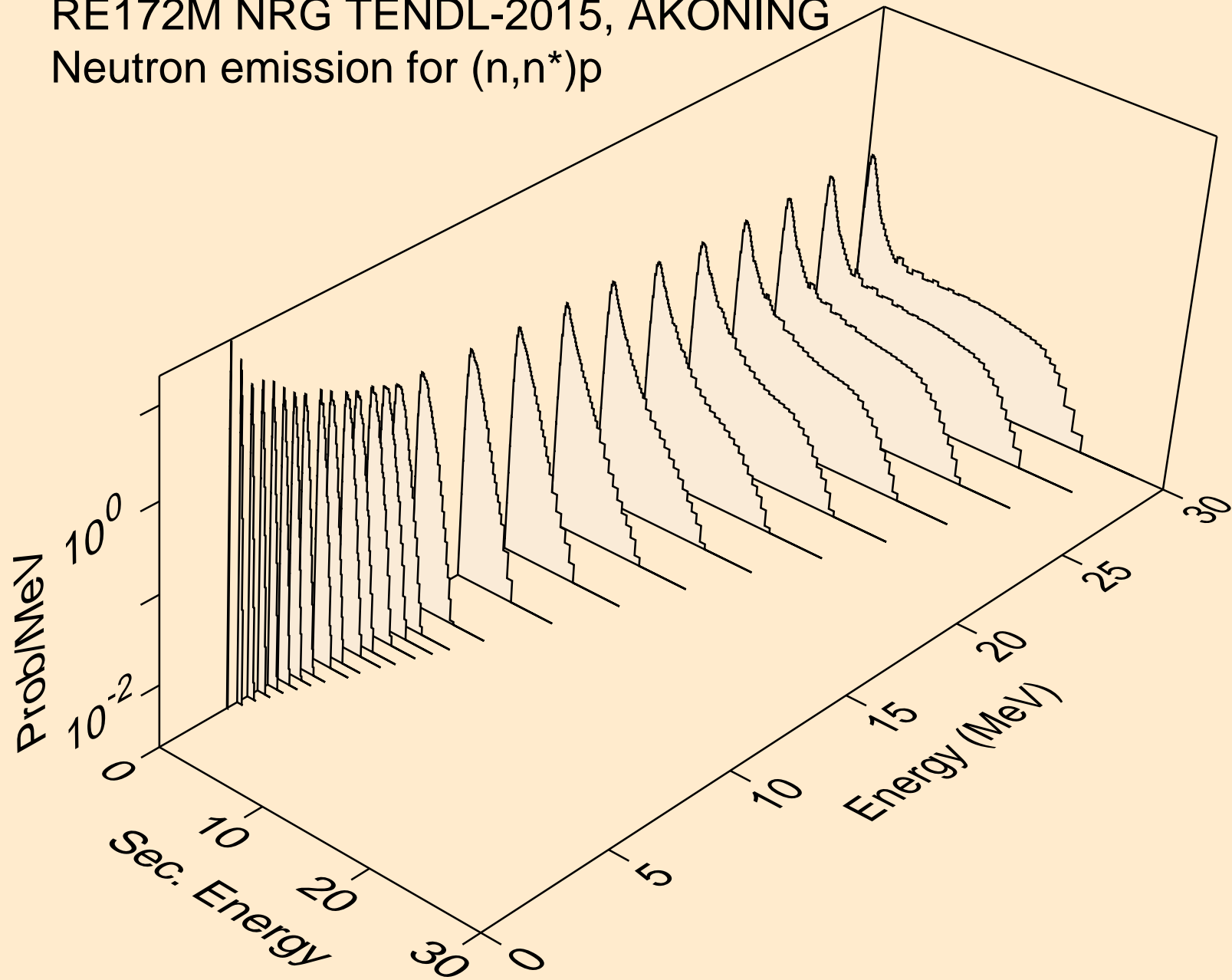

RE172M NRG TENDL-2015, AKONING
Neutron emission for (n,n*)2a

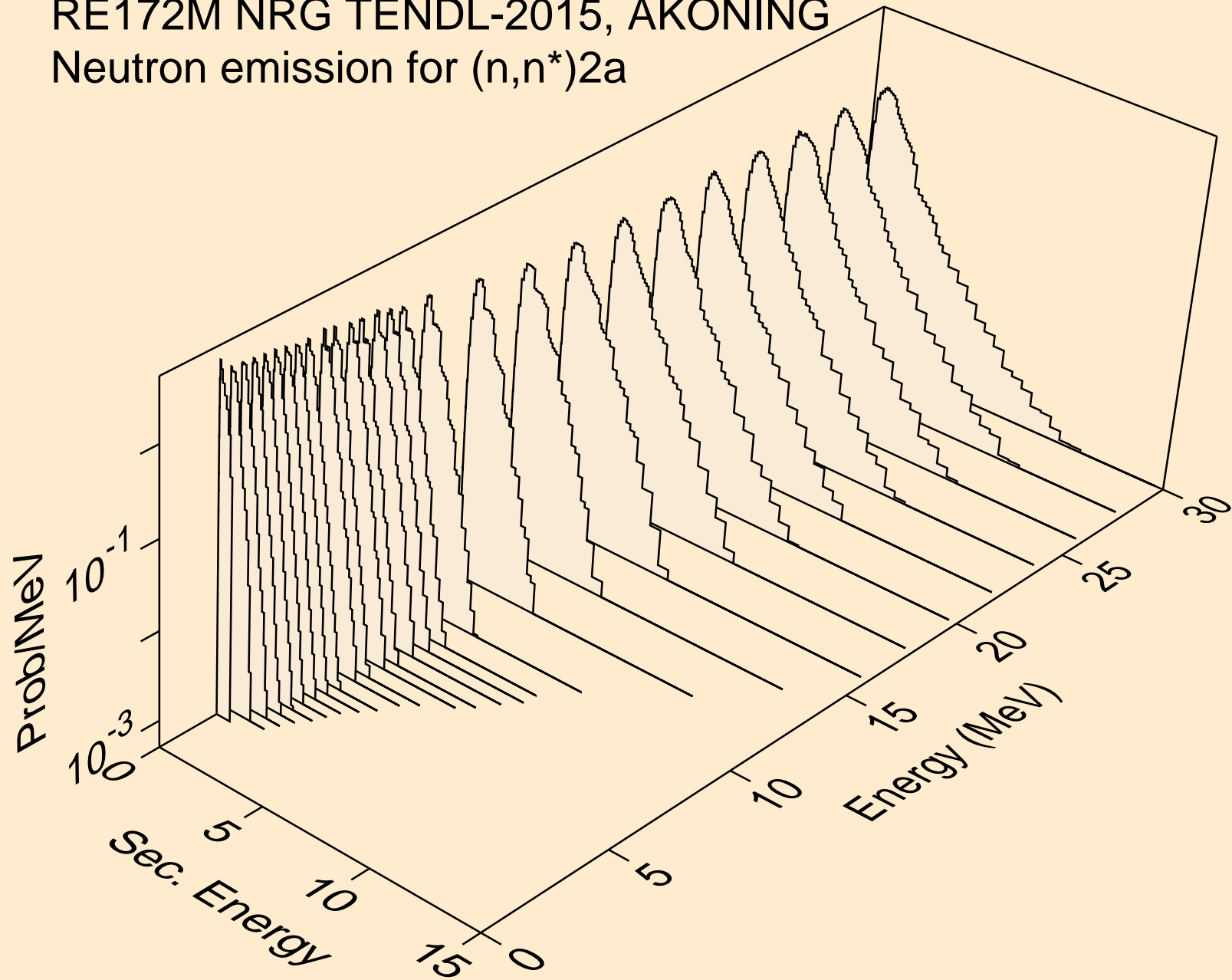

RE172M NRG TENDL-2015, AKONING
Neutron emission for (n,2n)2a

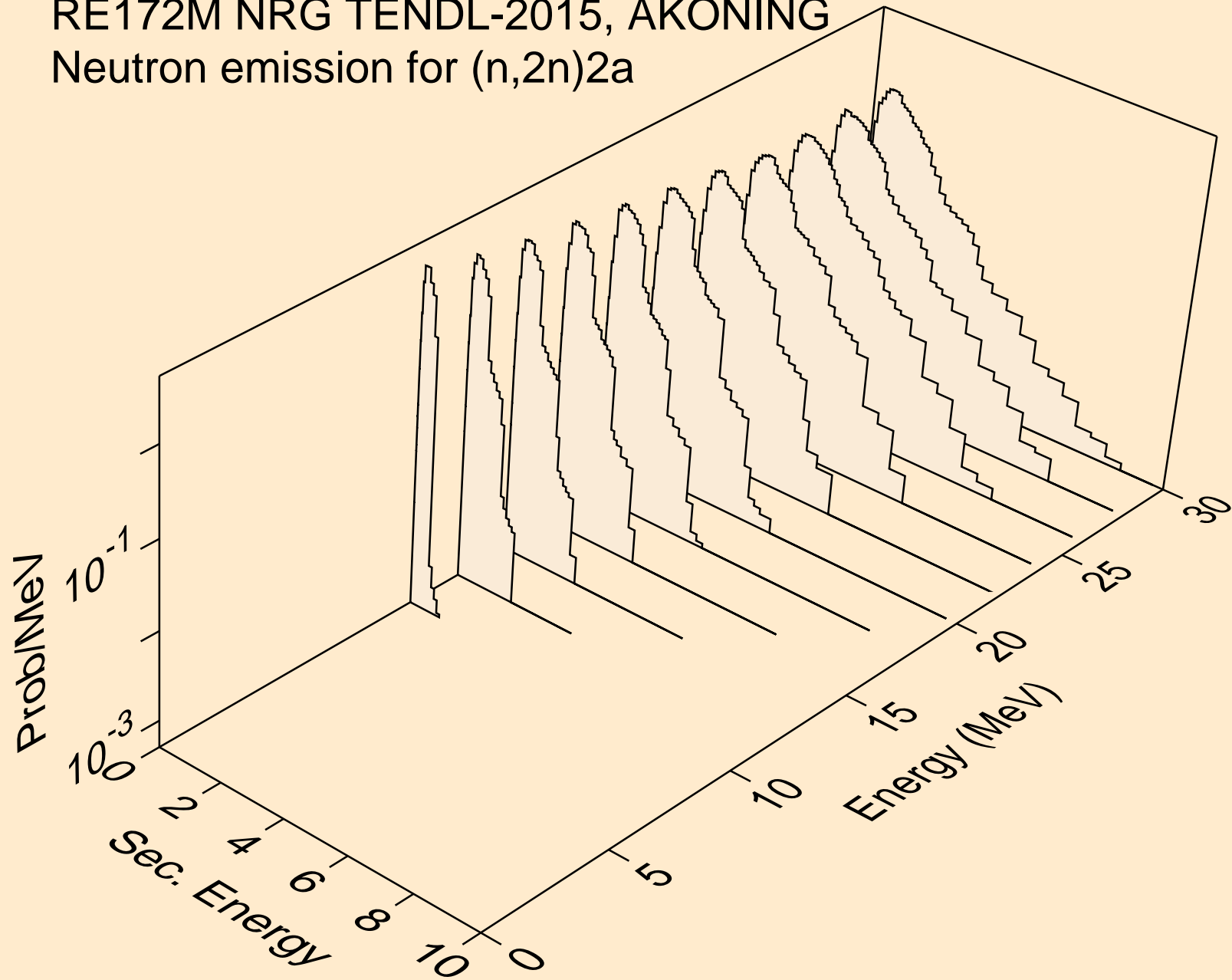

RE172M NRG TENDL-2015, AKONING
Neutron emission for (n,n*)d

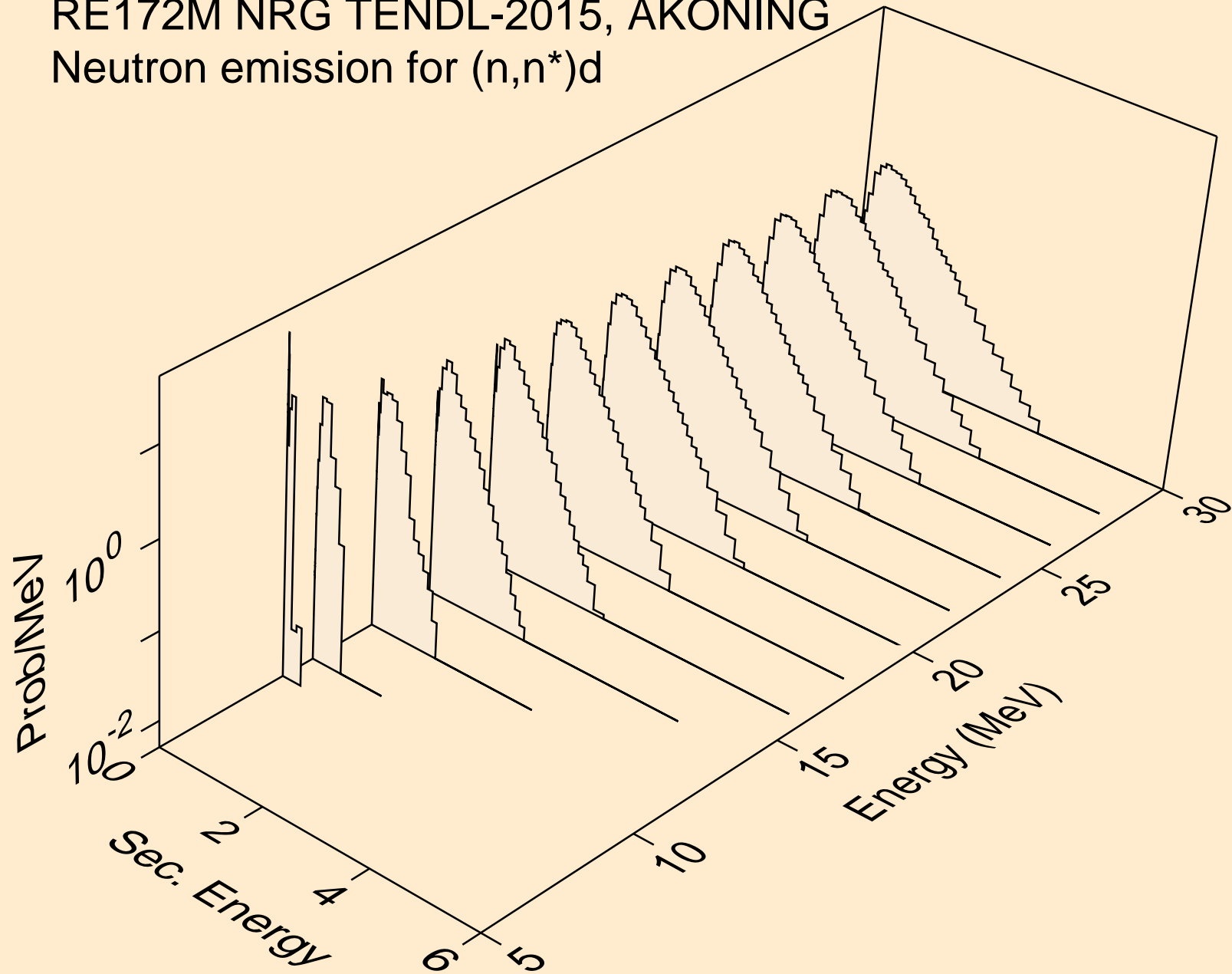

RE172M NRG TENDL-2015, AKONING
Neutron emission for (n,n*)t

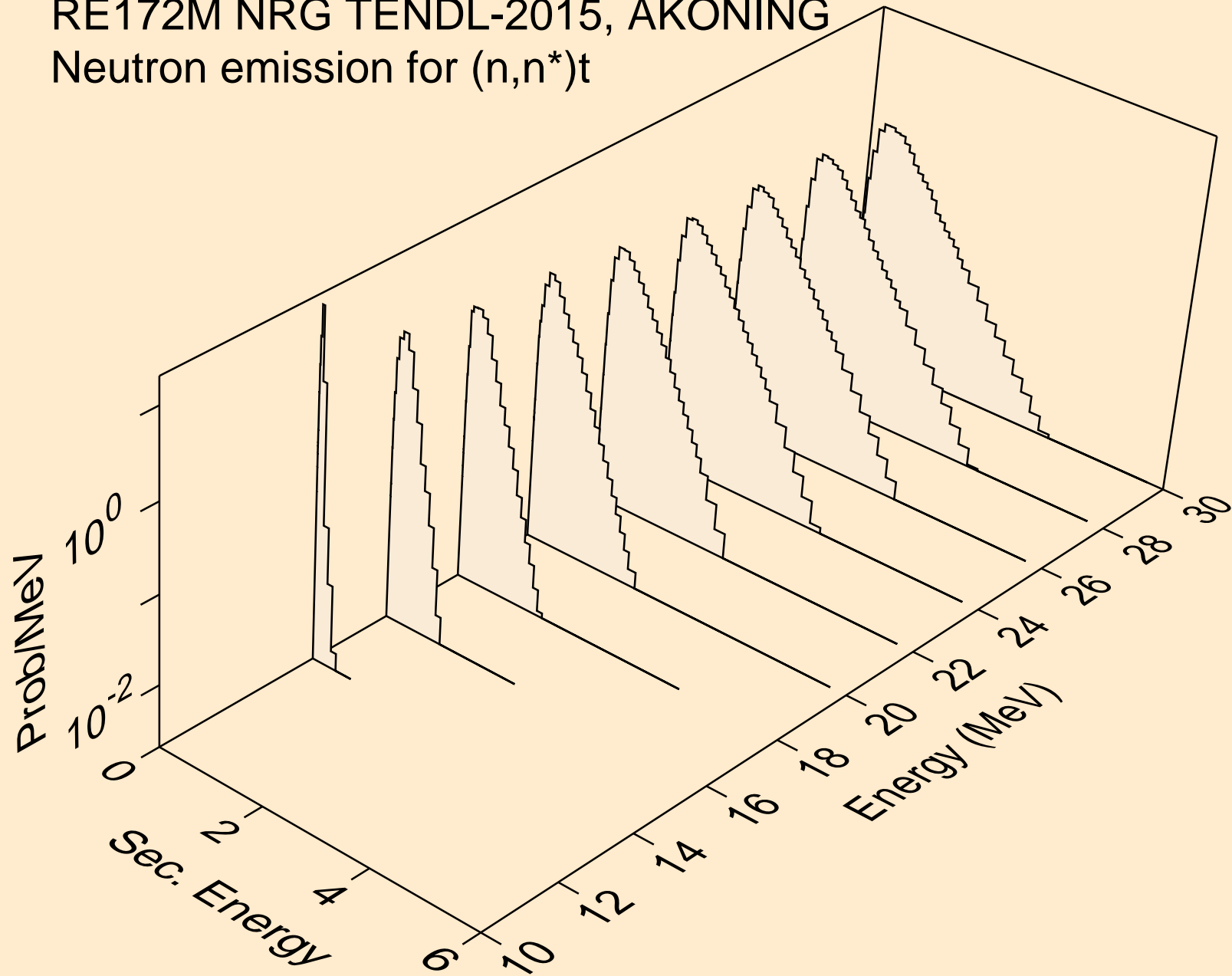

RE172M NRG TENDL-2015, AKONING
Neutron emission for (n,n*)he3

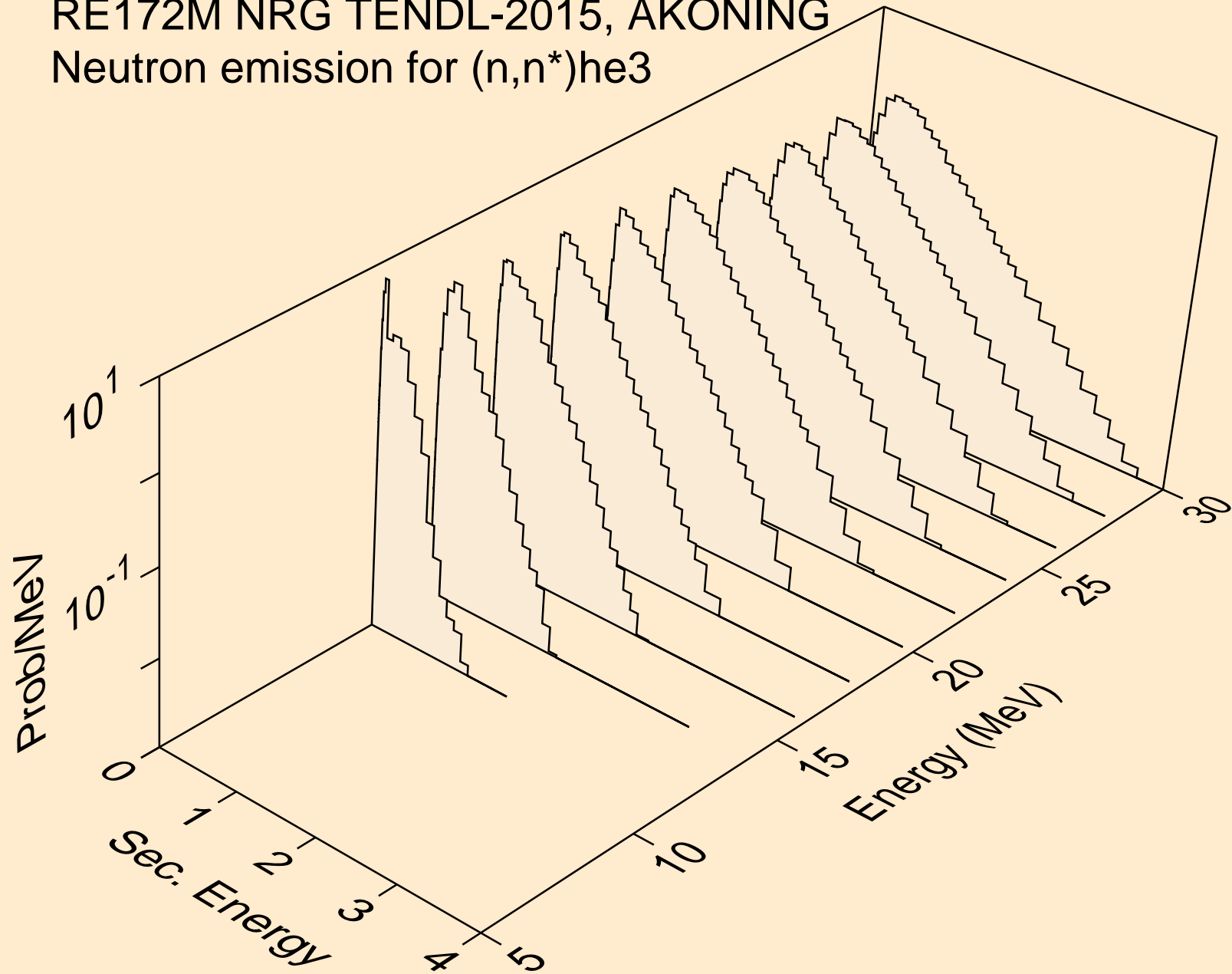

RE172M NRG TENDL-2015, AKONING
Neutron emission for (n,4n)

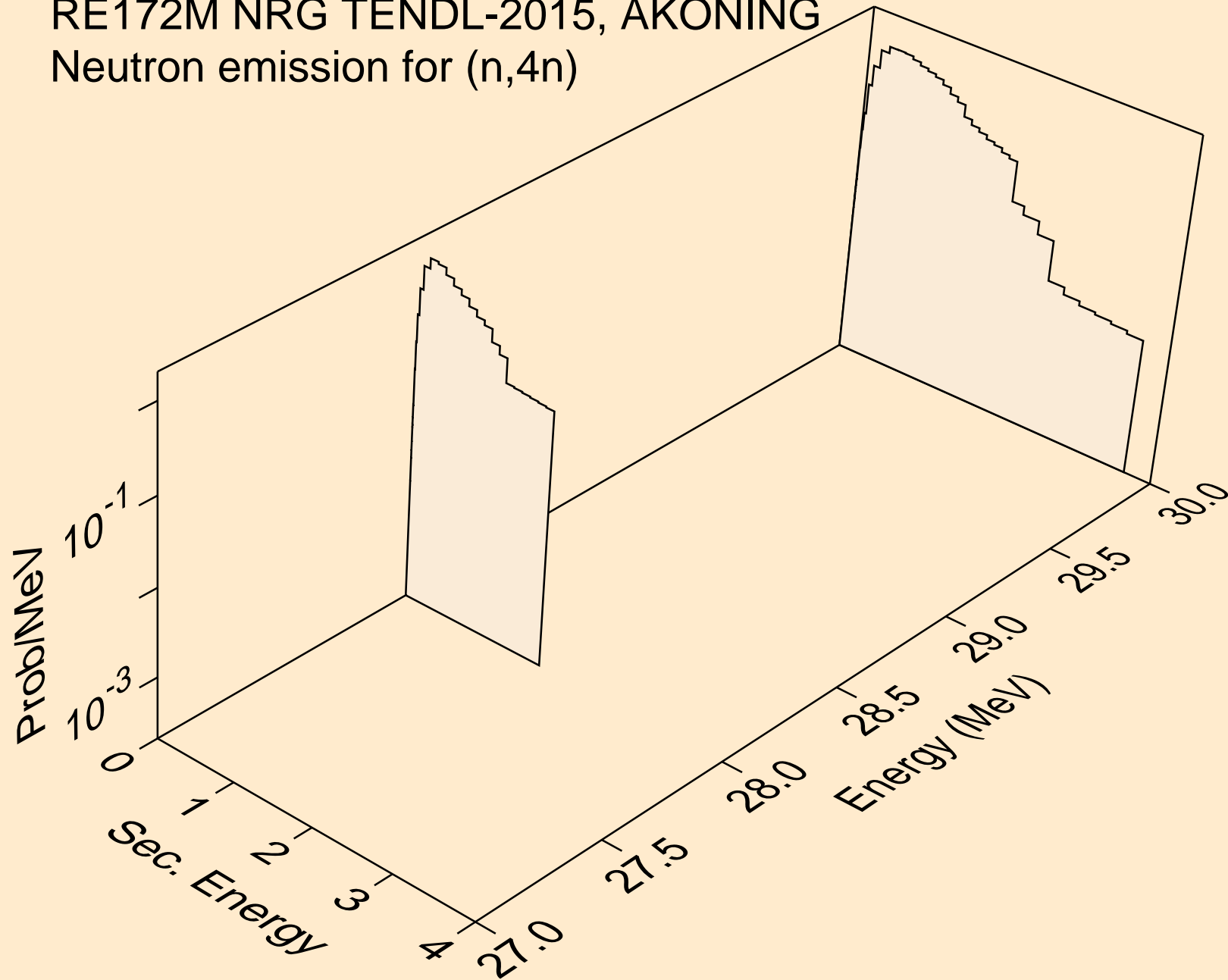

RE172M NRG TENDL-2015, AKONING
Neutron emission for (n,2np)

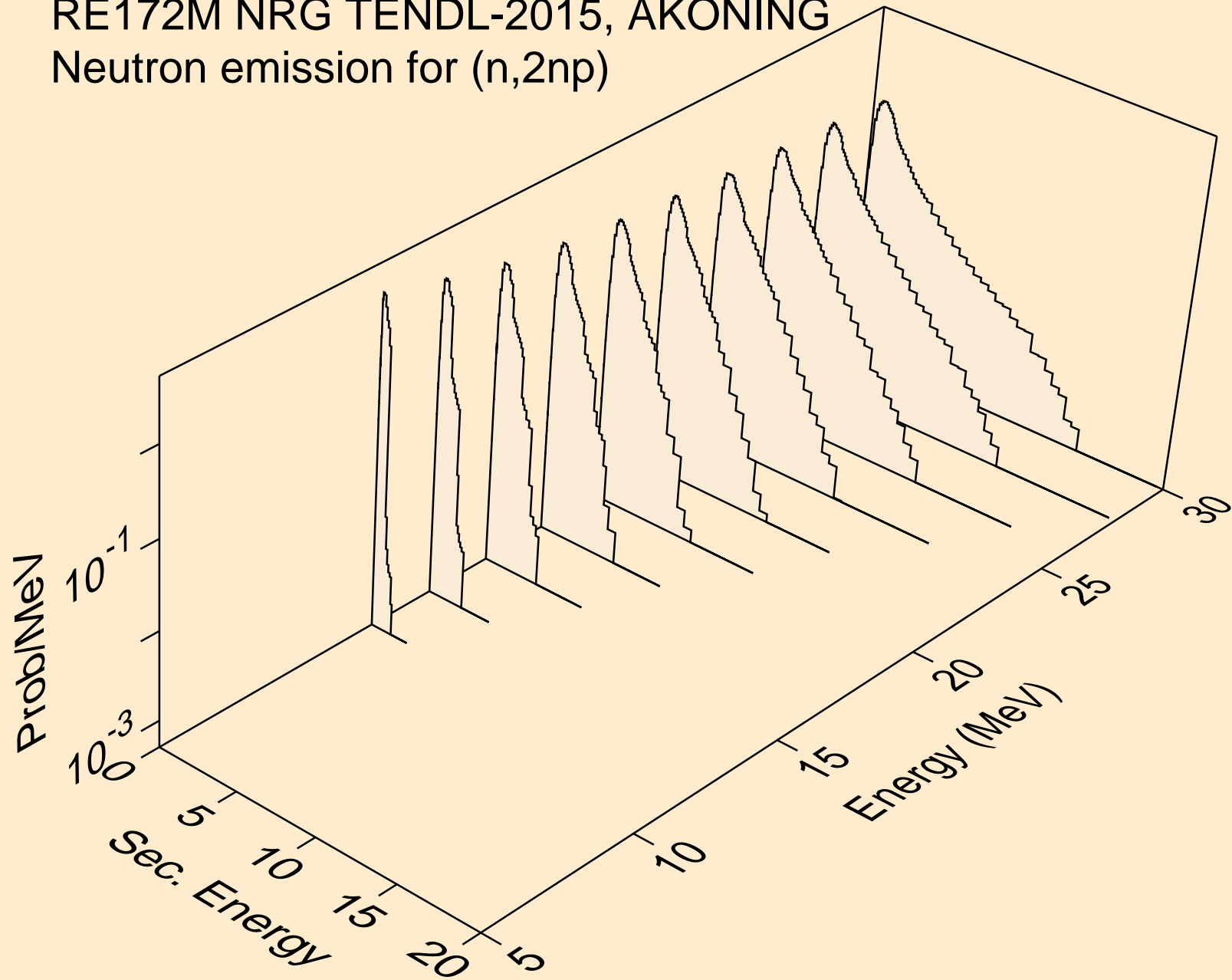

RE172M NRG TENDL-2015, AKONING
Neutron emission for (n,3np)

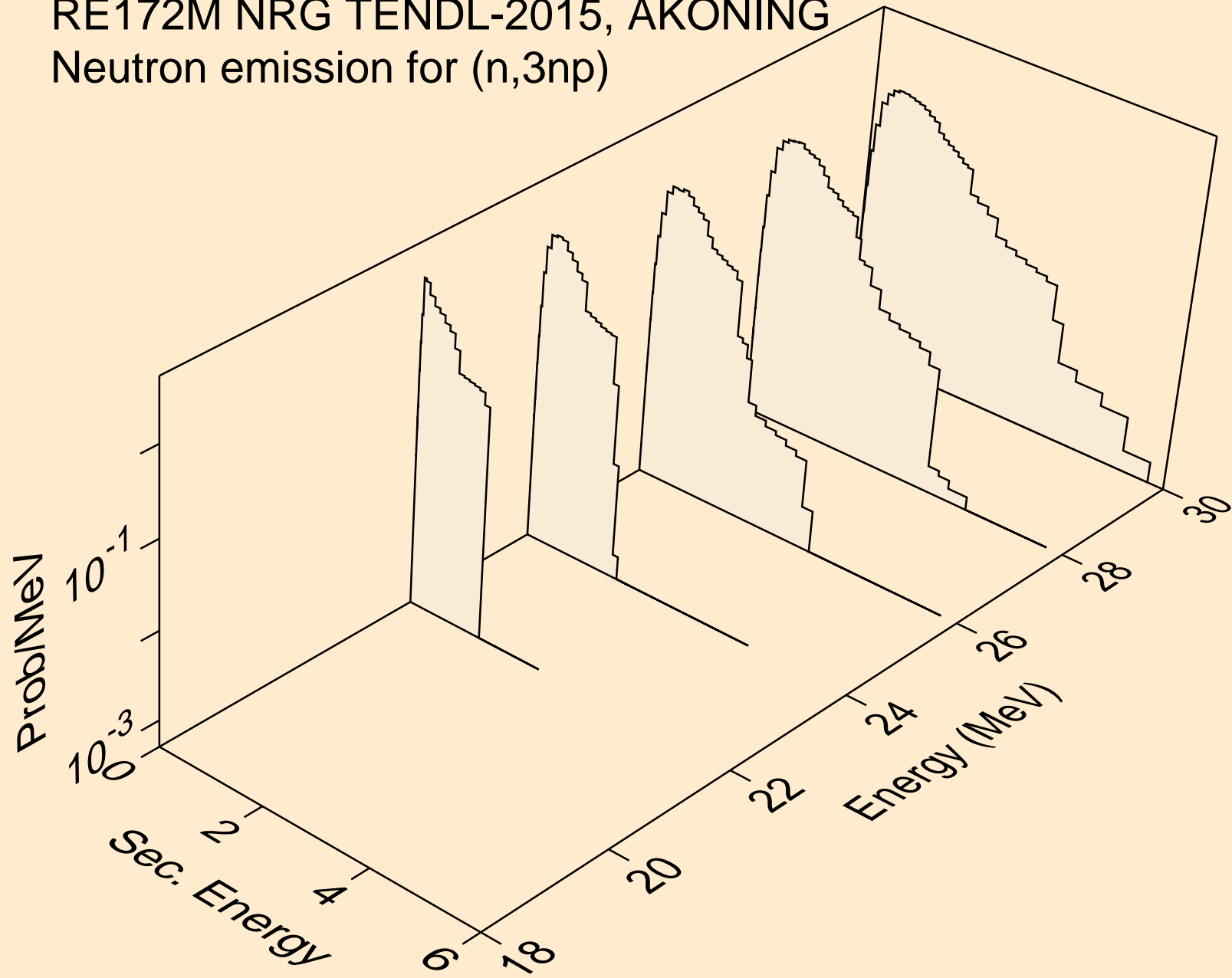

RE172M NRG TENDL-2015, AKONING
Neutron emission for (n,2np)

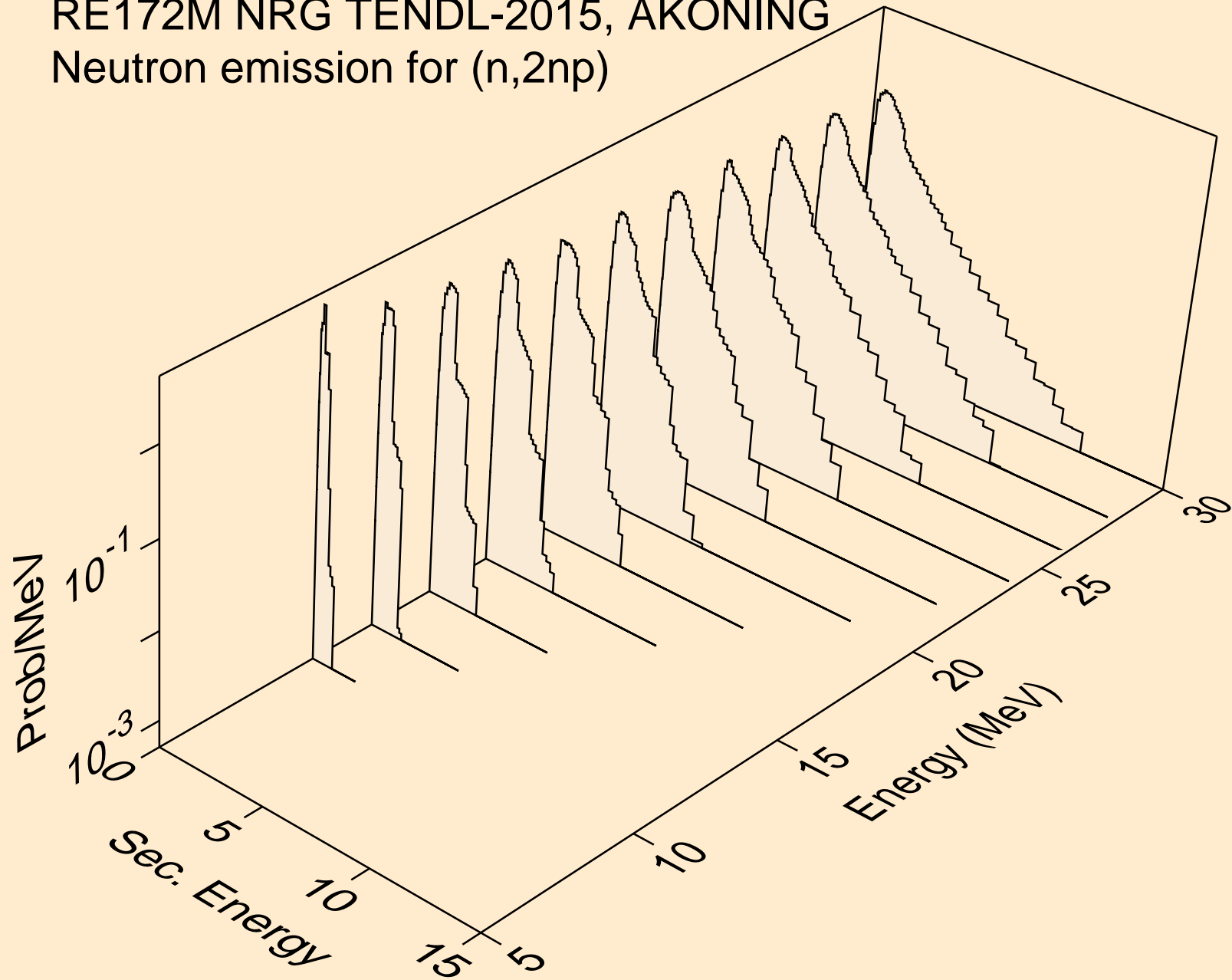

RE172M NRG TENDL-2015, AKONING
Neutron emission for (n,npa)

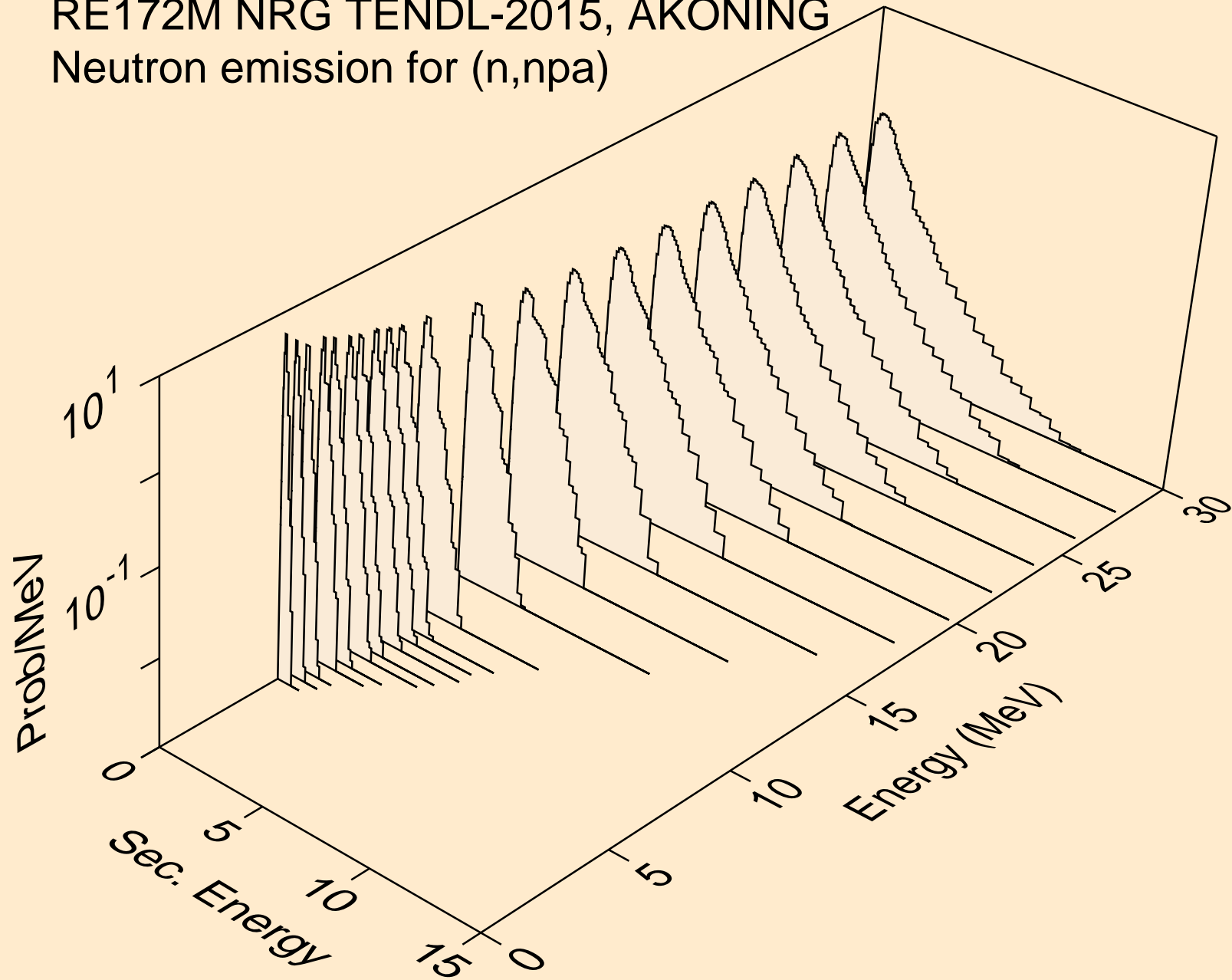

RE172M NRG TENDL-2015, AKONING
Neutron emission for (n,n*c)

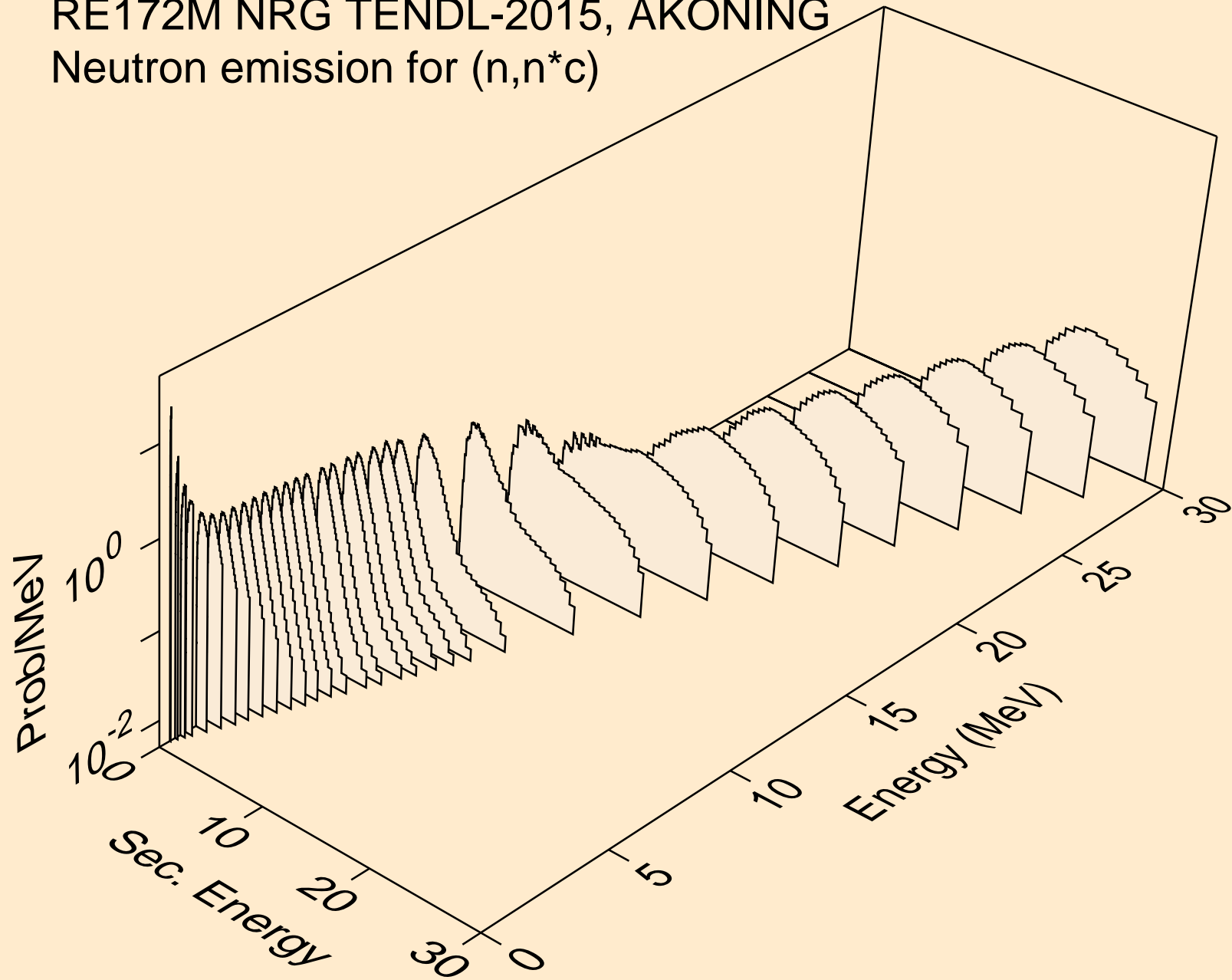

RE172M NRG TENDL-2015, AKONING
Photon emission for (n,x)

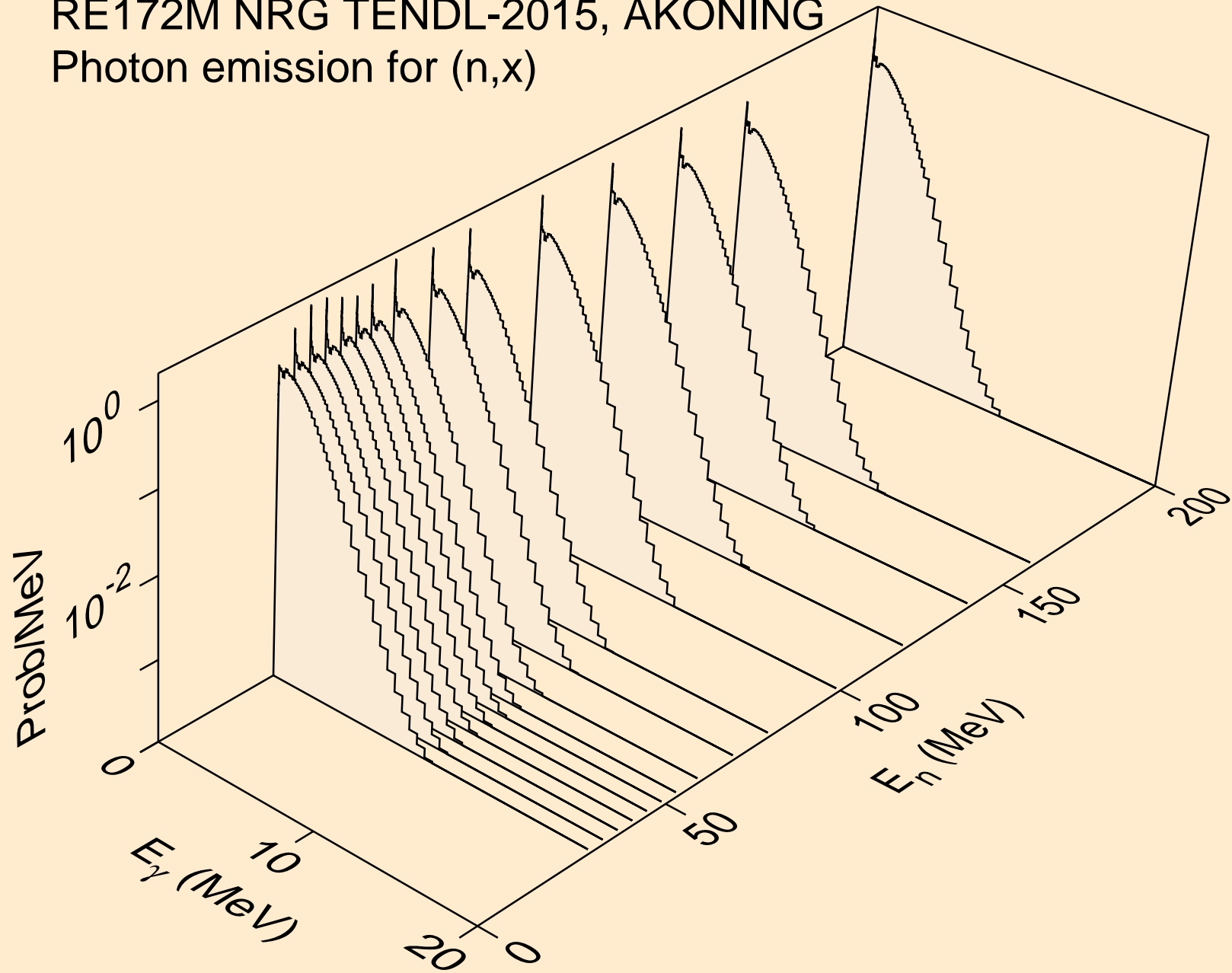

RE172M NRG TENDL-2015, AKONING
Photon emission for (n,2nd)

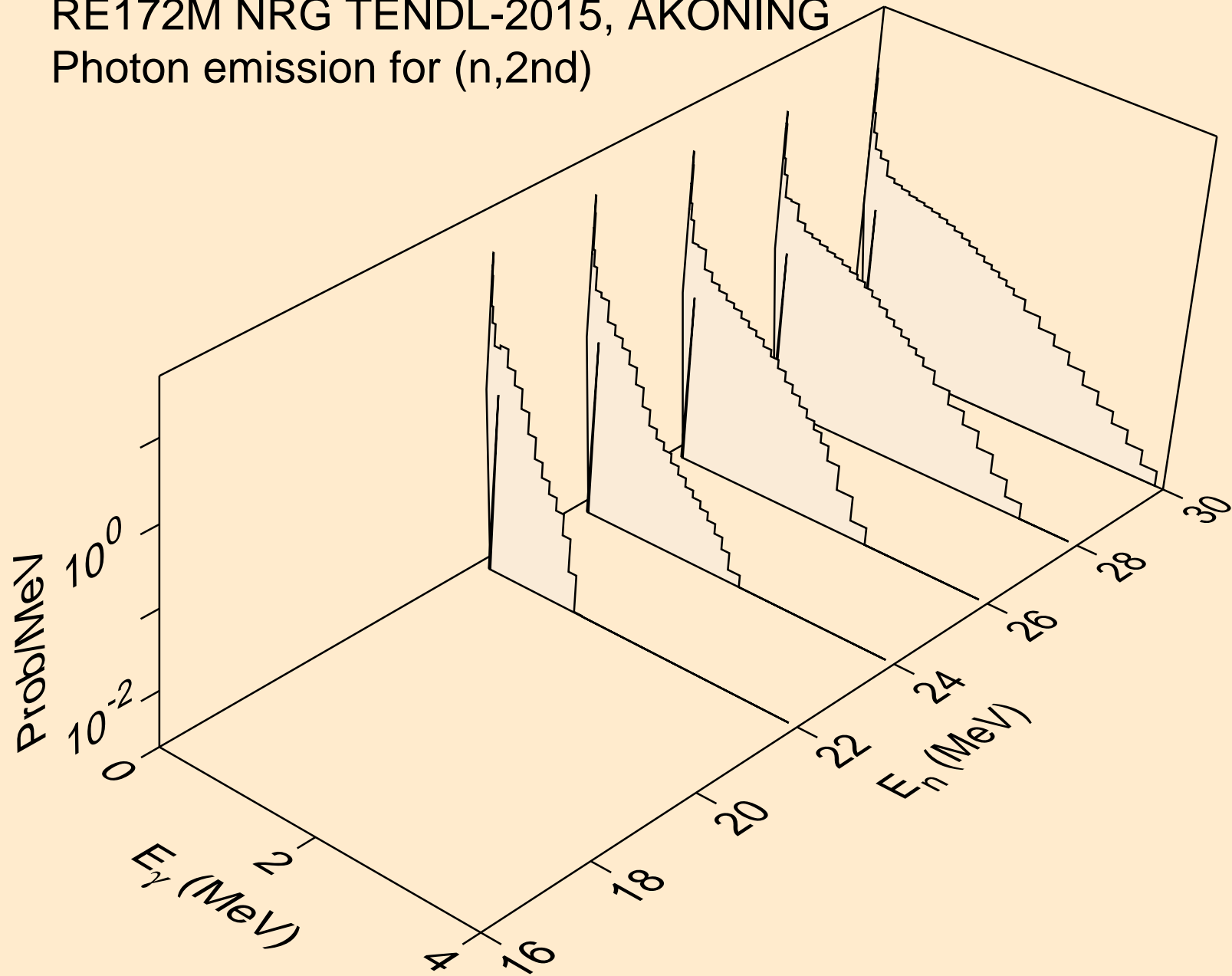

RE172M NRG TENDL-2015, AKONING
Photon emission for (n,2n)

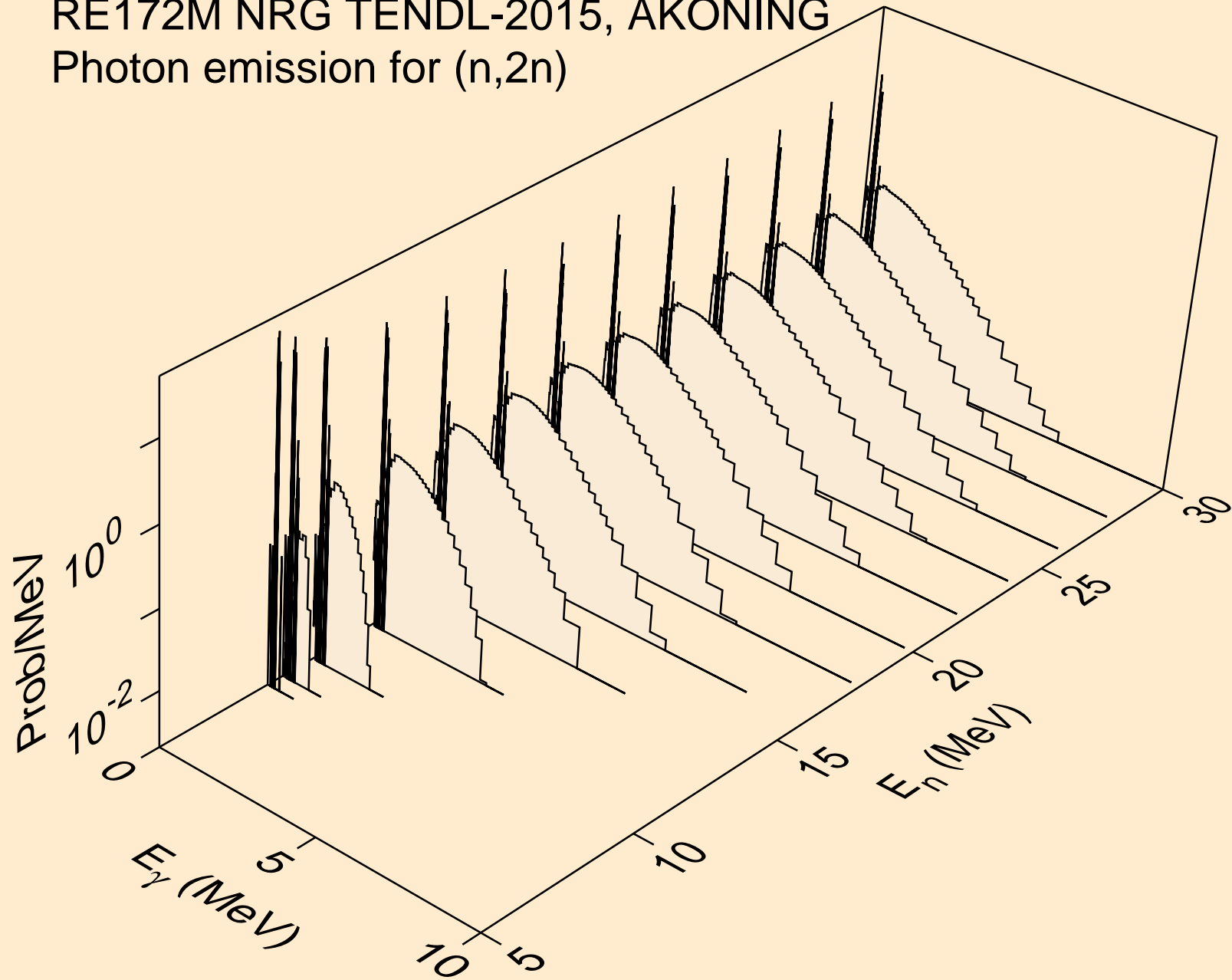

RE172M NRG TENDL-2015, AKONING
Photon emission for (n,3n)

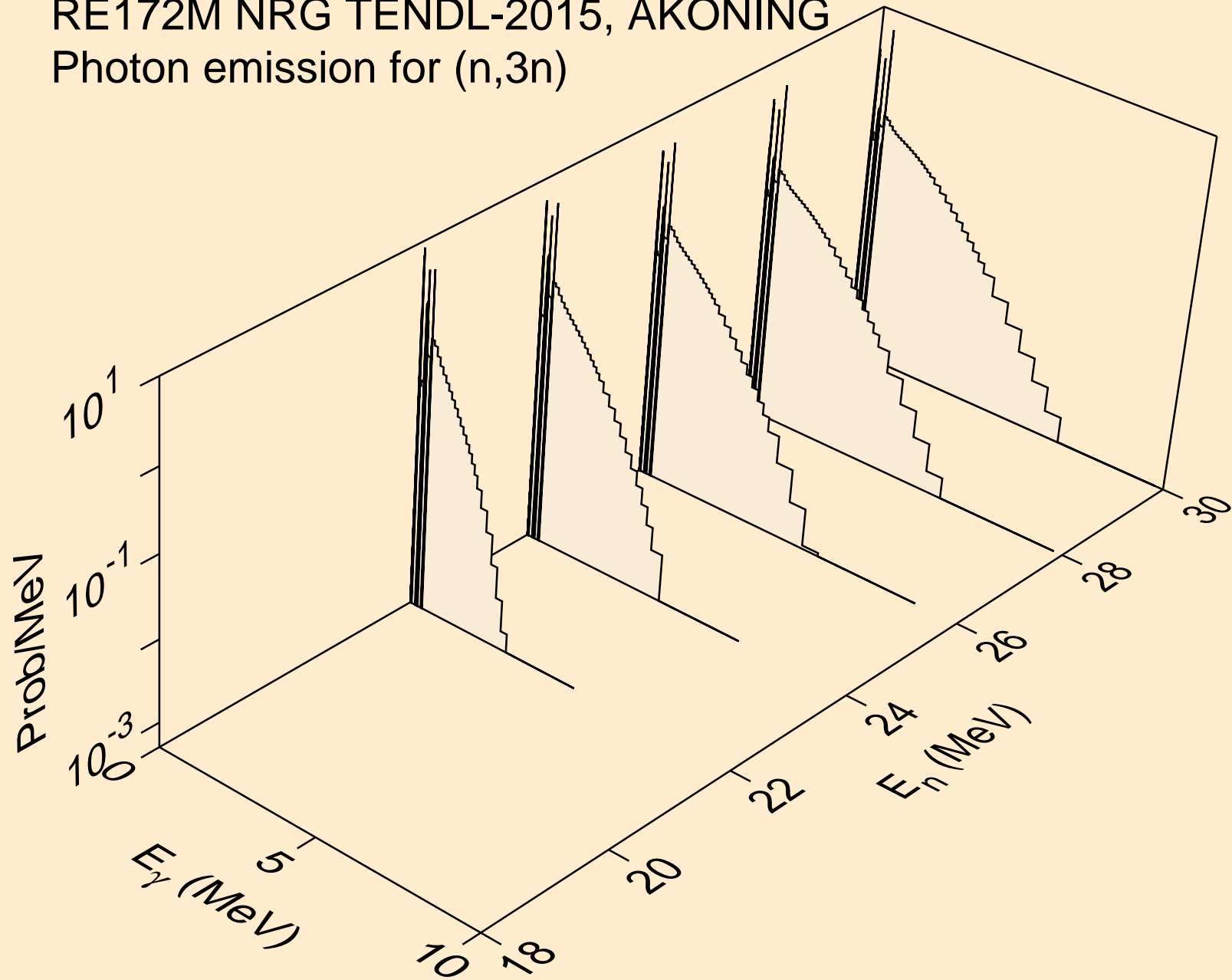

RE172M NRG TENDL-2015, AKONING
Photon emission for (n,n*)a

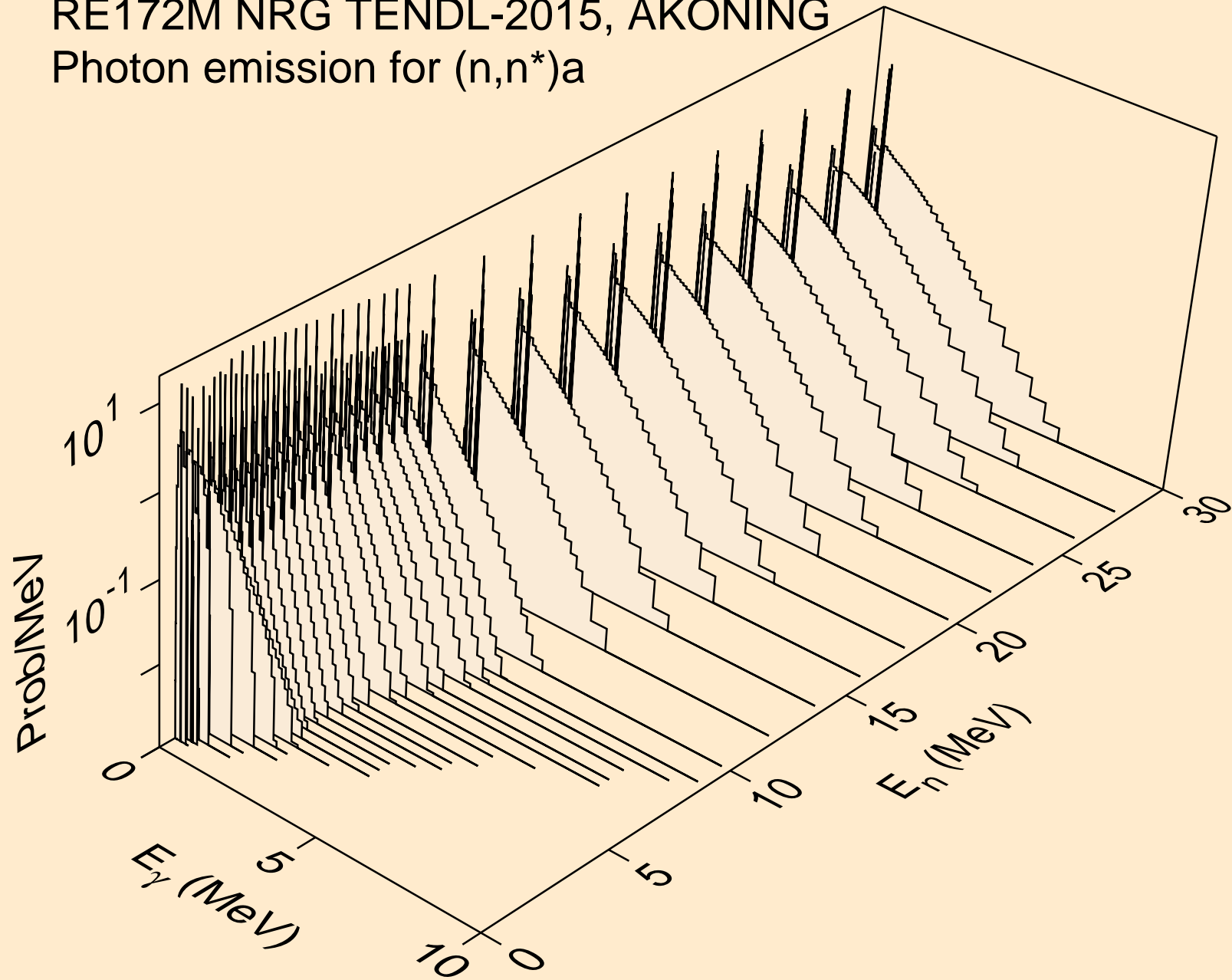

RE172M NRG TENDL-2015, AKONING
Photon emission for (n,n*)3a

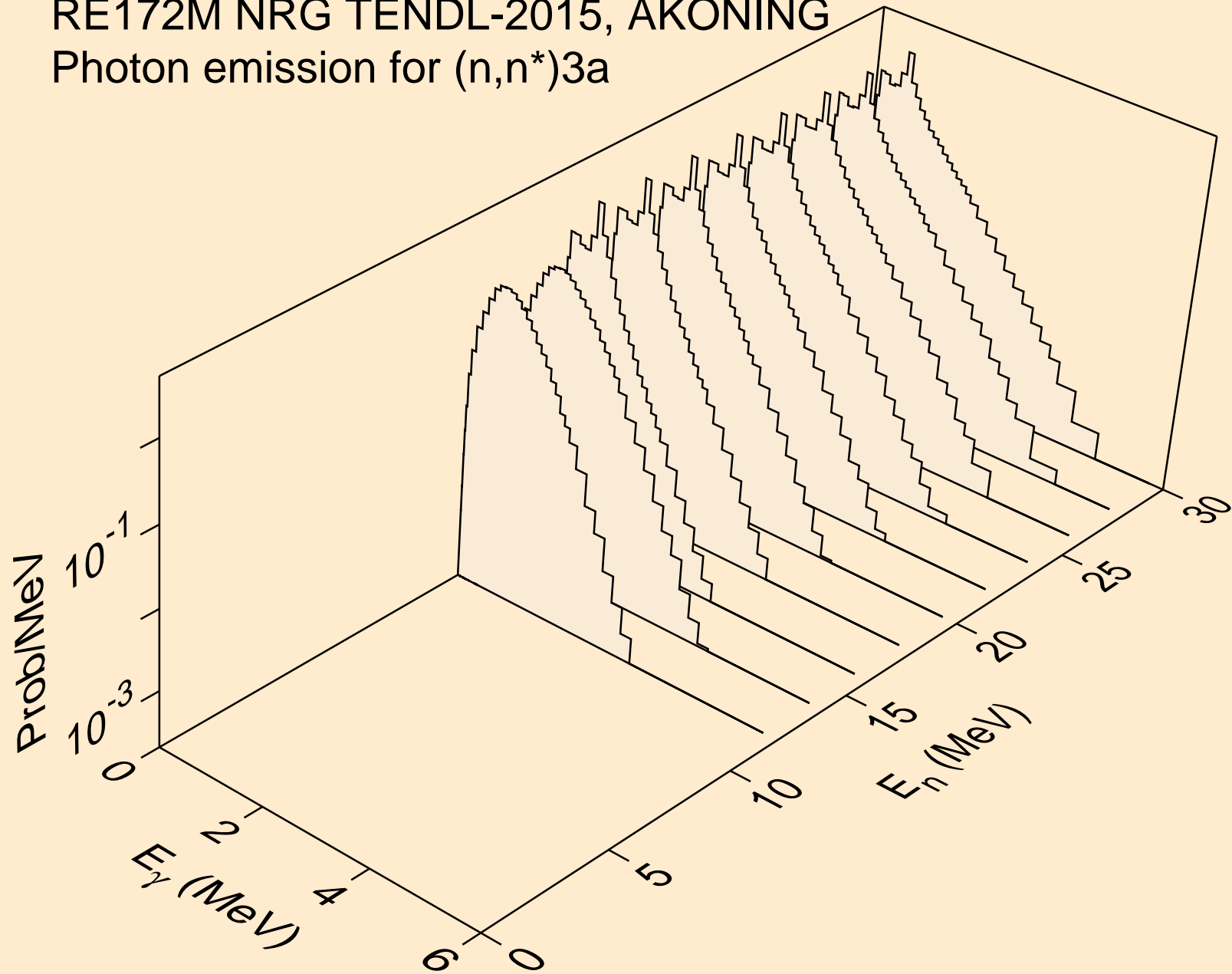

RE172M NRG TENDL-2015, AKONING
Photon emission for (n,2n)a

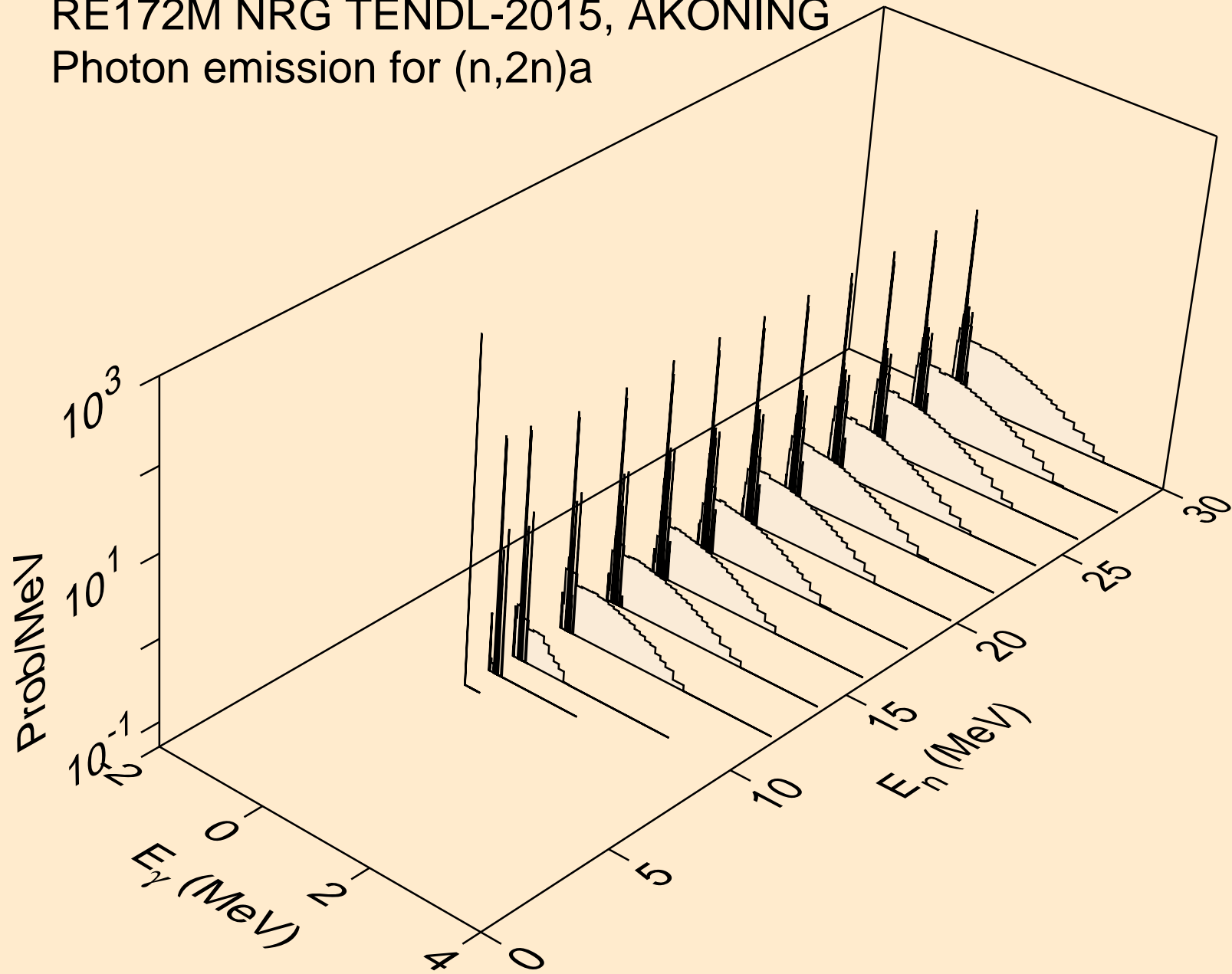

RE172M NRG TENDL-2015, AKONING
Photon emission for (n,3n)a

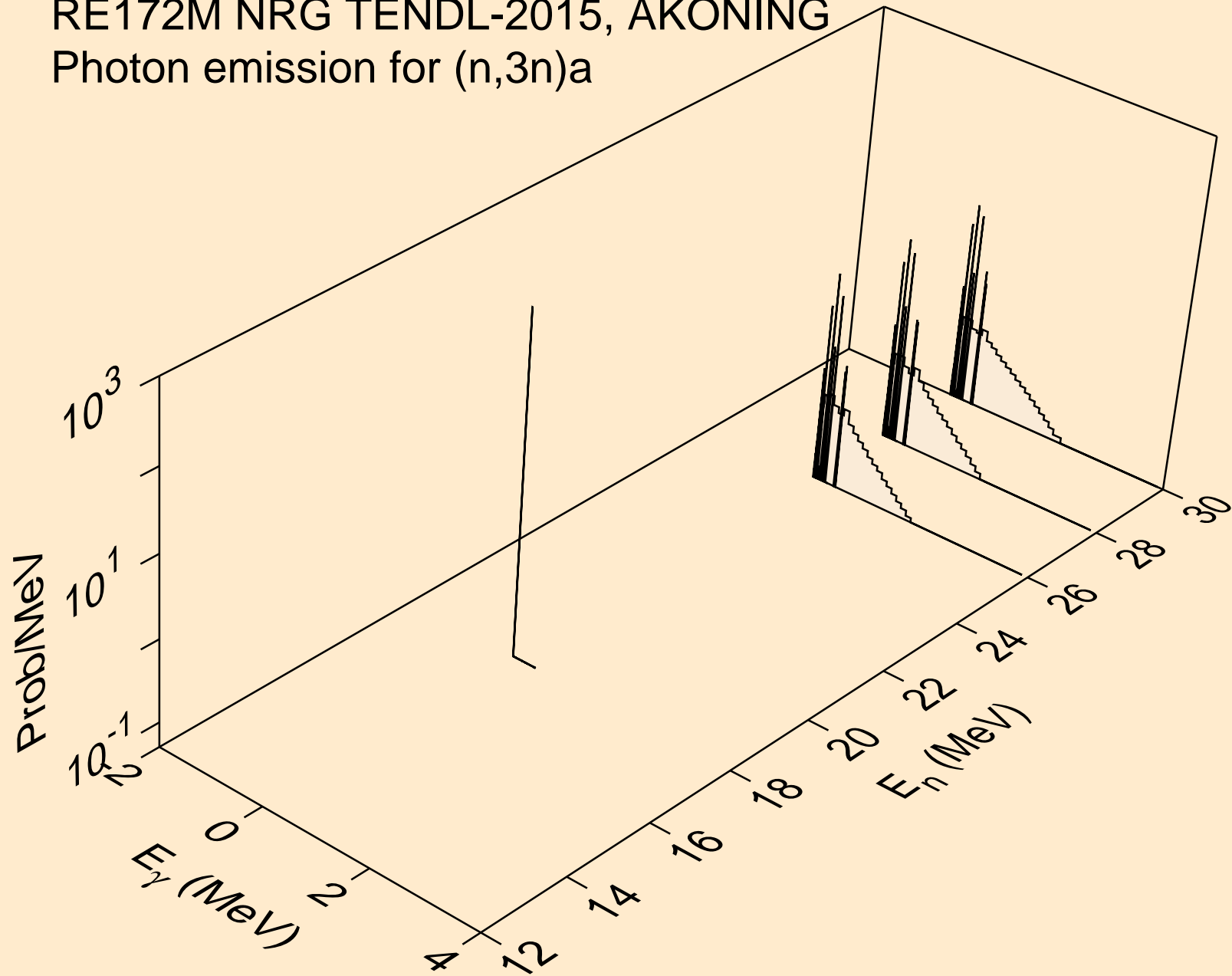

RE172M NRG TENDL-2015, AKONING
Photon emission for (n,n*)p

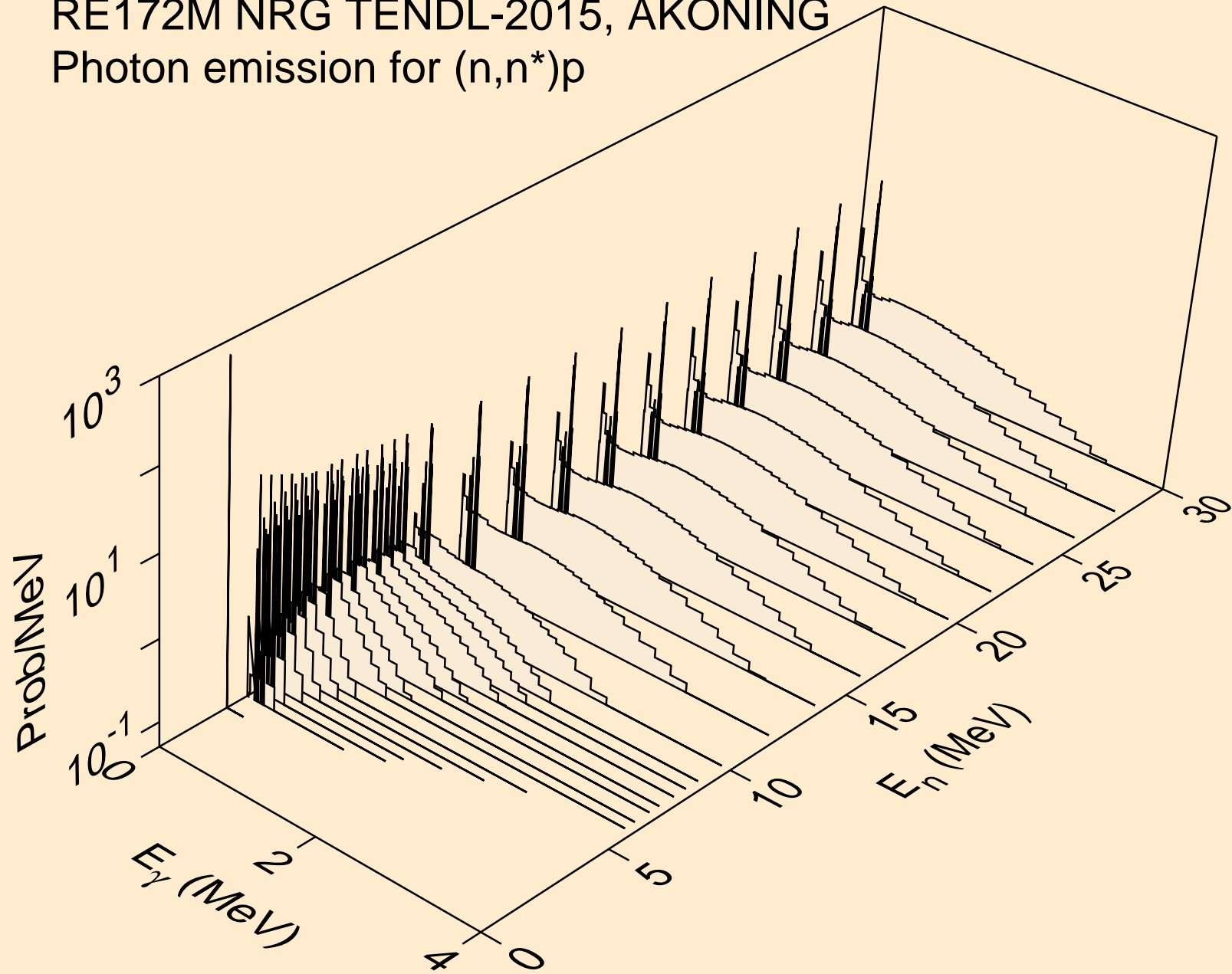

RE172M NRG TENDL-2015, AKONING
Photon emission for (n,n*)2a

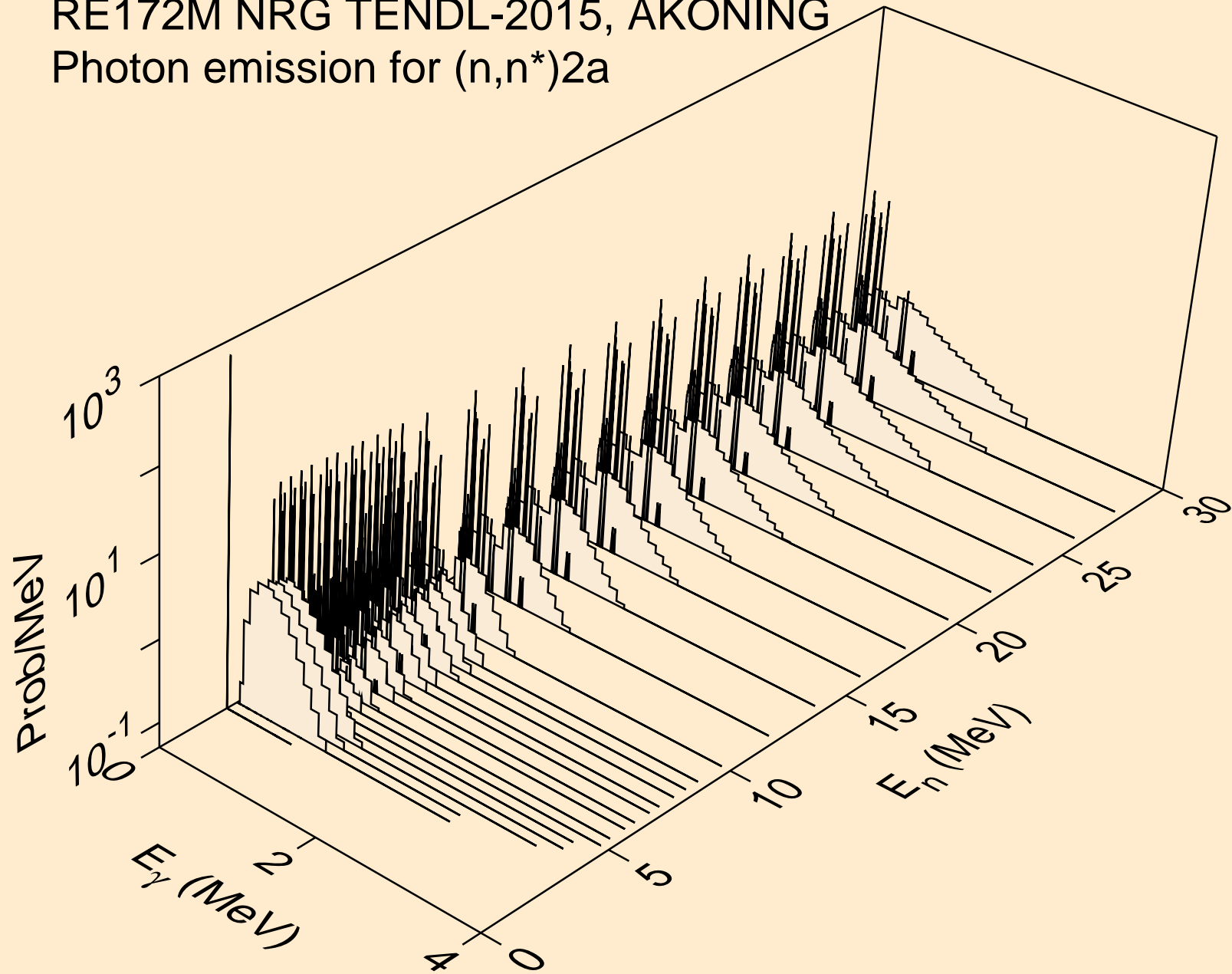

RE172M NRG TENDL-2015, AKONING
Photon emission for (n,2n)2a

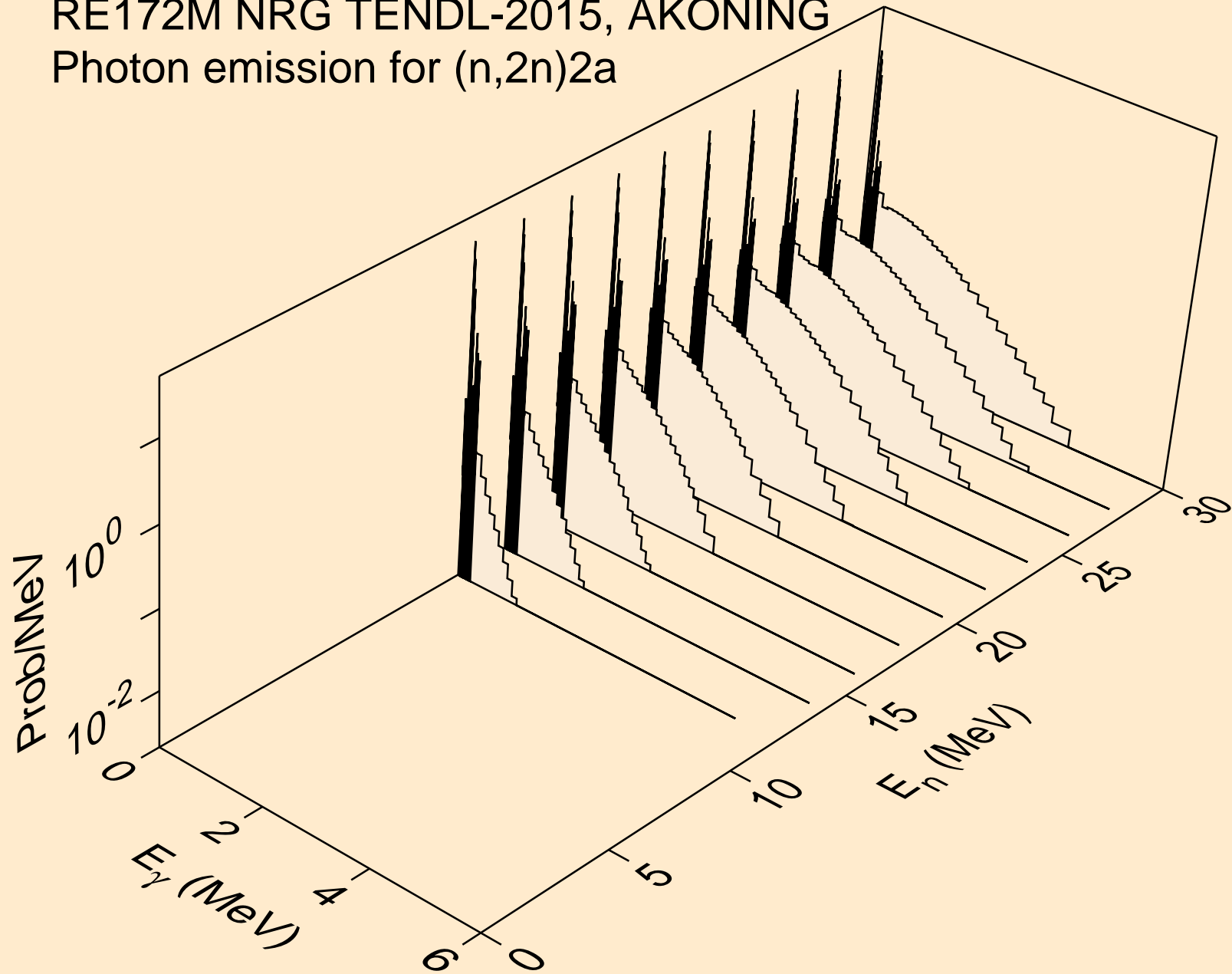

RE172M NRG TENDL-2015, AKONING
Photon emission for (n,n*)d

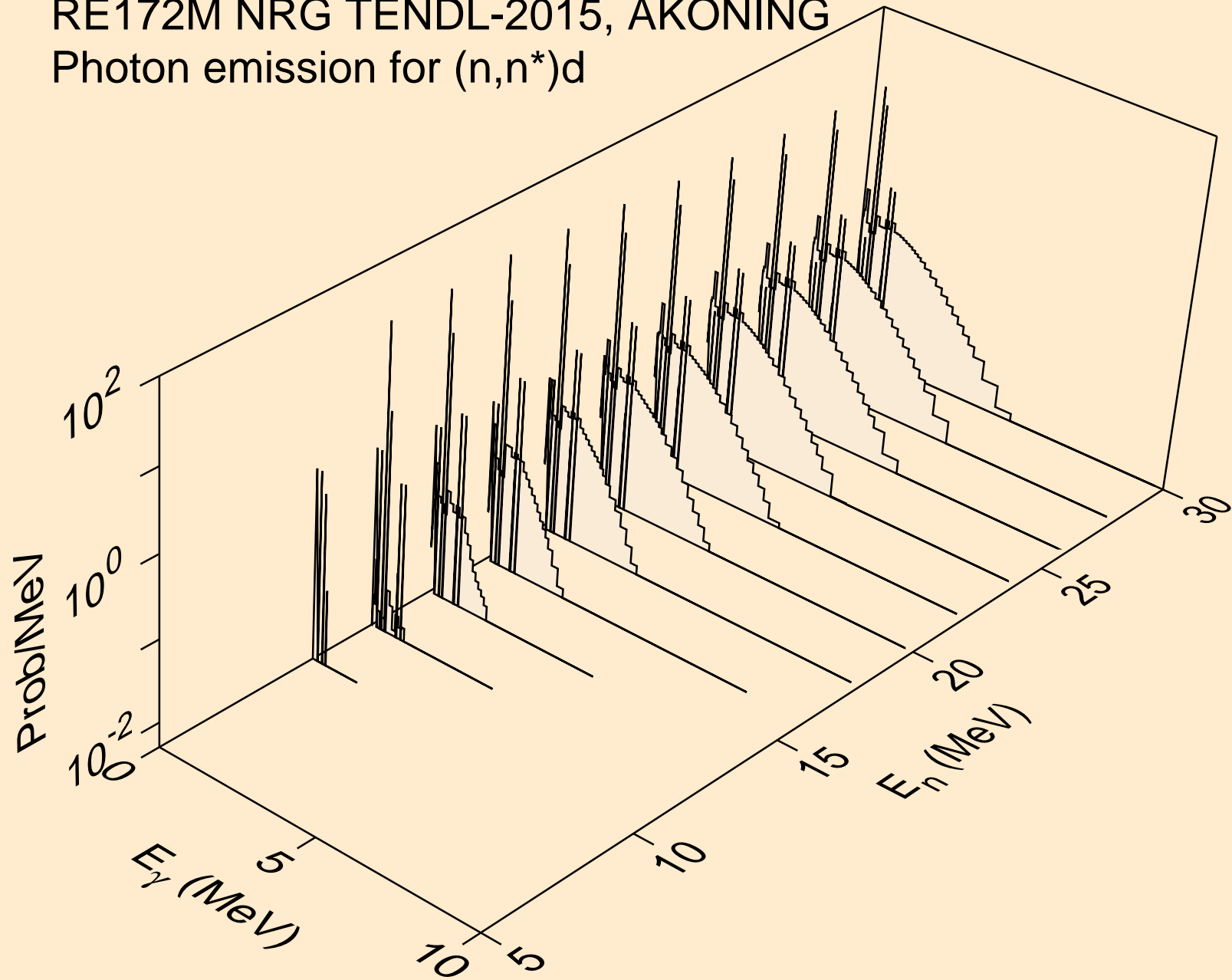

RE172M NRG TENDL-2015, AKONING
Photon emission for (n,n*)t

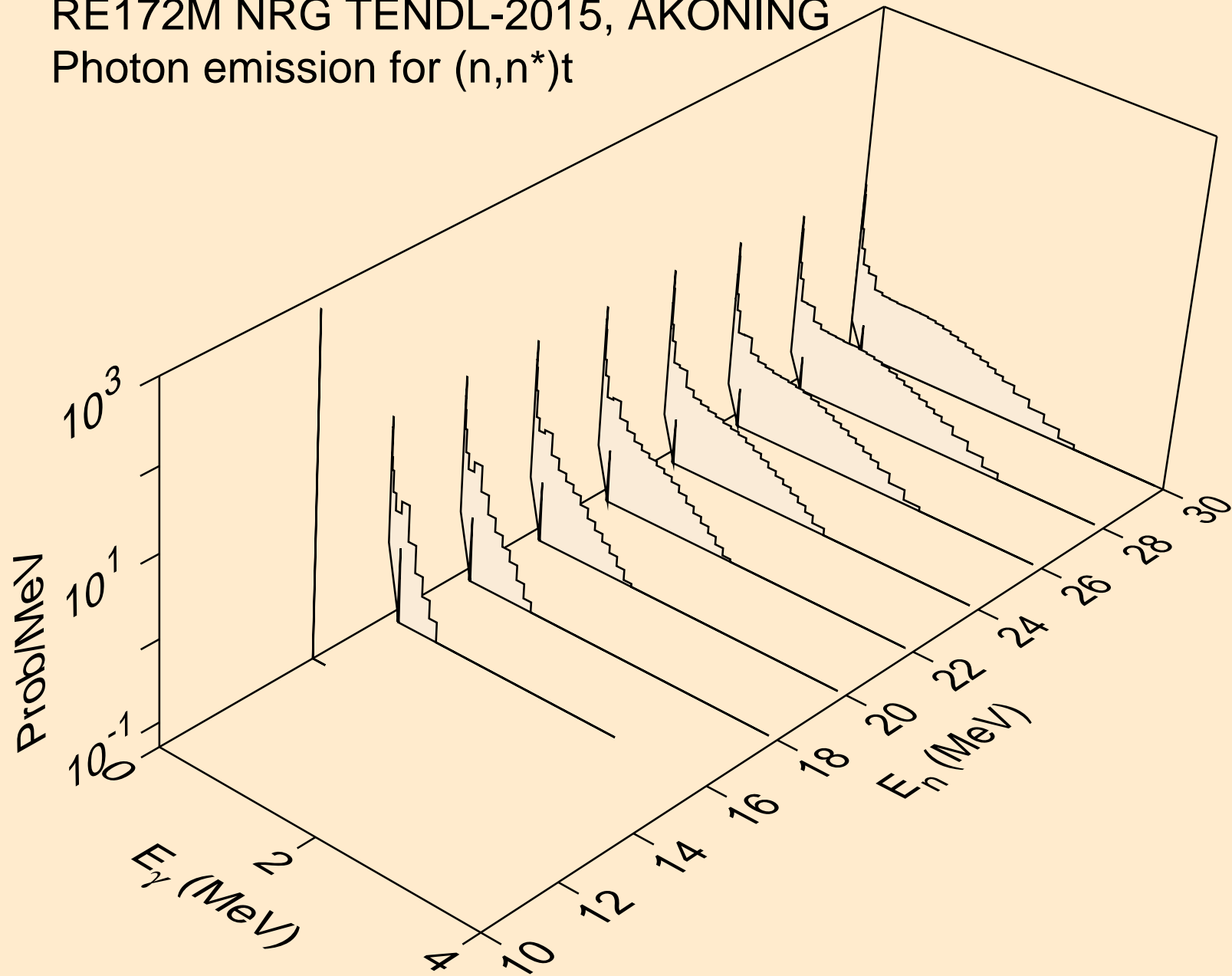

RE172M NRG TENDL-2015, AKONING
Photon emission for (n,n*)he3

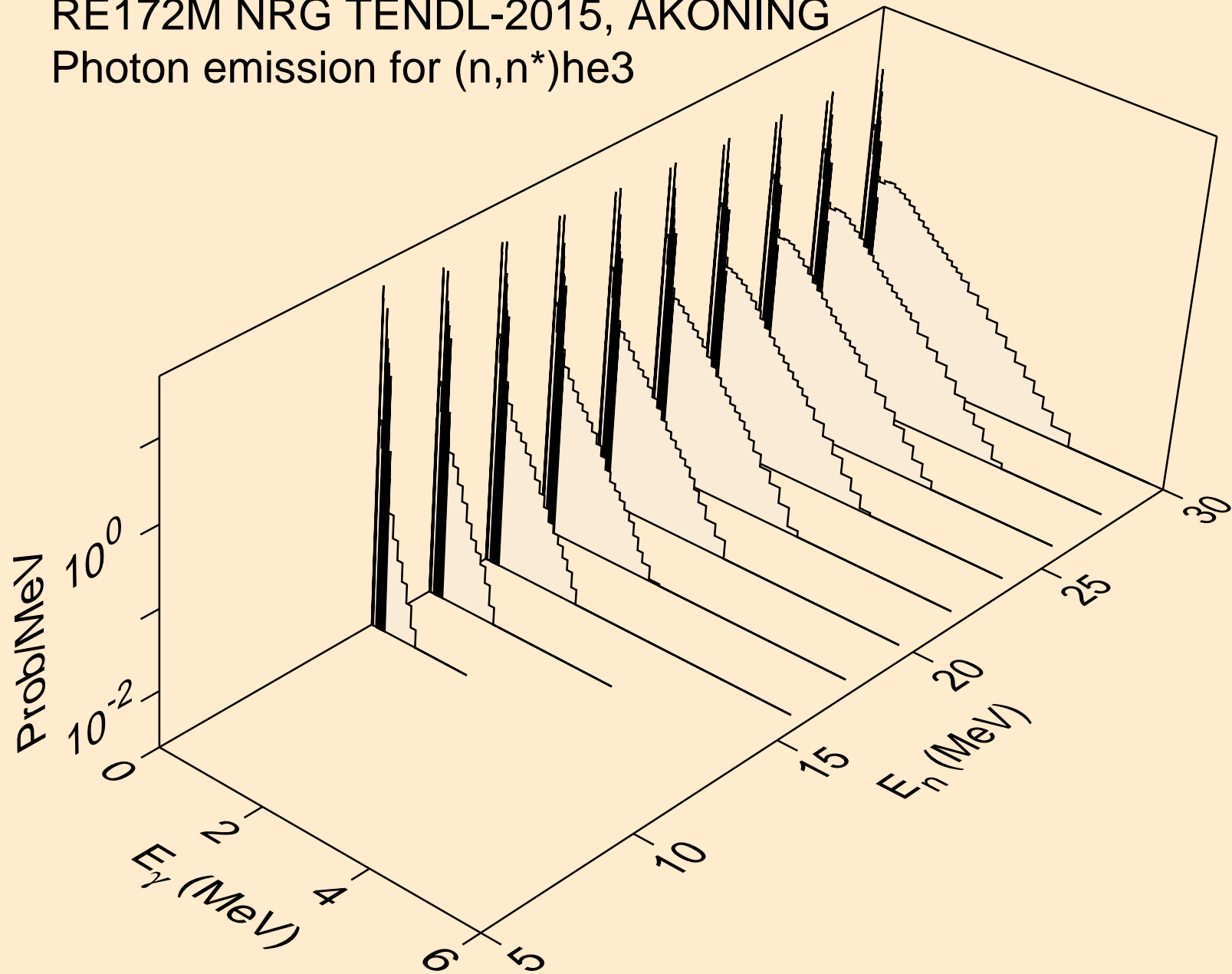

RE172M NRG TENDL-2015, AKONING
Photon emission for (n,4n)

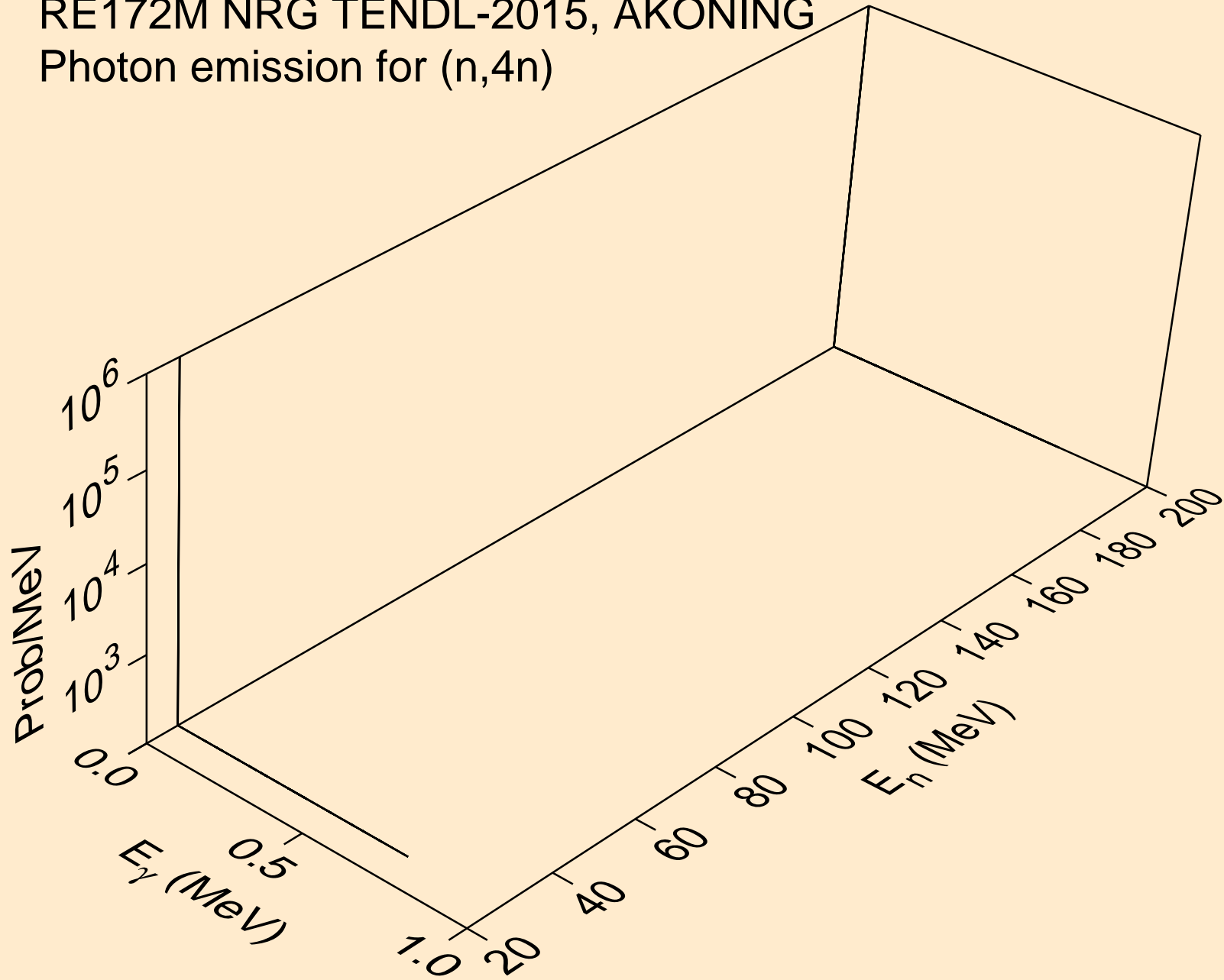

RE172M NRG TENDL-2015, AKONING
Photon emission for (n,2np)

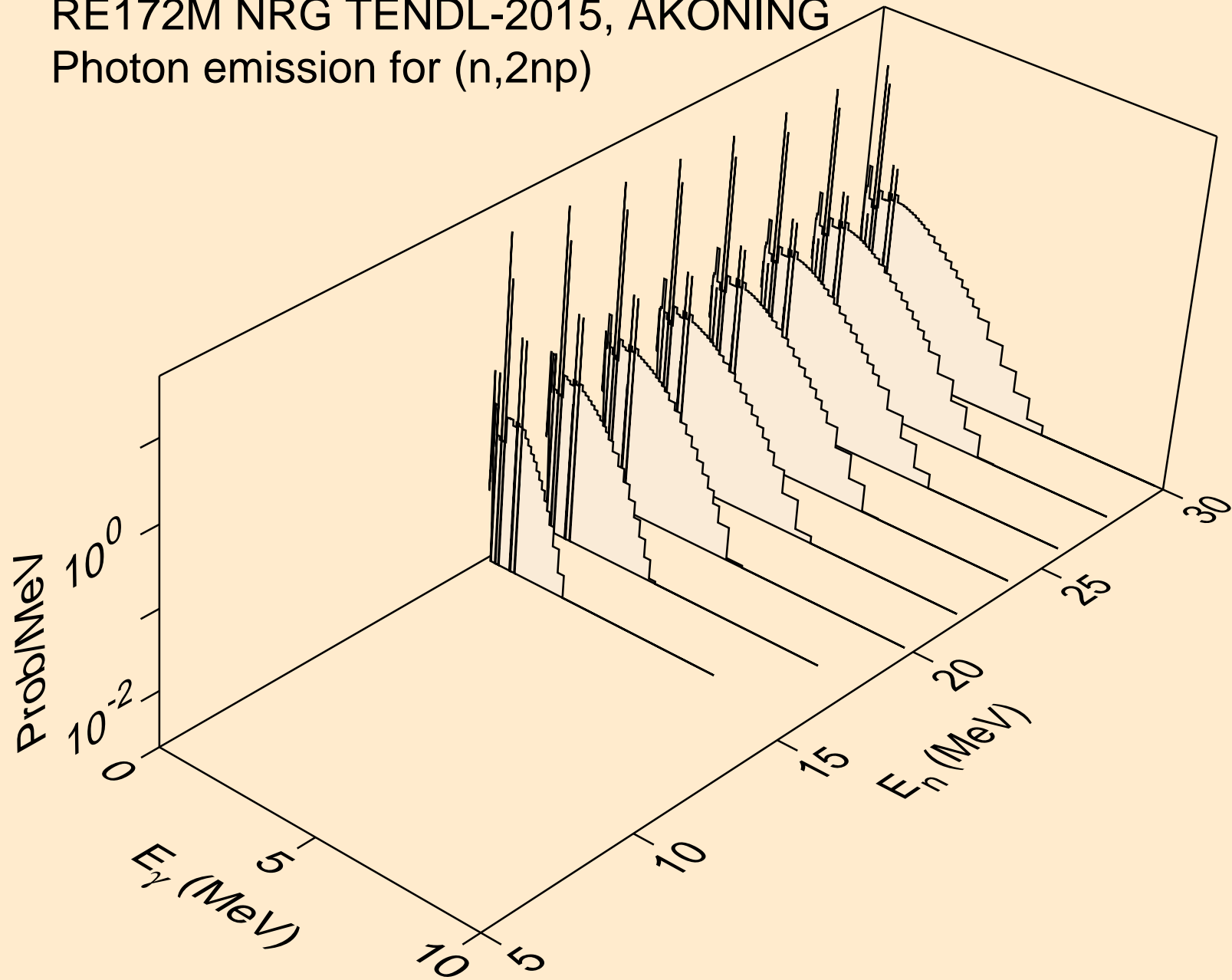

RE172M NRG TENDL-2015, AKONING
Photon emission for (n,3np)

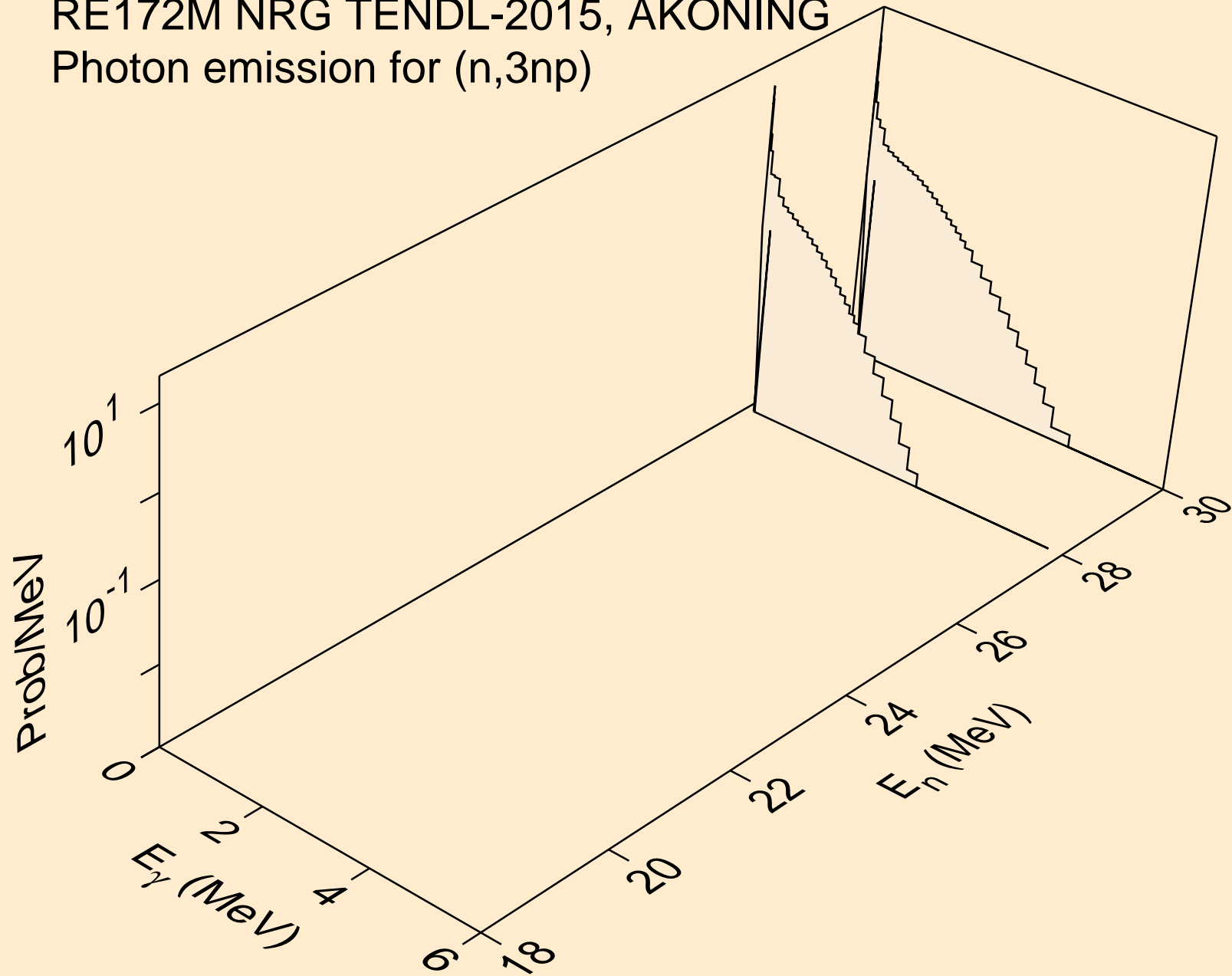

RE172M NRG TENDL-2015, AKONING
Photon emission for (n,2np)

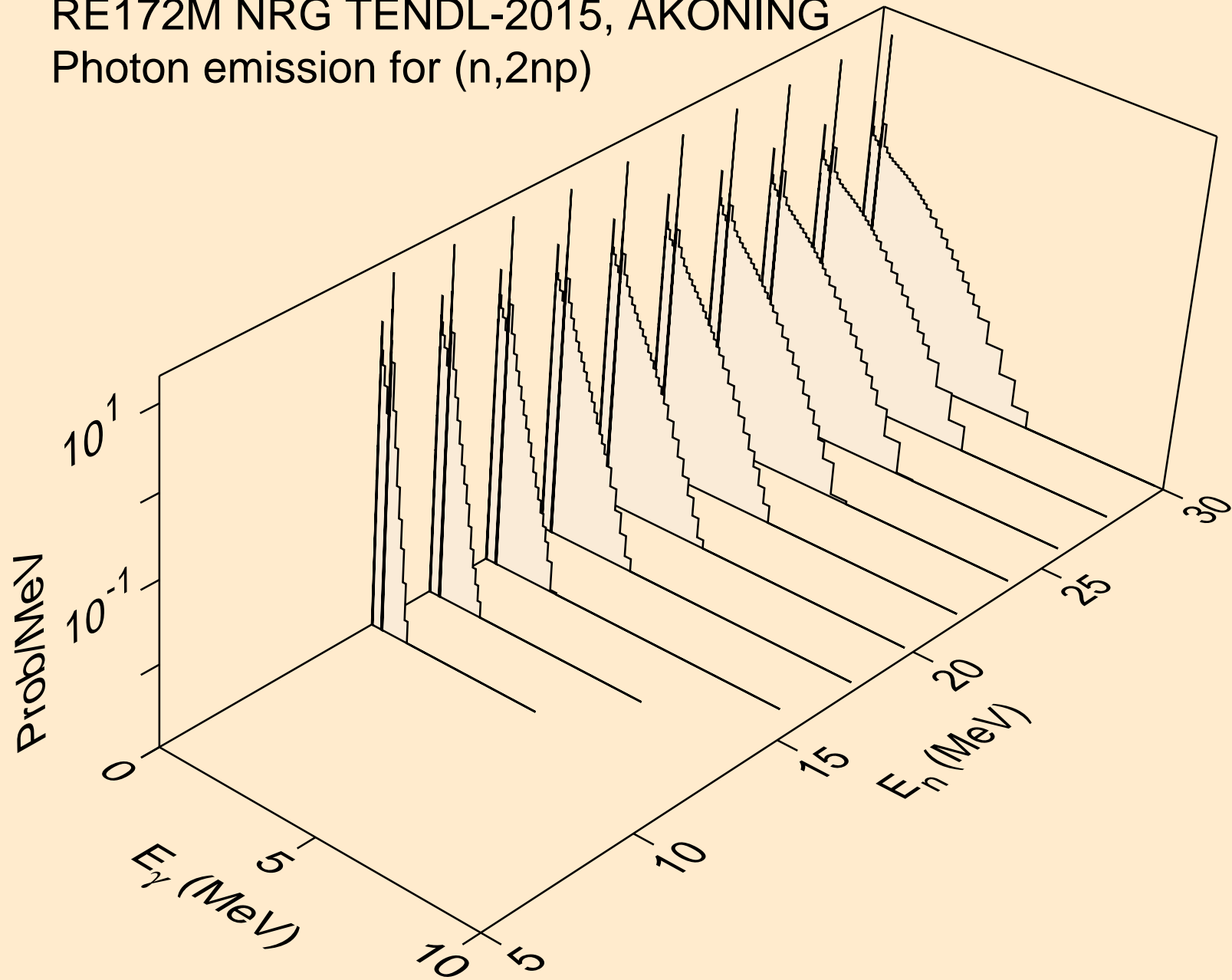

RE172M NRG TENDL-2015, AKONING
Photon emission for (n,npa)

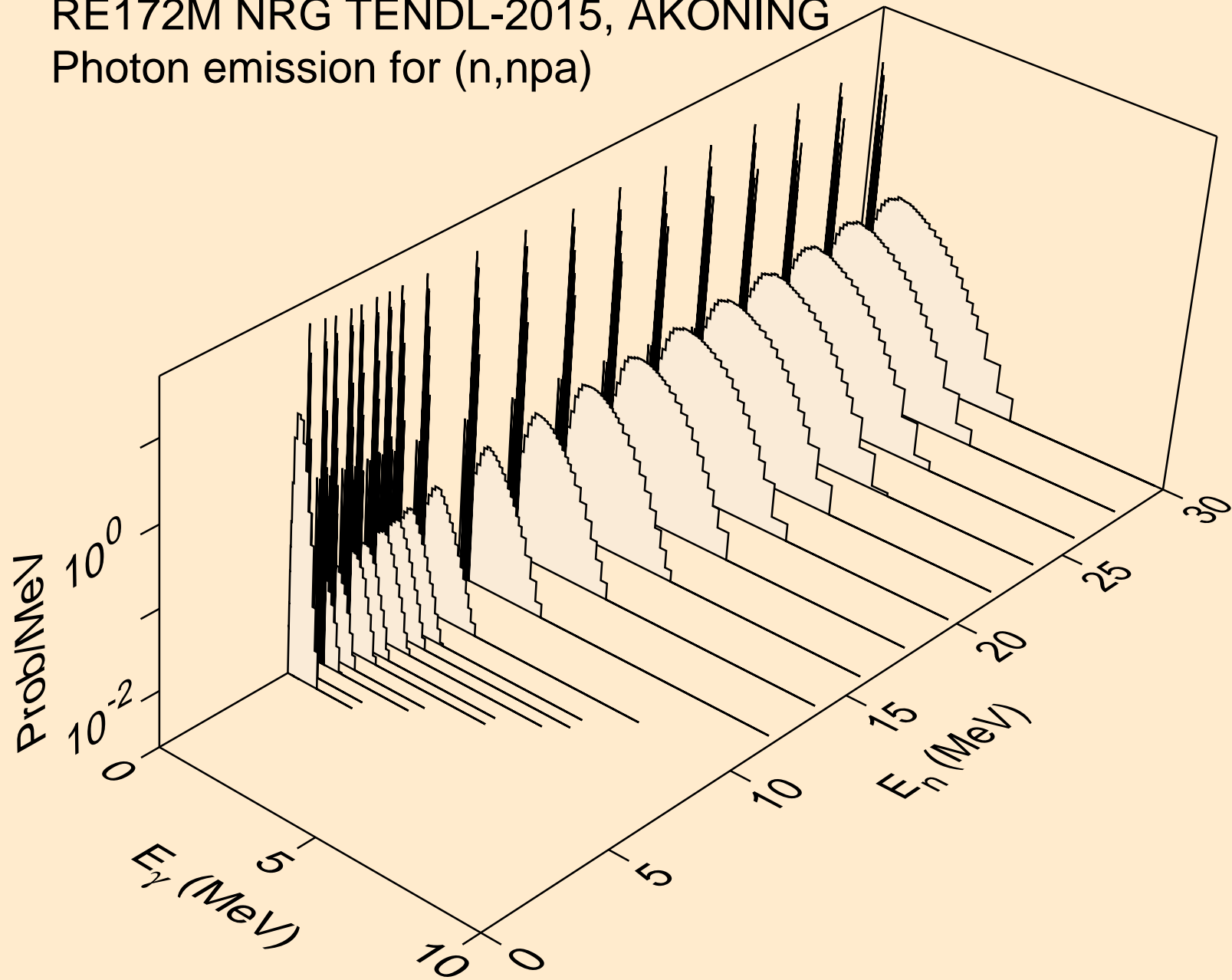

RE172M NRG TENDL-2015, AKONING
Photon emission for (n,n*2)

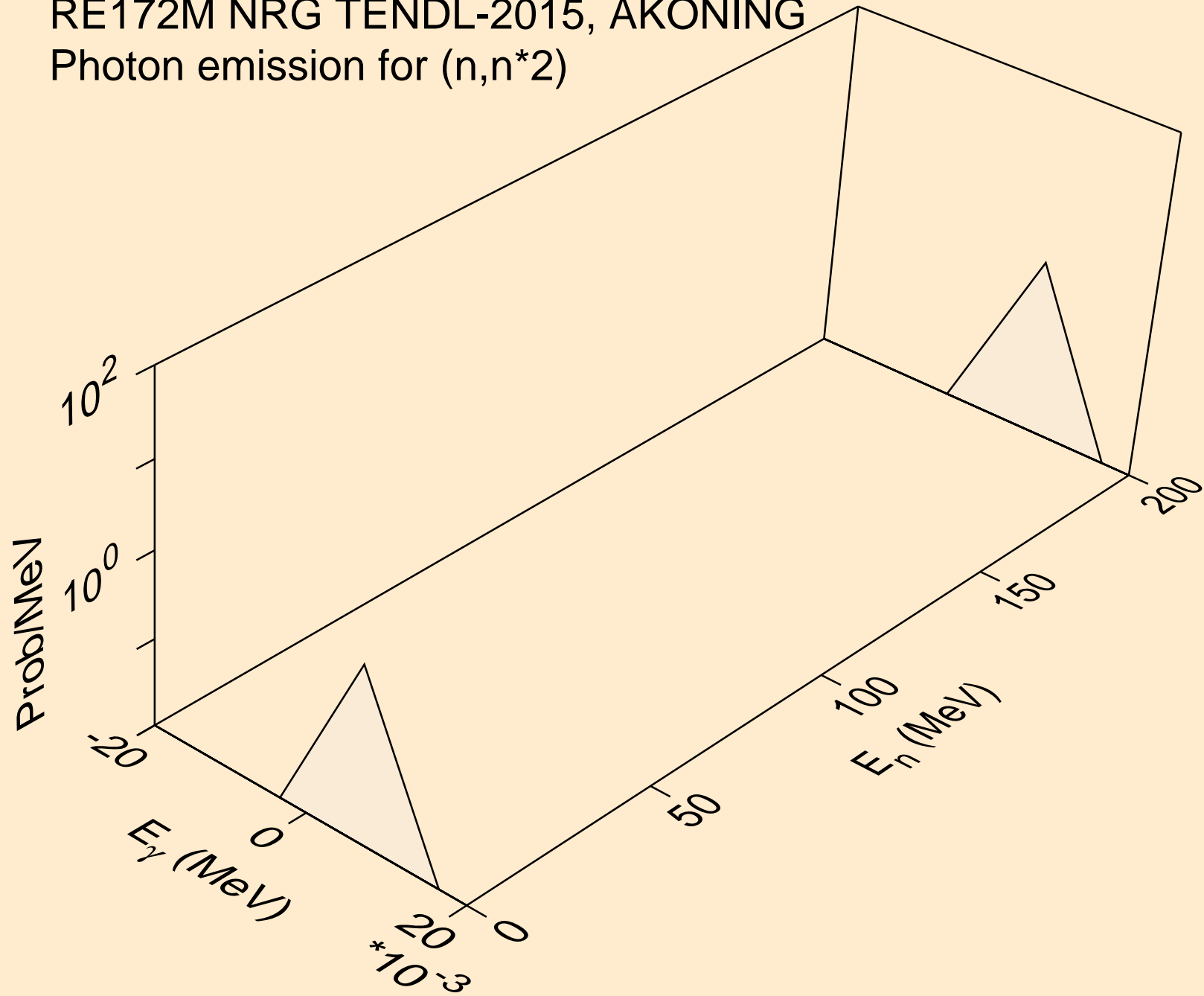

RE172M NRG TENDL-2015, AKONING
Photon emission for (n,n*3)

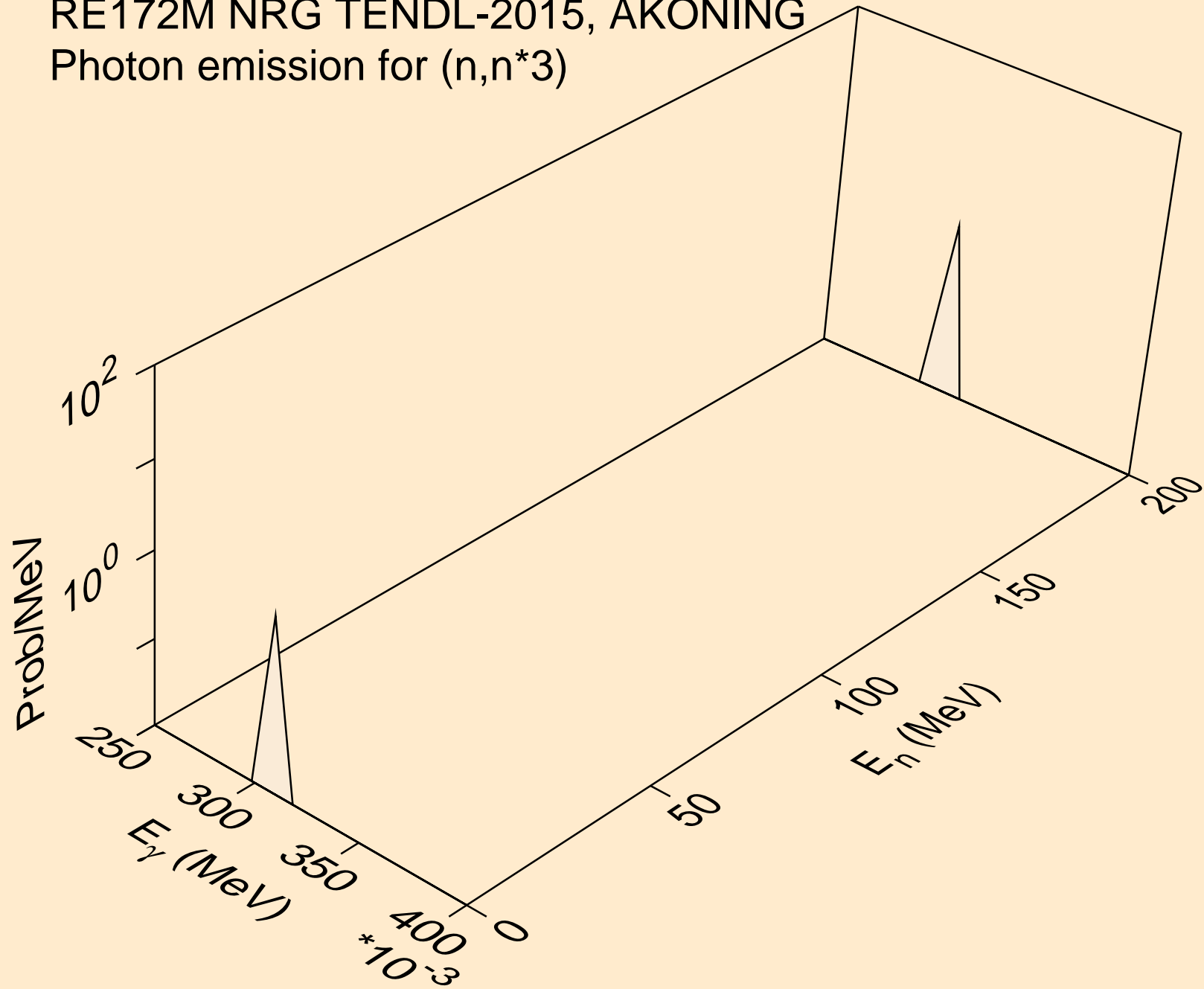

RE172M NRG TENDL-2015, AKONING
Photon emission for (n,n*4)

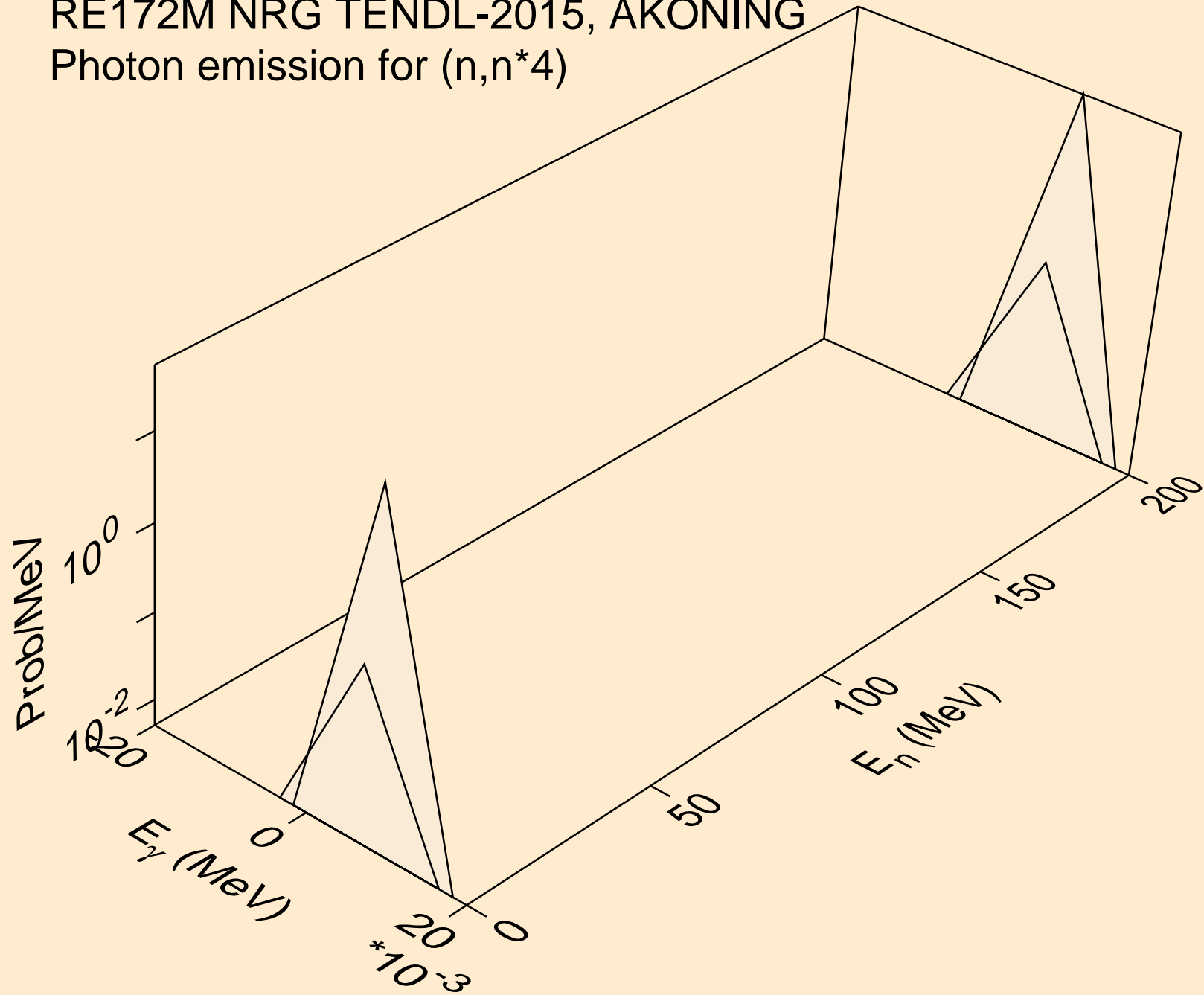

RE172M NRG TENDL-2015, AKONING
Photon emission for (n,n*5)

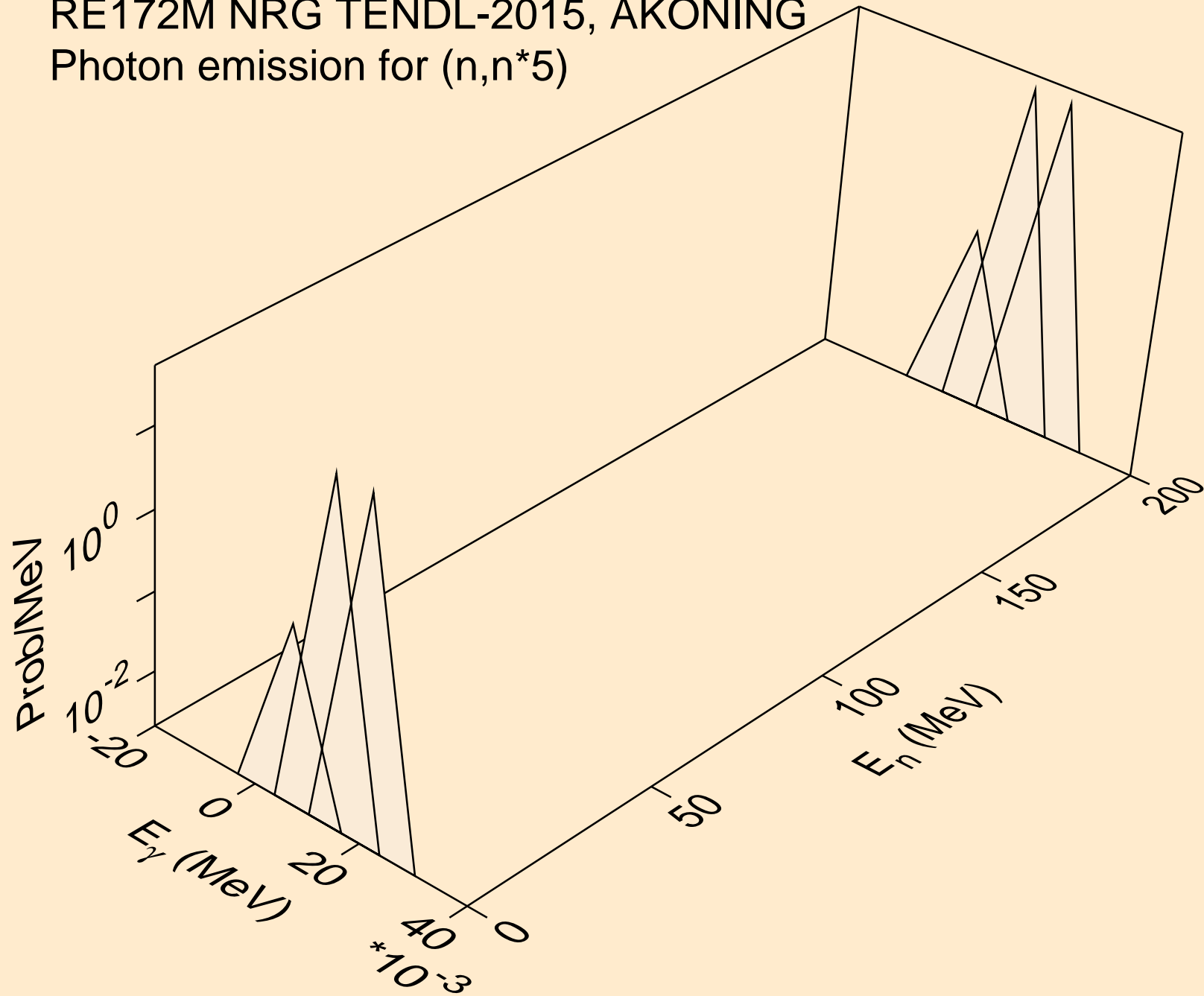

RE172M NRG TENDL-2015, AKONING
Photon emission for (n,n*6)

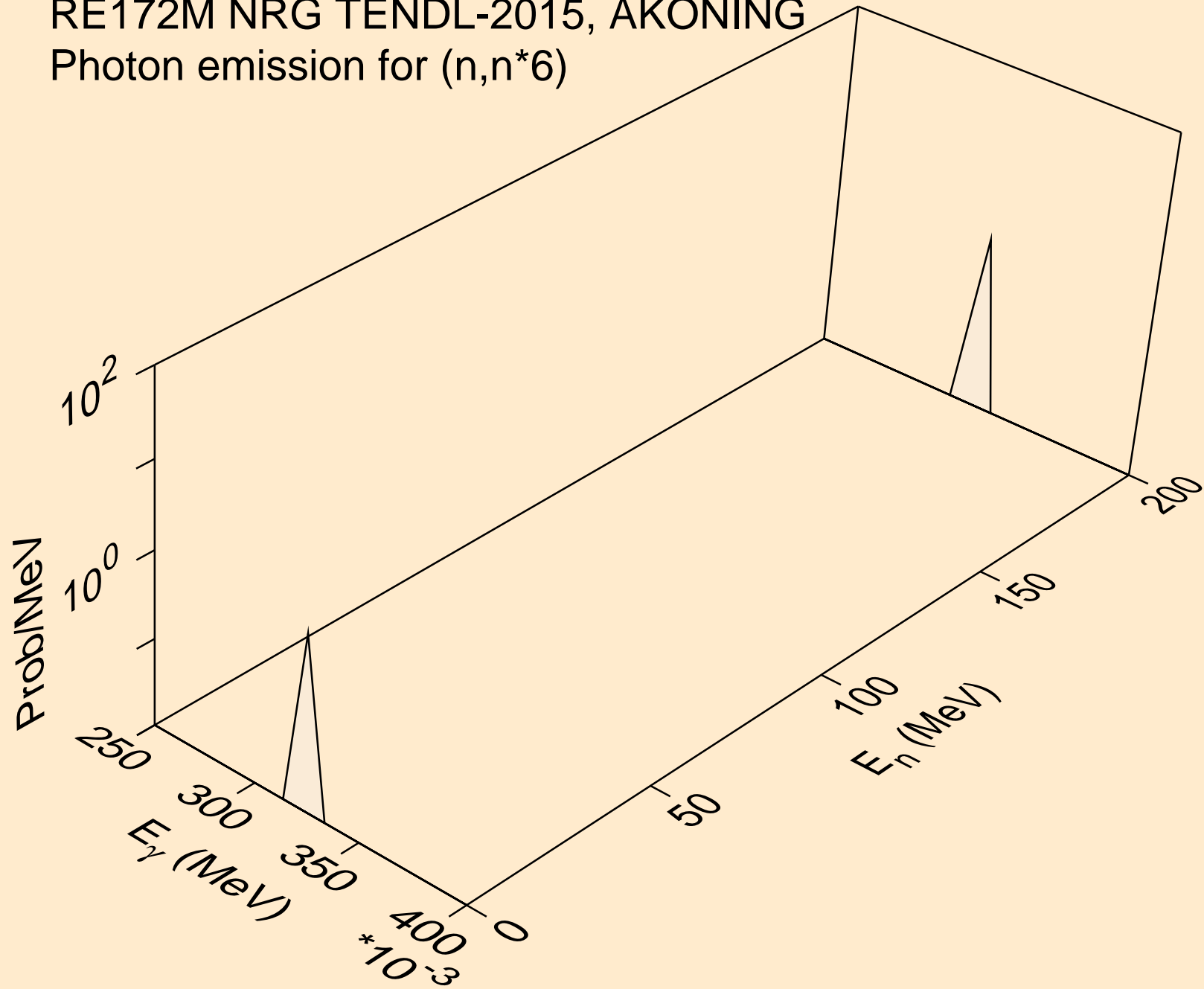

RE172M NRG TENDL-2015, AKONING
Photon emission for (n,n*7)

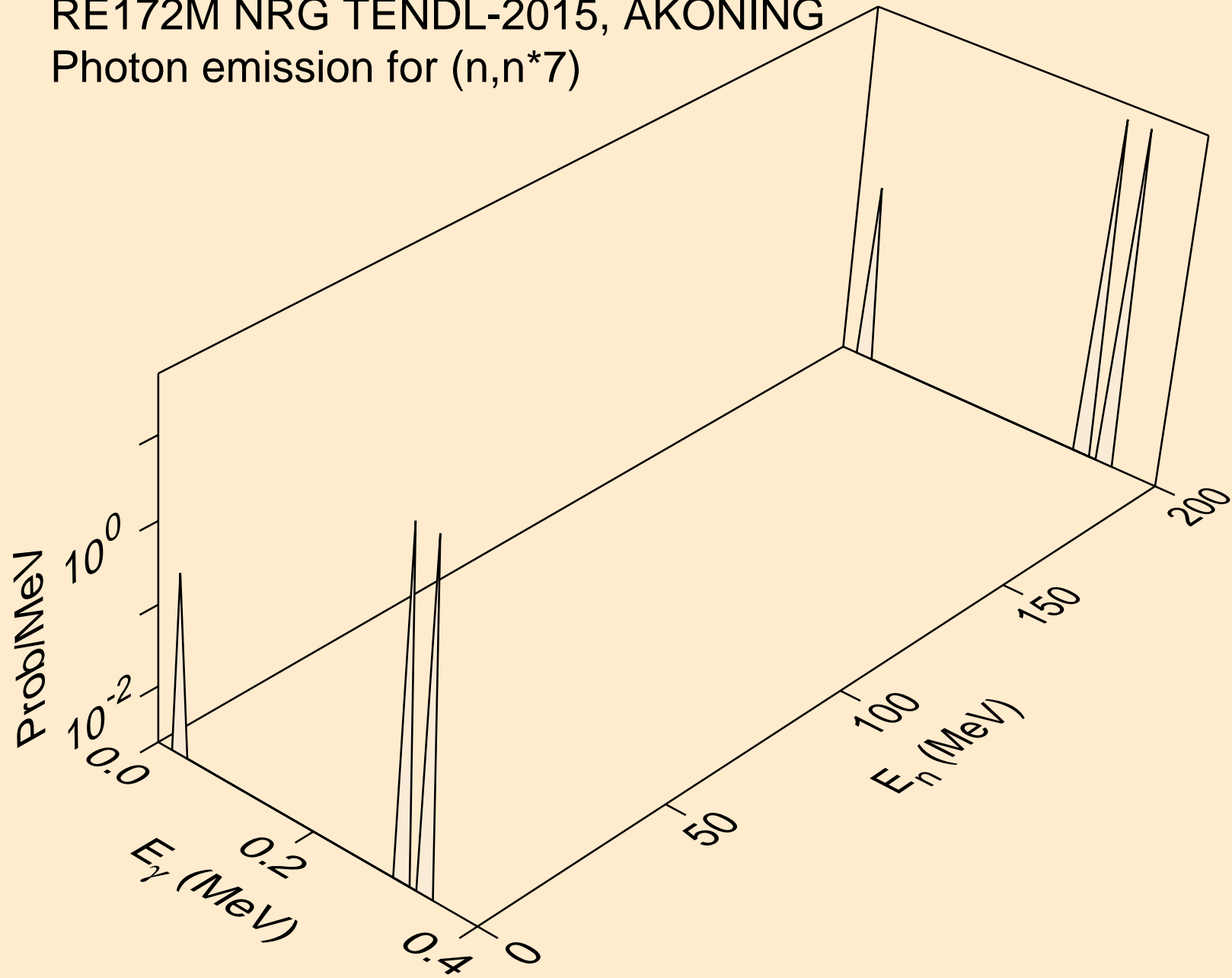

RE172M NRG TENDL-2015, AKONING
Photon emission for (n,n*8)

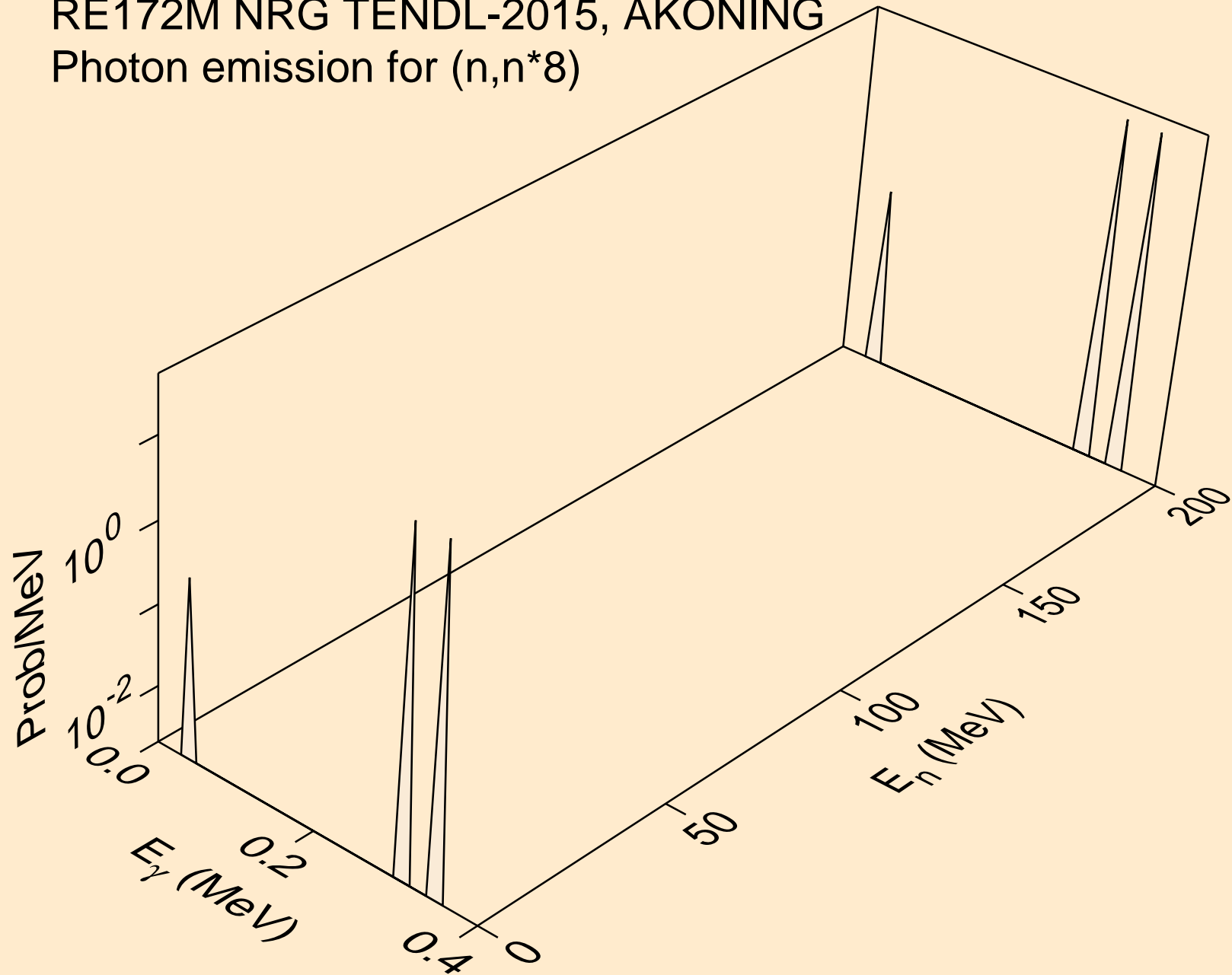

RE172M NRG TENDL-2015, AKONING
Photon emission for (n,n*9)

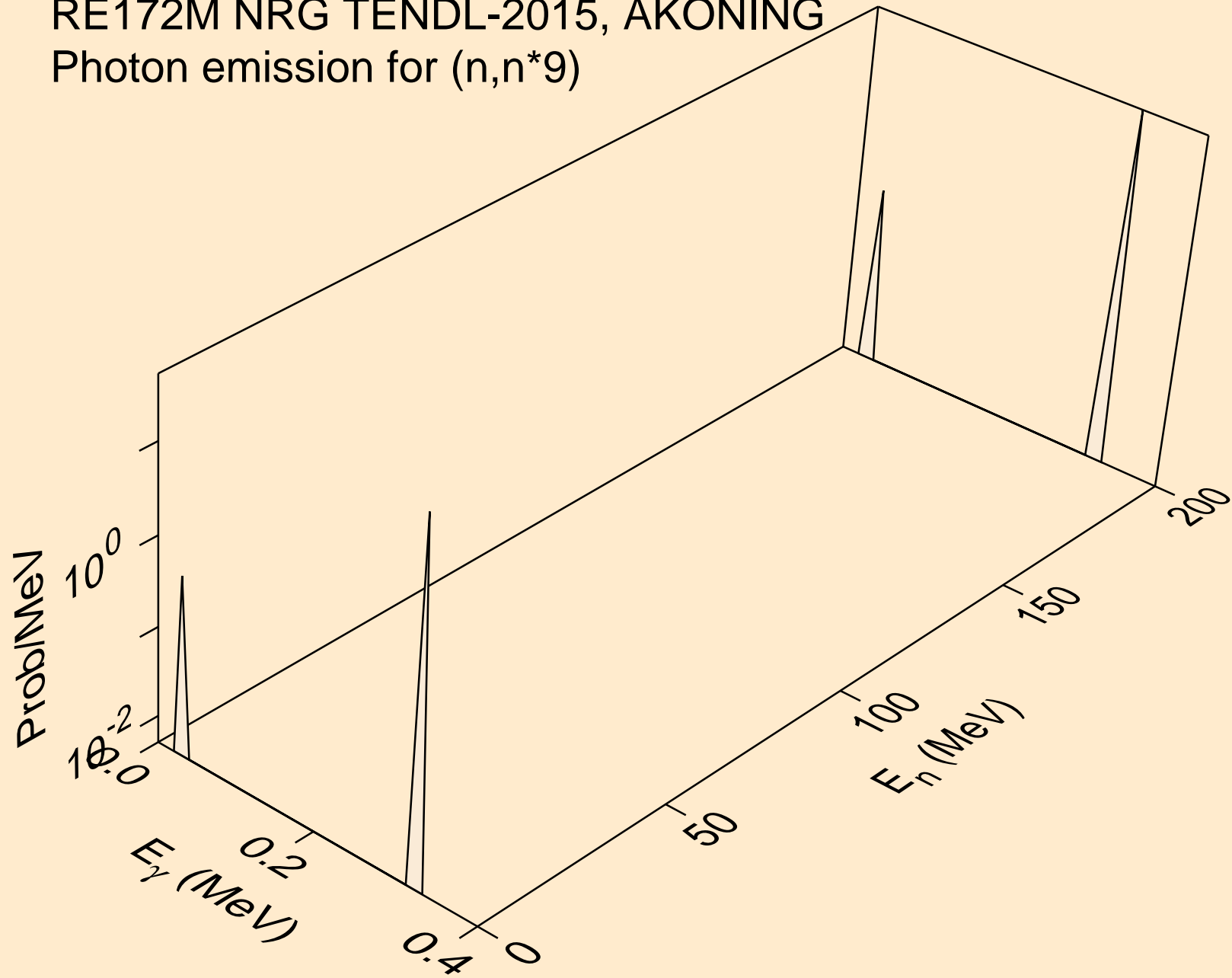

RE172M NRG TENDL-2015, AKONING
Photon emission for (n,n*10)

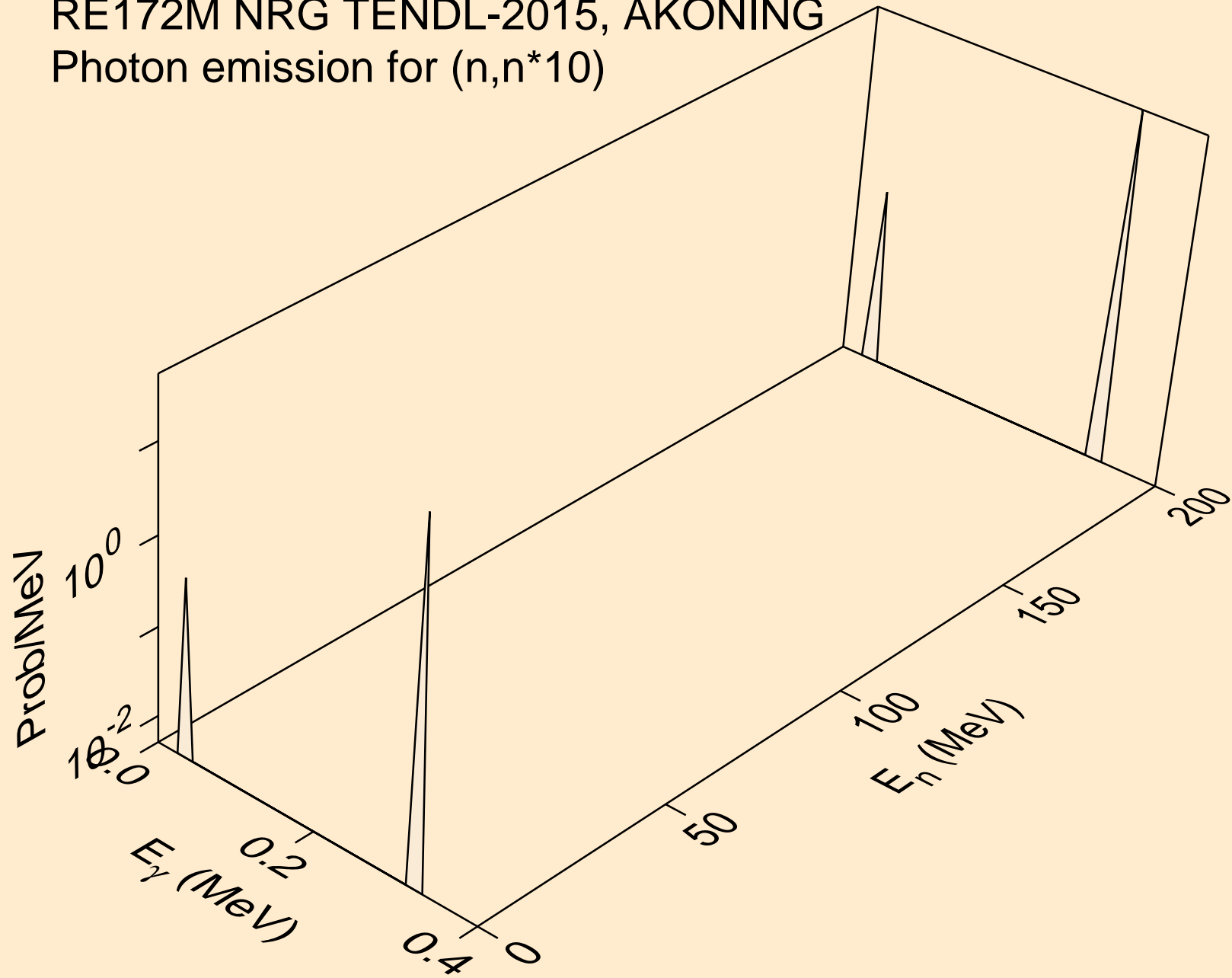

RE172M NRG TENDL-2015, AKONING
Photon emission for (n,n*11)

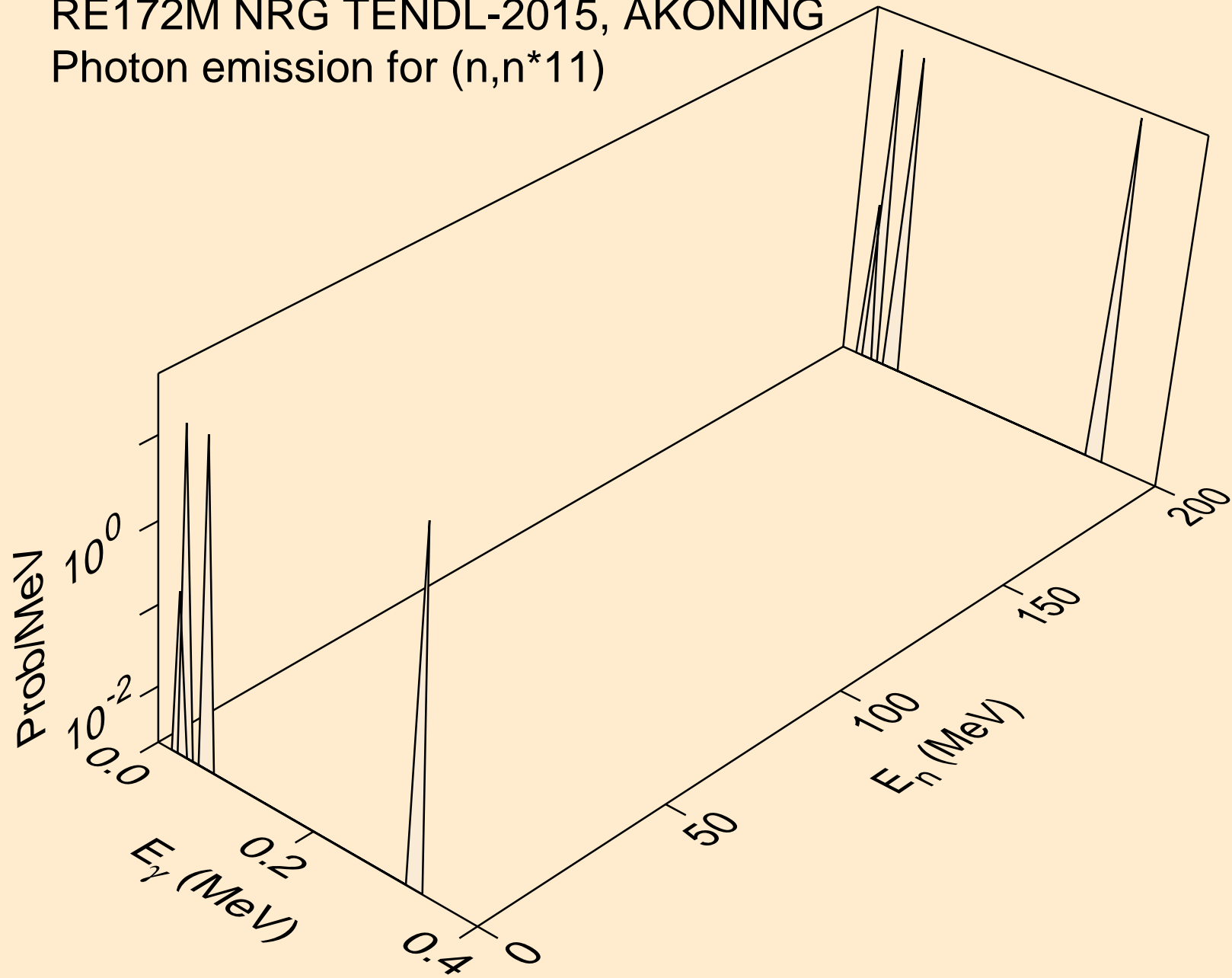

RE172M NRG TENDL-2015, AKONING
Photon emission for (n,n*12)

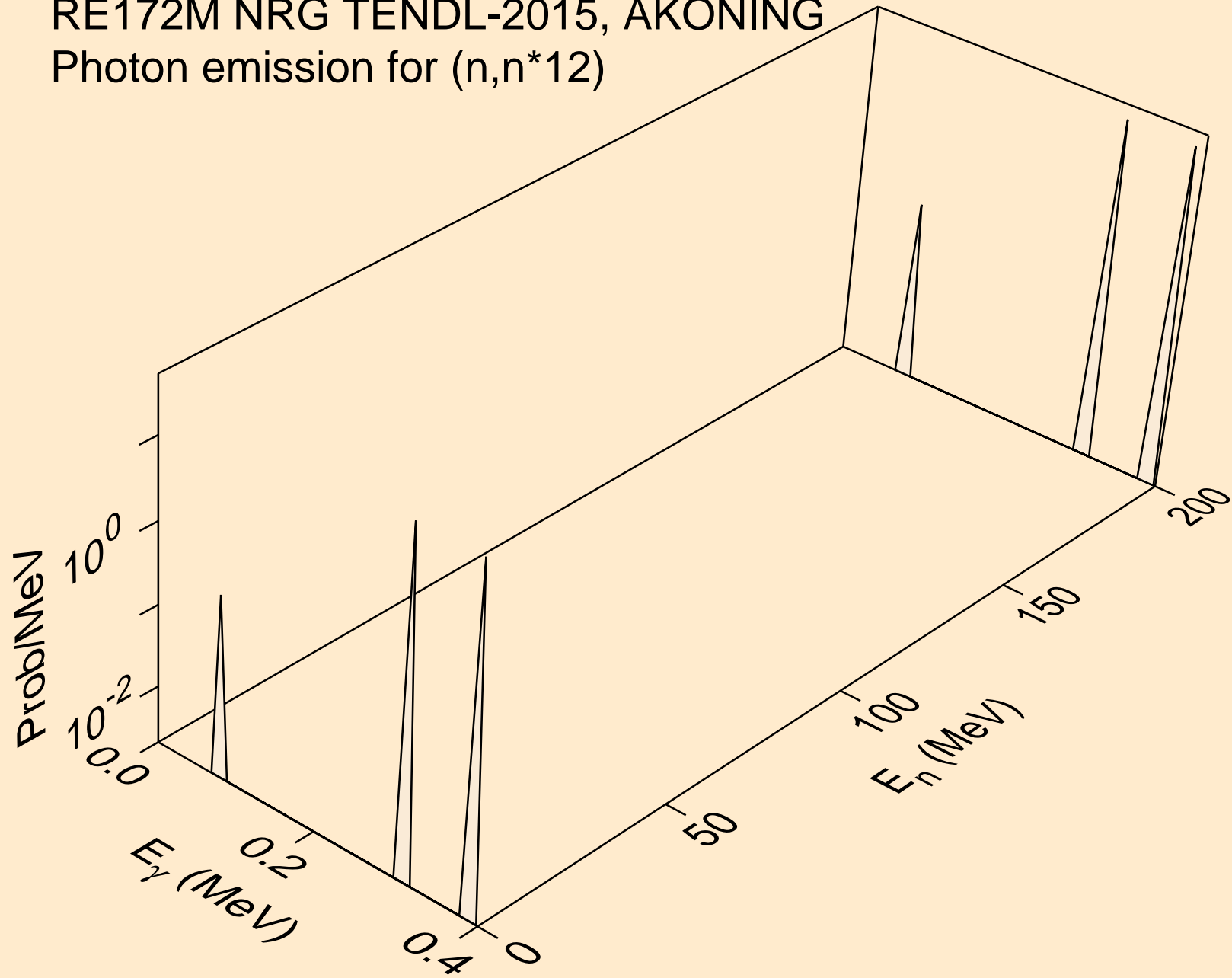

RE172M NRG TENDL-2015, AKONING
Photon emission for (n,n*13)

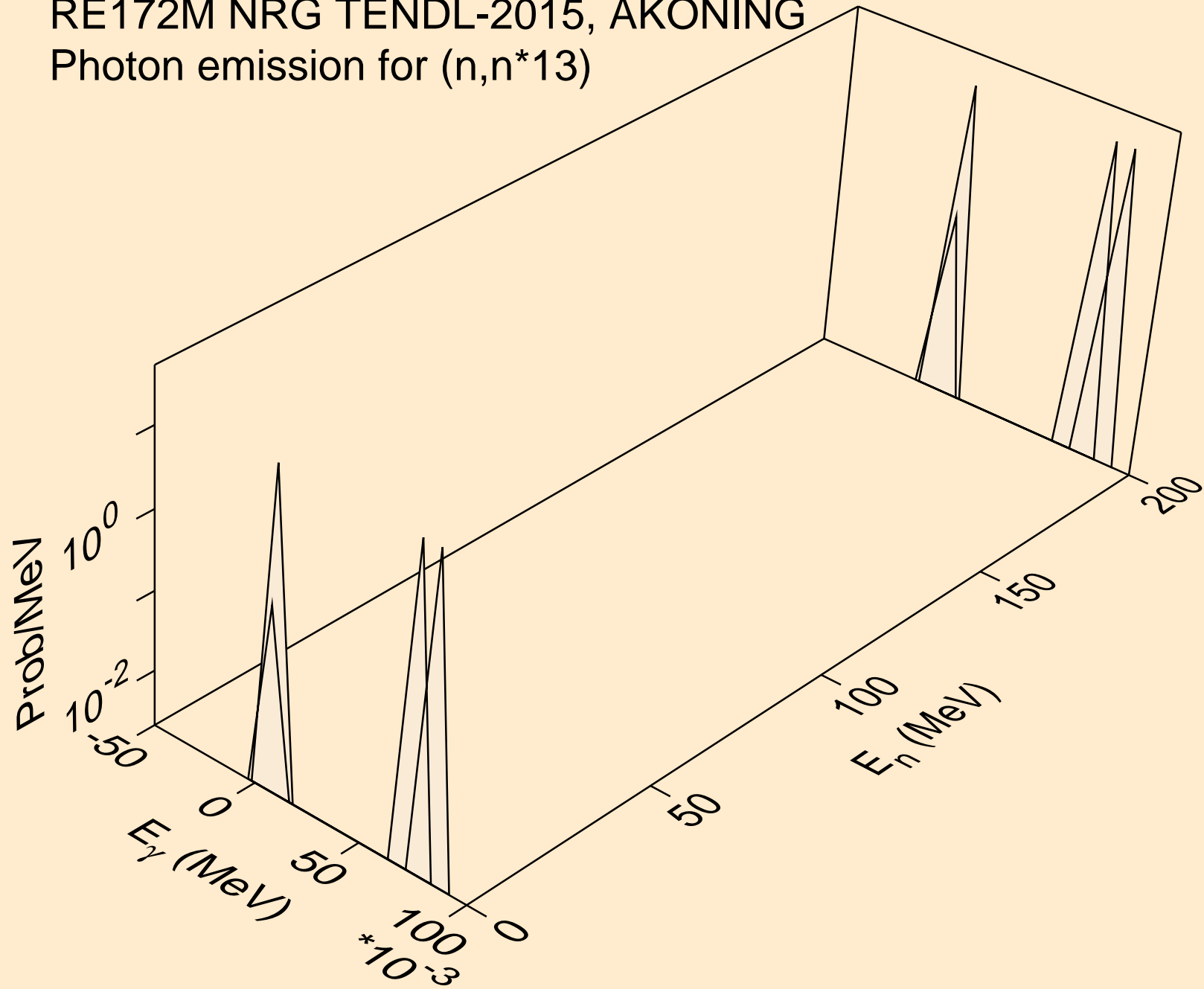

RE172M NRG TENDL-2015, AKONING
Photon emission for (n,n*14)

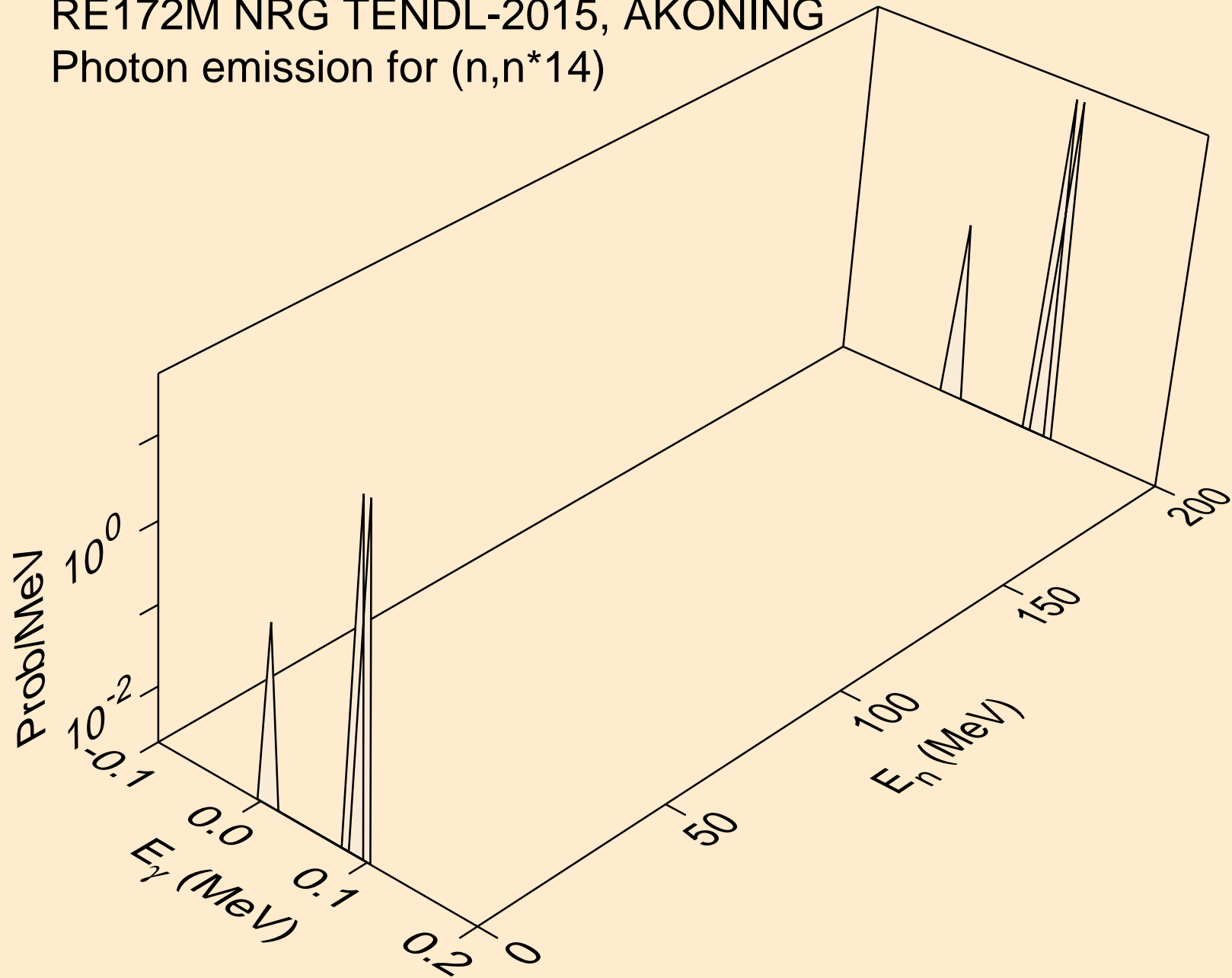

RE172M NRG TENDL-2015, AKONING
Photon emission for (n,n*15)

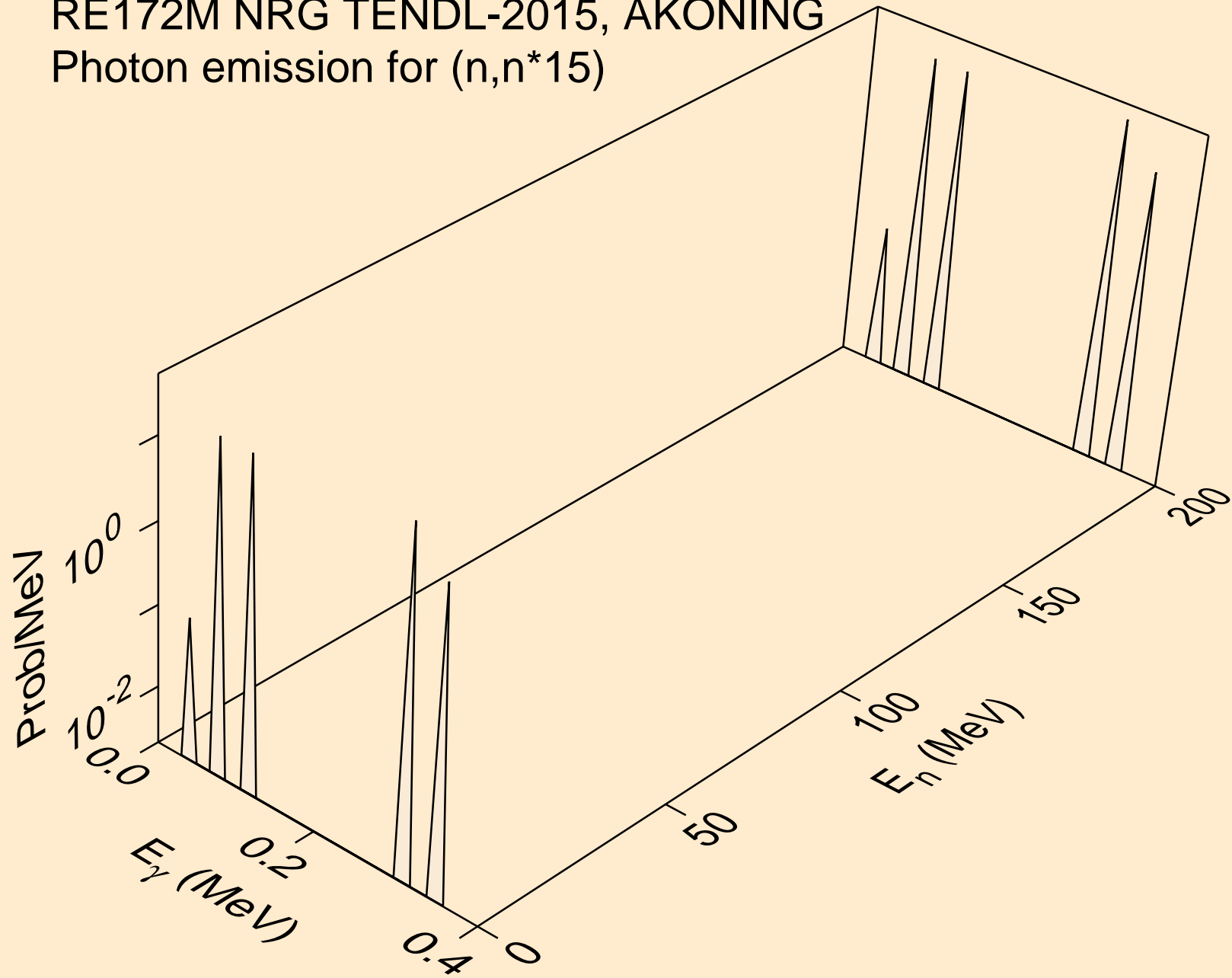

RE172M NRG TENDL-2015, AKONING
Photon emission for (n,n*16)

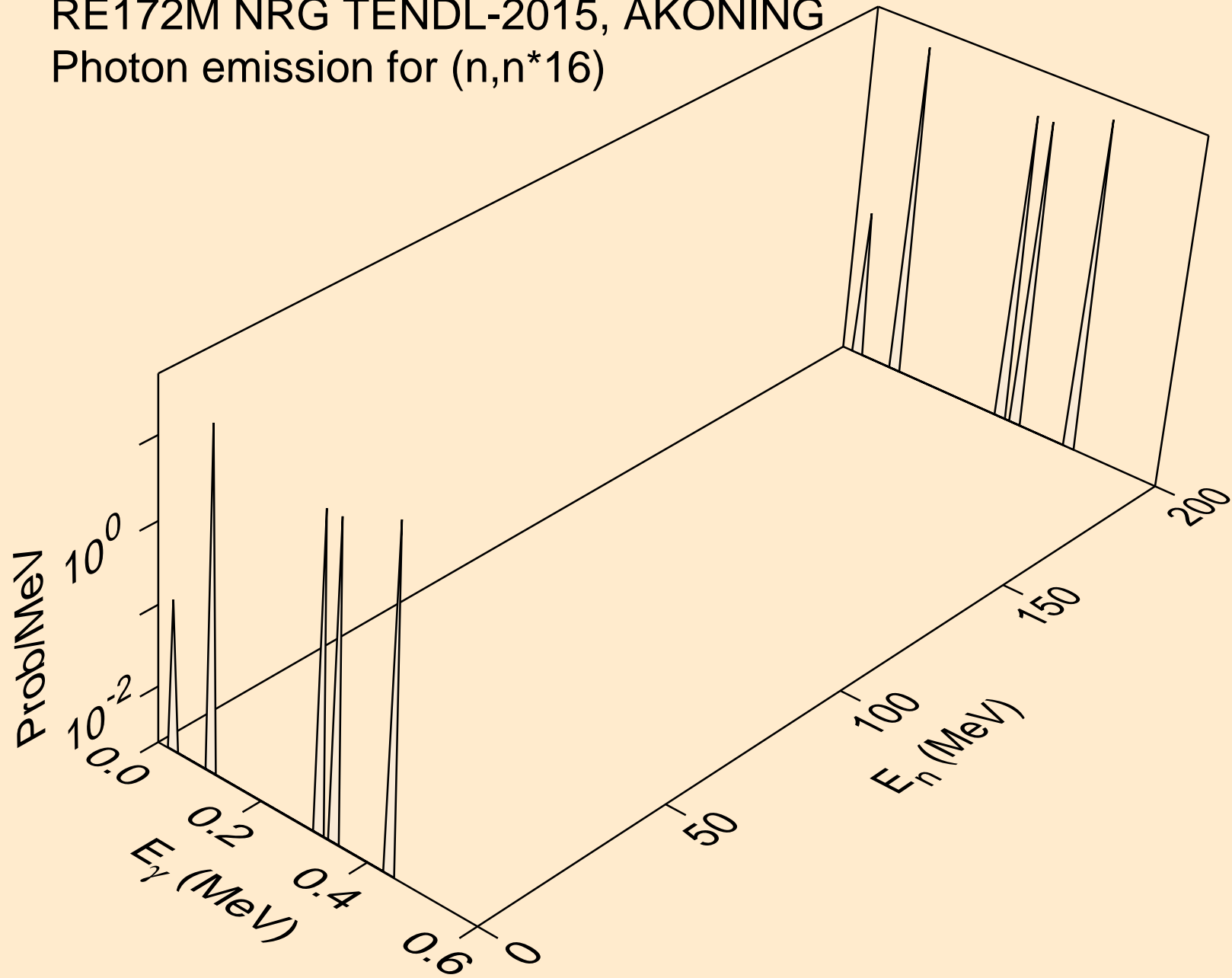

RE172M NRG TENDL-2015, AKONING
Photon emission for (n,n*17)

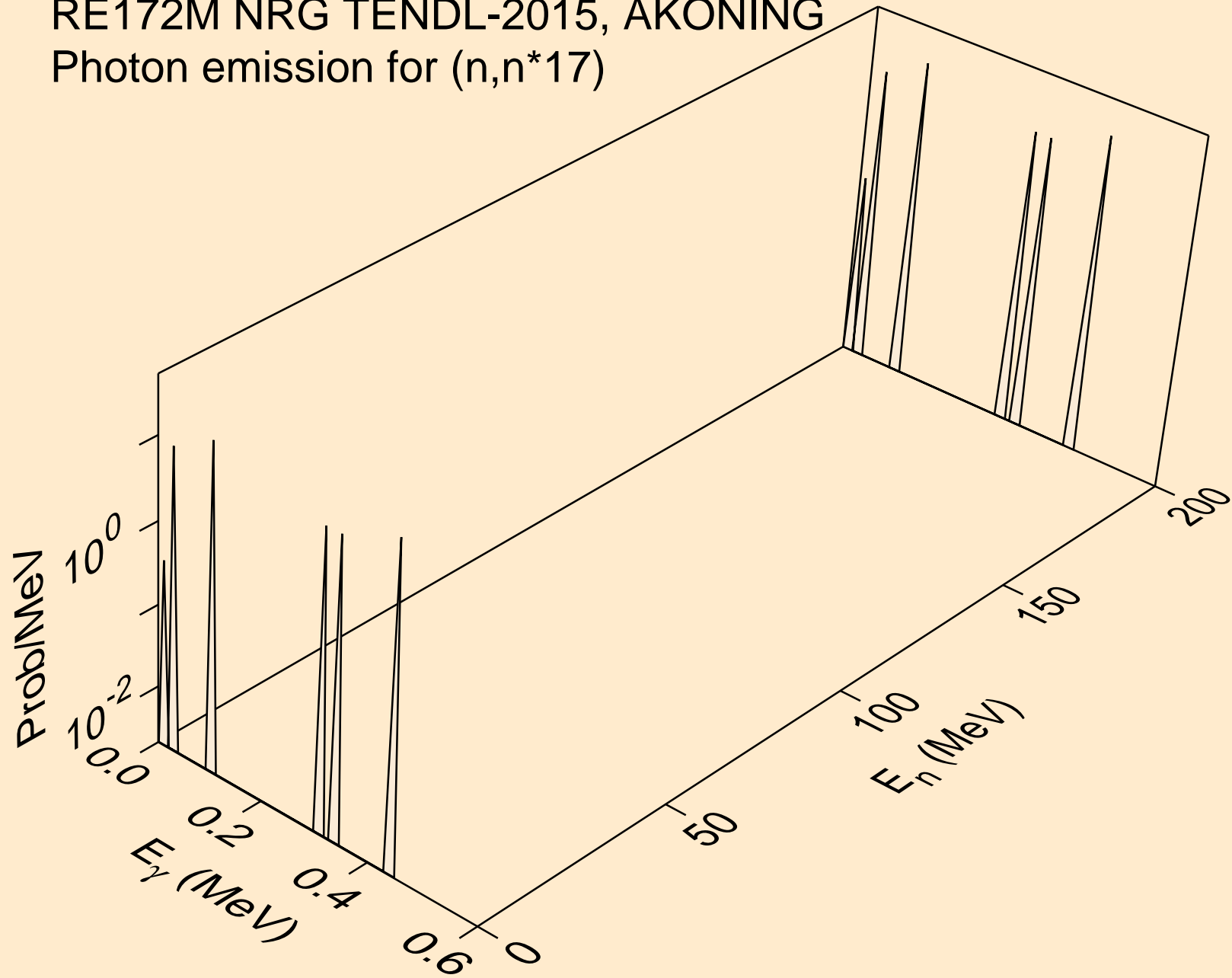

RE172M NRG TENDL-2015, AKONING
Photon emission for (n,n*18)

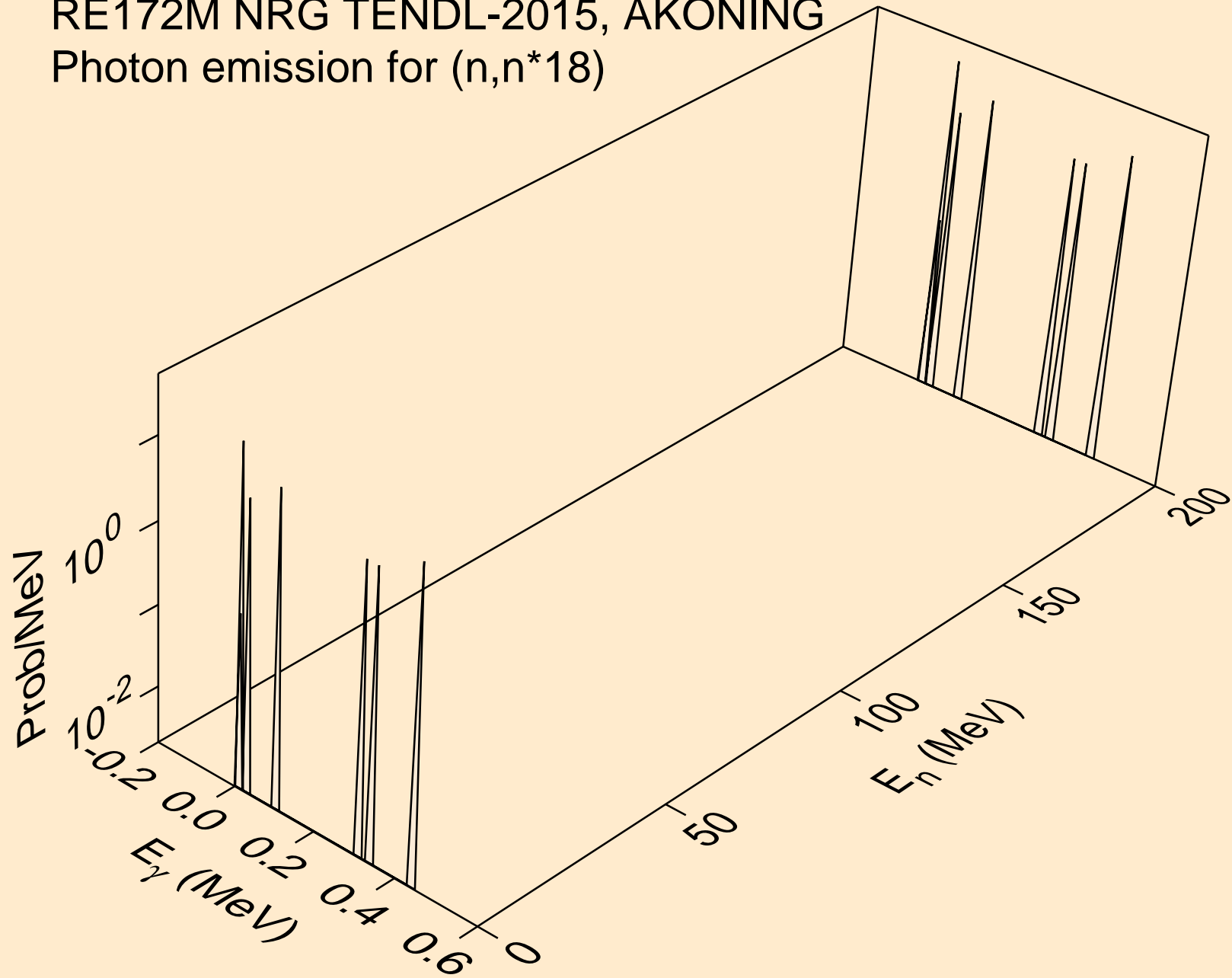

RE172M NRG TENDL-2015, AKONING
Photon emission for (n,n*19)

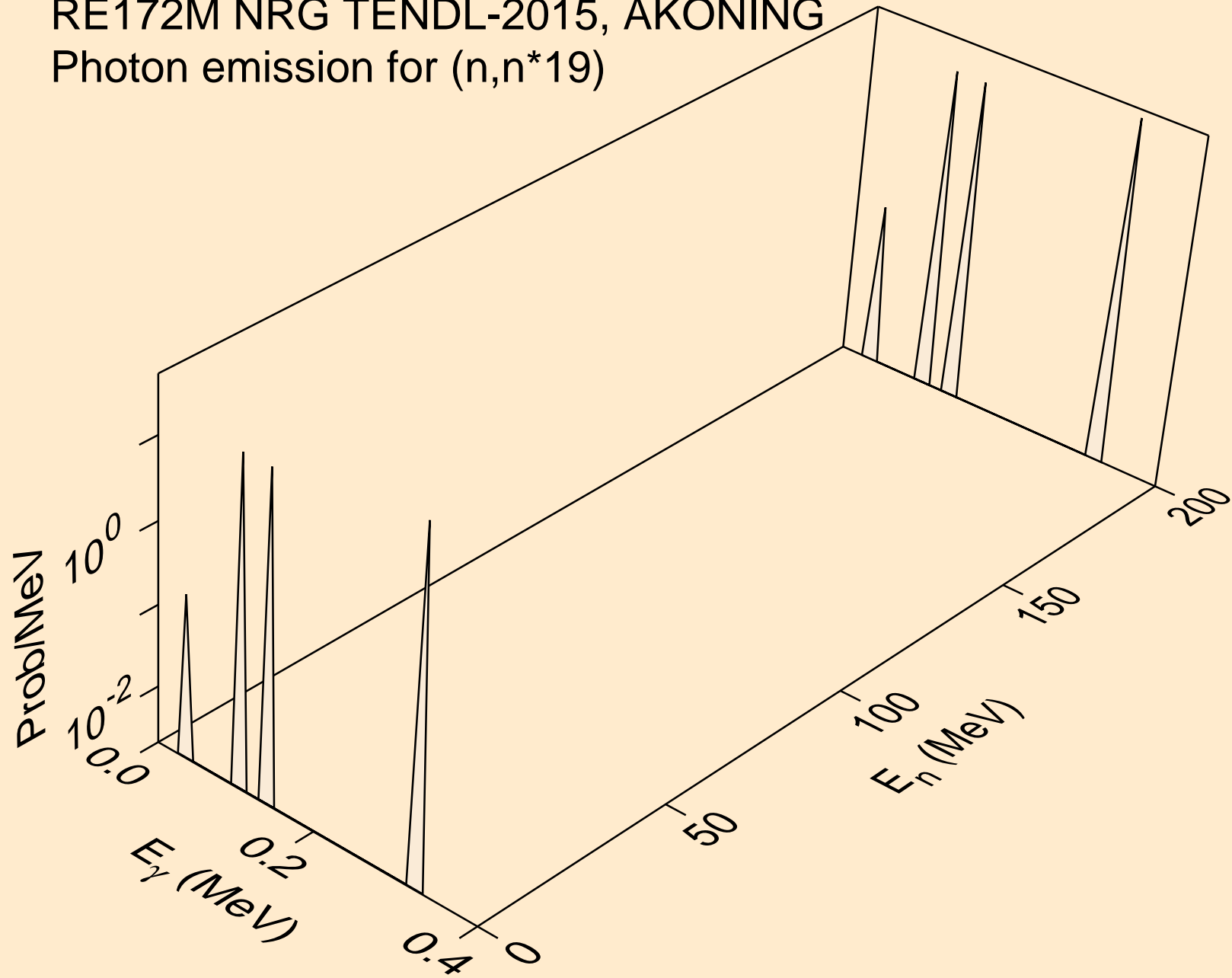

RE172M NRG TENDL-2015, AKONING
Photon emission for (n,n*20)

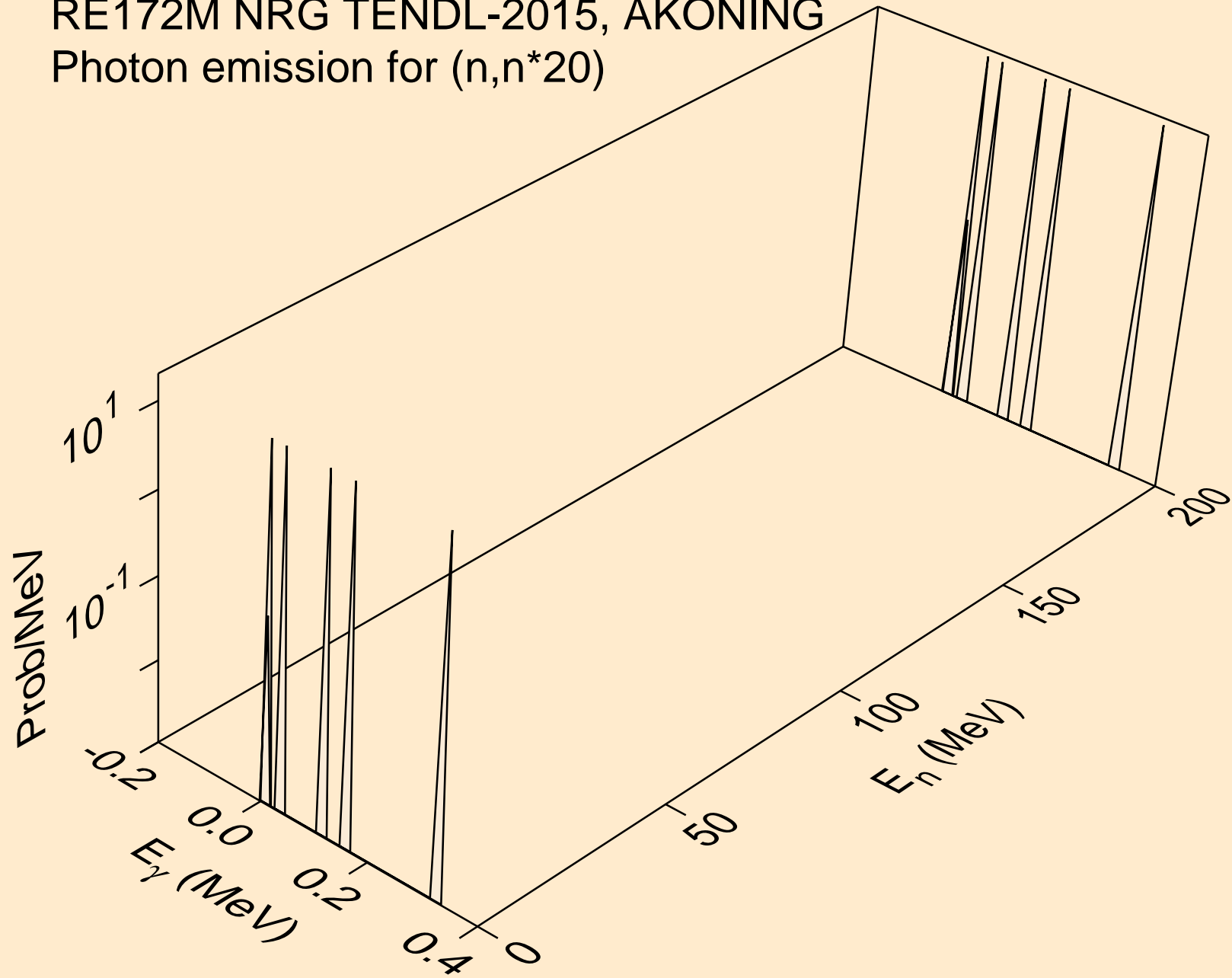

RE172M NRG TENDL-2015, AKONING
Photon emission for (n,n*21)

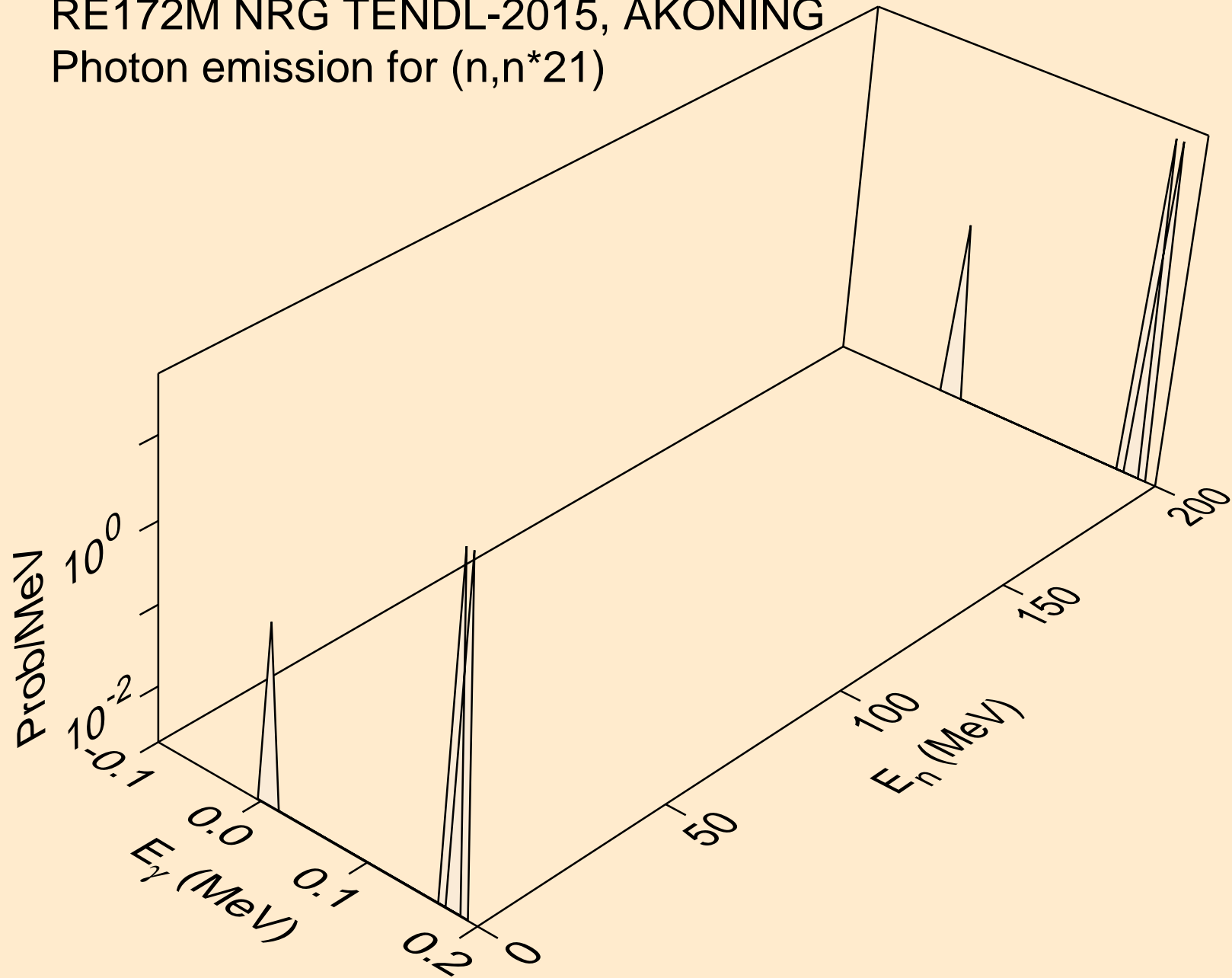

RE172M NRG TENDL-2015, AKONING
Photon emission for (n,n*22)

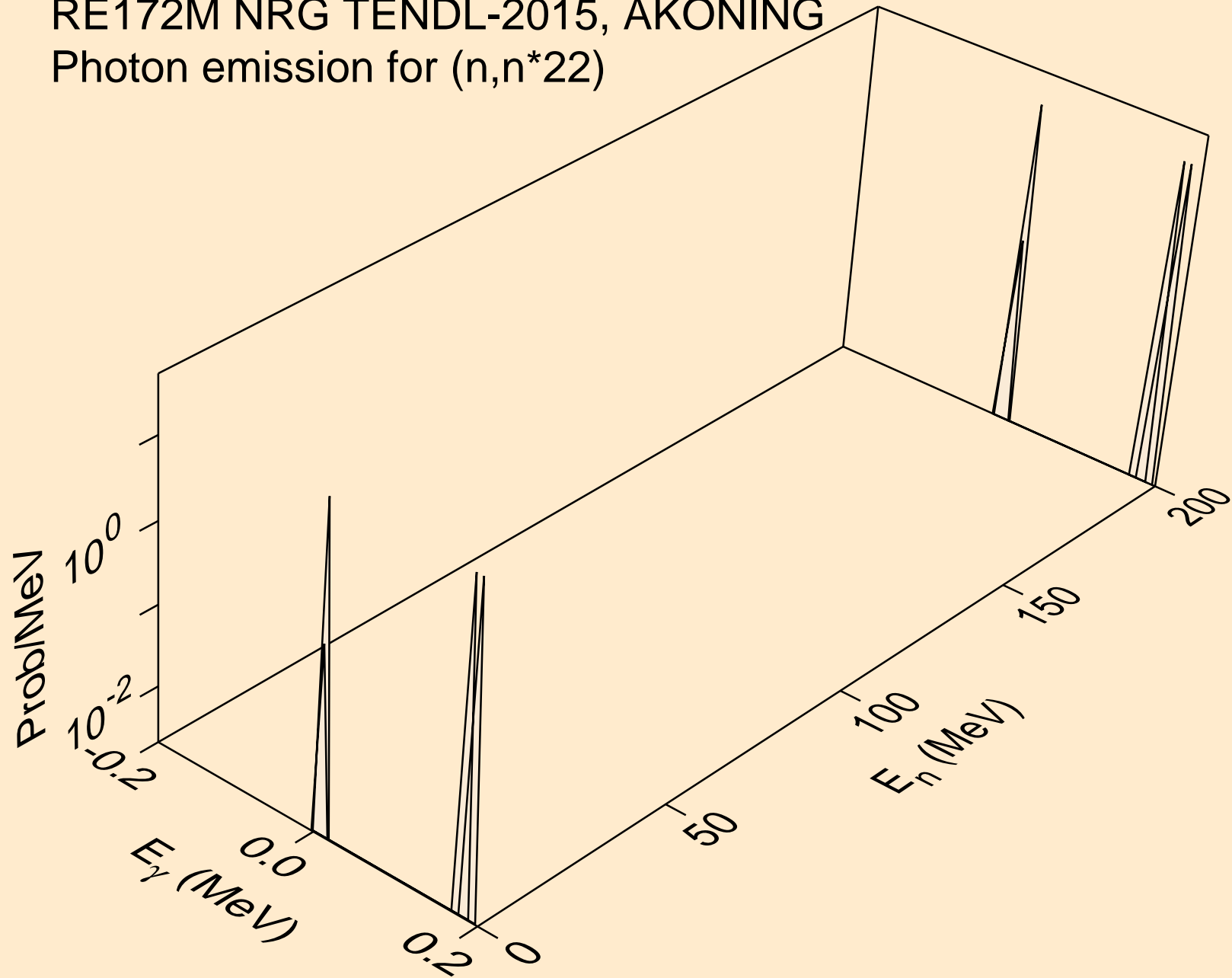

RE172M NRG TENDL-2015, AKONING
Photon emission for (n,n*23)

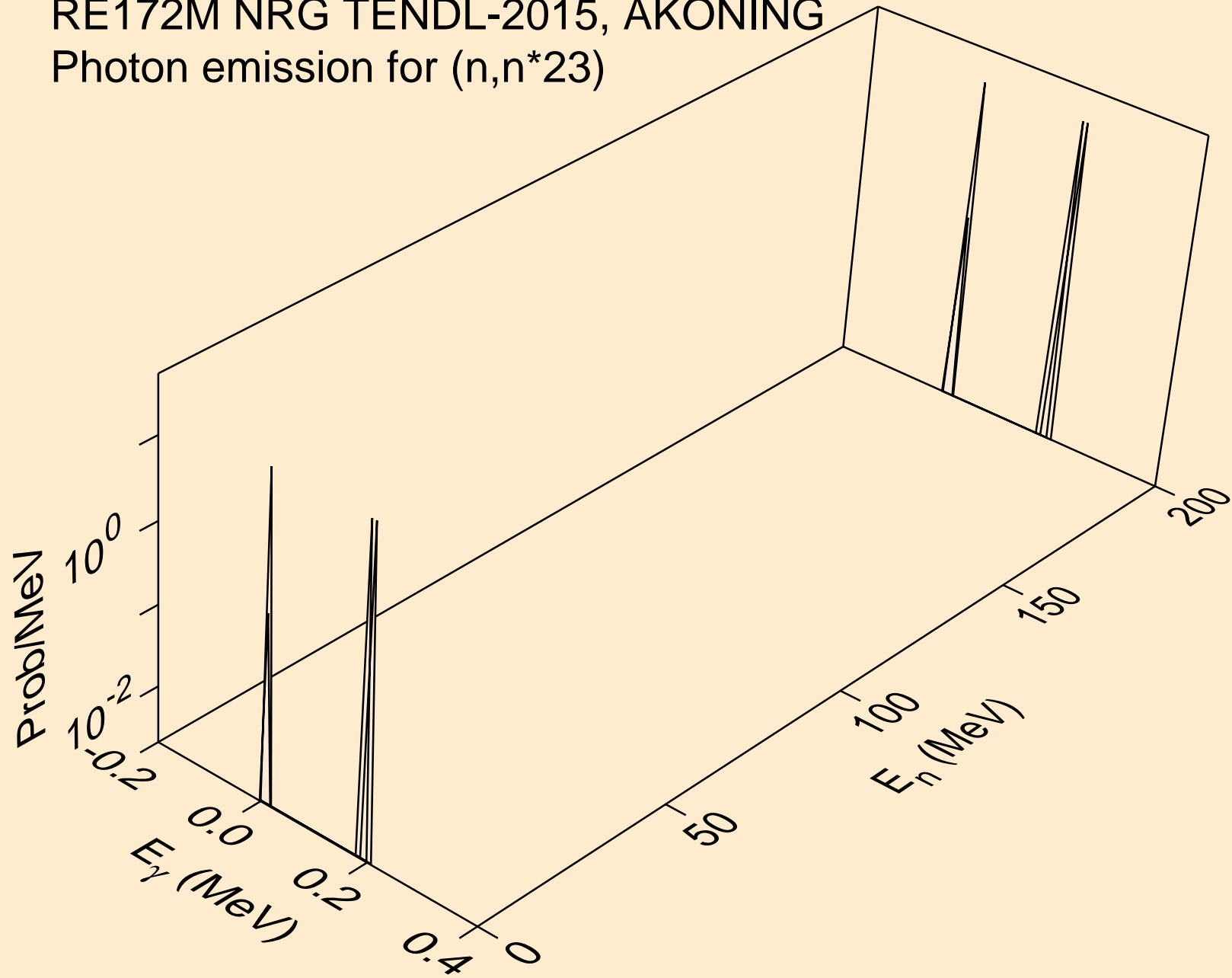

RE172M NRG TENDL-2015, AKONING
Photon emission for (n,n*24)

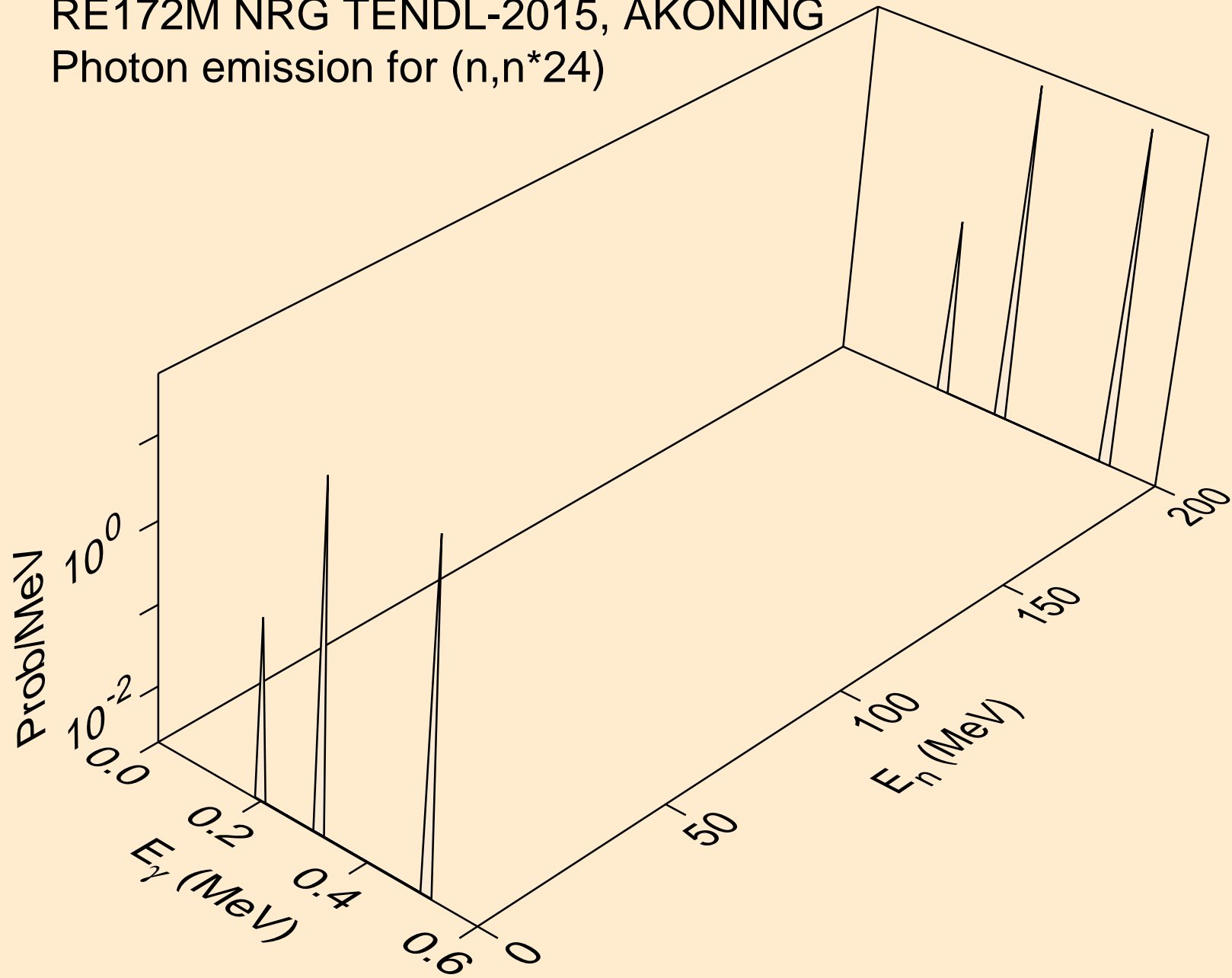

RE172M NRG TENDL-2015, AKONING
Photon emission for (n,n*25)

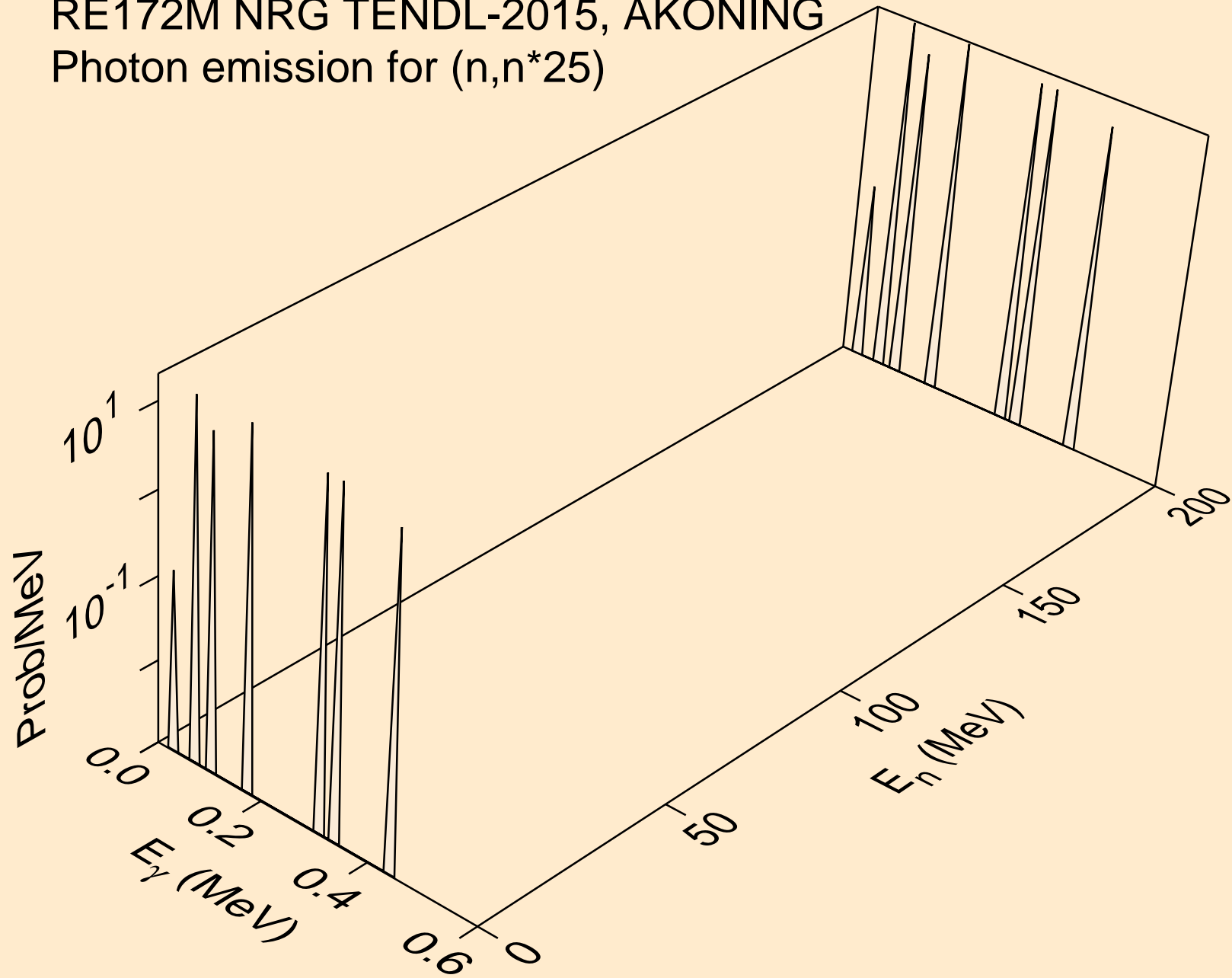

RE172M NRG TENDL-2015, AKONING
Photon emission for (n,n*26)

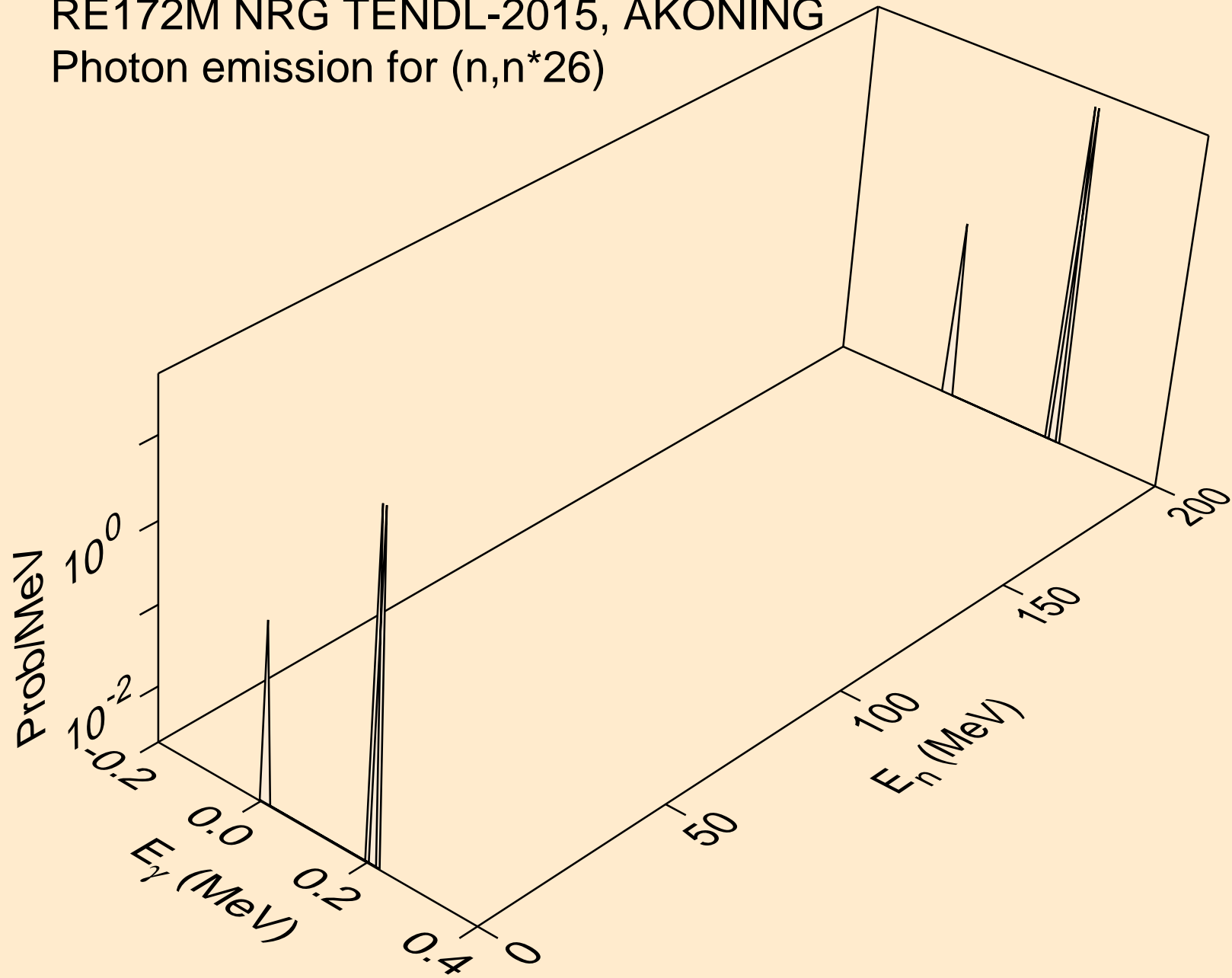

RE172M NRG TENDL-2015, AKONING
Photon emission for (n,n*c)

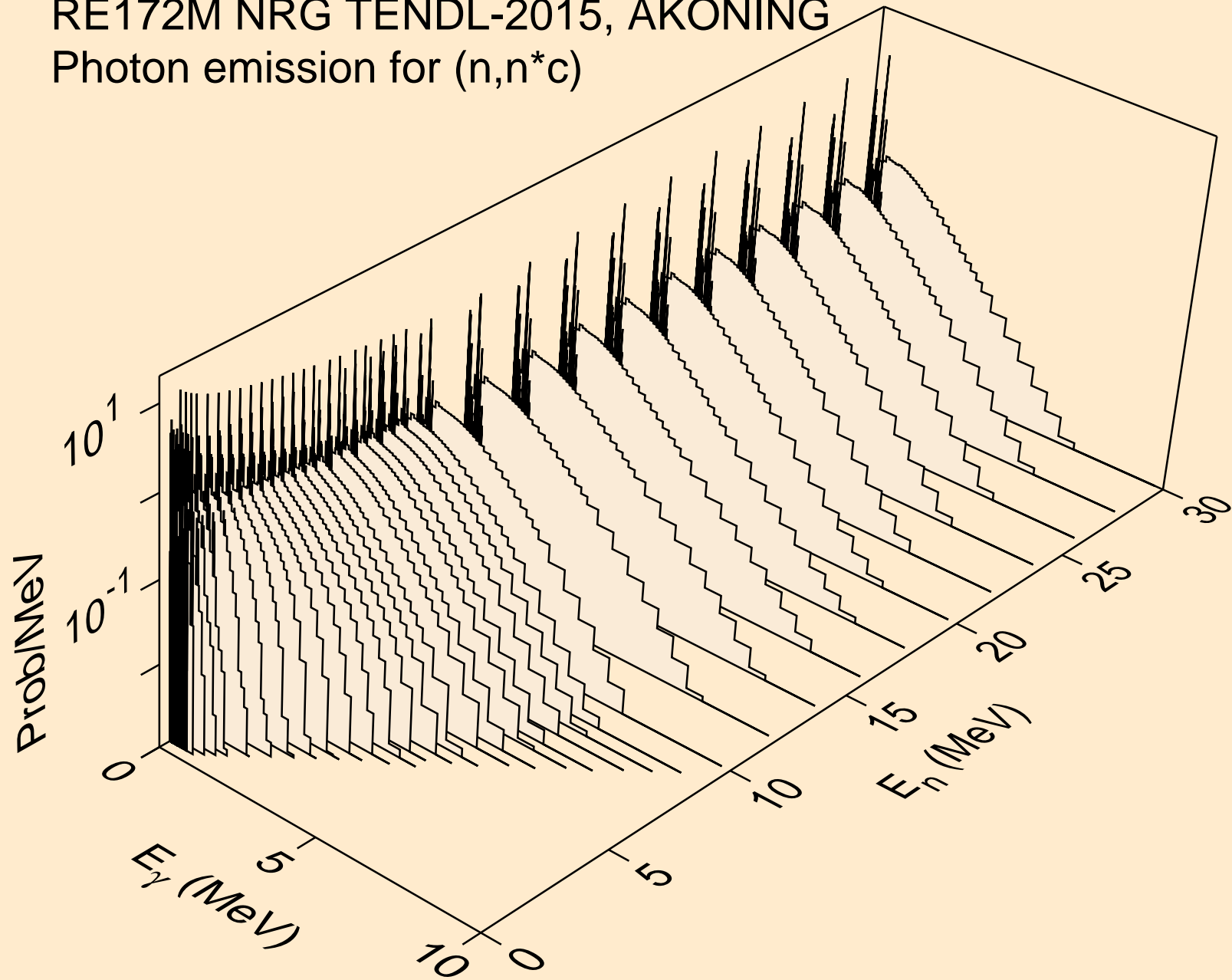

RE172M NRG TENDL-2015, AKONING
Photon emission for (n,gma)

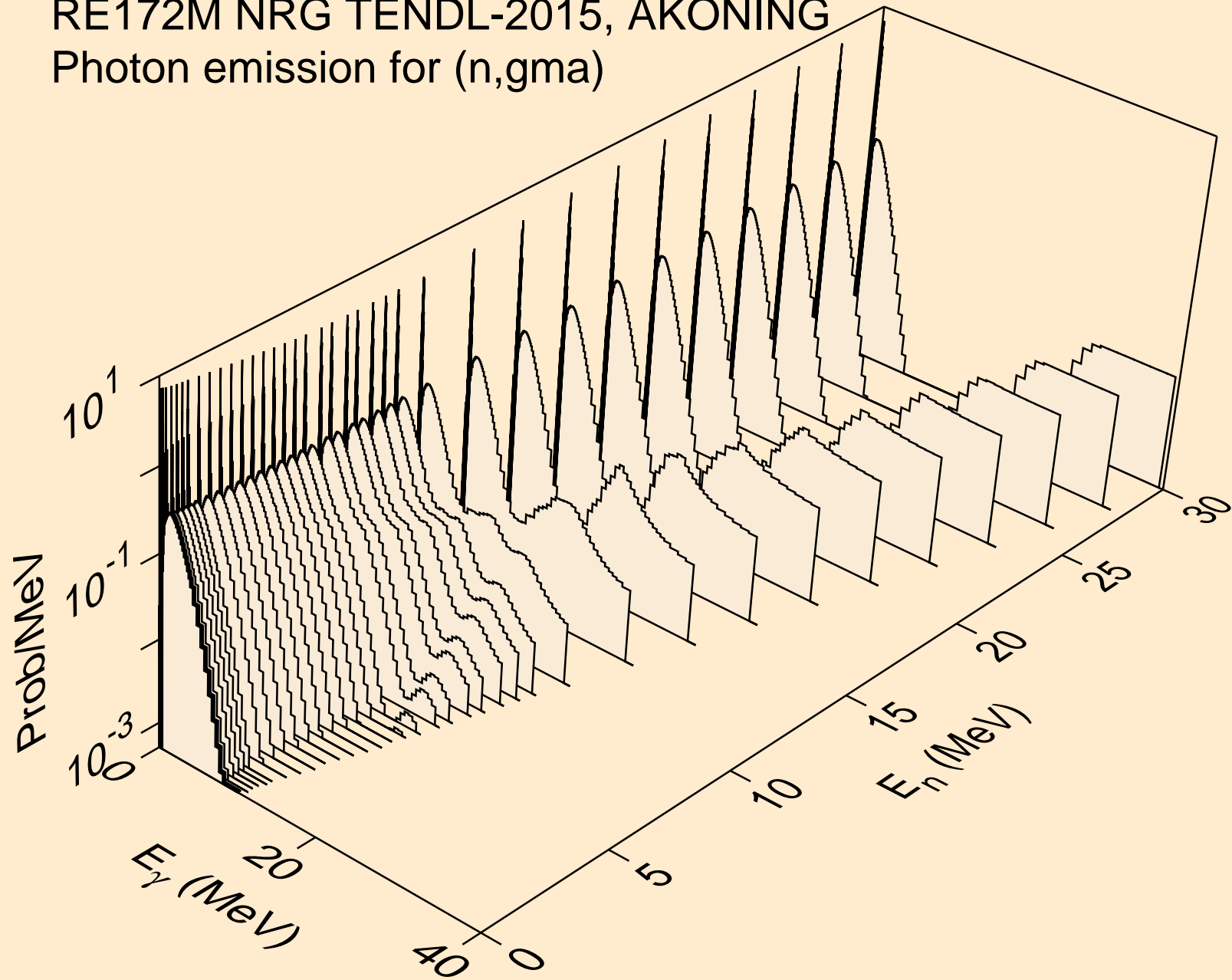

RE172M NRG TENDL-2015, AKONING
Photon emission for (n,p)

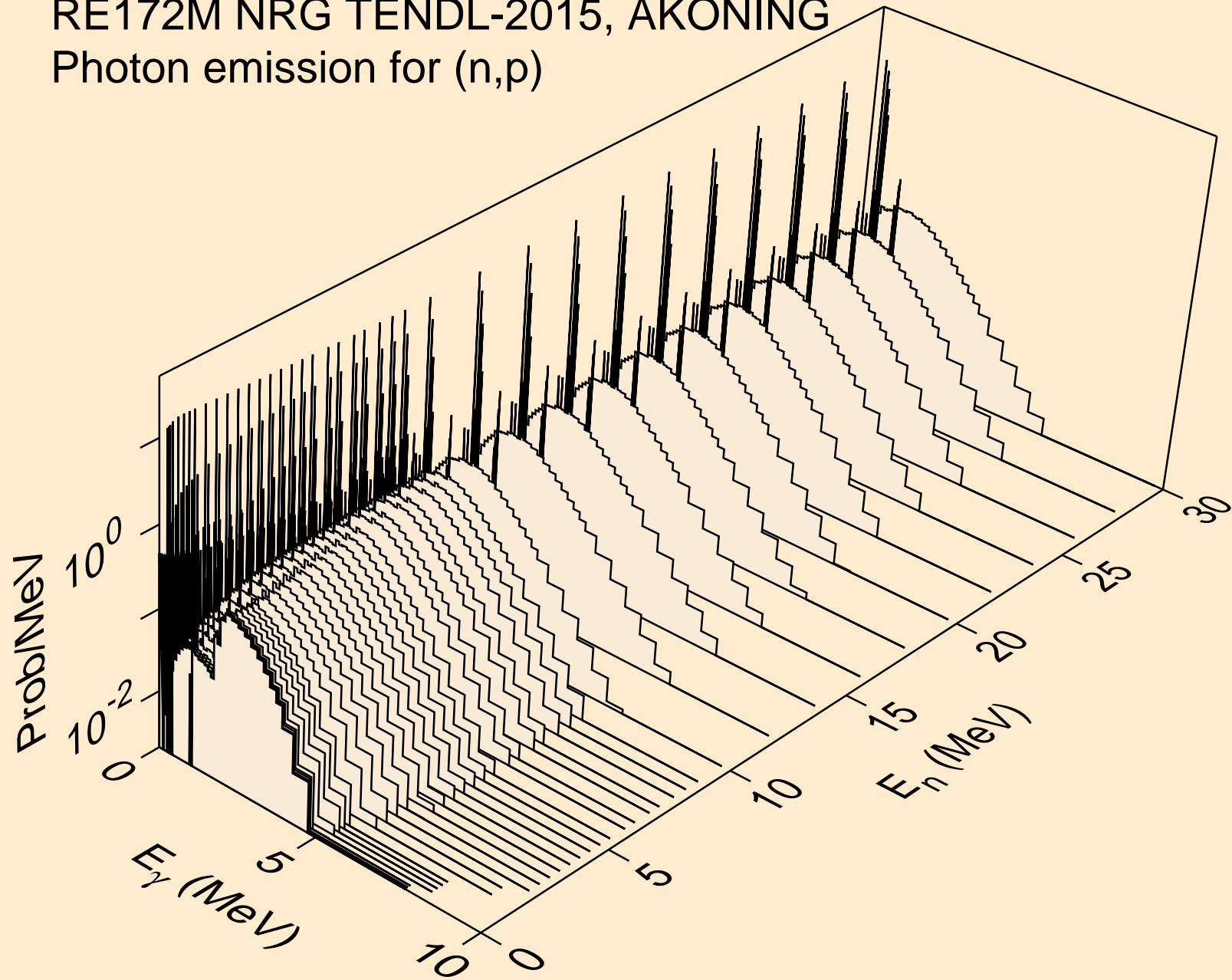

RE172M NRG TENDL-2015, AKONING
Photon emission for (n,d)

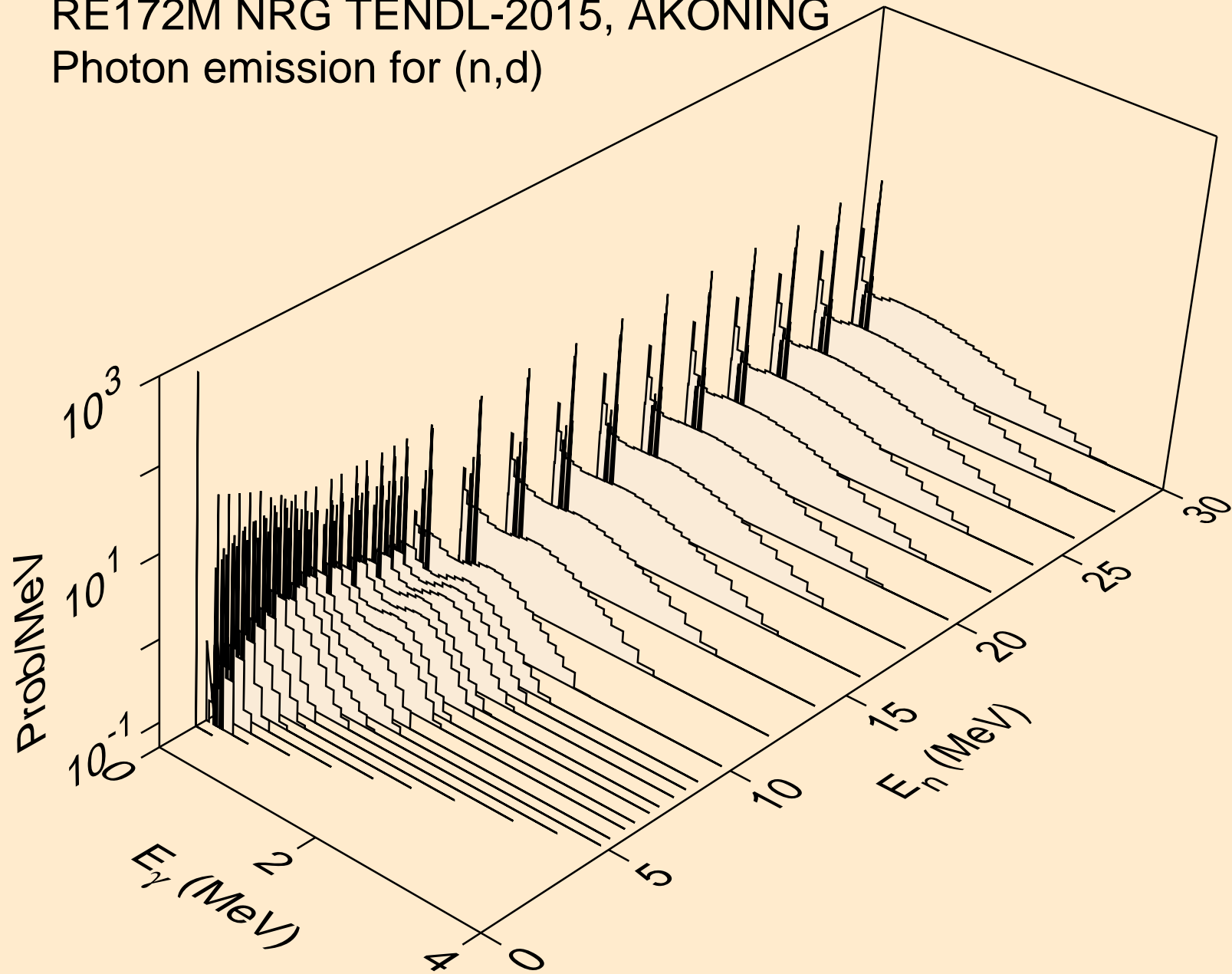

RE172M NRG TENDL-2015, AKONING
Photon emission for (n,t)

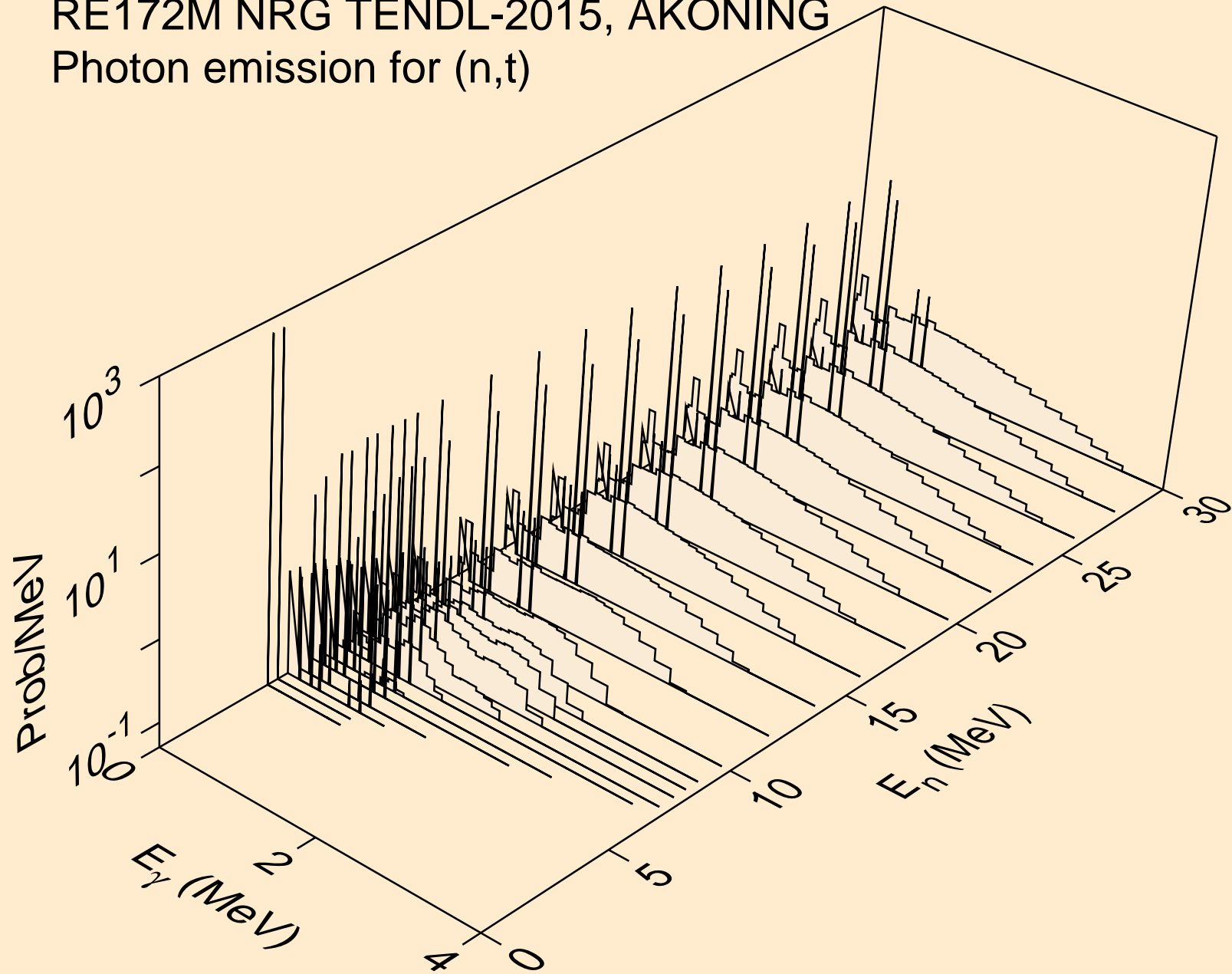

RE172M NRG TENDL-2015, AKONING
Photon emission for (n,he3)

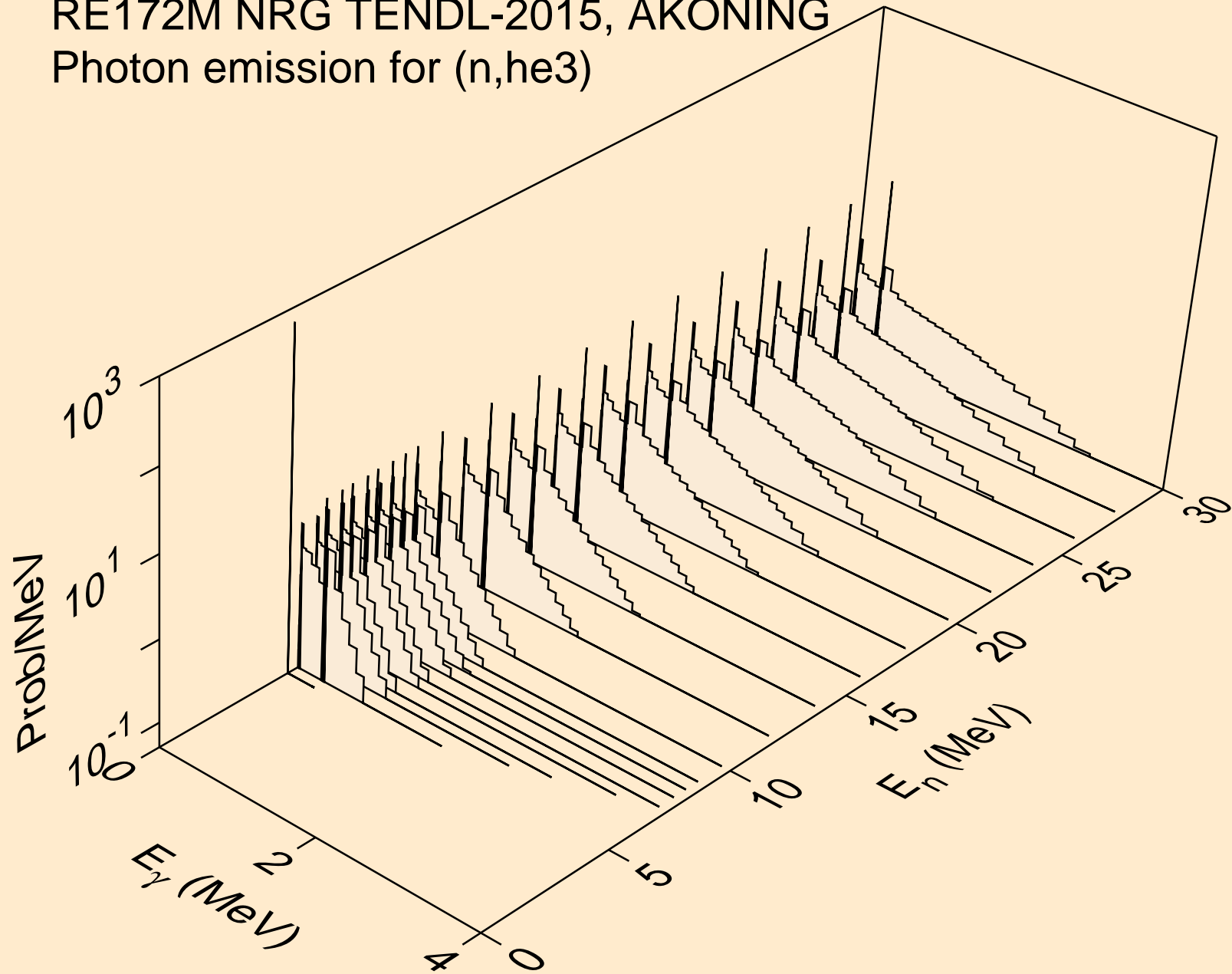

RE172M NRG TENDL-2015, AKONING
Photon emission for (n,a)

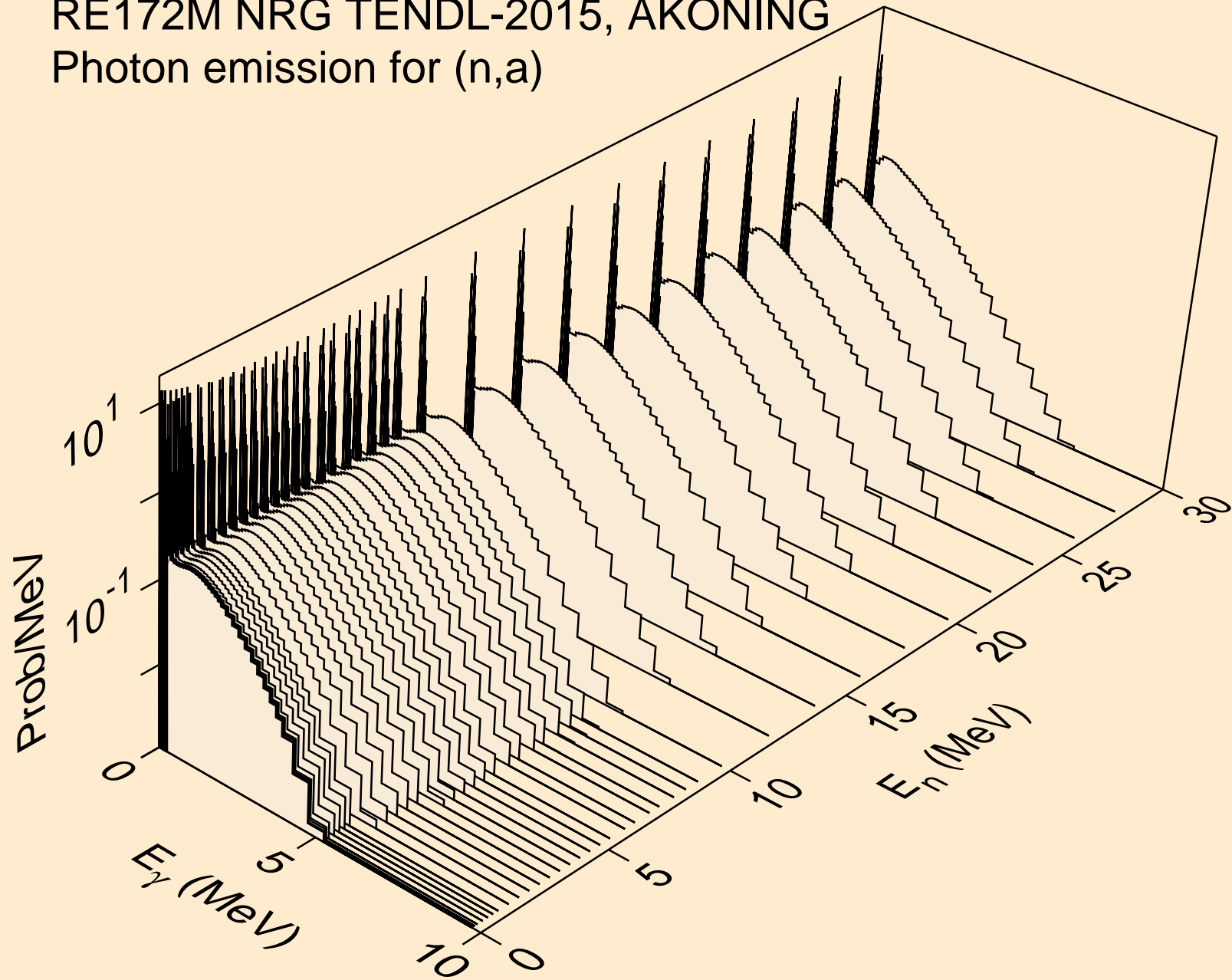

RE172M NRG TENDL-2015, AKONING
Photon emission for (n,2a)

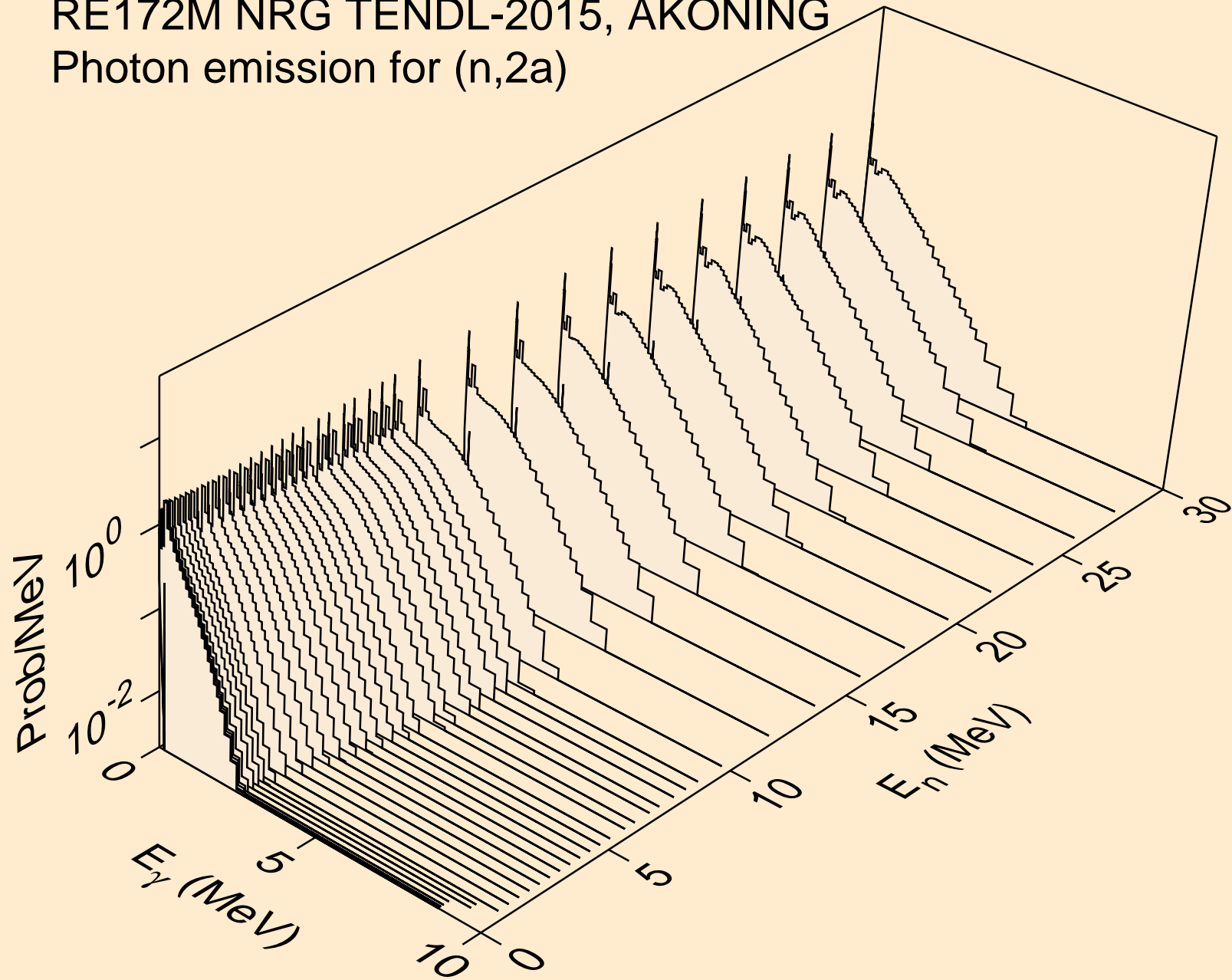

RE172M NRG TENDL-2015, AKONING
Photon emission for (n,3a)

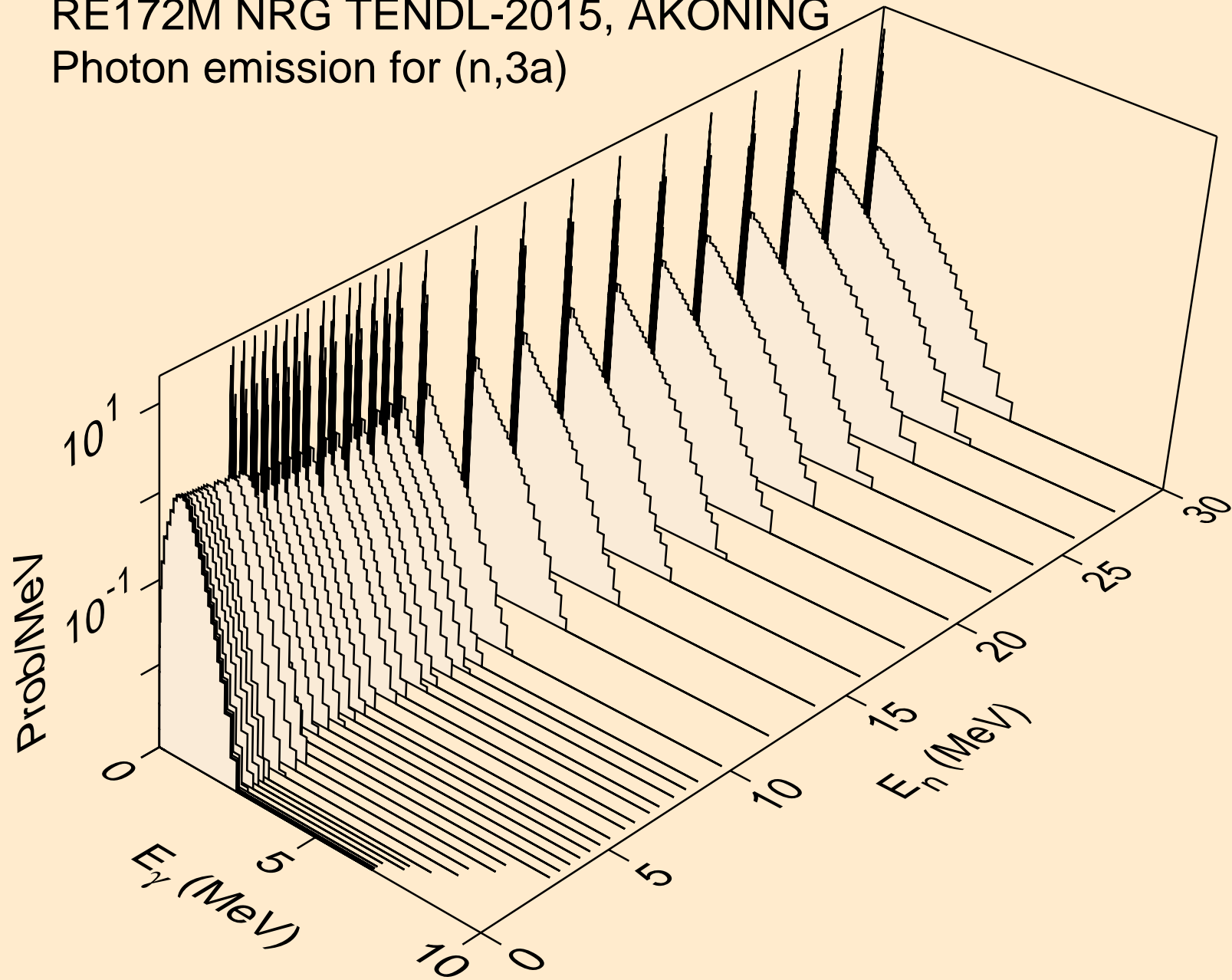

RE172M NRG TENDL-2015, AKONING
Photon emission for (n,2p)

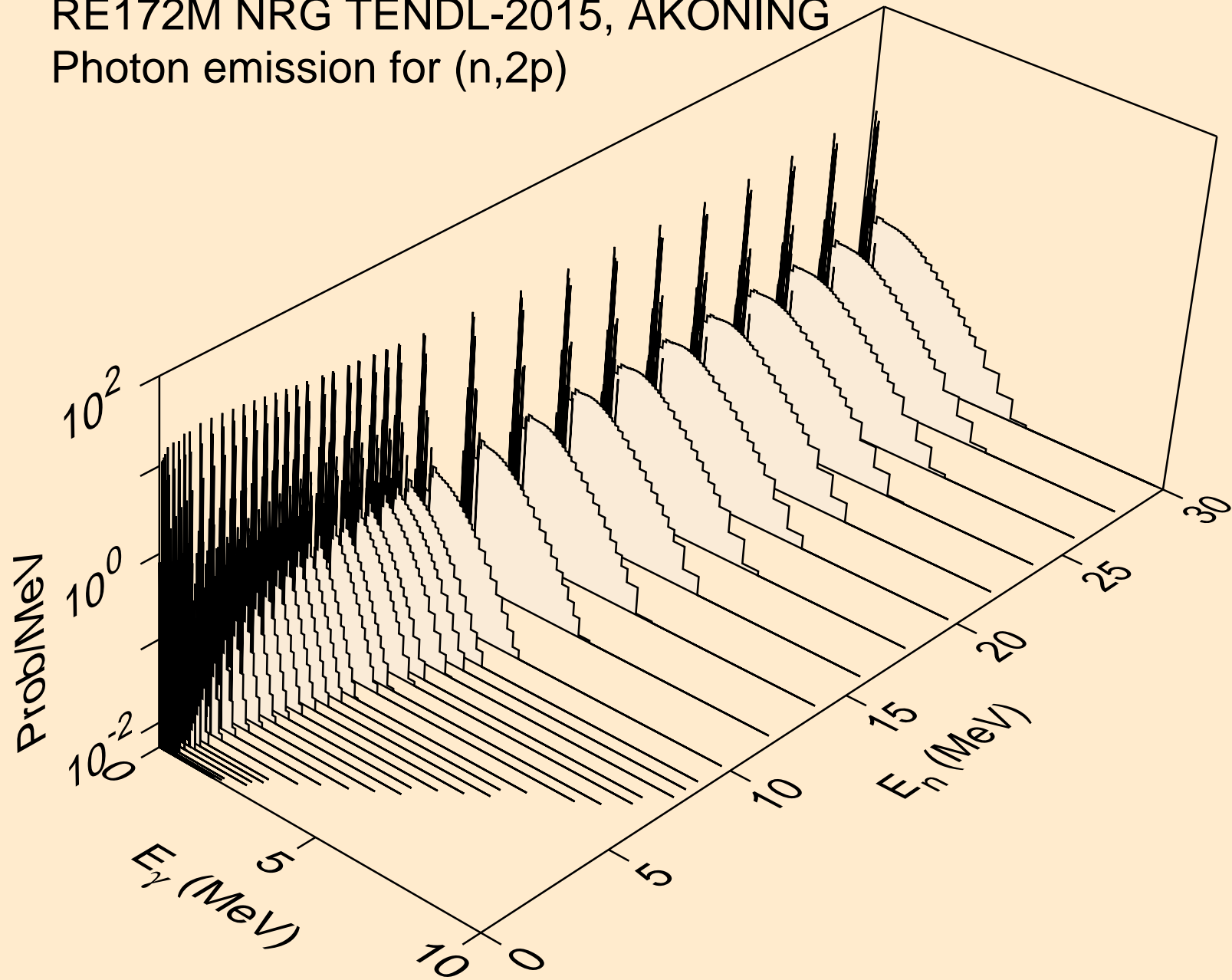

RE172M NRG TENDL-2015, AKONING
Photon emission for (n,p α)

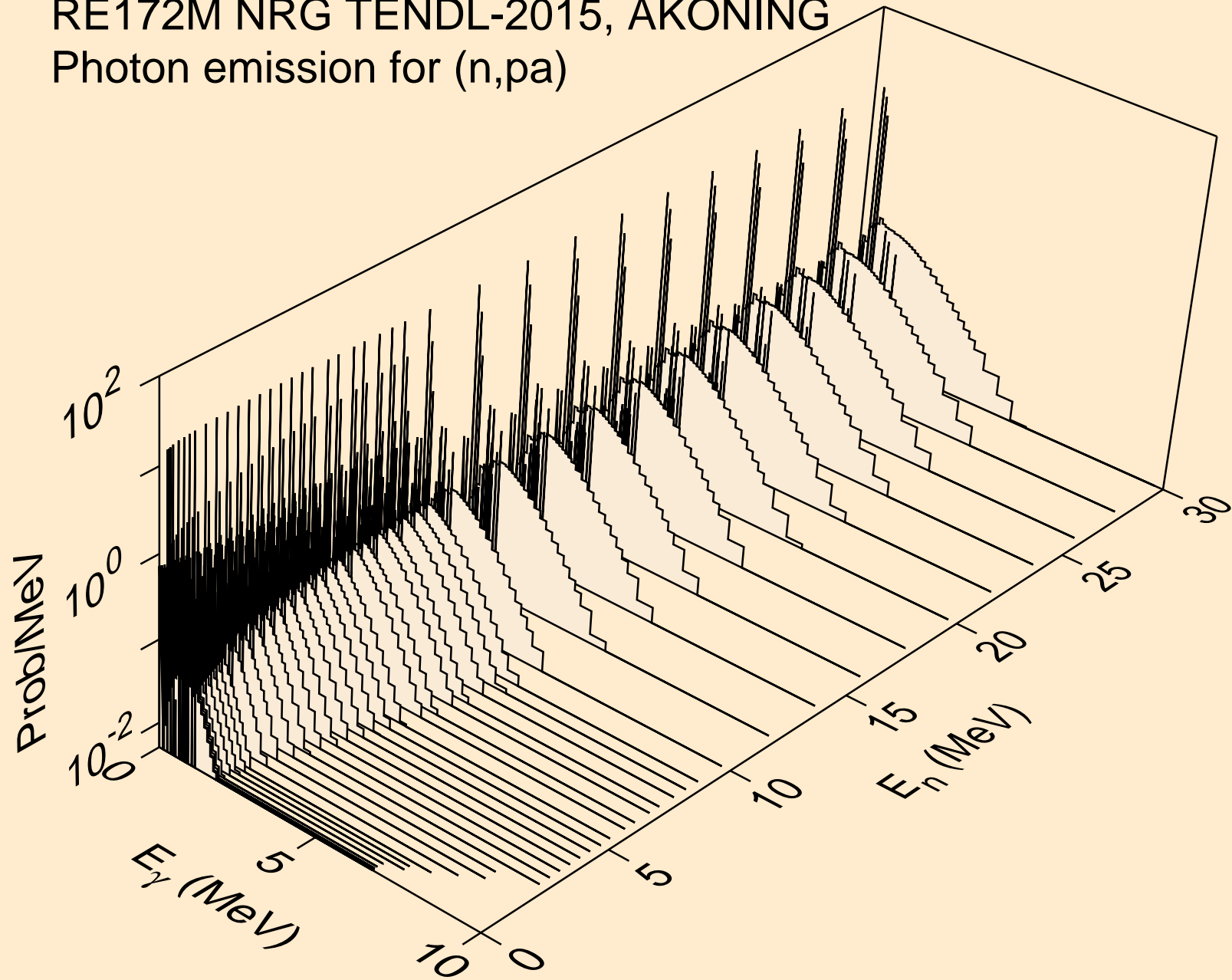

RE172M NRG TENDL-2015, AKONING
Photon emission for (n,t2a)

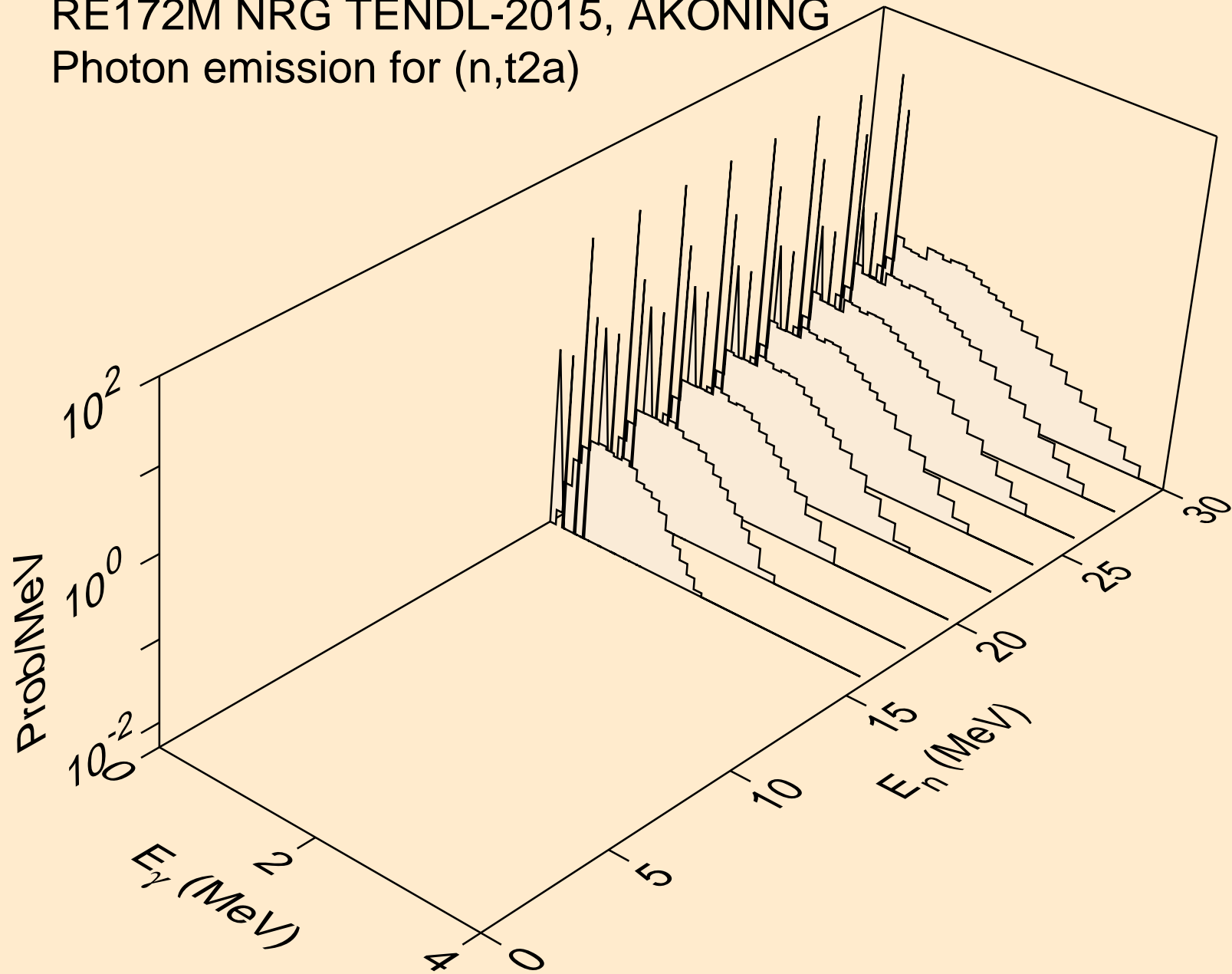

RE172M NRG TENDL-2015, AKONING
Photon emission for (n,d2a)

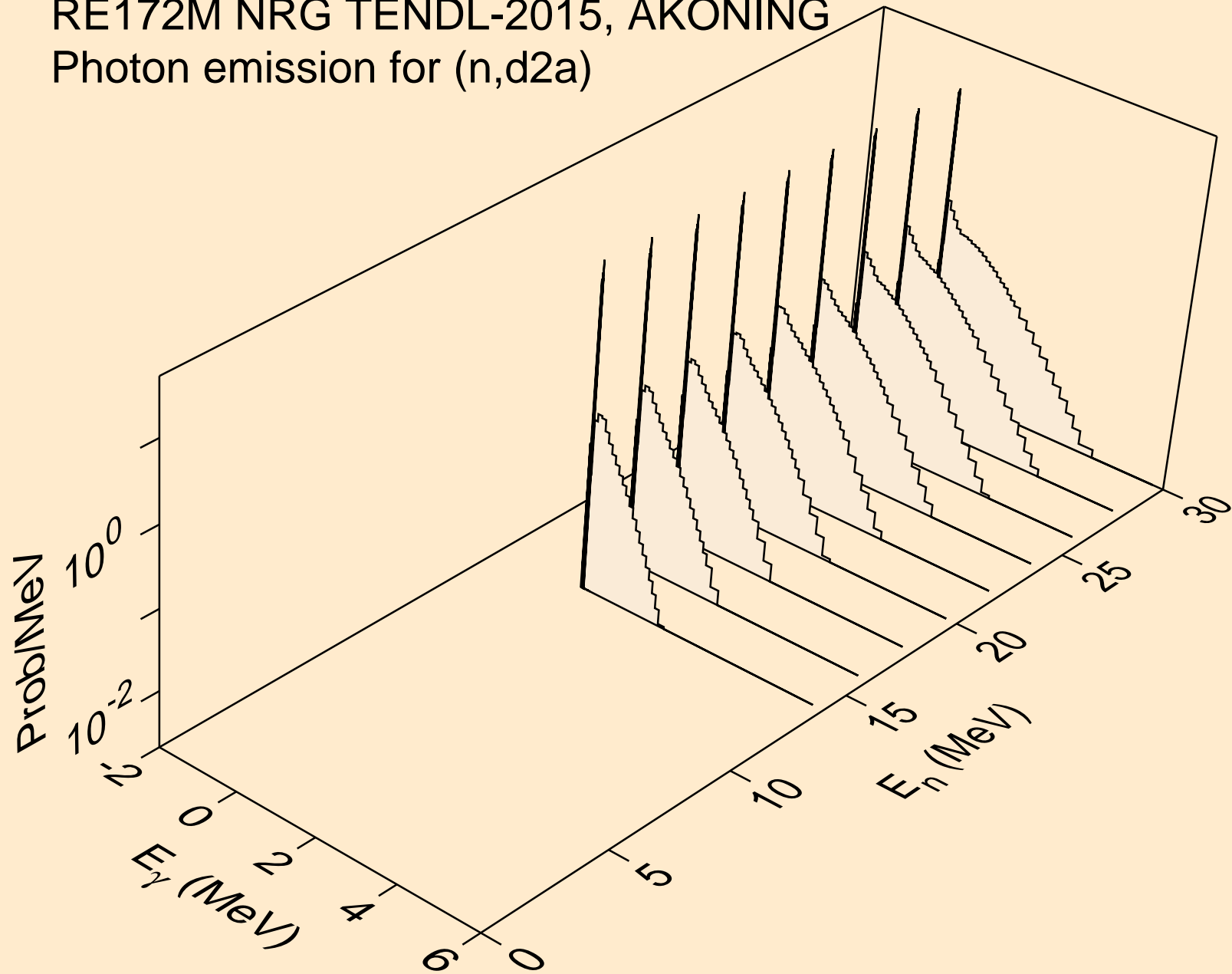

RE172M NRG TENDL-2015, AKONING
Photon emission for (n,pd)

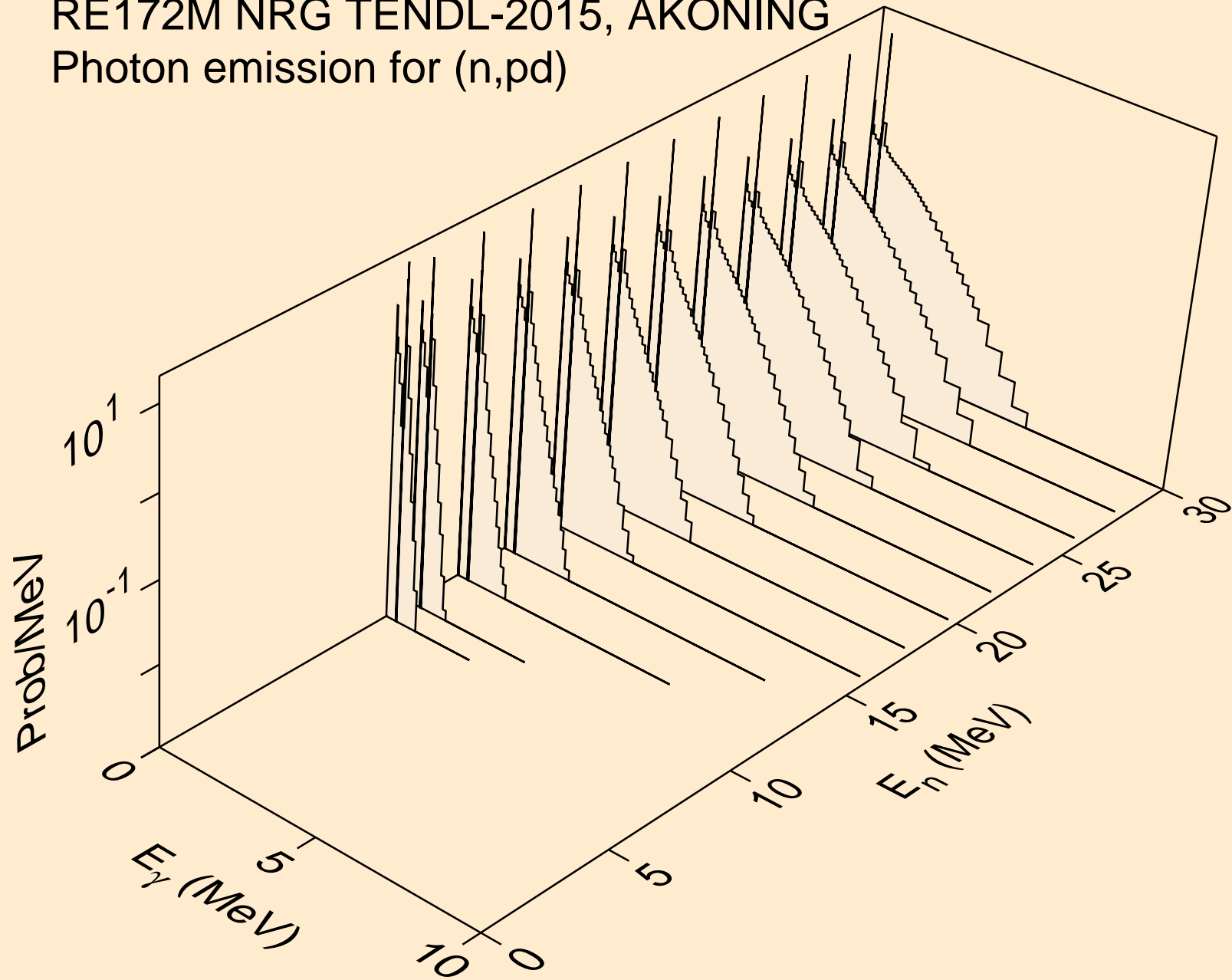

RE172M NRG TENDL-2015, AKONING
Photon emission for (n,pt)

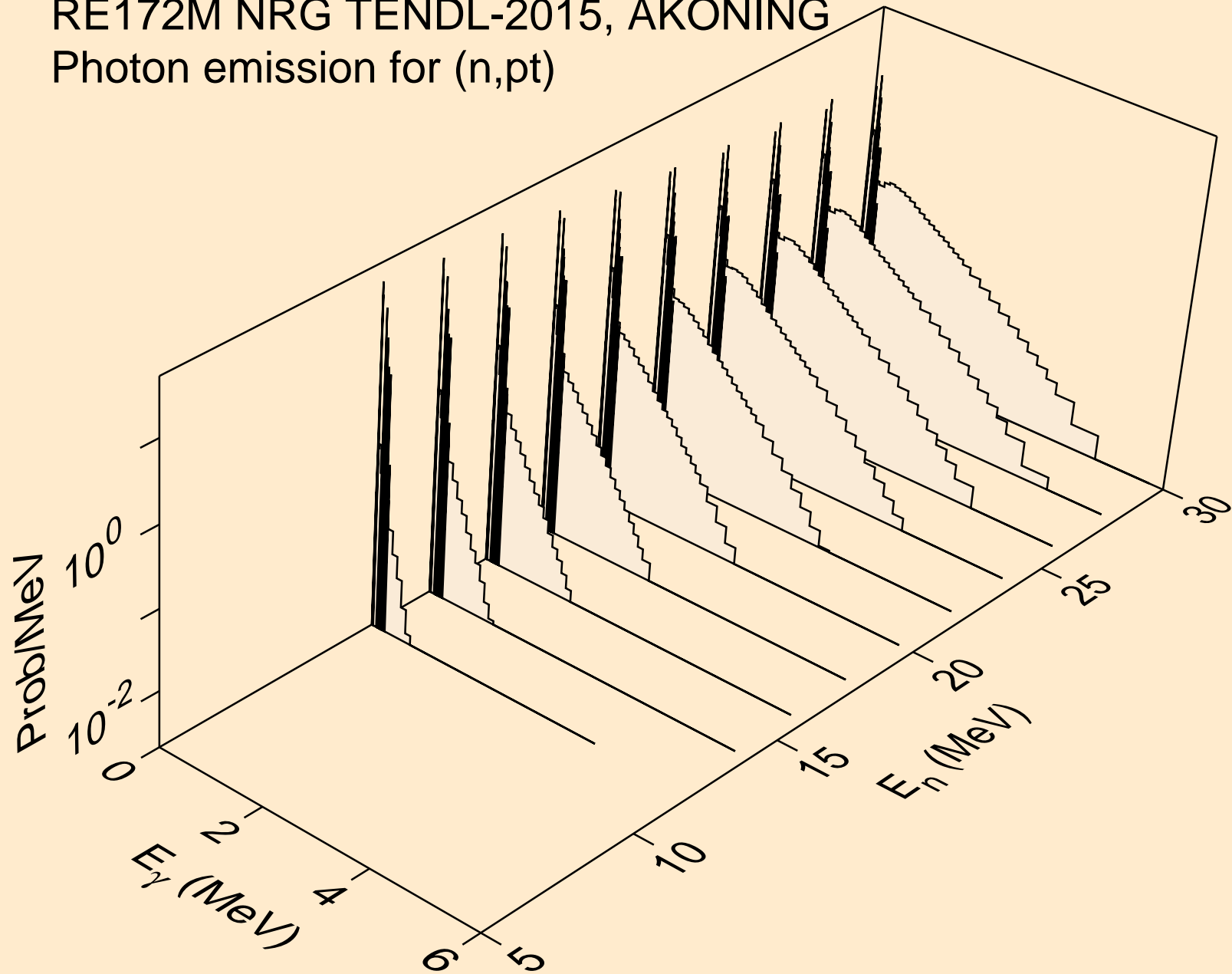

RE172M NRG TENDL-2015, AKONING
Photon emission for (n,da)

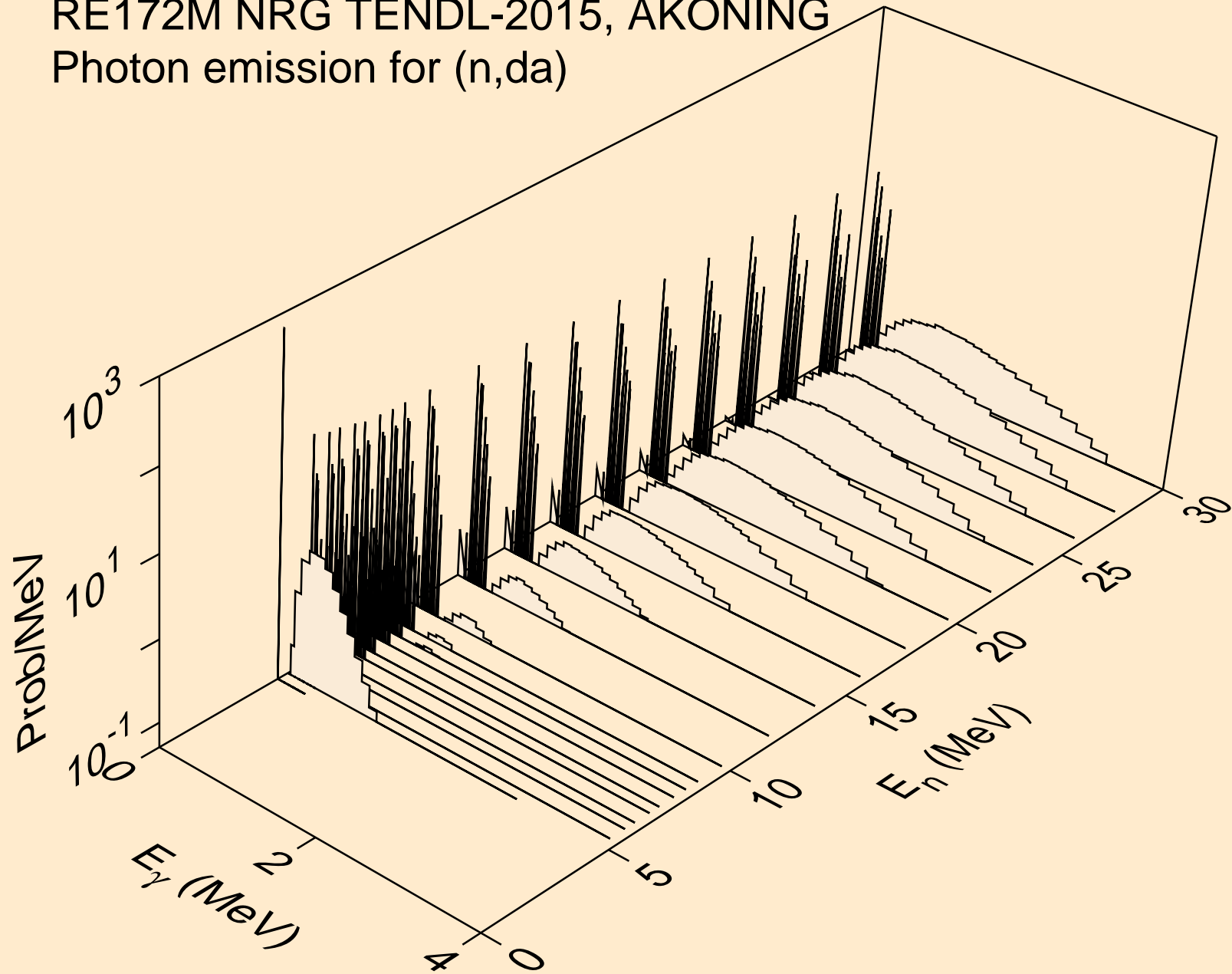

RE172M NRG TENDL-2015, AKONING
thermal capture photon spectrum

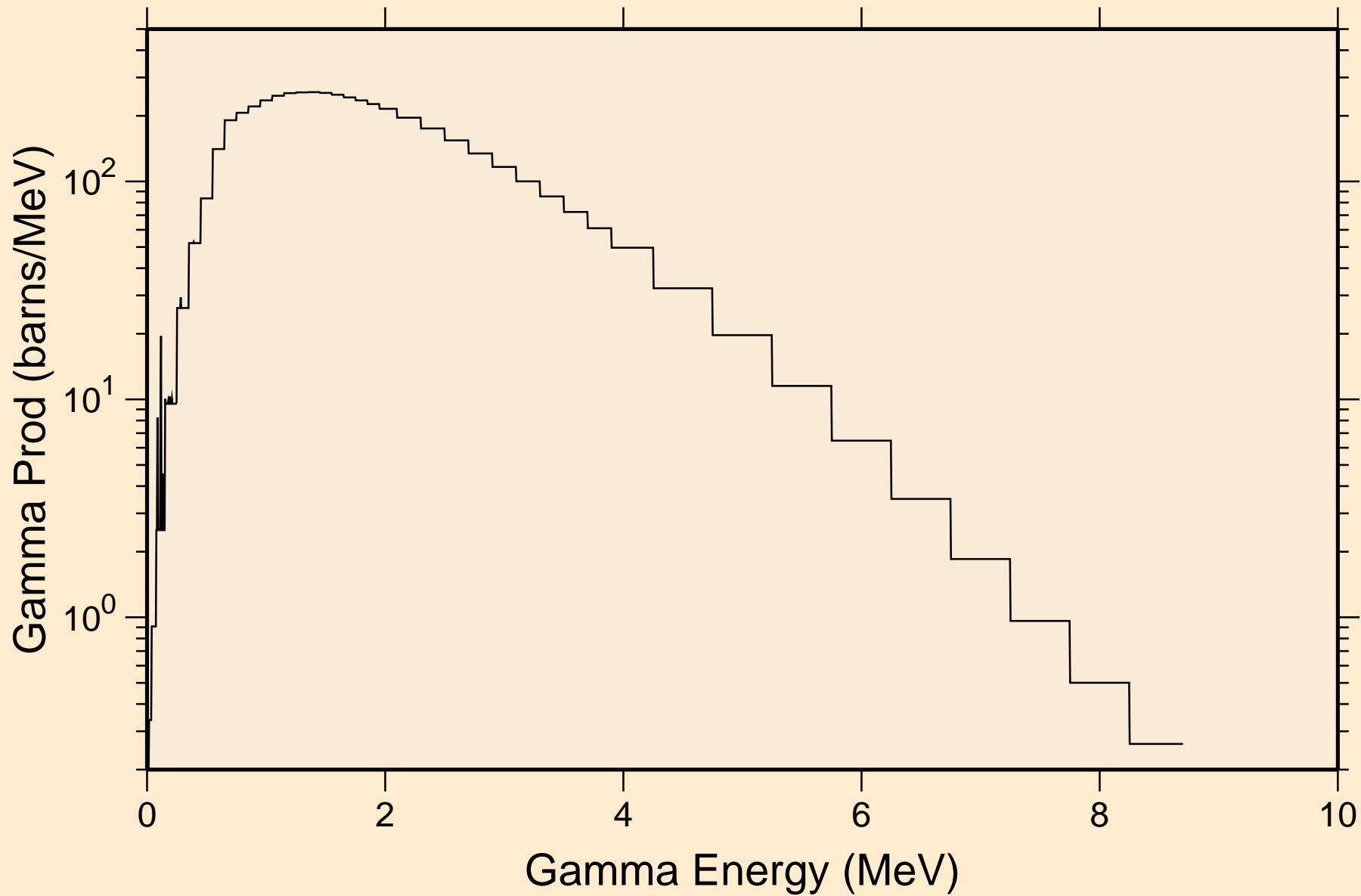

RE172M NRG TENDL-2015, AKONING
14 MeV photon spectrum

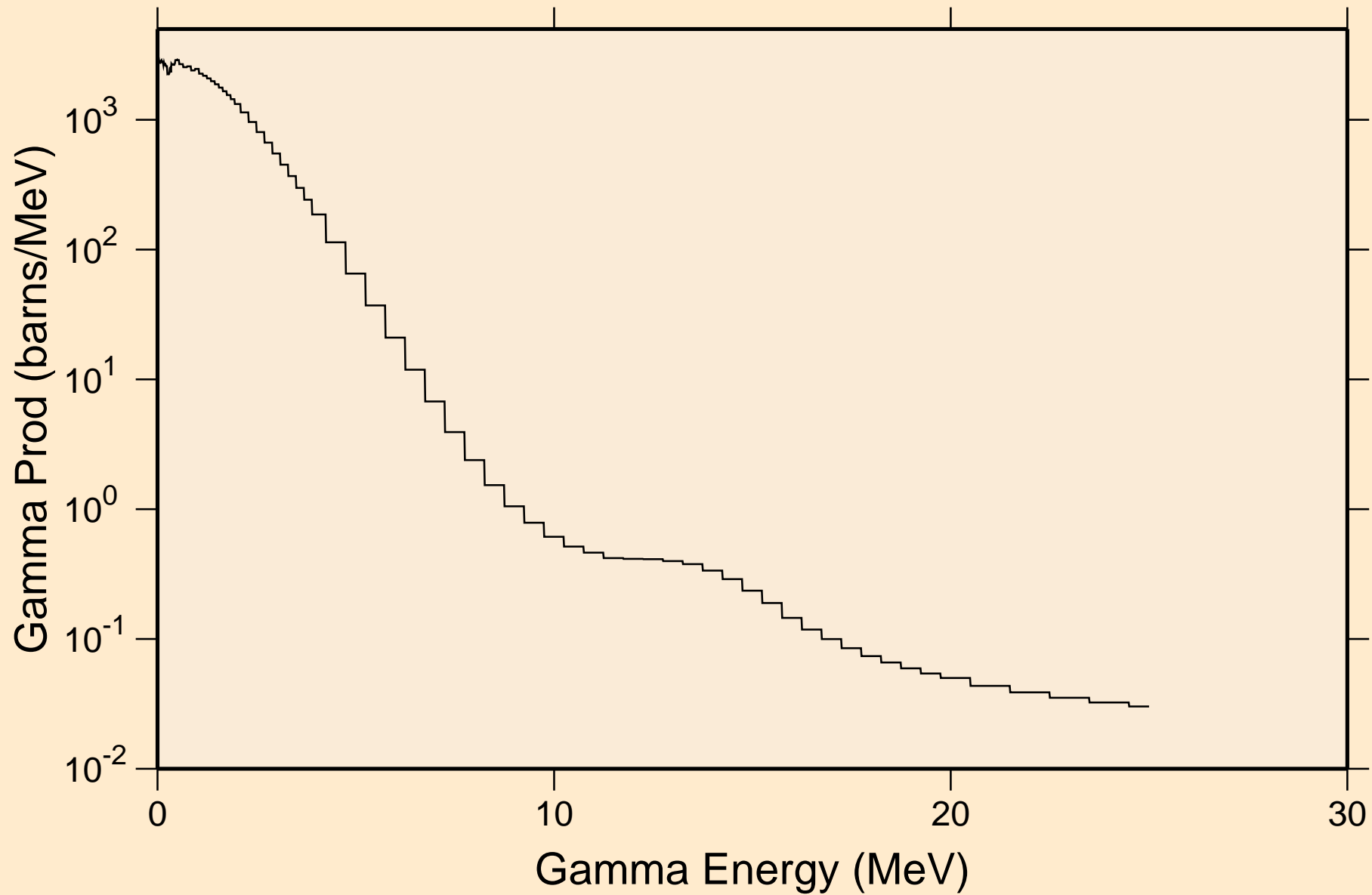

RE172M NRG TENDL-2015, AKONING

Particle heating contributions

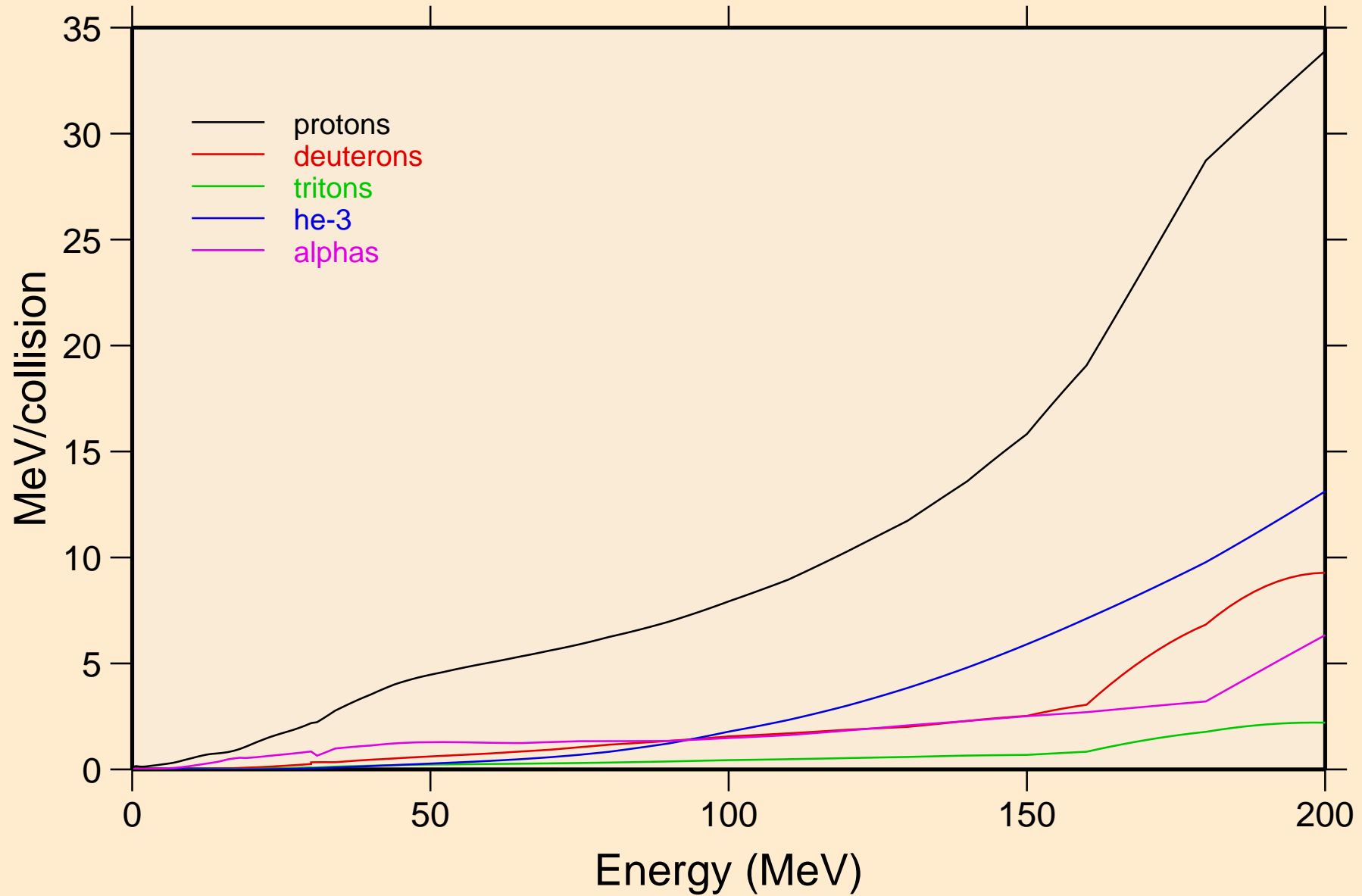

RE172M NRG TENDL-2015, AKONING

Recoil Heating

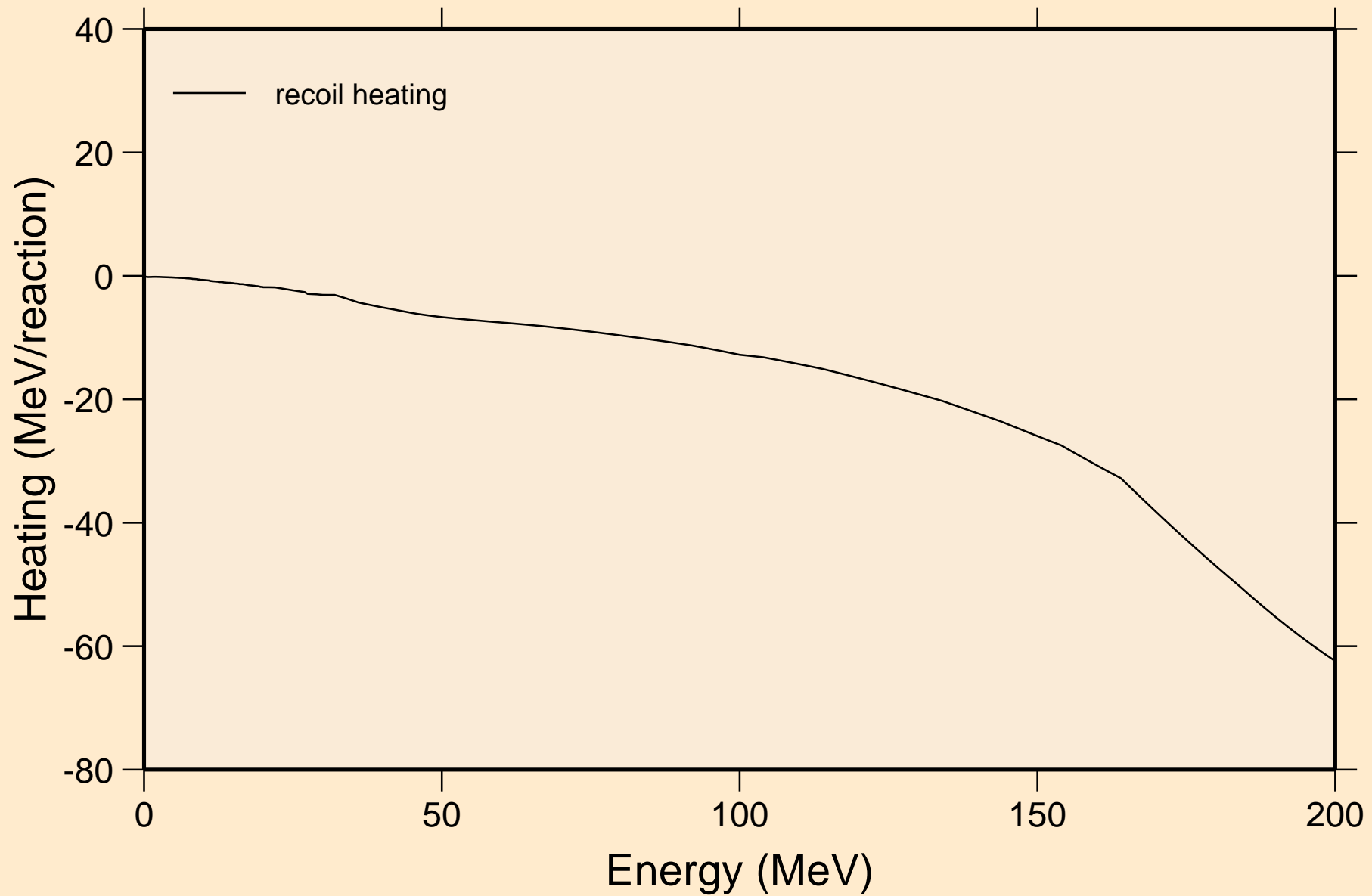

RE172M NRG TENDL-2015, AKONING

Particle production cross sections

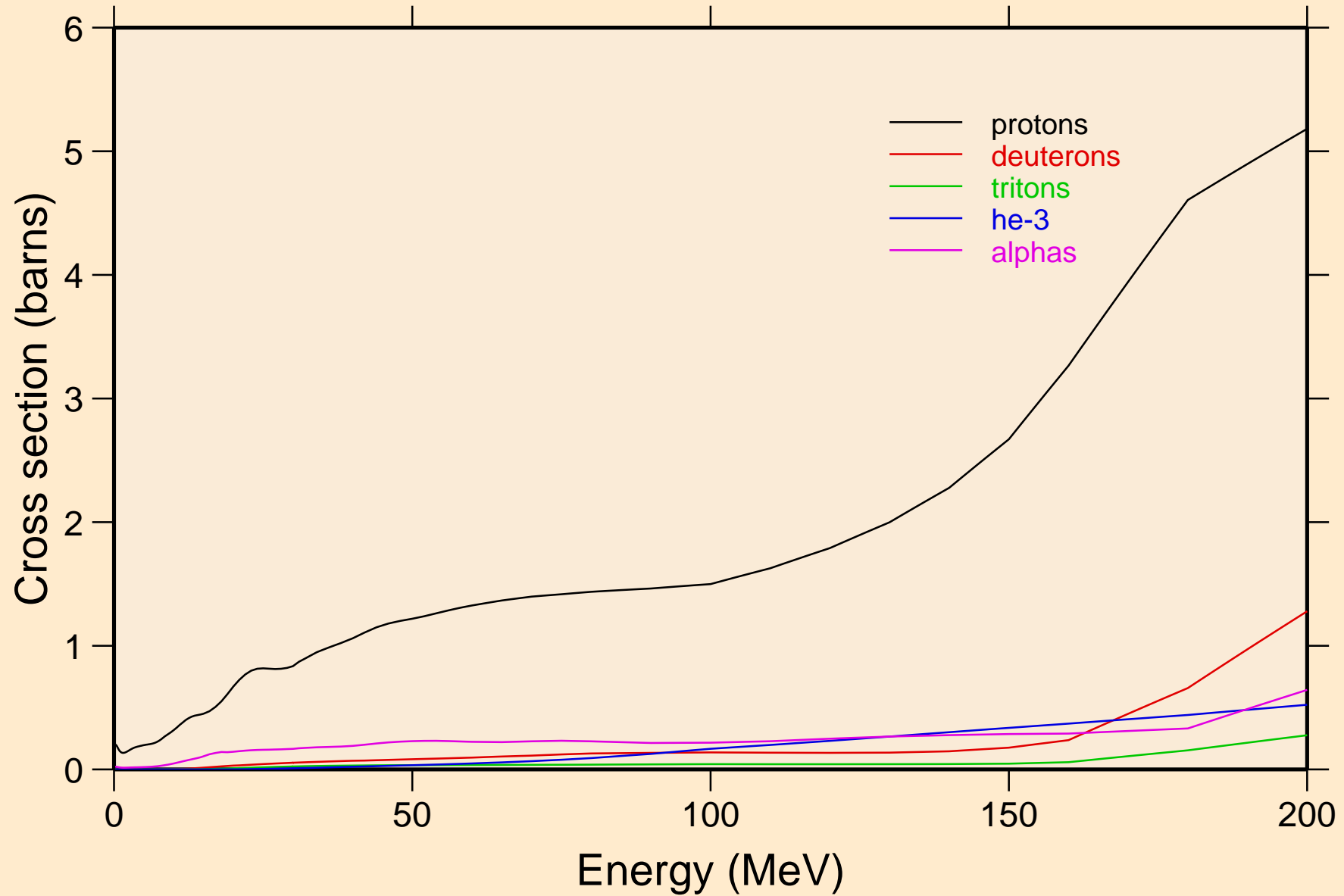

RE172M NRG TENDL-2015, AKONING
protons from (n,x)

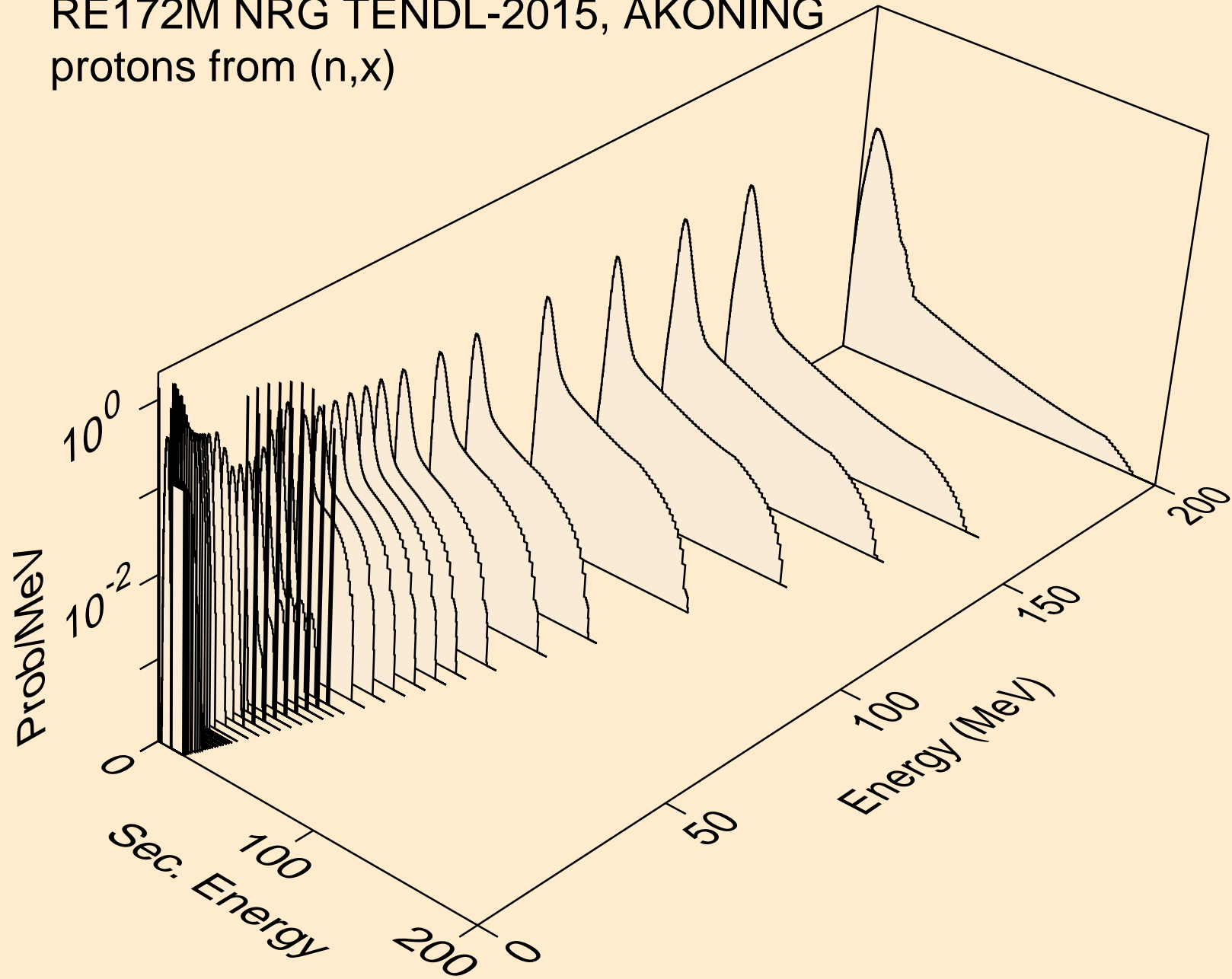

RE172M NRG TENDL-2015, AKONING
protons from (n,n*)p

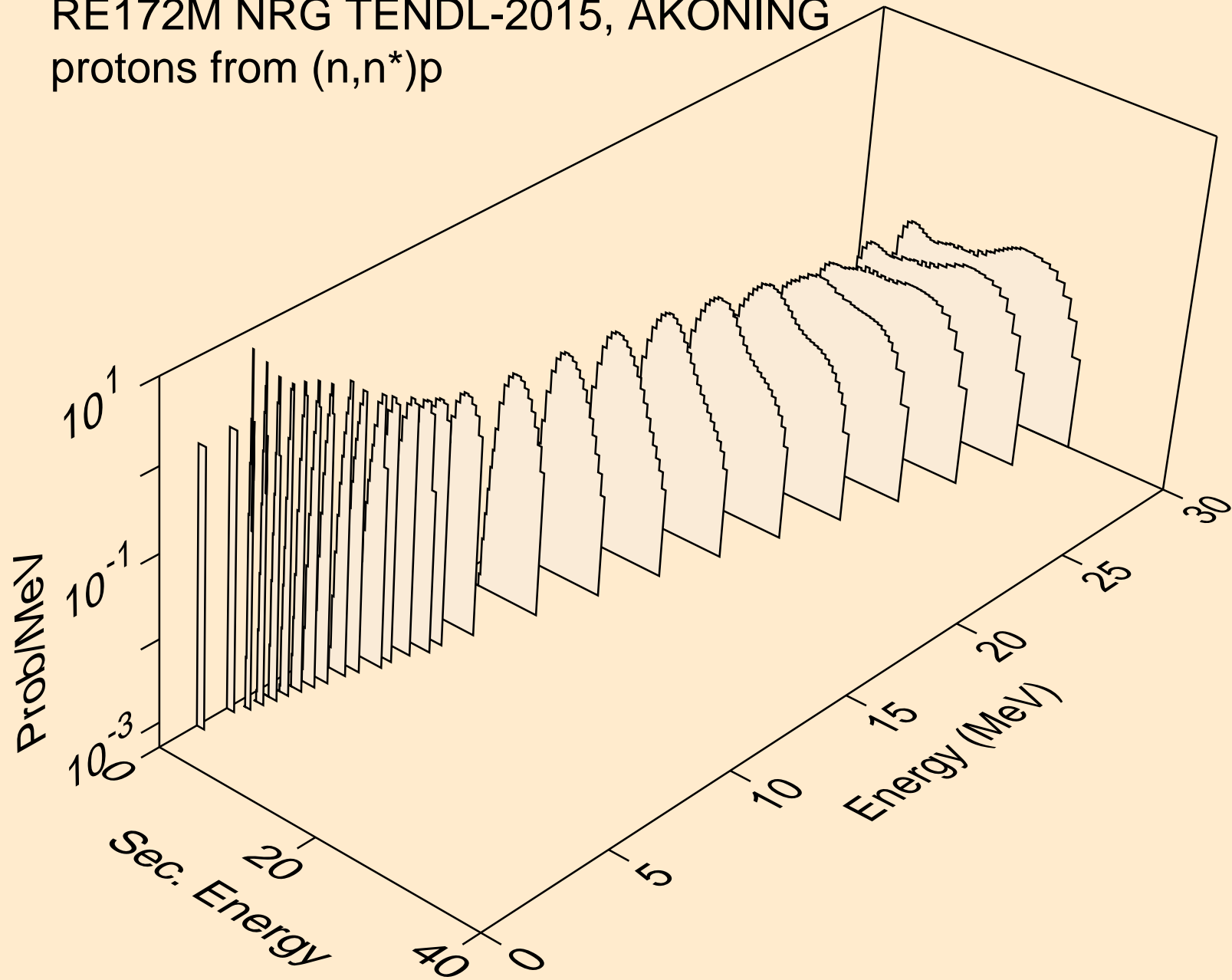

RE172M NRG TENDL-2015, AKONING
protons from (n,2np)

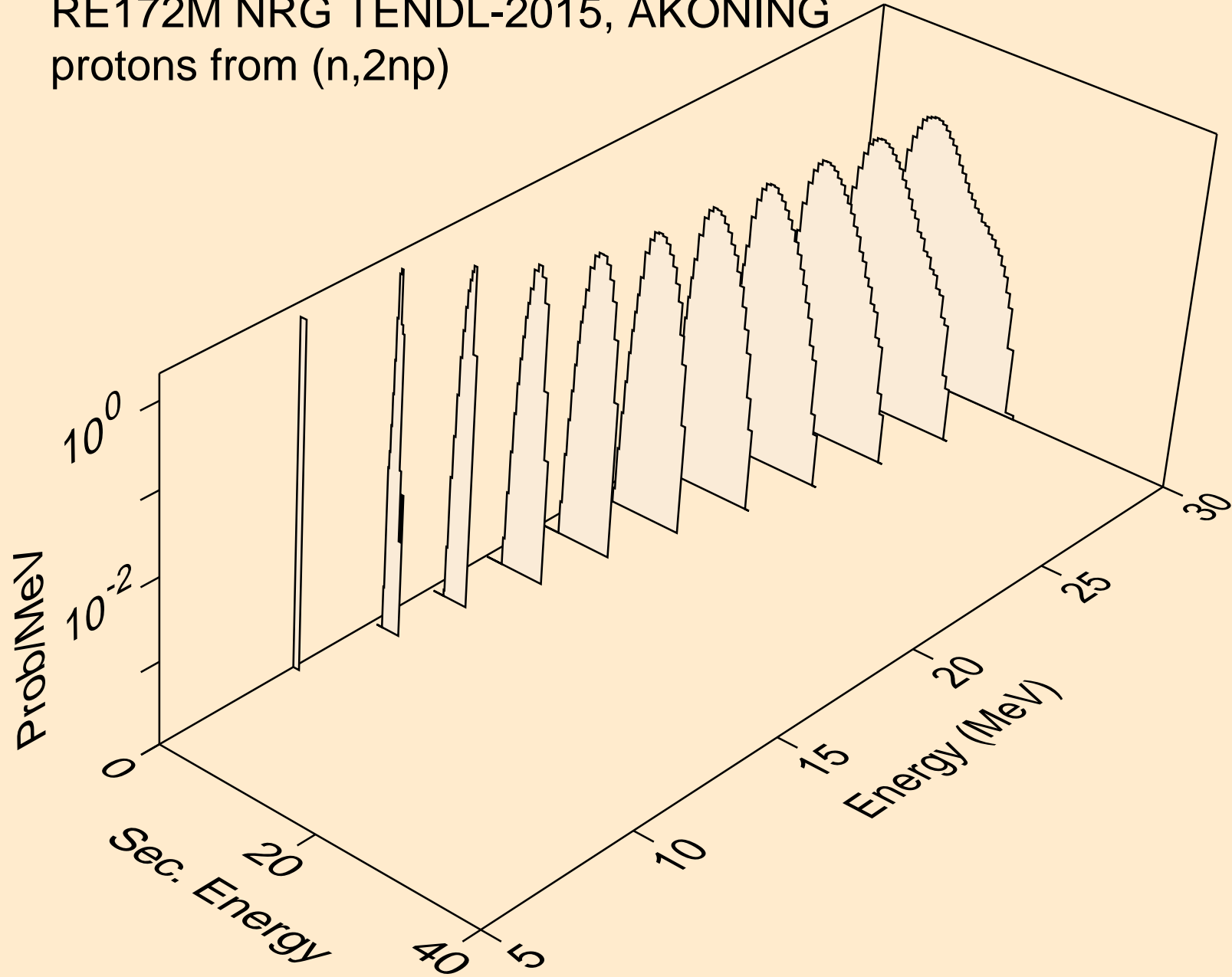

RE172M NRG TENDL-2015, AKONING
protons from (n,3np)

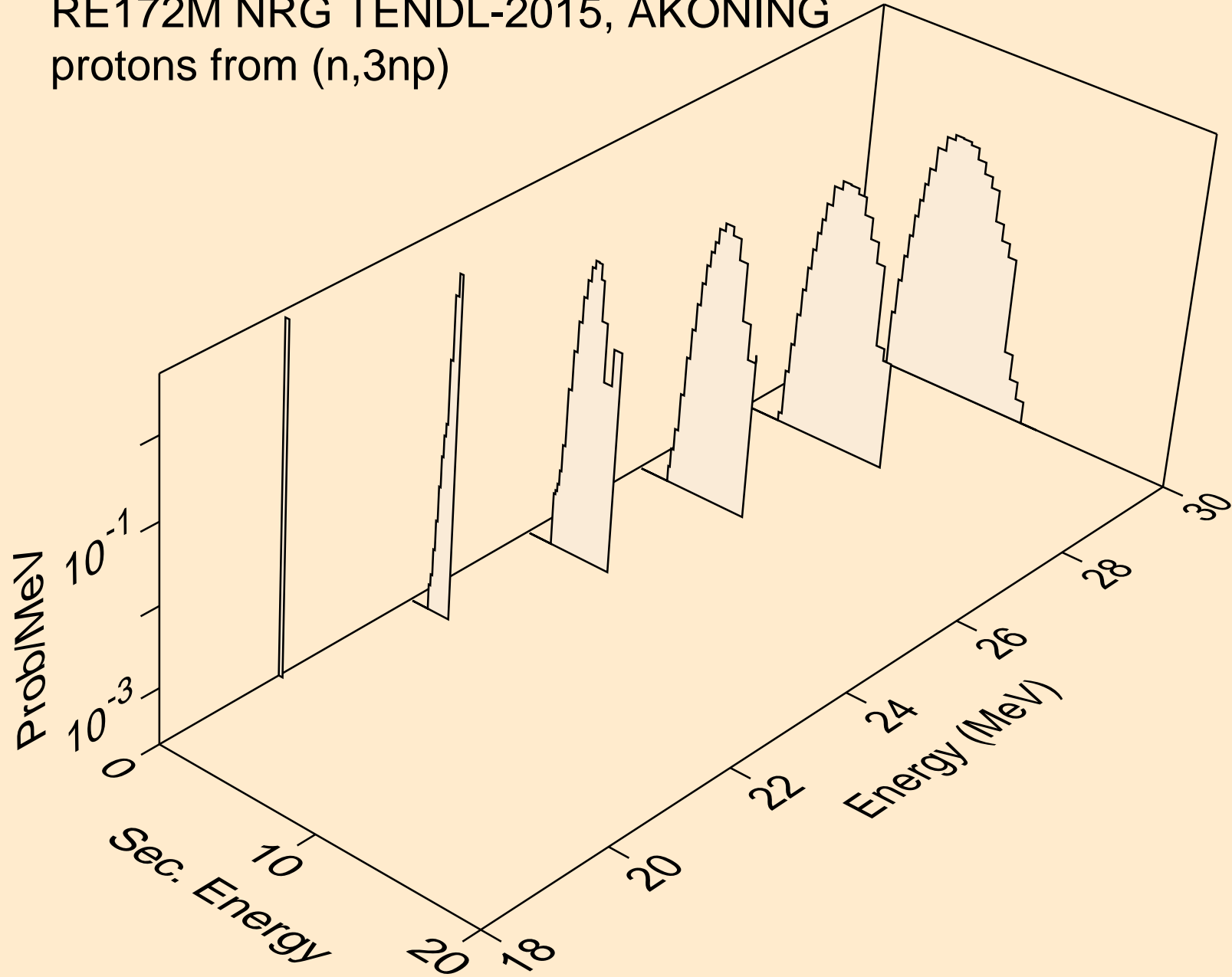

RE172M NRG TENDL-2015, AKONING
protons from (n,2np)

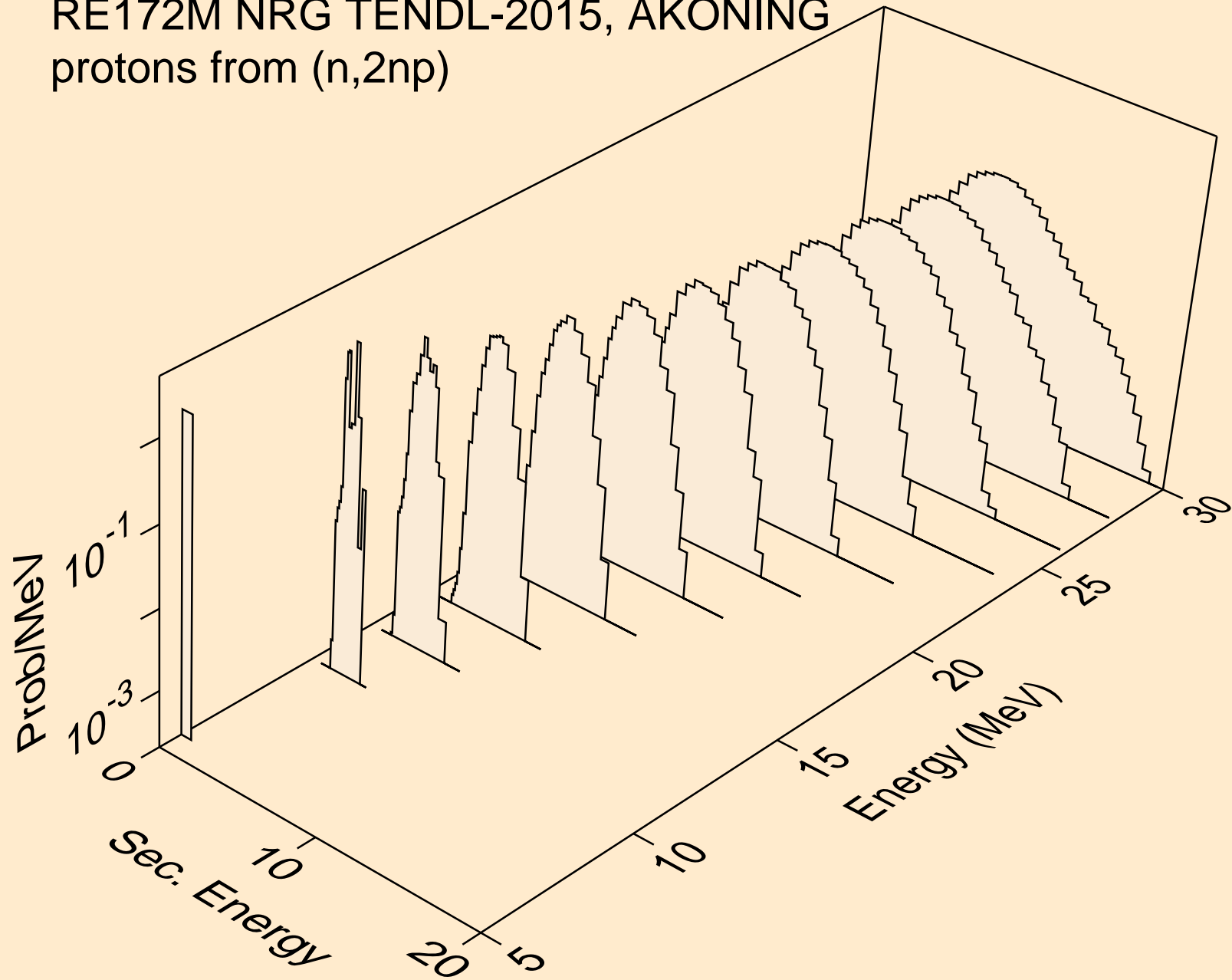

RE172M NRG TENDL-2015, AKONING
protons from (n,npa)

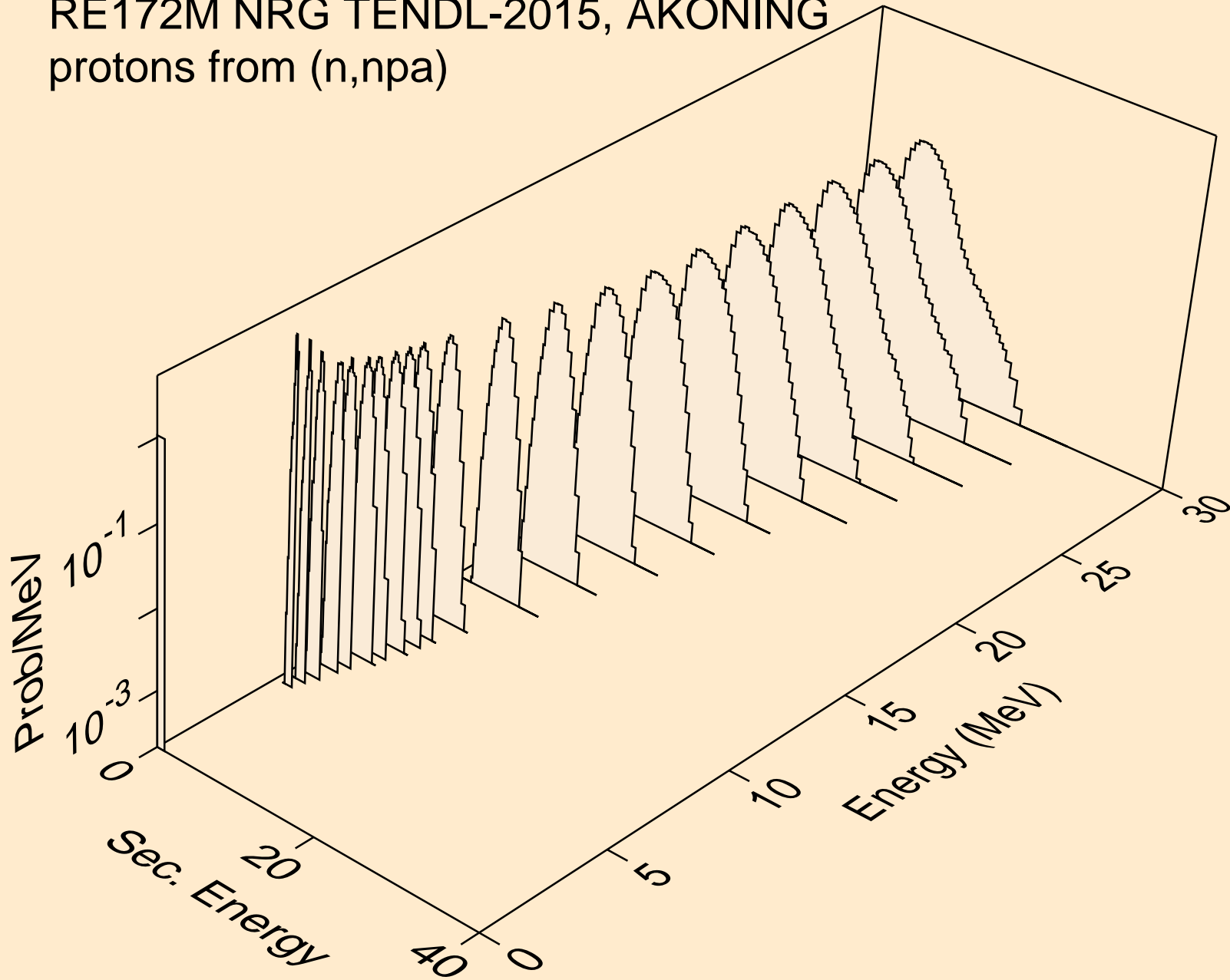

RE172M NRG TENDL-2015, AKONING
protons from (n,p)

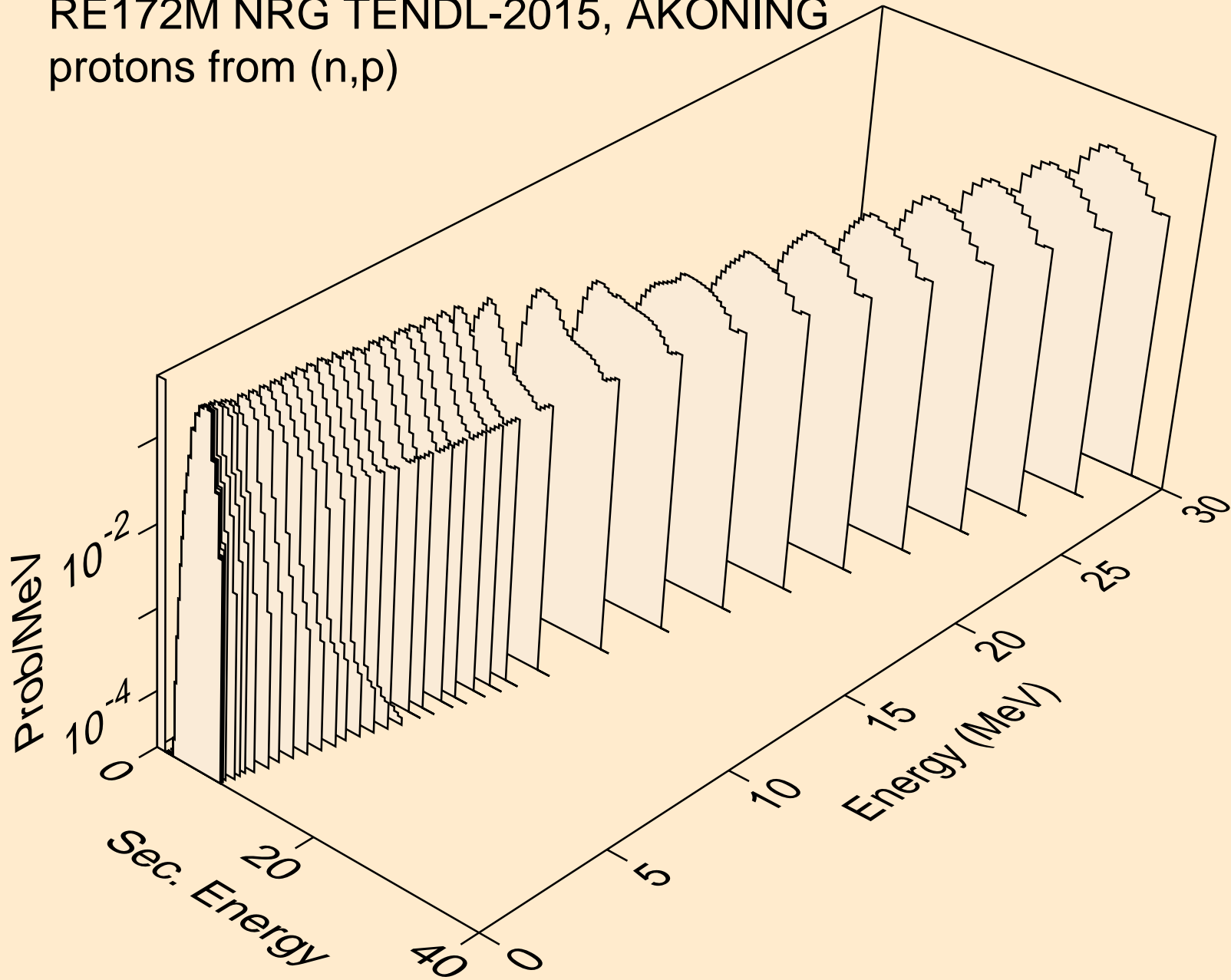

RE172M NRG TENDL-2015, AKONING
protons from (n,2p)

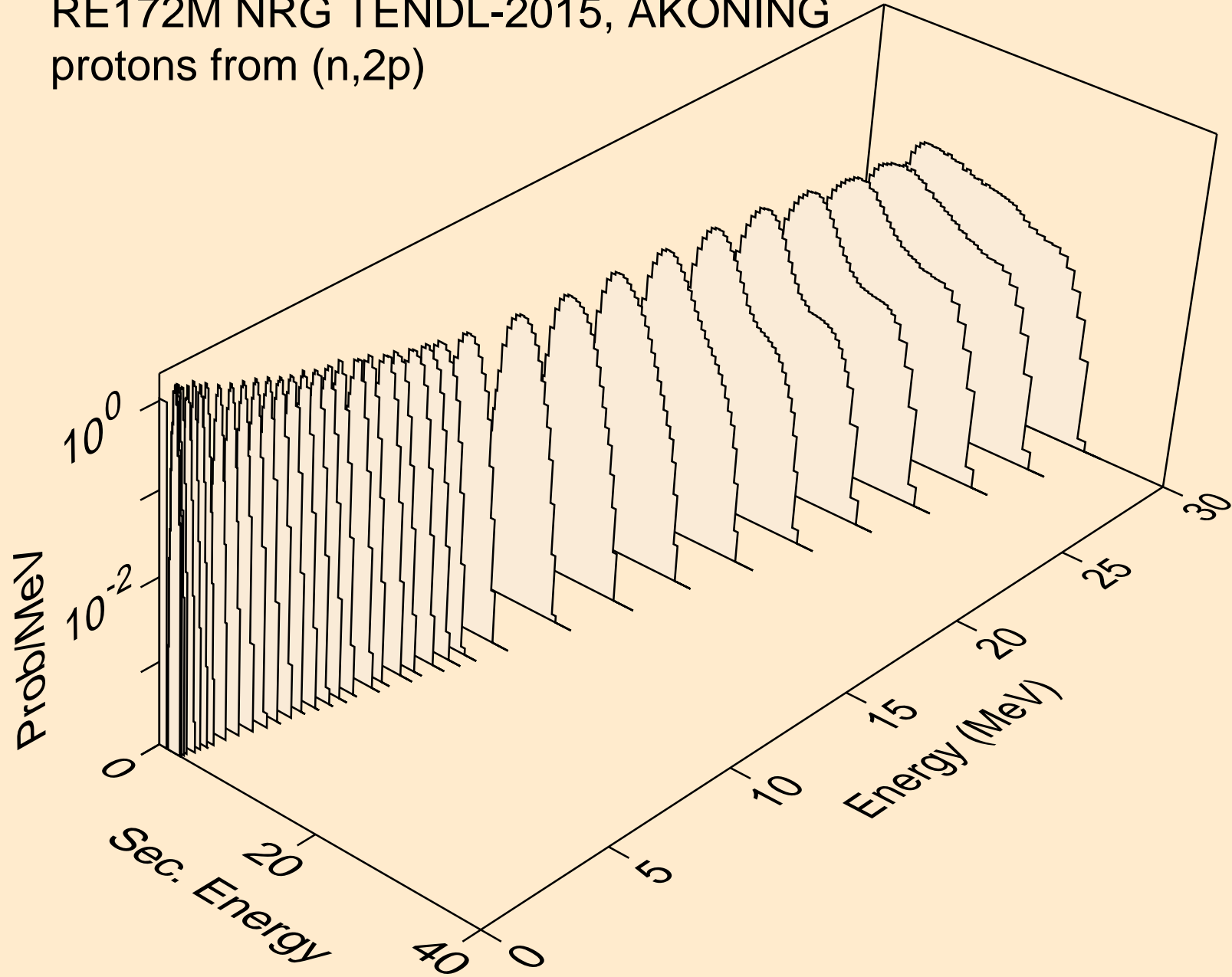

RE172M NRG TENDL-2015, AKONING
protons from (n,pa)

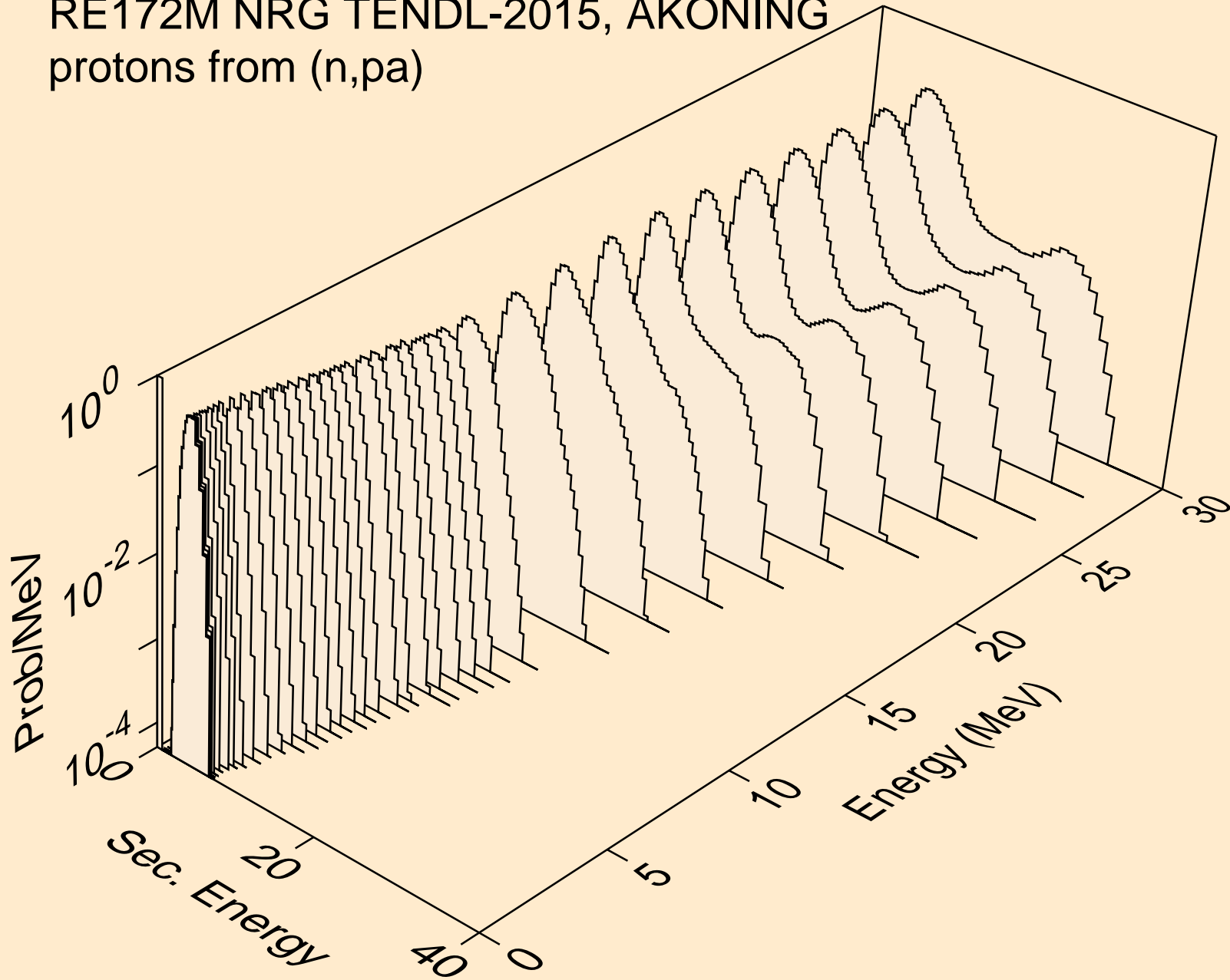

RE172M NRG TENDL-2015, AKONING
protons from (n,pd)

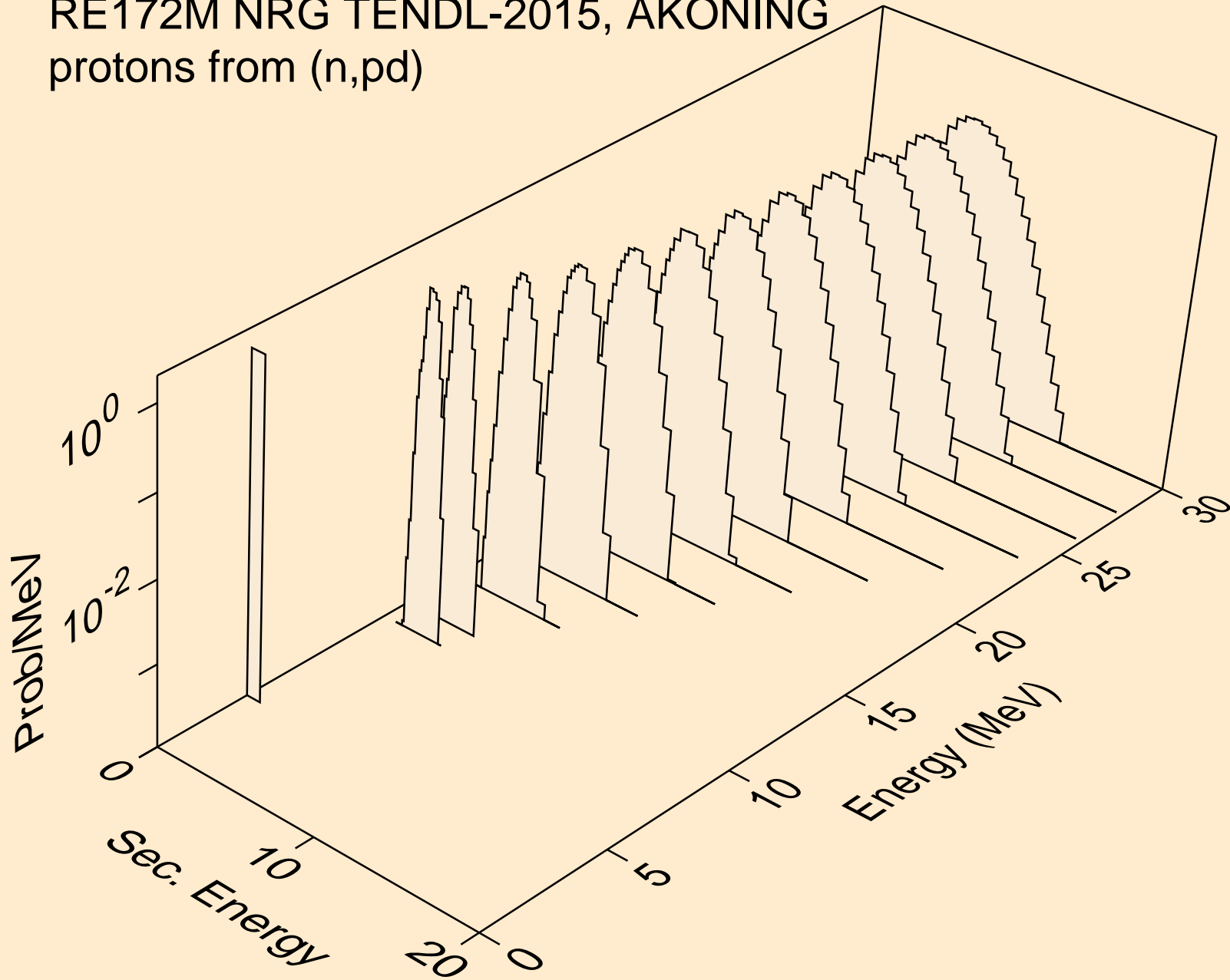

RE172M NRG TENDL-2015, AKONING
protons from (n,pt)

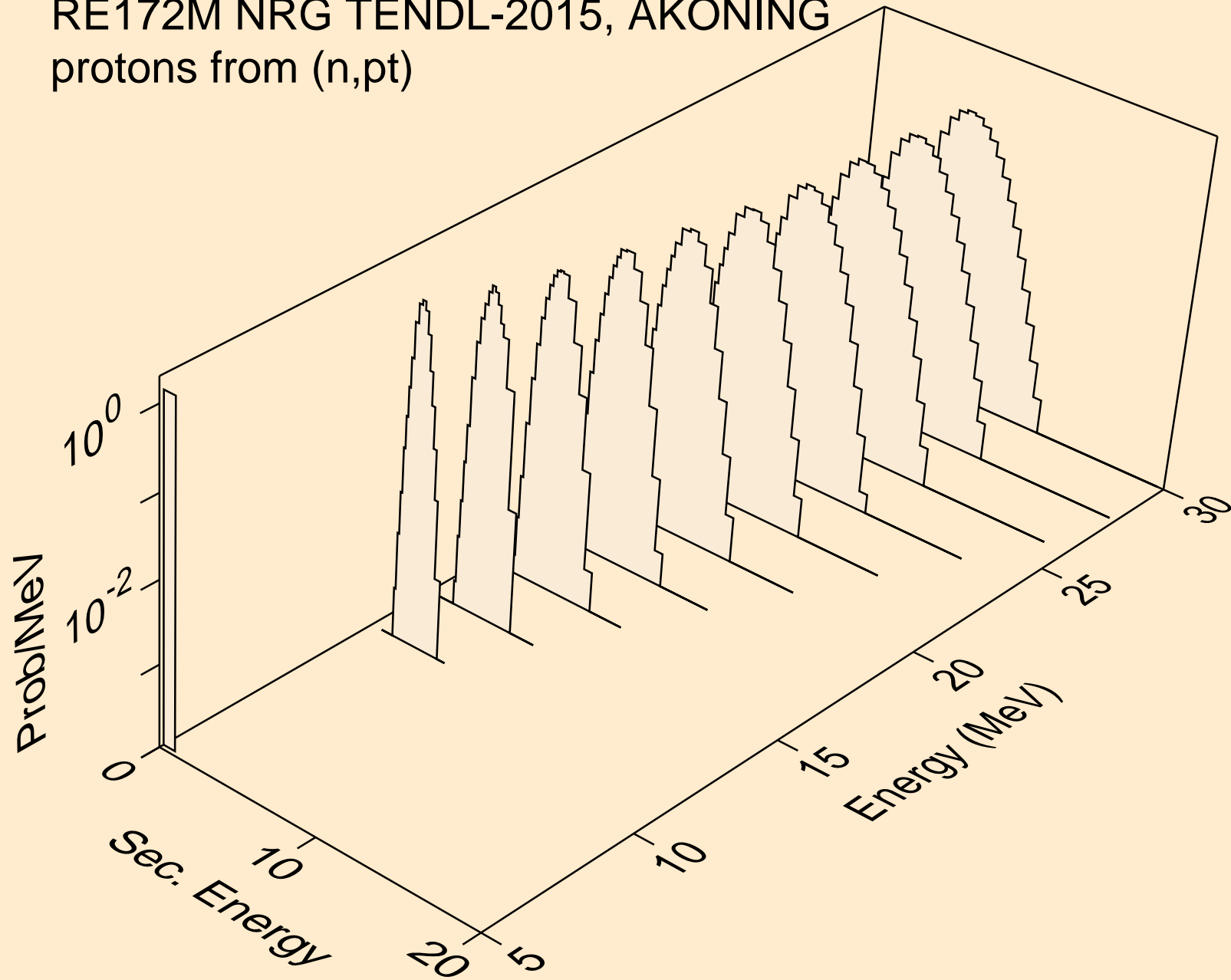

RE172M NRG TENDL-2015, AKONING
deuterons from (n,x)

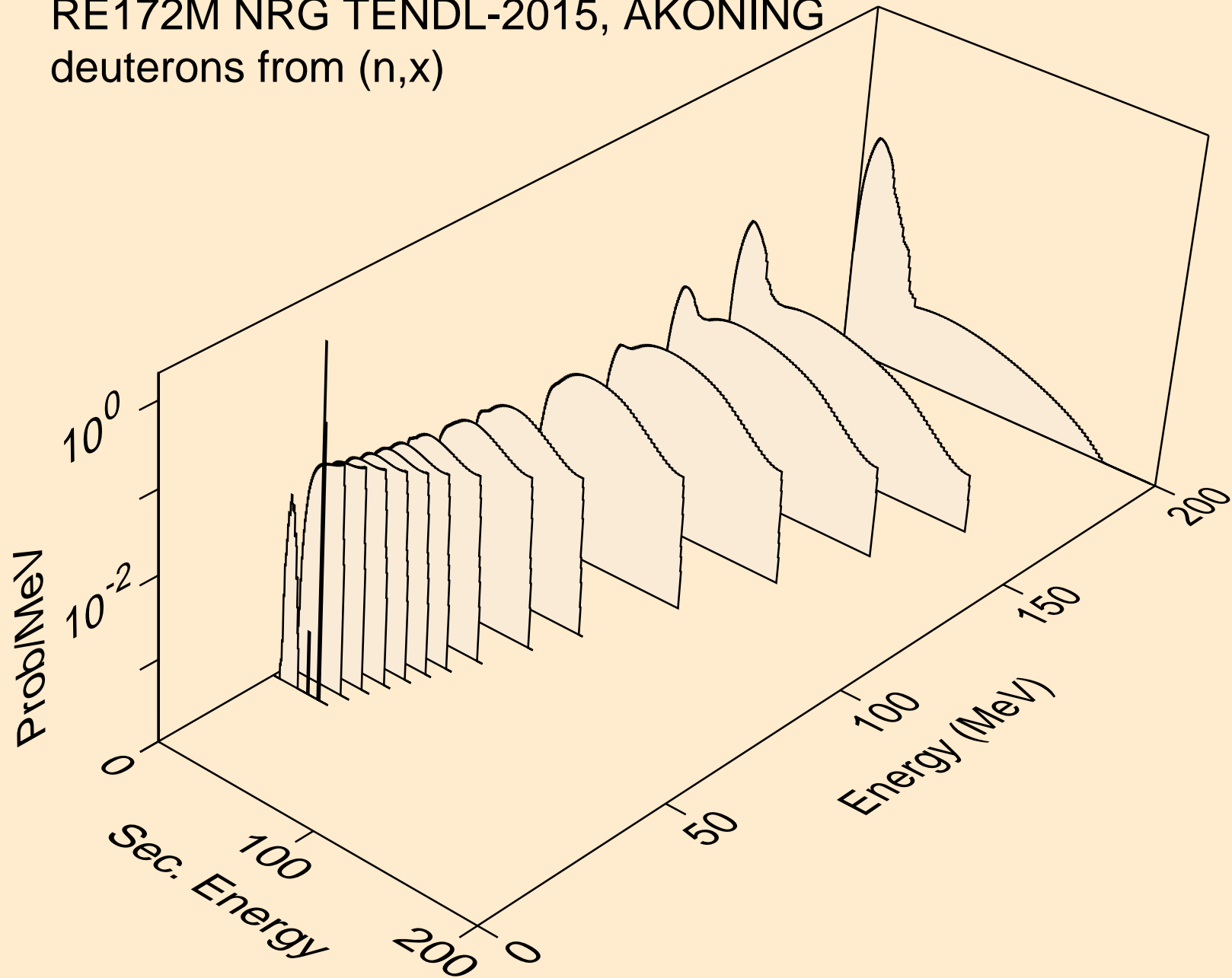

RE172M NRG TENDL-2015, AKONING
deuterons from (n,2nd)

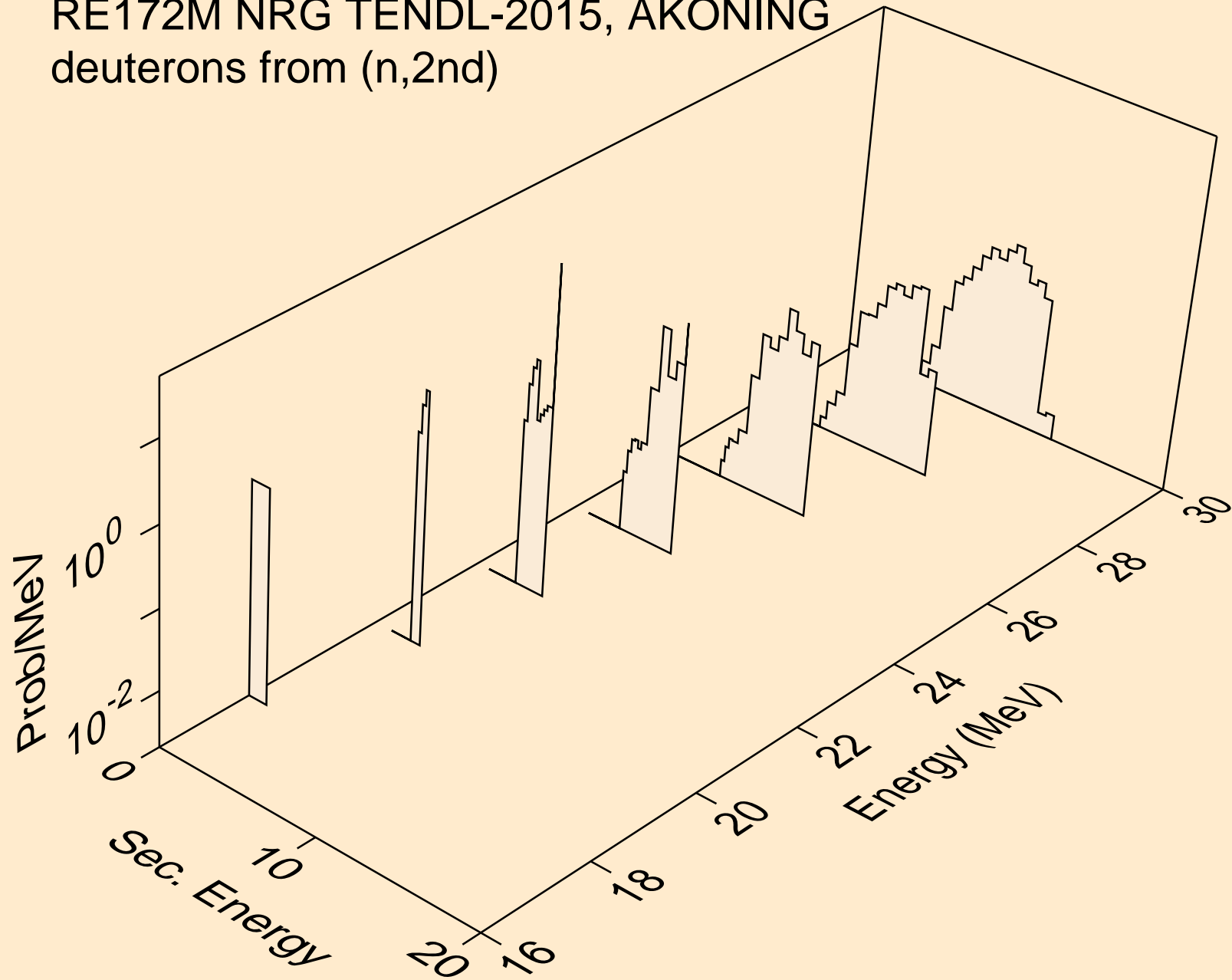

RE172M NRG TENDL-2015, AKONING
deuterons from (n,n*)d

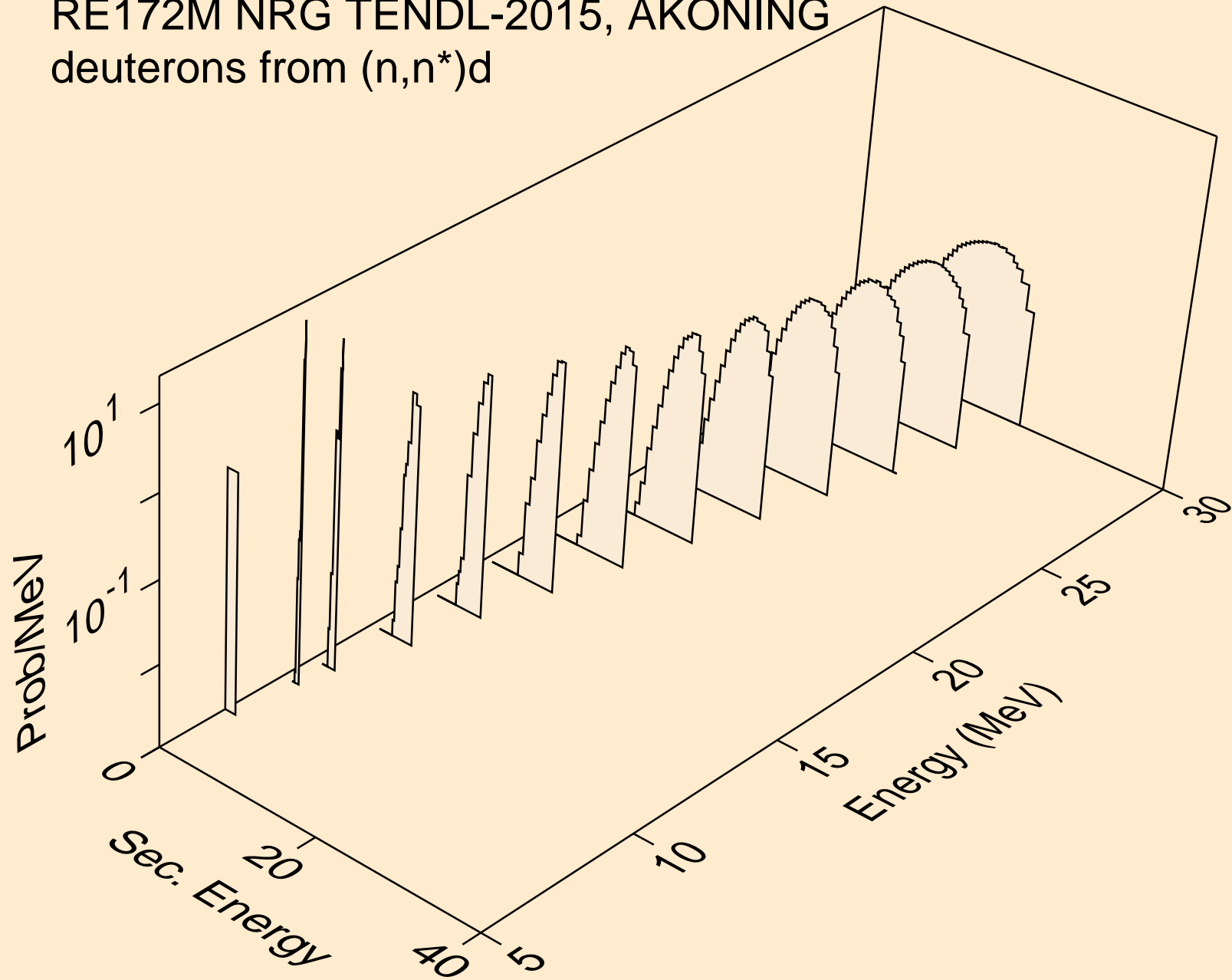

RE172M NRG TENDL-2015, AKONING
deuterons from (n,d)

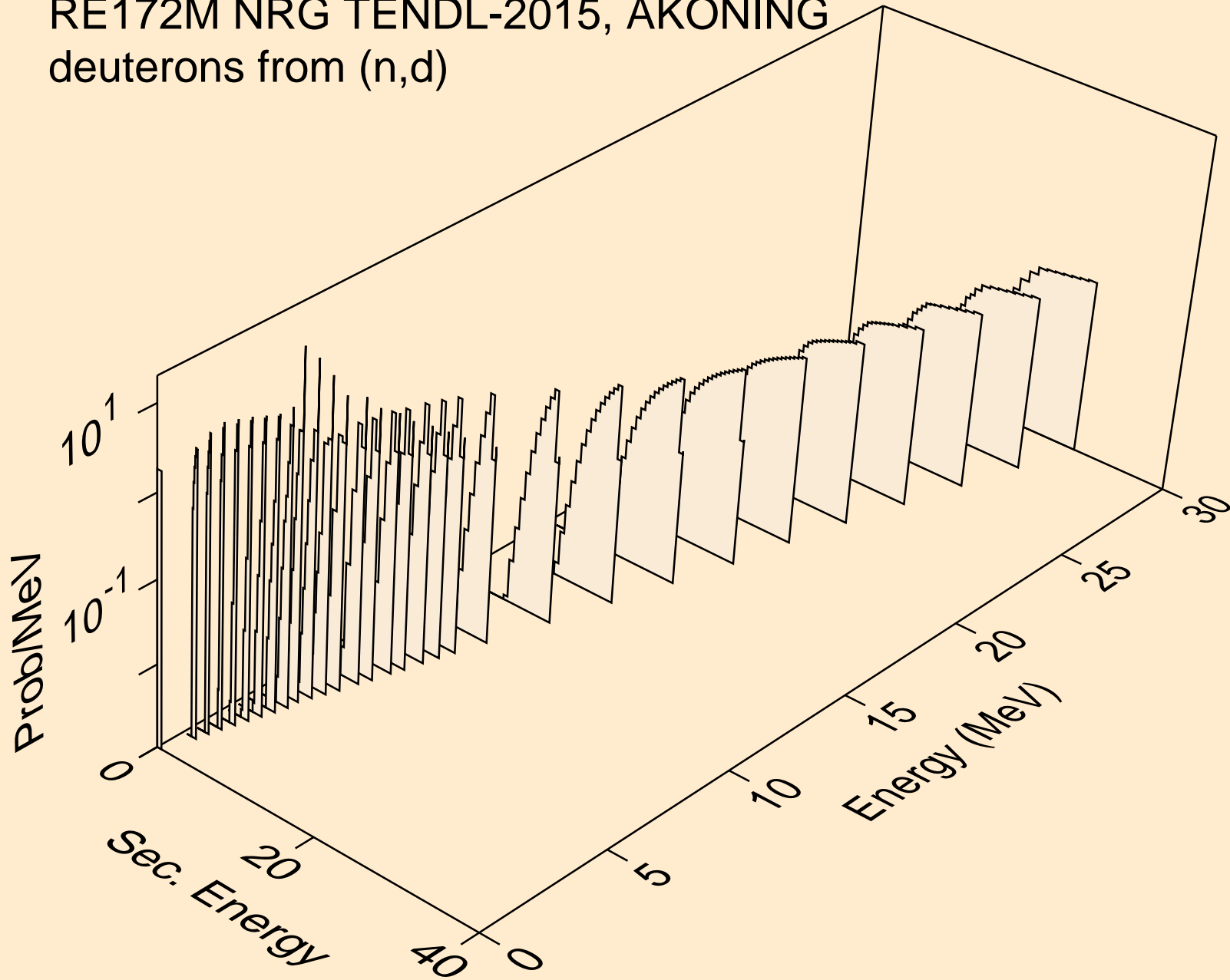

RE172M NRG TENDL-2015, AKONING
deuterons from (n,d2a)

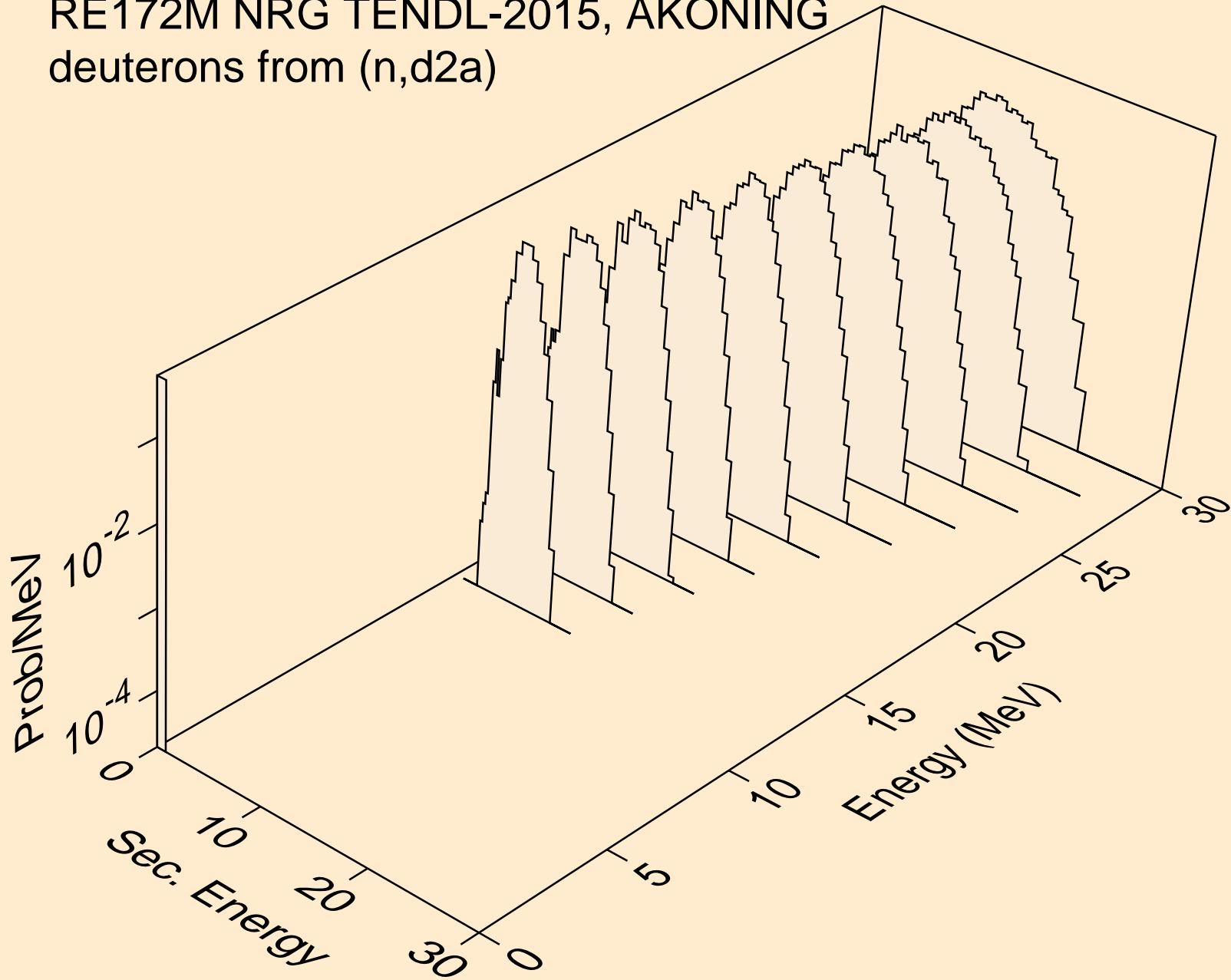

RE172M NRG TENDL-2015, AKONING
deuterons from (n,pd)

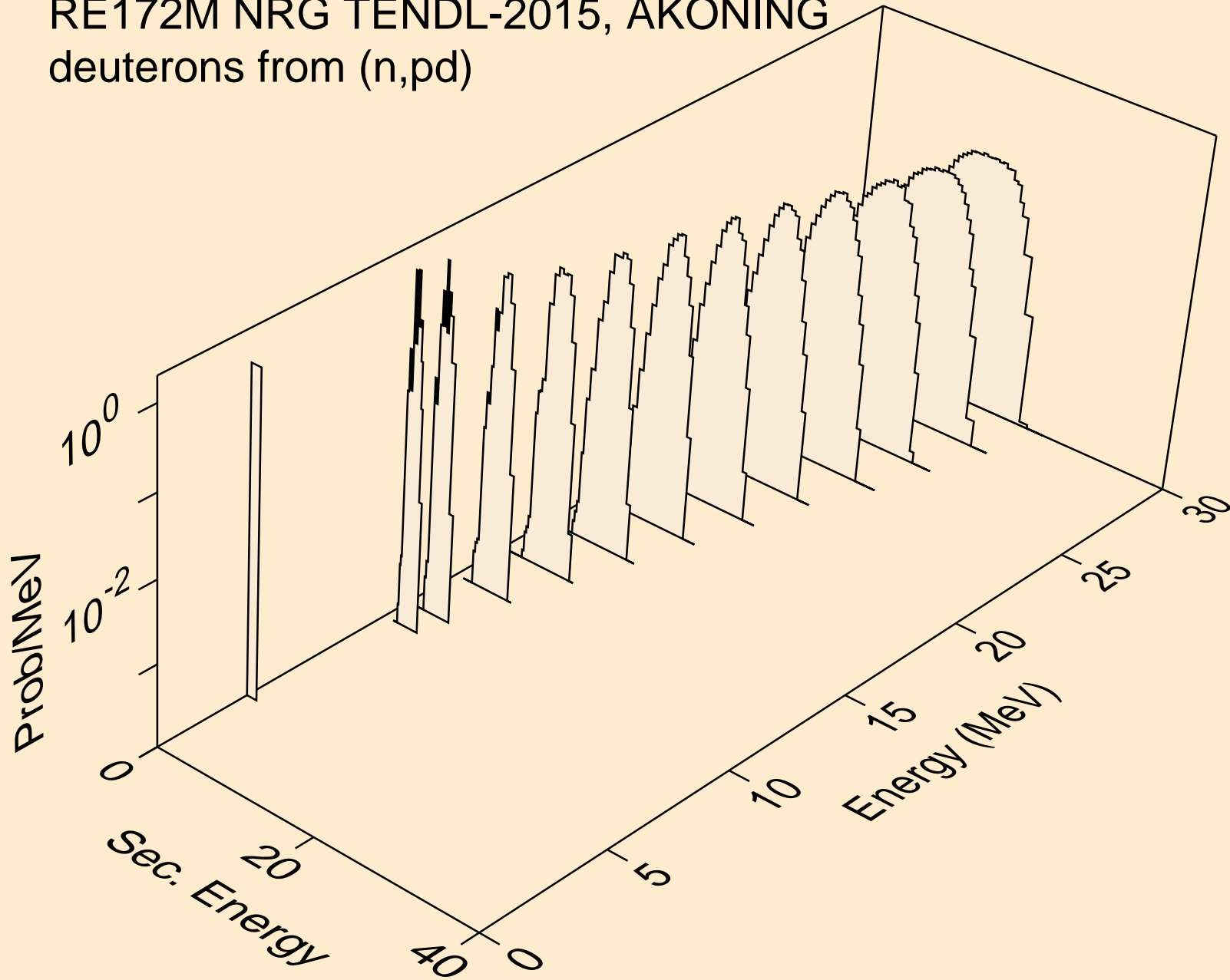

RE172M NRG TENDL-2015, AKONING
deuterons from (n,da)

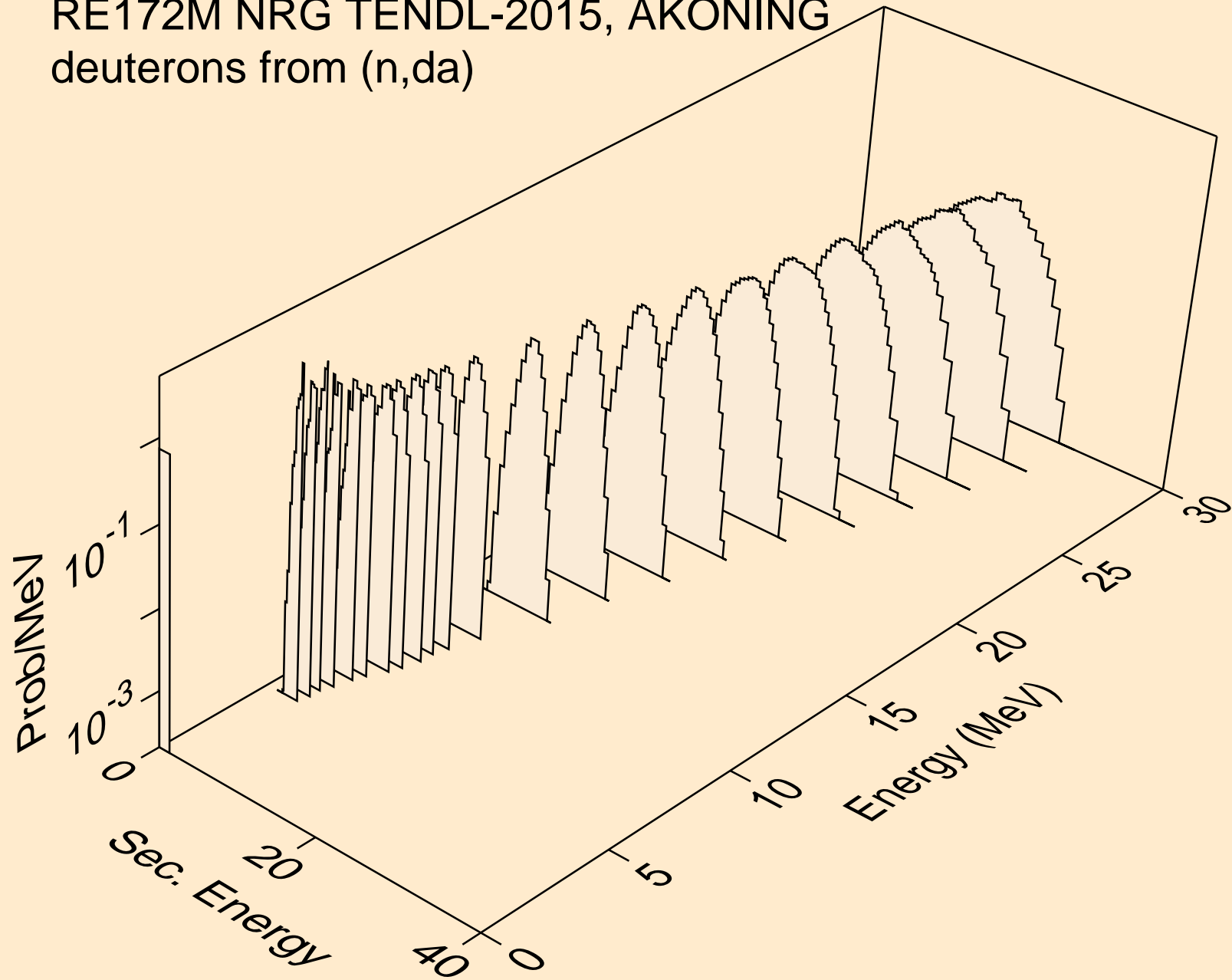

RE172M NRG TENDL-2015, AKONING
tritons from (n,x)

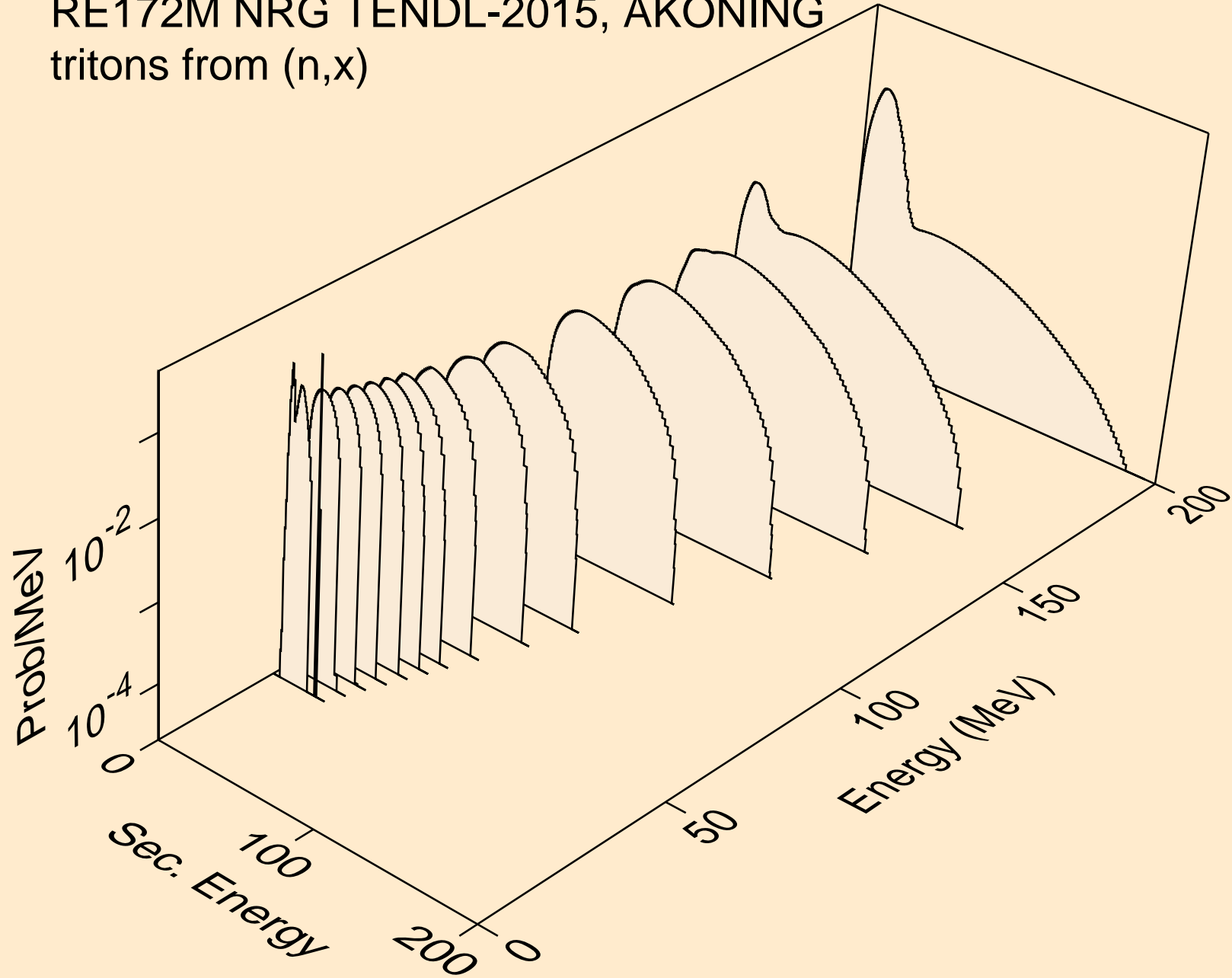

RE172M NRG TENDL-2015, AKONING
tritons from (n,n*)t

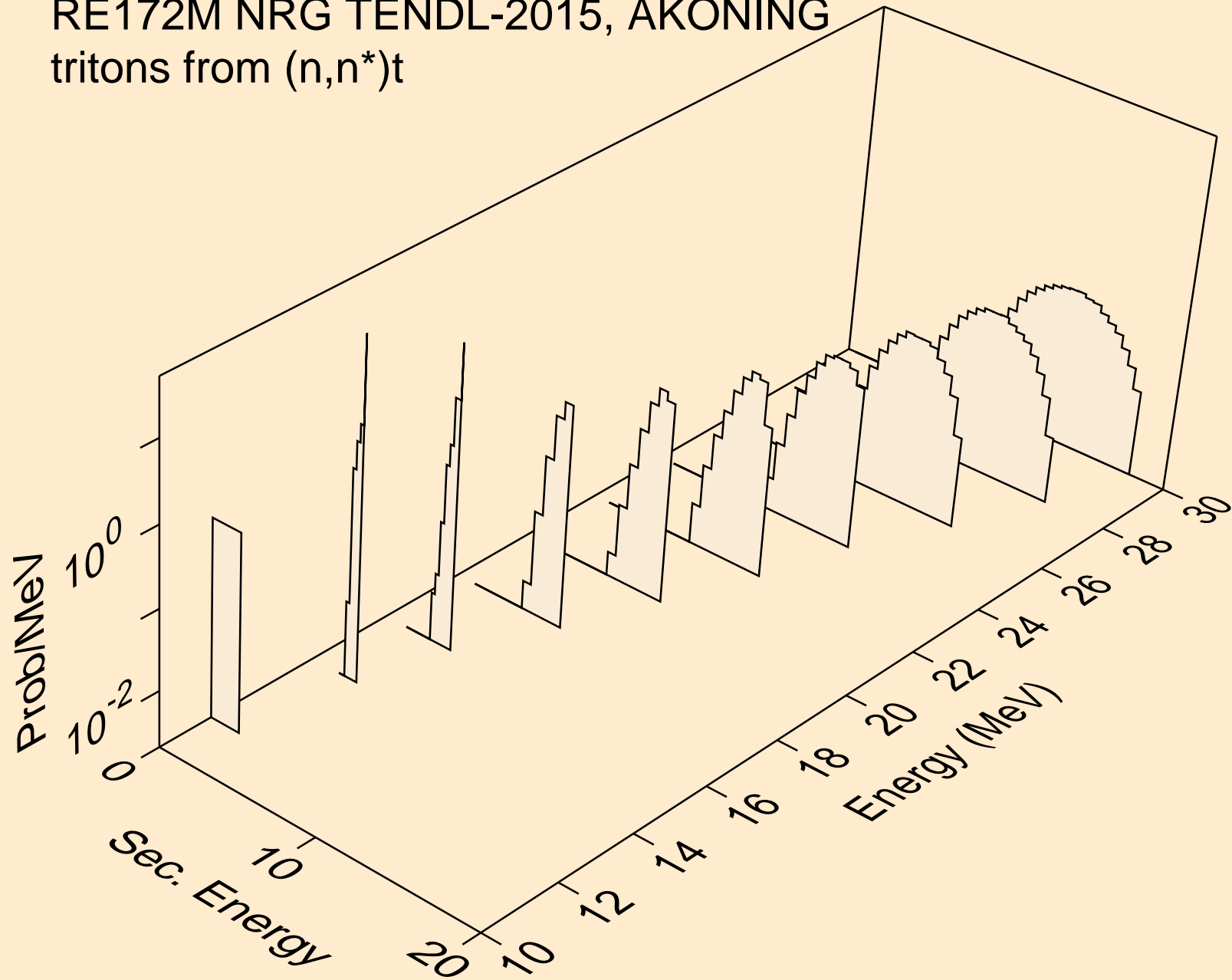

RE172M NRG TENDL-2015, AKONING
tritons from (n,t)

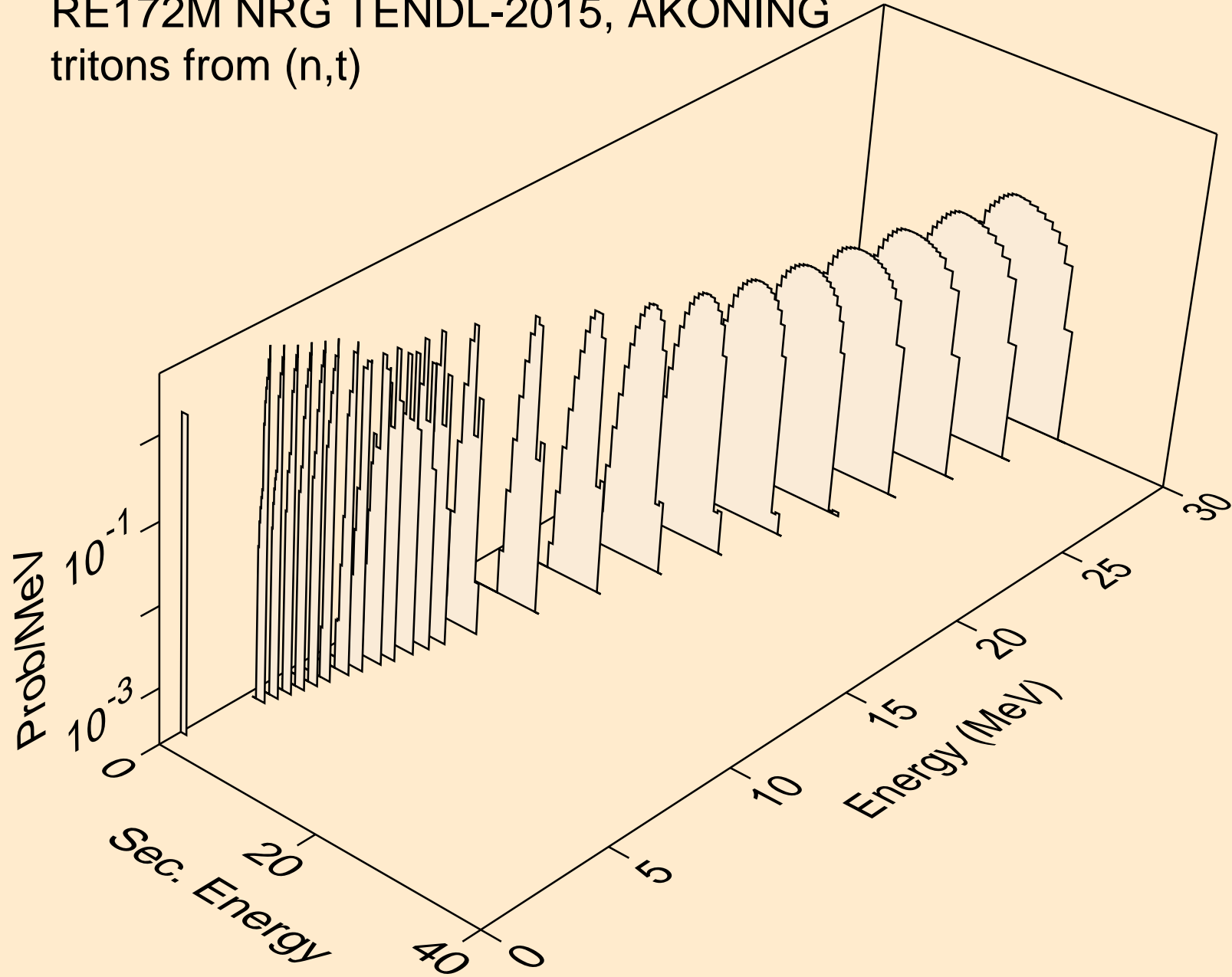

RE172M NRG TENDL-2015, AKONING
tritons from (n,t2a)

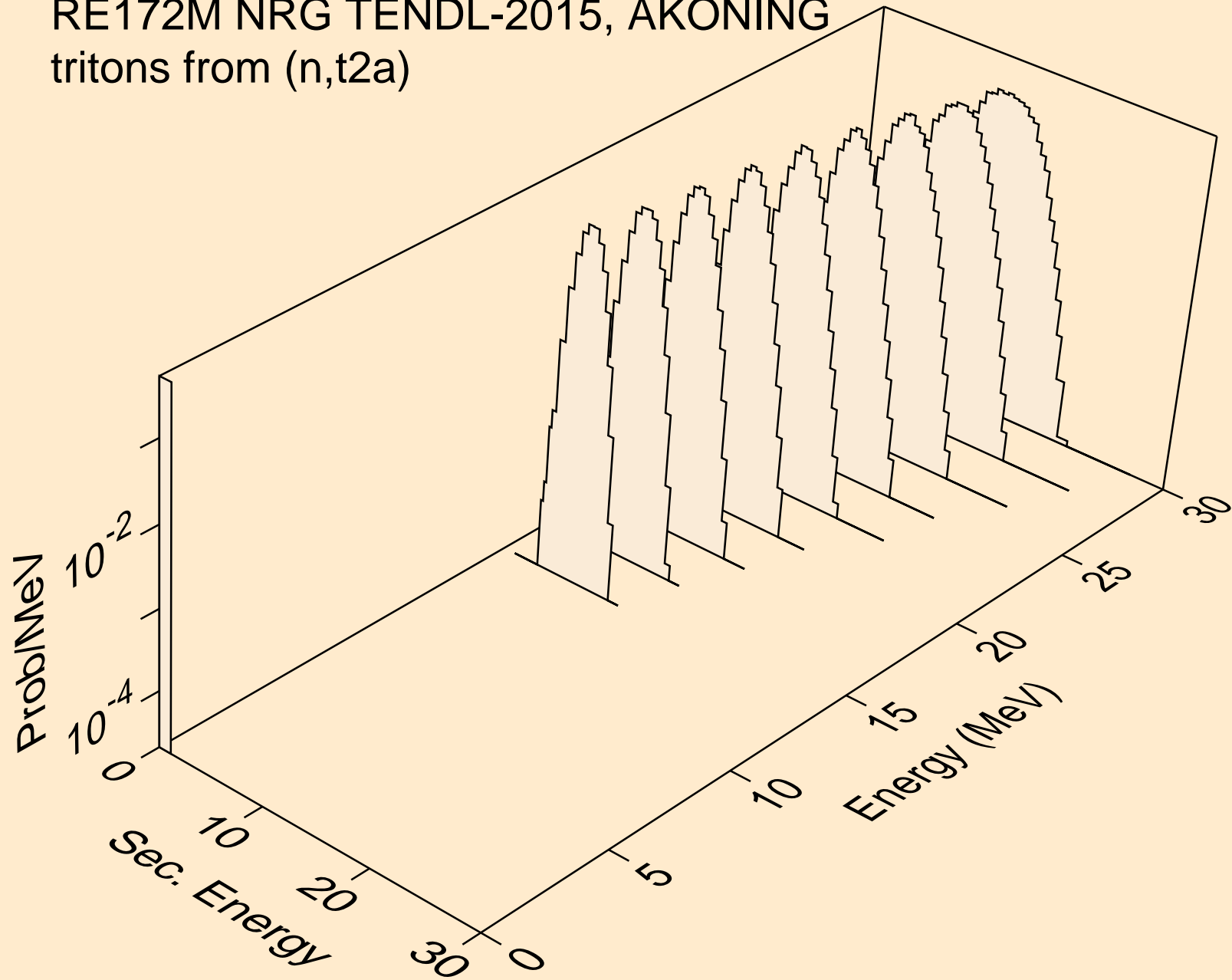

RE172M NRG TENDL-2015, AKONING
tritons from (n,pt)

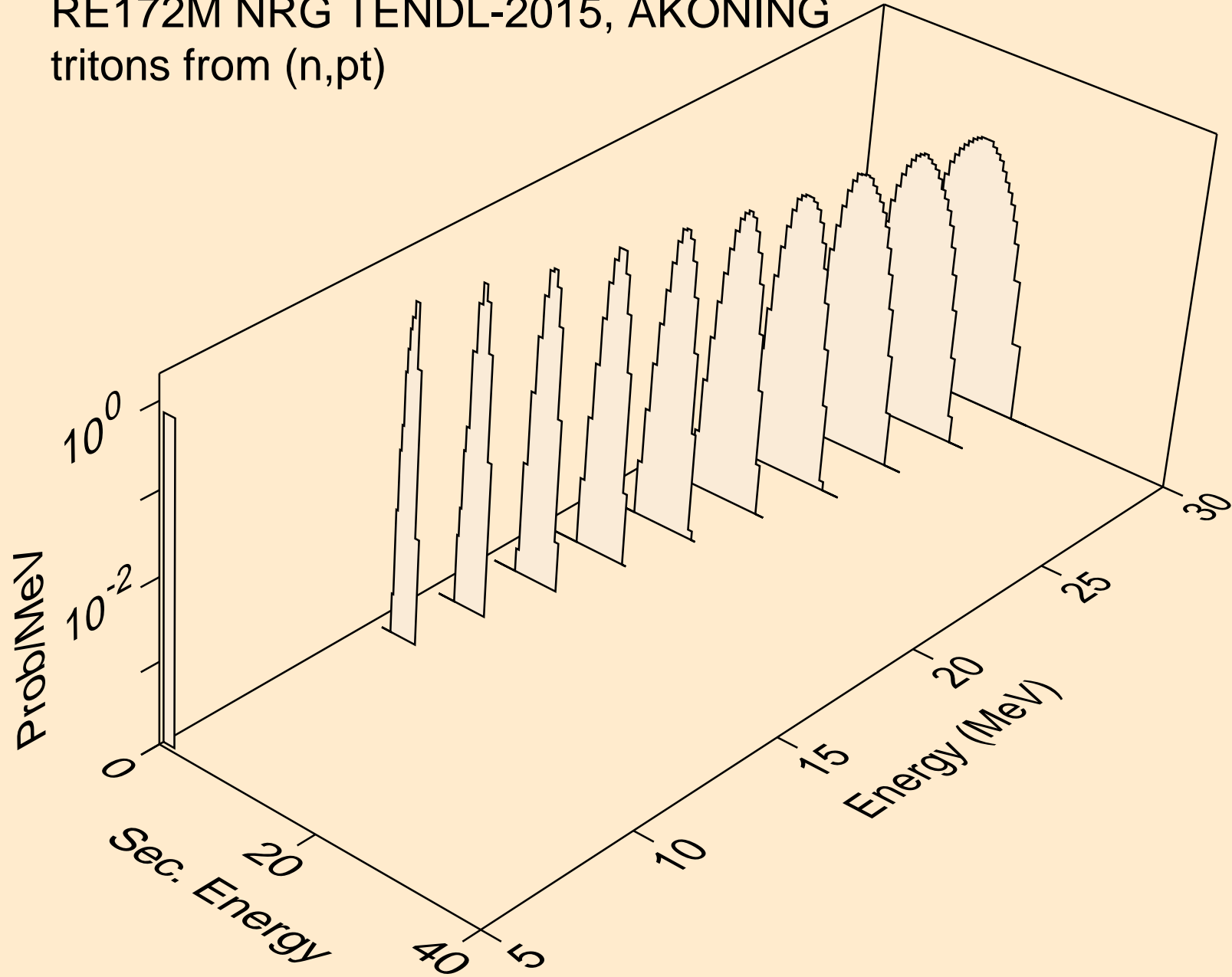

RE172M NRG TENDL-2015, AKONING
he3s from (n,x)

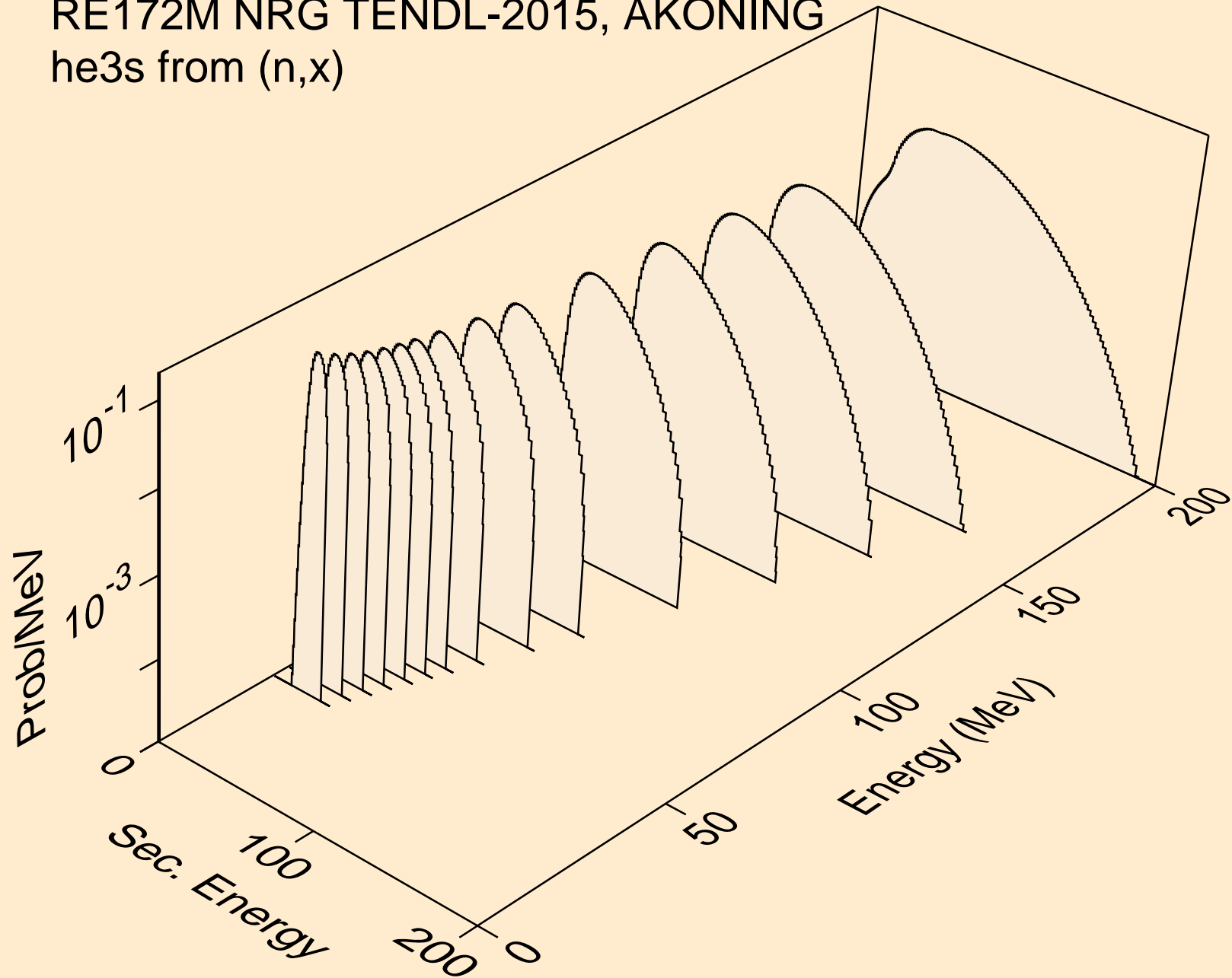

RE172M NRG TENDL-2015, AKONING
he3s from (n,n*)he3

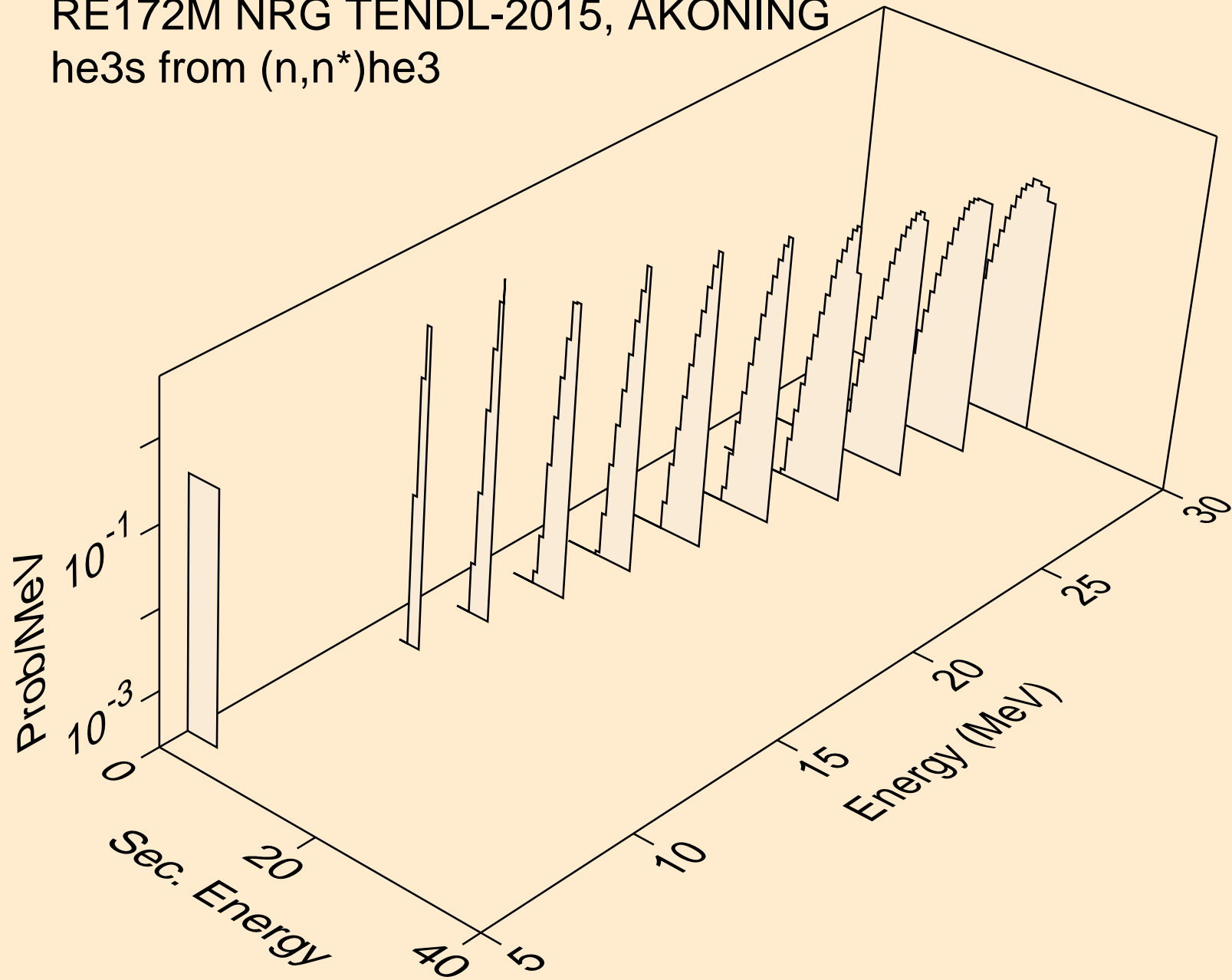

RE172M NRG TENDL-2015, AKONING
he3s from (n,he3)

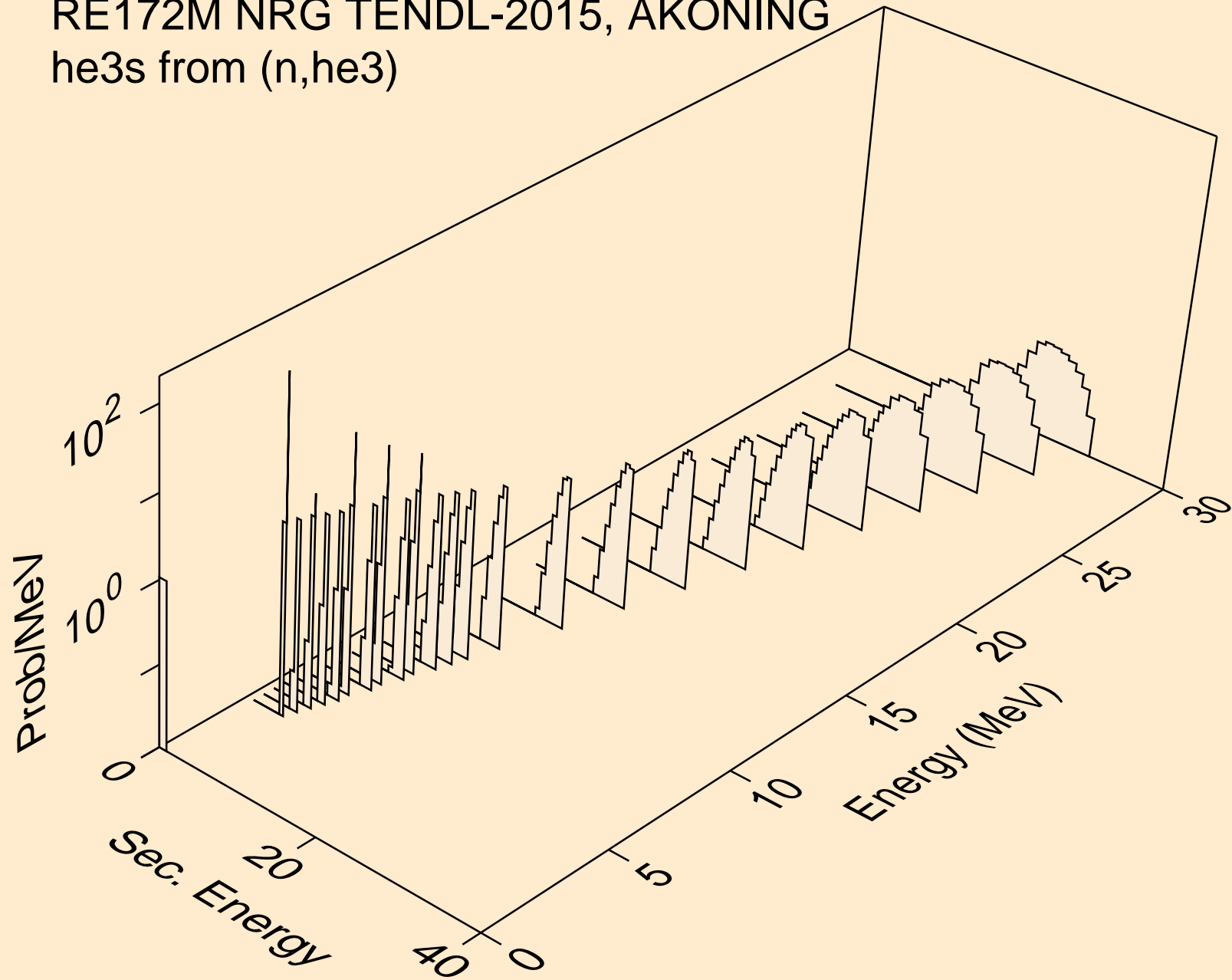

RE172M NRG TENDL-2015, AKONING
alphas from (n,x)

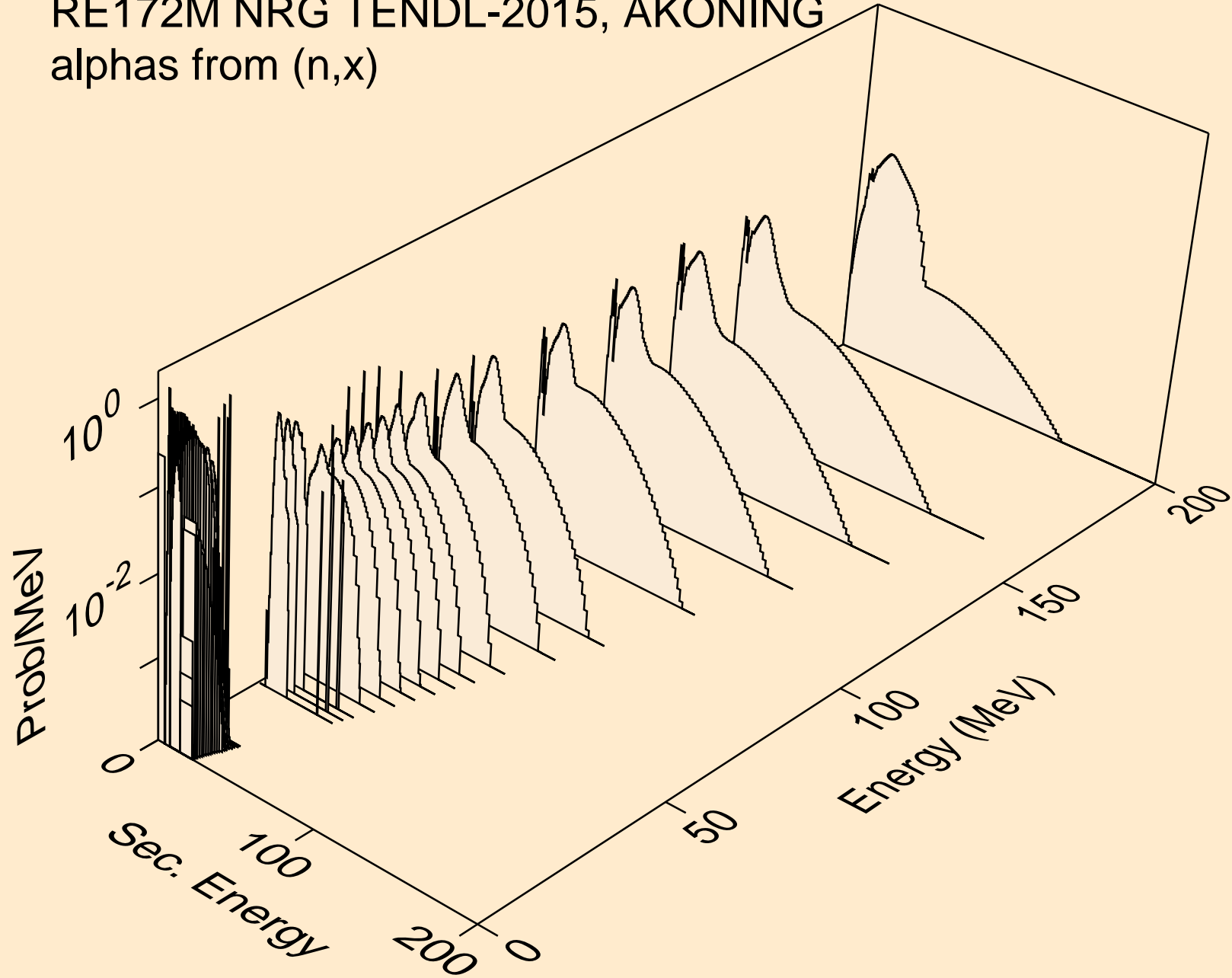

RE172M NRG TENDL-2015, AKONING
alphas from (n,n*)a

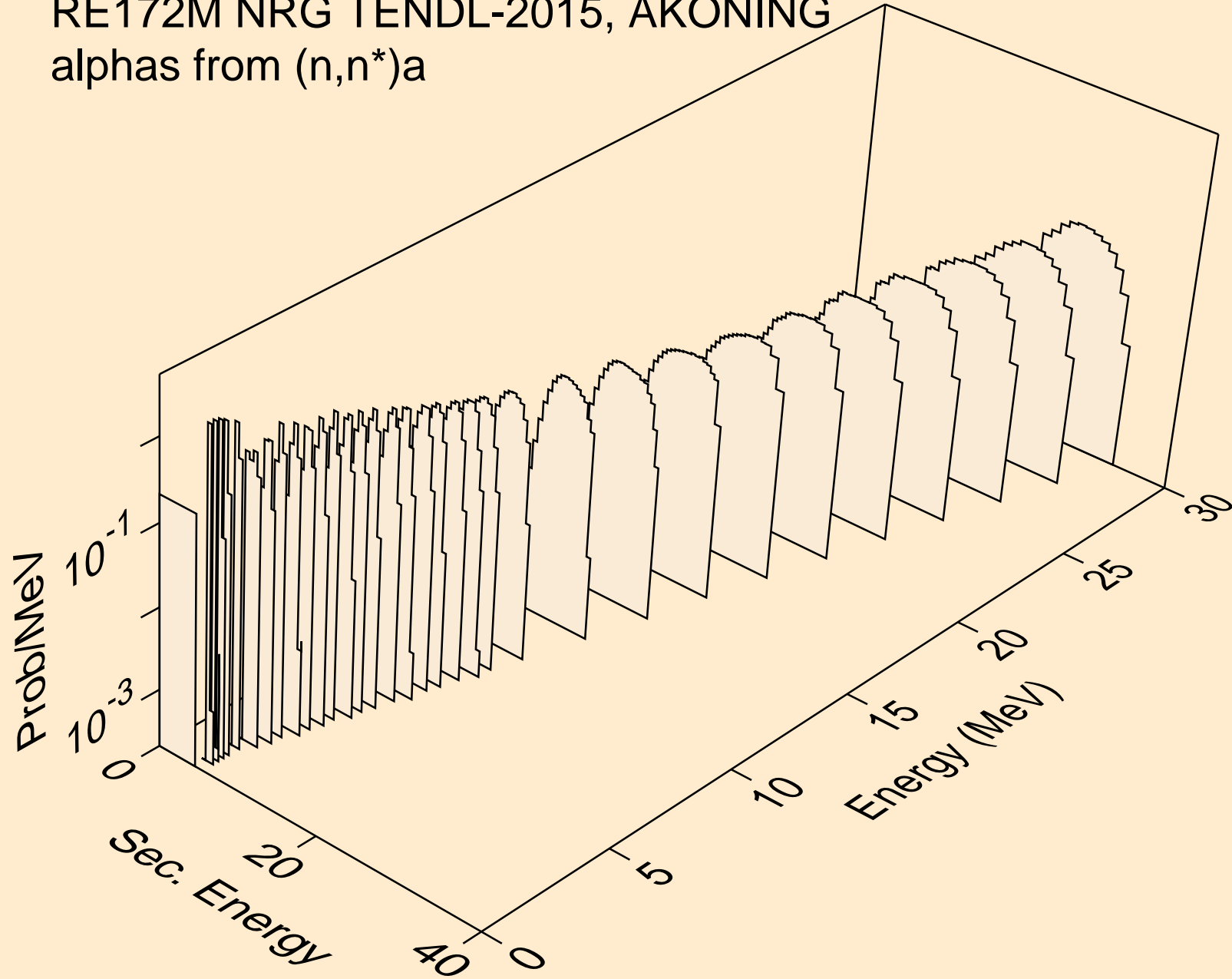

RE172M NRG TENDL-2015, AKONING
alphas from (n,n*)3a

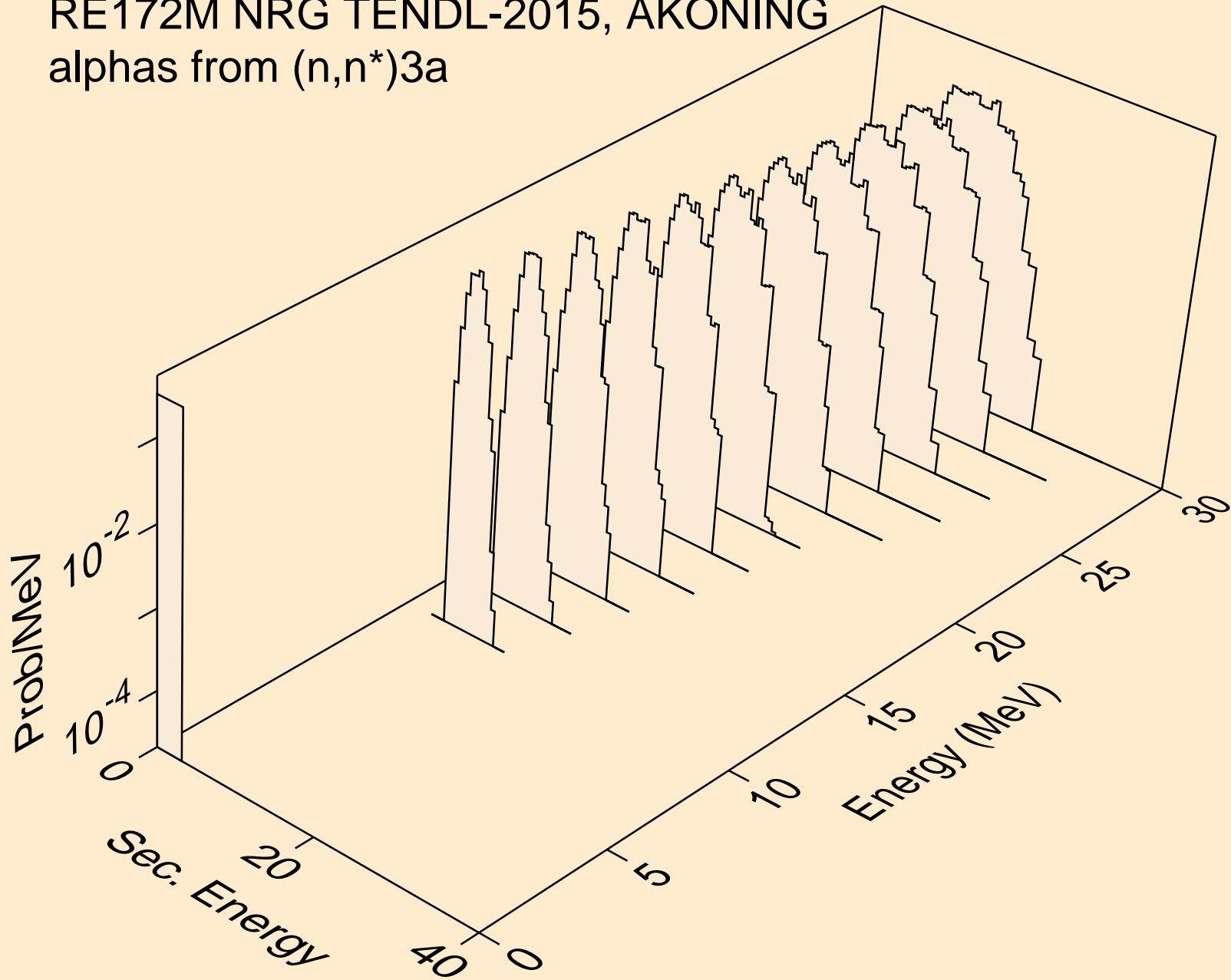

RE172M NRG TENDL-2015, AKONING
alphas from (n,2n)a

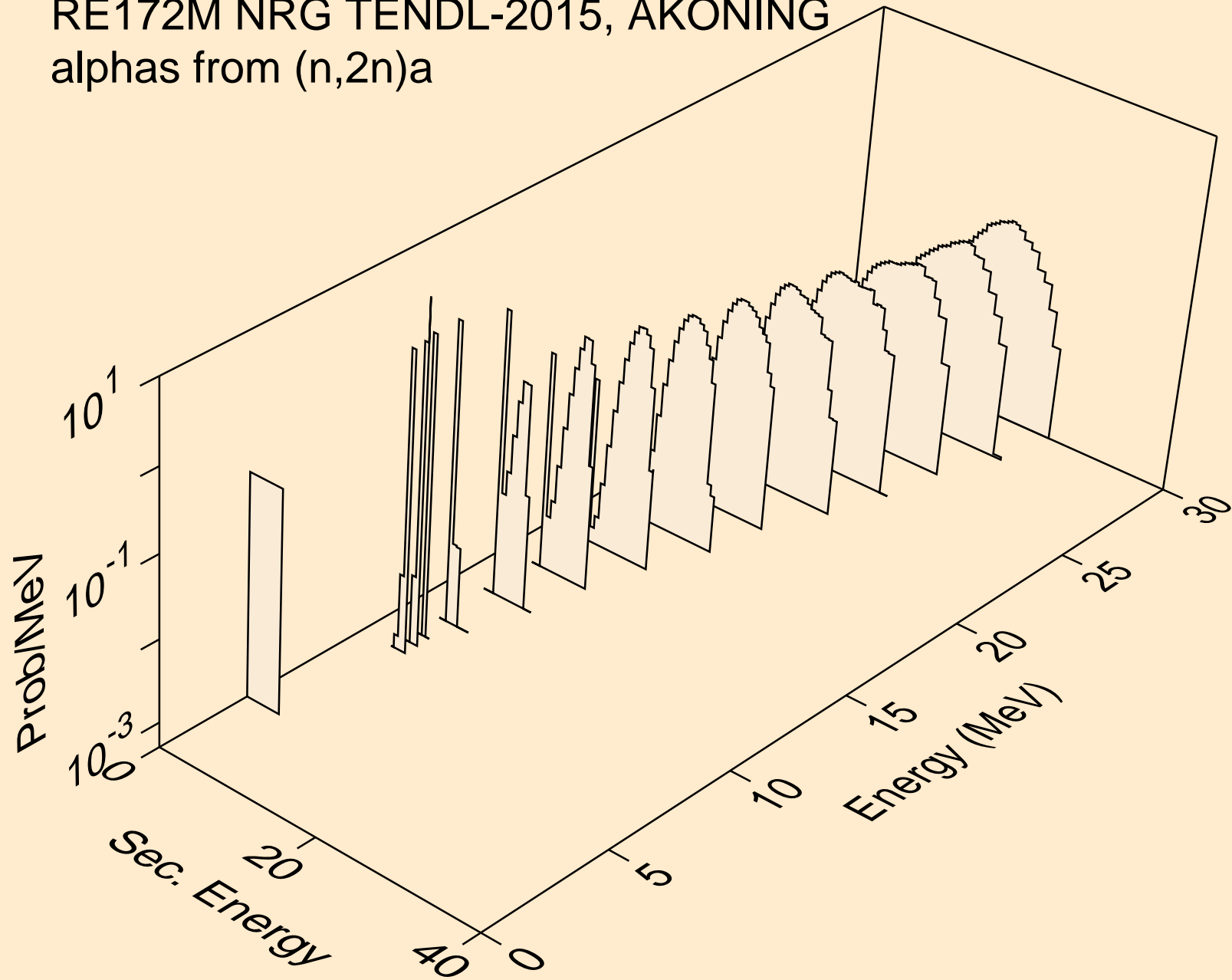

RE172M NRG TENDL-2015, AKONING
alphas from (n,3n)a

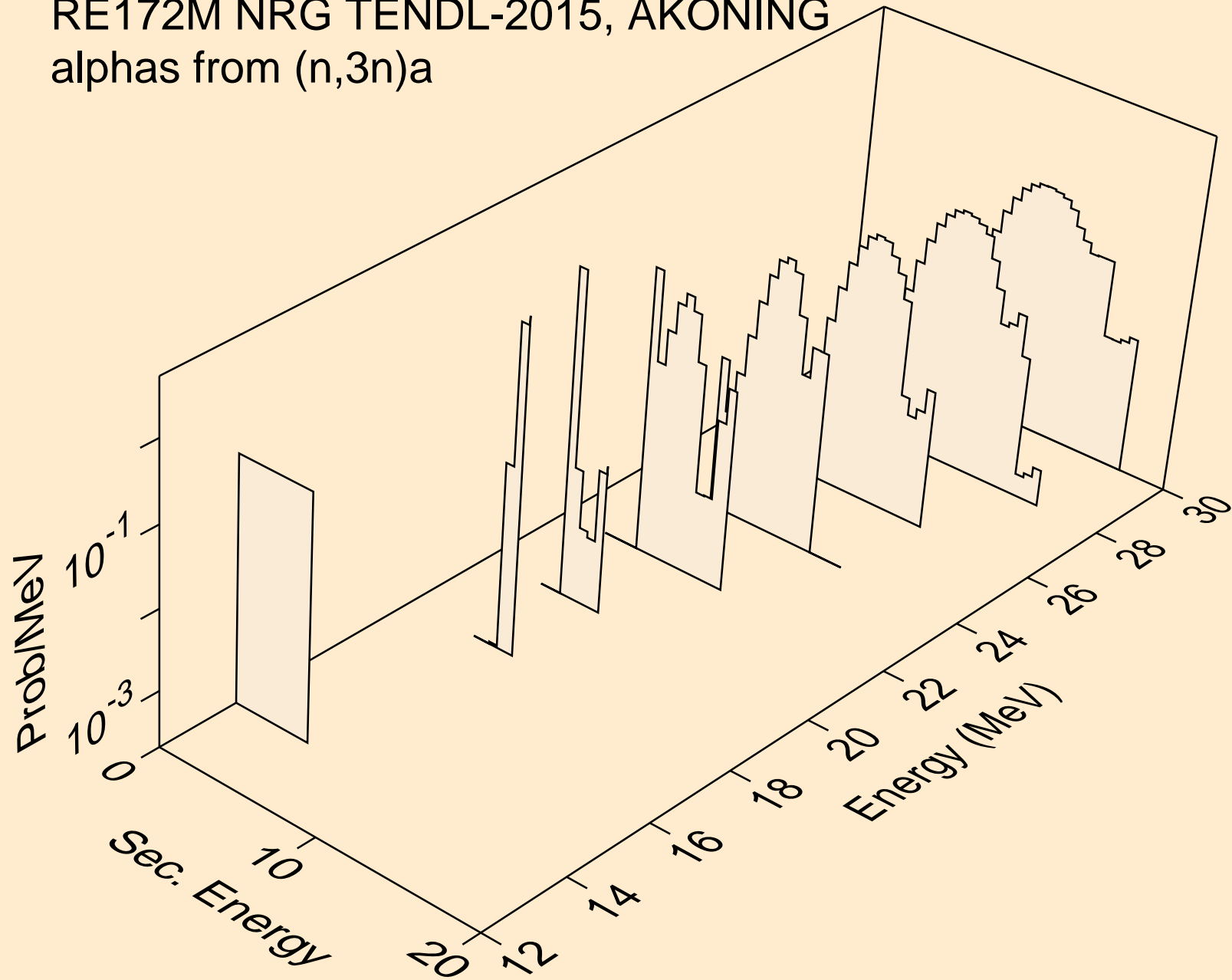

RE172M NRG TENDL-2015, AKONING
alphas from (n,n*)2a

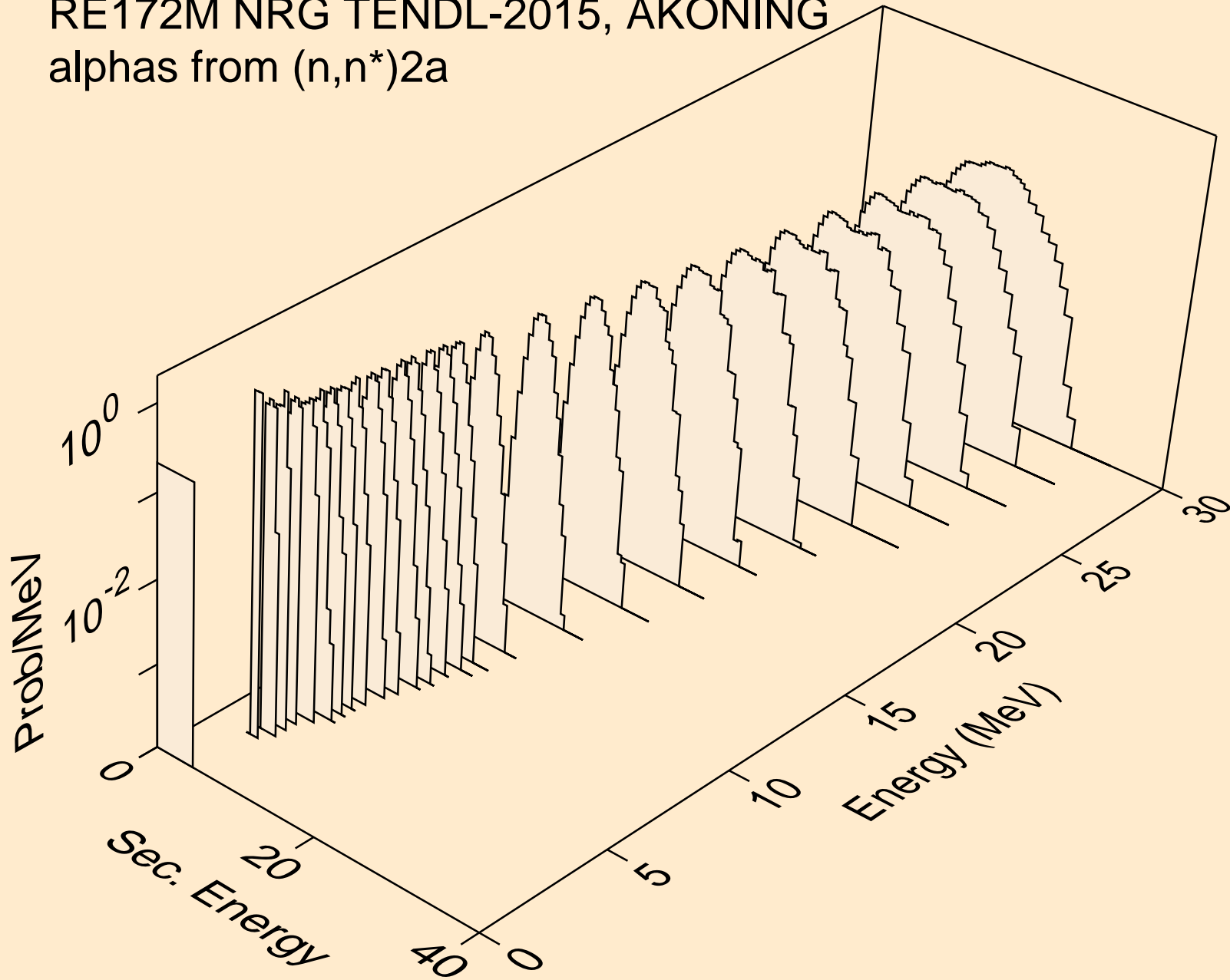

RE172M NRG TENDL-2015, AKONING
alphas from (n,2n)2a

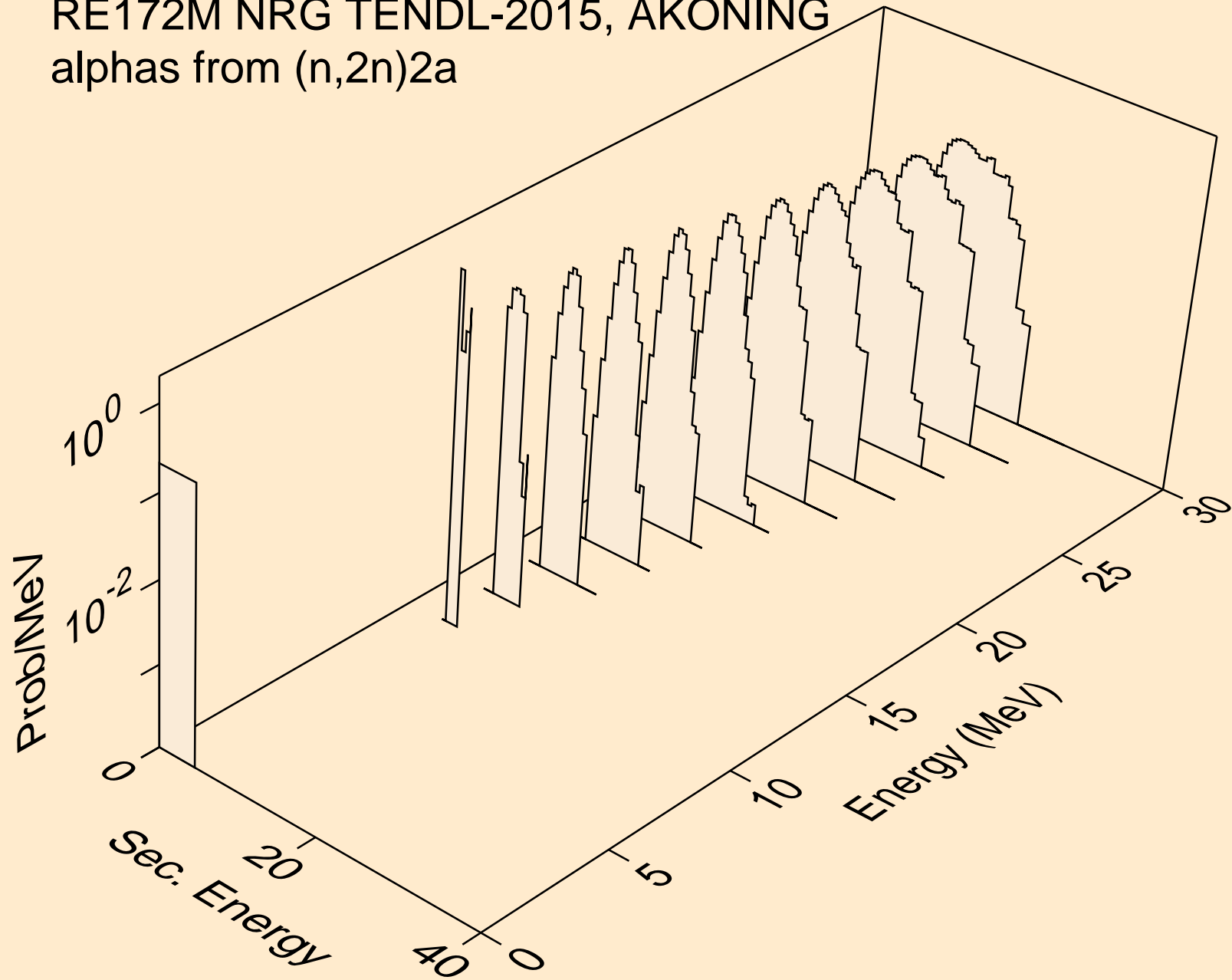

RE172M NRG TENDL-2015, AKONING
alphas from (n,npa)

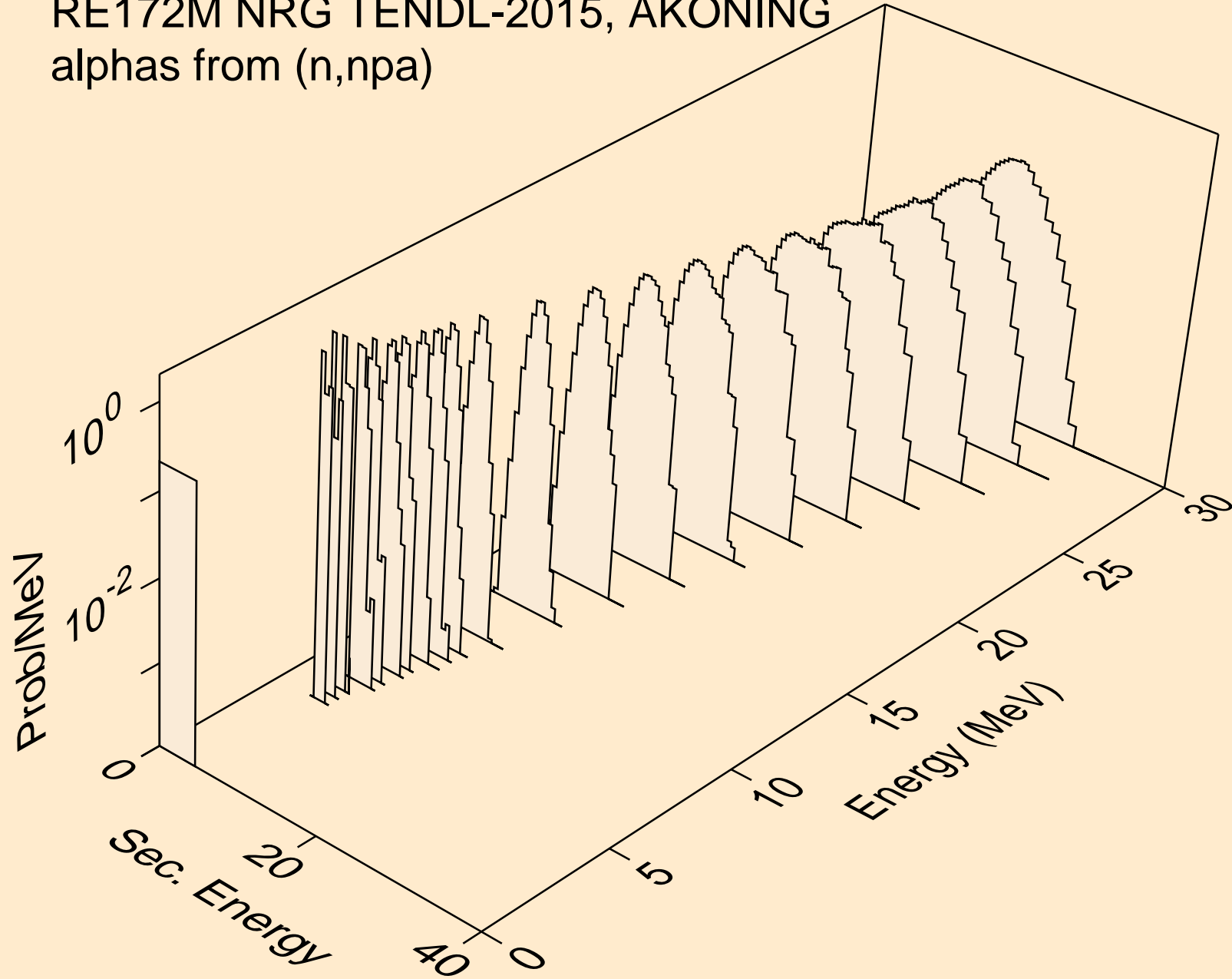

RE172M NRG TENDL-2015, AKONING
alphas from (n,a)

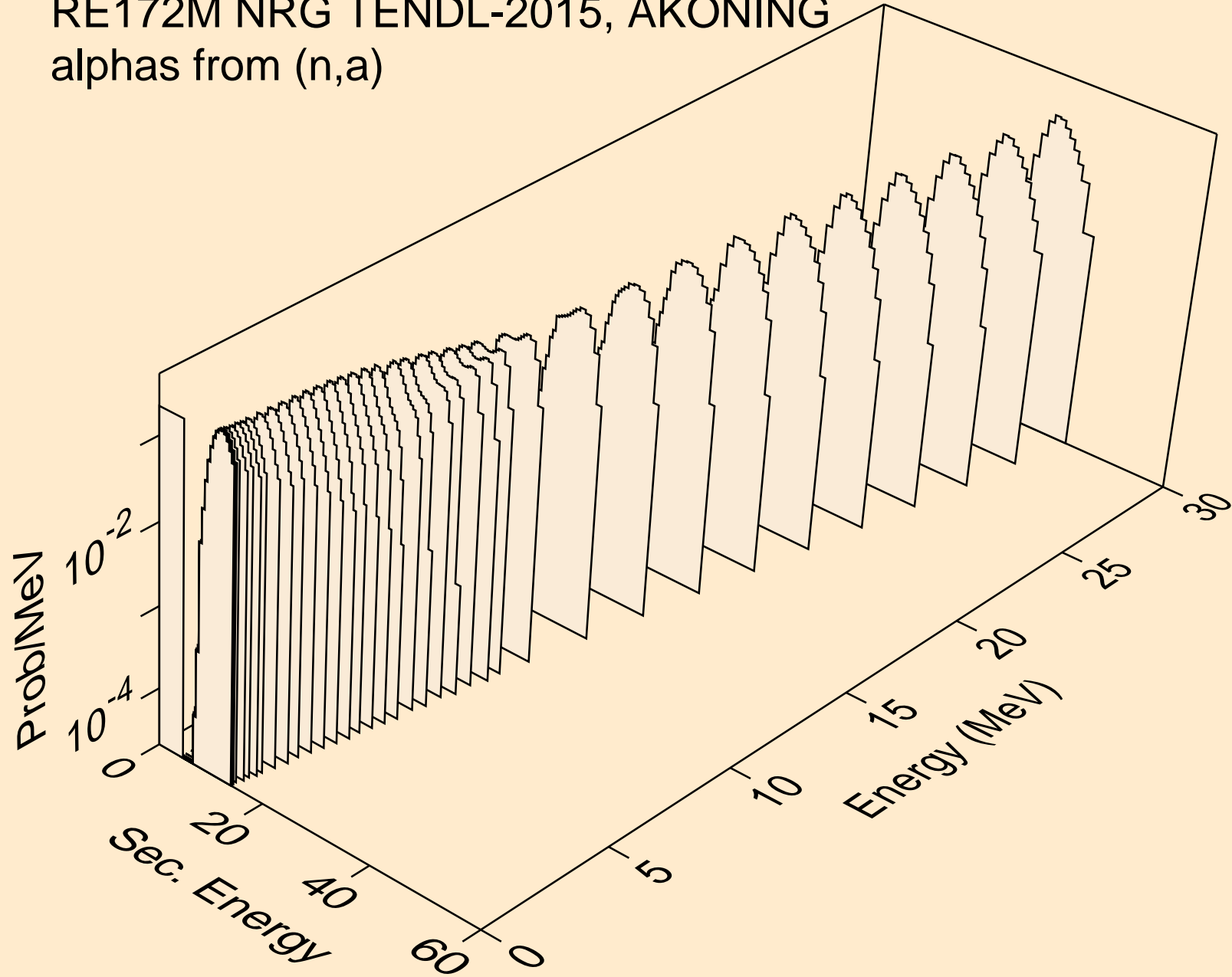

RE172M NRG TENDL-2015, AKONING
alphas from (n,2a)

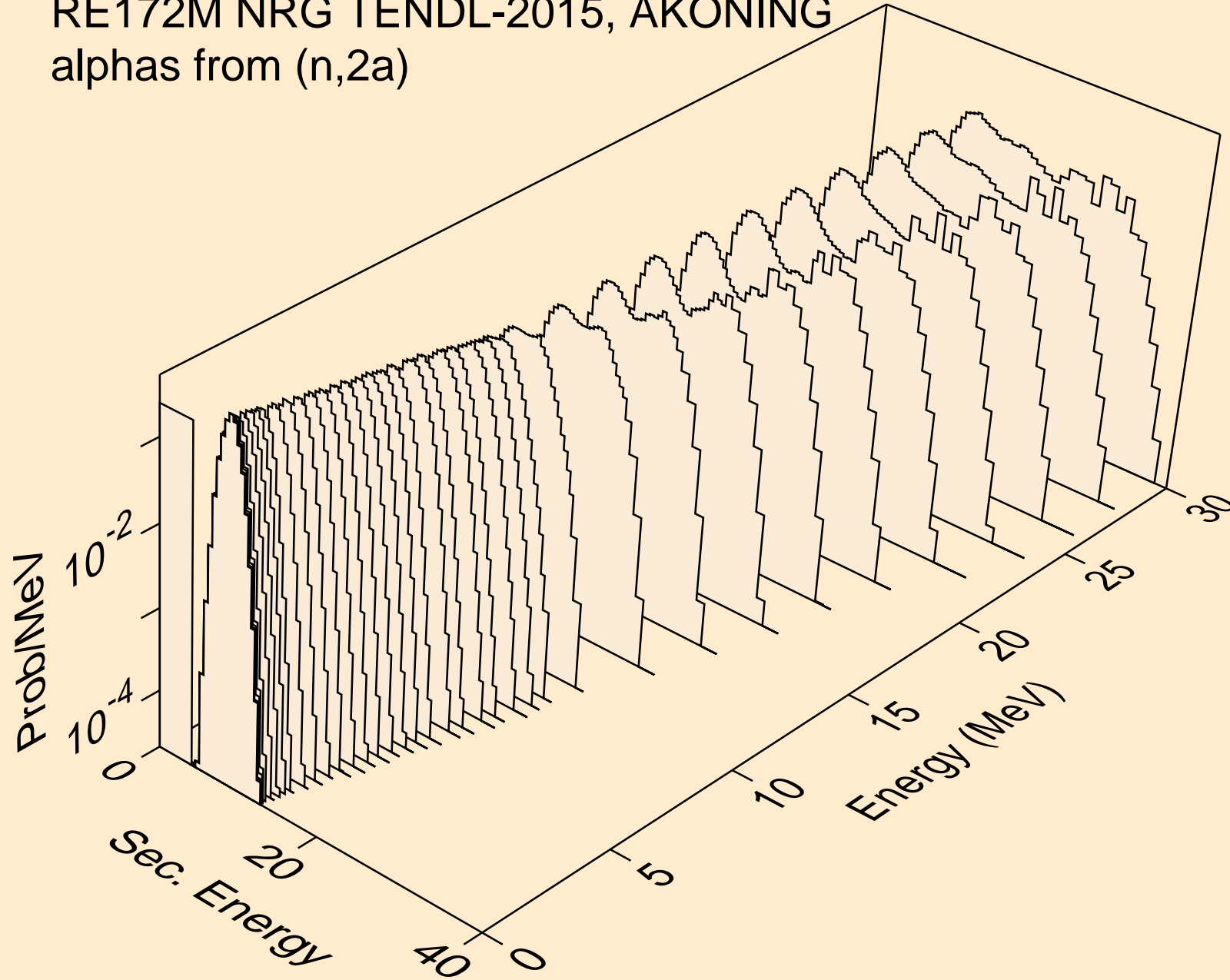

RE172M NRG TENDL-2015, AKONING
alphas from (n,3a)

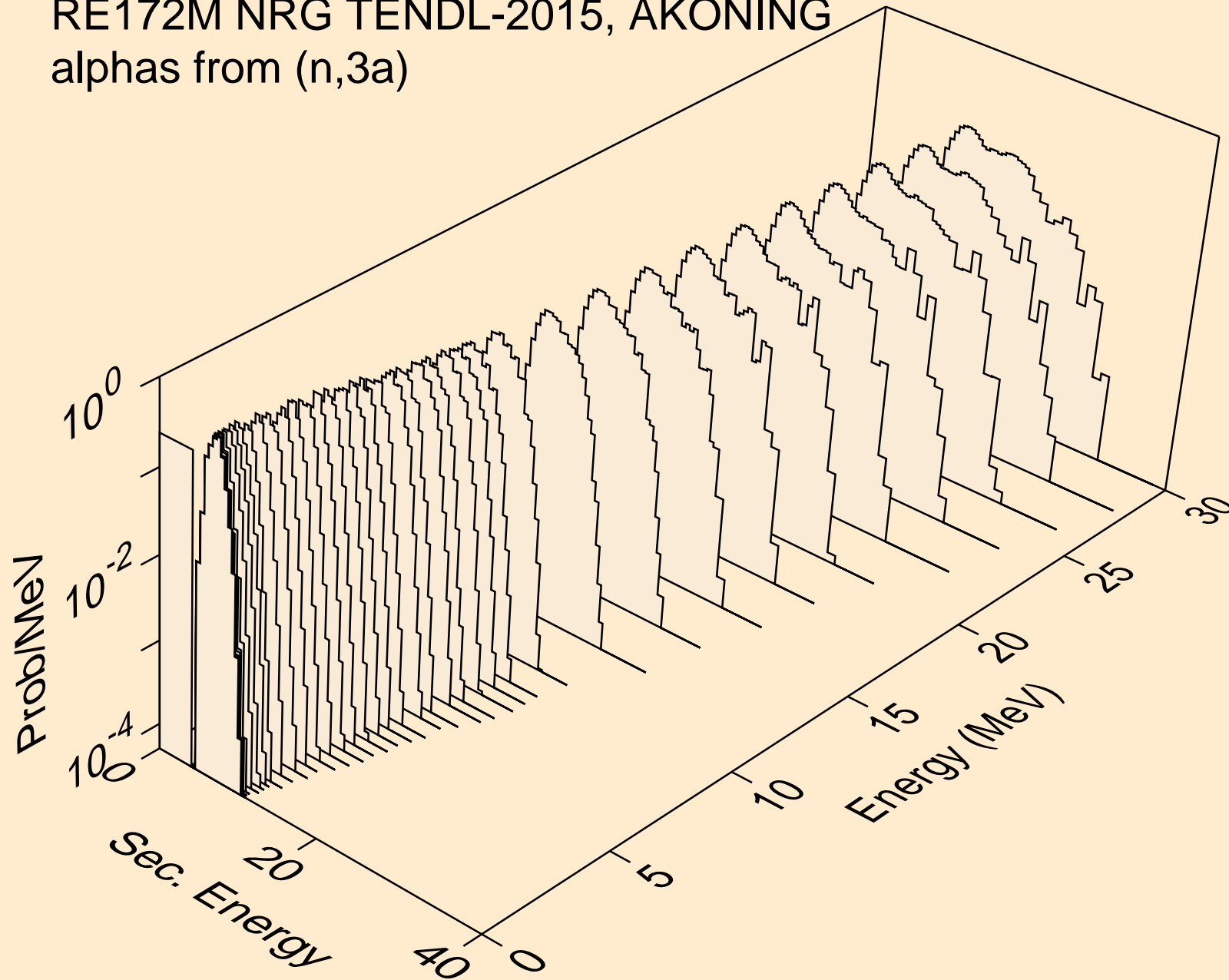

RE172M NRG TENDL-2015, AKONING
alphas from (n,pa)

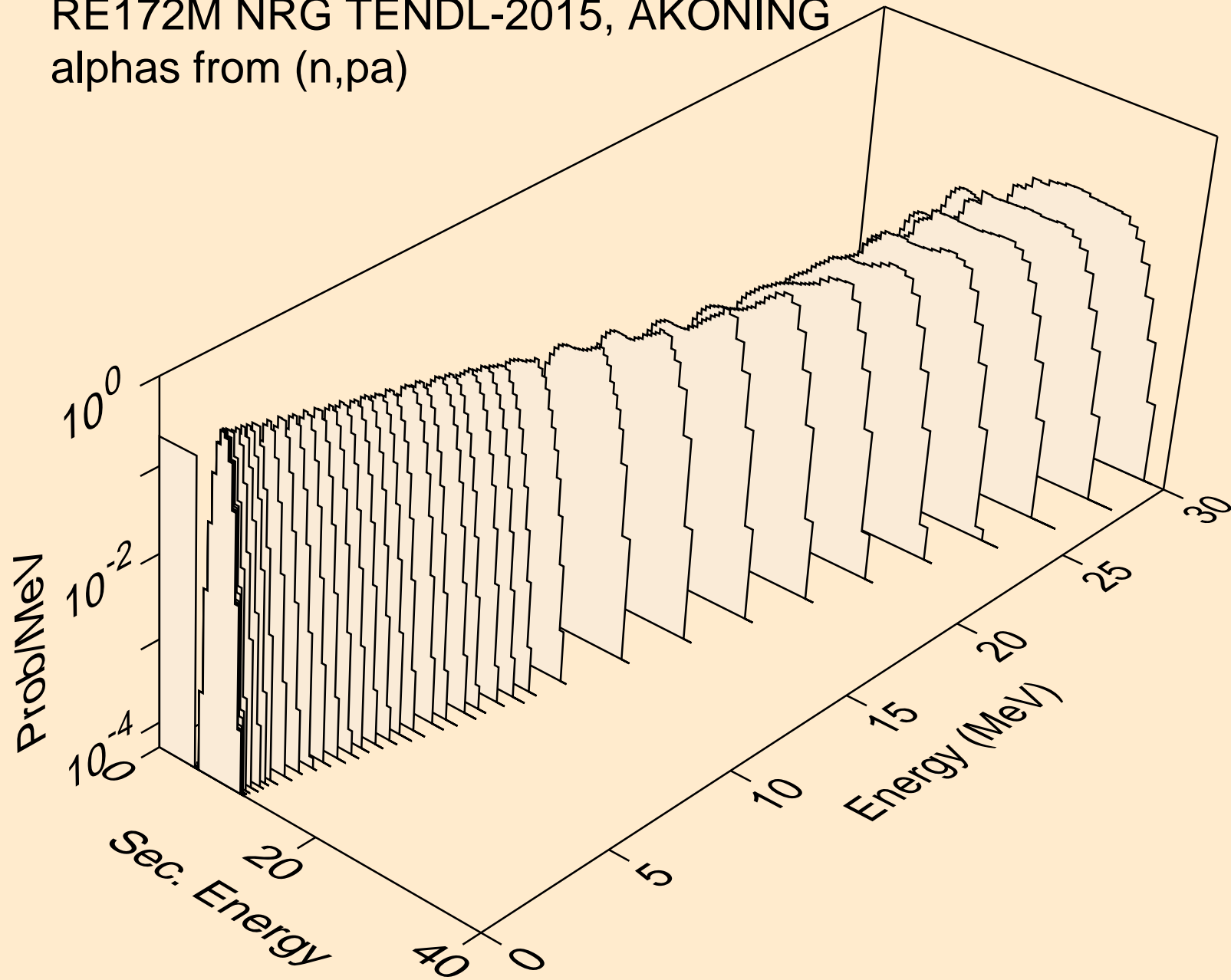

RE172M NRG TENDL-2015, AKONING
alphas from (n,t2a)

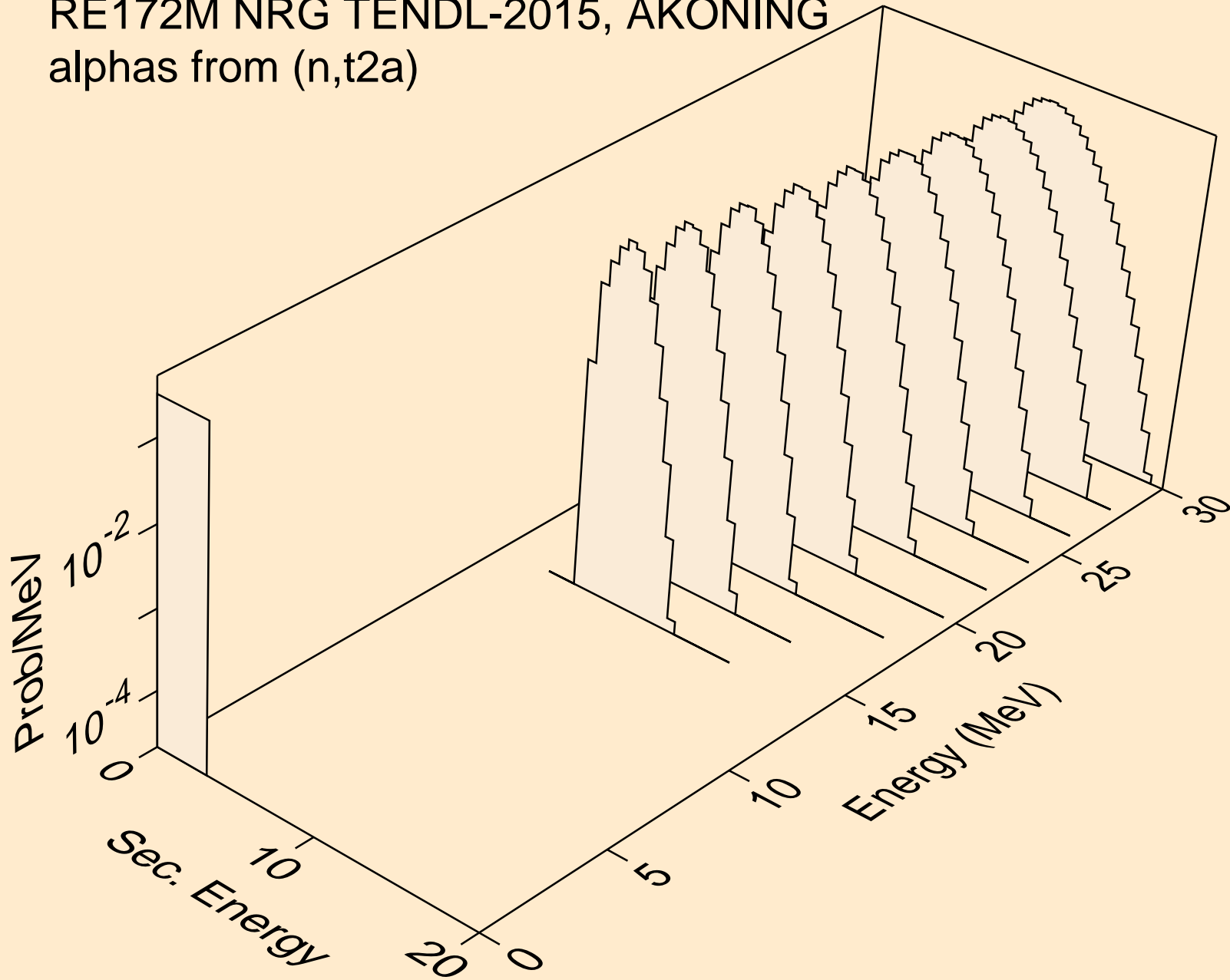

RE172M NRG TENDL-2015, AKONING
alphas from (n,d2a)

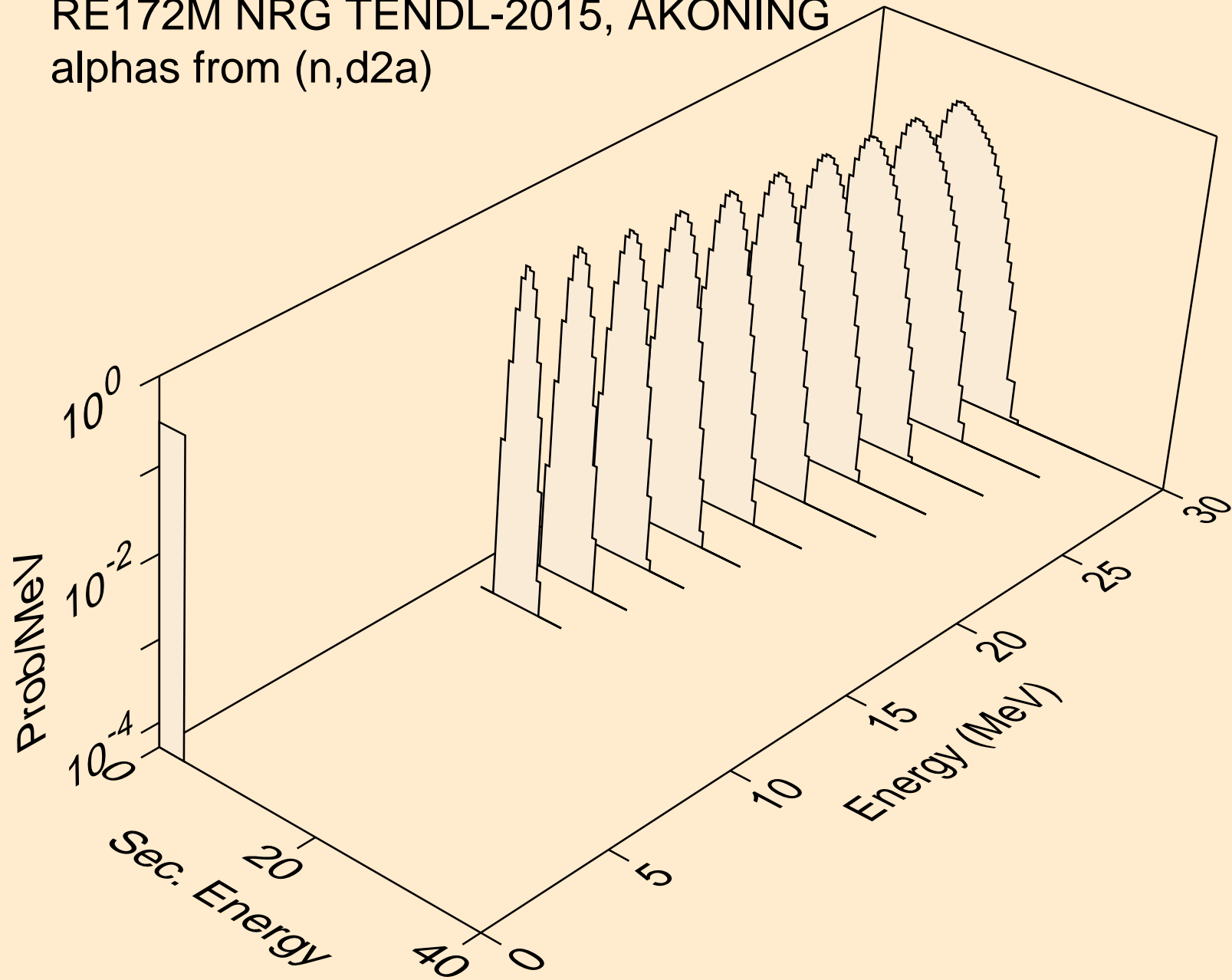

RE172M NRG TENDL-2015, AKONING
alphas from (n,da)

