

RF255 NRG TENDL-2015, AKONING

Principal cross sections

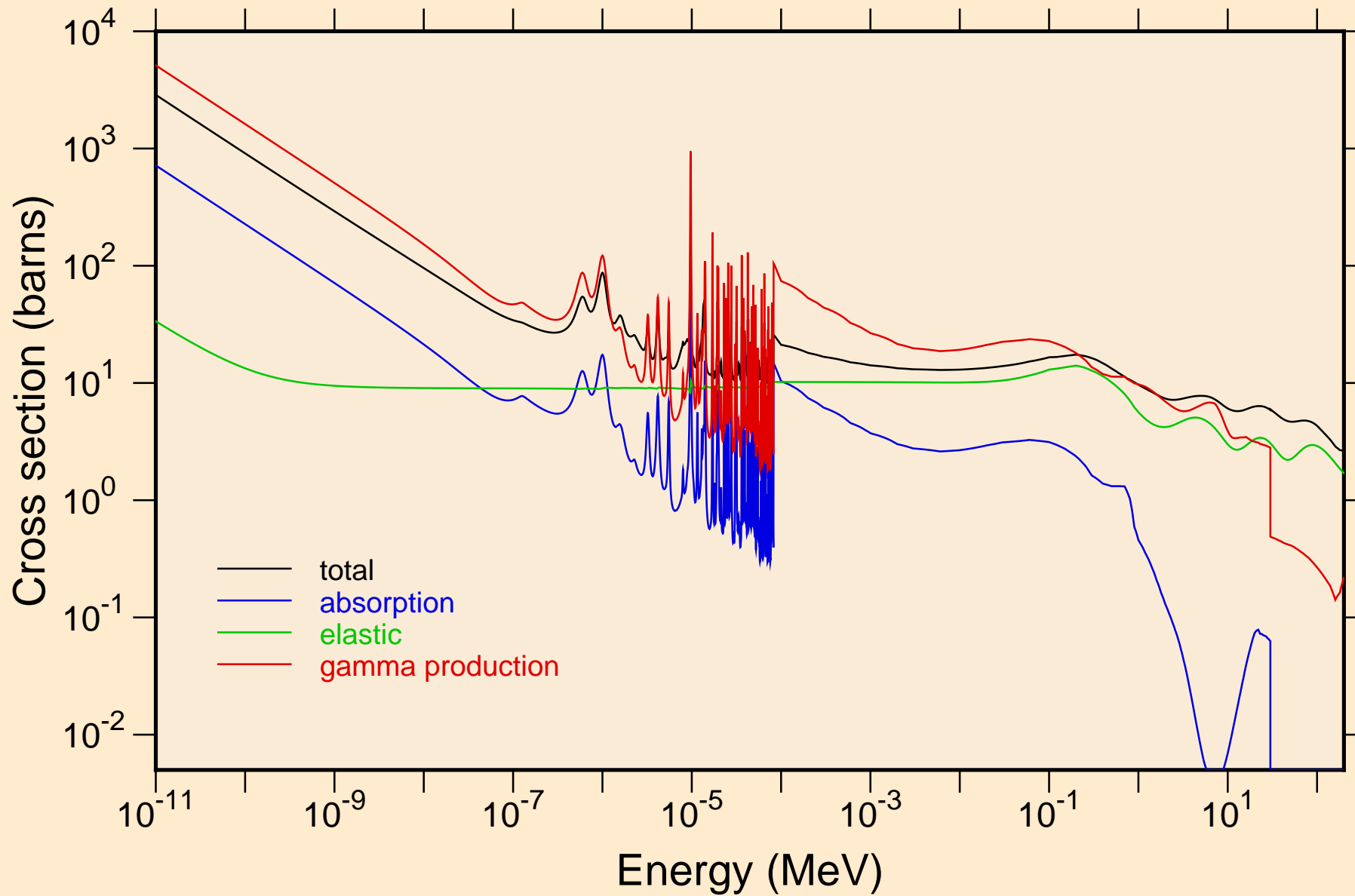

RF255 NRG TENDL-2015, AKONING
resonance total cross section

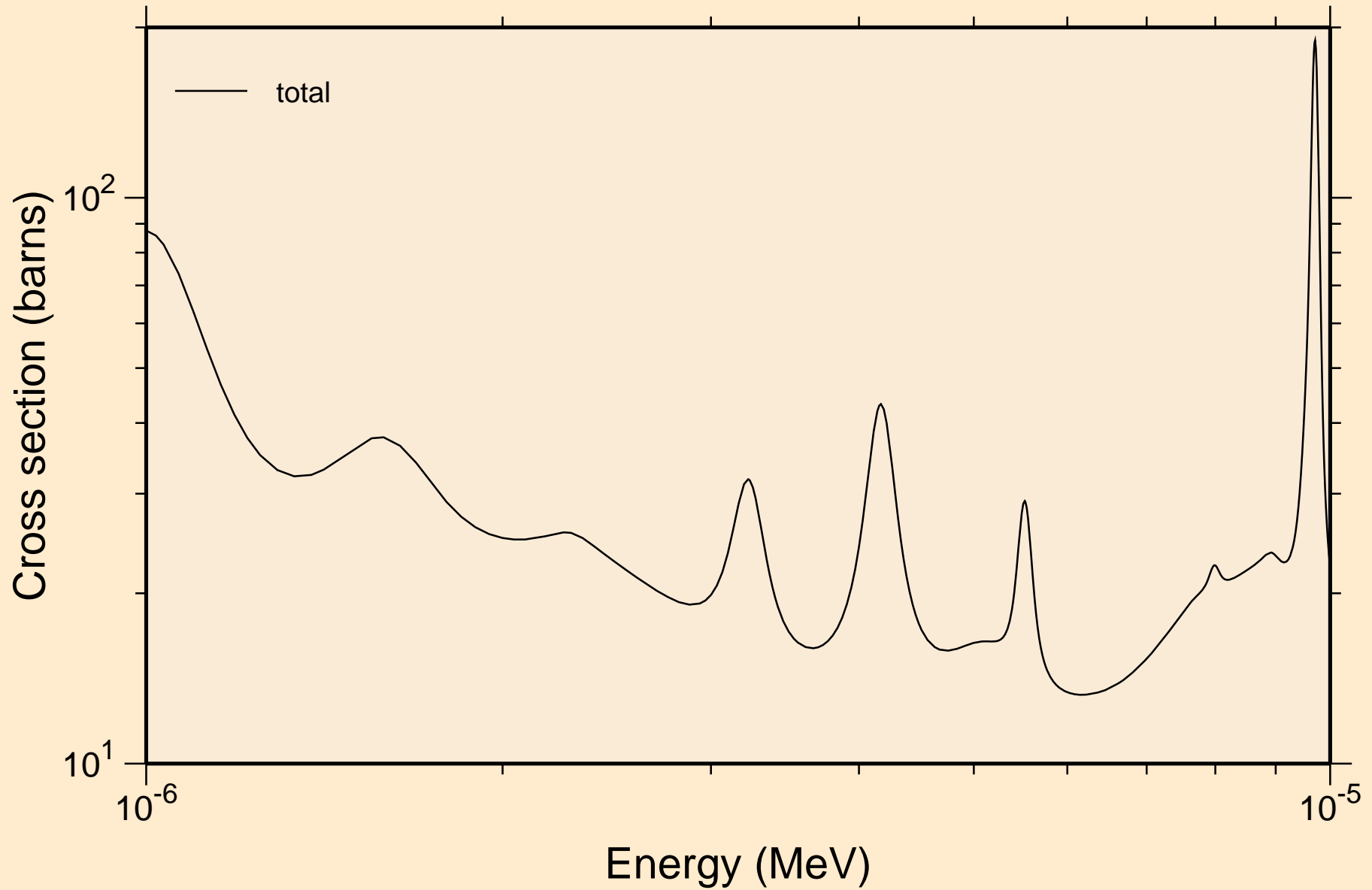

RF255 NRG TENDL-2015, AKONING
resonance total cross section

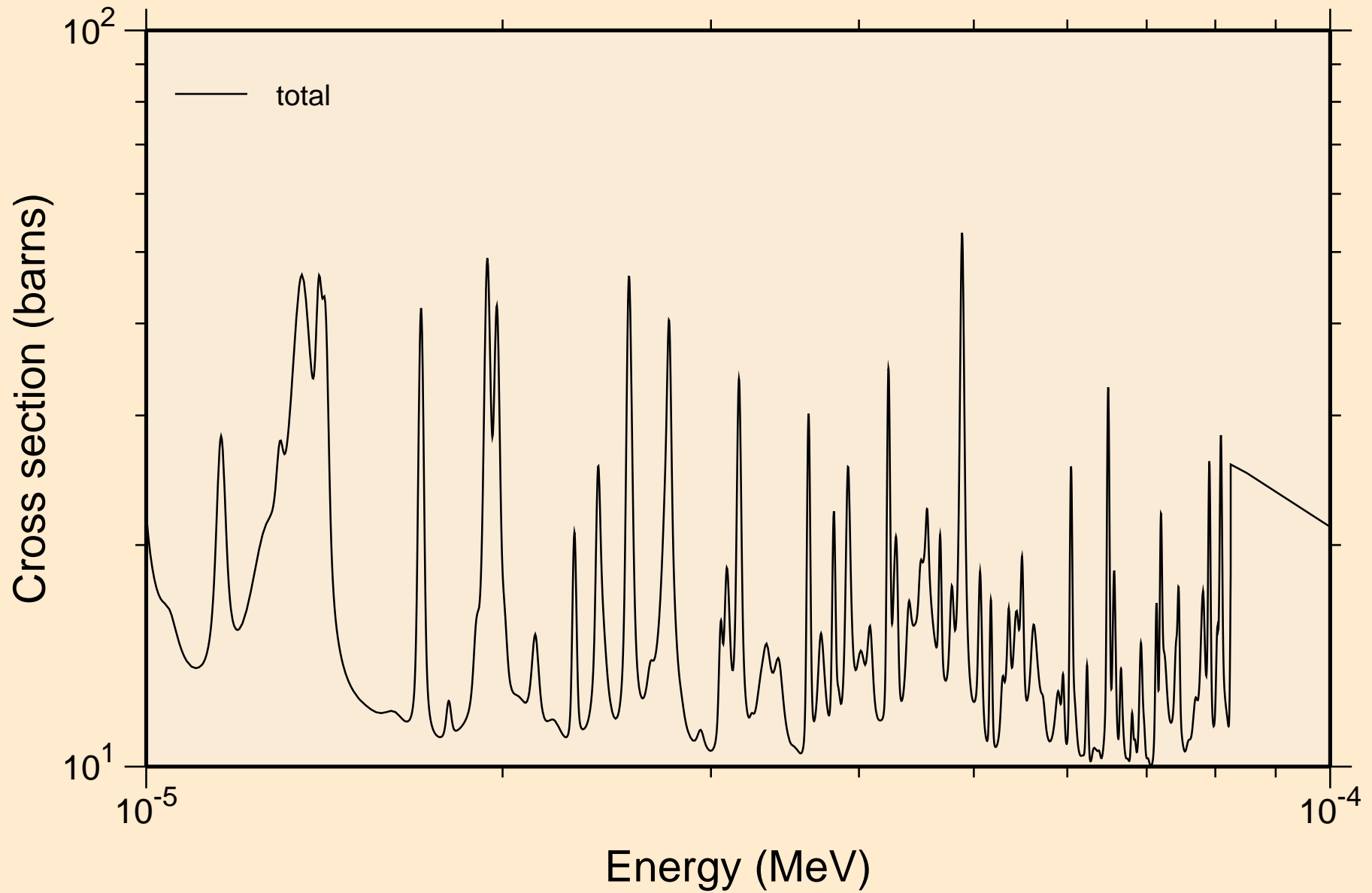

RF255 NRG TENDL-2015, AKONING
resonance total cross section

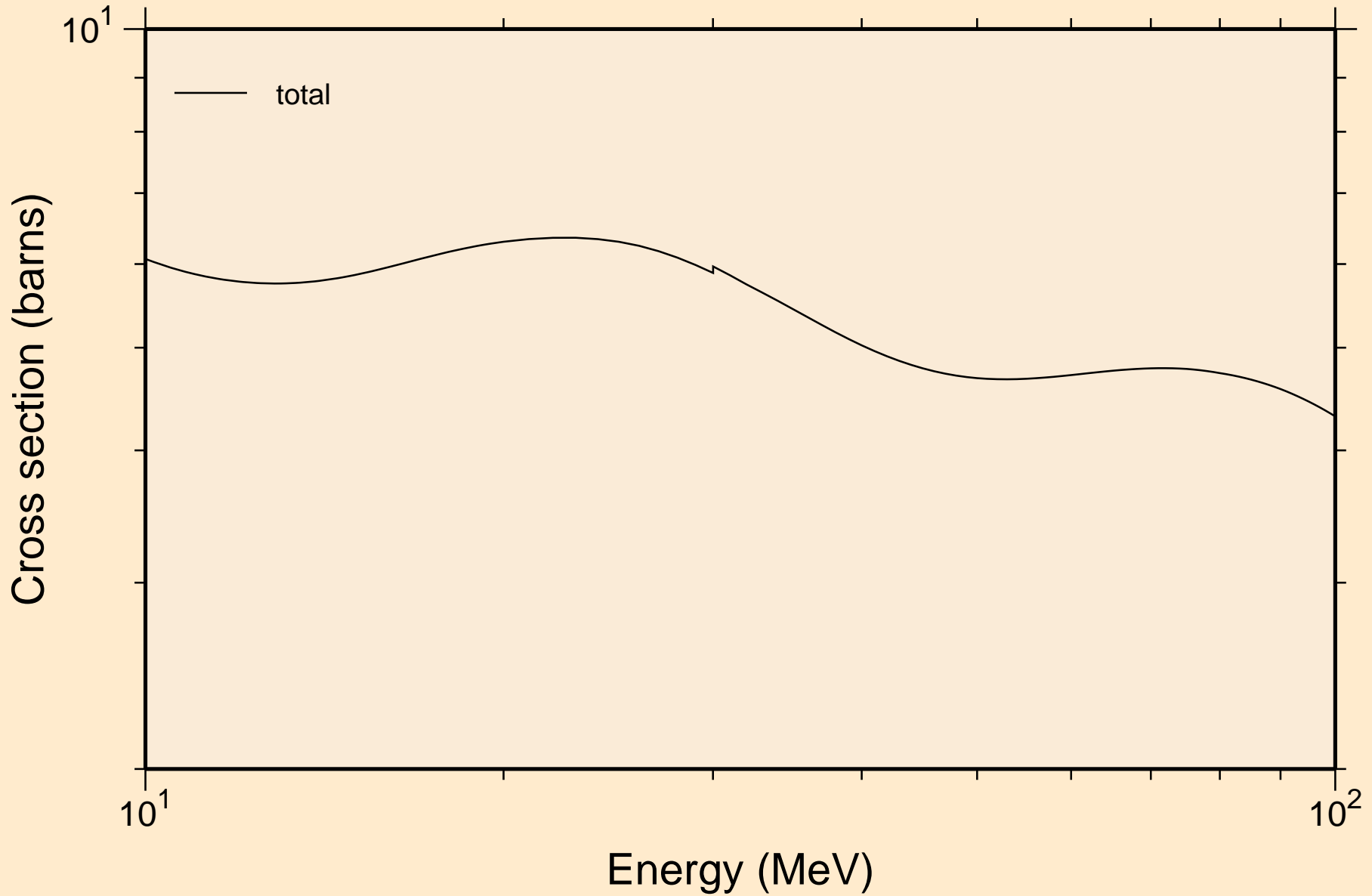

RF255 NRG TENDL-2015, AKONING
resonance absorption cross sections

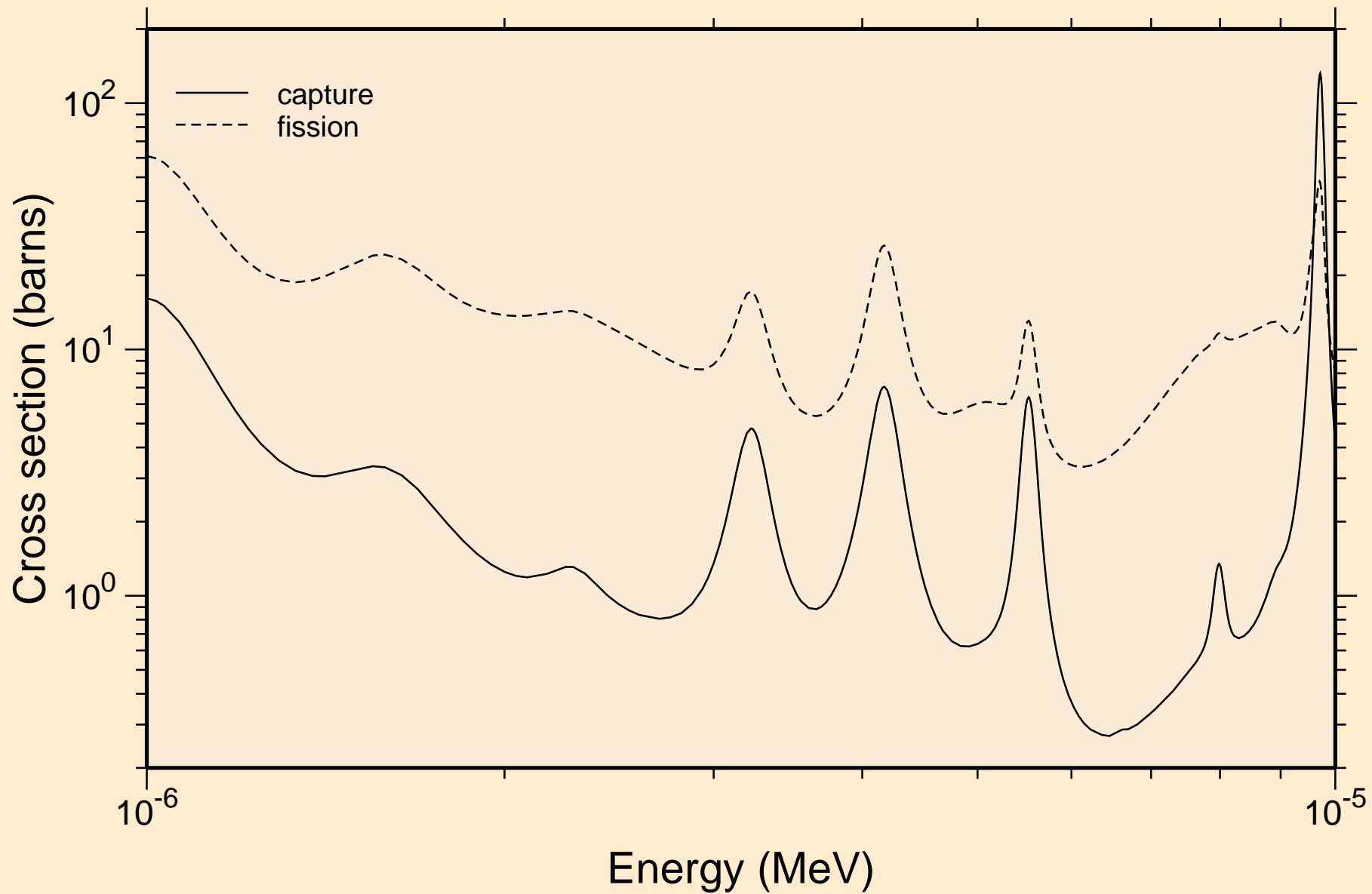

RF255 NRG TENDL-2015, AKONING
resonance absorption cross sections

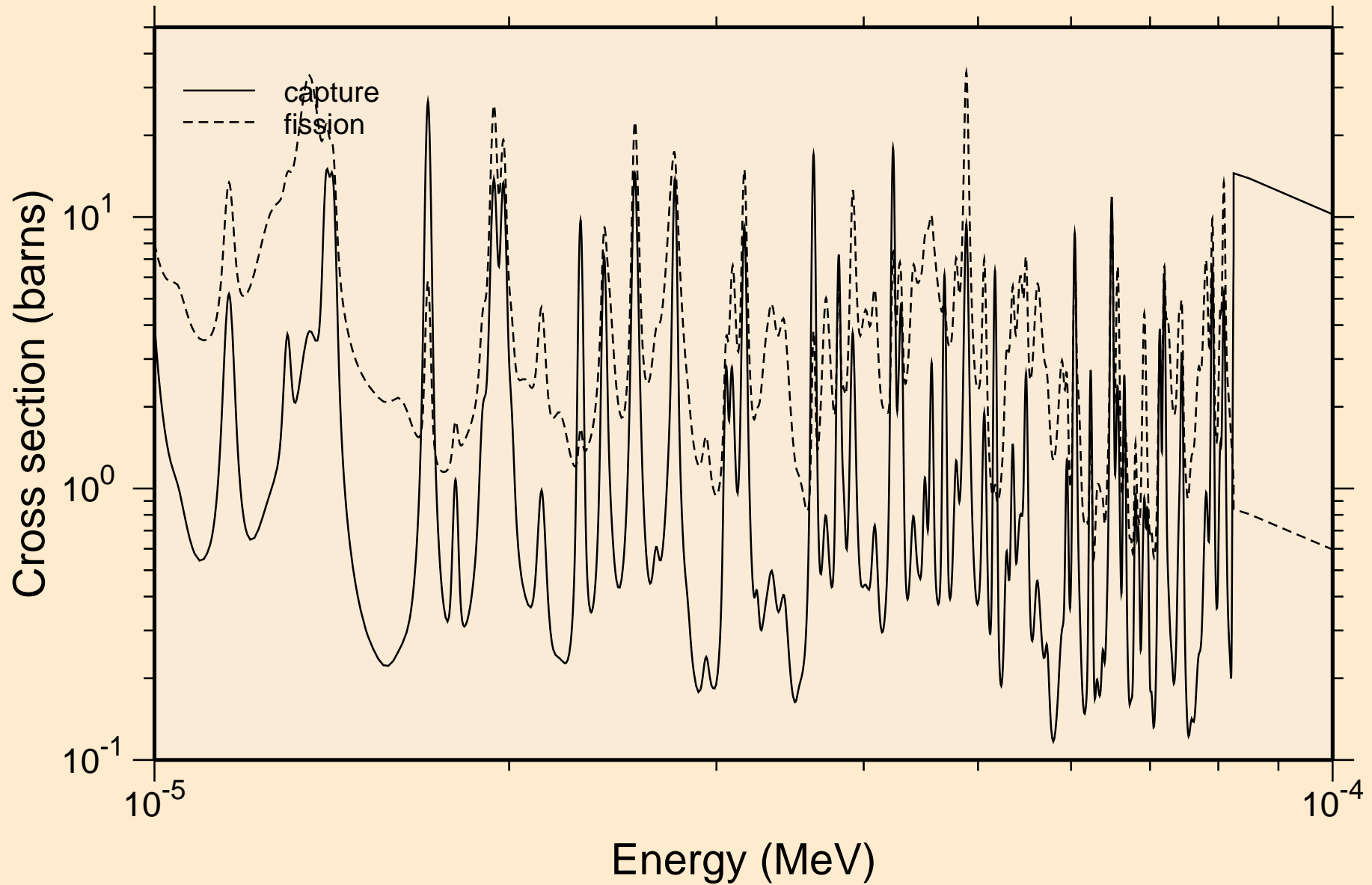

RF255 NRG TENDL-2015, AKONING
resonance absorption cross sections

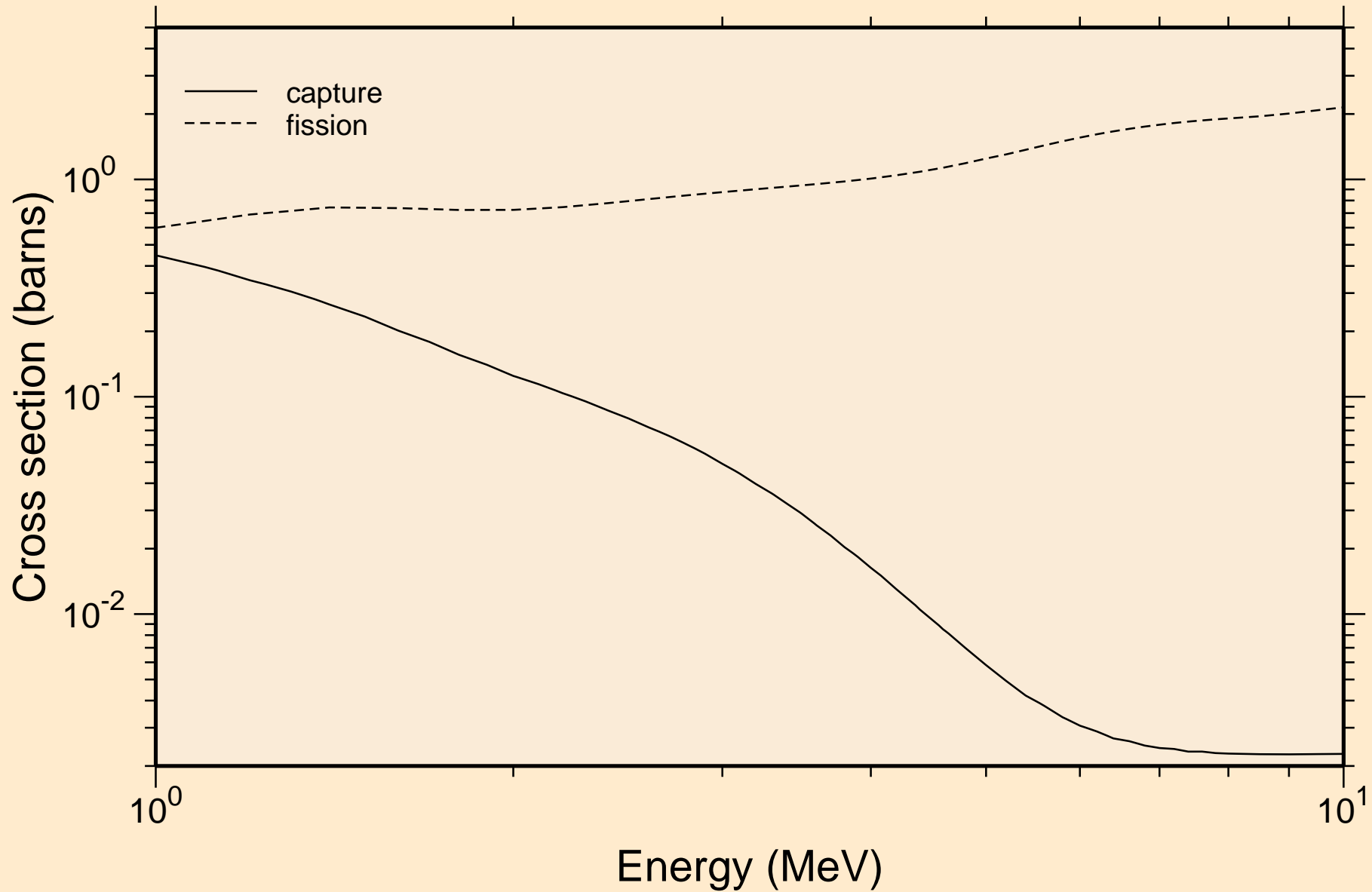

RF255 NRG TENDL-2015, AKONING

Non-threshold reactions

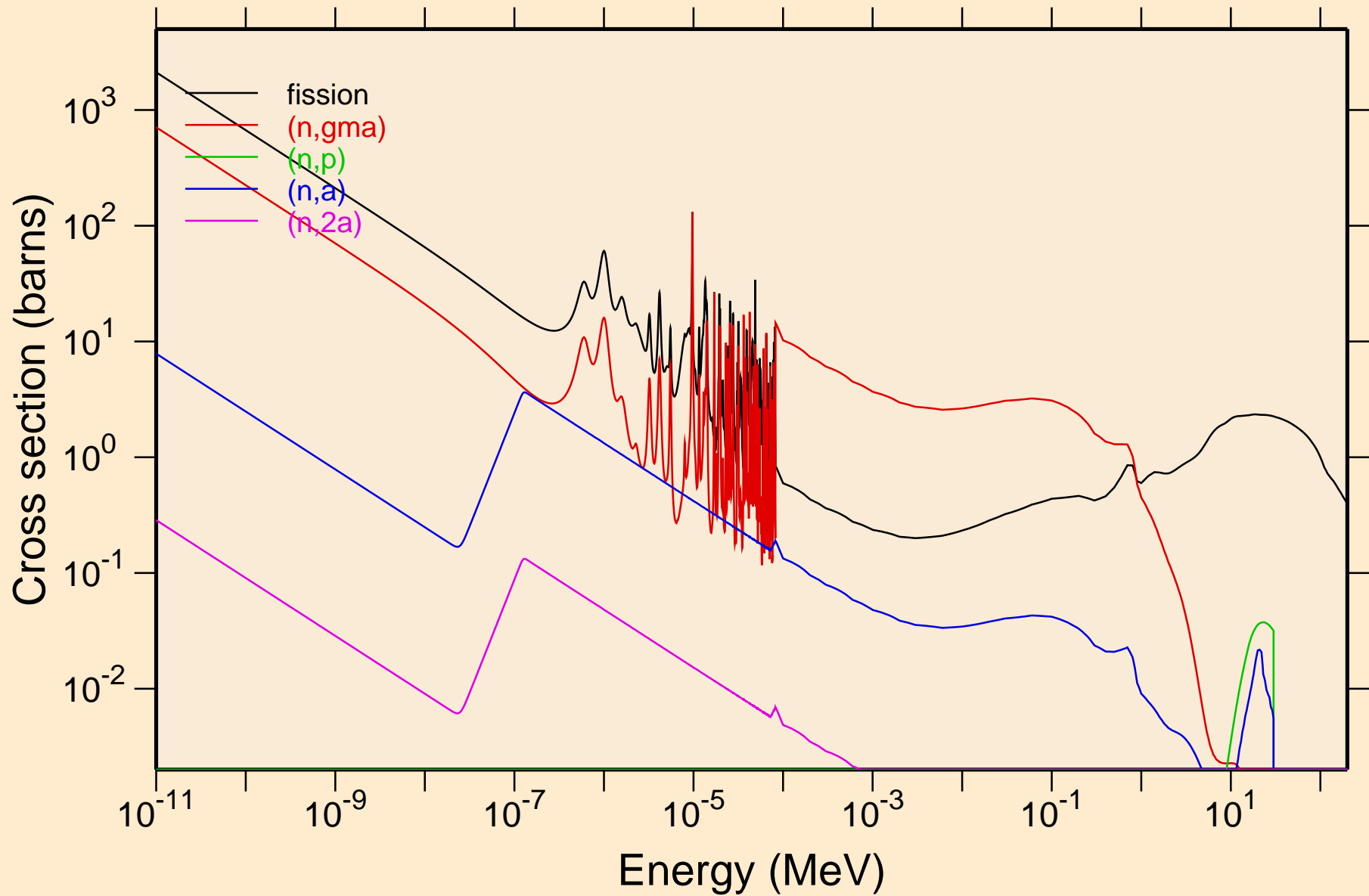

RF255 NRG TENDL-2015, AKONING

Non-threshold reactions

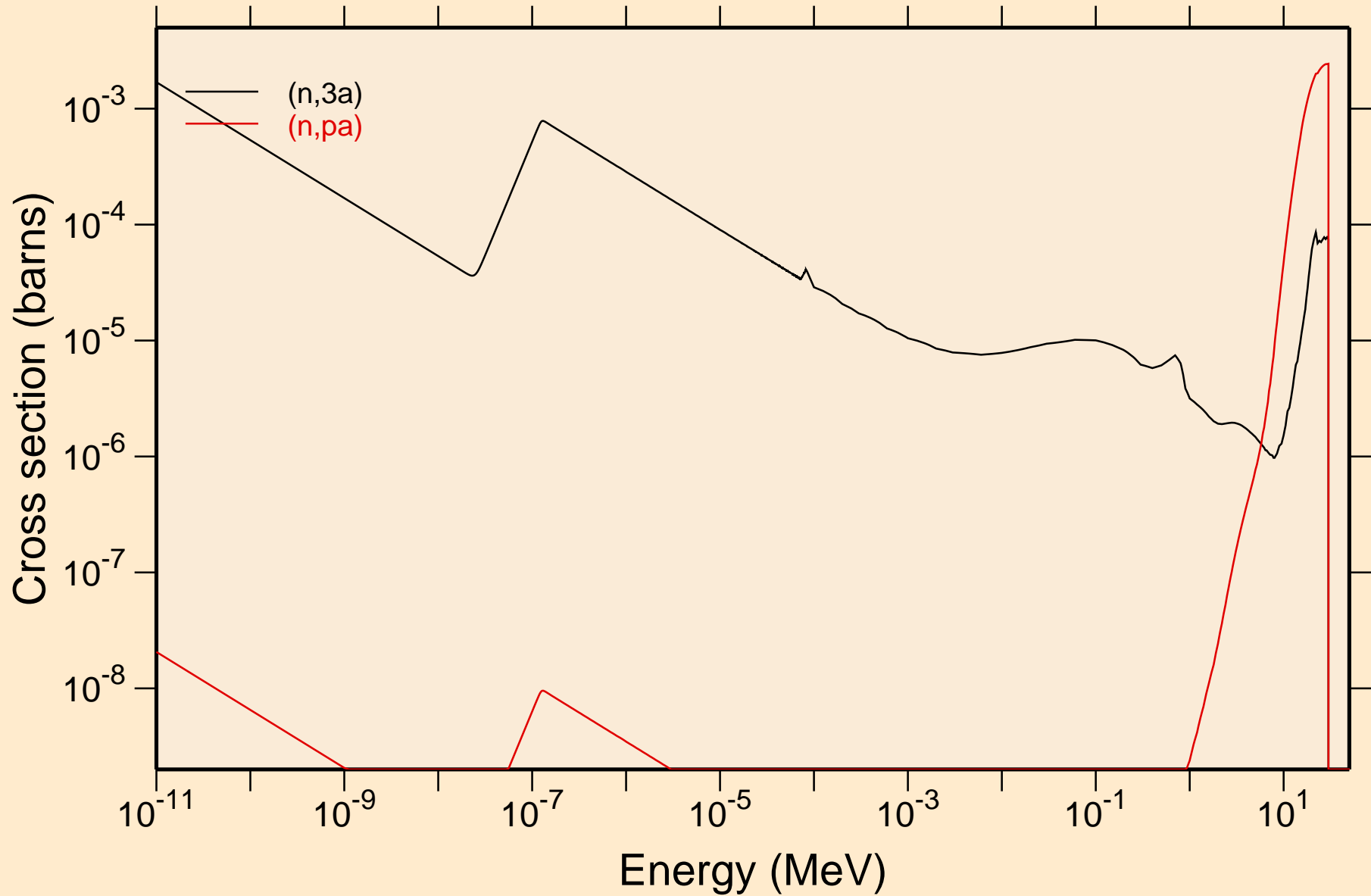

RF255 NRG TENDL-2015, AKONING

Principal cross sections

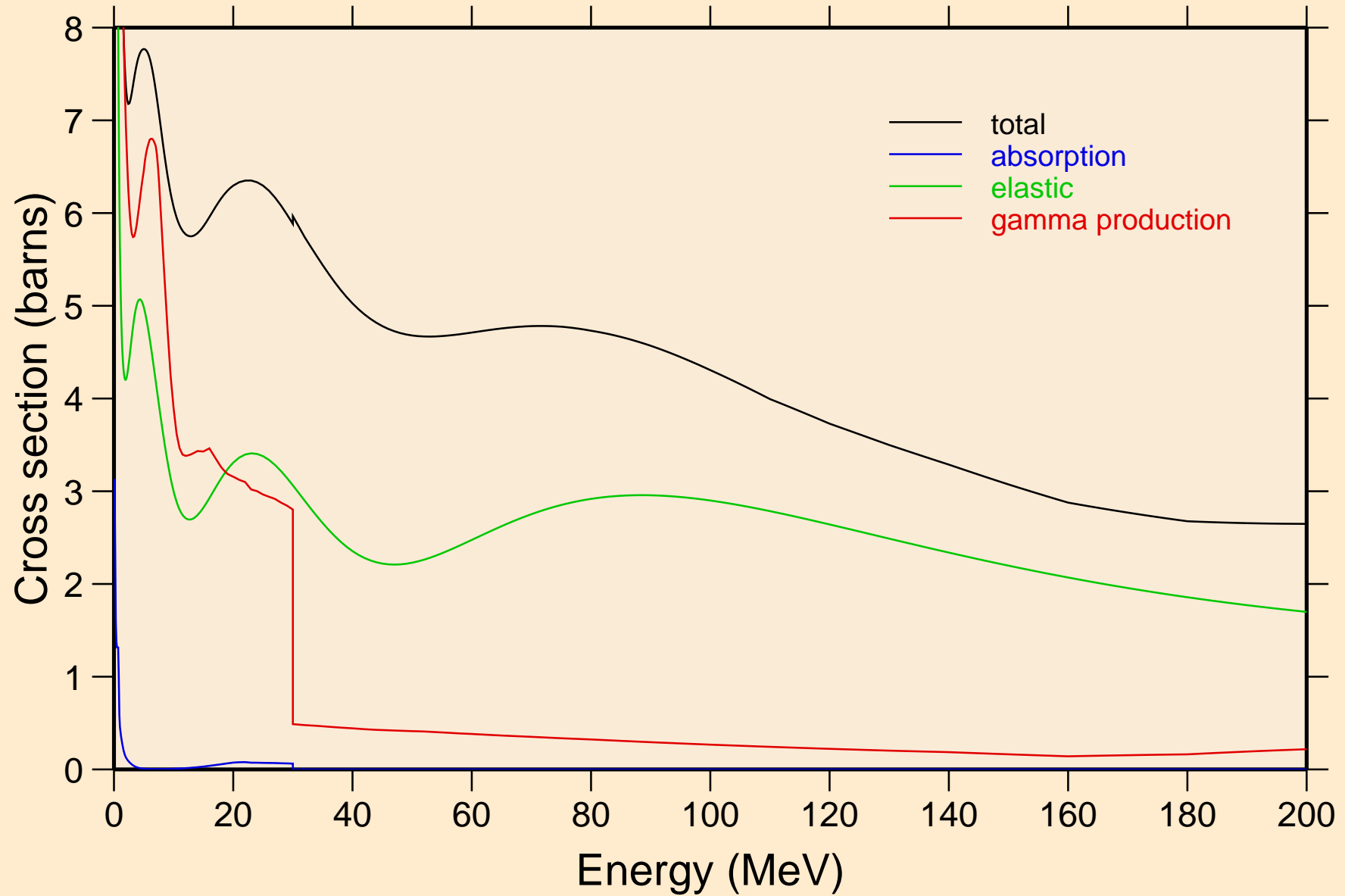

RF255 NRG TENDL-2015, AKONING

Non-threshold reactions

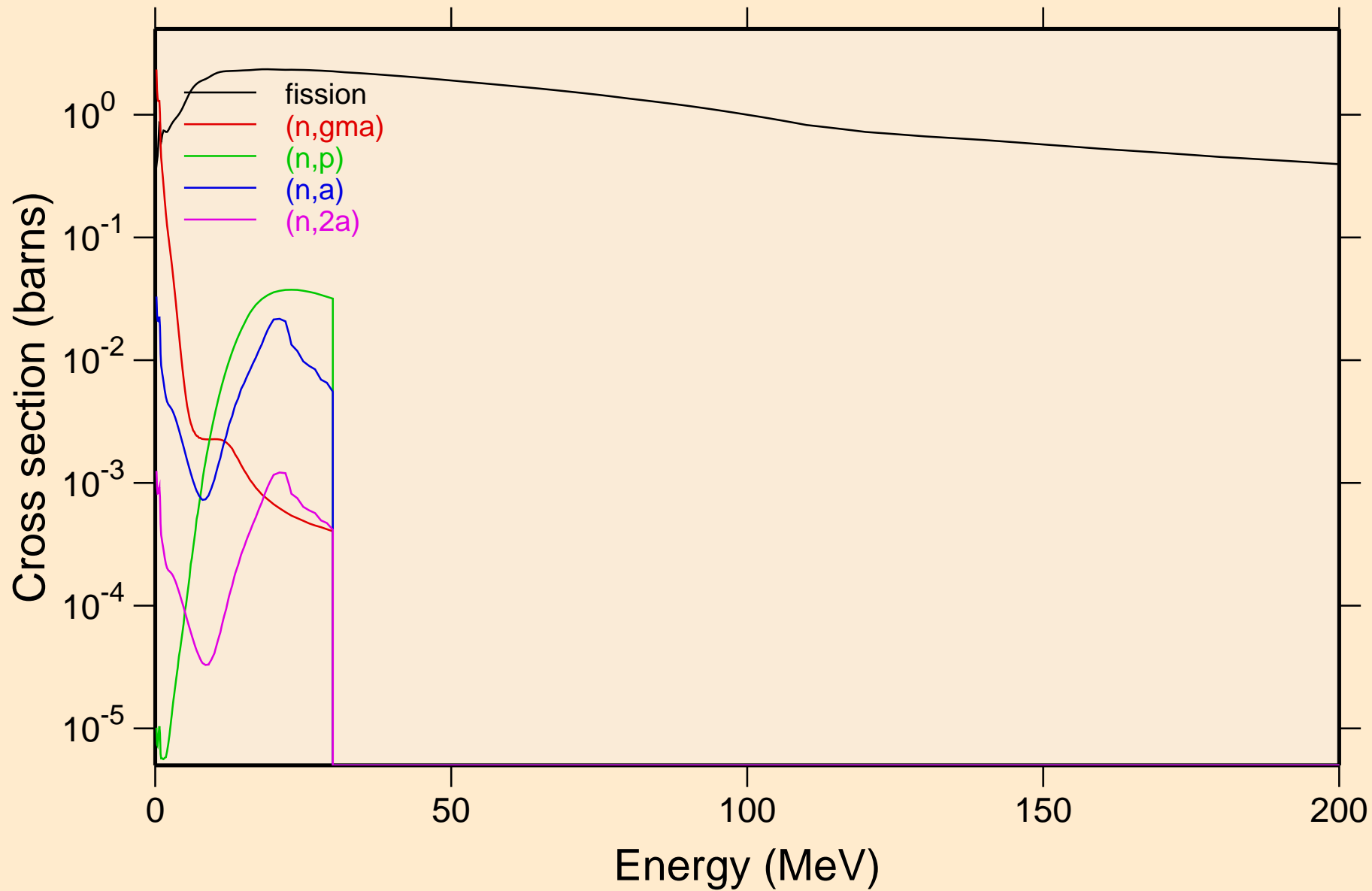

RF255 NRG TENDL-2015, AKONING

Non-threshold reactions

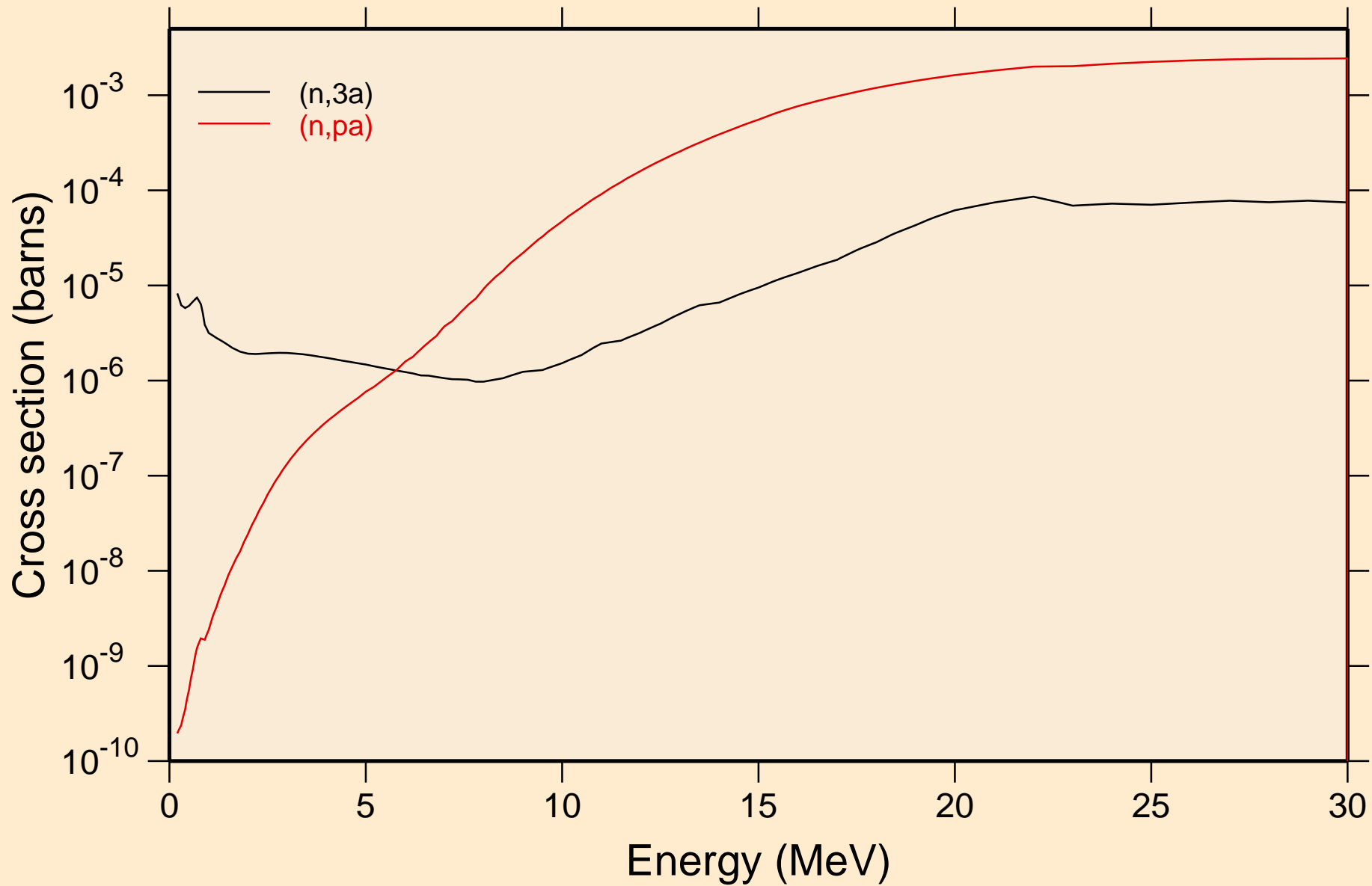

RF255 NRG TENDL-2015, AKONING

Inelastic levels

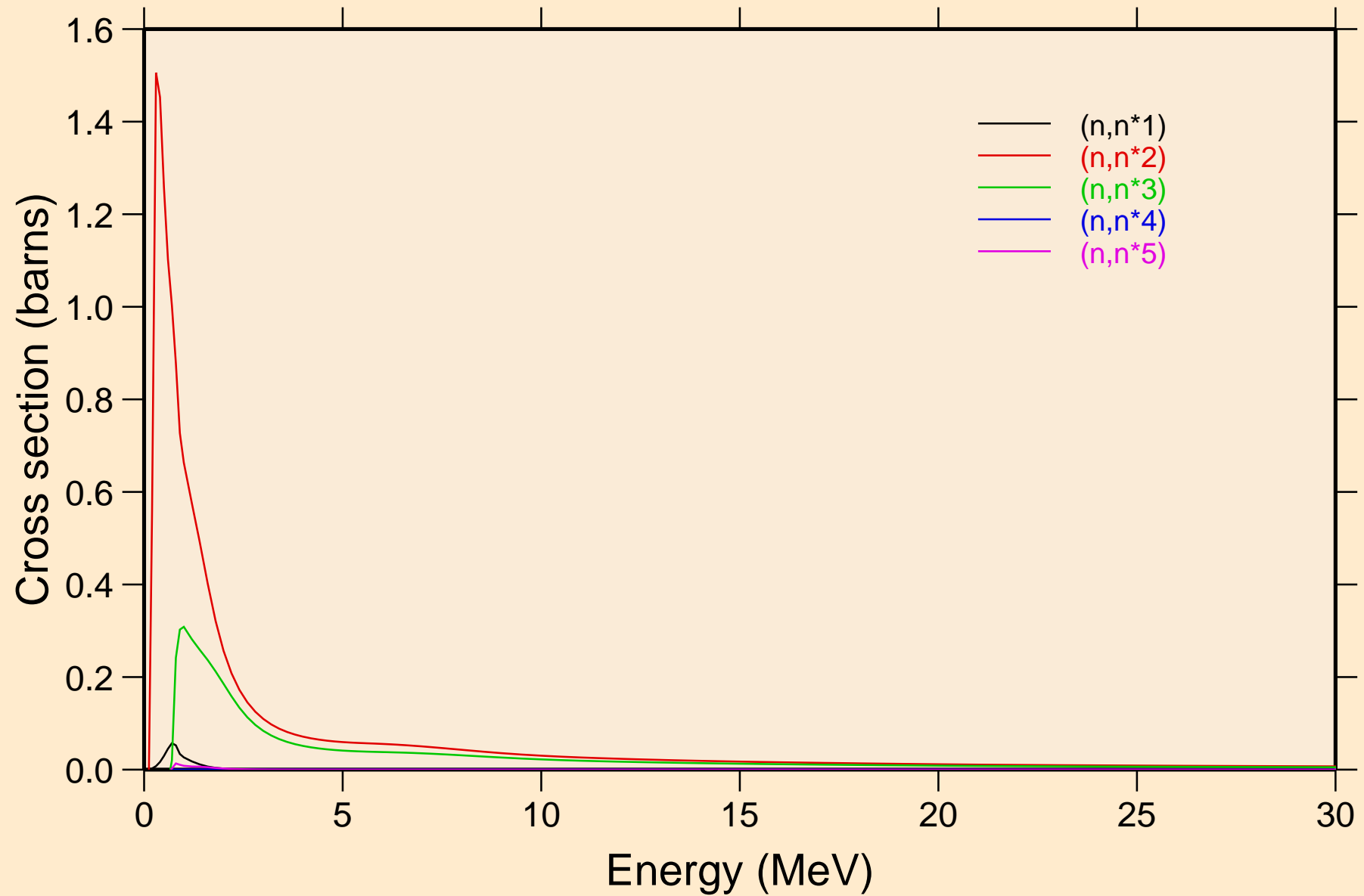

RF255 NRG TENDL-2015, AKONING

Inelastic levels

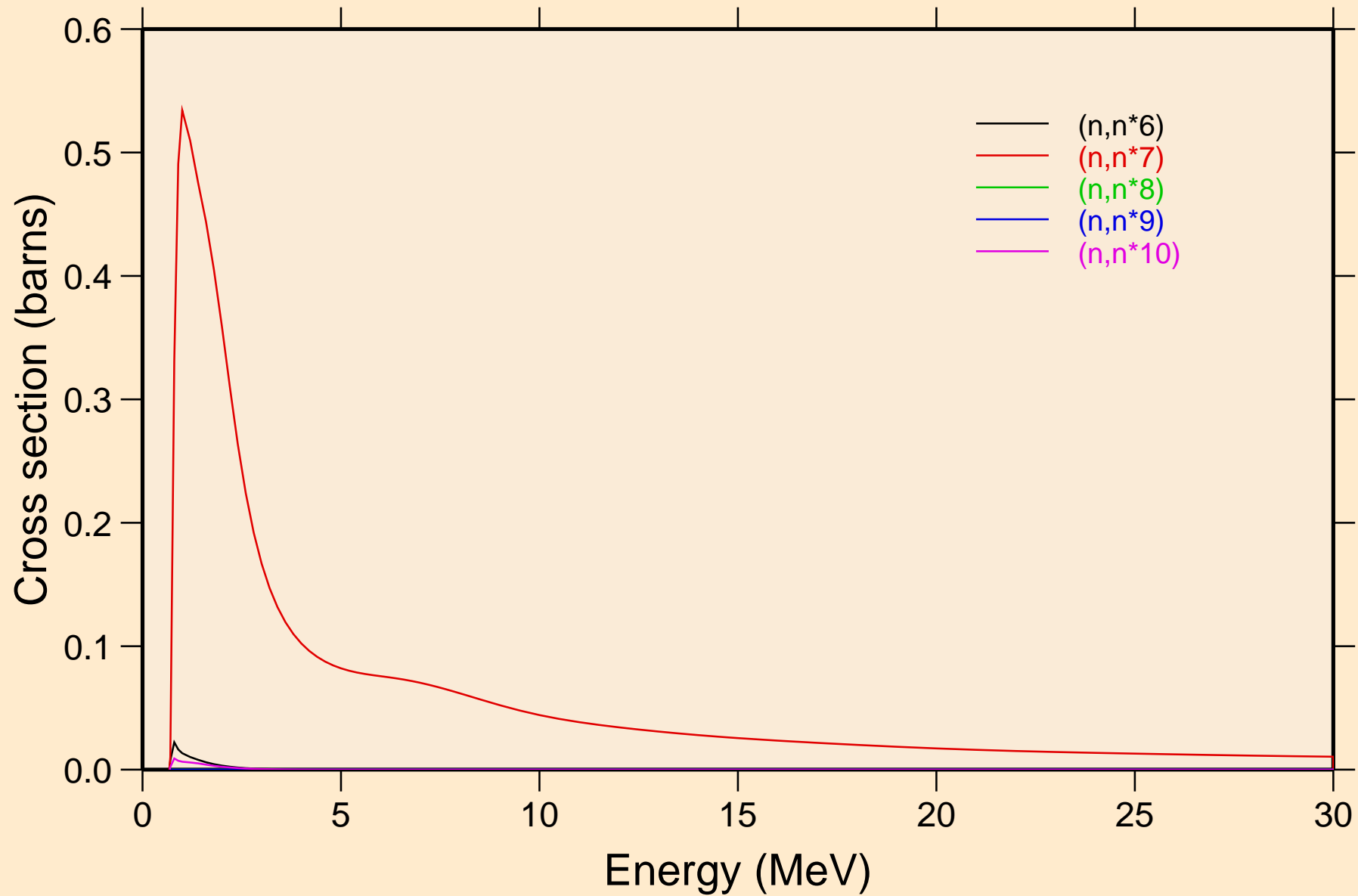

RF255 NRG TENDL-2015, AKONING

Inelastic levels

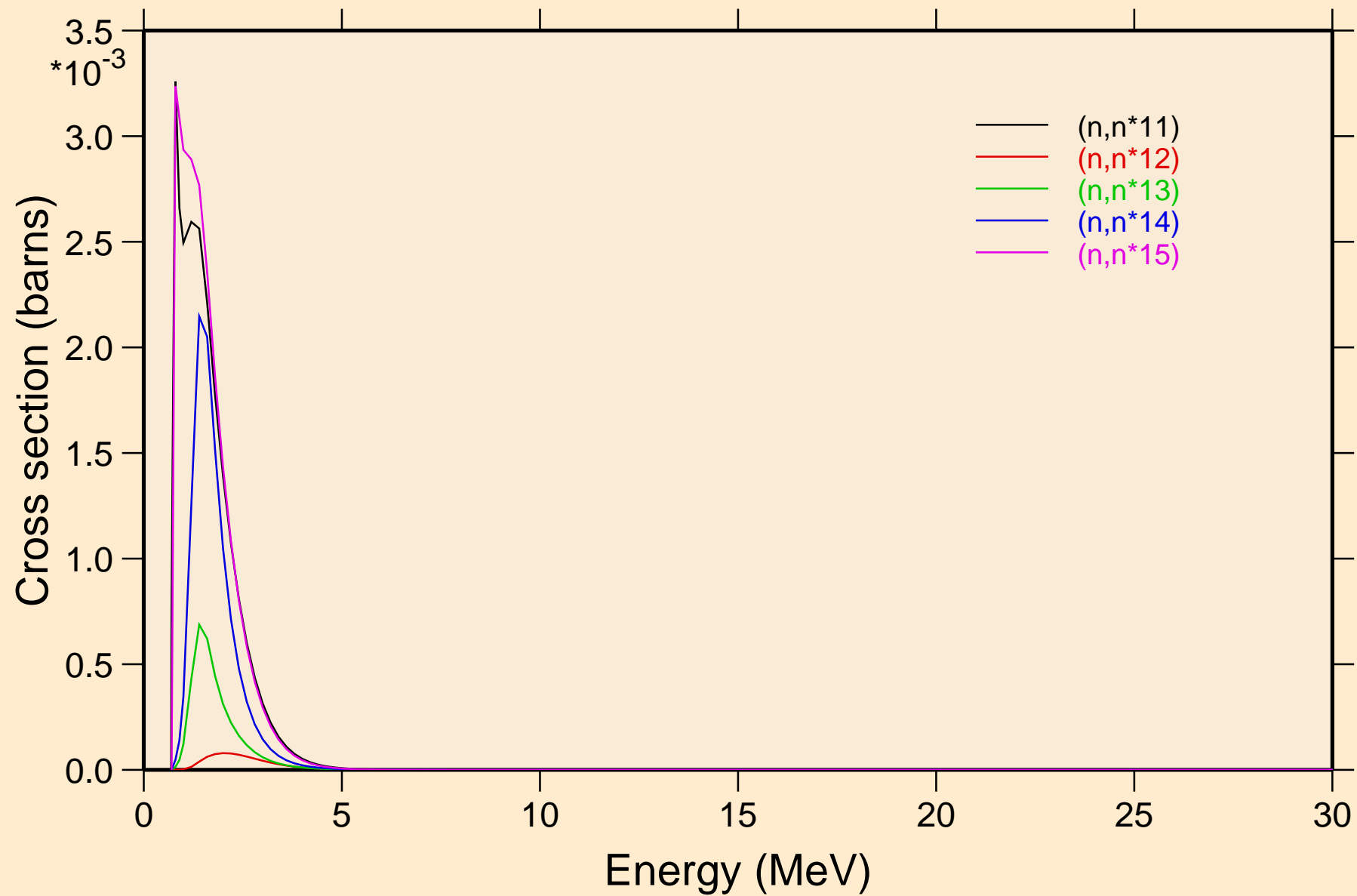

RF255 NRG TENDL-2015, AKONING

Inelastic levels

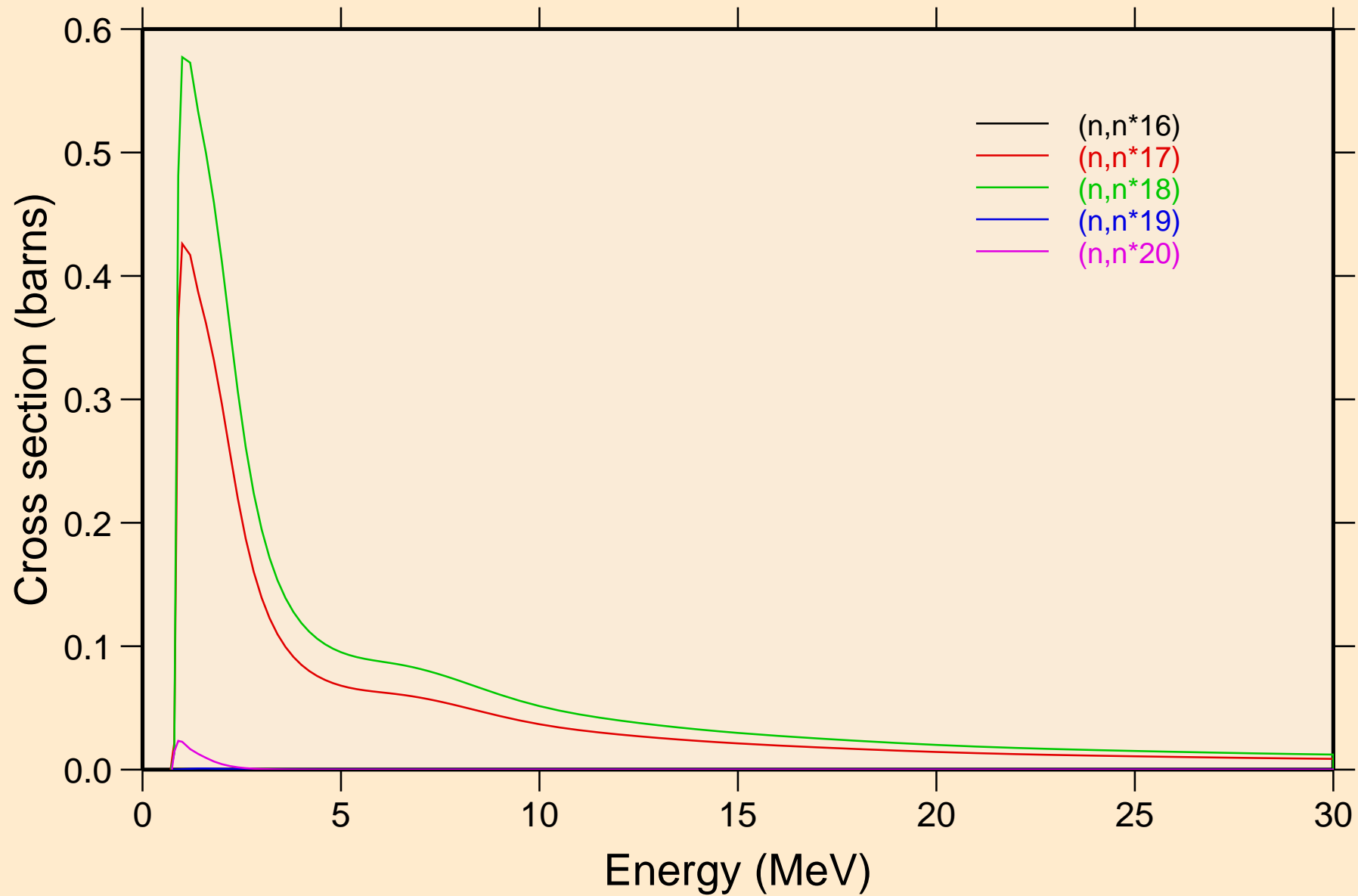

RF255 NRG TENDL-2015, AKONING

Inelastic levels

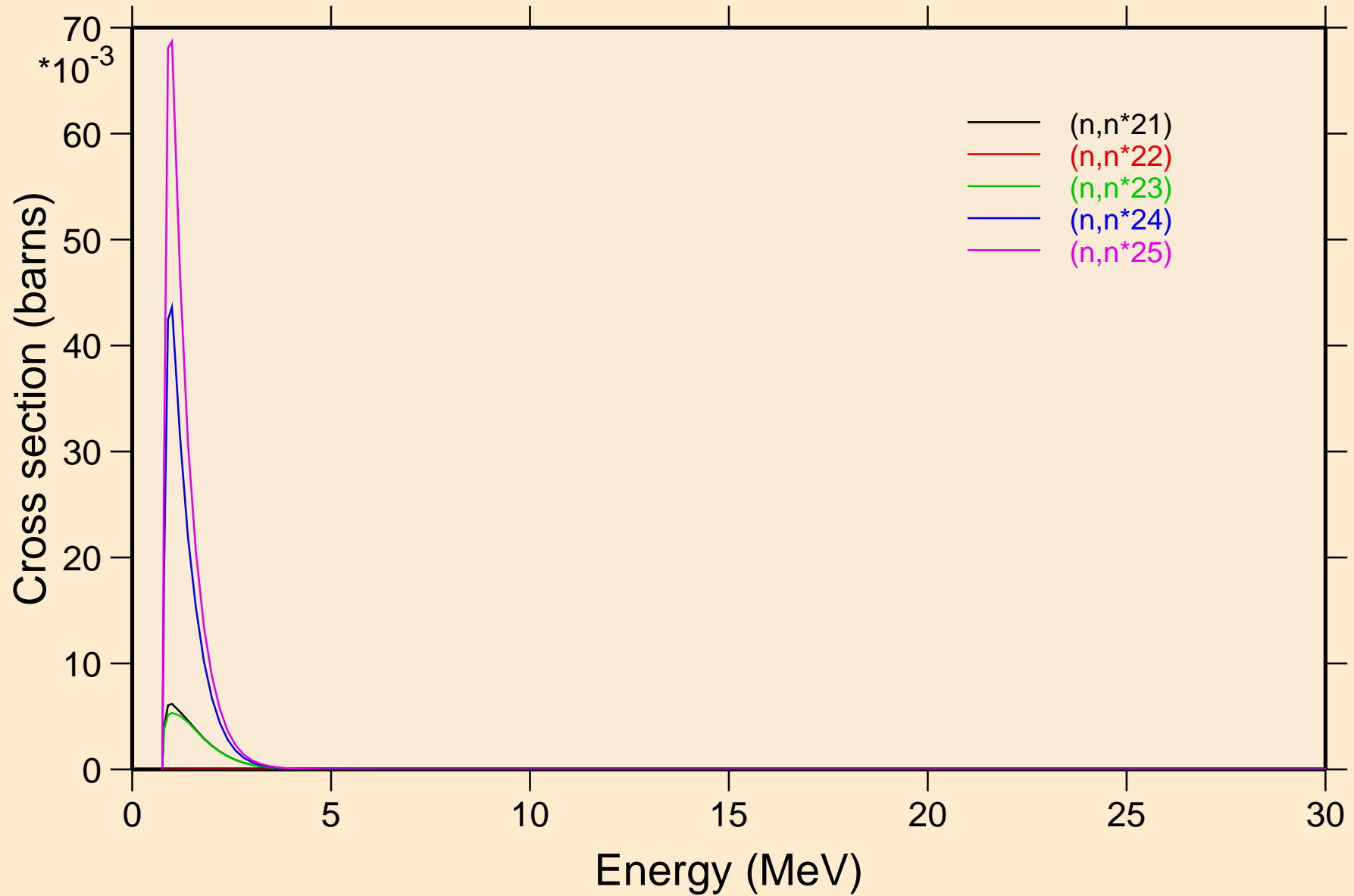

RF255 NRG TENDL-2015, AKONING

Inelastic levels

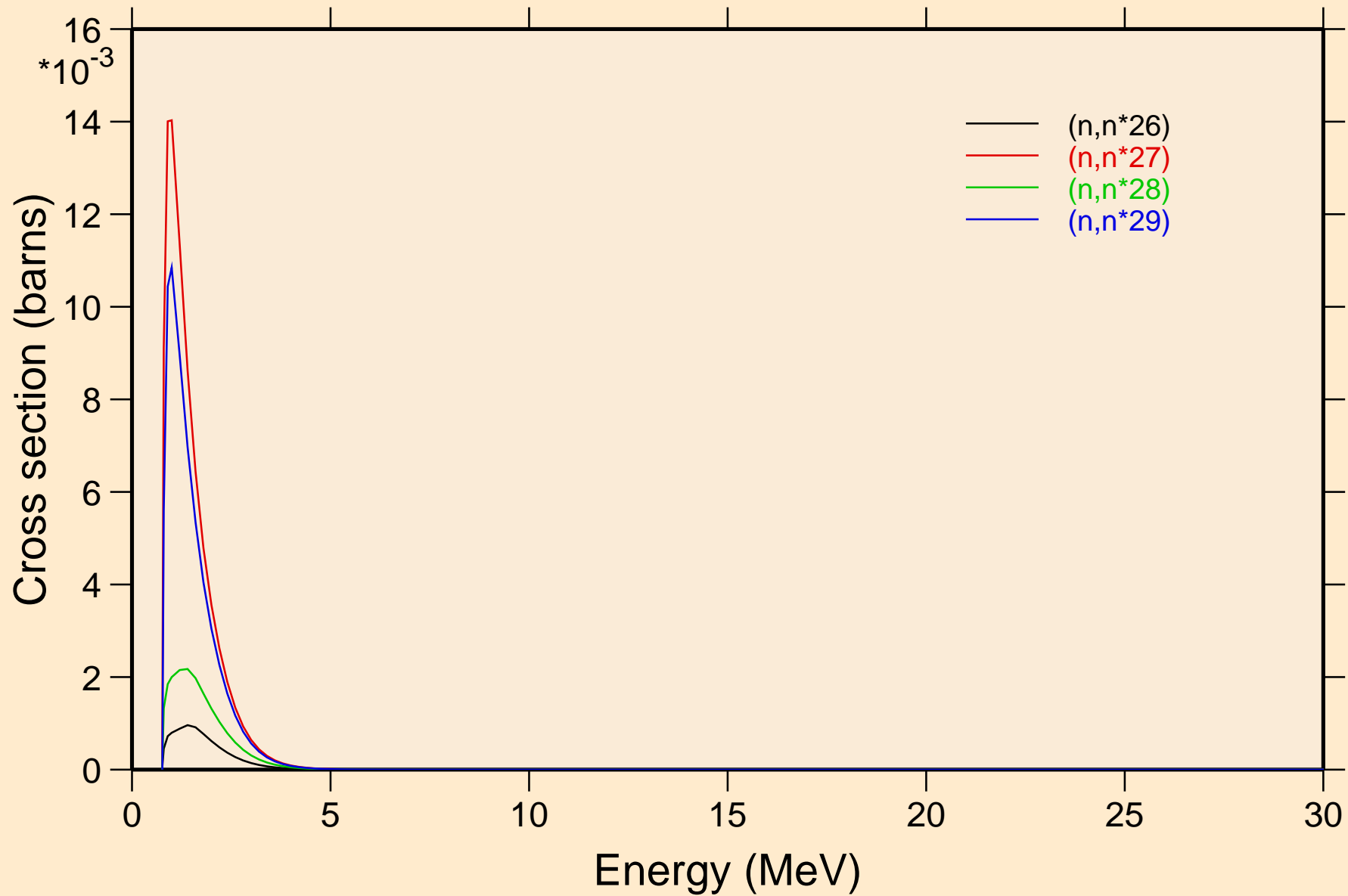

RF255 NRG TENDL-2015, AKONING

Threshold reactions

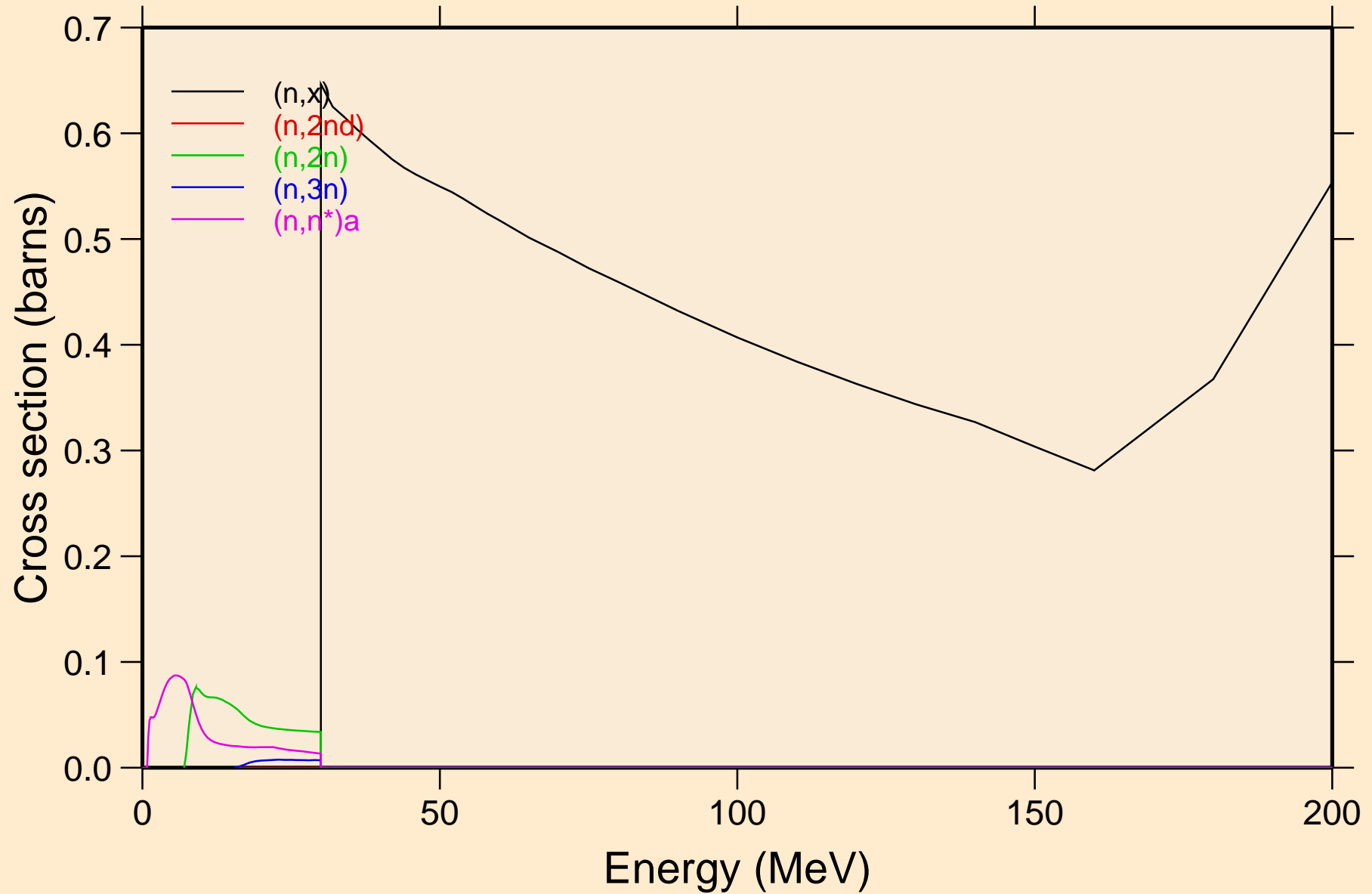

RF255 NRG TENDL-2015, AKONING

Threshold reactions

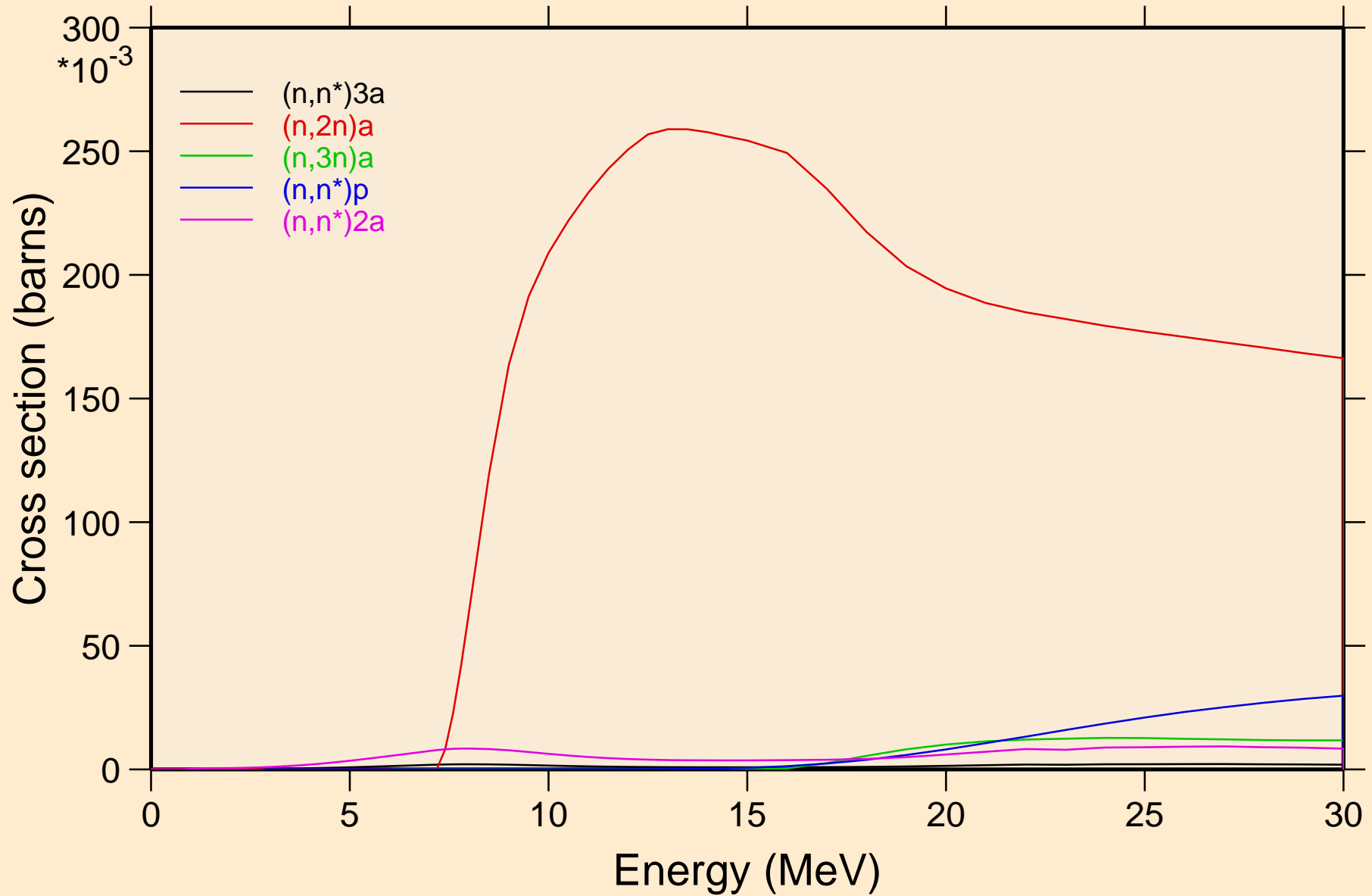

RF255 NRG TENDL-2015, AKONING

Threshold reactions

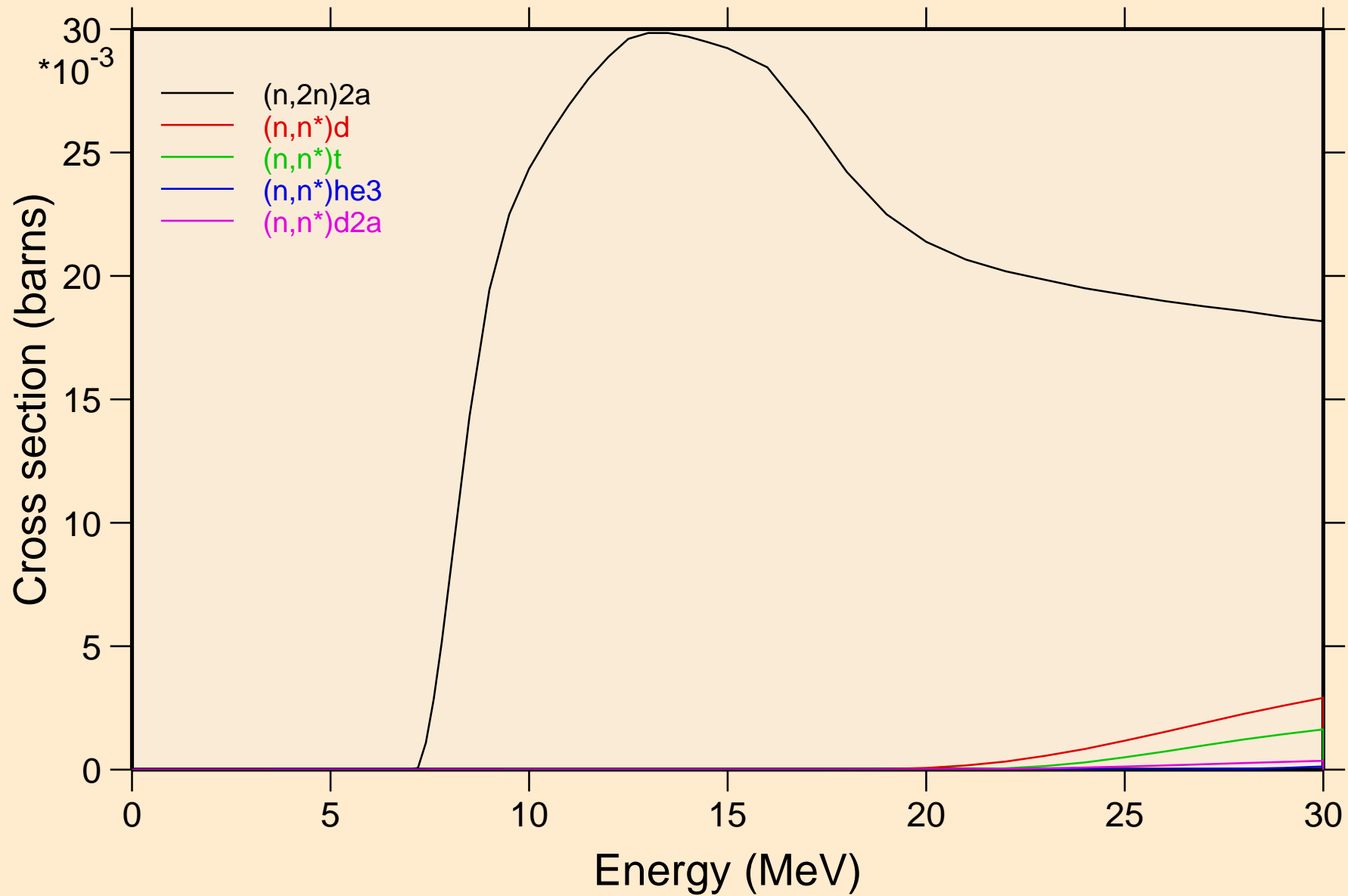

RF255 NRG TENDL-2015, AKONING

Threshold reactions

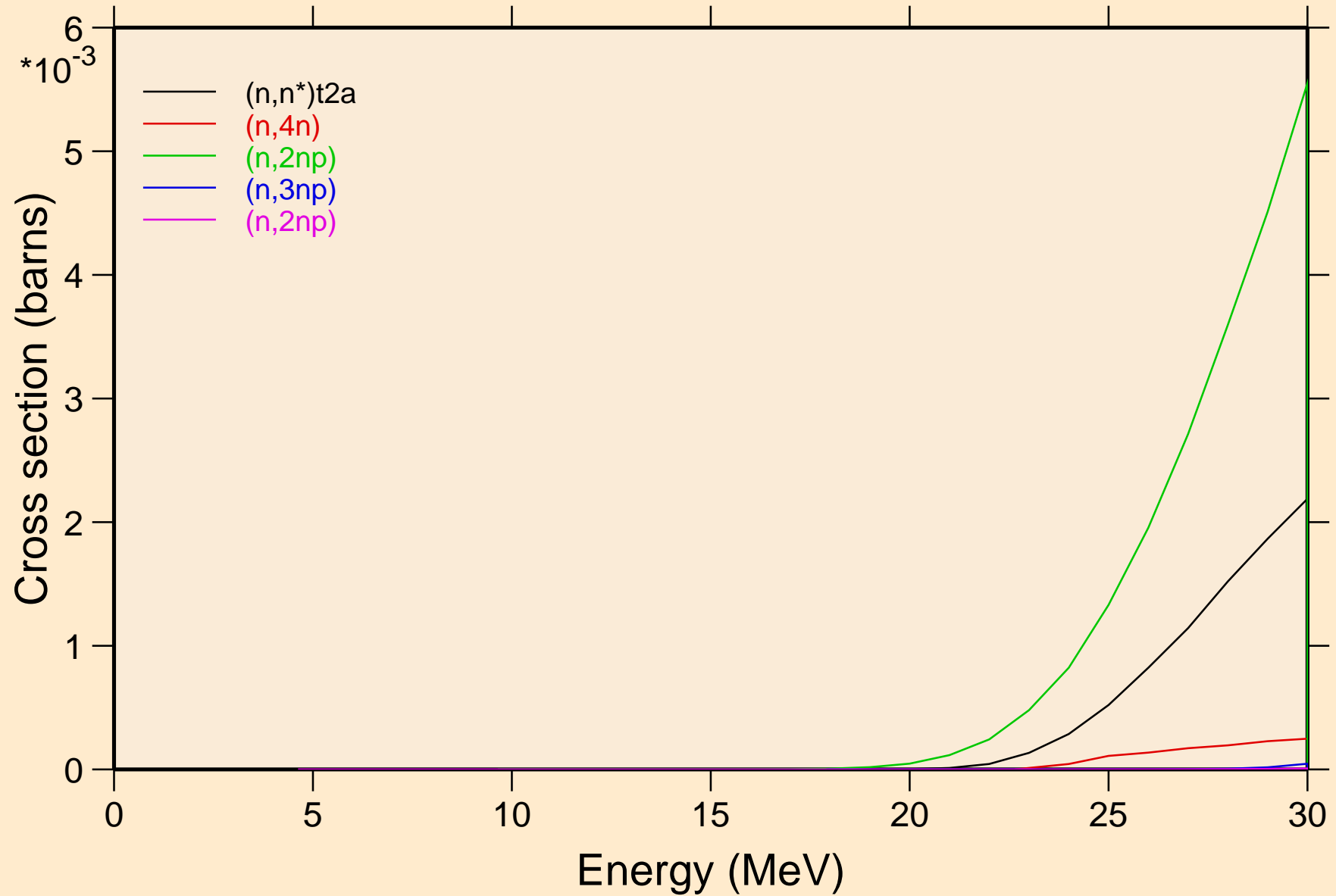

RF255 NRG TENDL-2015, AKONING

Threshold reactions

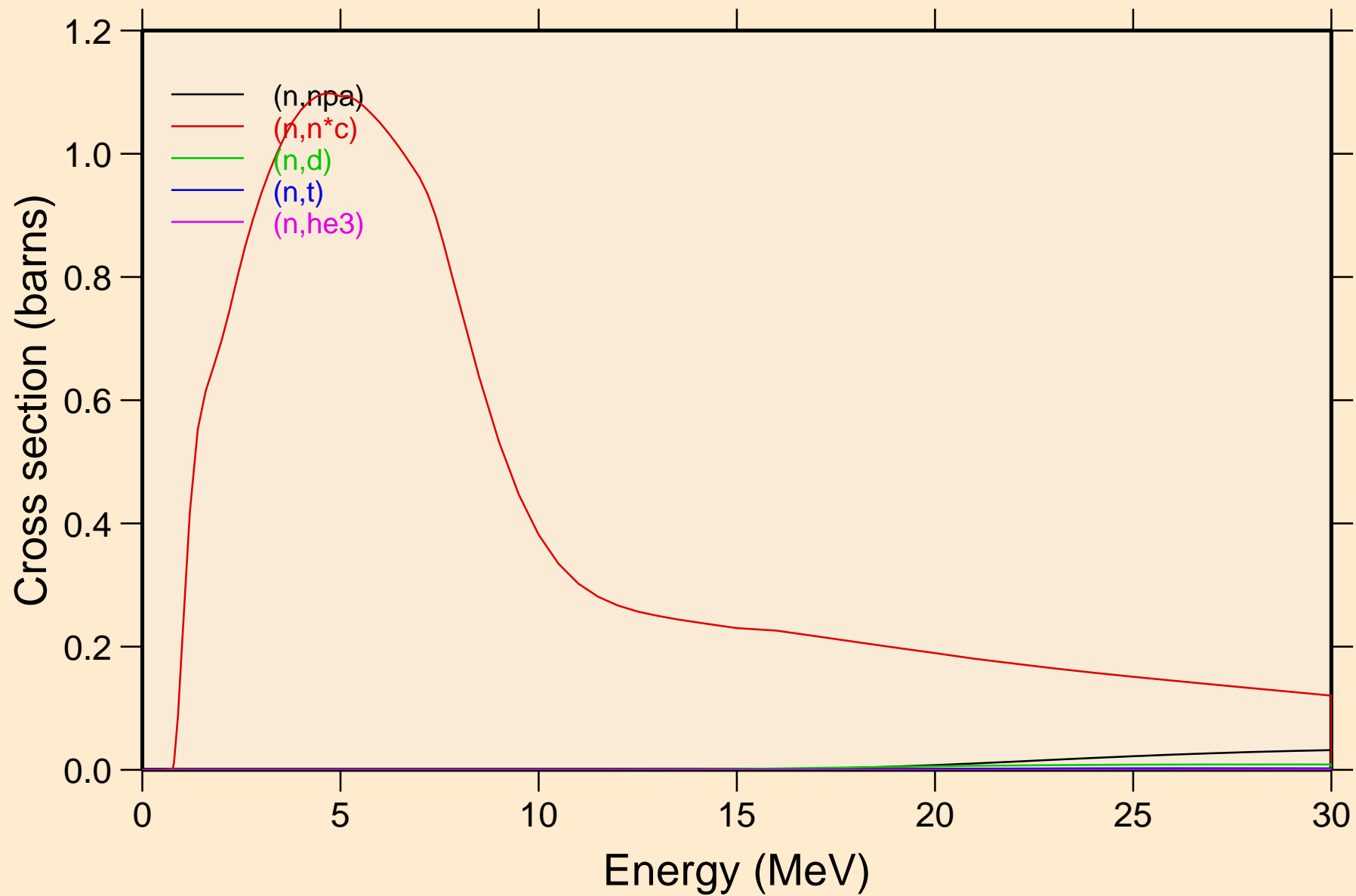

RF255 NRG TENDL-2015, AKONING

Threshold reactions

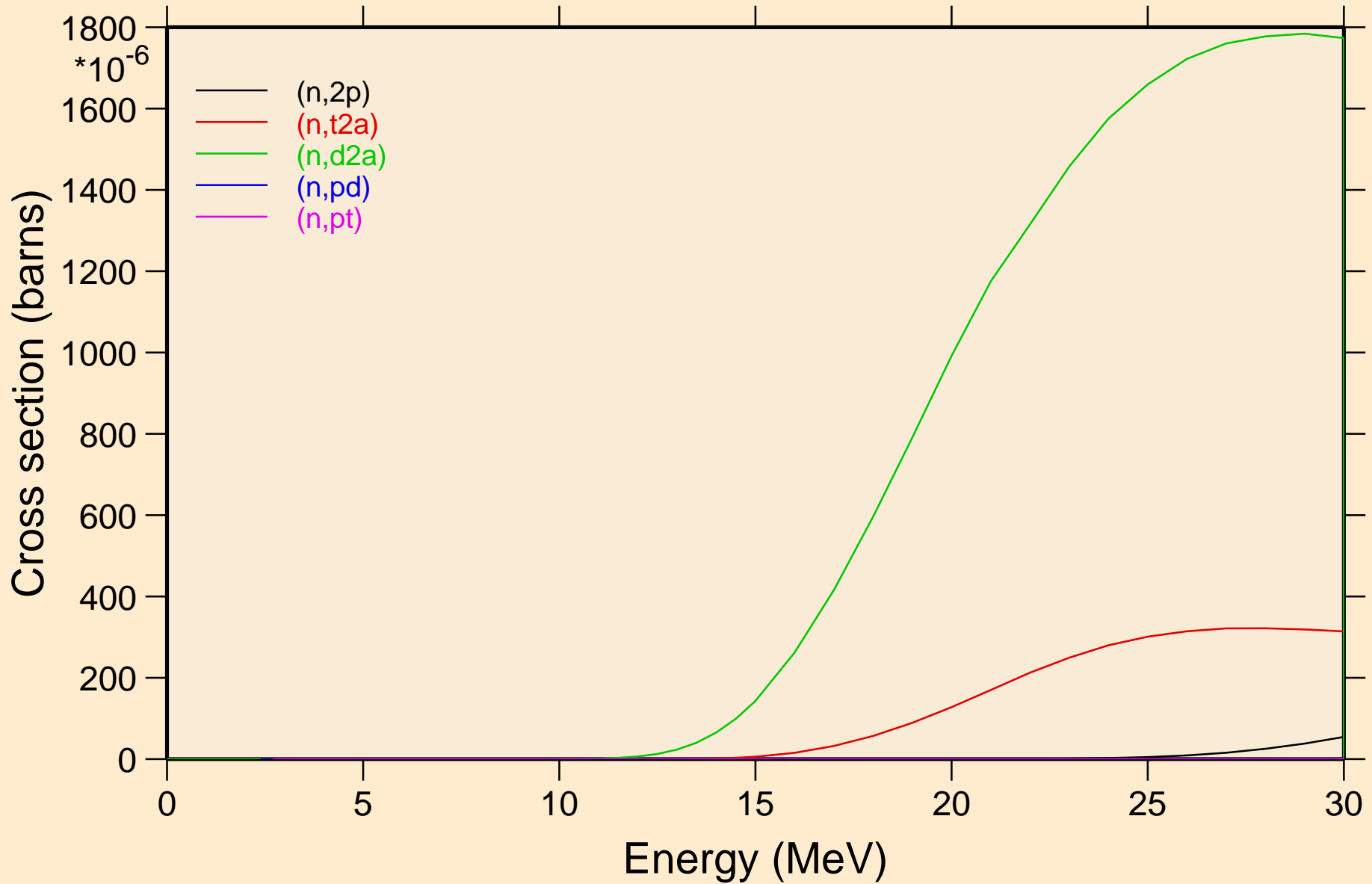

RF255 NRG TENDL-2015, AKONING
Threshold reactions

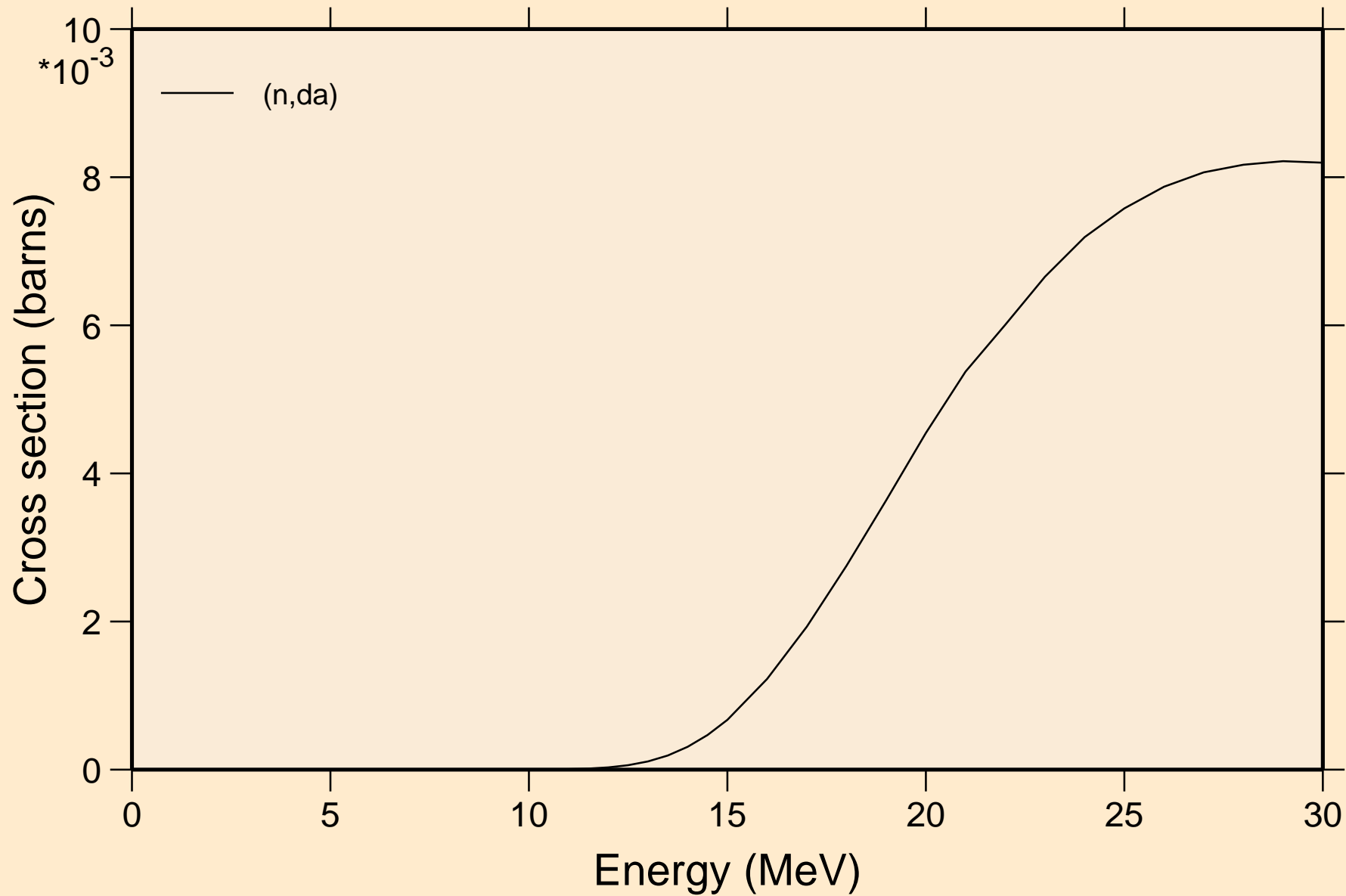

RF255 NRG TENDL-2015, AKONING
angular distribution for elastic

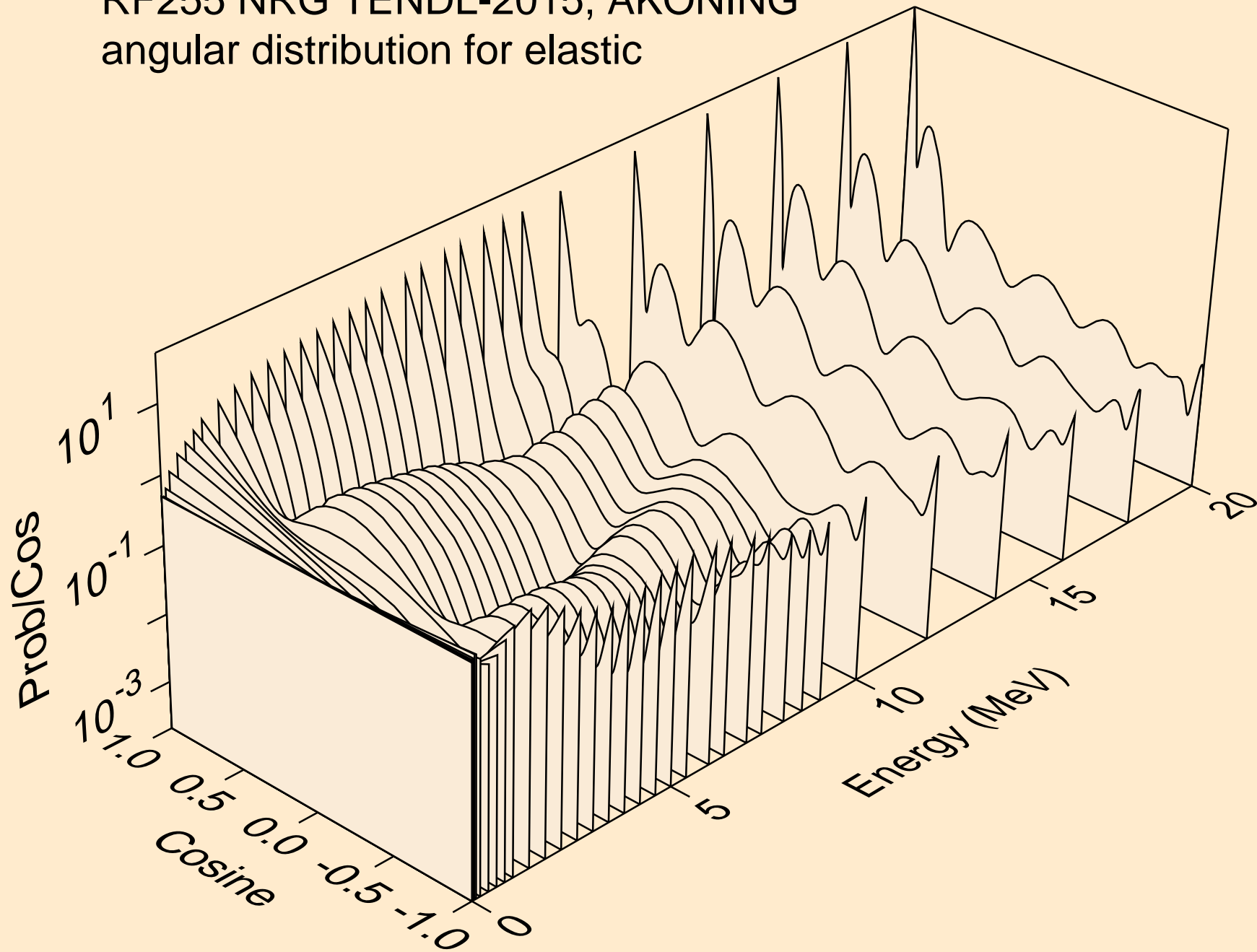

RF255 NRG TENDL-2015, AKONING
angular distribution for elastic

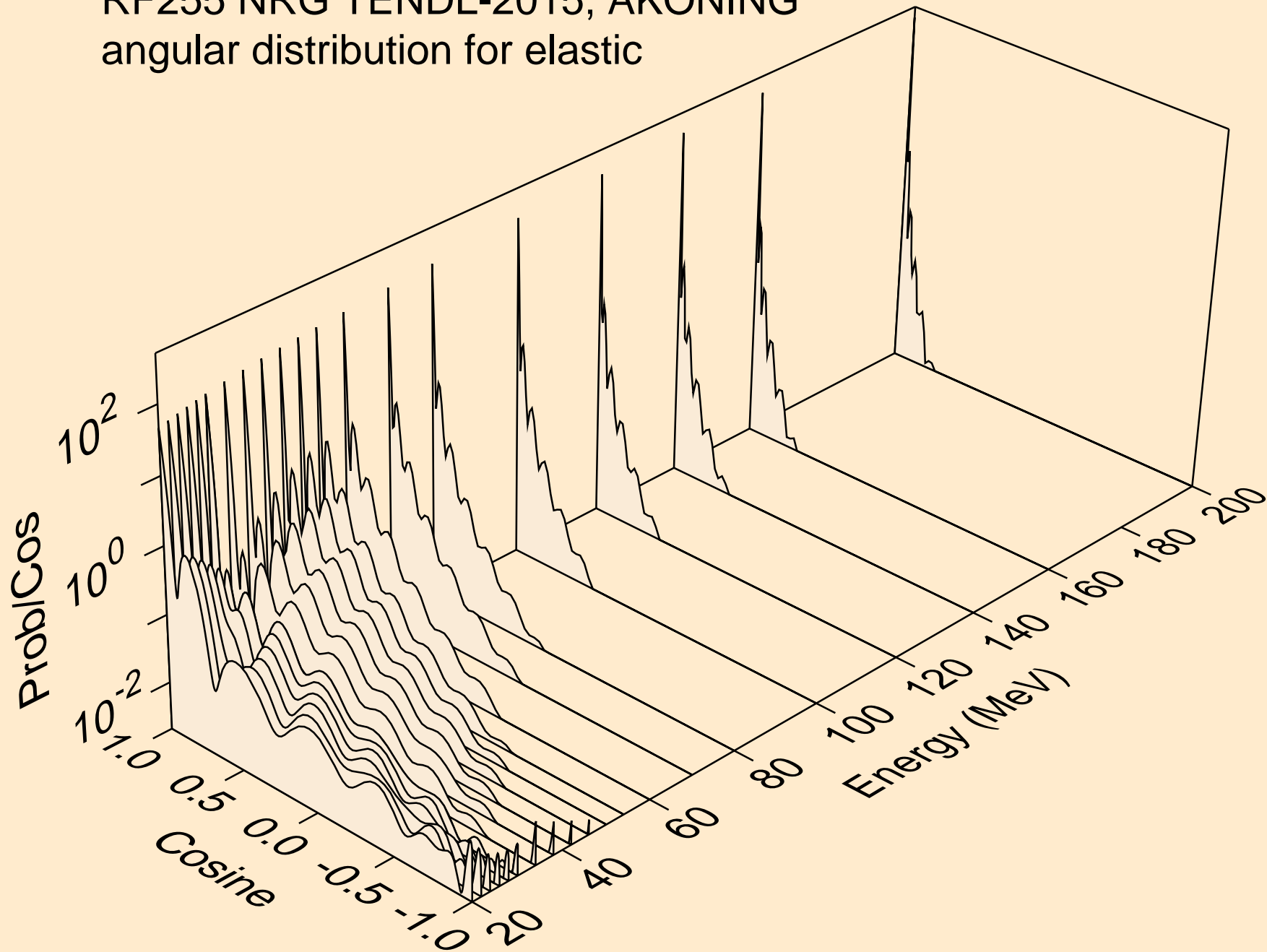

RF255 NRG TENDL-2015, AKONING
angular distribution for (n,n*1)

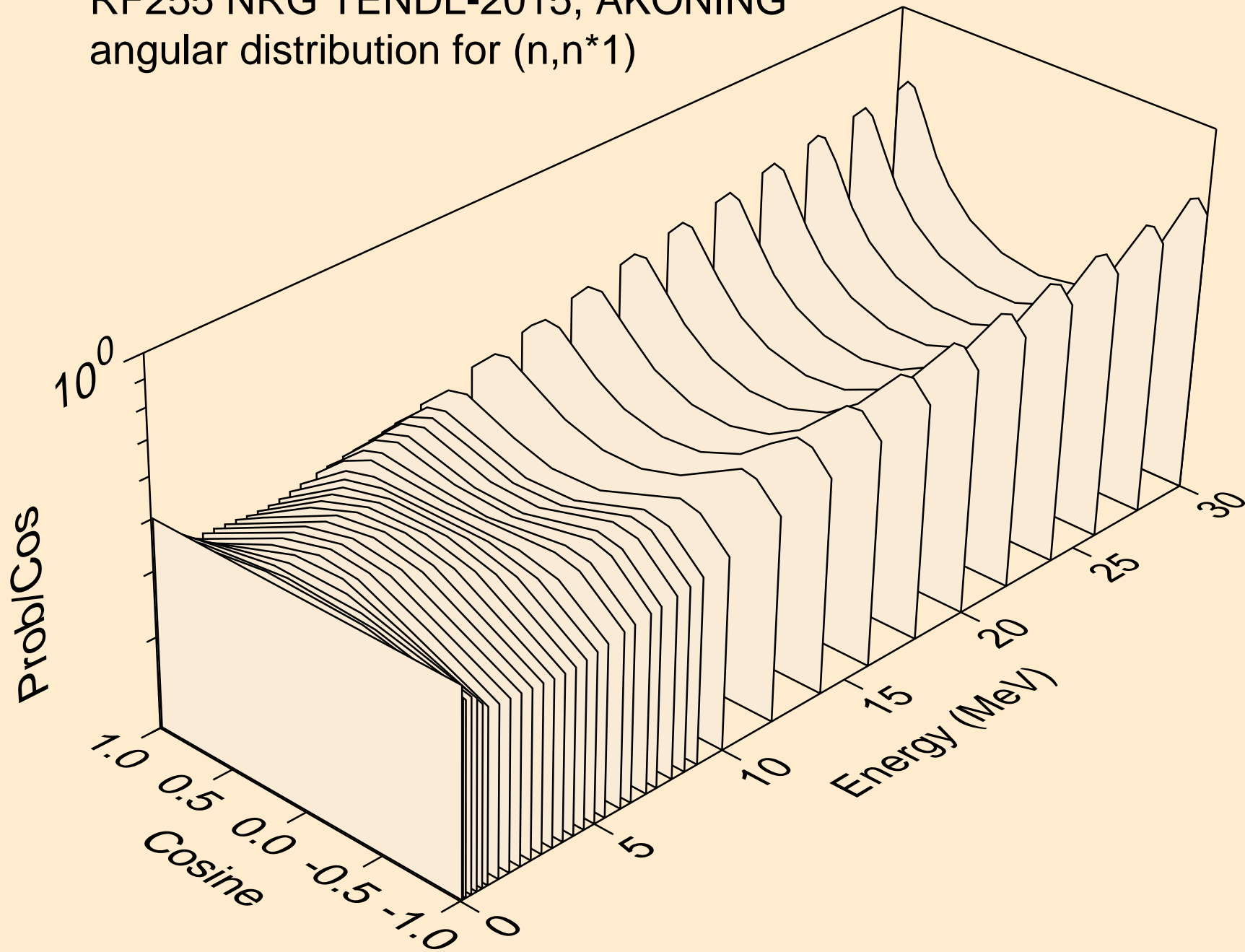

RF255 NRG TENDL-2015, AKONING
angular distribution for (n,n*2)

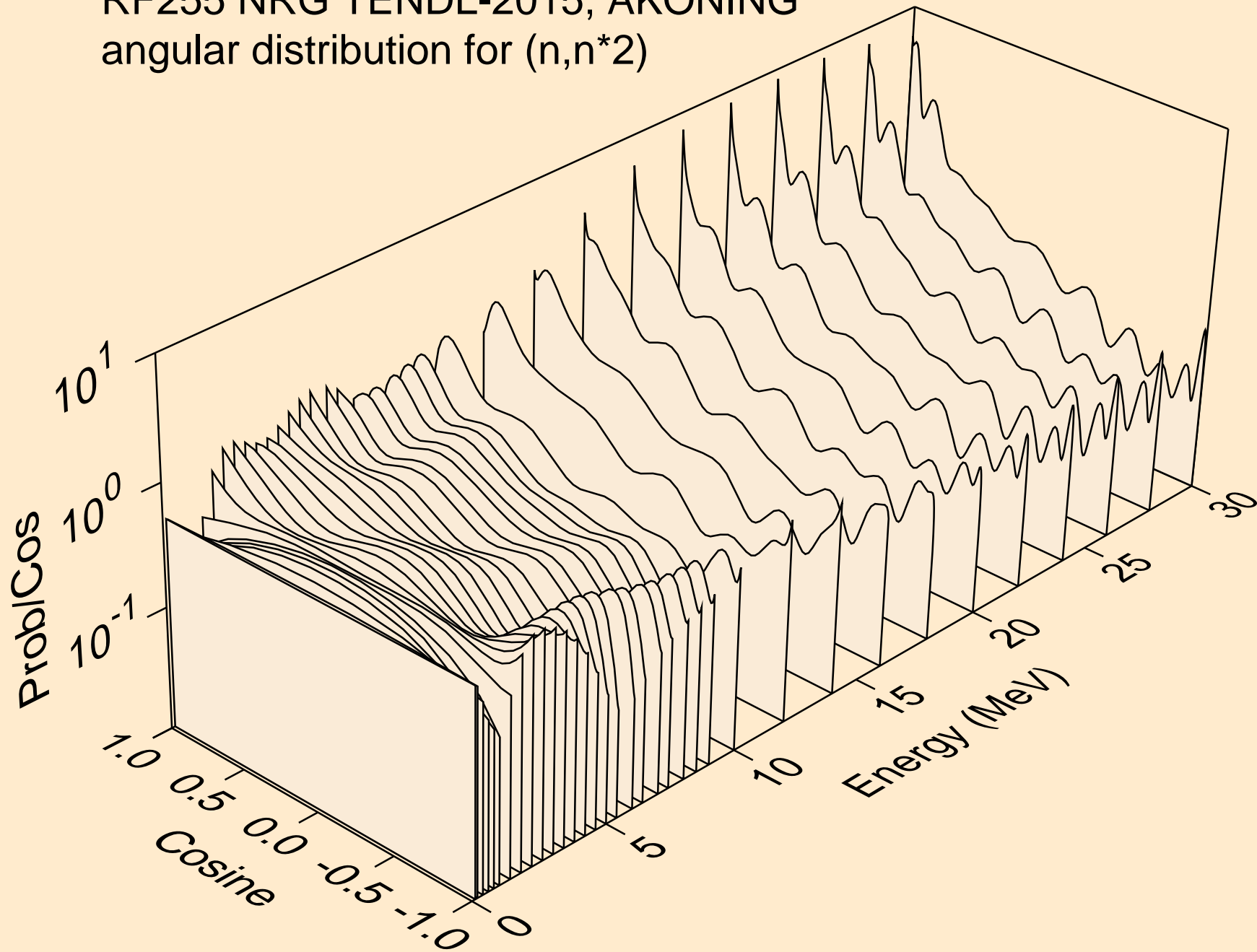

RF255 NRG TENDL-2015, AKONING
angular distribution for (n,n*3)

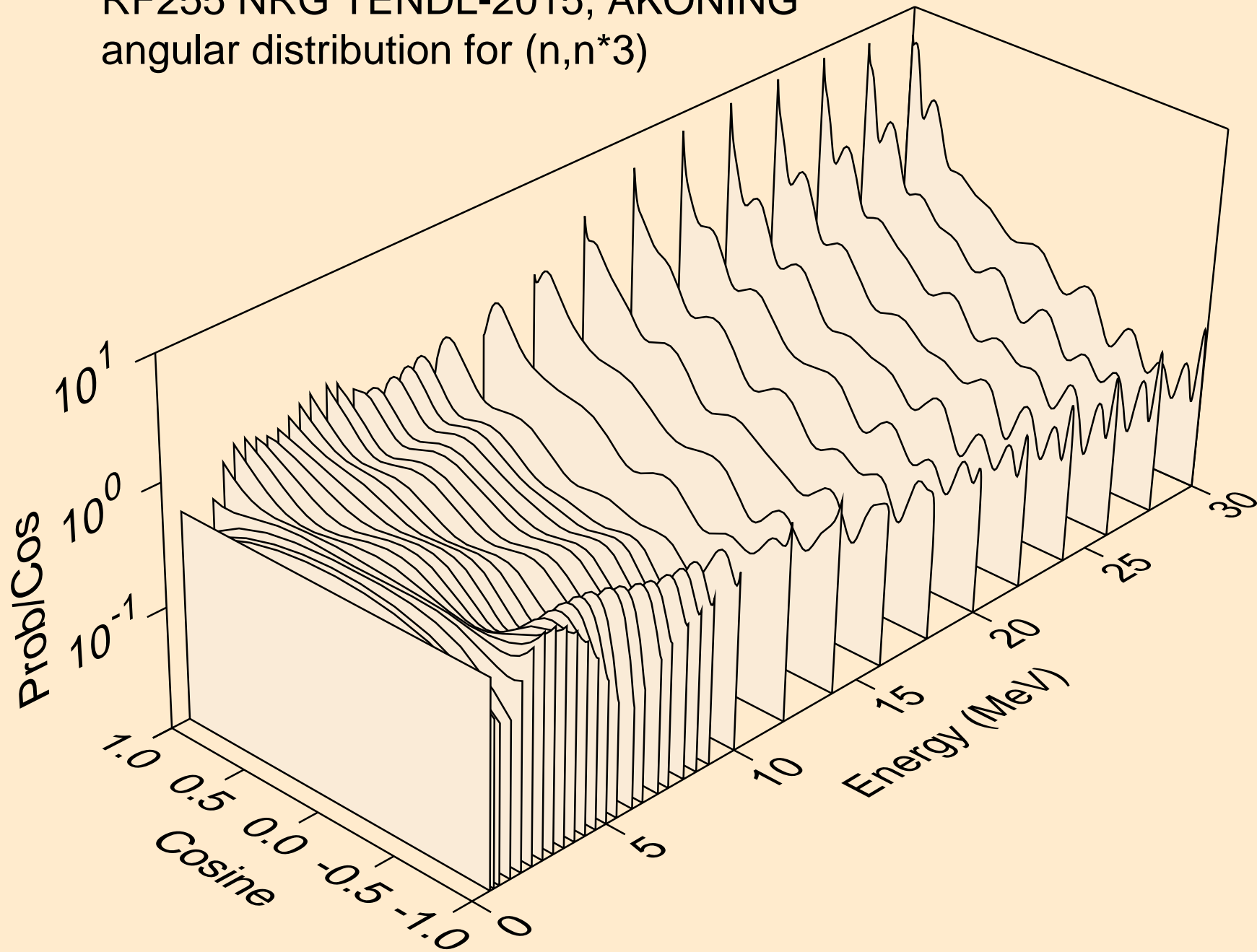

RF255 NRG TENDL-2015, AKONING
angular distribution for (n,n*4)

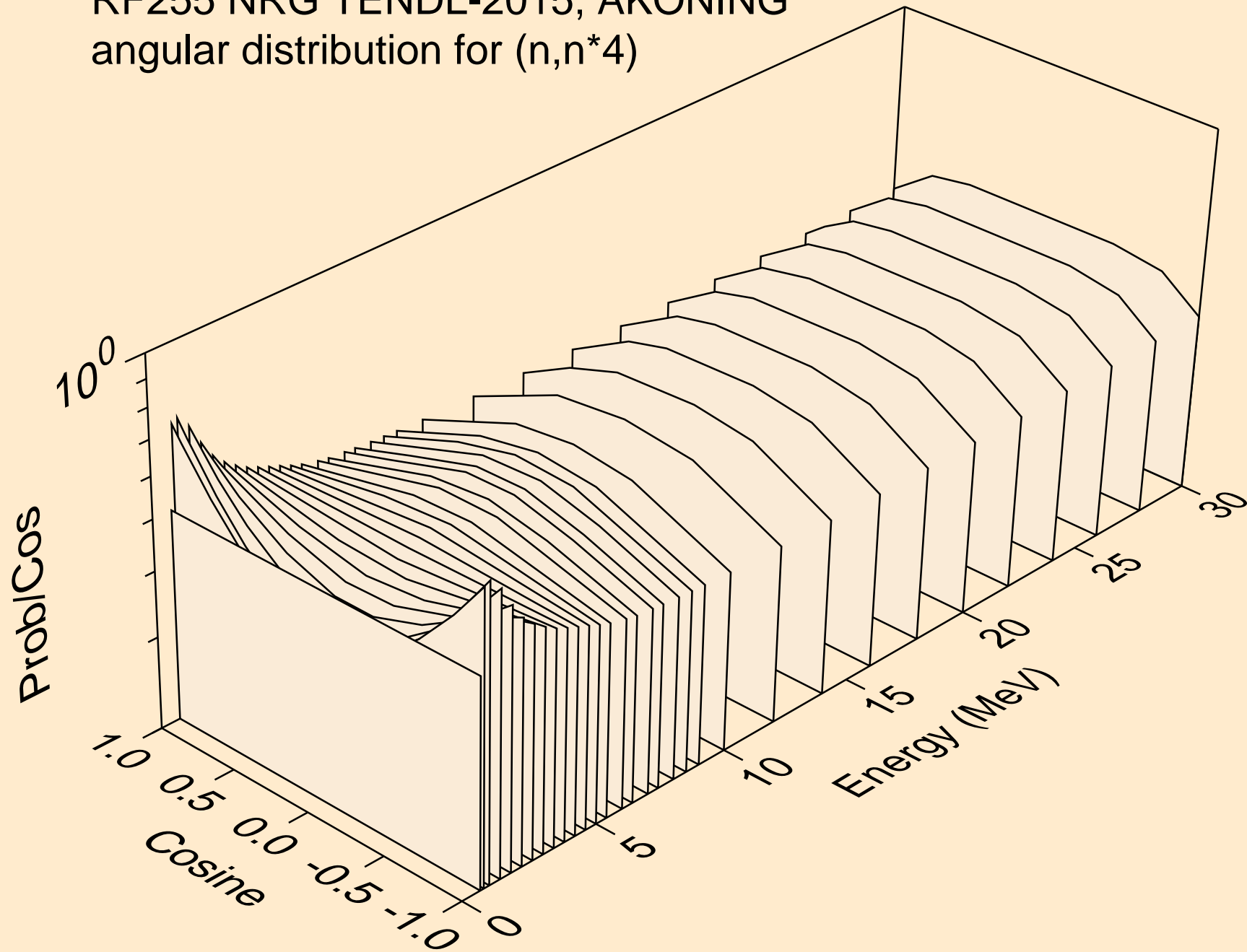

RF255 NRG TENDL-2015, AKONING
angular distribution for (n,n*5)

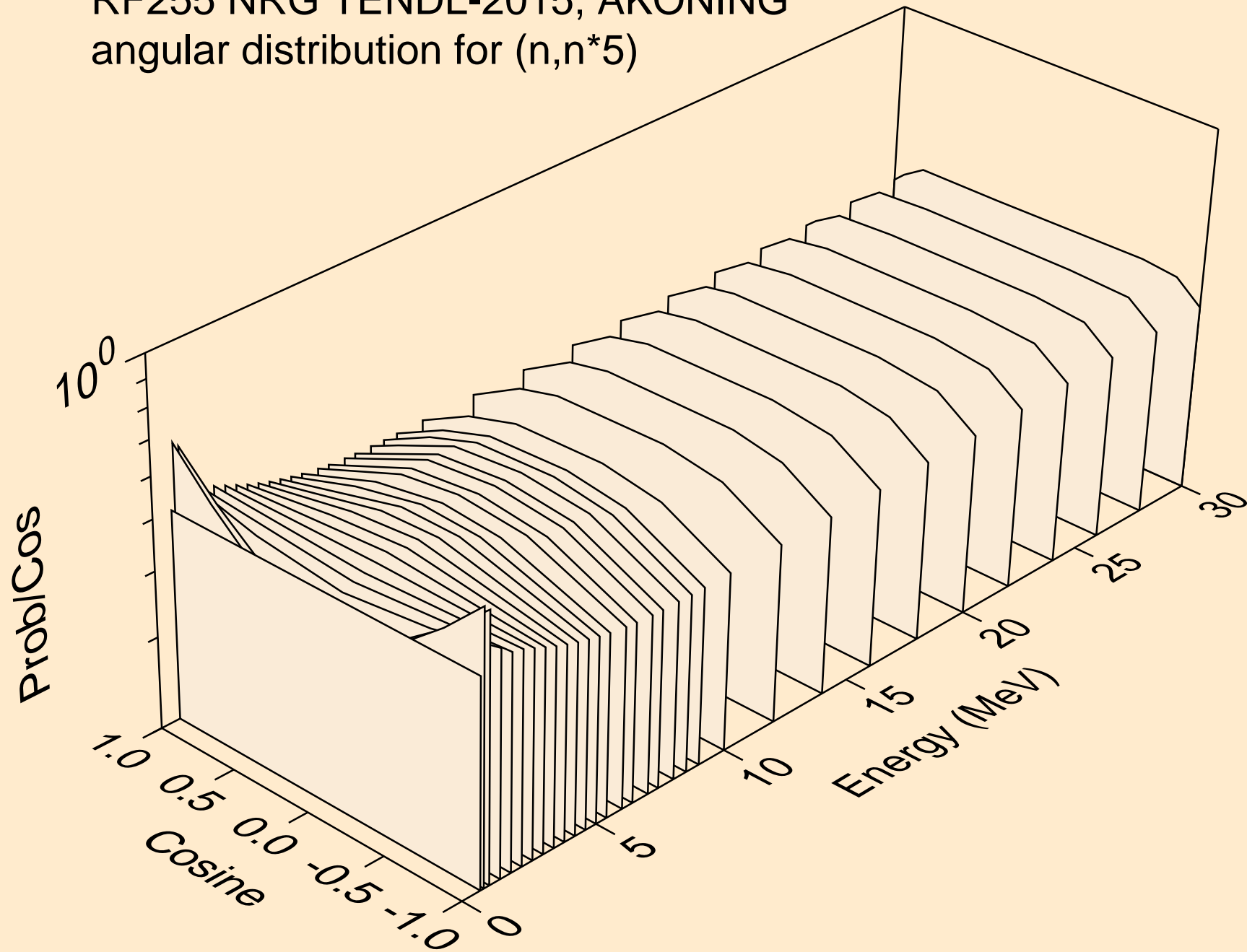

RF255 NRG TENDL-2015, AKONING
angular distribution for (n,n*6)

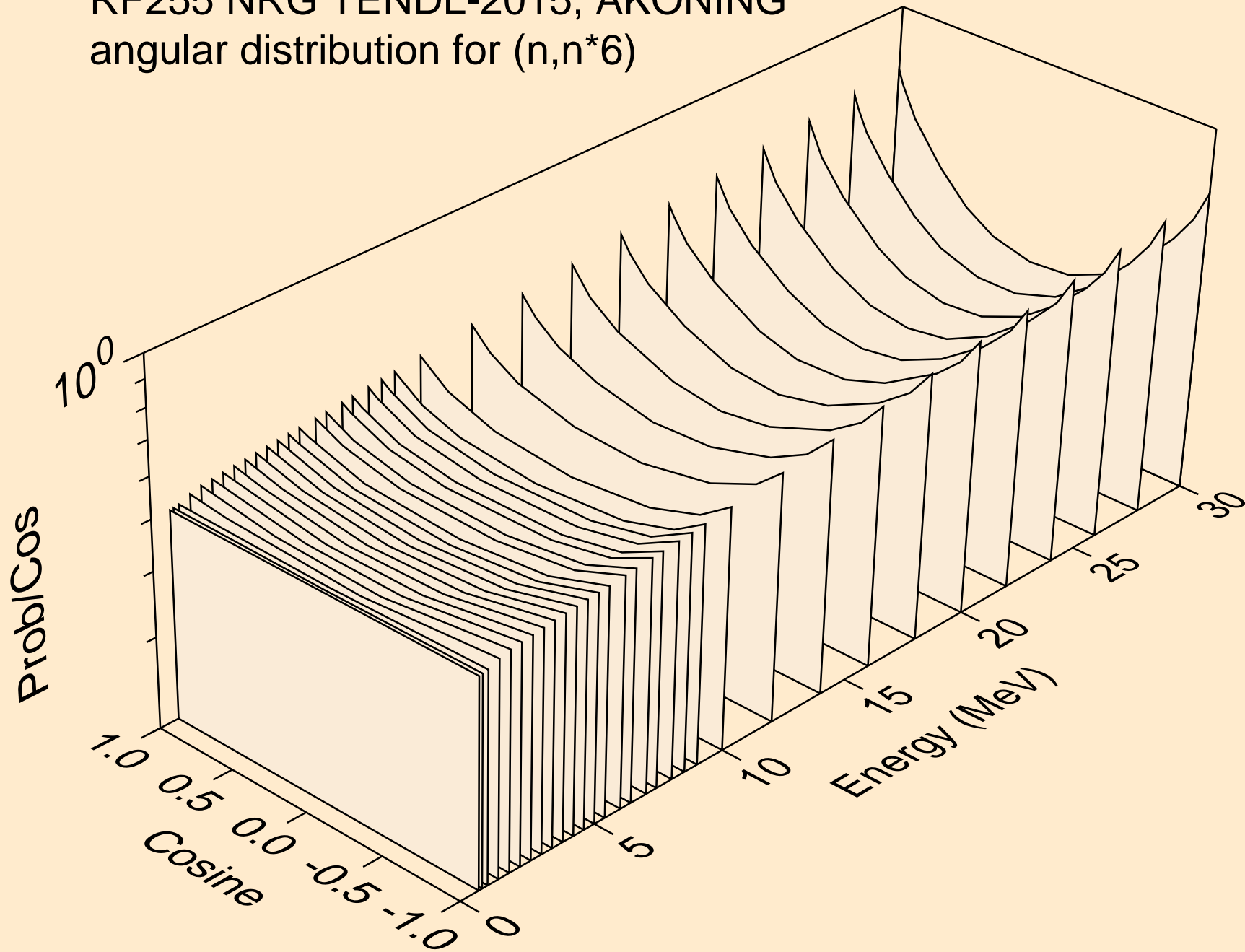

RF255 NRG TENDL-2015, AKONING
angular distribution for (n,n*7)

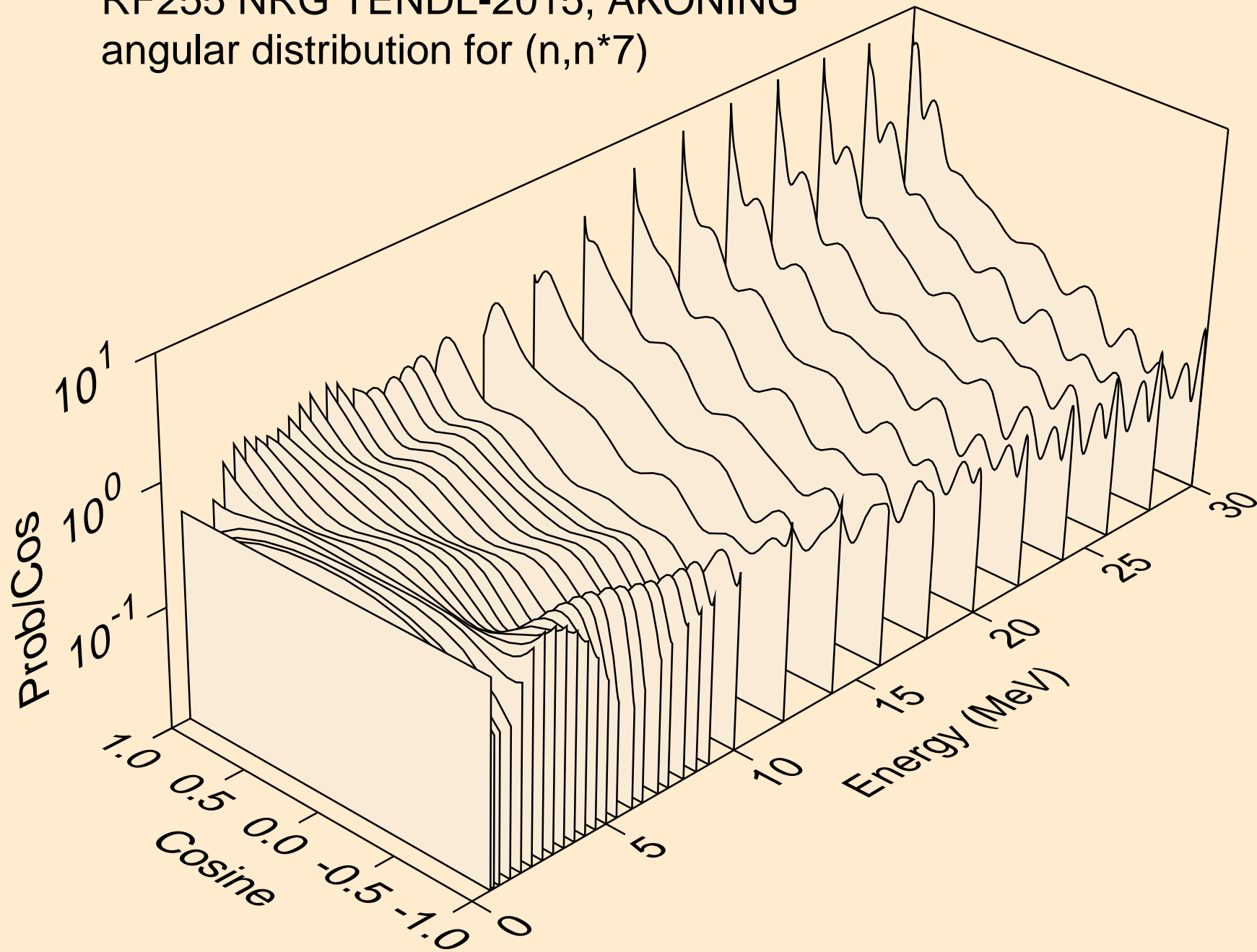

RF255 NRG TENDL-2015, AKONING
angular distribution for (n,n*8)

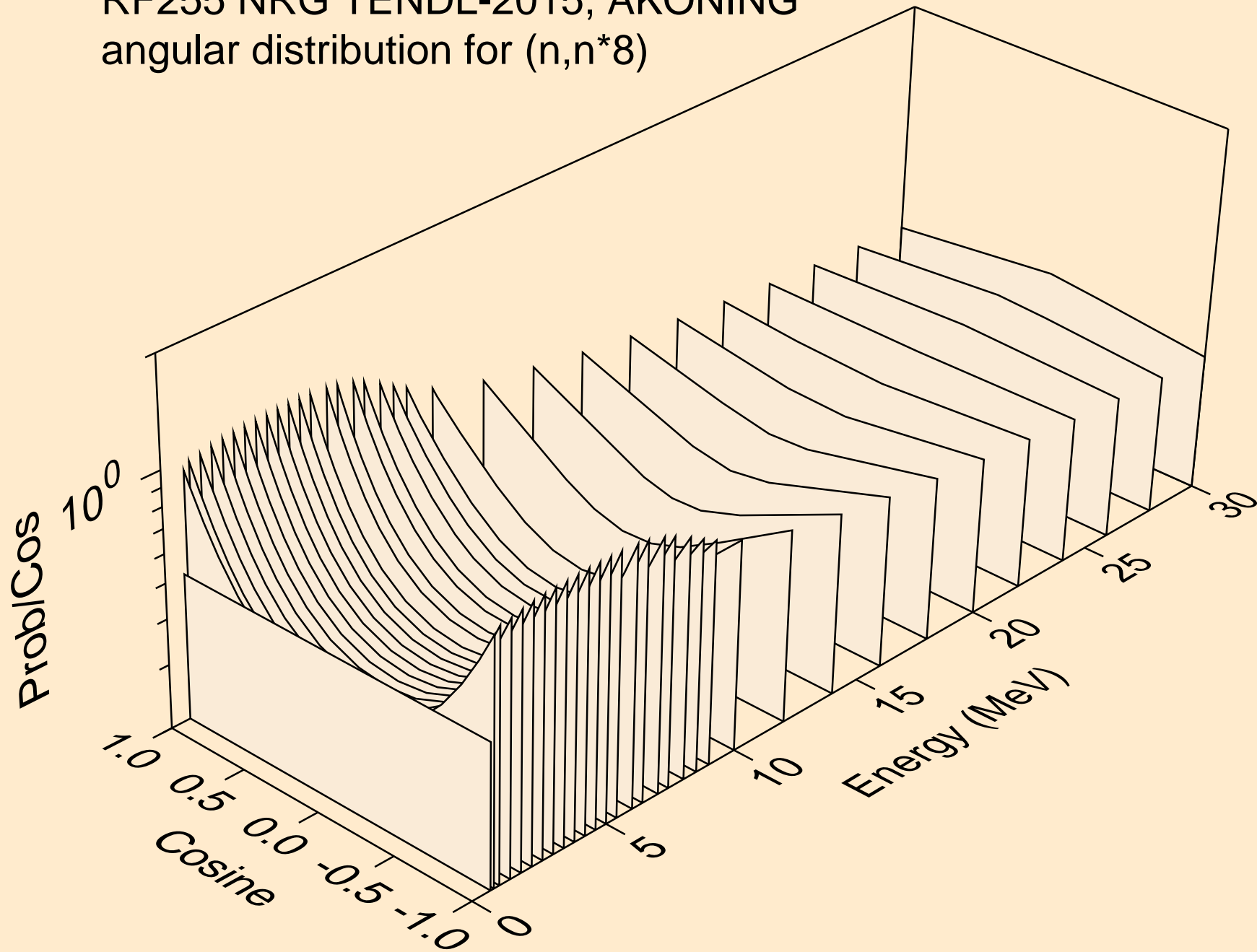

RF255 NRG TENDL-2015, AKONING
angular distribution for (n,n*9)

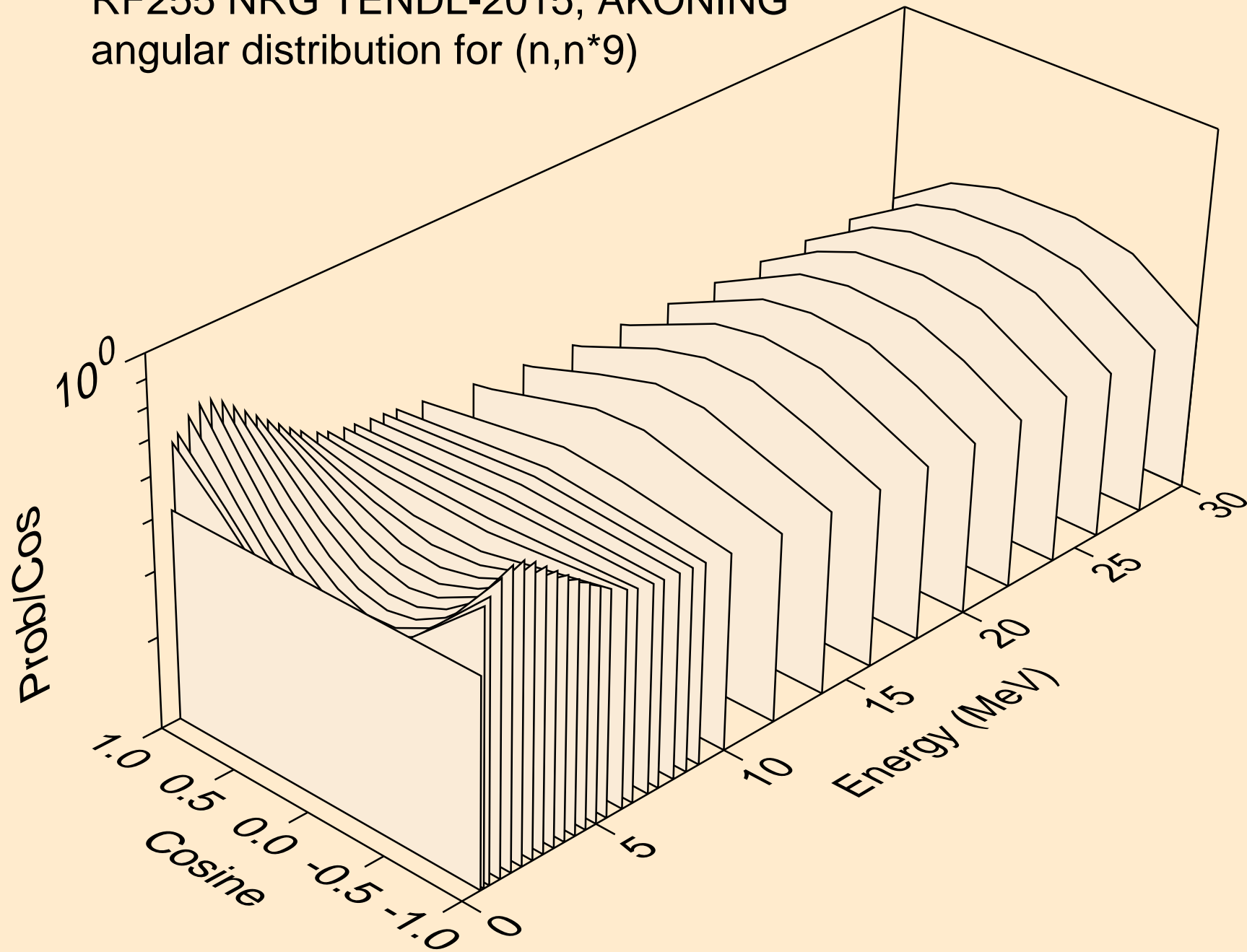

RF255 NRG TENDL-2015, AKONING
angular distribution for (n,n*10)

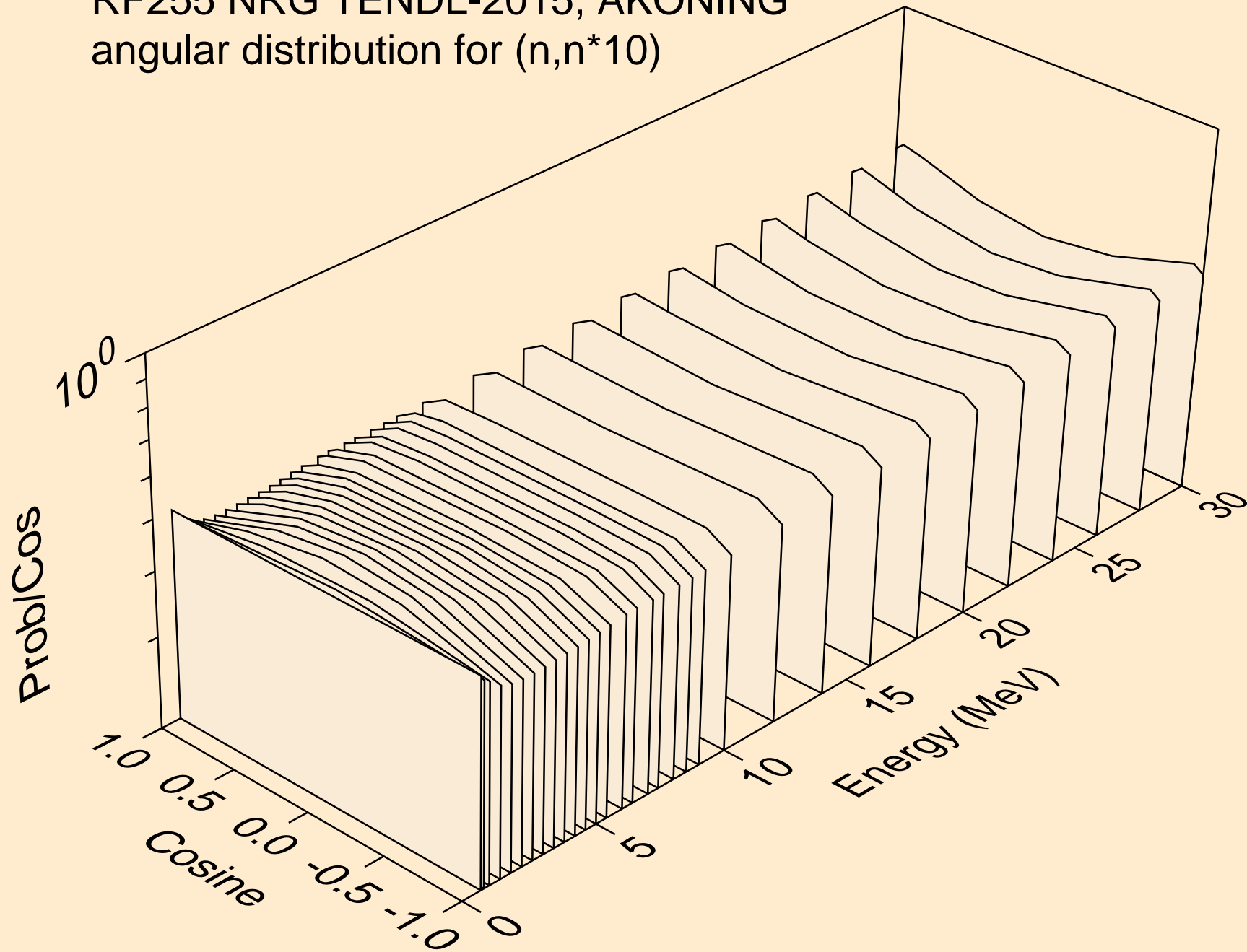

RF255 NRG TENDL-2015, AKONING
angular distribution for (n,n*11)

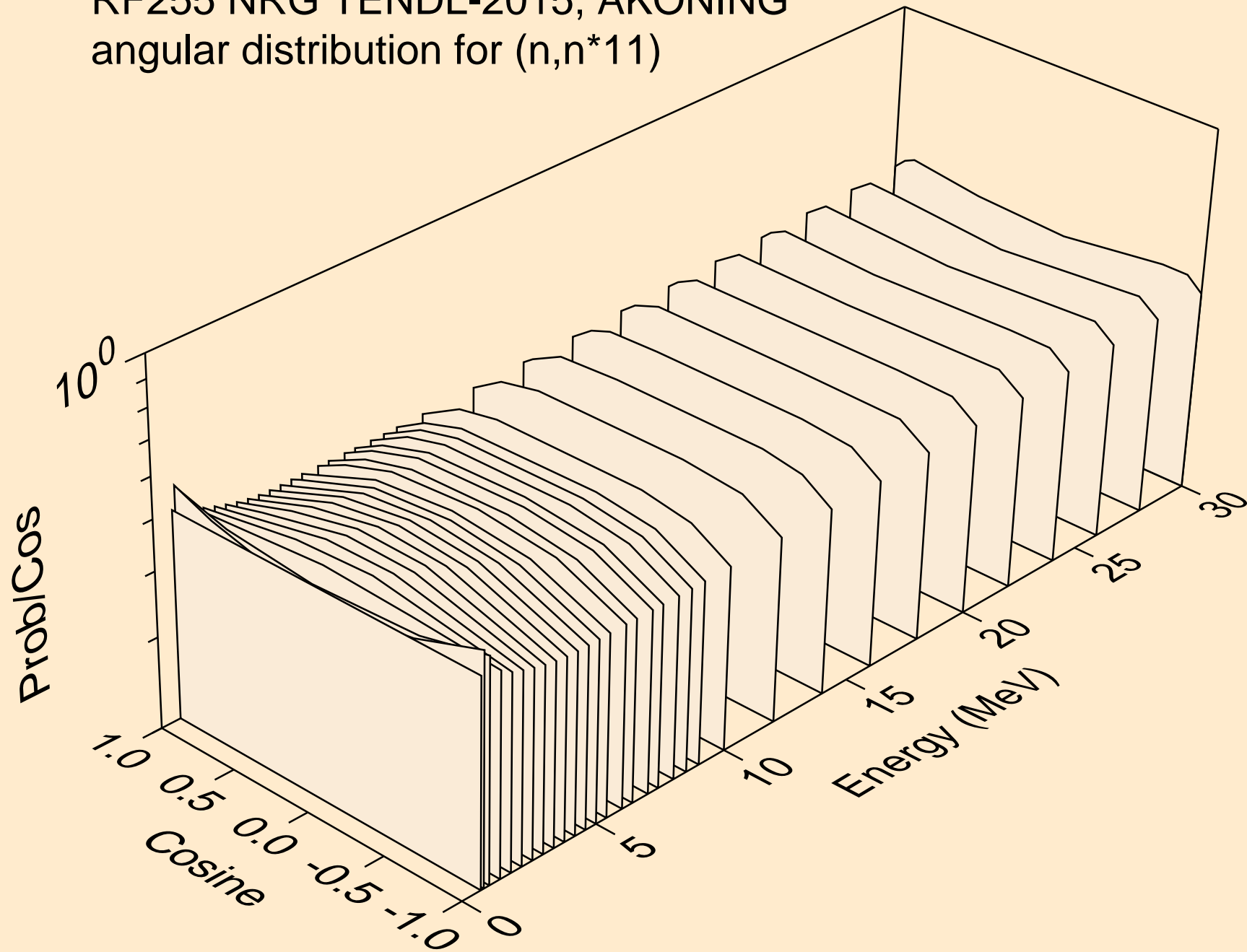

RF255 NRG TENDL-2015, AKONING
angular distribution for (n,n*12)

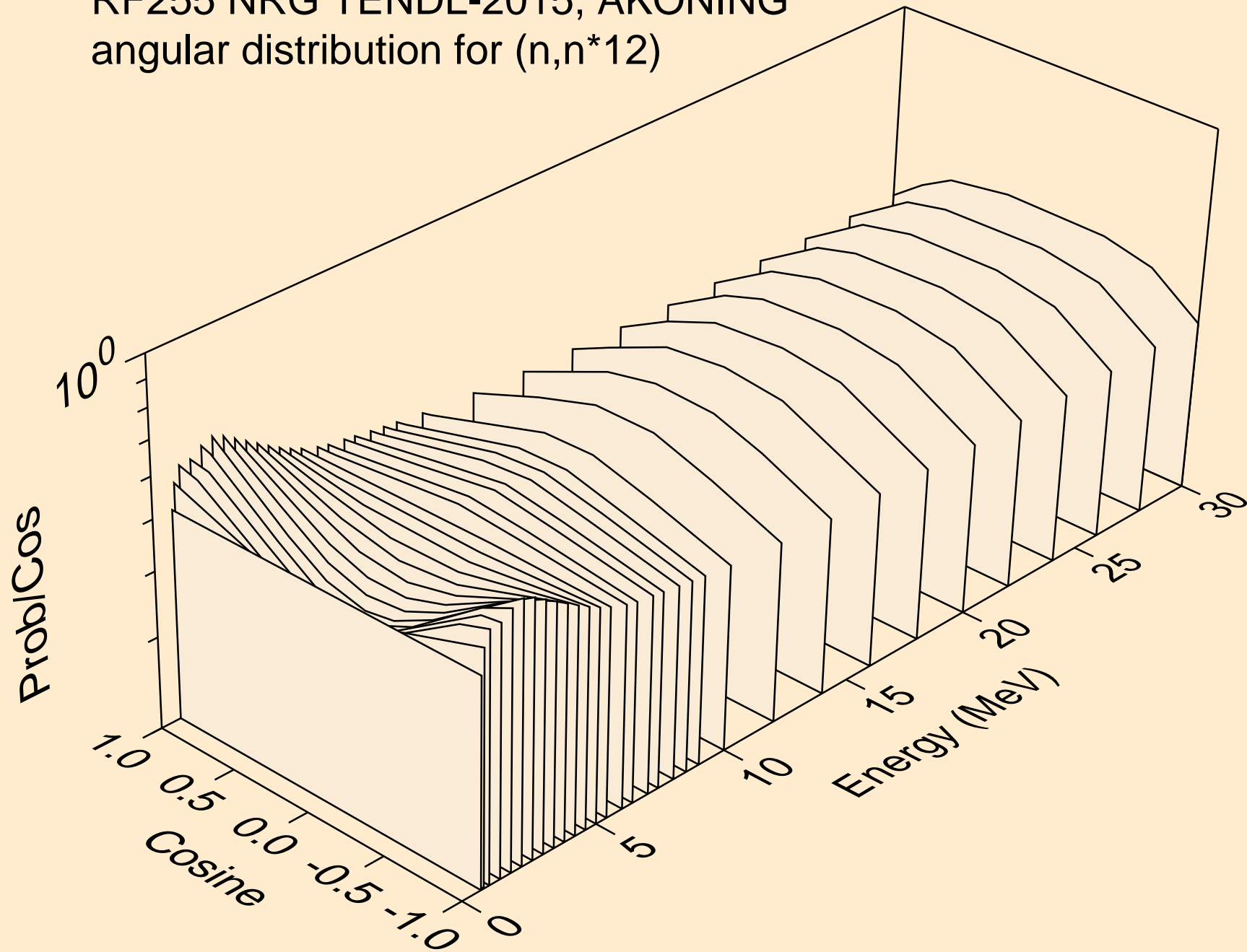

RF255 NRG TENDL-2015, AKONING
angular distribution for (n,n*13)

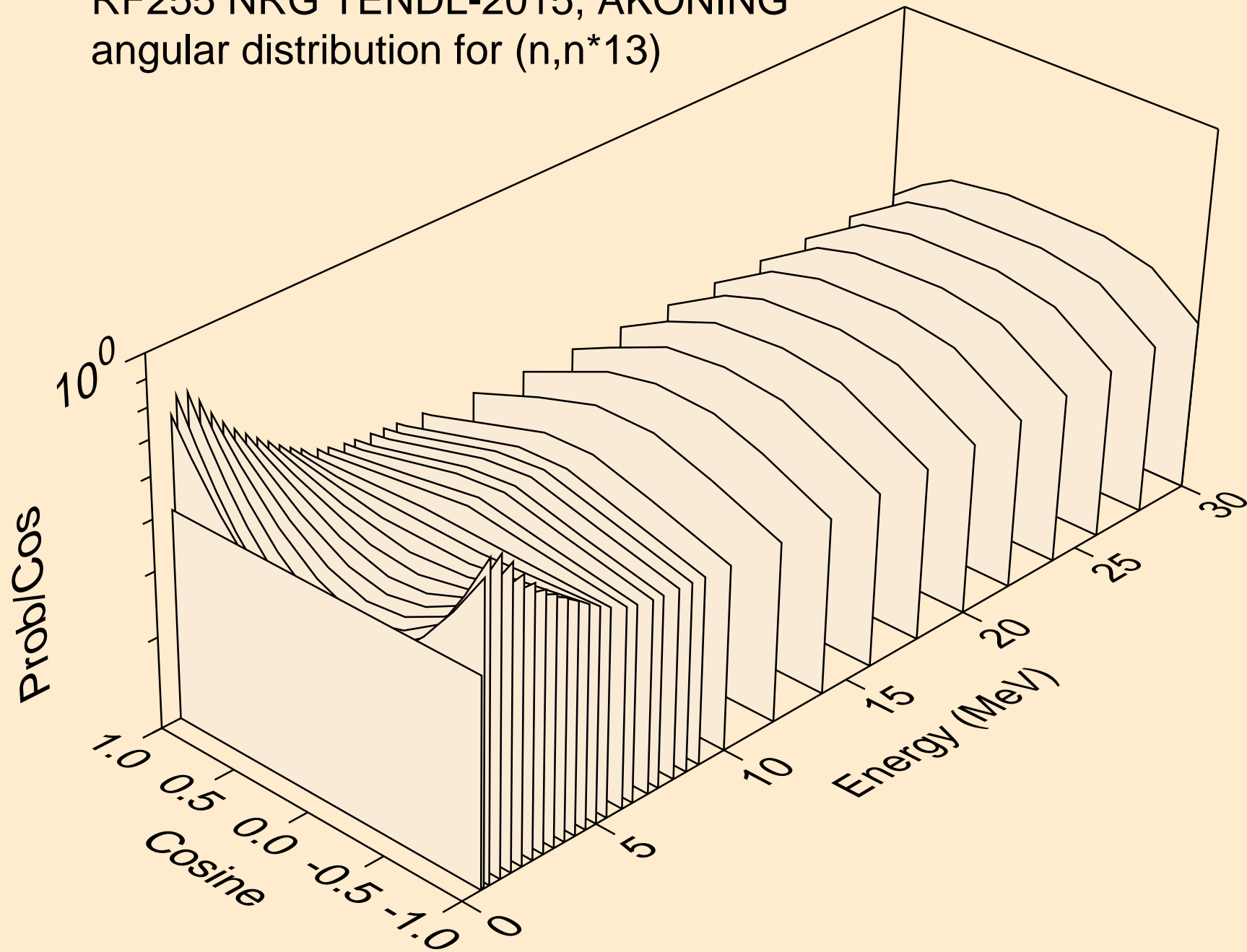

RF255 NRG TENDL-2015, AKONING
angular distribution for (n,n*14)

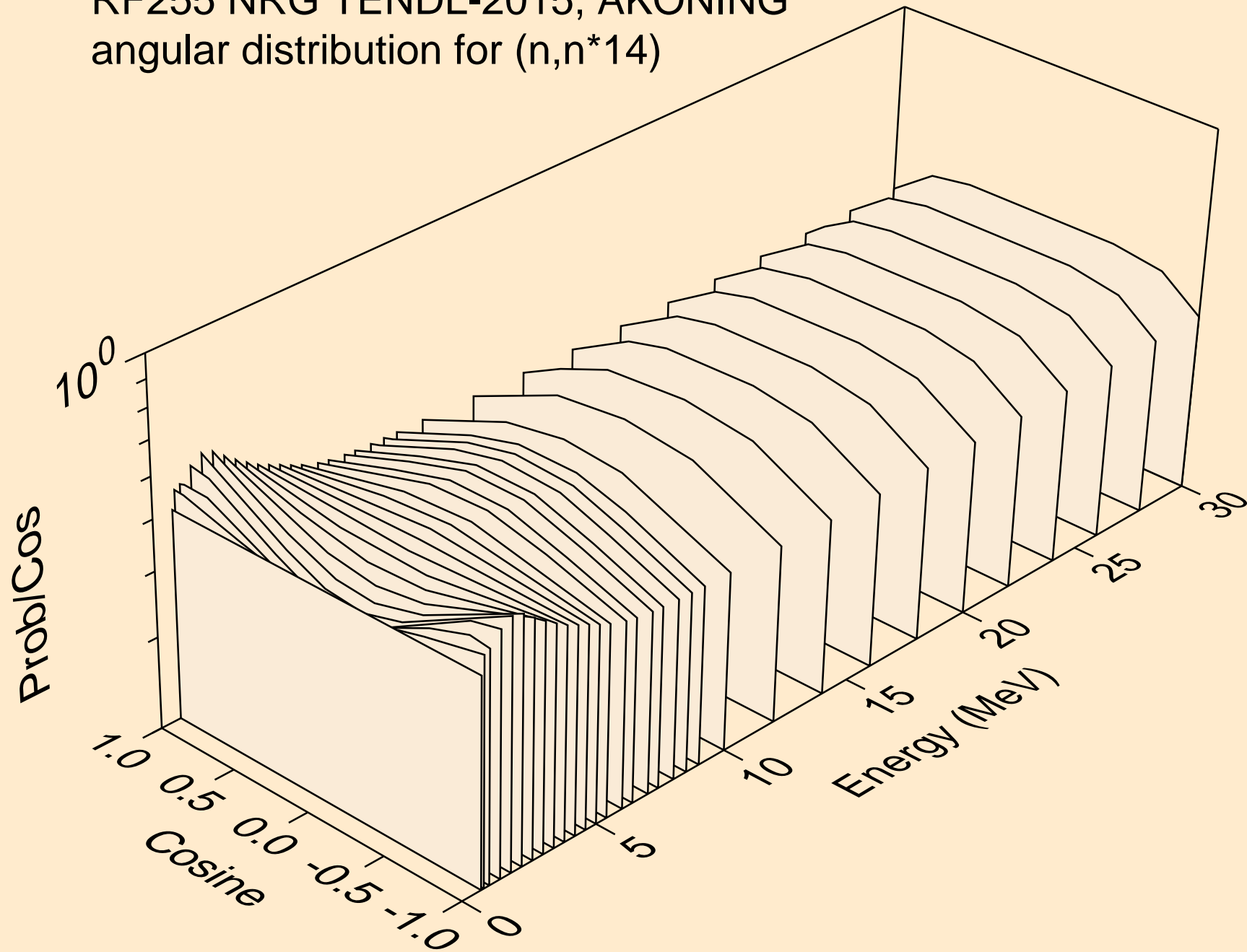

RF255 NRG TENDL-2015, AKONING
angular distribution for (n,n*15)

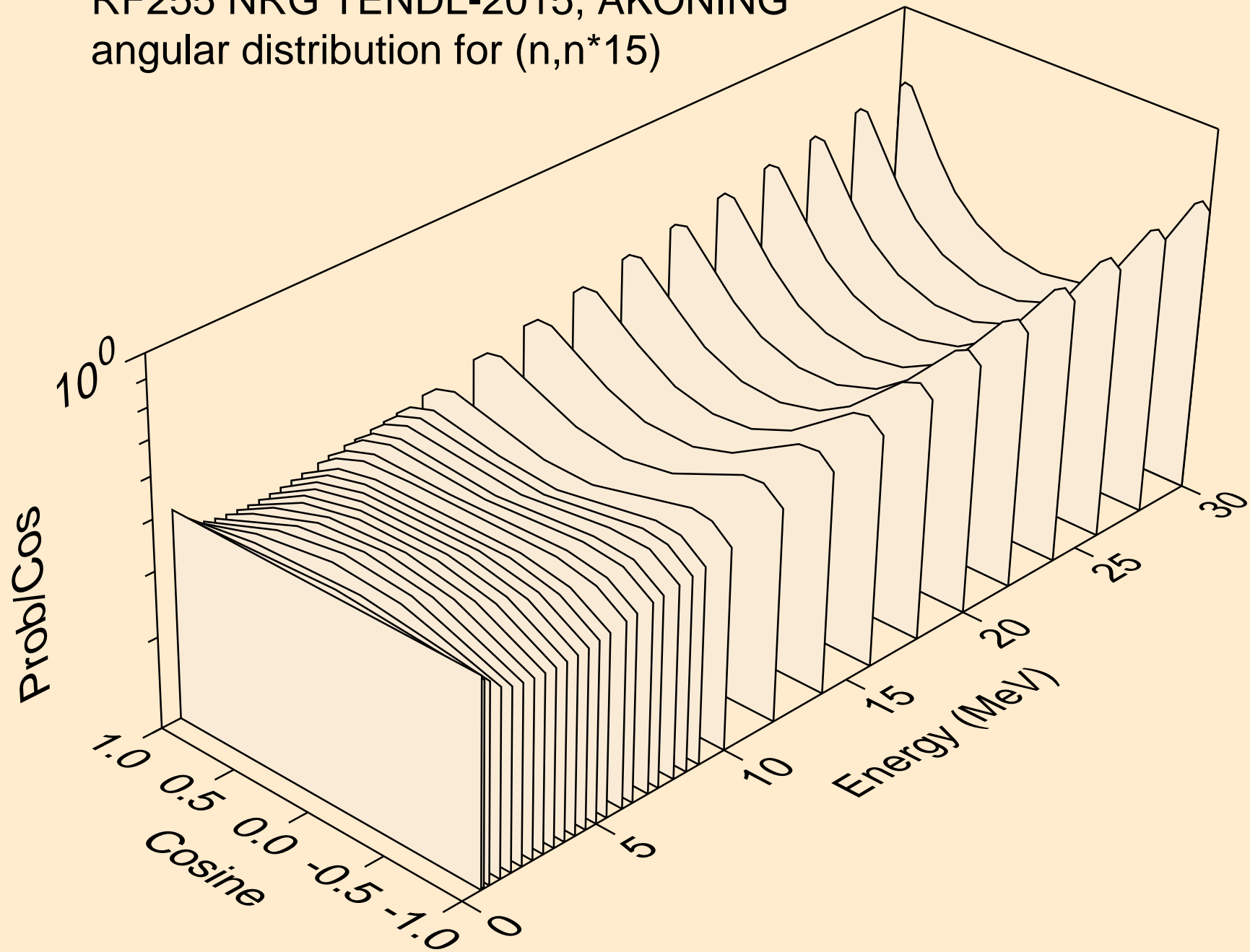

RF255 NRG TENDL-2015, AKONING
angular distribution for (n,n*16)

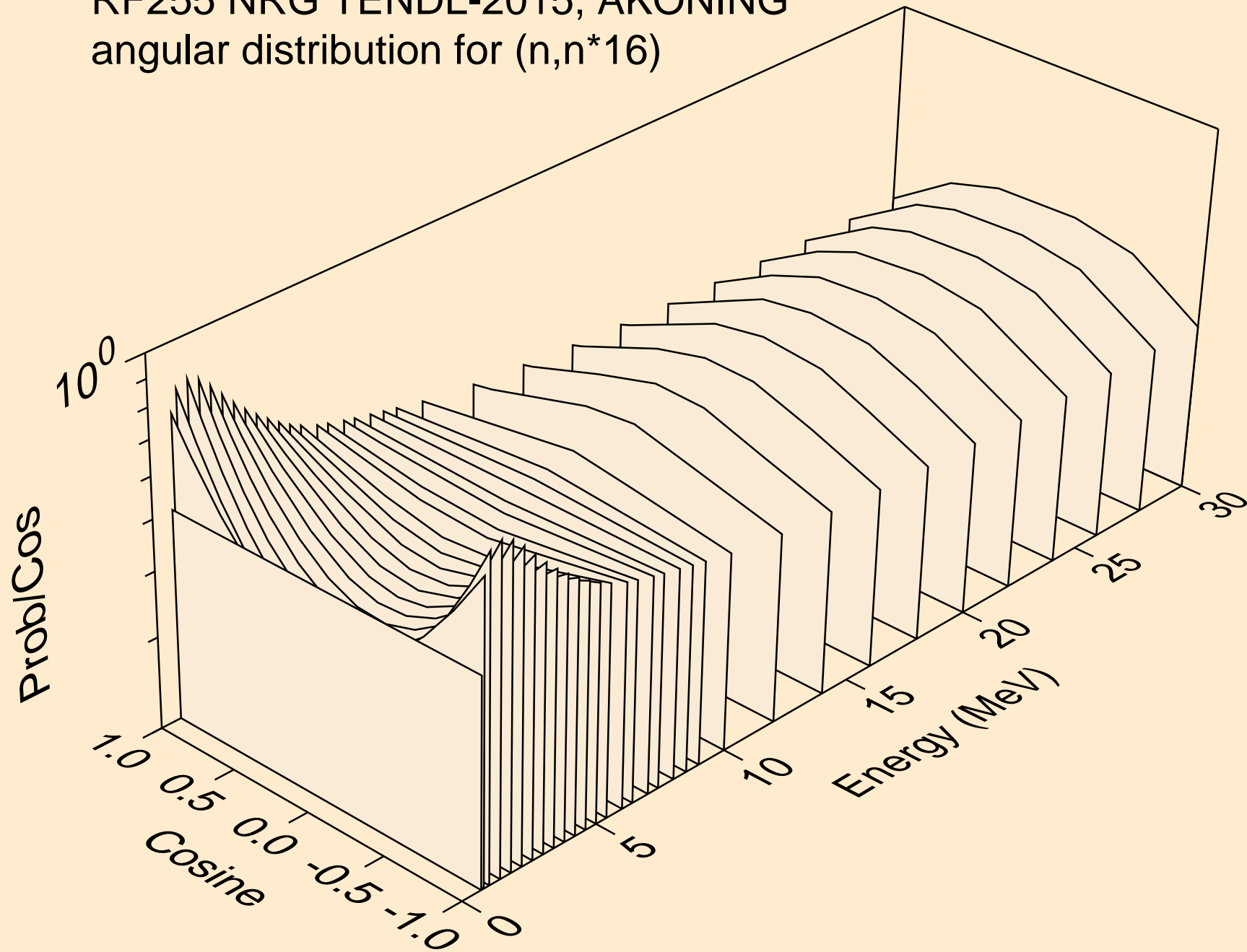

RF255 NRG TENDL-2015, AKONING
angular distribution for (n,n*17)

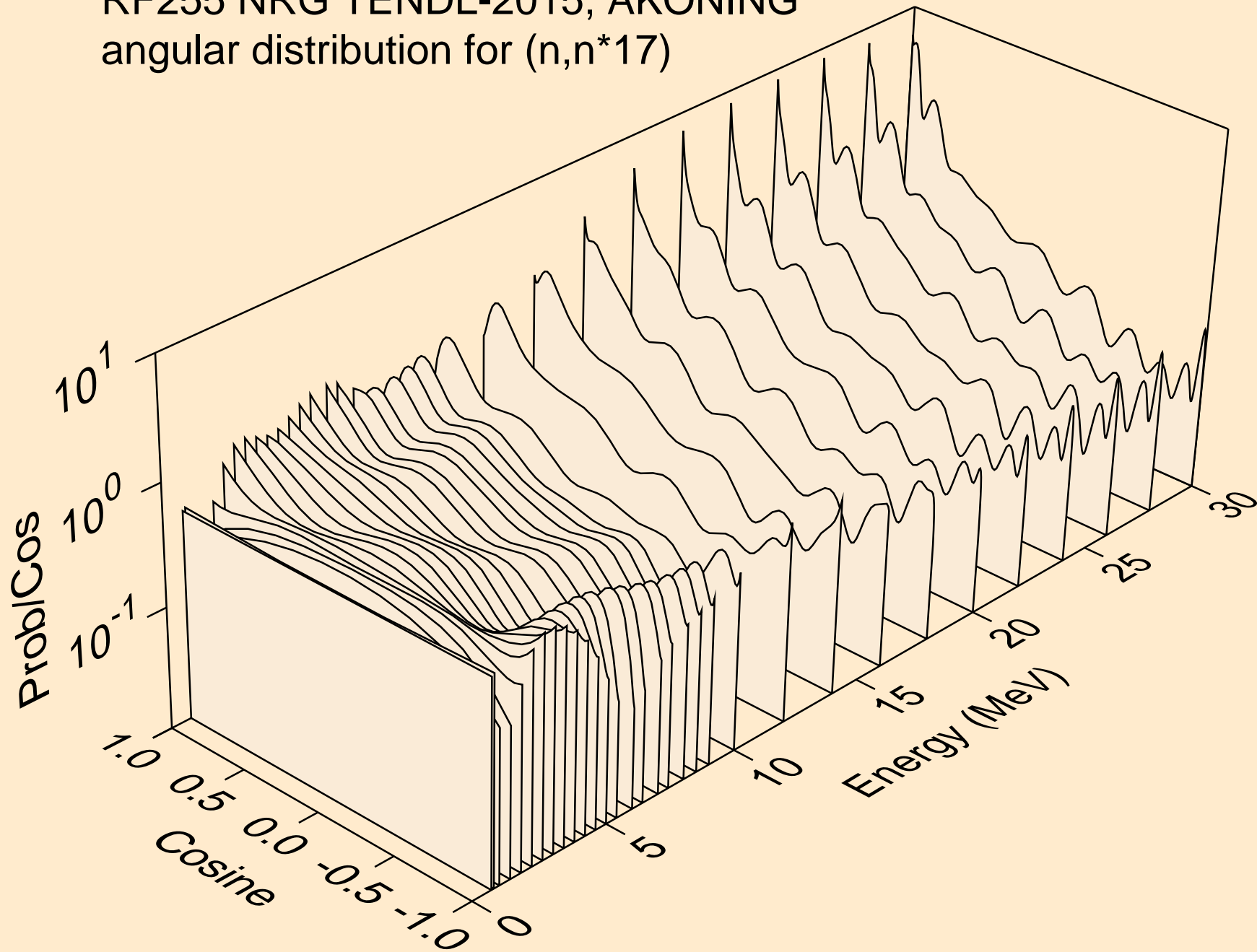

RF255 NRG TENDL-2015, AKONING
angular distribution for (n,n*18)

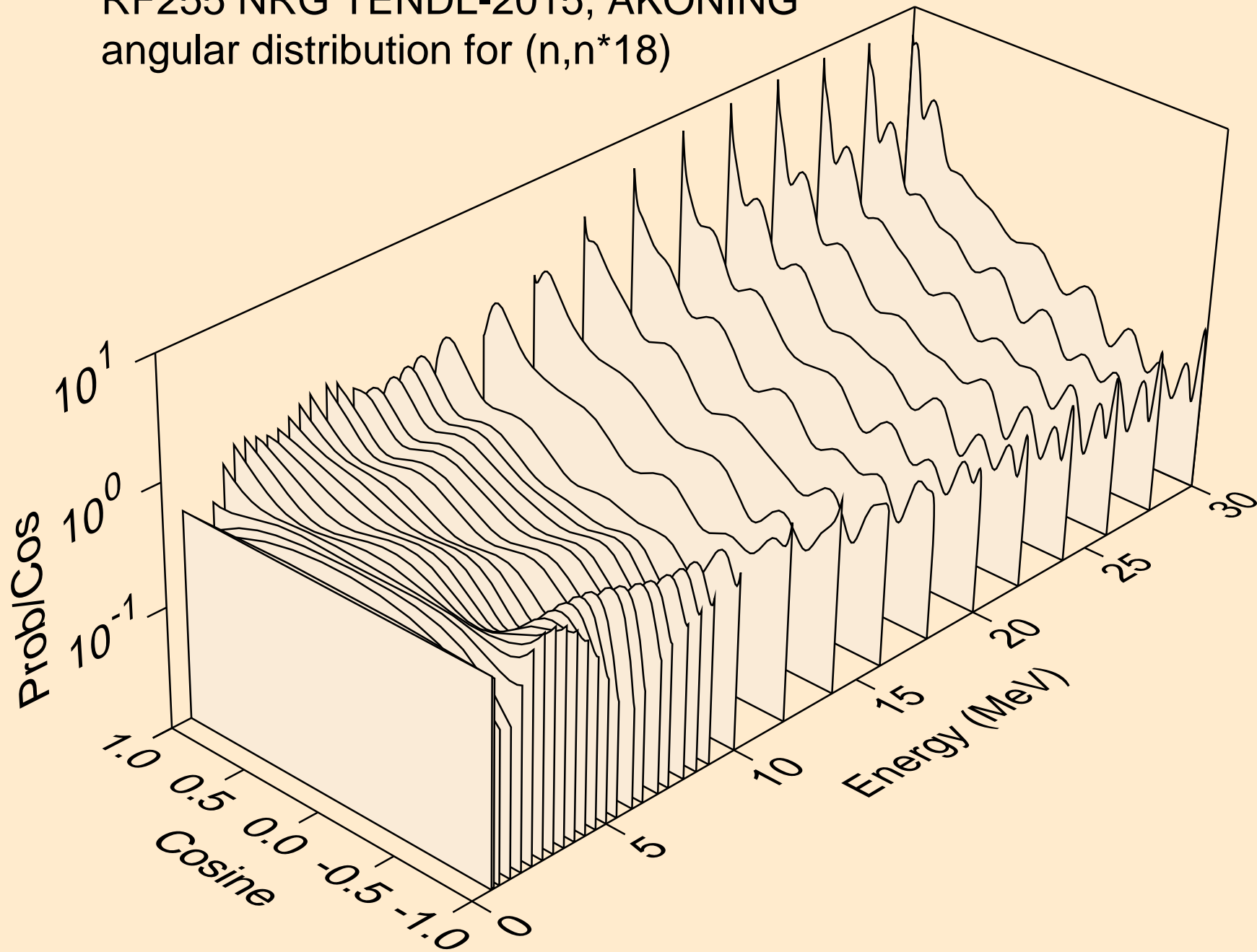

RF255 NRG TENDL-2015, AKONING
angular distribution for (n,n*19)

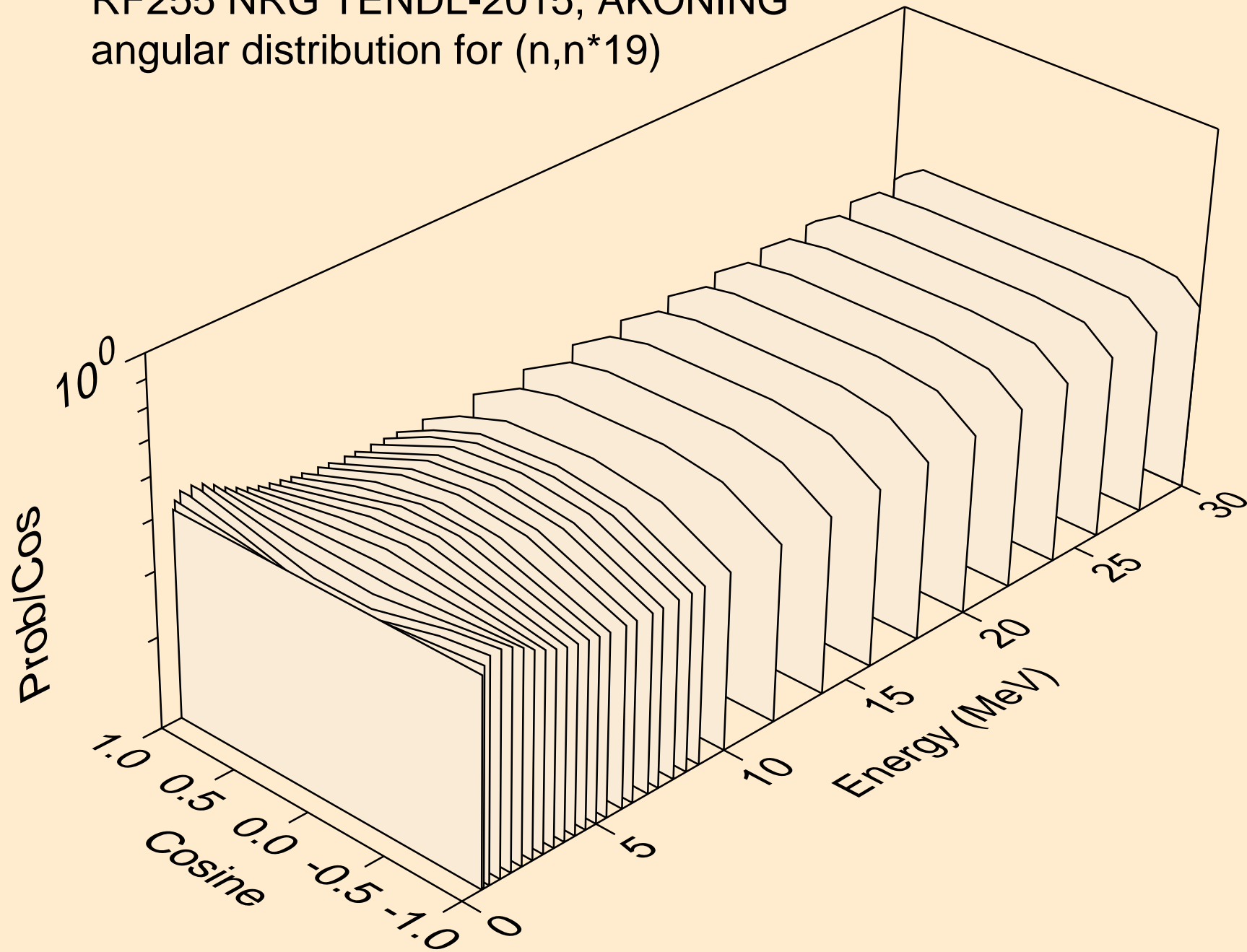

RF255 NRG TENDL-2015, AKONING
angular distribution for (n,n*20)

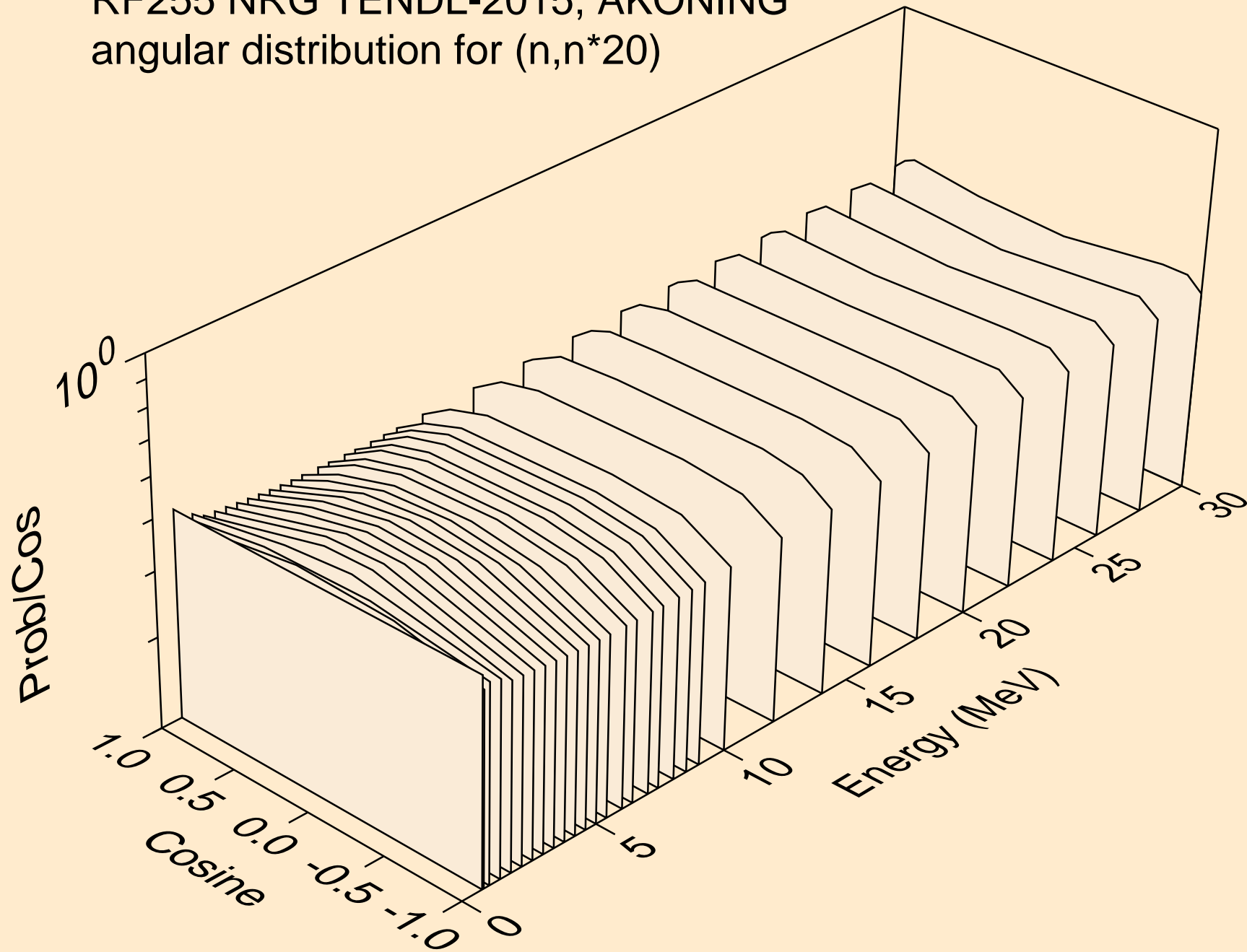

RF255 NRG TENDL-2015, AKONING
angular distribution for (n,n*21)

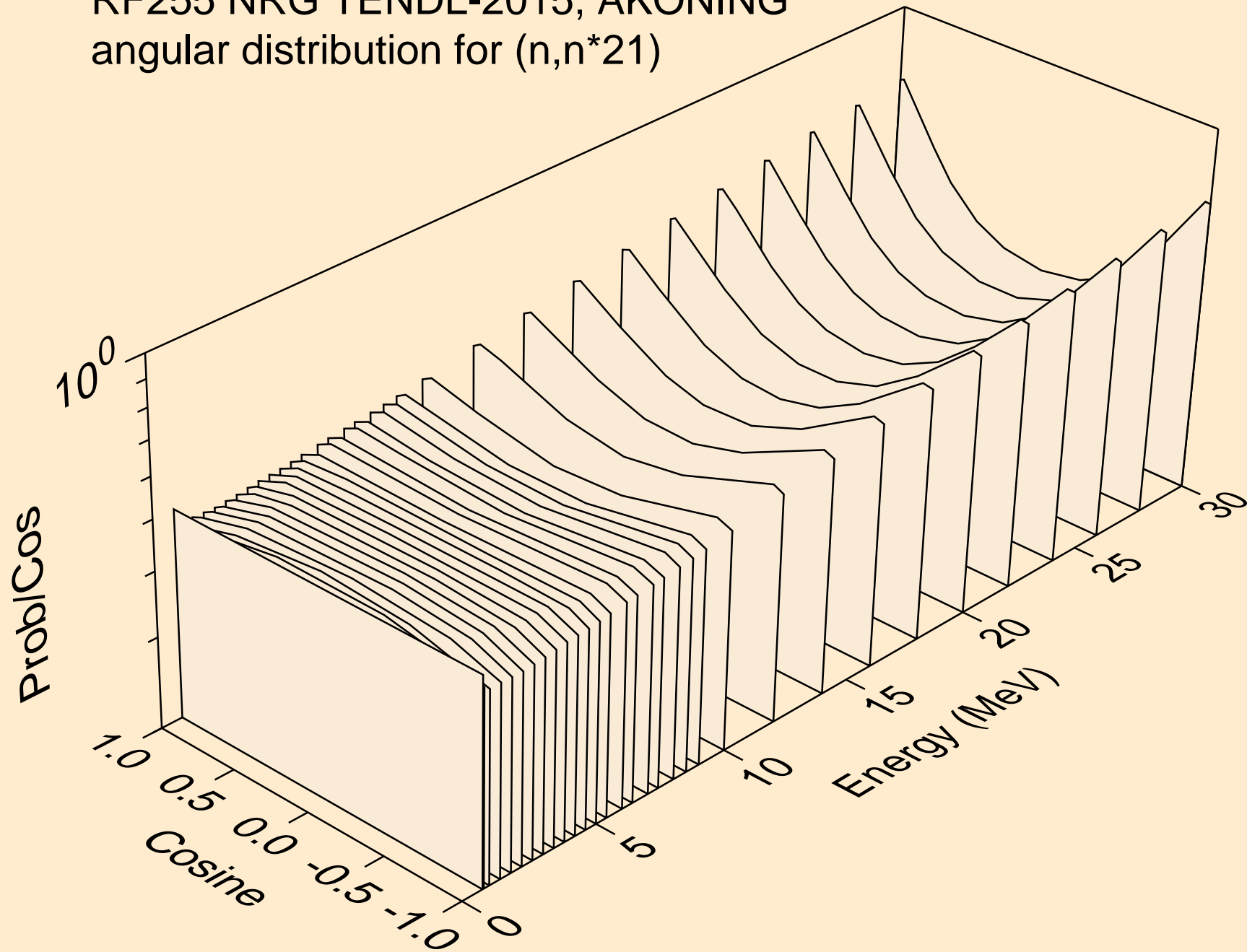

RF255 NRG TENDL-2015, AKONING
angular distribution for (n,n*22)

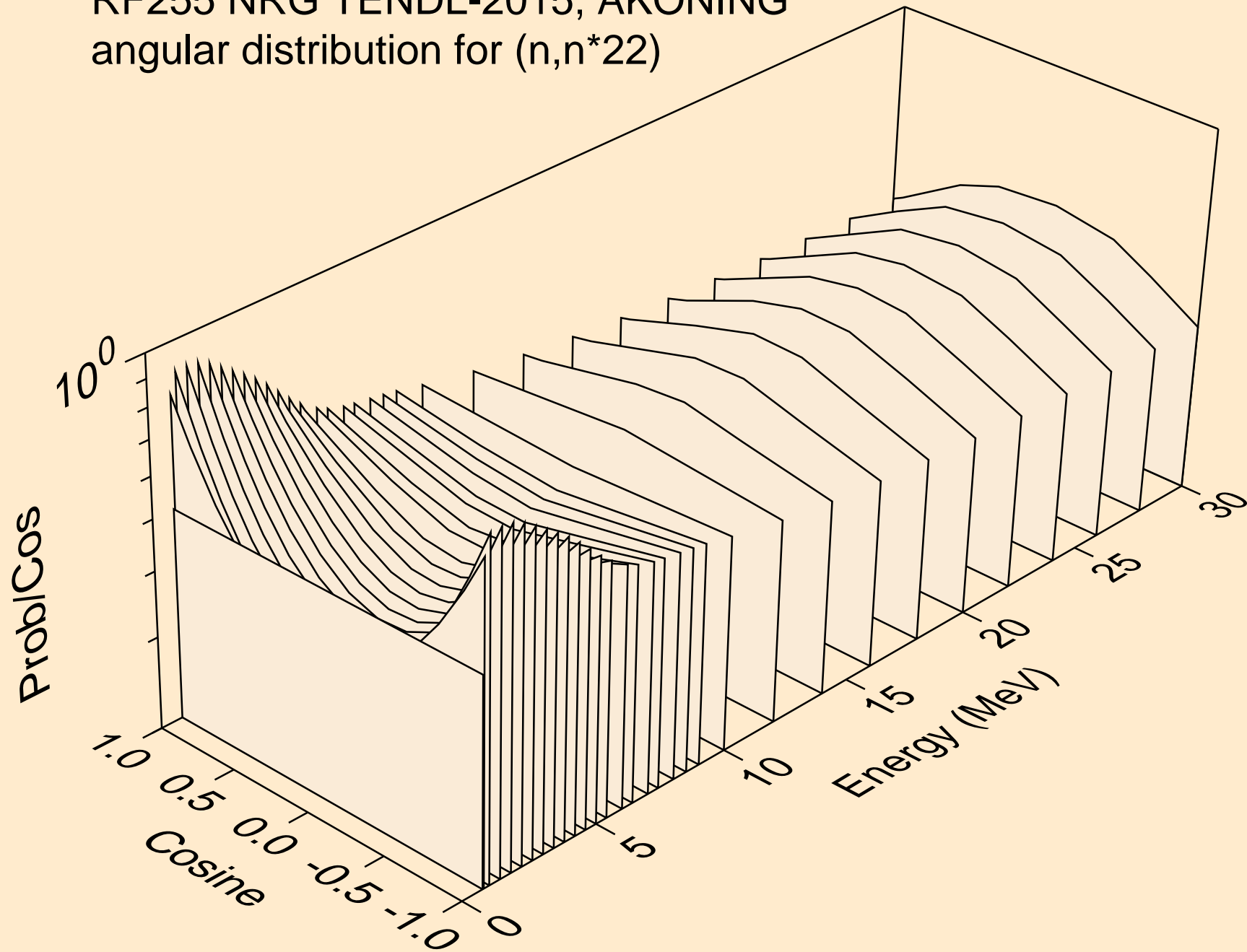

RF255 NRG TENDL-2015, AKONING
angular distribution for (n,n*23)

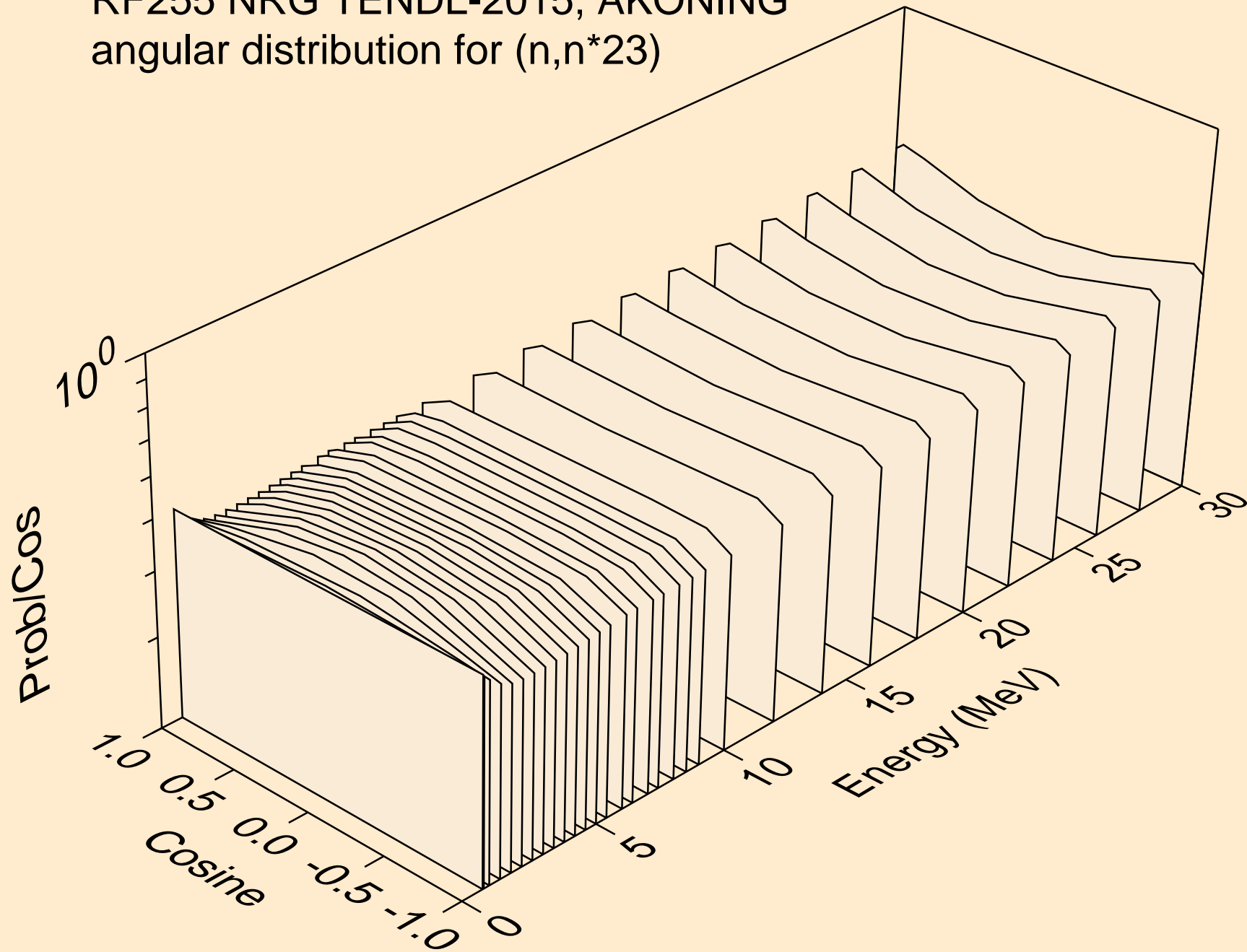

RF255 NRG TENDL-2015, AKONING
angular distribution for (n,n*24)

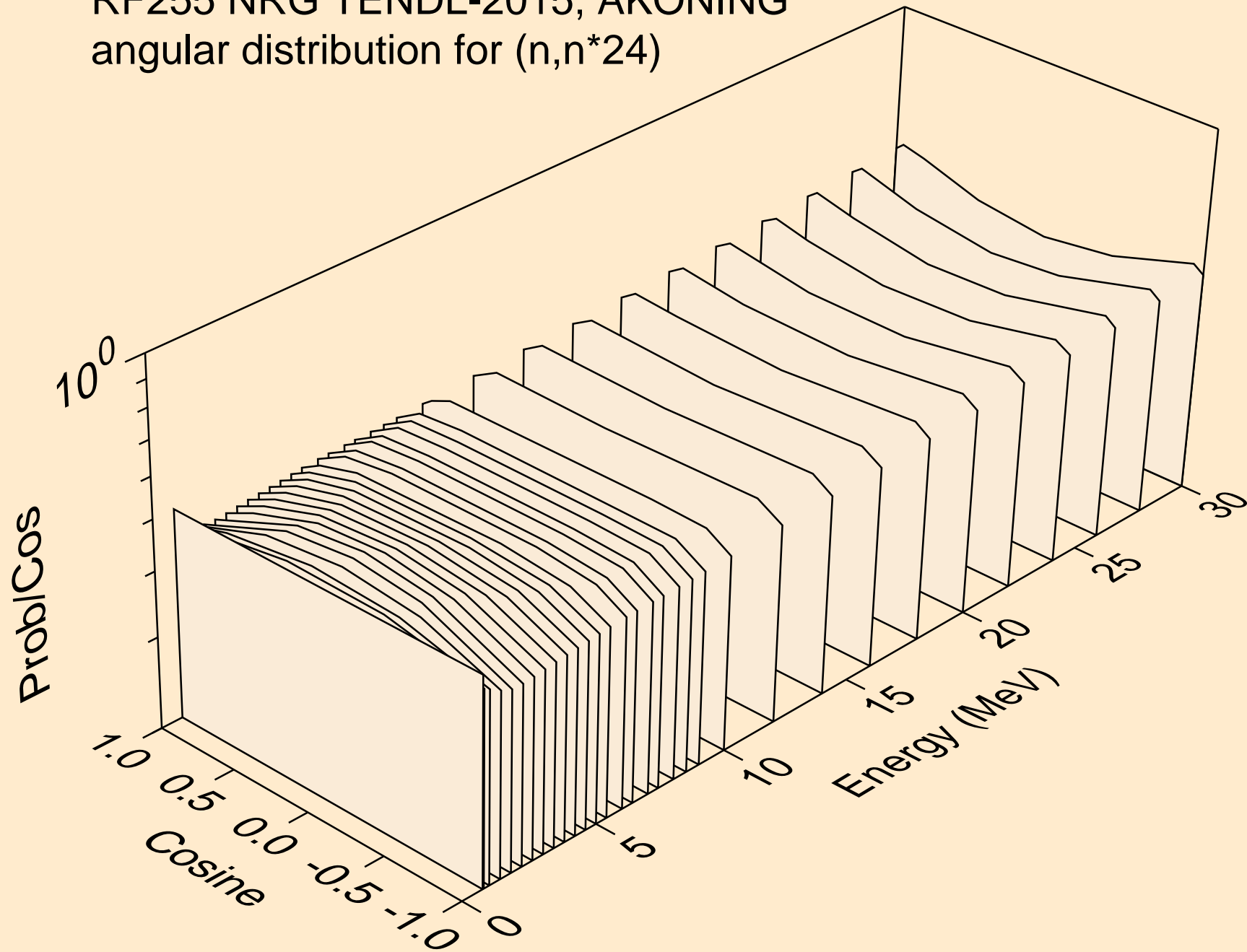

RF255 NRG TENDL-2015, AKONING
angular distribution for (n,n*25)

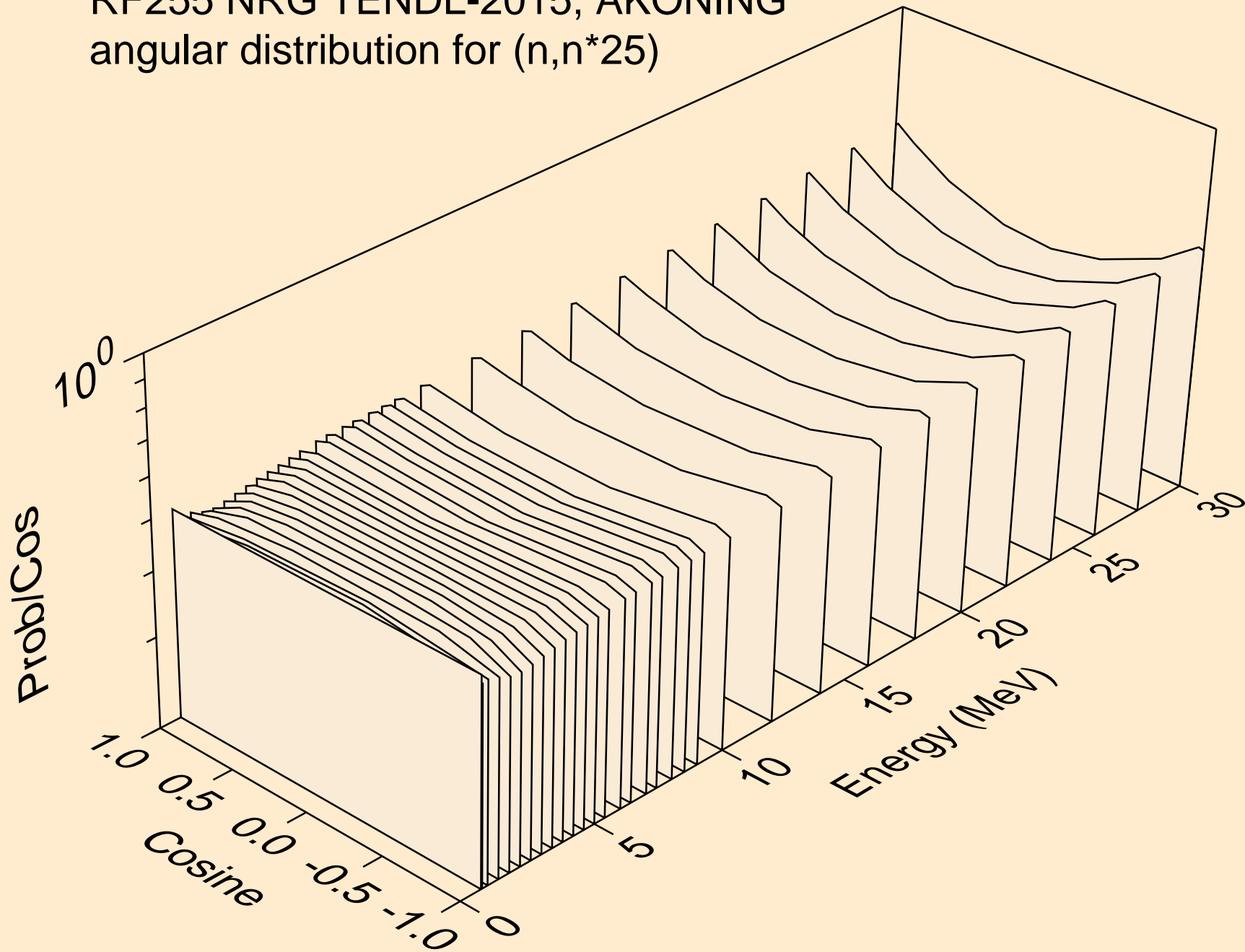

RF255 NRG TENDL-2015, AKONING
angular distribution for (n,n*26)

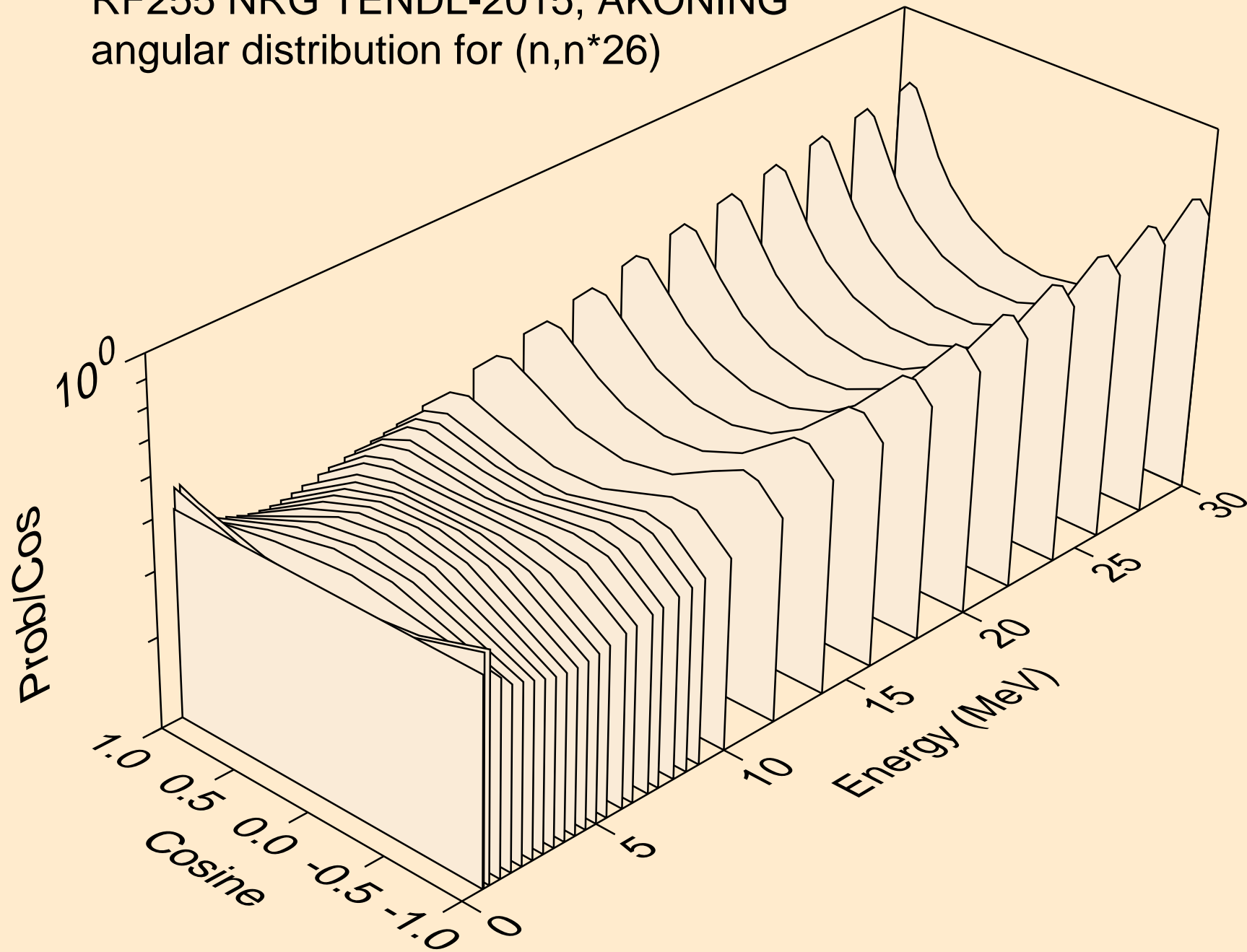

RF255 NRG TENDL-2015, AKONING
angular distribution for (n,n*27)

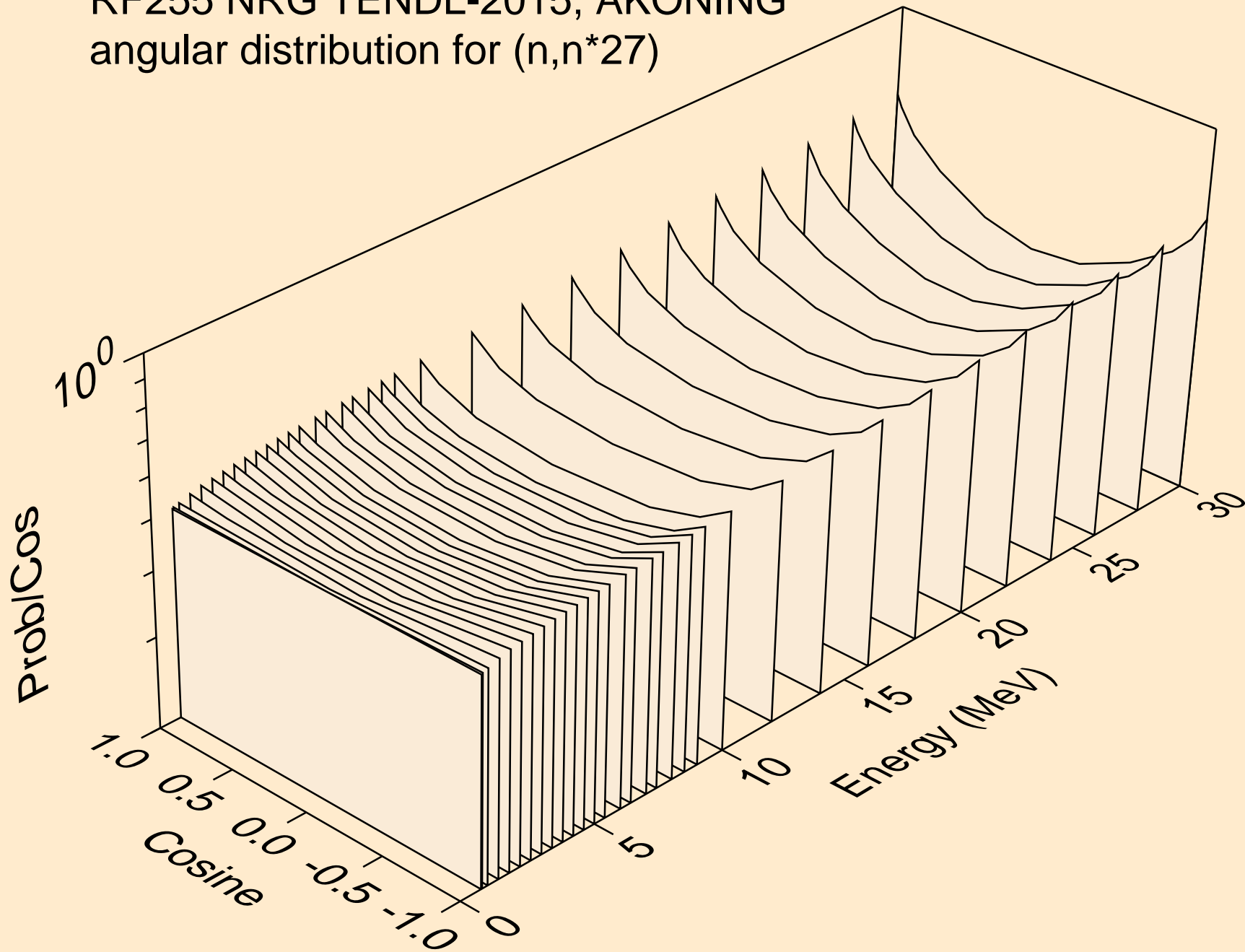

RF255 NRG TENDL-2015, AKONING
angular distribution for (n,n*28)

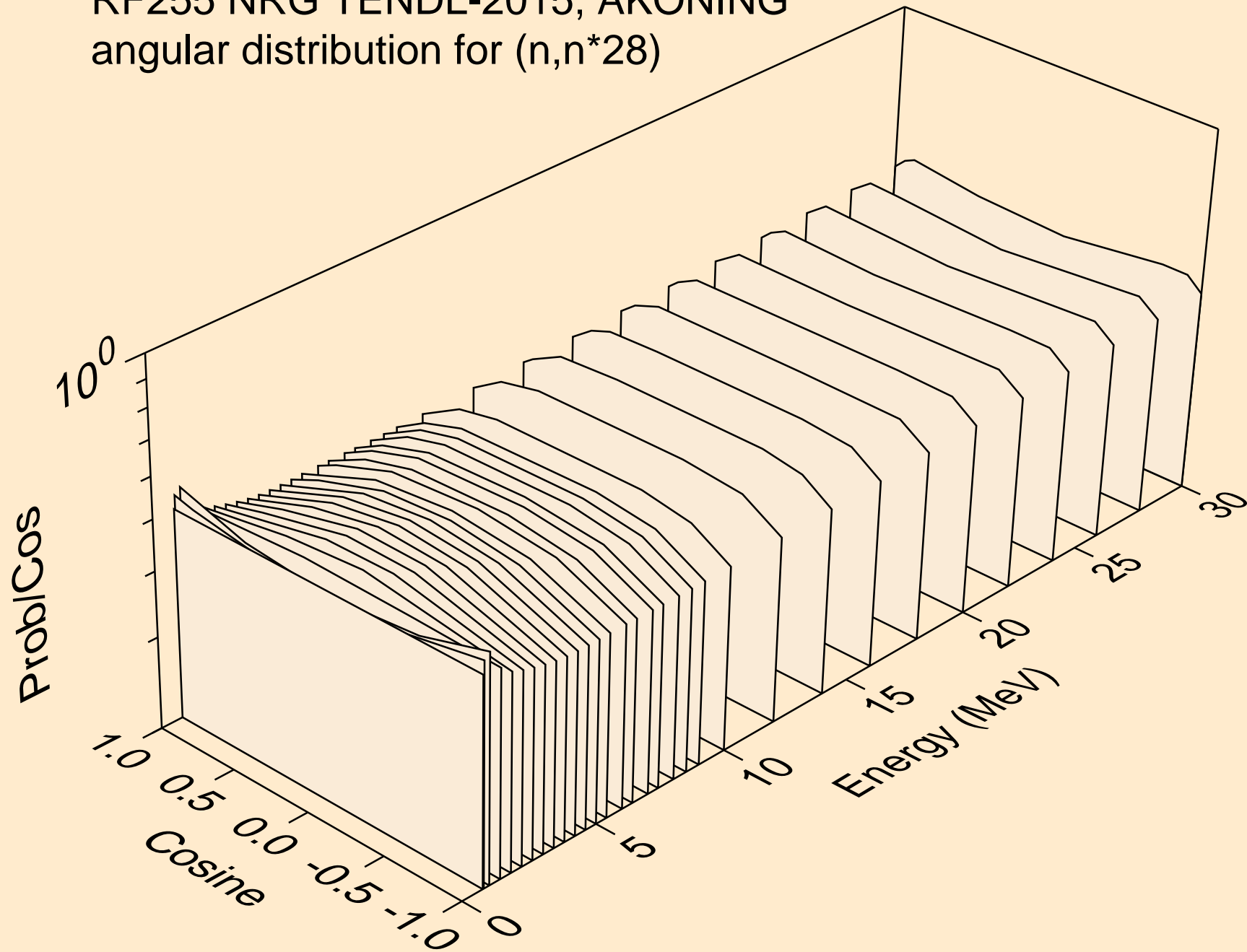

RF255 NRG TENDL-2015, AKONING
angular distribution for (n,n*29)

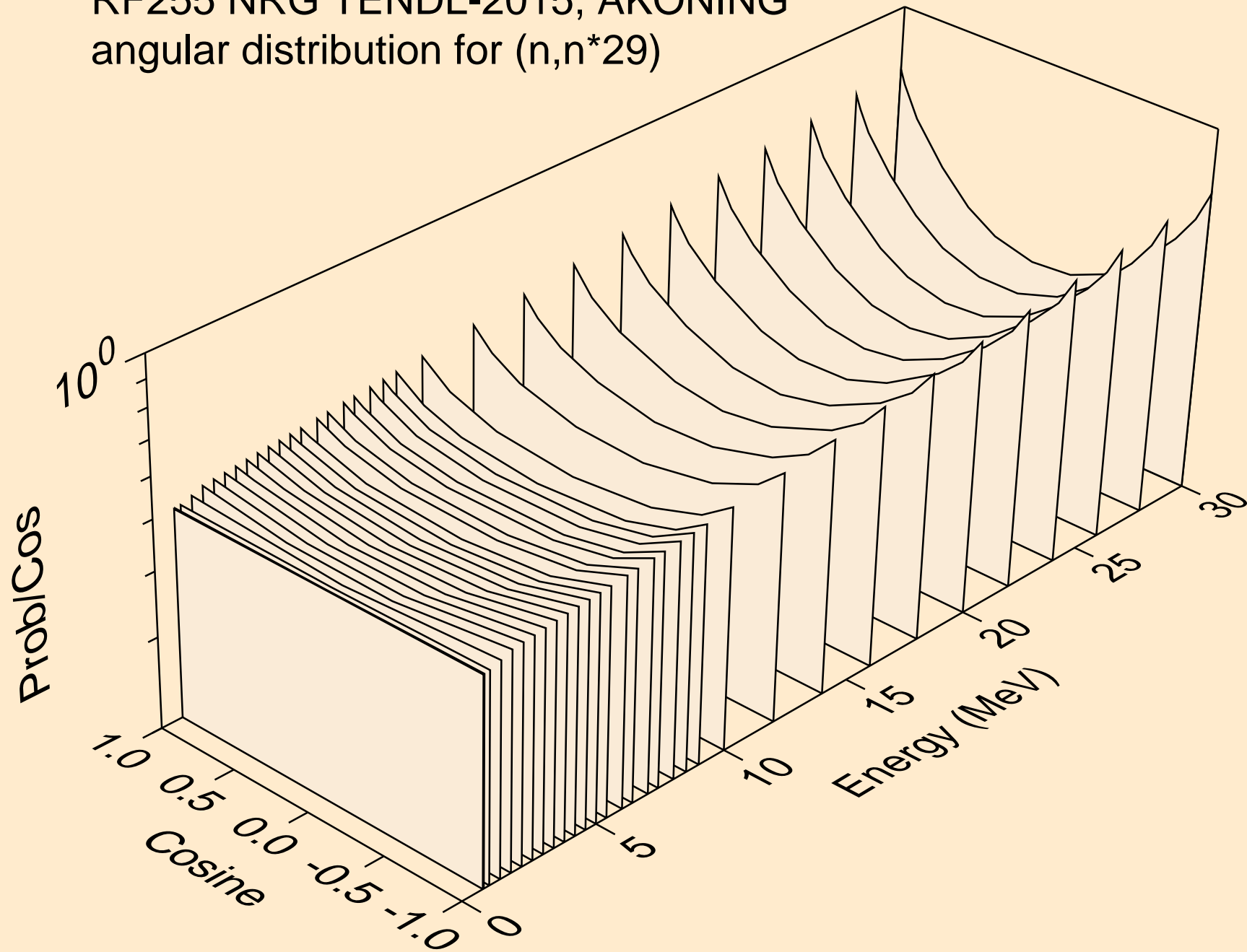

RF255 NRG TENDL-2015, AKONING

Total fission nubar

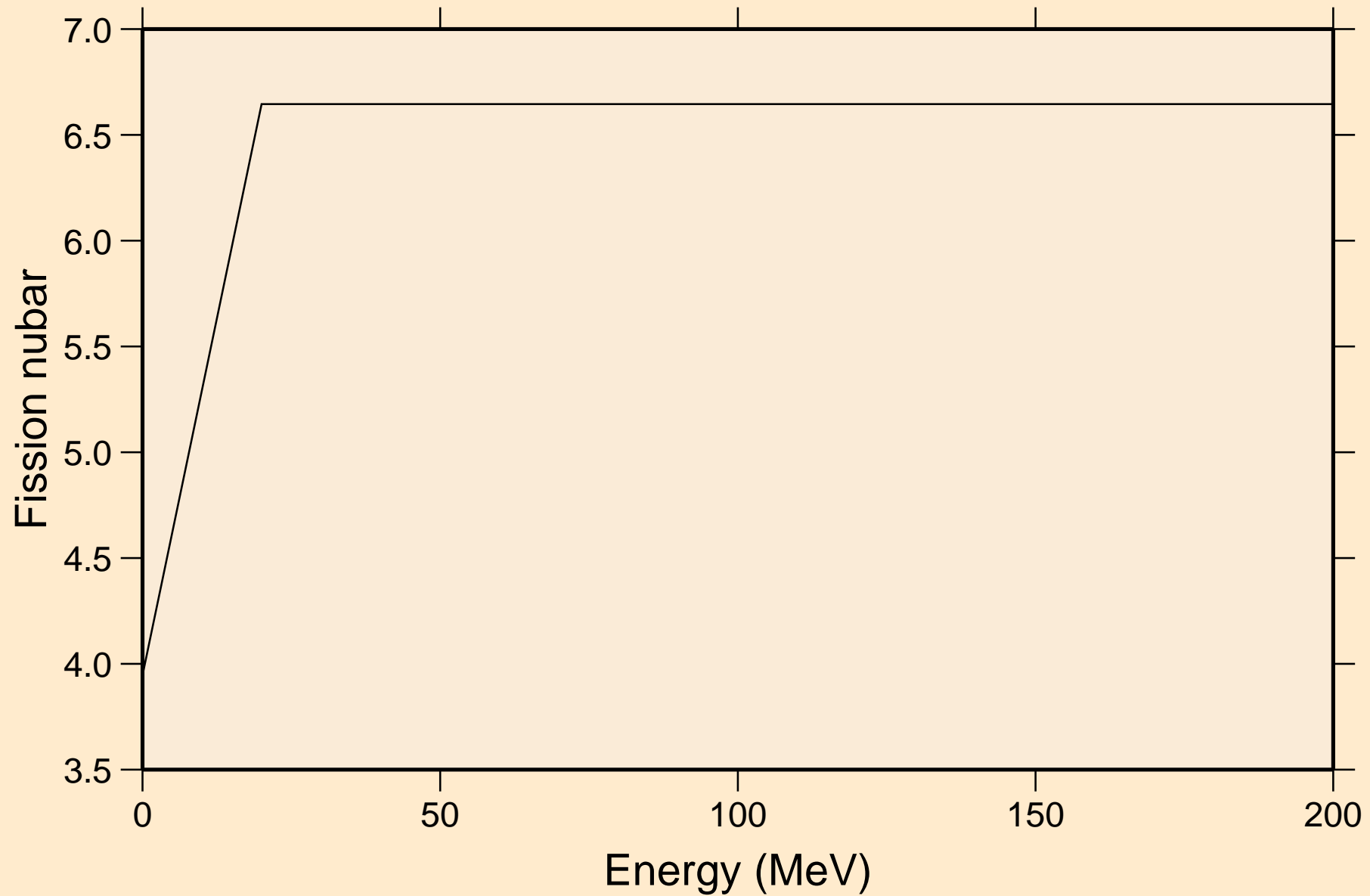

RF255 NRG TENDL-2015, AKONING
Neutron emission for (n,x)

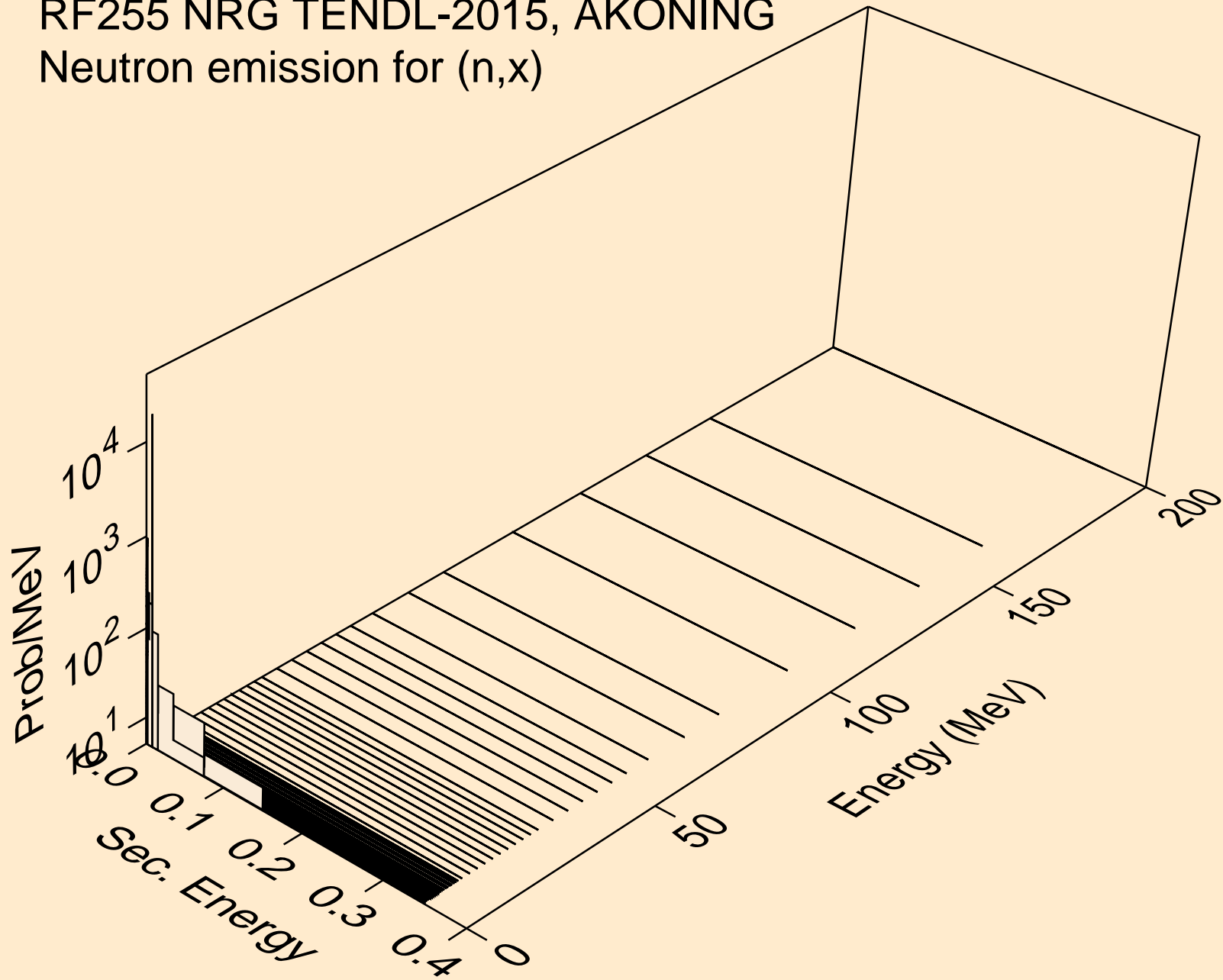

RF255 NRG TENDL-2015, AKONING
Neutron emission for (n,2nd)

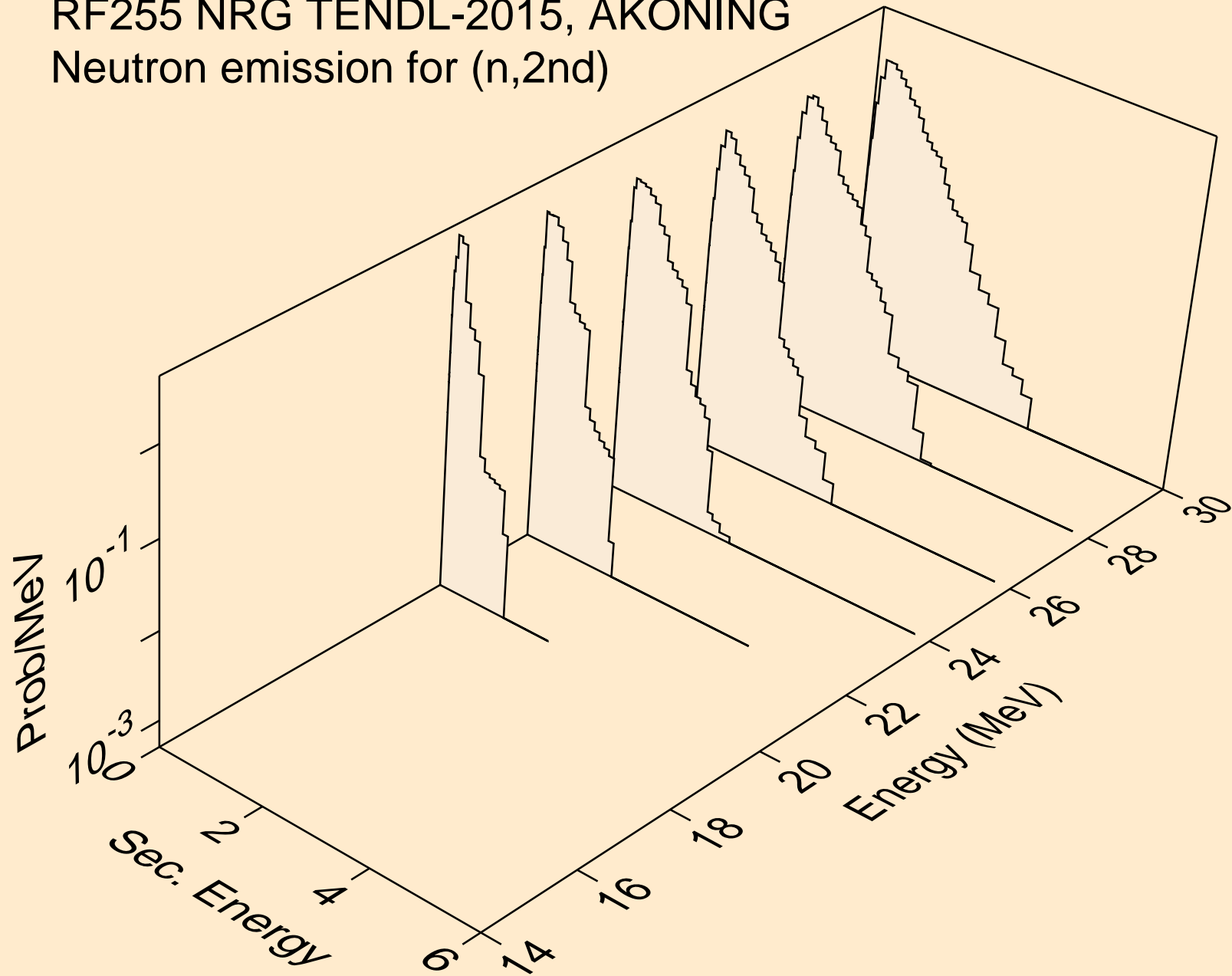

RF255 NRG TENDL-2015, AKONING
Neutron emission for (n,2n)

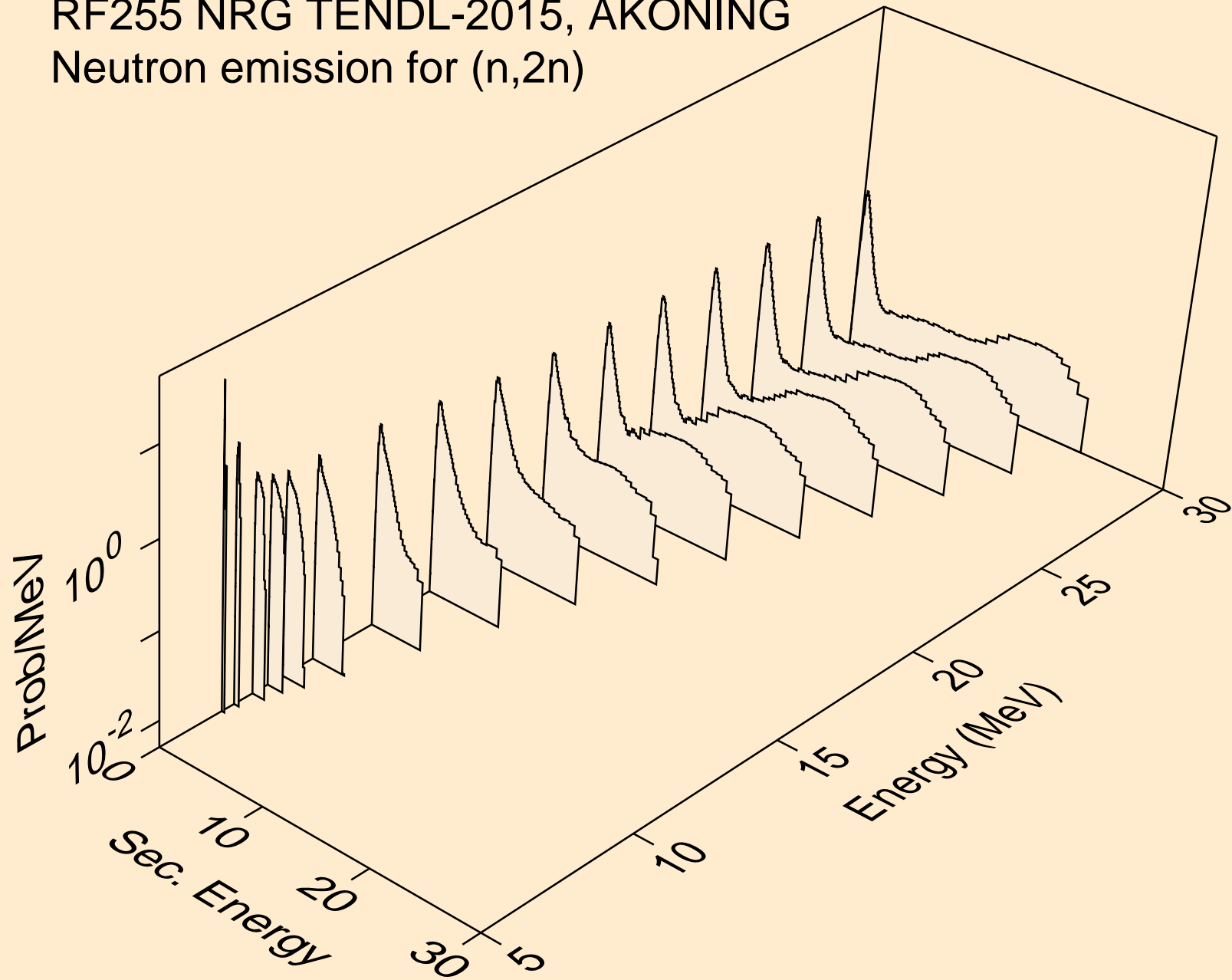

RF255 NRG TENDL-2015, AKONING
Neutron emission for (n,3n)

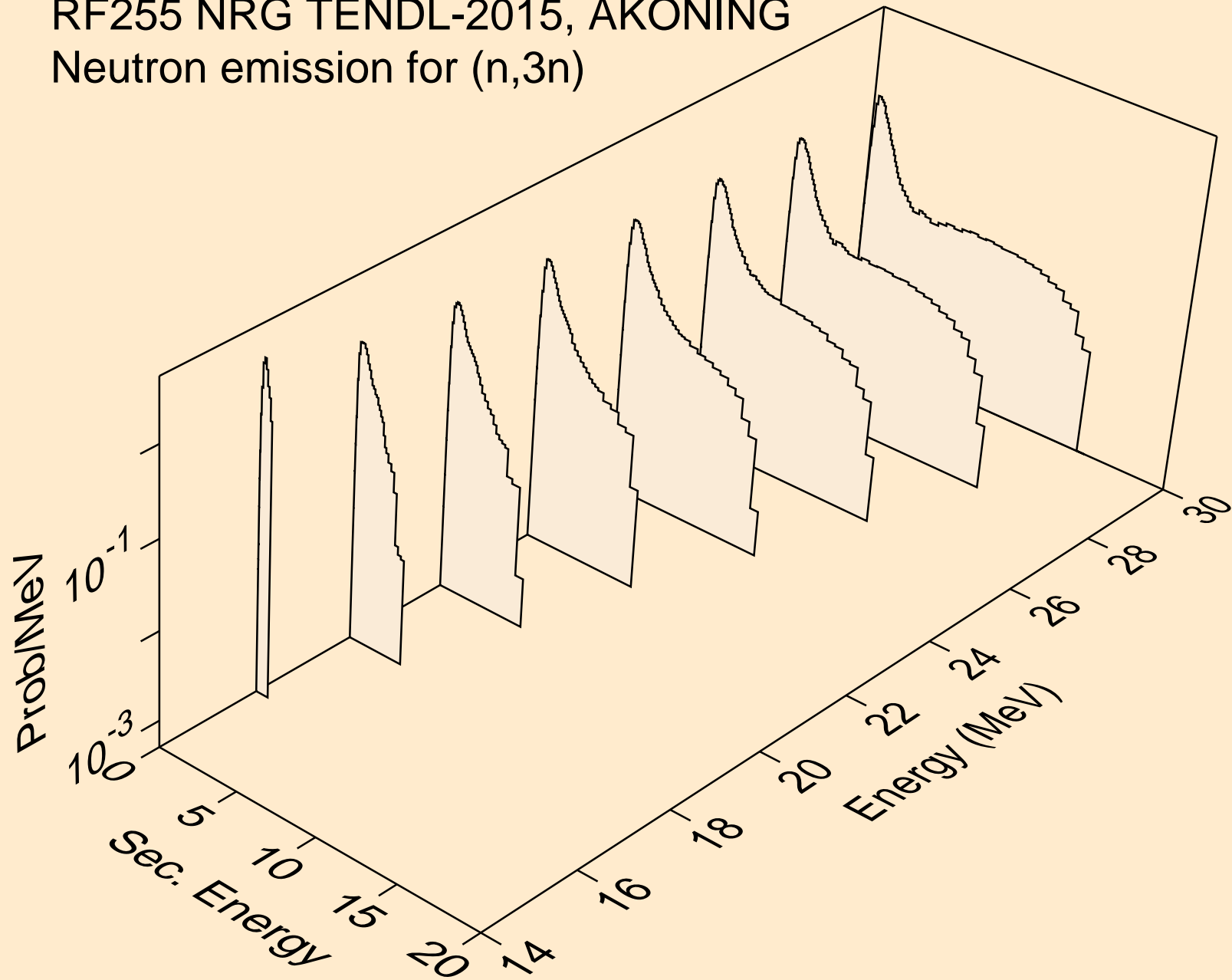

RF255 NRG TENDL-2015, AKONING
Neutron emission for fission

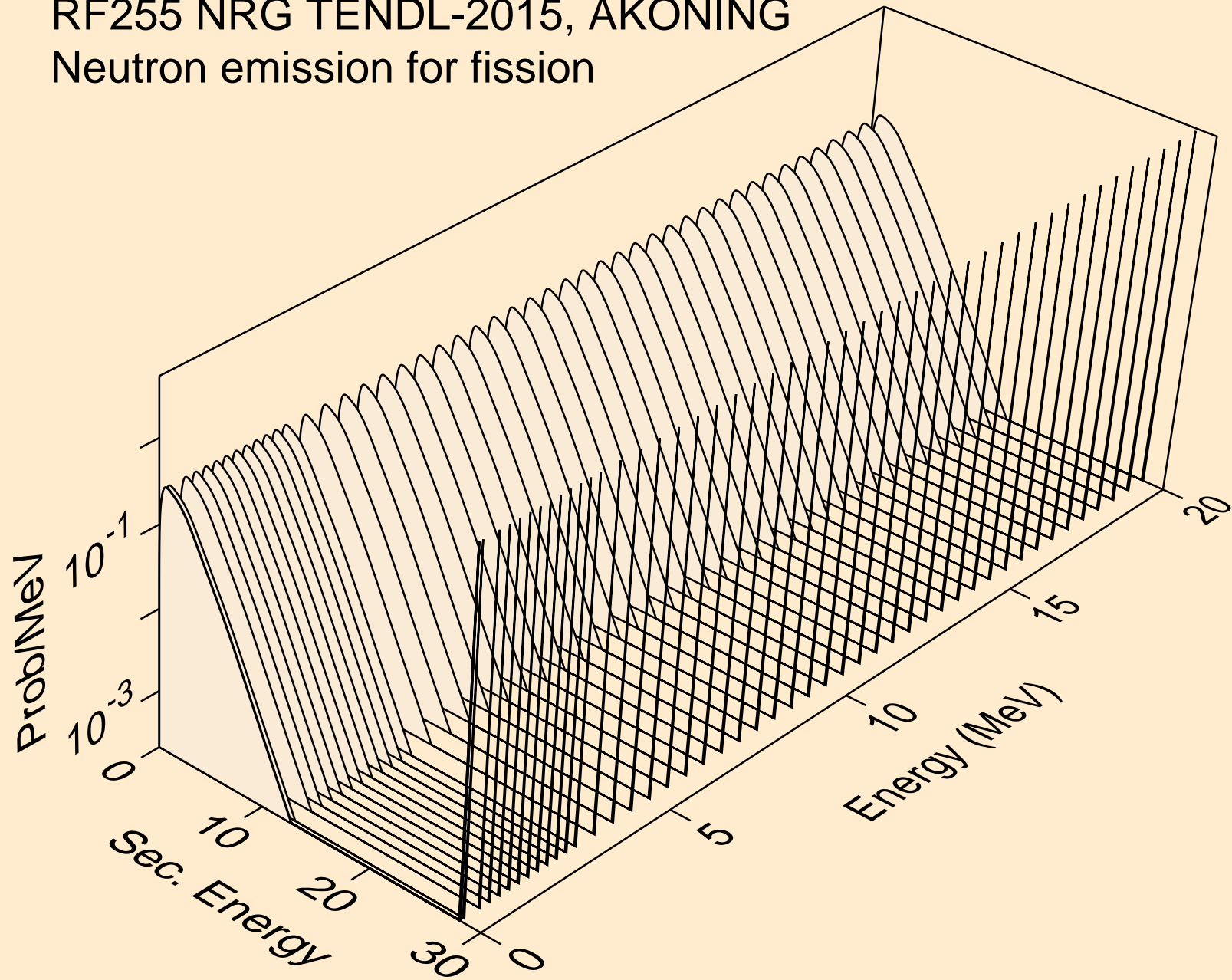

RF255 NRG TENDL-2015, AKONING
Neutron emission for (n,n*)a

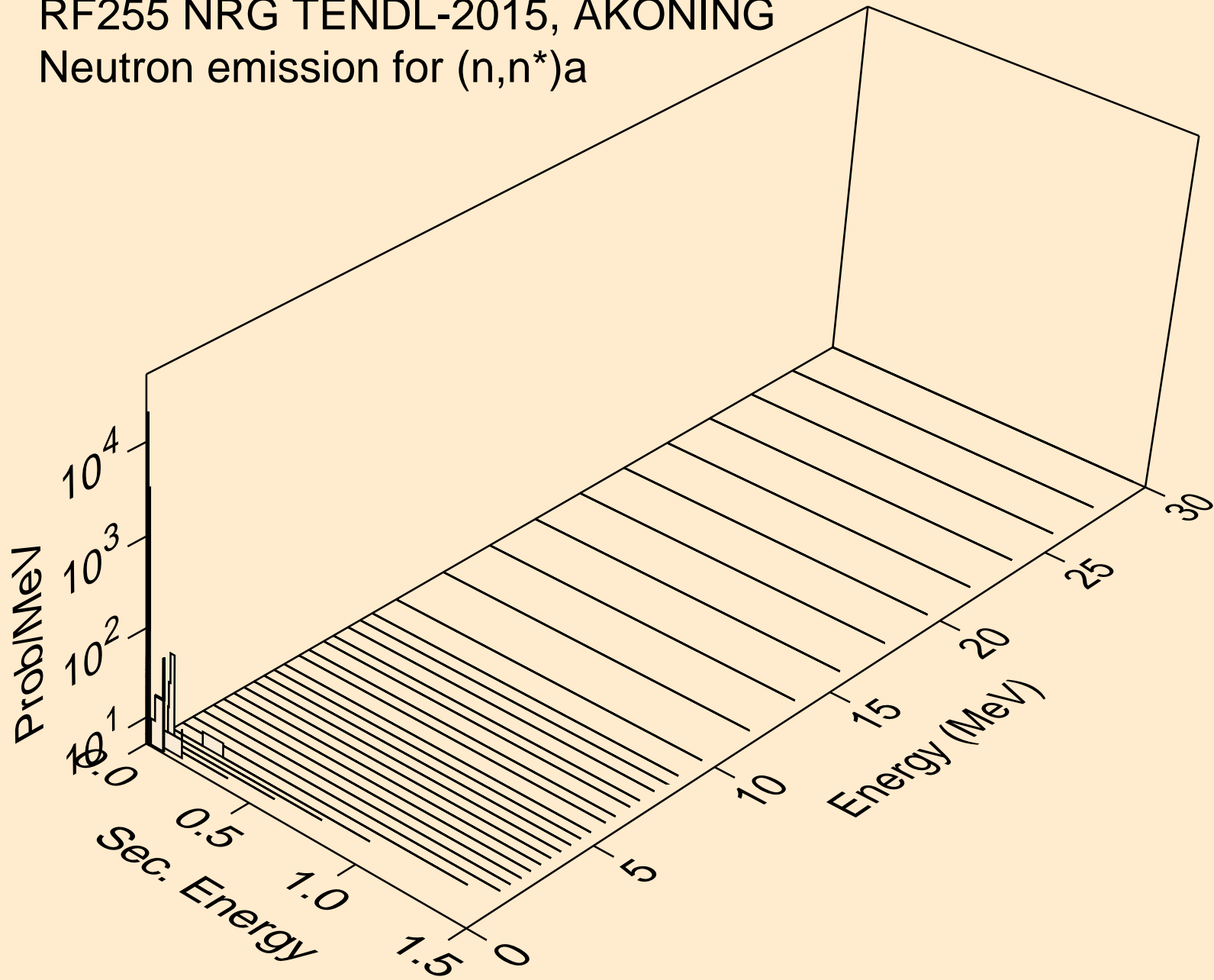

RF255 NRG TENDL-2015, AKONING
Neutron emission for (n,n*)3a

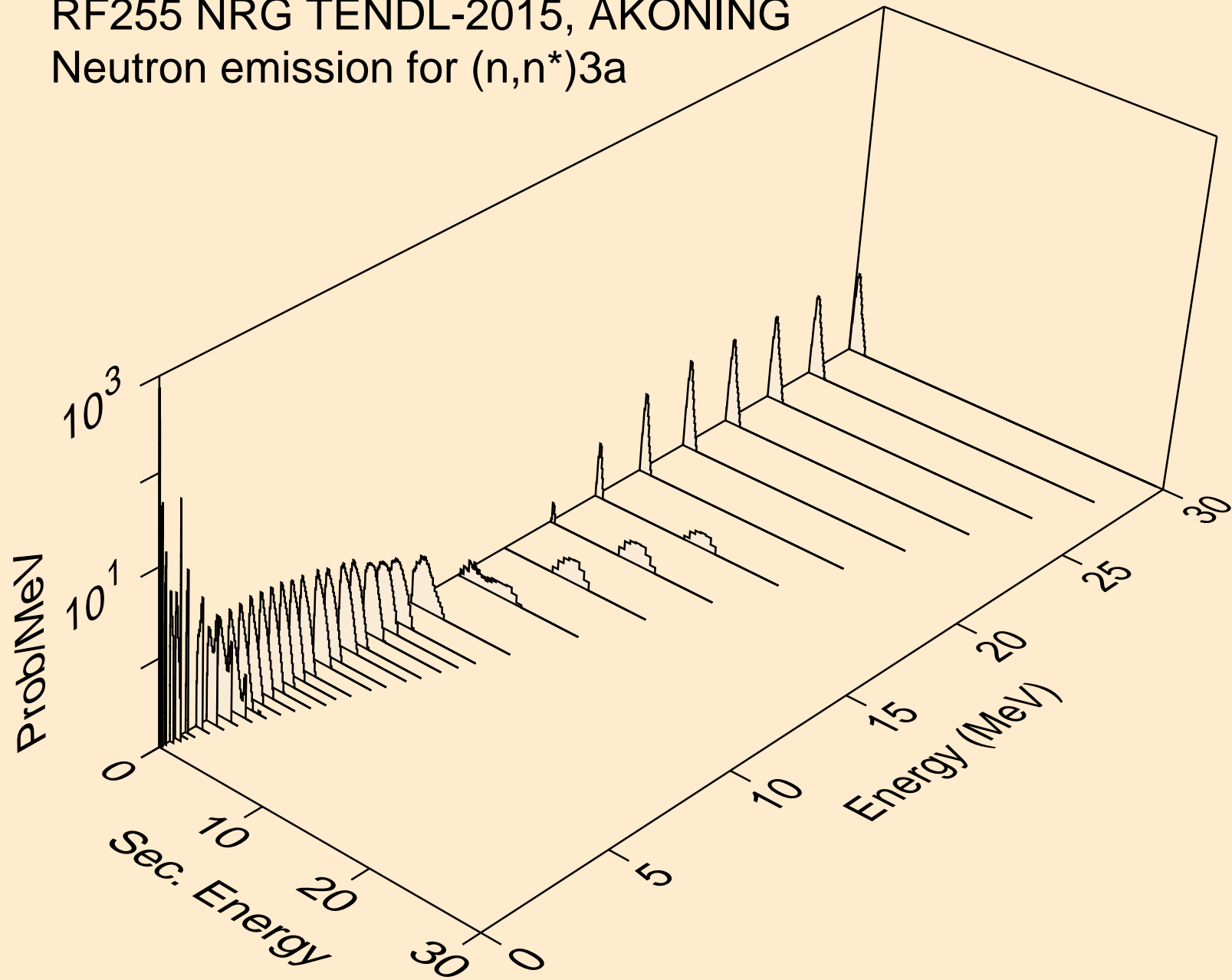

RF255 NRG TENDL-2015, AKONING
Neutron emission for (n,2n)_a

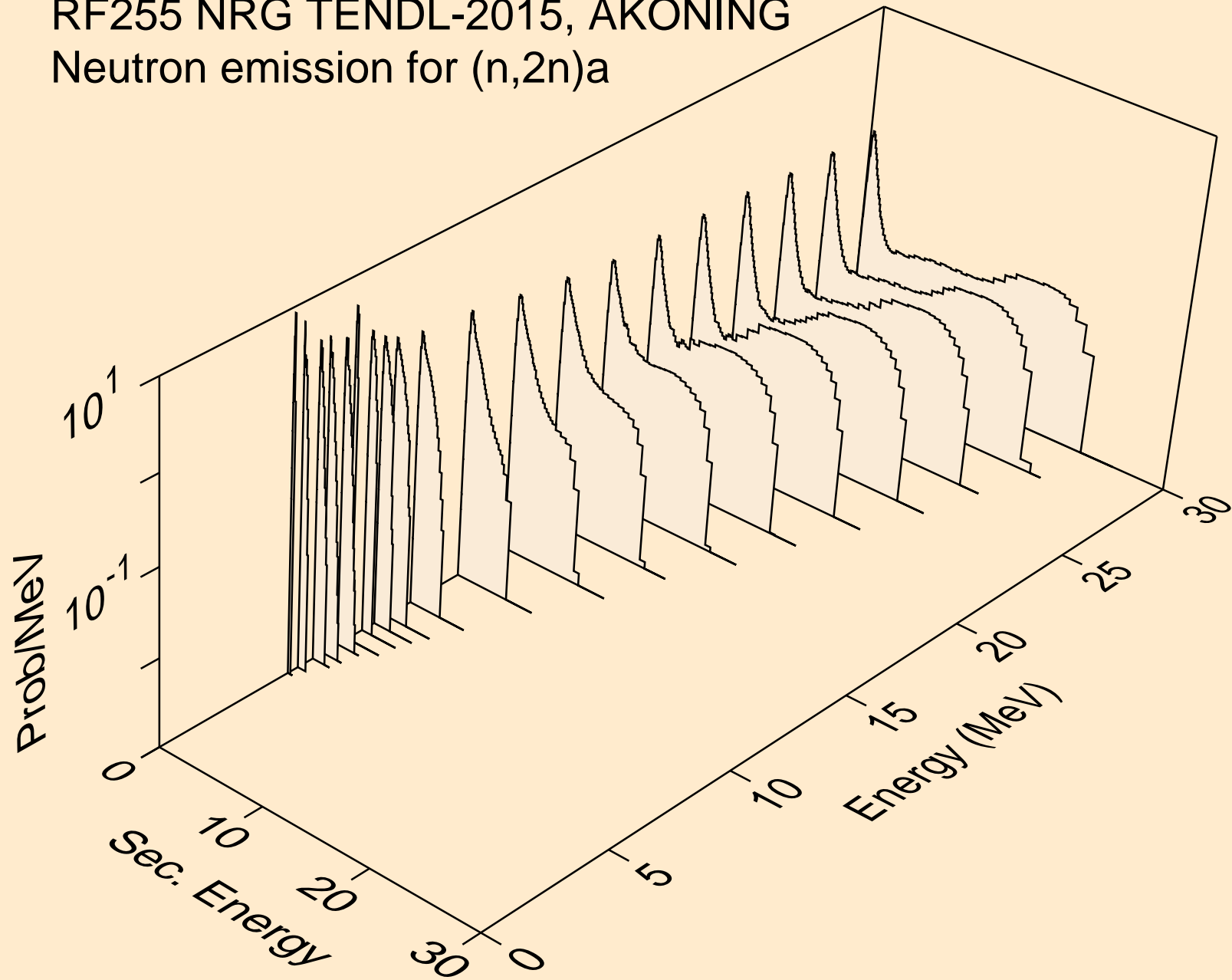

RF255 NRG TENDL-2015, AKONING
Neutron emission for (n,3n)_a

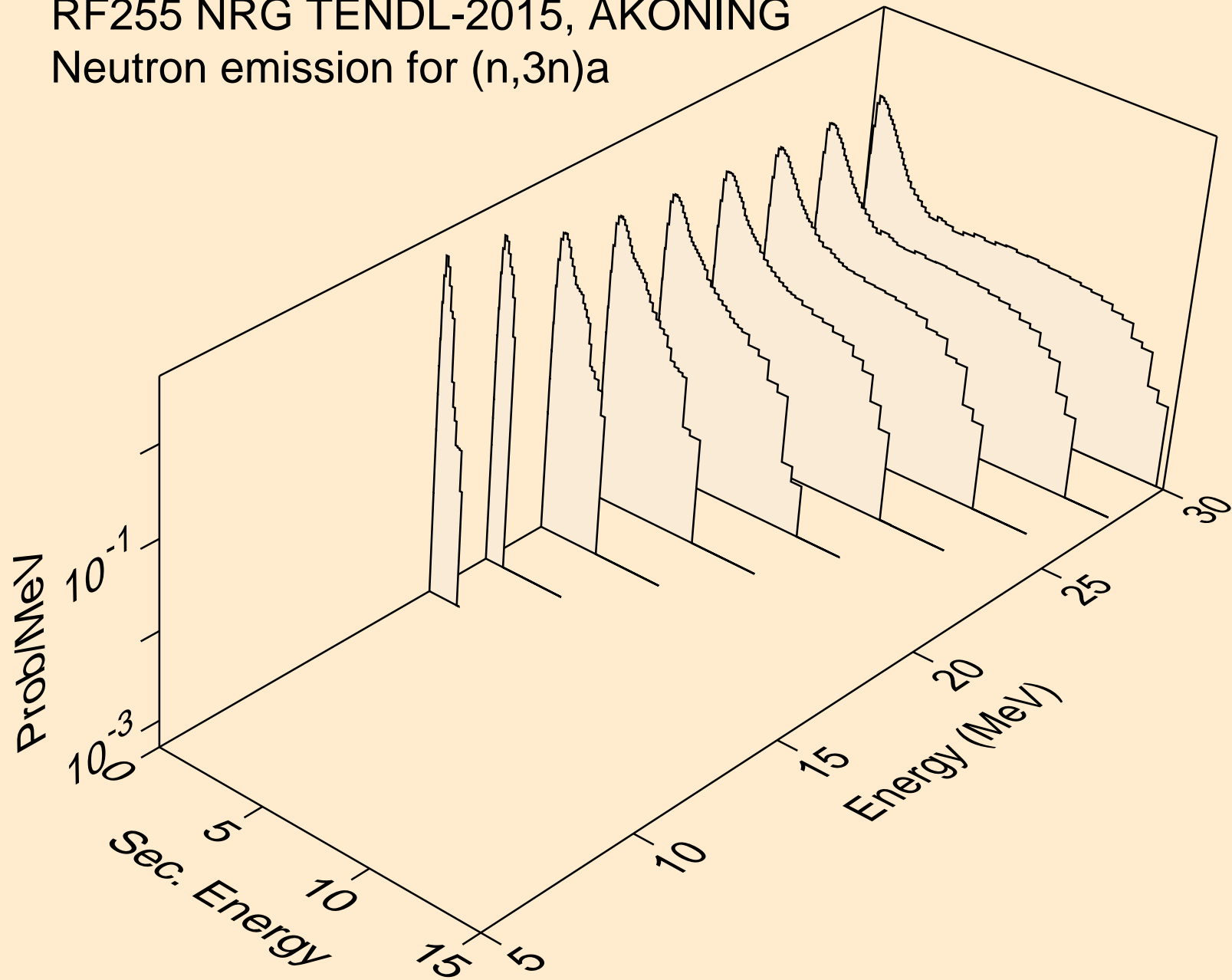

RF255 NRG TENDL-2015, AKONING
Neutron emission for (n,n*)p

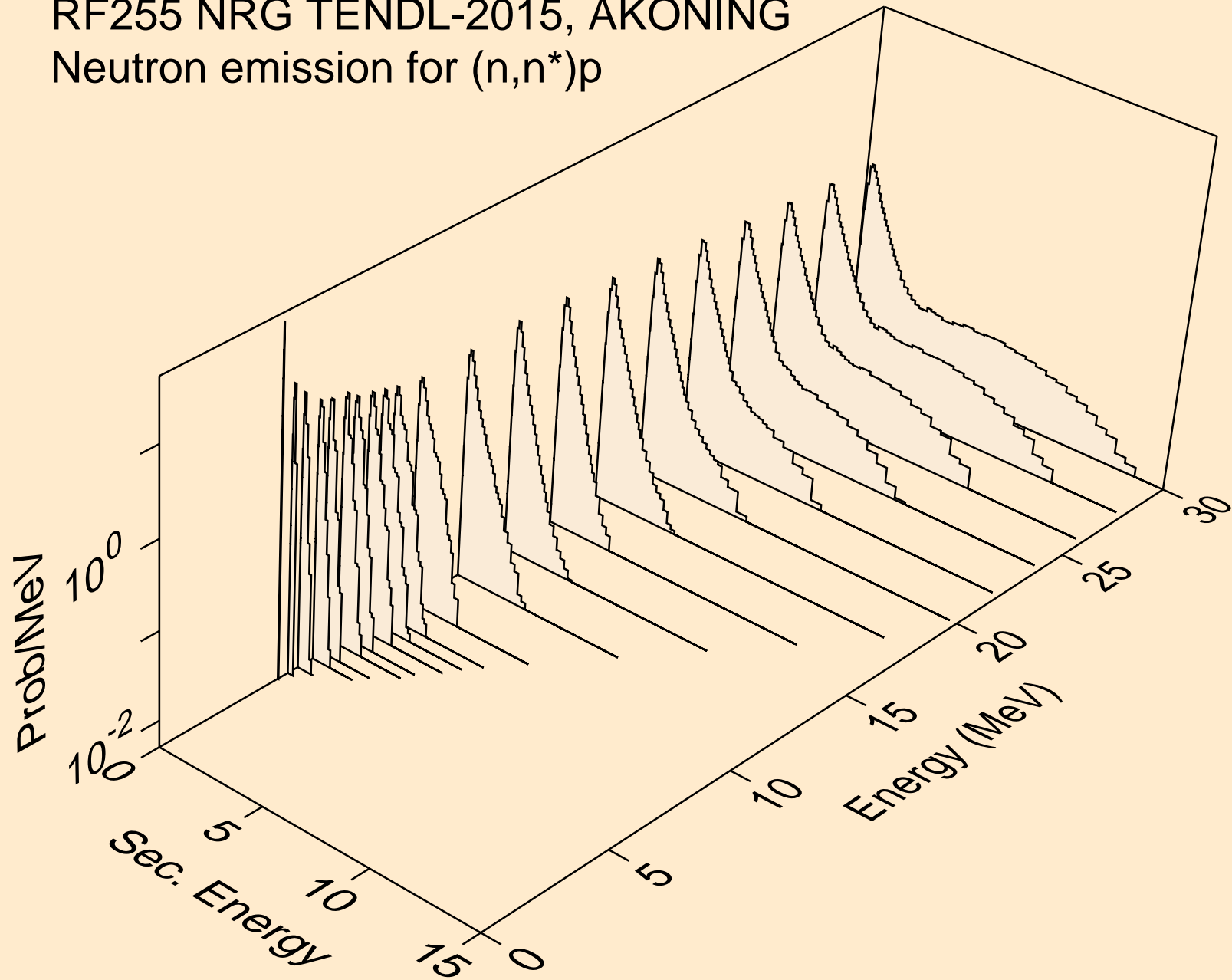

RF255 NRG TENDL-2015, AKONING
Neutron emission for (n,n*)2a

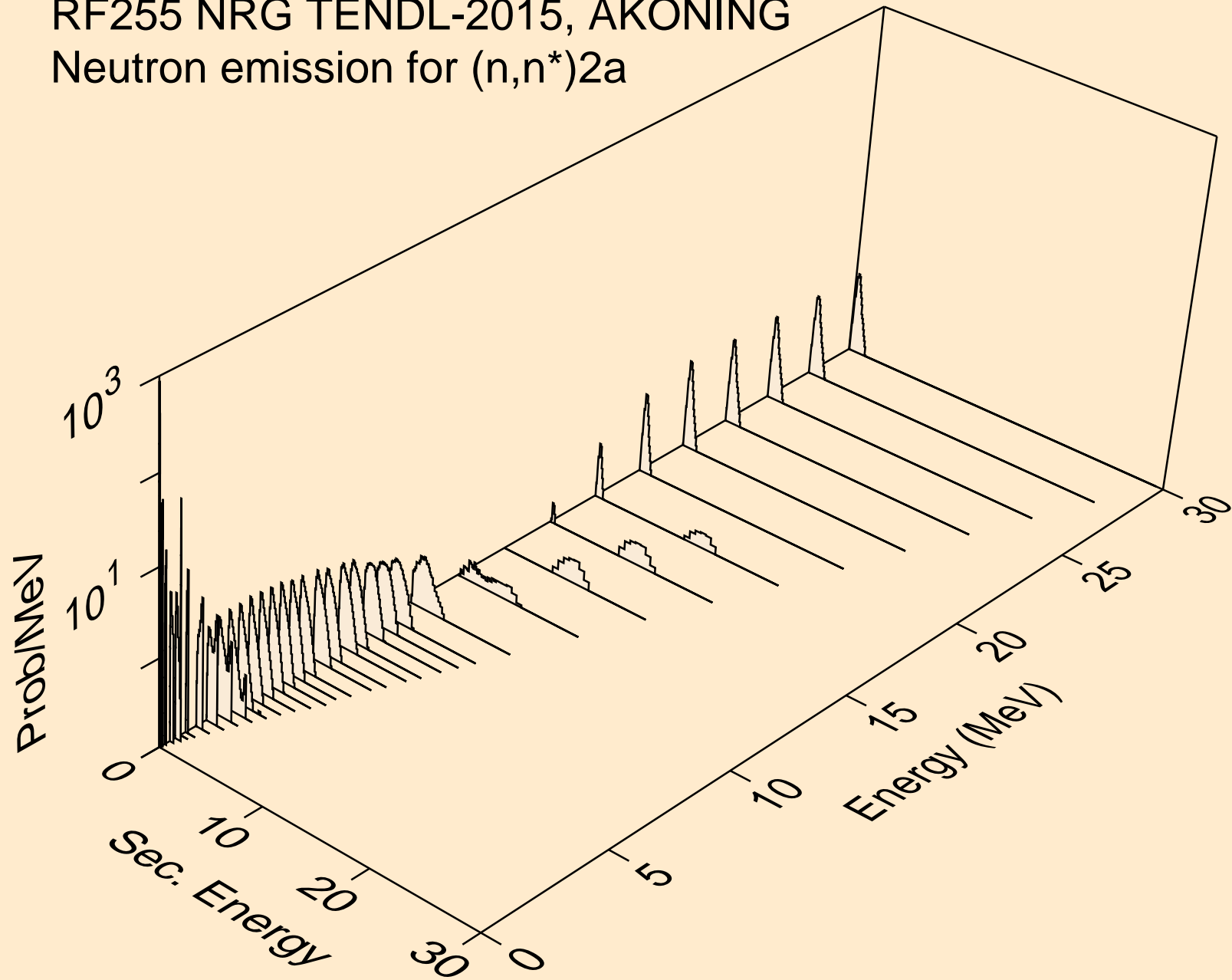

RF255 NRG TENDL-2015, AKONING
Neutron emission for (n,2n)2a

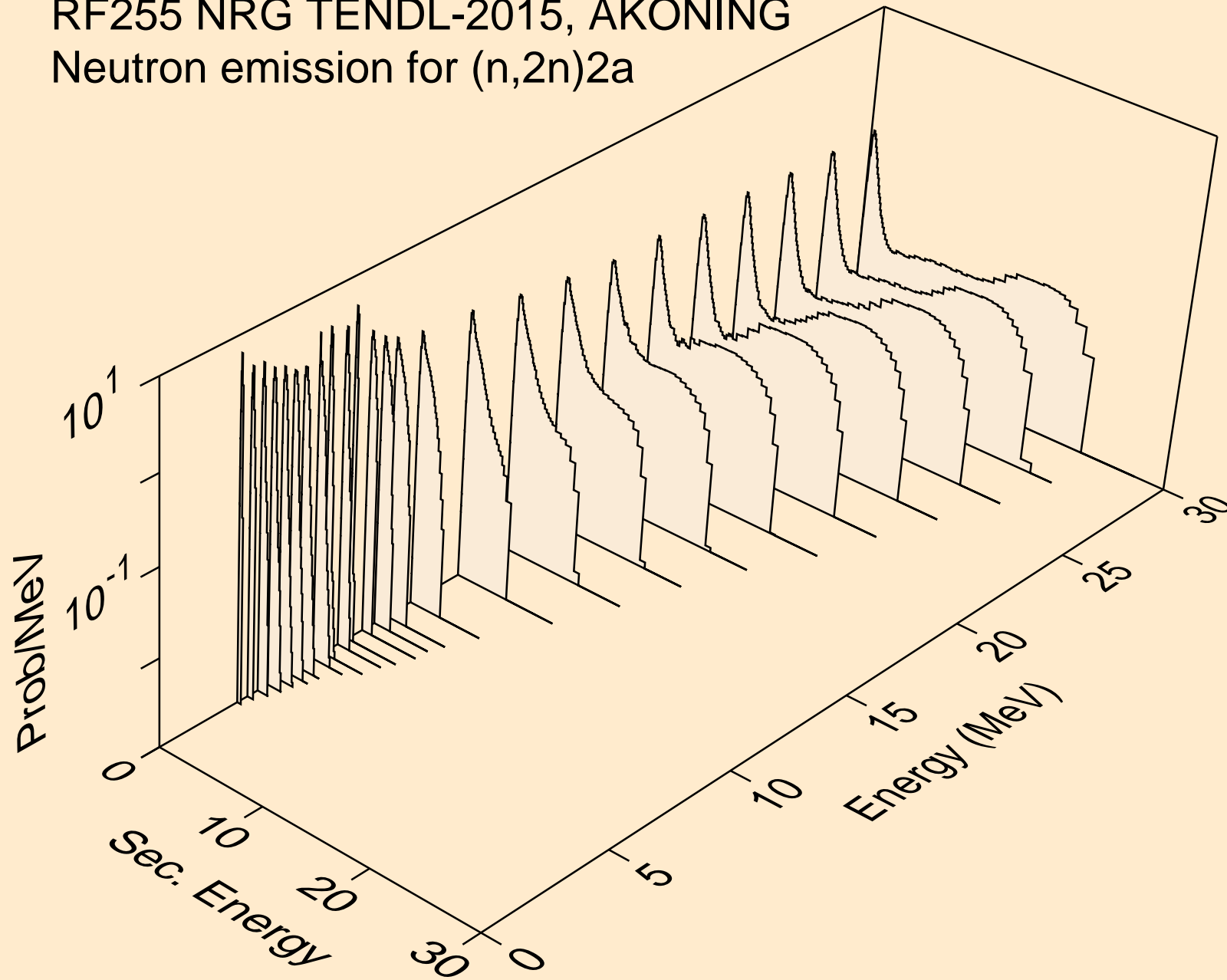

RF255 NRG TENDL-2015, AKONING
Neutron emission for (n,n*)d

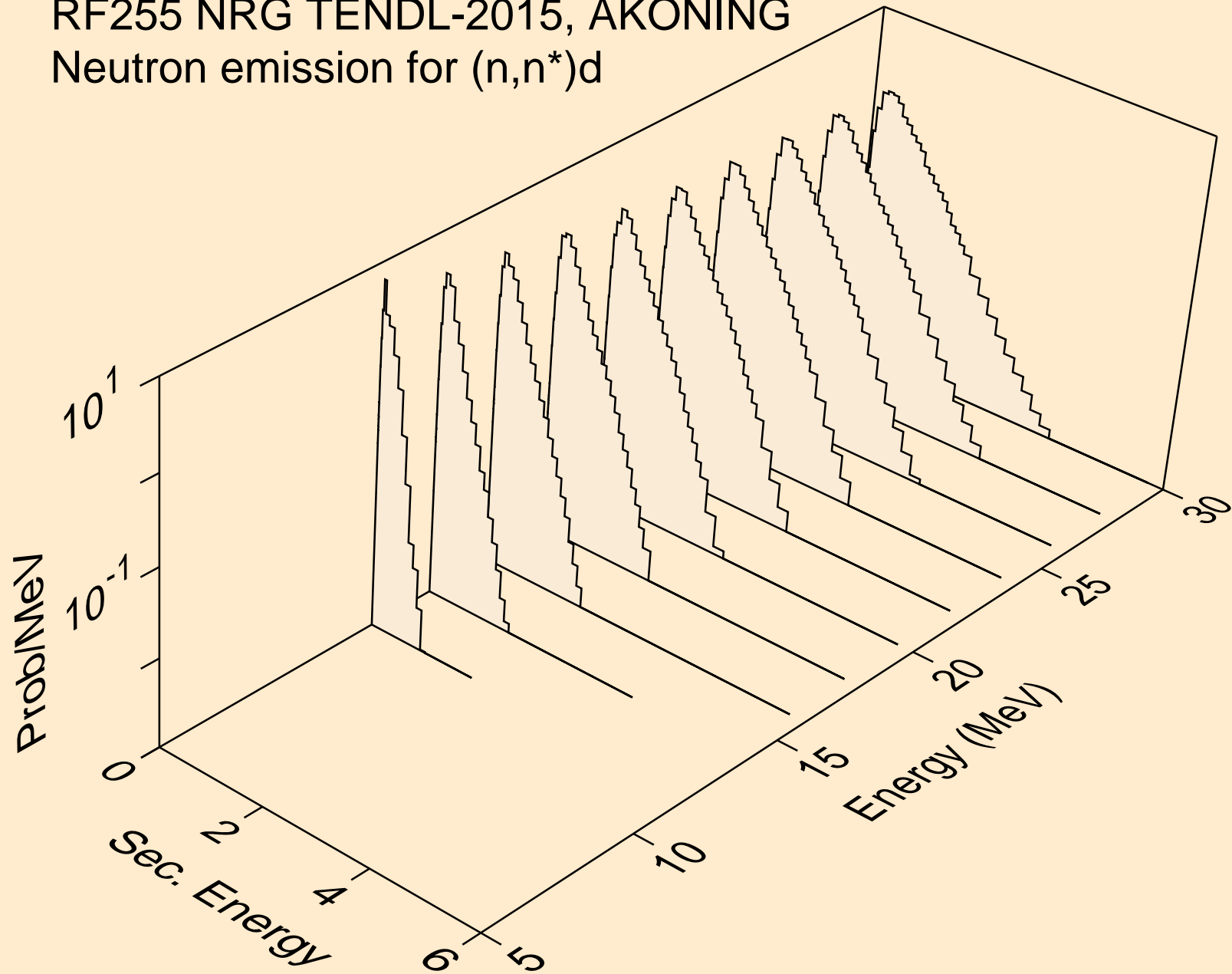

RF255 NRG TENDL-2015, AKONING
Neutron emission for (n,n*)t

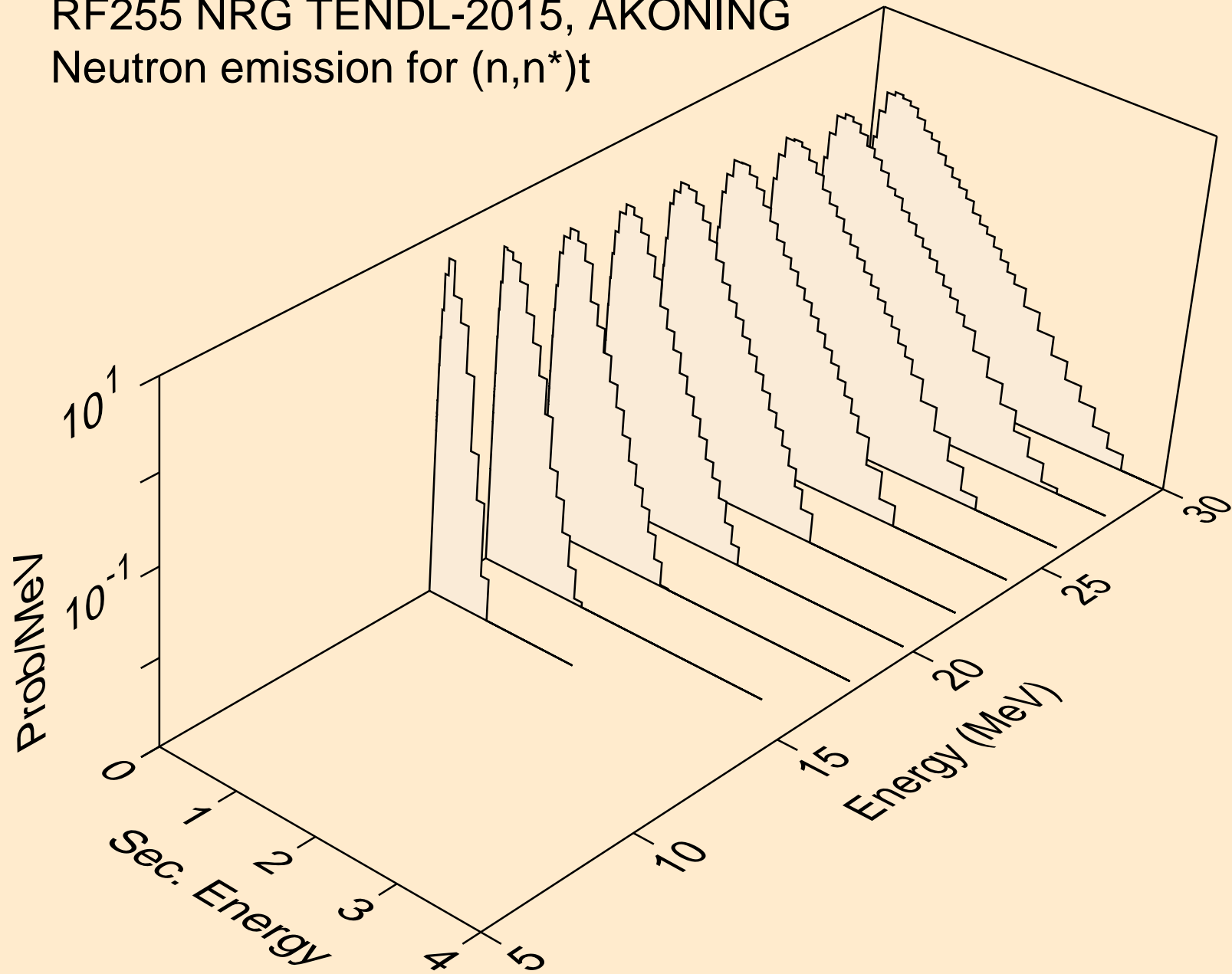

RF255 NRG TENDL-2015, AKONING
Neutron emission for (n,n*)he3

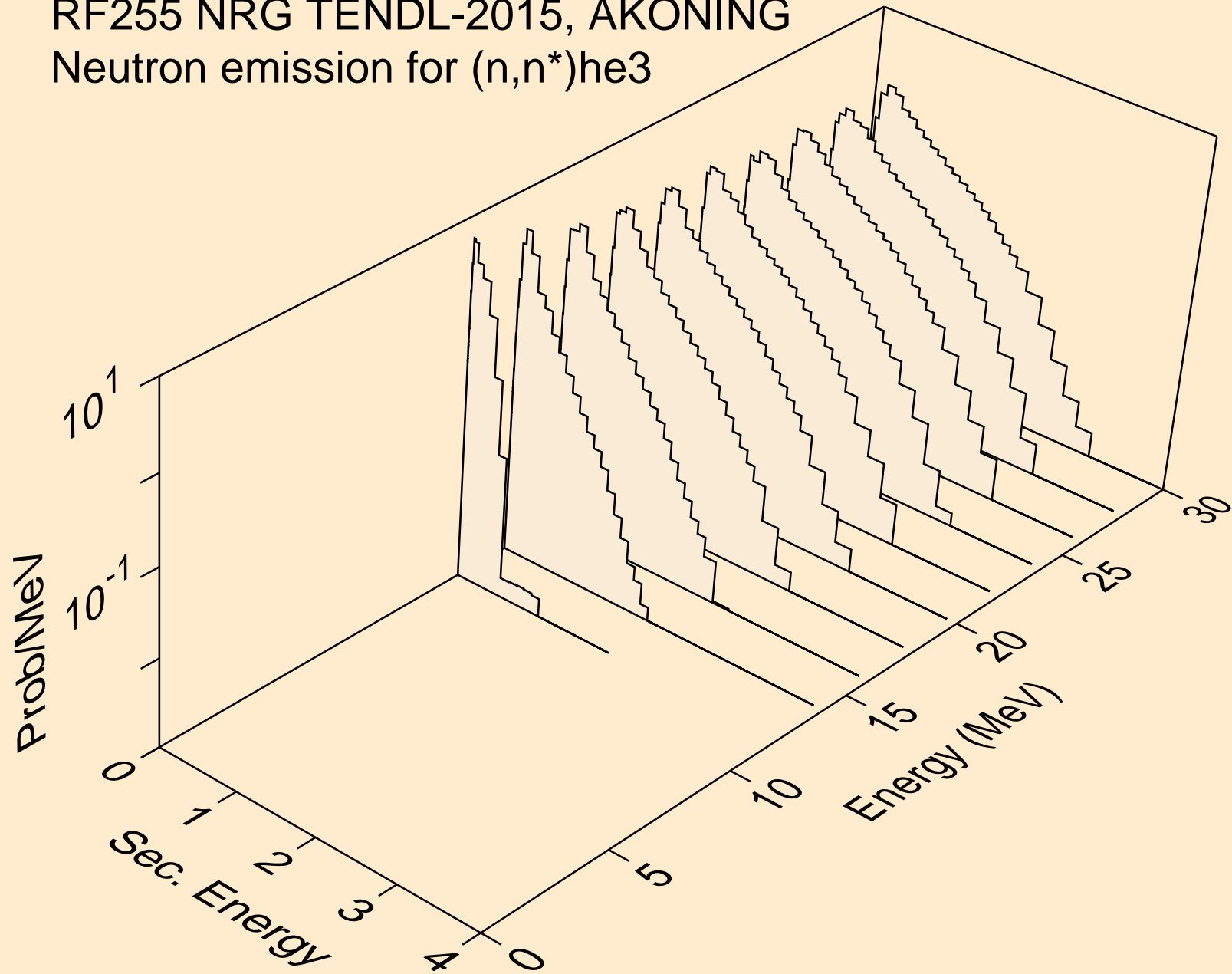

RF255 NRG TENDL-2015, AKONING
Neutron emission for (n,n*)d2a

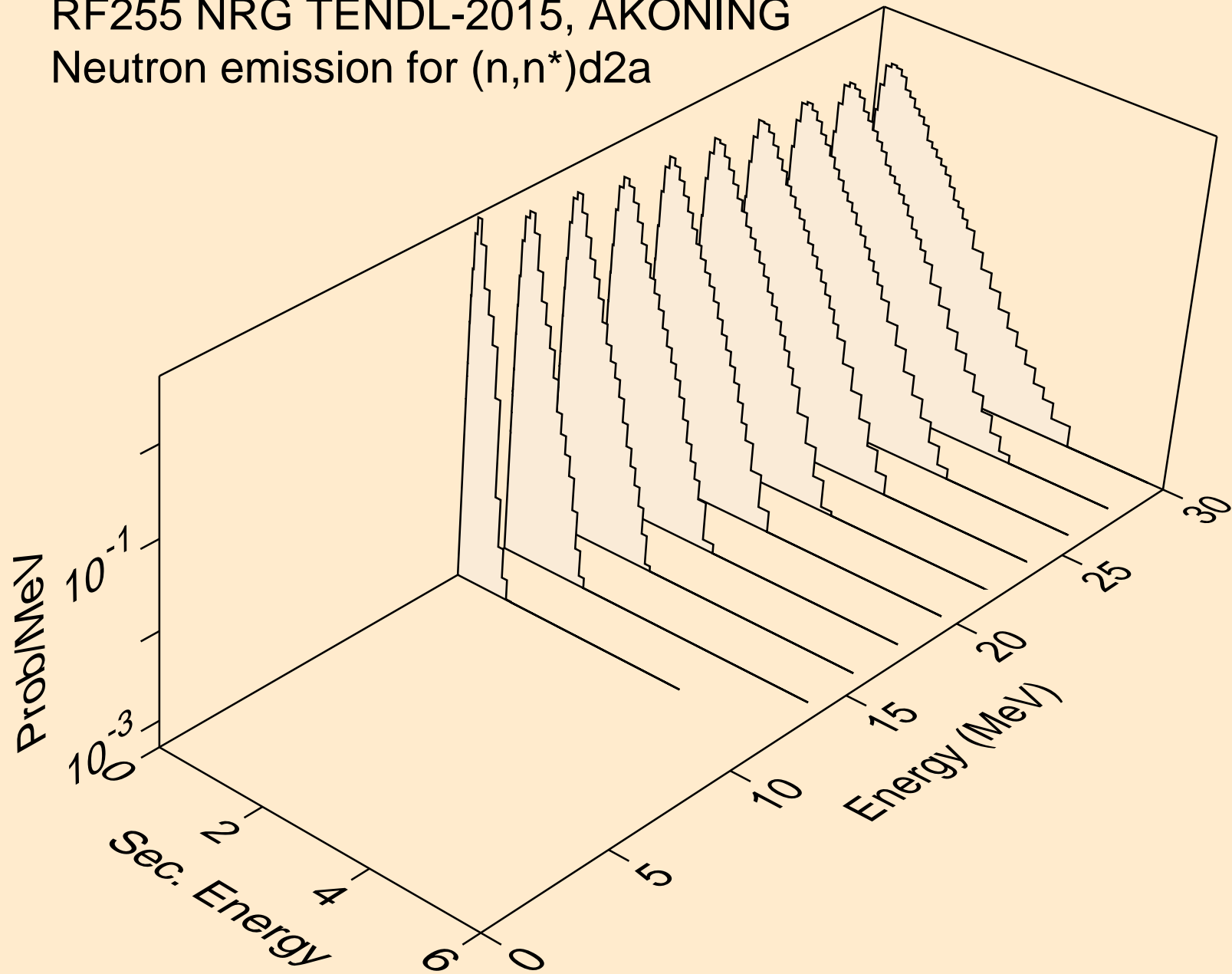

RF255 NRG TENDL-2015, AKONING
Neutron emission for (n,n*)t2a

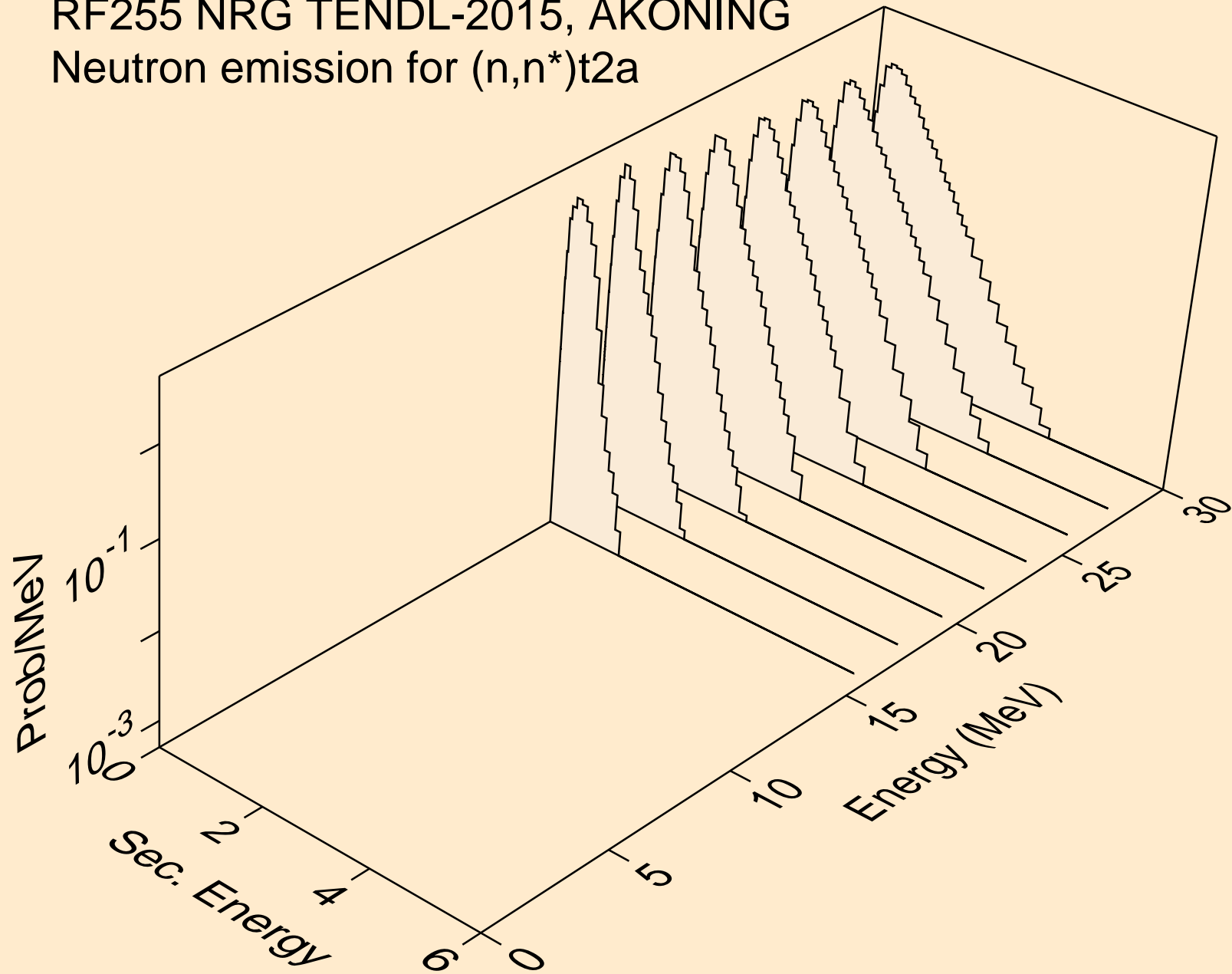

RF255 NRG TENDL-2015, AKONING
Neutron emission for (n,4n)

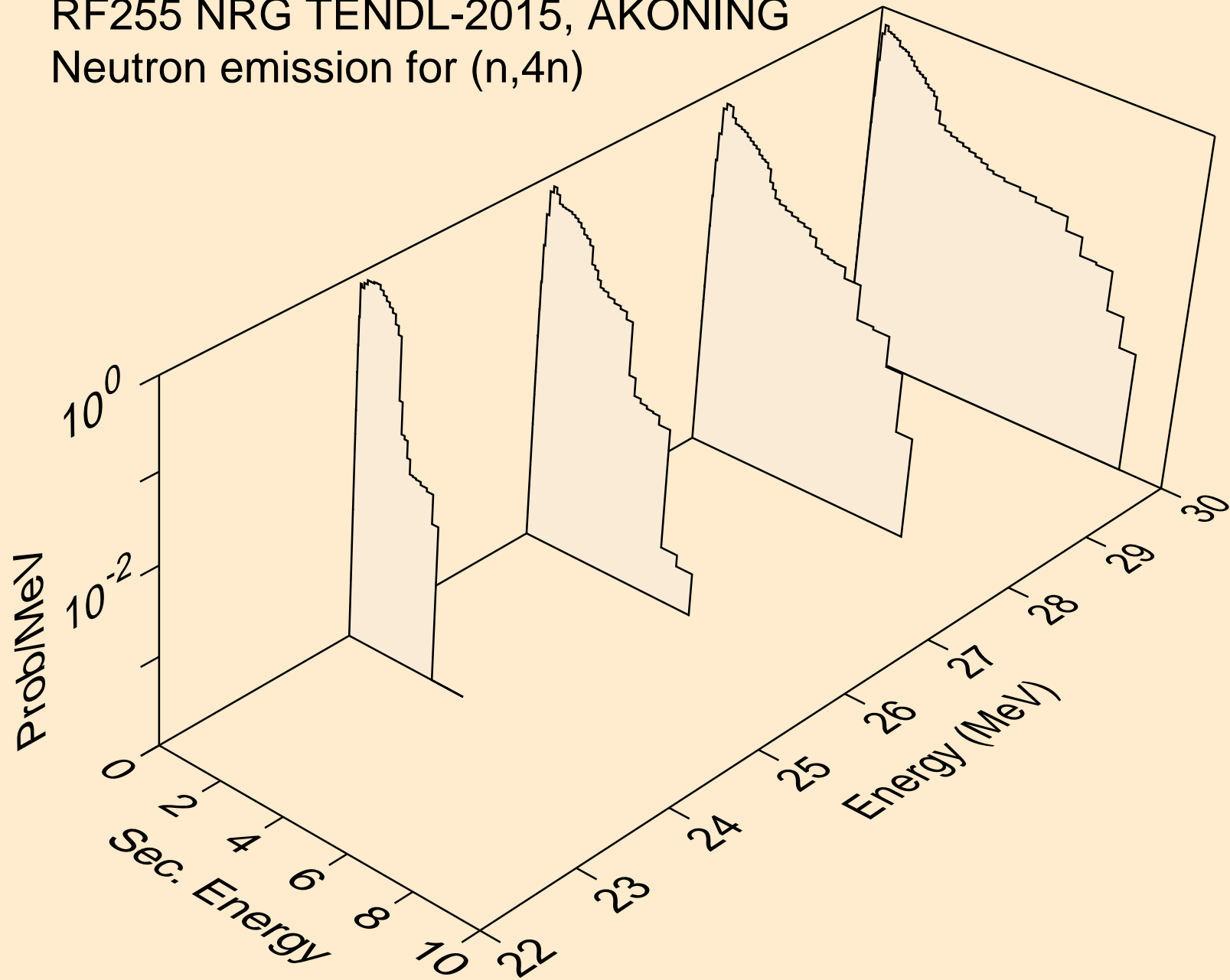

RF255 NRG TENDL-2015, AKONING
Neutron emission for (n,2np)

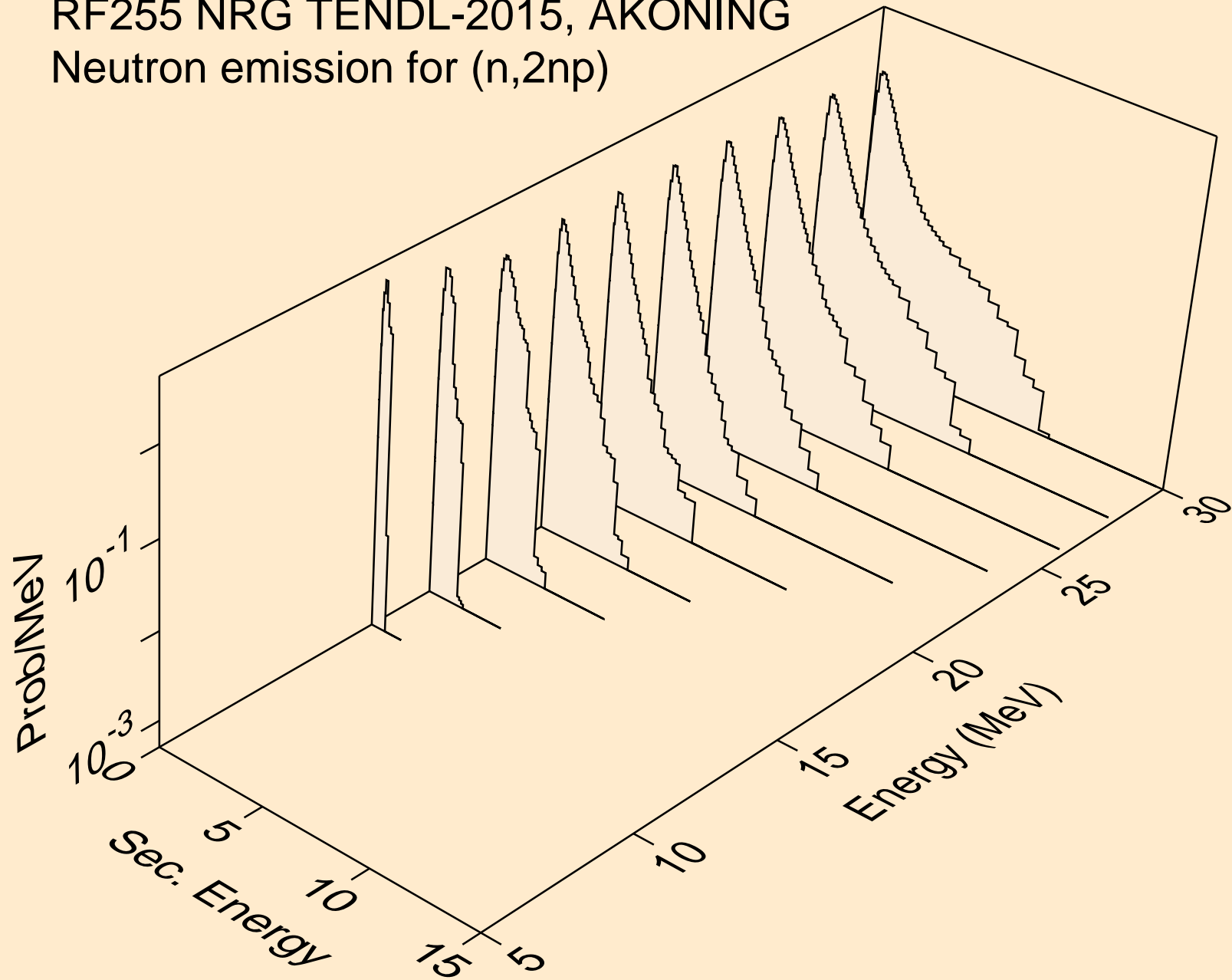

RF255 NRG TENDL-2015, AKONING
Neutron emission for (n,3np)

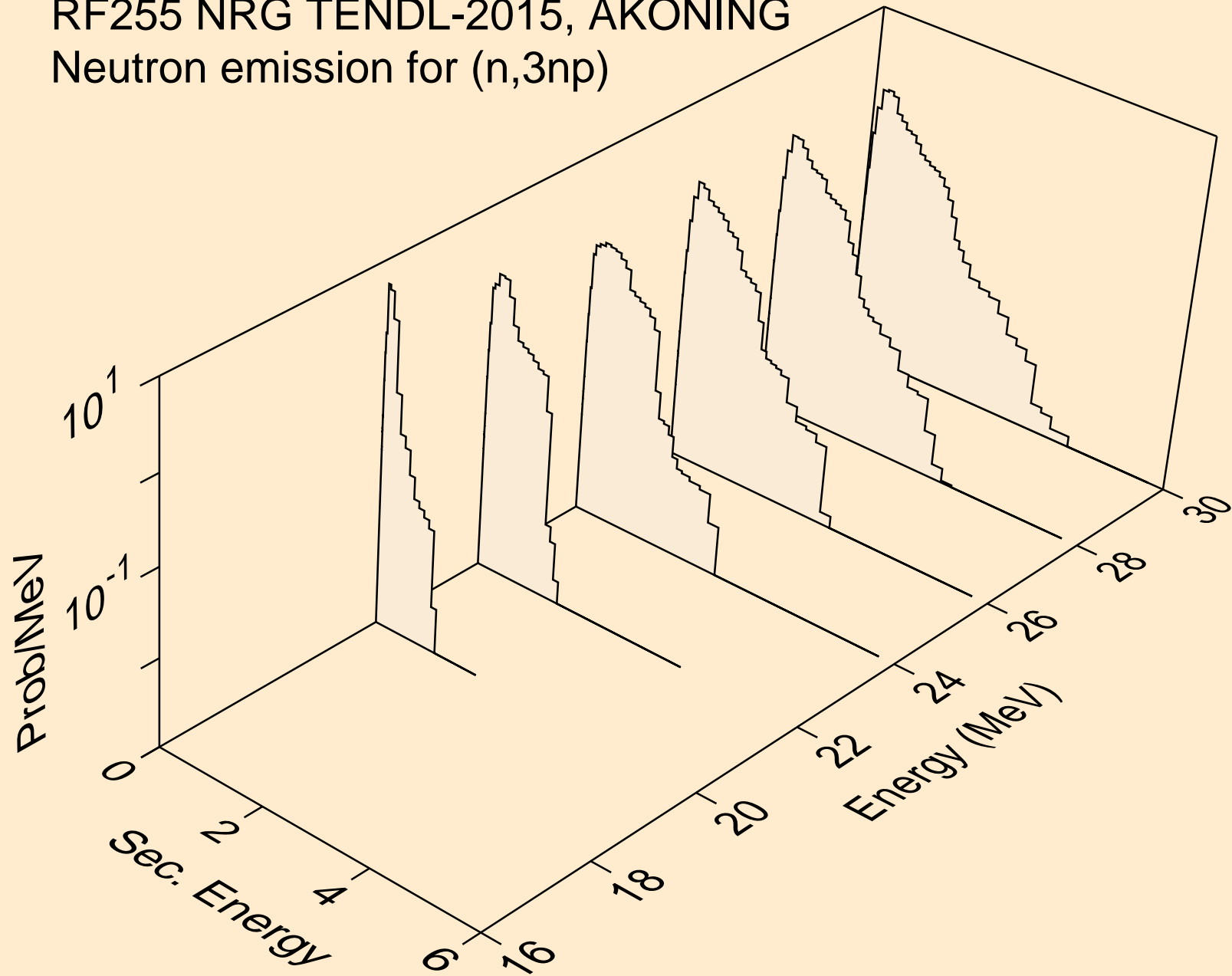

RF255 NRG TENDL-2015, AKONING
Neutron emission for (n,2np)

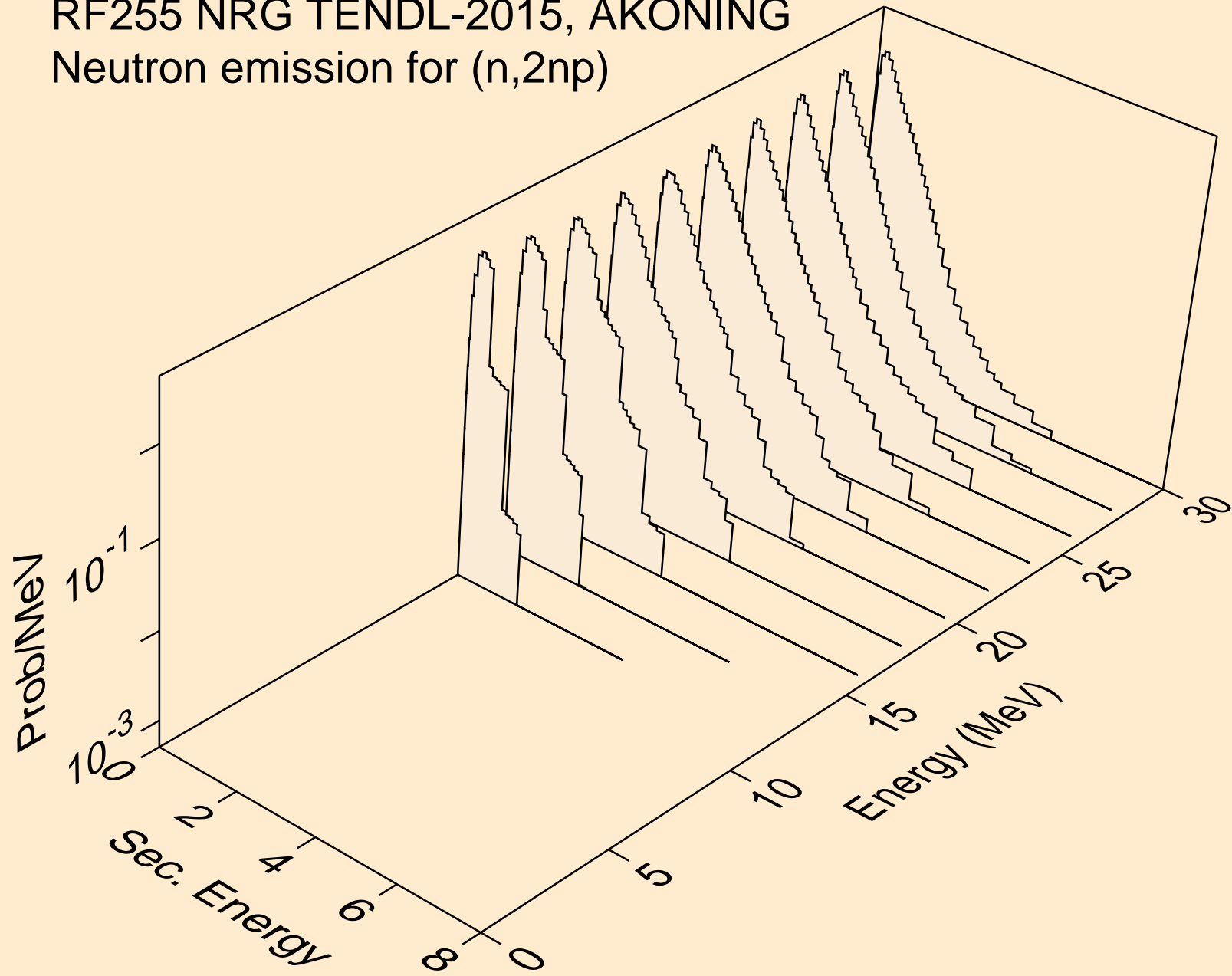

RF255 NRG TENDL-2015, AKONING
Neutron emission for (n,npa)

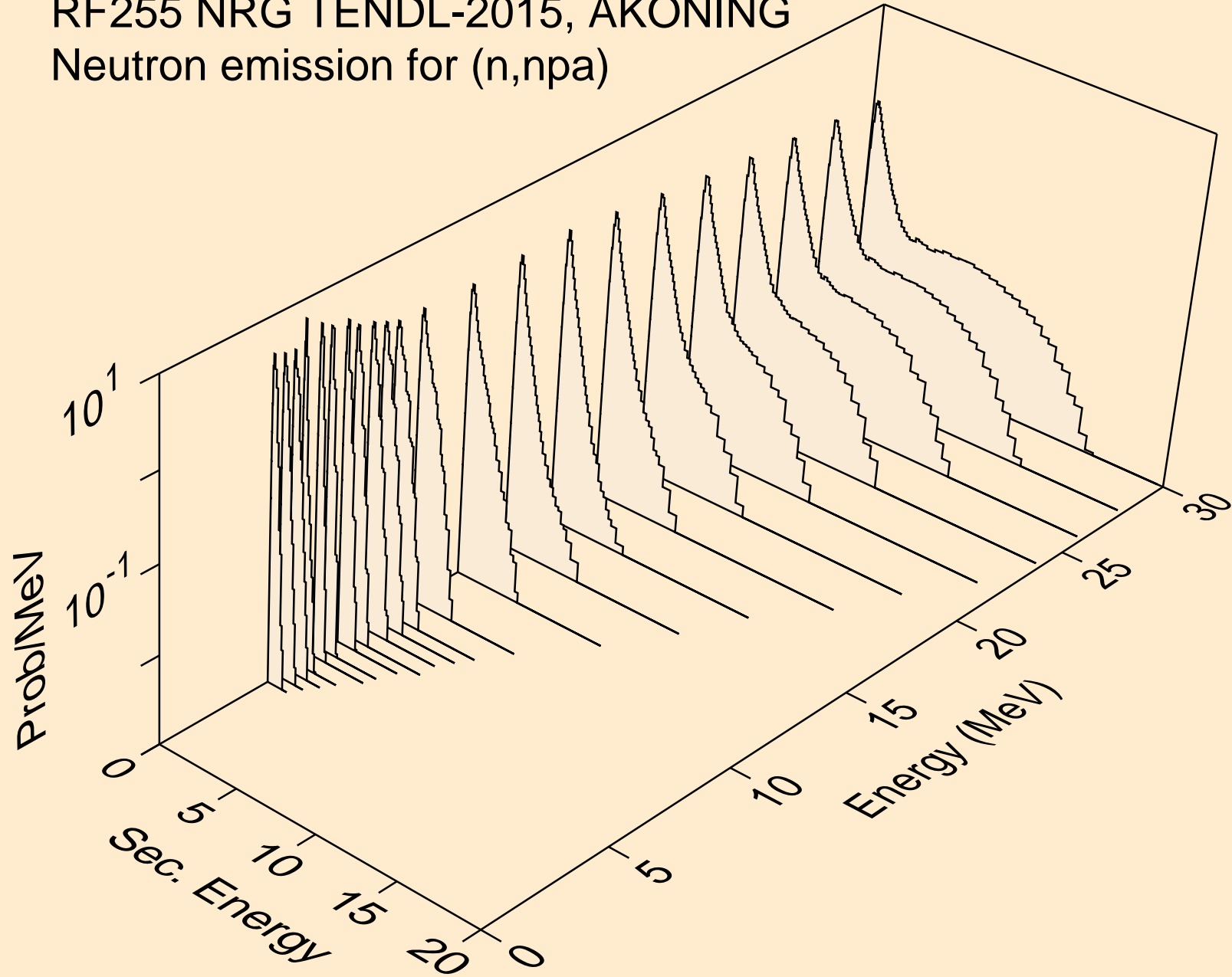

RF255 NRG TENDL-2015, AKONING
Neutron emission for (n,n*c)

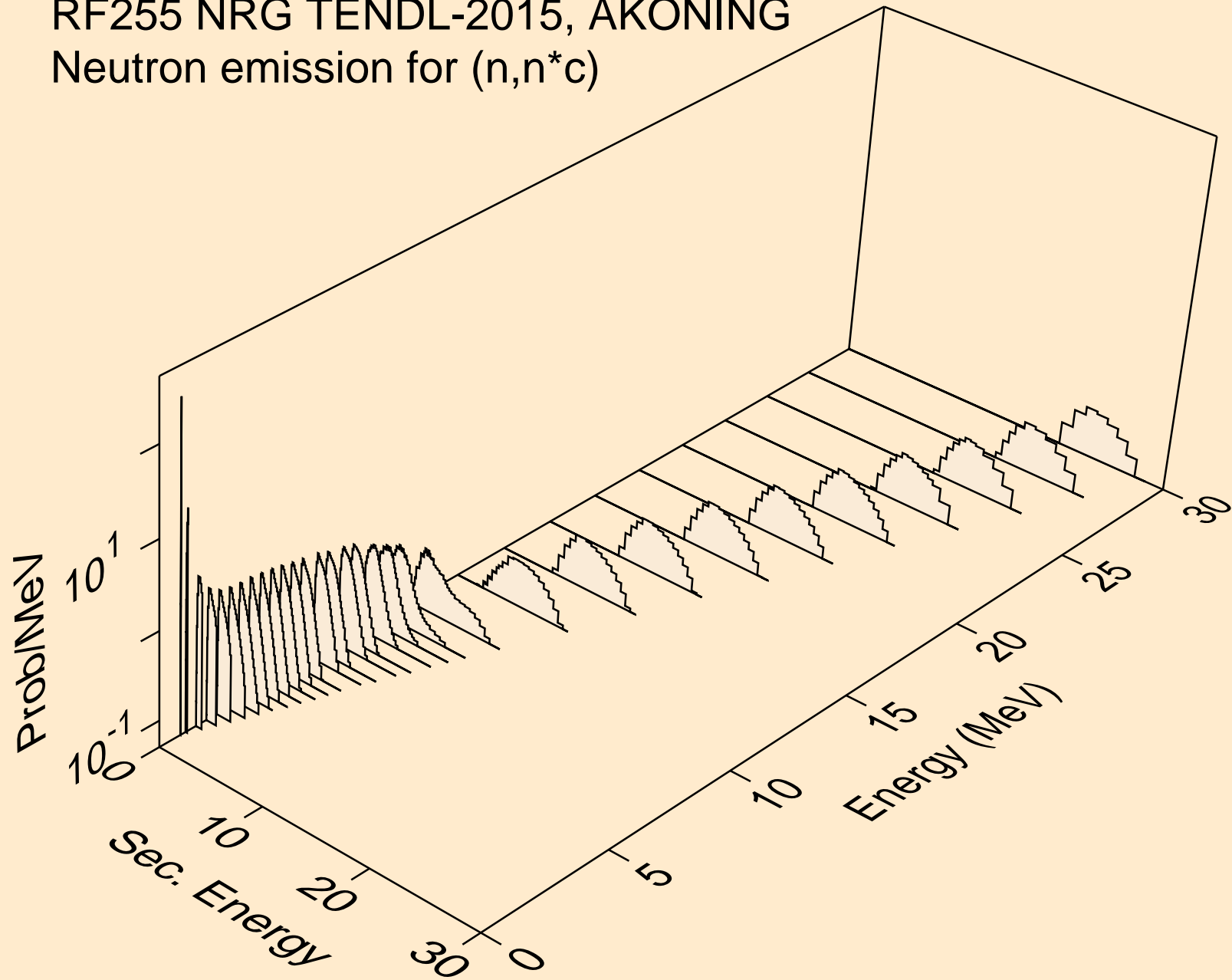

RF255 NRG TENDL-2015, AKONING

Delayed nubar

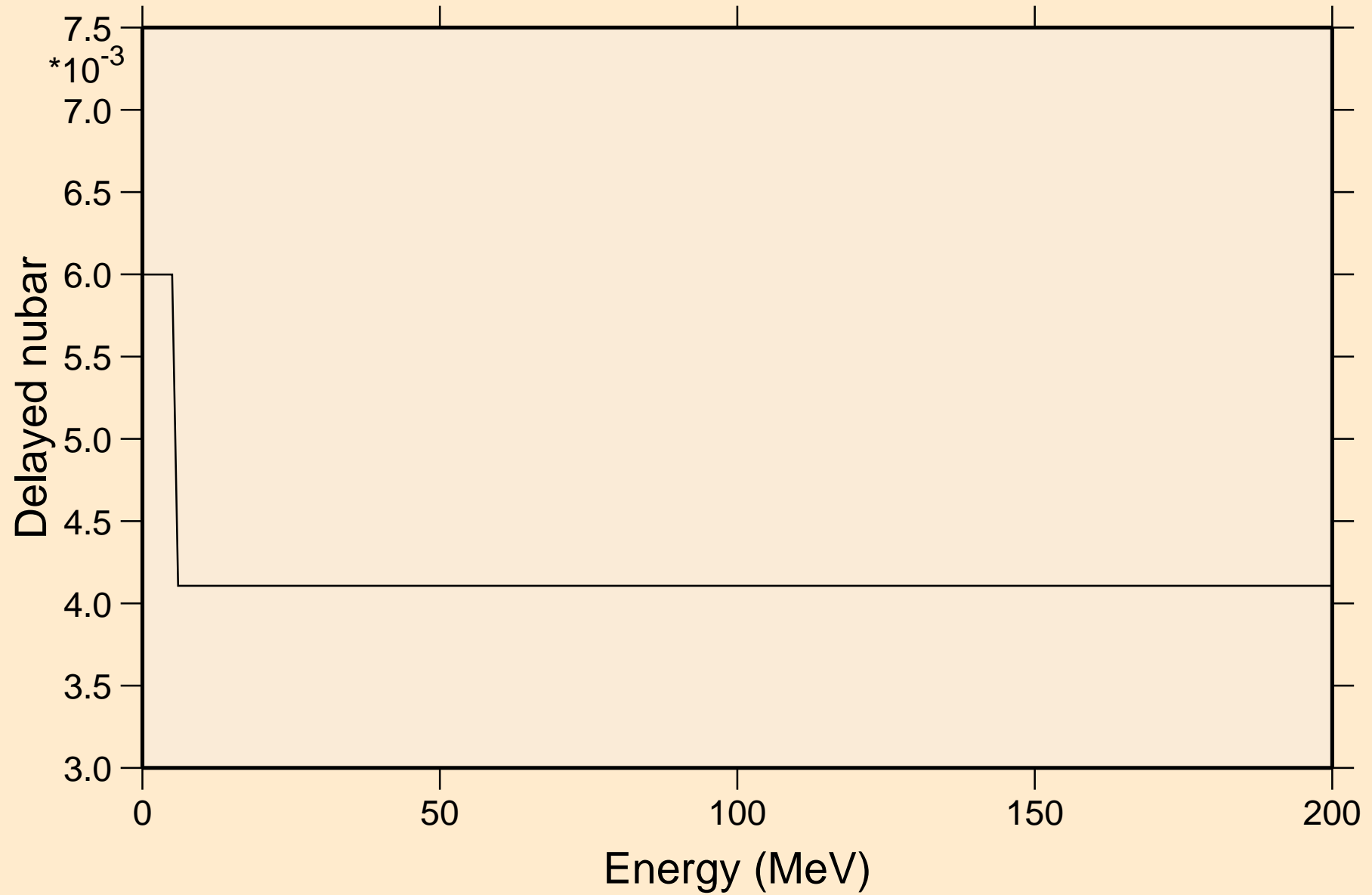

RF255 NRG TENDL-2015, AKONING

Delayed neutron spectra

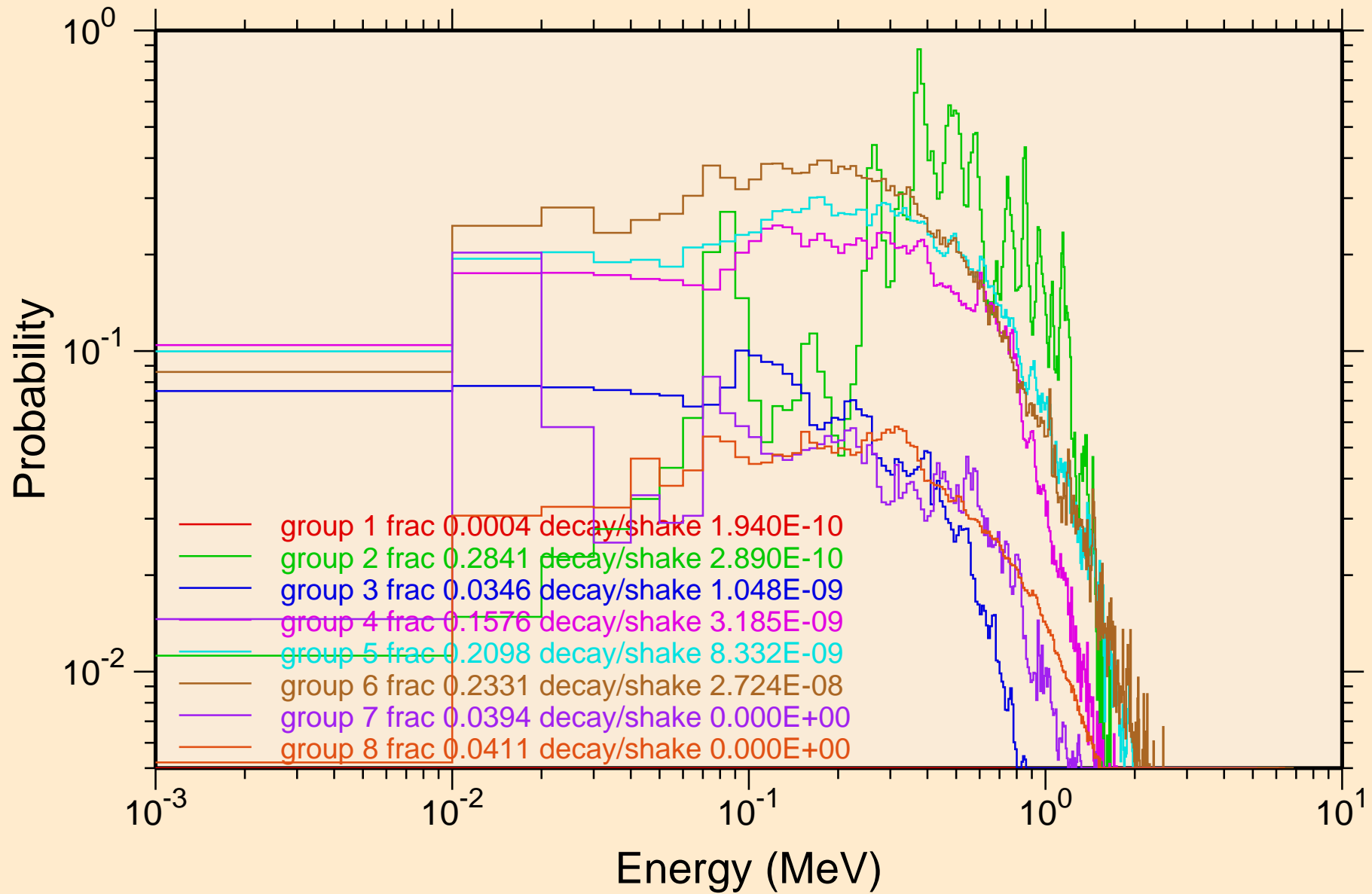

RF255 NRG TENDL-2015, AKONING
Photon emission for (n,x)

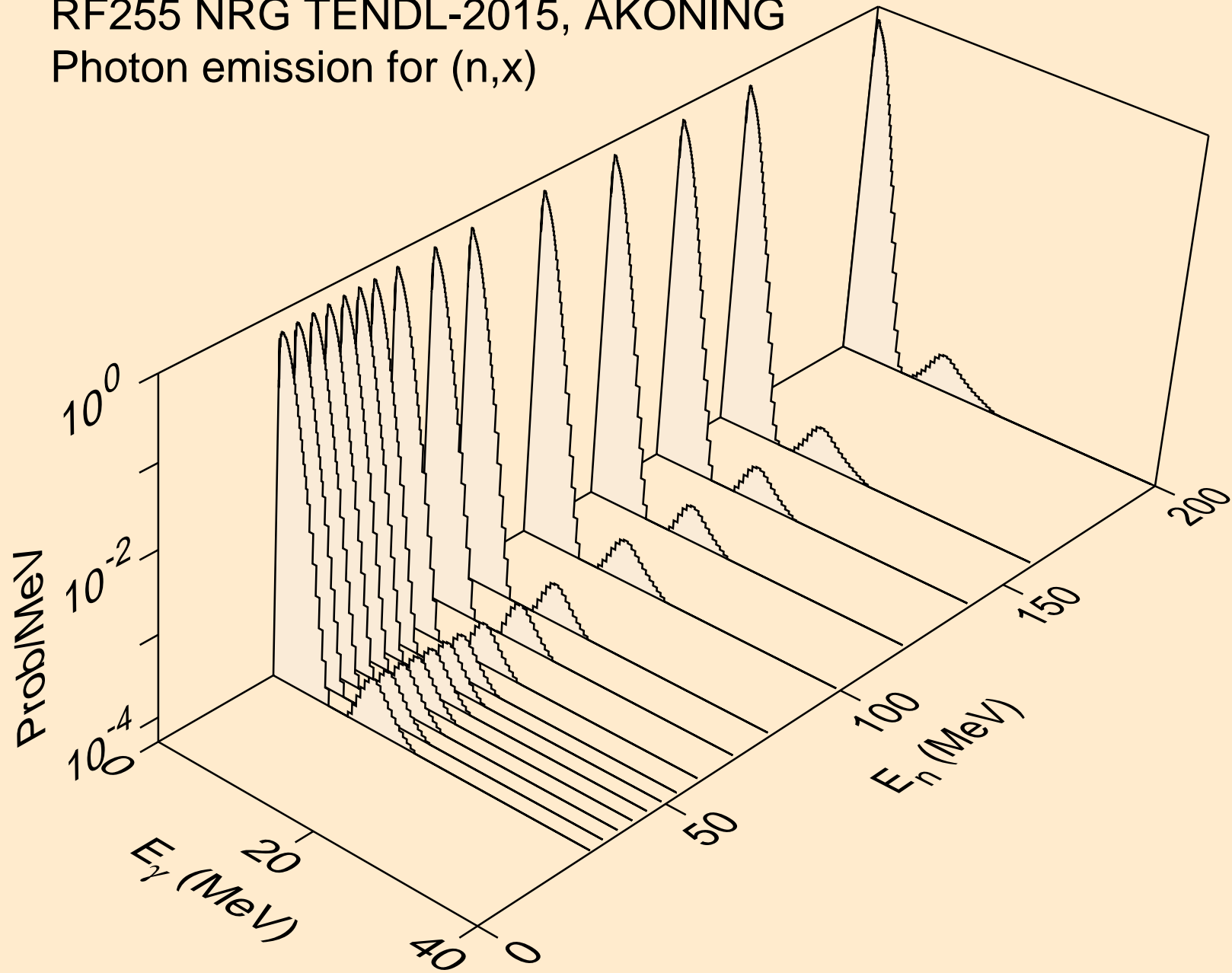

RF255 NRG TENDL-2015, AKONING
Photon emission for (n,2nd)

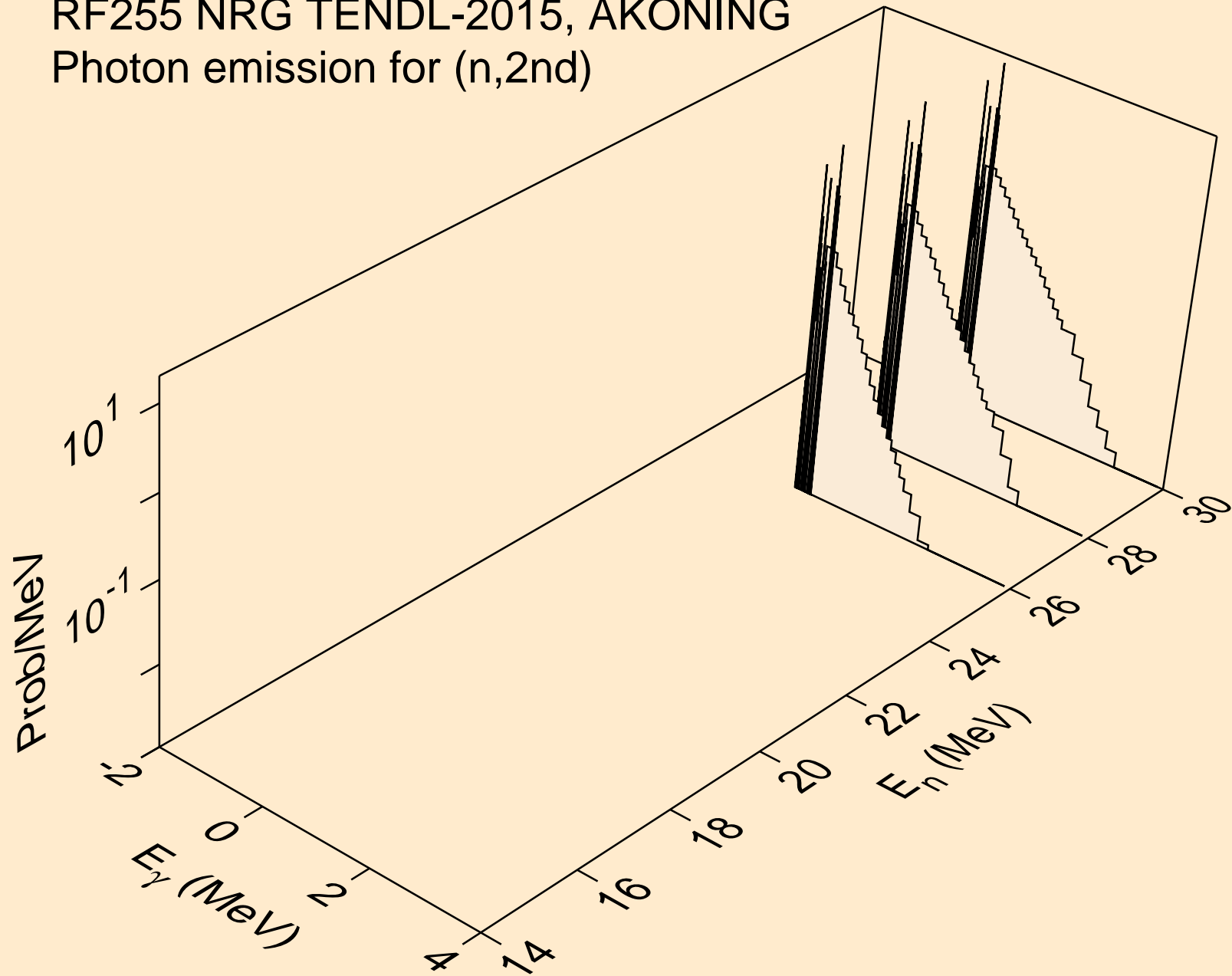

RF255 NRG TENDL-2015, AKONING
Photon emission for (n,2n)

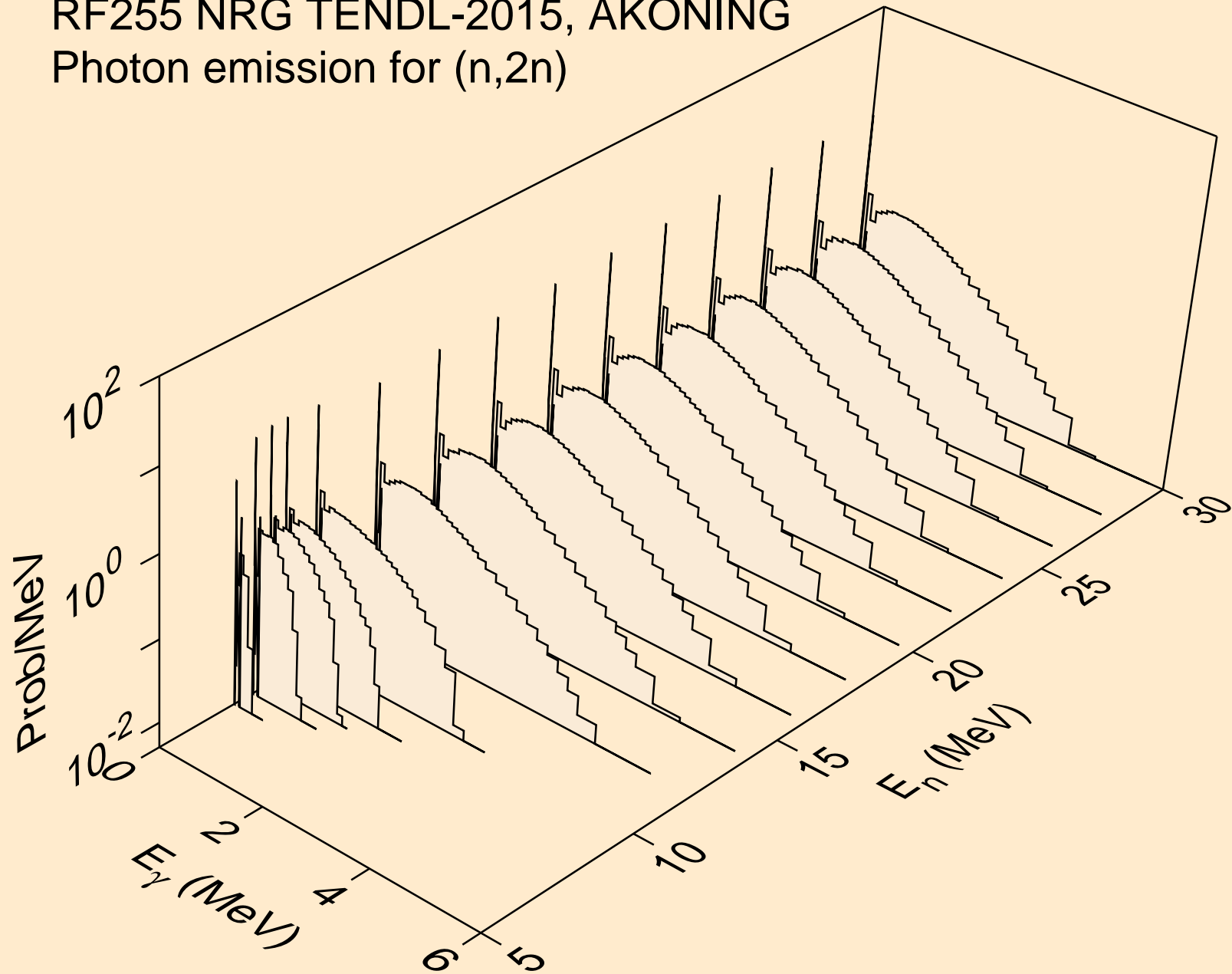

RF255 NRG TENDL-2015, AKONING
Photon emission for (n,3n)

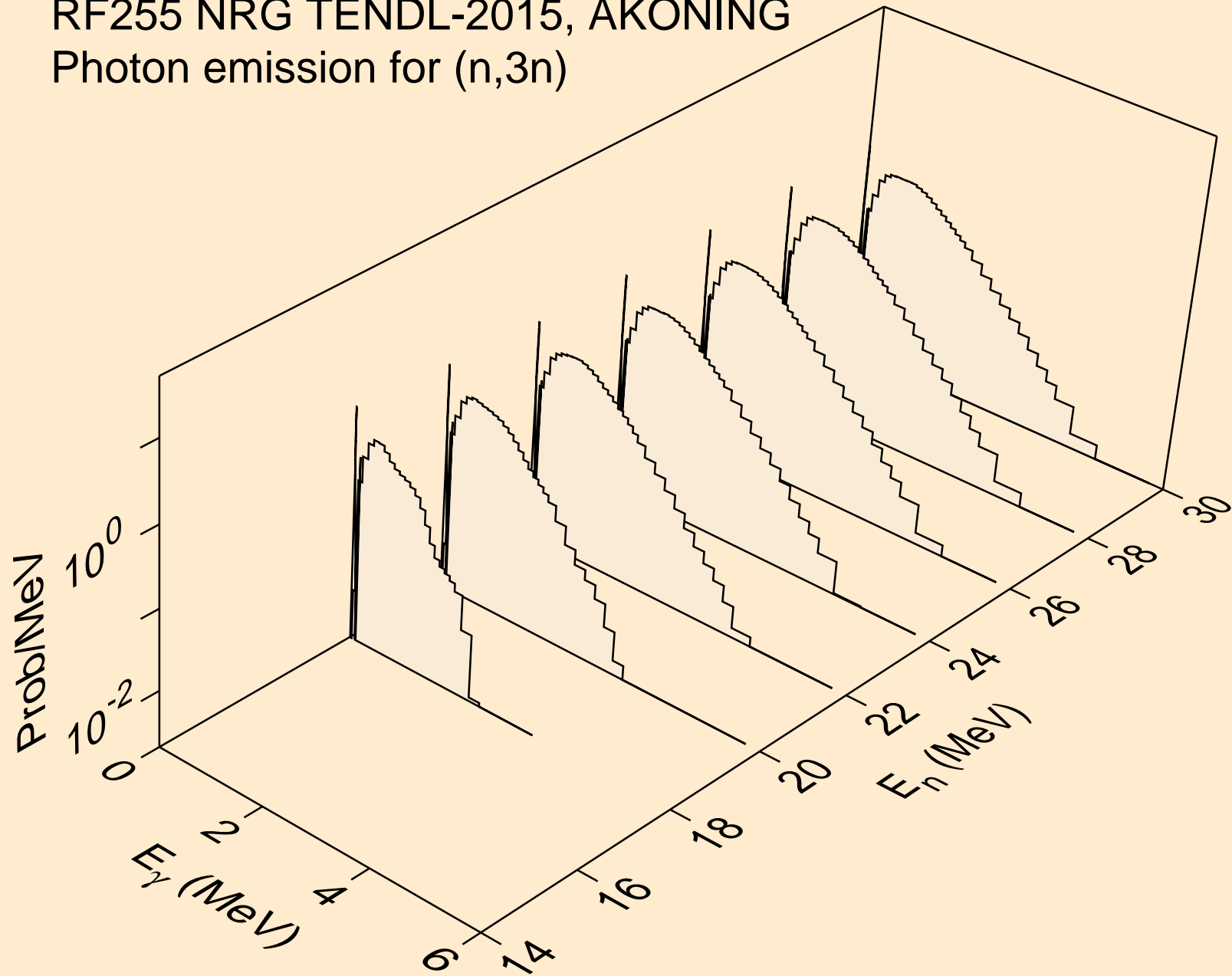

RF255 NRG TENDL-2015, AKONING
Photon emission for (n,n*)a

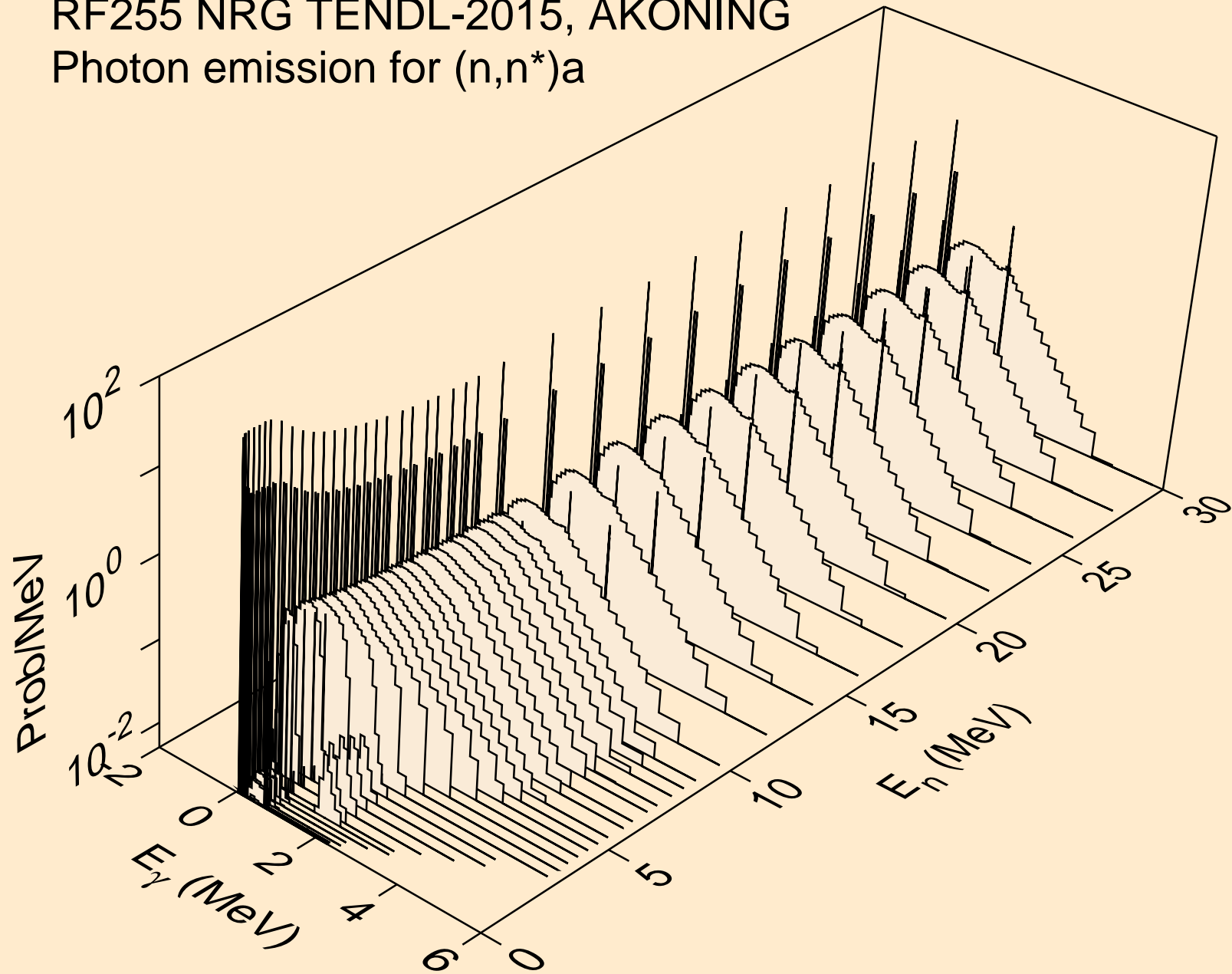

RF255 NRG TENDL-2015, AKONING
Photon emission for (n,n*)3a

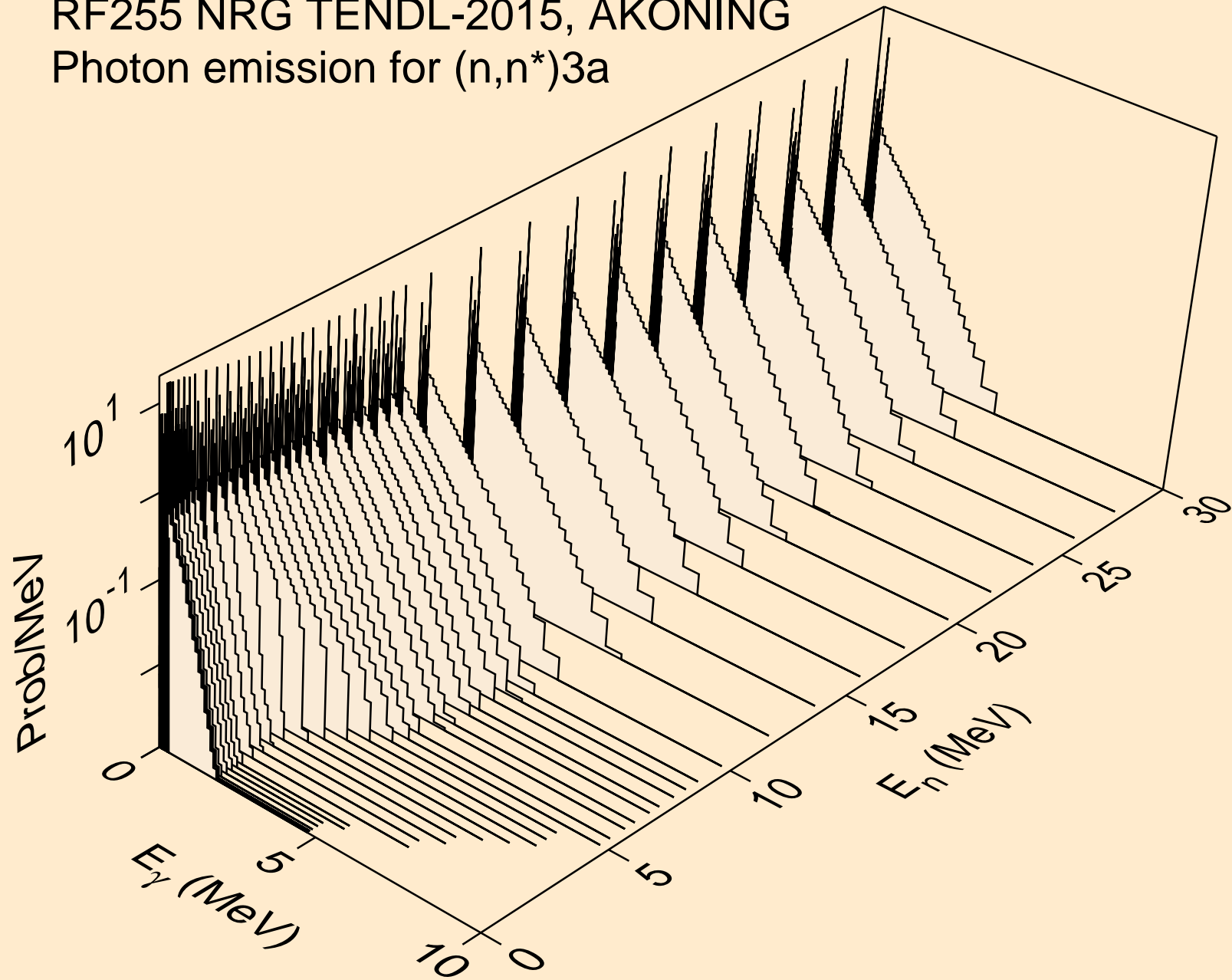

RF255 NRG TENDL-2015, AKONING
Photon emission for (n,2n)_a

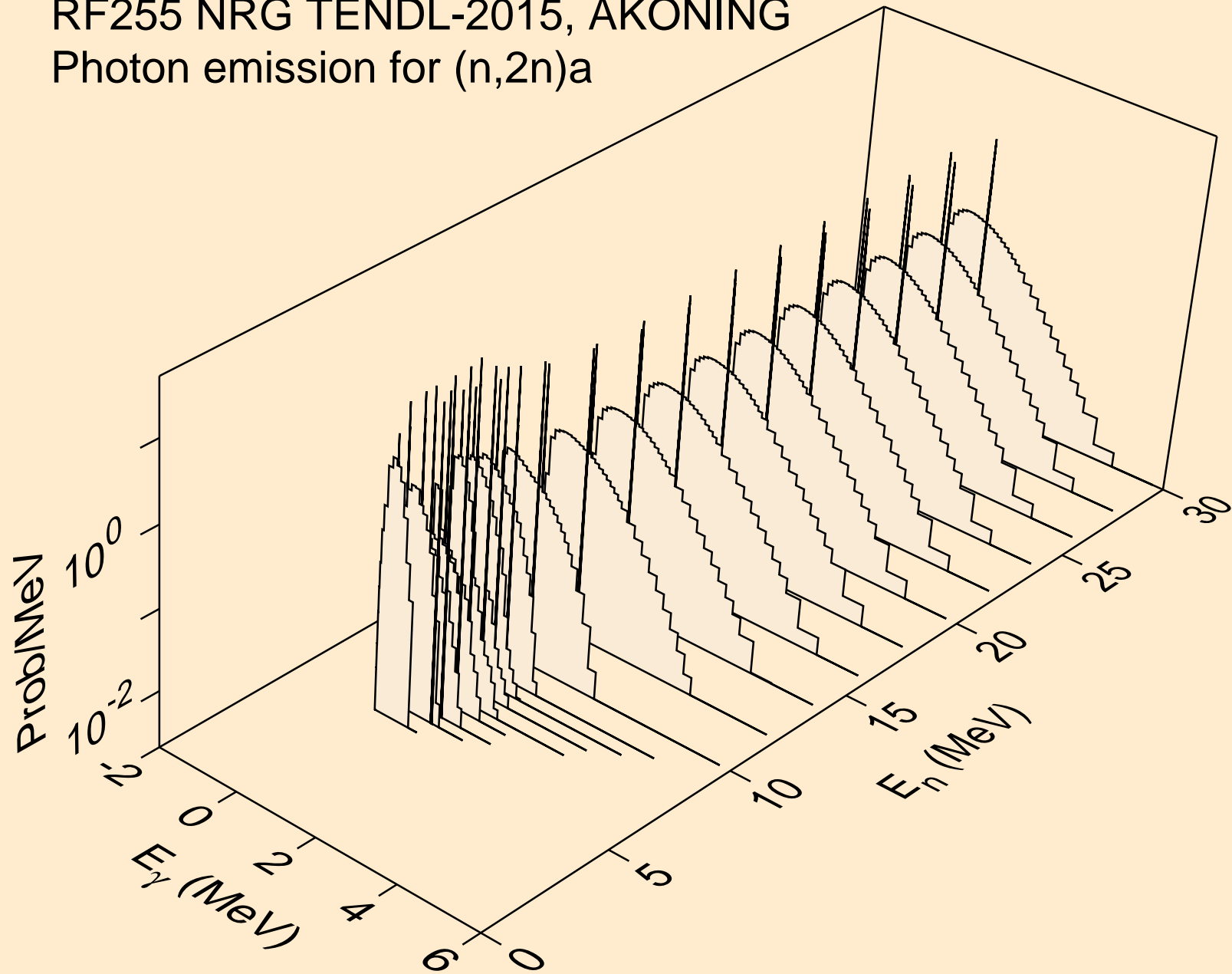

RF255 NRG TENDL-2015, AKONING
Photon emission for (n,3n)a

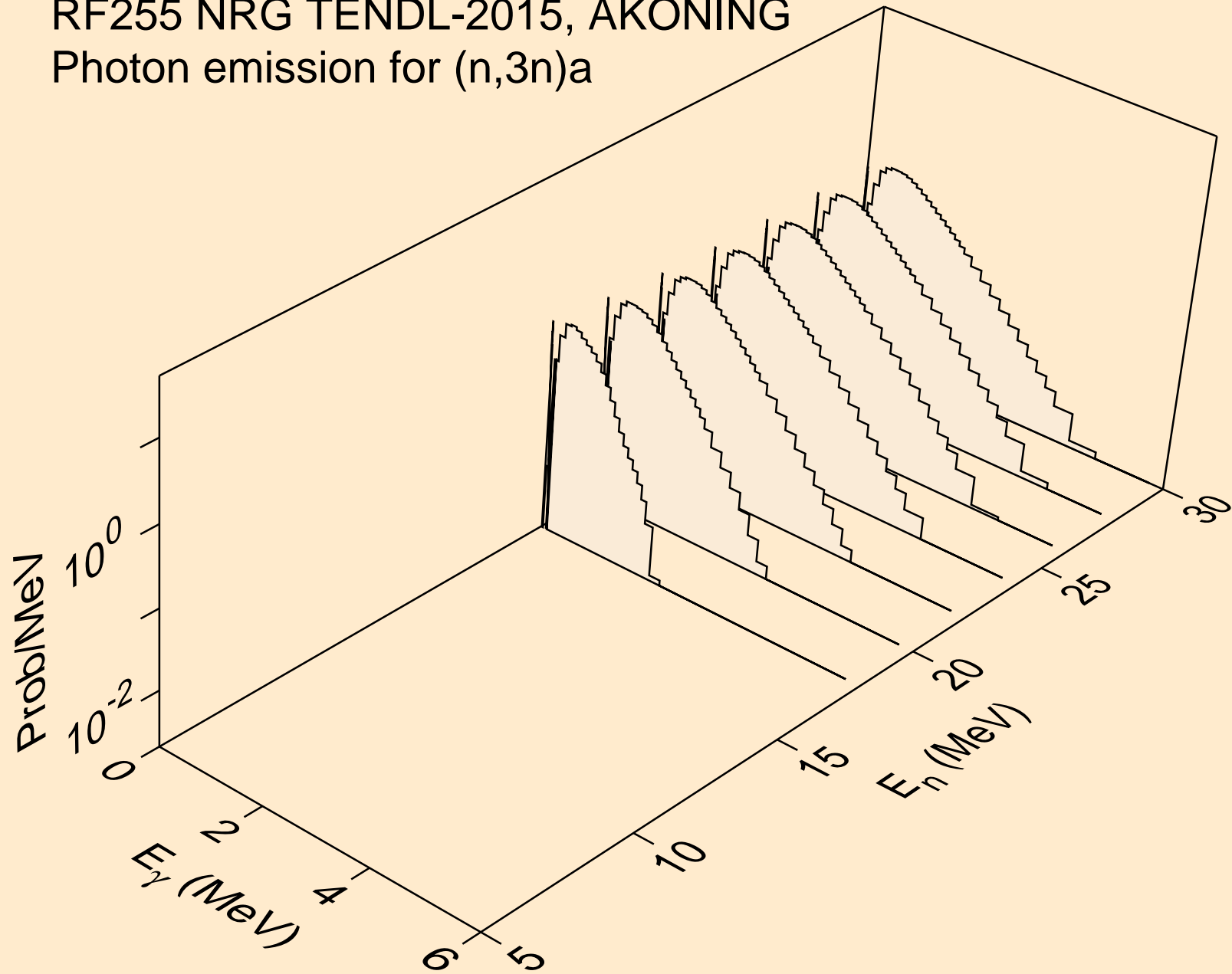

RF255 NRG TENDL-2015, AKONING
Photon emission for (n,n*)p

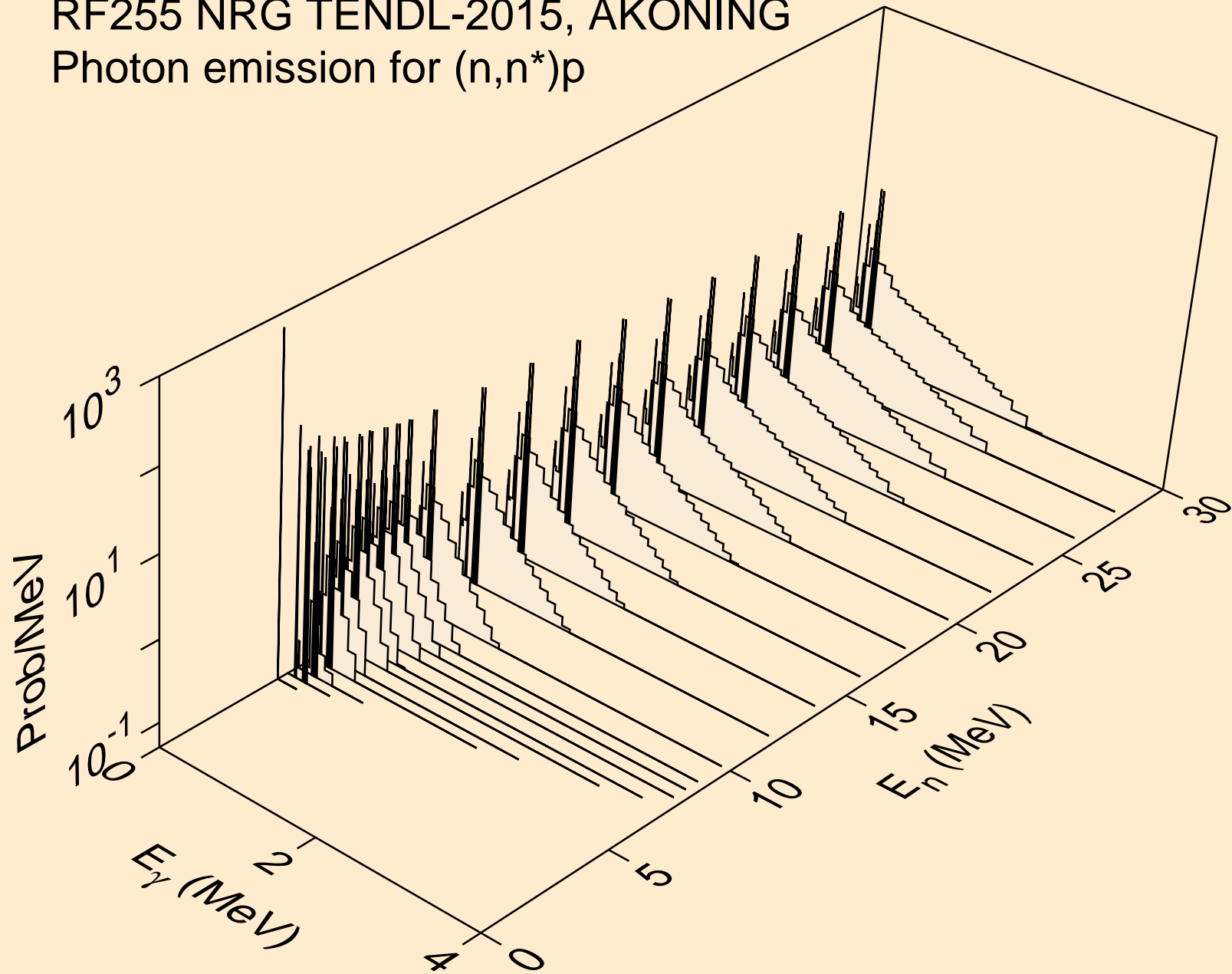

RF255 NRG TENDL-2015, AKONING
Photon emission for (n,n*)2a

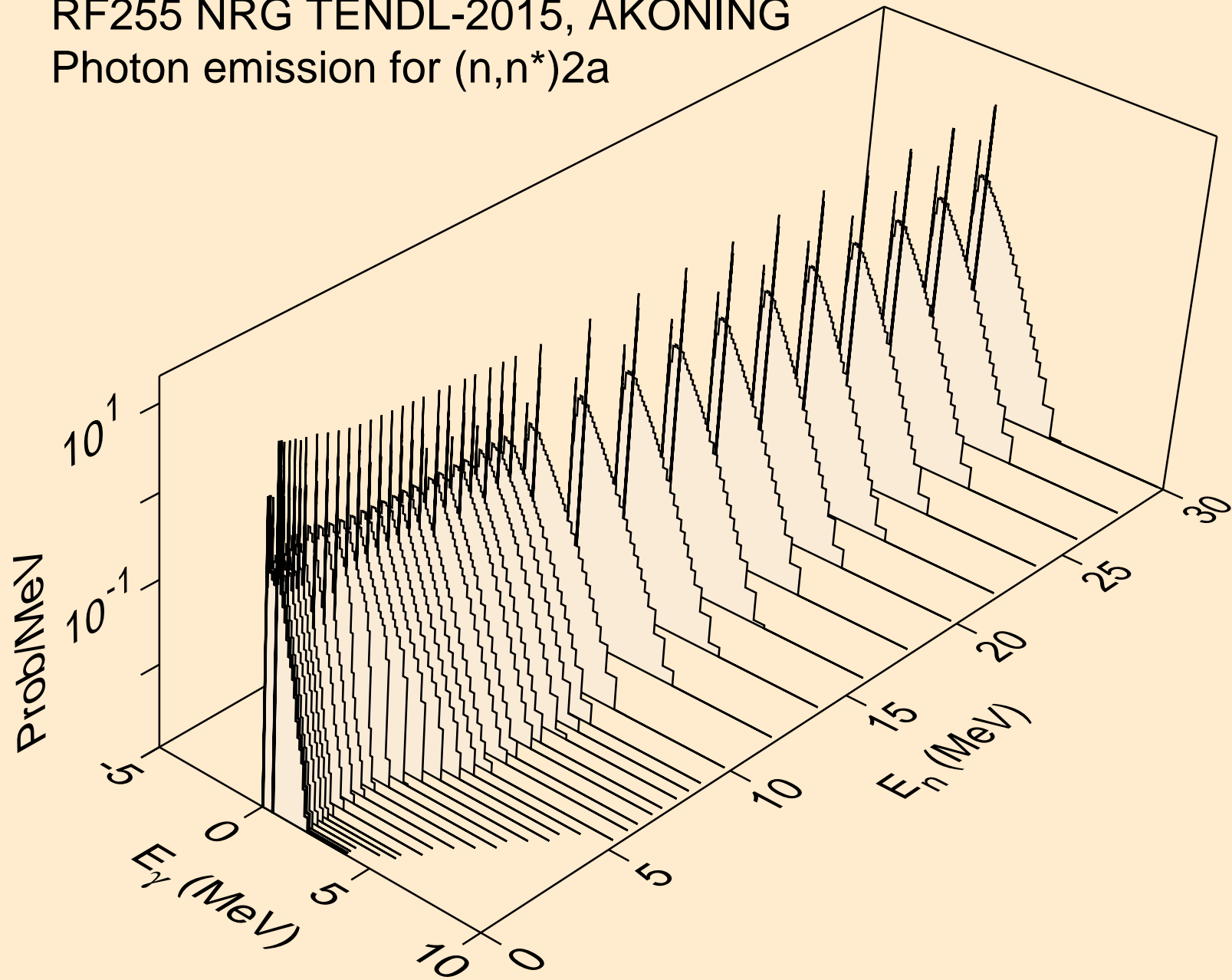

RF255 NRG TENDL-2015, AKONING
Photon emission for (n,2n)2a

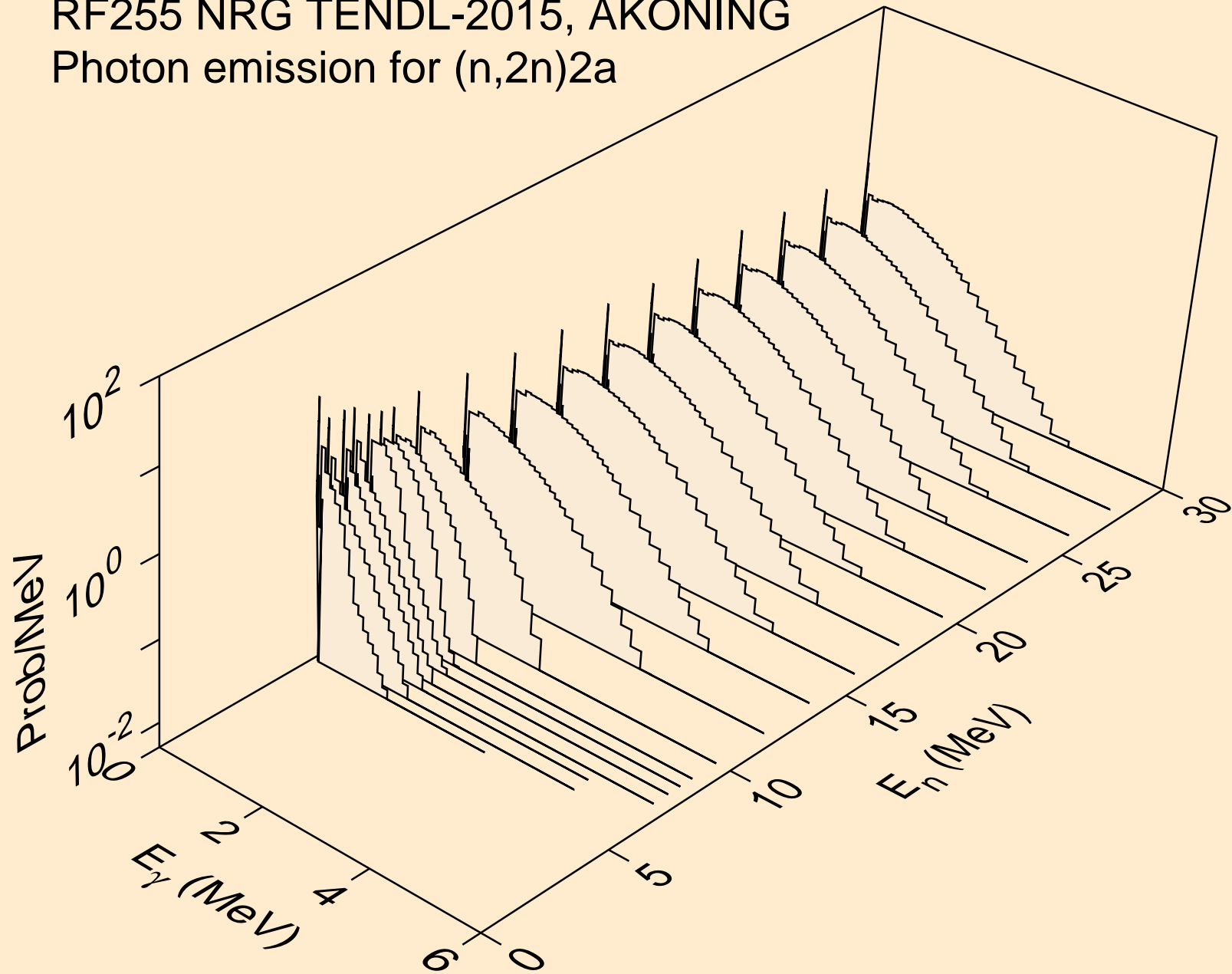

RF255 NRG TENDL-2015, AKONING
Photon emission for (n,n*)d

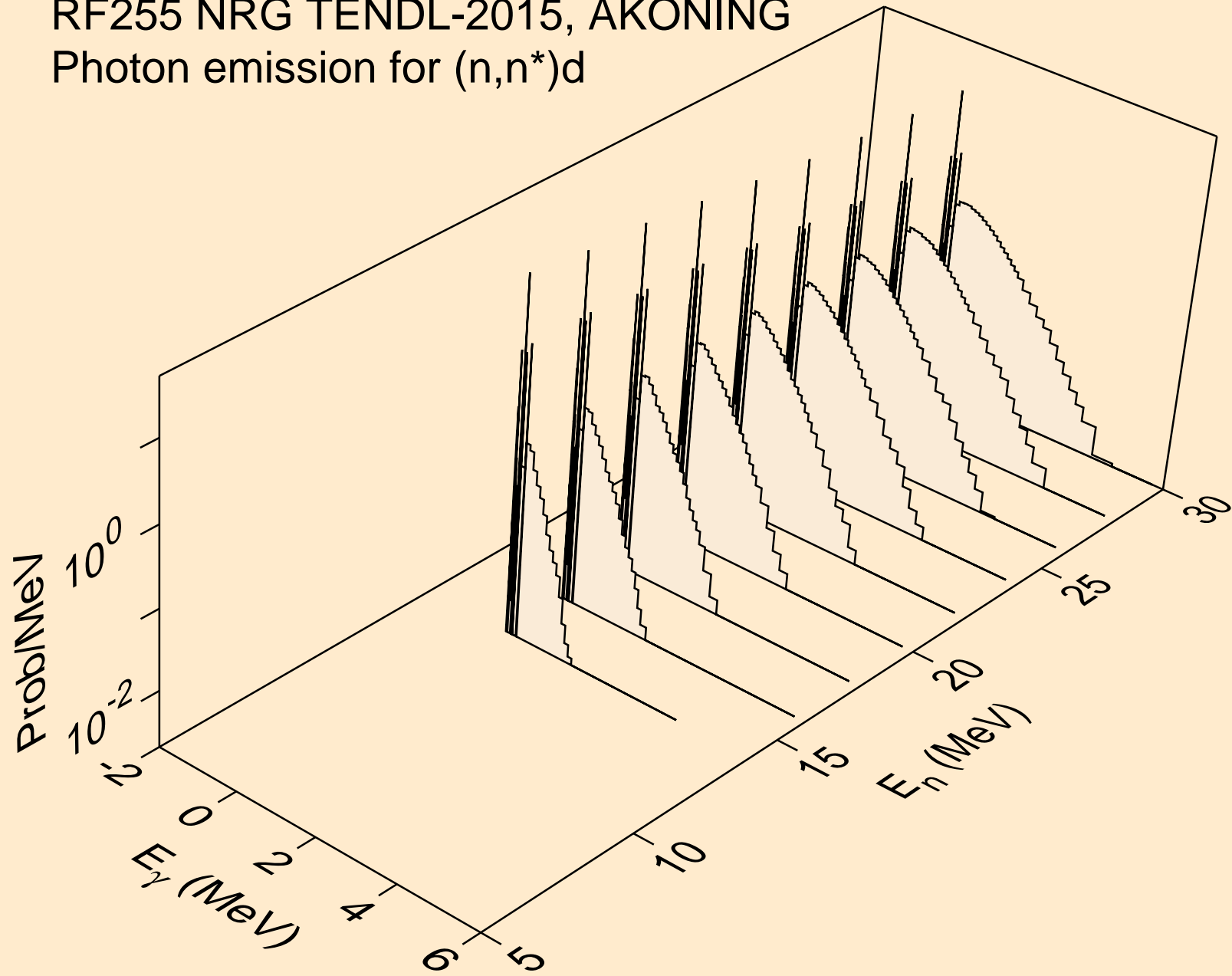

RF255 NRG TENDL-2015, AKONING
Photon emission for (n,n*)t

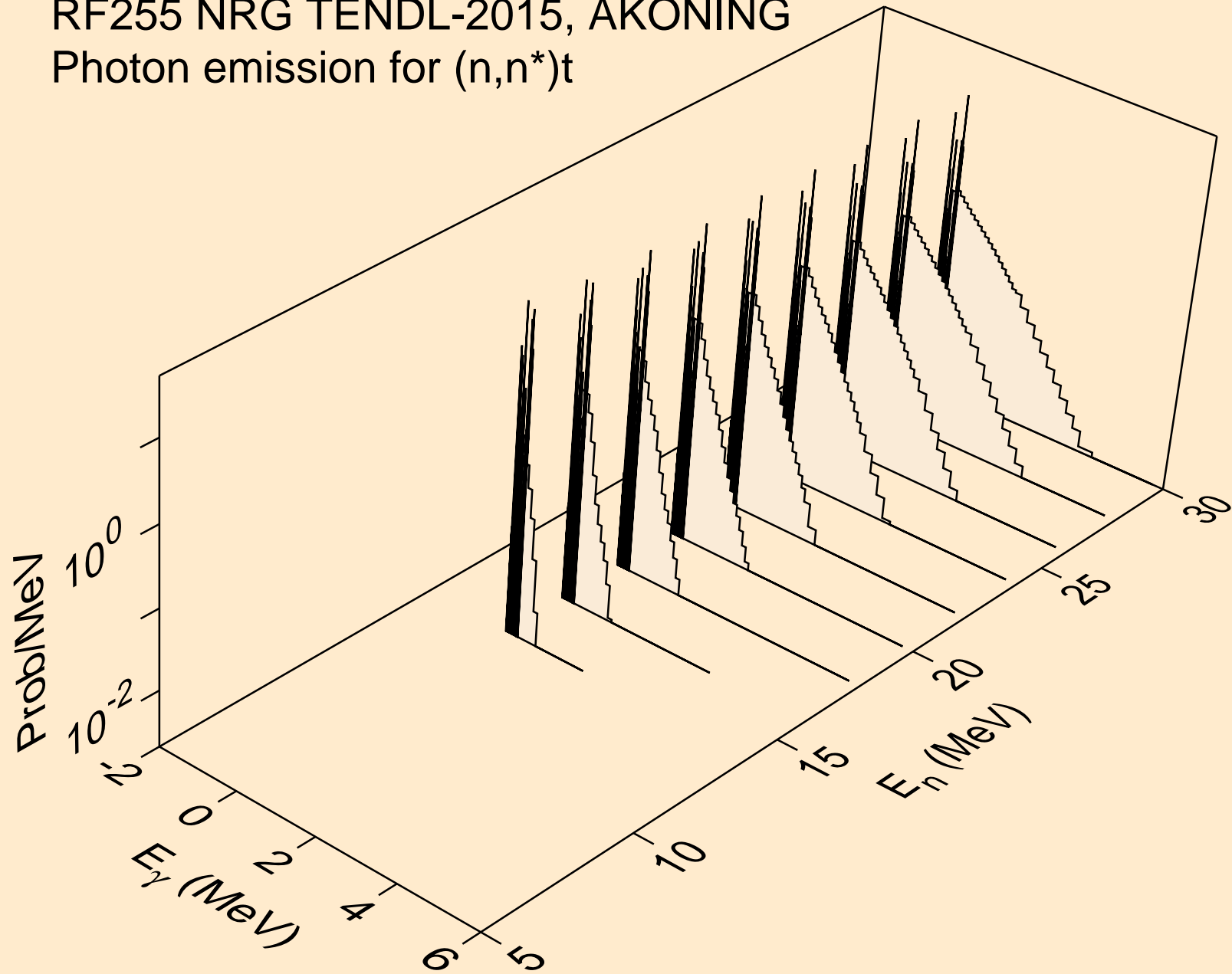

RF255 NRG TENDL-2015, AKONING
Photon emission for (n,n*)he3

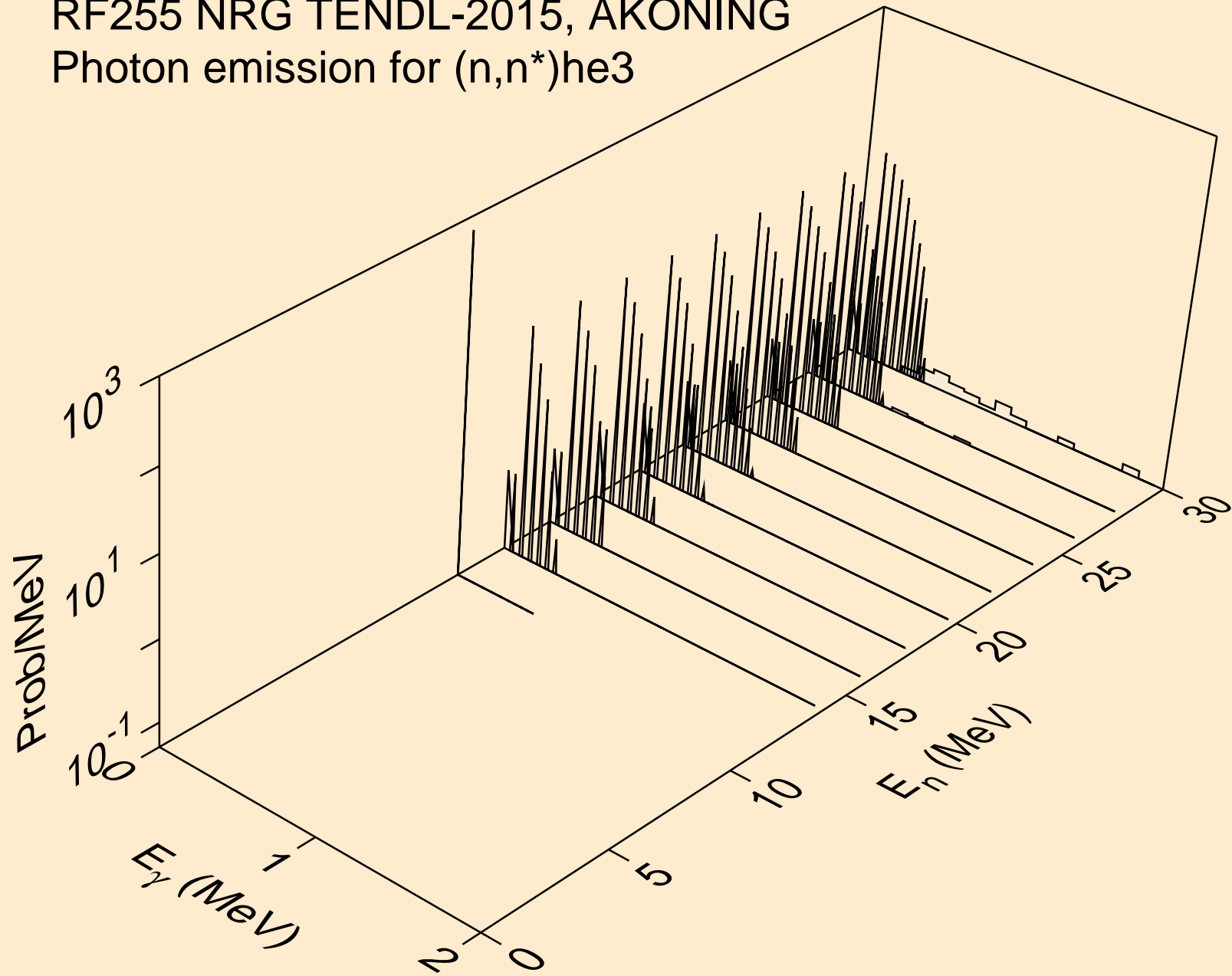

RF255 NRG TENDL-2015, AKONING
Photon emission for (n,n*)d2a

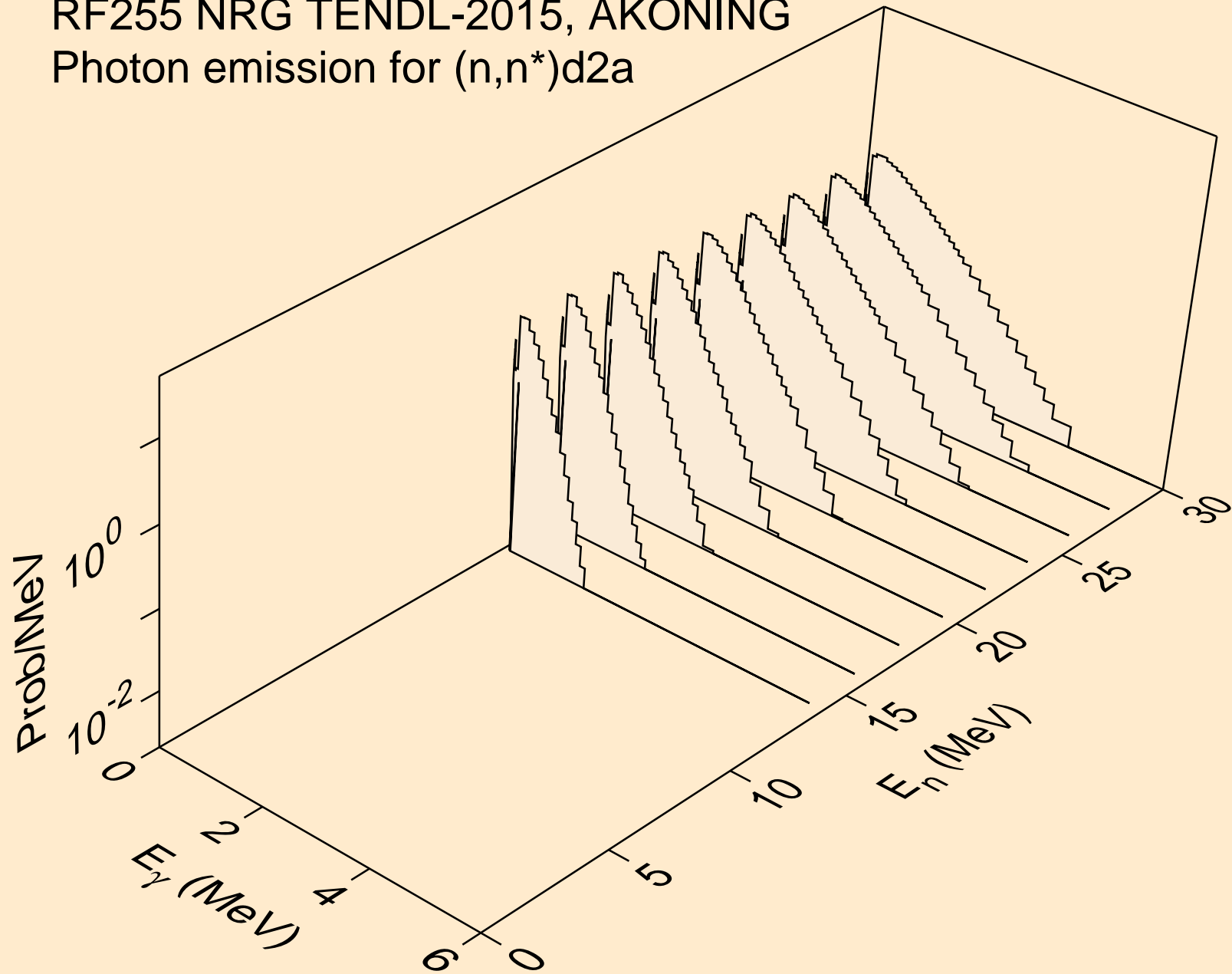

RF255 NRG TENDL-2015, AKONING
Photon emission for (n,n*)t2a

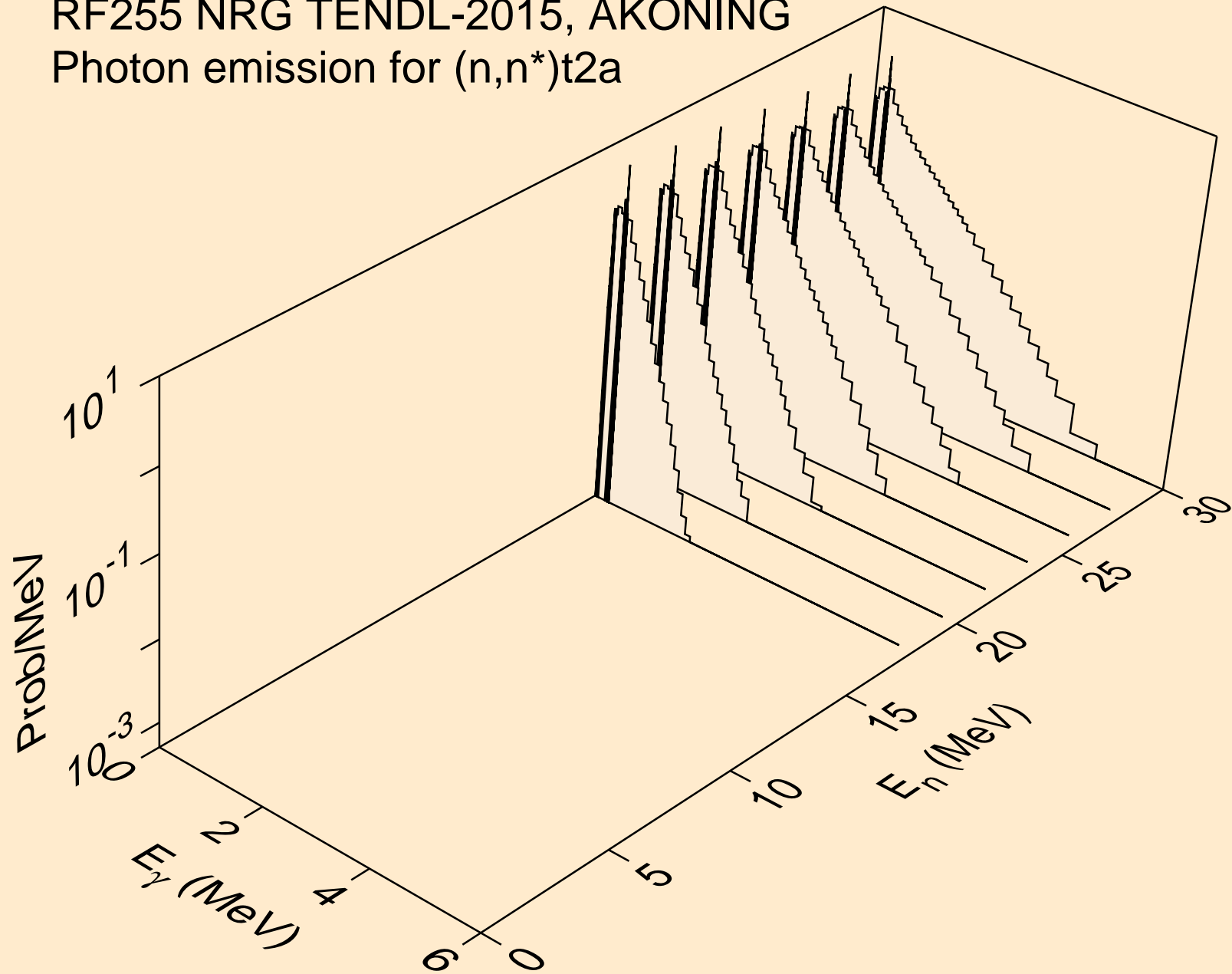

RF255 NRG TENDL-2015, AKONING
Photon emission for (n,4n)

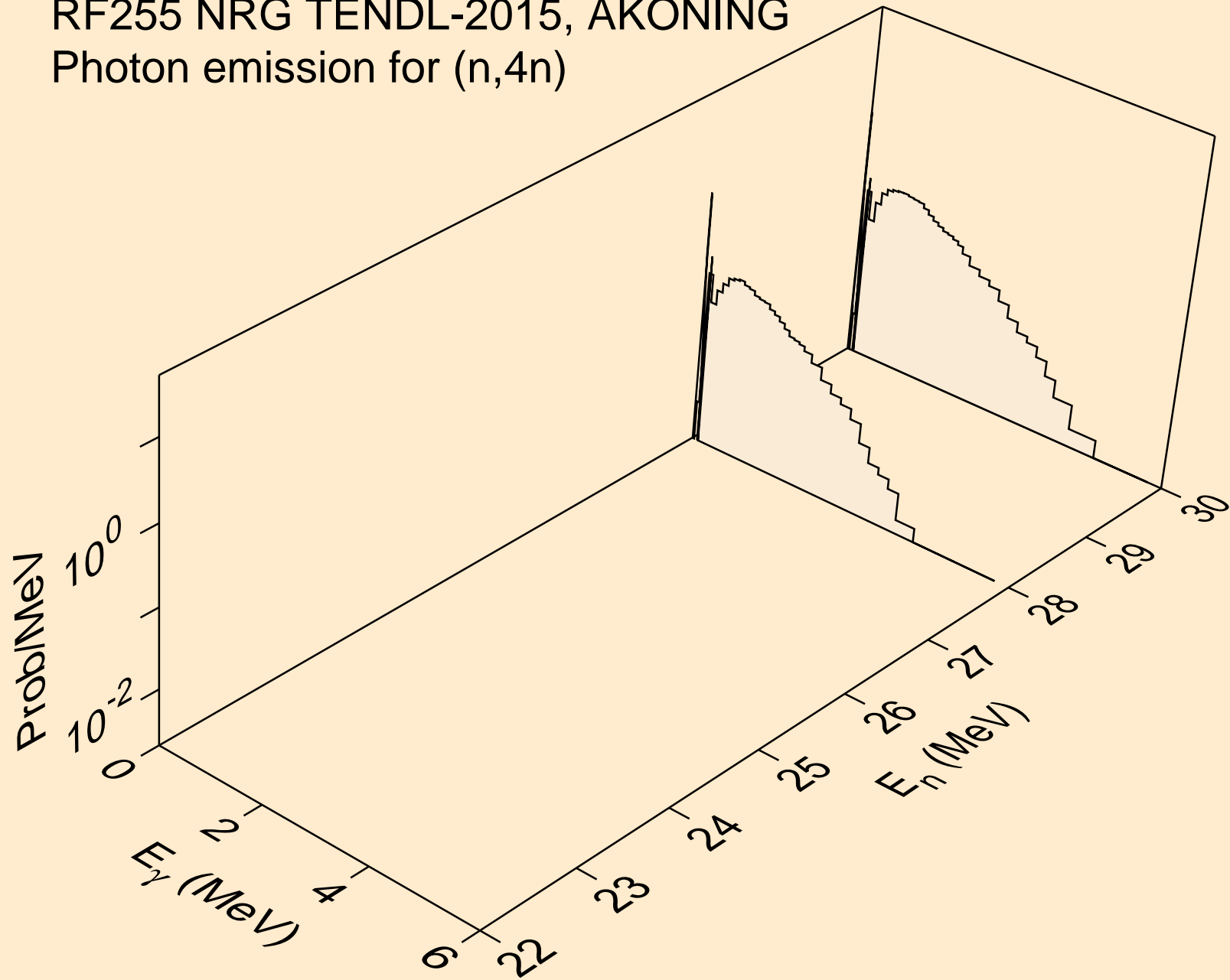

RF255 NRG TENDL-2015, AKONING
Photon emission for (n,2np)

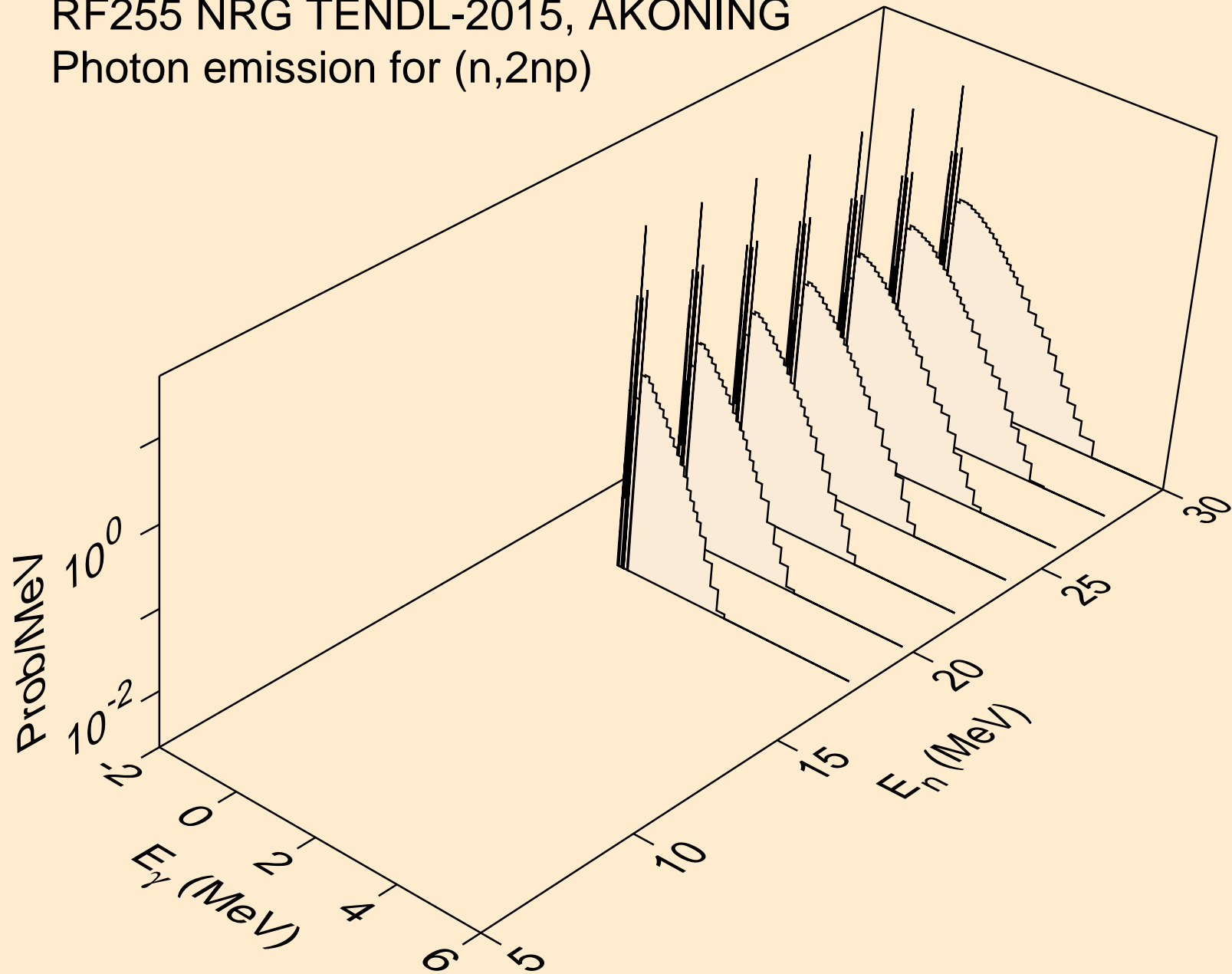

RF255 NRG TENDL-2015, AKONING
Photon emission for (n,3np)

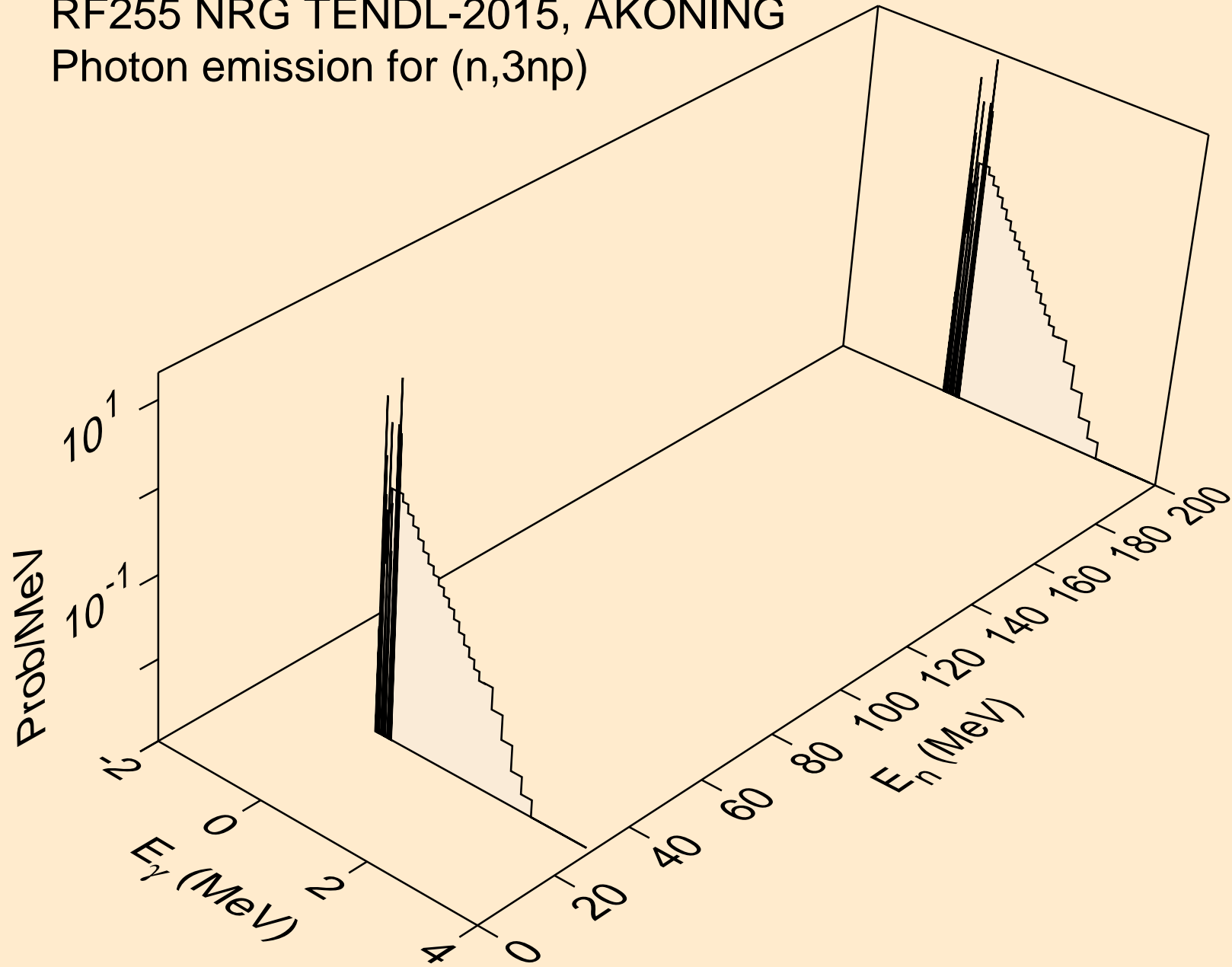

RF255 NRG TENDL-2015, AKONING
Photon emission for (n,2np)

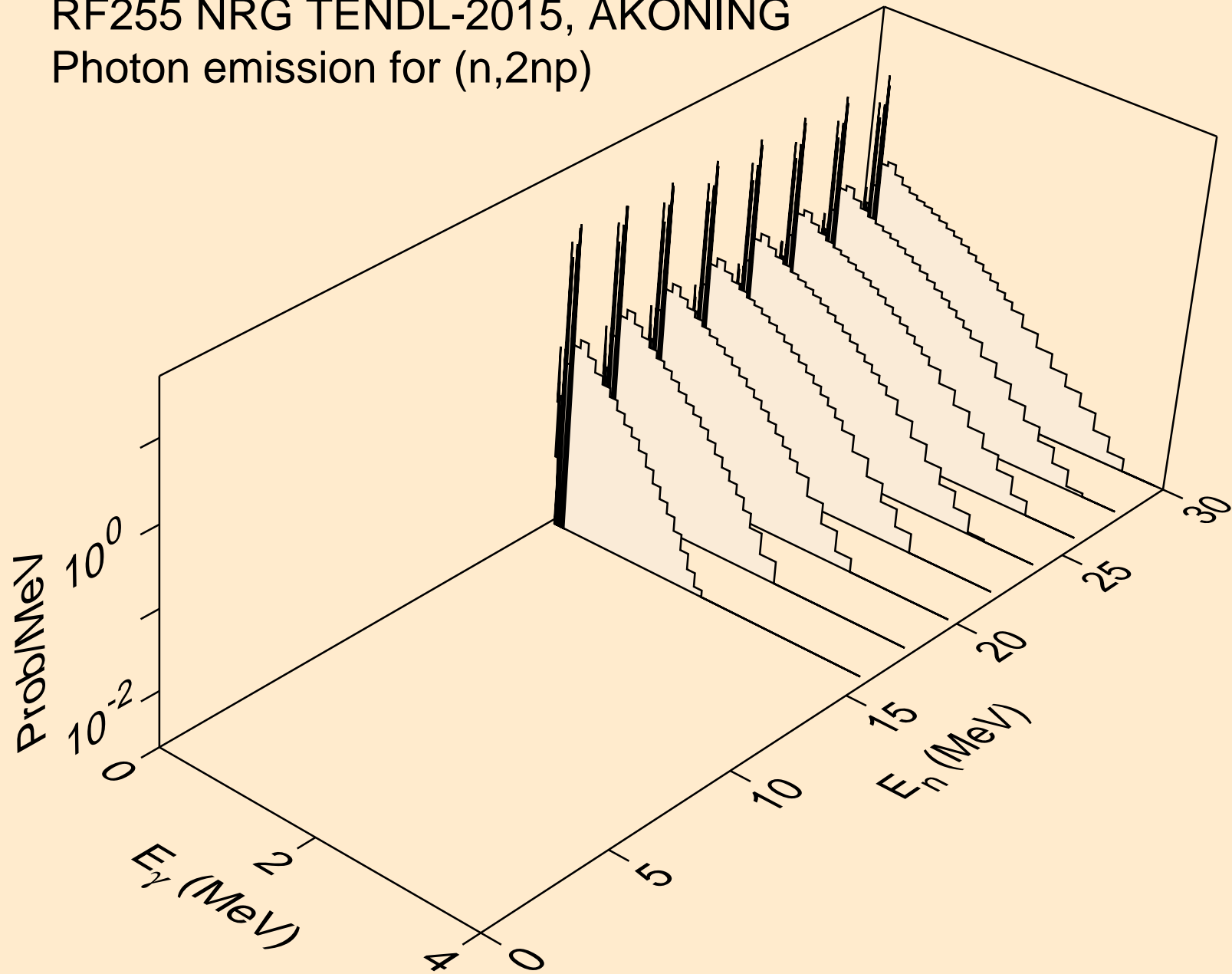

RF255 NRG TENDL-2015, AKONING
Photon emission for (n,npa)

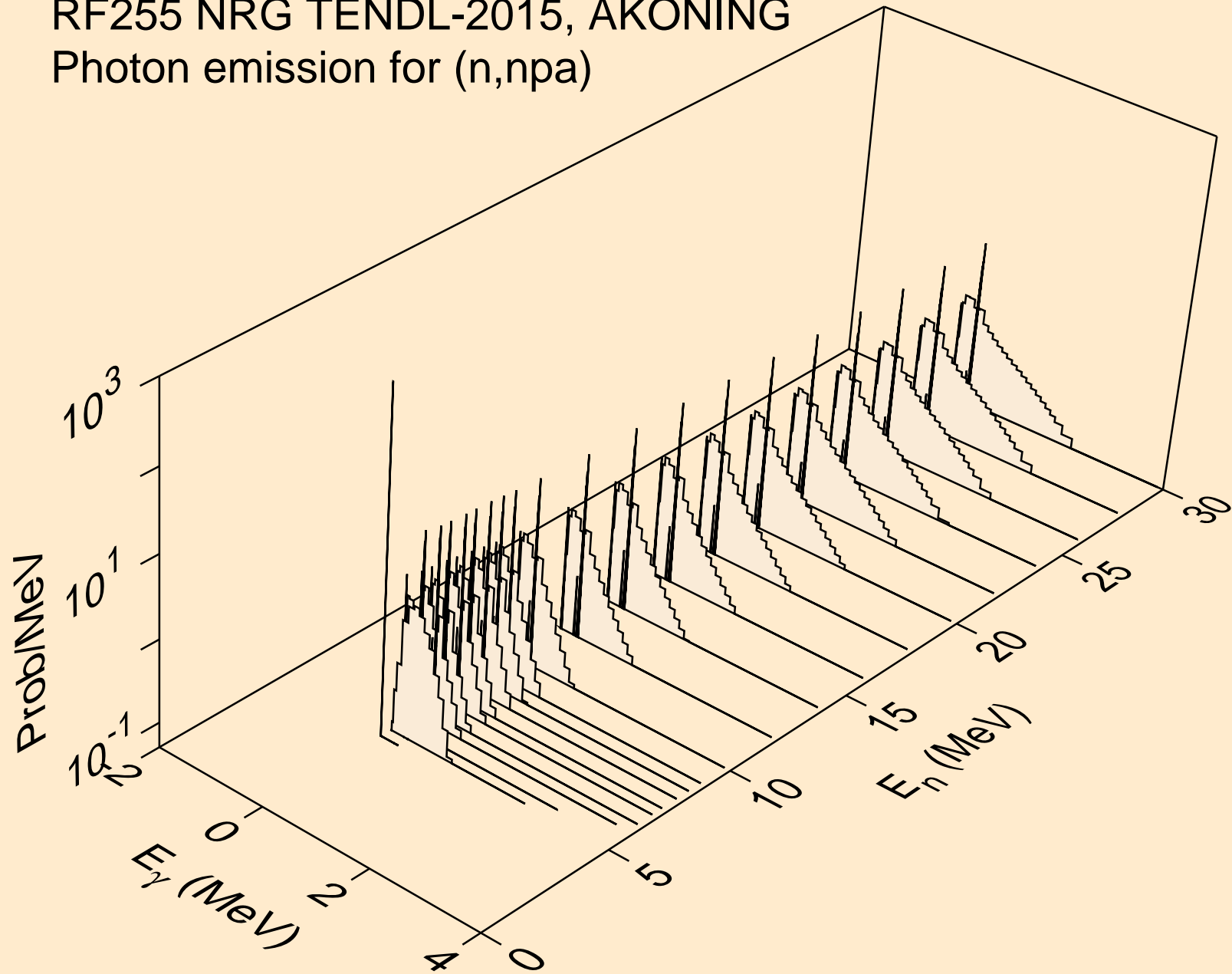

RF255 NRG TENDL-2015, AKONING
Photon emission for (n,n*c)

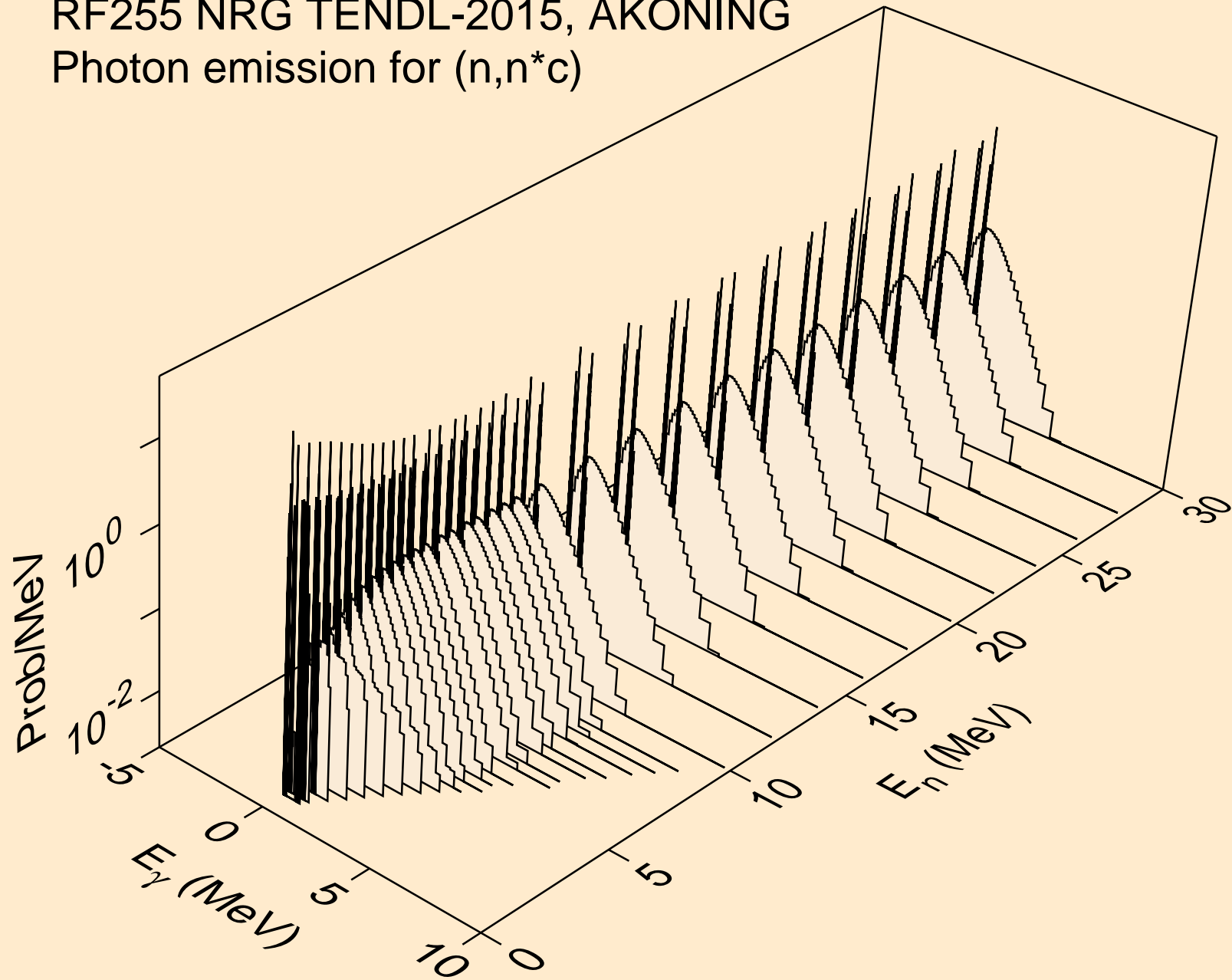

RF255 NRG TENDL-2015, AKONING
Photon emission for (n,gma)

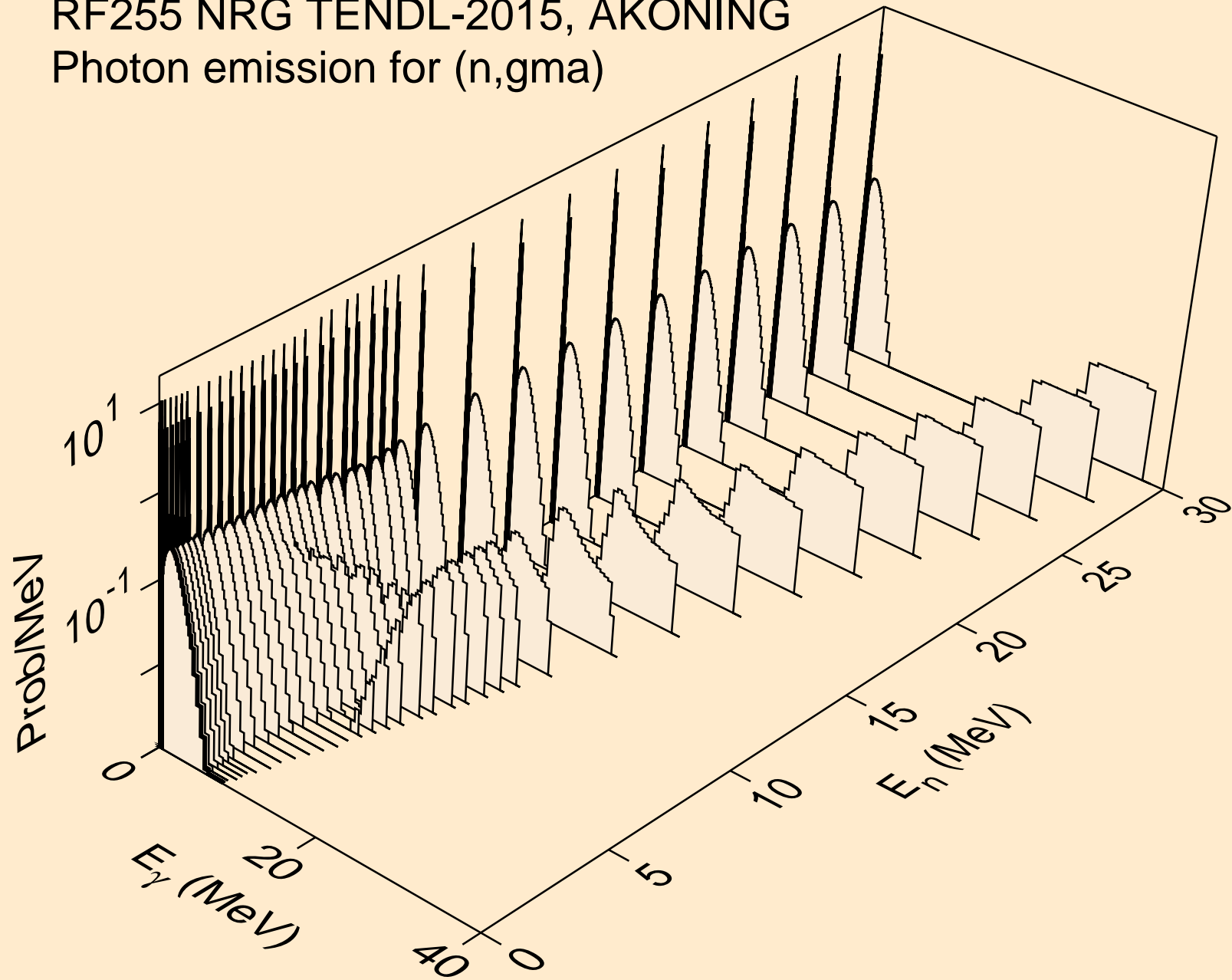

RF255 NRG TENDL-2015, AKONING
Photon emission for (n,p)

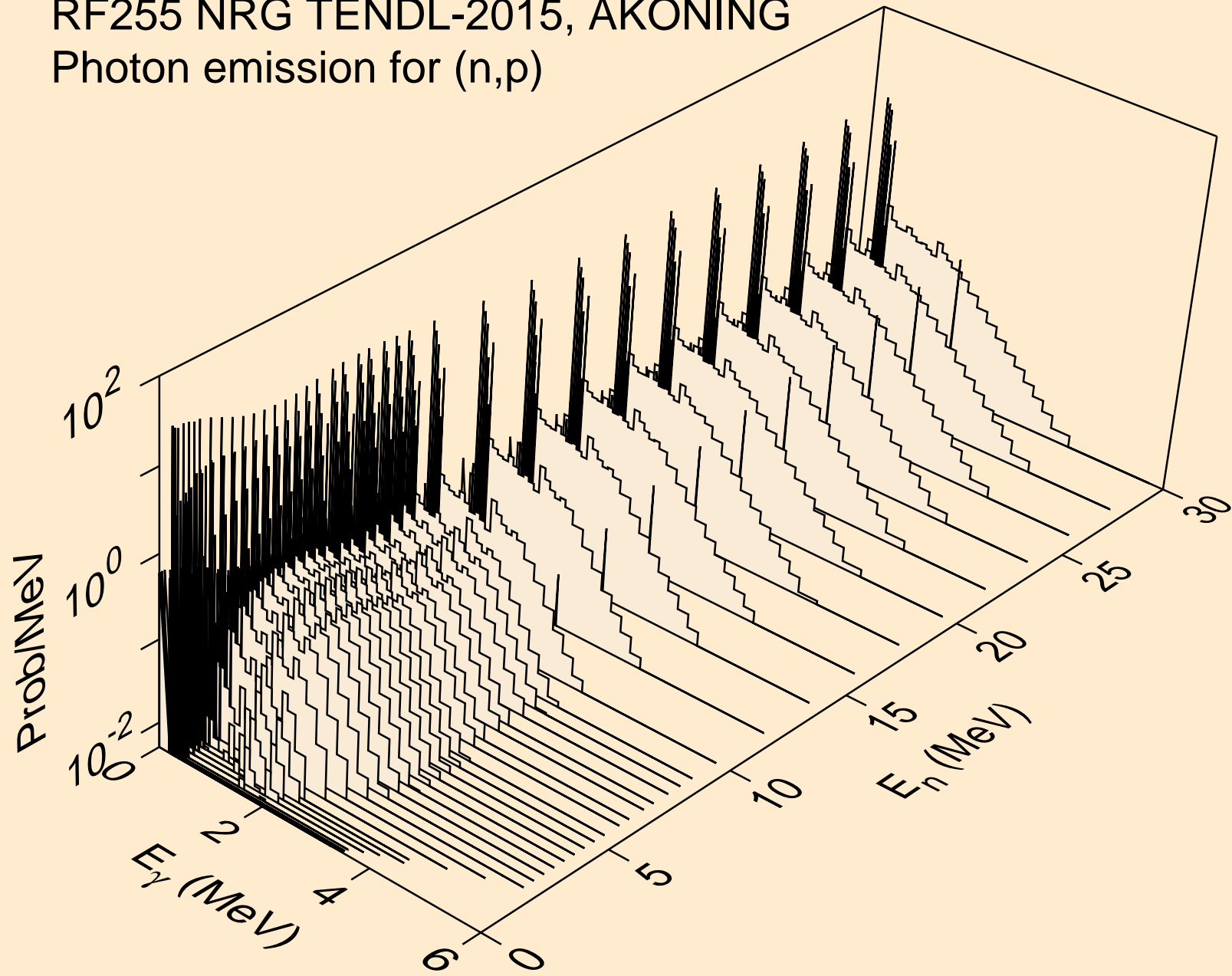

RF255 NRG TENDL-2015, AKONING
Photon emission for (n,d)

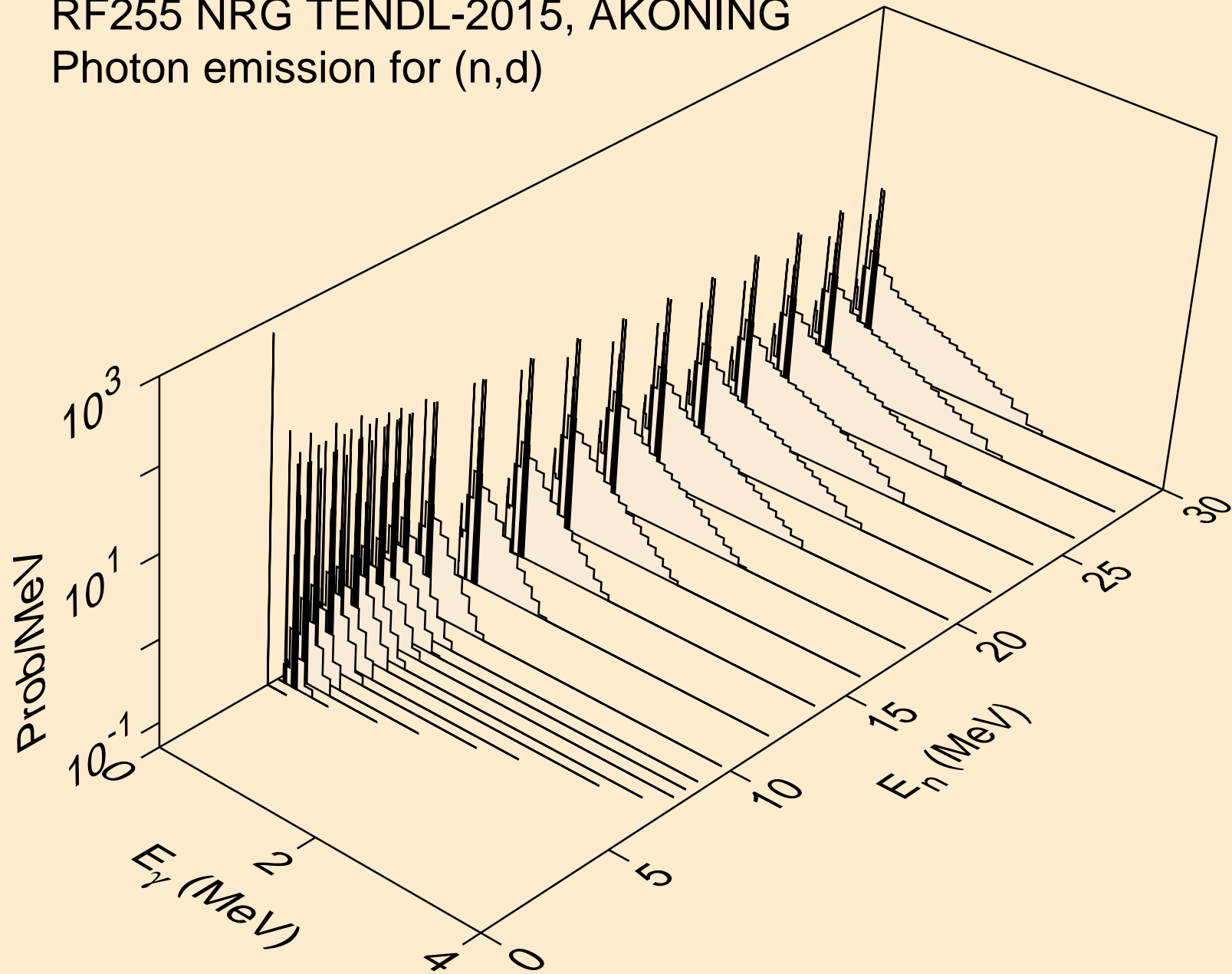

RF255 NRG TENDL-2015, AKONING
Photon emission for (n,t)

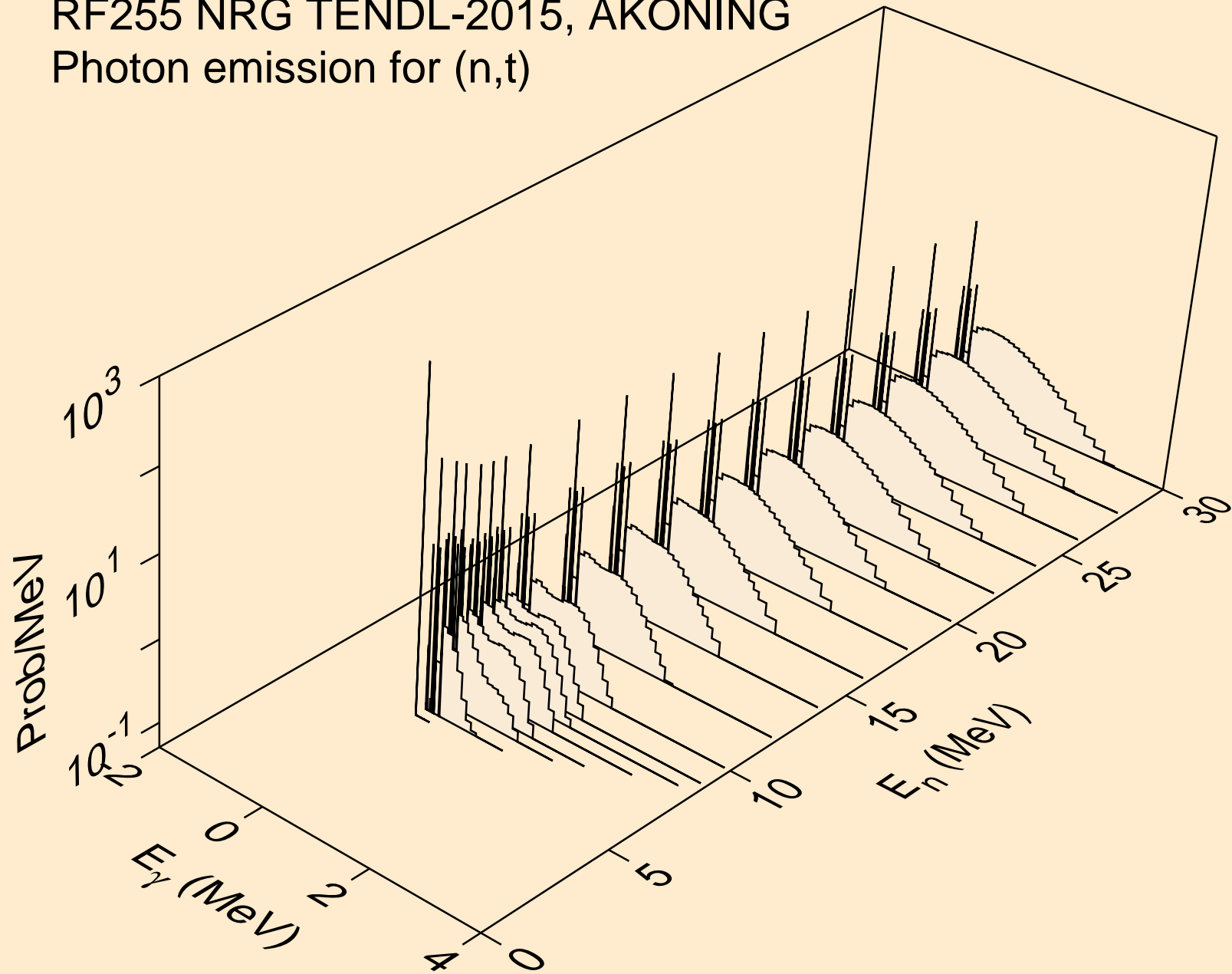

RF255 NRG TENDL-2015, AKONING
Photon emission for (n,he3)

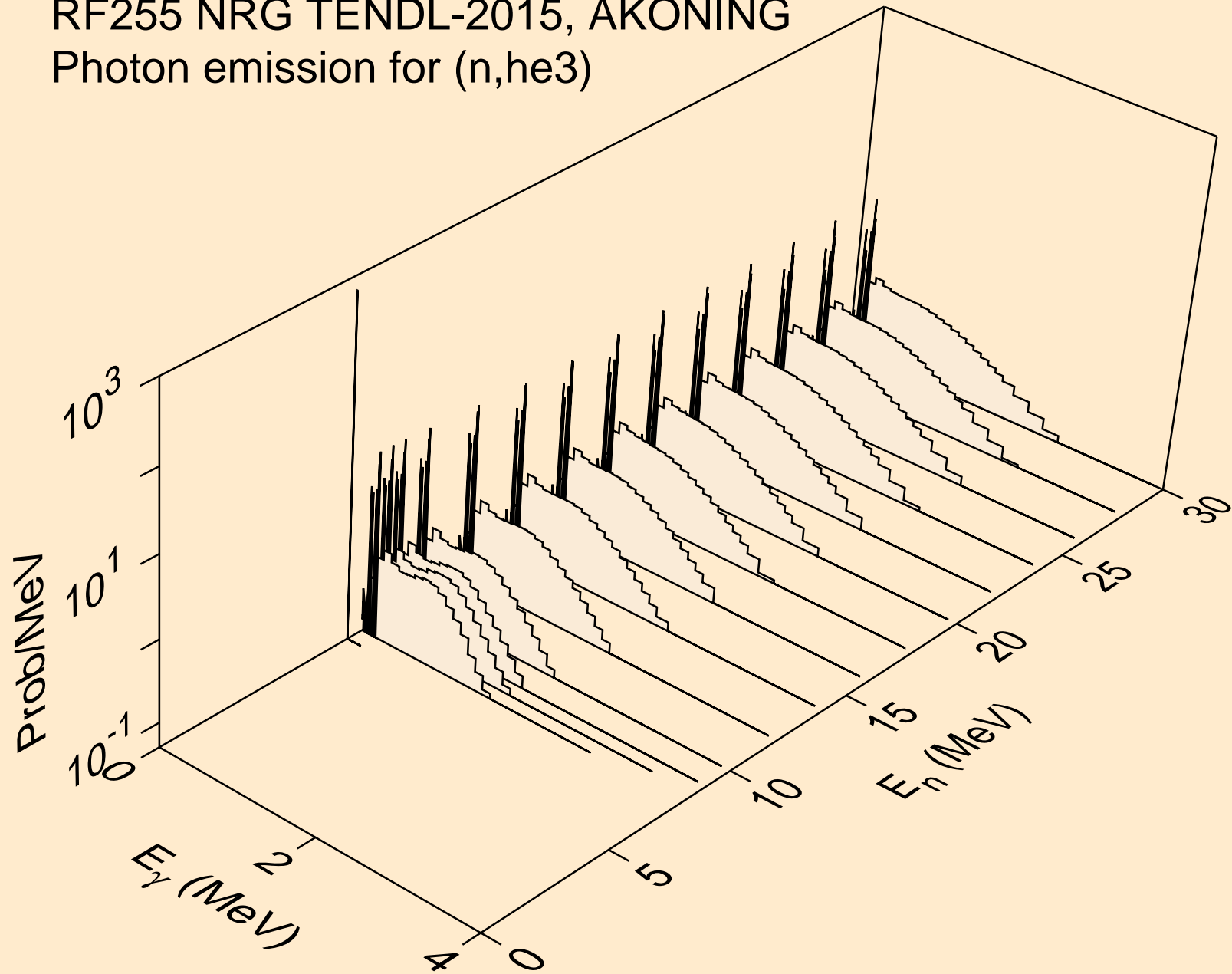

RF255 NRG TENDL-2015, AKONING
Photon emission for (n,a)

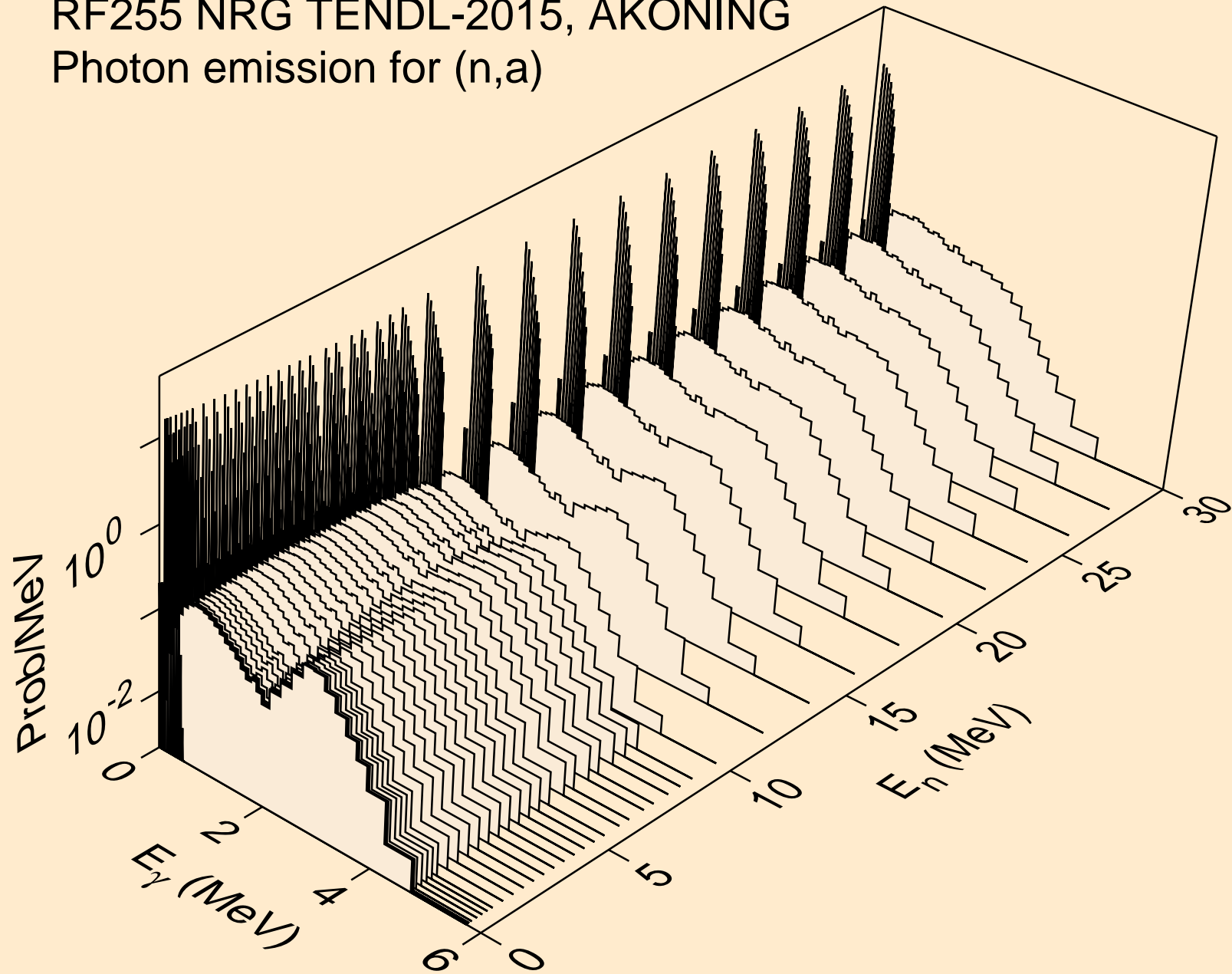

RF255 NRG TENDL-2015, AKONING
Photon emission for (n,2a)

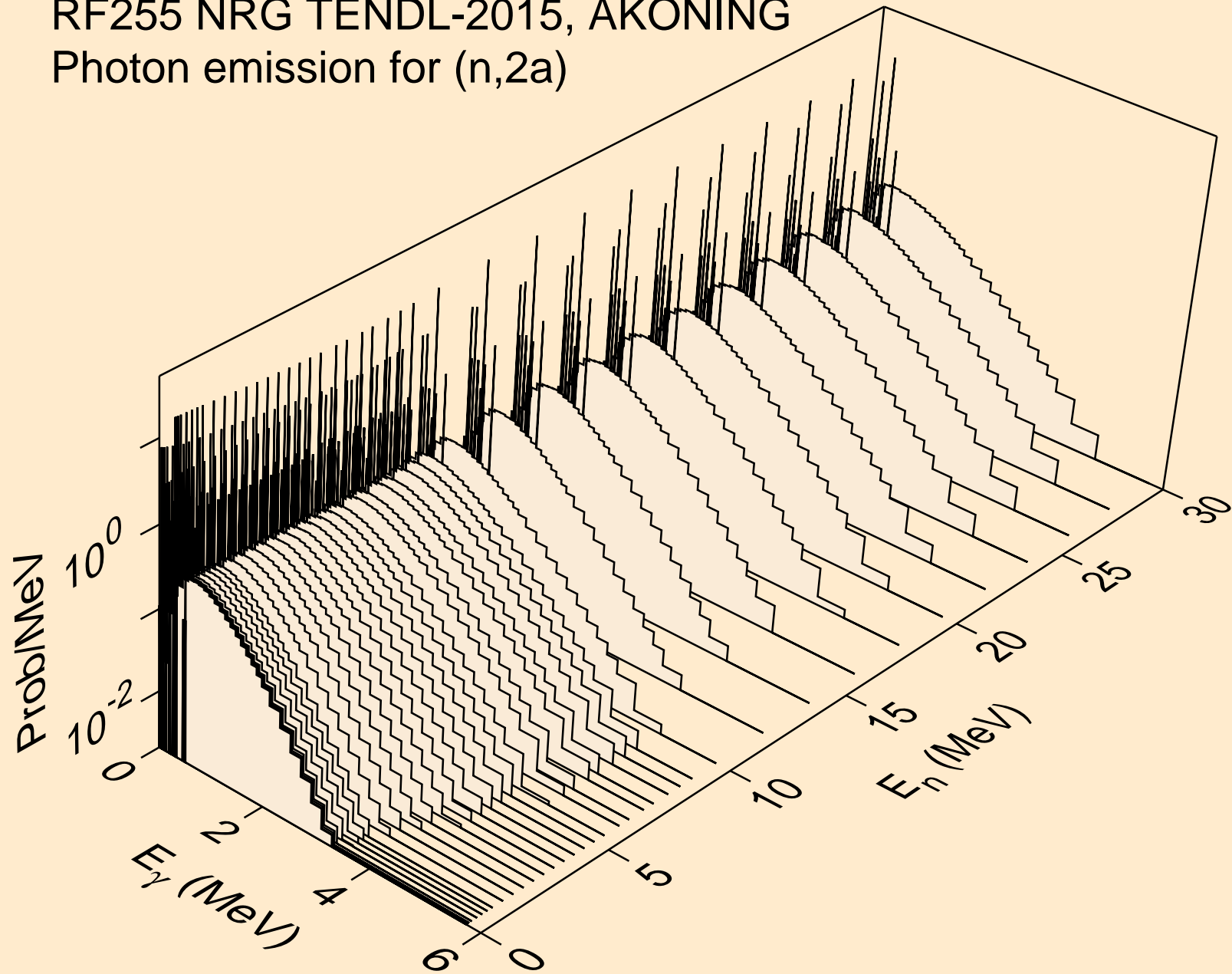

RF255 NRG TENDL-2015, AKONING
Photon emission for (n,3a)

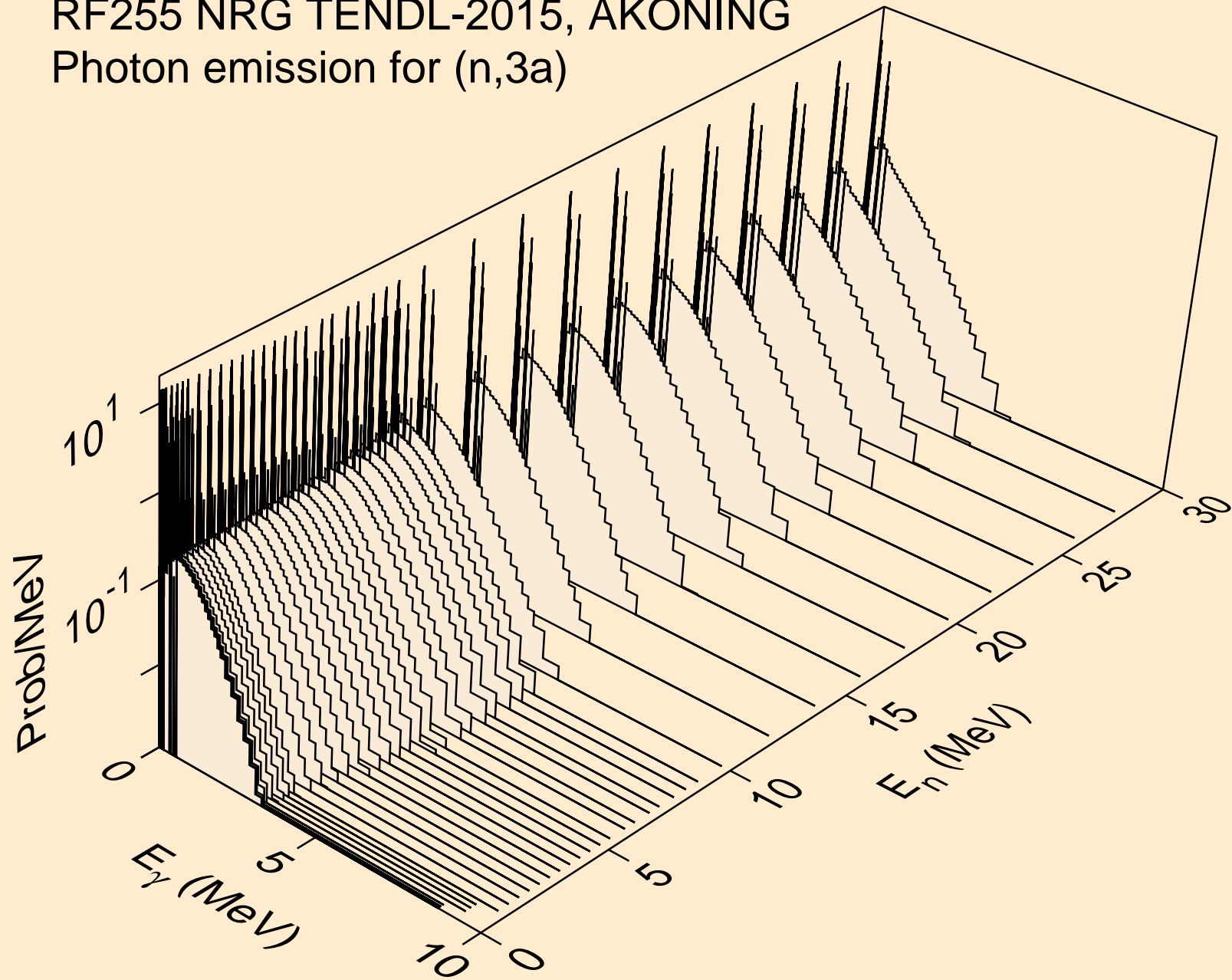

RF255 NRG TENDL-2015, AKONING
Photon emission for (n,2p)

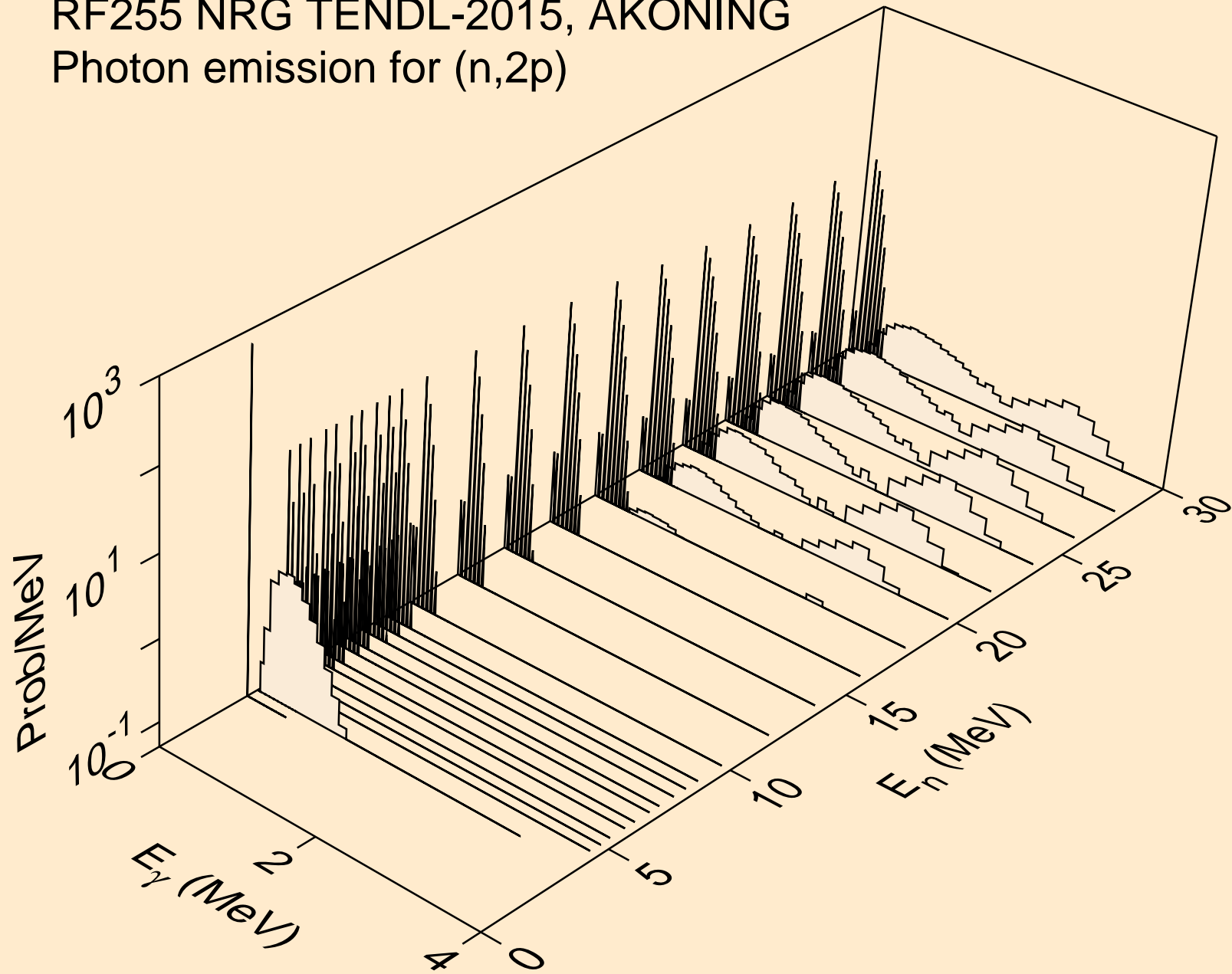

RF255 NRG TENDL-2015, AKONING
Photon emission for (n,p α)

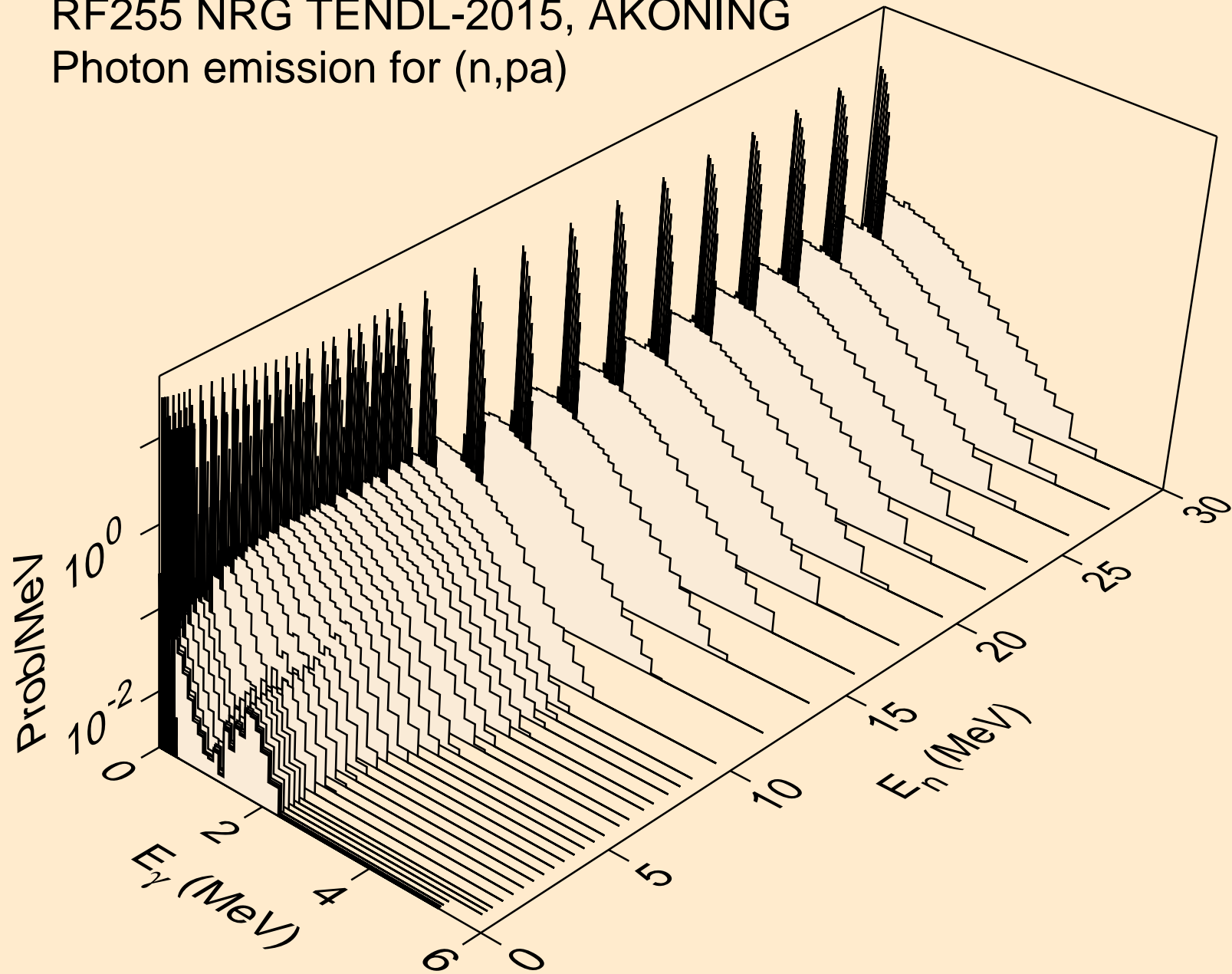

RF255 NRG TENDL-2015, AKONING
Photon emission for (n,t2a)

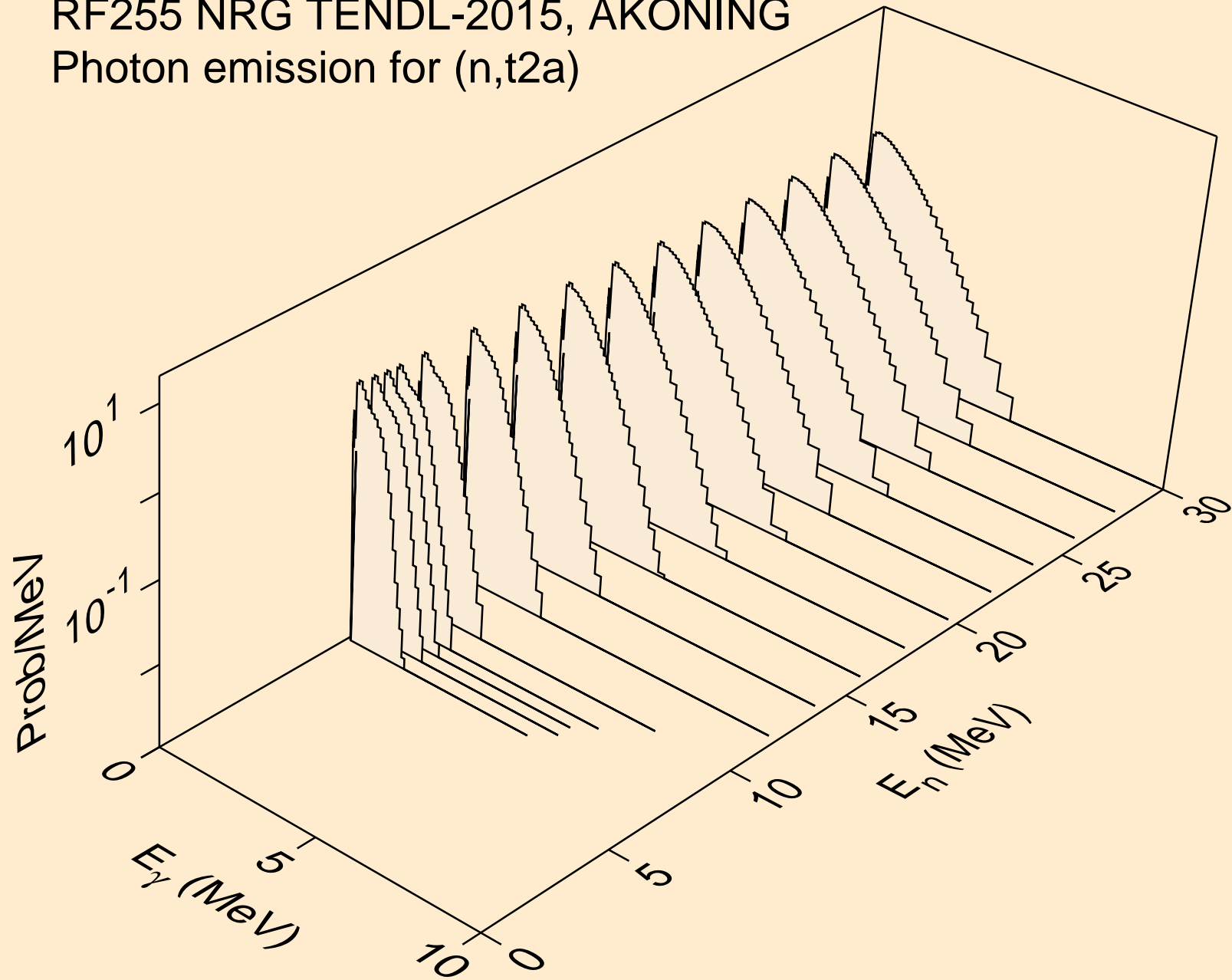

RF255 NRG TENDL-2015, AKONING
Photon emission for (n,d2a)

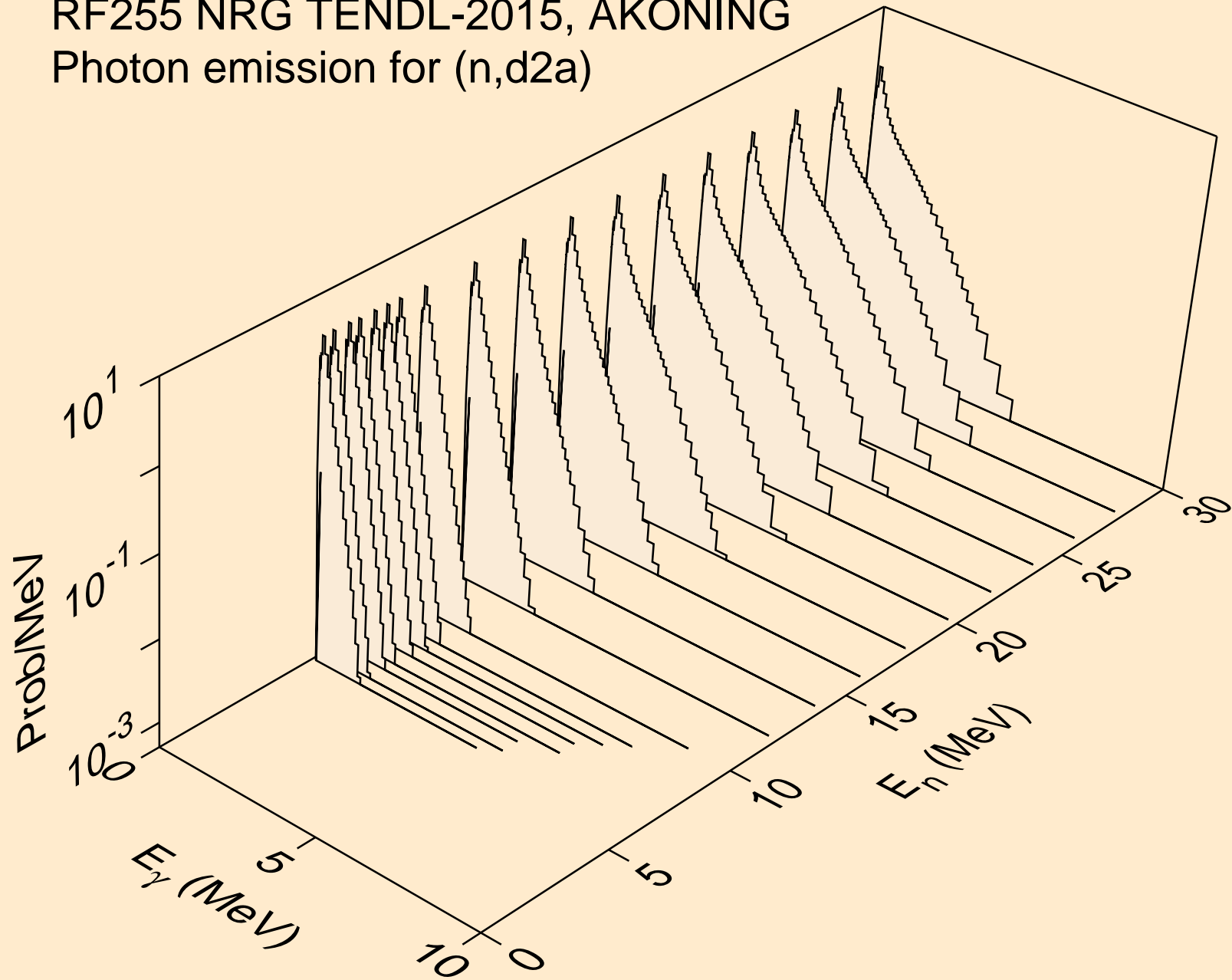

RF255 NRG TENDL-2015, AKONING
Photon emission for (n,pd)

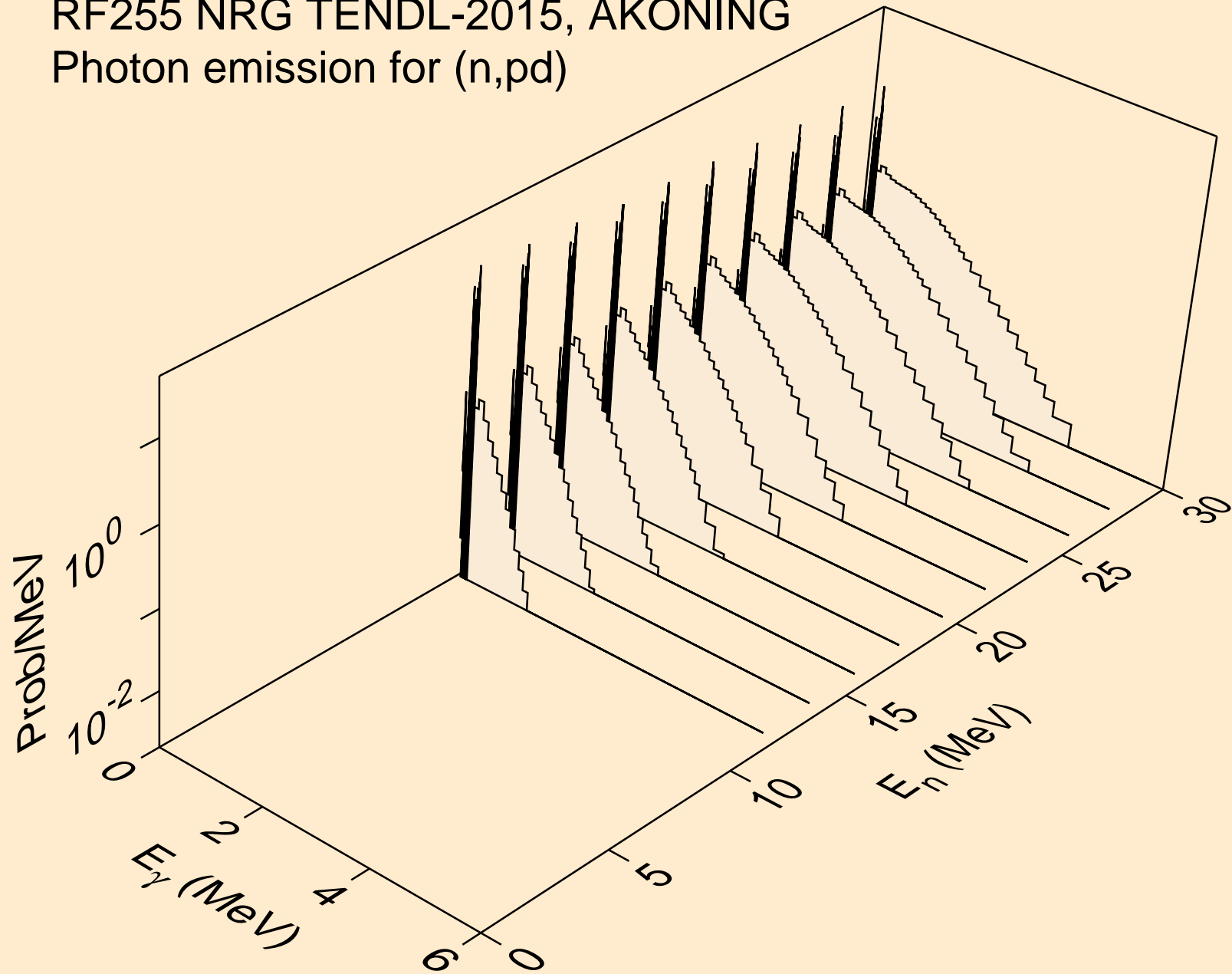

RF255 NRG TENDL-2015, AKONING
Photon emission for (n,pt)

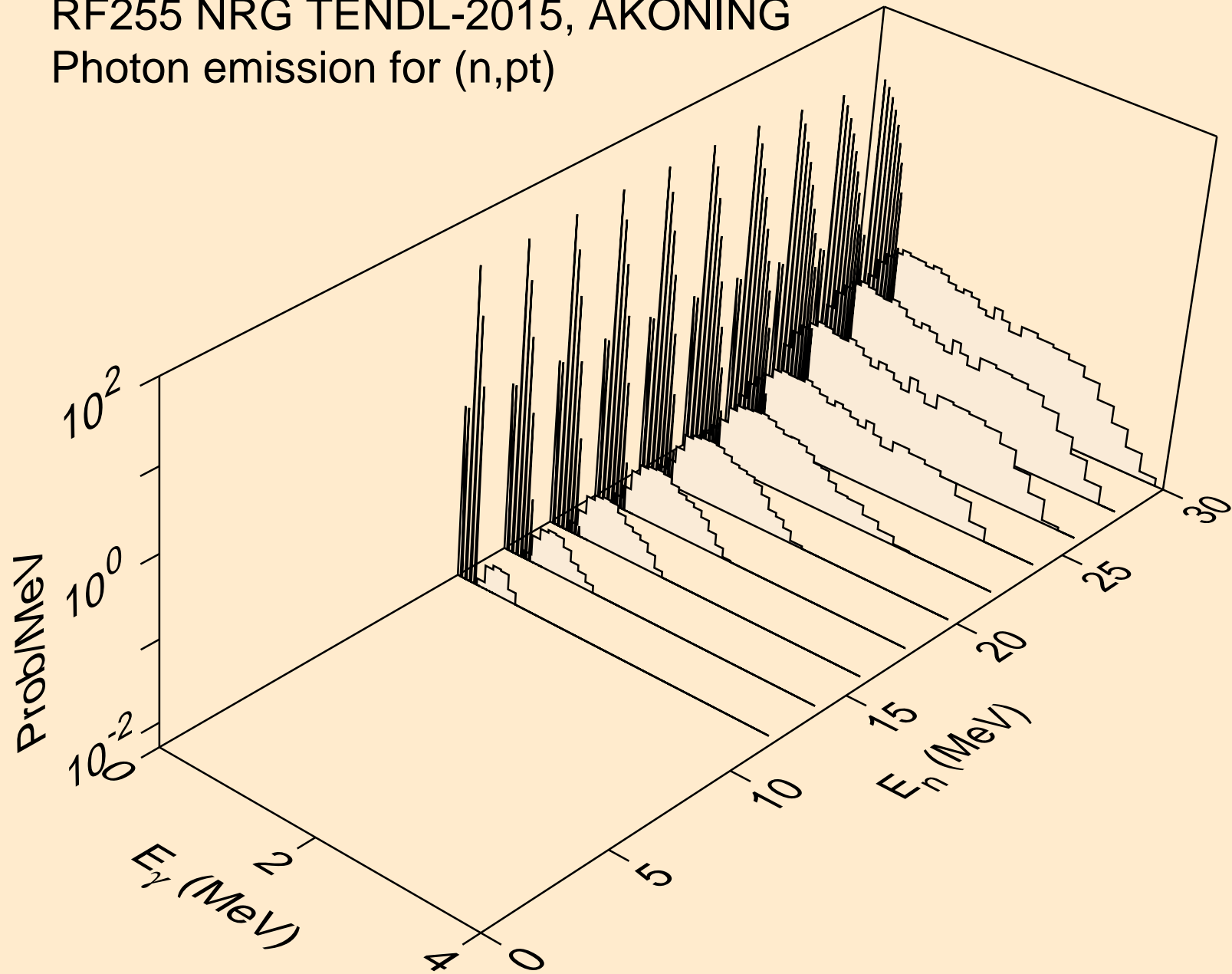

RF255 NRG TENDL-2015, AKONING
Photon emission for (n,da)

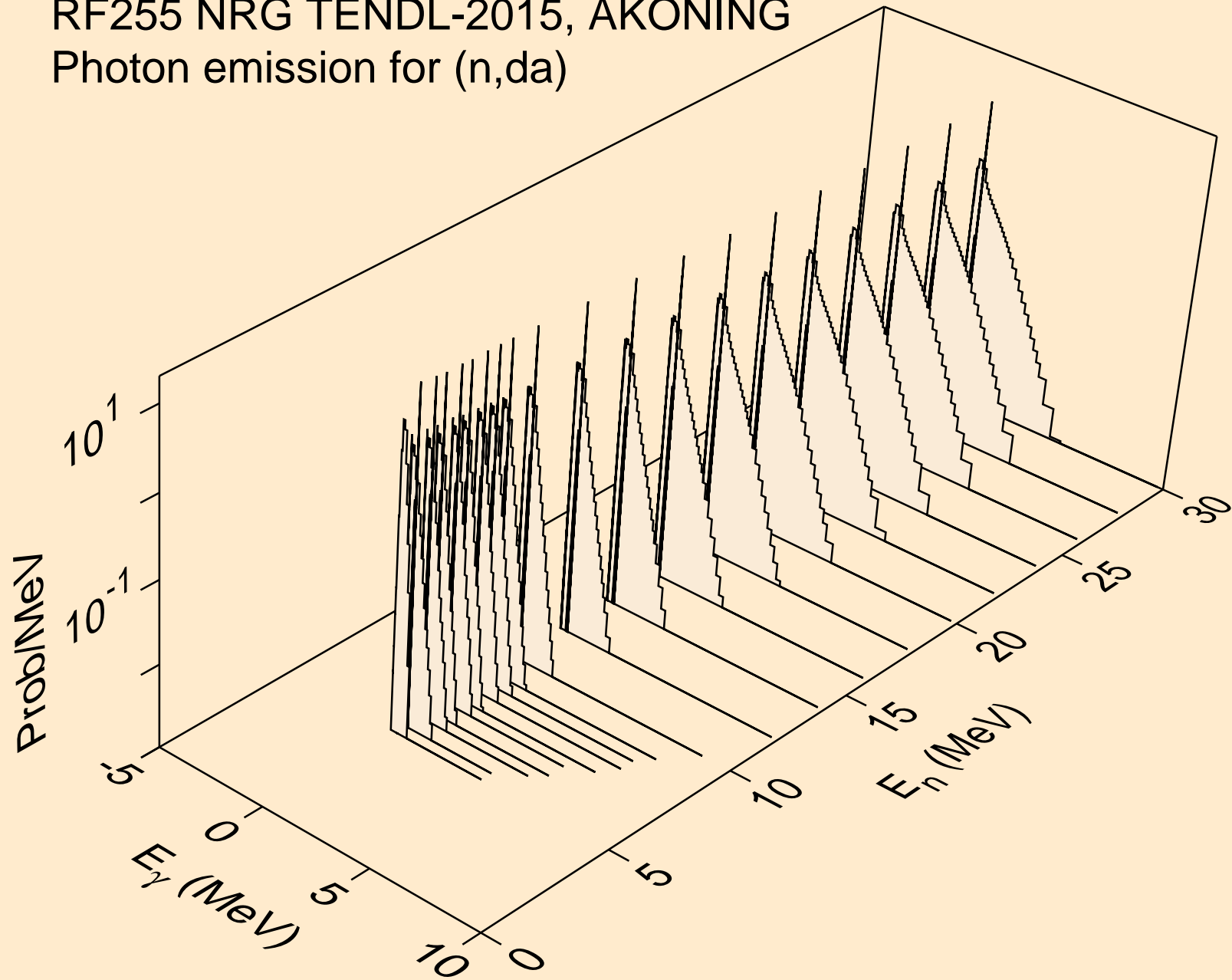

RF255 NRG TENDL-2015, AKONING
thermal capture photon spectrum

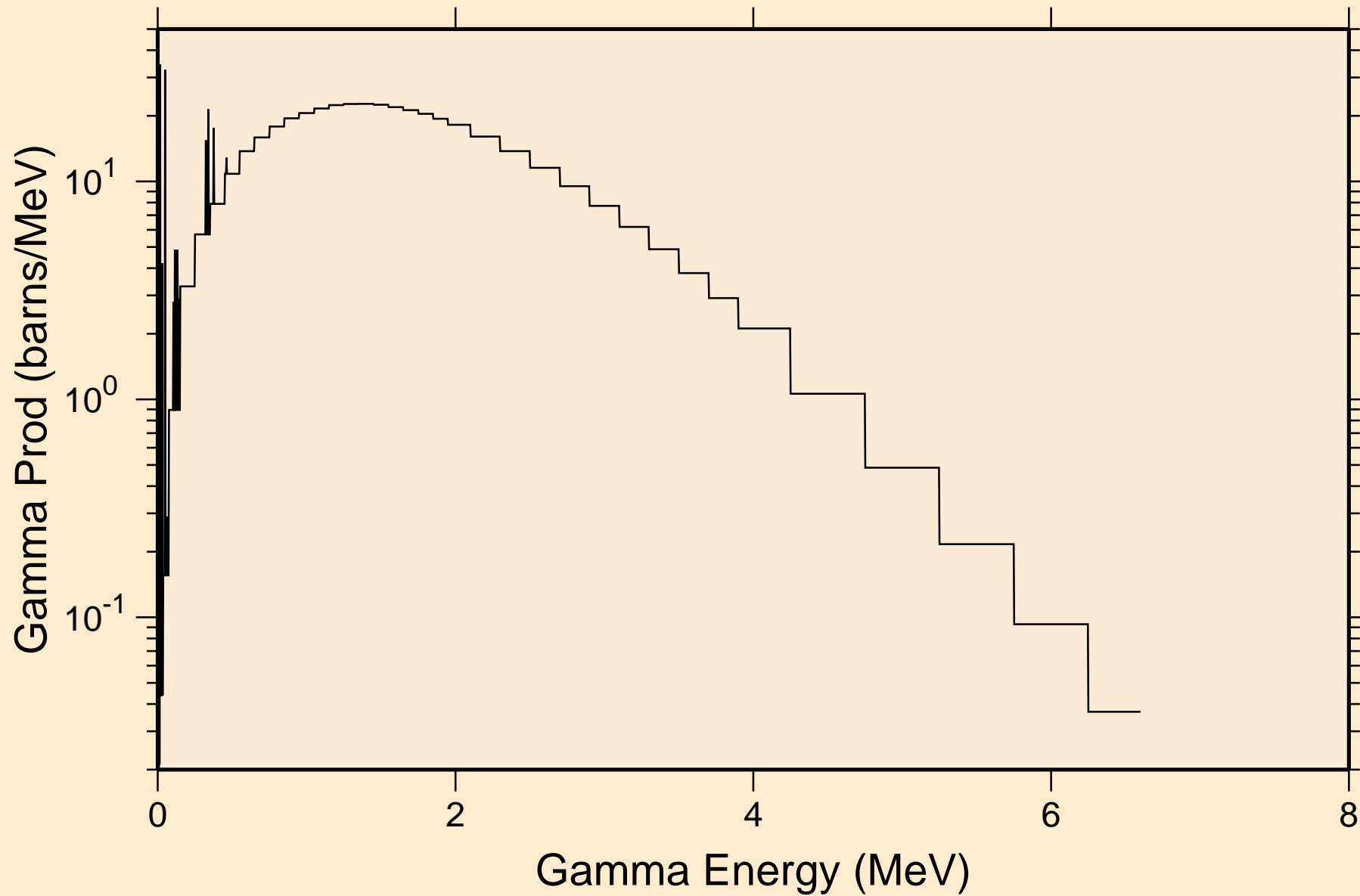

RF255 NRG TENDL-2015, AKONING
14 MeV photon spectrum

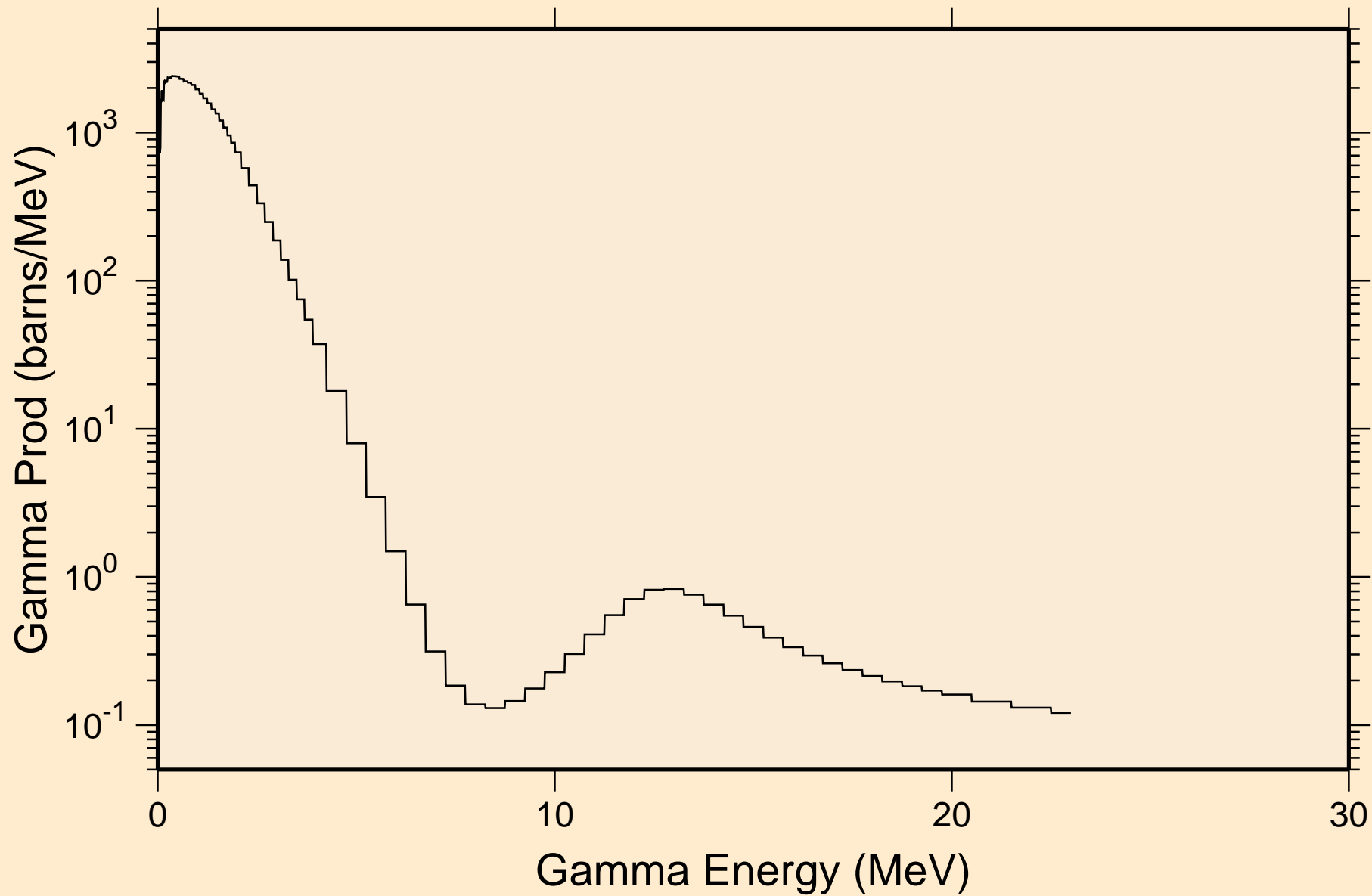

RF255 NRG TENDL-2015, AKONING

Particle heating contributions

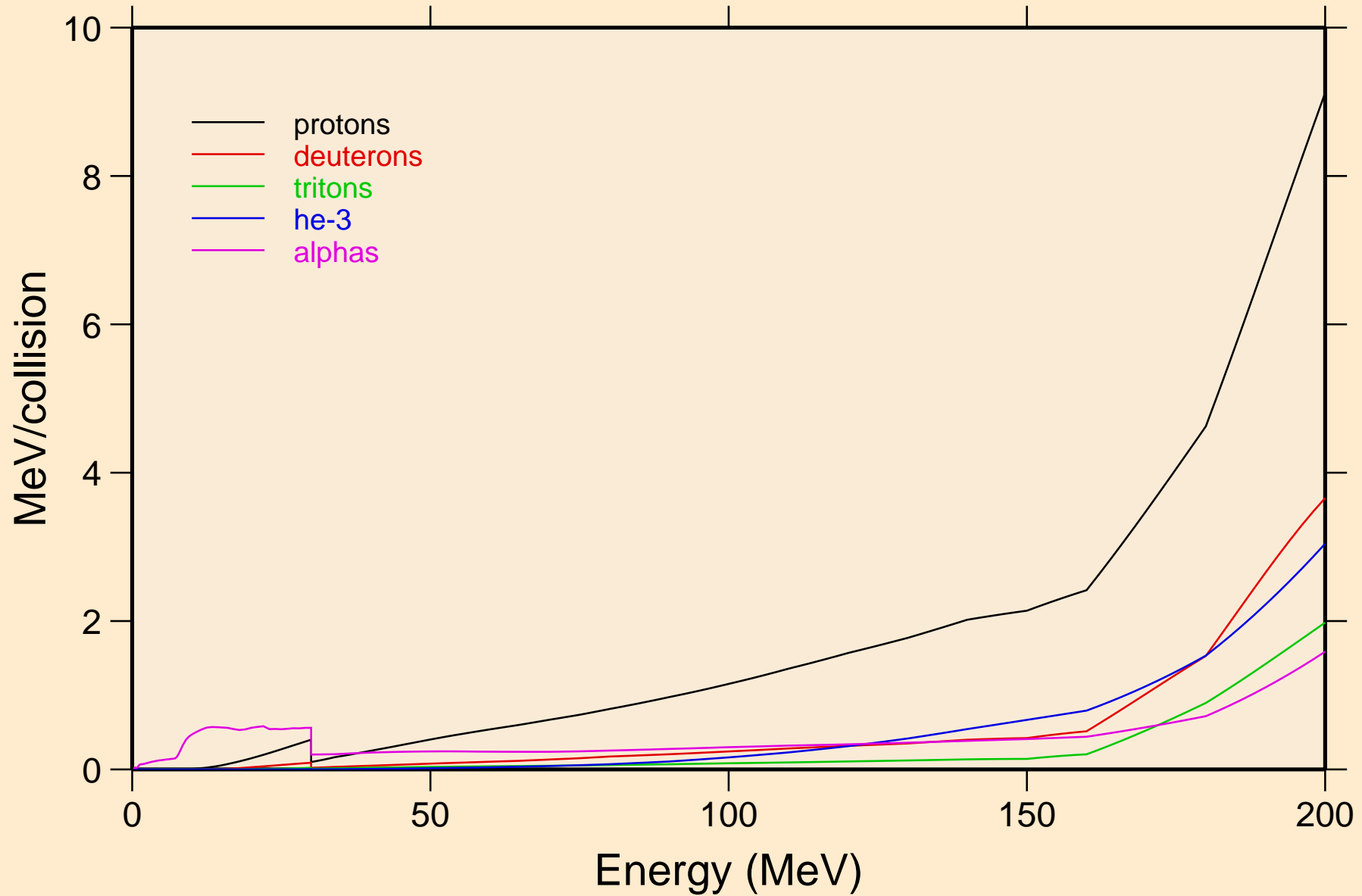

RF255 NRG TENDL-2015, AKONING

Recoil Heating

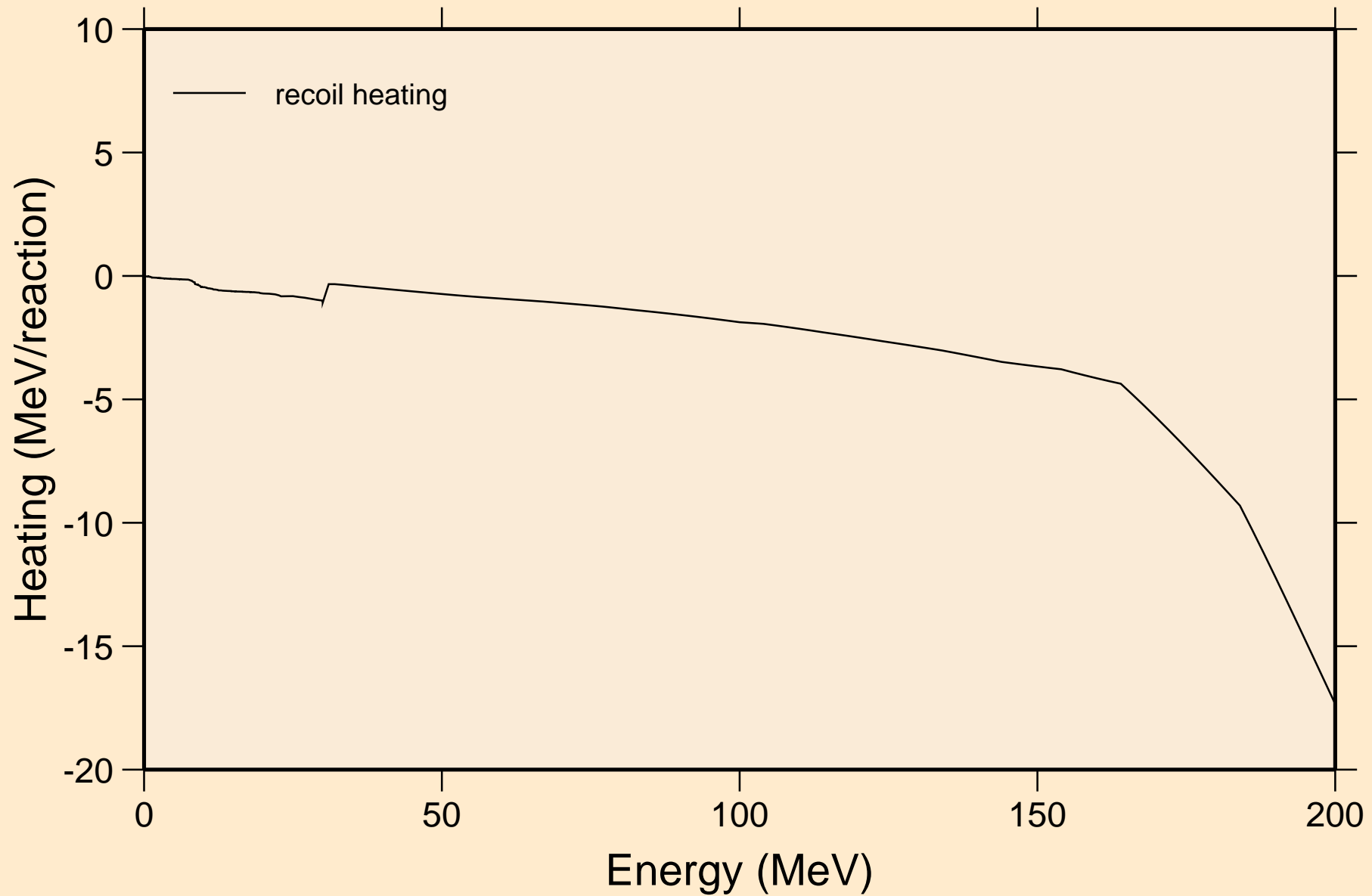

RF255 NRG TENDL-2015, AKONING

Particle production cross sections

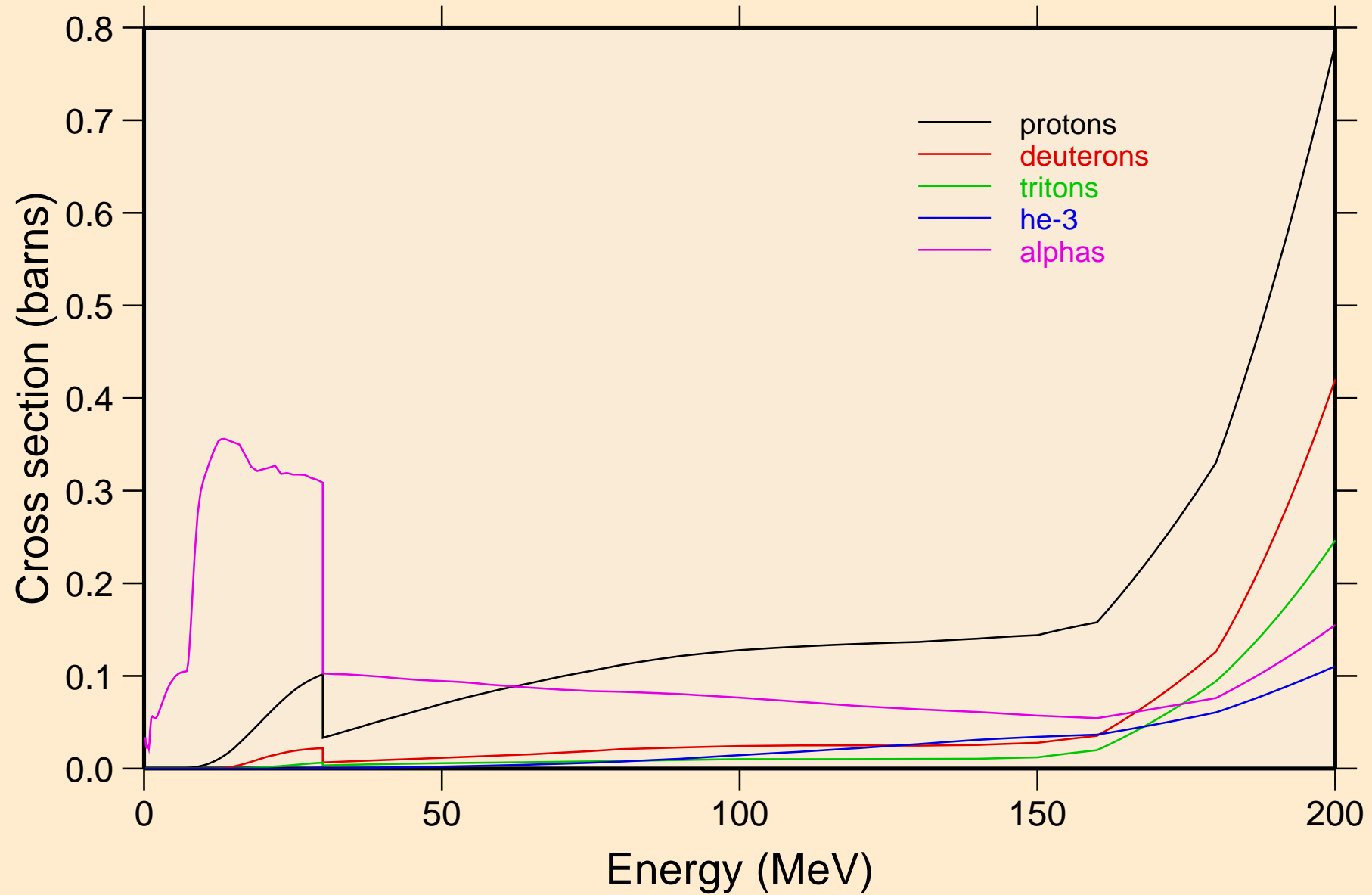

RF255 NRG TENDL-2015, AKONING
protons from (n,x)

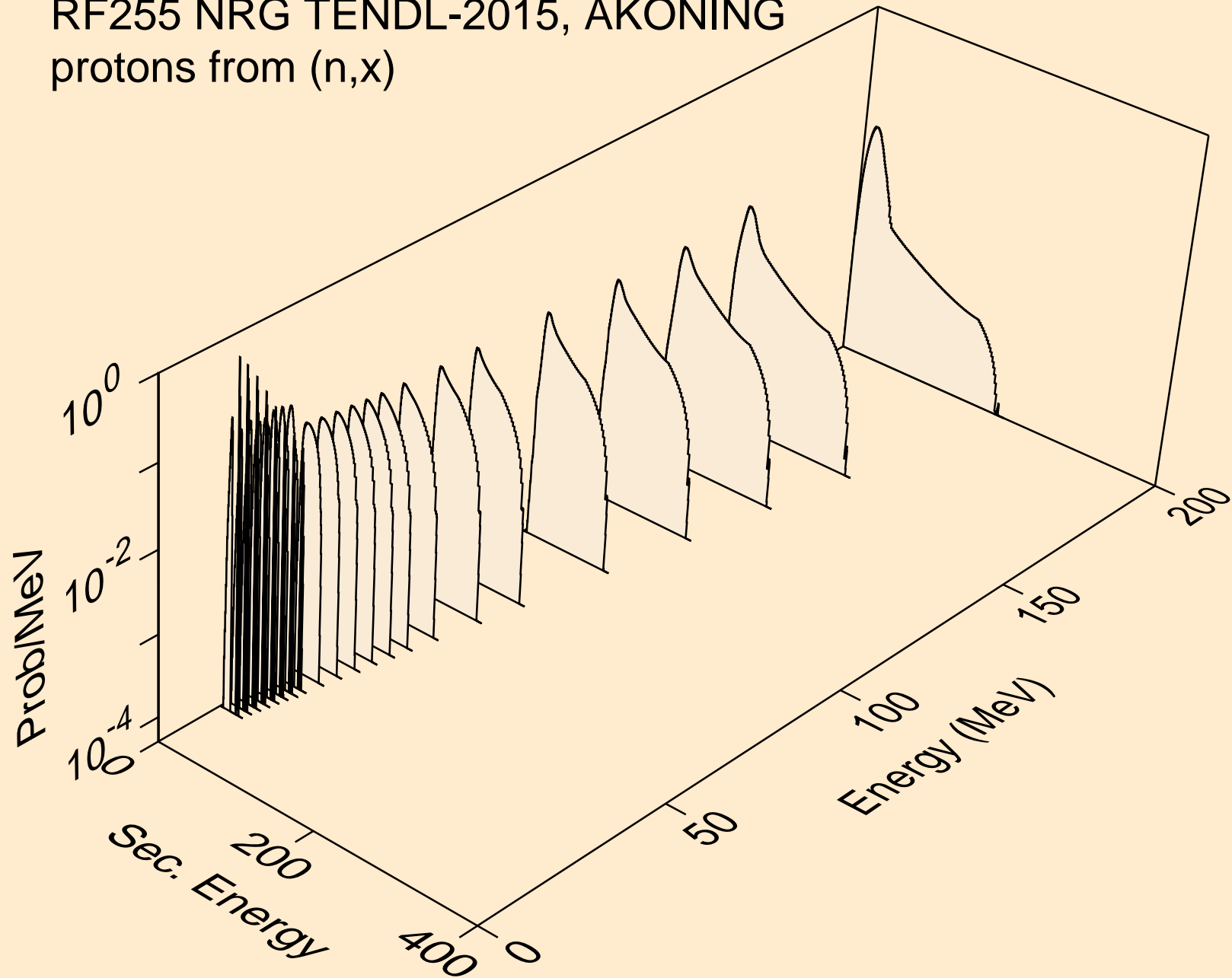

RF255 NRG TENDL-2015, AKONING
protons from (n,n*)p

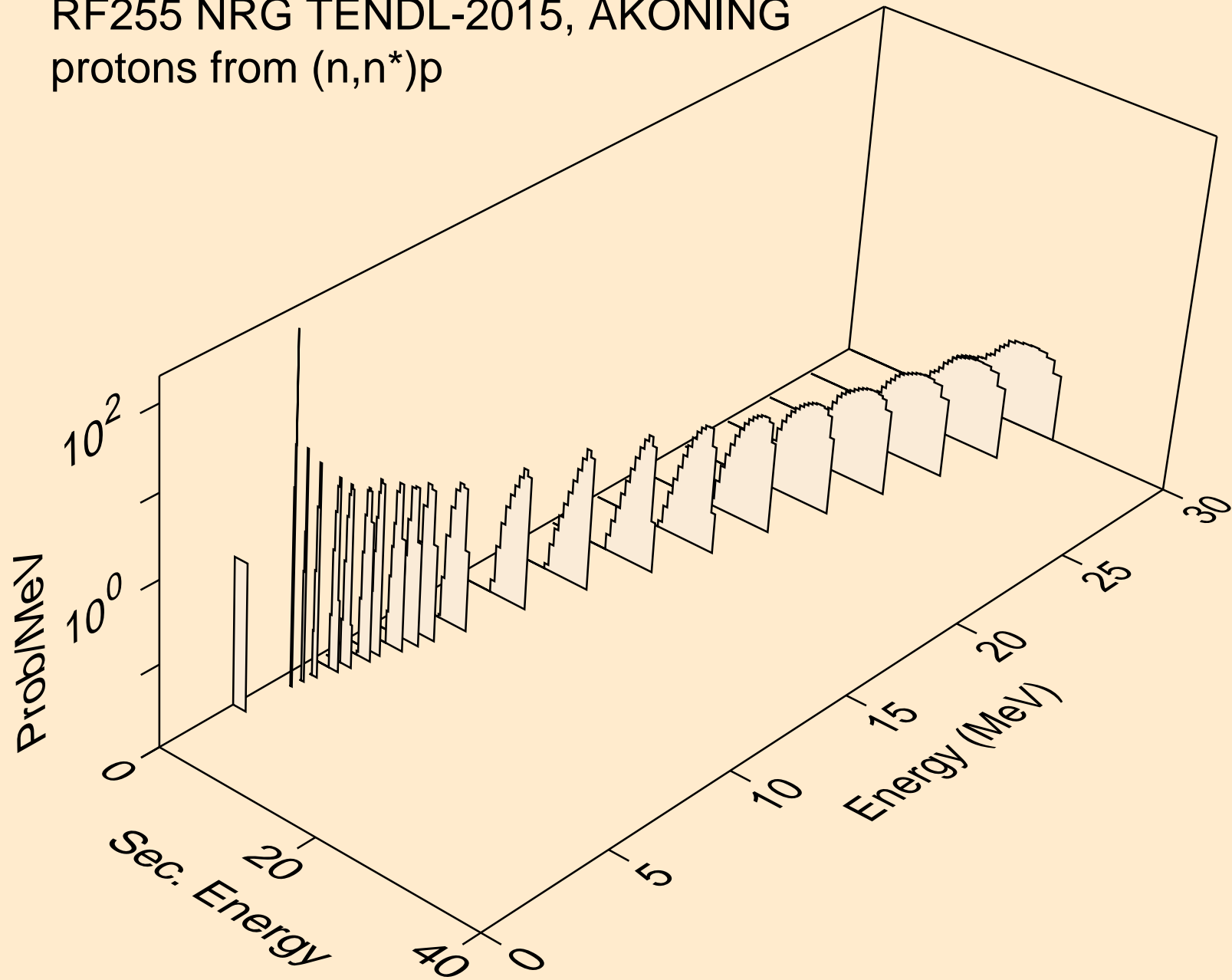

RF255 NRG TENDL-2015, AKONING
protons from (n,2np)

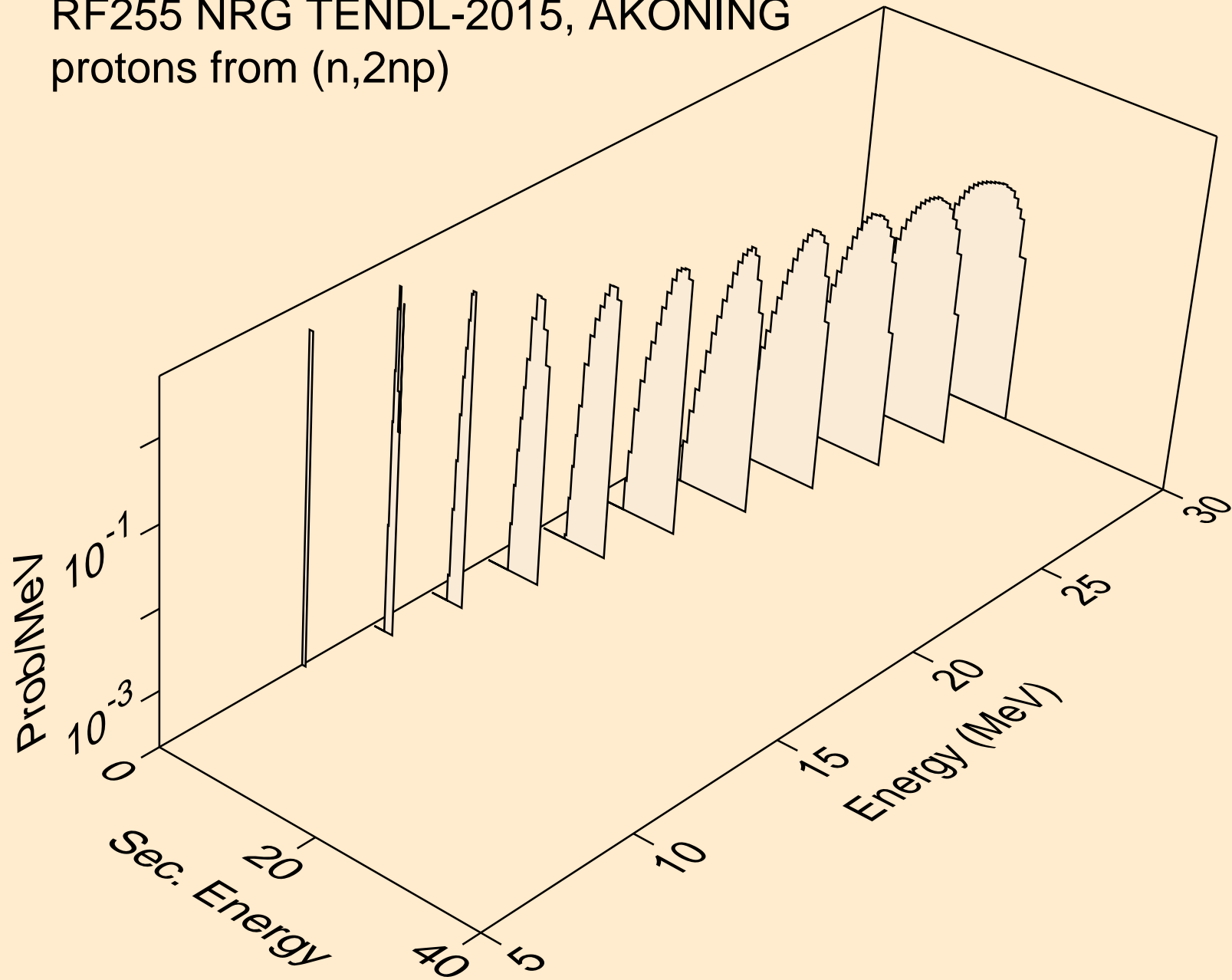

RF255 NRG TENDL-2015, AKONING
protons from (n,3np)

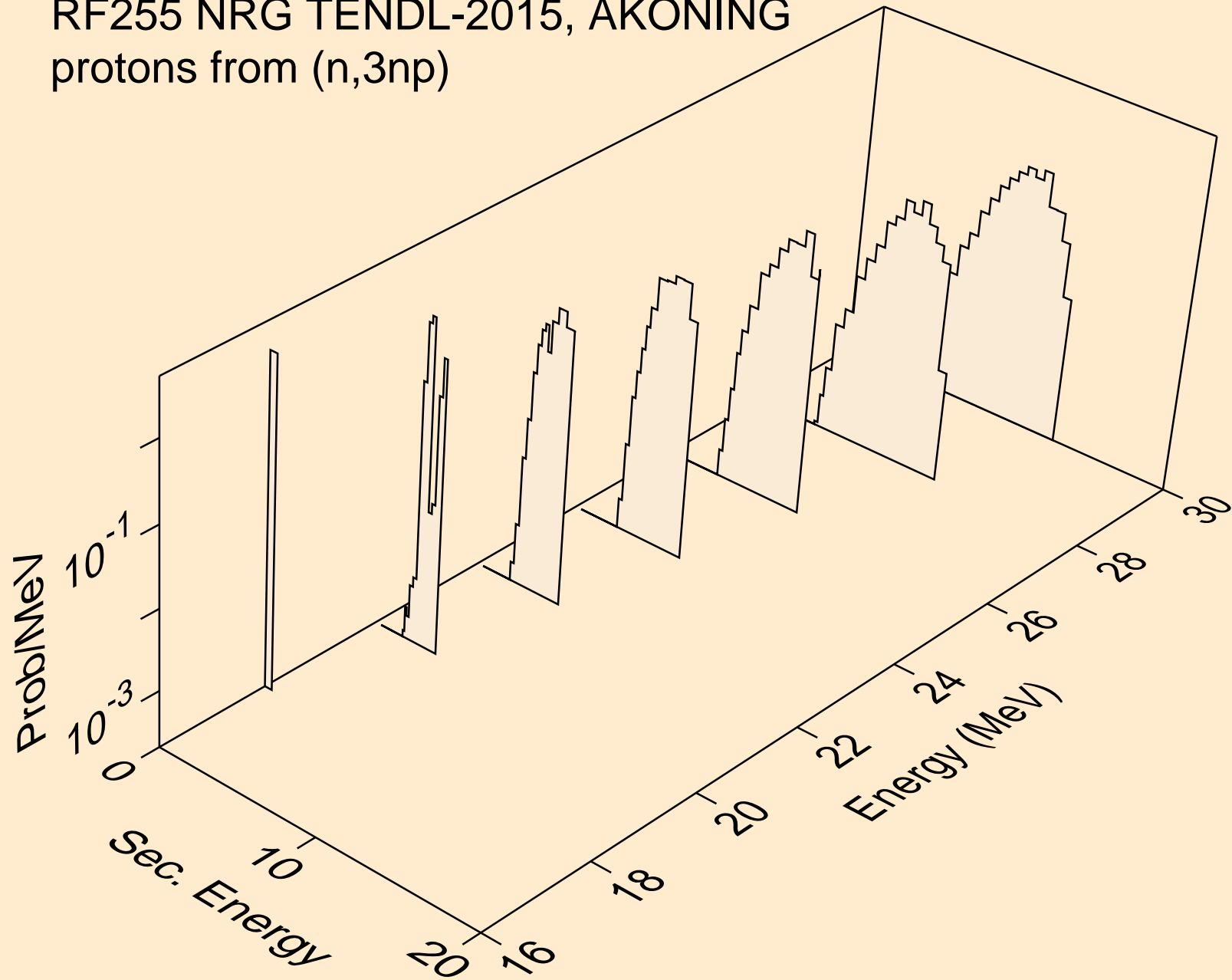

RF255 NRG TENDL-2015, AKONING
protons from (n,2np)

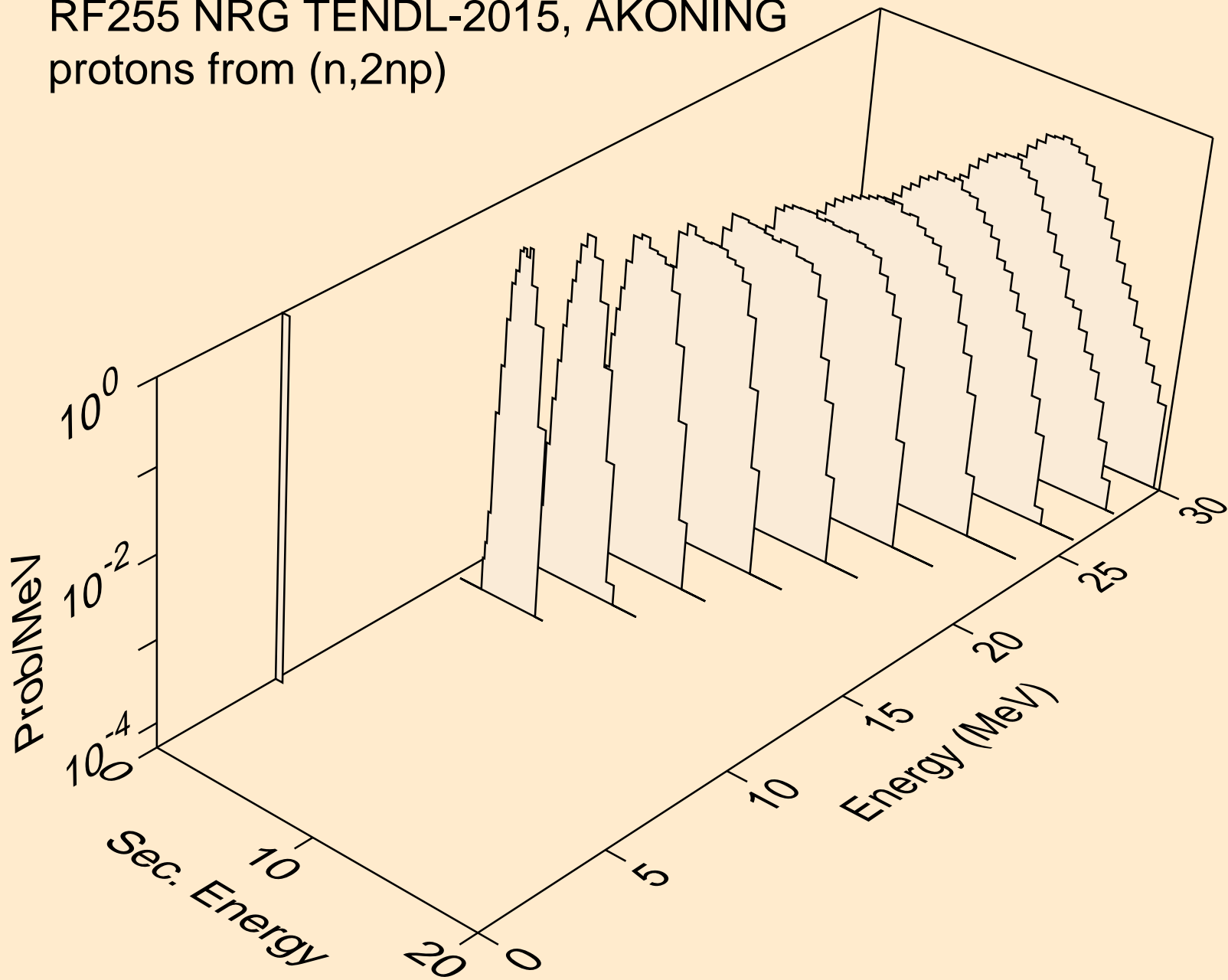

RF255 NRG TENDL-2015, AKONING
protons from (n,npa)

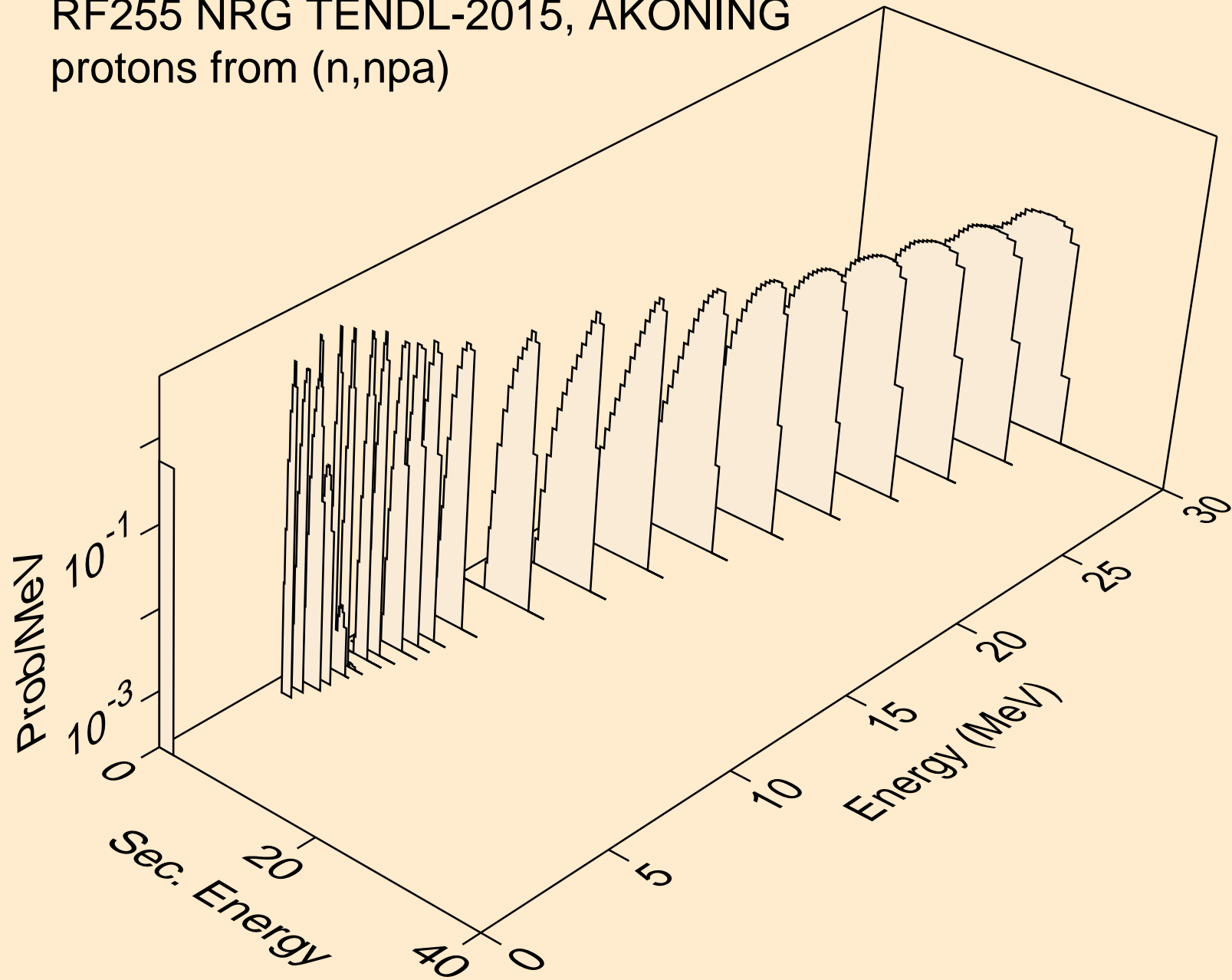

RF255 NRG TENDL-2015, AKONING
protons from (n,p)

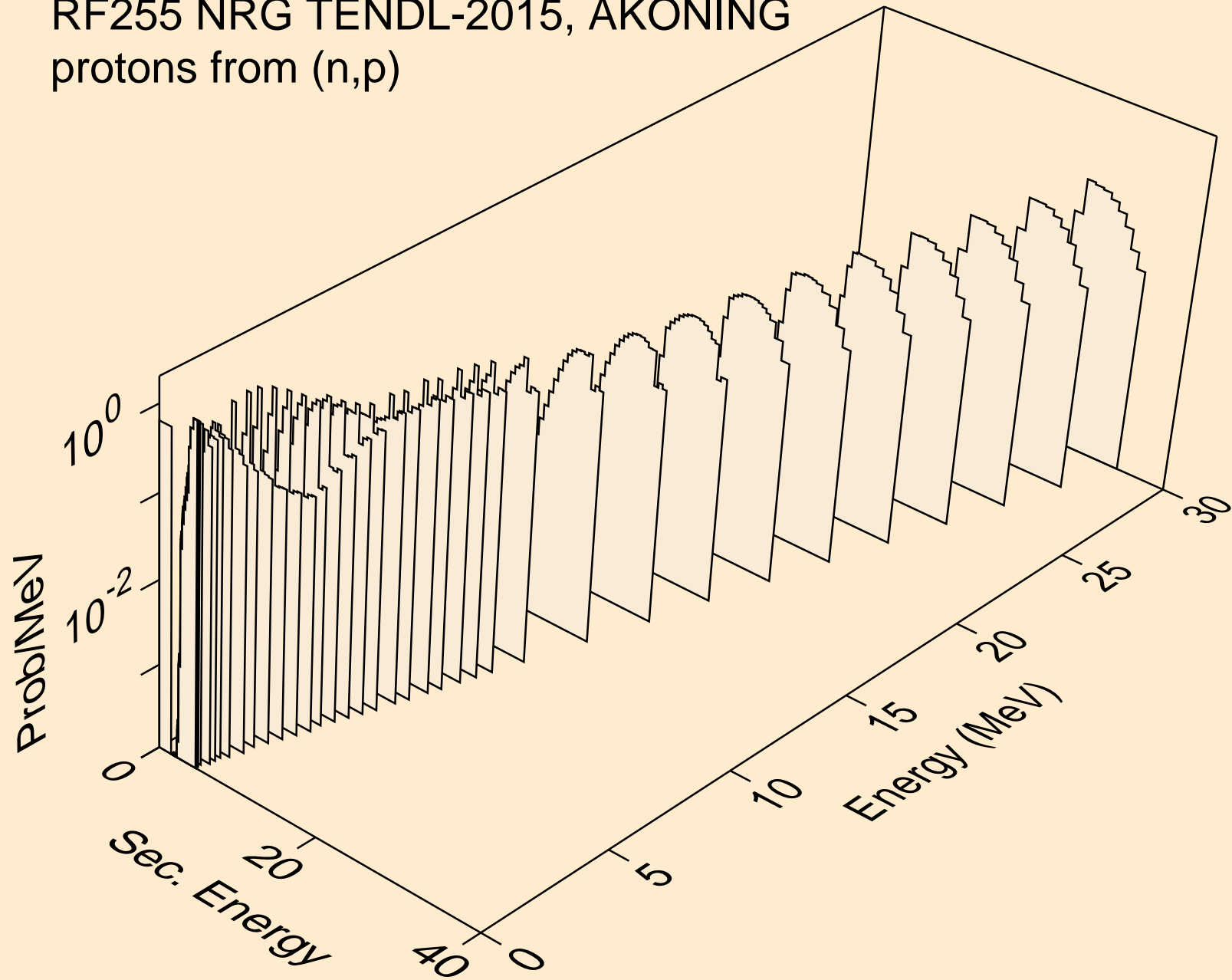

RF255 NRG TENDL-2015, AKONING
protons from (n,2p)

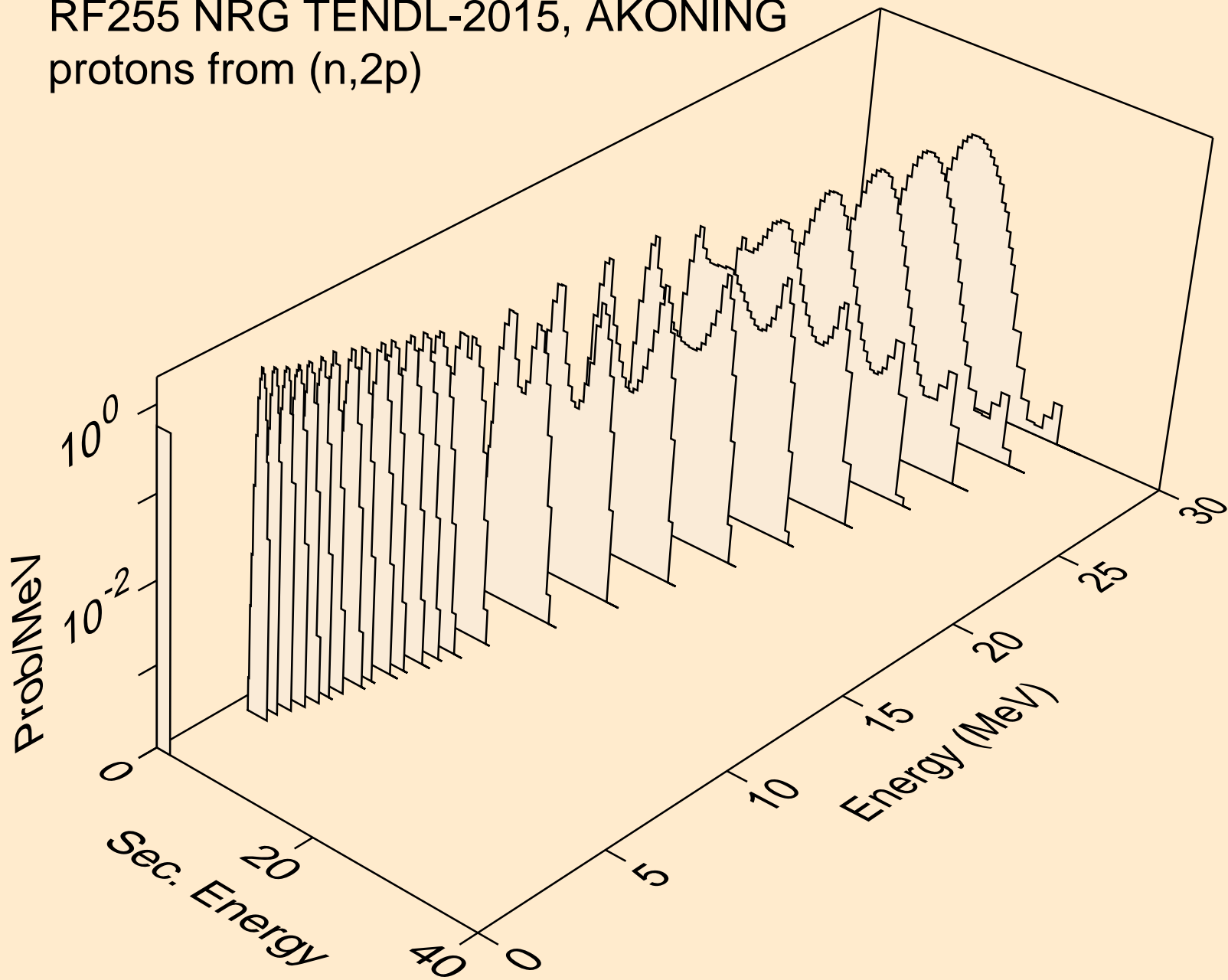

RF255 NRG TENDL-2015, AKONING
protons from (n,pa)

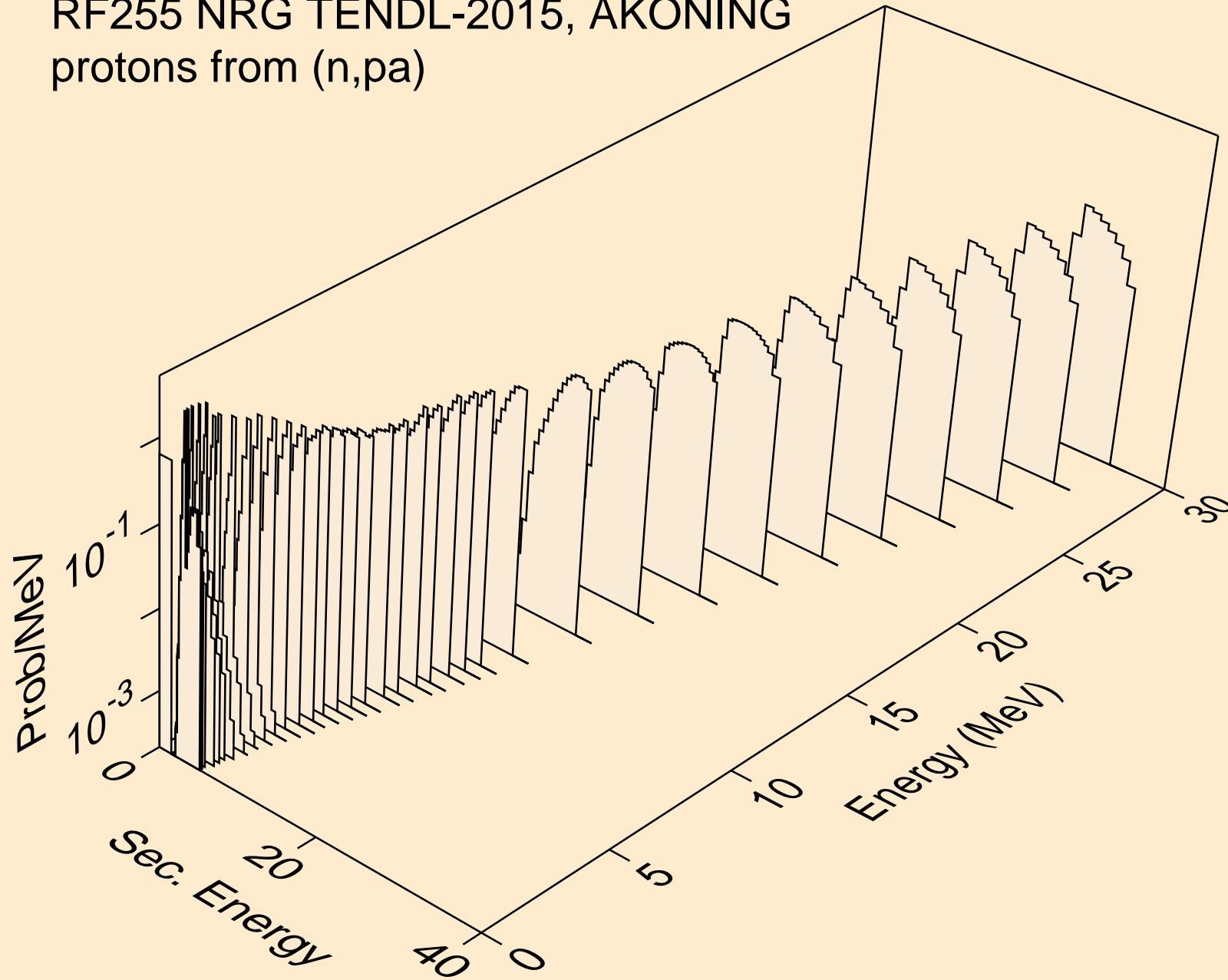

RF255 NRG TENDL-2015, AKONING
protons from (n,pd)

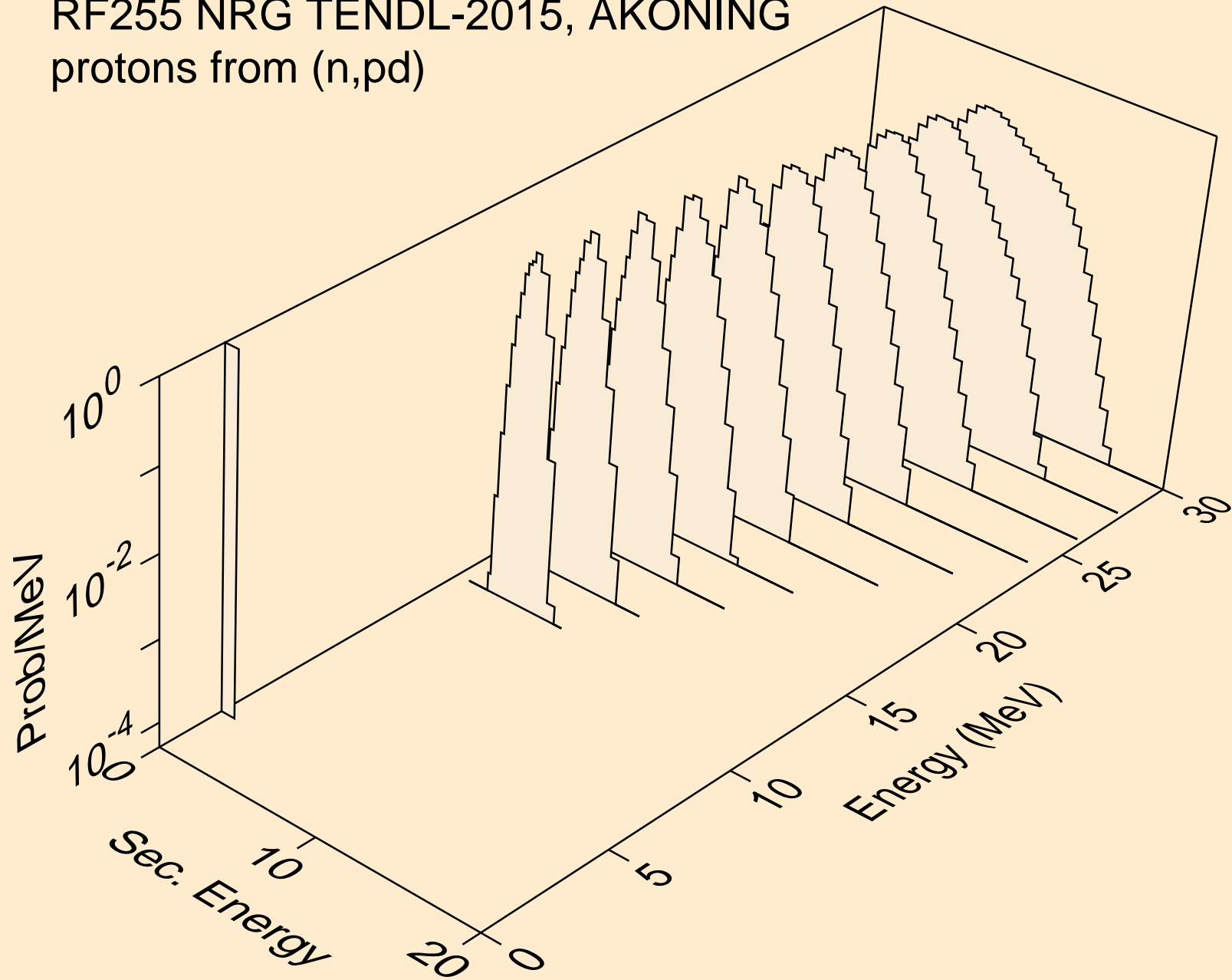

RF255 NRG TENDL-2015, AKONING
protons from (n,pt)

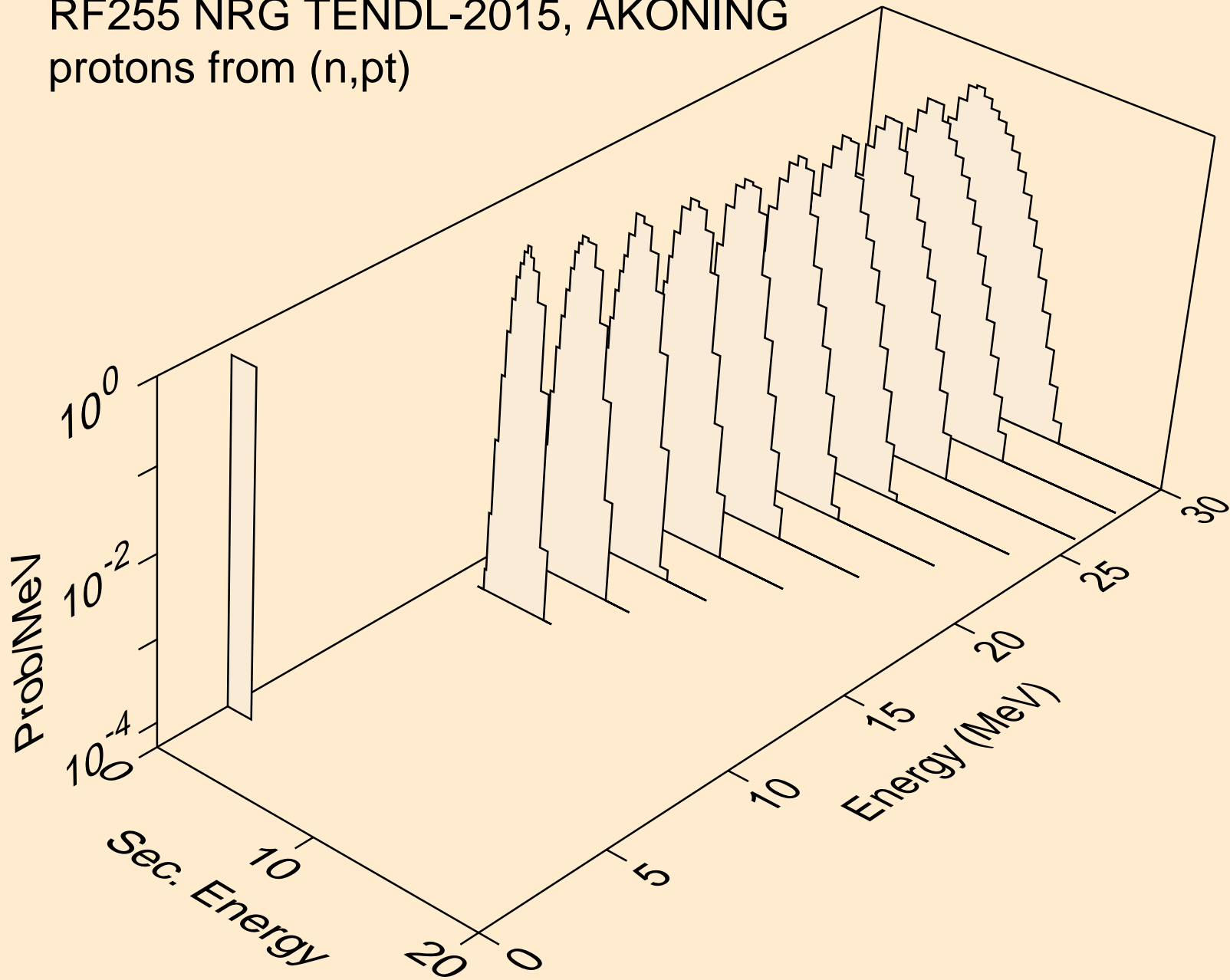

RF255 NRG TENDL-2015, AKONING
deuterons from (n,x)

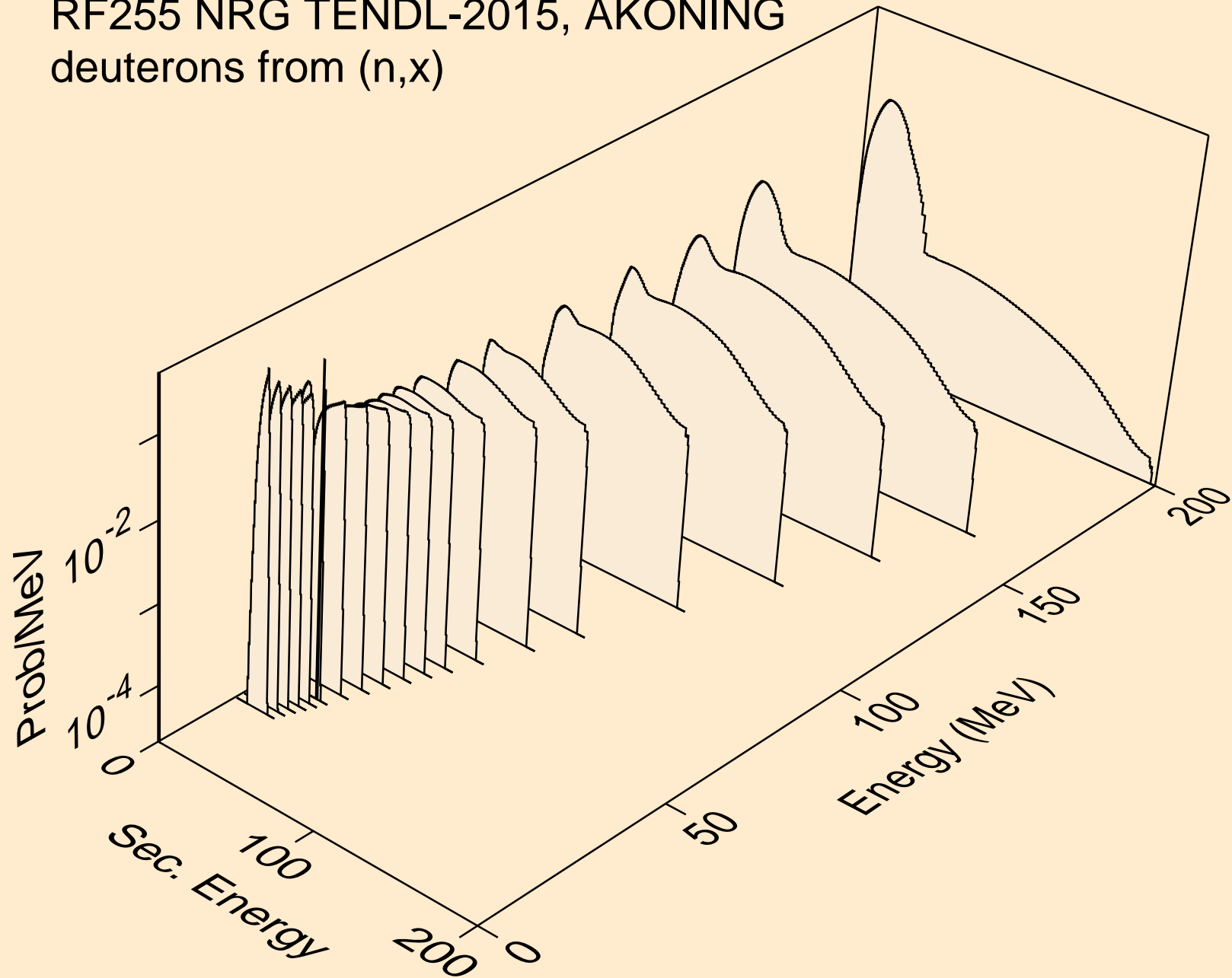

RF255 NRG TENDL-2015, AKONING
deuterons from (n,2nd)

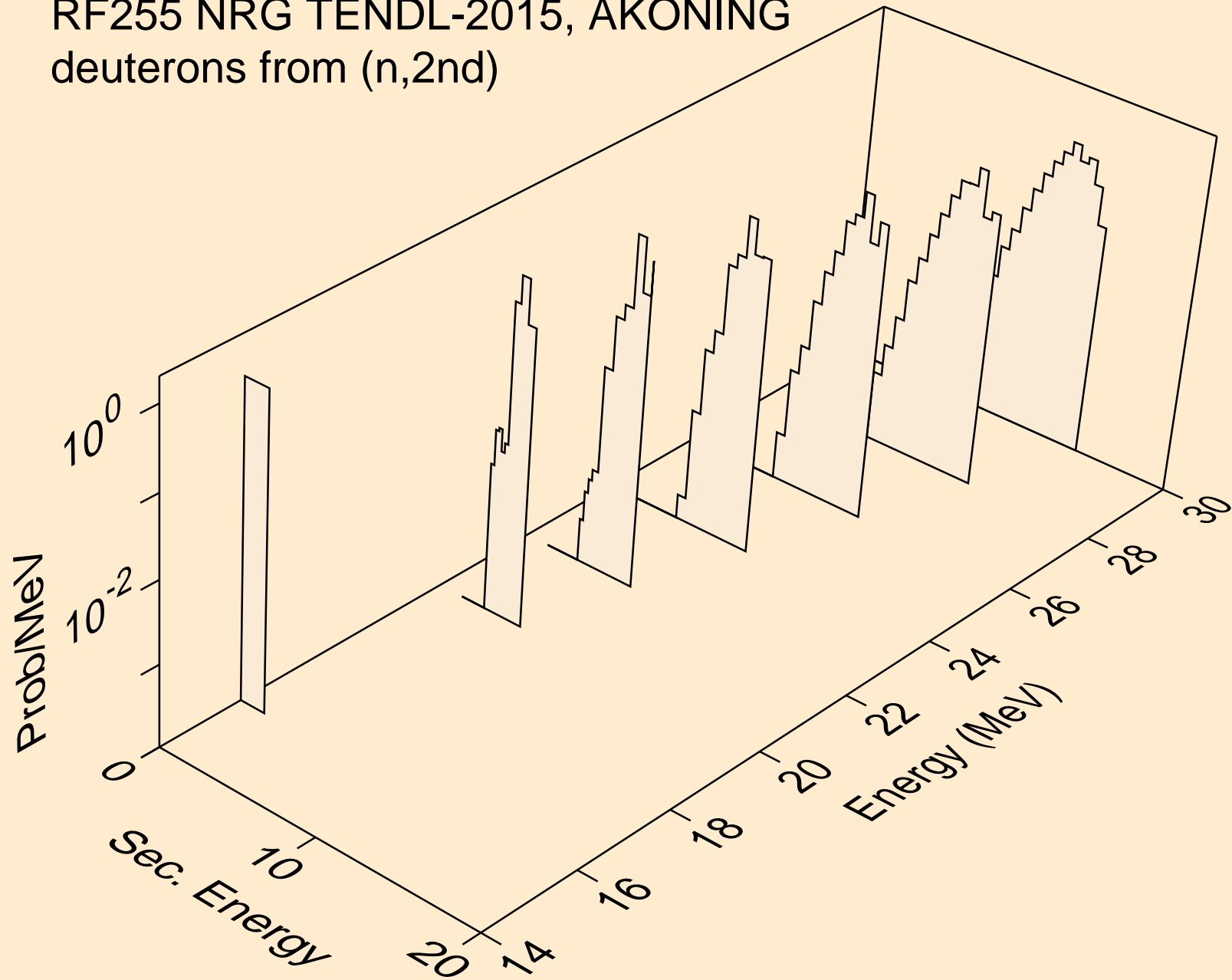

RF255 NRG TENDL-2015, AKONING
deuterons from (n,n*)d

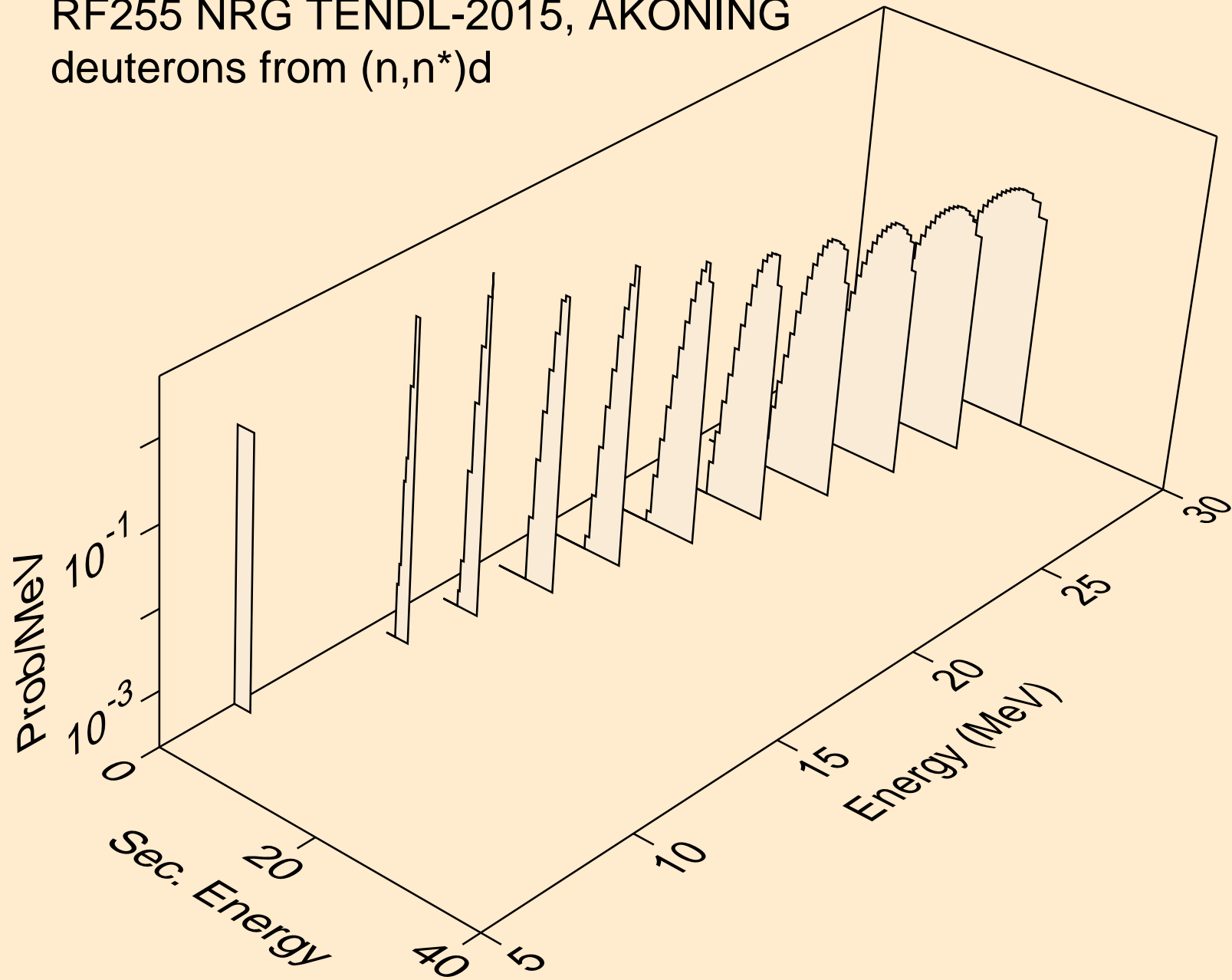

RF255 NRG TENDL-2015, AKONING
deuterons from (n,n*)d2a

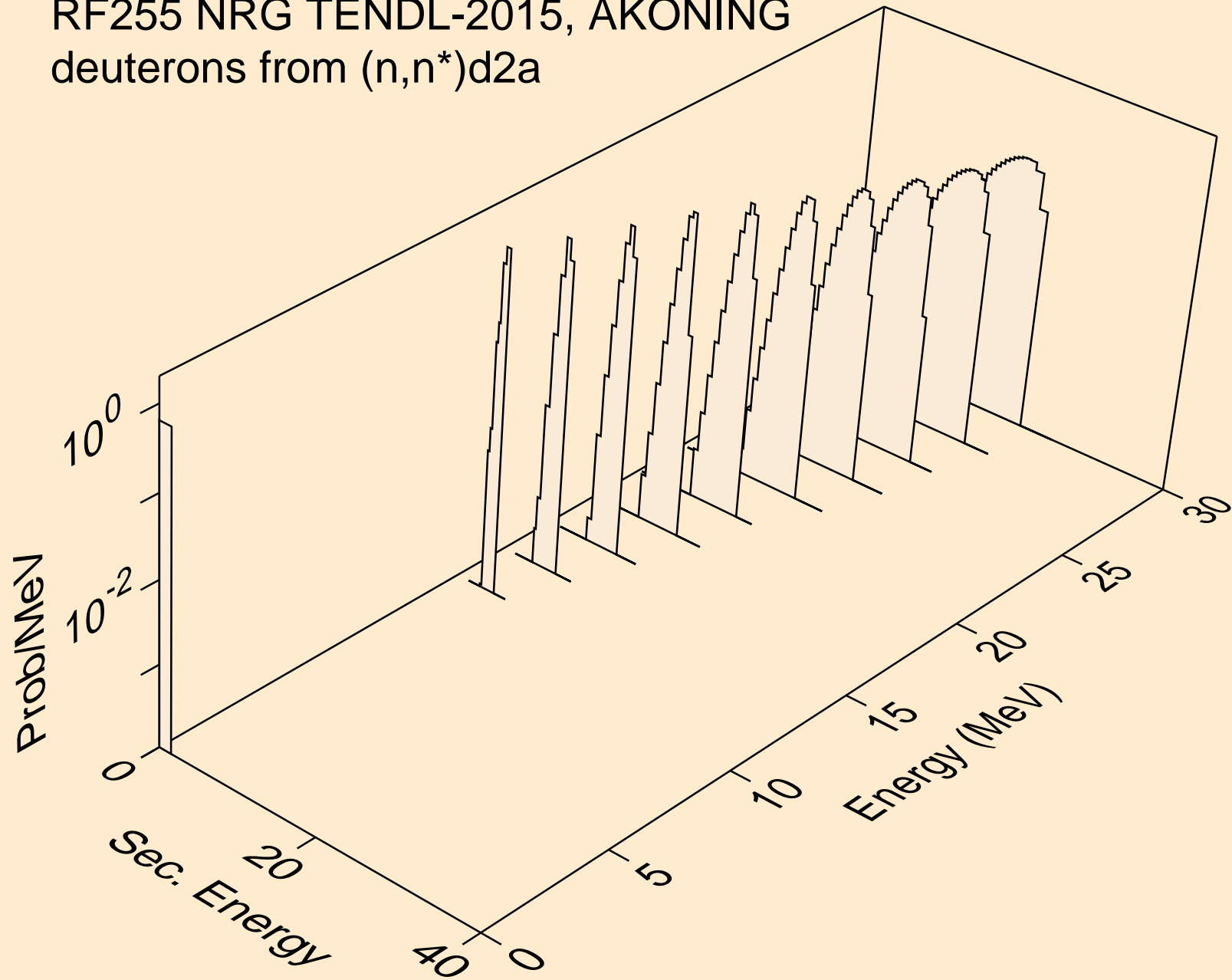

RF255 NRG TENDL-2015, AKONING
deuterons from (n,d)

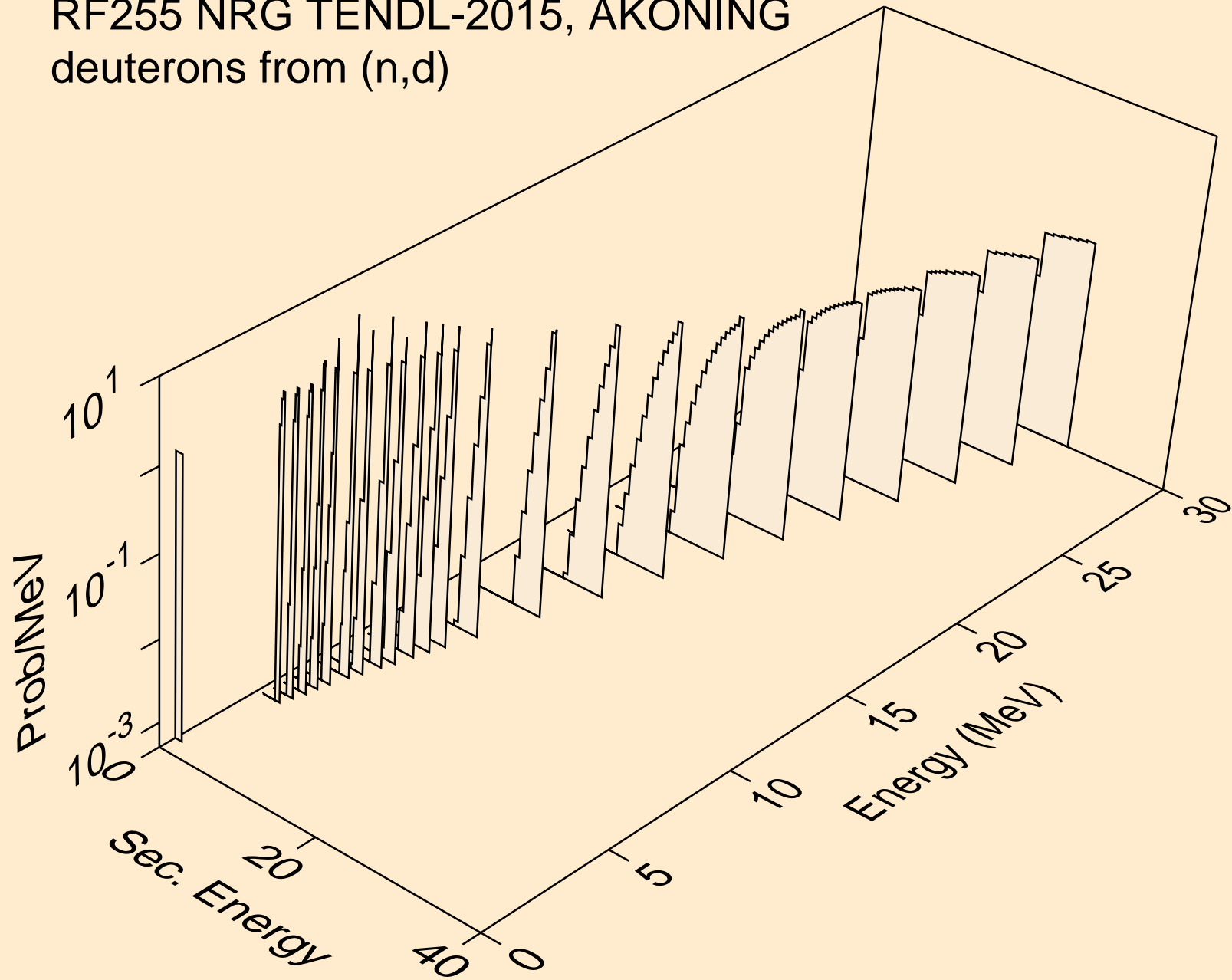

RF255 NRG TENDL-2015, AKONING
deuterons from (n,d2a)

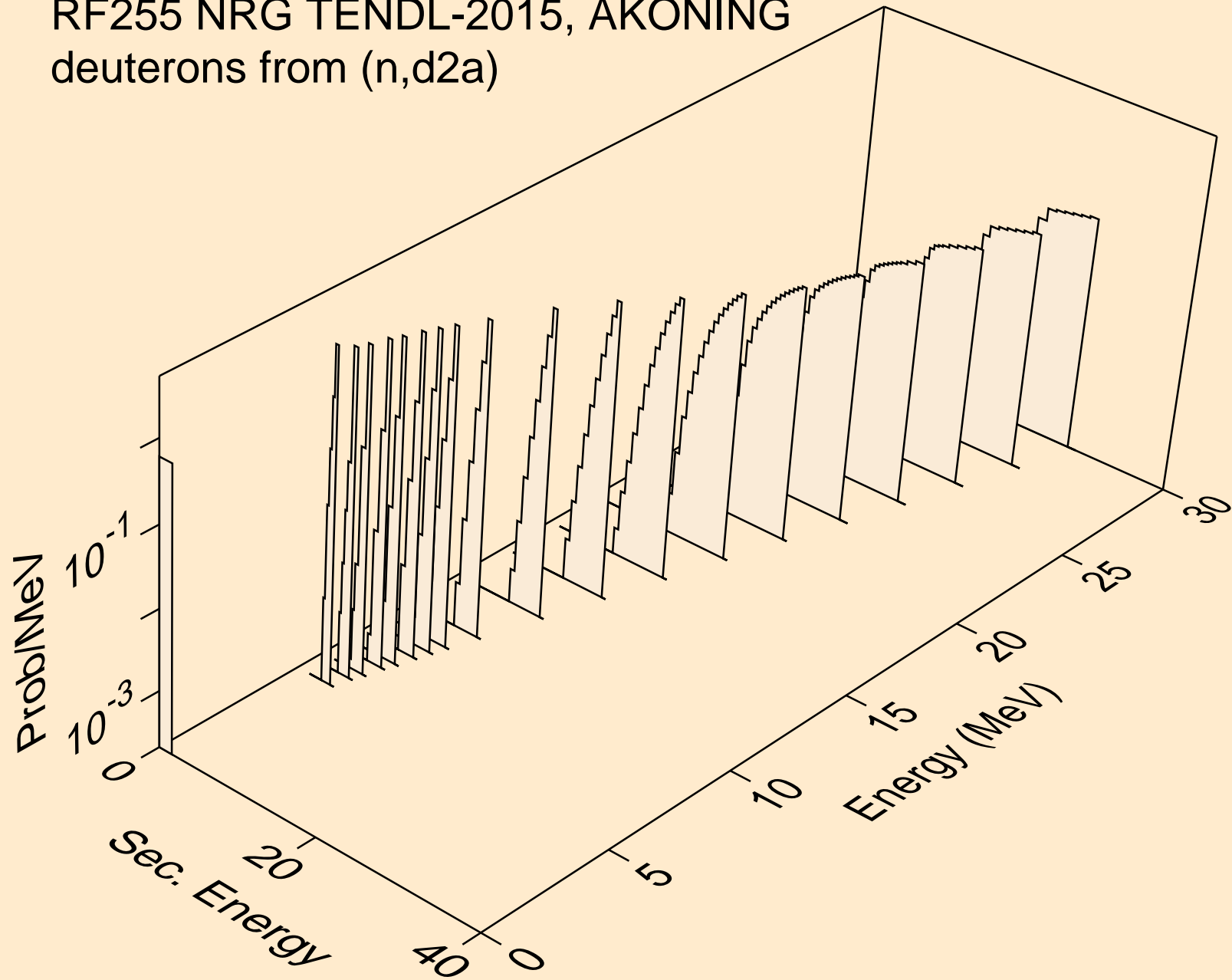

RF255 NRG TENDL-2015, AKONING
deuterons from (n,pd)

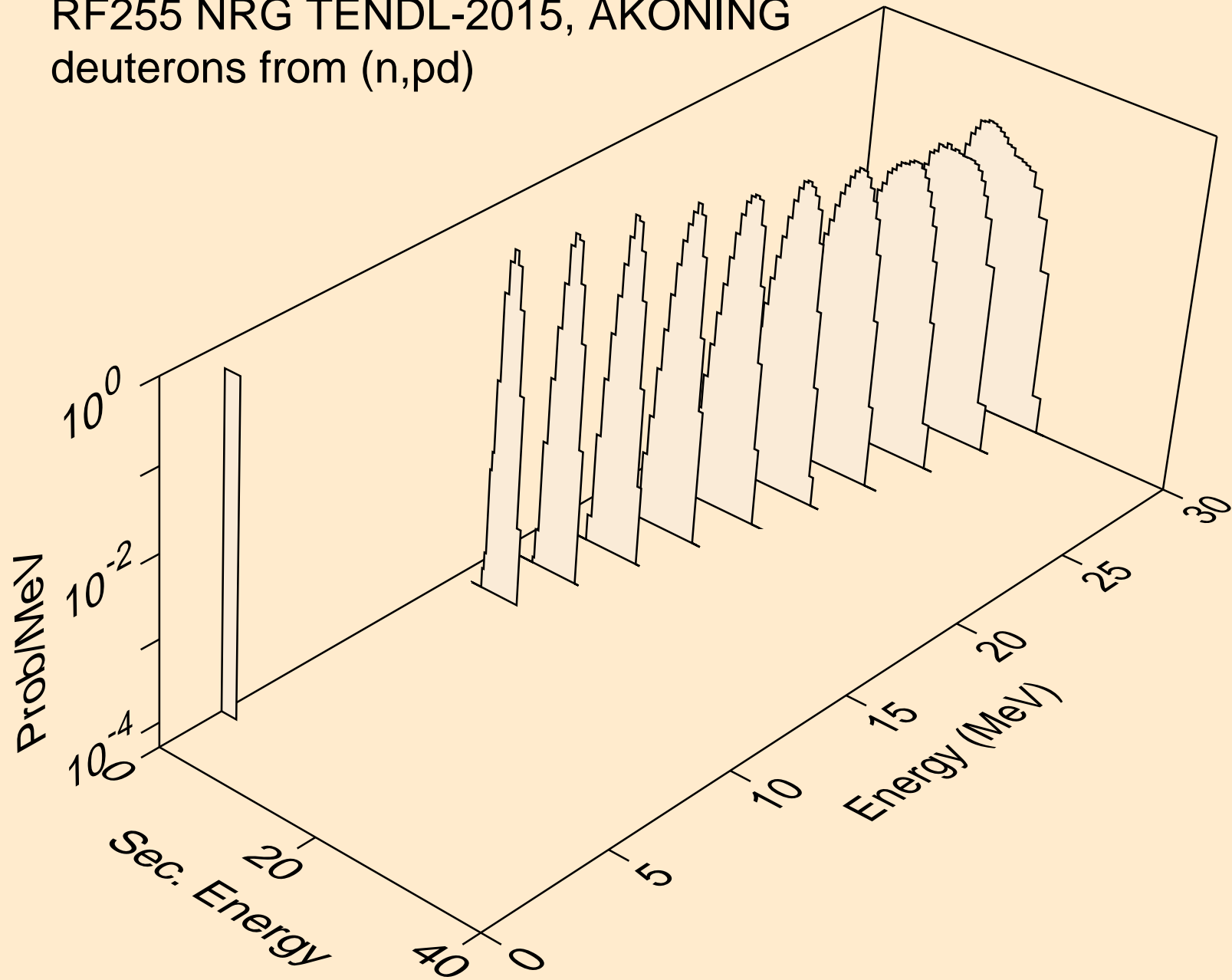

RF255 NRG TENDL-2015, AKONING
deuterons from (n,da)

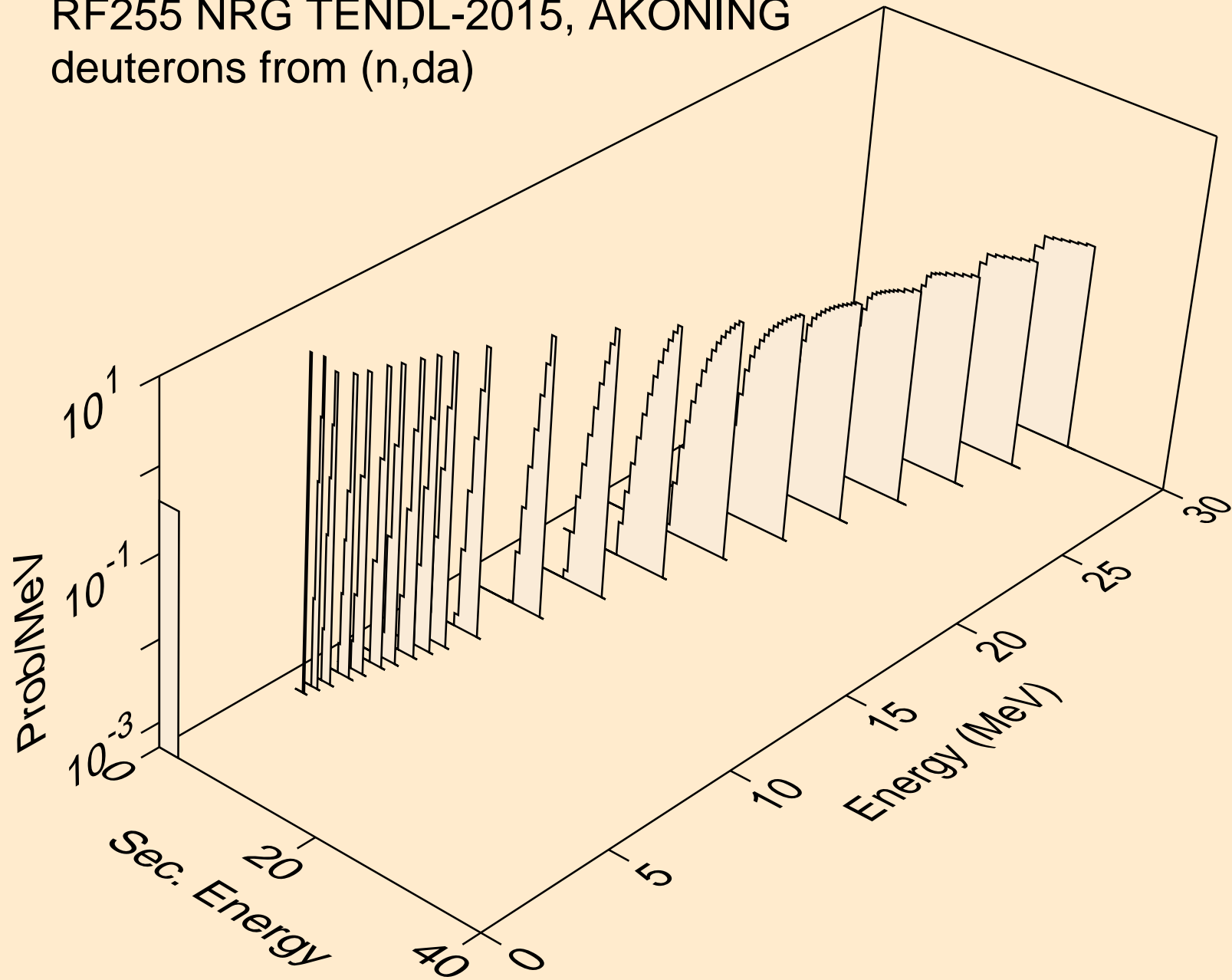

RF255 NRG TENDL-2015, AKONING
tritons from (n,x)

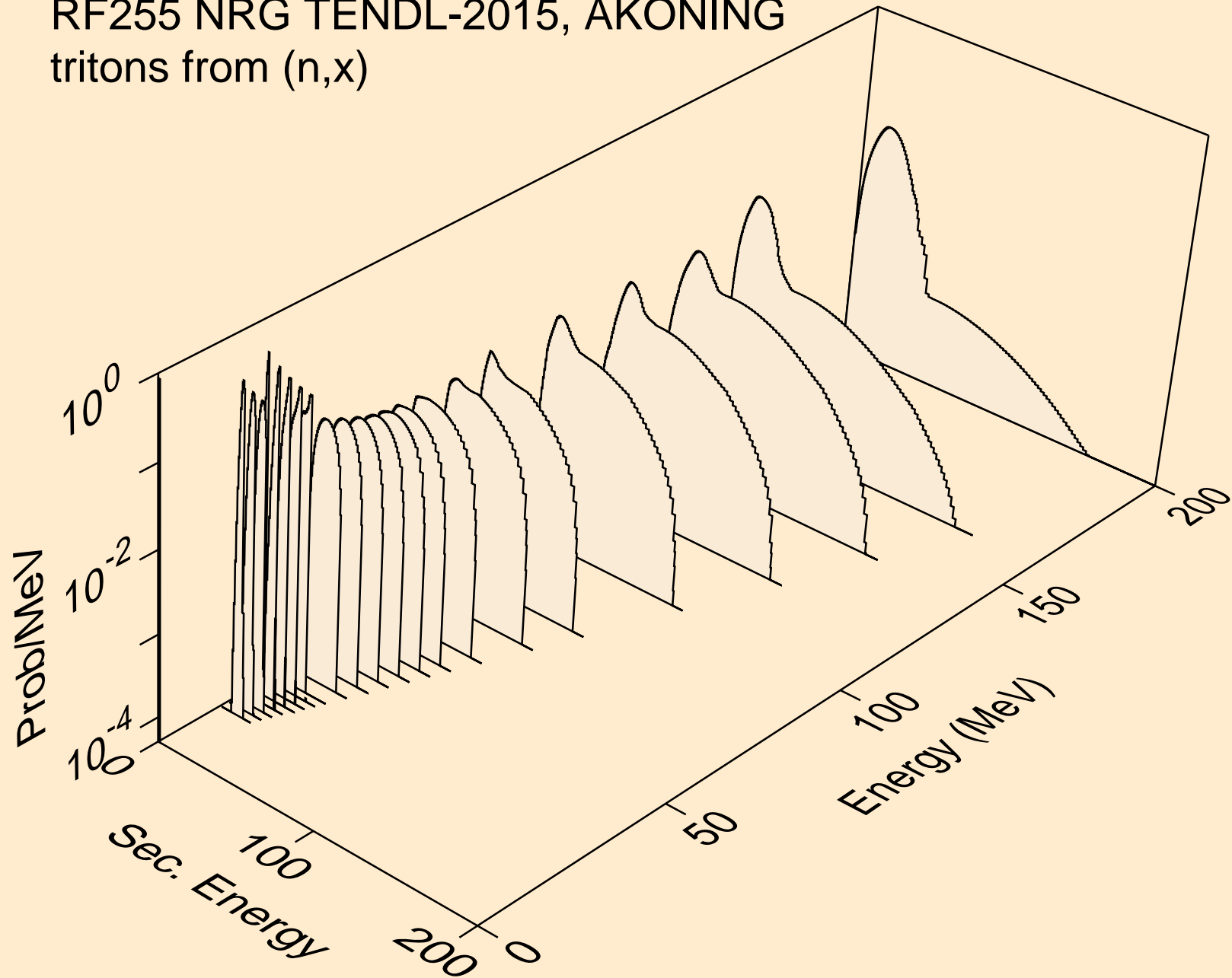

RF255 NRG TENDL-2015, AKONING
tritons from (n,n*)t

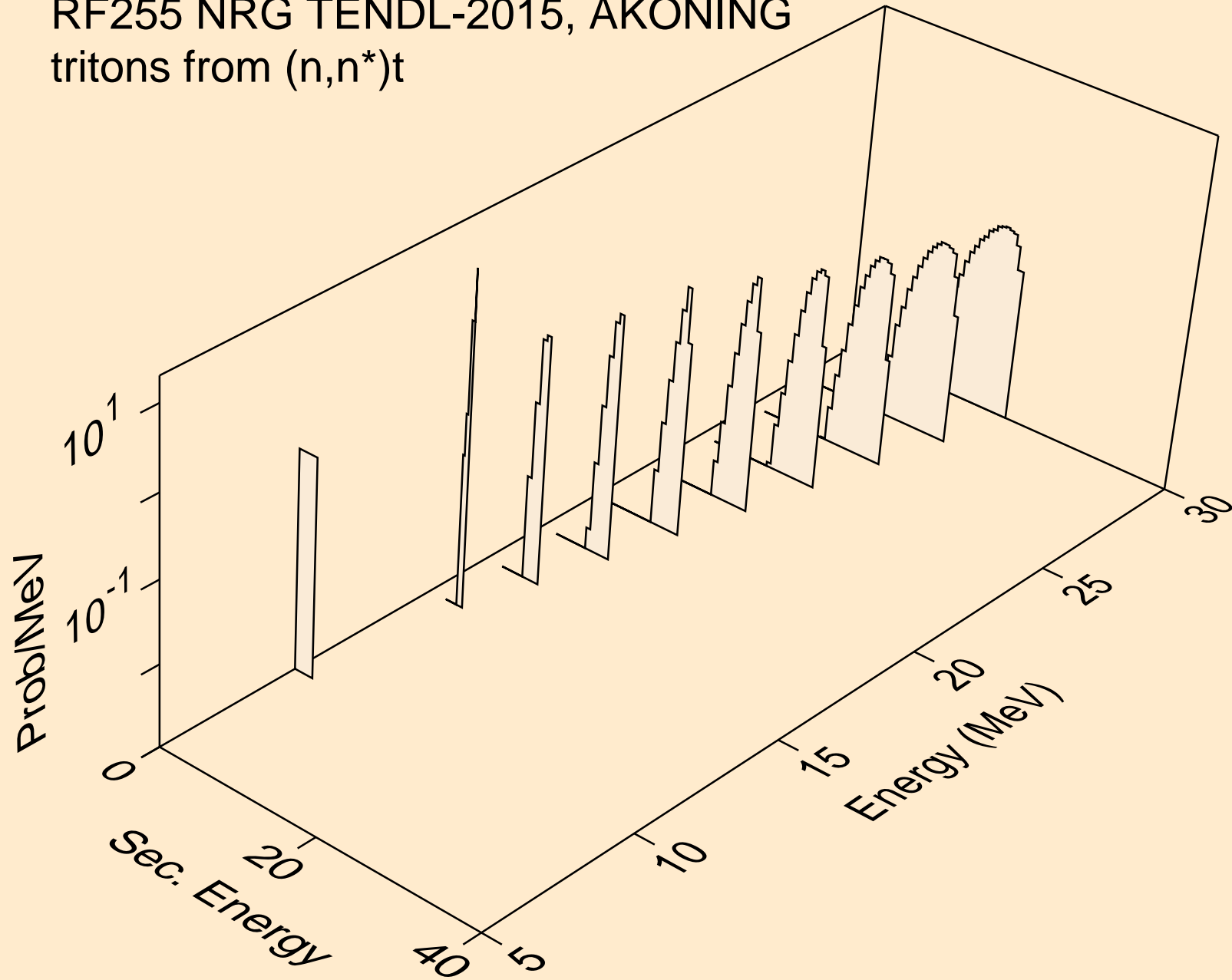

RF255 NRG TENDL-2015, AKONING
tritons from (n,n*)t2a

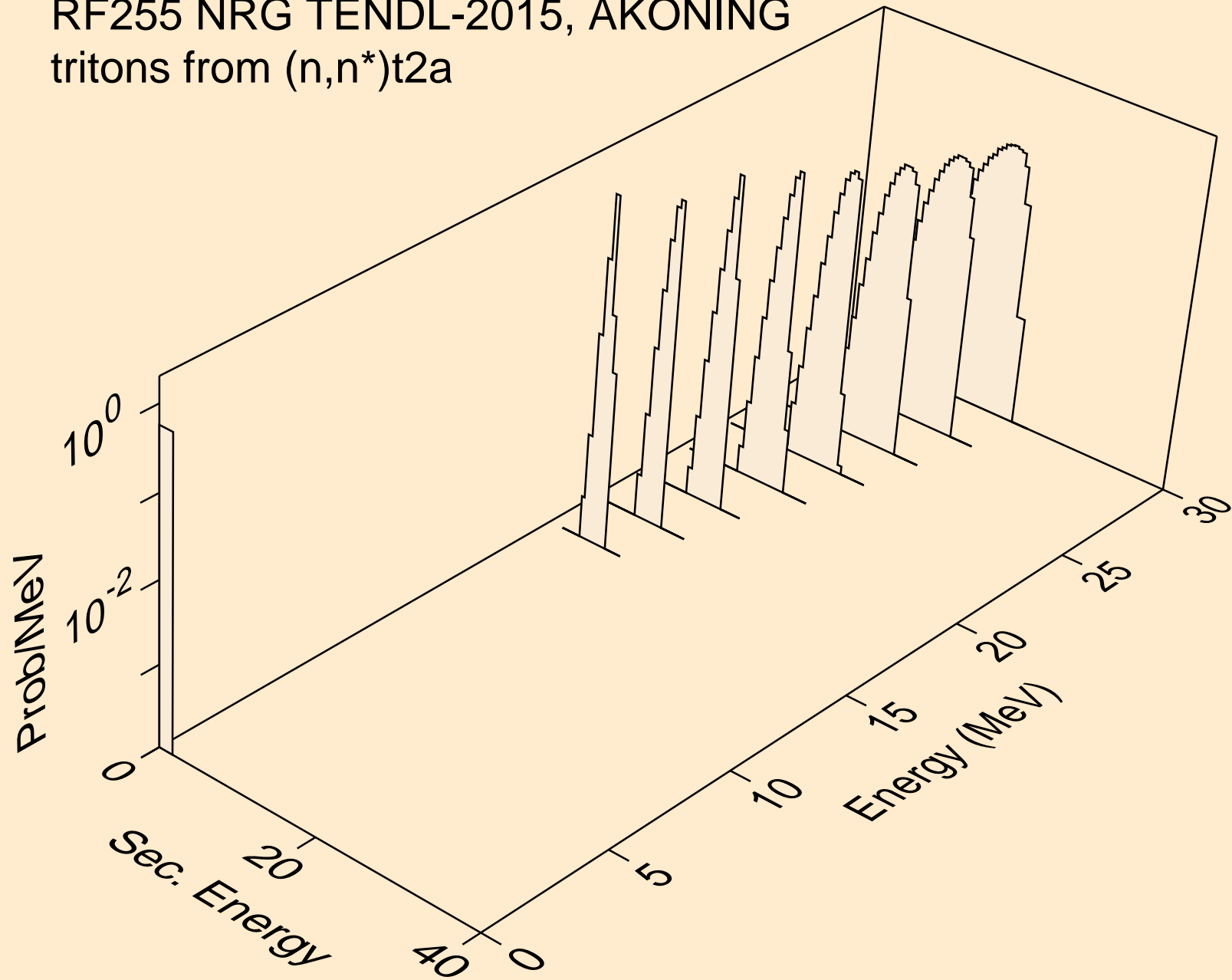

RF255 NRG TENDL-2015, AKONING
tritons from (n,t)

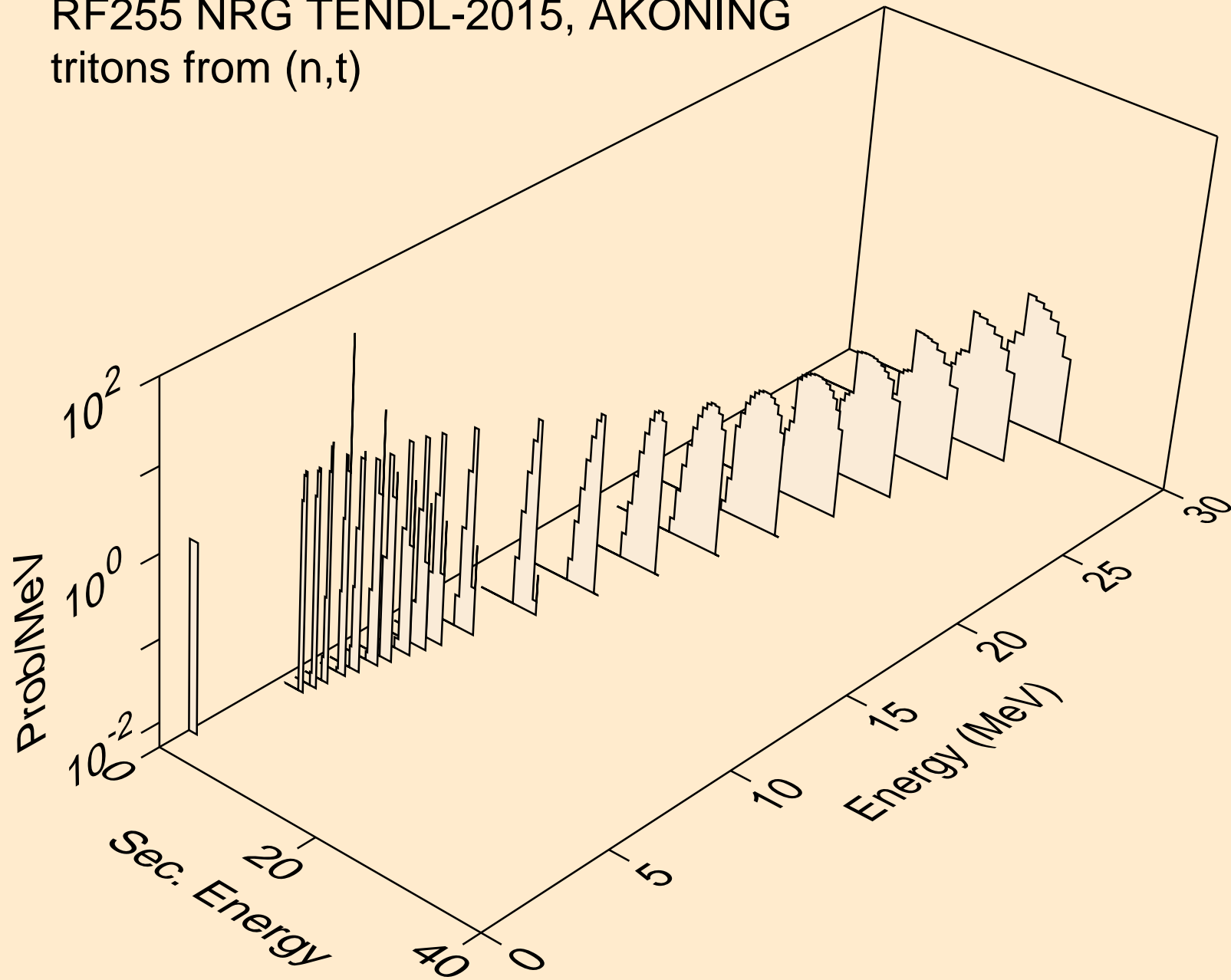

RF255 NRG TENDL-2015, AKONING
tritons from (n,t2a)

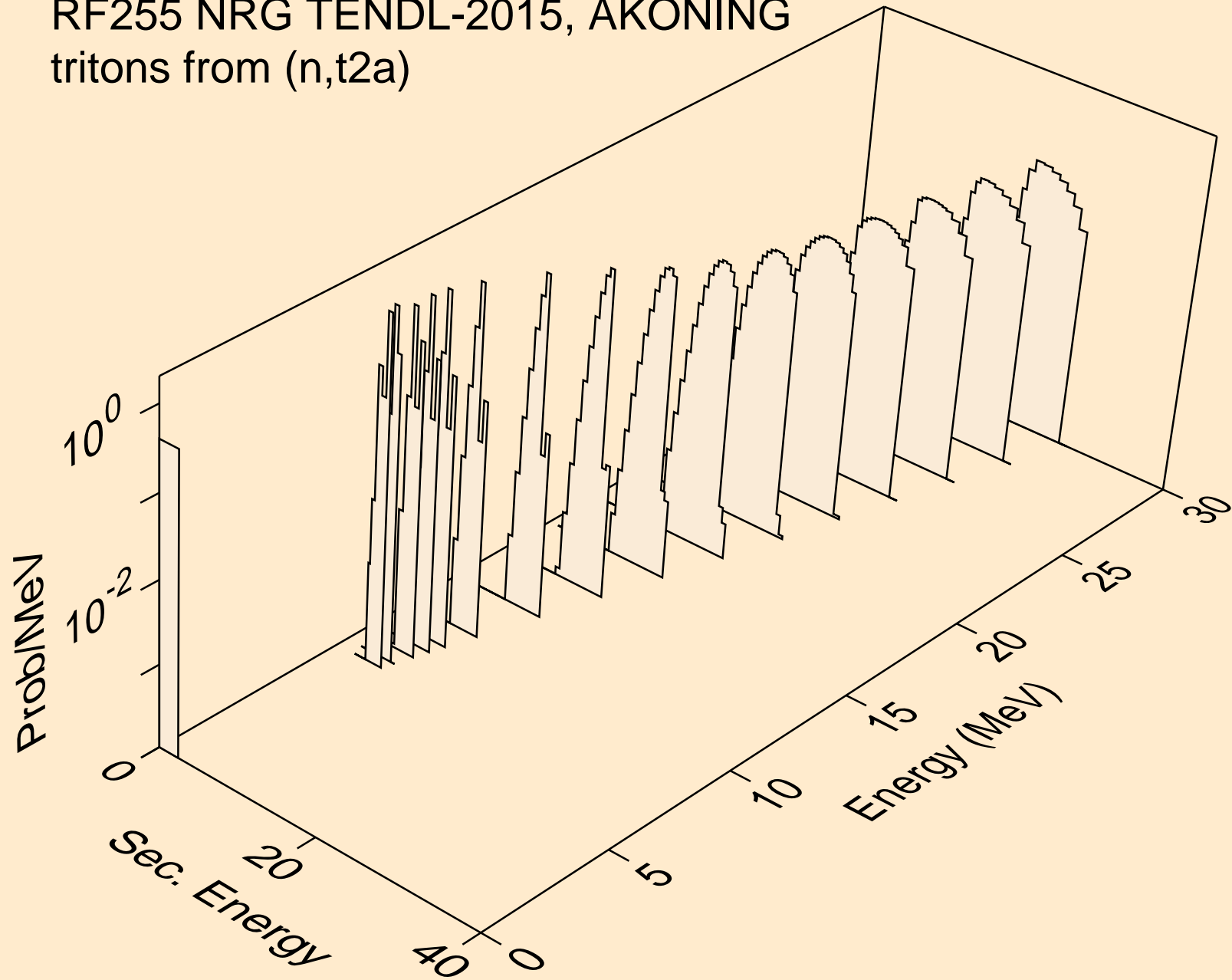

RF255 NRG TENDL-2015, AKONING
tritons from (n,pt)

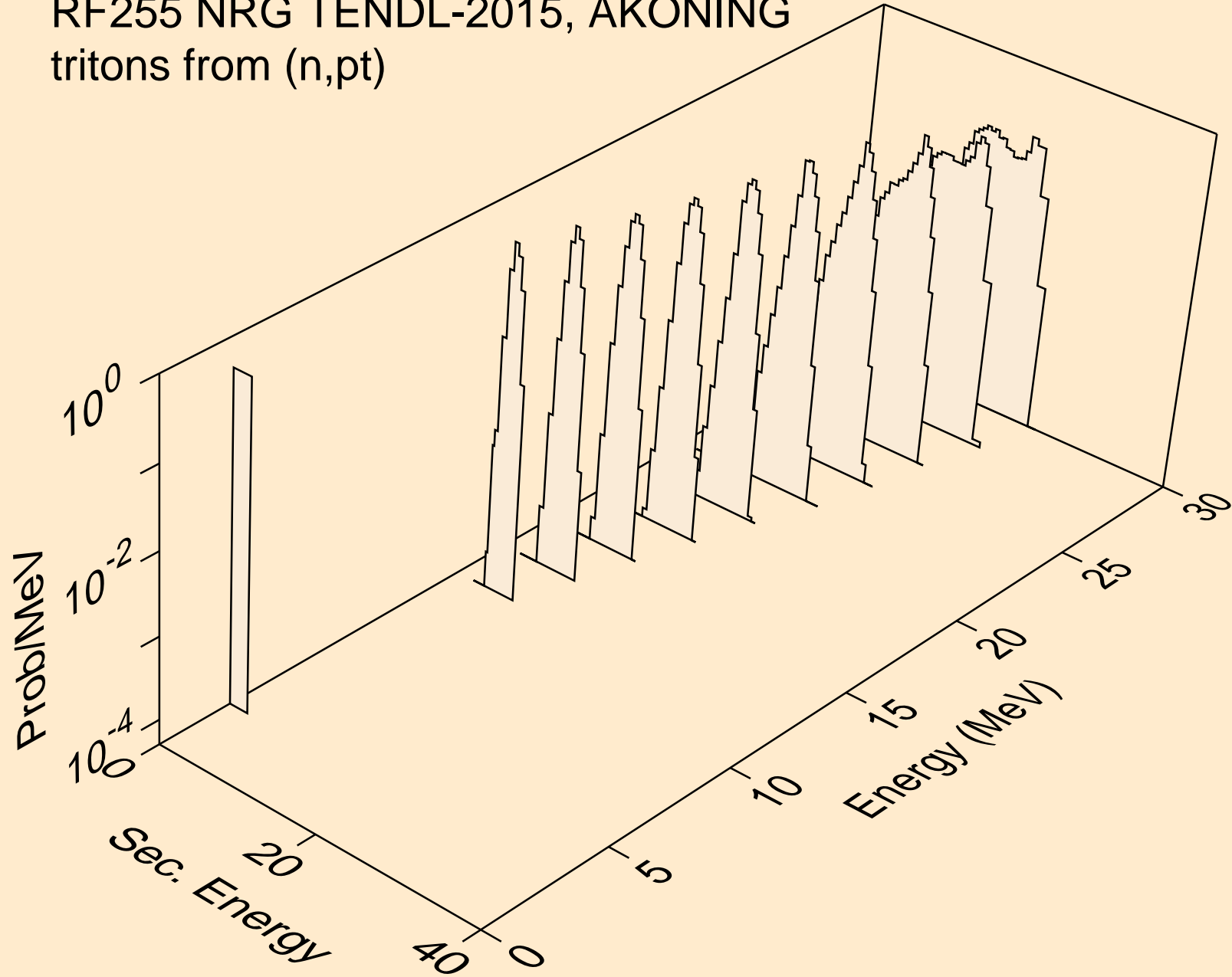

RF255 NRG TENDL-2015, AKONING
he3s from (n,x)

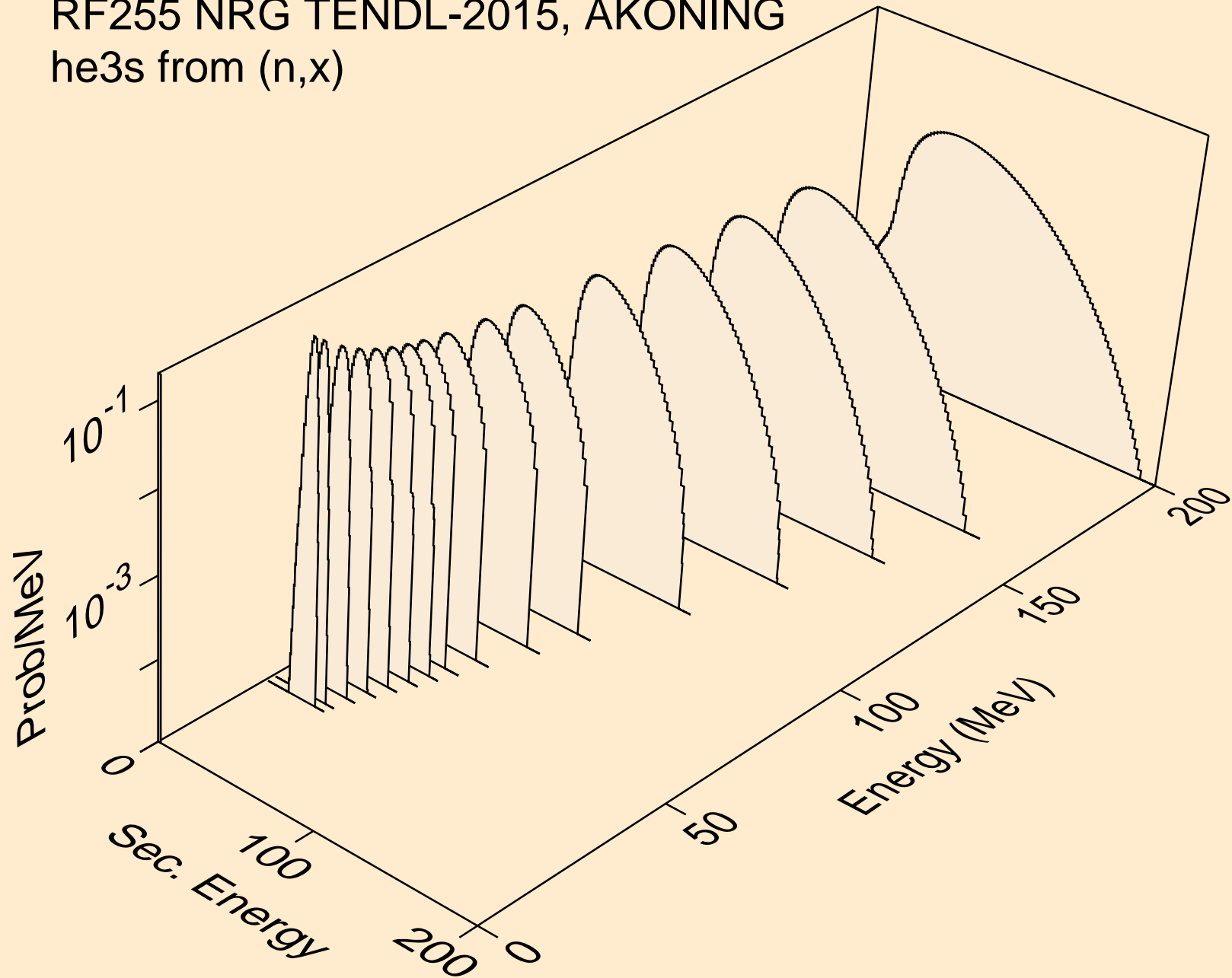

RF255 NRG TENDL-2015, AKONING
he3s from (n,n*)he3

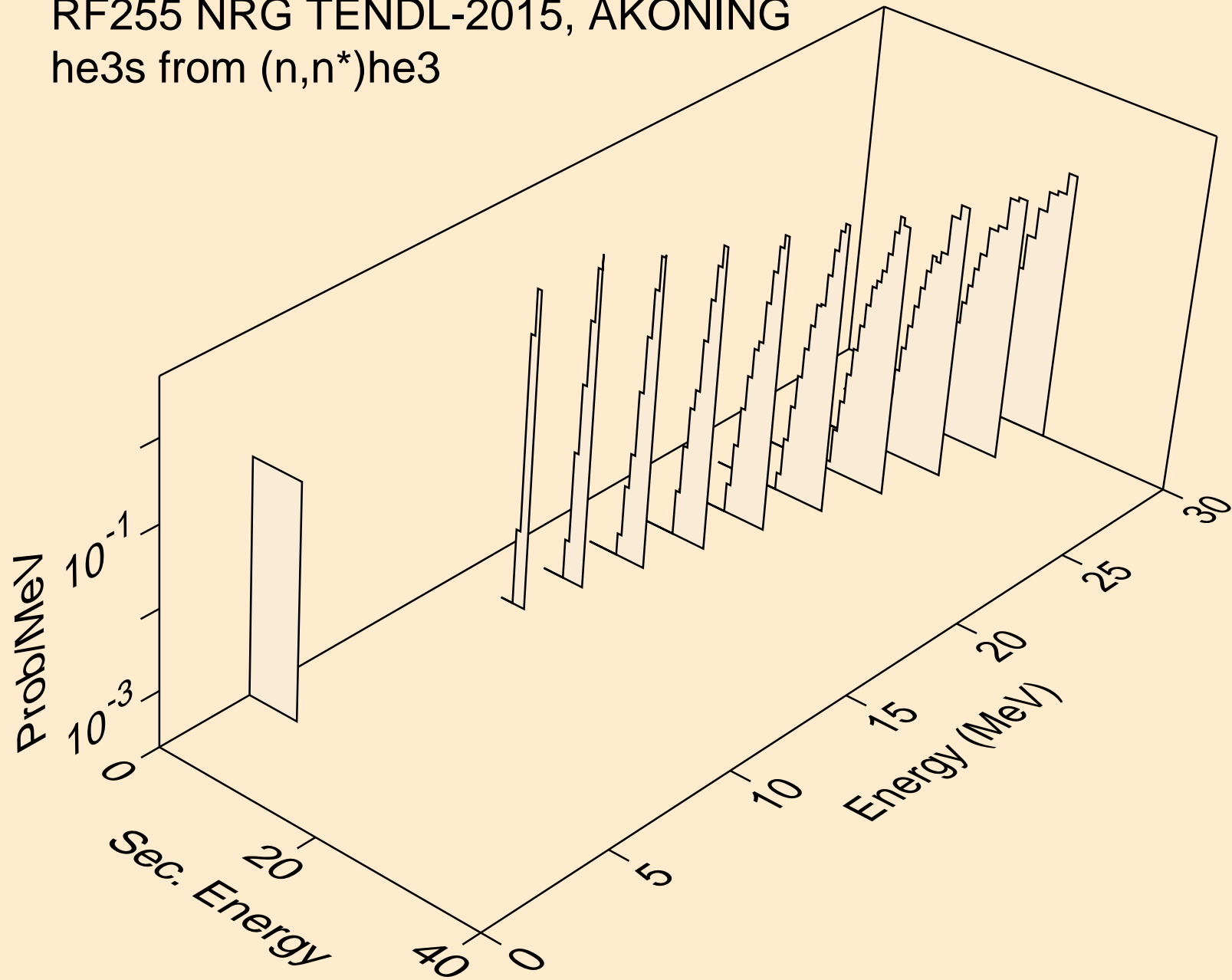

RF255 NRG TENDL-2015, AKONING
he3s from (n,he3)

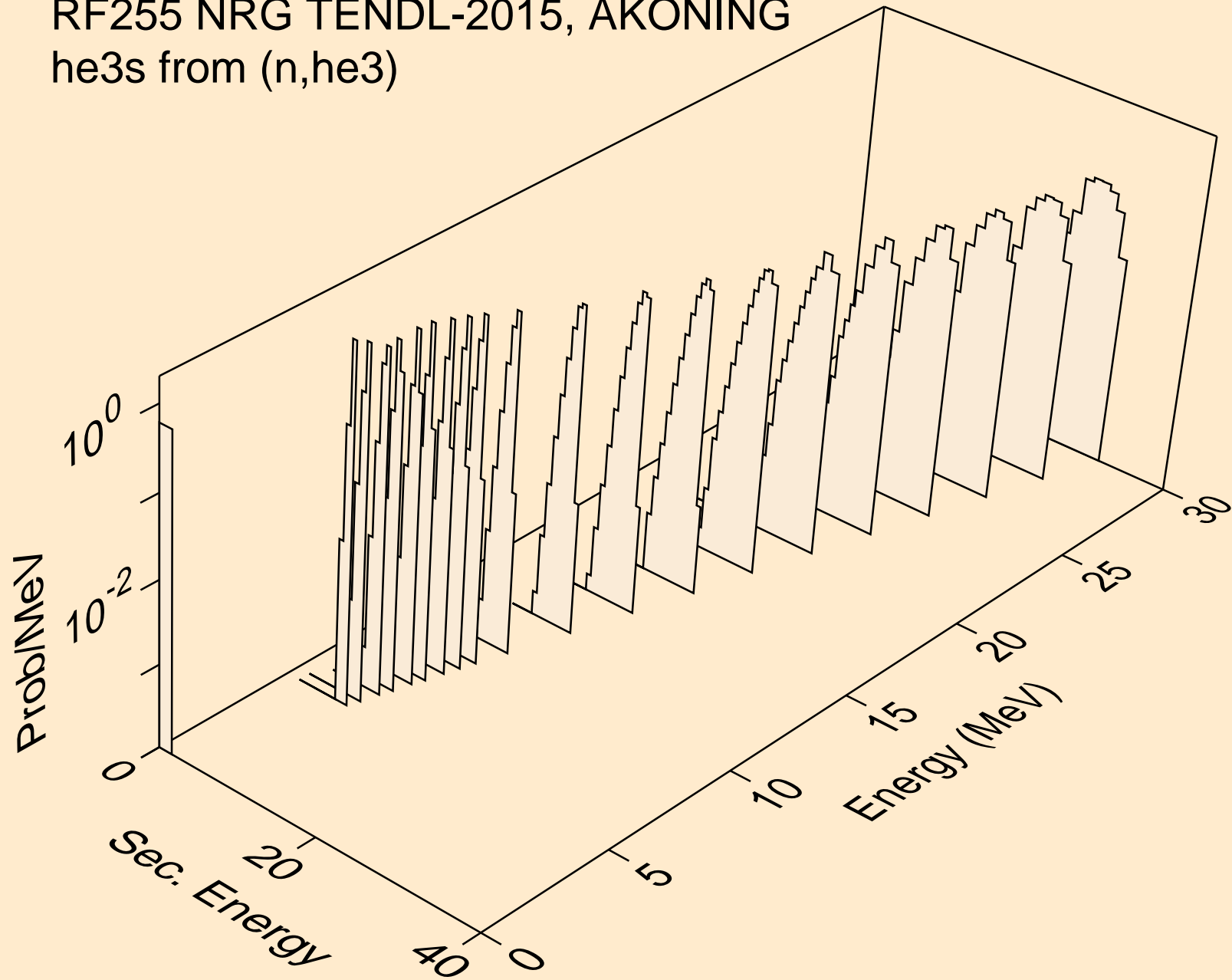

RF255 NRG TENDL-2015, AKONING
alphas from (n,x)

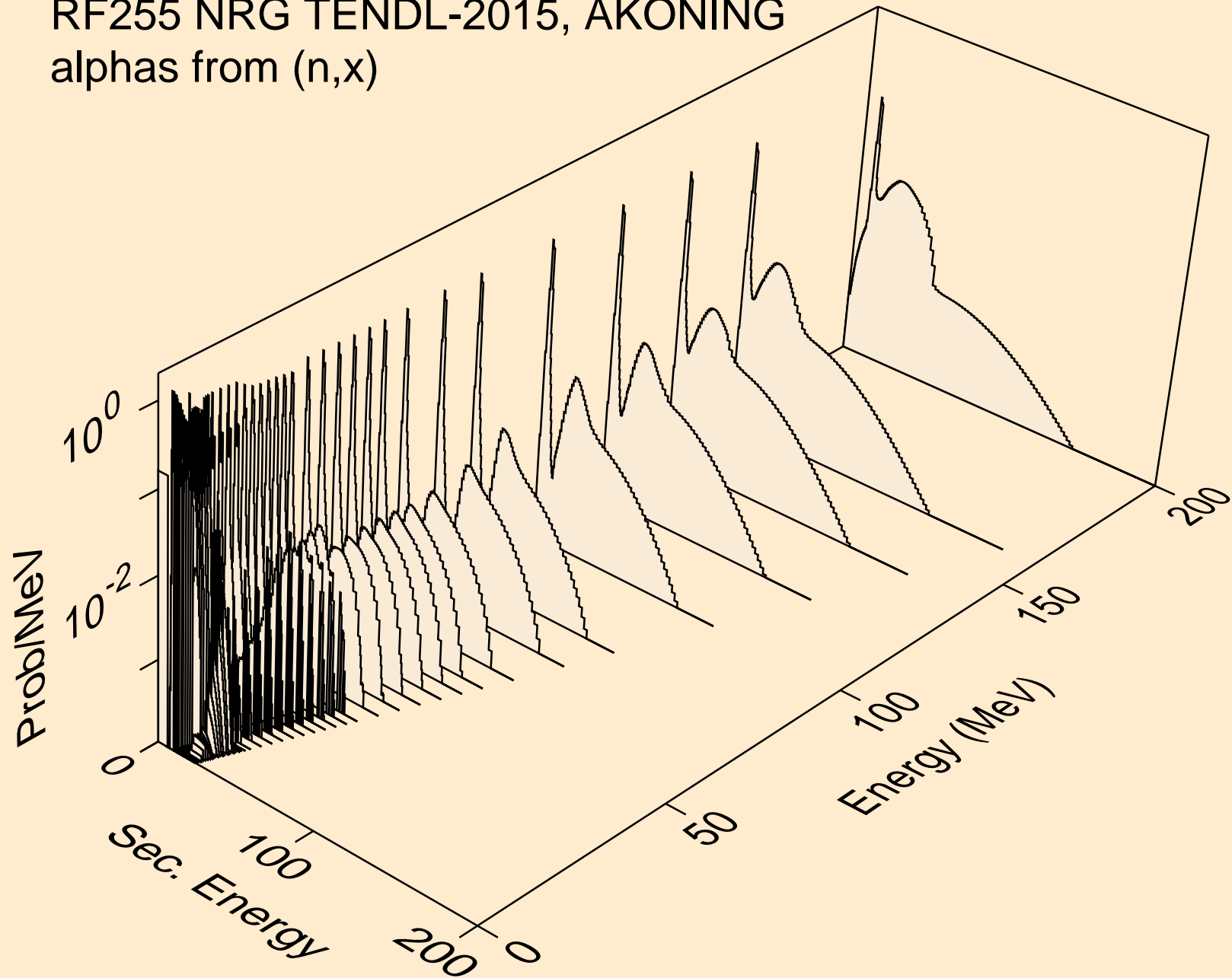

RF255 NRG TENDL-2015, AKONING
alphas from (n,n*)a

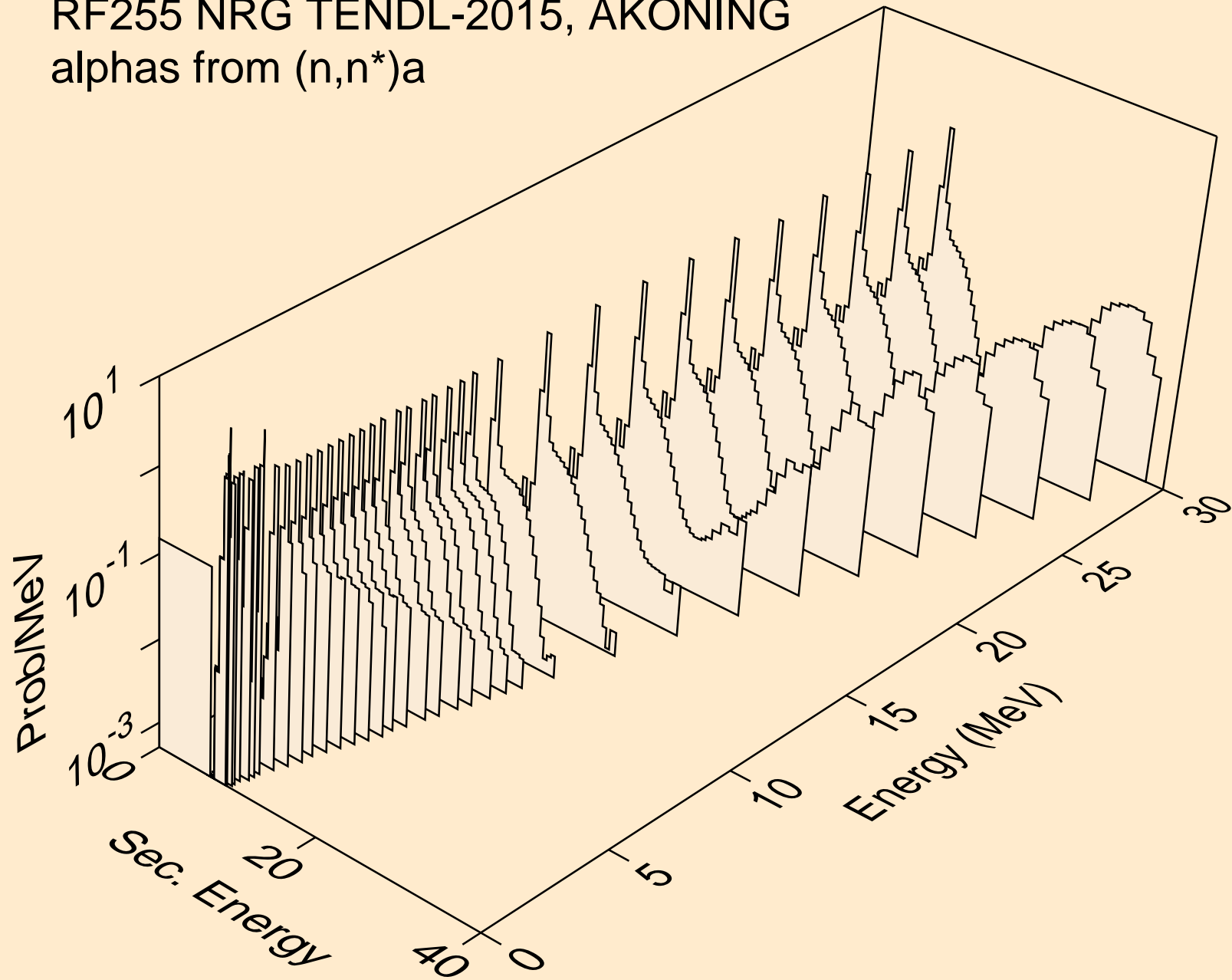

RF255 NRG TENDL-2015, AKONING
alphas from (n,n*)3a

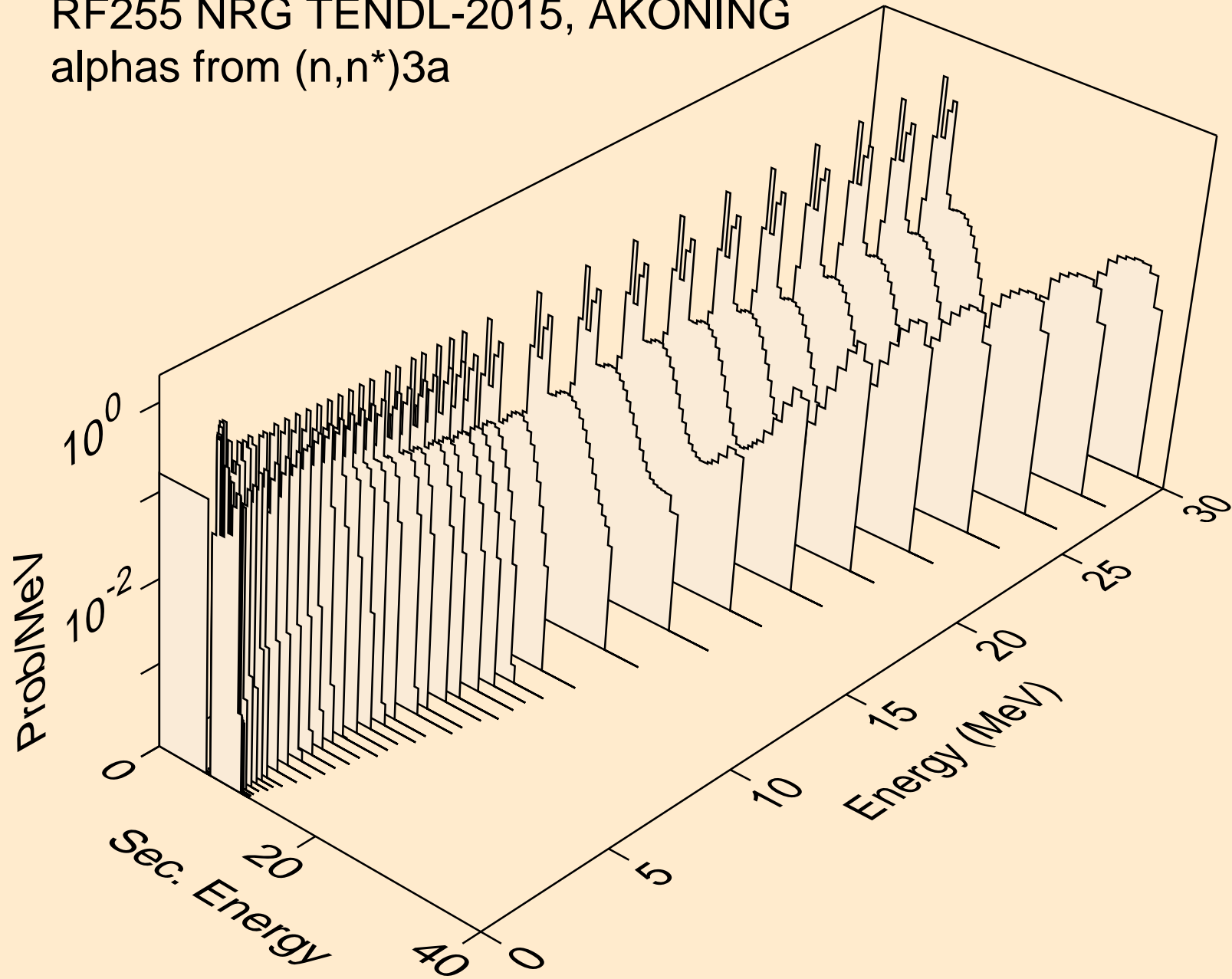

RF255 NRG TENDL-2015, AKONING
alphas from (n,2n)a

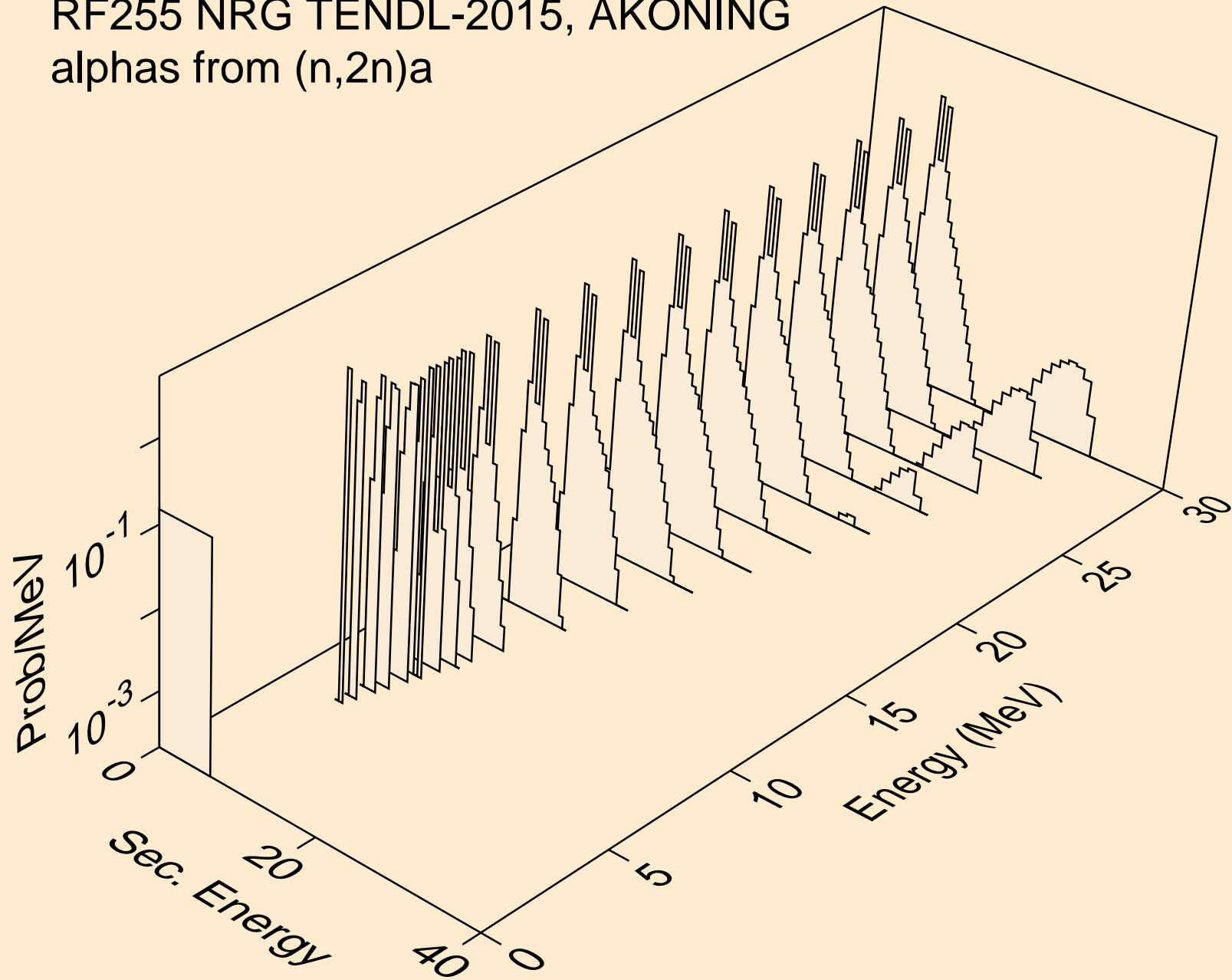

RF255 NRG TENDL-2015, AKONING
alphas from (n,3n)a

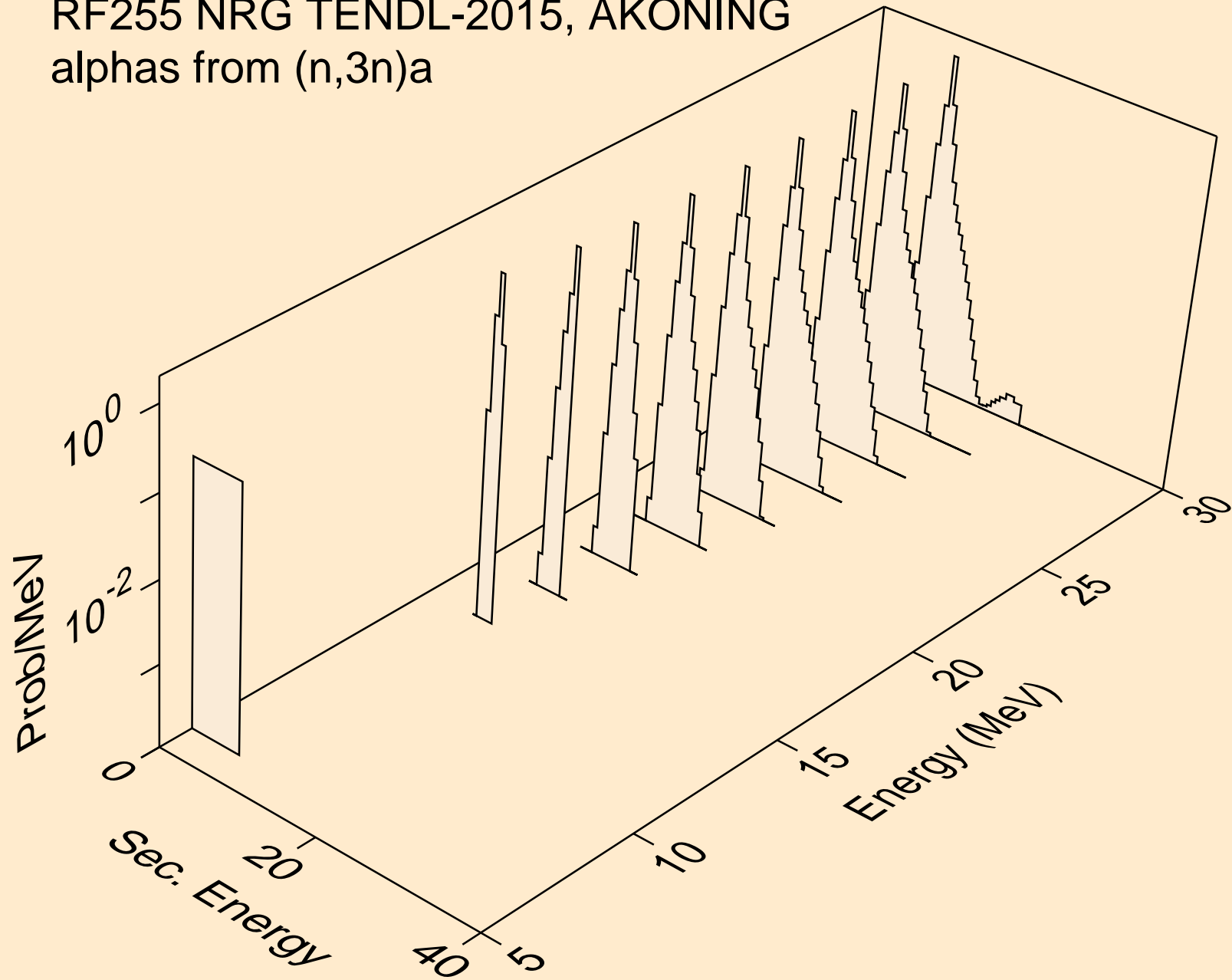

RF255 NRG TENDL-2015, AKONING
alphas from (n,n*)2a

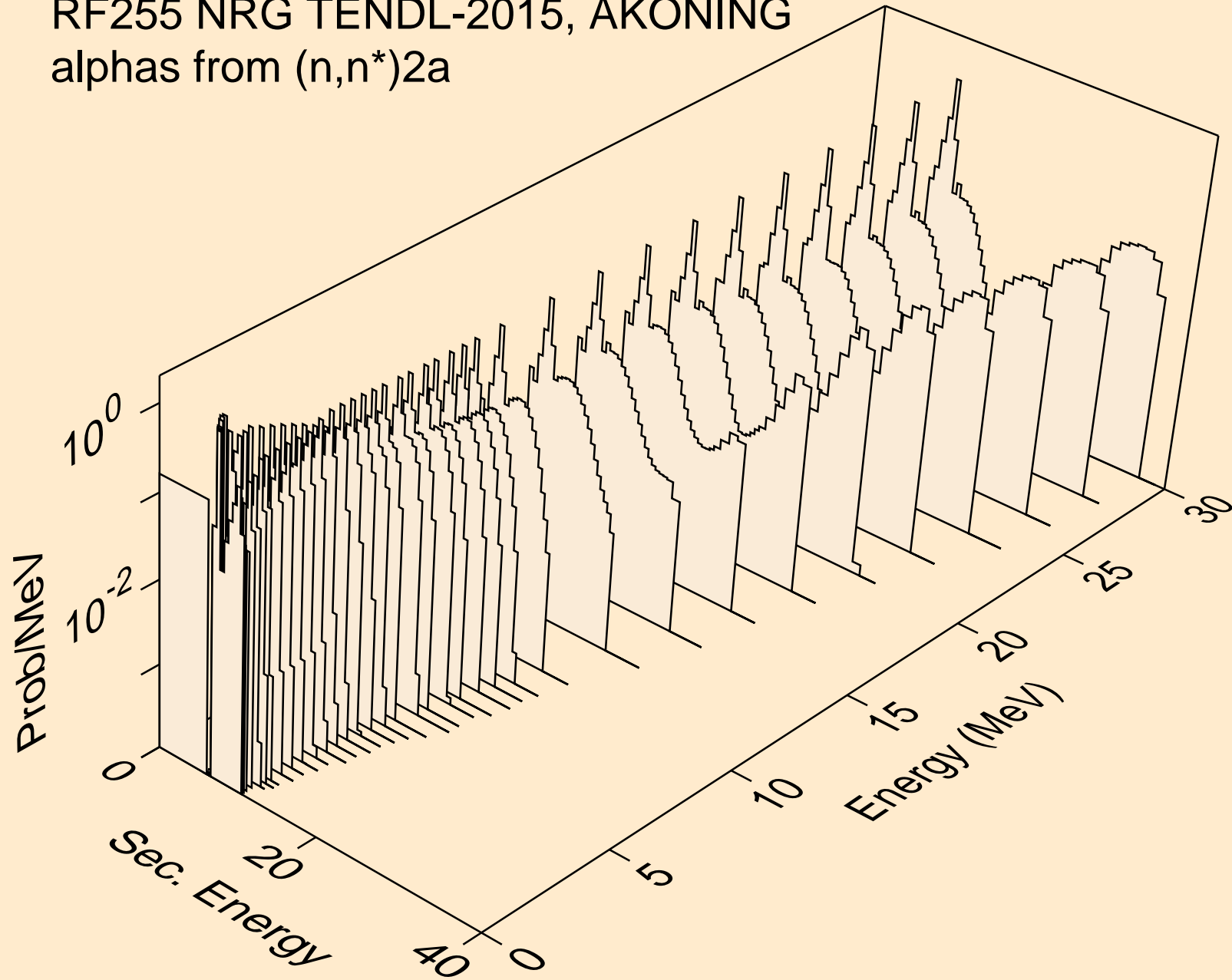

RF255 NRG TENDL-2015, AKONING
alphas from (n,2n)2a

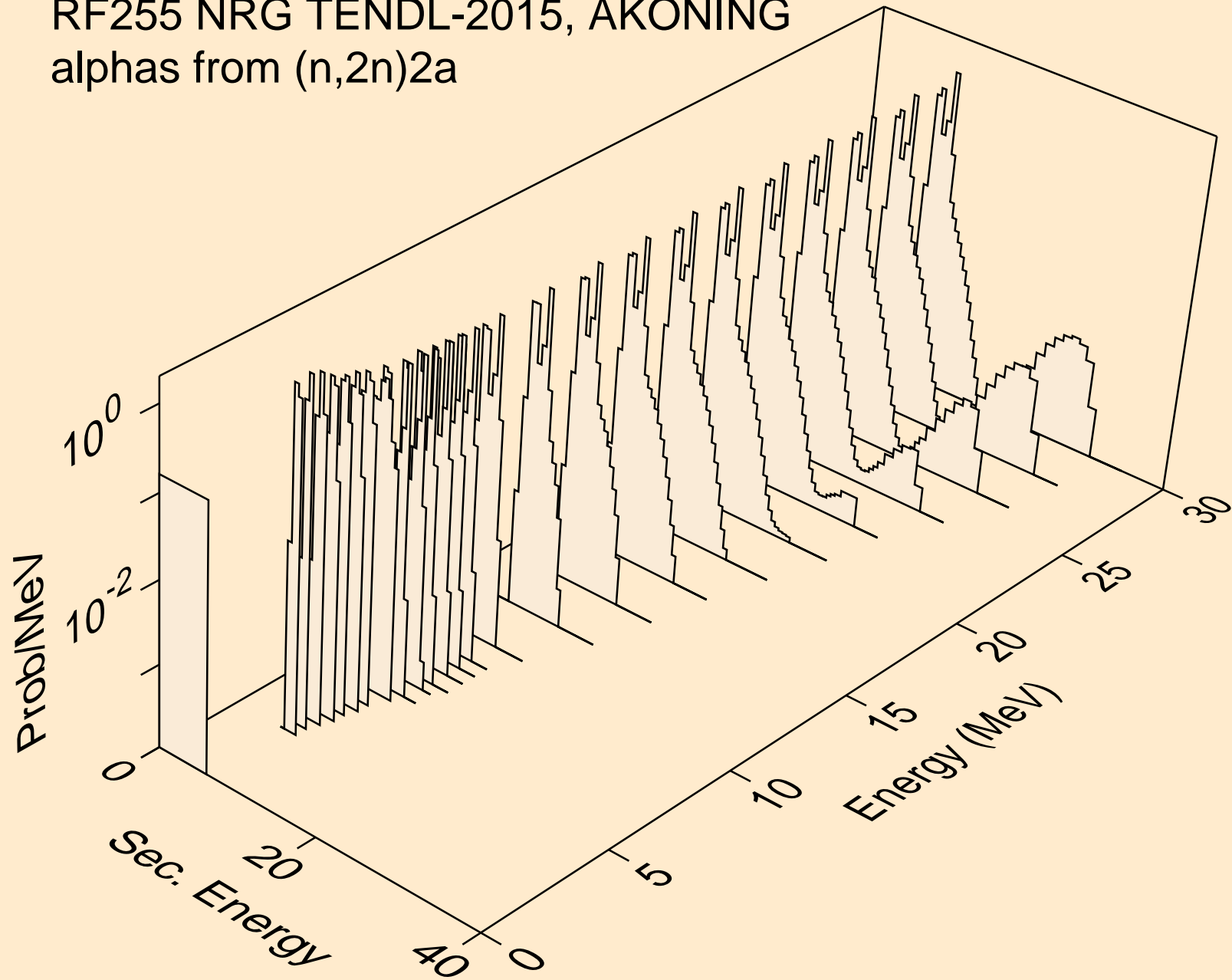

RF255 NRG TENDL-2015, AKONING
alphas from (n,n*)d2a

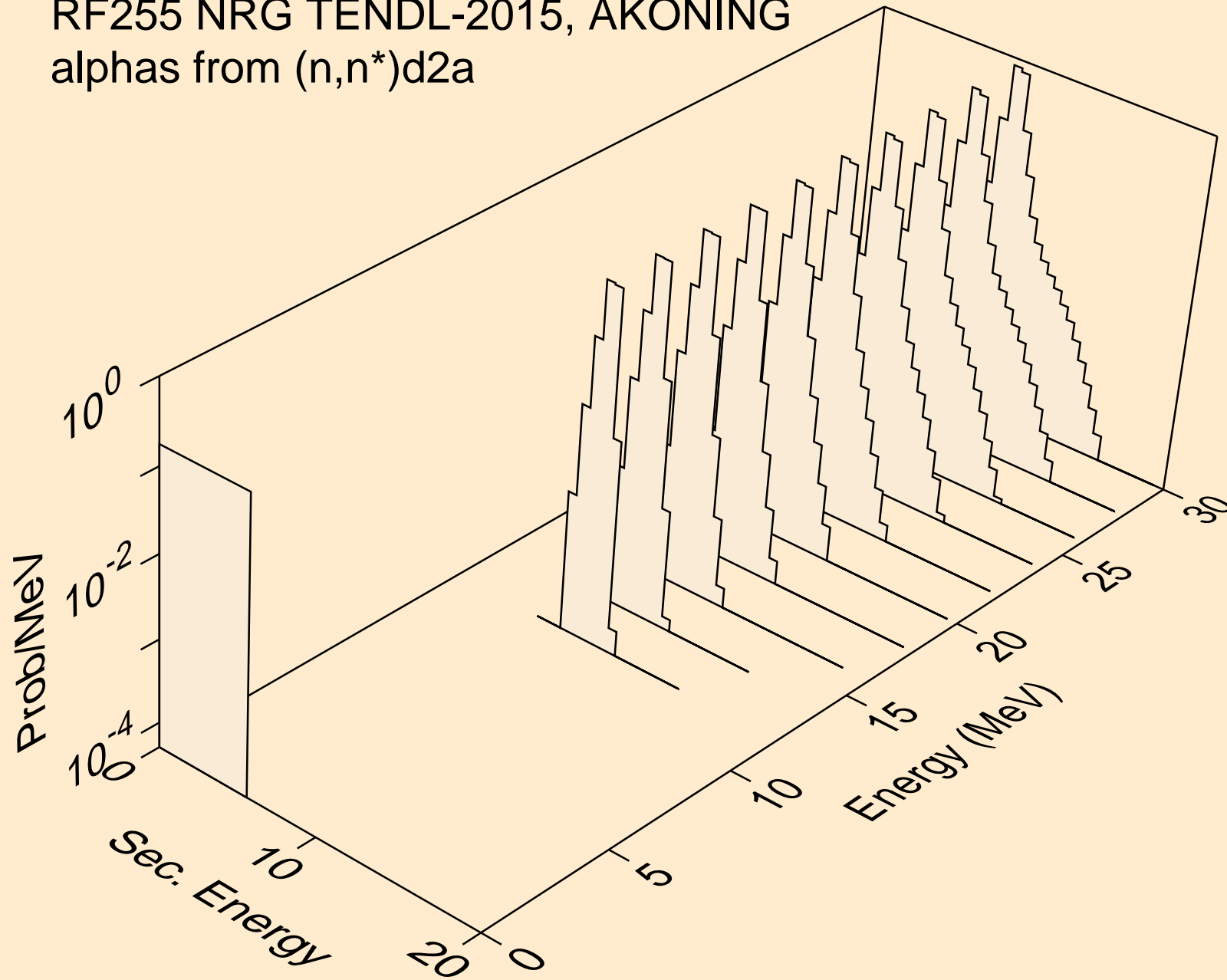

RF255 NRG TENDL-2015, AKONING
alphas from (n,n*)t2a

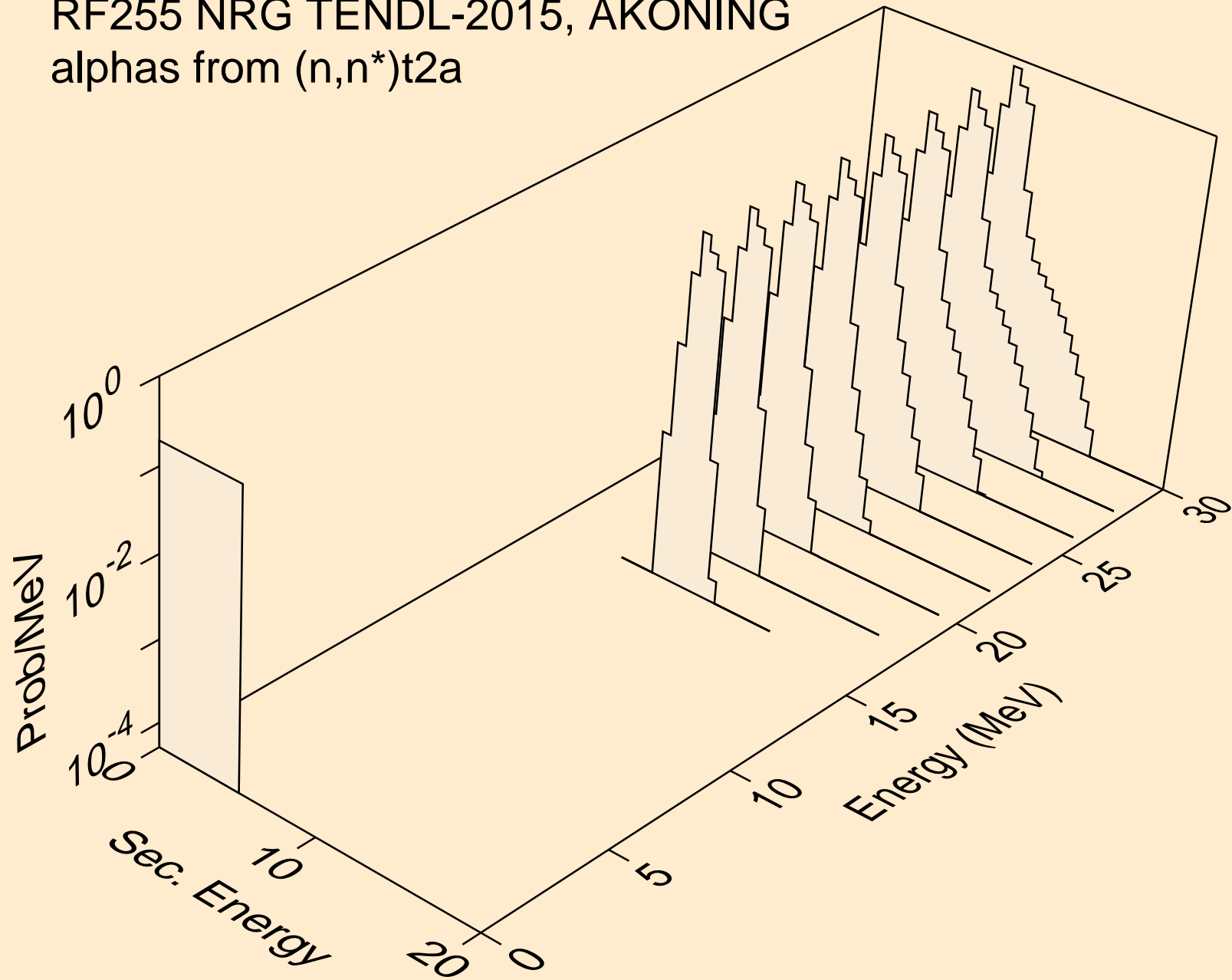

RF255 NRG TENDL-2015, AKONING
alphas from (n,npa)

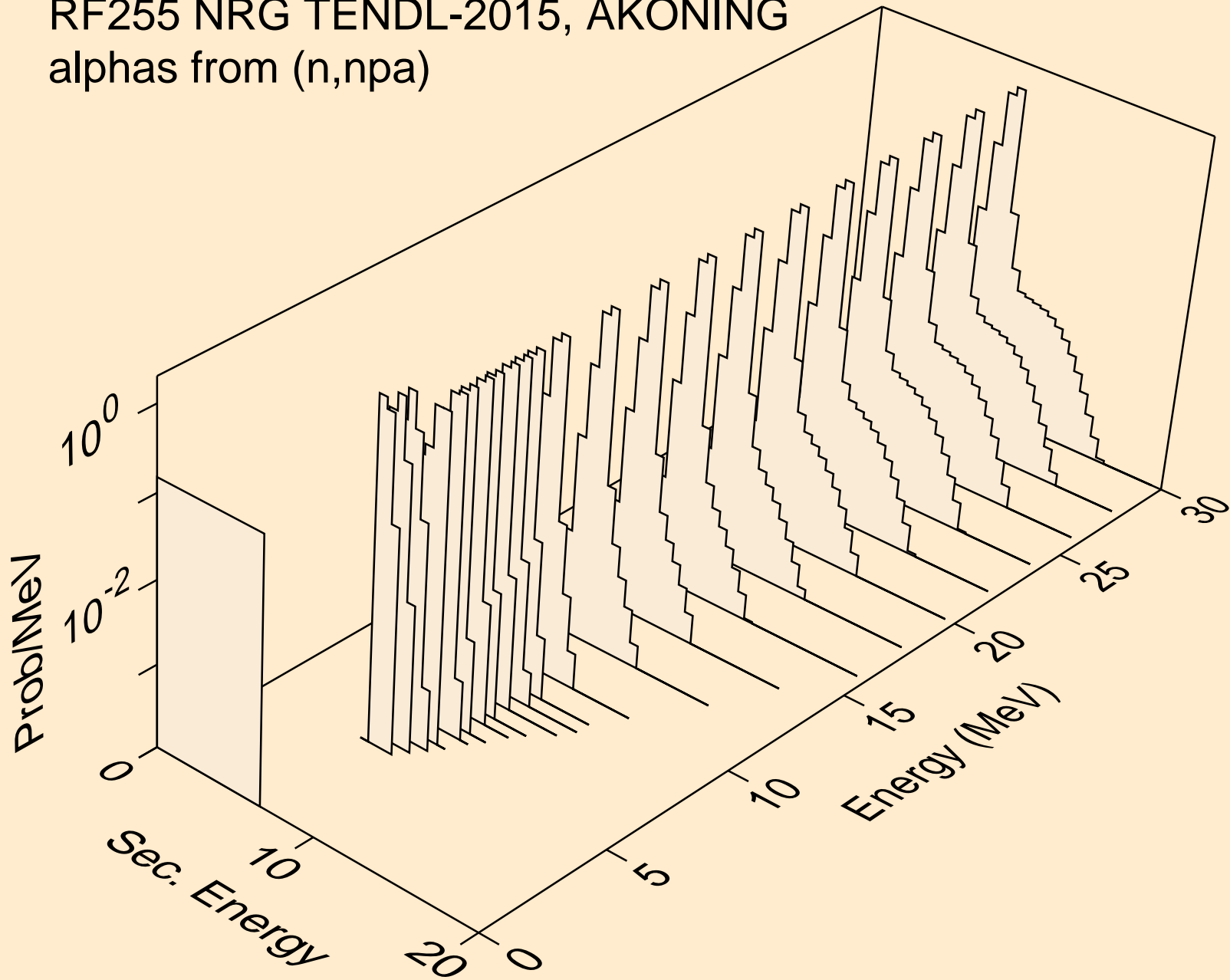

RF255 NRG TENDL-2015, AKONING
alphas from (n,a)

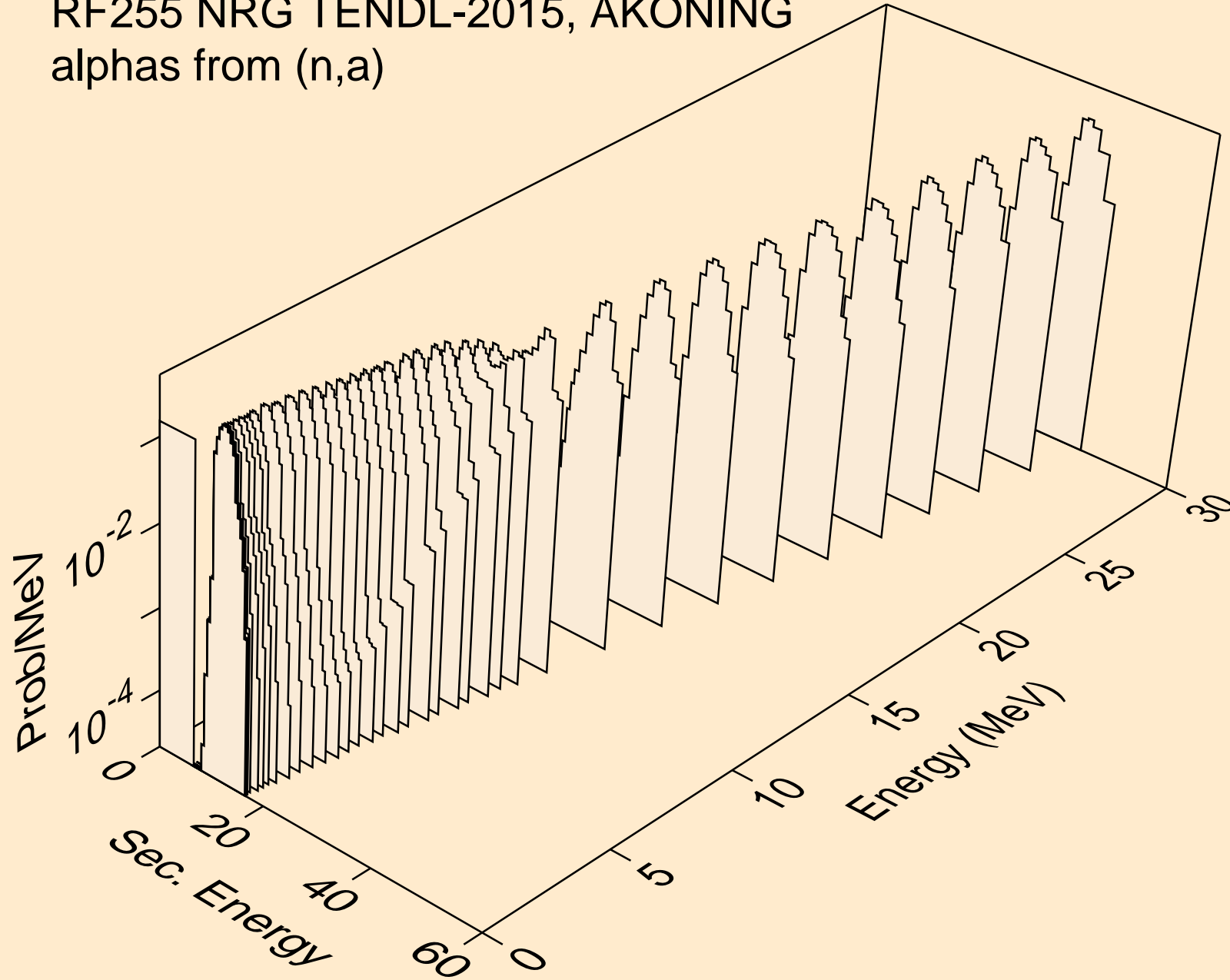

RF255 NRG TENDL-2015, AKONING
alphas from (n,2a)

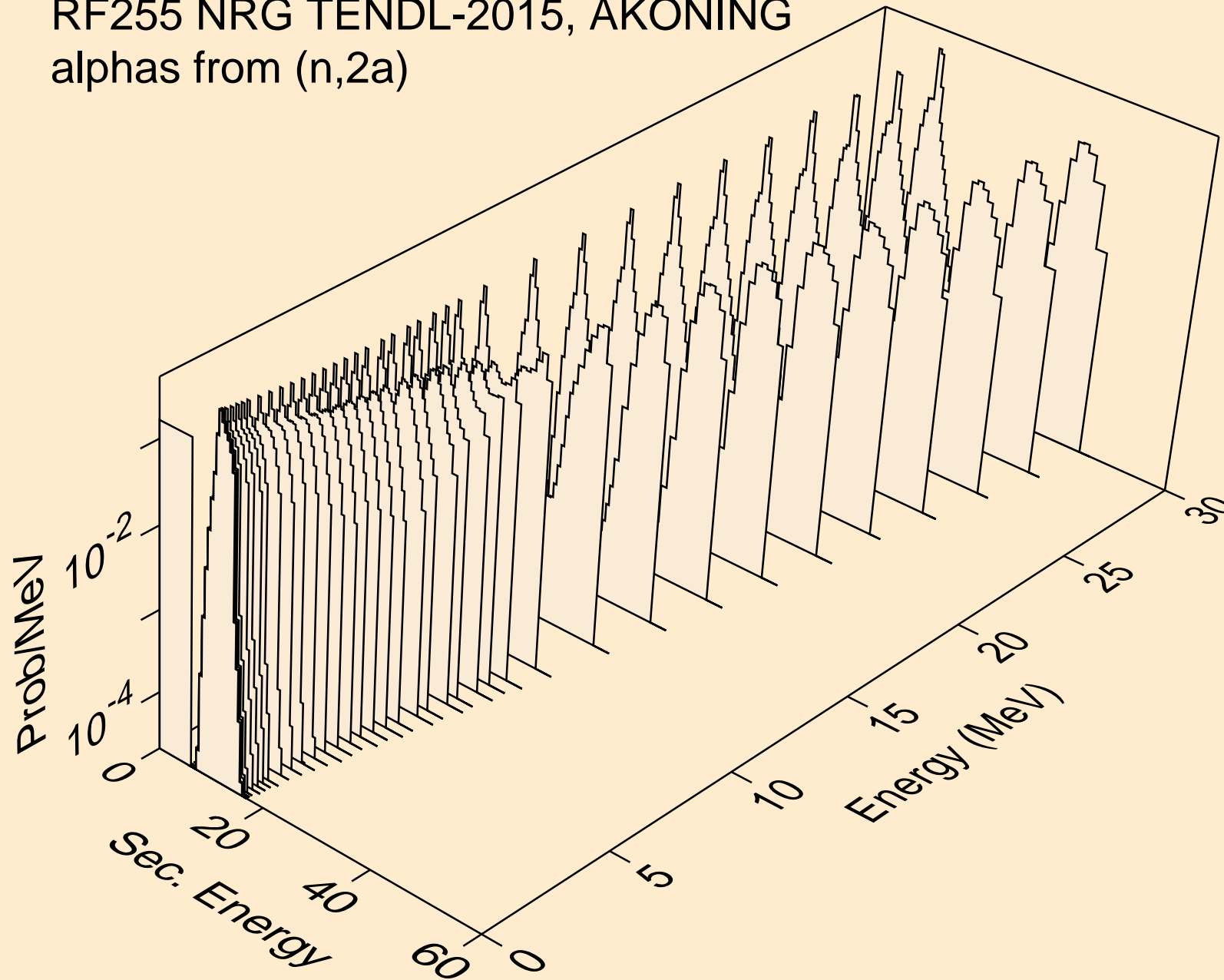

RF255 NRG TENDL-2015, AKONING
alphas from (n,3a)

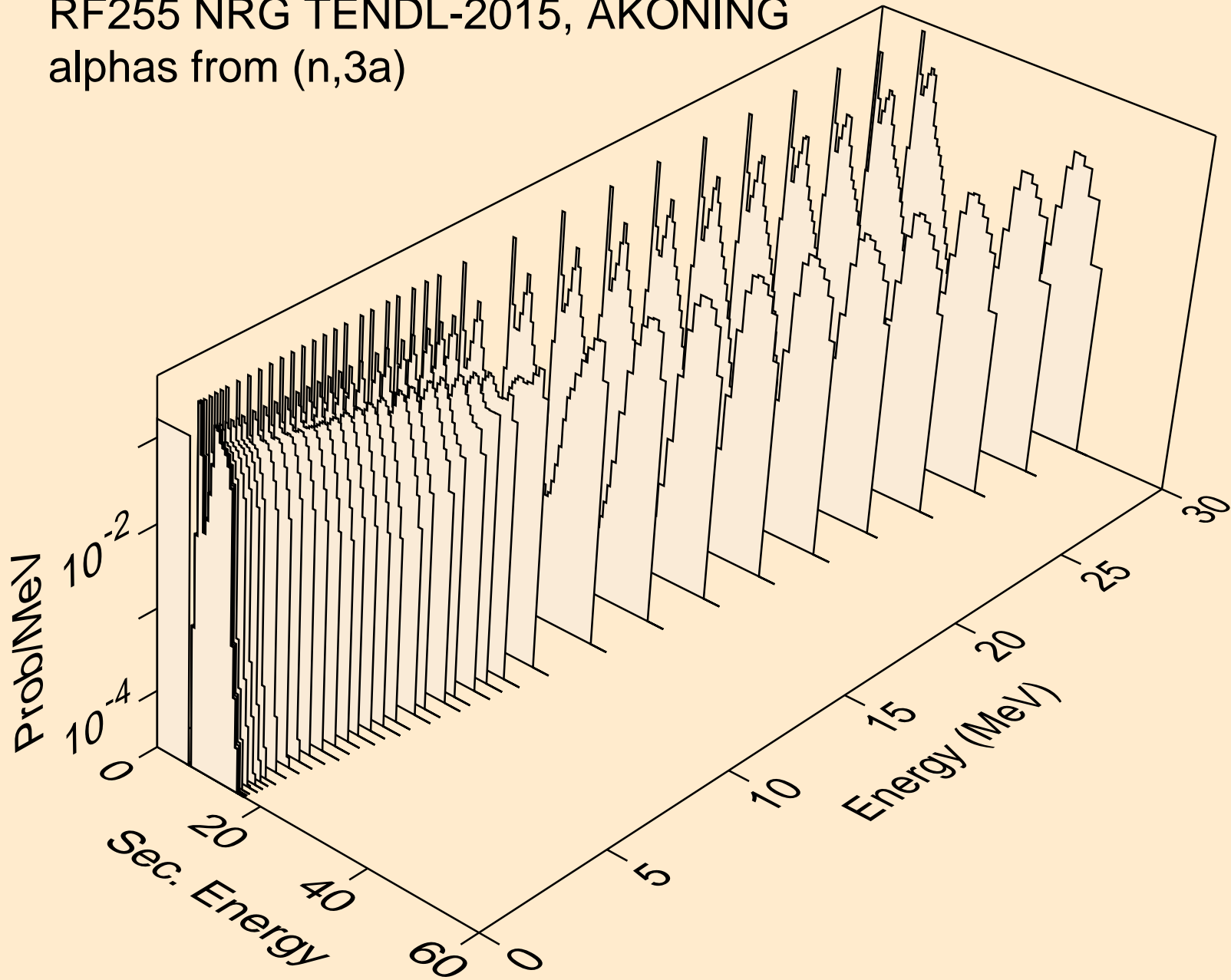

RF255 NRG TENDL-2015, AKONING
alphas from (n,pa)

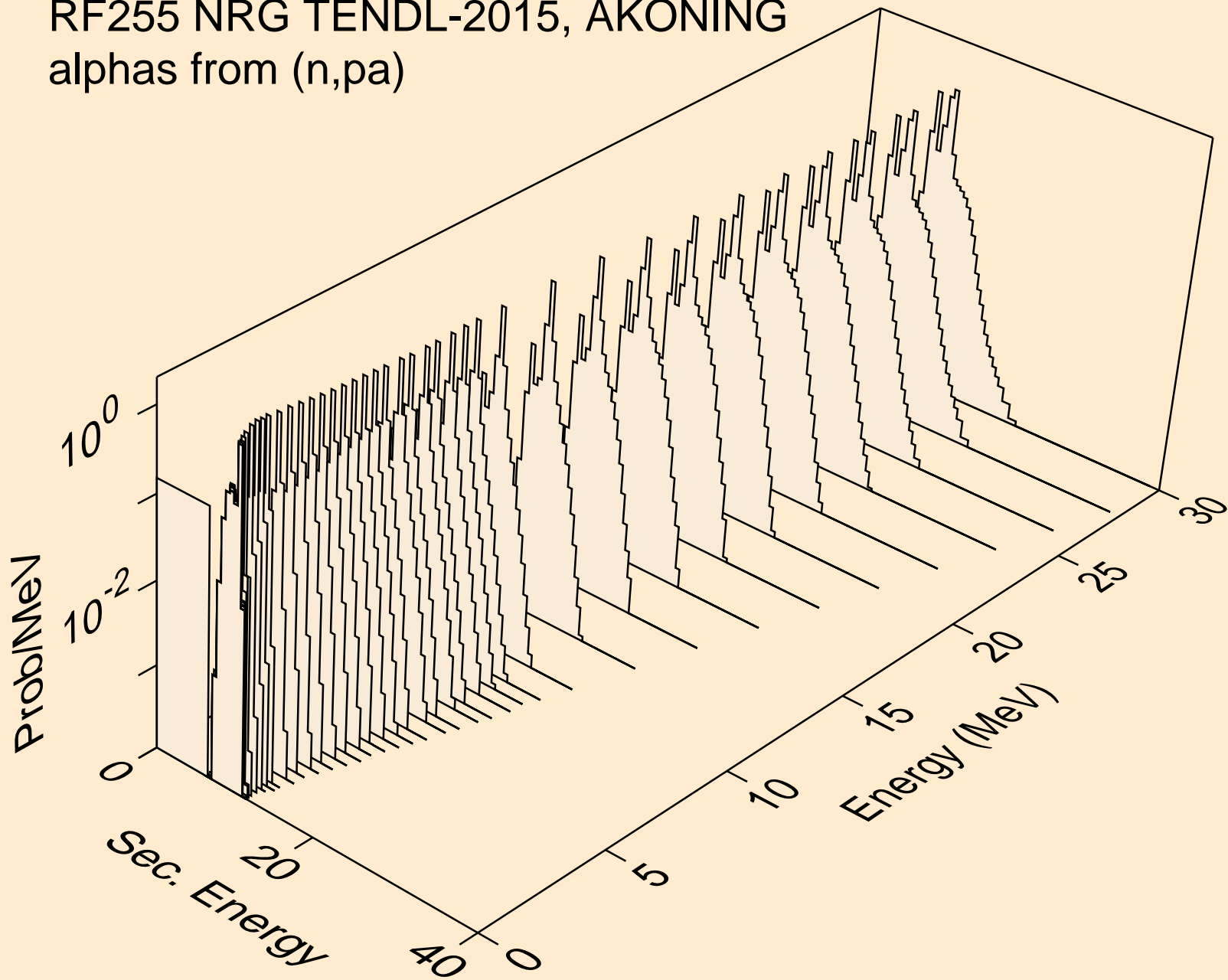

RF255 NRG TENDL-2015, AKONING
alphas from (n,t2a)

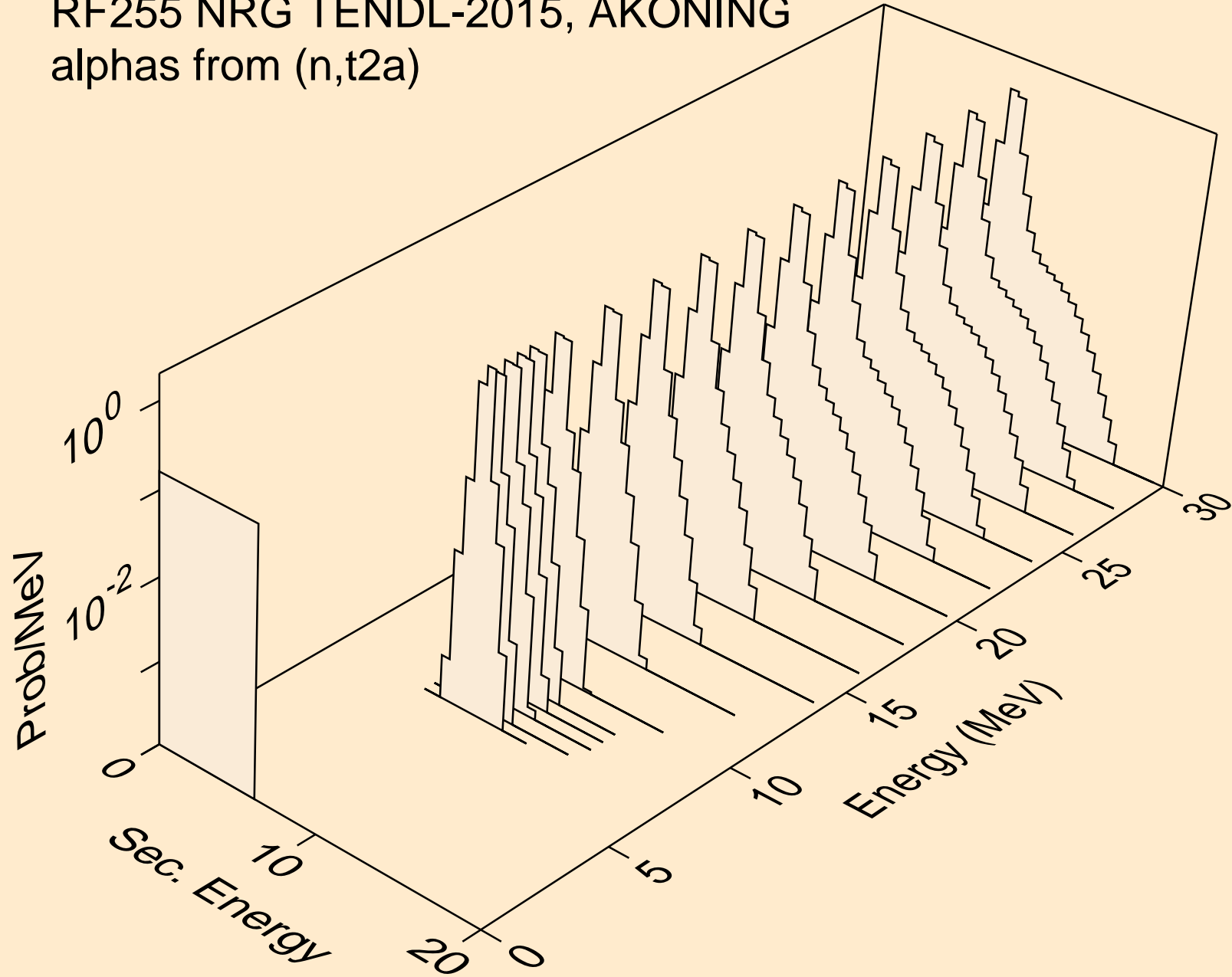

RF255 NRG TENDL-2015, AKONING
alphas from (n,d2a)

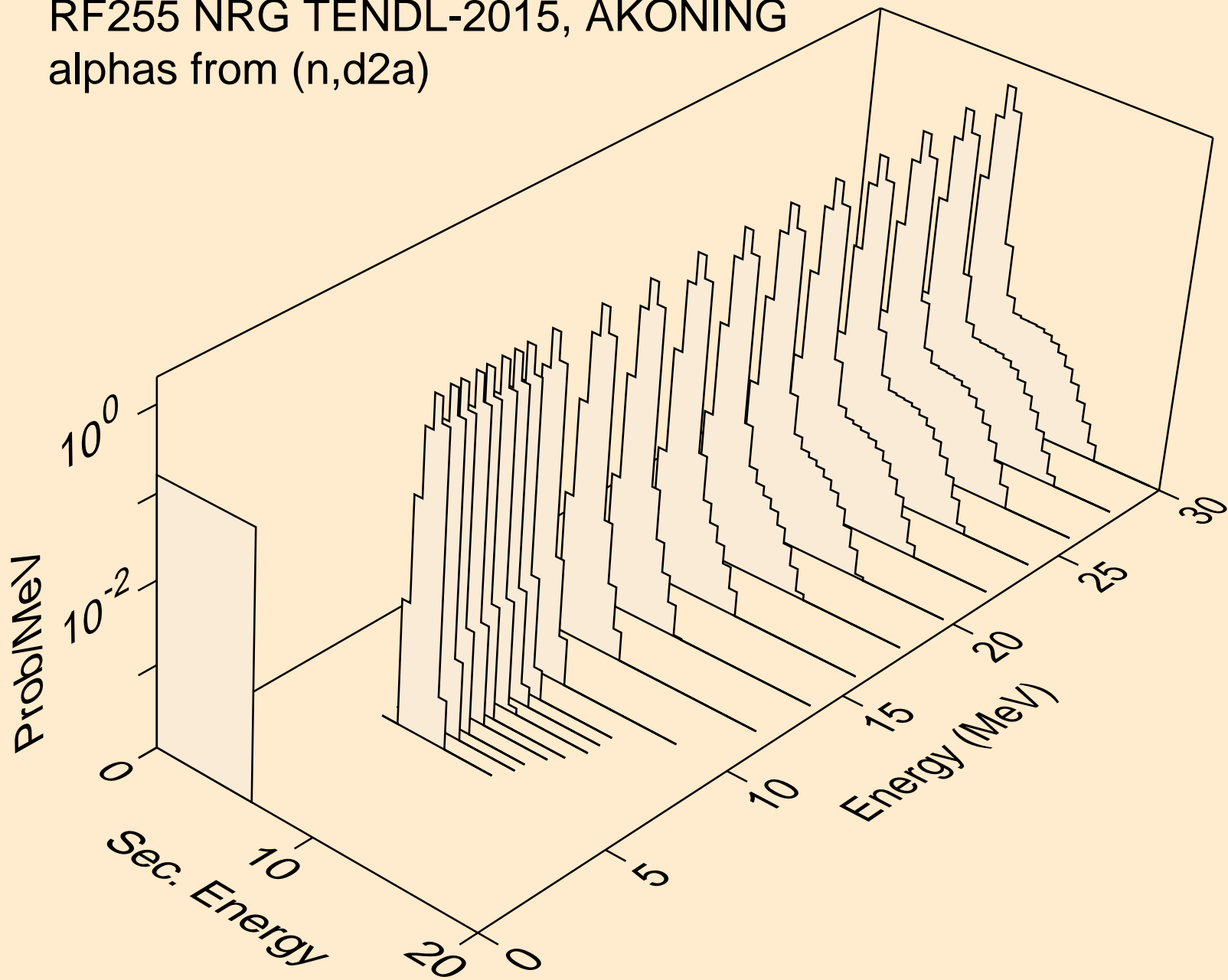

RF255 NRG TENDL-2015, AKONING
alphas from (n,da)

