

RF264 NRG TENDL-2015, AKONING

Principal cross sections

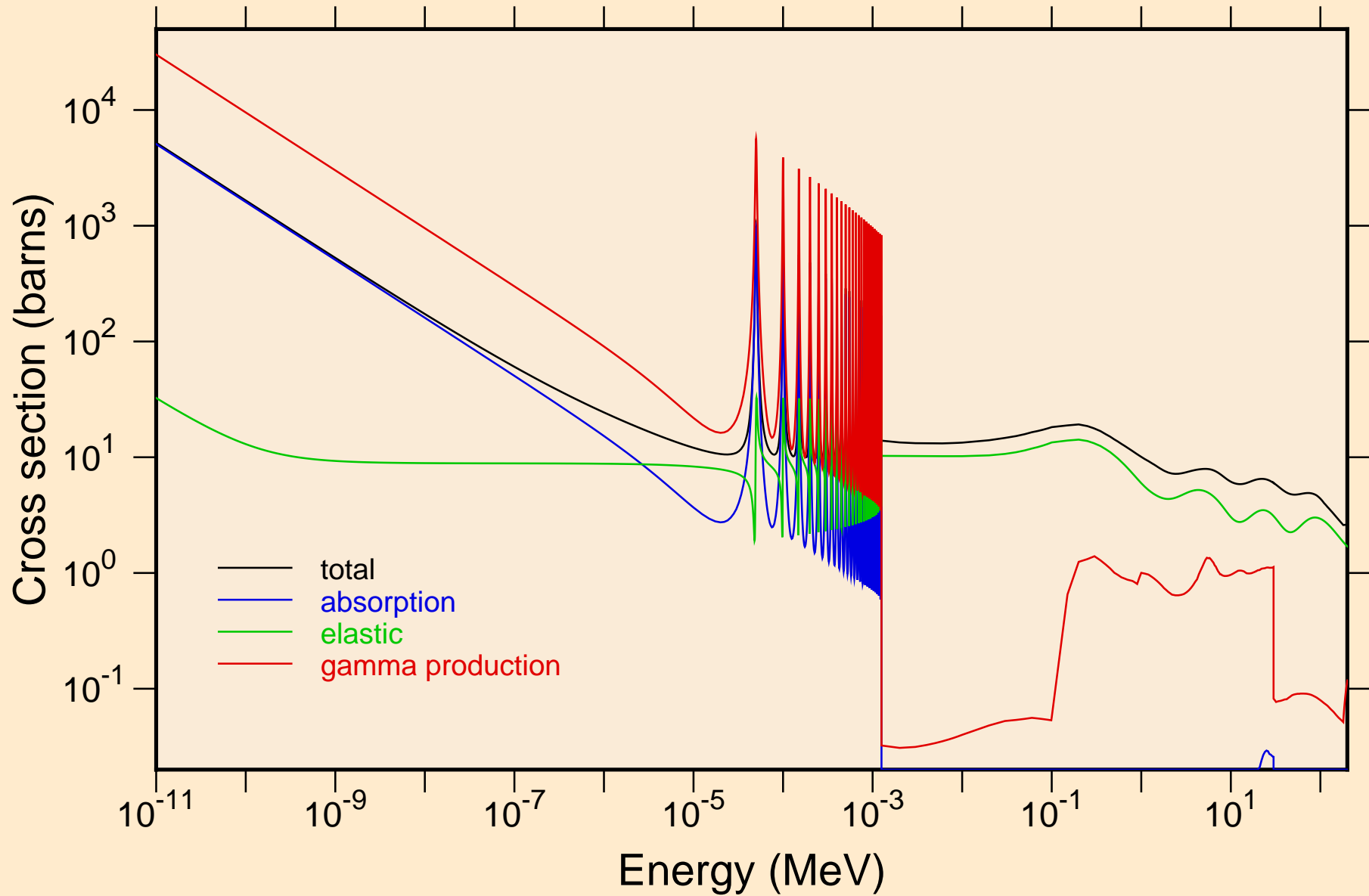

RF264 NRG TENDL-2015, AKONING
resonance total cross section

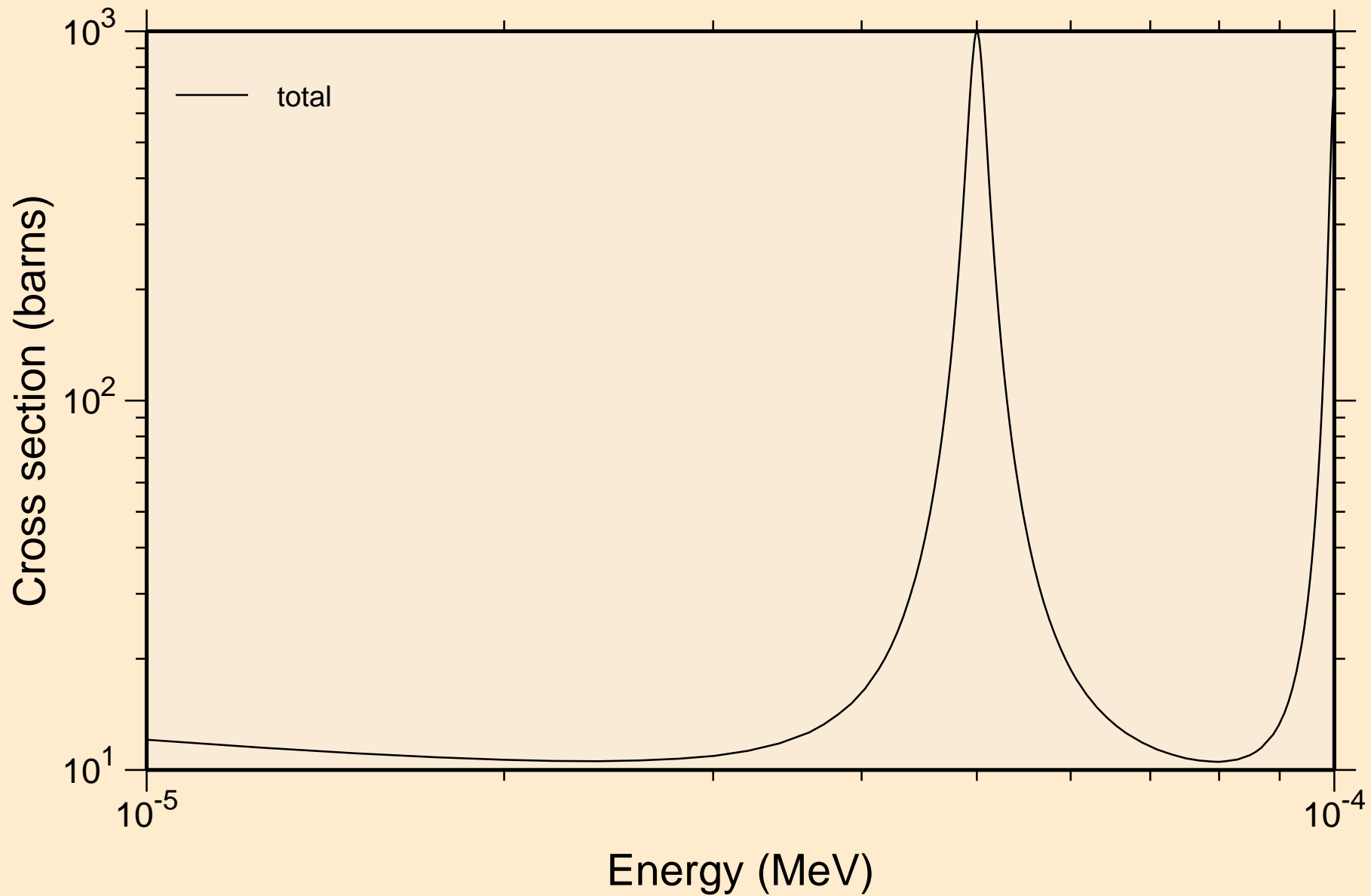

RF264 NRG TENDL-2015, AKONING
resonance total cross section

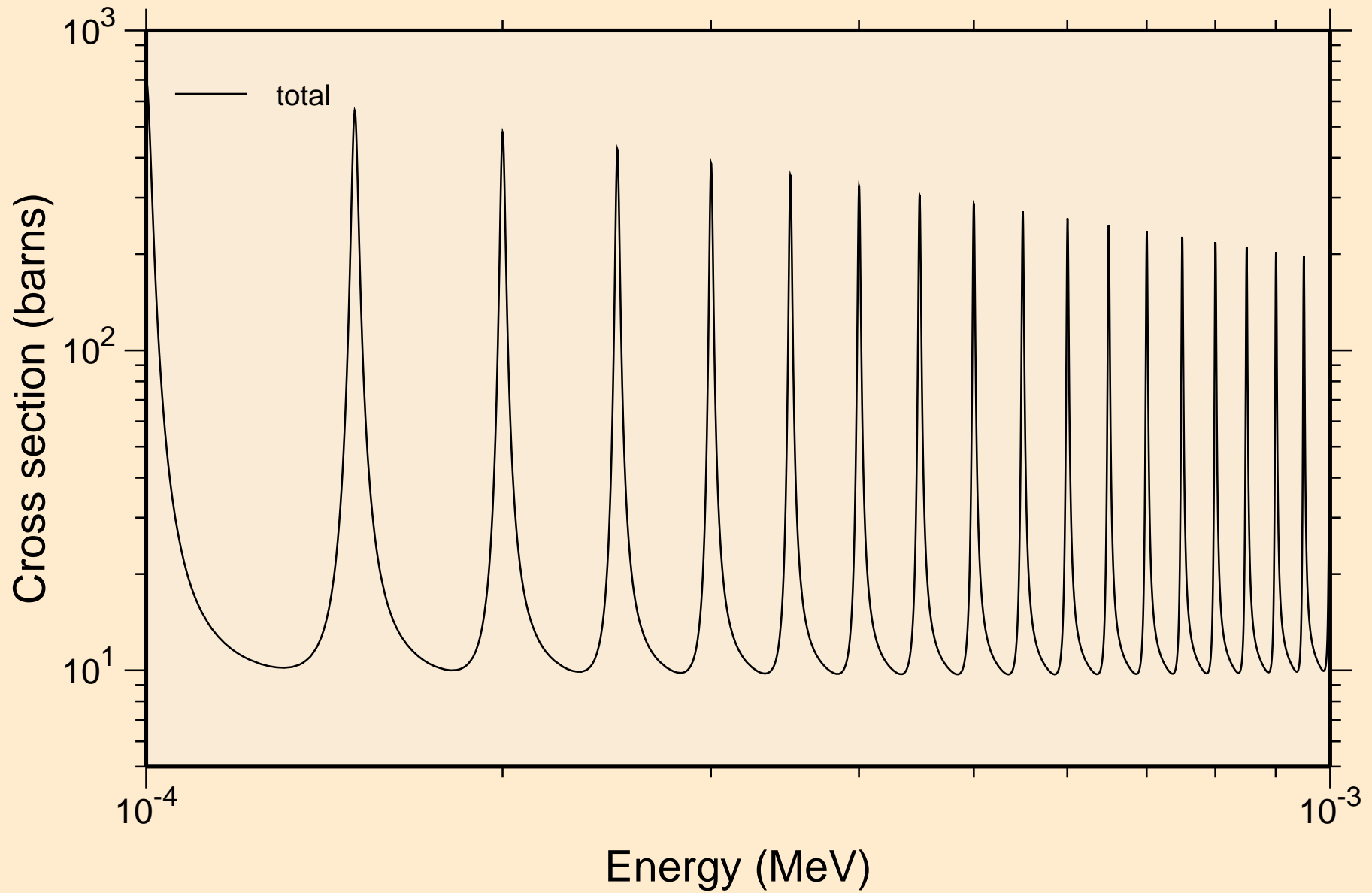

RF264 NRG TENDL-2015, AKONING
resonance total cross section

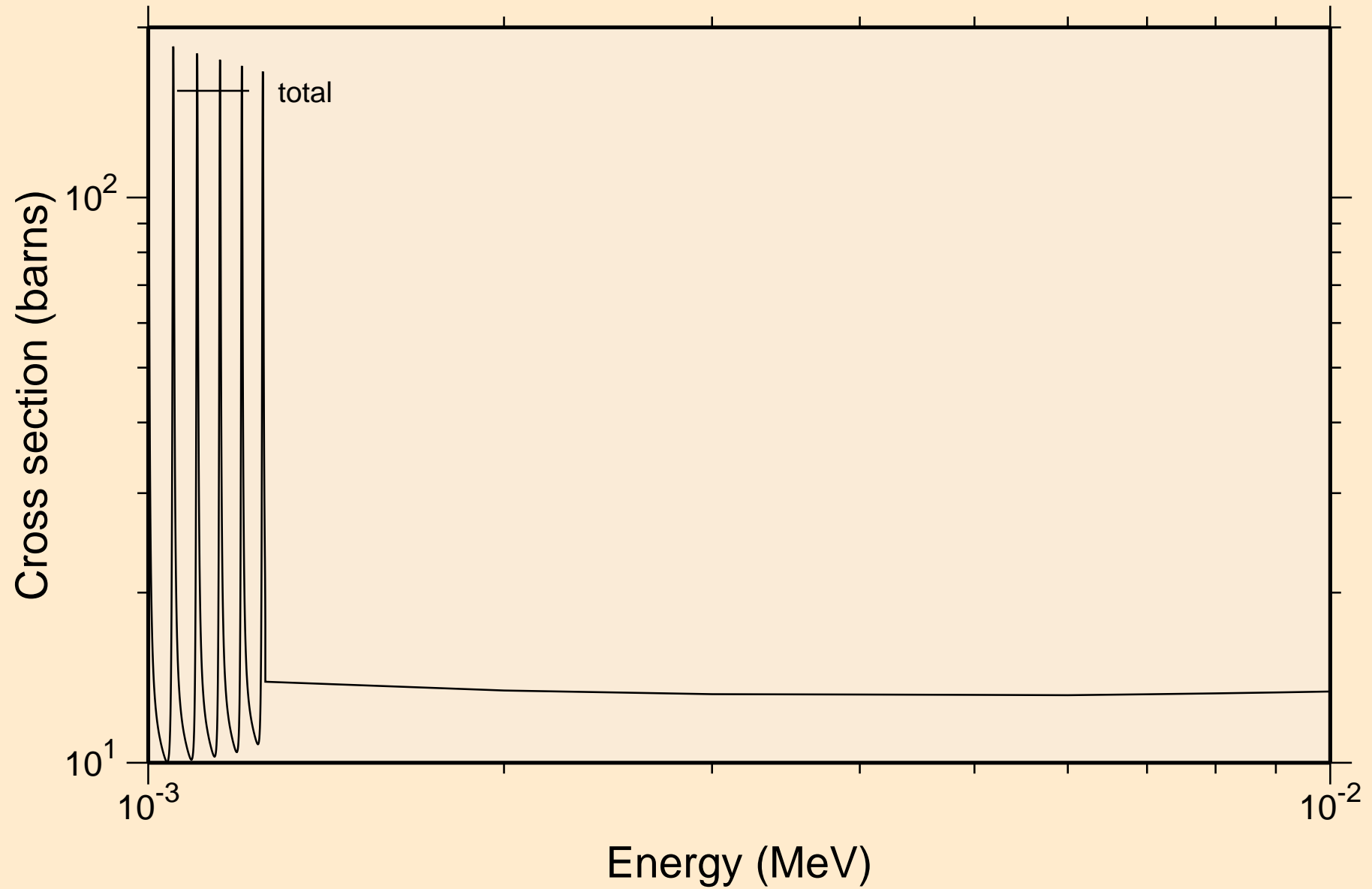

RF264 NRG TENDL-2015, AKONING
resonance total cross section

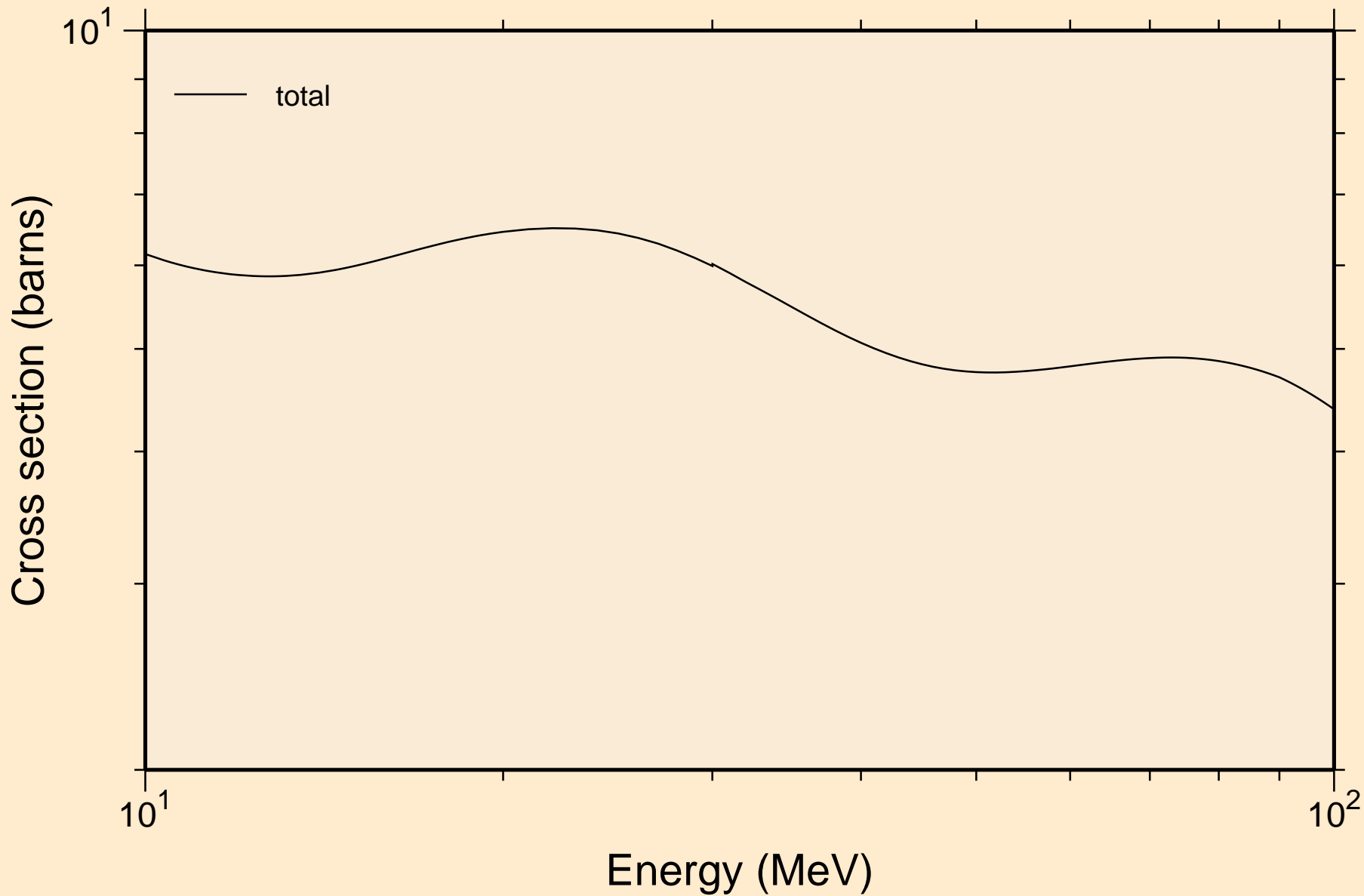

RF264 NRG TENDL-2015, AKONING
resonance absorption cross sections

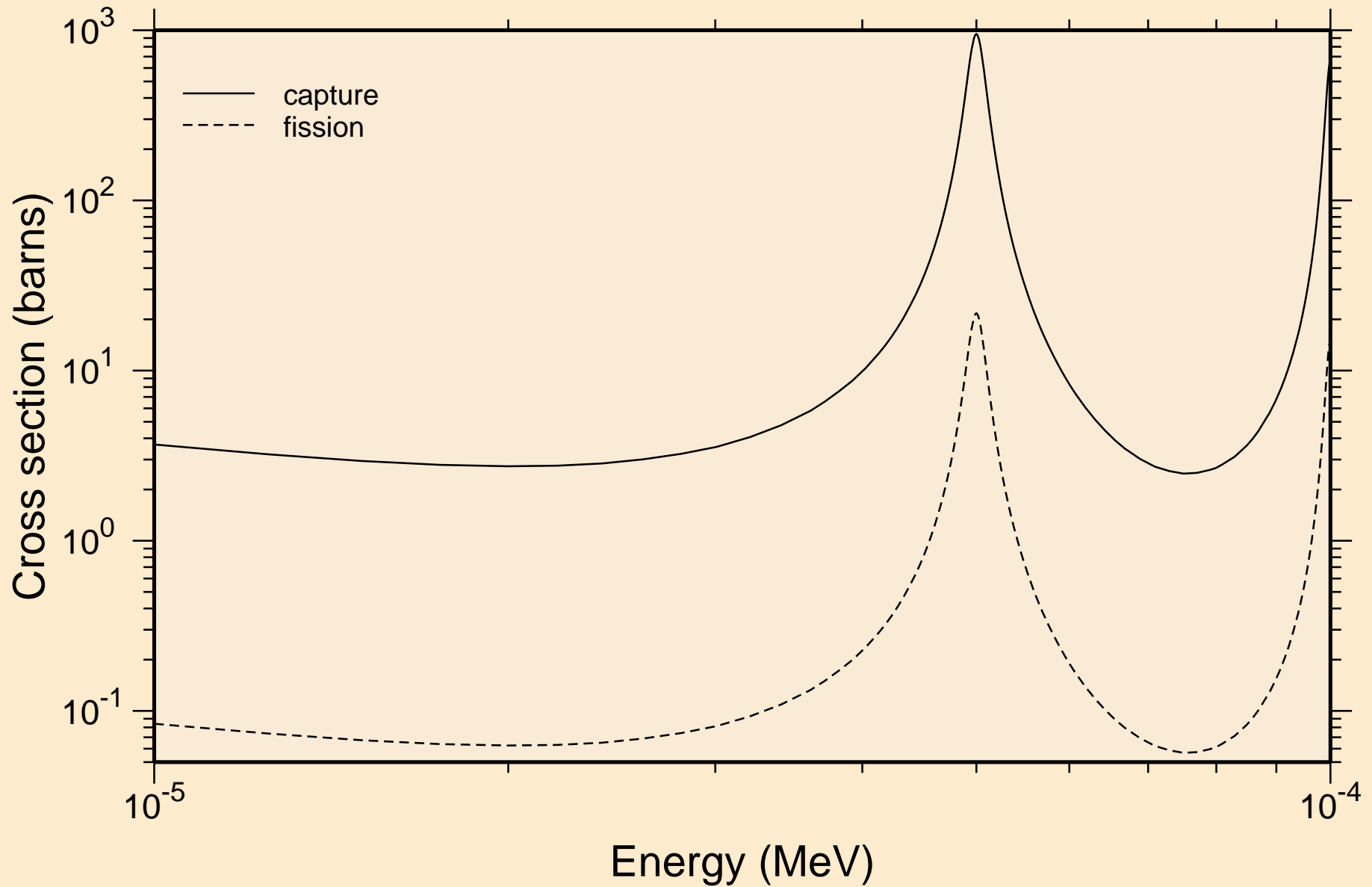

RF264 NRG TENDL-2015, AKONING

resonance absorption cross sections

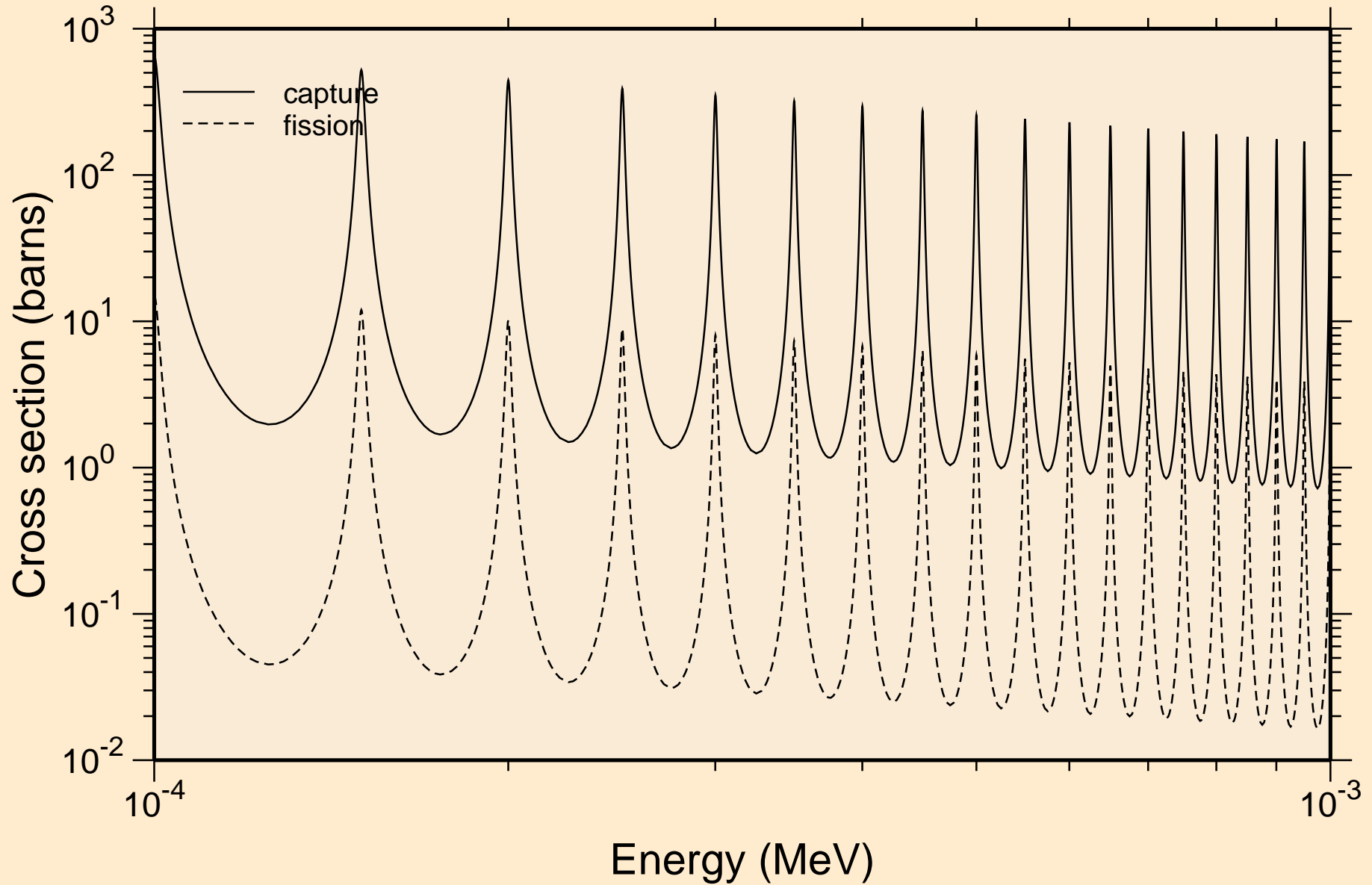

RF264 NRG TENDL-2015, AKONING resonance absorption cross sections

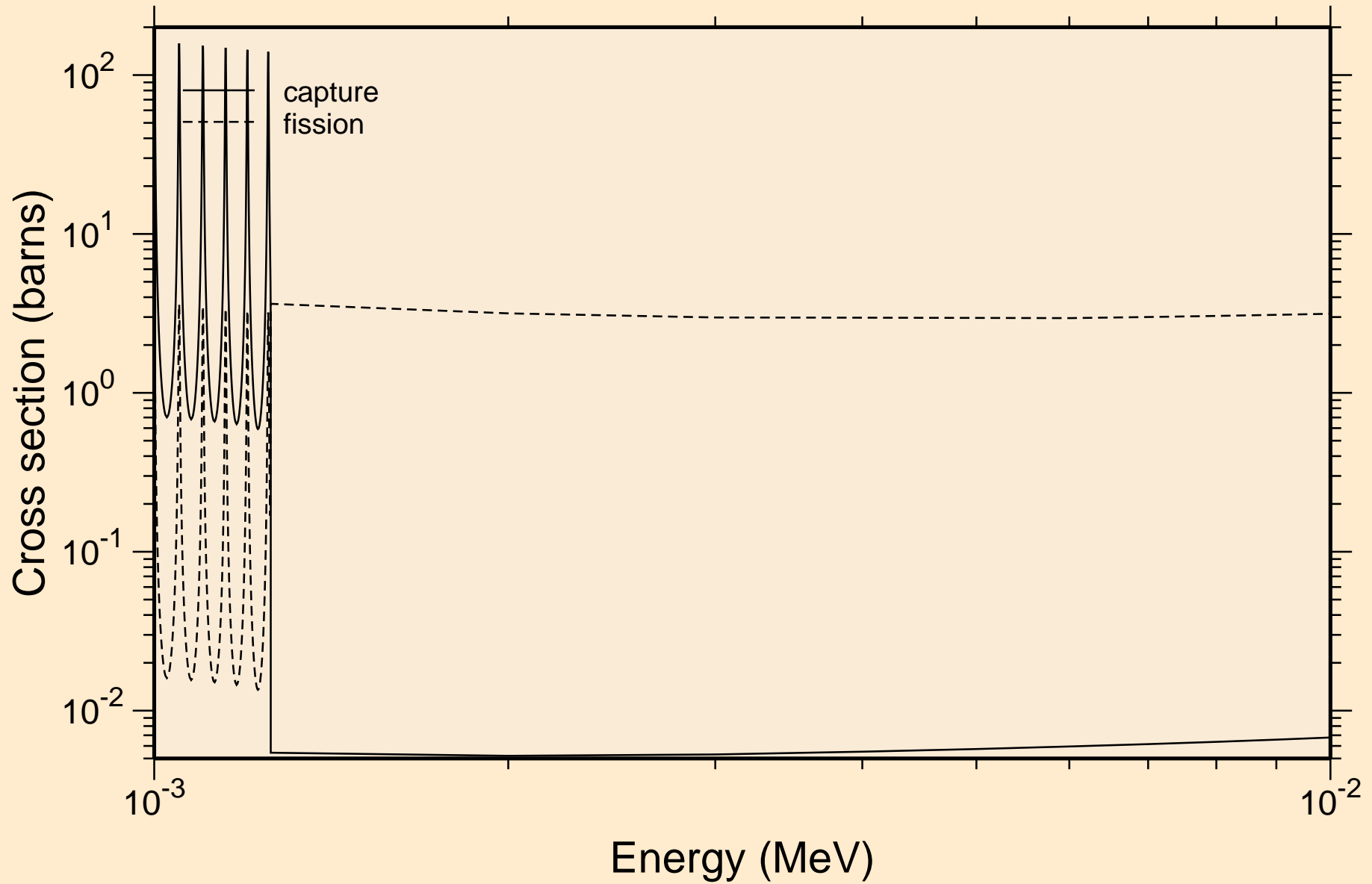

RF264 NRG TENDL-2015, AKONING
resonance absorption cross sections

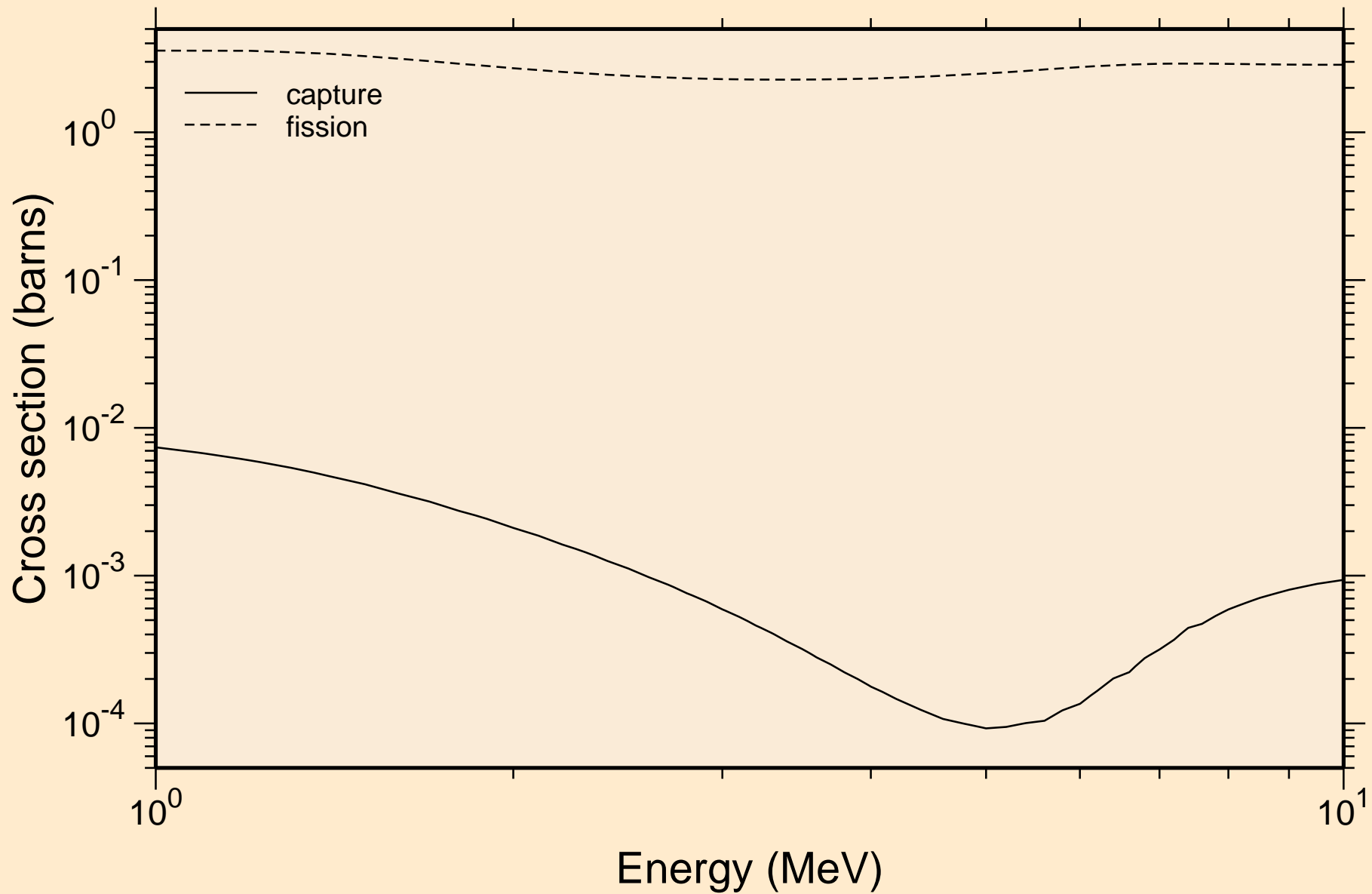

RF264 NRG TENDL-2015, AKONING

Non-threshold reactions

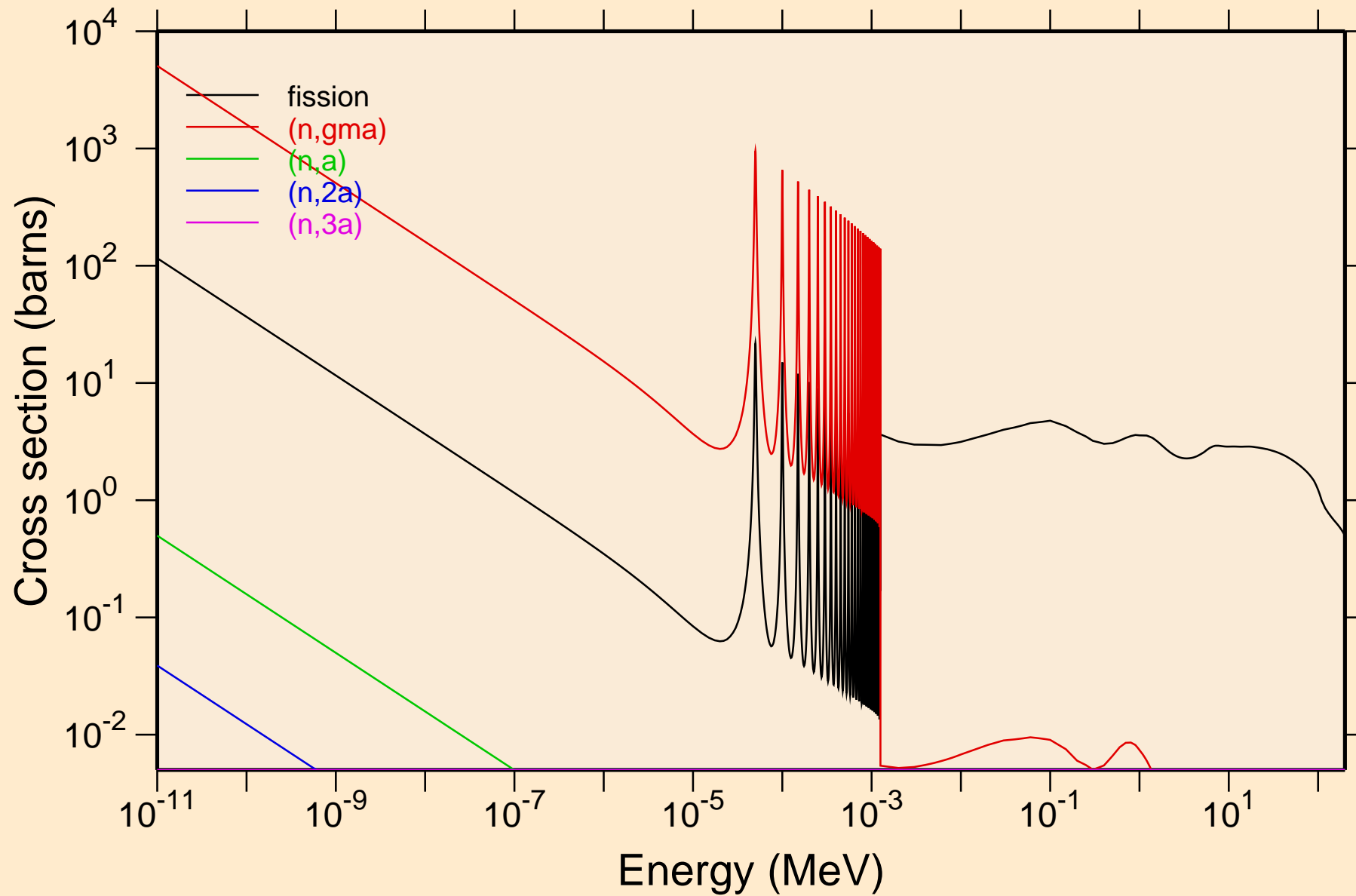

RF264 NRG TENDL-2015, AKONING

Principal cross sections

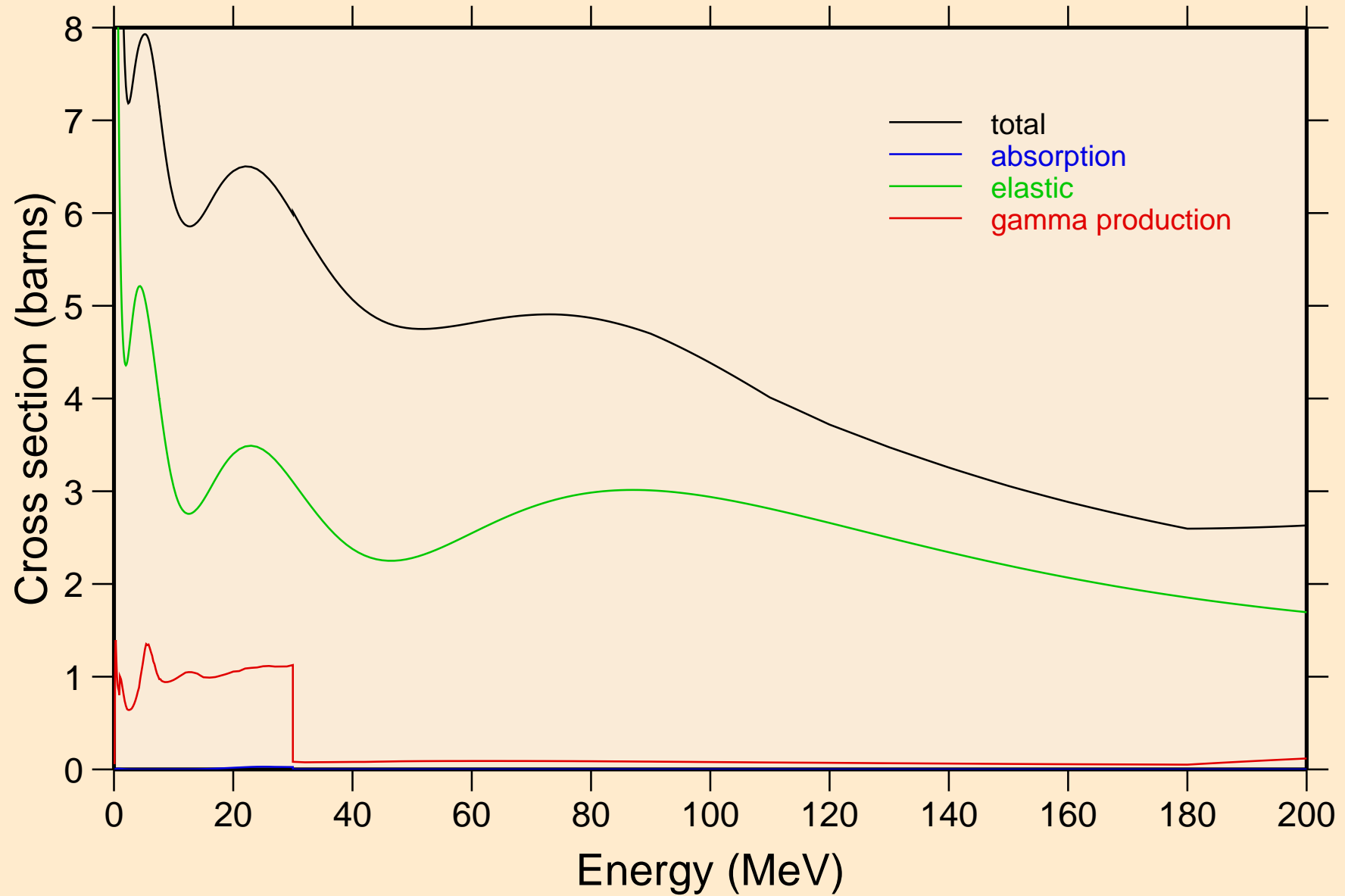

RF264 NRG TENDL-2015, AKONING

Non-threshold reactions

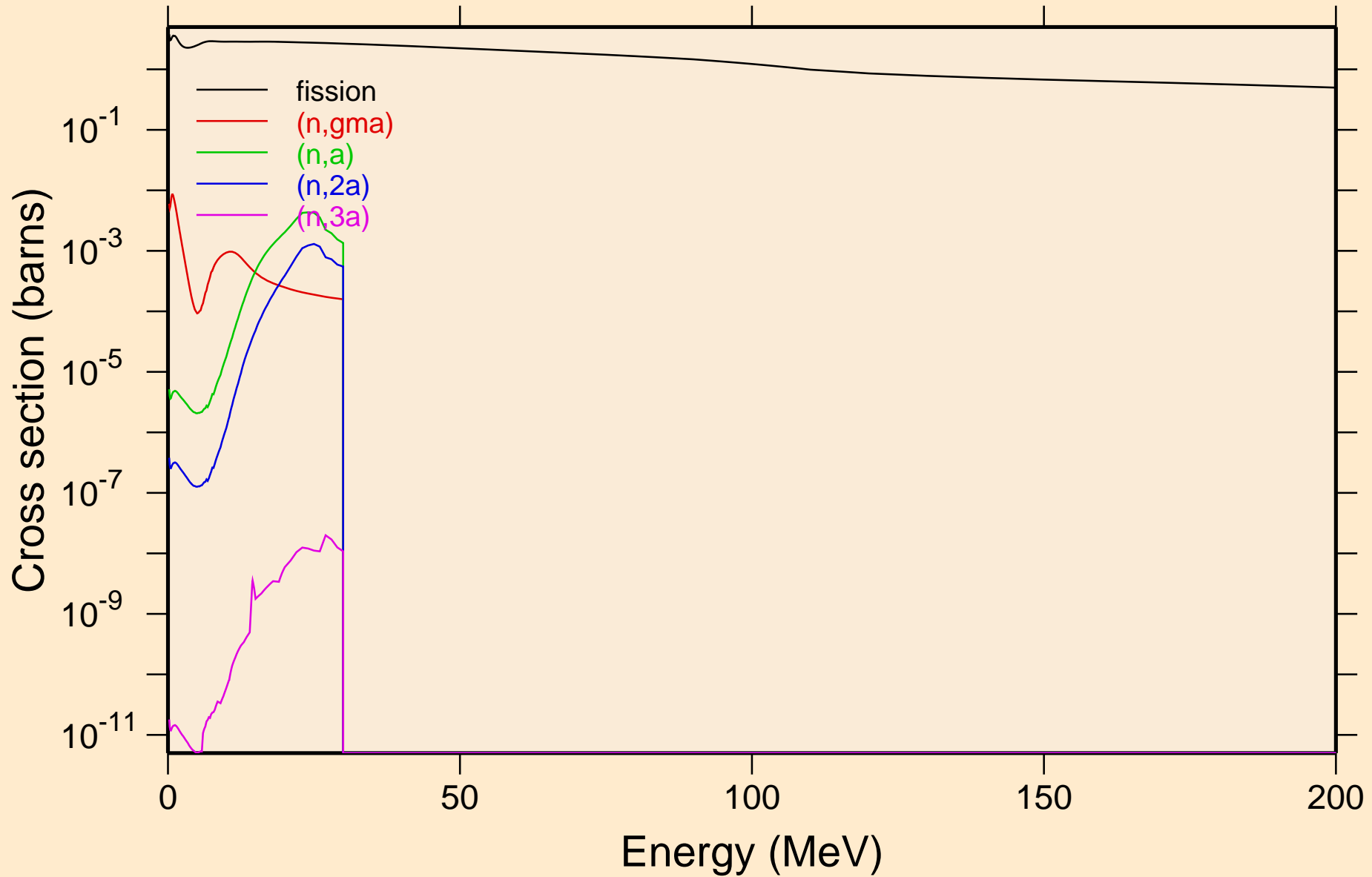

RF264 NRG TENDL-2015, AKONING
Inelastic levels

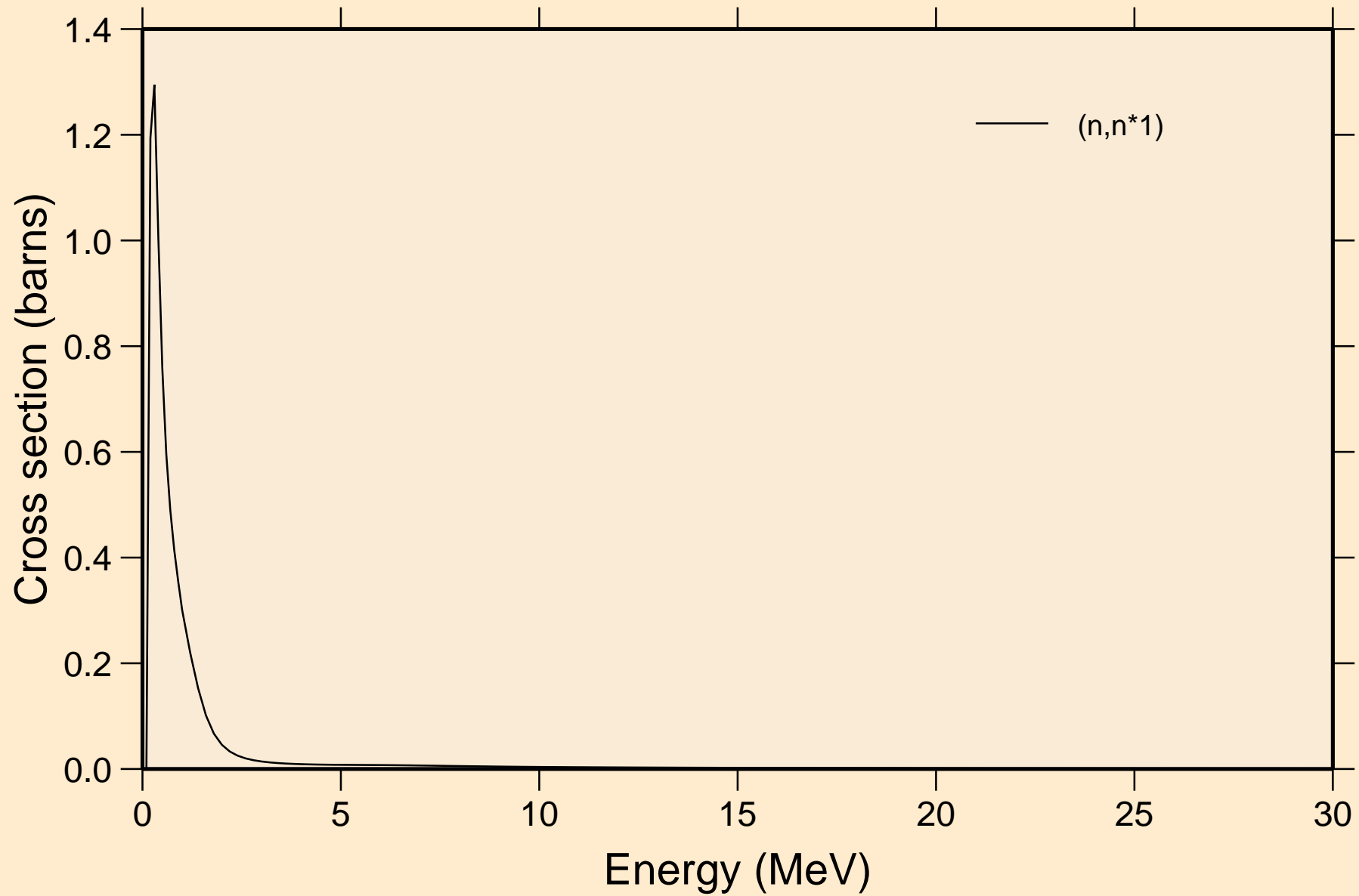

RF264 NRG TENDL-2015, AKONING

Threshold reactions

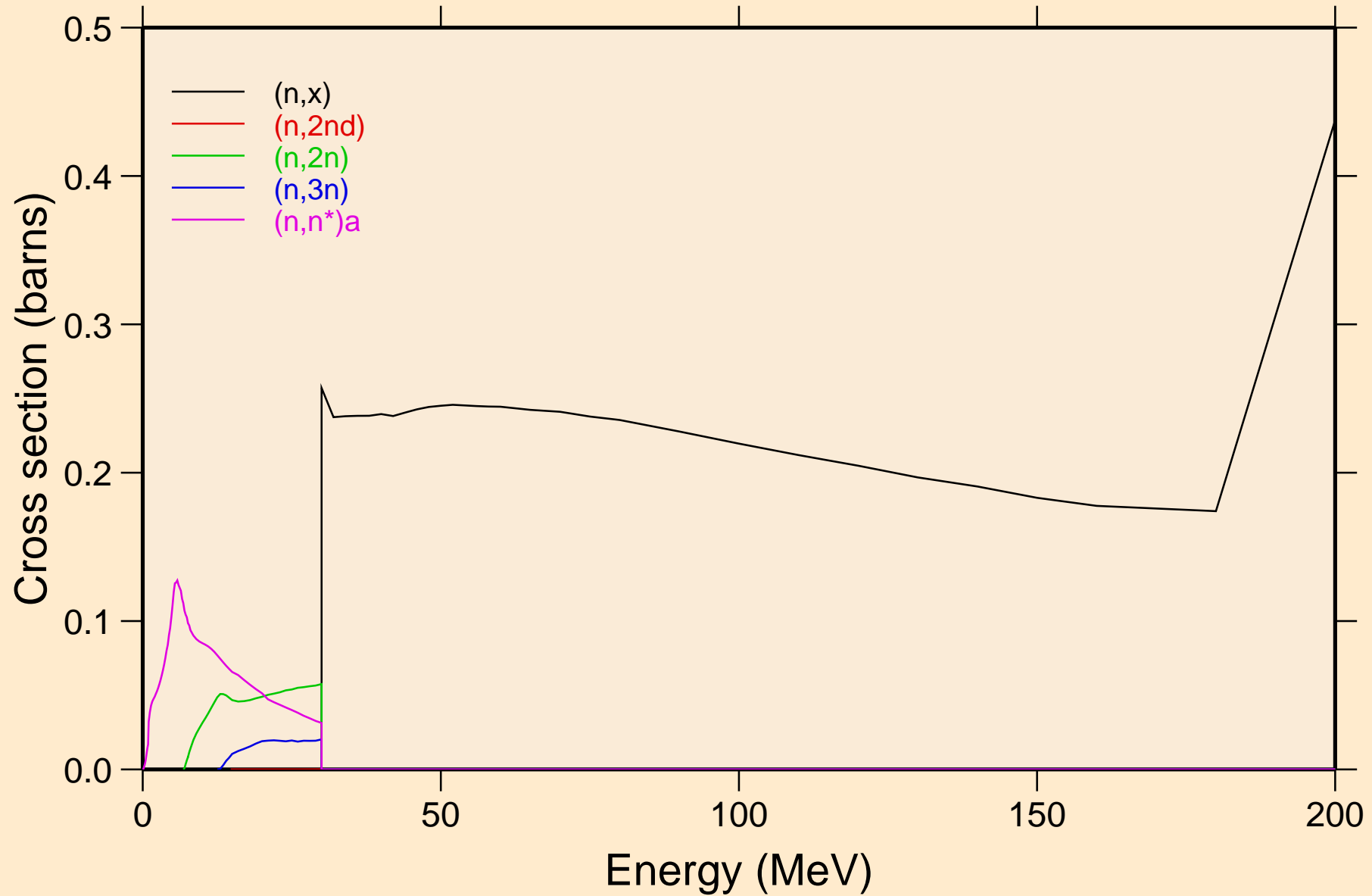

RF264 NRG TENDL-2015, AKONING

Threshold reactions

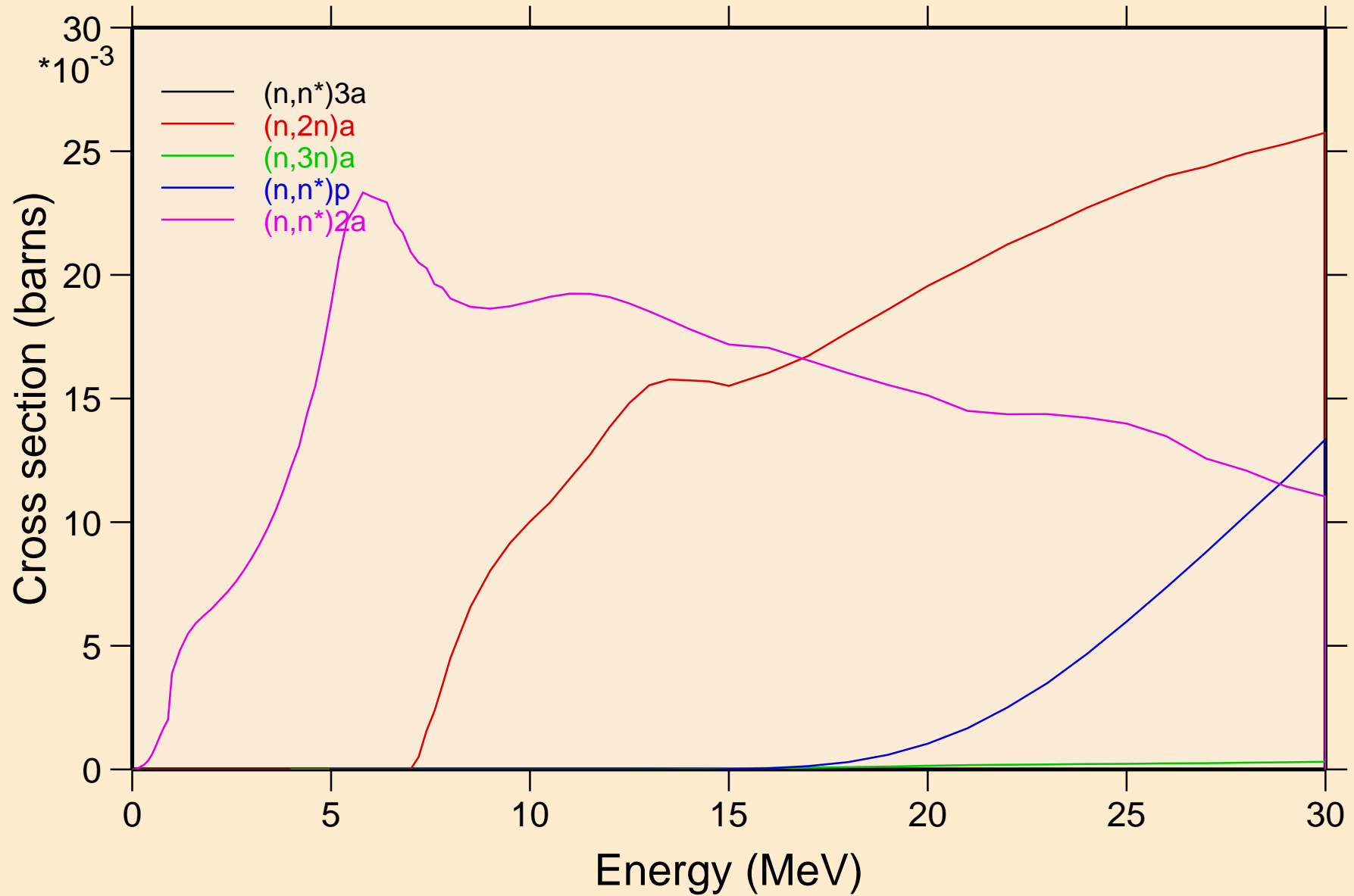

RF264 NRG TENDL-2015, AKONING

Threshold reactions

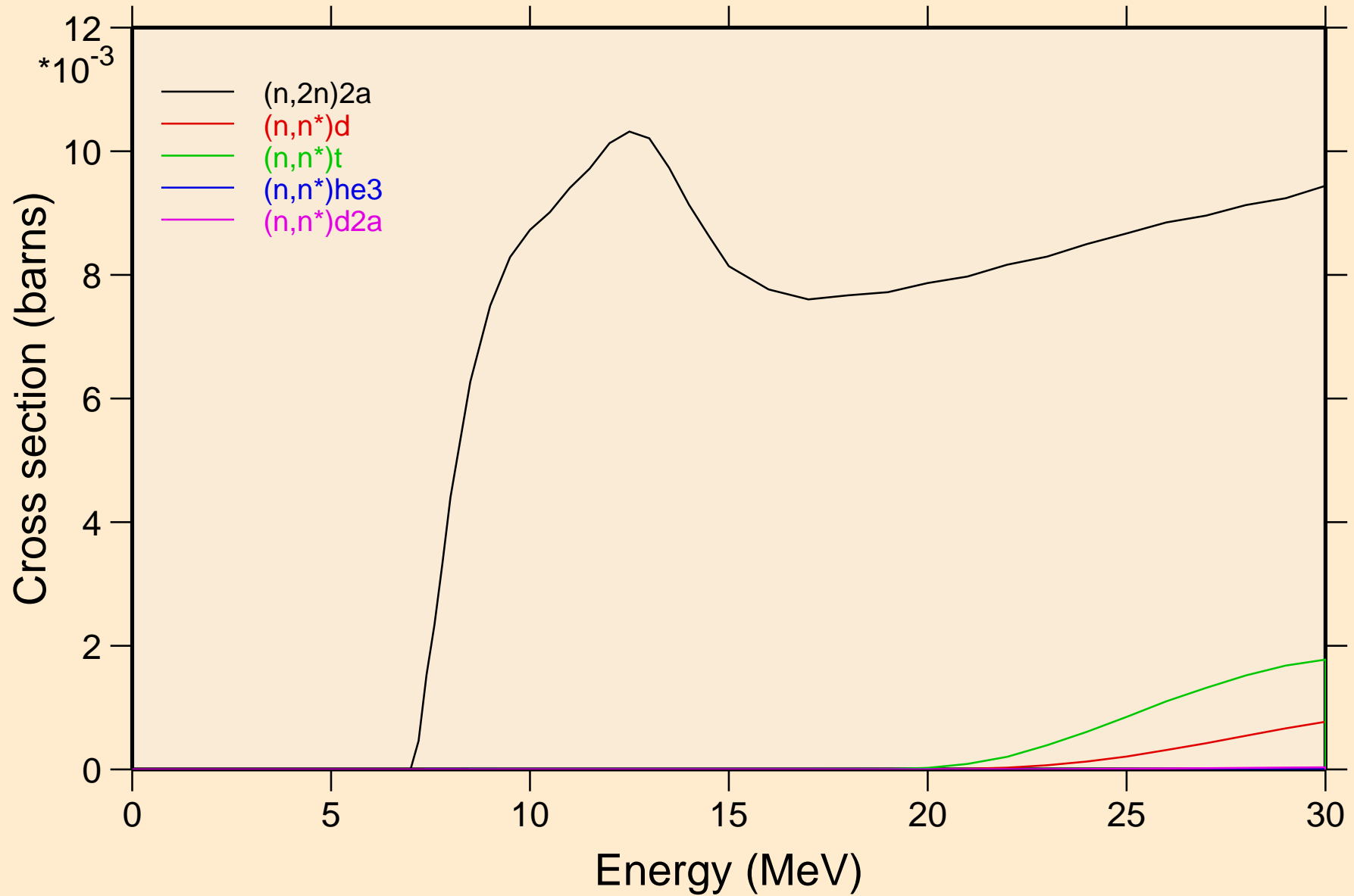

RF264 NRG TENDL-2015, AKONING

Threshold reactions

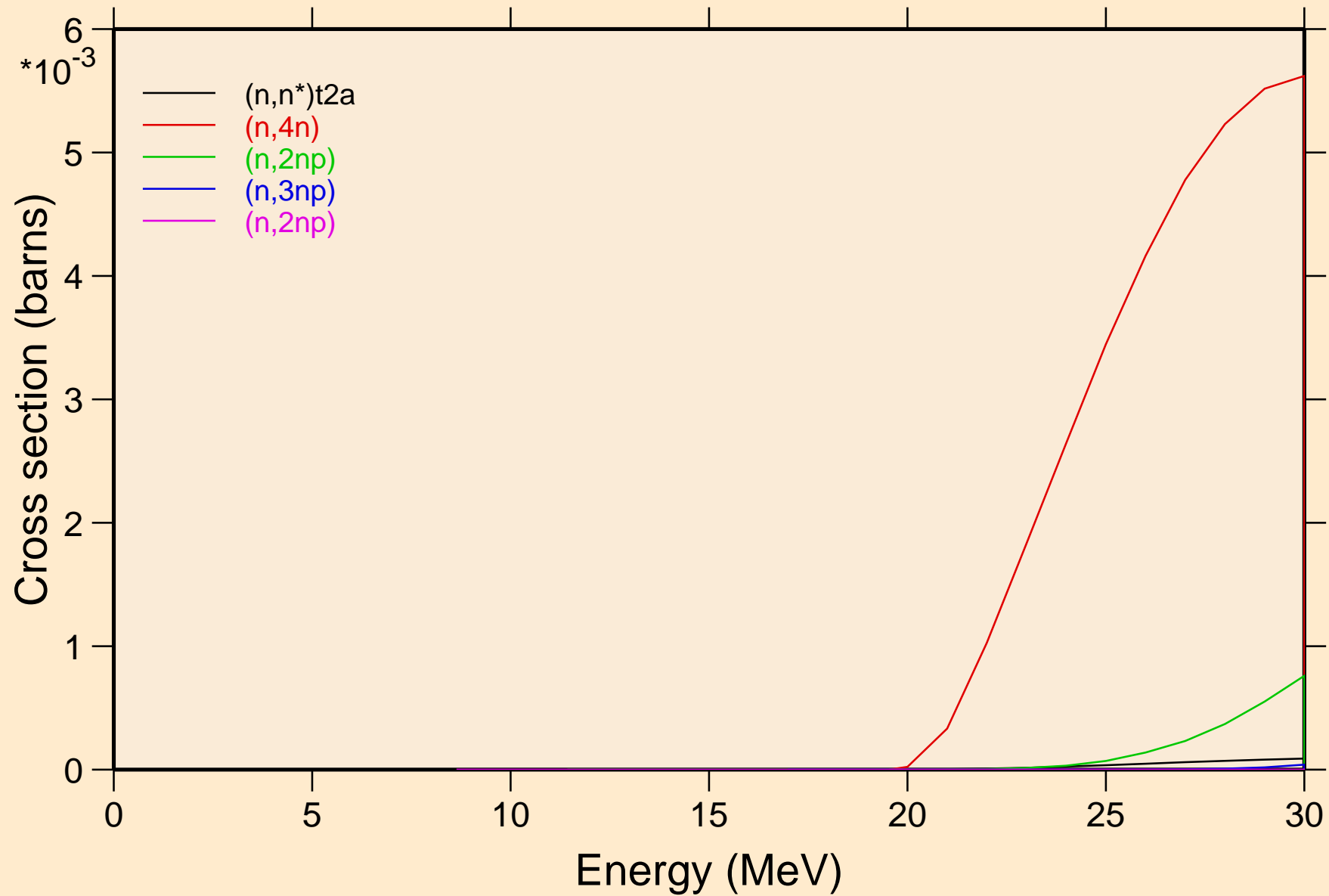

RF264 NRG TENDL-2015, AKONING

Threshold reactions

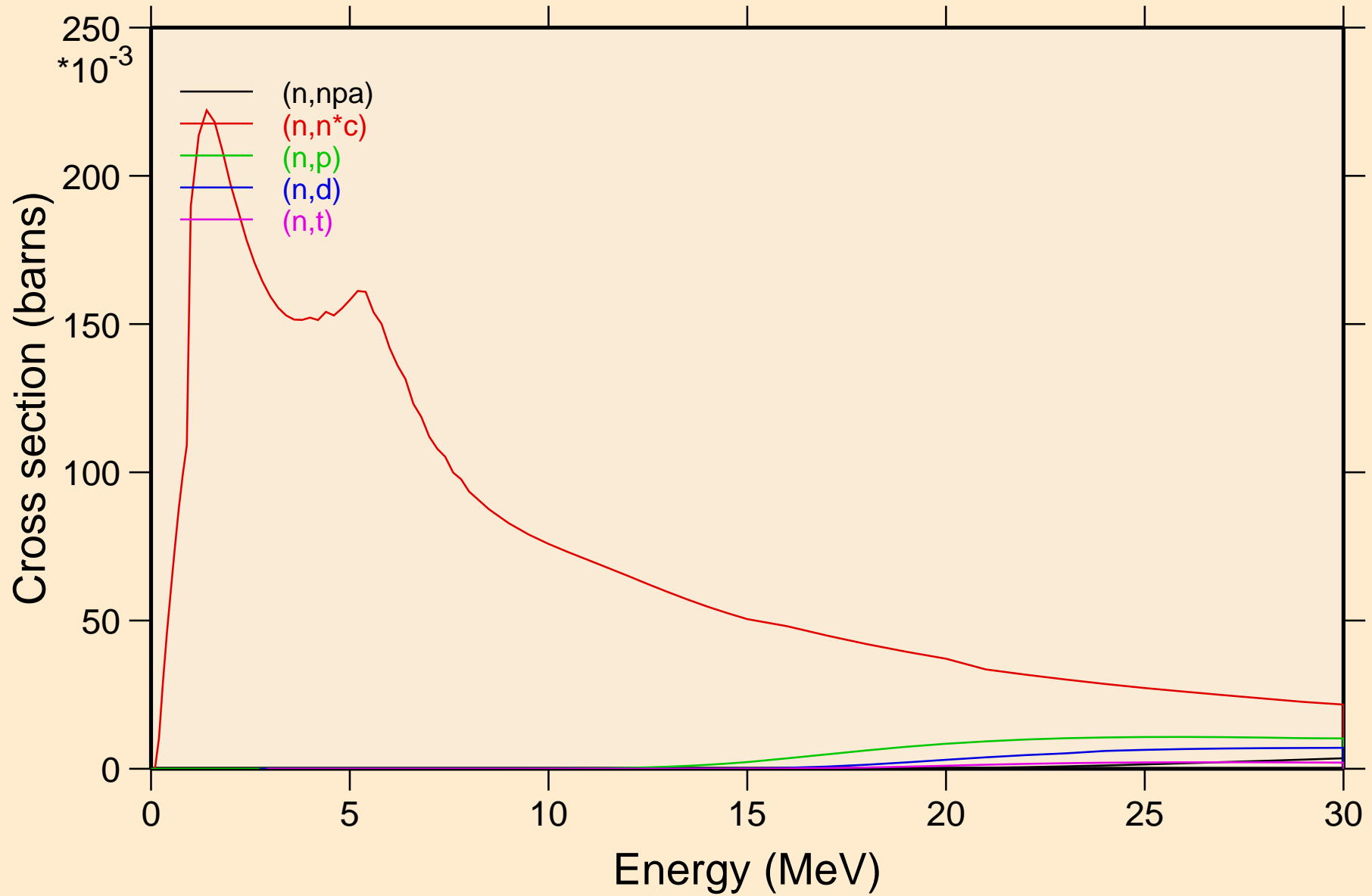

RF264 NRG TENDL-2015, AKONING

Threshold reactions

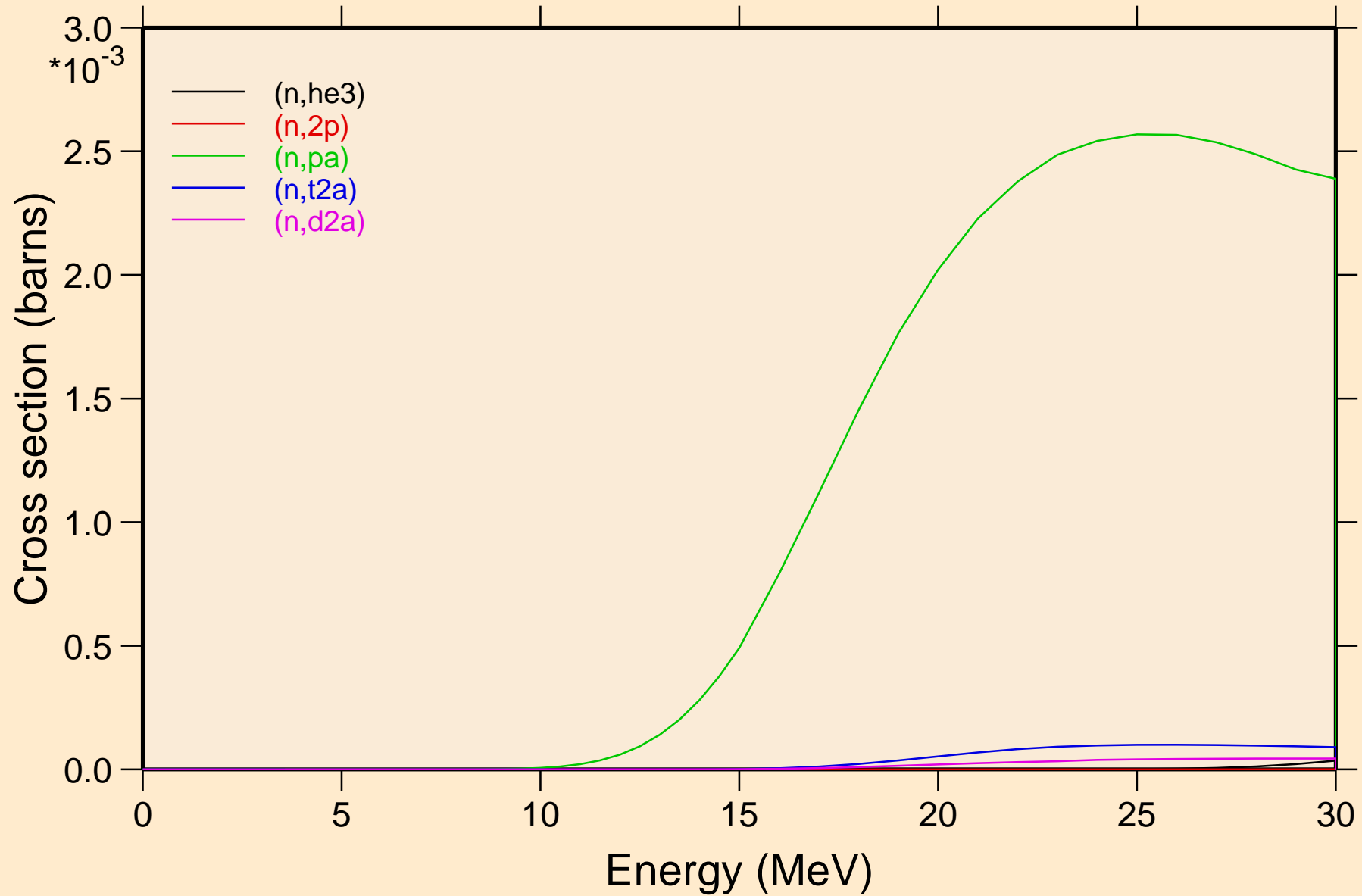

RF264 NRG TENDL-2015, AKONING

Threshold reactions

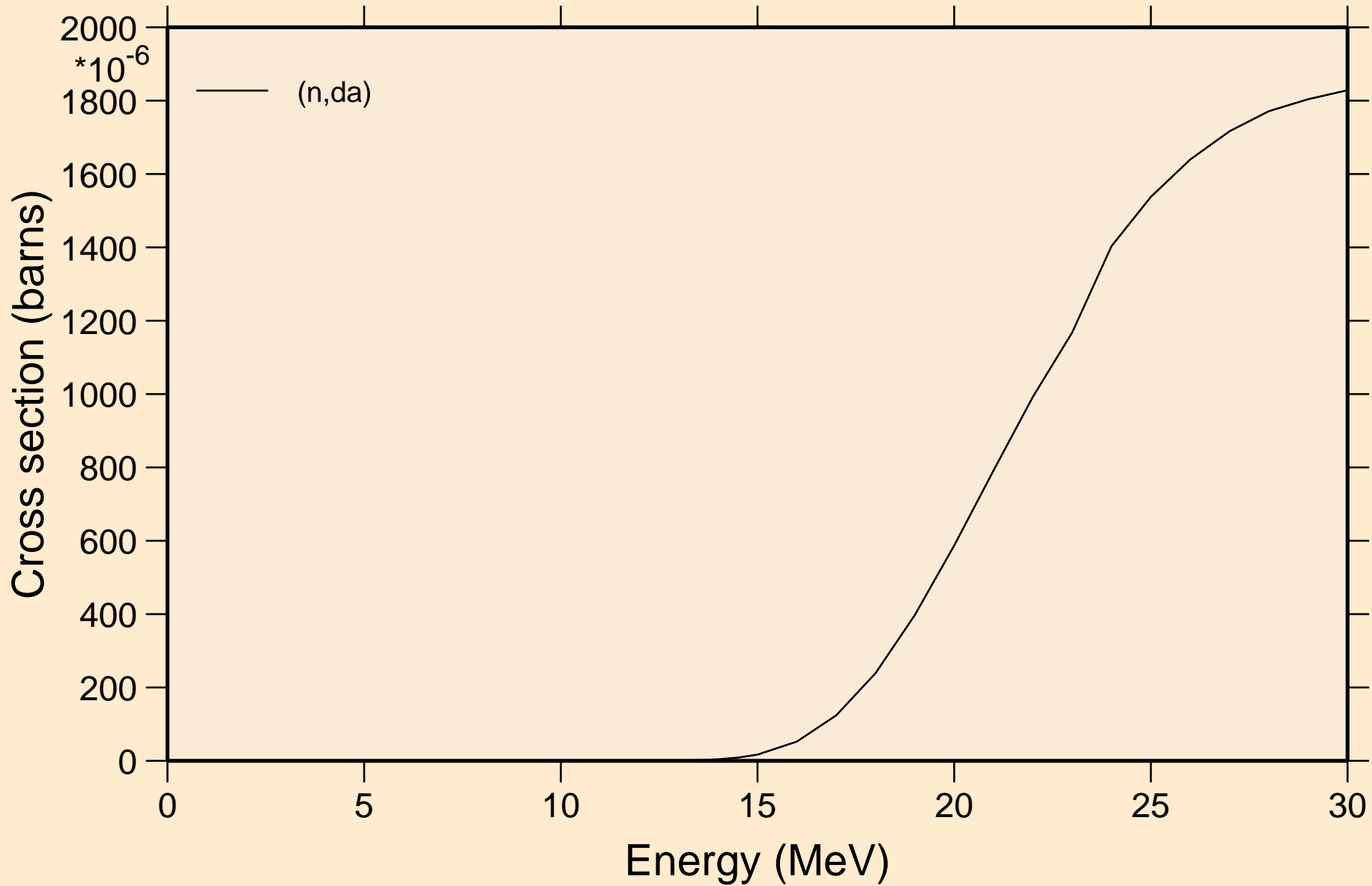

RF264 NRG TENDL-2015, AKONING
angular distribution for elastic

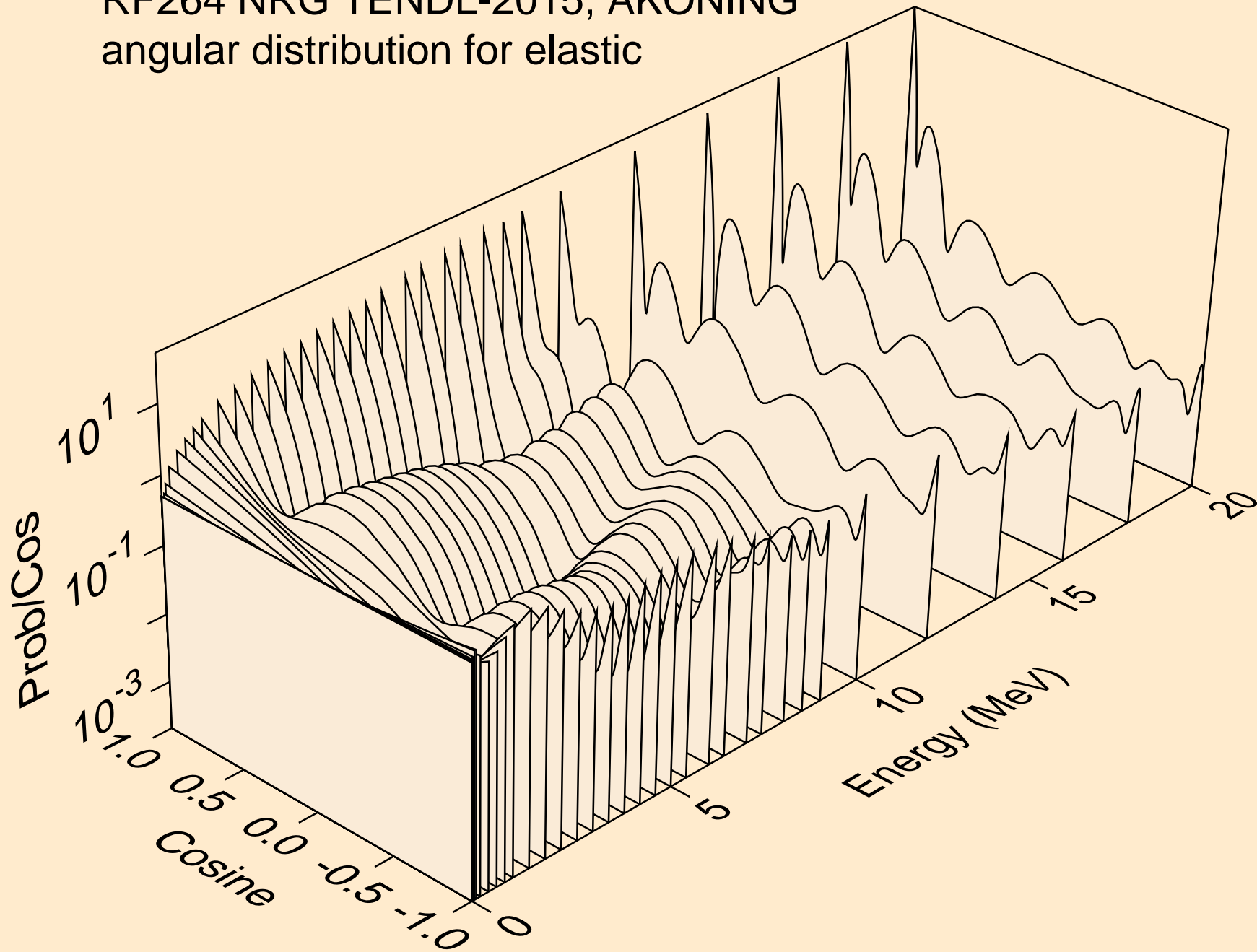

RF264 NRG TENDL-2015, AKONING
angular distribution for elastic

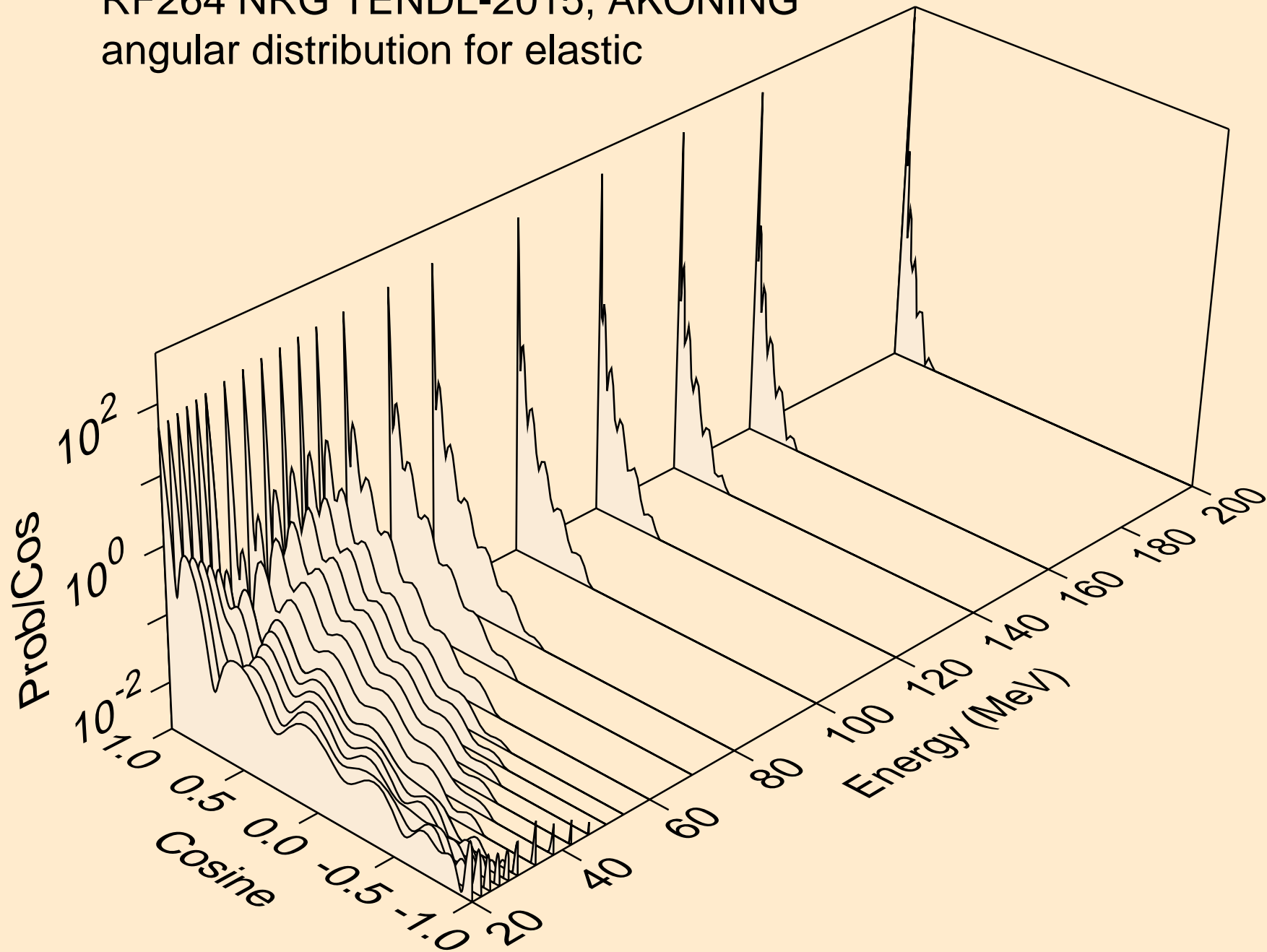

RF264 NRG TENDL-2015, AKONING
angular distribution for (n,n*1)

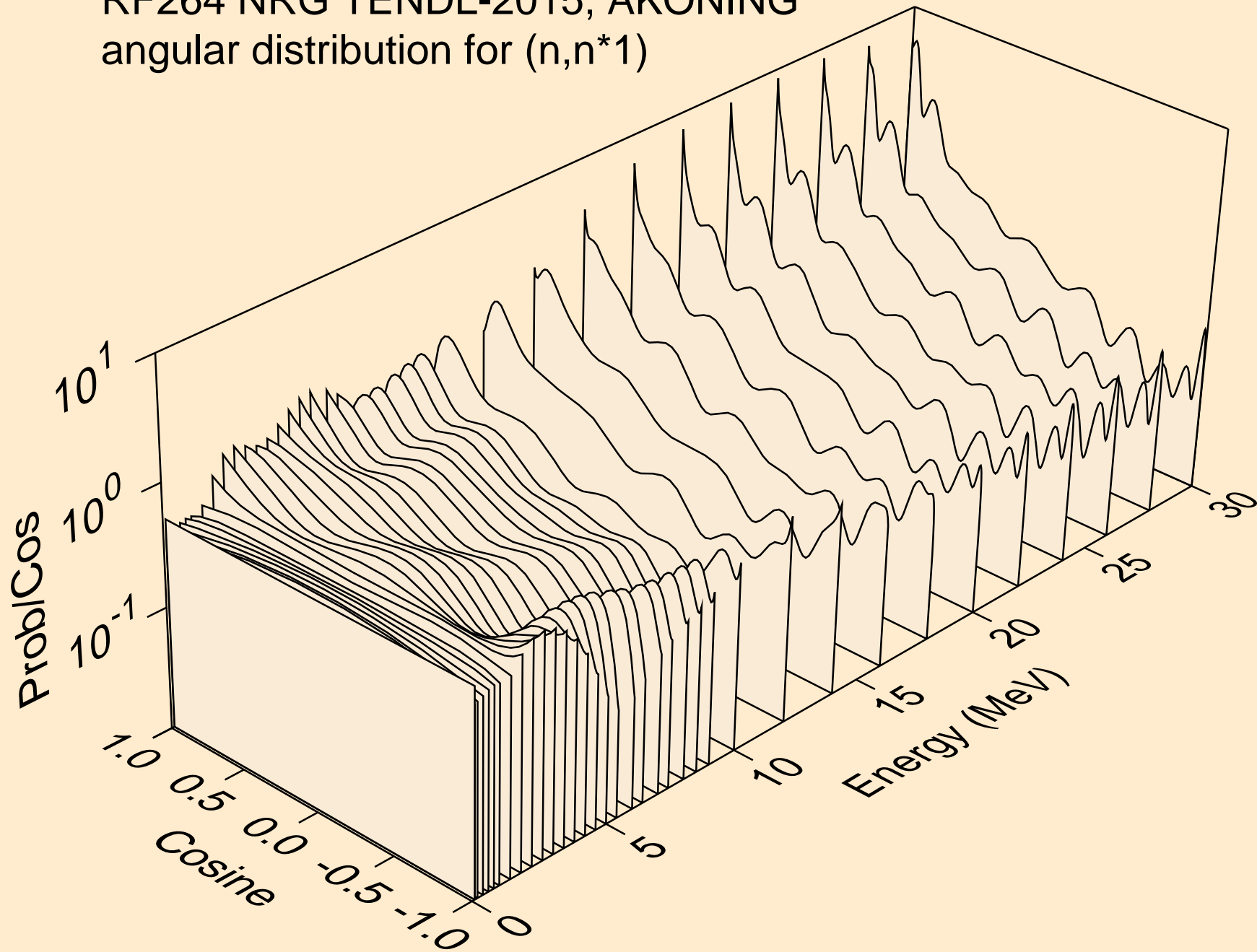

RF264 NRG TENDL-2015, AKONING

Total fission nubar

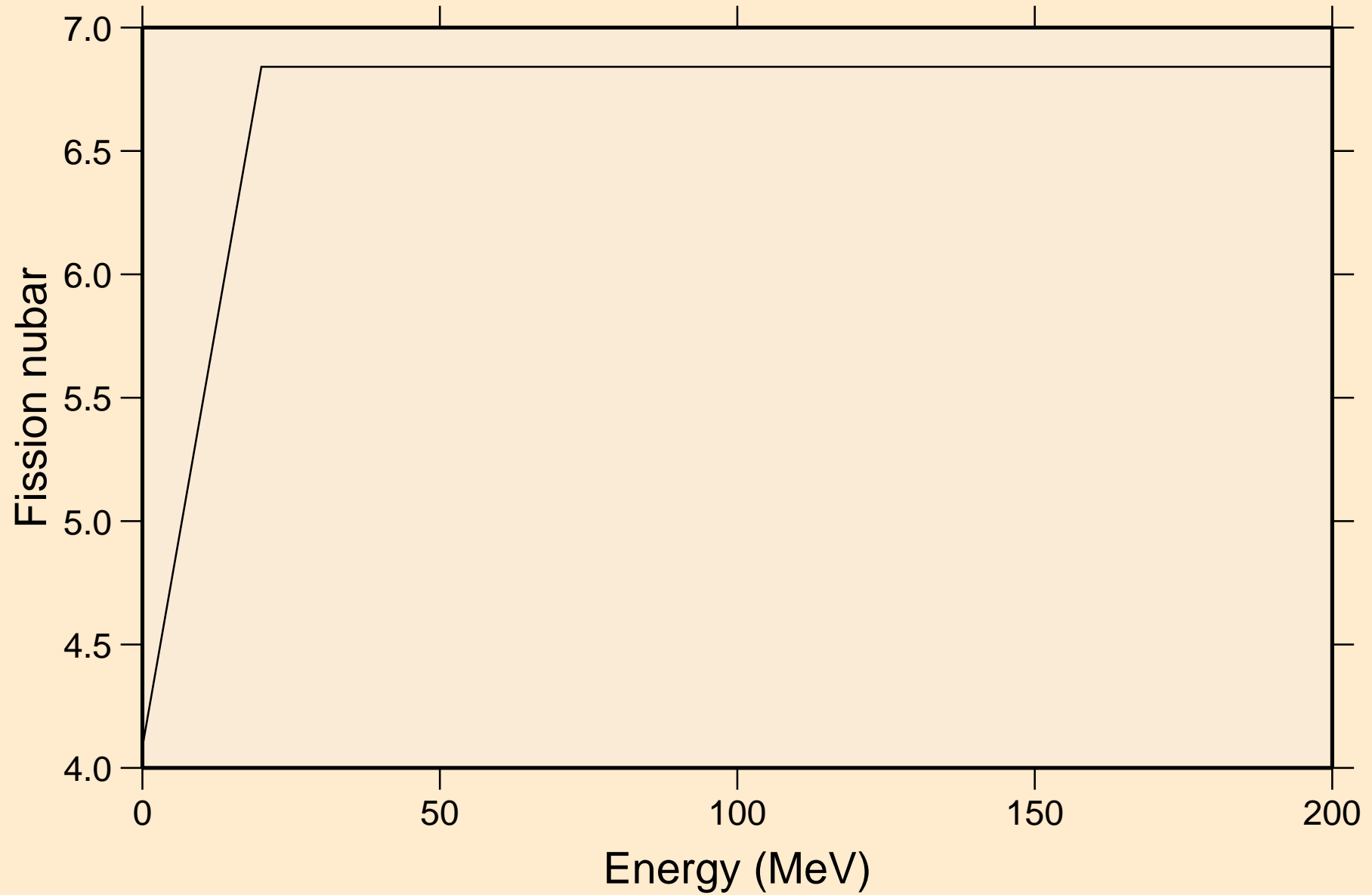

RF264 NRG TENDL-2015, AKONING
Neutron emission for (n,x)

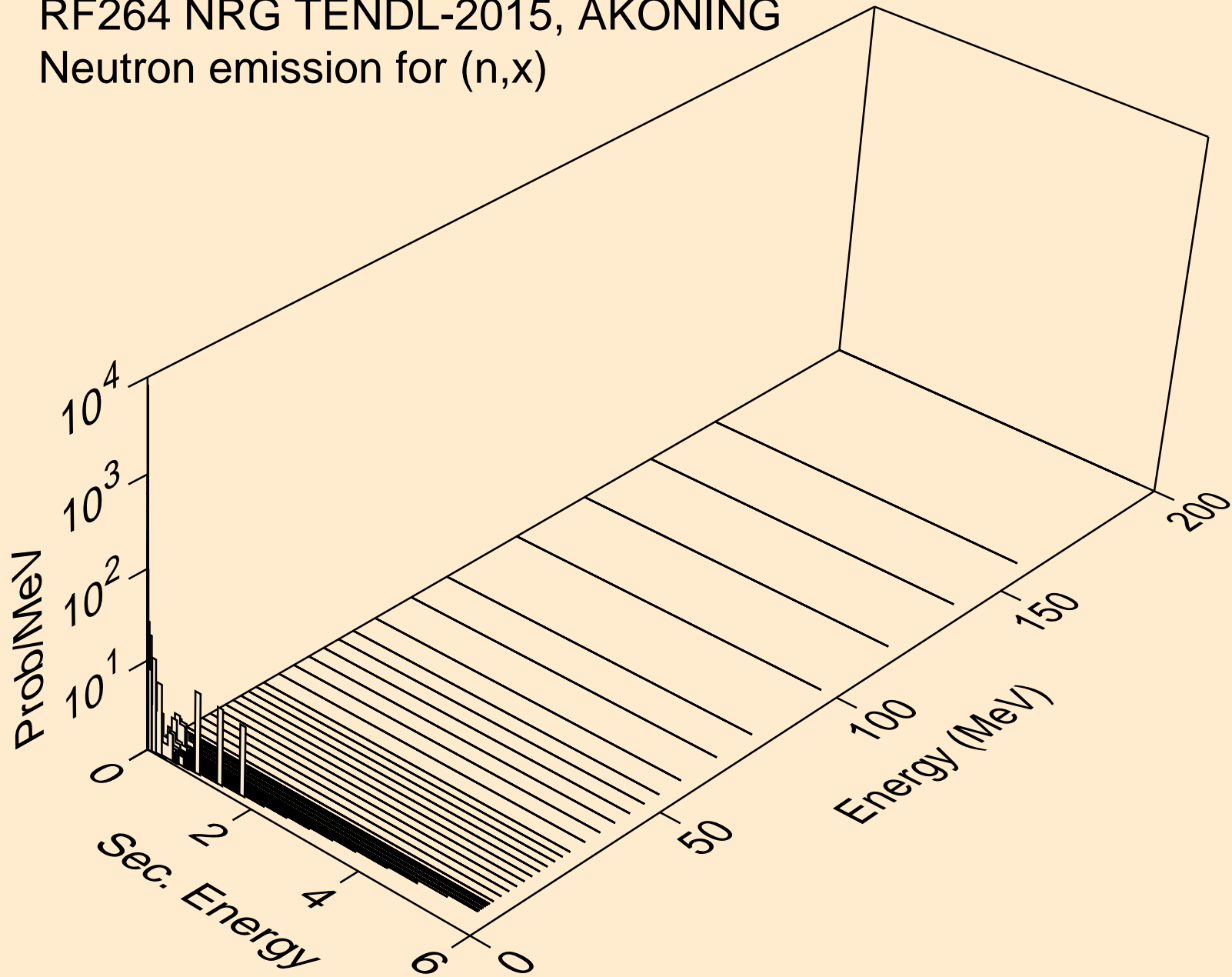

RF264 NRG TENDL-2015, AKONING
Neutron emission for (n,2nd)

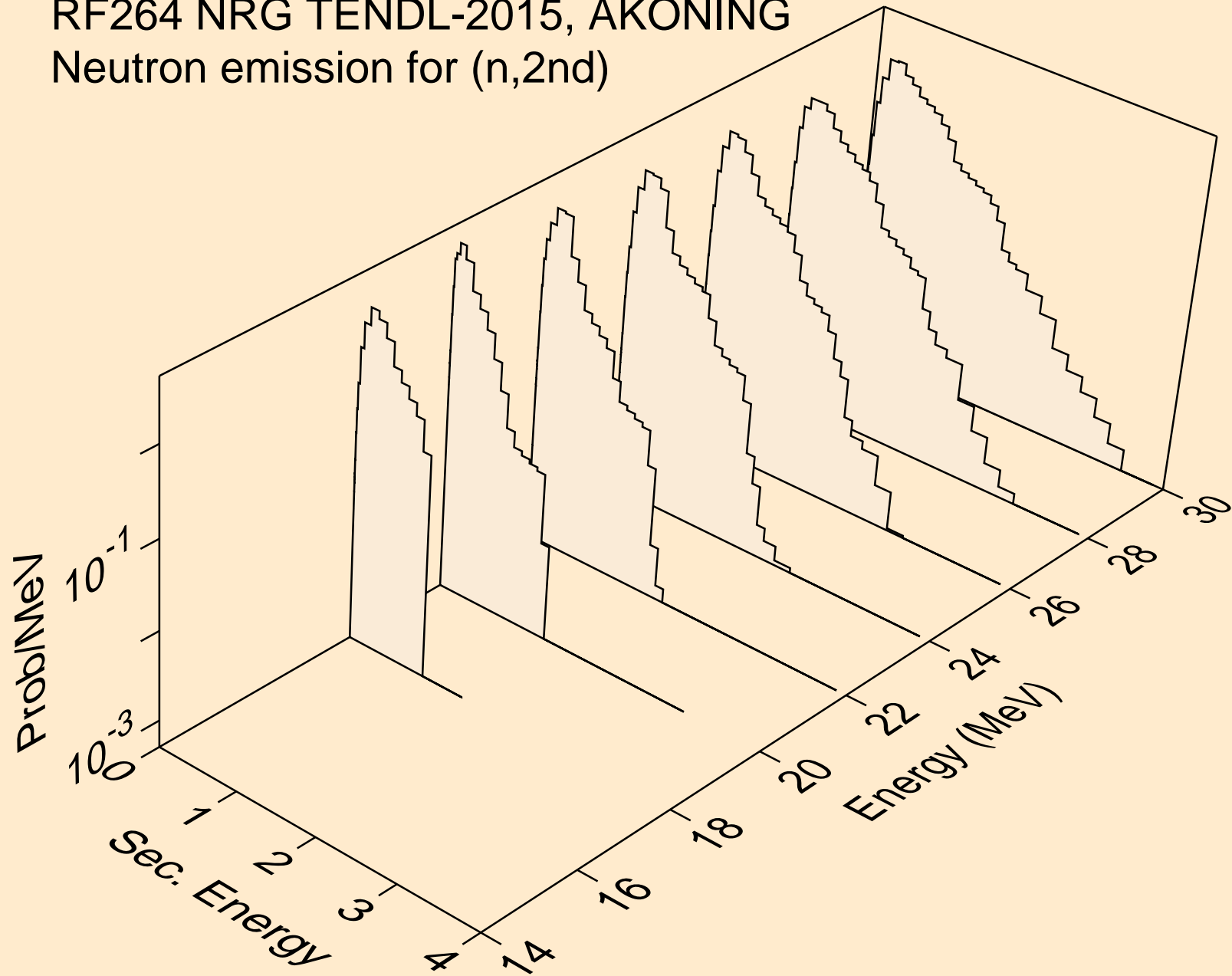

RF264 NRG TENDL-2015, AKONING
Neutron emission for (n,2n)

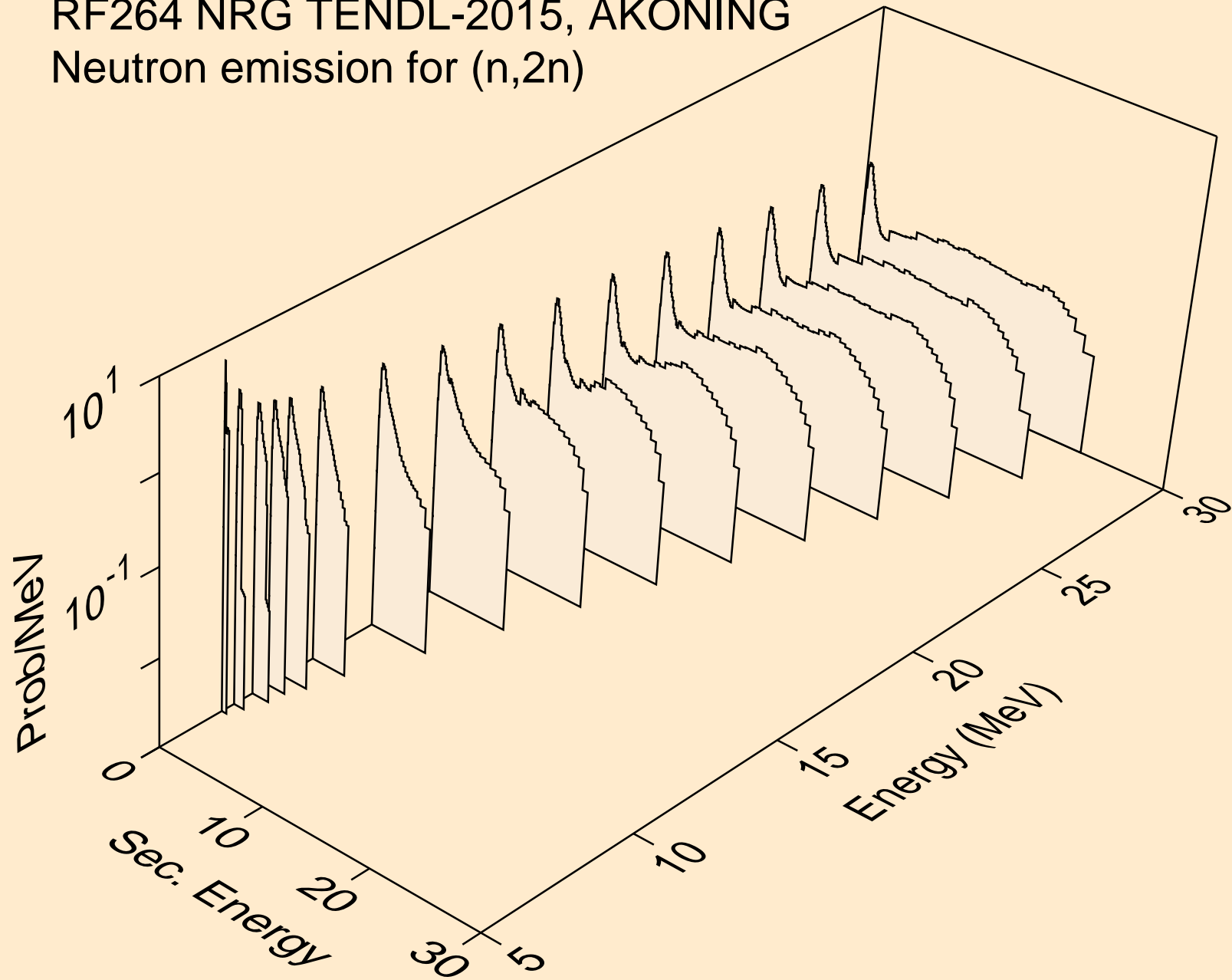

RF264 NRG TENDL-2015, AKONING
Neutron emission for (n,3n)

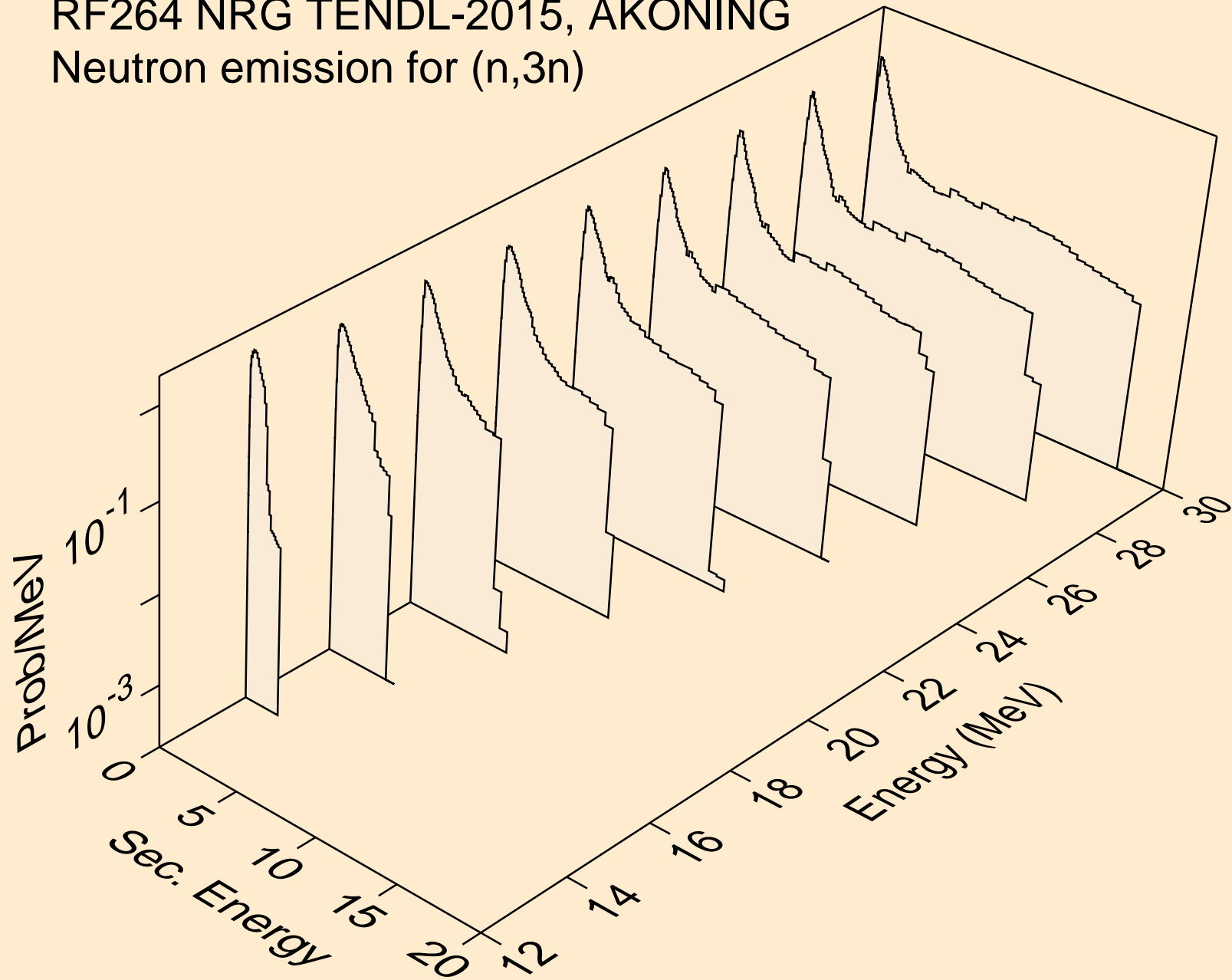

RF264 NRG TENDL-2015, AKONING
Neutron emission for fission

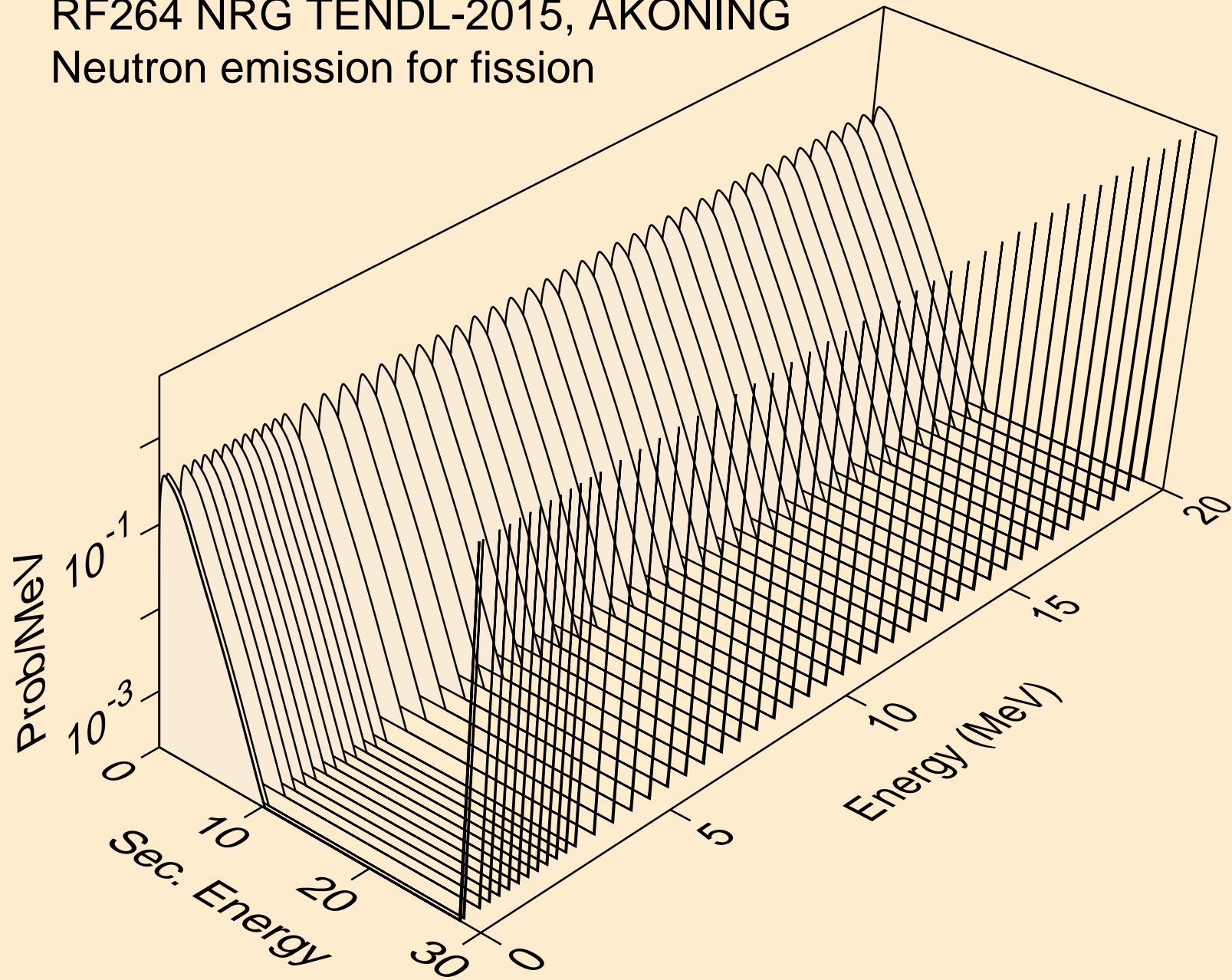

RF264 NRG TENDL-2015, AKONING
Neutron emission for (n,n*)a

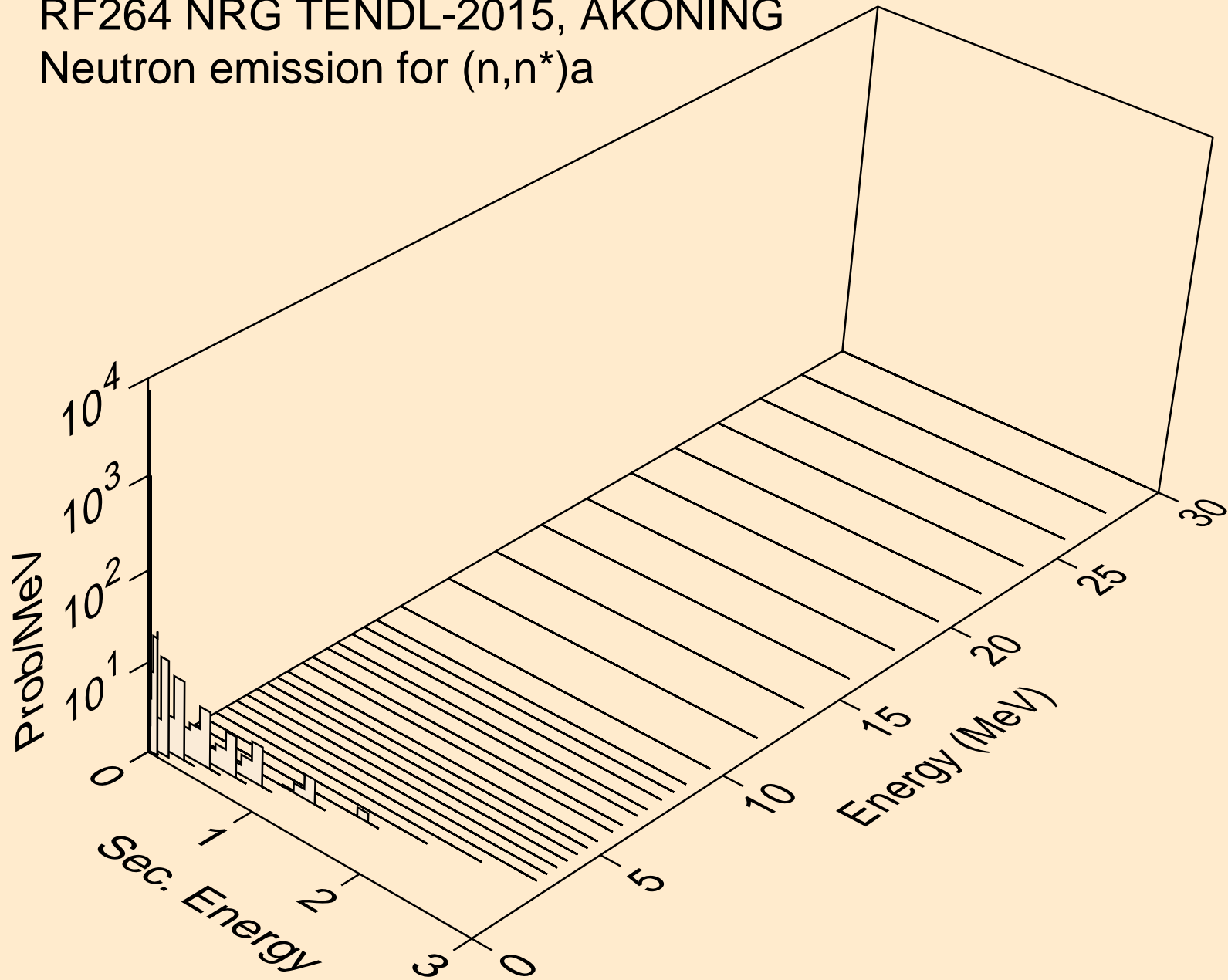

RF264 NRG TENDL-2015, AKONING
Neutron emission for (n,n*)3a

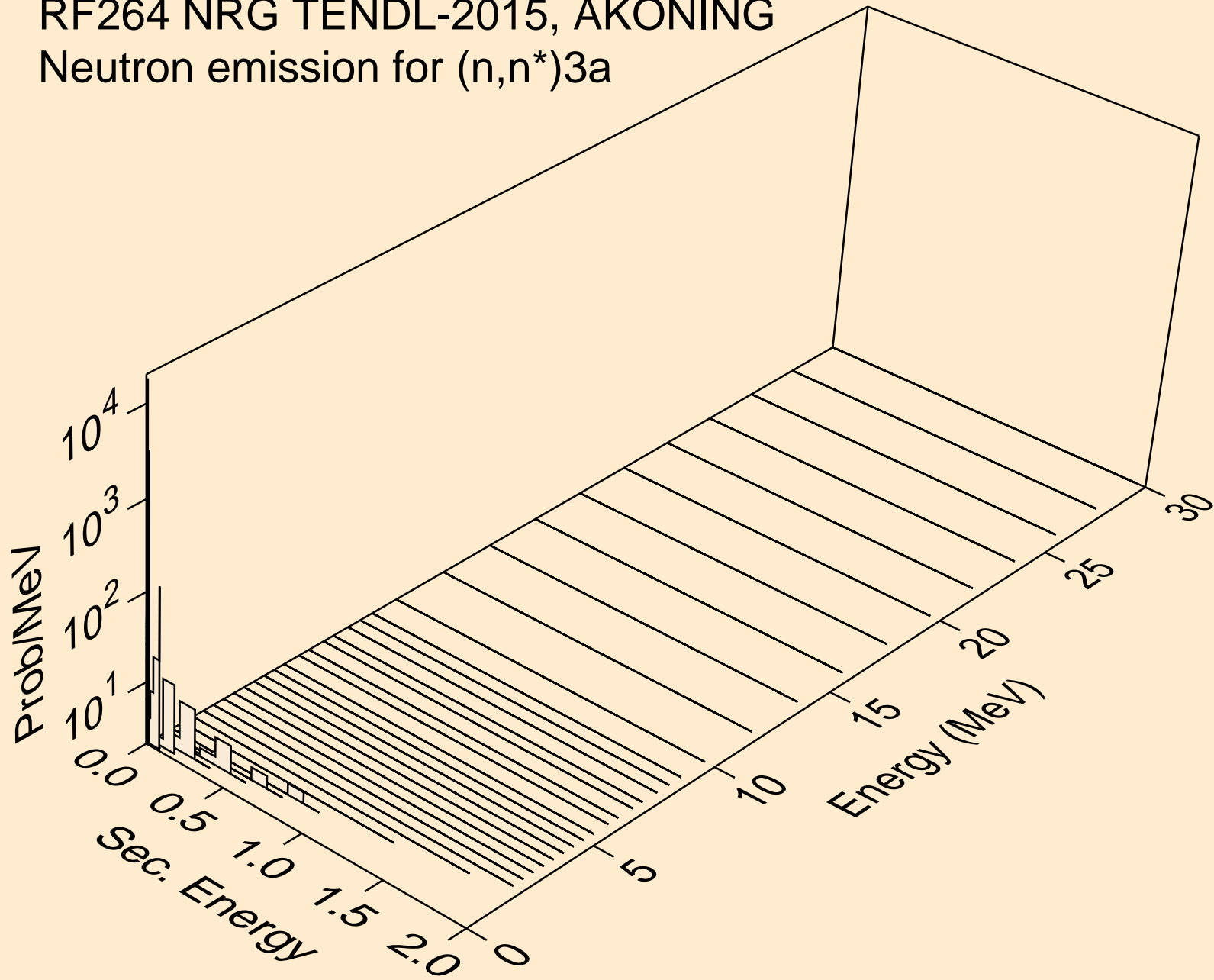

RF264 NRG TENDL-2015, AKONING
Neutron emission for (n,2n)a

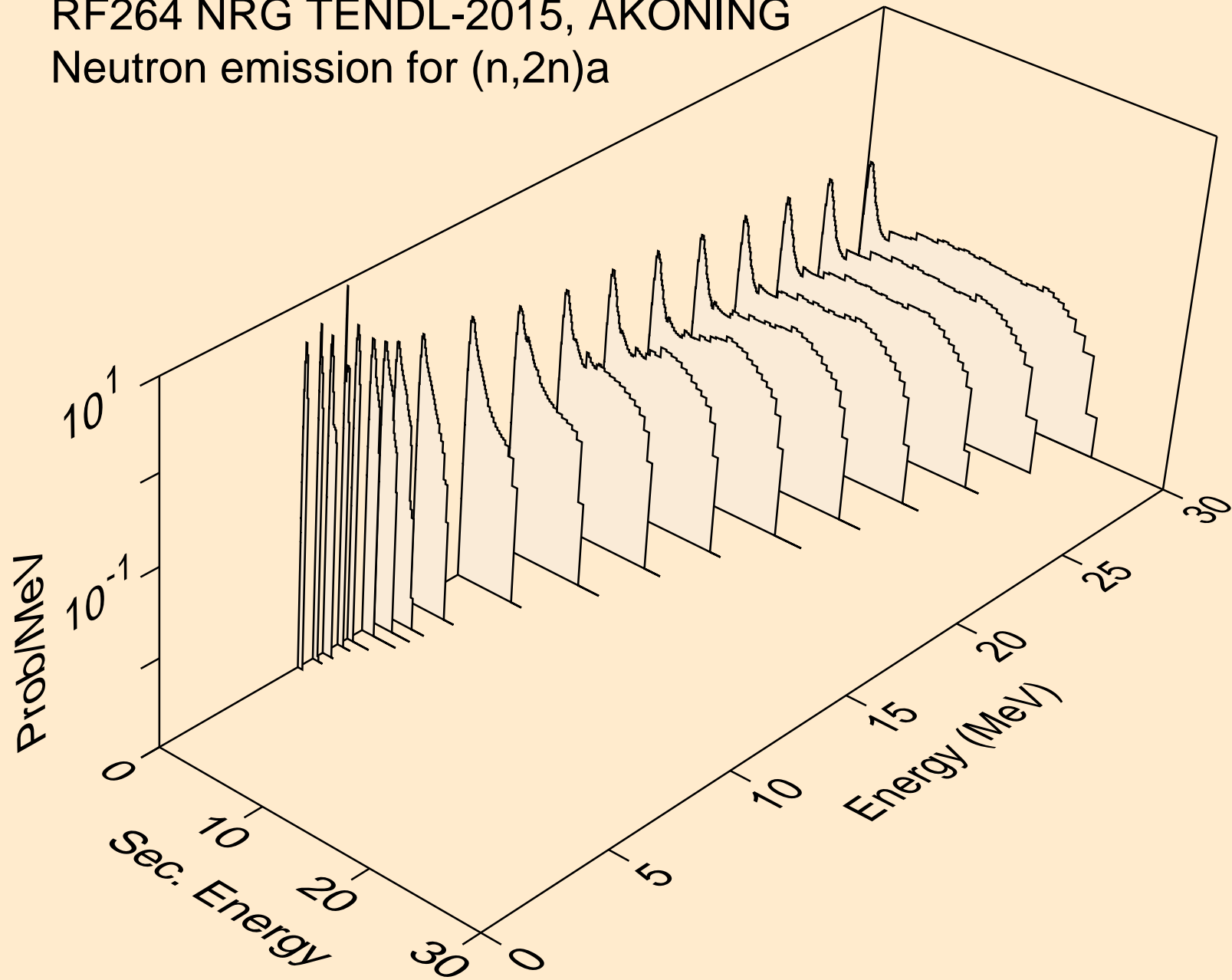

RF264 NRG TENDL-2015, AKONING
Neutron emission for (n,3n)a

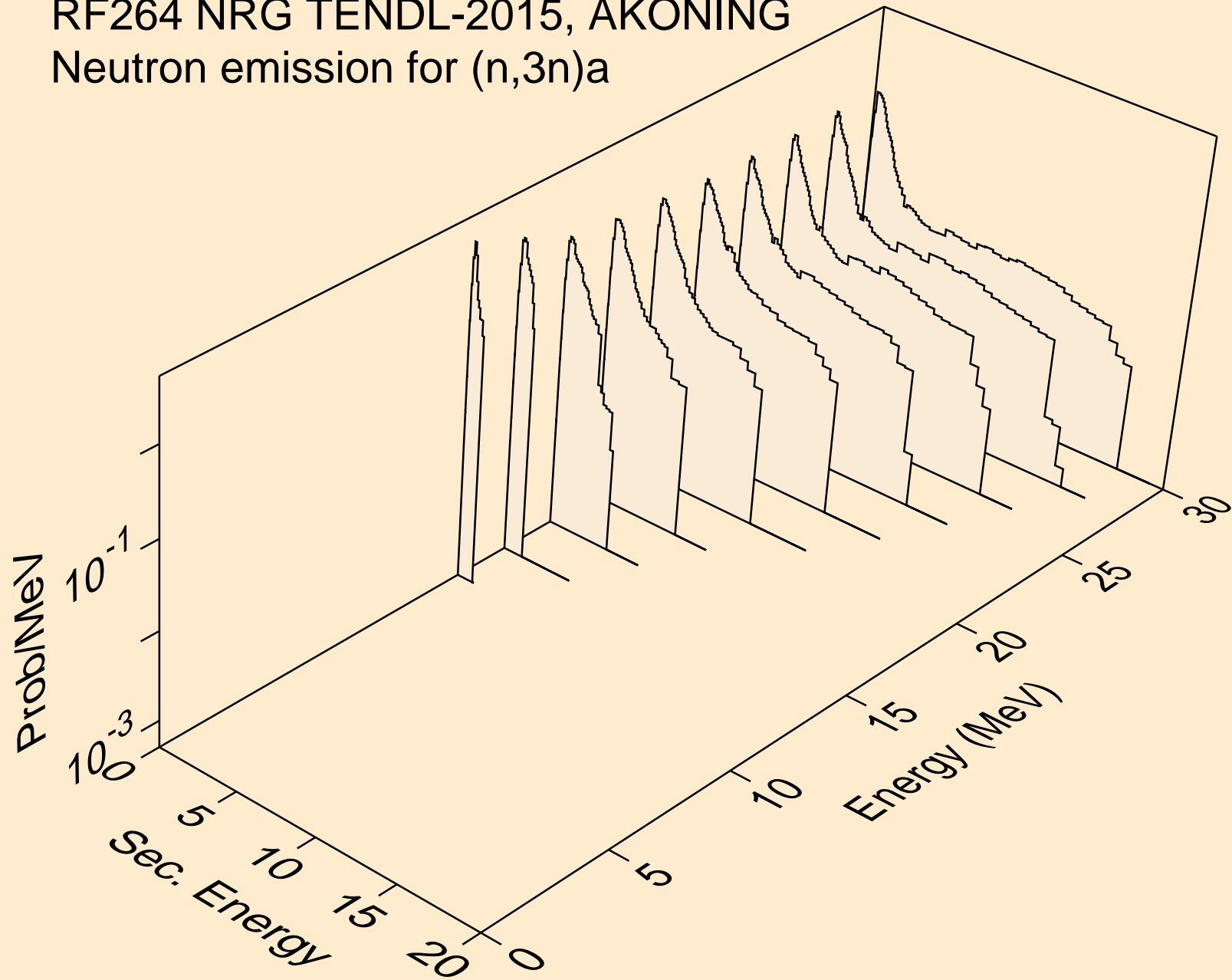

RF264 NRG TENDL-2015, AKONING
Neutron emission for (n,n*)p

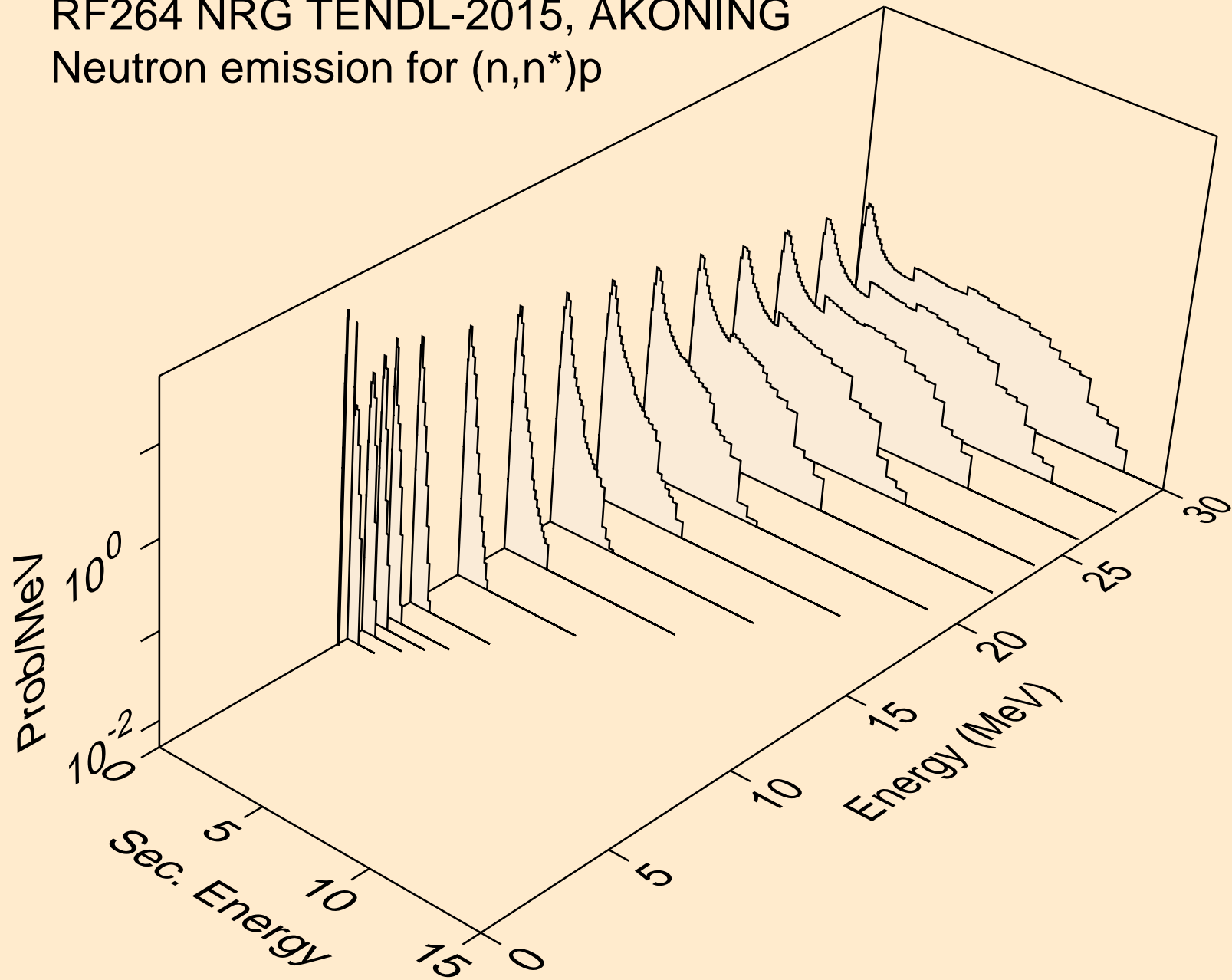

RF264 NRG TENDL-2015, AKONING
Neutron emission for (n,n*)2a

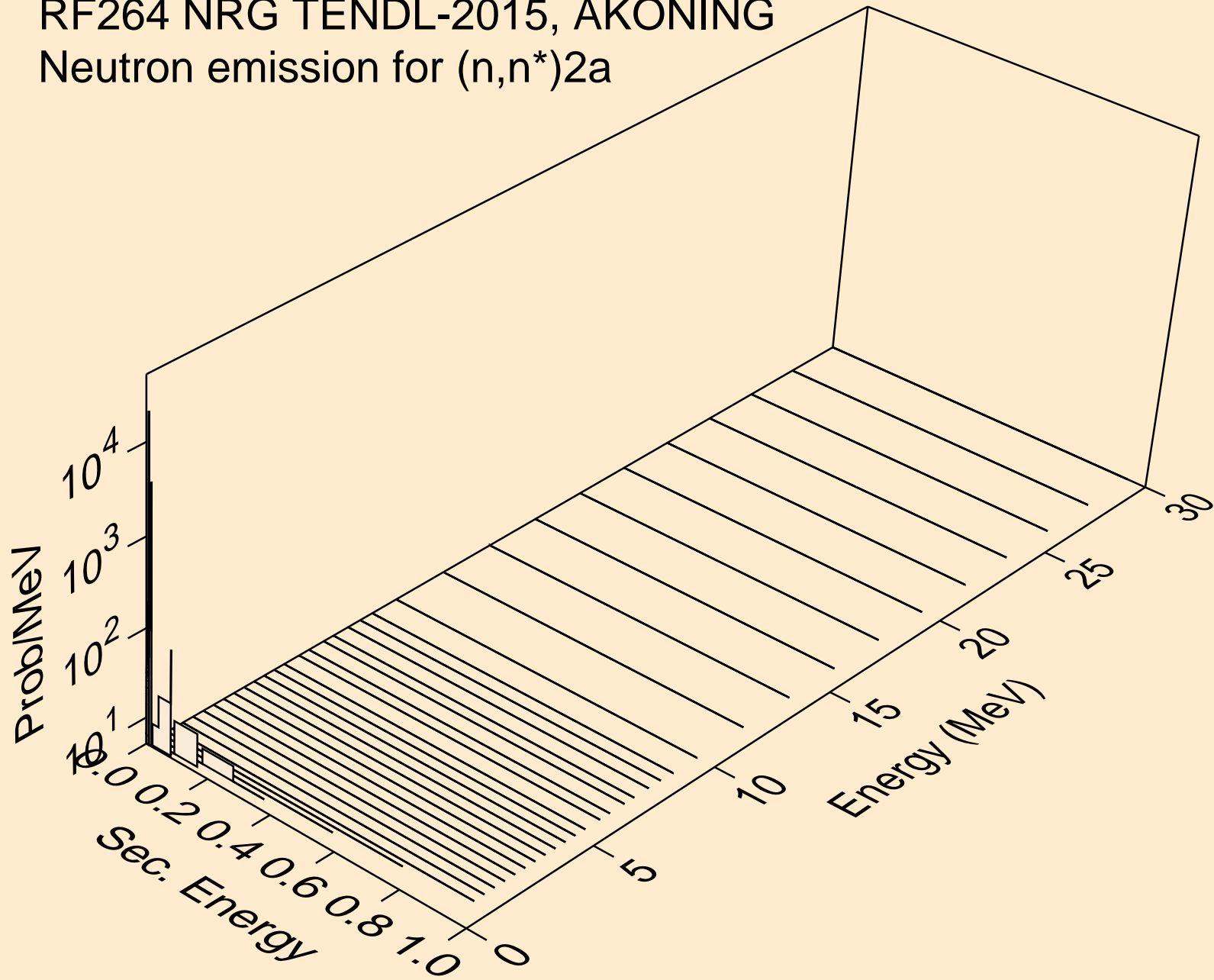

RF264 NRG TENDL-2015, AKONING
Neutron emission for (n,2n)2a

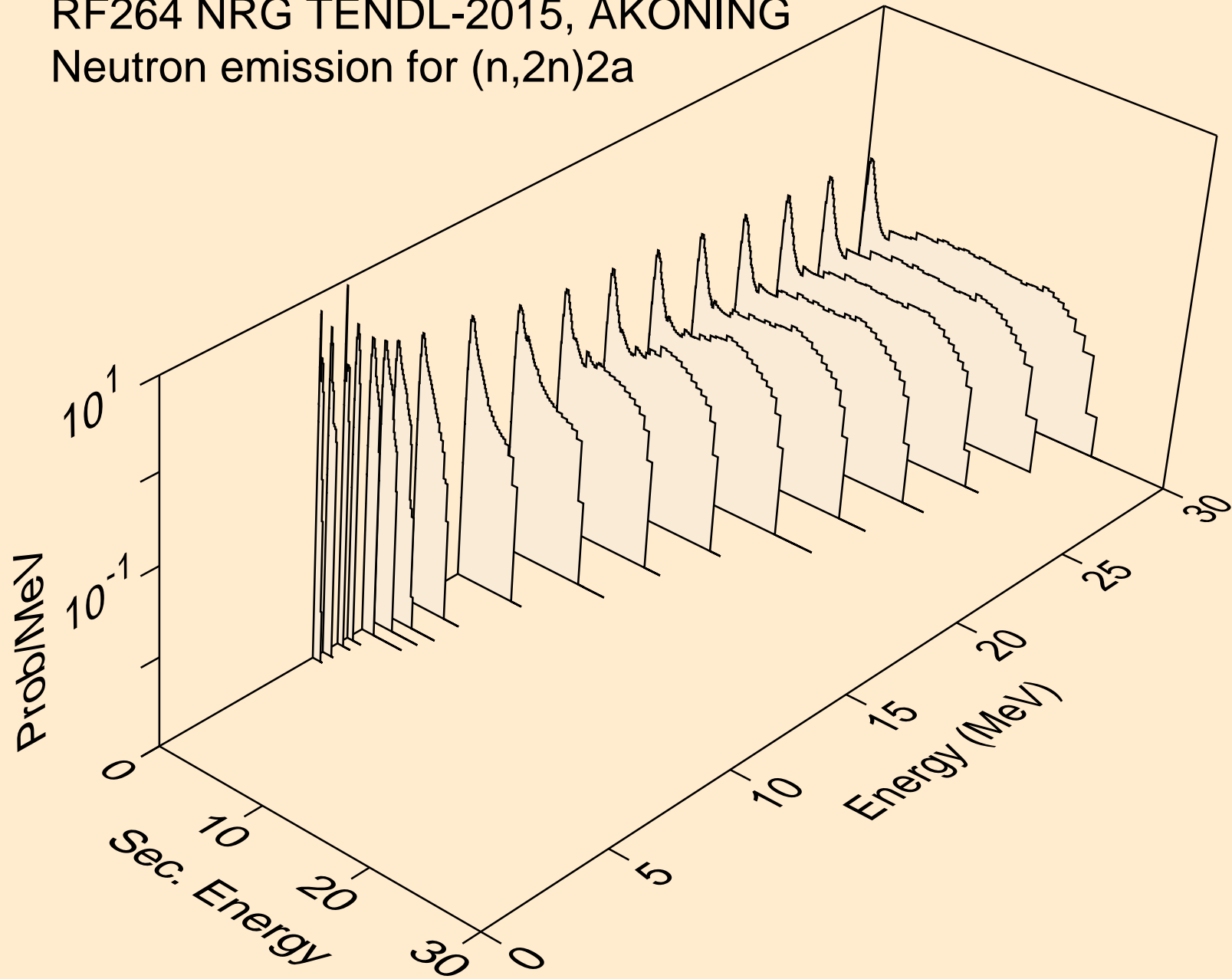

RF264 NRG TENDL-2015, AKONING
Neutron emission for (n,n*)d

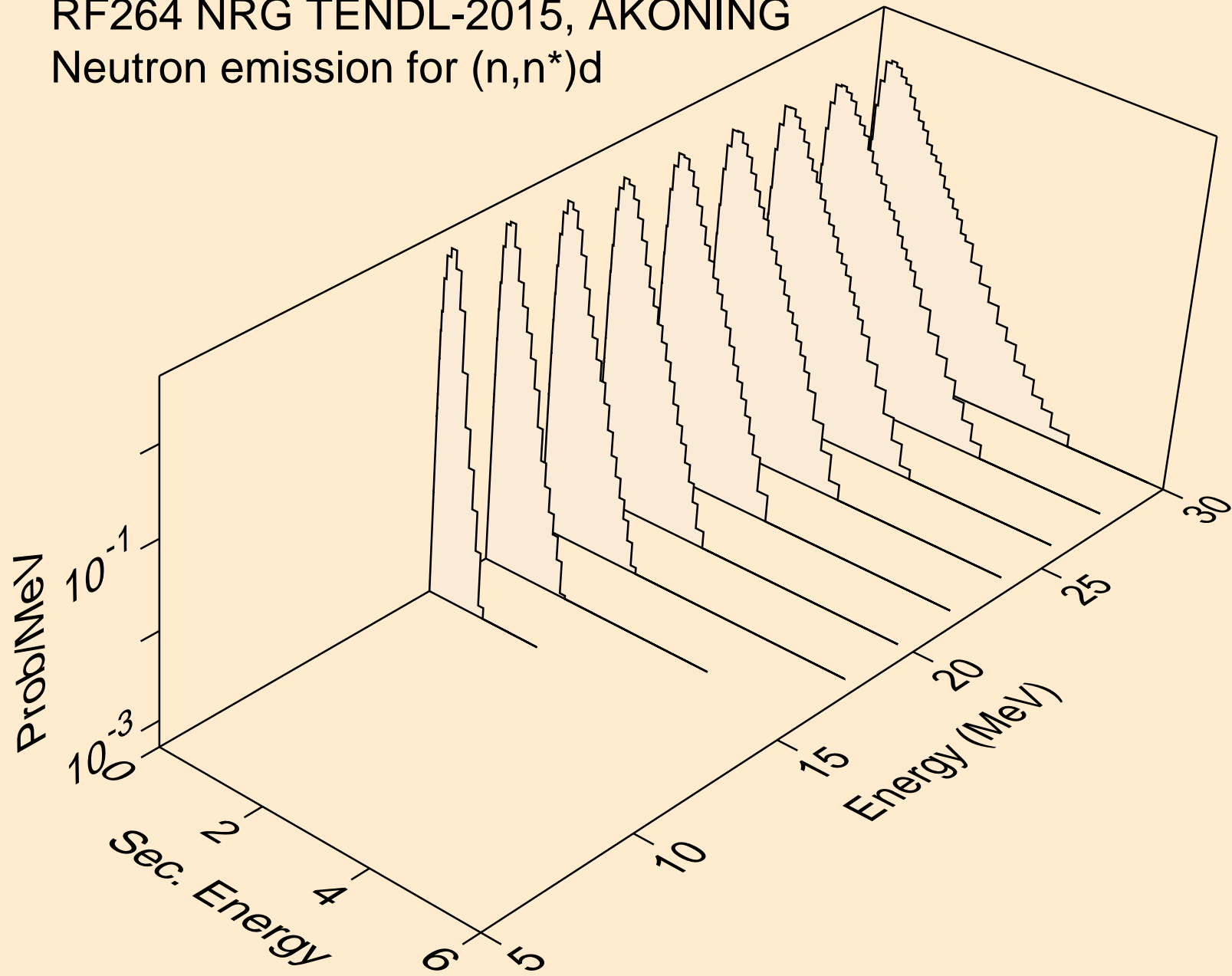

RF264 NRG TENDL-2015, AKONING
Neutron emission for (n,n*)t

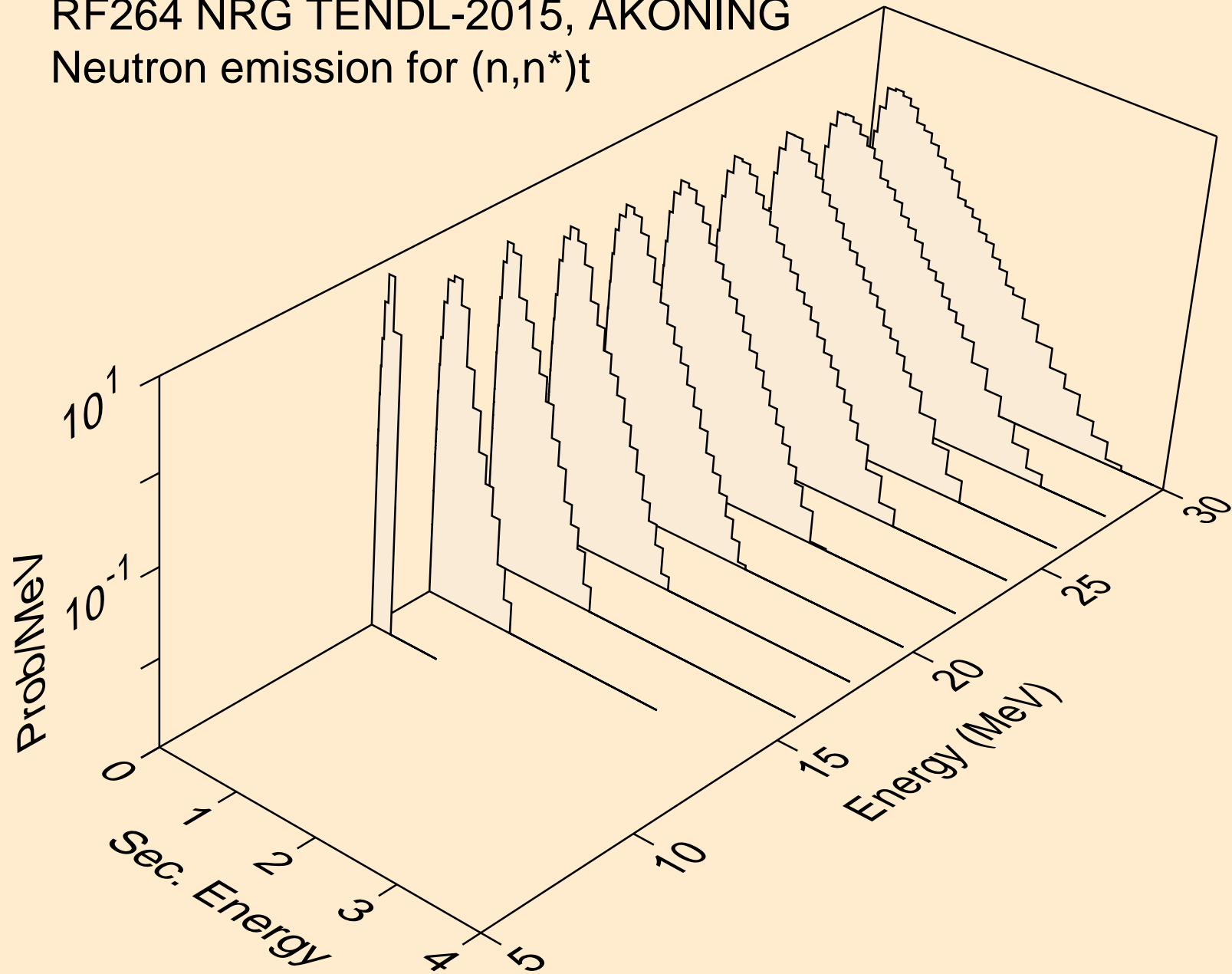

RF264 NRG TENDL-2015, AKONING
Neutron emission for (n,n*)he3

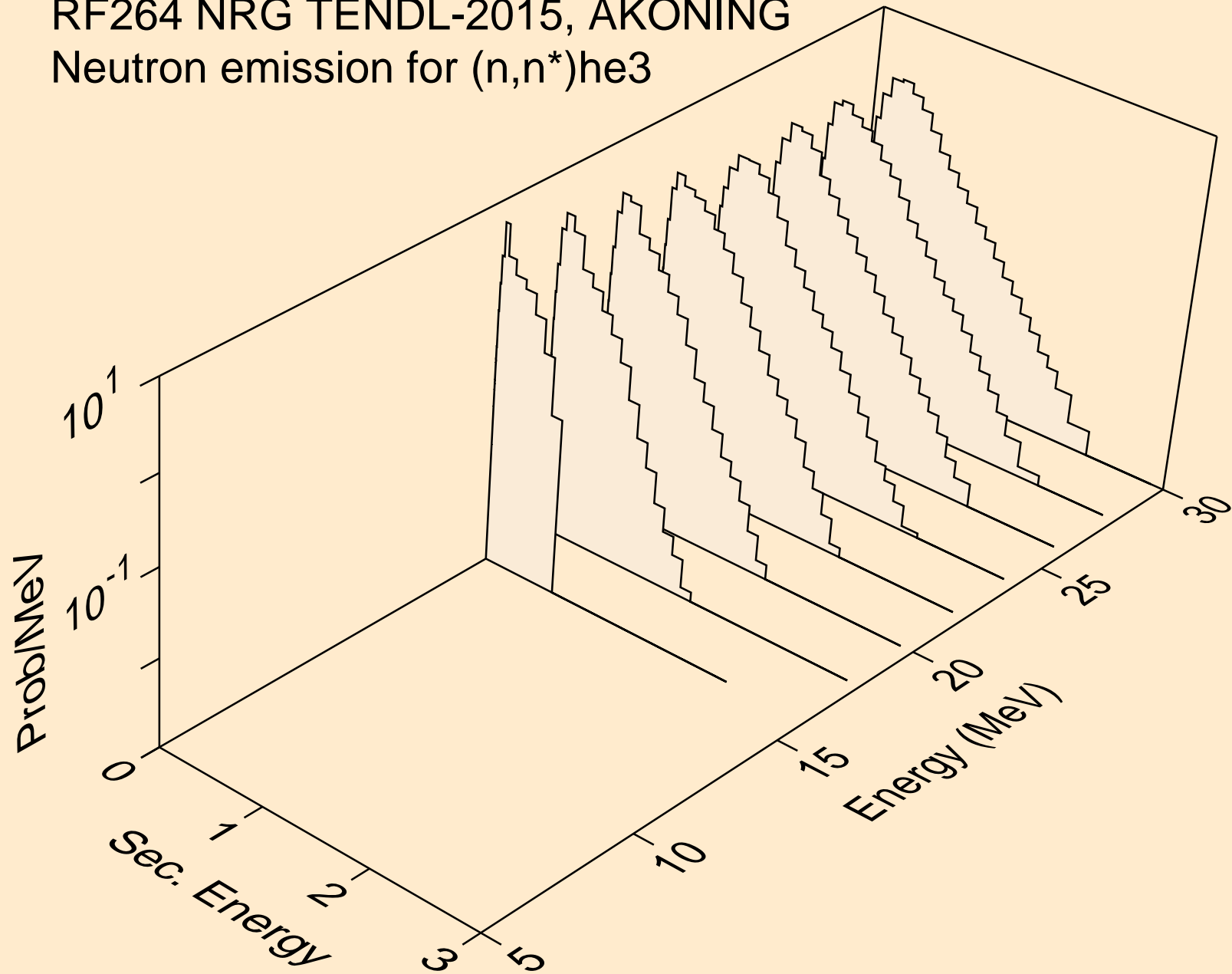

RF264 NRG TENDL-2015, AKONING
Neutron emission for (n,n*)d2a

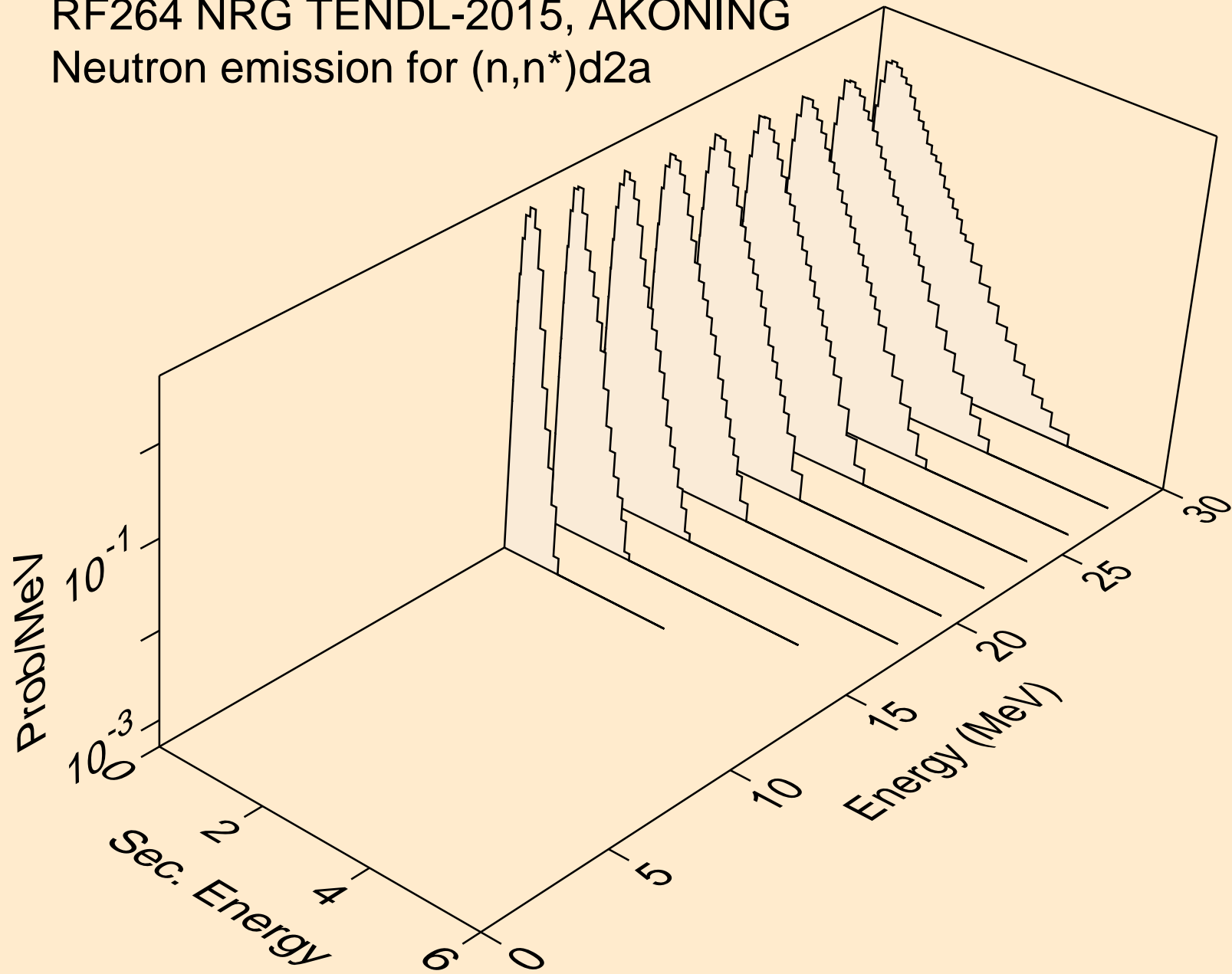

RF264 NRG TENDL-2015, AKONING
Neutron emission for (n,n*)t2a

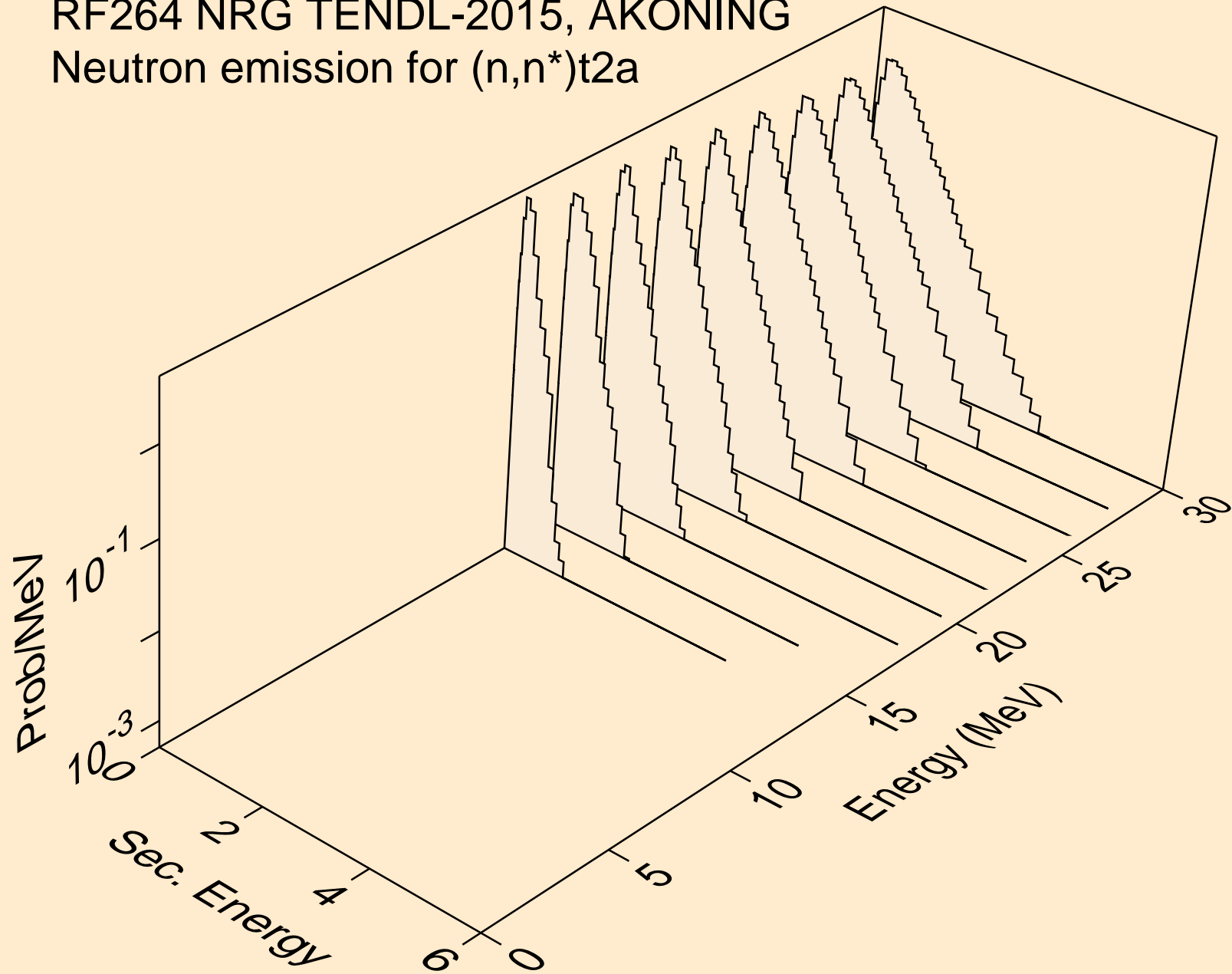

RF264 NRG TENDL-2015, AKONING
Neutron emission for (n,4n)

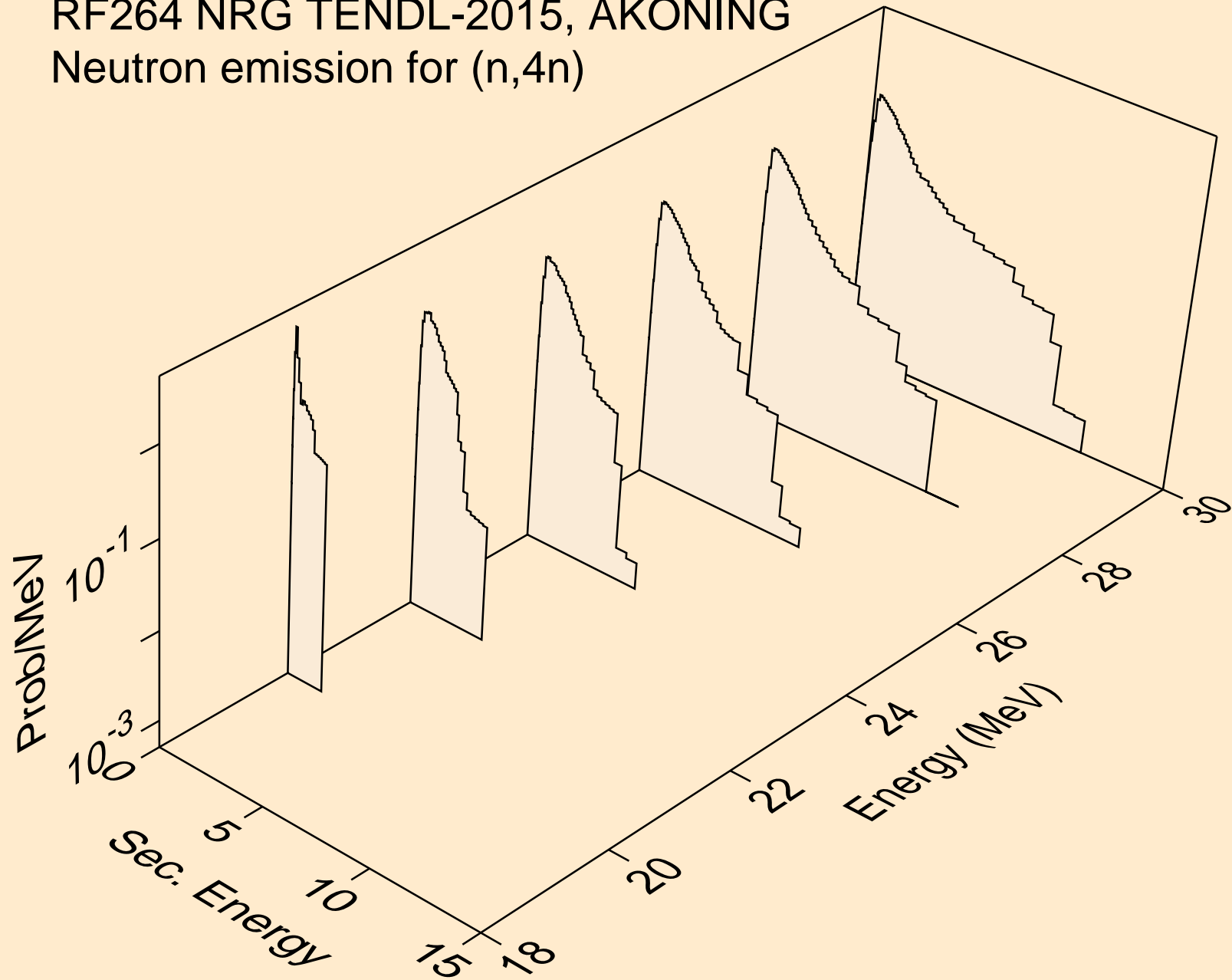

RF264 NRG TENDL-2015, AKONING
Neutron emission for (n,2np)

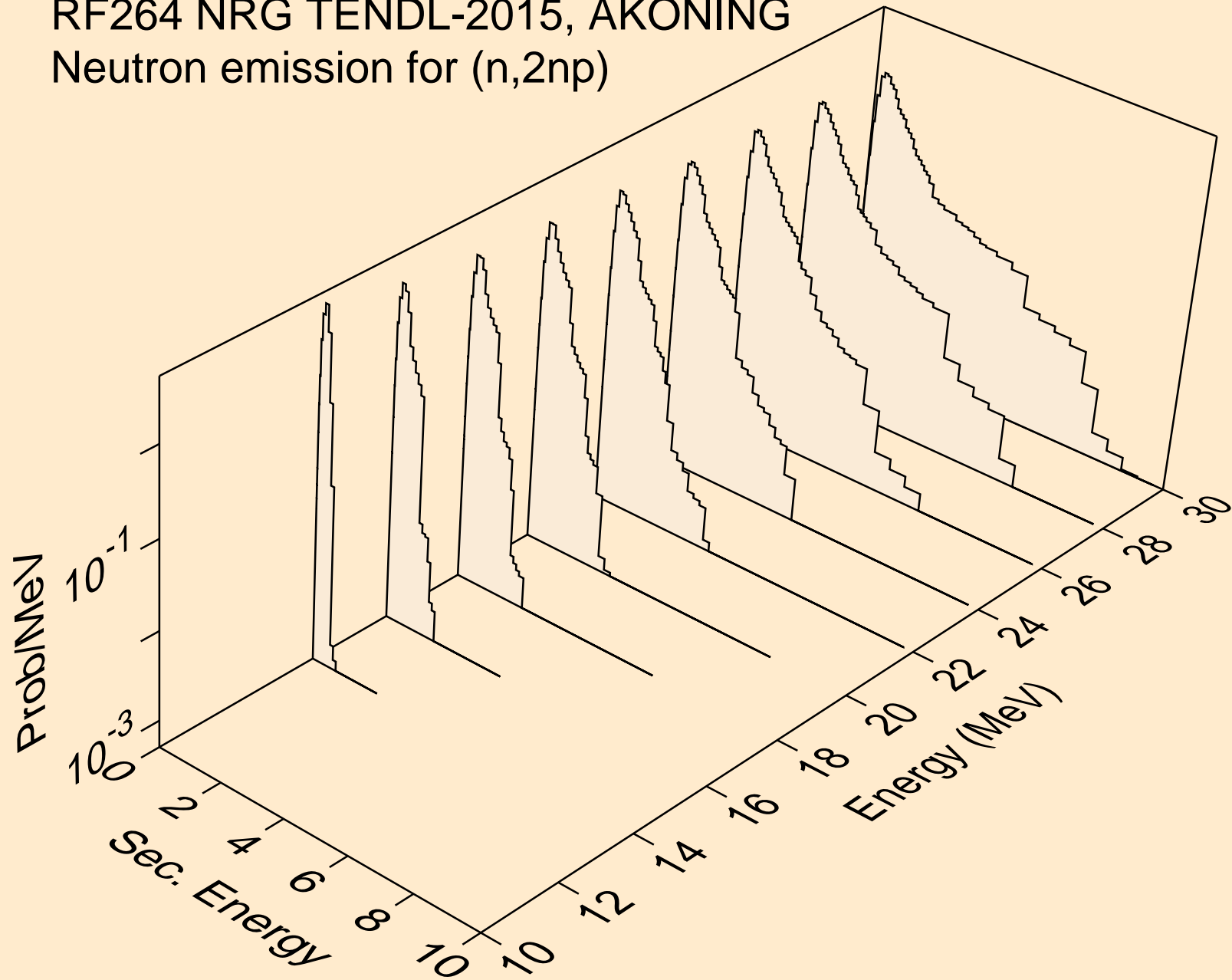

RF264 NRG TENDL-2015, AKONING
Neutron emission for (n,3np)

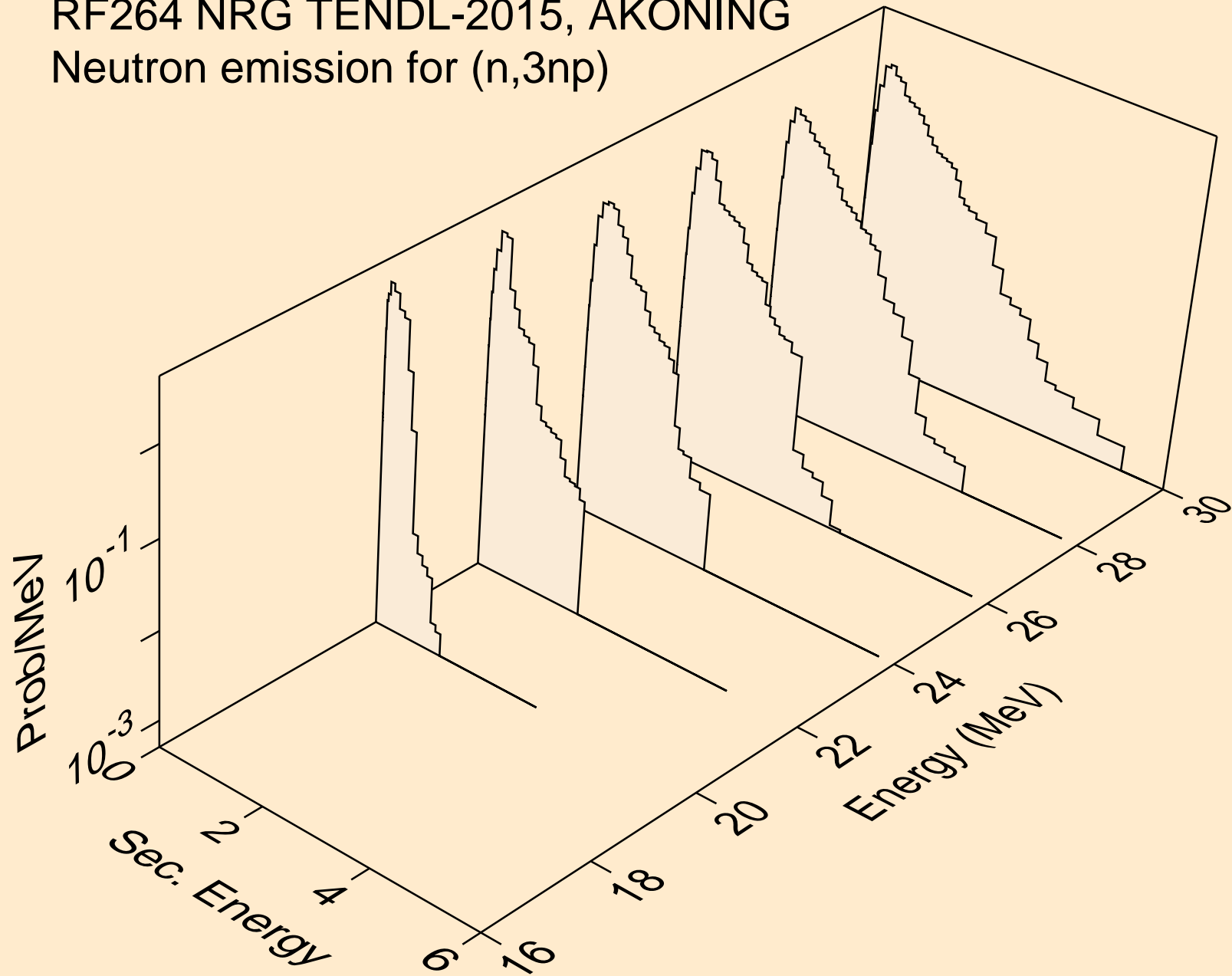

RF264 NRG TENDL-2015, AKONING
Neutron emission for (n,2np)

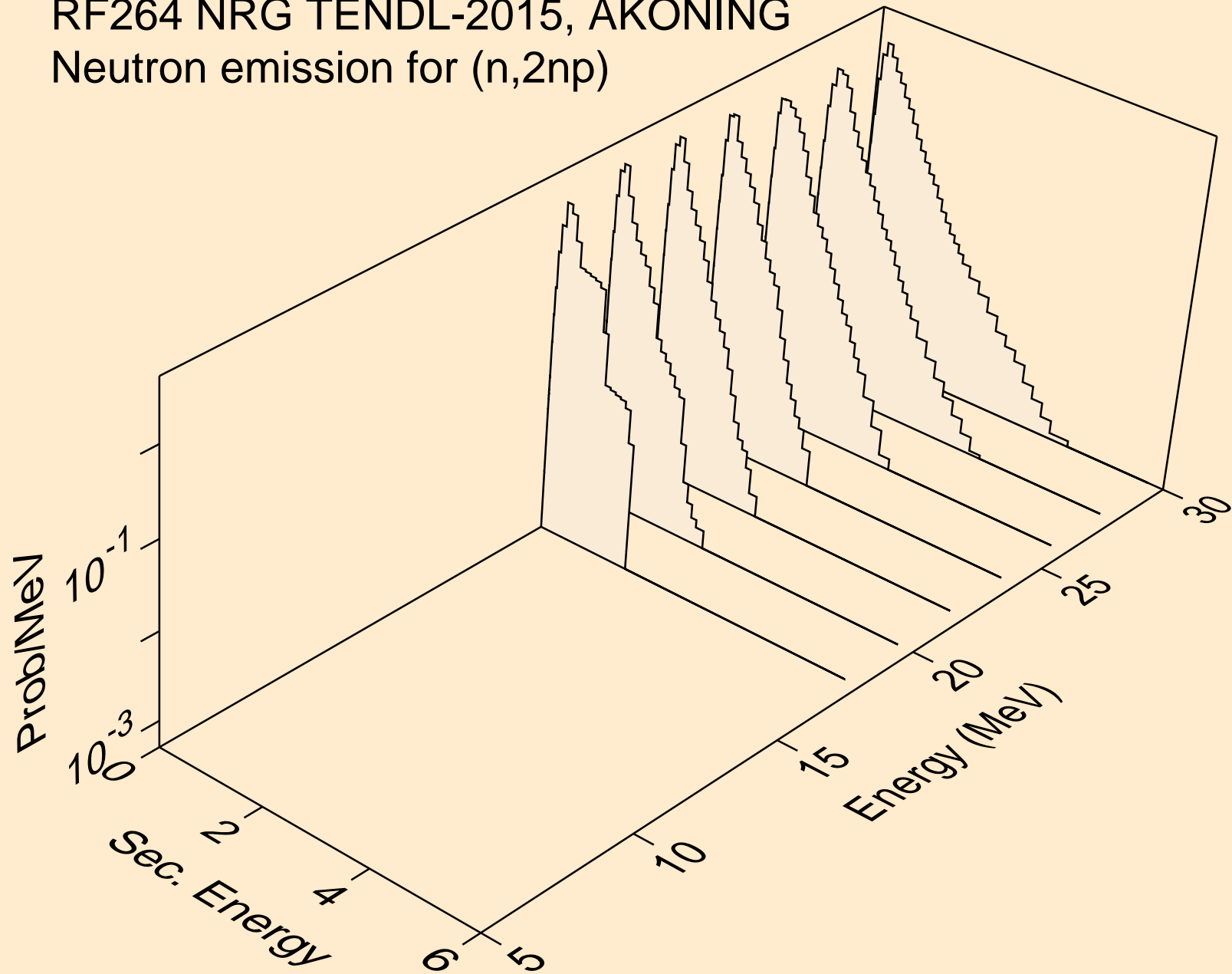

RF264 NRG TENDL-2015, AKONING
Neutron emission for (n,npa)

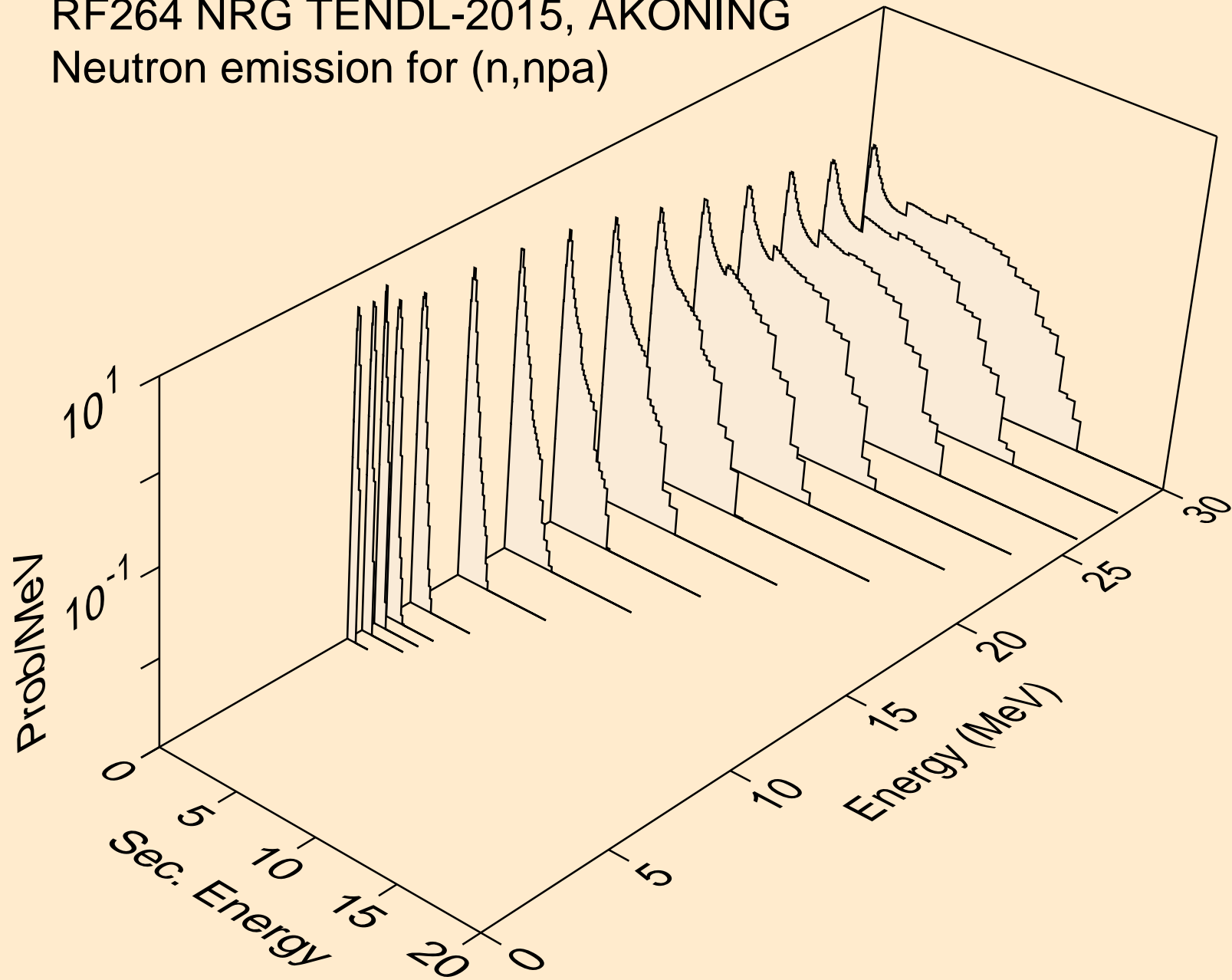

RF264 NRG TENDL-2015, AKONING
Neutron emission for (n,n*c)

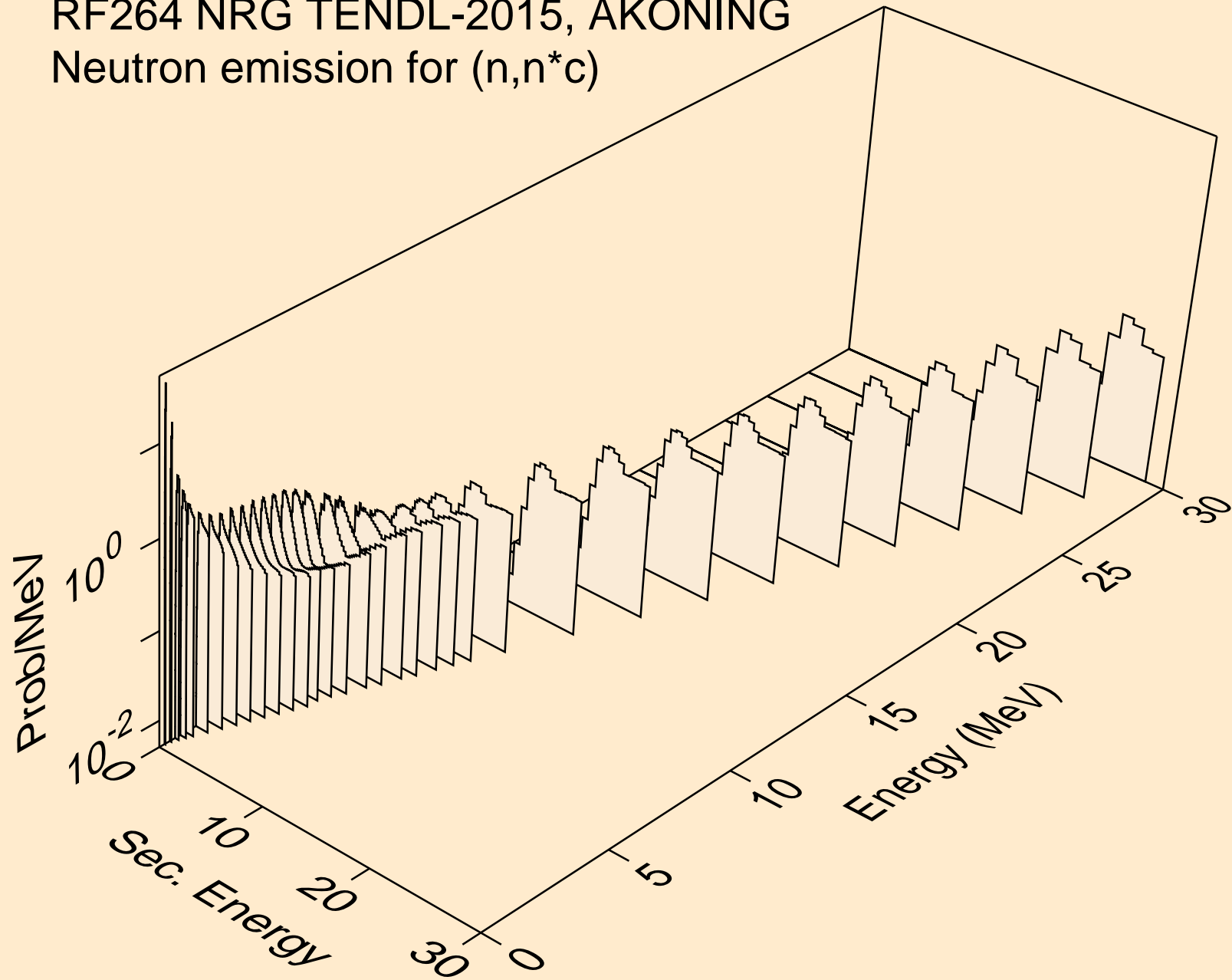

RF264 NRG TENDL-2015, AKONING

Delayed nubar

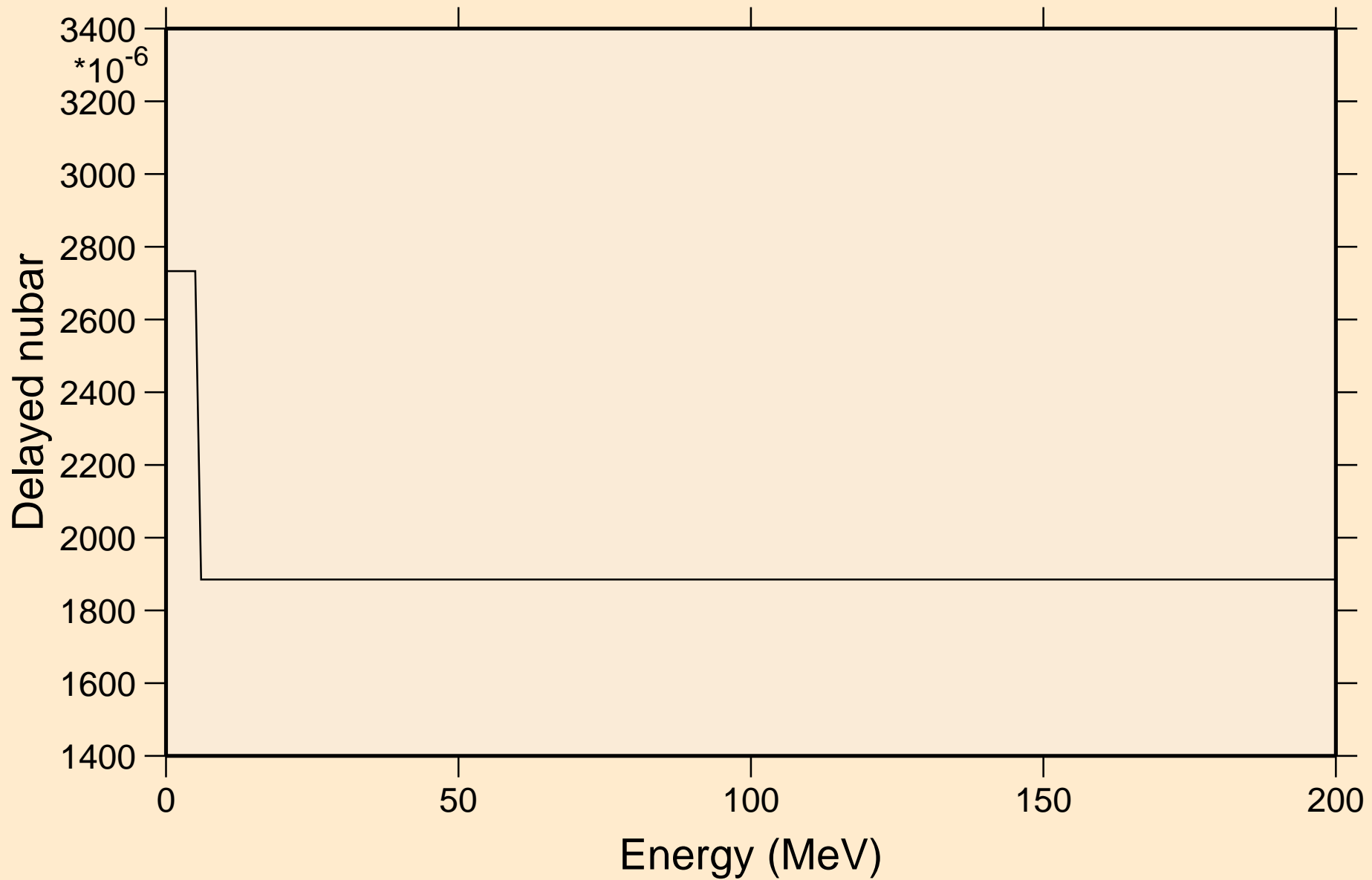

RF264 NRG TENDL-2015, AKONING

Delayed neutron spectra

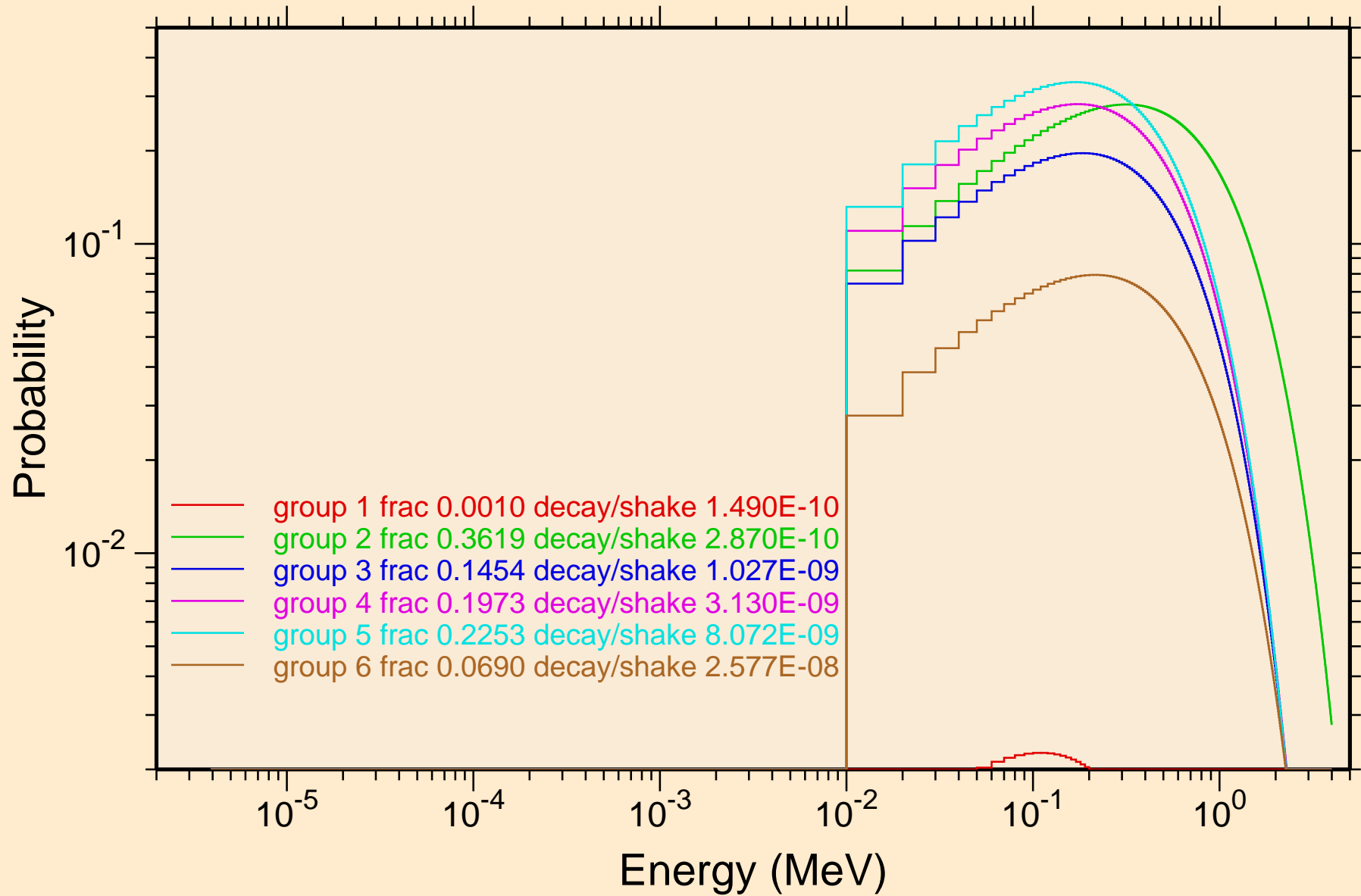

RF264 NRG TENDL-2015, AKONING
Photon emission for (n,x)

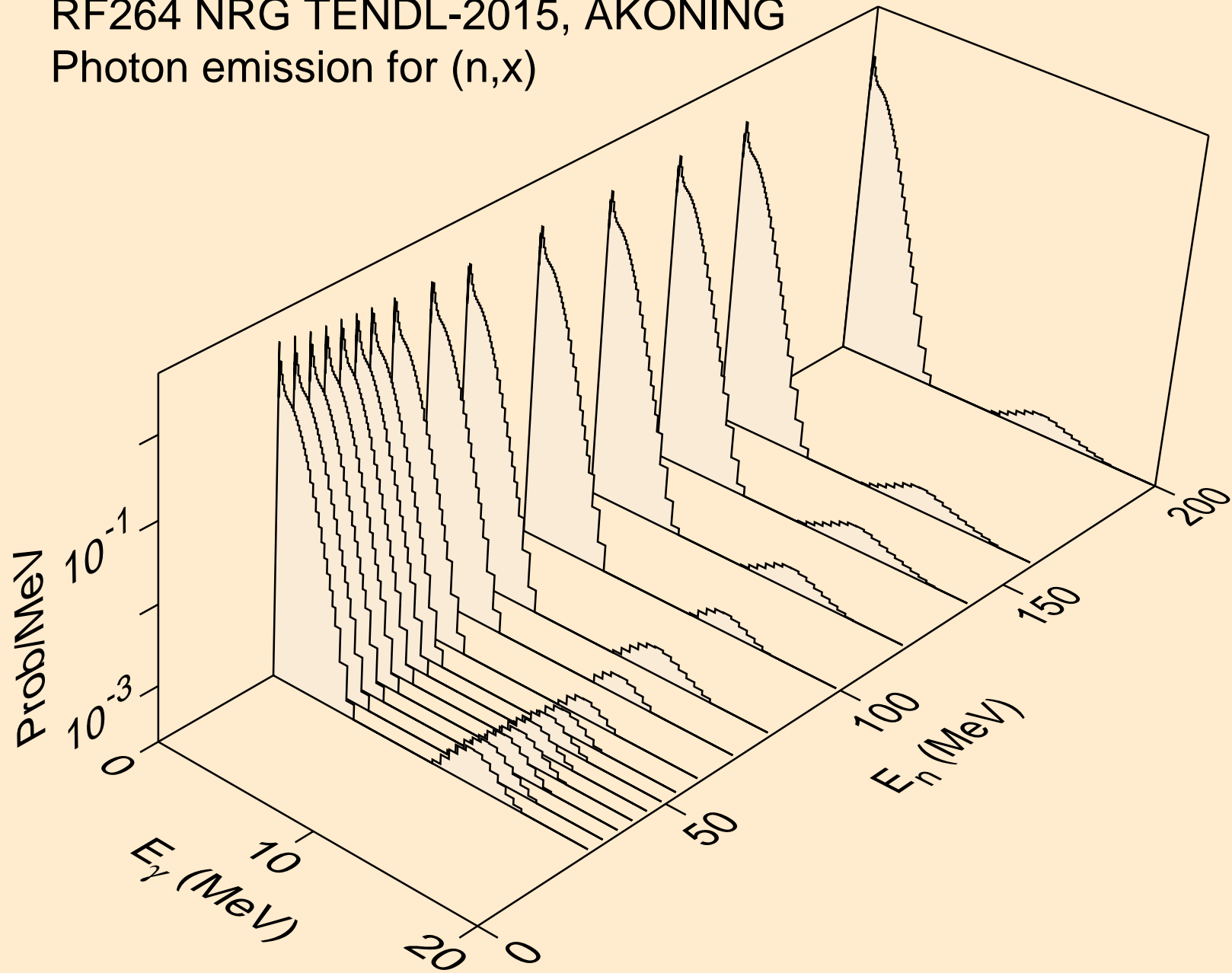

RF264 NRG TENDL-2015, AKONING
Photon emission for (n,2nd)

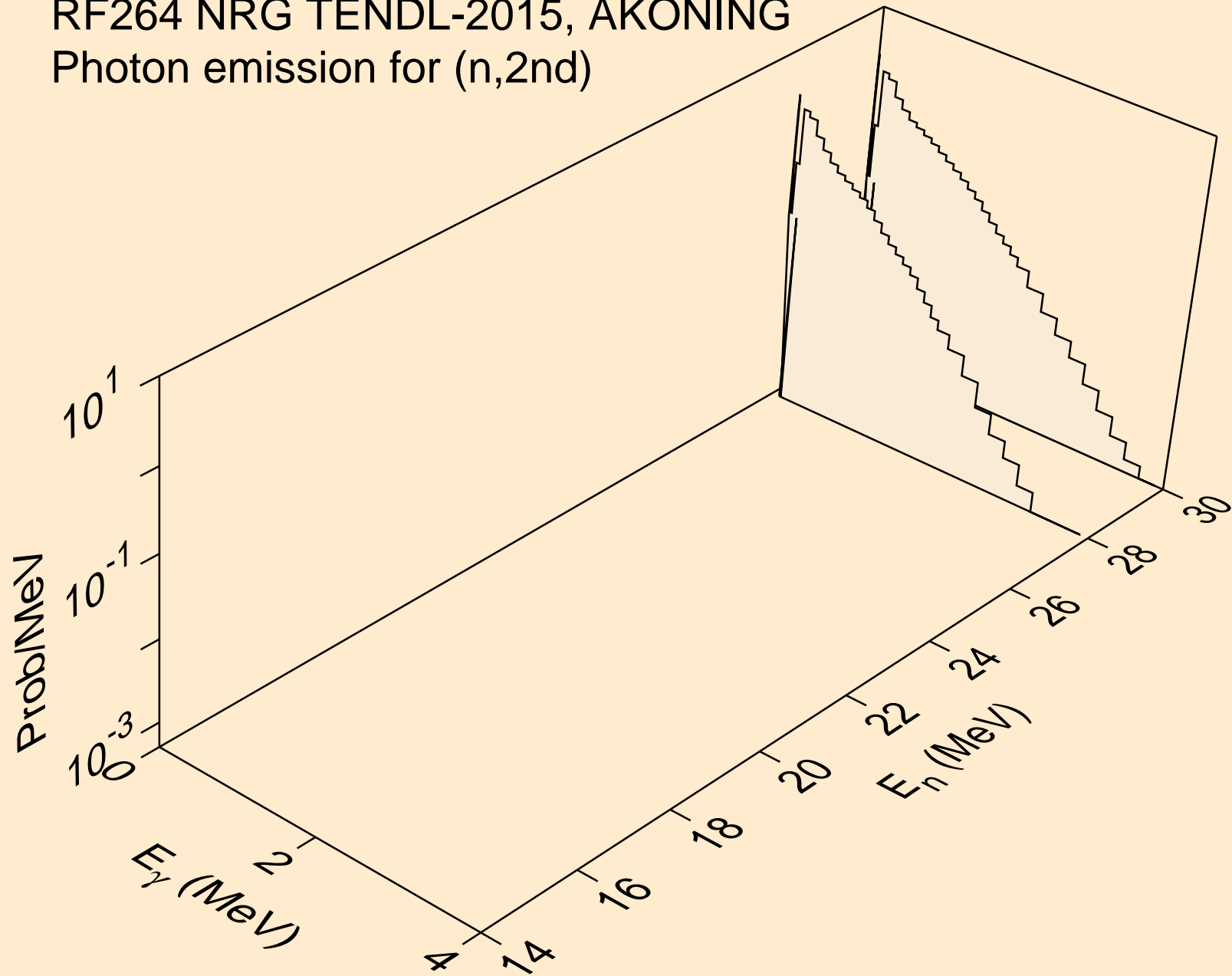

RF264 NRG TENDL-2015, AKONING
Photon emission for (n,2n)

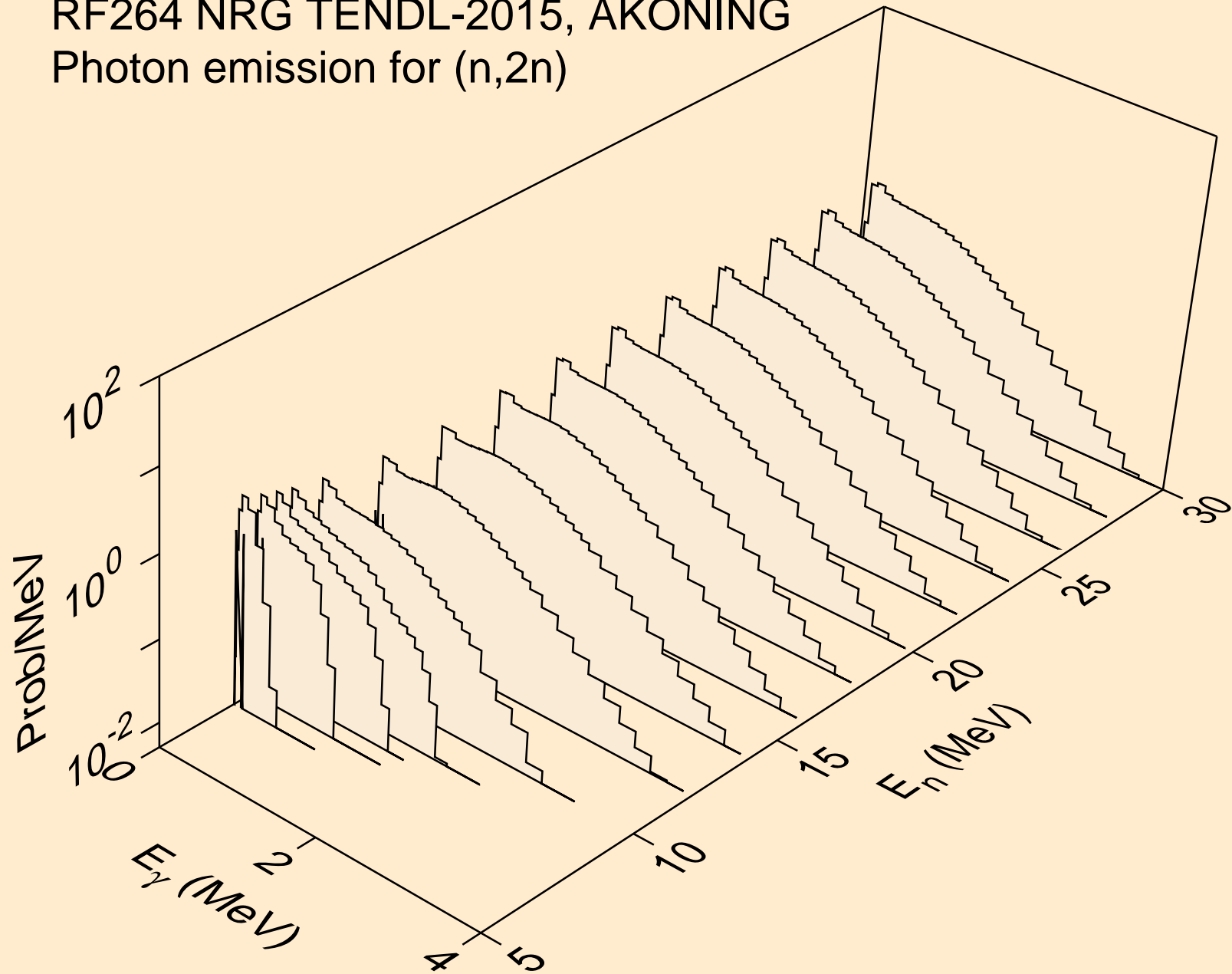

RF264 NRG TENDL-2015, AKONING
Photon emission for (n,3n)

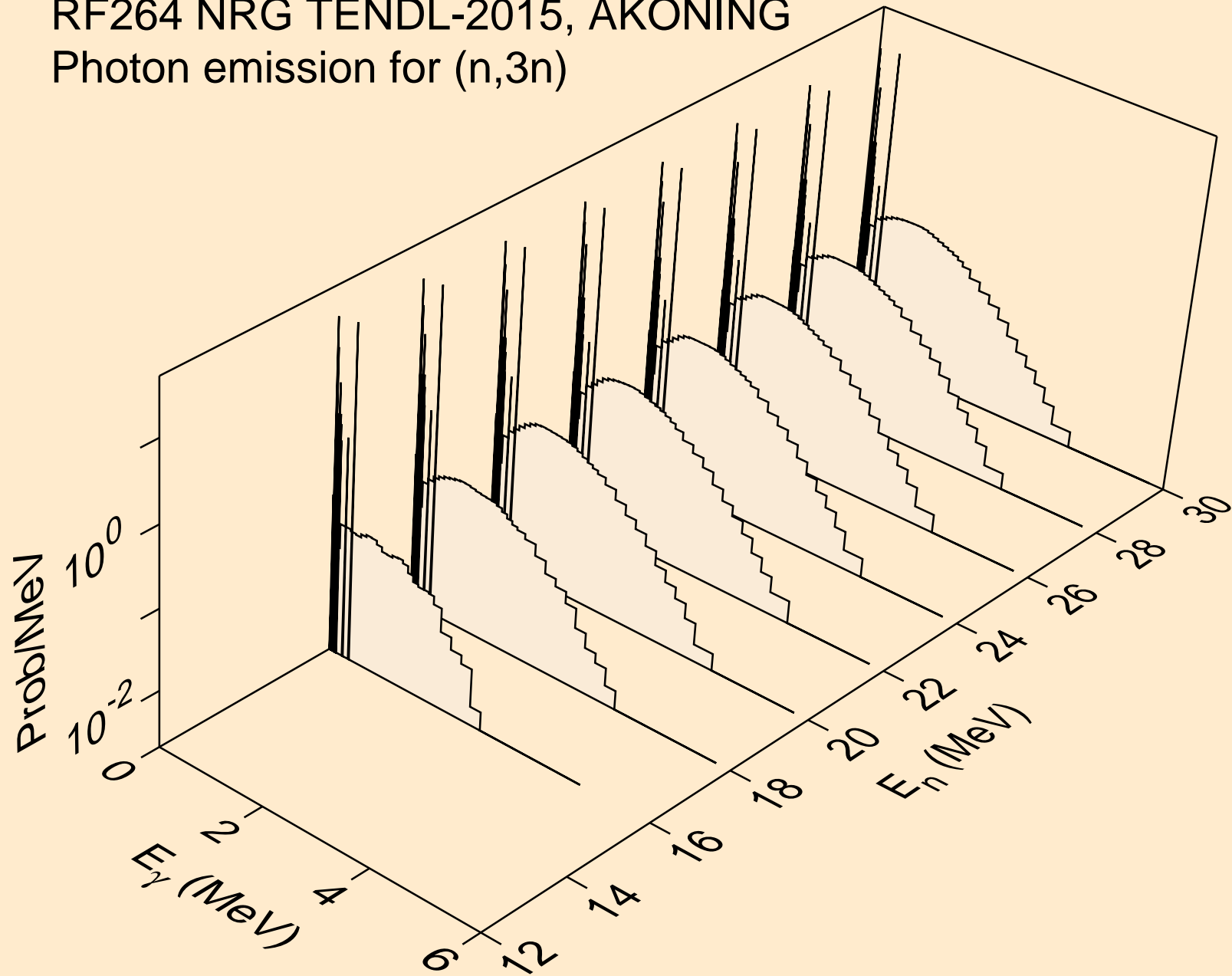

RF264 NRG TENDL-2015, AKONING
Photon emission for (n,n*)a

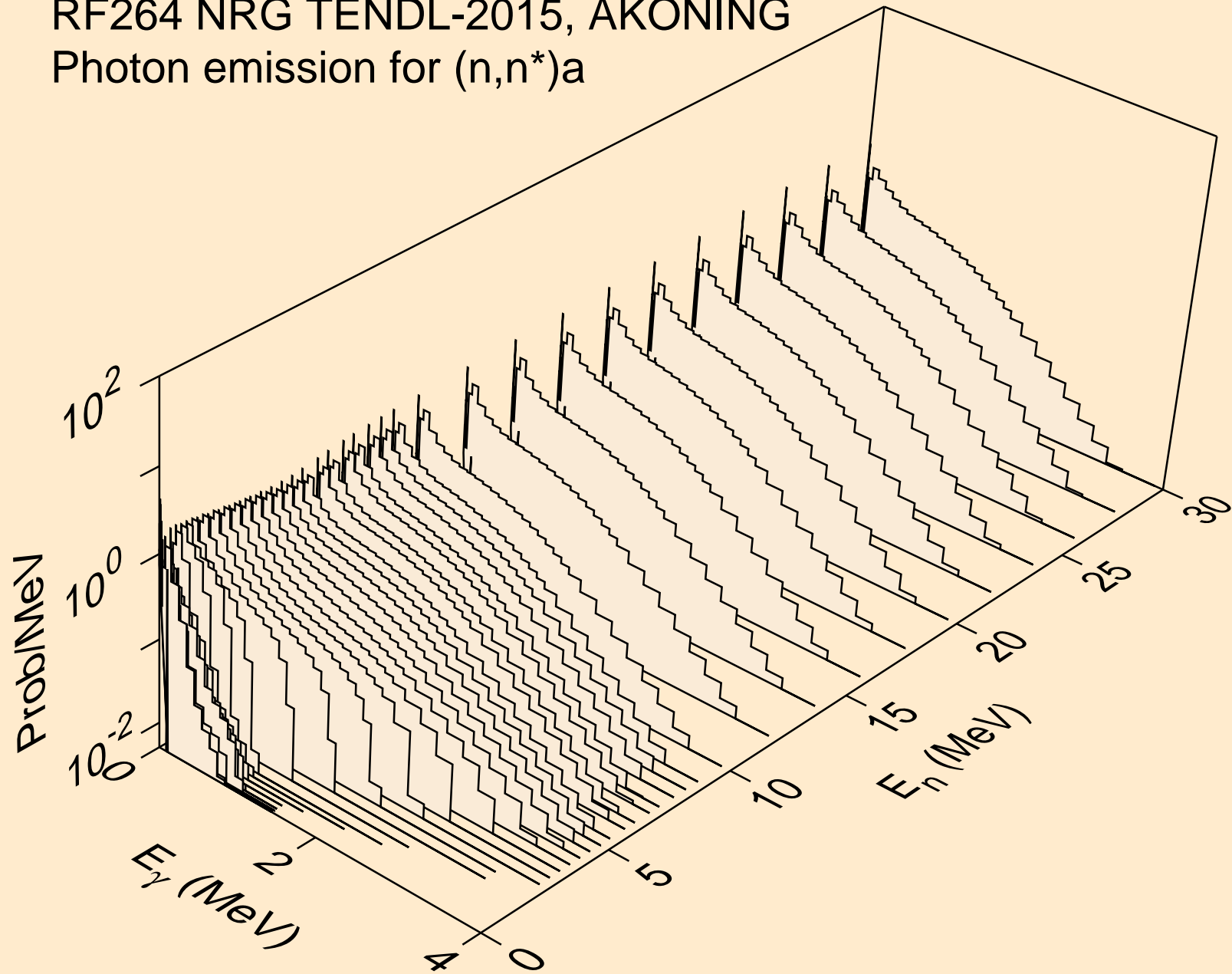

RF264 NRG TENDL-2015, AKONING
Photon emission for (n,n*)3a

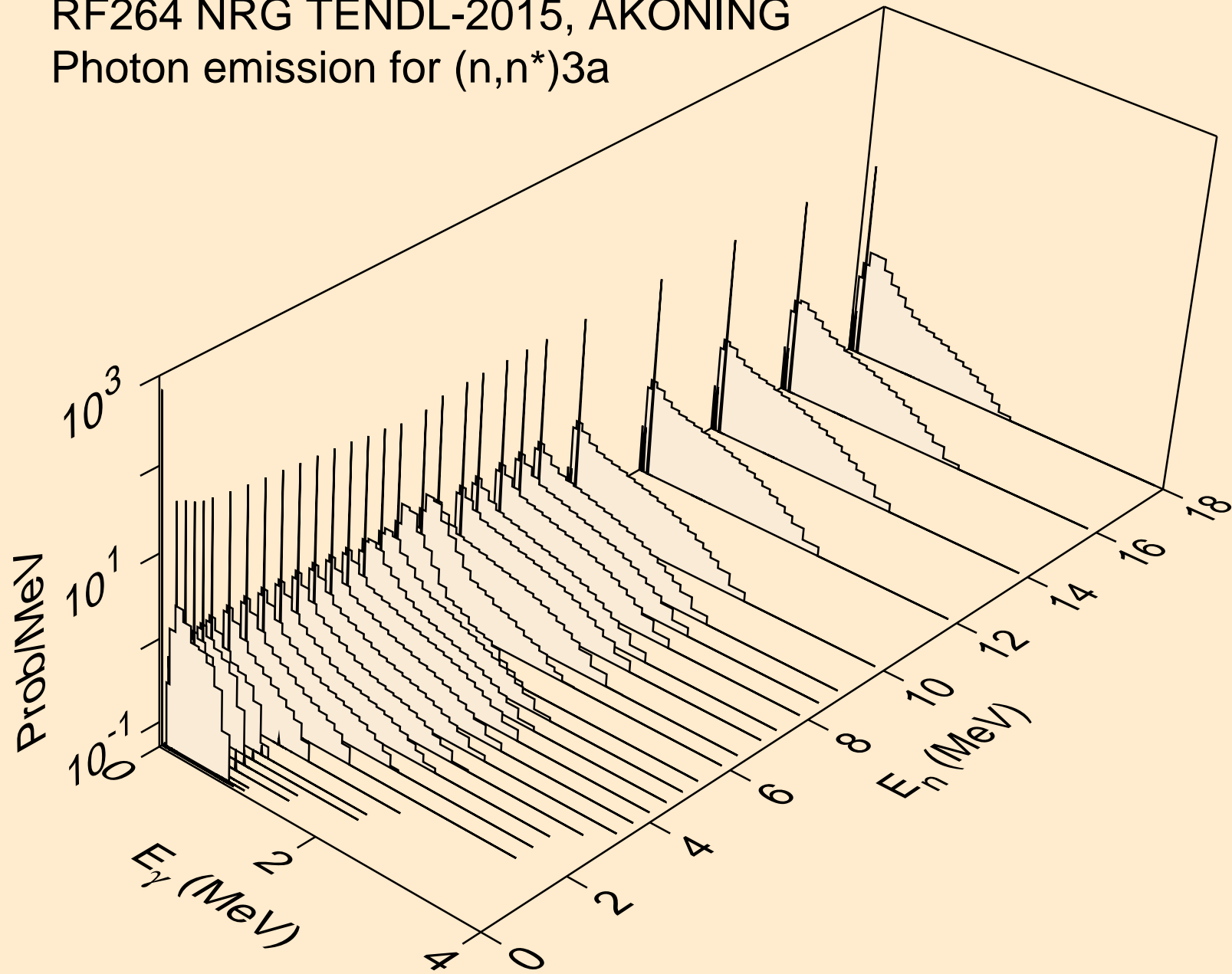

RF264 NRG TENDL-2015, AKONING
Photon emission for (n,2n)a

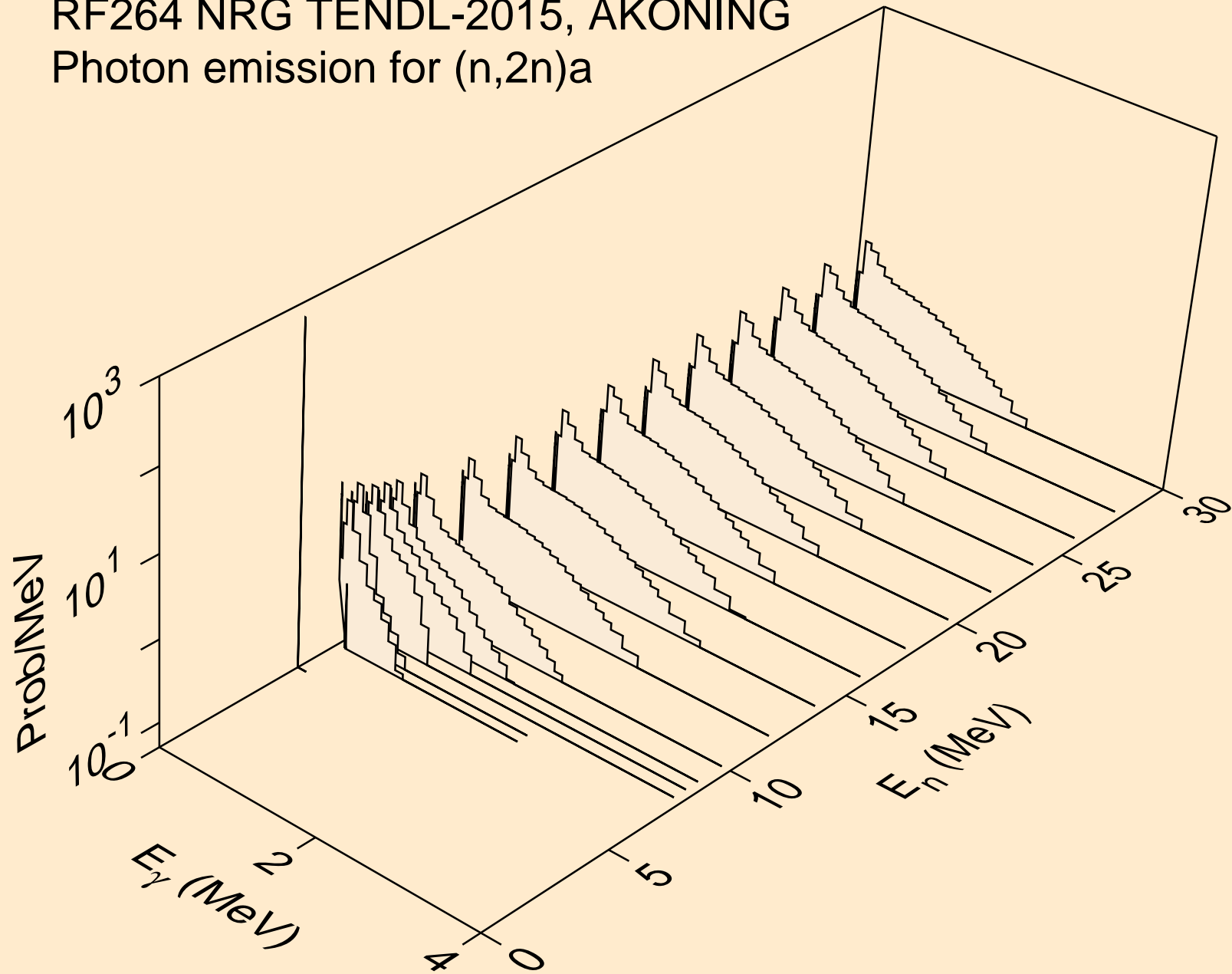

RF264 NRG TENDL-2015, AKONING
Photon emission for (n,3n)a

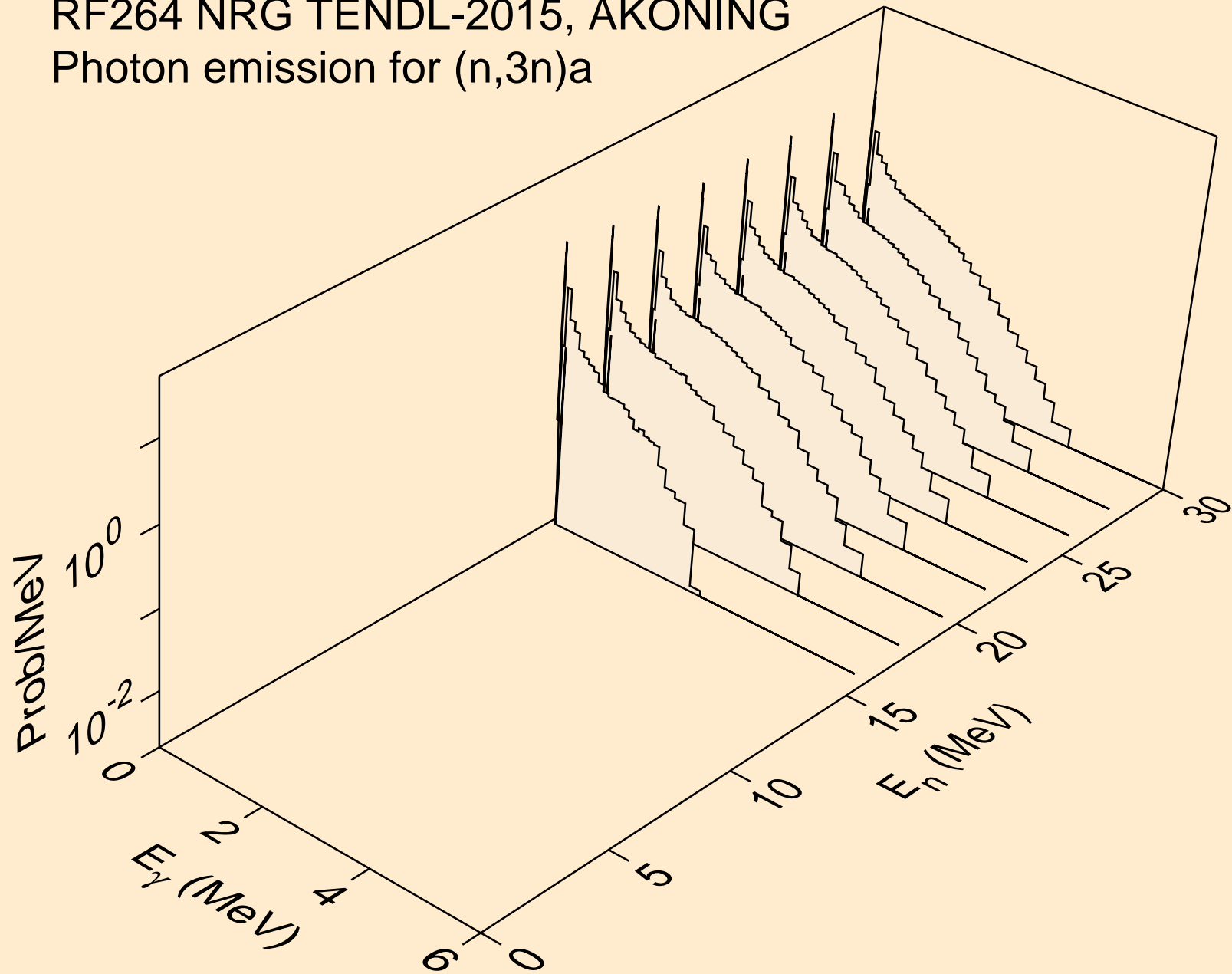

RF264 NRG TENDL-2015, AKONING
Photon emission for (n,n*)p

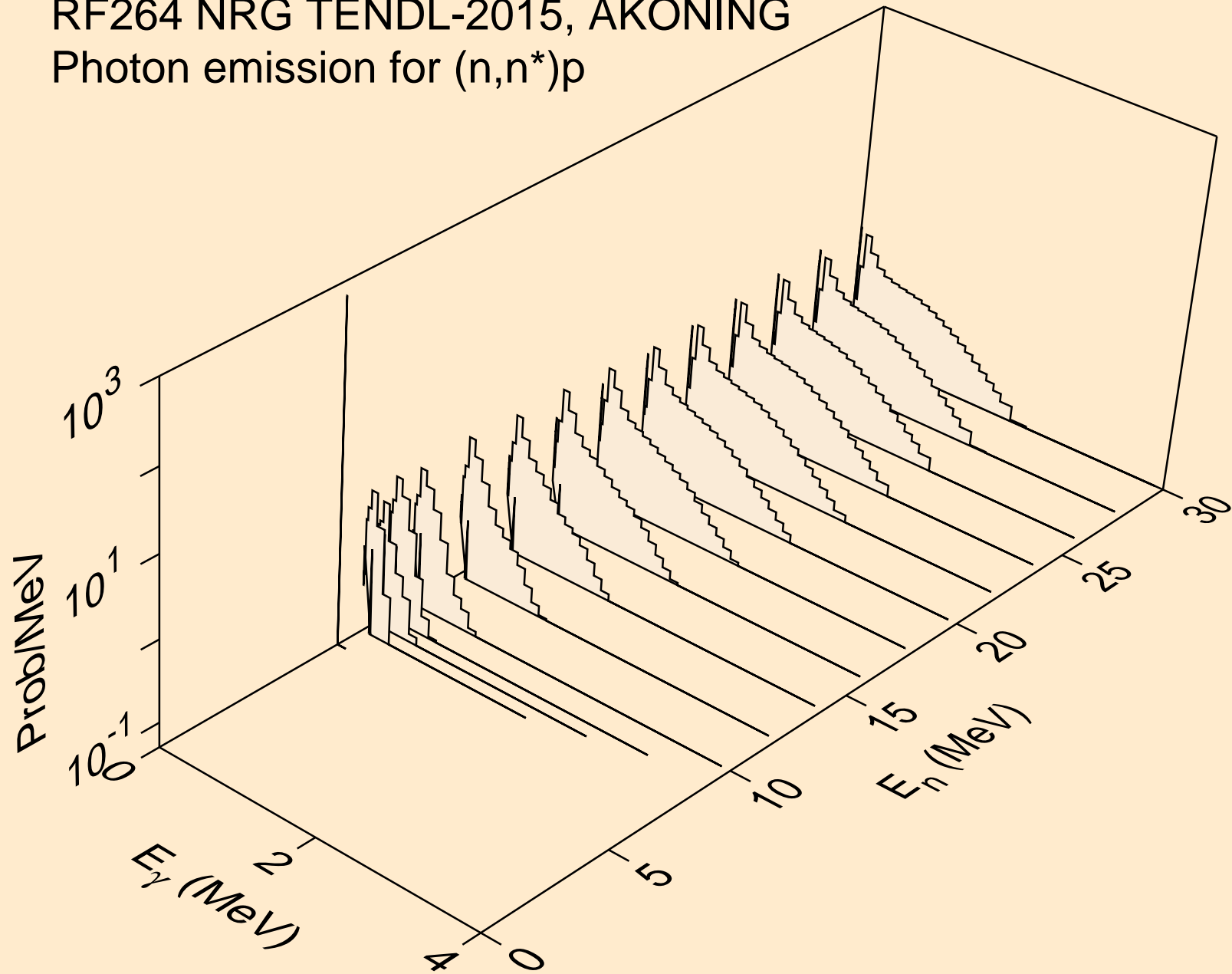

RF264 NRG TENDL-2015, AKONING
Photon emission for (n,n*)2a

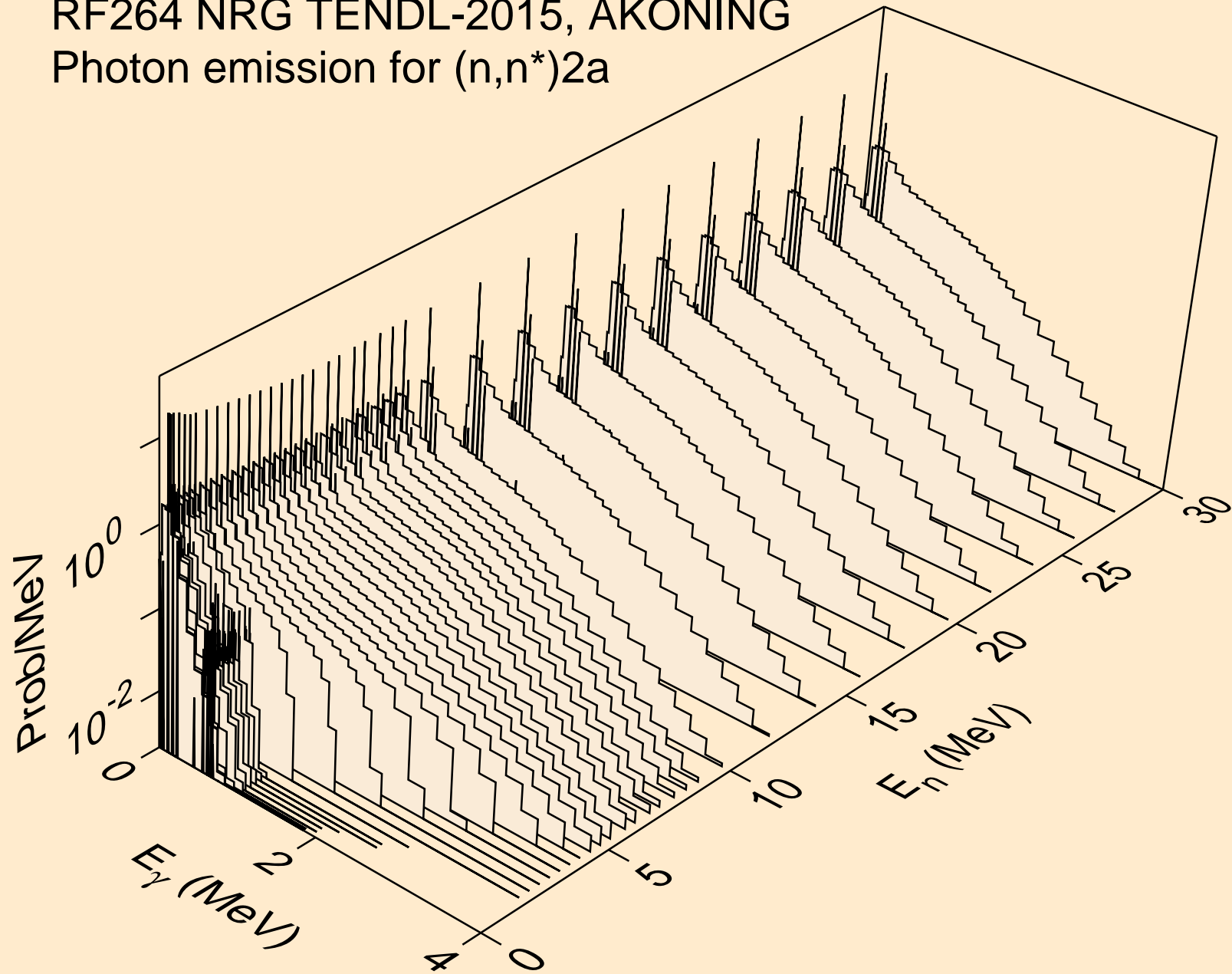

RF264 NRG TENDL-2015, AKONING
Photon emission for (n,2n)2a

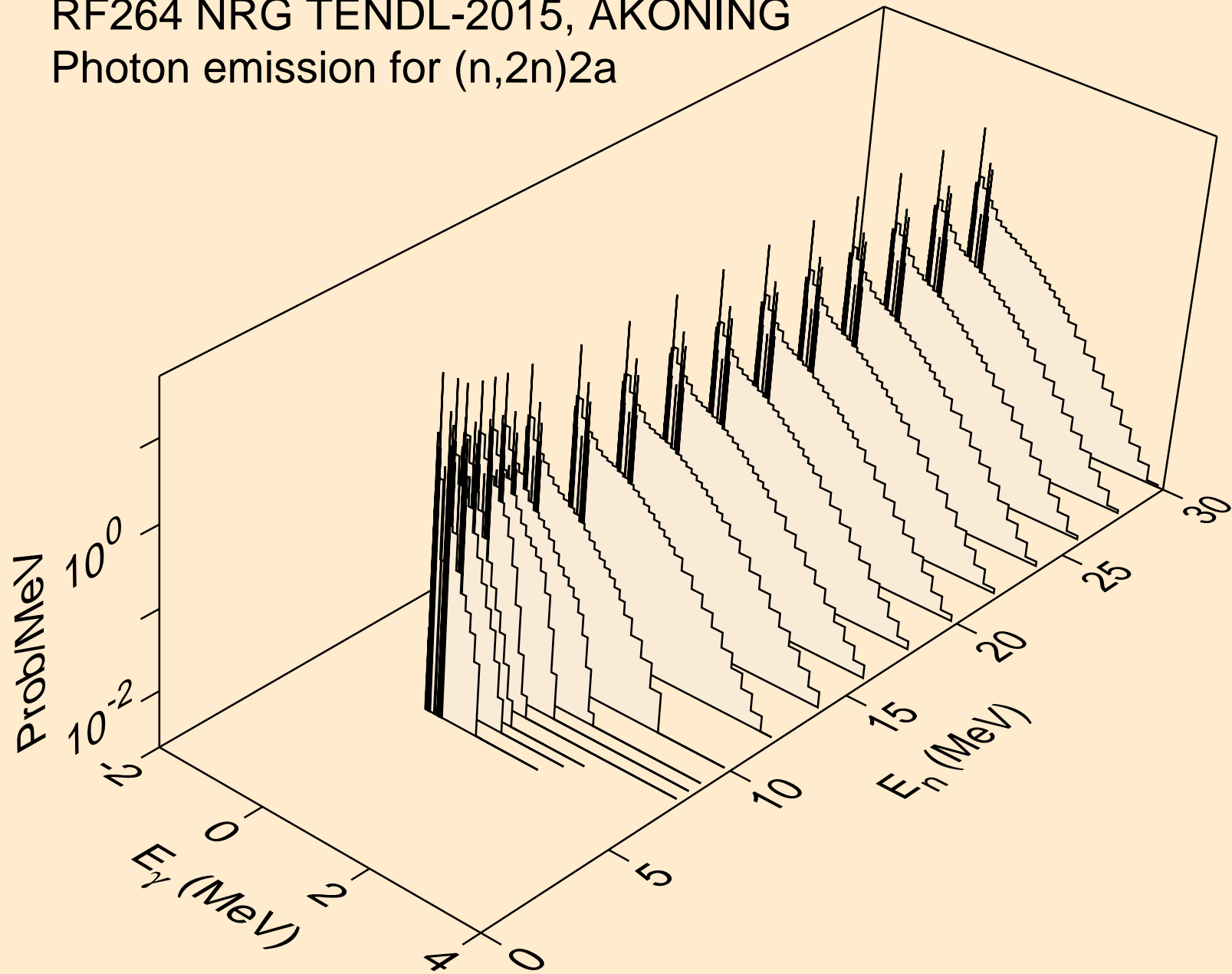

RF264 NRG TENDL-2015, AKONING
Photon emission for (n,n*)d

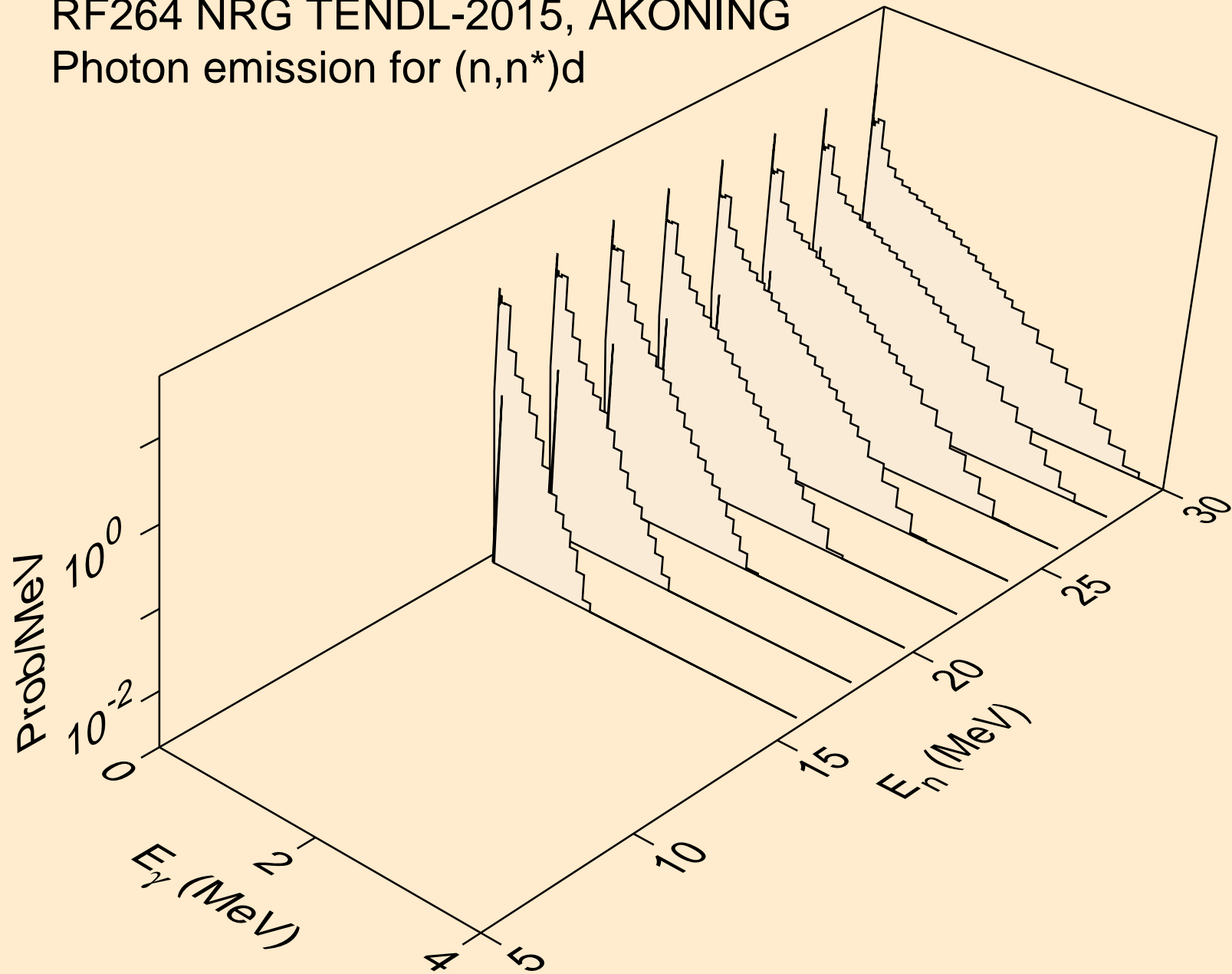

RF264 NRG TENDL-2015, AKONING
Photon emission for (n,n*)t

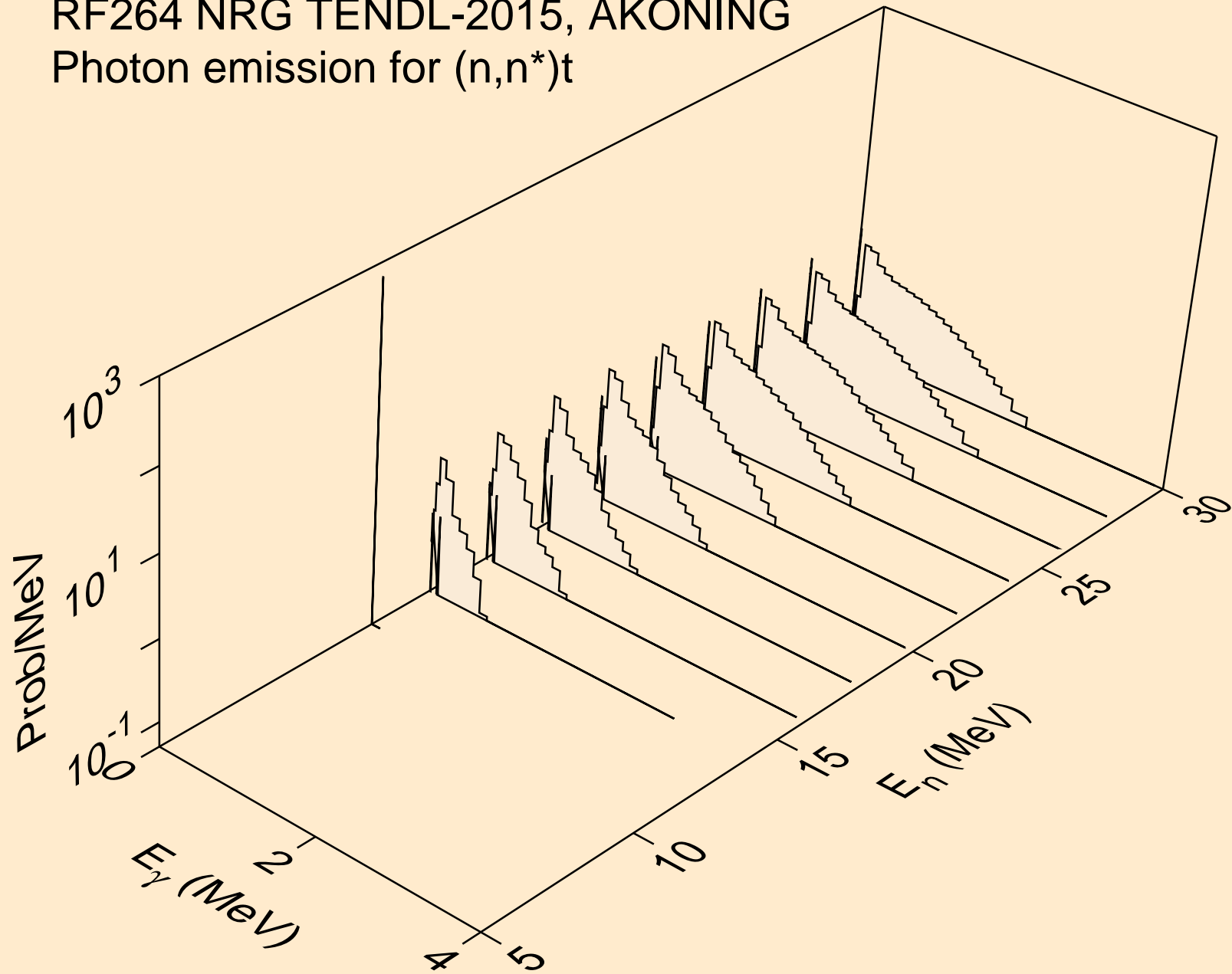

RF264 NRG TENDL-2015, AKONING
Photon emission for (n,n*)he3

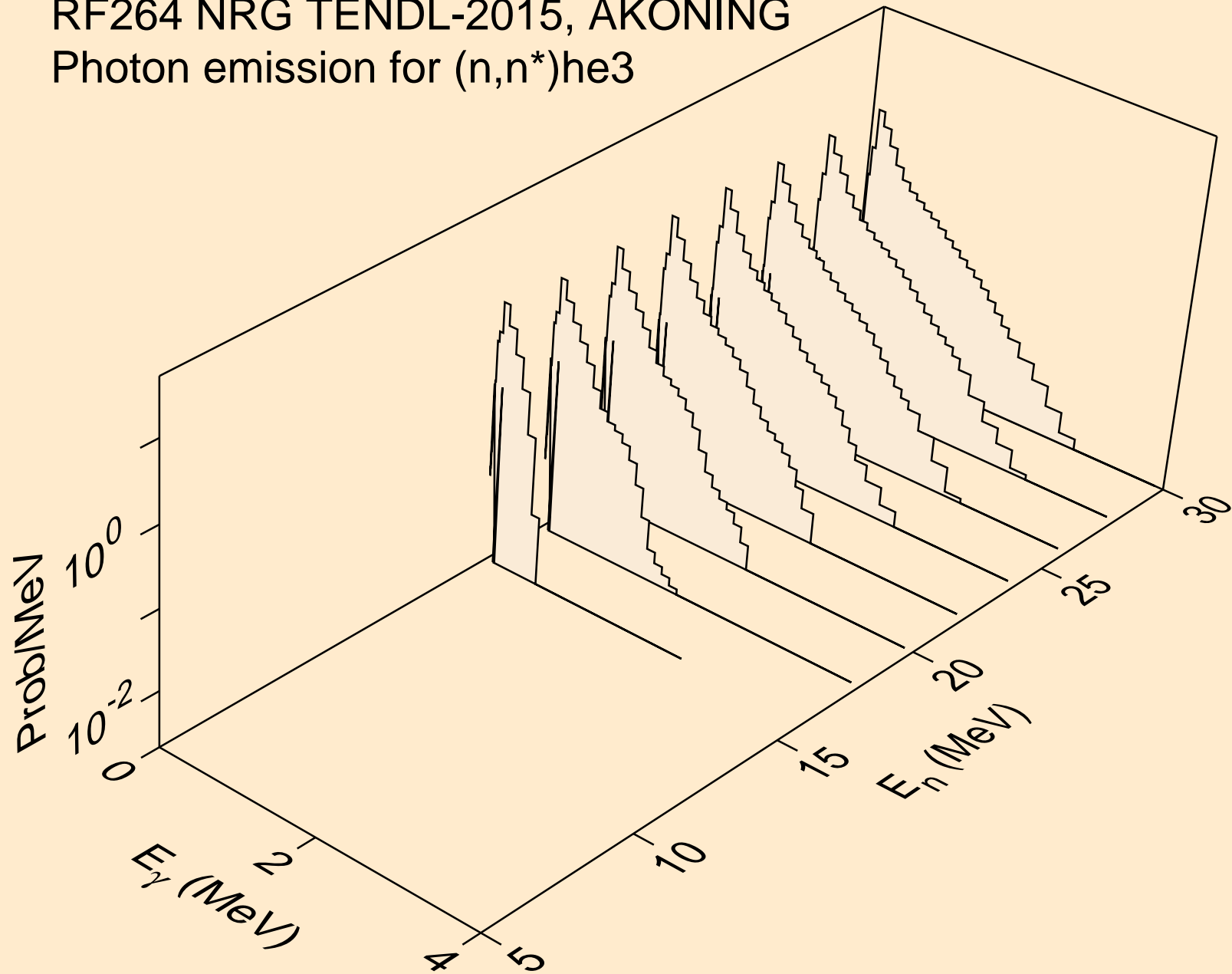

RF264 NRG TENDL-2015, AKONING
Photon emission for (n,n*)d2a

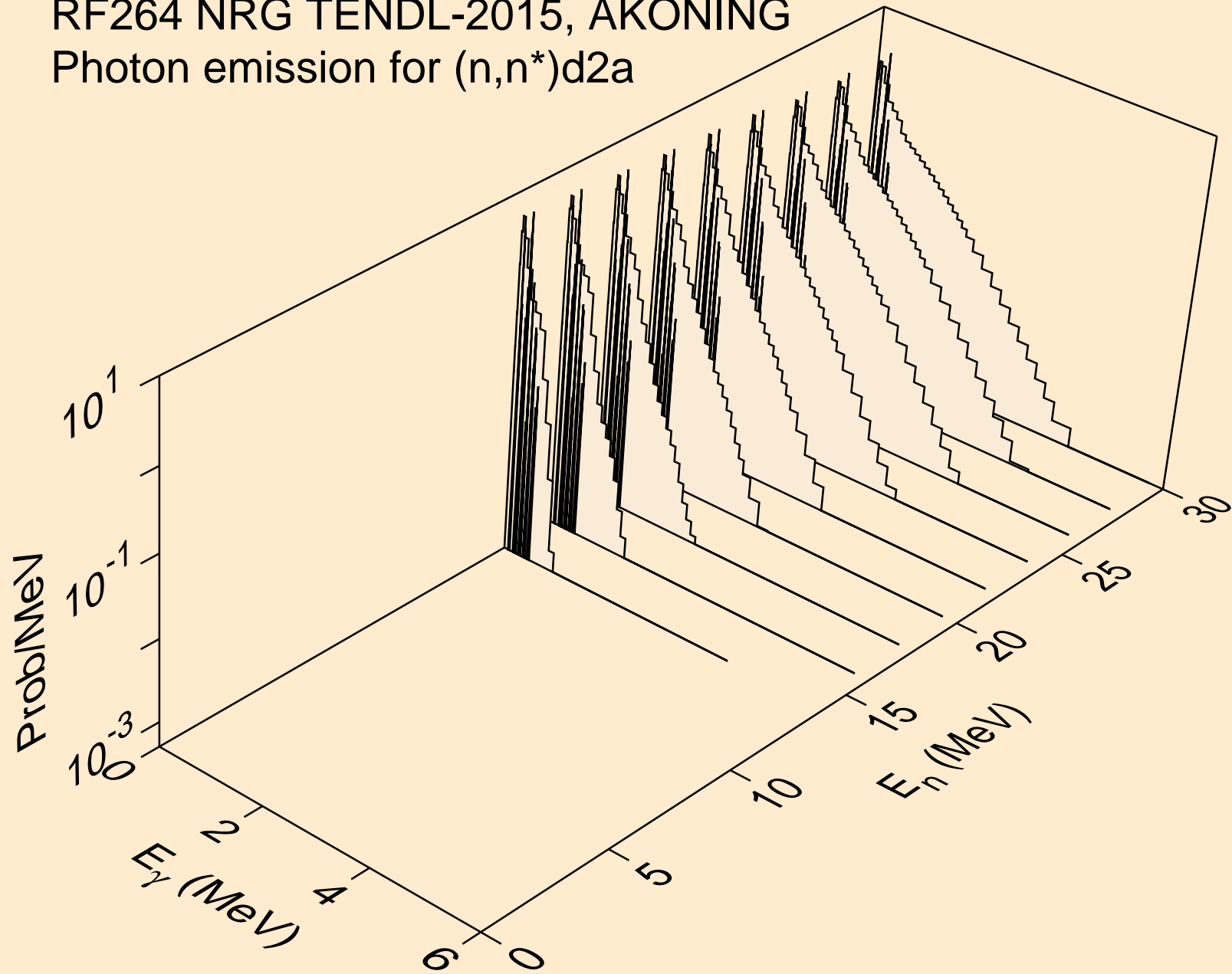

RF264 NRG TENDL-2015, AKONING
Photon emission for (n,n*)t2a

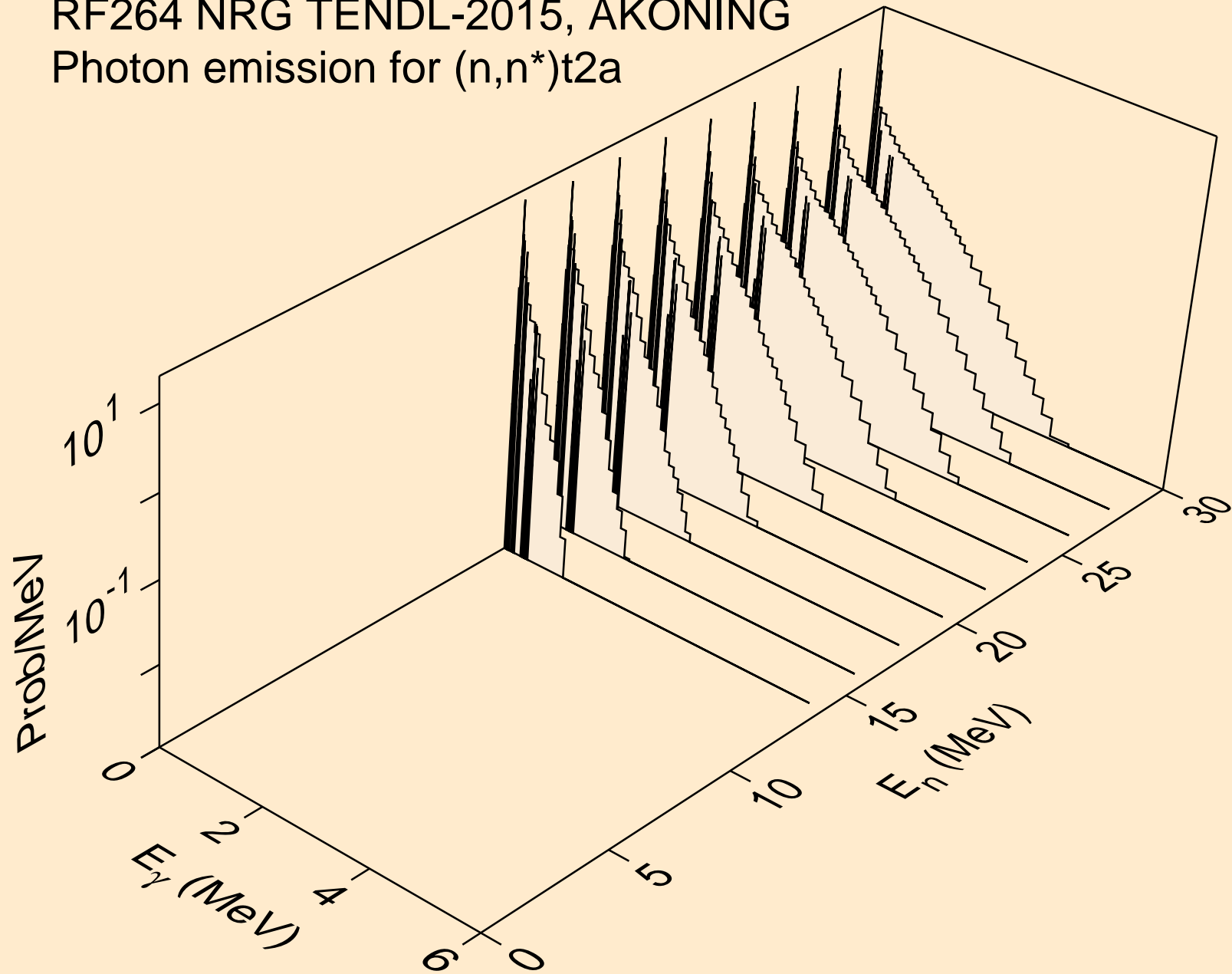

RF264 NRG TENDL-2015, AKONING
Photon emission for (n,4n)

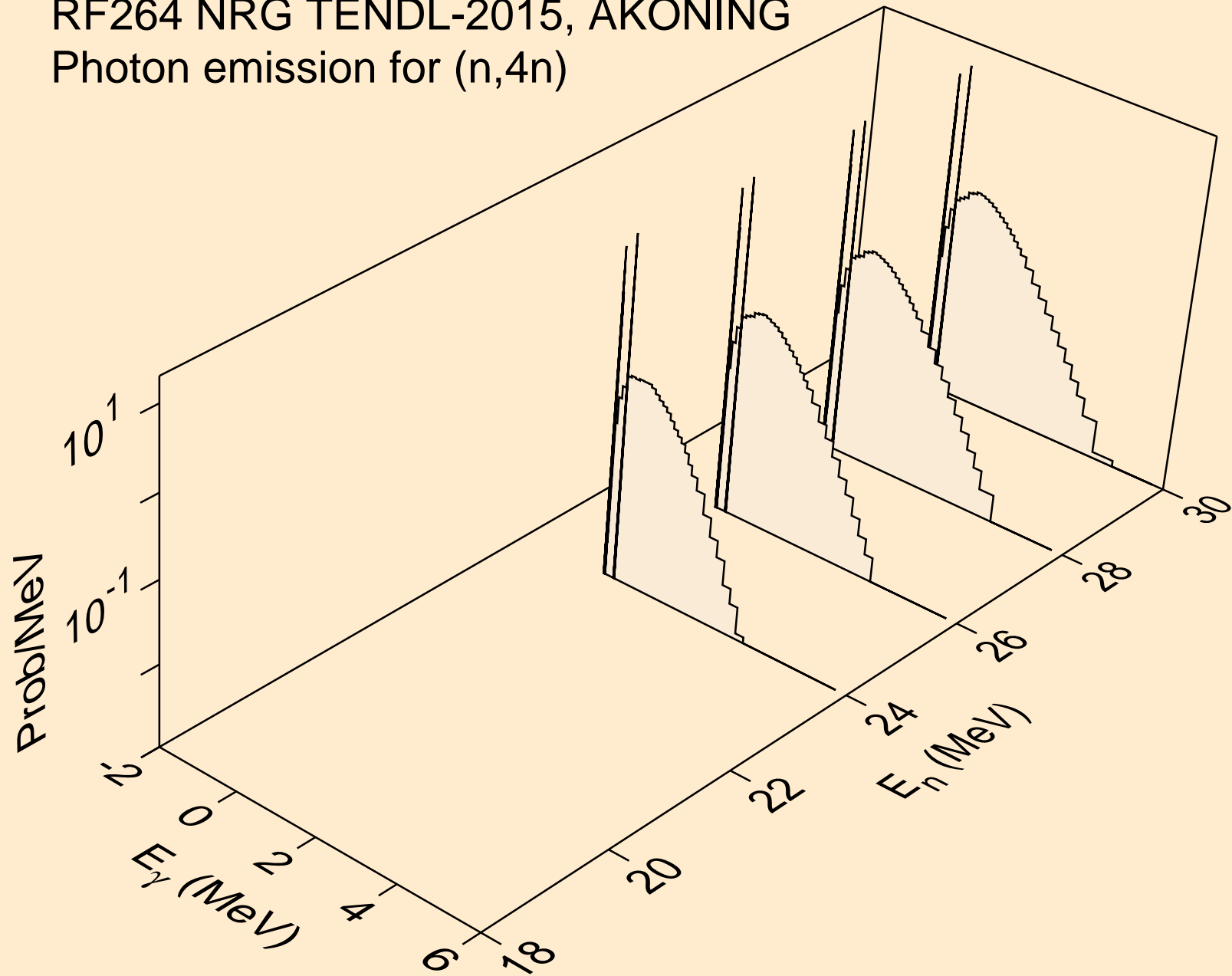

RF264 NRG TENDL-2015, AKONING
Photon emission for (n,2np)

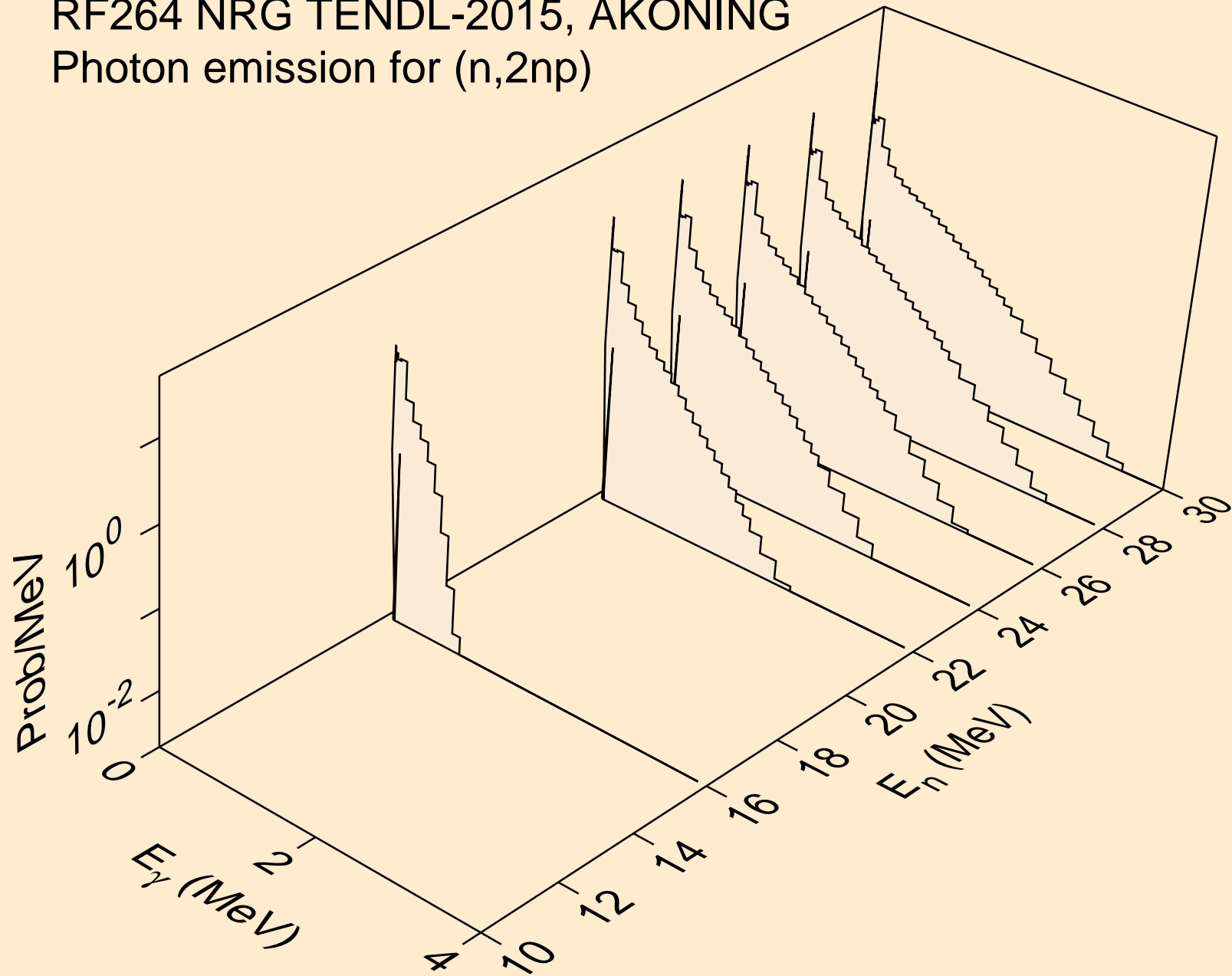

RF264 NRG TENDL-2015, AKONING
Photon emission for (n,3np)

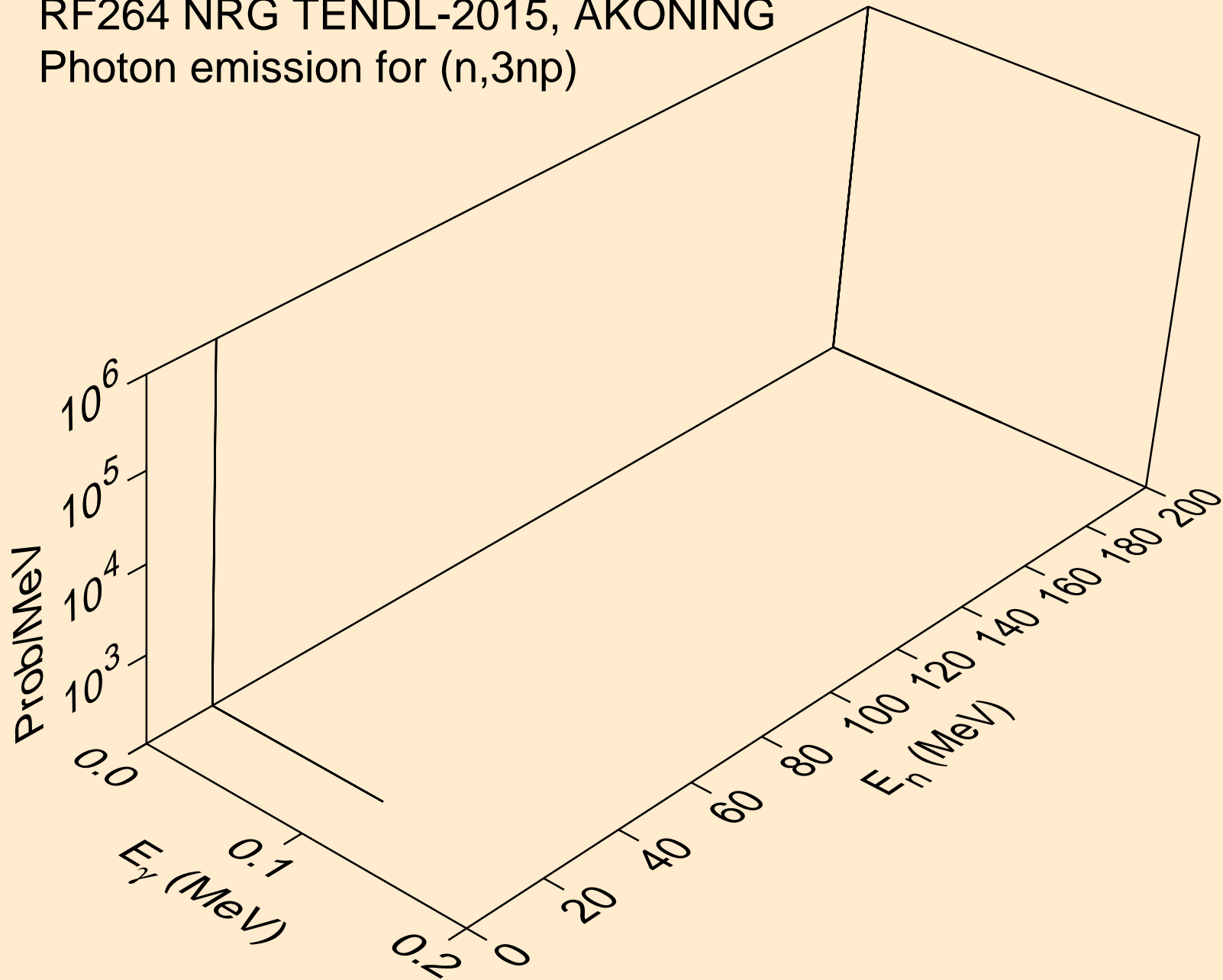

RF264 NRG TENDL-2015, AKONING
Photon emission for (n,2np)

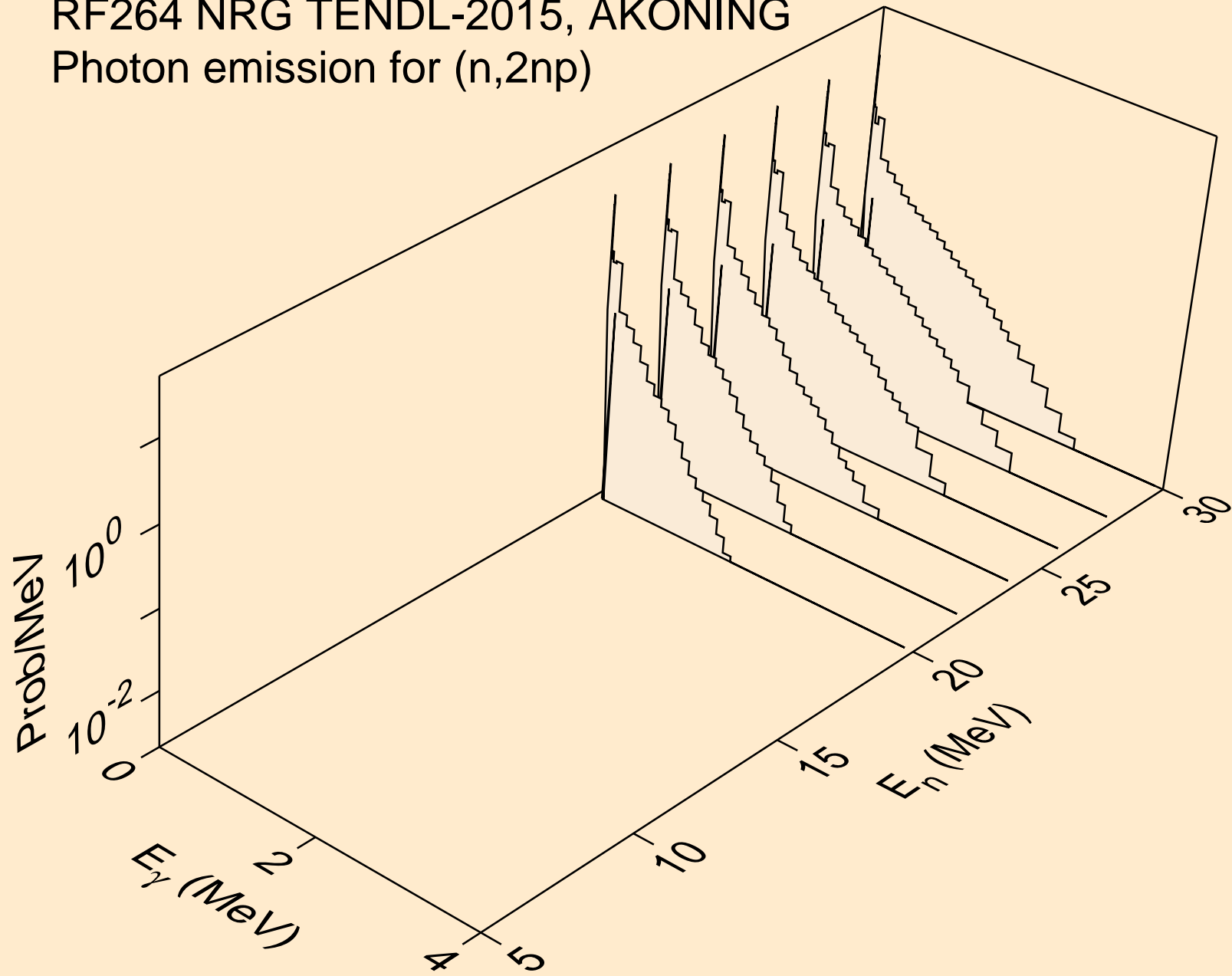

RF264 NRG TENDL-2015, AKONING
Photon emission for (n,npa)

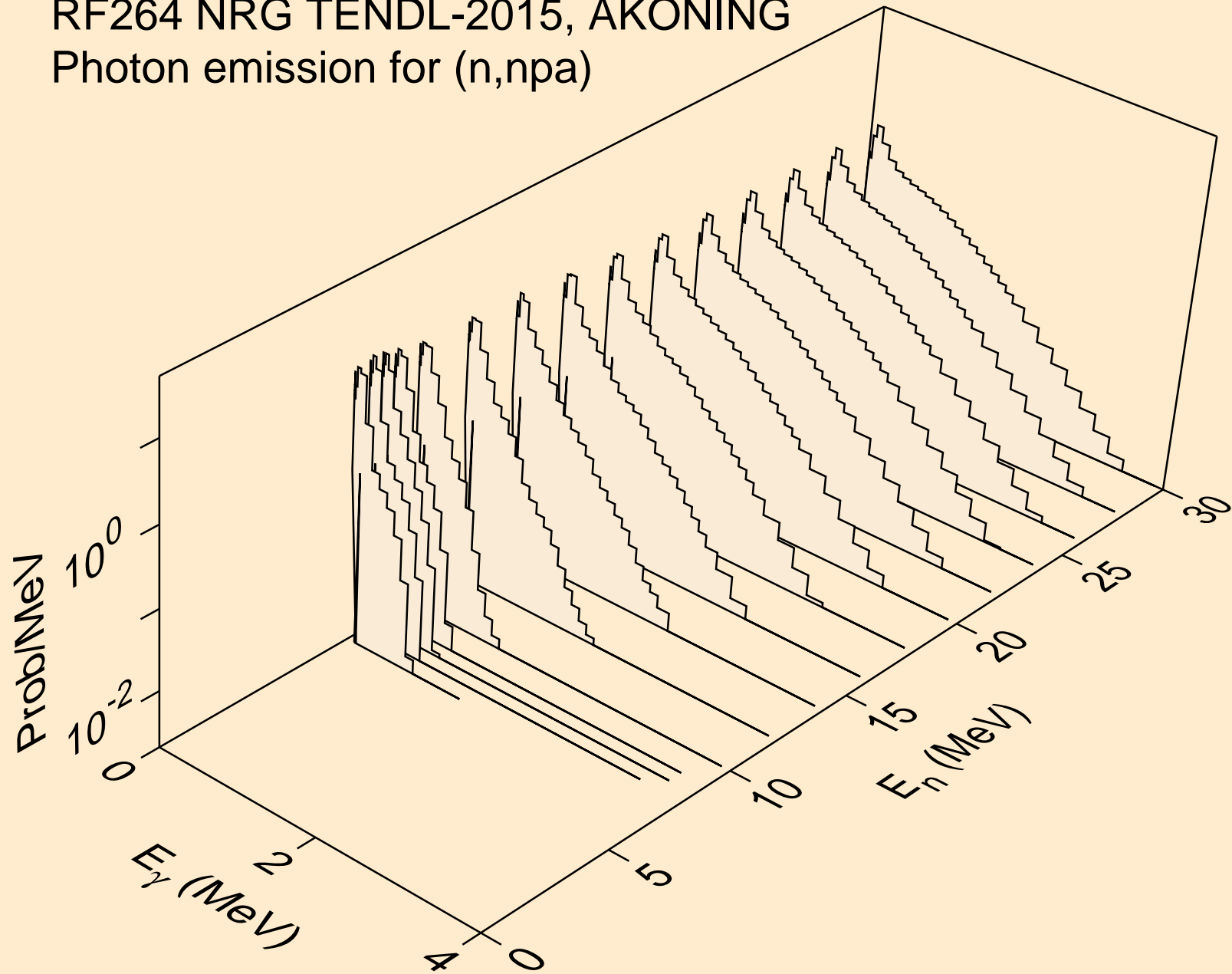

RF264 NRG TENDL-2015, AKONING
Photon emission for (n,n*c)

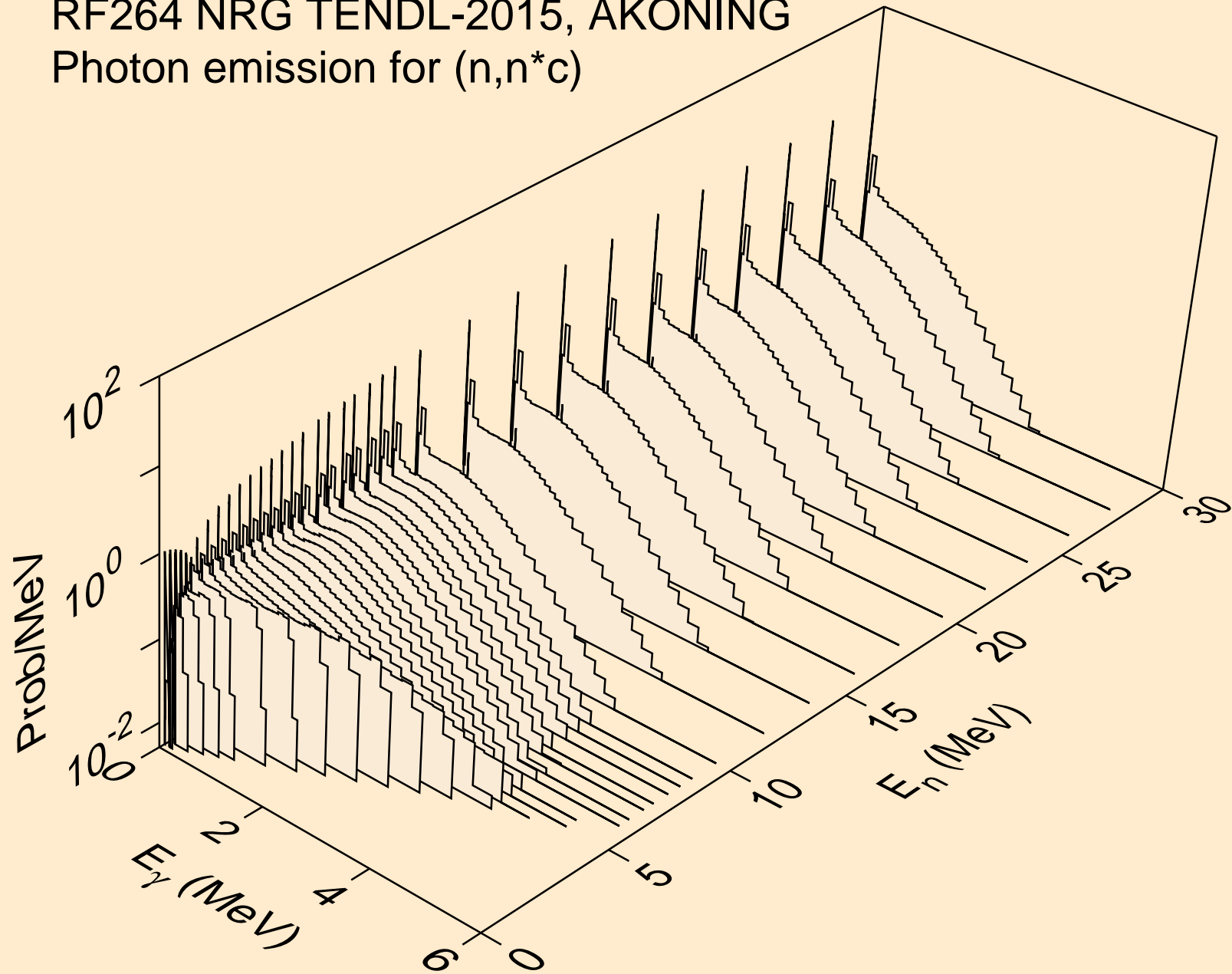

RF264 NRG TENDL-2015, AKONING
Photon emission for (n,gma)

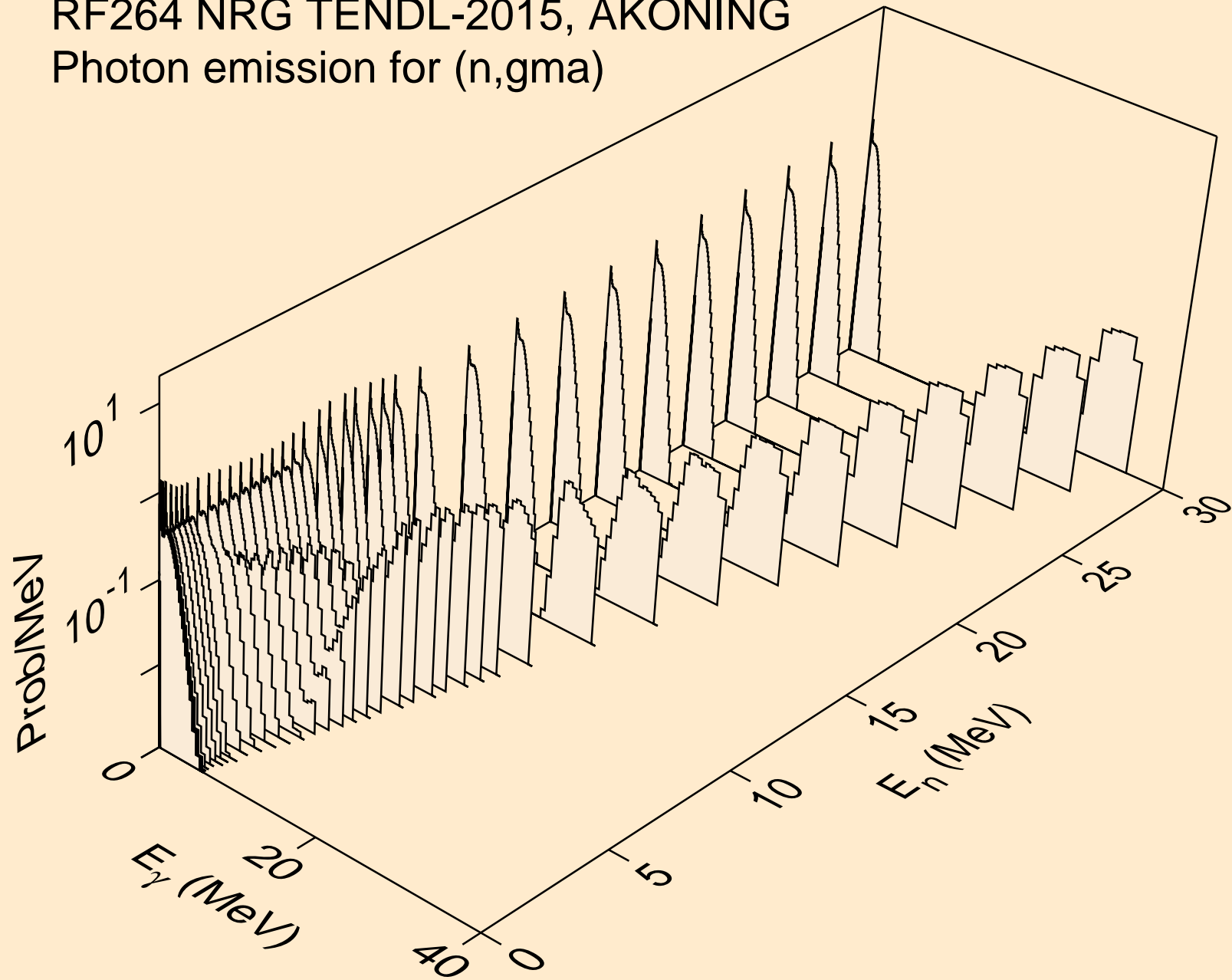

RF264 NRG TENDL-2015, AKONING
Photon emission for (n,p)

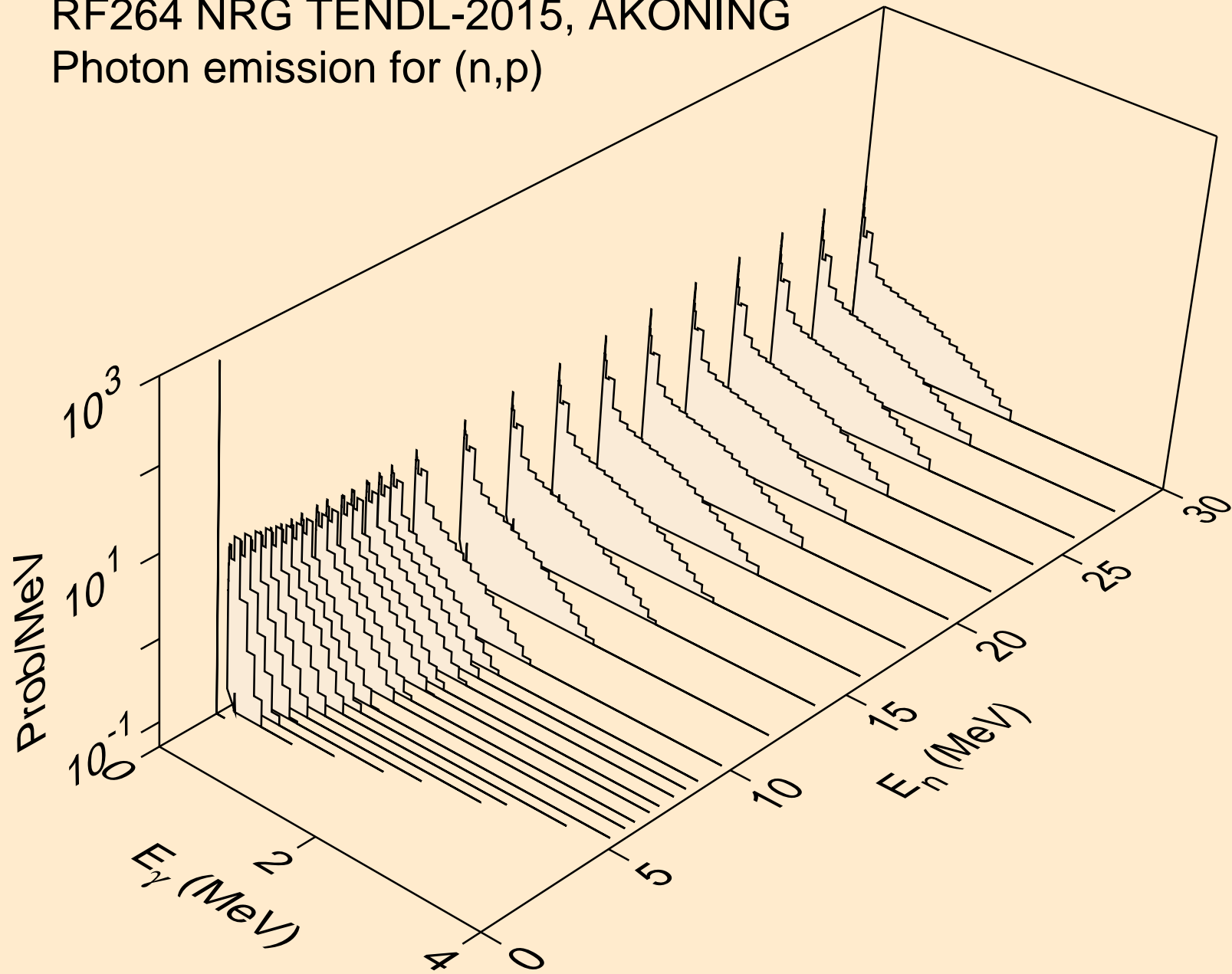

RF264 NRG TENDL-2015, AKONING
Photon emission for (n,d)

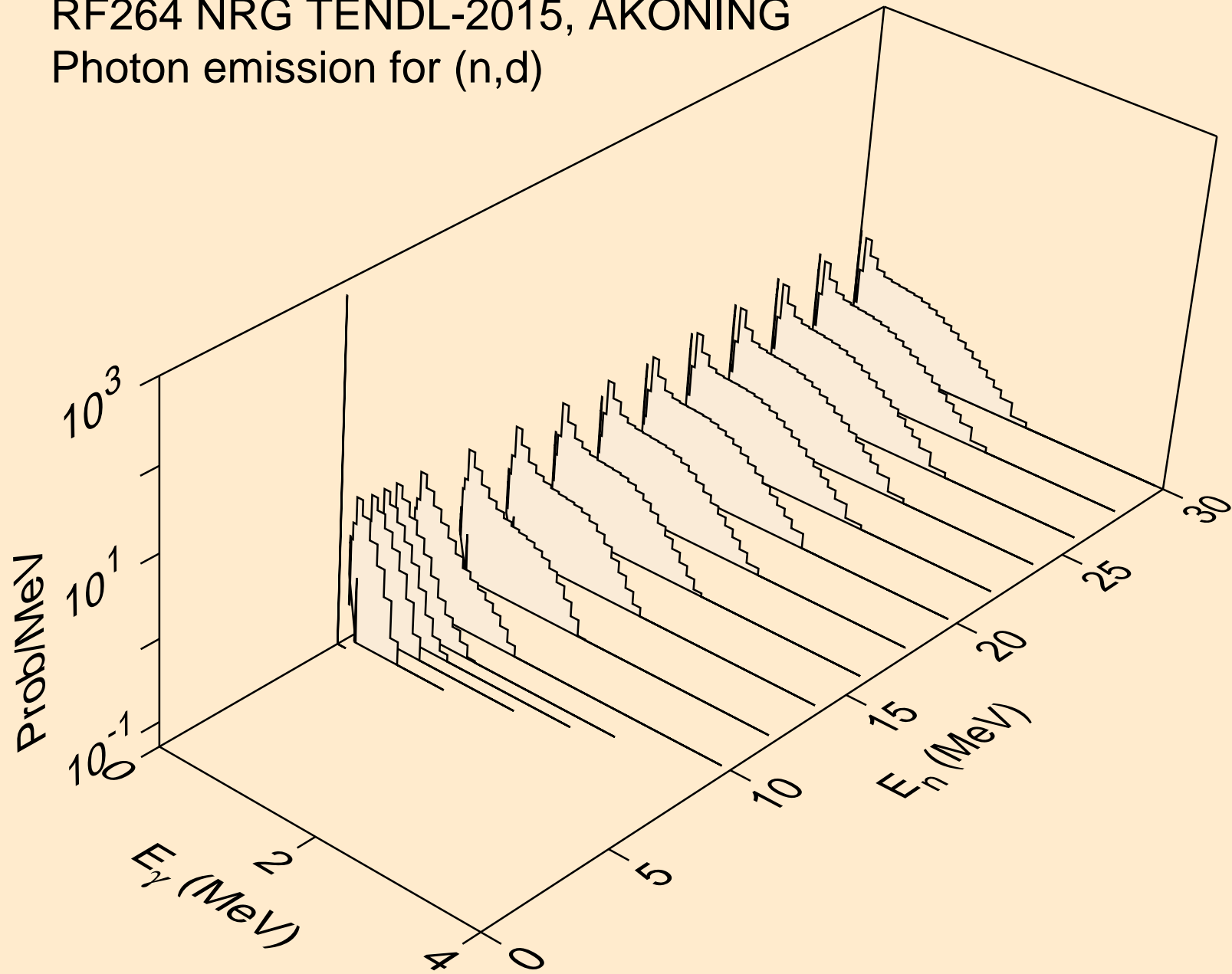

RF264 NRG TENDL-2015, AKONING
Photon emission for (n,t)

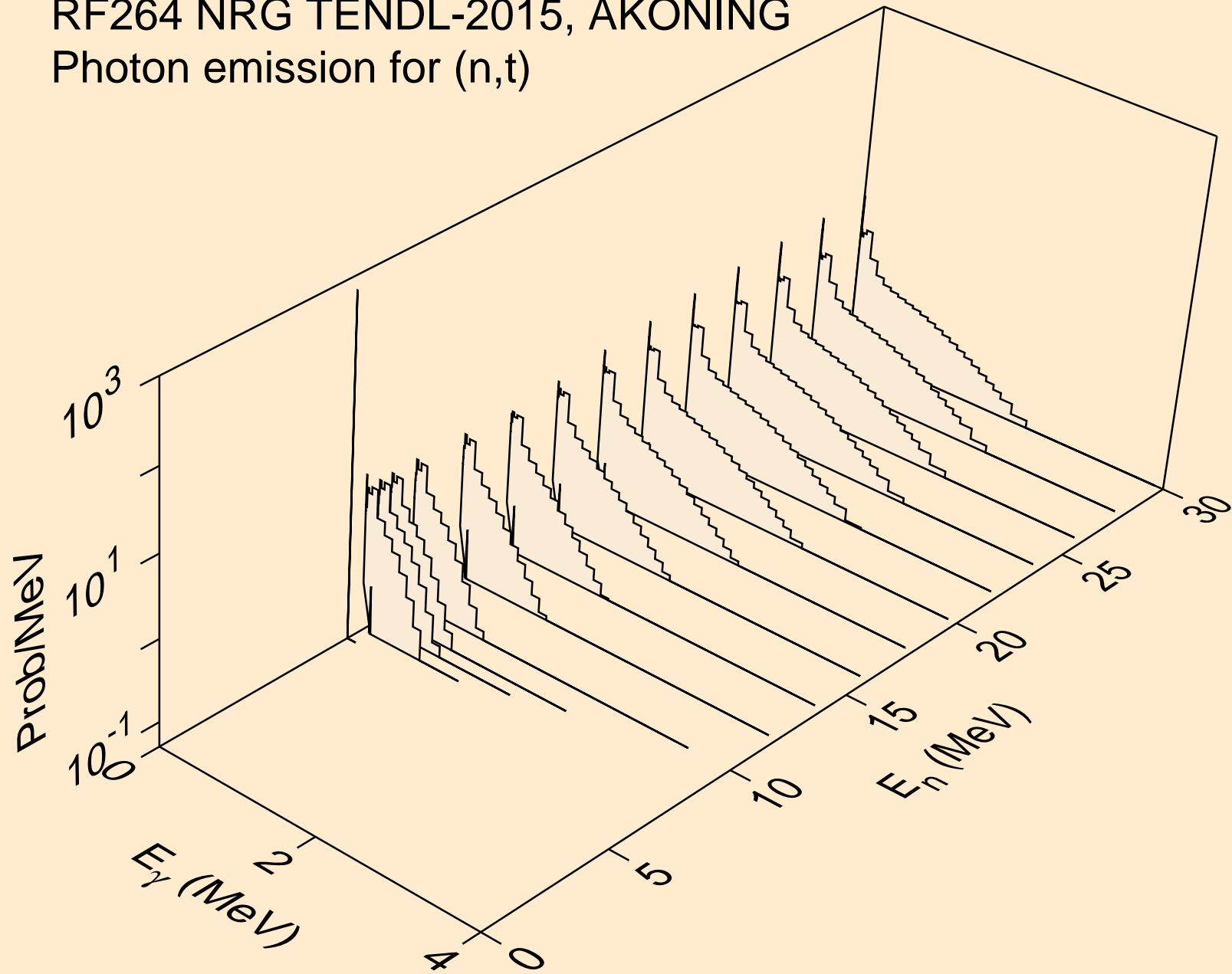

RF264 NRG TENDL-2015, AKONING
Photon emission for (n,he3)

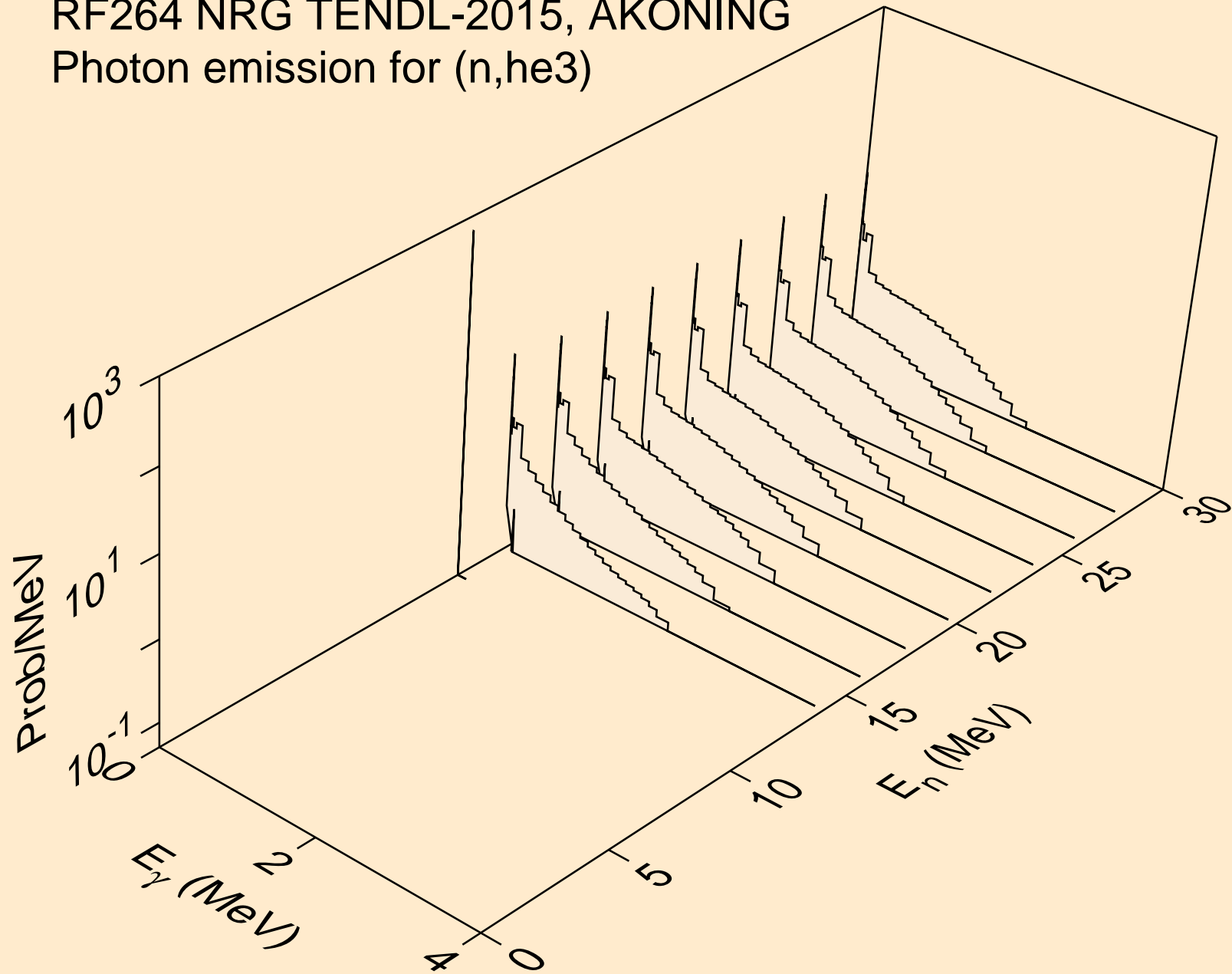

RF264 NRG TENDL-2015, AKONING
Photon emission for (n,a)

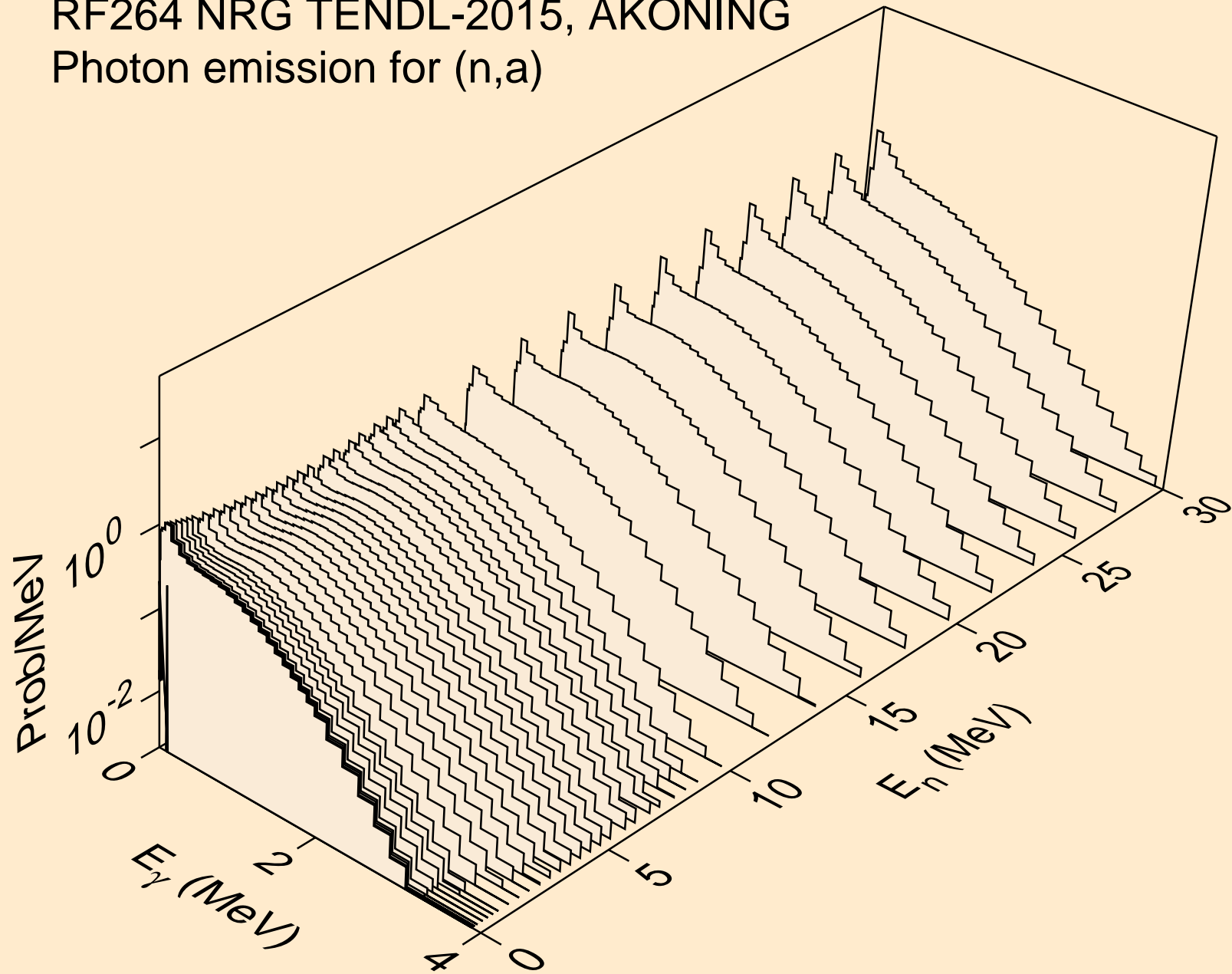

RF264 NRG TENDL-2015, AKONING
Photon emission for (n,2a)

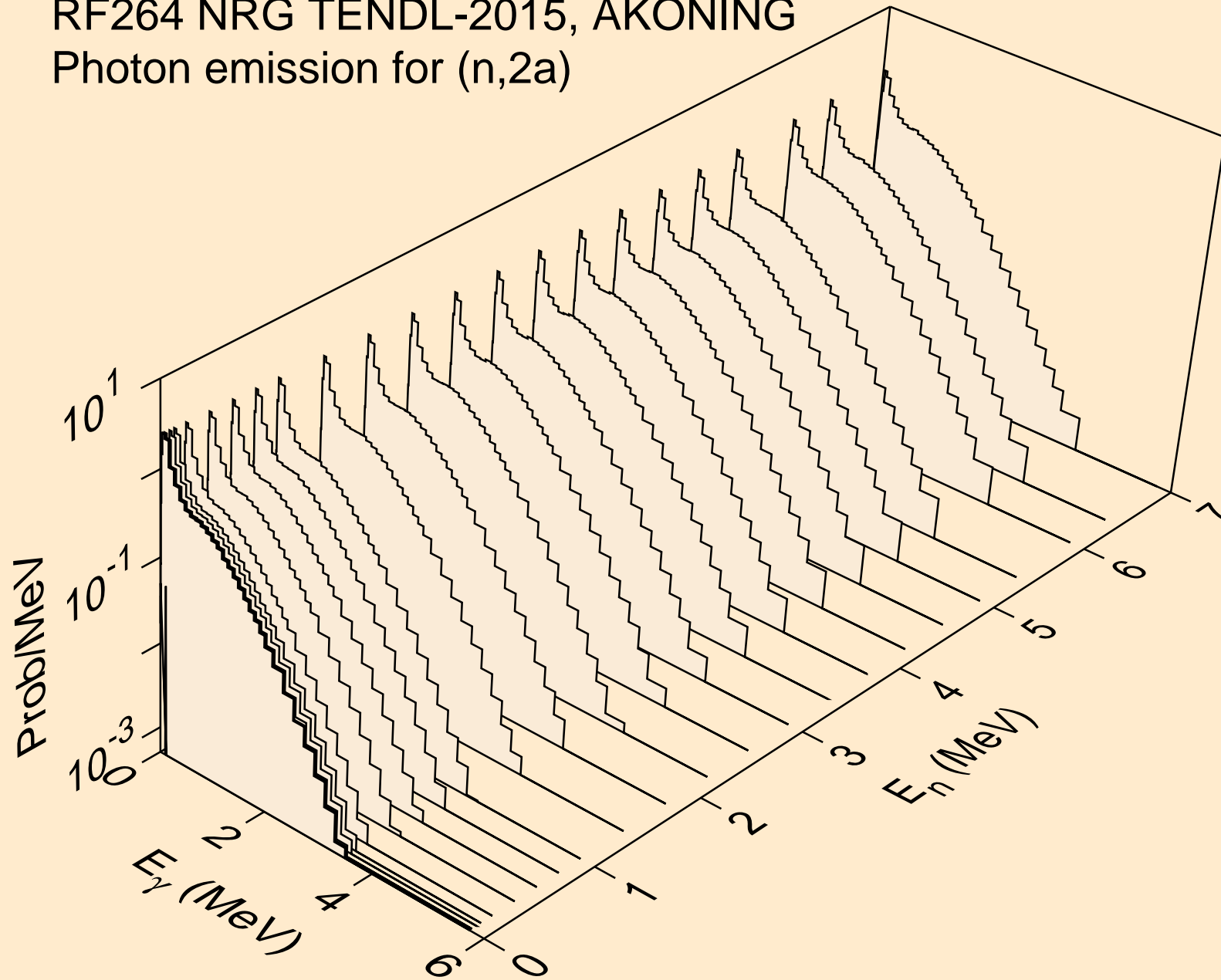

RF264 NRG TENDL-2015, AKONING
Photon emission for (n,3a)

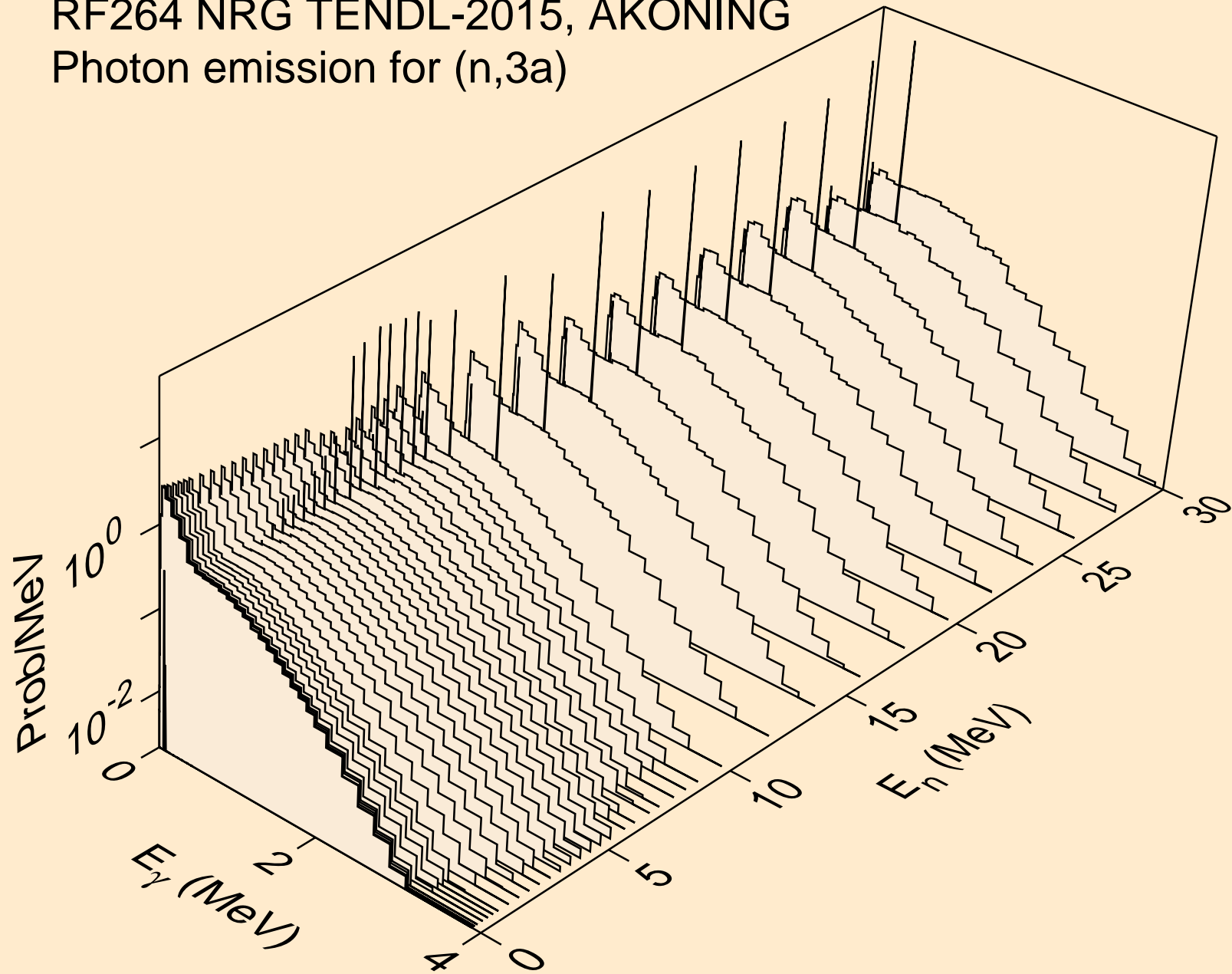

RF264 NRG TENDL-2015, AKONING
Photon emission for (n,2p)

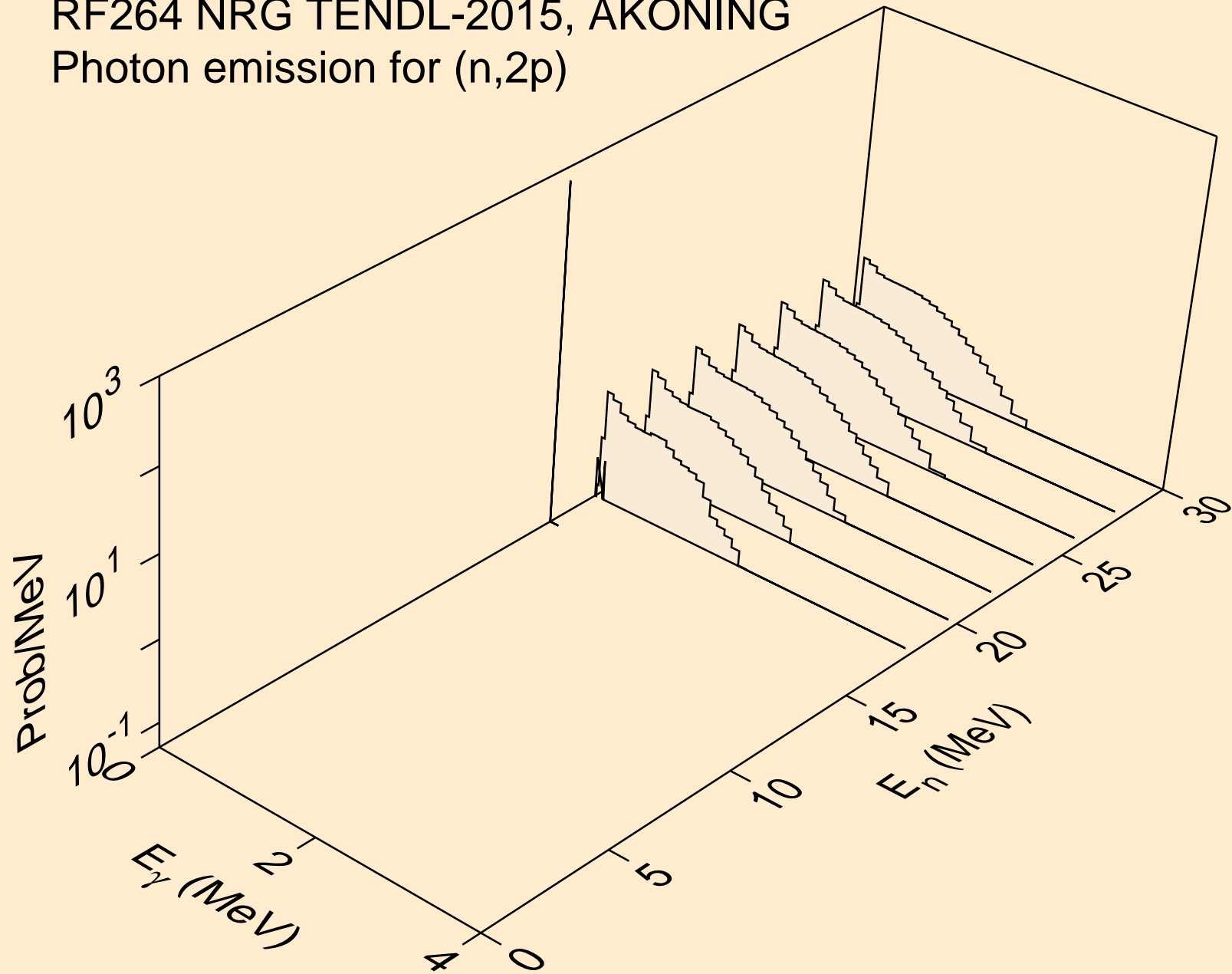

RF264 NRG TENDL-2015, AKONING
Photon emission for (n,pa)

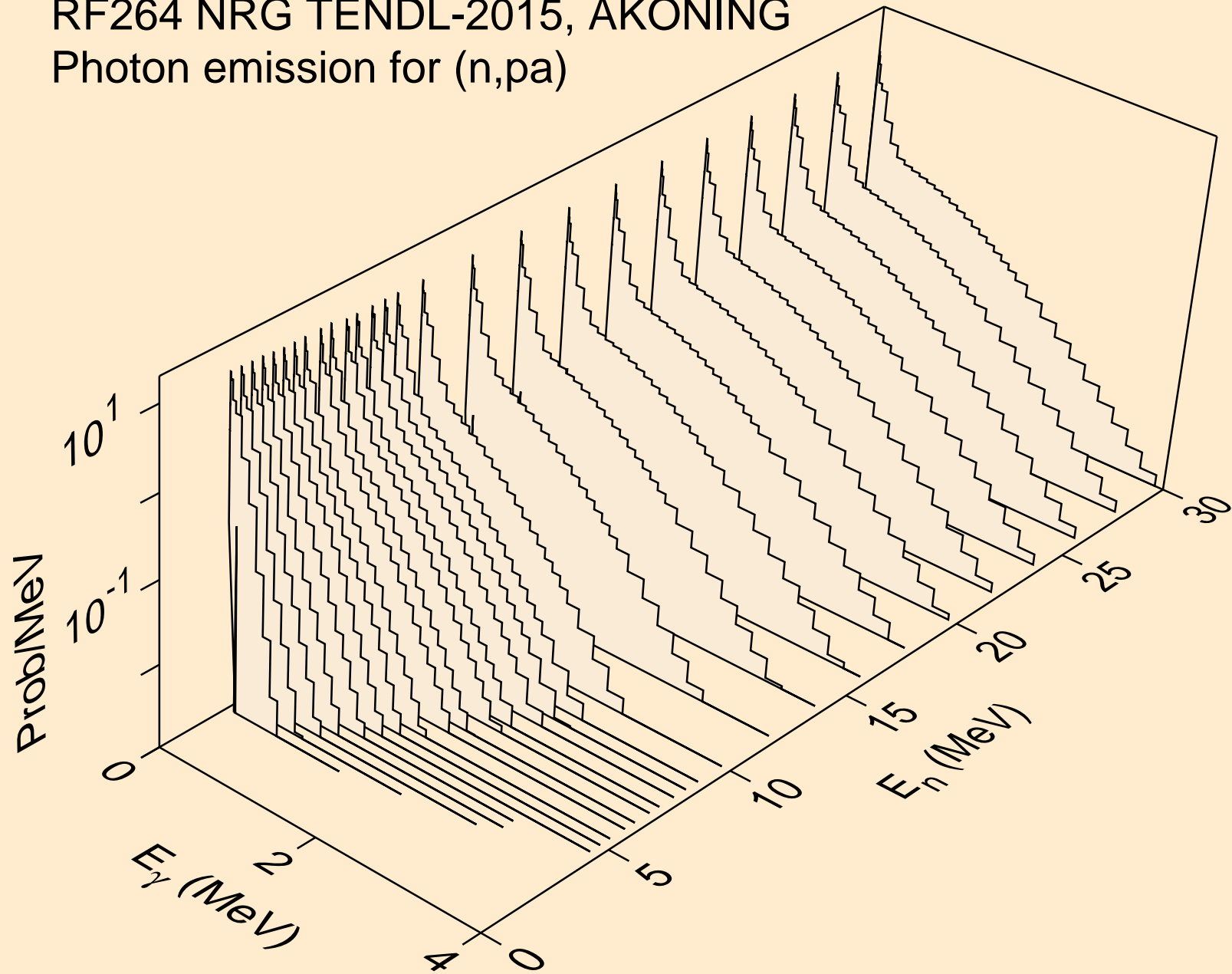

RF264 NRG TENDL-2015, AKONING
Photon emission for (n,t2a)

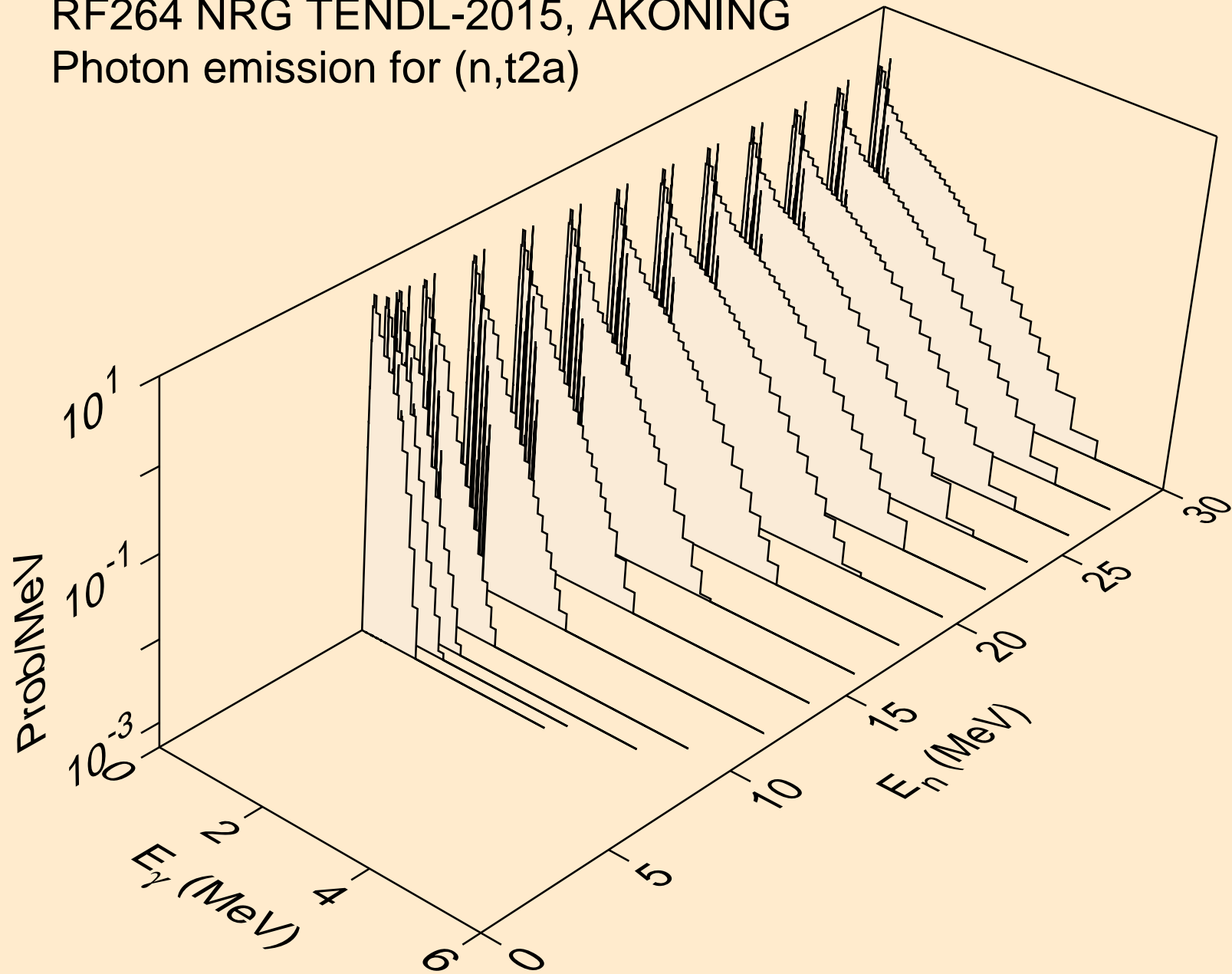

RF264 NRG TENDL-2015, AKONING
Photon emission for (n,d2a)

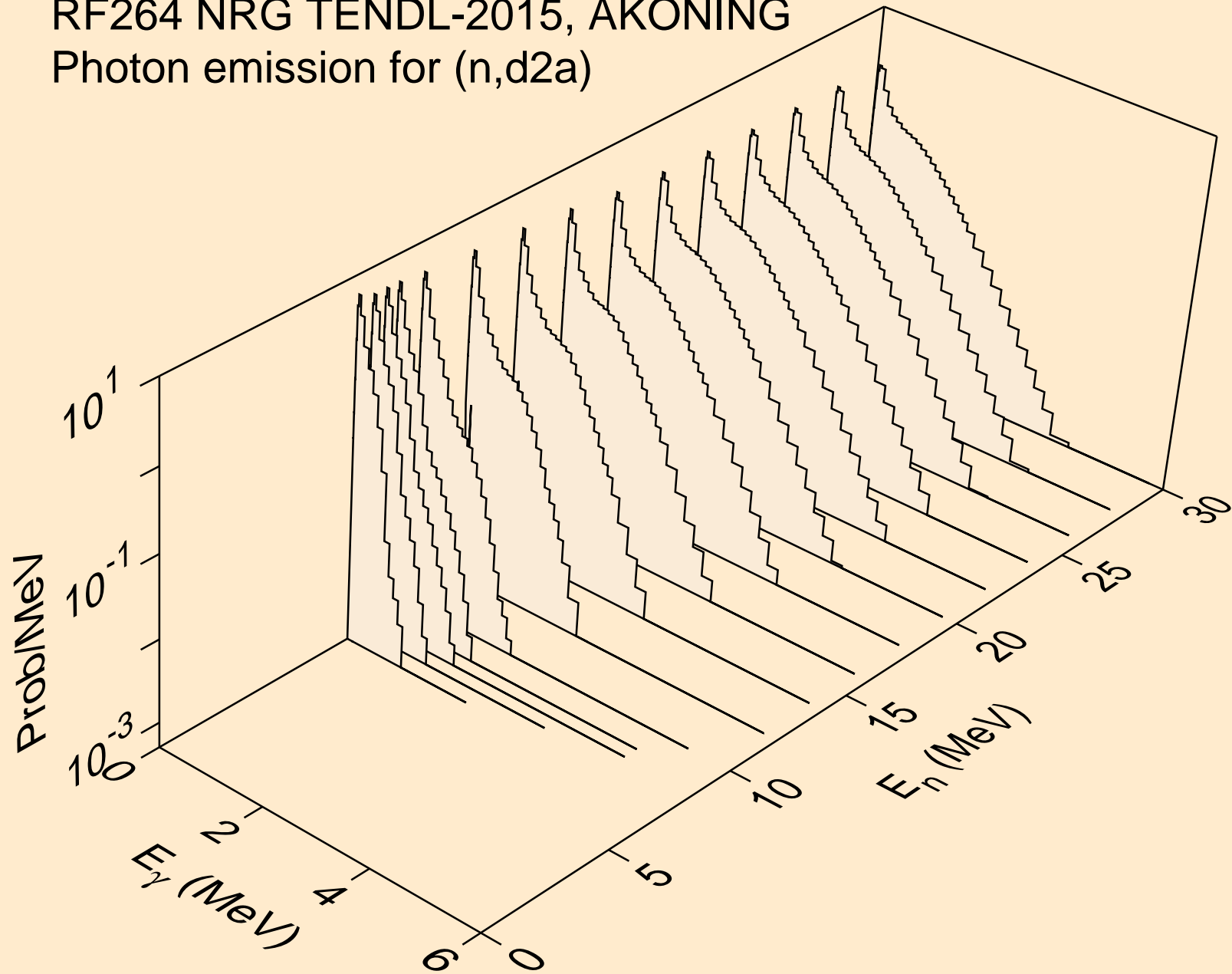

RF264 NRG TENDL-2015, AKONING
Photon emission for (n,da)

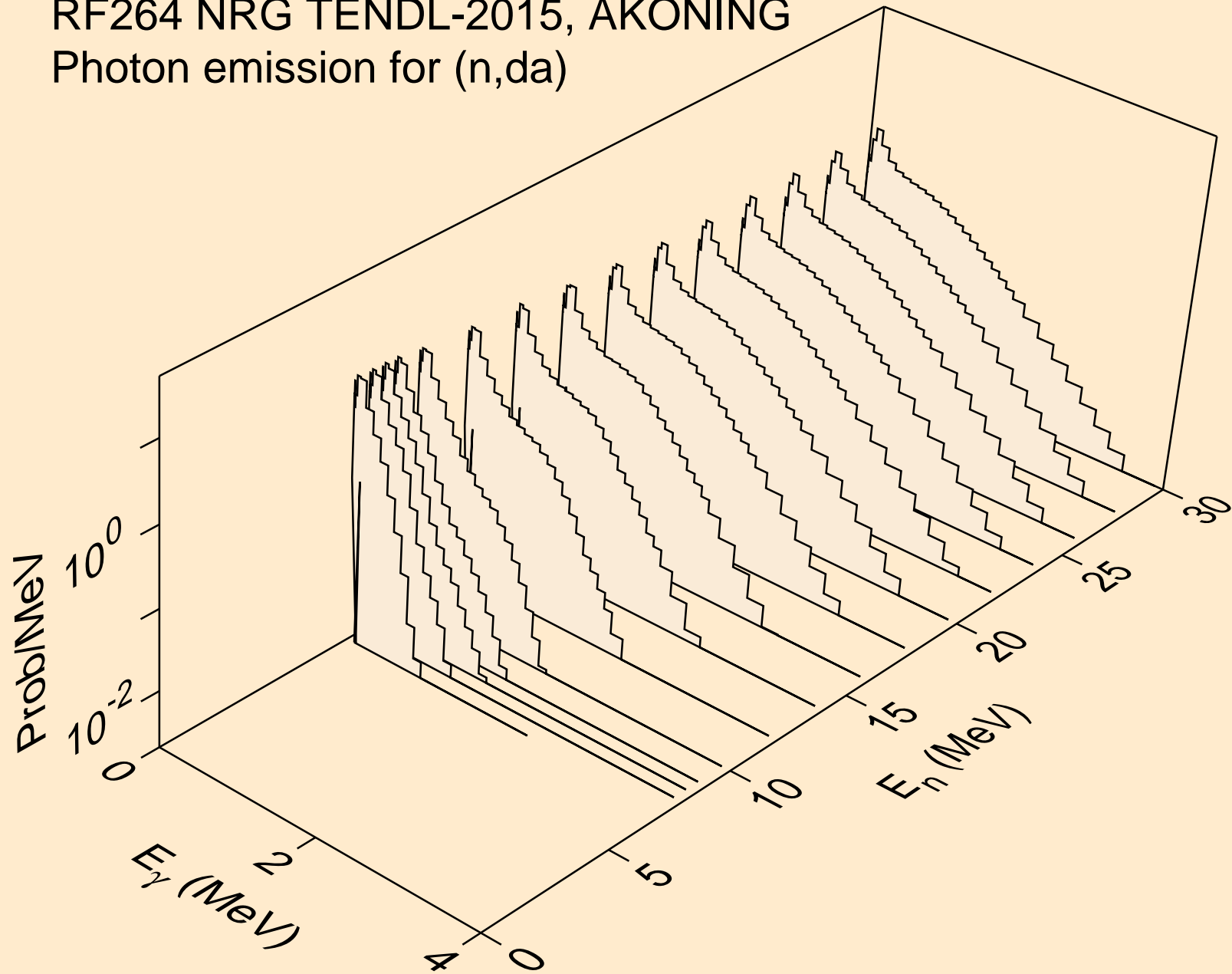

RF264 NRG TENDL-2015, AKONING
thermal capture photon spectrum

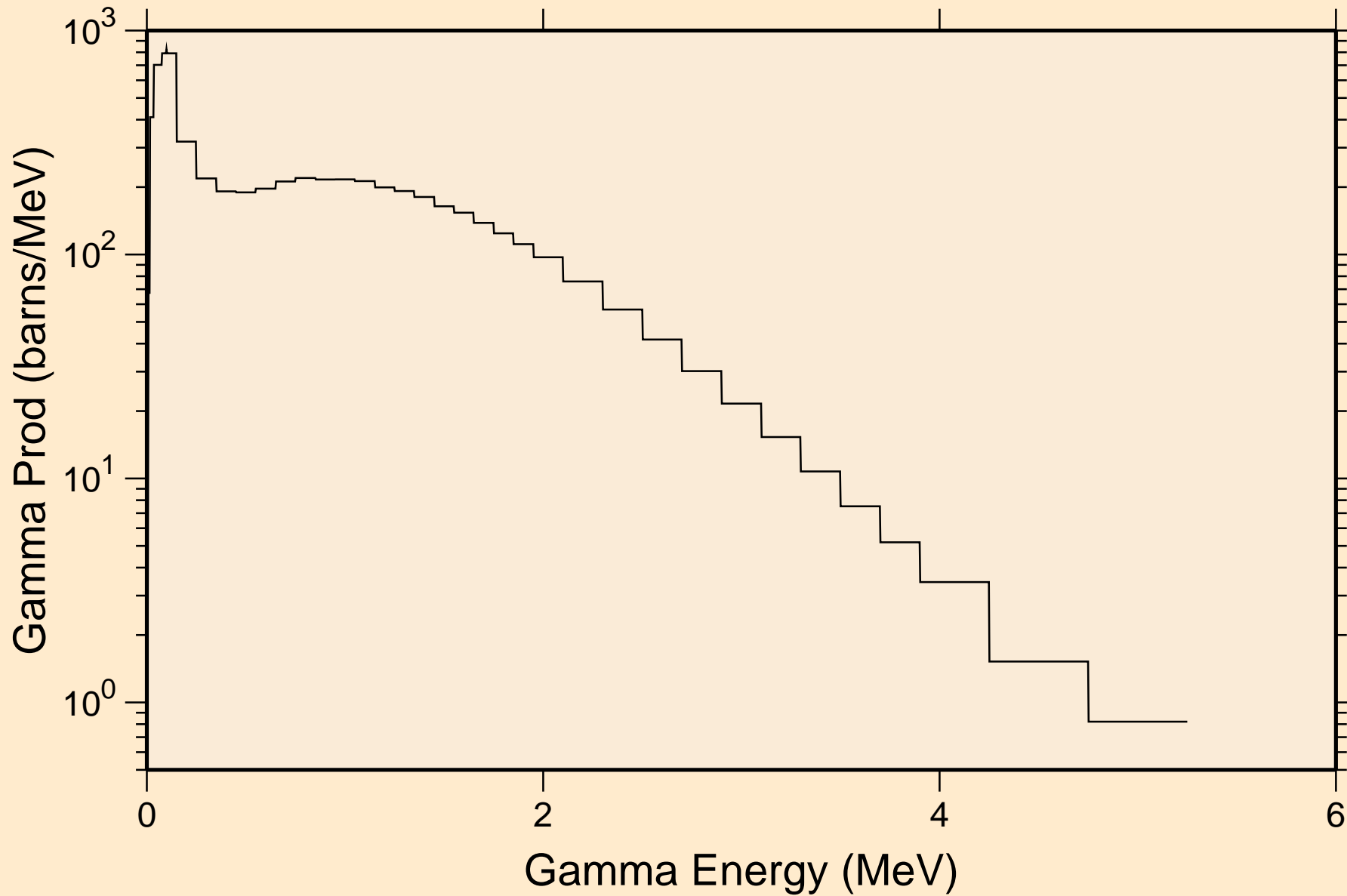

RF264 NRG TENDL-2015, AKONING
14 MeV photon spectrum

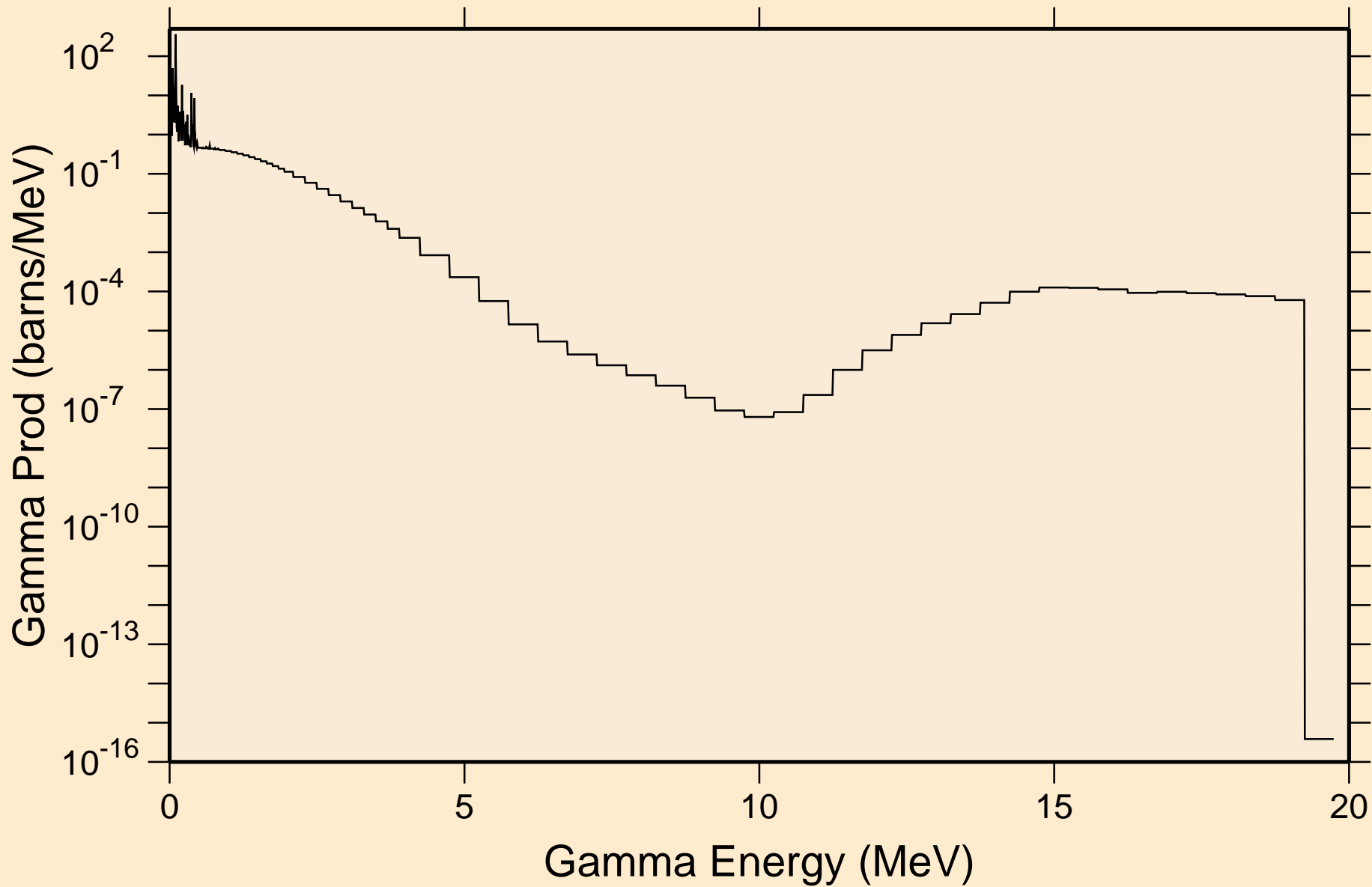

RF264 NRG TENDL-2015, AKONING

Particle heating contributions

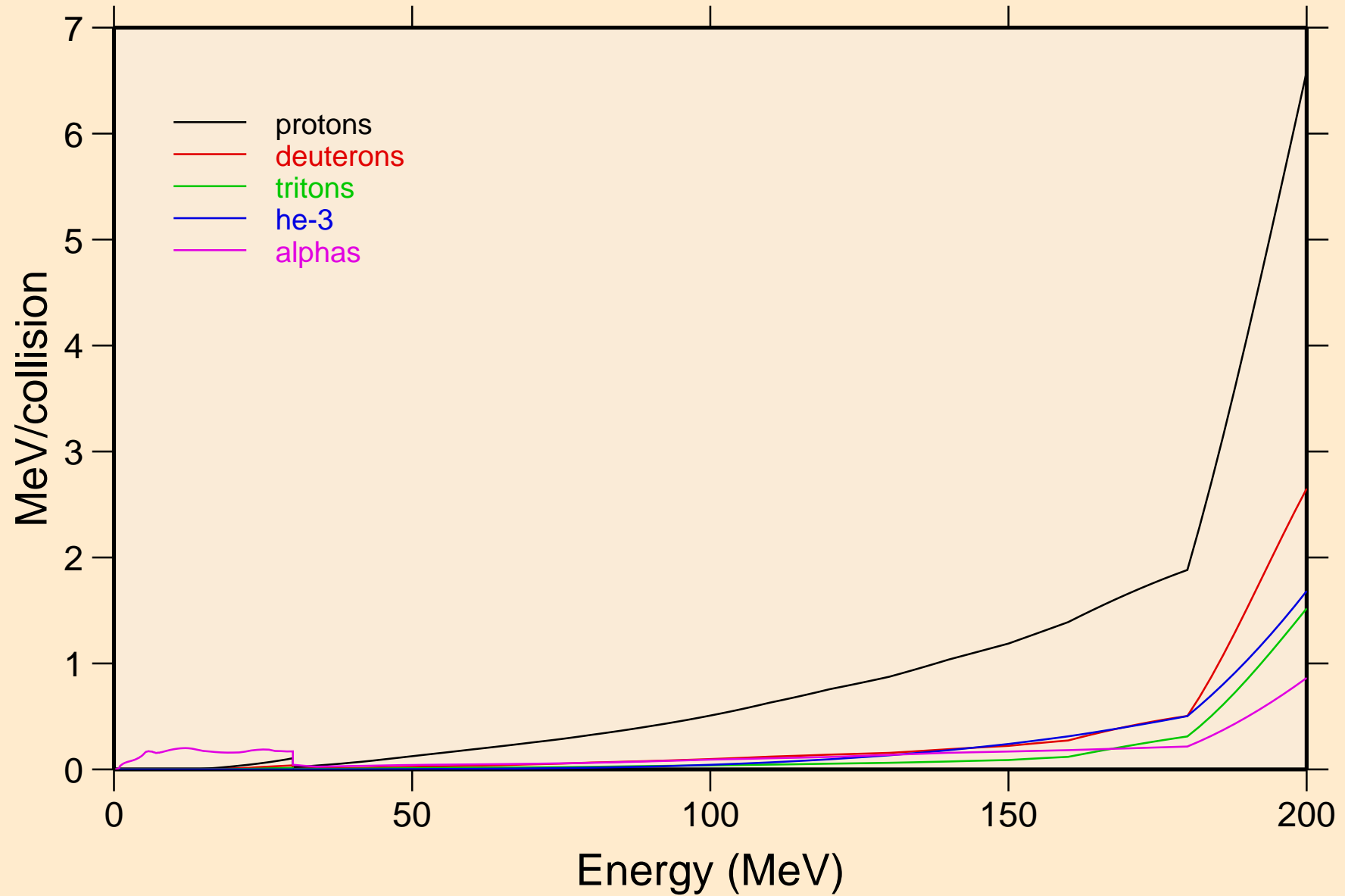

RF264 NRG TENDL-2015, AKONING

Recoil Heating

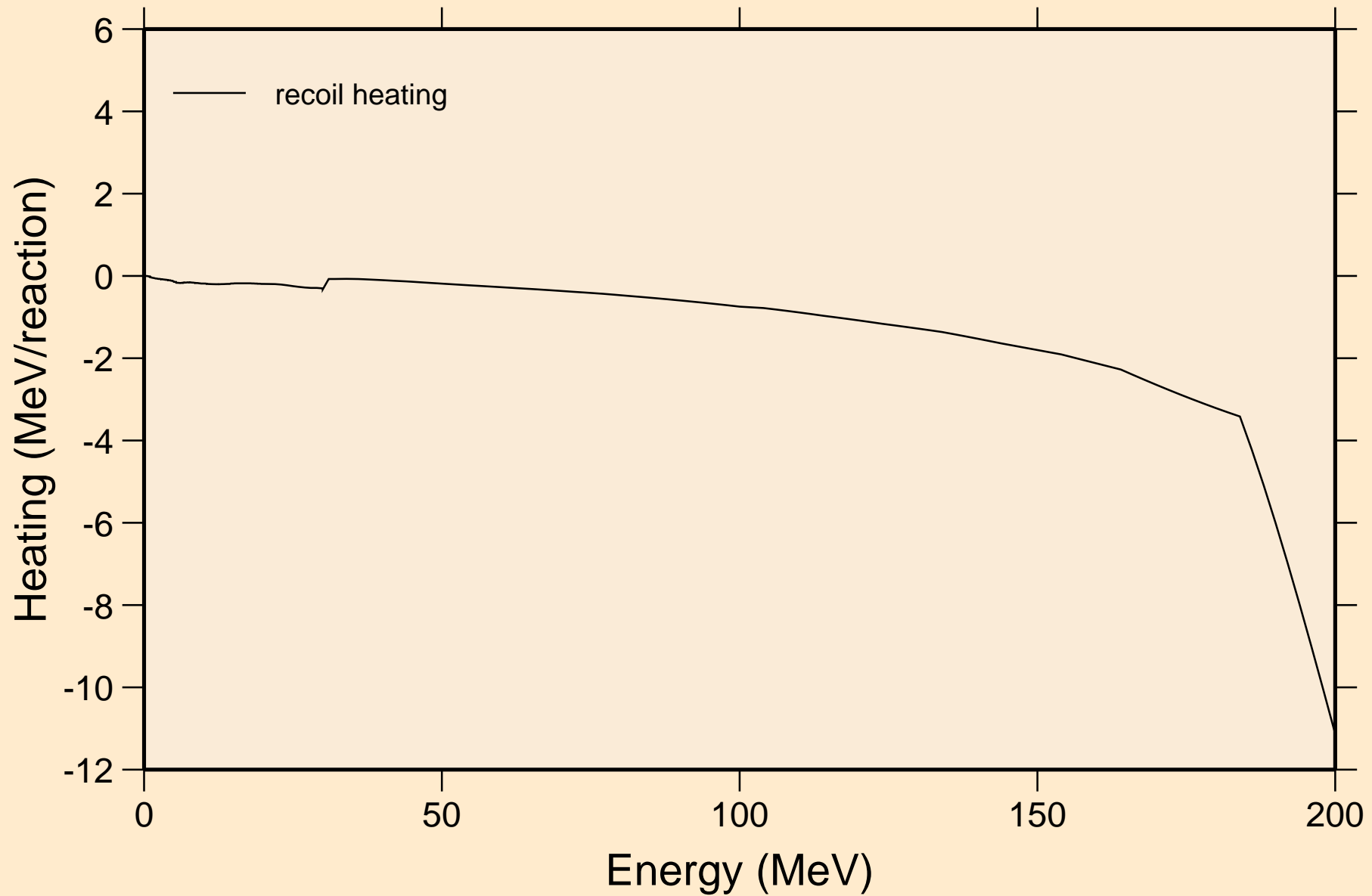

RF264 NRG TENDL-2015, AKONING

Particle production cross sections

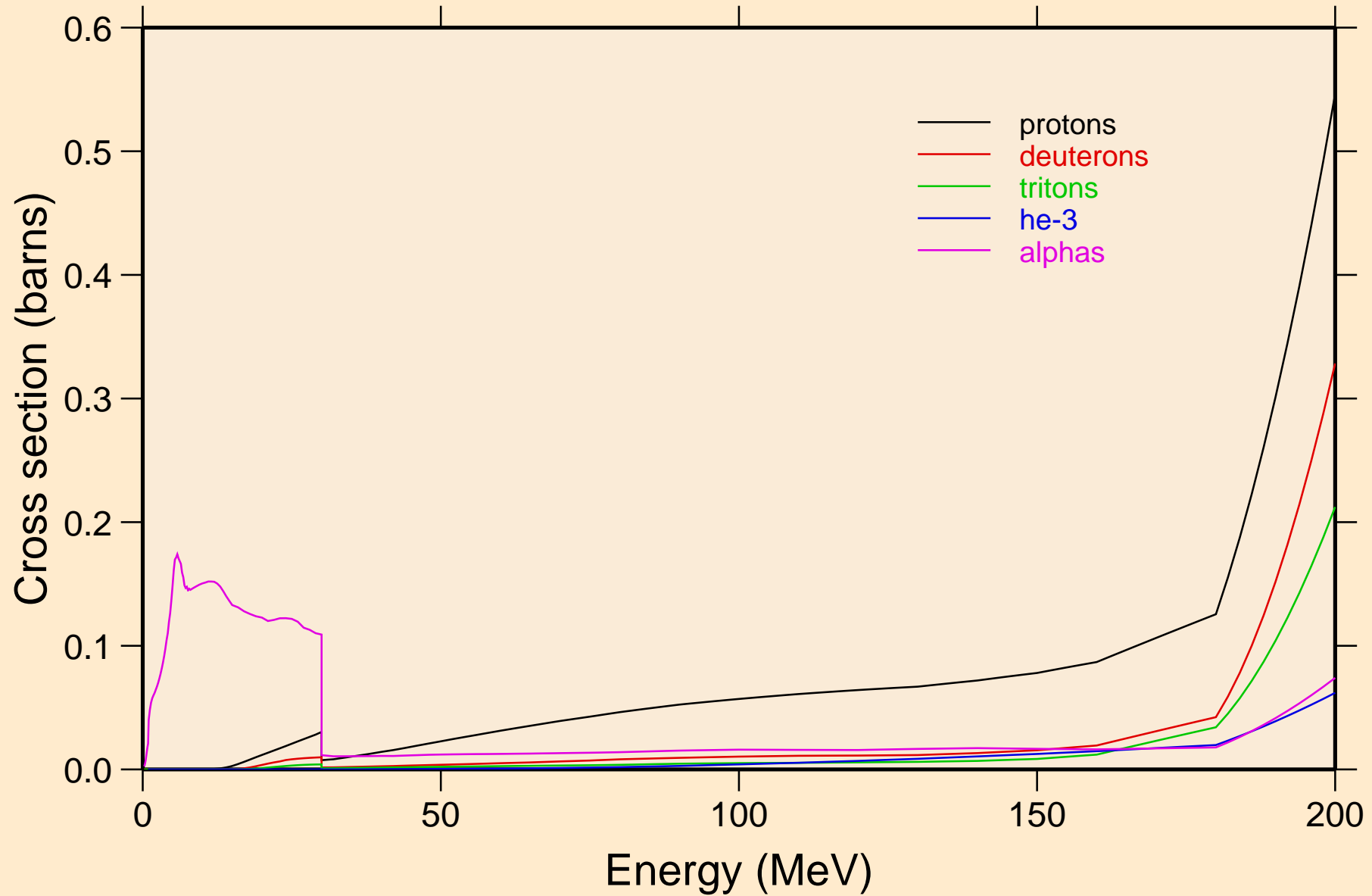

RF264 NRG TENDL-2015, AKONING
protons from (n,x)

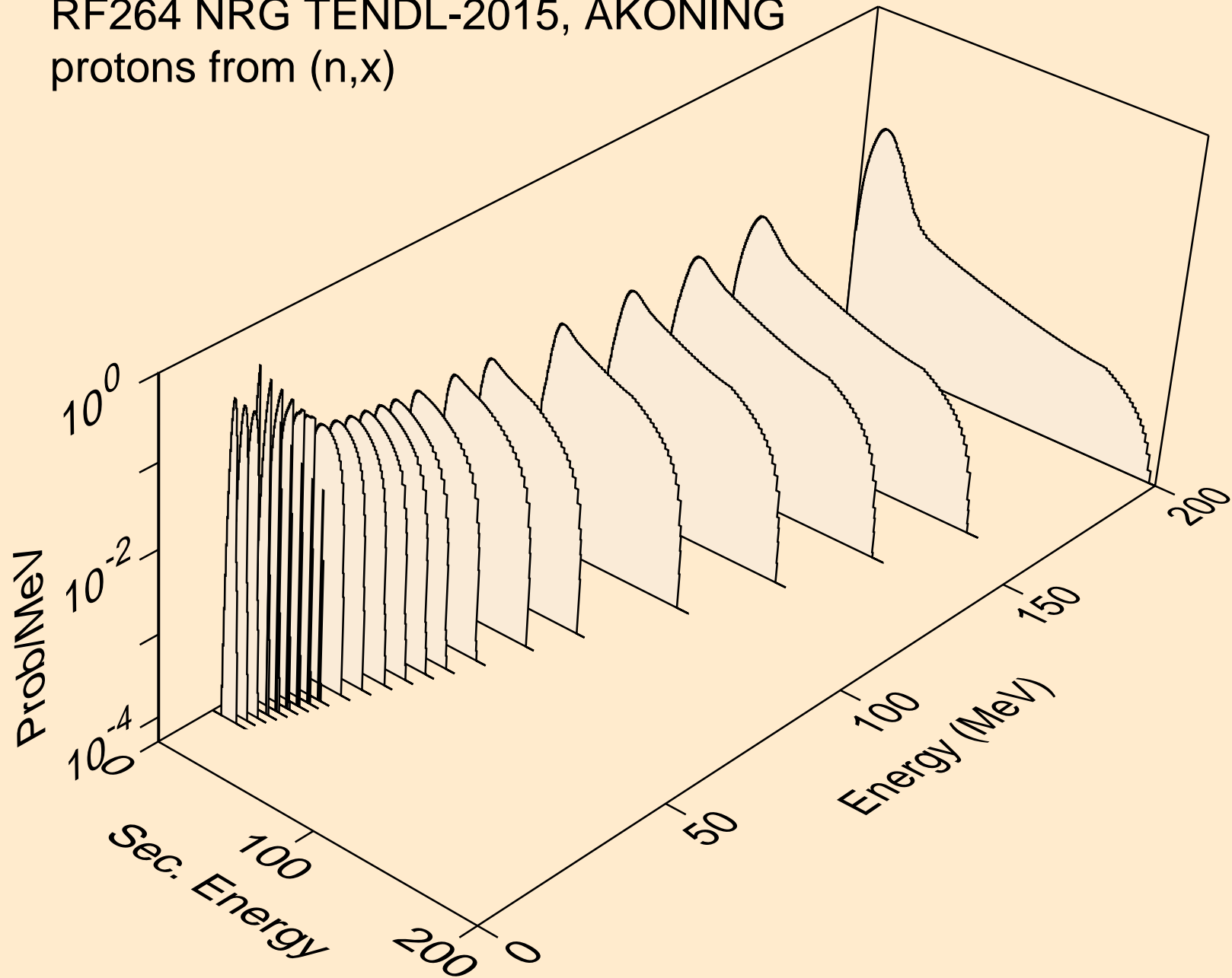

RF264 NRG TENDL-2015, AKONING
protons from (n,n*)p

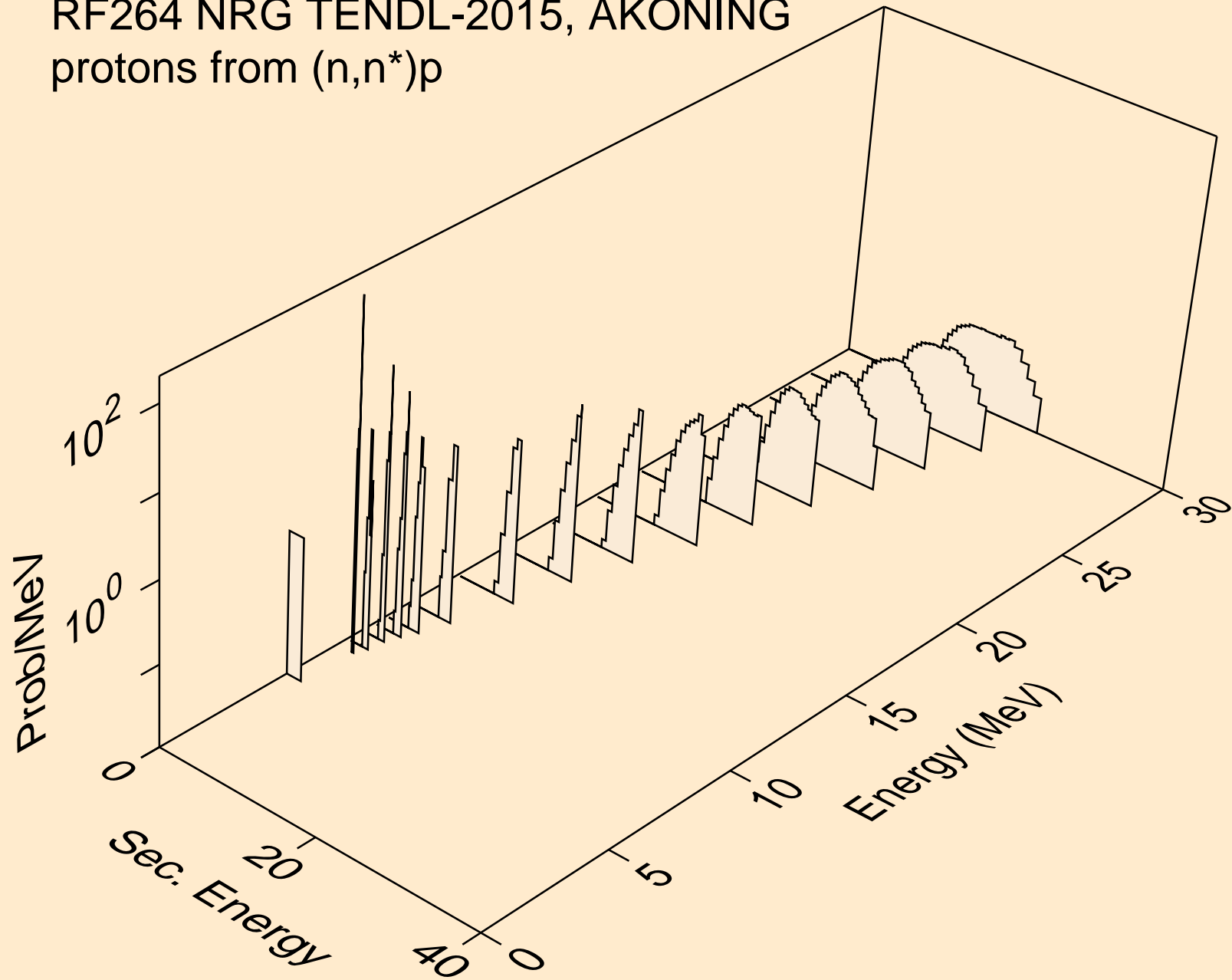

RF264 NRG TENDL-2015, AKONING
protons from (n,2np)

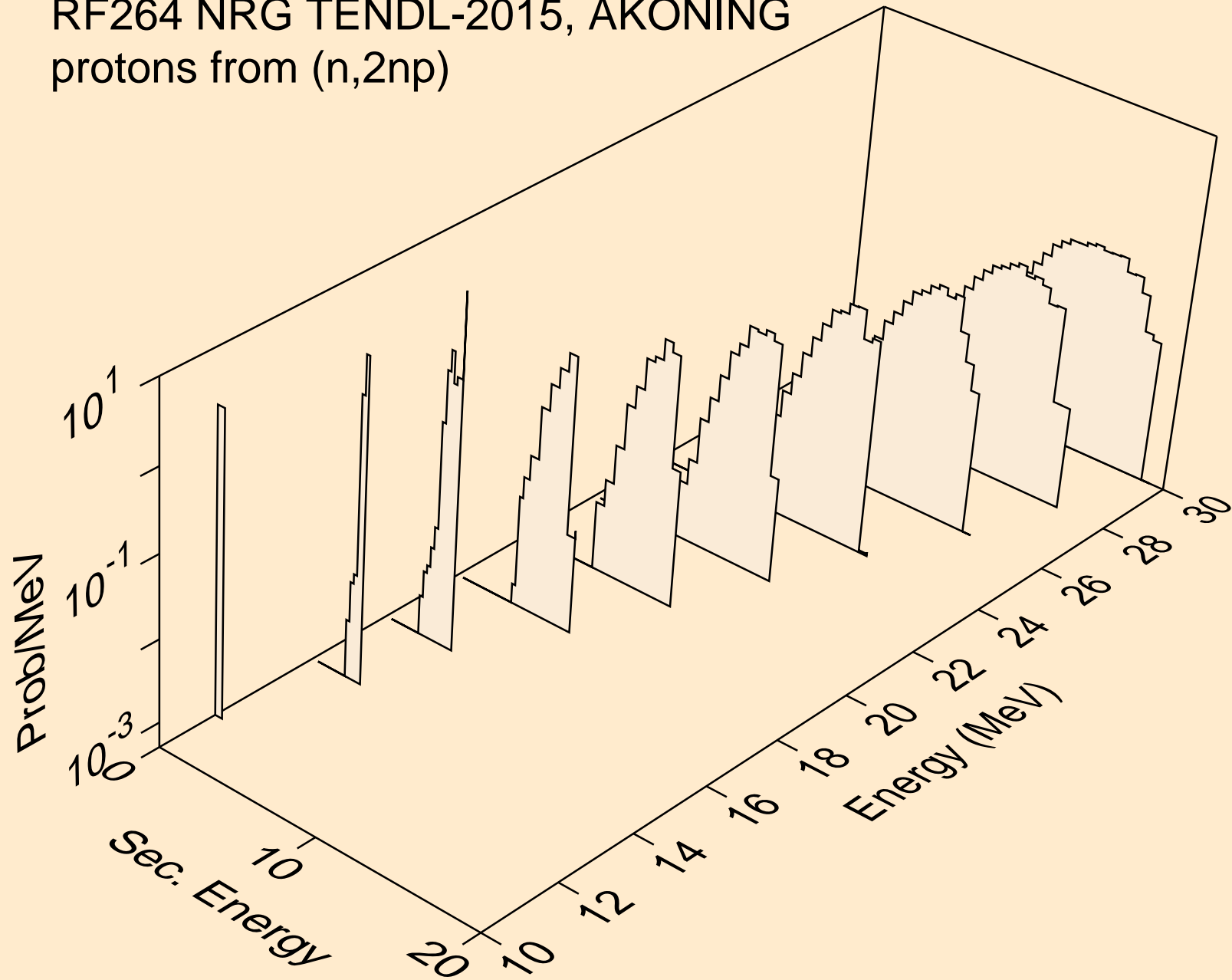

RF264 NRG TENDL-2015, AKONING
protons from (n,3np)

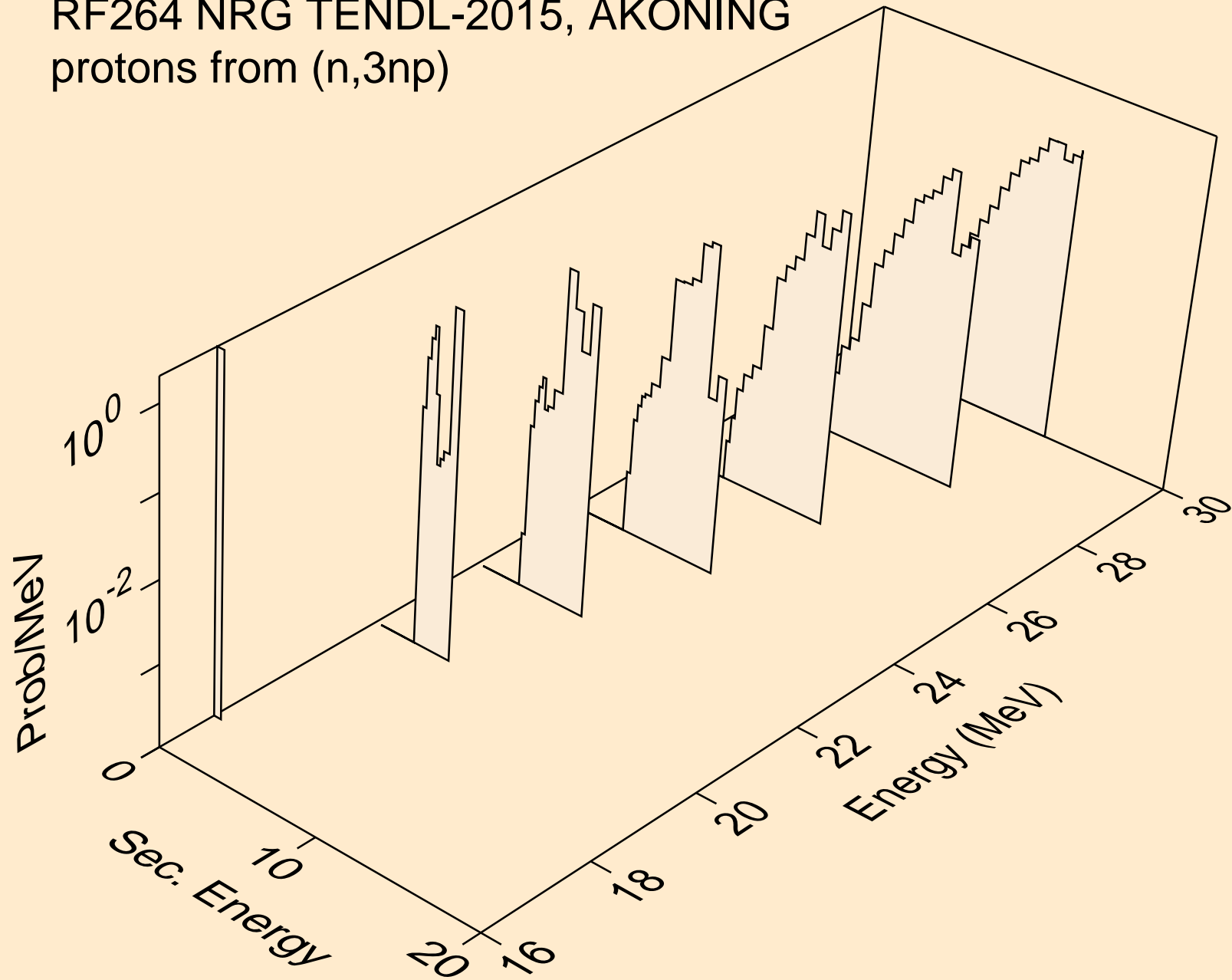

RF264 NRG TENDL-2015, AKONING
protons from (n,2np)

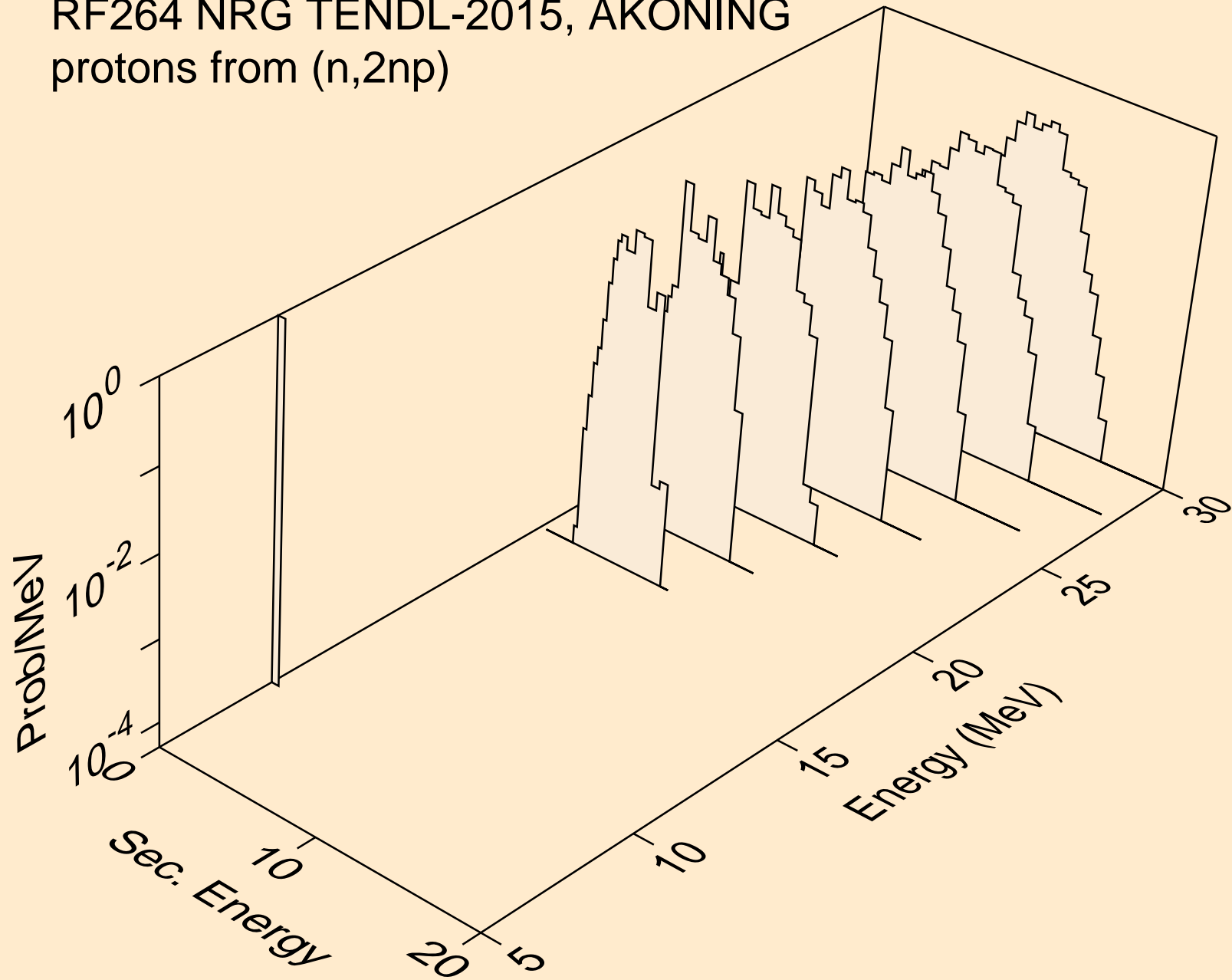

RF264 NRG TENDL-2015, AKONING
protons from (n,npa)

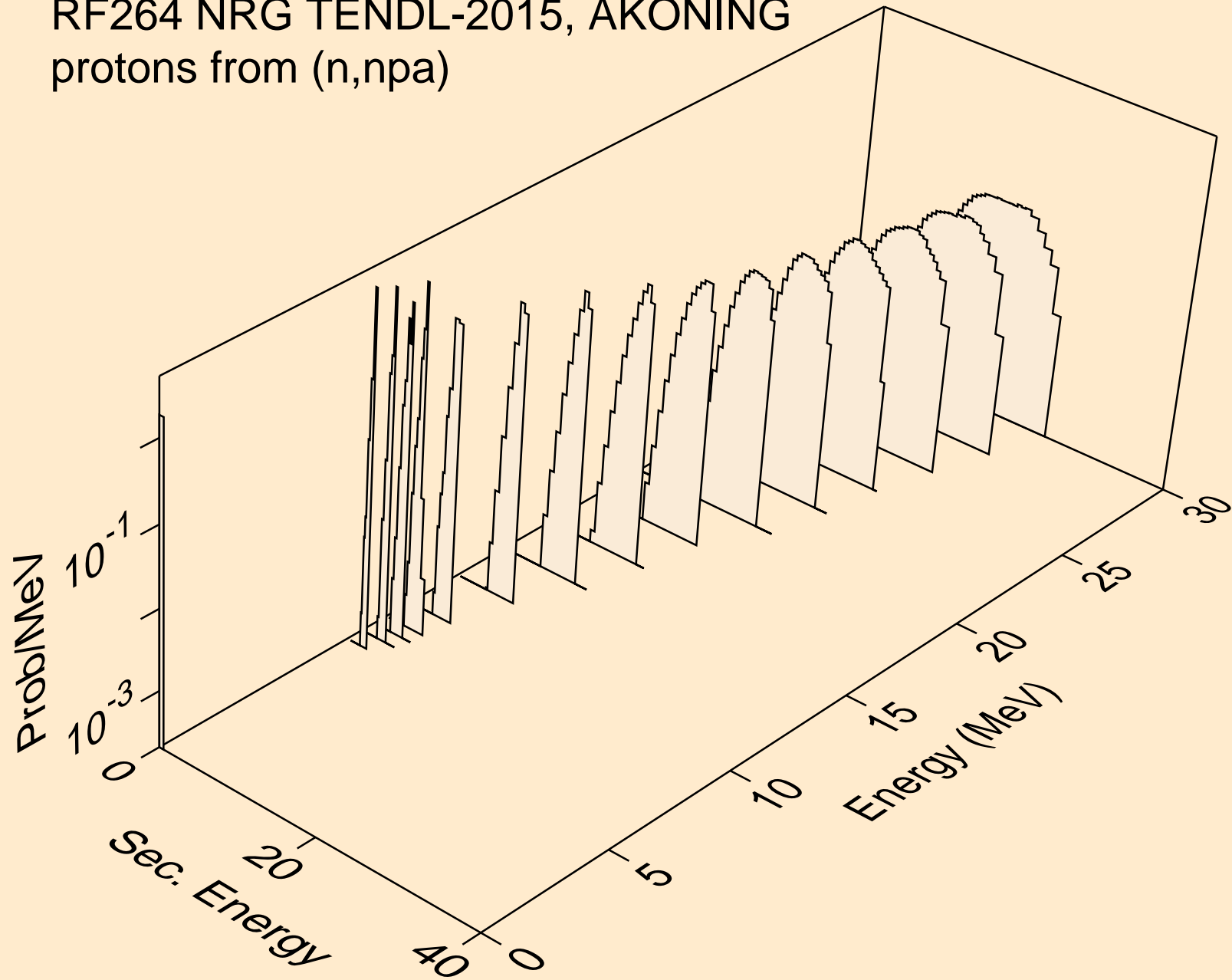

RF264 NRG TENDL-2015, AKONING
protons from (n,p)

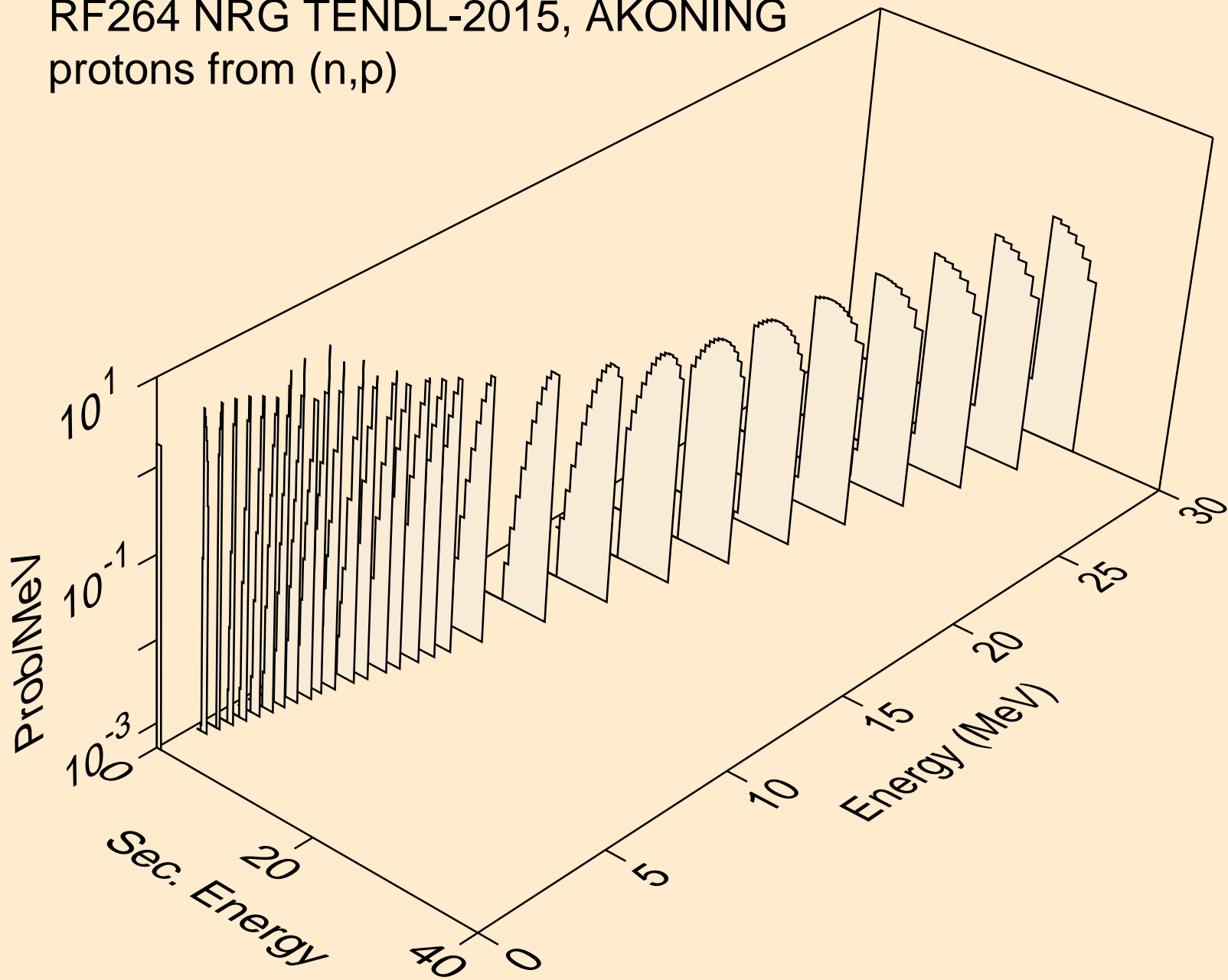

RF264 NRG TENDL-2015, AKONING
protons from (n,2p)

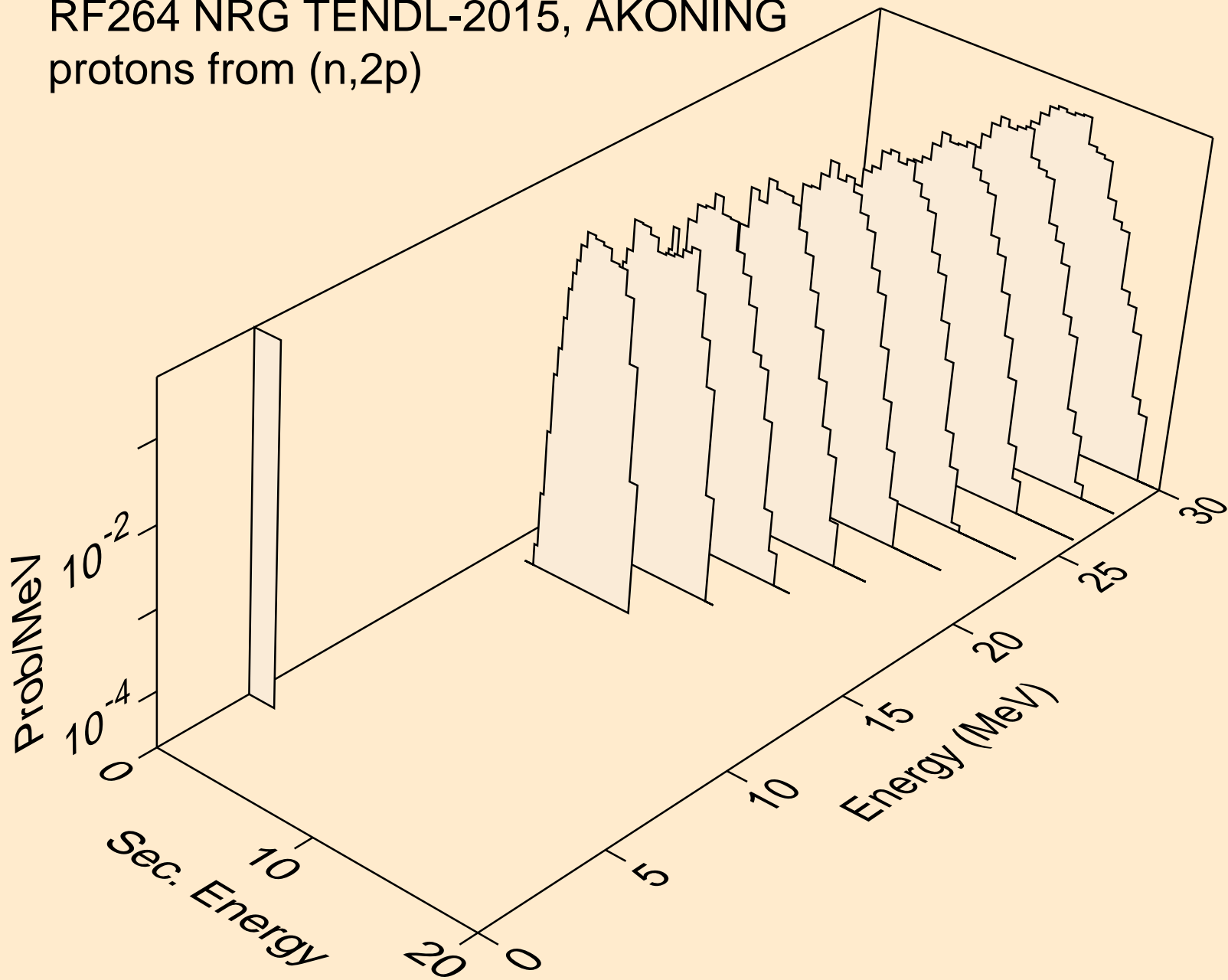

RF264 NRG TENDL-2015, AKONING
protons from (n,pa)

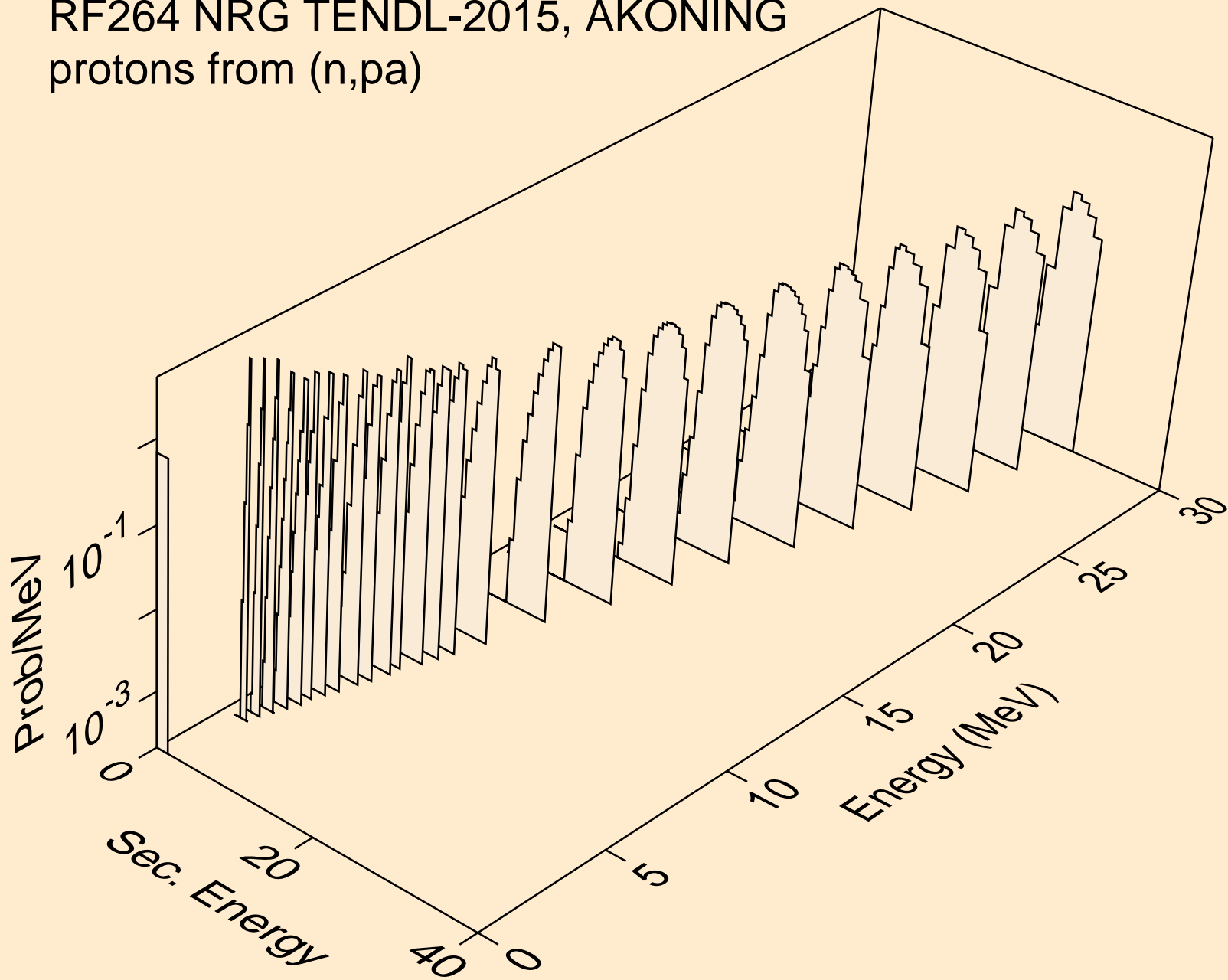

RF264 NRG TENDL-2015, AKONING
deuterons from (n,x)

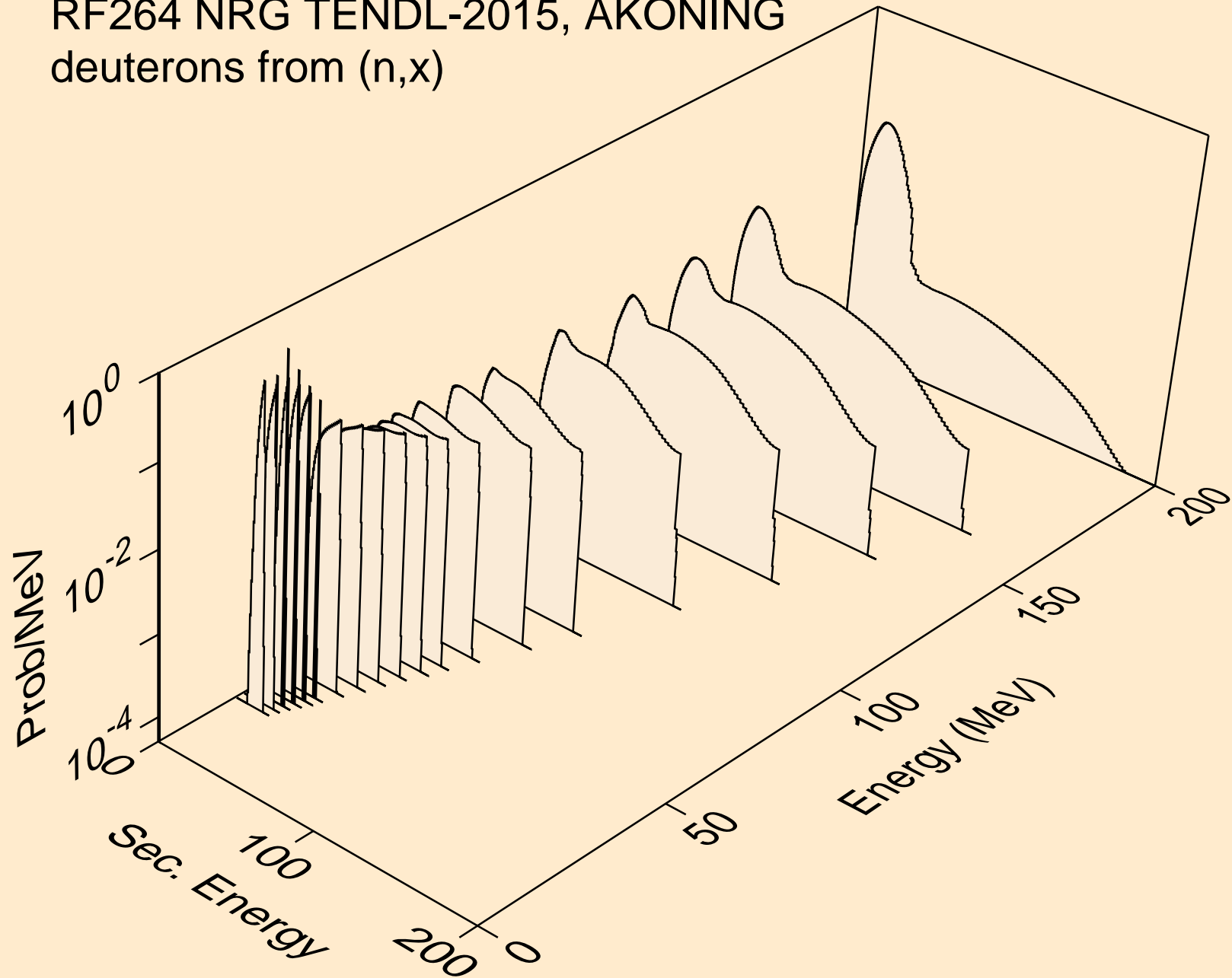

RF264 NRG TENDL-2015, AKONING
deuterons from (n,2nd)

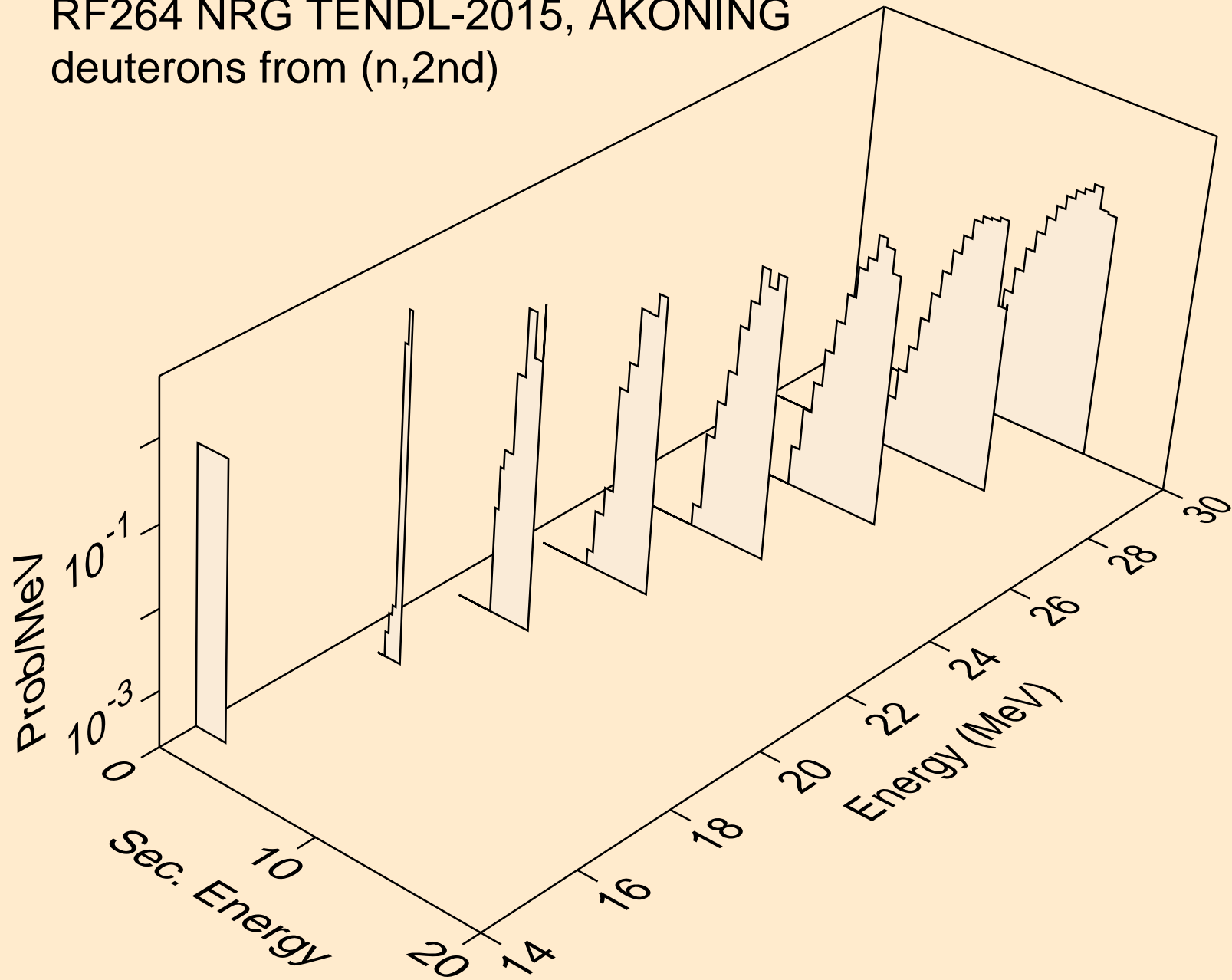

RF264 NRG TENDL-2015, AKONING
deuterons from (n,n*)d

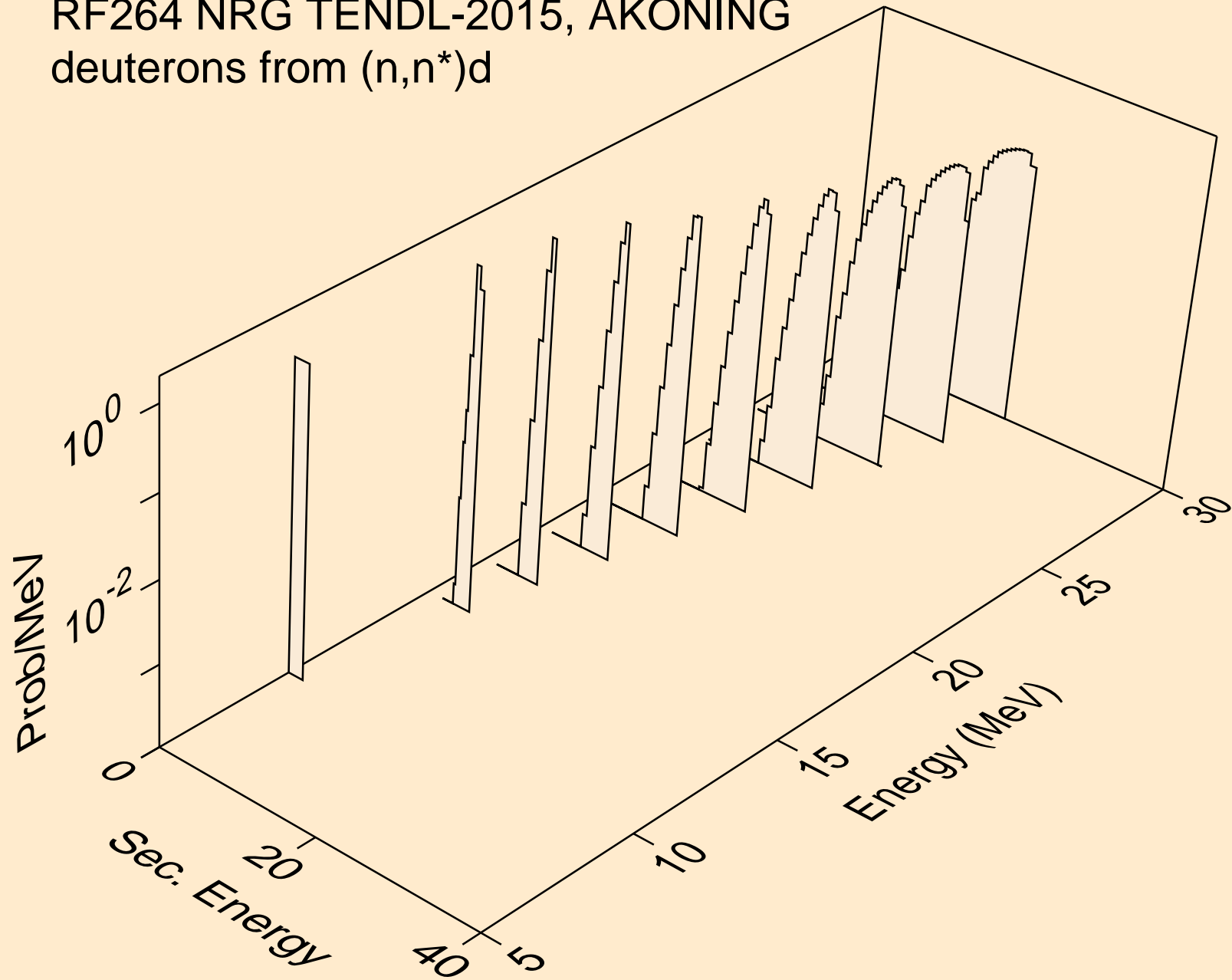

RF264 NRG TENDL-2015, AKONING
deuterons from (n,n*)d2a

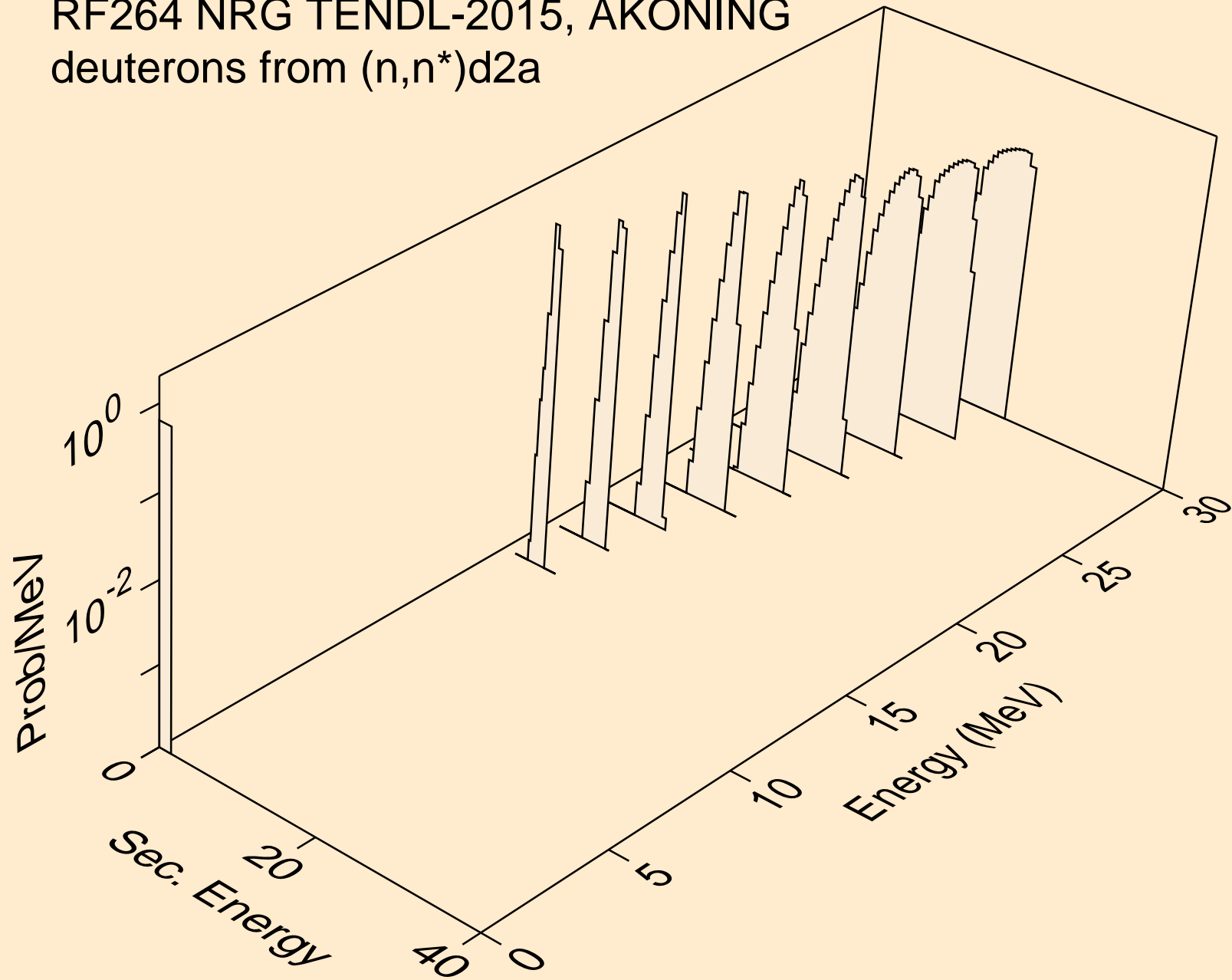

RF264 NRG TENDL-2015, AKONING
deuterons from (n,d)

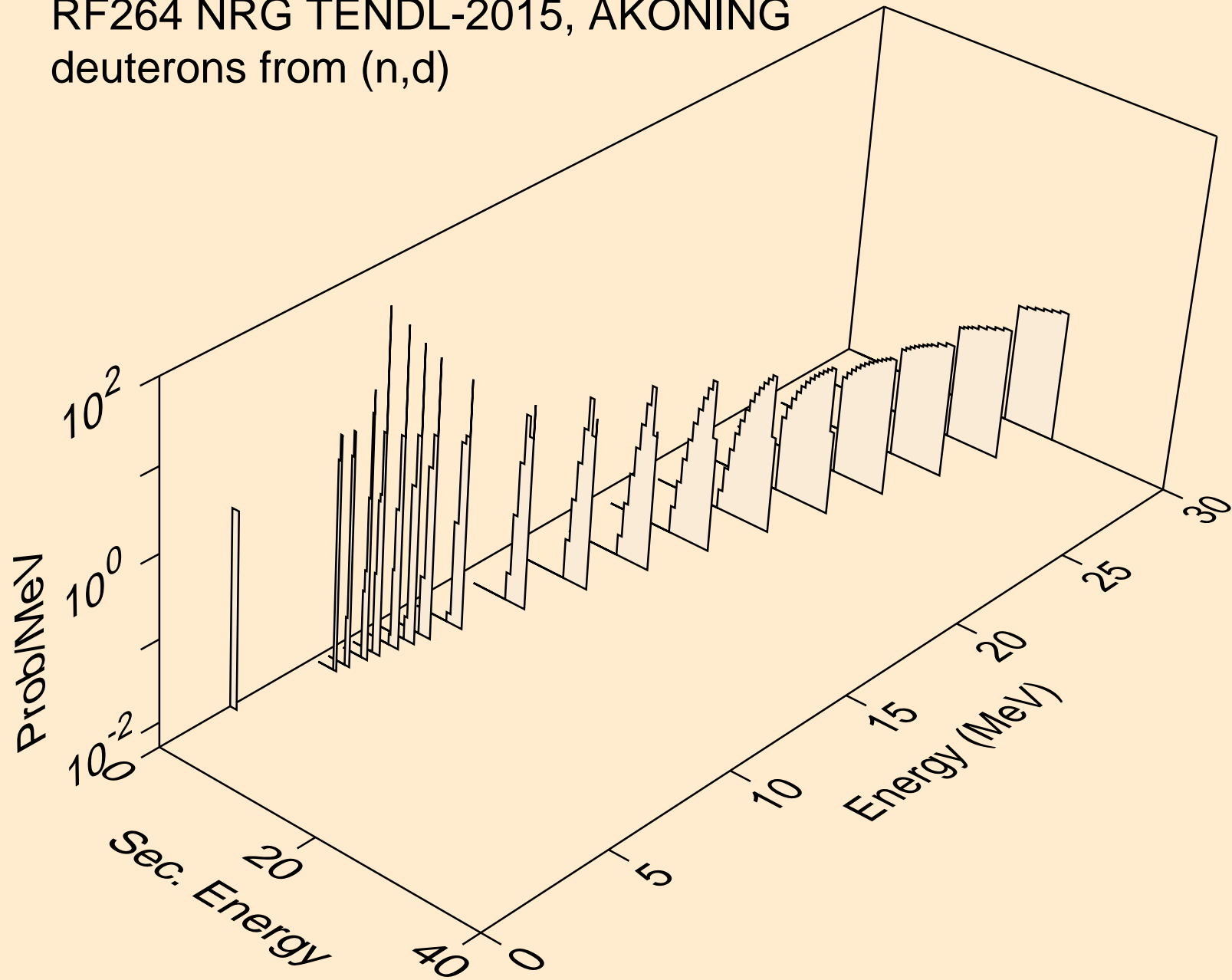

RF264 NRG TENDL-2015, AKONING
deuterons from (n,d2a)

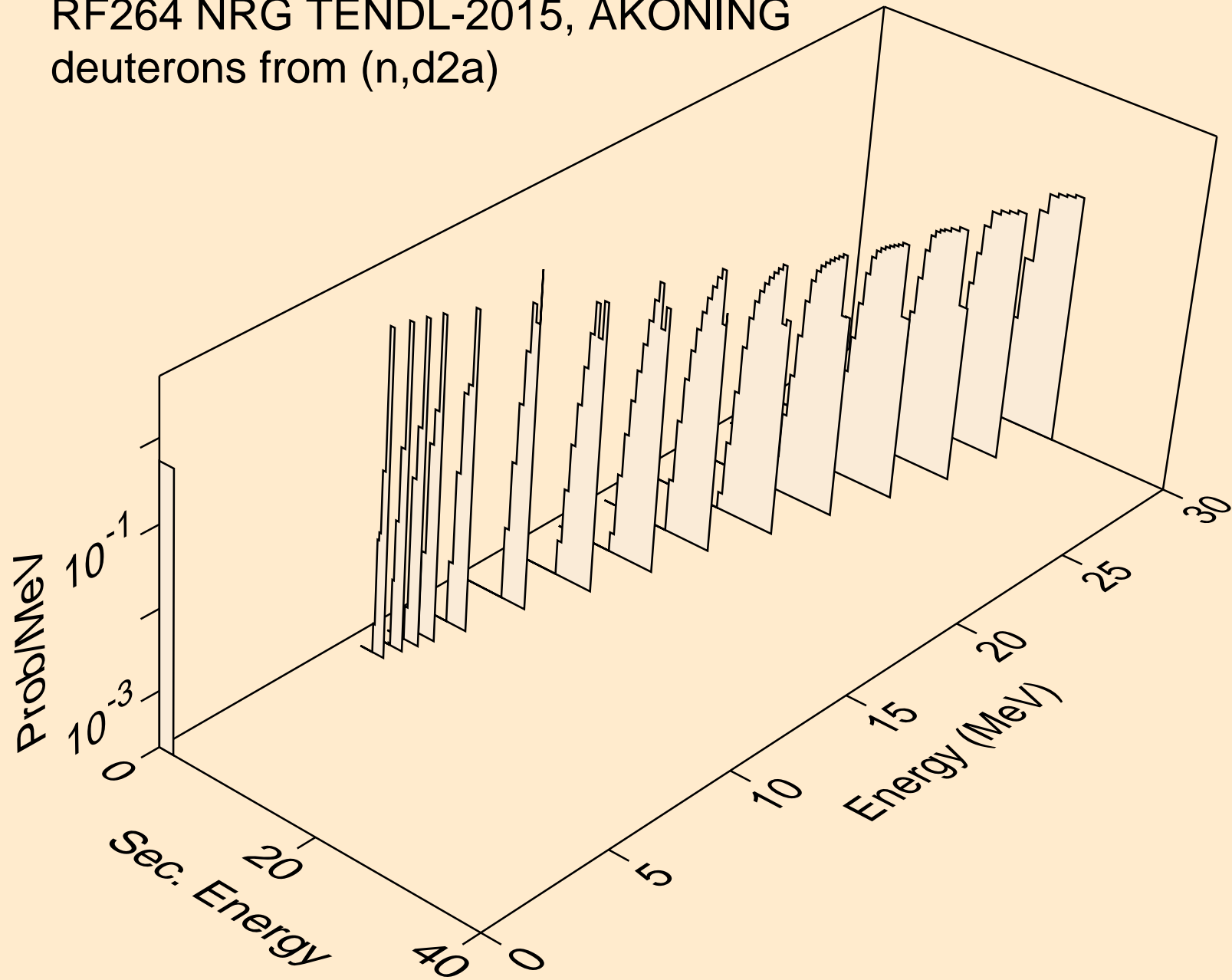

RF264 NRG TENDL-2015, AKONING
deuterons from (n,da)

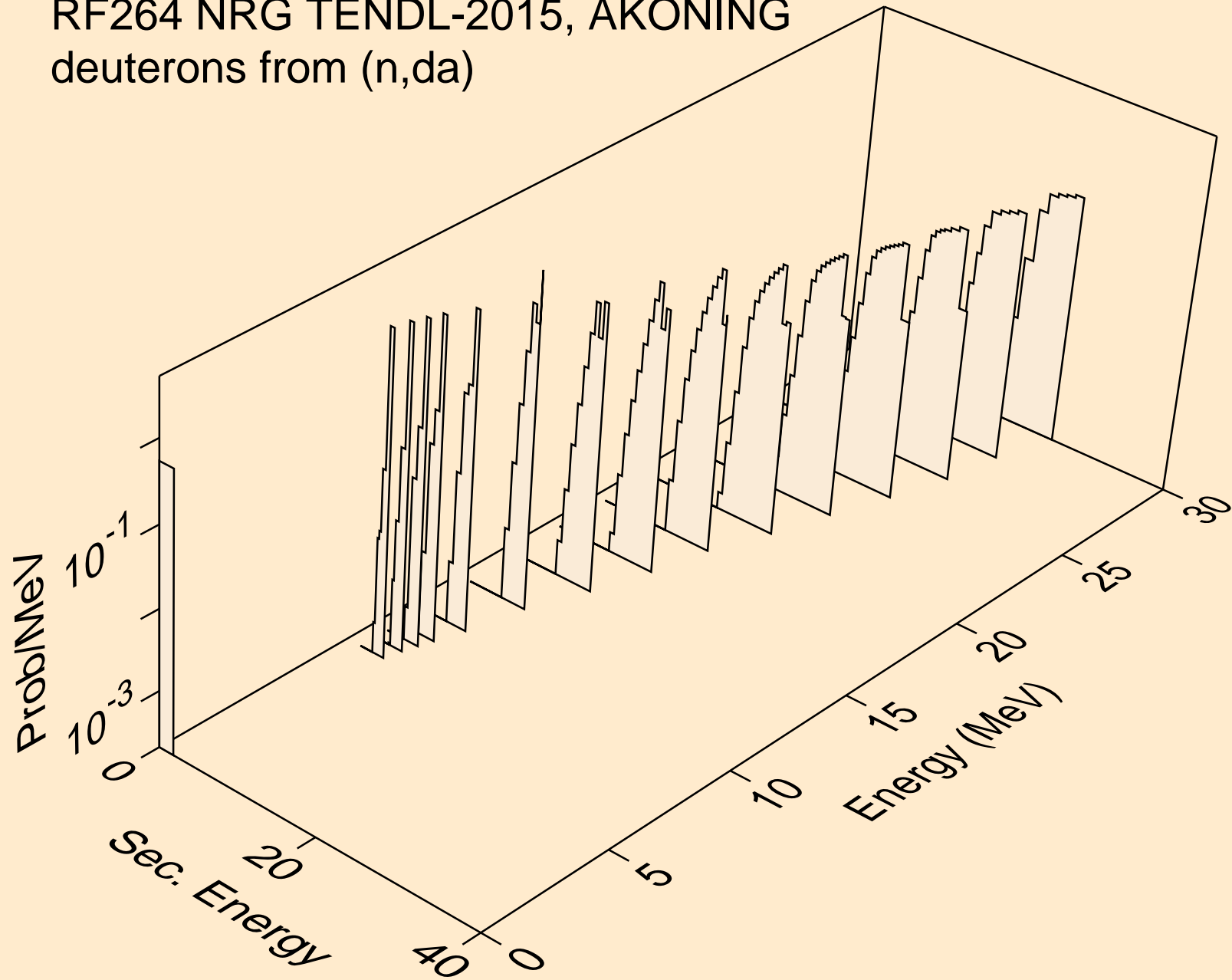

RF264 NRG TENDL-2015, AKONING
tritons from (n,x)

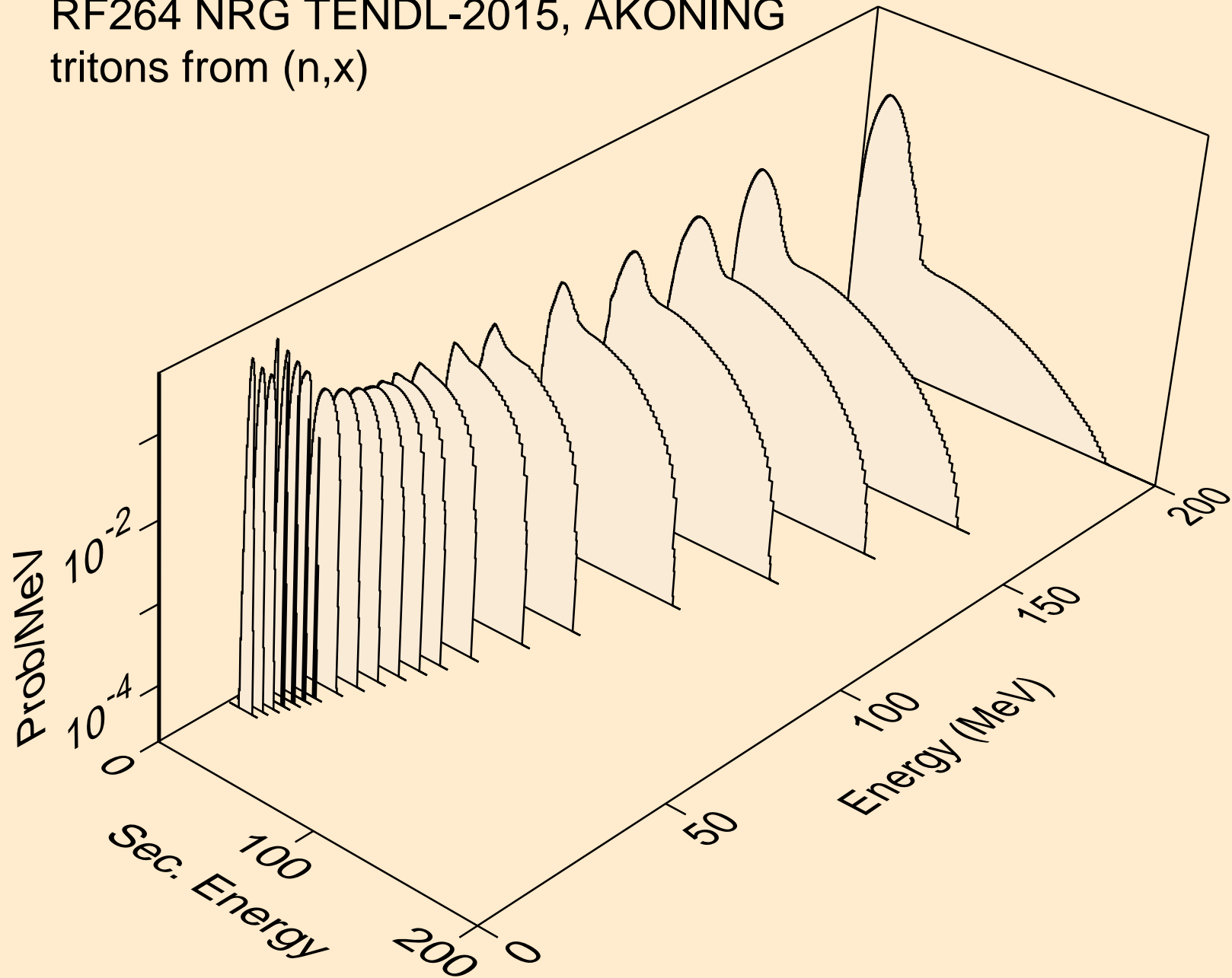

RF264 NRG TENDL-2015, AKONING
tritons from (n,n*)t

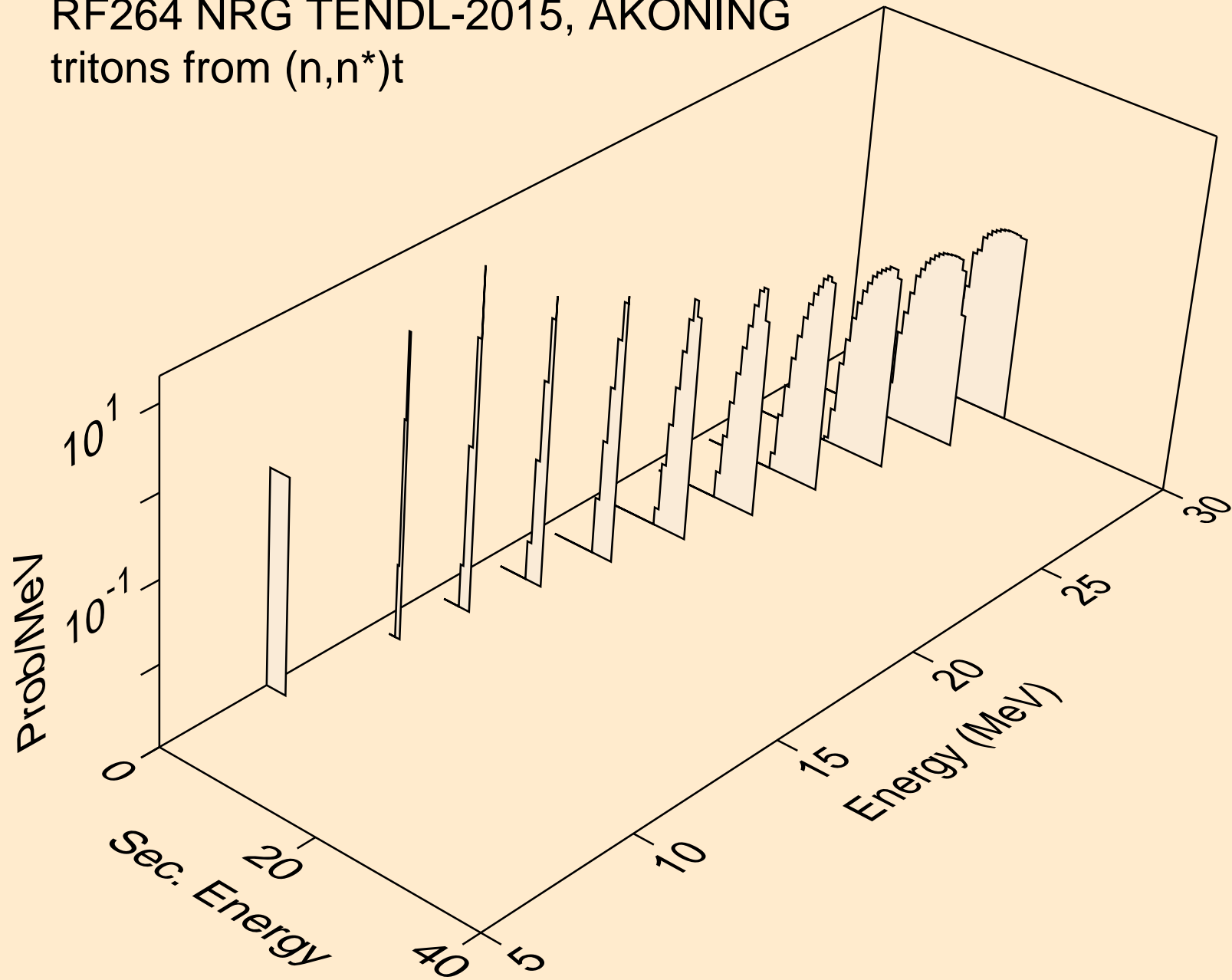

RF264 NRG TENDL-2015, AKONING
tritons from (n,n*)t2a

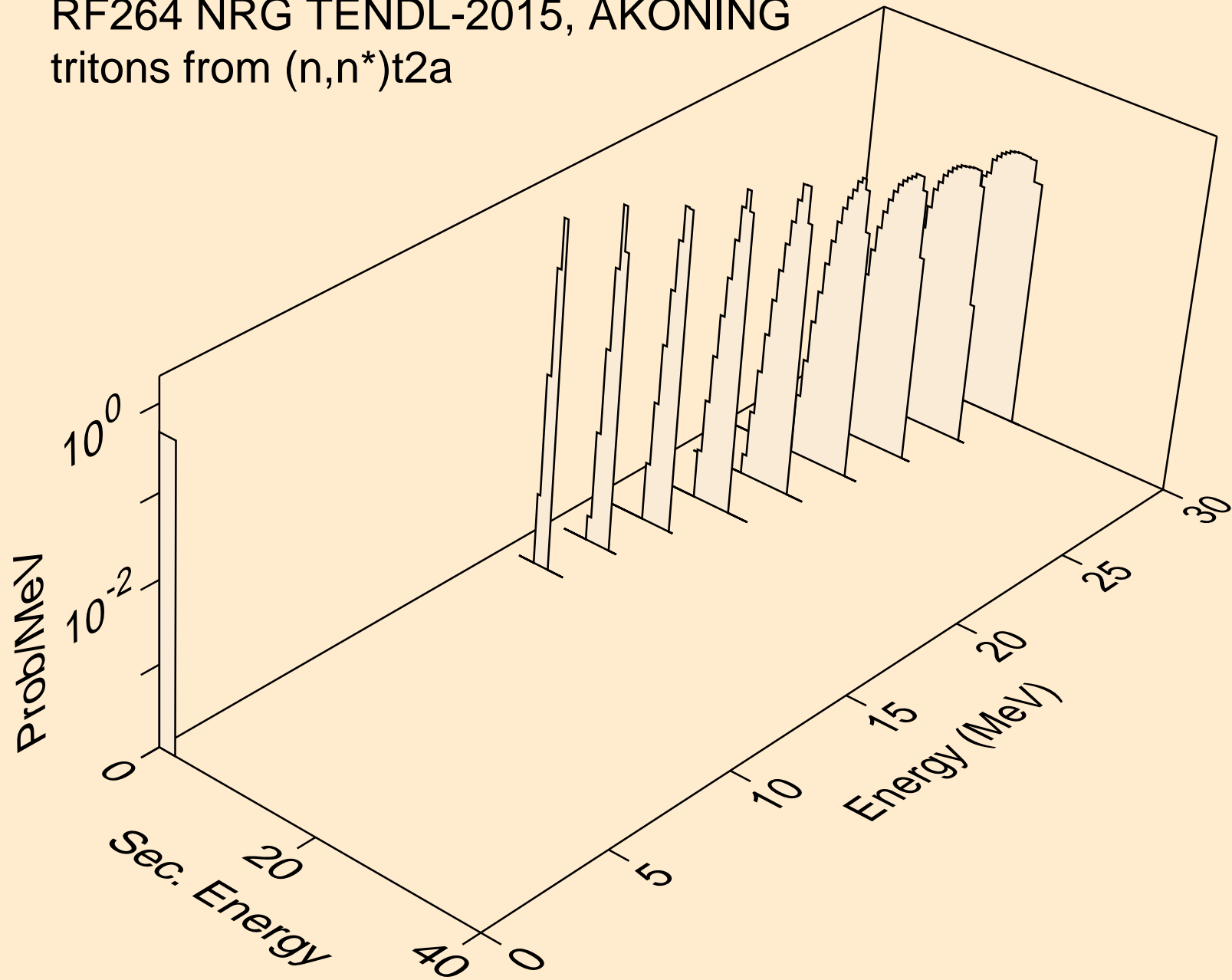

RF264 NRG TENDL-2015, AKONING
tritons from (n,t)

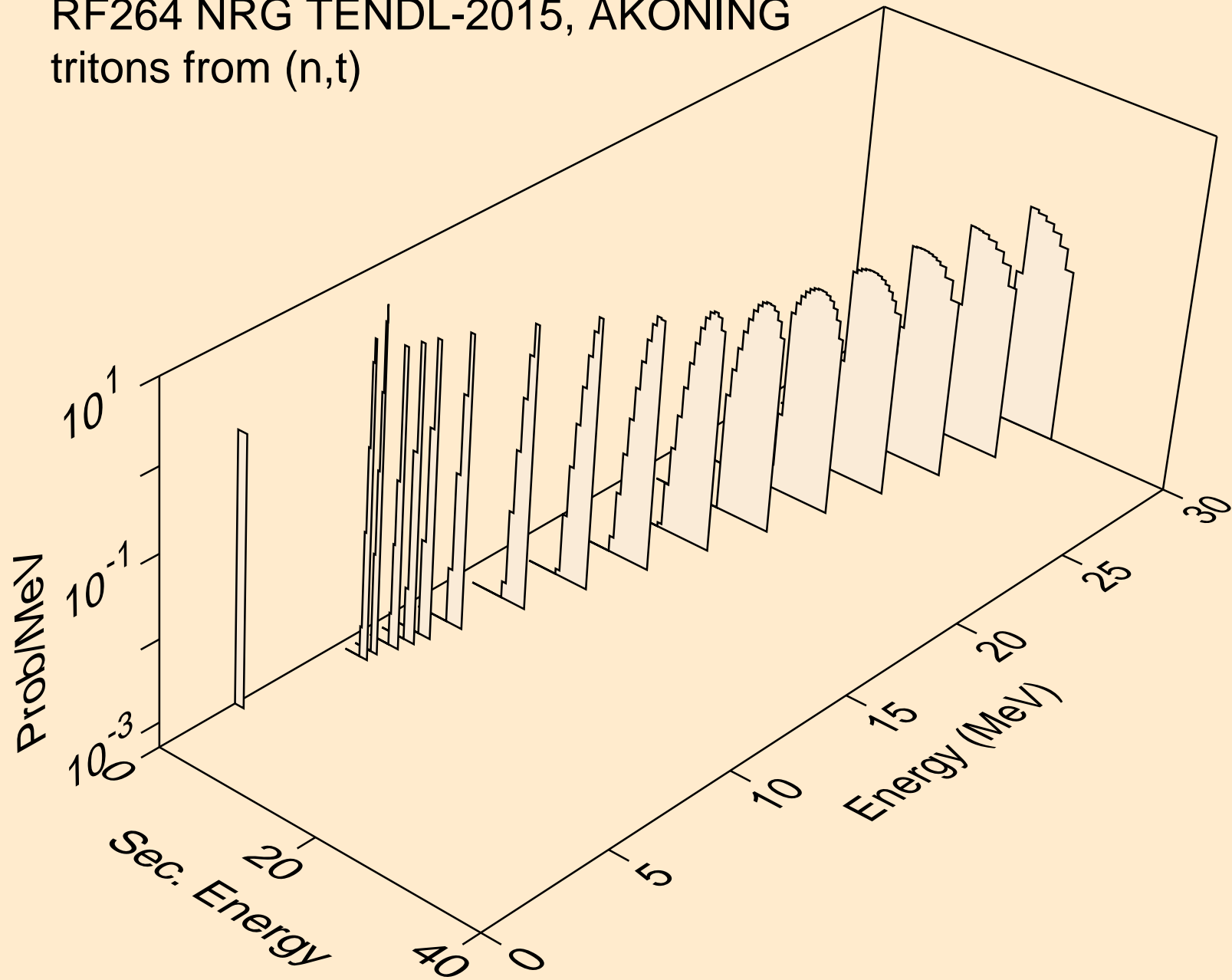

RF264 NRG TENDL-2015, AKONING
tritons from (n,t2a)

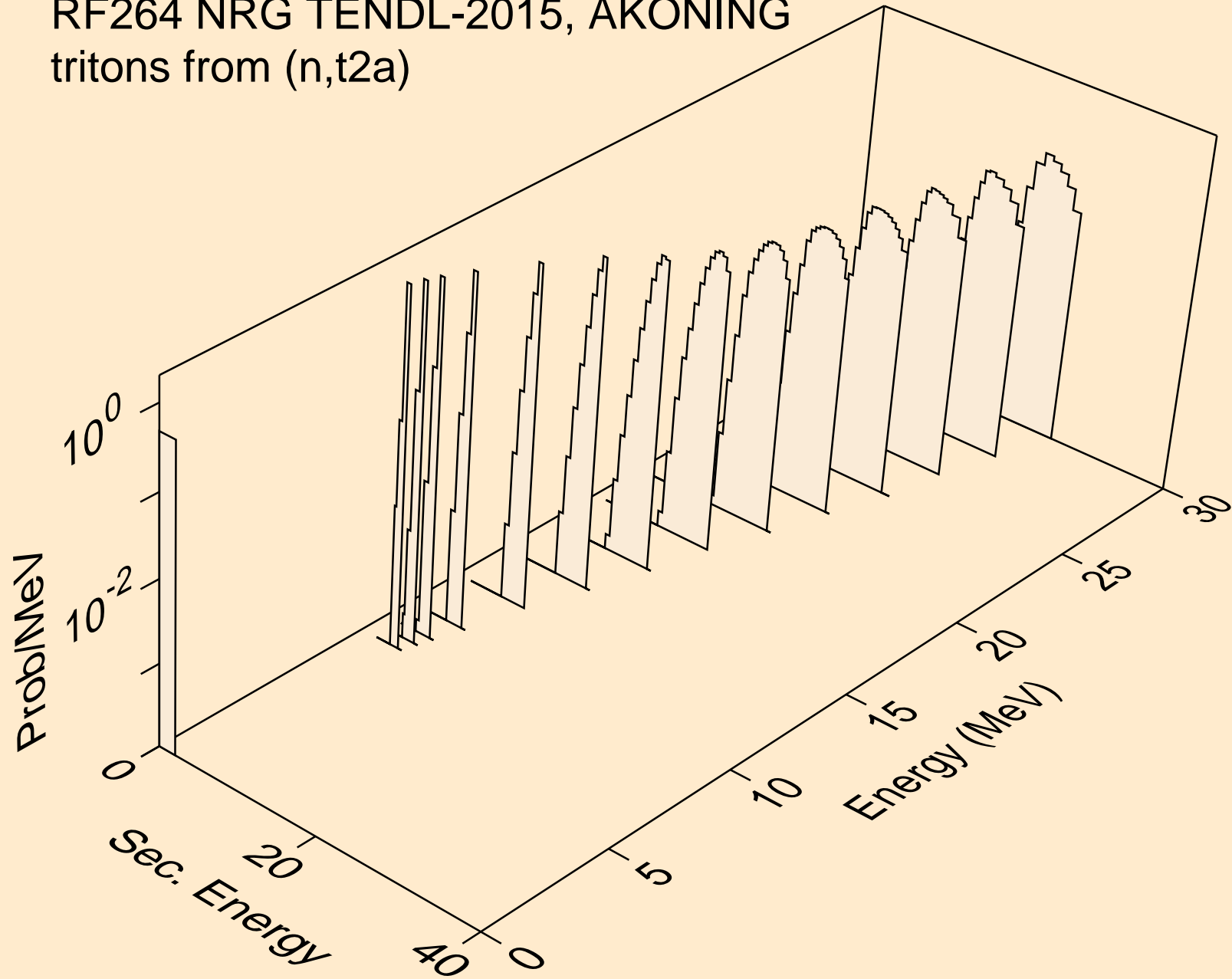

RF264 NRG TENDL-2015, AKONING
he3s from (n,x)

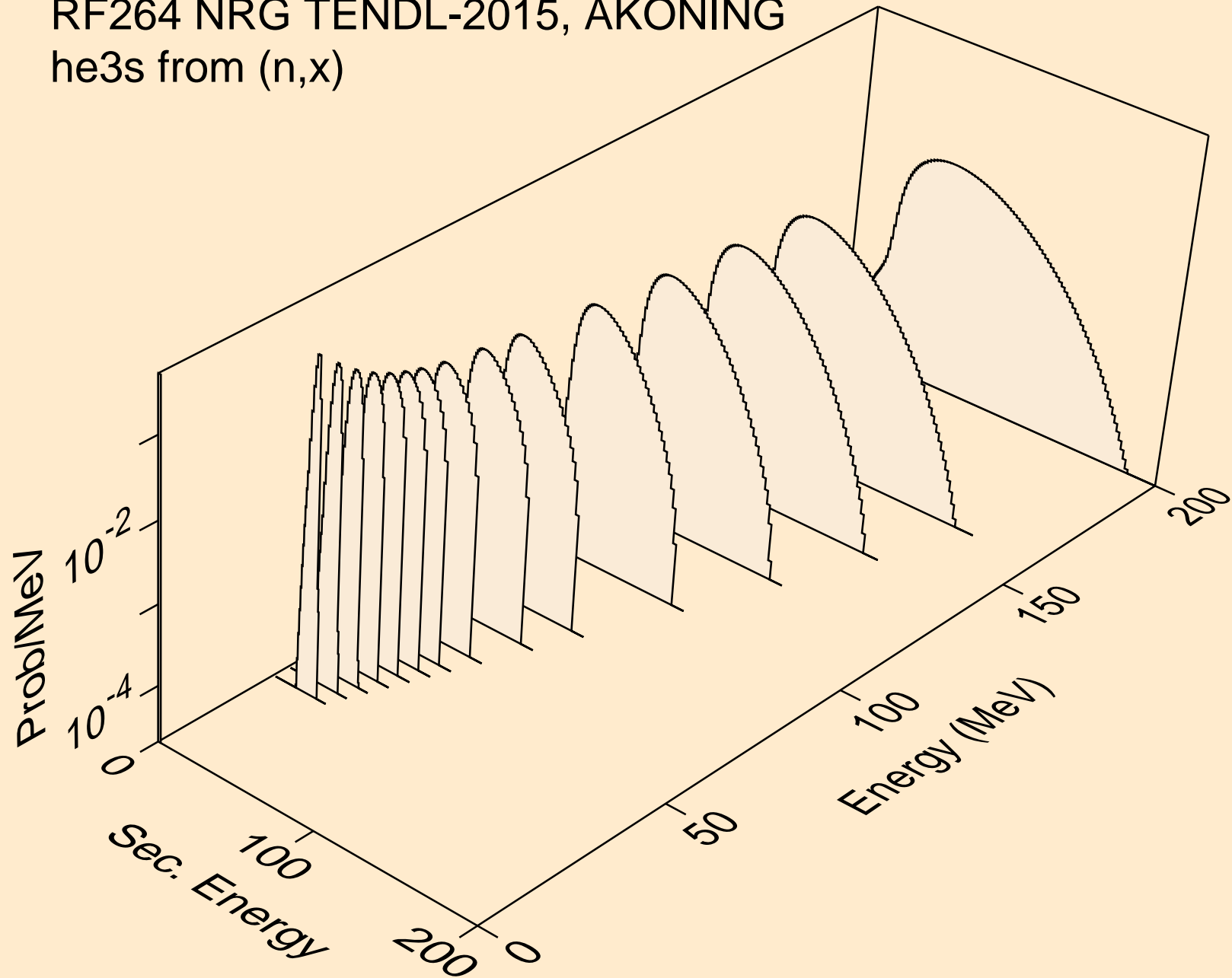

RF264 NRG TENDL-2015, AKONING
he3s from (n,n*)he3

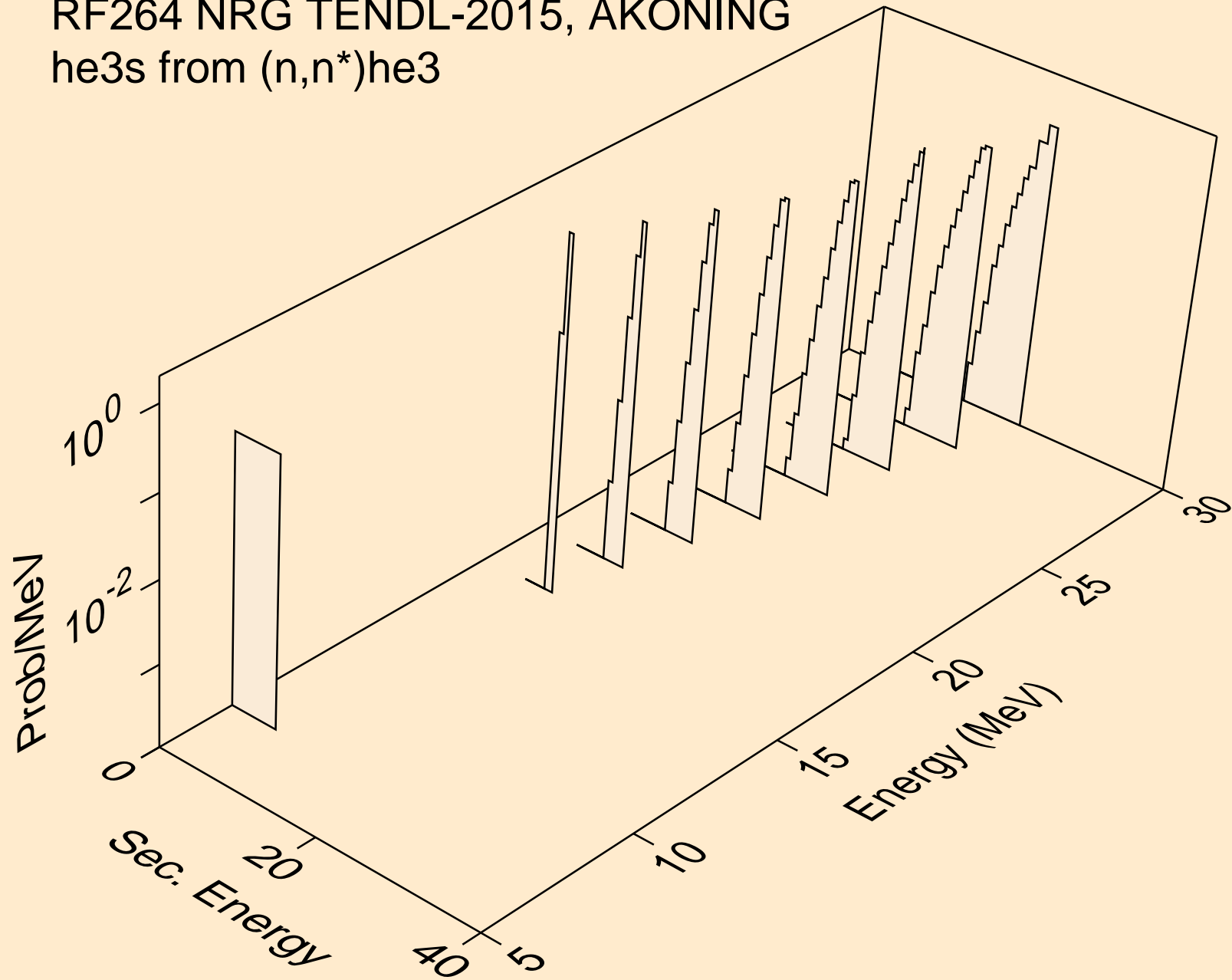

RF264 NRG TENDL-2015, AKONING
he3s from (n,he3)

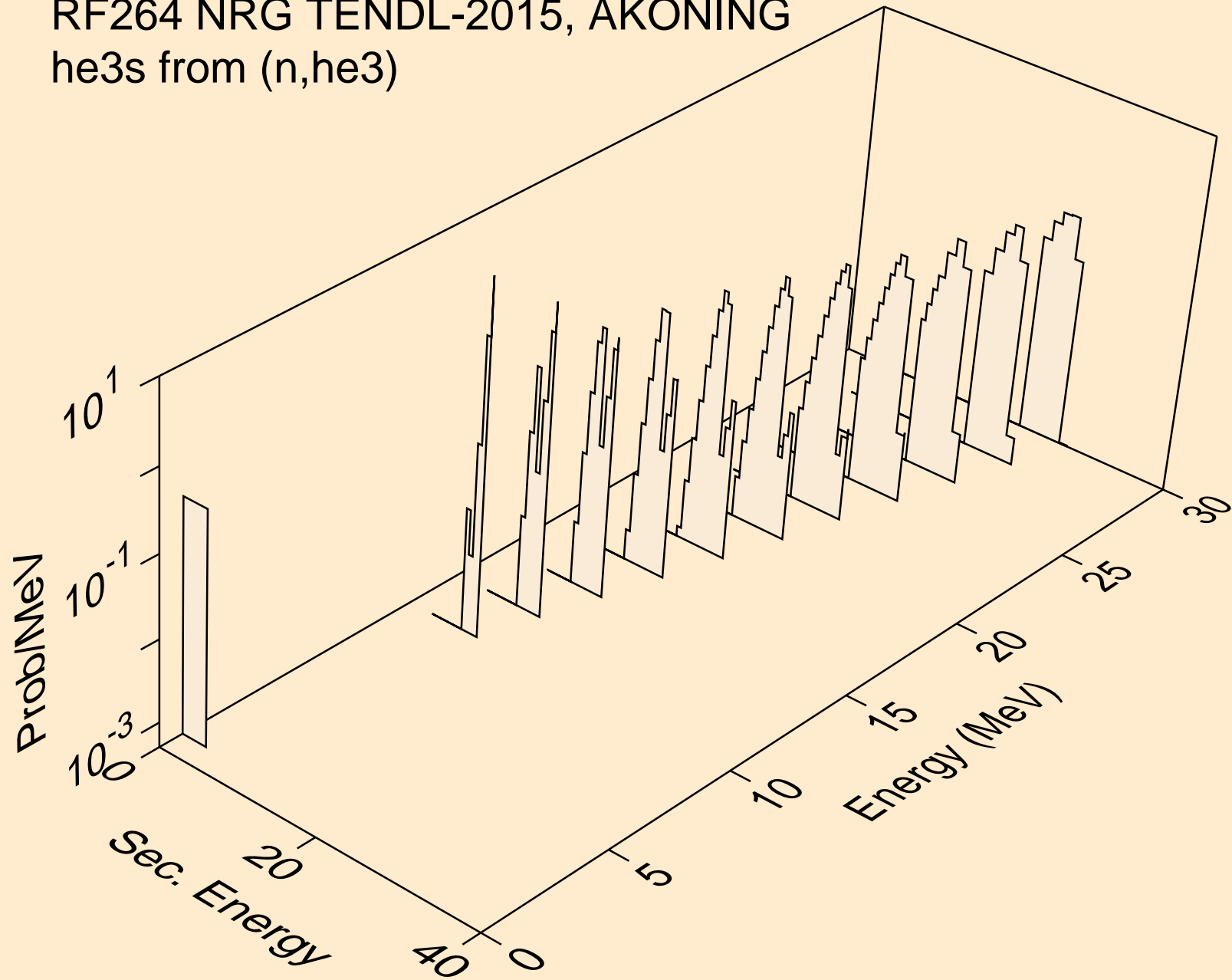

RF264 NRG TENDL-2015, AKONING
alphas from (n,x)

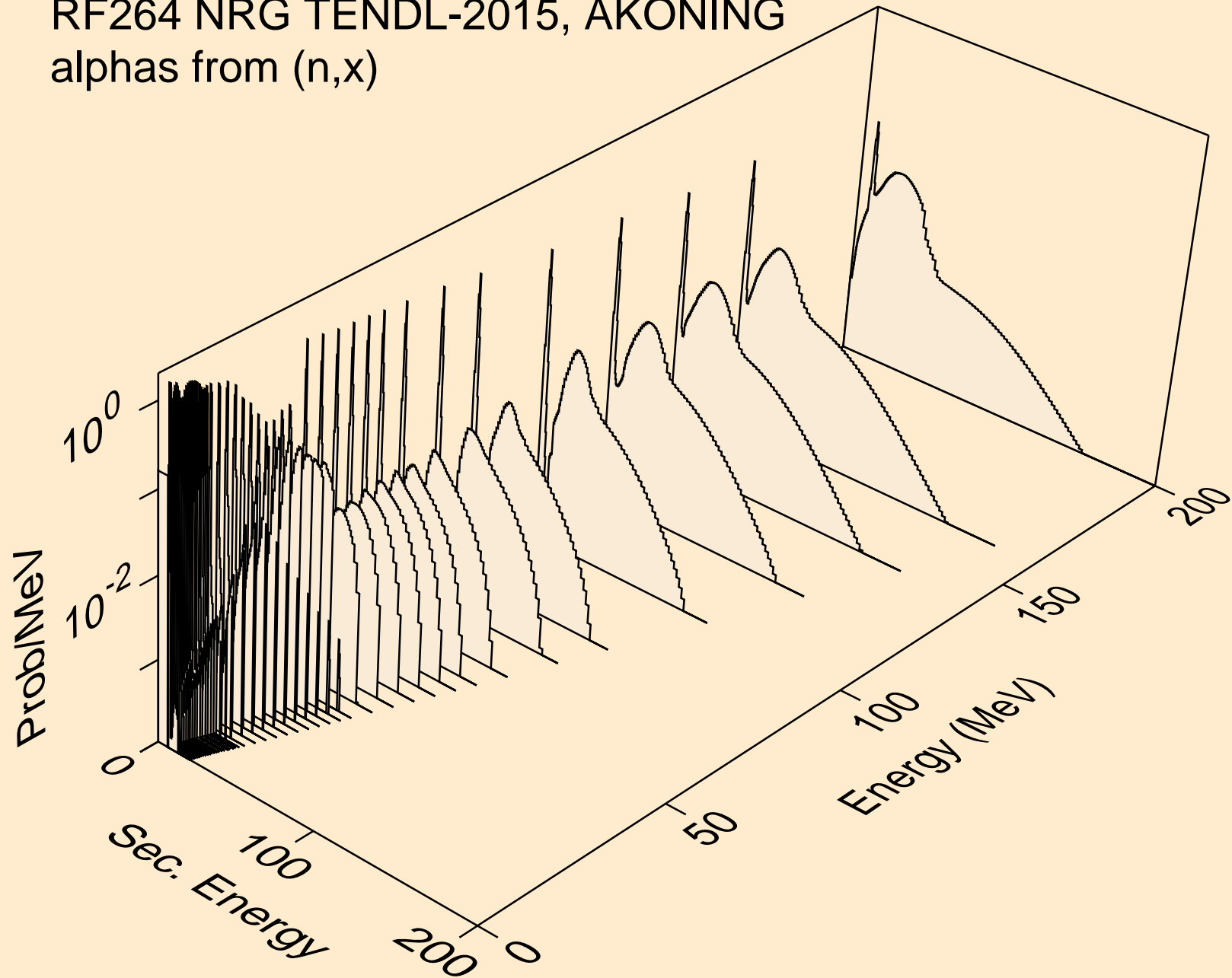

RF264 NRG TENDL-2015, AKONING
alphas from (n,n*)a

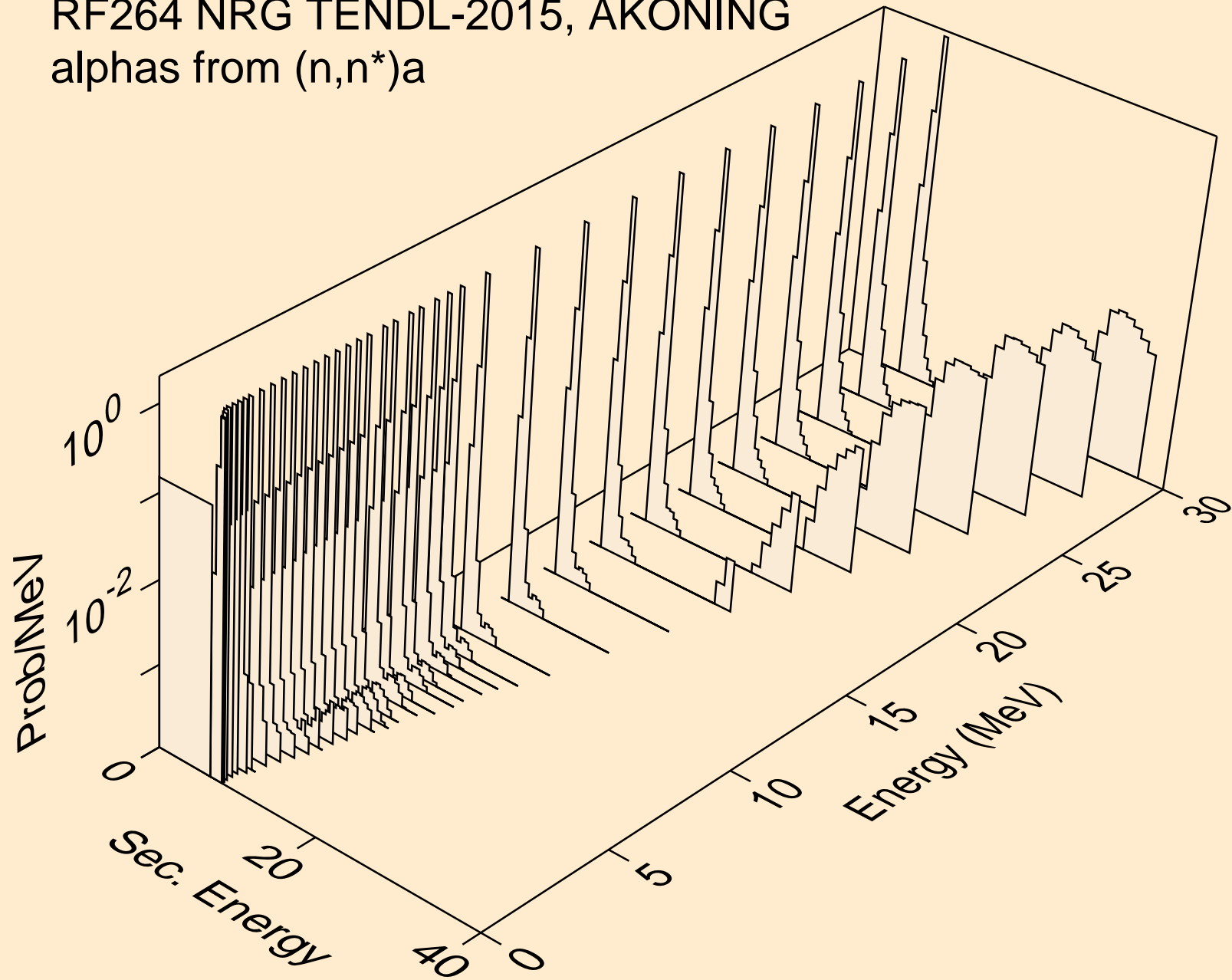

RF264 NRG TENDL-2015, AKONING
alphas from (n,n*)3a

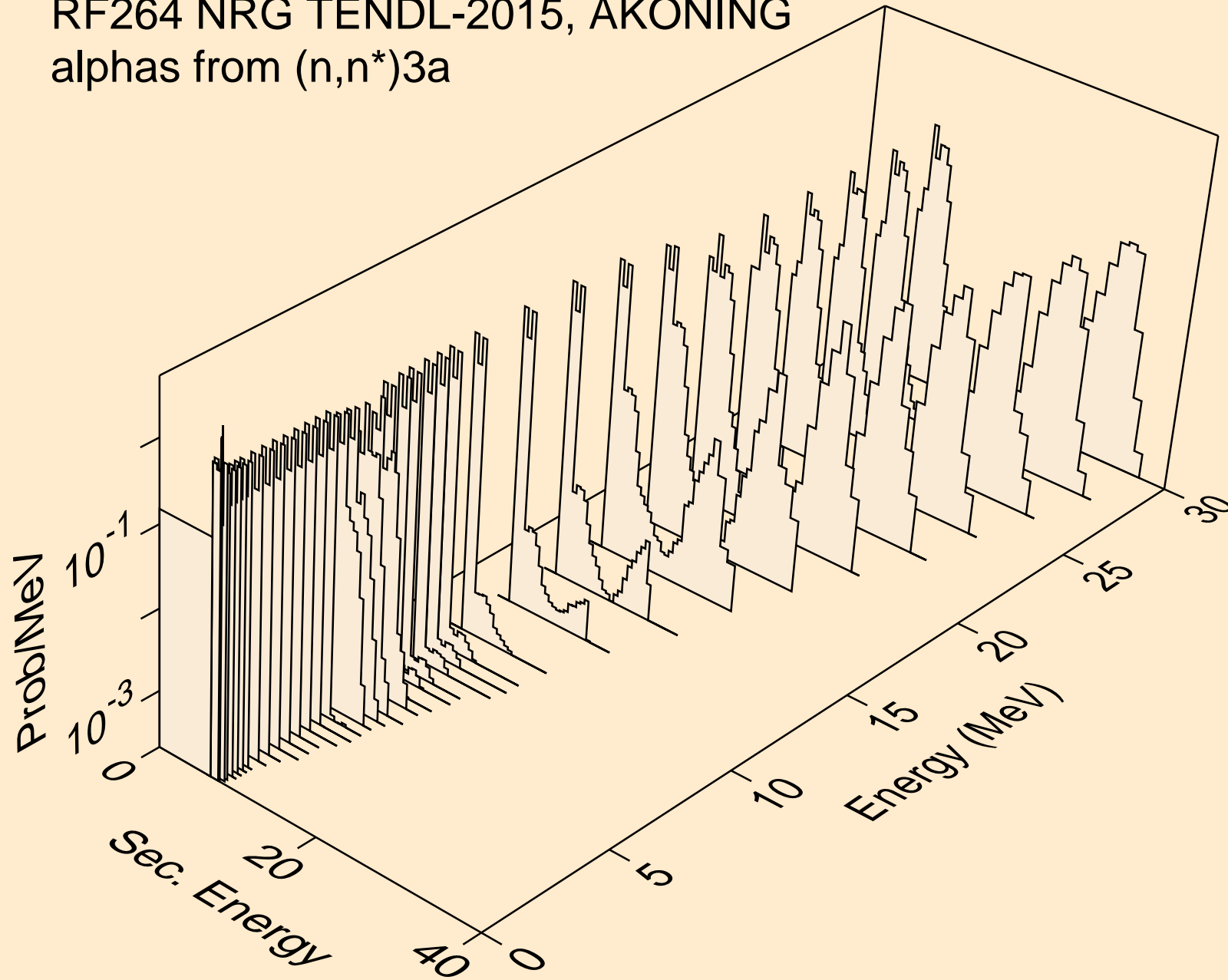

RF264 NRG TENDL-2015, AKONING
alphas from (n,2n)a

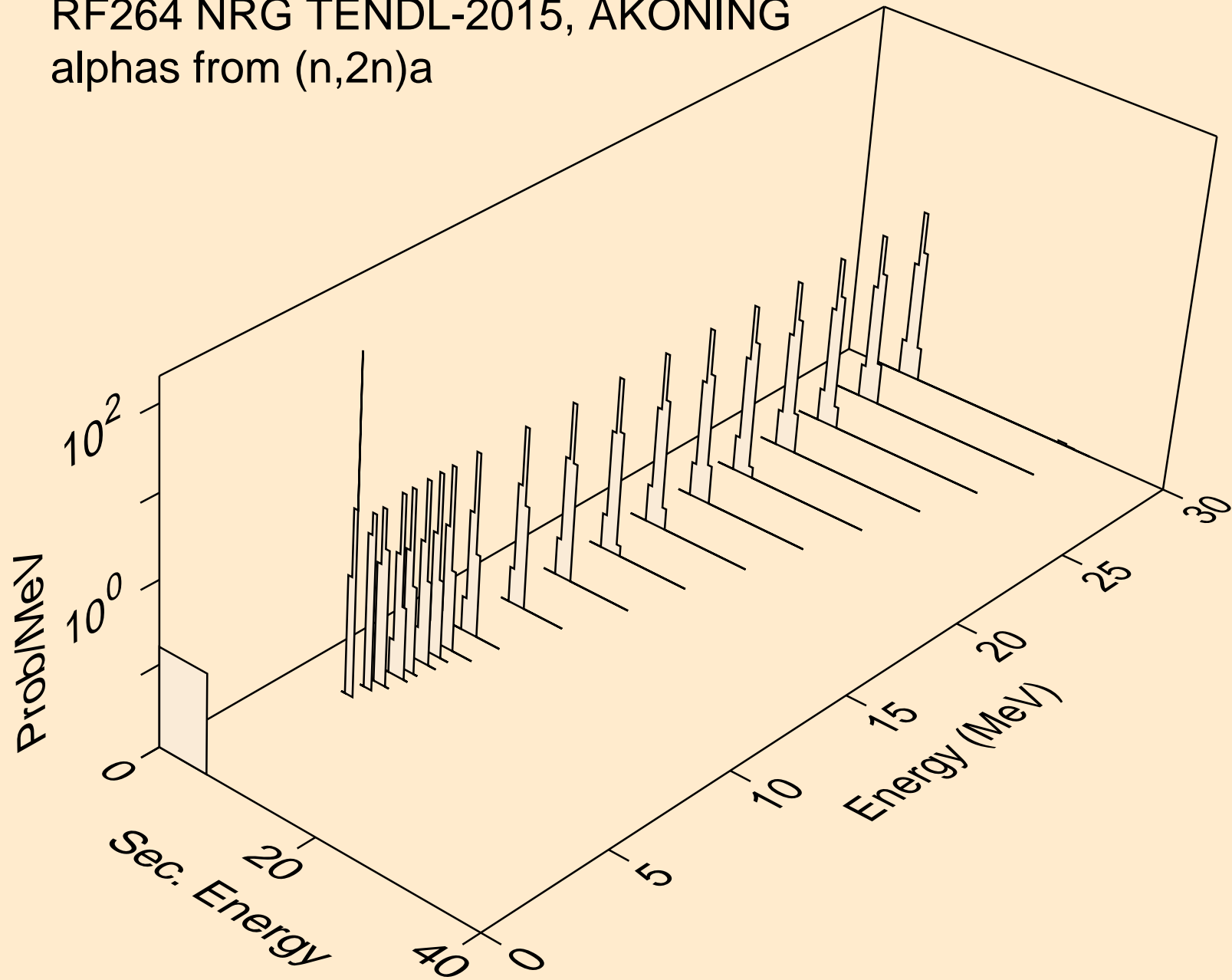

RF264 NRG TENDL-2015, AKONING
alphas from (n,3n)a

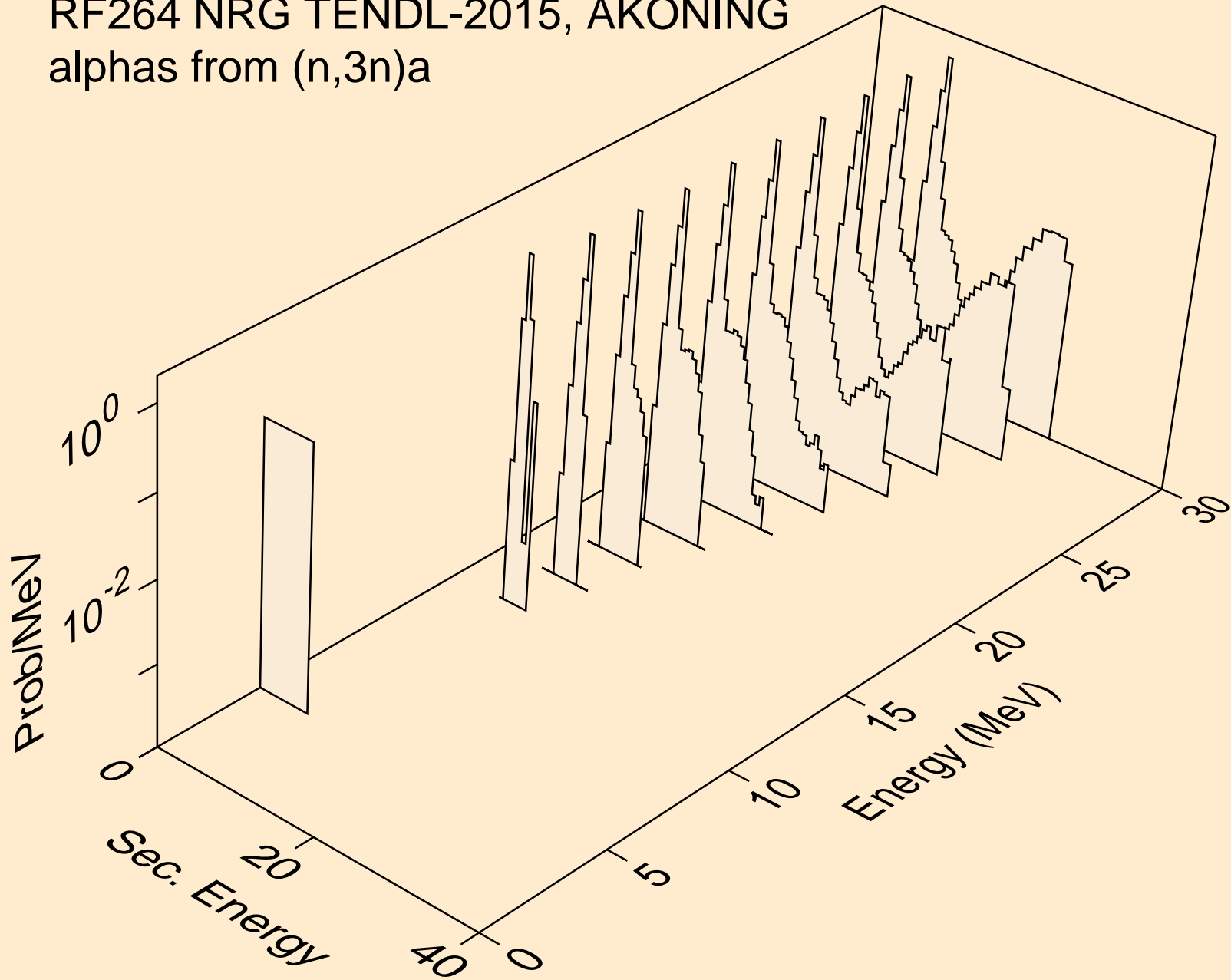

RF264 NRG TENDL-2015, AKONING
alphas from (n,n*)2a

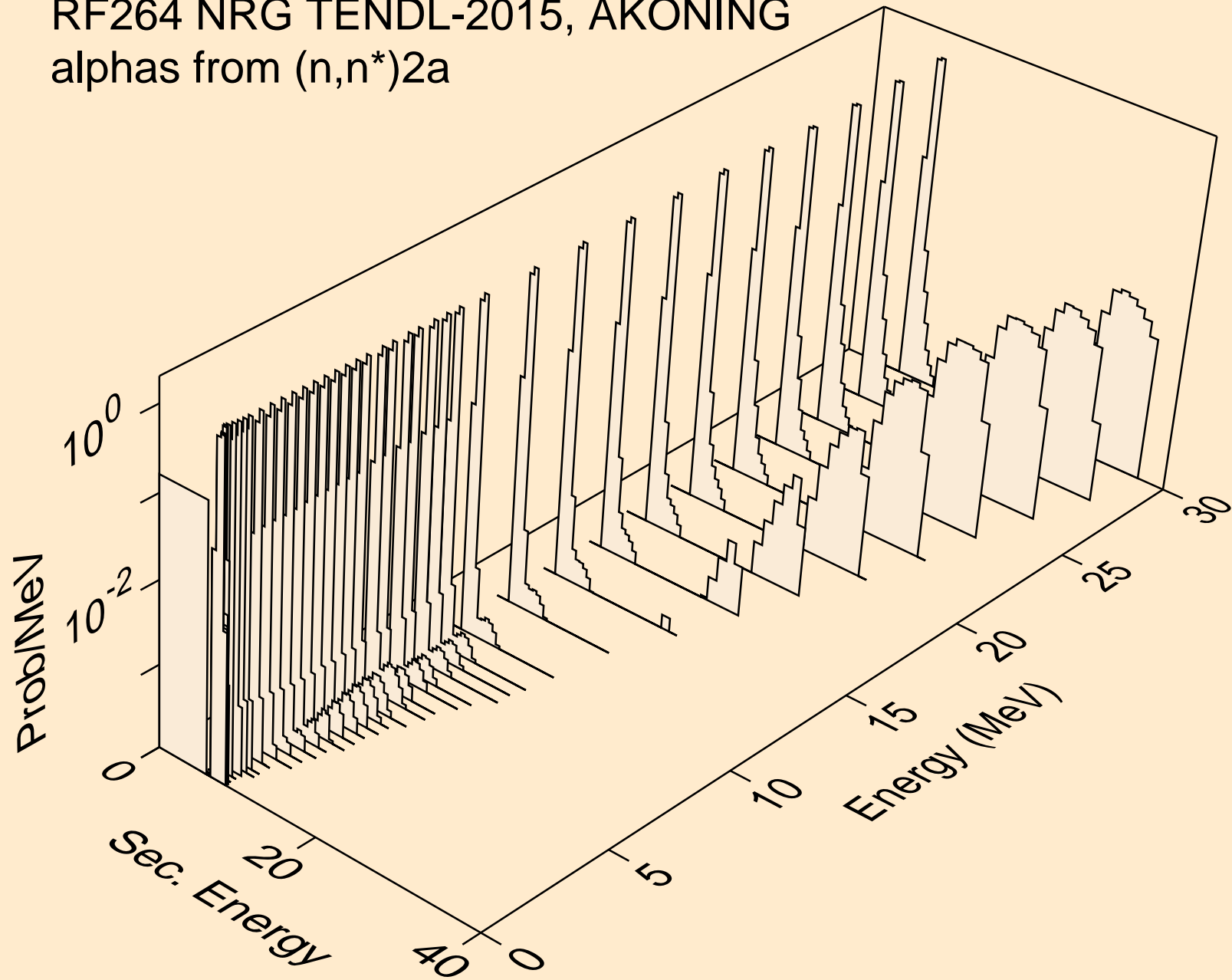

RF264 NRG TENDL-2015, AKONING
alphas from (n,2n)2a

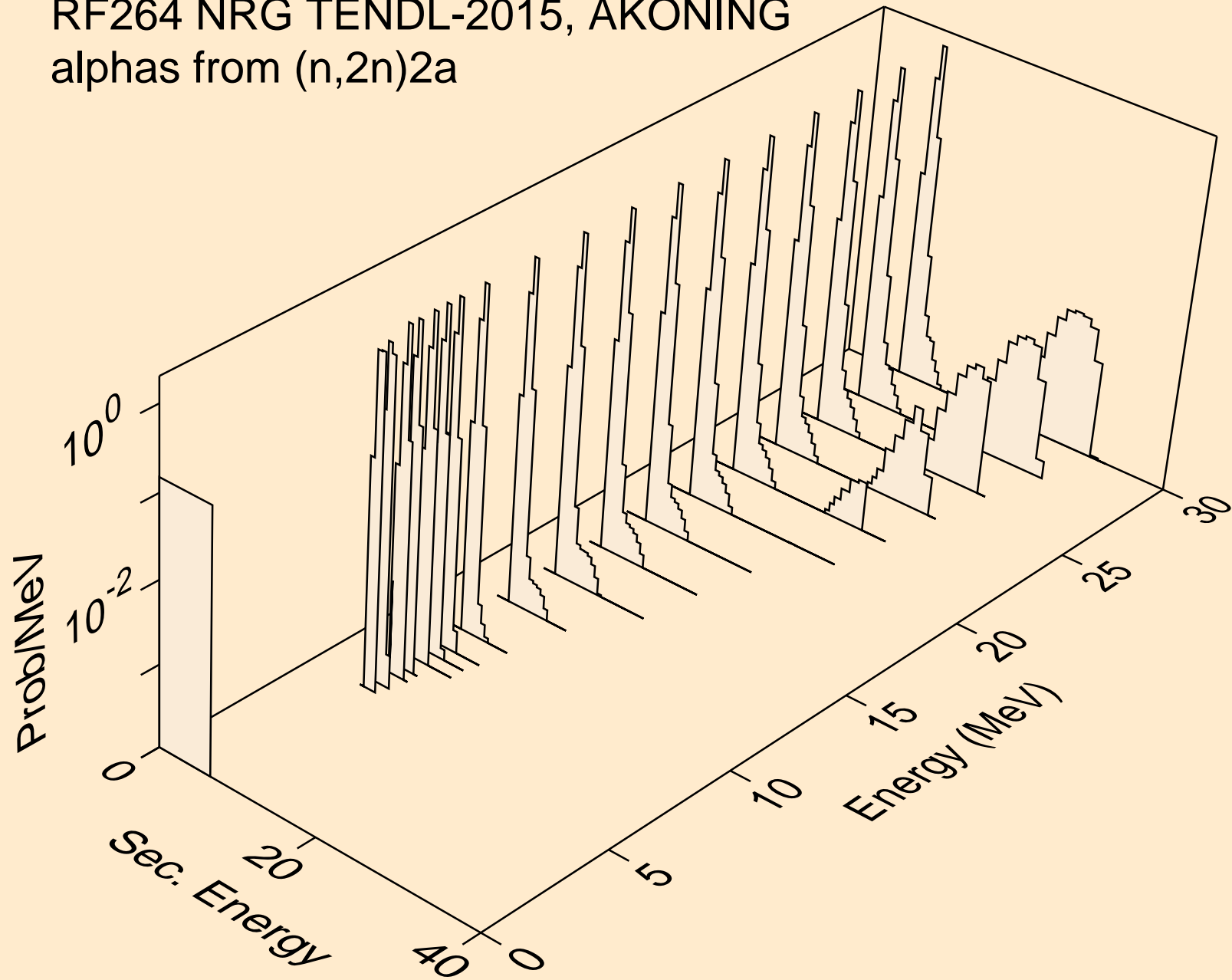

RF264 NRG TENDL-2015, AKONING
alphas from (n,n*)d2a

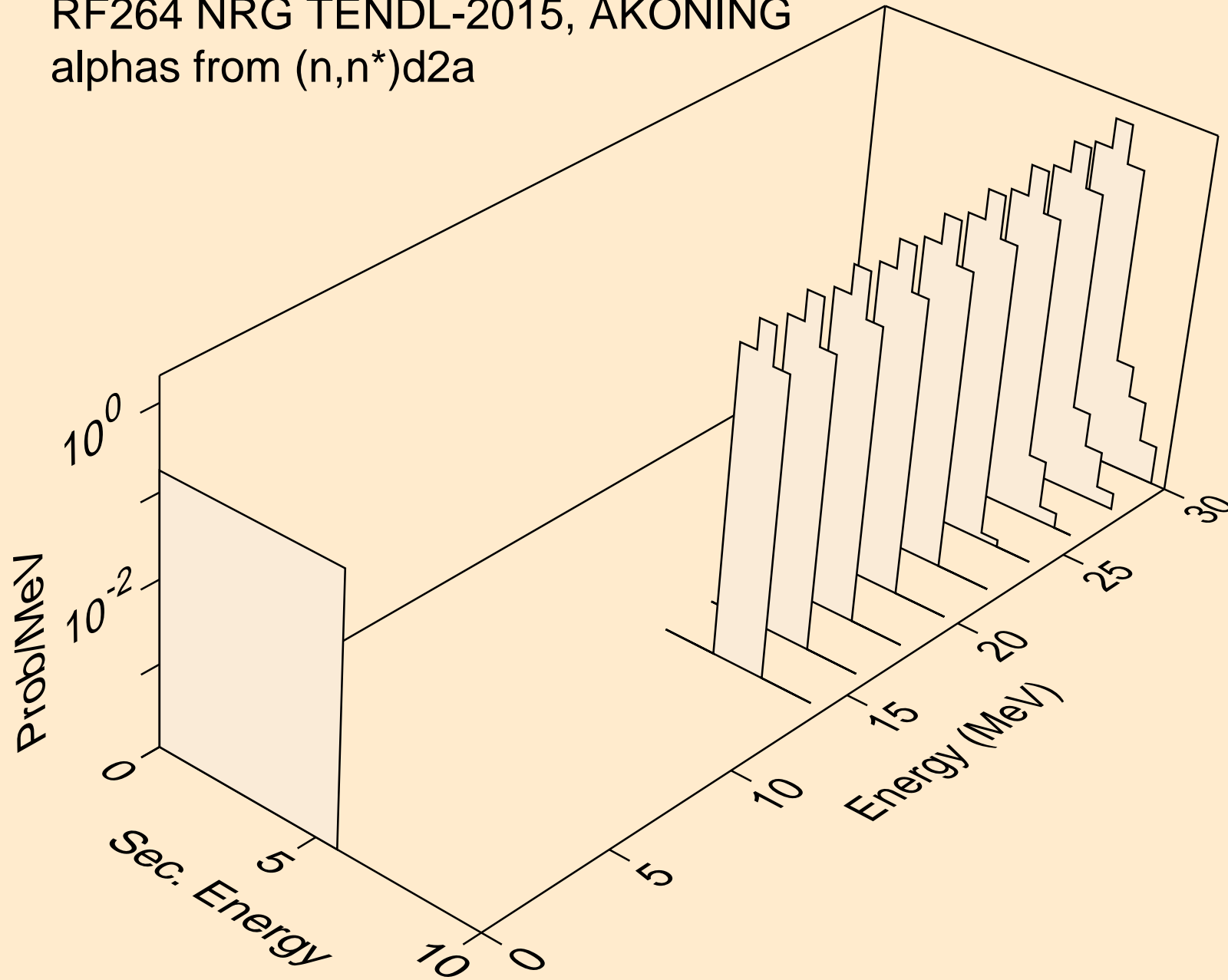

RF264 NRG TENDL-2015, AKONING
alphas from (n,n*)t2a

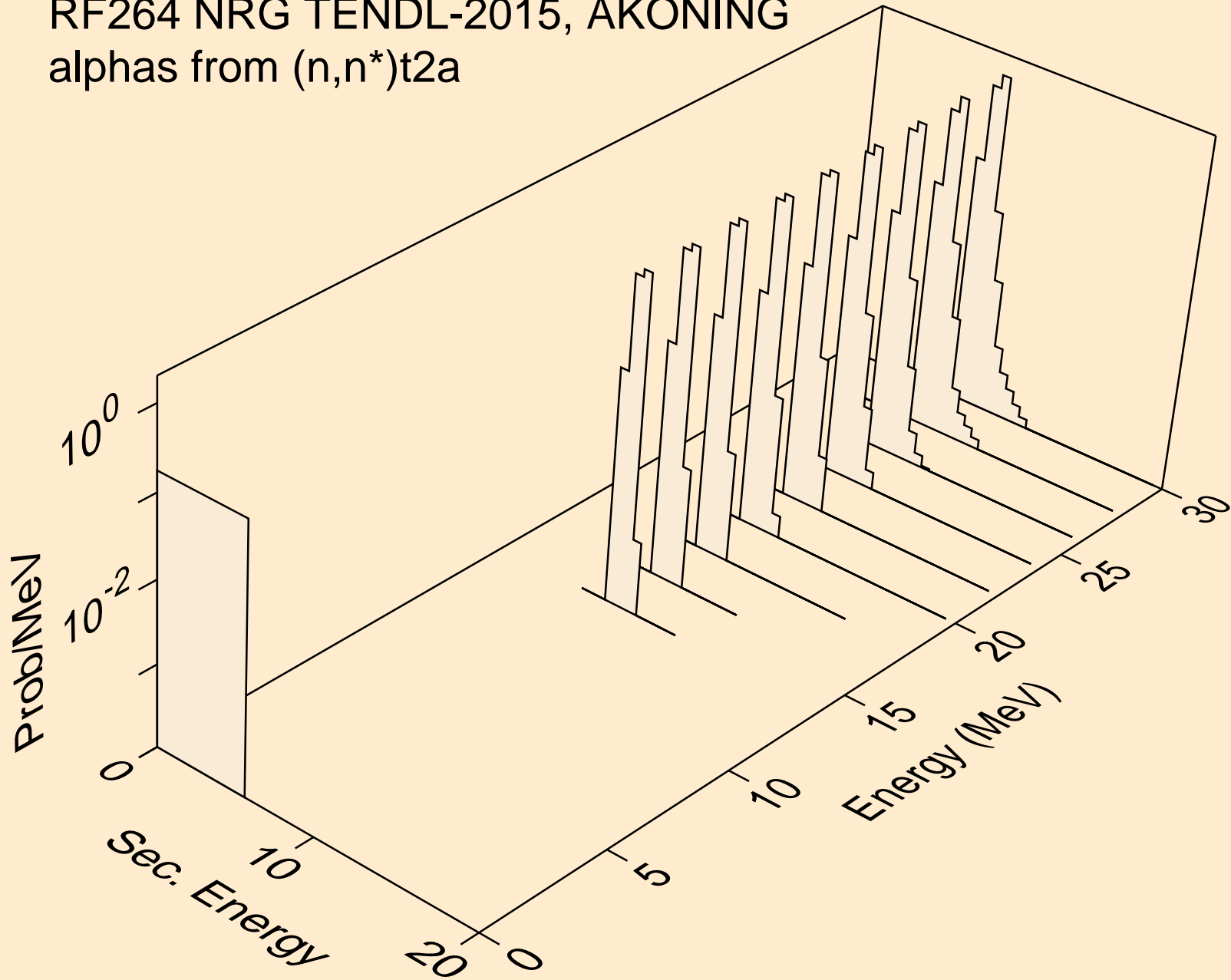

RF264 NRG TENDL-2015, AKONING
alphas from (n,npa)

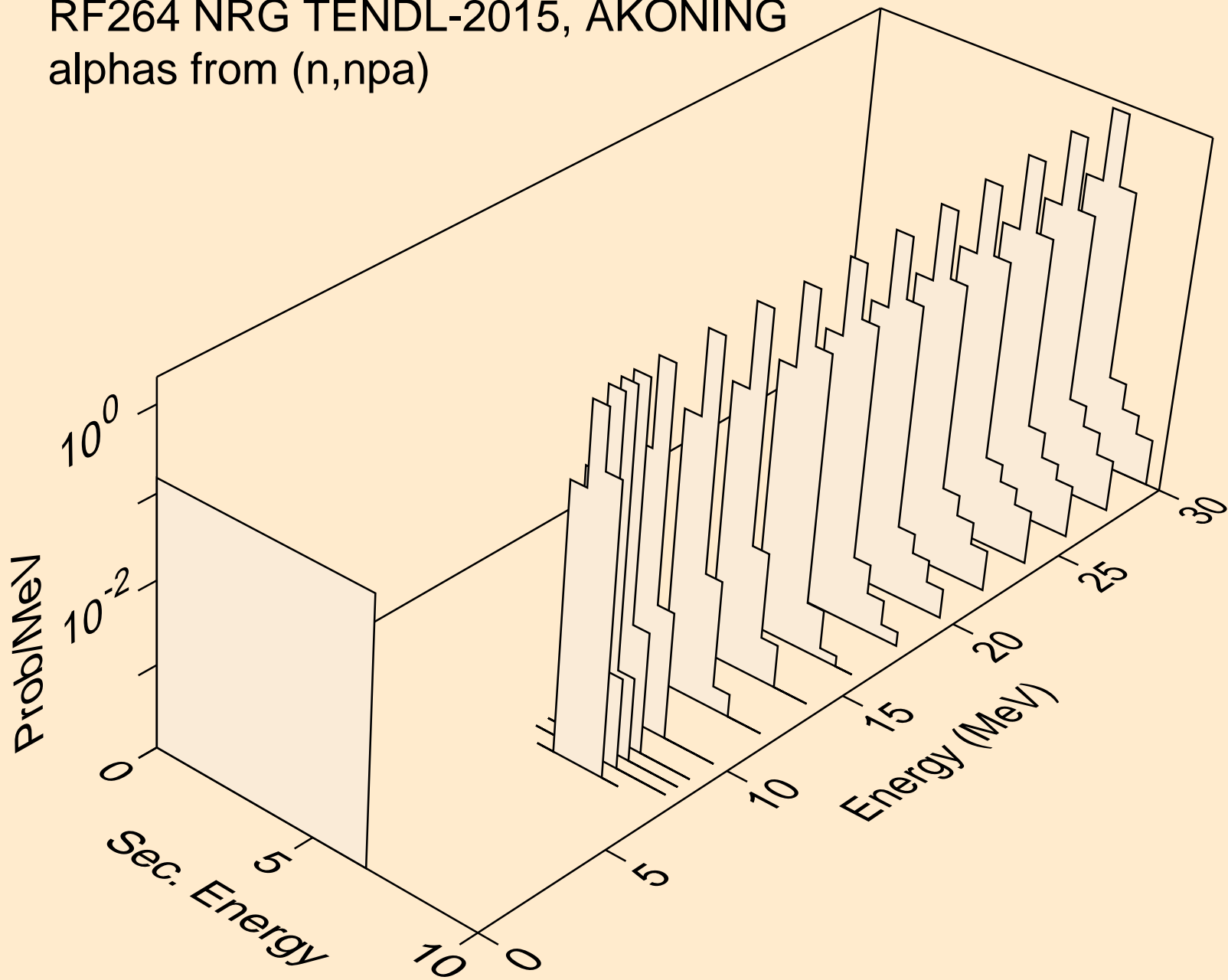

RF264 NRG TENDL-2015, AKONING
alphas from (n,a)

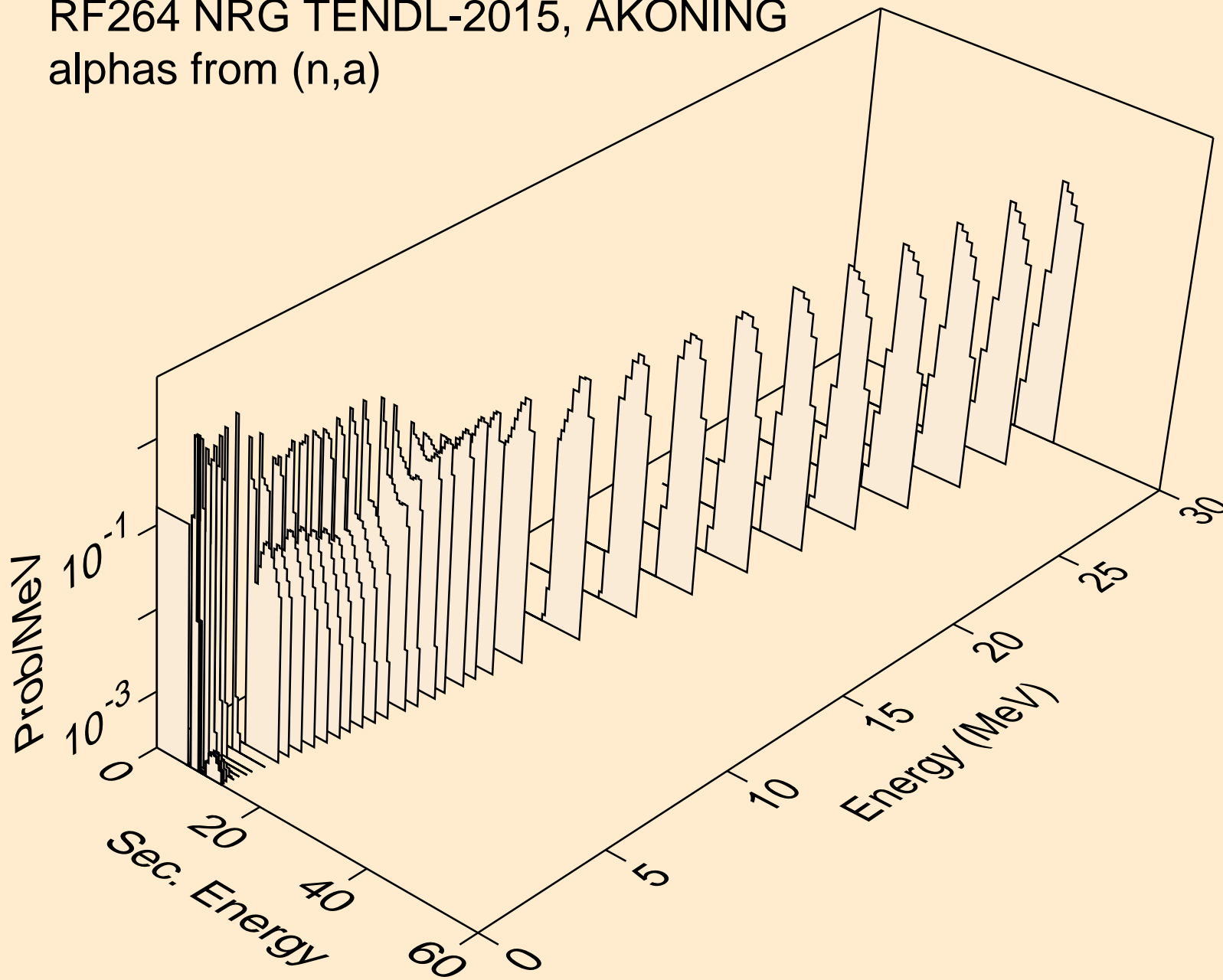

RF264 NRG TENDL-2015, AKONING
alphas from (n,2a)

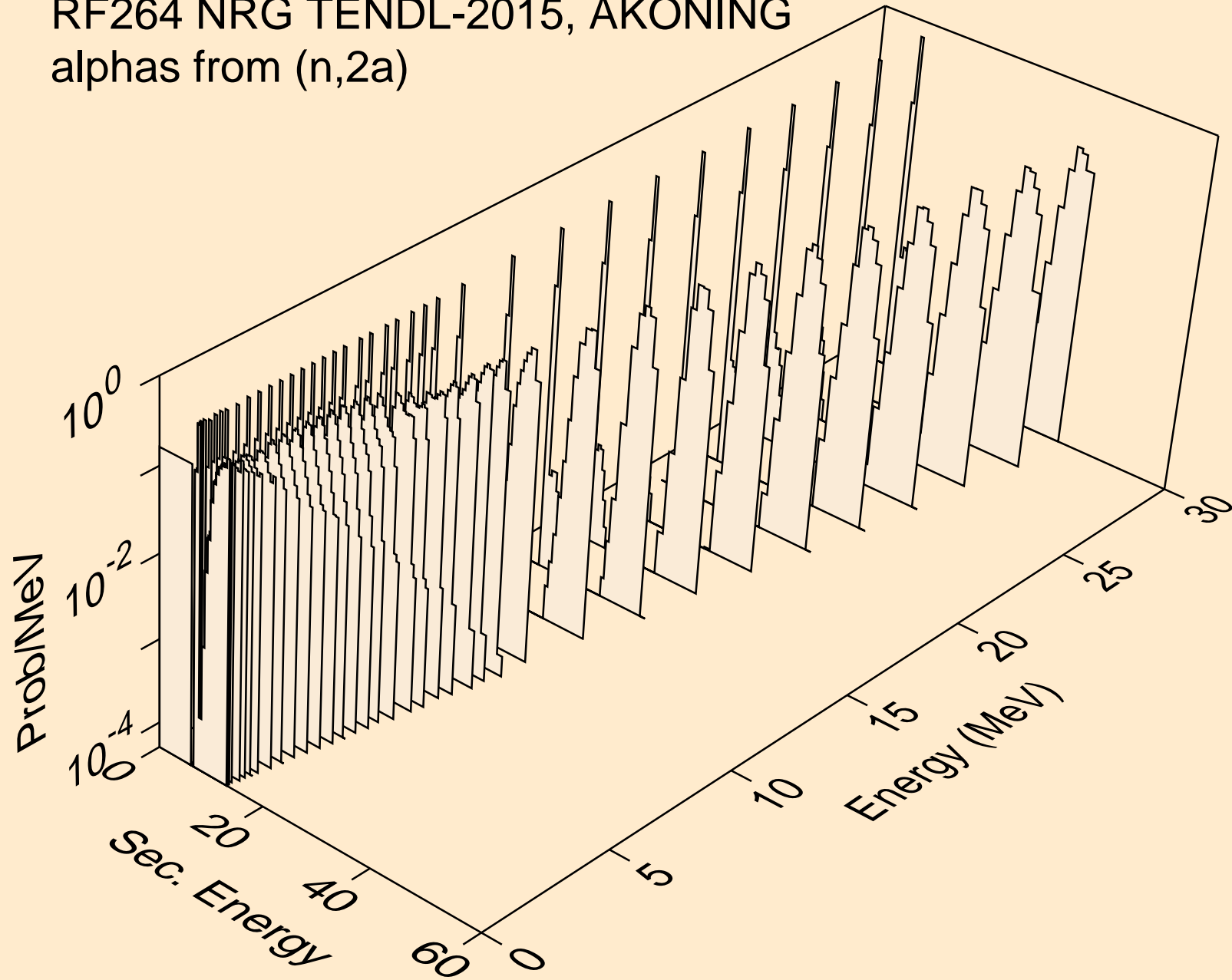

RF264 NRG TENDL-2015, AKONING
alphas from (n,3a)

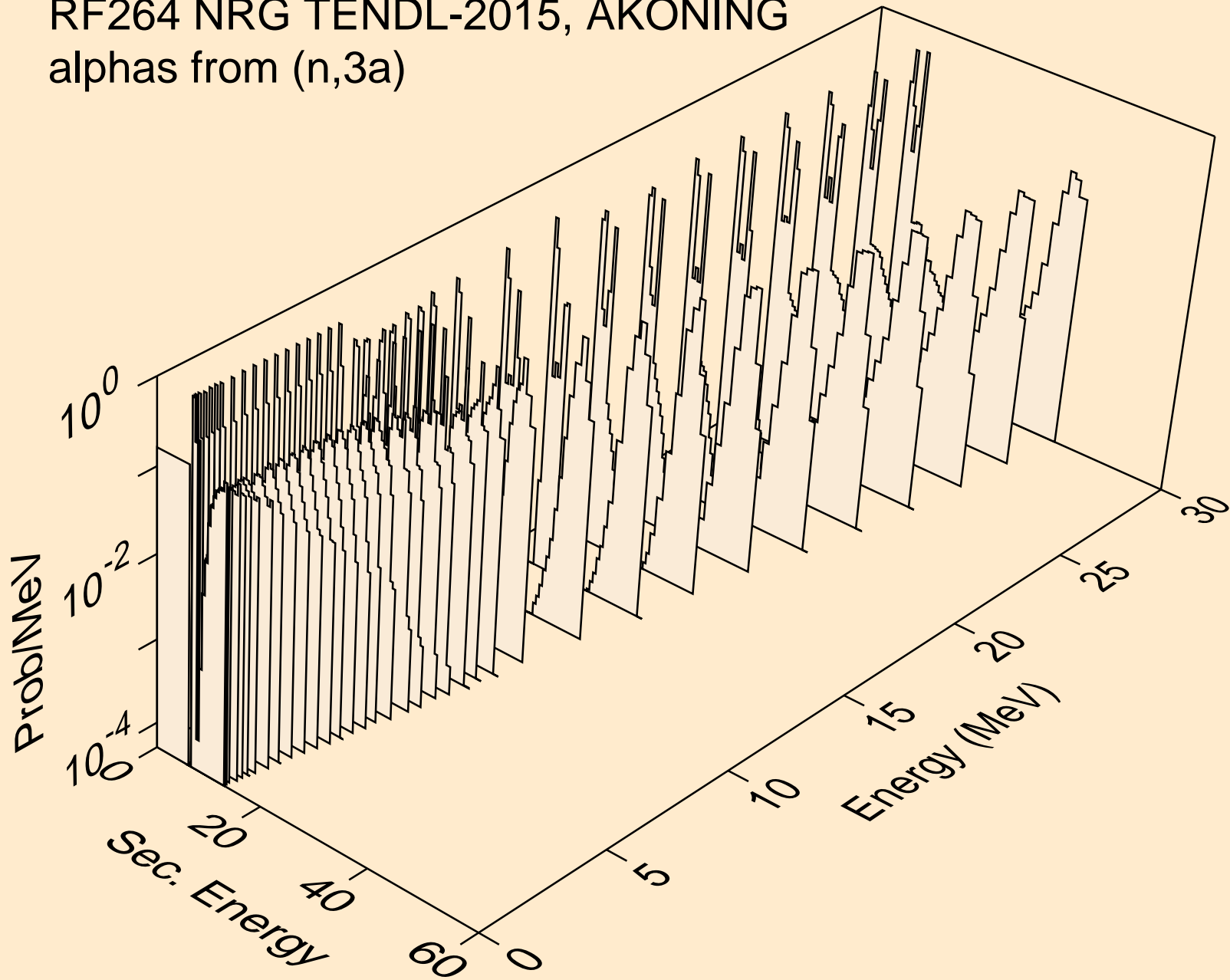

RF264 NRG TENDL-2015, AKONING
alphas from (n,pa)

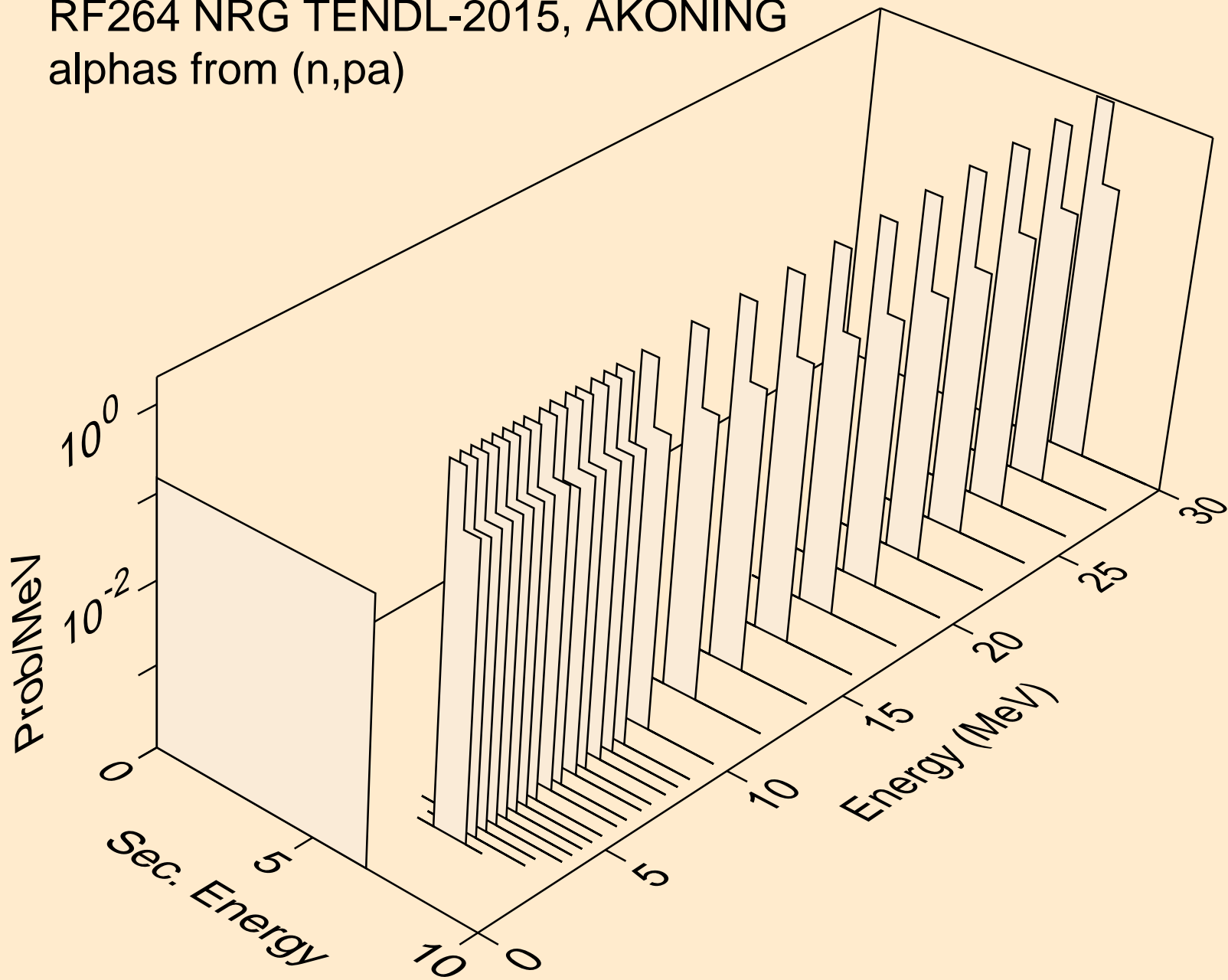

RF264 NRG TENDL-2015, AKONING
alphas from (n,t2a)

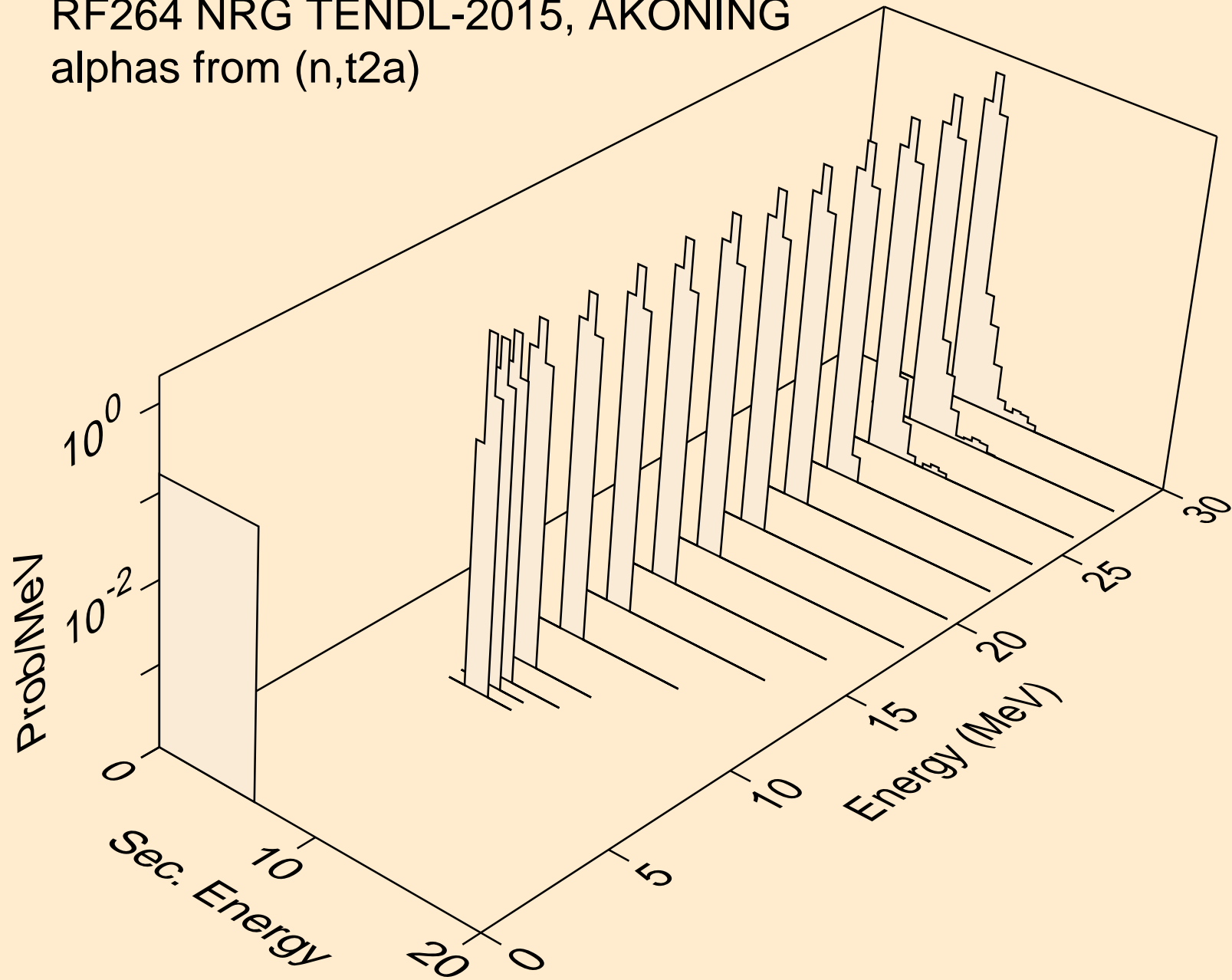

RF264 NRG TENDL-2015, AKONING
alphas from (n,d2a)

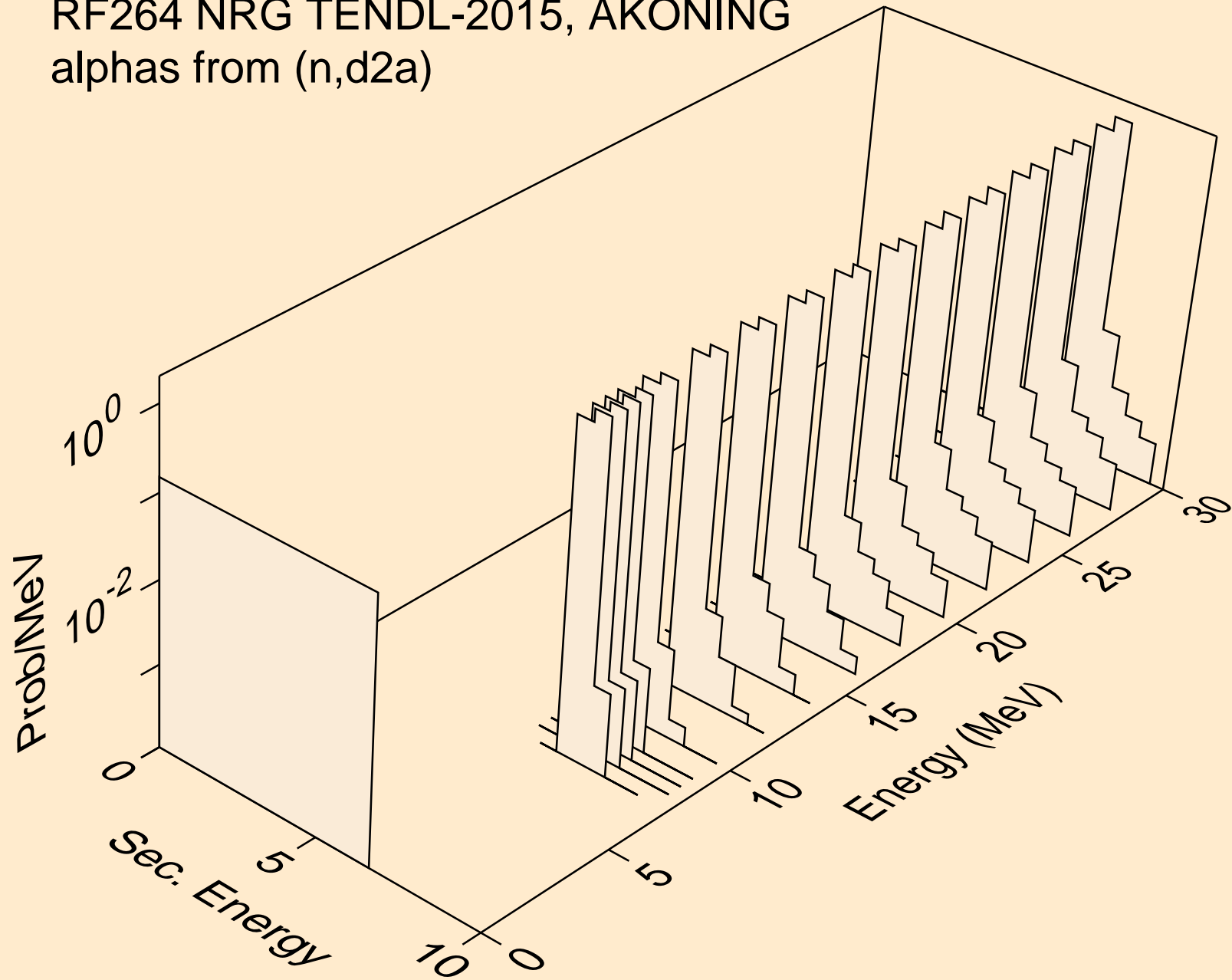

RF264 NRG TENDL-2015, AKONING
alphas from (n,da)

