

RN211 NRG TENDL-2015, AKONING

Principal cross sections

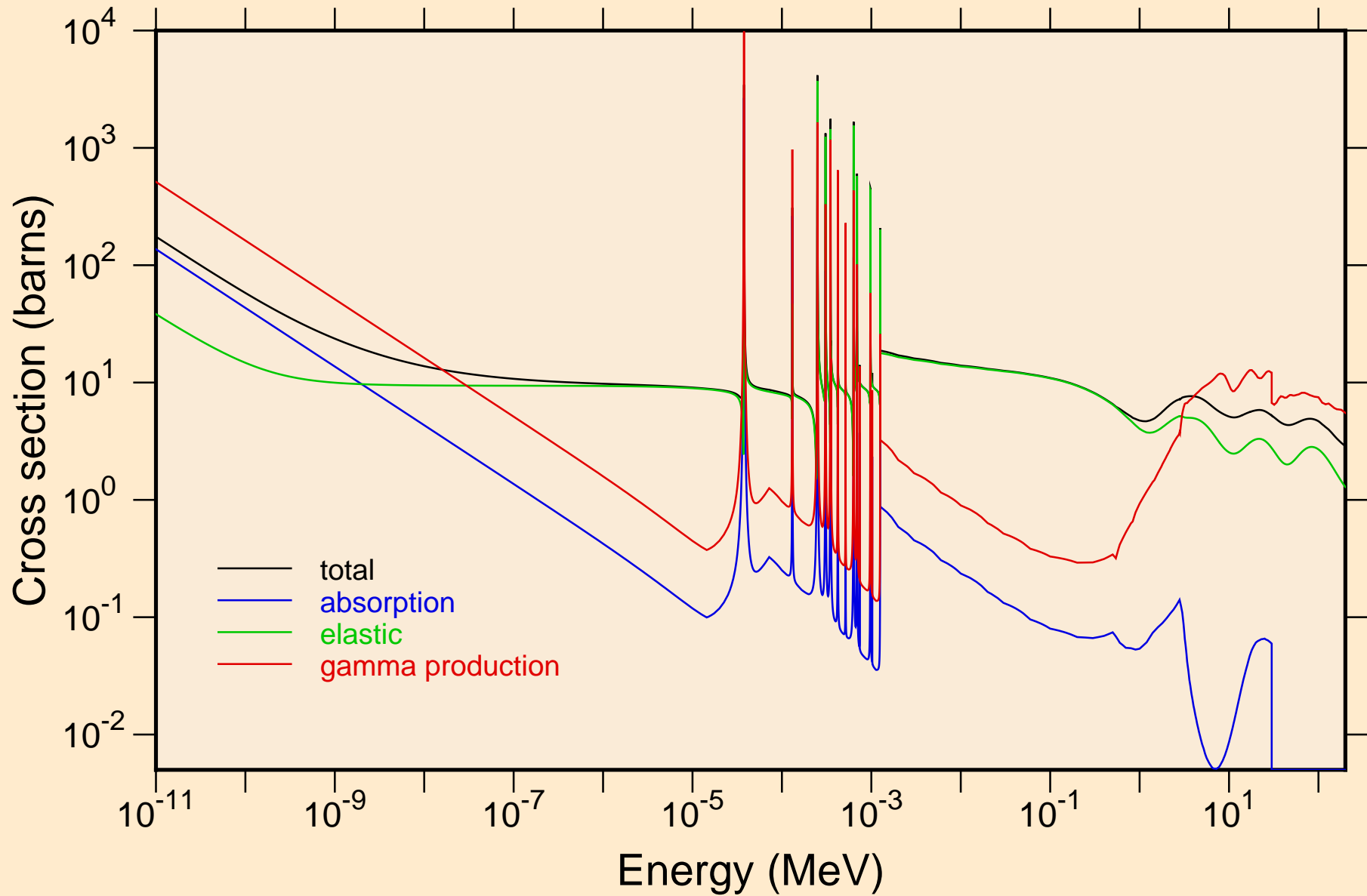

RN211 NRG TENDL-2015, AKONING
resonance total cross section

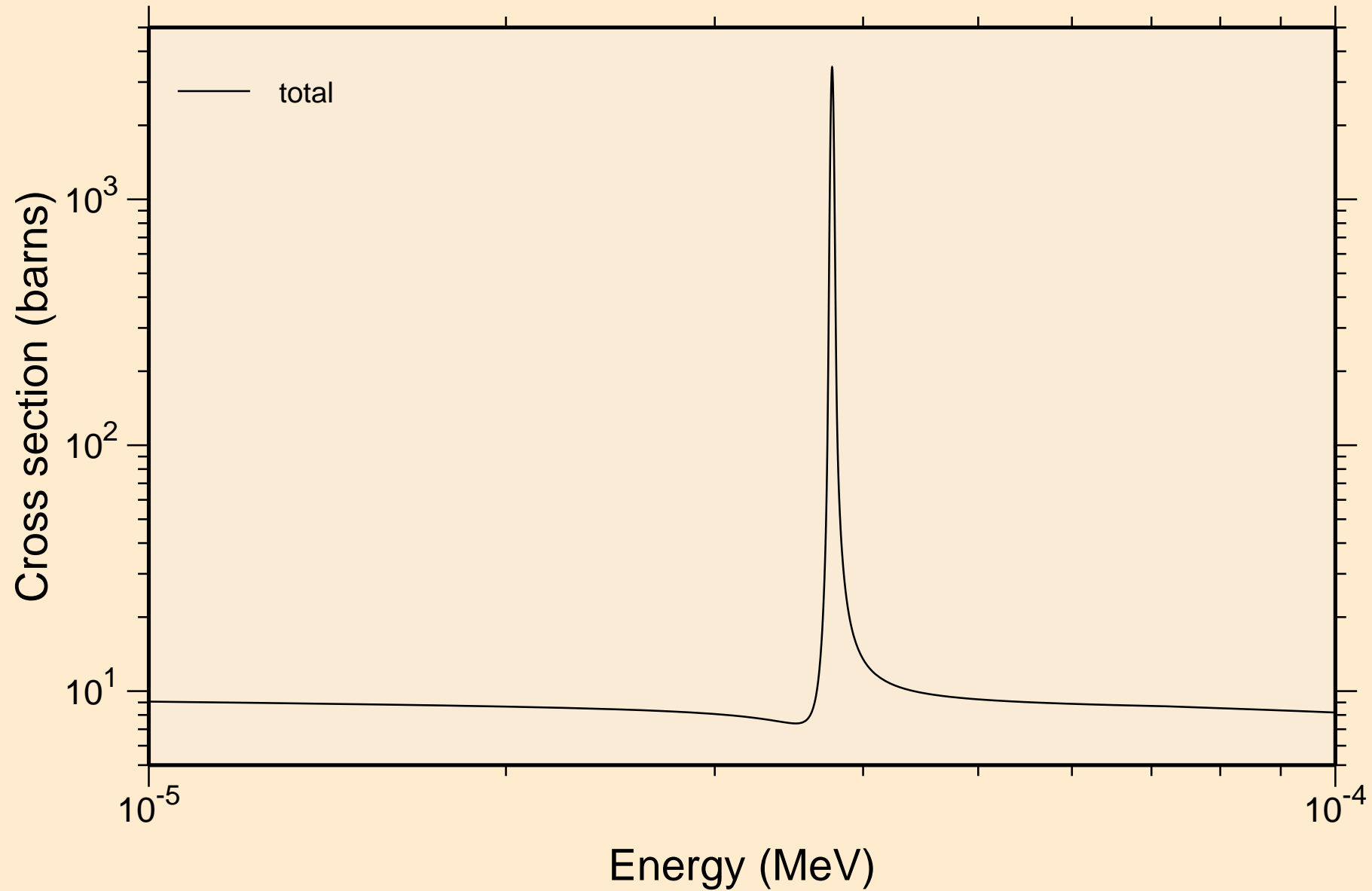

RN211 NRG TENDL-2015, AKONING
resonance total cross section

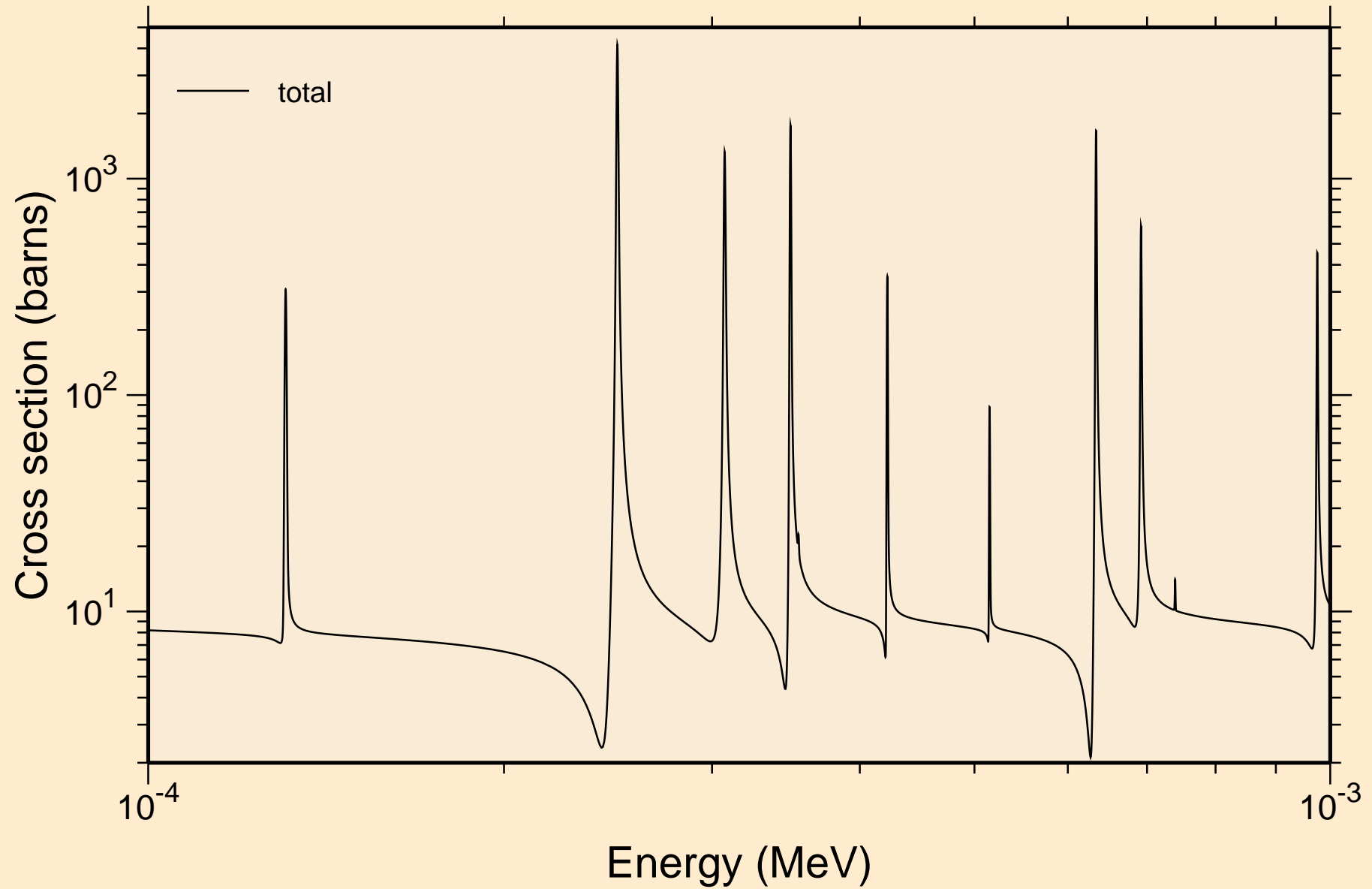

RN211 NRG TENDL-2015, AKONING
resonance total cross section

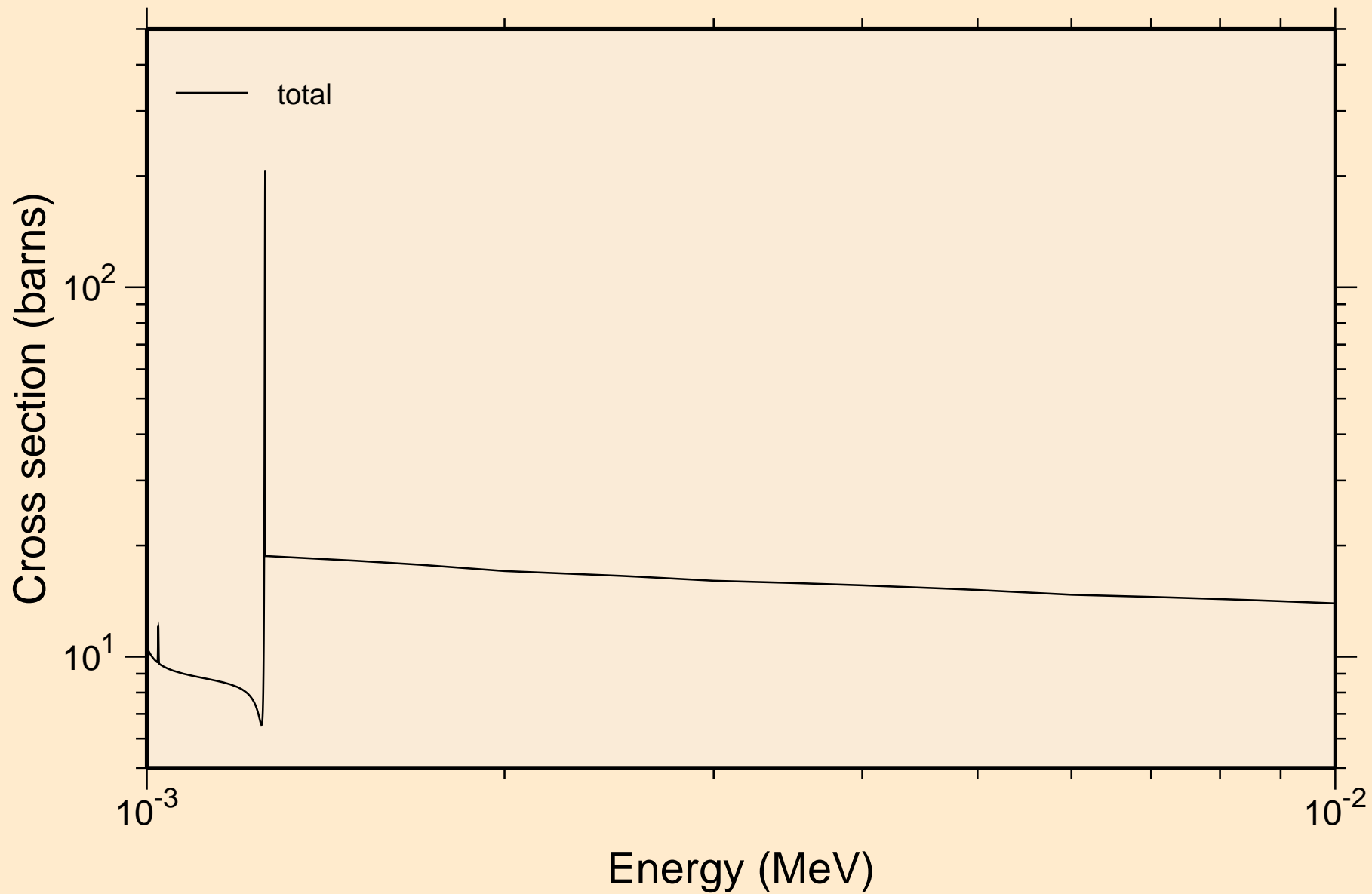

RN211 NRG TENDL-2015, AKONING
resonance total cross section

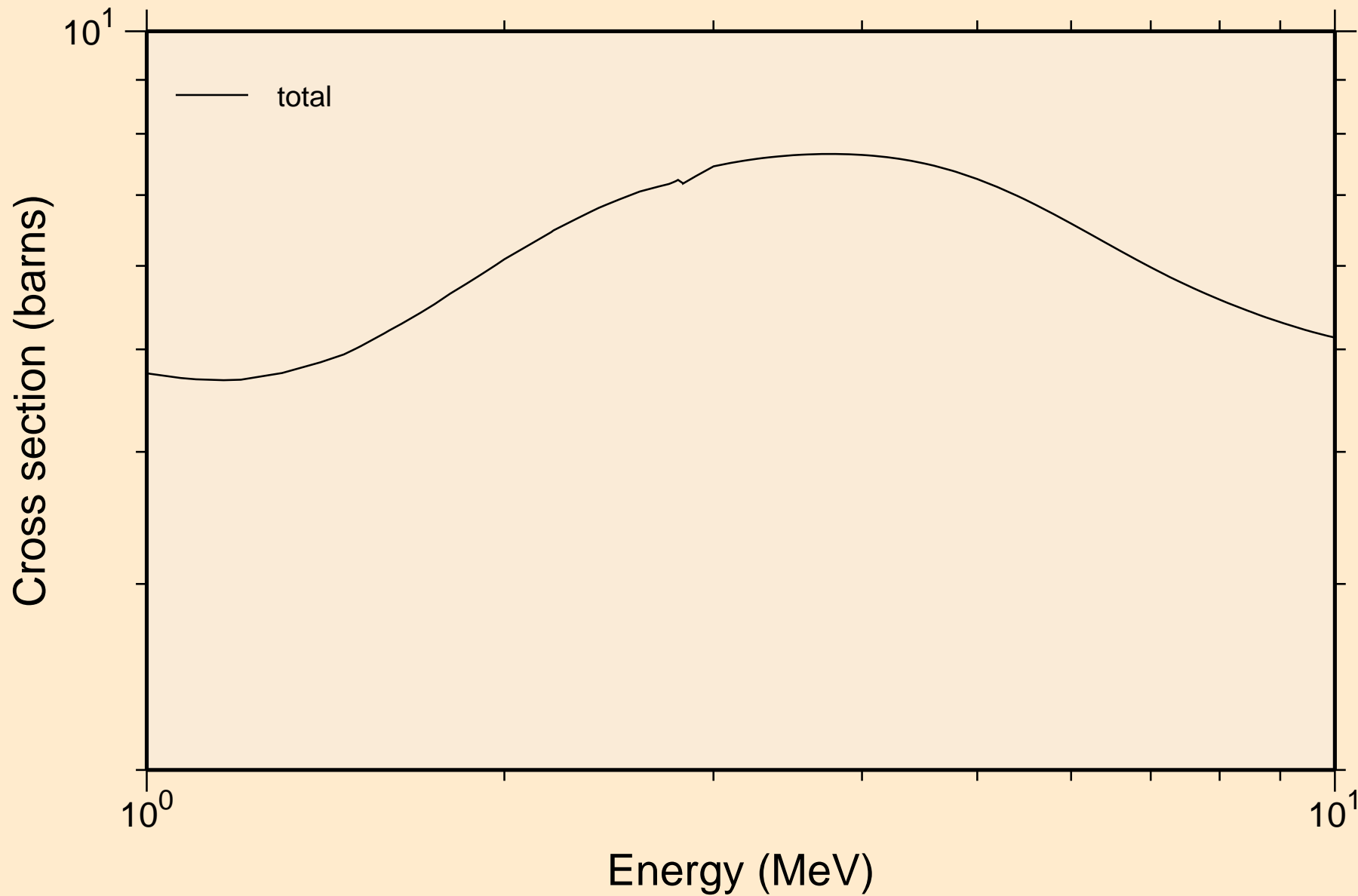

RN211 NRG TENDL-2015, AKONING
resonance absorption cross sections

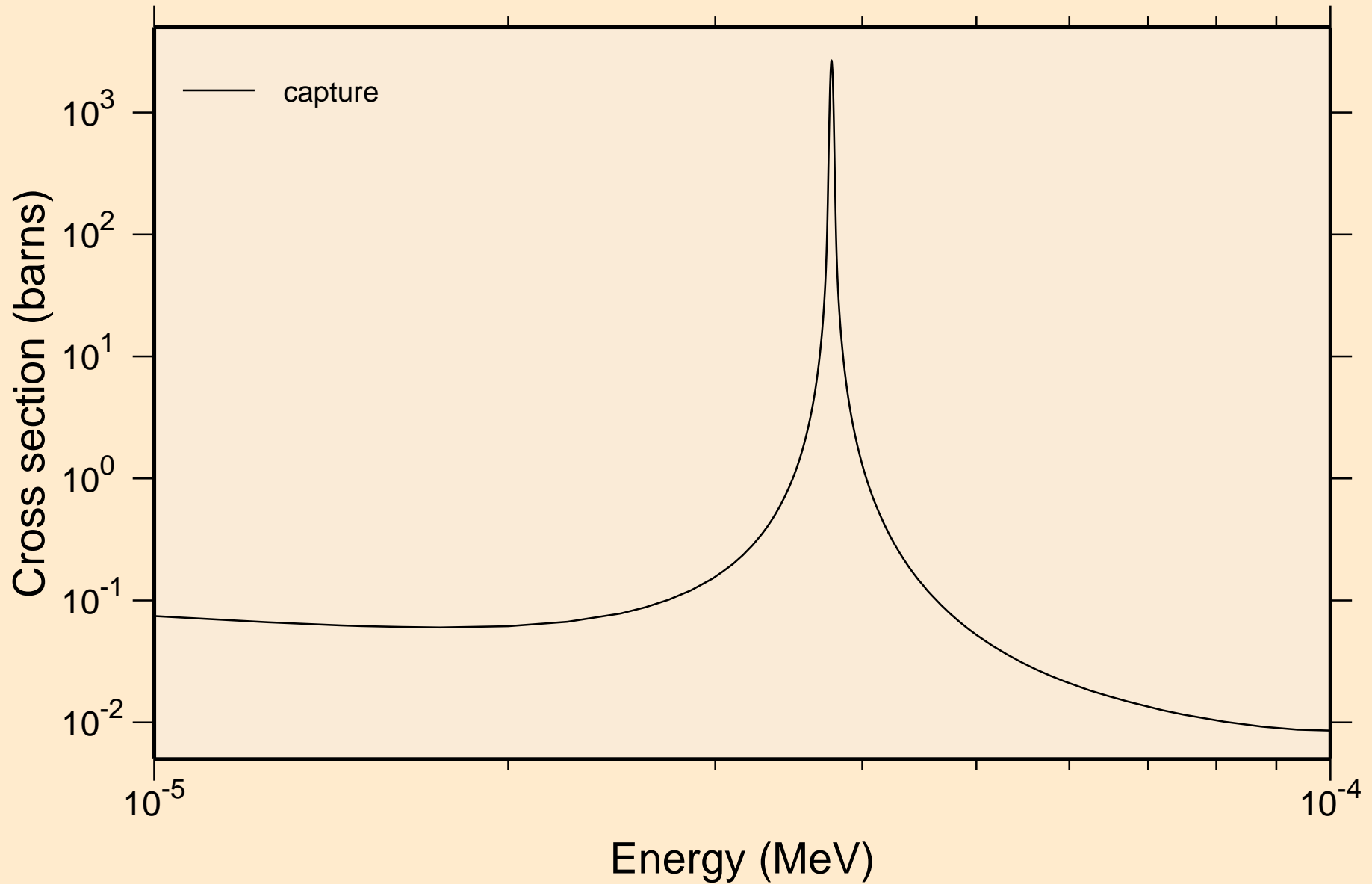

RN211 NRG TENDL-2015, AKONING
resonance absorption cross sections

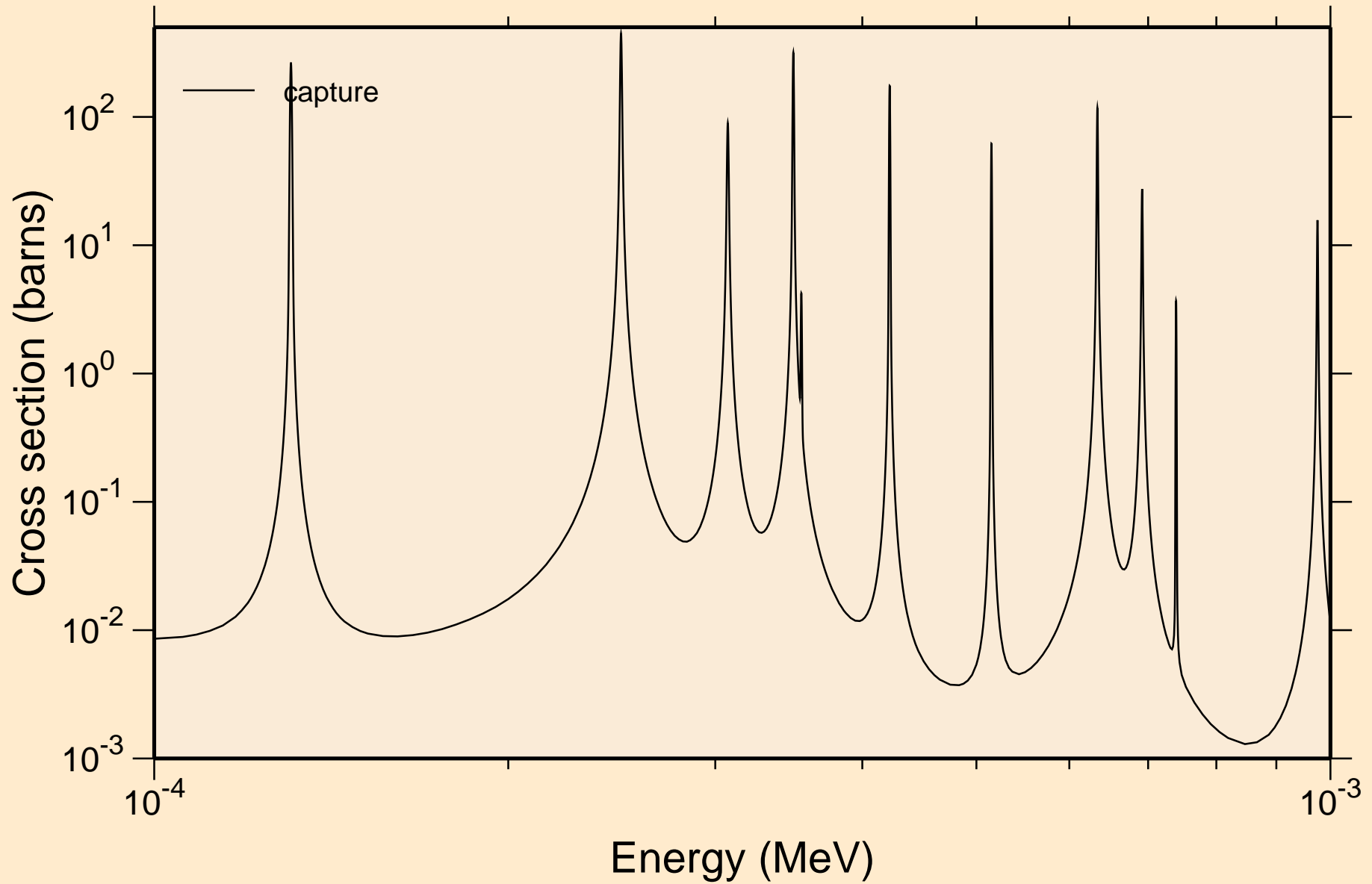

RN211 NRG TENDL-2015, AKONING
resonance absorption cross sections

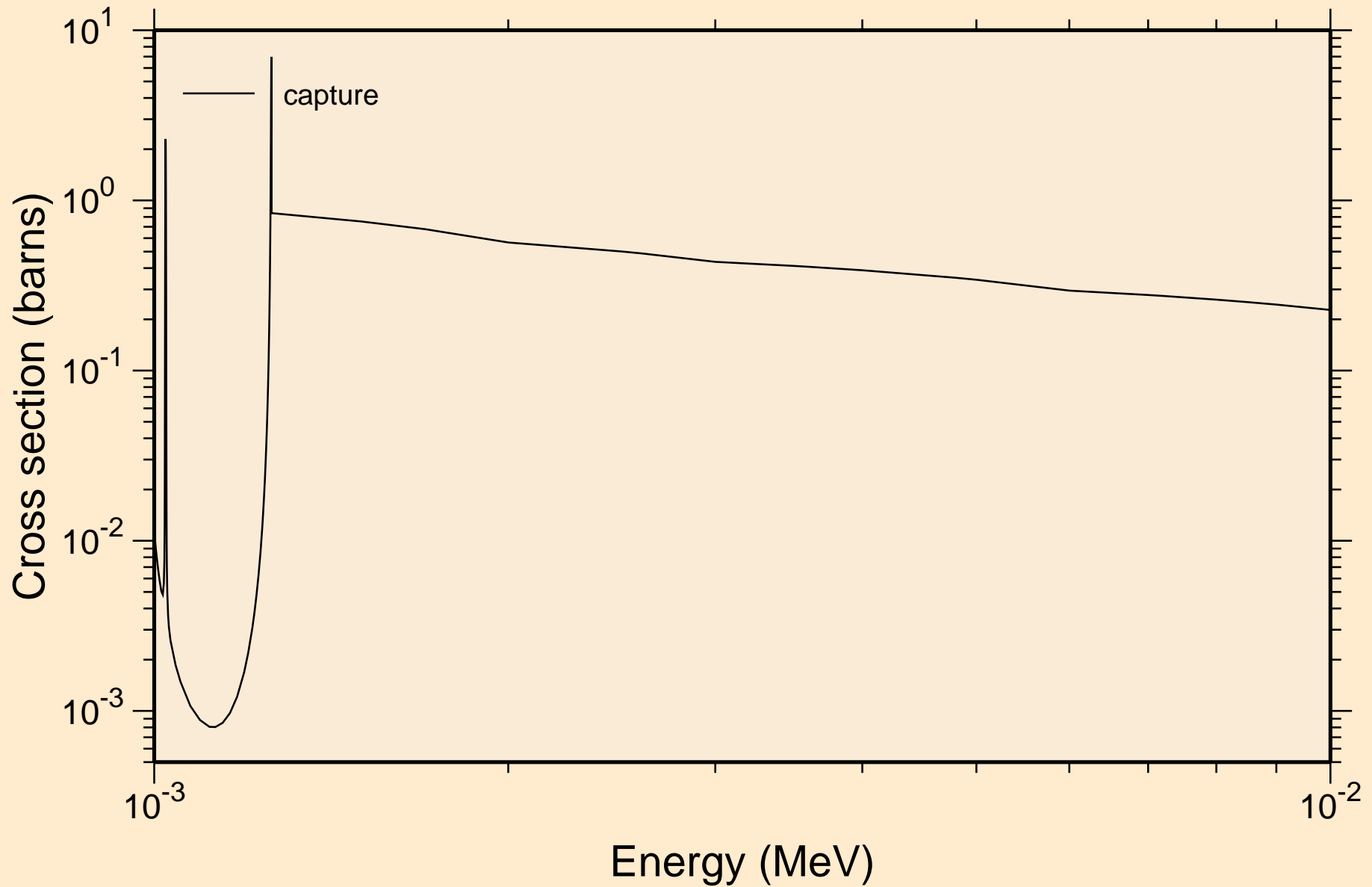

RN211 NRG TENDL-2015, AKONING
resonance absorption cross sections

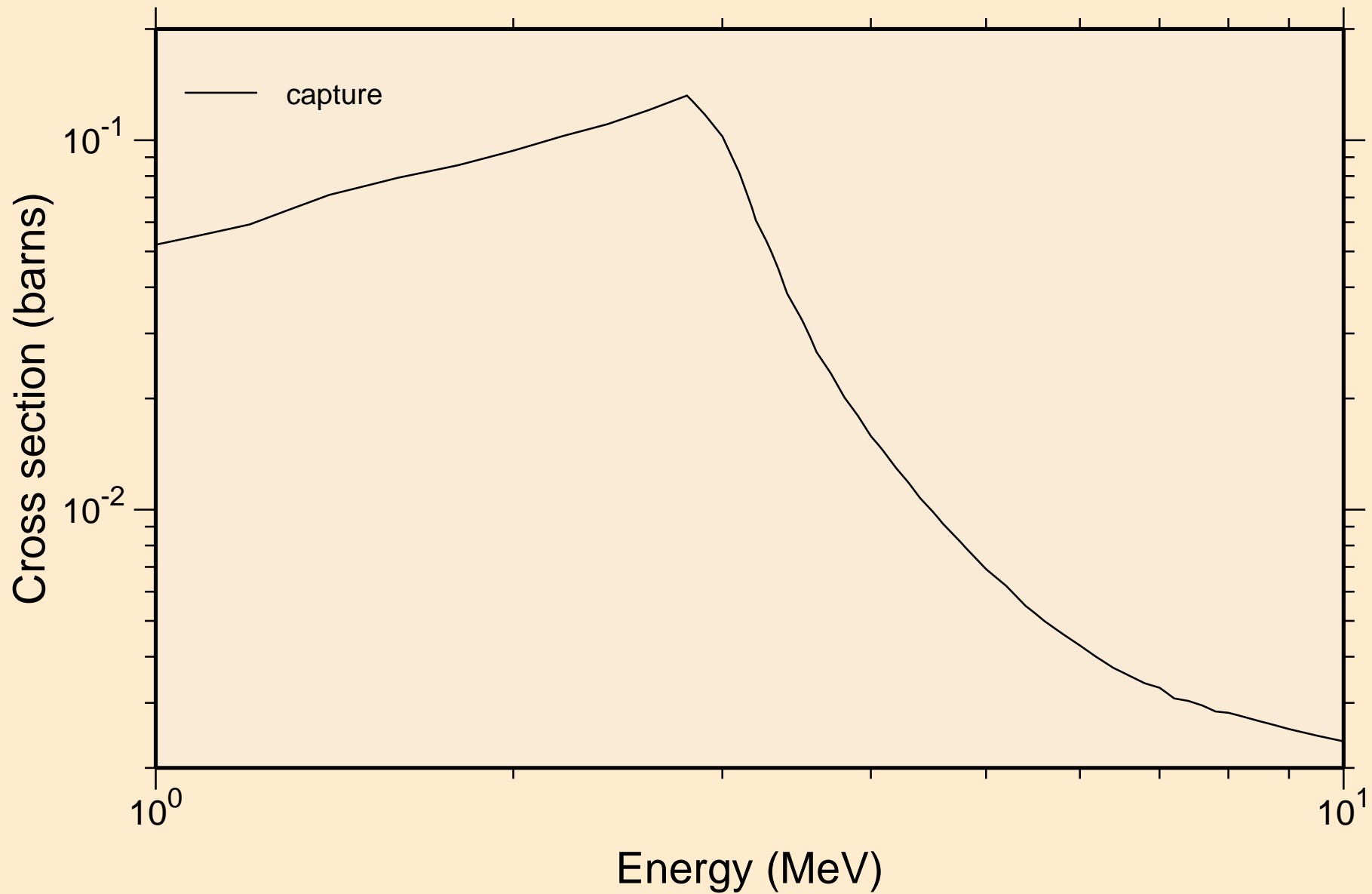

RN211 NRG TENDL-2015, AKONING

Non-threshold reactions

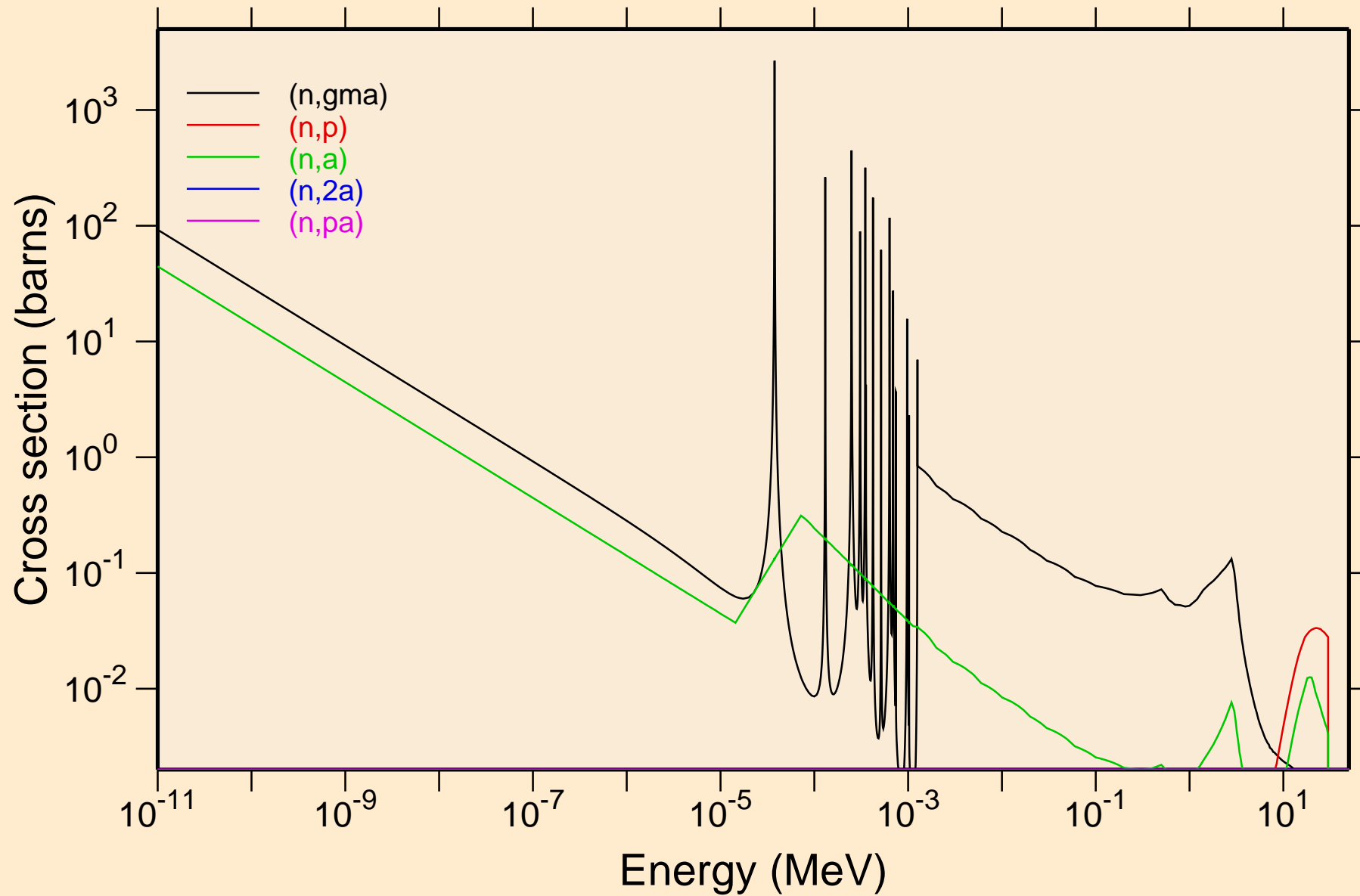

RN211 NRG TENDL-2015, AKONING

Principal cross sections

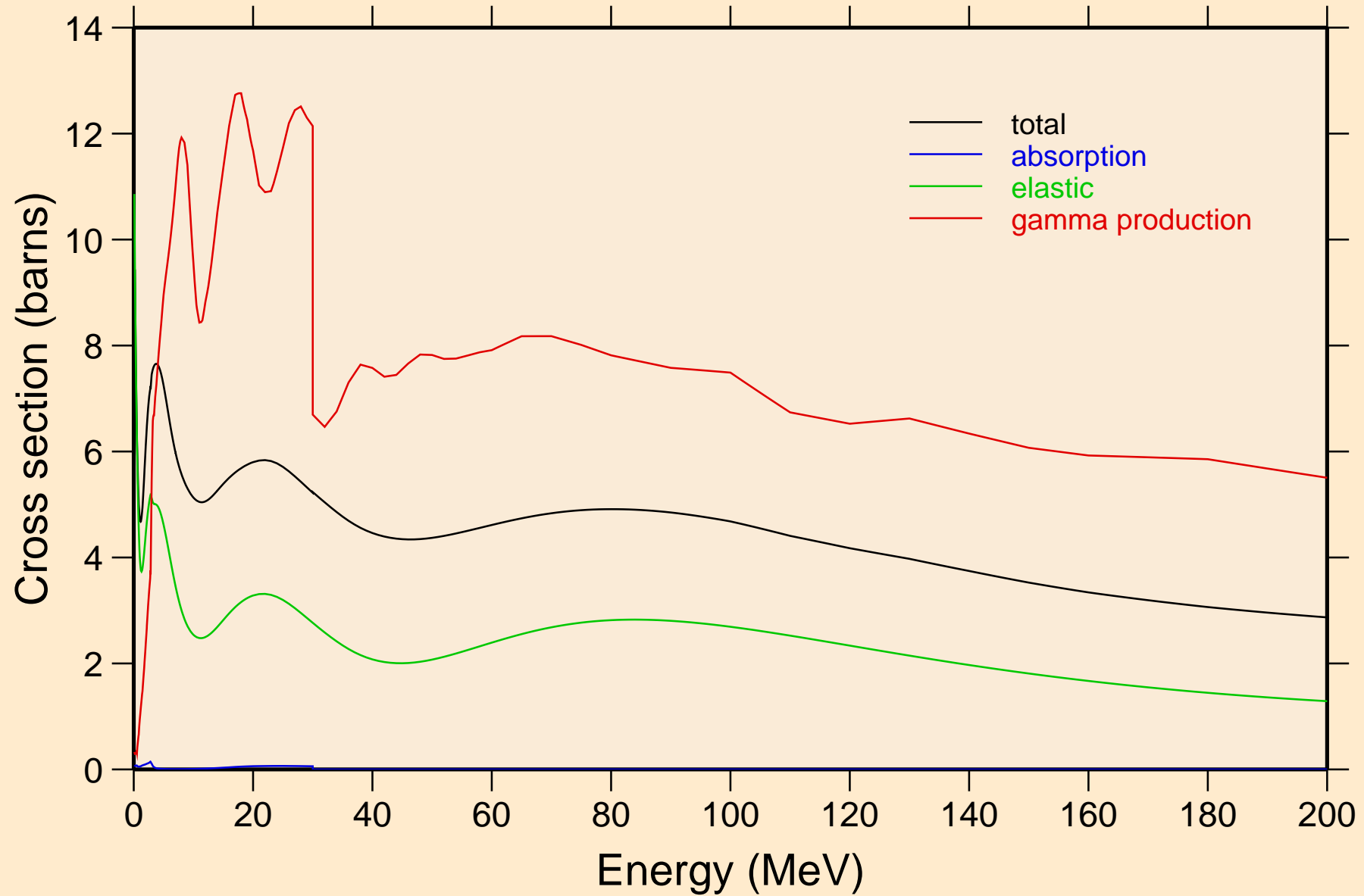

RN211 NRG TENDL-2015, AKONING

Non-threshold reactions

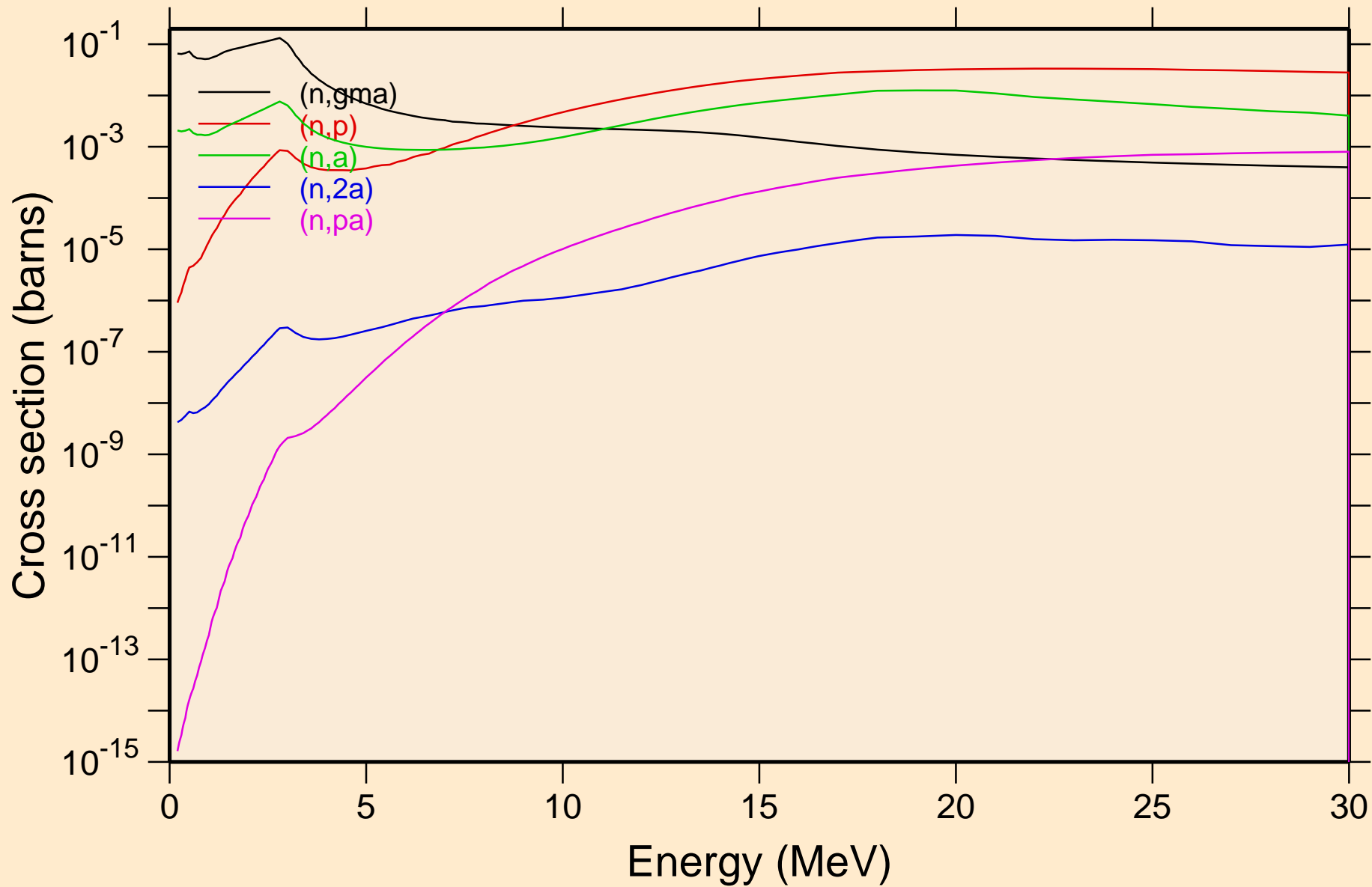

RN211 NRG TENDL-2015, AKONING

Inelastic levels

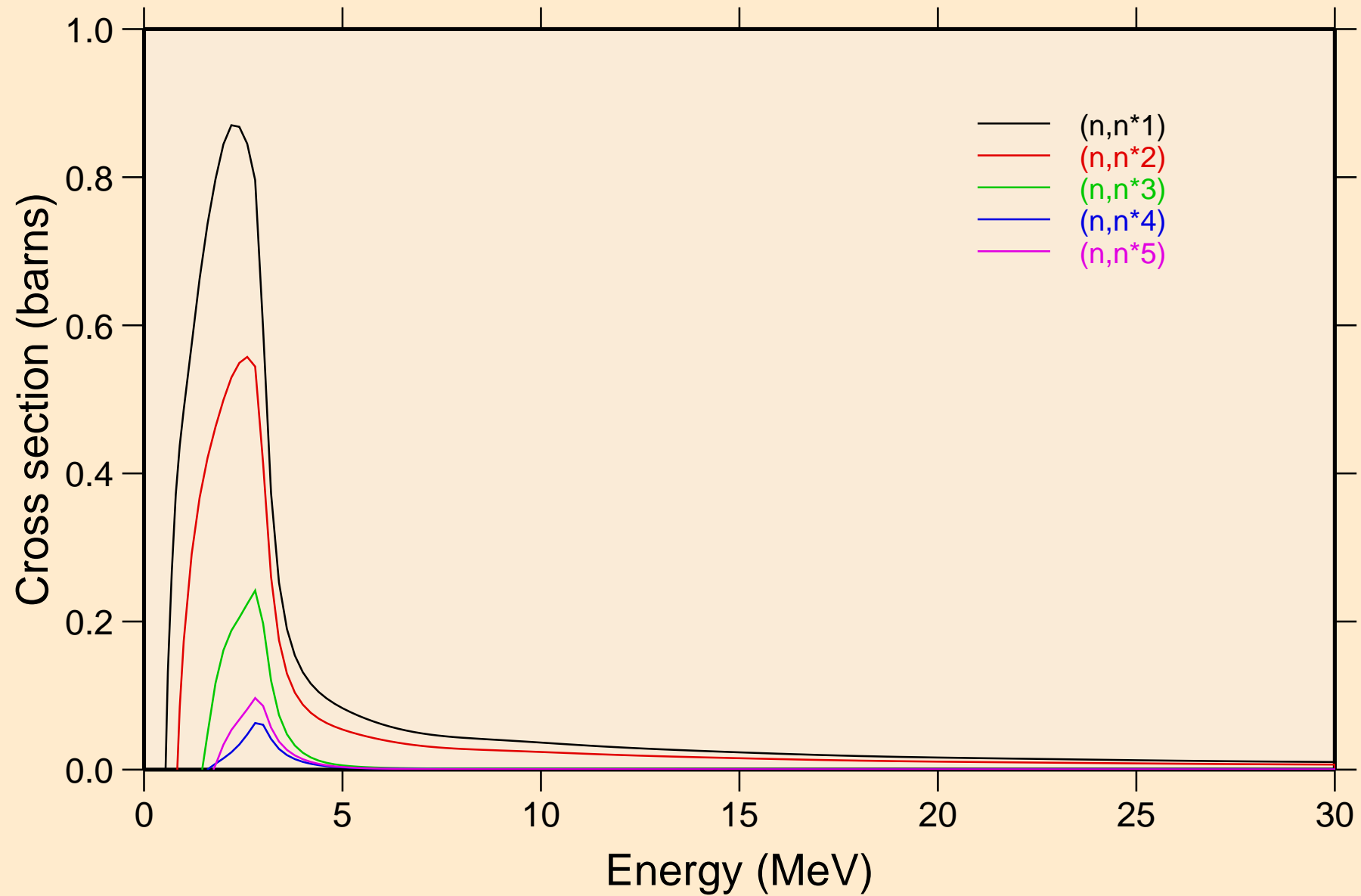

RN211 NRG TENDL-2015, AKONING

Inelastic levels

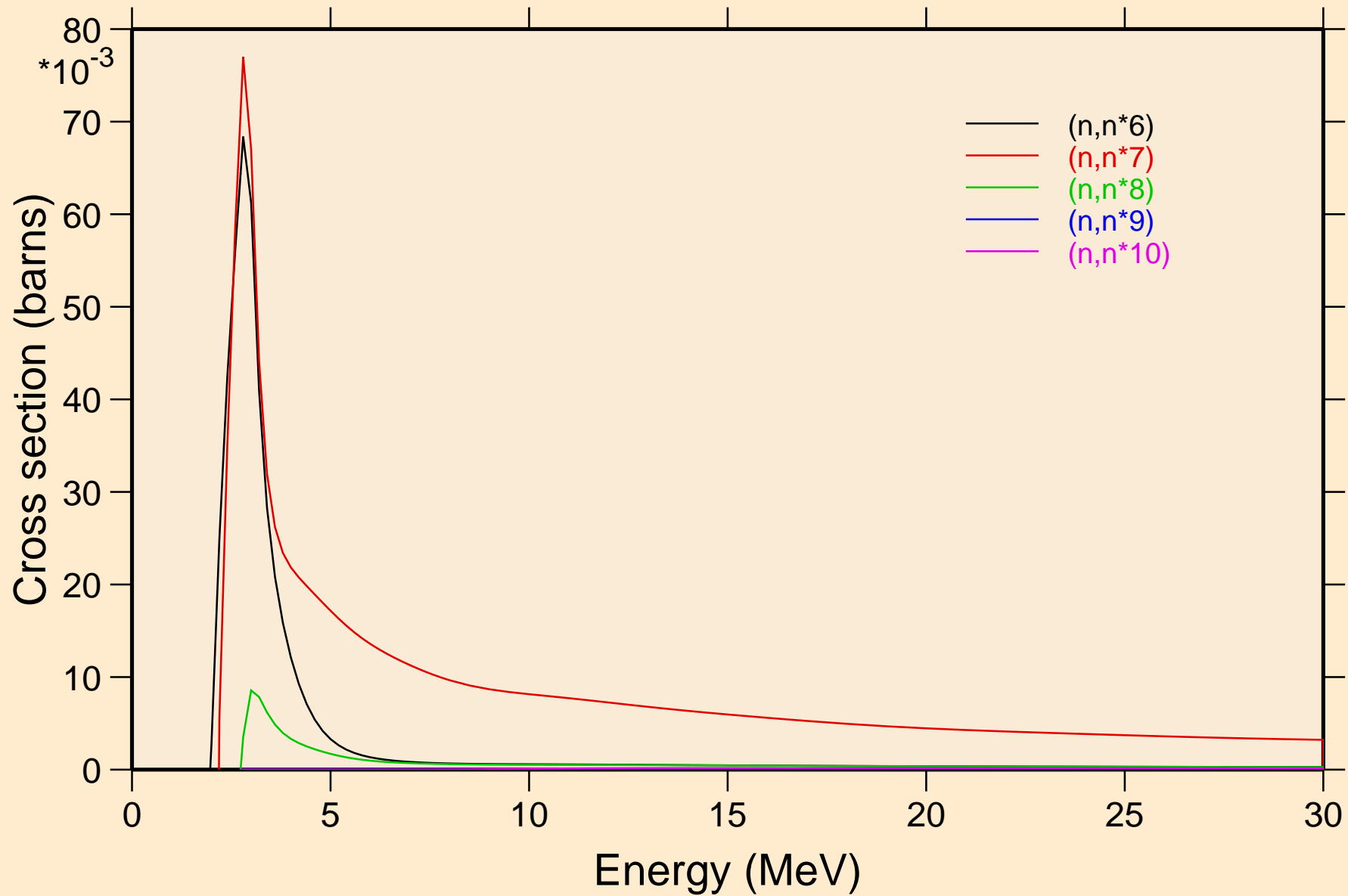

RN211 NRG TENDL-2015, AKONING

Inelastic levels

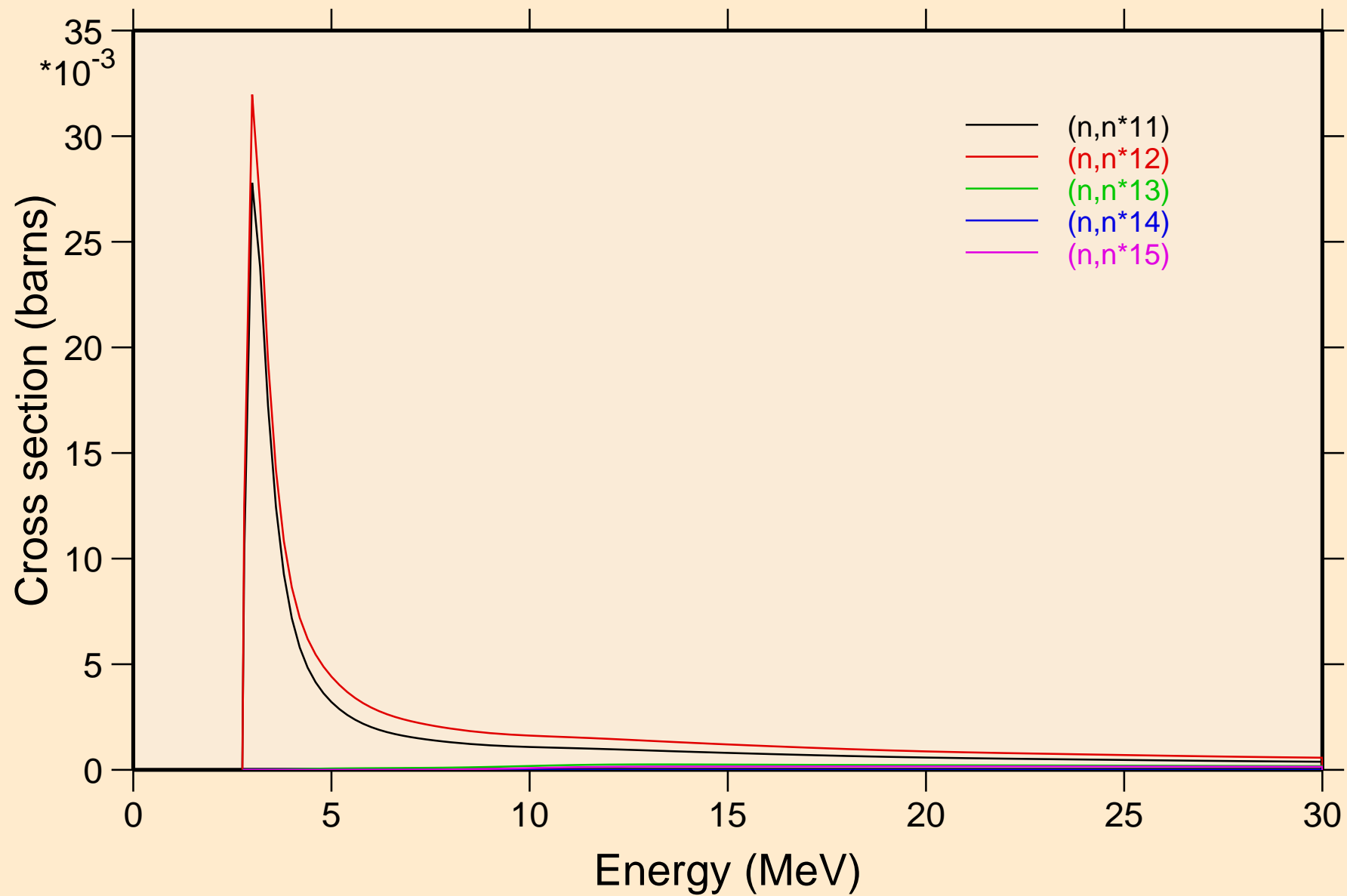

RN211 NRG TENDL-2015, AKONING

Inelastic levels

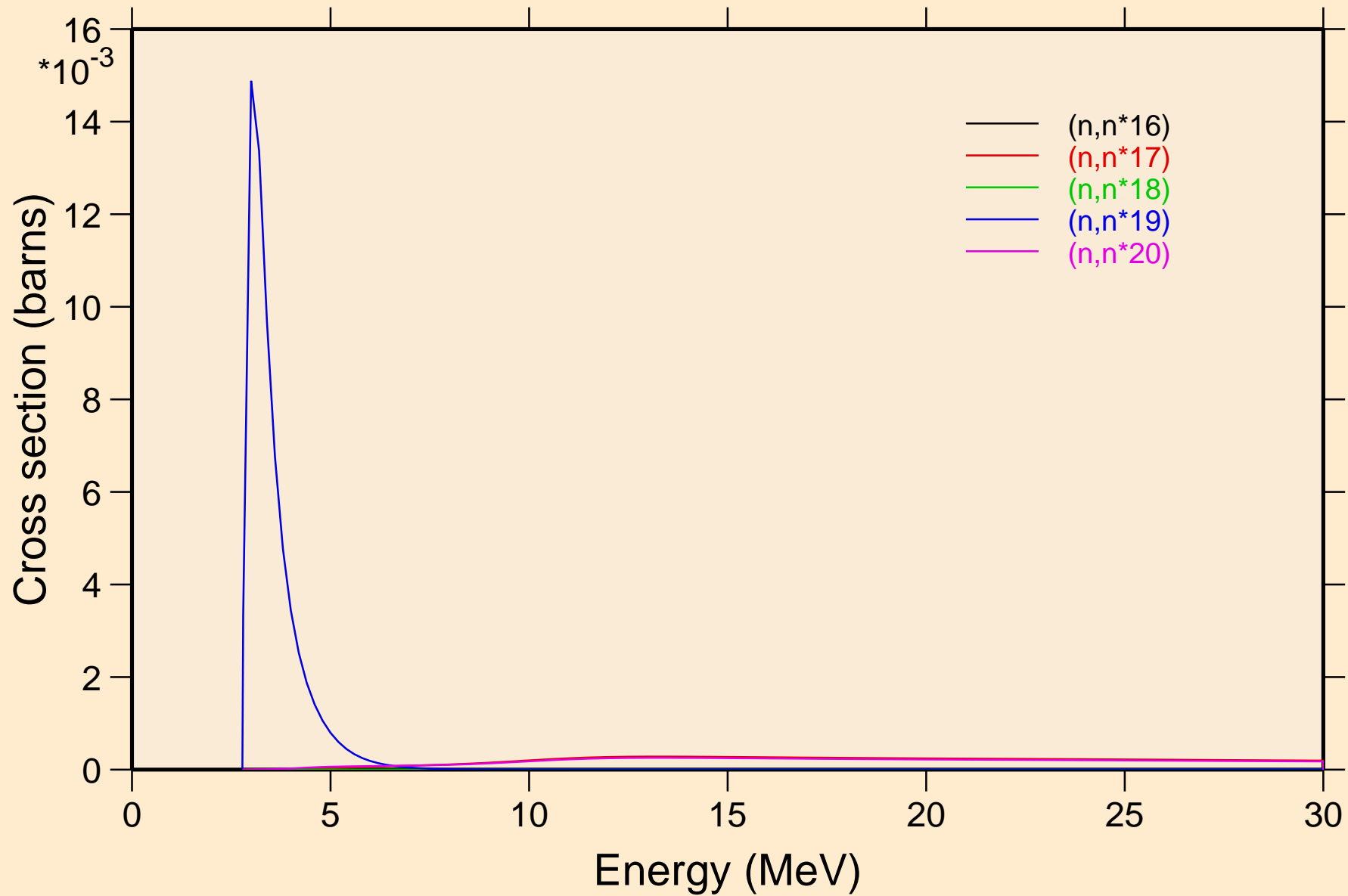

RN211 NRG TENDL-2015, AKONING

Inelastic levels

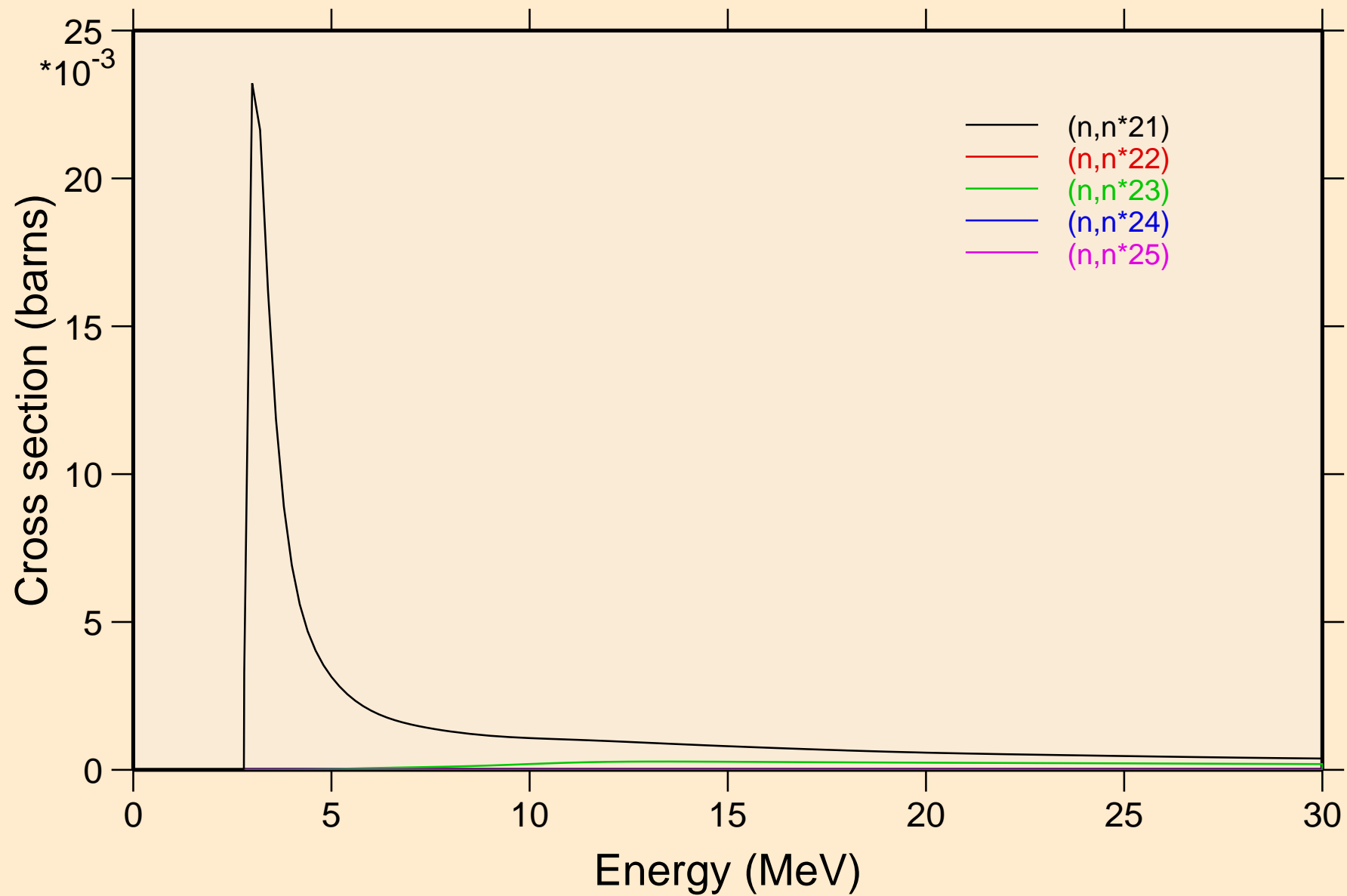

RN211 NRG TENDL-2015, AKONING

Inelastic levels

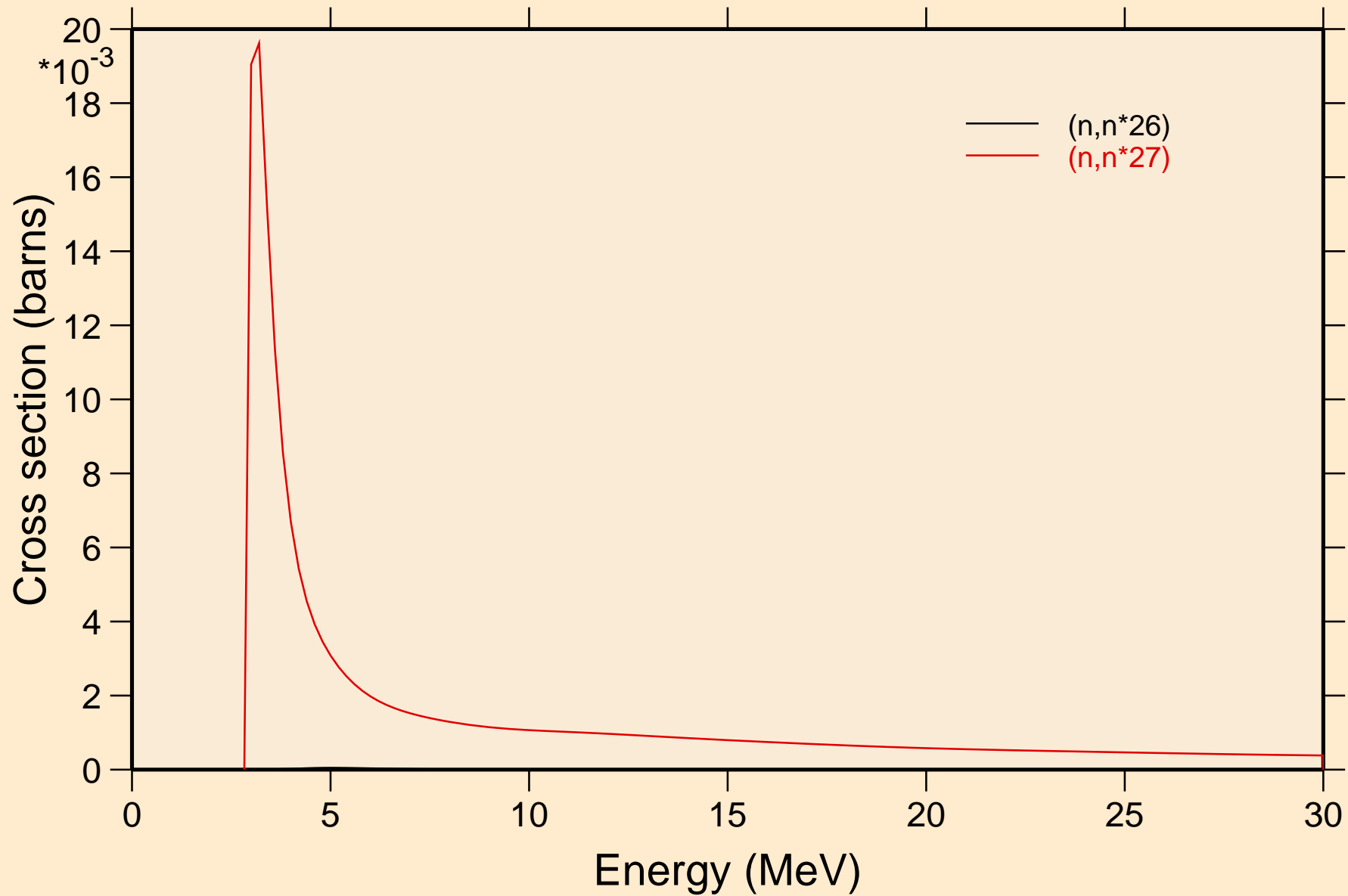

RN211 NRG TENDL-2015, AKONING

Threshold reactions

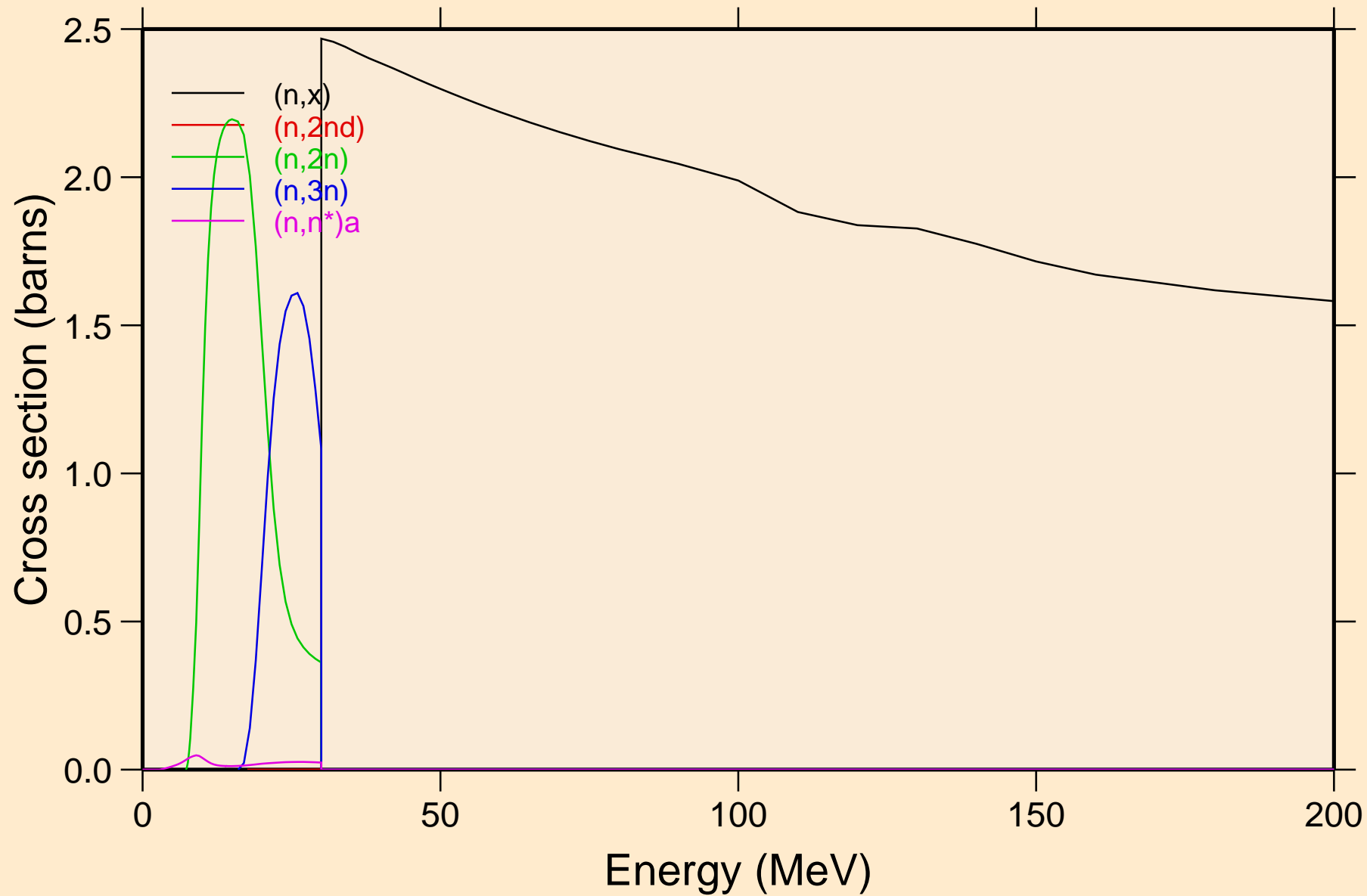

RN211 NRG TENDL-2015, AKONING

Threshold reactions

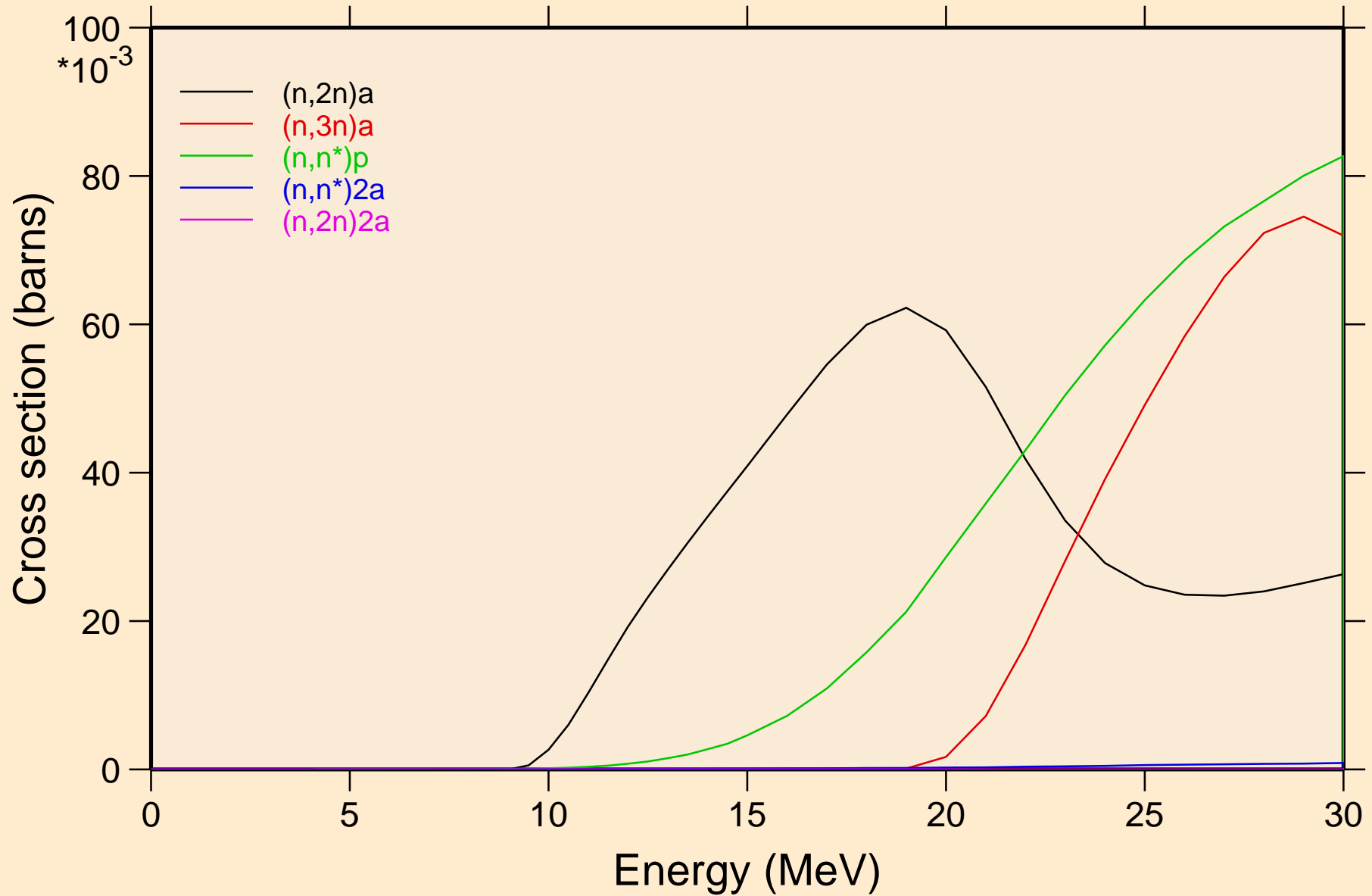

RN211 NRG TENDL-2015, AKONING

Threshold reactions

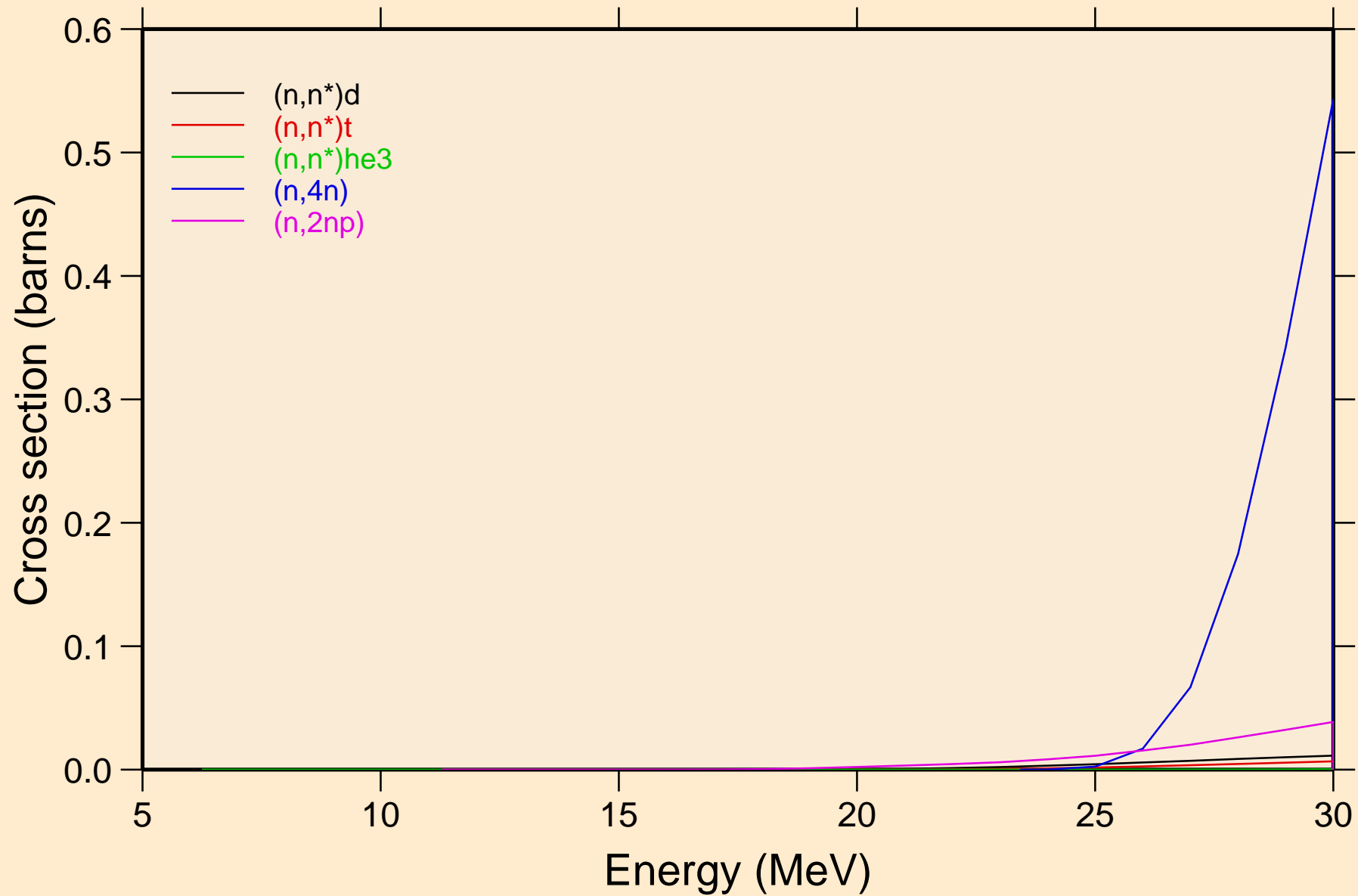

RN211 NRG TENDL-2015, AKONING

Threshold reactions

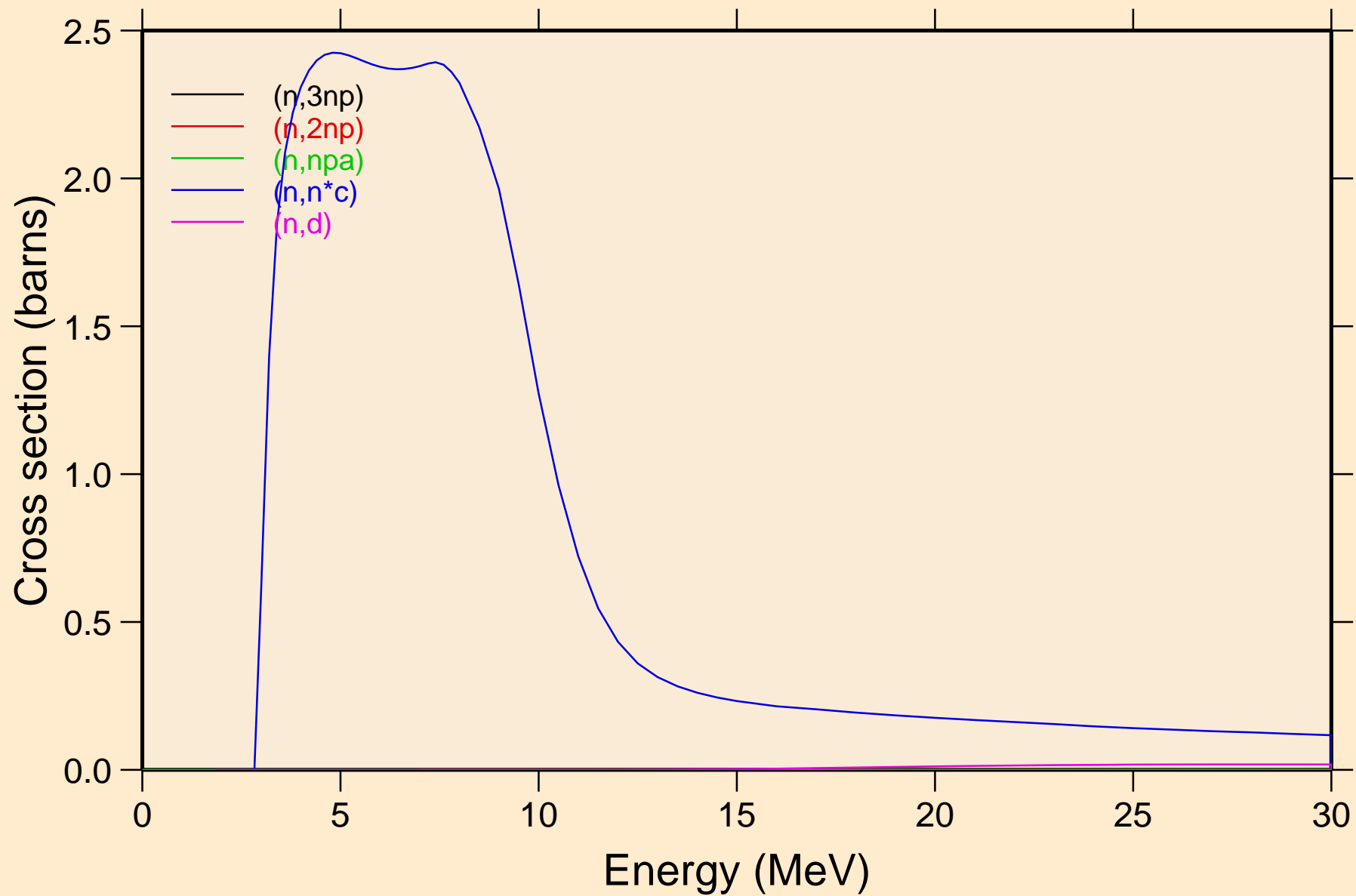

RN211 NRG TENDL-2015, AKONING

Threshold reactions

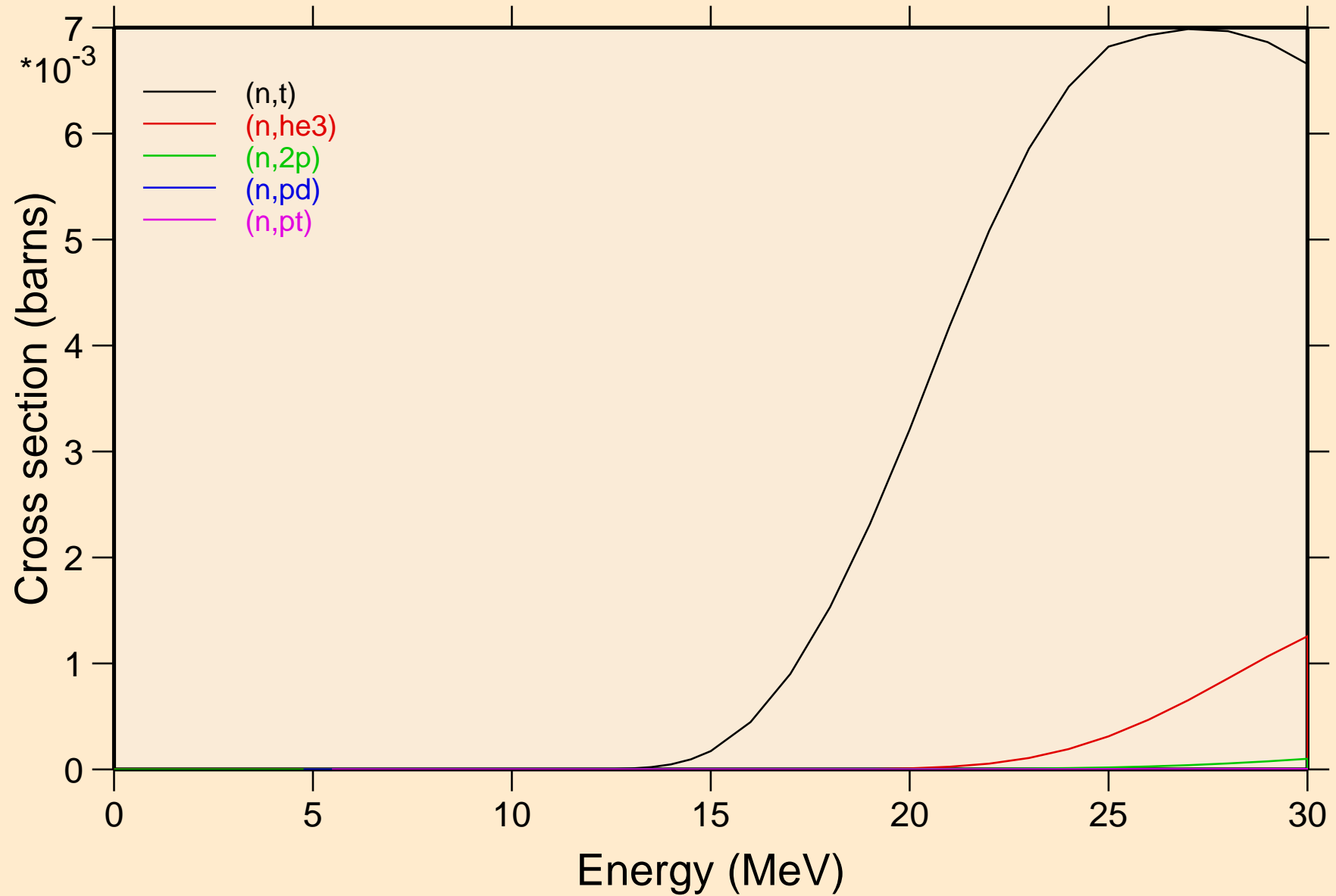

RN211 NRG TENDL-2015, AKONING

Threshold reactions

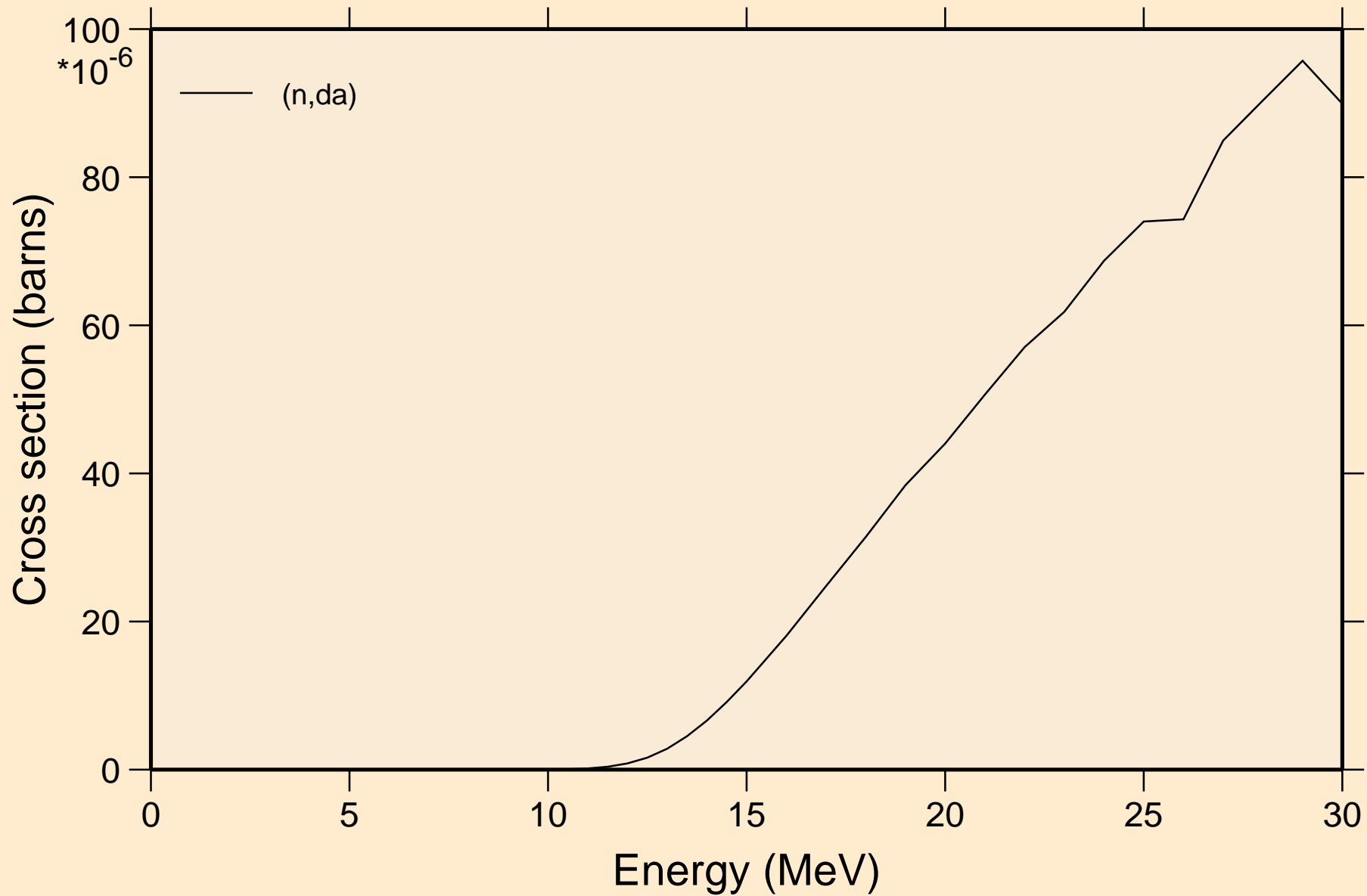

RN211 NRG TENDL-2015, AKONING
angular distribution for elastic

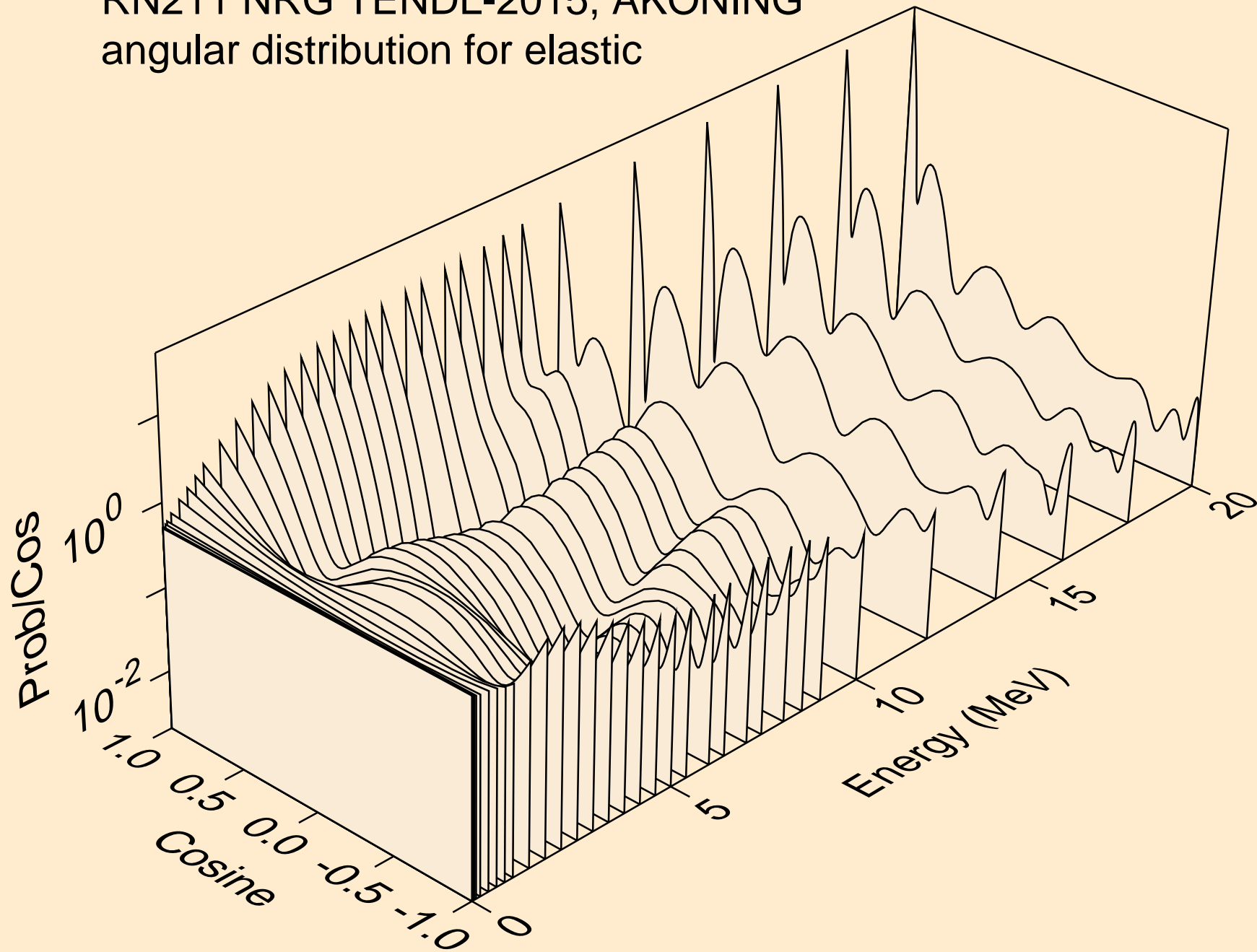

RN211 NRG TENDL-2015, AKONING
angular distribution for elastic

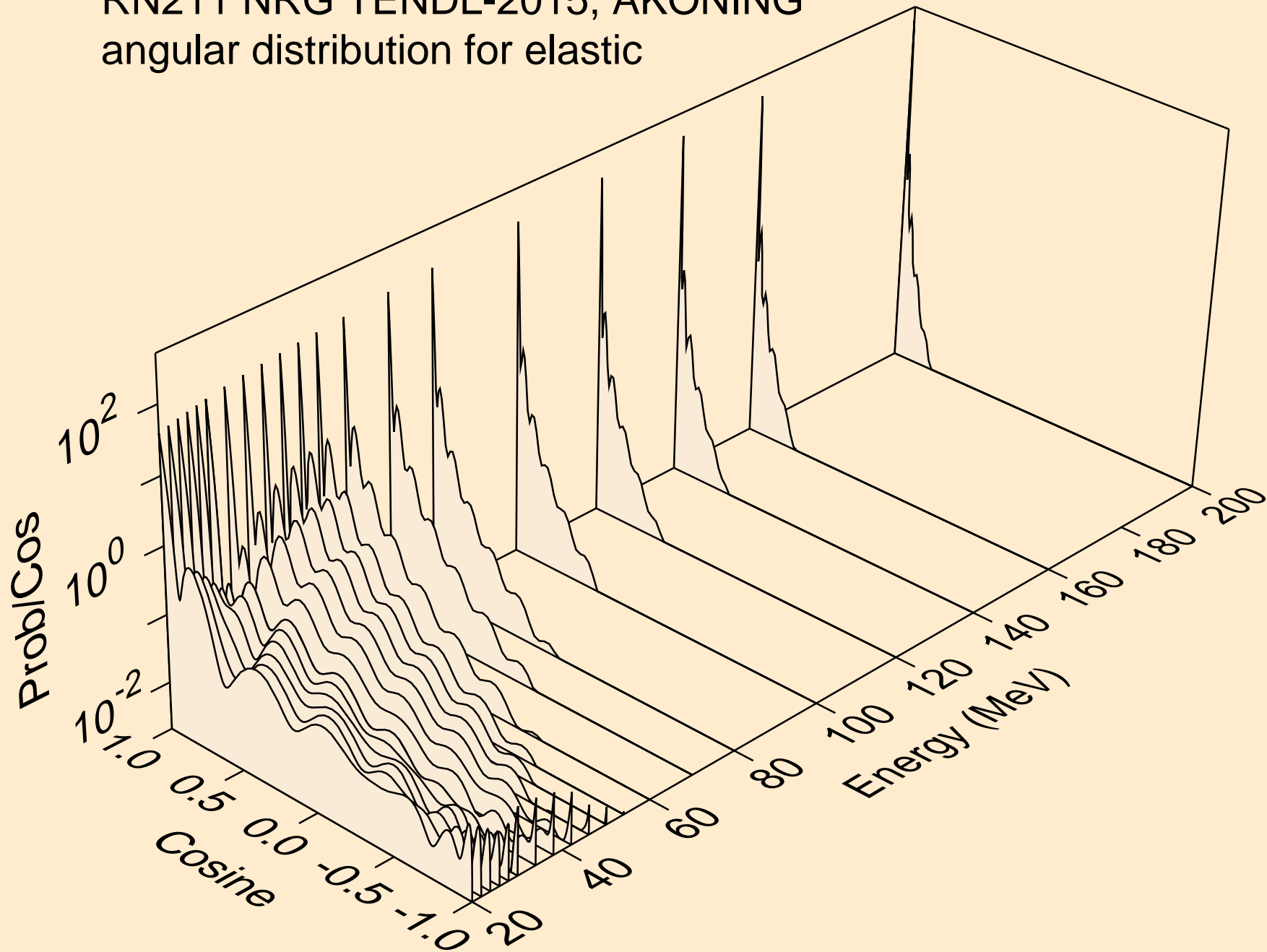

RN211 NRG TENDL-2015, AKONING
angular distribution for (n,n*1)

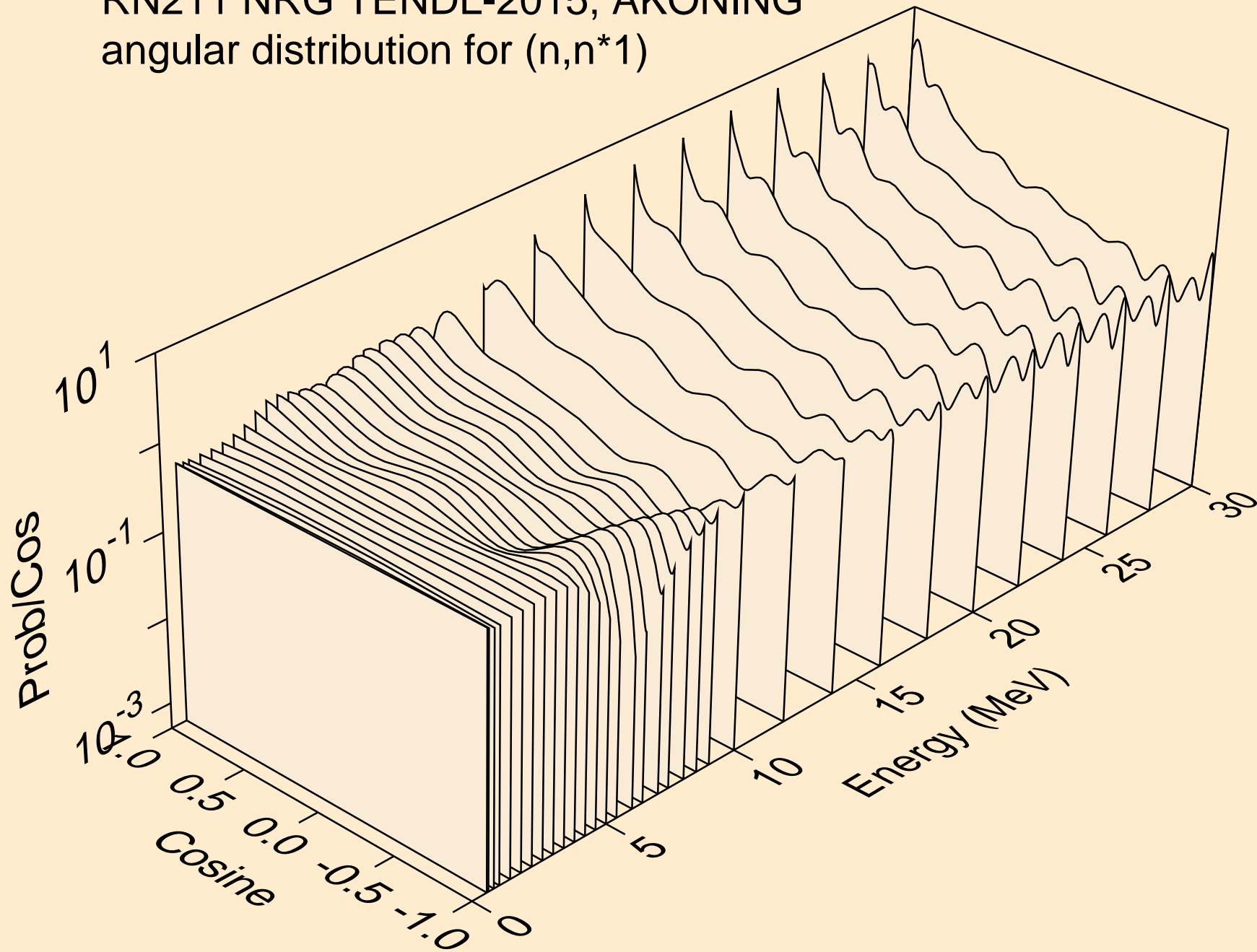

RN211 NRG TENDL-2015, AKONING
angular distribution for (n,n*2)

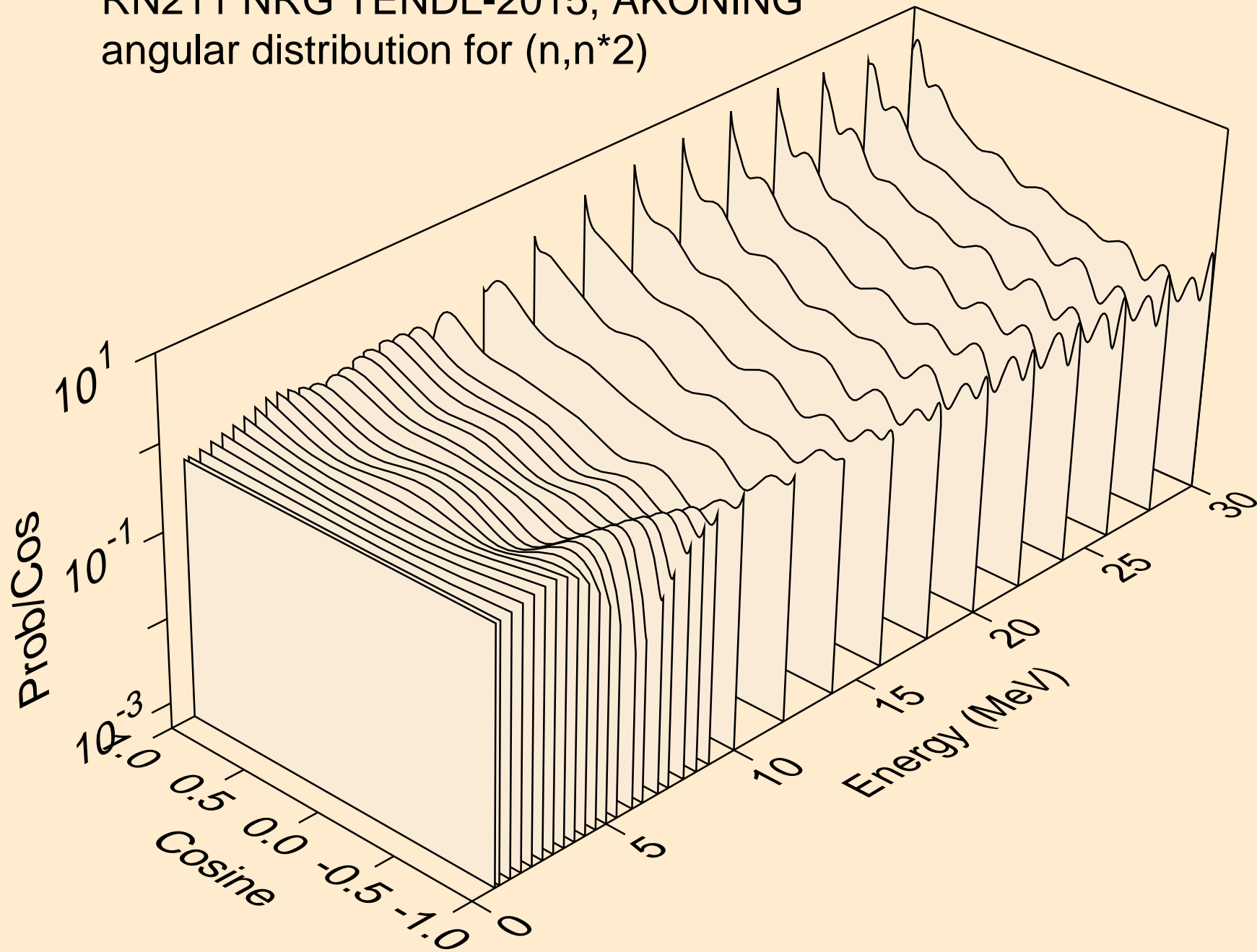

RN211 NRG TENDL-2015, AKONING
angular distribution for (n,n*3)

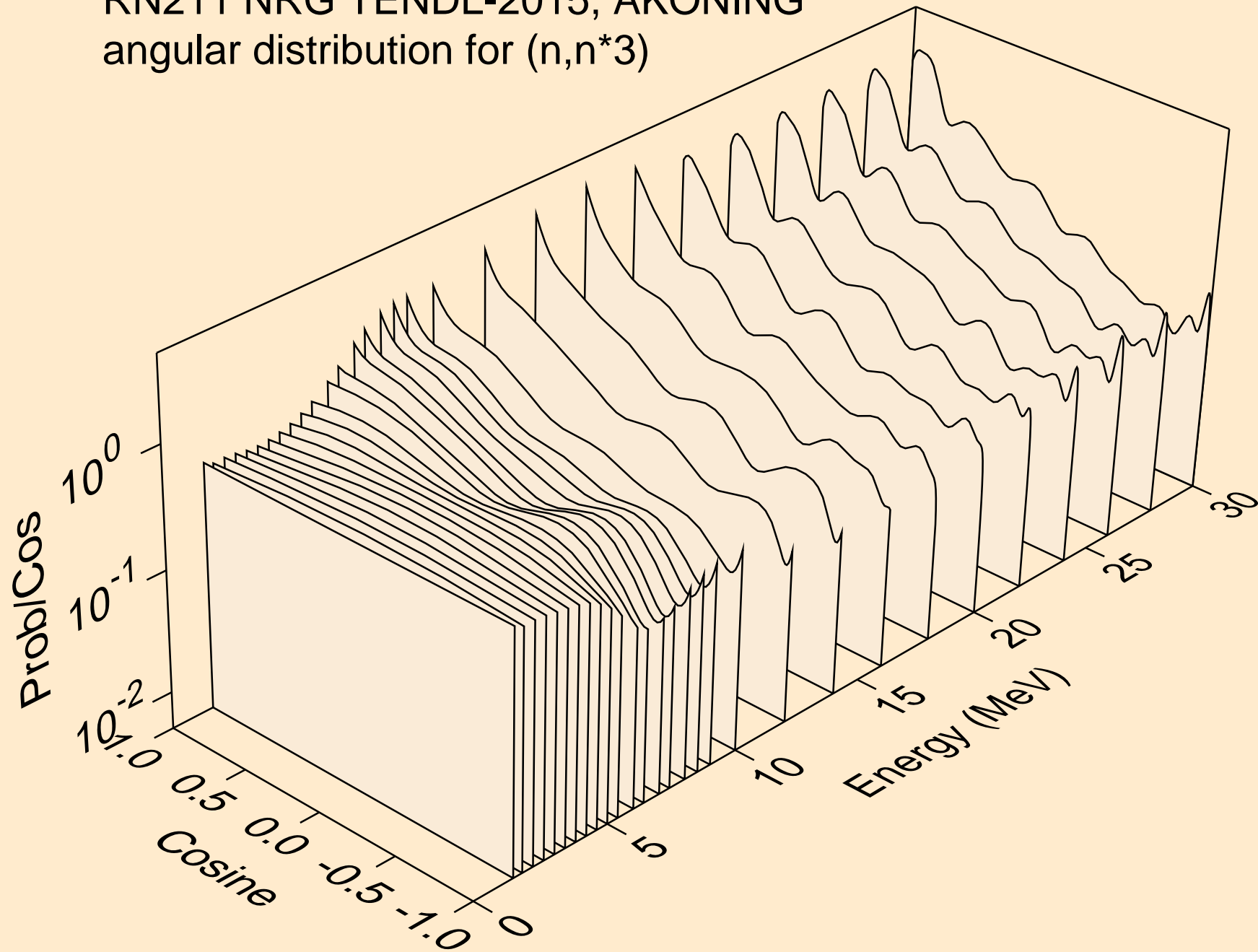

RN211 NRG TENDL-2015, AKONING
angular distribution for (n,n*4)

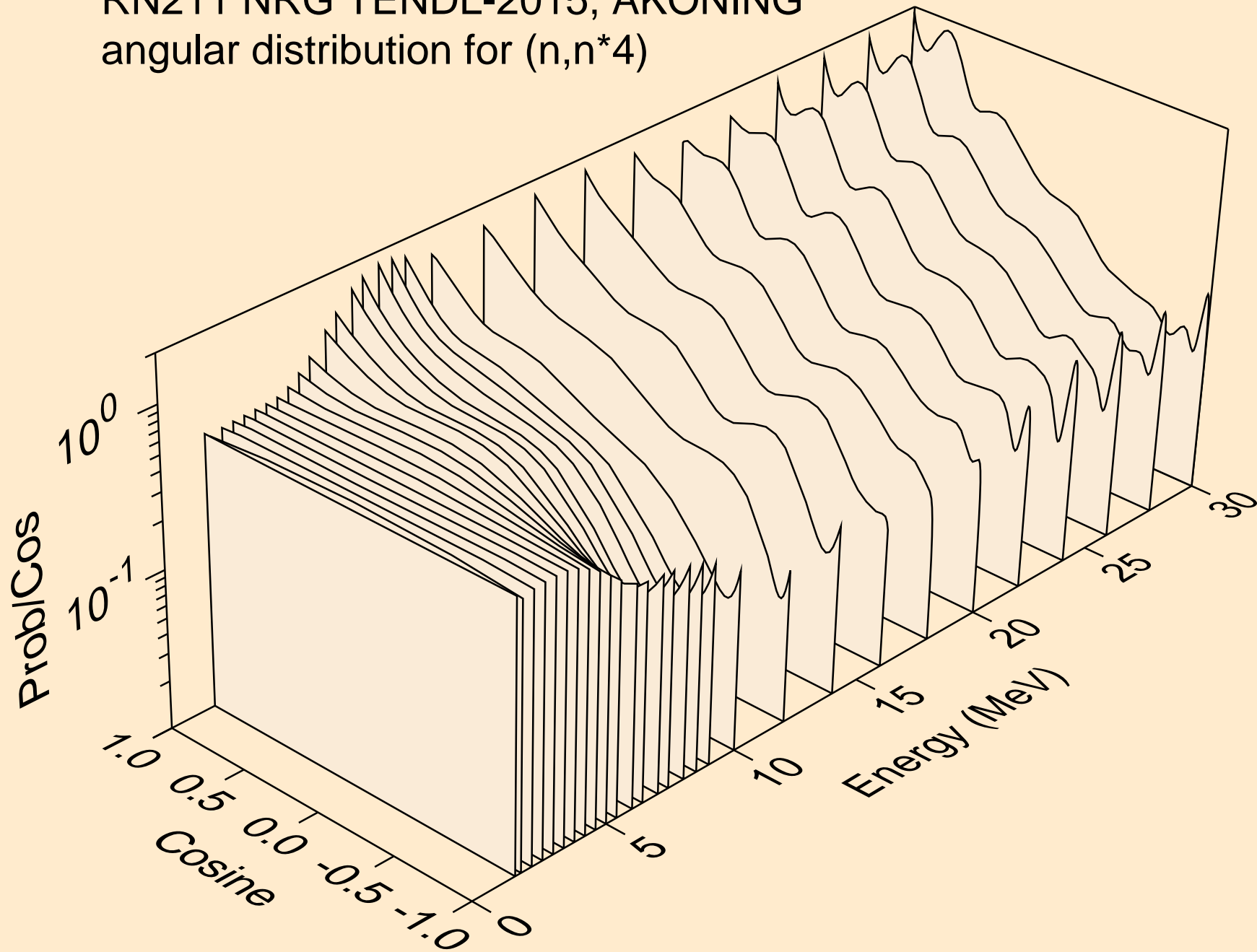

RN211 NRG TENDL-2015, AKONING
angular distribution for (n,n*5)

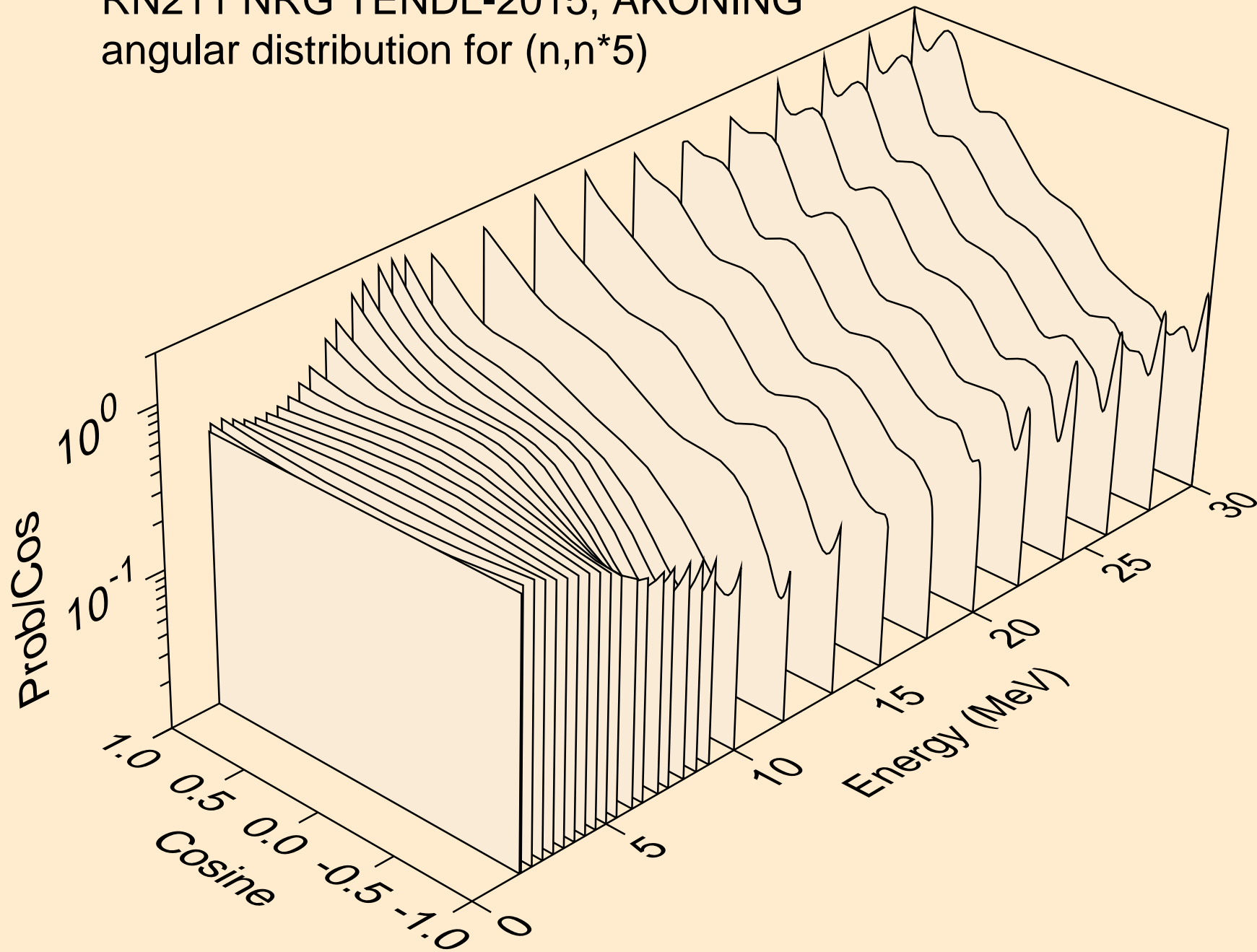

RN211 NRG TENDL-2015, AKONING
angular distribution for (n,n*6)

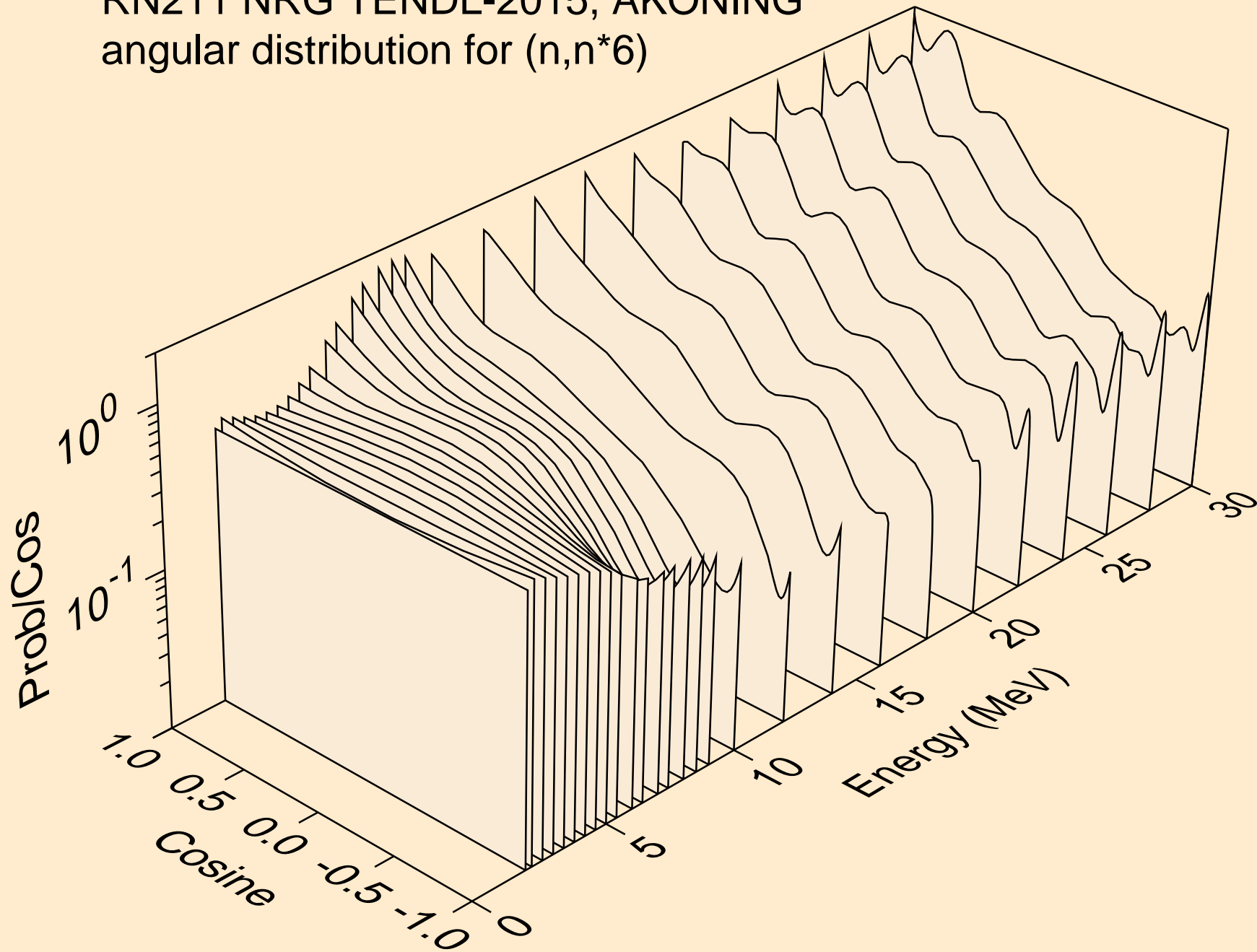

RN211 NRG TENDL-2015, AKONING
angular distribution for (n,n*7)

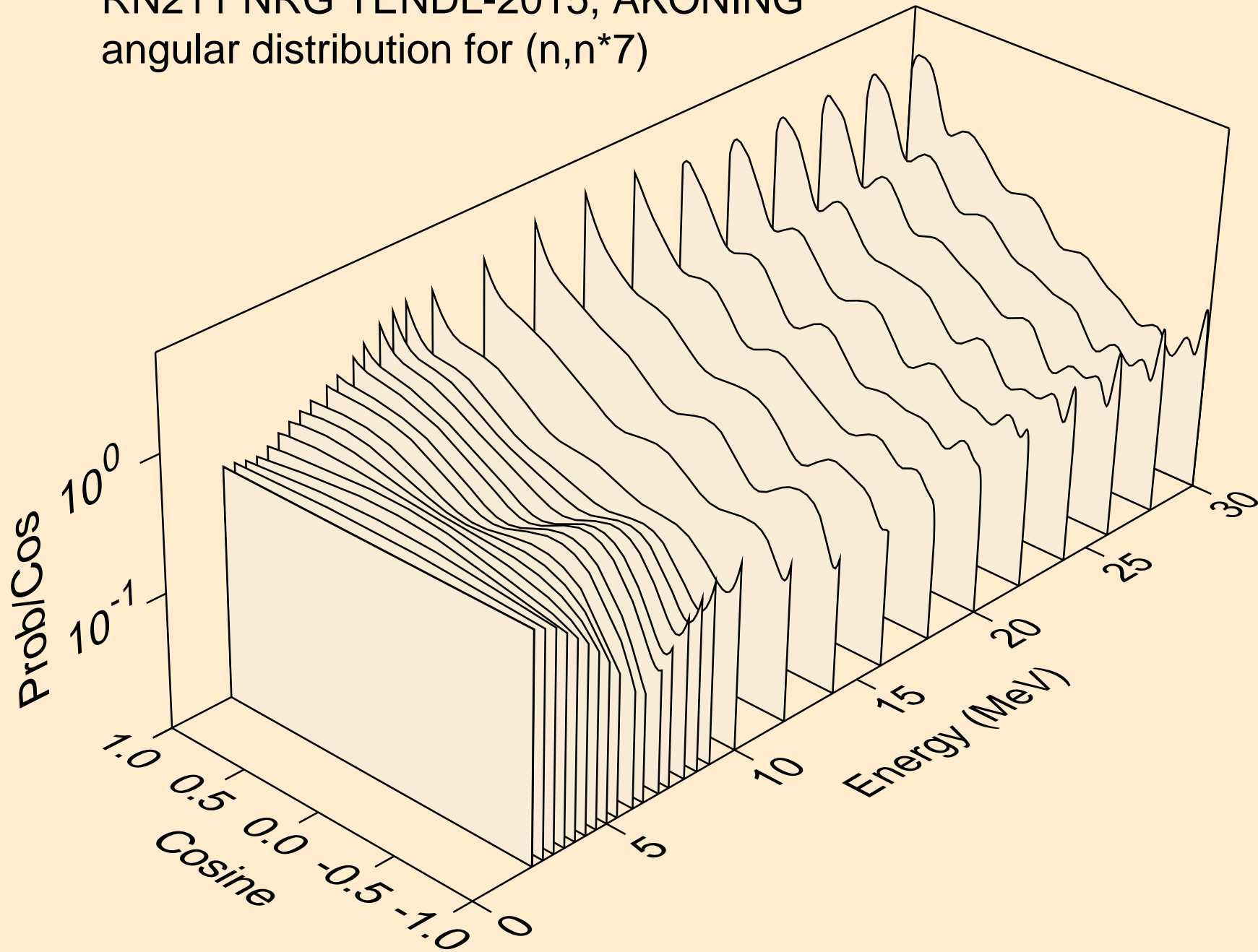

RN211 NRG TENDL-2015, AKONING
angular distribution for (n,n*8)

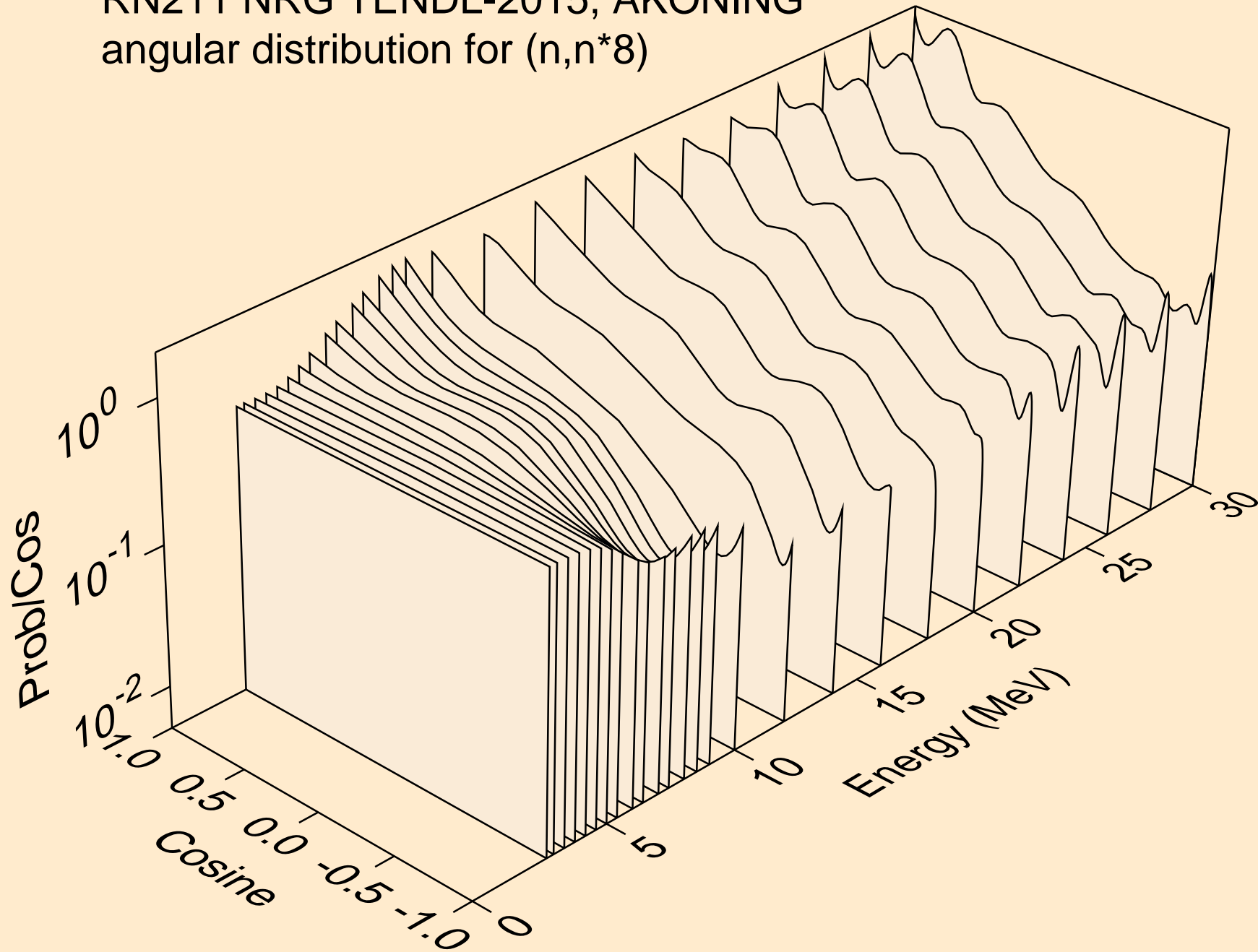

RN211 NRG TENDL-2015, AKONING
angular distribution for (n,n*9)

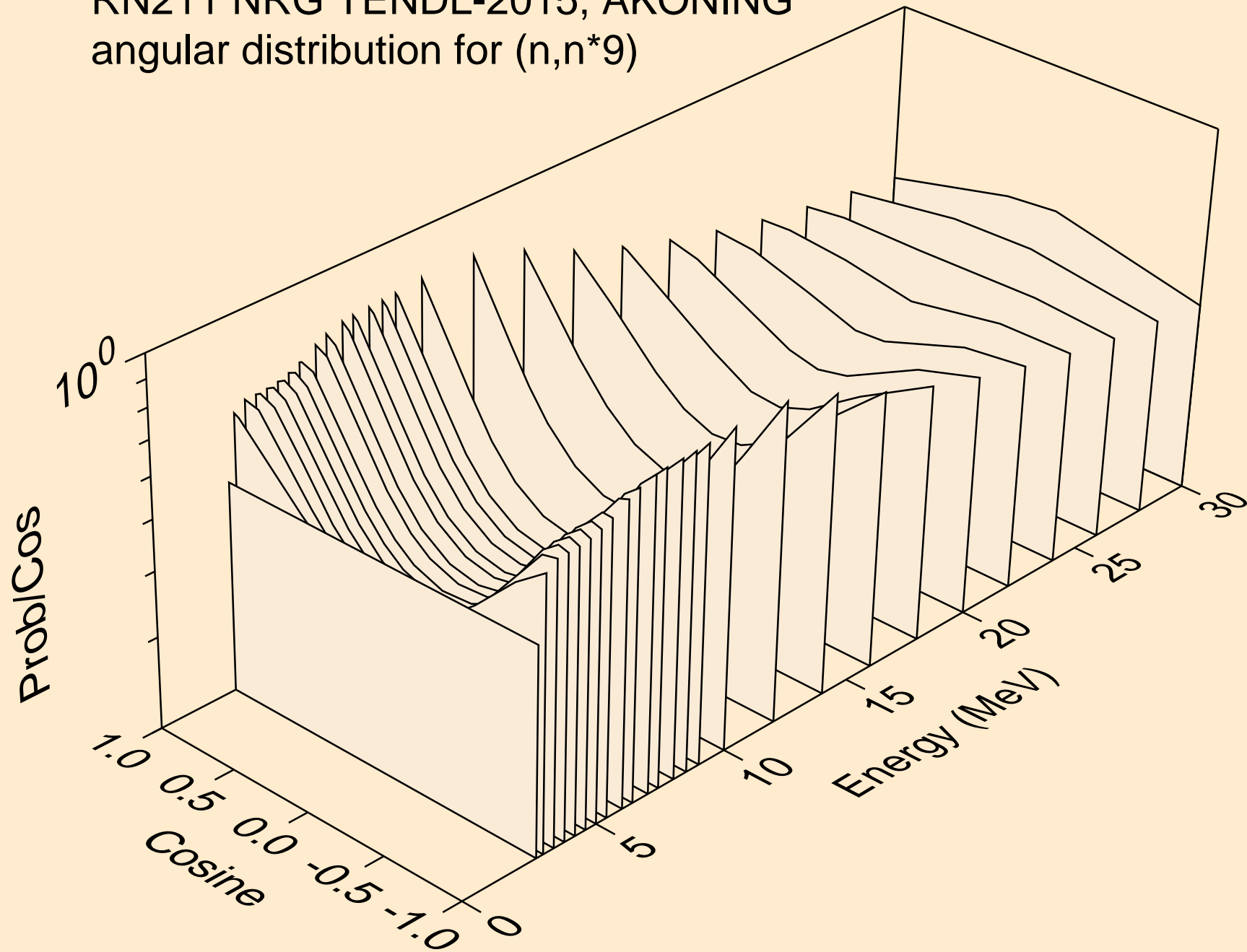

RN211 NRG TENDL-2015, AKONING
angular distribution for (n,n*10)

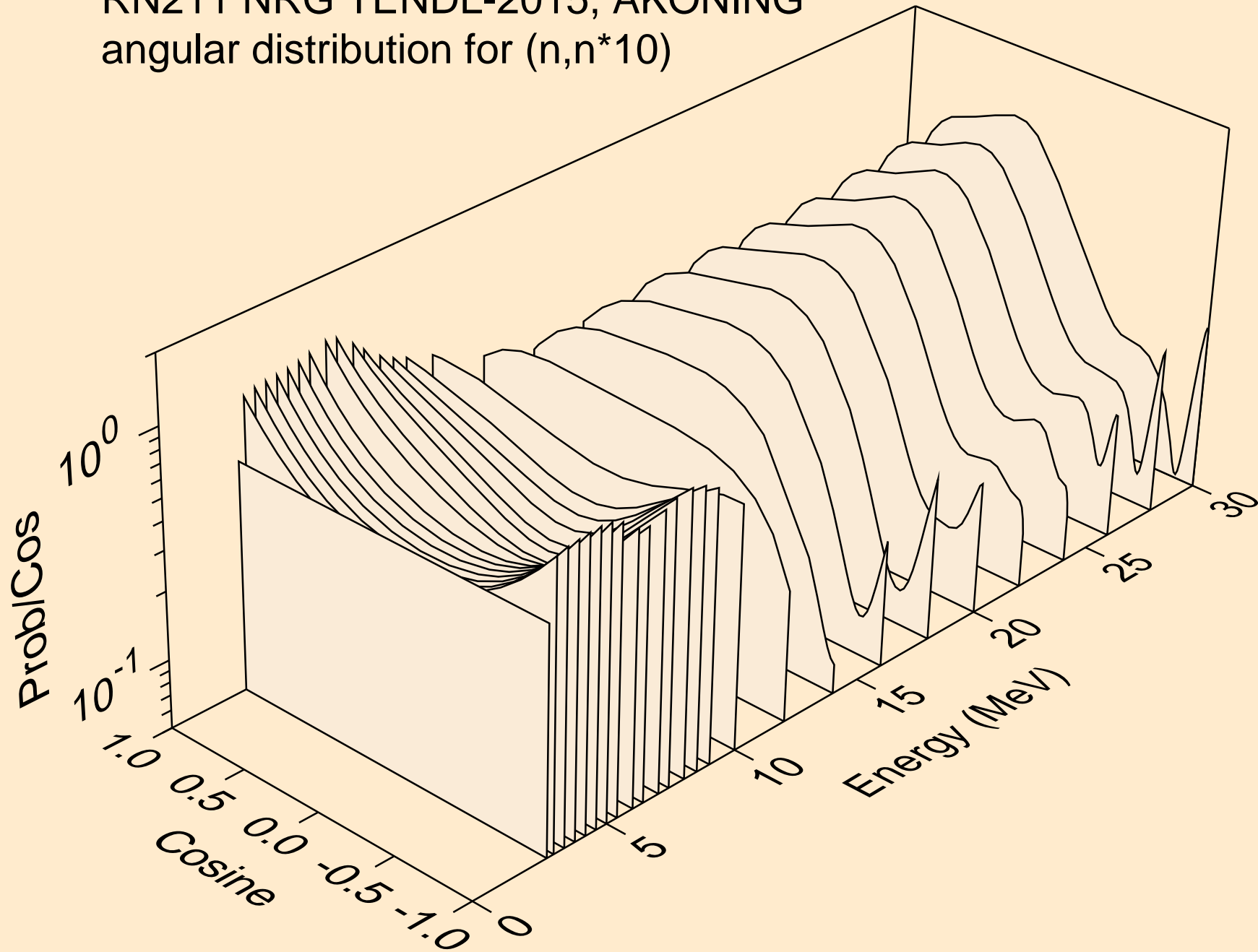

RN211 NRG TENDL-2015, AKONING
angular distribution for (n,n*11)

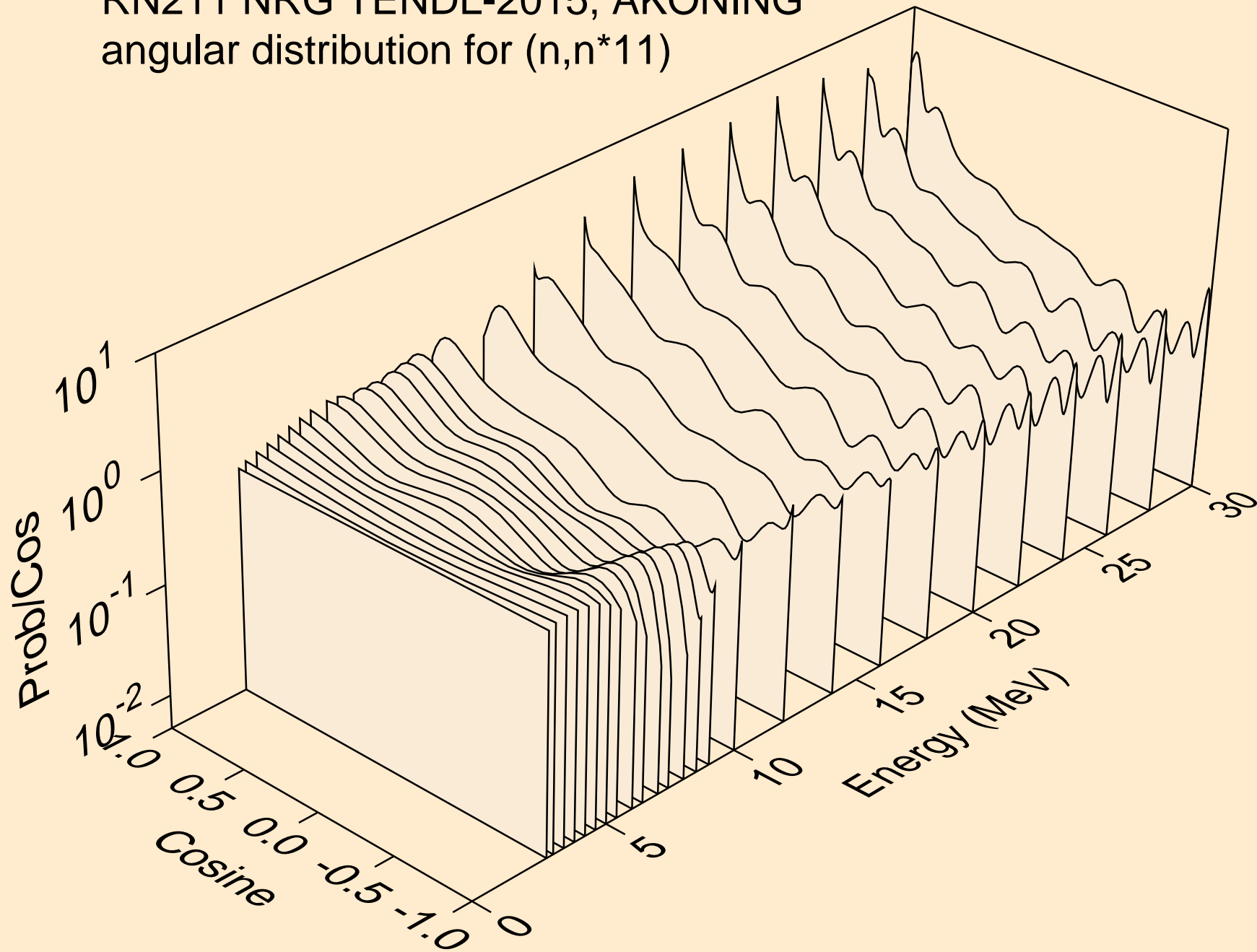

RN211 NRG TENDL-2015, AKONING
angular distribution for (n,n*12)

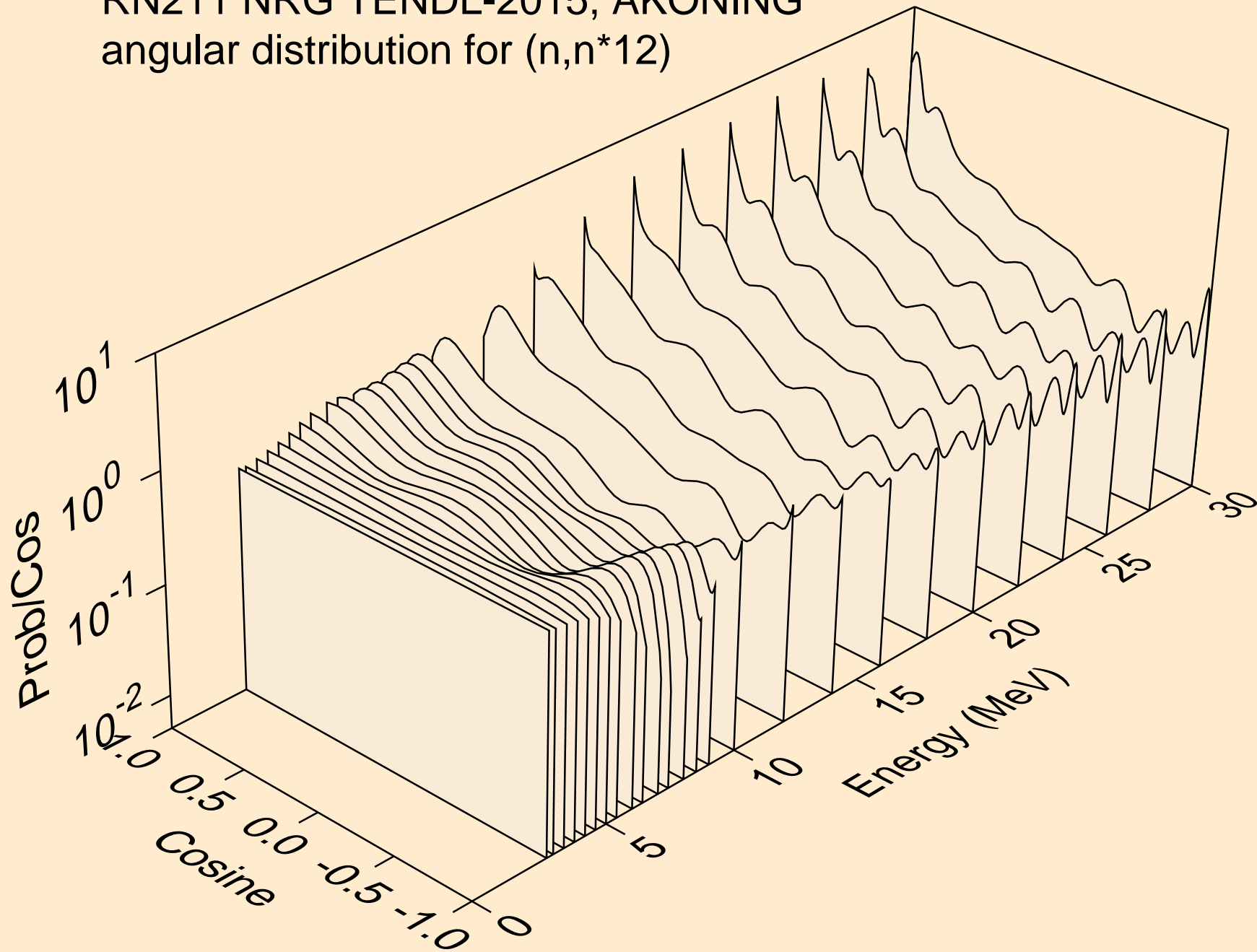

RN211 NRG TENDL-2015, AKONING
angular distribution for (n,n*13)

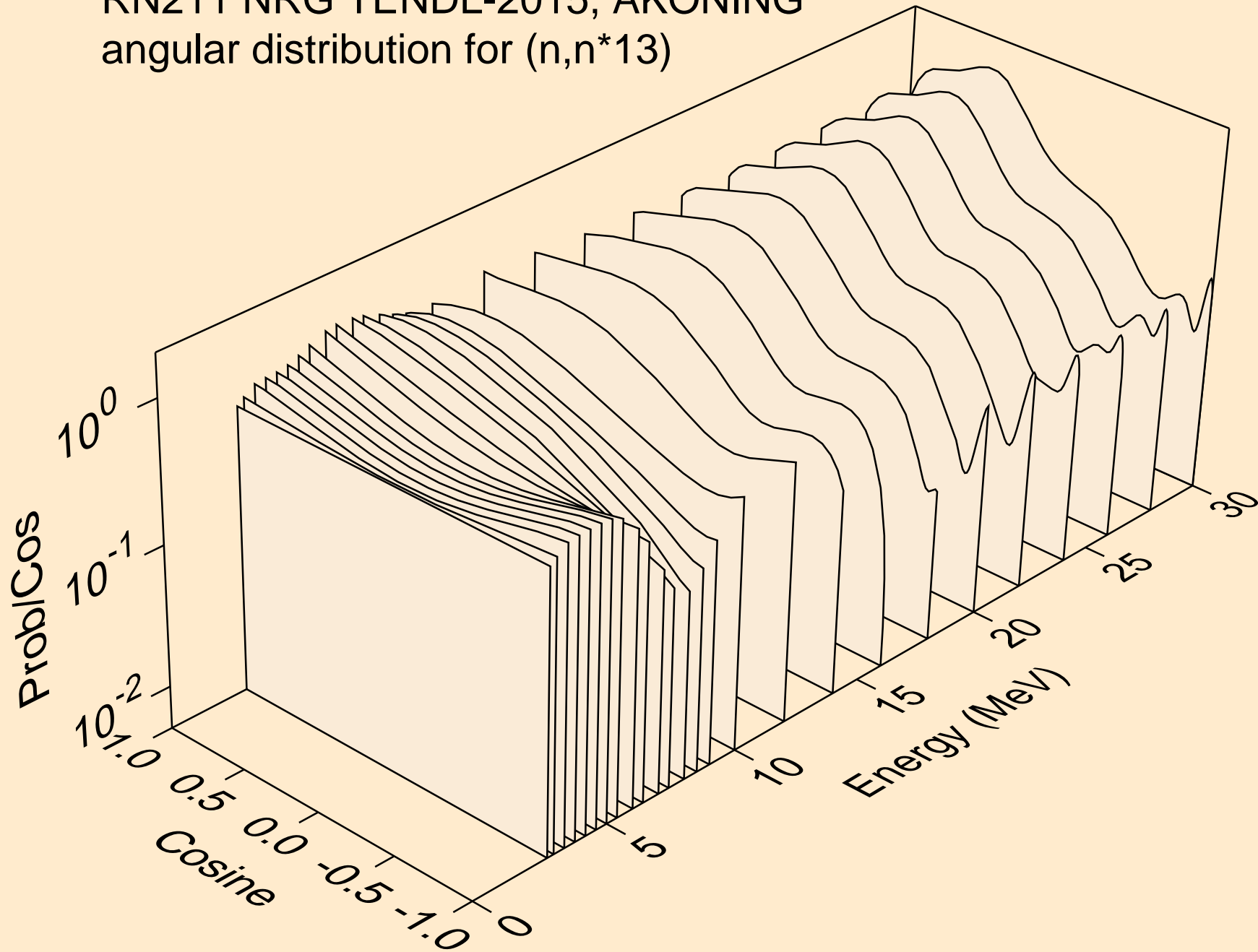

RN211 NRG TENDL-2015, AKONING
angular distribution for (n,n*14)

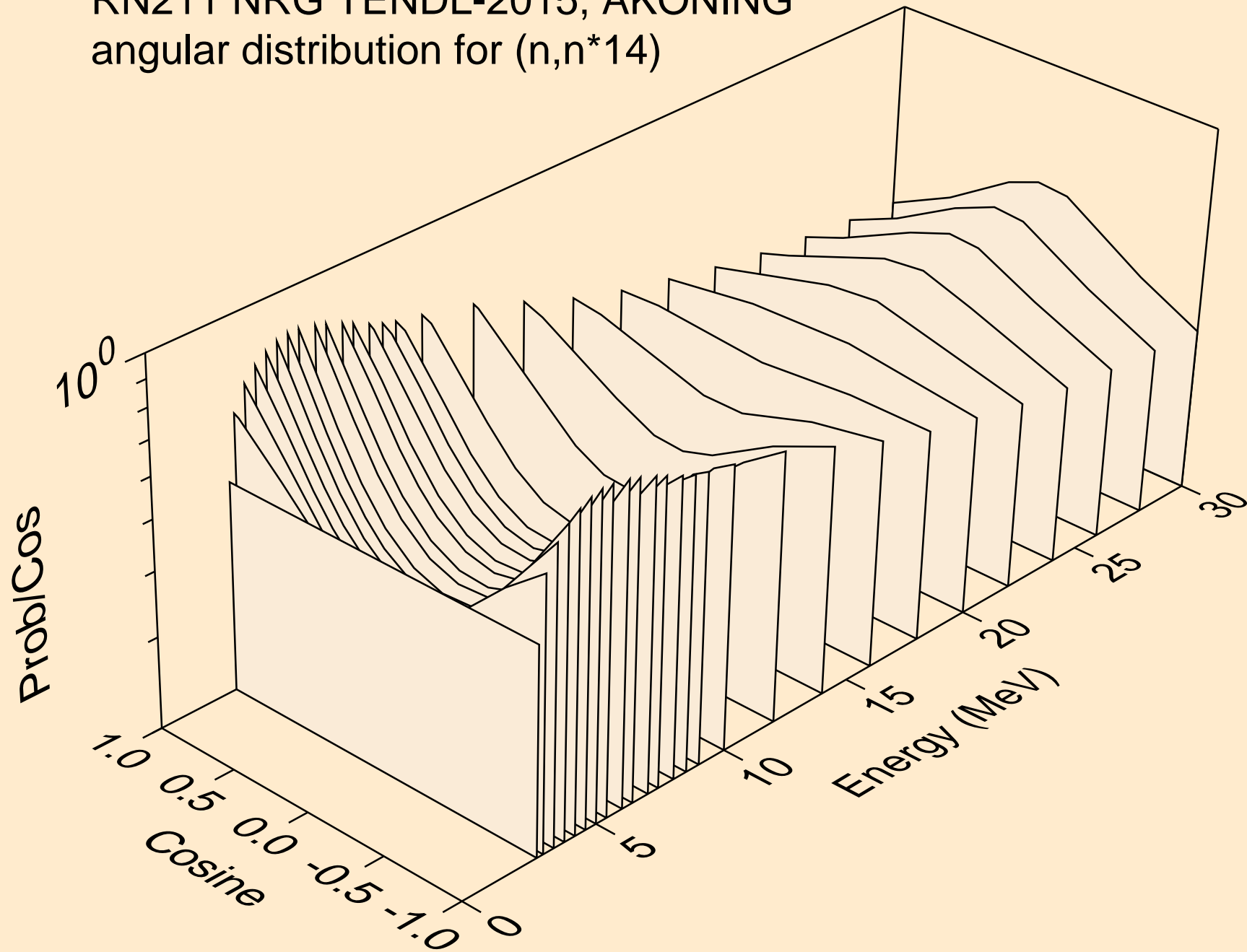

RN211 NRG TENDL-2015, AKONING
angular distribution for (n,n*15)

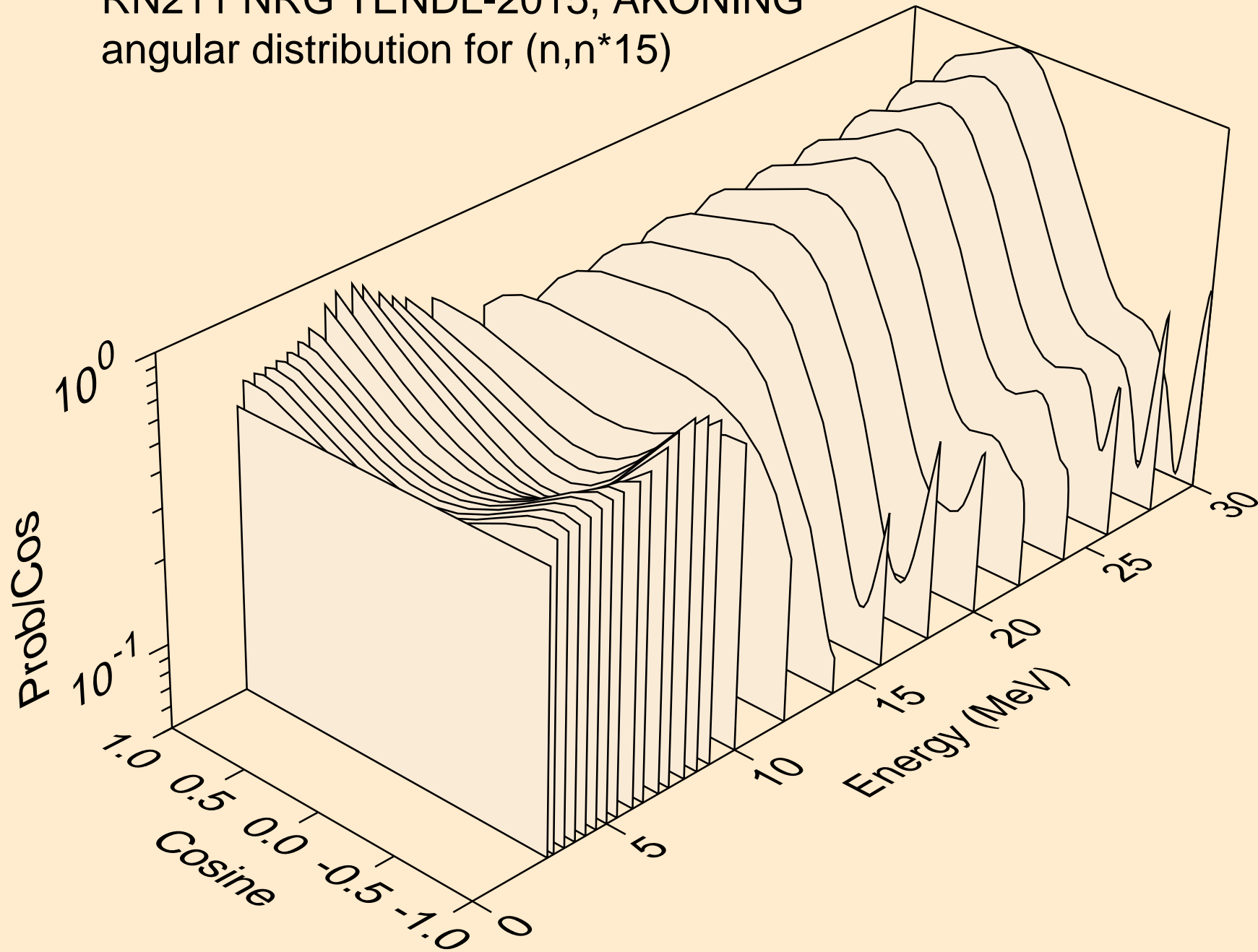

RN211 NRG TENDL-2015, AKONING
angular distribution for (n,n*16)

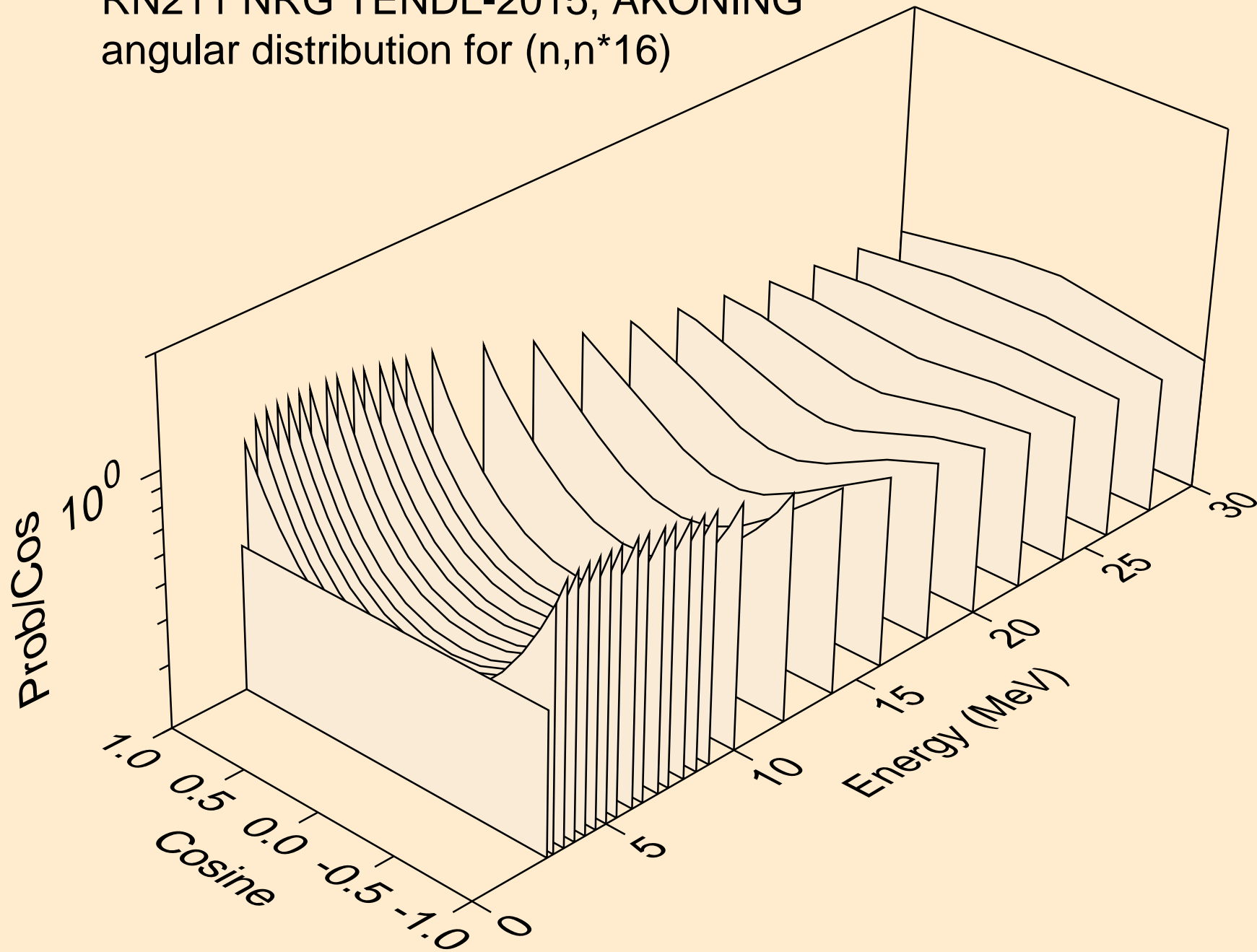

RN211 NRG TENDL-2015, AKONING
angular distribution for (n,n*17)

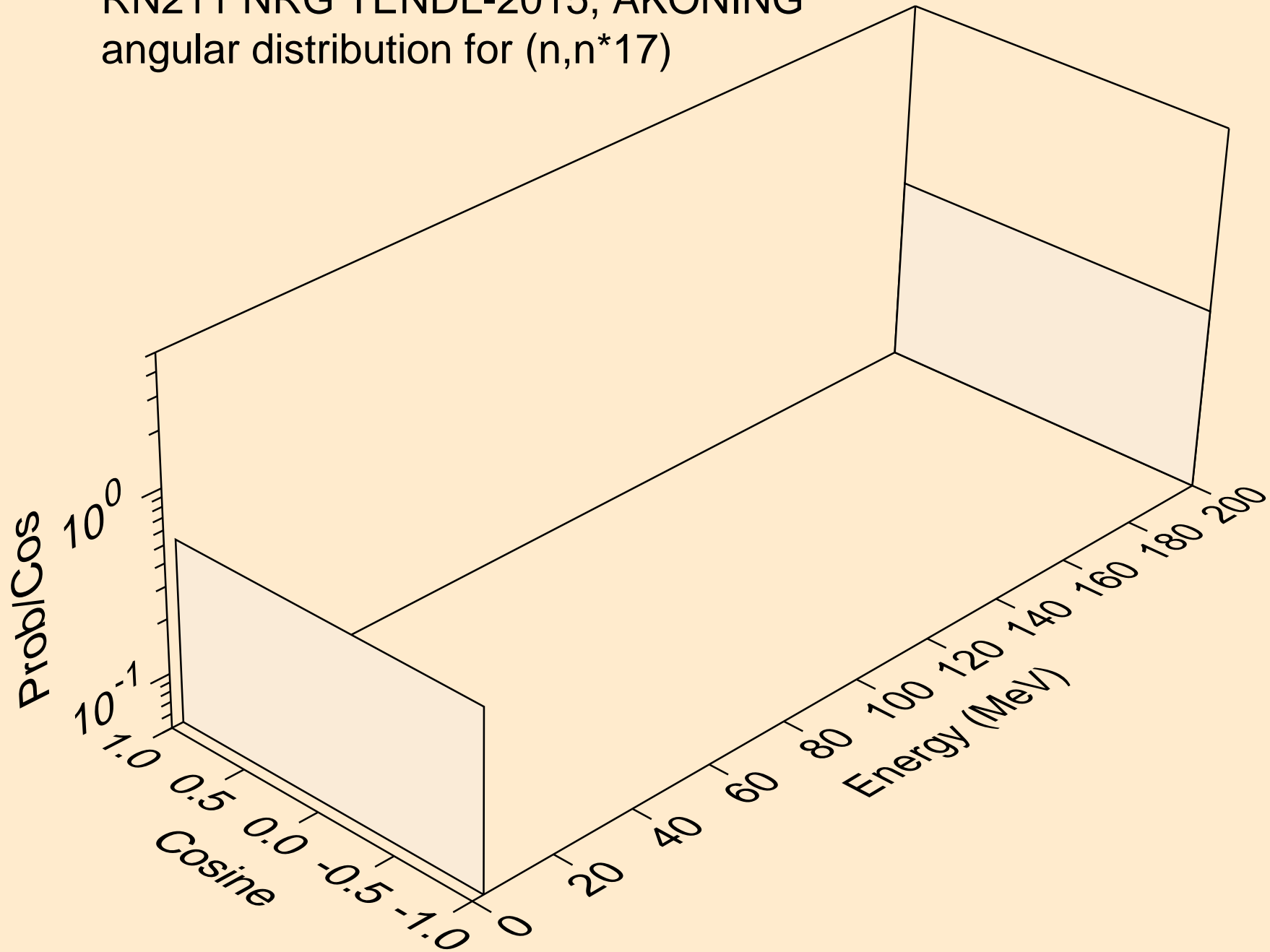

RN211 NRG TENDL-2015, AKONING
angular distribution for (n,n*18)

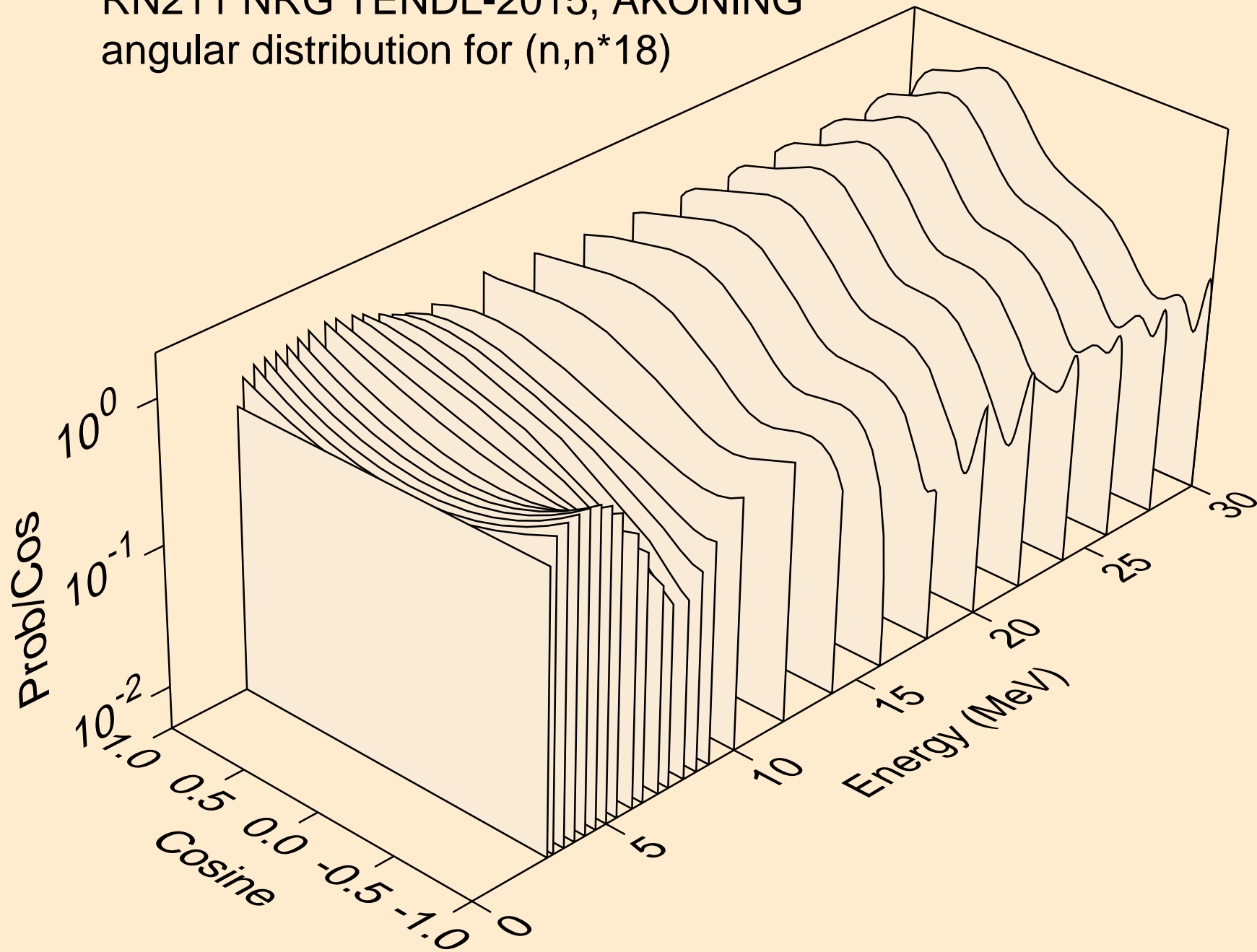

RN211 NRG TENDL-2015, AKONING
angular distribution for (n,n*19)

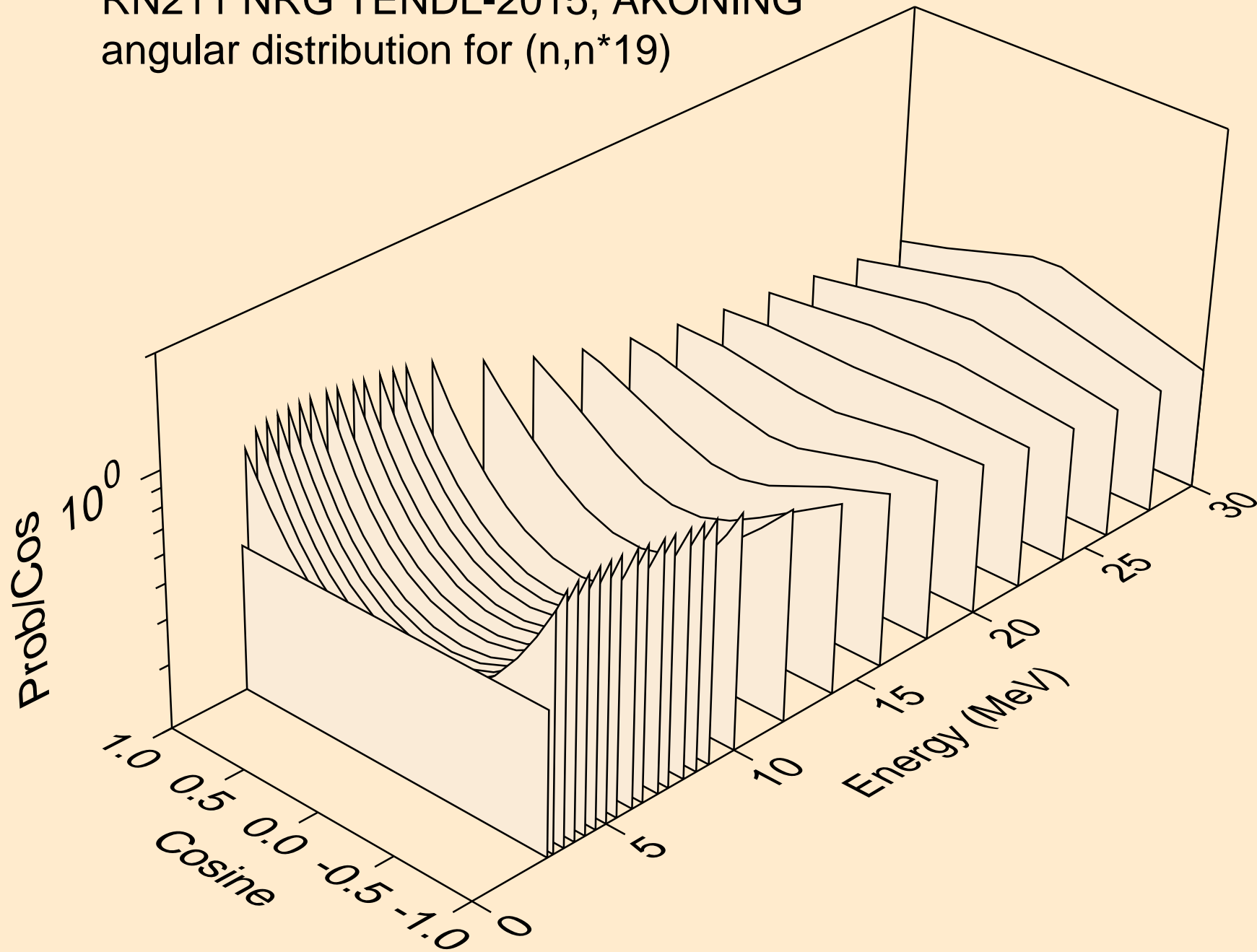

RN211 NRG TENDL-2015, AKONING
angular distribution for (n,n*20)

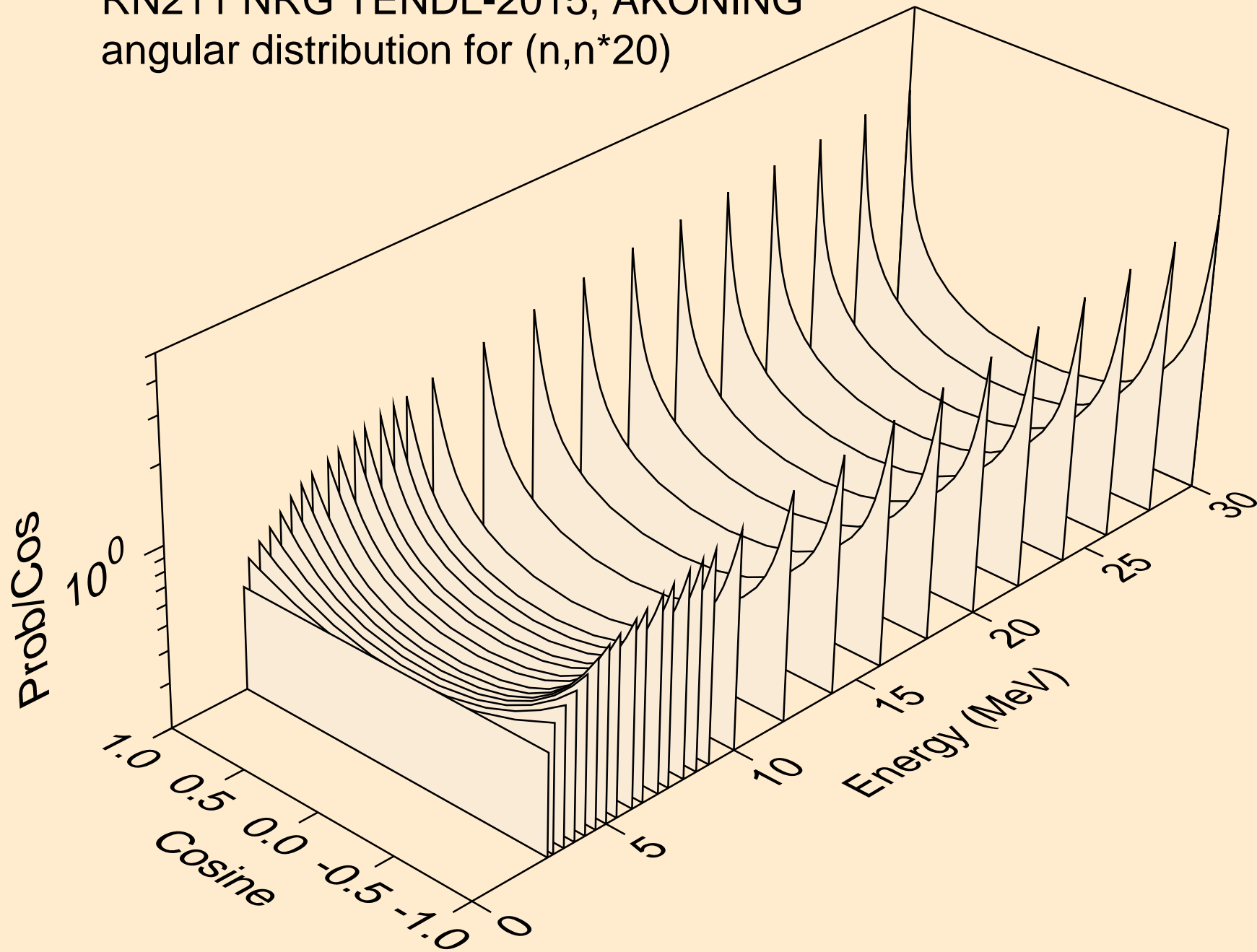

RN211 NRG TENDL-2015, AKONING
angular distribution for (n,n*21)

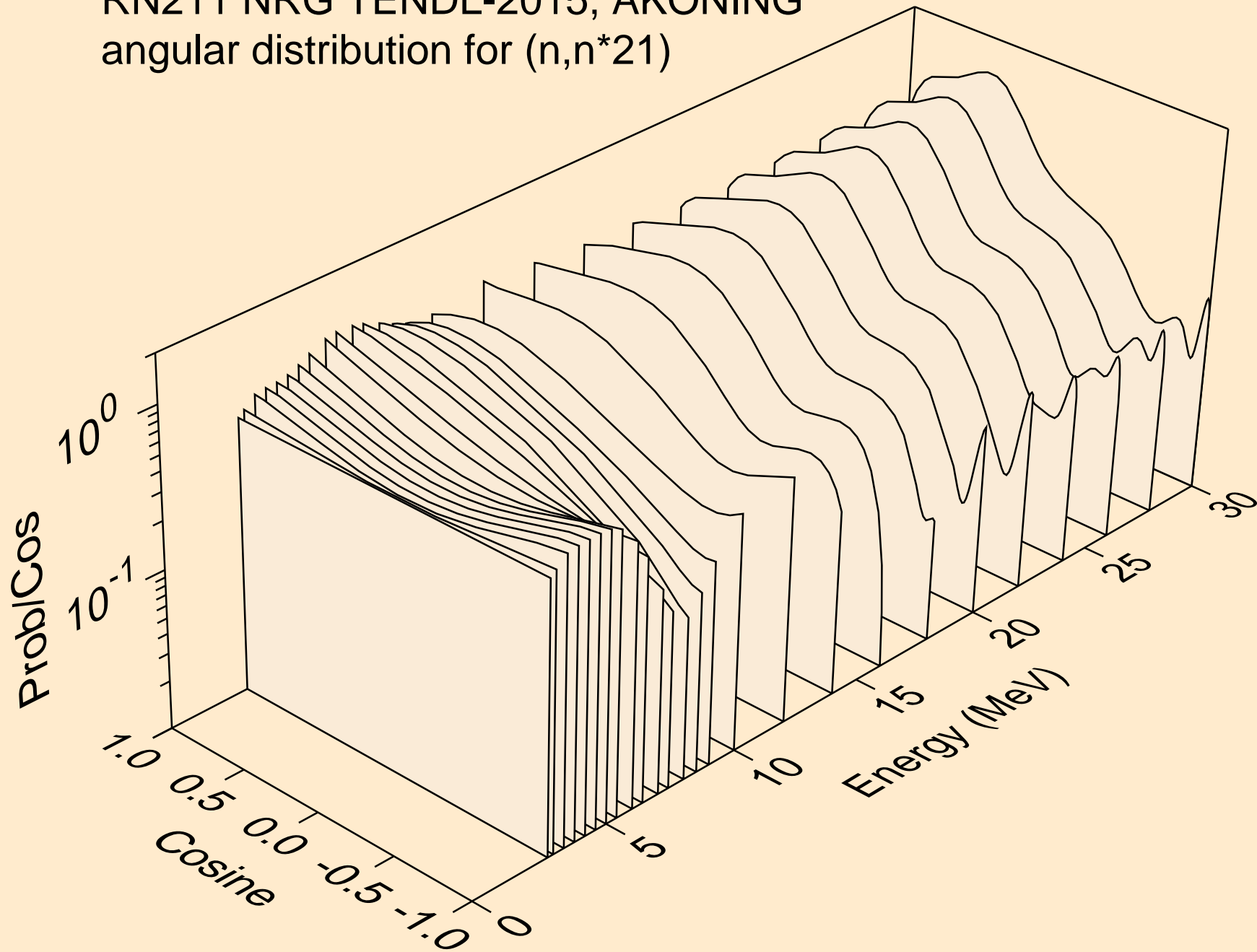

RN211 NRG TENDL-2015, AKONING
angular distribution for (n,n*22)

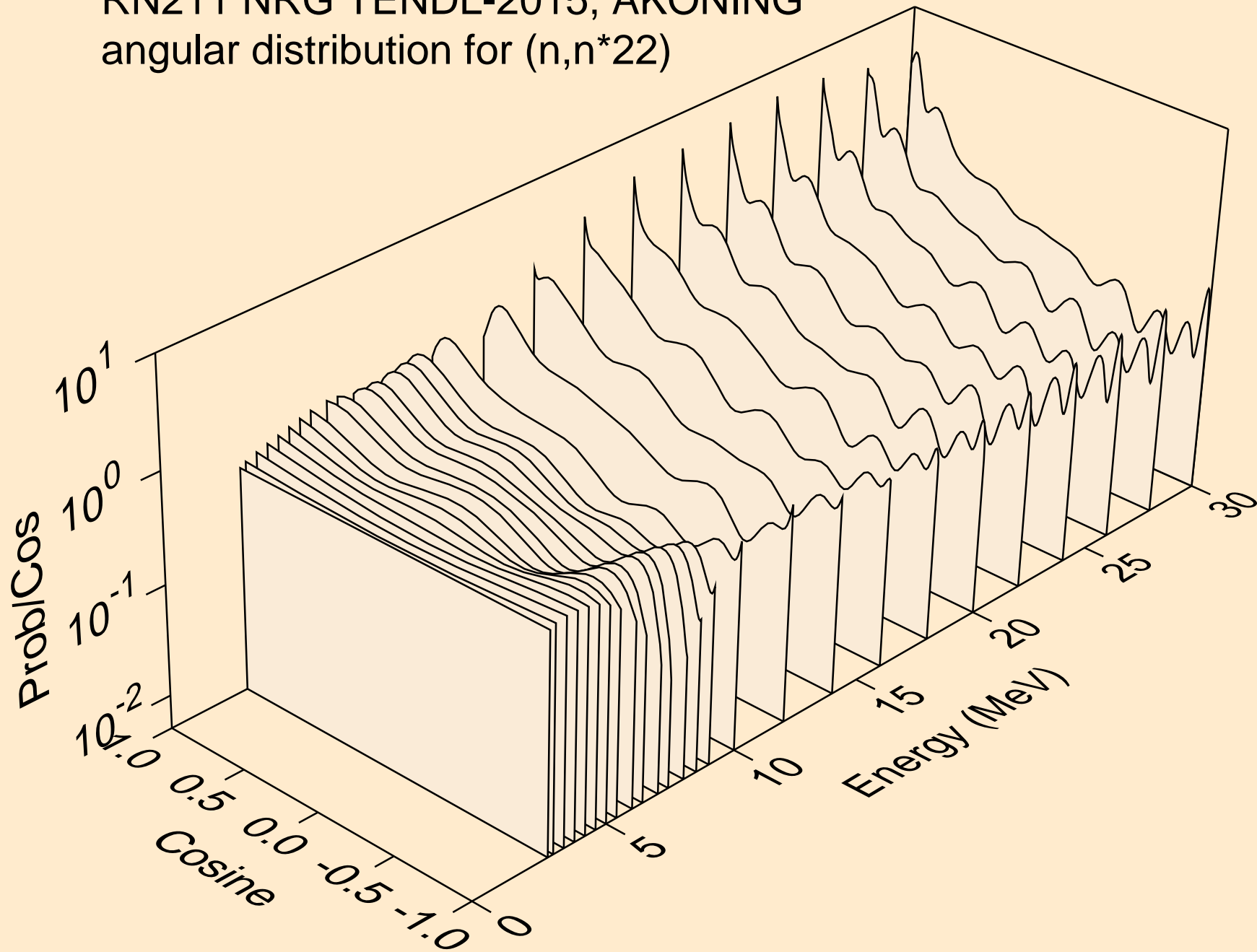

RN211 NRG TENDL-2015, AKONING
angular distribution for (n,n*23)

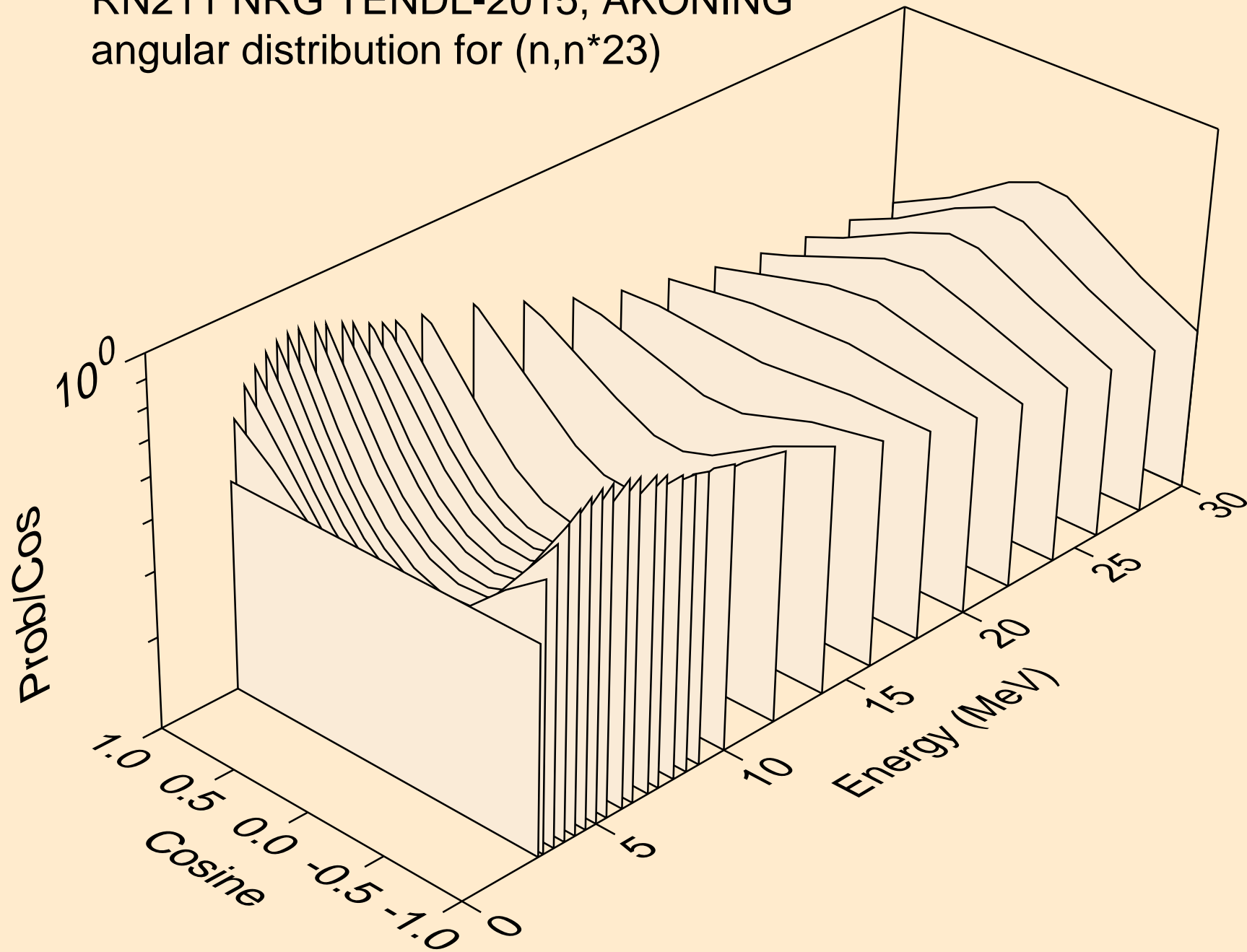

RN211 NRG TENDL-2015, AKONING
angular distribution for (n,n*24)

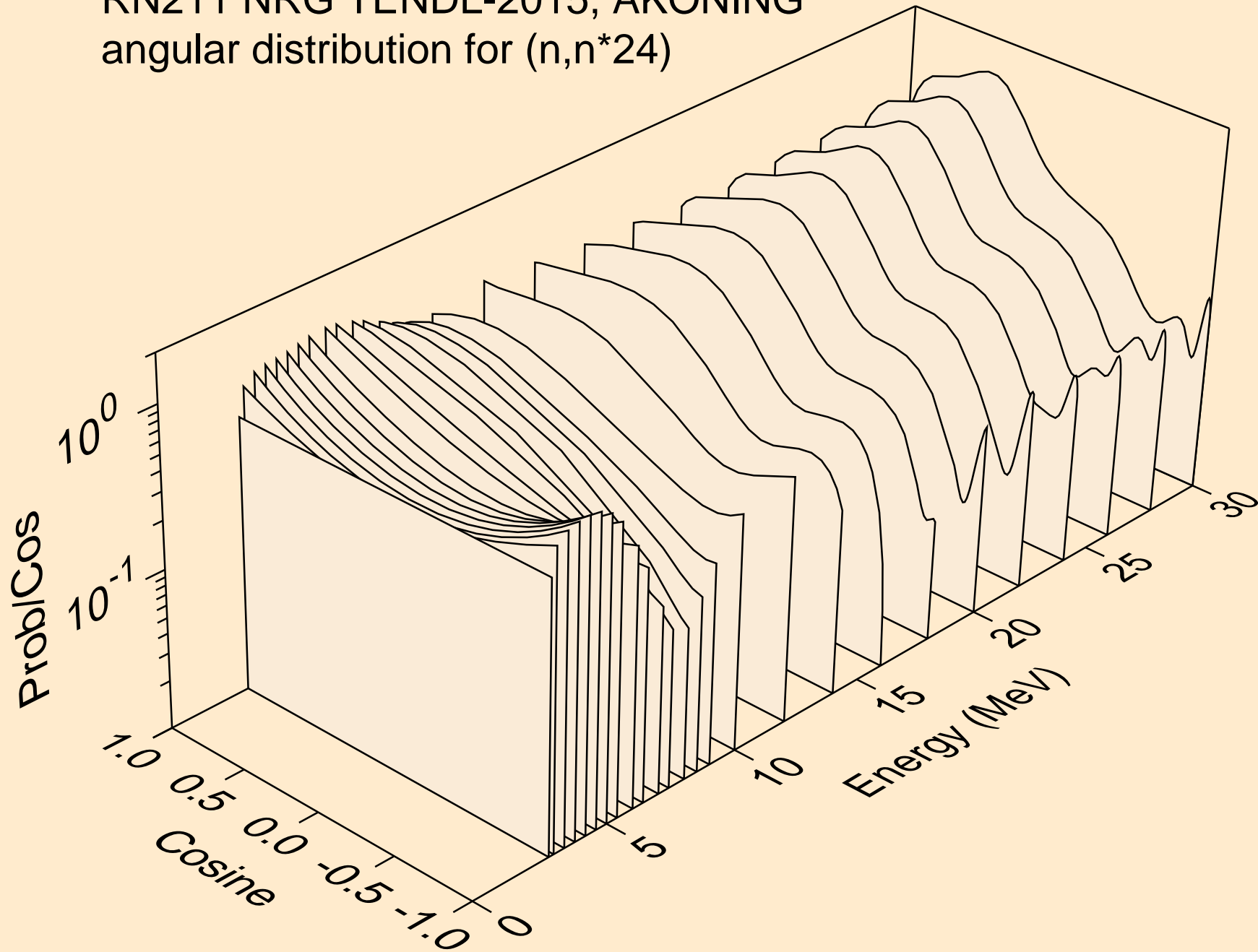

RN211 NRG TENDL-2015, AKONING
angular distribution for (n,n*25)

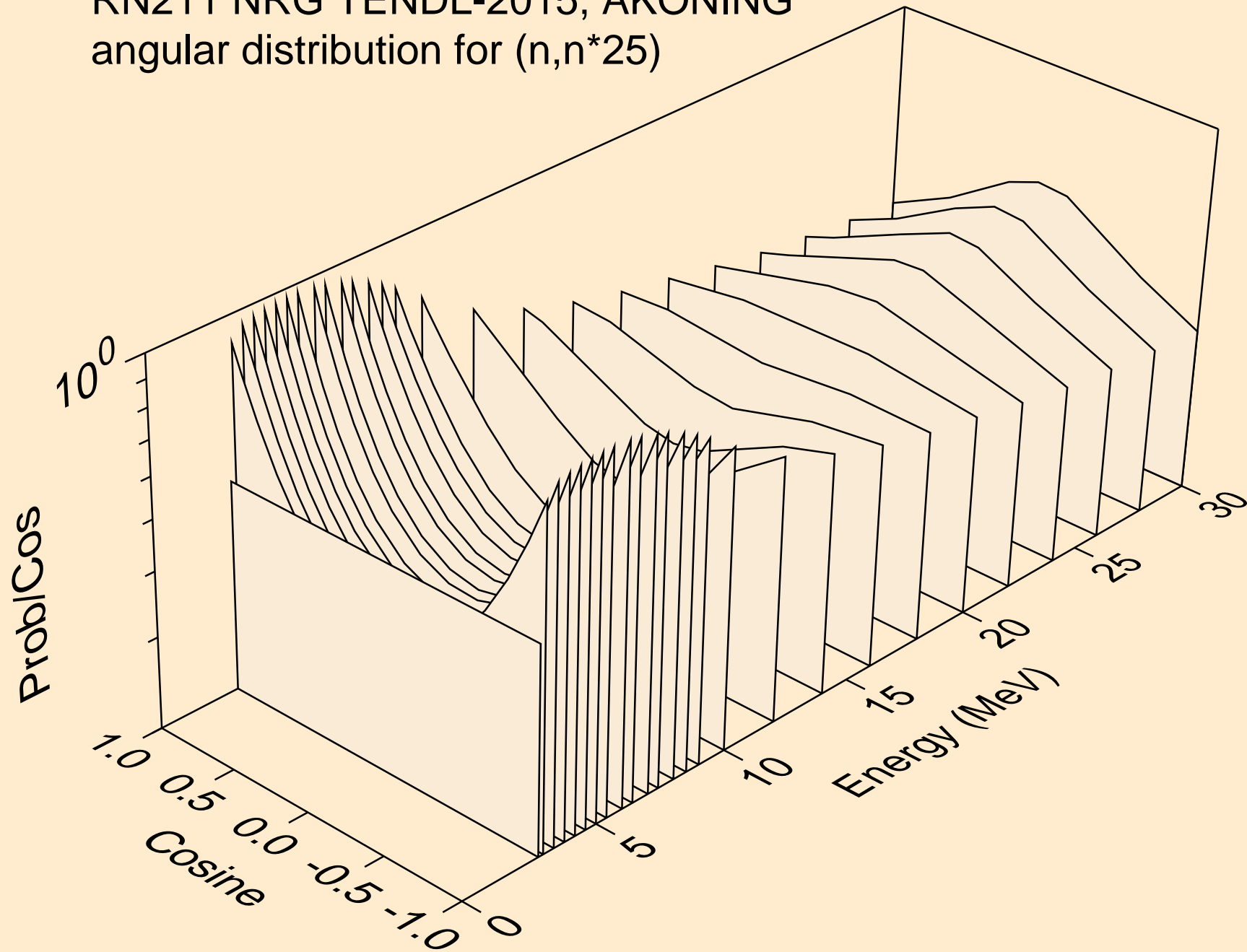

RN211 NRG TENDL-2015, AKONING
angular distribution for (n,n*26)

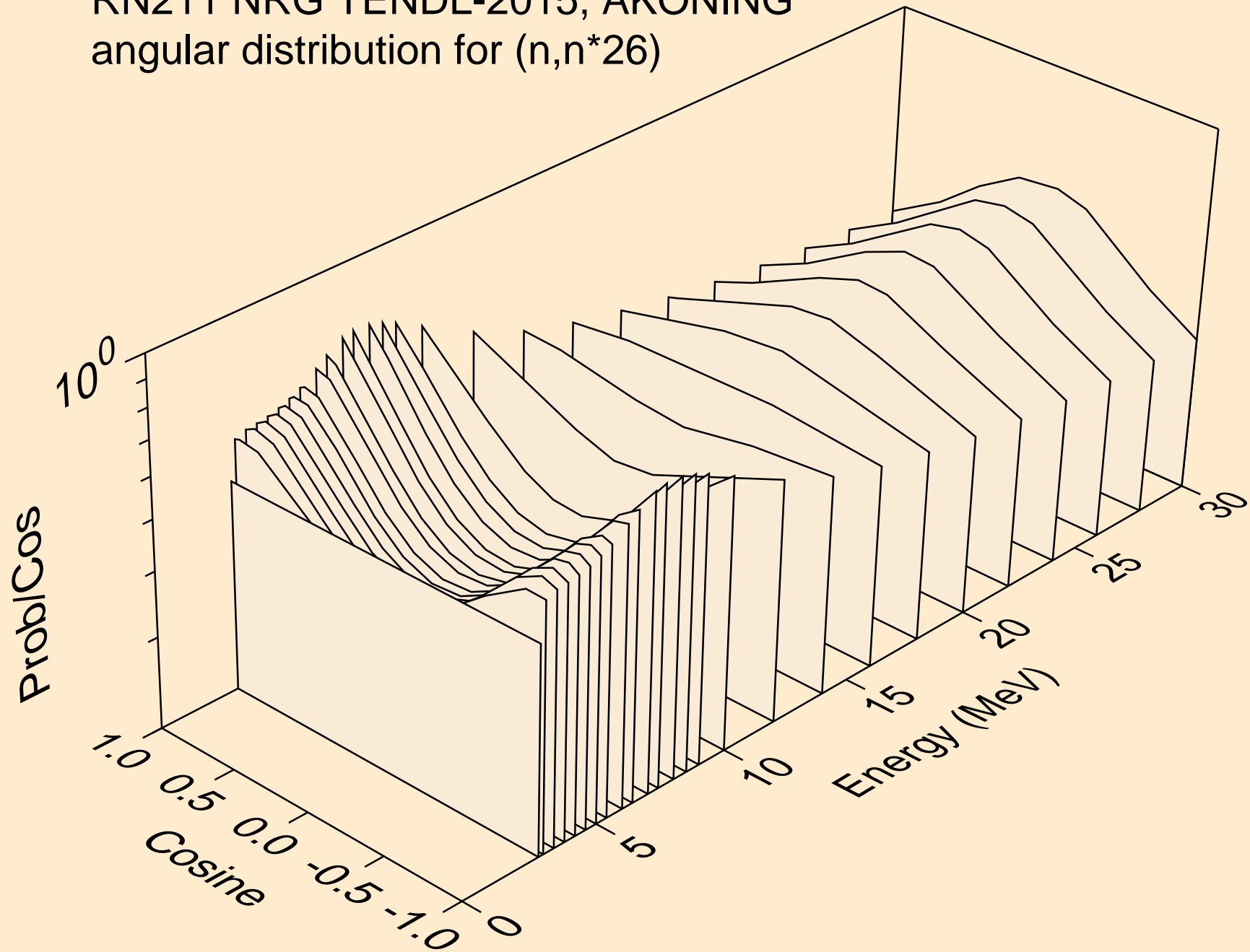

RN211 NRG TENDL-2015, AKONING
angular distribution for (n,n*27)

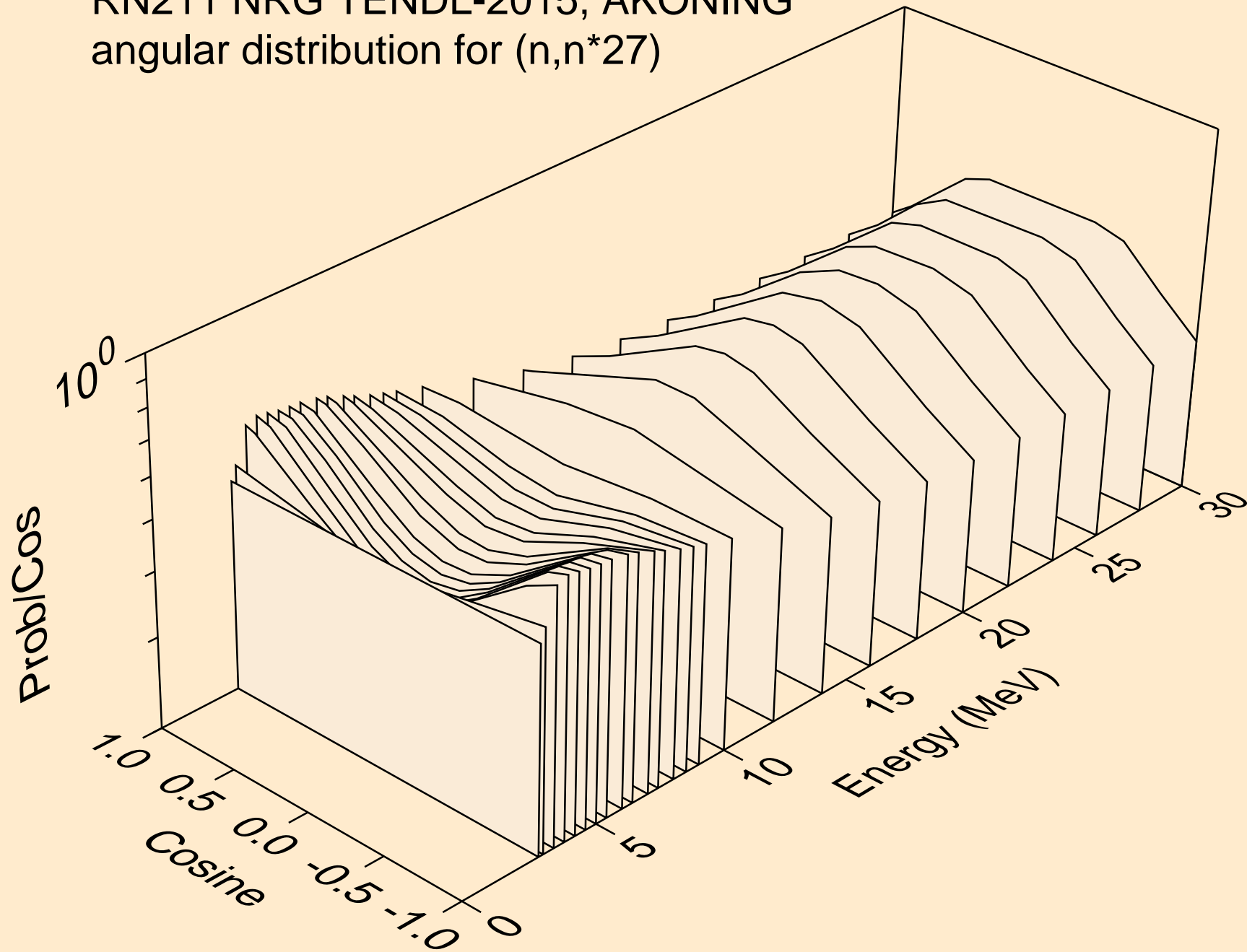

RN211 NRG TENDL-2015, AKONING
Neutron emission for (n,x)

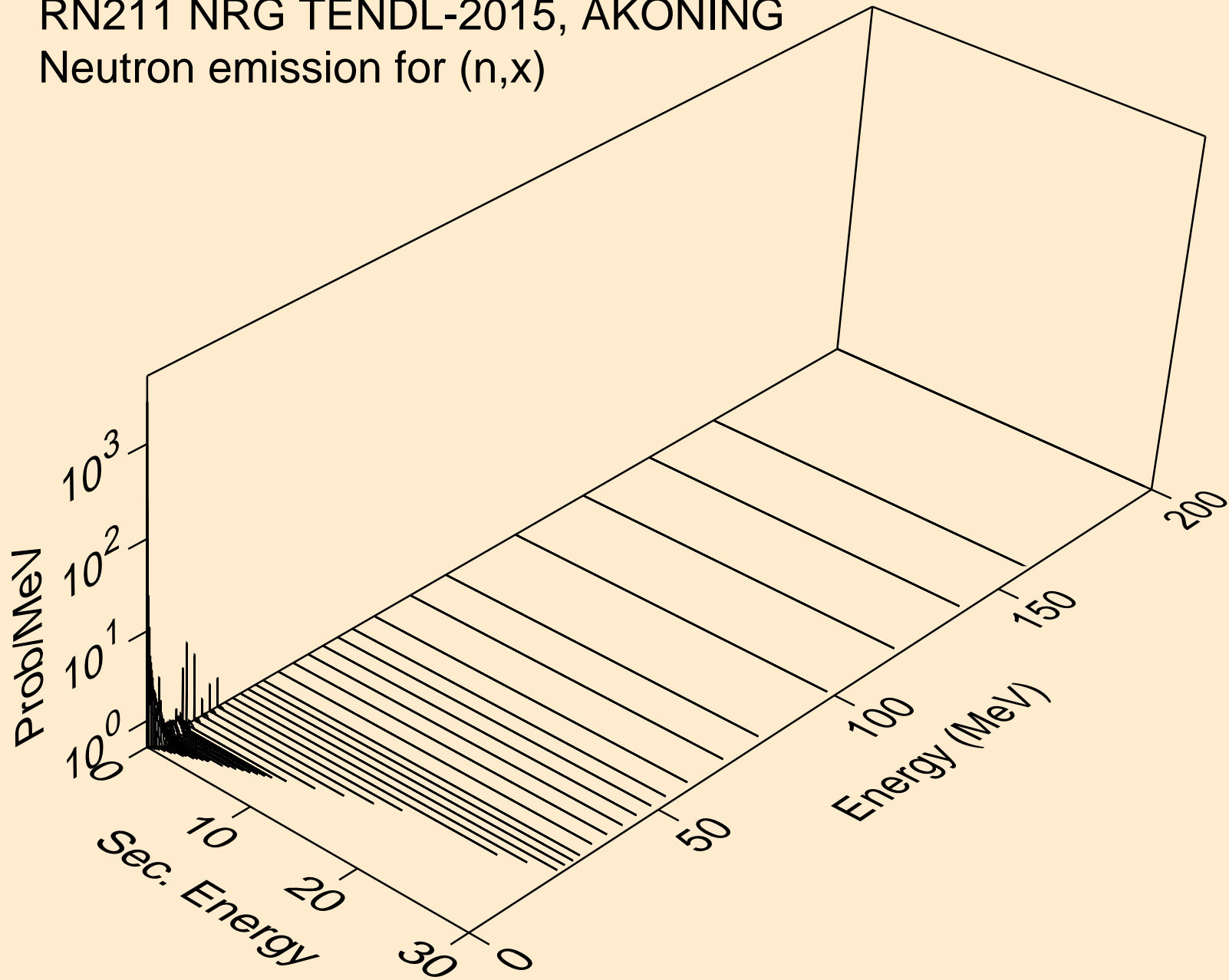

RN211 NRG TENDL-2015, AKONING
Neutron emission for (n,2nd)

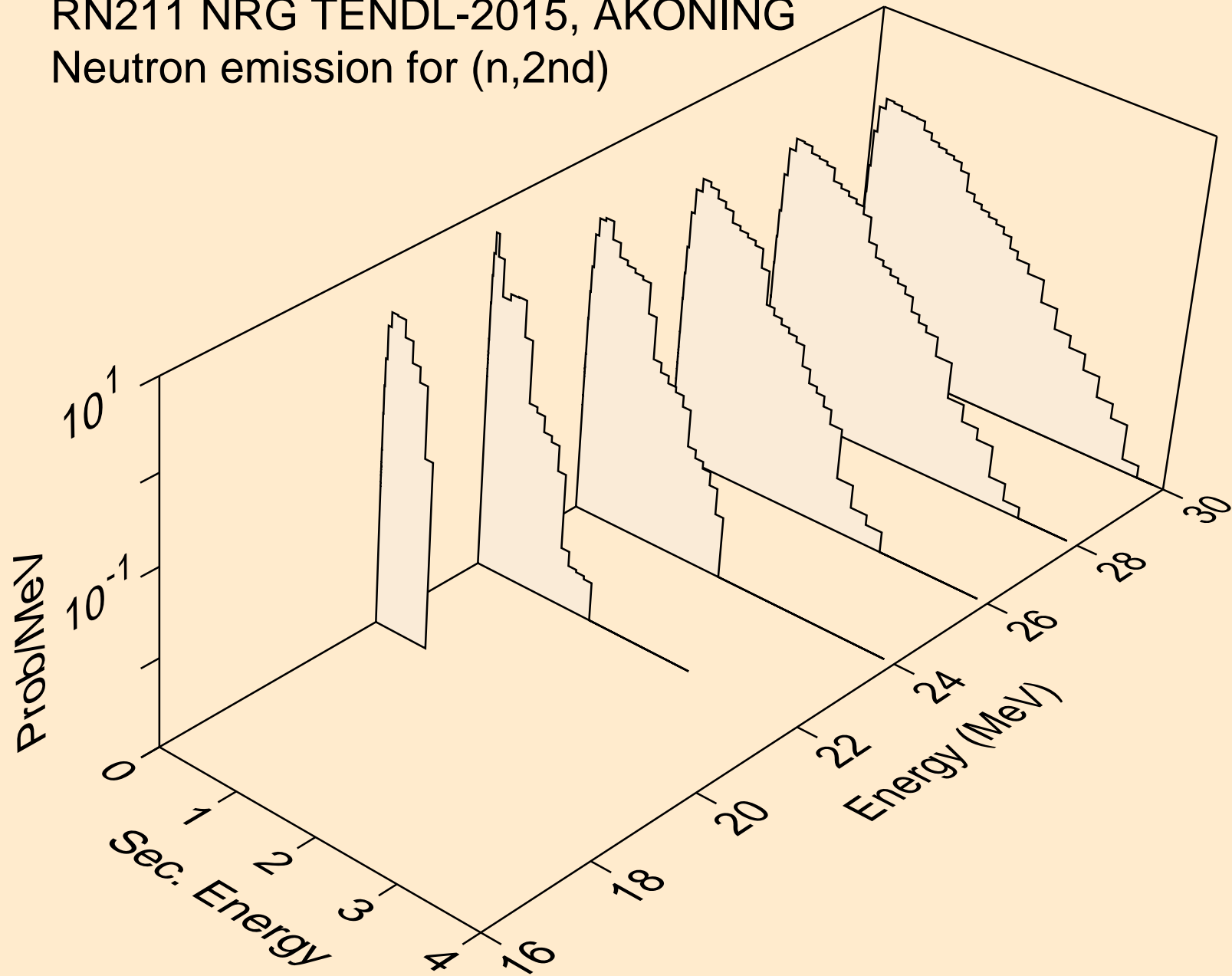

RN211 NRG TENDL-2015, AKONING
Neutron emission for (n,2n)

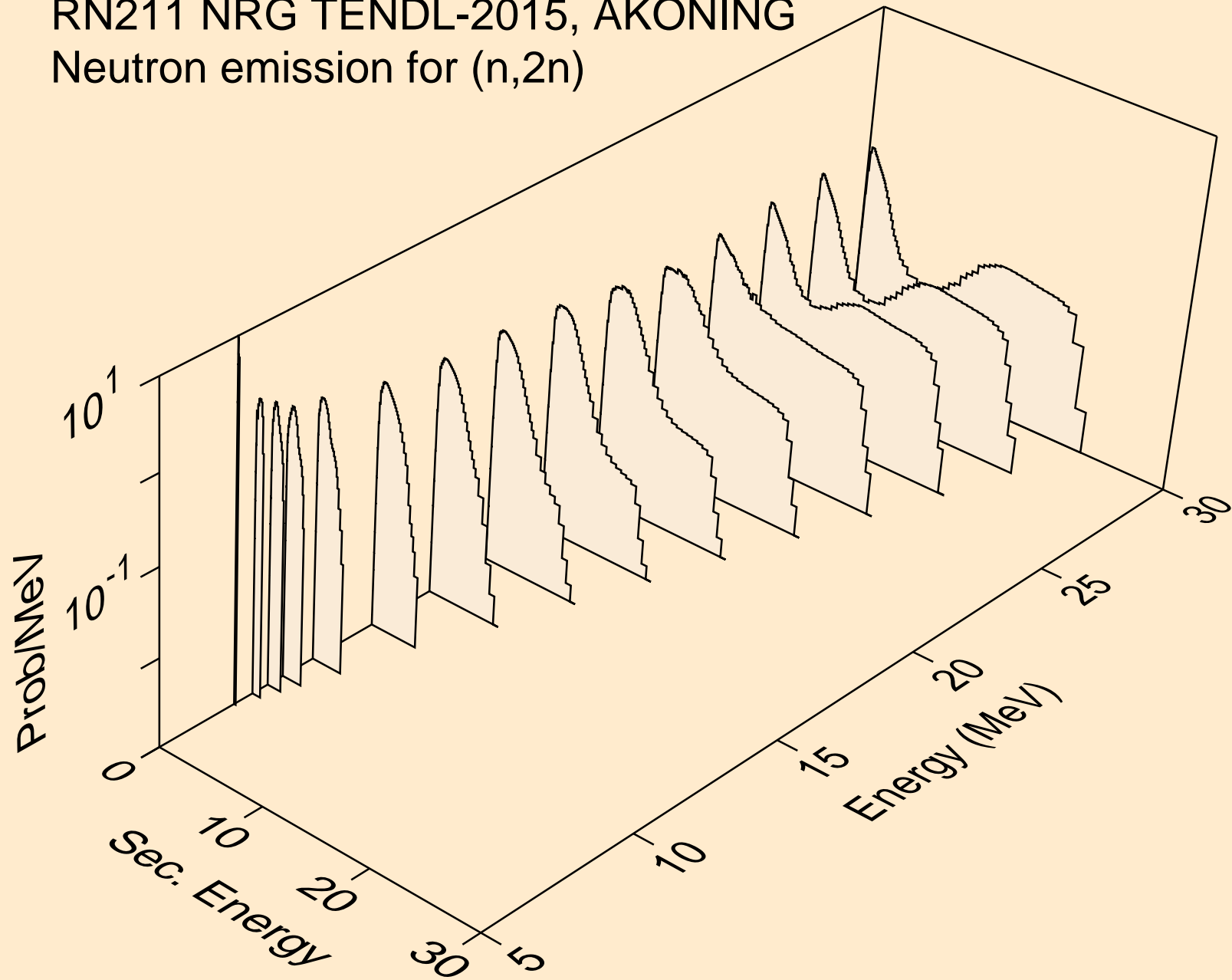

RN211 NRG TENDL-2015, AKONING
Neutron emission for (n,3n)

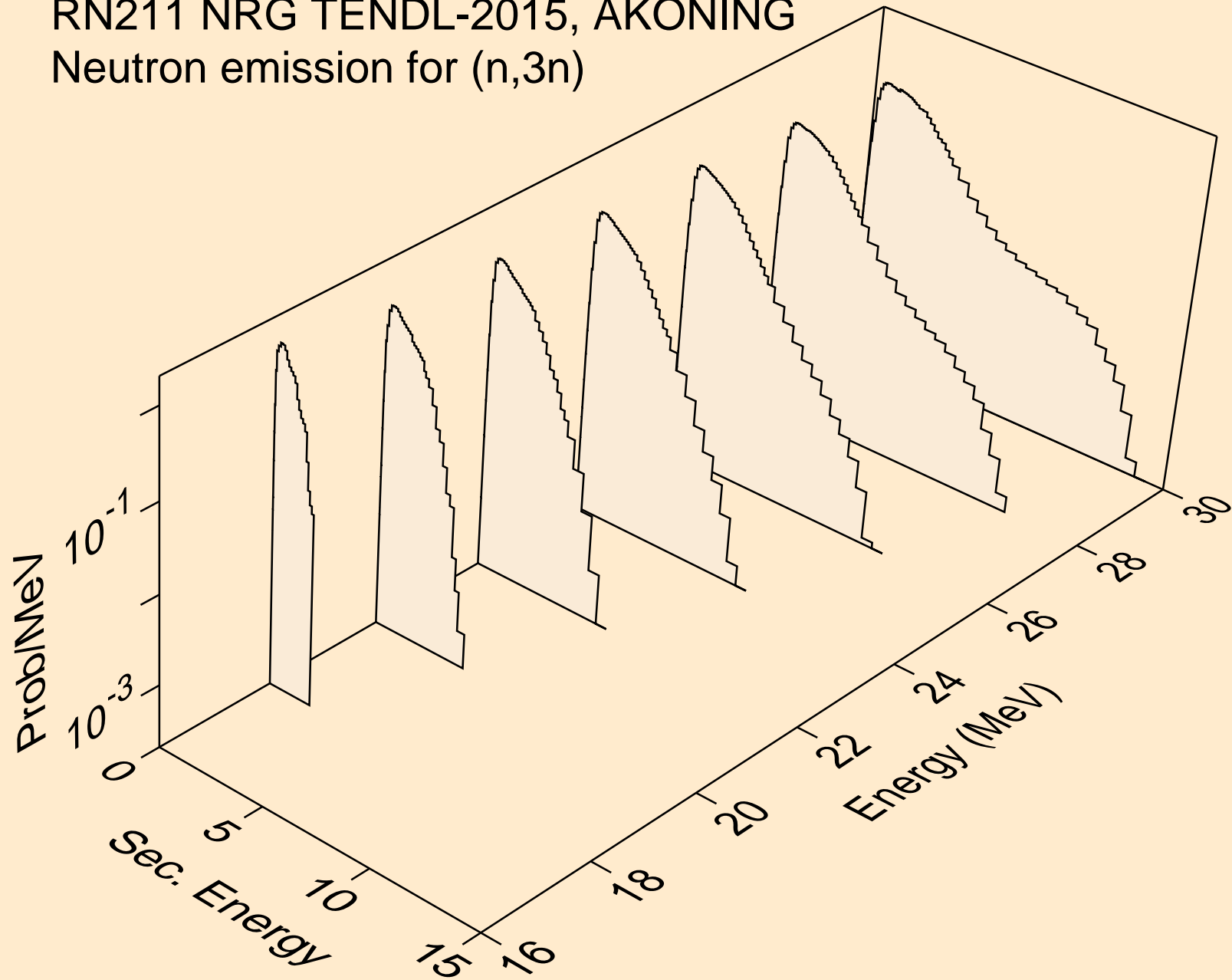

RN211 NRG TENDL-2015, AKONING
Neutron emission for (n,n*)a

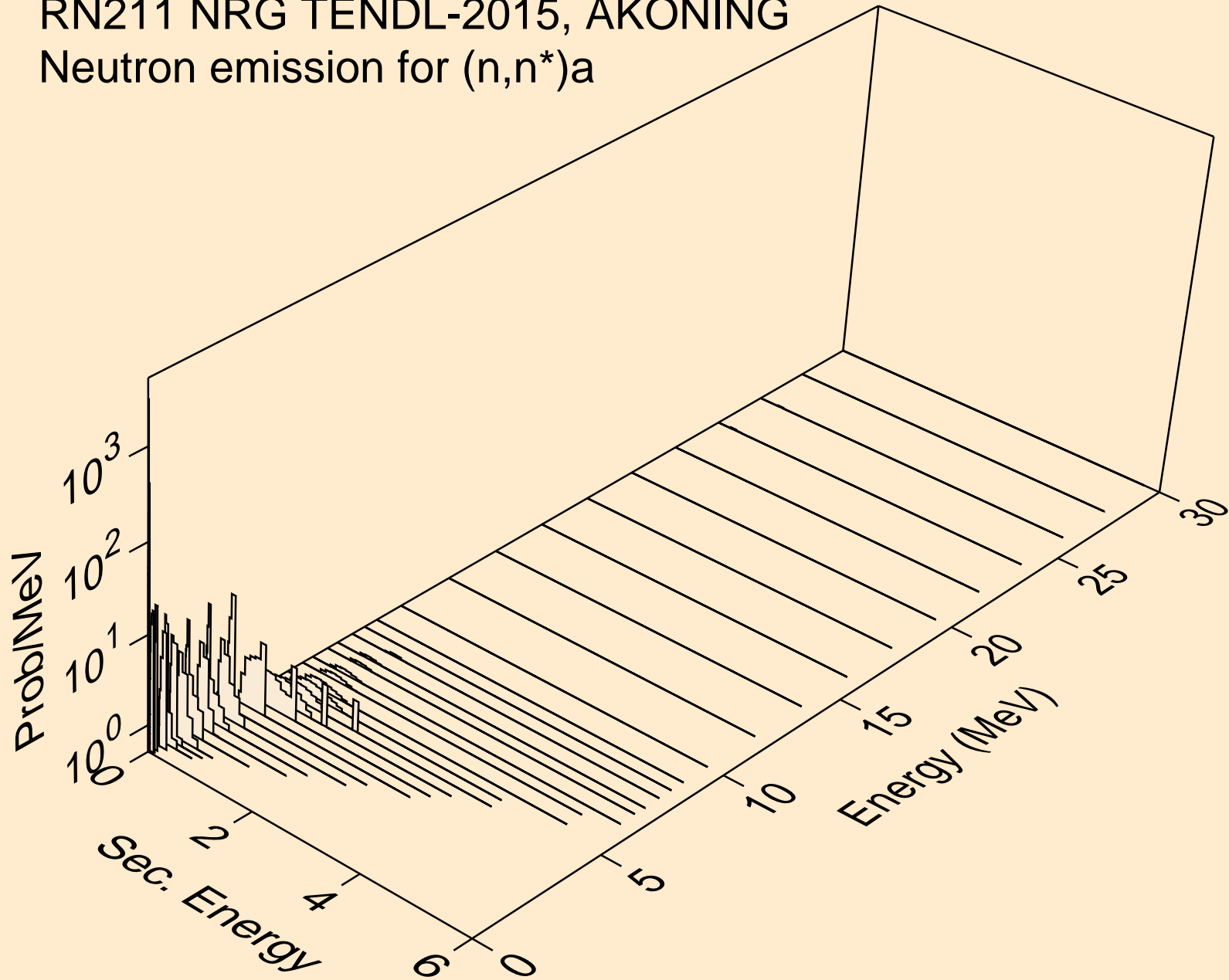

RN211 NRG TENDL-2015, AKONING
Neutron emission for (n,2n)a

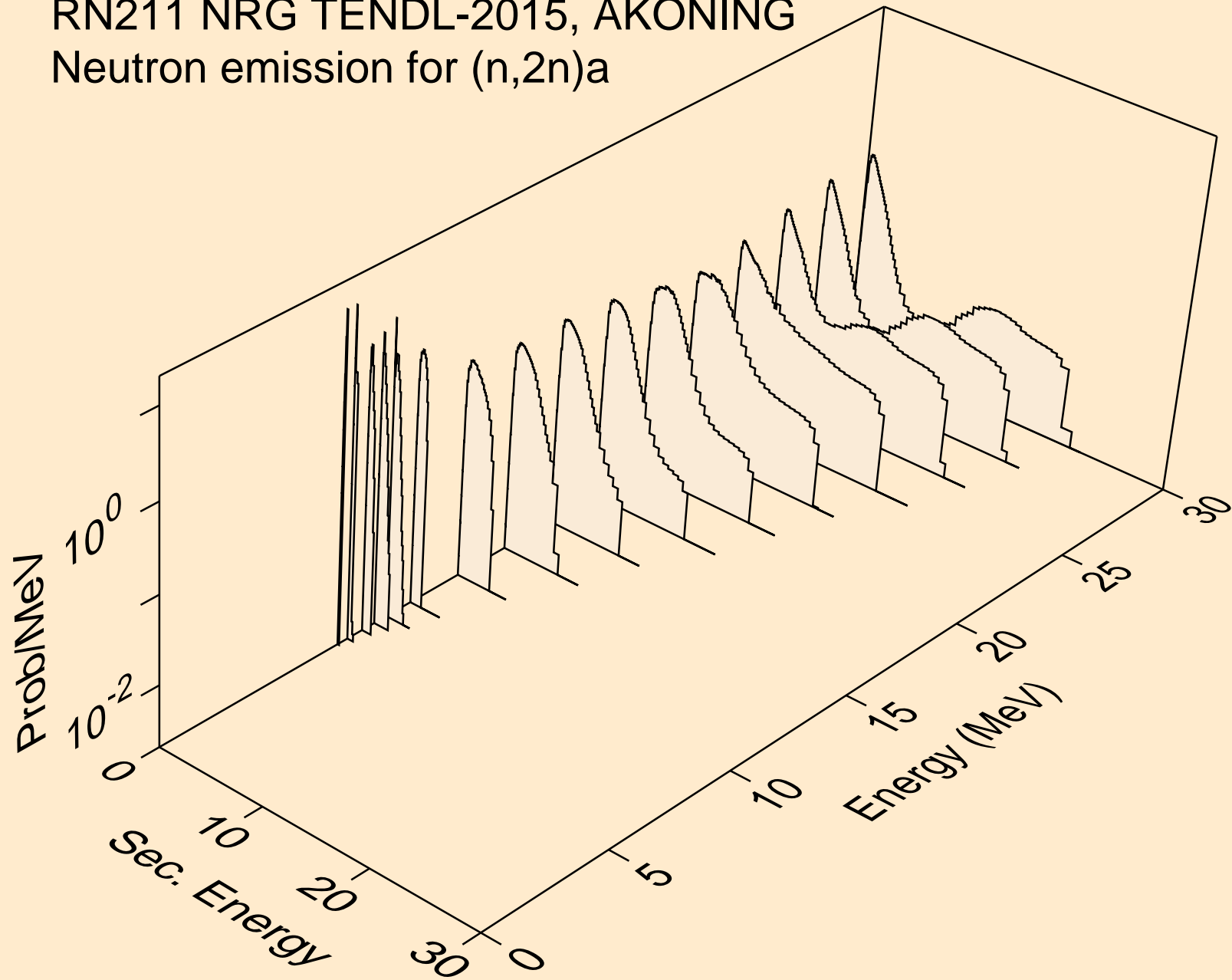

RN211 NRG TENDL-2015, AKONING
Neutron emission for (n,3n)a

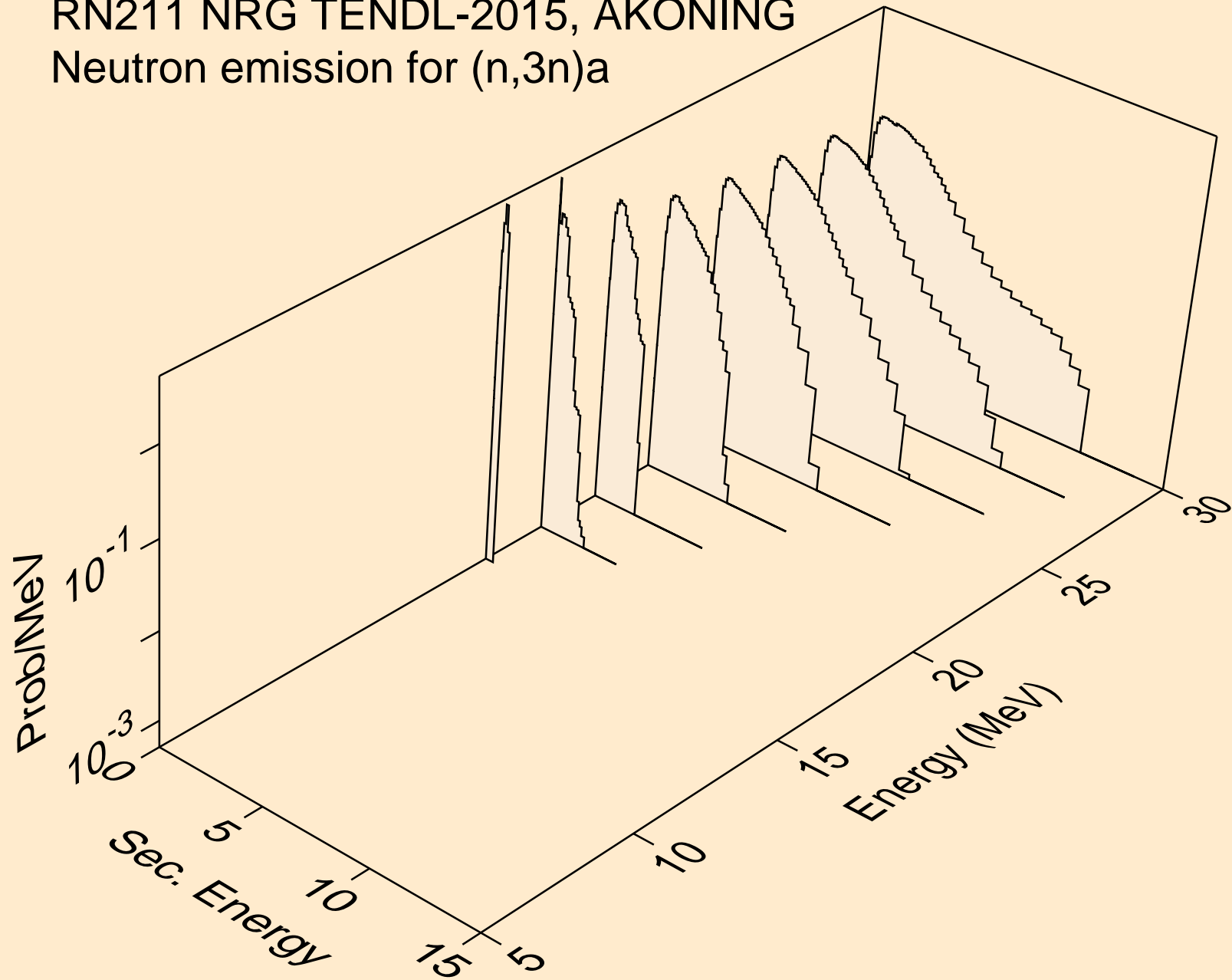

RN211 NRG TENDL-2015, AKONING
Neutron emission for (n,n*)p

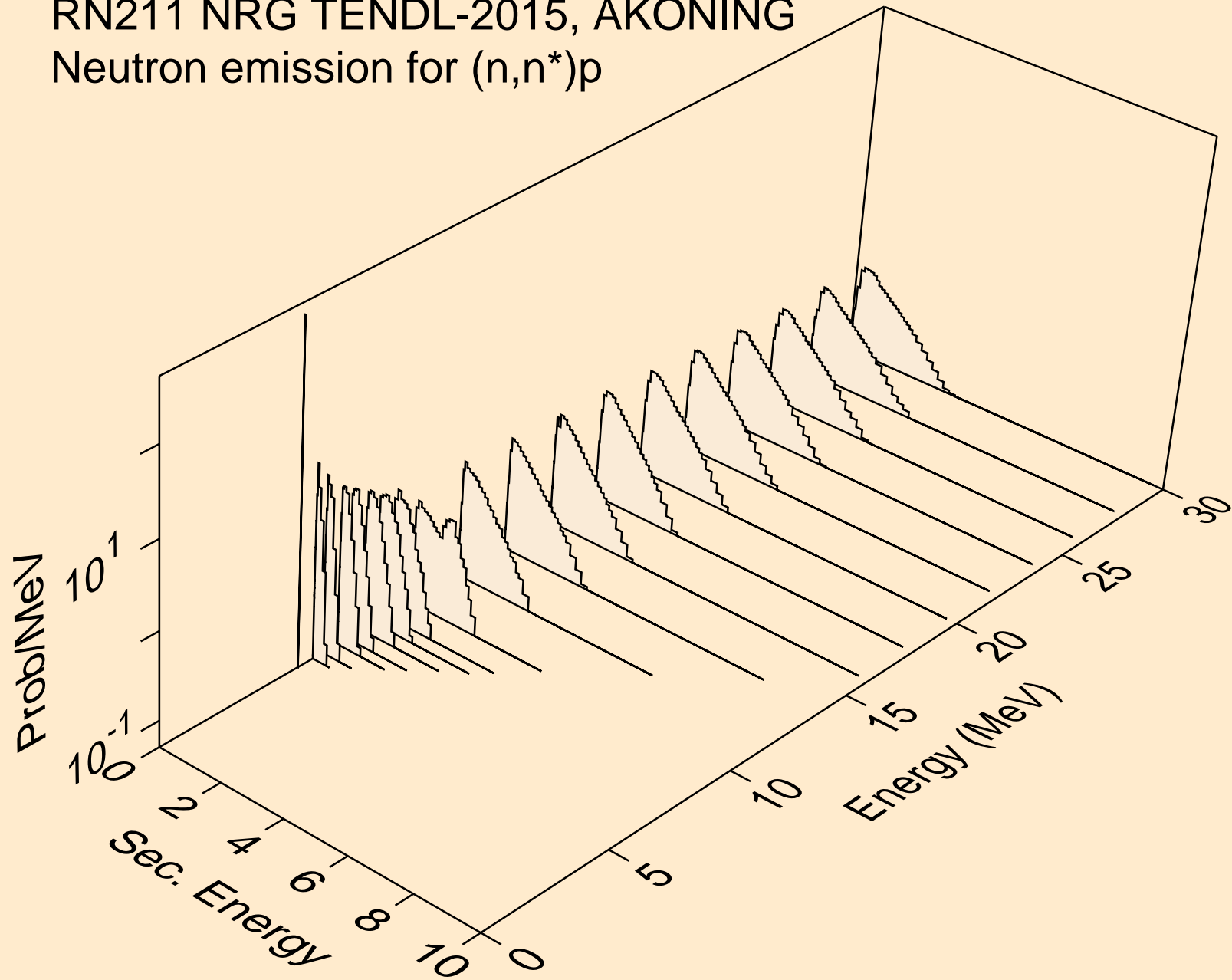

RN211 NRG TENDL-2015, AKONING
Neutron emission for (n,n*)2a

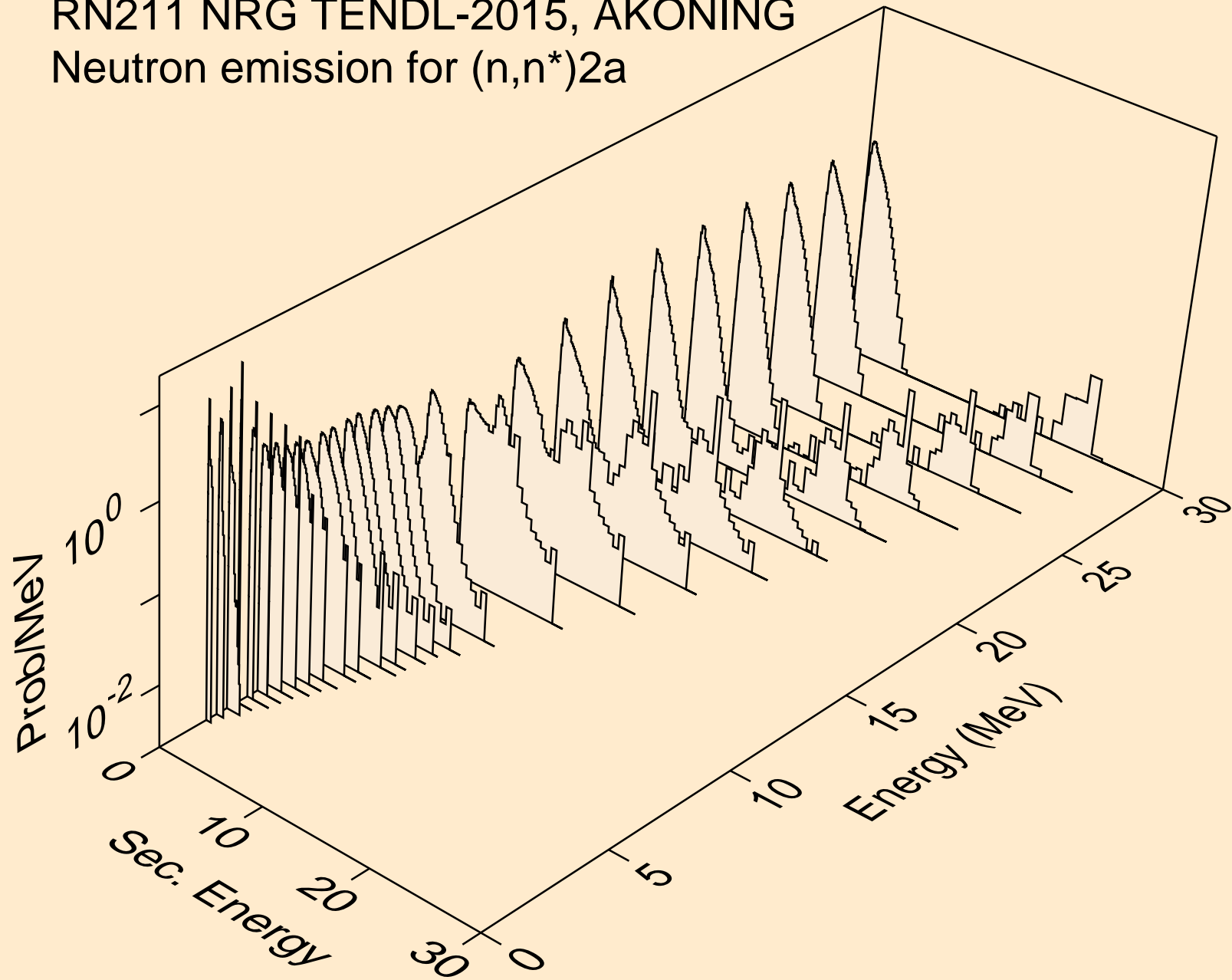

RN211 NRG TENDL-2015, AKONING
Neutron emission for (n,2n)2a

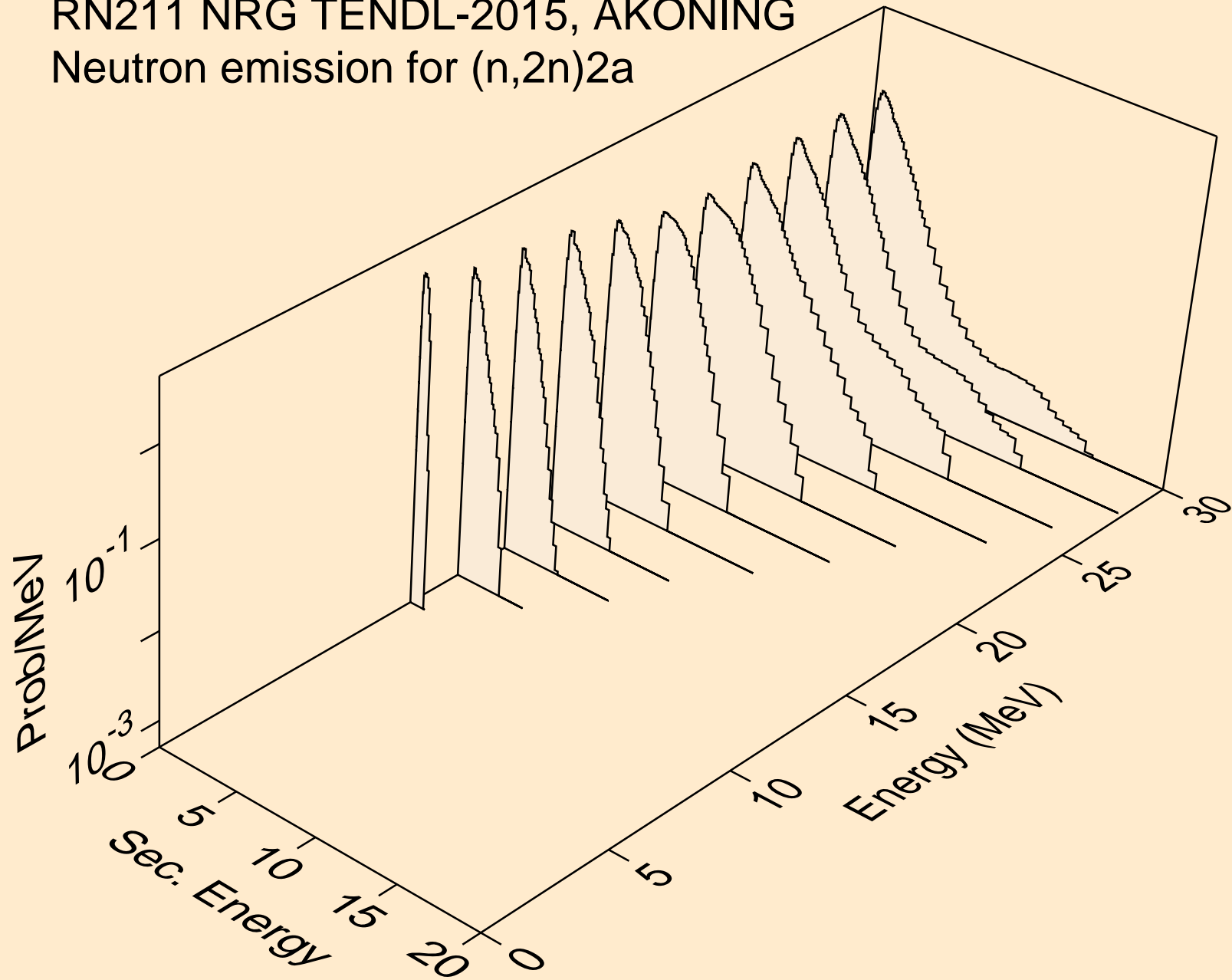

RN211 NRG TENDL-2015, AKONING
Neutron emission for (n,n*)d

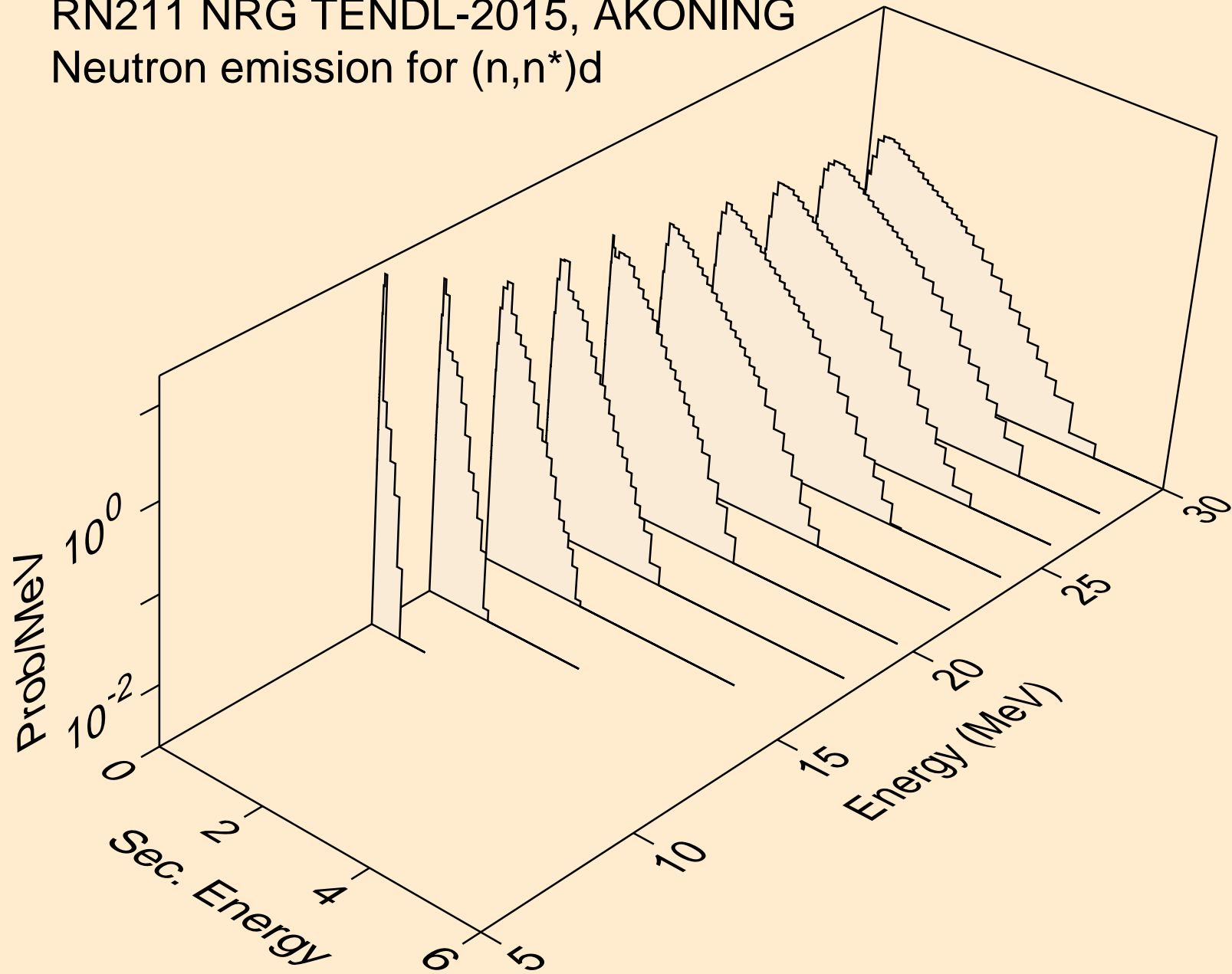

RN211 NRG TENDL-2015, AKONING
Neutron emission for (n,n*)t

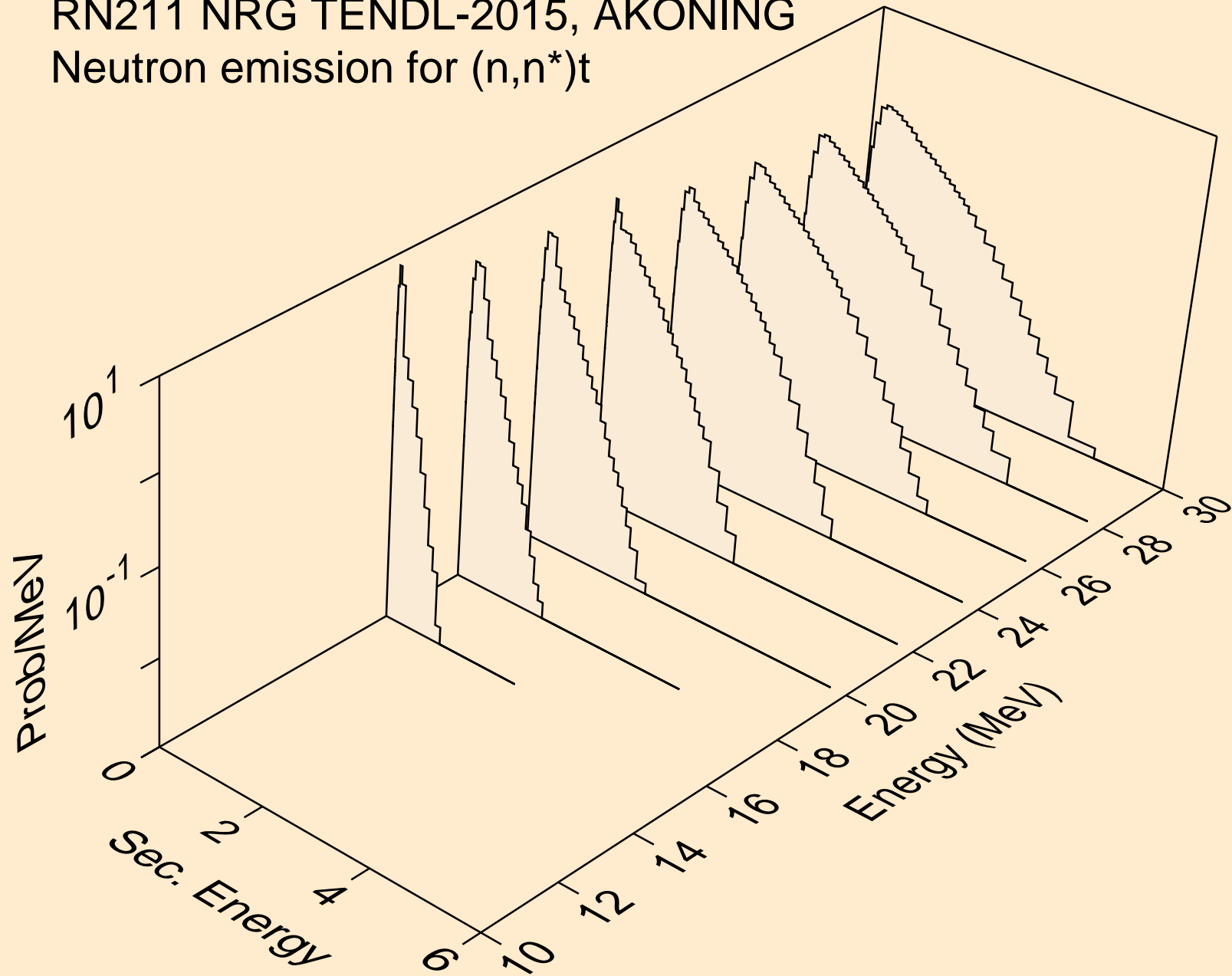

RN211 NRG TENDL-2015, AKONING
Neutron emission for (n,n*)he3

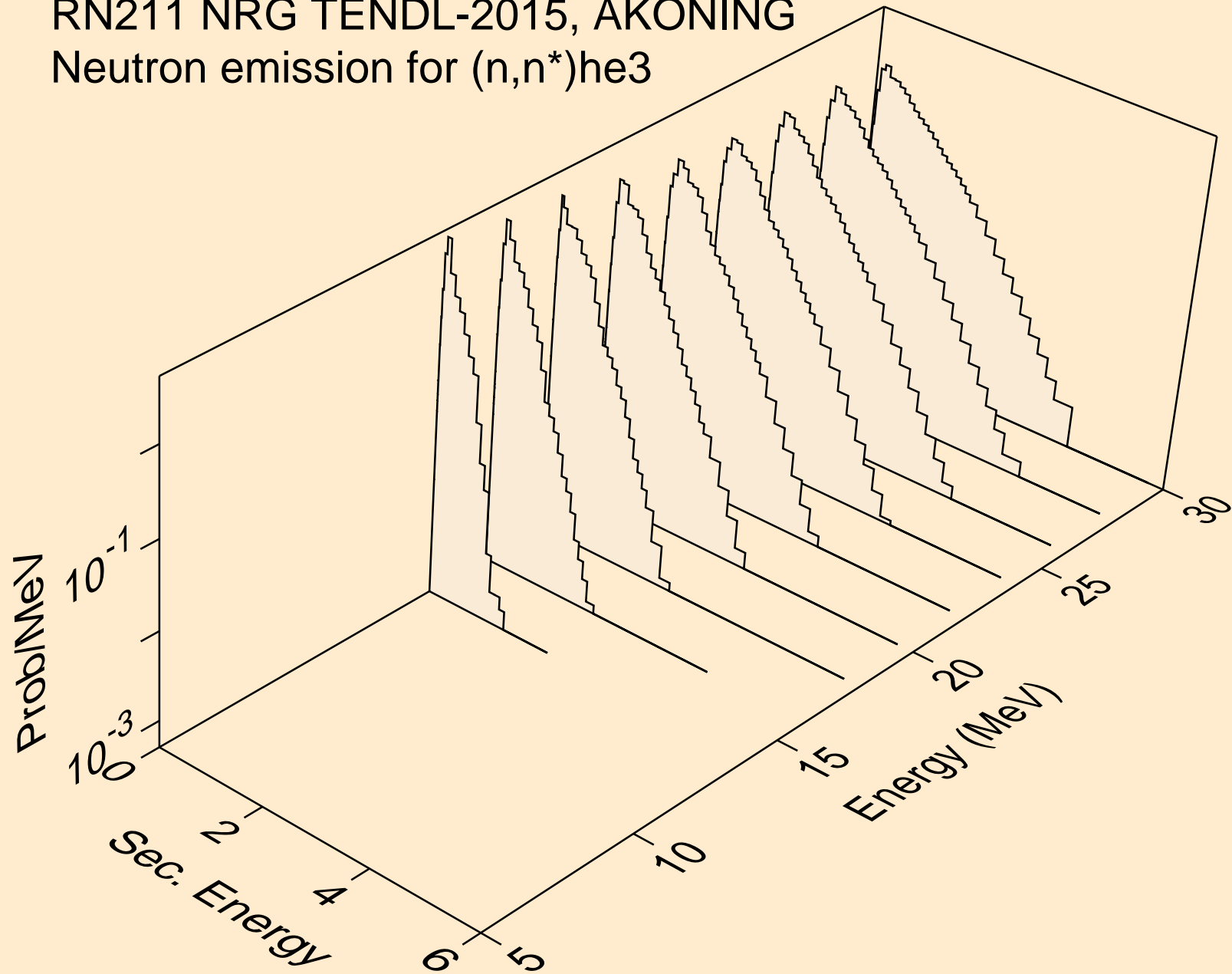

RN211 NRG TENDL-2015, AKONING
Neutron emission for (n,4n)

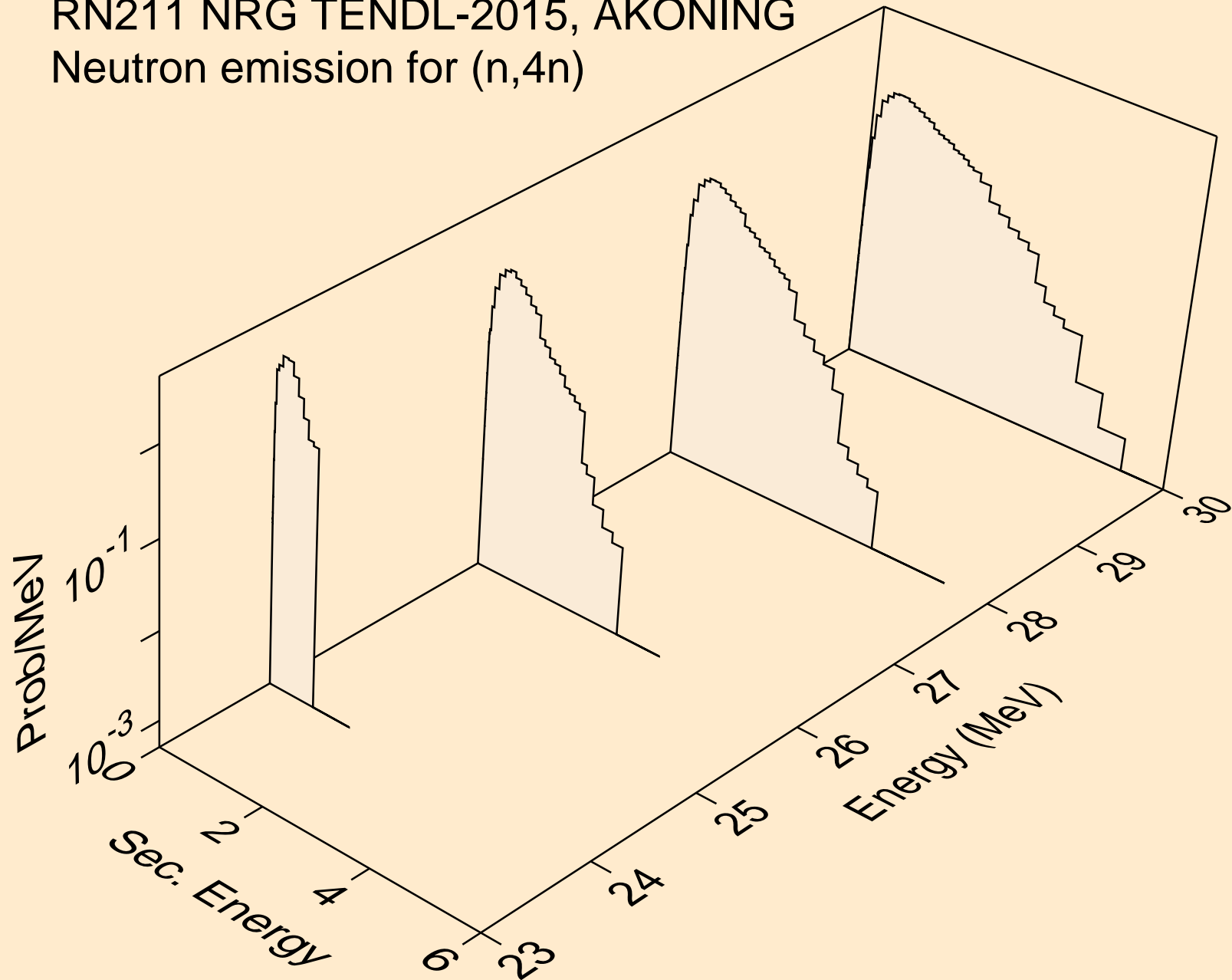

RN211 NRG TENDL-2015, AKONING
Neutron emission for (n,2np)

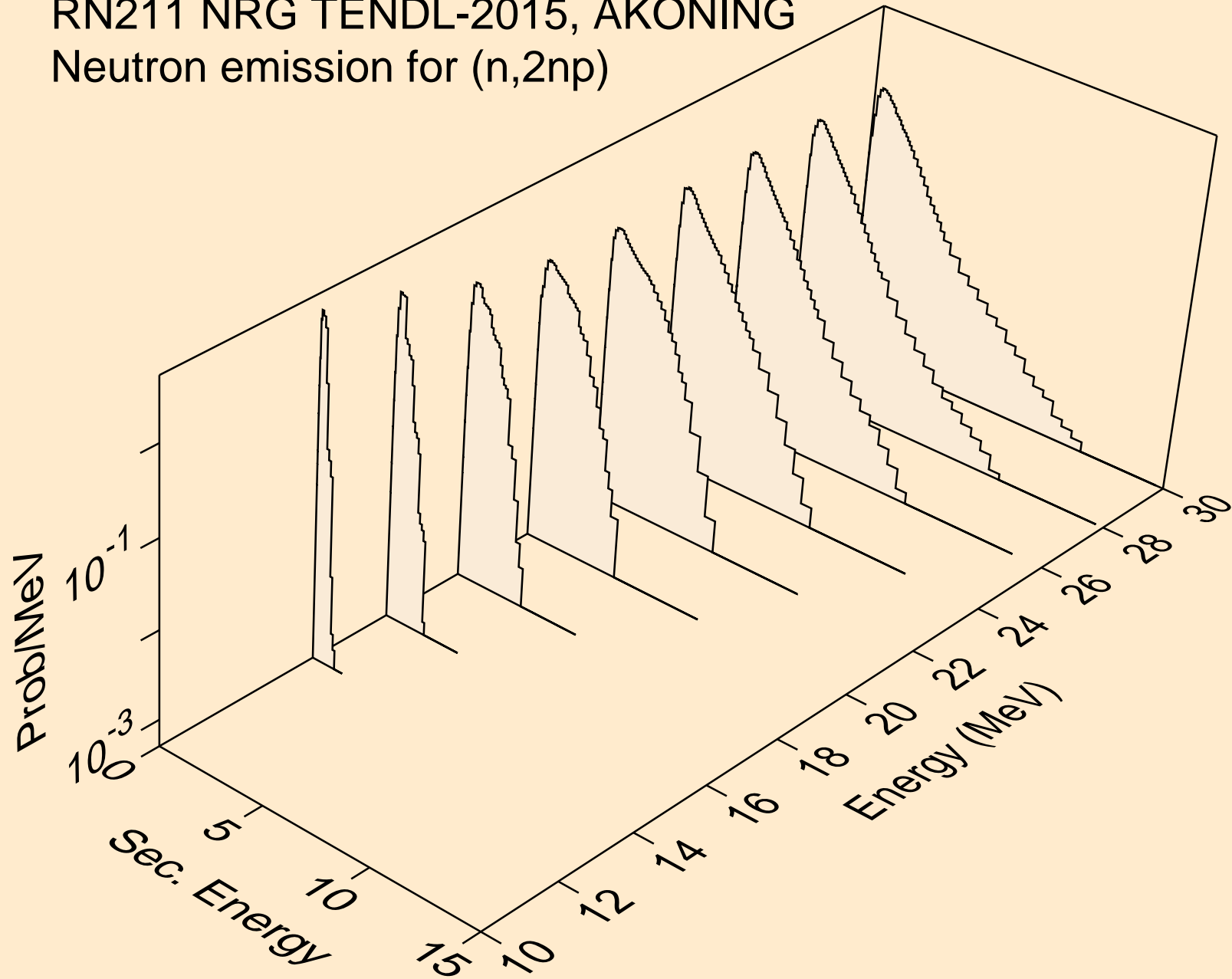

RN211 NRG TENDL-2015, AKONING
Neutron emission for (n,3np)

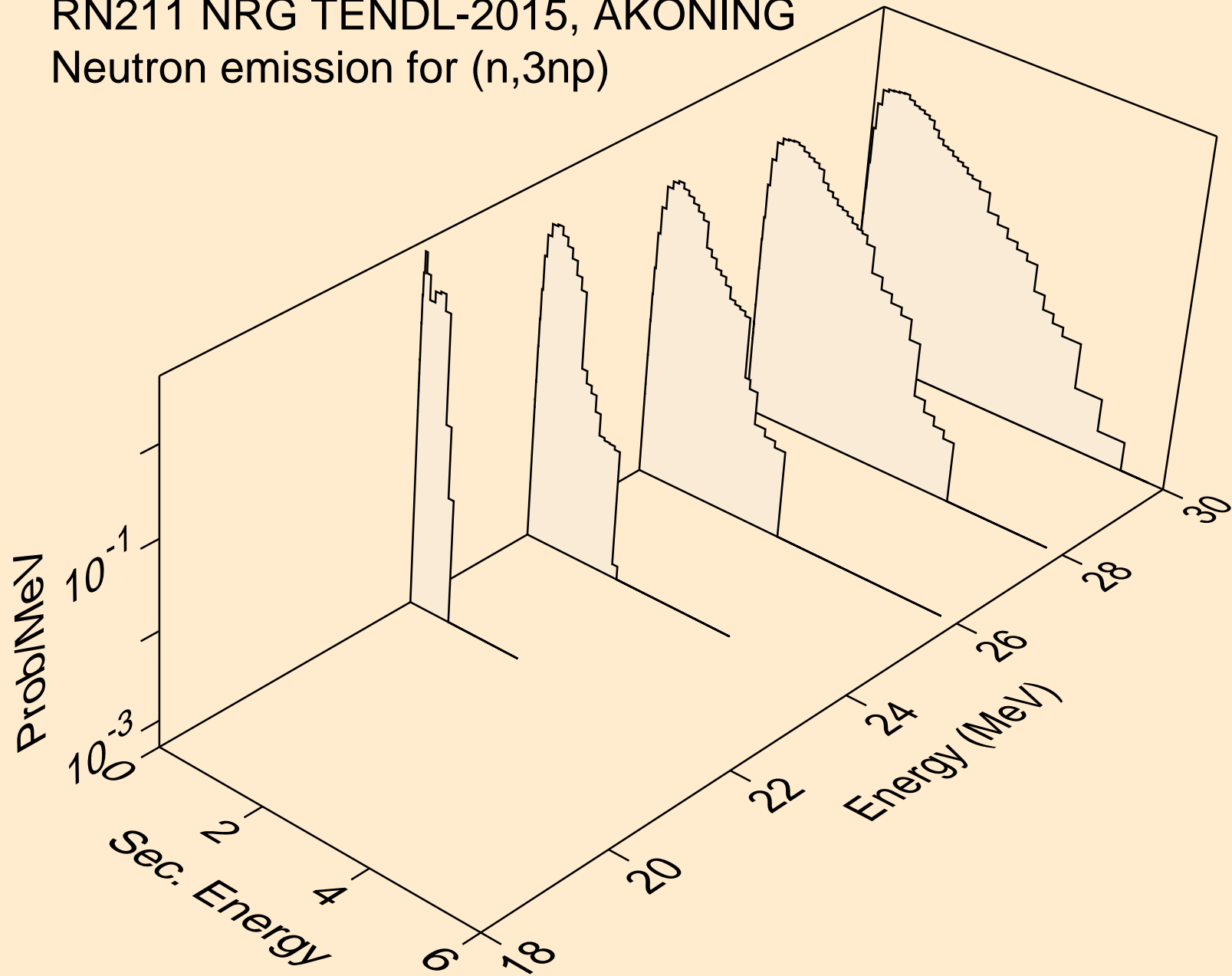

RN211 NRG TENDL-2015, AKONING
Neutron emission for (n,2np)

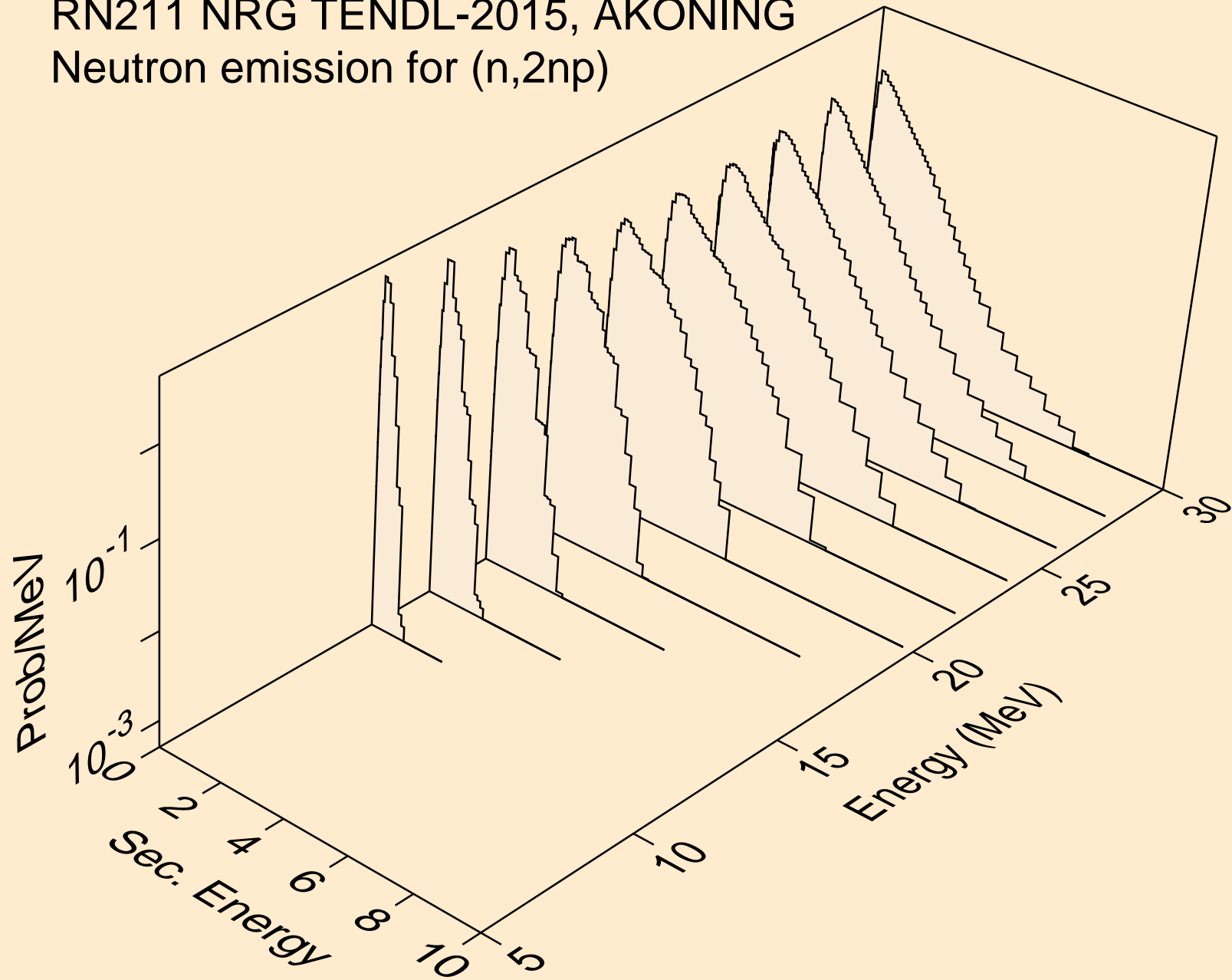

RN211 NRG TENDL-2015, AKONING
Neutron emission for (n,npa)

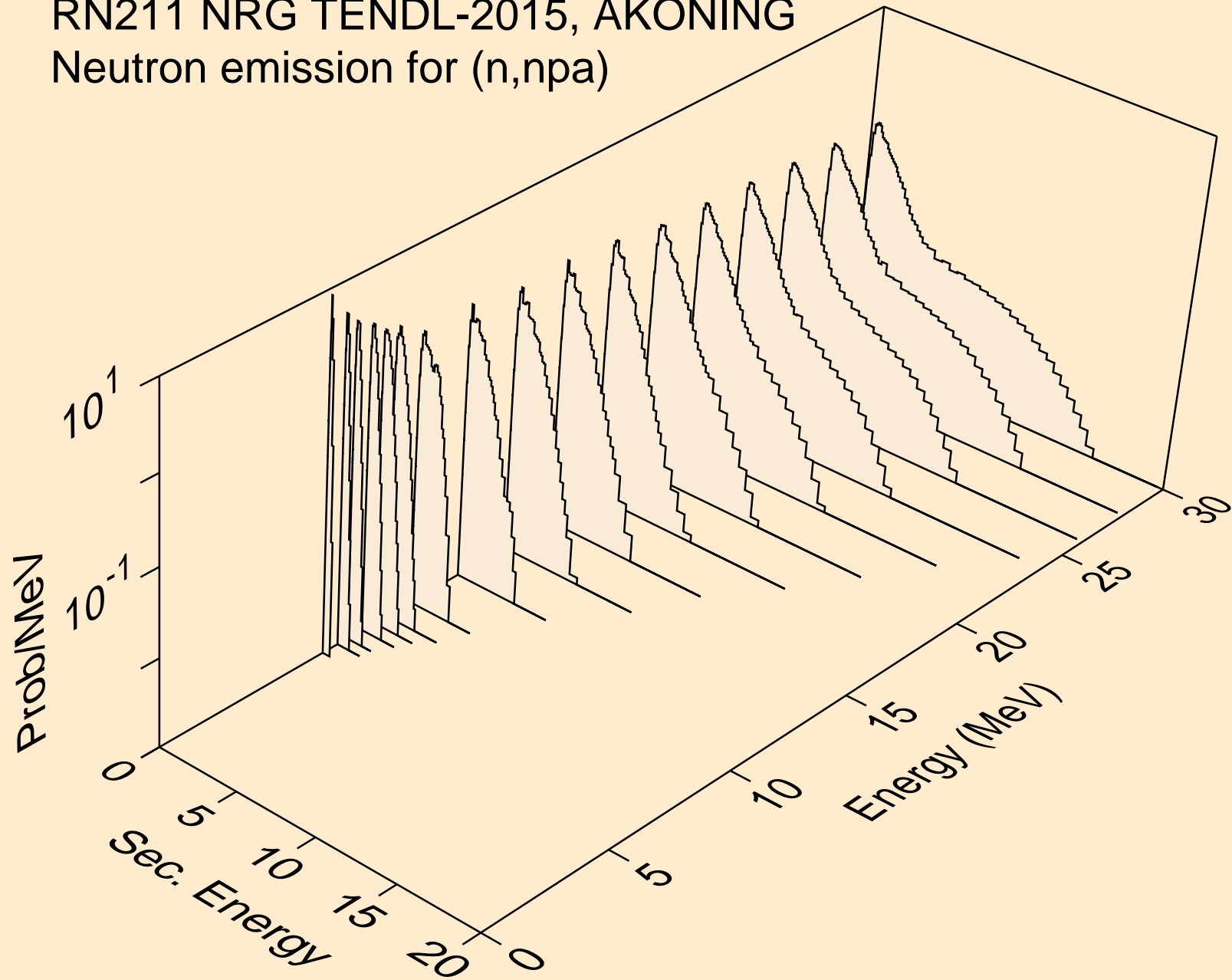

RN211 NRG TENDL-2015, AKONING
Neutron emission for (n,n*c)

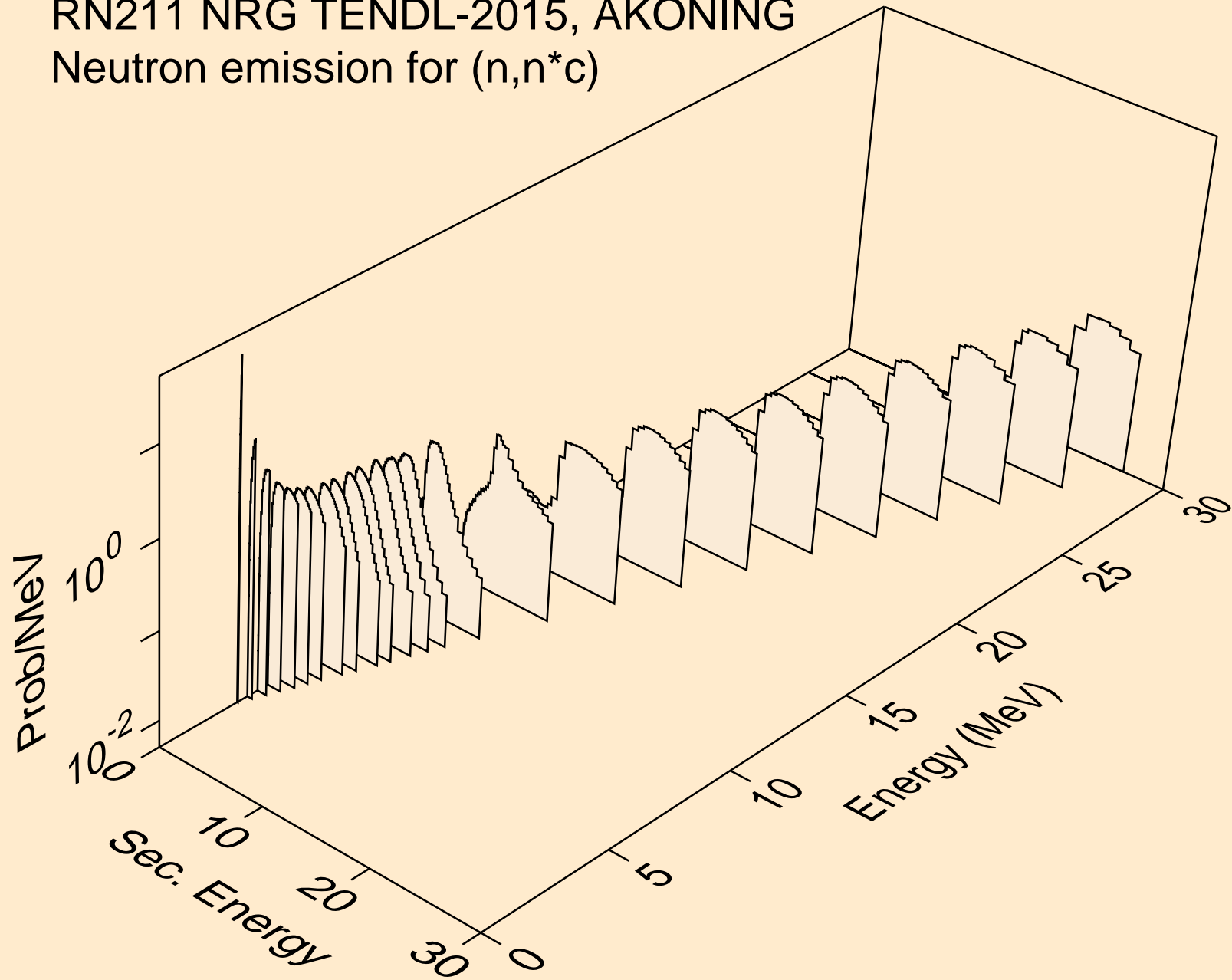

RN211 NRG TENDL-2015, AKONING
Photon emission for (n,x)

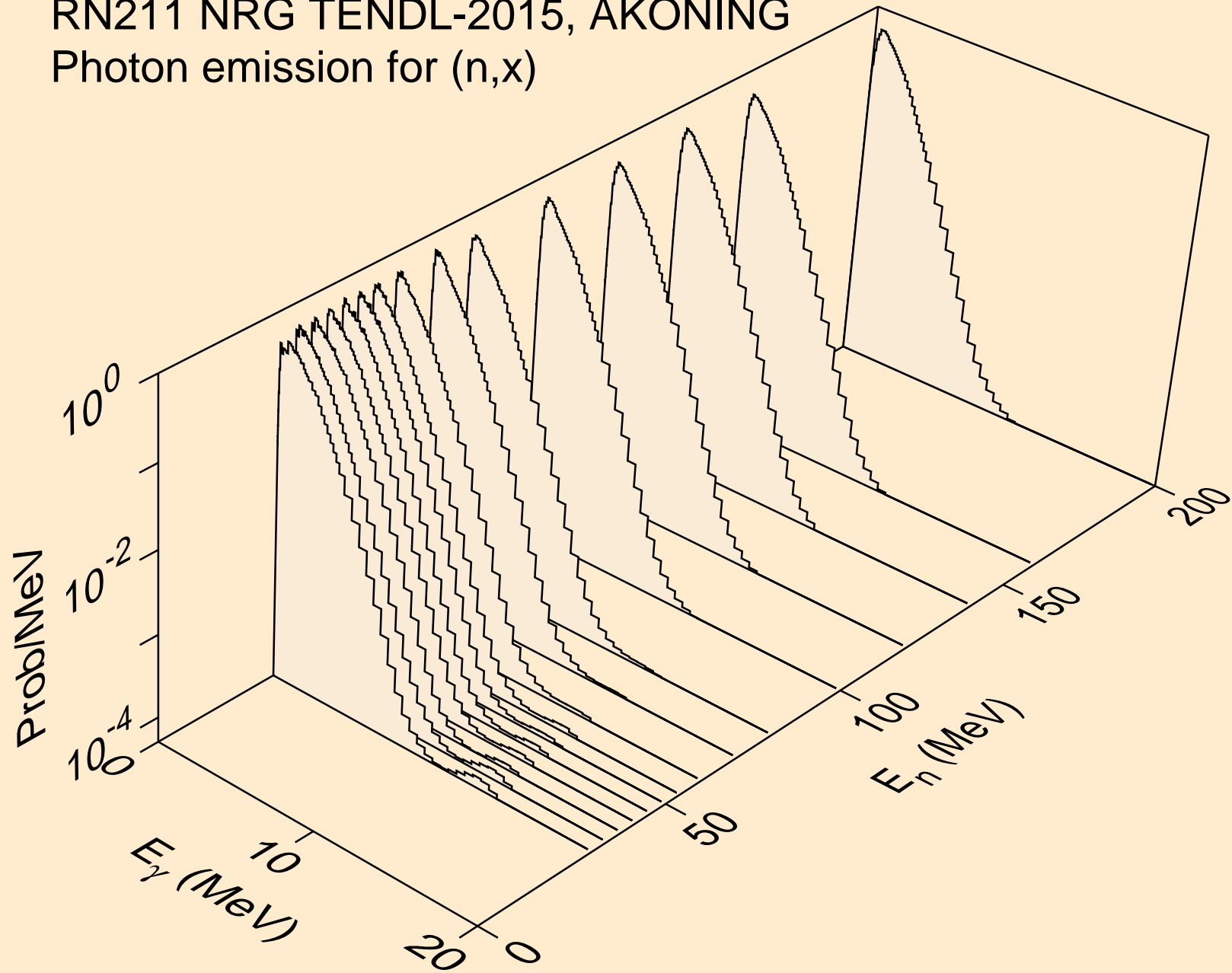

RN211 NRG TENDL-2015, AKONING
Photon emission for (n,2nd)

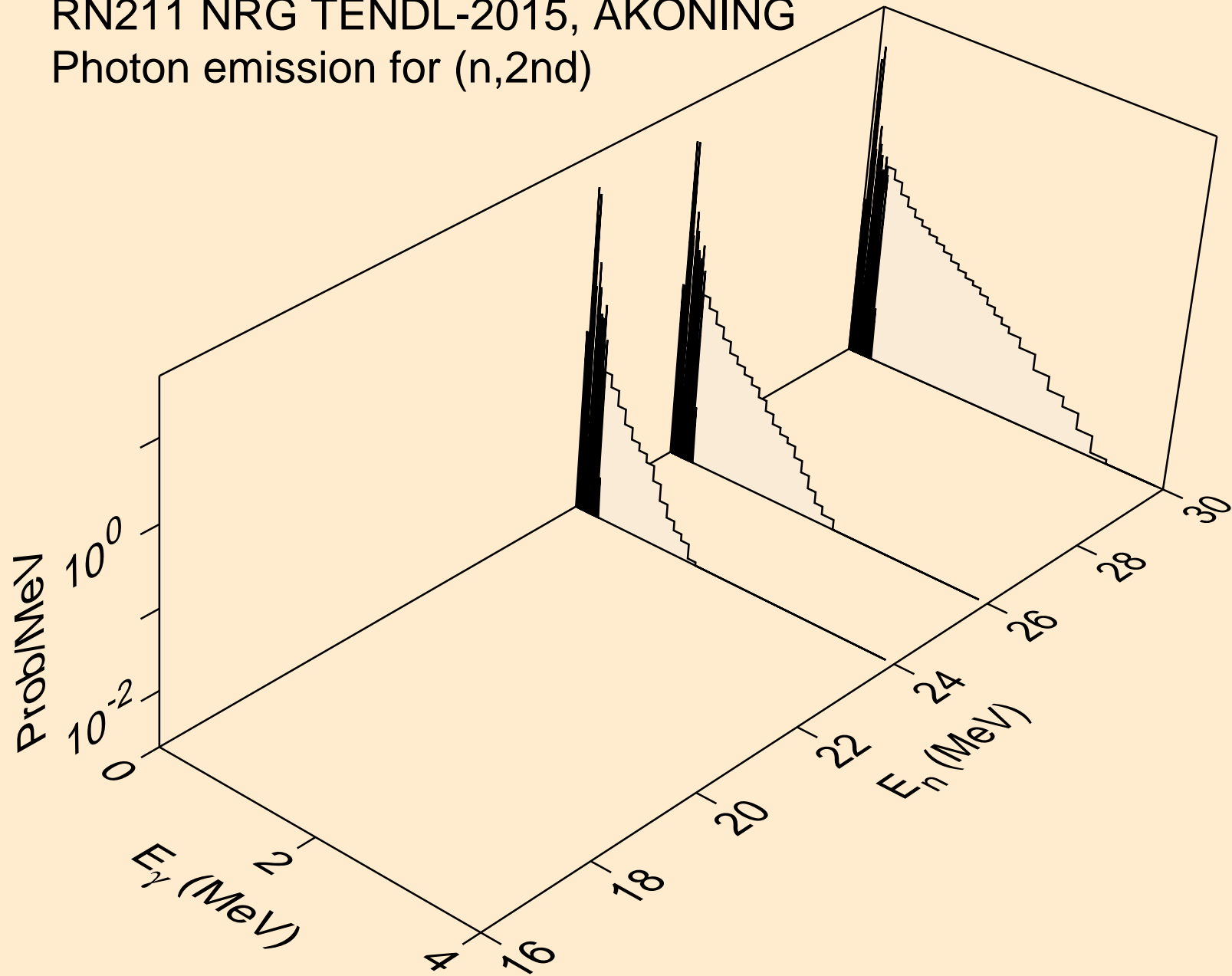

RN211 NRG TENDL-2015, AKONING
Photon emission for (n,2n)

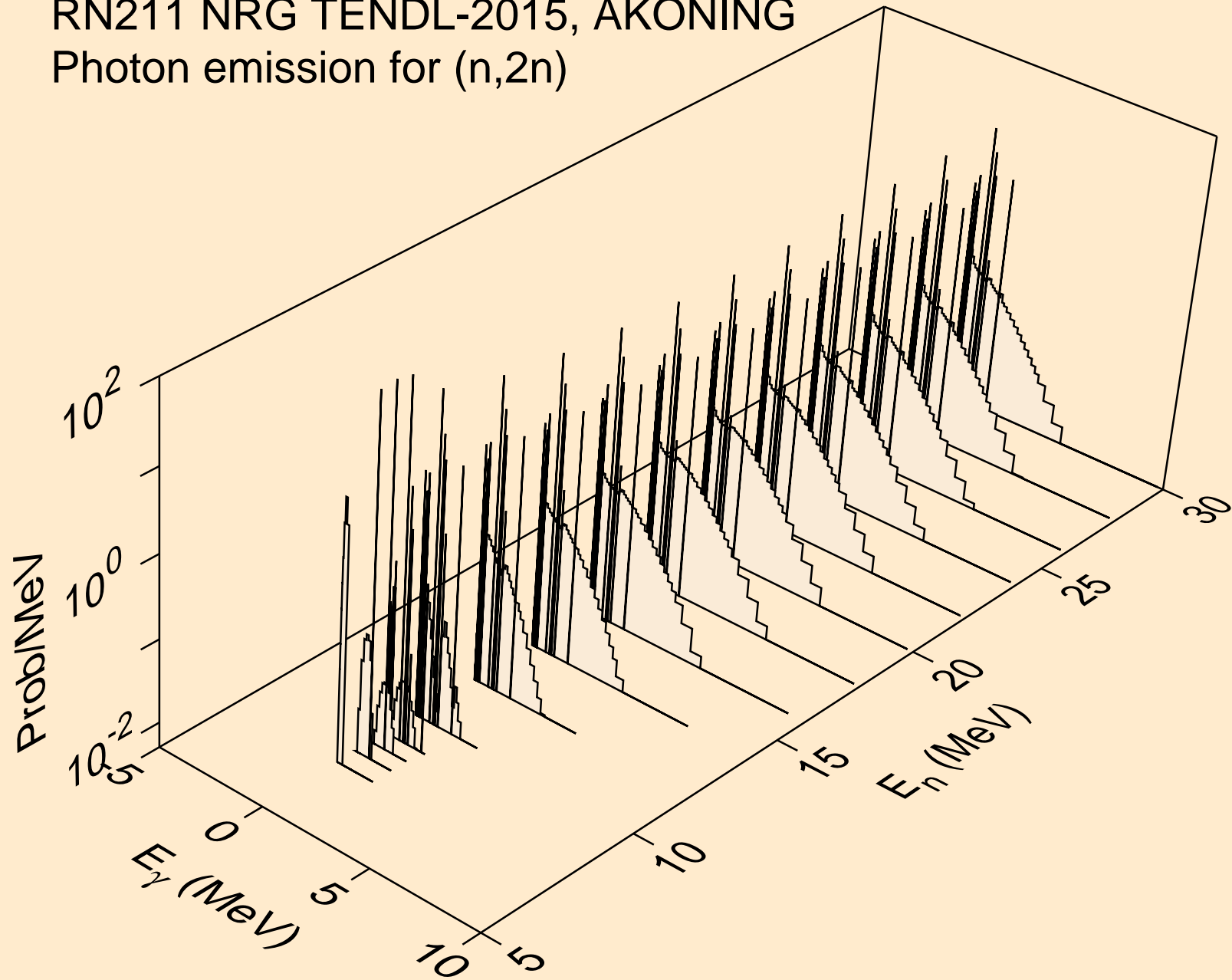

RN211 NRG TENDL-2015, AKONING
Photon emission for (n,3n)

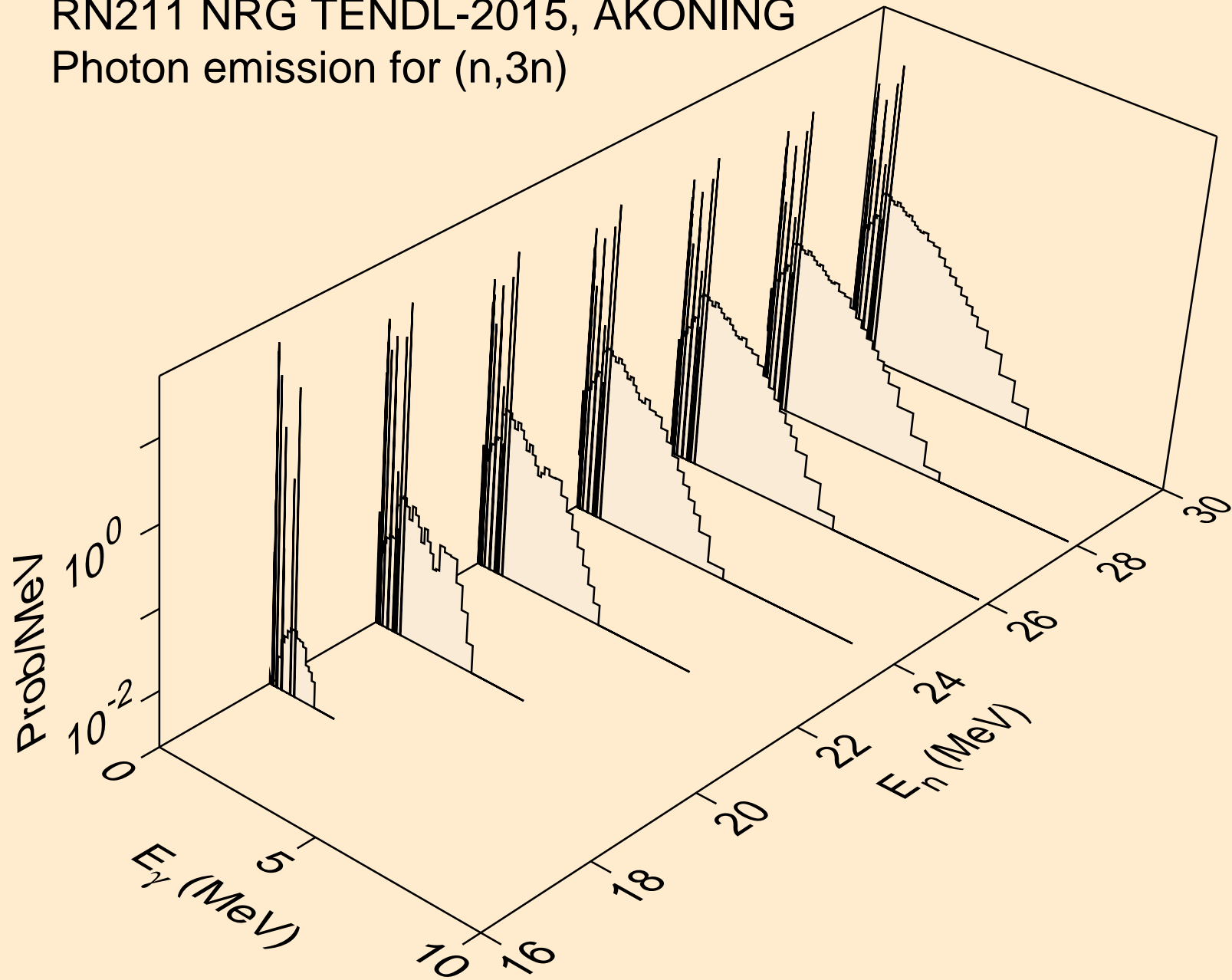

RN211 NRG TENDL-2015, AKONING
Photon emission for (n,n*)a

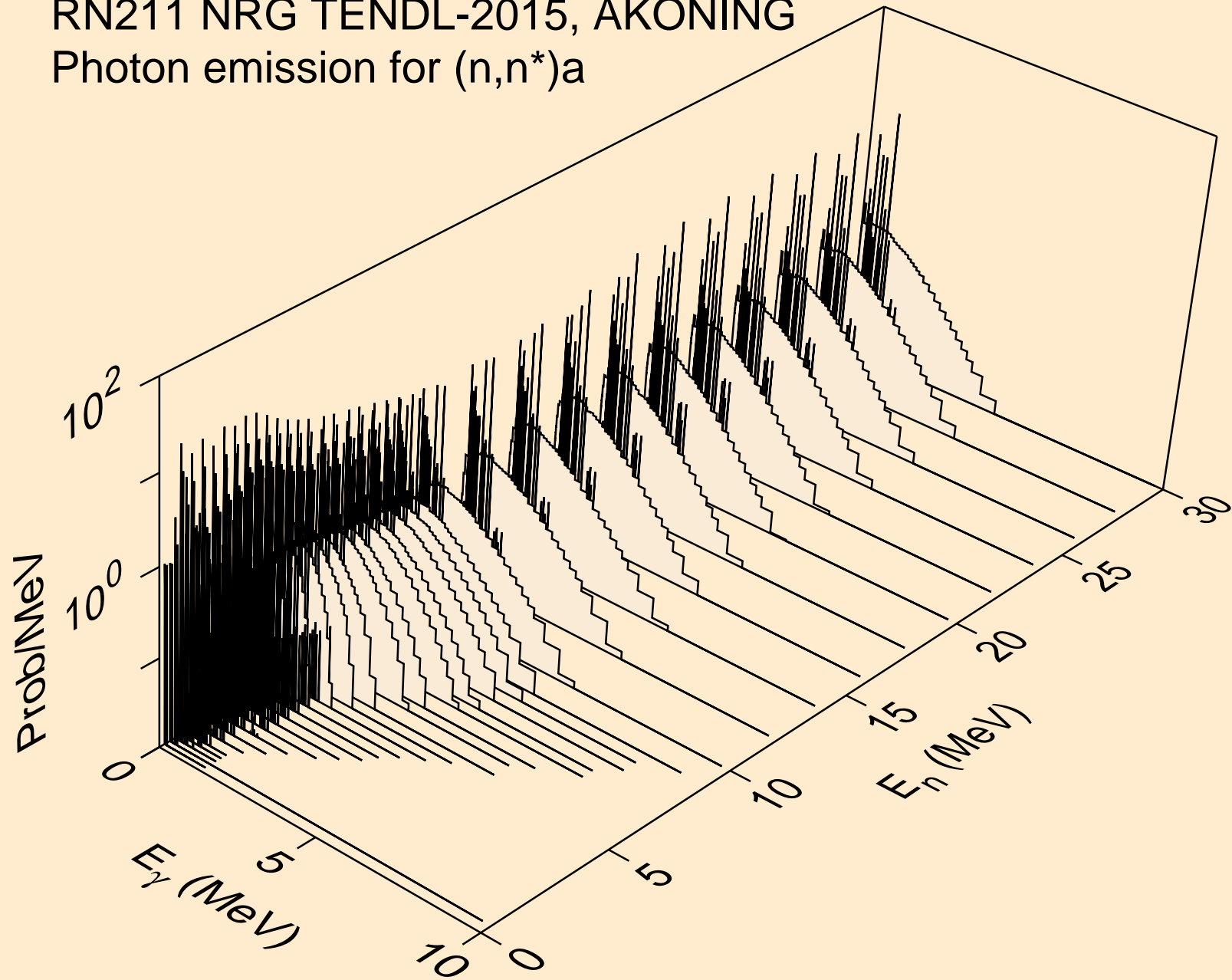

RN211 NRG TENDL-2015, AKONING
Photon emission for (n,2n)a

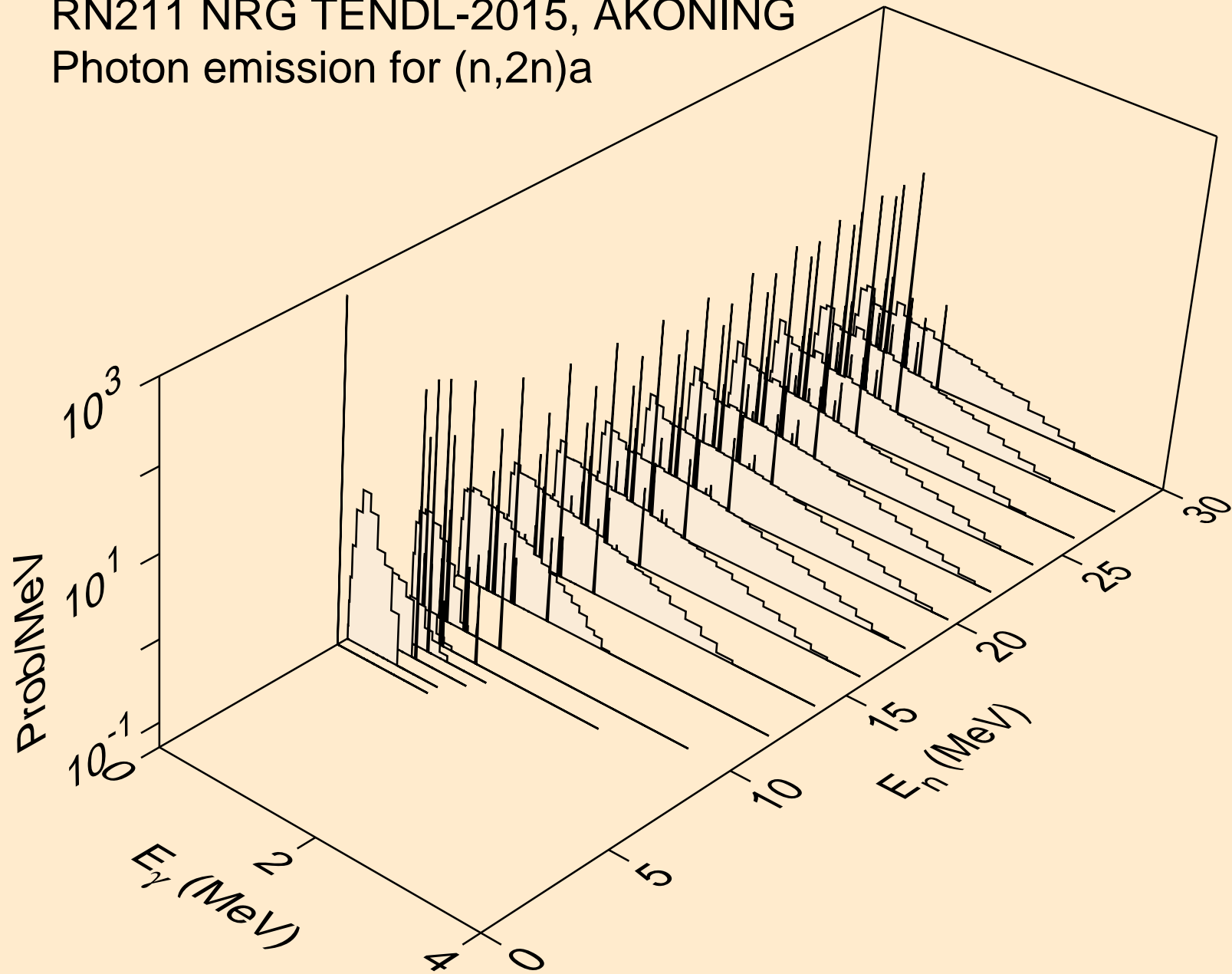

RN211 NRG TENDL-2015, AKONING
Photon emission for (n,3n)a

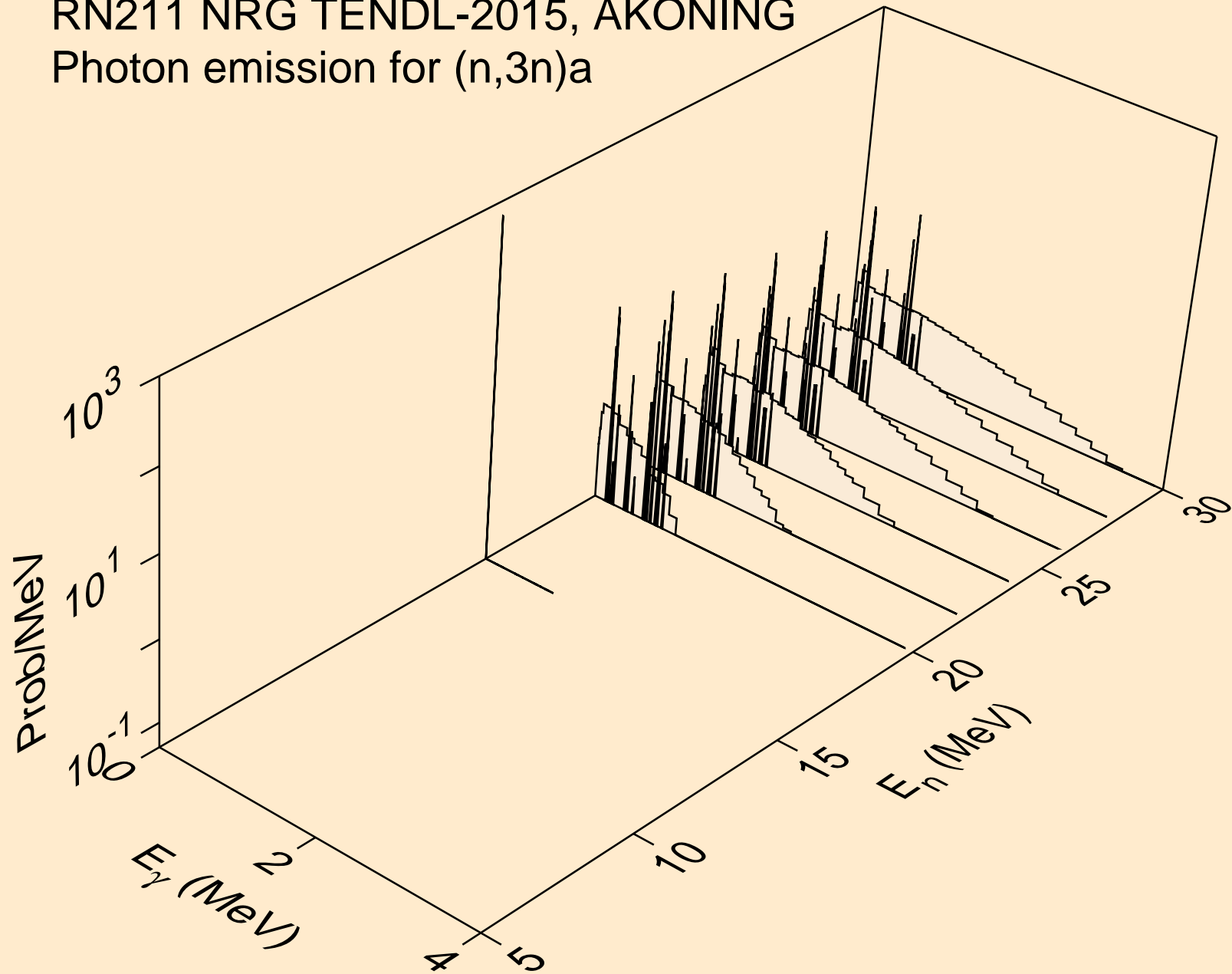

RN211 NRG TENDL-2015, AKONING
Photon emission for (n,n*)p

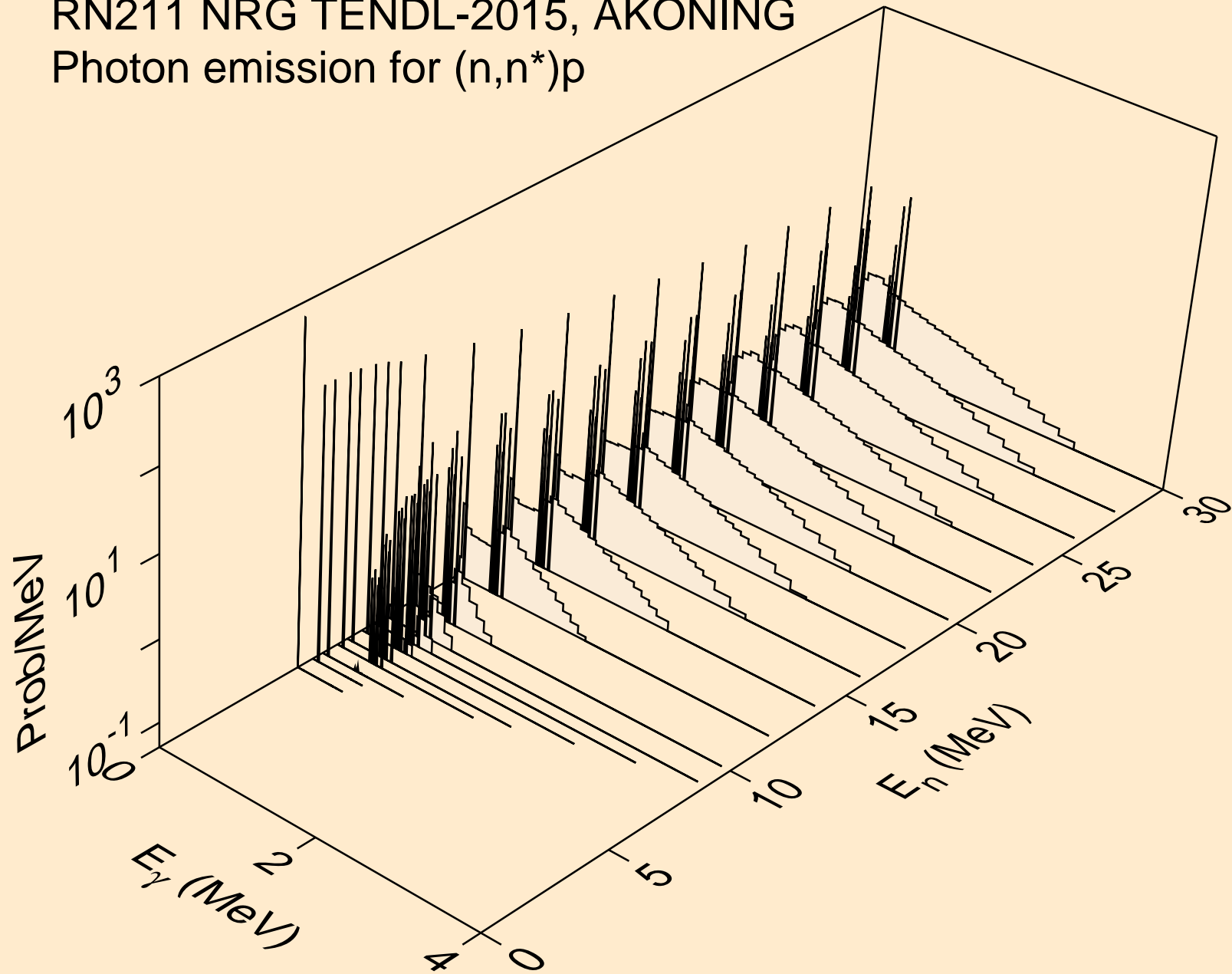

RN211 NRG TENDL-2015, AKONING
Photon emission for (n,n*)2a

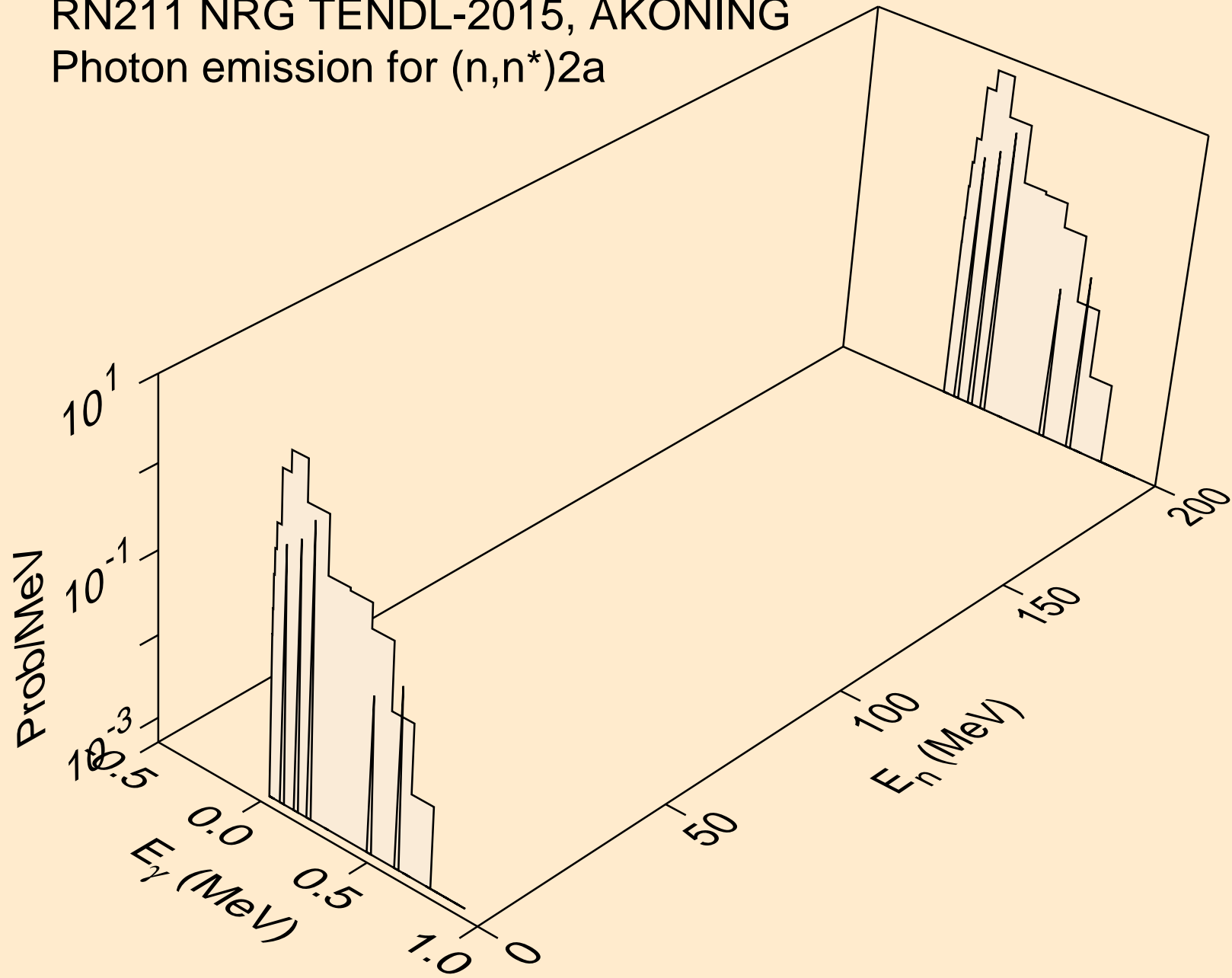

RN211 NRG TENDL-2015, AKONING
Photon emission for (n,2n)2a

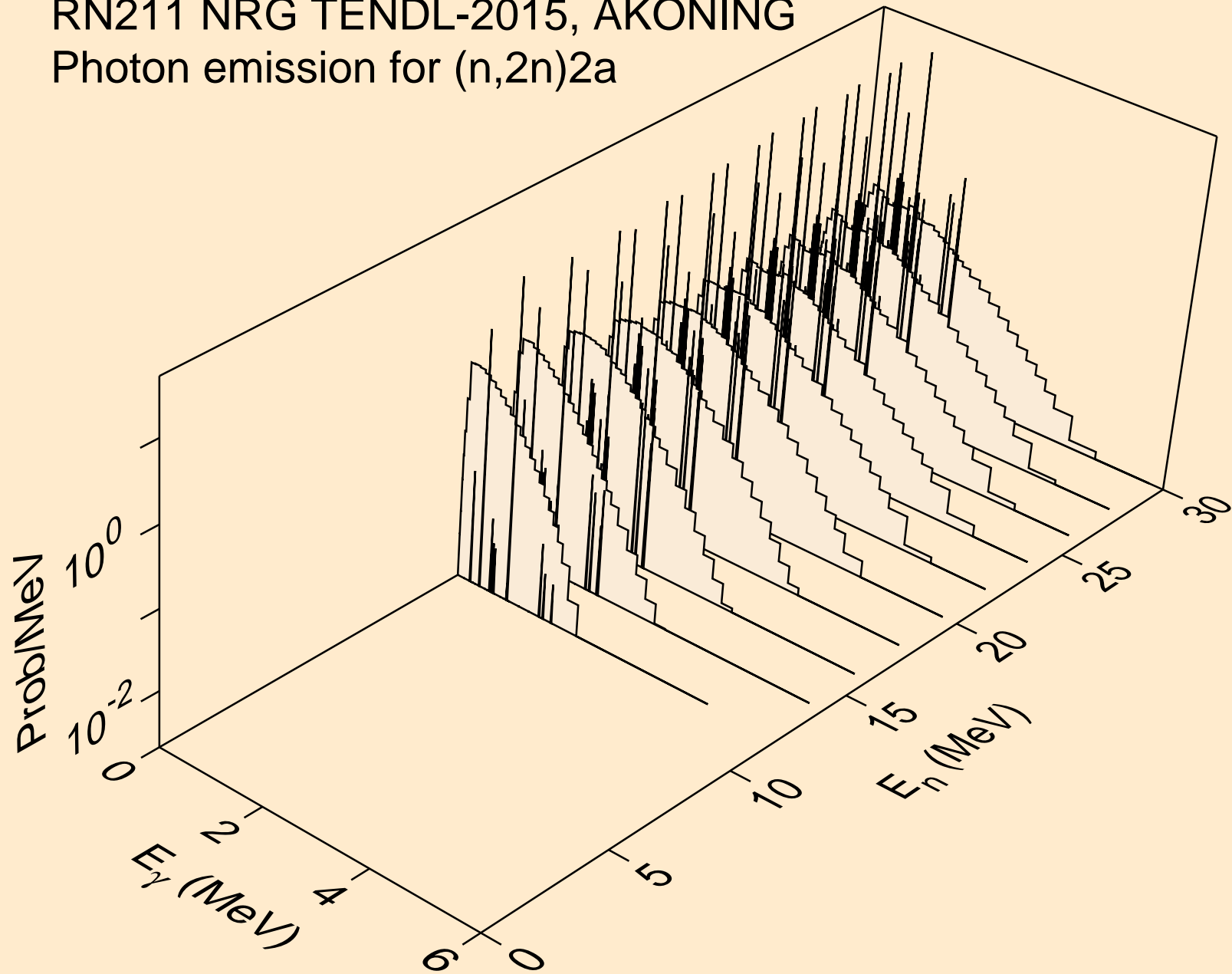

RN211 NRG TENDL-2015, AKONING
Photon emission for (n,n*)d

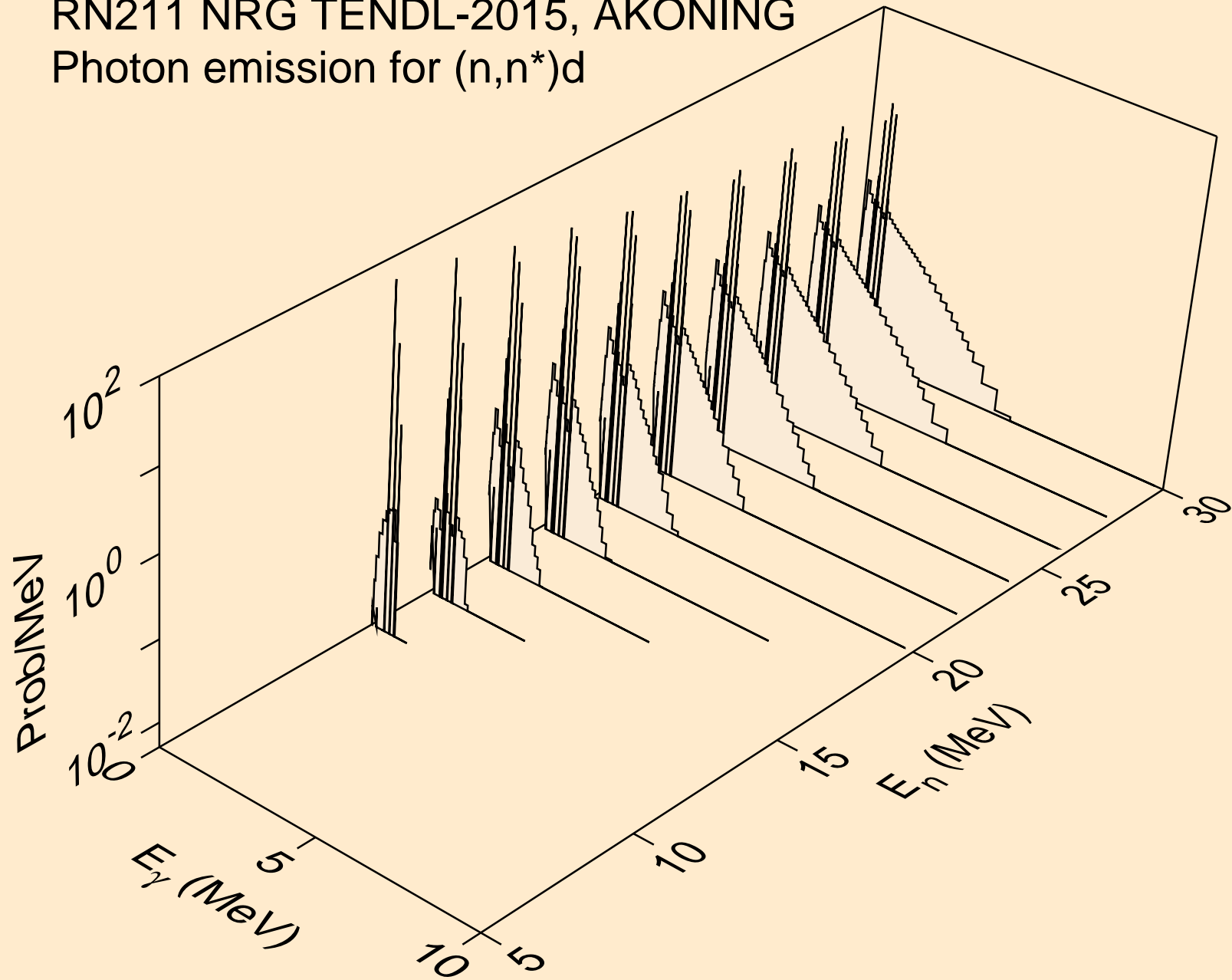

RN211 NRG TENDL-2015, AKONING
Photon emission for (n,n*)t

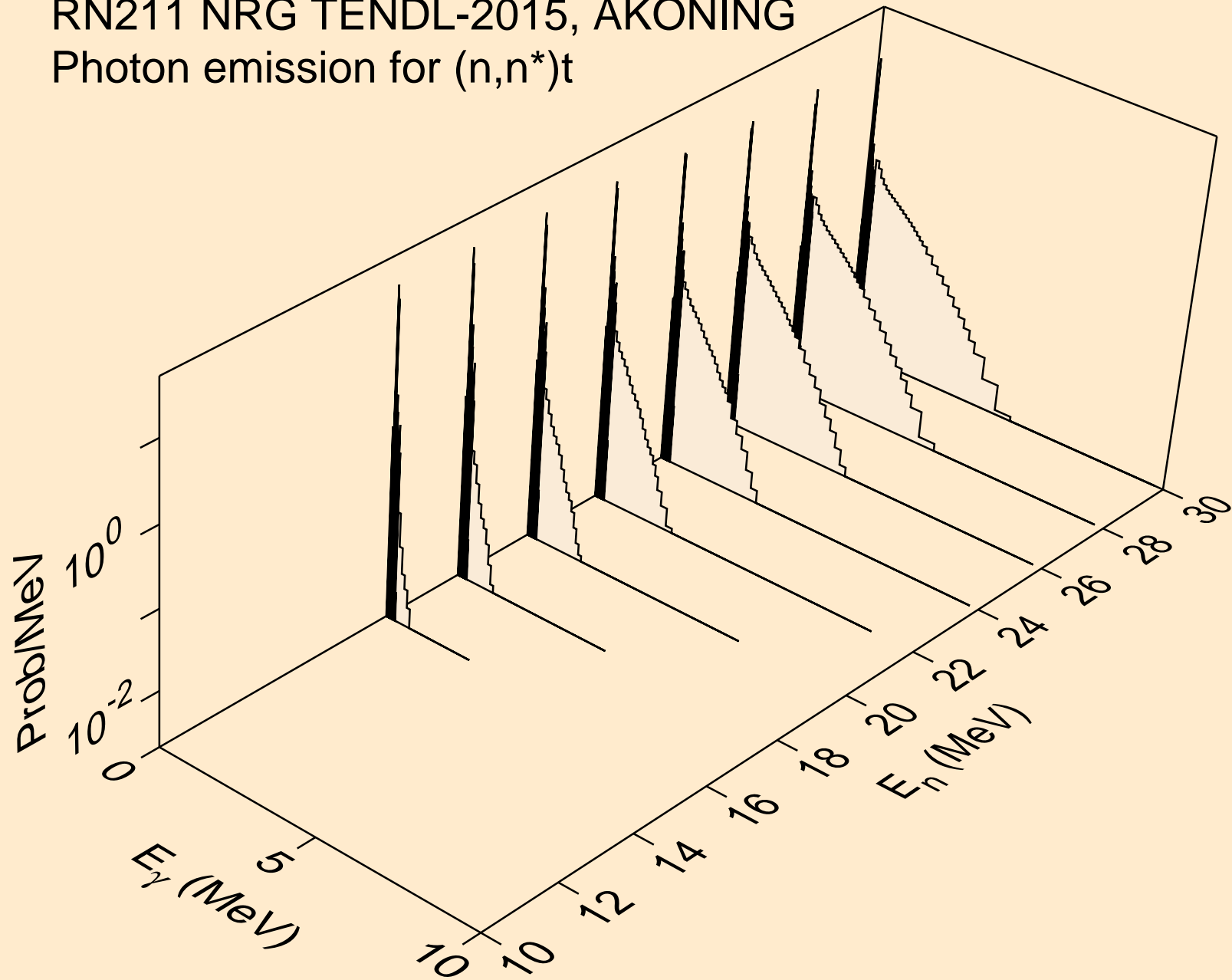

RN211 NRG TENDL-2015, AKONING
Photon emission for (n,n*)he3

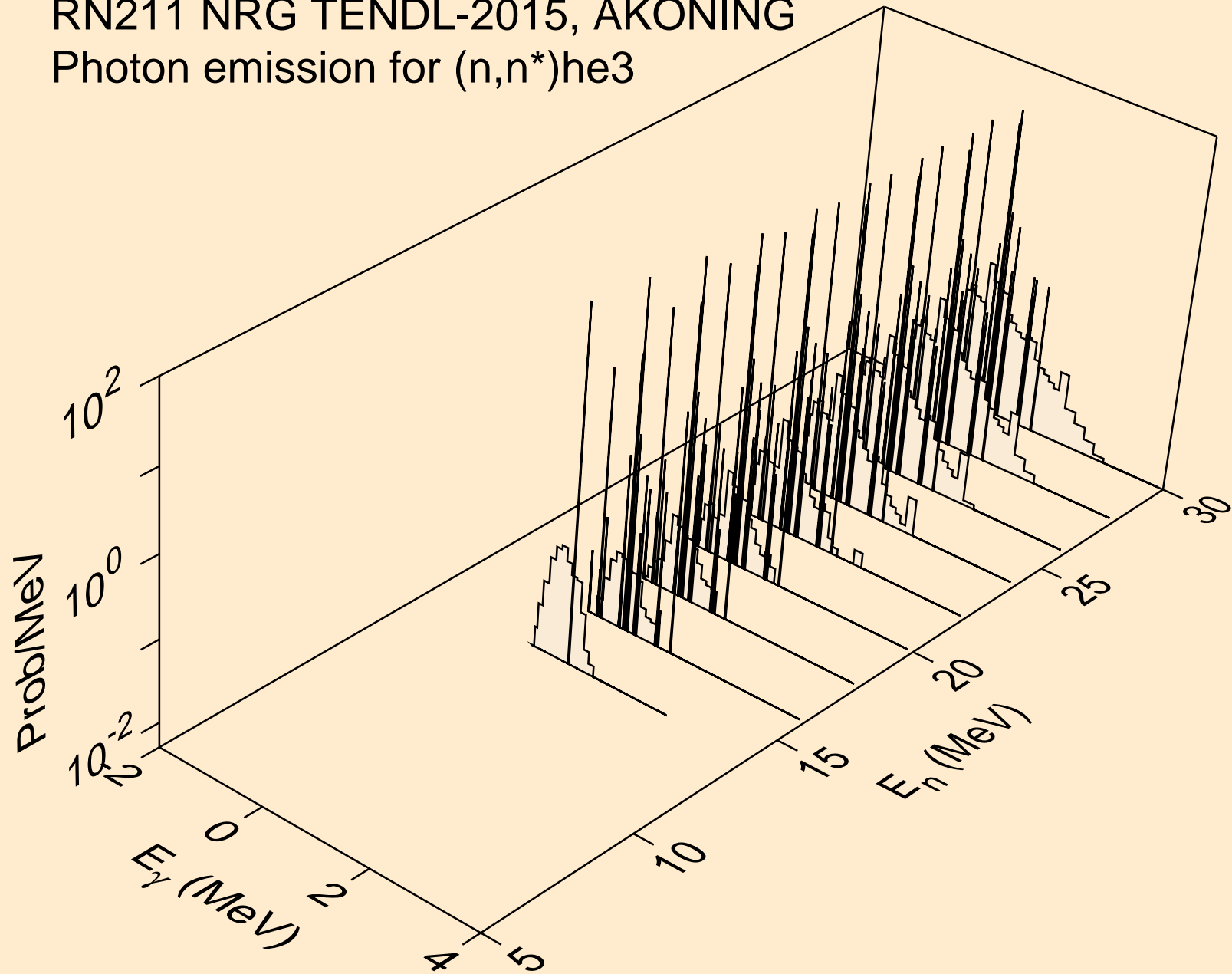

RN211 NRG TENDL-2015, AKONING
Photon emission for (n,4n)

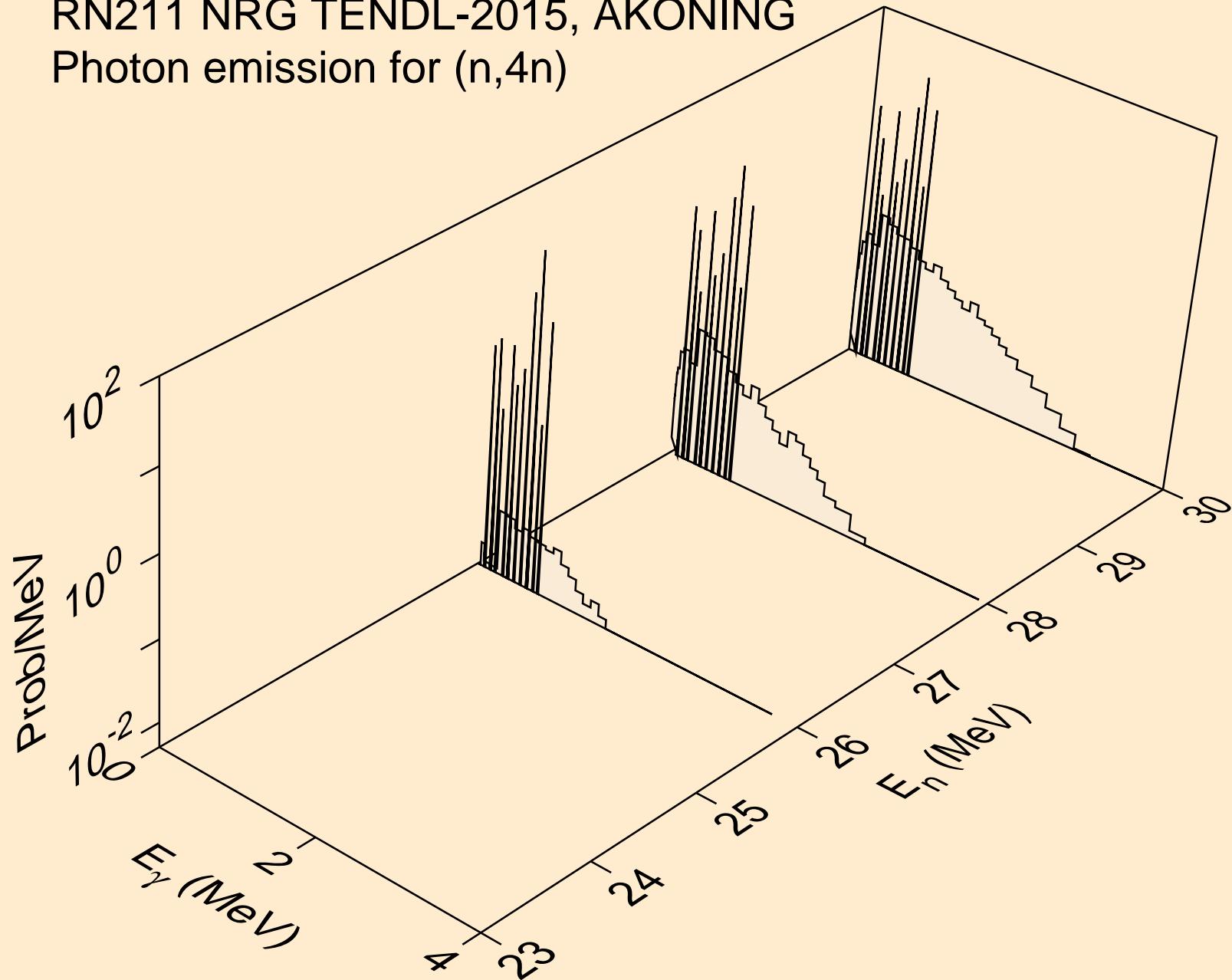

RN211 NRG TENDL-2015, AKONING
Photon emission for (n,2np)

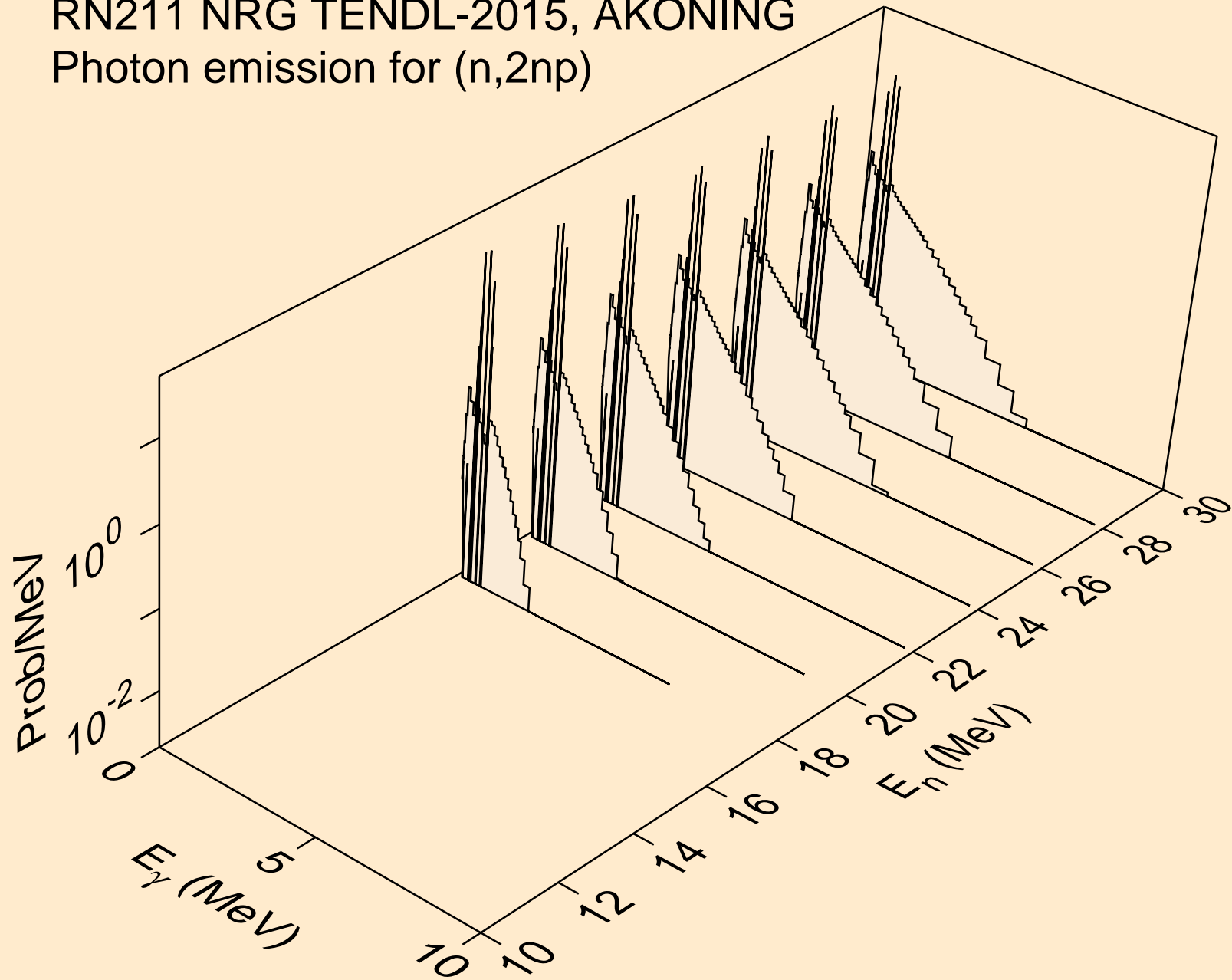

RN211 NRG TENDL-2015, AKONING
Photon emission for (n,3np)

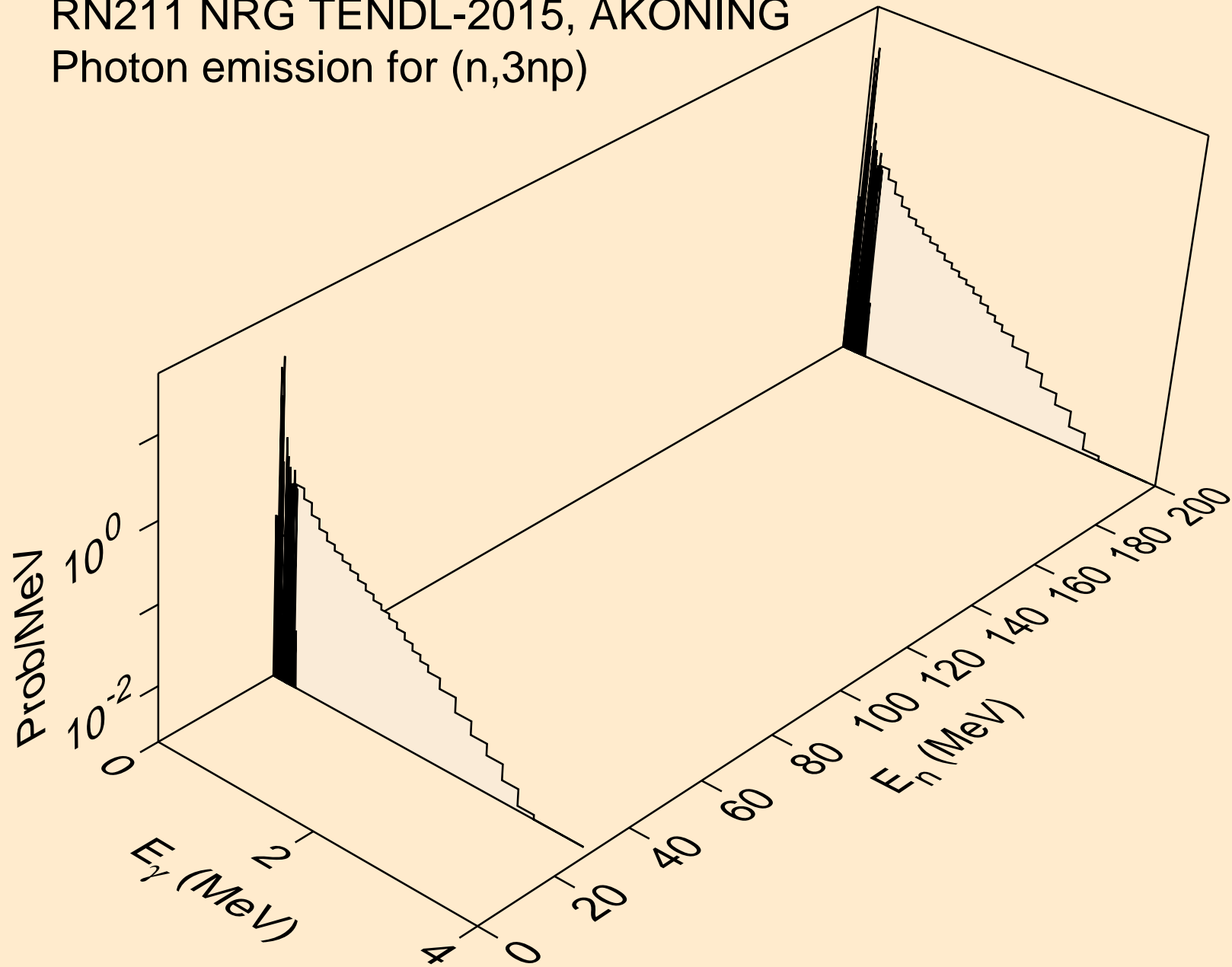

RN211 NRG TENDL-2015, AKONING
Photon emission for (n,2np)

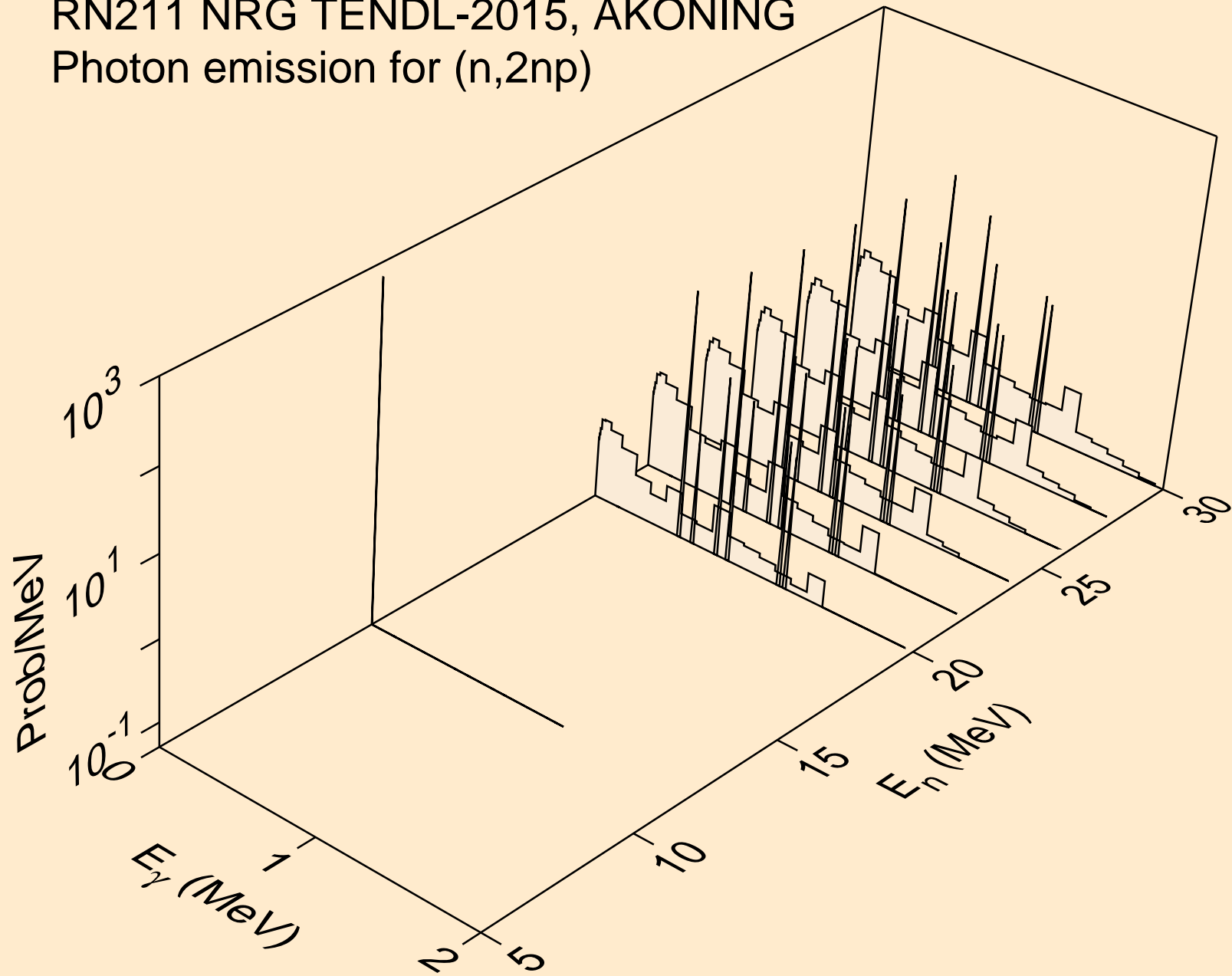

RN211 NRG TENDL-2015, AKONING
Photon emission for (n,npa)

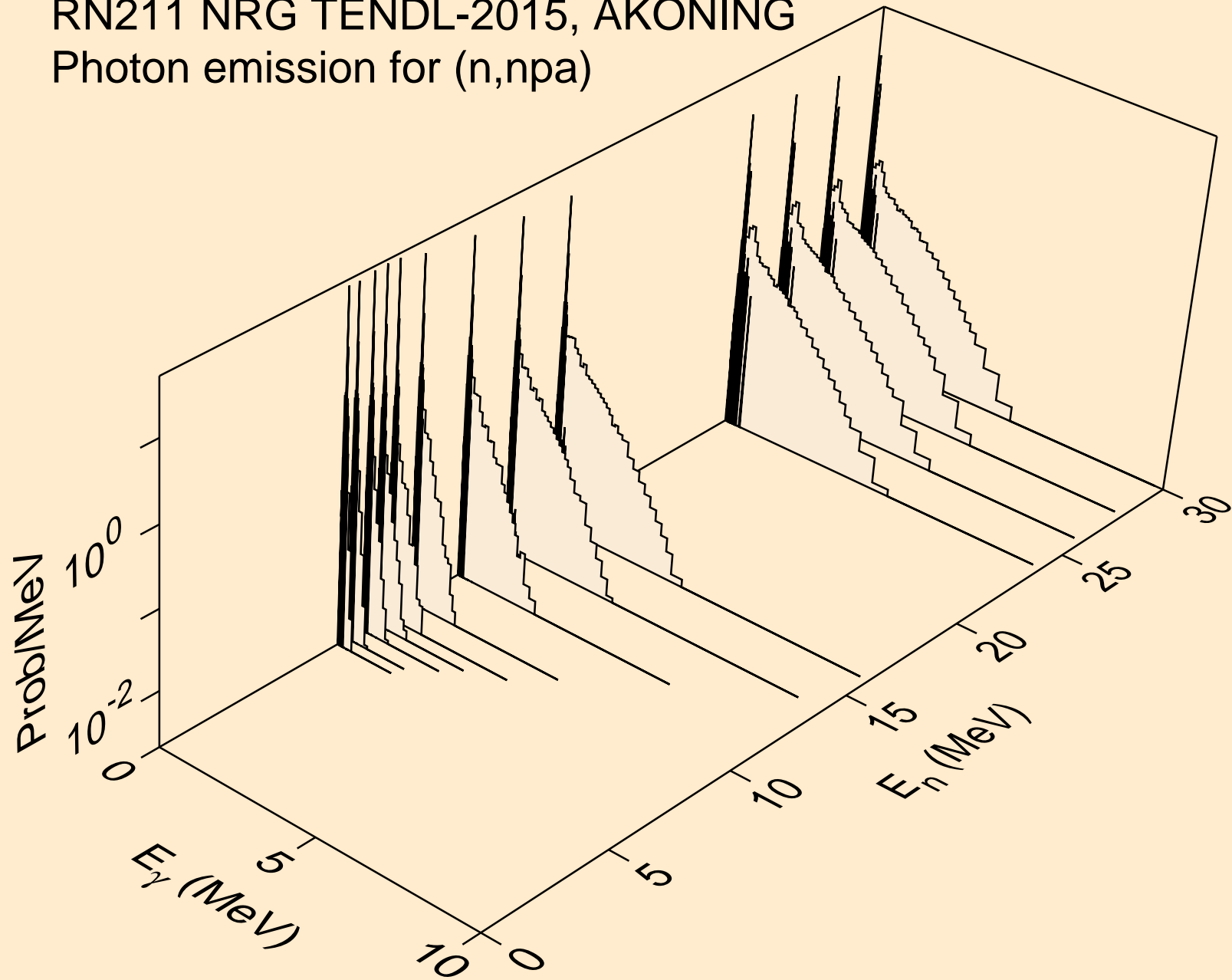

RN211 NRG TENDL-2015, AKONING
Photon emission for (n,n*c)

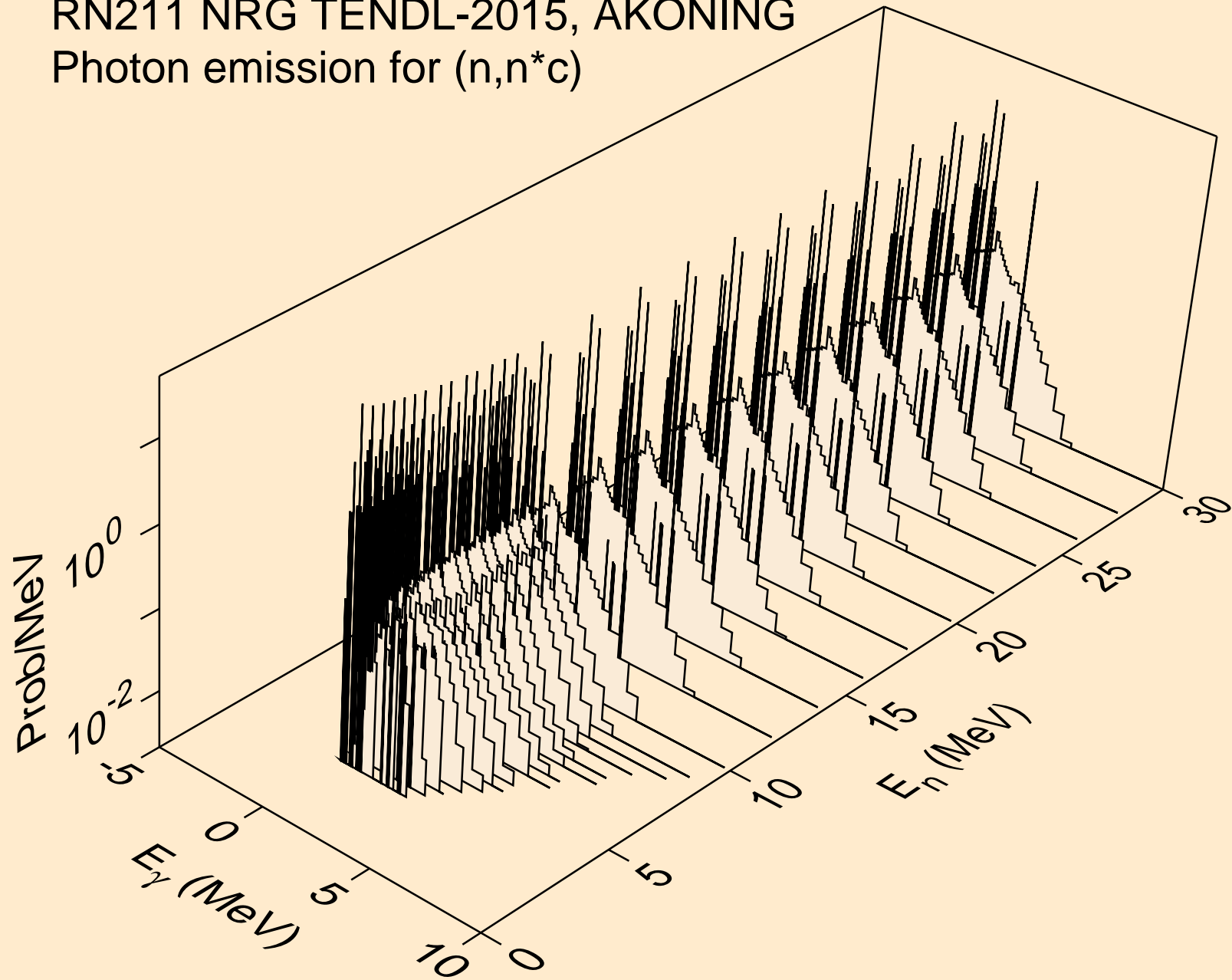

RN211 NRG TENDL-2015, AKONING
Photon emission for (n,gma)

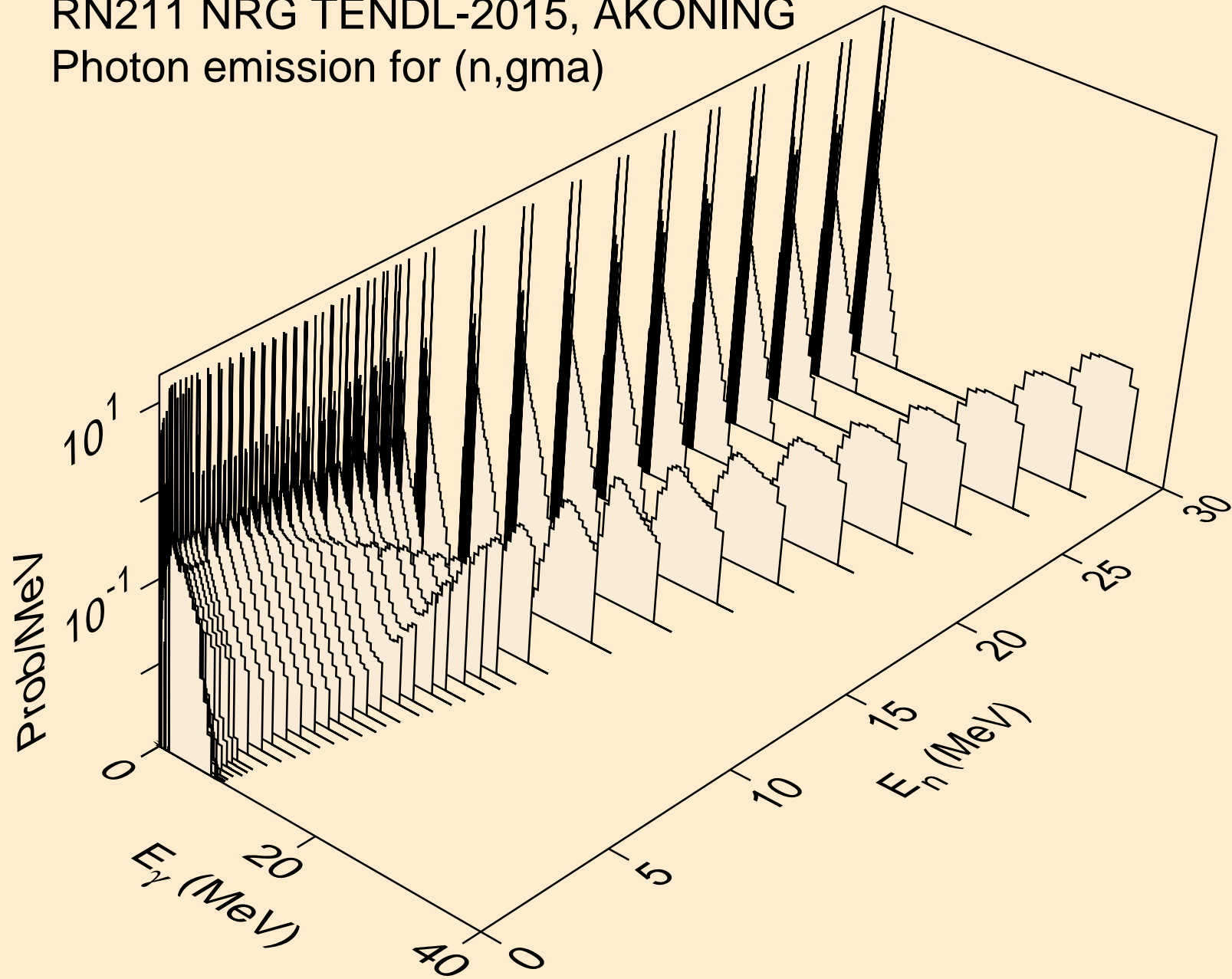

RN211 NRG TENDL-2015, AKONING
Photon emission for (n,p)

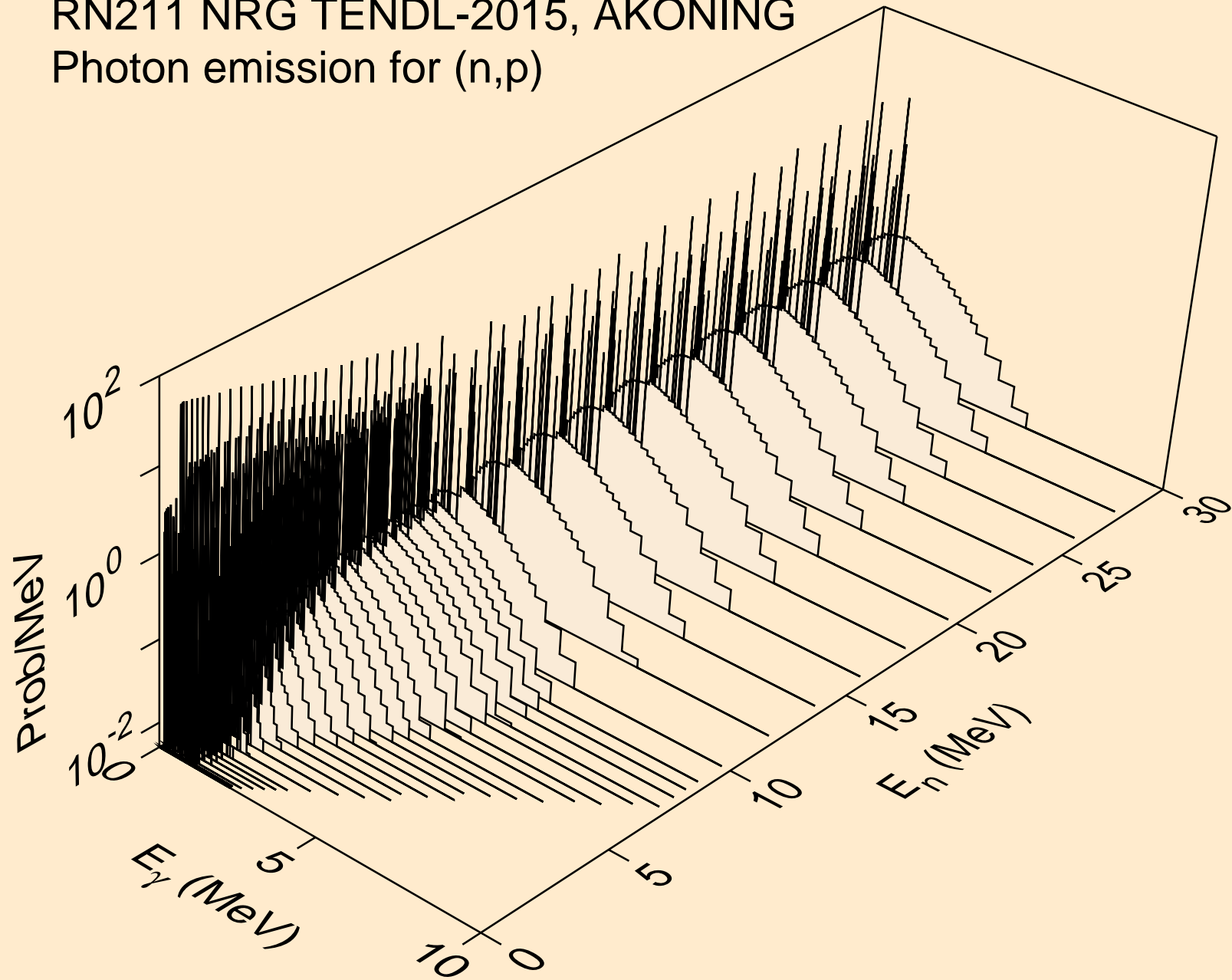

RN211 NRG TENDL-2015, AKONING
Photon emission for (n,d)

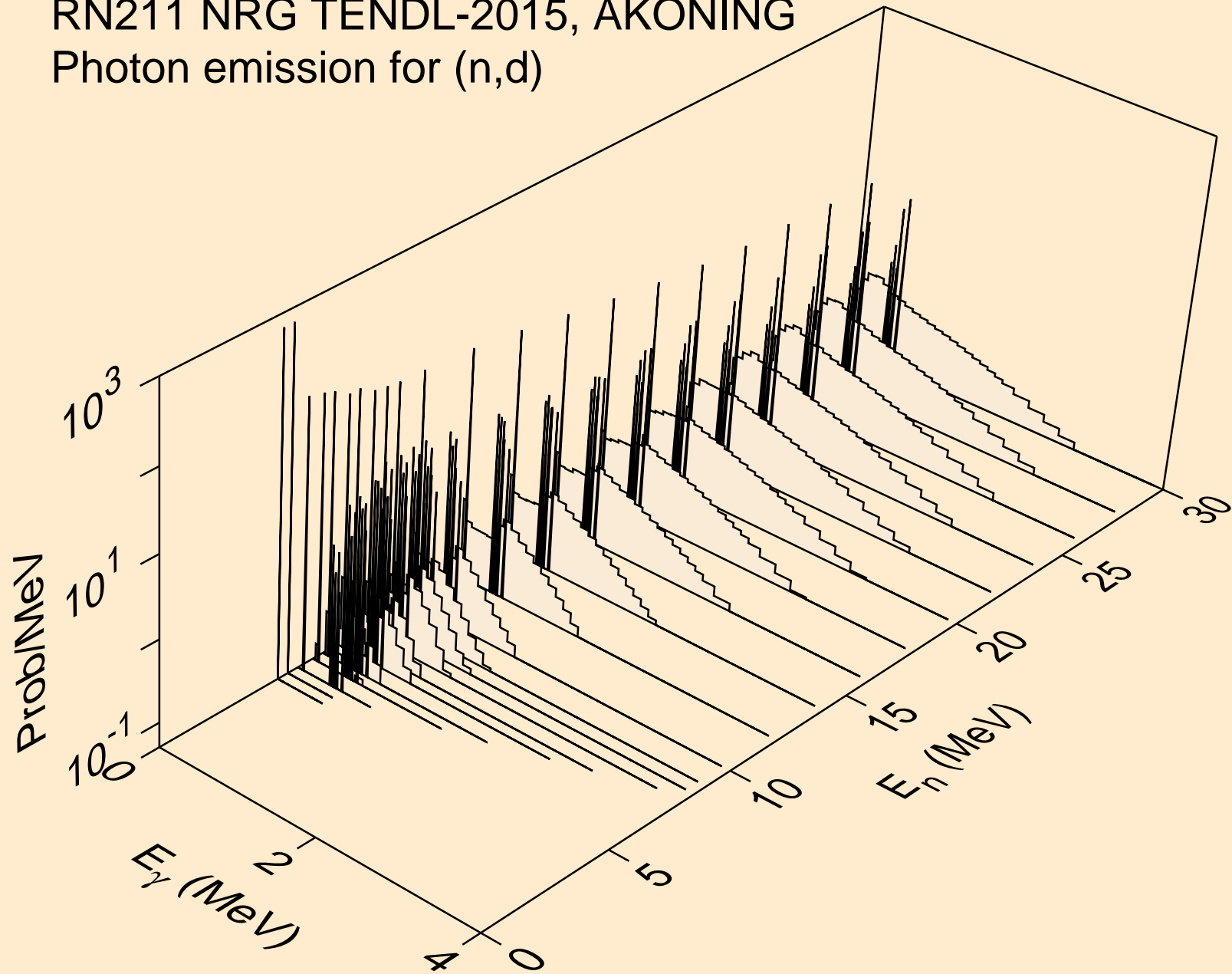

RN211 NRG TENDL-2015, AKONING
Photon emission for (n,t)

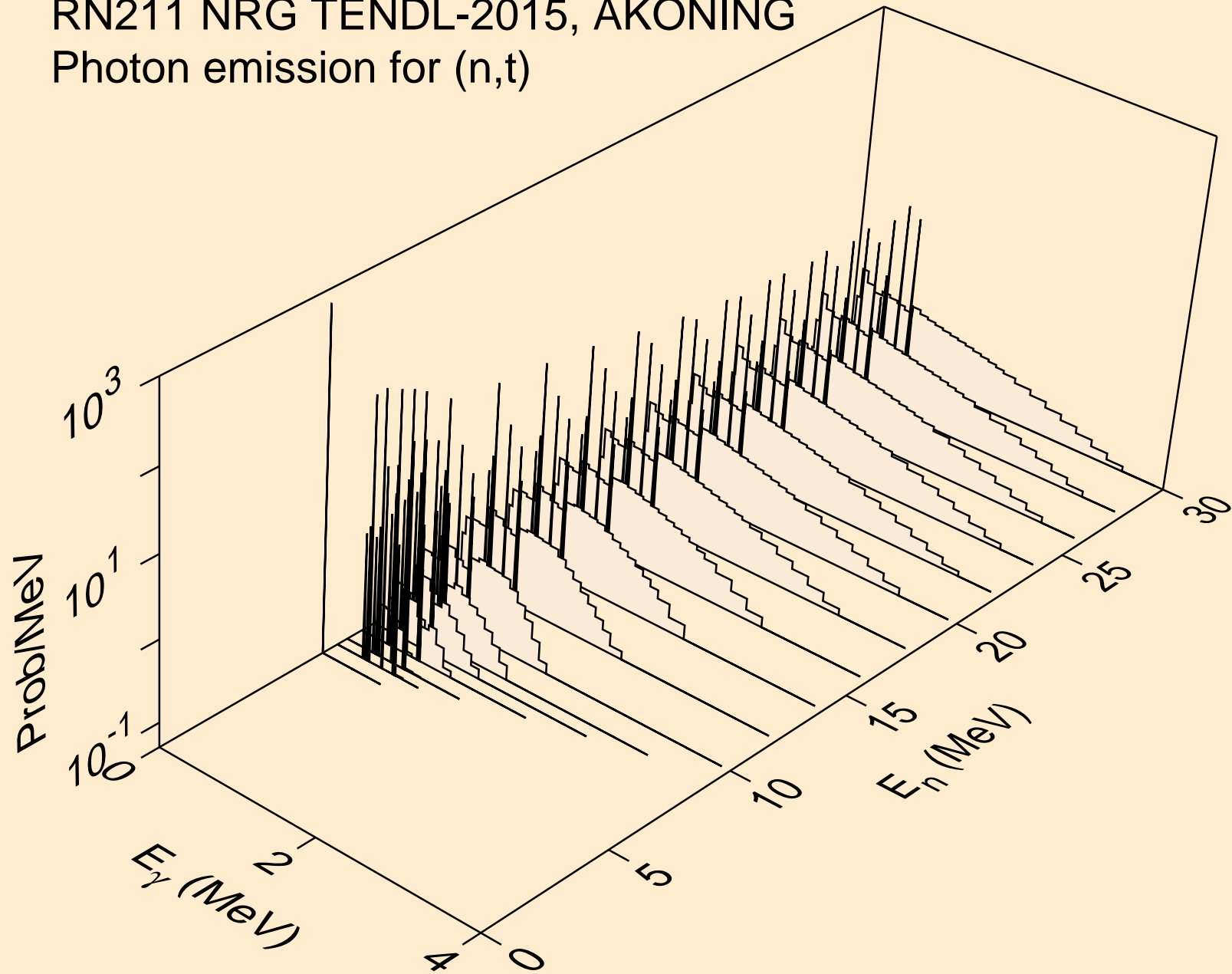

RN211 NRG TENDL-2015, AKONING
Photon emission for (n,he3)

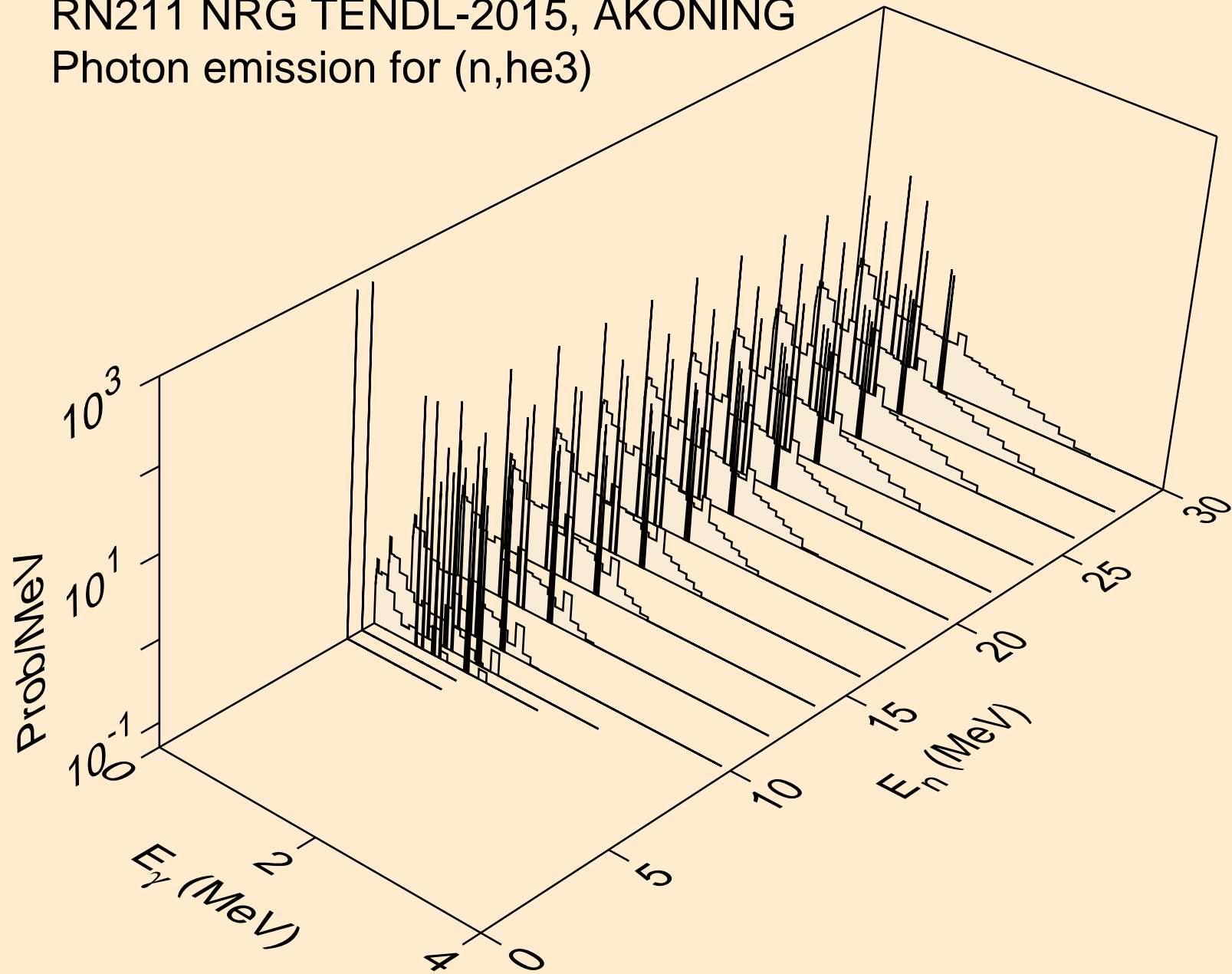

RN211 NRG TENDL-2015, AKONING
Photon emission for (n,a)

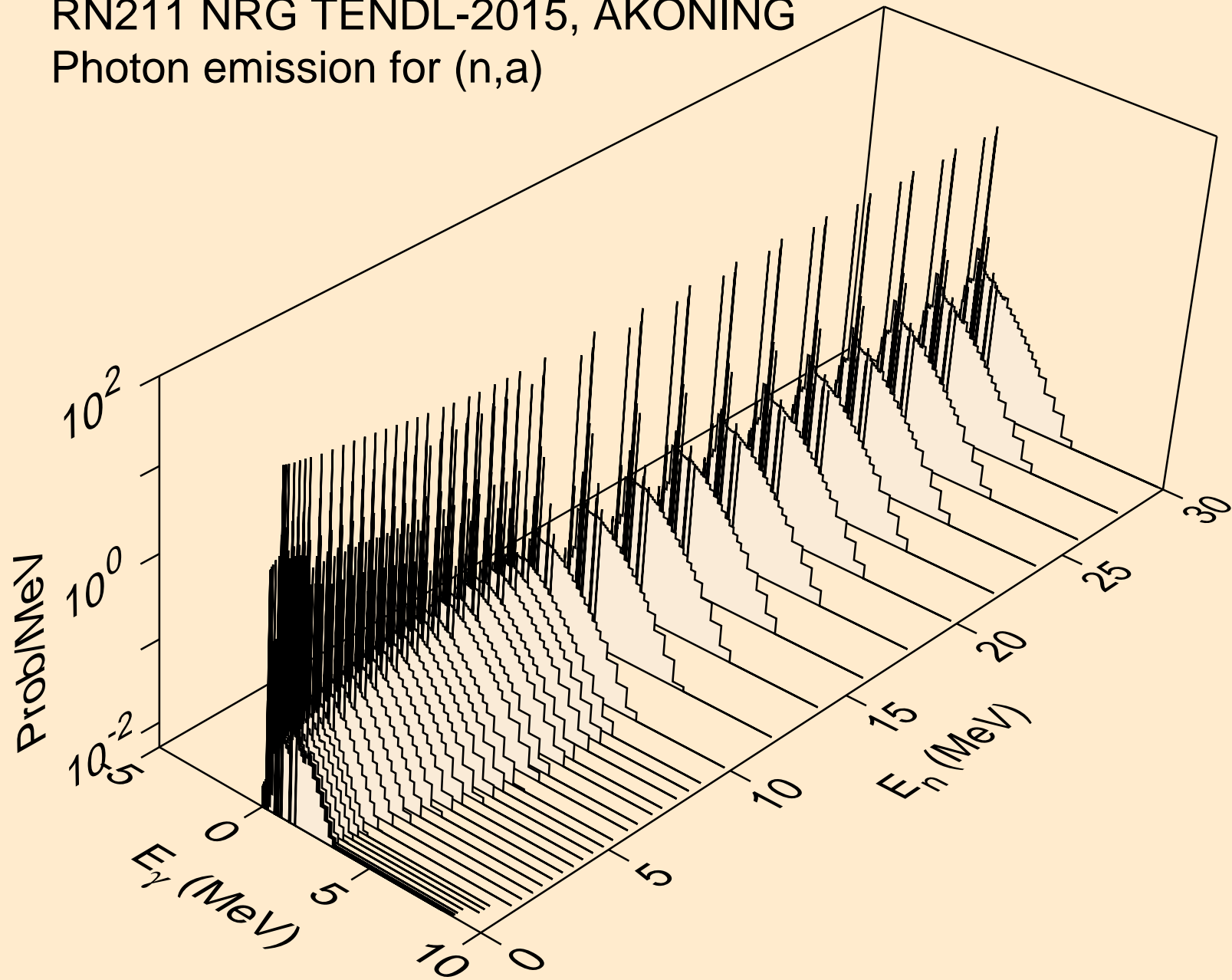

RN211 NRG TENDL-2015, AKONING
Photon emission for (n,2a)

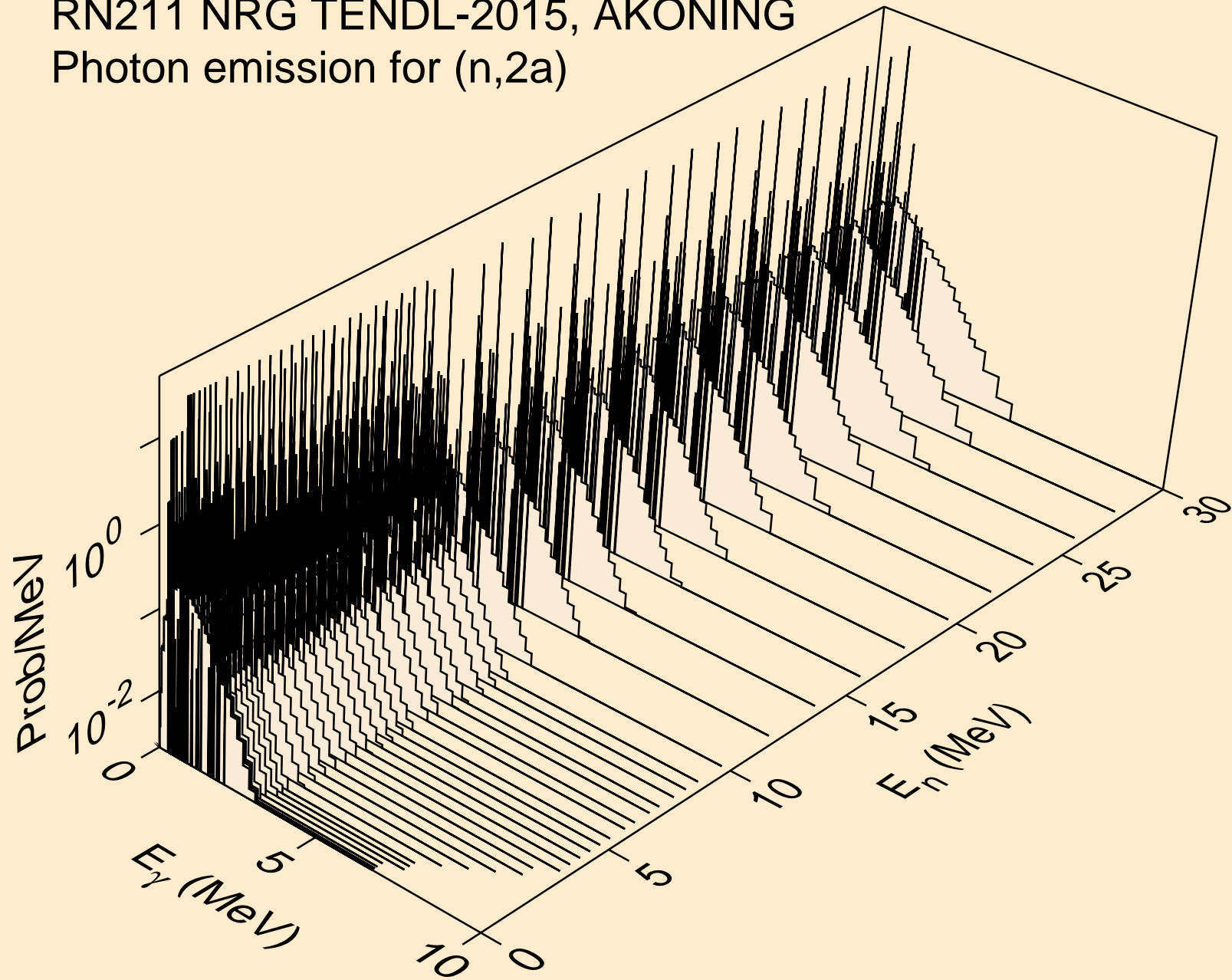

RN211 NRG TENDL-2015, AKONING
Photon emission for (n,2p)

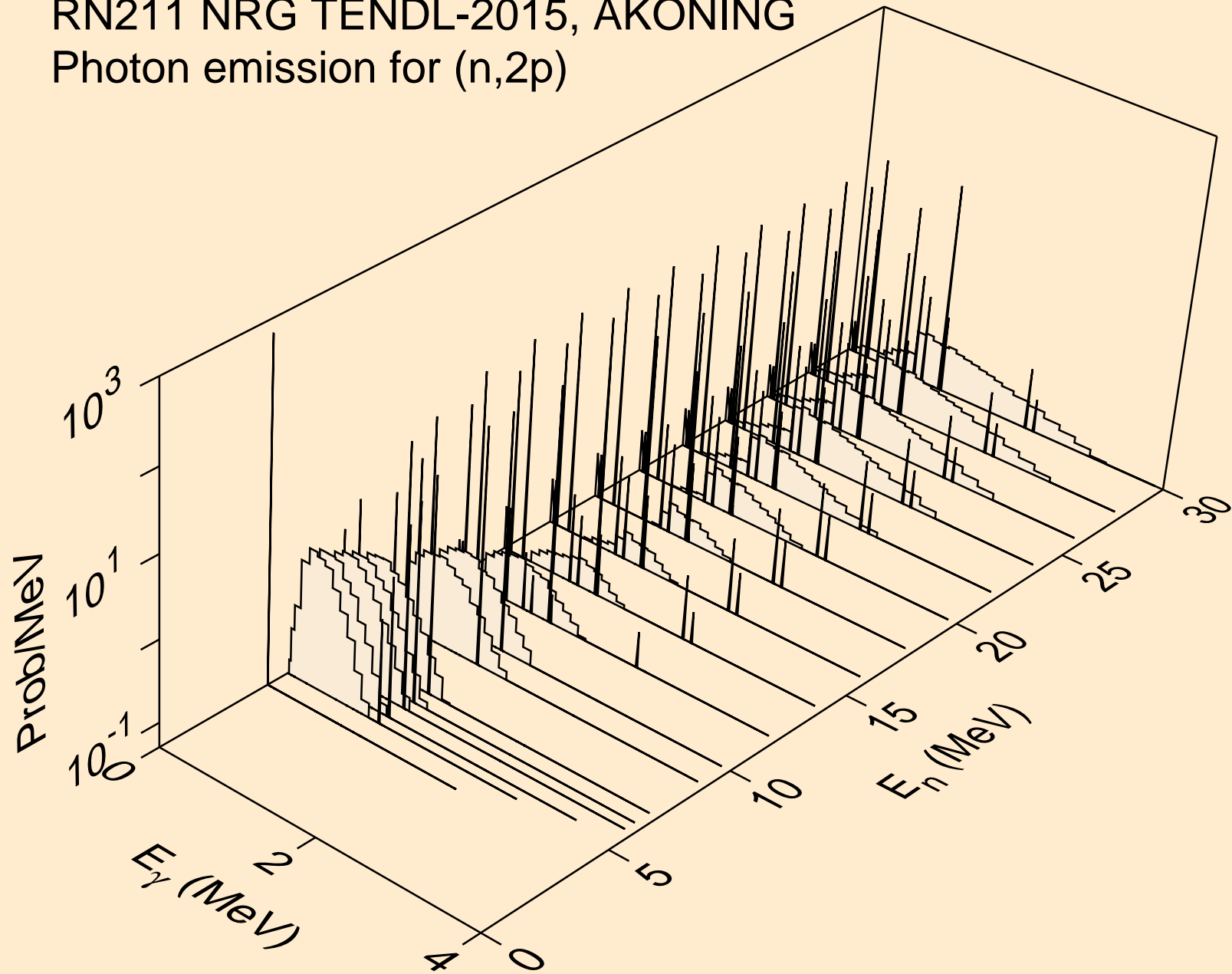

RN211 NRG TENDL-2015, AKONING
Photon emission for (n,pa)

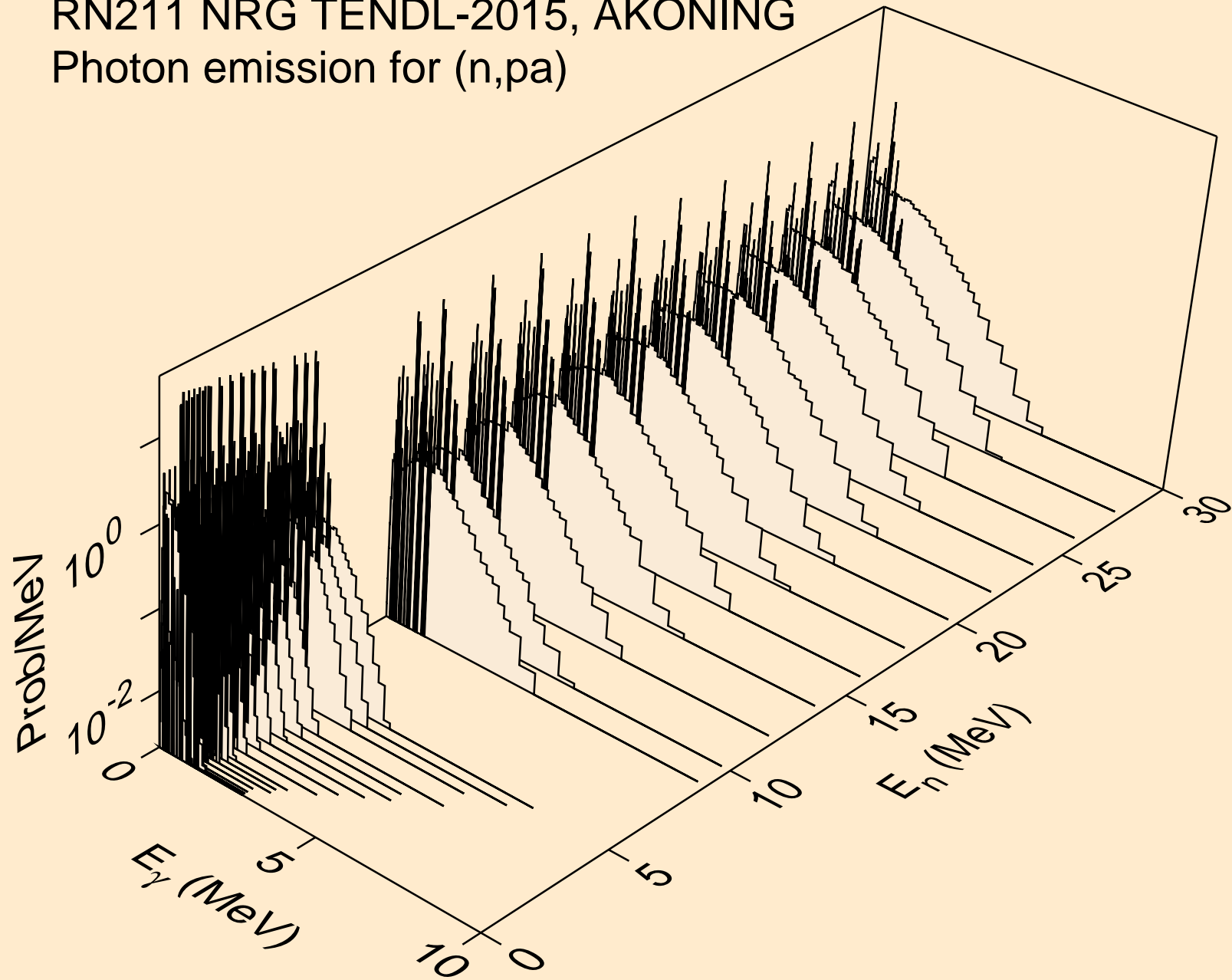

RN211 NRG TENDL-2015, AKONING
Photon emission for (n,pd)

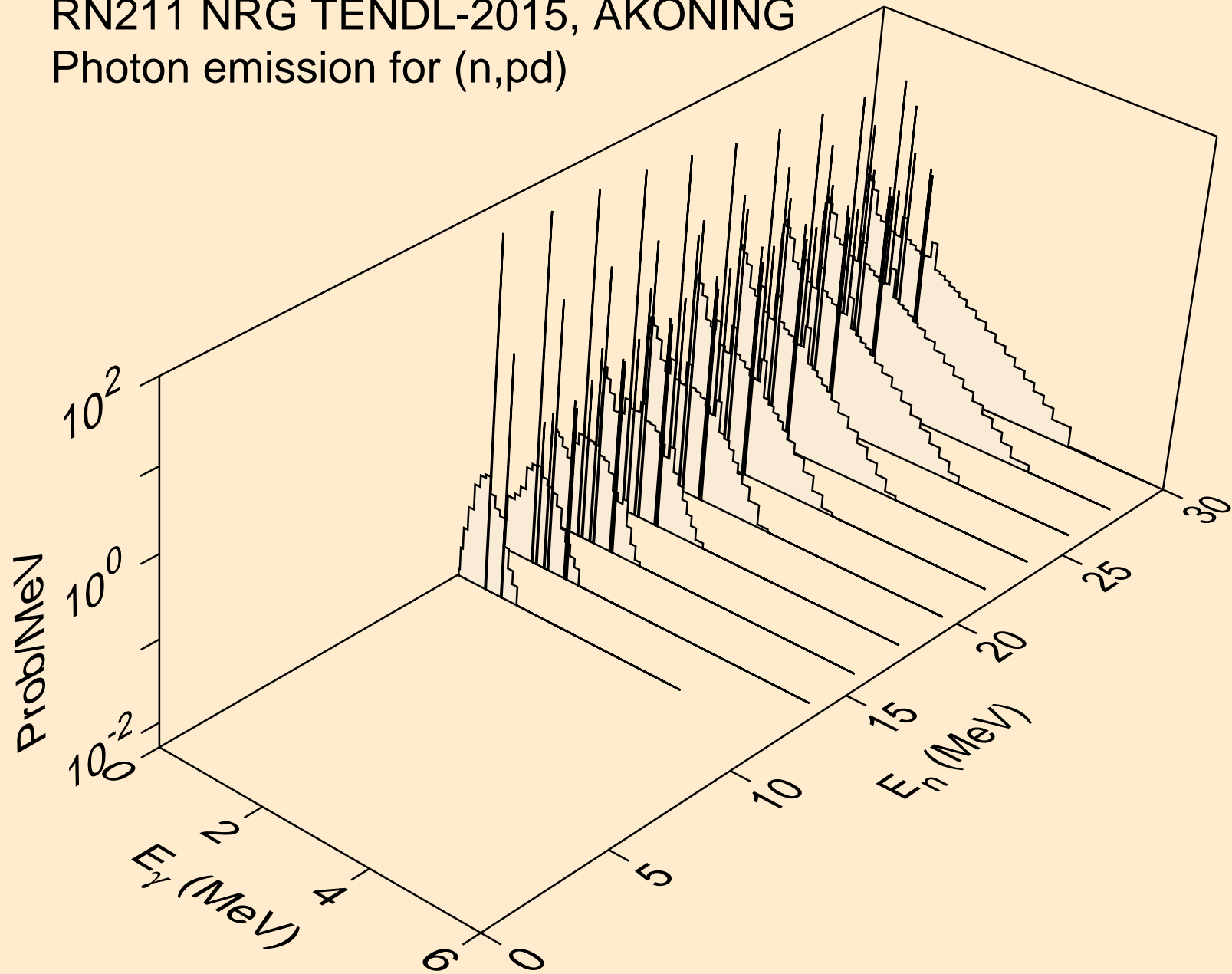

RN211 NRG TENDL-2015, AKONING
Photon emission for (n,pt)

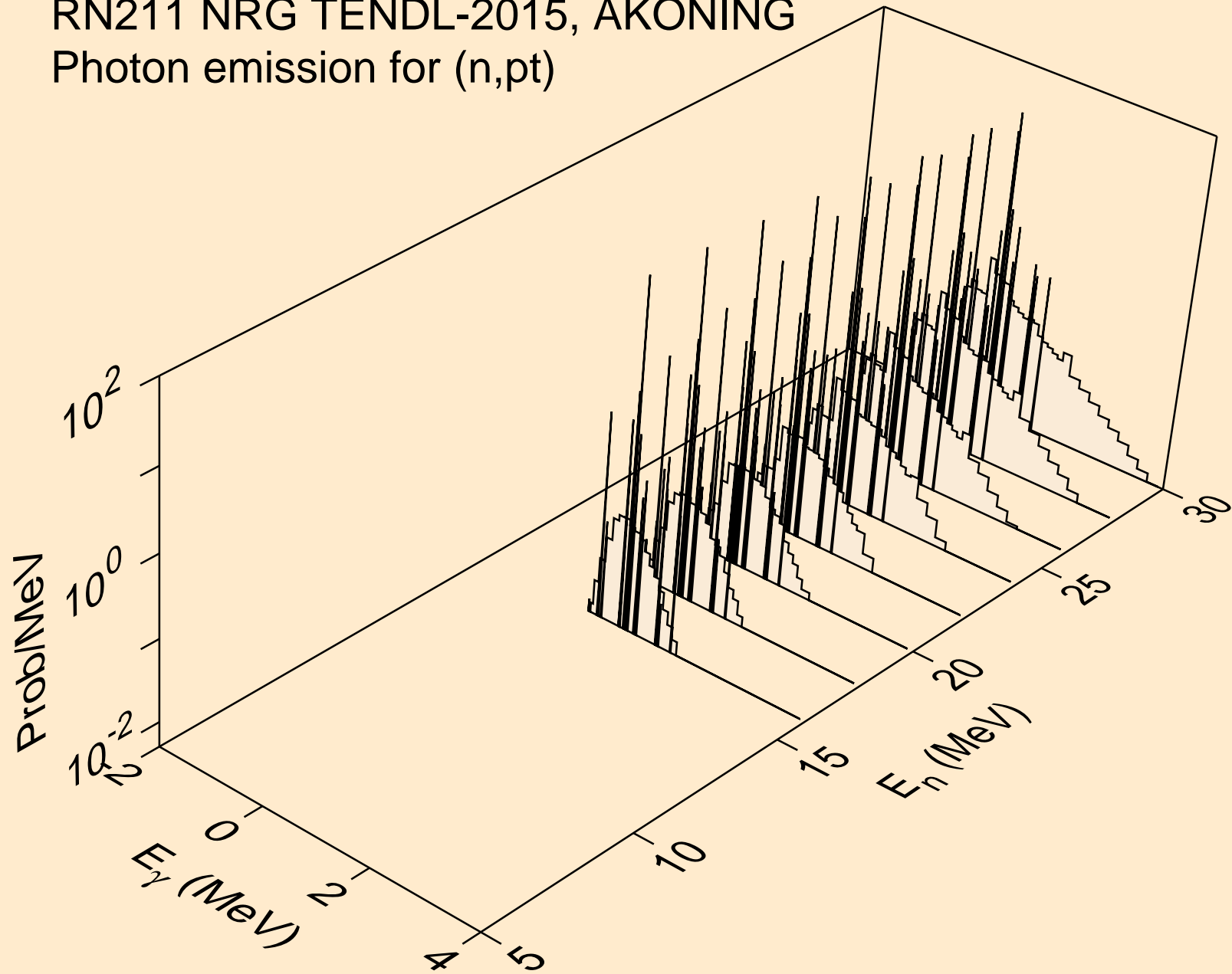

RN211 NRG TENDL-2015, AKONING
Photon emission for (n,da)

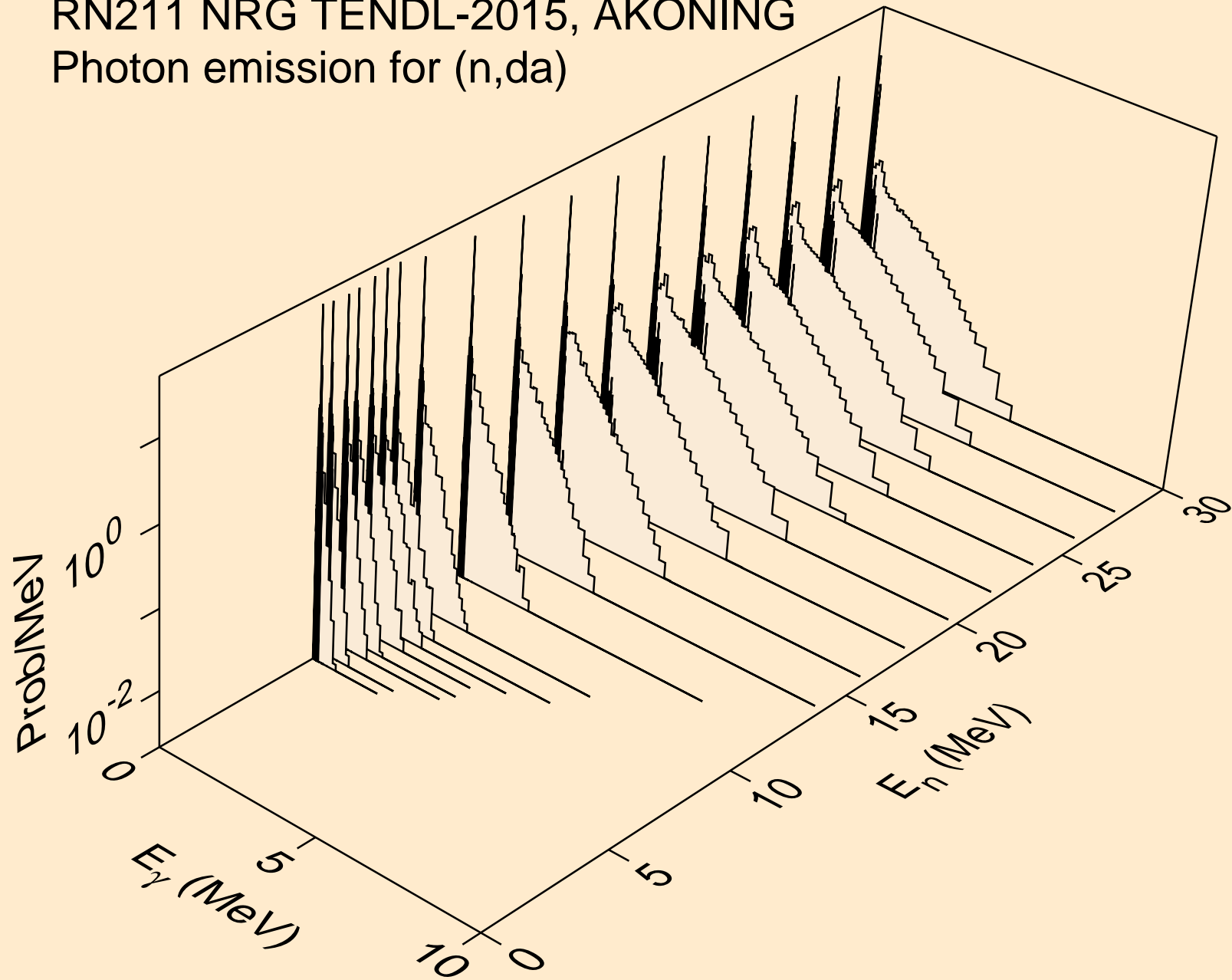

RN211 NRG TENDL-2015, AKONING
thermal capture photon spectrum

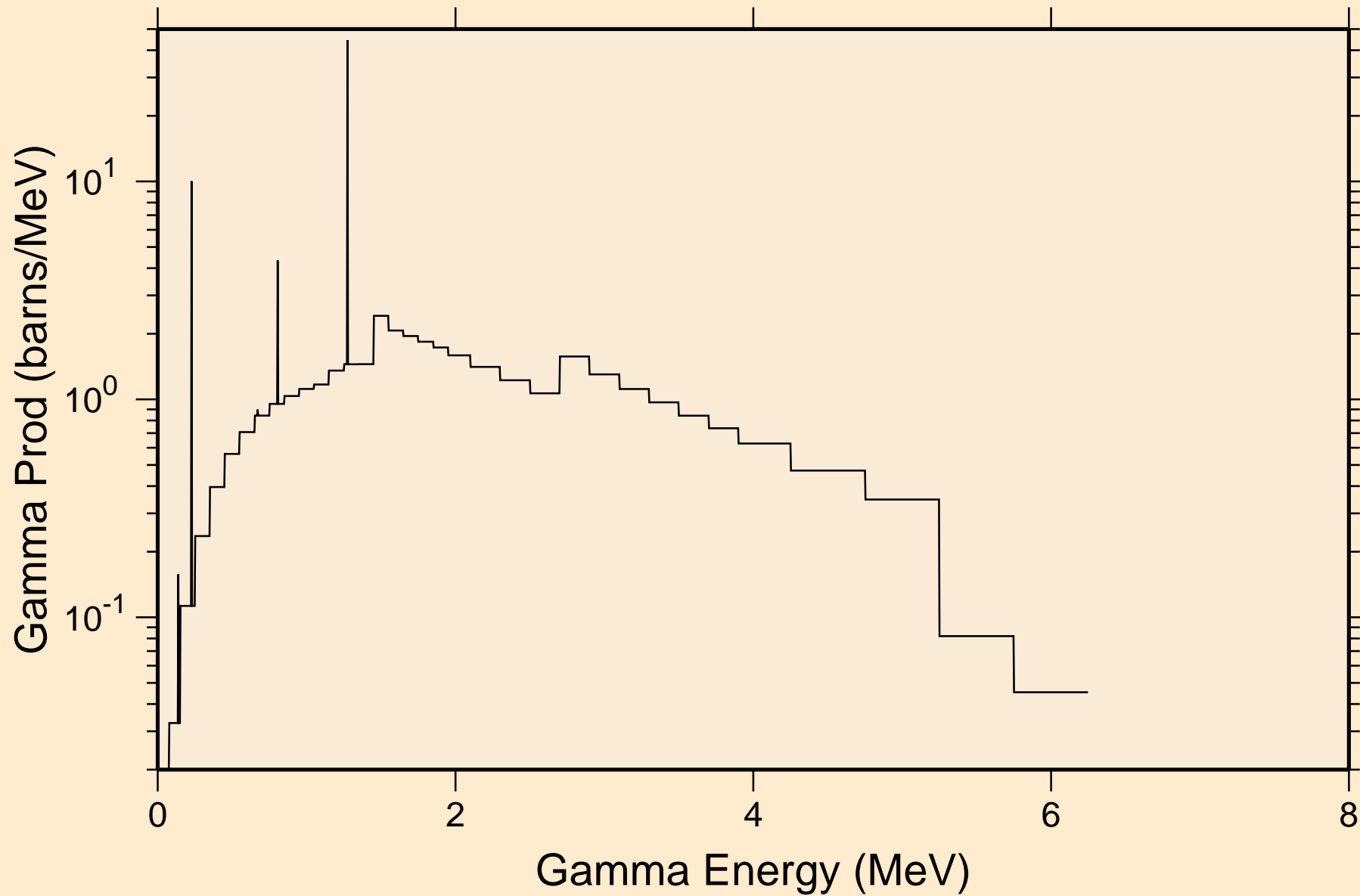

RN211 NRG TENDL-2015, AKONING
14 MeV photon spectrum

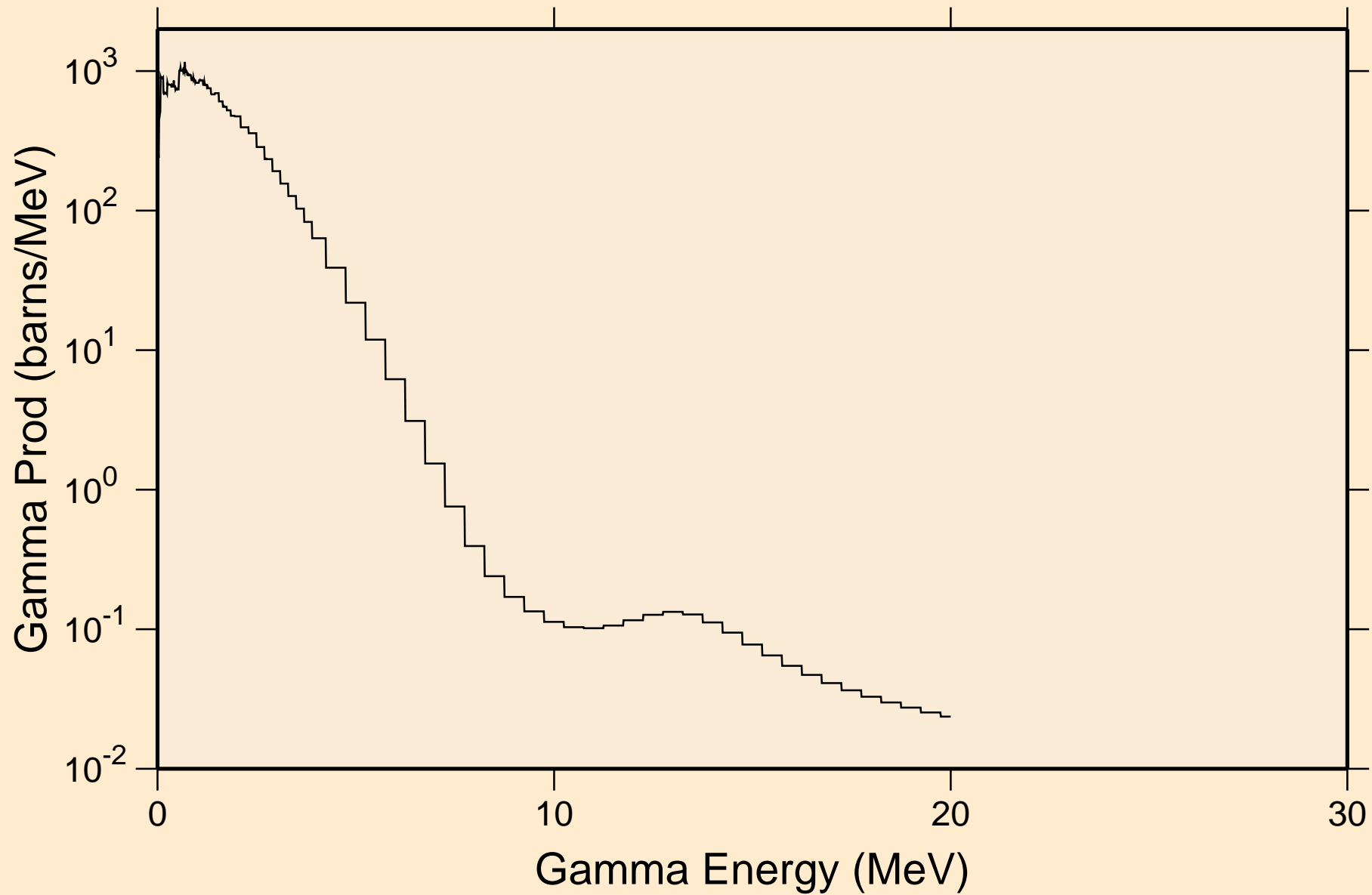

RN211 NRG TENDL-2015, AKONING

Particle heating contributions

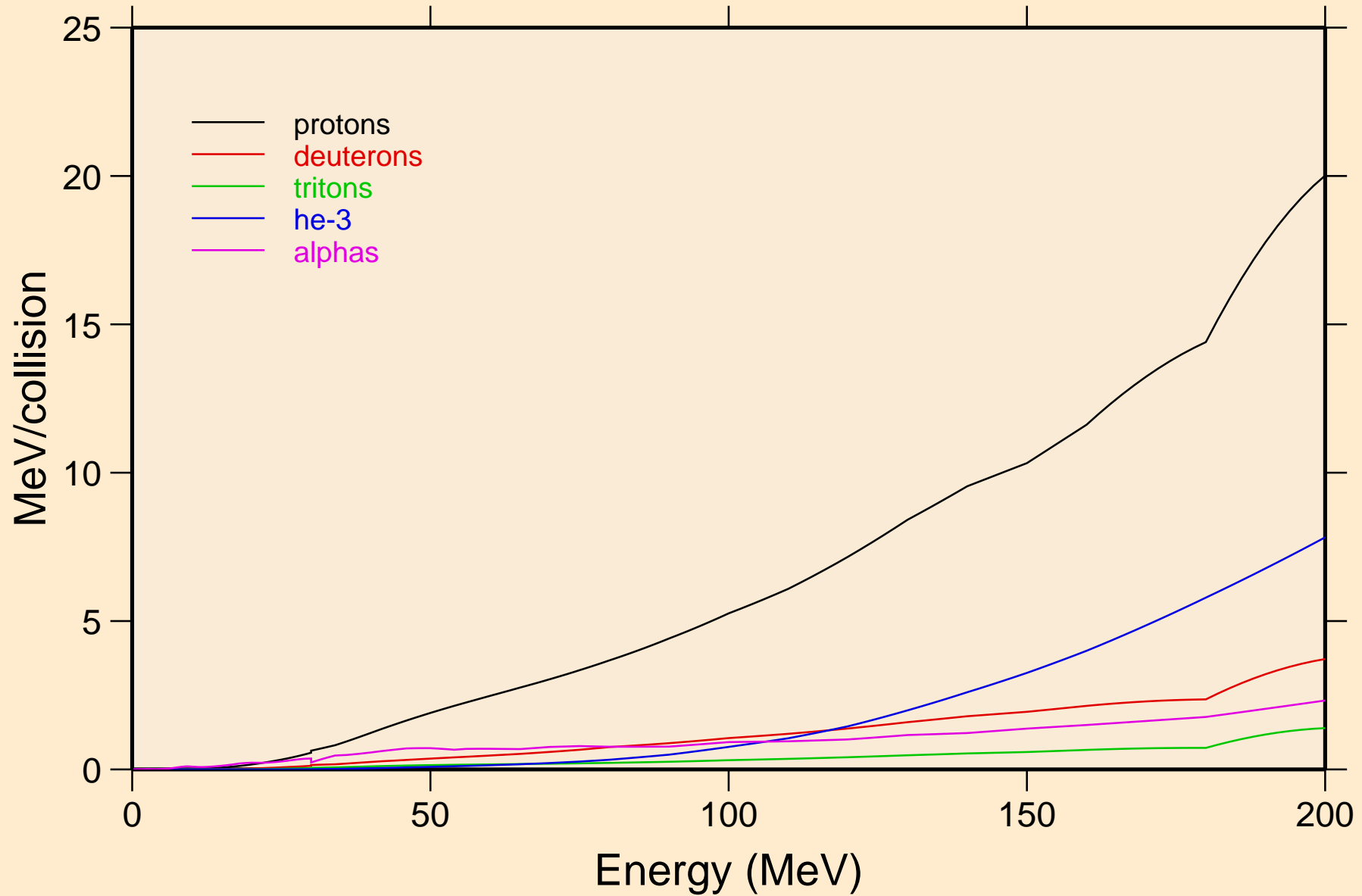

RN211 NRG TENDL-2015, AKONING

Recoil Heating

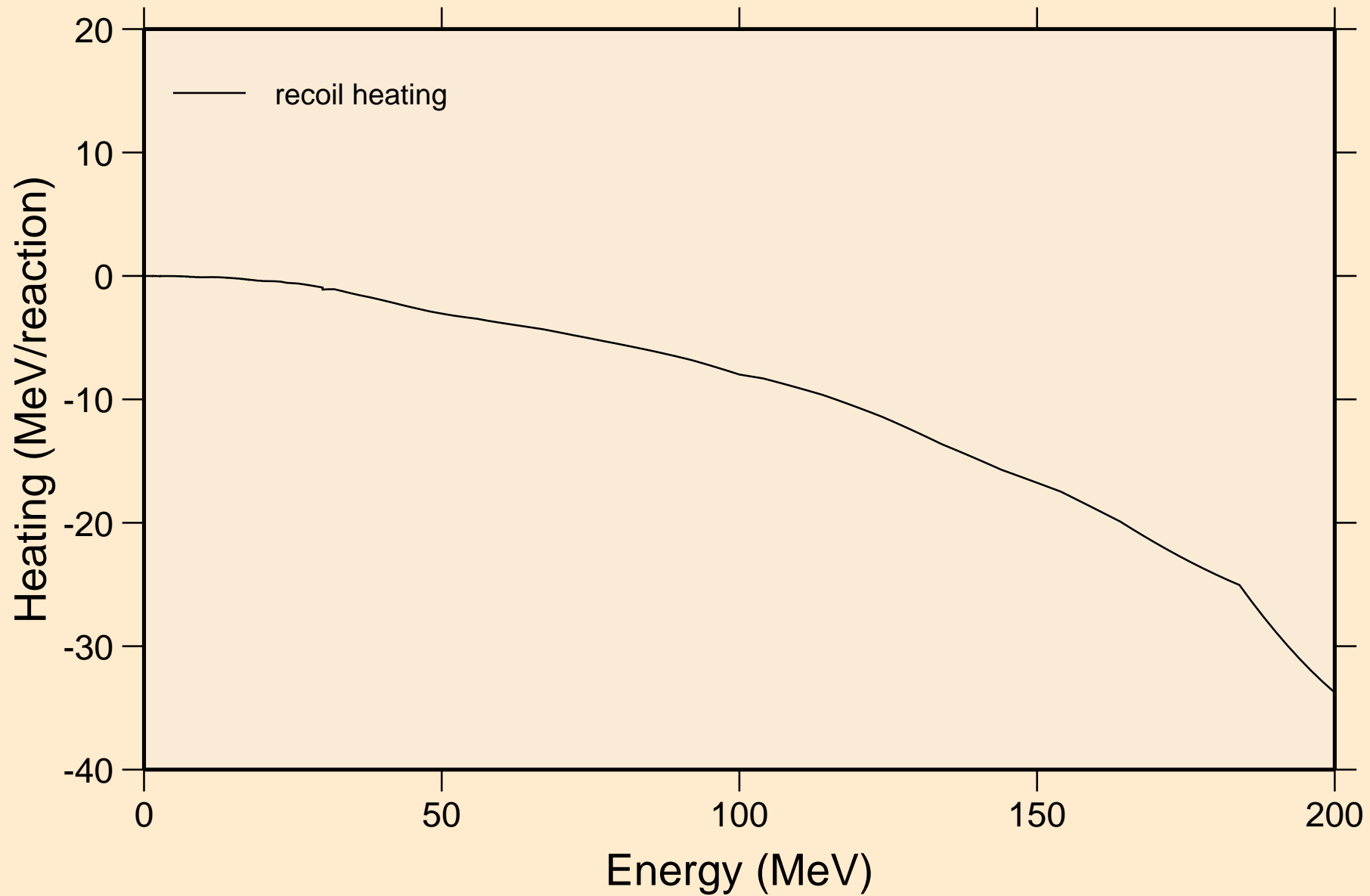

RN211 NRG TENDL-2015, AKONING

Particle production cross sections

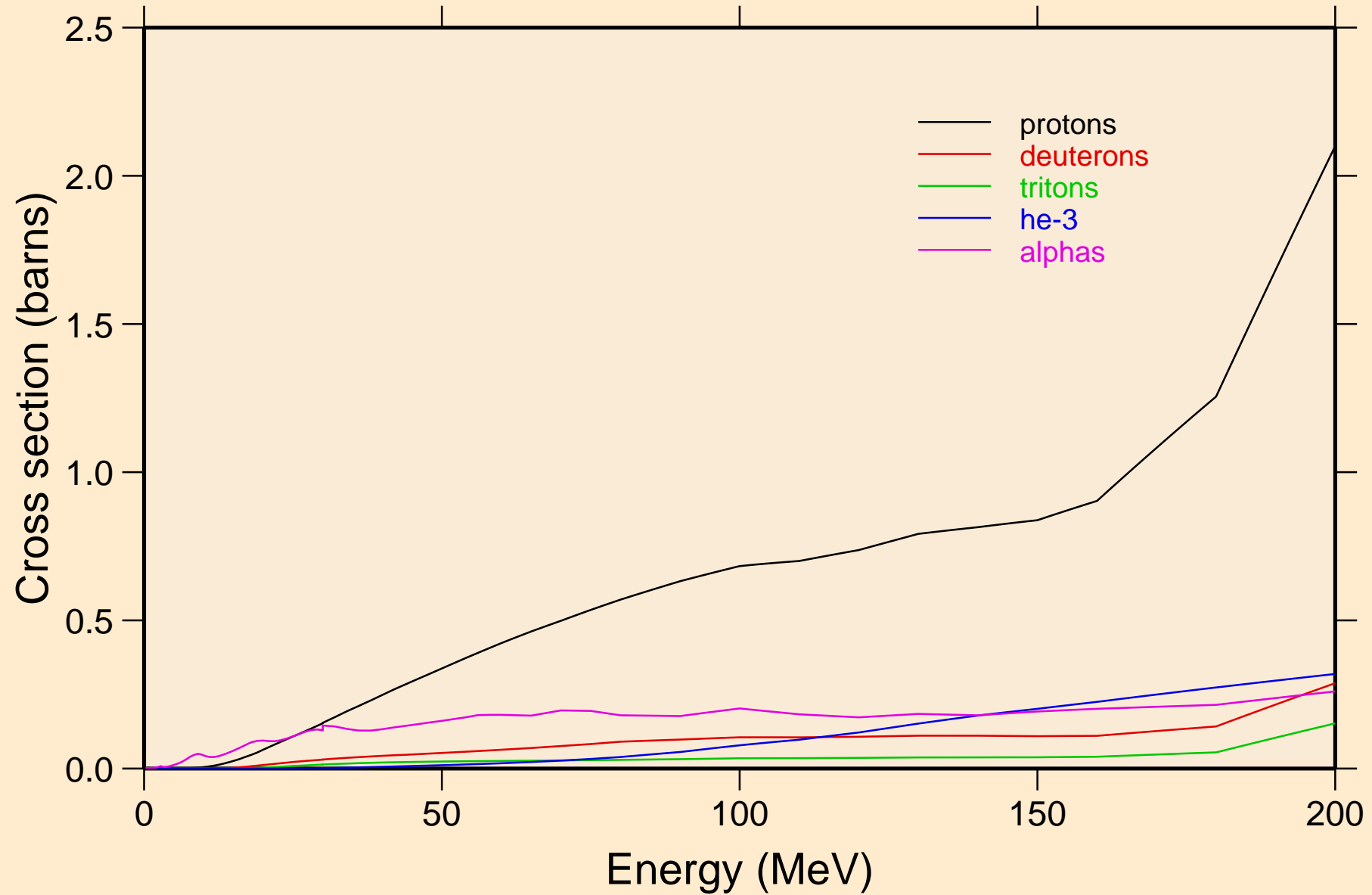

RN211 NRG TENDL-2015, AKONING
protons from (n,x)

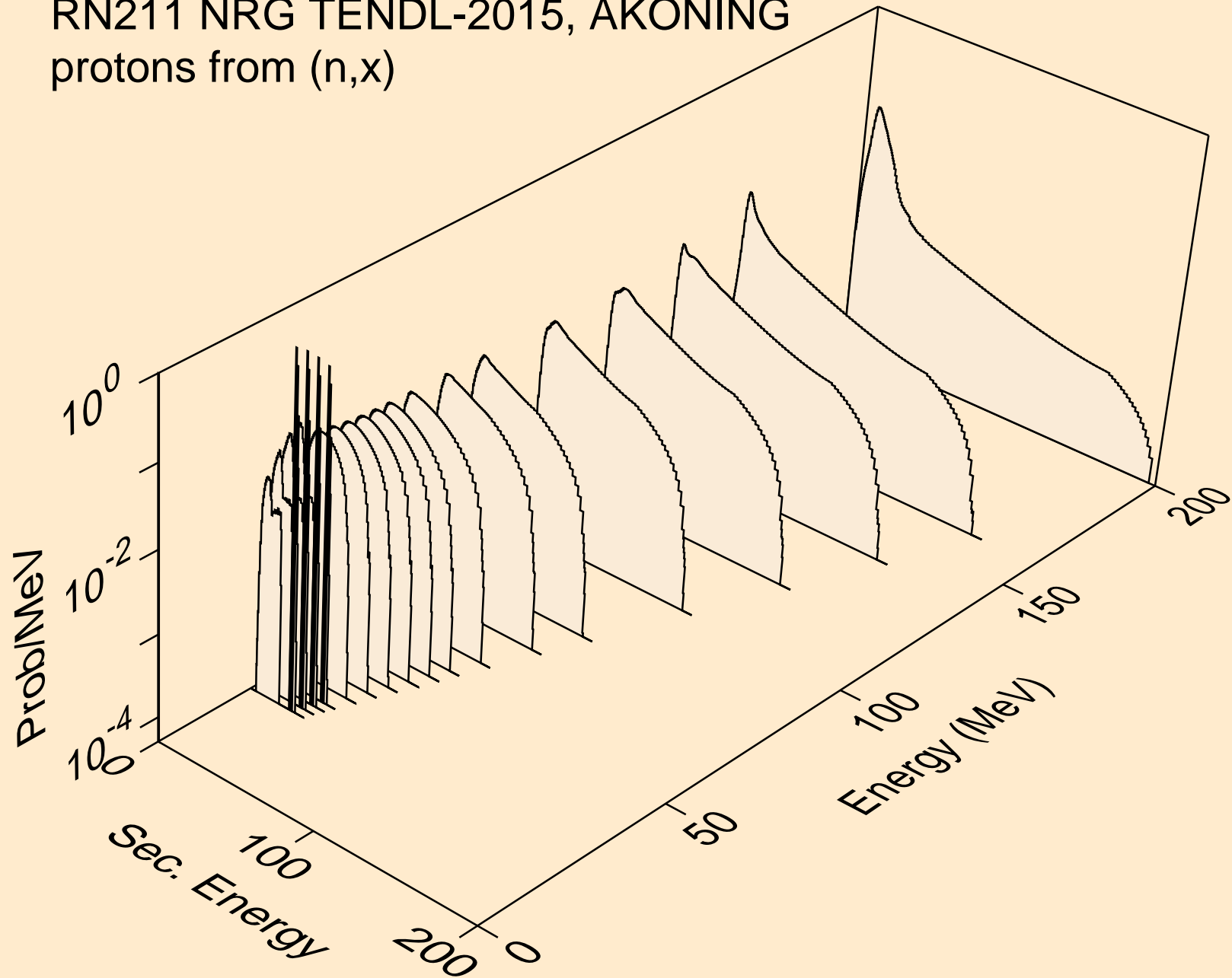

RN211 NRG TENDL-2015, AKONING
protons from (n,n*)p

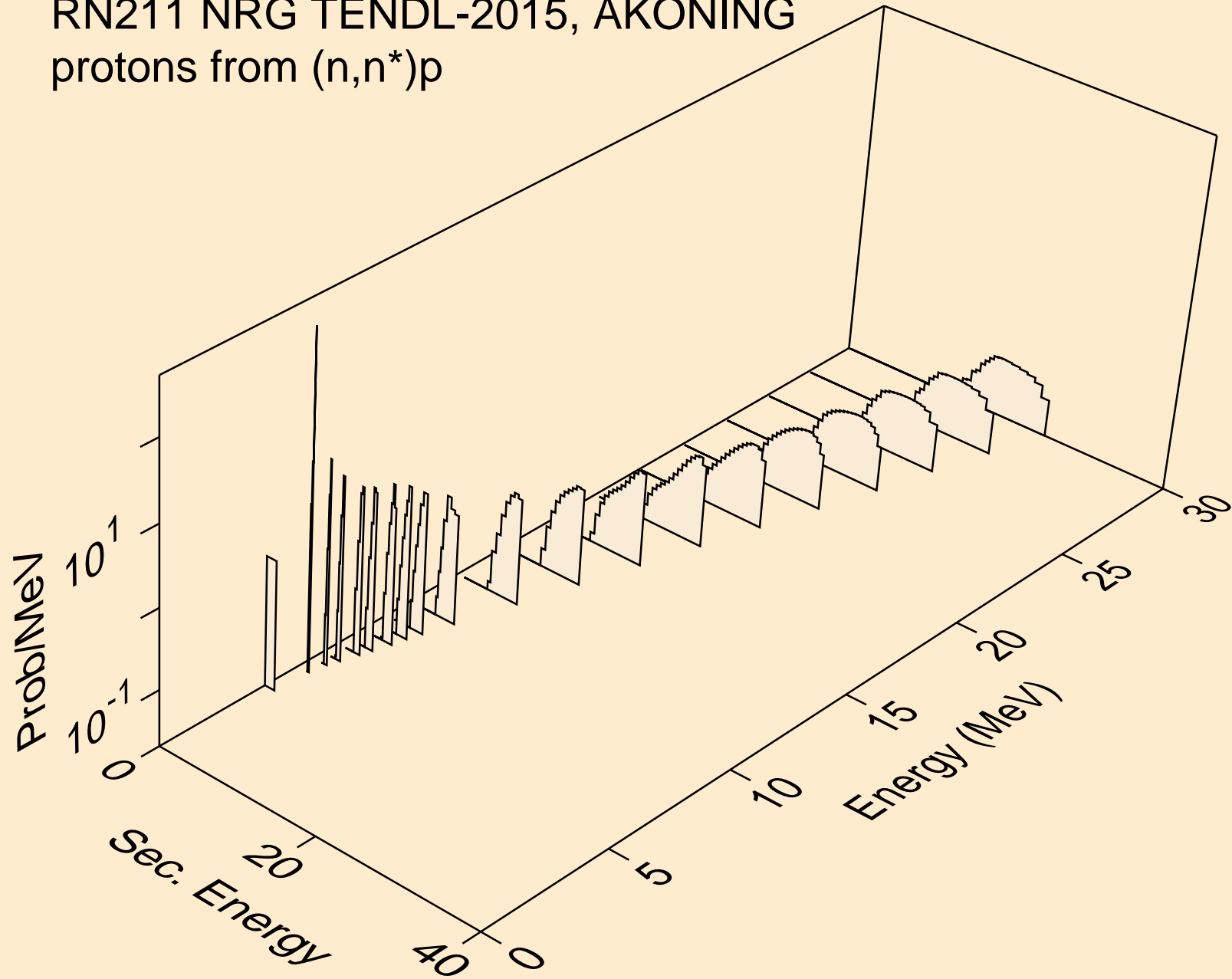

RN211 NRG TENDL-2015, AKONING
protons from (n,2np)

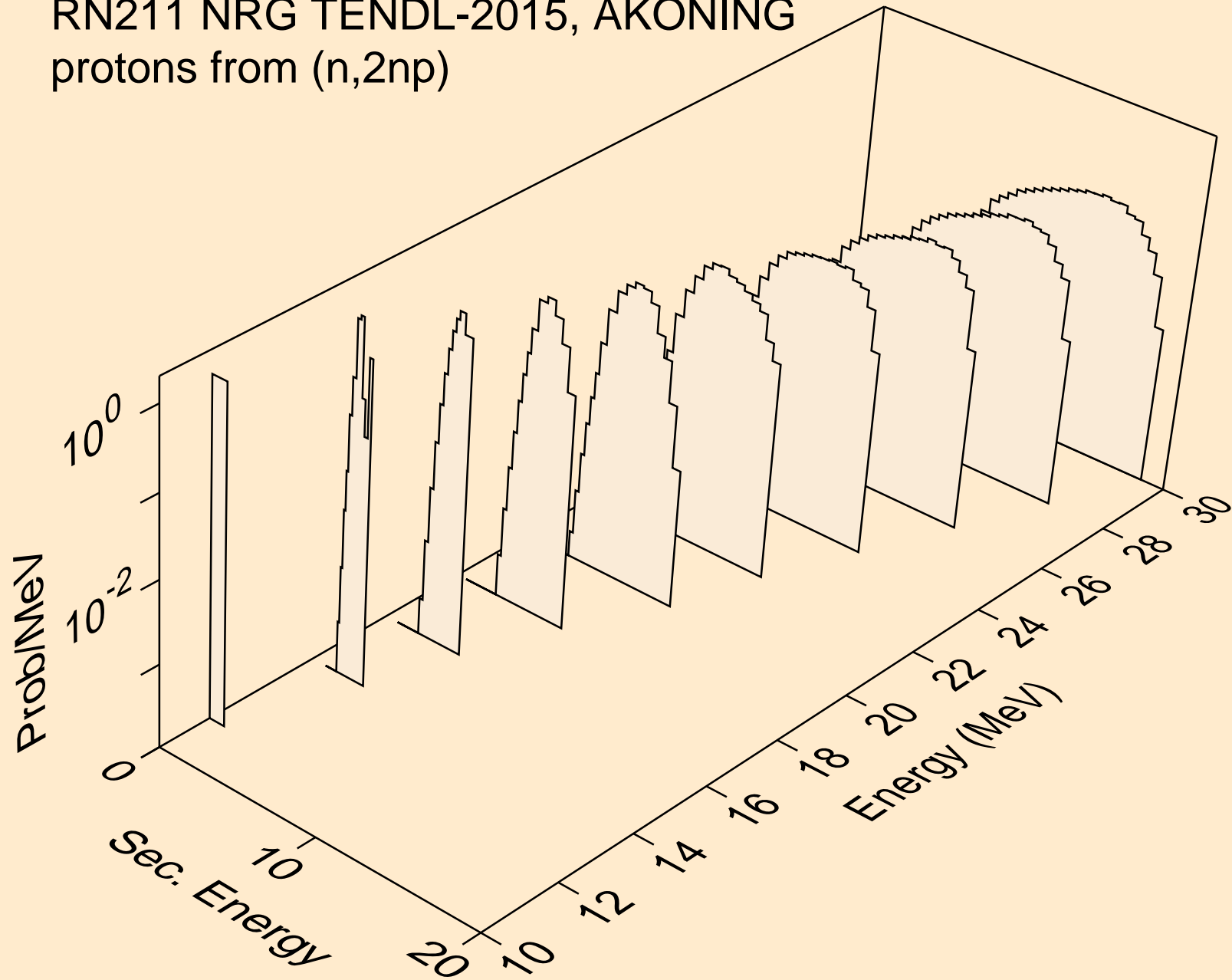

RN211 NRG TENDL-2015, AKONING
protons from (n,3np)

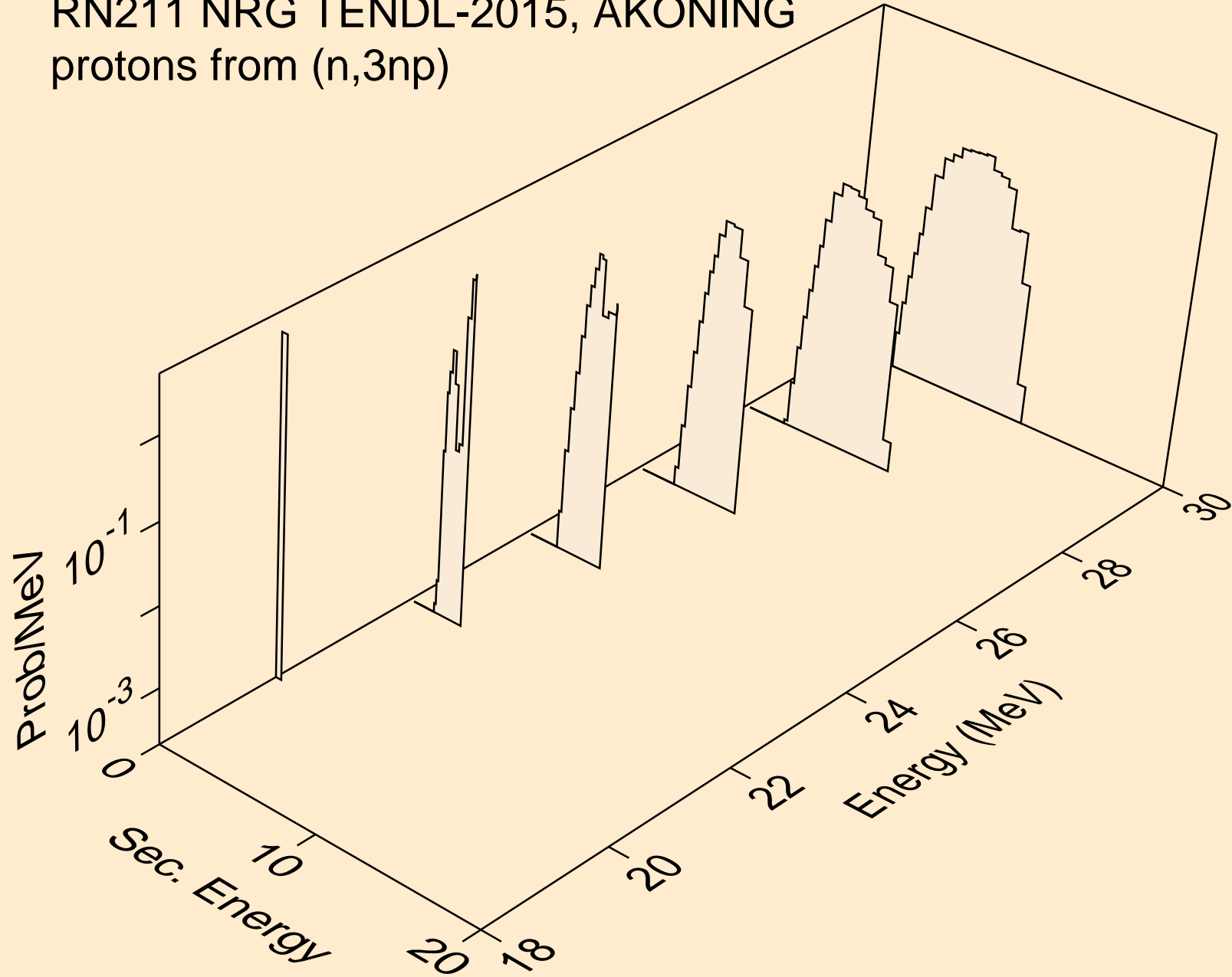

RN211 NRG TENDL-2015, AKONING
protons from (n,2np)

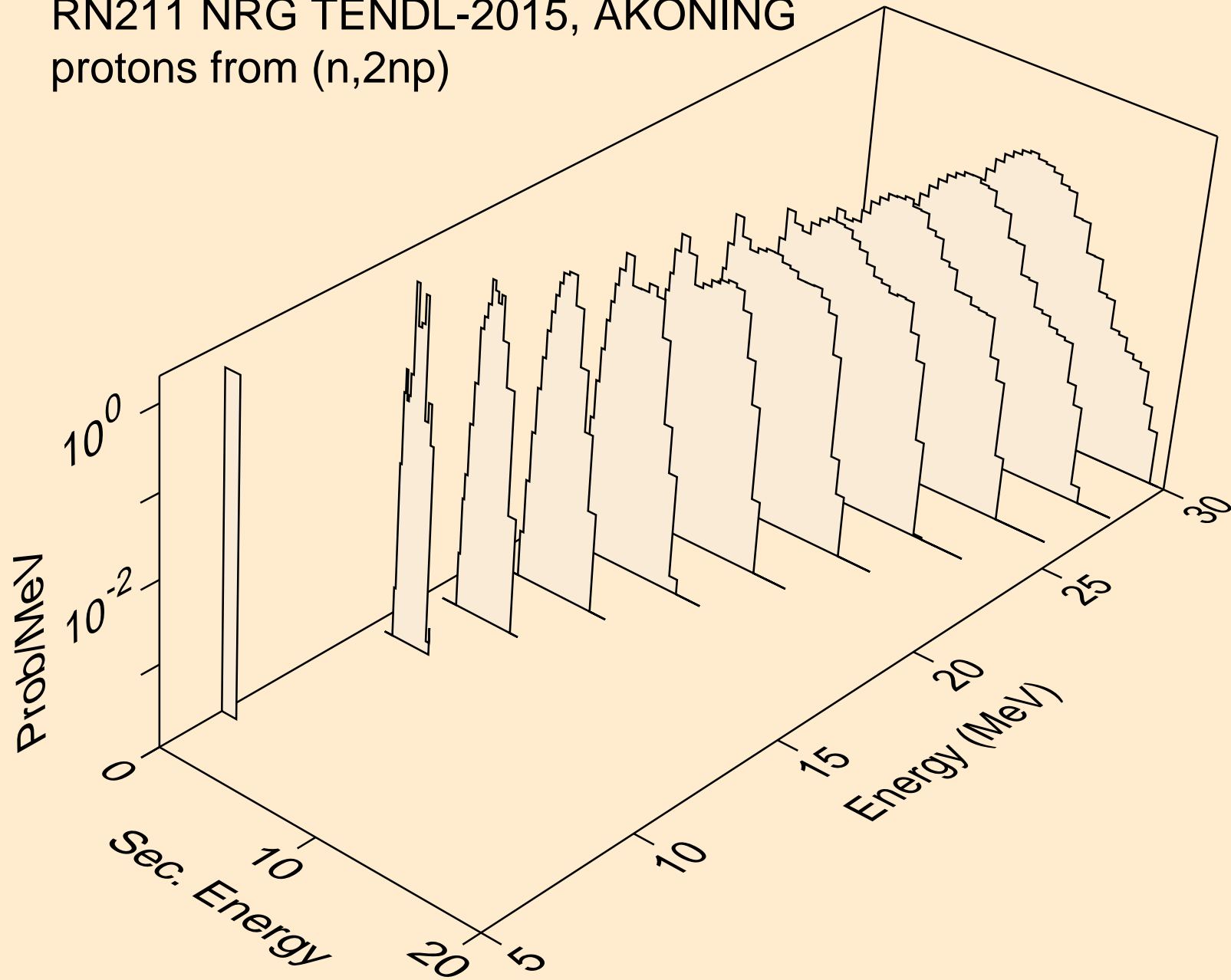

RN211 NRG TENDL-2015, AKONING
protons from (n,npa)

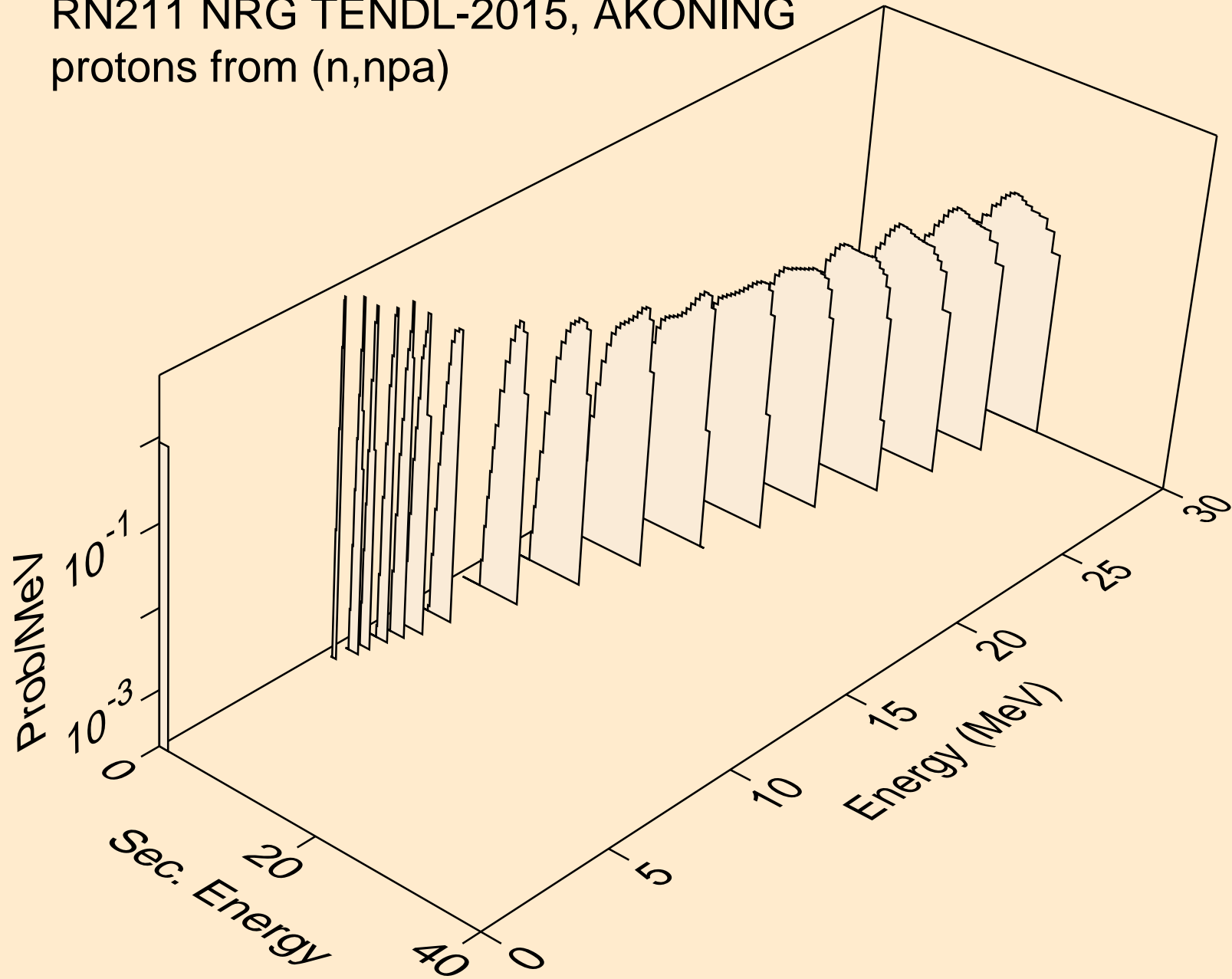

RN211 NRG TENDL-2015, AKONING
protons from (n,p)

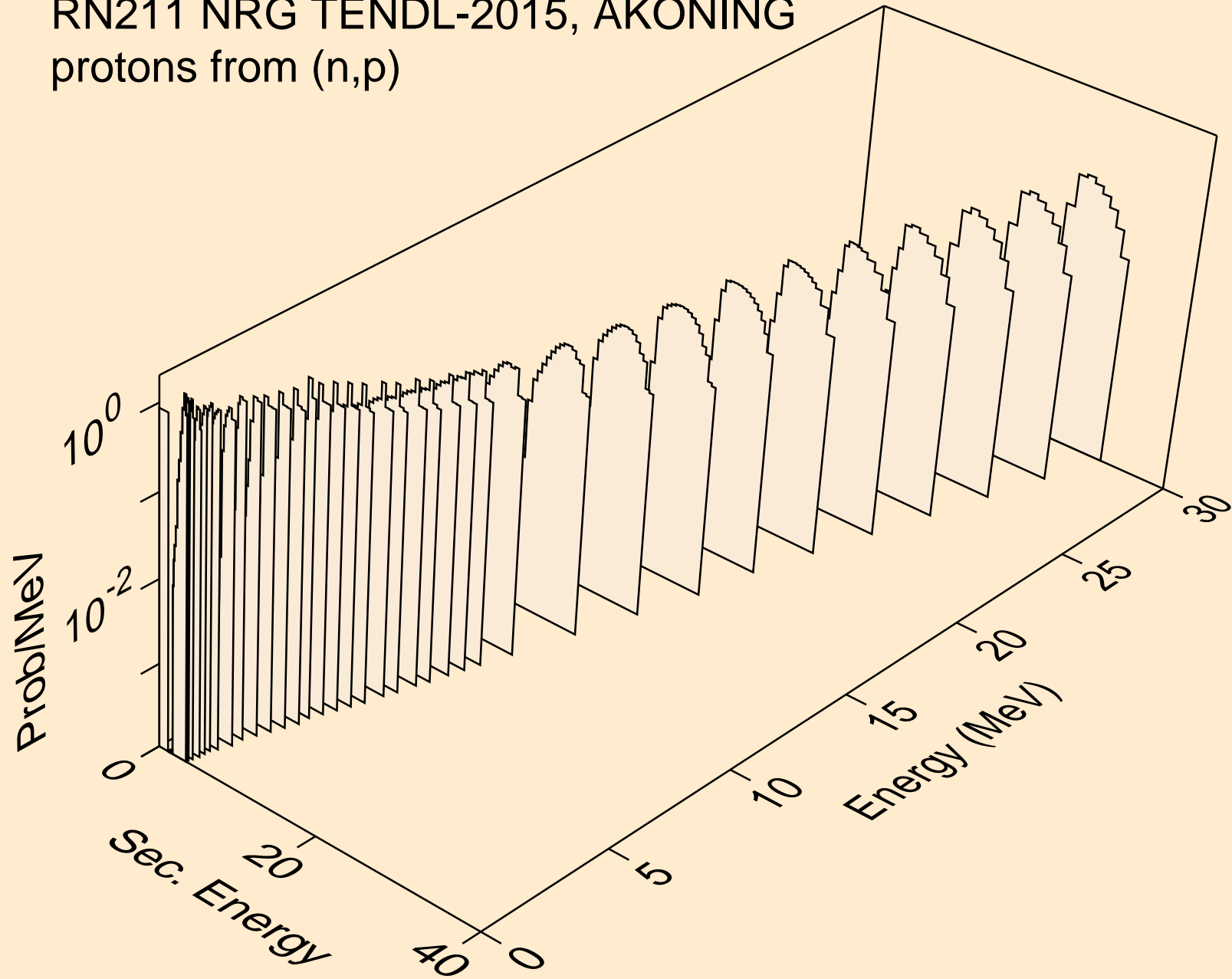

RN211 NRG TENDL-2015, AKONING
protons from (n,2p)

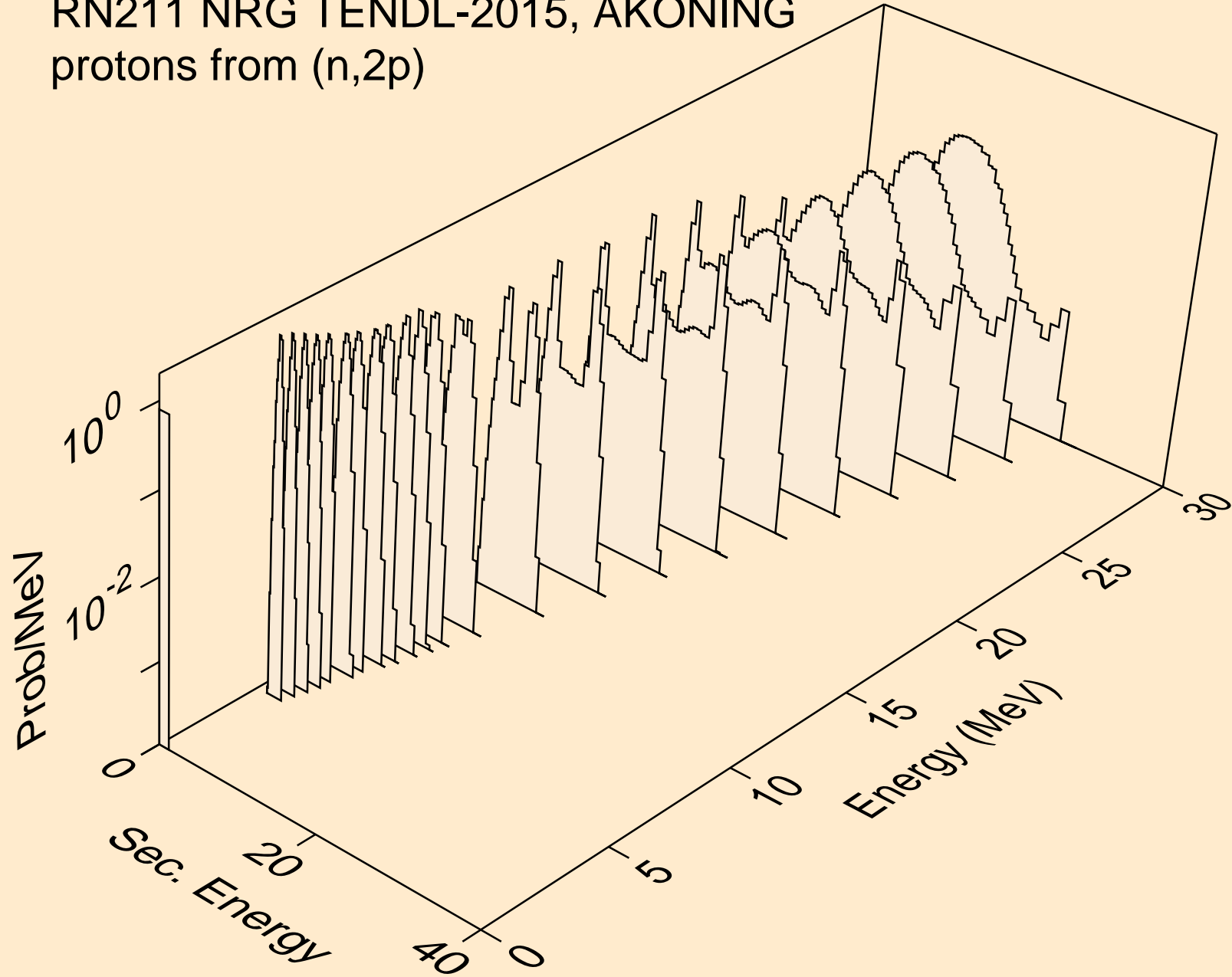

RN211 NRG TENDL-2015, AKONING
protons from (n,pa)

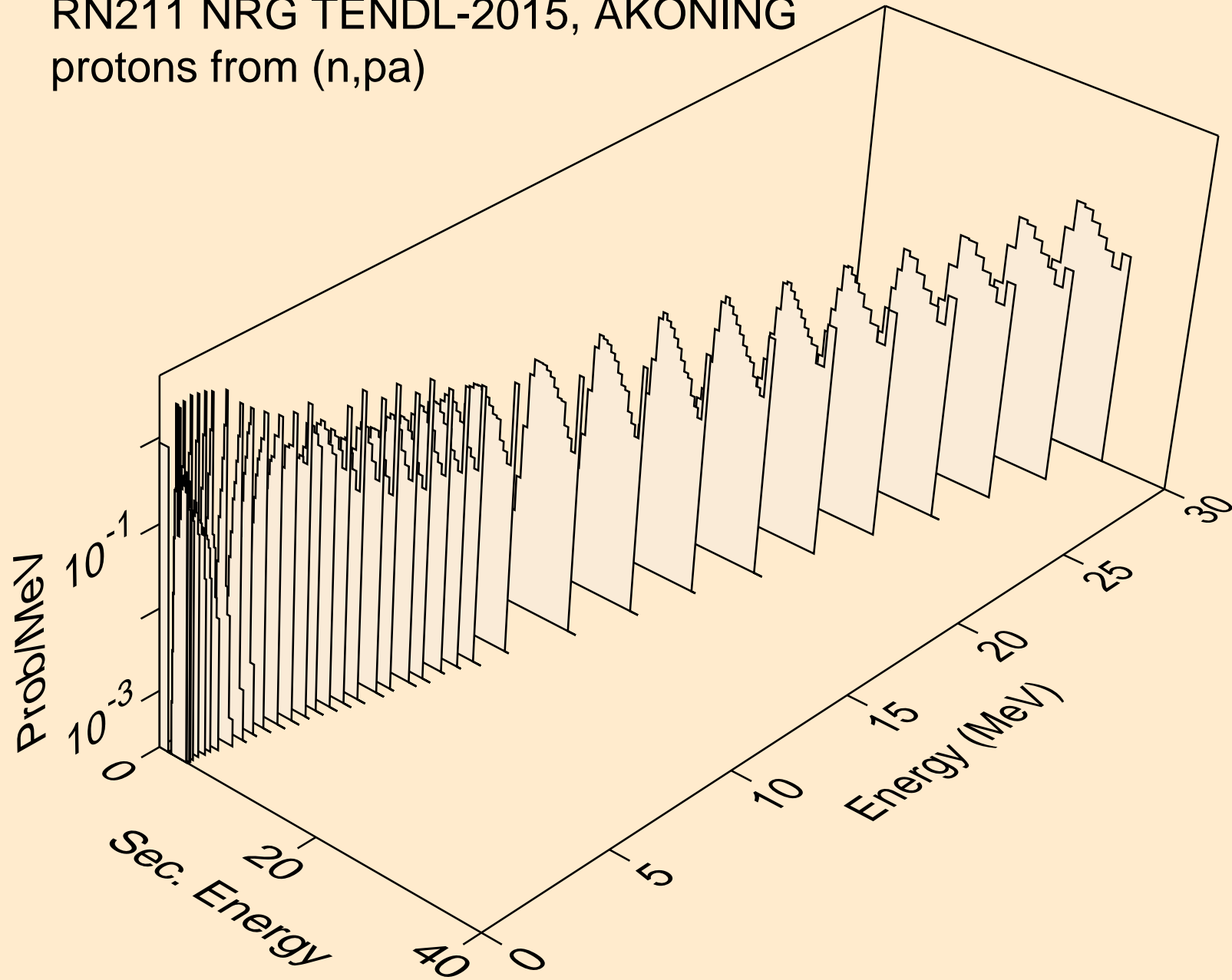

RN211 NRG TENDL-2015, AKONING
protons from (n,pd)

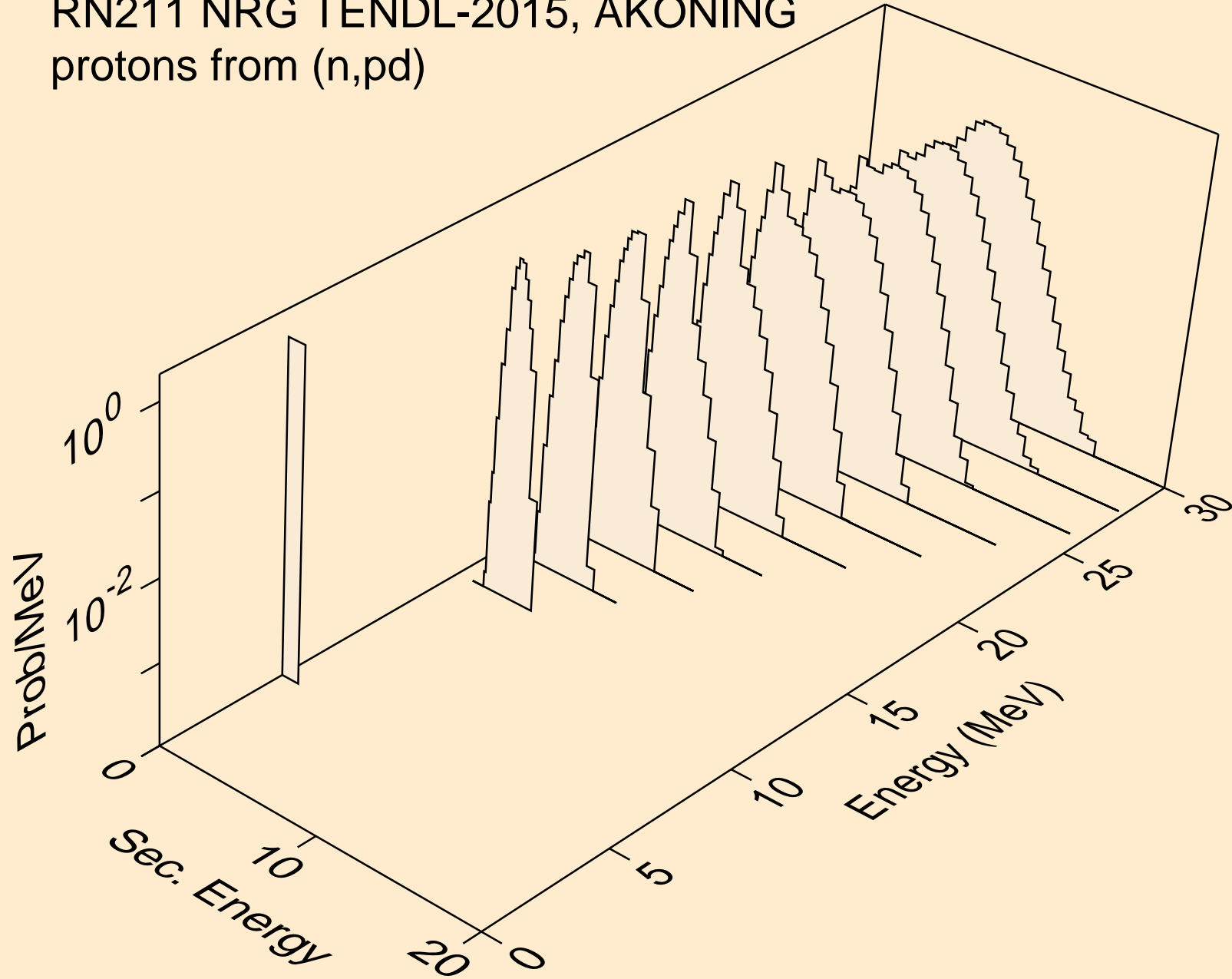

RN211 NRG TENDL-2015, AKONING
protons from (n,pt)

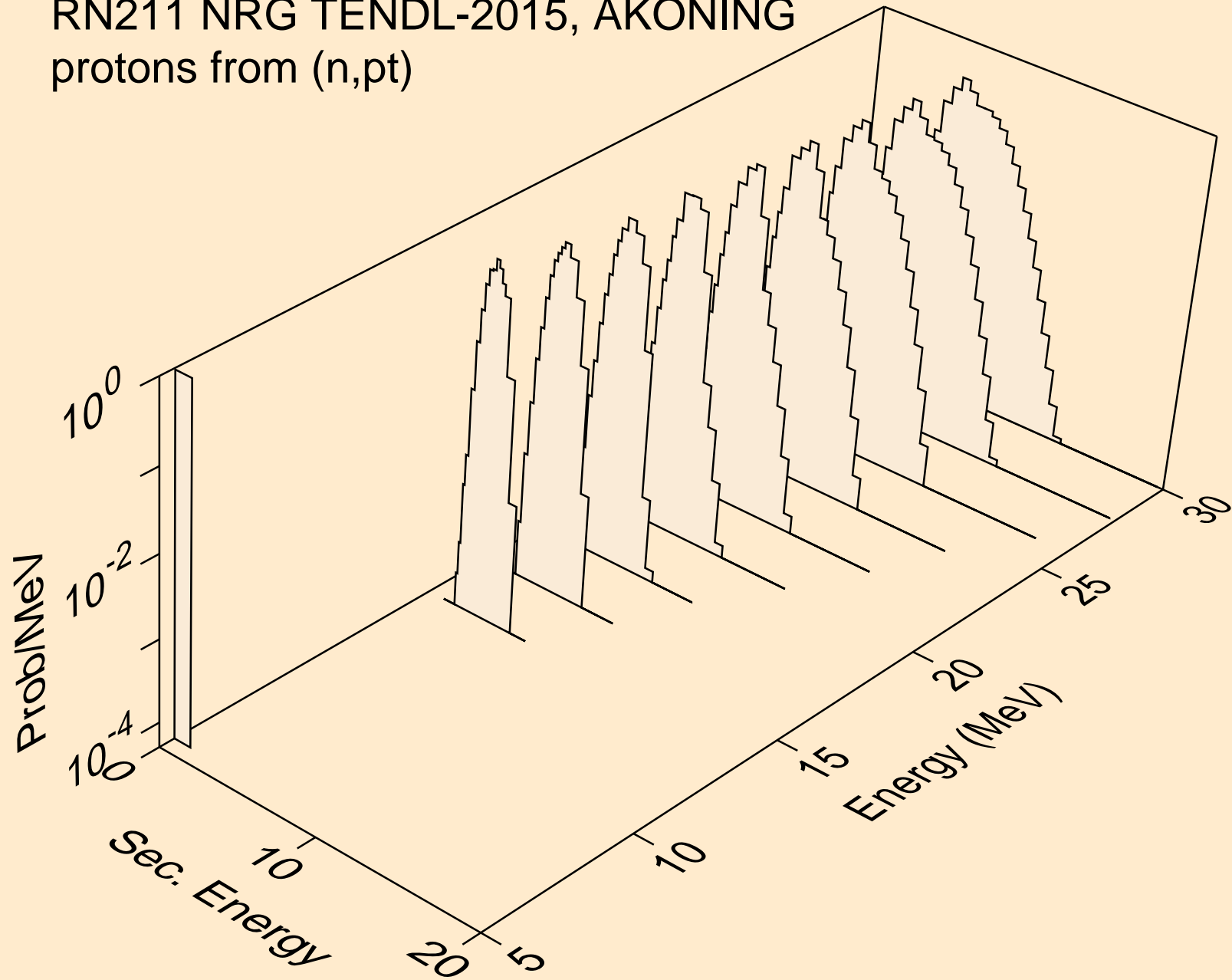

RN211 NRG TENDL-2015, AKONING
deuterons from (n,x)

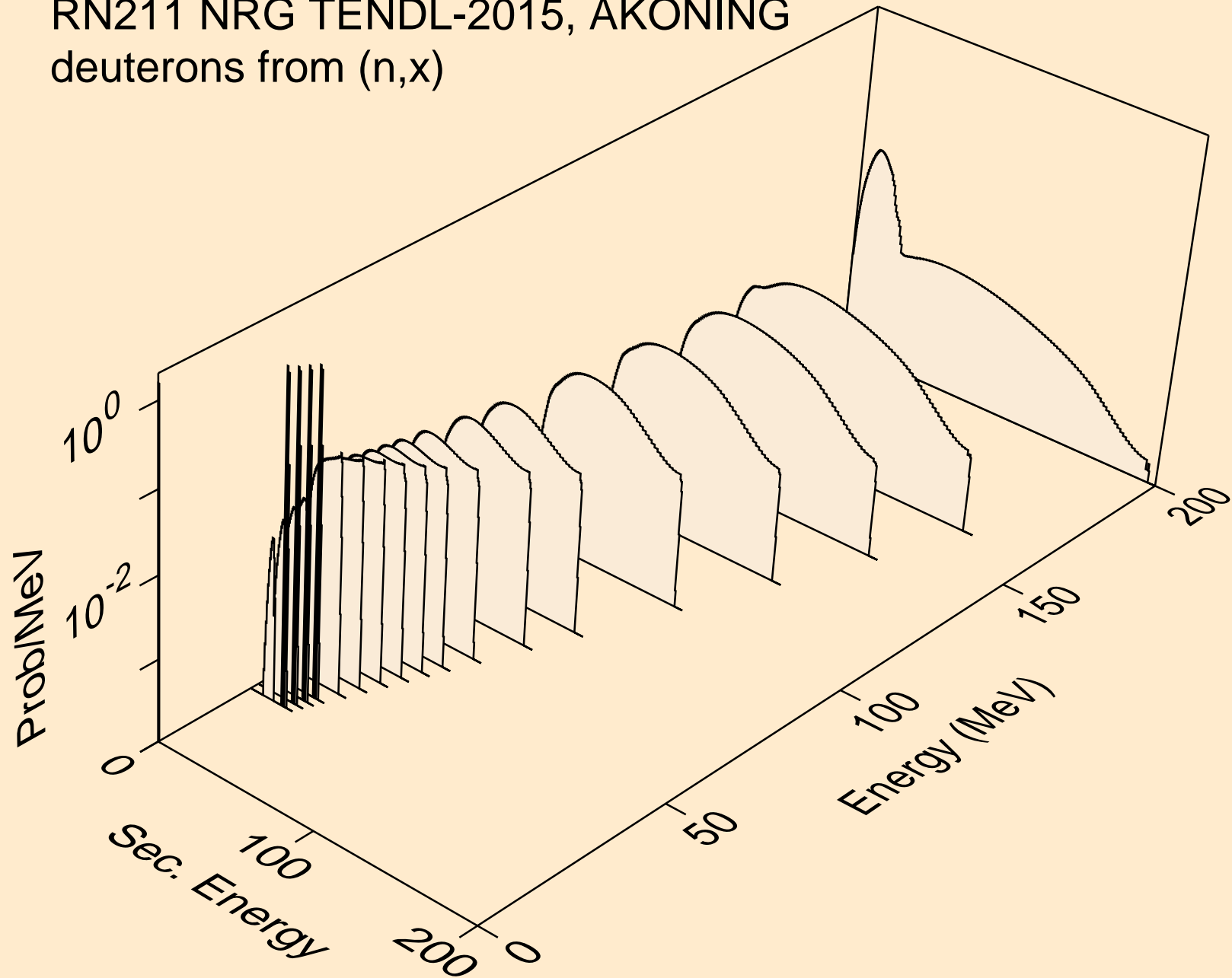

RN211 NRG TENDL-2015, AKONING
deuterons from (n,2nd)

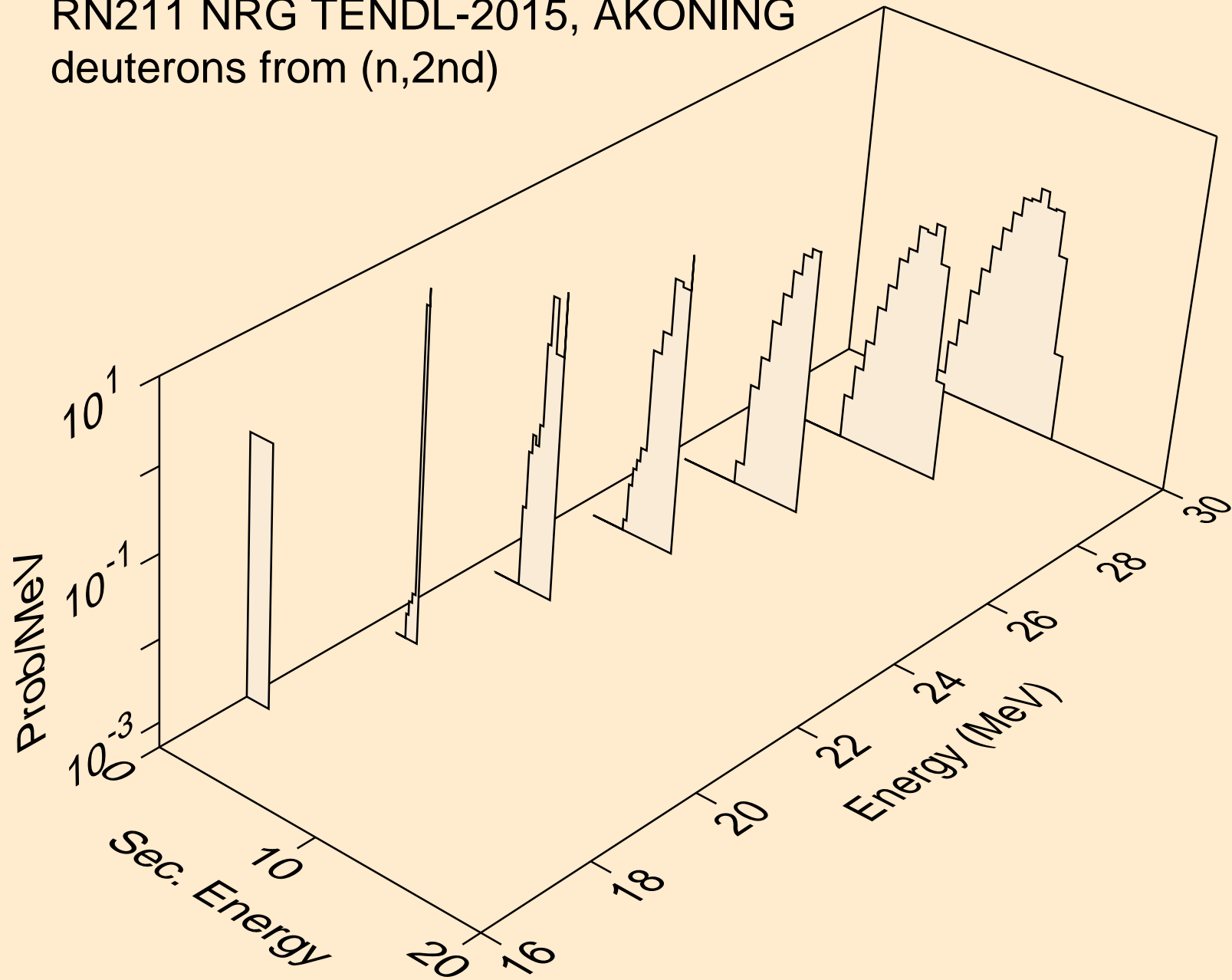

RN211 NRG TENDL-2015, AKONING
deuterons from (n,n*)d

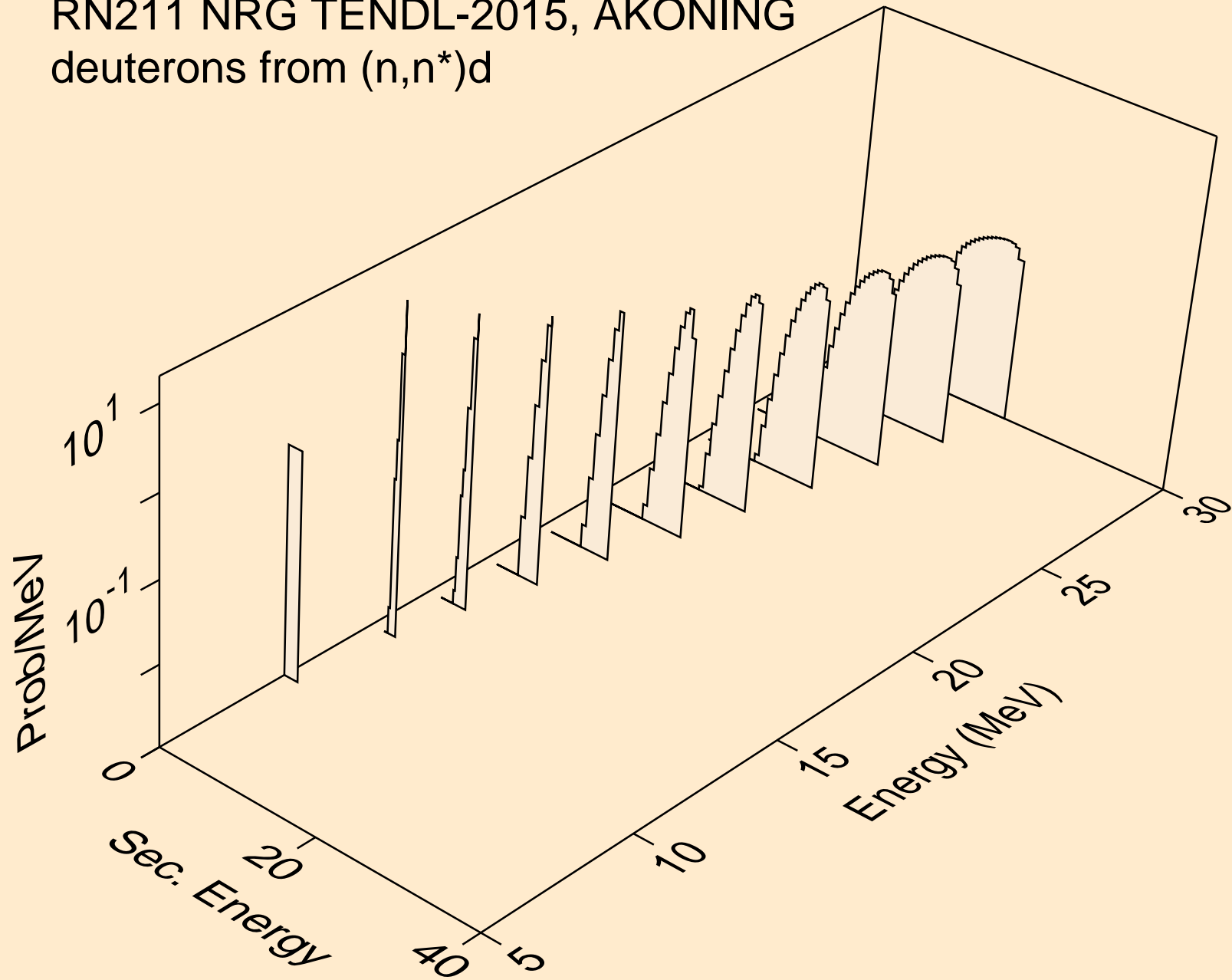

RN211 NRG TENDL-2015, AKONING
deuterons from (n,d)

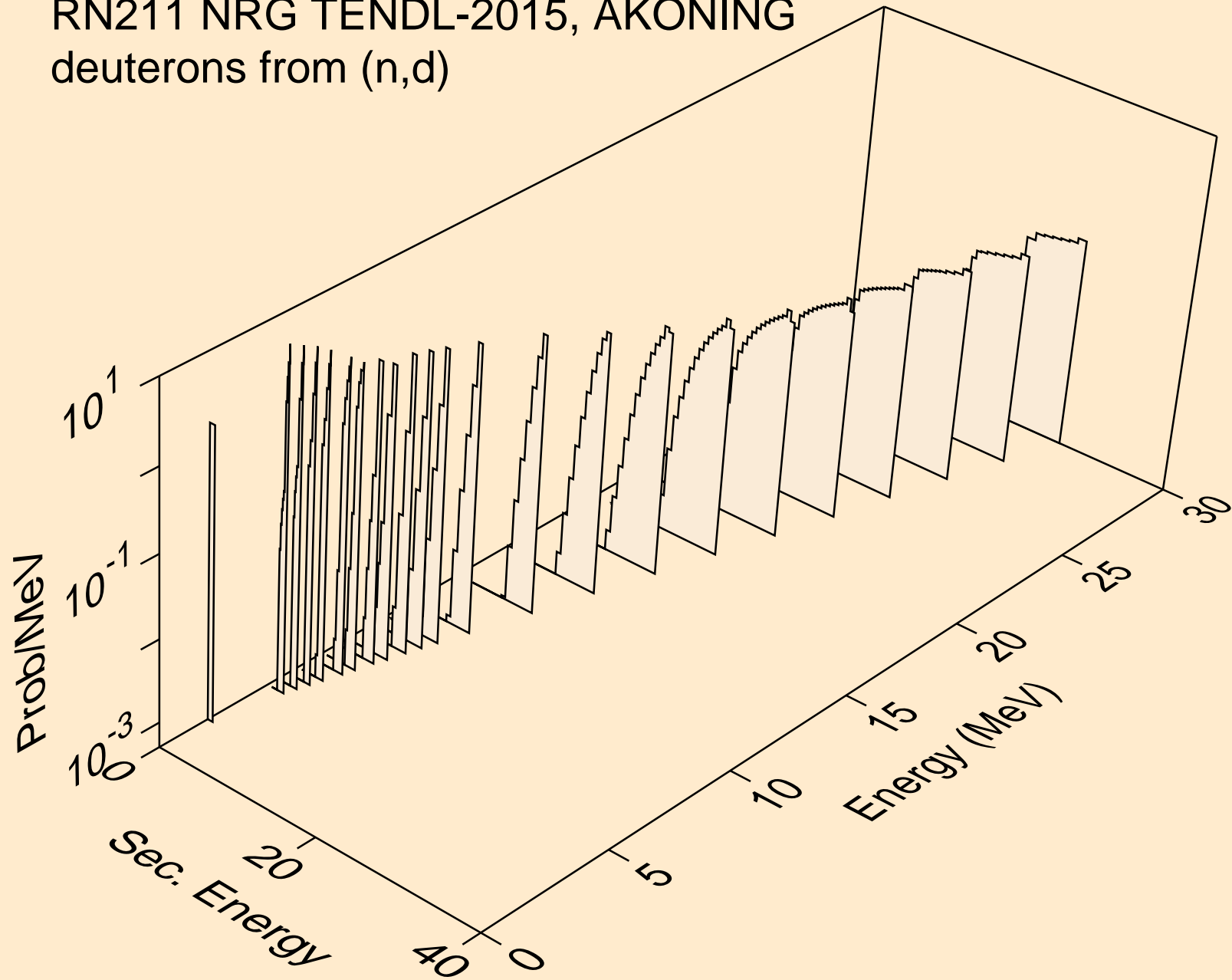

RN211 NRG TENDL-2015, AKONING
deuterons from (n,pd)

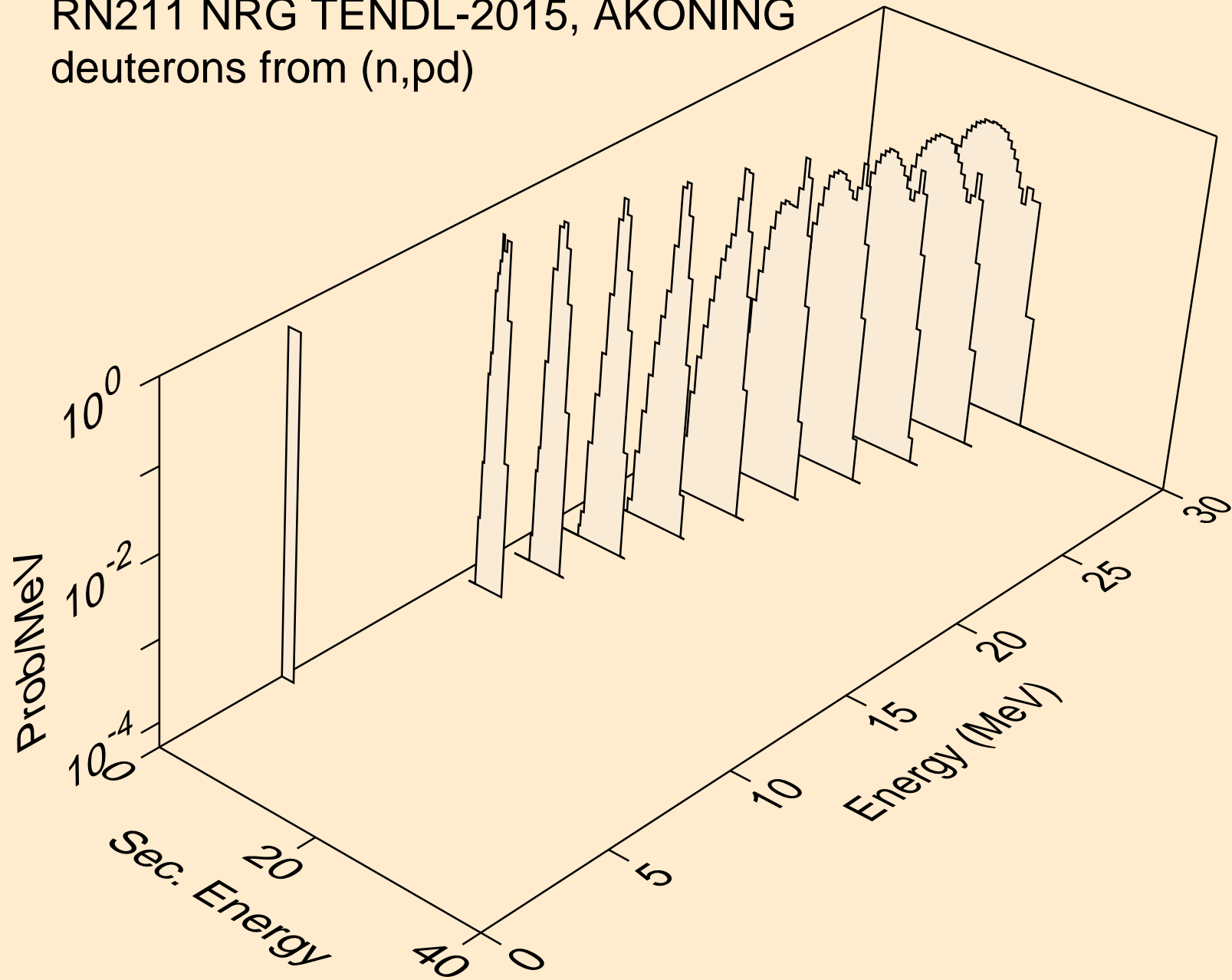

RN211 NRG TENDL-2015, AKONING
deuterons from (n,da)

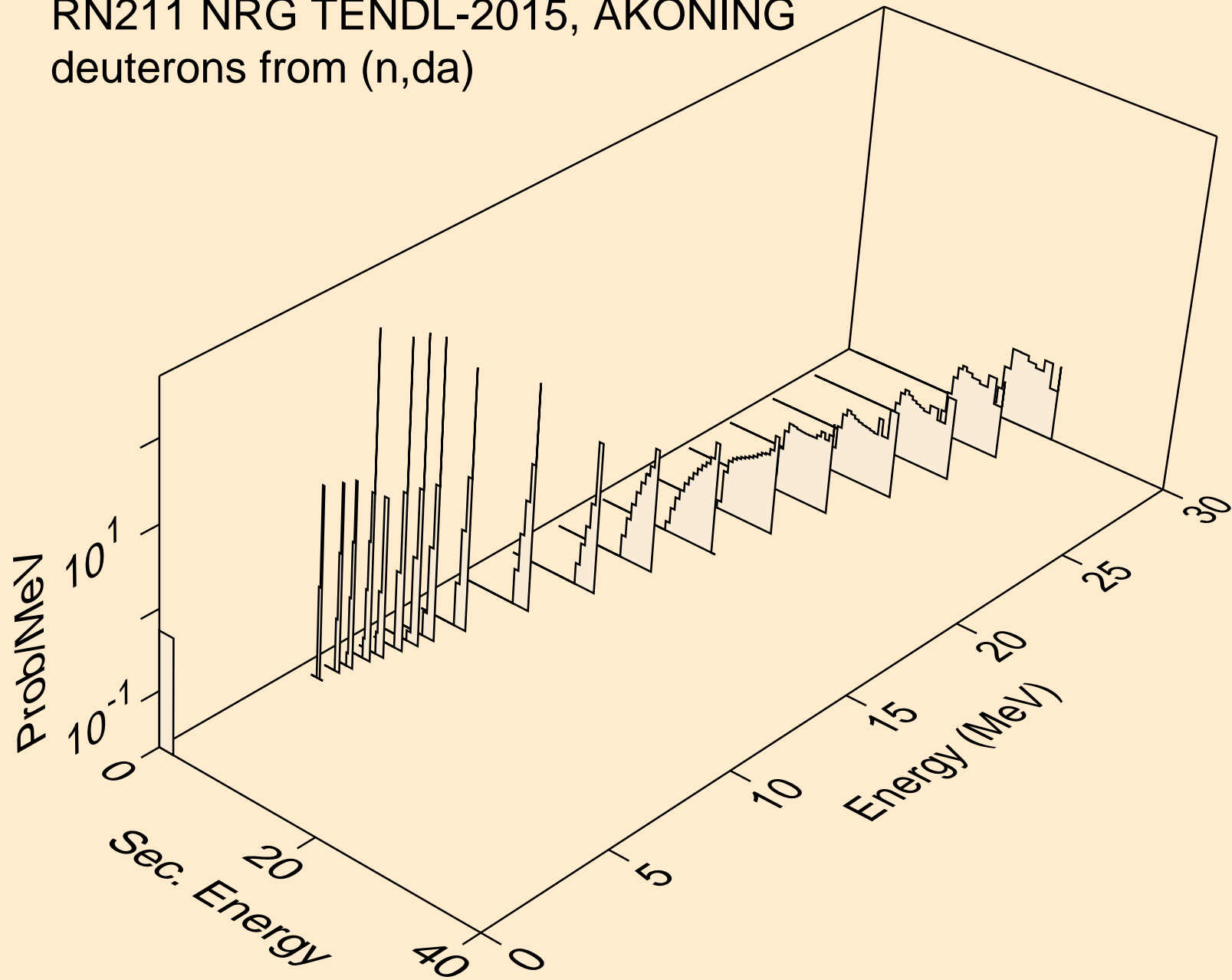

RN211 NRG TENDL-2015, AKONING
tritons from (n,x)

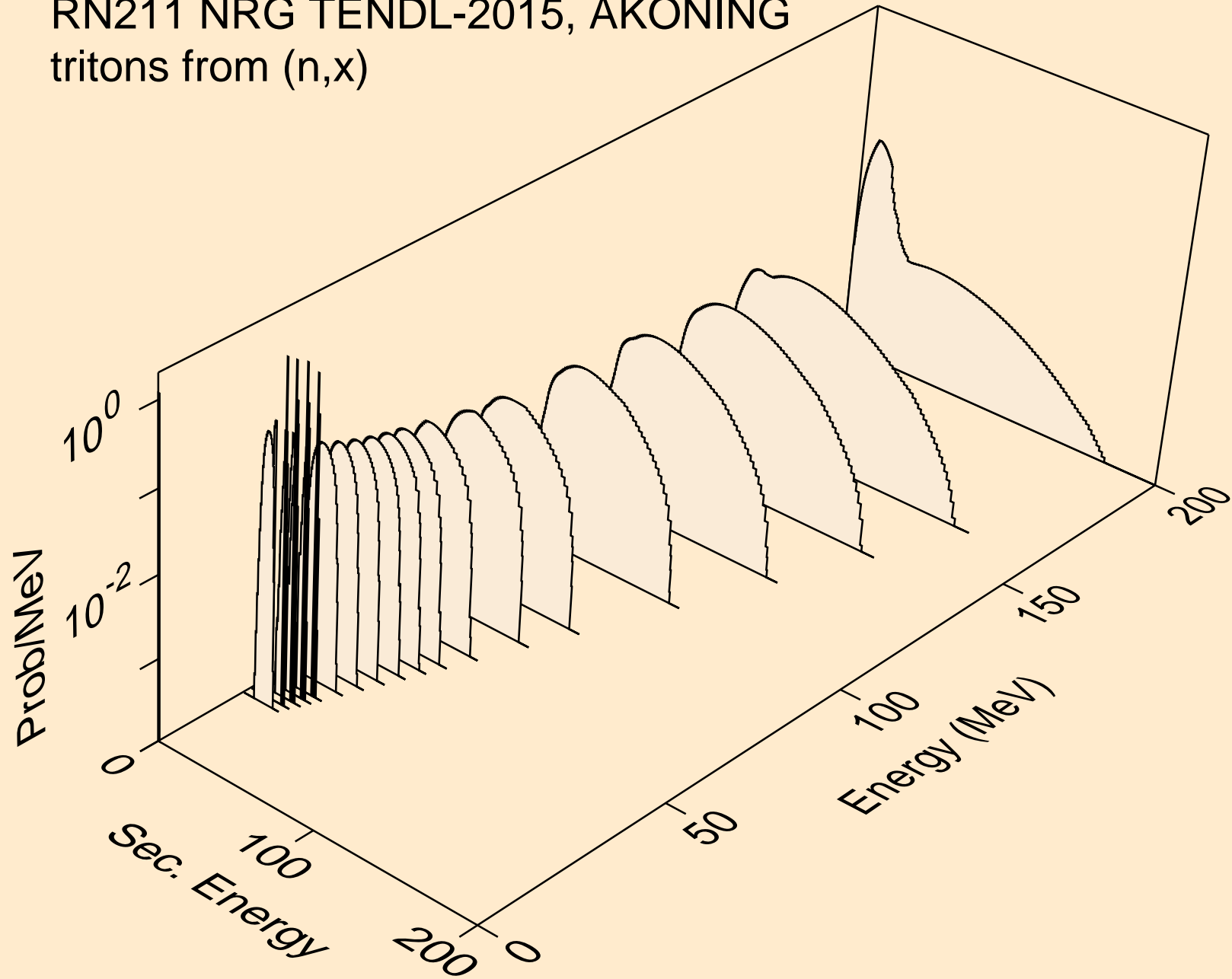

RN211 NRG TENDL-2015, AKONING
tritons from (n,n*)t

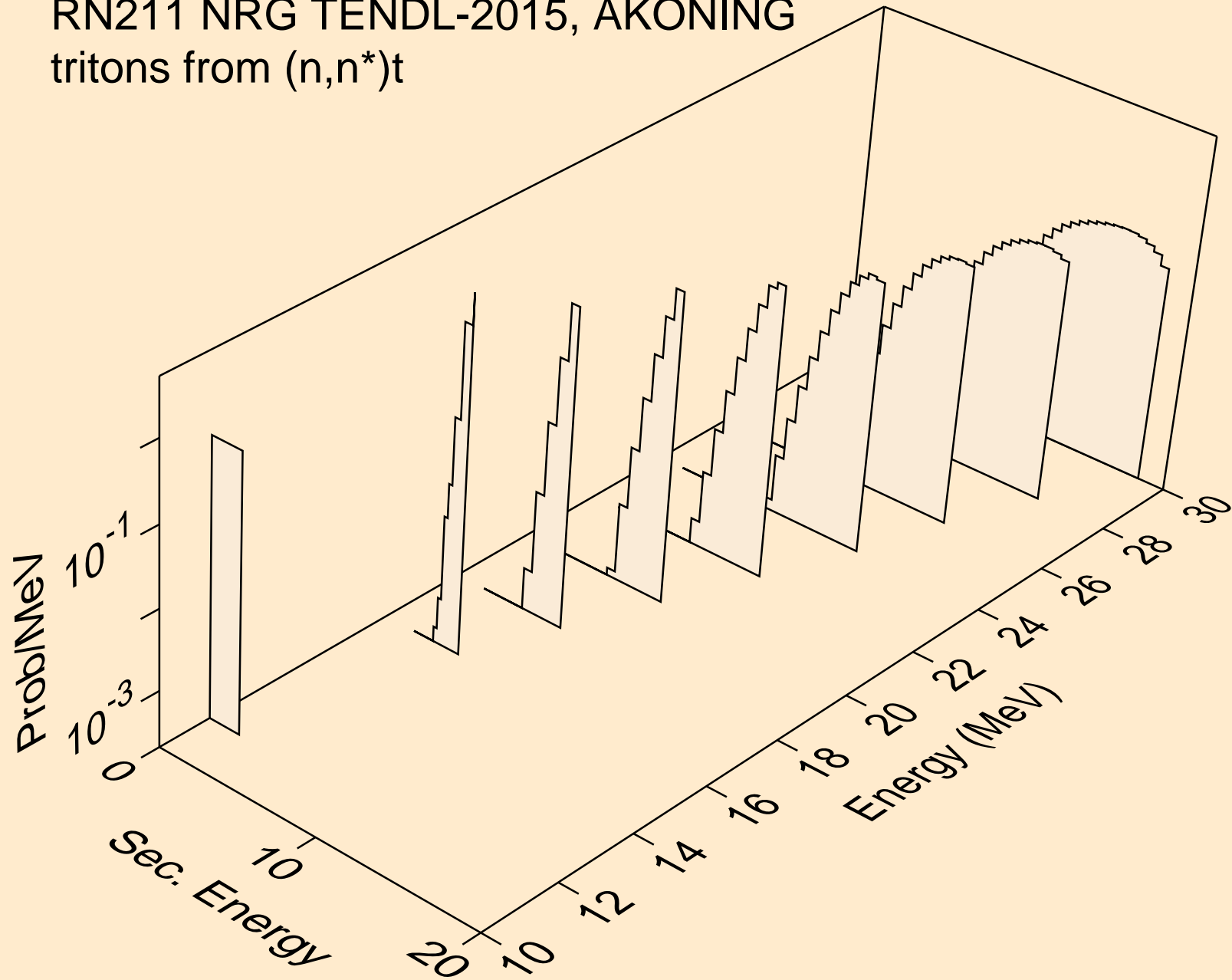

RN211 NRG TENDL-2015, AKONING
tritons from (n,t)

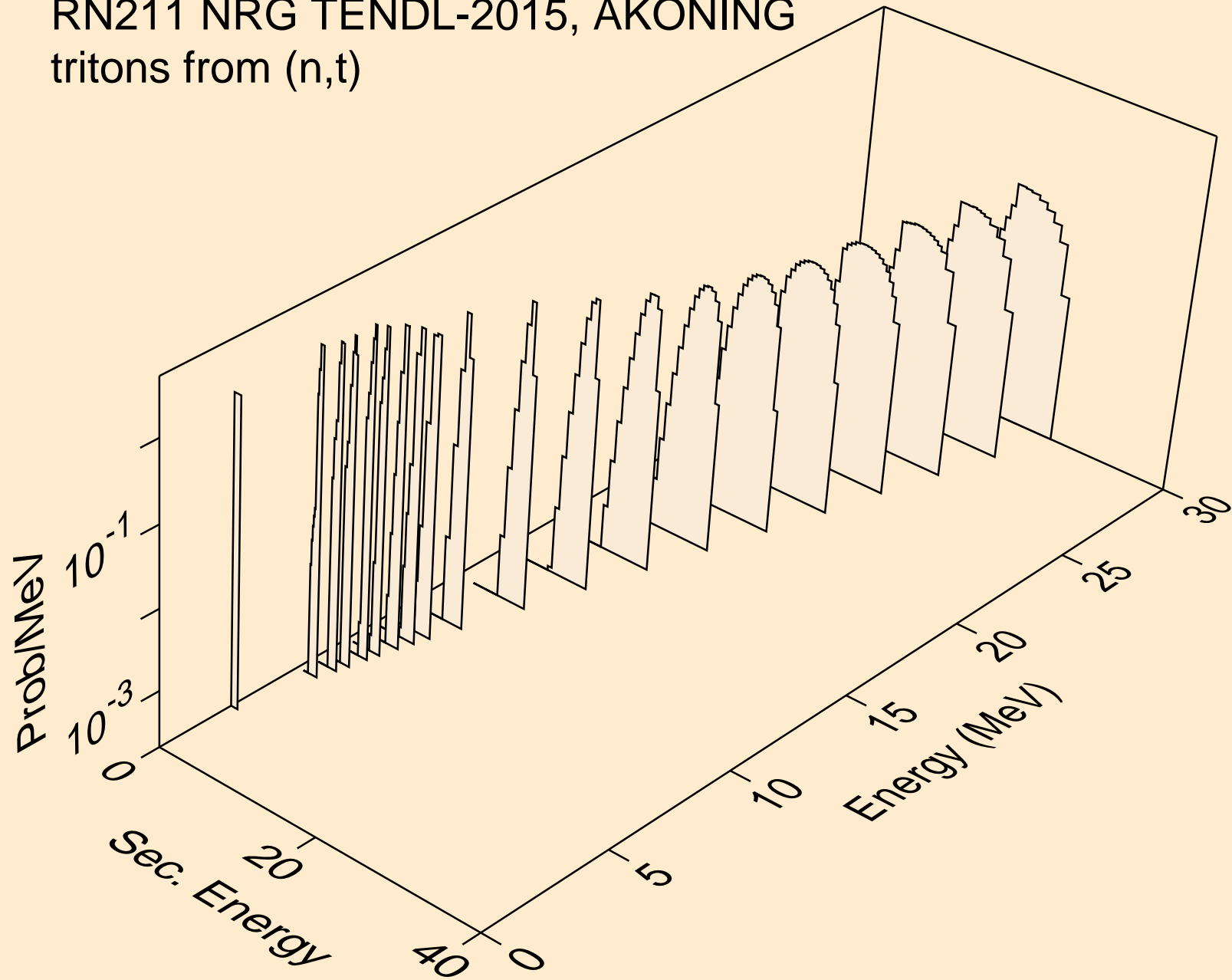

RN211 NRG TENDL-2015, AKONING
tritons from (n,pt)

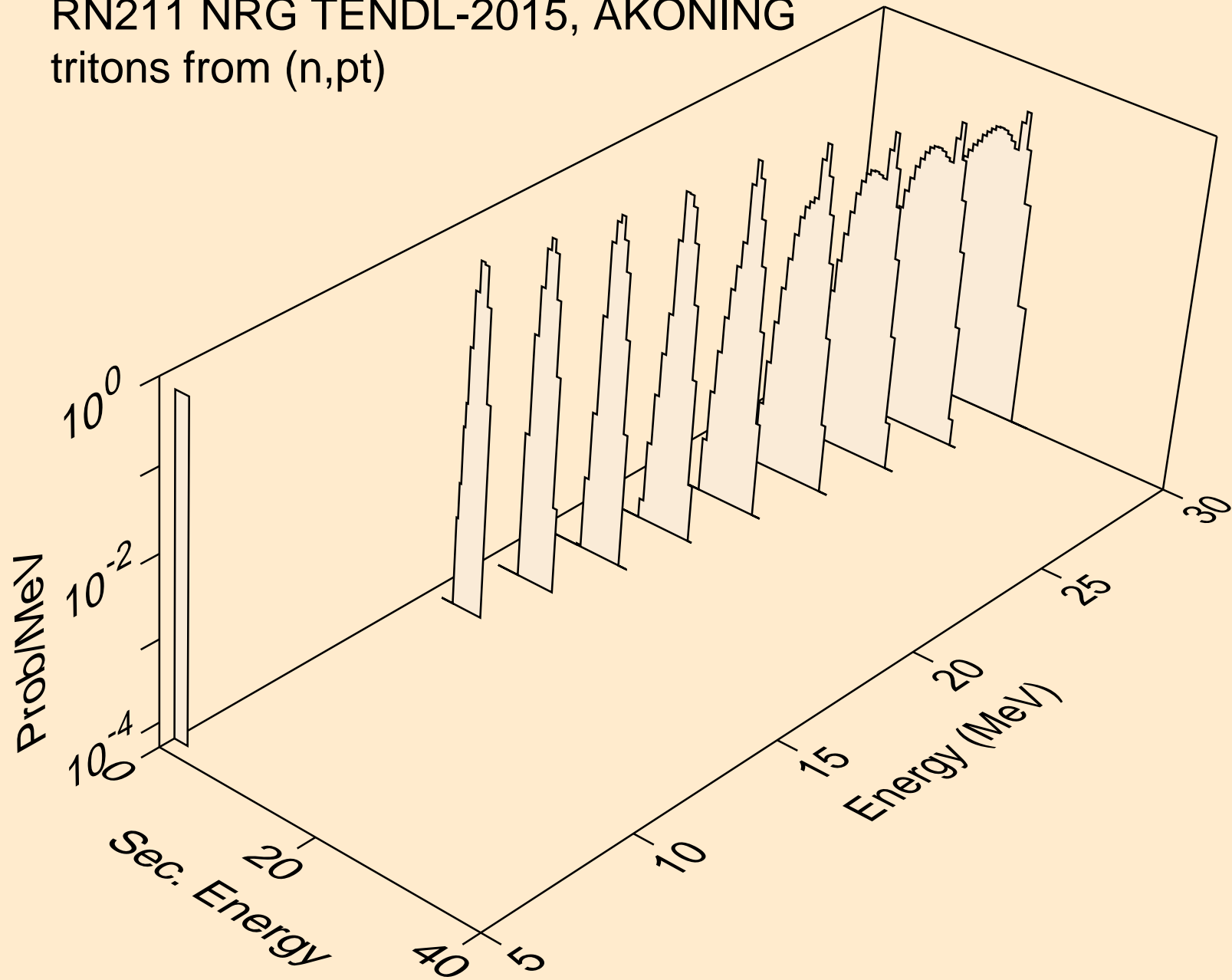

RN211 NRG TENDL-2015, AKONING
he3s from (n,x)

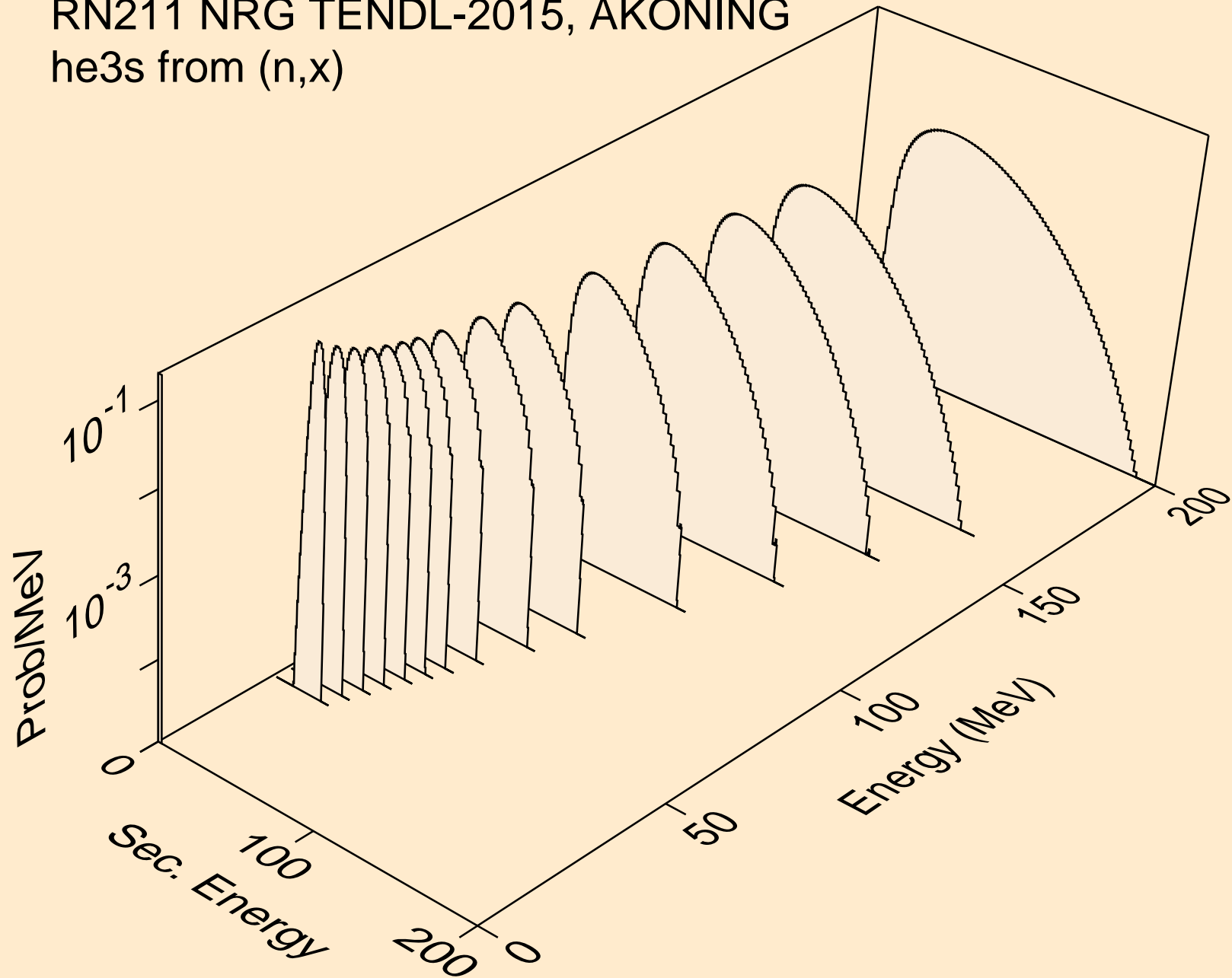

RN211 NRG TENDL-2015, AKONING
he3s from (n,n*)he3

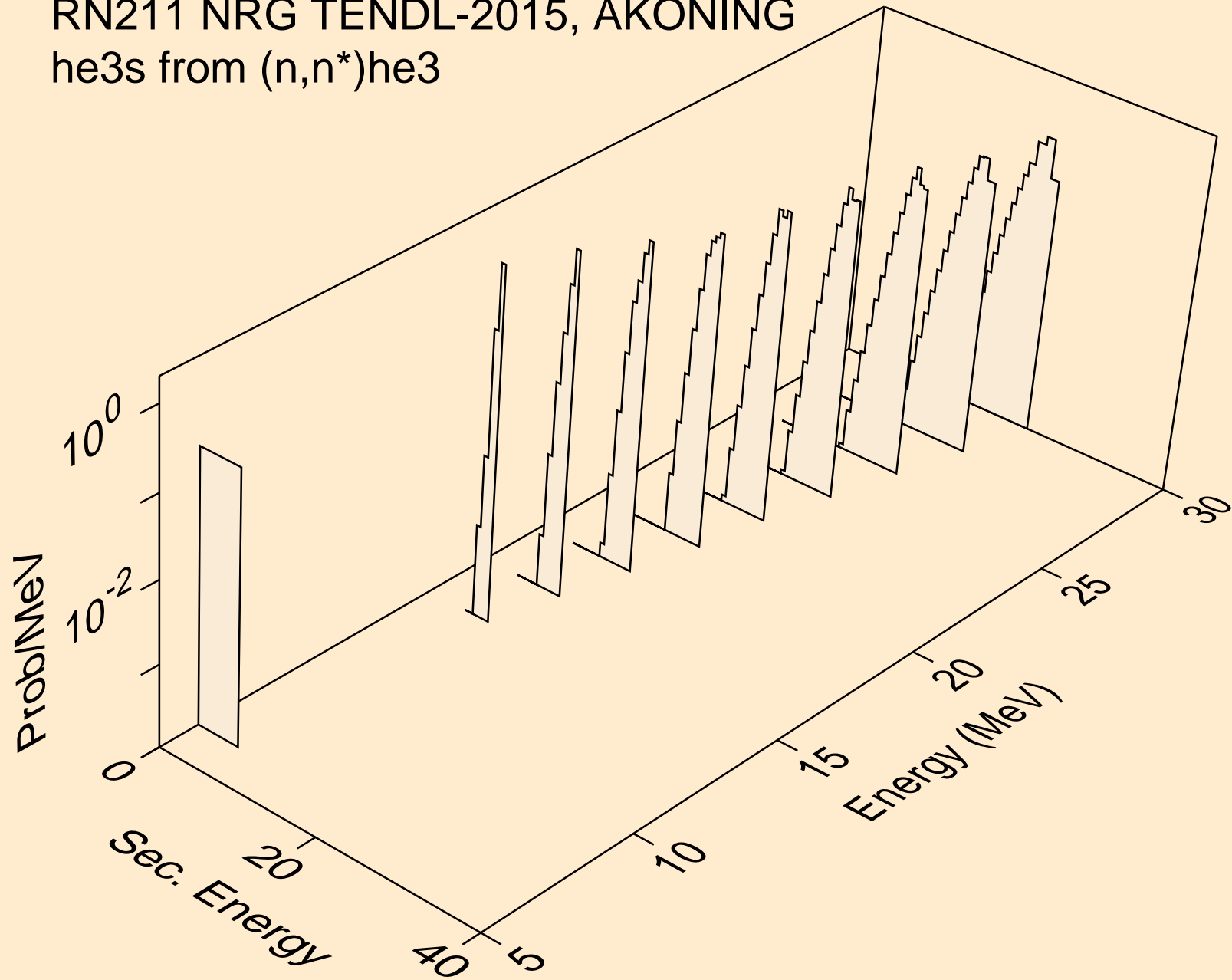

RN211 NRG TENDL-2015, AKONING
he3s from (n,he3)

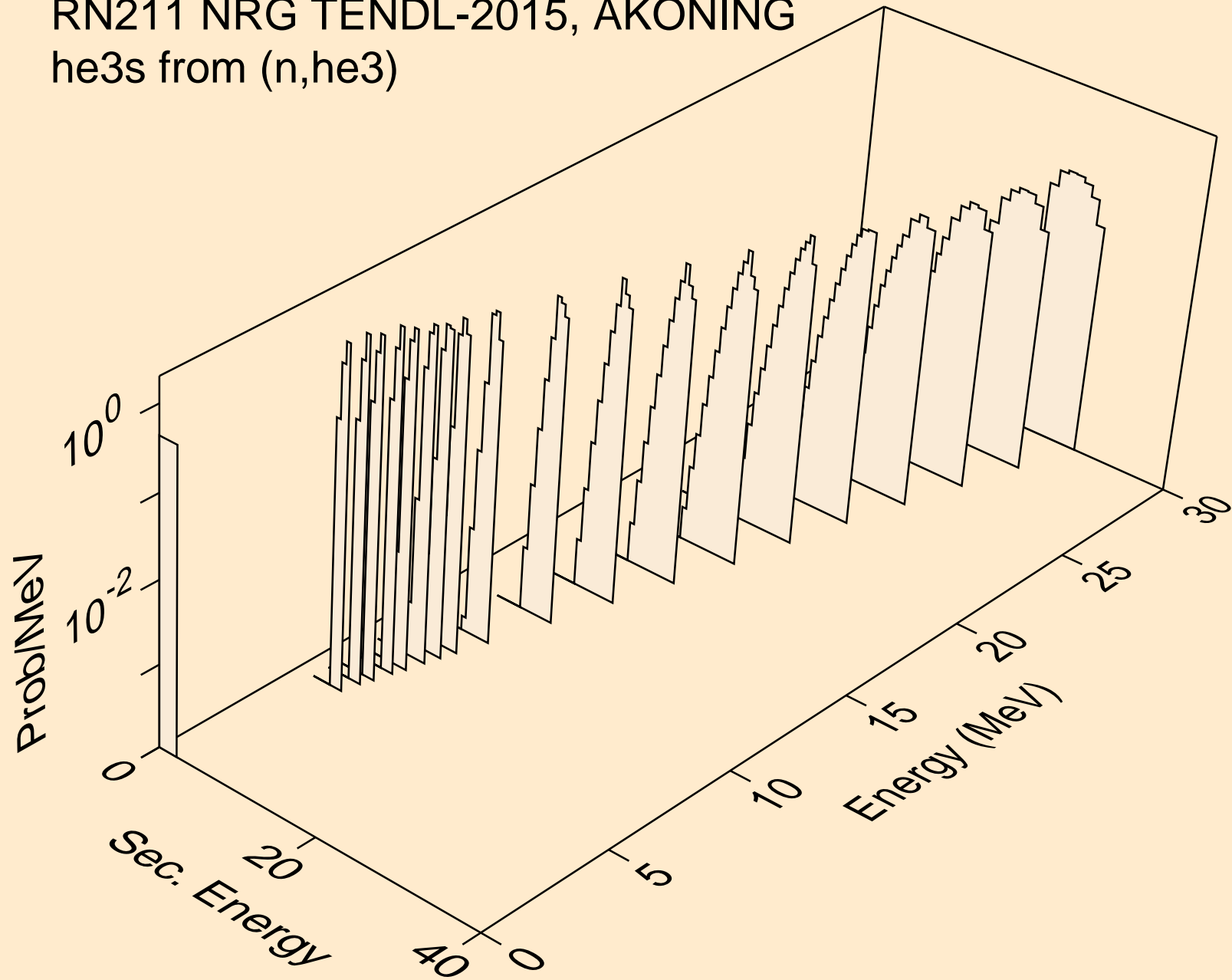

RN211 NRG TENDL-2015, AKONING
alphas from (n,x)

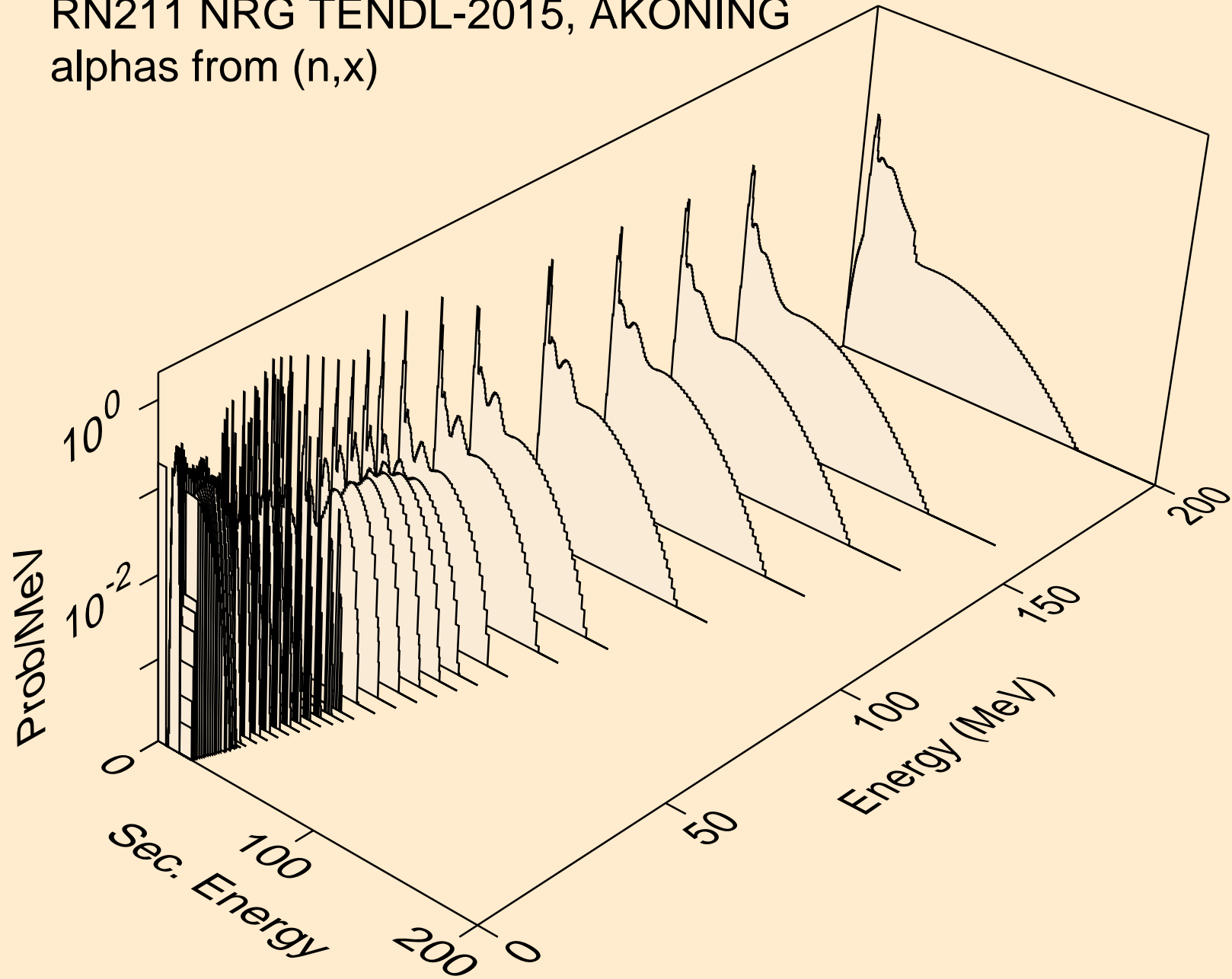

RN211 NRG TENDL-2015, AKONING
alphas from (n,n*)a

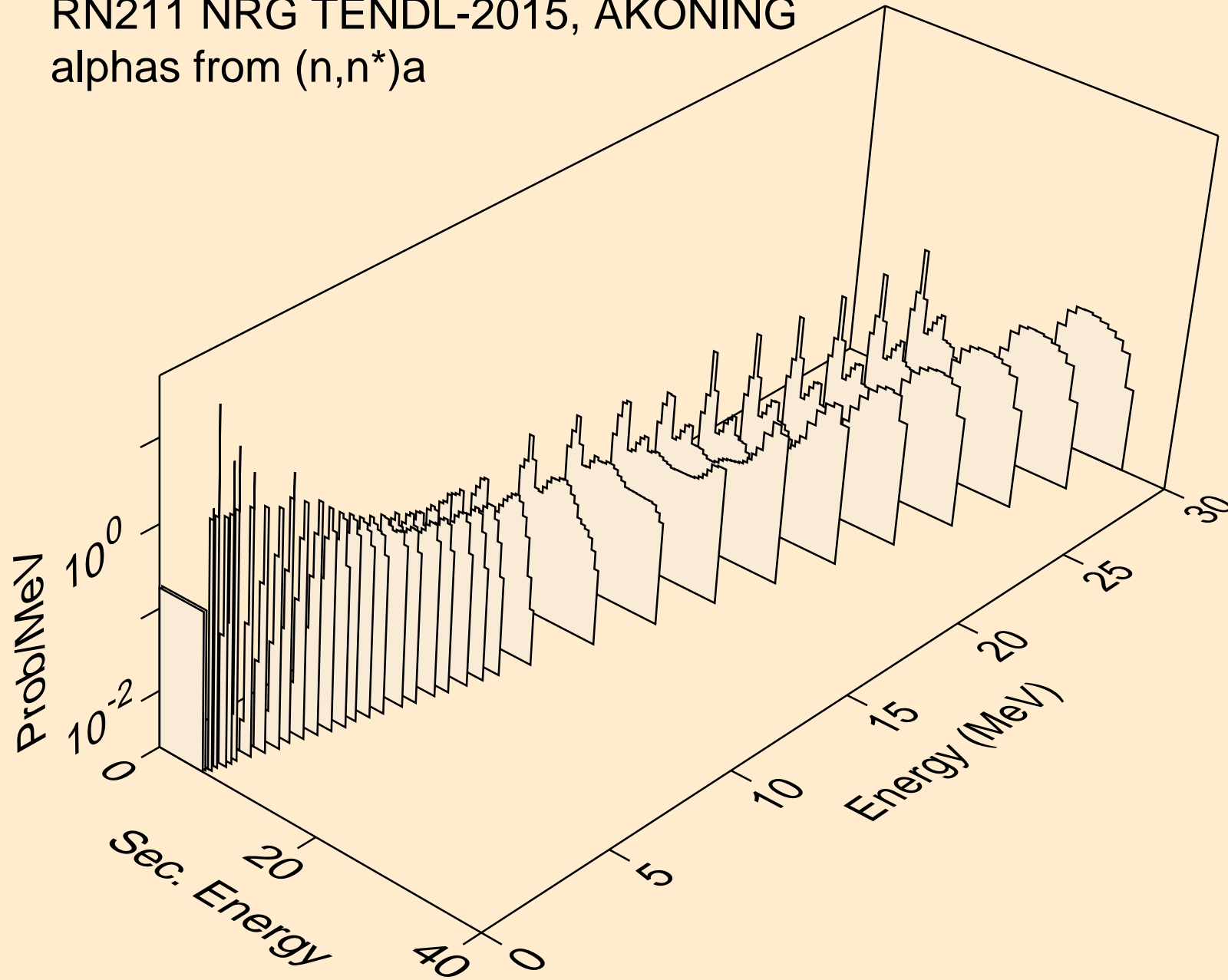

RN211 NRG TENDL-2015, AKONING
alphas from (n,2n)a

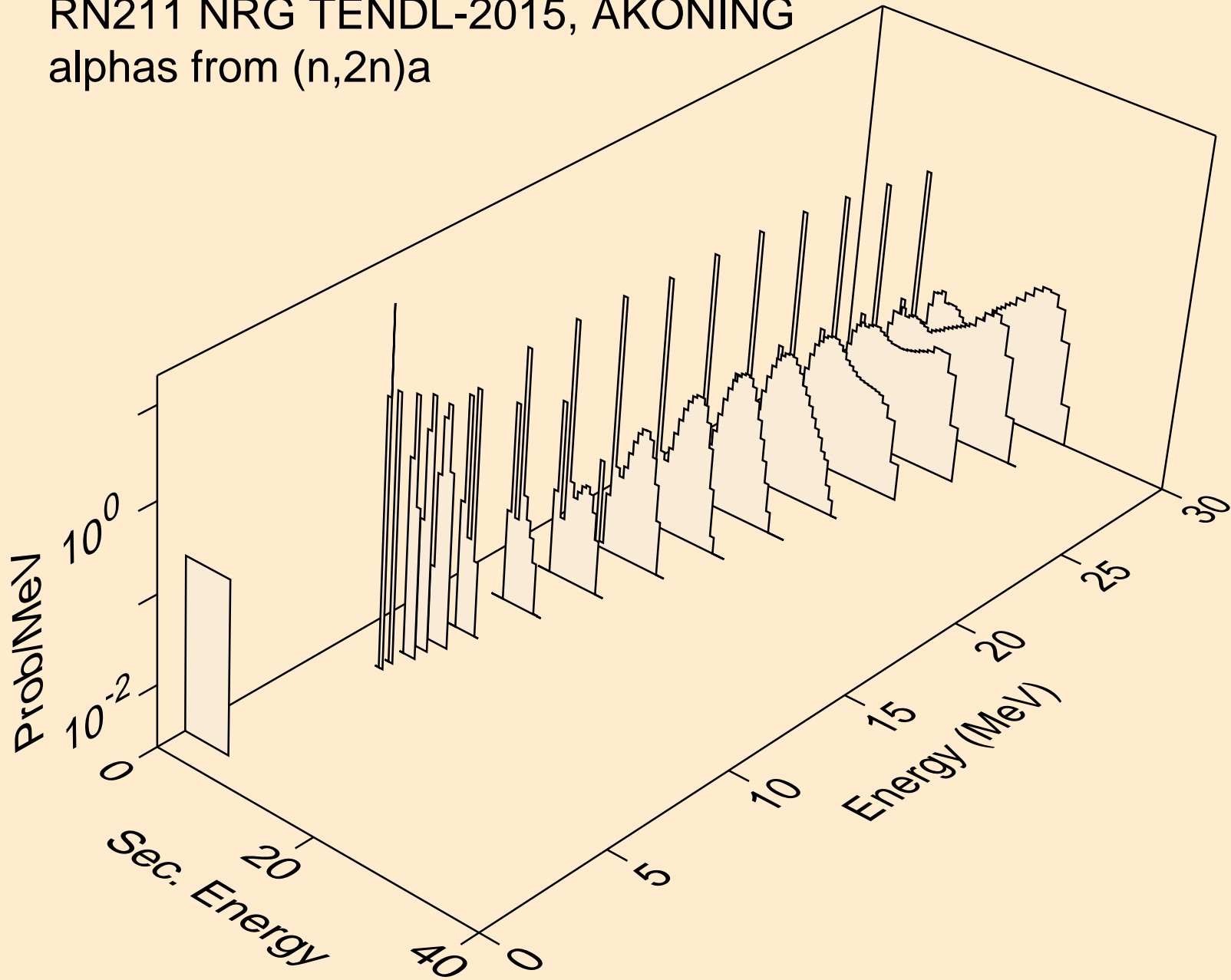

RN211 NRG TENDL-2015, AKONING
alphas from (n,3n)a

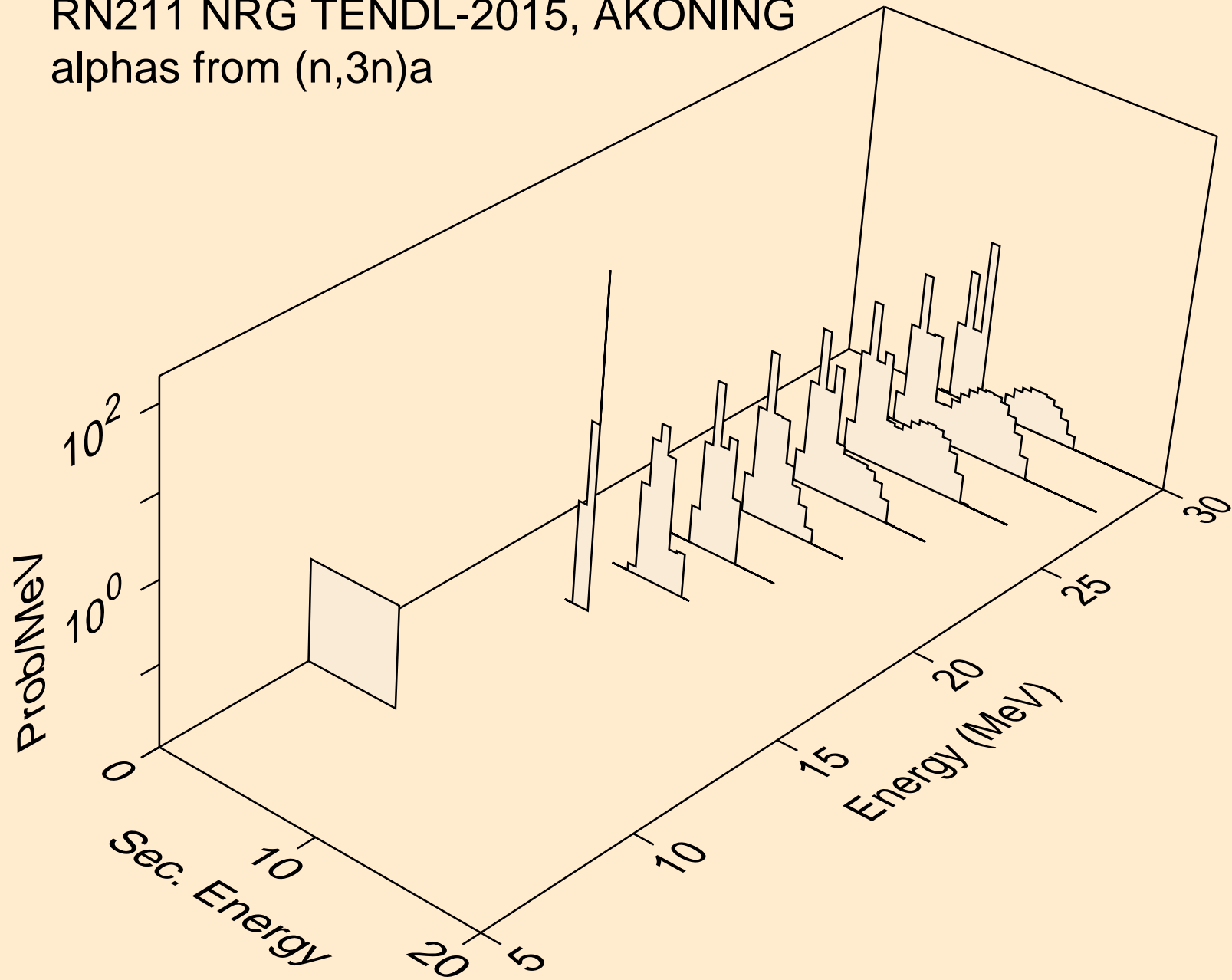

RN211 NRG TENDL-2015, AKONING
alphas from (n,n*)2a

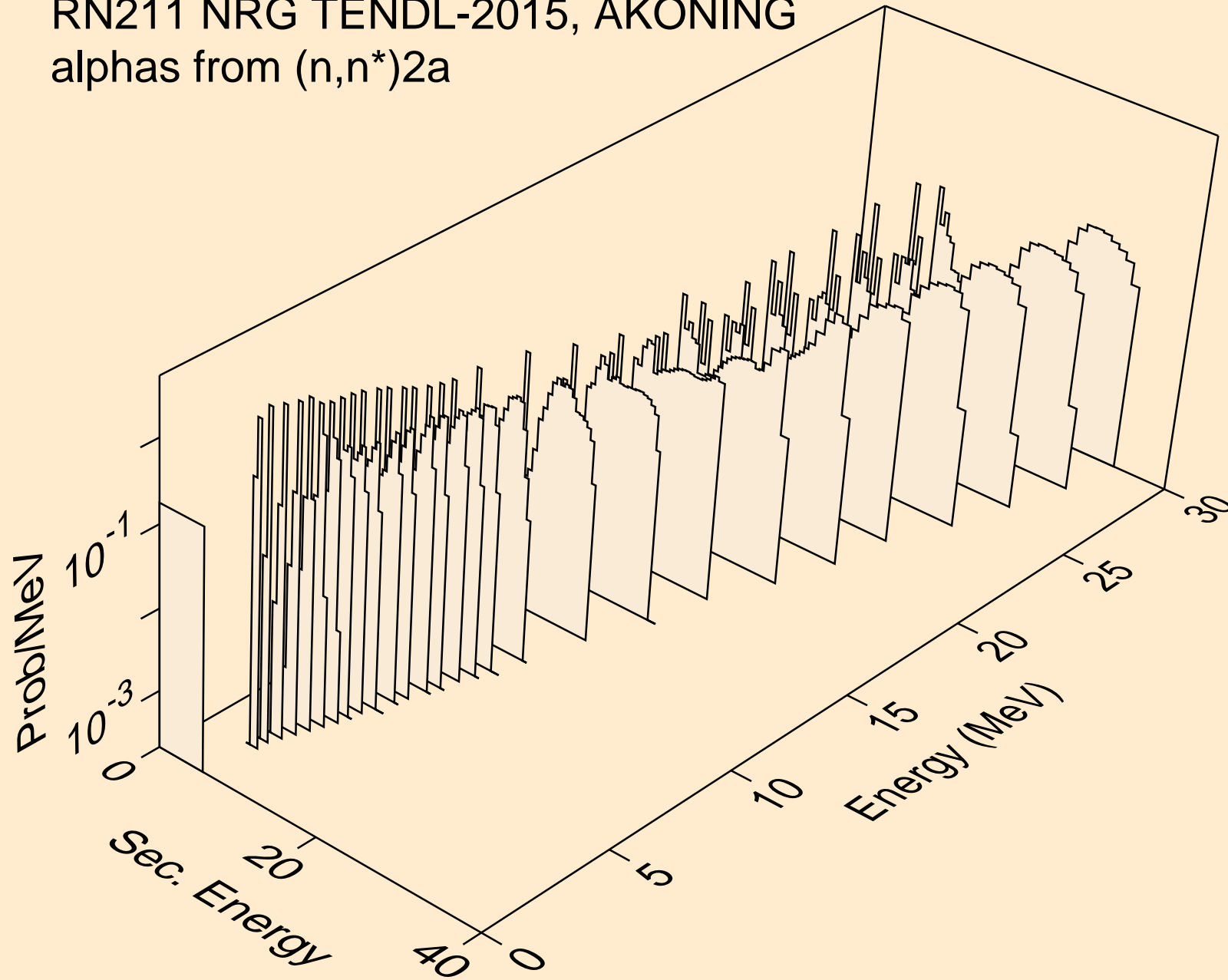

RN211 NRG TENDL-2015, AKONING
alphas from (n,2n)2a

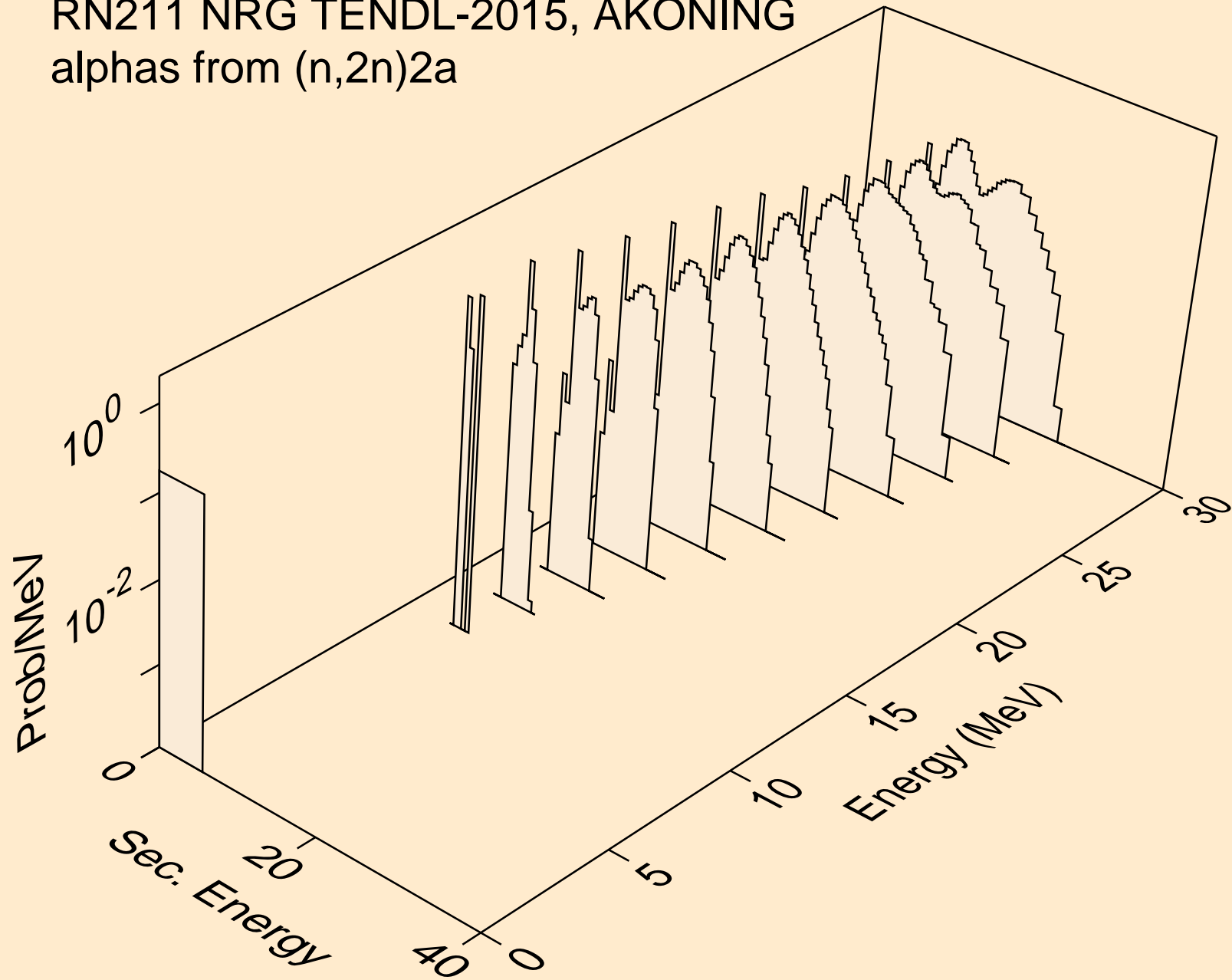

RN211 NRG TENDL-2015, AKONING
alphas from (n,npa)

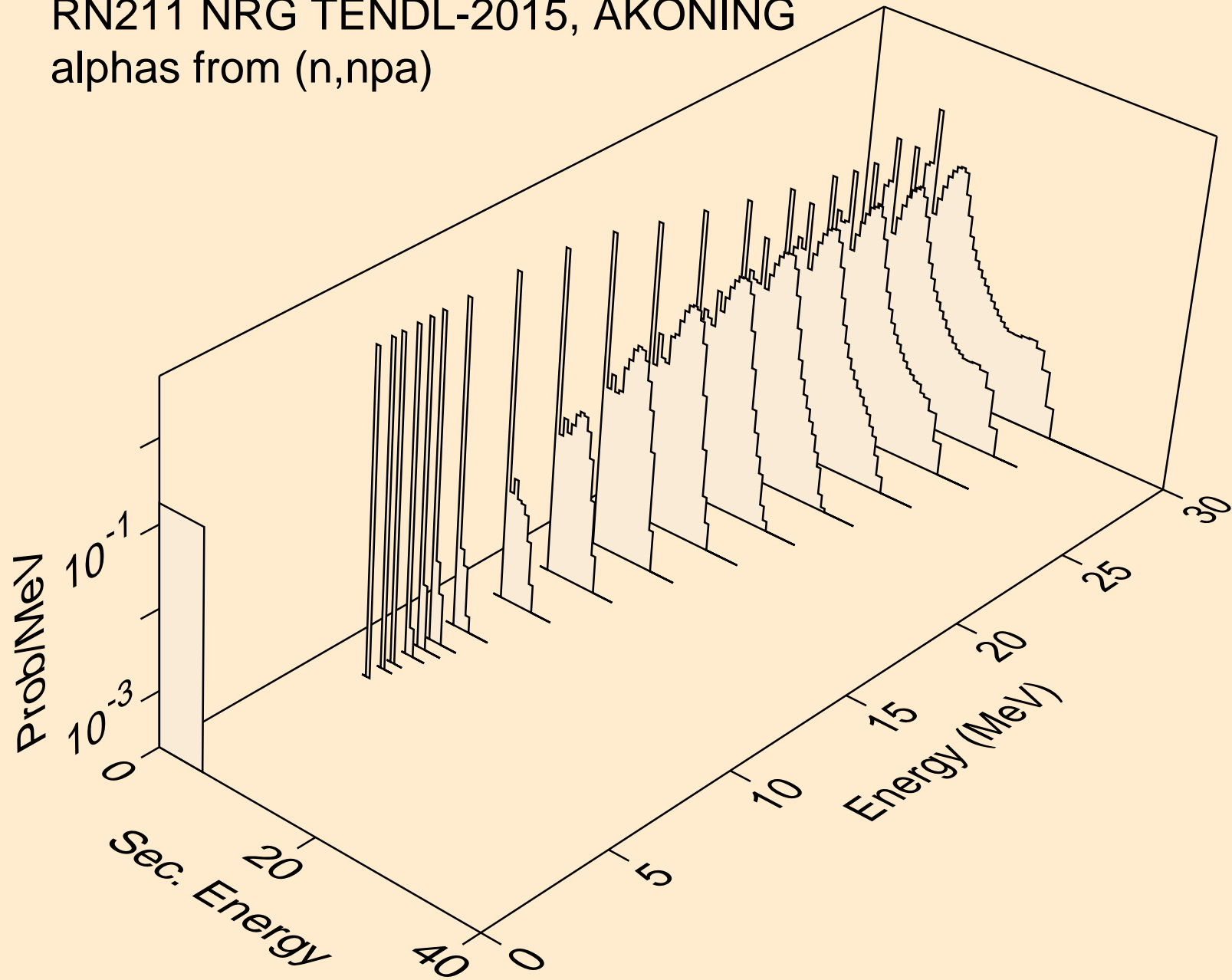

RN211 NRG TENDL-2015, AKONING
alphas from (n,a)

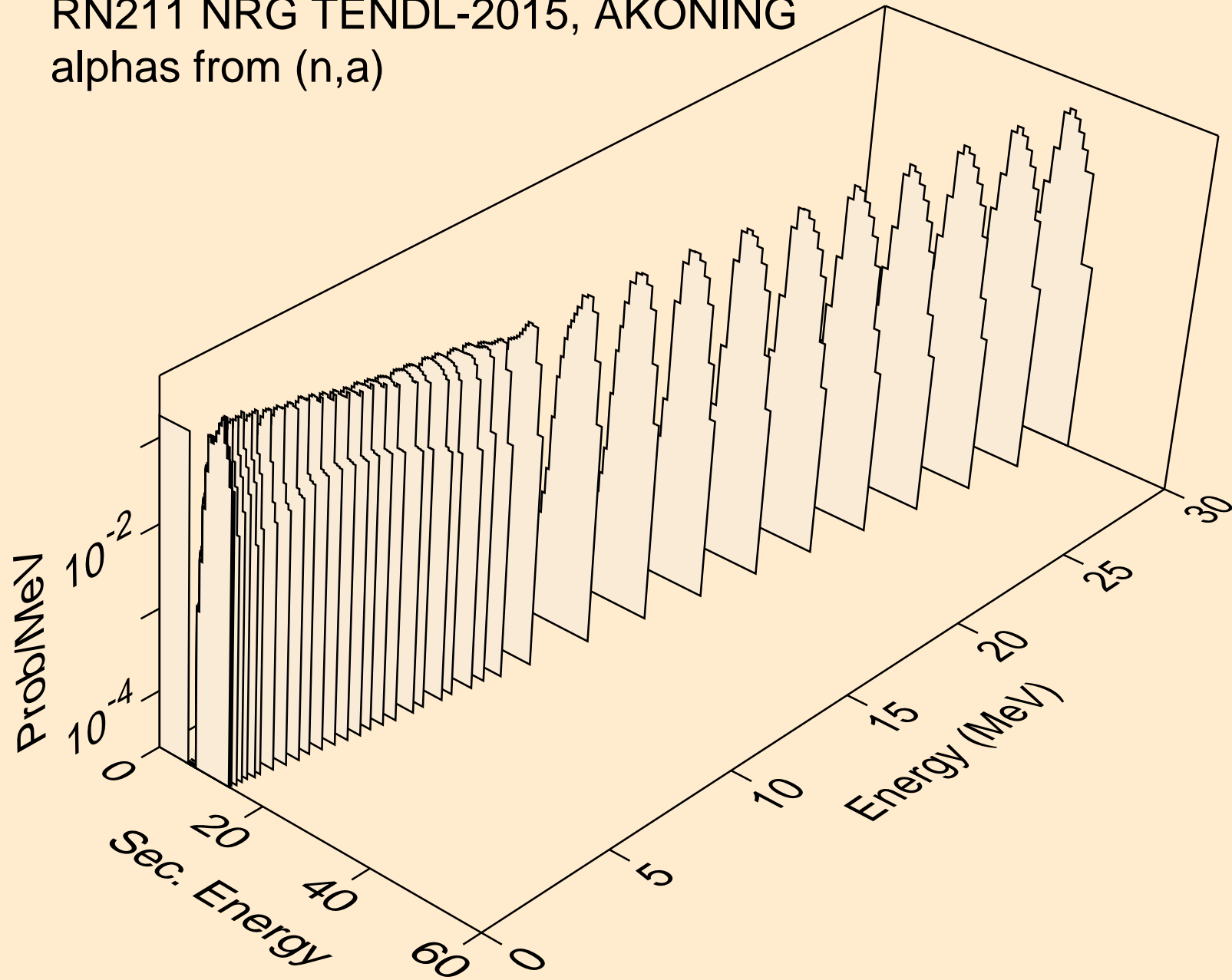

RN211 NRG TENDL-2015, AKONING
alphas from (n,2a)

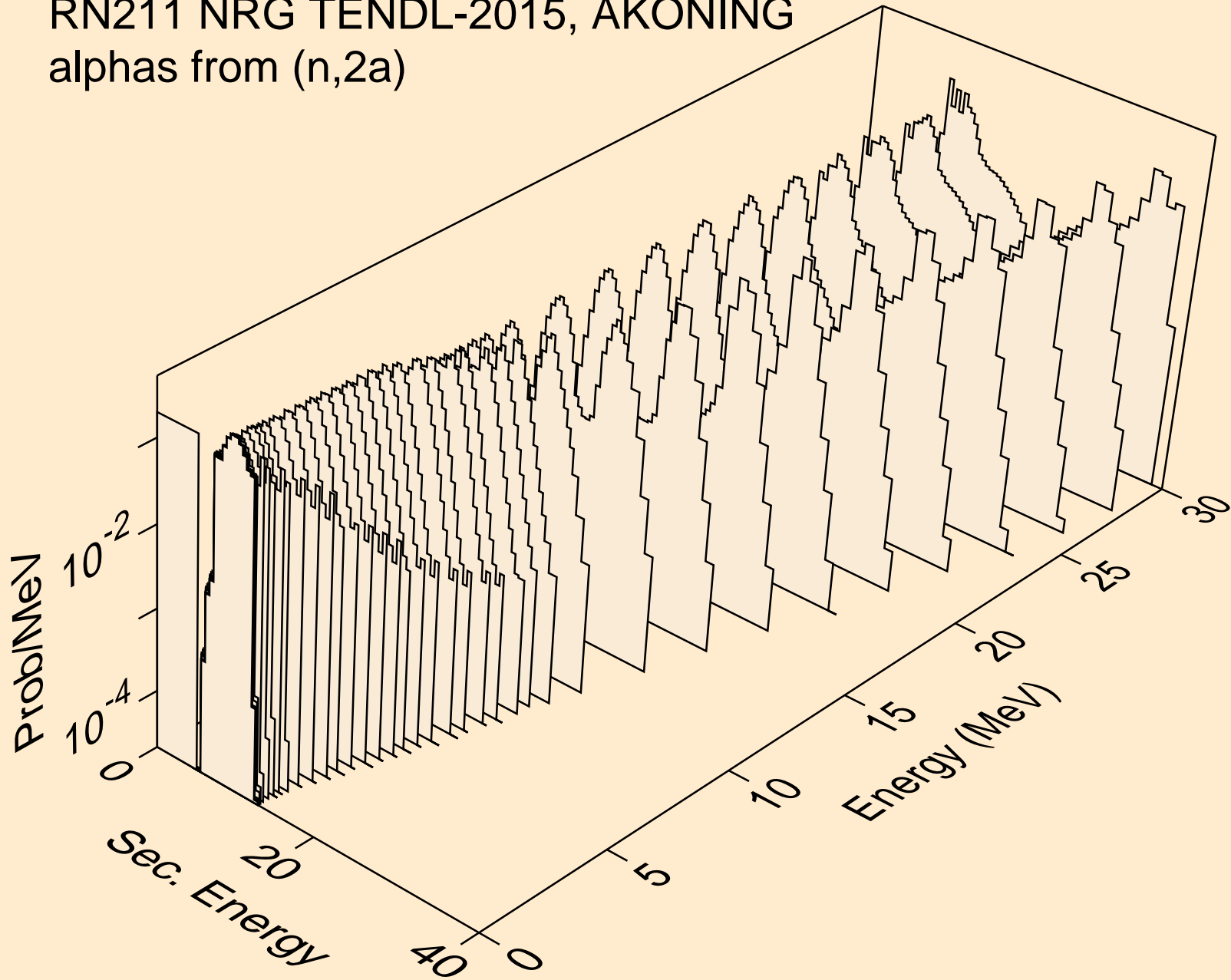

RN211 NRG TENDL-2015, AKONING
alphas from (n,pa)

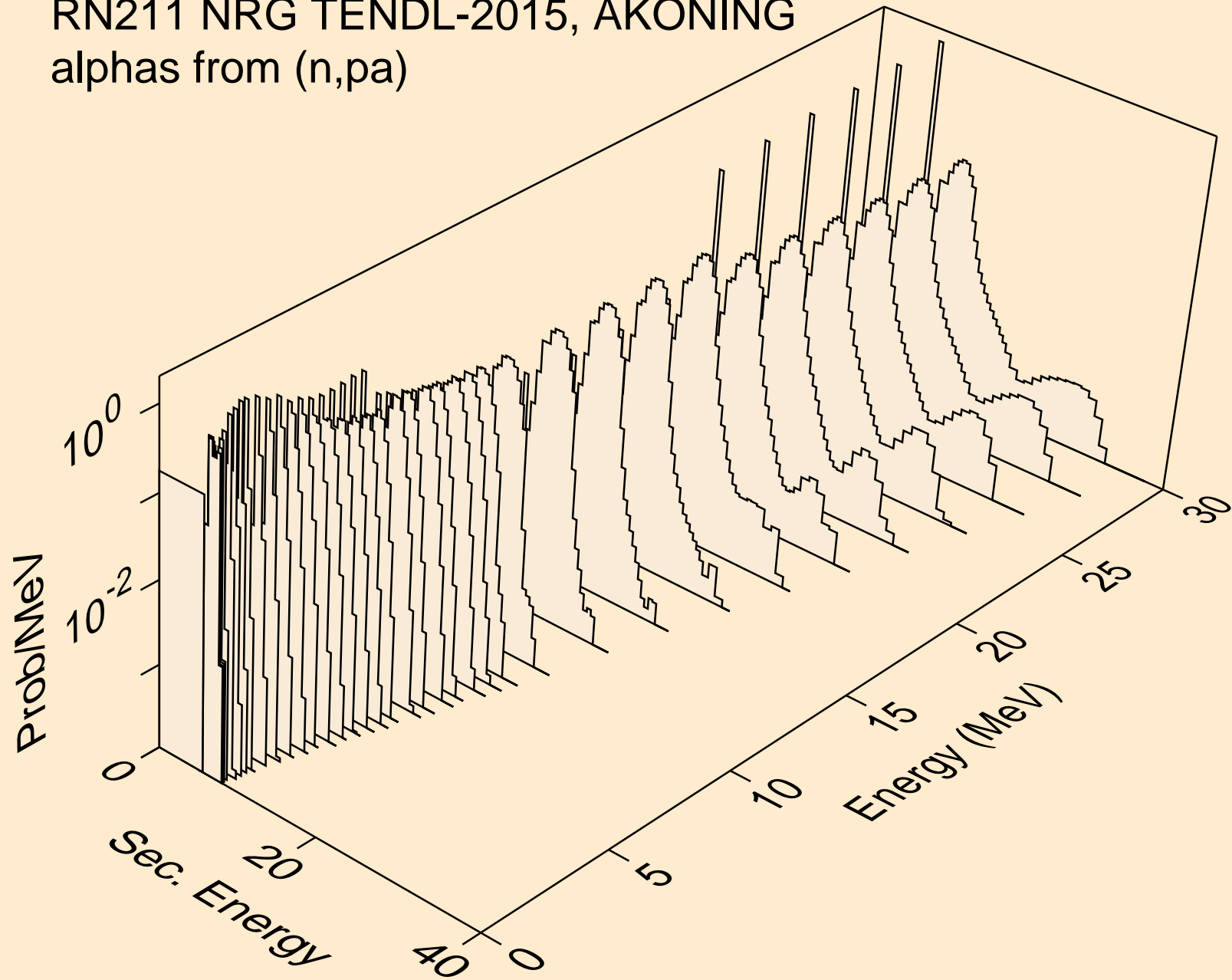

RN211 NRG TENDL-2015, AKONING
alphas from (n,da)

