

# S038 NRG TENDL-2015, AKONING

## Principal cross sections

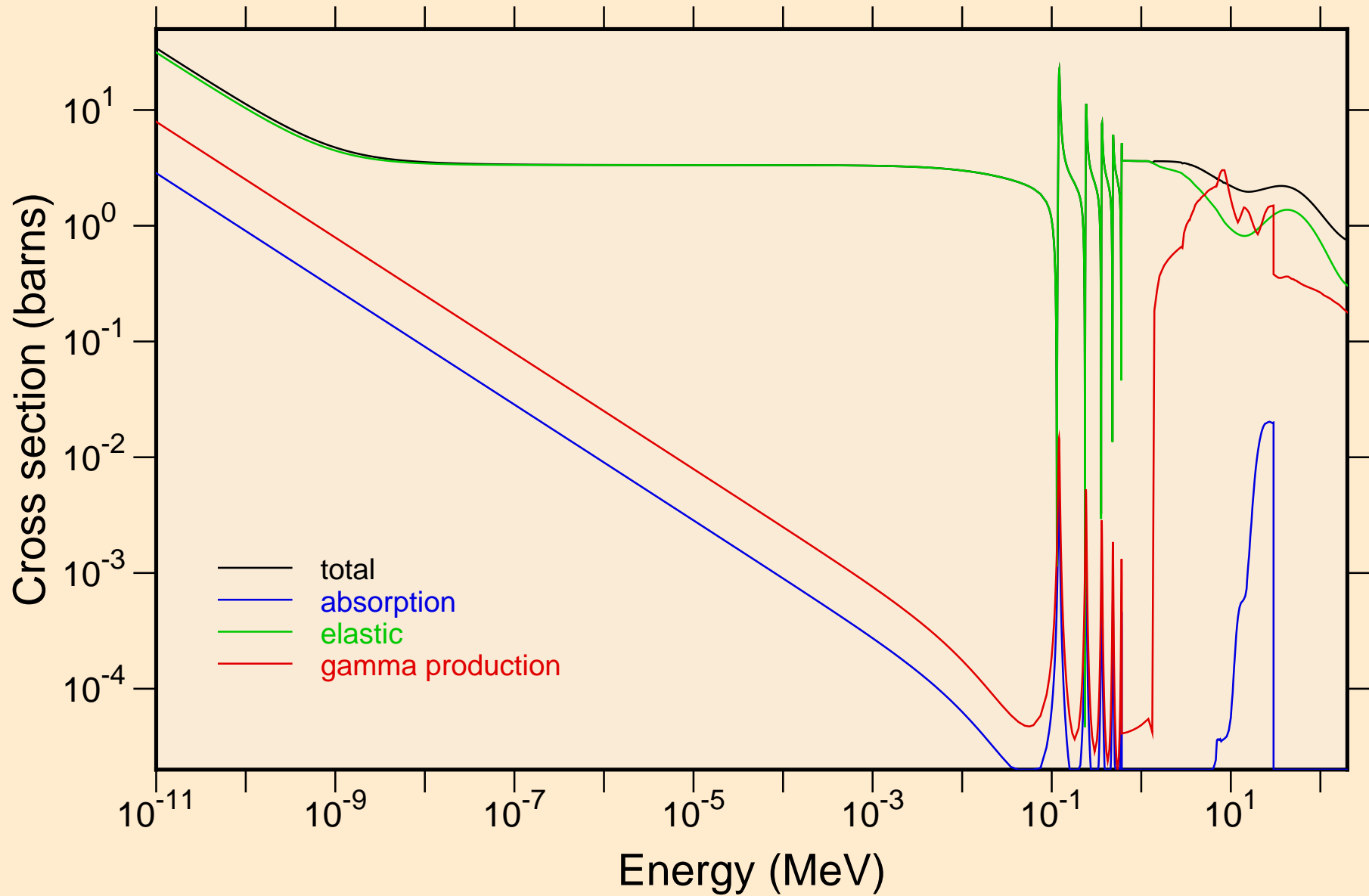

S038 NRG TENDL-2015, AKONING  
Non-threshold reactions

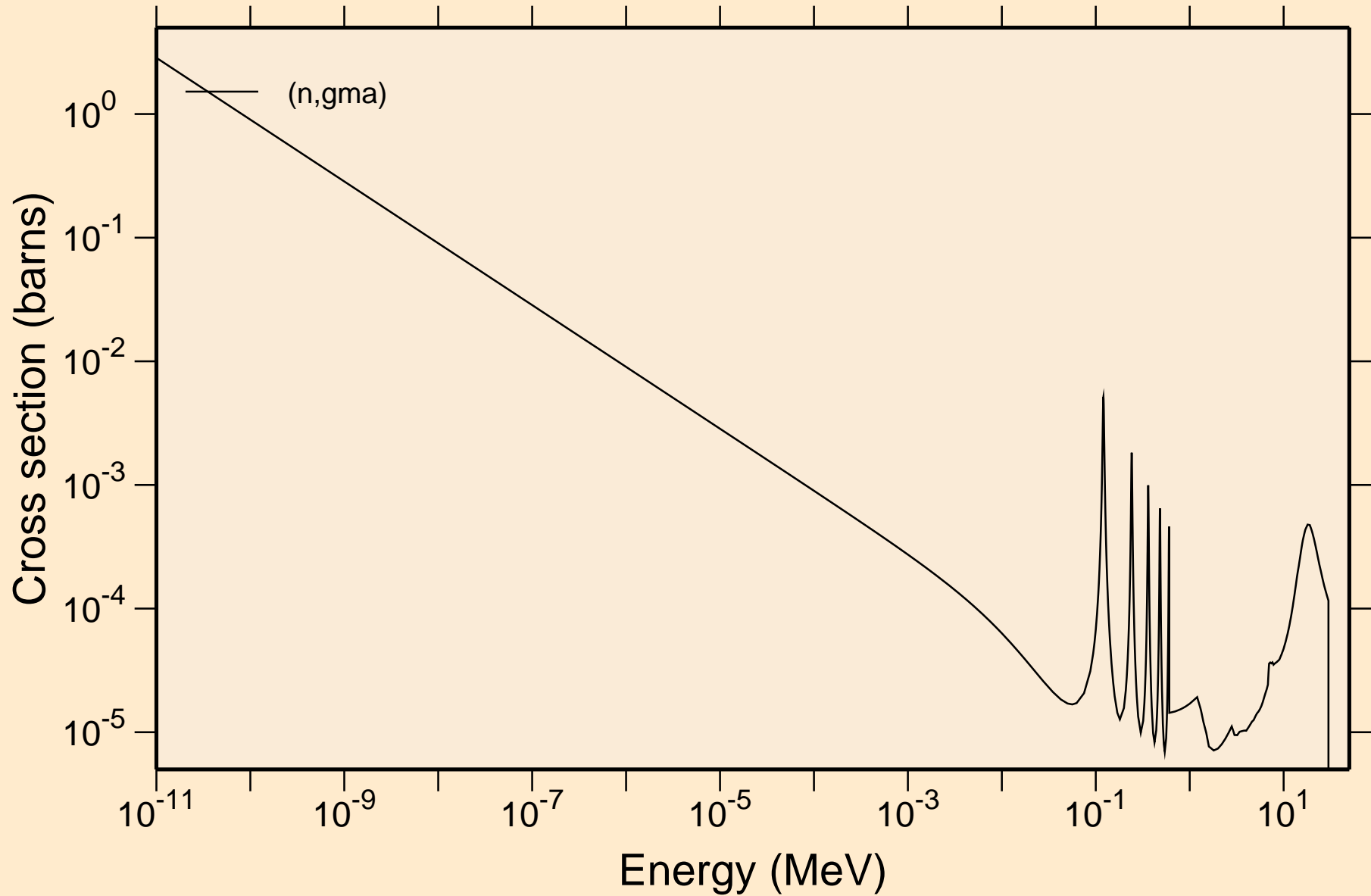

# S038 NRG TENDL-2015, AKONING

## Principal cross sections

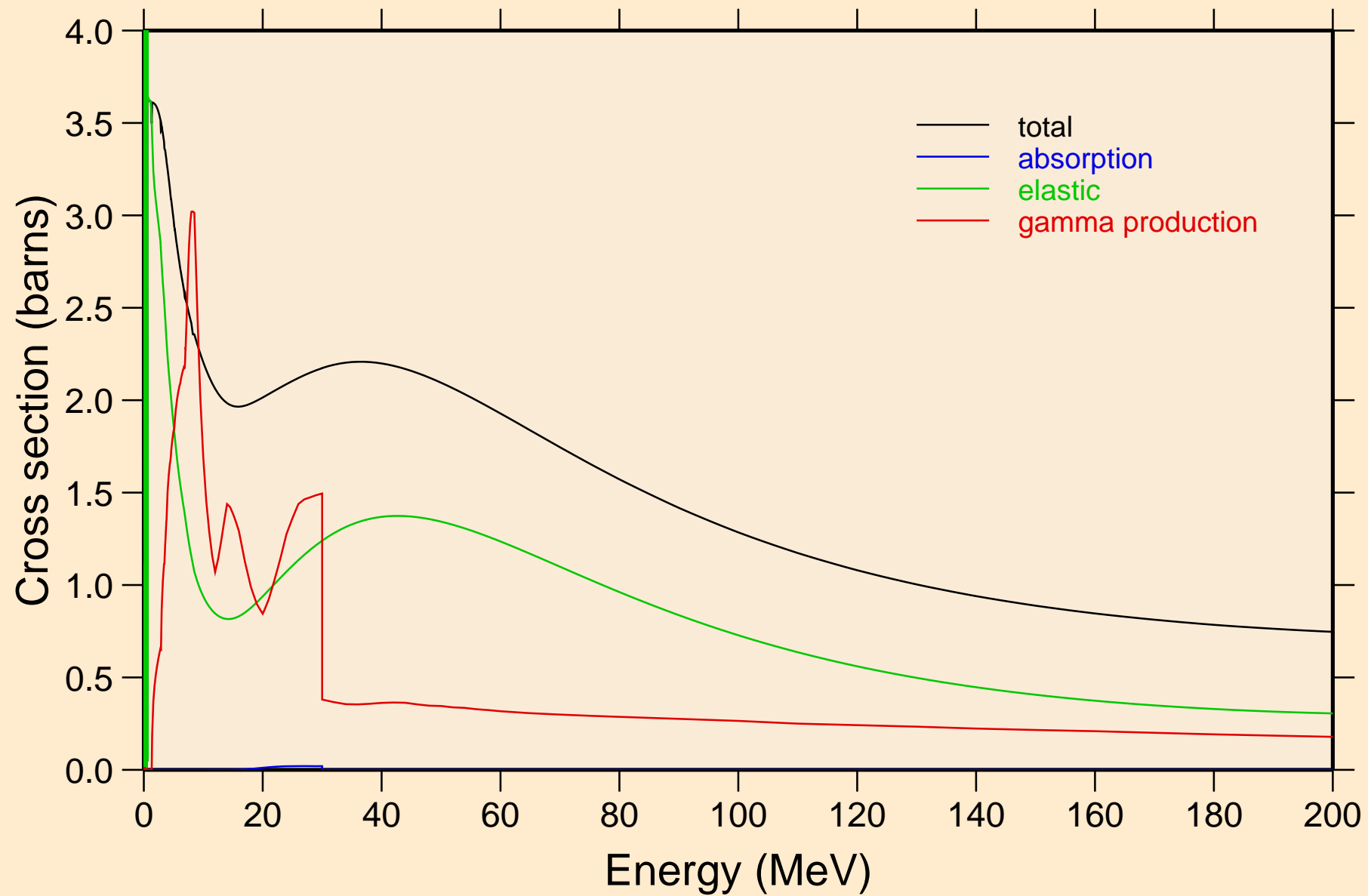

S038 NRG TENDL-2015, AKONING  
Non-threshold reactions

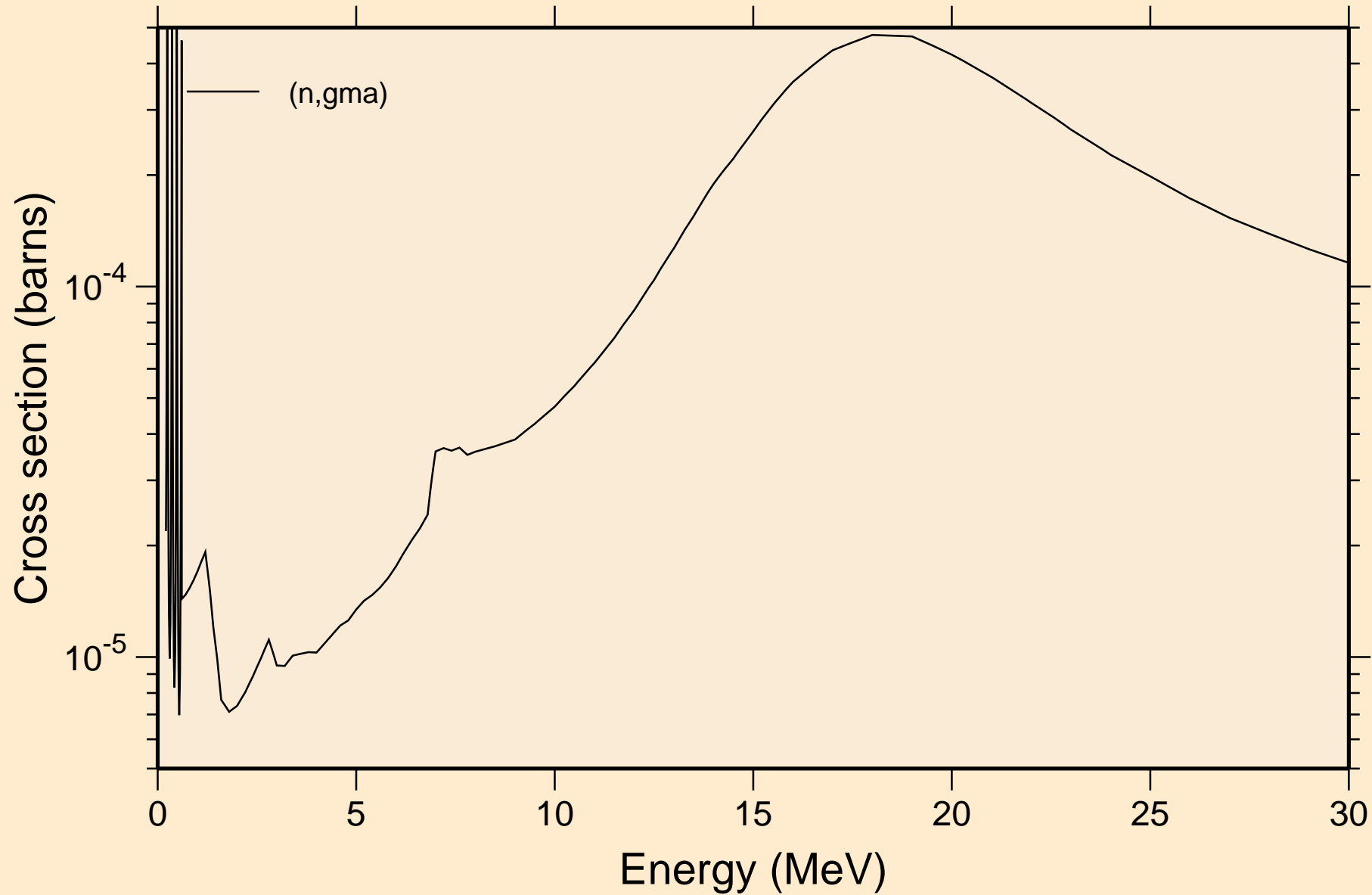

# S038 NRG TENDL-2015, AKONING

## Inelastic levels

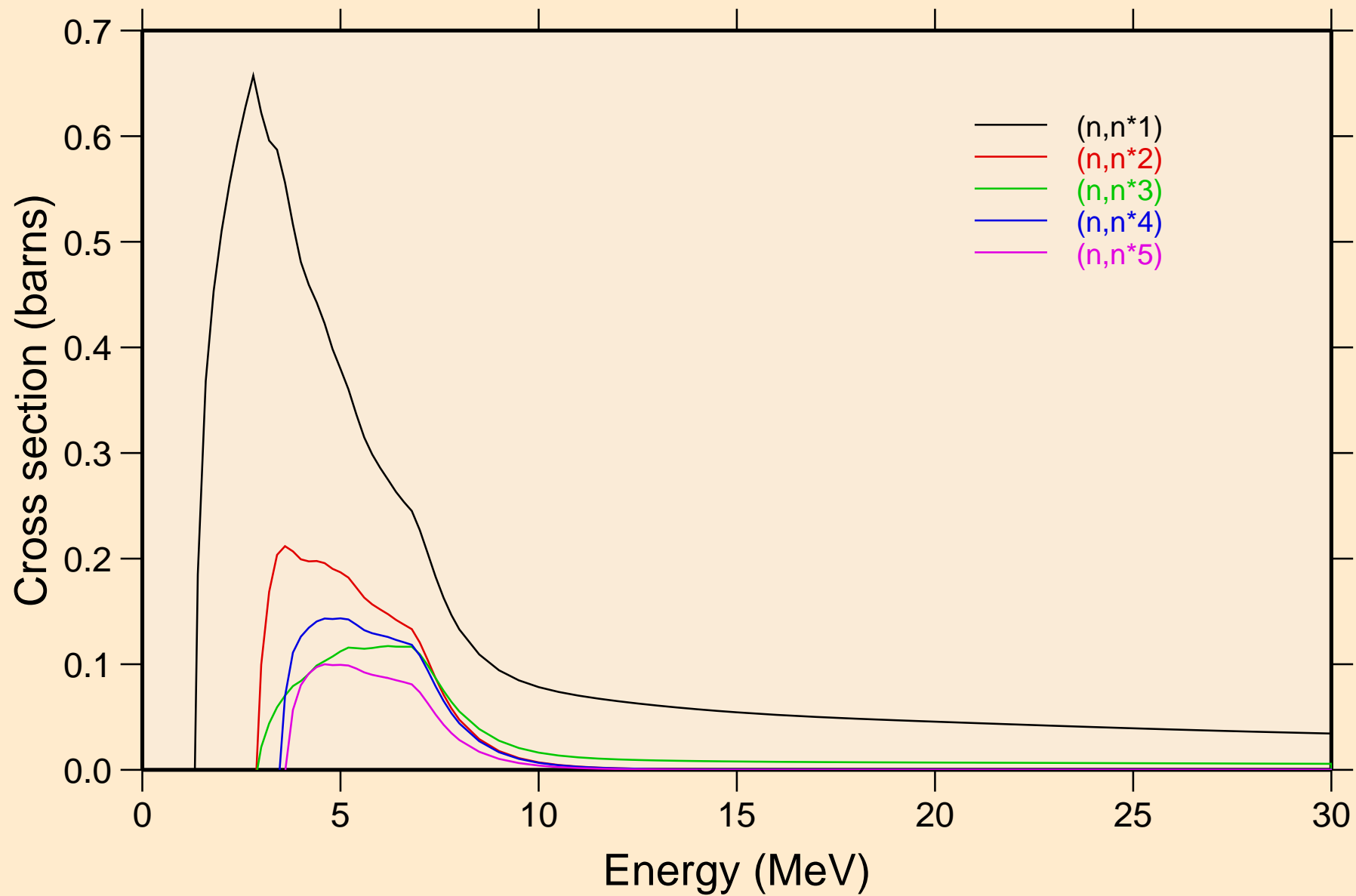

# S038 NRG TENDL-2015, AKONING

## Inelastic levels

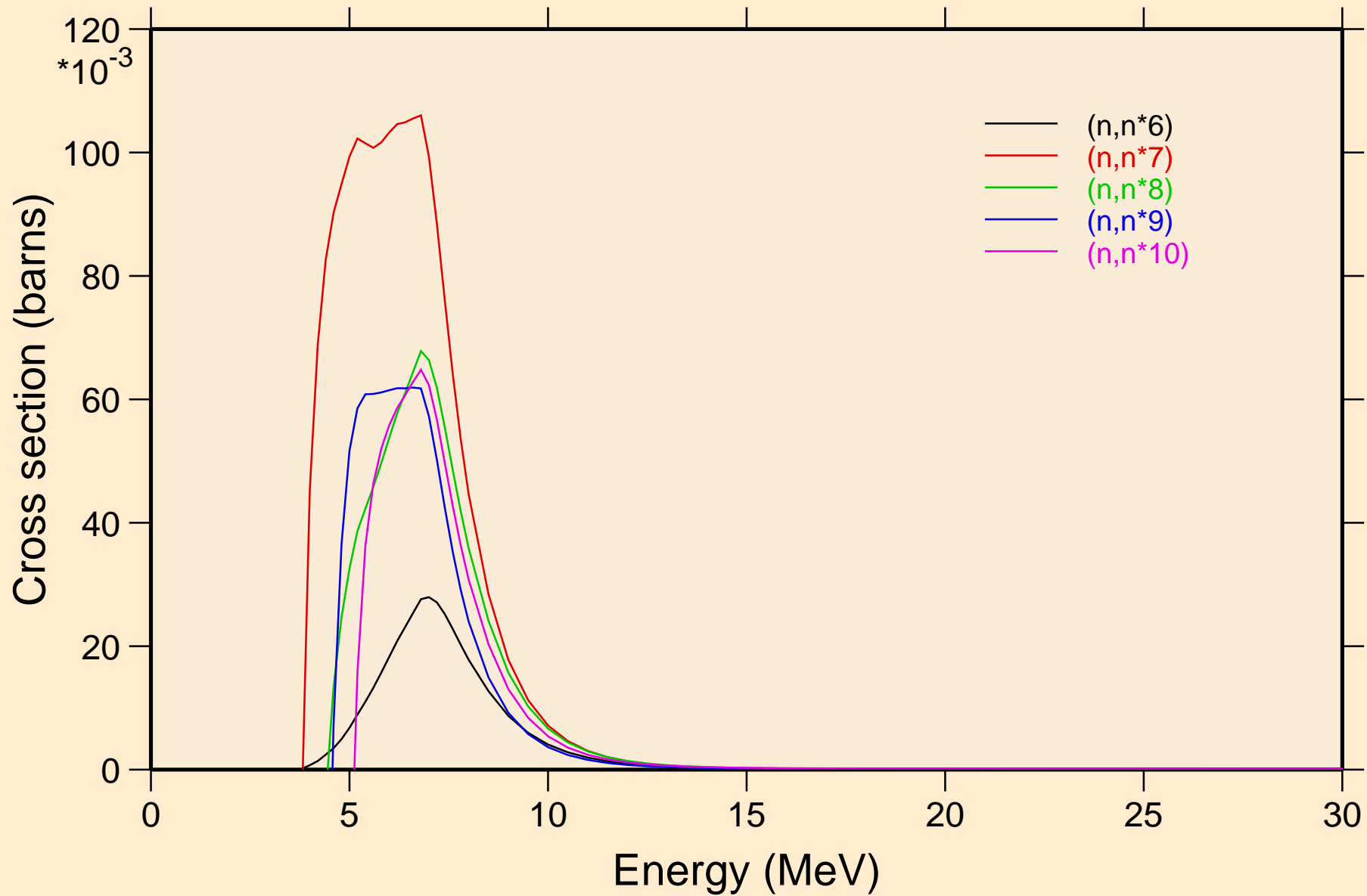

# S038 NRG TENDL-2015, AKONING

## Inelastic levels

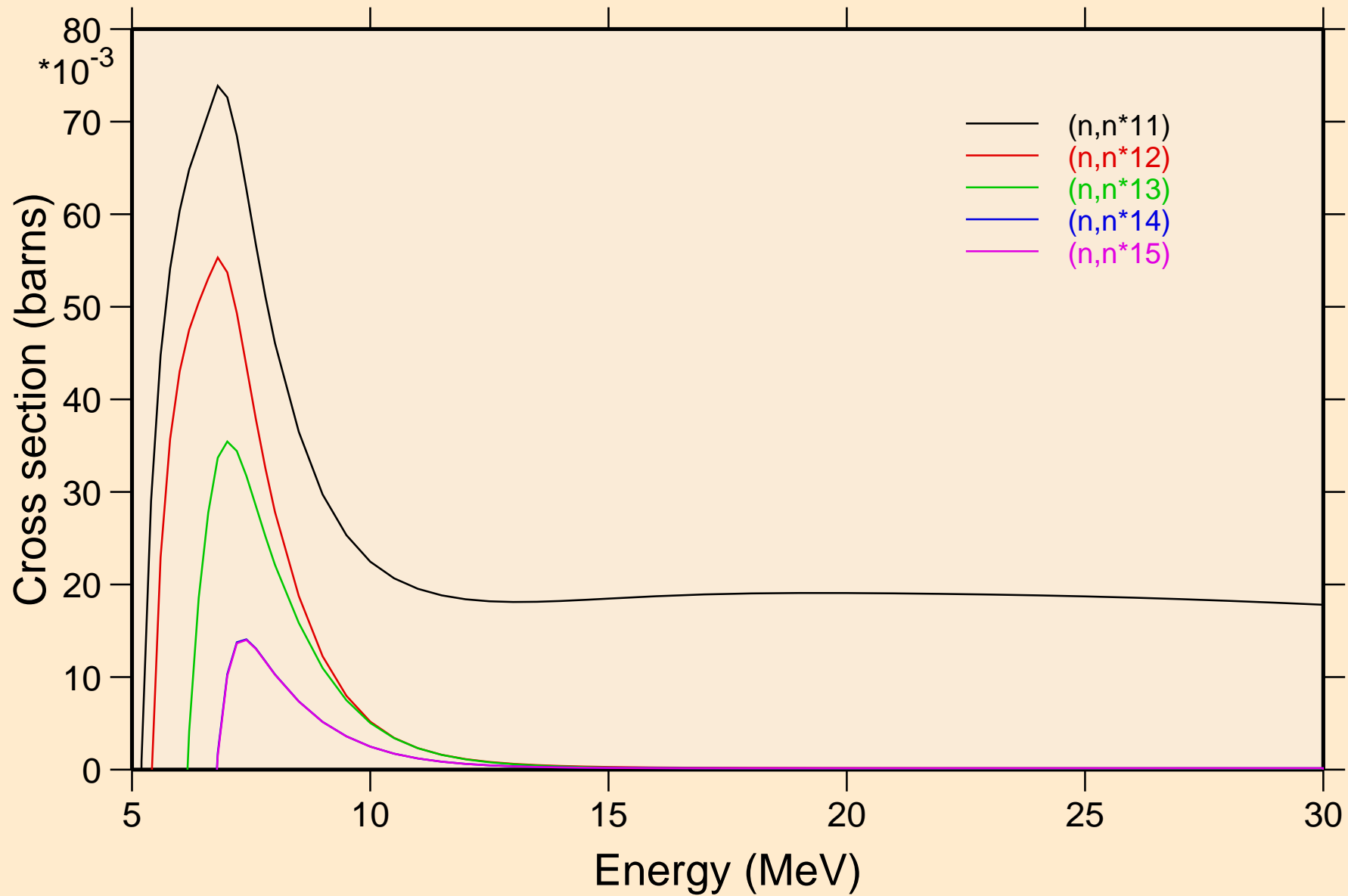

# S038 NRG TENDL-2015, AKONING

## Inelastic levels

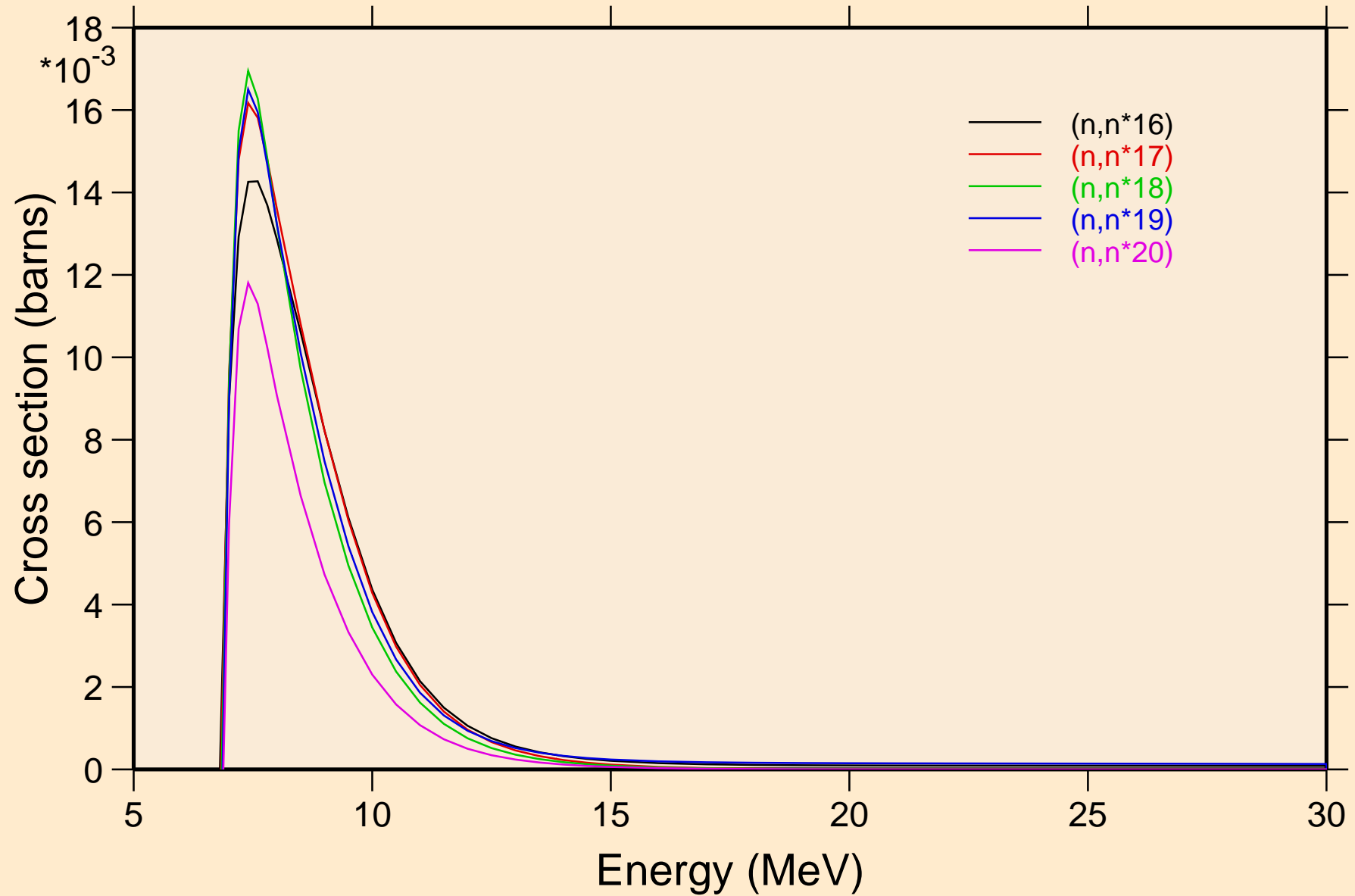



# S038 NRG TENDL-2015, AKONING

## Inelastic levels

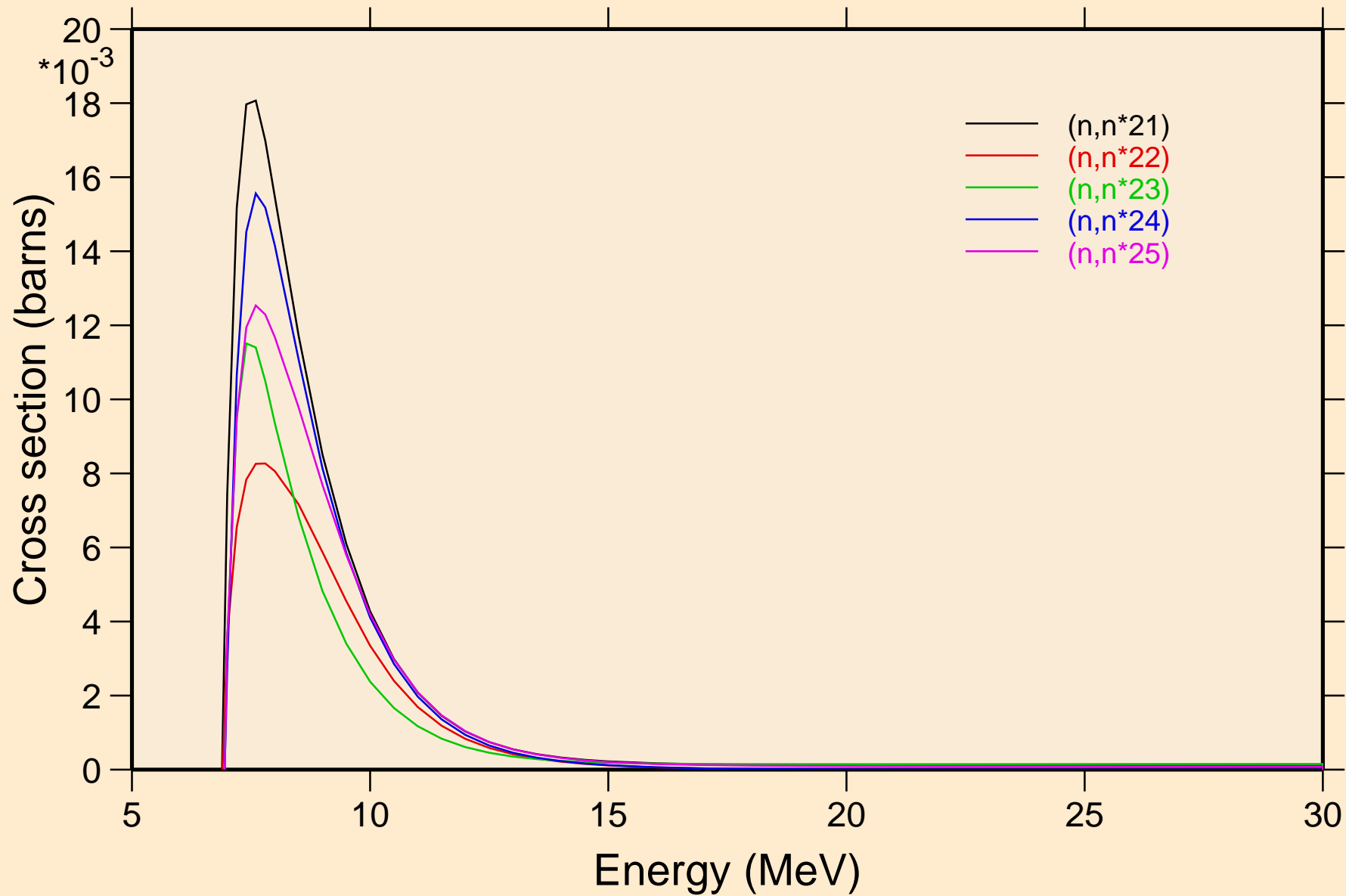

S038 NRG TENDL-2015, AKONING  
Inelastic levels

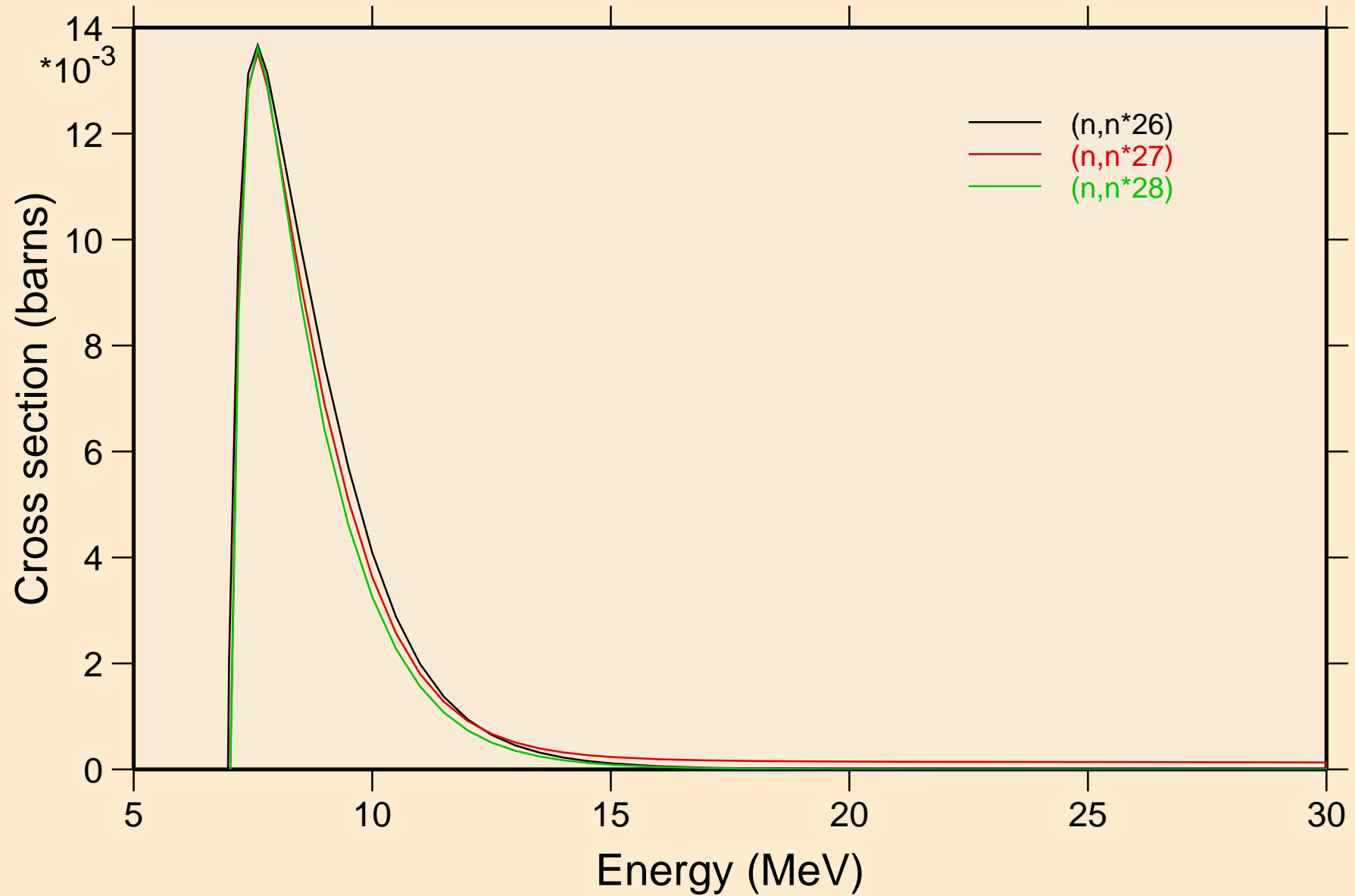

# S038 NRG TENDL-2015, AKONING

## Threshold reactions

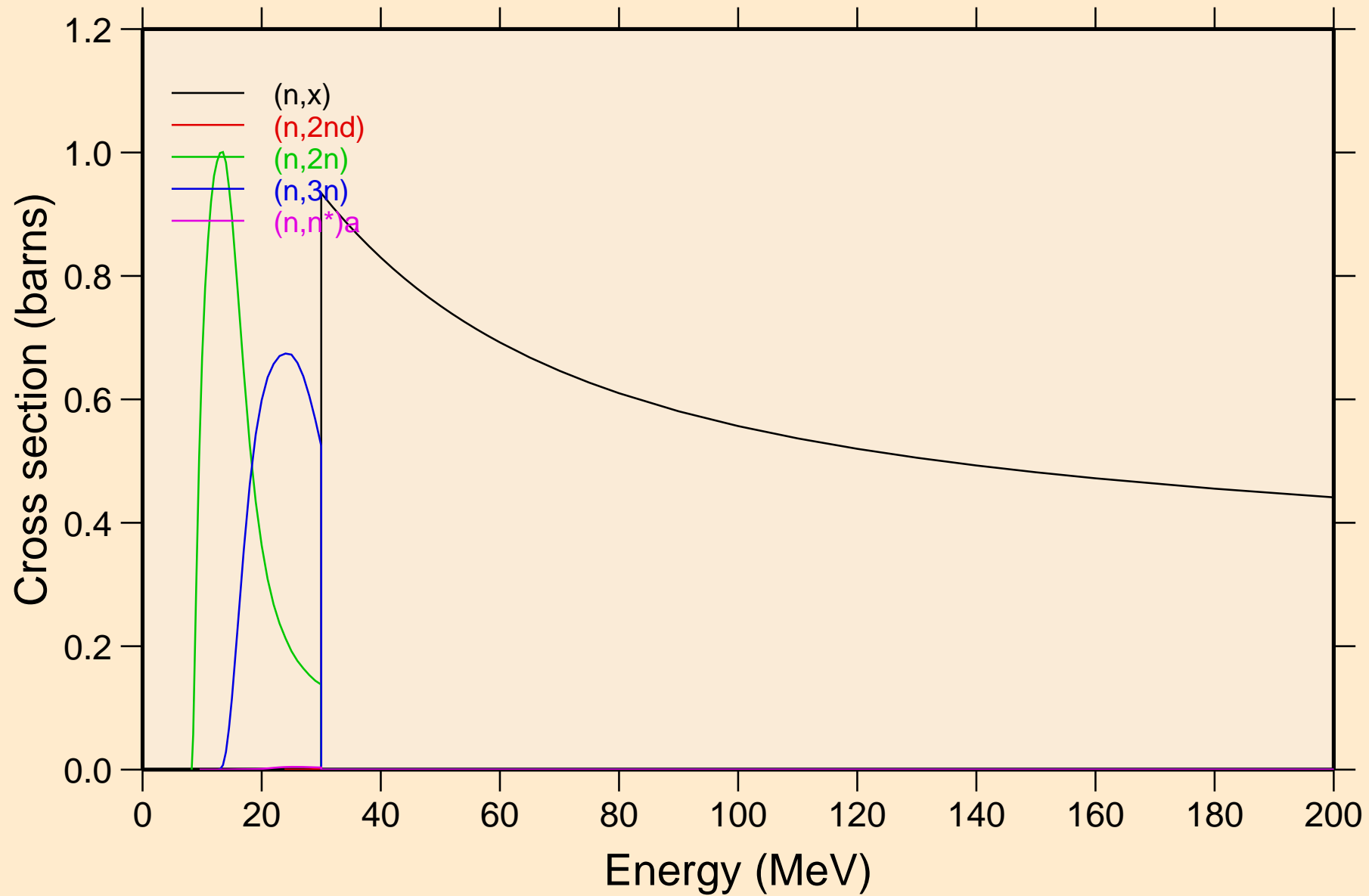

# S038 NRG TENDL-2015, AKONING

## Threshold reactions

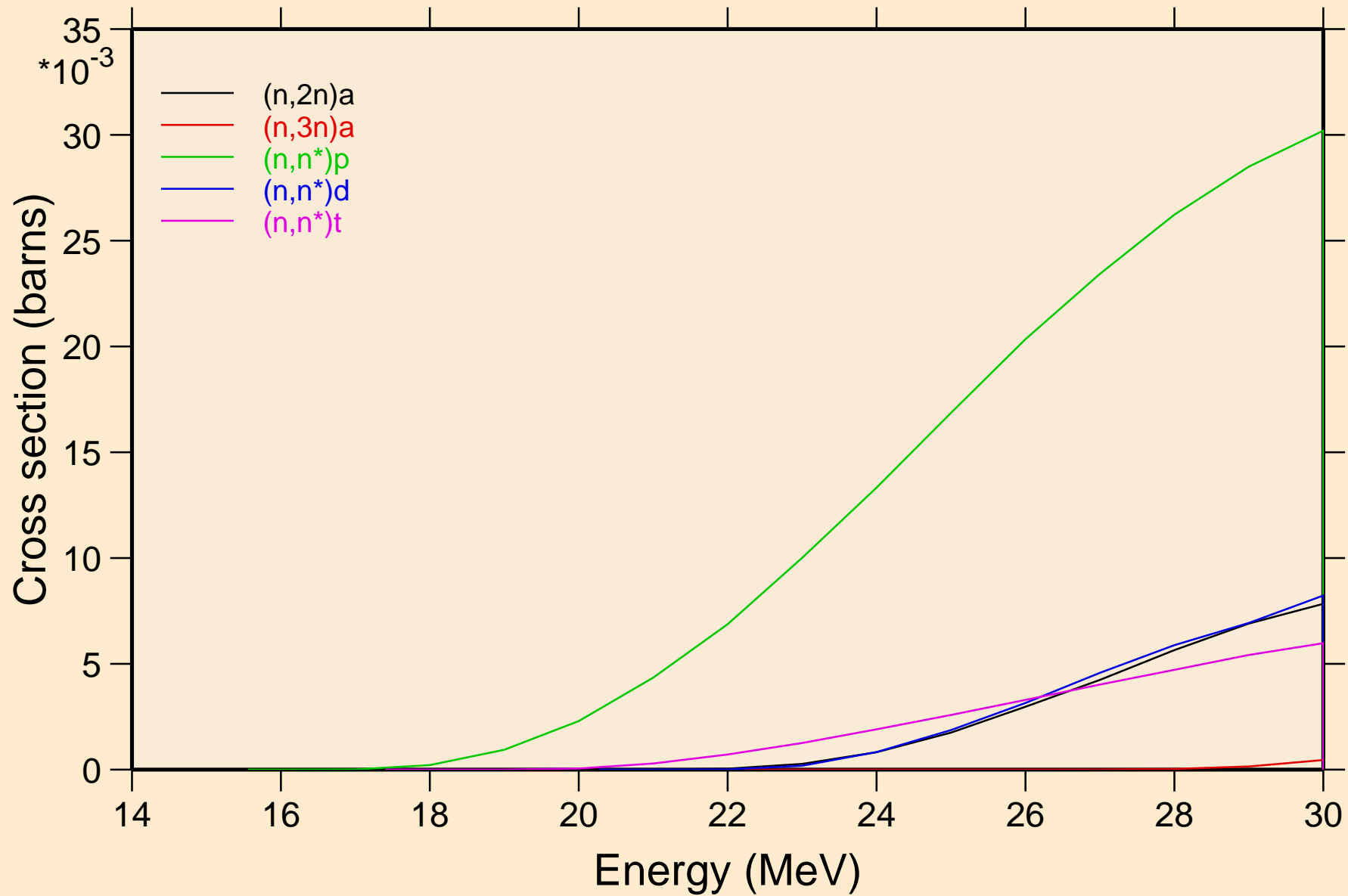

# S038 NRG TENDL-2015, AKONING

## Threshold reactions

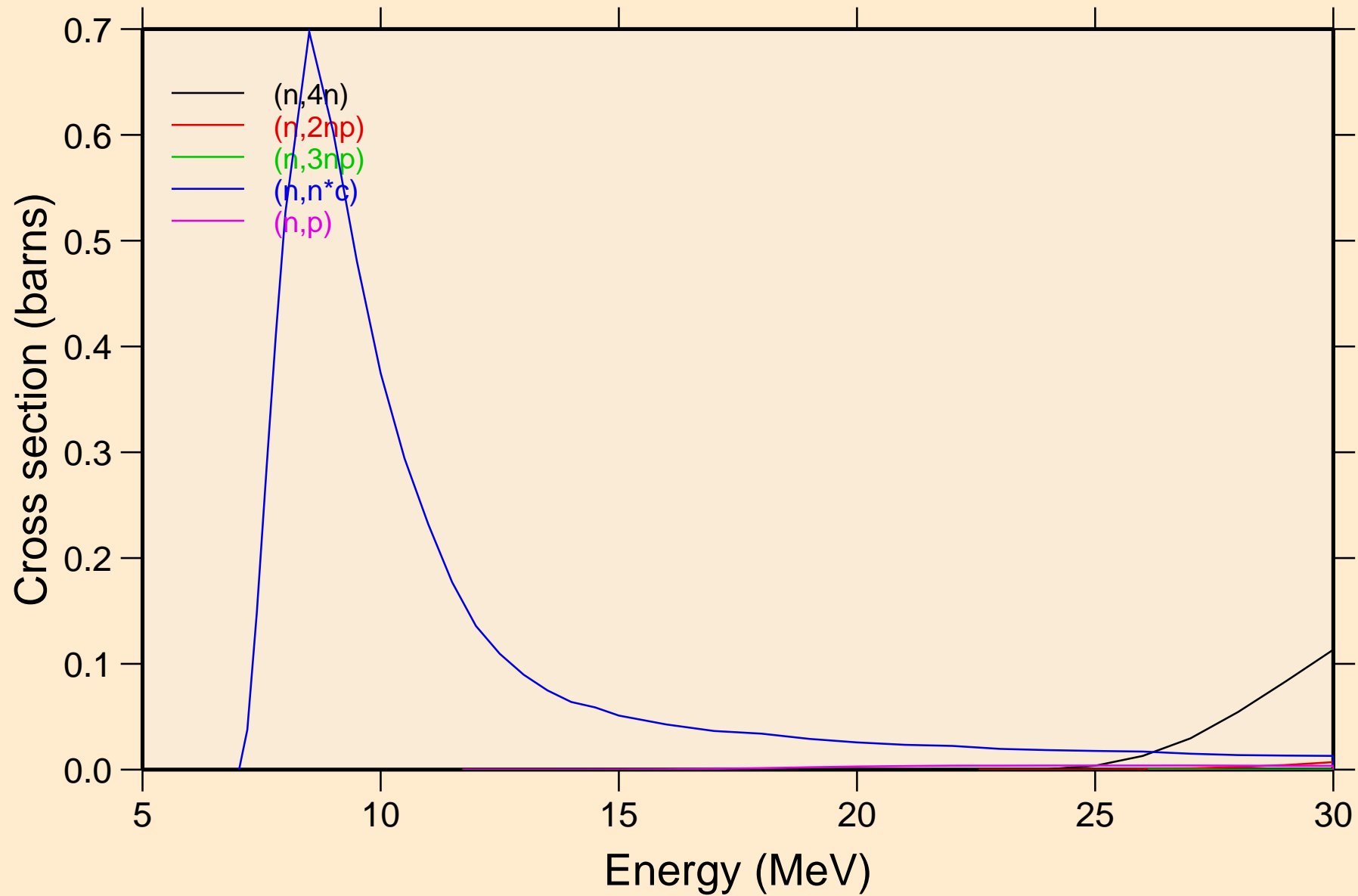

# S038 NRG TENDL-2015, AKONING

## Threshold reactions

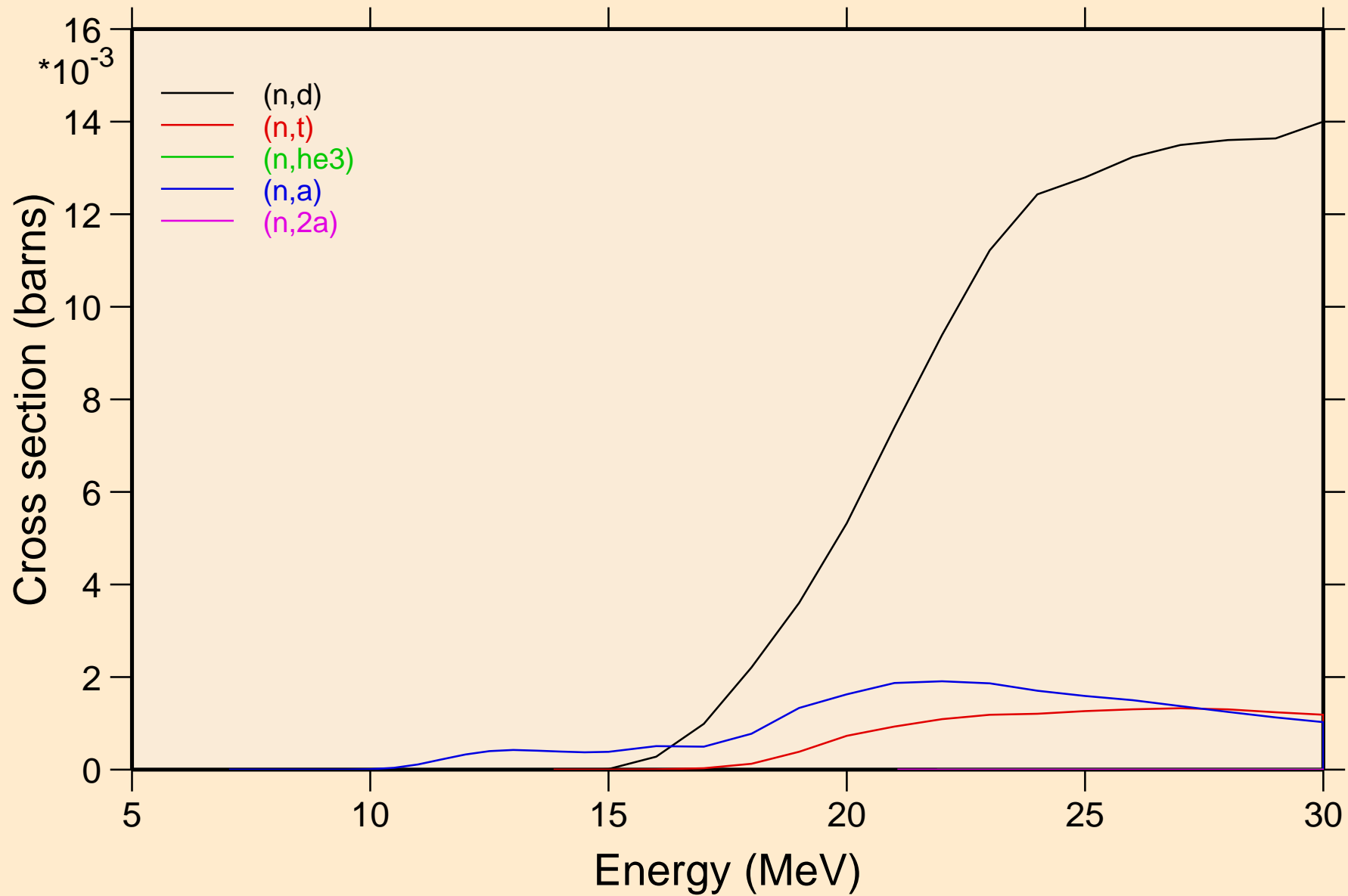

S038 NRG TENDL-2015, AKONING  
angular distribution for elastic

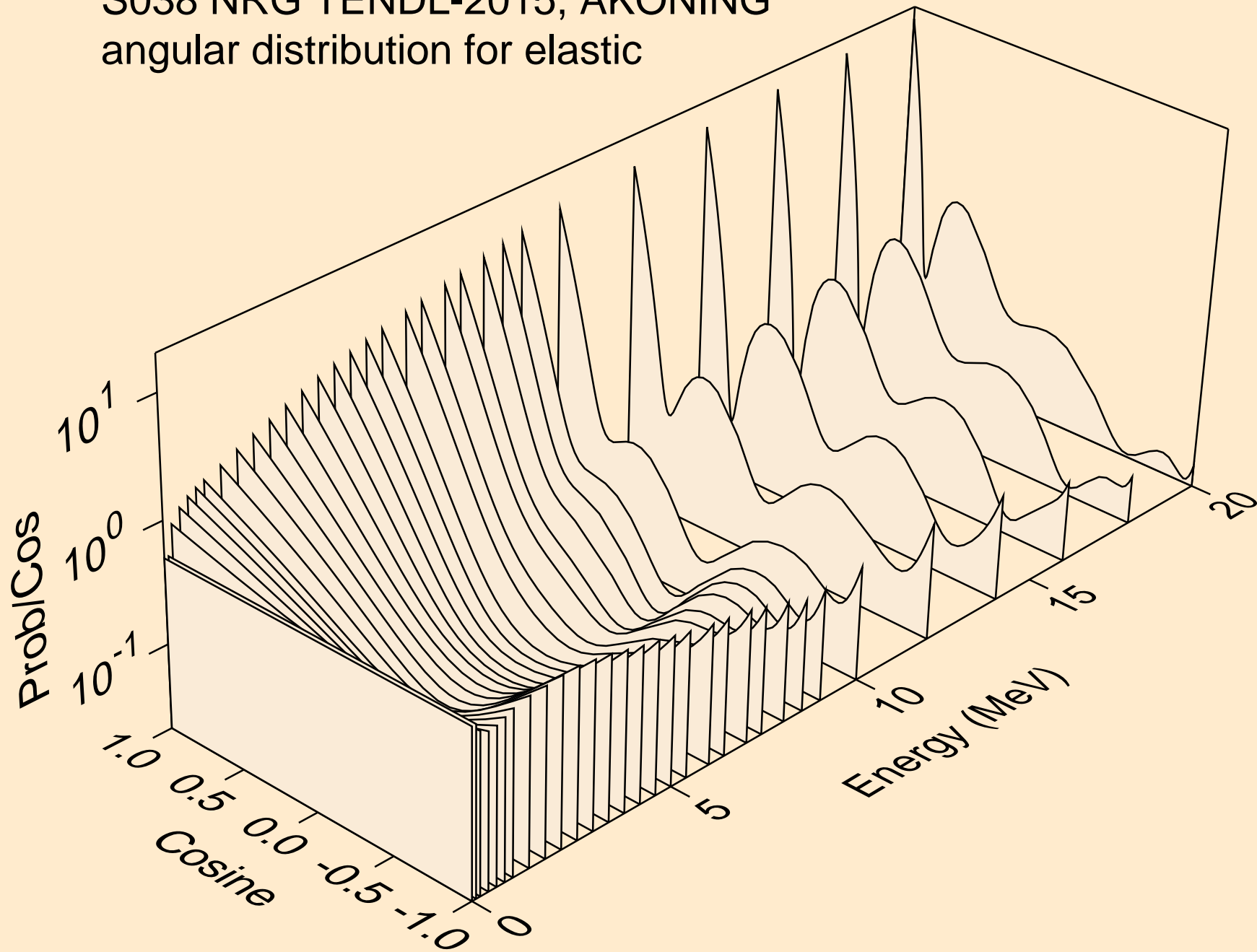

S038 NRG TENDL-2015, AKONING  
angular distribution for elastic

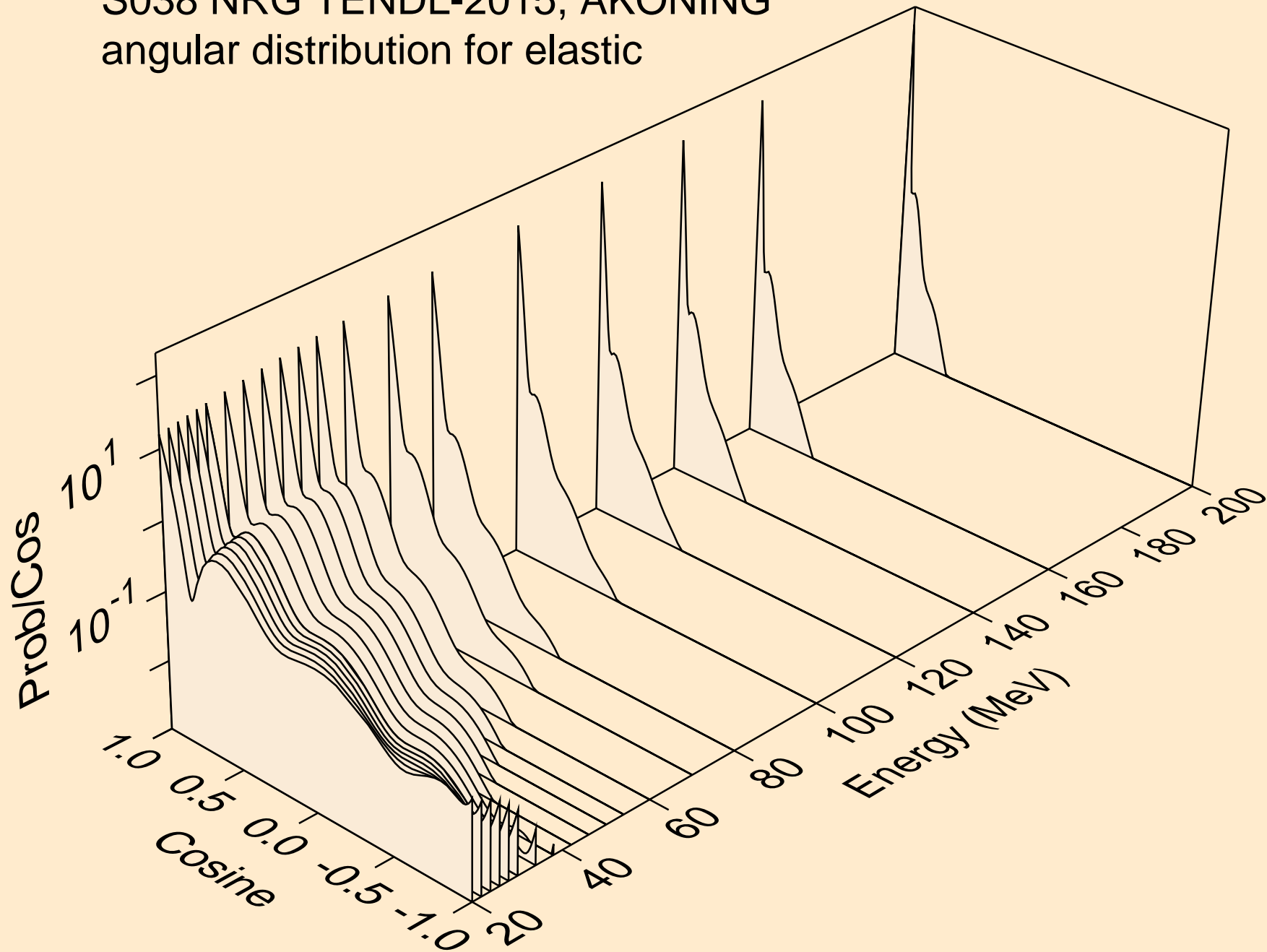



S038 NRG TENDL-2015, AKONING  
angular distribution for (n,n\*1)

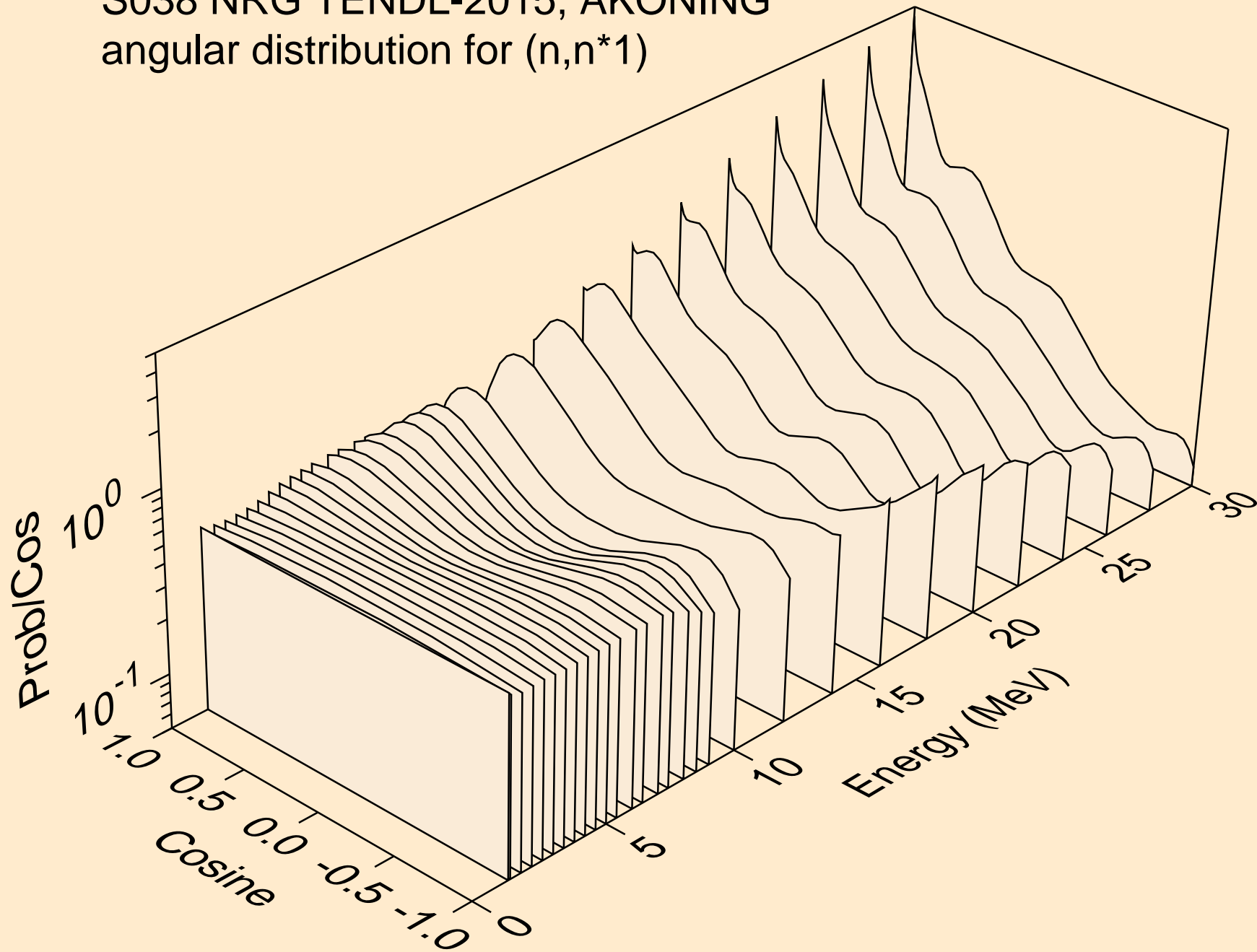

S038 NRG TENDL-2015, AKONING  
angular distribution for (n,n\*2)

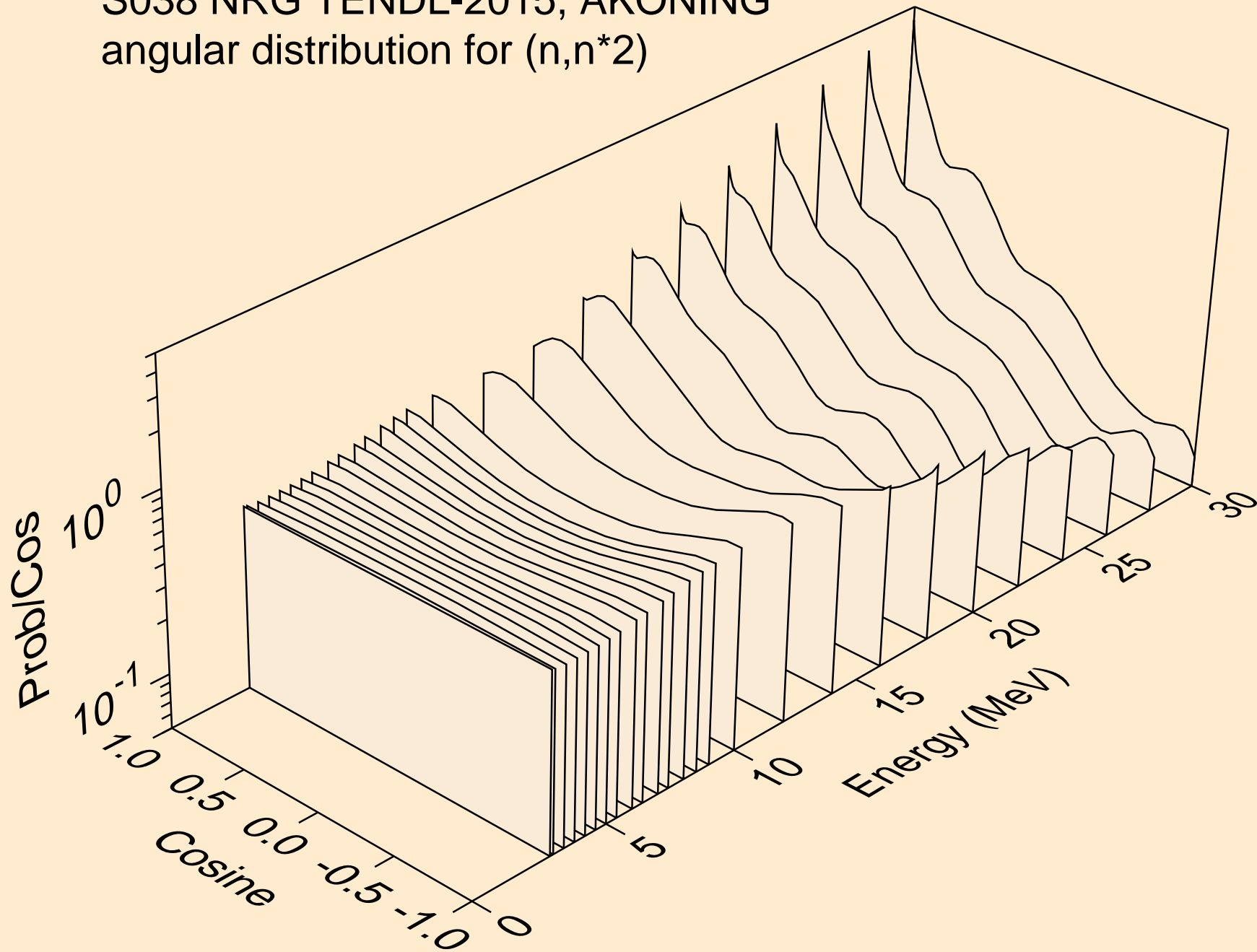

S038 NRG TENDL-2015, AKONING  
angular distribution for (n,n\*3)

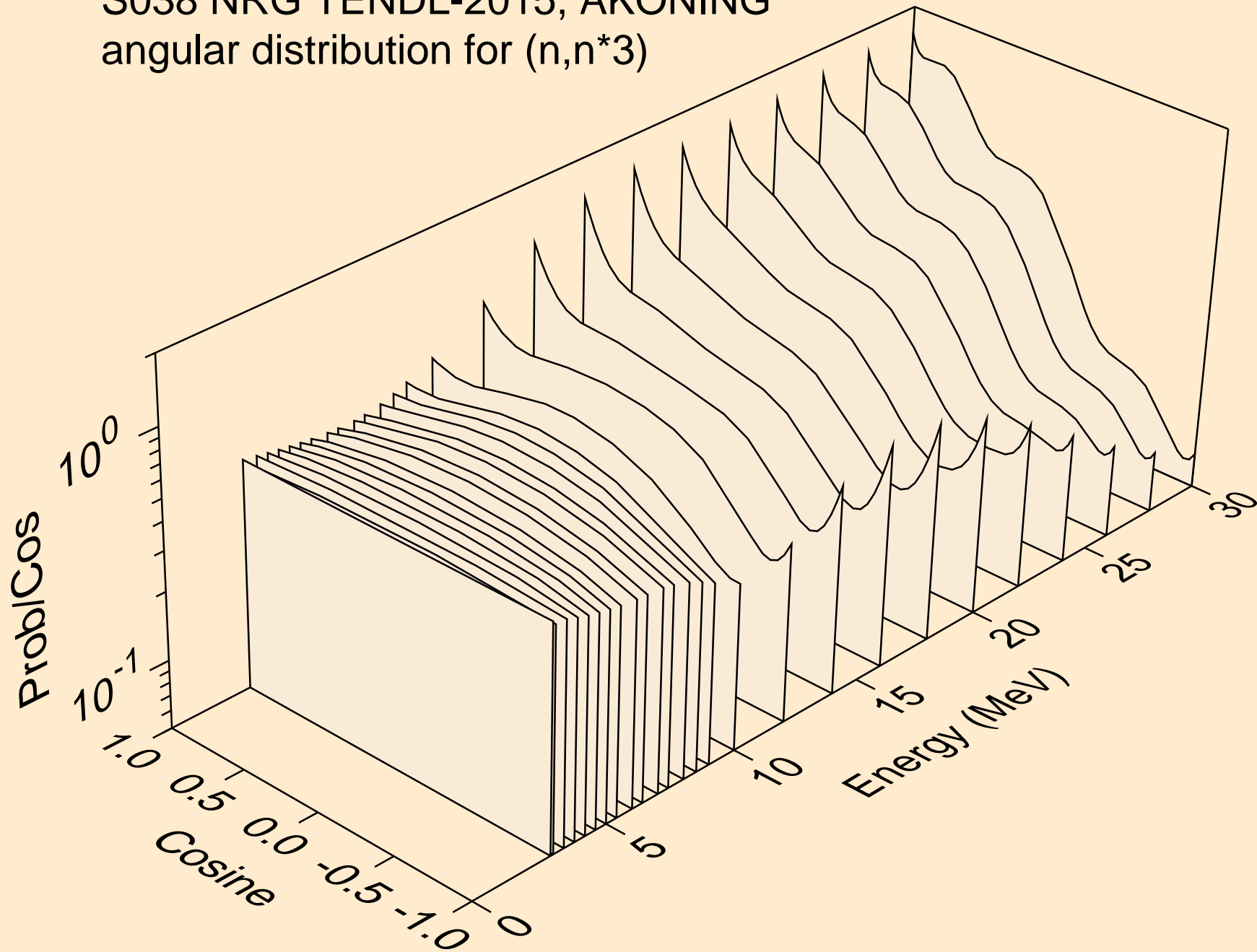

S038 NRG TENDL-2015, AKONING  
angular distribution for (n,n\*4)

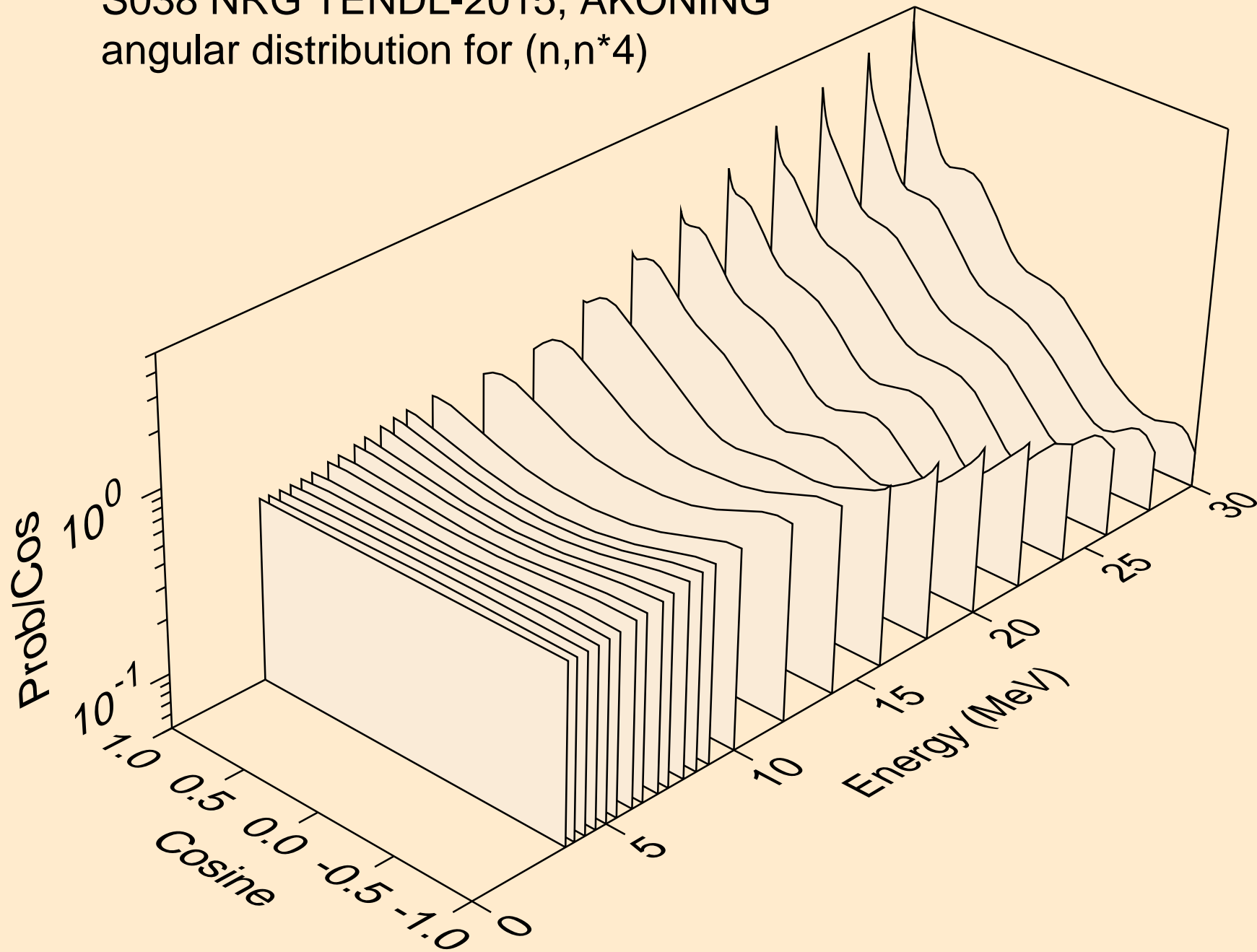

S038 NRG TENDL-2015, AKONING  
angular distribution for (n,n\*5)

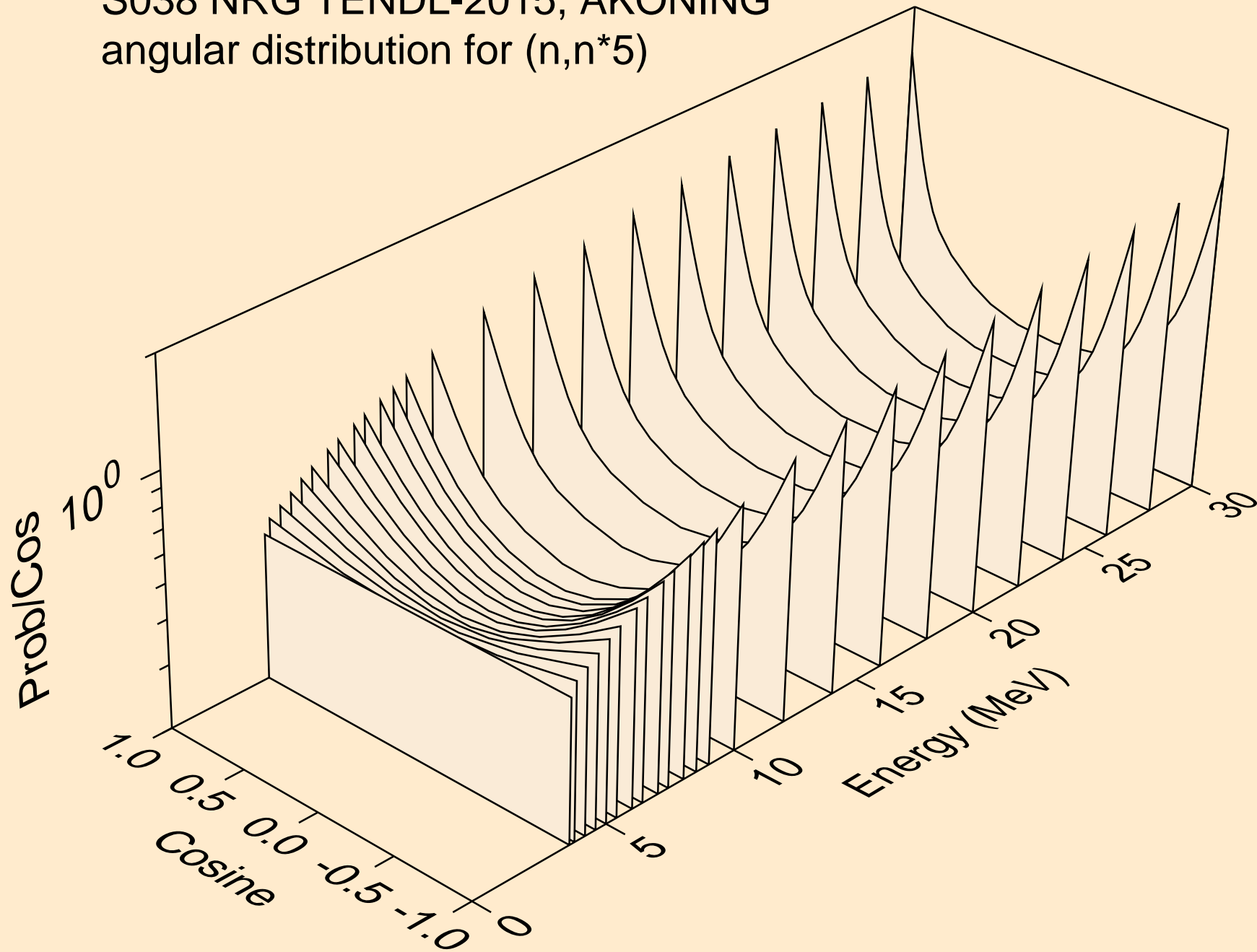

S038 NRG TENDL-2015, AKONING  
angular distribution for (n,n\*6)

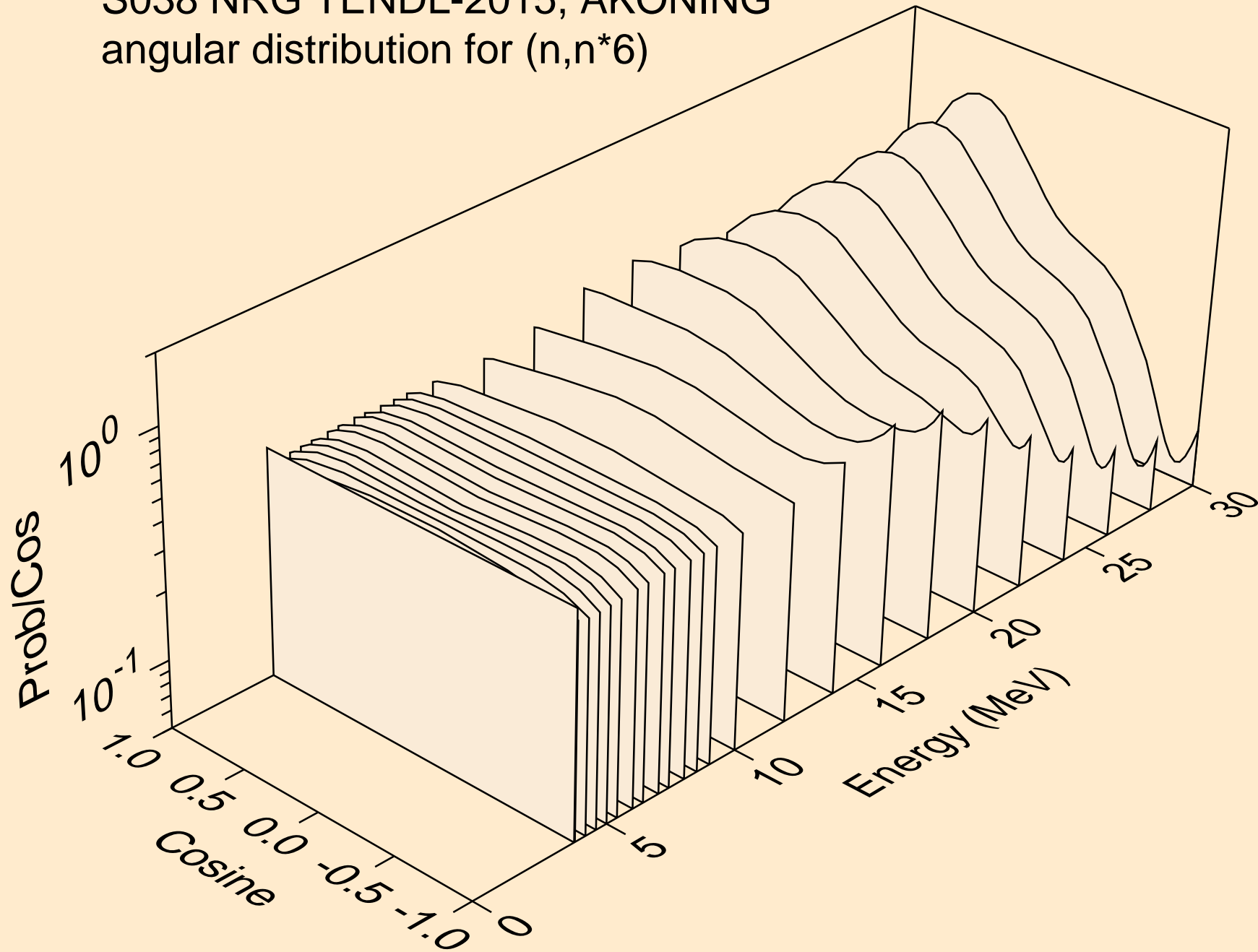

S038 NRG TENDL-2015, AKONING  
angular distribution for (n,n\*7)

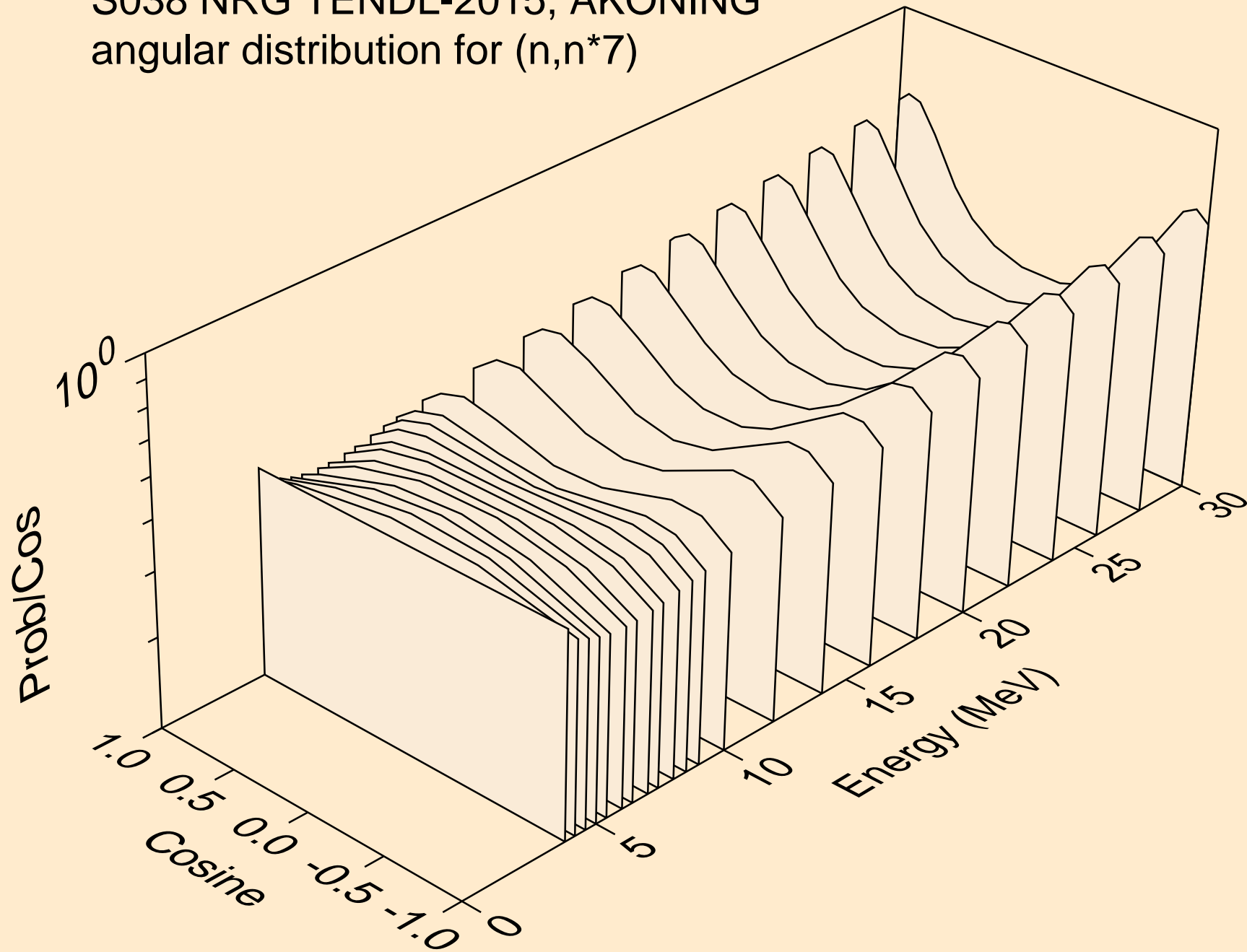

S038 NRG TENDL-2015, AKONING  
angular distribution for (n,n\*8)

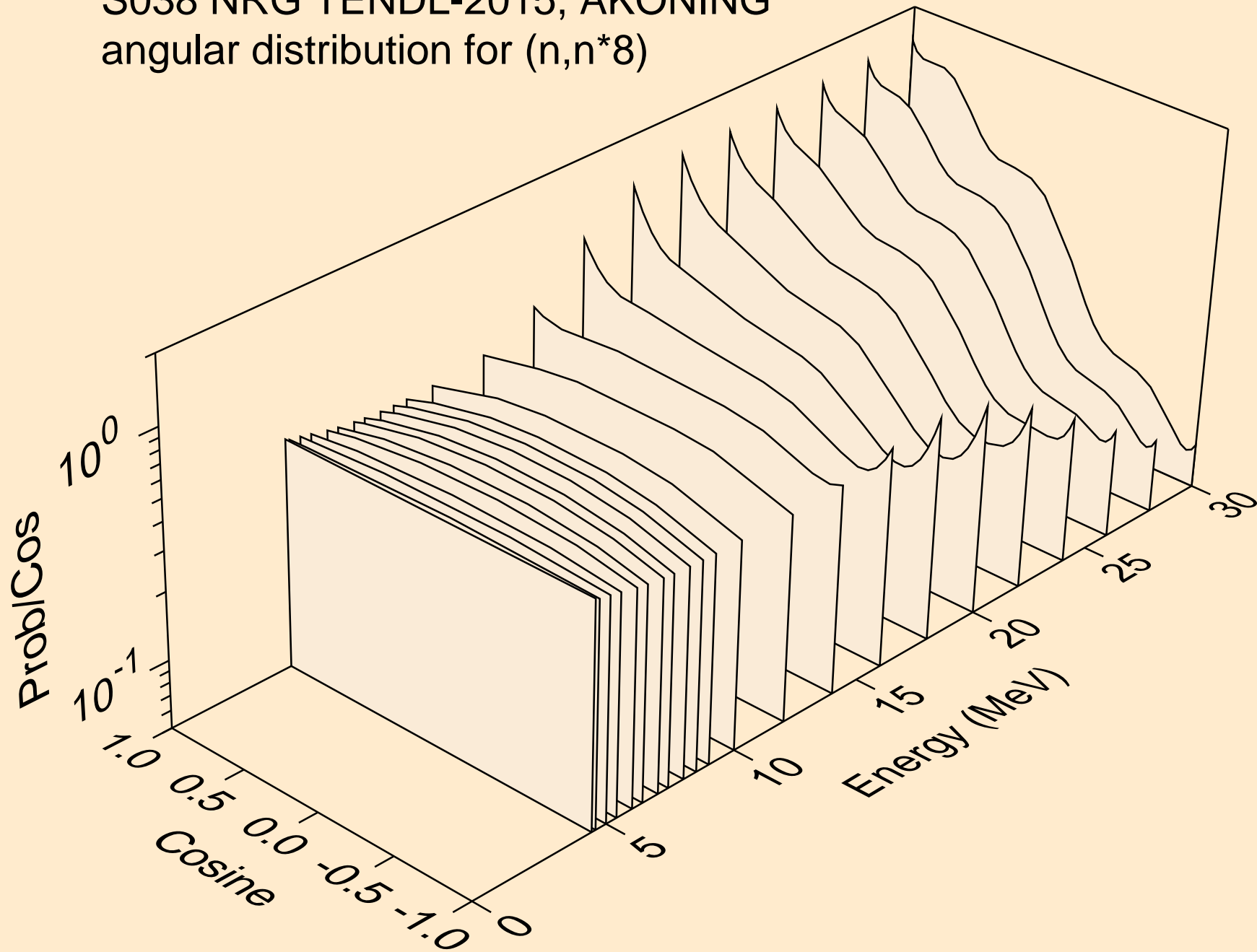



S038 NRG TENDL-2015, AKONING  
angular distribution for (n,n\*9)

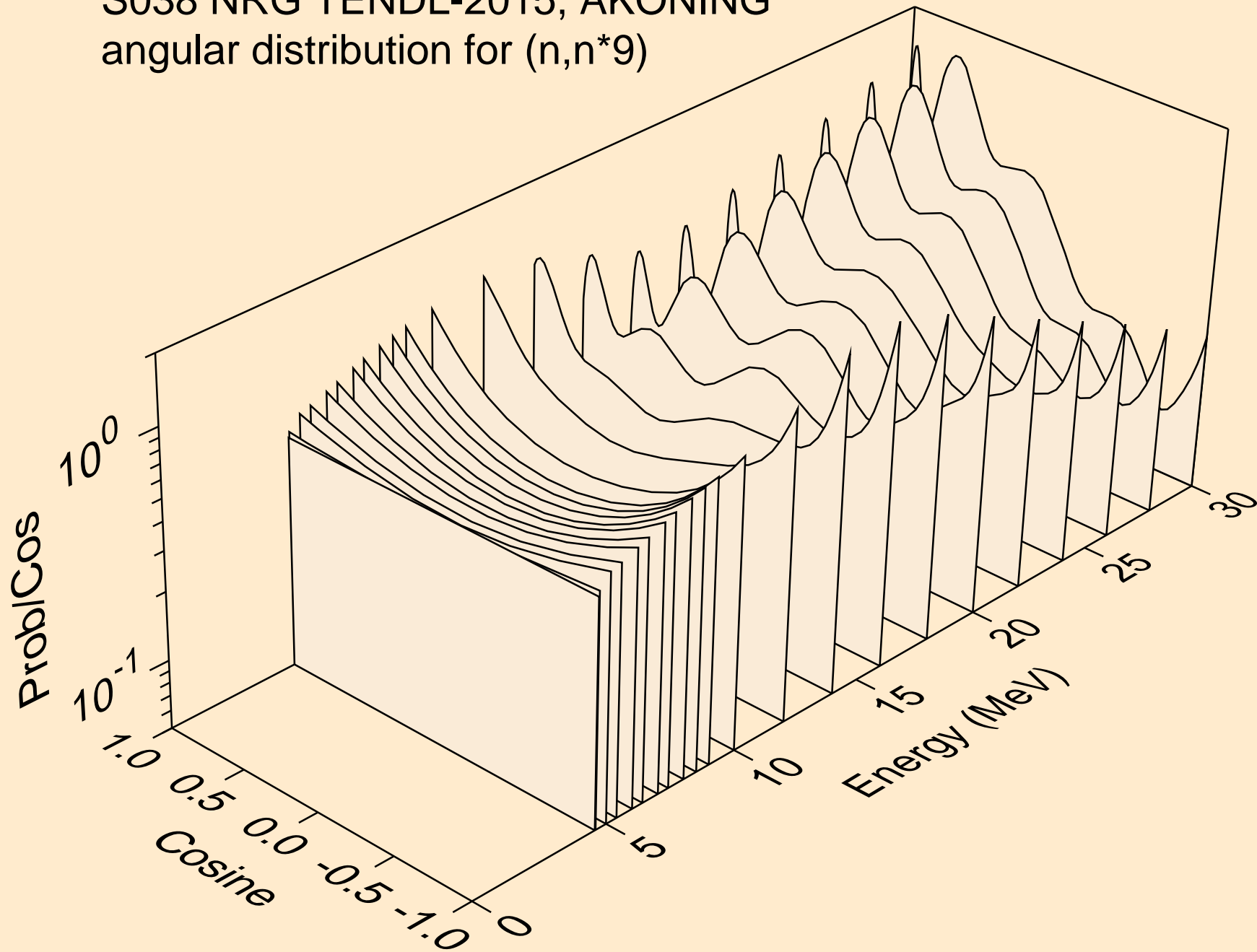

S038 NRG TENDL-2015, AKONING  
angular distribution for (n,n\*10)

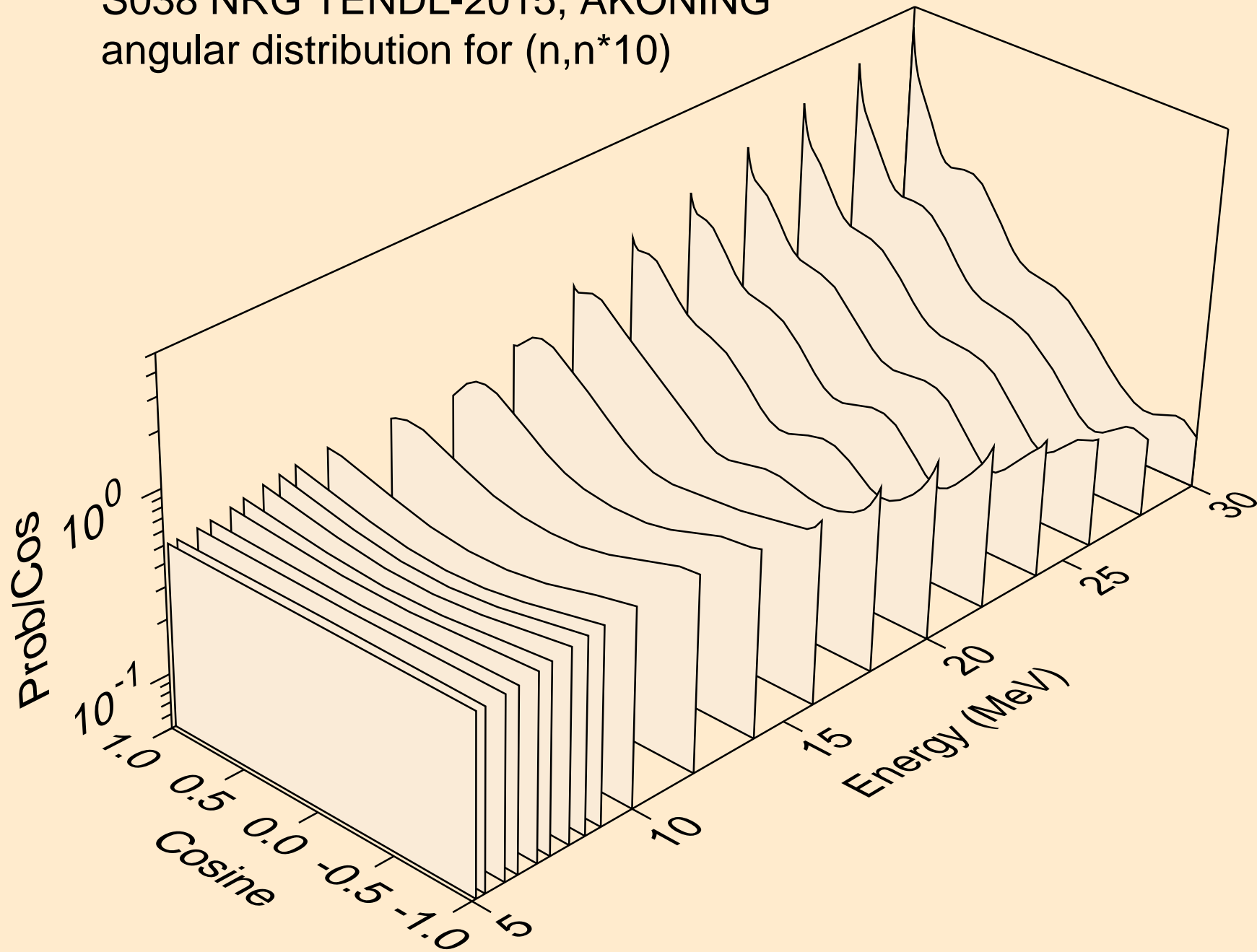

S038 NRG TENDL-2015, AKONING  
angular distribution for (n,n\*11)

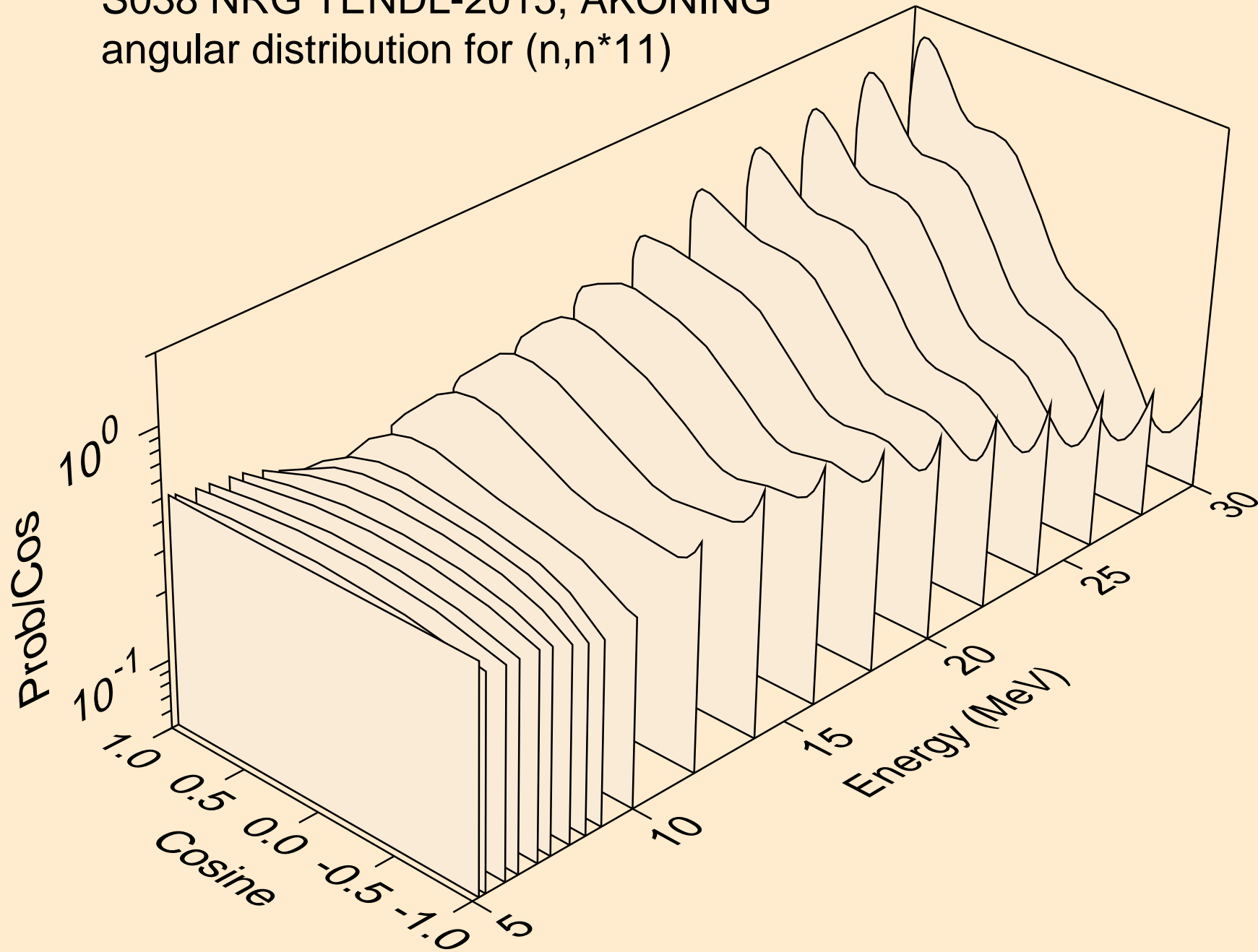

S038 NRG TENDL-2015, AKONING  
angular distribution for (n,n\*12)

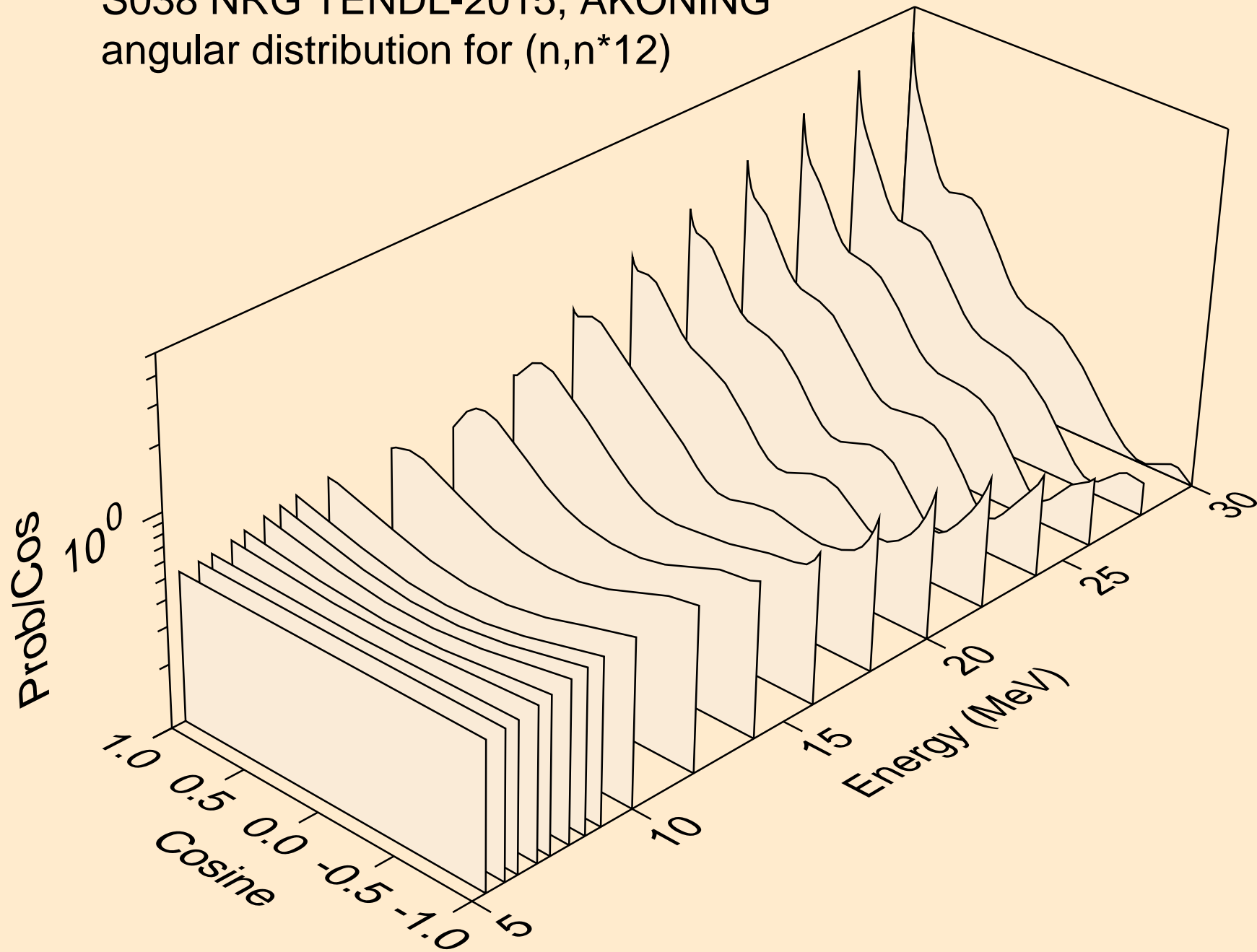

S038 NRG TENDL-2015, AKONING  
angular distribution for (n,n\*13)

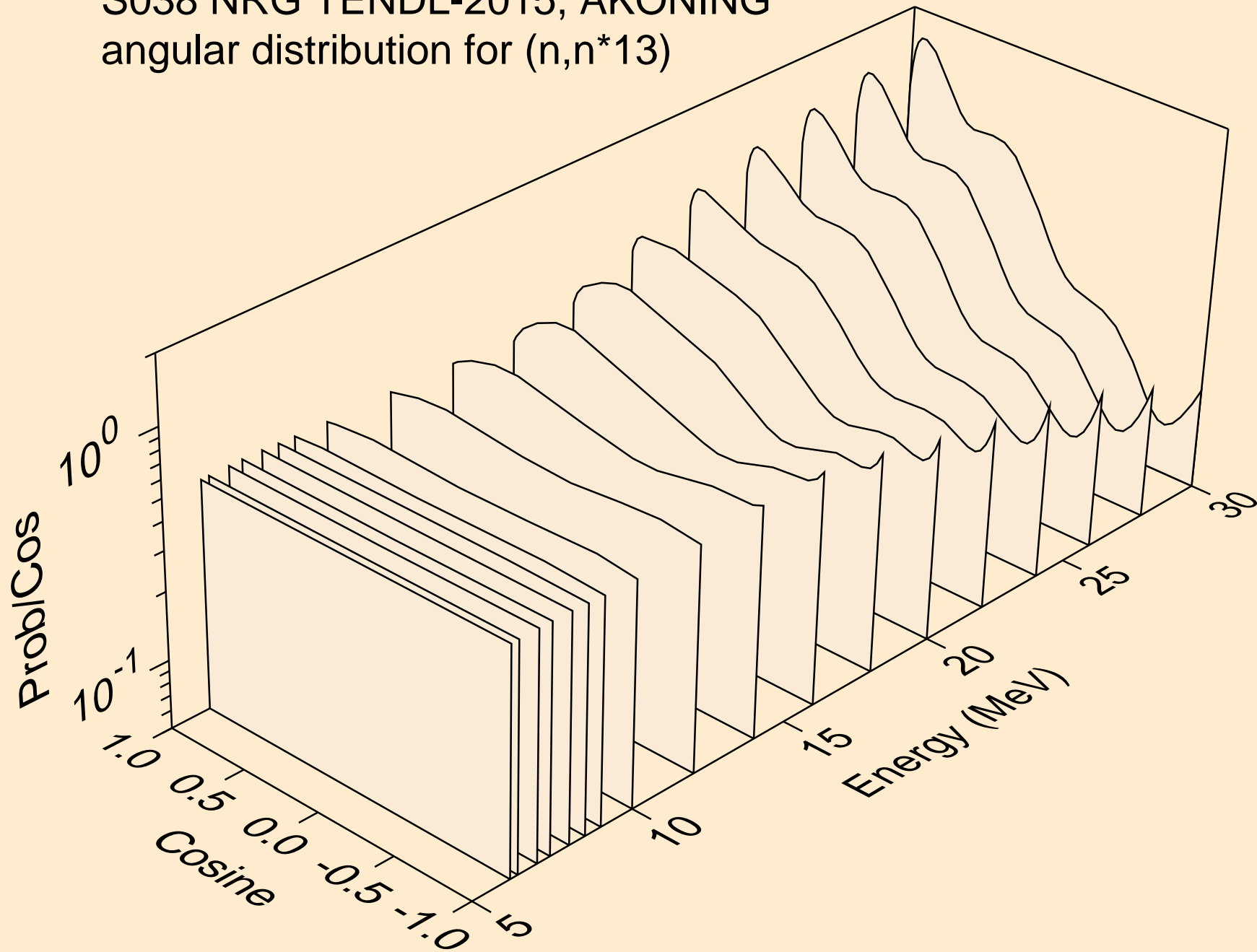

S038 NRG TENDL-2015, AKONING  
angular distribution for (n,n\*14)

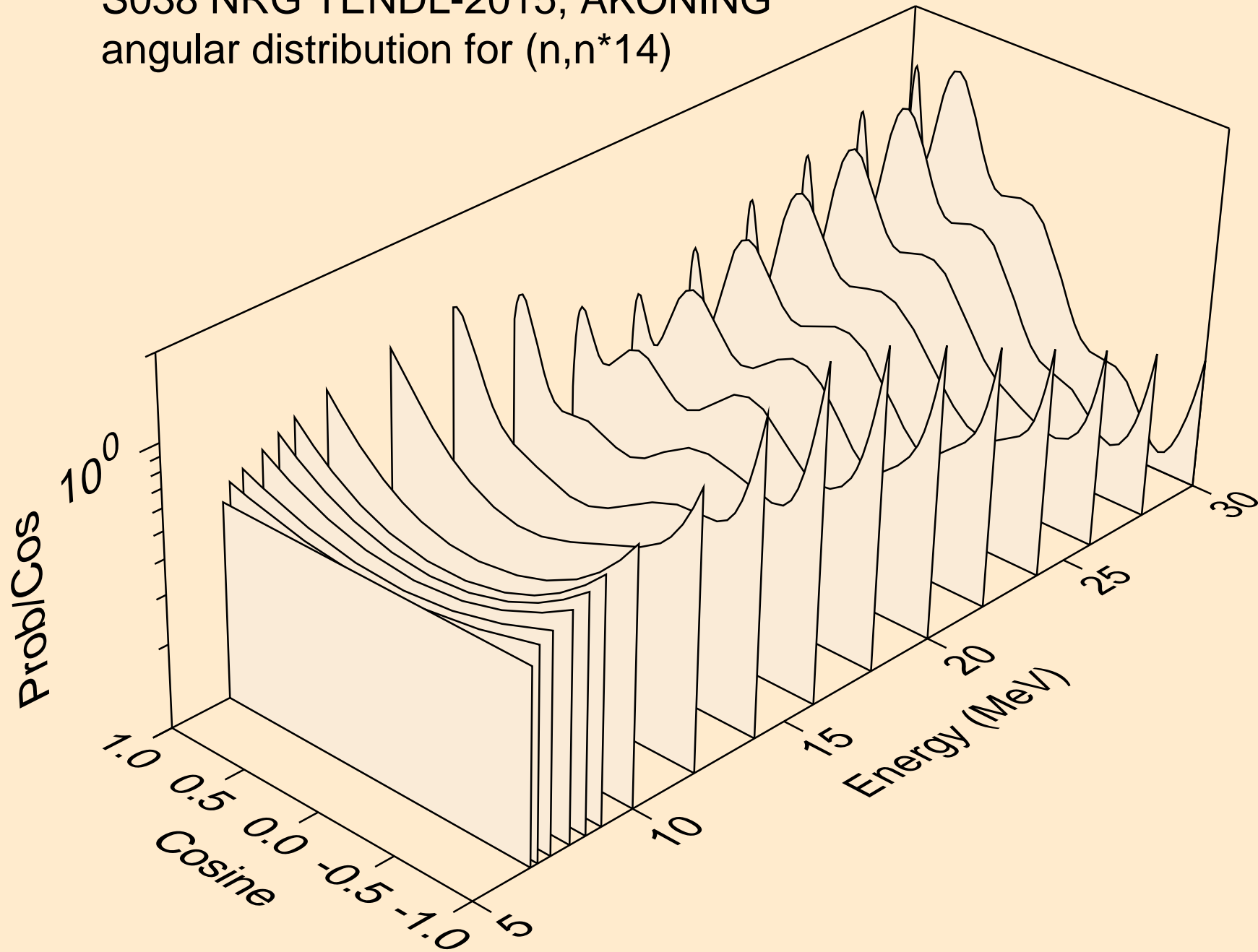

S038 NRG TENDL-2015, AKONING  
angular distribution for (n,n\*15)

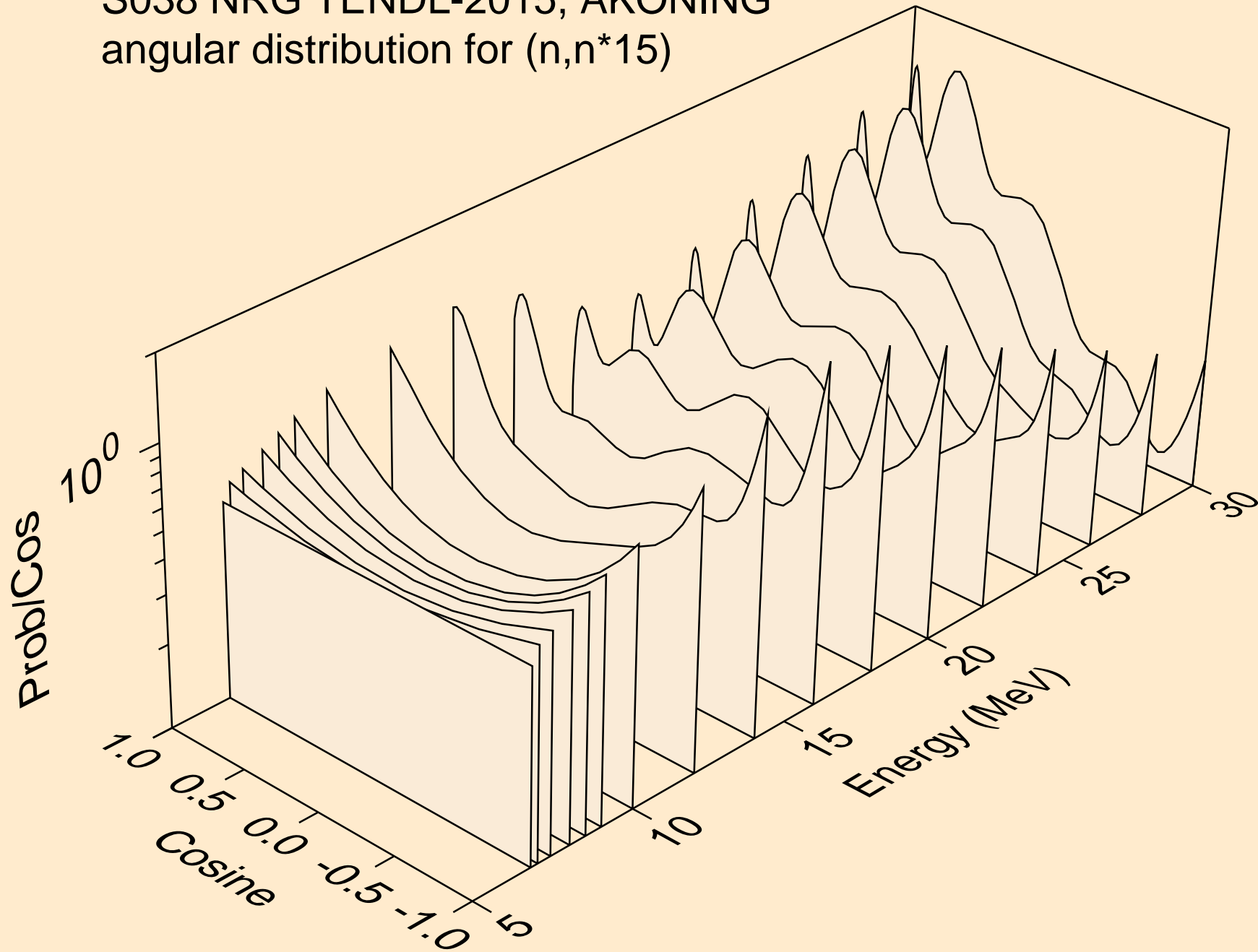

S038 NRG TENDL-2015, AKONING  
angular distribution for (n,n\*16)

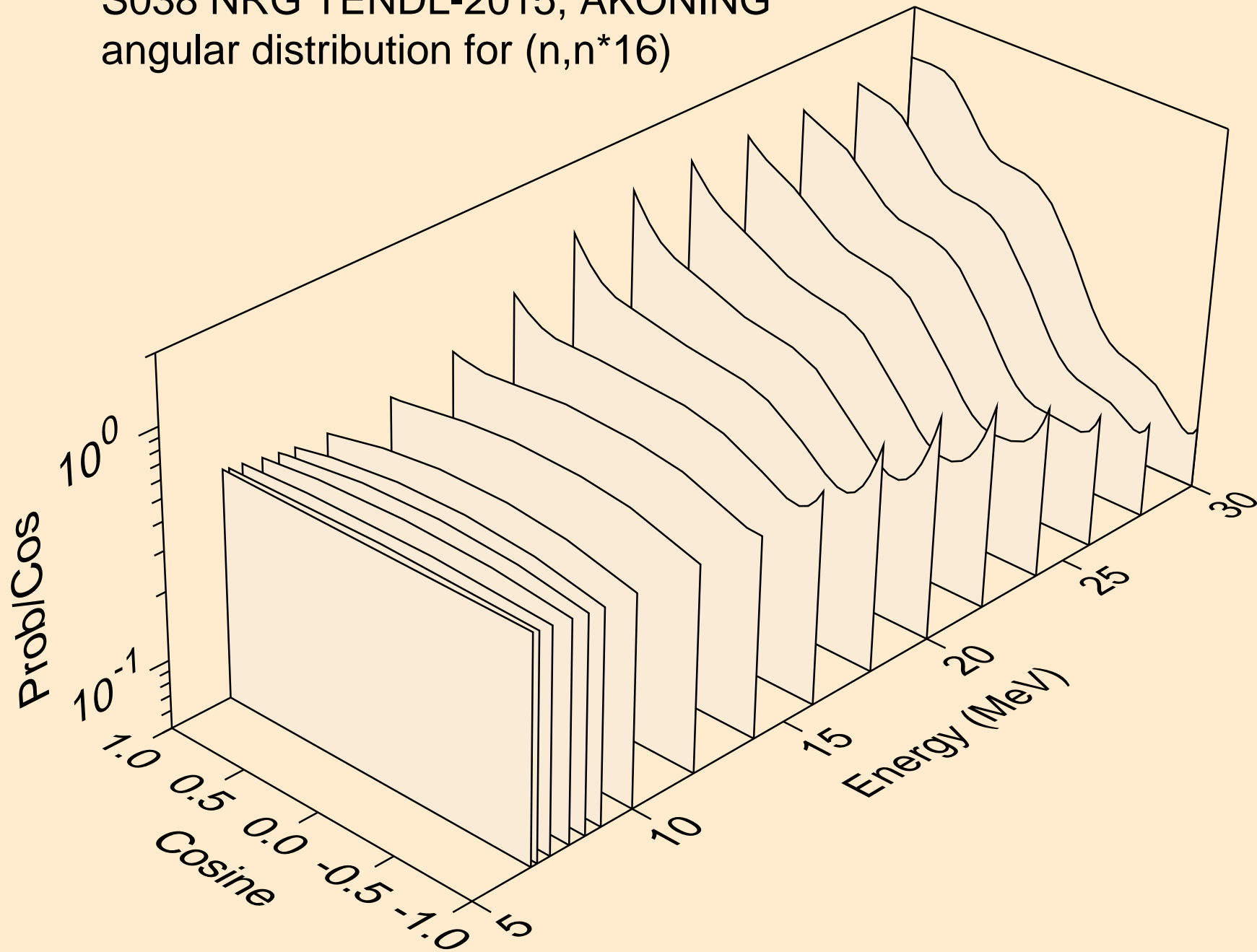



S038 NRG TENDL-2015, AKONING  
angular distribution for (n,n\*17)

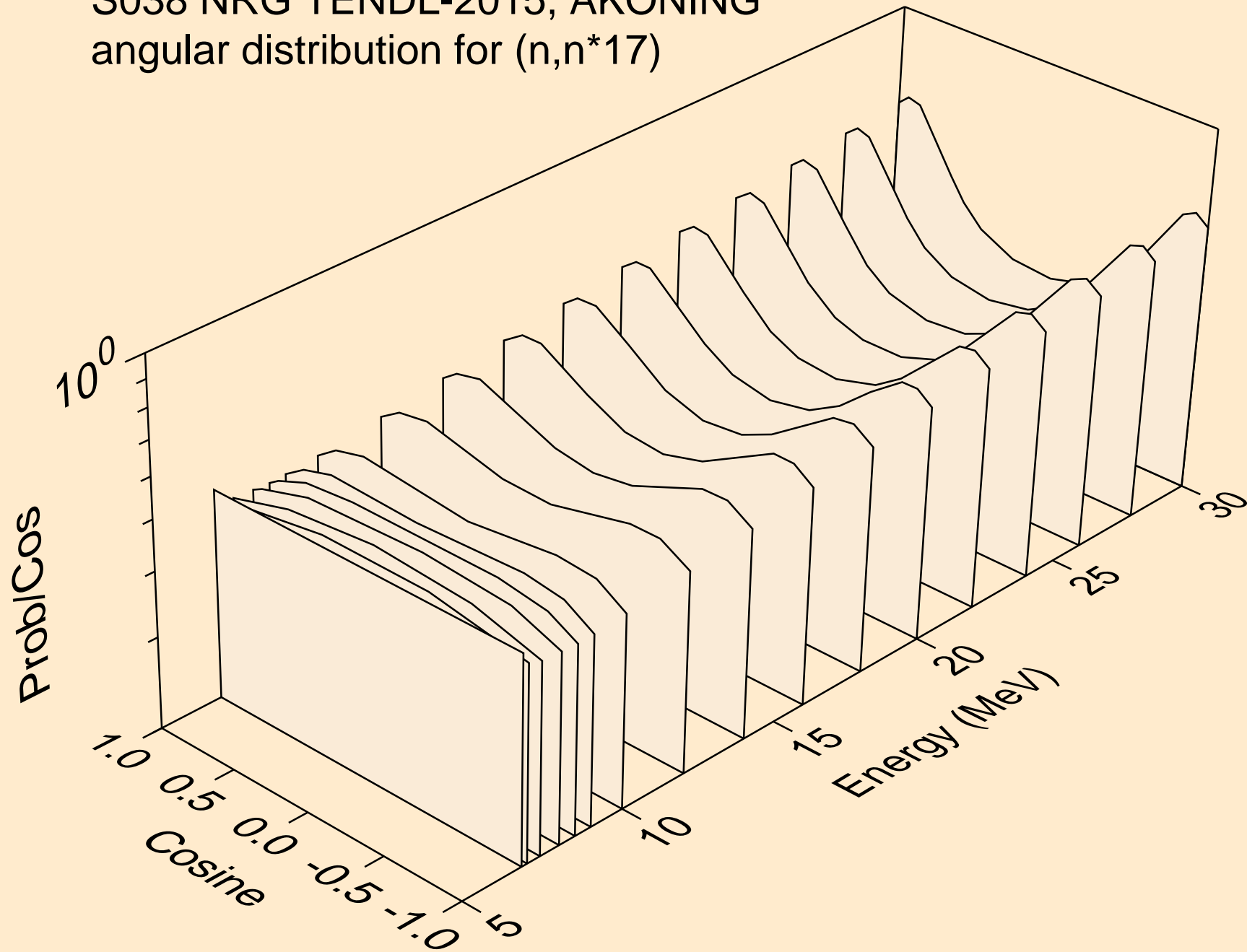

S038 NRG TENDL-2015, AKONING  
angular distribution for (n,n\*18)

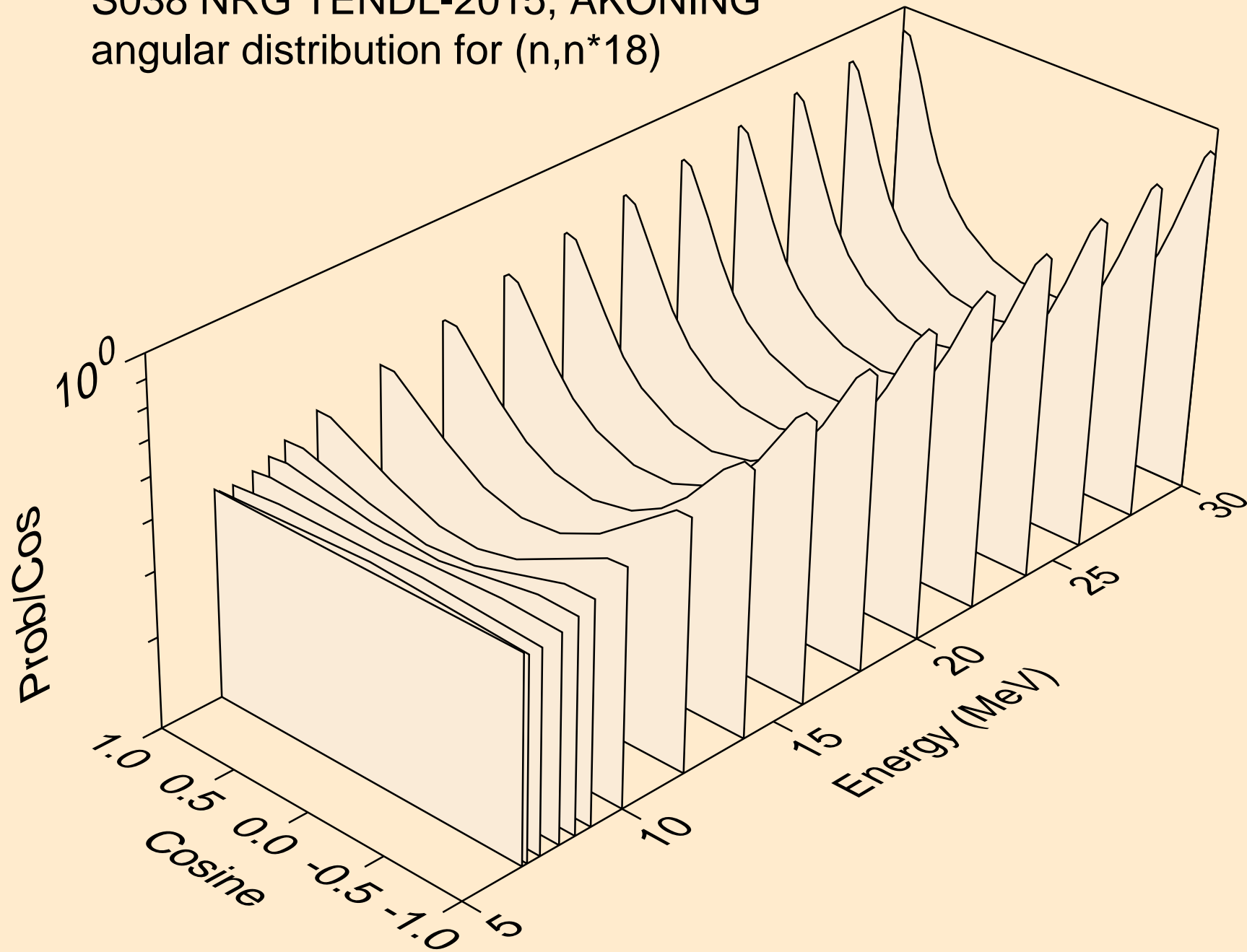

S038 NRG TENDL-2015, AKONING  
angular distribution for (n,n\*19)

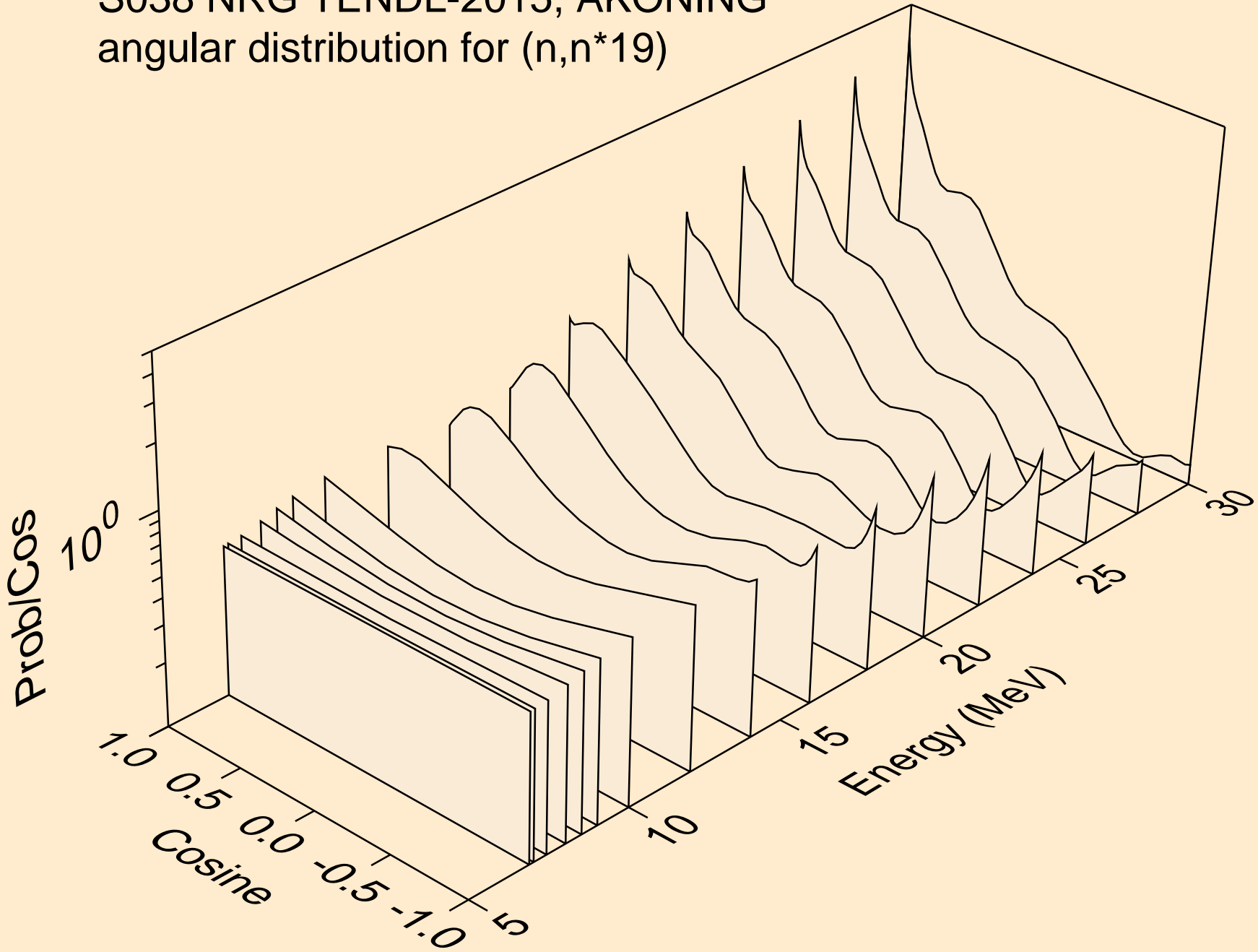

S038 NRG TENDL-2015, AKONING  
angular distribution for (n,n\*20)

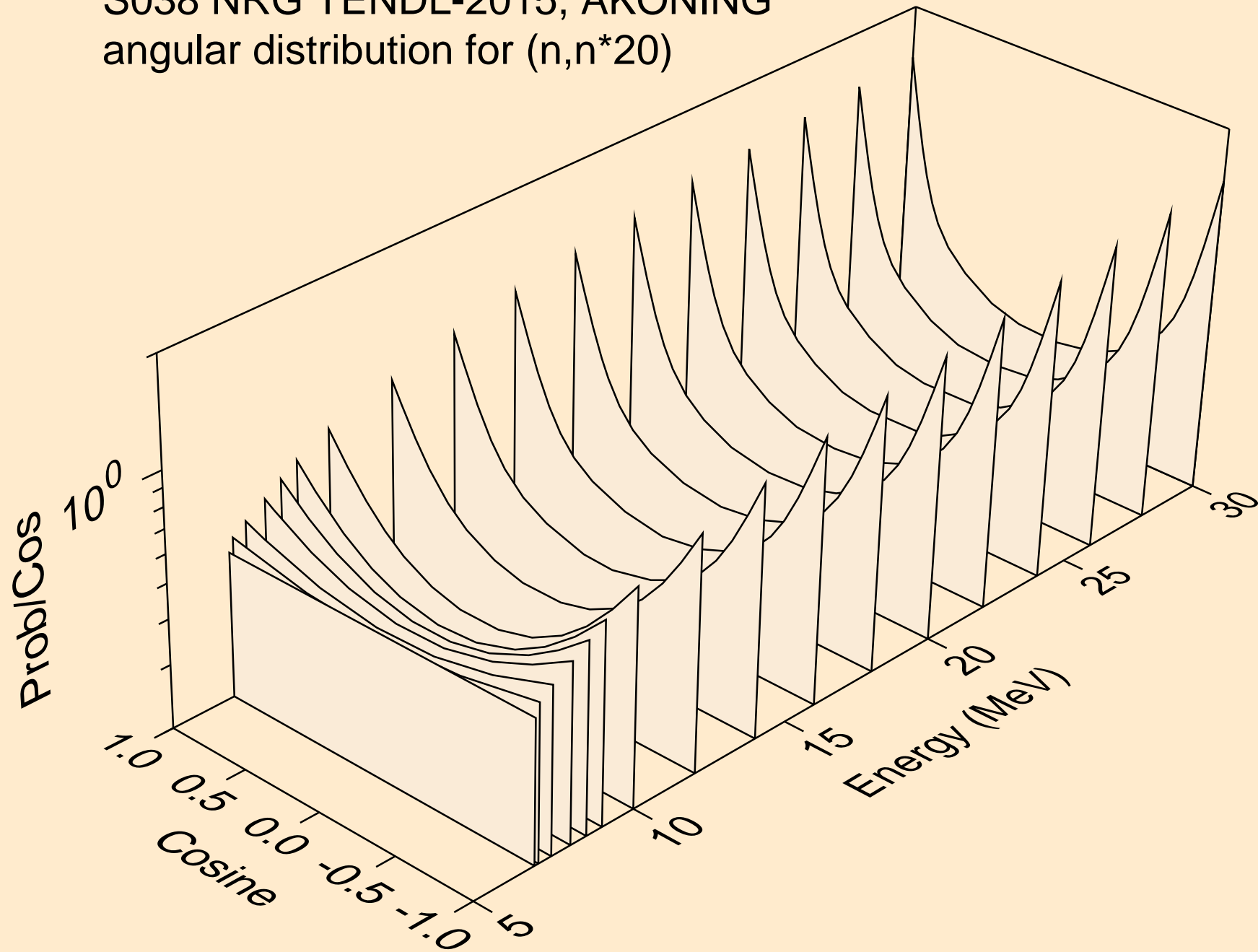

S038 NRG TENDL-2015, AKONING  
angular distribution for (n,n\*21)

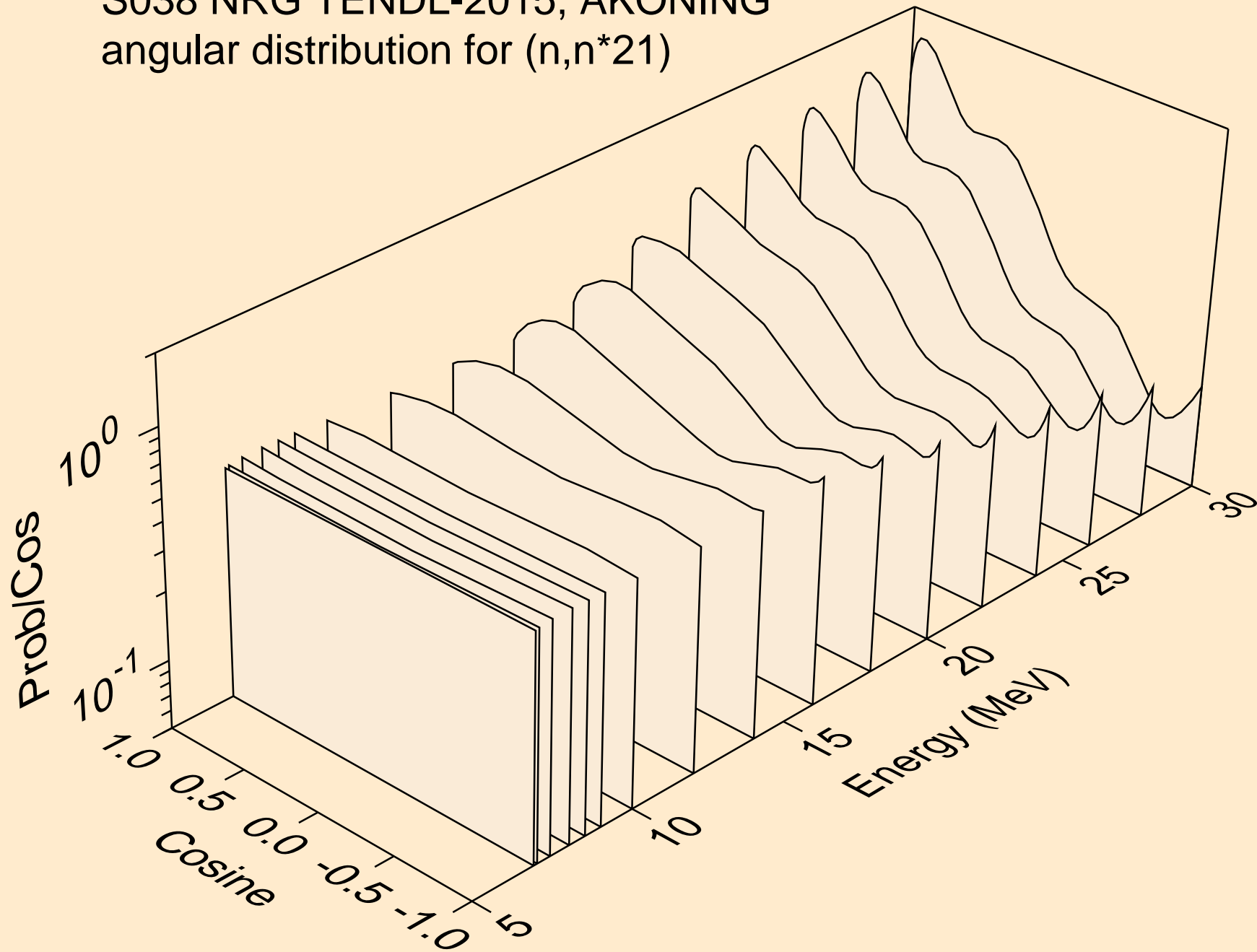

S038 NRG TENDL-2015, AKONING  
angular distribution for (n,n\*22)

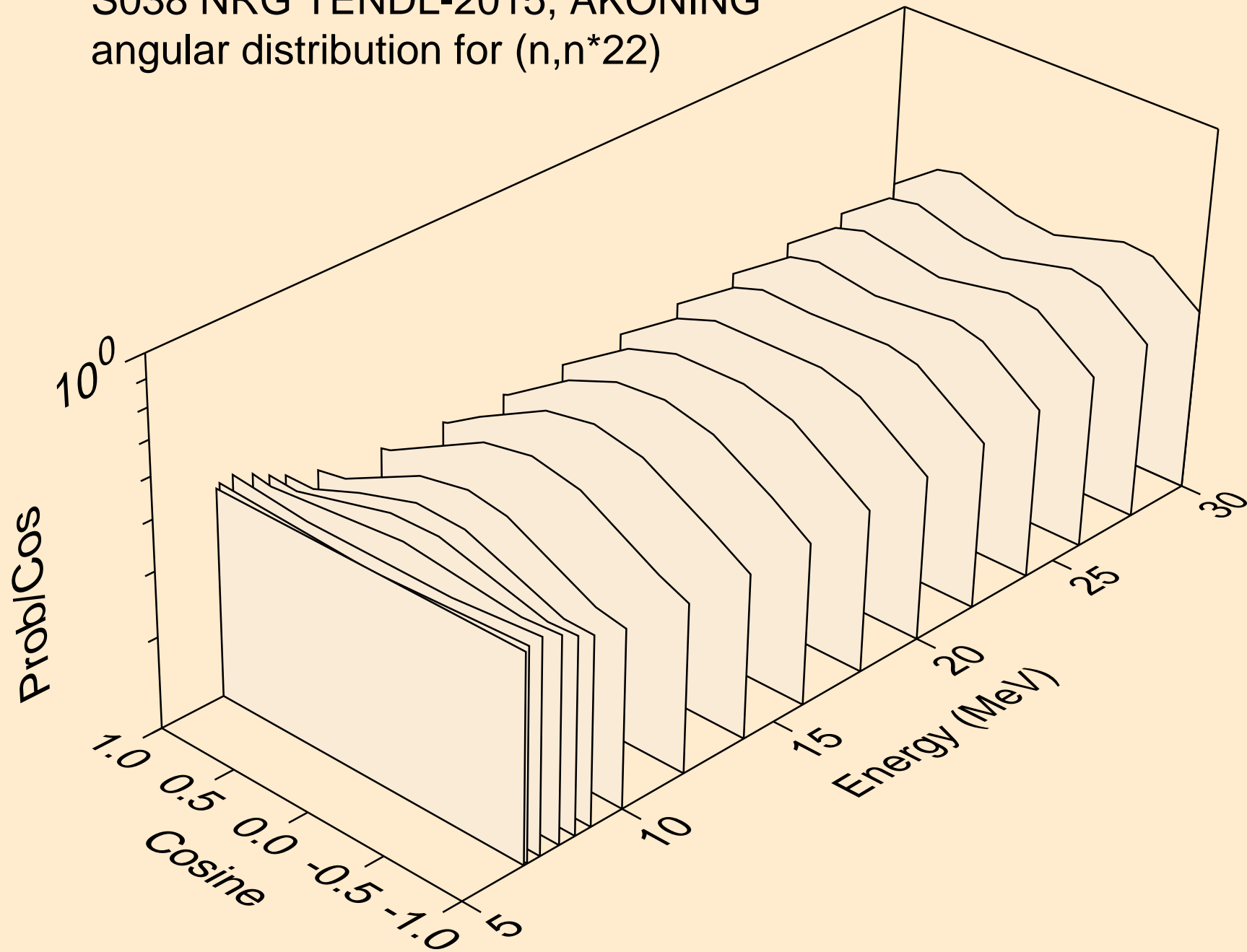

S038 NRG TENDL-2015, AKONING  
angular distribution for (n,n\*23)

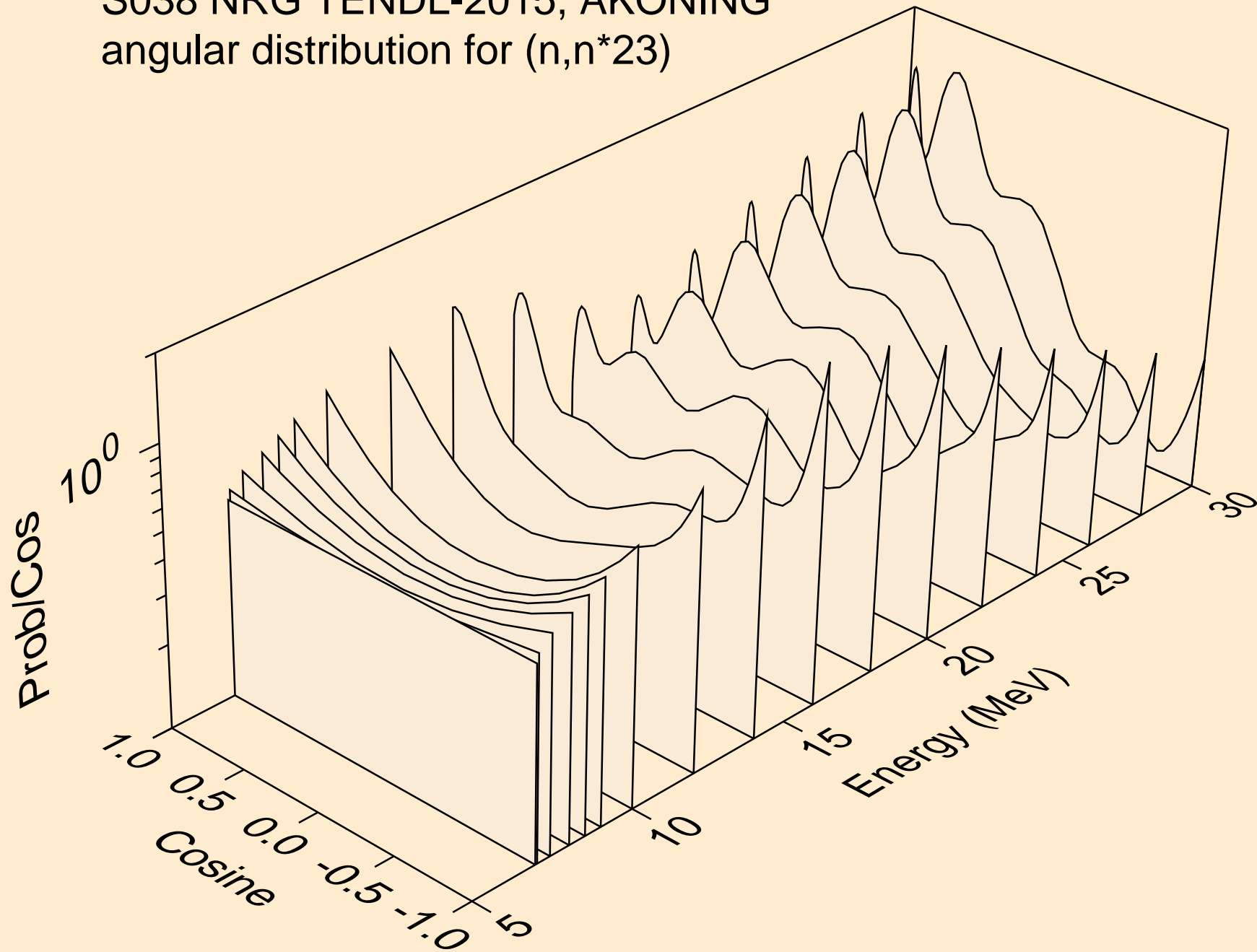

S038 NRG TENDL-2015, AKONING  
angular distribution for (n,n\*24)

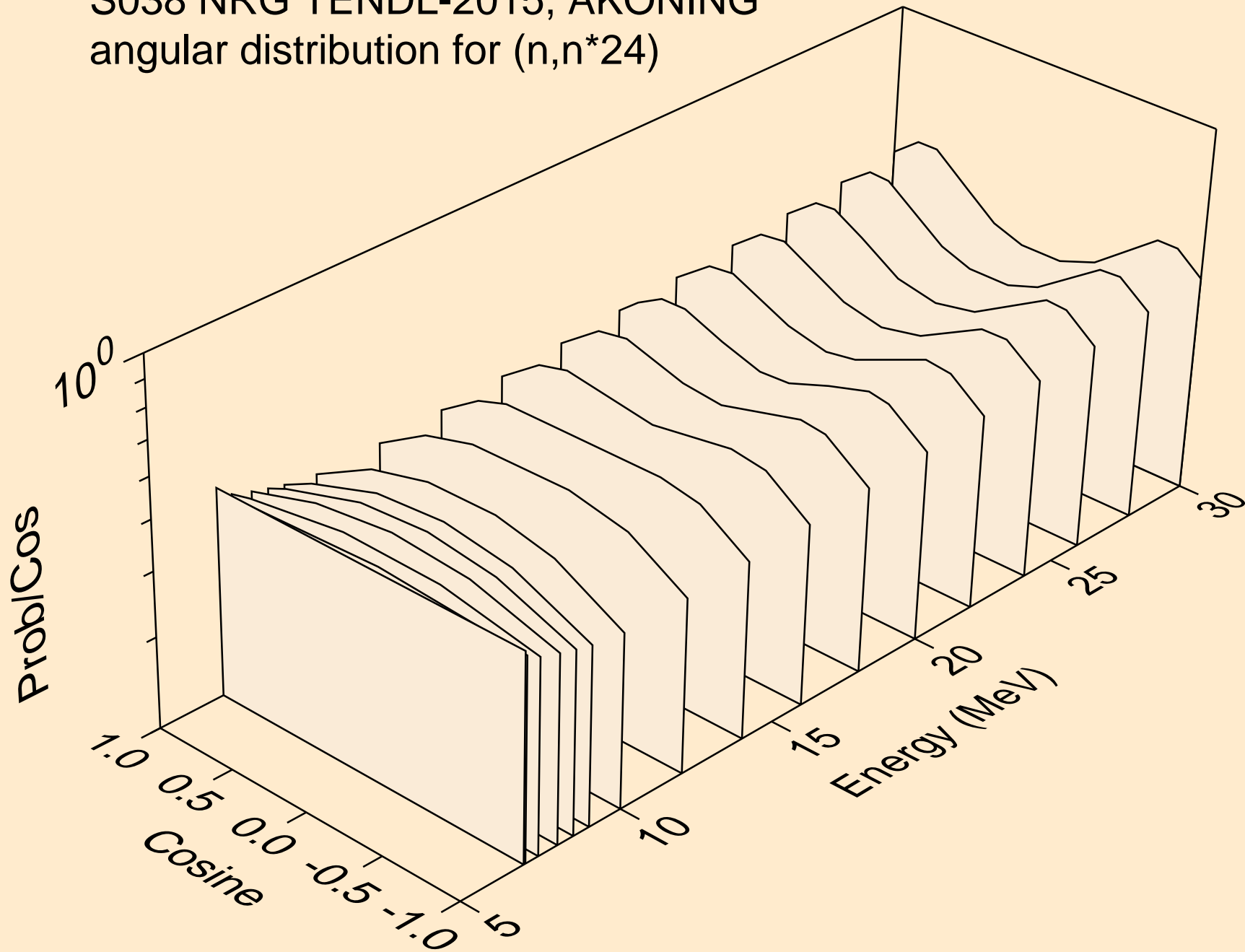



S038 NRG TENDL-2015, AKONING  
angular distribution for (n,n\*25)

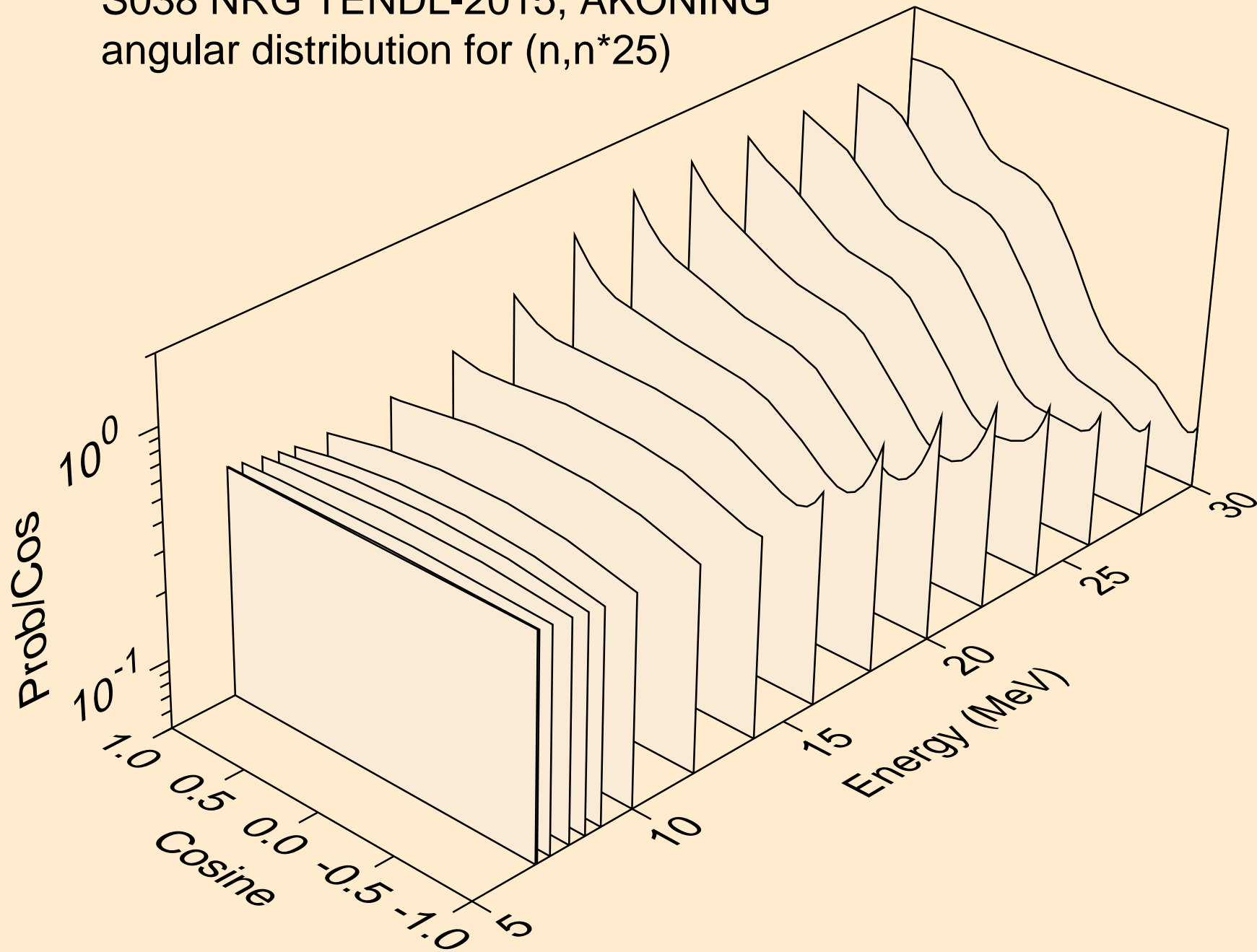

S038 NRG TENDL-2015, AKONING  
angular distribution for (n,n\*26)

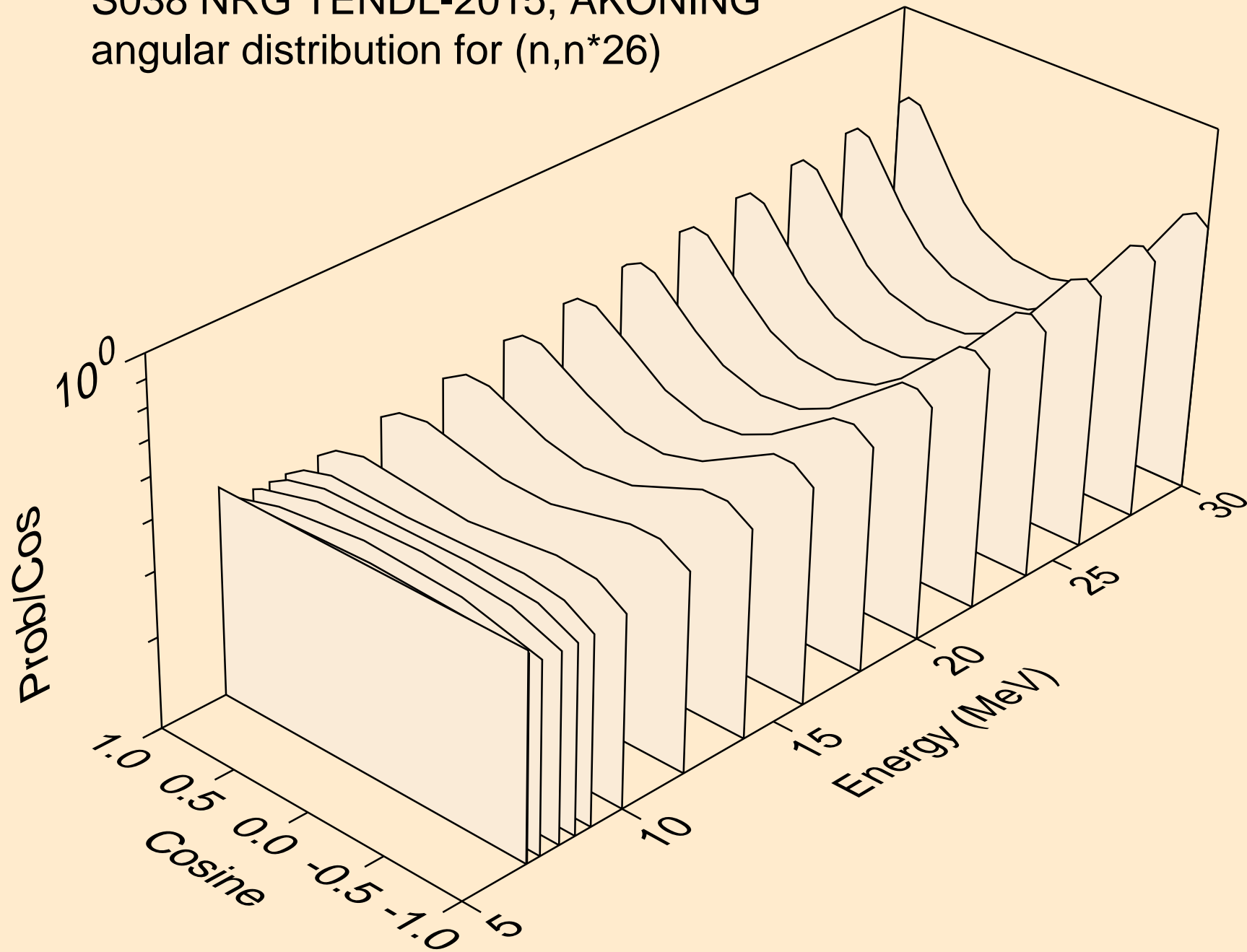

S038 NRG TENDL-2015, AKONING  
angular distribution for (n,n\*27)

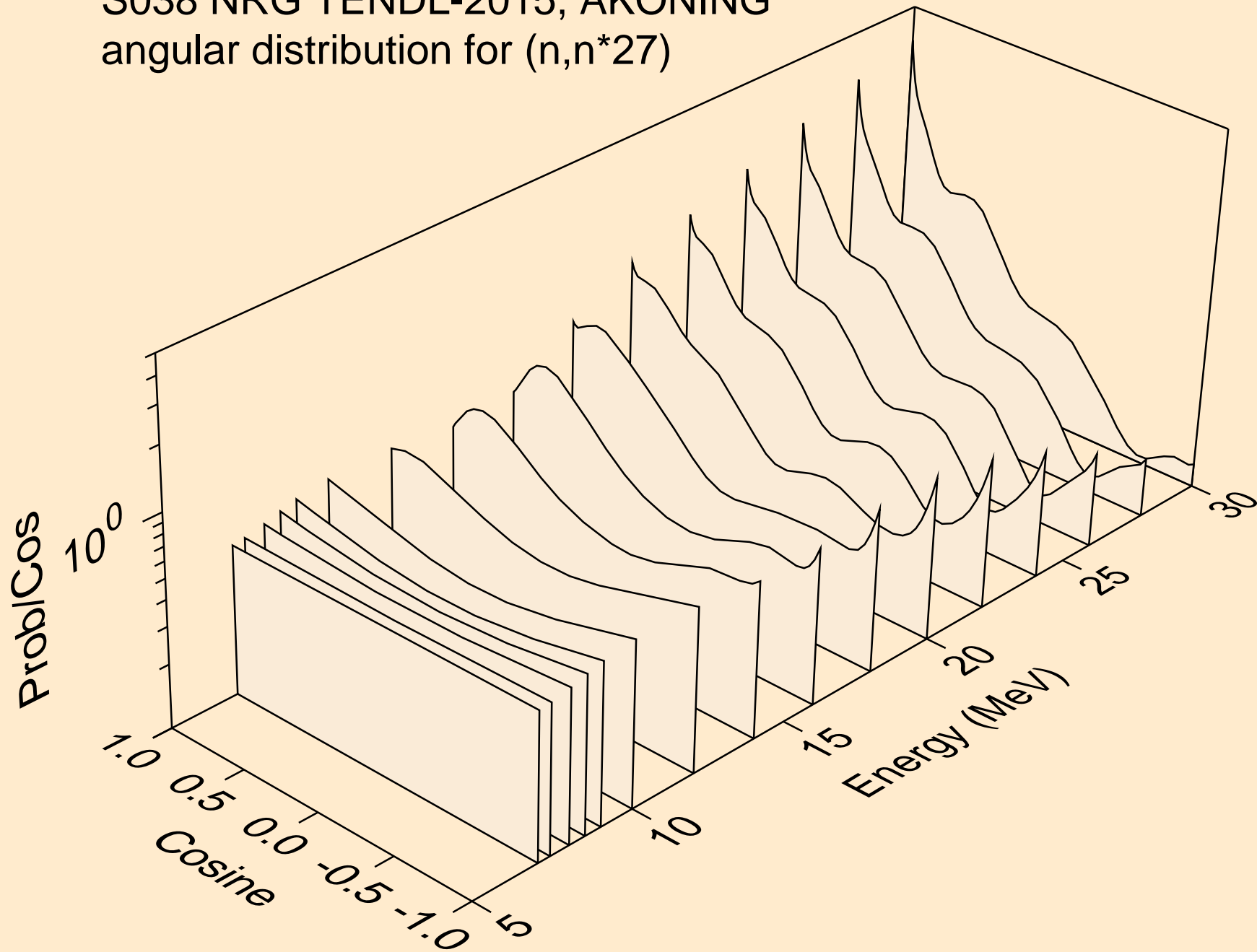

S038 NRG TENDL-2015, AKONING  
angular distribution for (n,n\*28)

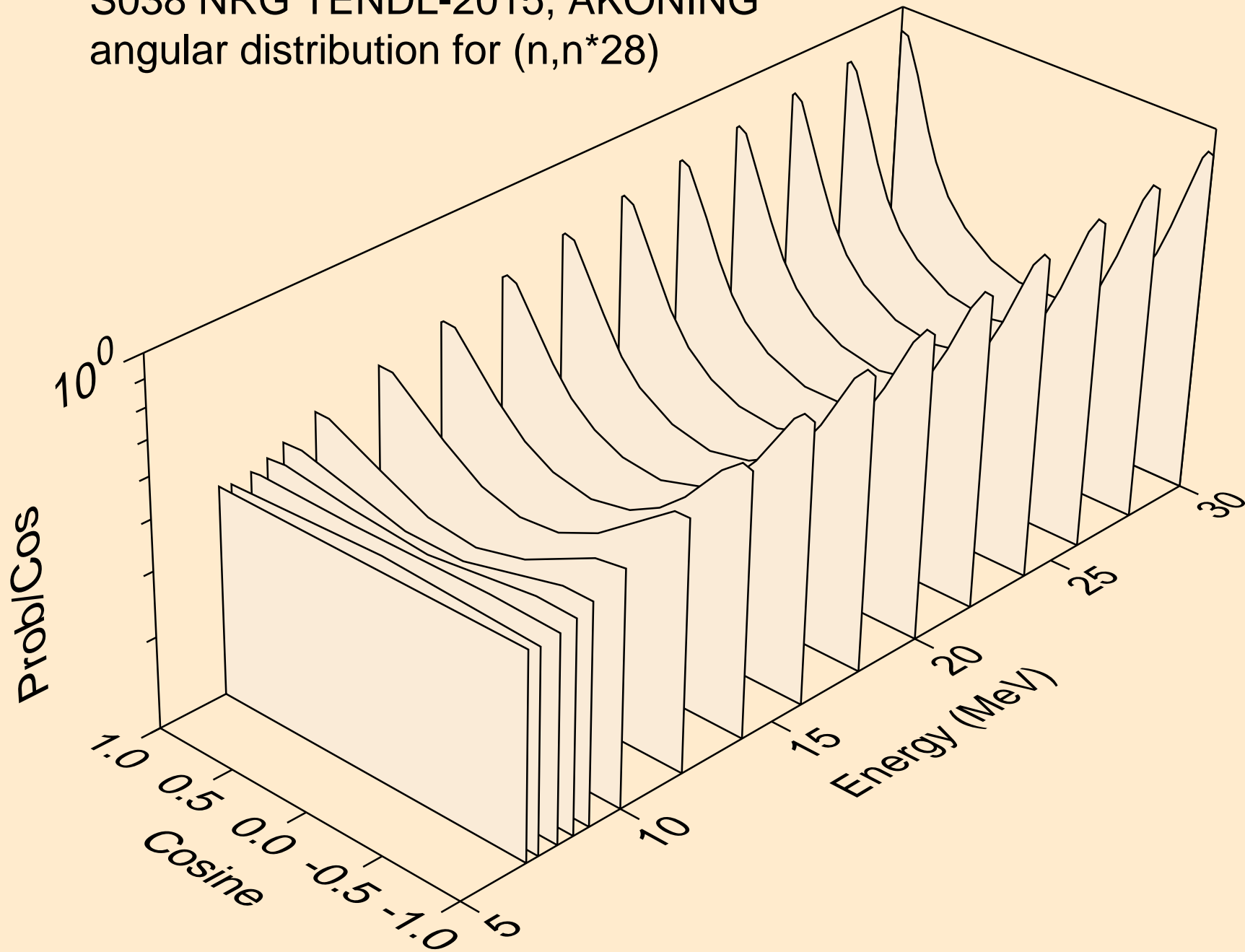

S038 NRG TENDL-2015, AKONING  
Neutron emission for (n,x)

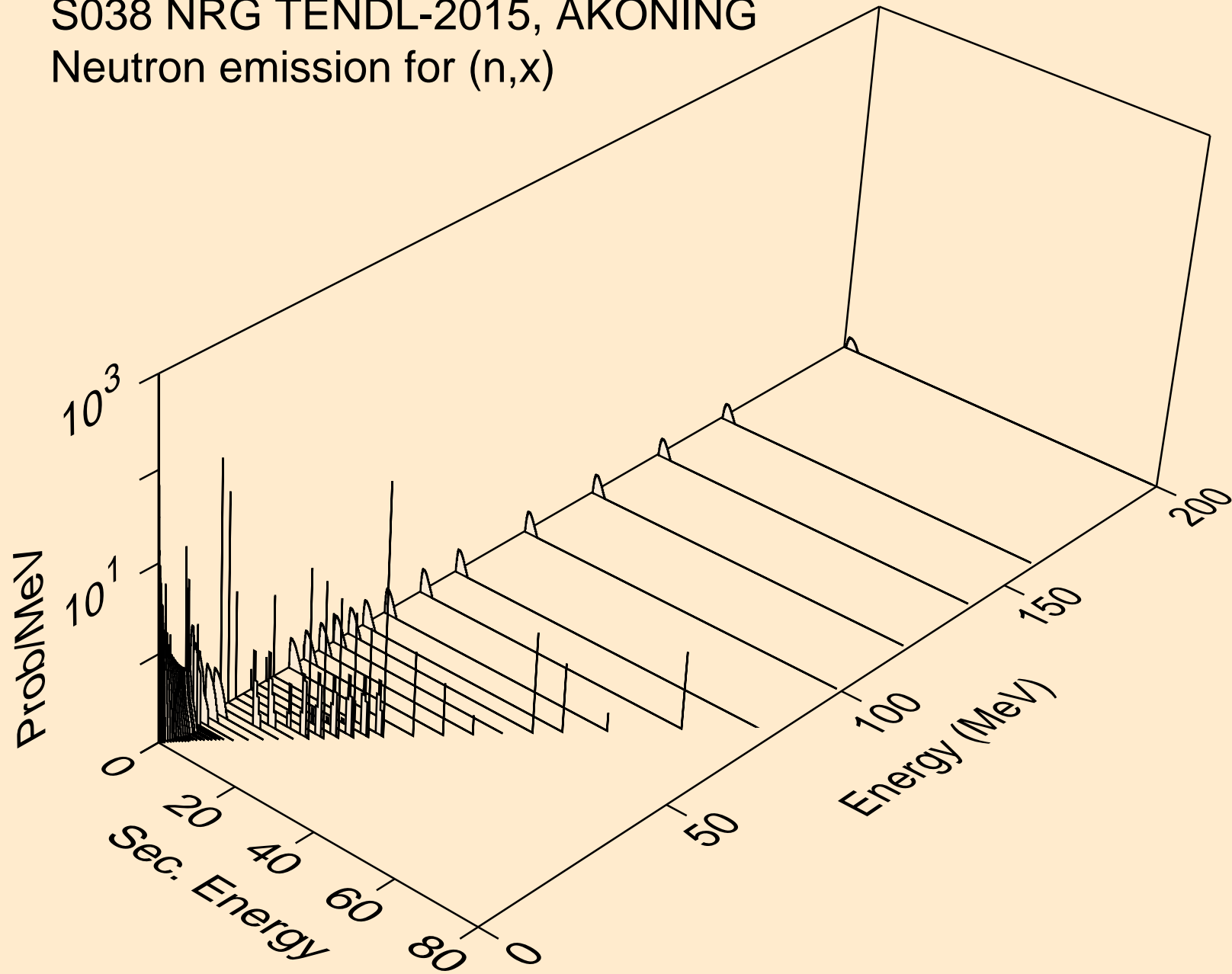

S038 NRG TENDL-2015, AKONING  
Neutron emission for (n,2nd)

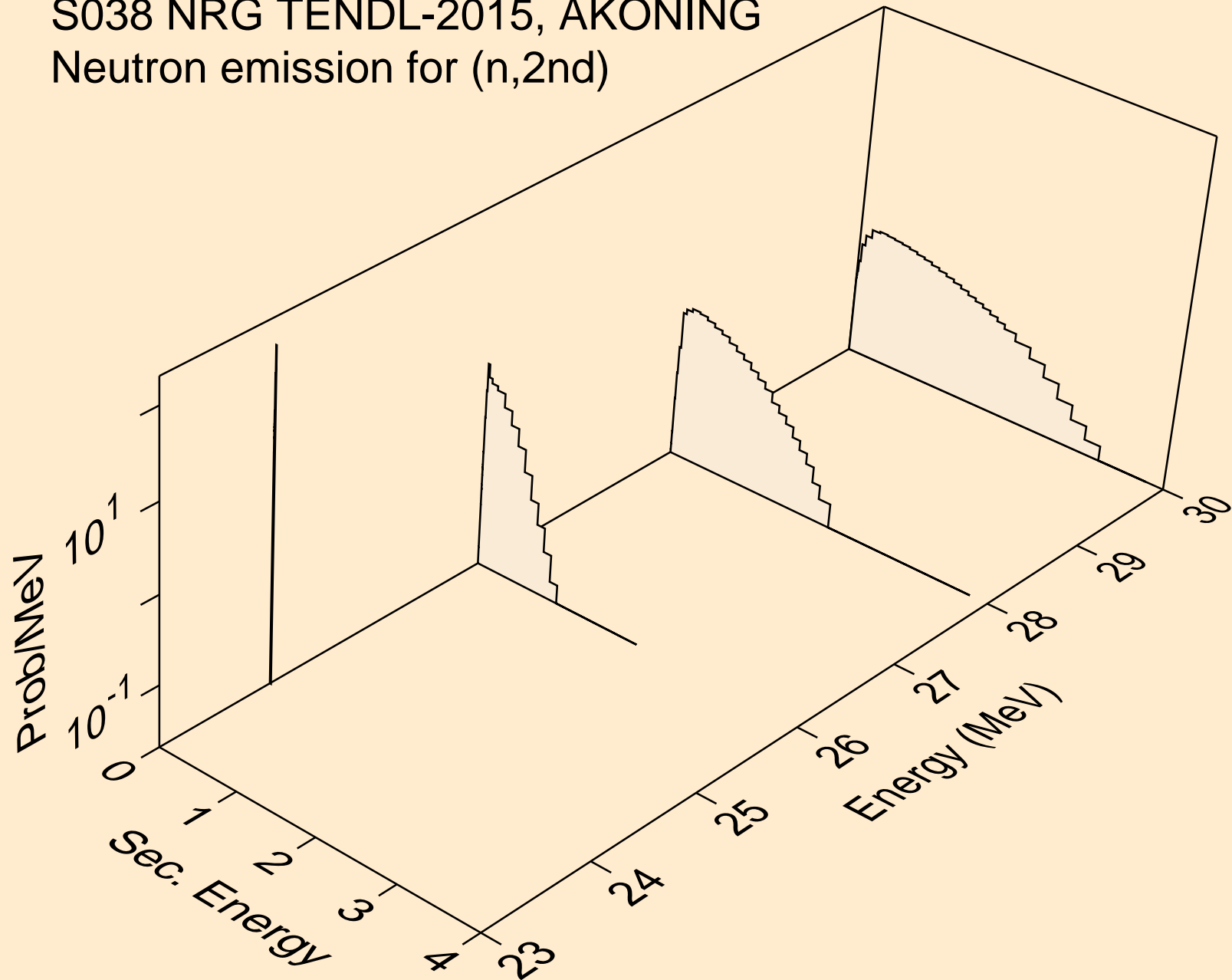

S038 NRG TENDL-2015, AKONING  
Neutron emission for (n,2n)

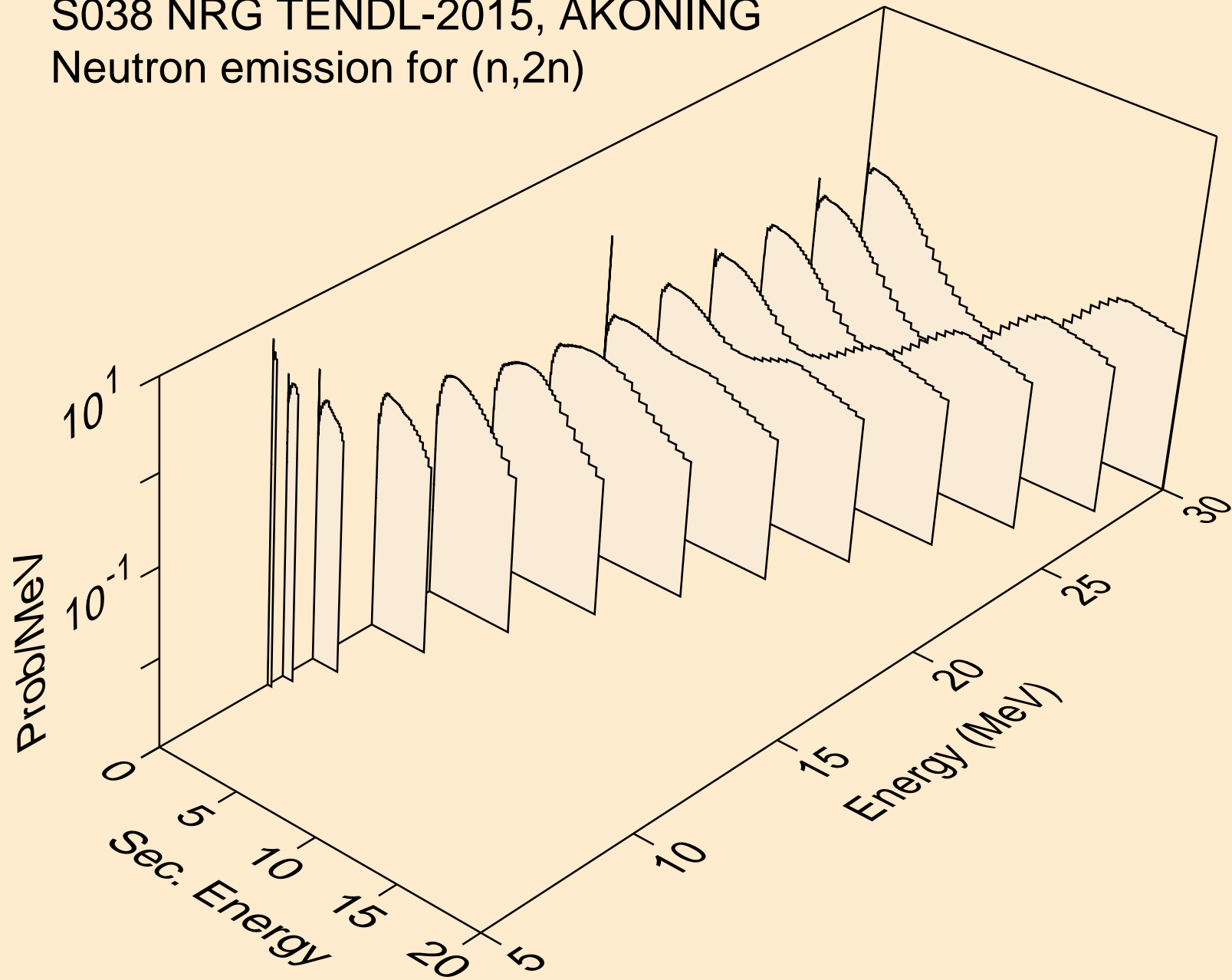

S038 NRG TENDL-2015, AKONING  
Neutron emission for (n,3n)

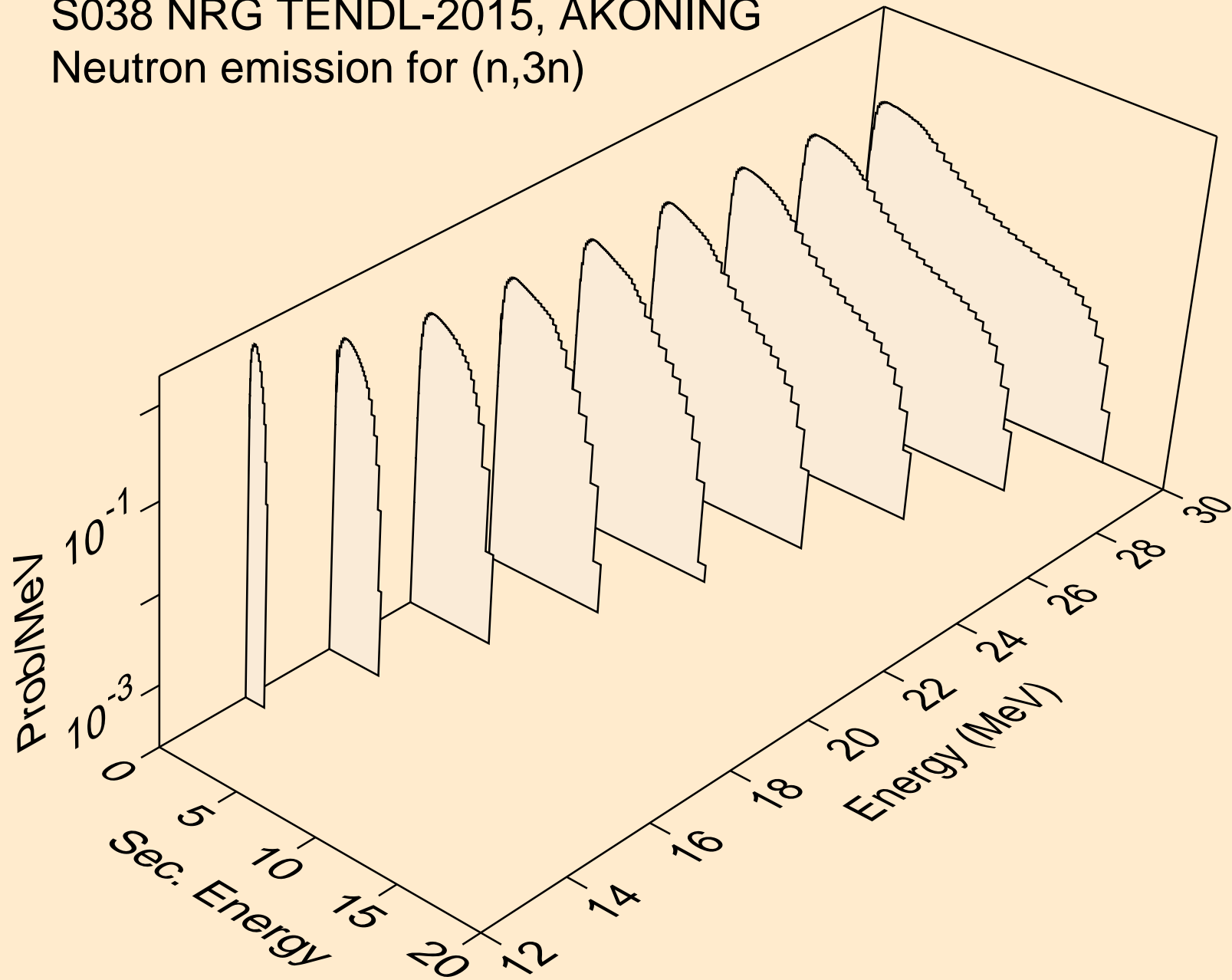



S038 NRG TENDL-2015, AKONING  
Neutron emission for (n,n\*)a

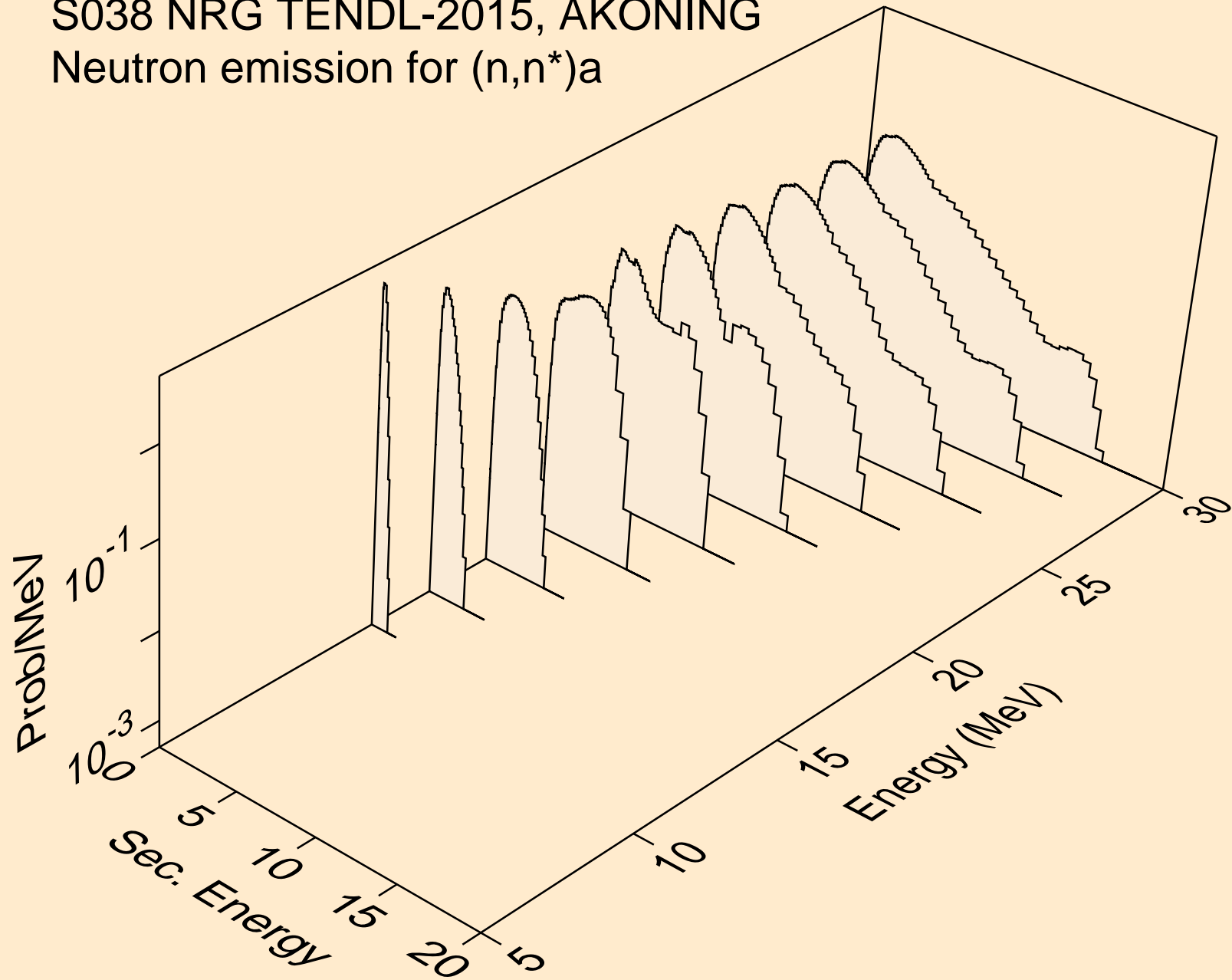

S038 NRG TENDL-2015, AKONING  
Neutron emission for (n,2n)a

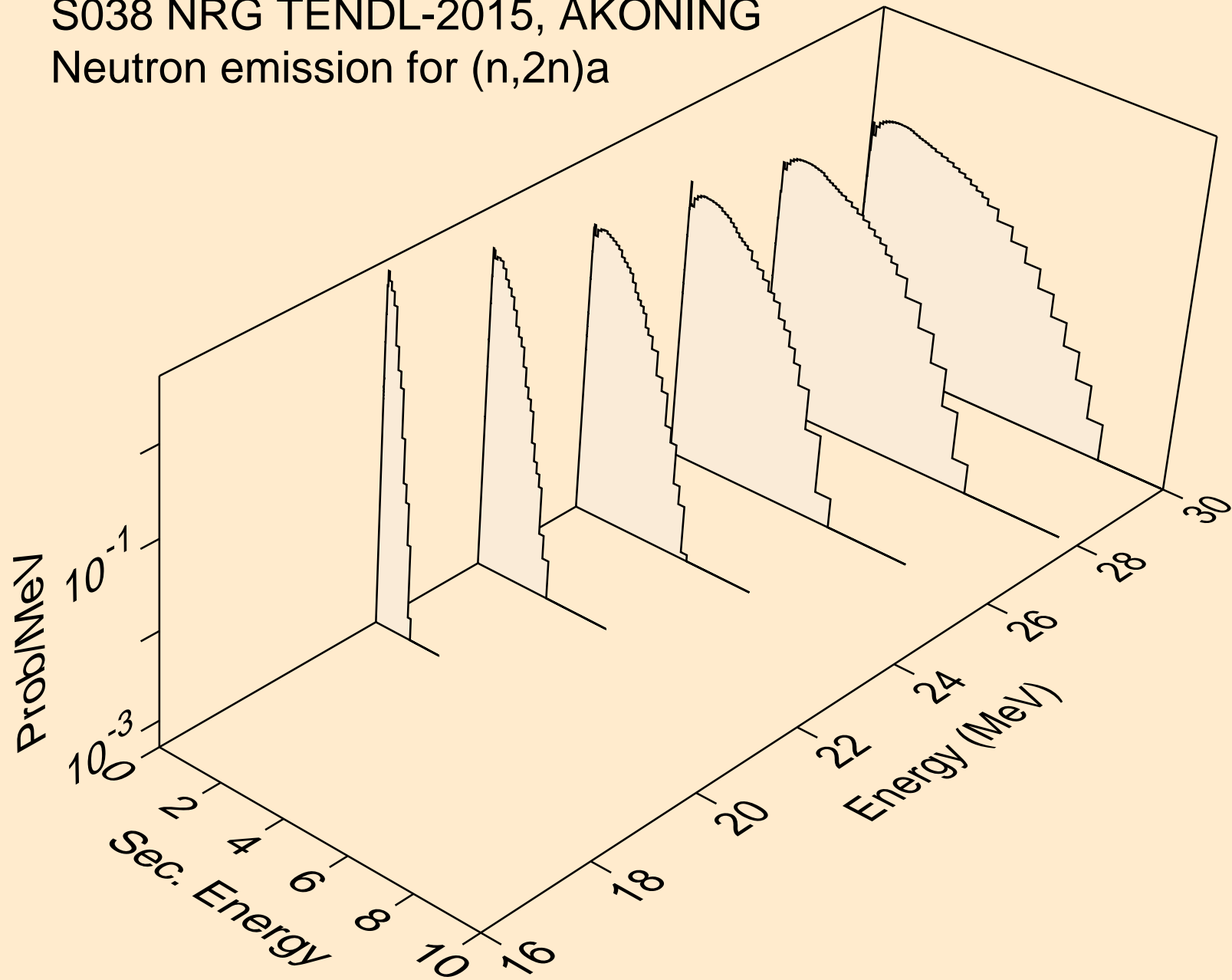

S038 NRG TENDL-2015, AKONING  
Neutron emission for (n,3n)a

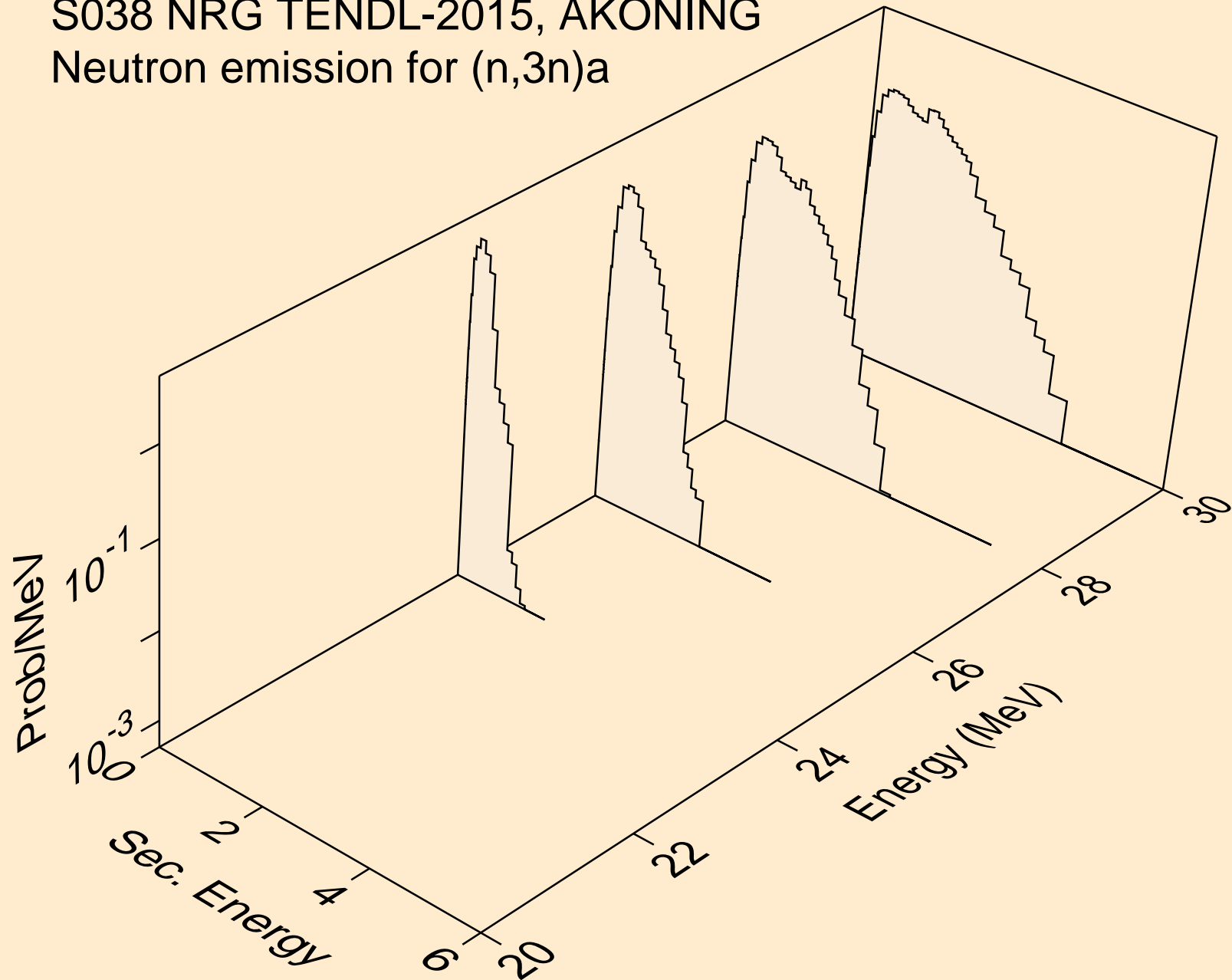

S038 NRG TENDL-2015, AKONING  
Neutron emission for (n,n\*)p

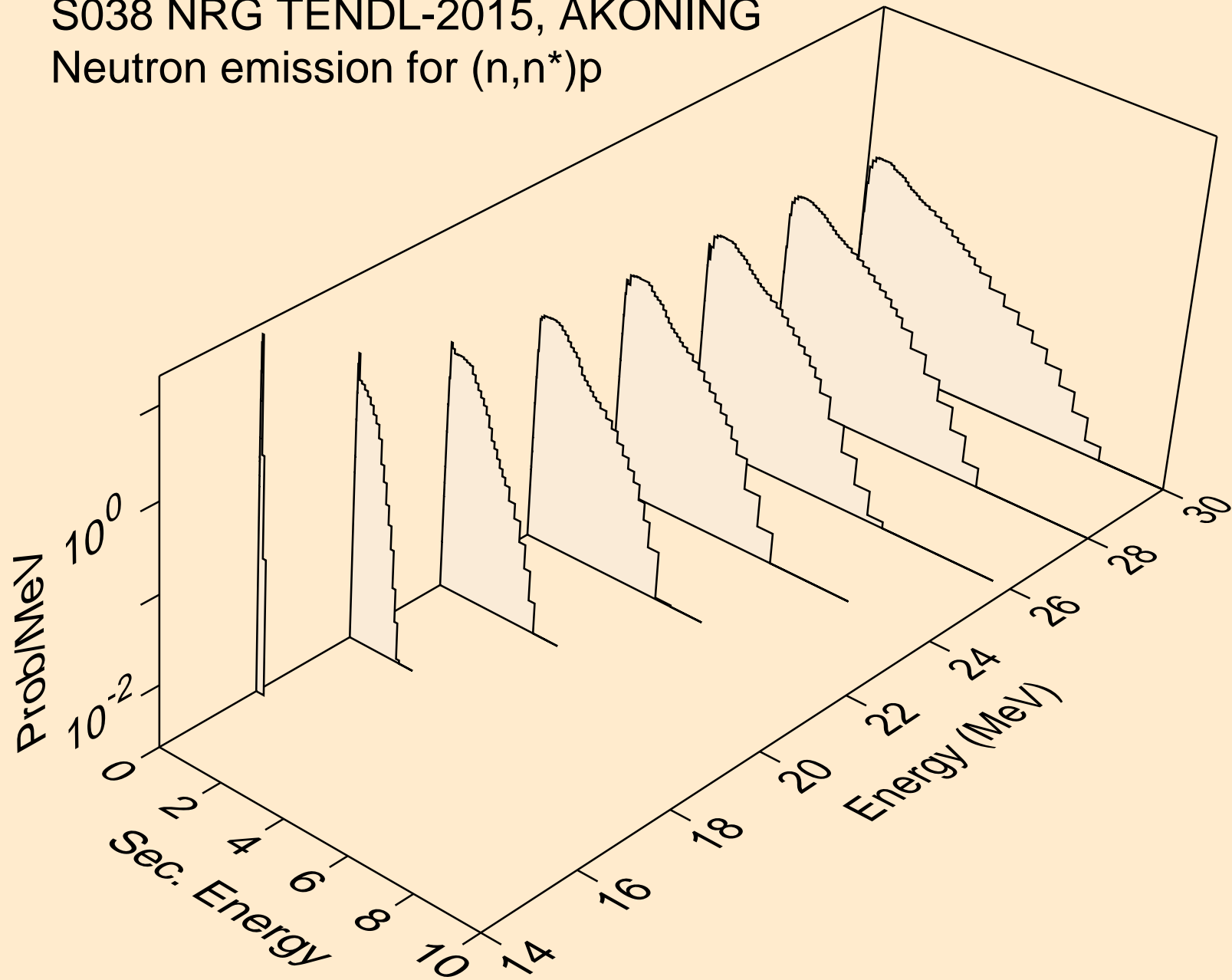

S038 NRG TENDL-2015, AKONING  
Neutron emission for (n,n\*)d

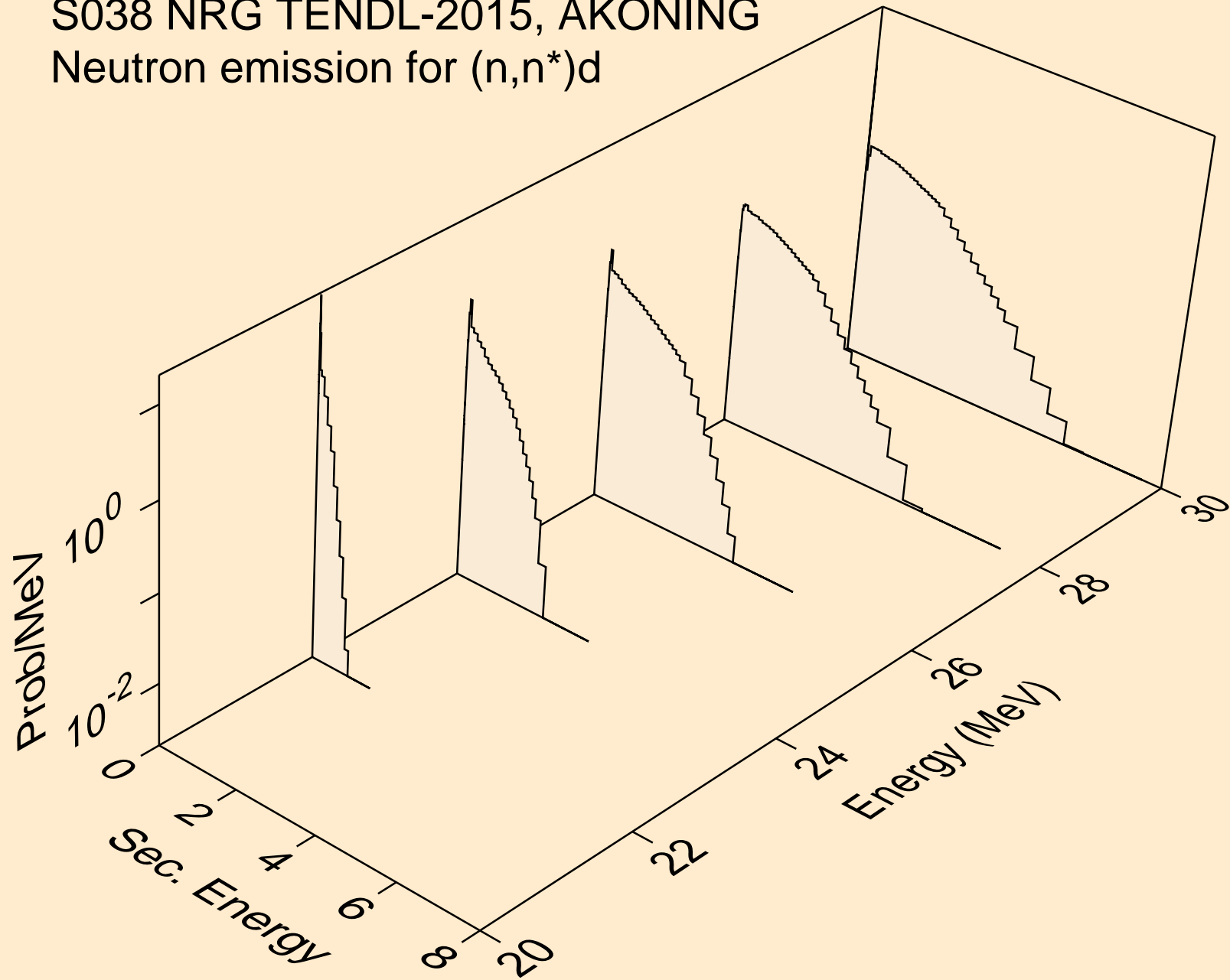

S038 NRG TENDL-2015, AKONING  
Neutron emission for (n,n\*)t

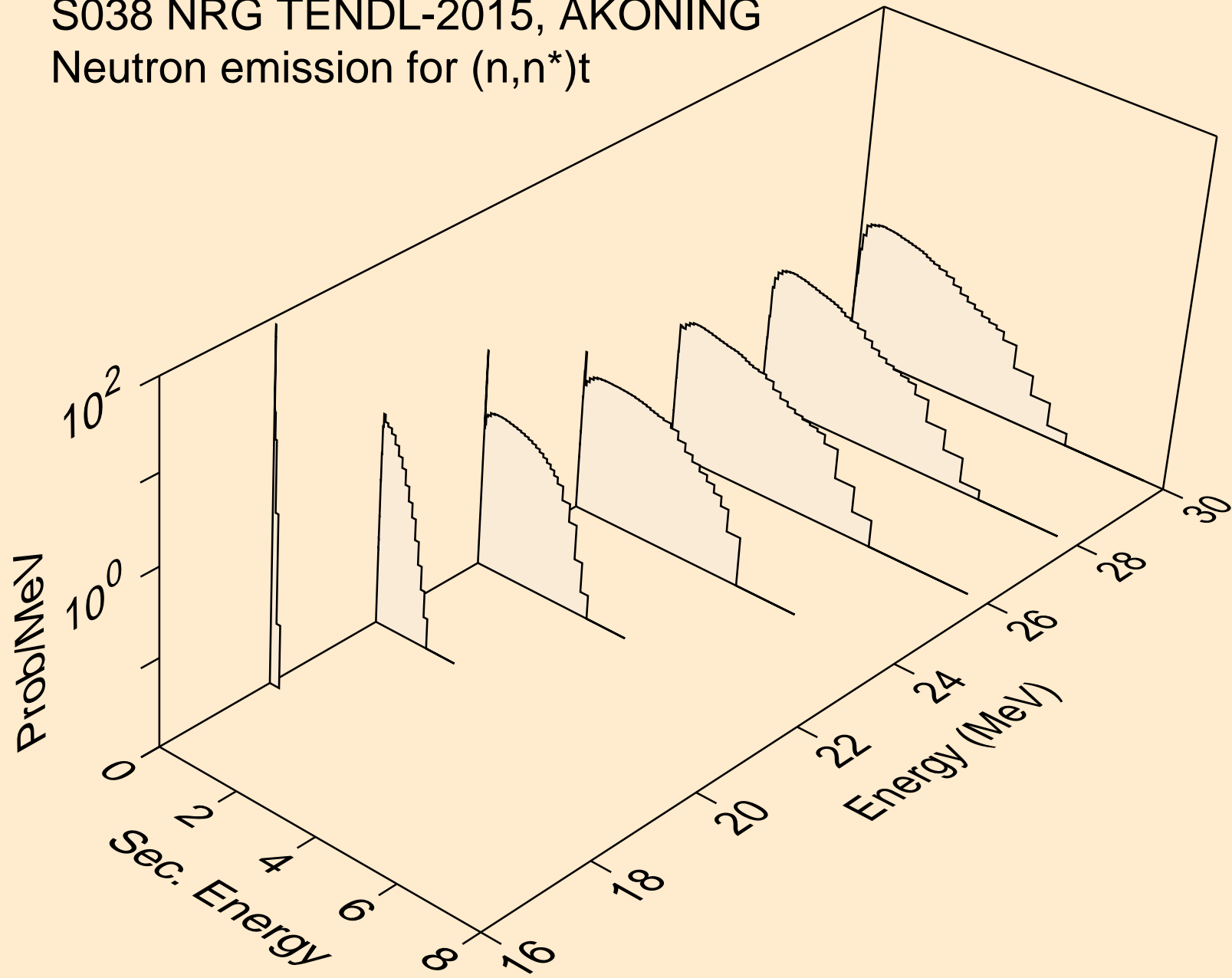

S038 NRG TENDL-2015, AKONING  
Neutron emission for (n,4n)

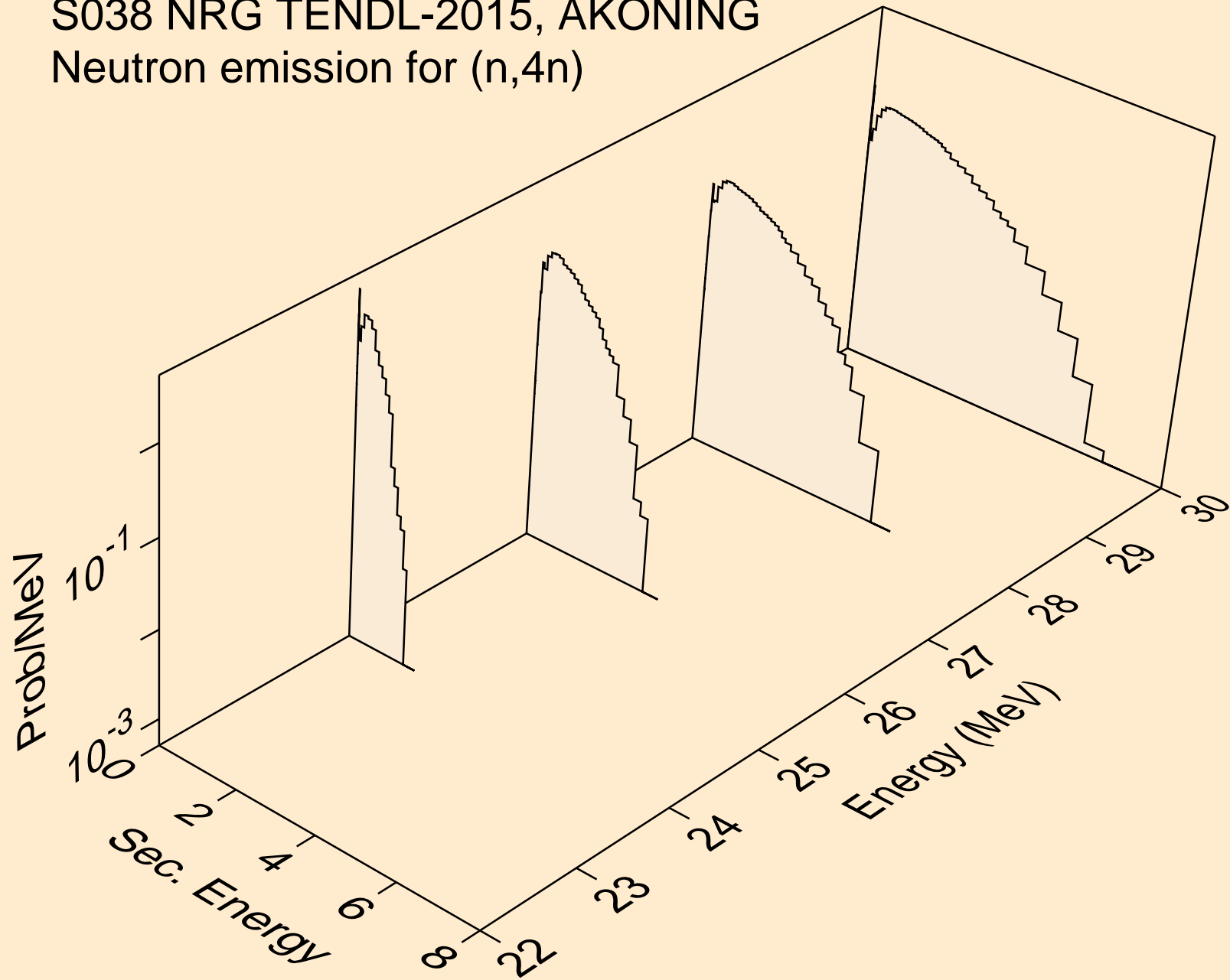

S038 NRG TENDL-2015, AKONING  
Neutron emission for (n,2np)

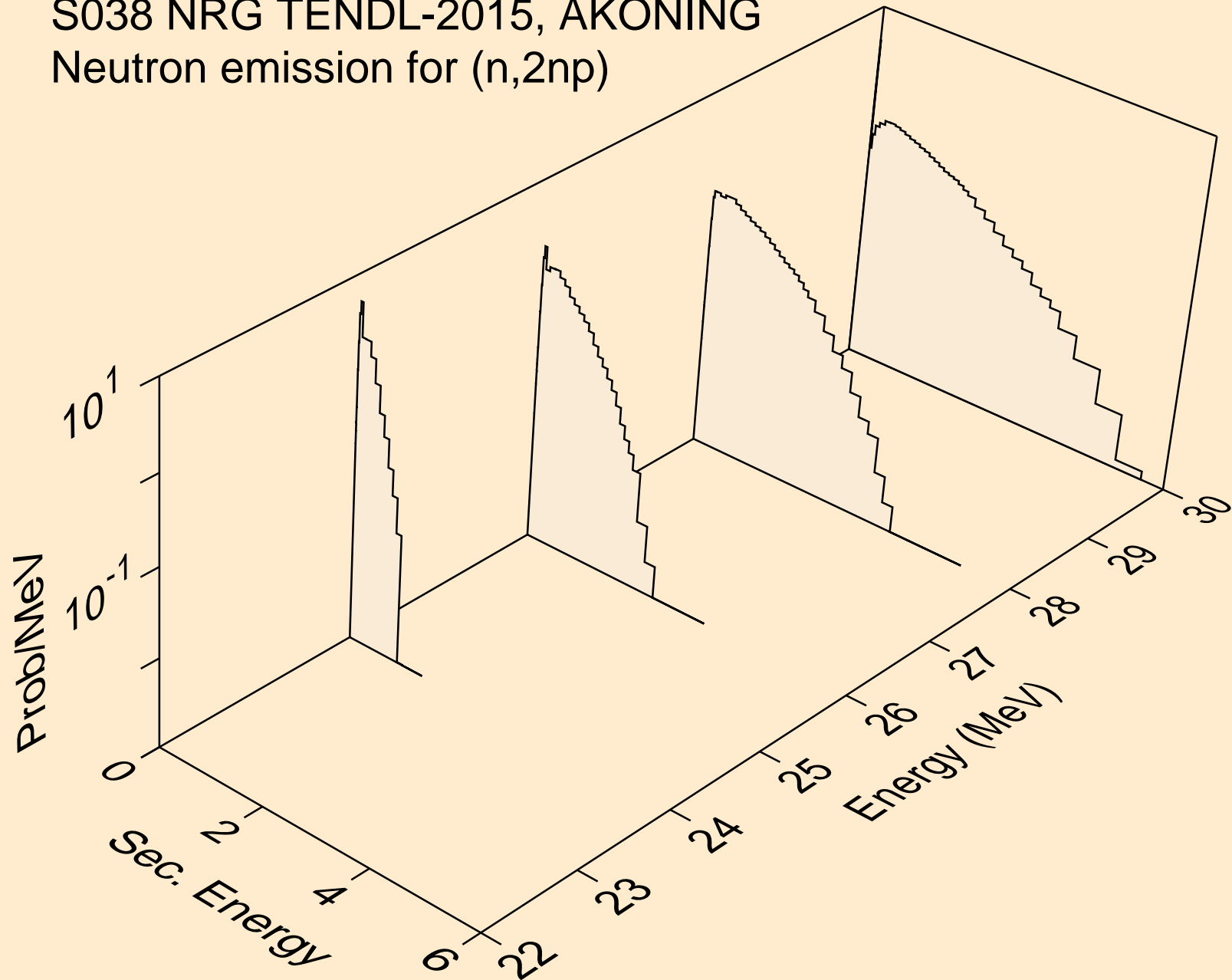



S038 NRG TENDL-2015, AKONING  
Neutron emission for (n,3np)

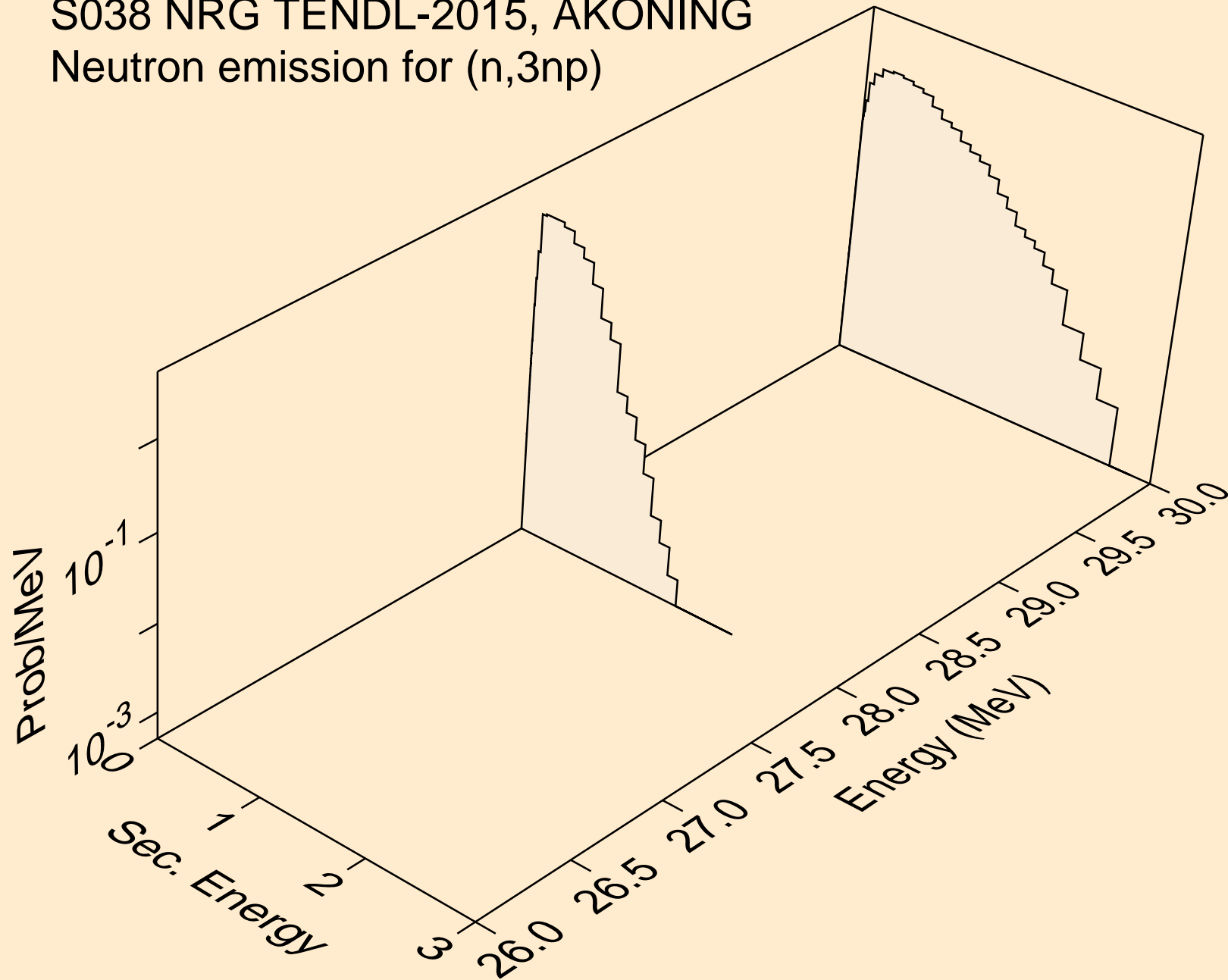

S038 NRG TENDL-2015, AKONING  
Neutron emission for (n,n\*c)

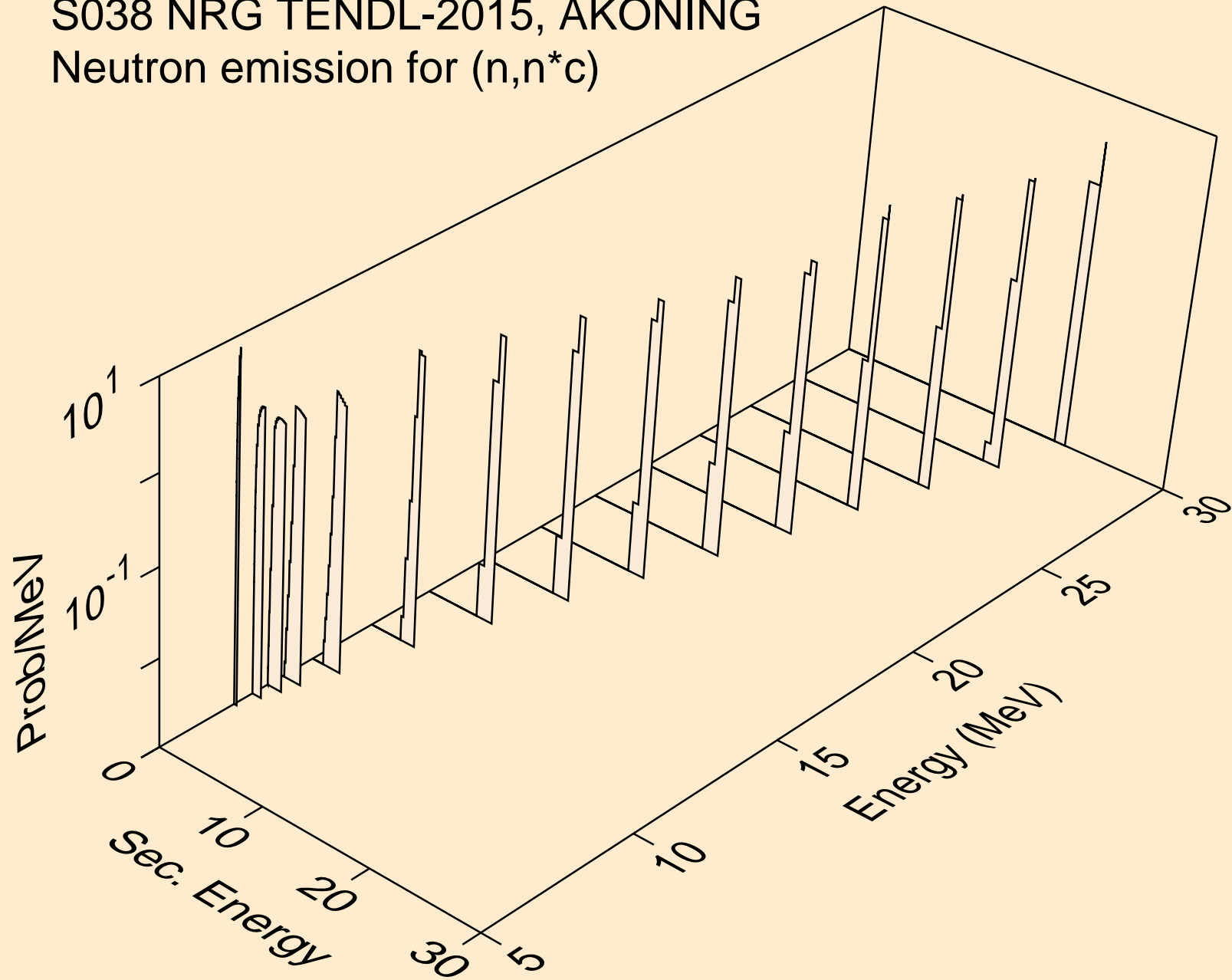

S038 NRG TENDL-2015, AKONING  
Photon emission for (n,x)

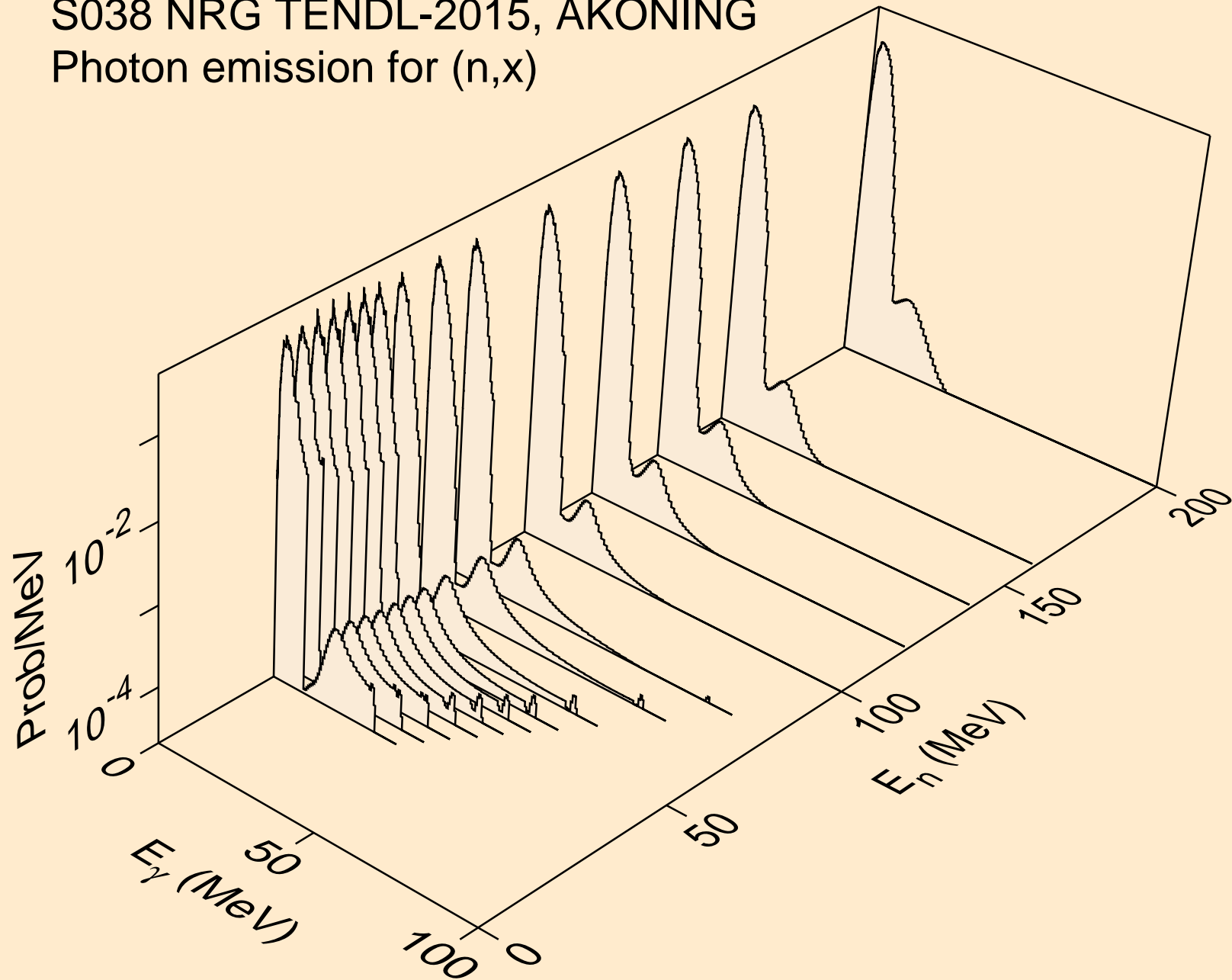

S038 NRG TENDL-2015, AKONING  
Photon emission for (n,2nd)

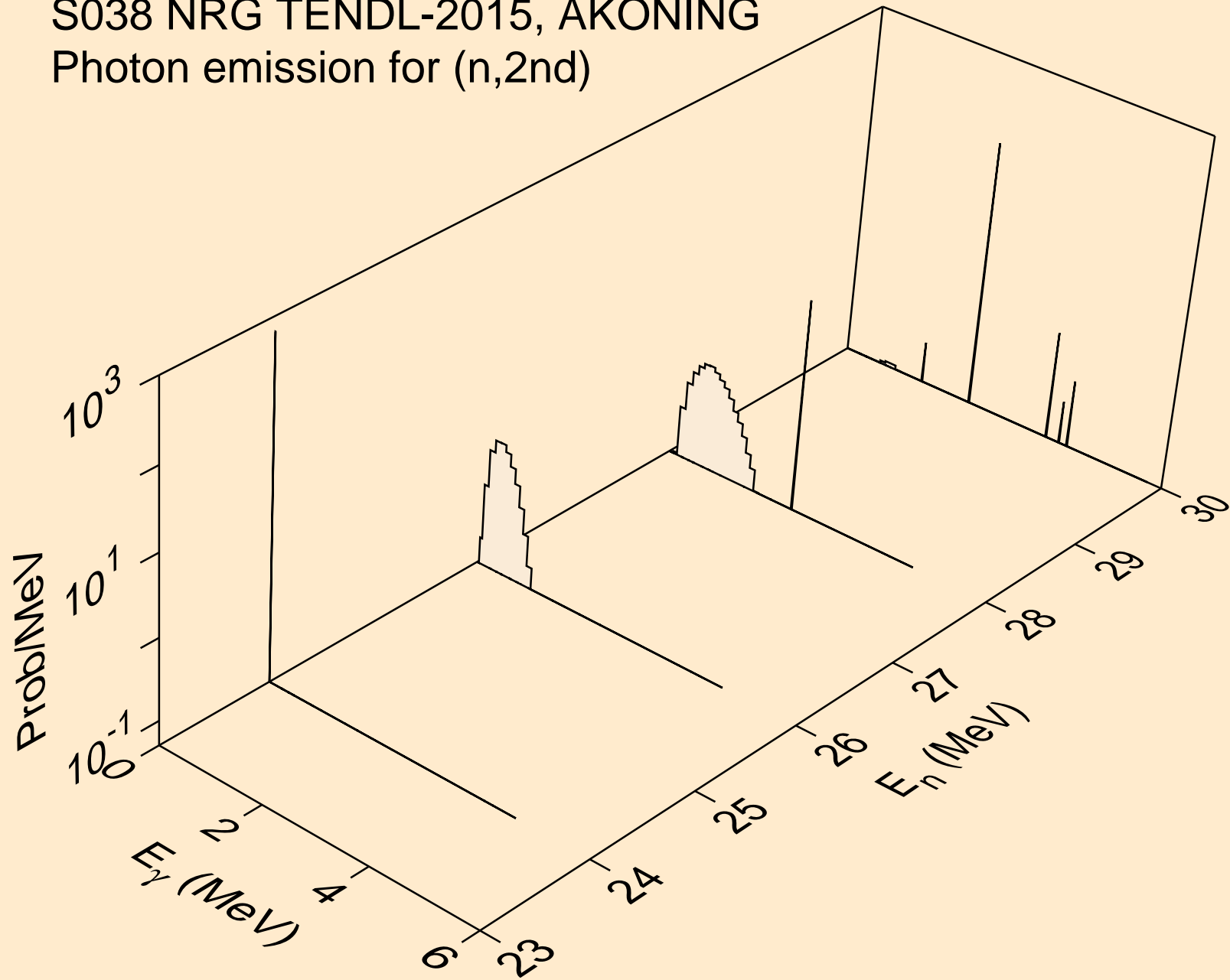

S038 NRG TENDL-2015, AKONING  
Photon emission for (n,2n)

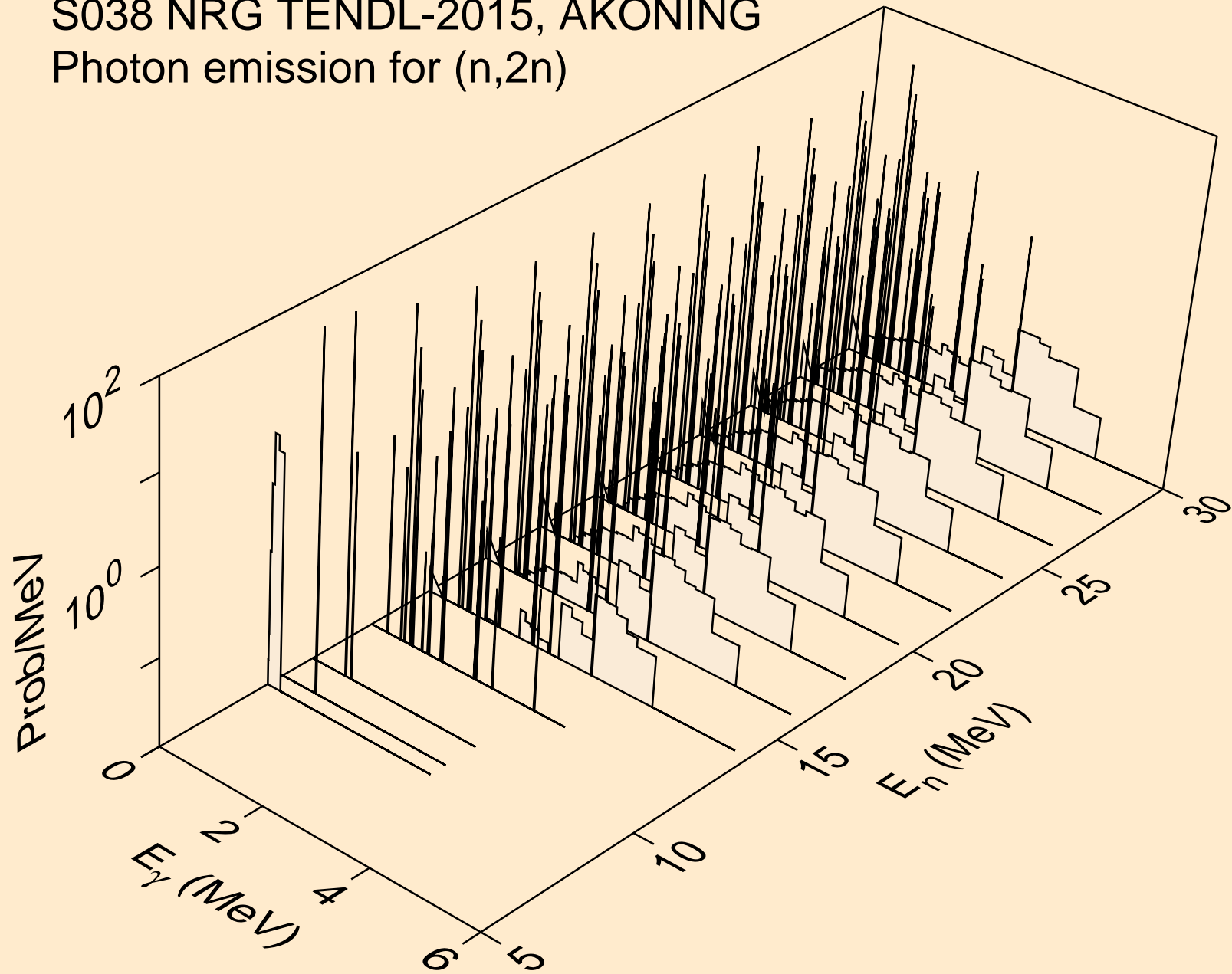

S038 NRG TENDL-2015, AKONING  
Photon emission for (n,3n)

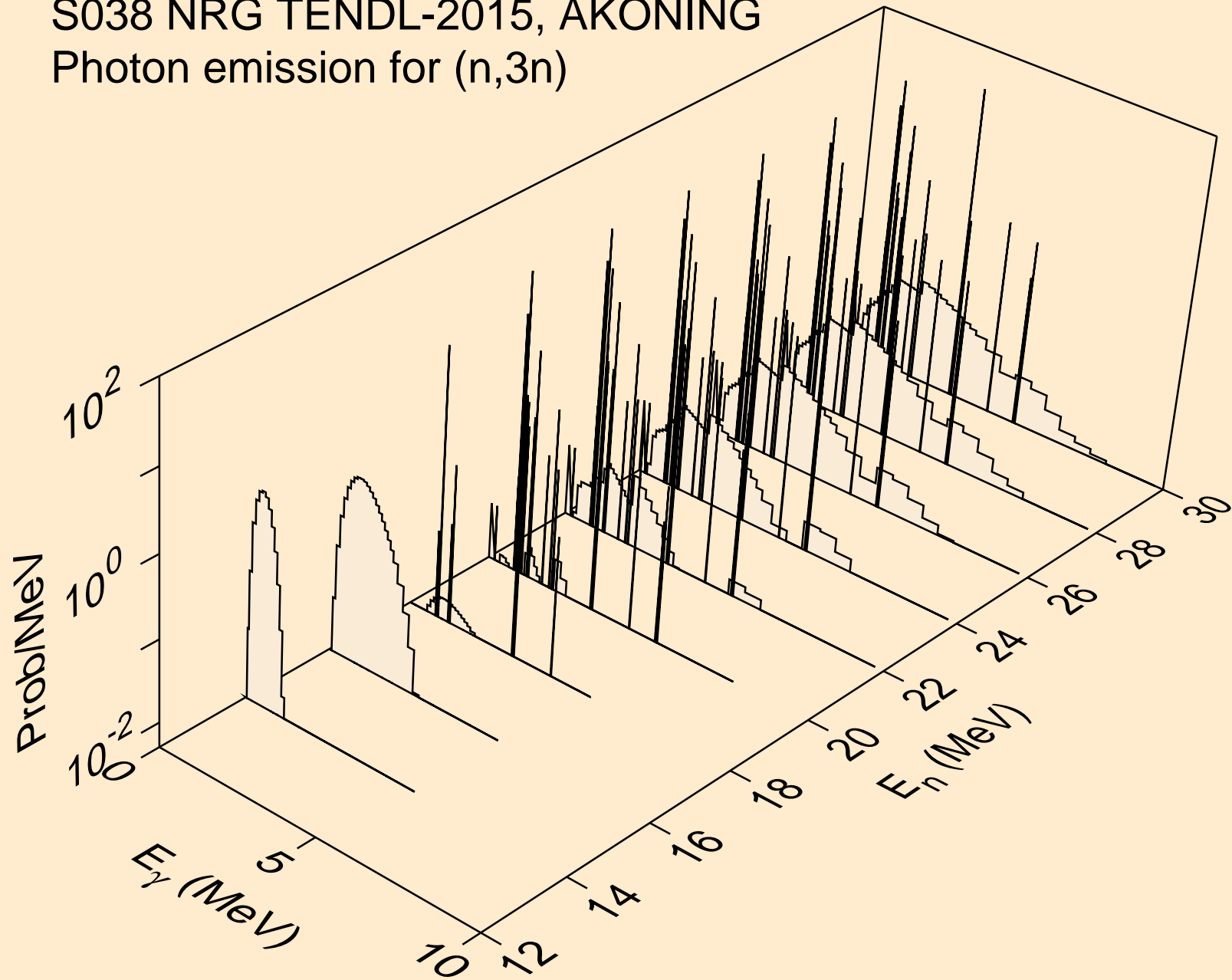

S038 NRG TENDL-2015, AKONING  
Photon emission for (n,n\*)a

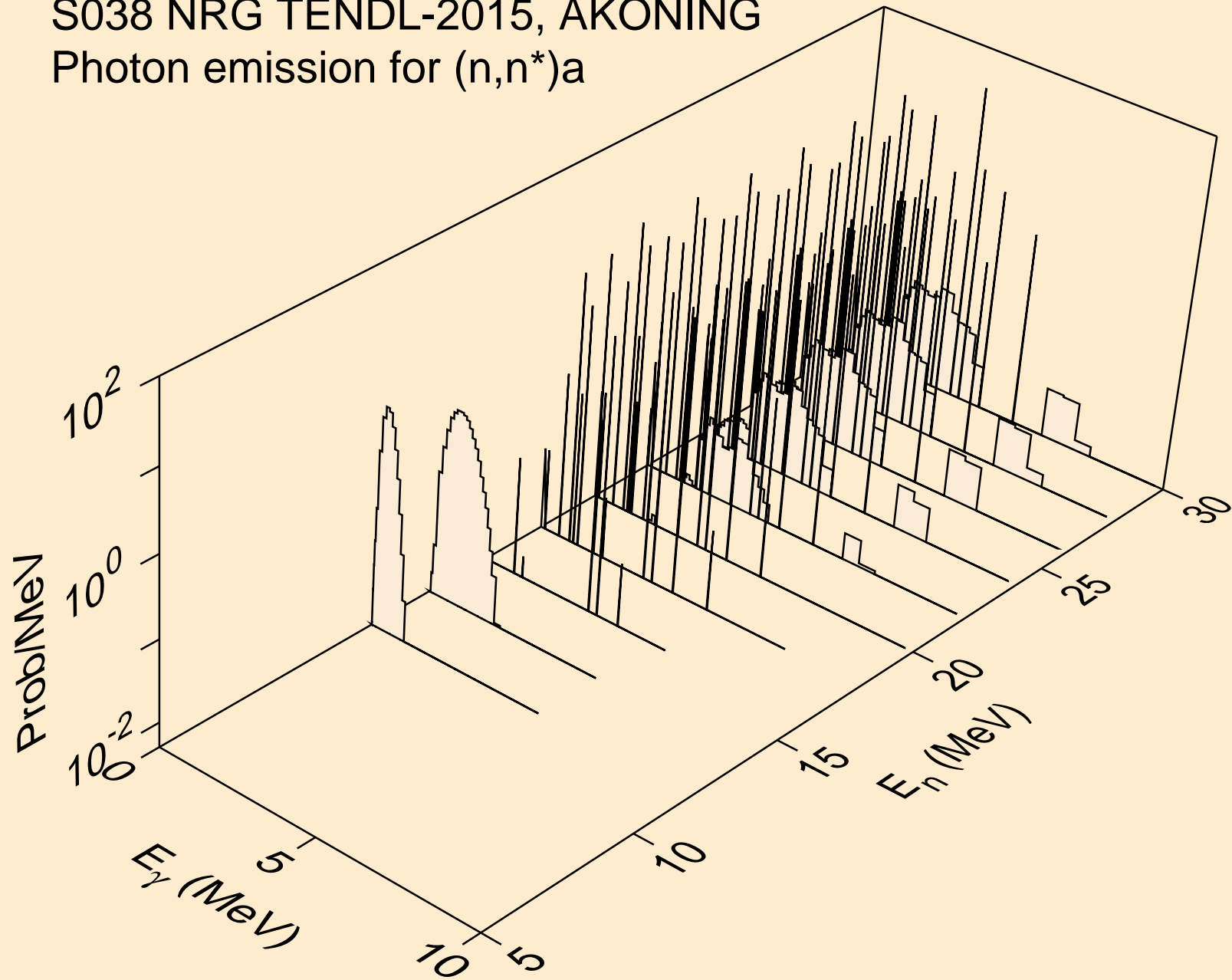

S038 NRG TENDL-2015, AKONING  
Photon emission for (n,2n)a

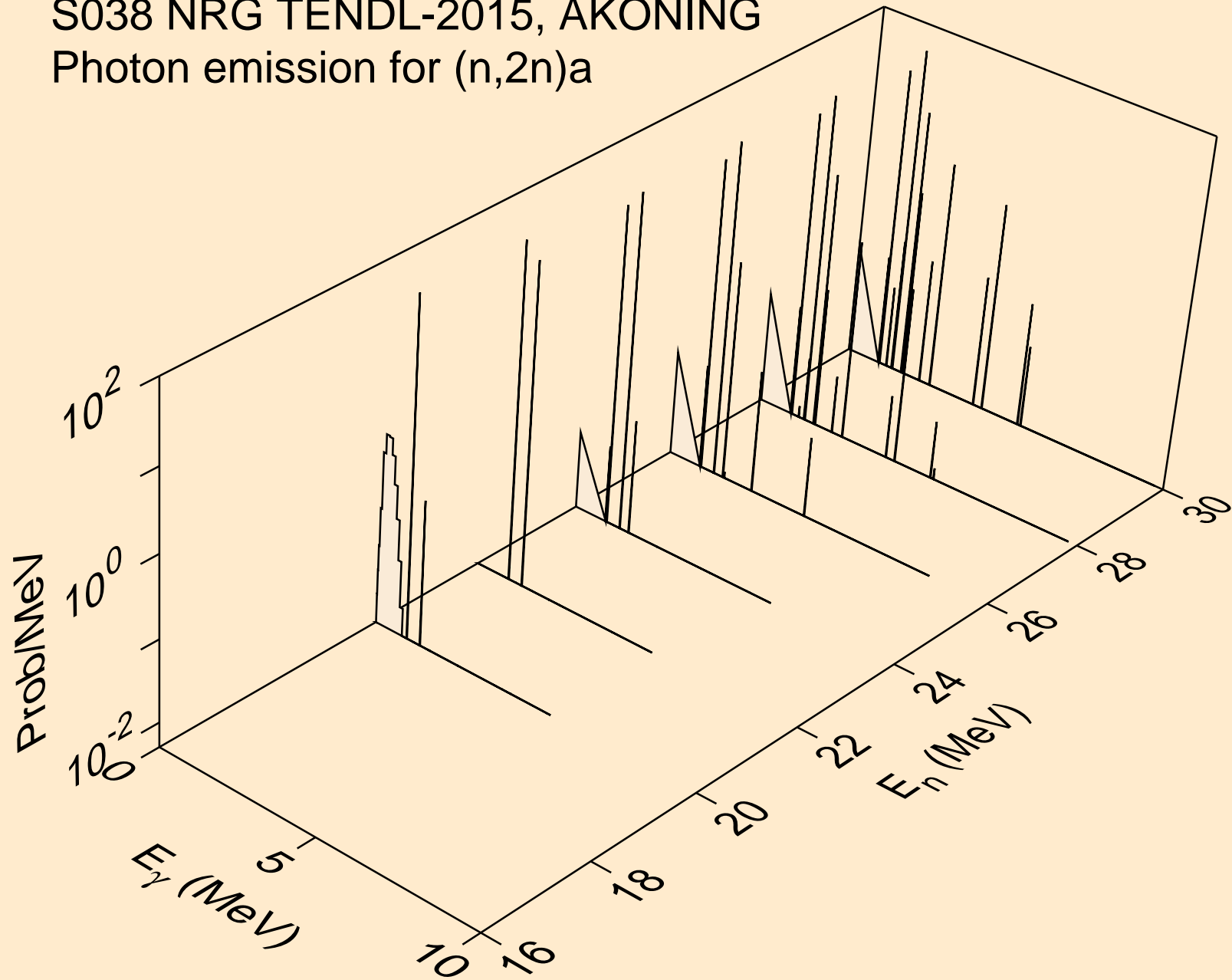



S038 NRG TENDL-2015, AKONING  
Photon emission for (n,3n)a

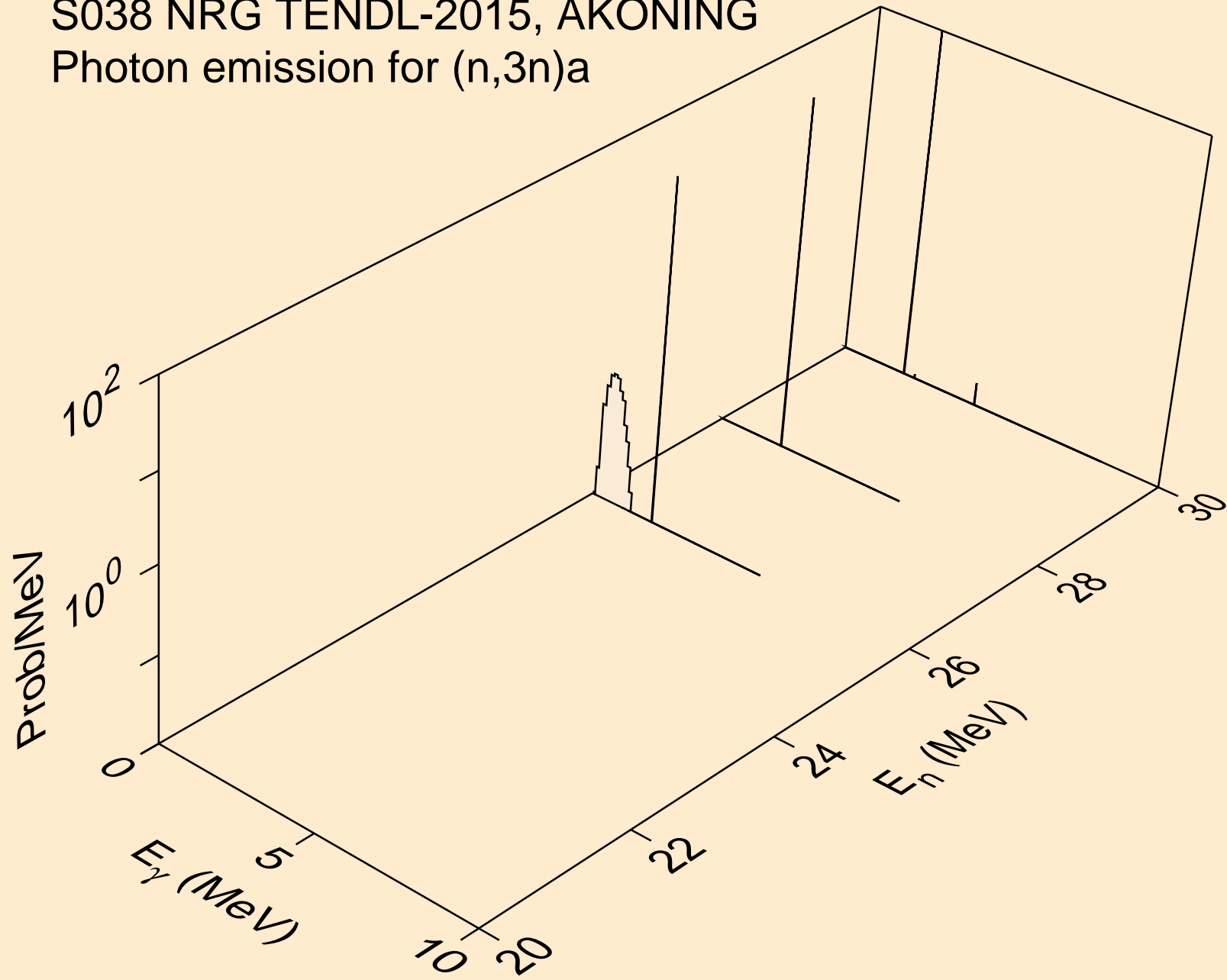

S038 NRG TENDL-2015, AKONING  
Photon emission for (n,n\*)p

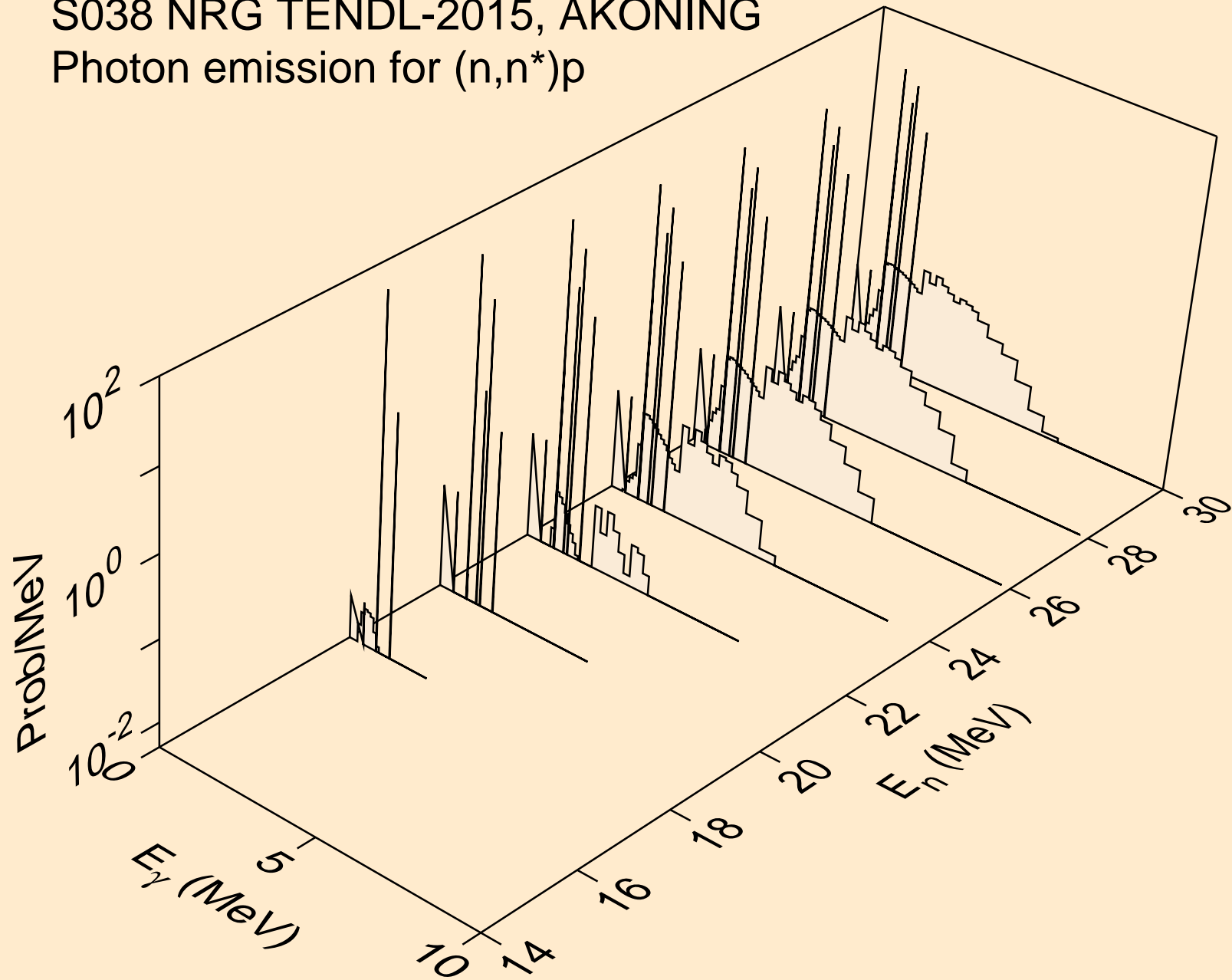

S038 NRG TENDL-2015, AKONING  
Photon emission for (n,n\*)d

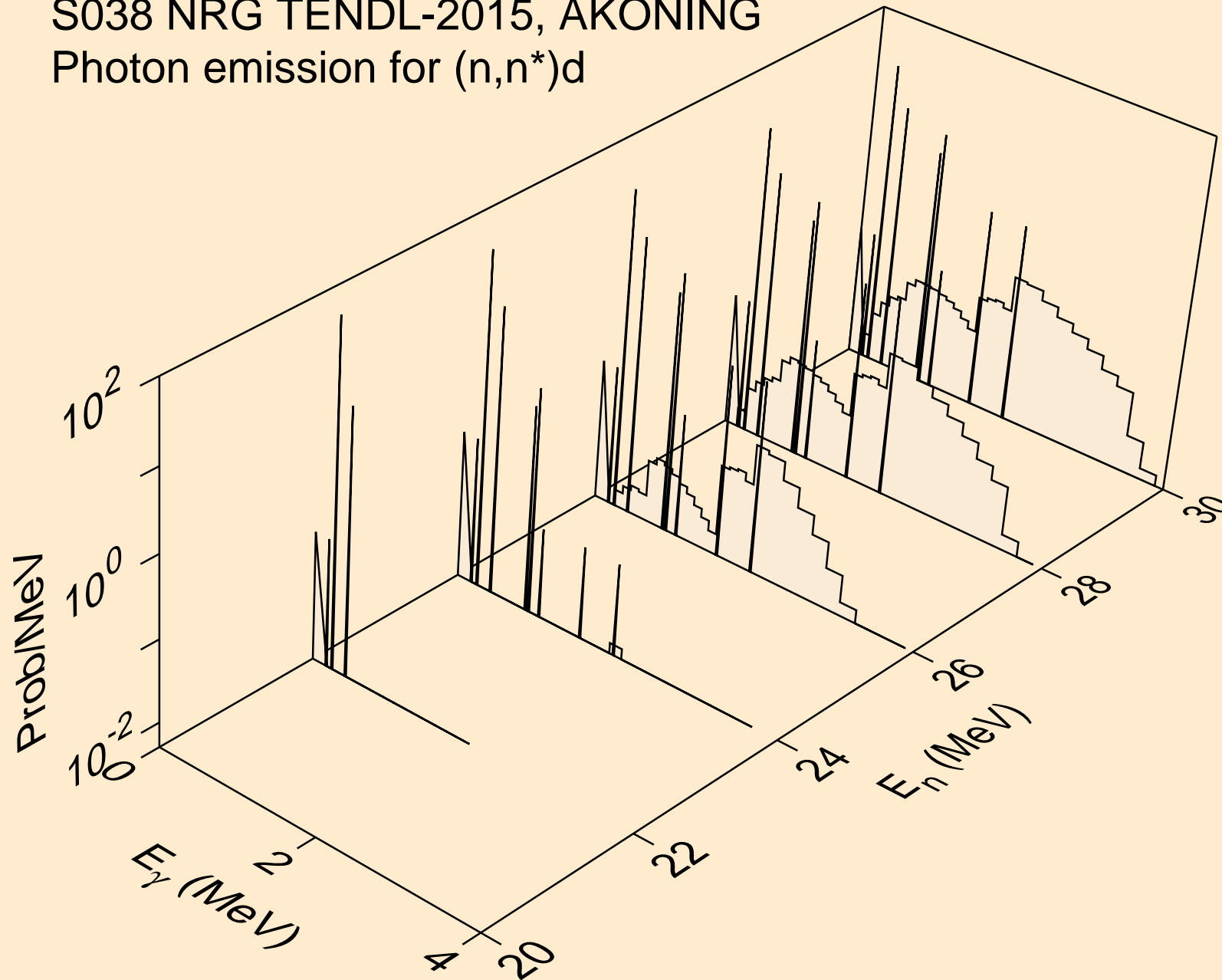

S038 NRG TENDL-2015, AKONING  
Photon emission for (n,n\*)t

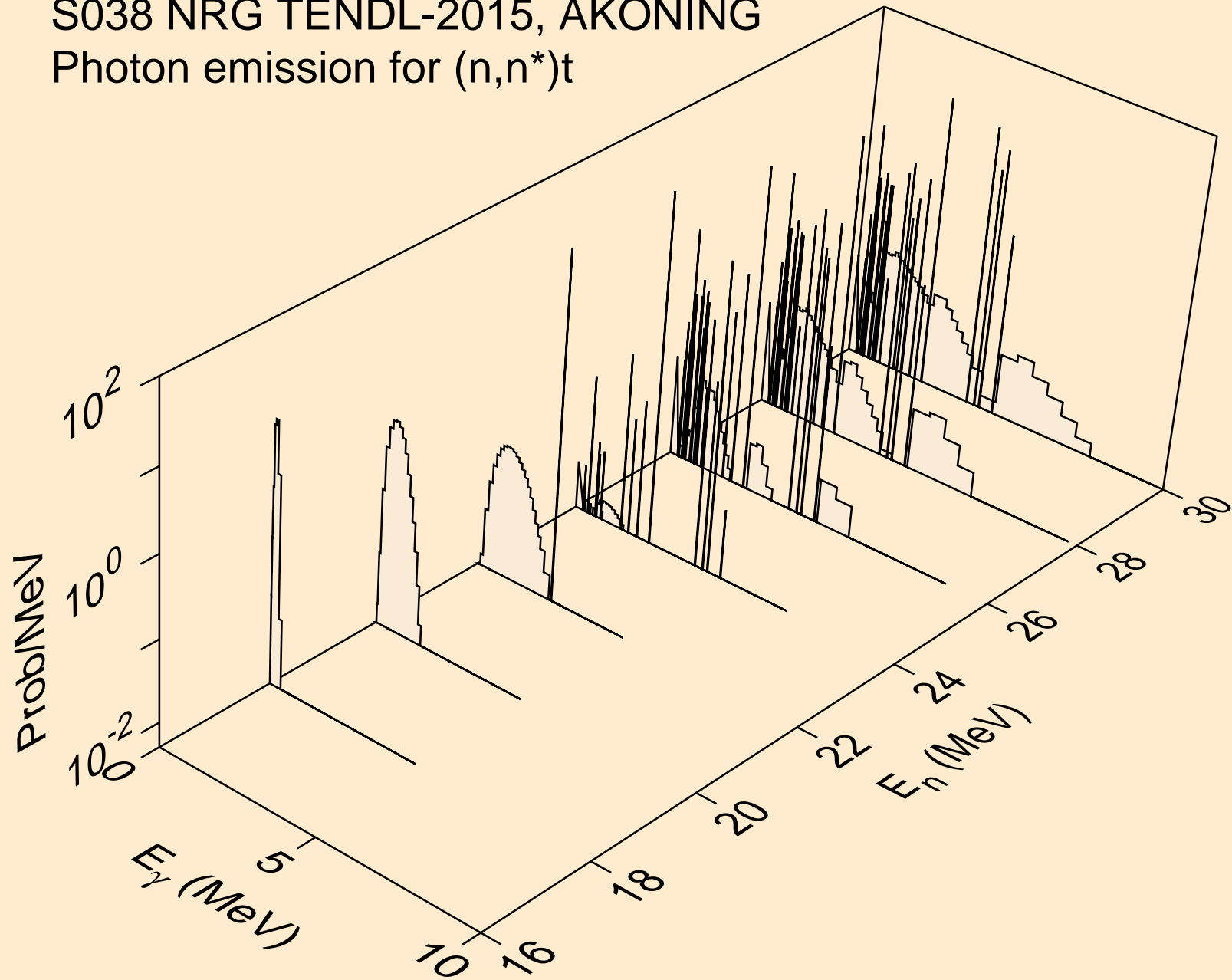

S038 NRG TENDL-2015, AKONING  
Photon emission for (n,4n)

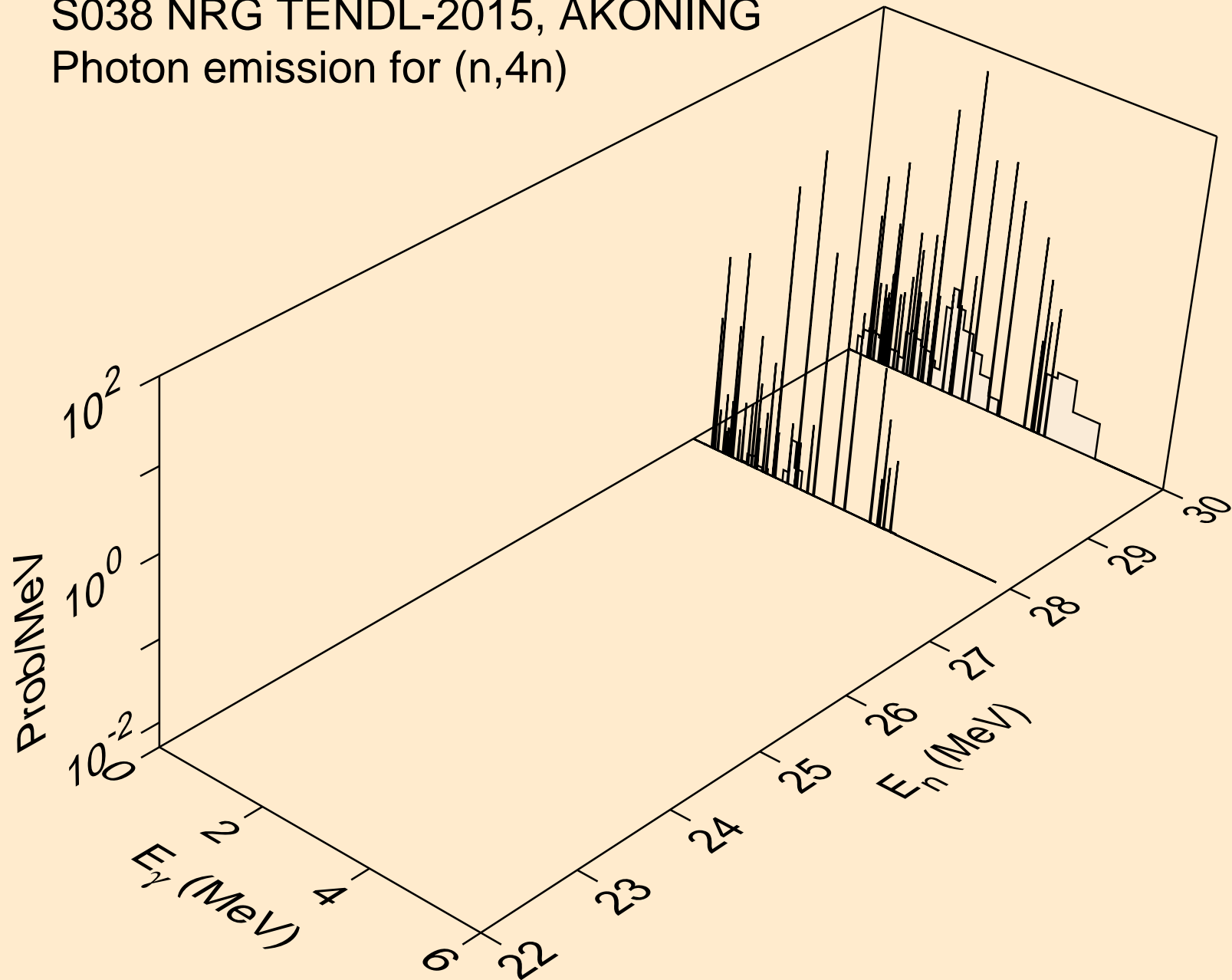

S038 NRG TENDL-2015, AKONING  
Photon emission for (n,2np)

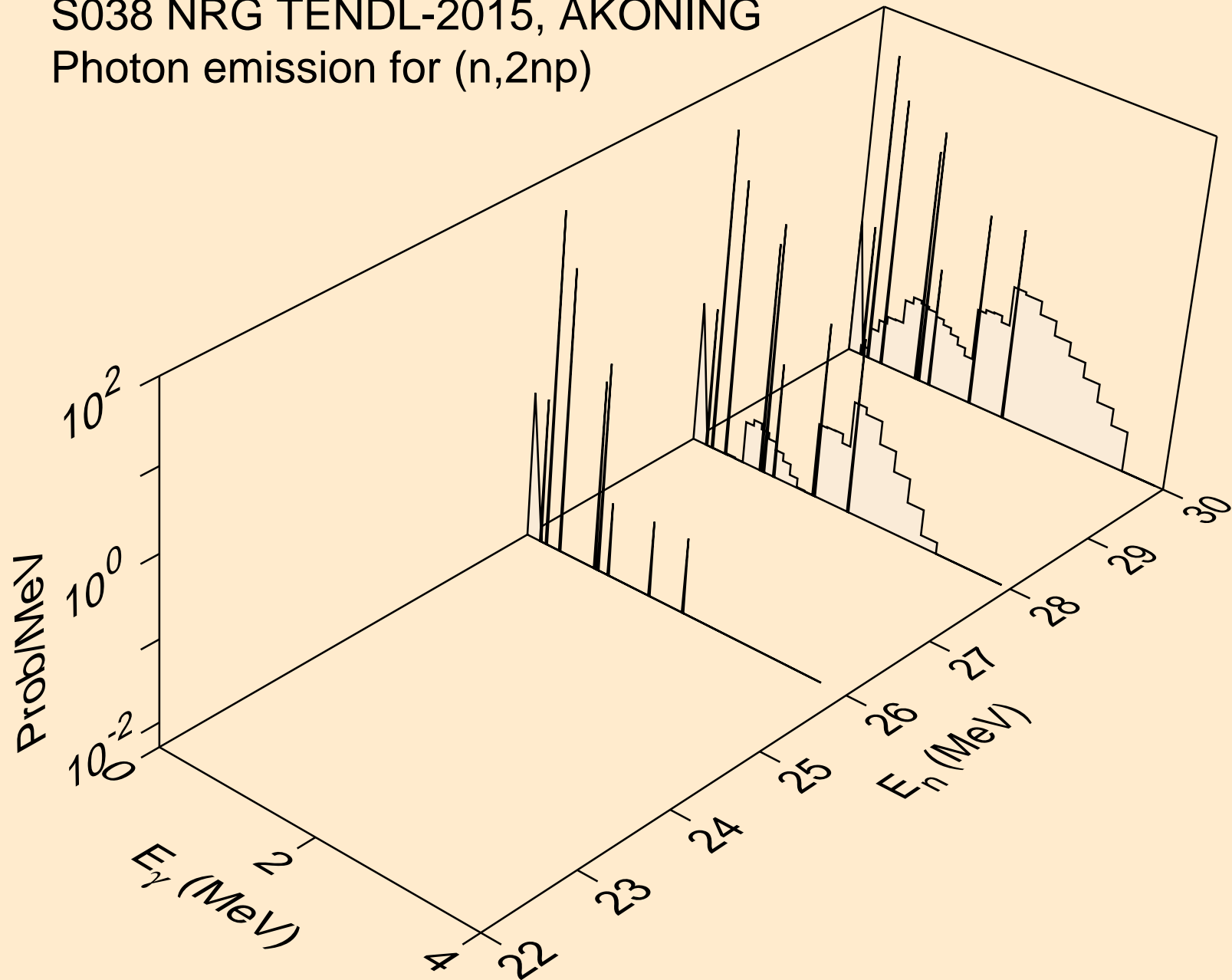

S038 NRG TENDL-2015, AKONING  
Photon emission for (n,3np)

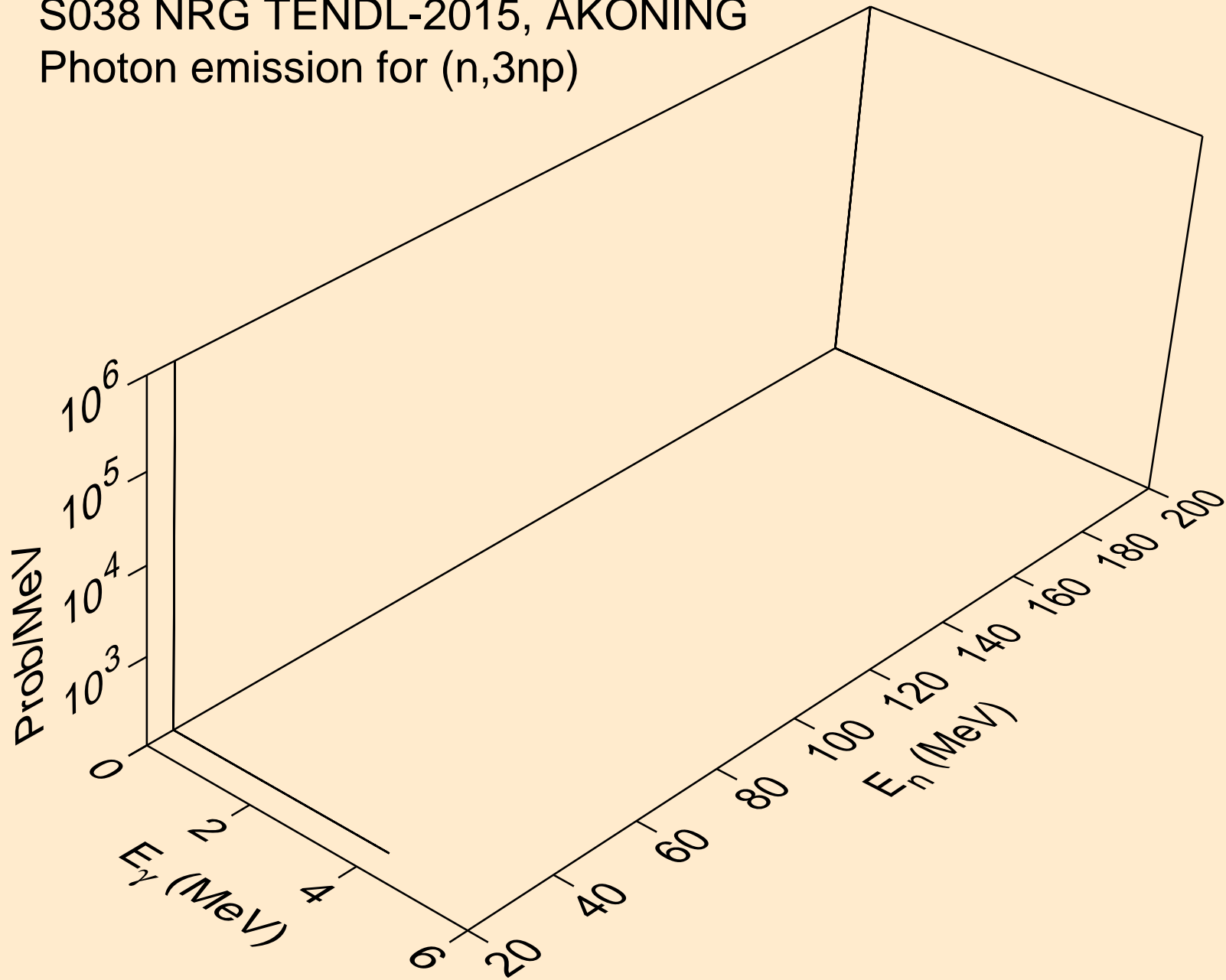

S038 NRG TENDL-2015, AKONING  
Photon emission for (n,n\*c)

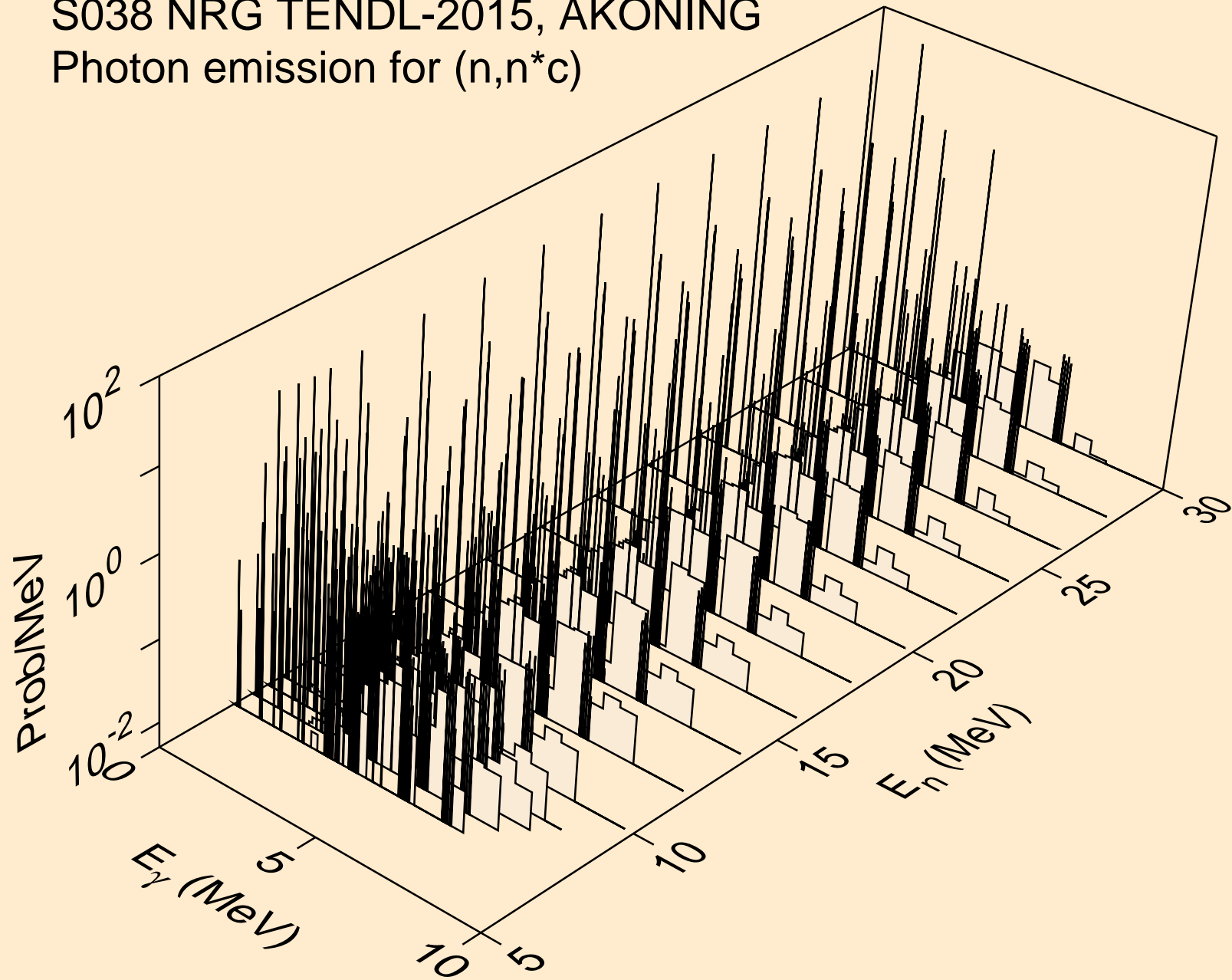



S038 NRG TENDL-2015, AKONING  
Photon emission for (n,gma)

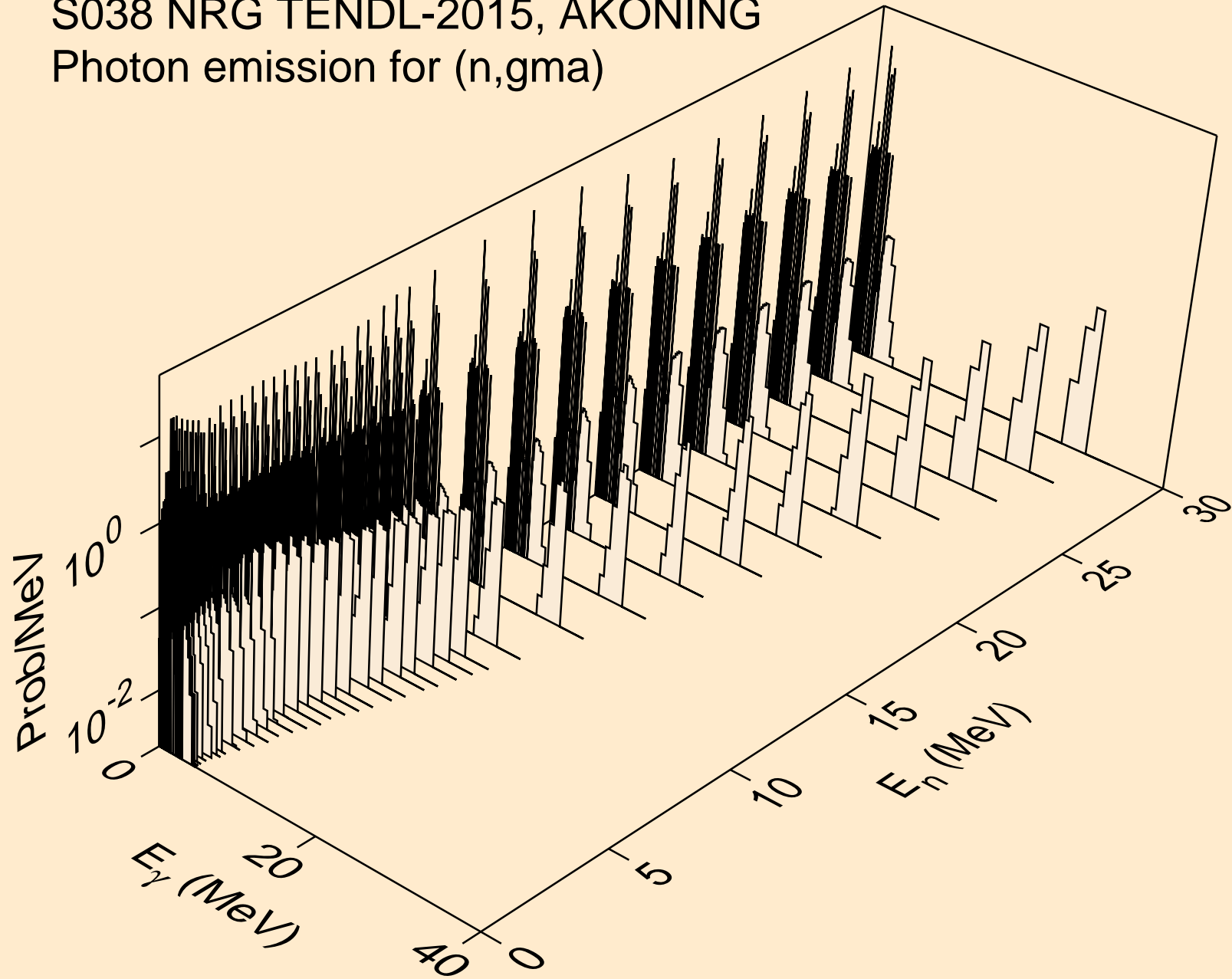

S038 NRG TENDL-2015, AKONING  
Photon emission for (n,p)

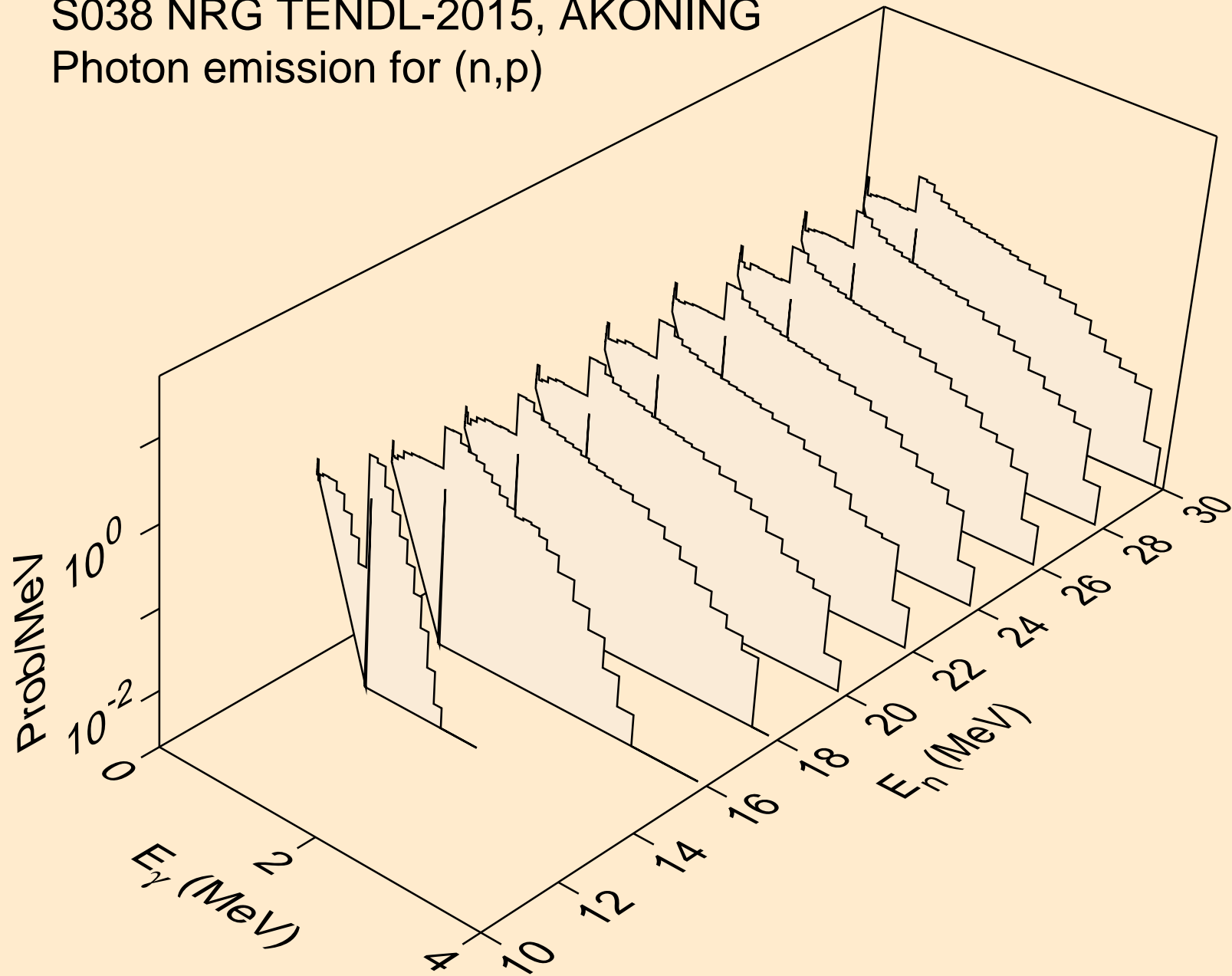

S038 NRG TENDL-2015, AKONING  
Photon emission for (n,d)

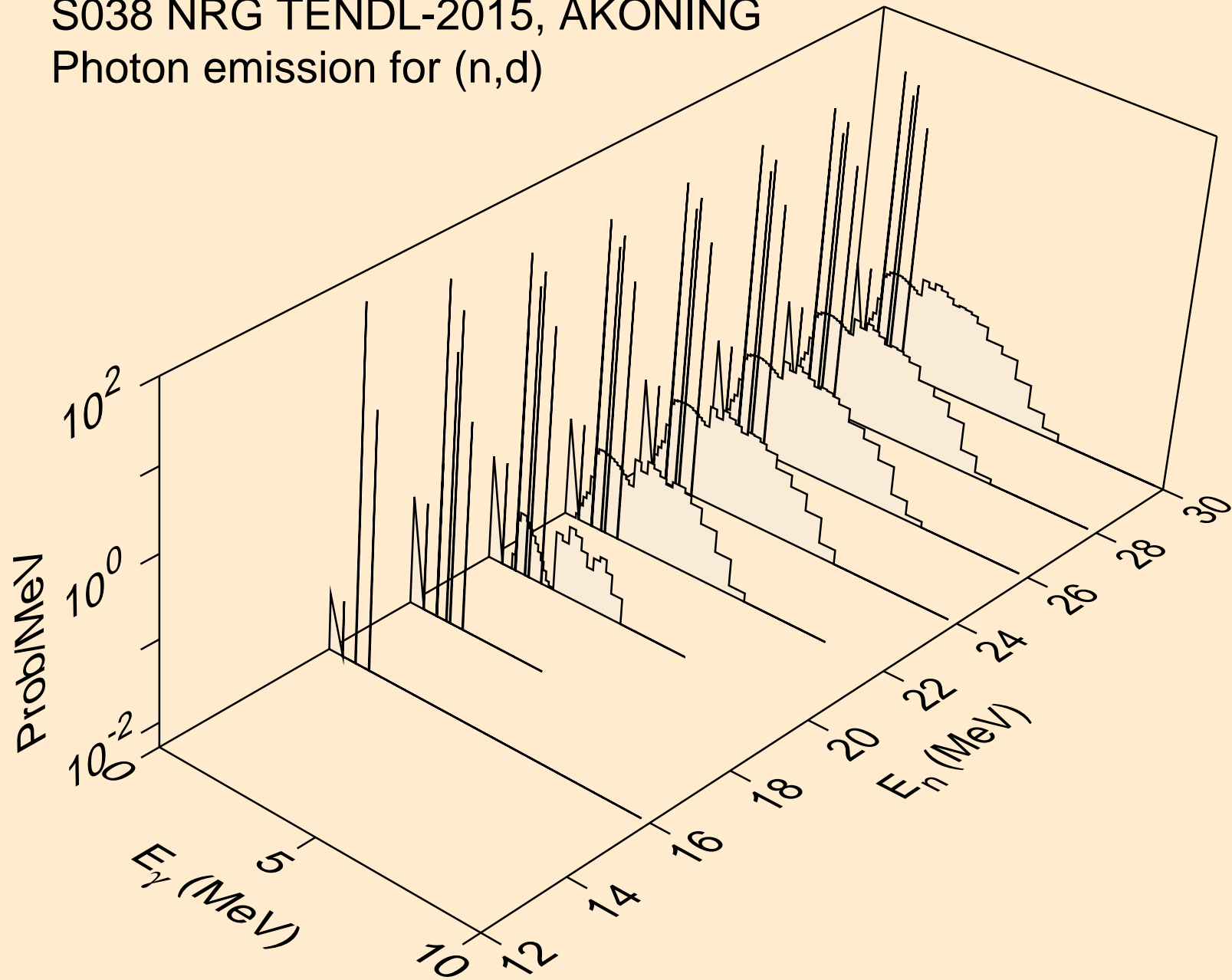

S038 NRG TENDL-2015, AKONING  
Photon emission for (n,t)

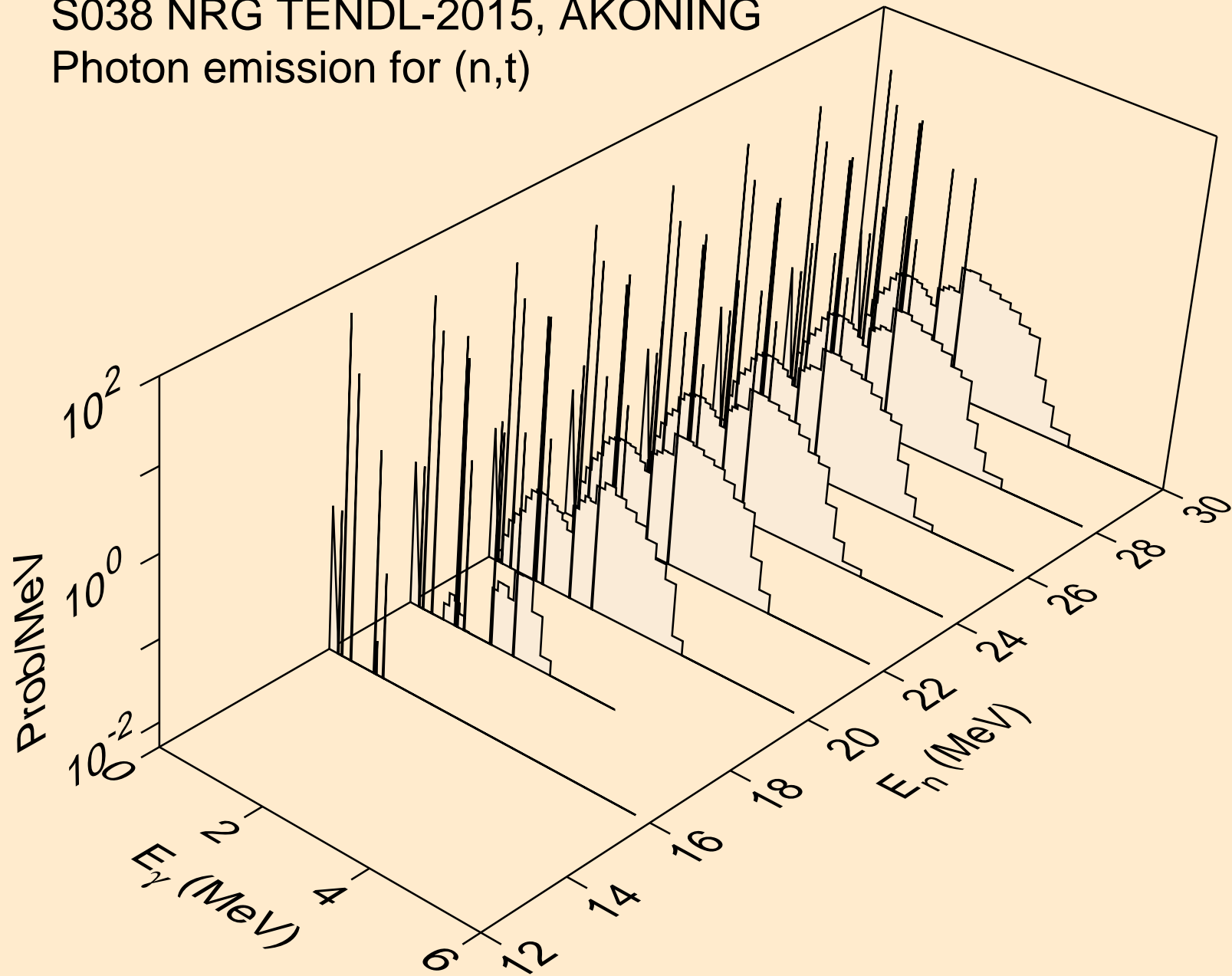

S038 NRG TENDL-2015, AKONING  
Photon emission for (n,he3)

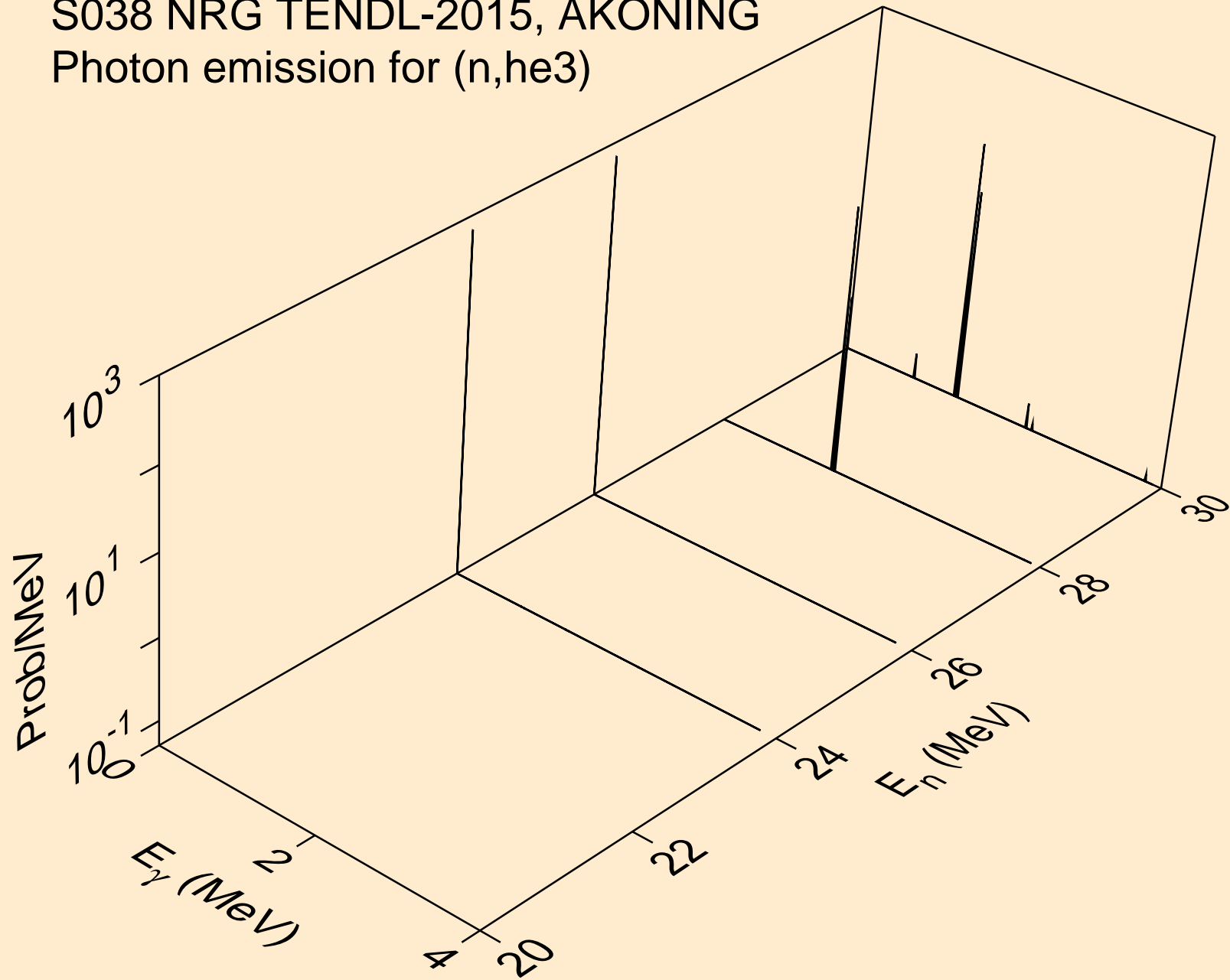

S038 NRG TENDL-2015, AKONING  
Photon emission for (n,a)

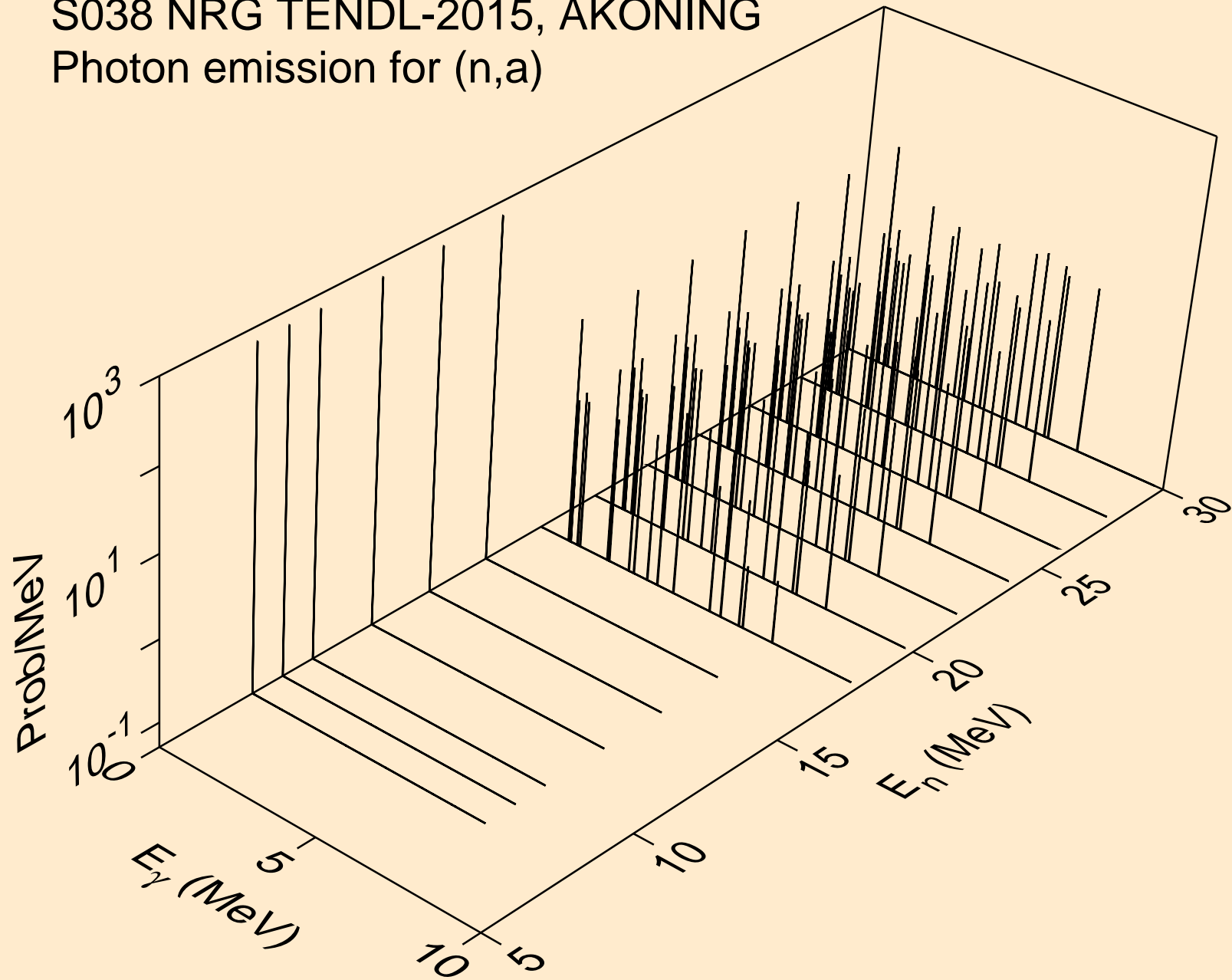

S038 NRG TENDL-2015, AKONING  
Photon emission for (n,2a)

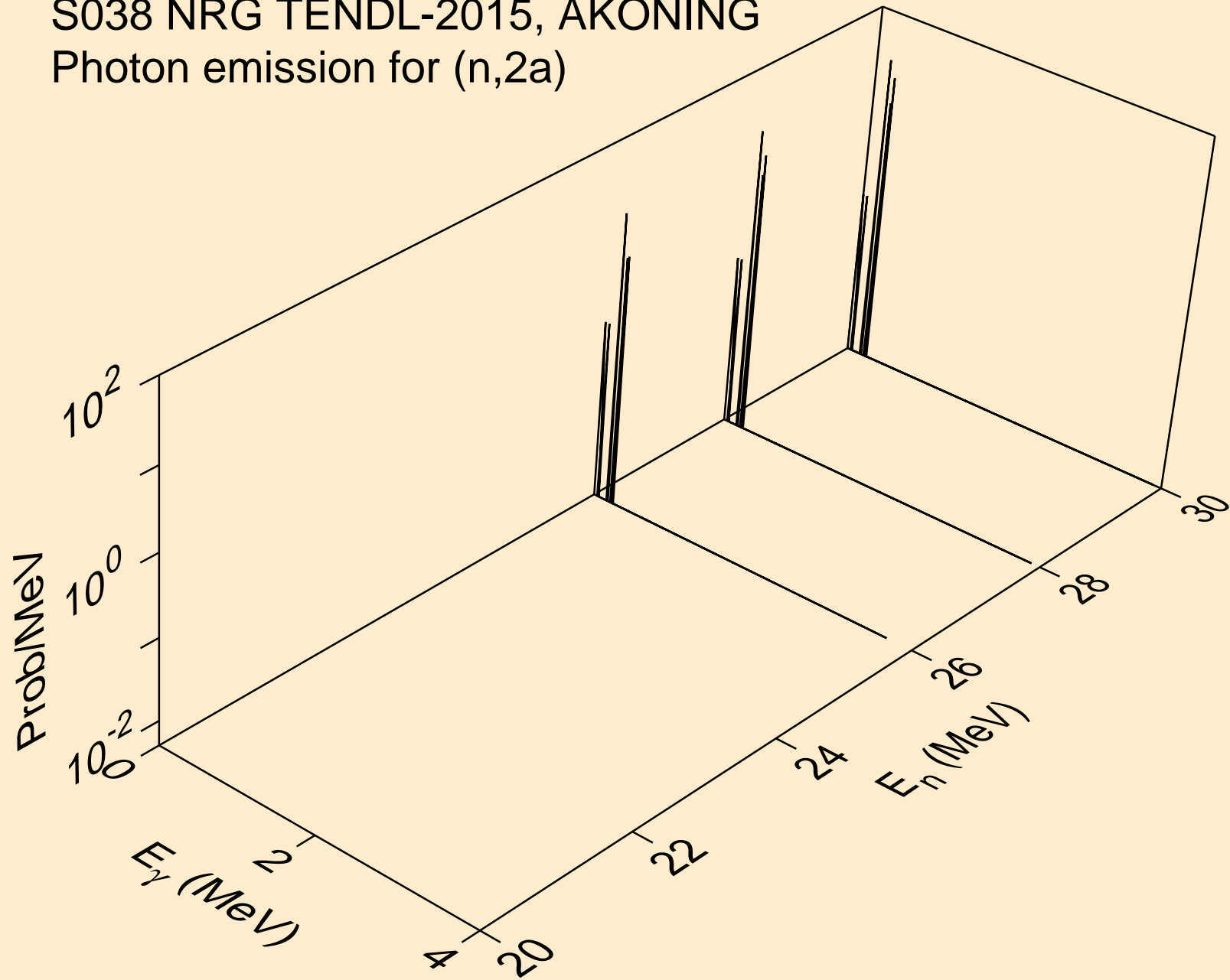

S038 NRG TENDL-2015, AKONING  
thermal capture photon spectrum

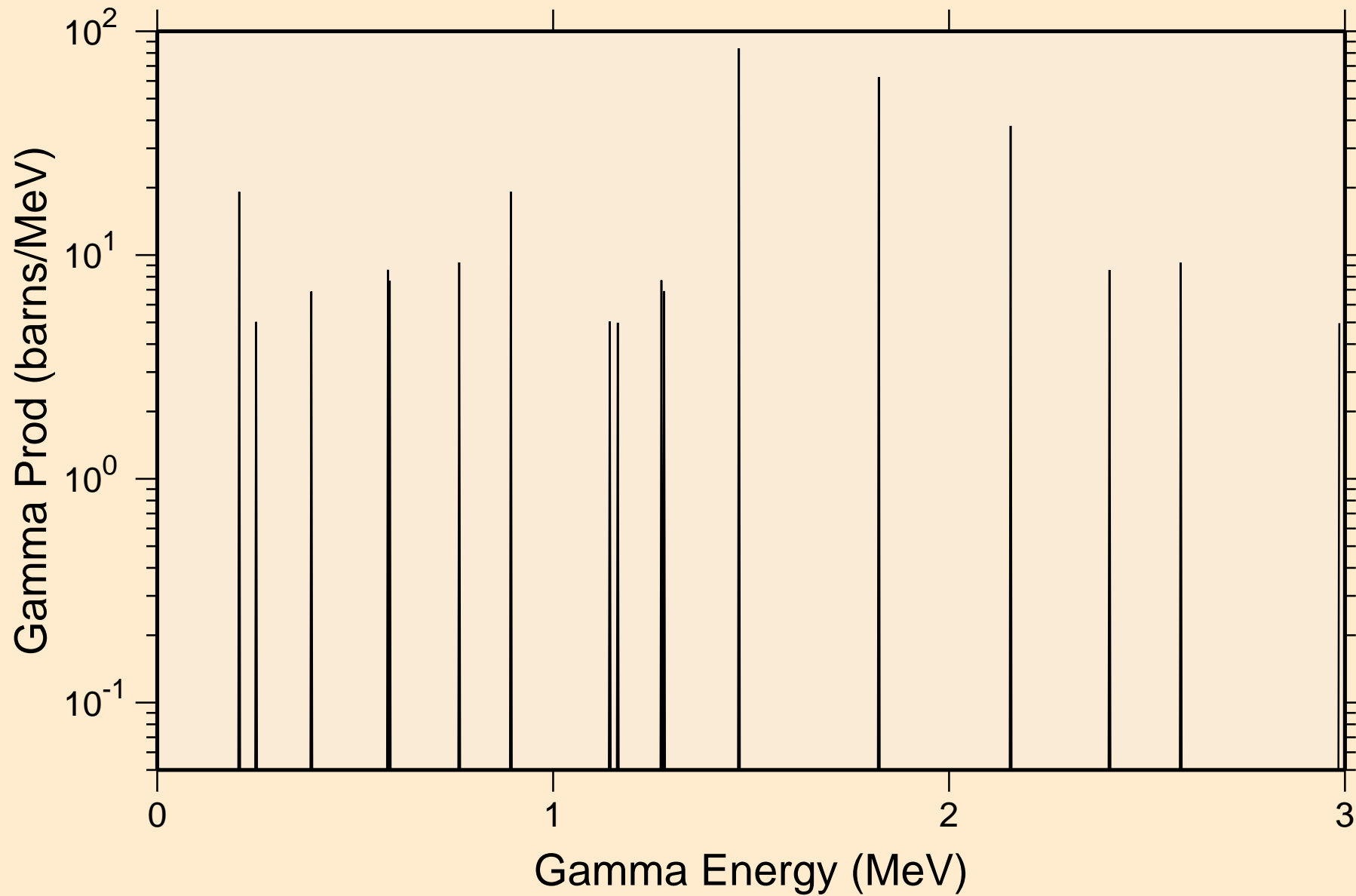



S038 NRG TENDL-2015, AKONING  
14 MeV photon spectrum

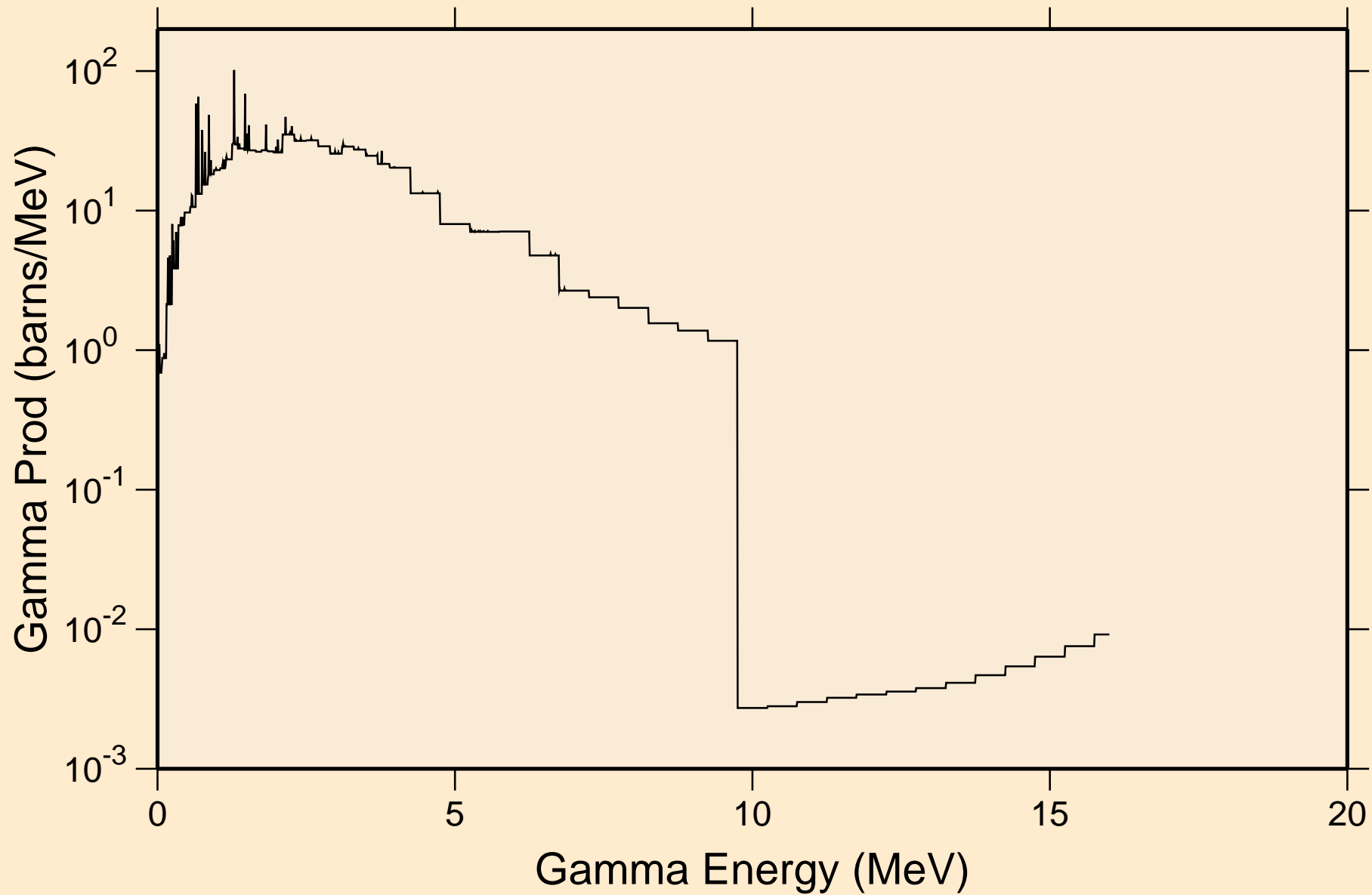

# S038 NRG TENDL-2015, AKONING

## Particle heating contributions

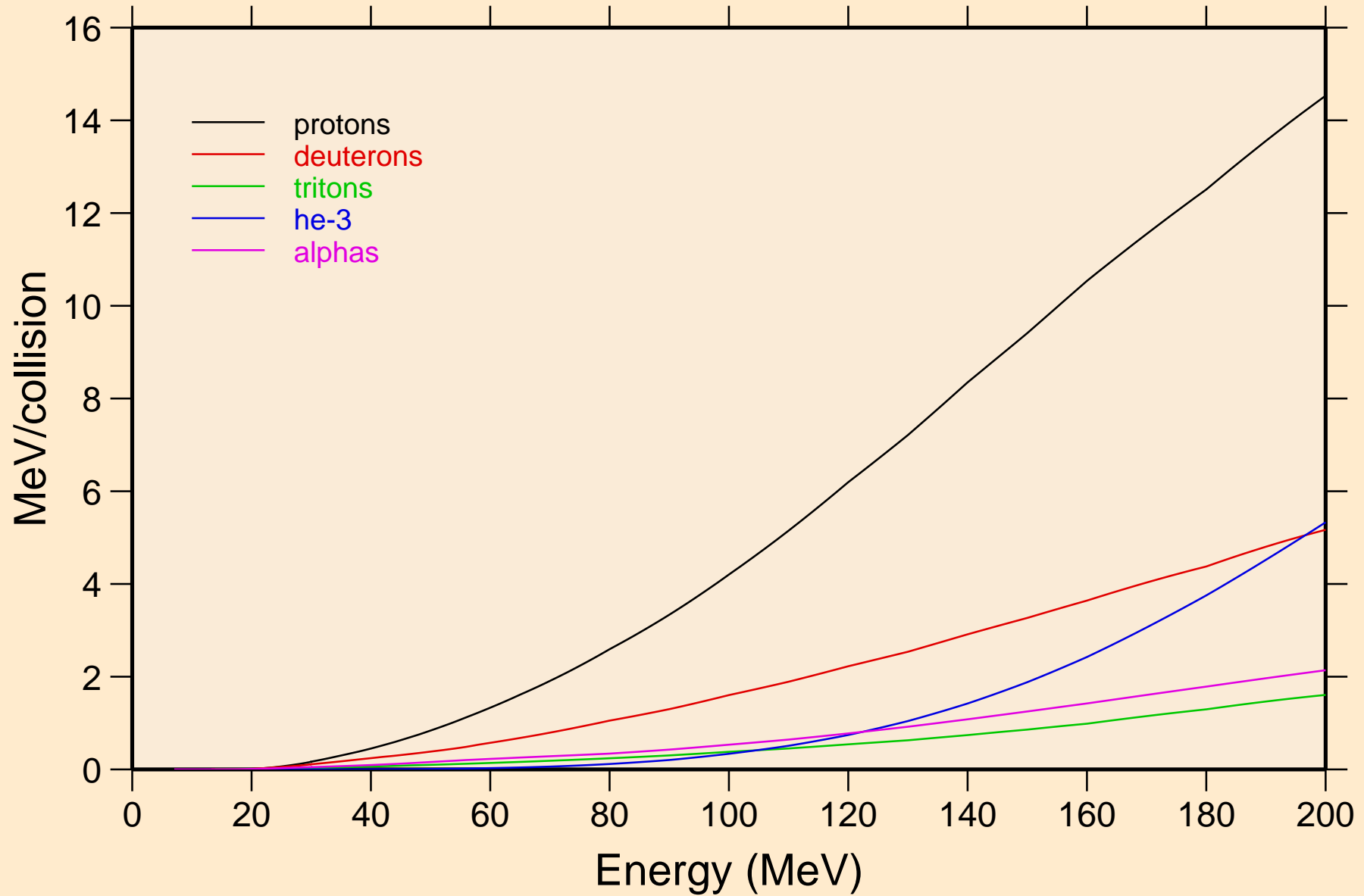

# S038 NRG TENDL-2015, AKONING

## Recoil Heating

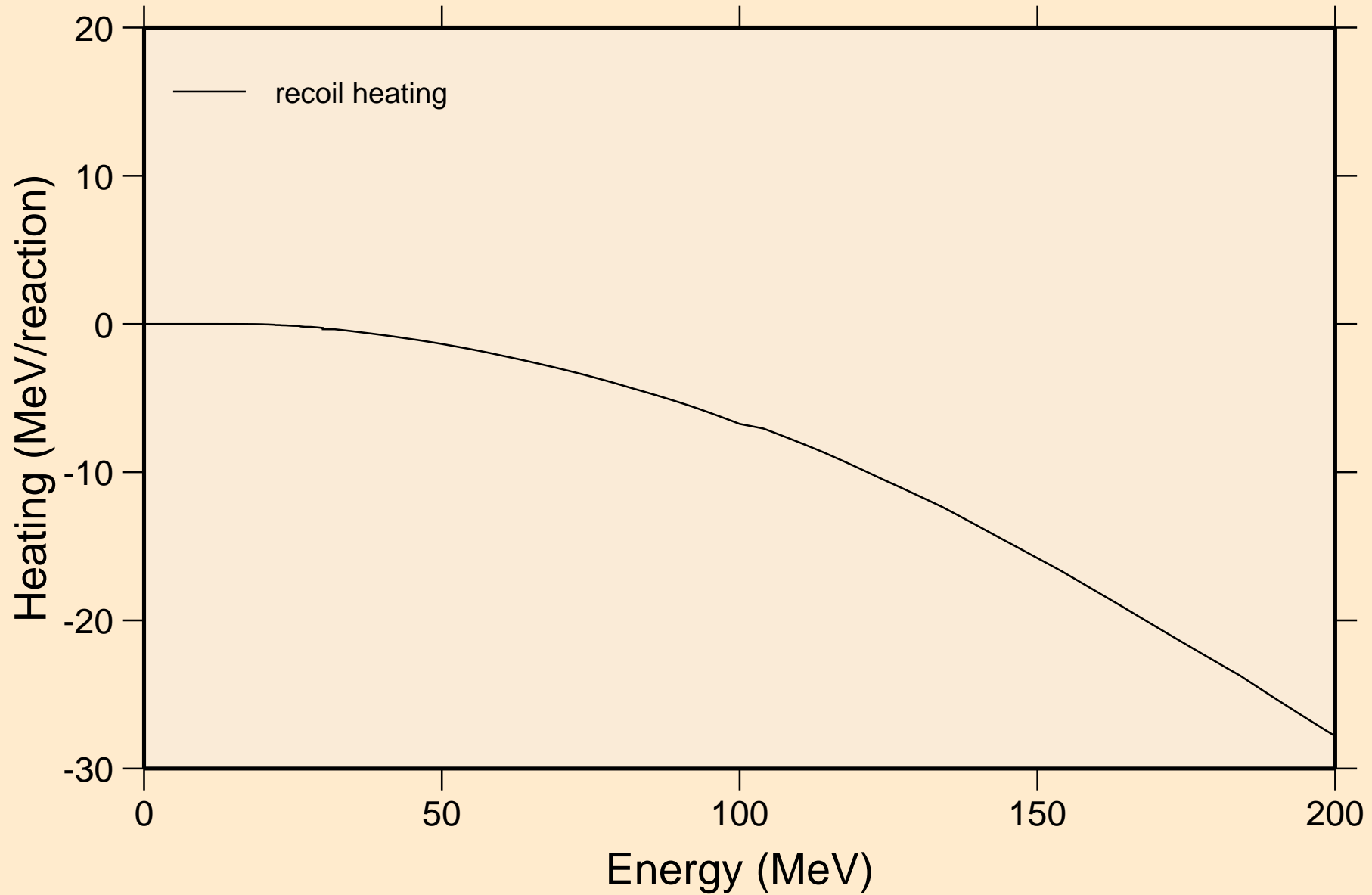

# S038 NRG TENDL-2015, AKONING

## Particle production cross sections

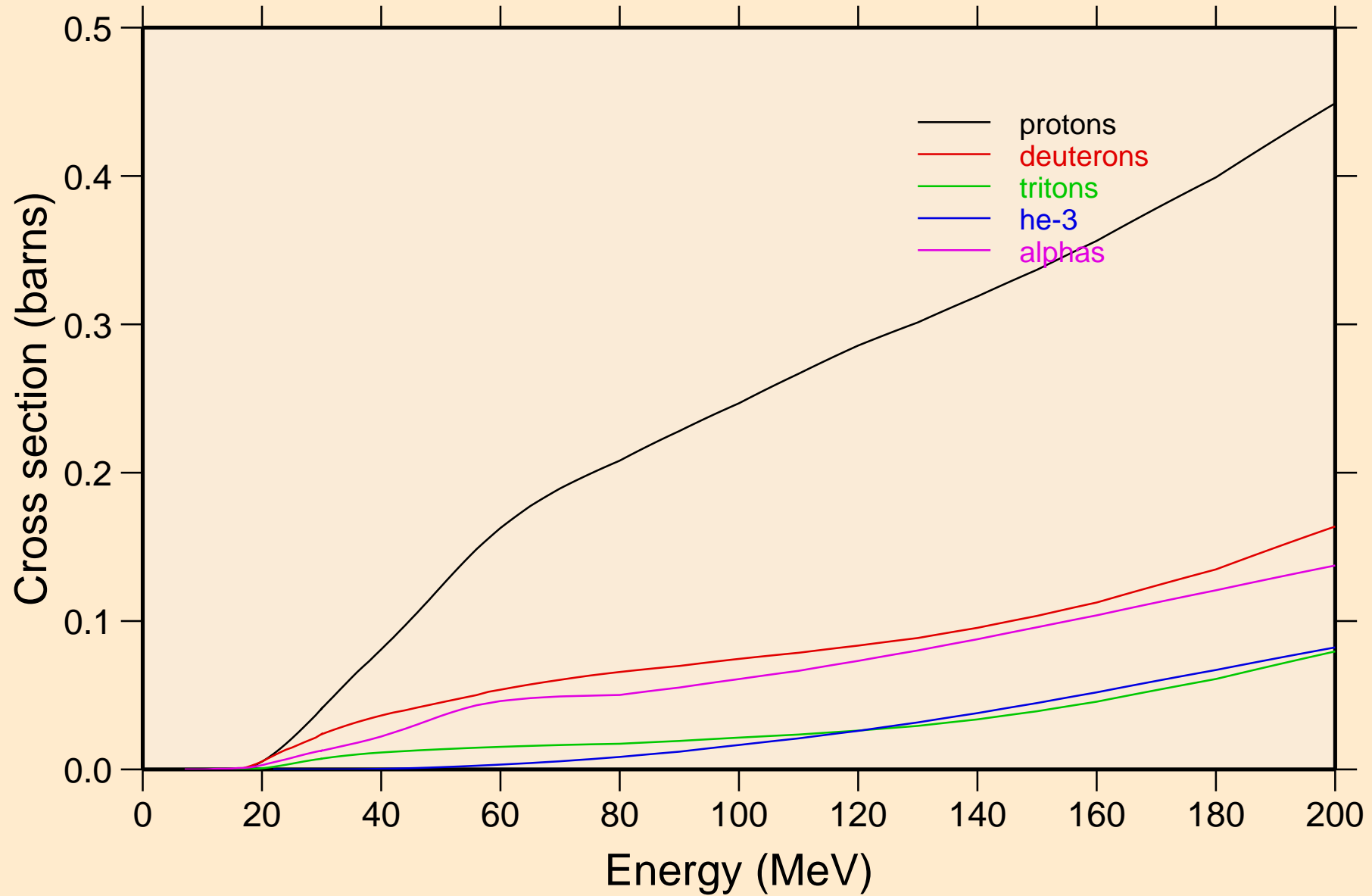

S038 NRG TENDL-2015, AKONING  
protons from (n,x)

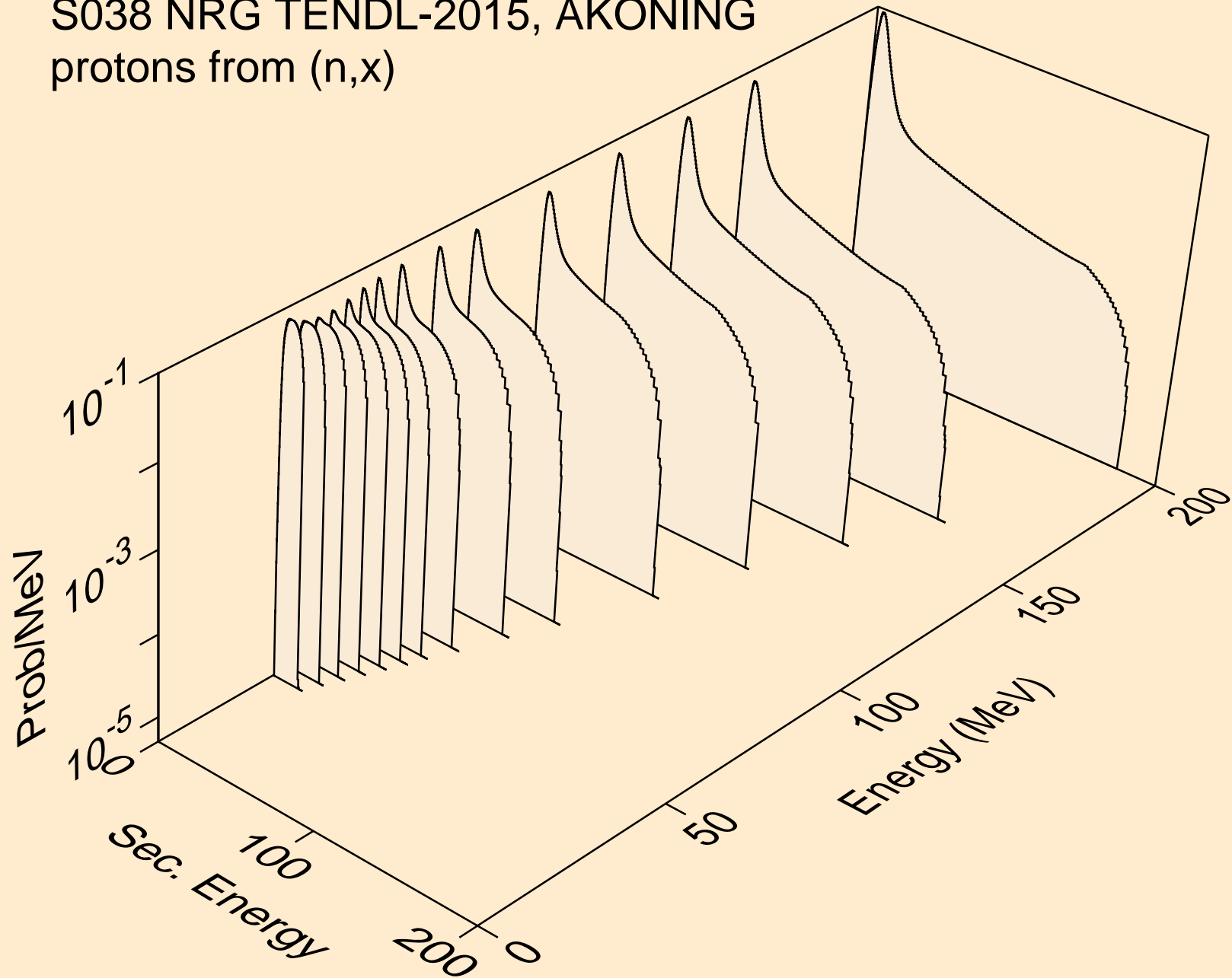

S038 NRG TENDL-2015, AKONING  
protons from (n,n\*)p

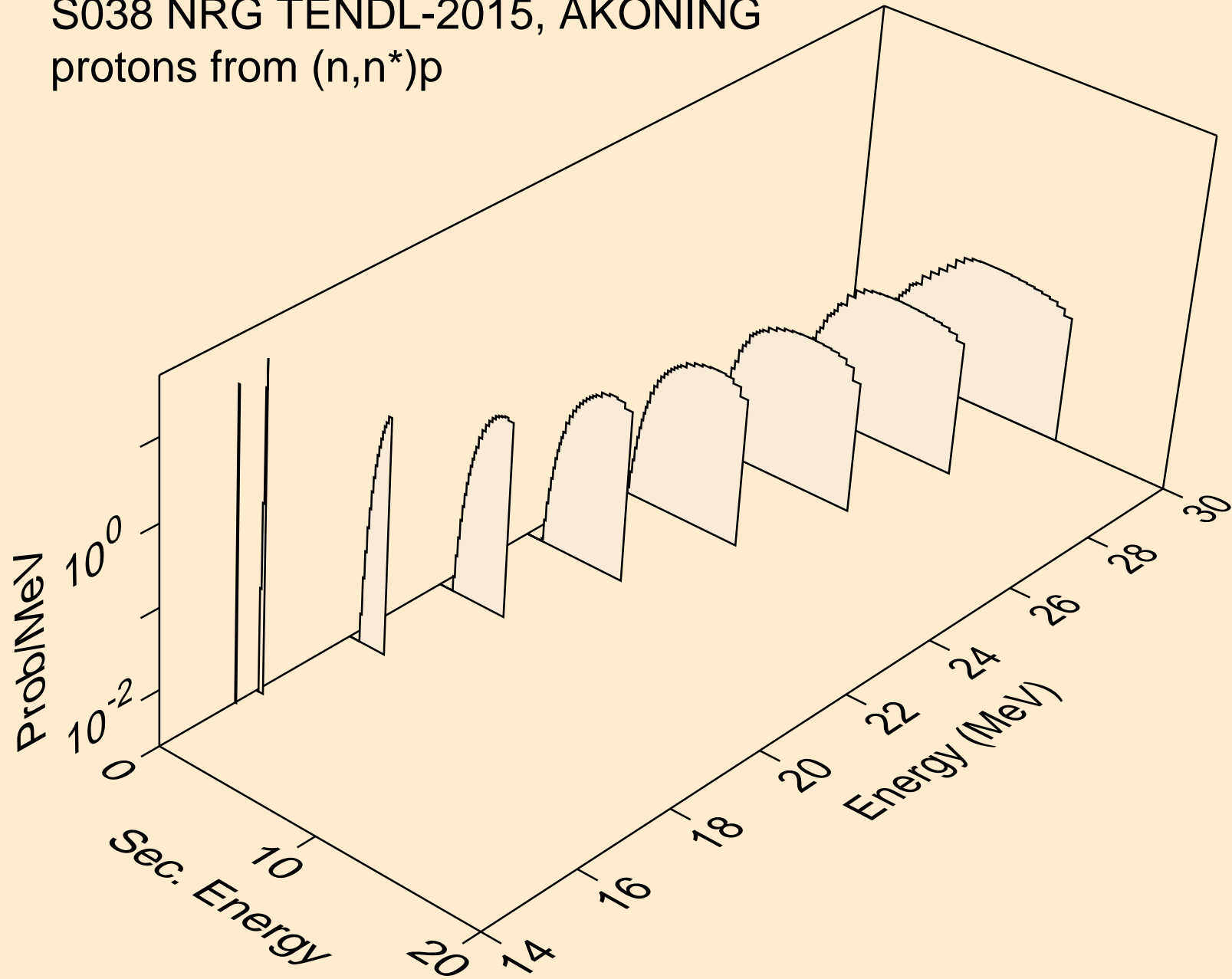

S038 NRG TENDL-2015, AKONING  
protons from (n,2np)

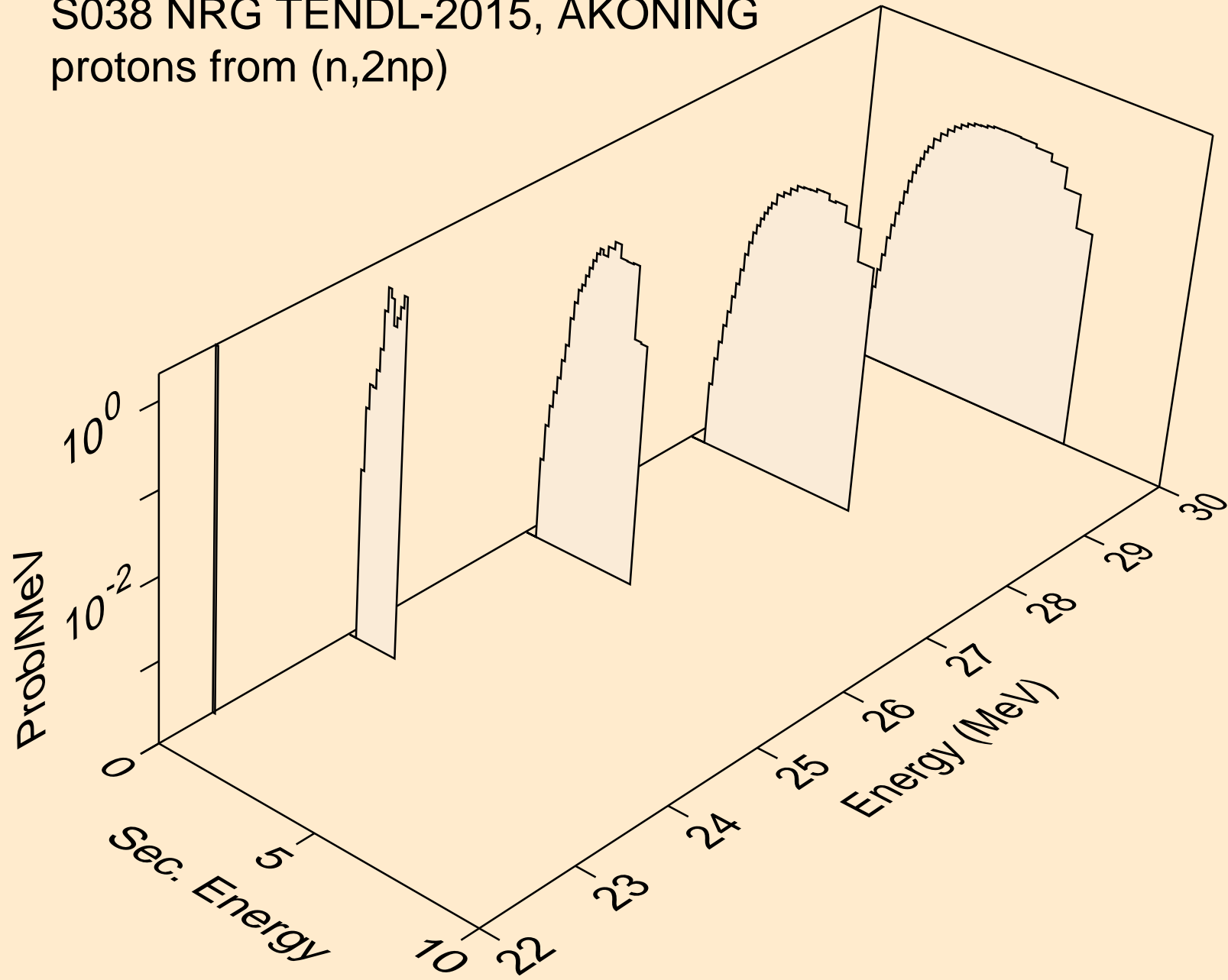

S038 NRG TENDL-2015, AKONING  
protons from (n,3np)

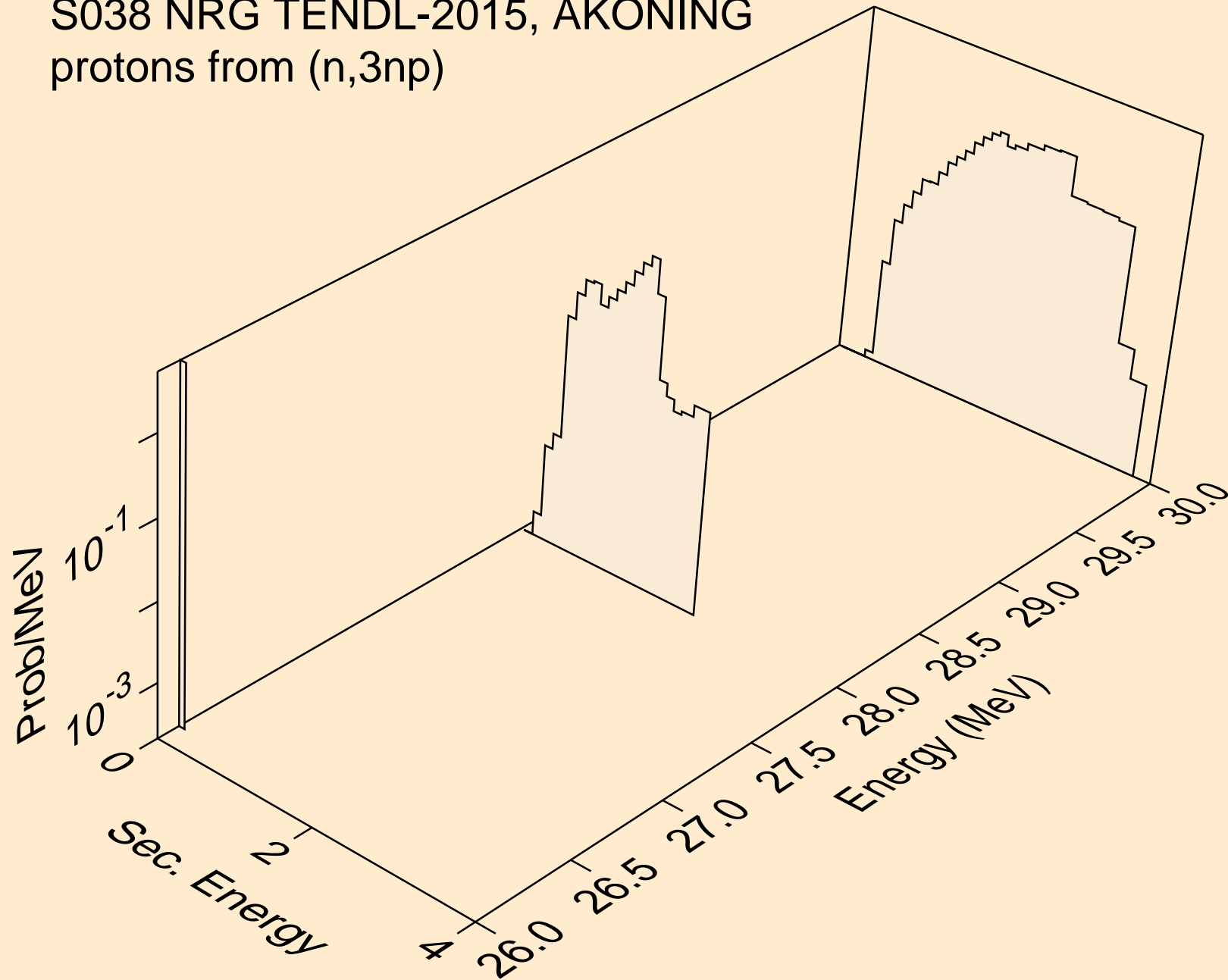



S038 NRG TENDL-2015, AKONING  
protons from (n,p)

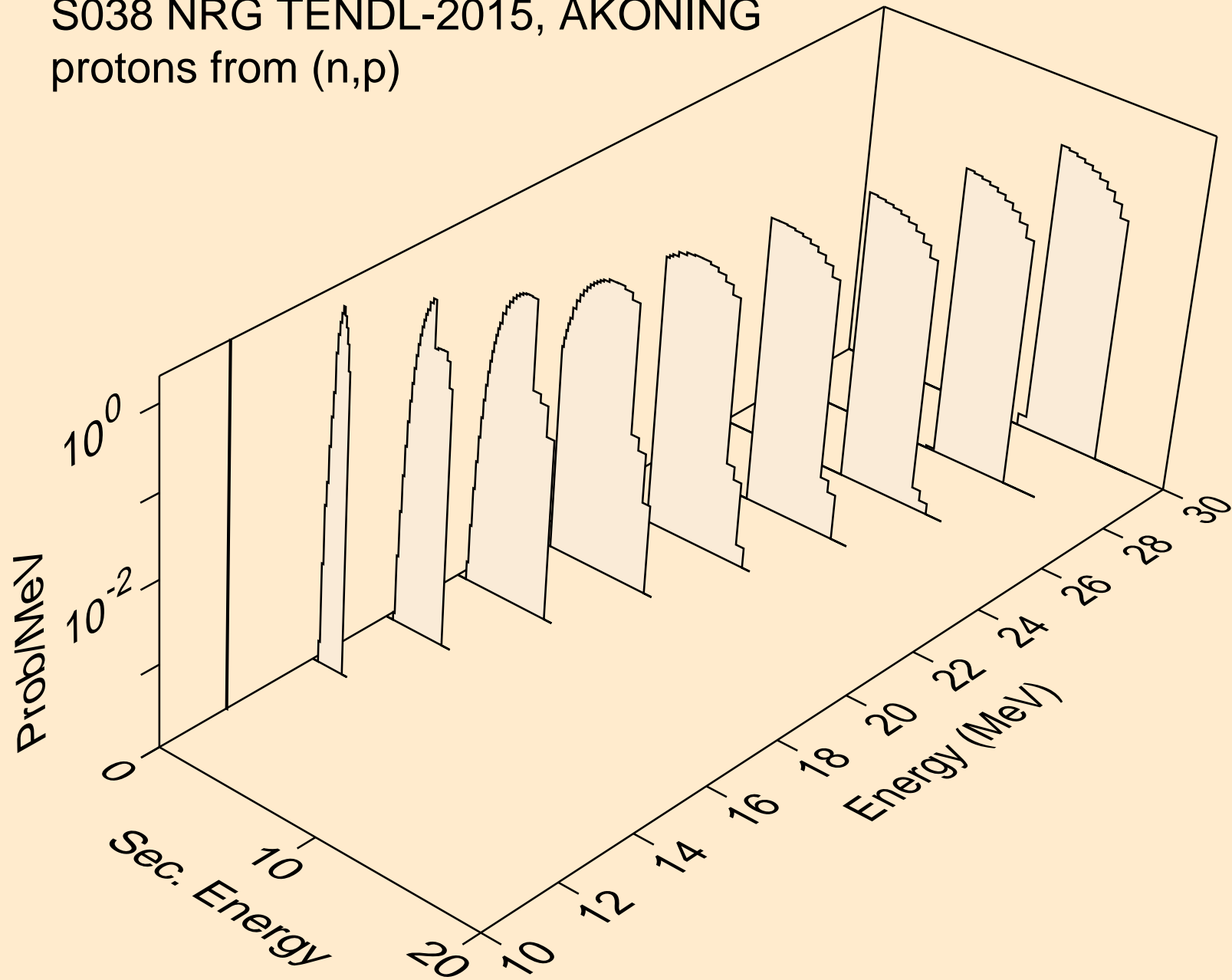

S038 NRG TENDL-2015, AKONING  
deuterons from (n,x)

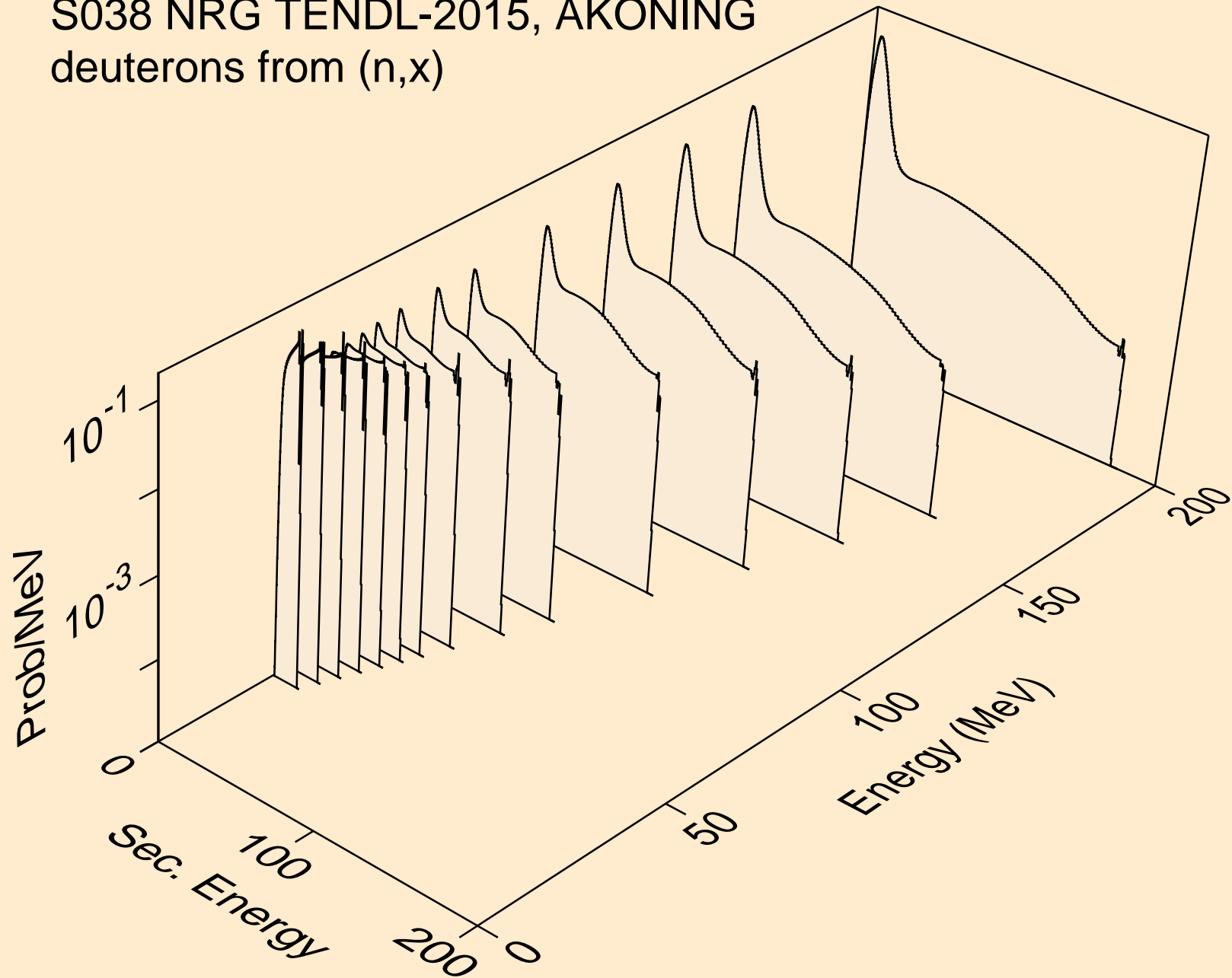

S038 NRG TENDL-2015, AKONING  
deuterons from (n,2nd)

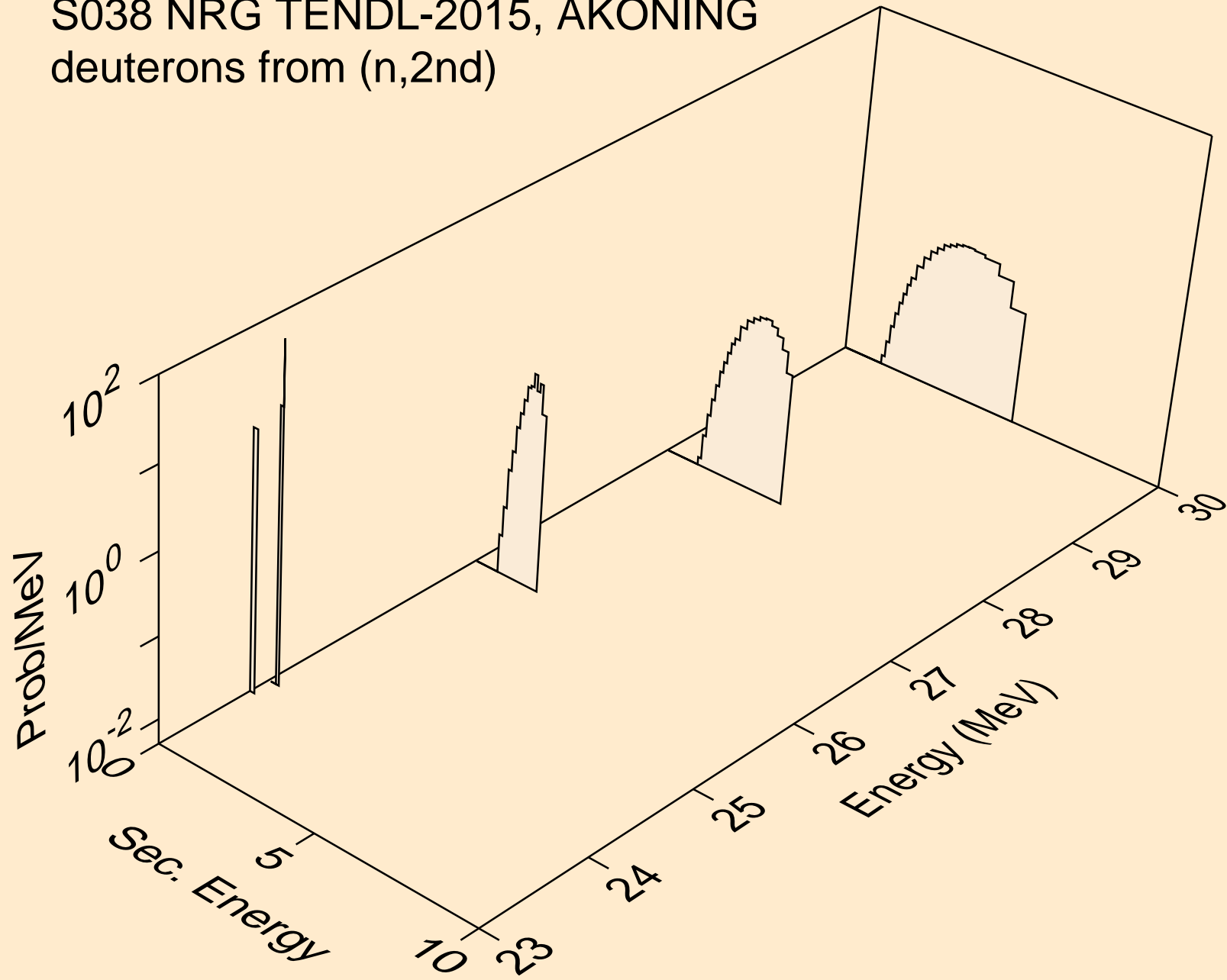

S038 NRG TENDL-2015, AKONING  
deuterons from (n,n\*)d

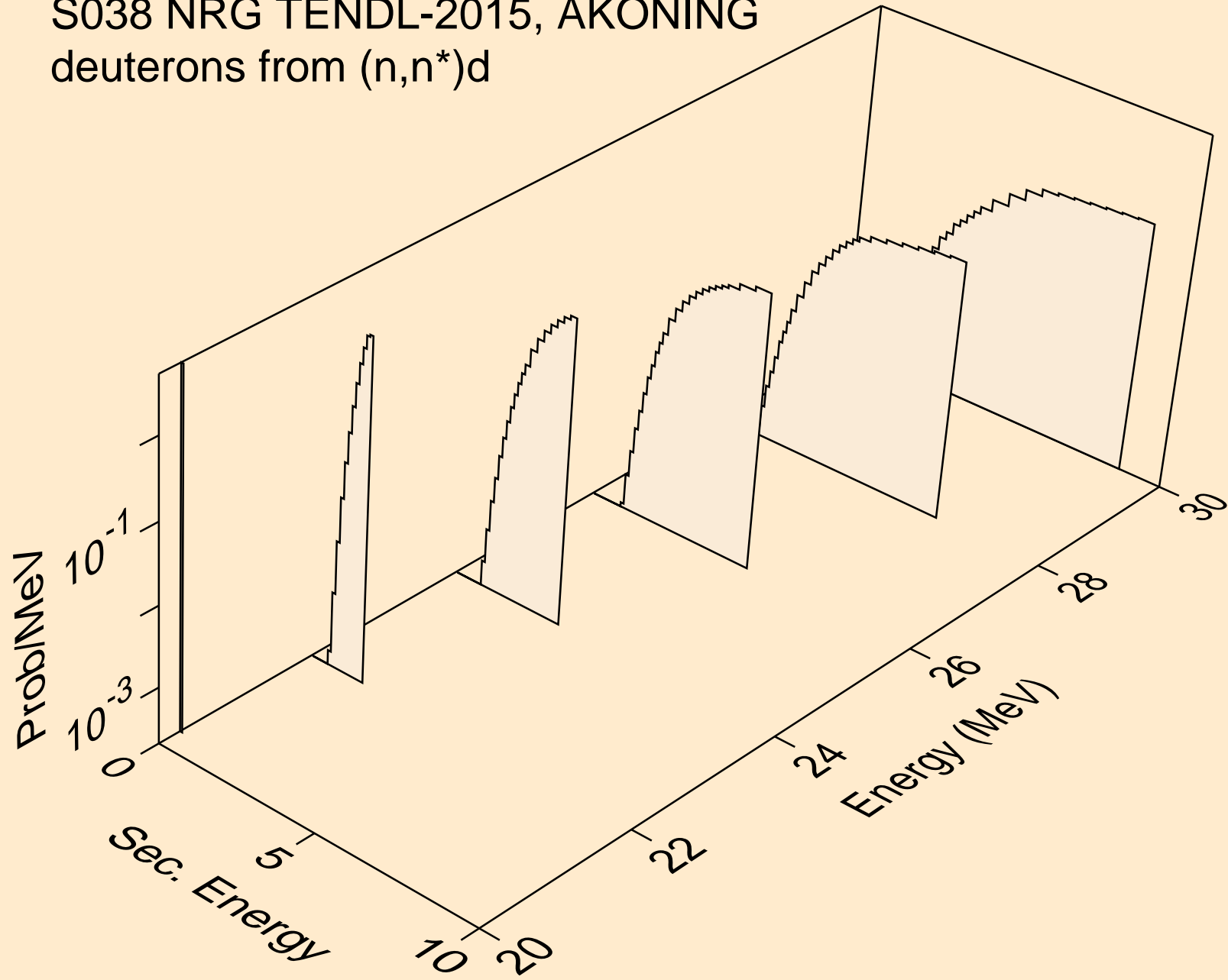

S038 NRG TENDL-2015, AKONING  
deuterons from (n,d)

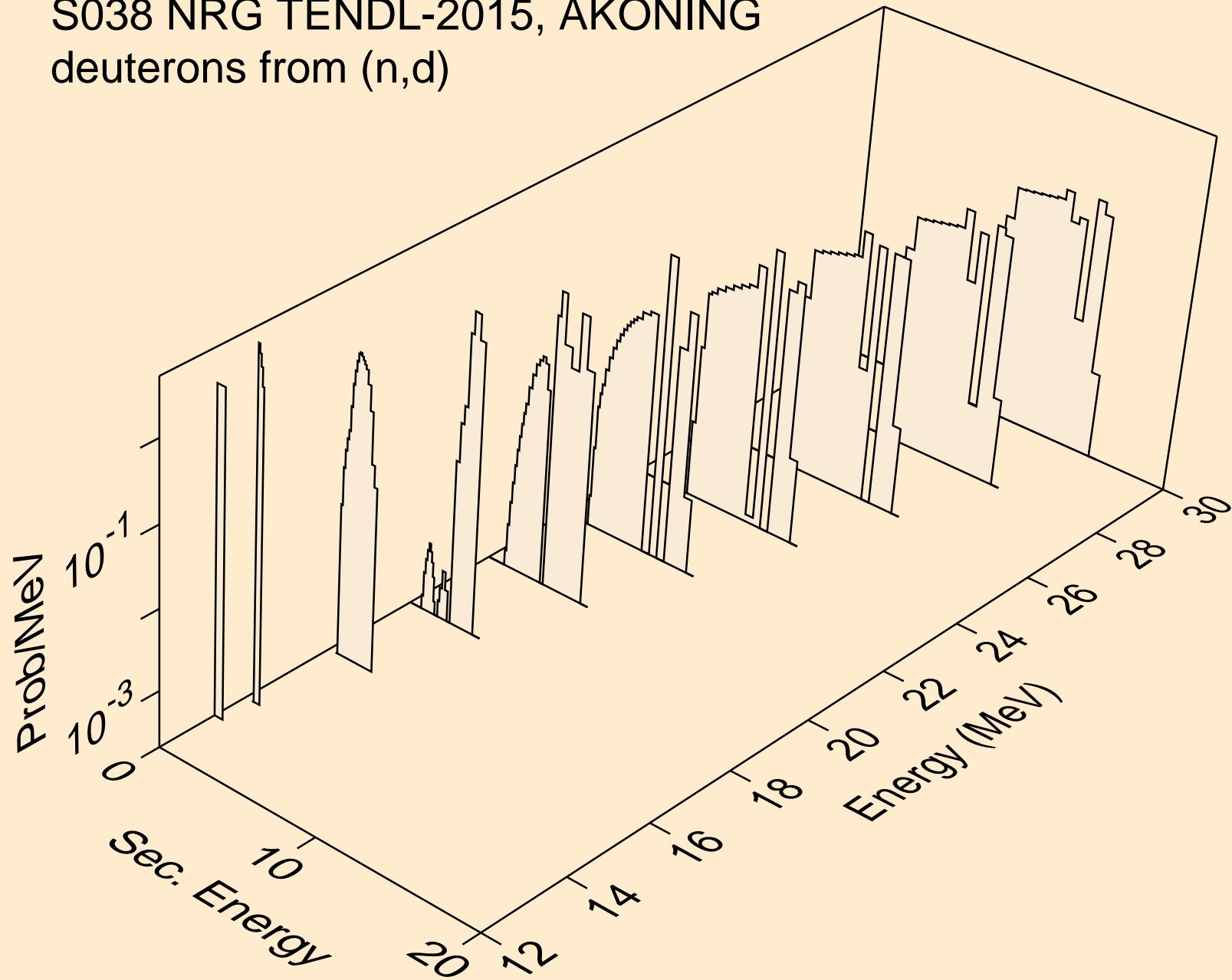

S038 NRG TENDL-2015, AKONING  
tritons from (n,x)

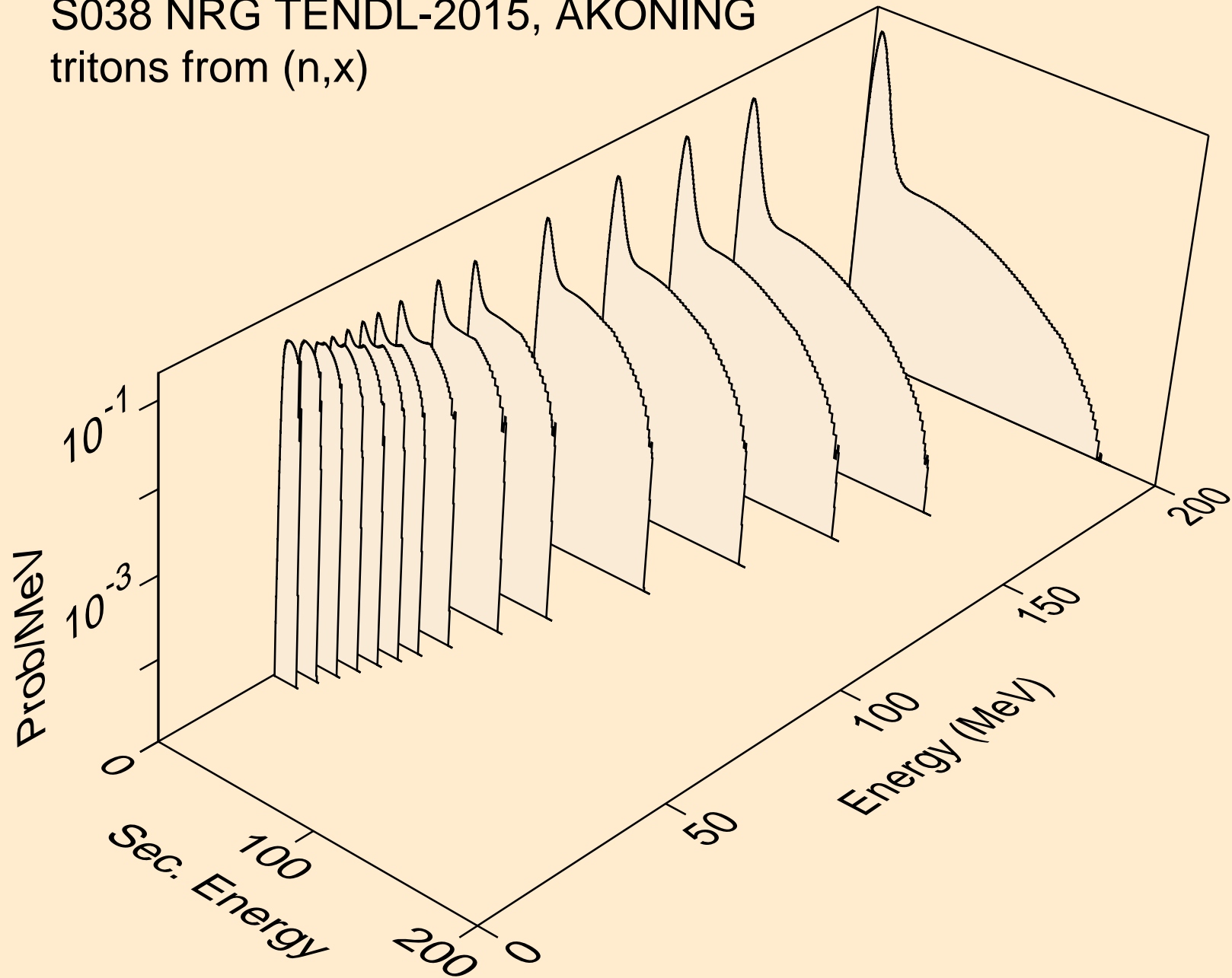

S038 NRG TENDL-2015, AKONING  
tritons from (n,n\*)t

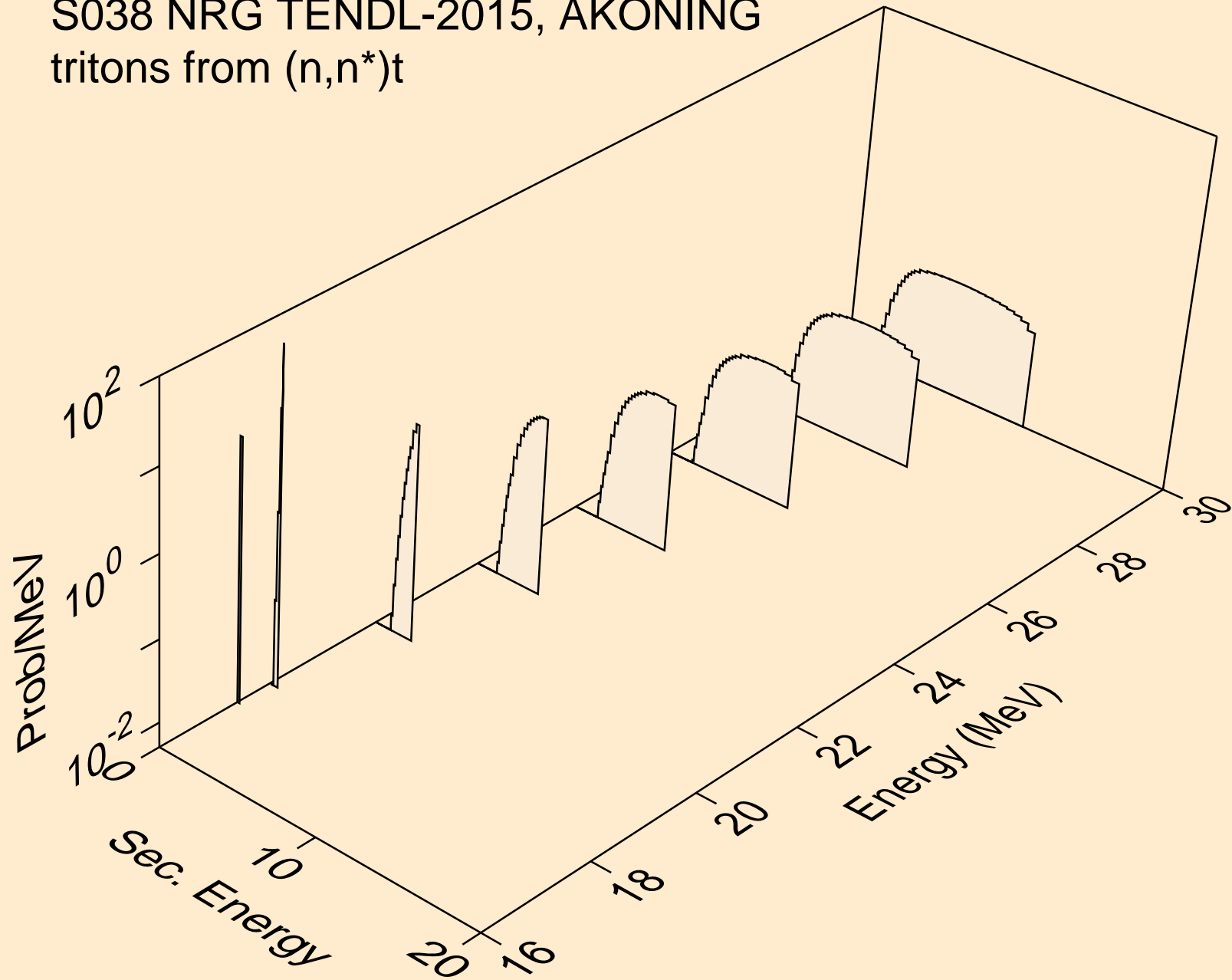

S038 NRG TENDL-2015, AKONING  
tritons from (n,t)

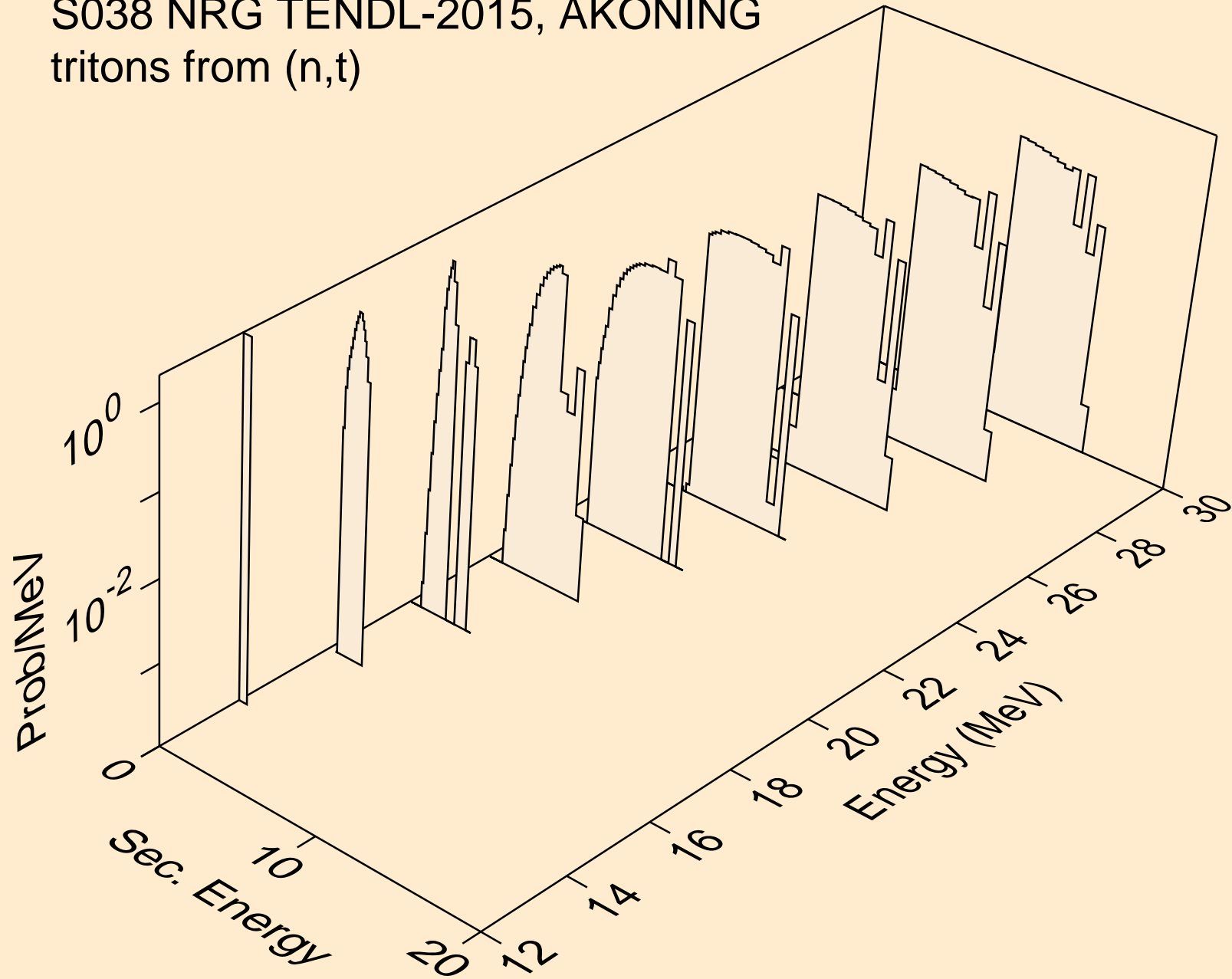



S038 NRG TENDL-2015, AKONING  
he3s from (n,x)

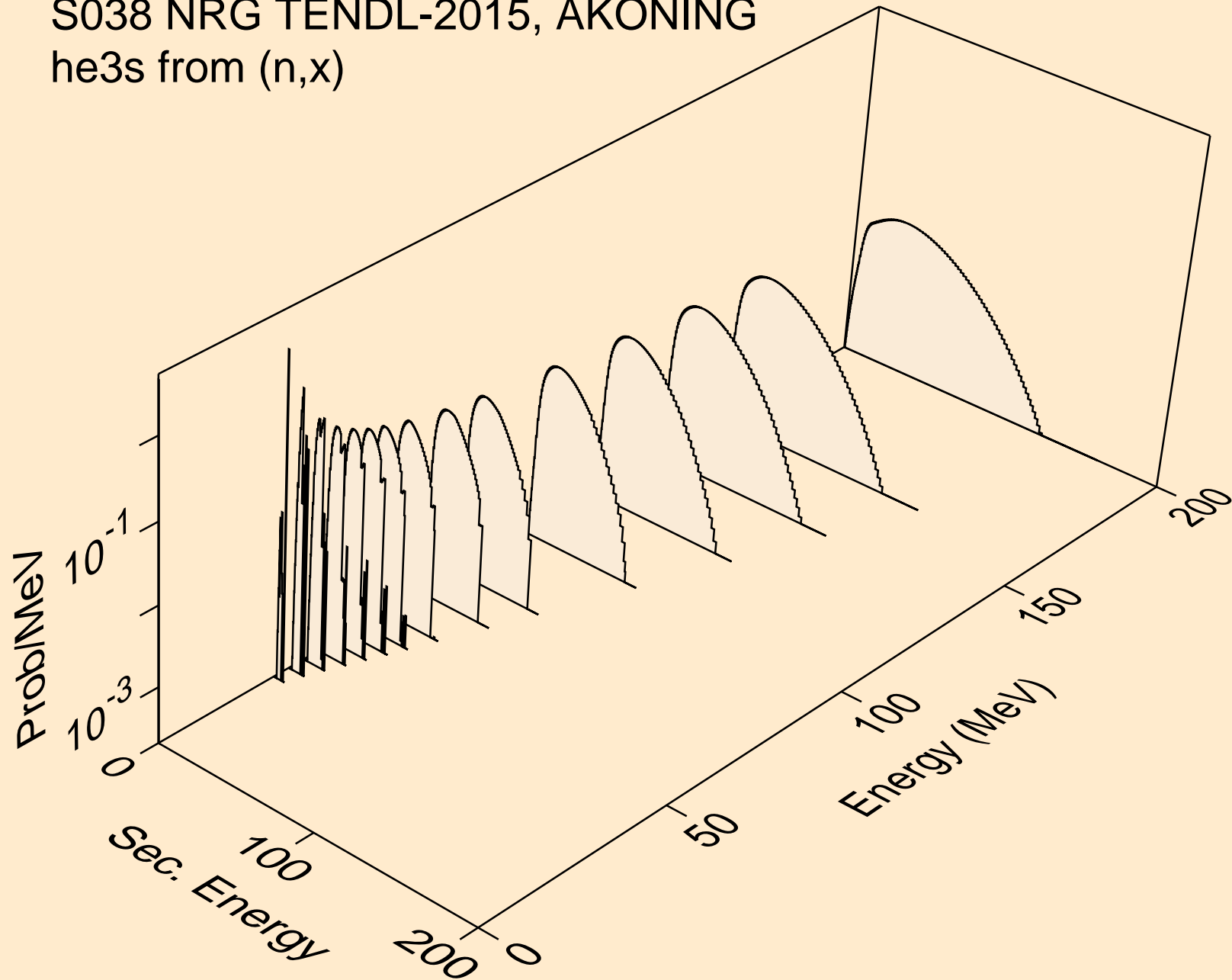

S038 NRG TENDL-2015, AKONING  
he3s from (n,he3)

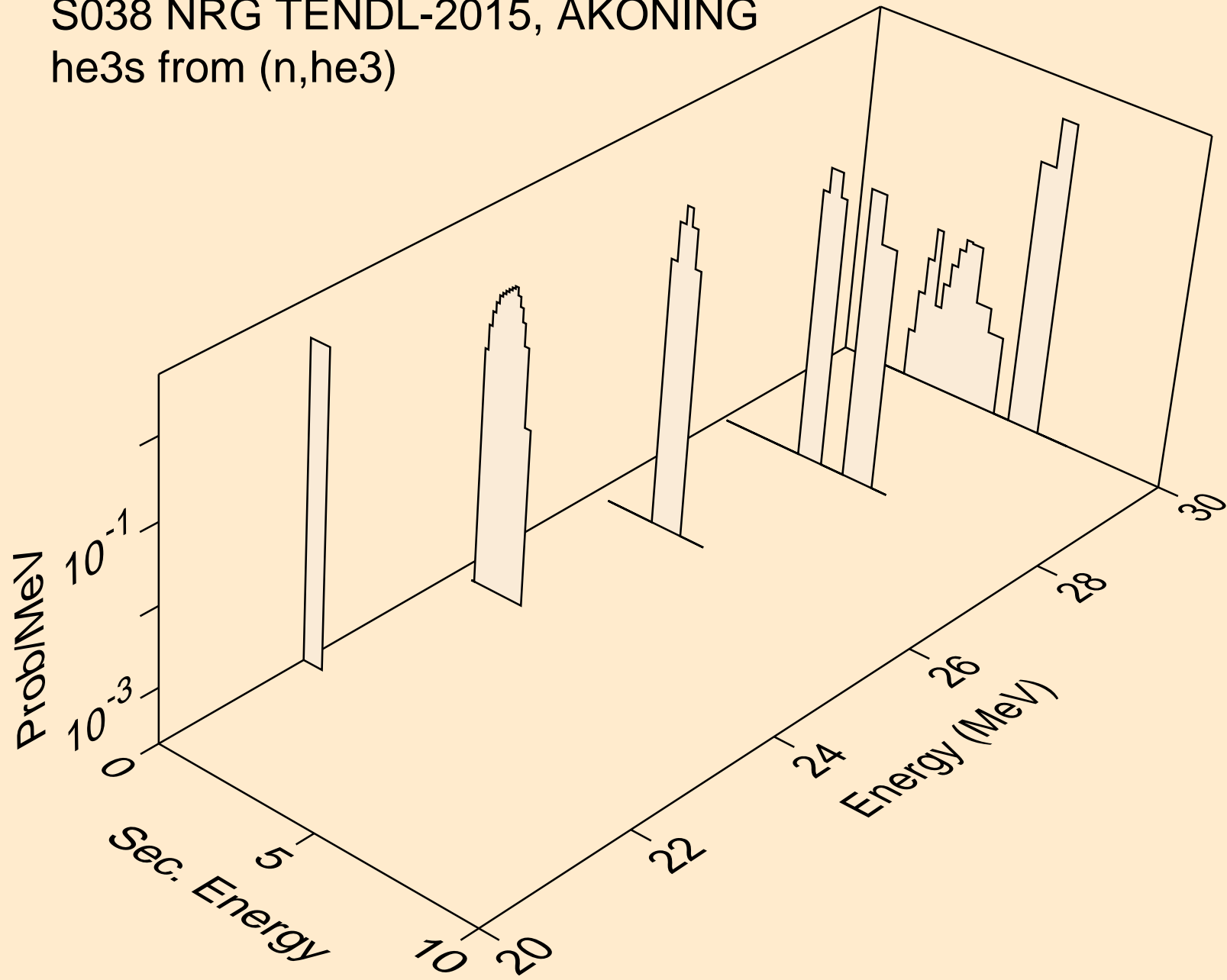

S038 NRG TENDL-2015, AKONING  
alphas from (n,x)

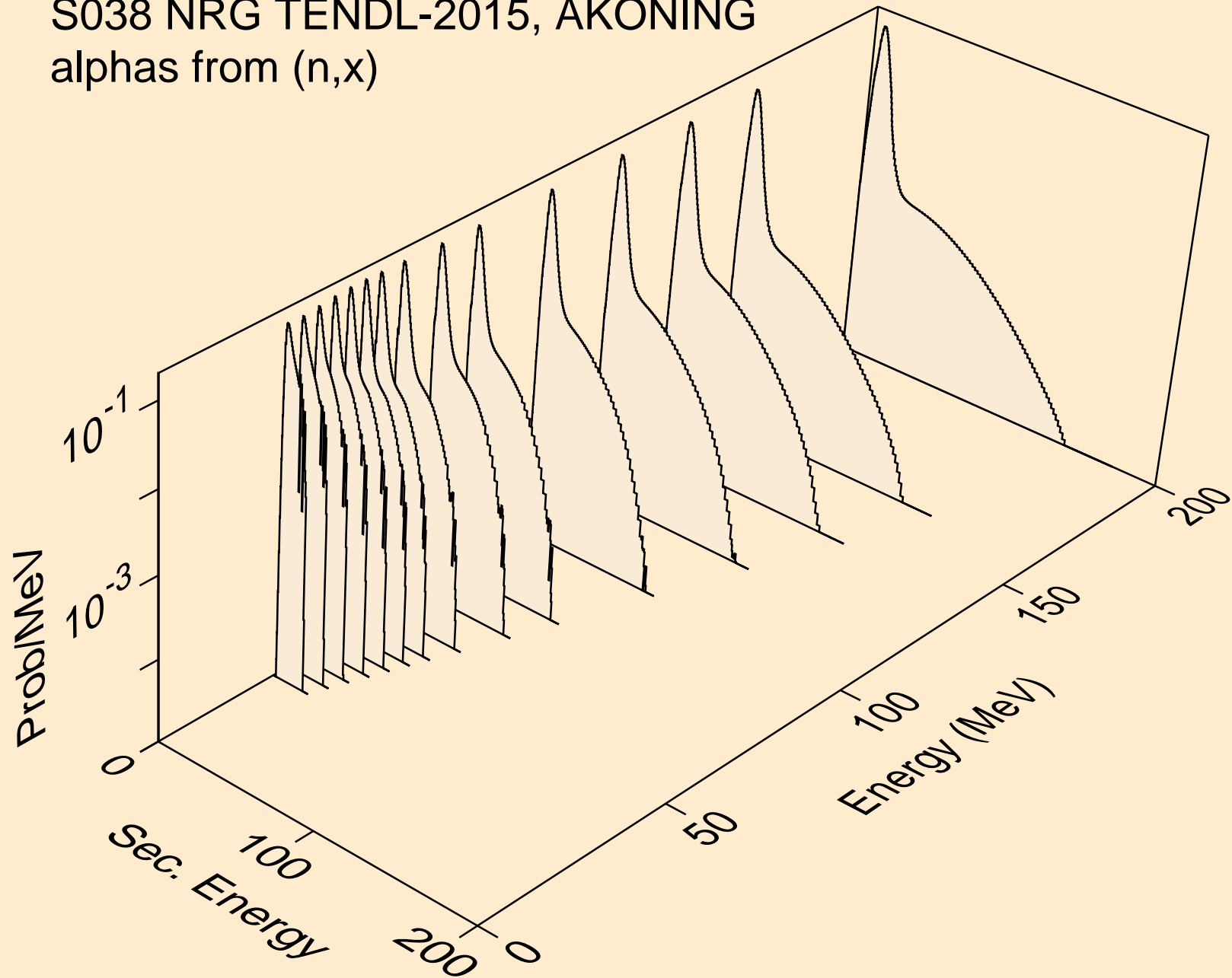

S038 NRG TENDL-2015, AKONING  
alphas from (n,n\*)a

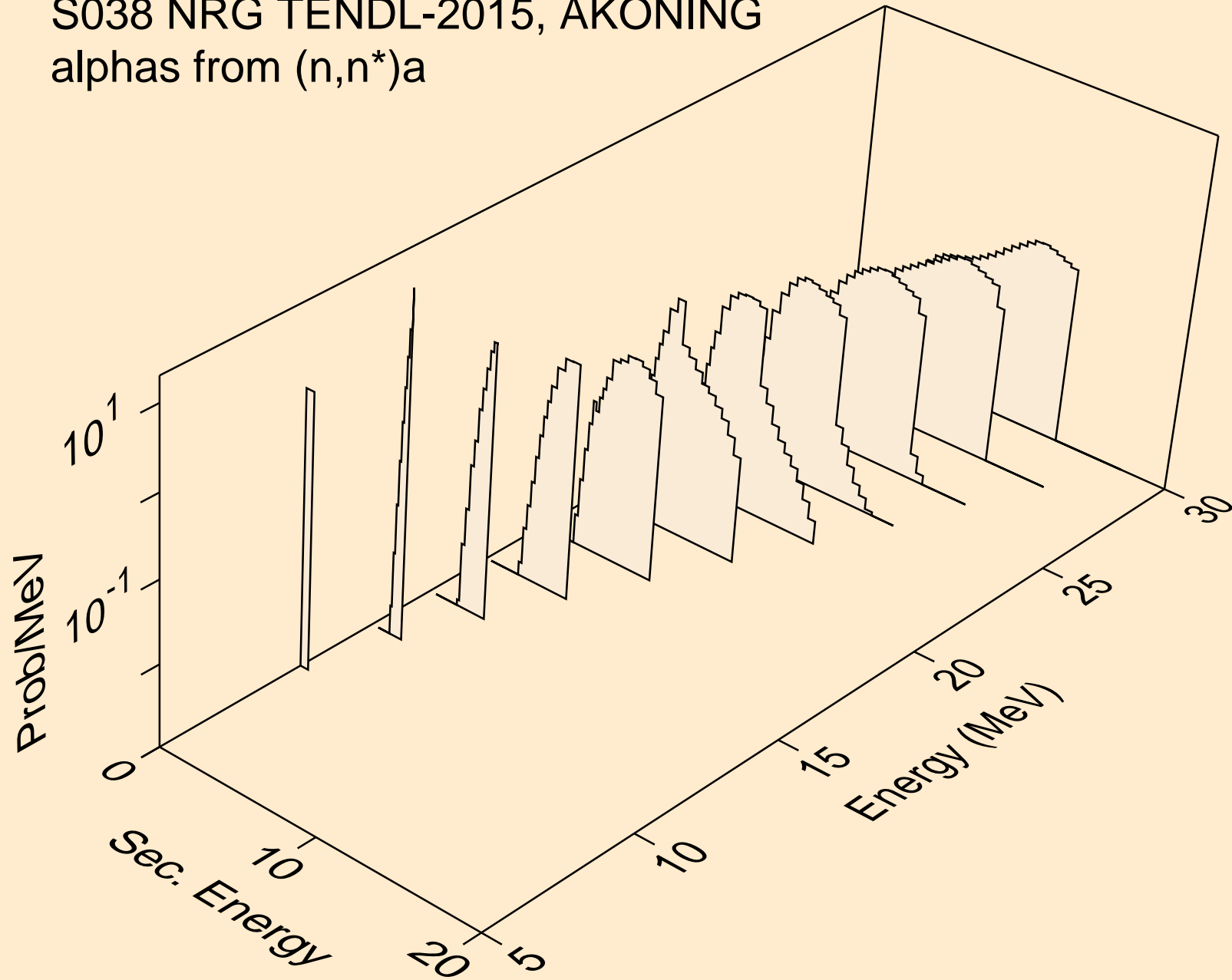

S038 NRG TENDL-2015, AKONING  
alphas from (n,2n)a

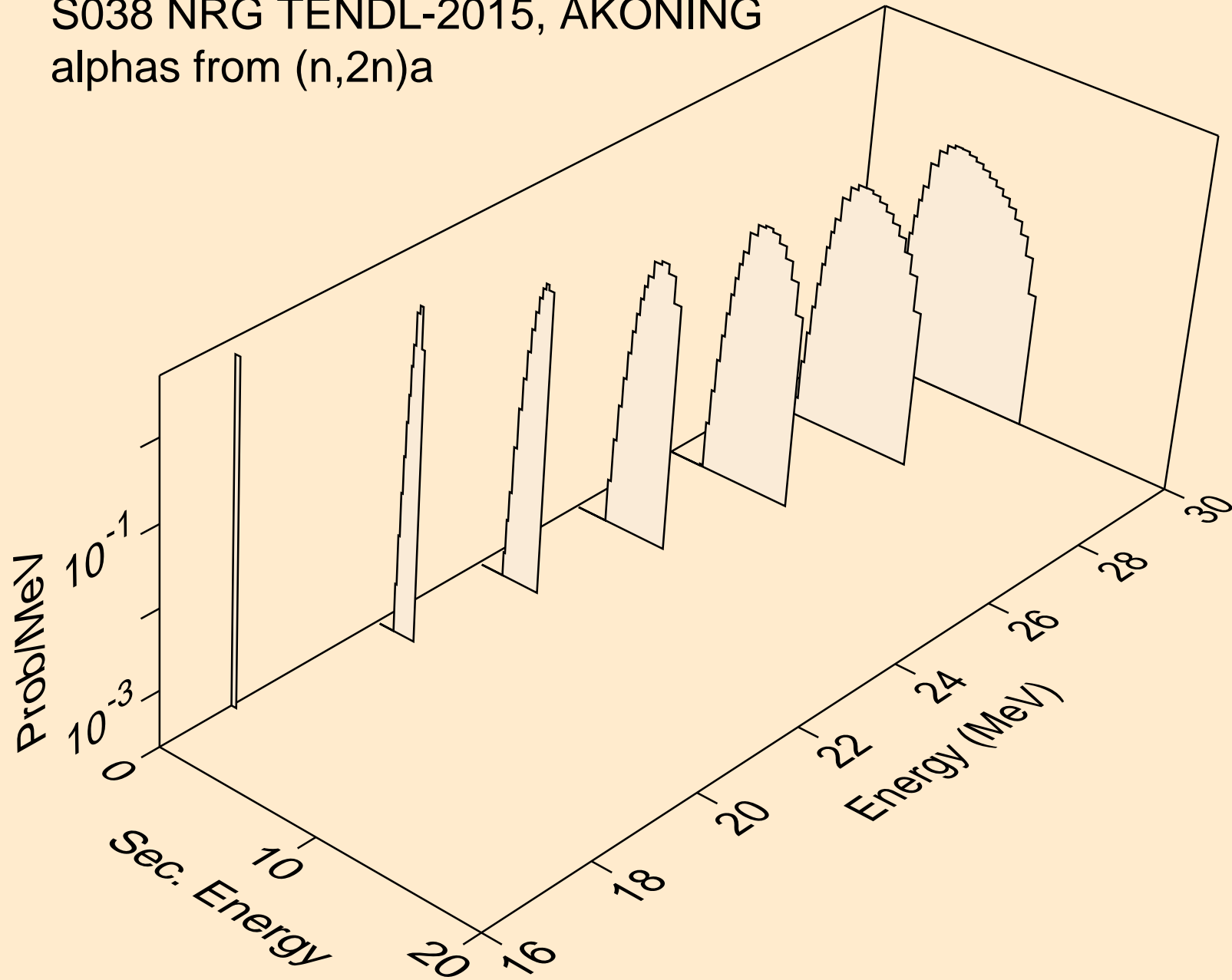

S038 NRG TENDL-2015, AKONING  
alphas from (n,3n)a

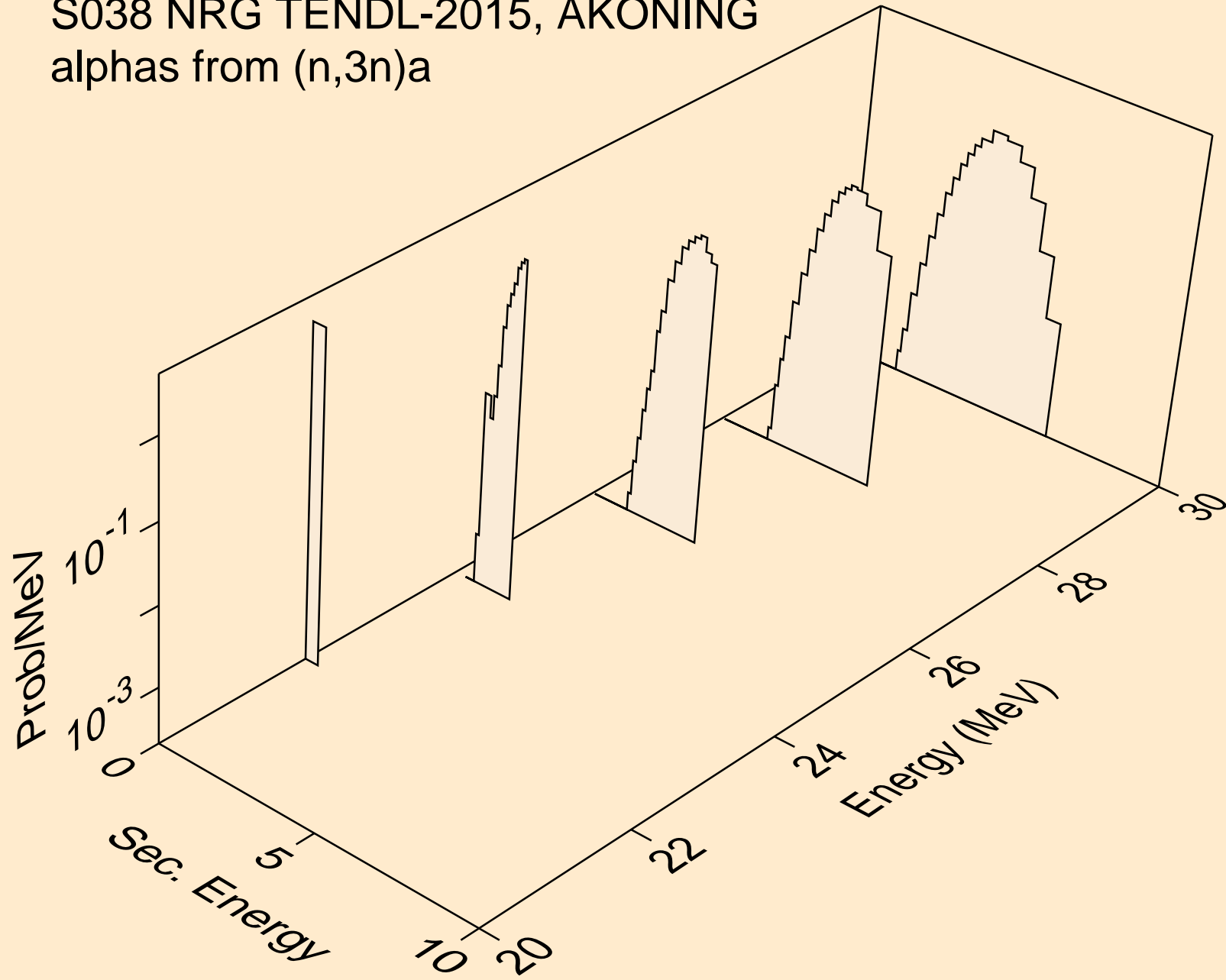

S038 NRG TENDL-2015, AKONING  
alphas from (n,a)

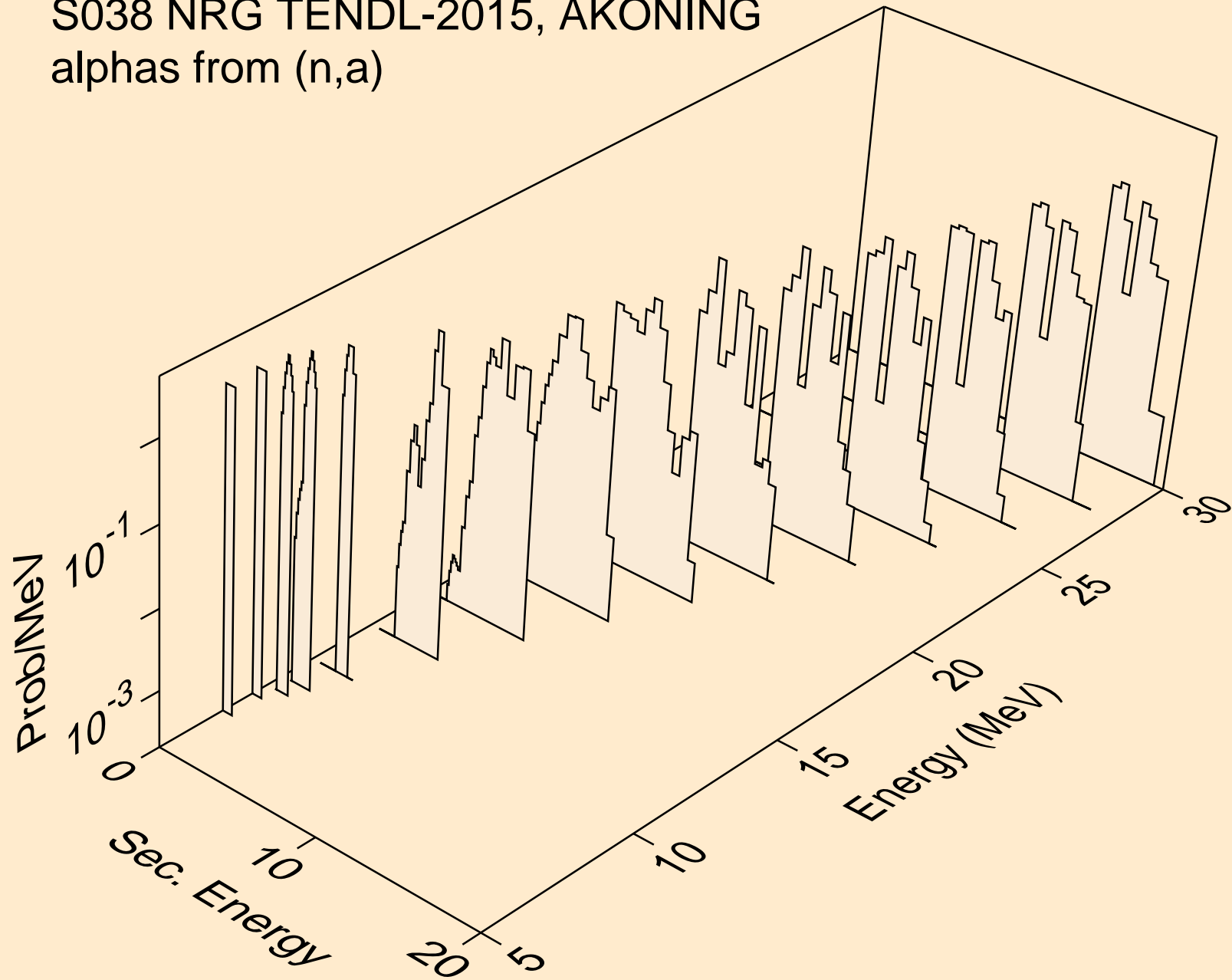

S038 NRG TENDL-2015, AKONING  
alphas from (n,2a)

