

# SB115 NRG TENDL-2015, AKONING

## Principal cross sections

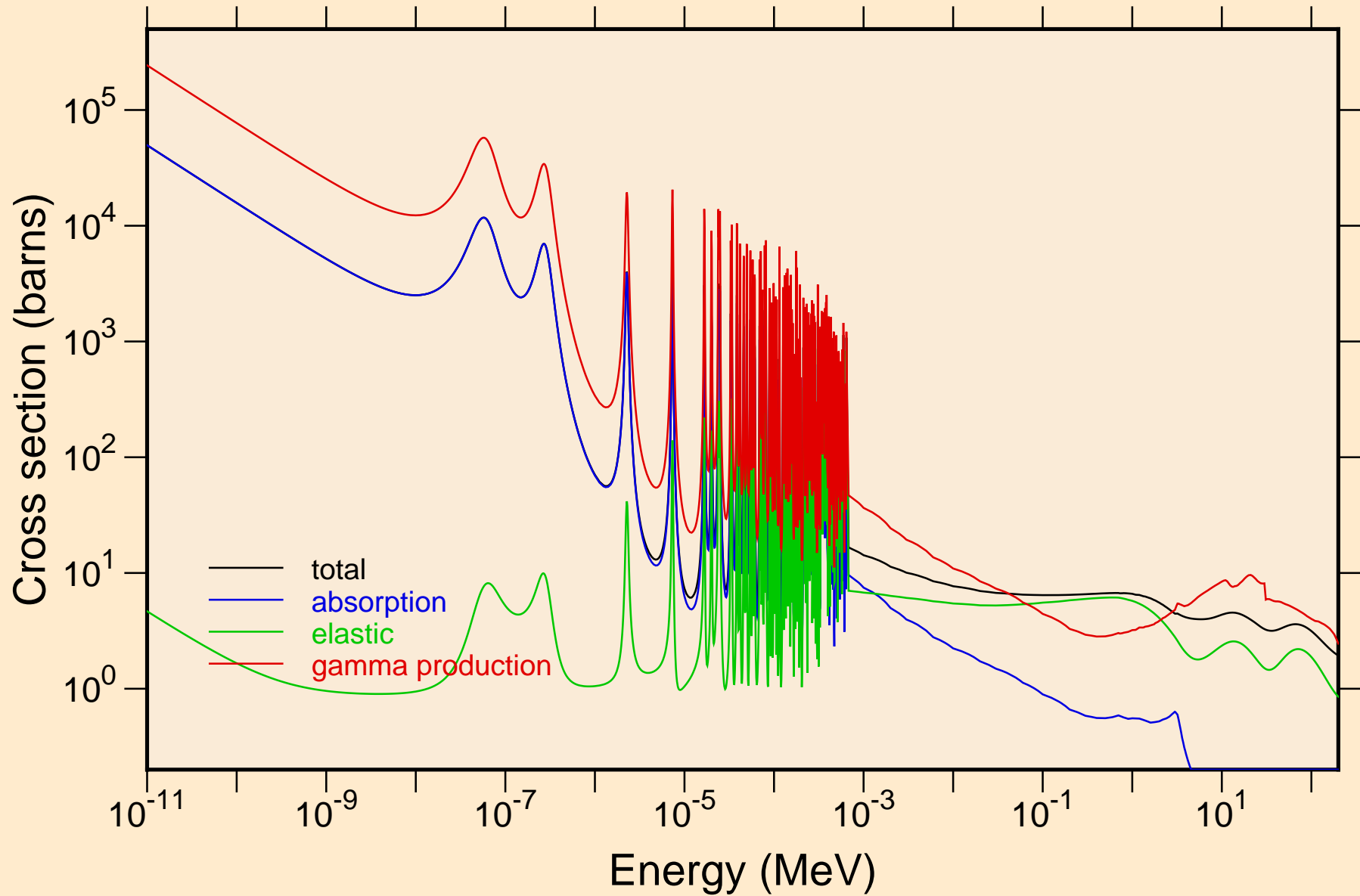

SB115 NRG TENDL-2015, AKONING  
resonance total cross section

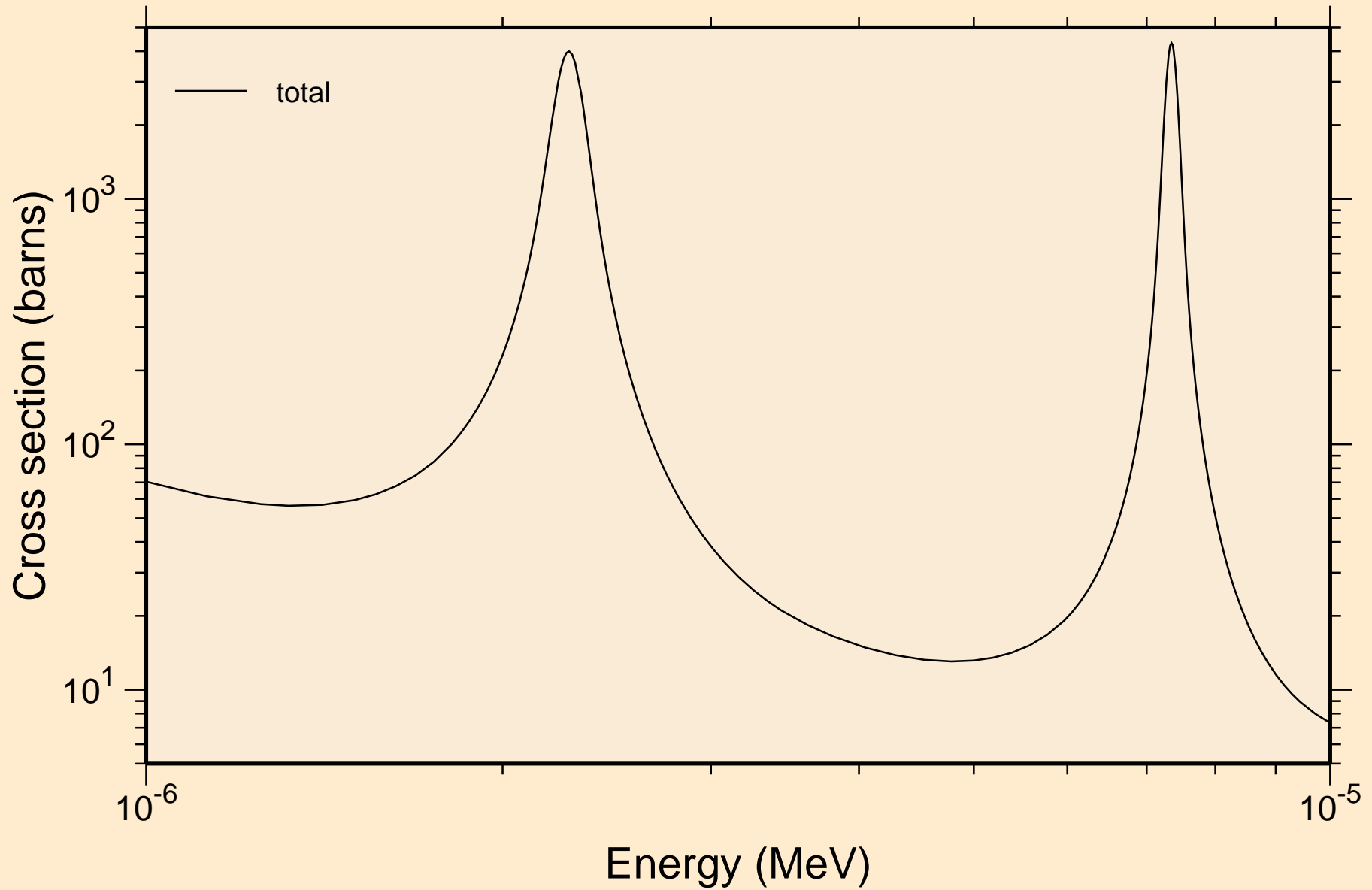

SB115 NRG TENDL-2015, AKONING  
resonance total cross section

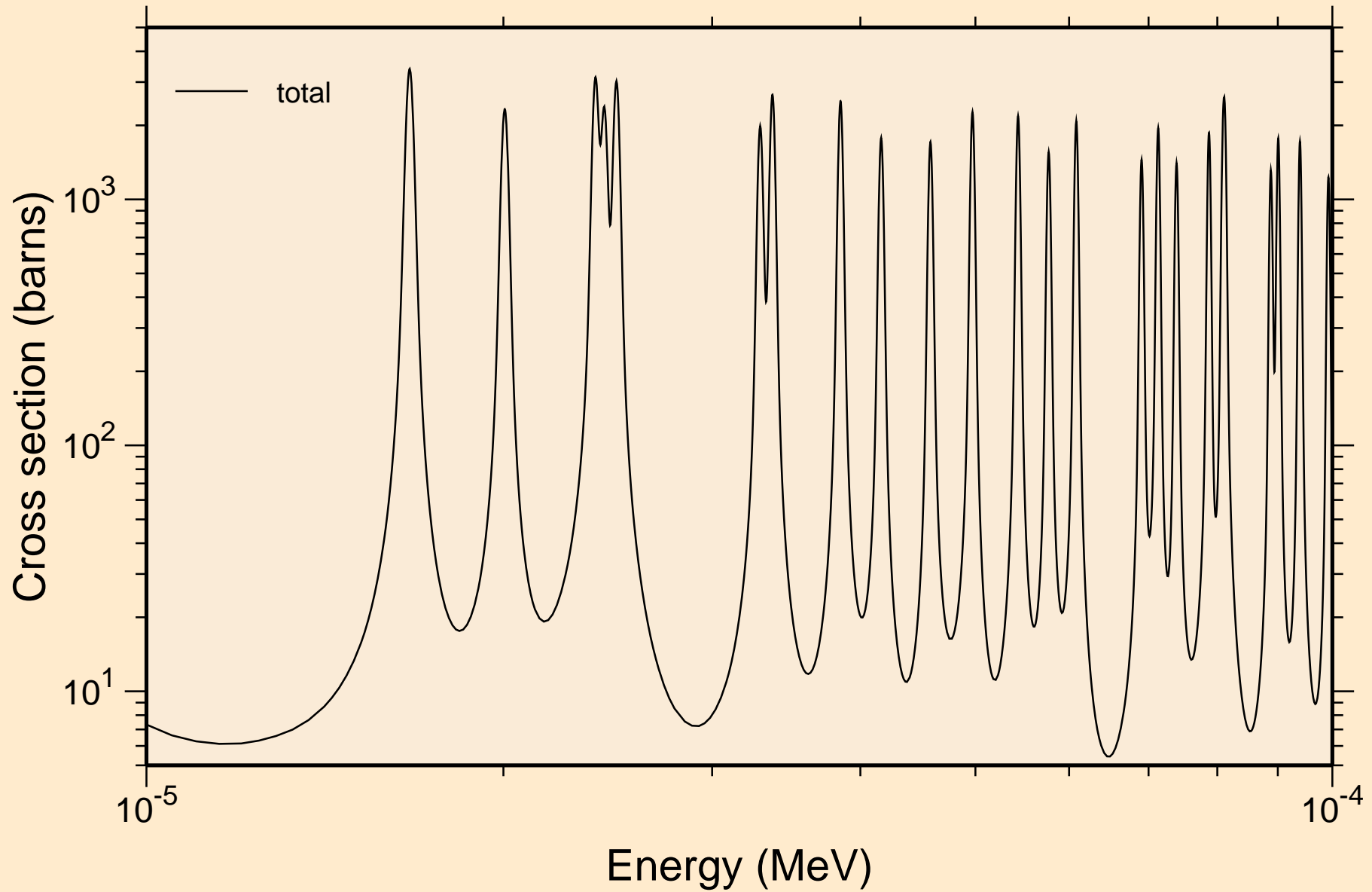

SB115 NRG TENDL-2015, AKONING  
resonance total cross section

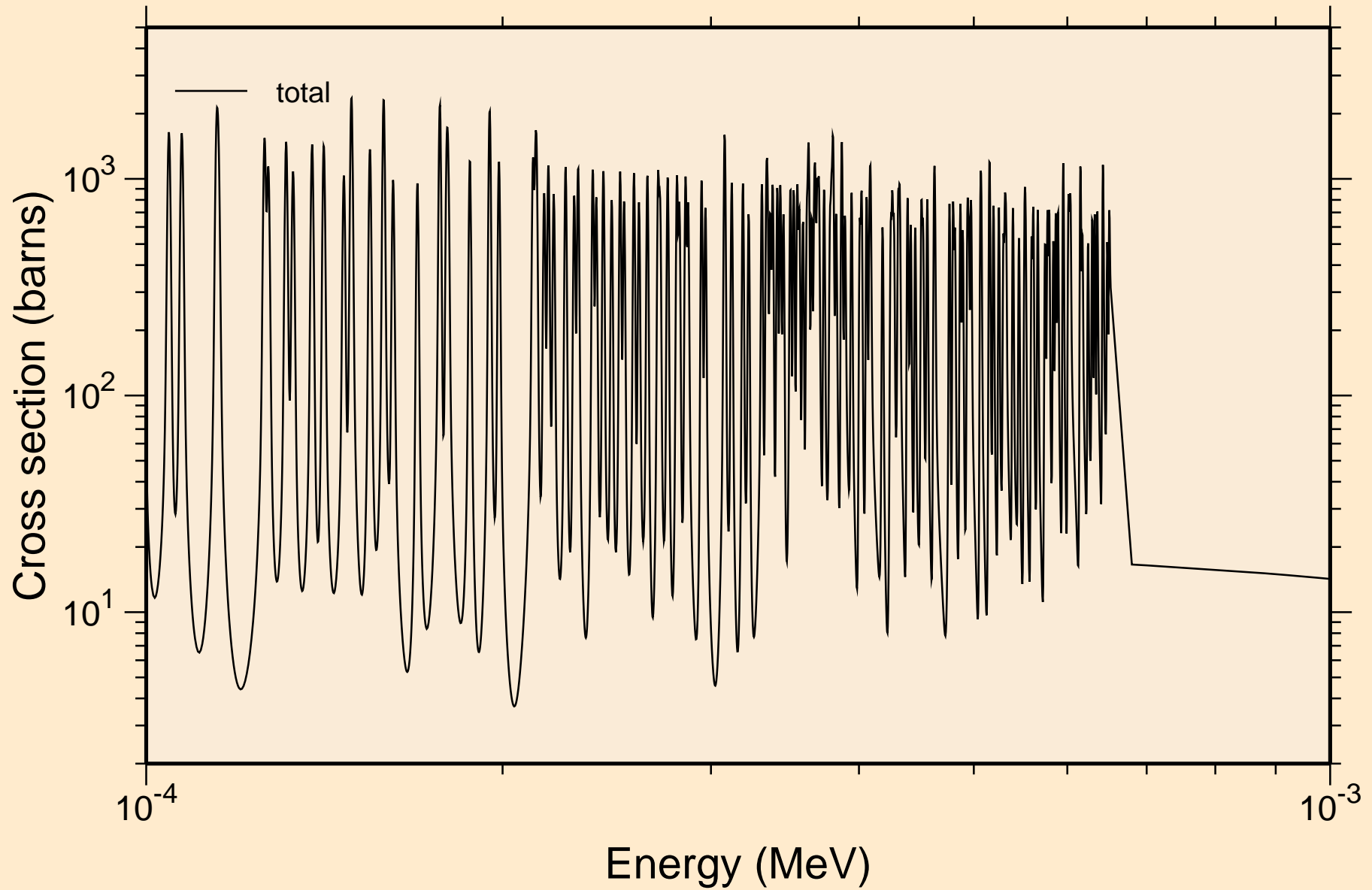

SB115 NRG TENDL-2015, AKONING  
resonance total cross section

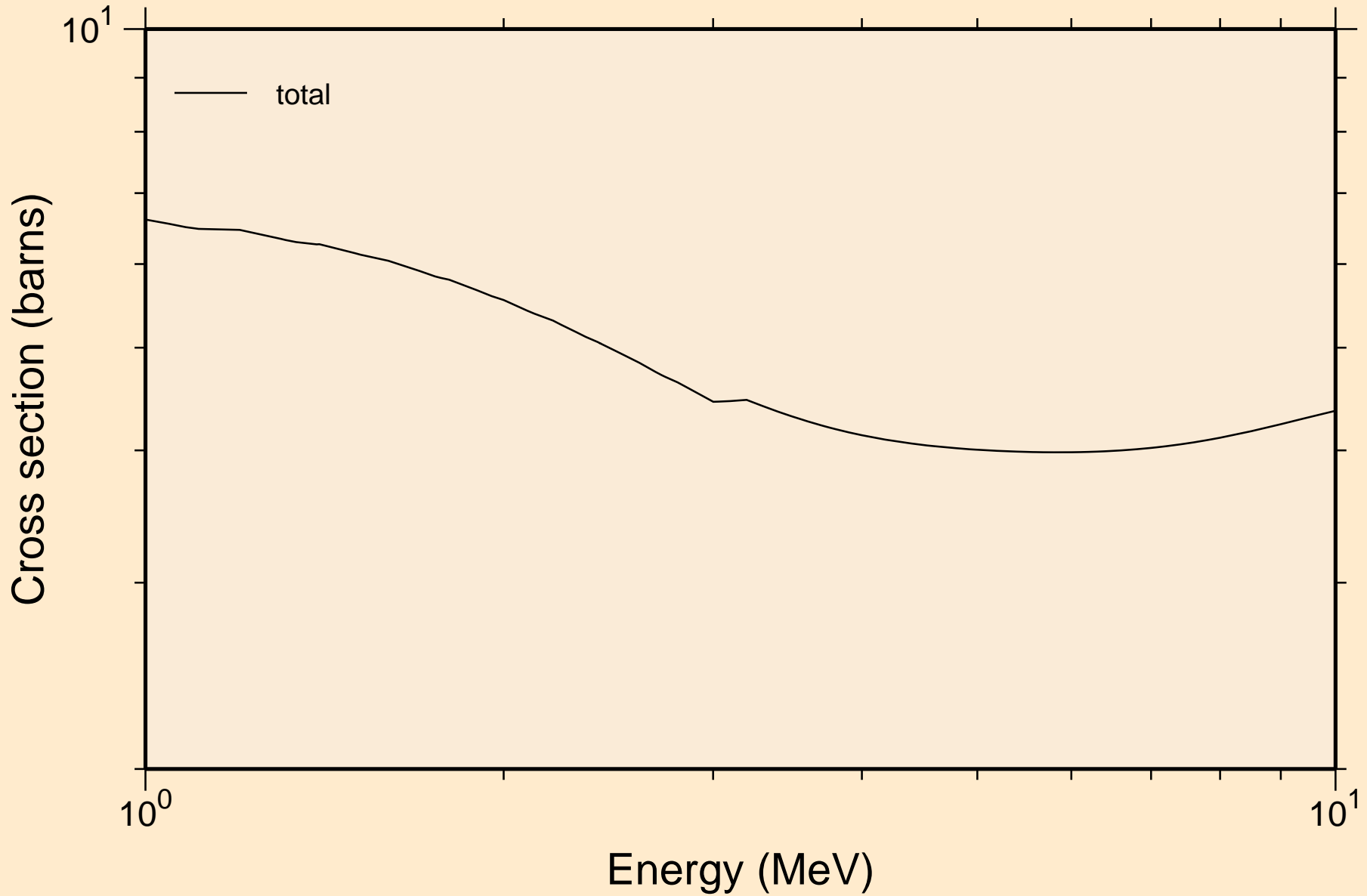

SB115 NRG TENDL-2015, AKONING  
resonance absorption cross sections

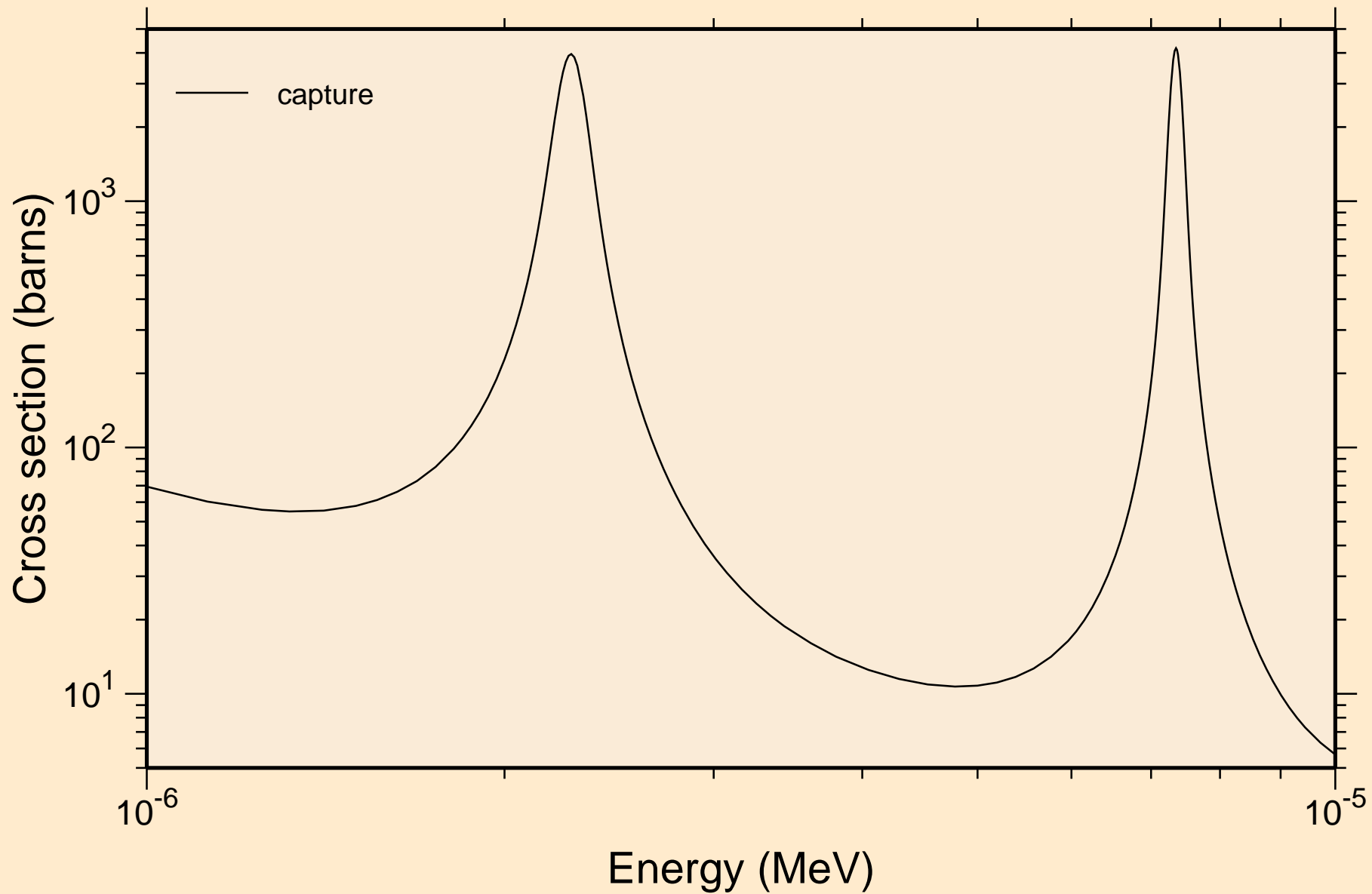

SB115 NRG TENDL-2015, AKONING  
resonance absorption cross sections

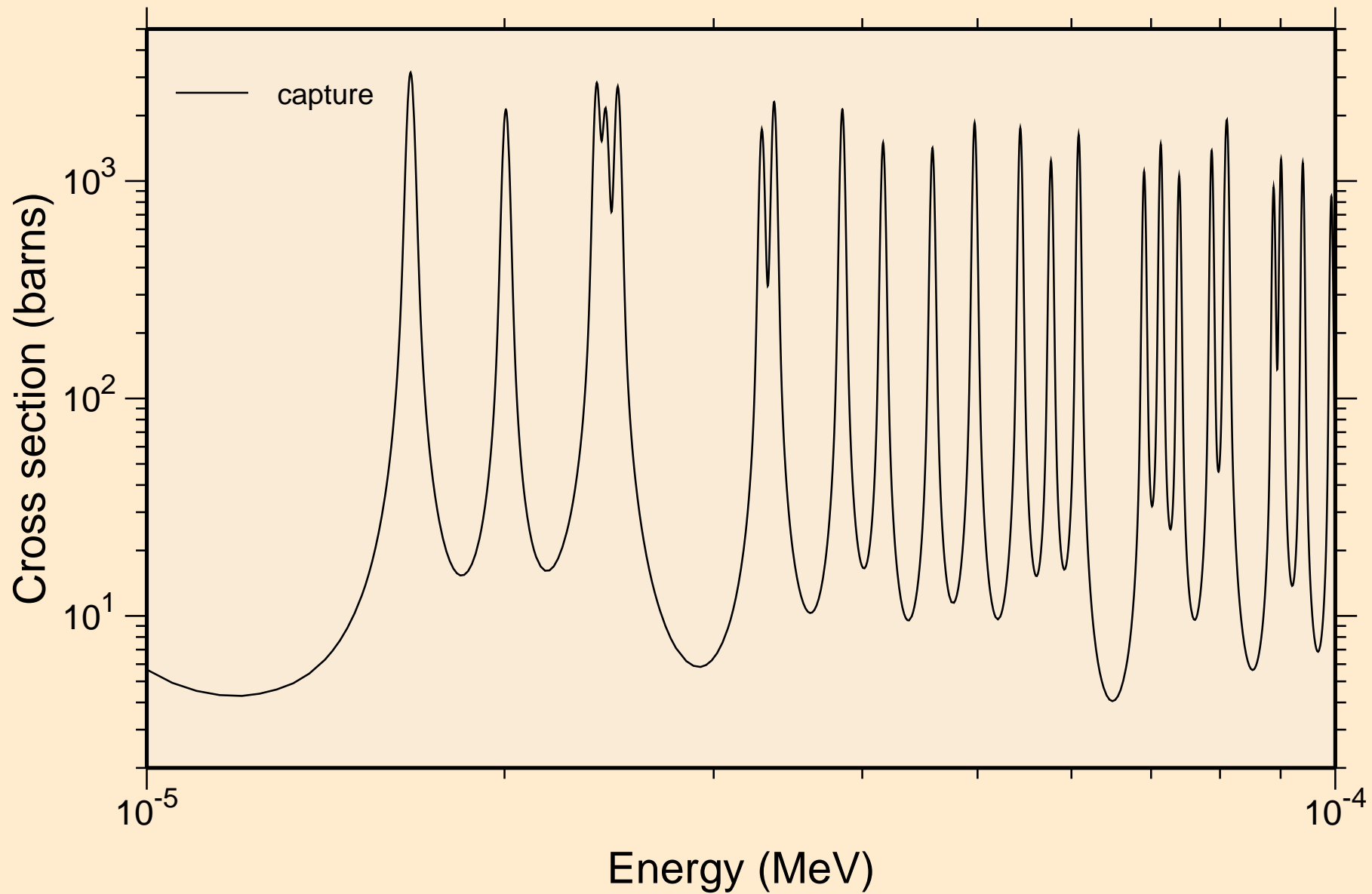

SB115 NRG TENDL-2015, AKONING  
resonance absorption cross sections

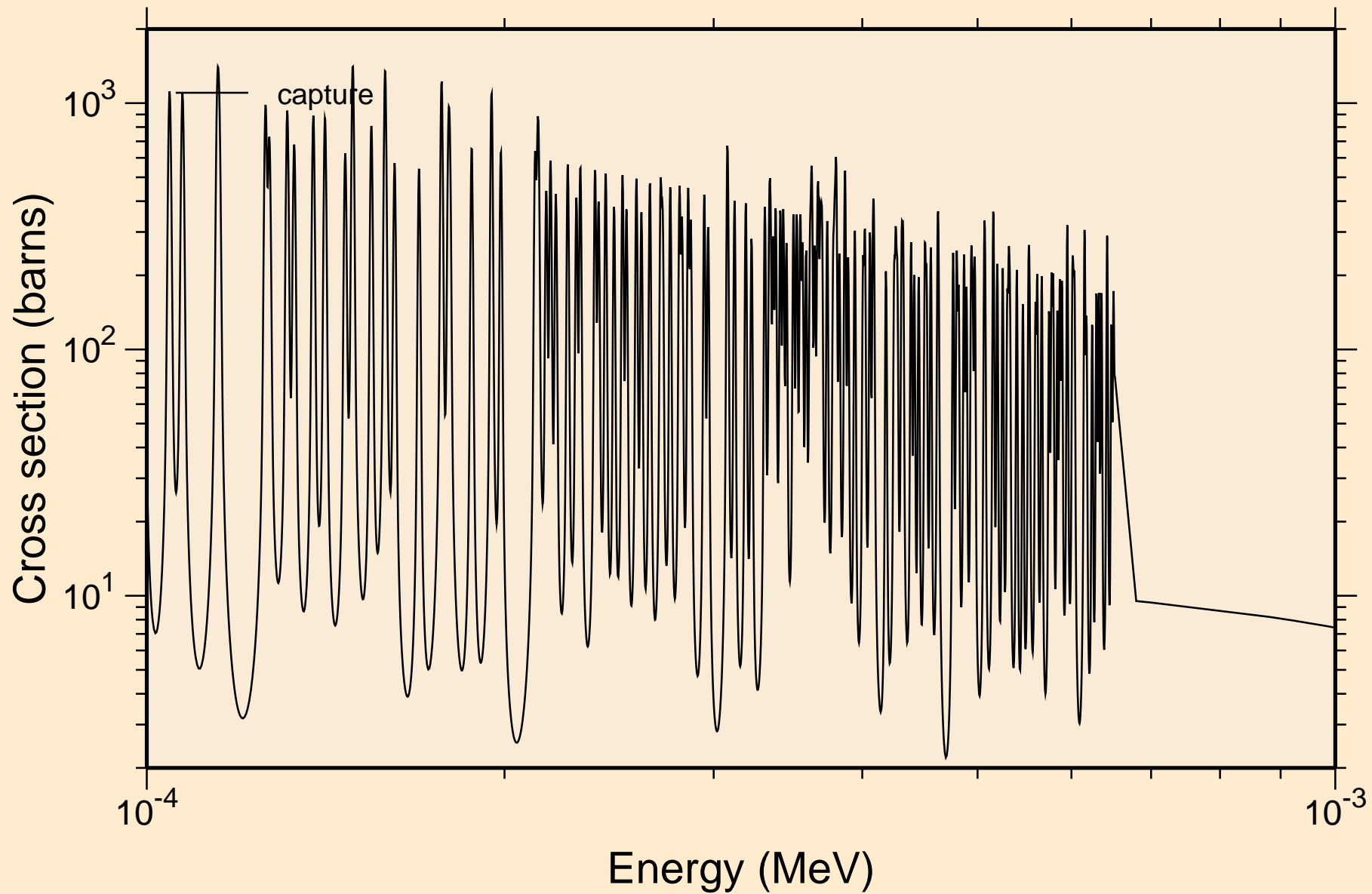



SB115 NRG TENDL-2015, AKONING  
resonance absorption cross sections

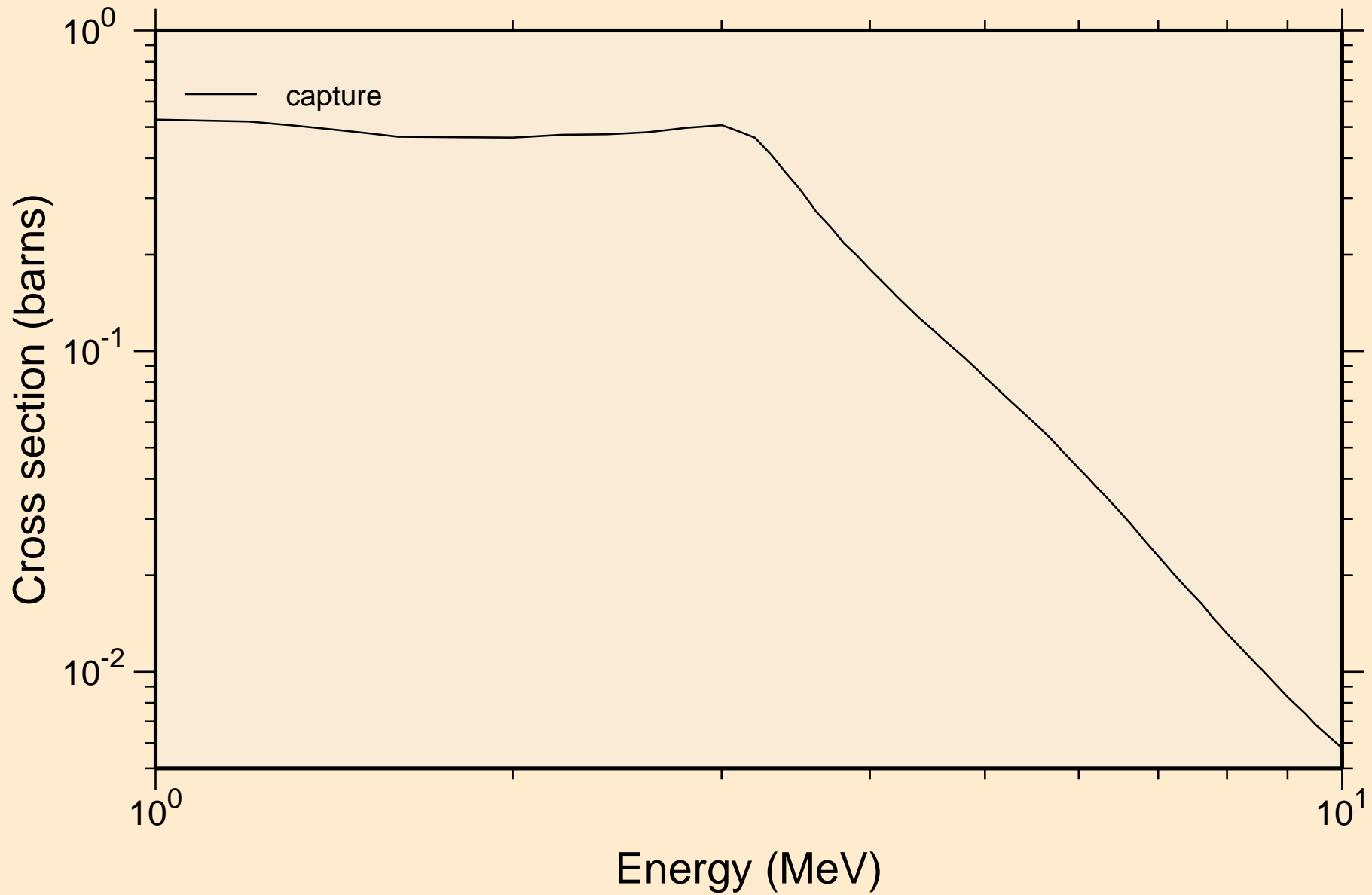

# SB115 NRG TENDL-2015, AKONING

## Non-threshold reactions

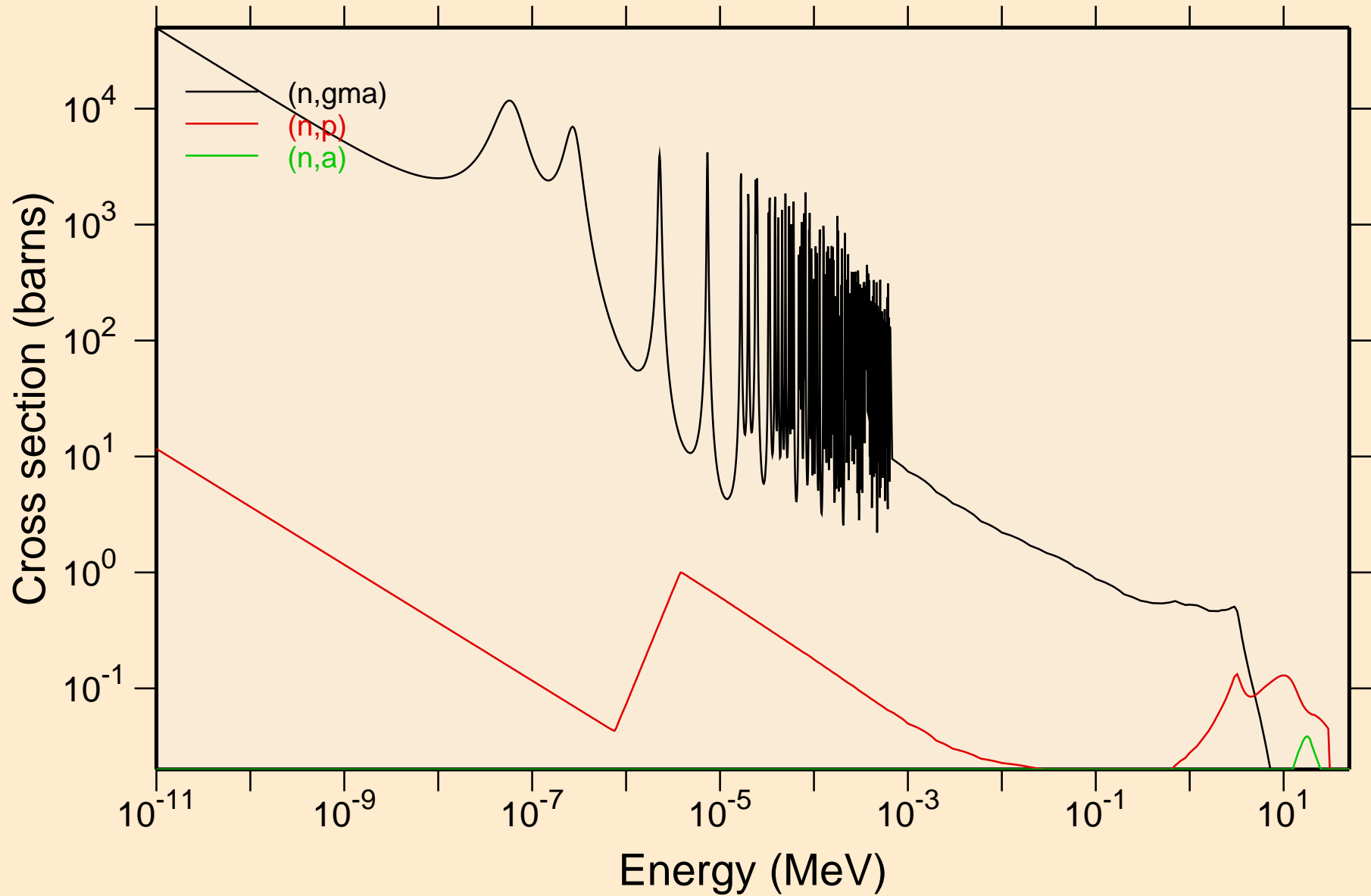

# SB115 NRG TENDL-2015, AKONING

## Principal cross sections

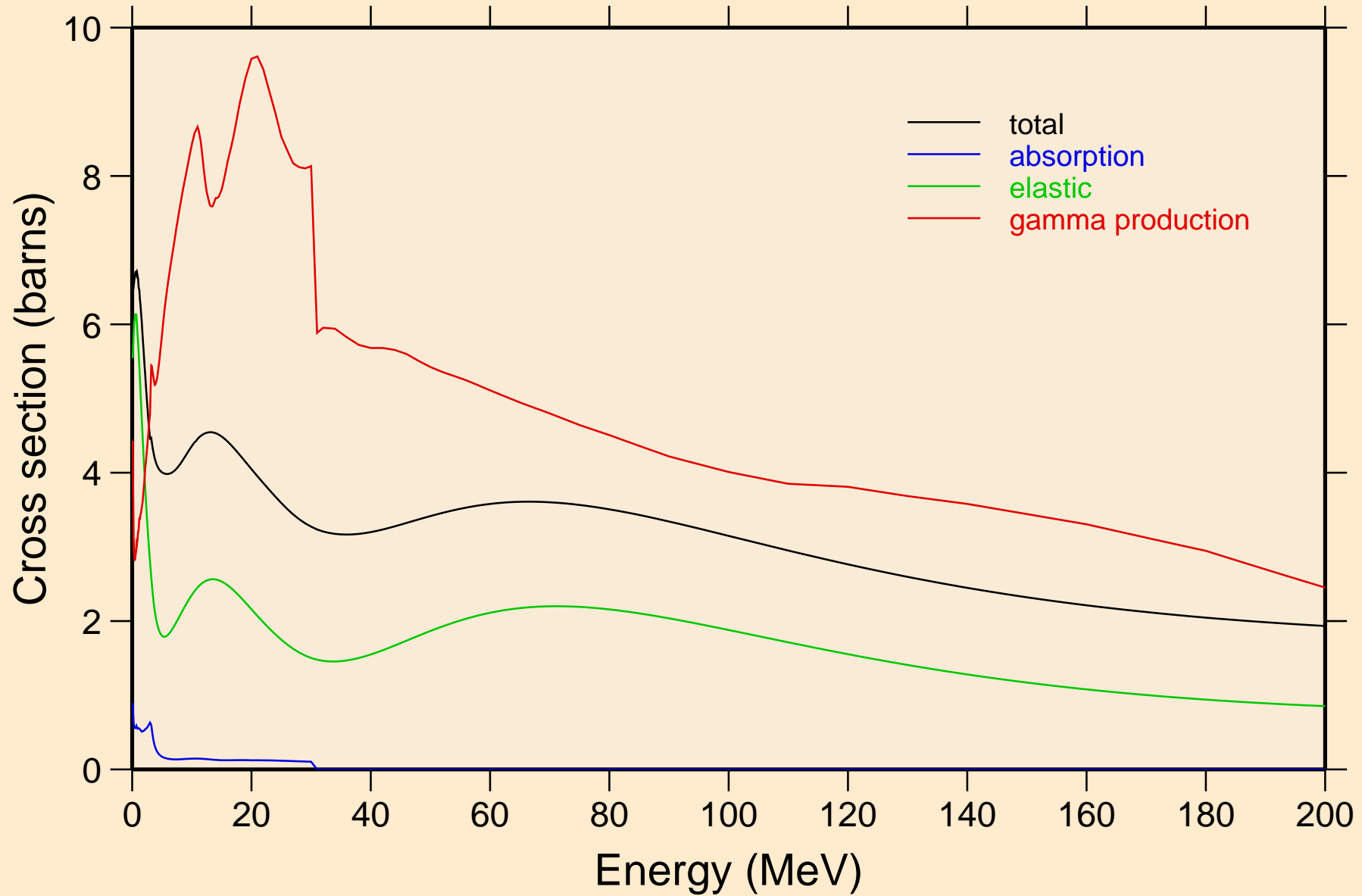

# SB115 NRG TENDL-2015, AKONING

## Non-threshold reactions

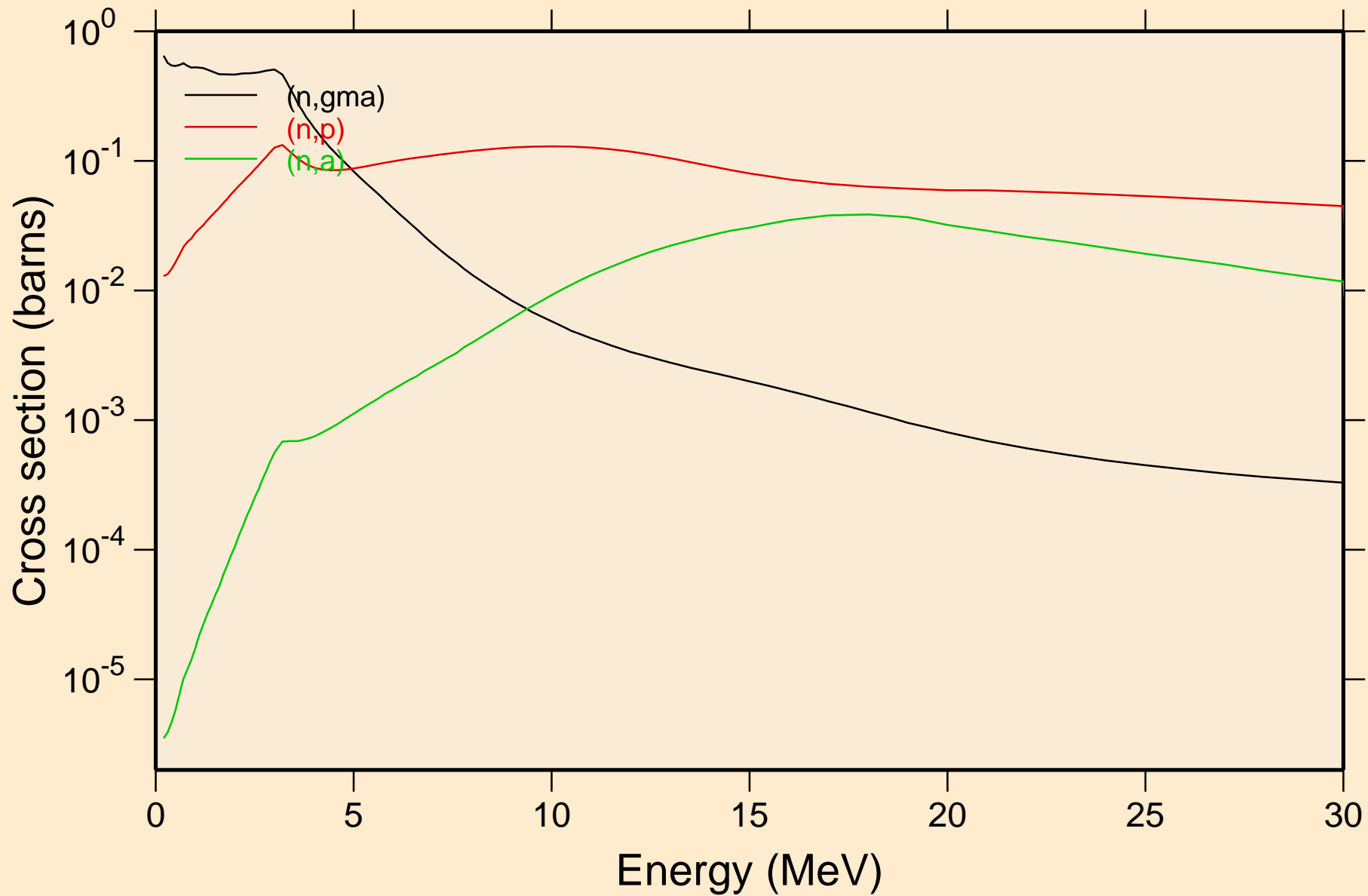

# SB115 NRG TENDL-2015, AKONING

## Inelastic levels

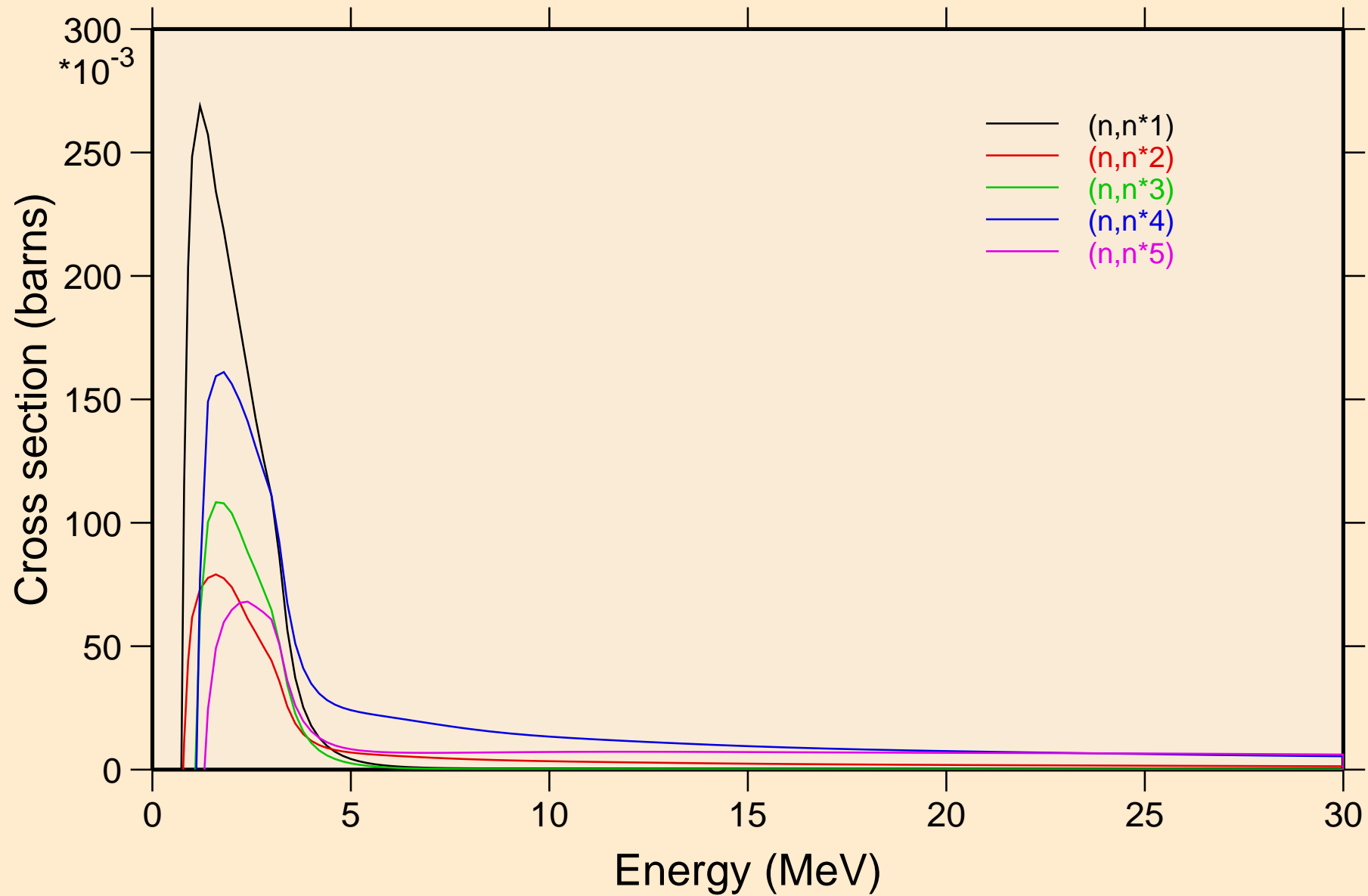

# SB115 NRG TENDL-2015, AKONING

## Inelastic levels

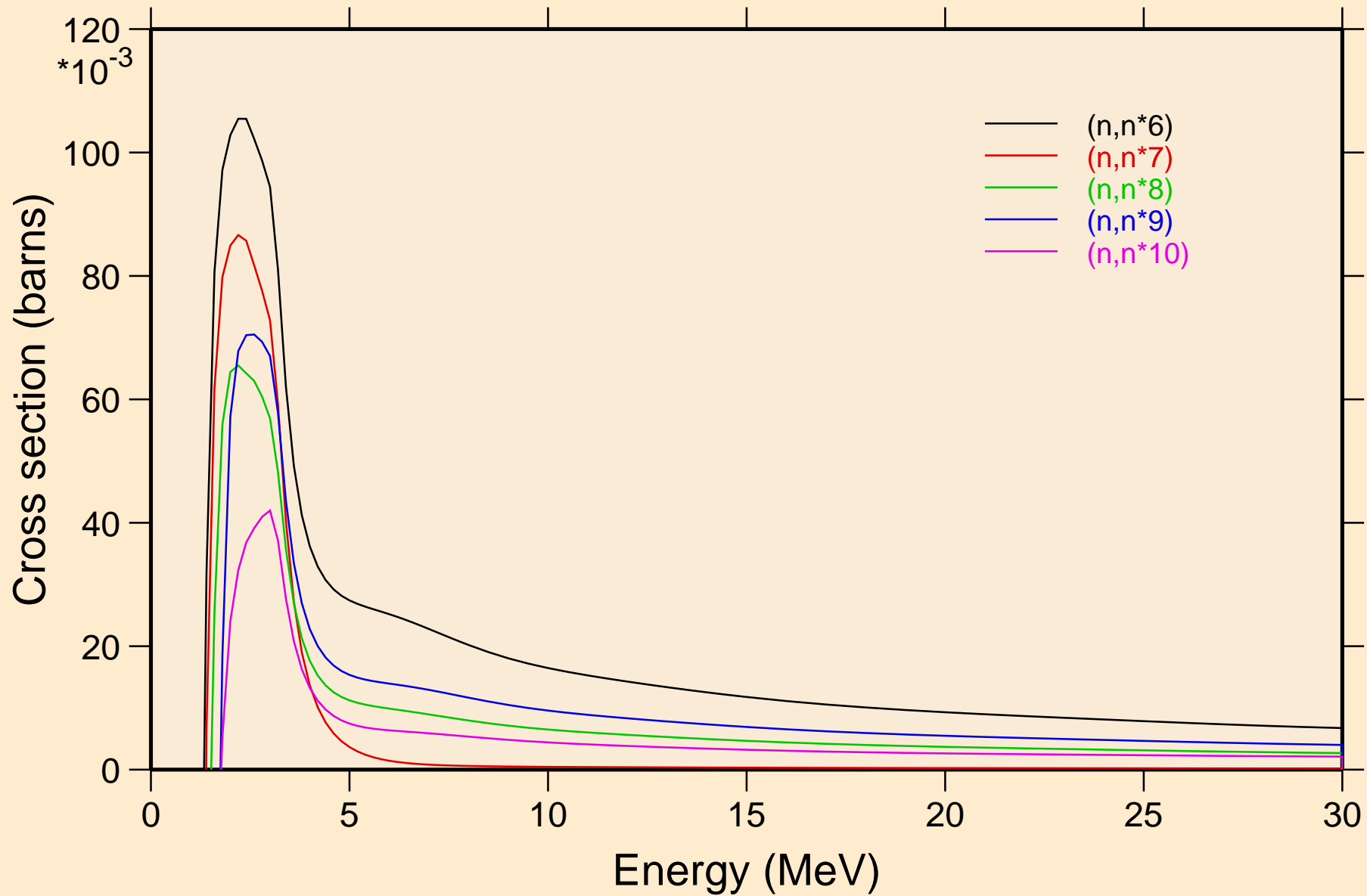

# SB115 NRG TENDL-2015, AKONING

## Inelastic levels

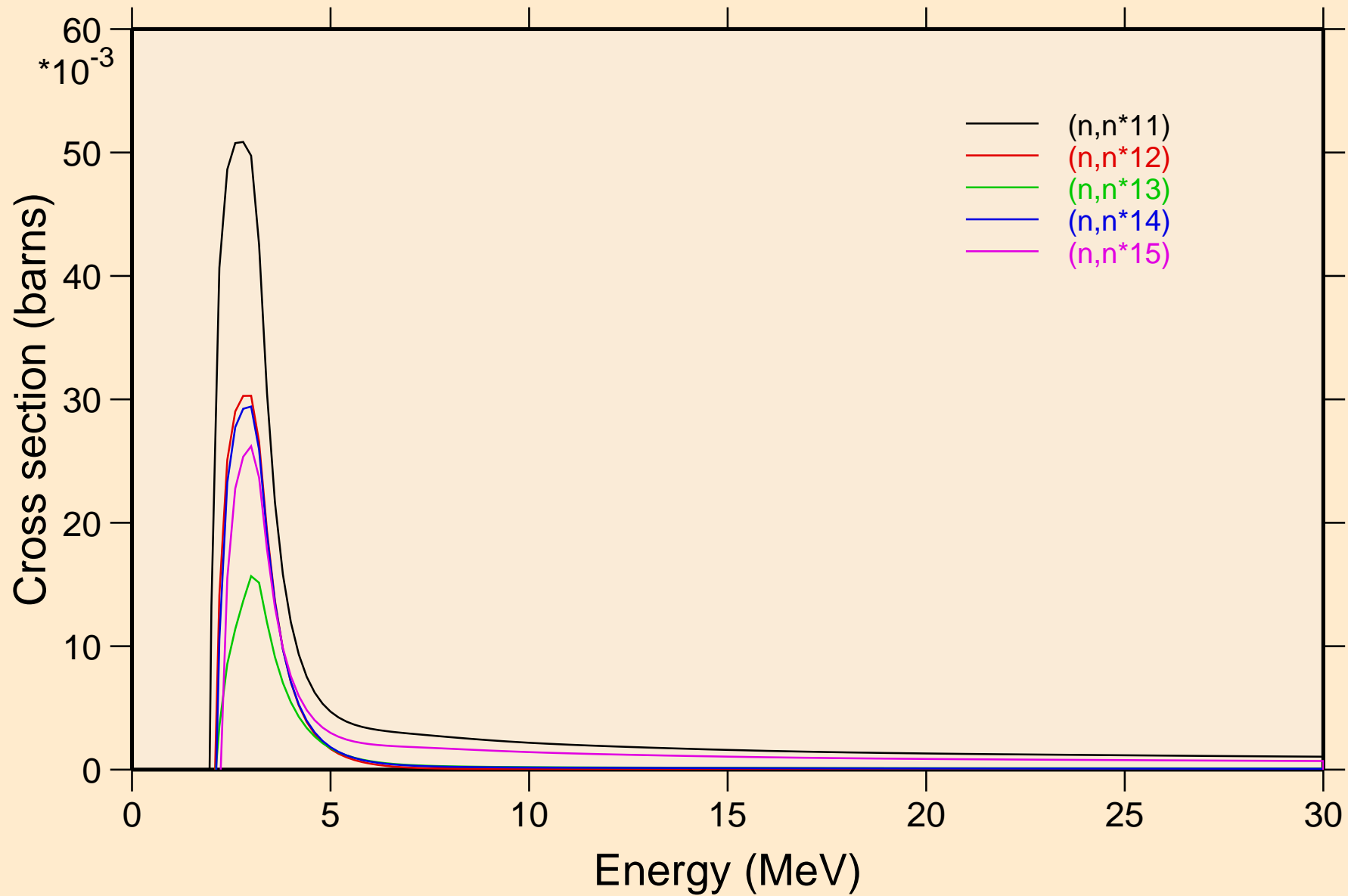

# SB115 NRG TENDL-2015, AKONING

## Inelastic levels

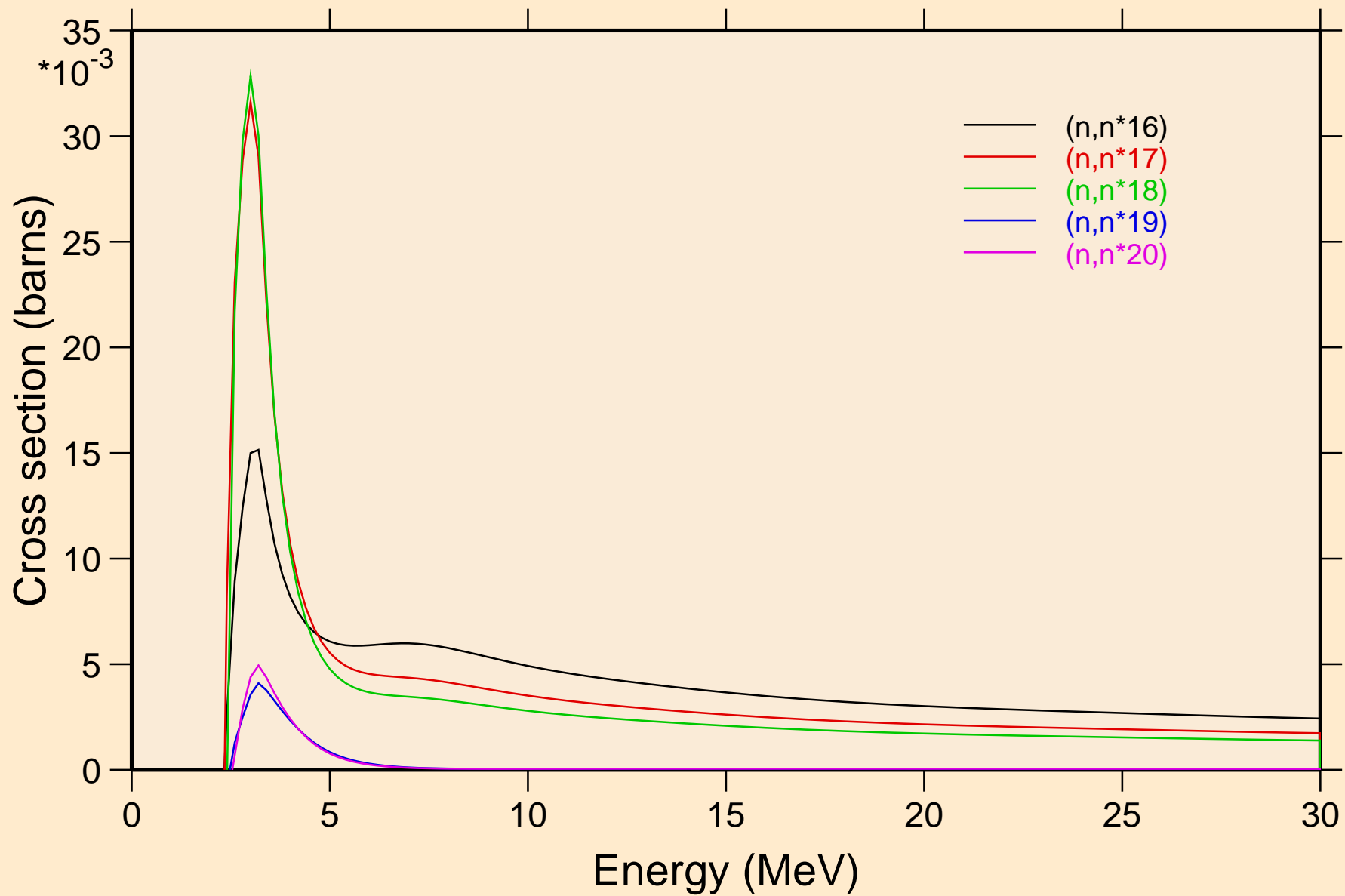



# SB115 NRG TENDL-2015, AKONING

## Inelastic levels

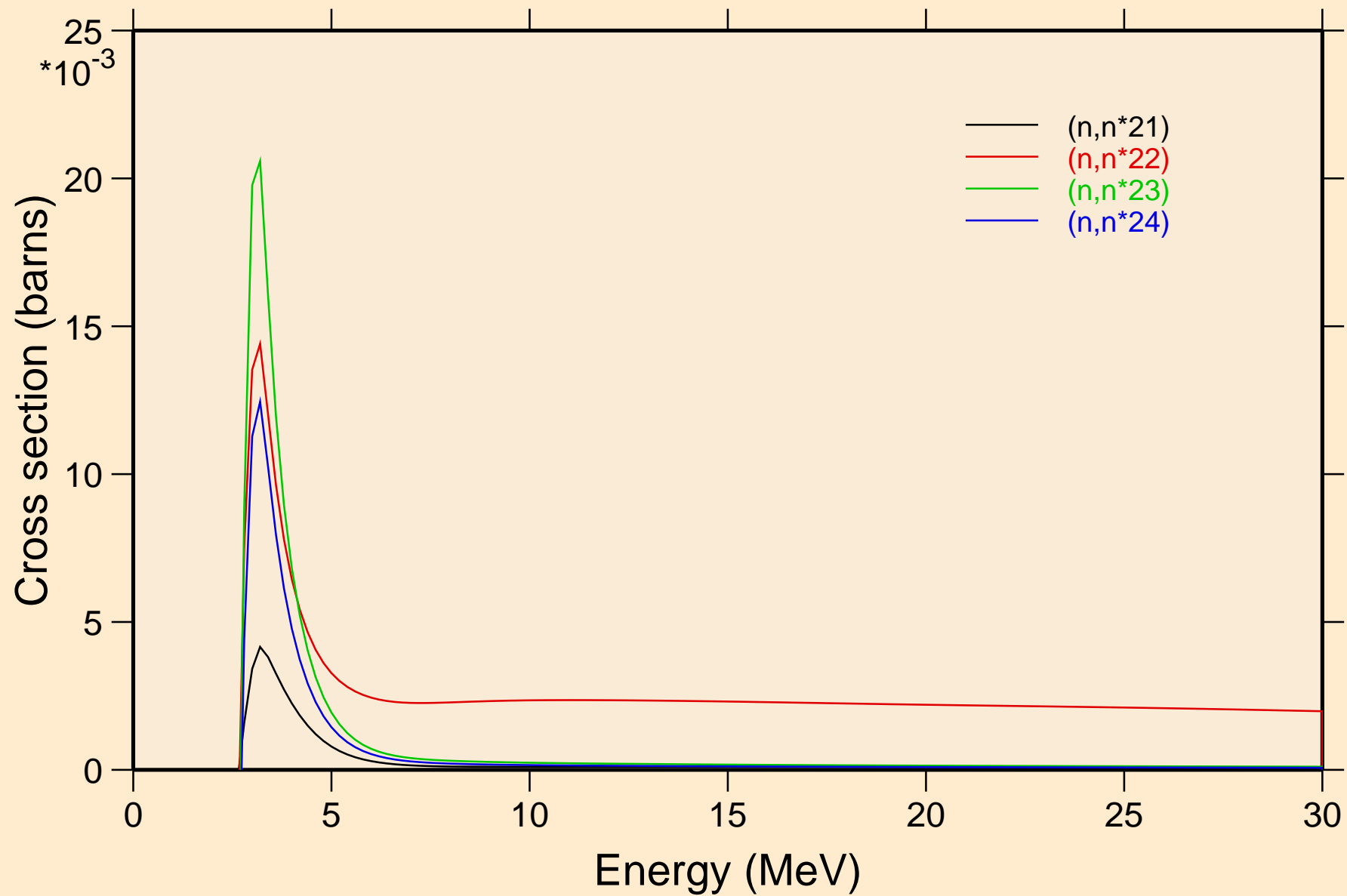

# SB115 NRG TENDL-2015, AKONING

## Threshold reactions

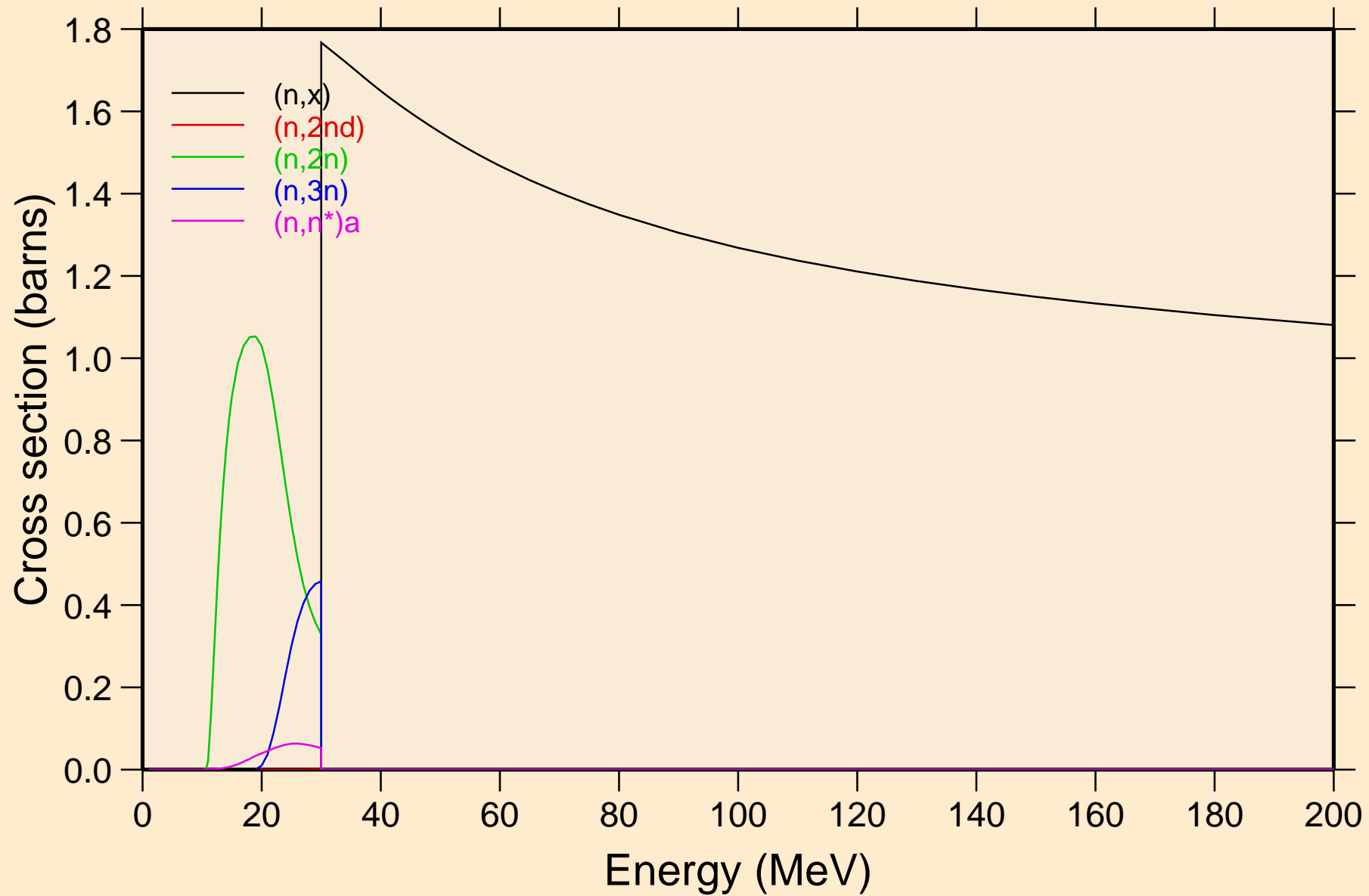

# SB115 NRG TENDL-2015, AKONING

## Threshold reactions

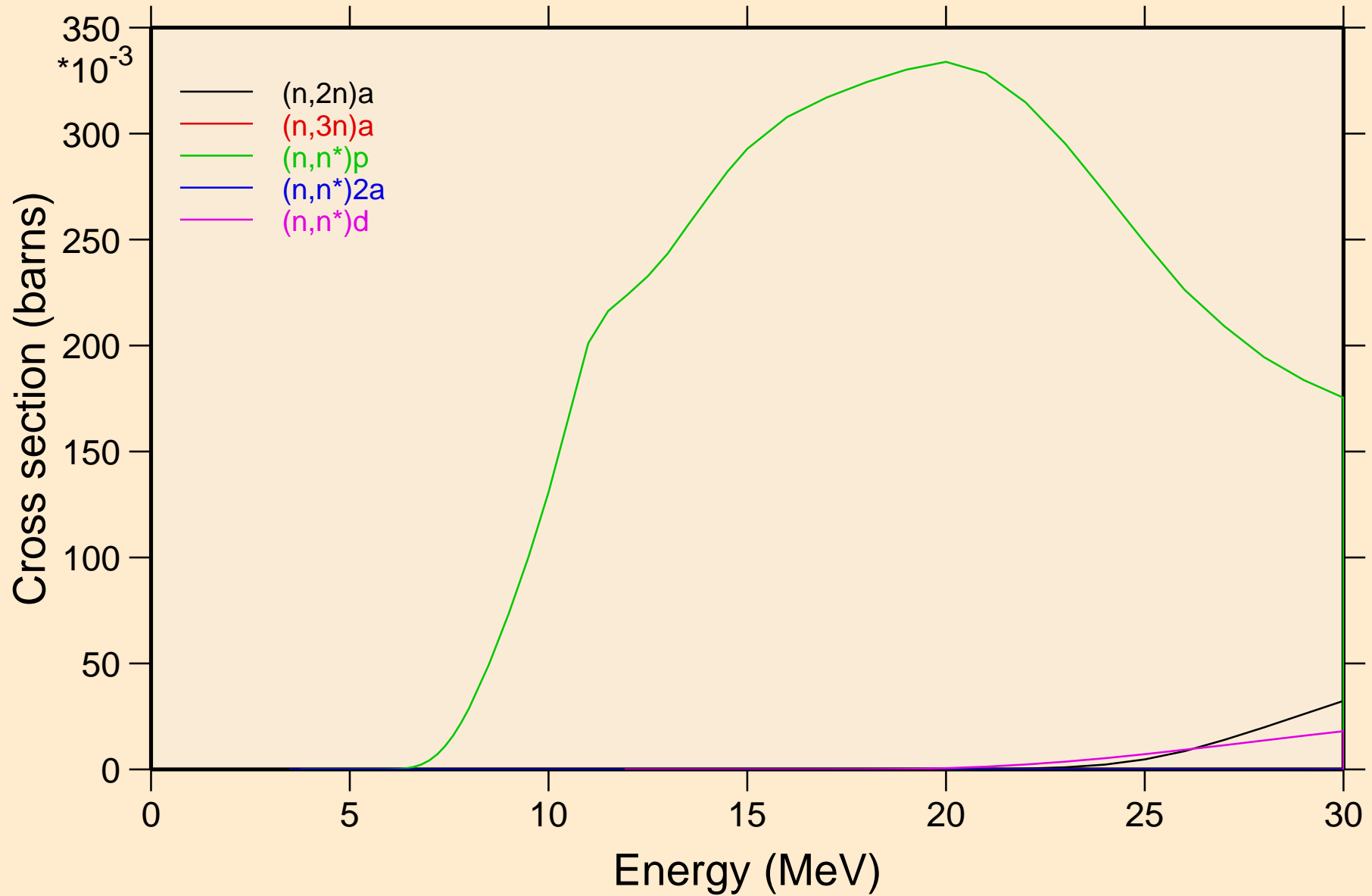

# SB115 NRG TENDL-2015, AKONING

## Threshold reactions

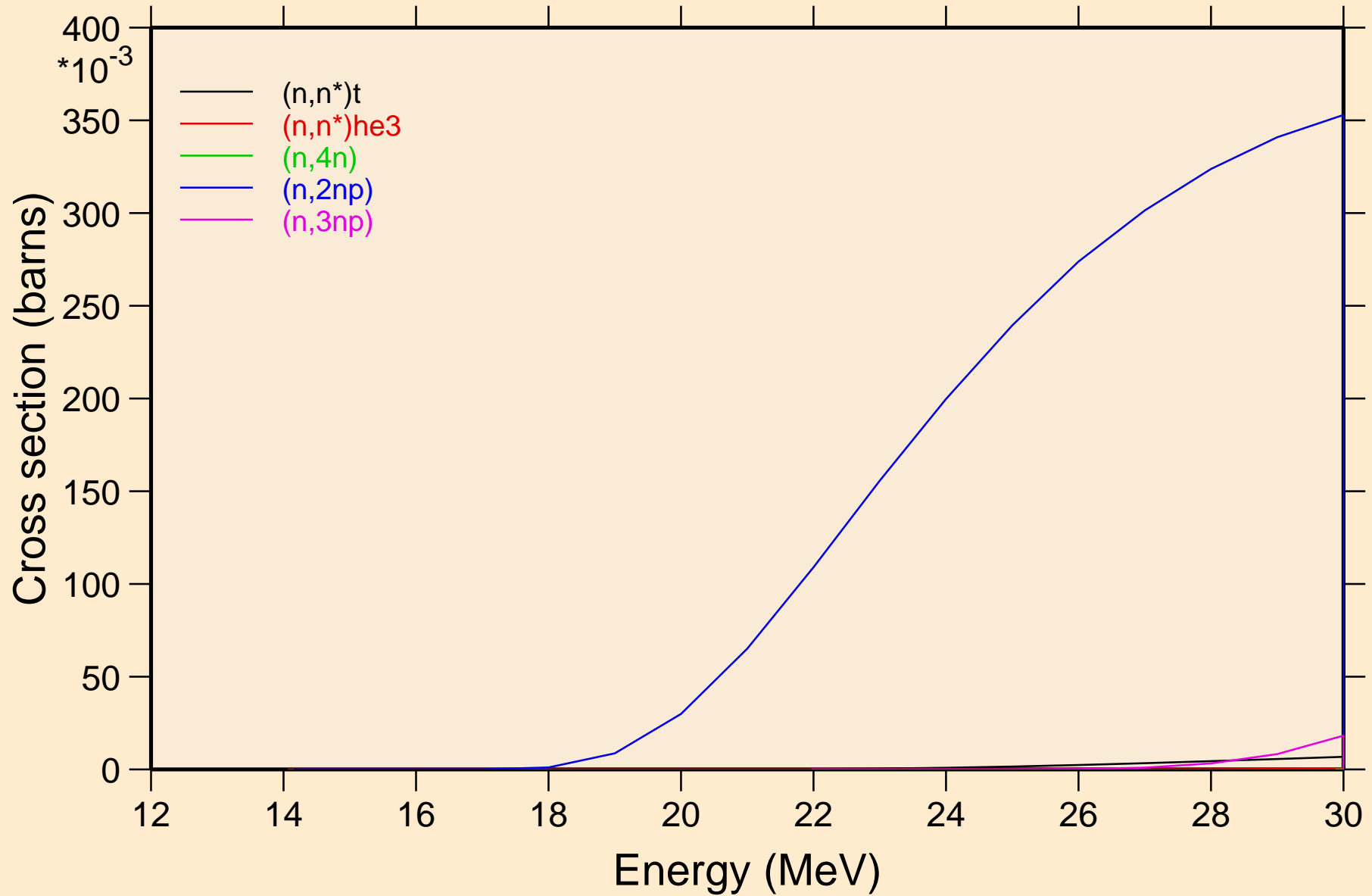

# SB115 NRG TENDL-2015, AKONING

## Threshold reactions

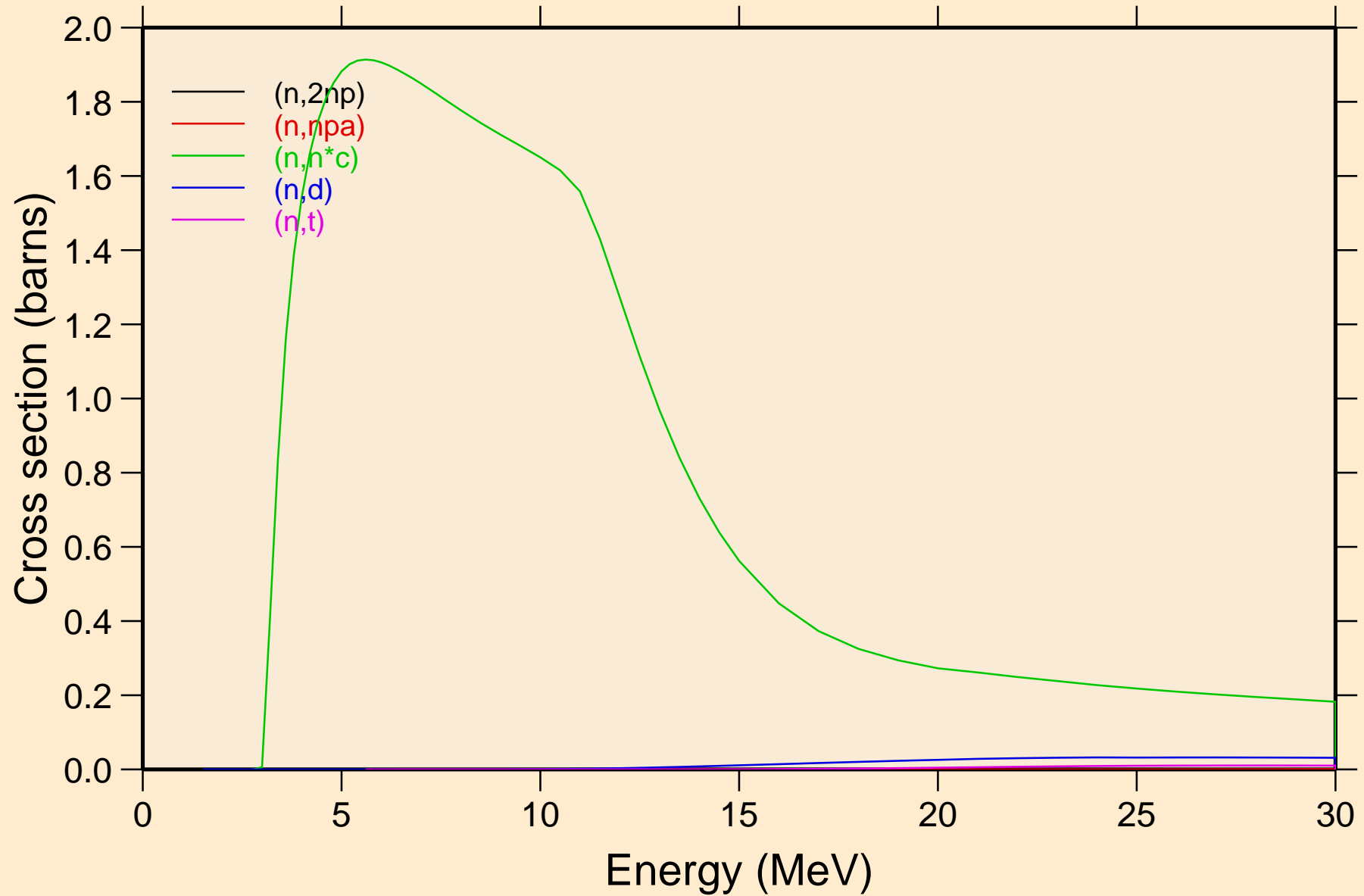

# SB115 NRG TENDL-2015, AKONING

## Threshold reactions

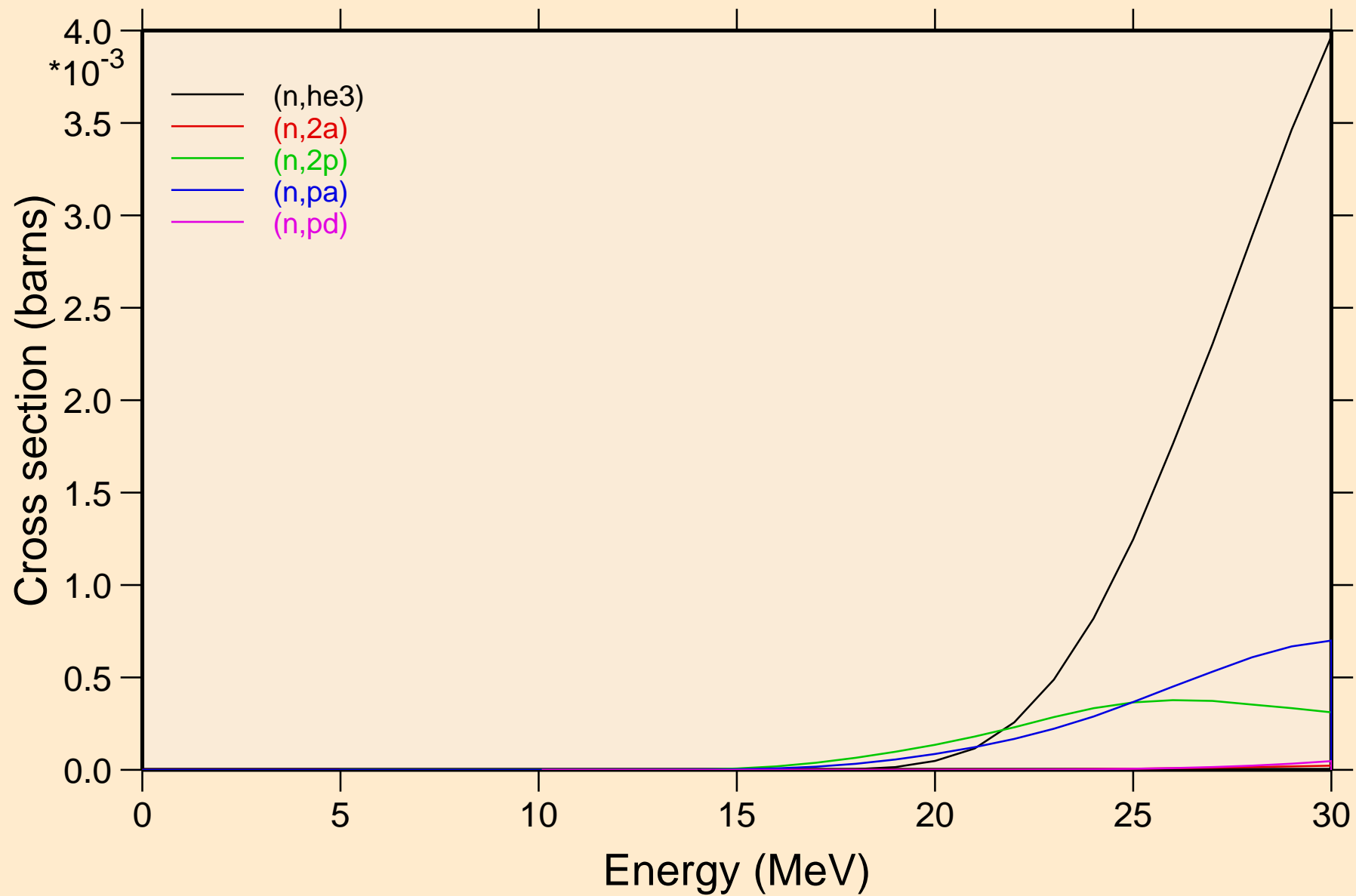

# SB115 NRG TENDL-2015, AKONING

## Threshold reactions

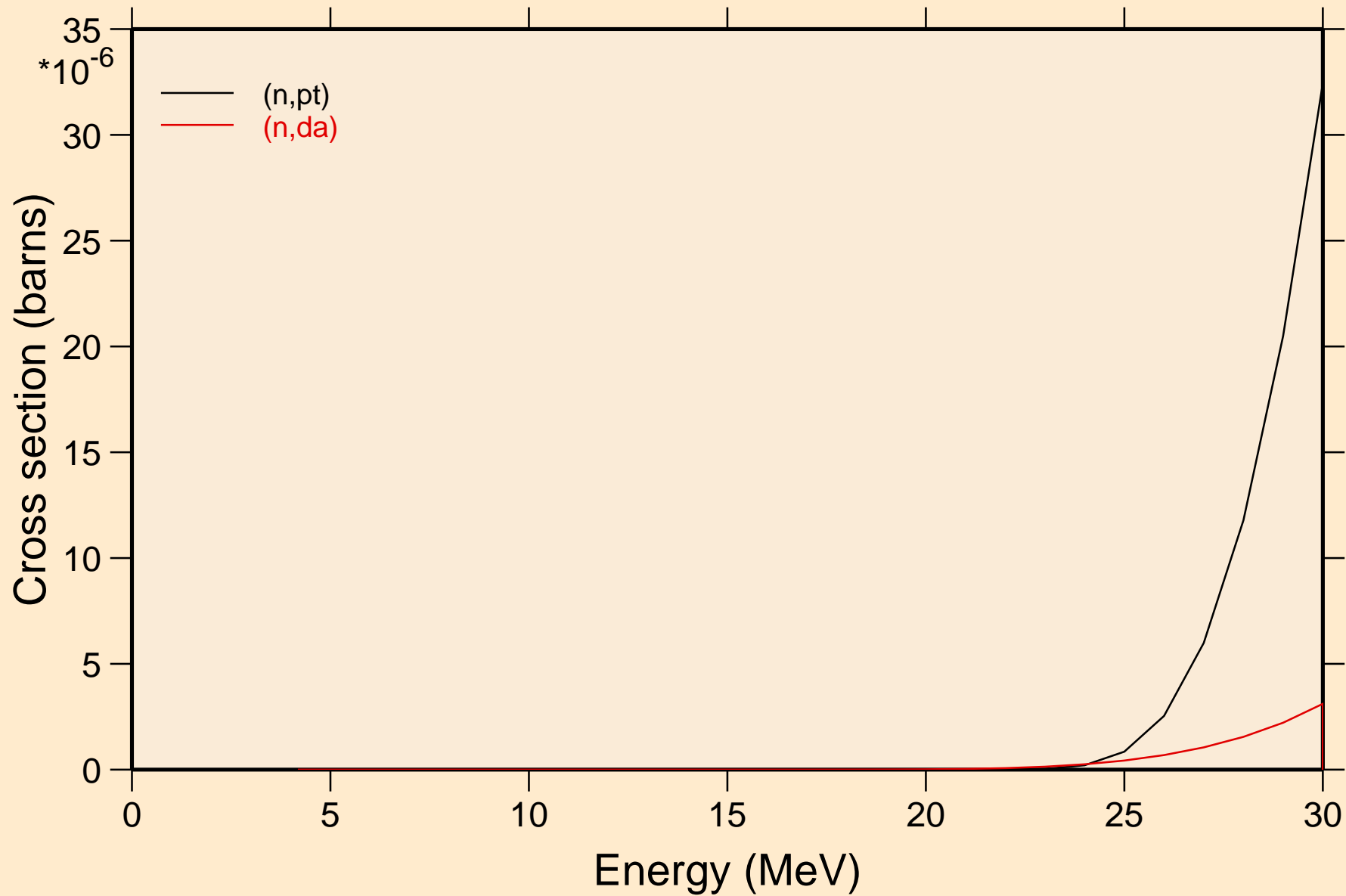

SB115 NRG TENDL-2015, AKONING  
angular distribution for elastic

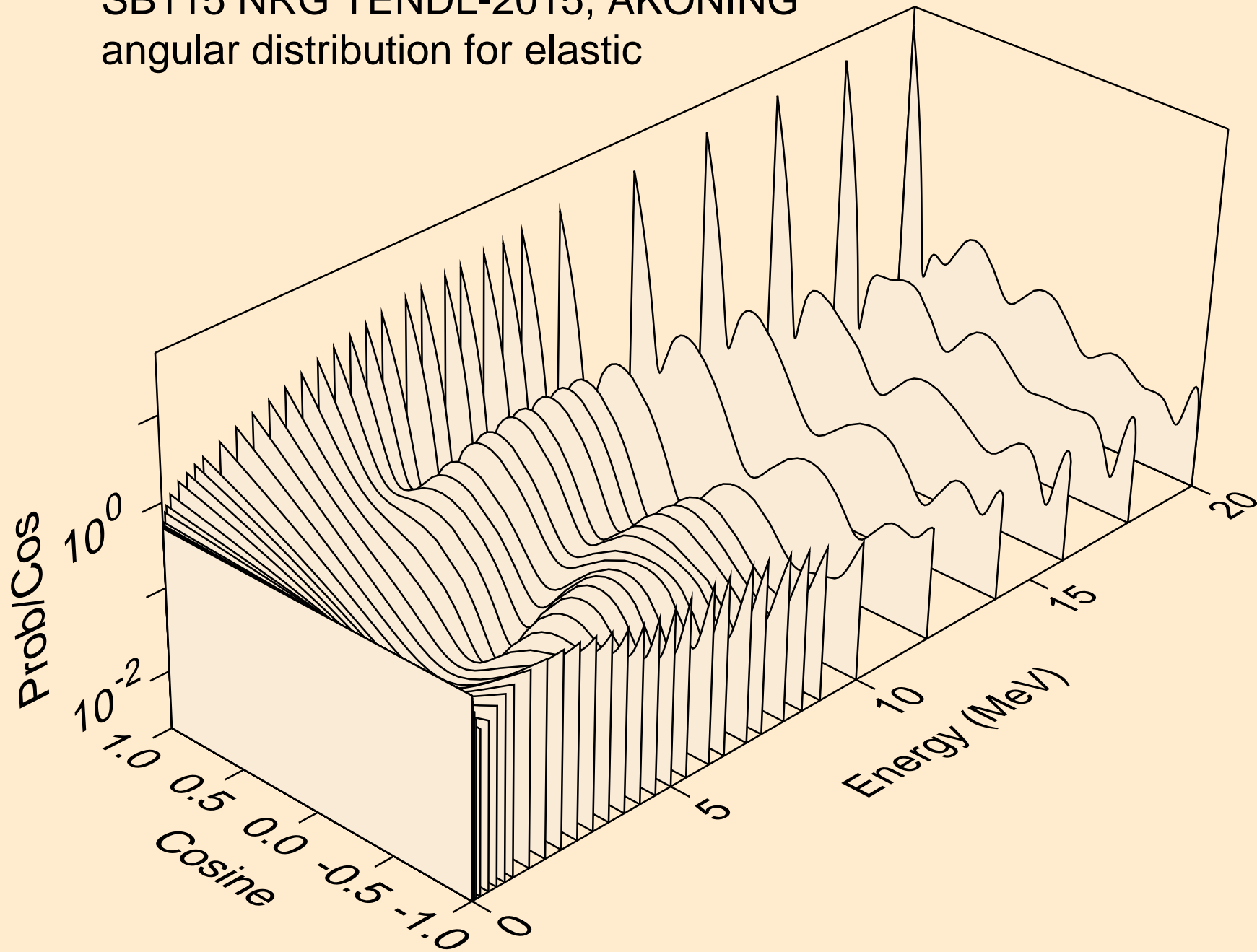



SB115 NRG TENDL-2015, AKONING  
angular distribution for elastic

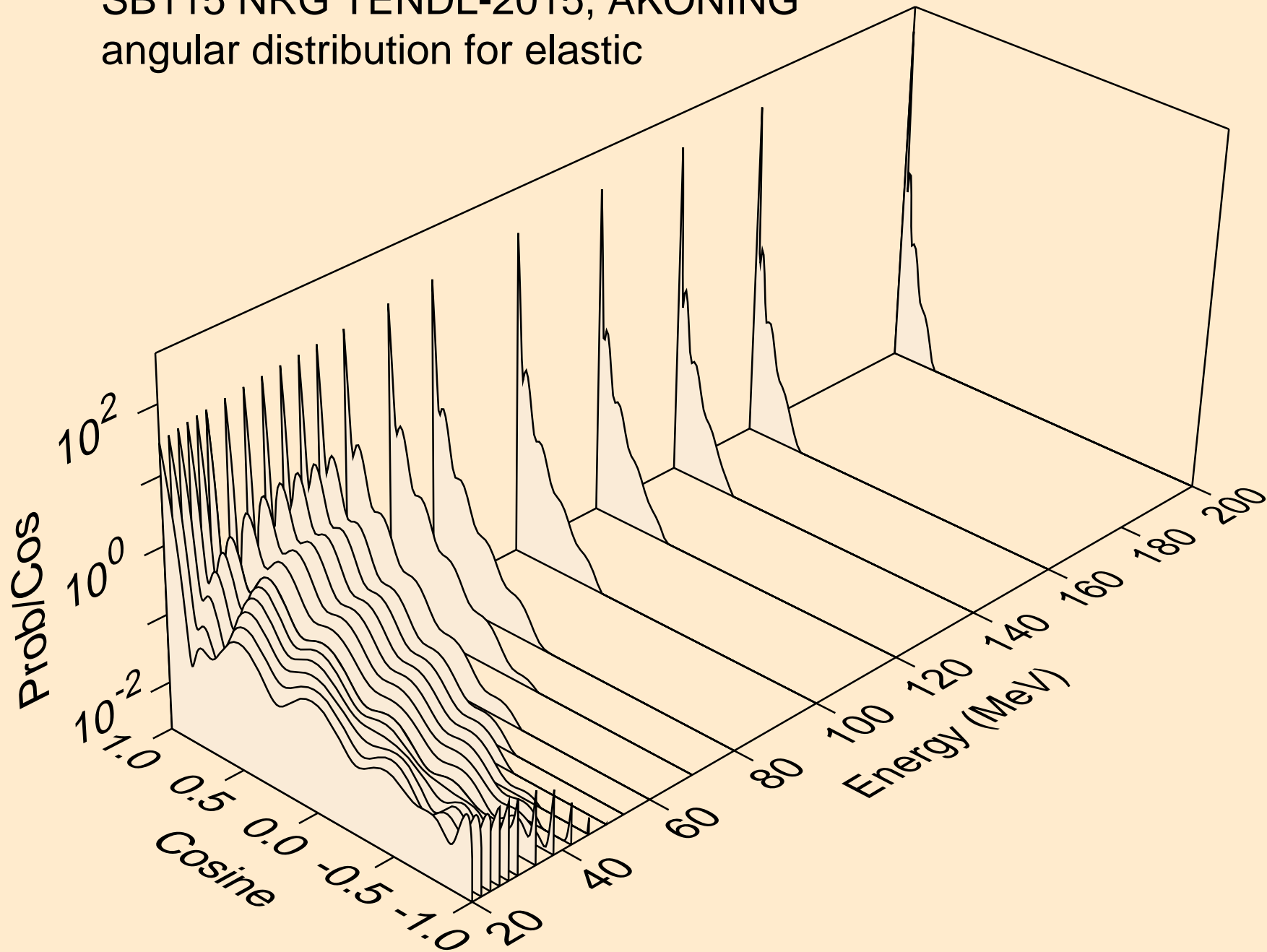

SB115 NRG TENDL-2015, AKONING  
angular distribution for (n,n\*1)

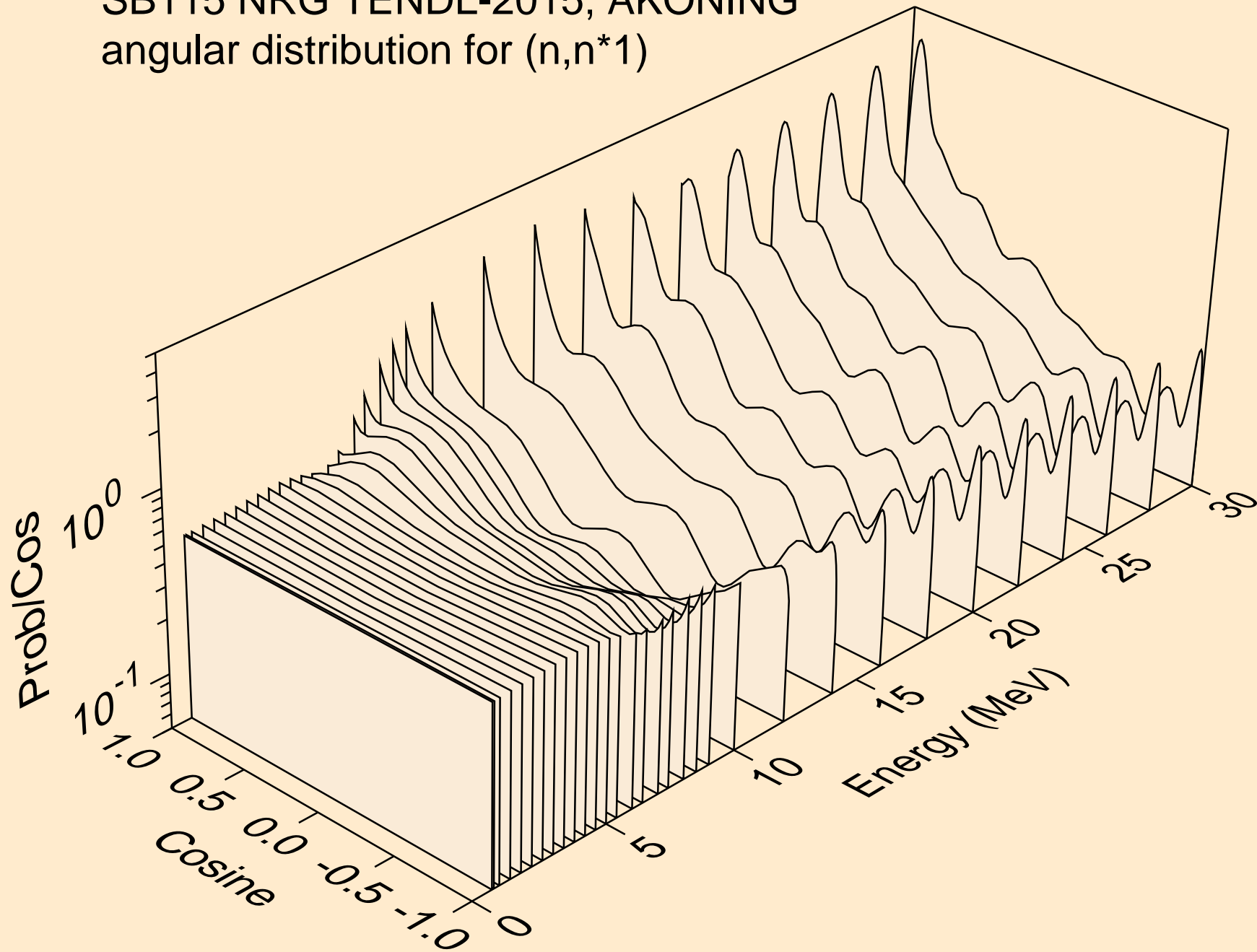

SB115 NRG TENDL-2015, AKONING  
angular distribution for (n,n\*2)

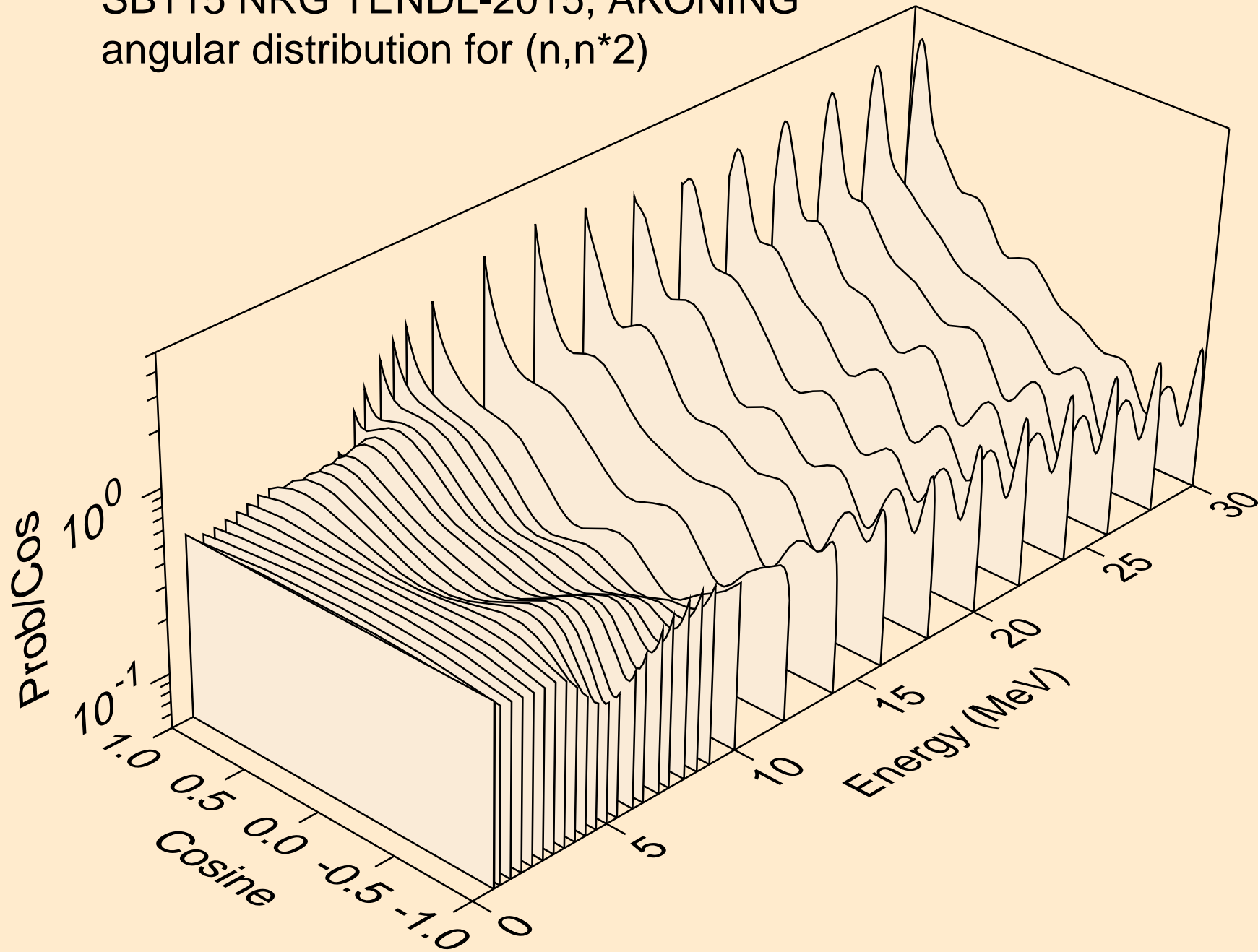

SB115 NRG TENDL-2015, AKONING  
angular distribution for (n,n\*3)

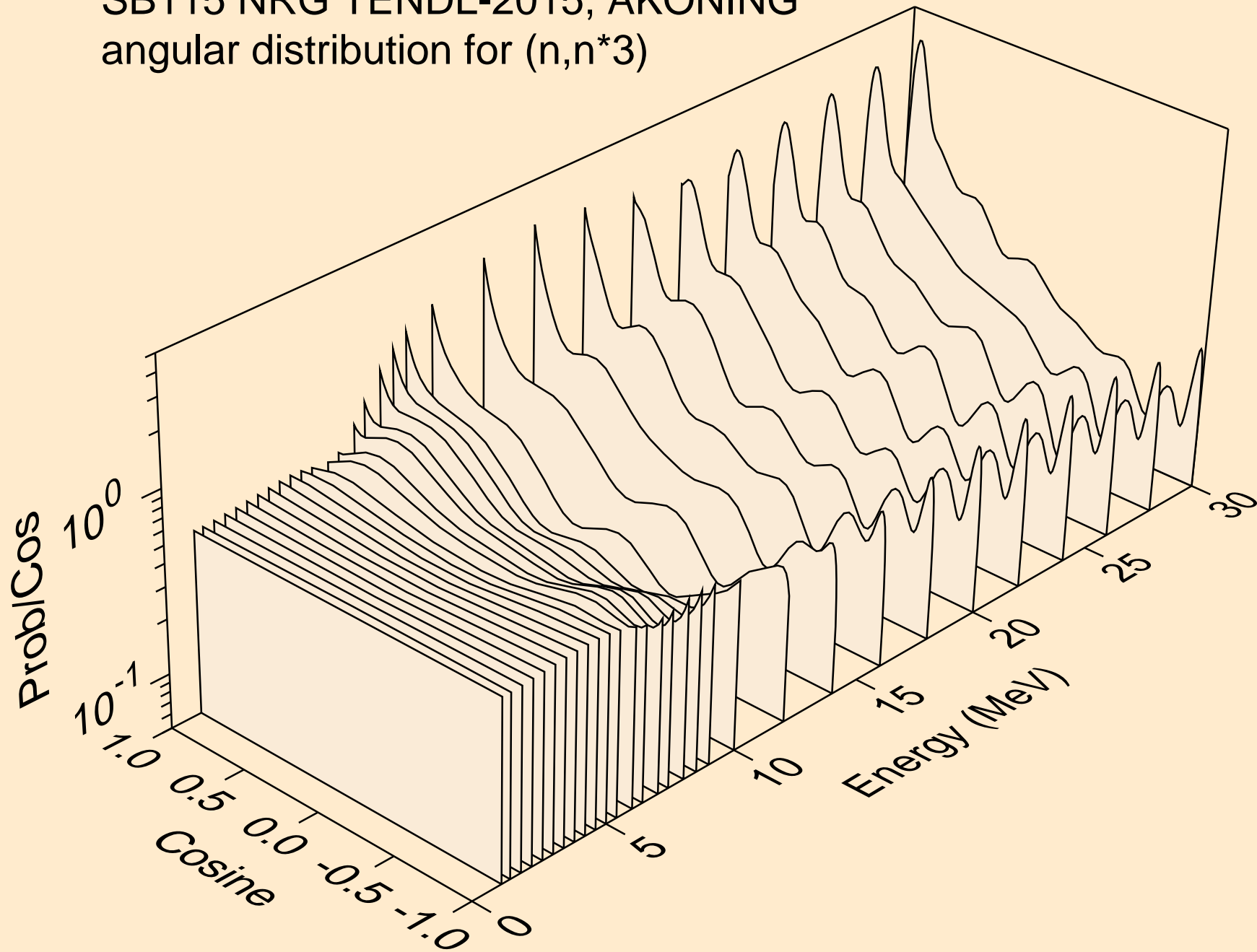

SB115 NRG TENDL-2015, AKONING  
angular distribution for (n,n\*4)

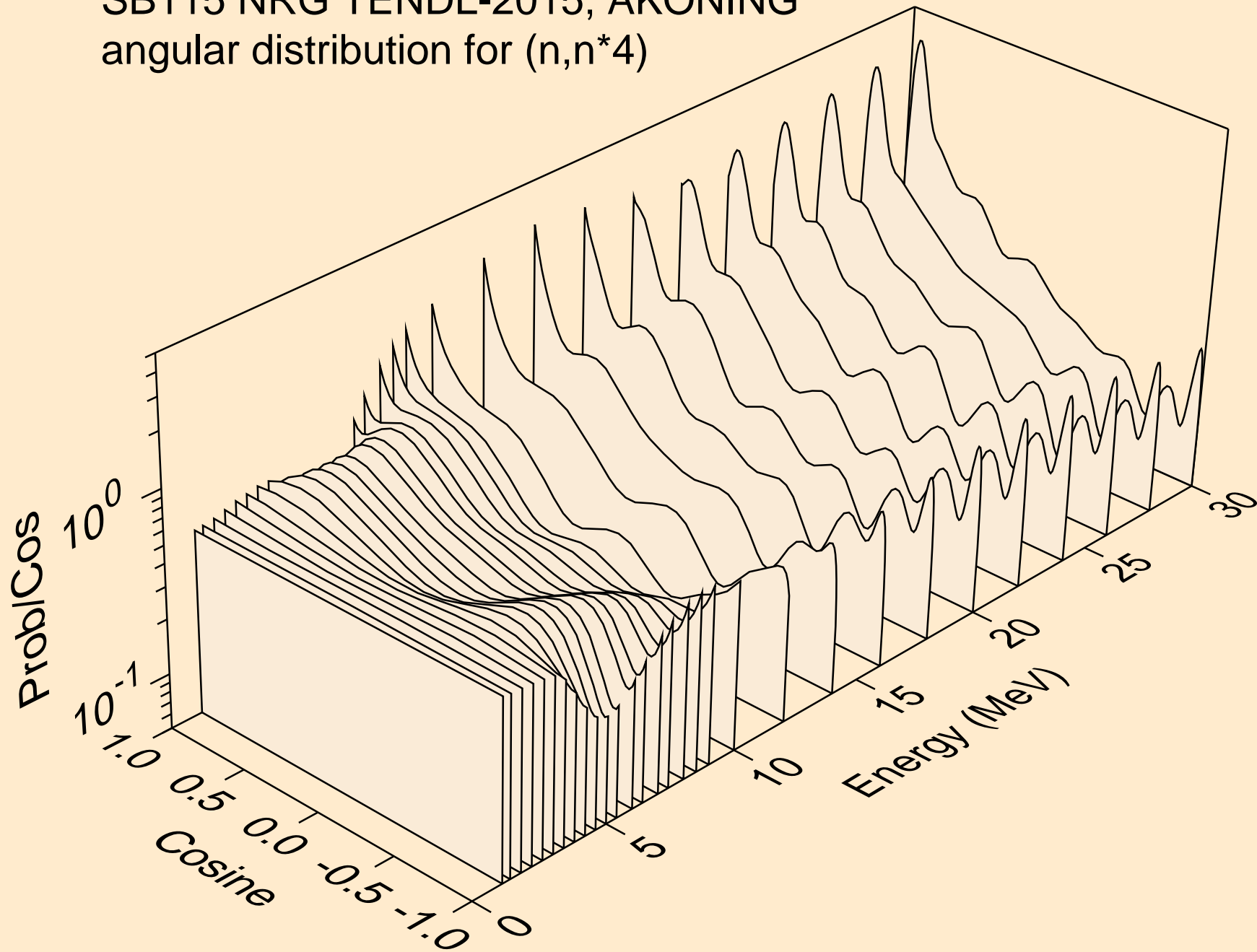

SB115 NRG TENDL-2015, AKONING  
angular distribution for (n,n\*5)

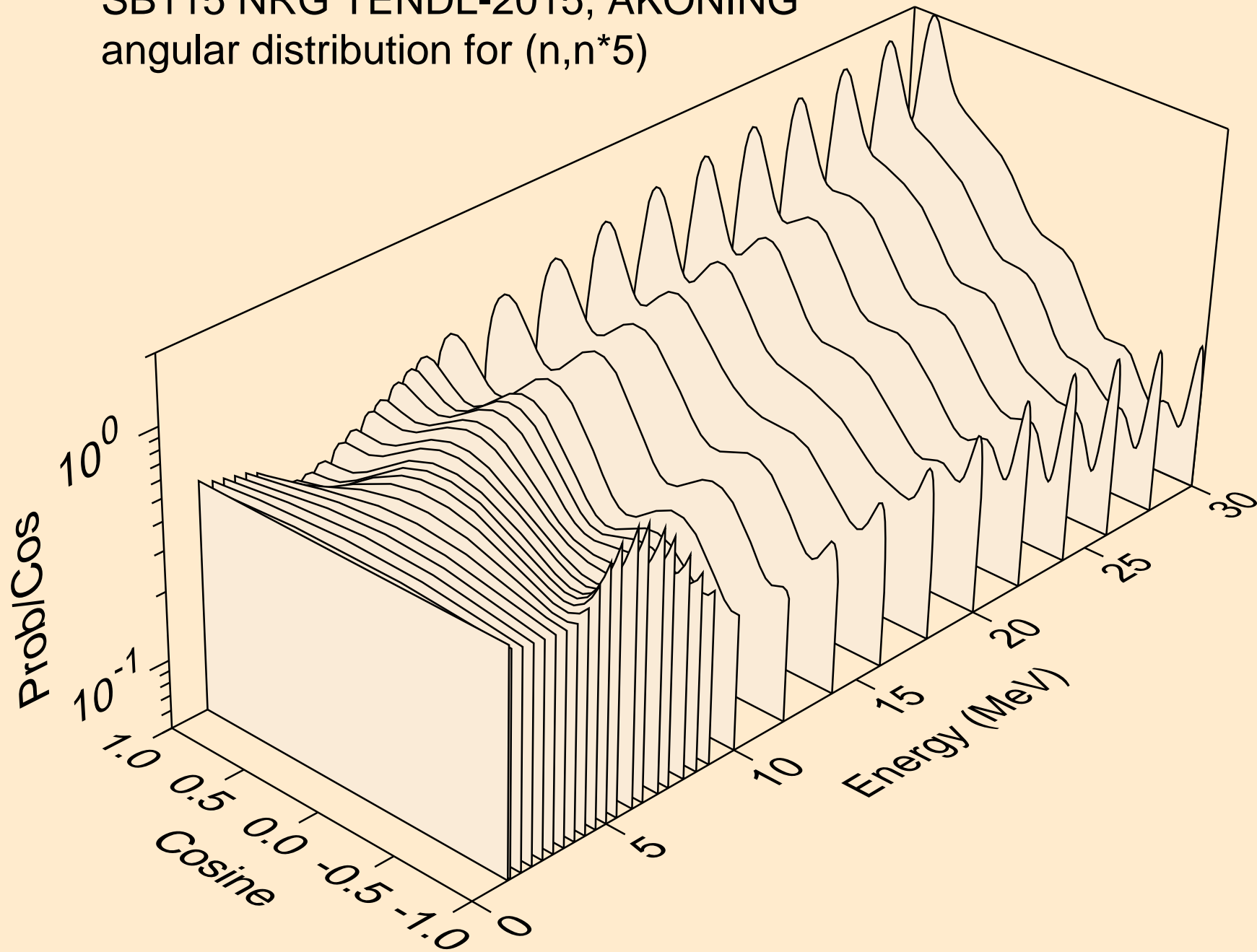

SB115 NRG TENDL-2015, AKONING  
angular distribution for (n,n\*6)

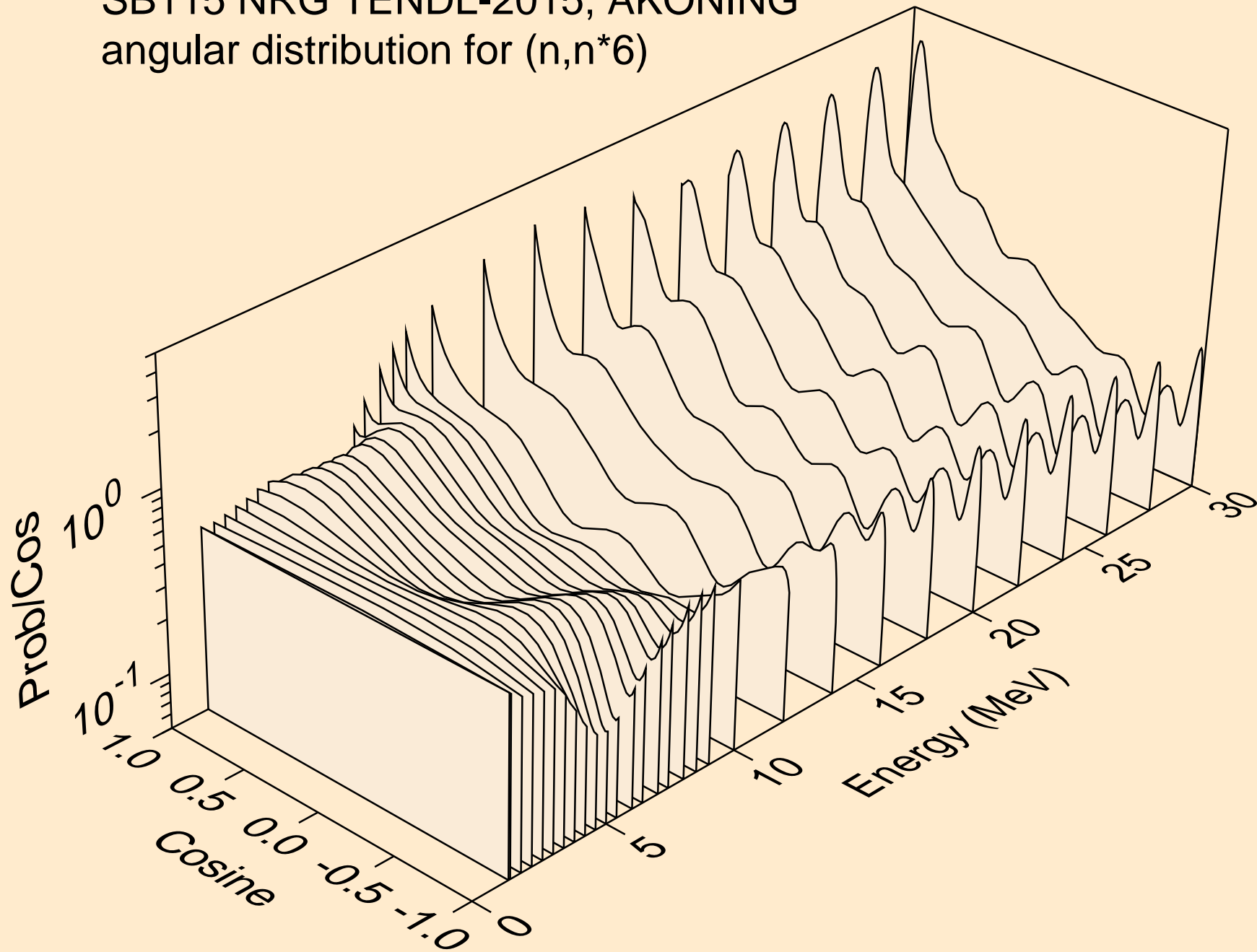

SB115 NRG TENDL-2015, AKONING  
angular distribution for (n,n\*7)

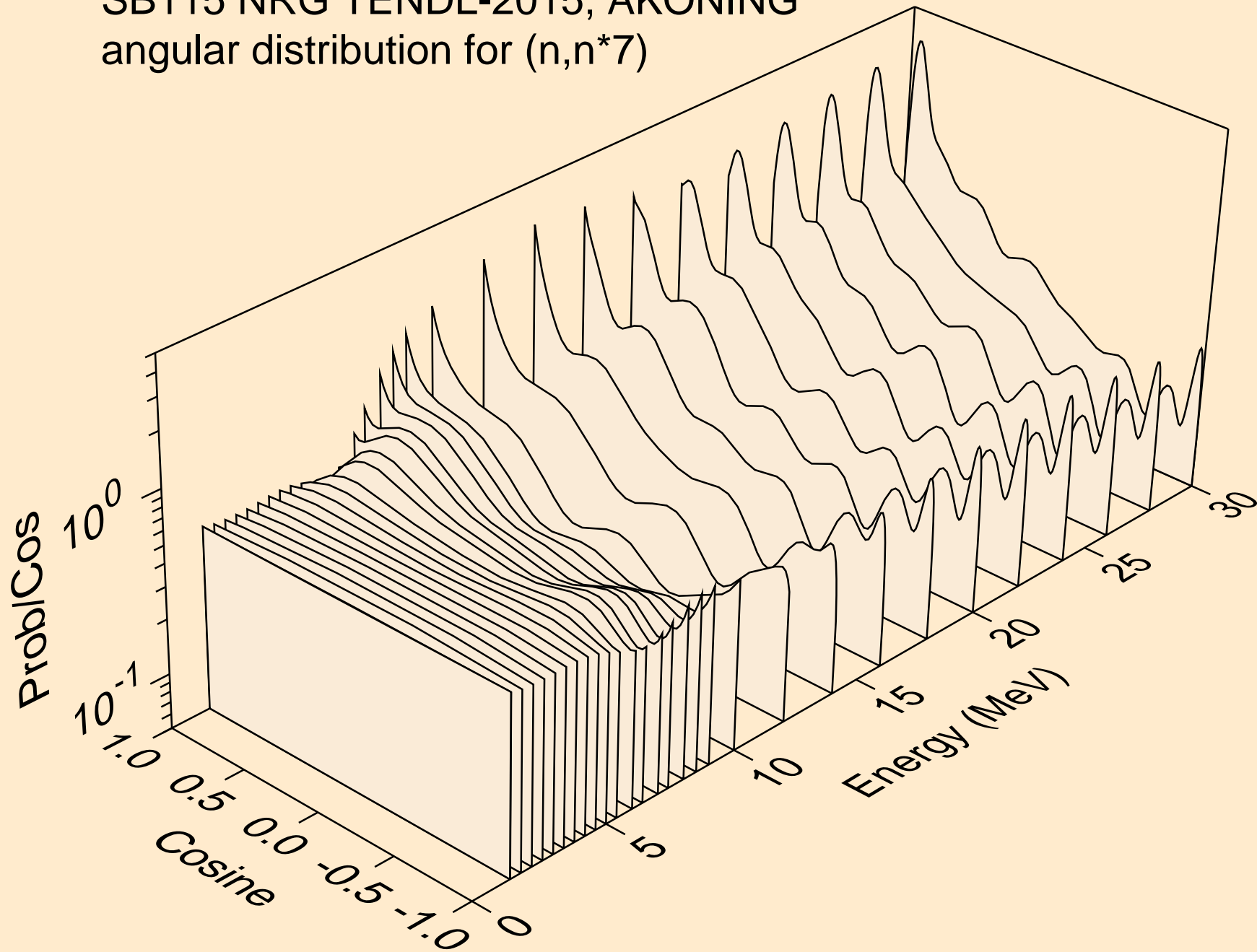



SB115 NRG TENDL-2015, AKONING  
angular distribution for (n,n\*8)

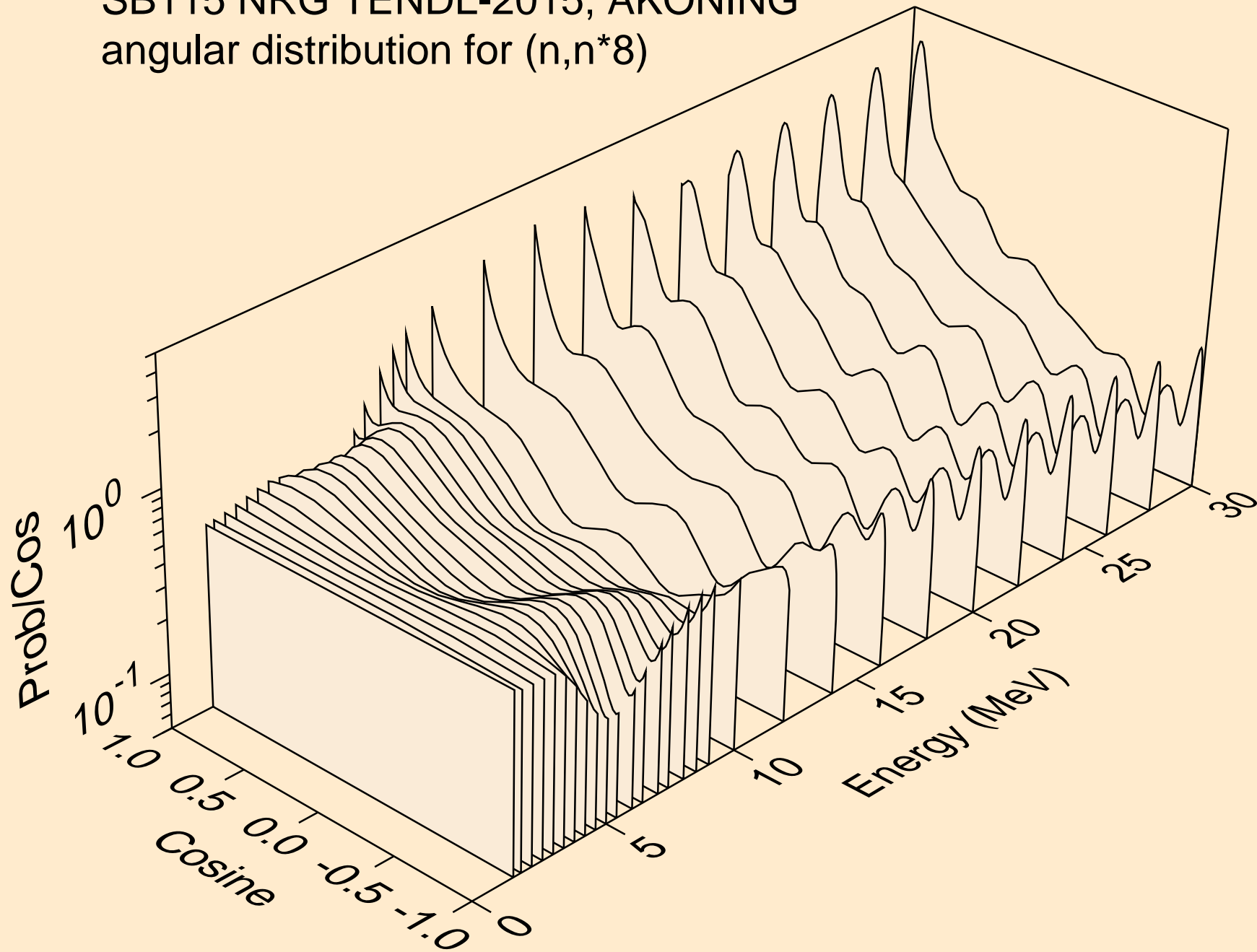

SB115 NRG TENDL-2015, AKONING  
angular distribution for (n,n\*9)

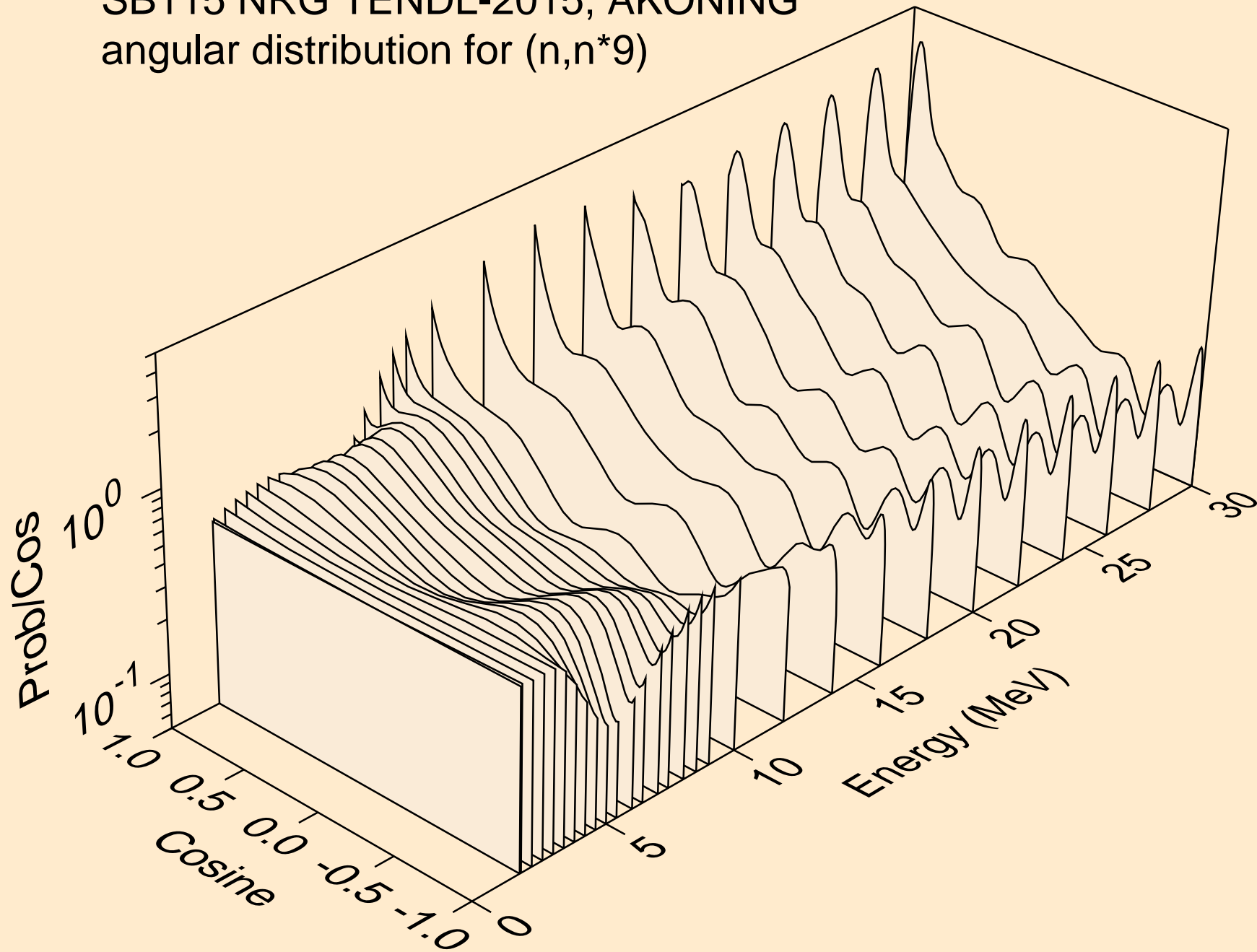

SB115 NRG TENDL-2015, AKONING  
angular distribution for (n,n\*10)

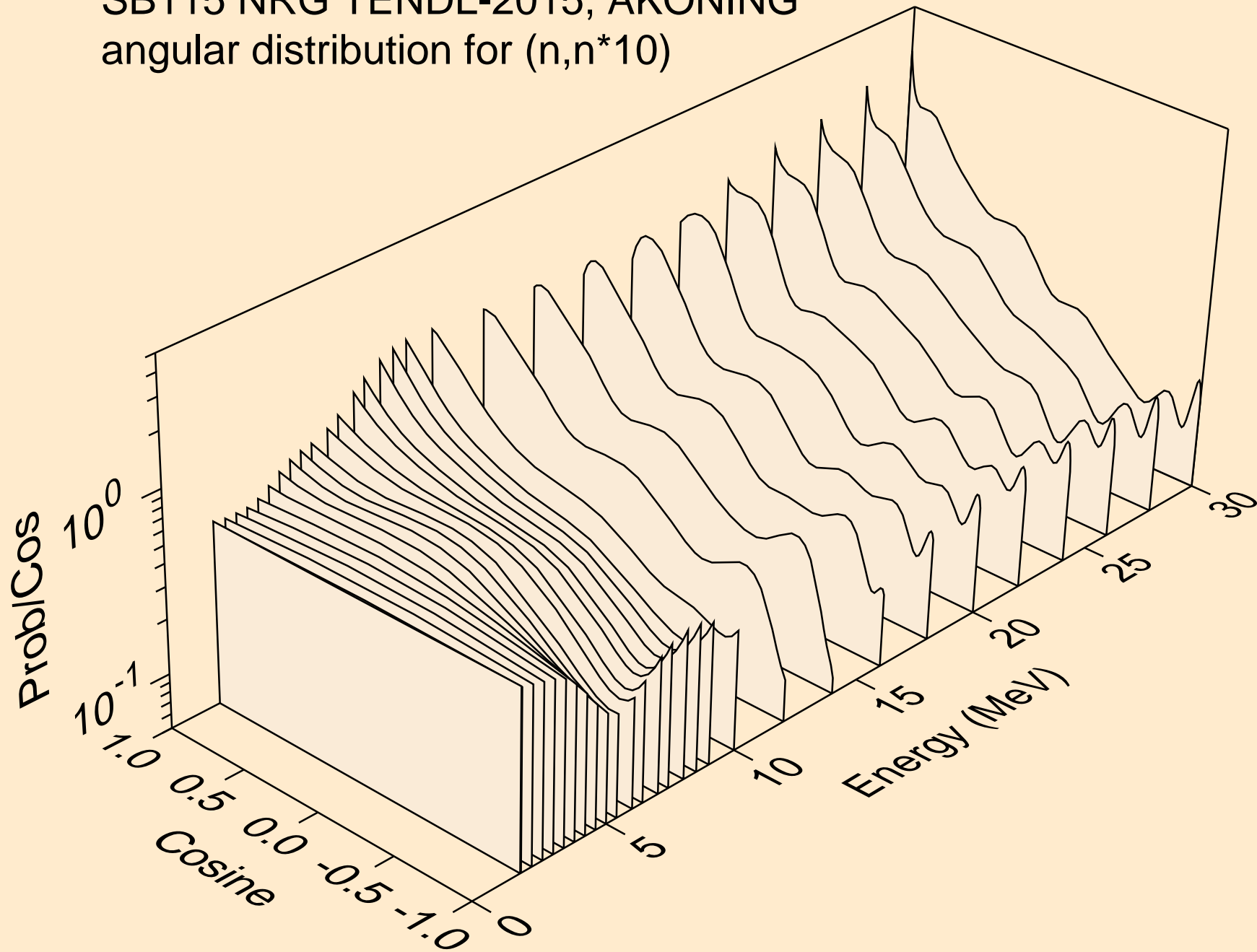

SB115 NRG TENDL-2015, AKONING  
angular distribution for (n,n\*11)

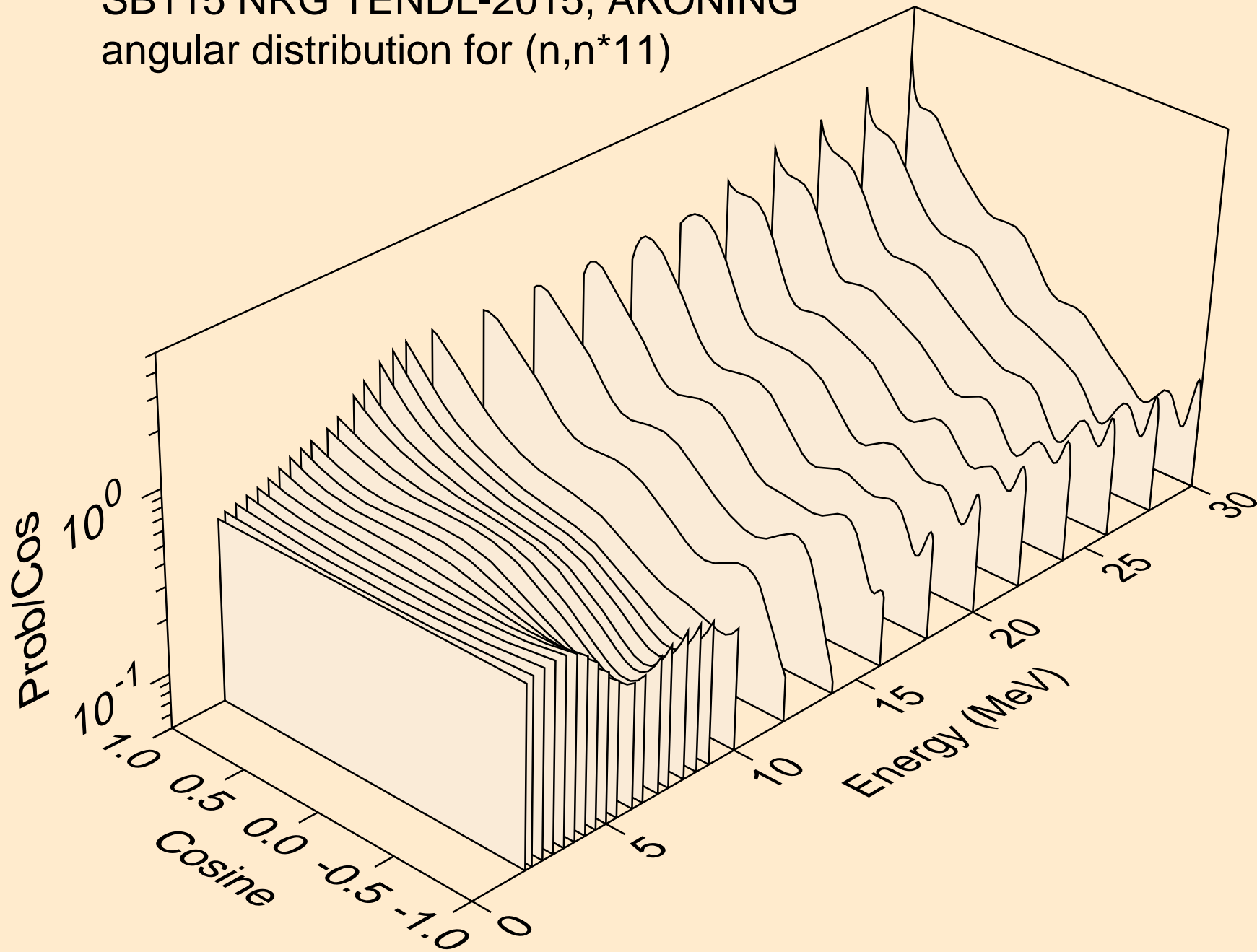

SB115 NRG TENDL-2015, AKONING  
angular distribution for (n,n\*12)

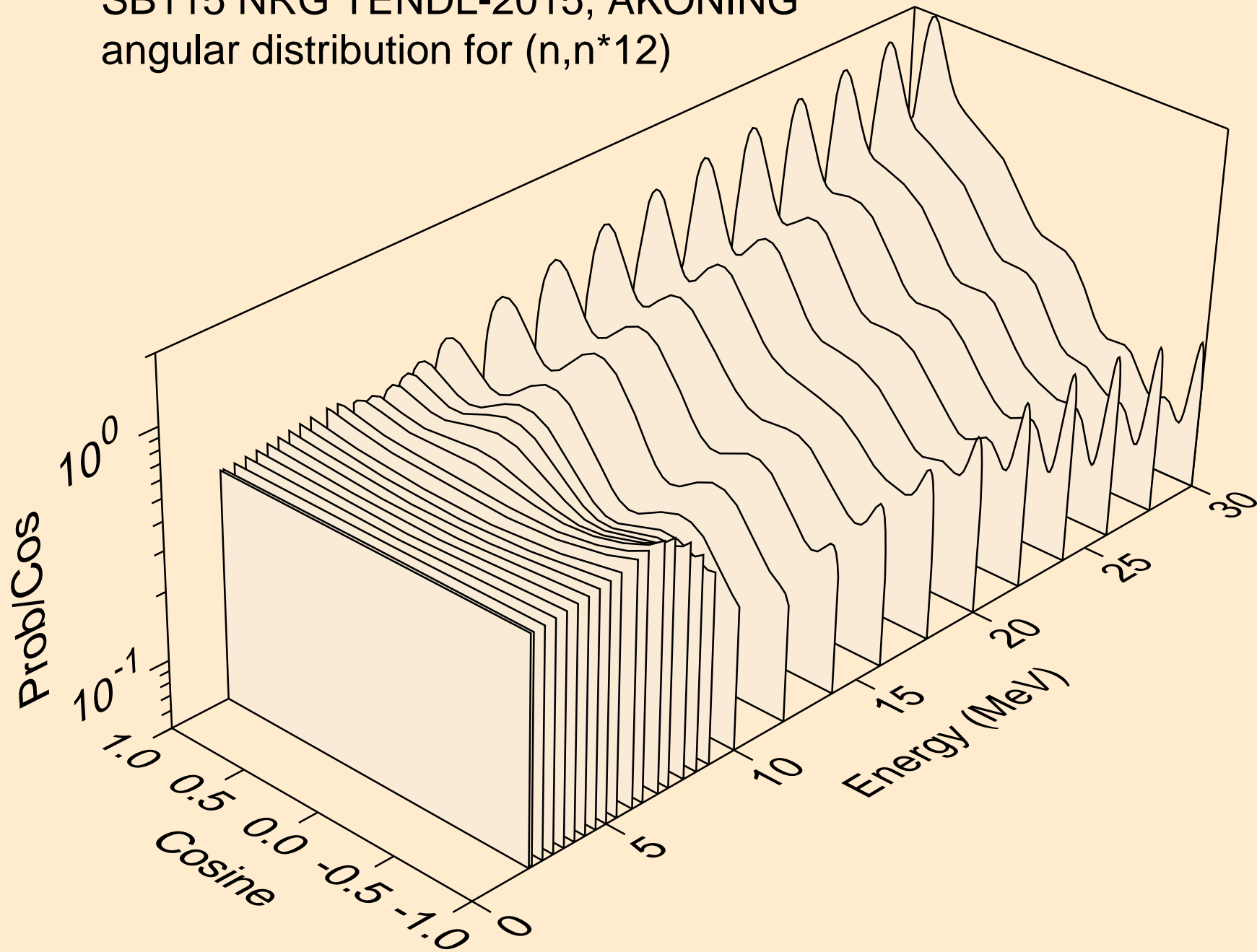

SB115 NRG TENDL-2015, AKONING  
angular distribution for (n,n\*13)

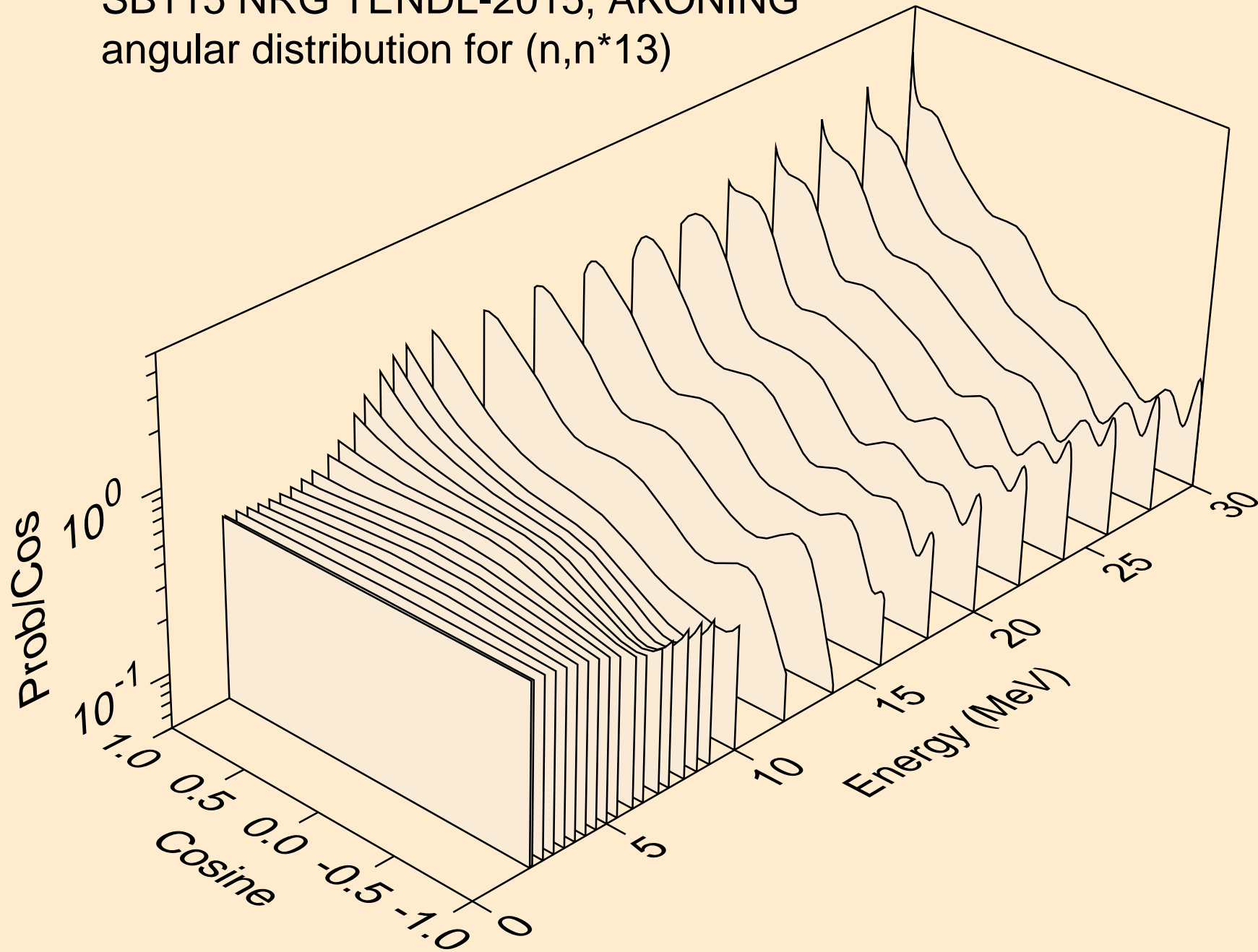

SB115 NRG TENDL-2015, AKONING  
angular distribution for (n,n\*14)

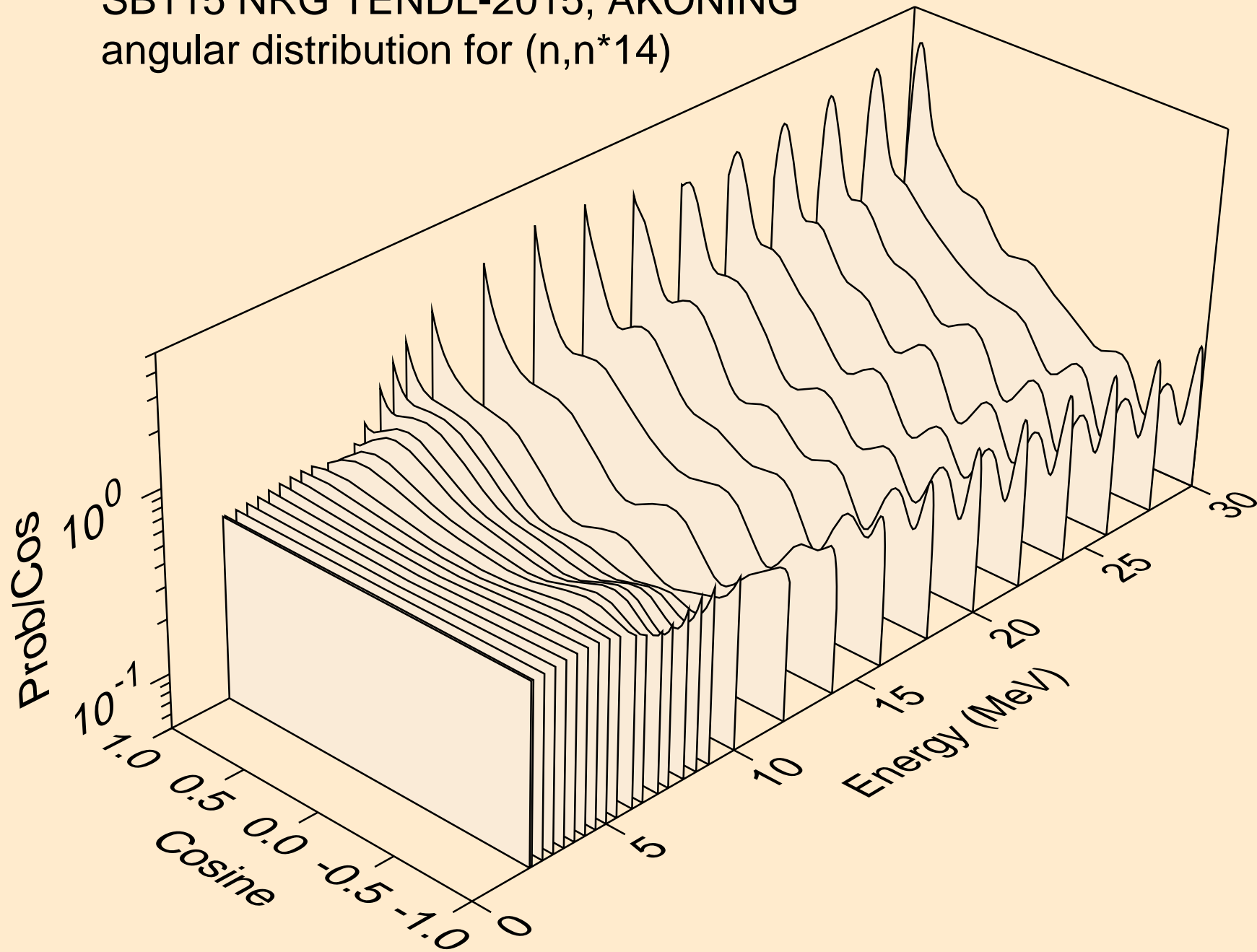

SB115 NRG TENDL-2015, AKONING  
angular distribution for (n,n\*15)

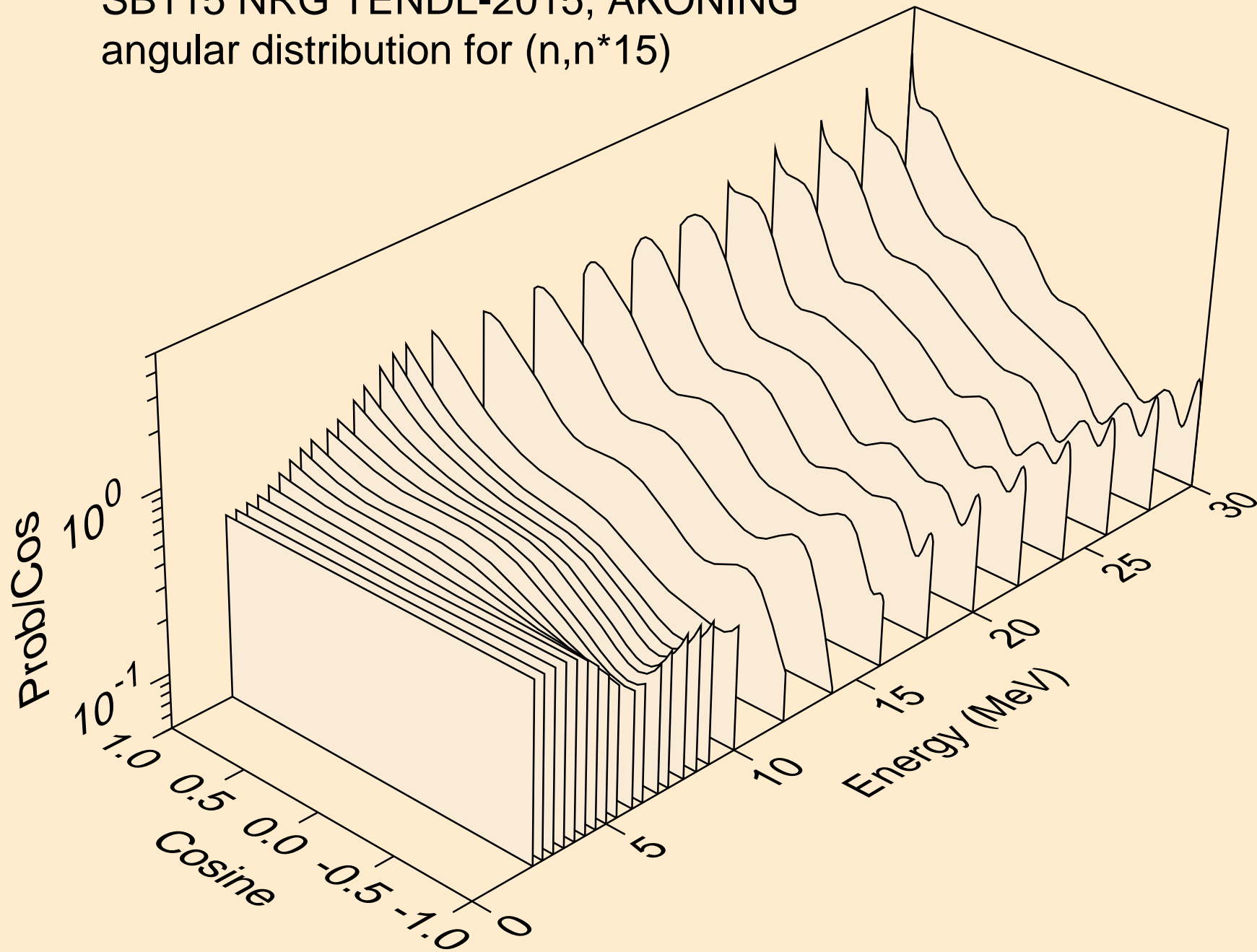



SB115 NRG TENDL-2015, AKONING  
angular distribution for (n,n\*16)

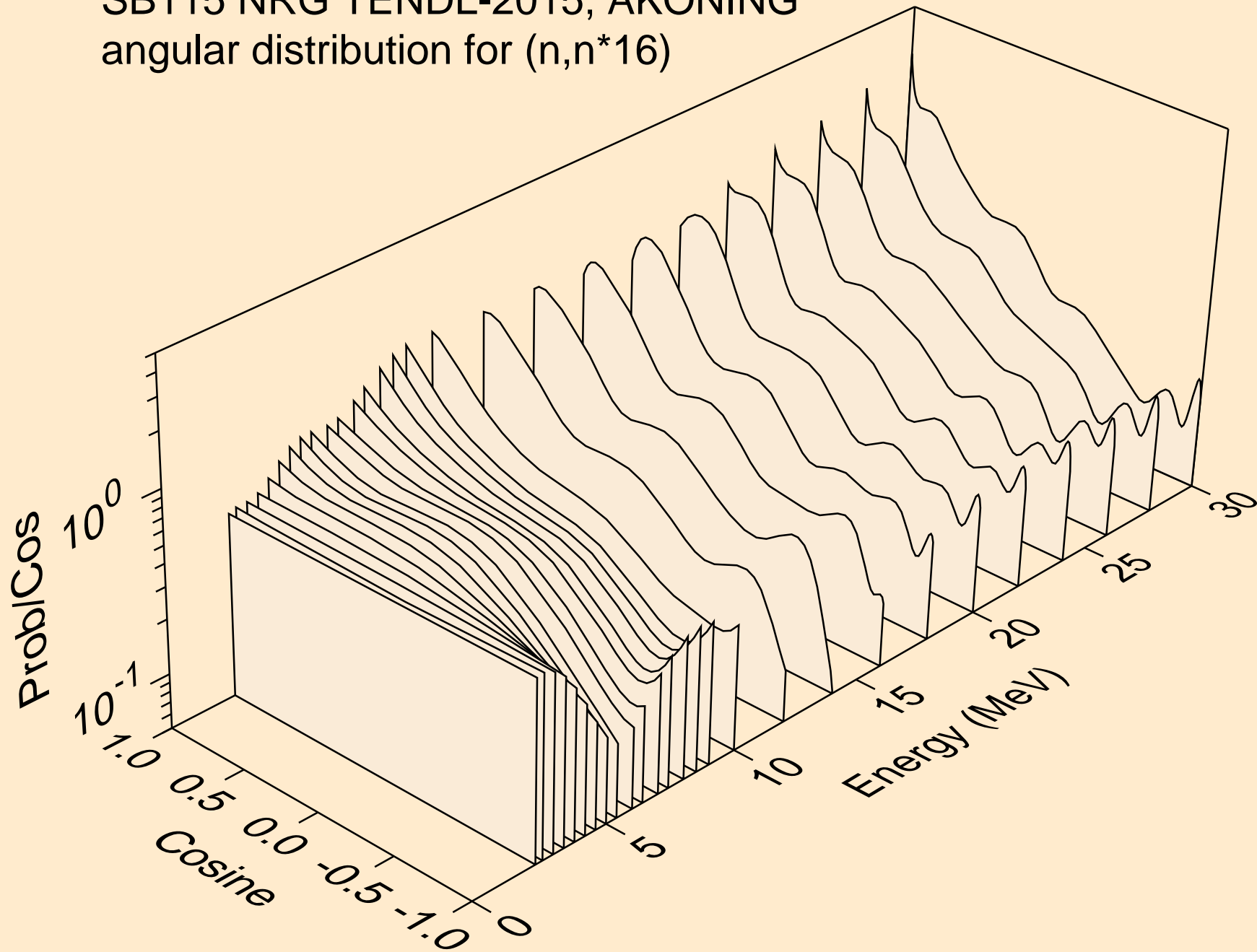

SB115 NRG TENDL-2015, AKONING  
angular distribution for (n,n\*17)

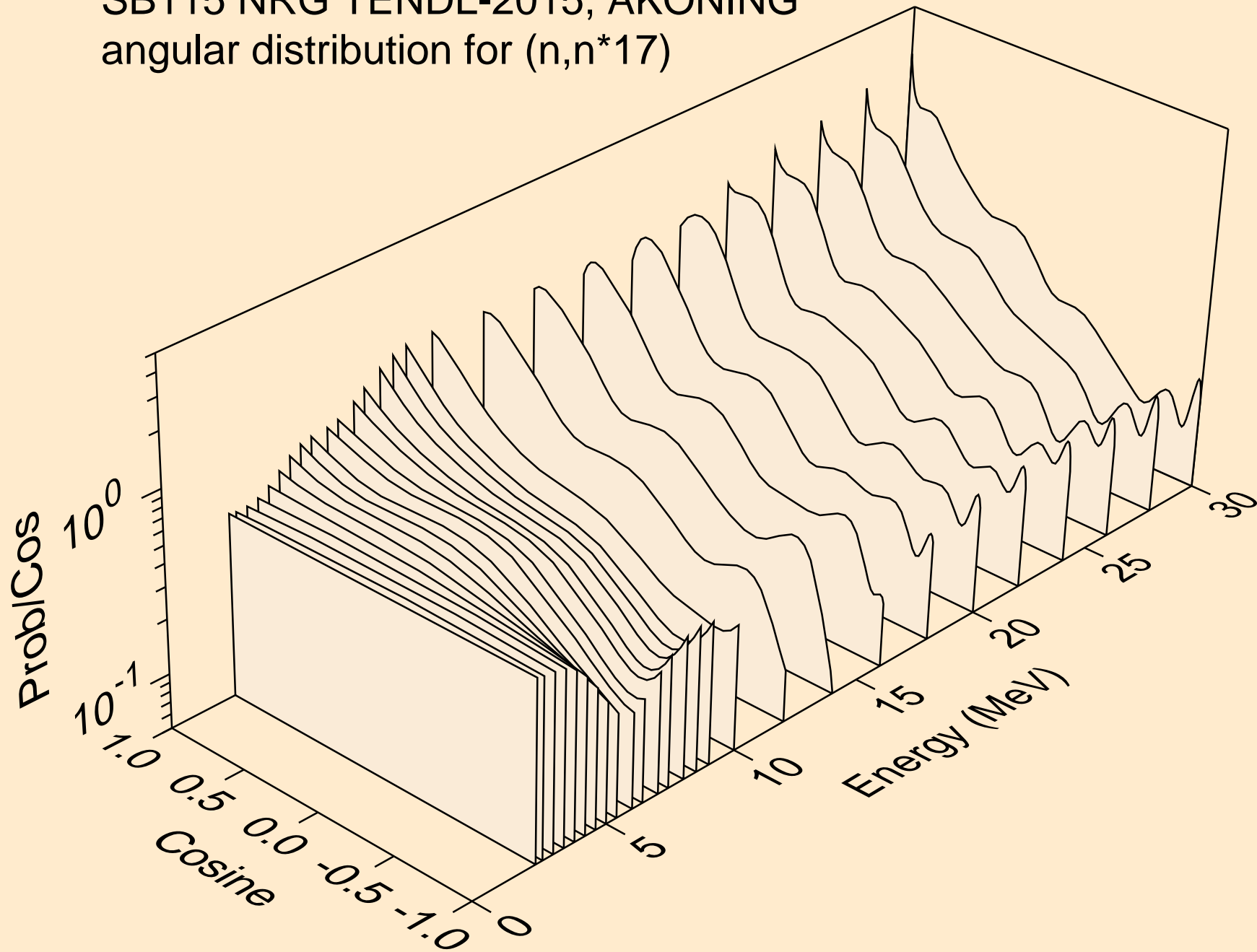

SB115 NRG TENDL-2015, AKONING  
angular distribution for (n,n\*18)

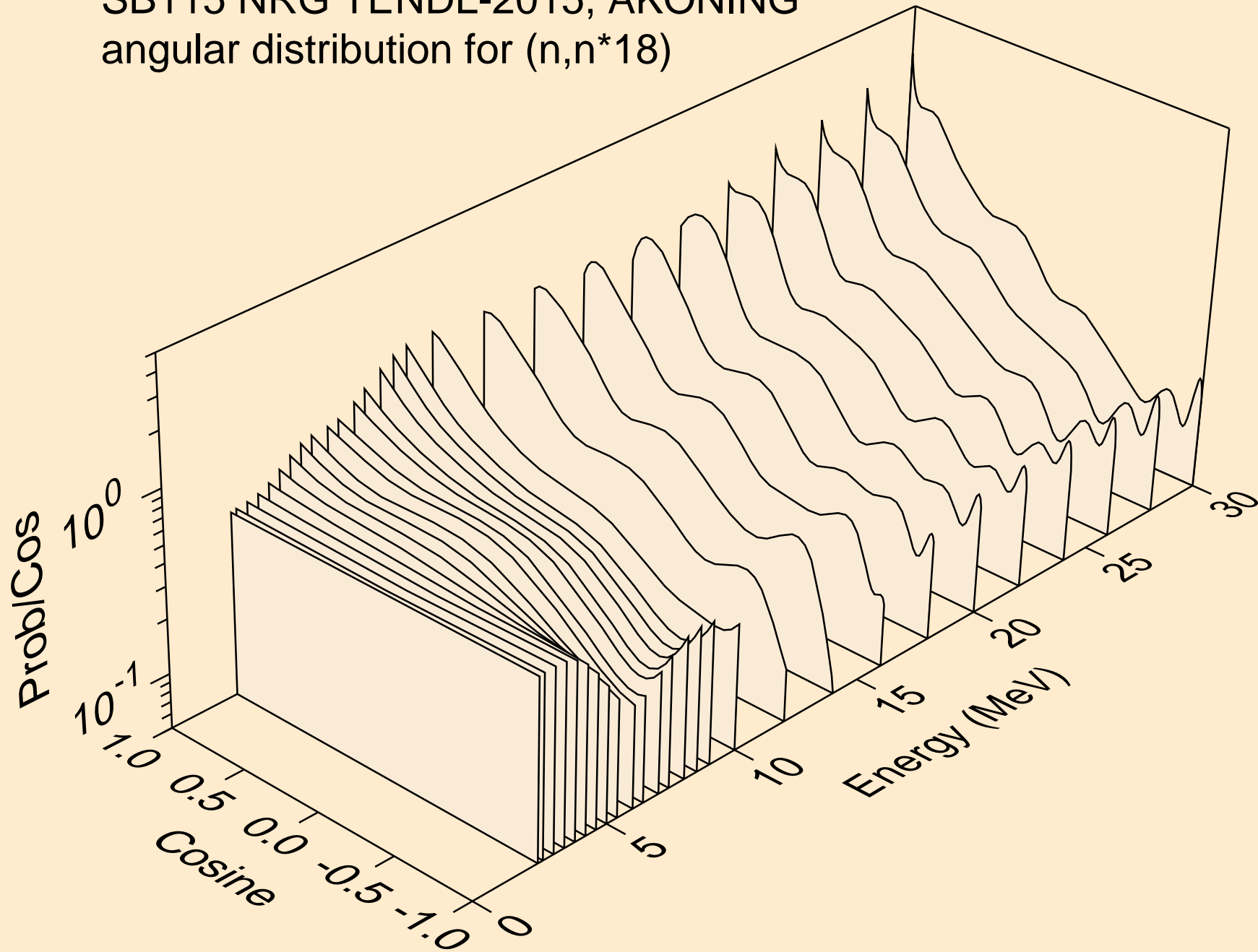

SB115 NRG TENDL-2015, AKONING  
angular distribution for (n,n\*19)

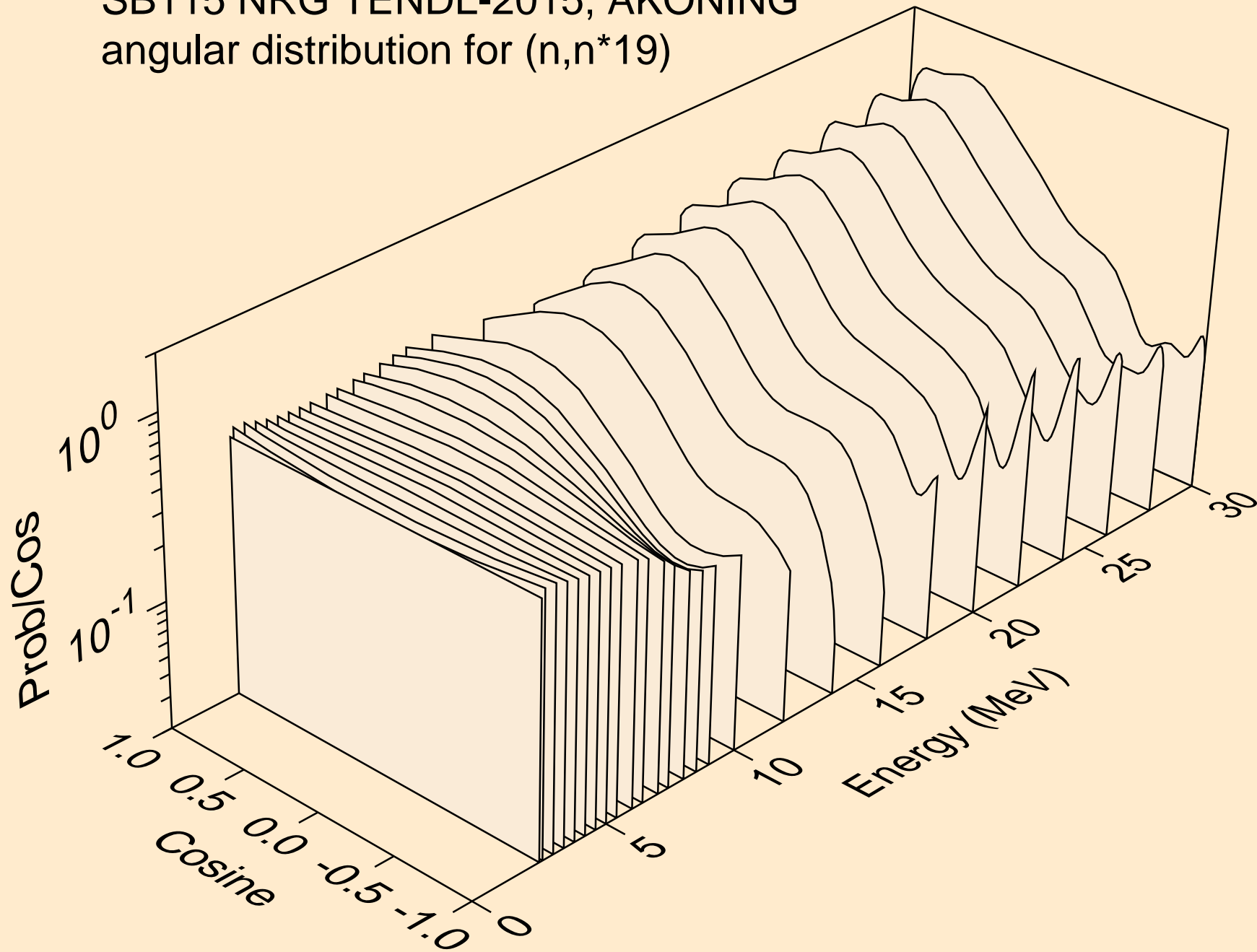

SB115 NRG TENDL-2015, AKONING  
angular distribution for (n,n\*20)

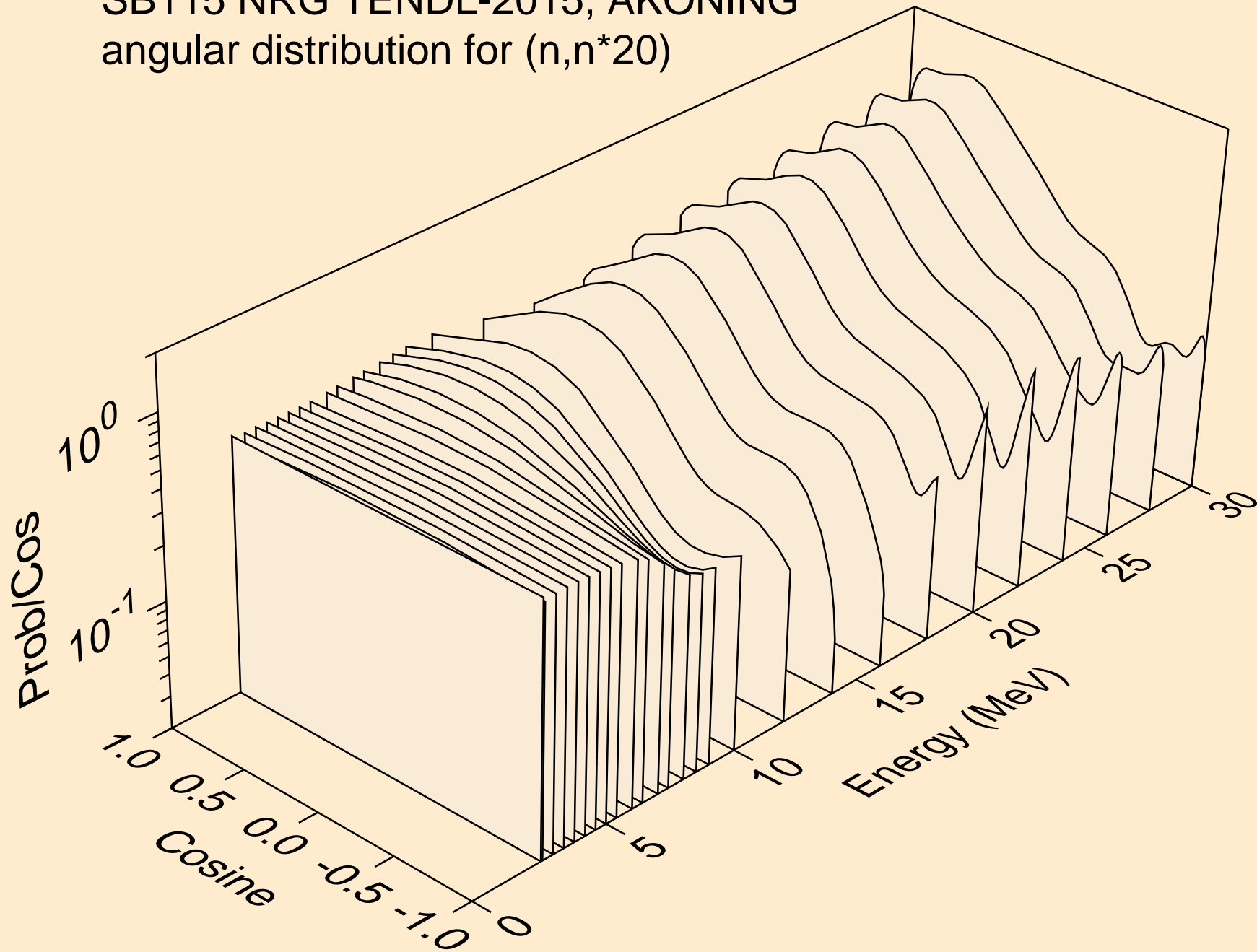

SB115 NRG TENDL-2015, AKONING  
angular distribution for (n,n\*21)

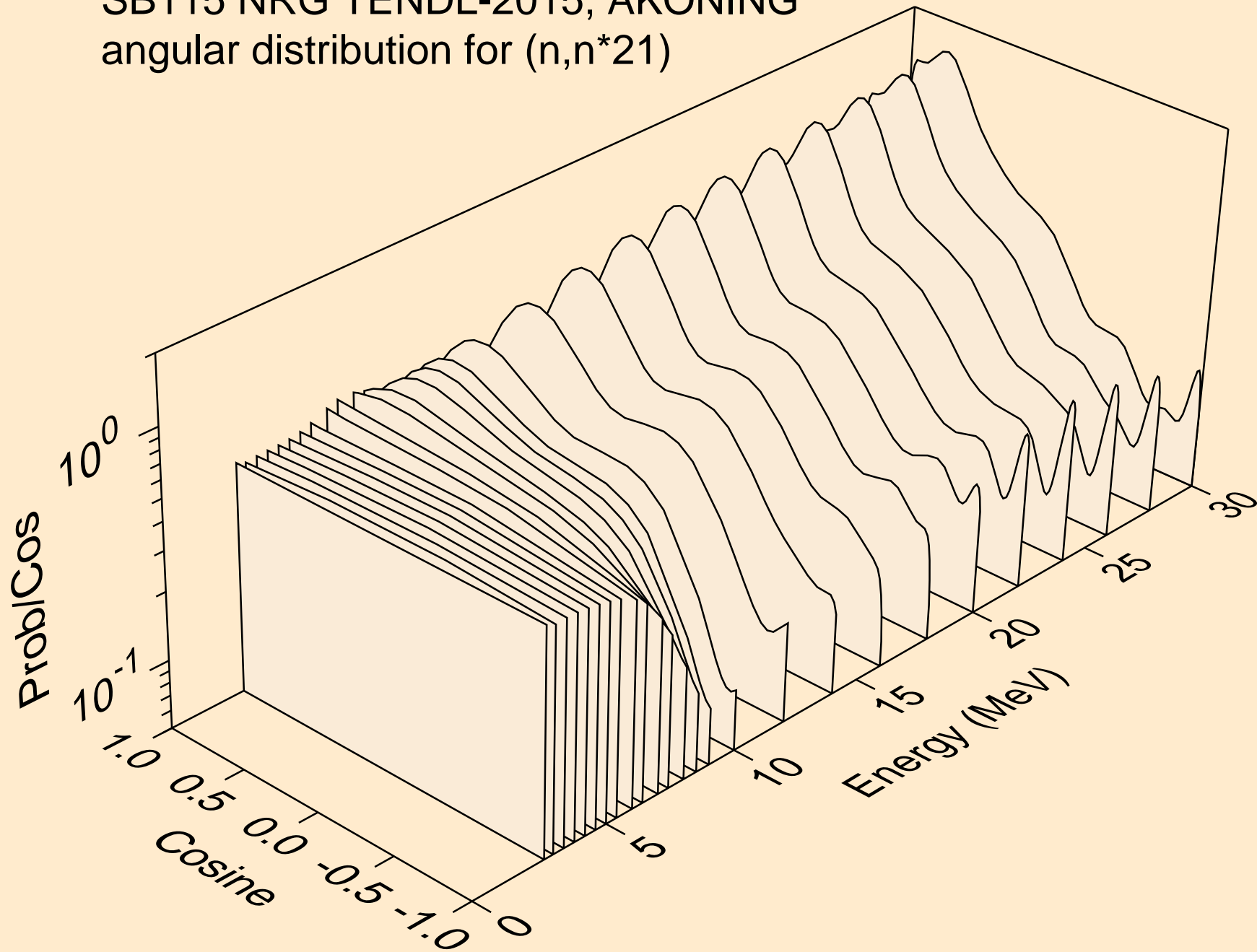

SB115 NRG TENDL-2015, AKONING  
angular distribution for (n,n\*22)

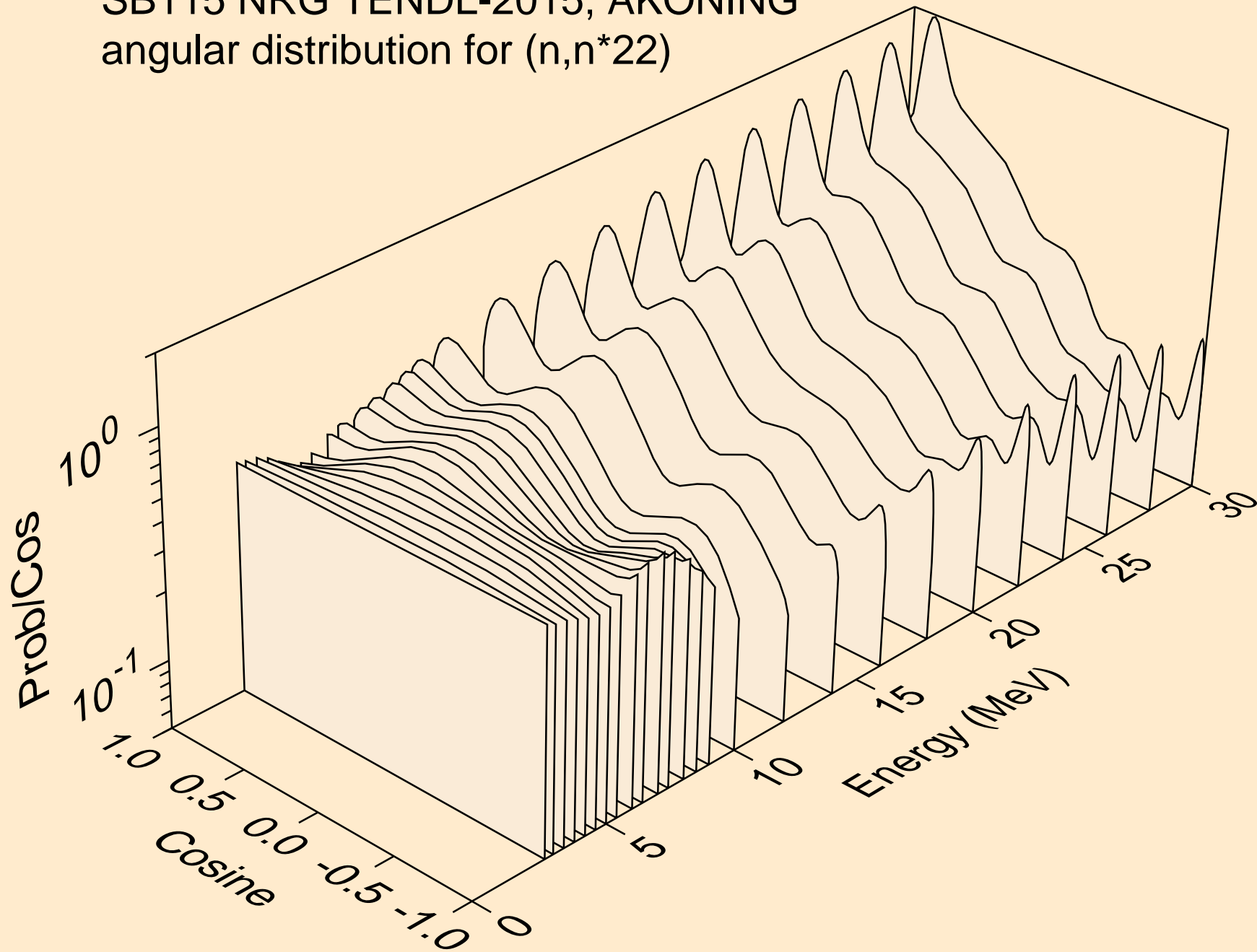

SB115 NRG TENDL-2015, AKONING  
angular distribution for (n,n\*23)

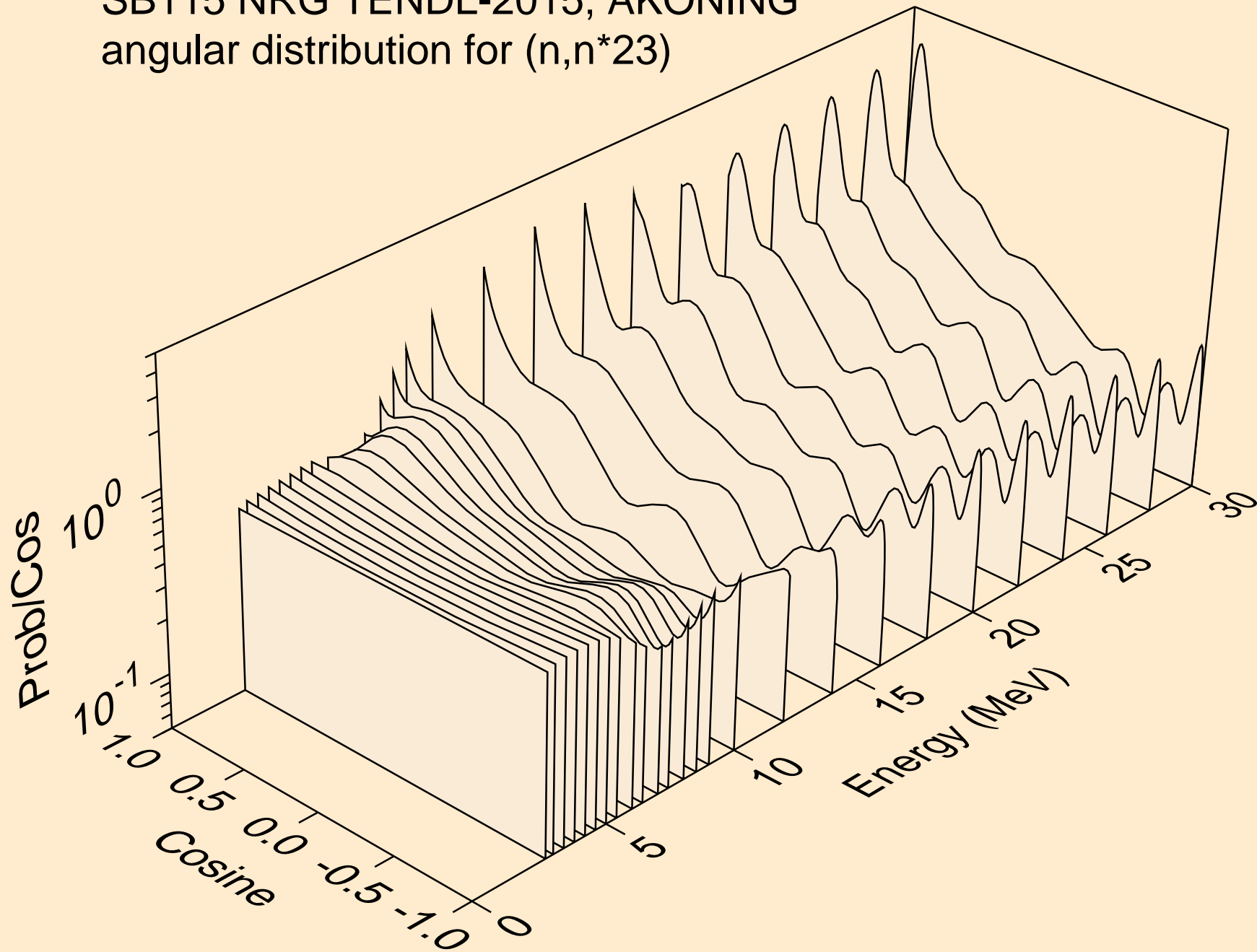



SB115 NRG TENDL-2015, AKONING  
angular distribution for (n,n\*24)

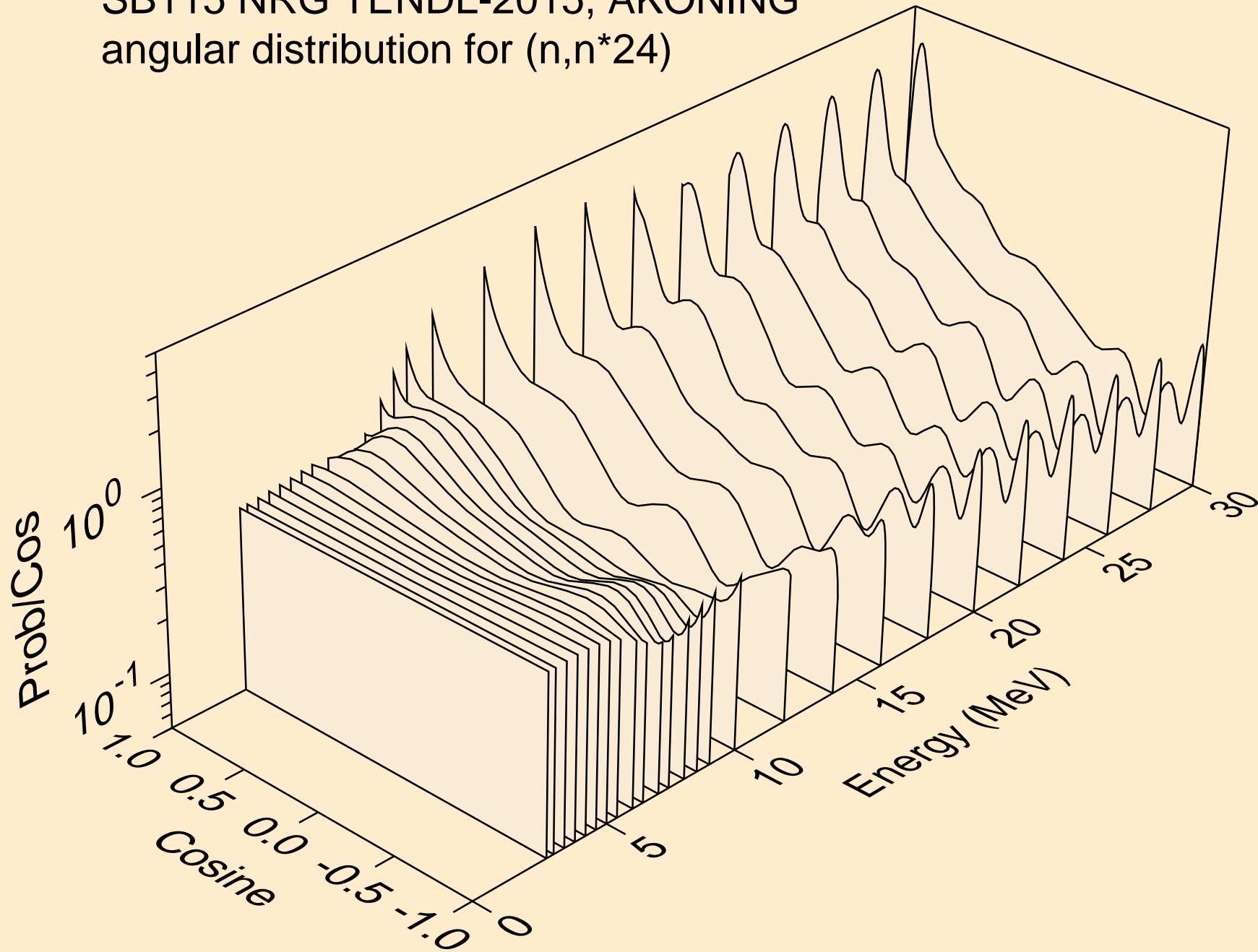

SB115 NRG TENDL-2015, AKONING  
Neutron emission for (n,x)

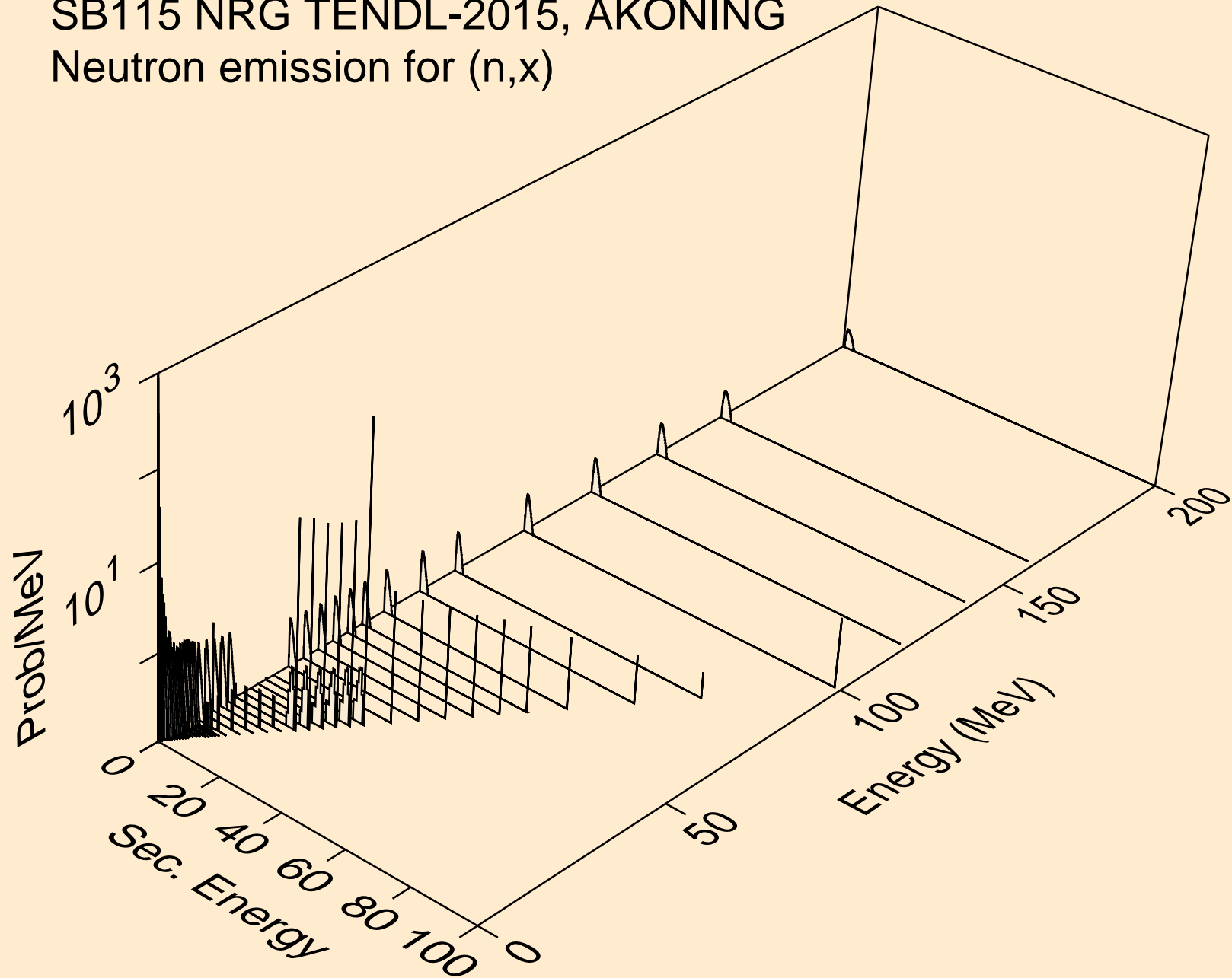

SB115 NRG TENDL-2015, AKONING  
Neutron emission for (n,2nd)

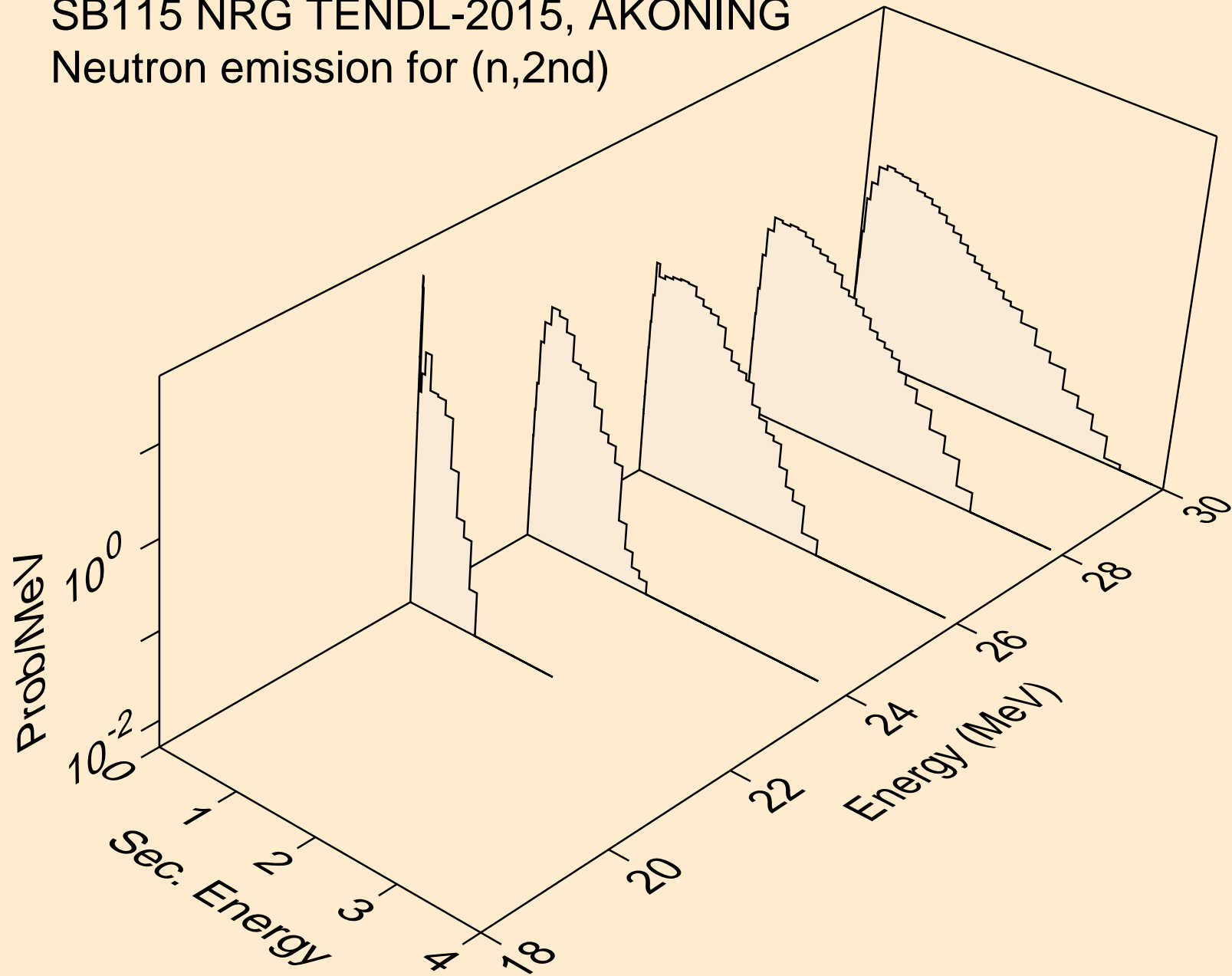

SB115 NRG TENDL-2015, AKONING  
Neutron emission for (n,2n)

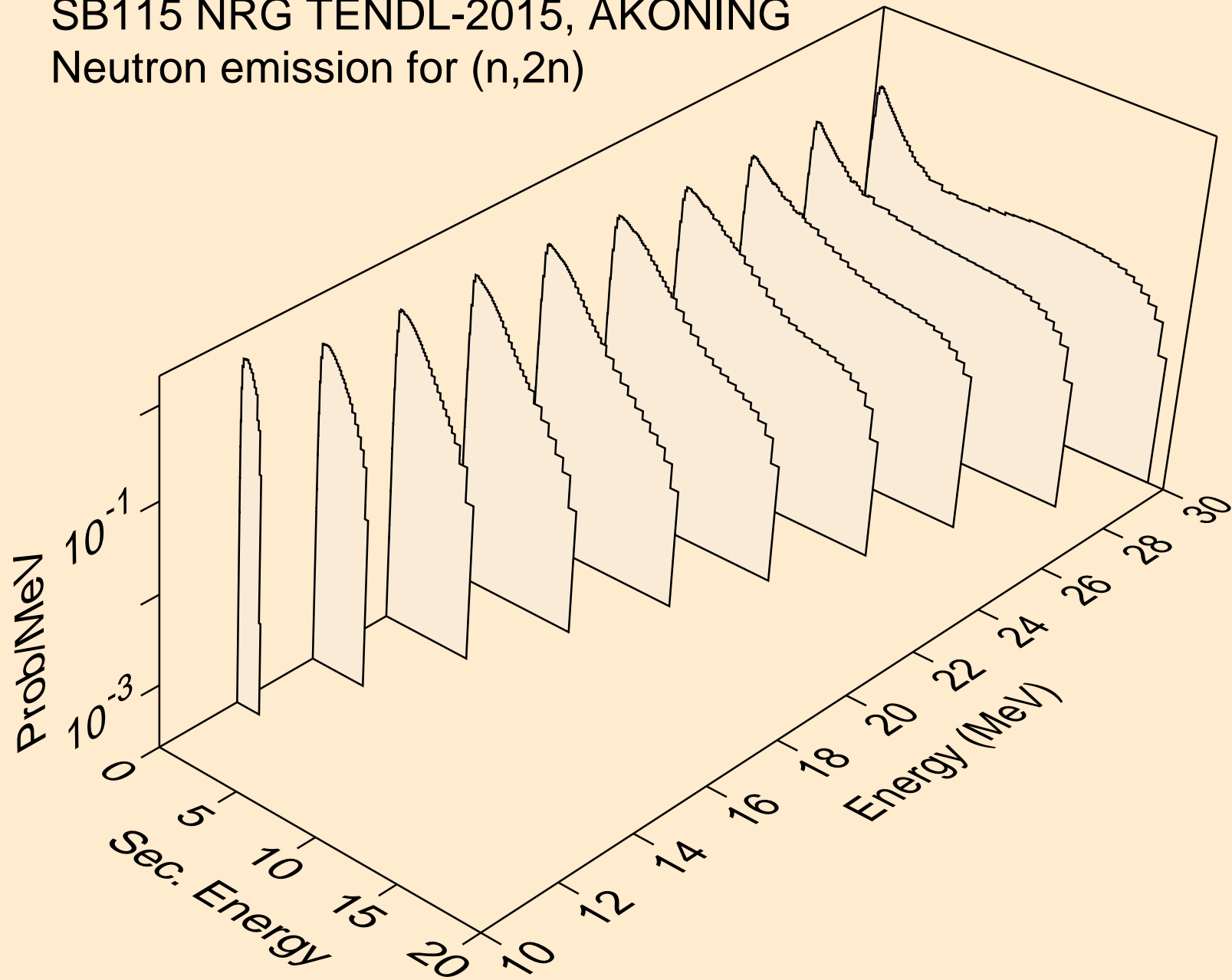

SB115 NRG TENDL-2015, AKONING  
Neutron emission for (n,3n)

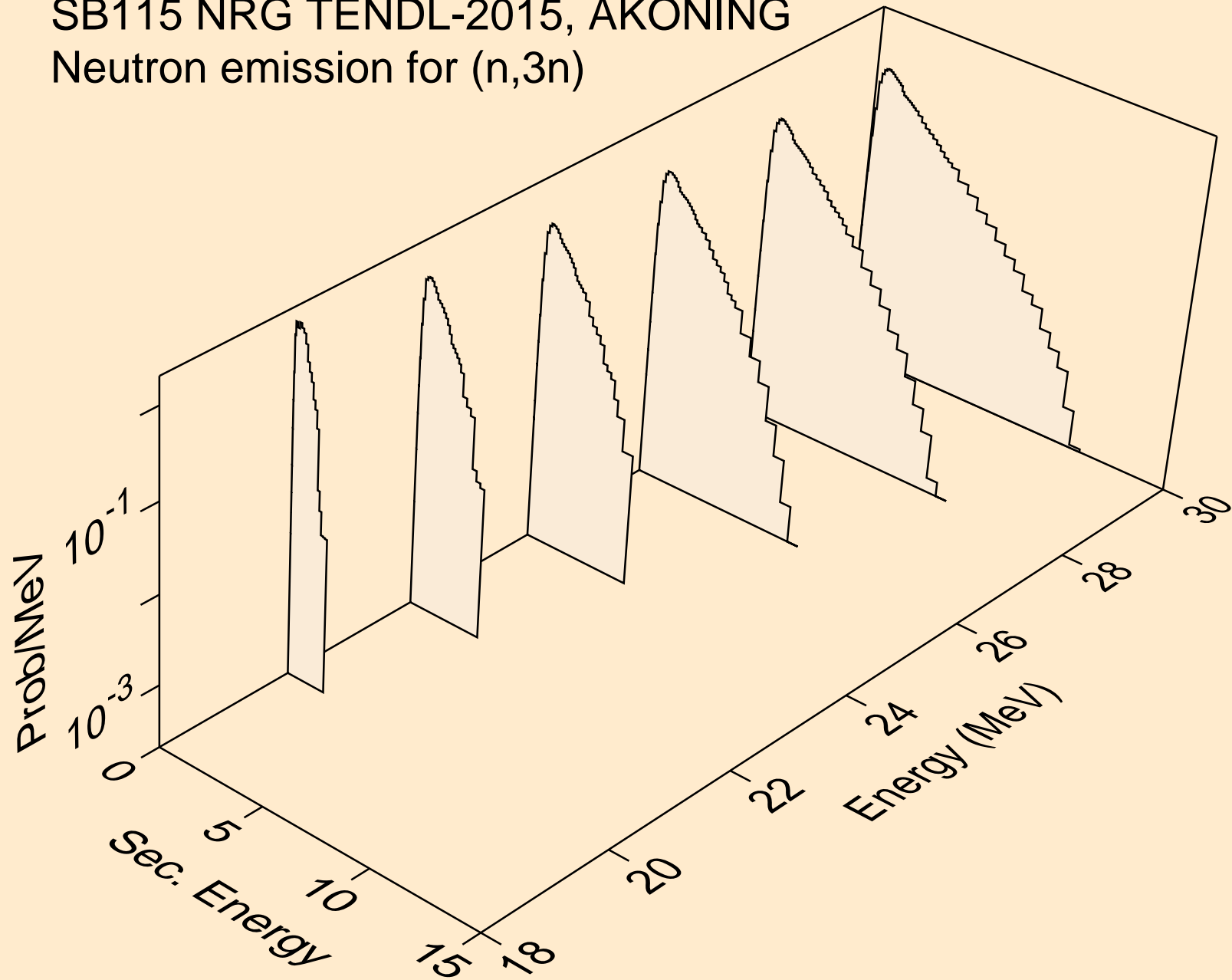

SB115 NRG TENDL-2015, AKONING  
Neutron emission for (n,n\*)a

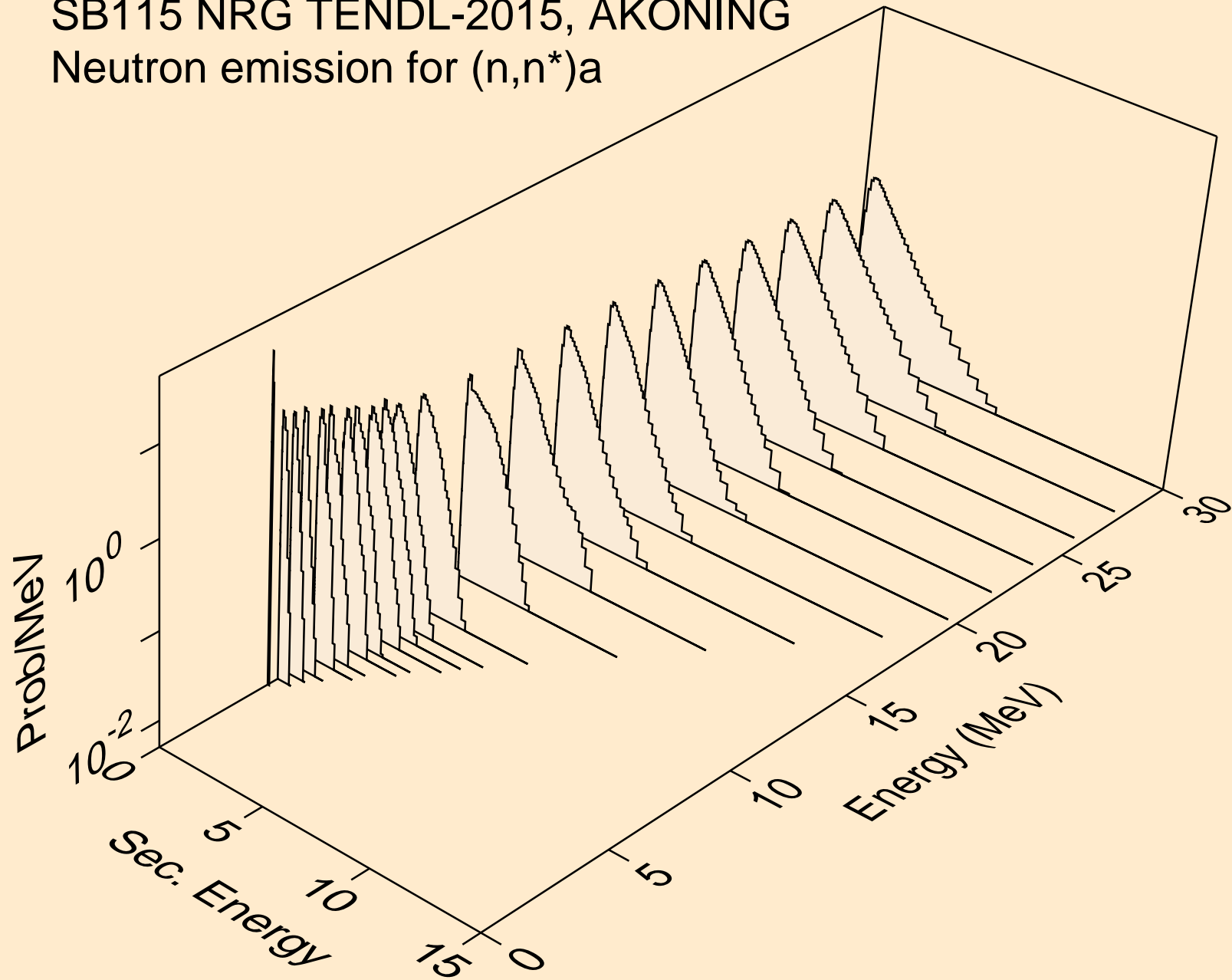

SB115 NRG TENDL-2015, AKONING  
Neutron emission for (n,2n)<sub>a</sub>

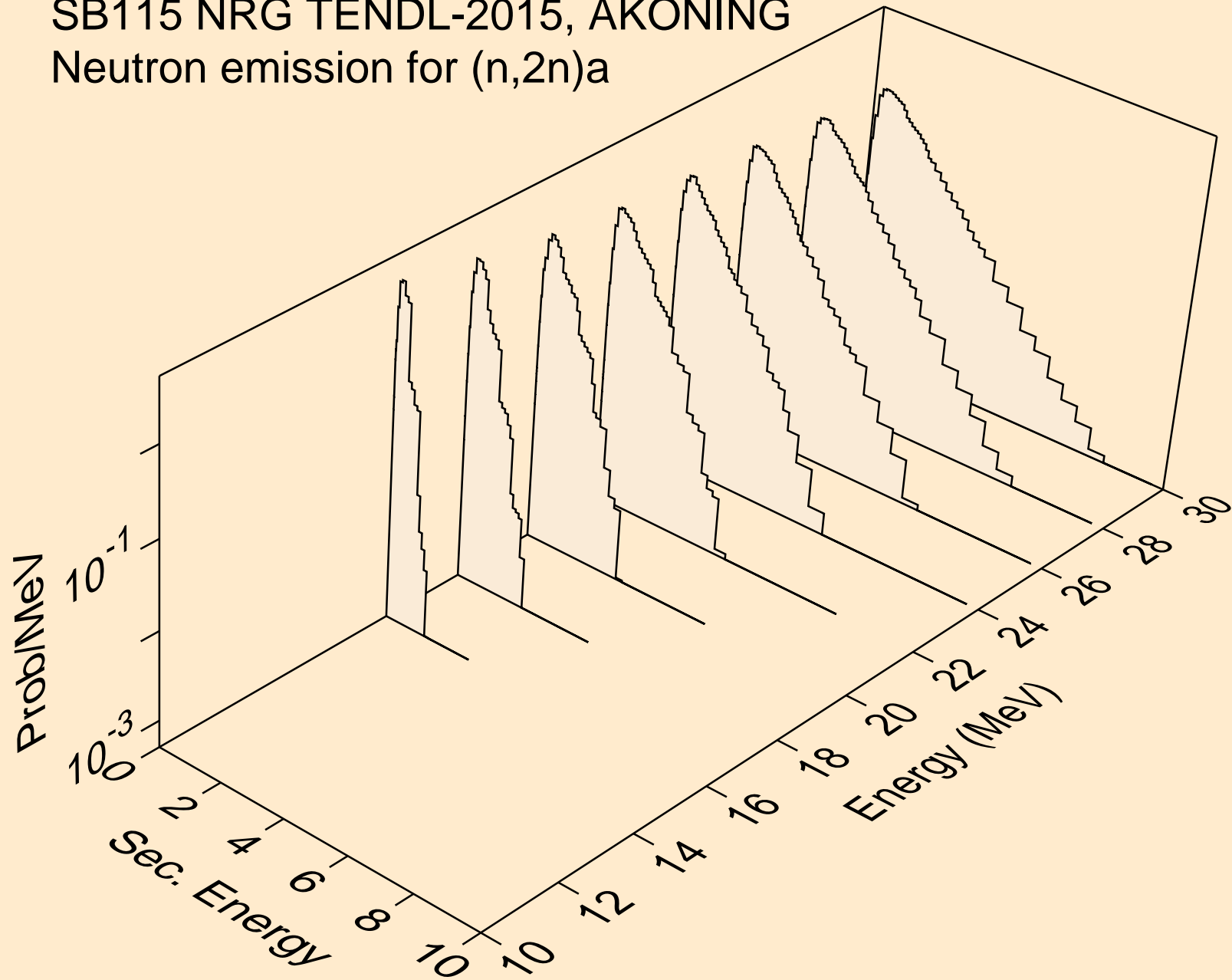

SB115 NRG TENDL-2015, AKONING  
Neutron emission for (n,3n)a

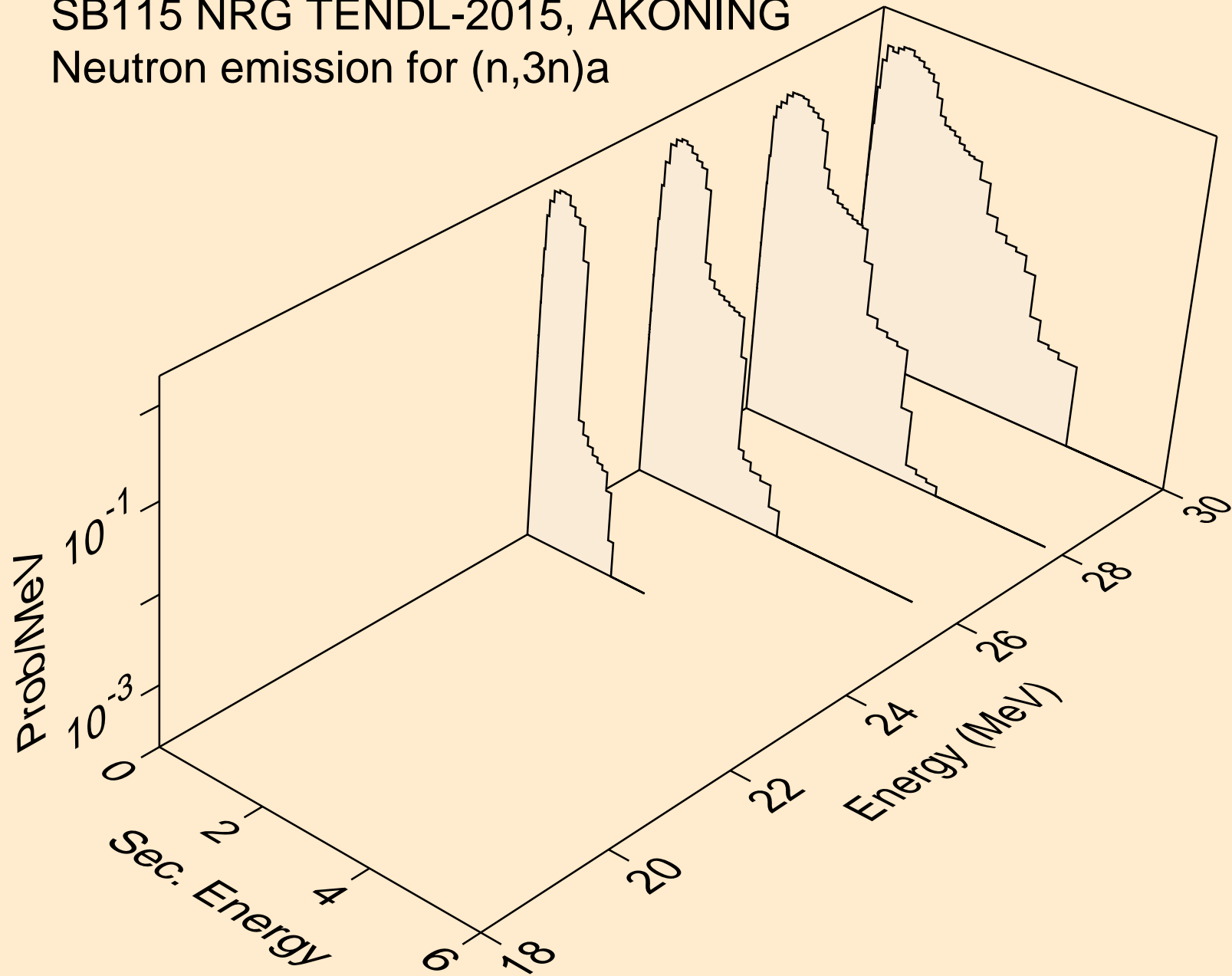



SB115 NRG TENDL-2015, AKONING  
Neutron emission for (n,n\*)p

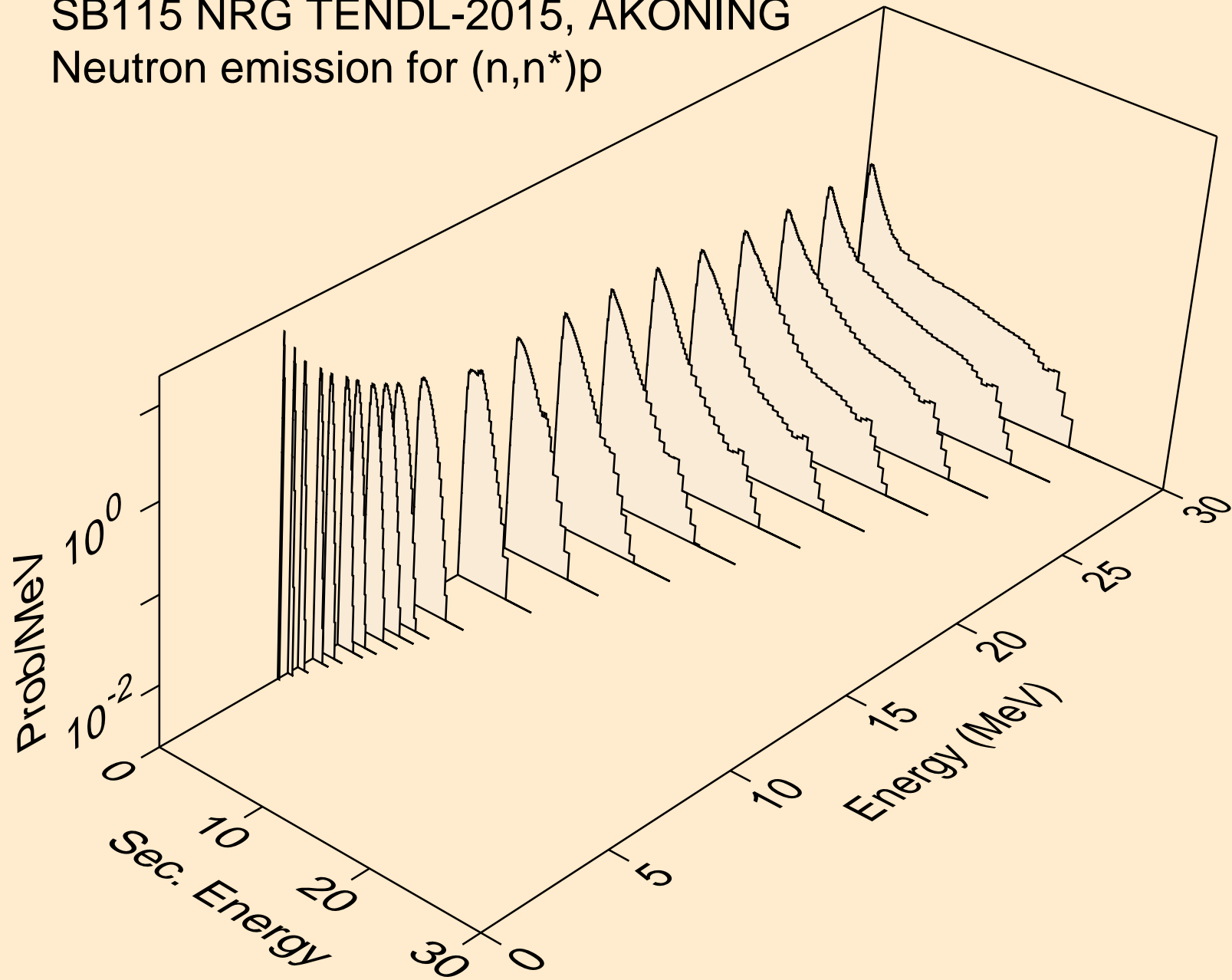

SB115 NRG TENDL-2015, AKONING  
Neutron emission for (n,n\*)2a

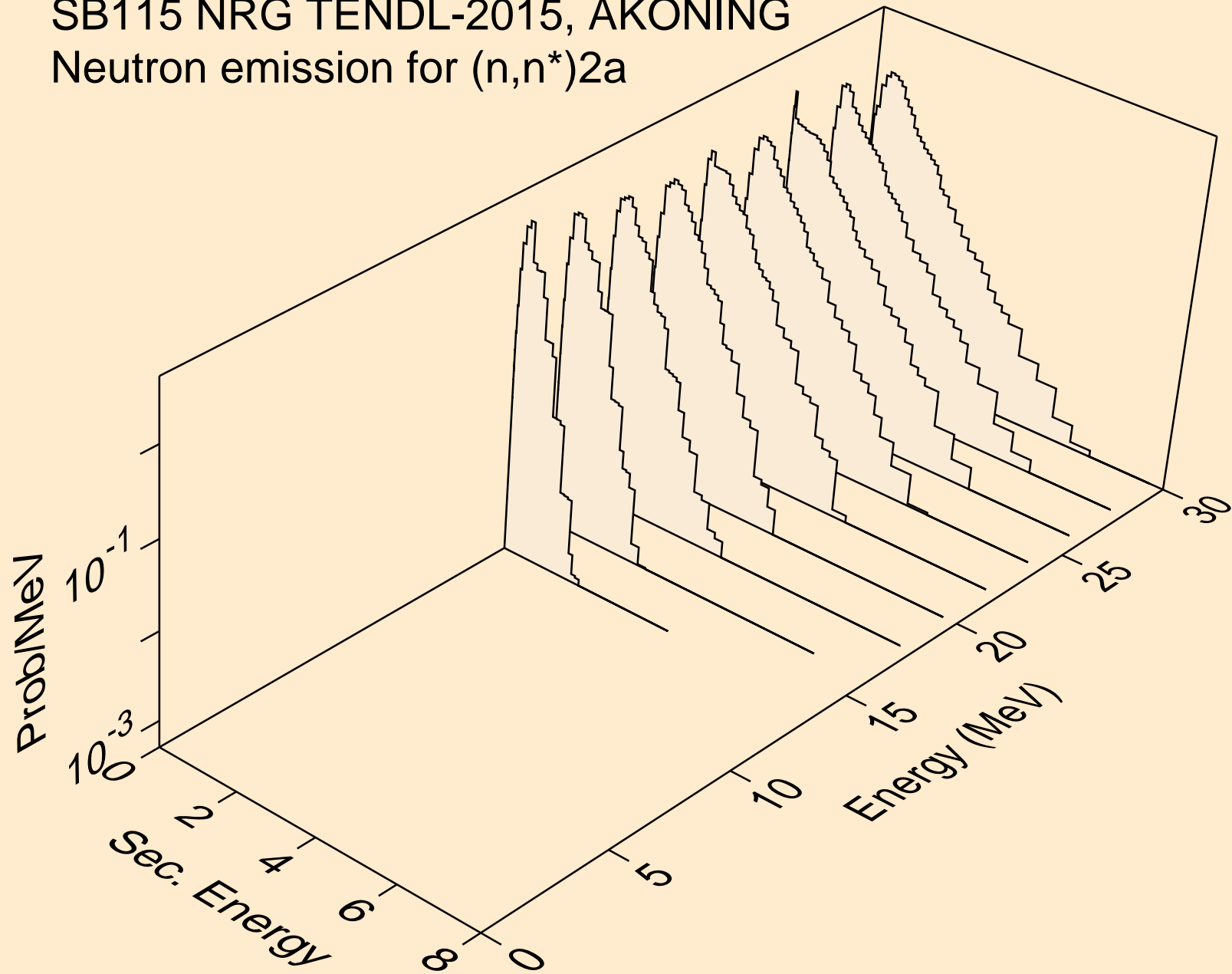

SB115 NRG TENDL-2015, AKONING  
Neutron emission for (n,n\*)d

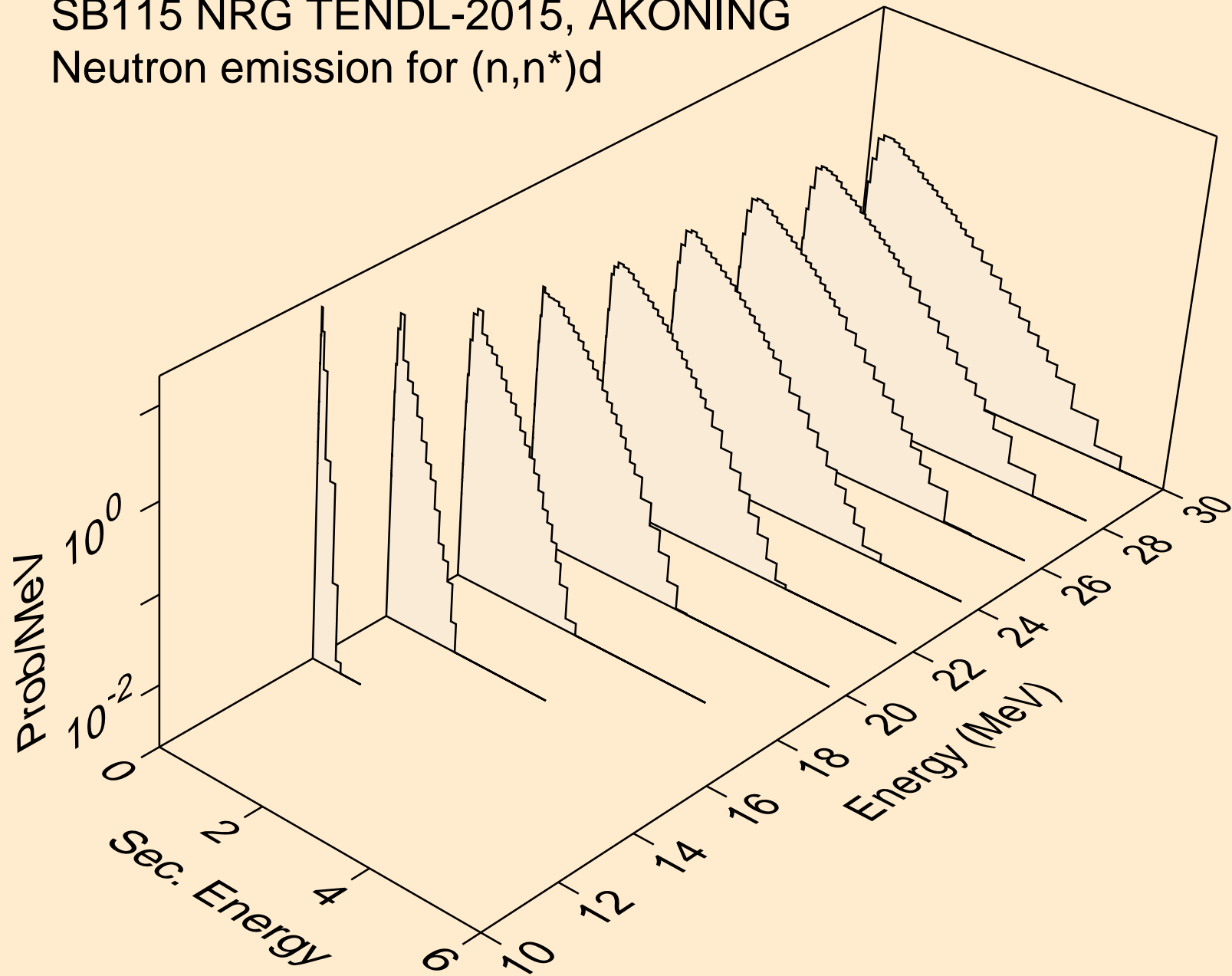

SB115 NRG TENDL-2015, AKONING  
Neutron emission for (n,n\*)t

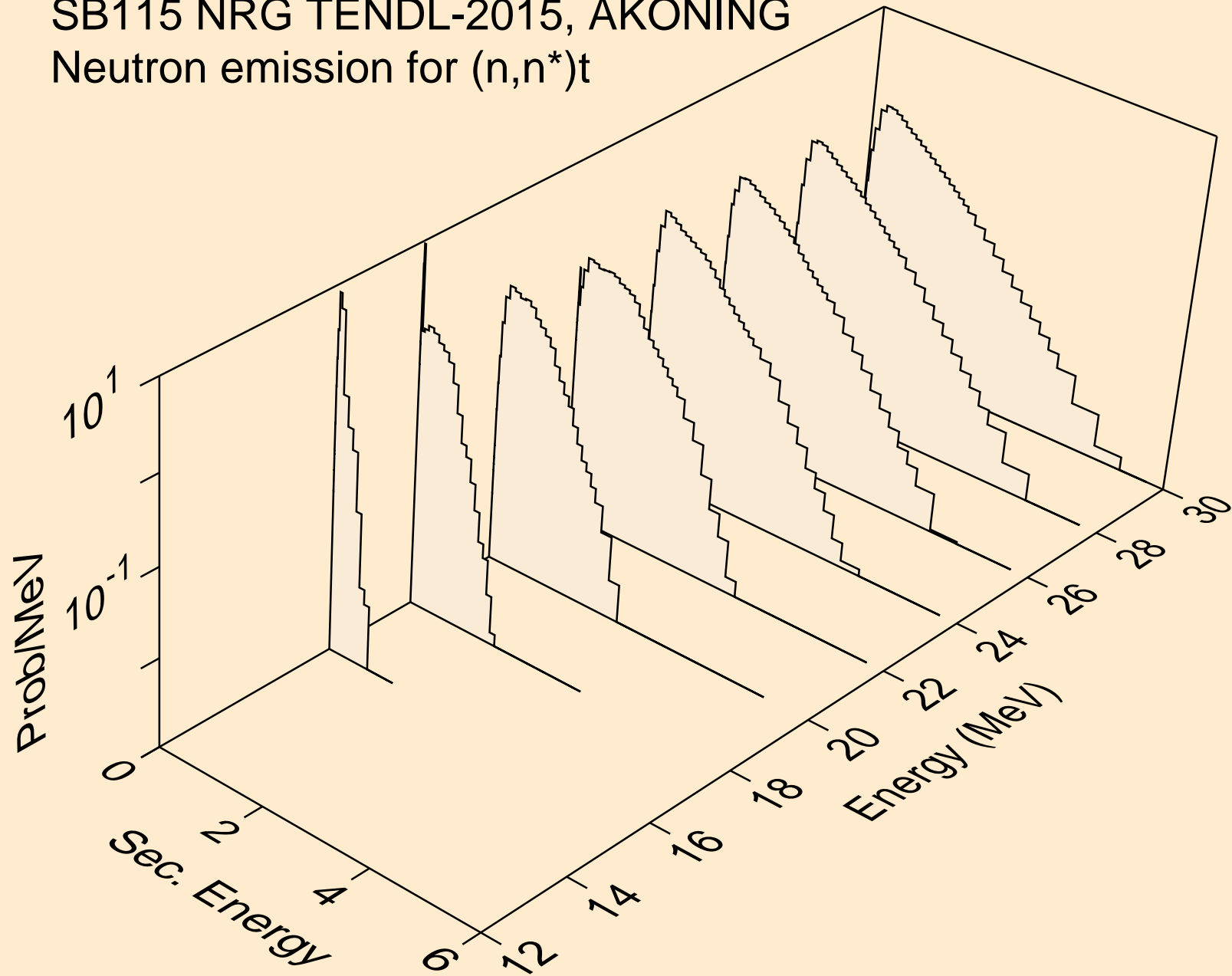

SB115 NRG TENDL-2015, AKONING  
Neutron emission for (n,n\*)he3

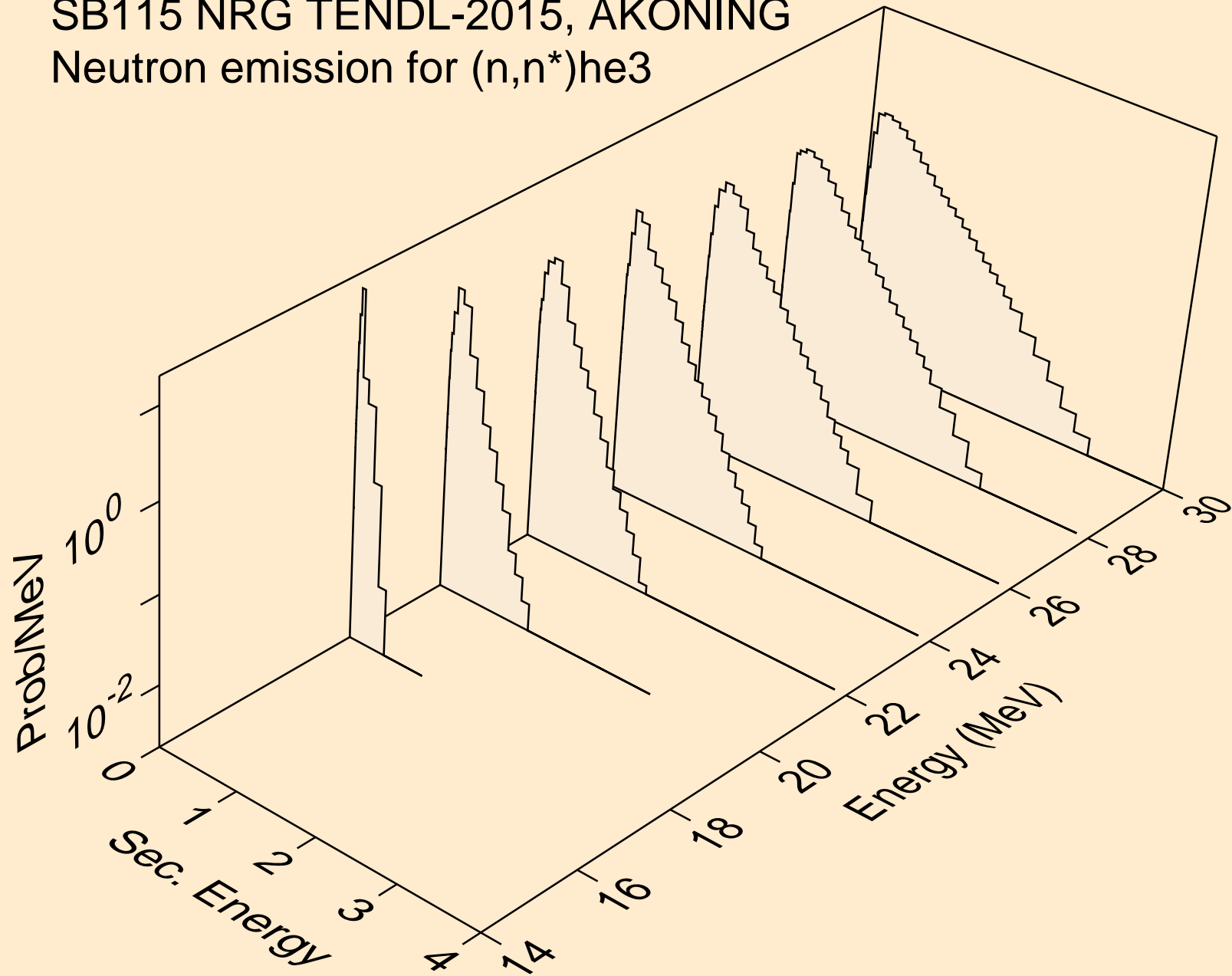

SB115 NRG TENDL-2015, AKONING  
Neutron emission for (n,4n)

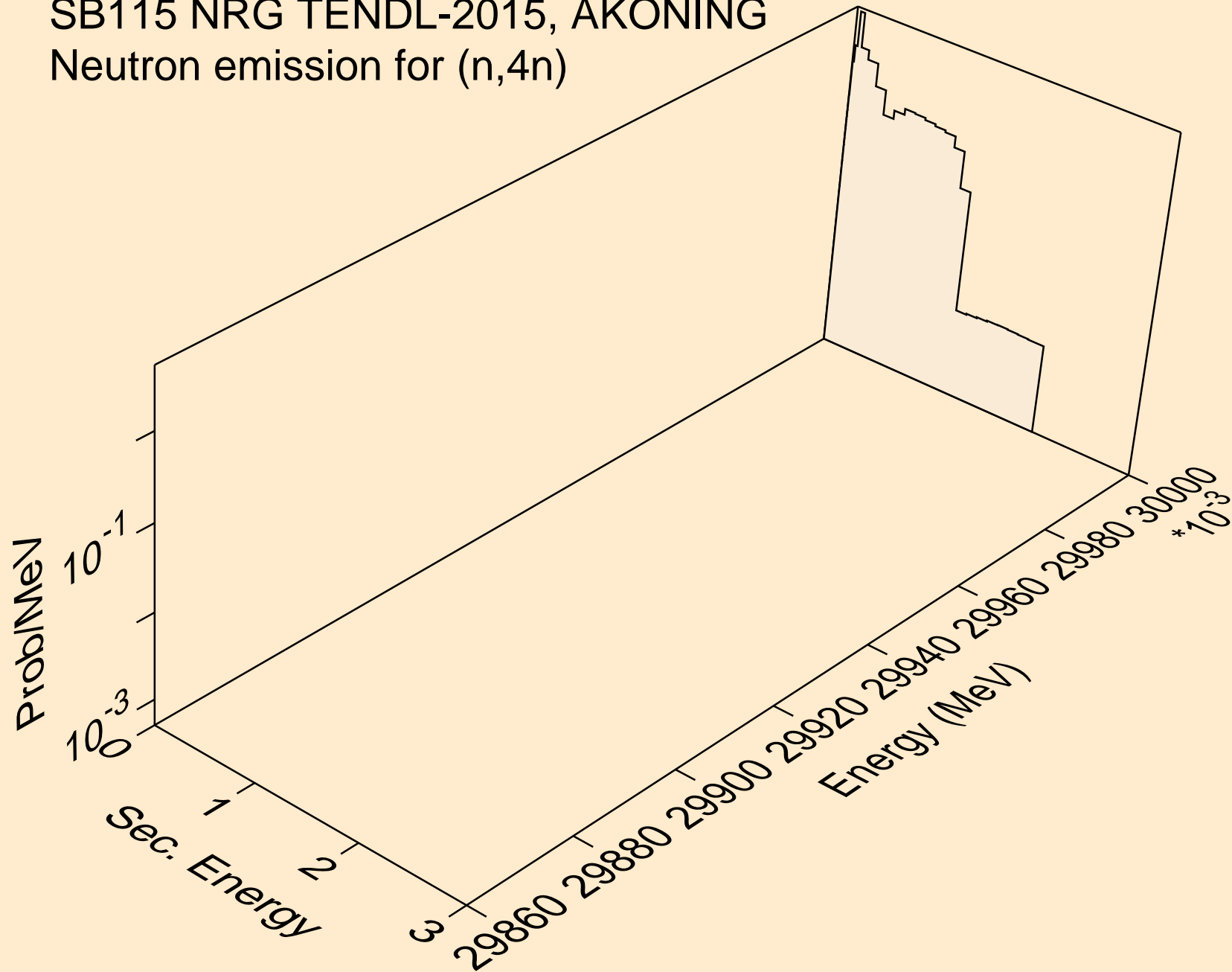

SB115 NRG TENDL-2015, AKONING  
Neutron emission for (n,2np)

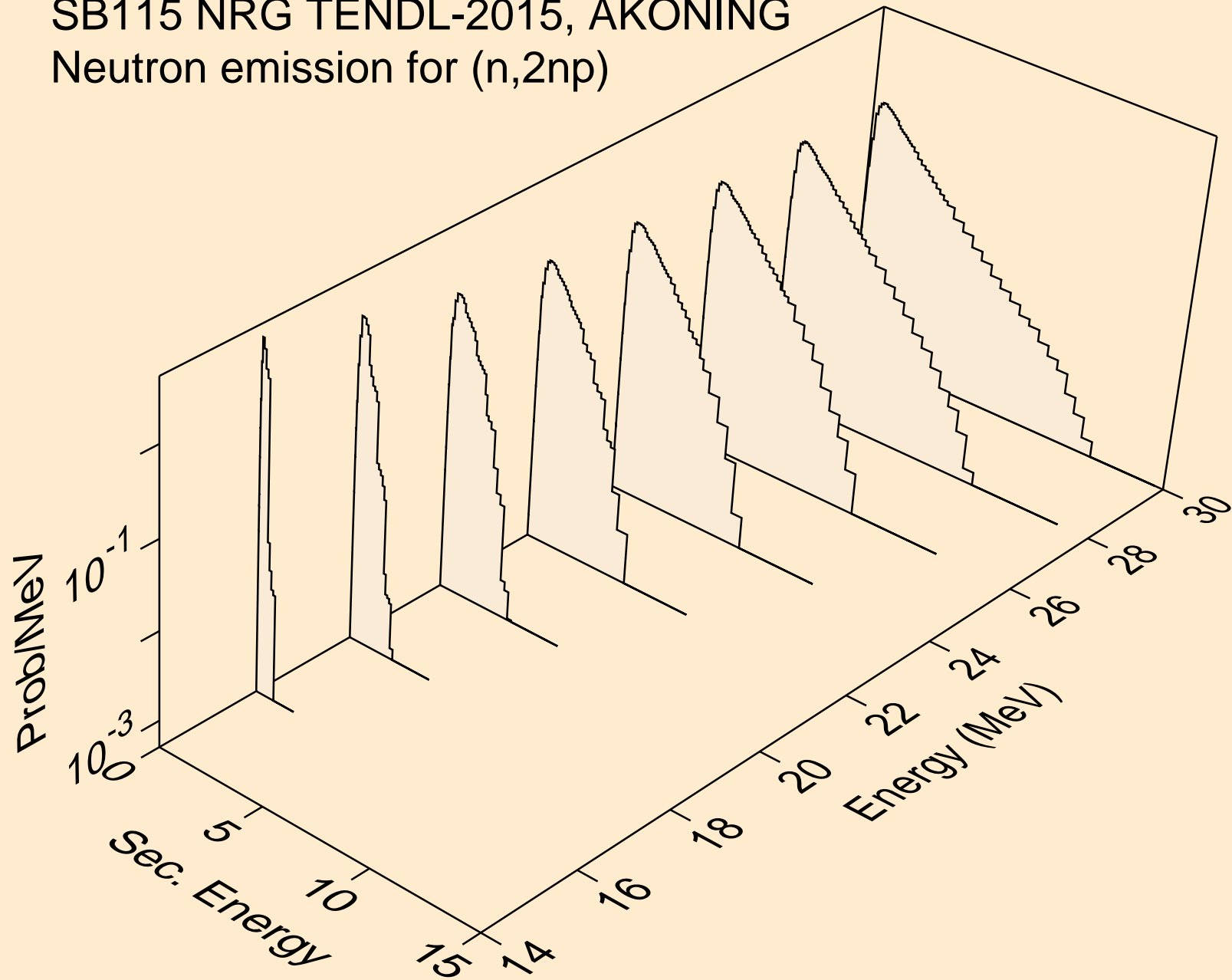

SB115 NRG TENDL-2015, AKONING  
Neutron emission for (n,3np)

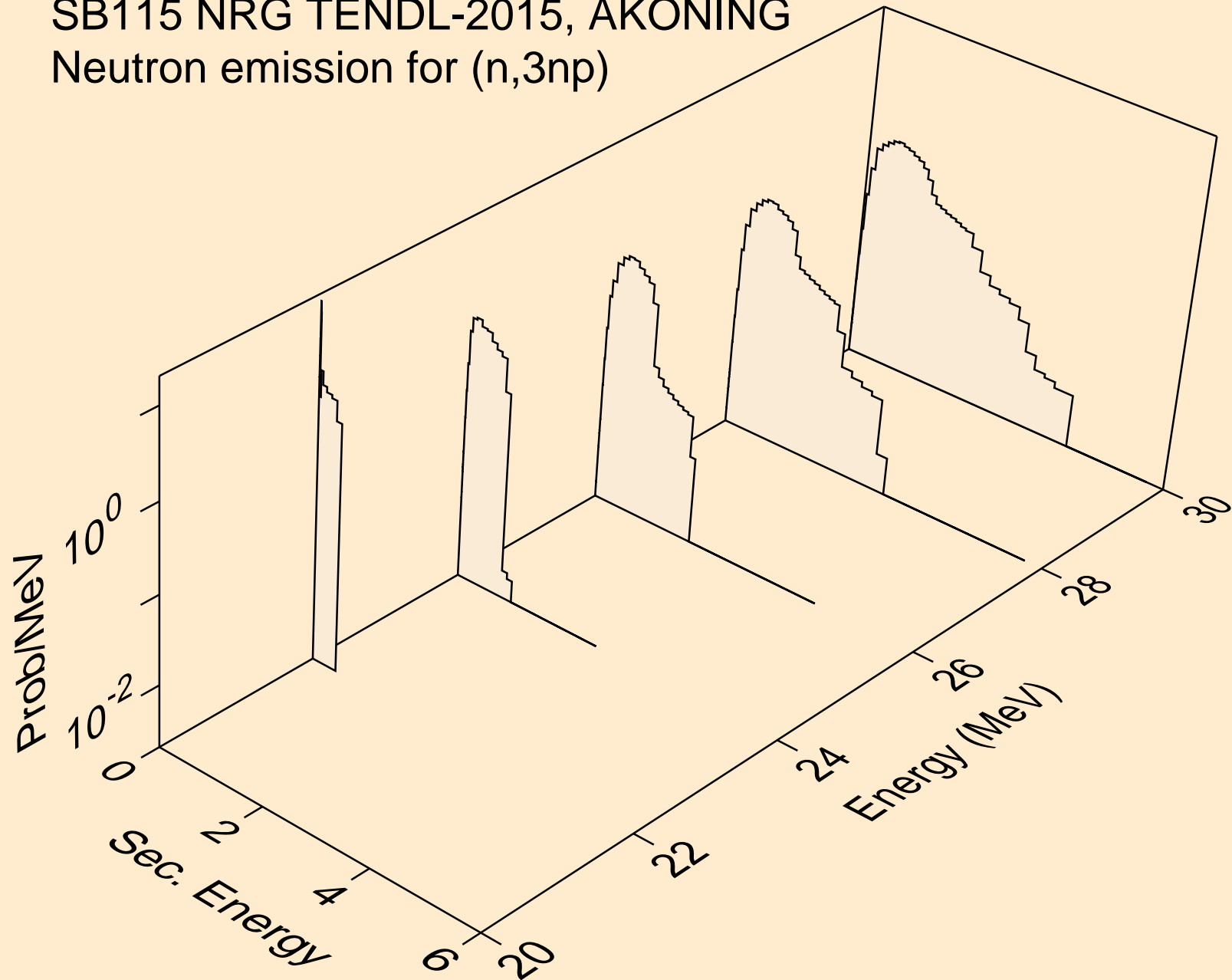



SB115 NRG TENDL-2015, AKONING  
Neutron emission for (n,2np)

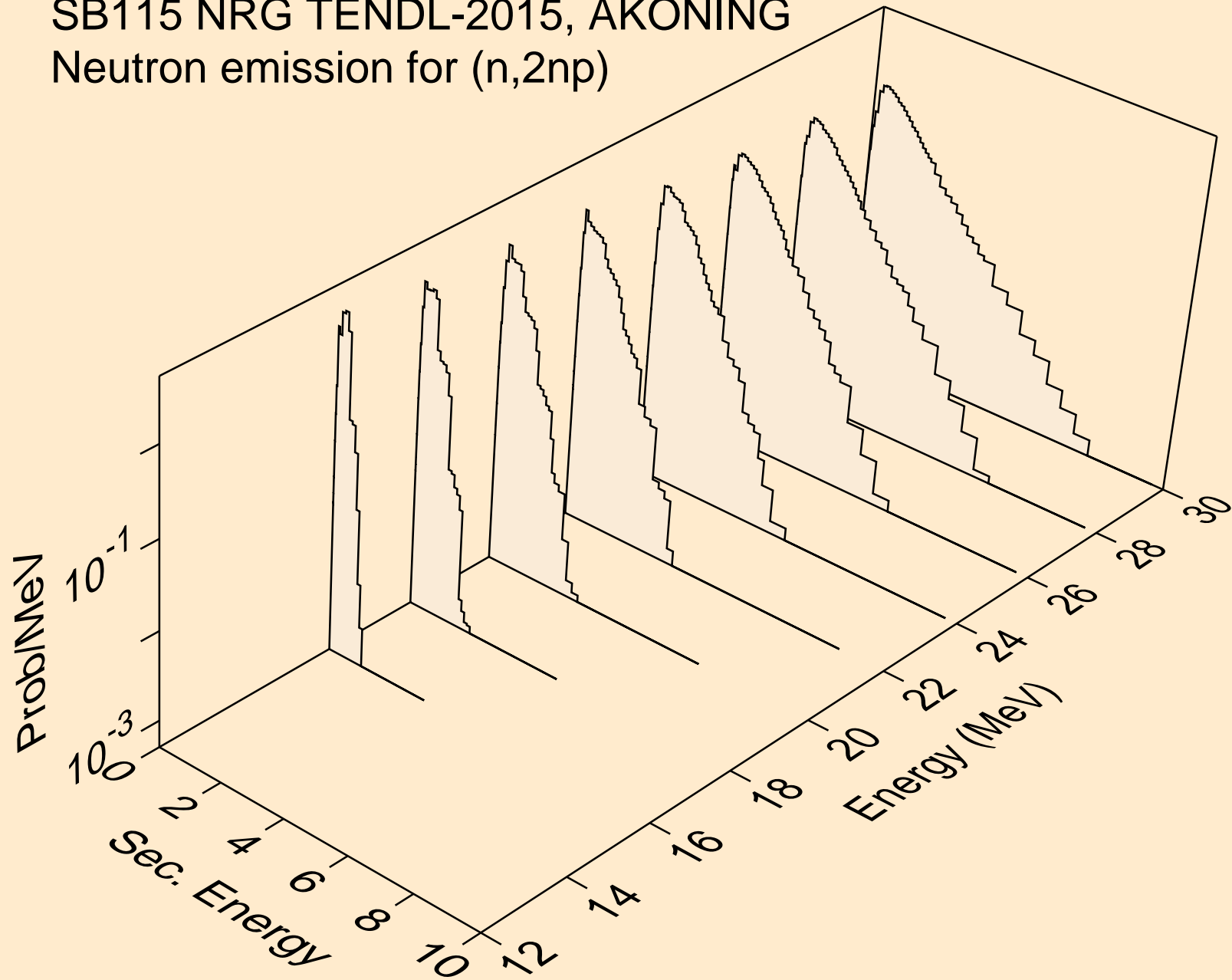

SB115 NRG TENDL-2015, AKONING  
Neutron emission for (n,npa)

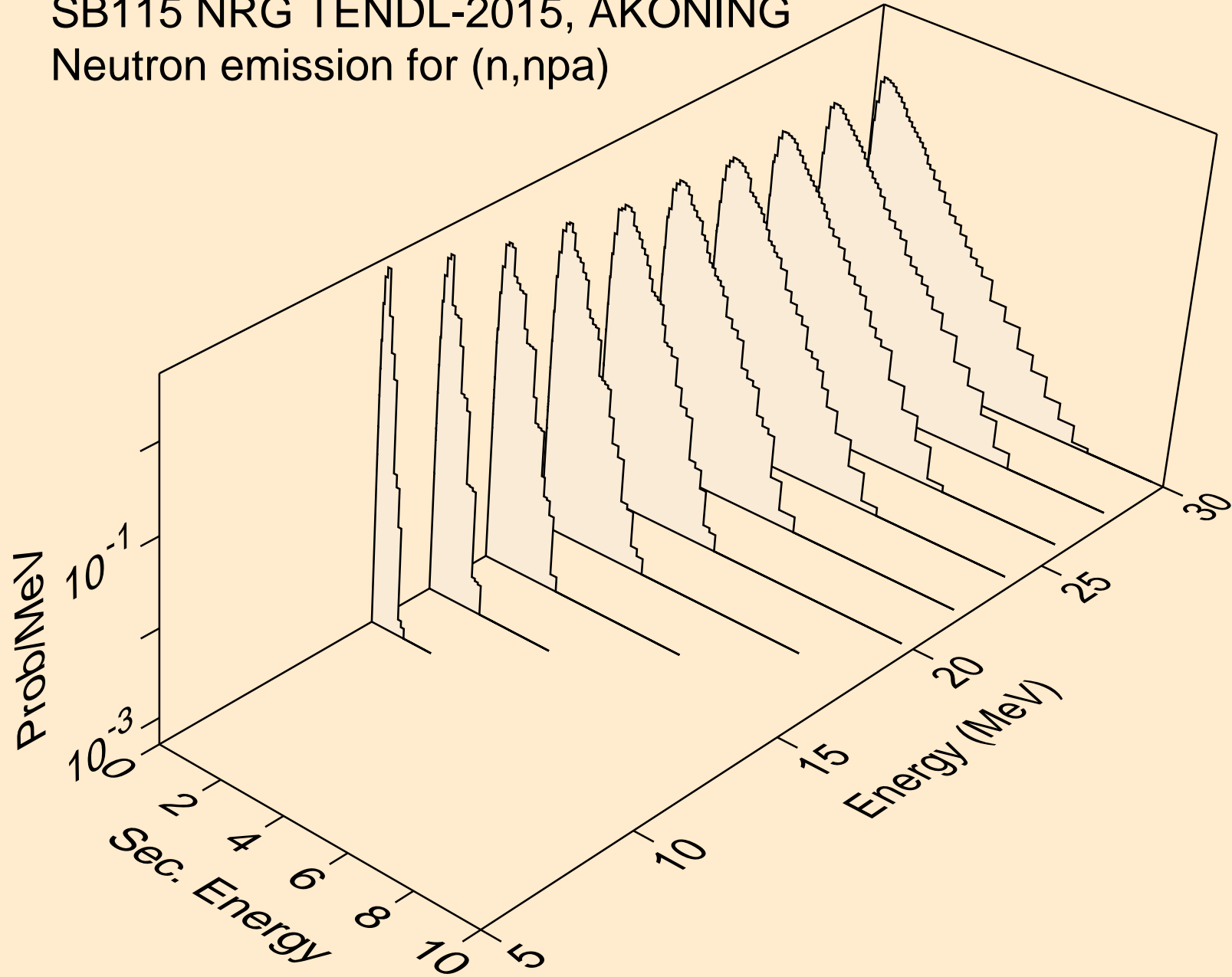

SB115 NRG TENDL-2015, AKONING  
Neutron emission for (n,n\*c)

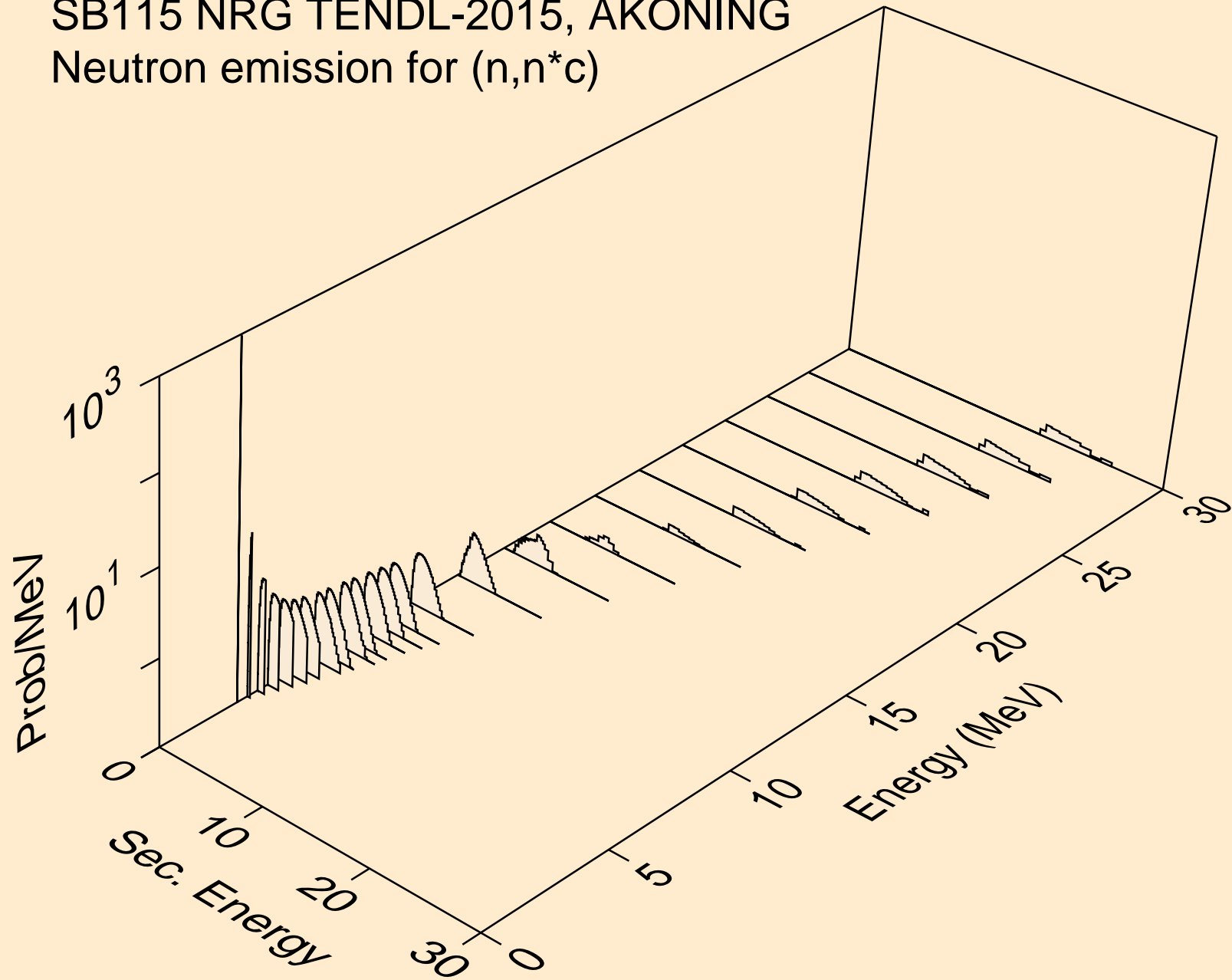

SB115 NRG TENDL-2015, AKONING  
Photon emission for (n,x)

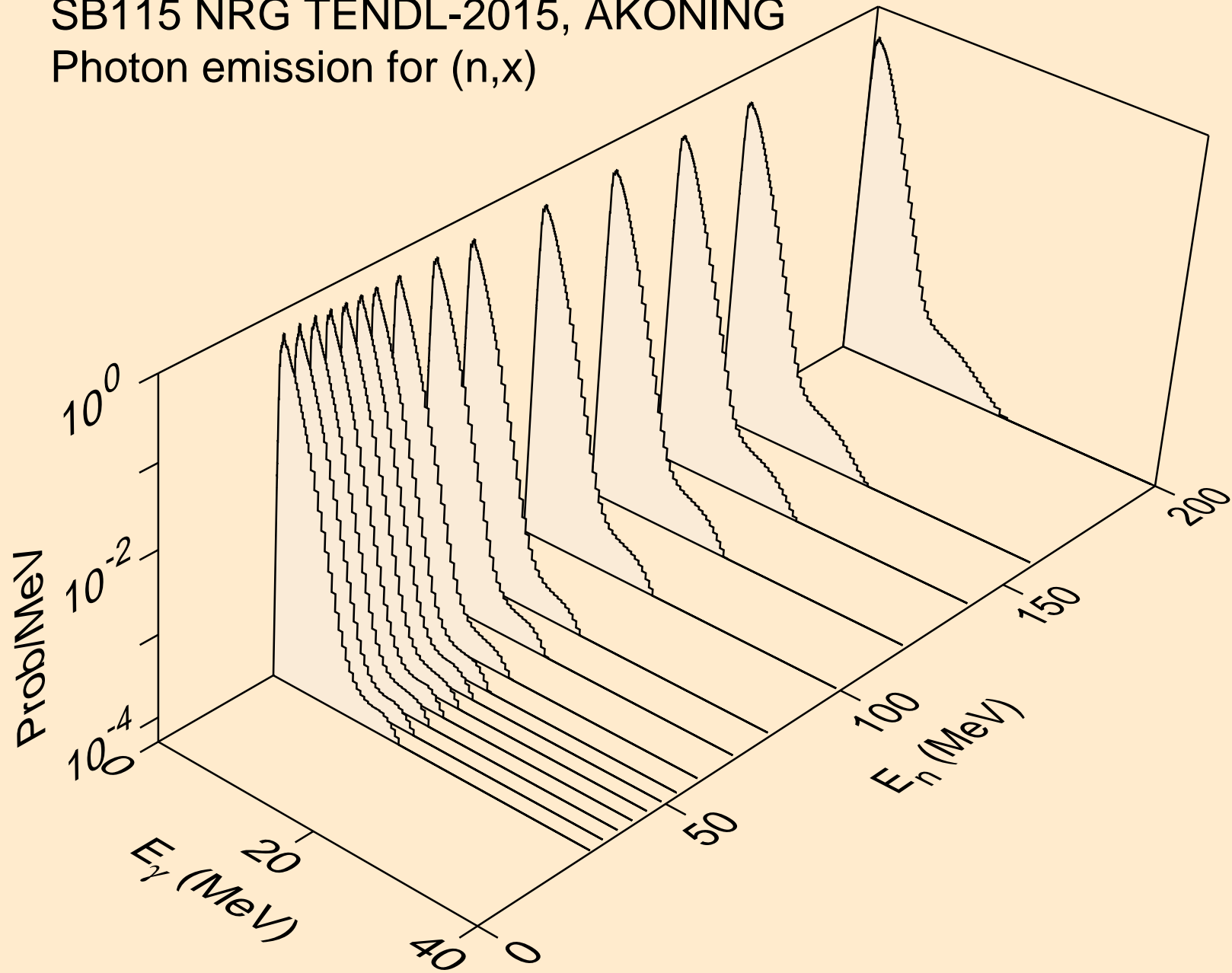

SB115 NRG TENDL-2015, AKONING  
Photon emission for (n,2nd)

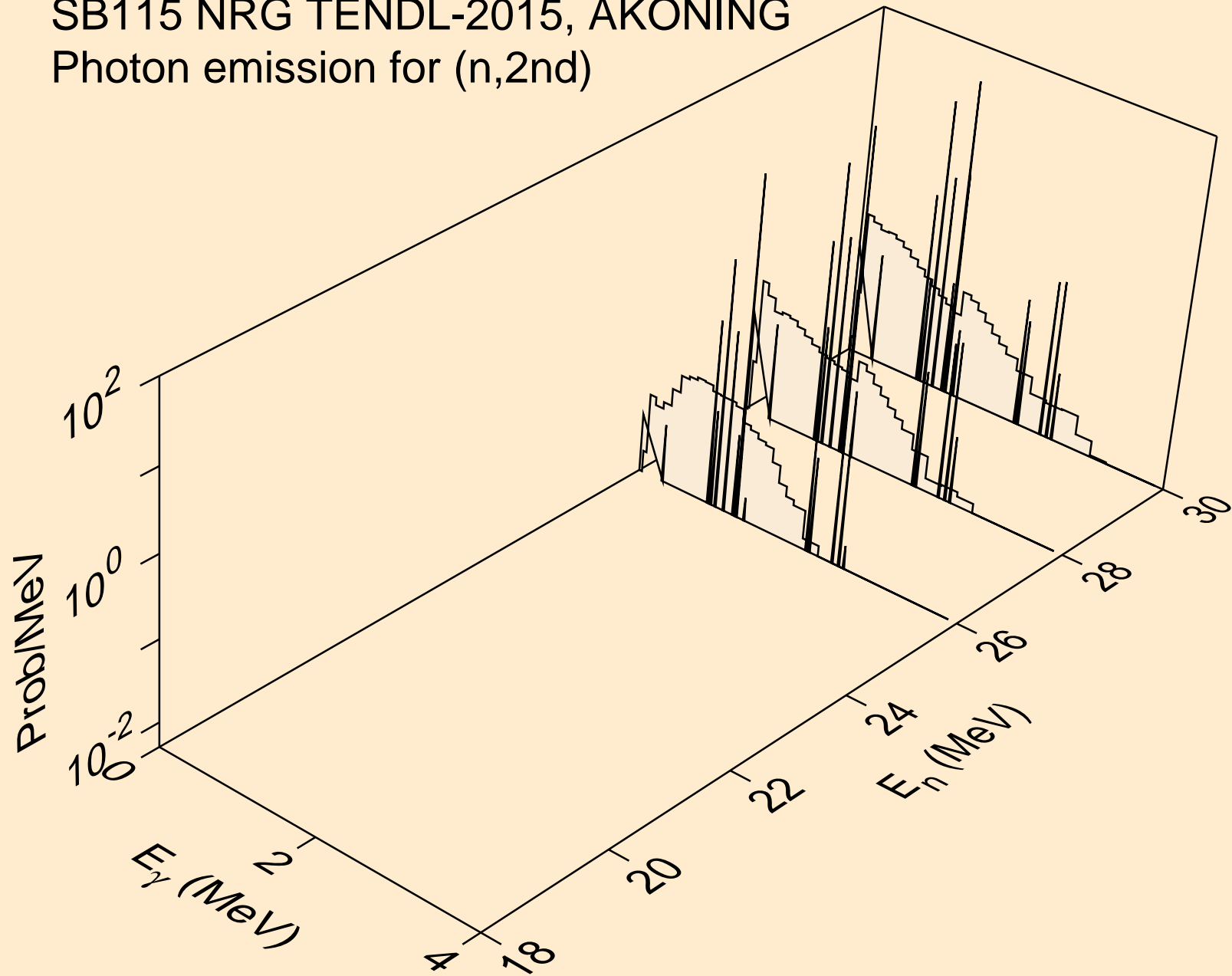

SB115 NRG TENDL-2015, AKONING  
Photon emission for (n,2n)

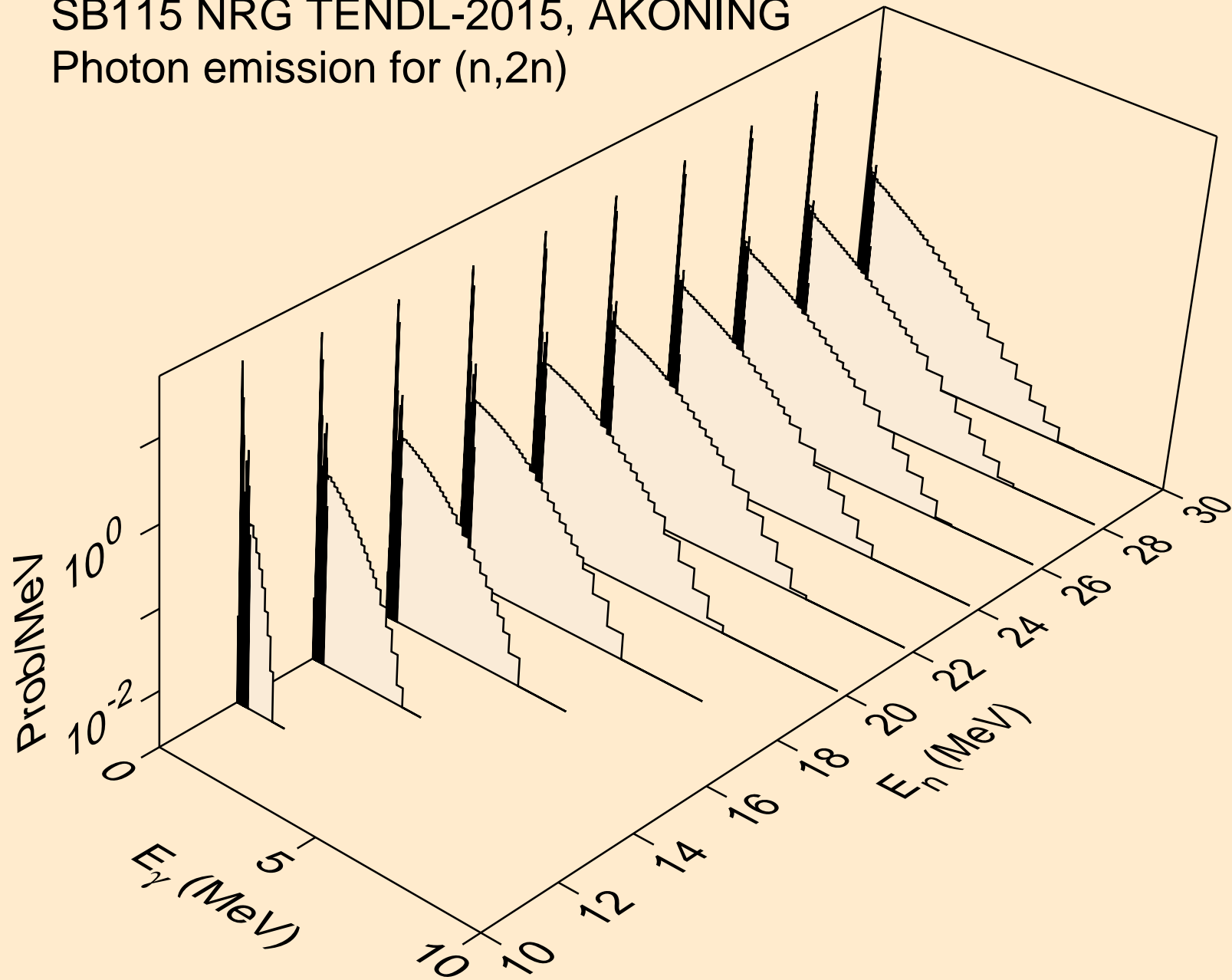

SB115 NRG TENDL-2015, AKONING  
Photon emission for (n,3n)

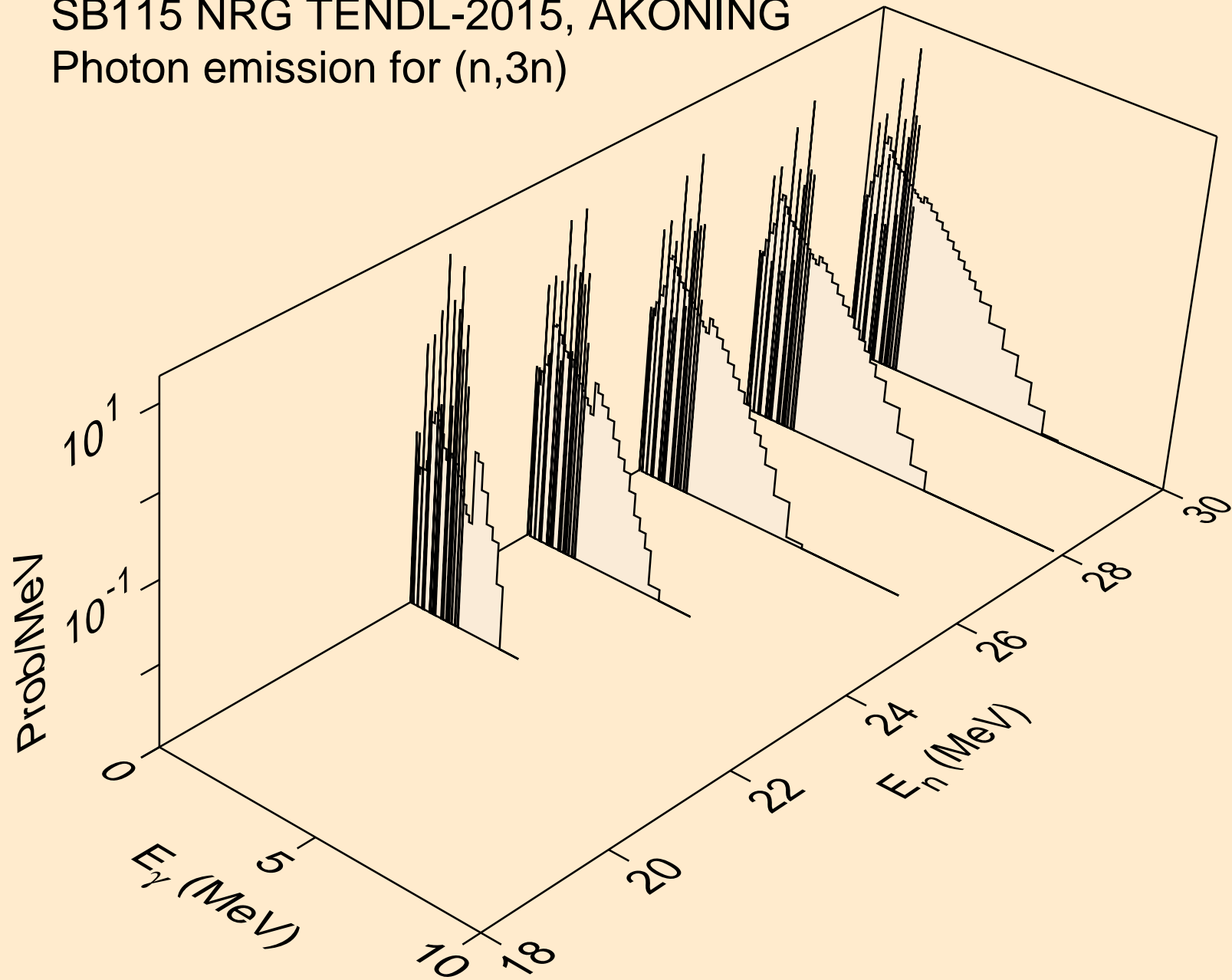

SB115 NRG TENDL-2015, AKONING  
Photon emission for (n,n\*)a

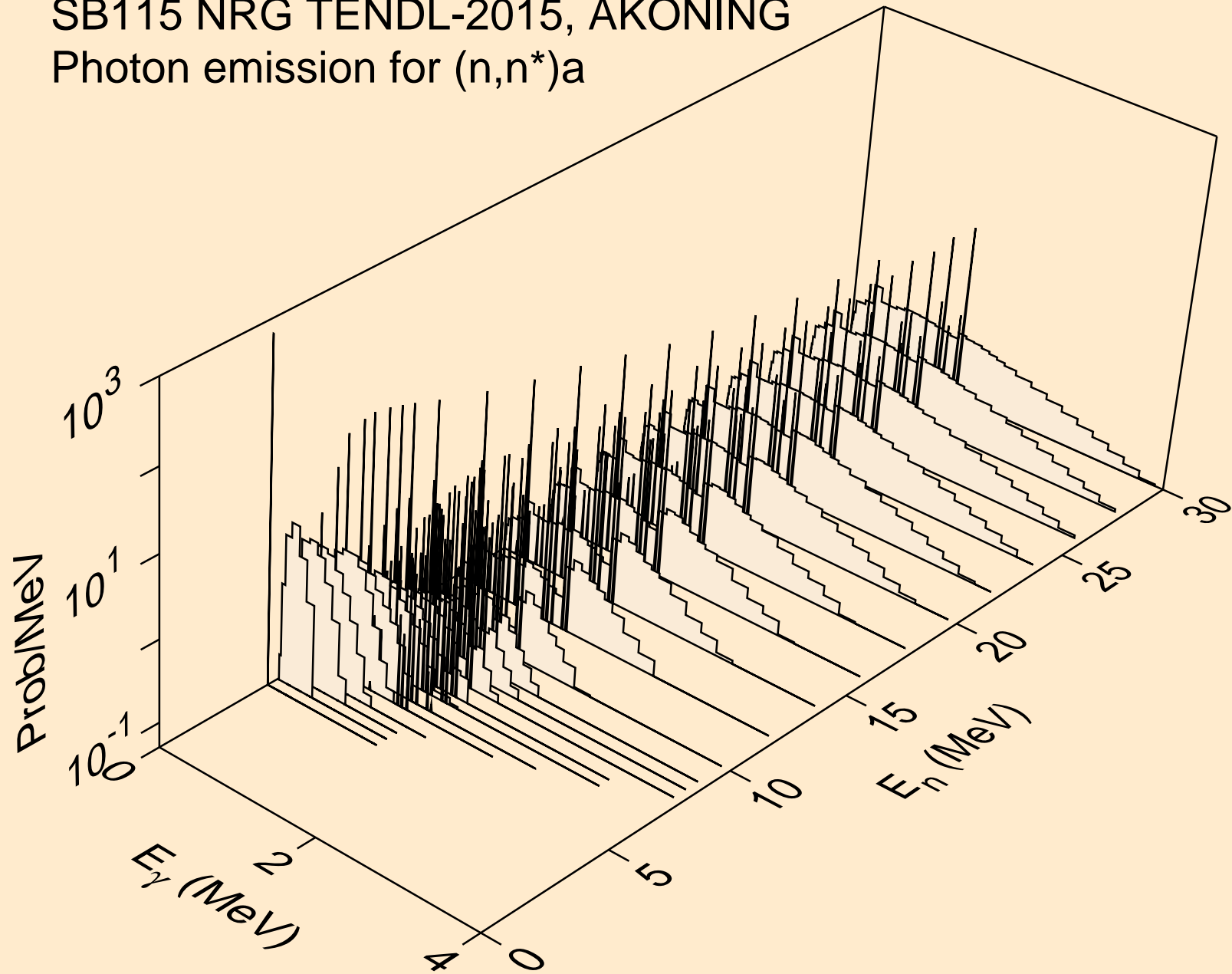



SB115 NRG TENDL-2015, AKONING  
Photon emission for (n,2n)a

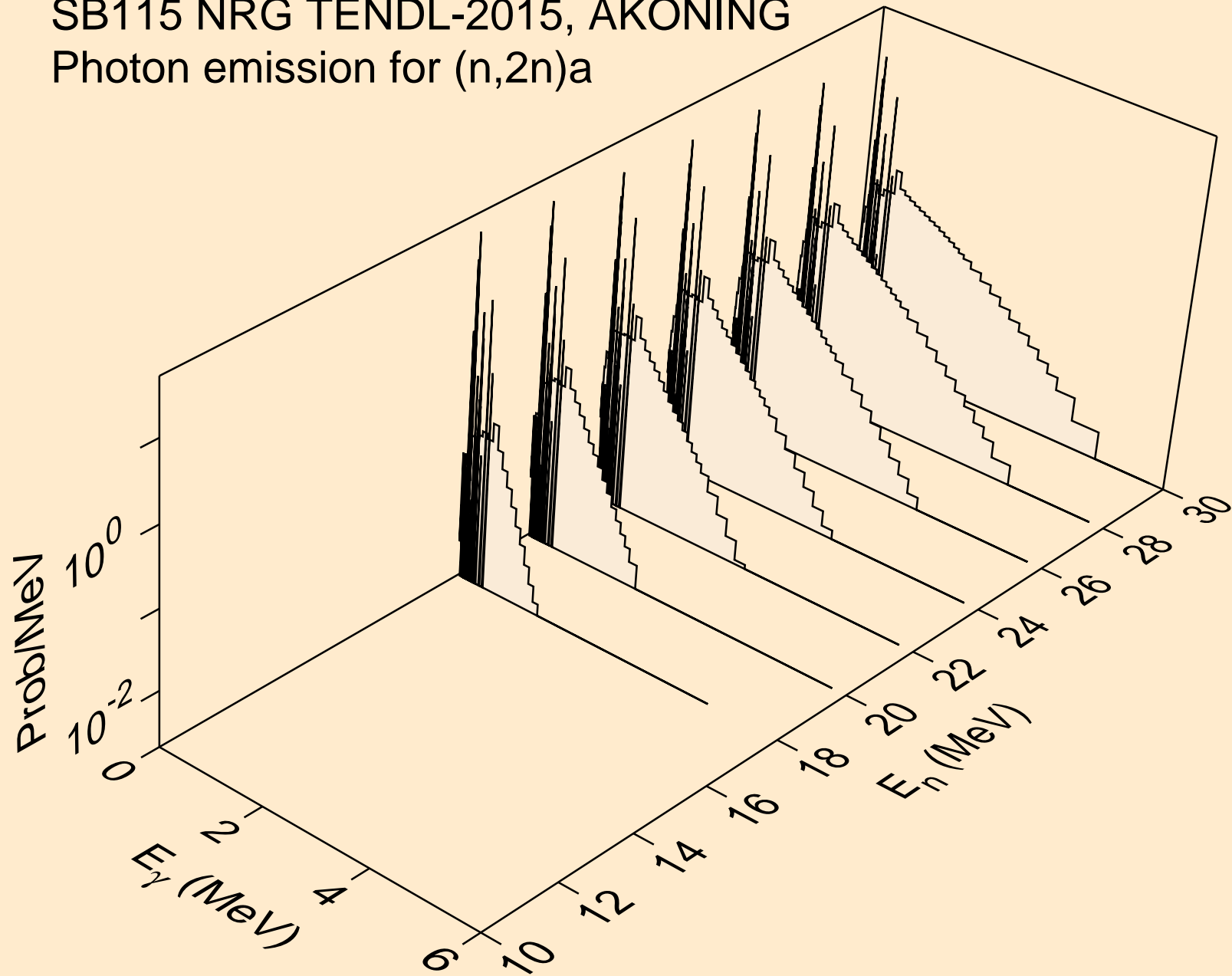

SB115 NRG TENDL-2015, AKONING  
Photon emission for (n,3n)a

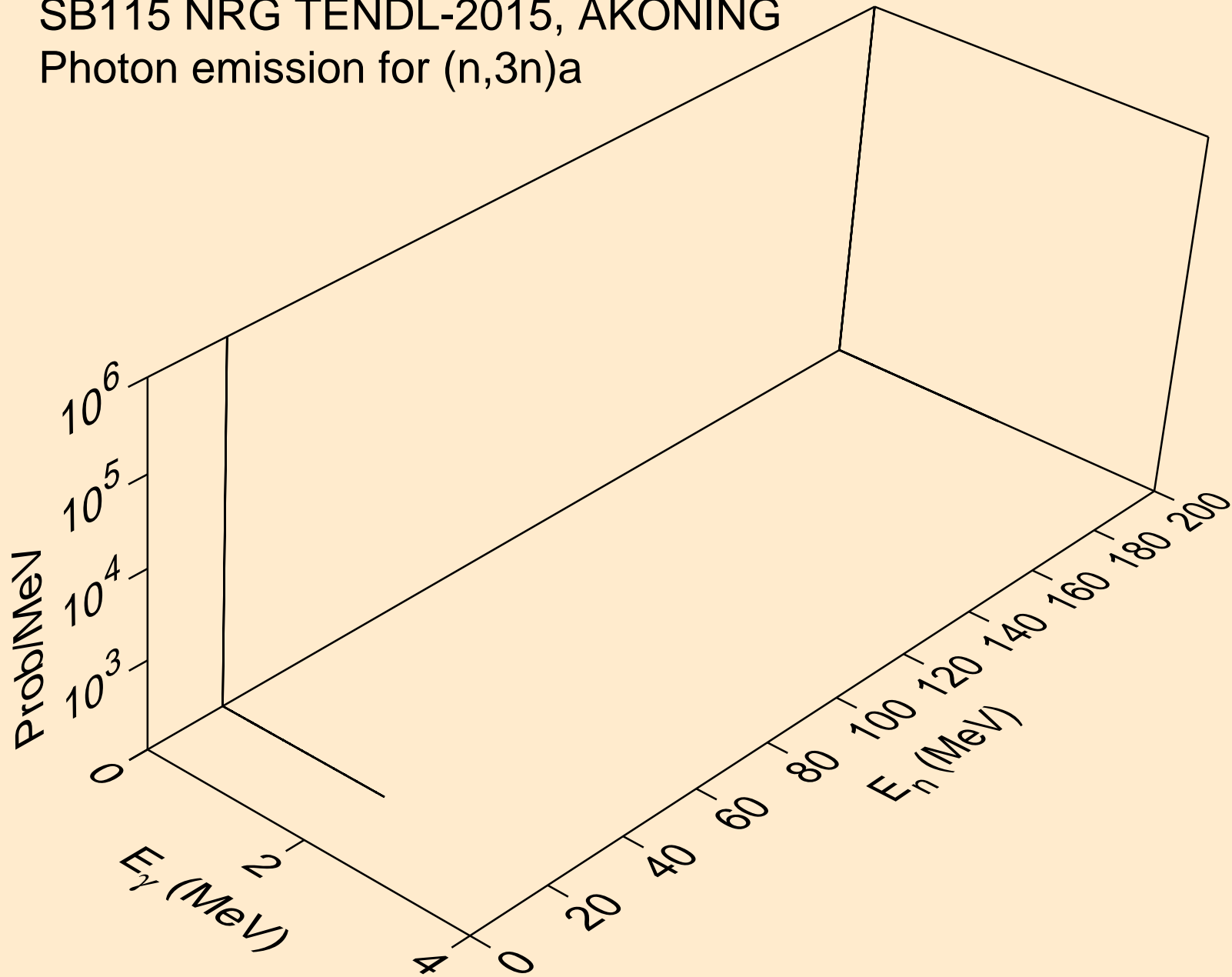

SB115 NRG TENDL-2015, AKONING  
Photon emission for (n,n\*)p

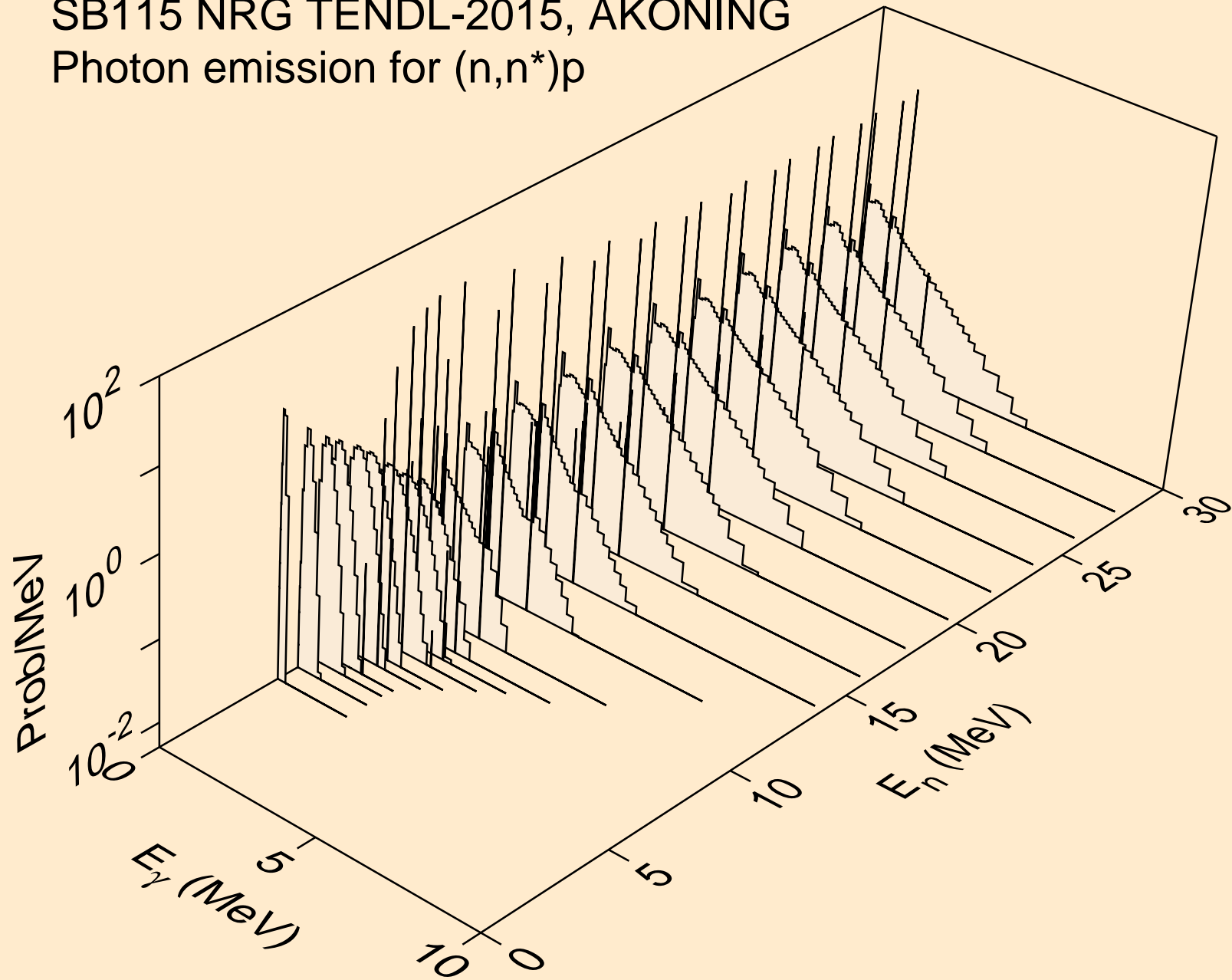

SB115 NRG TENDL-2015, AKONING  
Photon emission for (n,n\*)2a

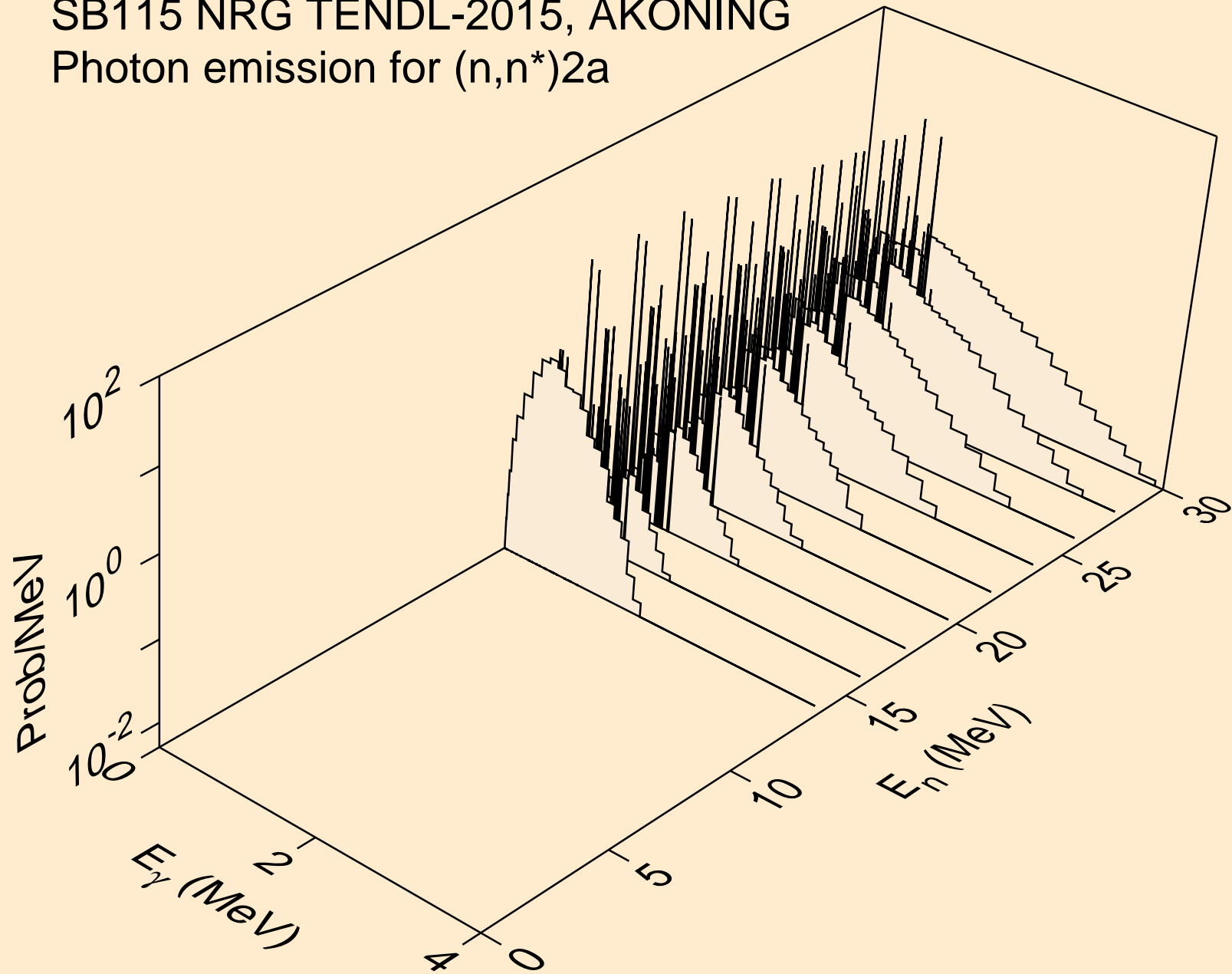

SB115 NRG TENDL-2015, AKONING  
Photon emission for (n,n\*)d

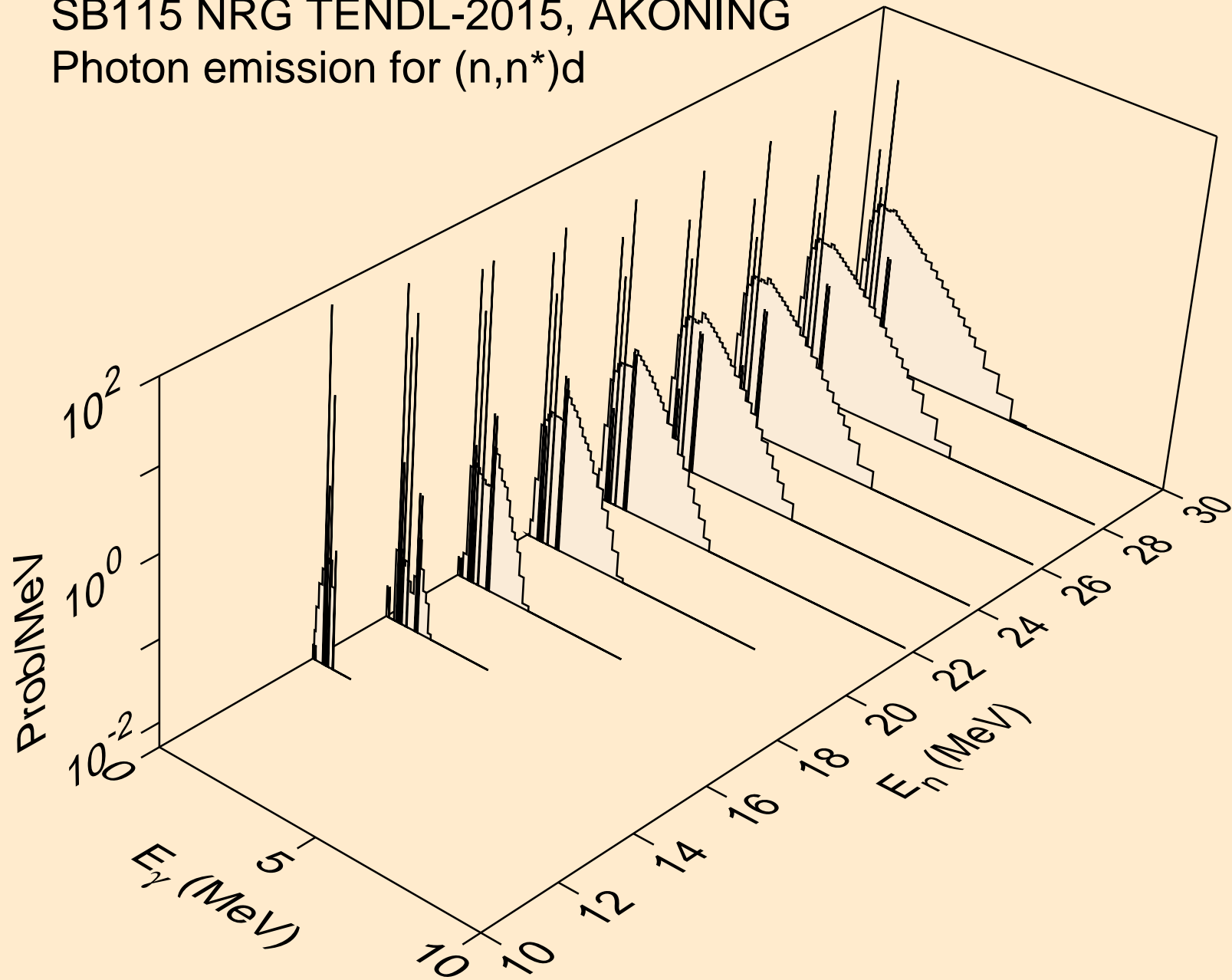

SB115 NRG TENDL-2015, AKONING  
Photon emission for (n,n\*)t

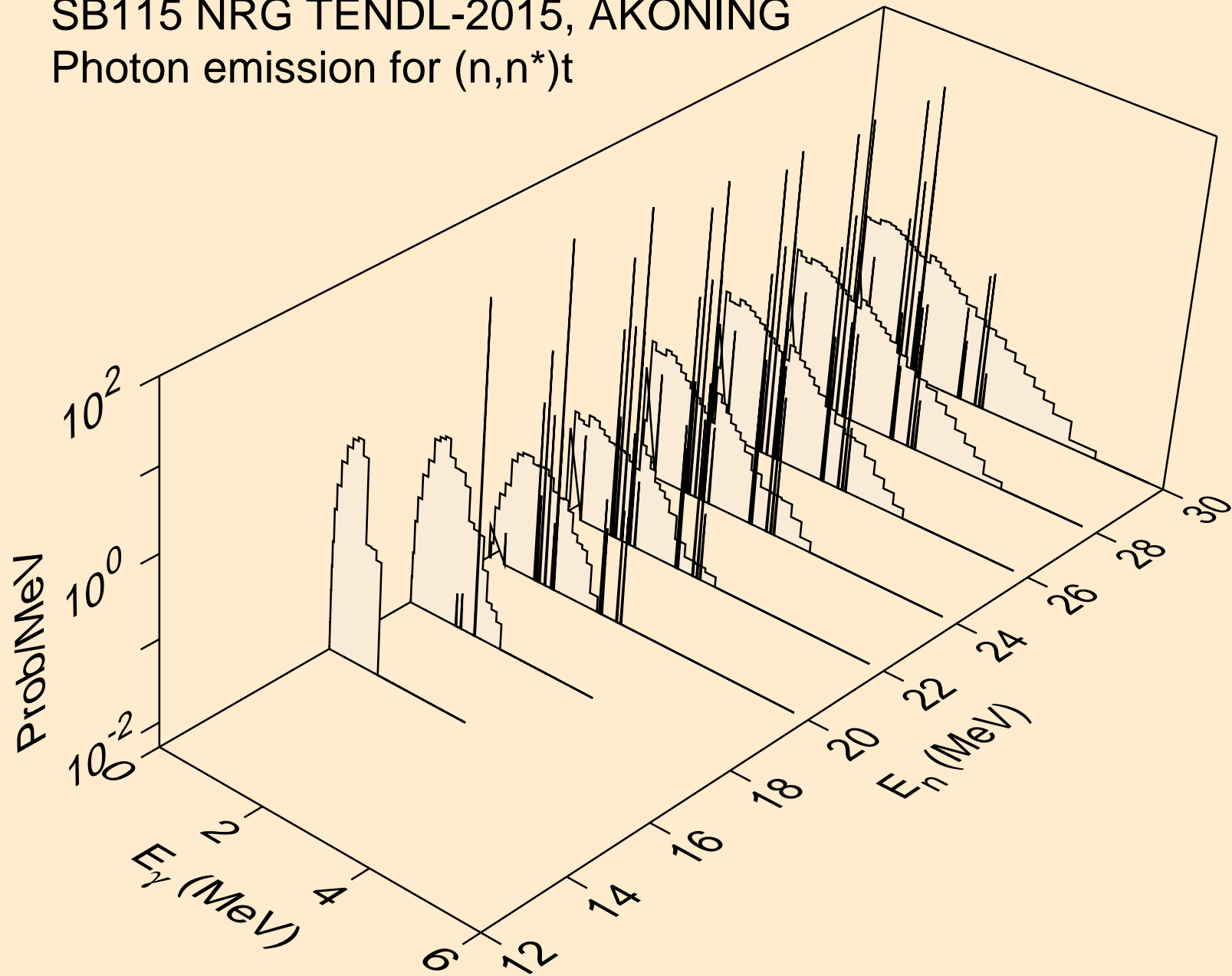

SB115 NRG TENDL-2015, AKONING  
Photon emission for (n,n\*)he3

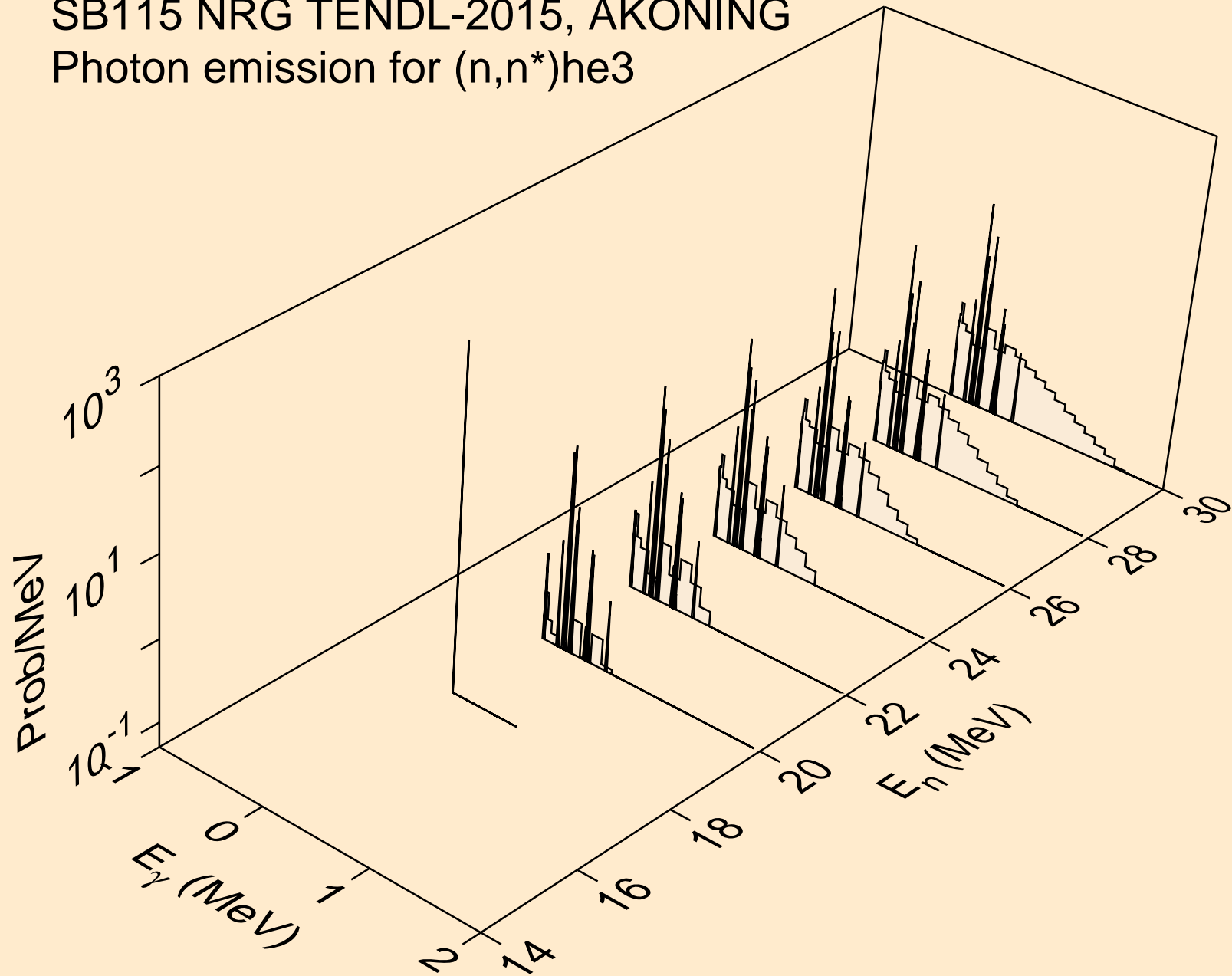

SB115 NRG TENDL-2015, AKONING  
Photon emission for (n,4n)

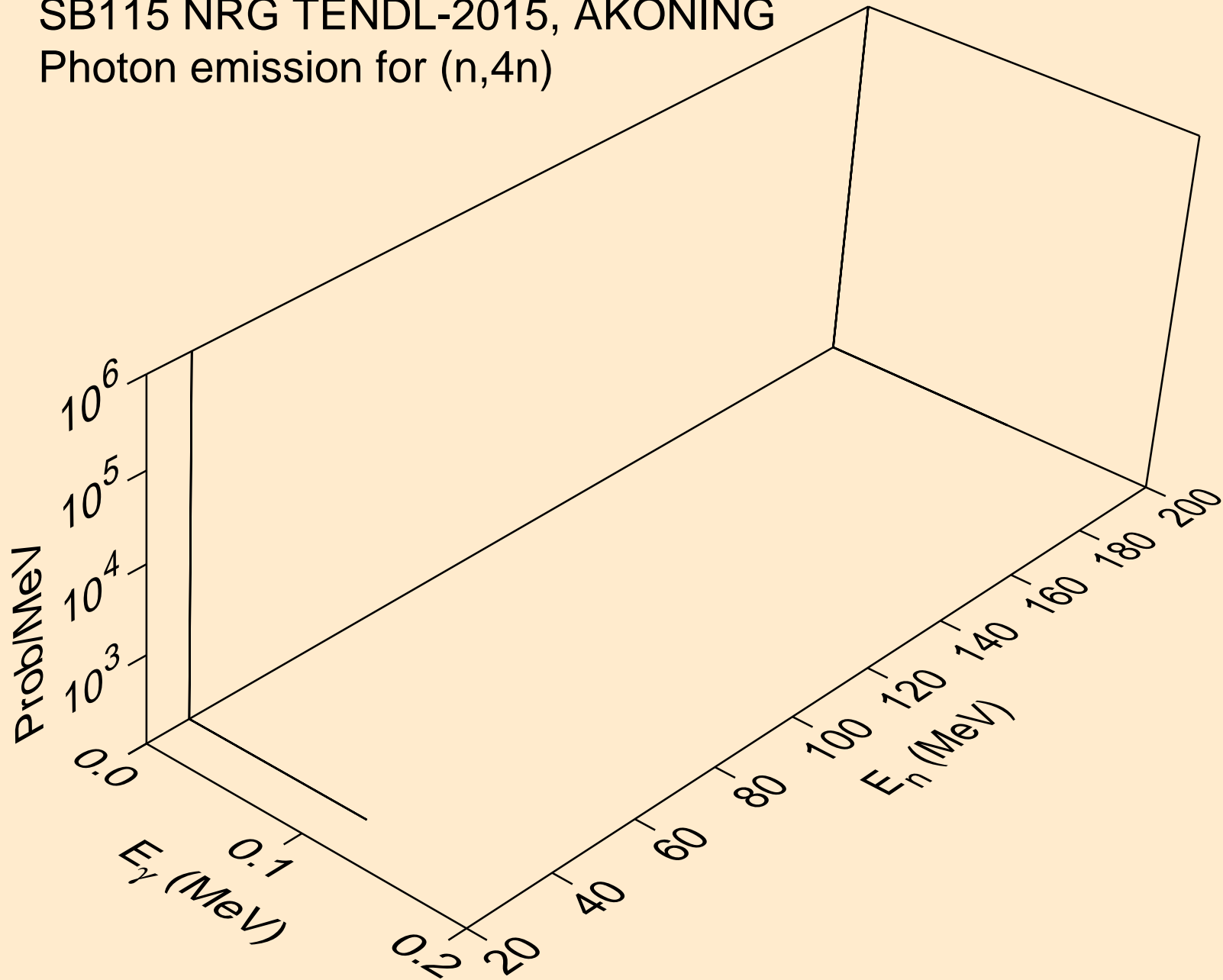



SB115 NRG TENDL-2015, AKONING  
Photon emission for (n,2np)

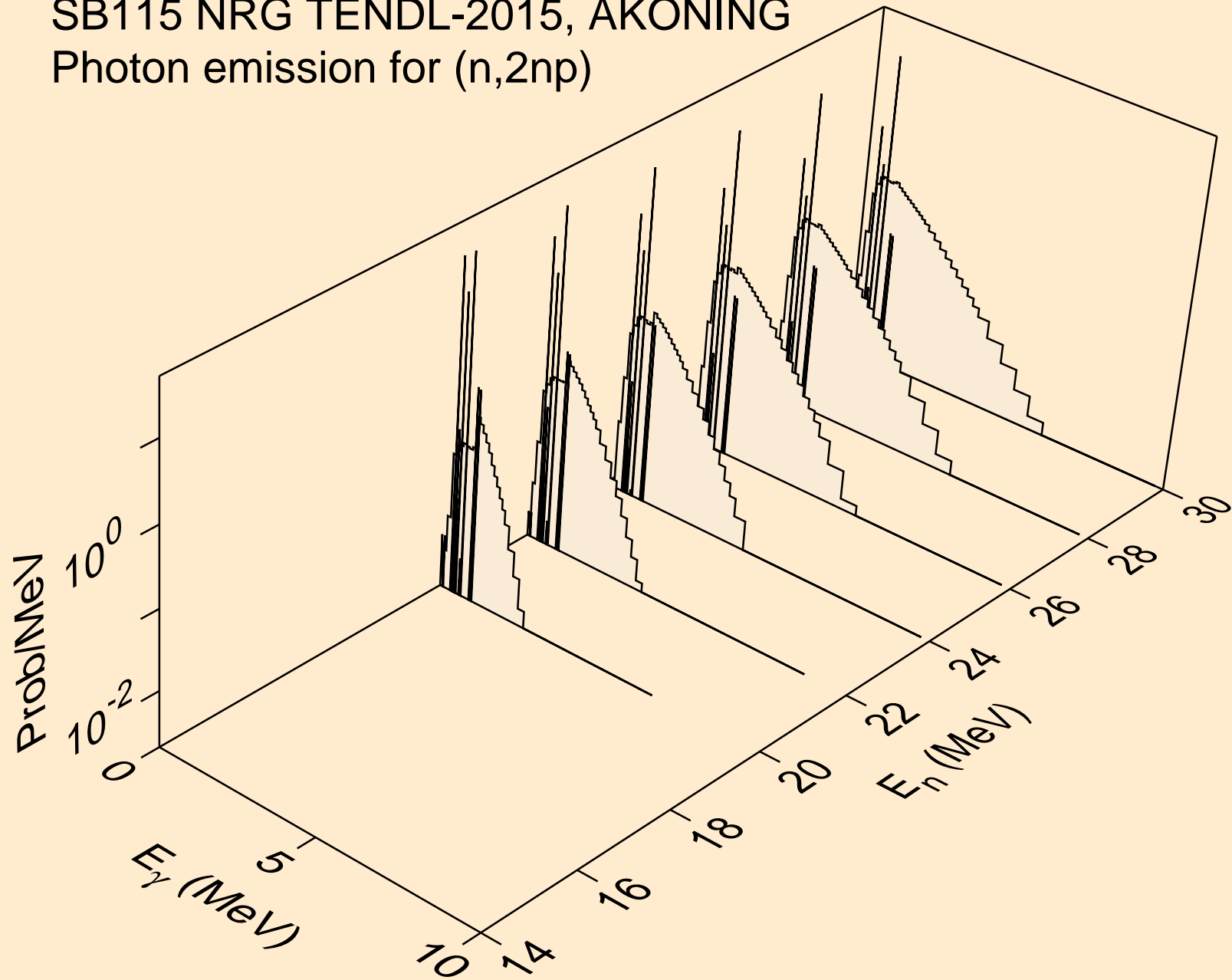

SB115 NRG TENDL-2015, AKONING  
Photon emission for (n,3np)

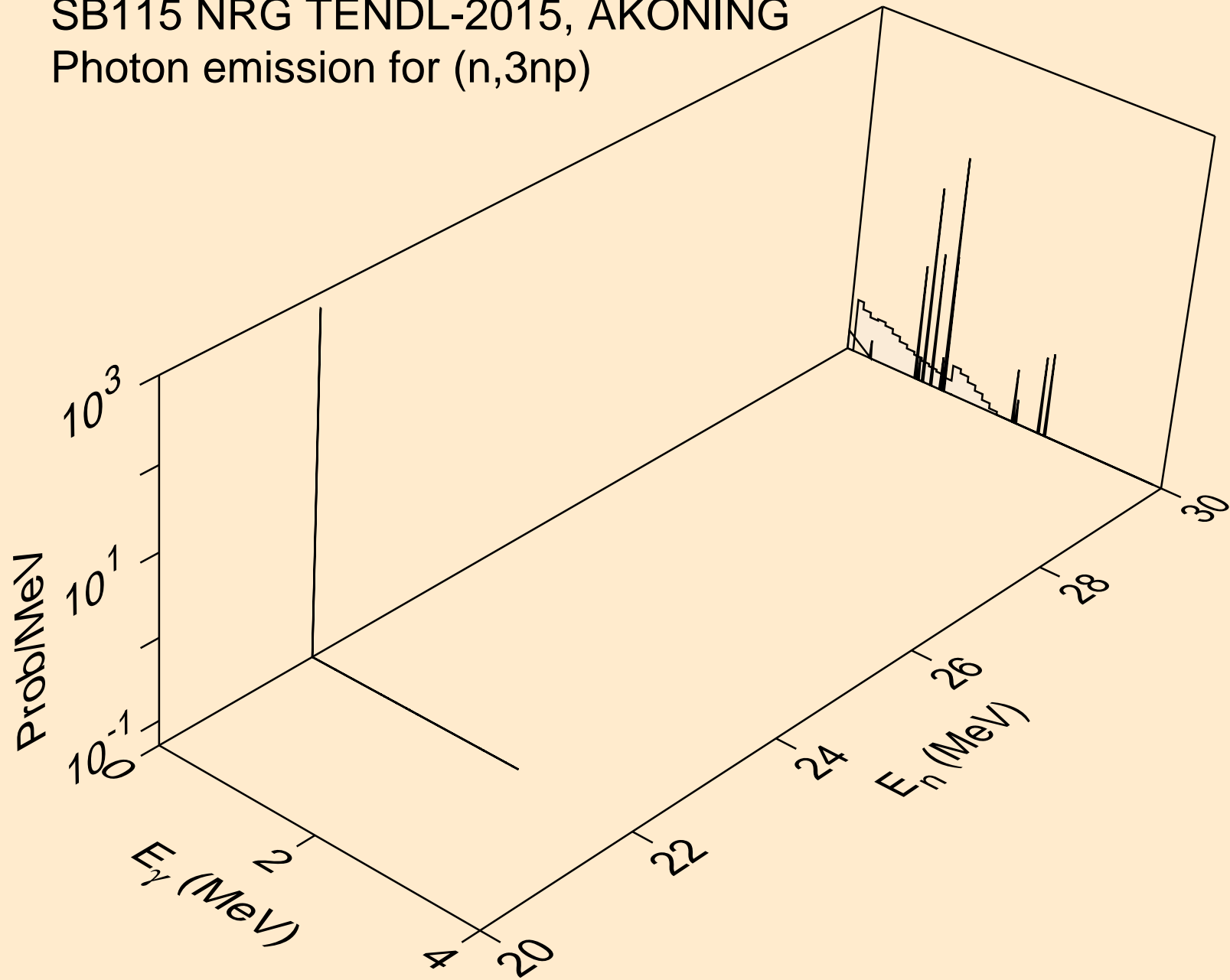

SB115 NRG TENDL-2015, AKONING  
Photon emission for (n,2np)

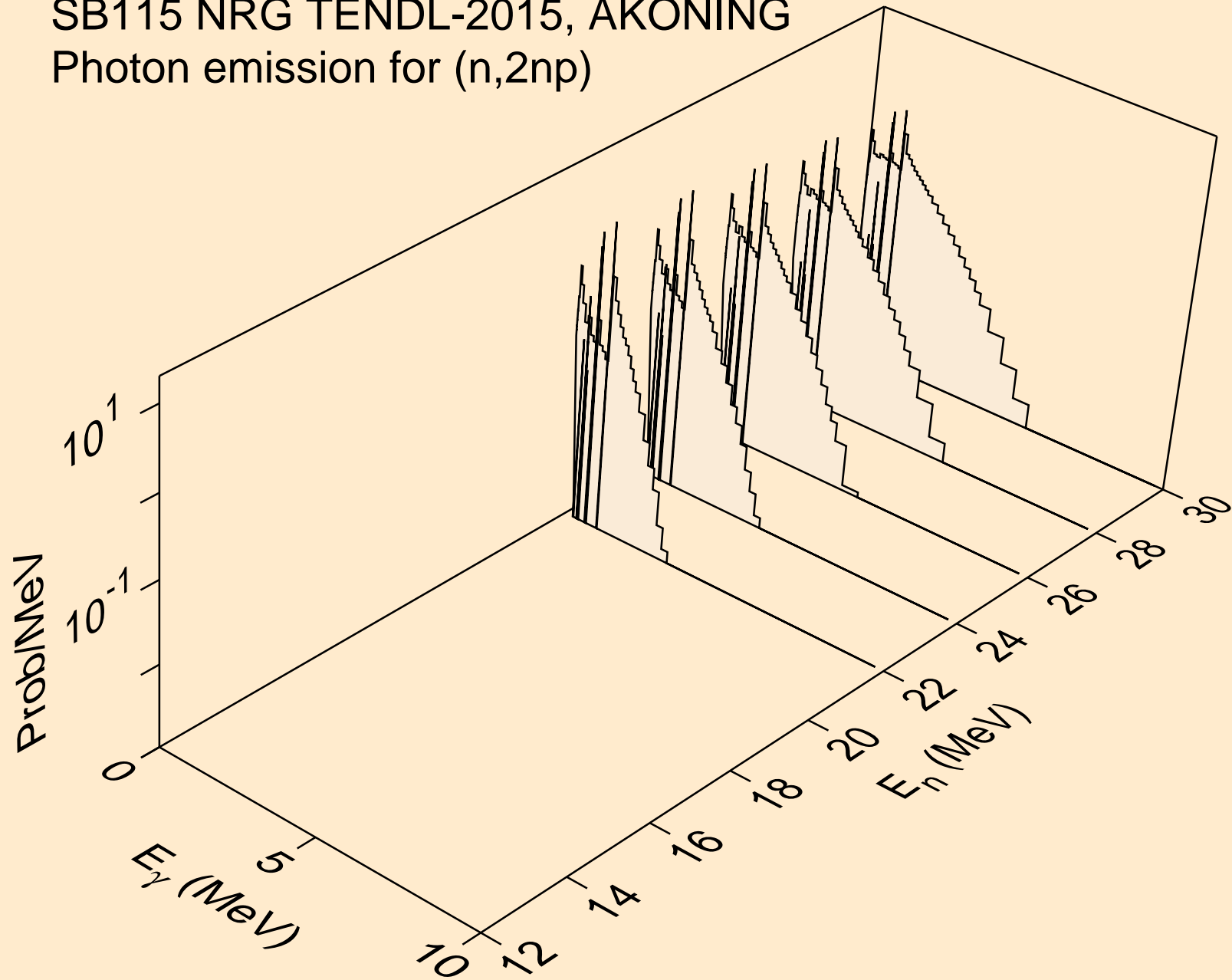

SB115 NRG TENDL-2015, AKONING  
Photon emission for (n,npa)

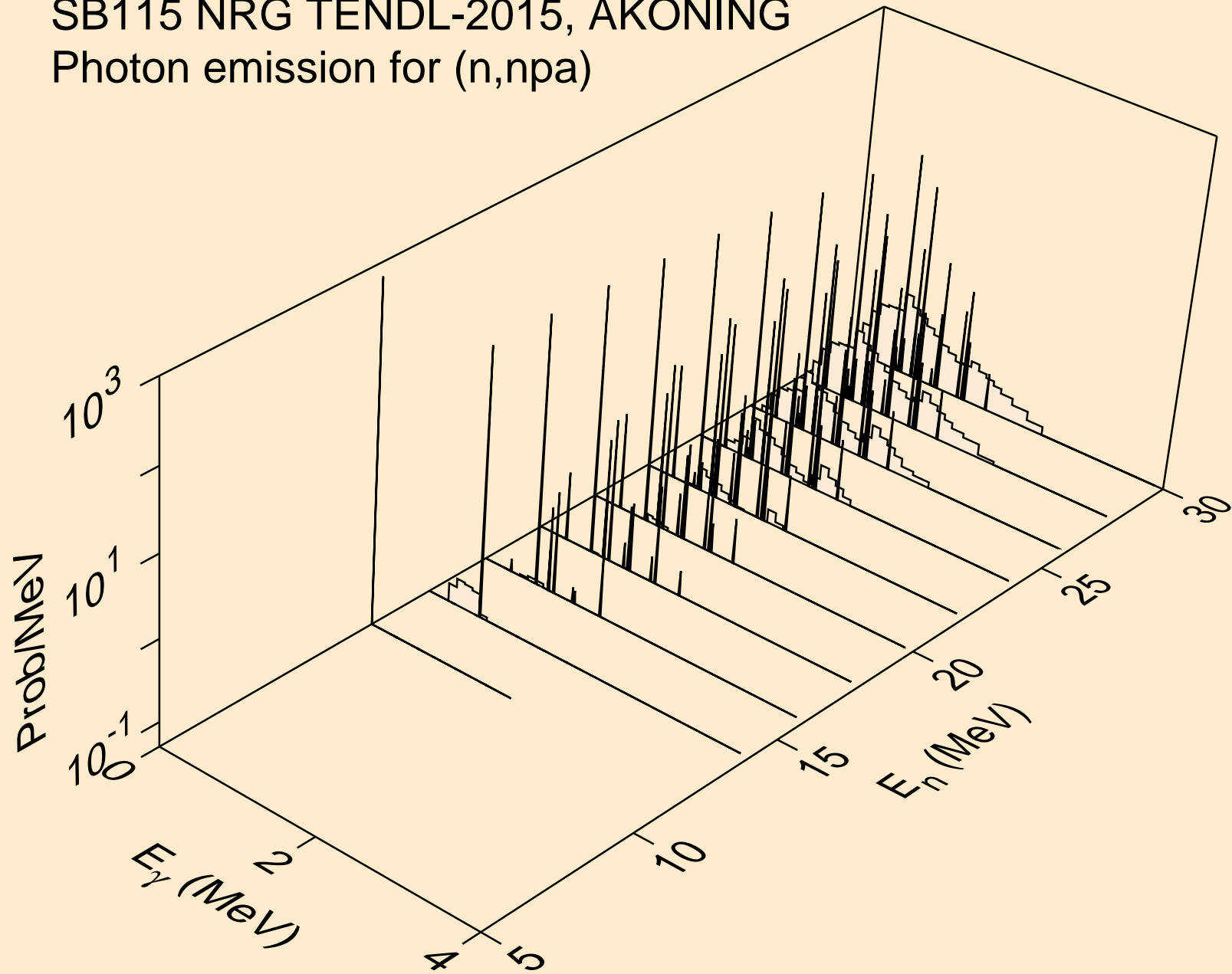

SB115 NRG TENDL-2015, AKONING  
Photon emission for (n,n\*c)

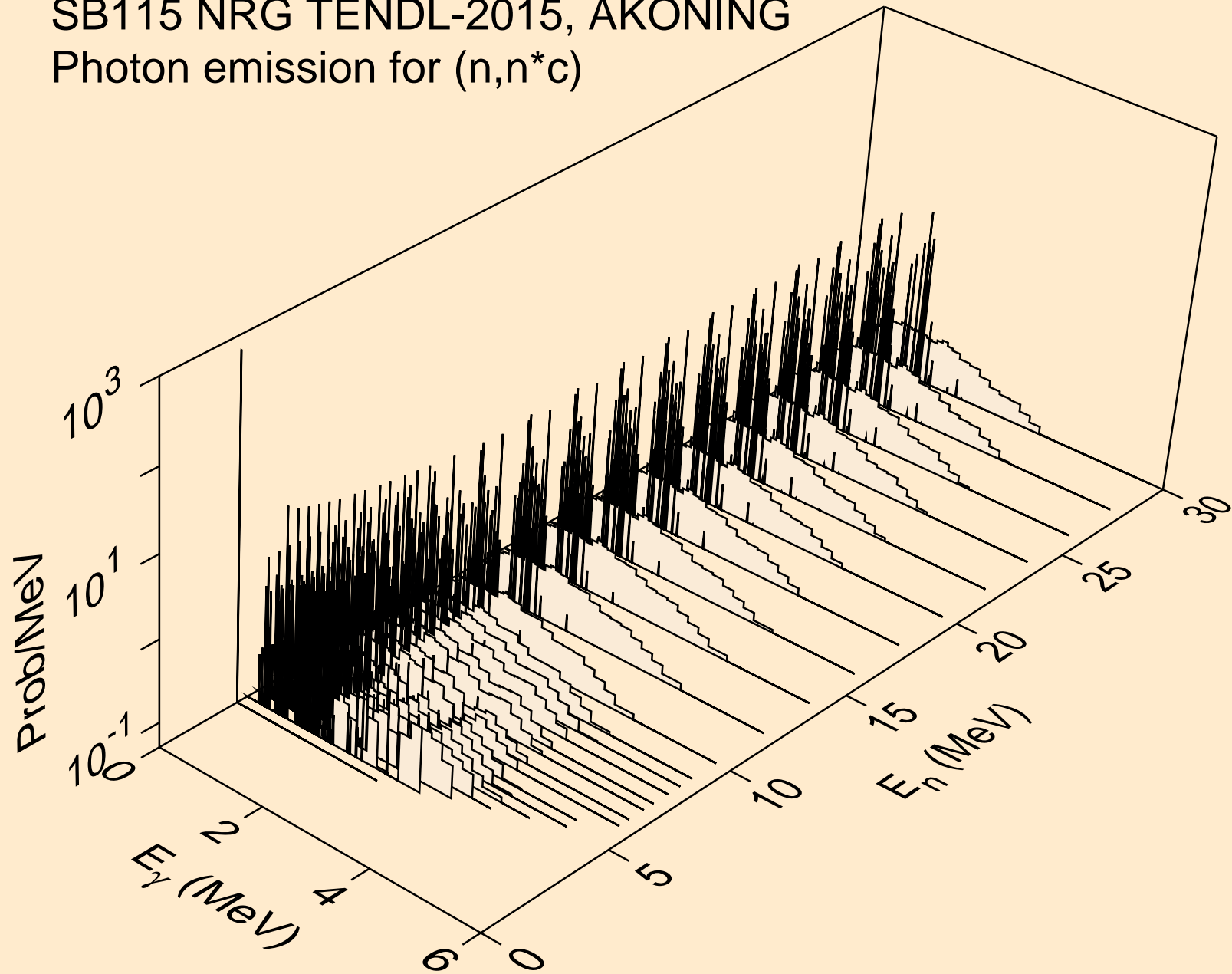

SB115 NRG TENDL-2015, AKONING  
Photon emission for (n,gma)

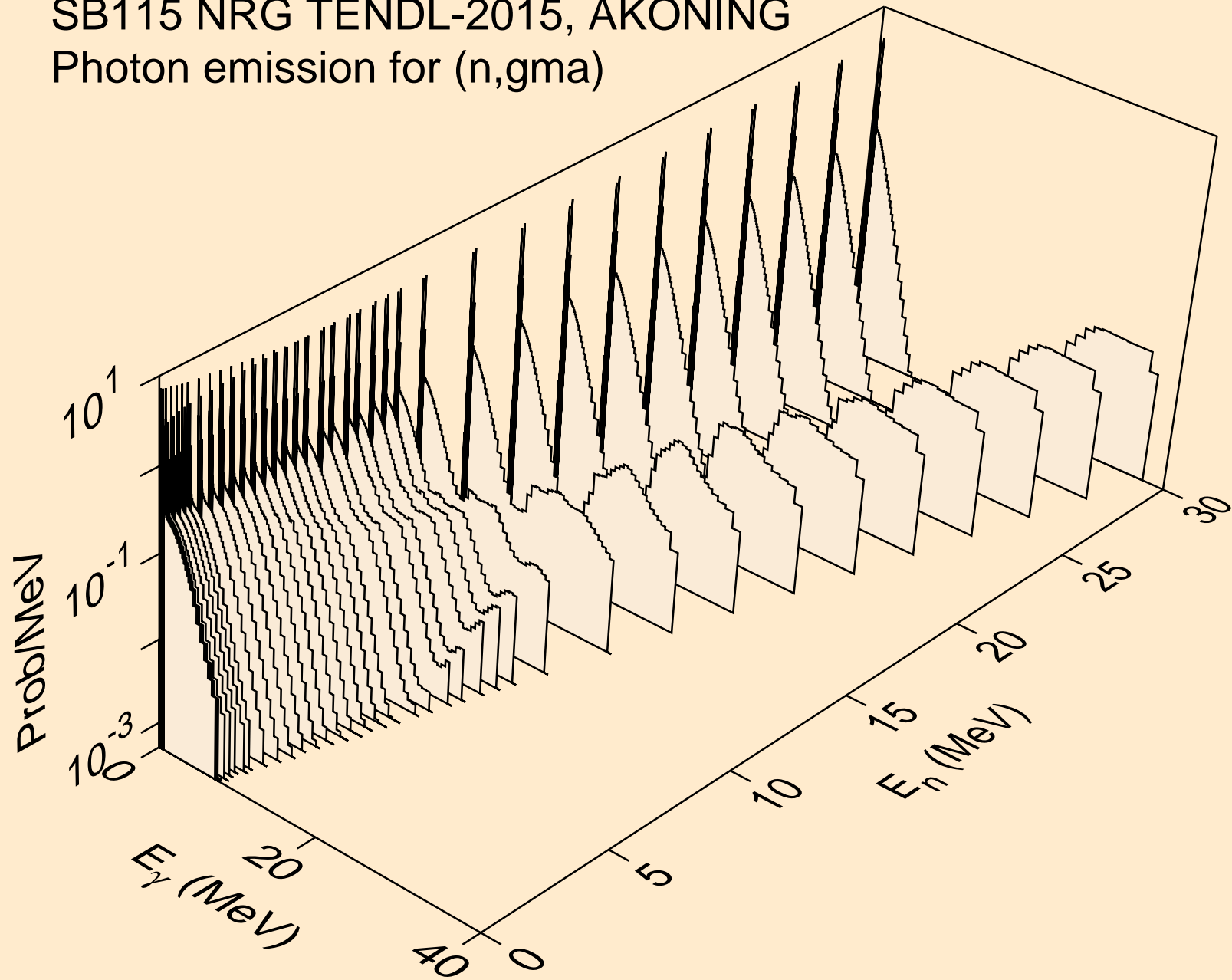

SB115 NRG TENDL-2015, AKONING  
Photon emission for (n,p)

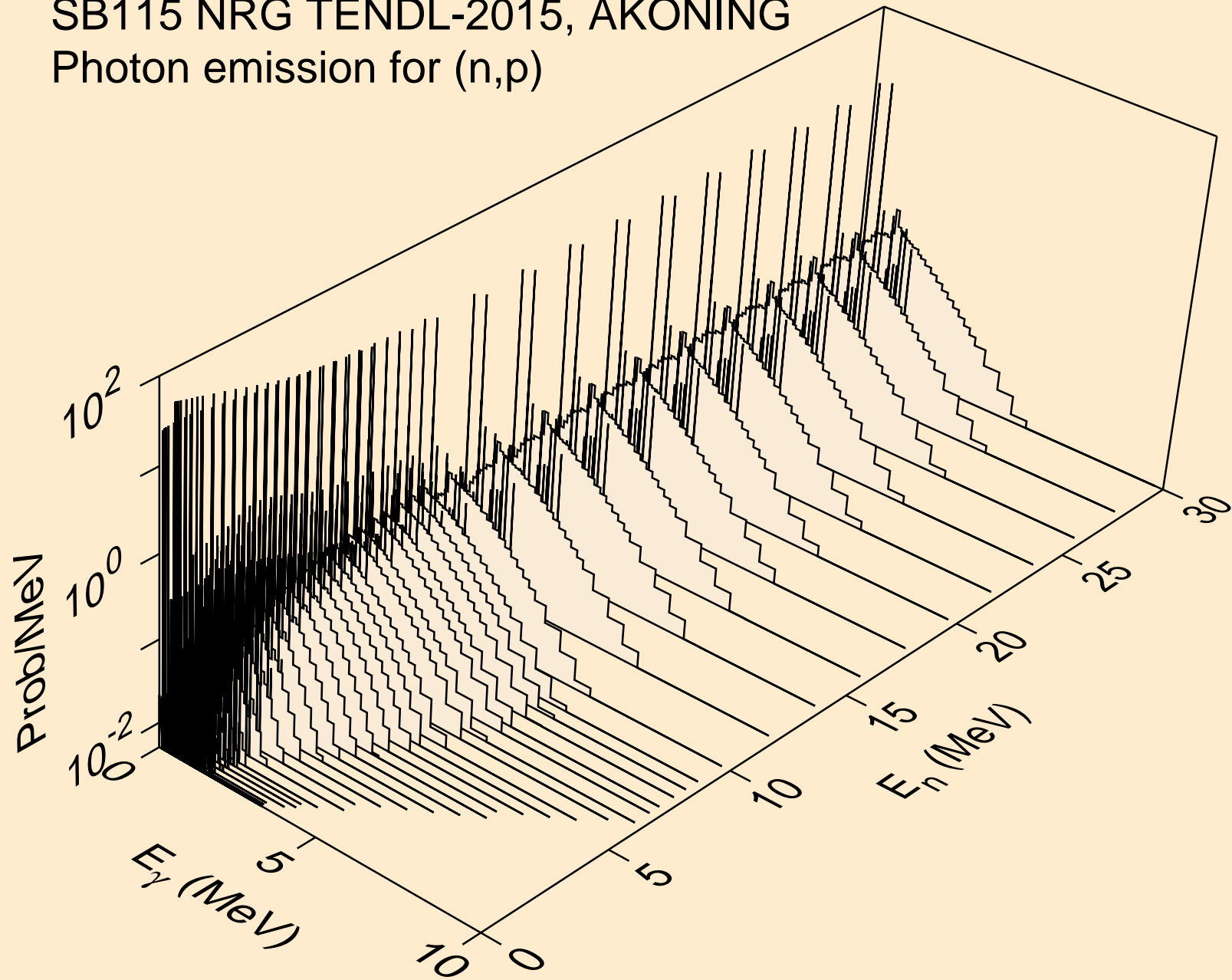

SB115 NRG TENDL-2015, AKONING  
Photon emission for (n,d)

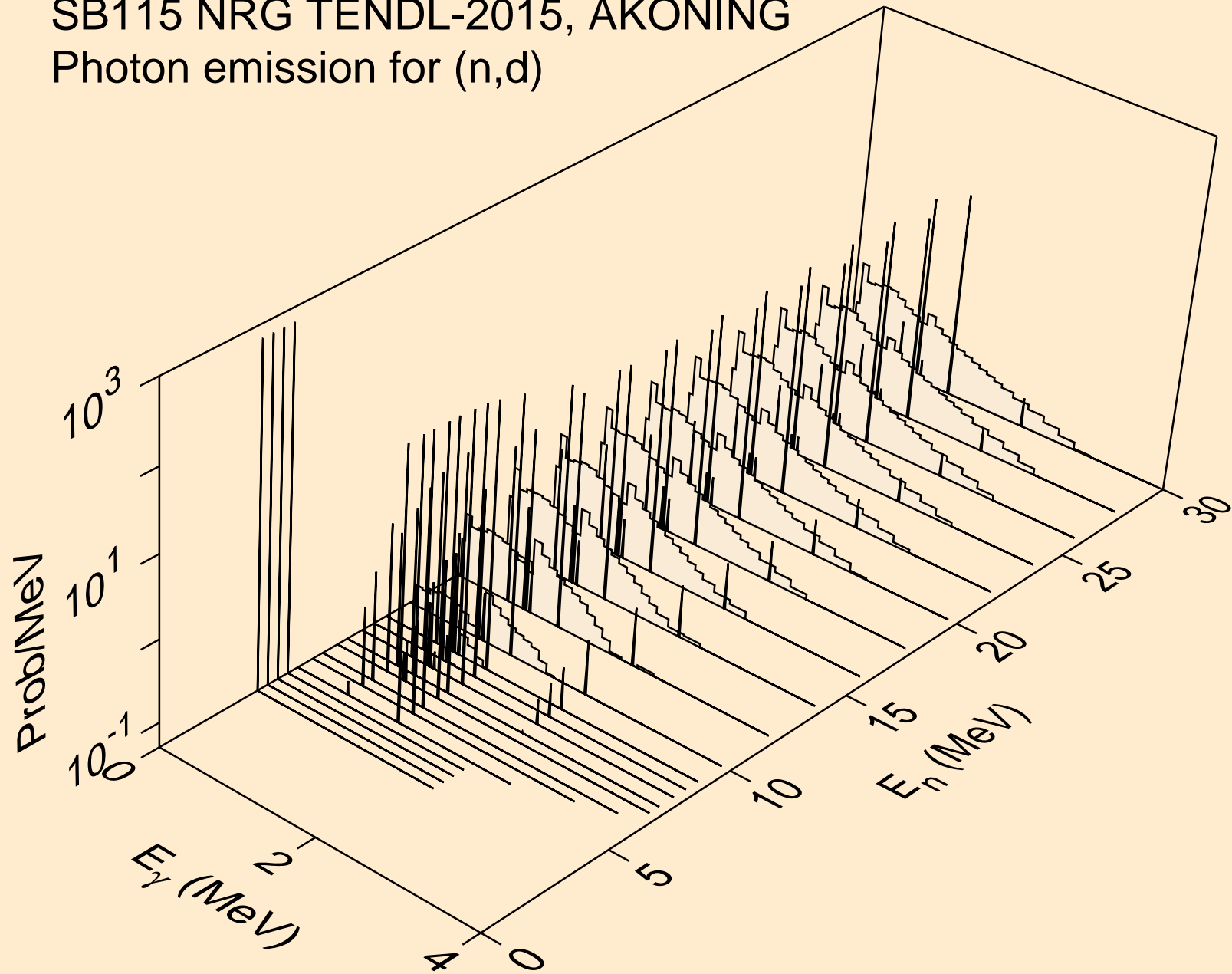



SB115 NRG TENDL-2015, AKONING  
Photon emission for (n,t)

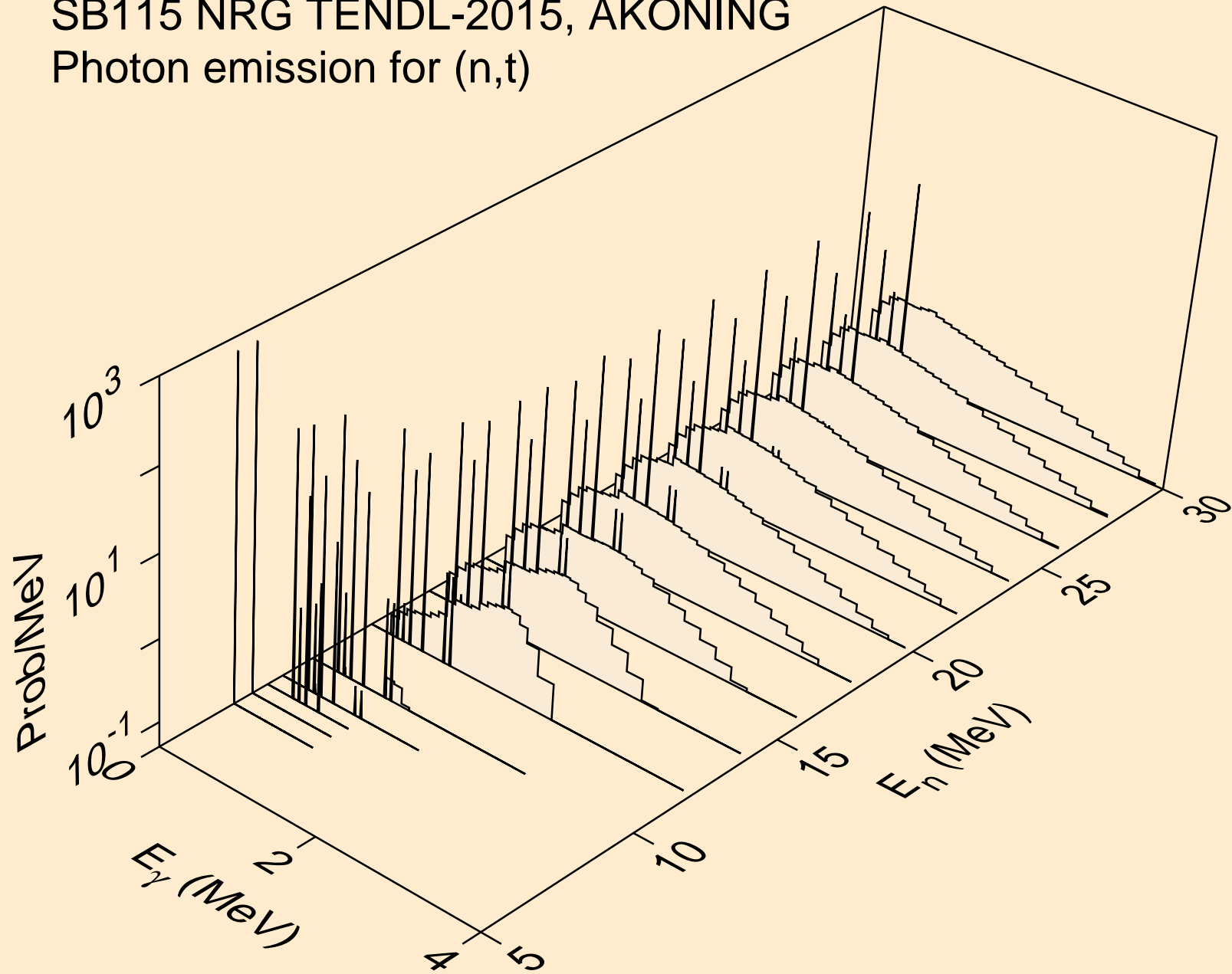

SB115 NRG TENDL-2015, AKONING  
Photon emission for (n,he3)

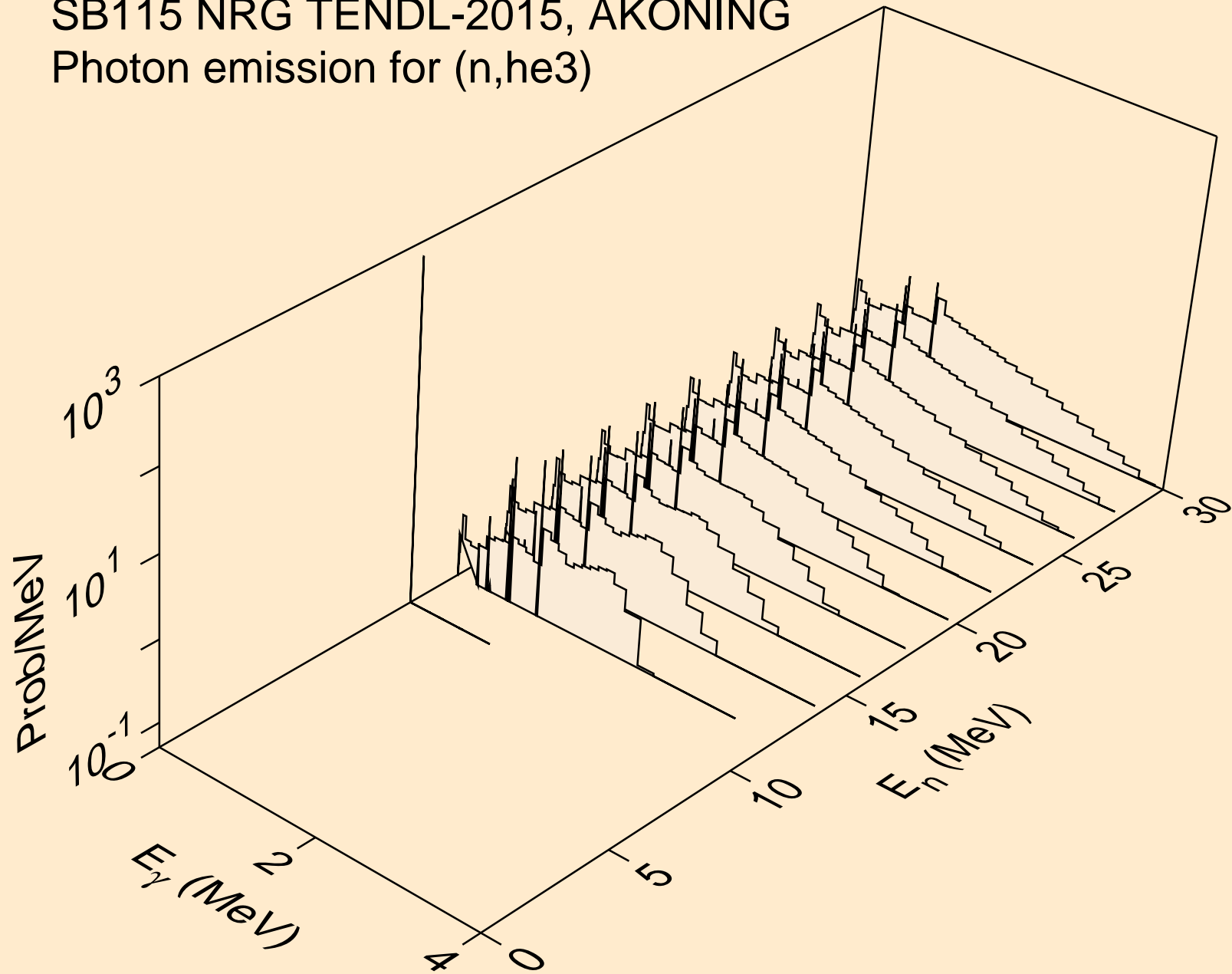

SB115 NRG TENDL-2015, AKONING  
Photon emission for (n,a)

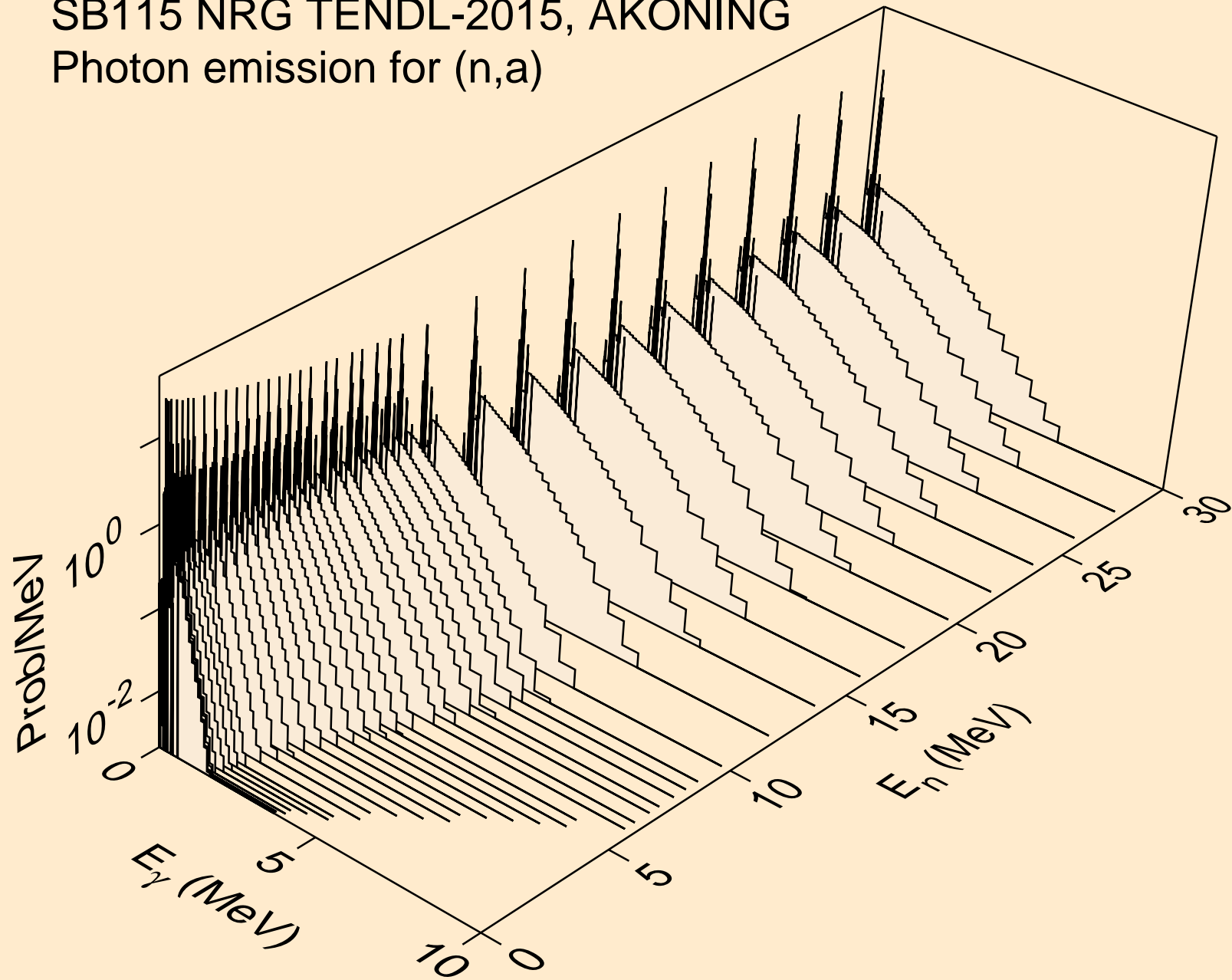

SB115 NRG TENDL-2015, AKONING  
Photon emission for (n,2a)

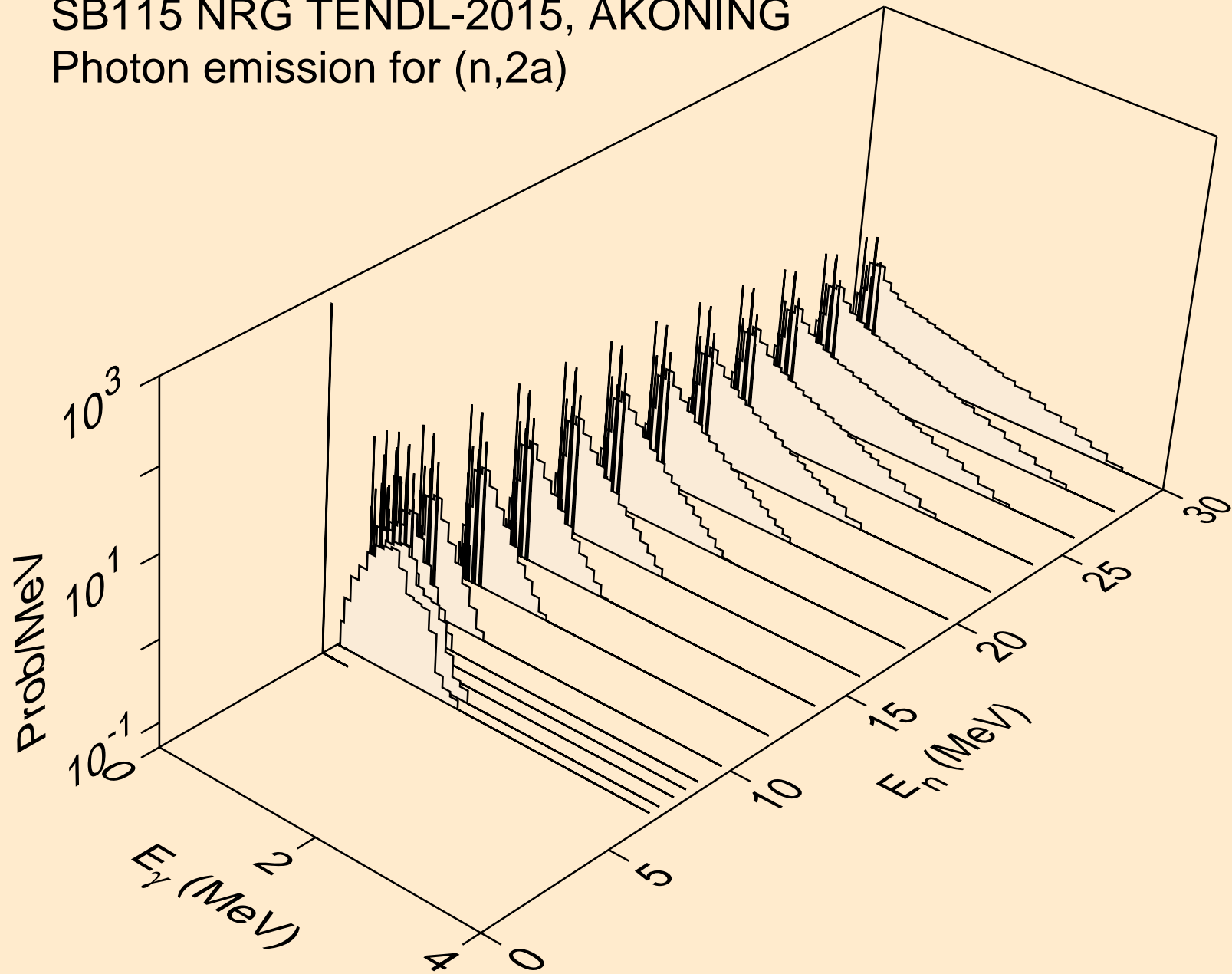

SB115 NRG TENDL-2015, AKONING  
Photon emission for (n,2p)

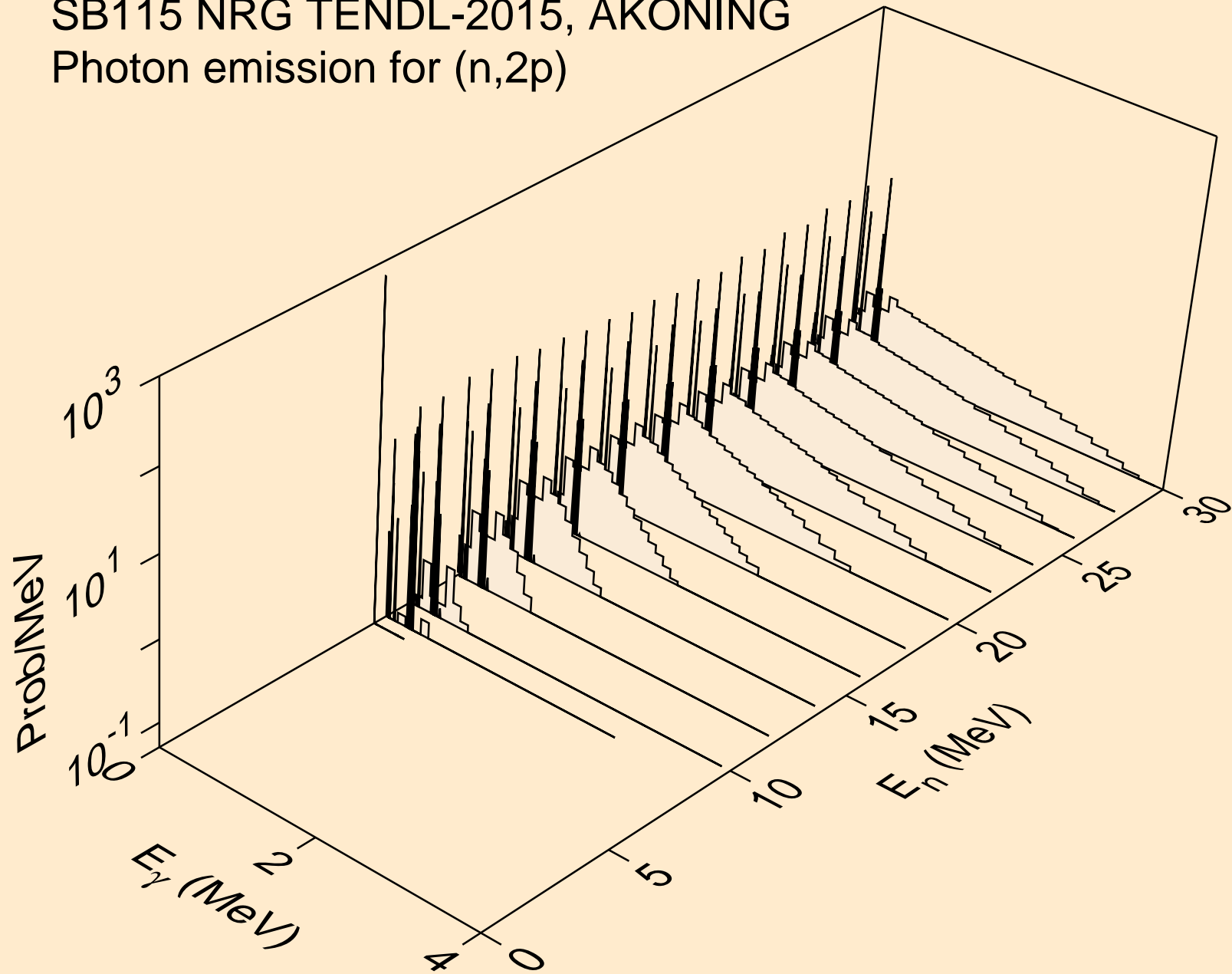

SB115 NRG TENDL-2015, AKONING  
Photon emission for (n,p $\alpha$ )

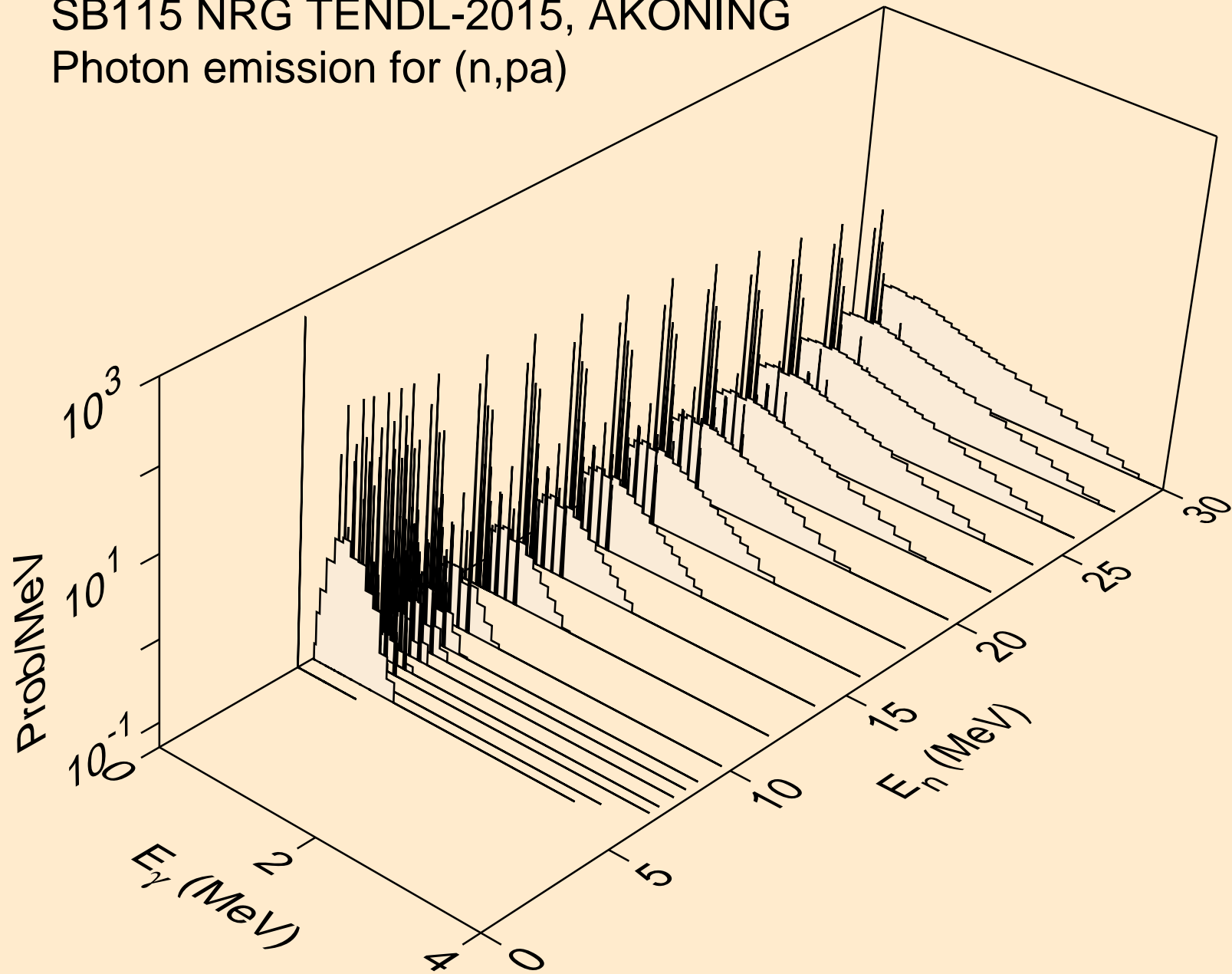

SB115 NRG TENDL-2015, AKONING  
Photon emission for (n,pd)

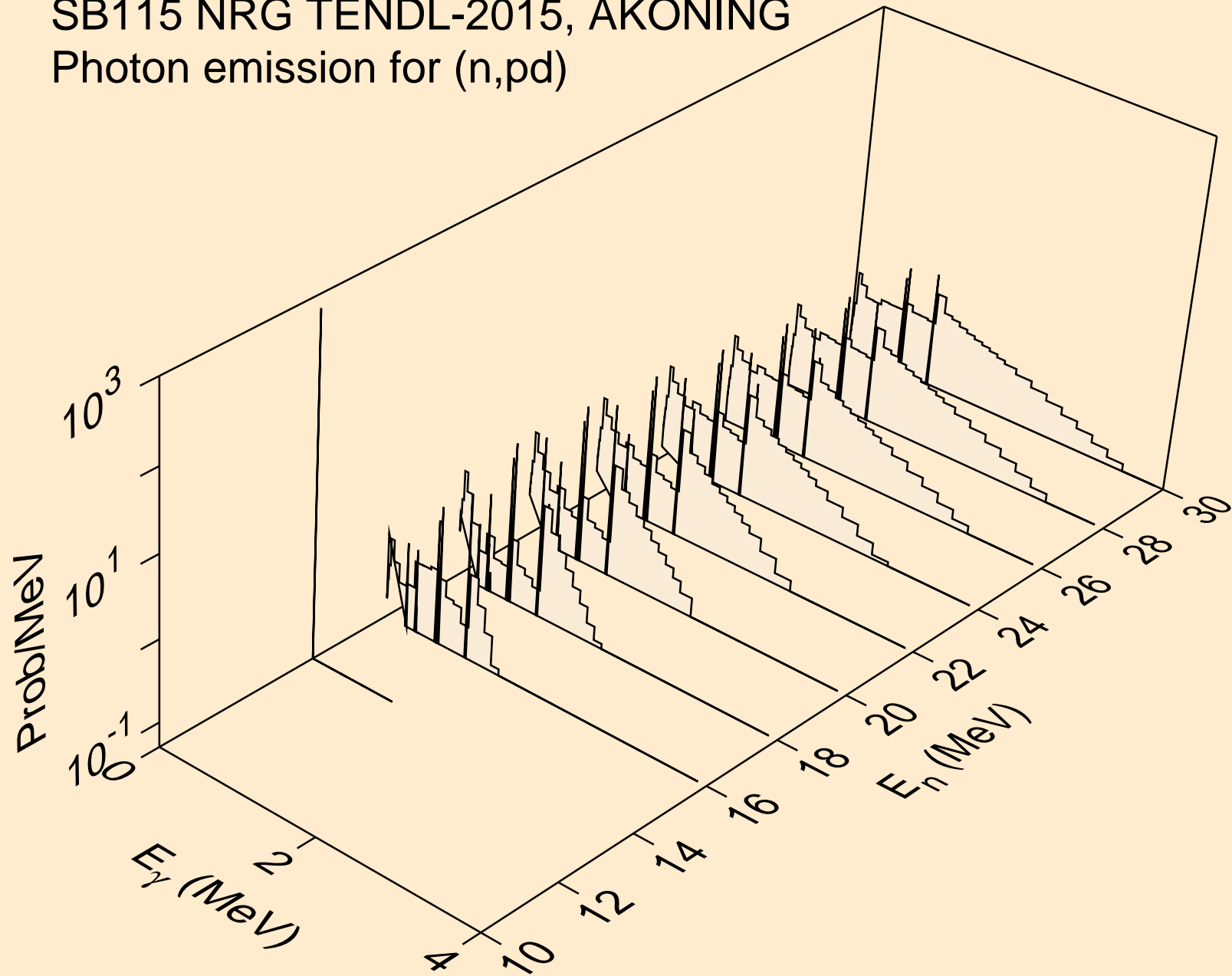

SB115 NRG TENDL-2015, AKONING  
Photon emission for (n,pt)

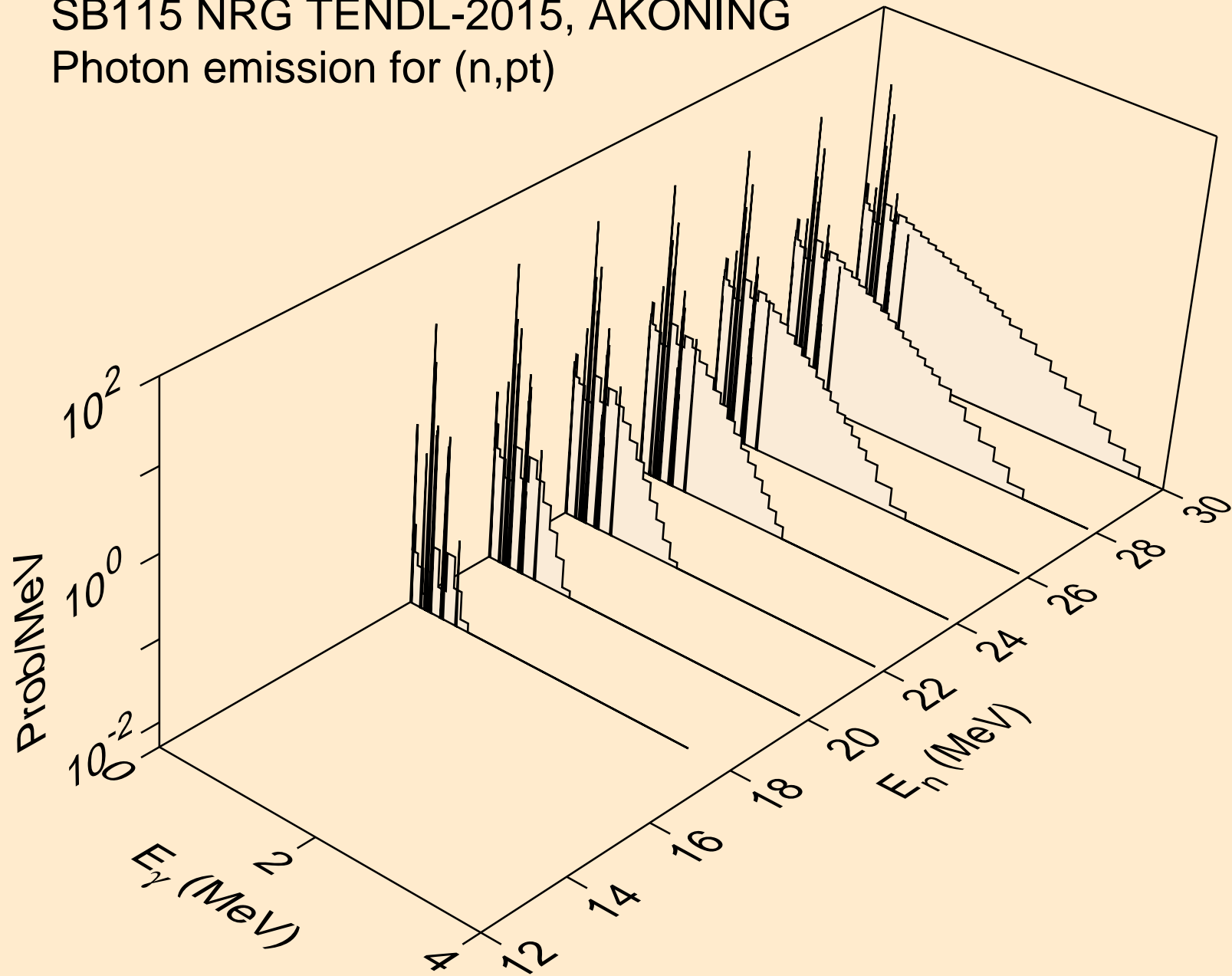



SB115 NRG TENDL-2015, AKONING  
Photon emission for (n,da)

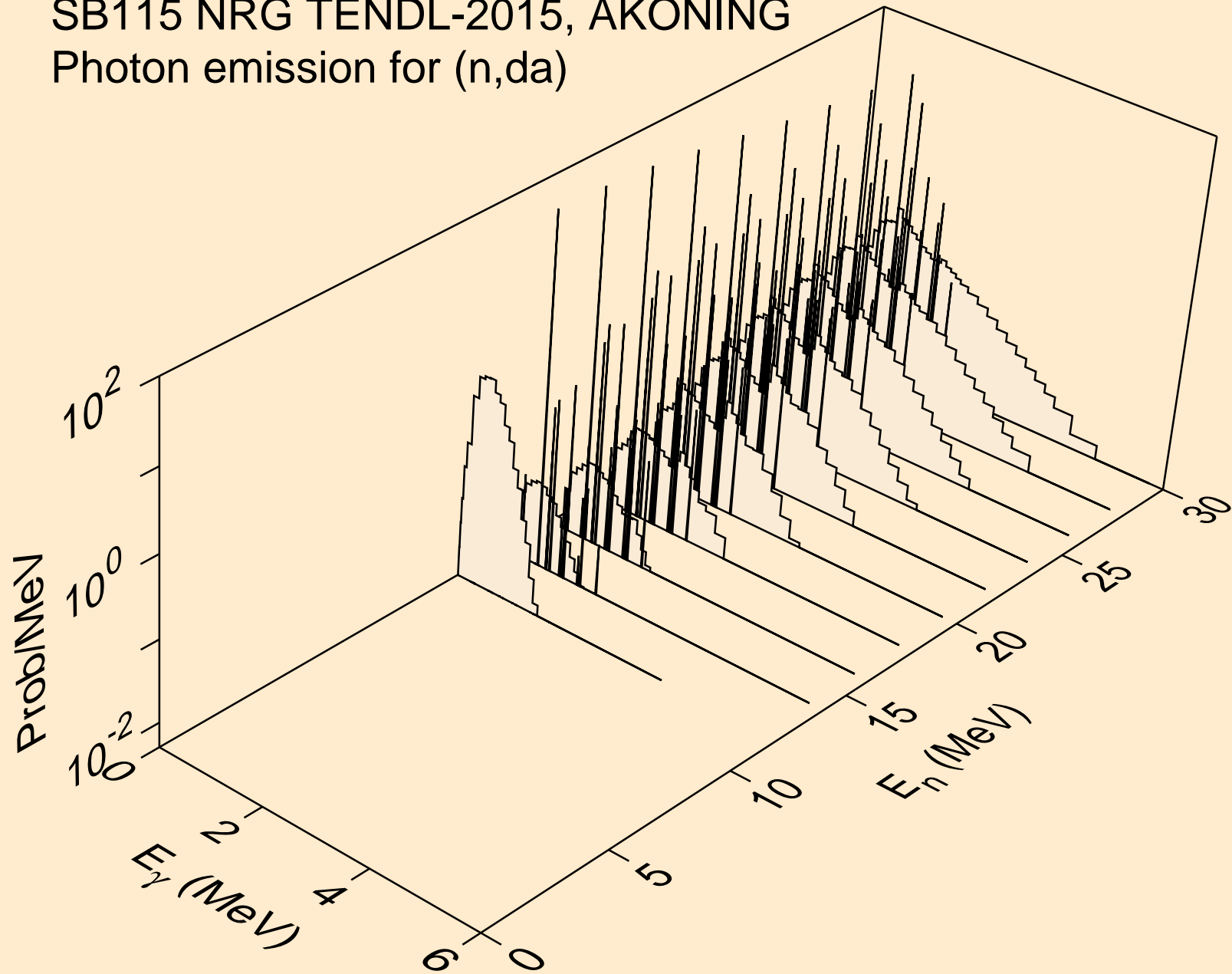

SB115 NRG TENDL-2015, AKONING  
thermal capture photon spectrum

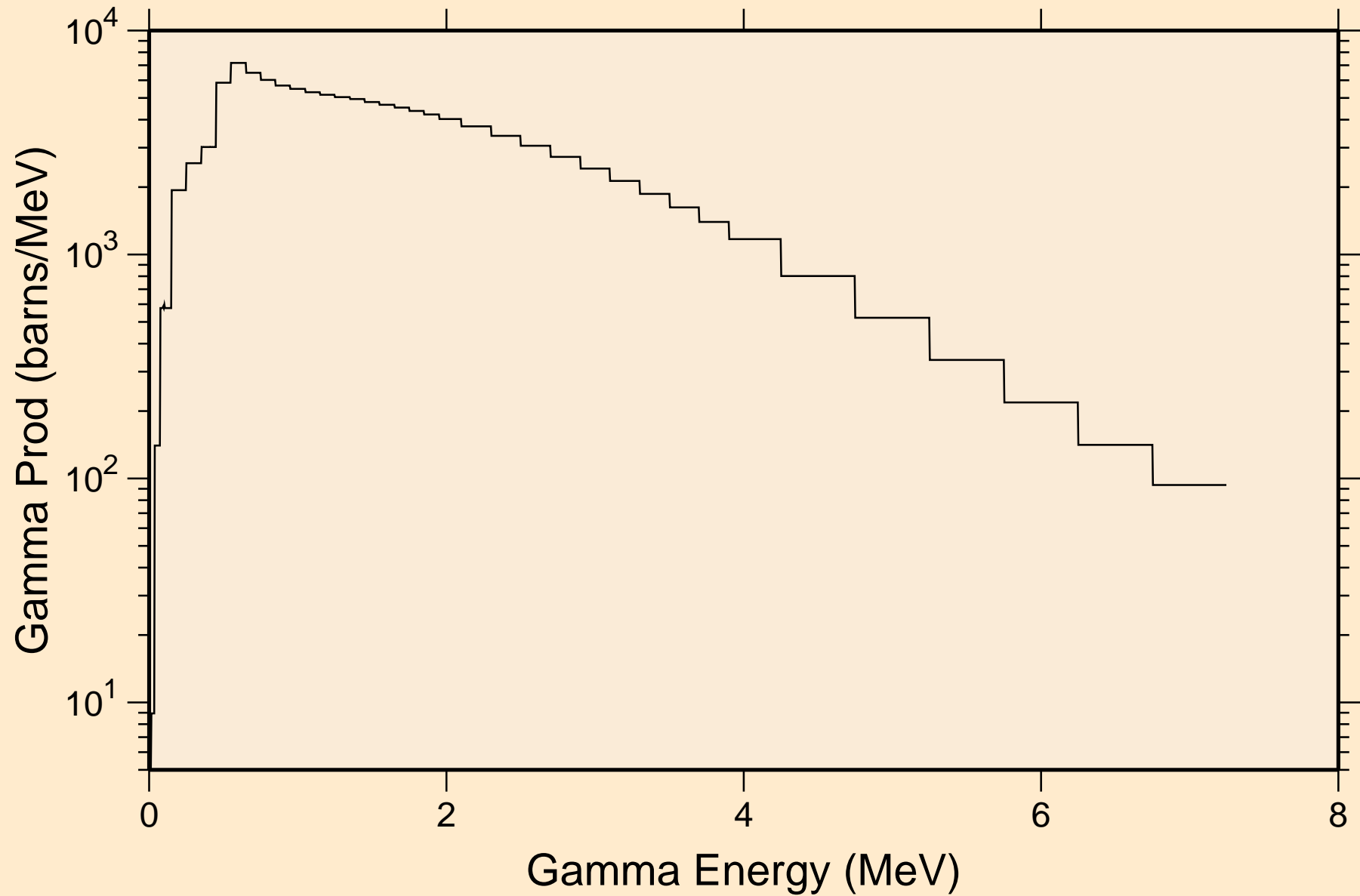

SB115 NRG TENDL-2015, AKONING  
14 MeV photon spectrum

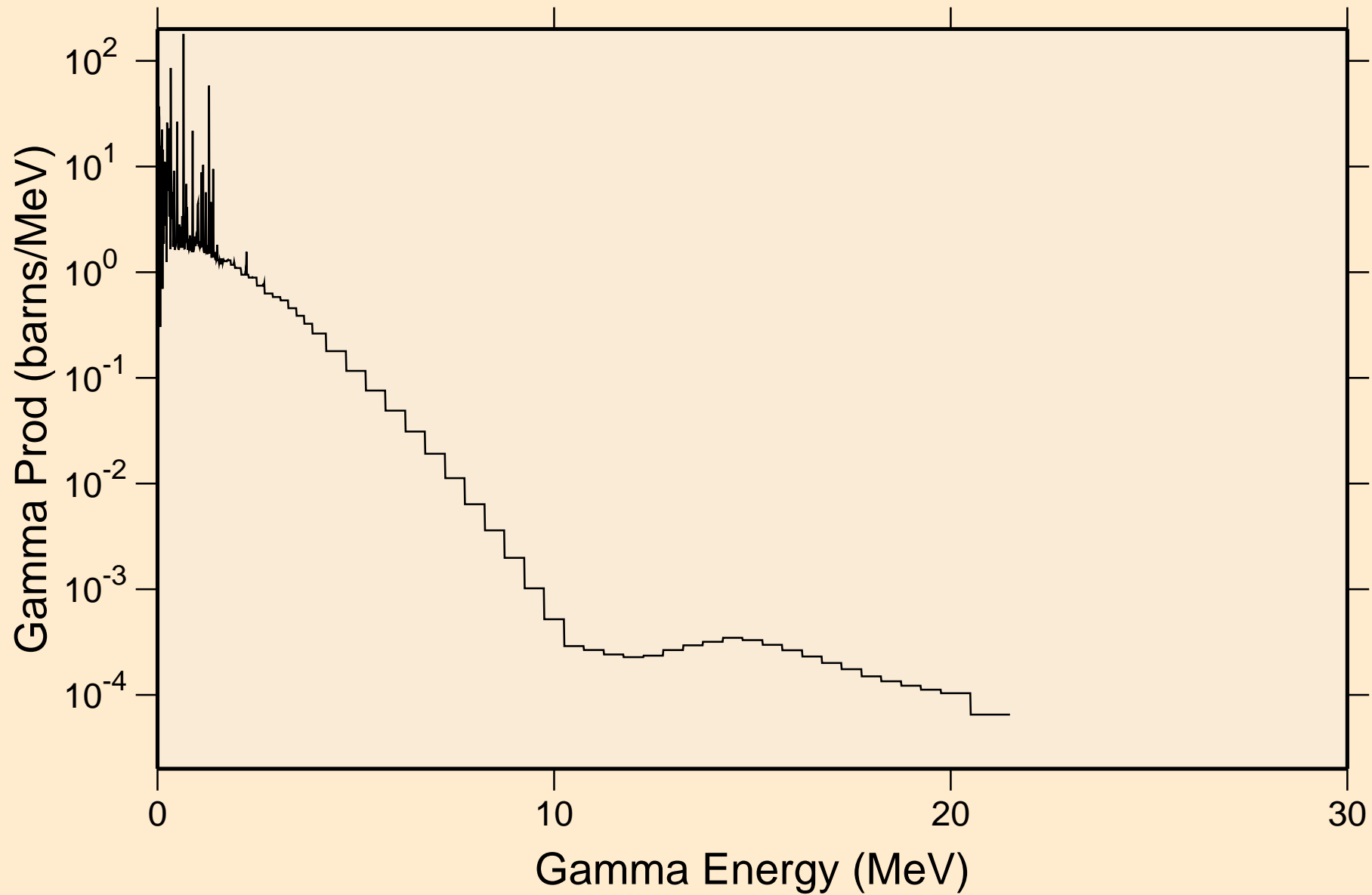

# SB115 NRG TENDL-2015, AKONING

## Particle heating contributions

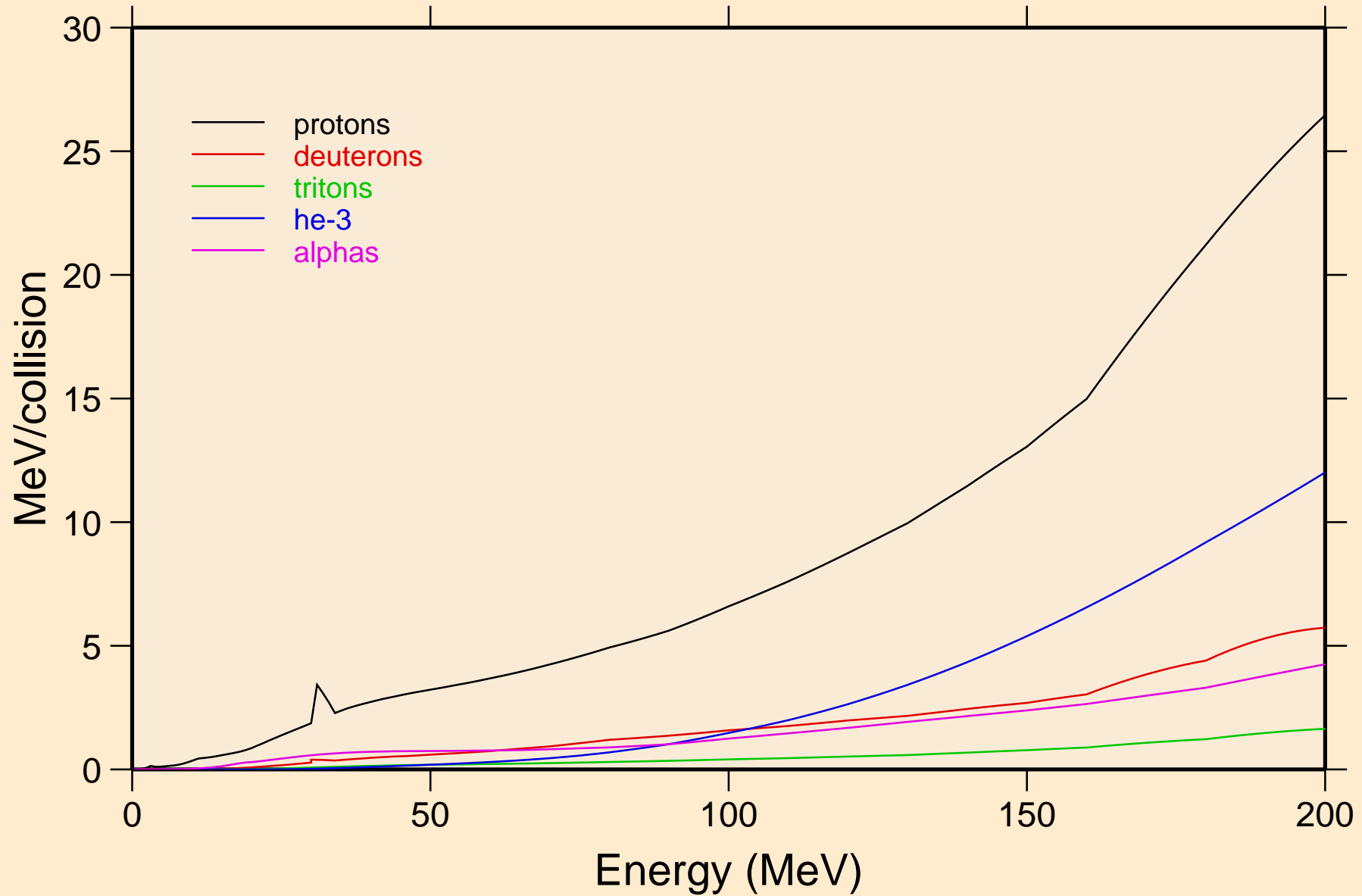

# SB115 NRG TENDL-2015, AKONING

## Recoil Heating

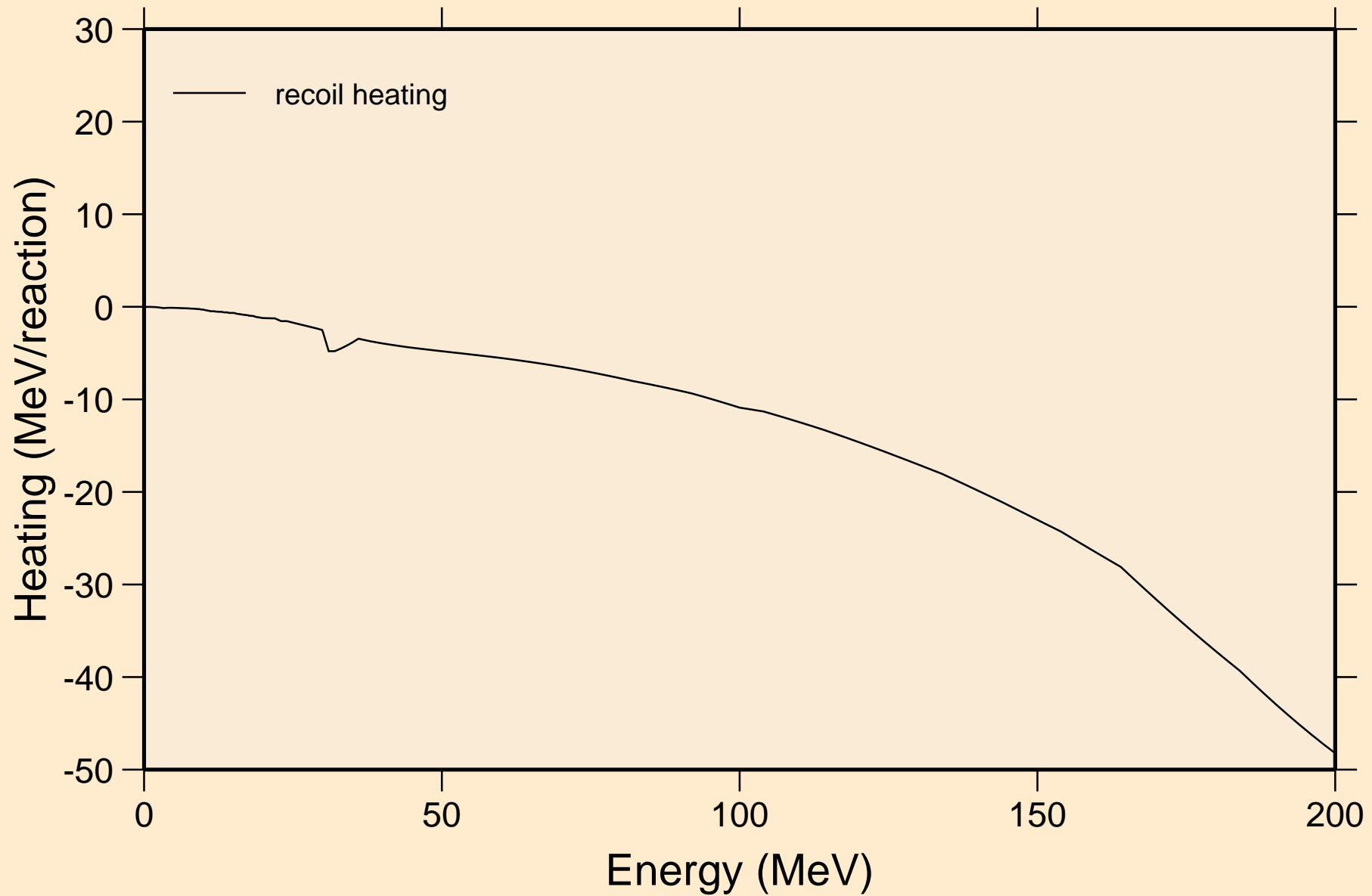

# SB115 NRG TENDL-2015, AKONING

## Particle production cross sections

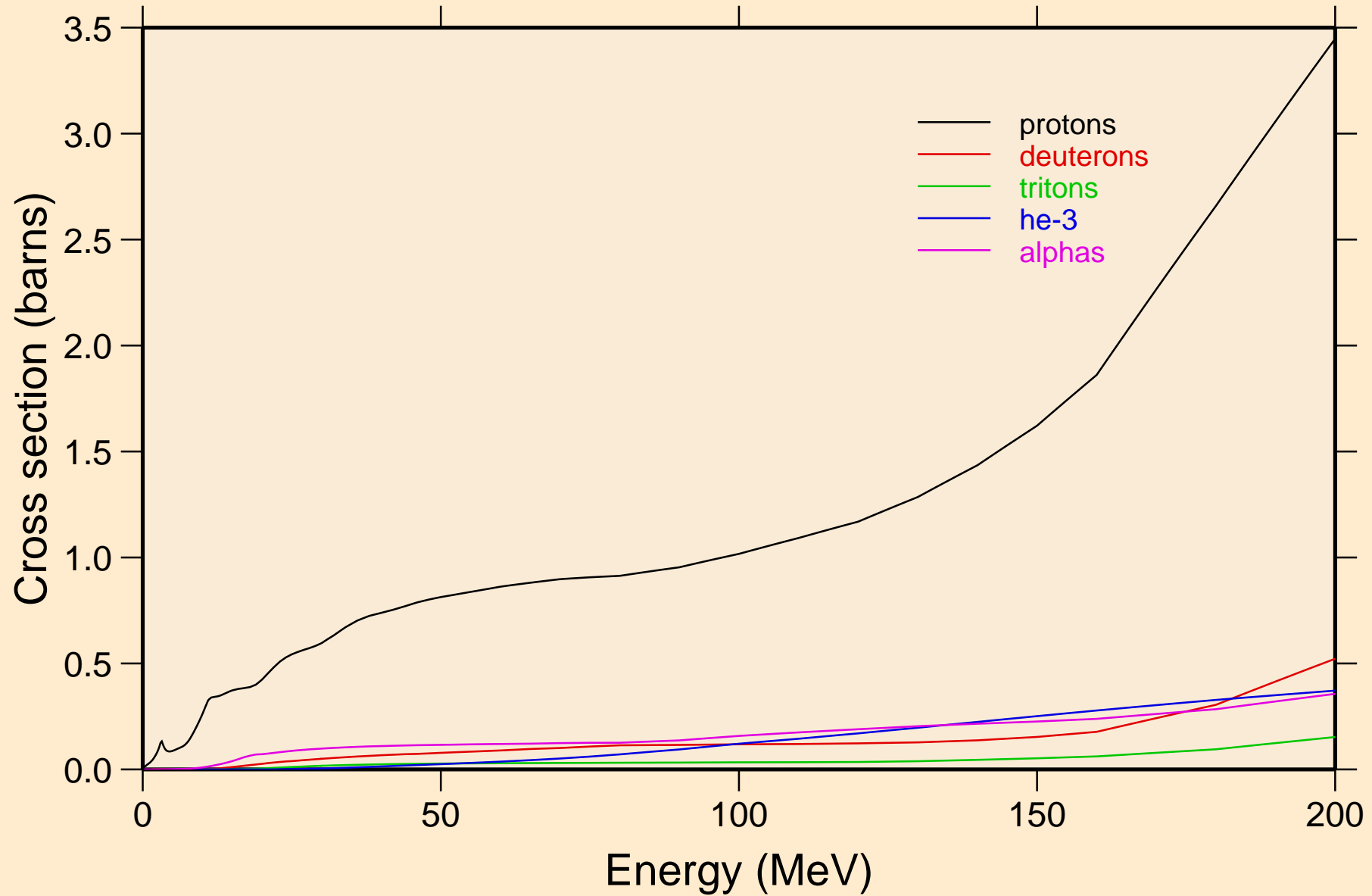

SB115 NRG TENDL-2015, AKONING  
protons from (n,x)

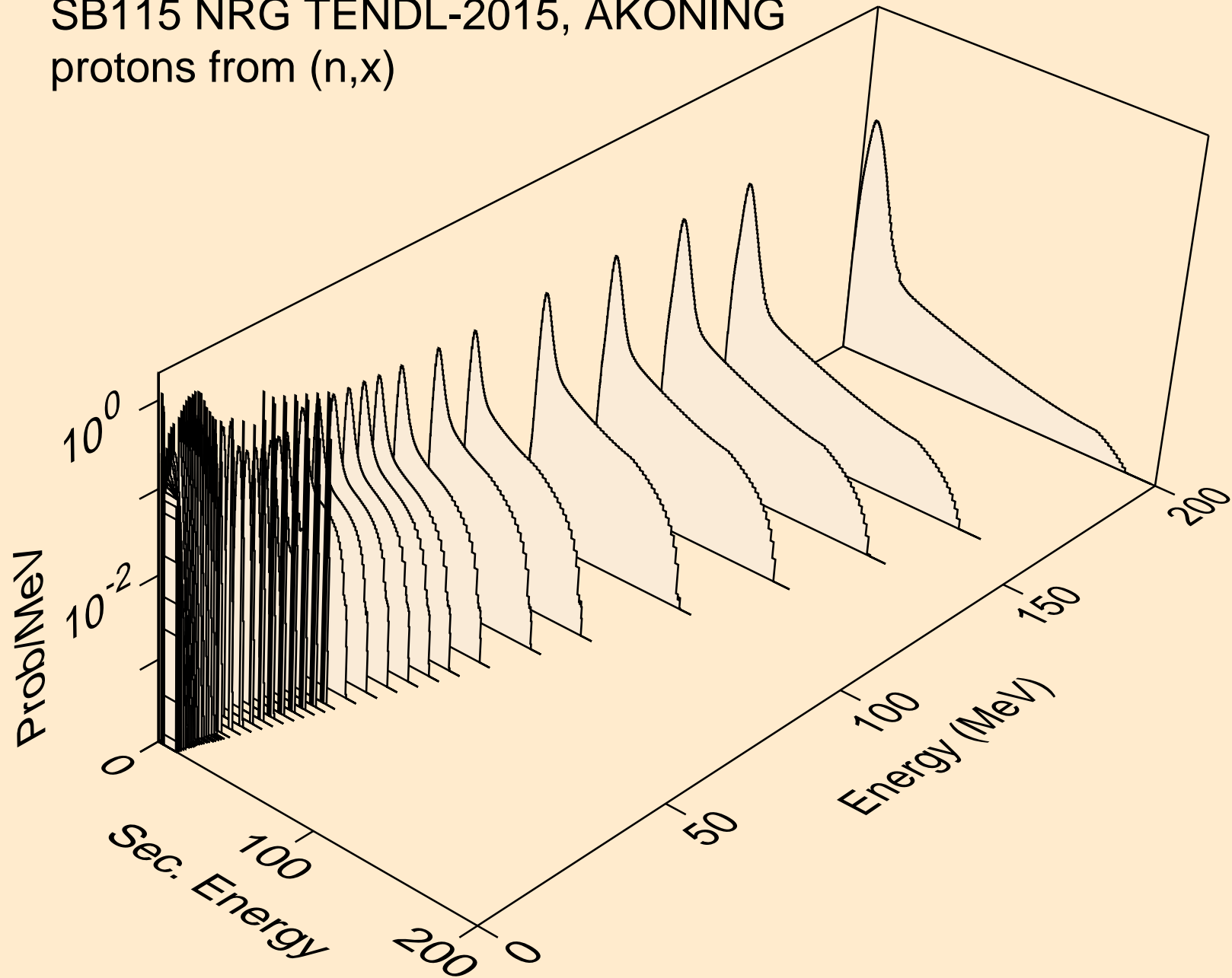

SB115 NRG TENDL-2015, AKONING  
protons from (n,n\*)p

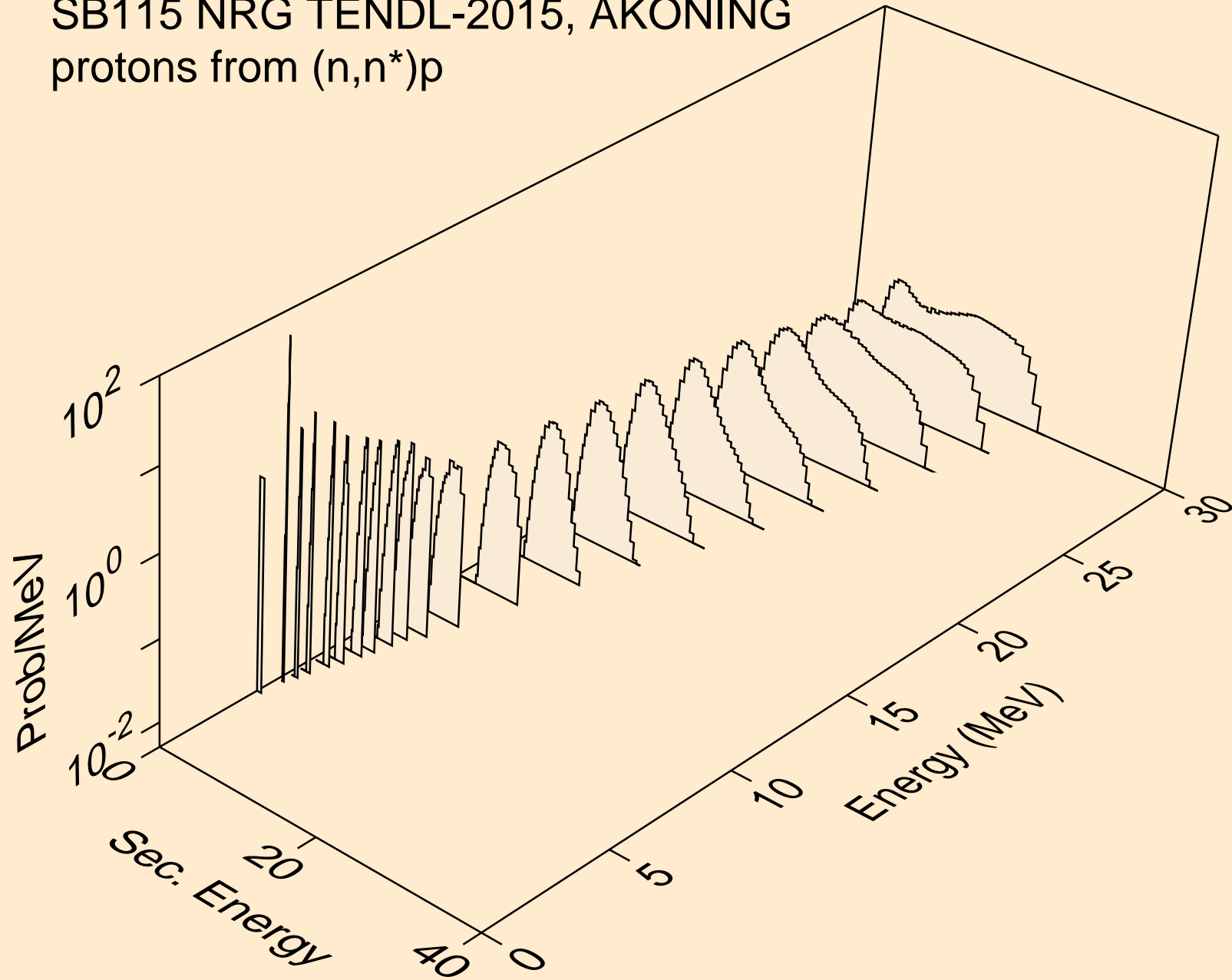



SB115 NRG TENDL-2015, AKONING  
protons from (n,2np)

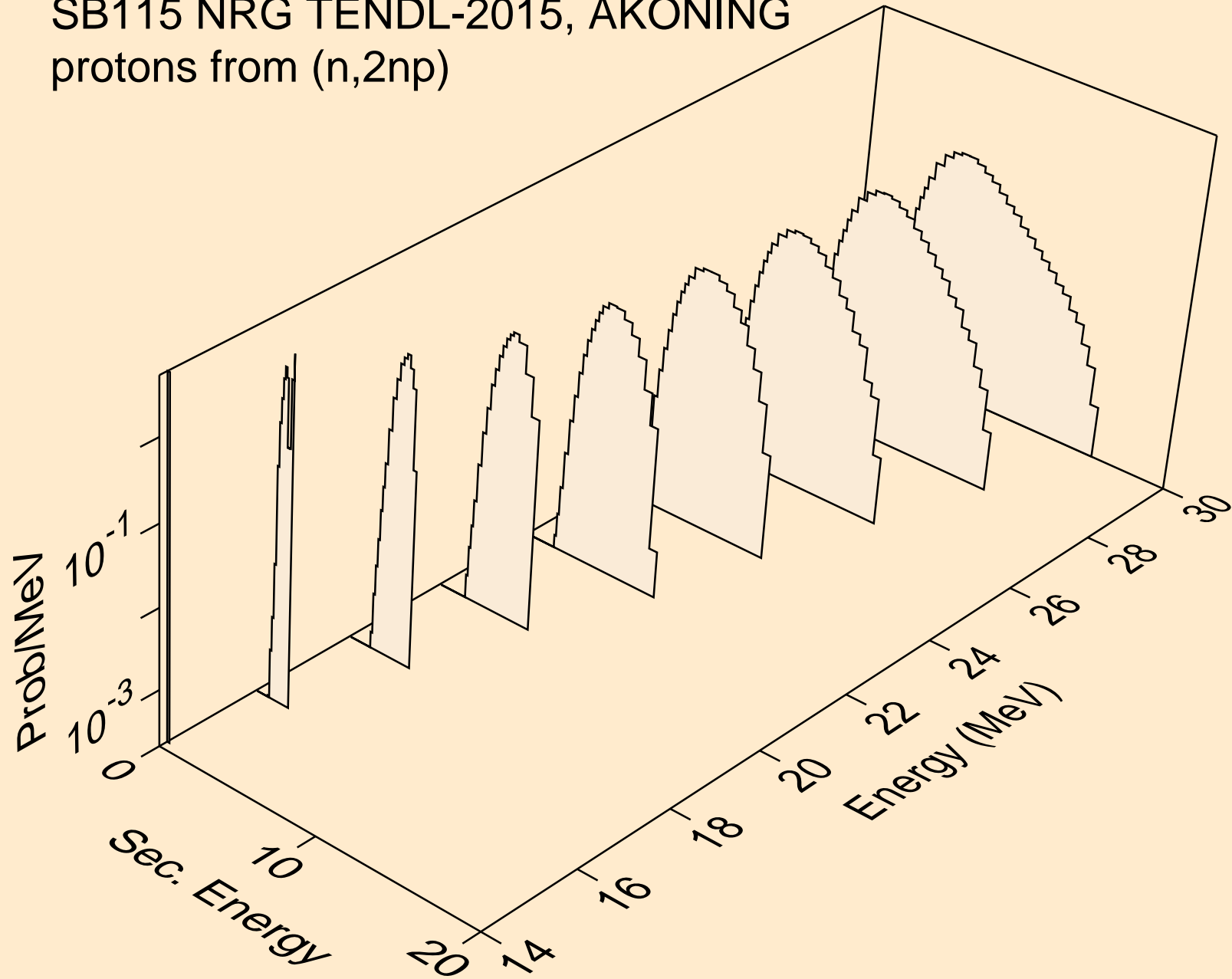

SB115 NRG TENDL-2015, AKONING  
protons from (n,3np)

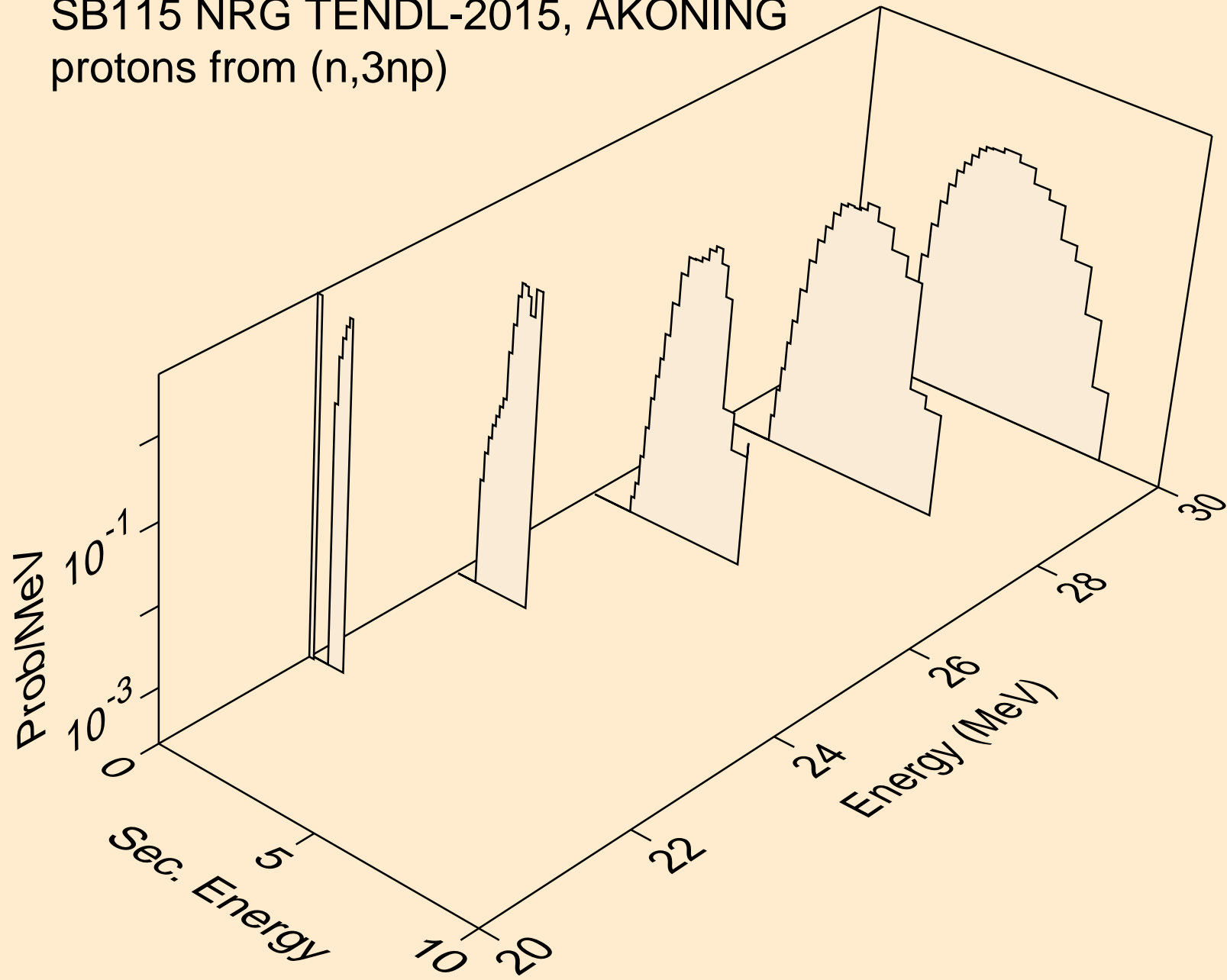

SB115 NRG TENDL-2015, AKONING  
protons from (n,2np)

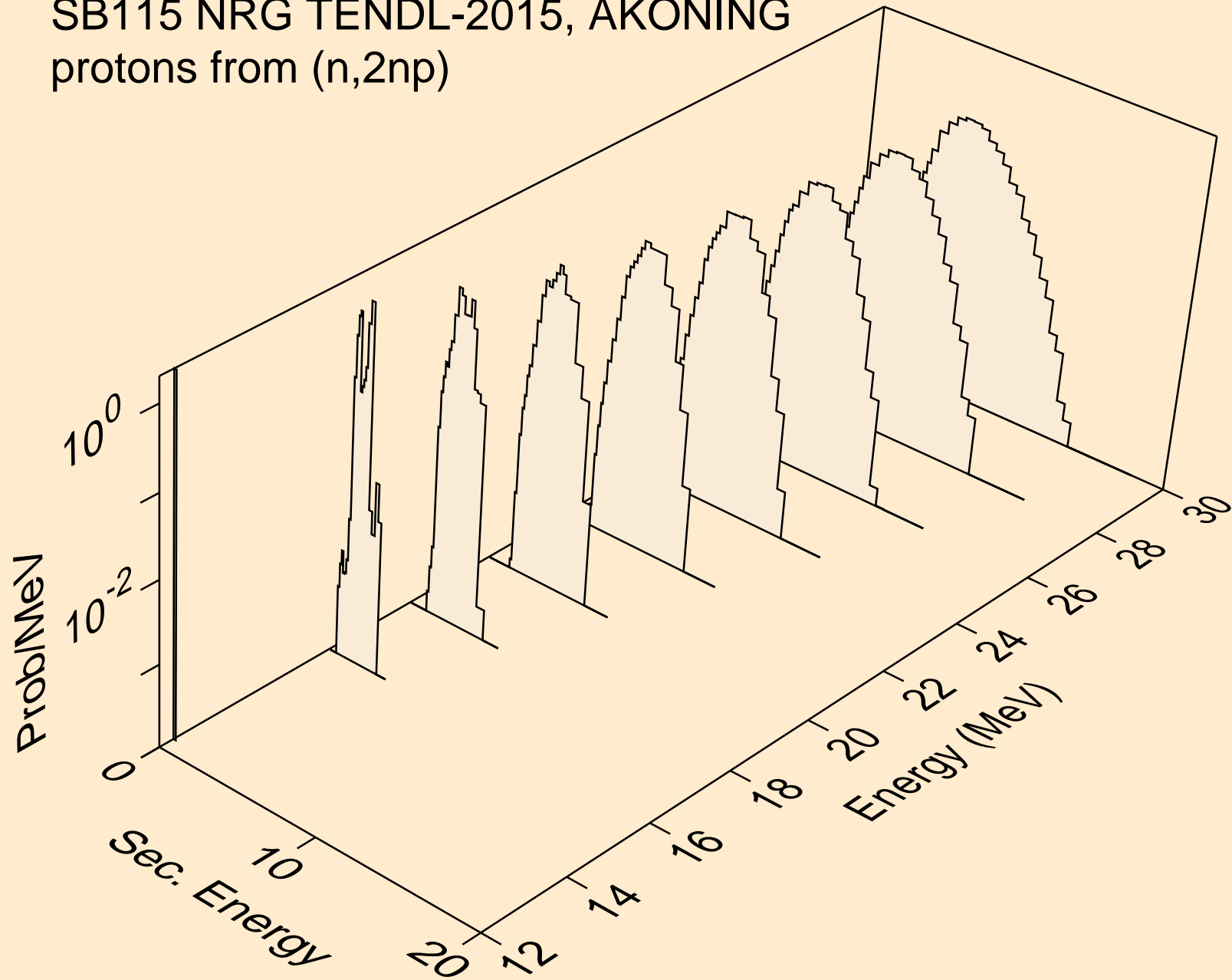

SB115 NRG TENDL-2015, AKONING  
protons from (n,npa)

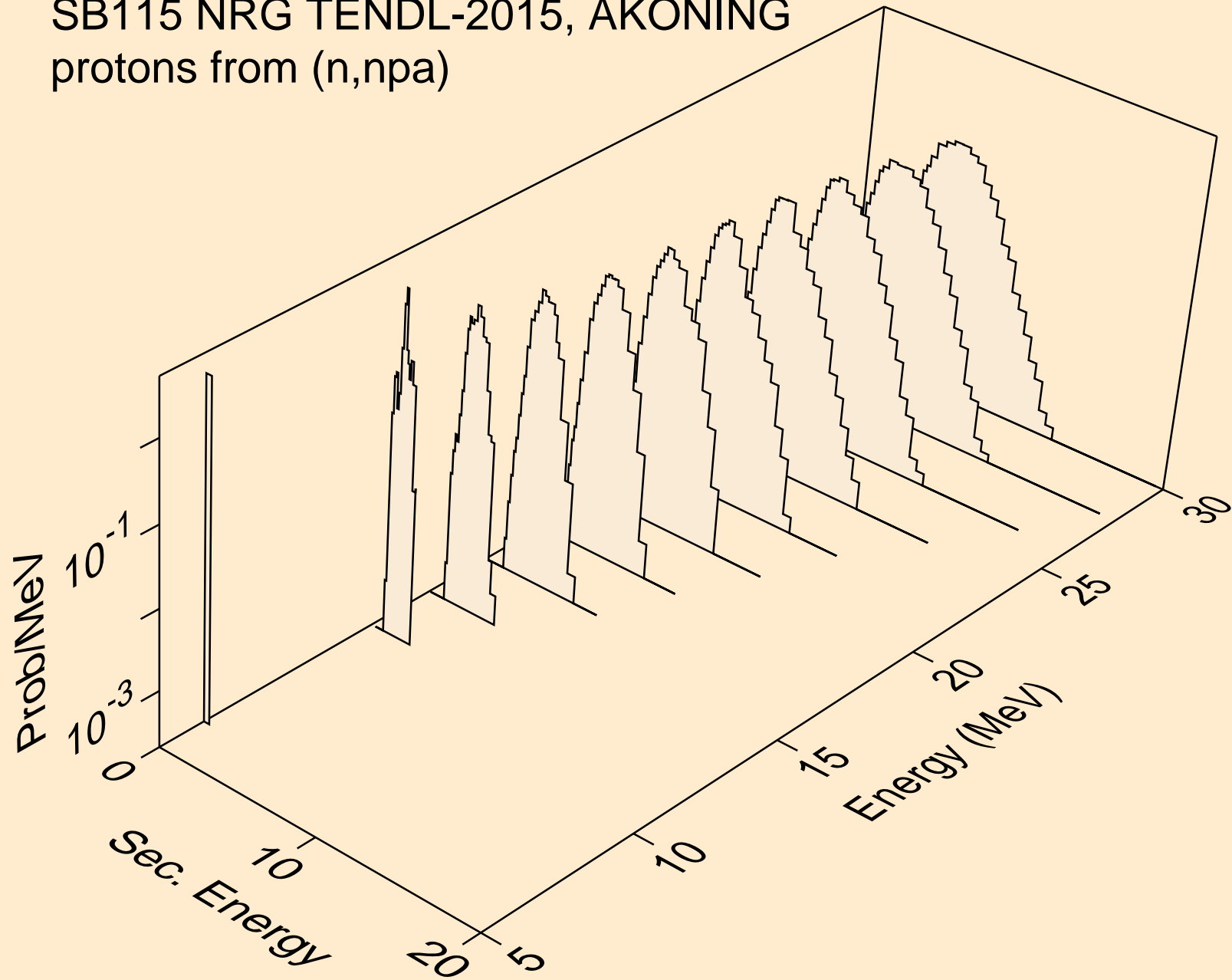

SB115 NRG TENDL-2015, AKONING  
protons from (n,p)

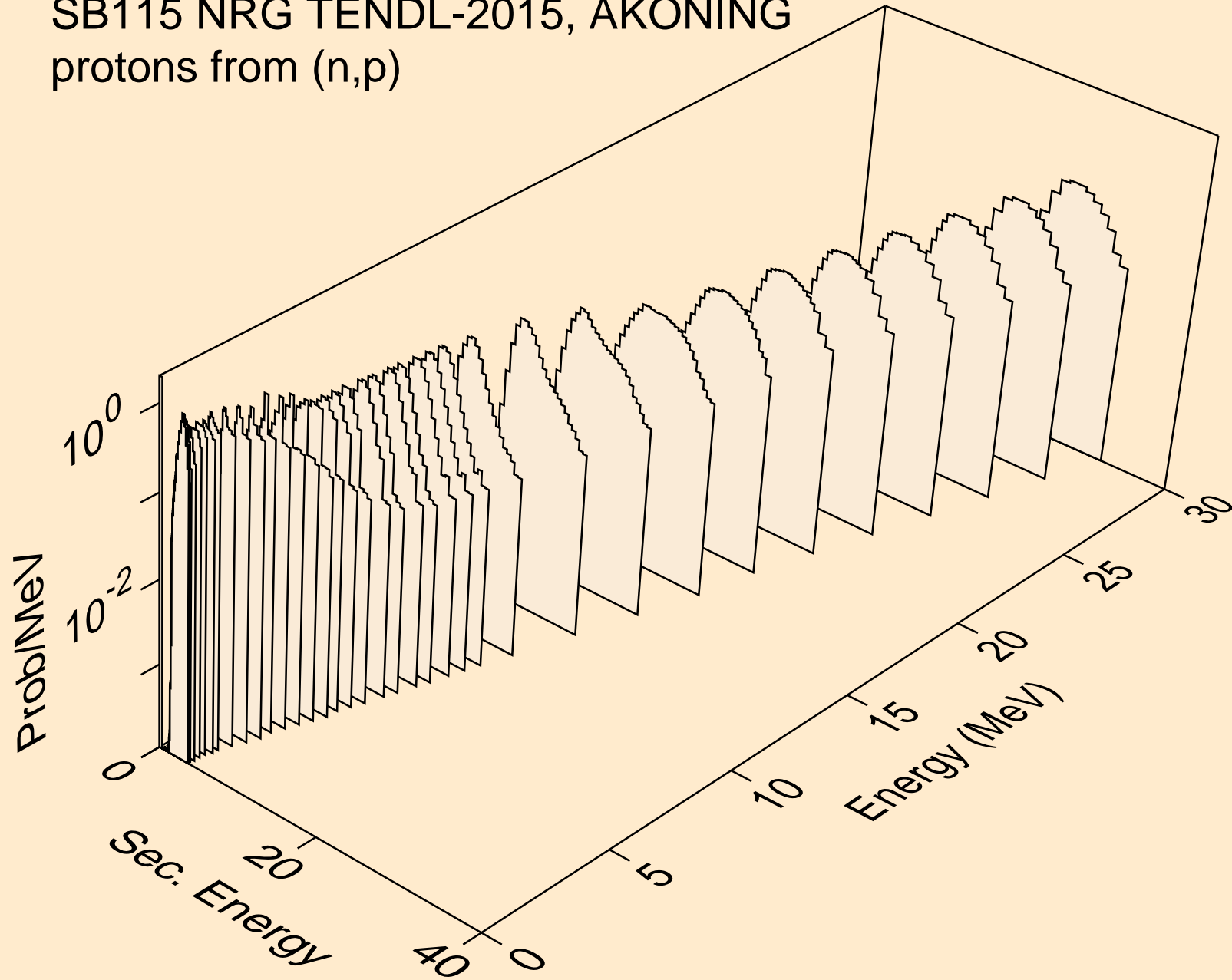

SB115 NRG TENDL-2015, AKONING  
protons from (n,2p)

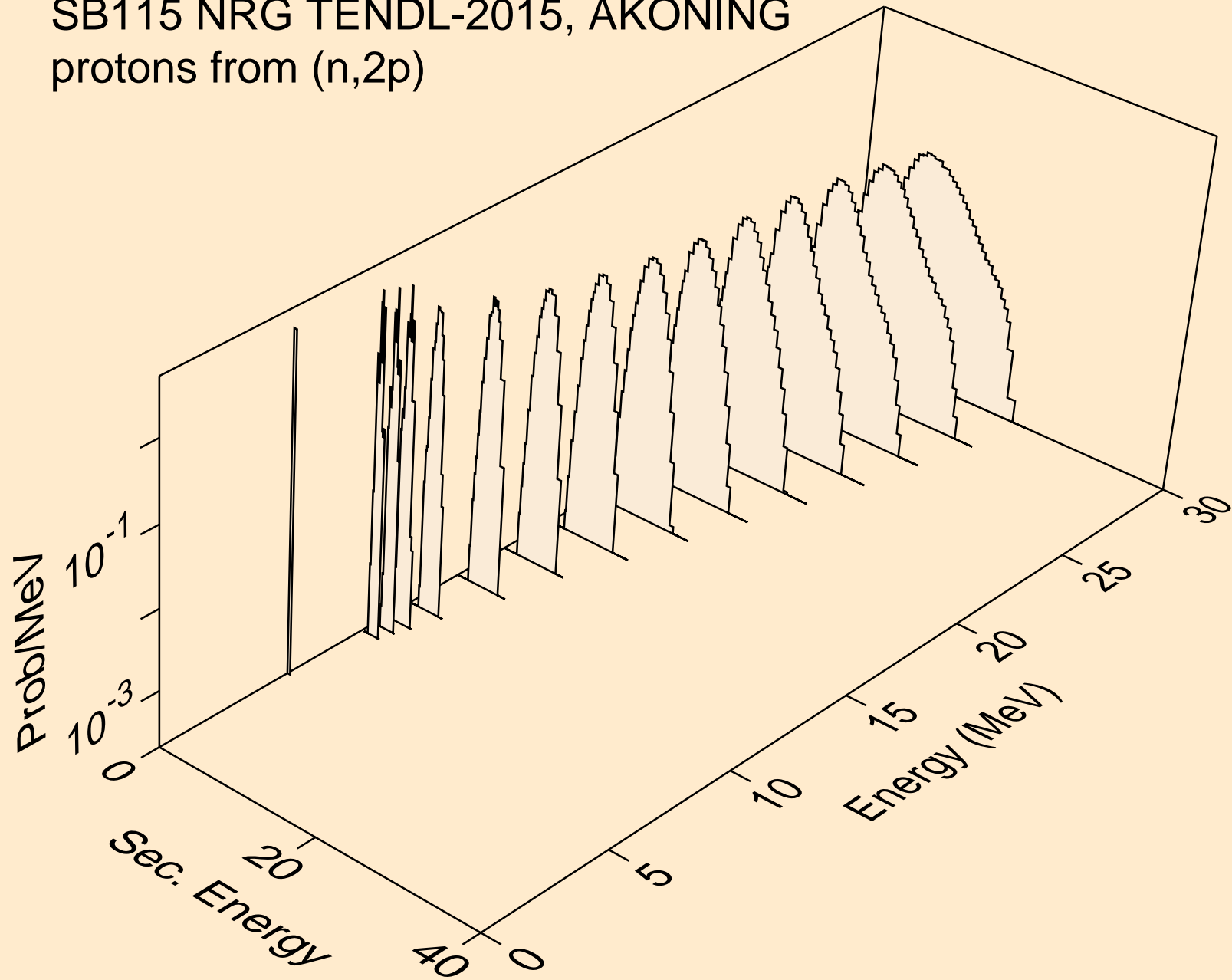

SB115 NRG TENDL-2015, AKONING  
protons from (n,pa)

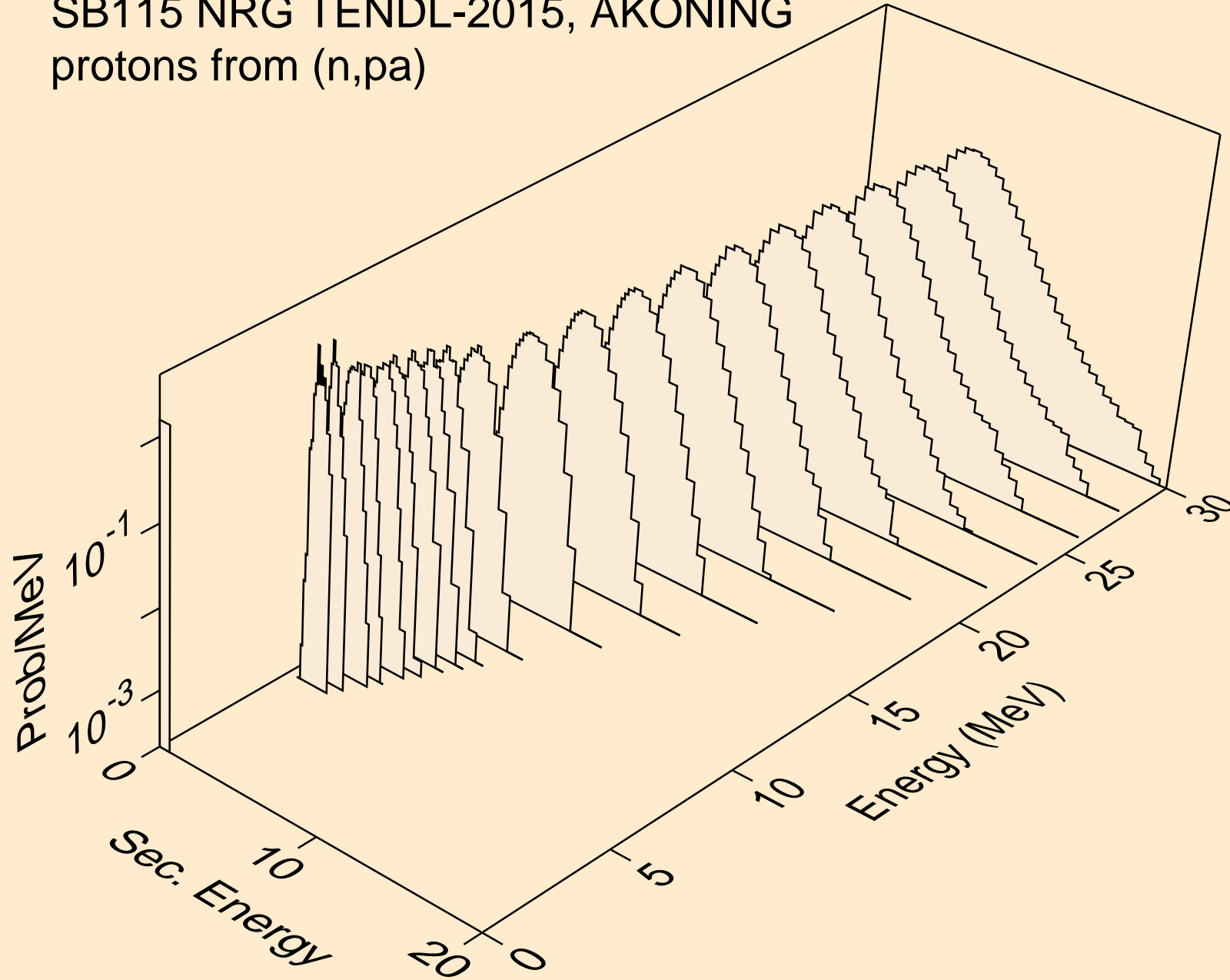

SB115 NRG TENDL-2015, AKONING  
protons from (n,pd)

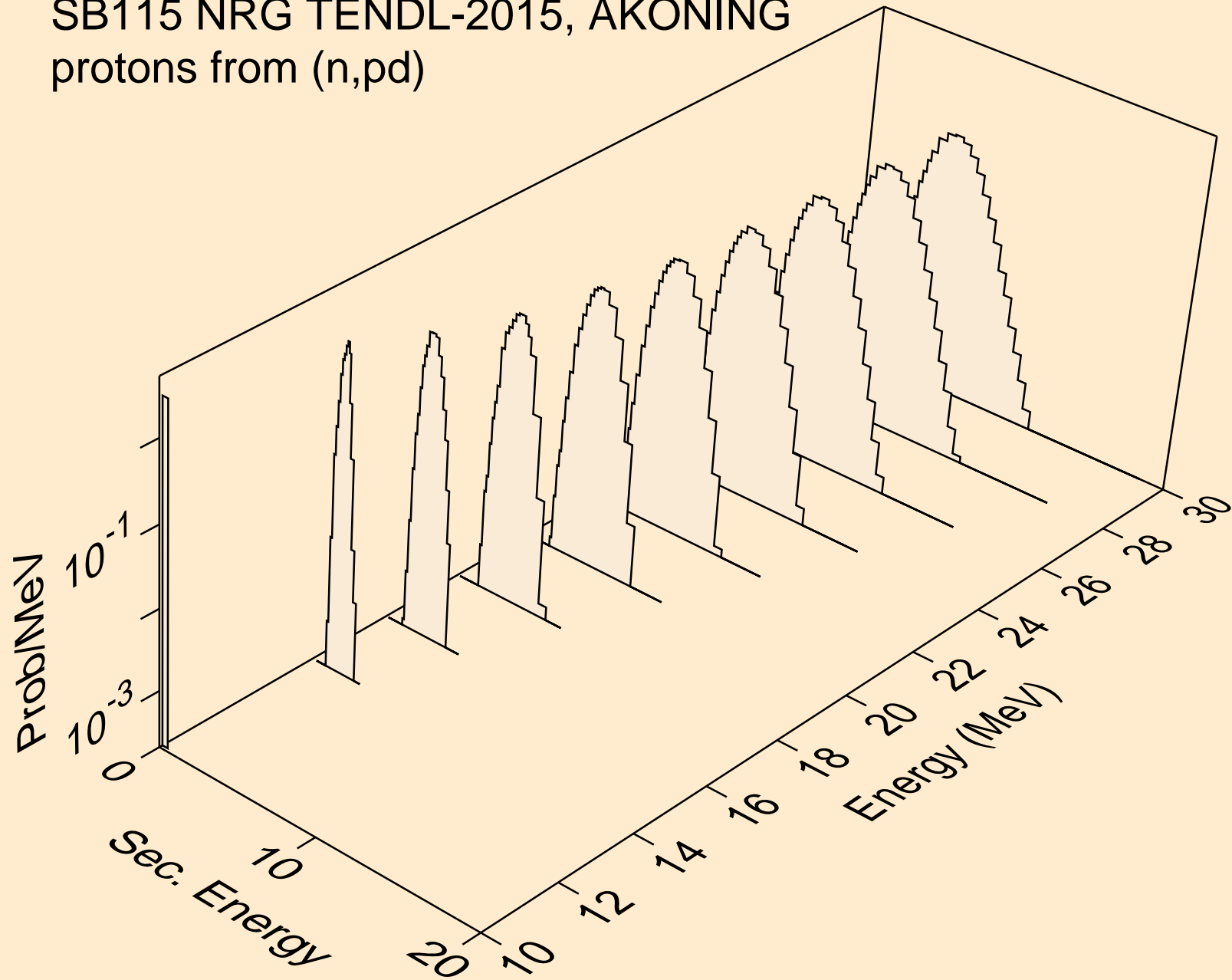



SB115 NRG TENDL-2015, AKONING  
protons from (n,pt)

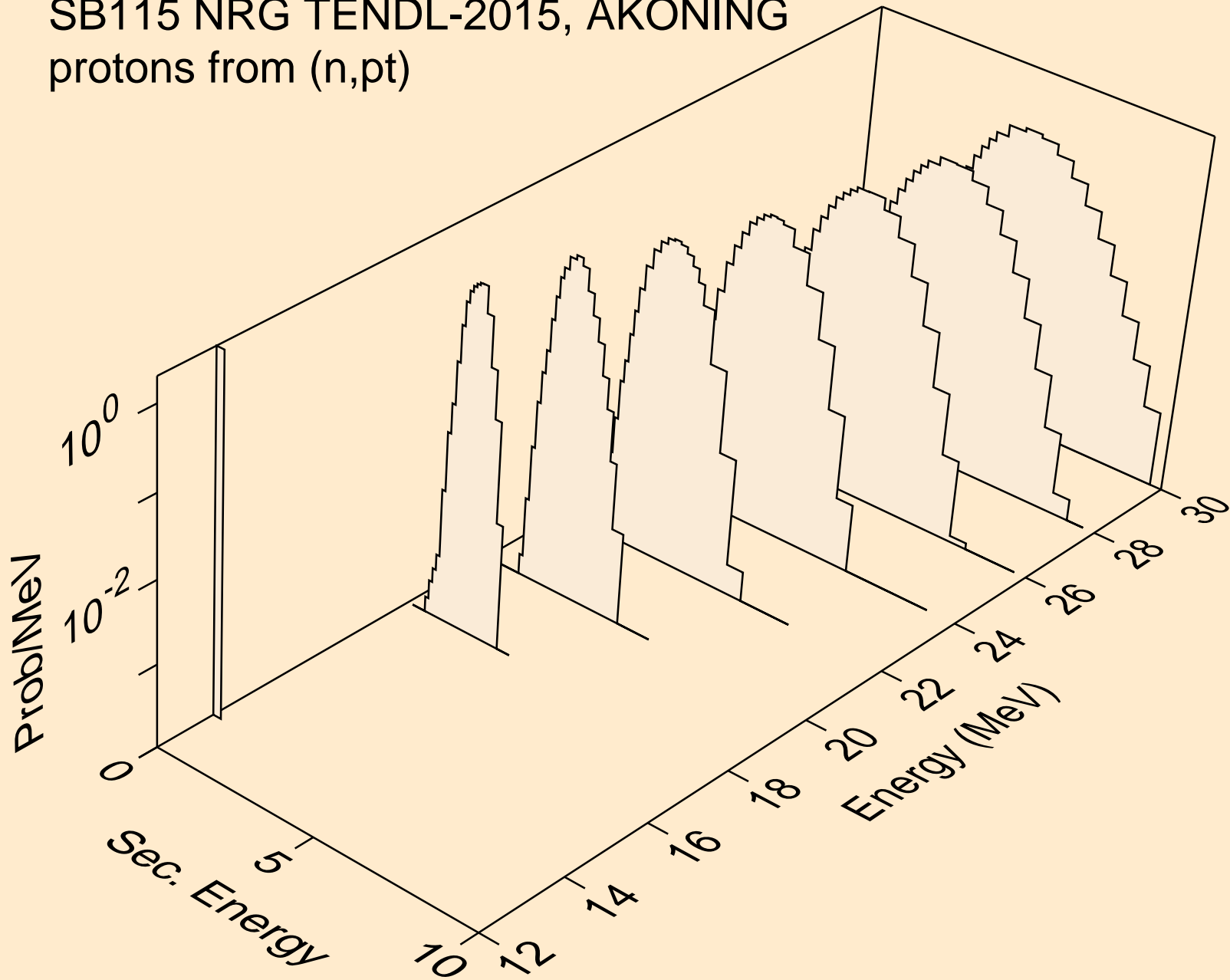

SB115 NRG TENDL-2015, AKONING  
deuterons from (n,x)

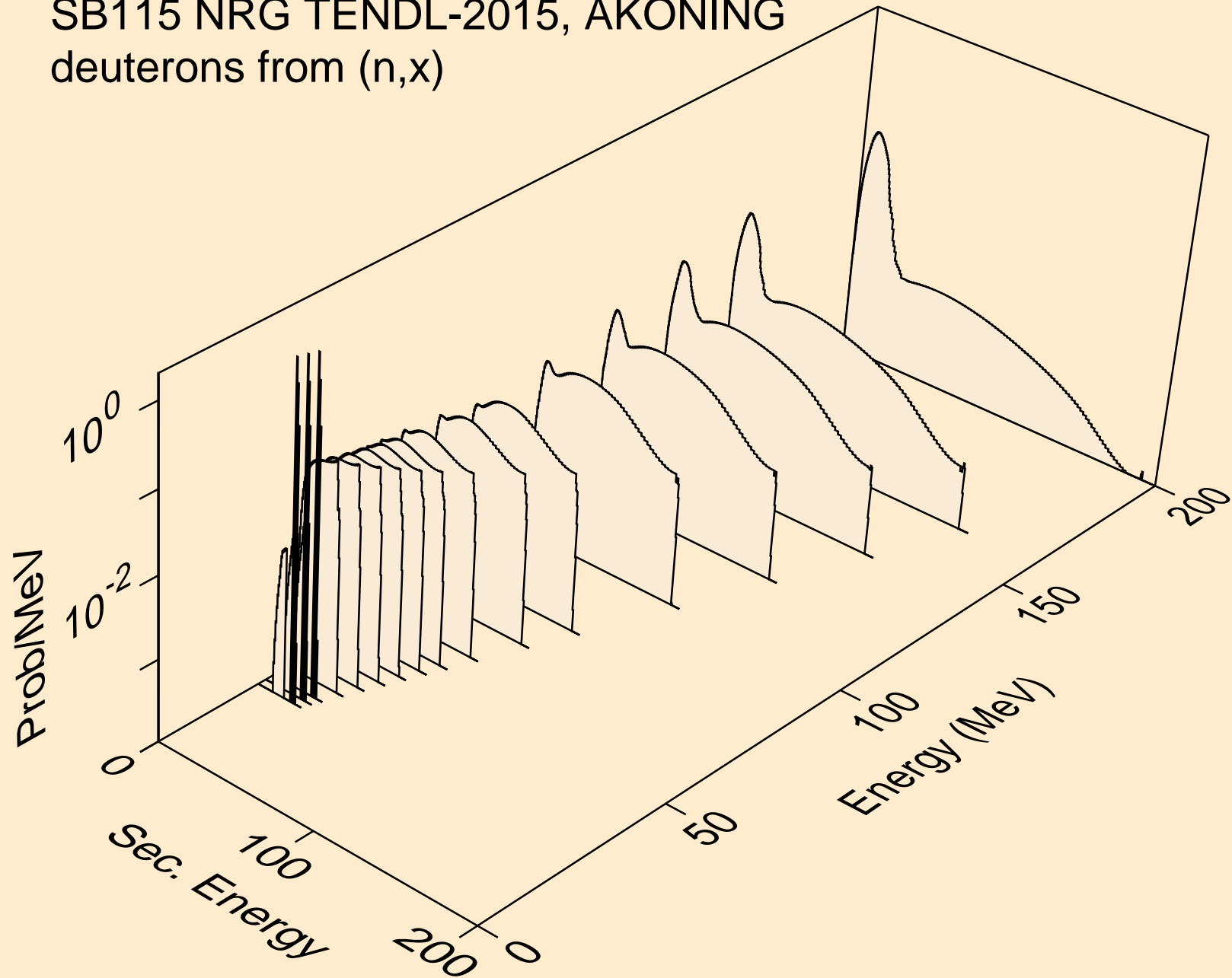

SB115 NRG TENDL-2015, AKONING  
deuterons from (n,2nd)

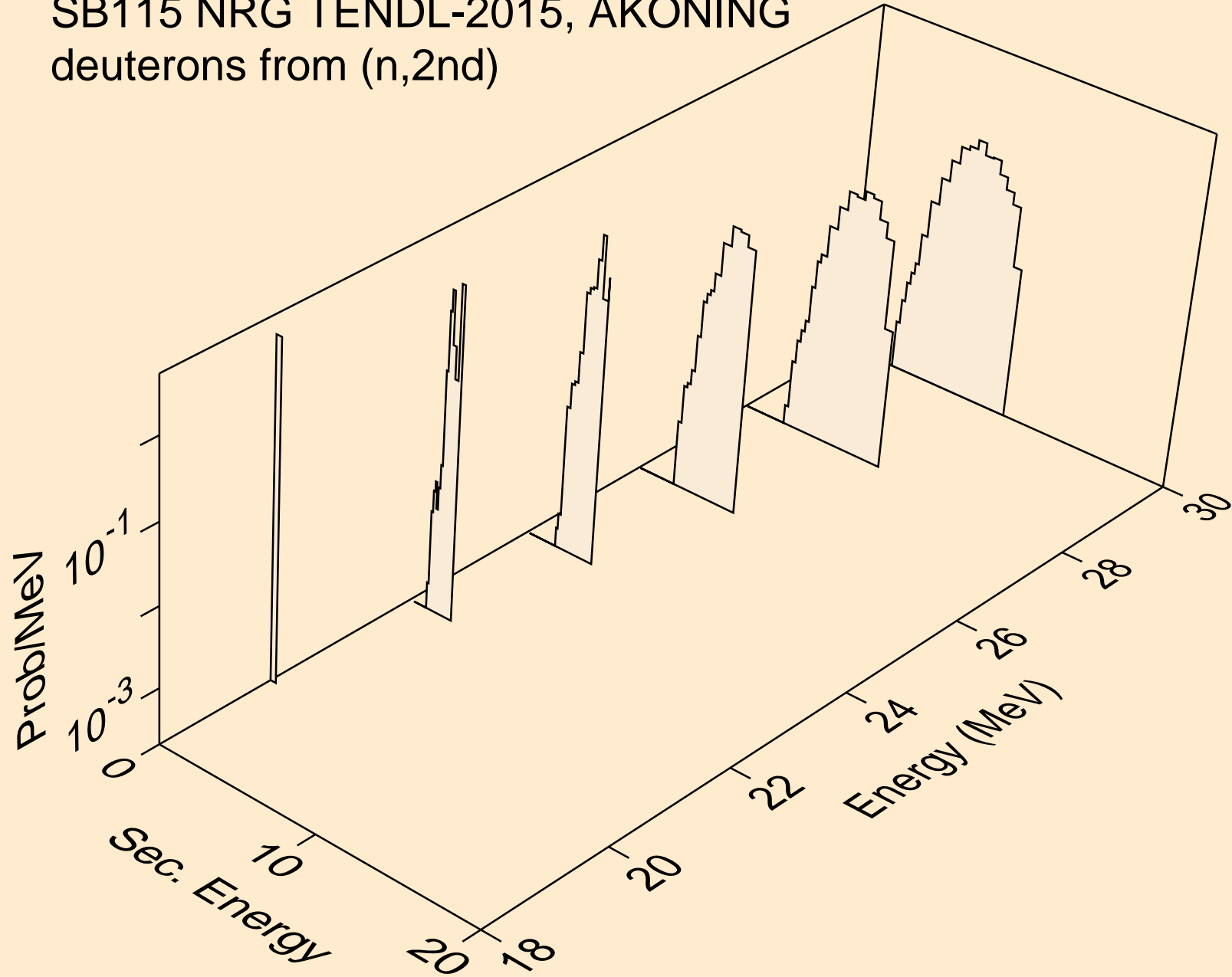

SB115 NRG TENDL-2015, AKONING  
deuterons from (n,n\*)d

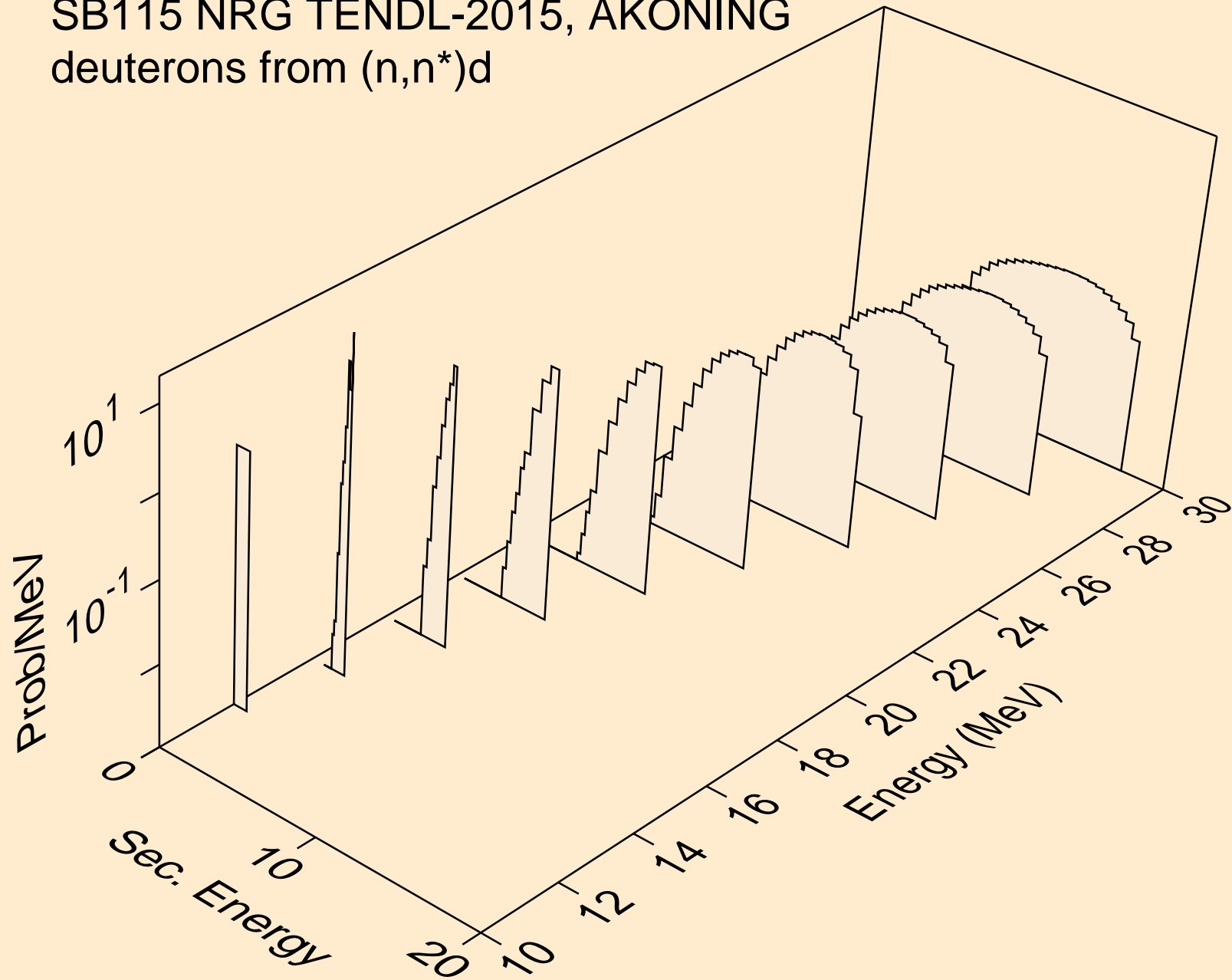

SB115 NRG TENDL-2015, AKONING  
deuterons from (n,d)

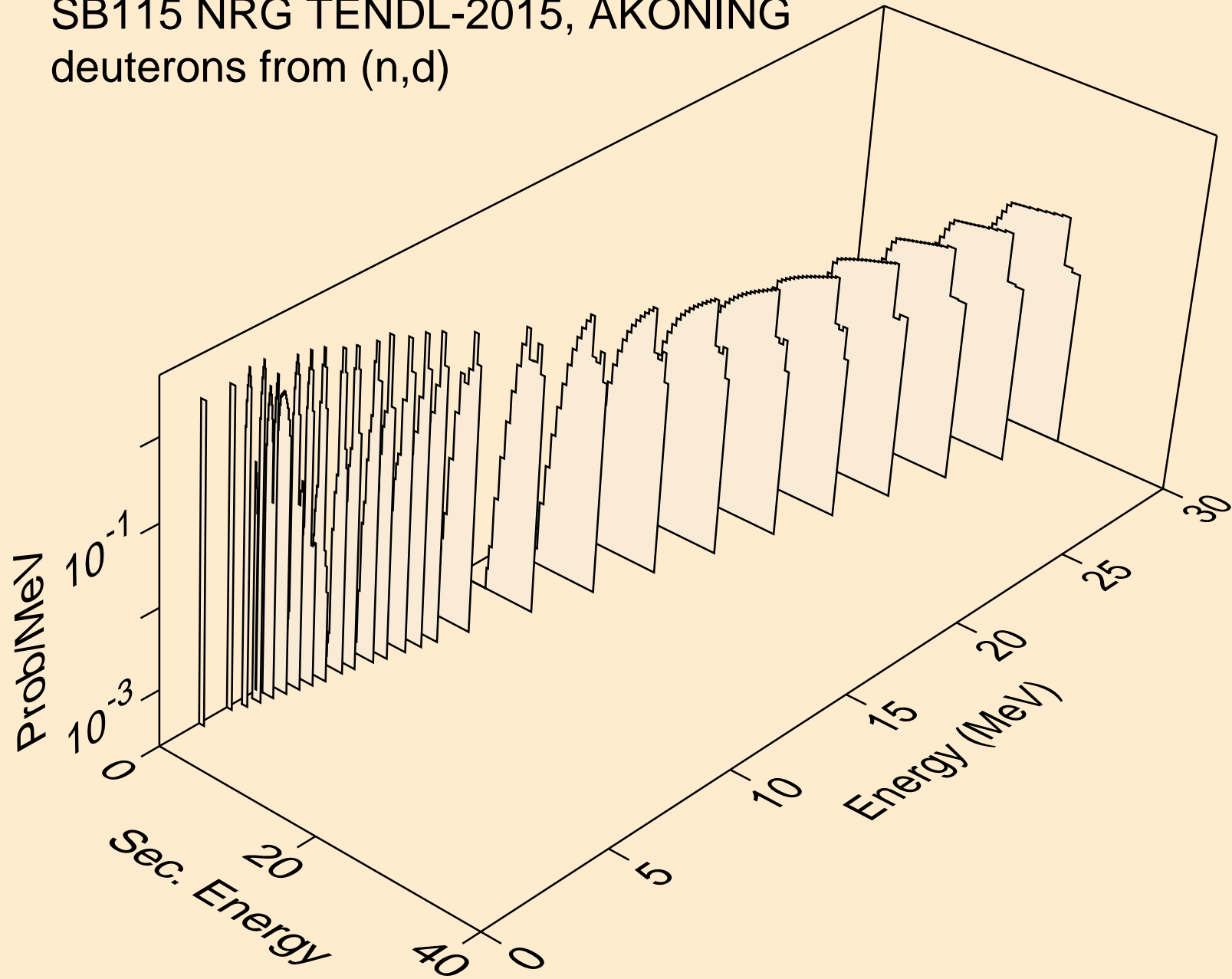

SB115 NRG TENDL-2015, AKONING  
deuterons from (n,pd)

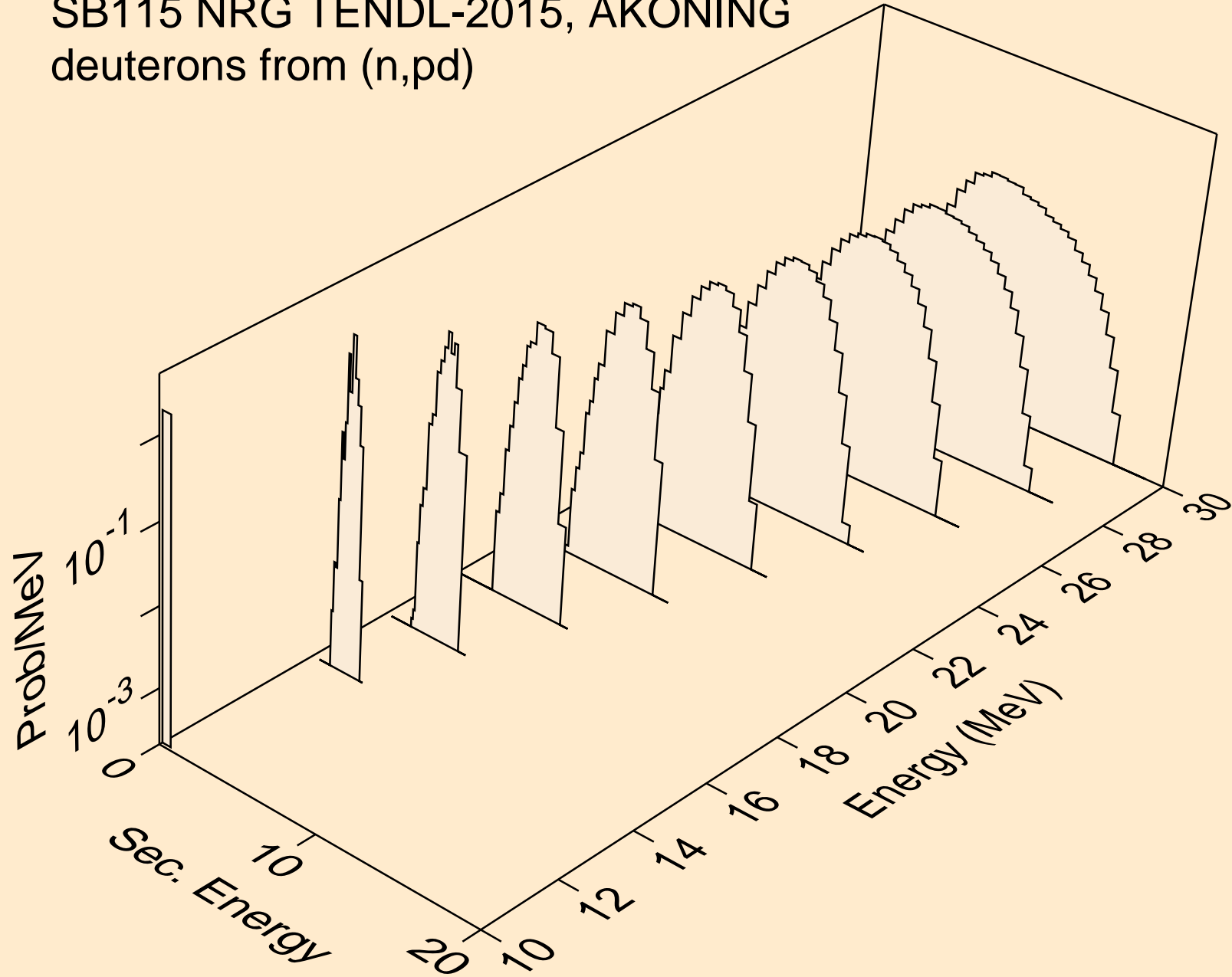

SB115 NRG TENDL-2015, AKONING  
deuterons from (n,da)

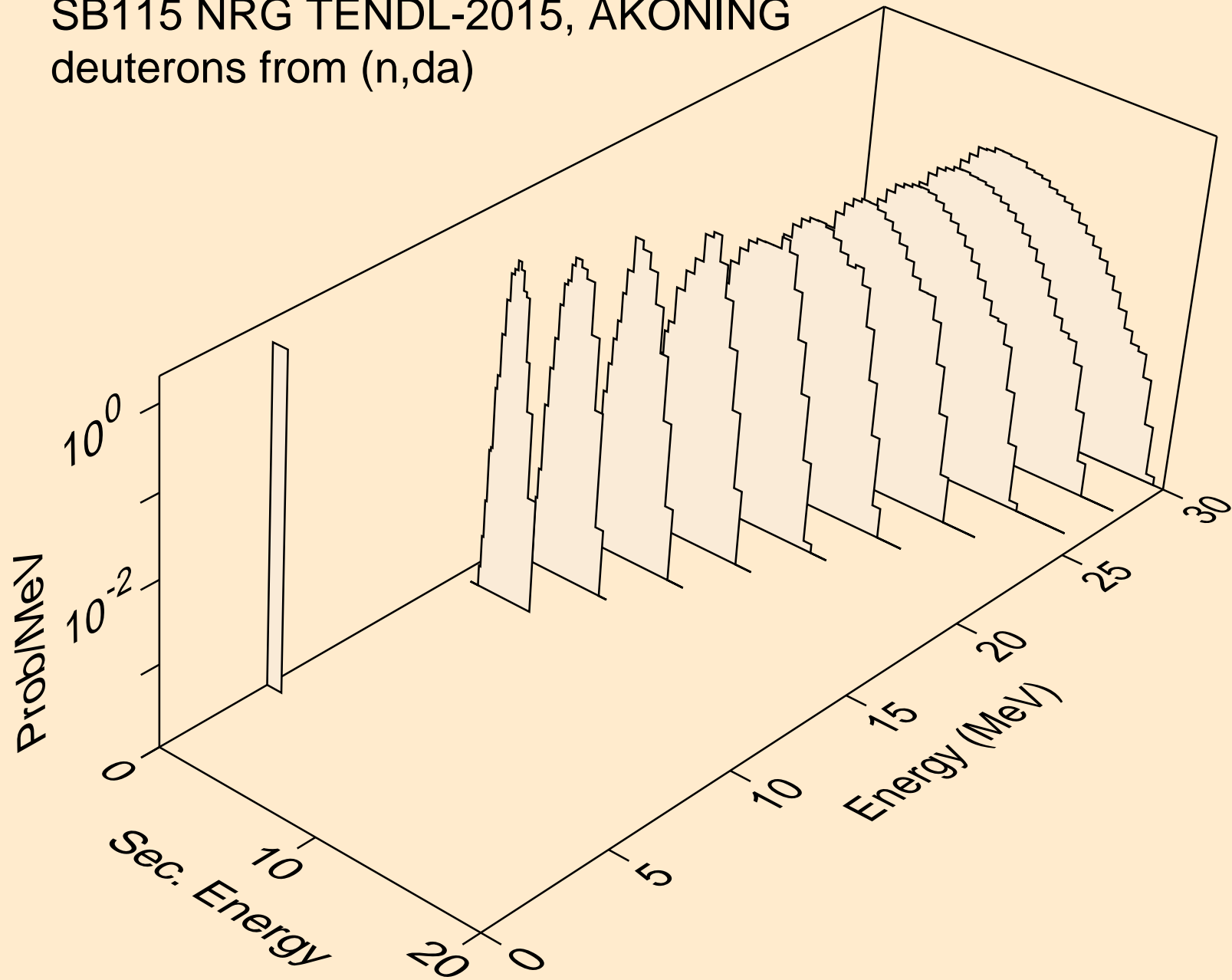

SB115 NRG TENDL-2015, AKONING  
tritons from (n,x)

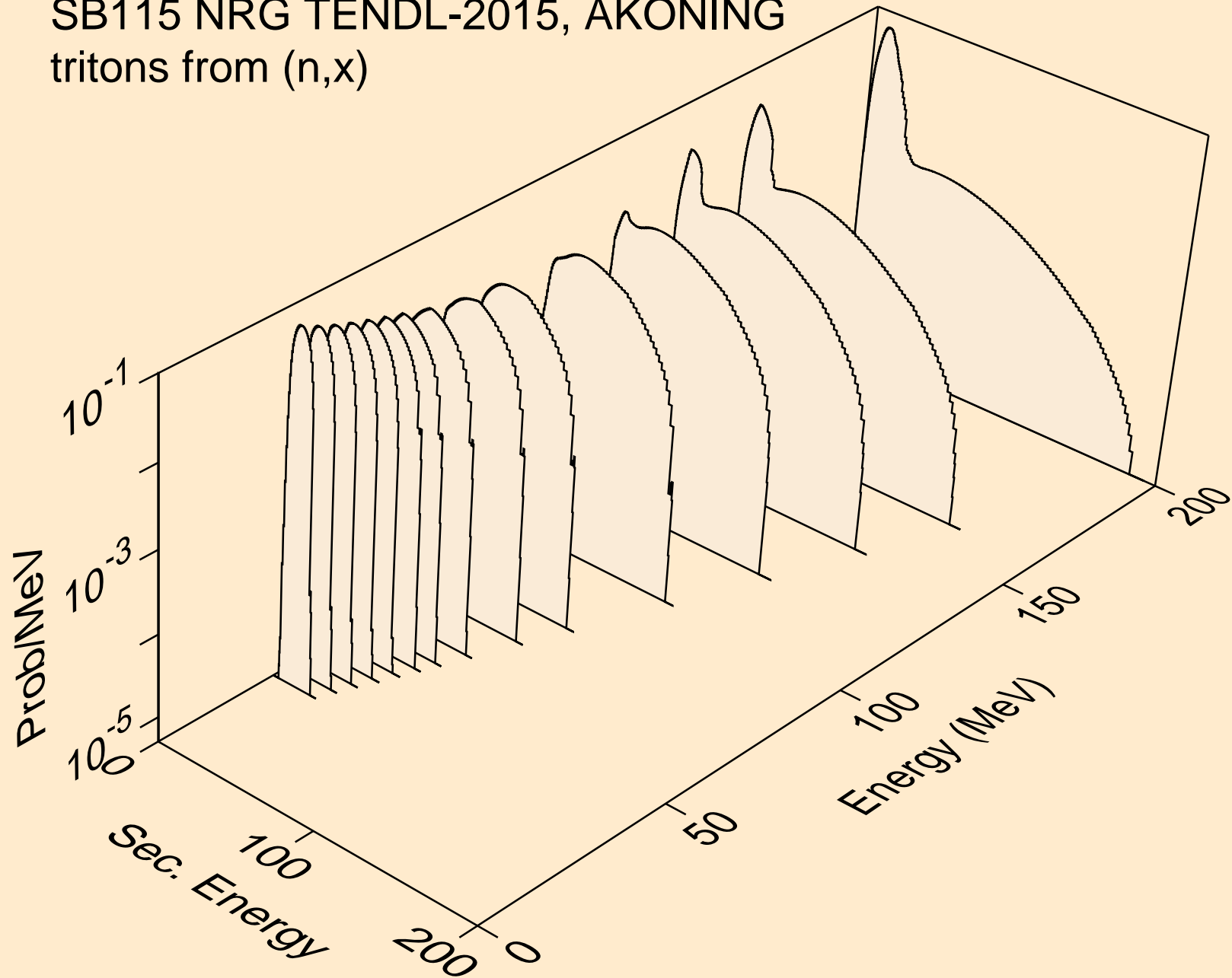



SB115 NRG TENDL-2015, AKONING  
tritons from (n,n\*)t

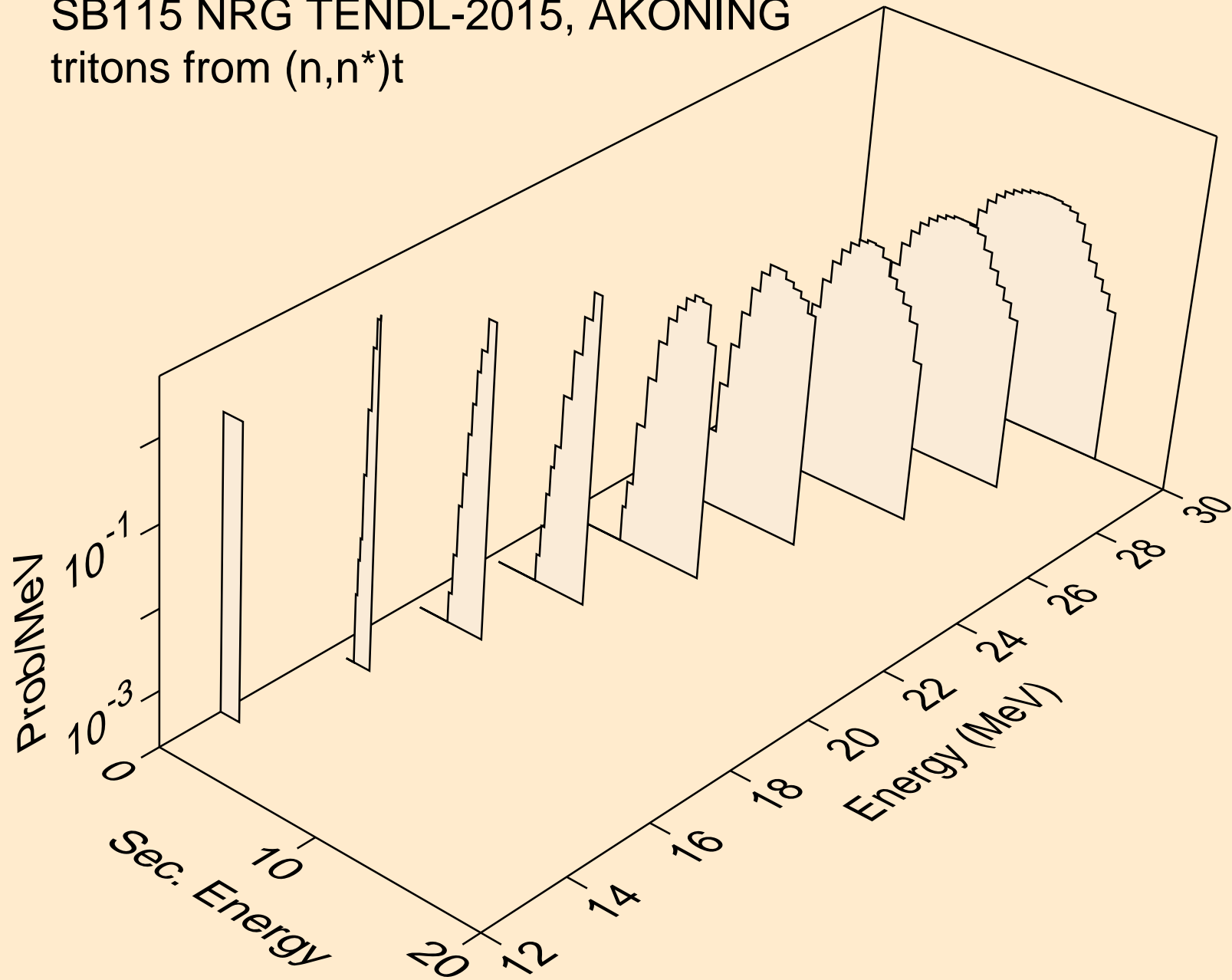

SB115 NRG TENDL-2015, AKONING  
tritons from (n,t)

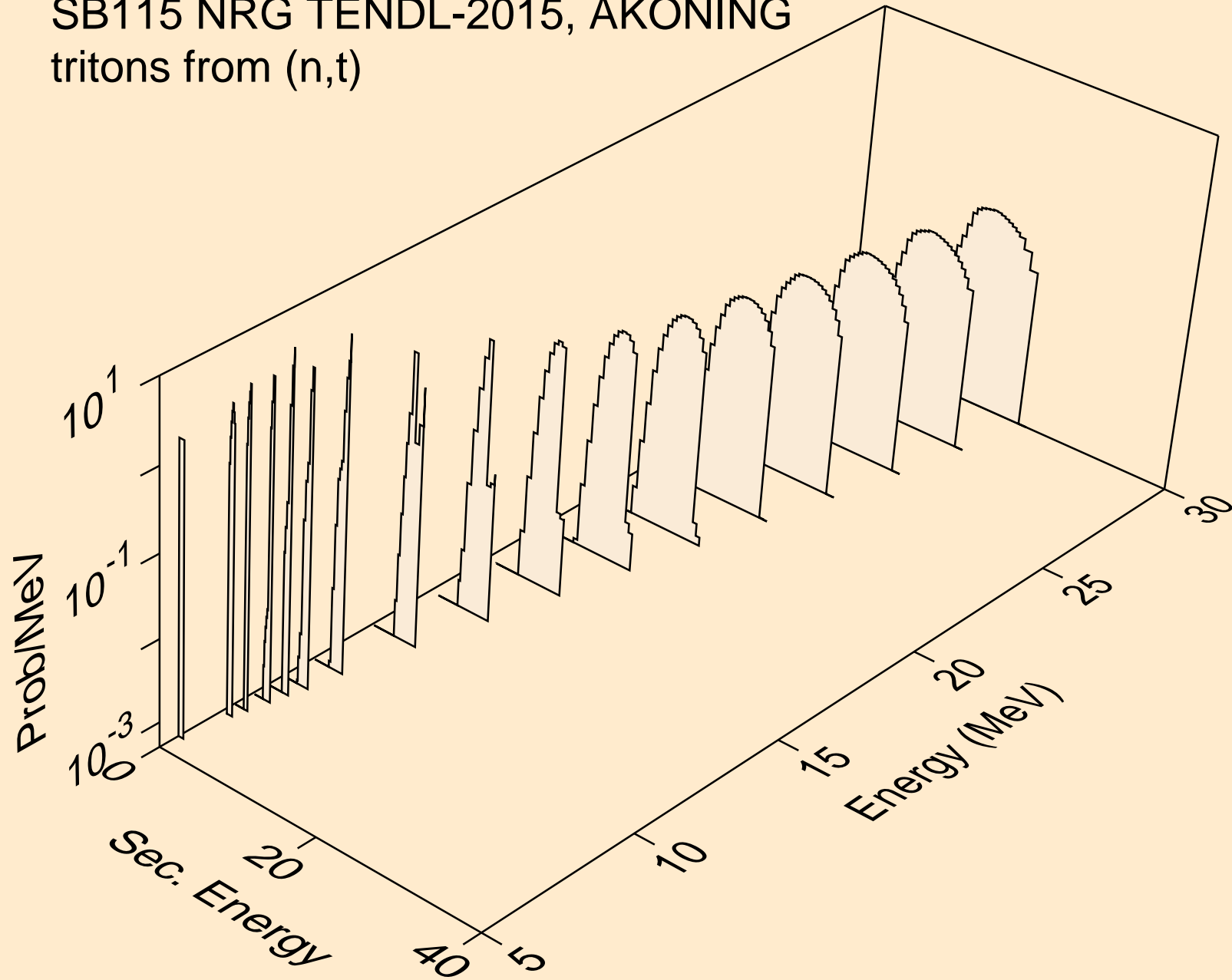

SB115 NRG TENDL-2015, AKONING  
tritons from (n,pt)

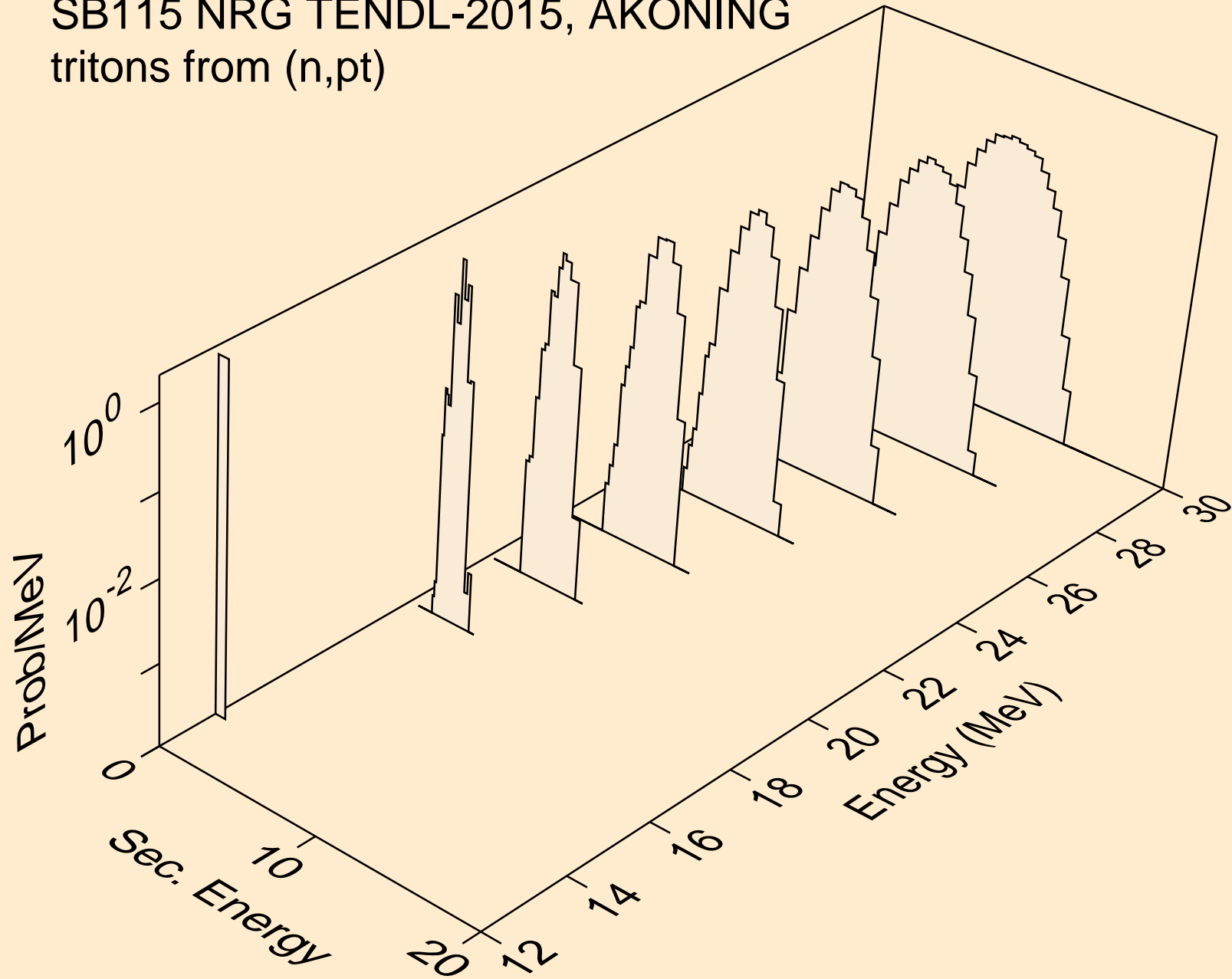

SB115 NRG TENDL-2015, AKONING  
he3s from (n,x)

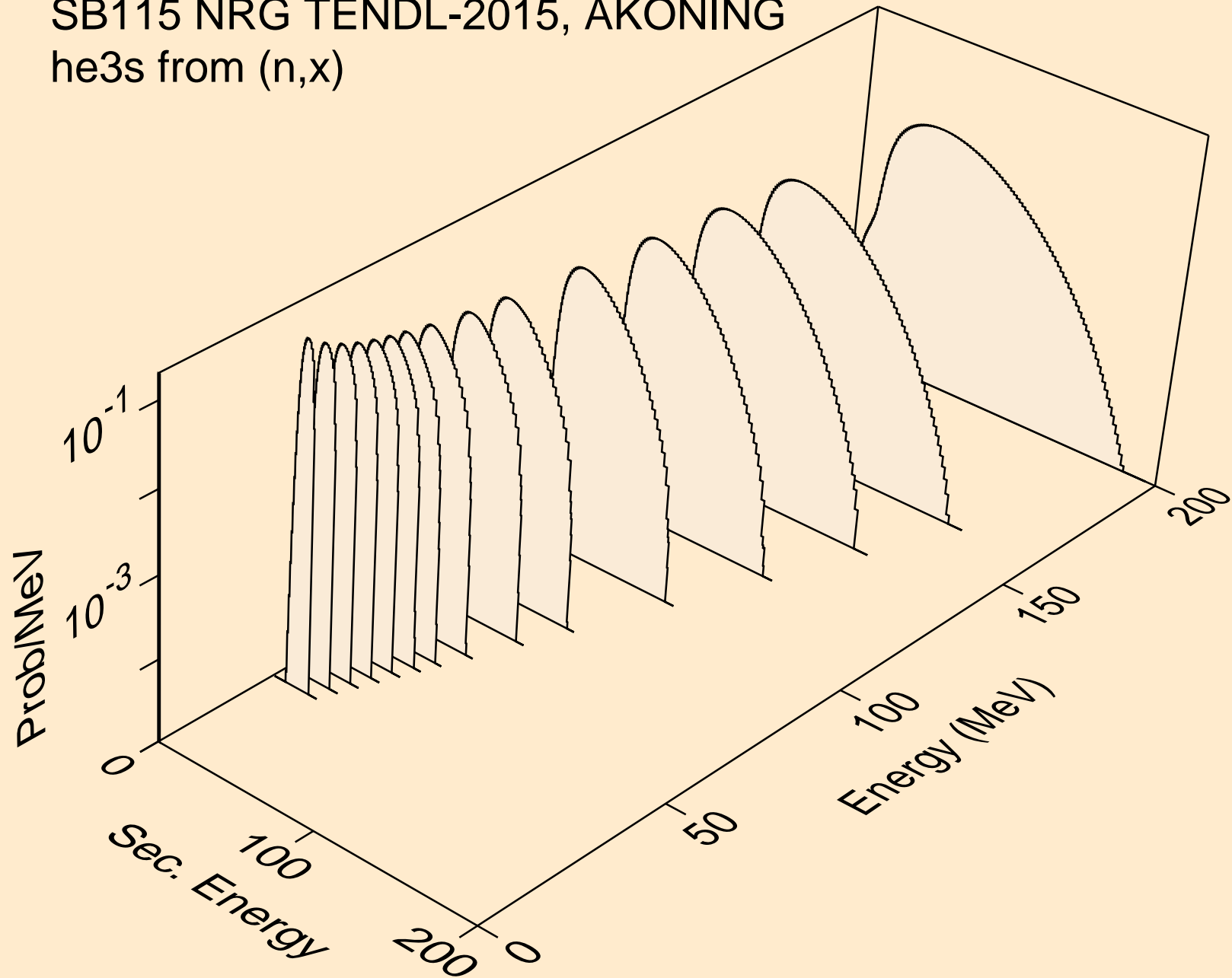

SB115 NRG TENDL-2015, AKONING  
he3s from (n,n\*)he3

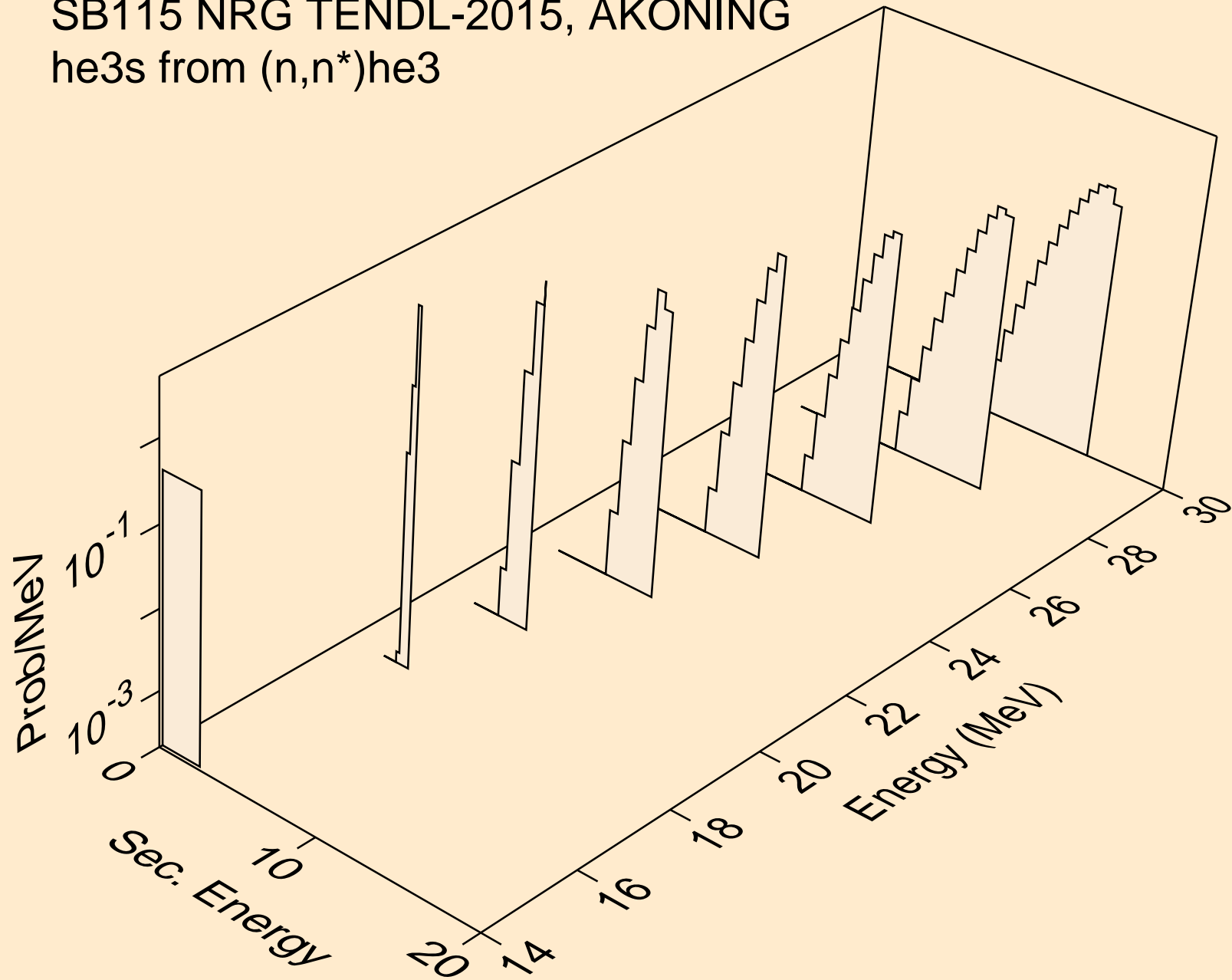

SB115 NRG TENDL-2015, AKONING  
he3s from (n,he3)

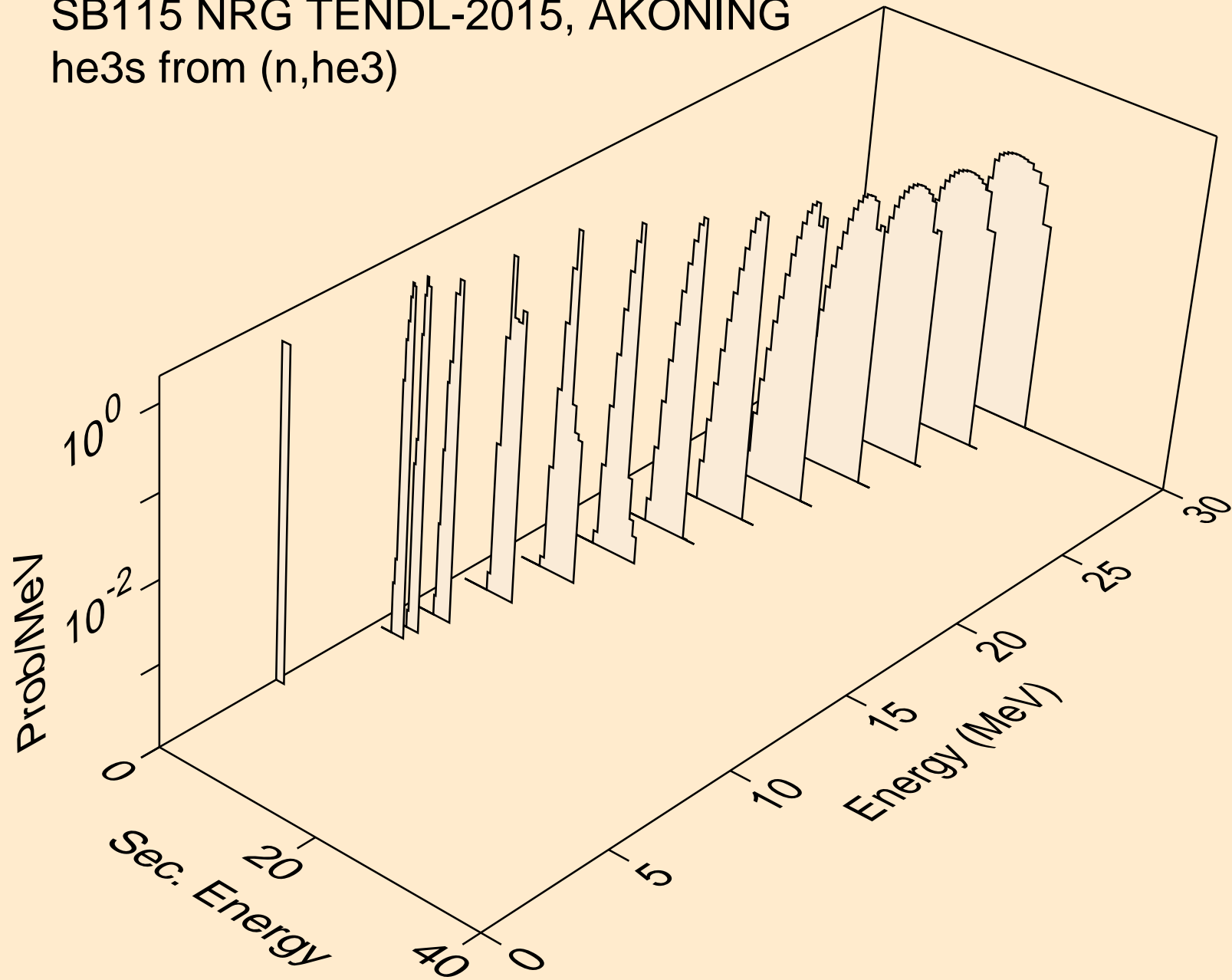

SB115 NRG TENDL-2015, AKONING  
alphas from (n,x)

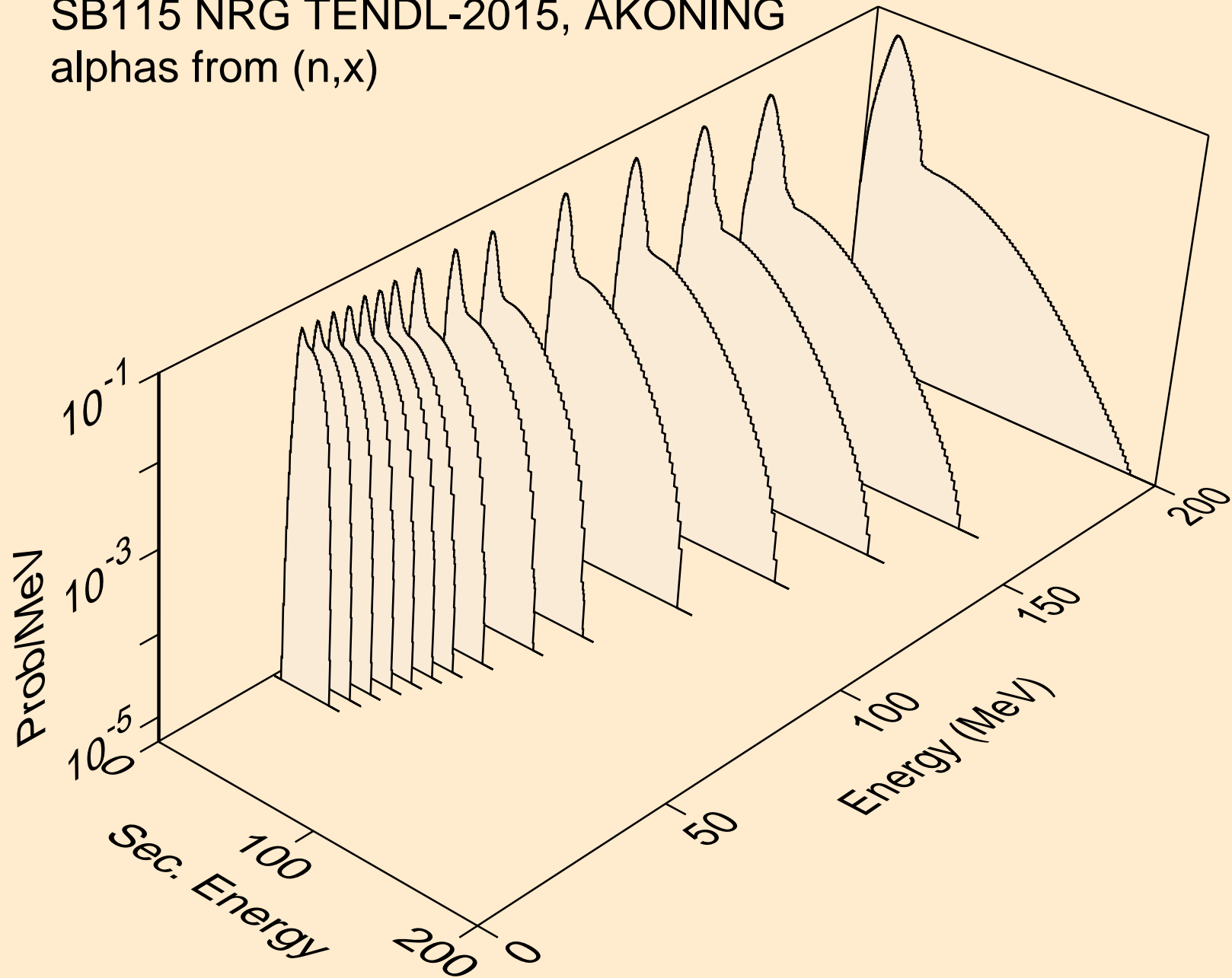

SB115 NRG TENDL-2015, AKONING  
alphas from (n,n\*)a

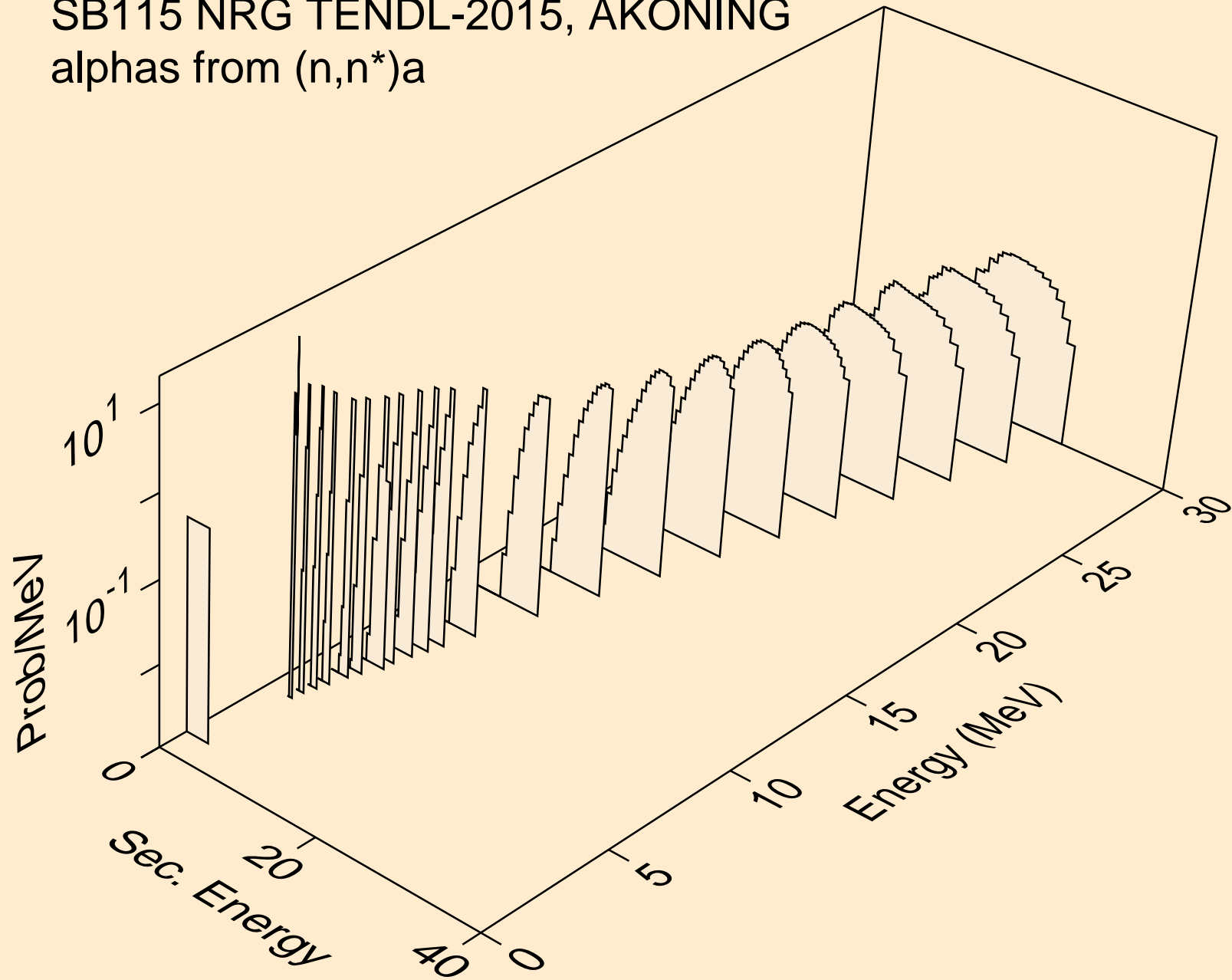



SB115 NRG TENDL-2015, AKONING  
alphas from (n,2n)a

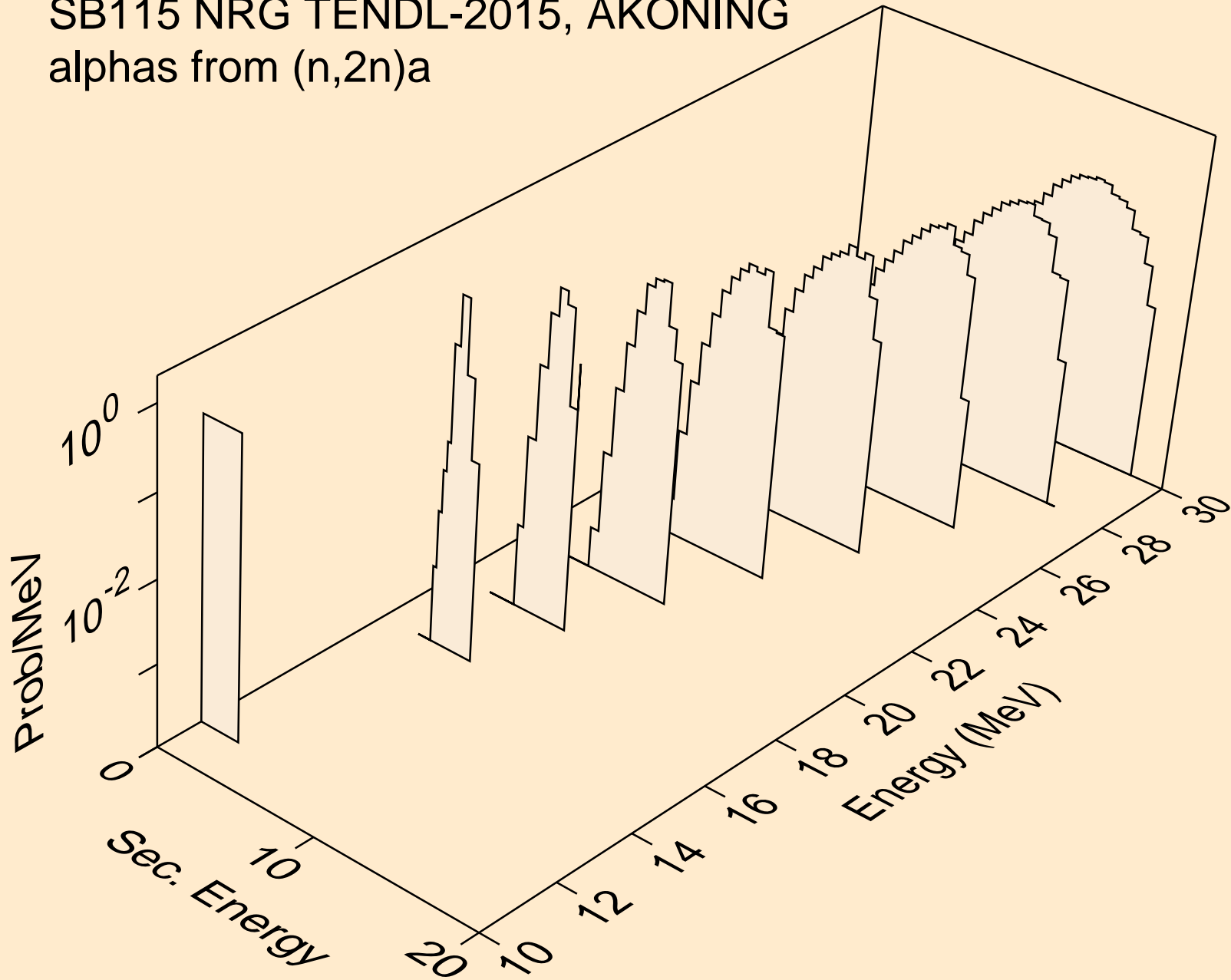

SB115 NRG TENDL-2015, AKONING  
alphas from (n,3n)a

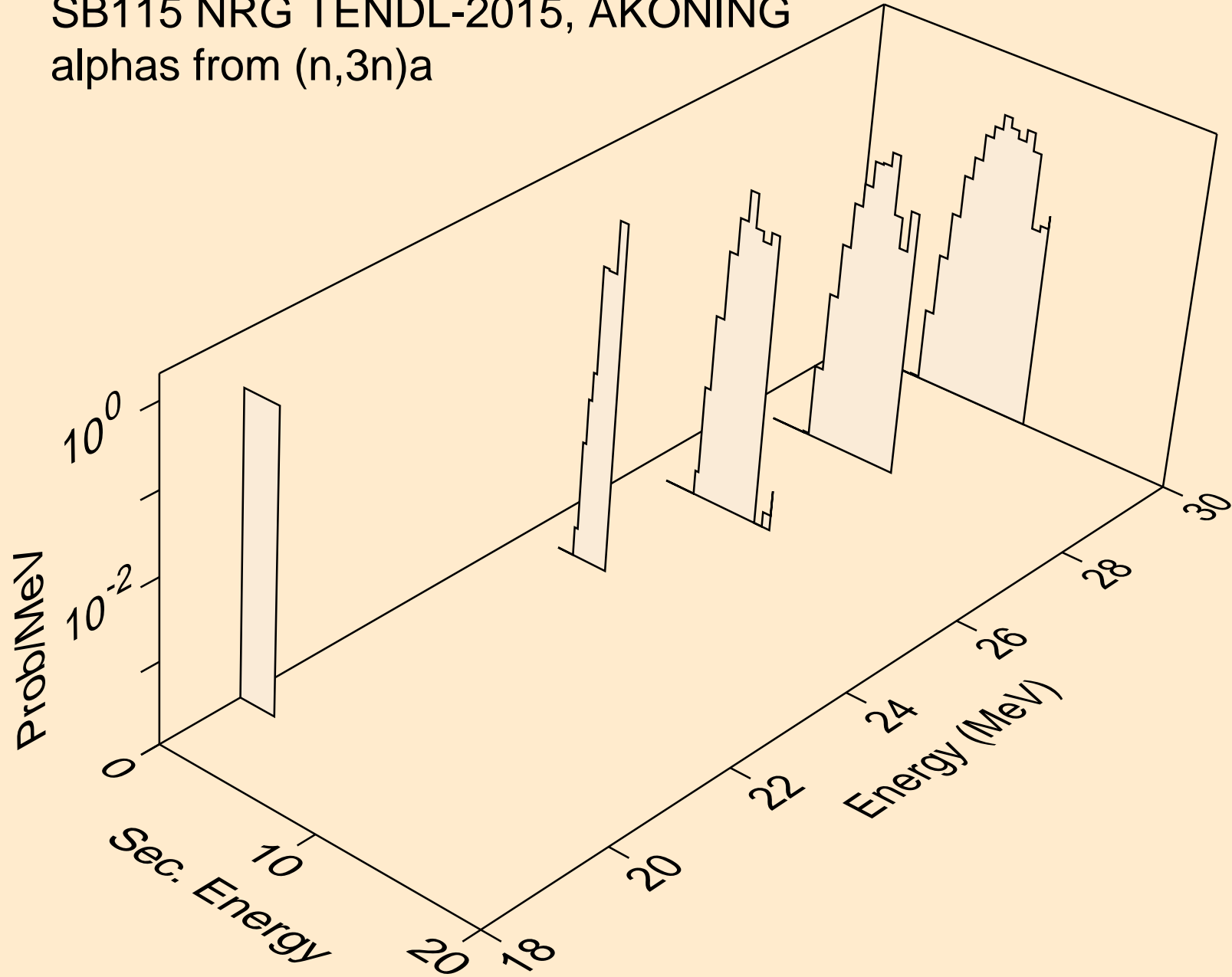

SB115 NRG TENDL-2015, AKONING  
alphas from (n,n\*)2a

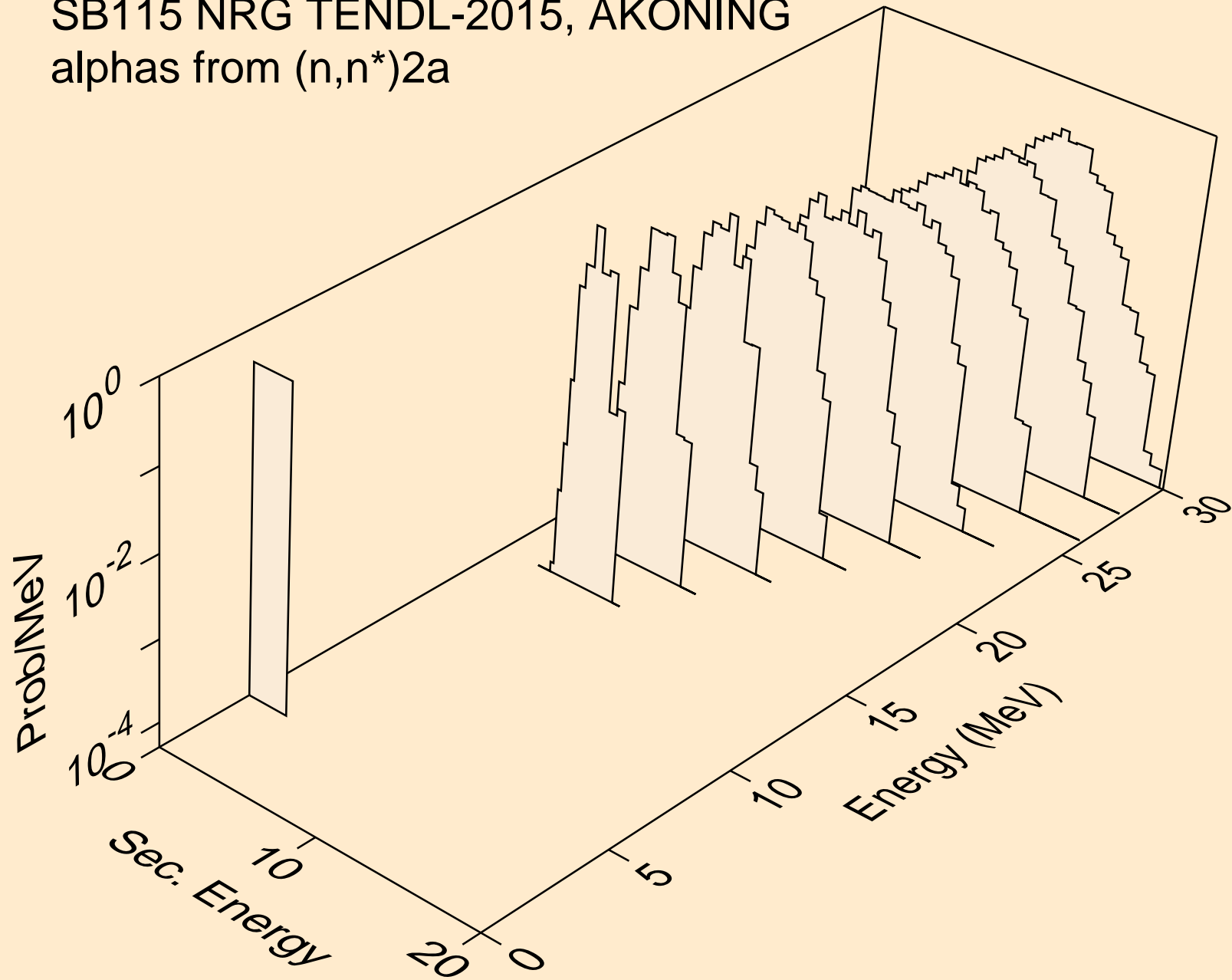

SB115 NRG TENDL-2015, AKONING  
alphas from (n,npa)

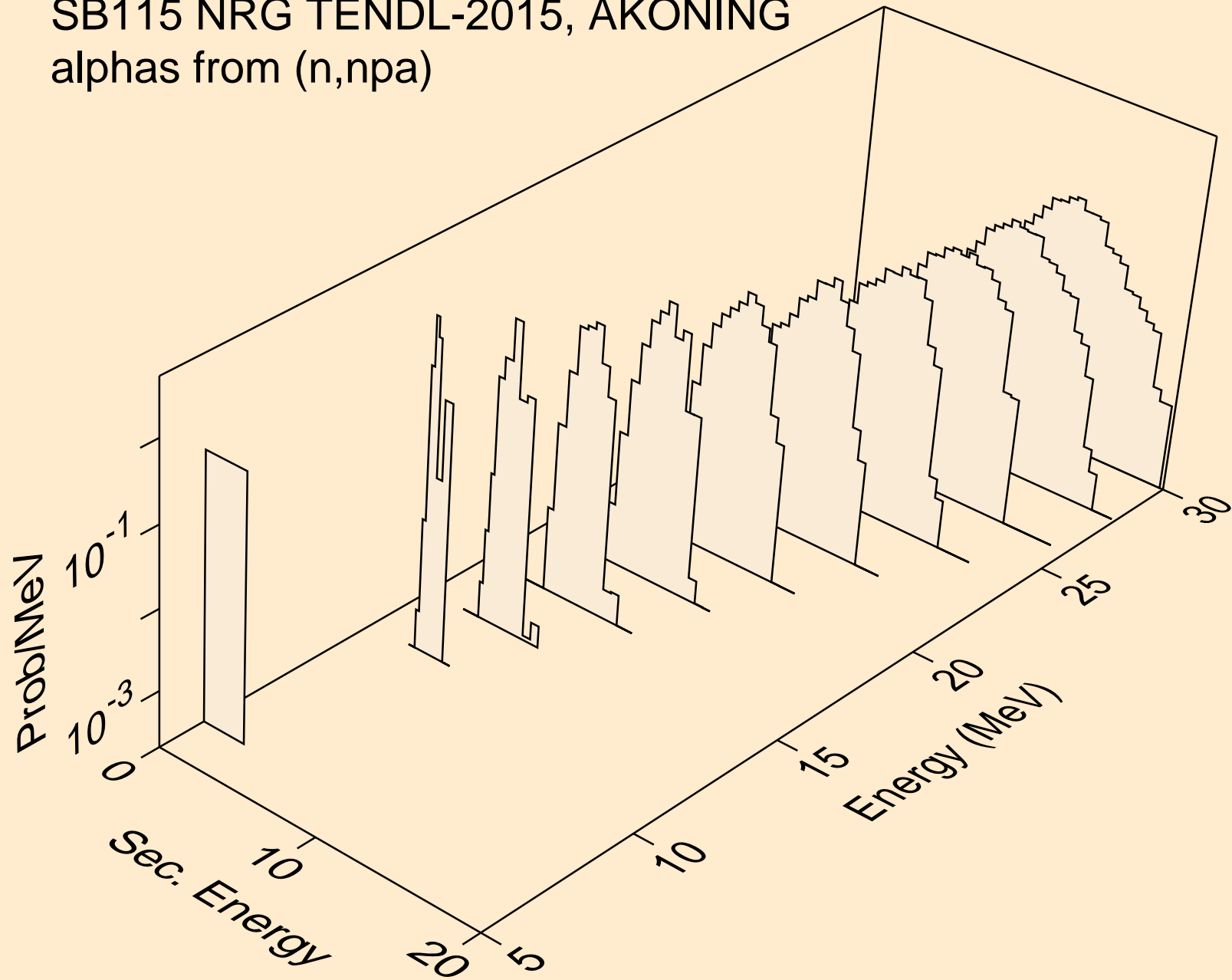

SB115 NRG TENDL-2015, AKONING  
alphas from (n,a)

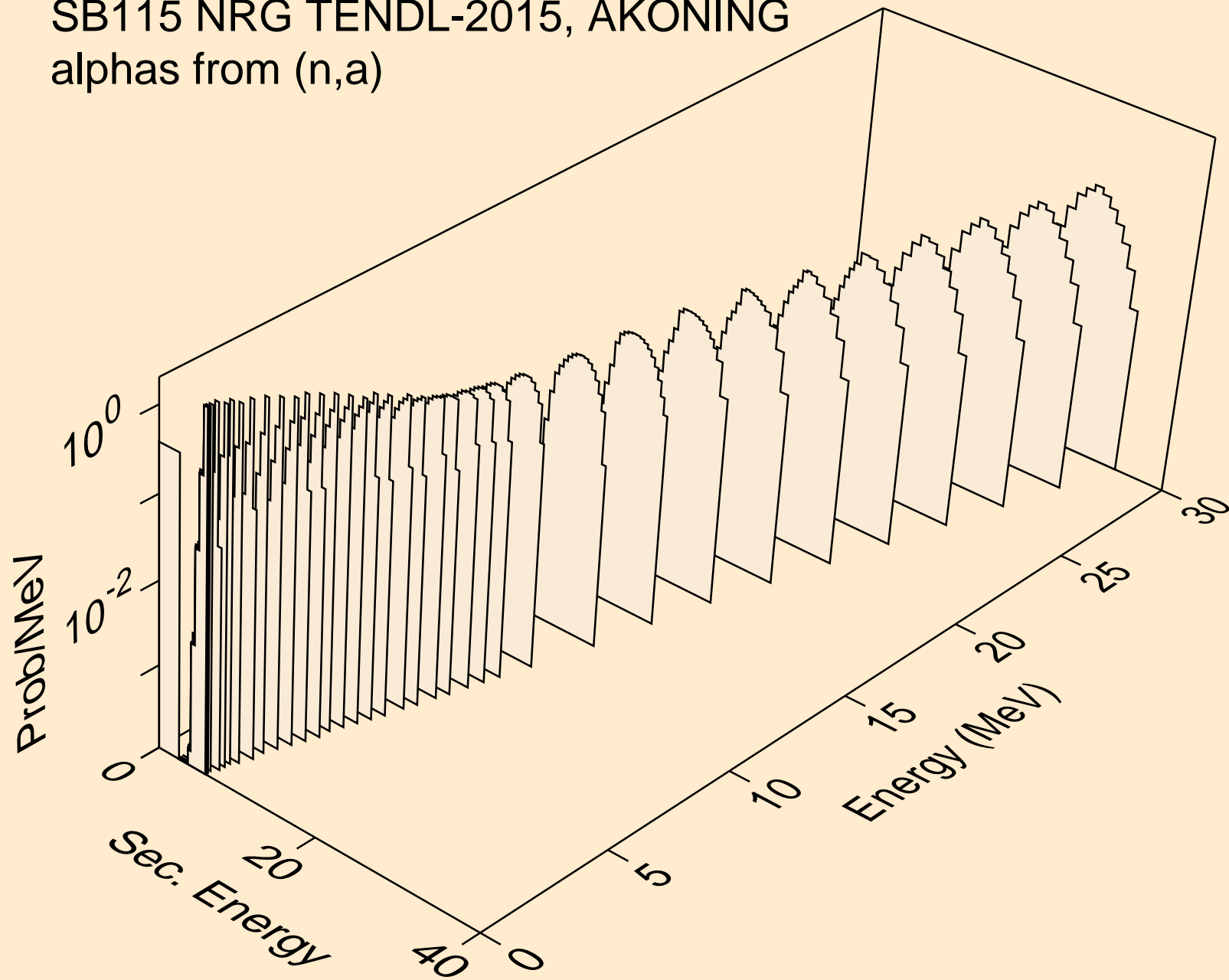

SB115 NRG TENDL-2015, AKONING  
alphas from (n,2a)

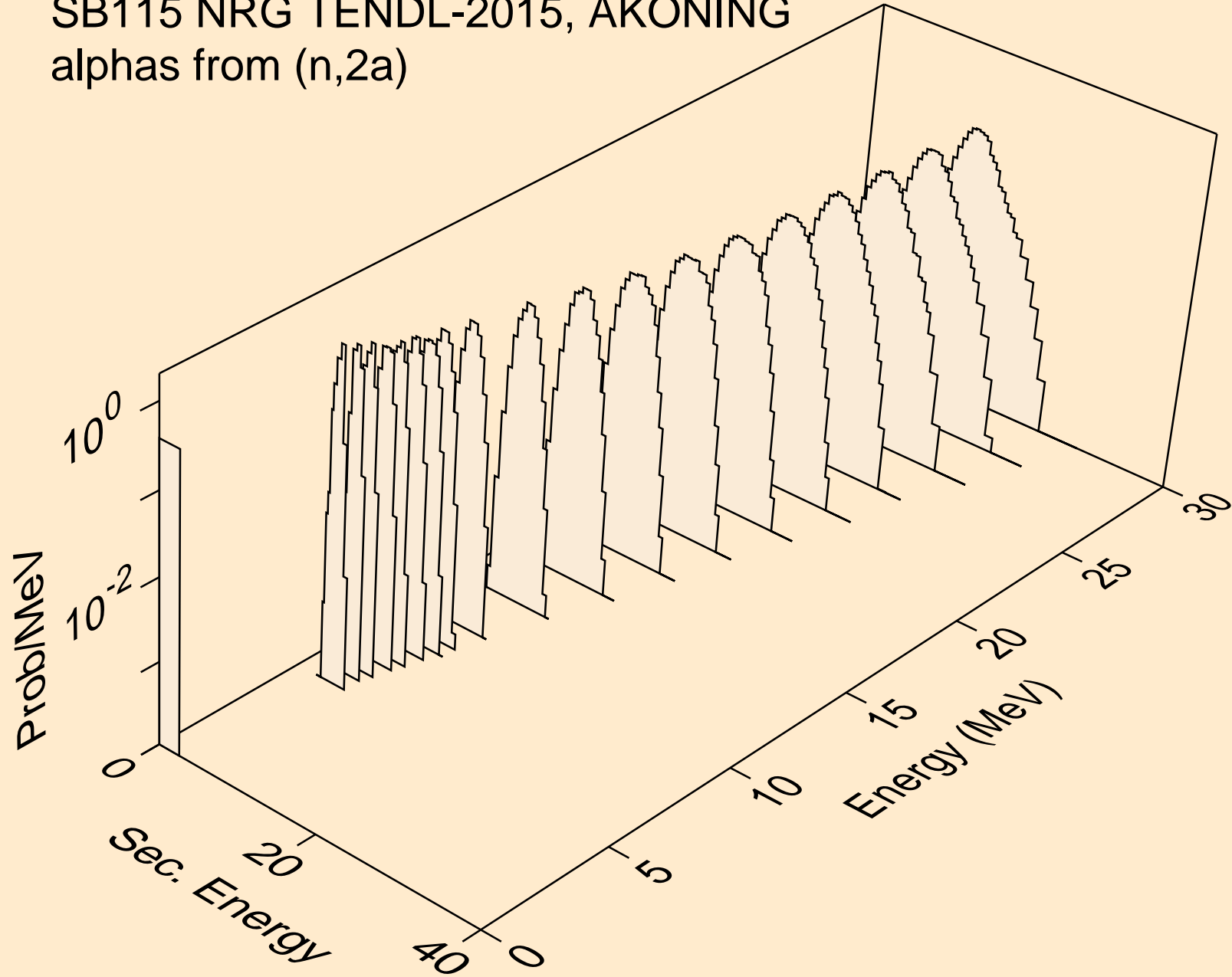

SB115 NRG TENDL-2015, AKONING  
alphas from (n,pa)

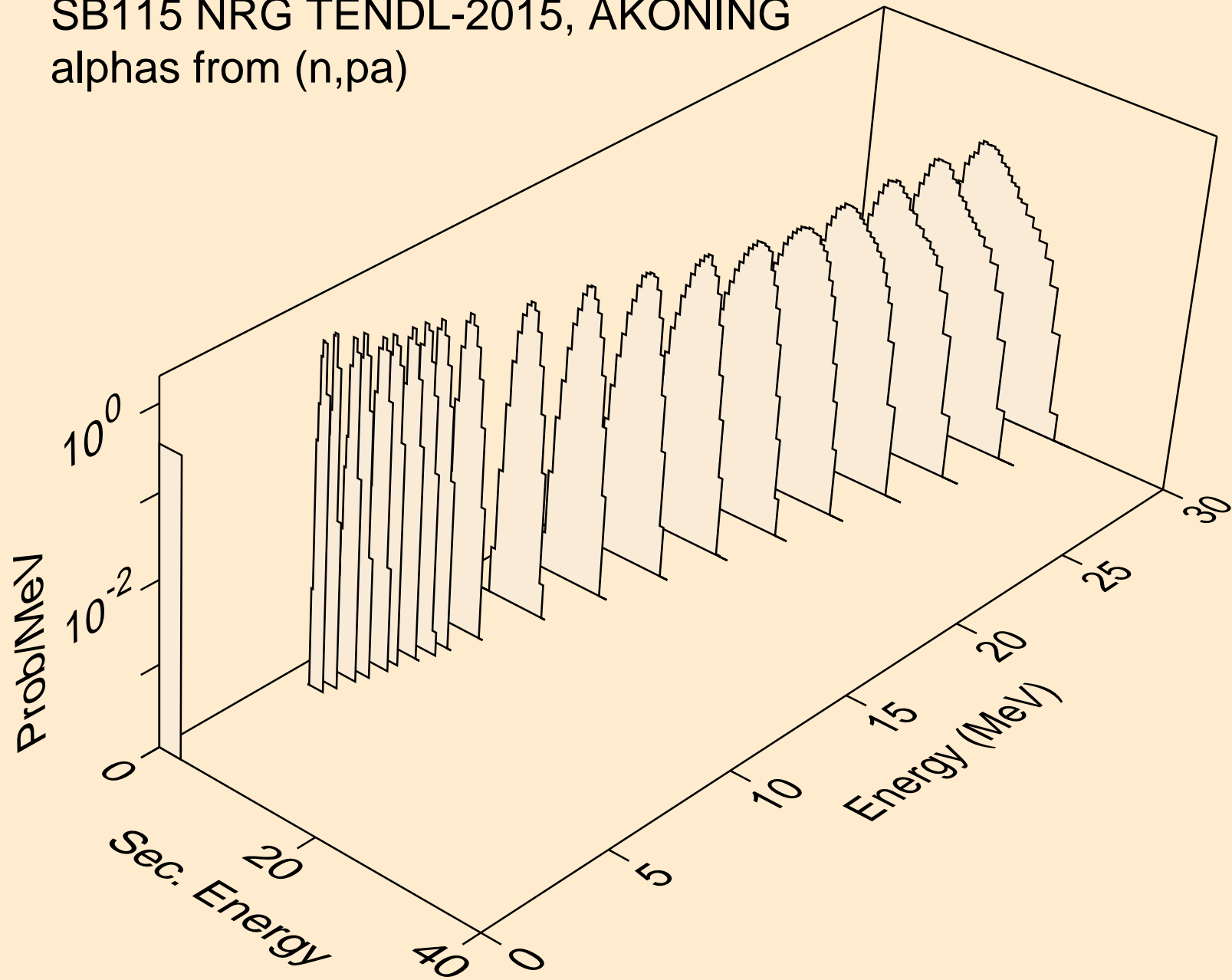

SB115 NRG TENDL-2015, AKONING  
alphas from (n,da)

