

SG265 NRG TENDL-2015, AKONING

Principal cross sections

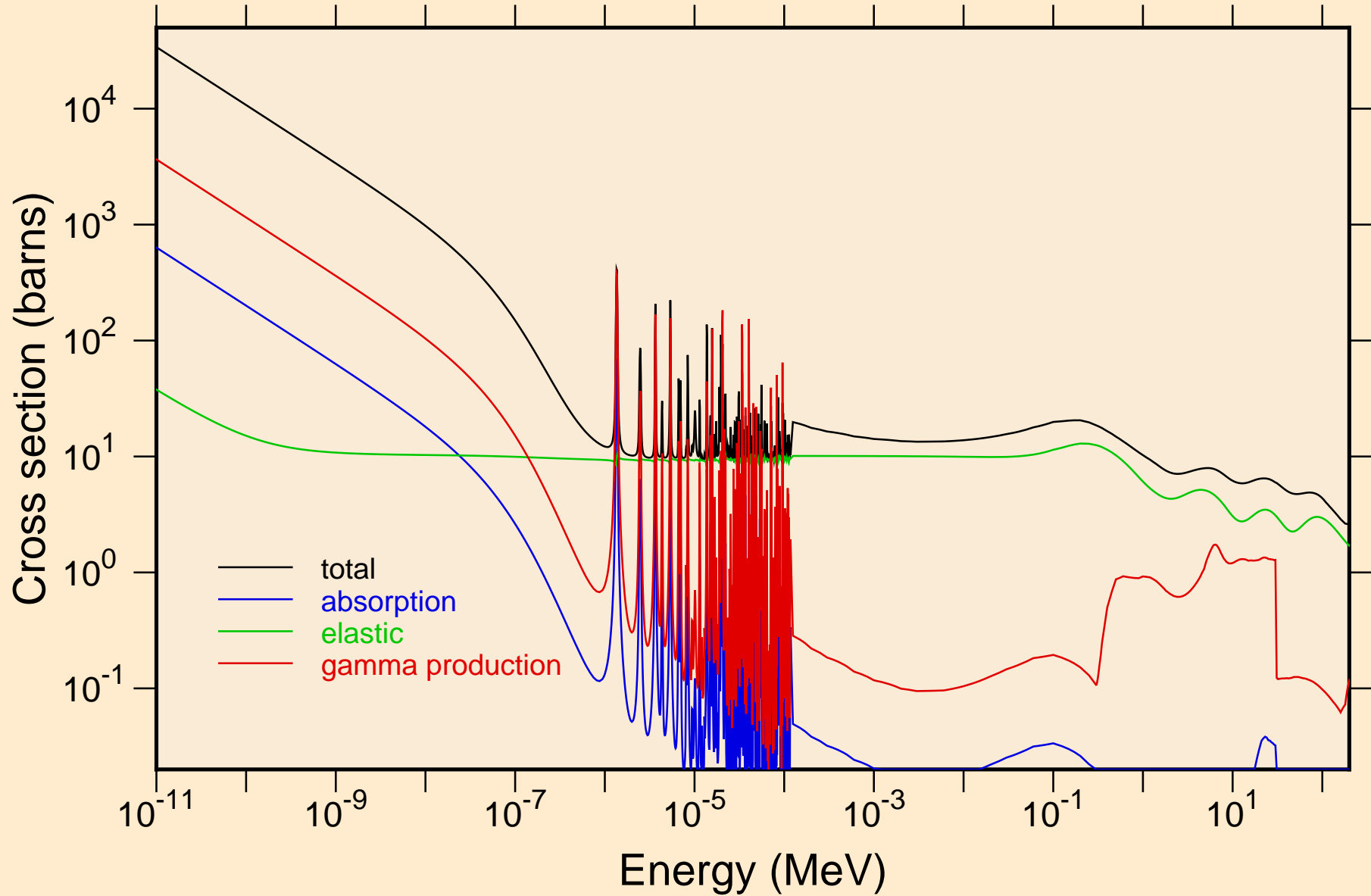

SG265 NRG TENDL-2015, AKONING
resonance total cross section

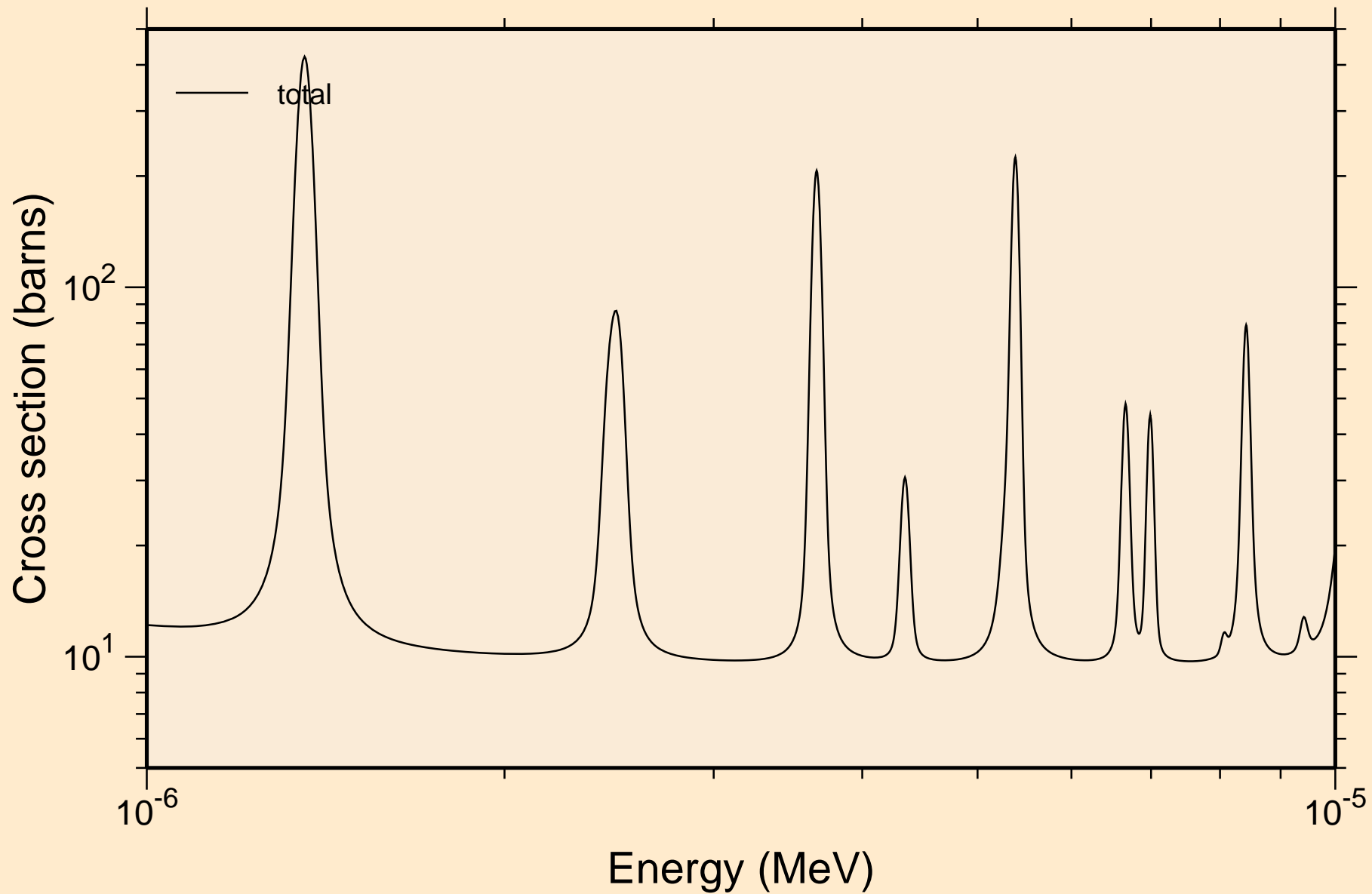

SG265 NRG TENDL-2015, AKONING
resonance total cross section

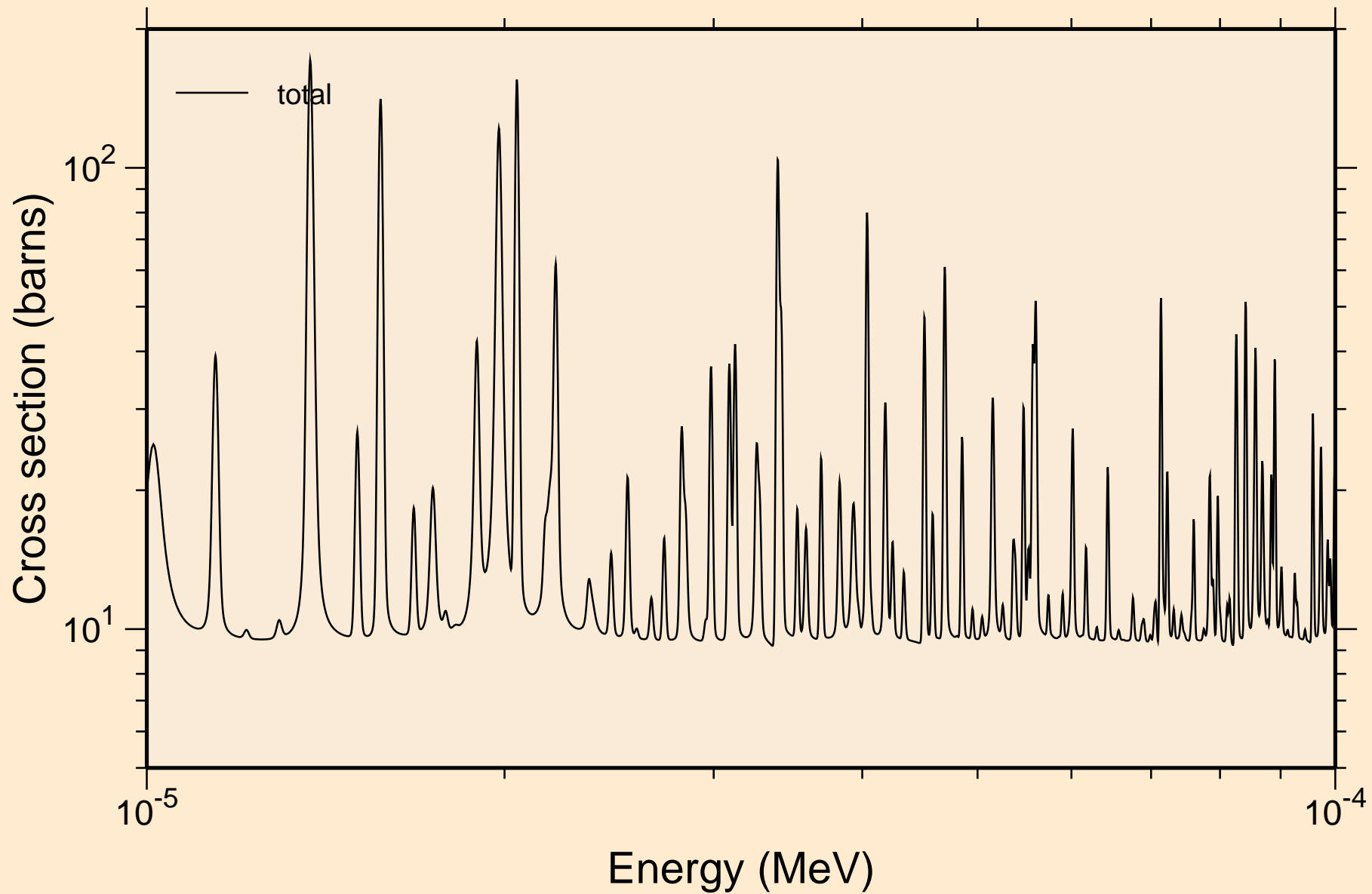

SG265 NRG TENDL-2015, AKONING
resonance total cross section

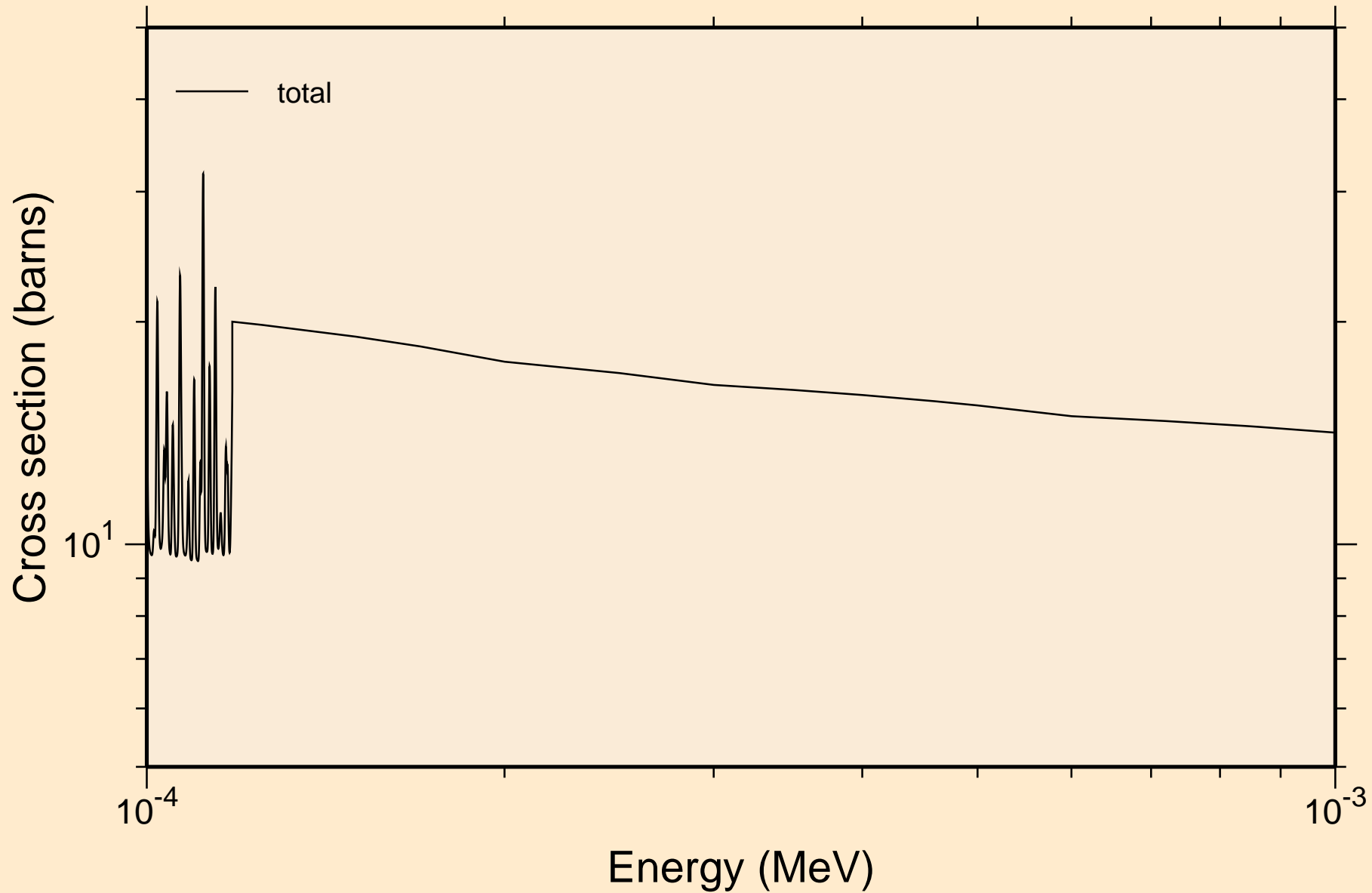

SG265 NRG TENDL-2015, AKONING
resonance total cross section

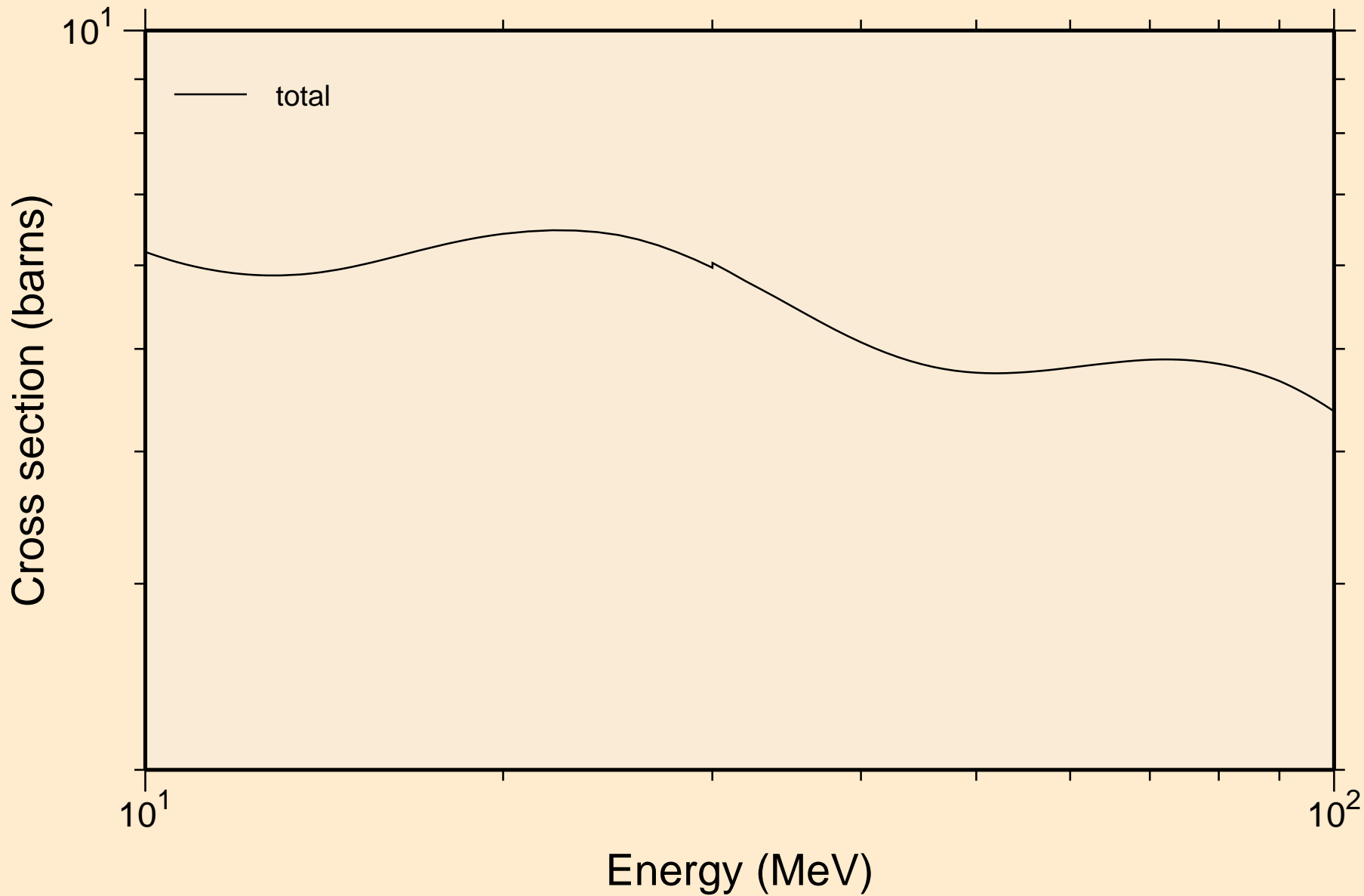

SG265 NRG TENDL-2015, AKONING resonance absorption cross sections

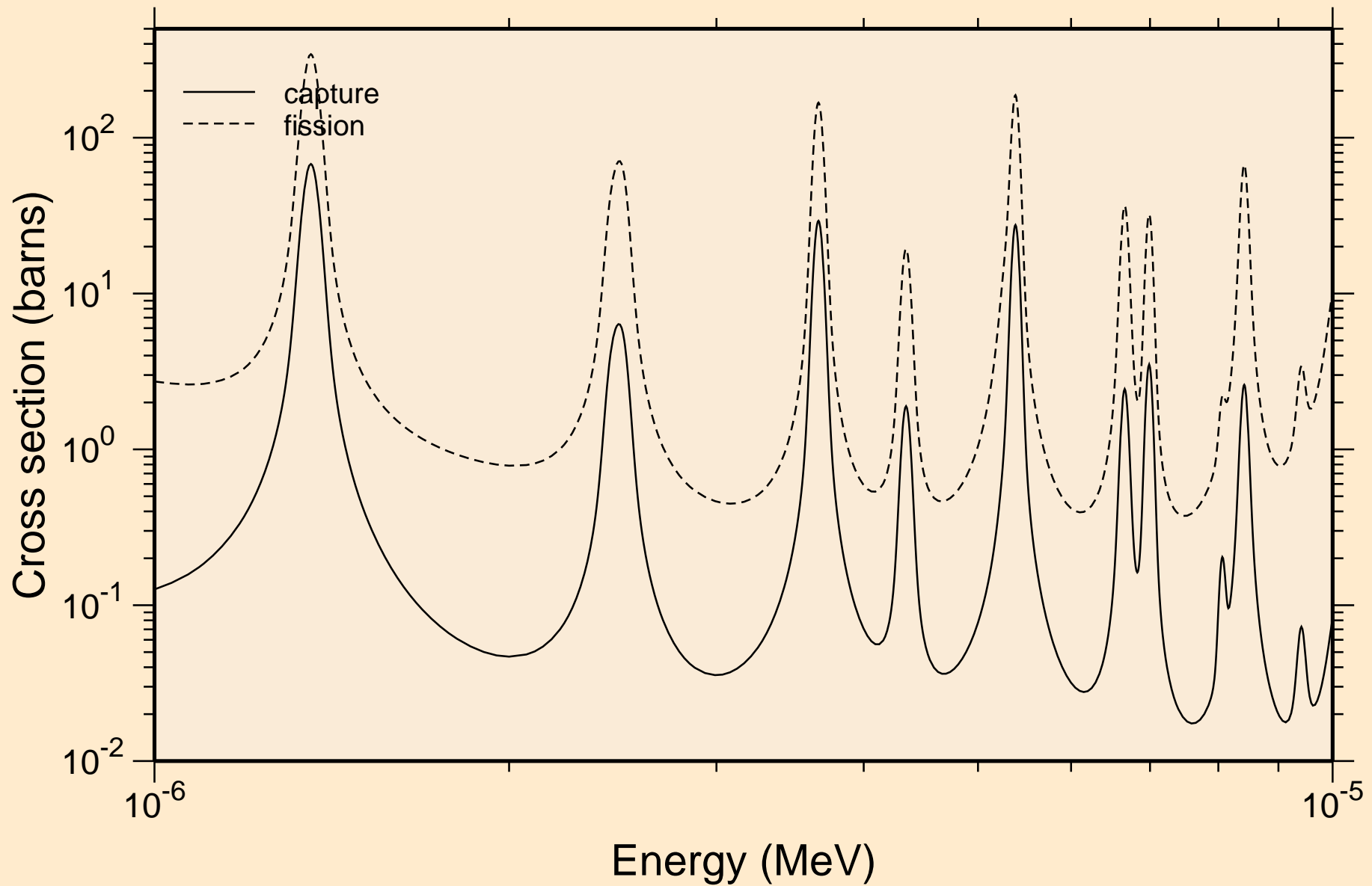

SG265 NRG TENDL-2015, AKONING
resonance absorption cross sections

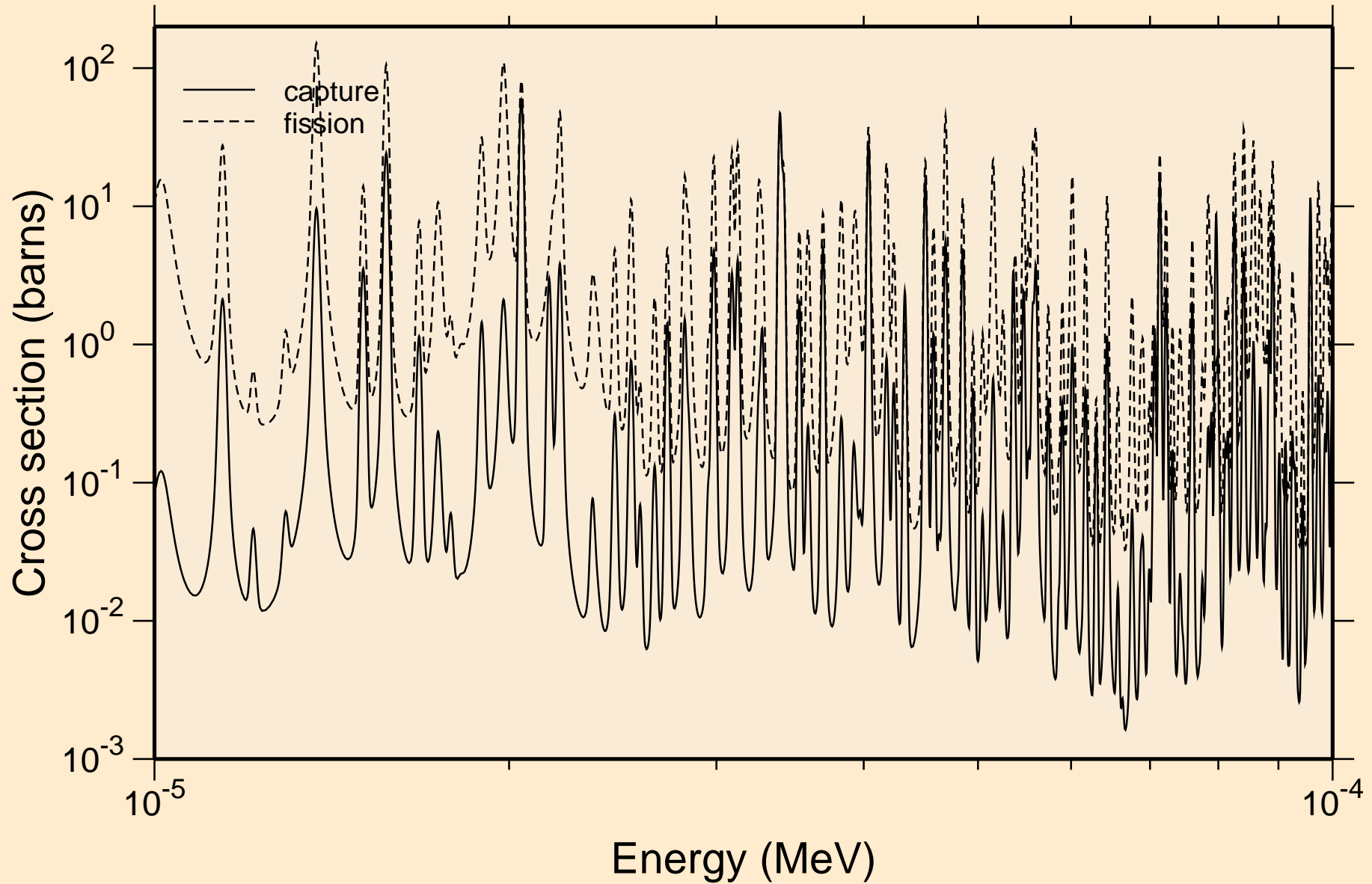

SG265 NRG TENDL-2015, AKONING
resonance absorption cross sections

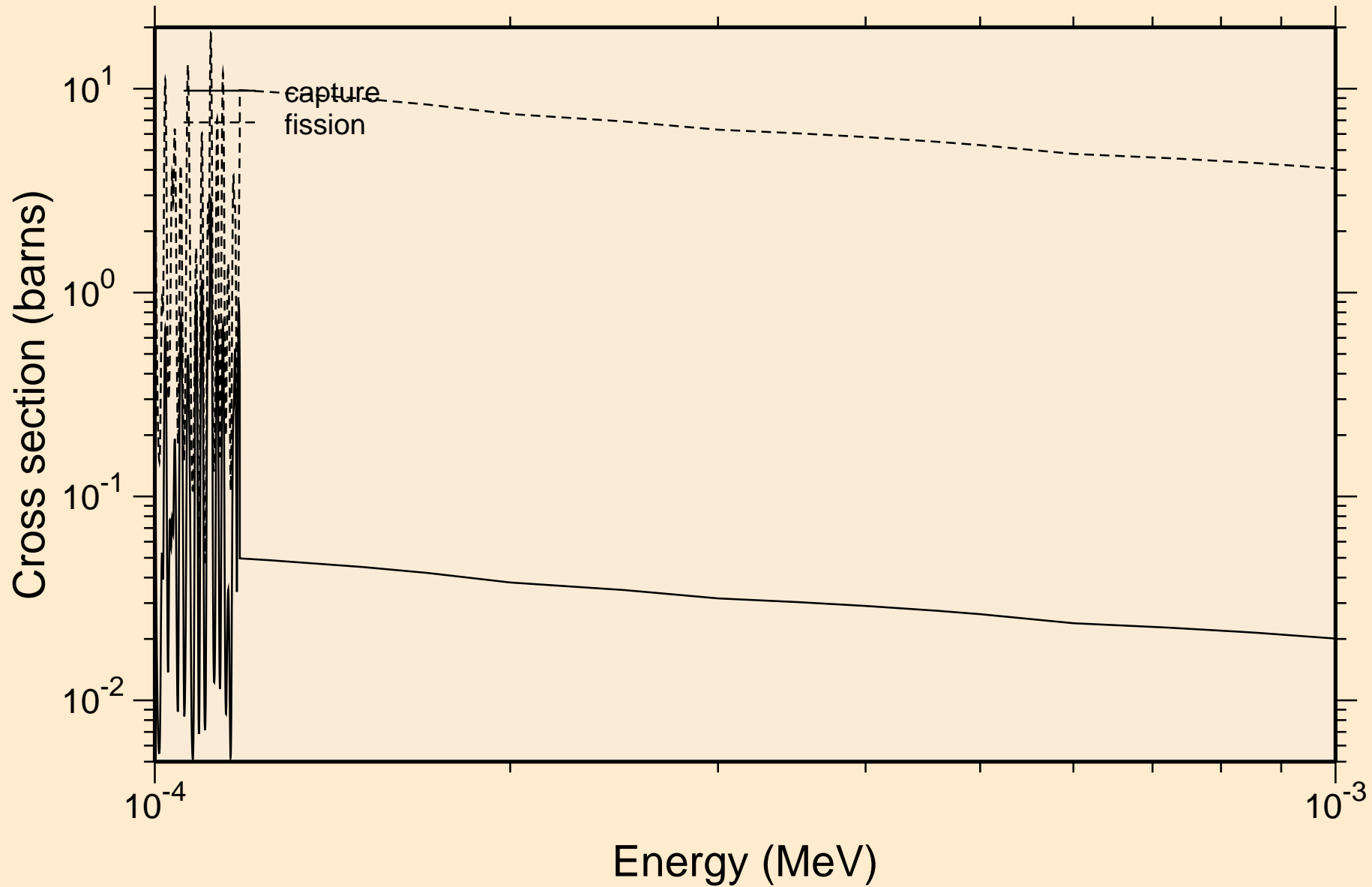

SG265 NRG TENDL-2015, AKONING

resonance absorption cross sections

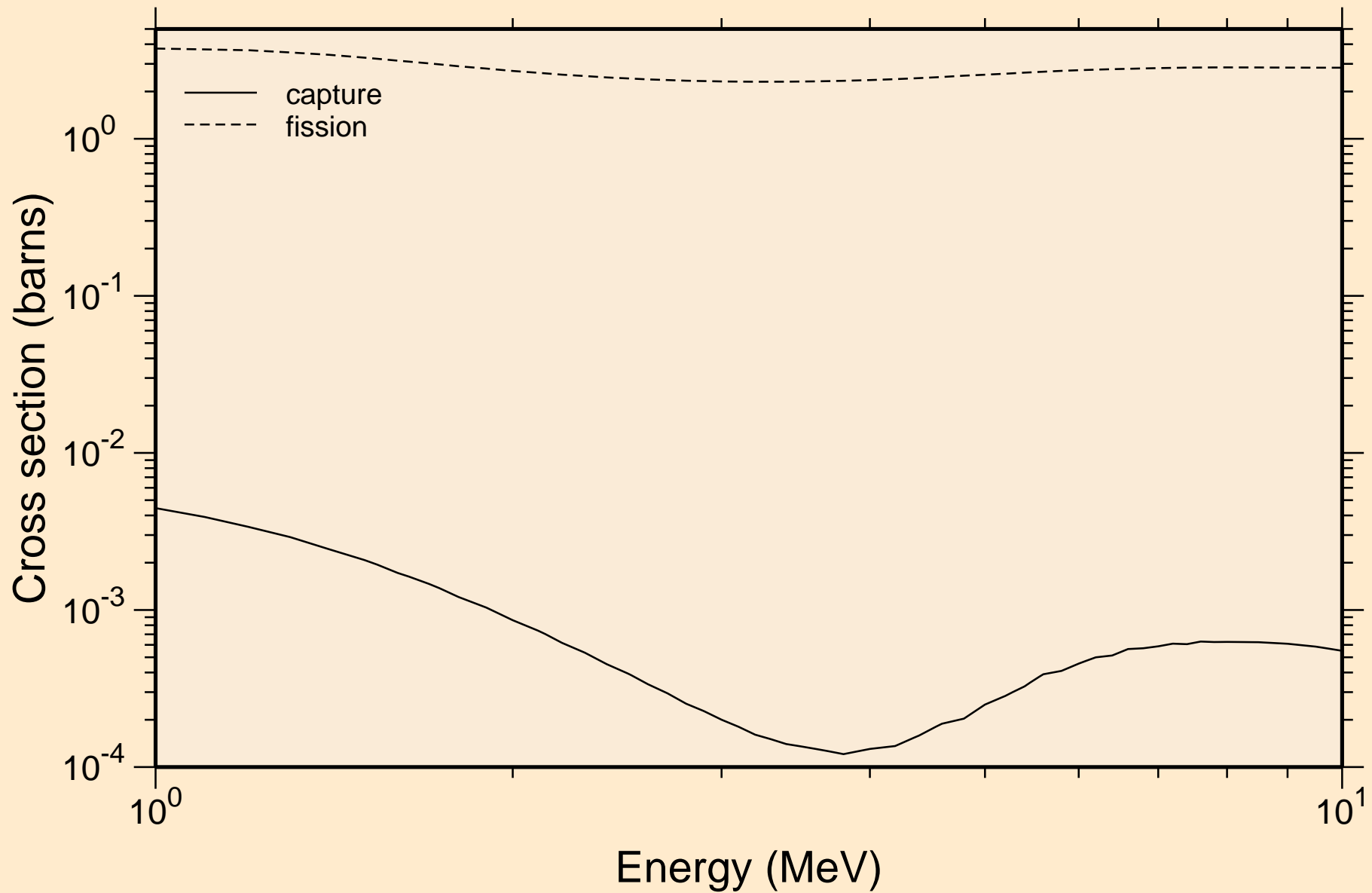

SG265 NRG TENDL-2015, AKONING

Non-threshold reactions

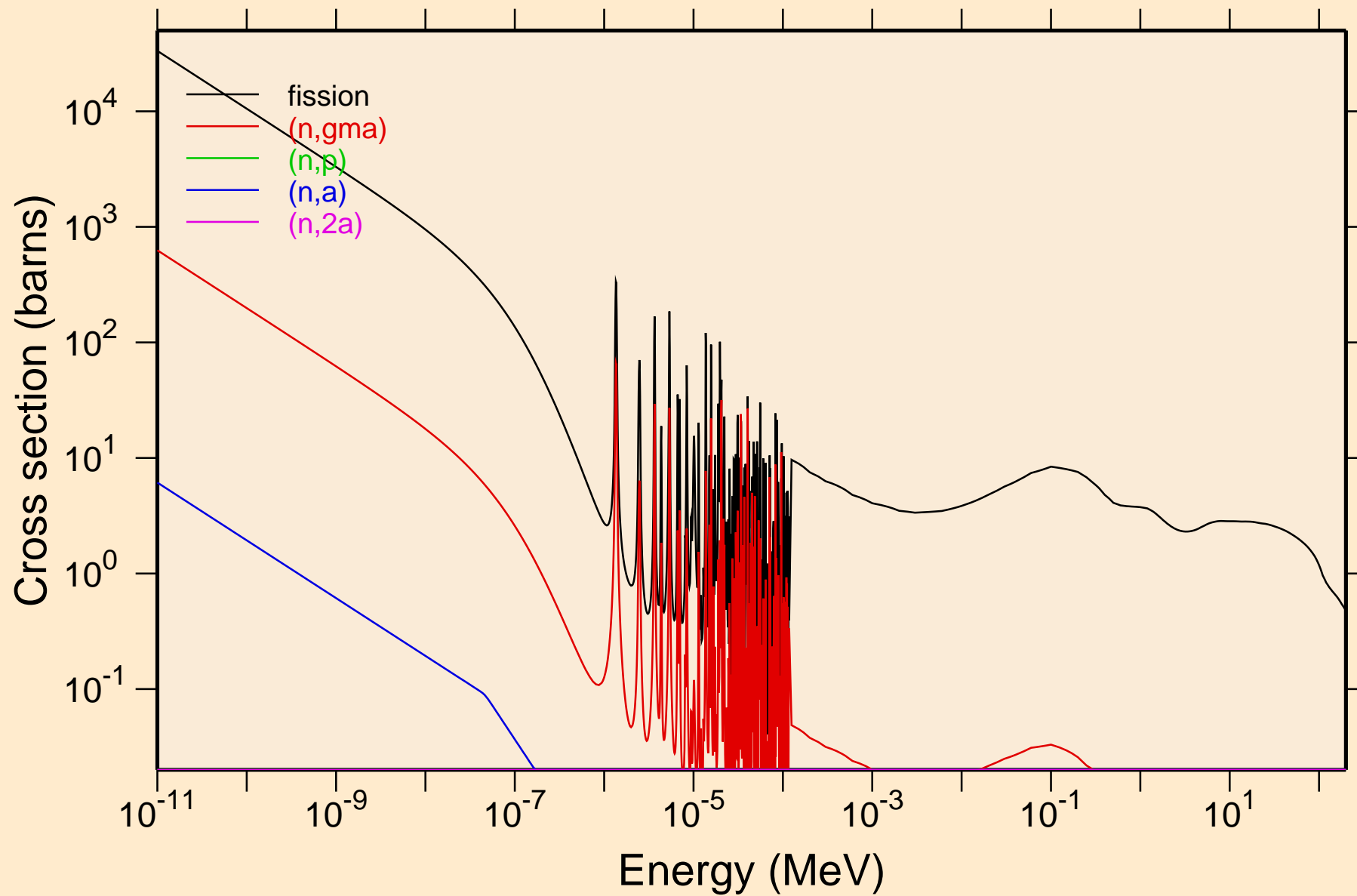

SG265 NRG TENDL-2015, AKONING

Non-threshold reactions

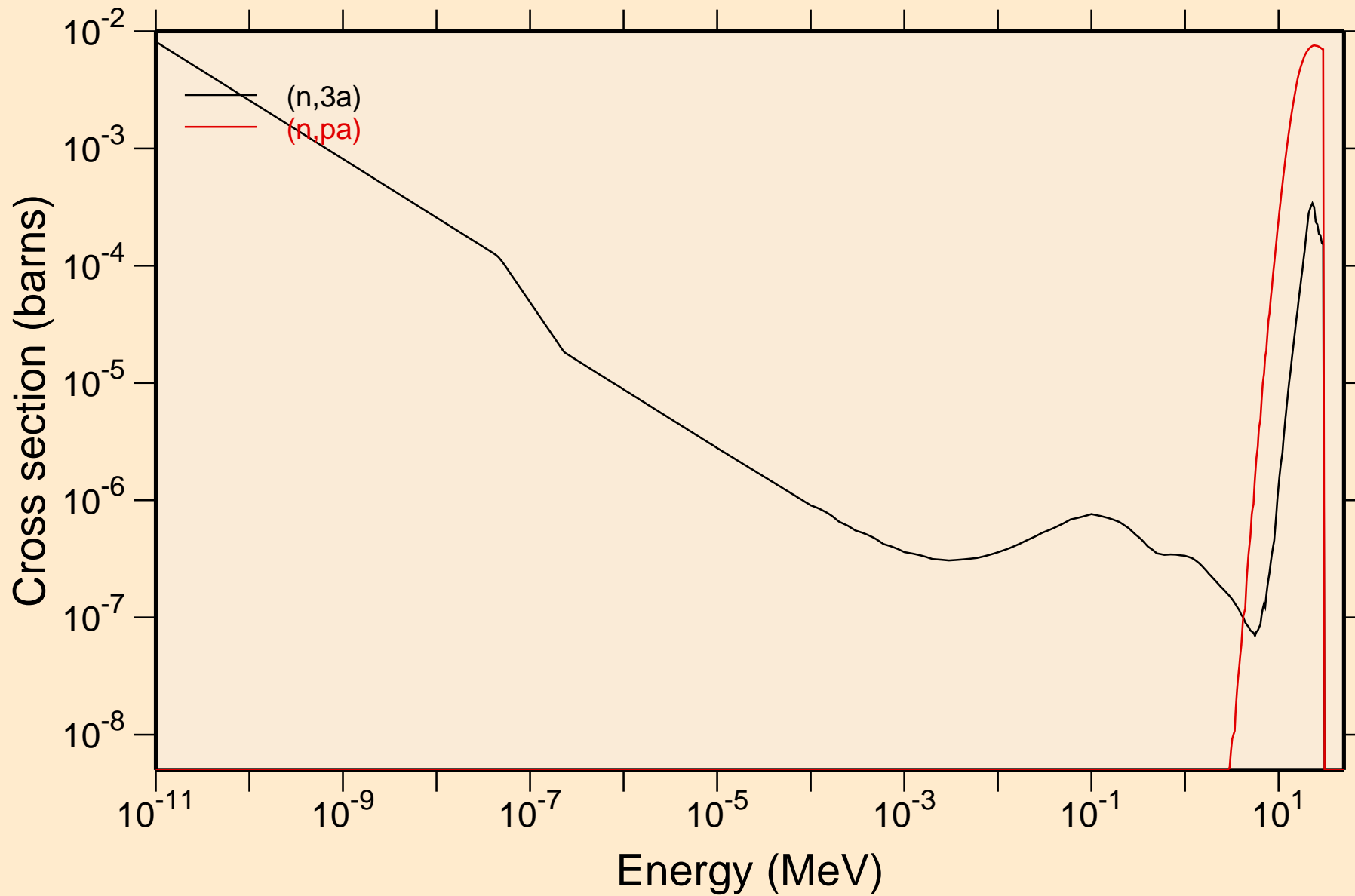

SG265 NRG TENDL-2015, AKONING

Principal cross sections

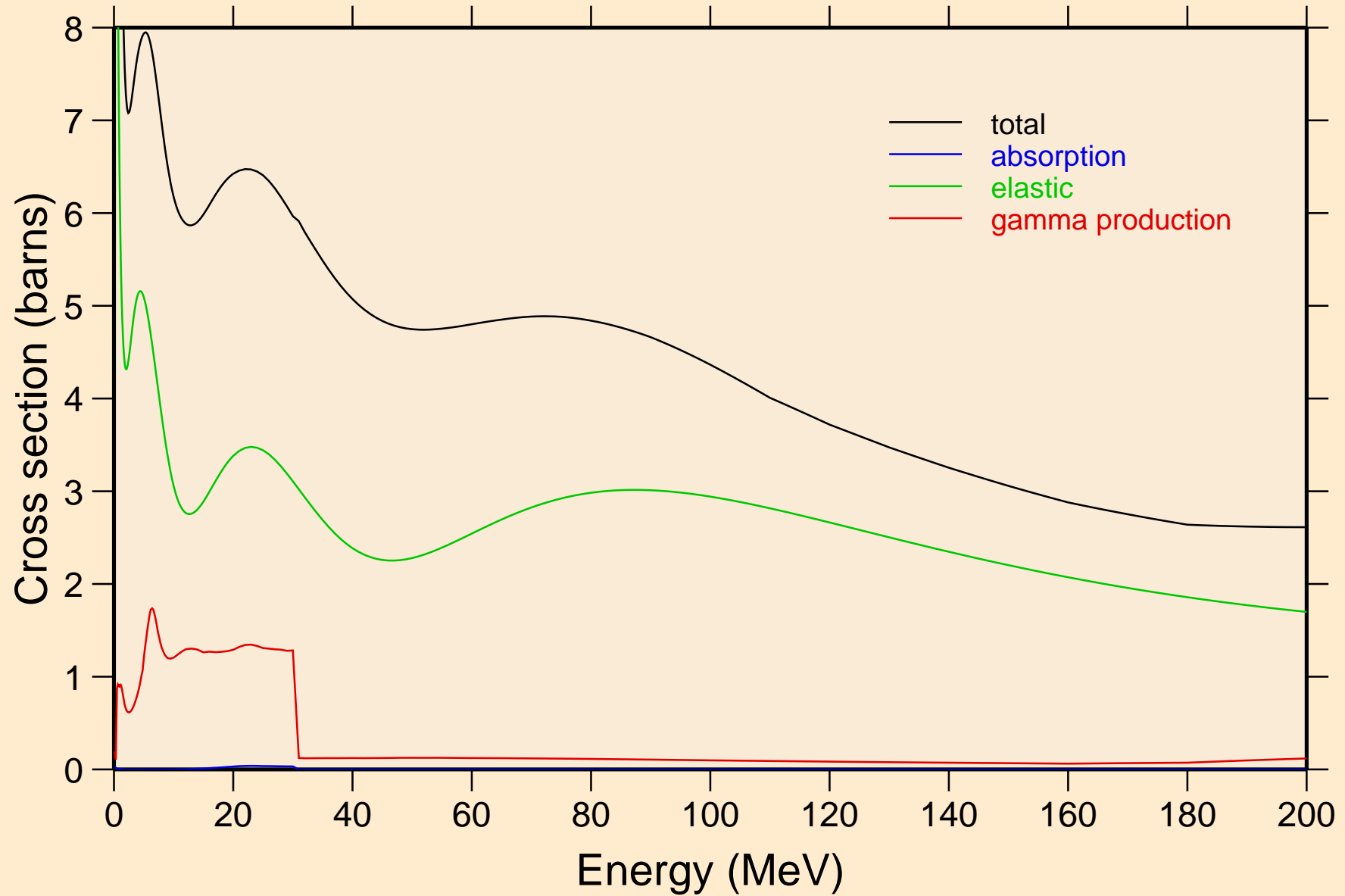

SG265 NRG TENDL-2015, AKONING

Non-threshold reactions

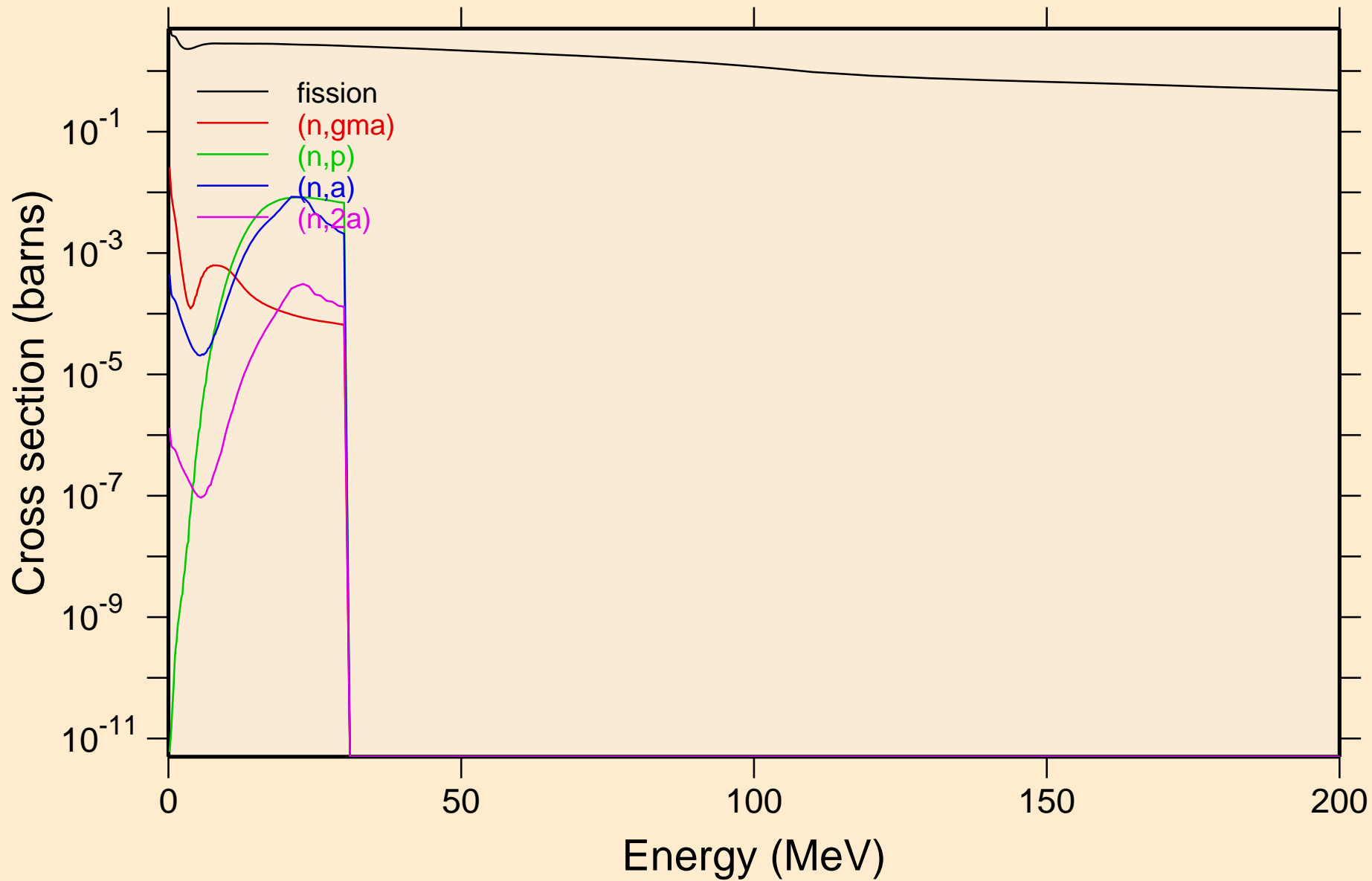

SG265 NRG TENDL-2015, AKONING

Non-threshold reactions

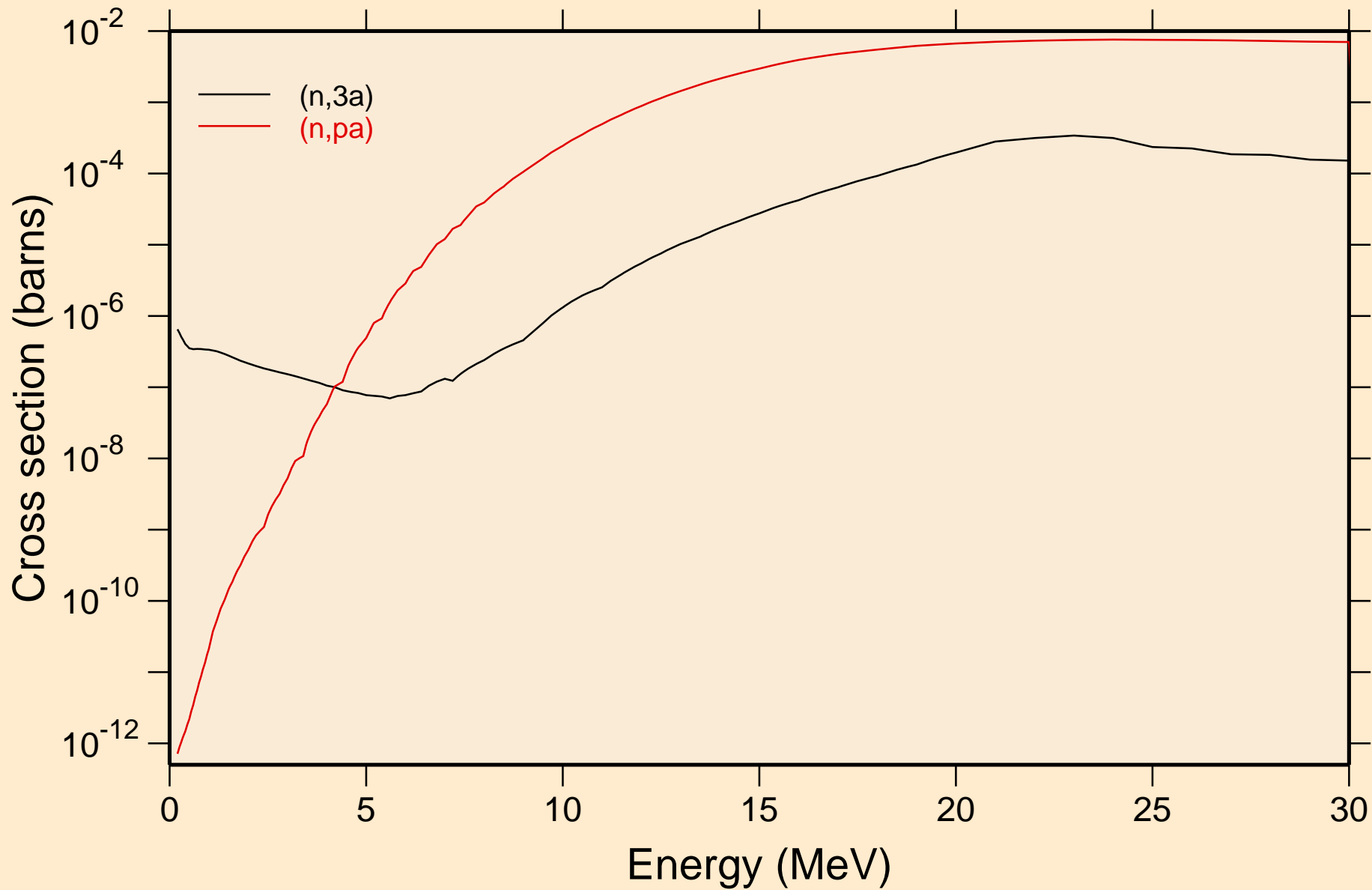

SG265 NRG TENDL-2015, AKONING

Inelastic levels

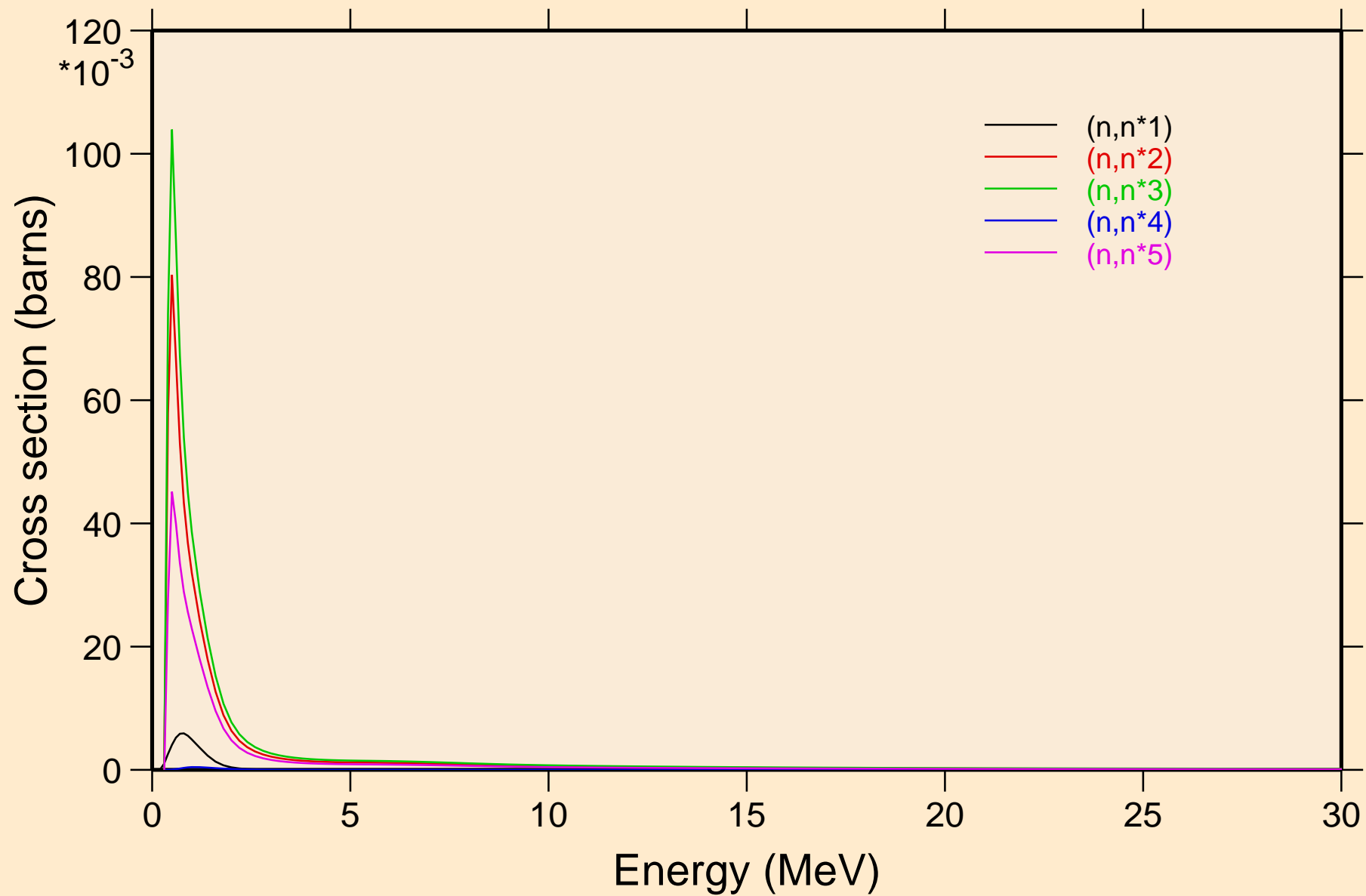

SG265 NRG TENDL-2015, AKONING

Inelastic levels

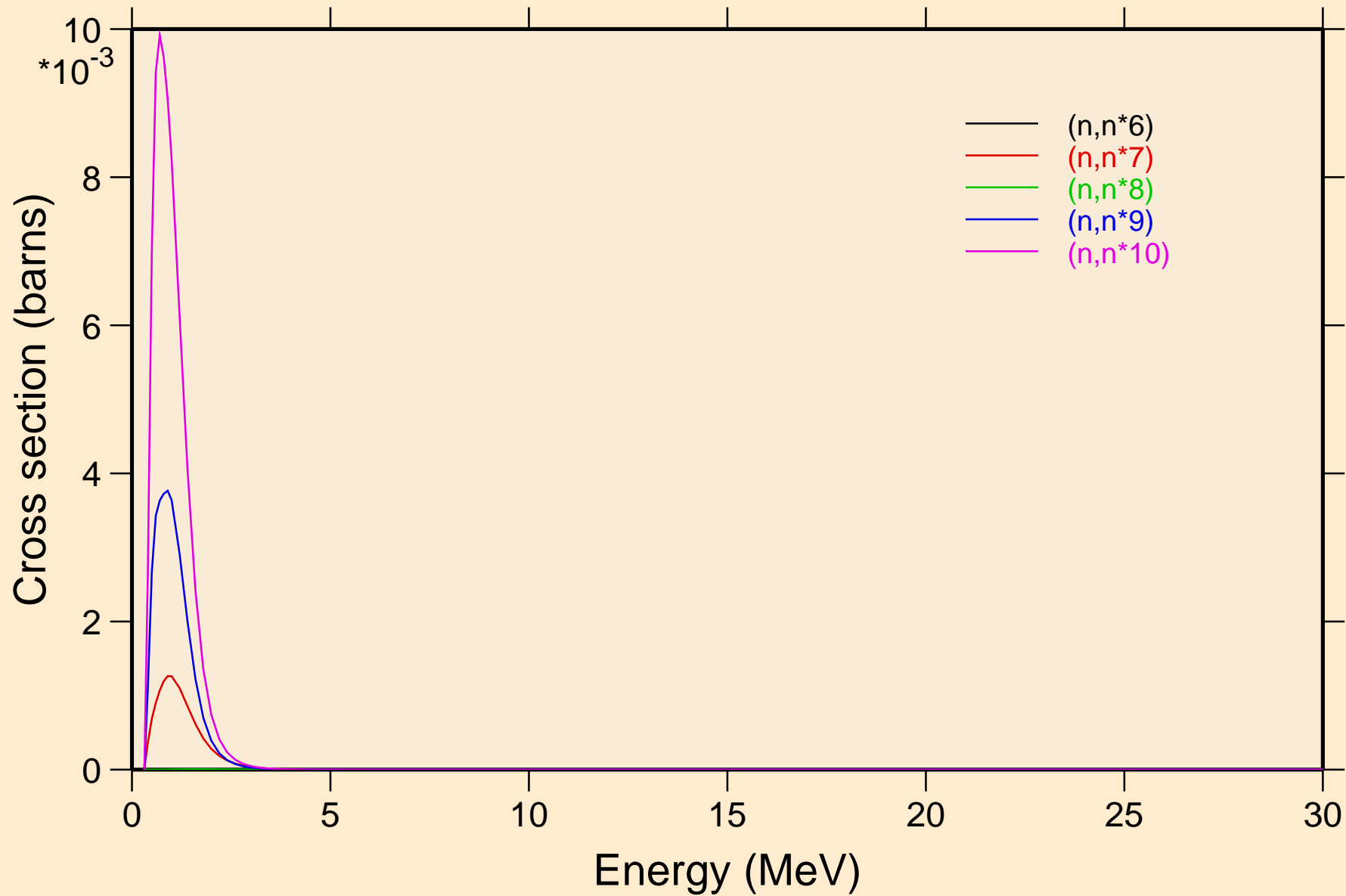

SG265 NRG TENDL-2015, AKONING

Inelastic levels

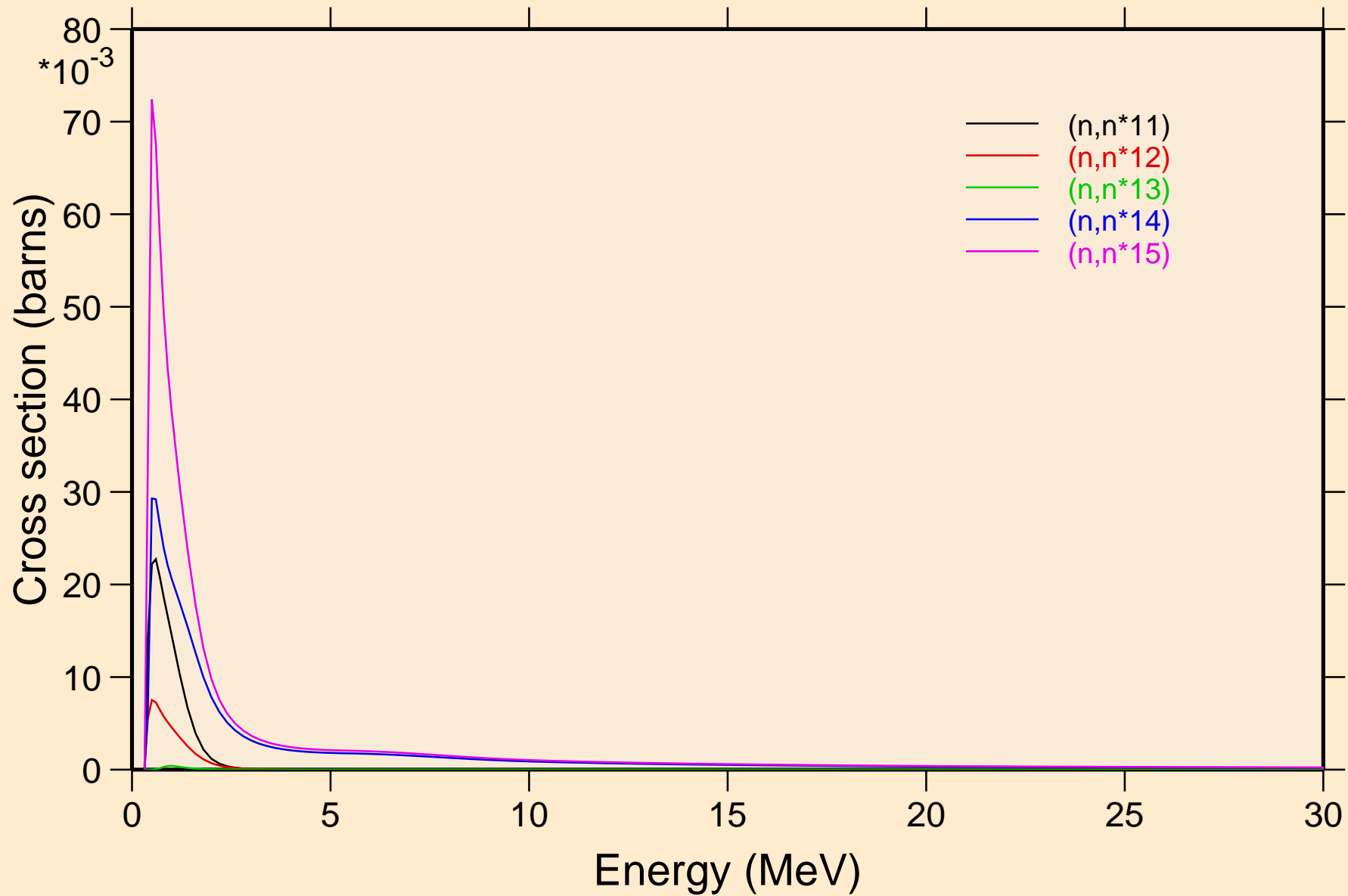

SG265 NRG TENDL-2015, AKONING

Inelastic levels

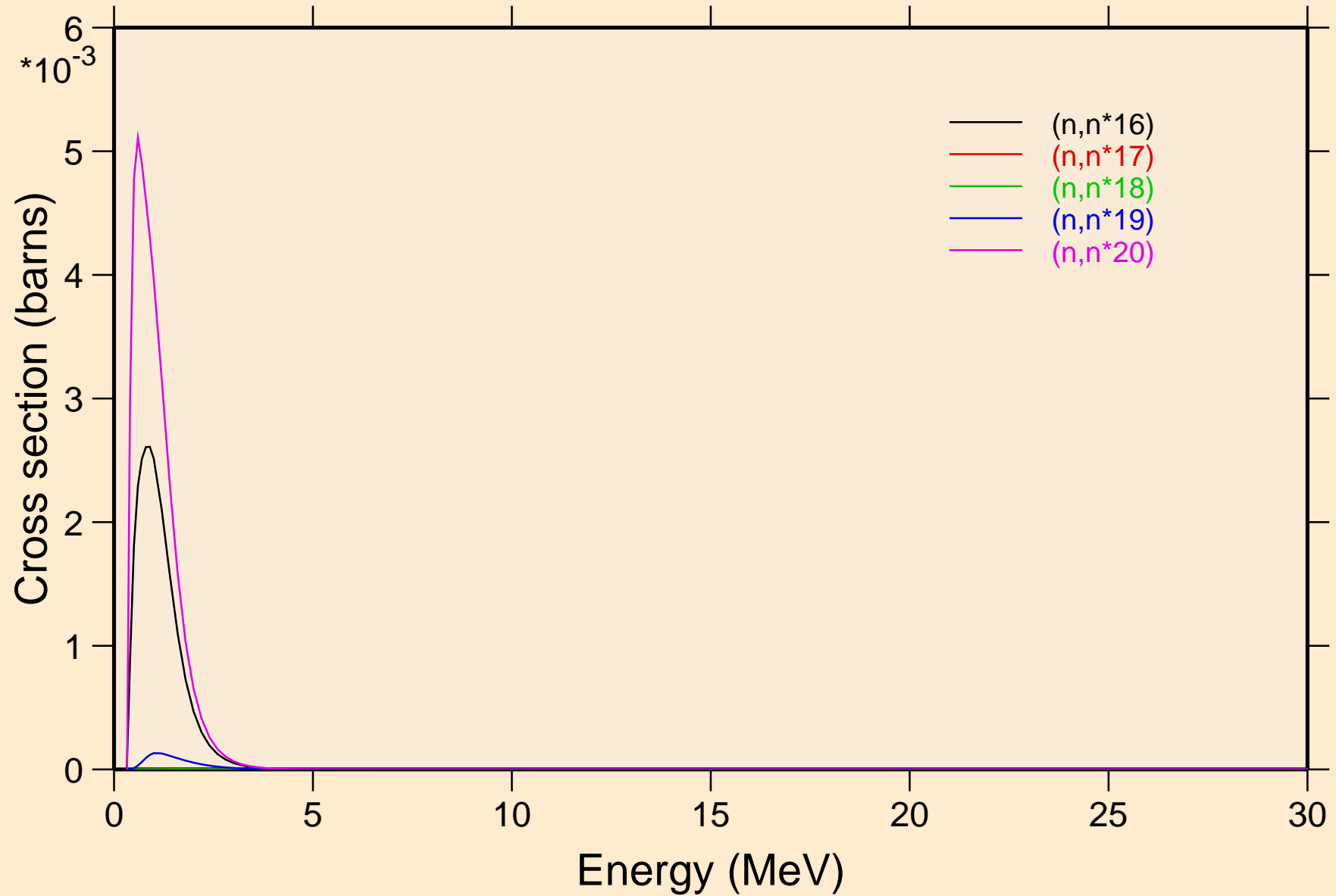

SG265 NRG TENDL-2015, AKONING

Inelastic levels

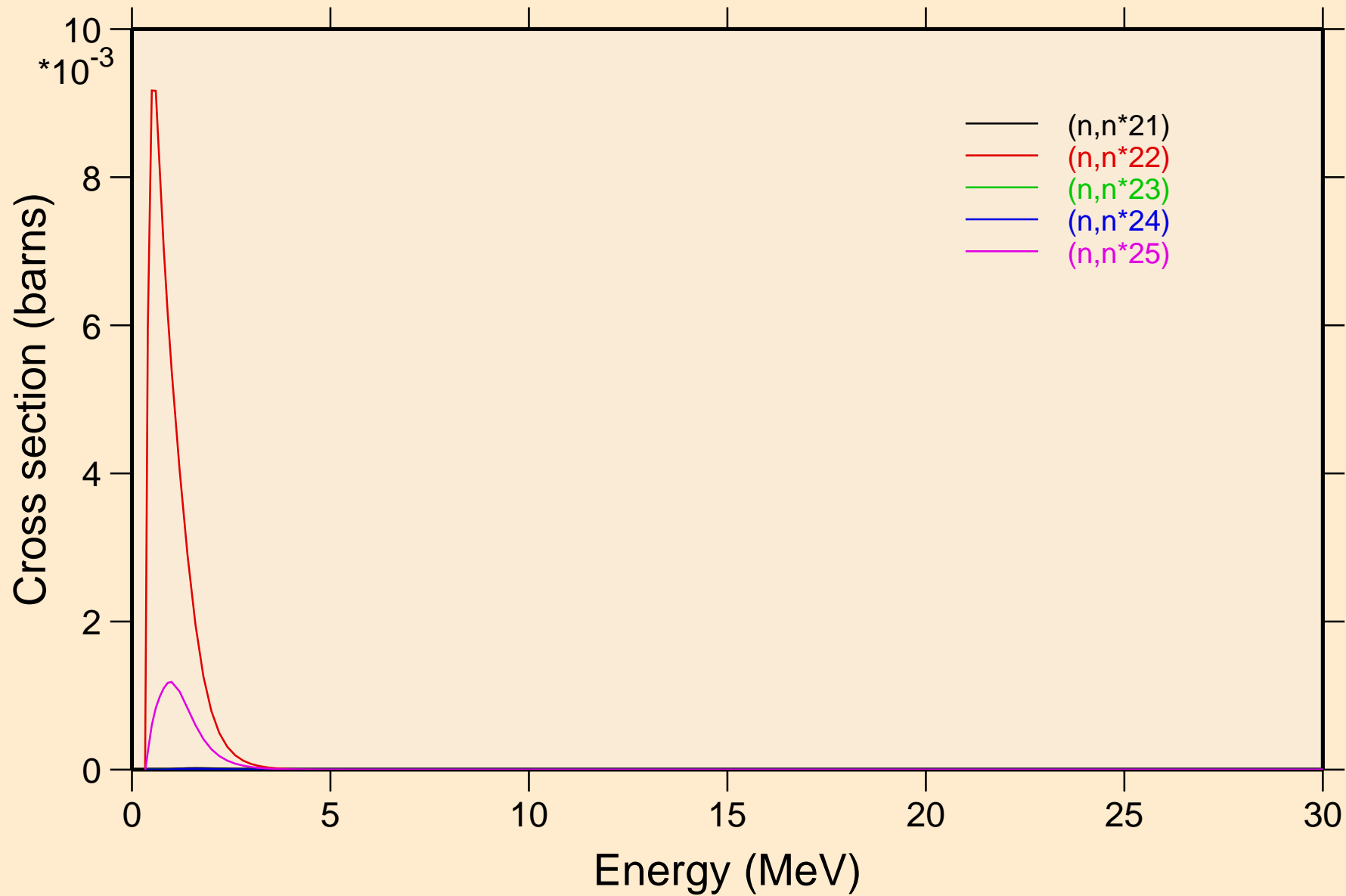

SG265 NRG TENDL-2015, AKONING

Inelastic levels

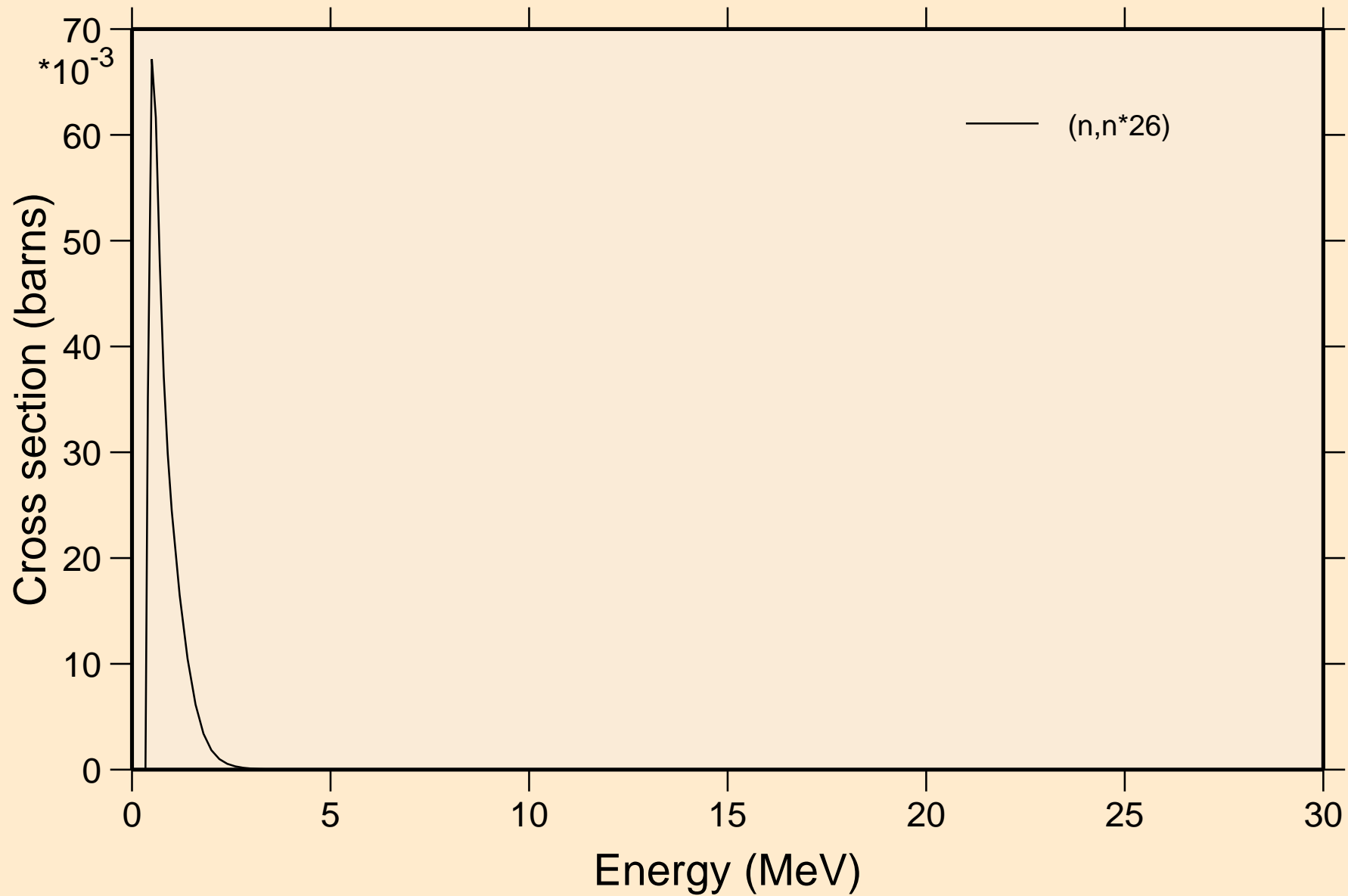

SG265 NRG TENDL-2015, AKONING

Threshold reactions

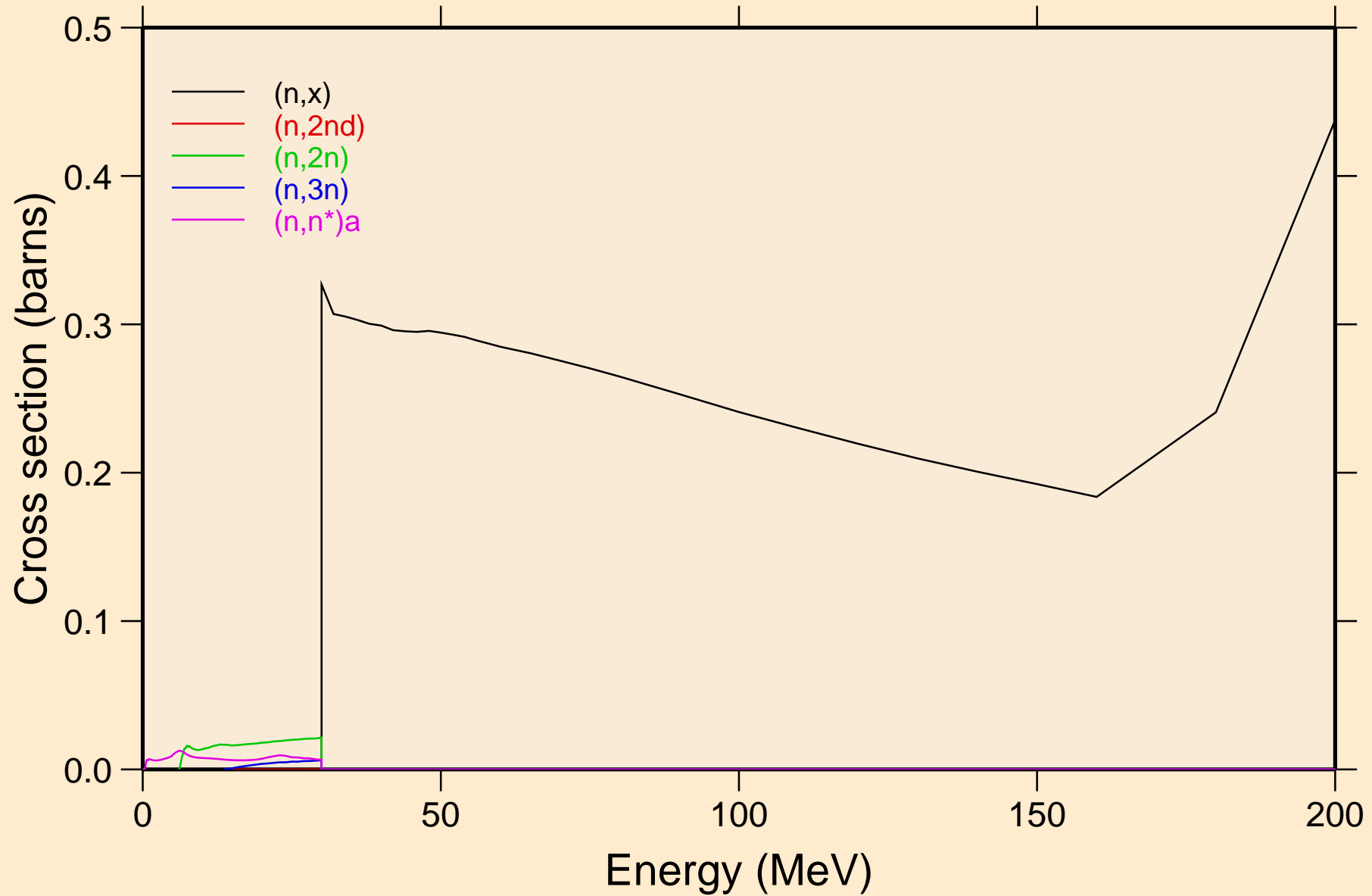

SG265 NRG TENDL-2015, AKONING

Threshold reactions

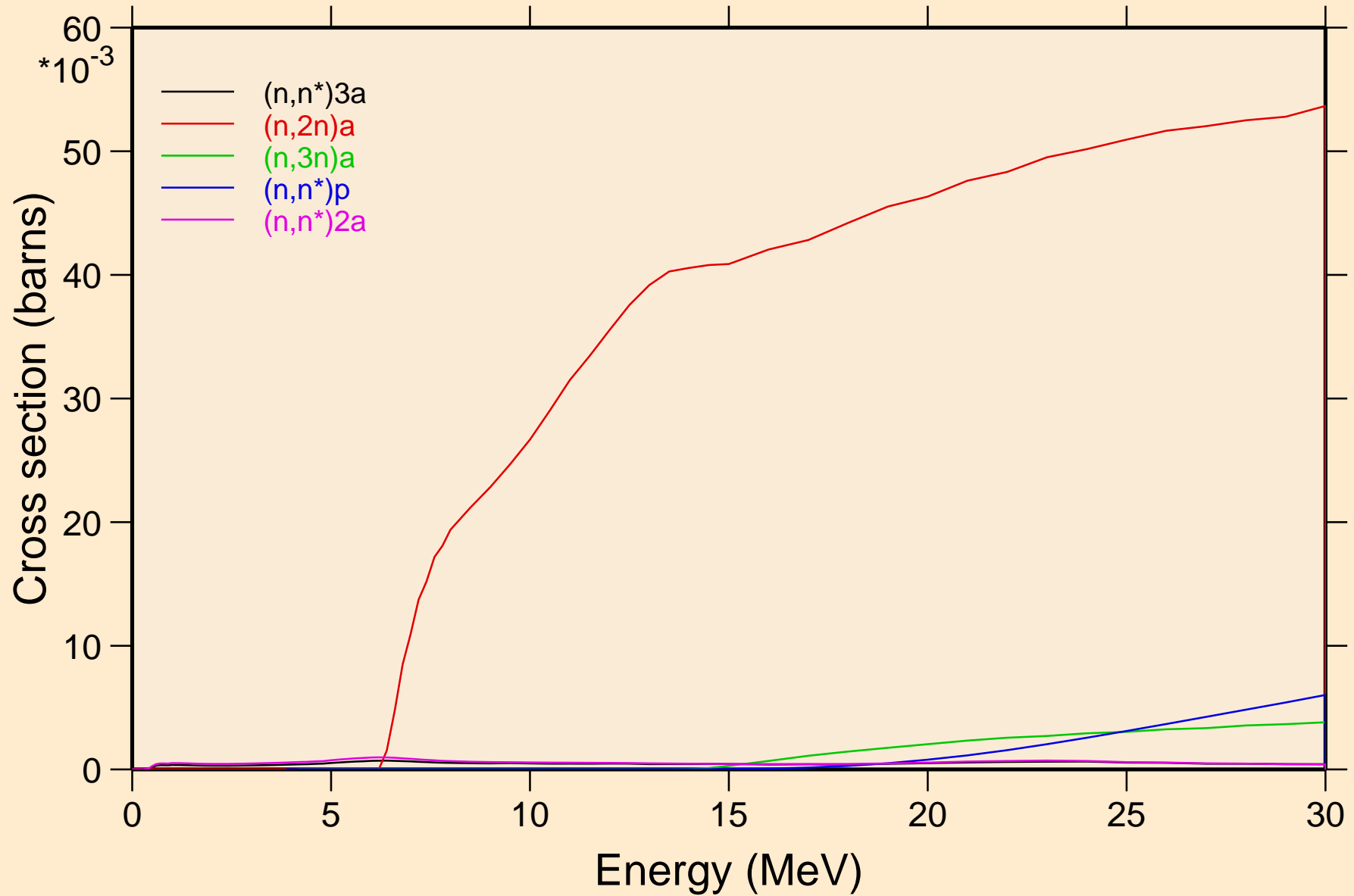

SG265 NRG TENDL-2015, AKONING

Threshold reactions

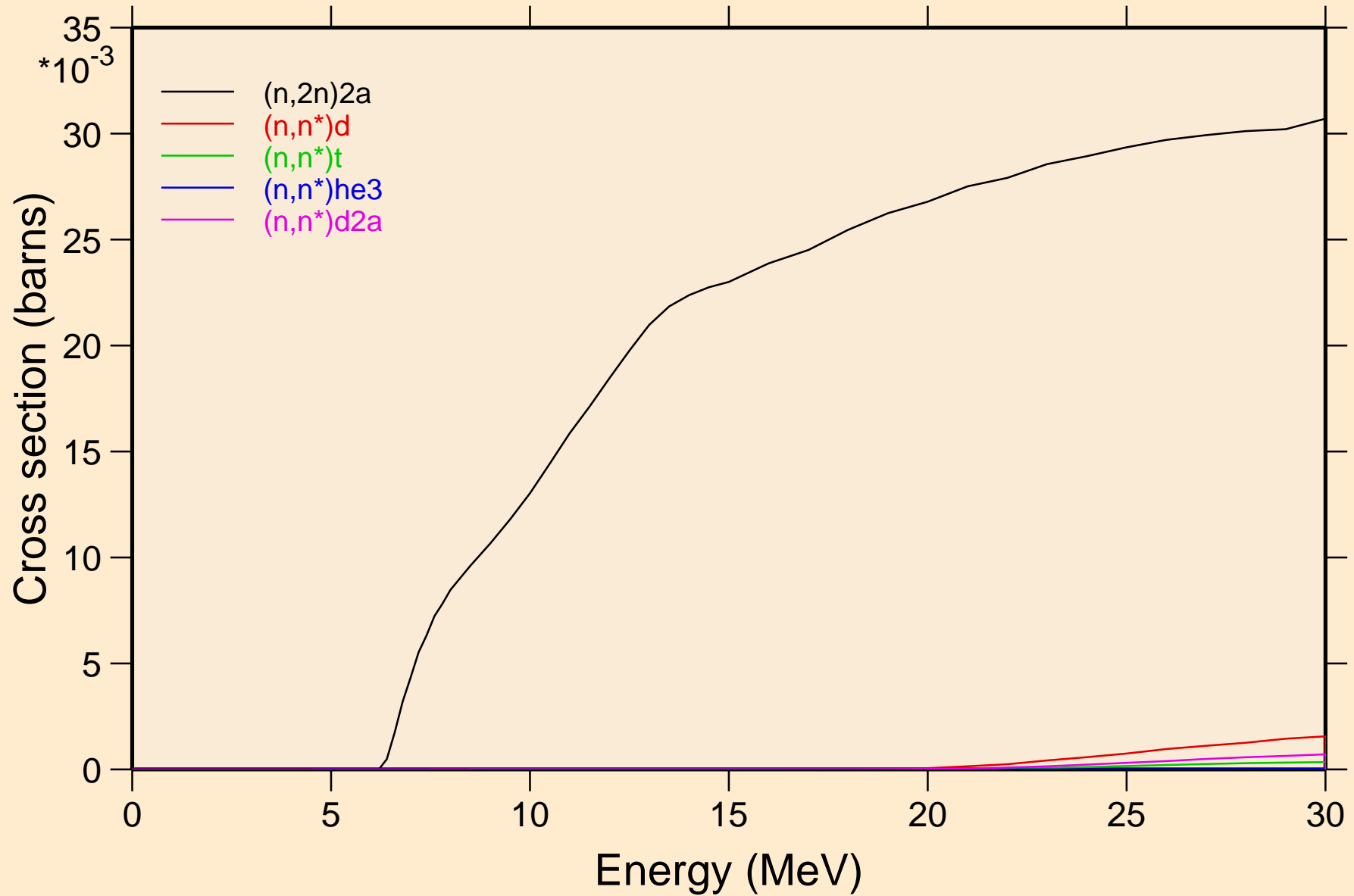

SG265 NRG TENDL-2015, AKONING

Threshold reactions

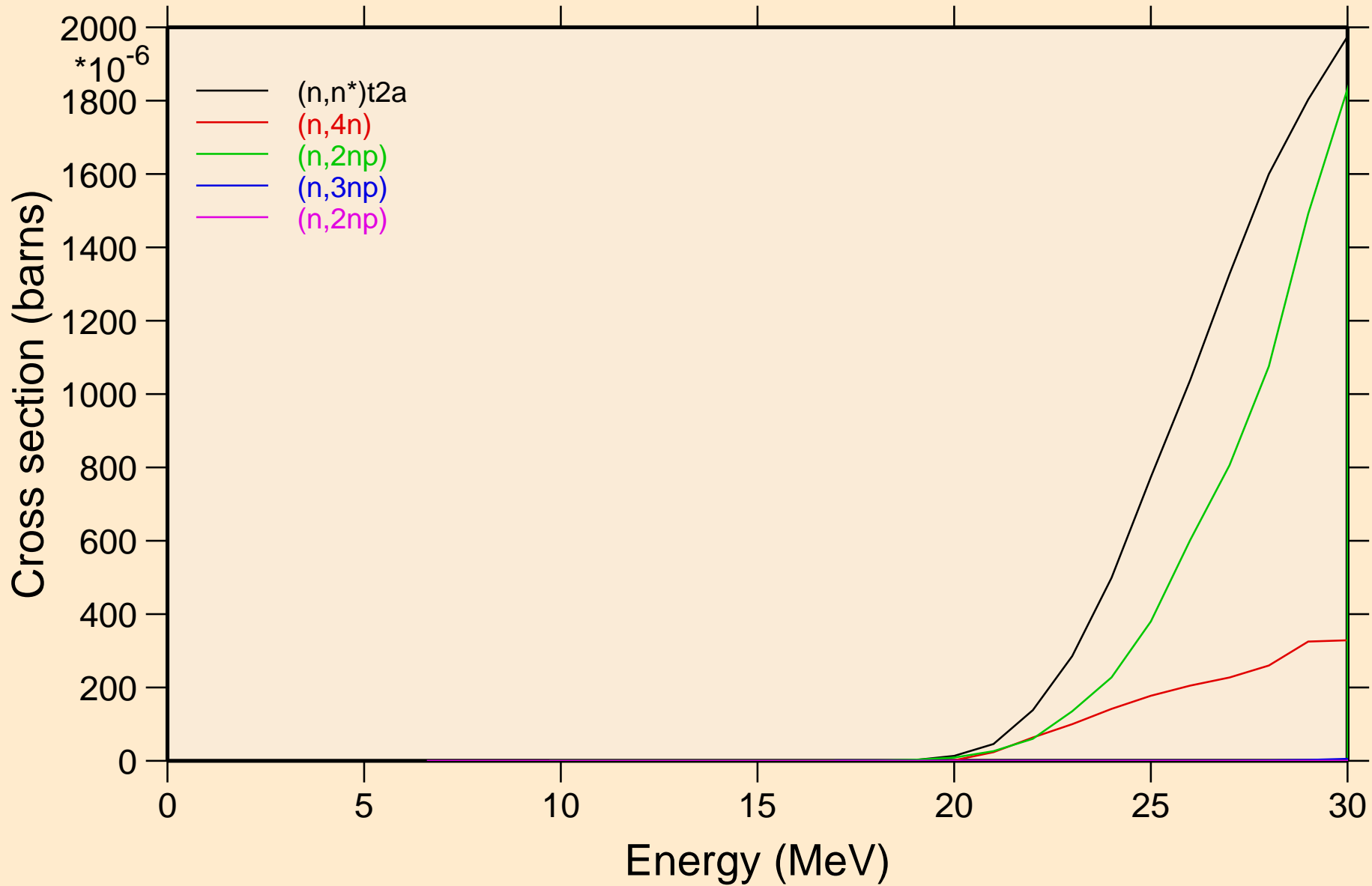

SG265 NRG TENDL-2015, AKONING

Threshold reactions

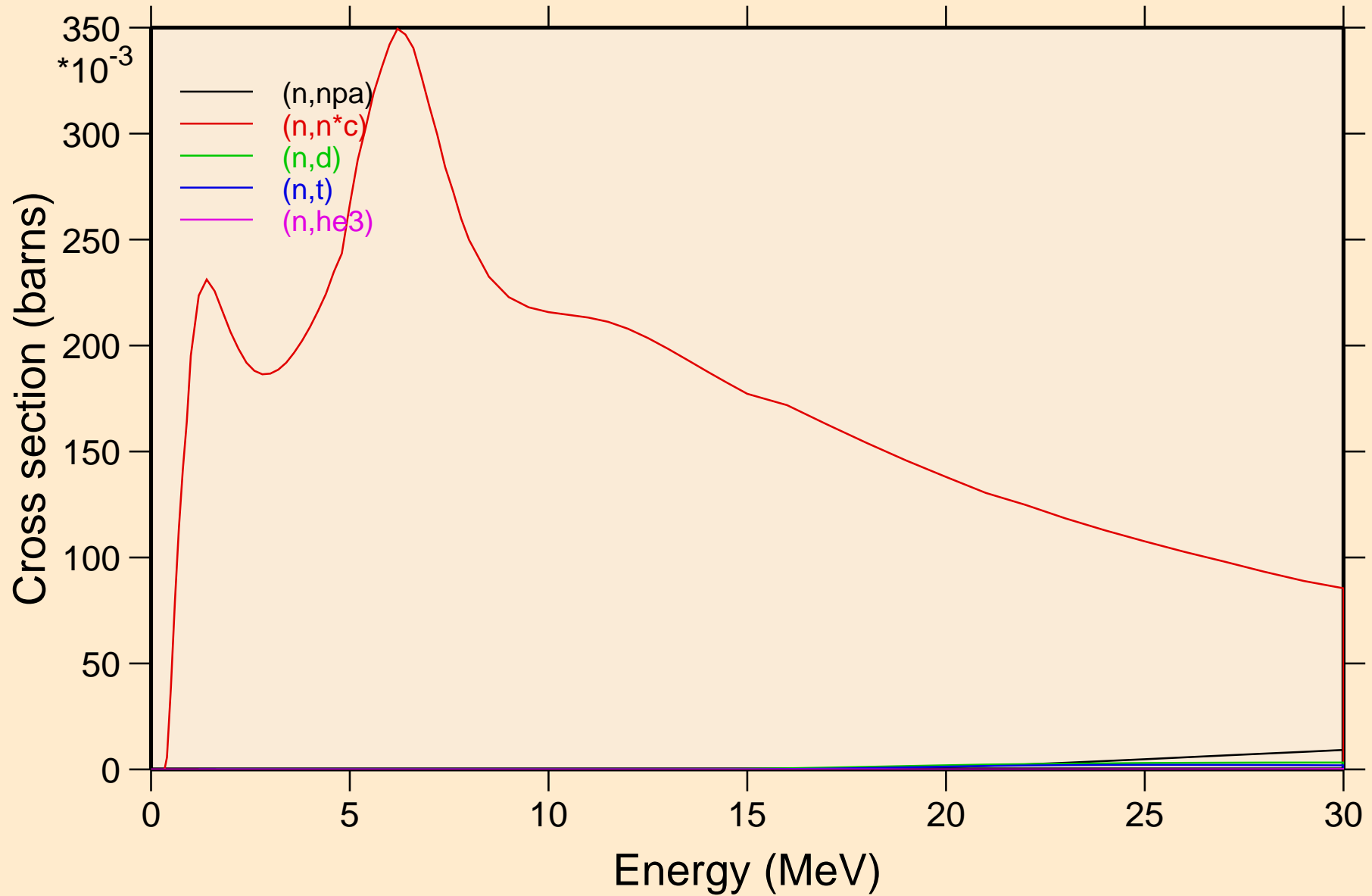

SG265 NRG TENDL-2015, AKONING

Threshold reactions

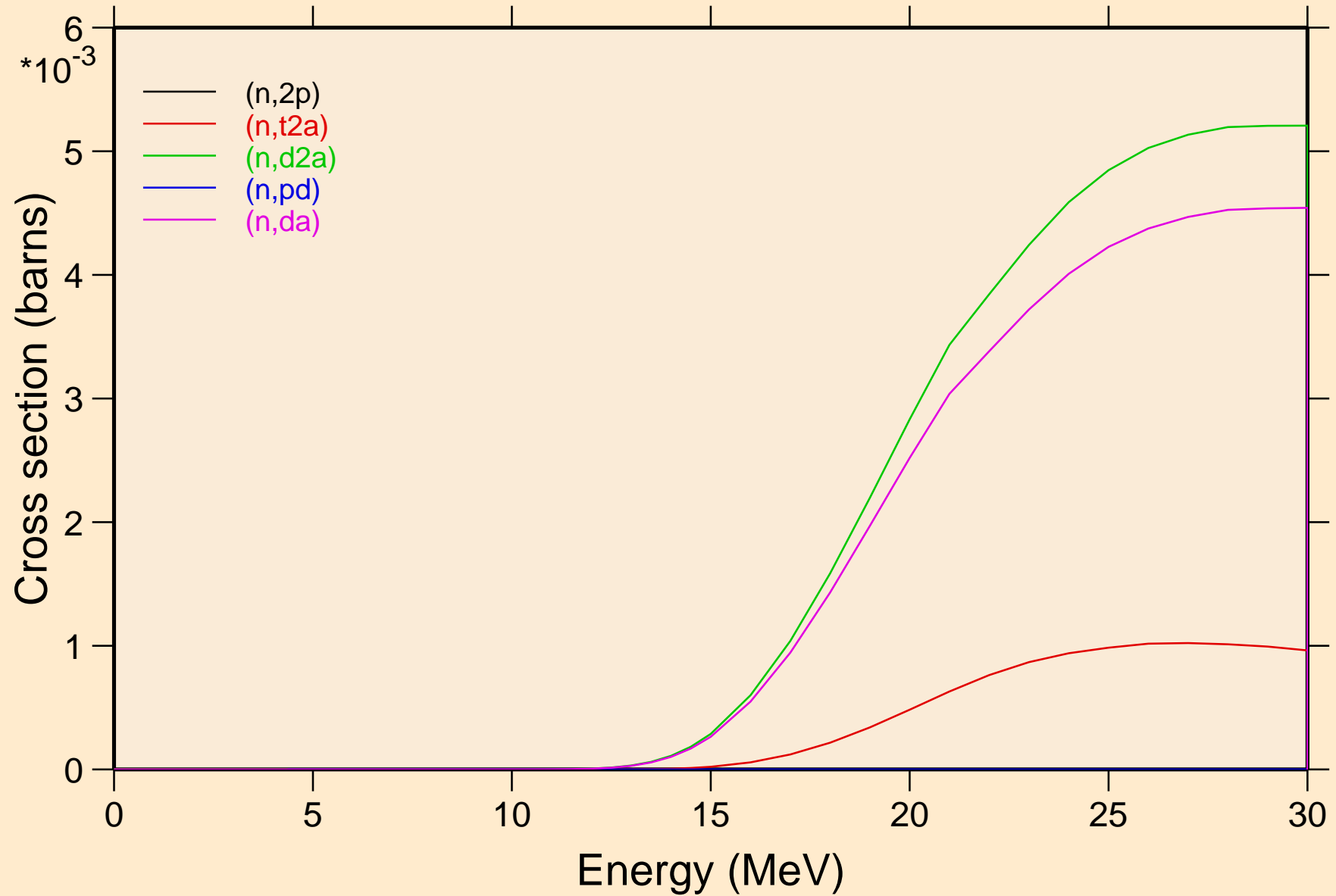

SG265 NRG TENDL-2015, AKONING
angular distribution for elastic

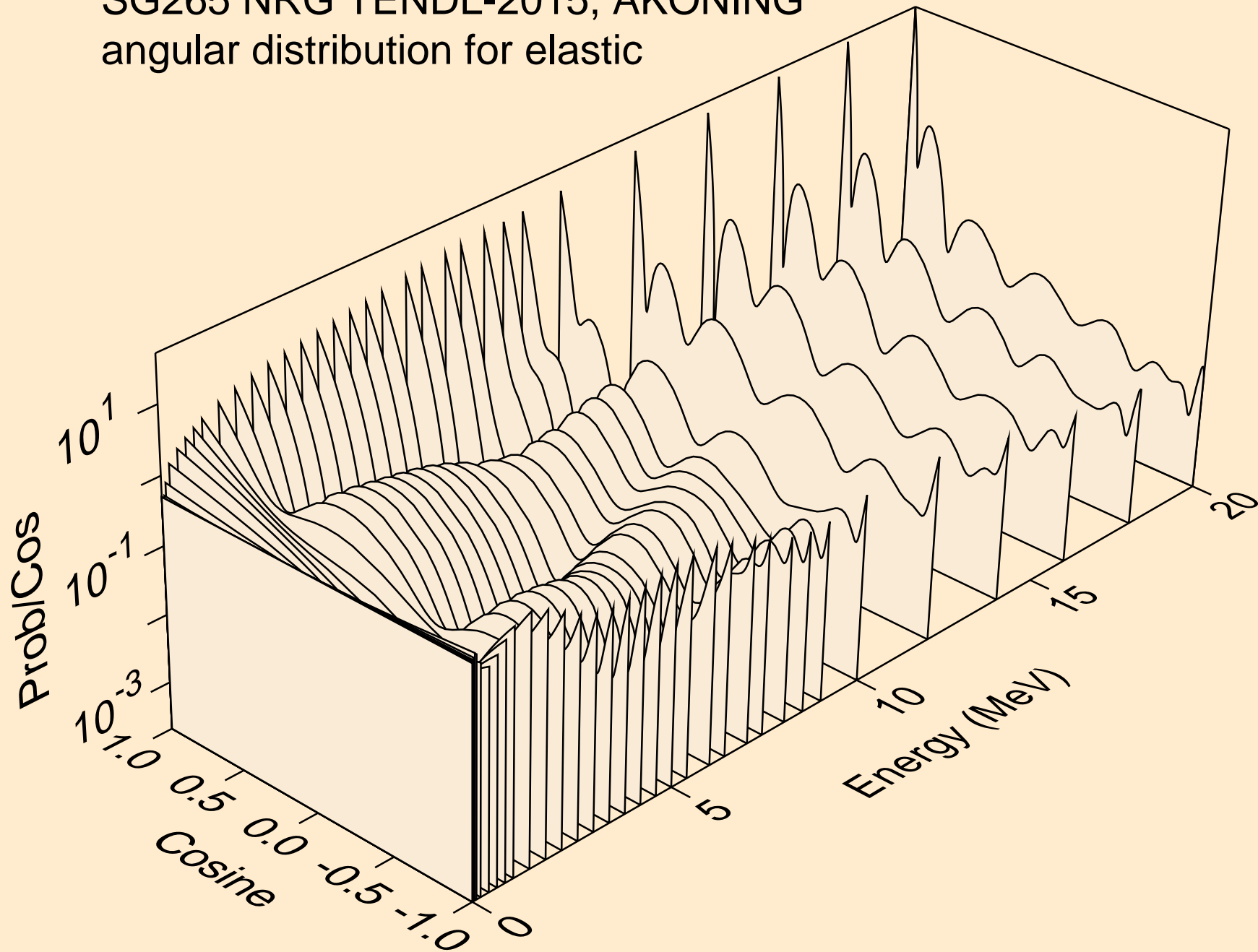

SG265 NRG TENDL-2015, AKONING
angular distribution for elastic

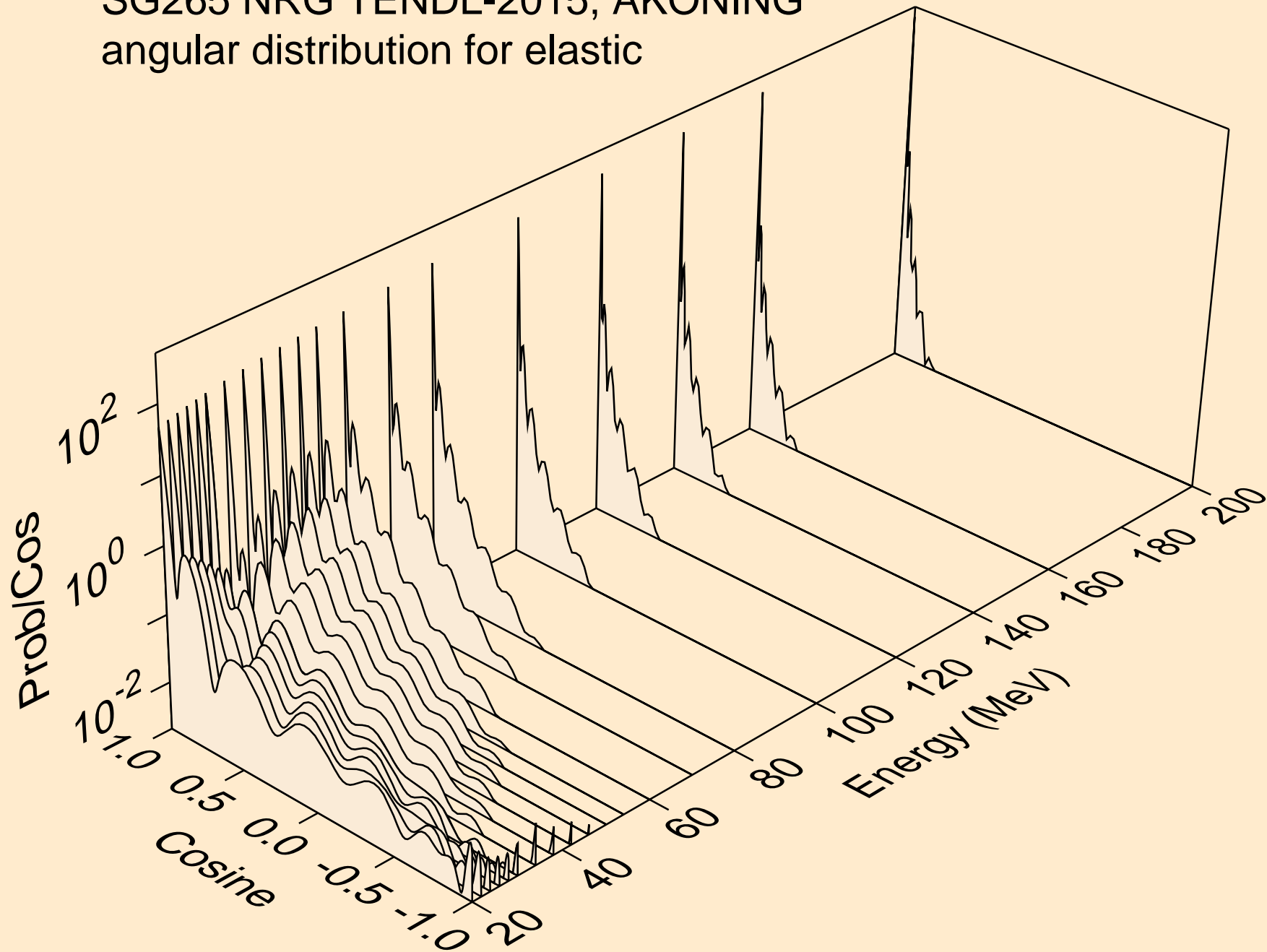

SG265 NRG TENDL-2015, AKONING
angular distribution for (n,n*1)

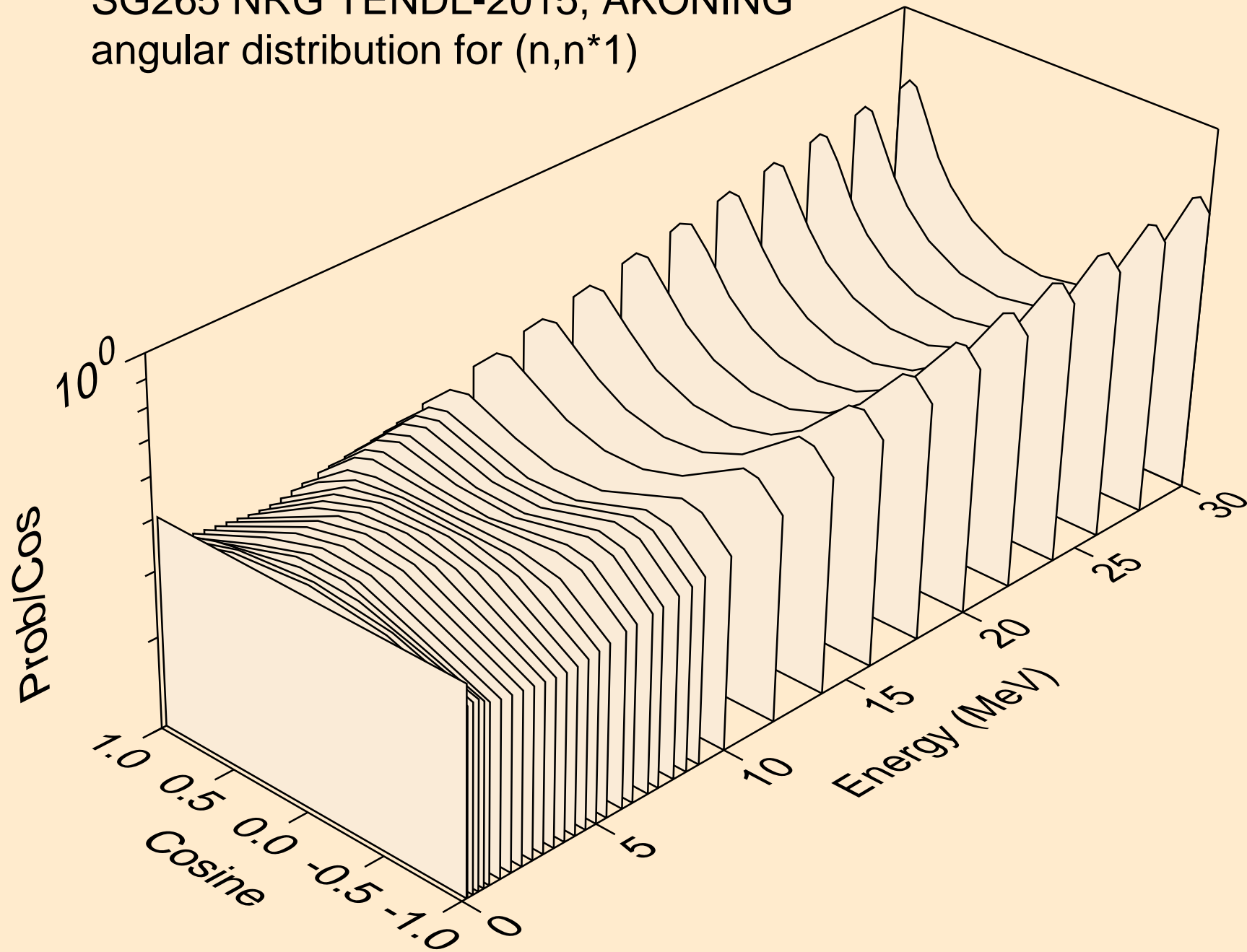

SG265 NRG TENDL-2015, AKONING
angular distribution for (n,n*2)

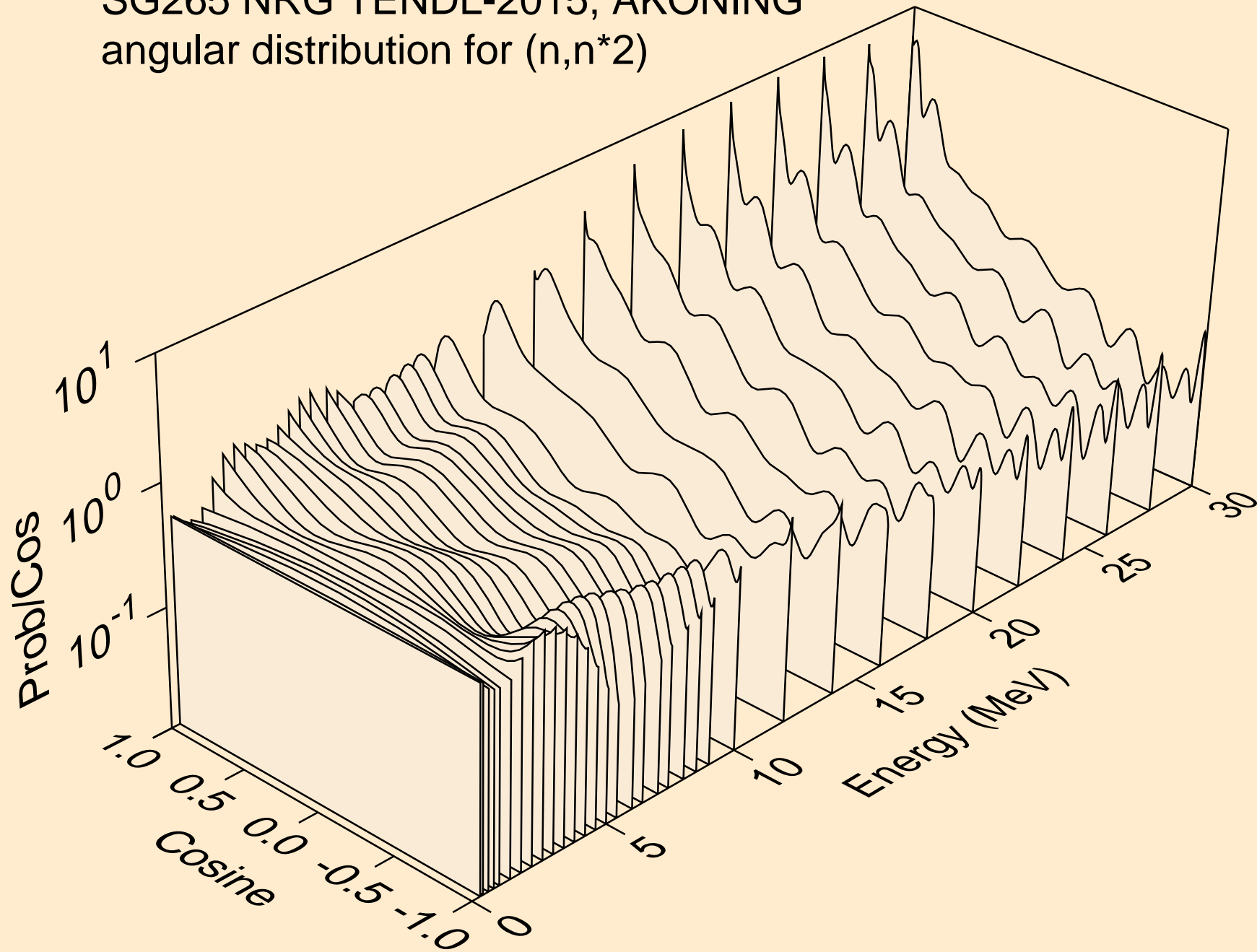

SG265 NRG TENDL-2015, AKONING
angular distribution for (n,n*3)

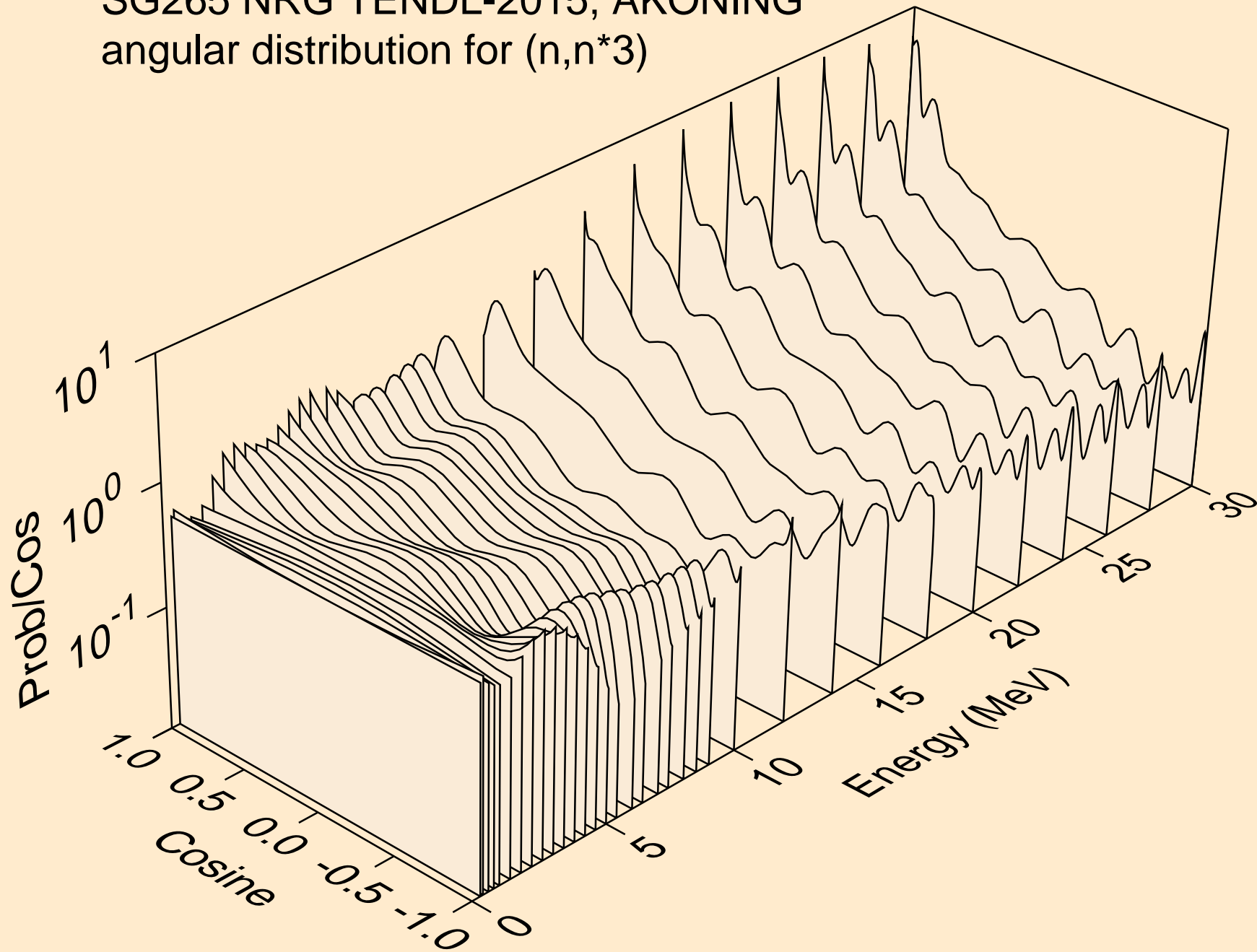

SG265 NRG TENDL-2015, AKONING
angular distribution for (n,n*4)

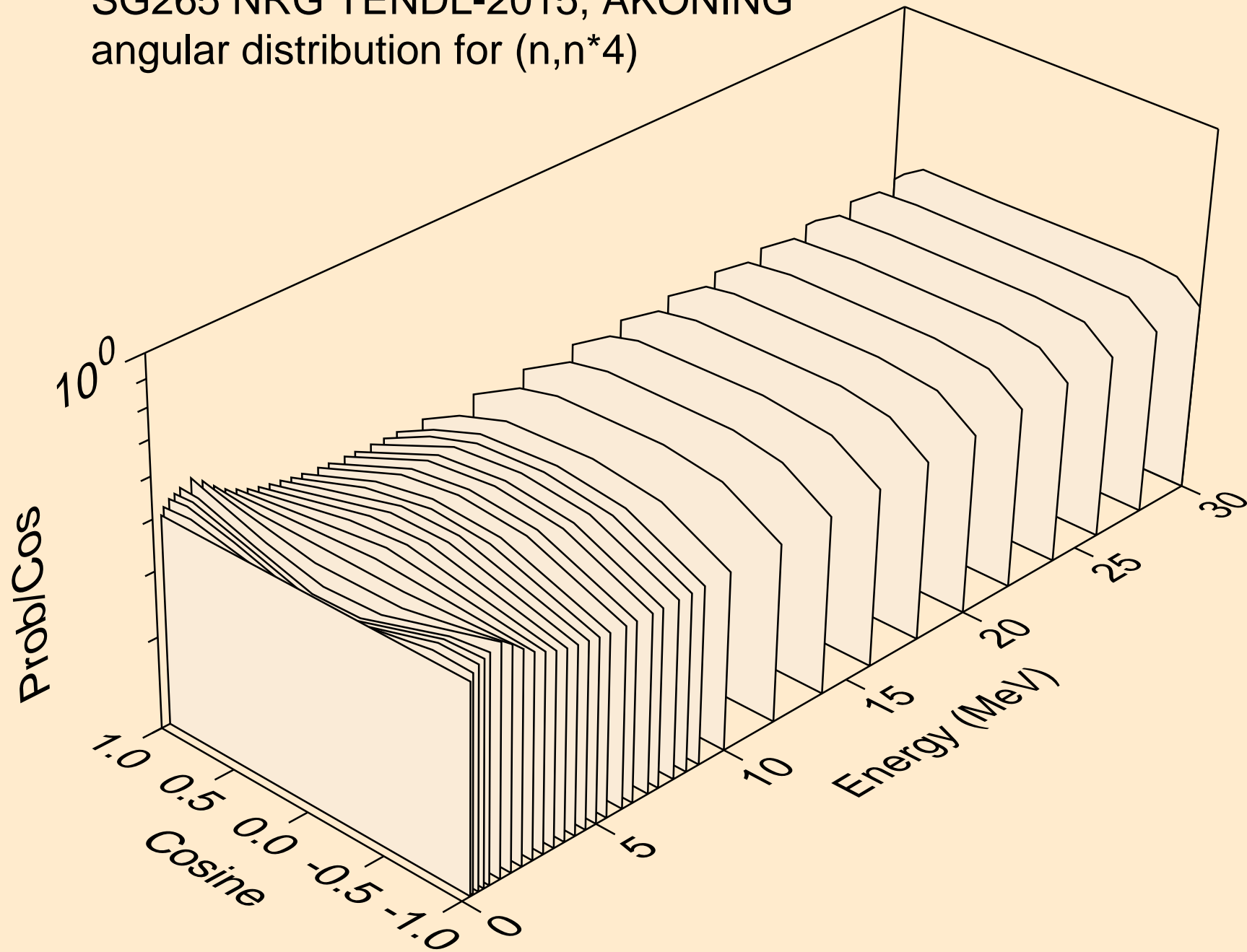

SG265 NRG TENDL-2015, AKONING
angular distribution for (n,n*5)

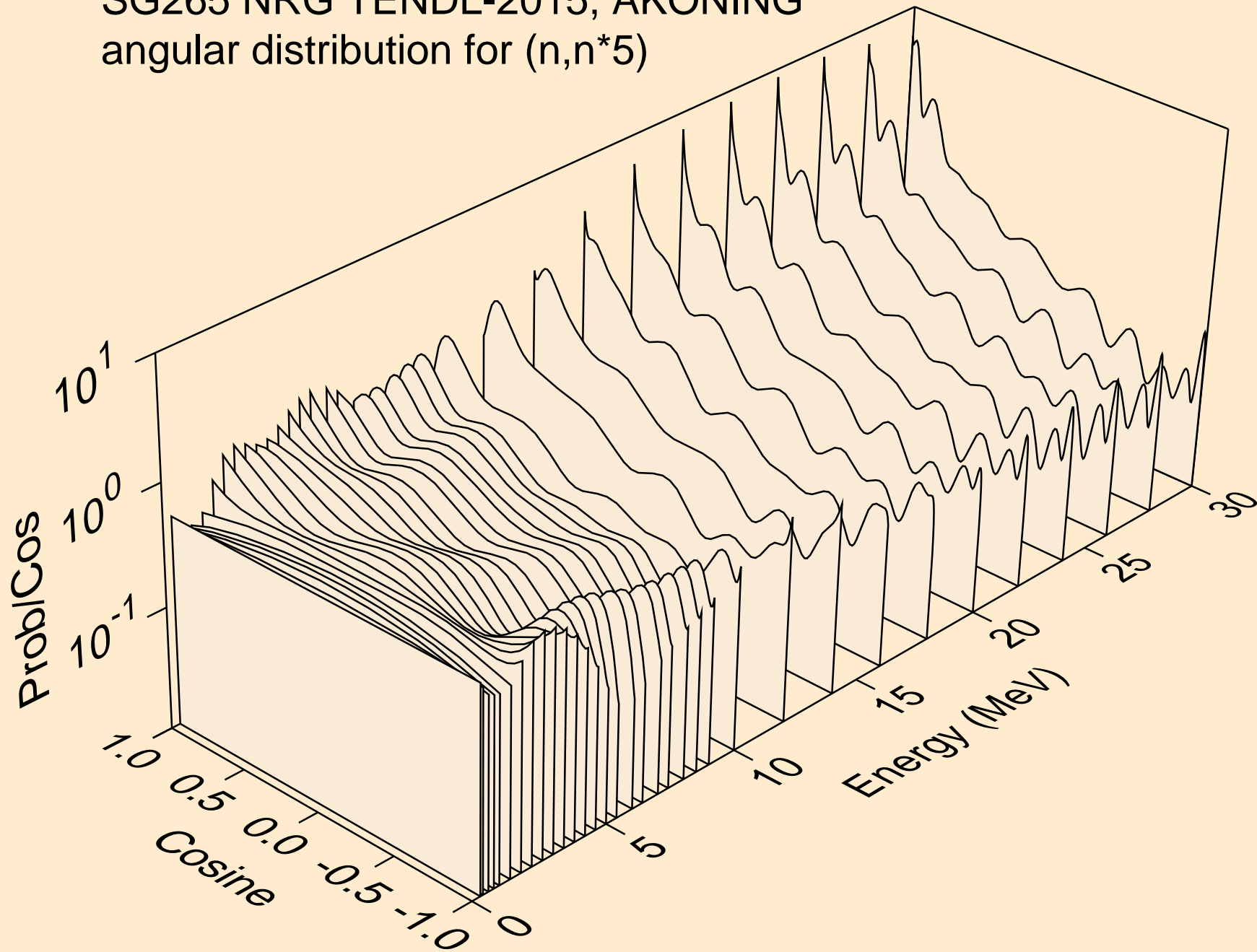

SG265 NRG TENDL-2015, AKONING
angular distribution for (n,n*6)

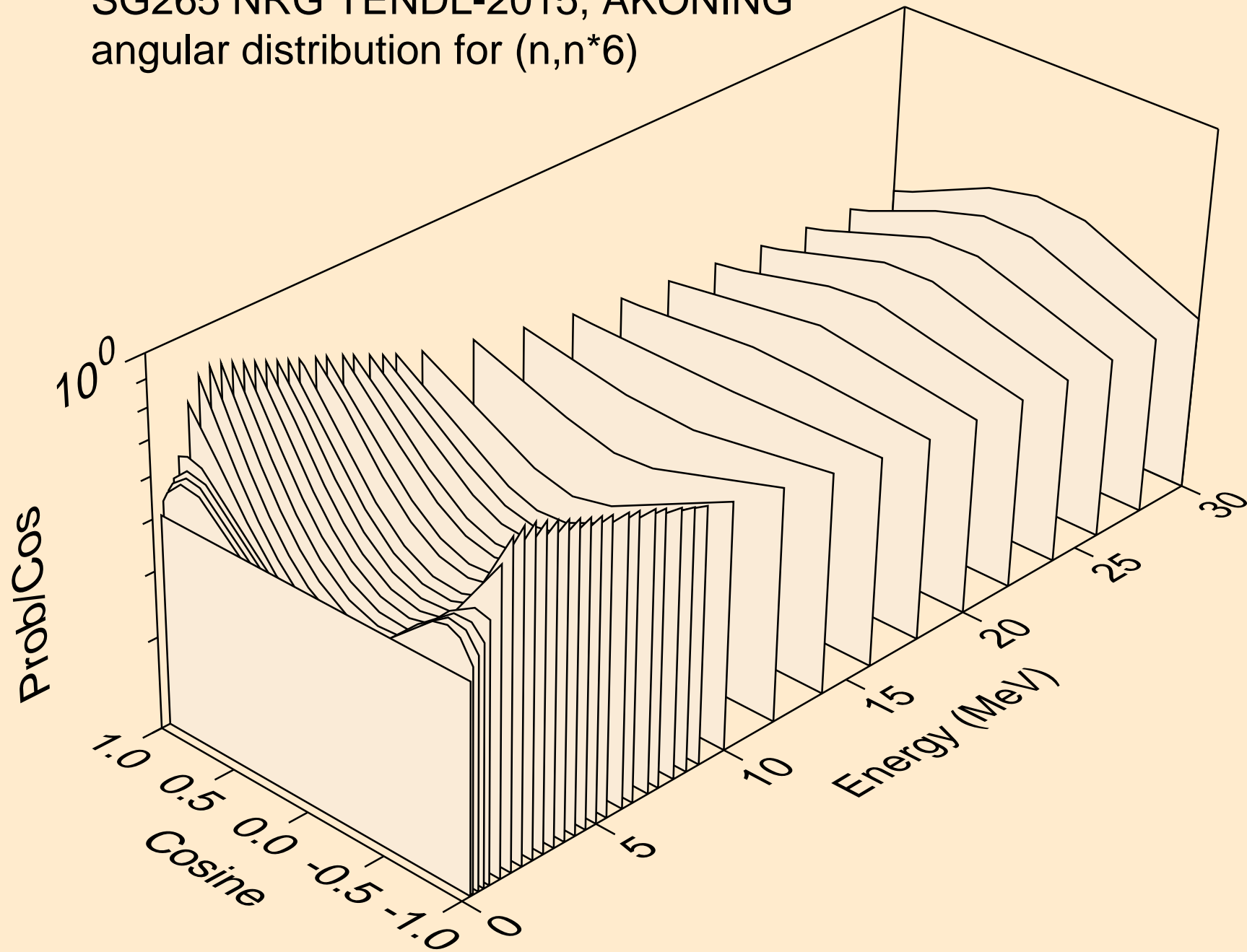

SG265 NRG TENDL-2015, AKONING
angular distribution for (n,n*7)

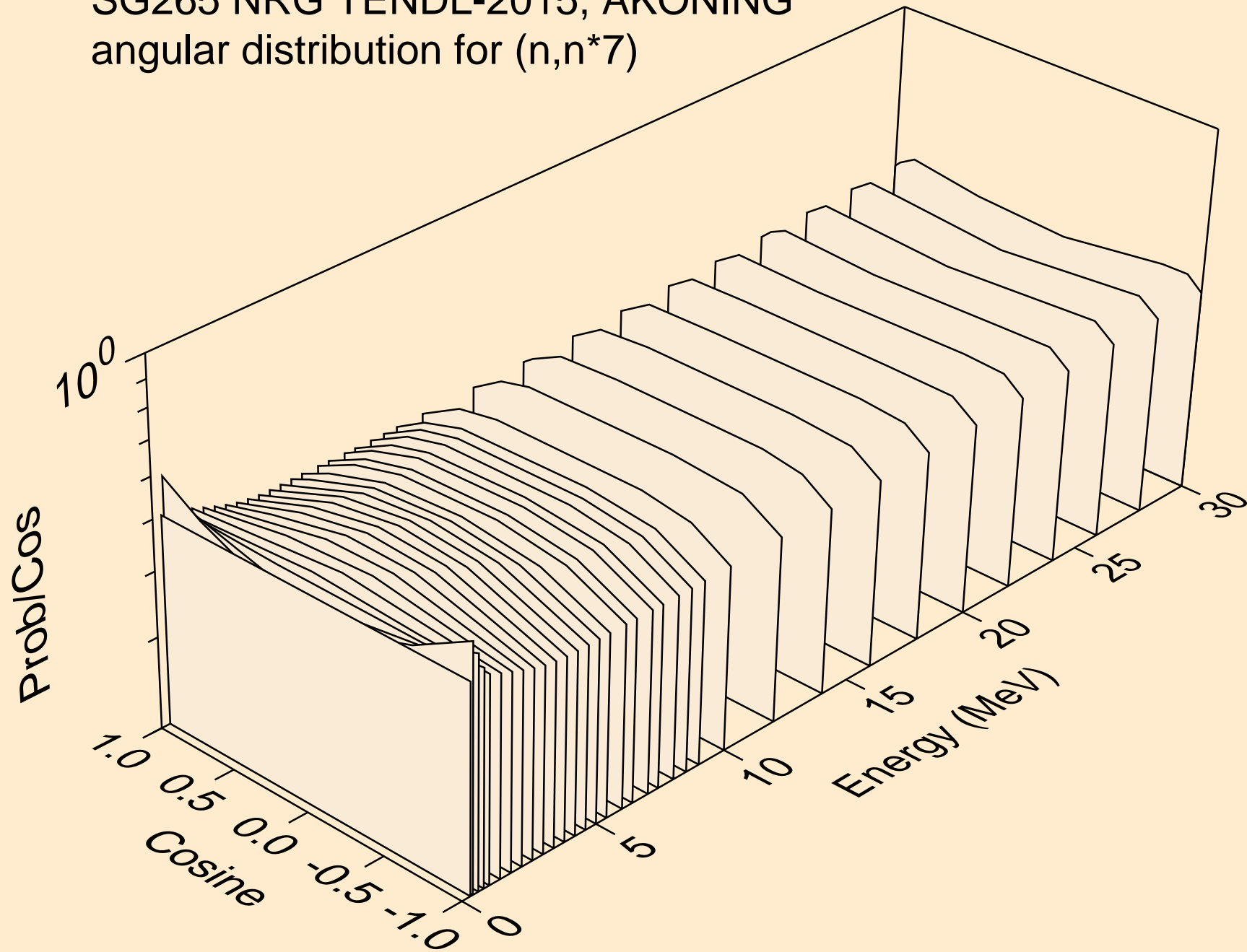

SG265 NRG TENDL-2015, AKONING
angular distribution for (n,n*8)

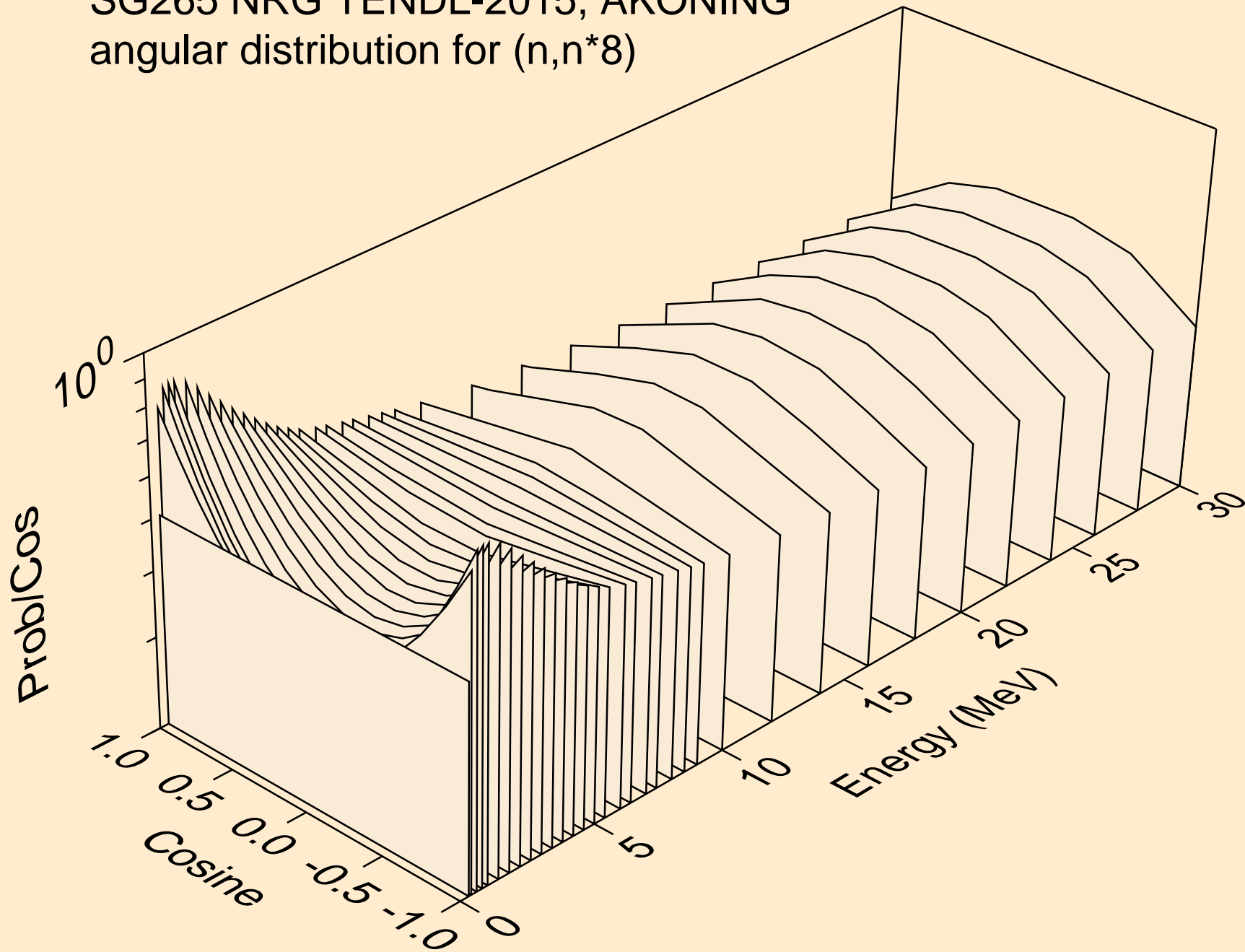

SG265 NRG TENDL-2015, AKONING
angular distribution for (n,n*9)

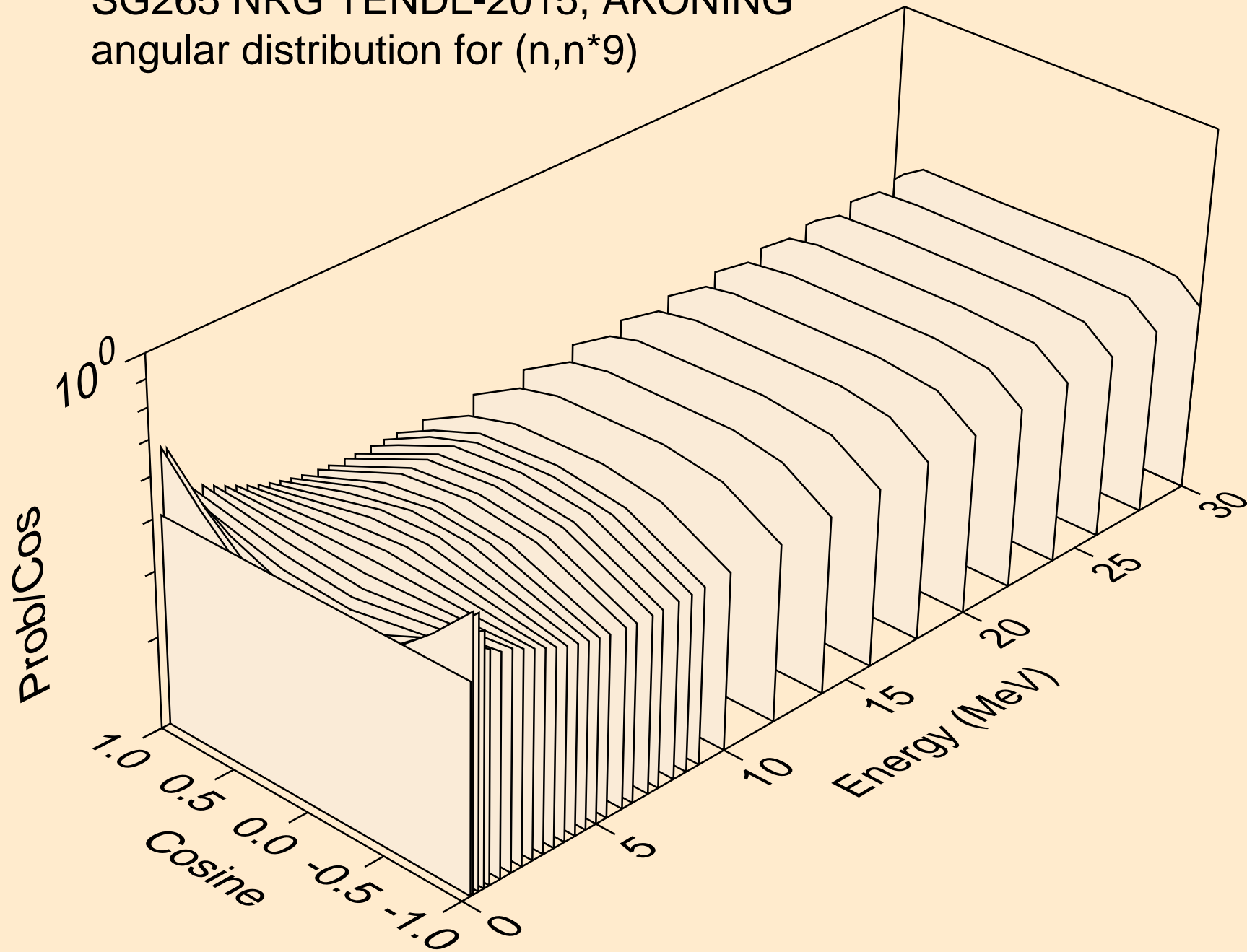

SG265 NRG TENDL-2015, AKONING
angular distribution for (n,n*10)

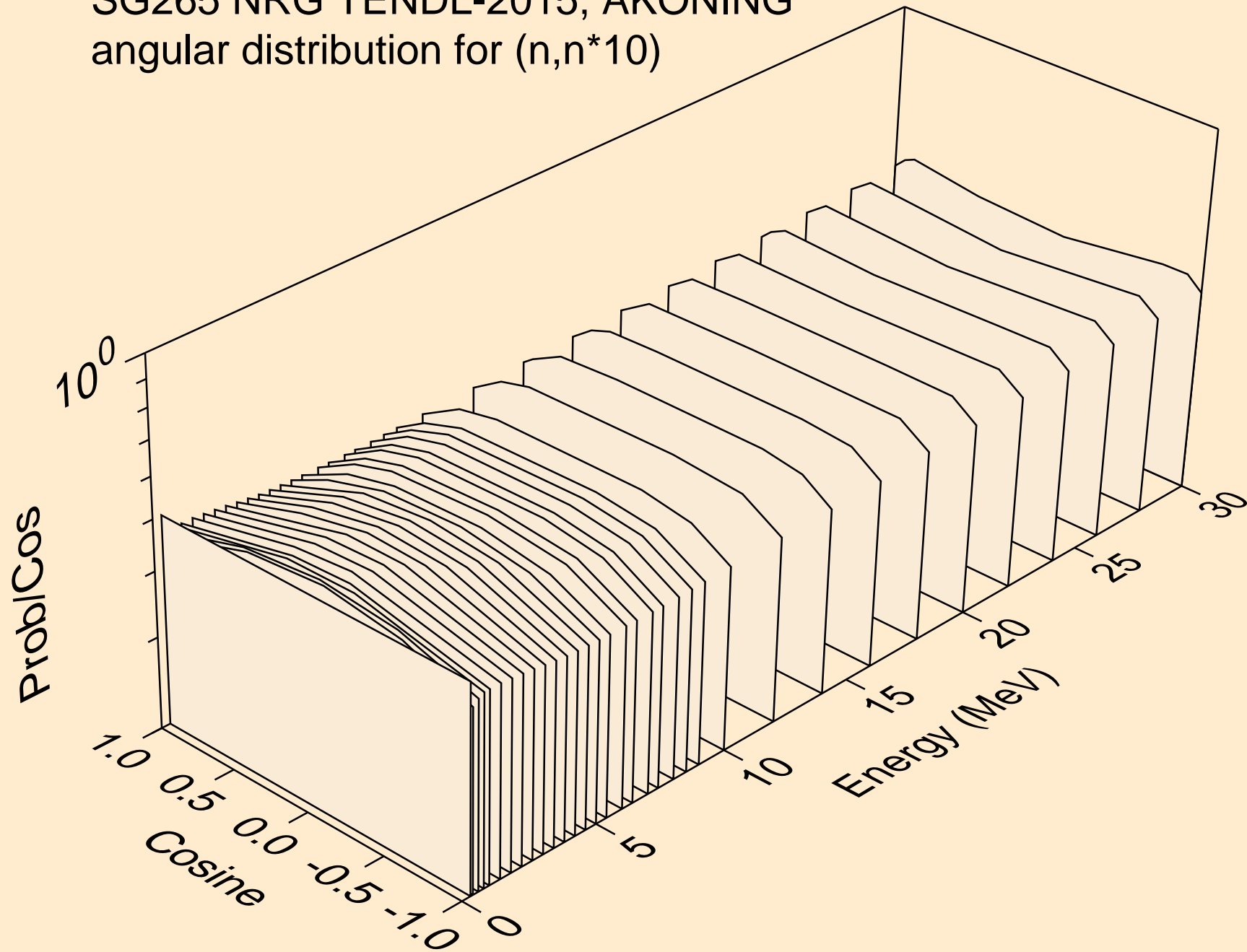

SG265 NRG TENDL-2015, AKONING
angular distribution for (n,n*11)

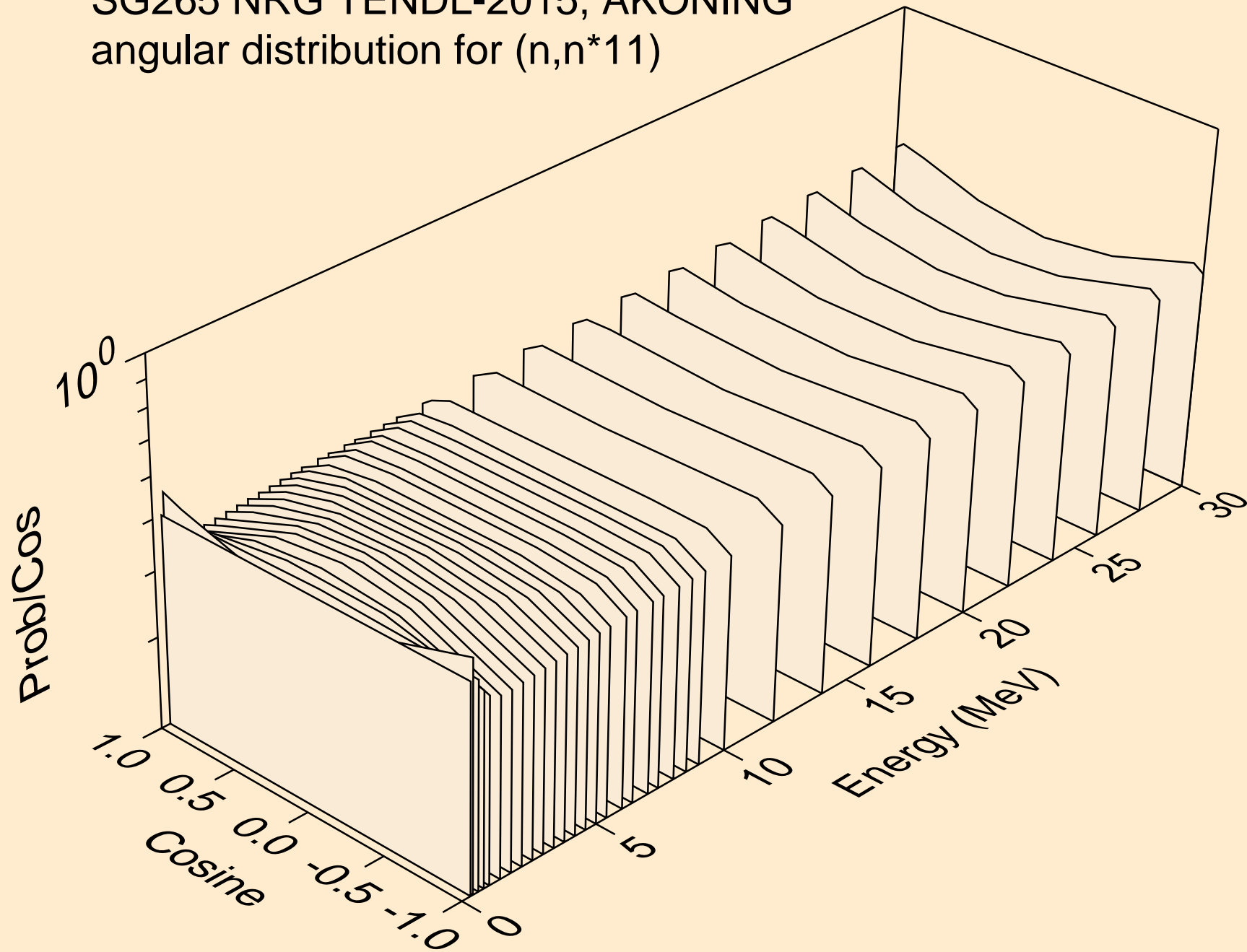

SG265 NRG TENDL-2015, AKONING
angular distribution for (n,n*12)

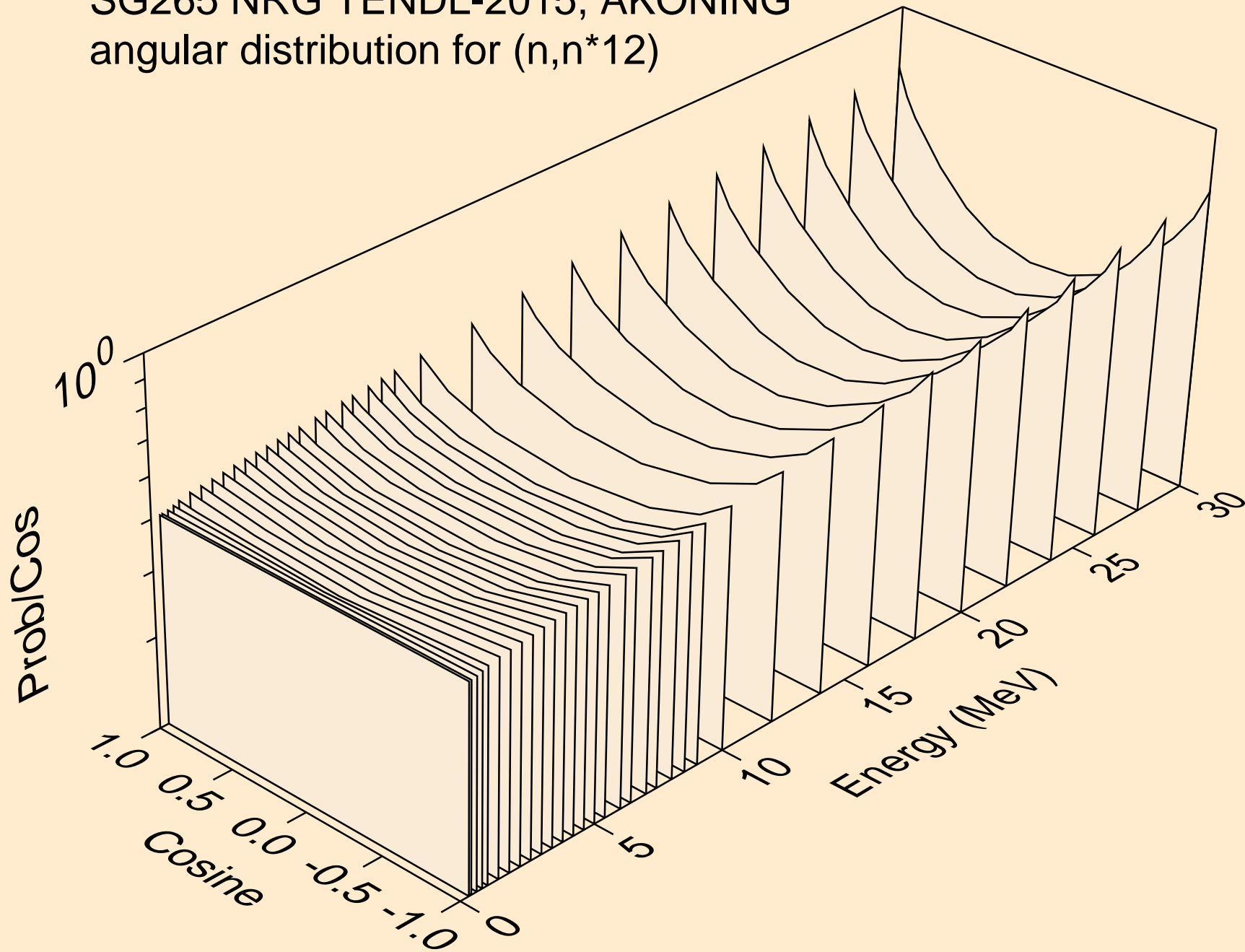

SG265 NRG TENDL-2015, AKONING
angular distribution for (n,n*13)

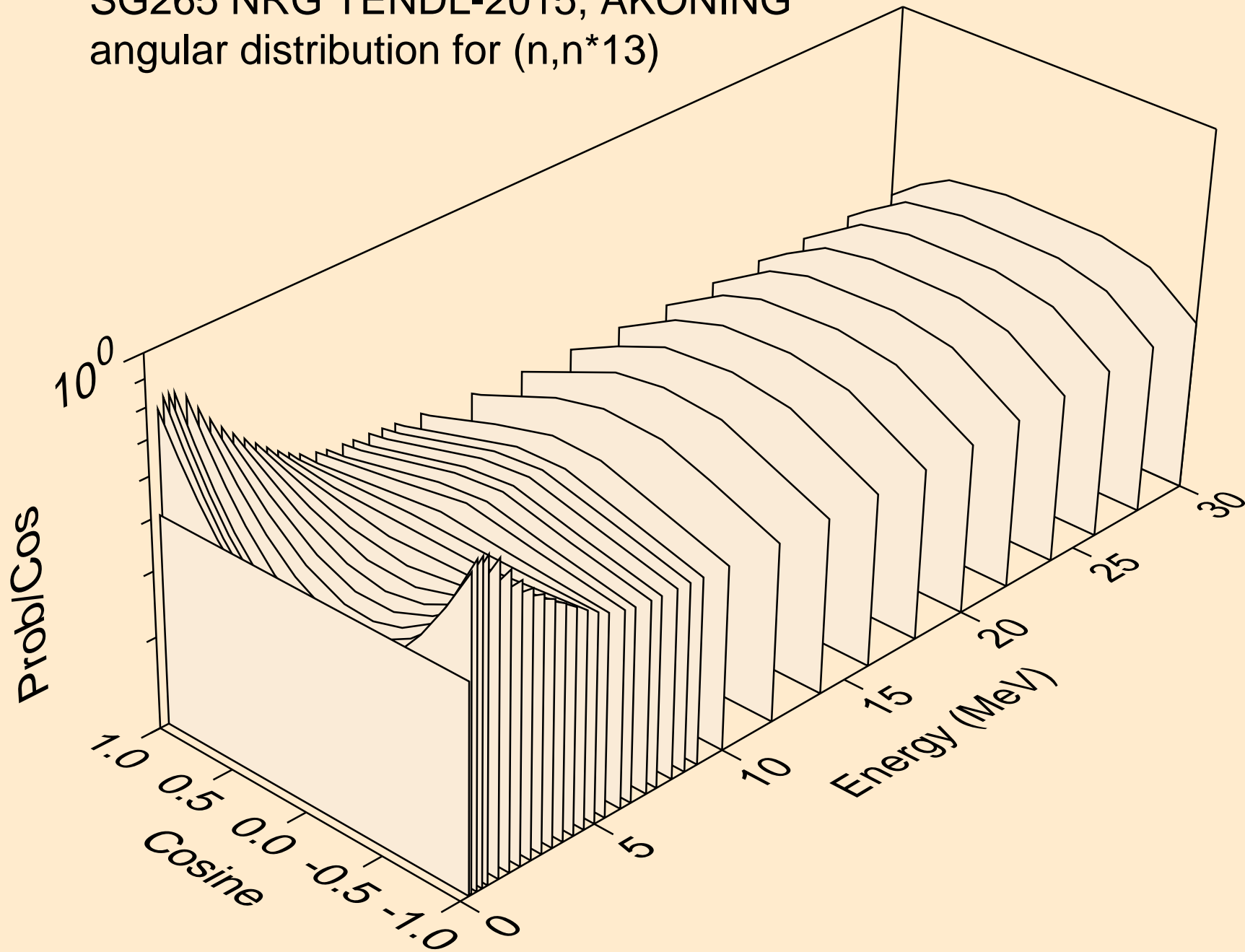

SG265 NRG TENDL-2015, AKONING
angular distribution for (n,n*14)

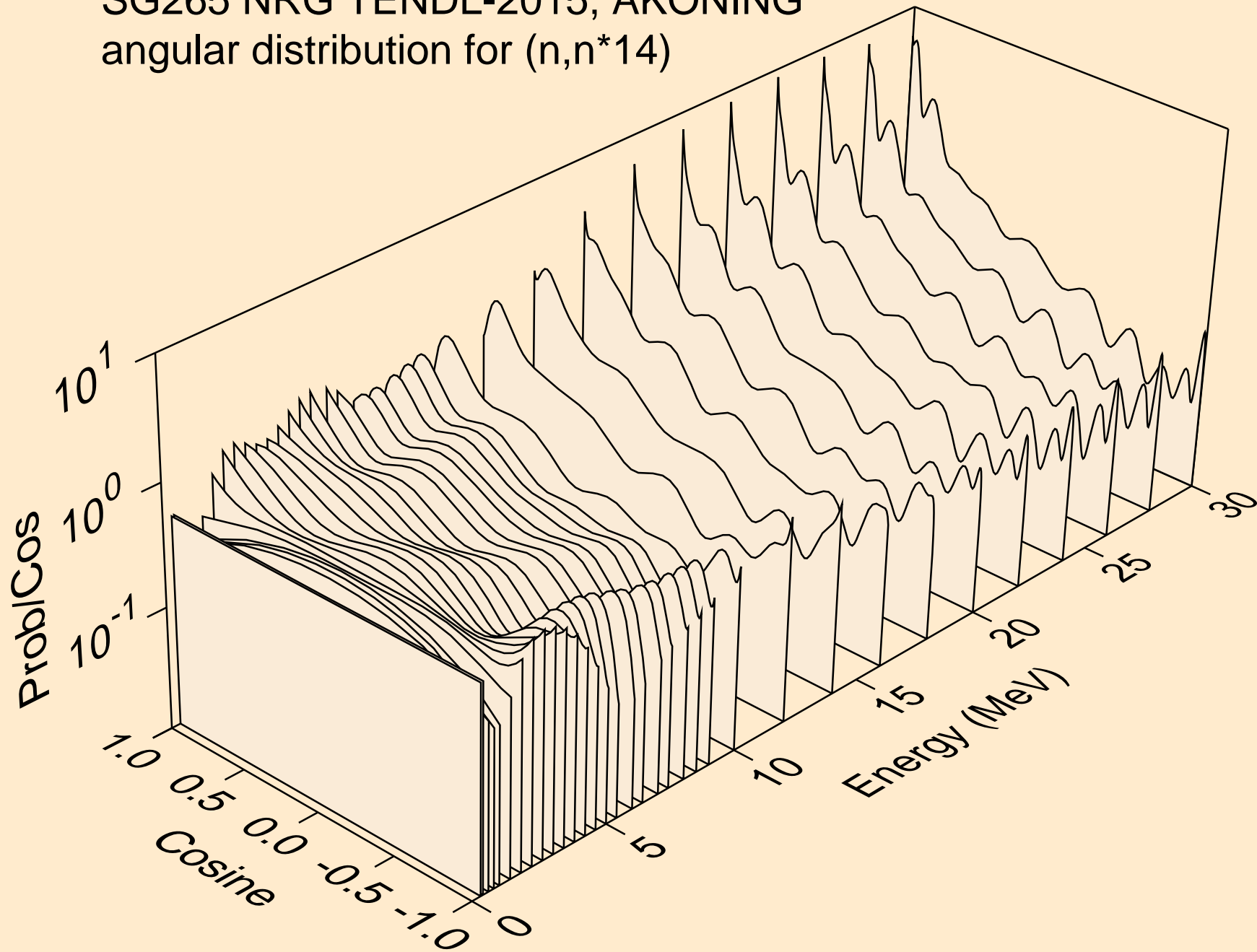

SG265 NRG TENDL-2015, AKONING
angular distribution for (n,n*15)

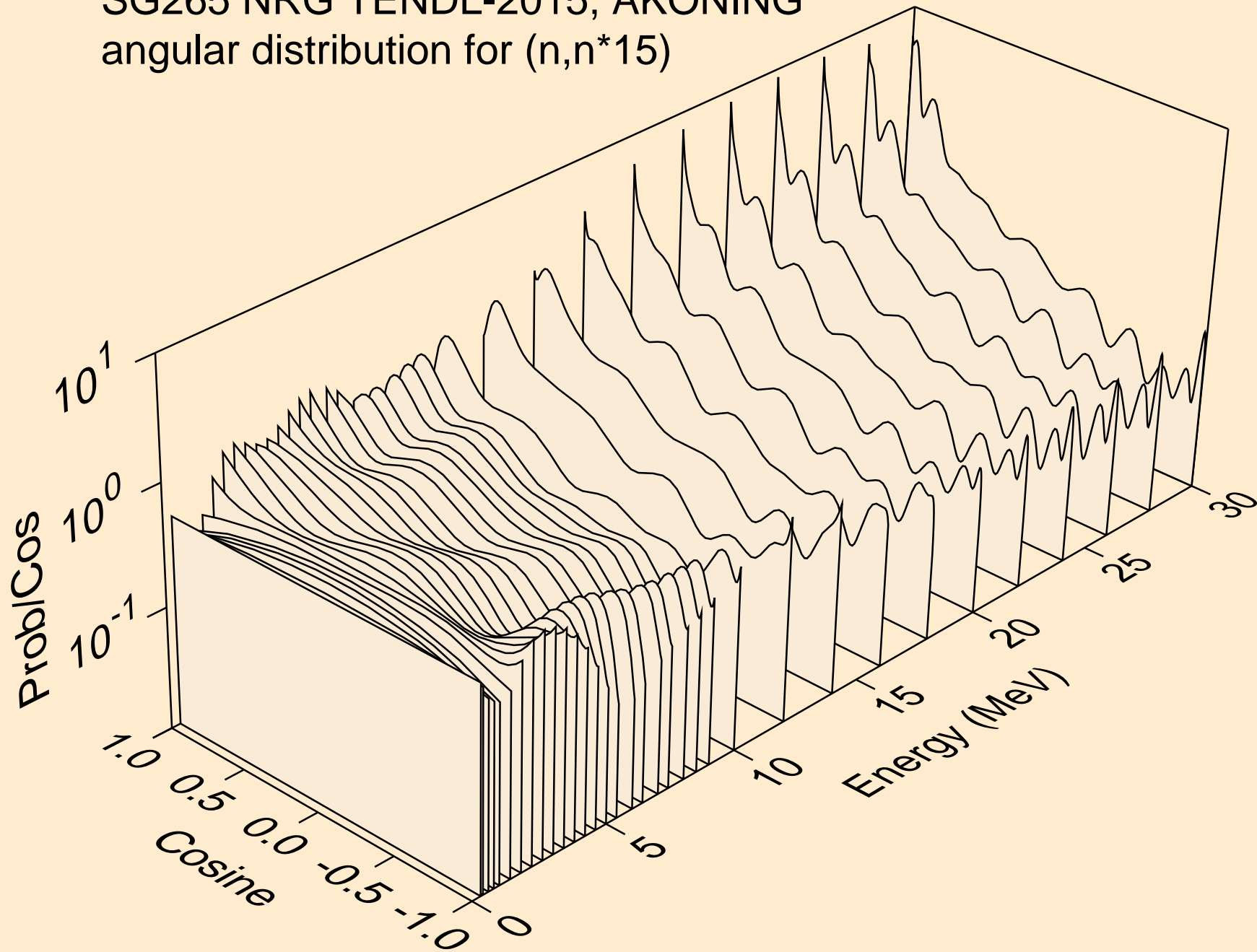

SG265 NRG TENDL-2015, AKONING
angular distribution for (n,n*16)

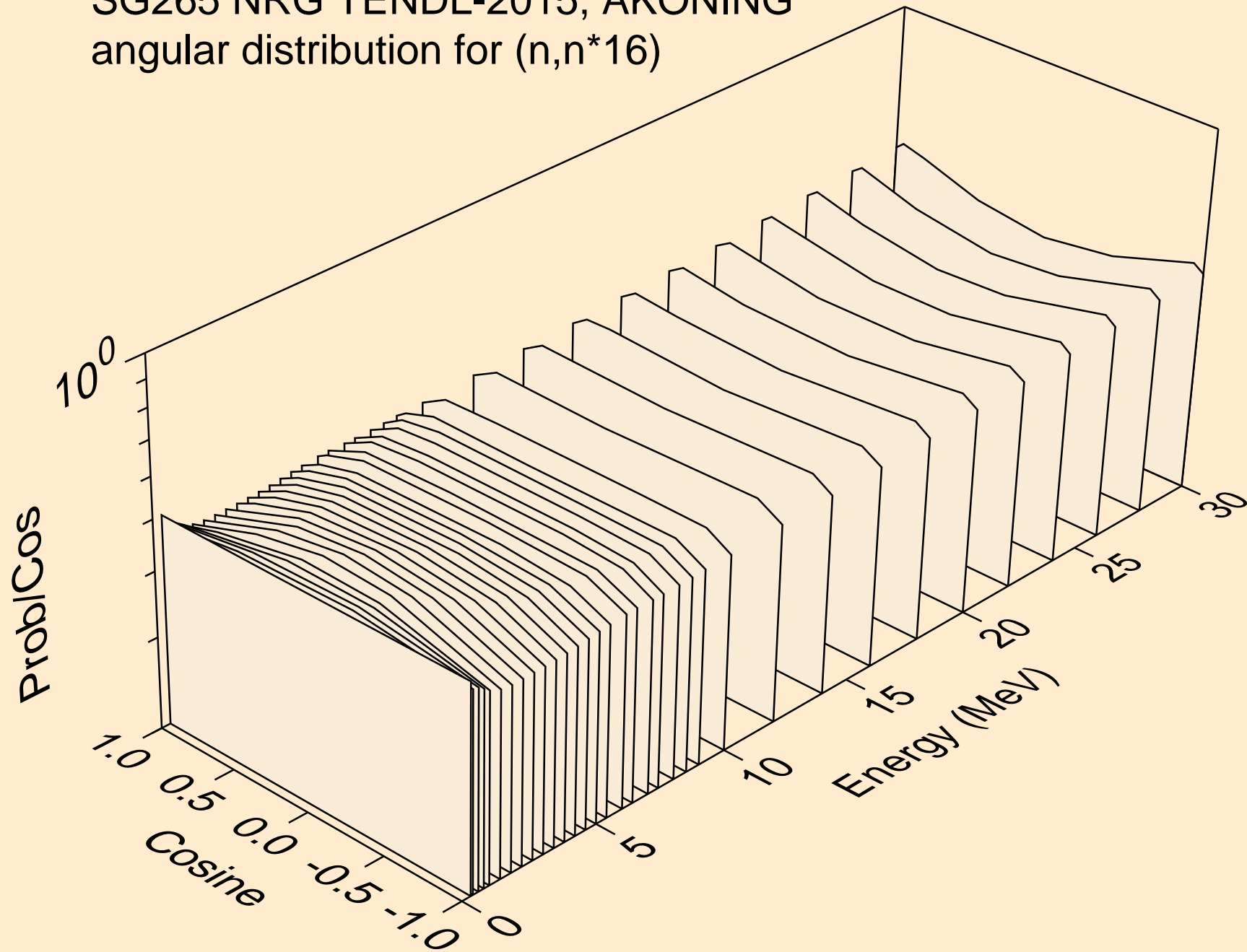

SG265 NRG TENDL-2015, AKONING
angular distribution for (n,n*17)

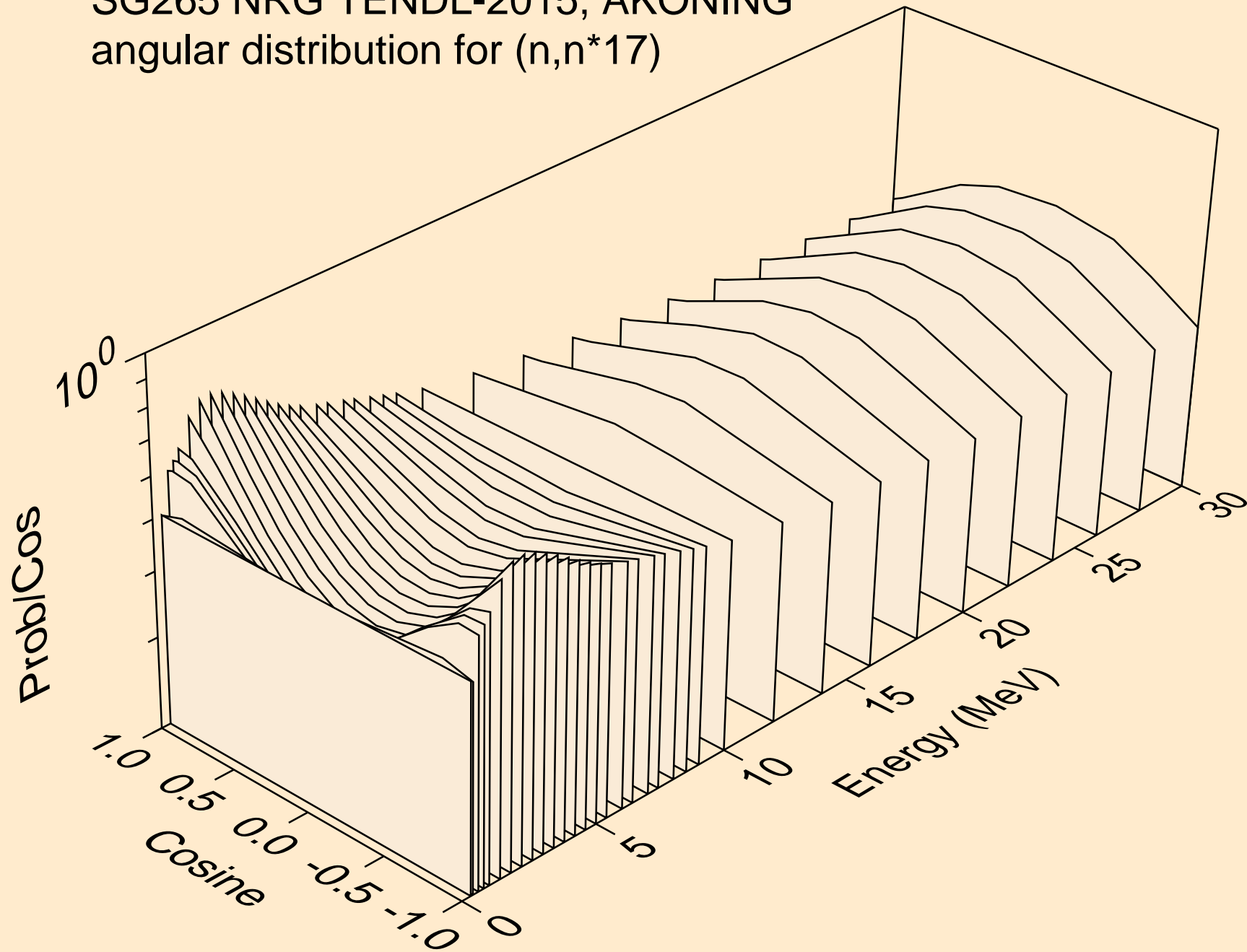

SG265 NRG TENDL-2015, AKONING
angular distribution for (n,n*18)

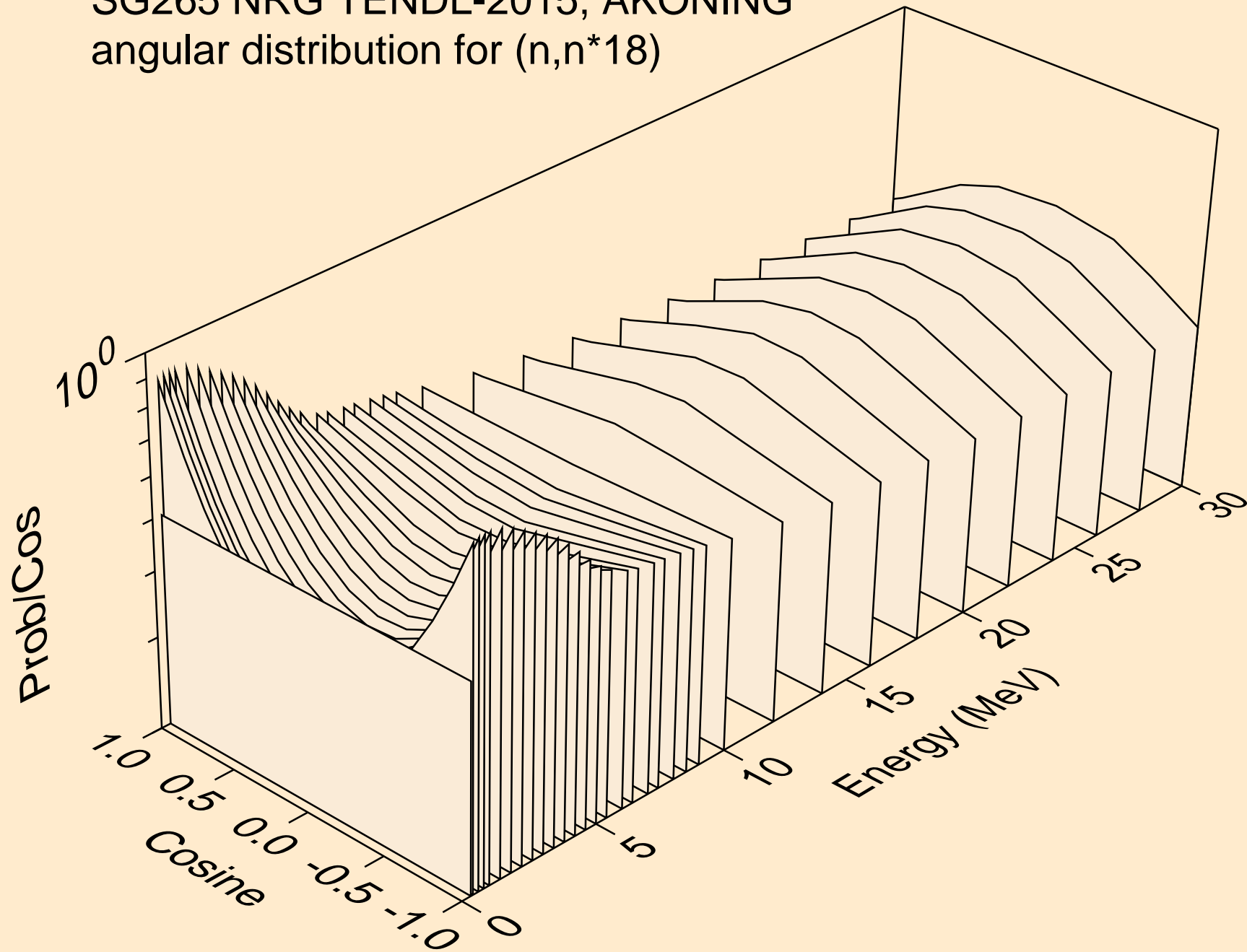

SG265 NRG TENDL-2015, AKONING
angular distribution for (n,n*19)

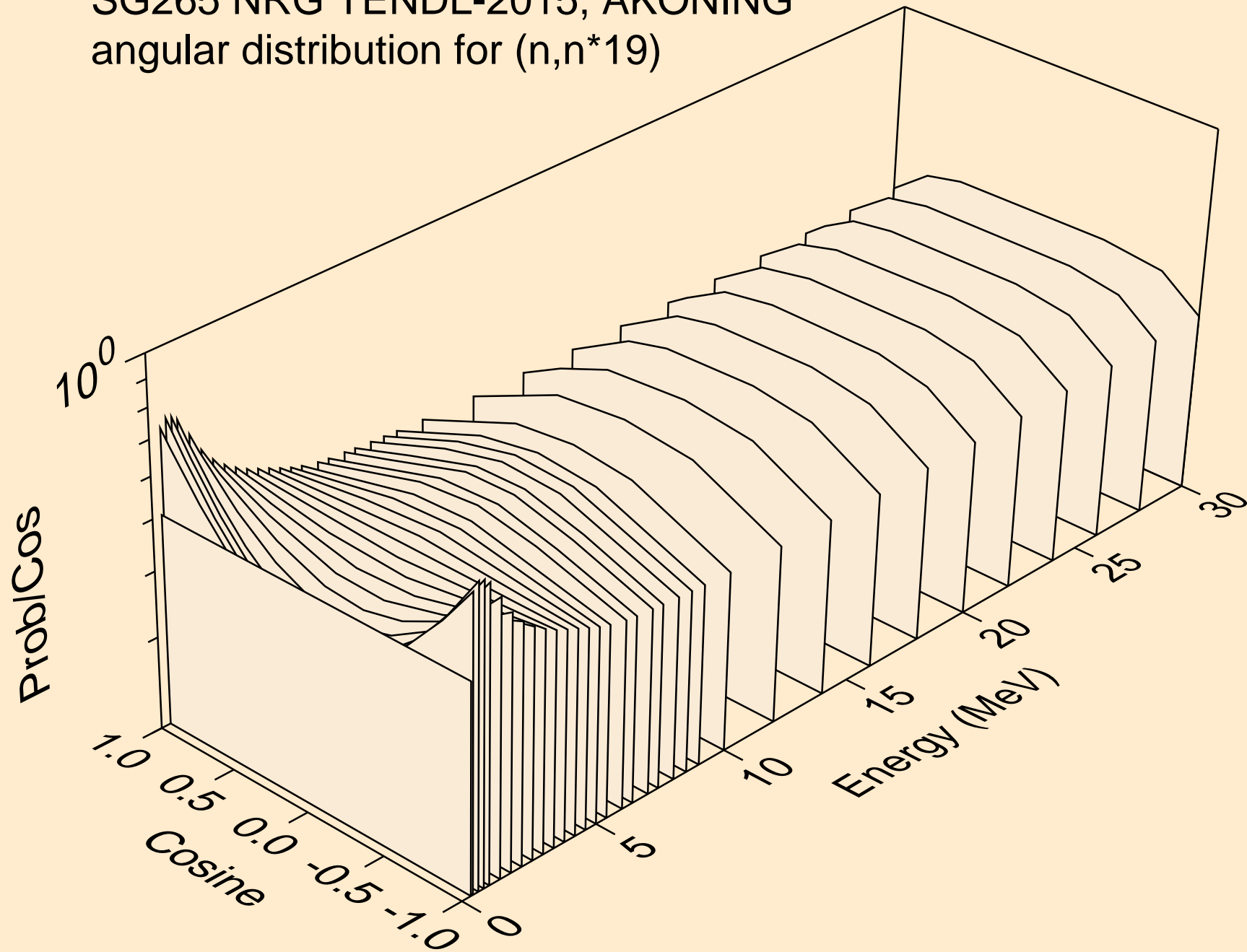

SG265 NRG TENDL-2015, AKONING
angular distribution for (n,n*20)

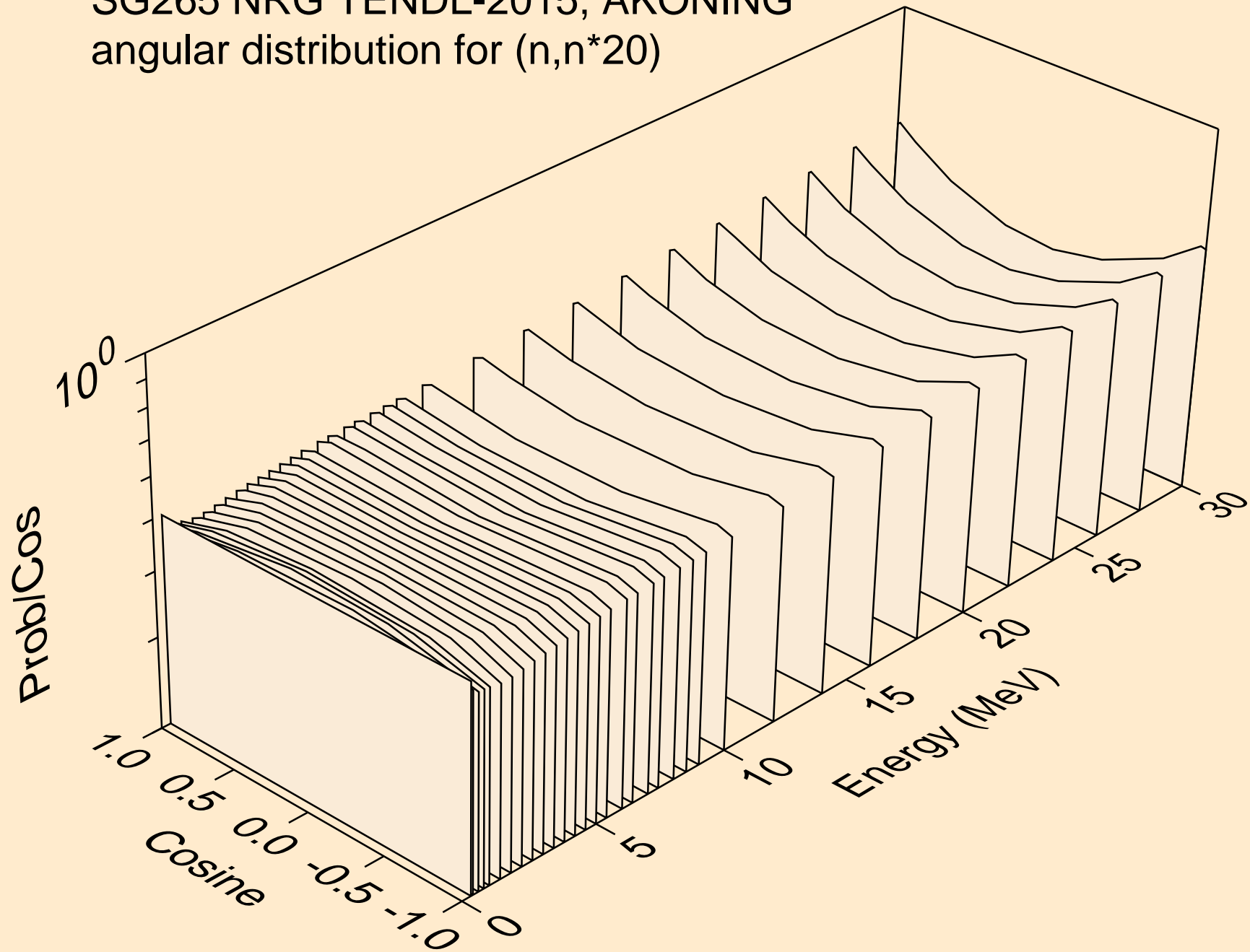

SG265 NRG TENDL-2015, AKONING
angular distribution for (n,n*21)

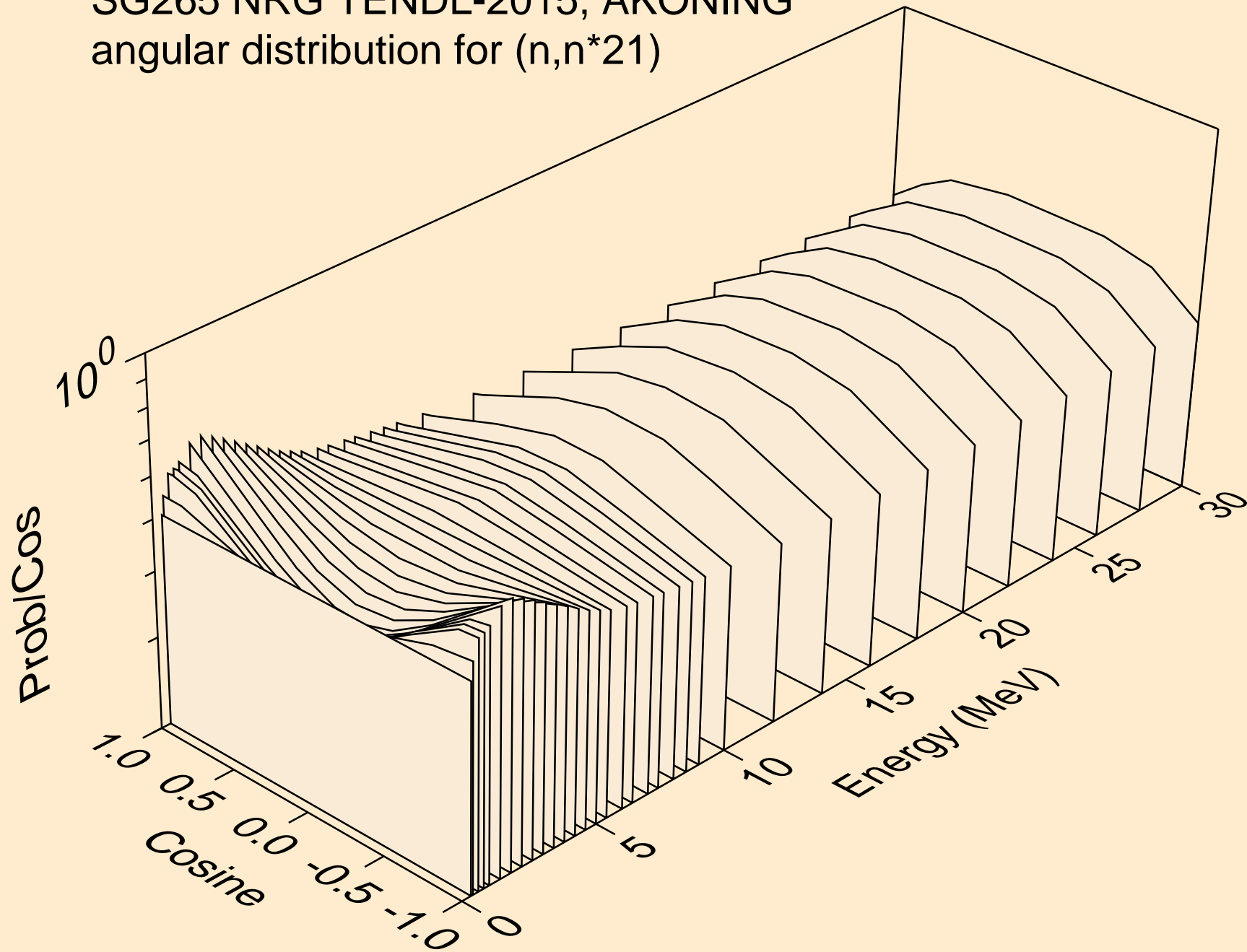

SG265 NRG TENDL-2015, AKONING
angular distribution for (n,n*22)

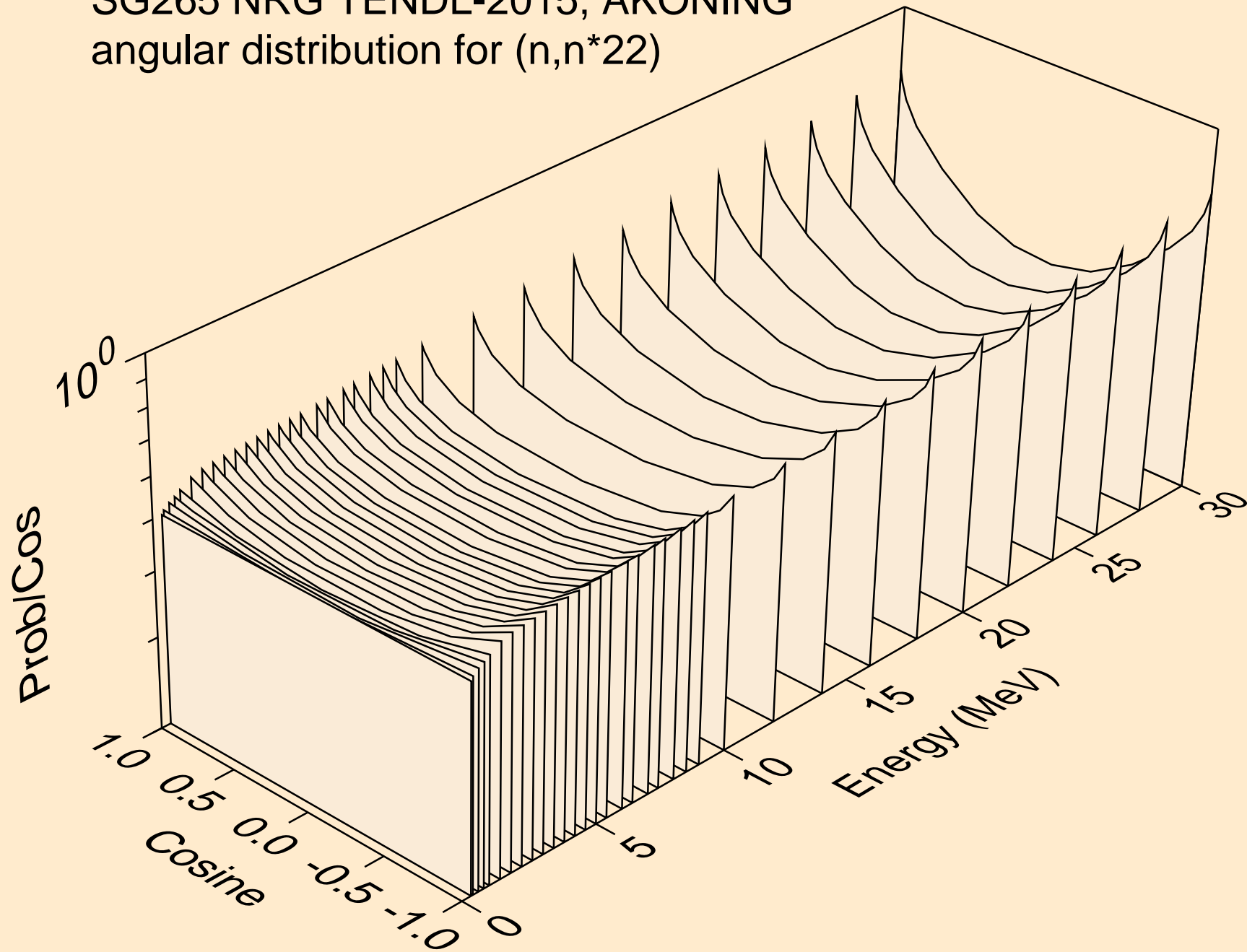

SG265 NRG TENDL-2015, AKONING
angular distribution for (n,n*23)

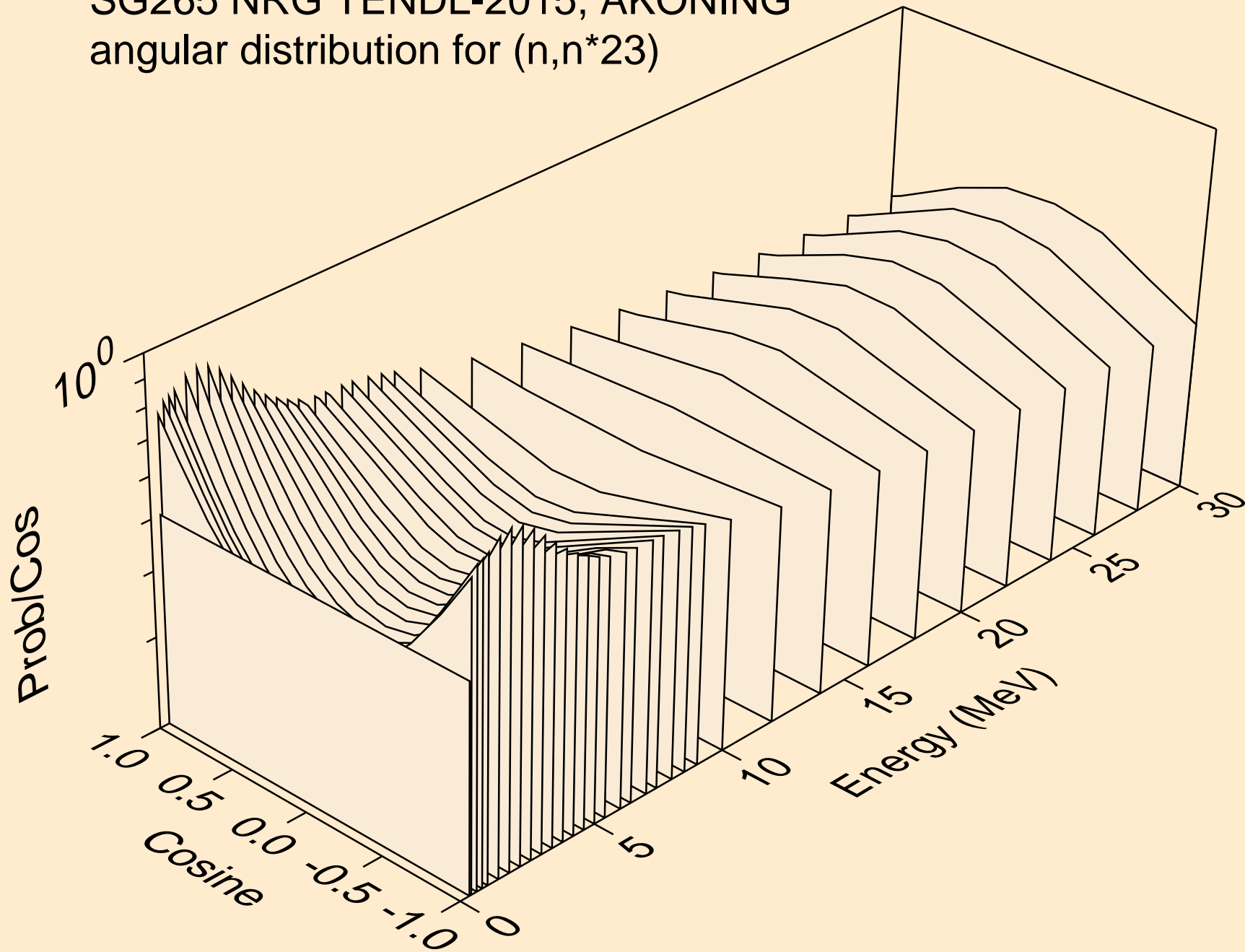

SG265 NRG TENDL-2015, AKONING
angular distribution for (n,n*24)

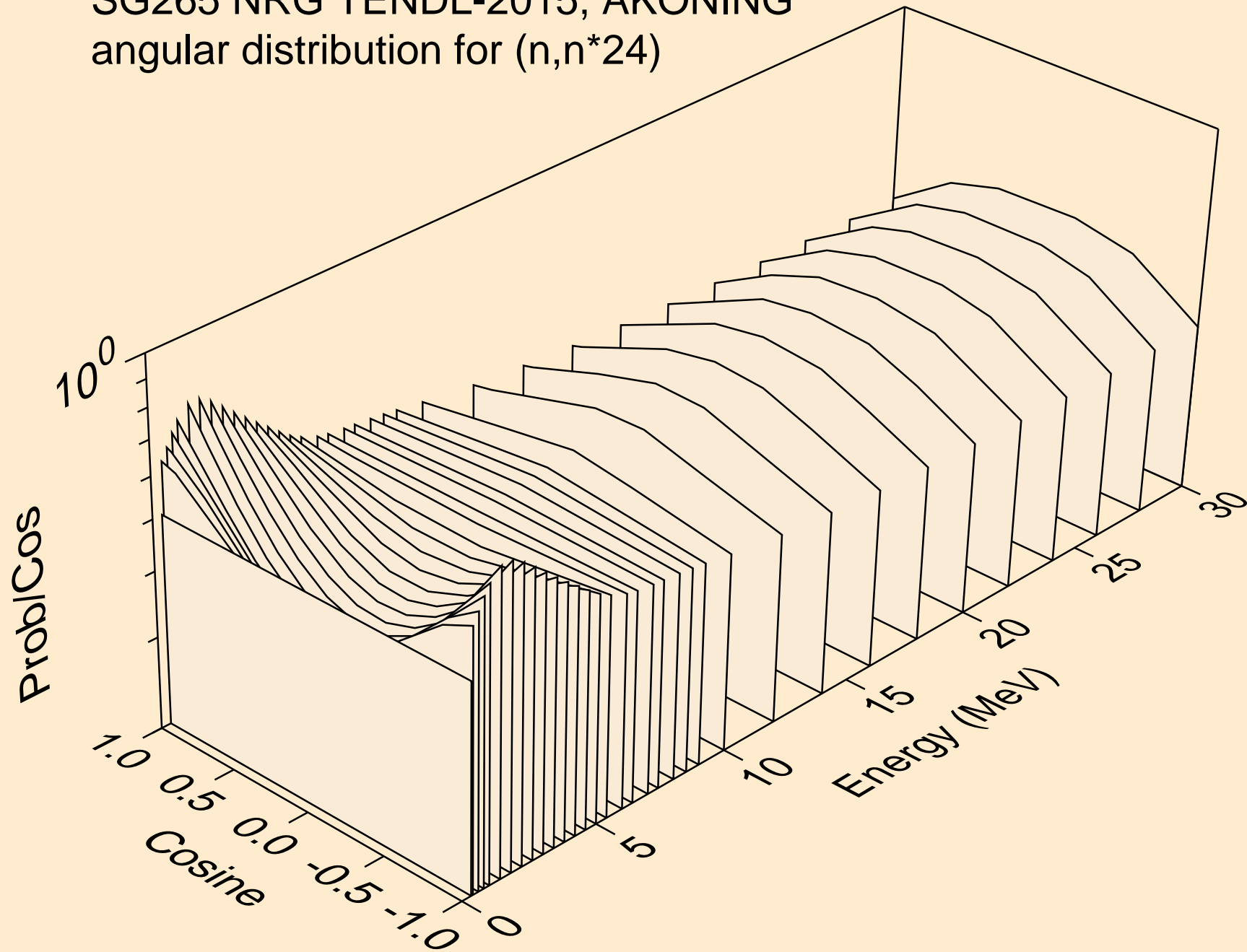

SG265 NRG TENDL-2015, AKONING
angular distribution for (n,n*25)

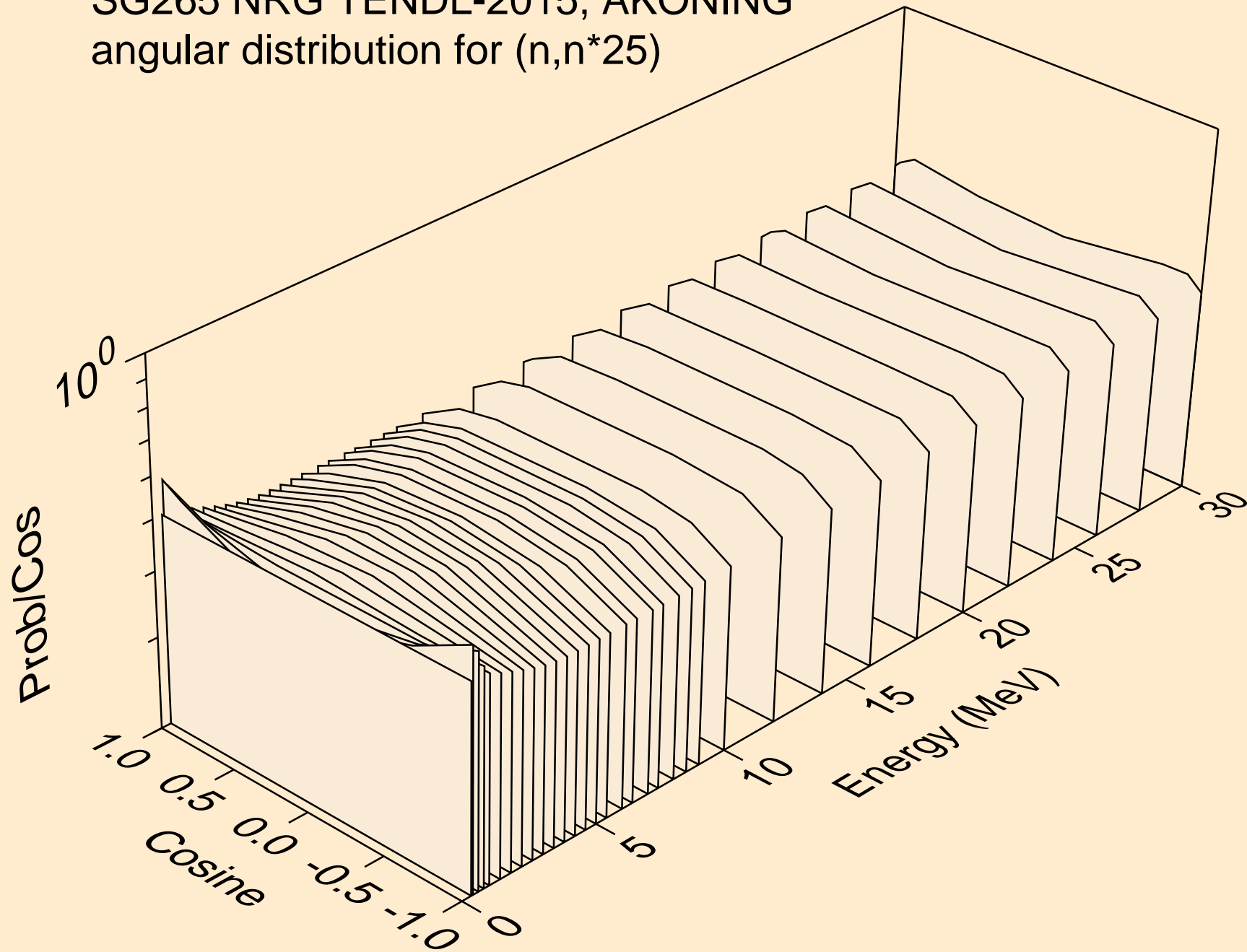

SG265 NRG TENDL-2015, AKONING
angular distribution for (n,n*26)

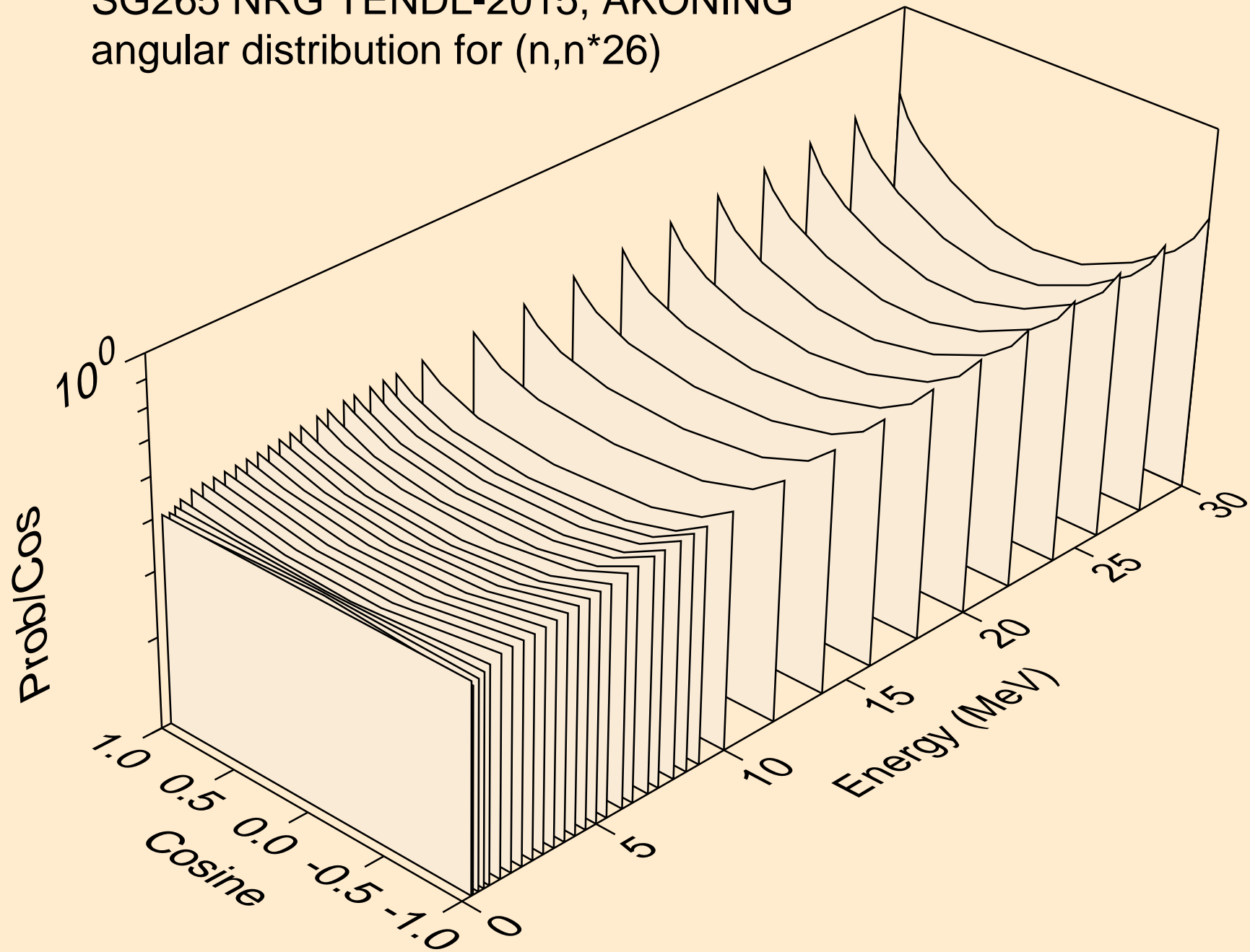

SG265 NRG TENDL-2015, AKONING

Total fission nubar

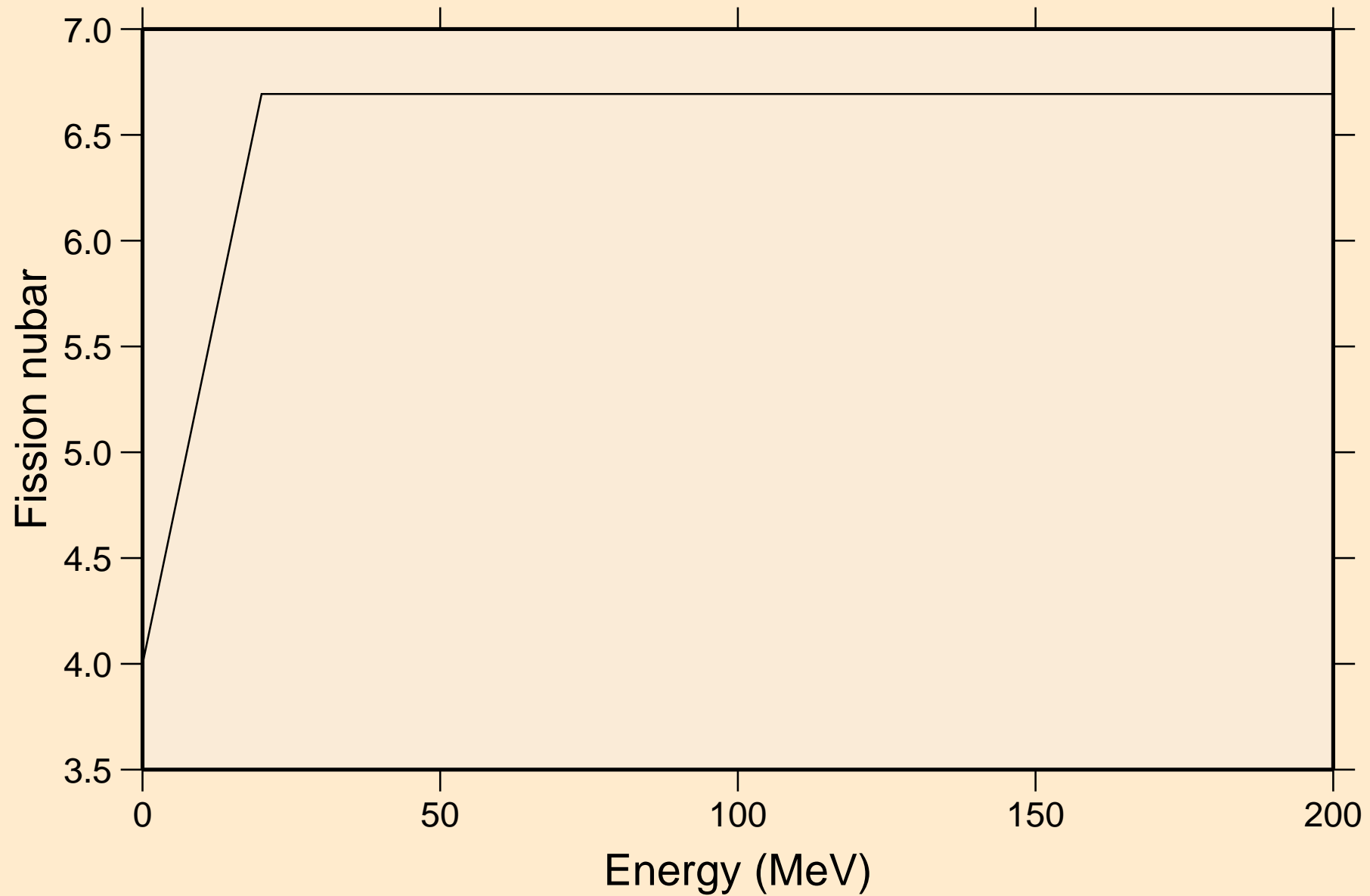

SG265 NRG TENDL-2015, AKONING
Neutron emission for (n,x)

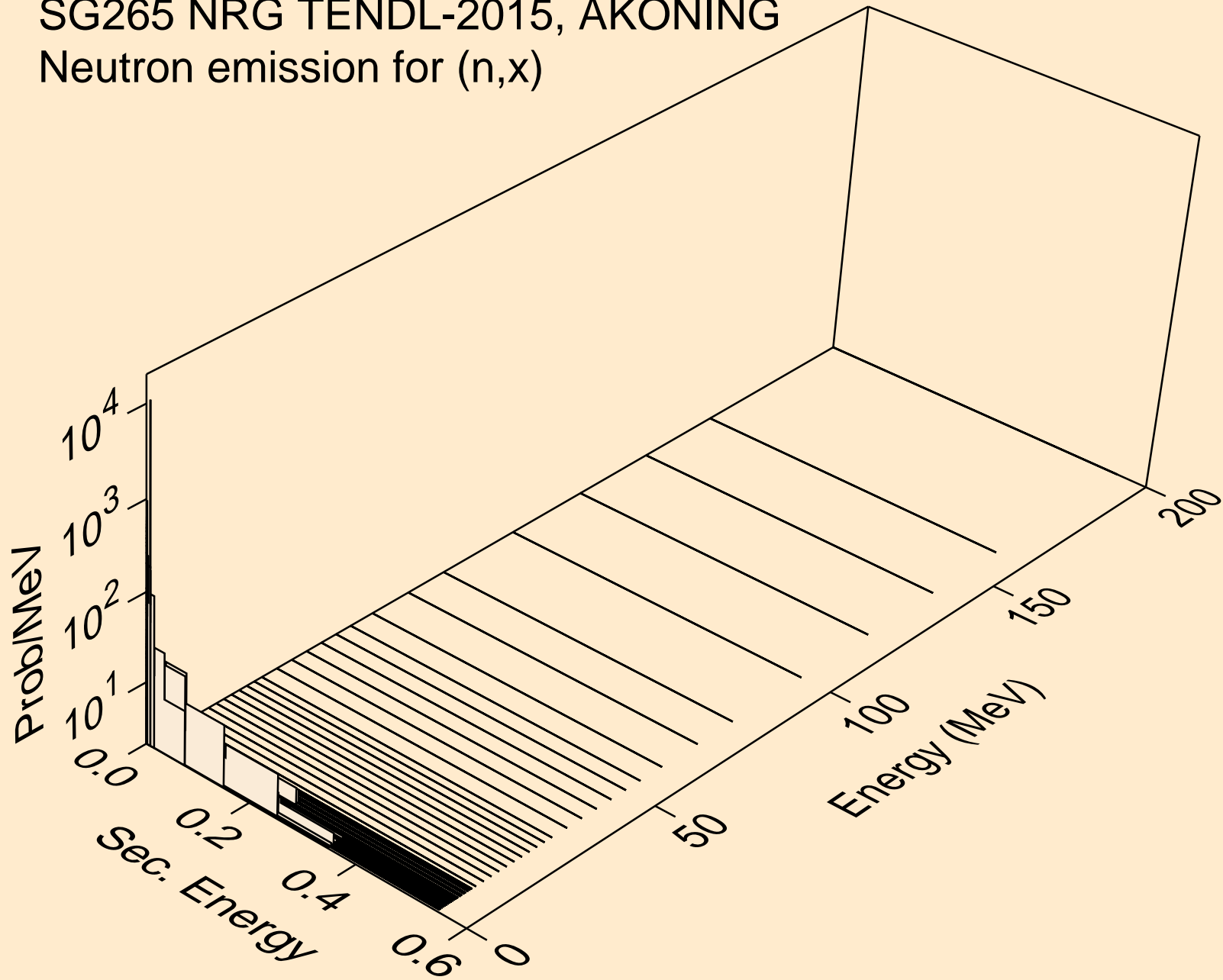

SG265 NRG TENDL-2015, AKONING
Neutron emission for (n,2nd)

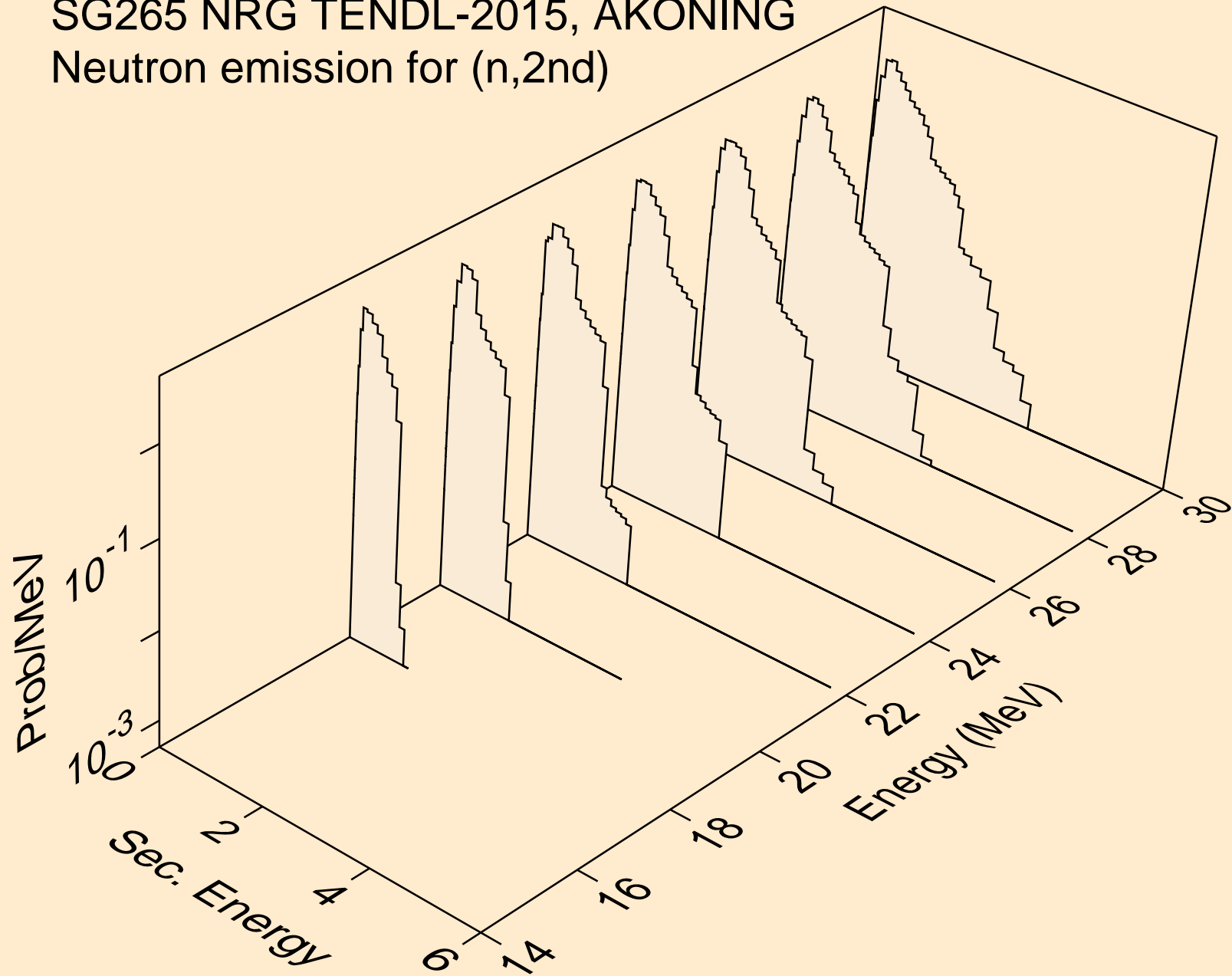

SG265 NRG TENDL-2015, AKONING
Neutron emission for (n,2n)

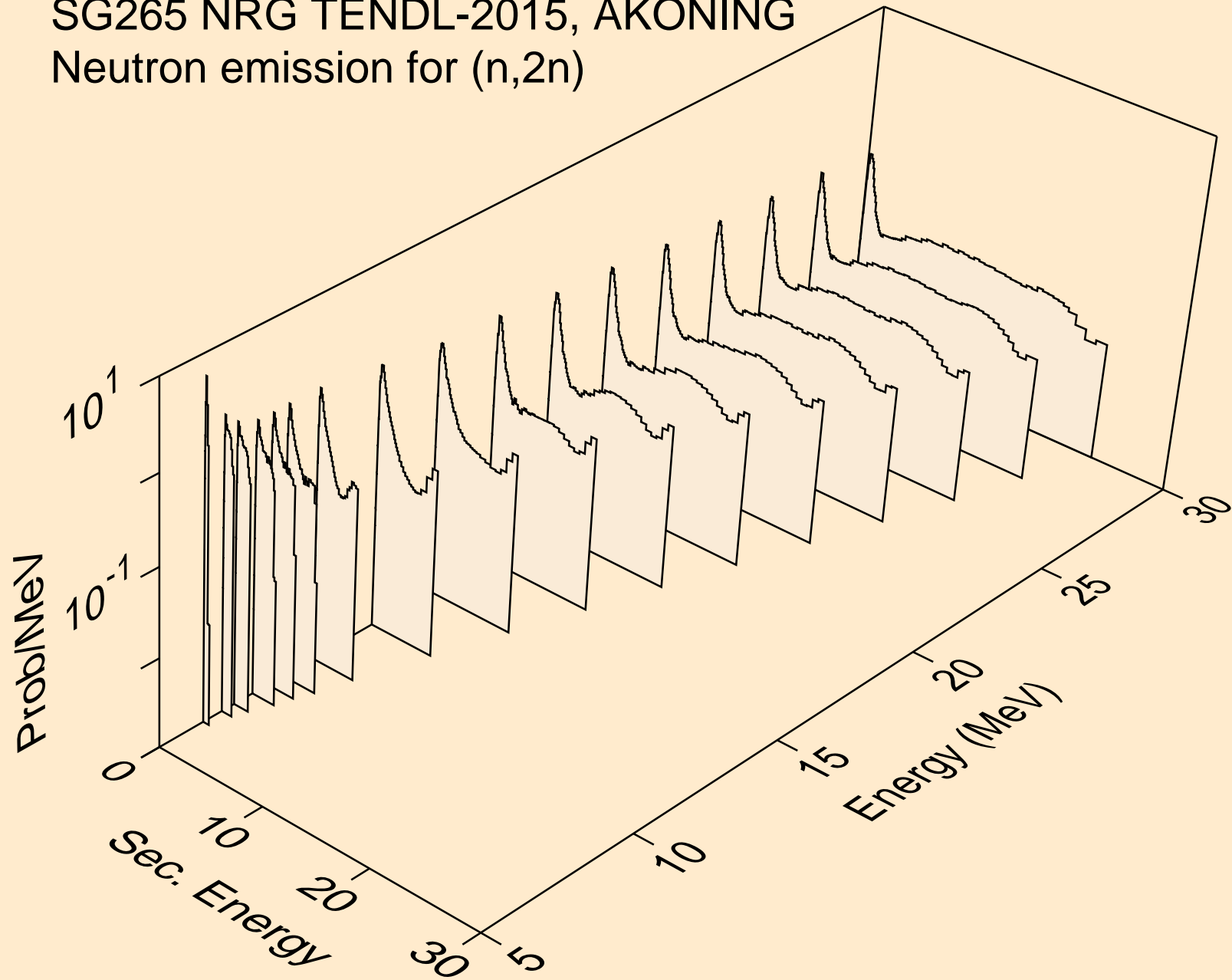

SG265 NRG TENDL-2015, AKONING
Neutron emission for (n,3n)

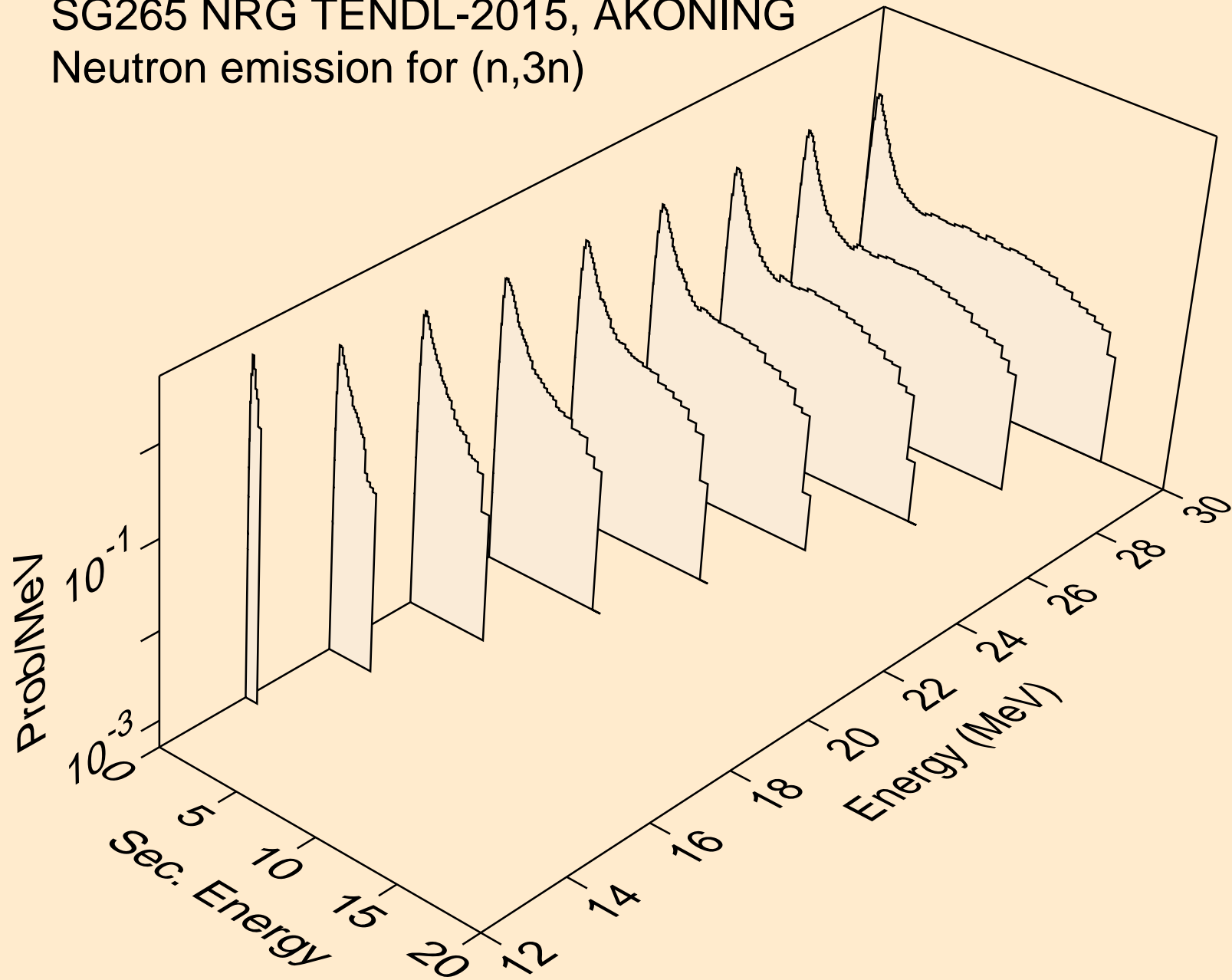

SG265 NRG TENDL-2015, AKONING
Neutron emission for fission

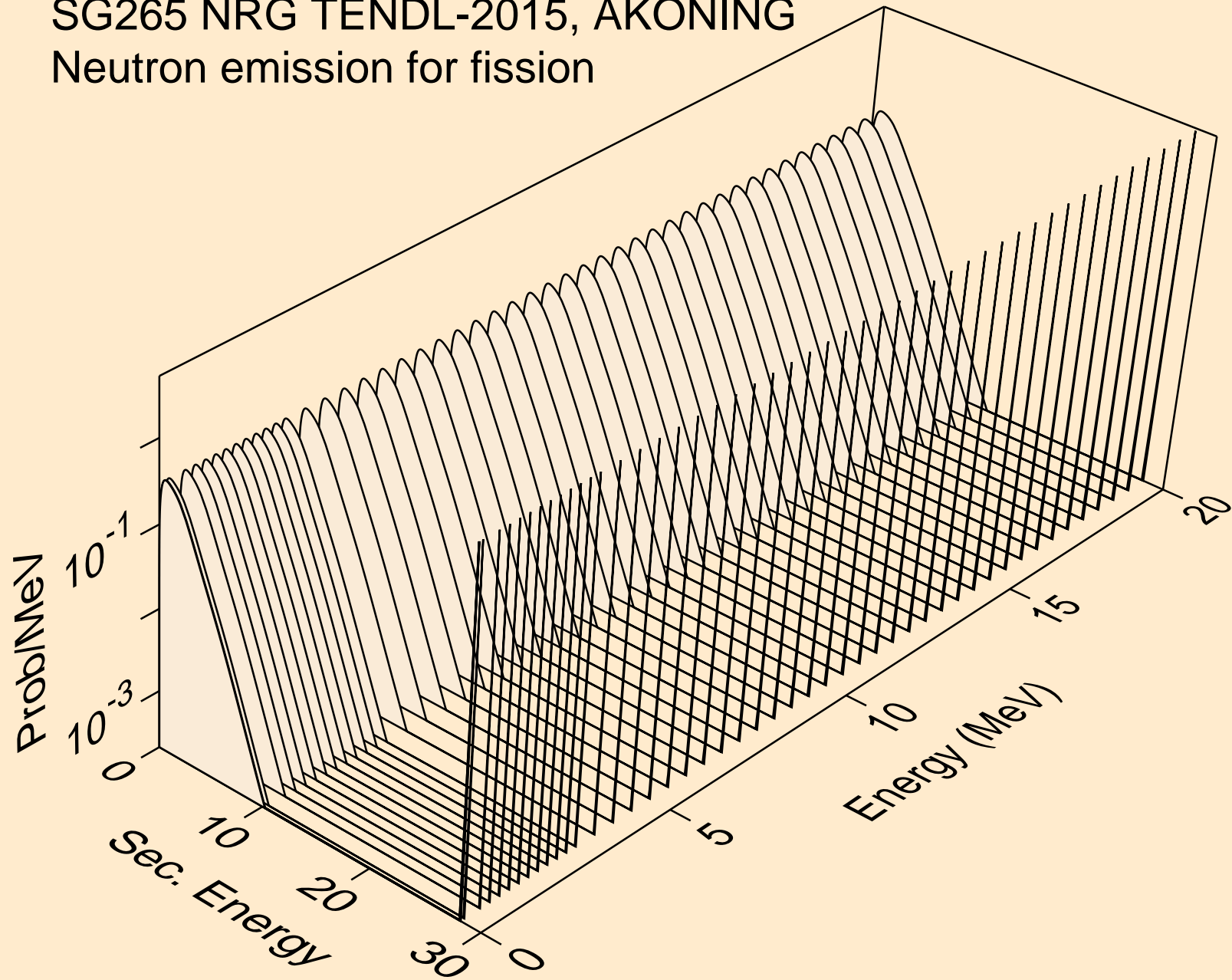

SG265 NRG TENDL-2015, AKONING
Neutron emission for (n,n*)a

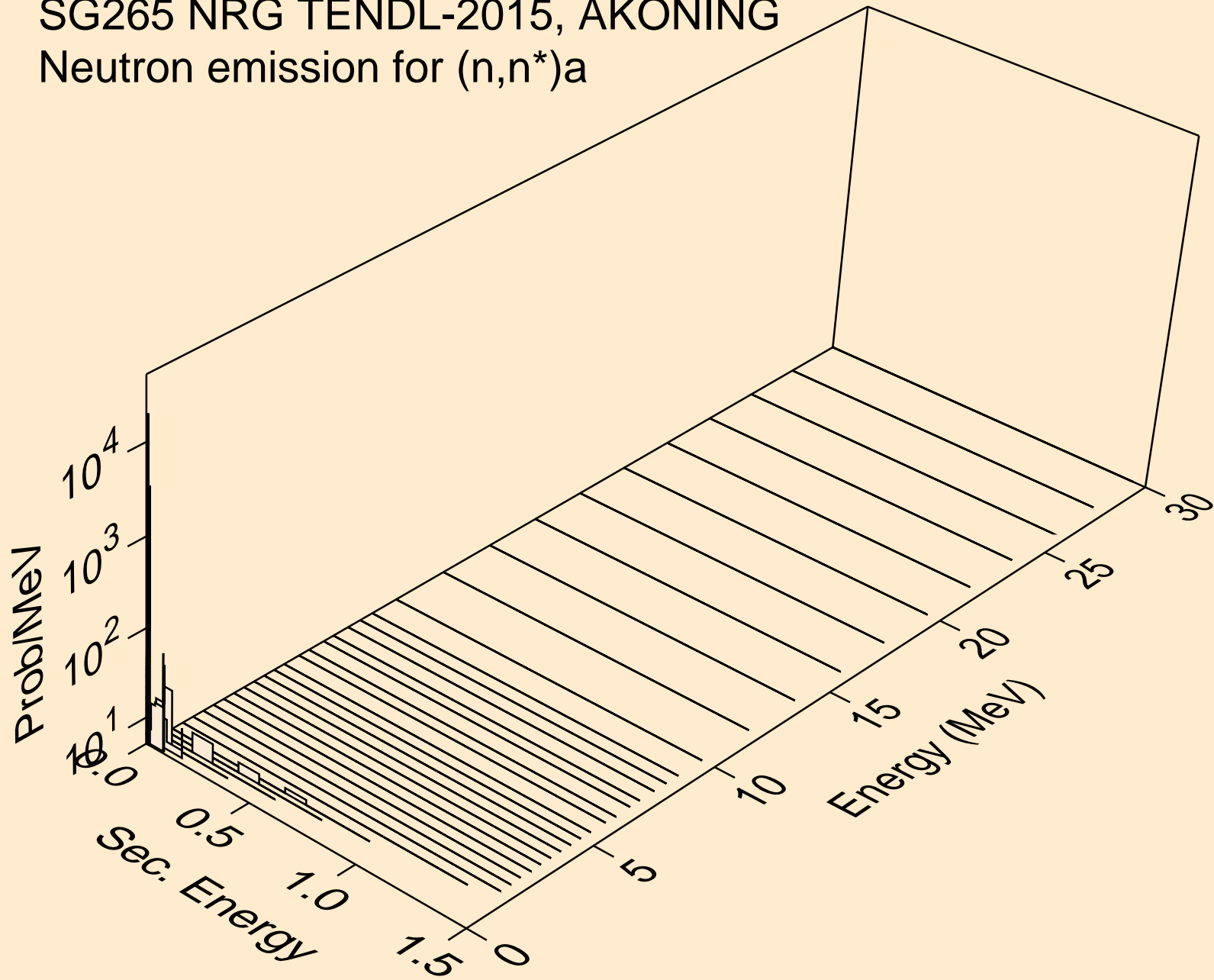

SG265 NRG TENDL-2015, AKONING
Neutron emission for (n,n*)3a

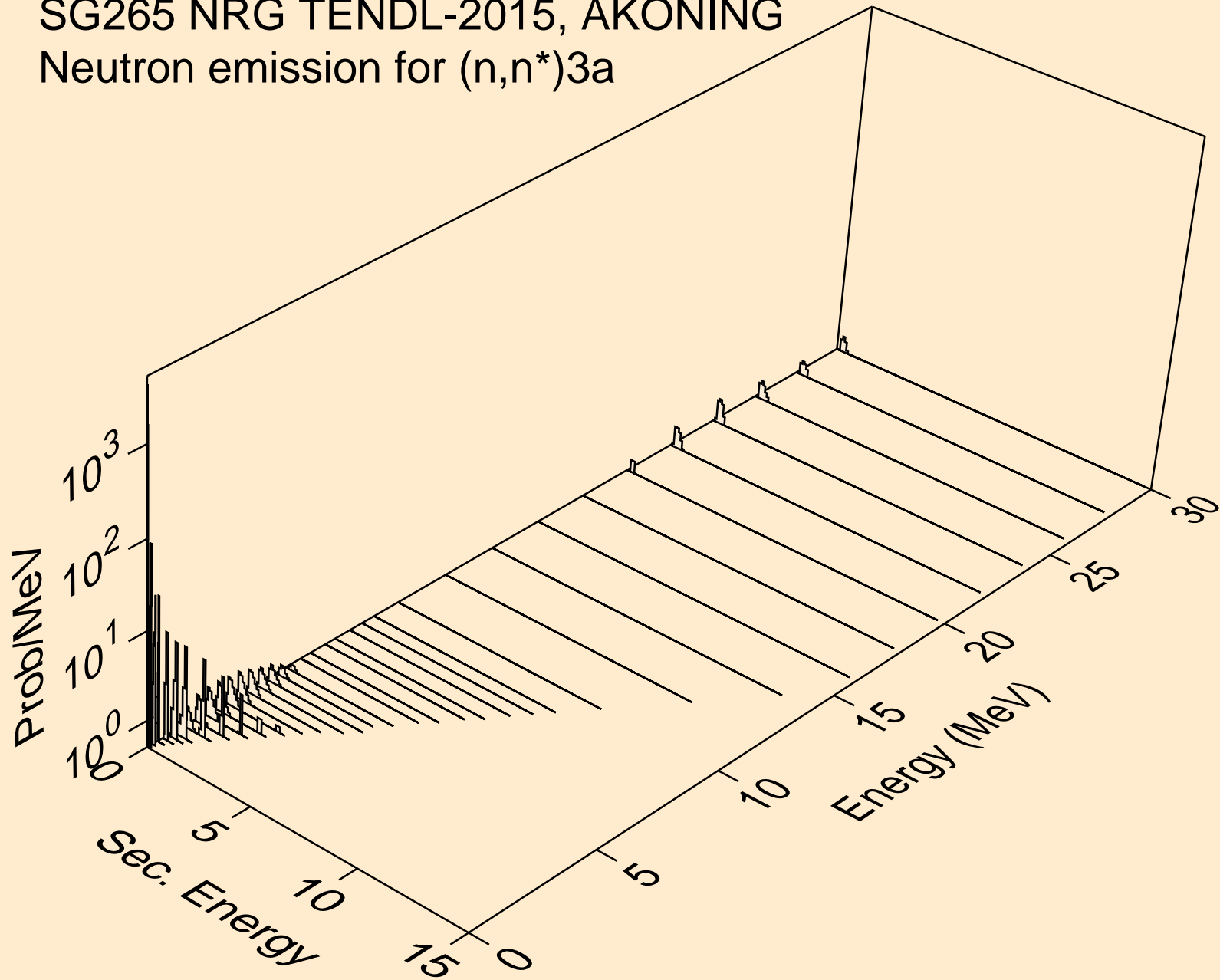

SG265 NRG TENDL-2015, AKONING
Neutron emission for (n,2n)a

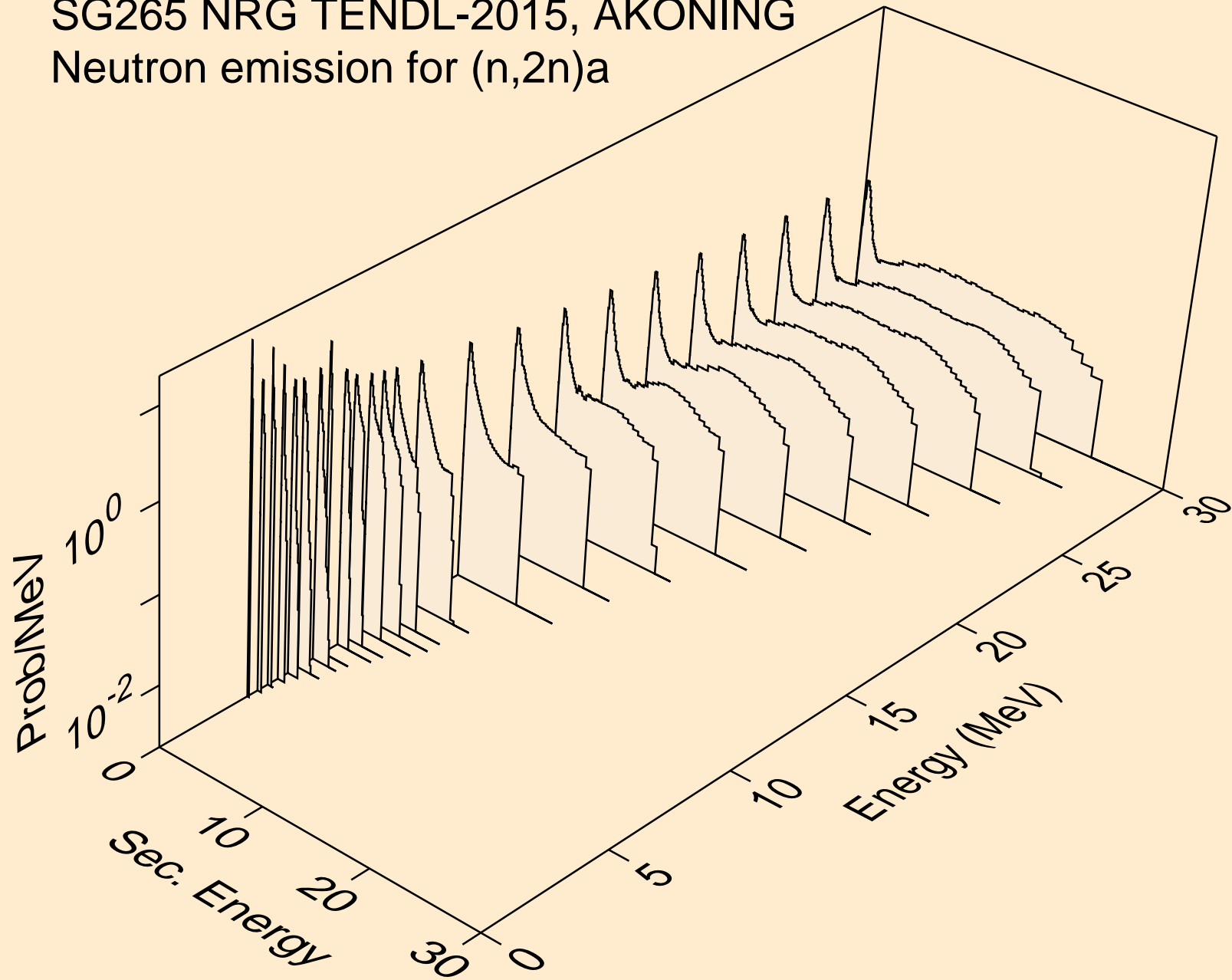

SG265 NRG TENDL-2015, AKONING
Neutron emission for (n,3n)a

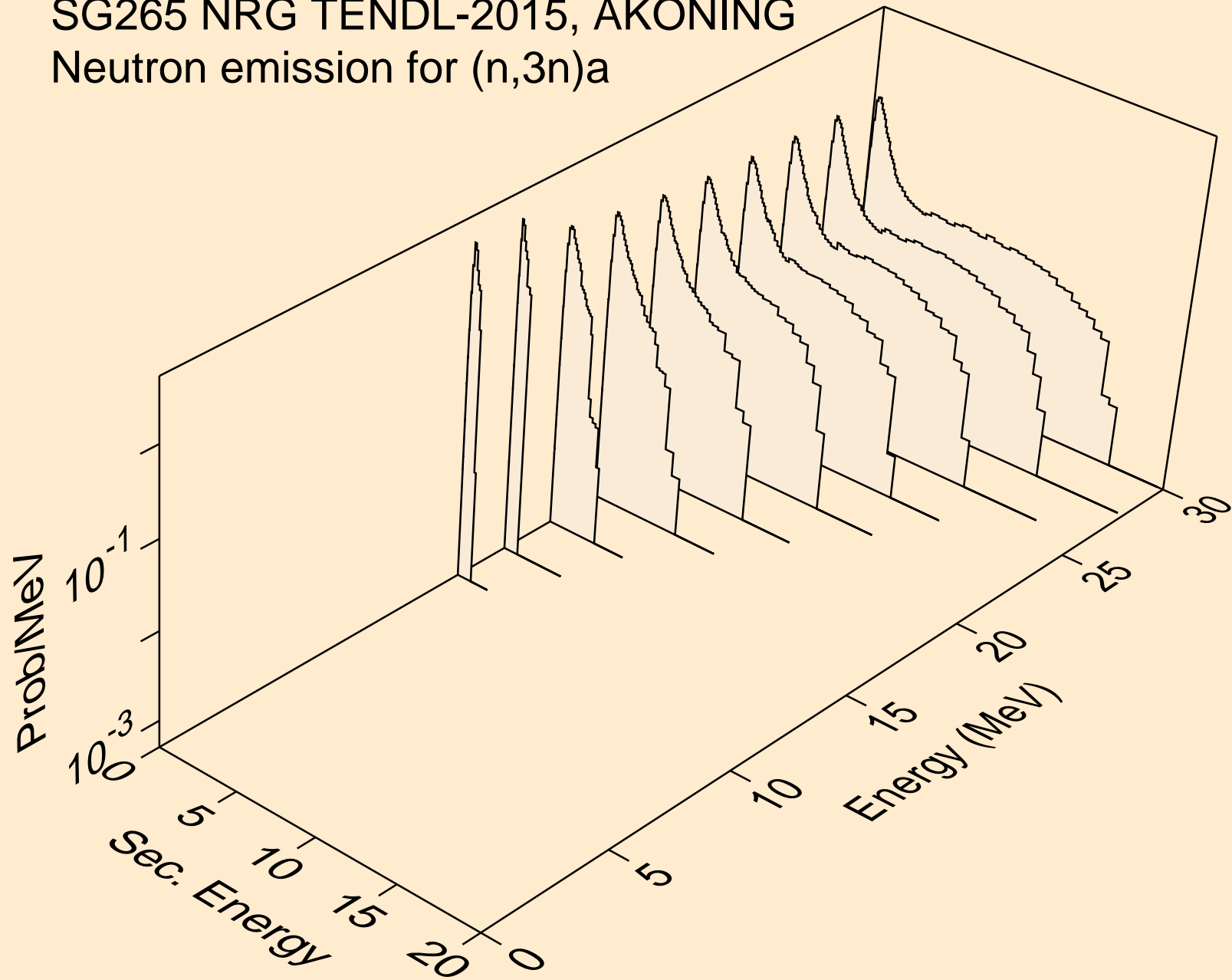

SG265 NRG TENDL-2015, AKONING
Neutron emission for (n,n*)p

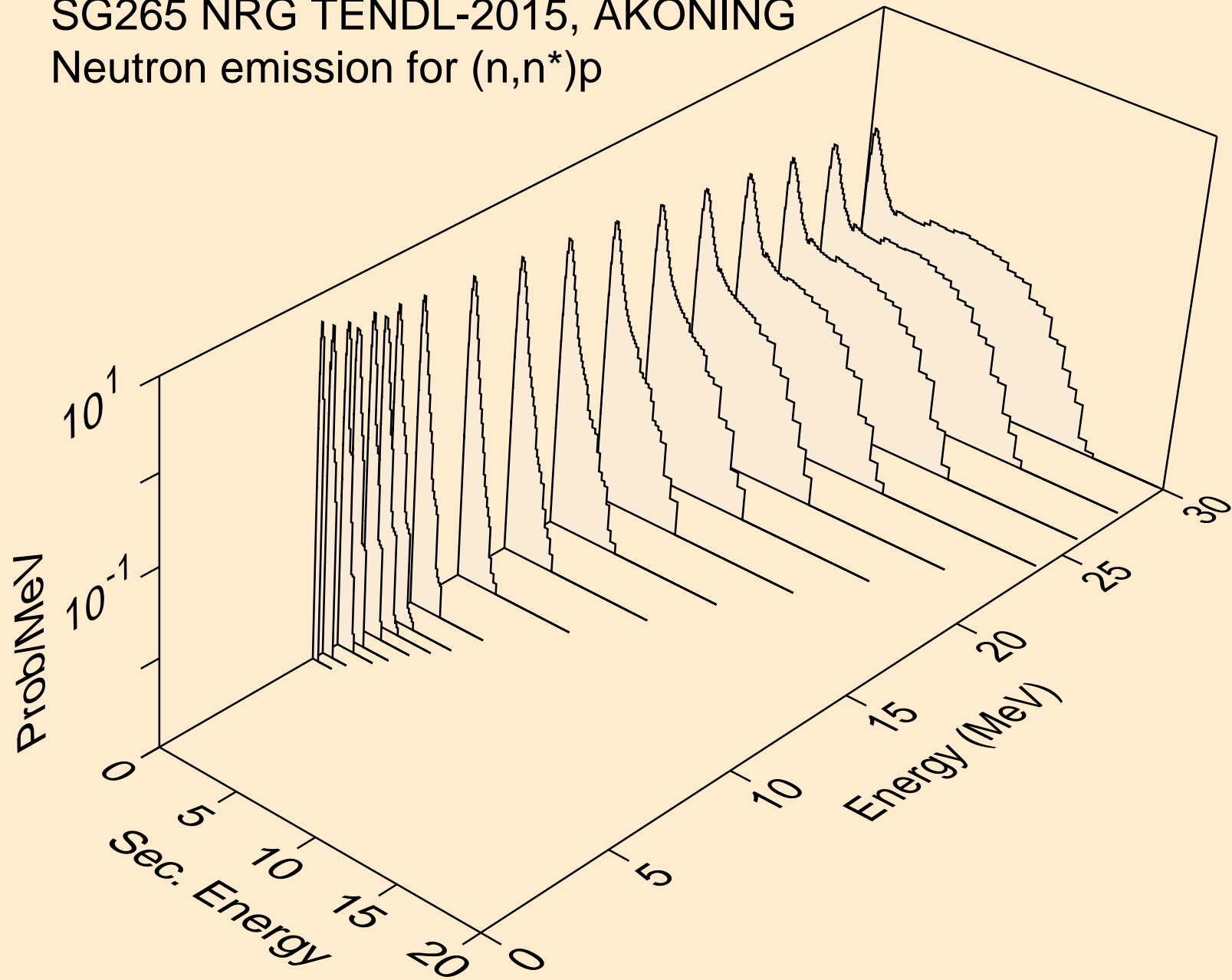

SG265 NRG TENDL-2015, AKONING
Neutron emission for (n,n*)2a

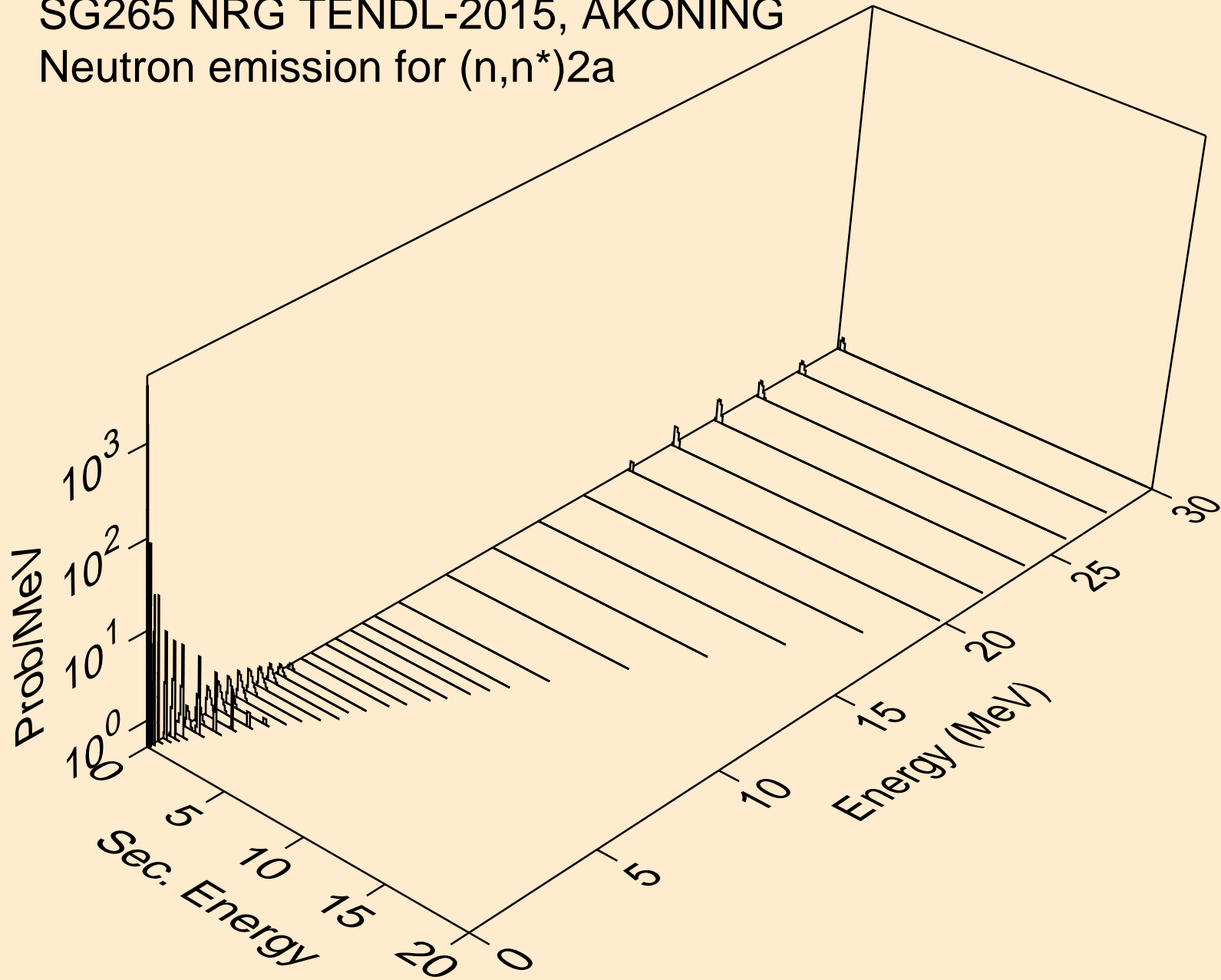

SG265 NRG TENDL-2015, AKONING
Neutron emission for (n,2n)2a

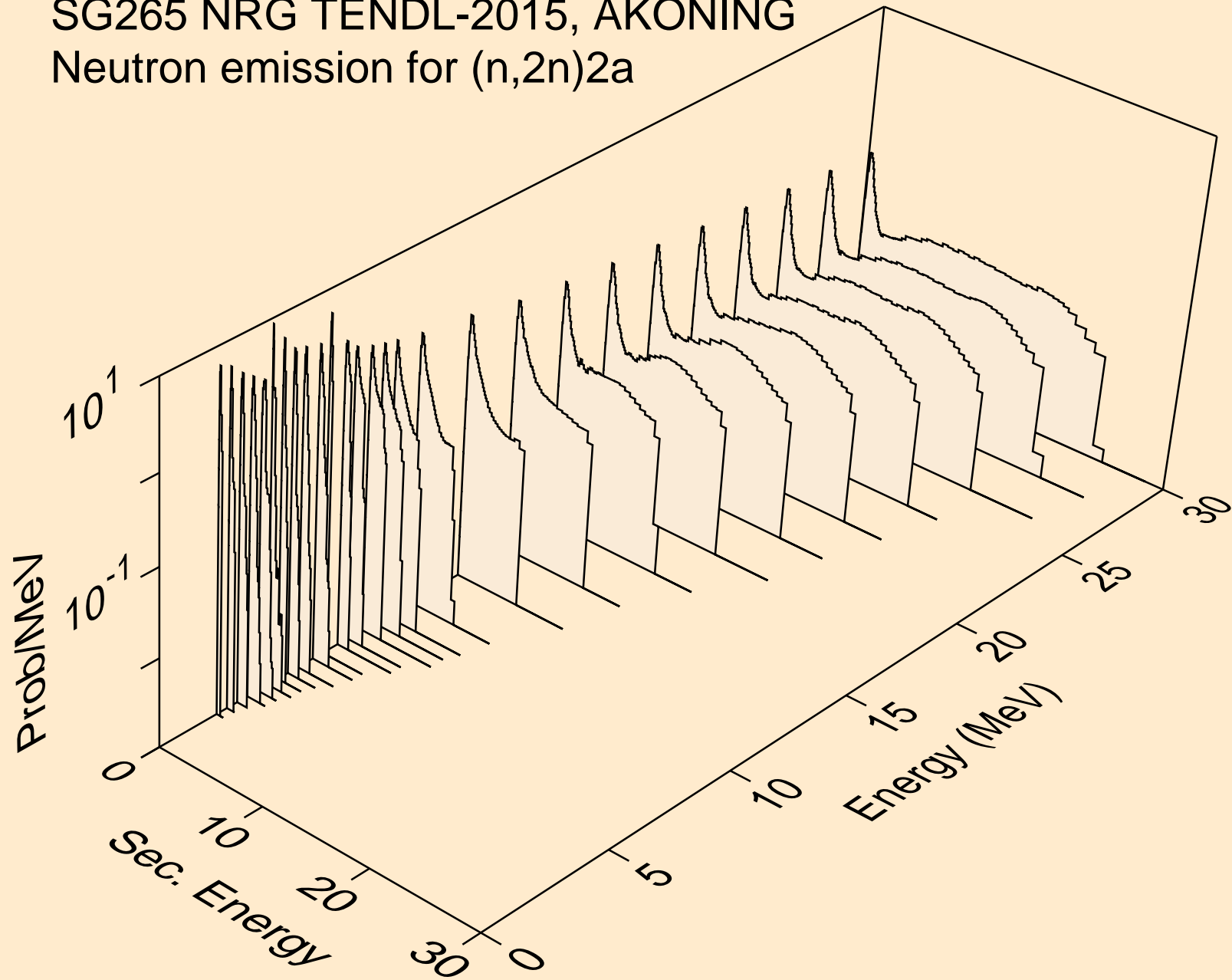

SG265 NRG TENDL-2015, AKONING
Neutron emission for (n,n*)d

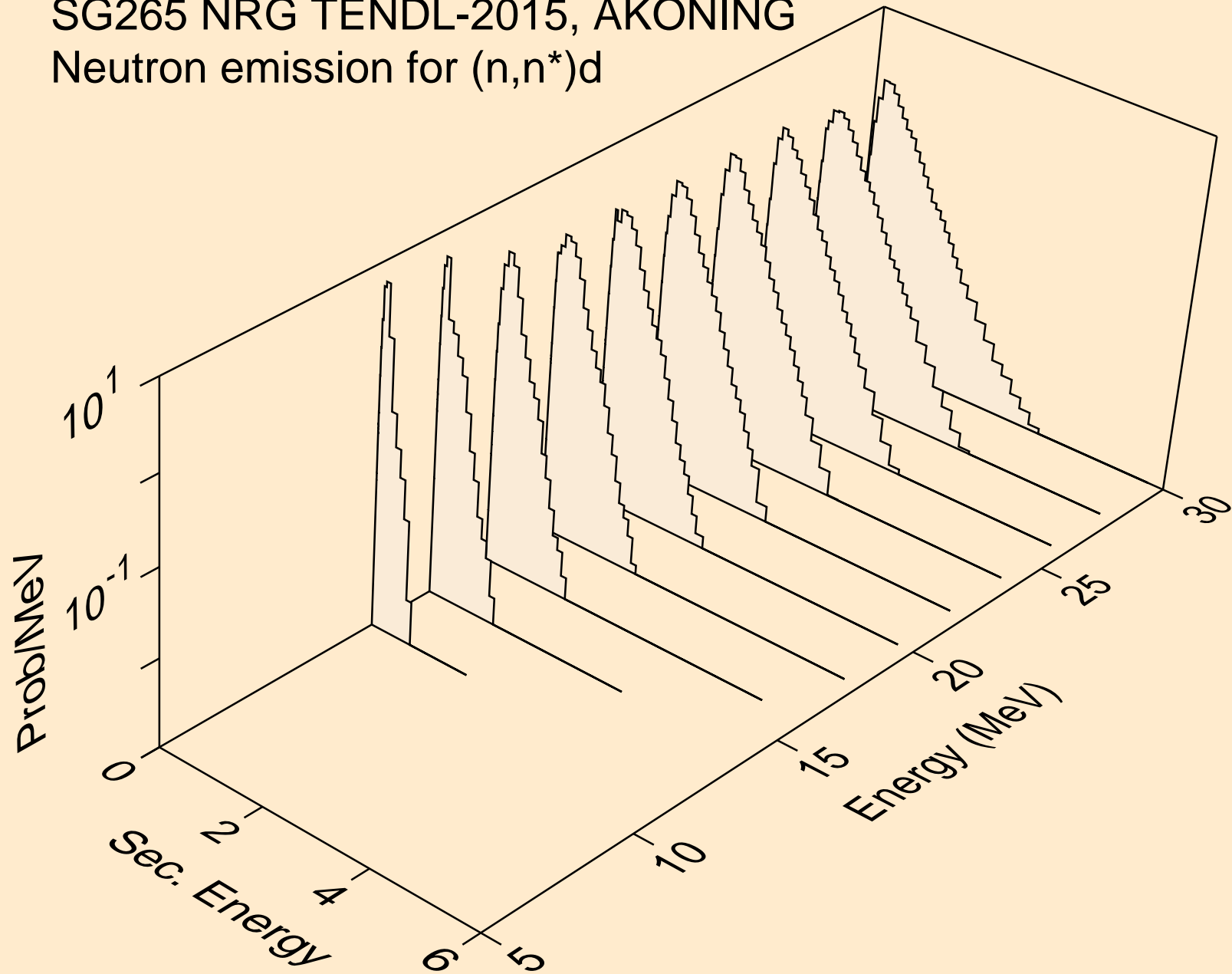

SG265 NRG TENDL-2015, AKONING
Neutron emission for (n,n*)t

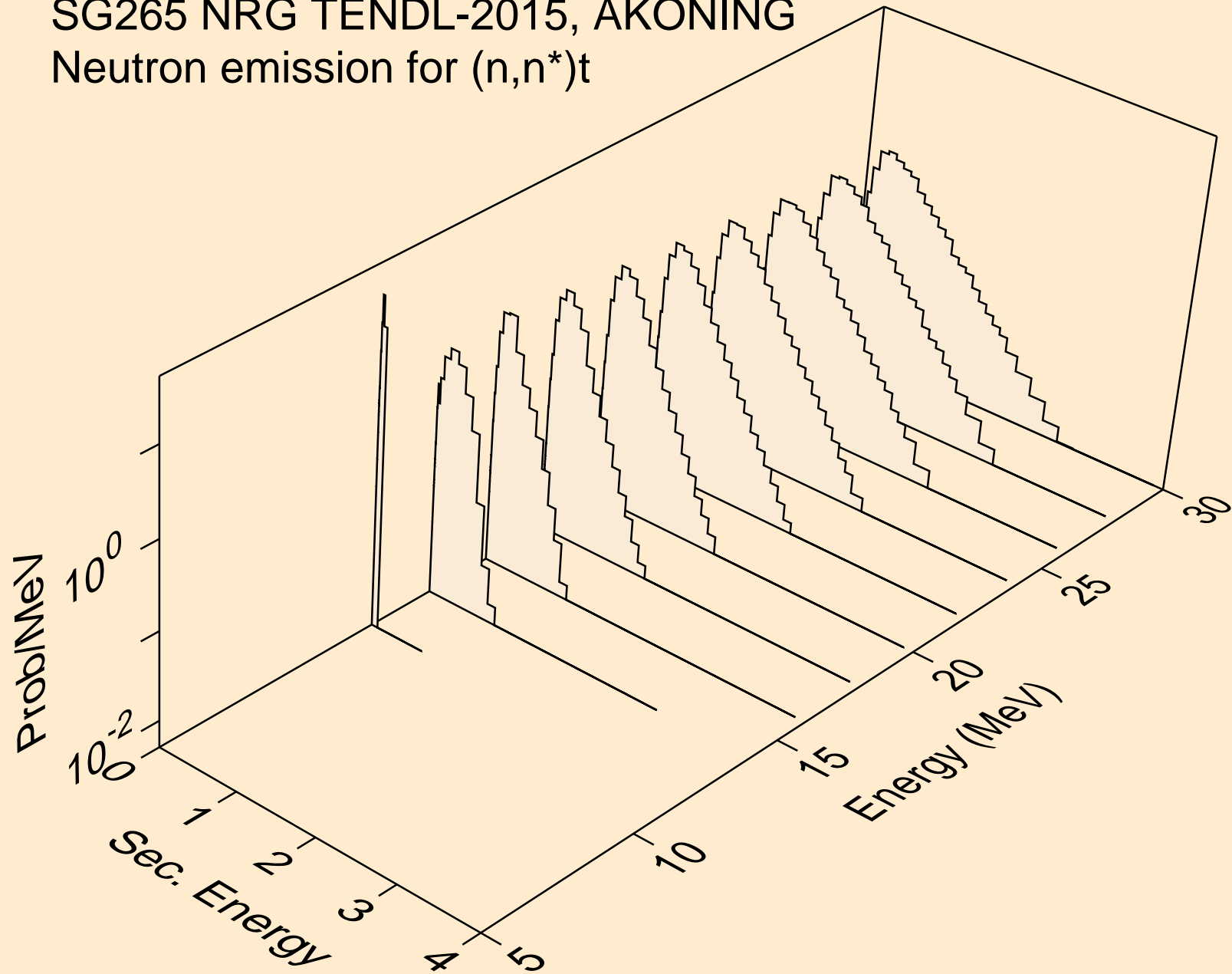

SG265 NRG TENDL-2015, AKONING
Neutron emission for (n,n*)he3

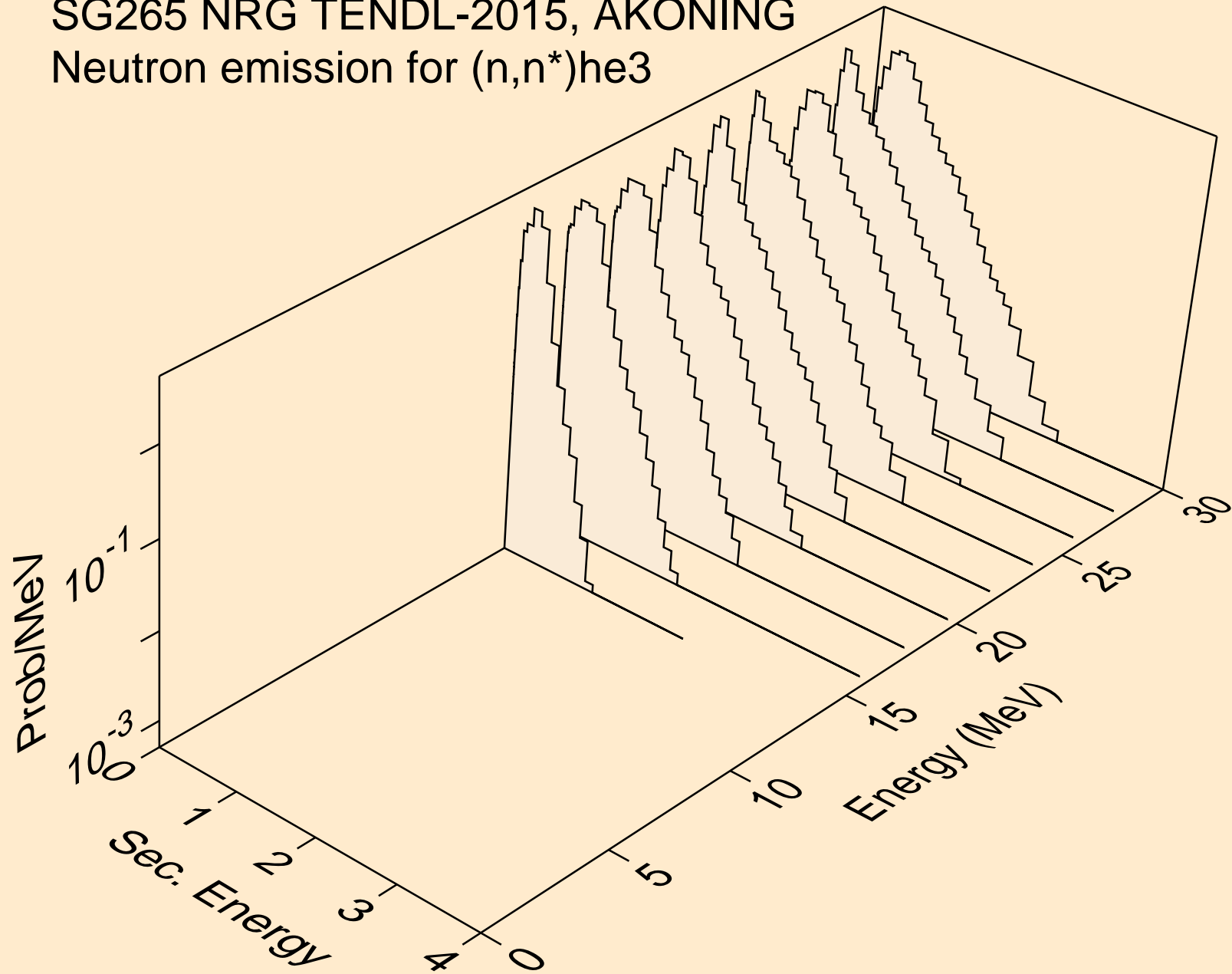

SG265 NRG TENDL-2015, AKONING
Neutron emission for (n,n*)d2a

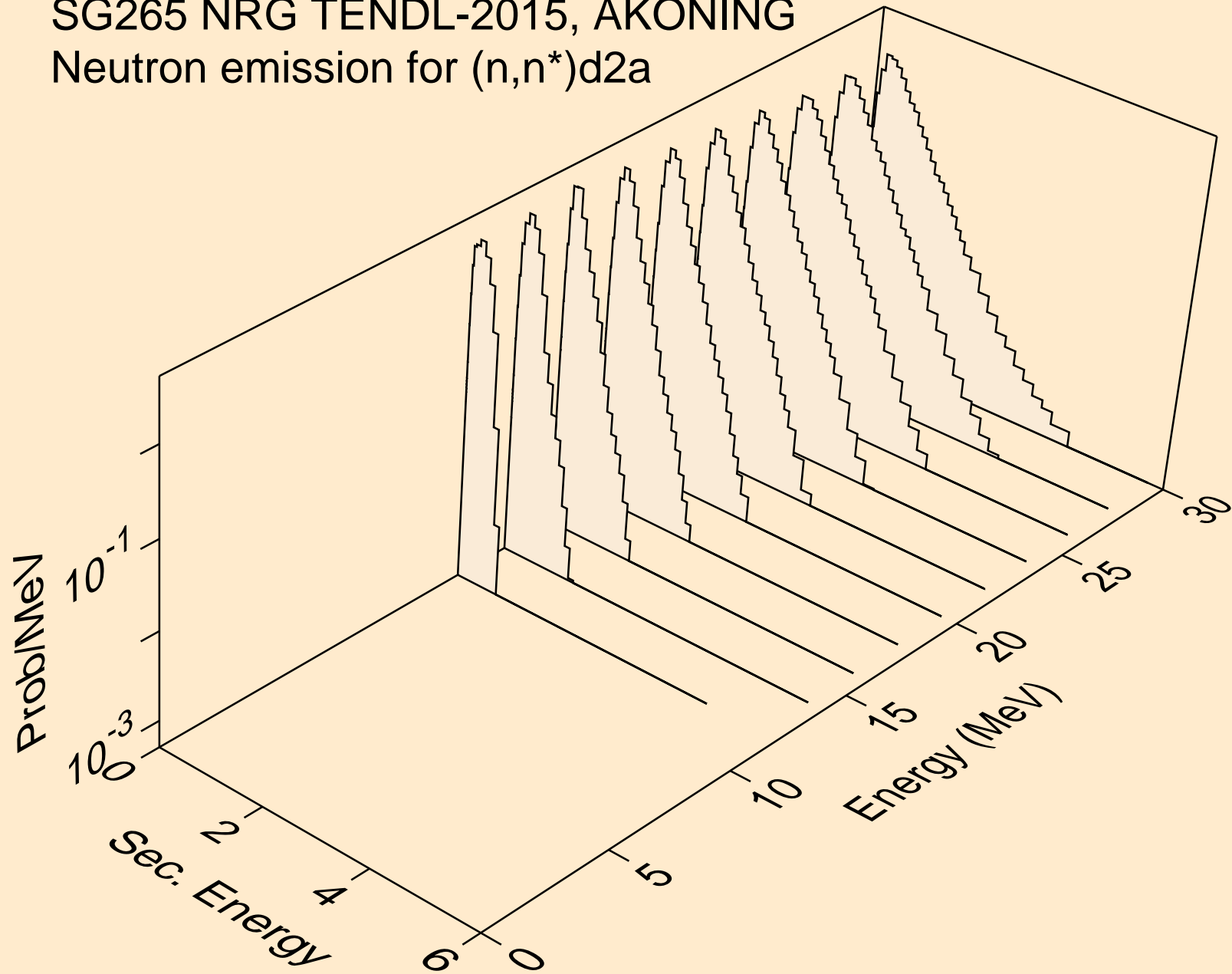

SG265 NRG TENDL-2015, AKONING
Neutron emission for (n,n*)t2a

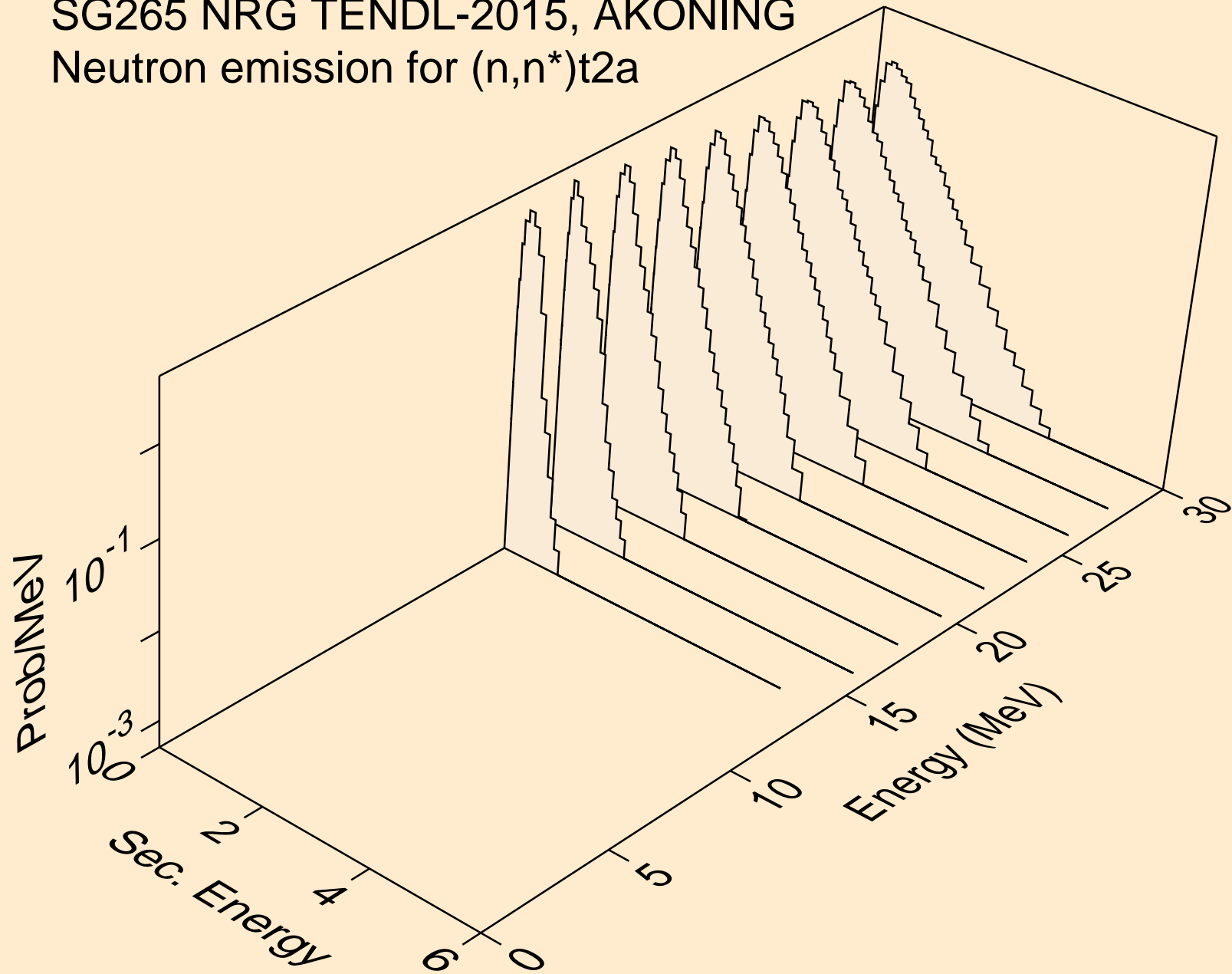

SG265 NRG TENDL-2015, AKONING
Neutron emission for (n,4n)

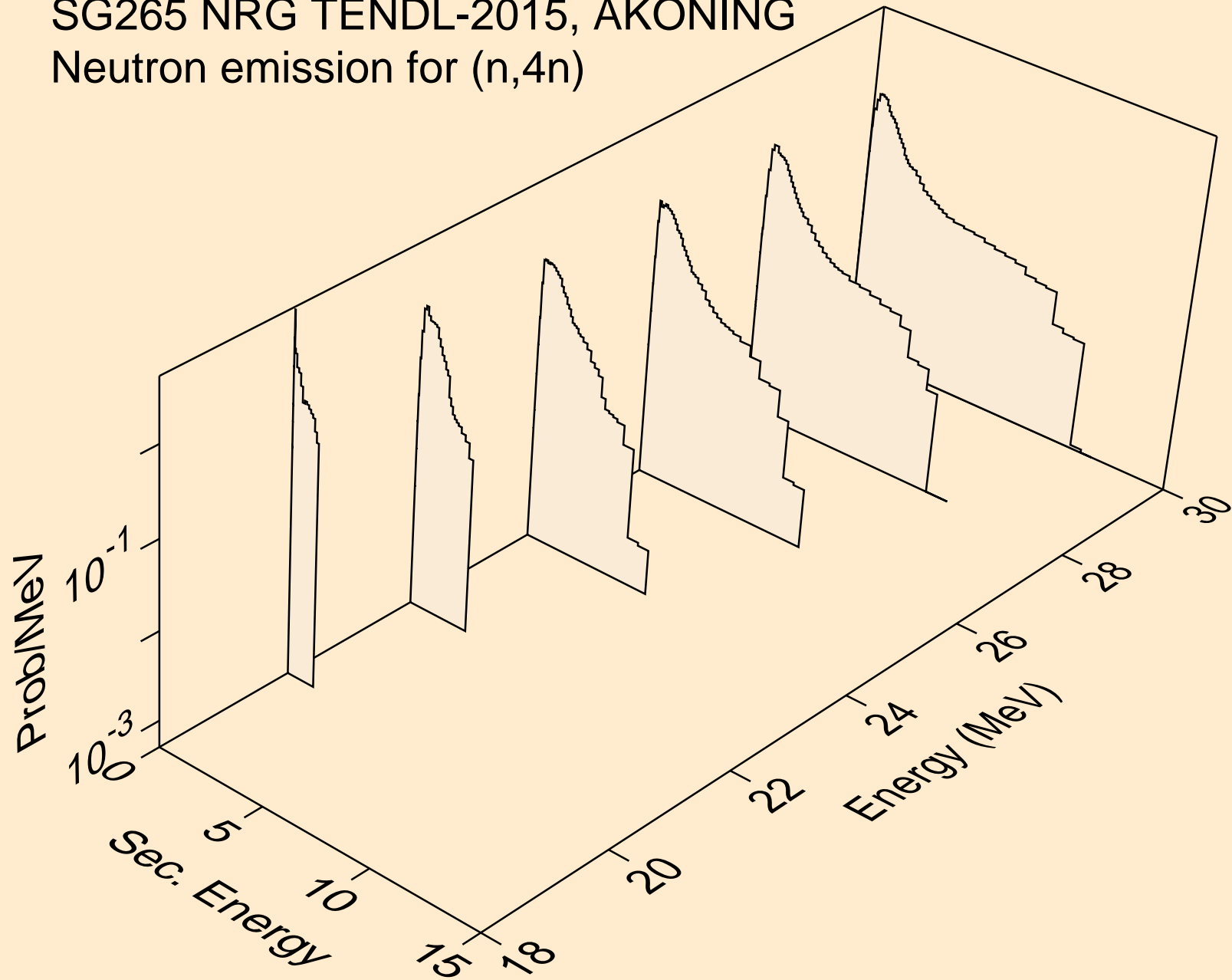

SG265 NRG TENDL-2015, AKONING
Neutron emission for (n,2np)

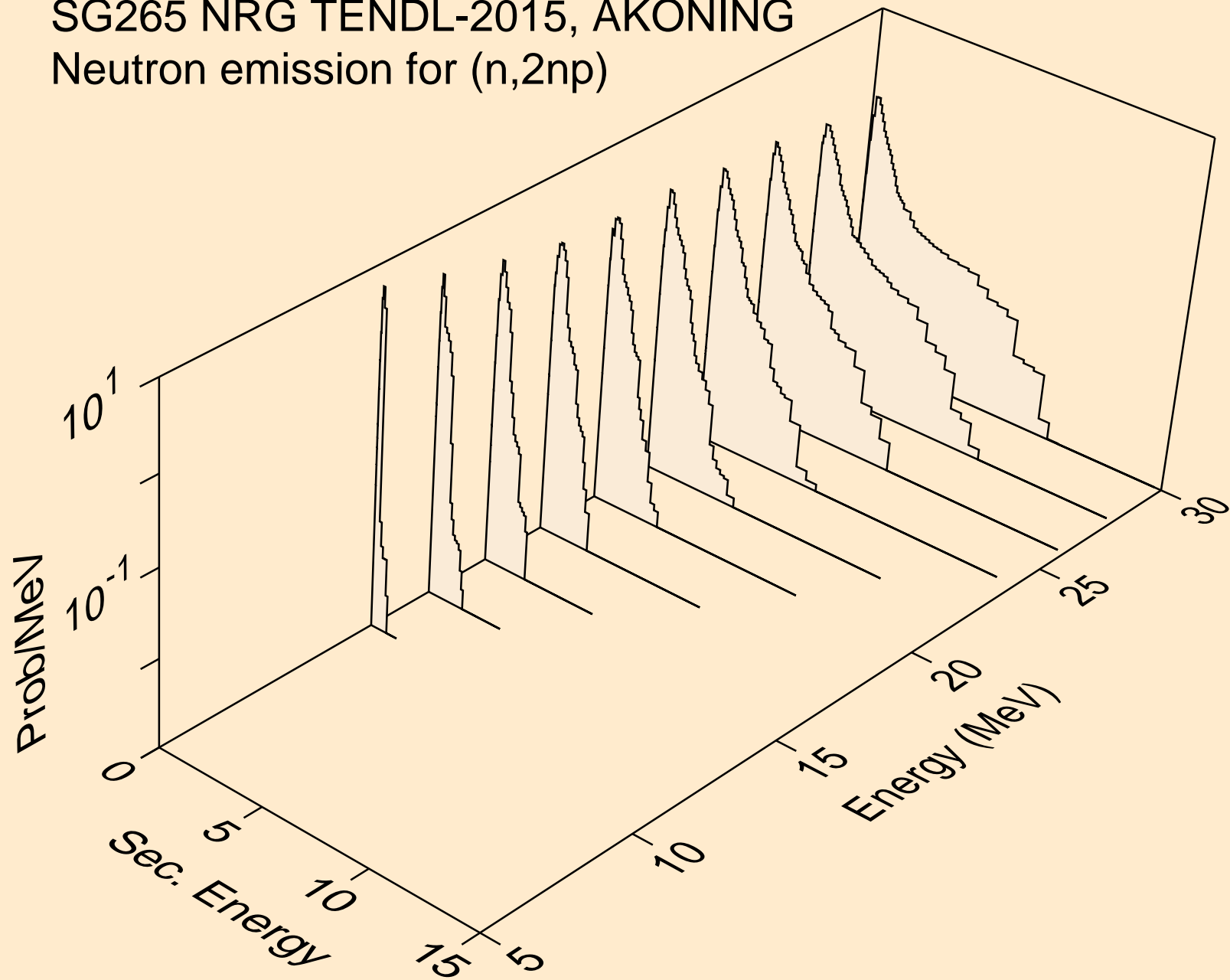

SG265 NRG TENDL-2015, AKONING
Neutron emission for (n,3np)

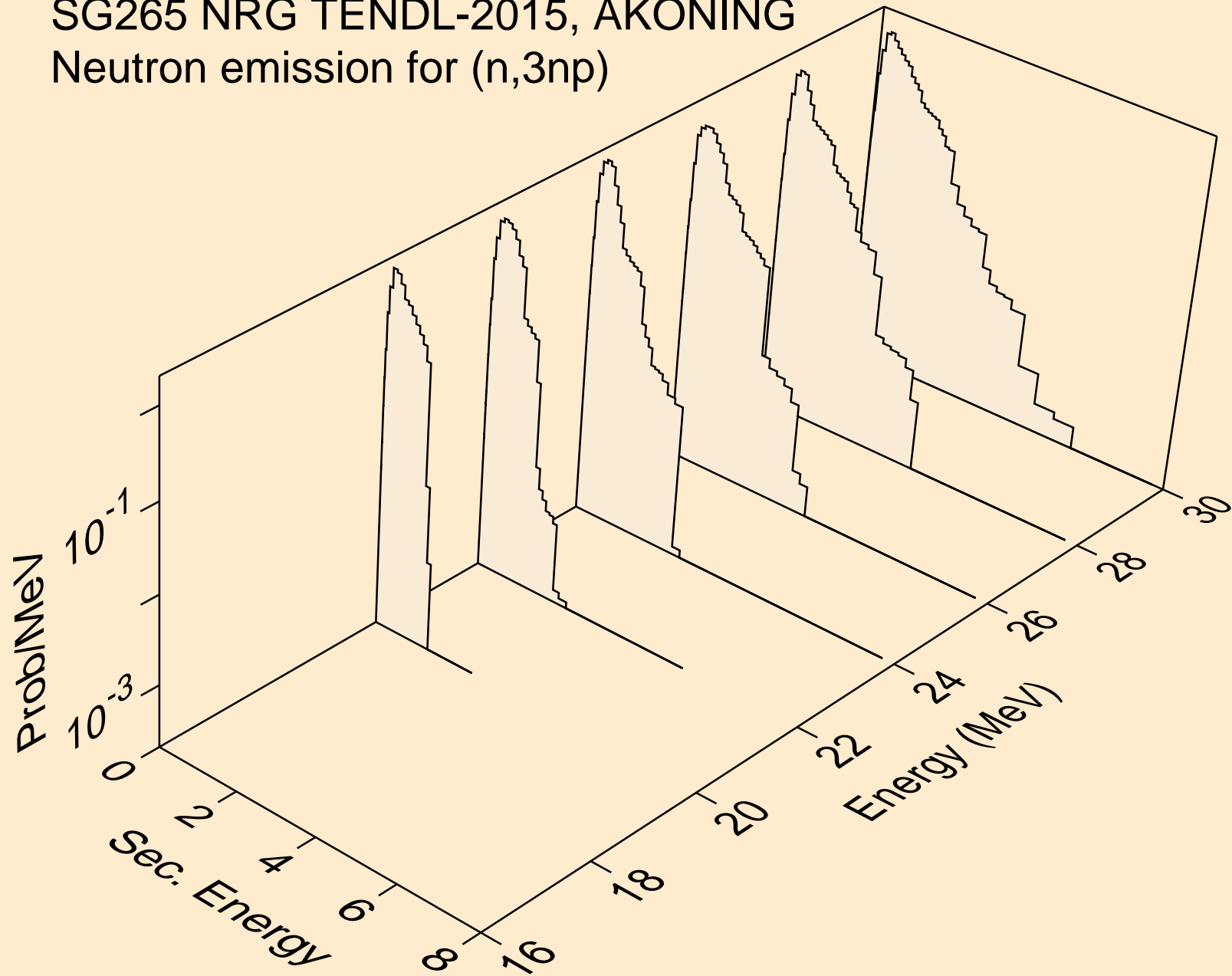

SG265 NRG TENDL-2015, AKONING
Neutron emission for (n,2np)

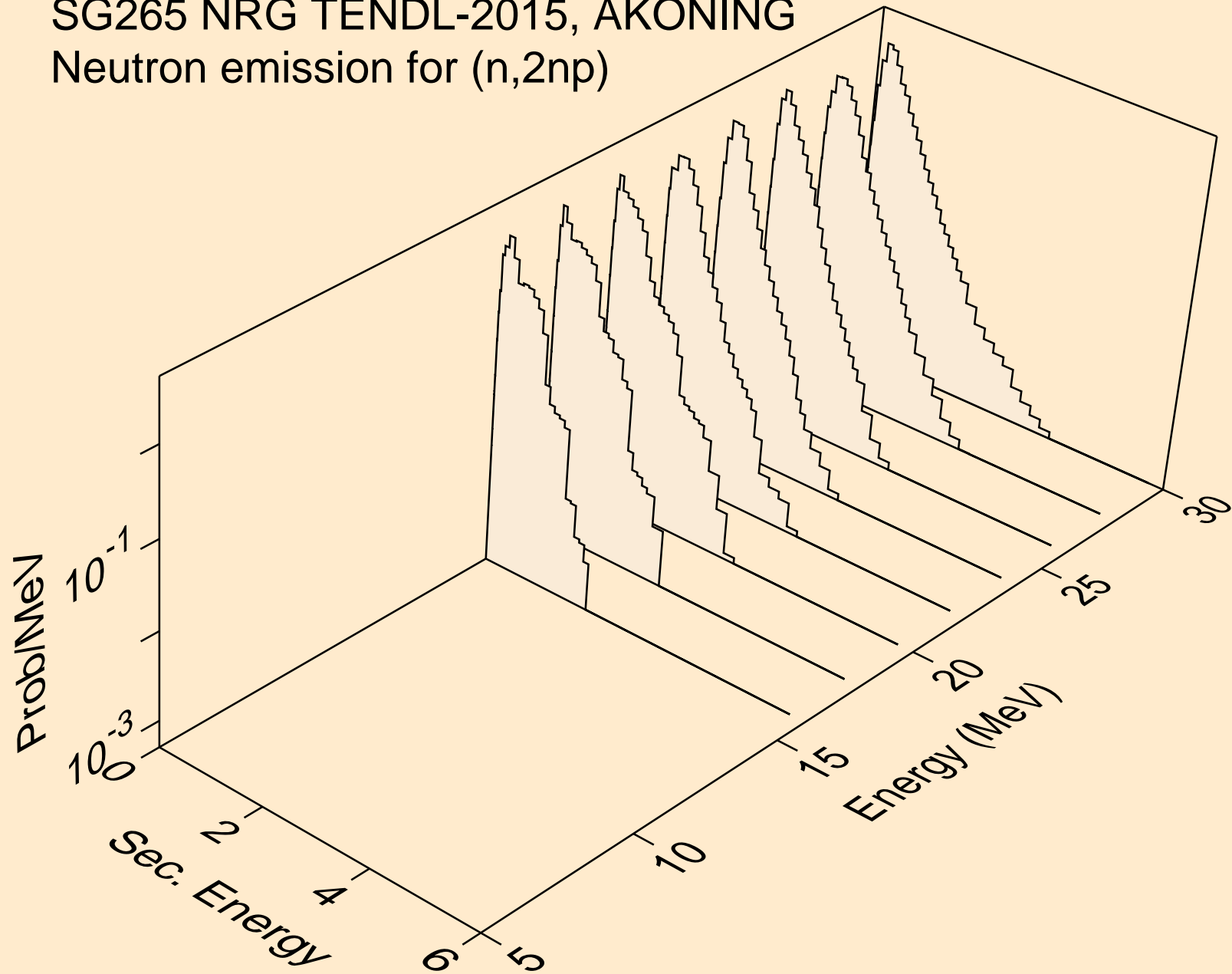

SG265 NRG TENDL-2015, AKONING
Neutron emission for (n,npa)

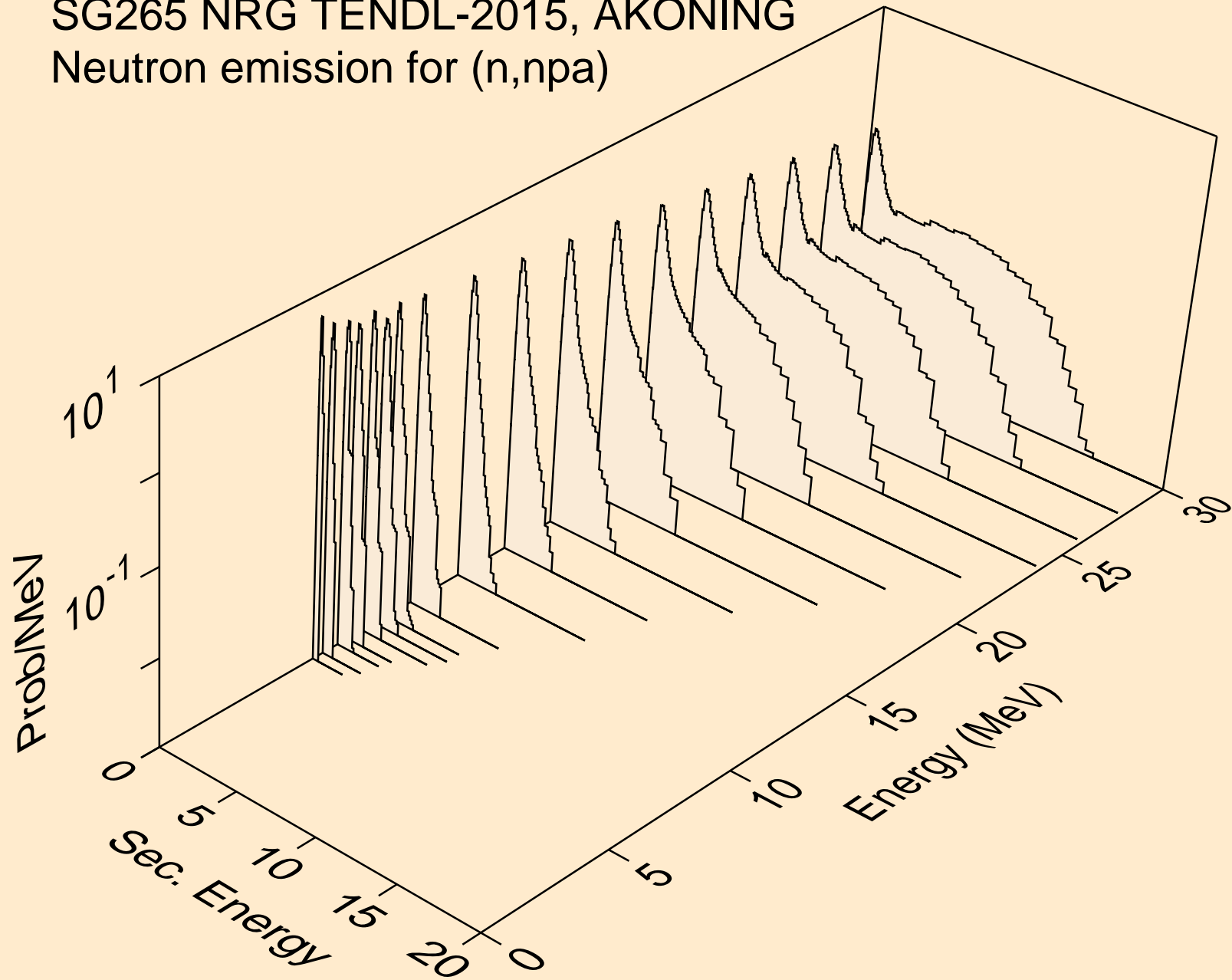

SG265 NRG TENDL-2015, AKONING
Neutron emission for (n,n*c)

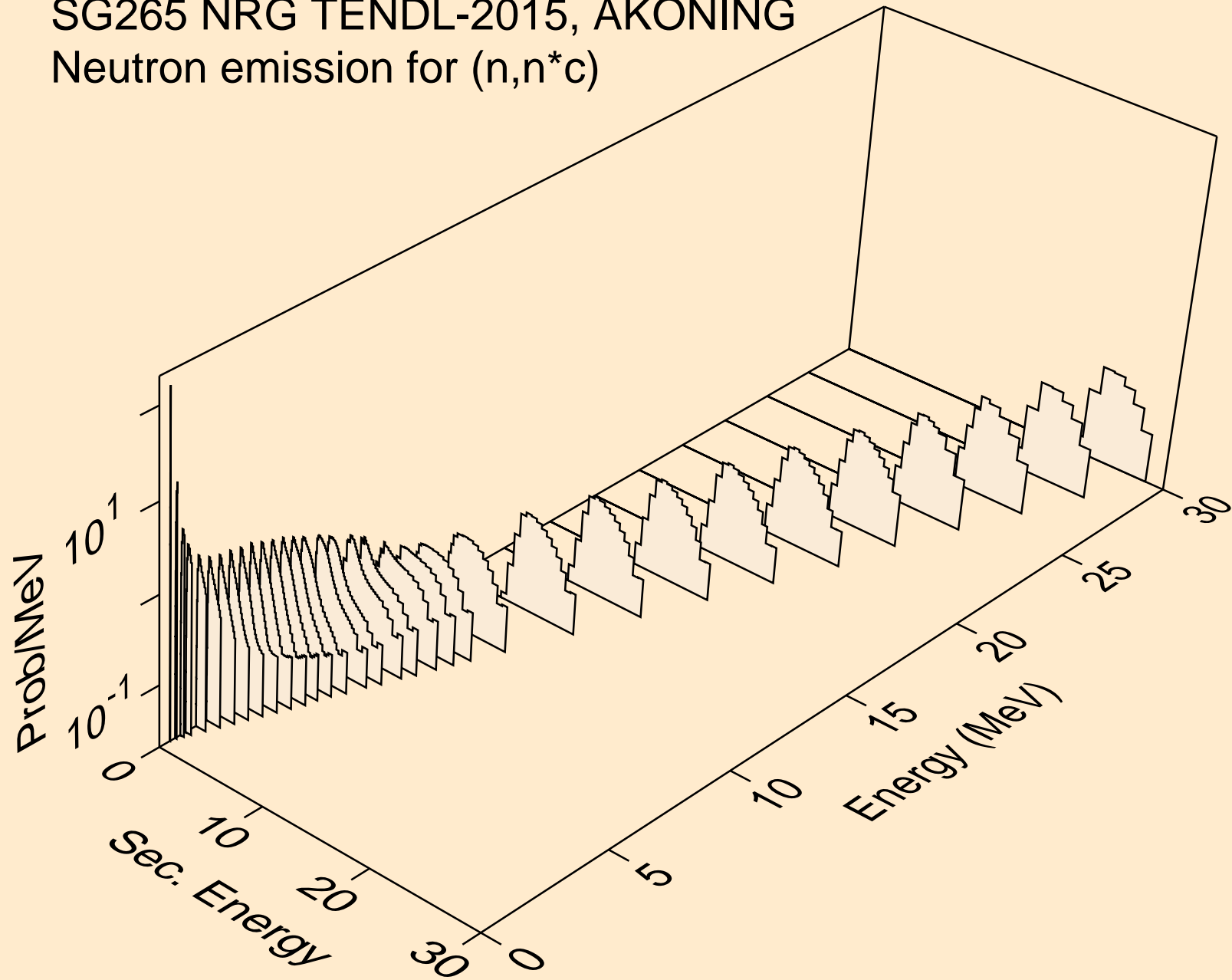

SG265 NRG TENDL-2015, AKONING

Delayed nubar

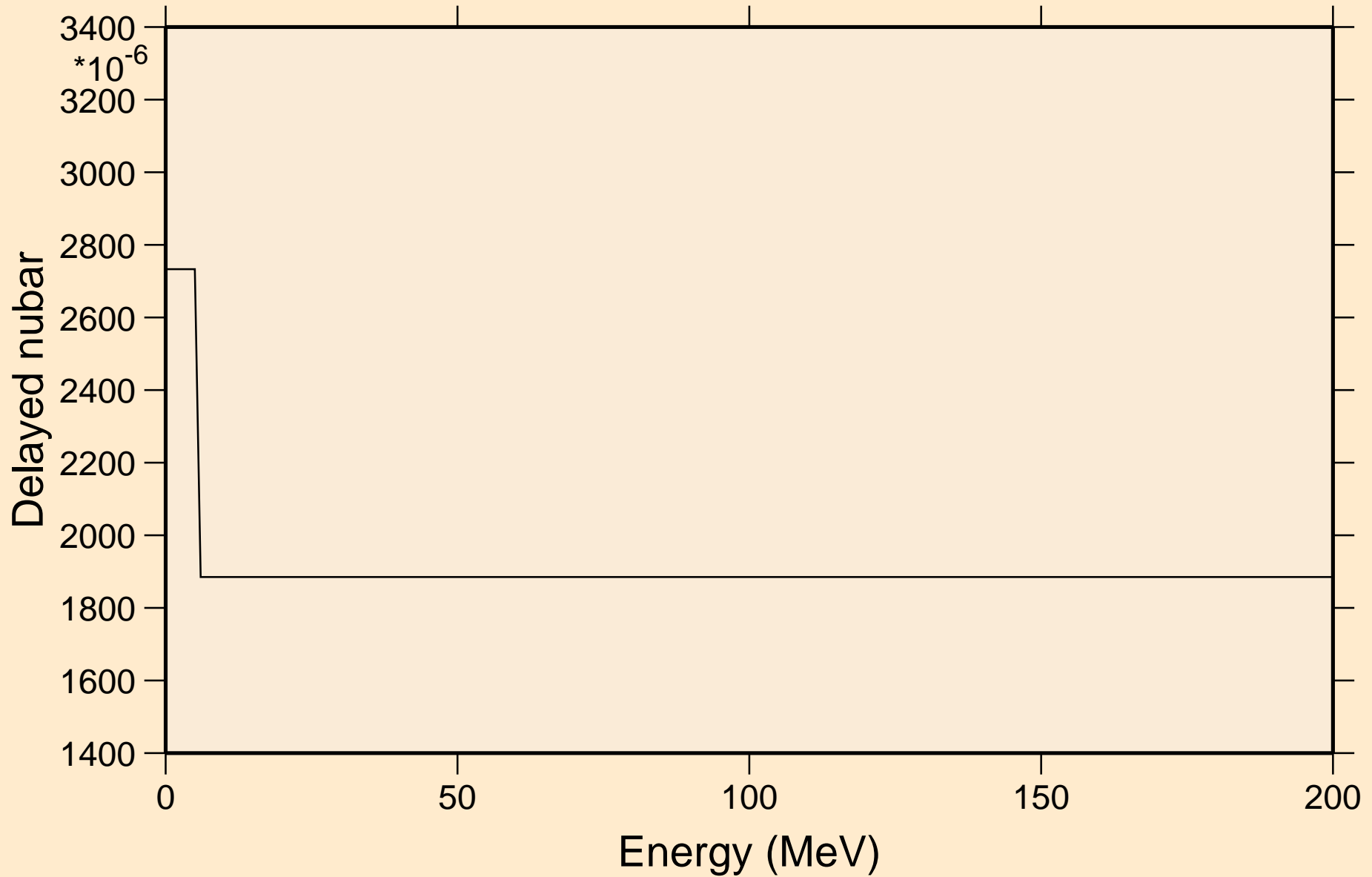

SG265 NRG TENDL-2015, AKONING

Delayed neutron spectra

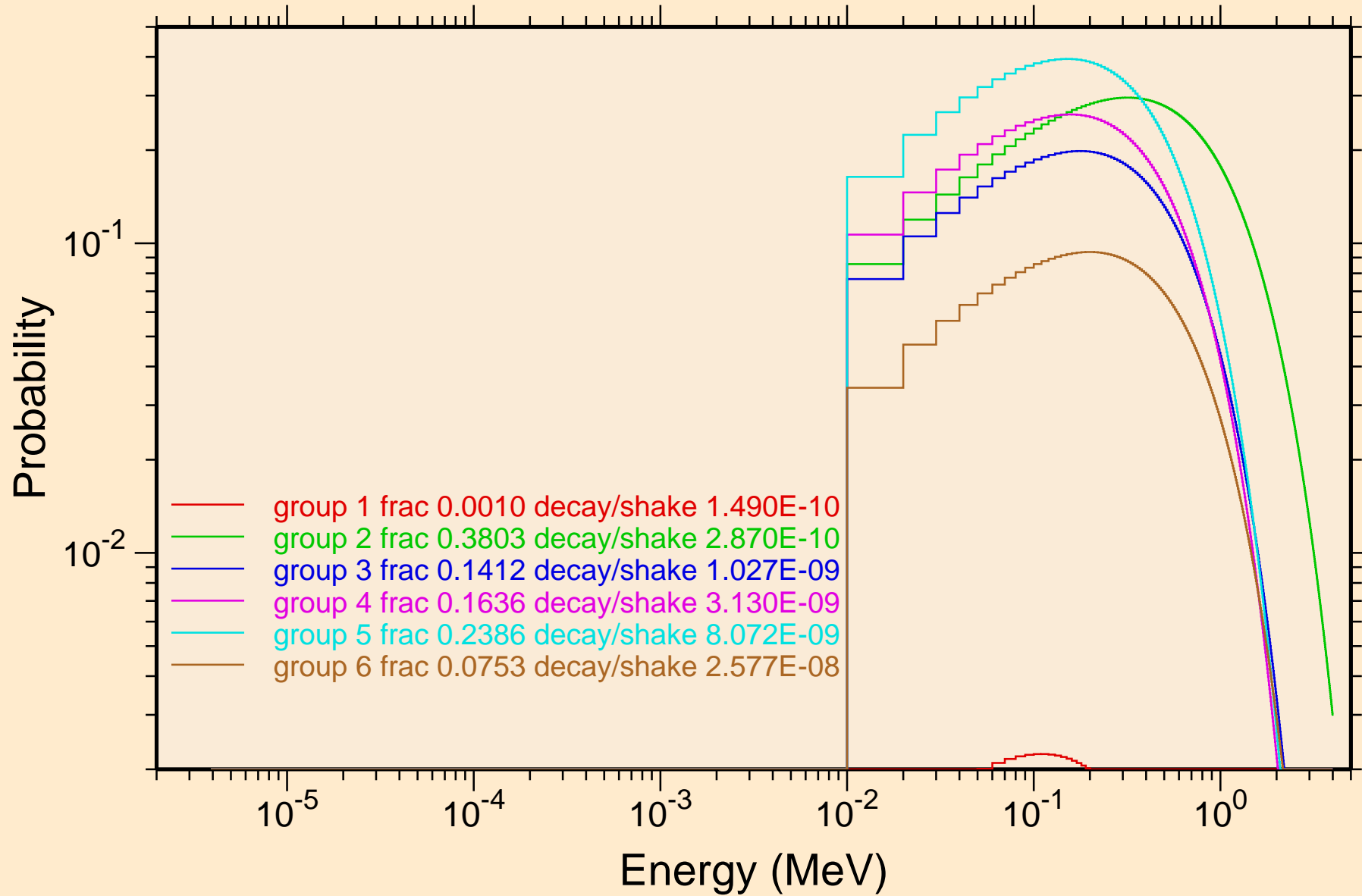

SG265 NRG TENDL-2015, AKONING
Photon emission for (n,x)

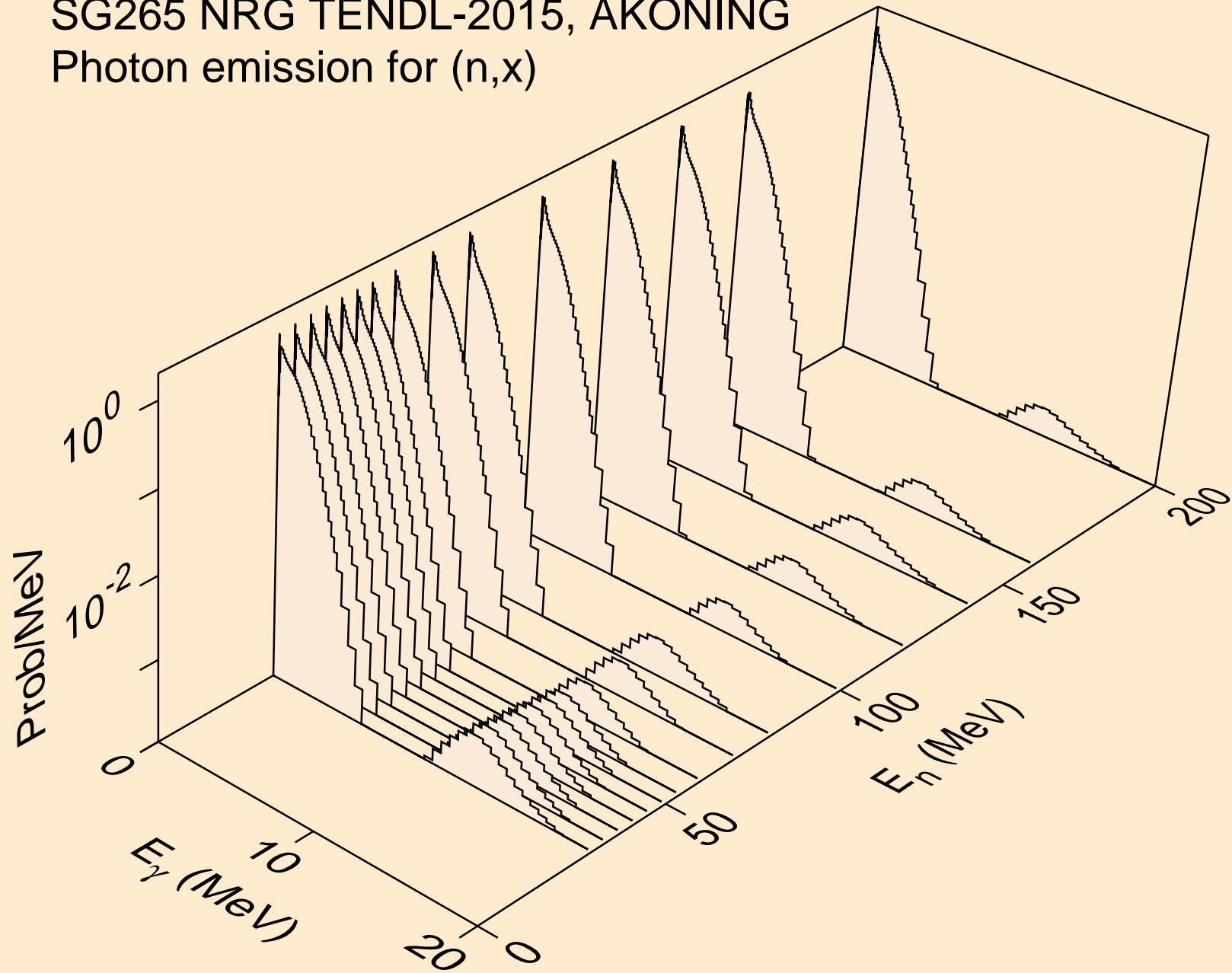

SG265 NRG TENDL-2015, AKONING
Photon emission for (n,2nd)

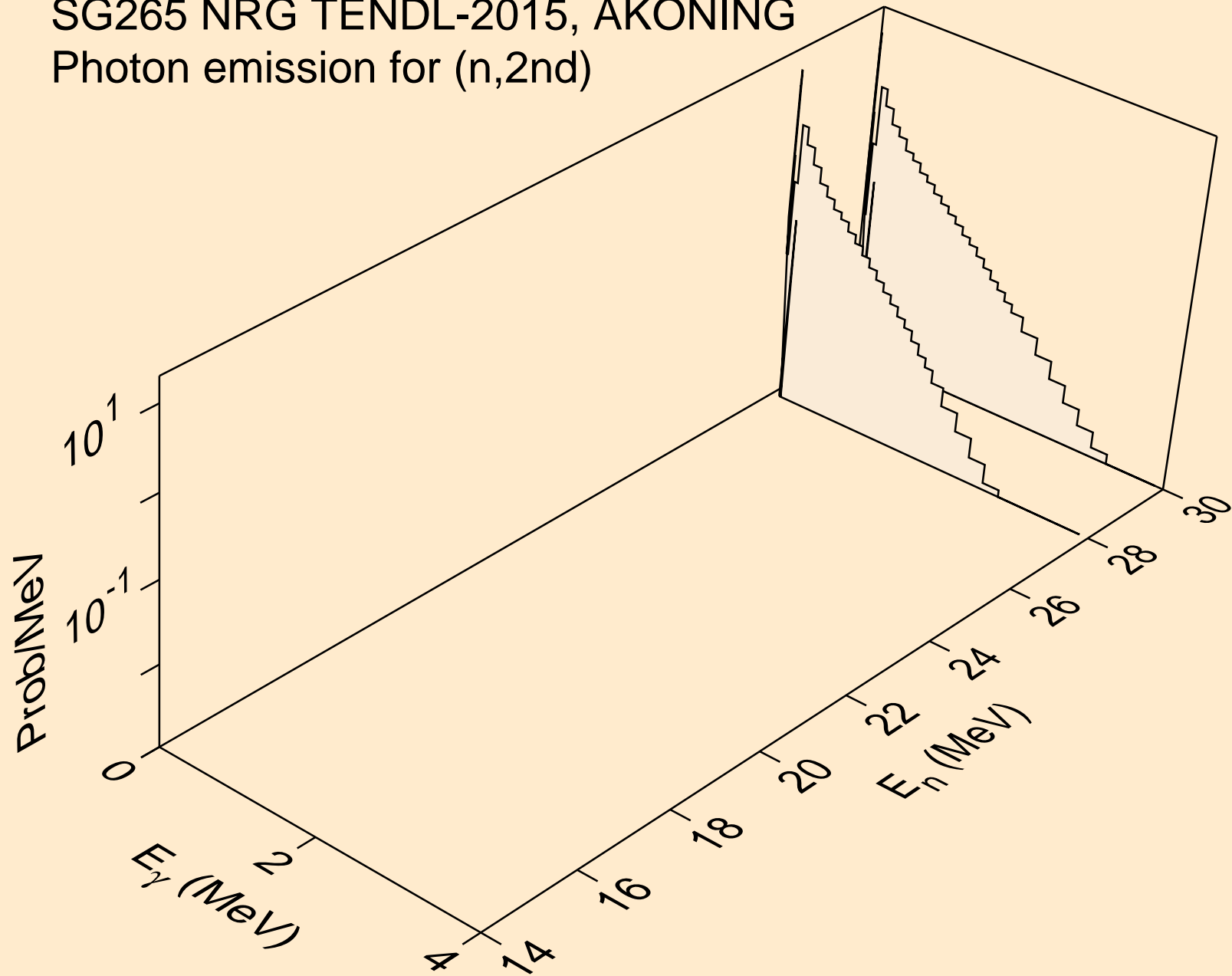

SG265 NRG TENDL-2015, AKONING
Photon emission for (n,2n)

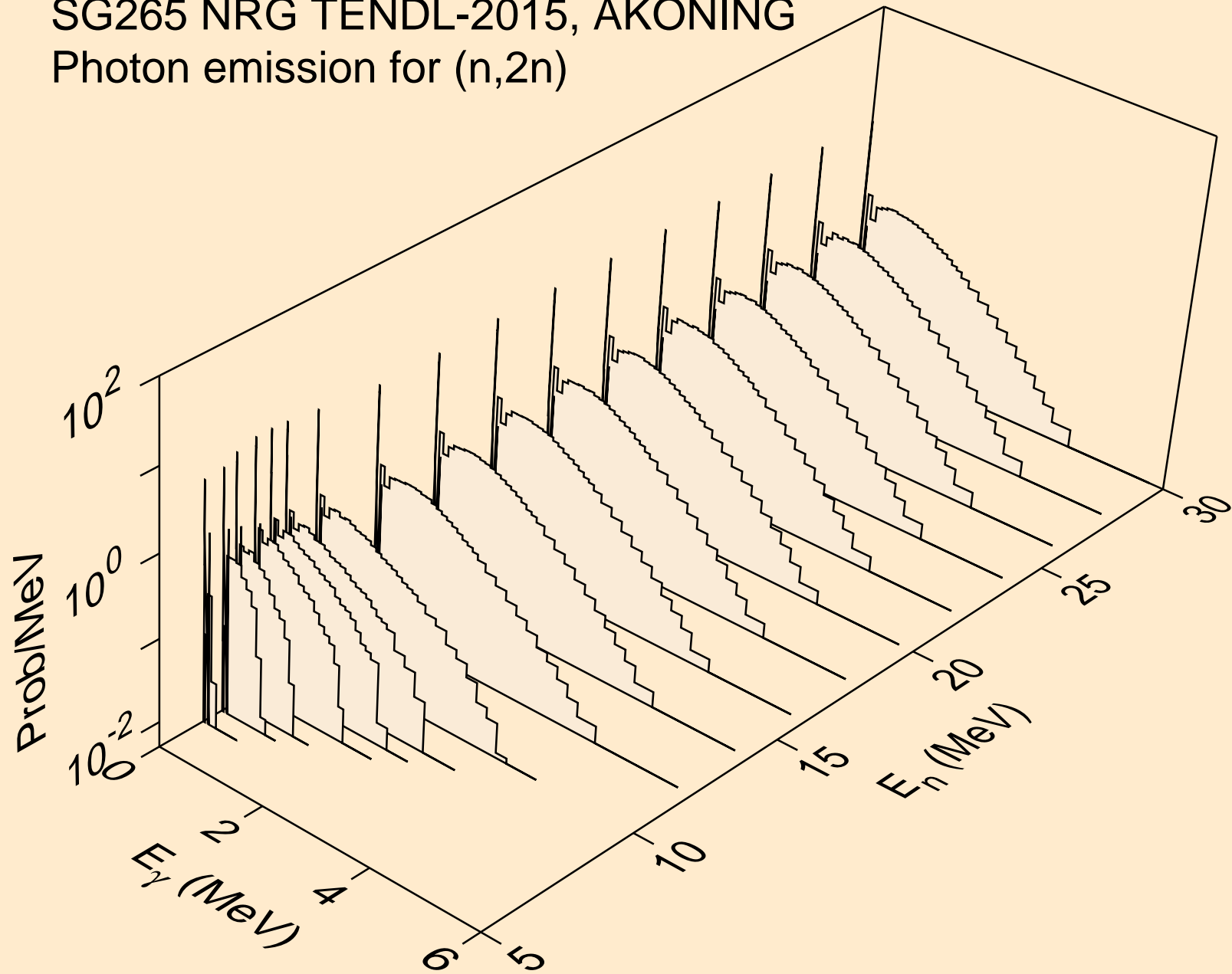

SG265 NRG TENDL-2015, AKONING
Photon emission for (n,3n)

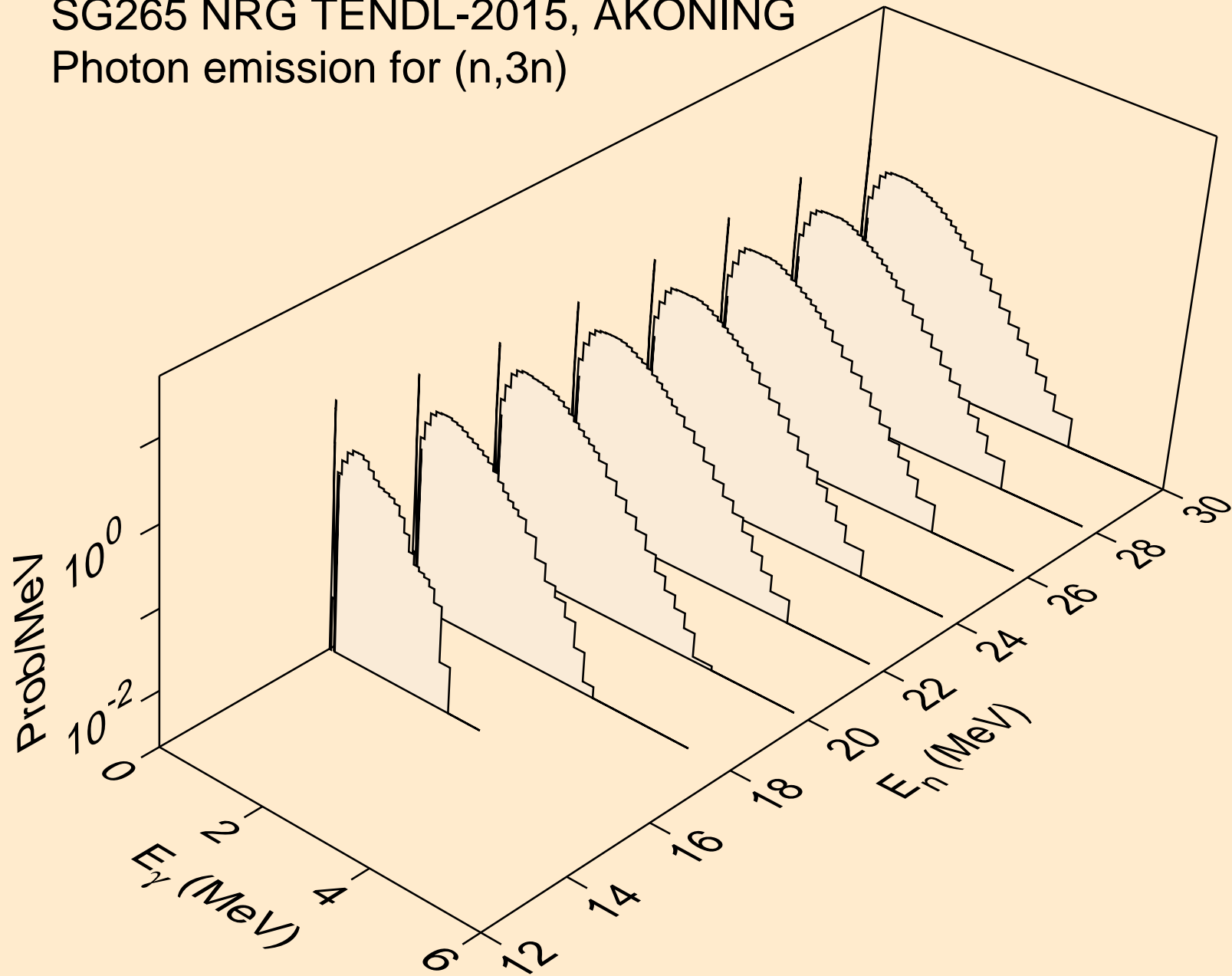

SG265 NRG TENDL-2015, AKONING
Photon emission for (n,n*)a

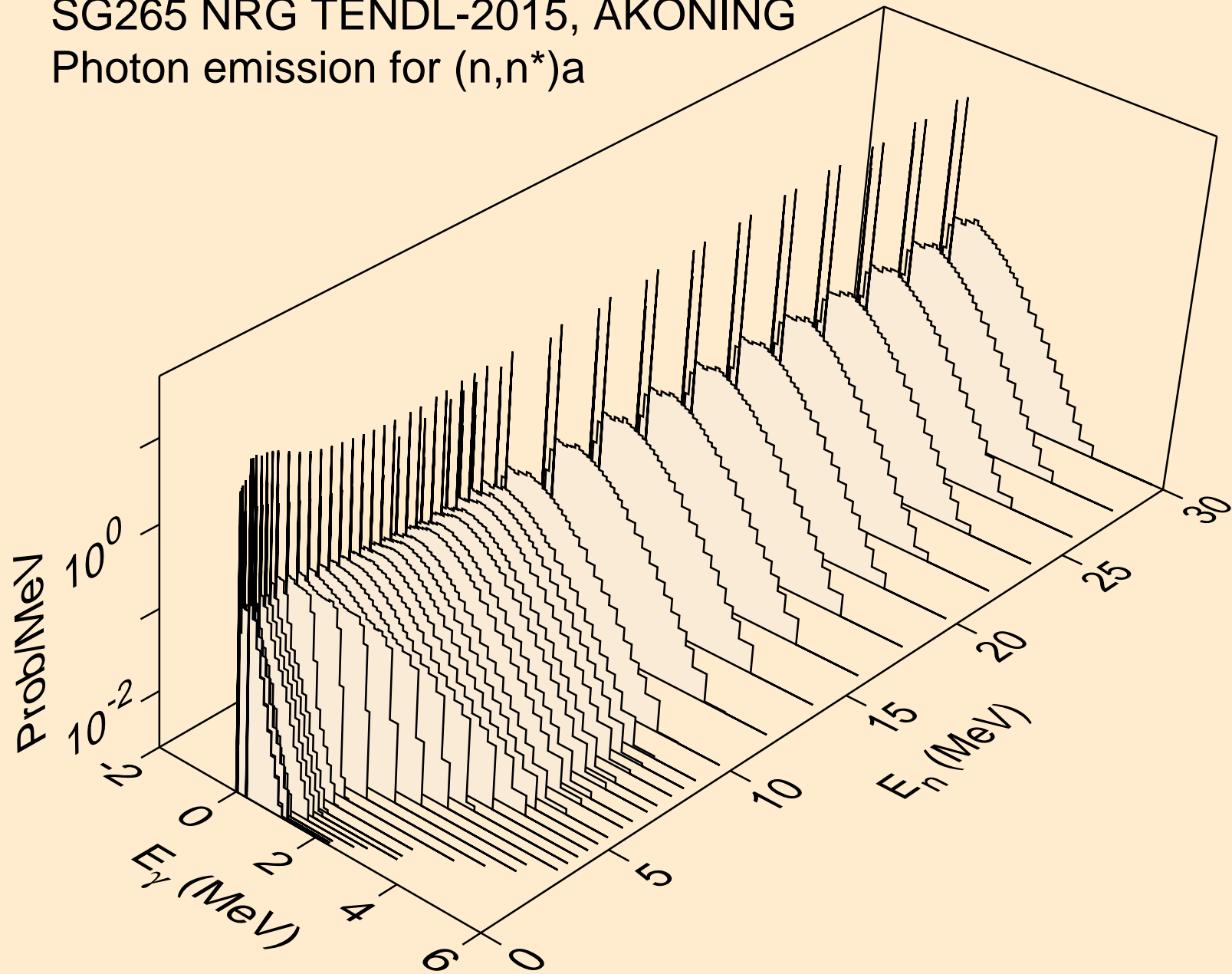

SG265 NRG TENDL-2015, AKONING
Photon emission for (n,n*)3a

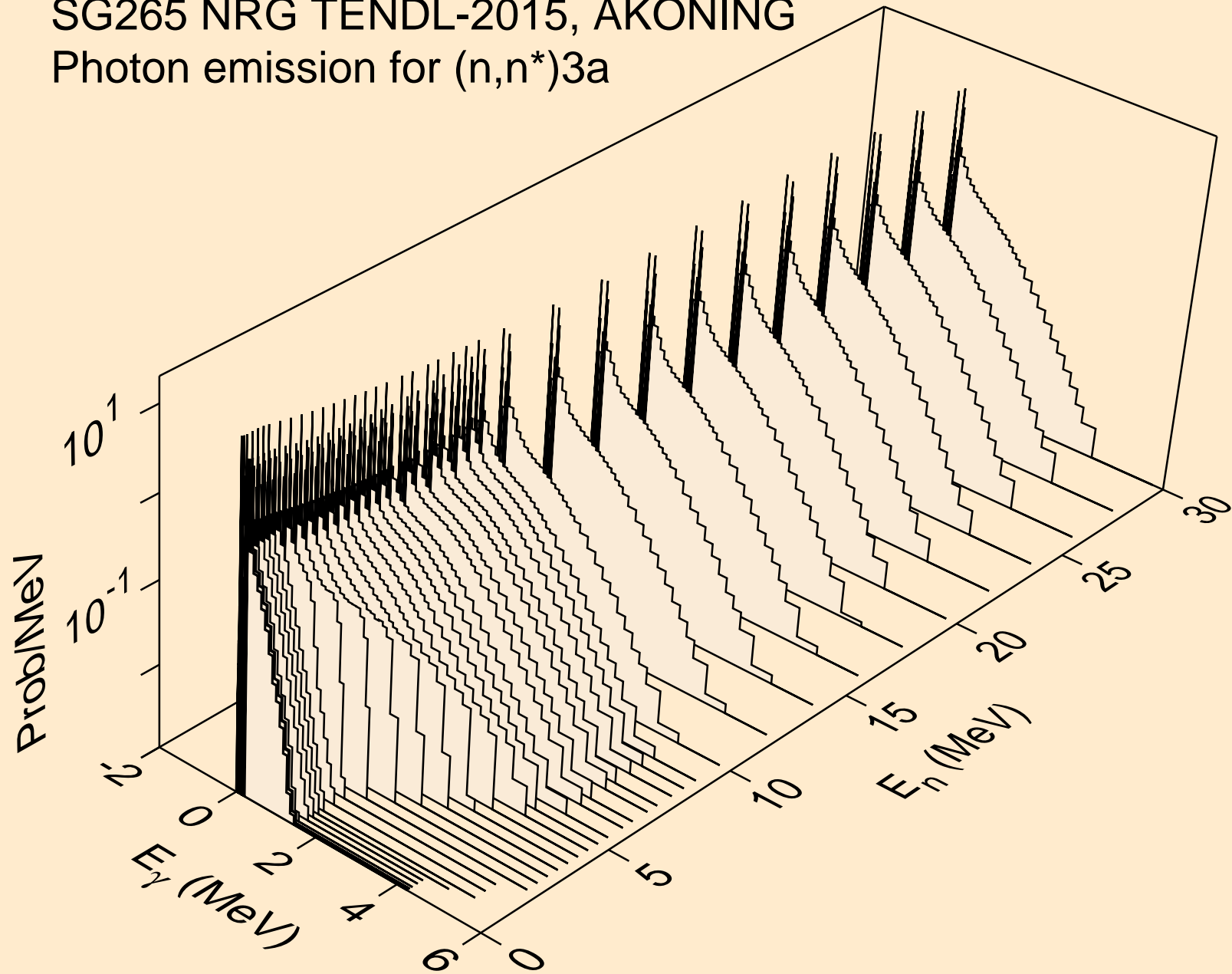

SG265 NRG TENDL-2015, AKONING
Photon emission for (n,2n)a

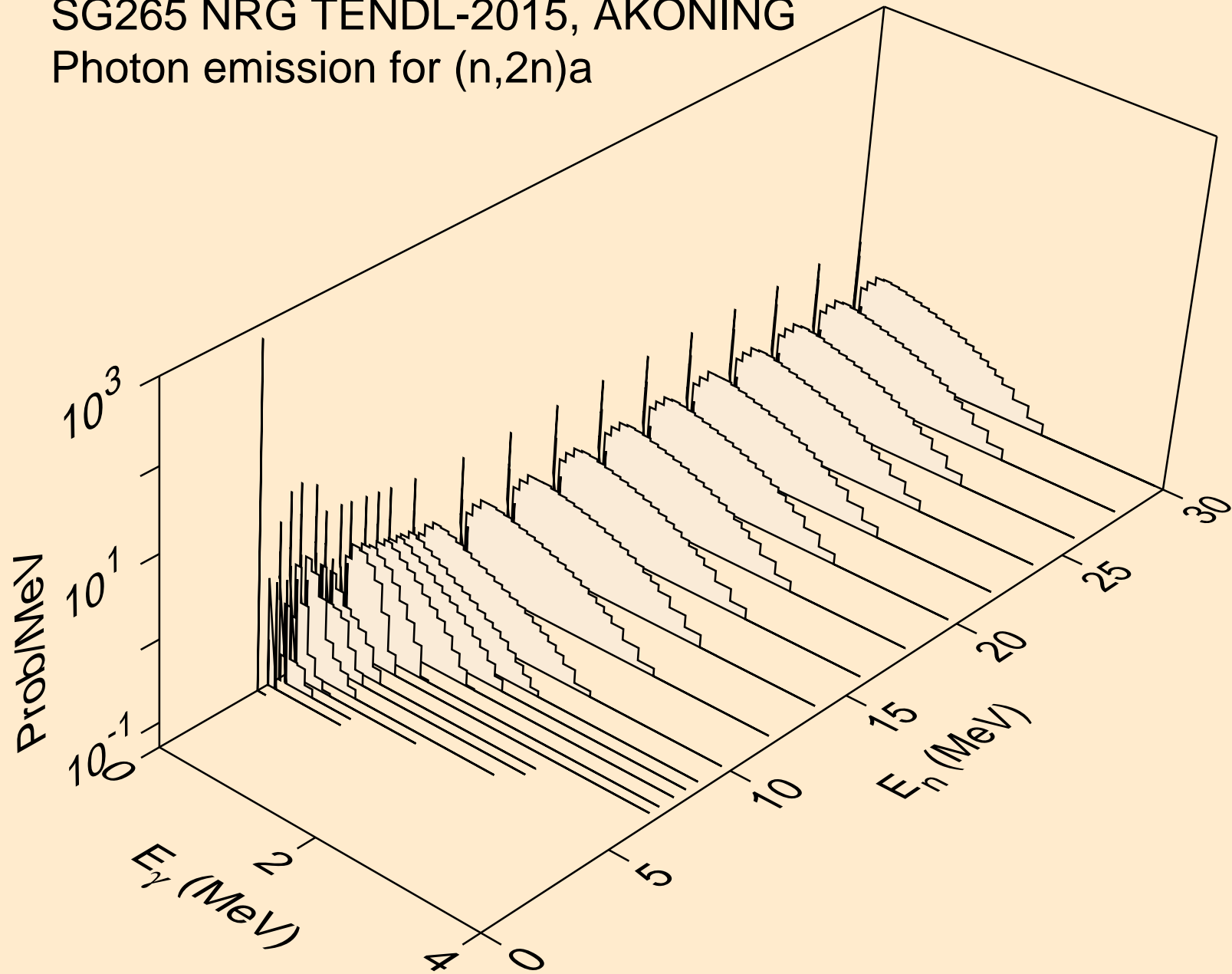

SG265 NRG TENDL-2015, AKONING
Photon emission for (n,3n)a

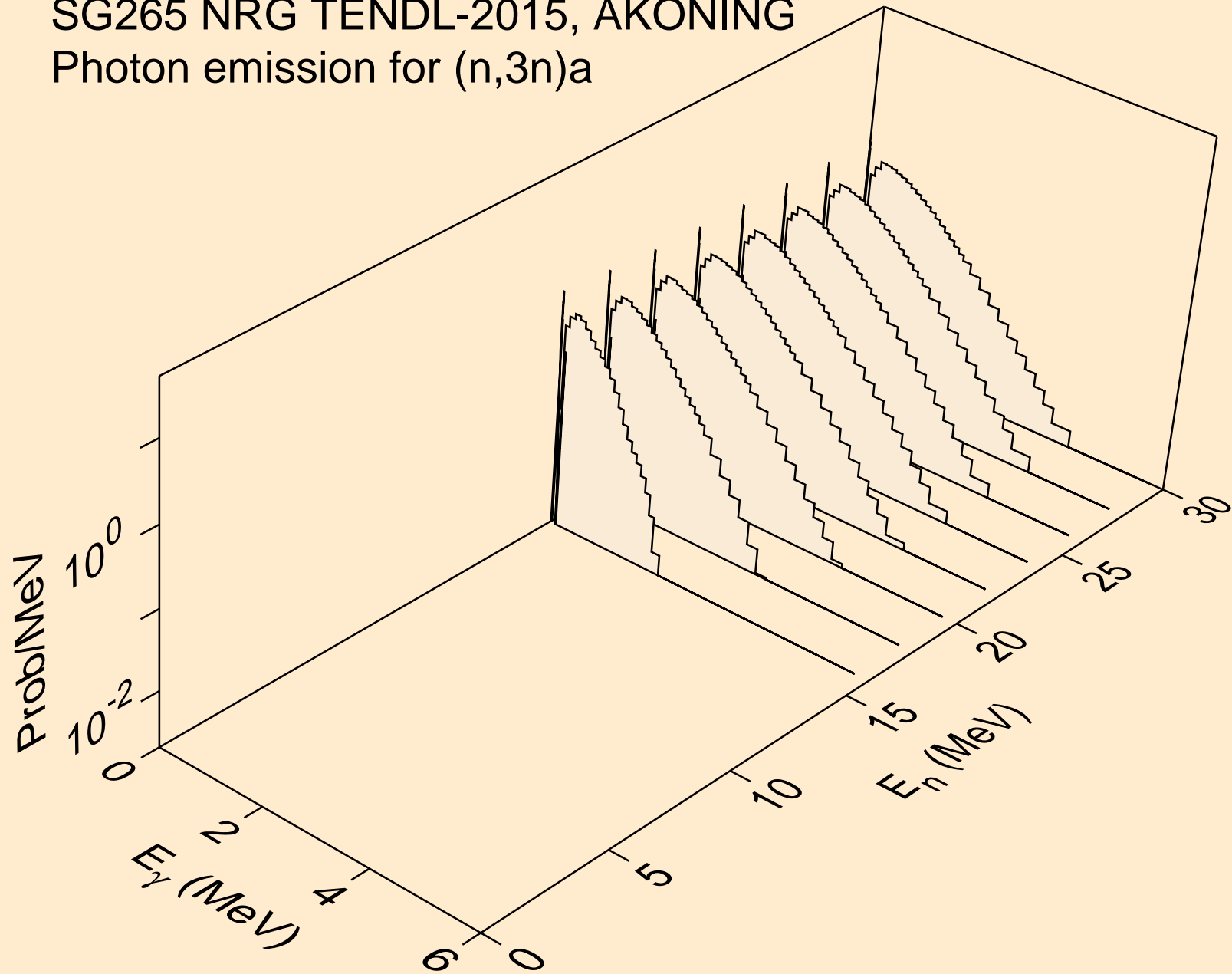

SG265 NRG TENDL-2015, AKONING
Photon emission for (n,n*)p

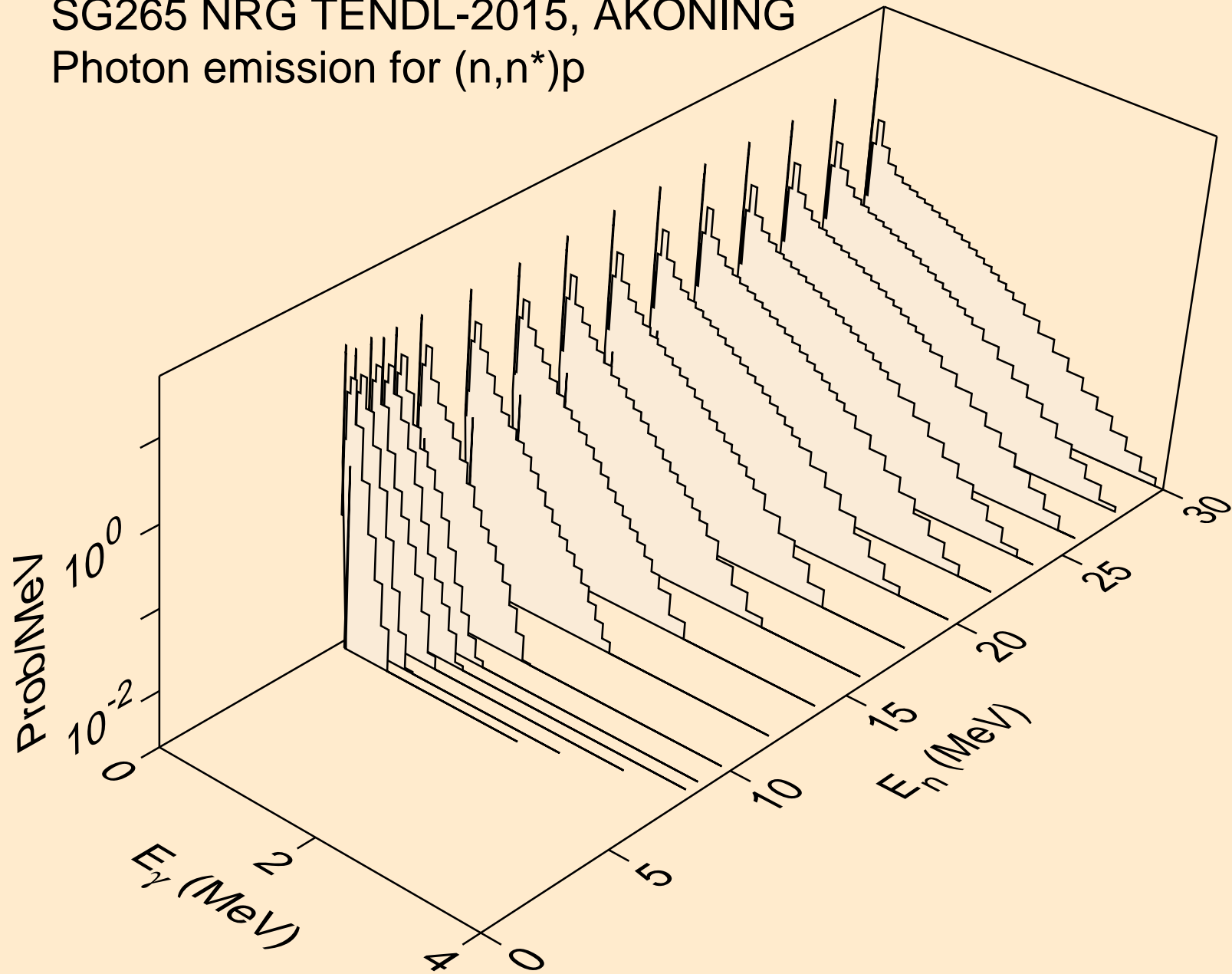

SG265 NRG TENDL-2015, AKONING
Photon emission for (n,n*)2a

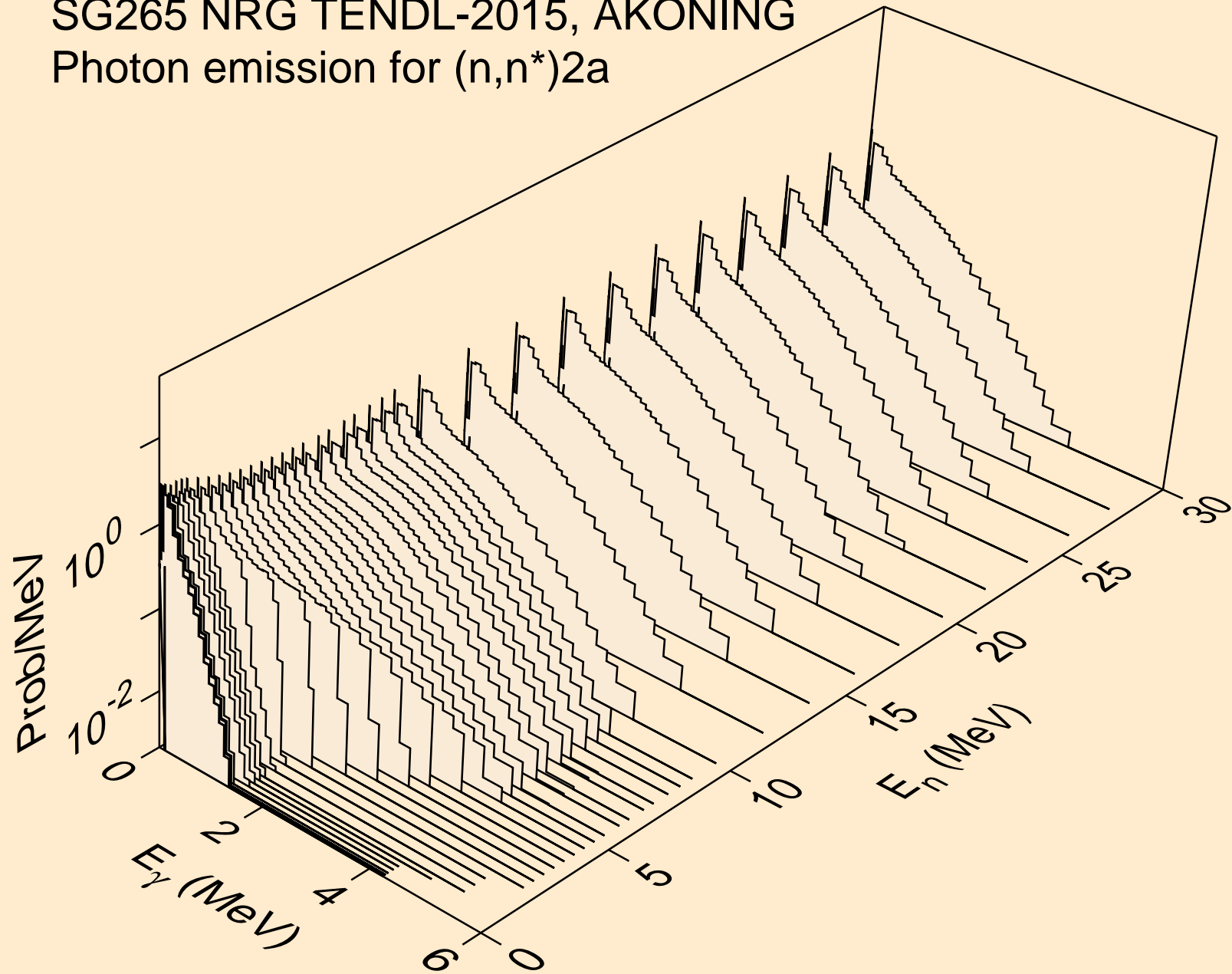

SG265 NRG TENDL-2015, AKONING
Photon emission for (n,2n)2a

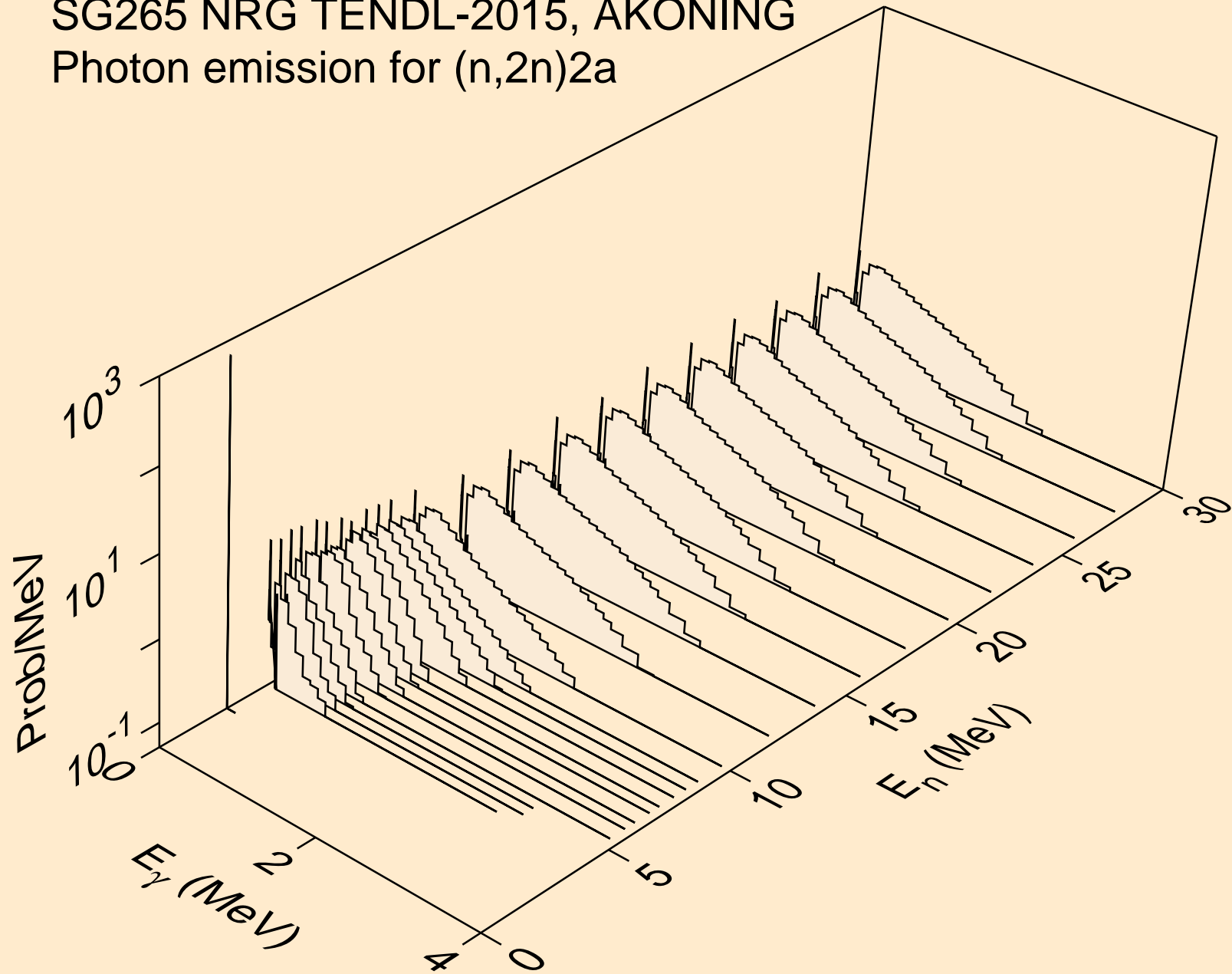

SG265 NRG TENDL-2015, AKONING
Photon emission for (n,n*)d

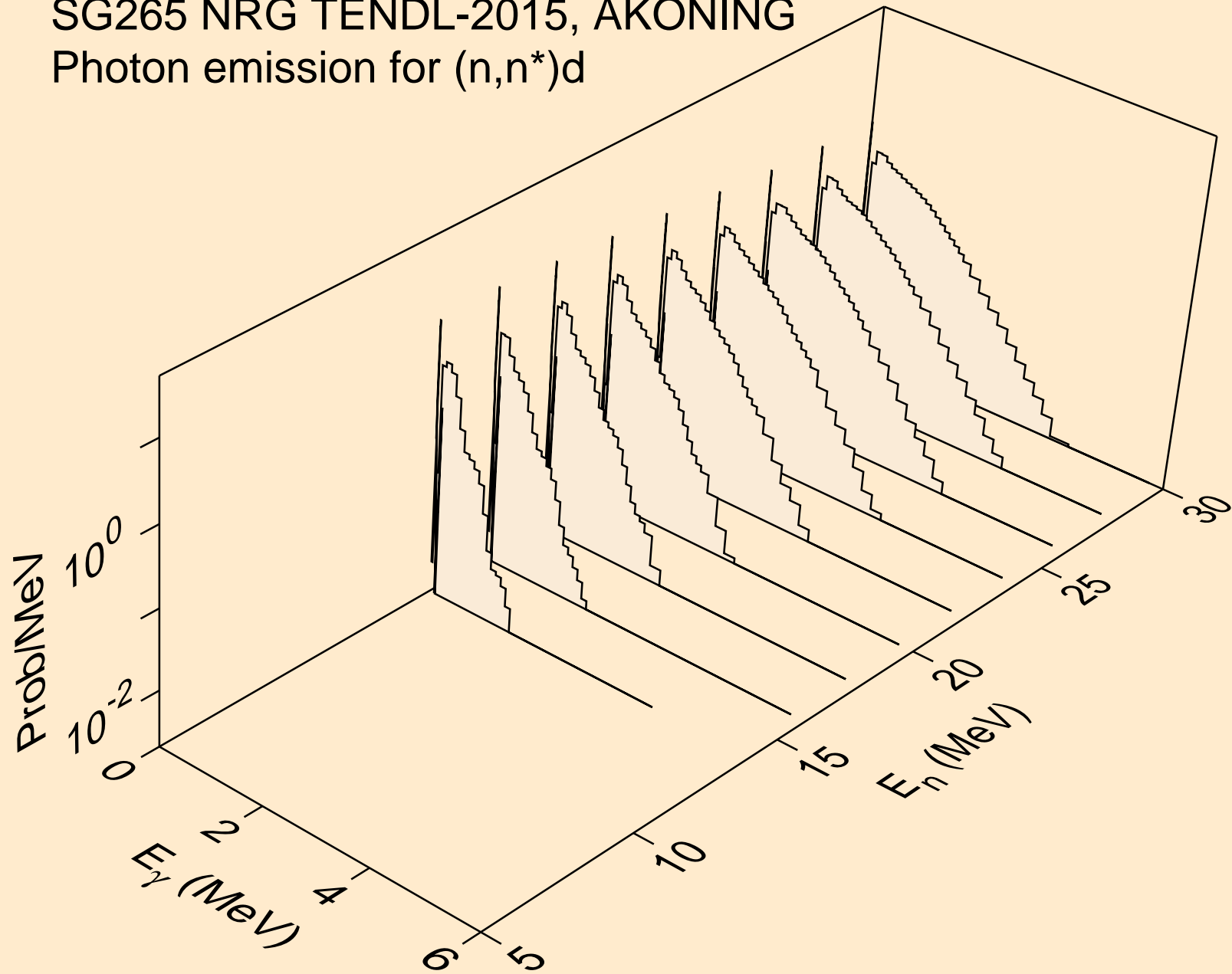

SG265 NRG TENDL-2015, AKONING
Photon emission for (n,n*)t

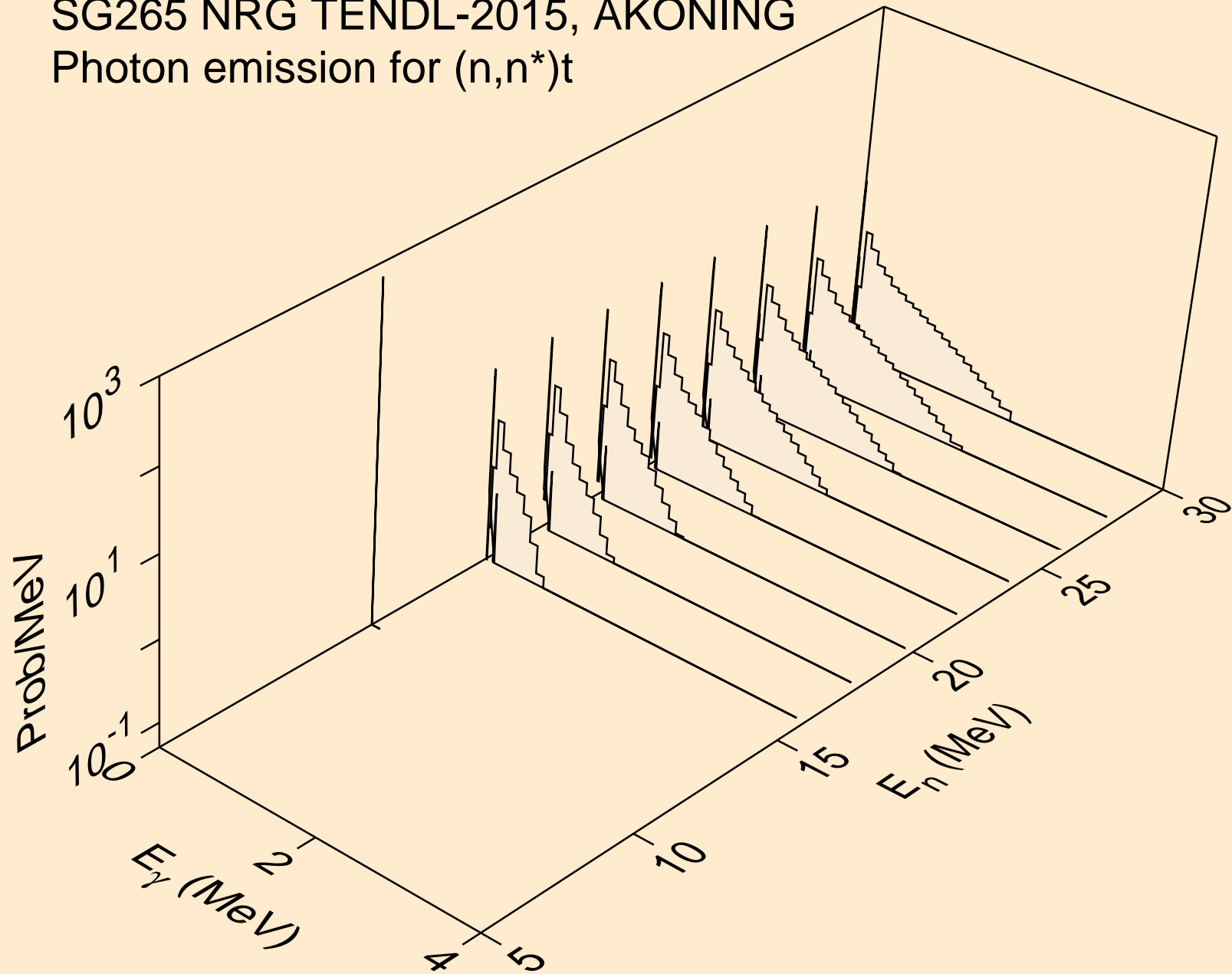

SG265 NRG TENDL-2015, AKONING
Photon emission for (n,n*)he3

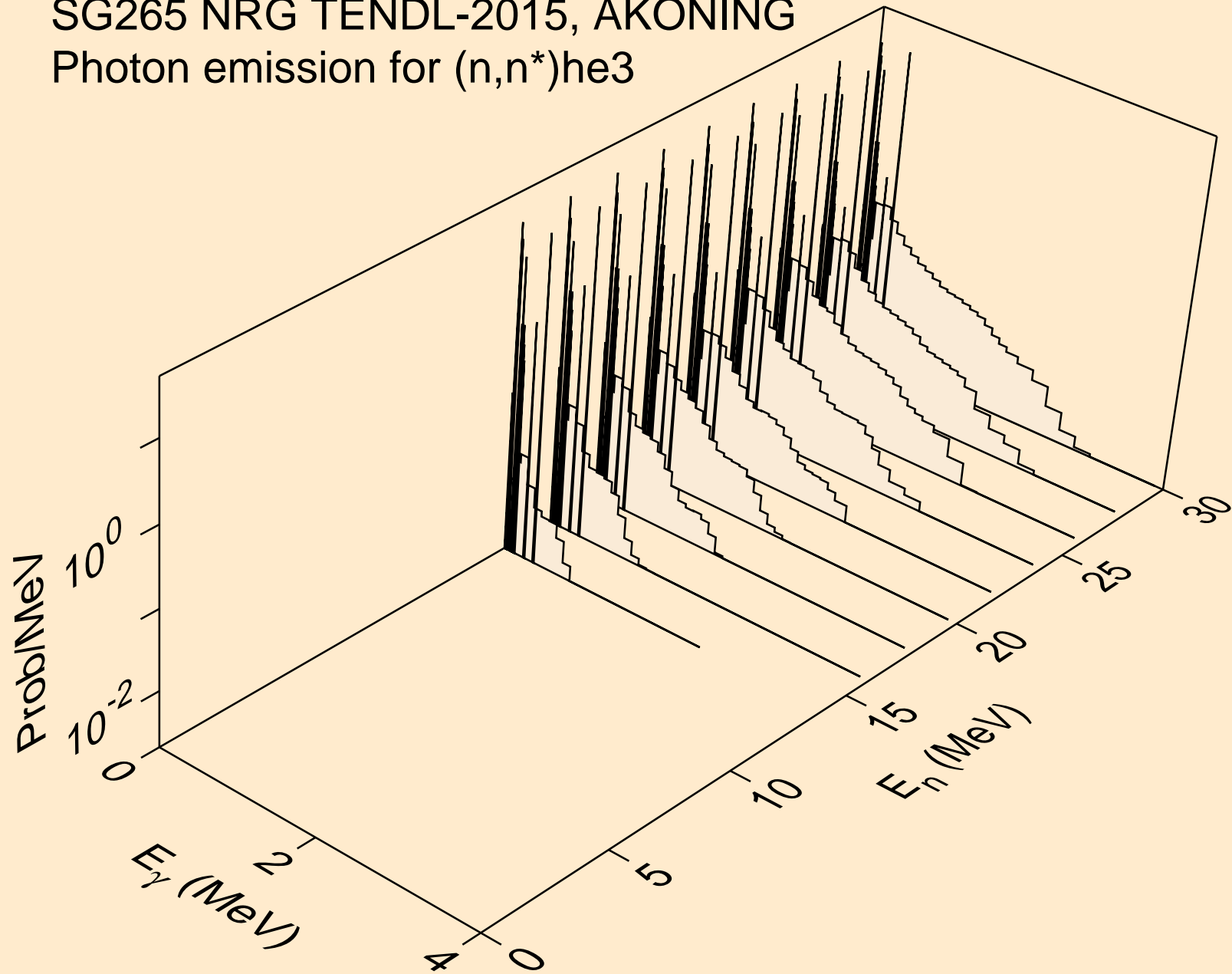

SG265 NRG TENDL-2015, AKONING
Photon emission for (n,n*)d2a

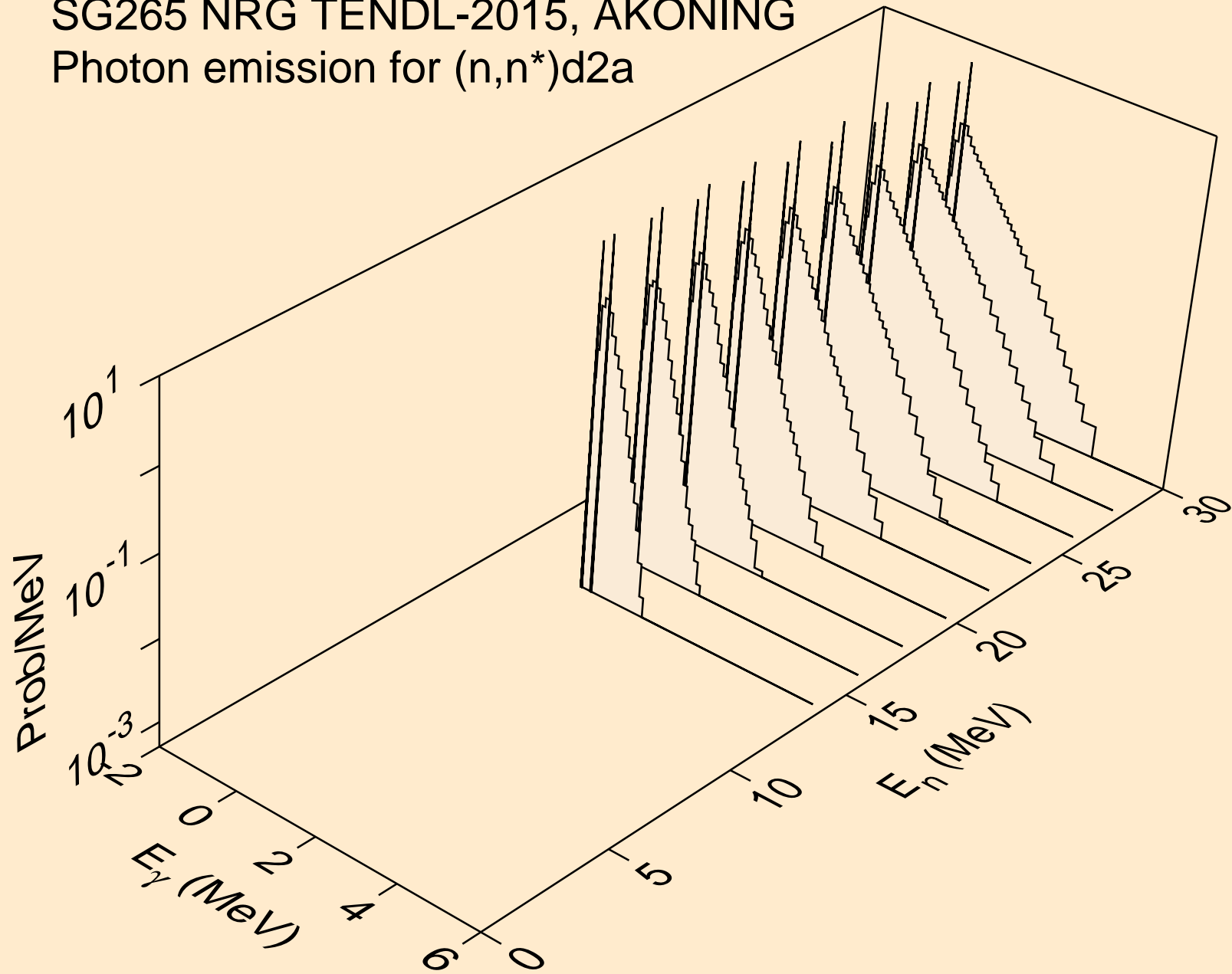

SG265 NRG TENDL-2015, AKONING
Photon emission for (n,n*)t2a

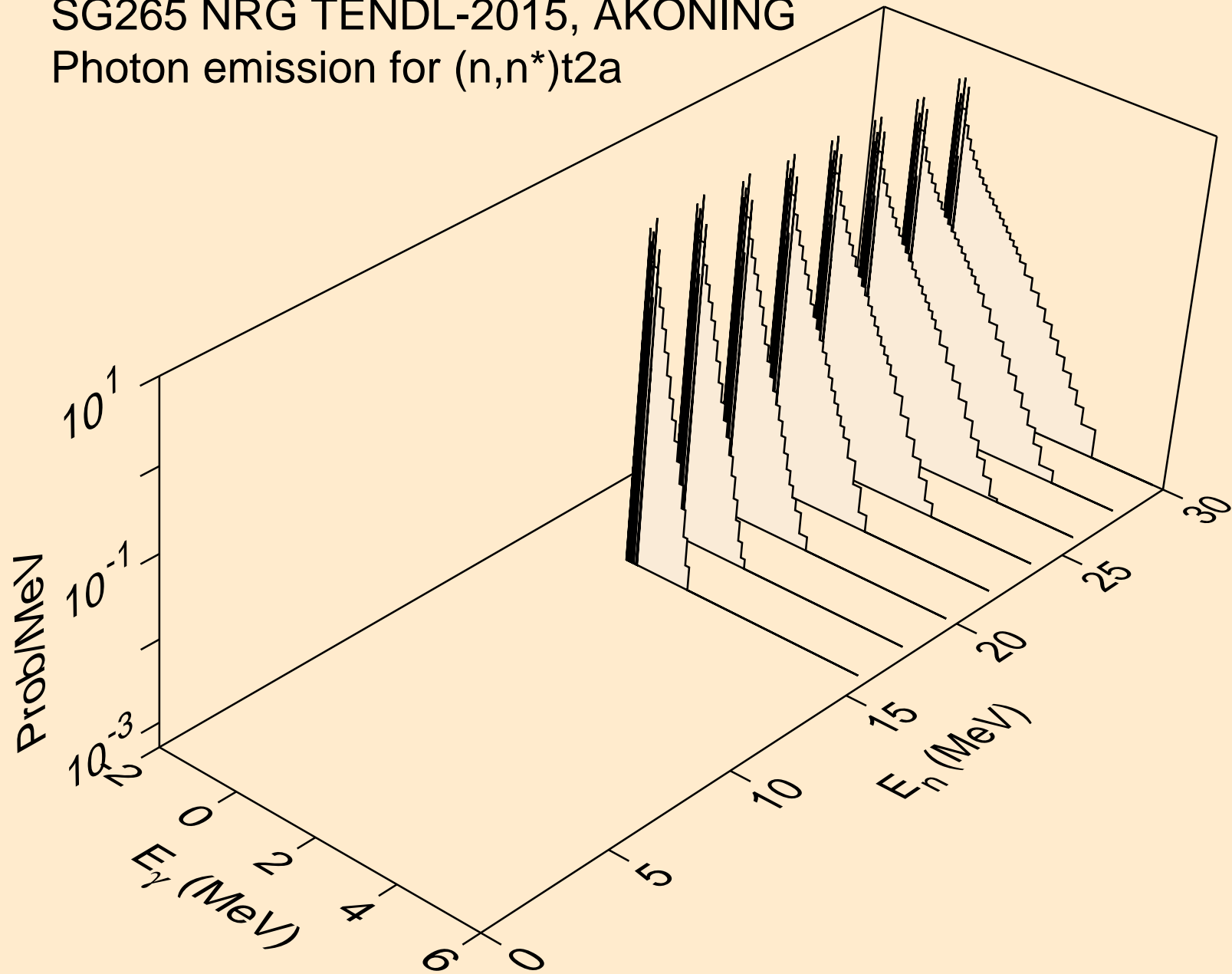

SG265 NRG TENDL-2015, AKONING
Photon emission for (n,4n)

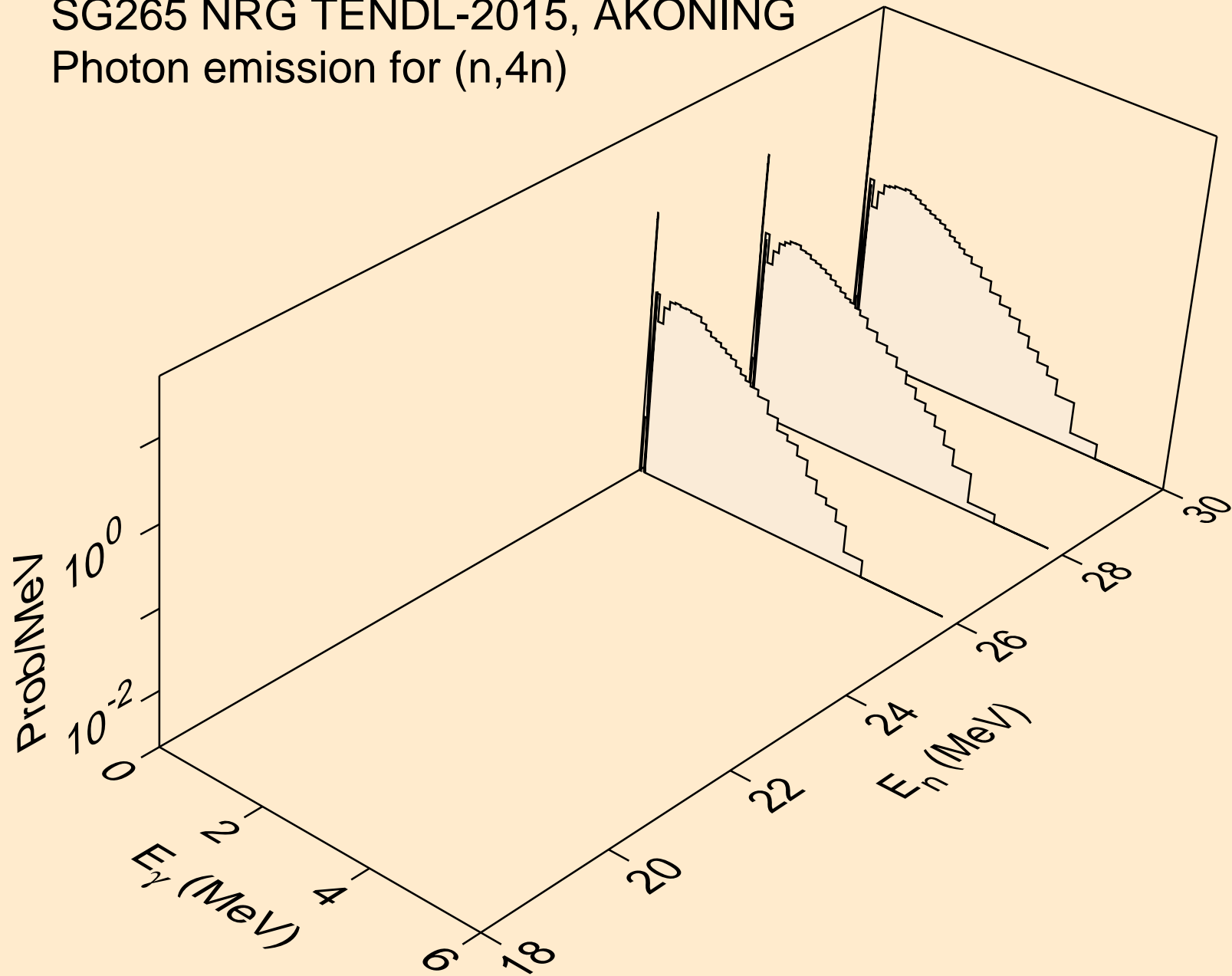

SG265 NRG TENDL-2015, AKONING
Photon emission for (n,2np)

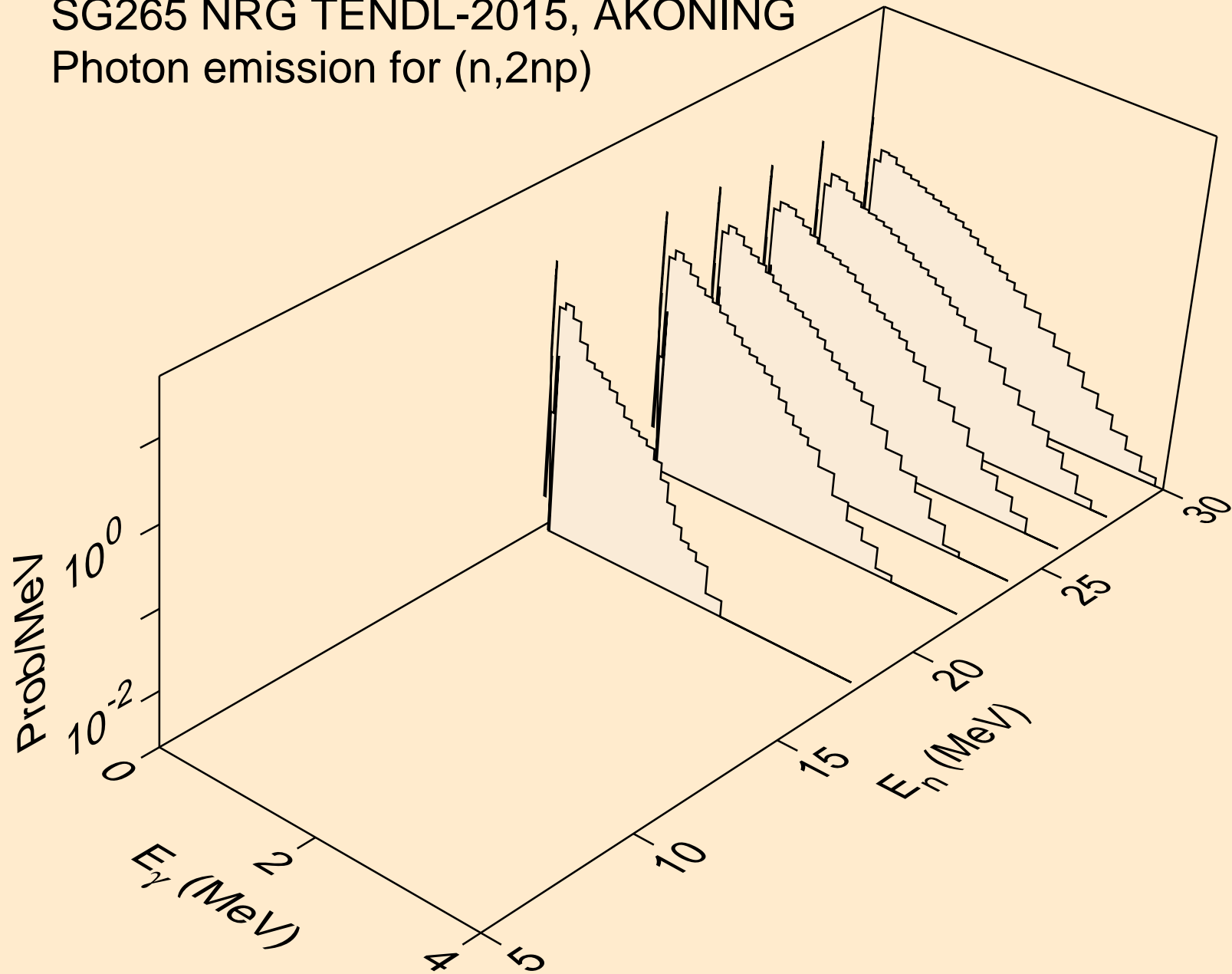

SG265 NRG TENDL-2015, AKONING
Photon emission for (n,3np)

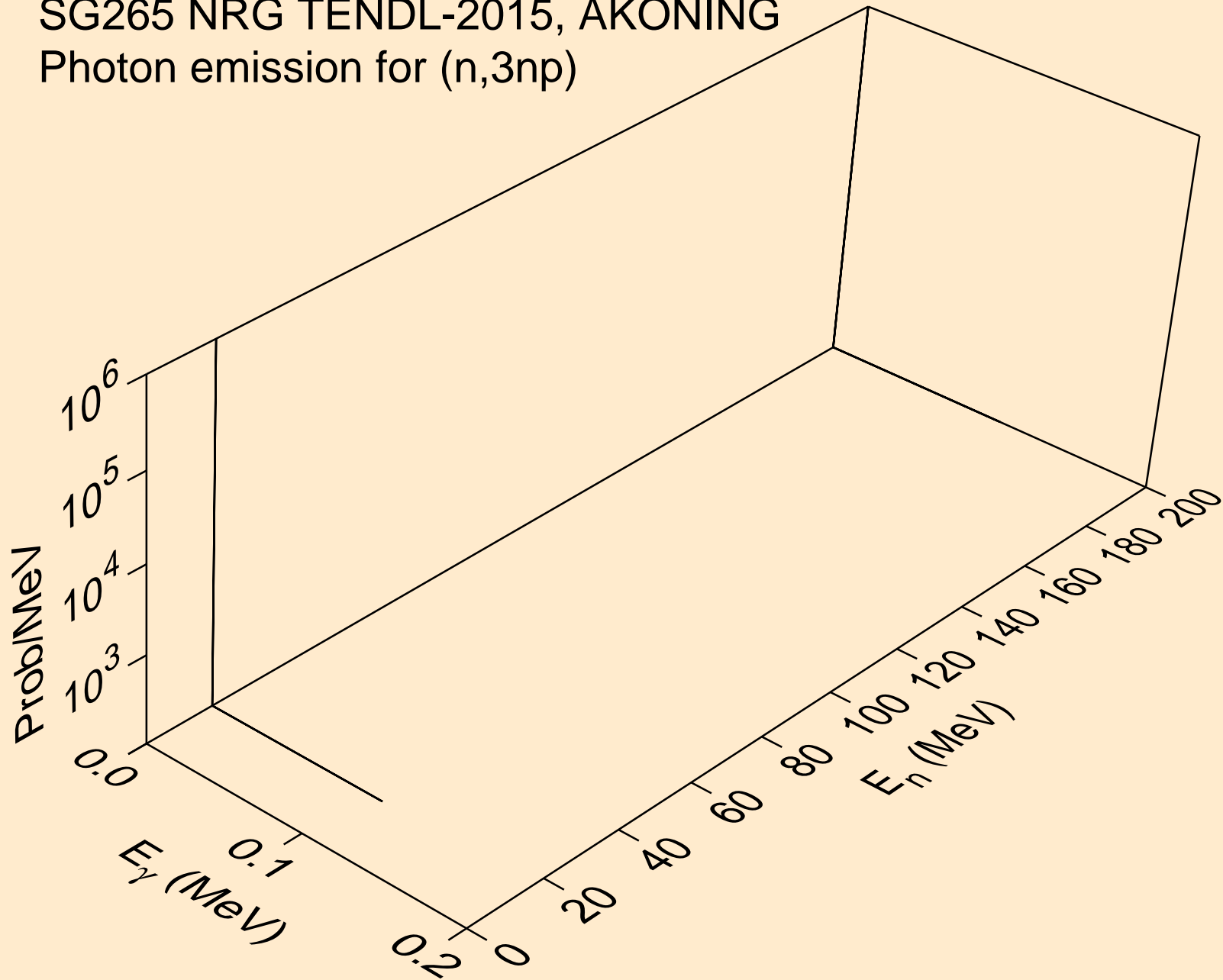

SG265 NRG TENDL-2015, AKONING
Photon emission for (n,2np)

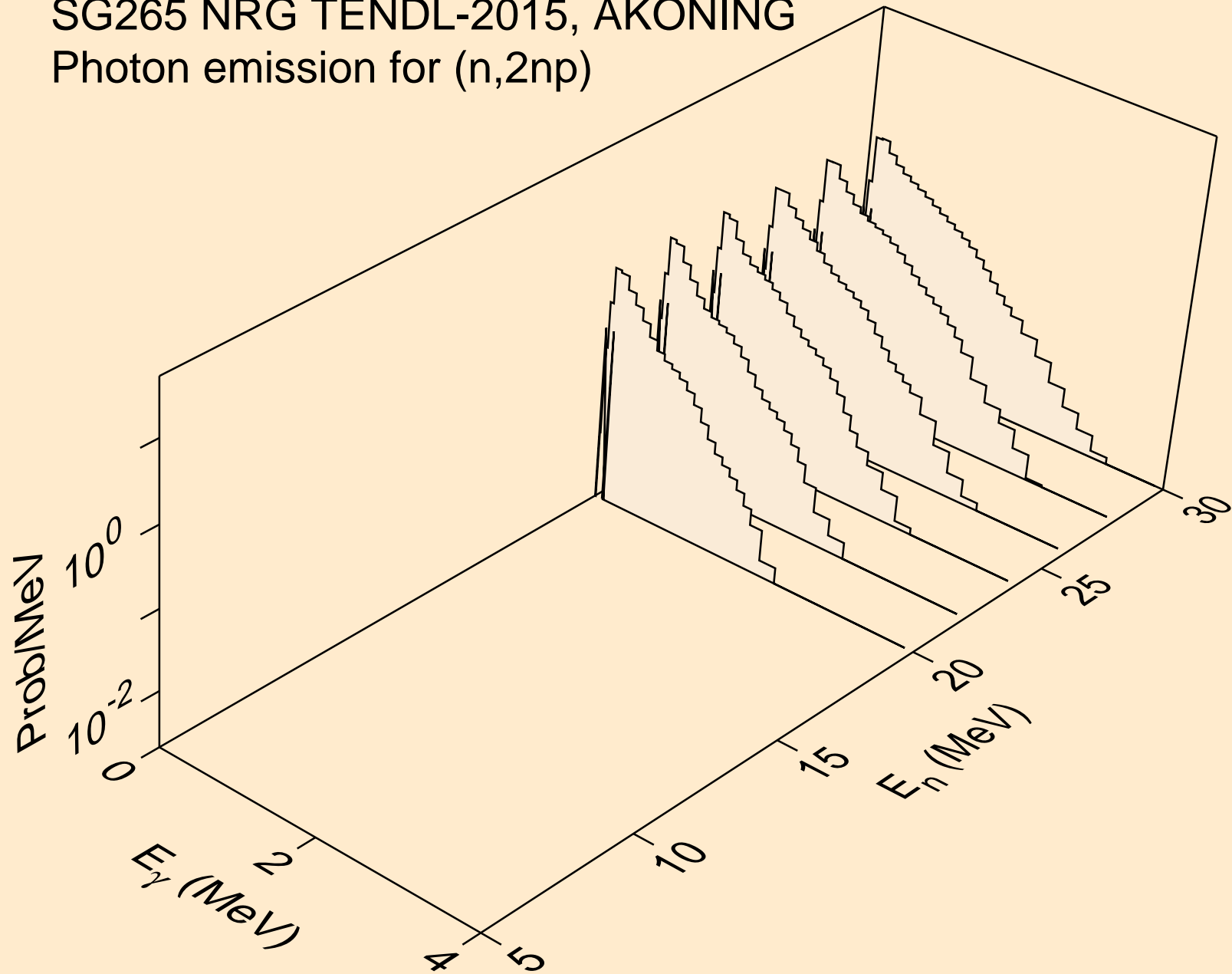

SG265 NRG TENDL-2015, AKONING
Photon emission for (n,npa)

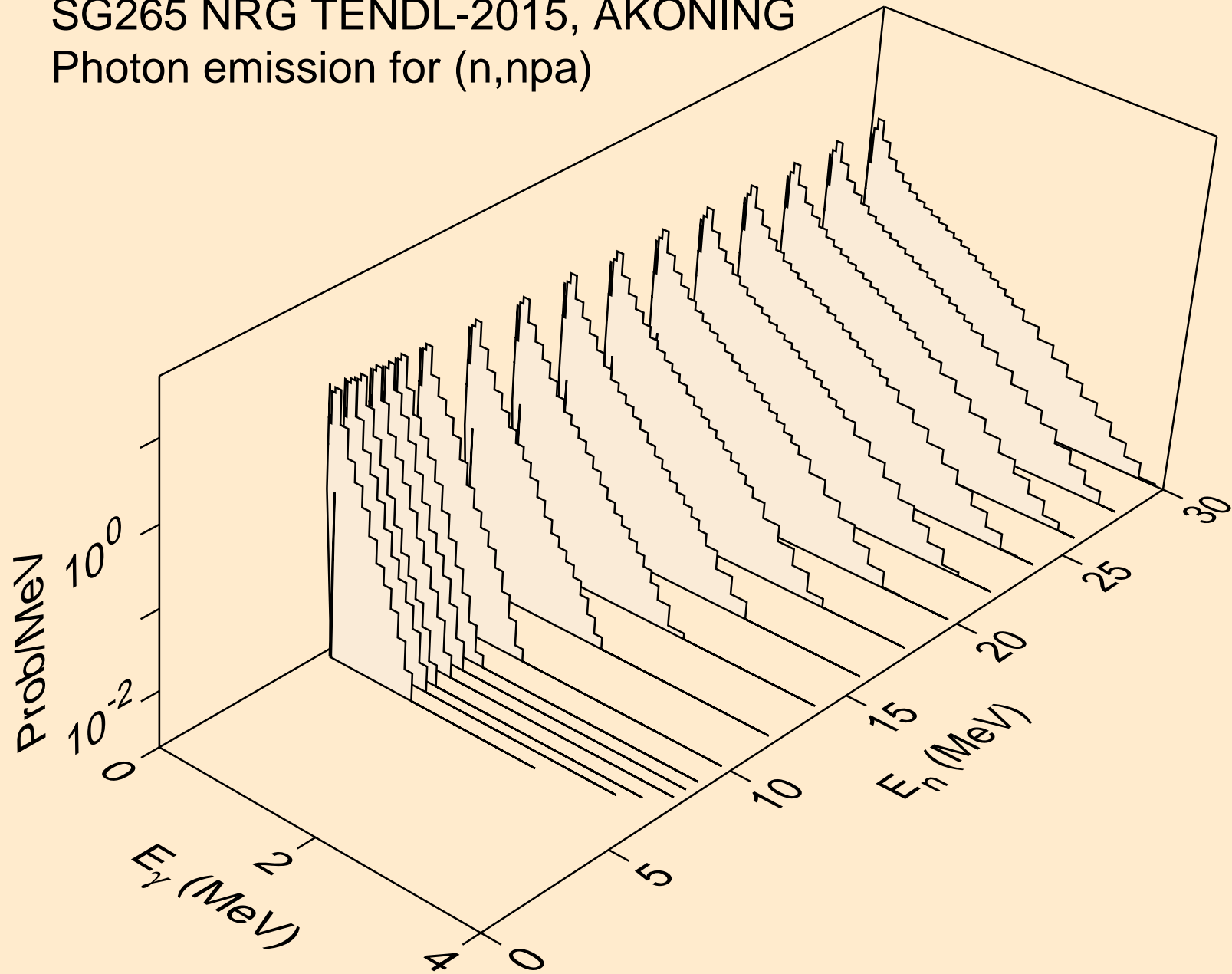

SG265 NRG TENDL-2015, AKONING
Photon emission for (n,n*c)

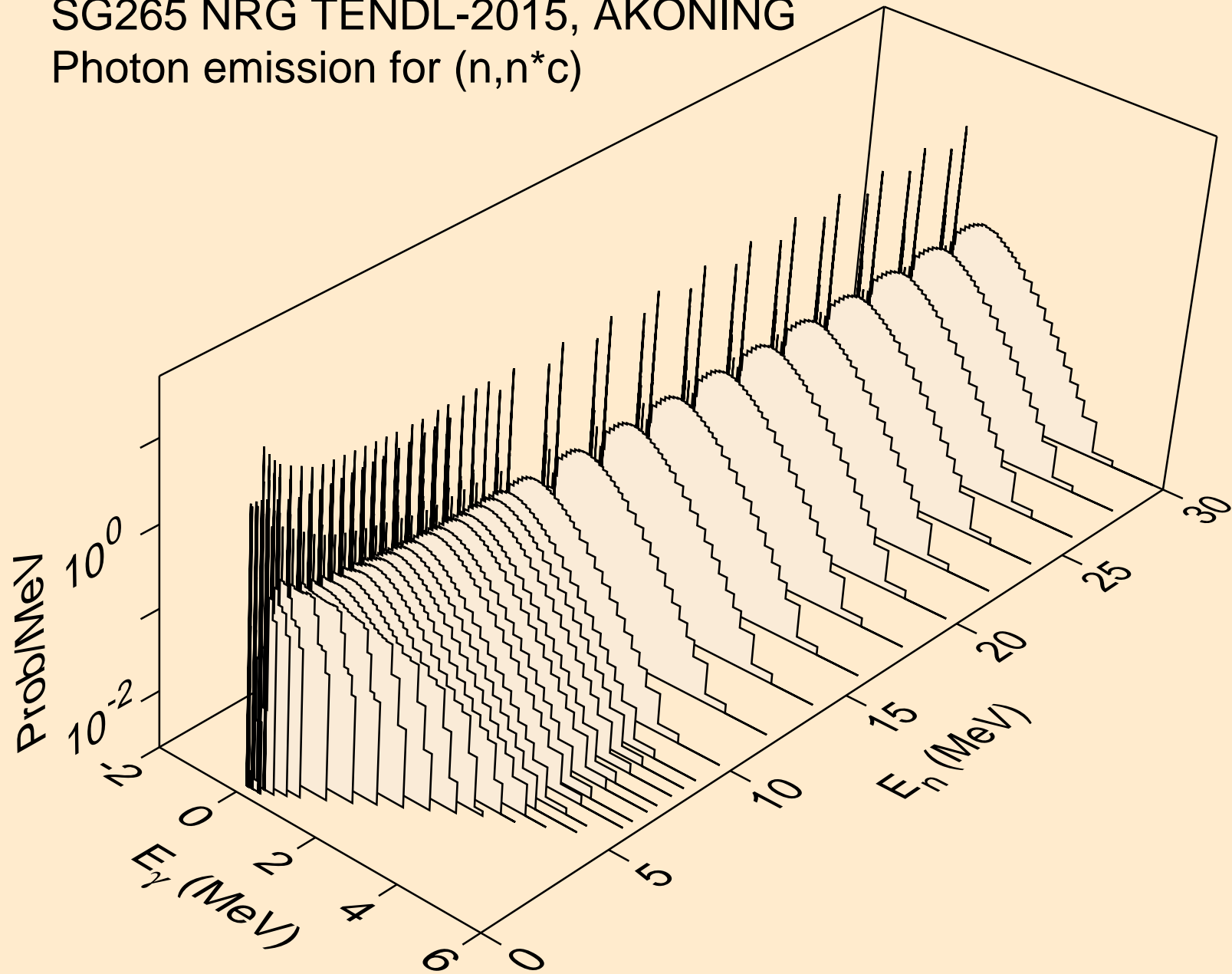

SG265 NRG TENDL-2015, AKONING
Photon emission for (n,gma)

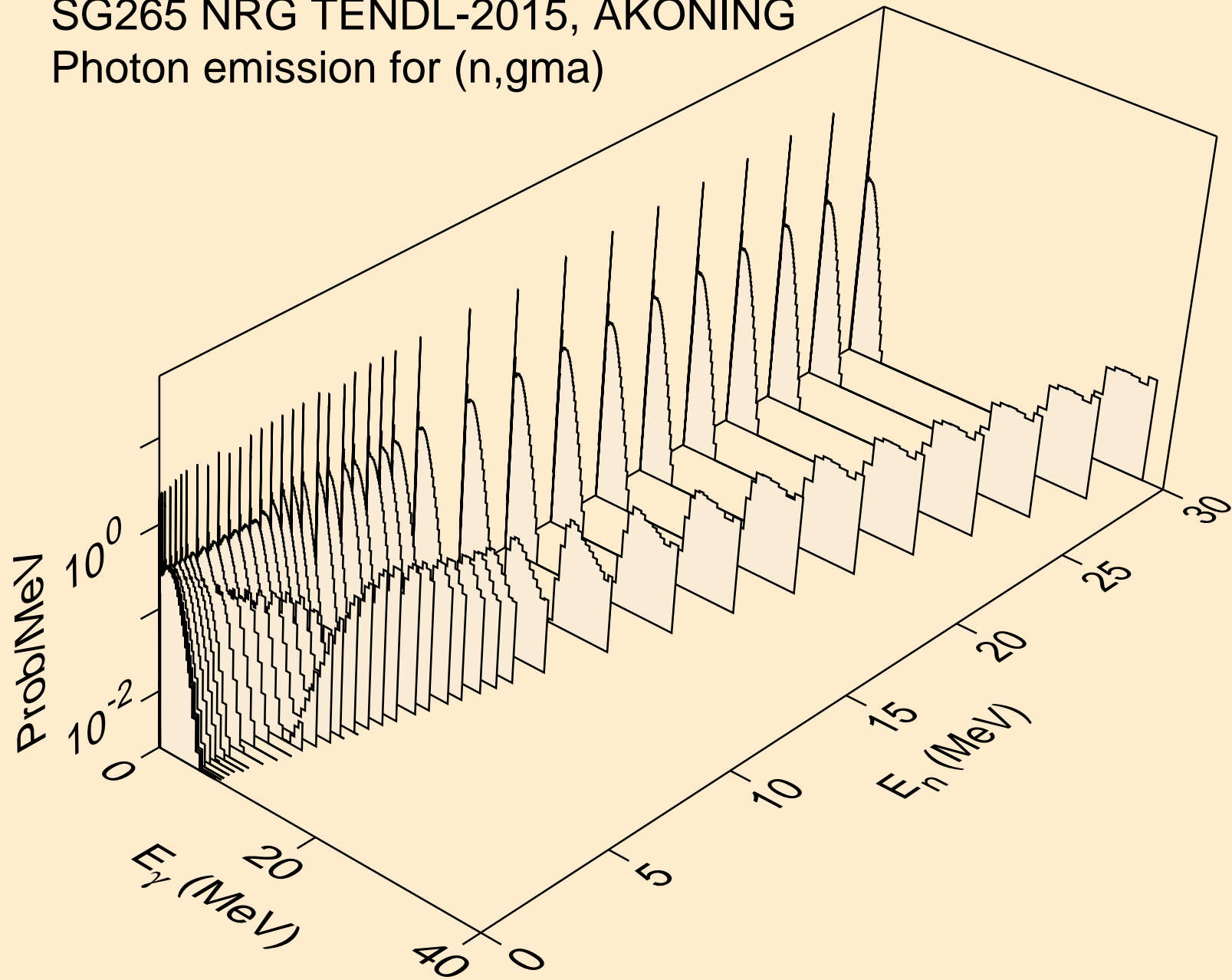

SG265 NRG TENDL-2015, AKONING
Photon emission for (n,p)

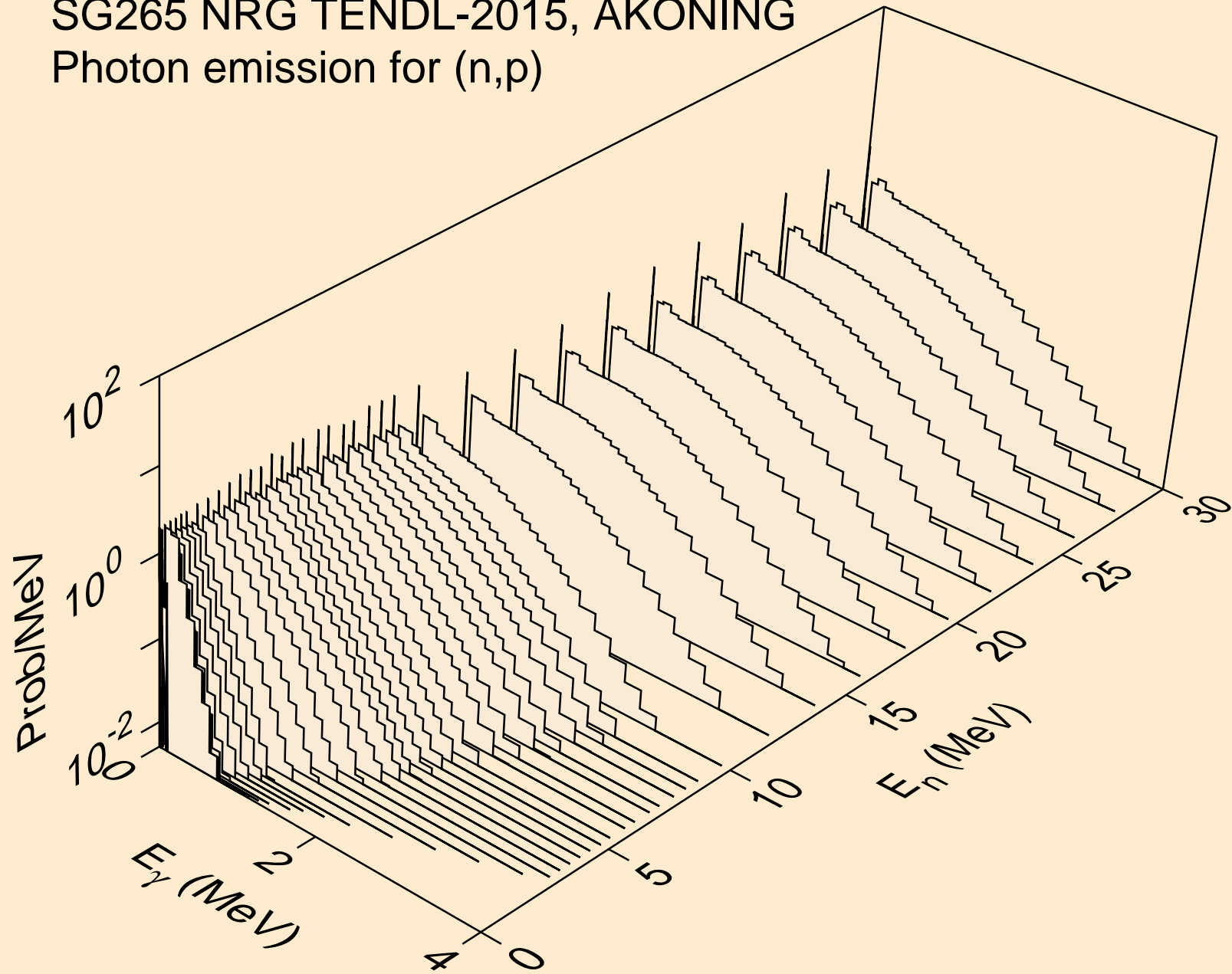

SG265 NRG TENDL-2015, AKONING
Photon emission for (n,d)

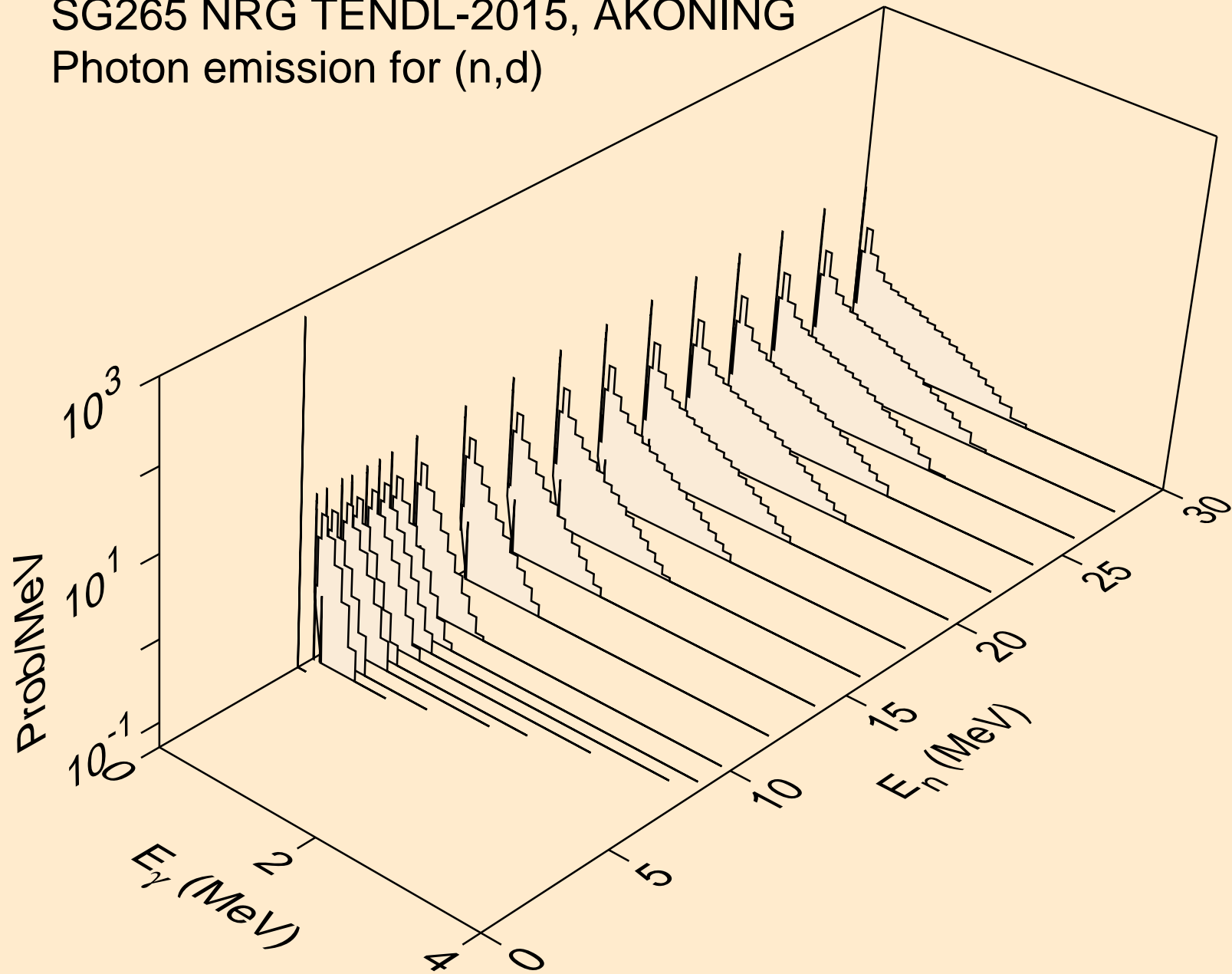

SG265 NRG TENDL-2015, AKONING
Photon emission for (n,t)

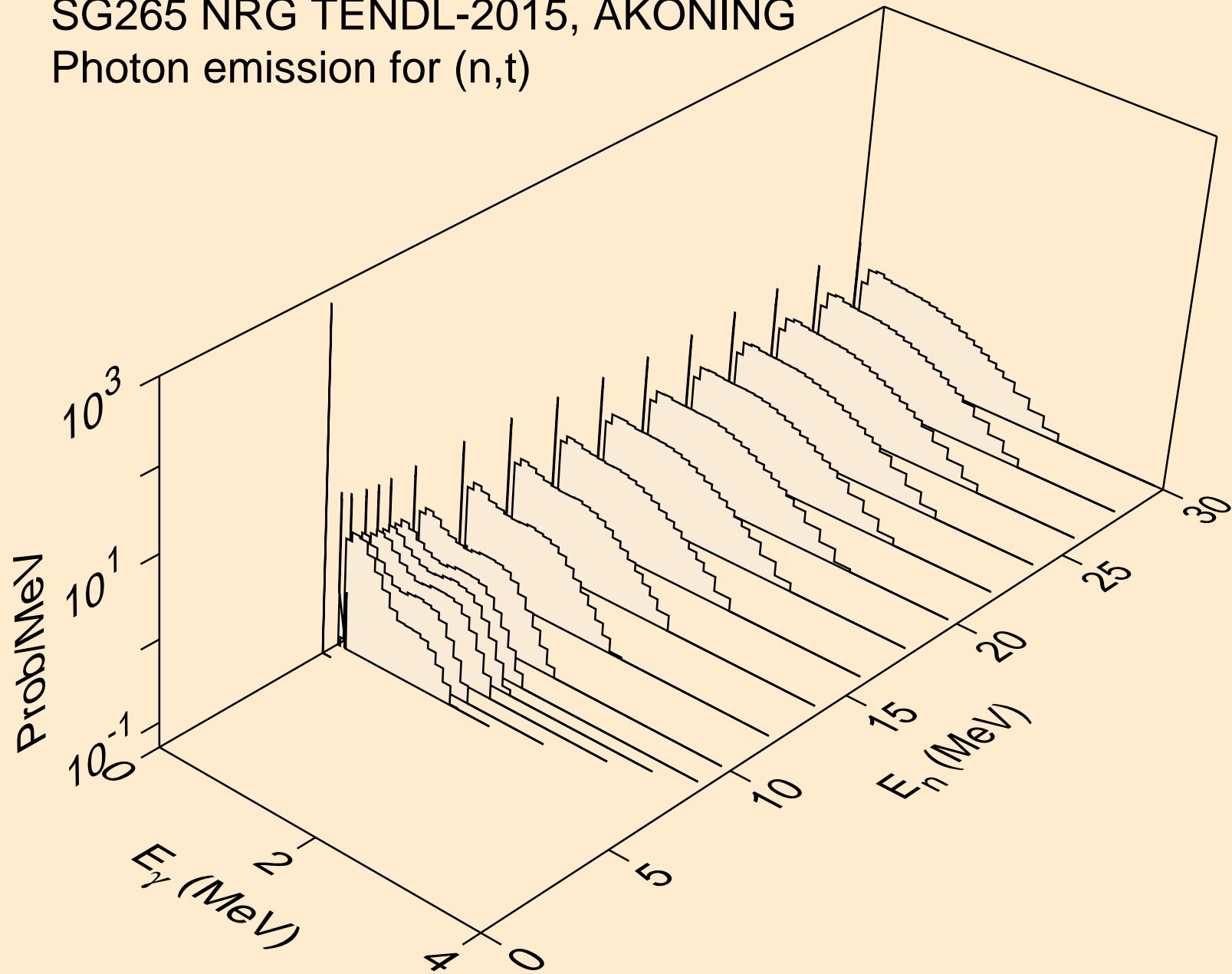

SG265 NRG TENDL-2015, AKONING
Photon emission for (n,he3)

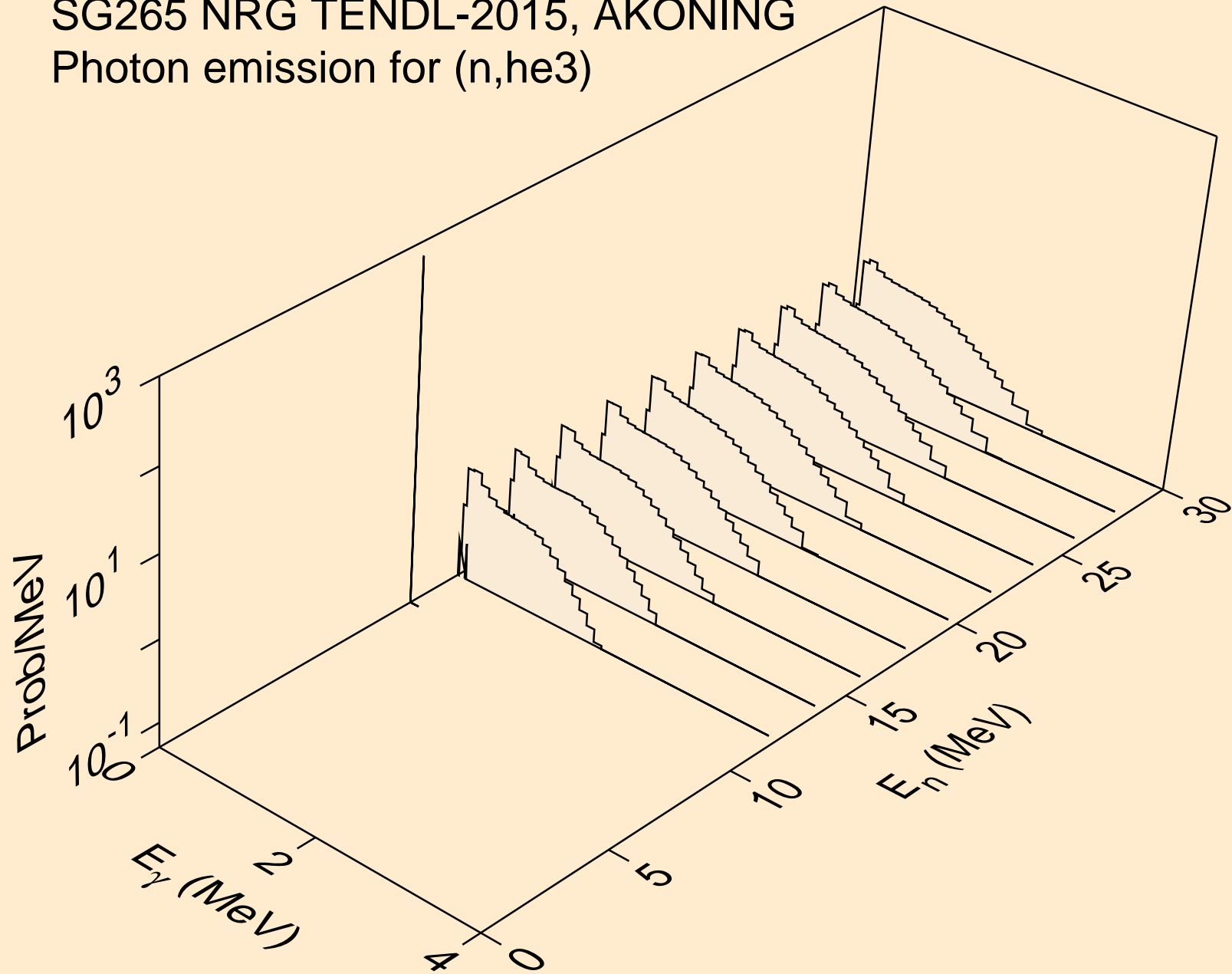

SG265 NRG TENDL-2015, AKONING
Photon emission for (n,a)

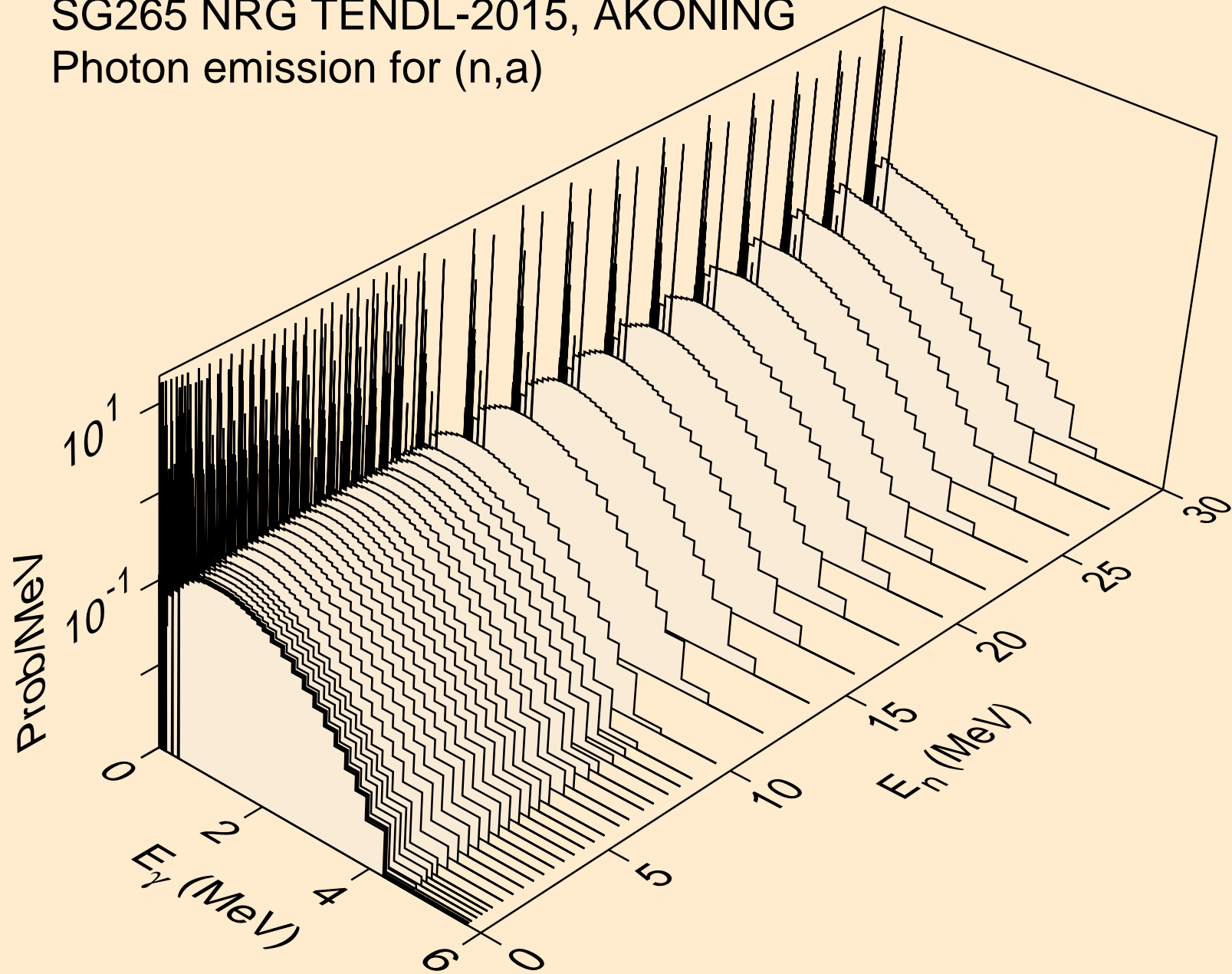

SG265 NRG TENDL-2015, AKONING
Photon emission for (n,2a)

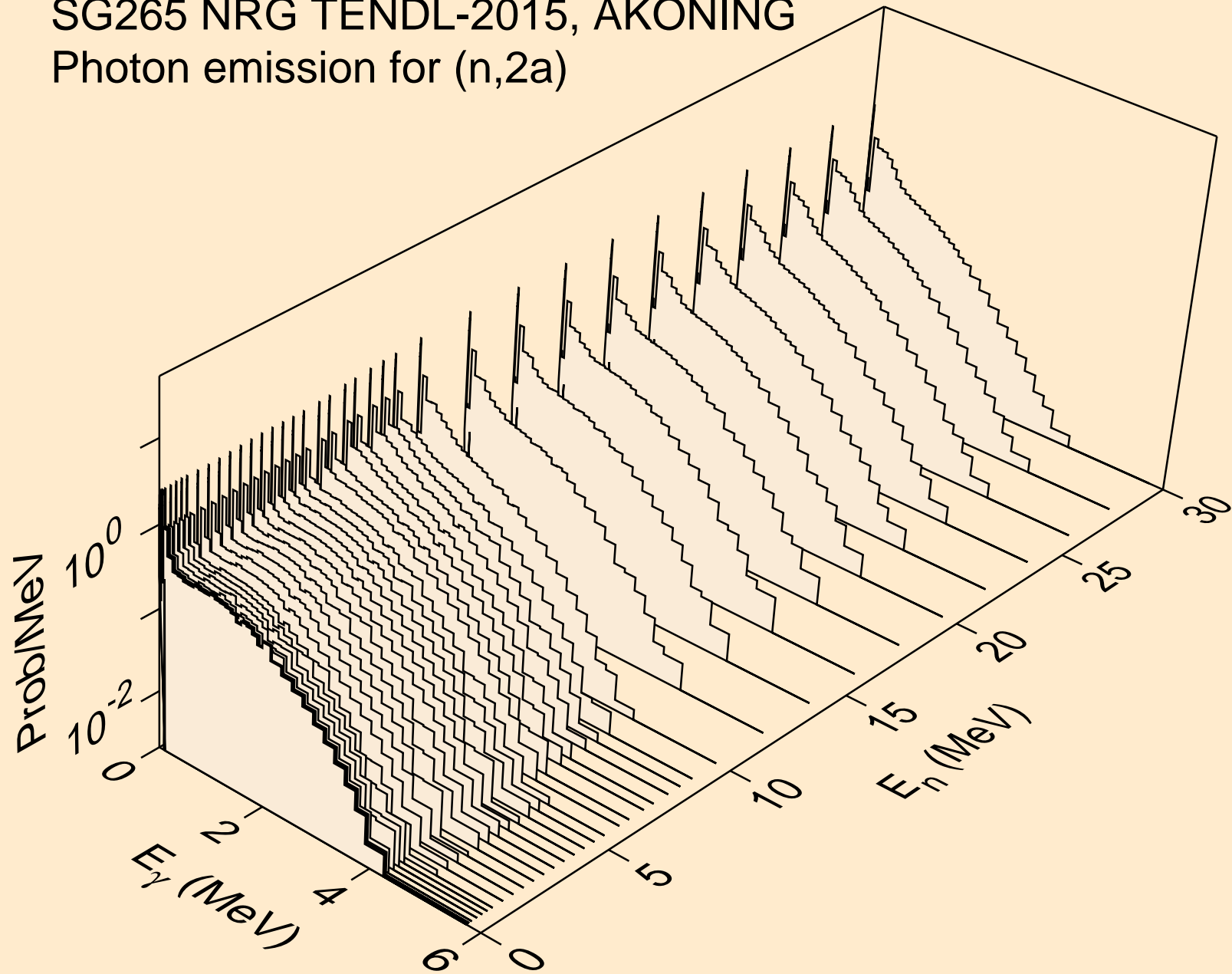

SG265 NRG TENDL-2015, AKONING
Photon emission for (n,3a)

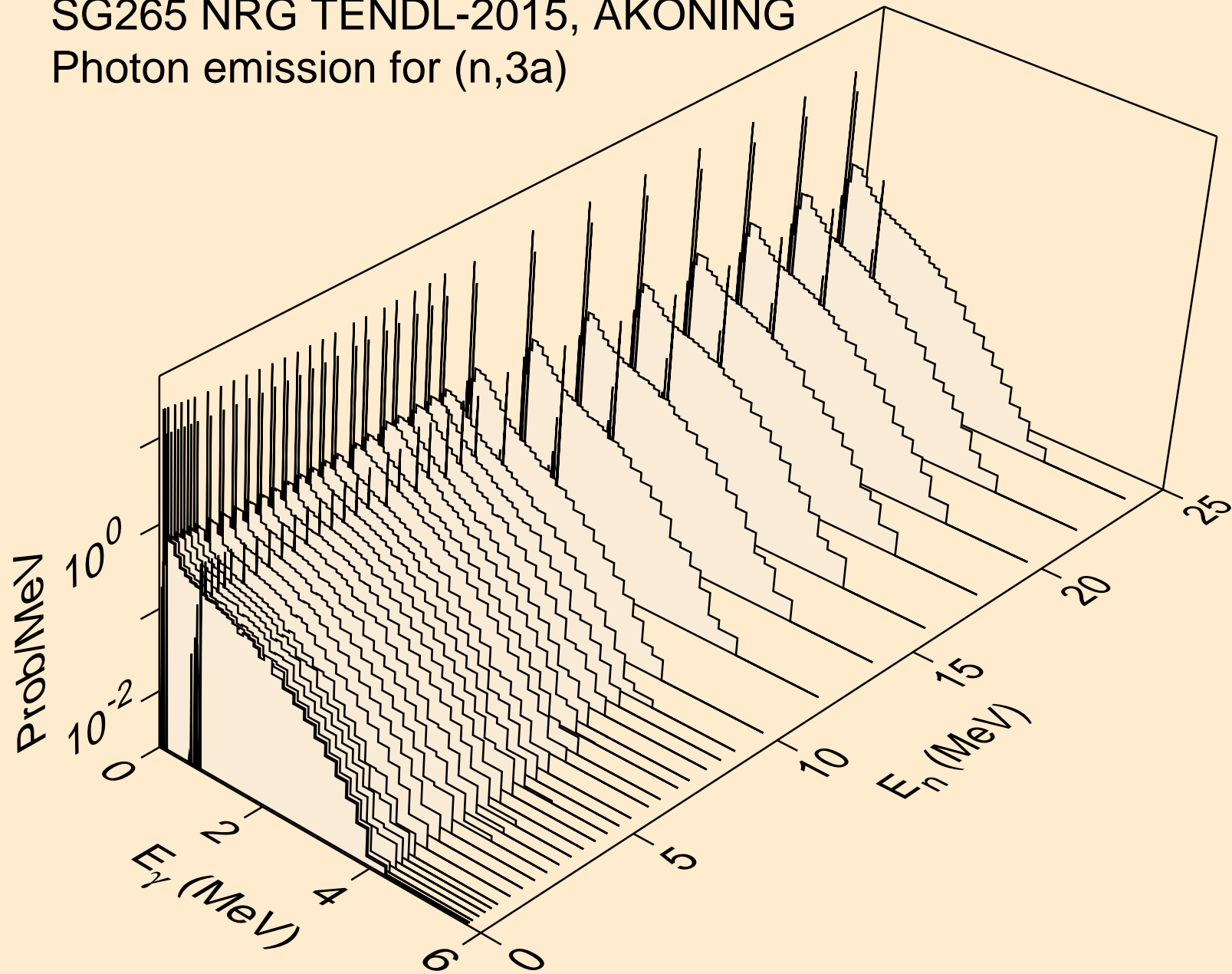

SG265 NRG TENDL-2015, AKONING
Photon emission for (n,2p)

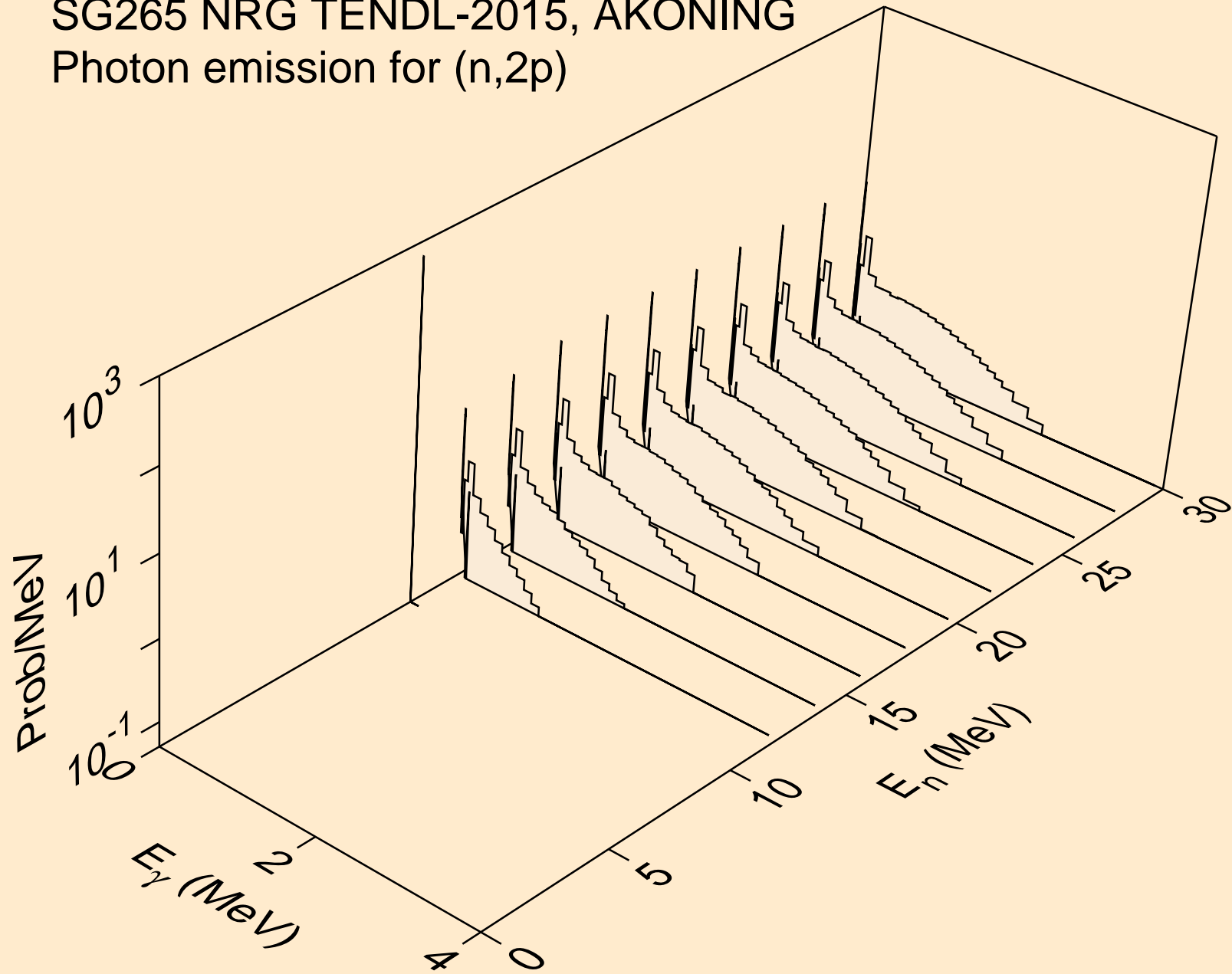

SG265 NRG TENDL-2015, AKONING
Photon emission for (n,p α)

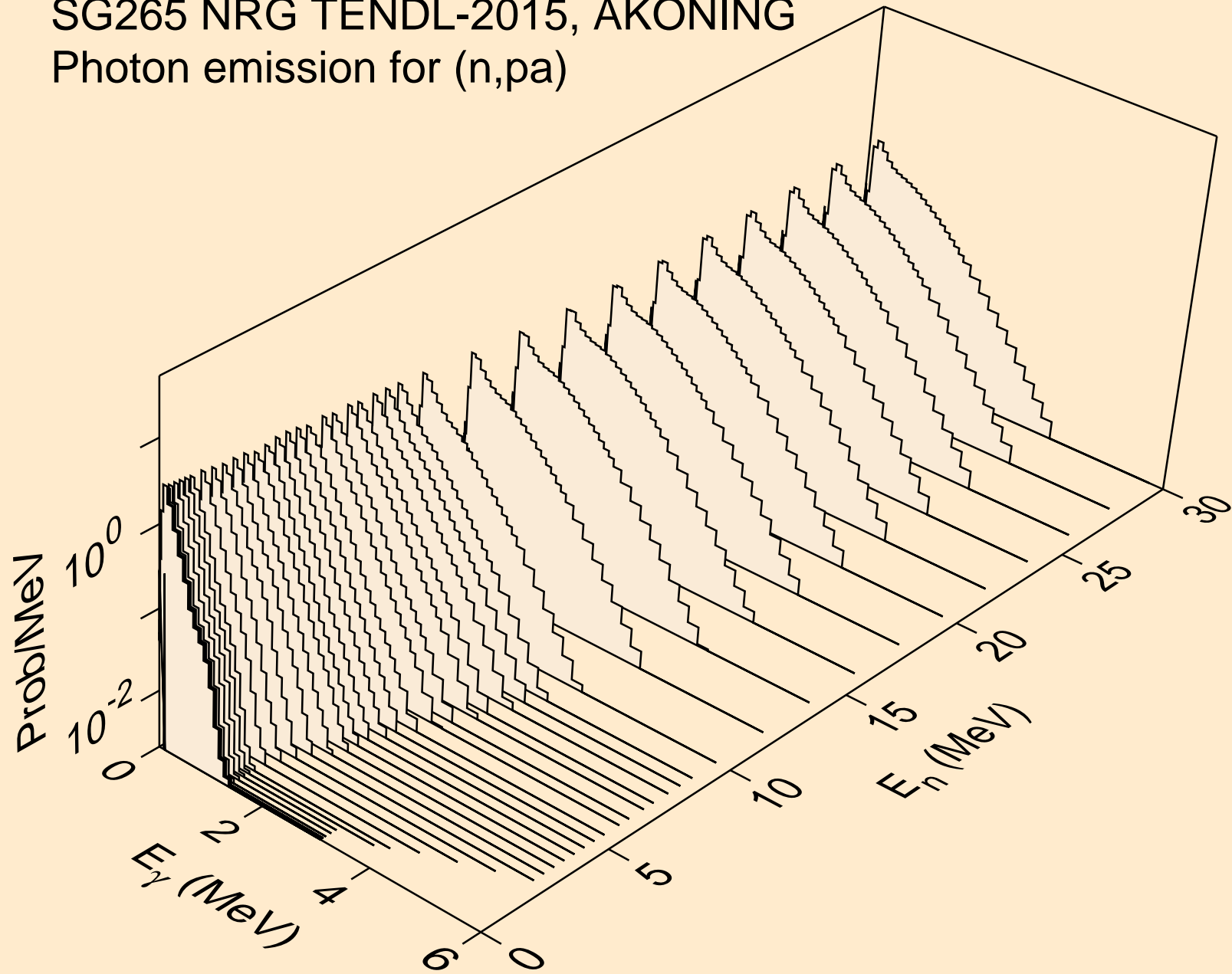

SG265 NRG TENDL-2015, AKONING
Photon emission for (n,t2a)

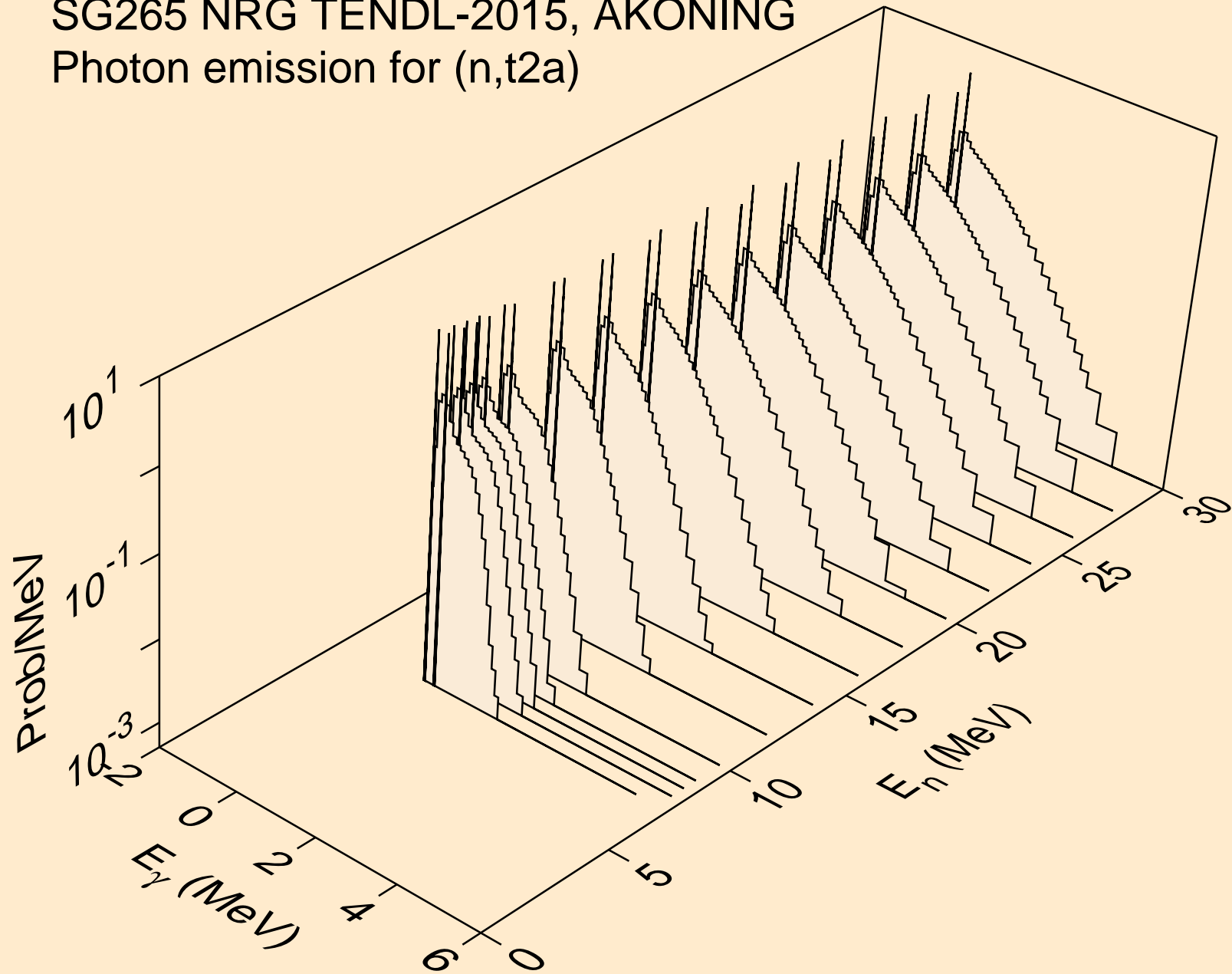

SG265 NRG TENDL-2015, AKONING
Photon emission for (n,d2a)

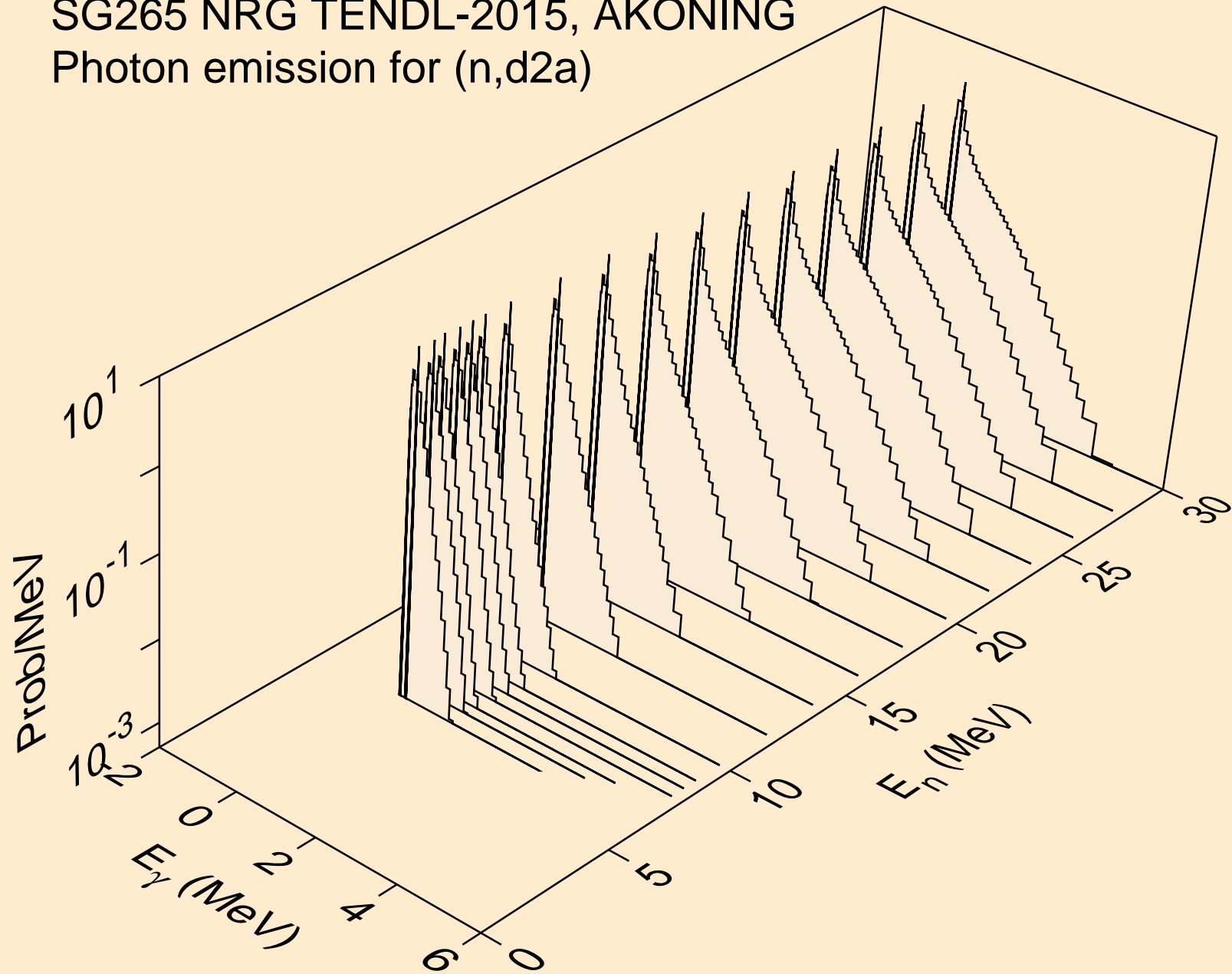

SG265 NRG TENDL-2015, AKONING
Photon emission for (n,pd)

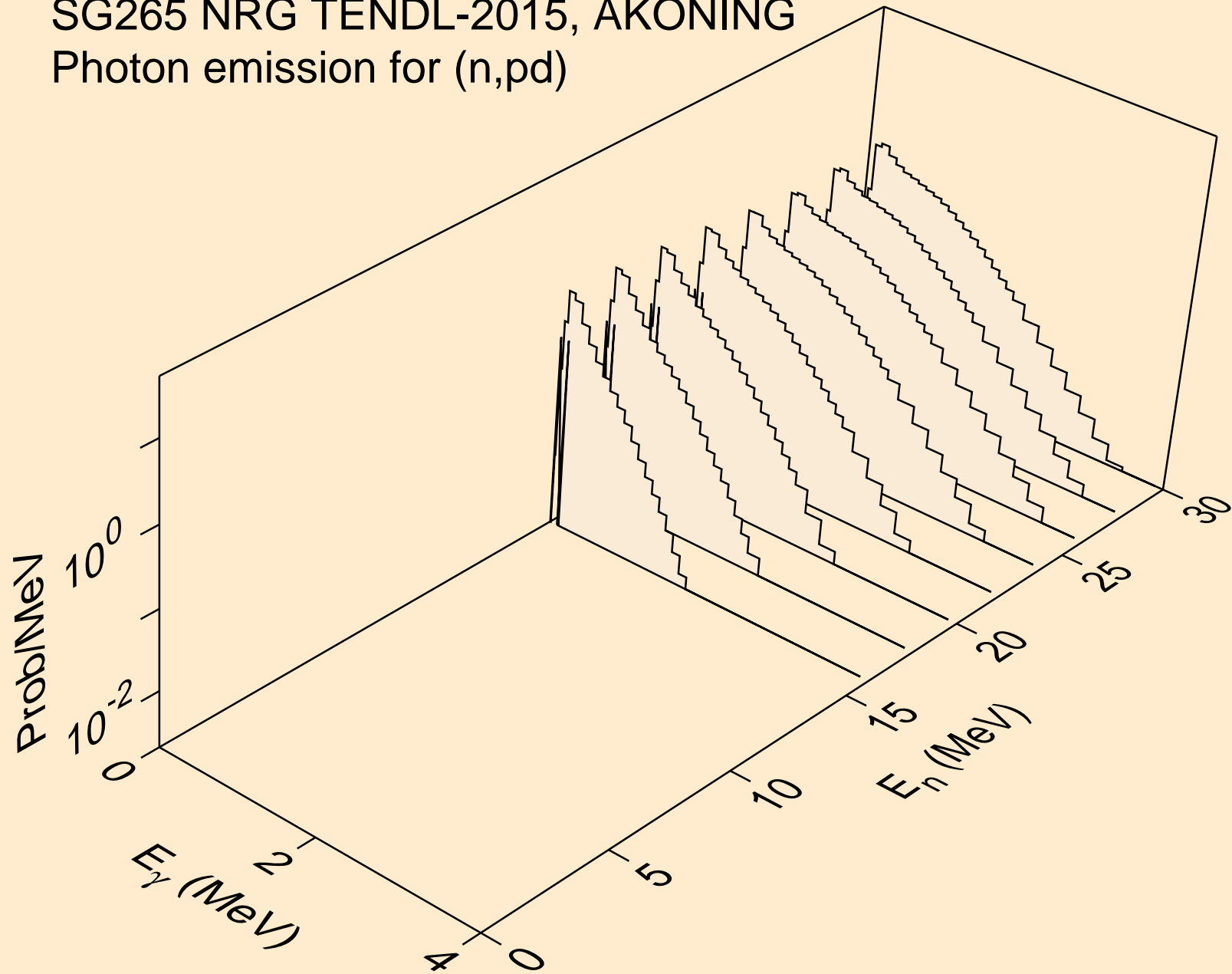

SG265 NRG TENDL-2015, AKONING
Photon emission for (n,da)

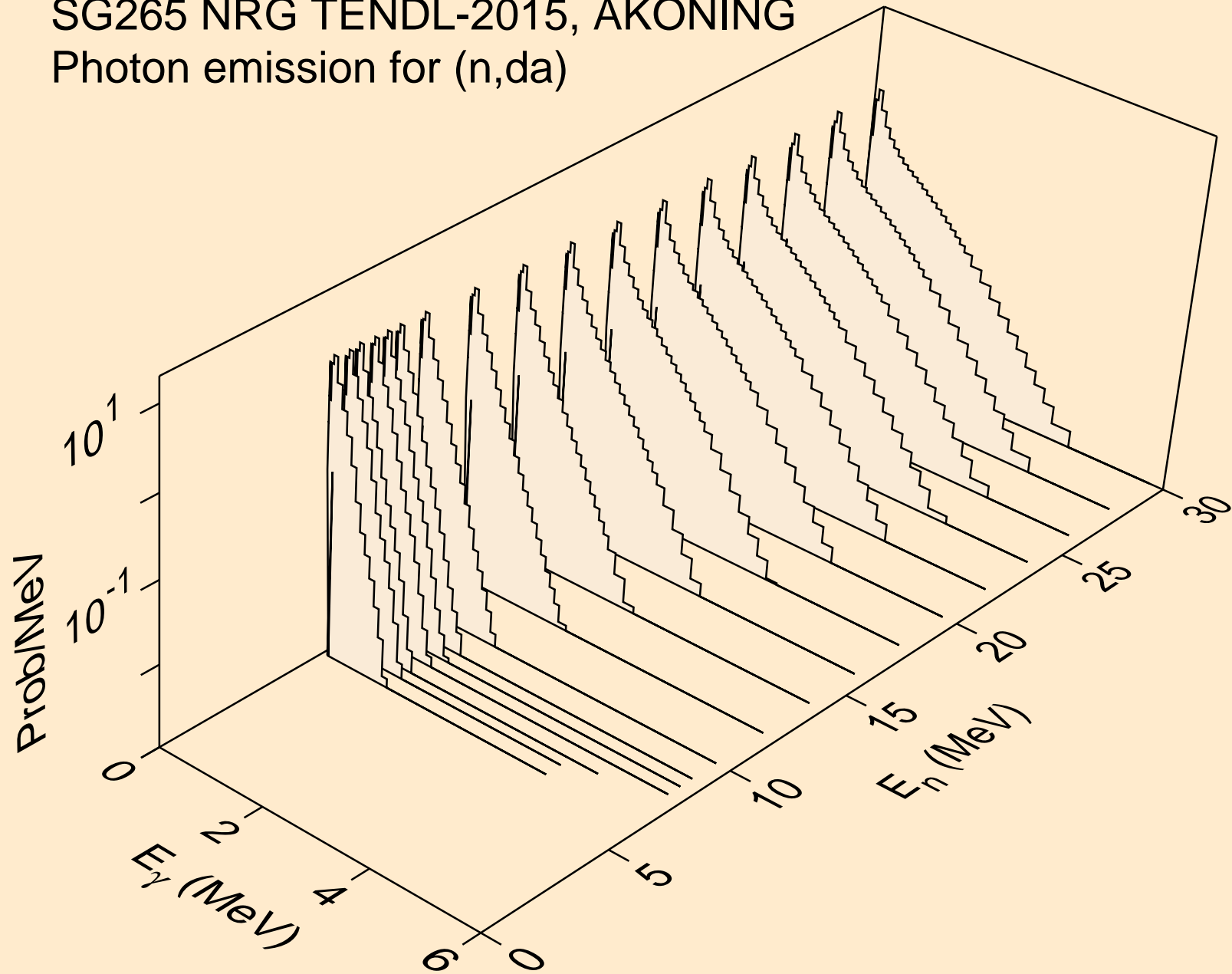

SG265 NRG TENDL-2015, AKONING
thermal capture photon spectrum

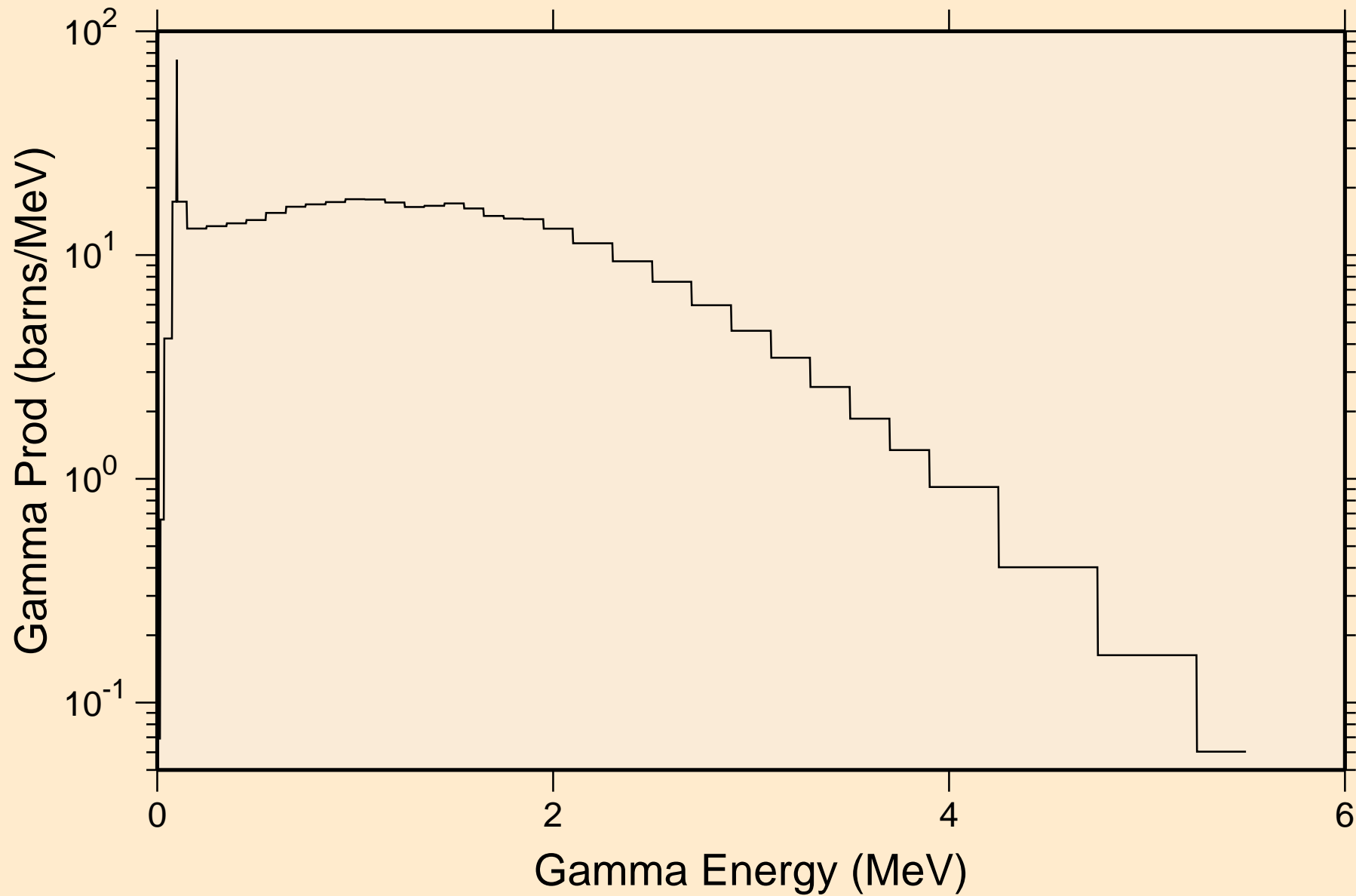

SG265 NRG TENDL-2015, AKONING
14 MeV photon spectrum

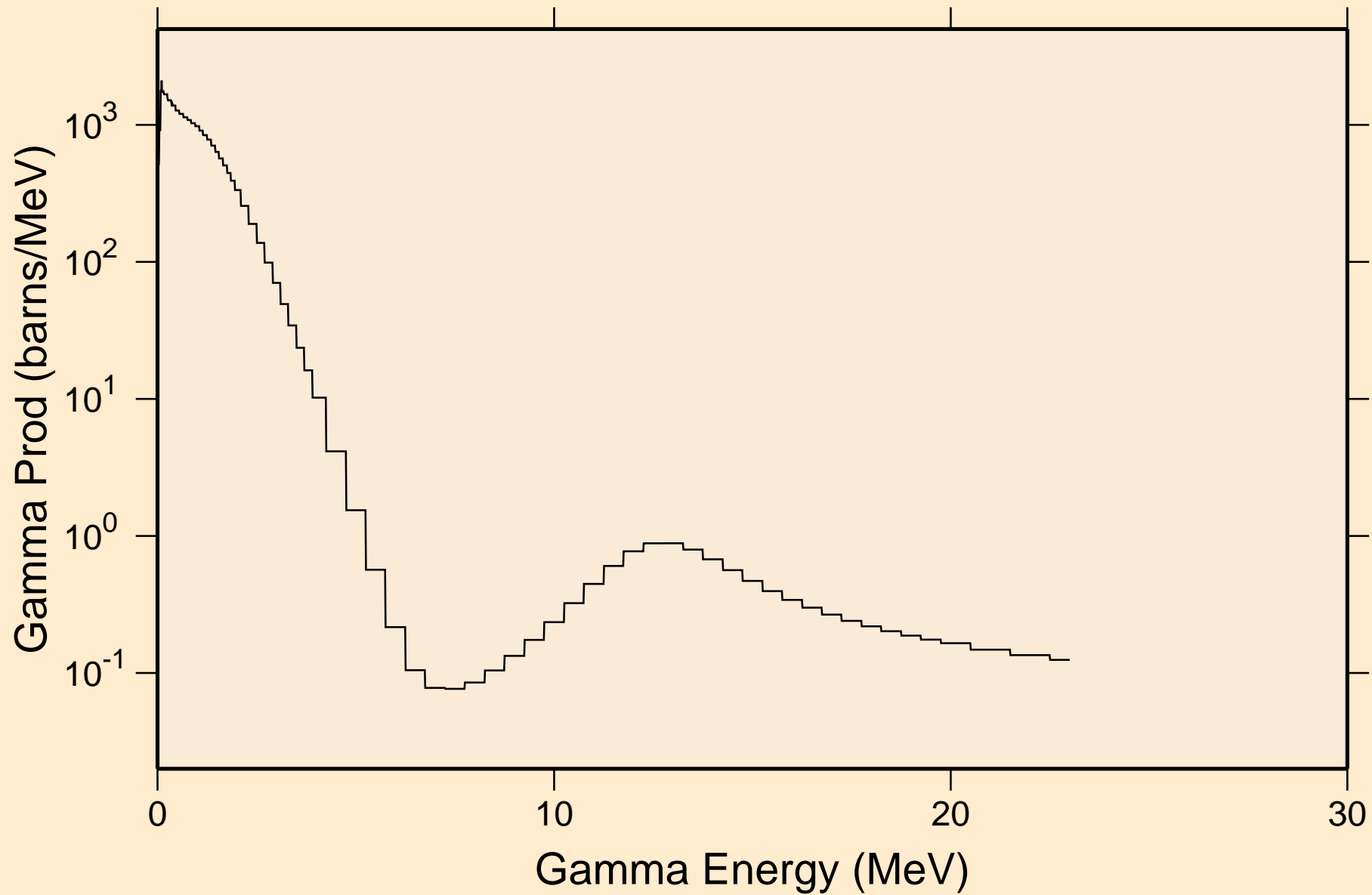

SG265 NRG TENDL-2015, AKONING

Particle heating contributions

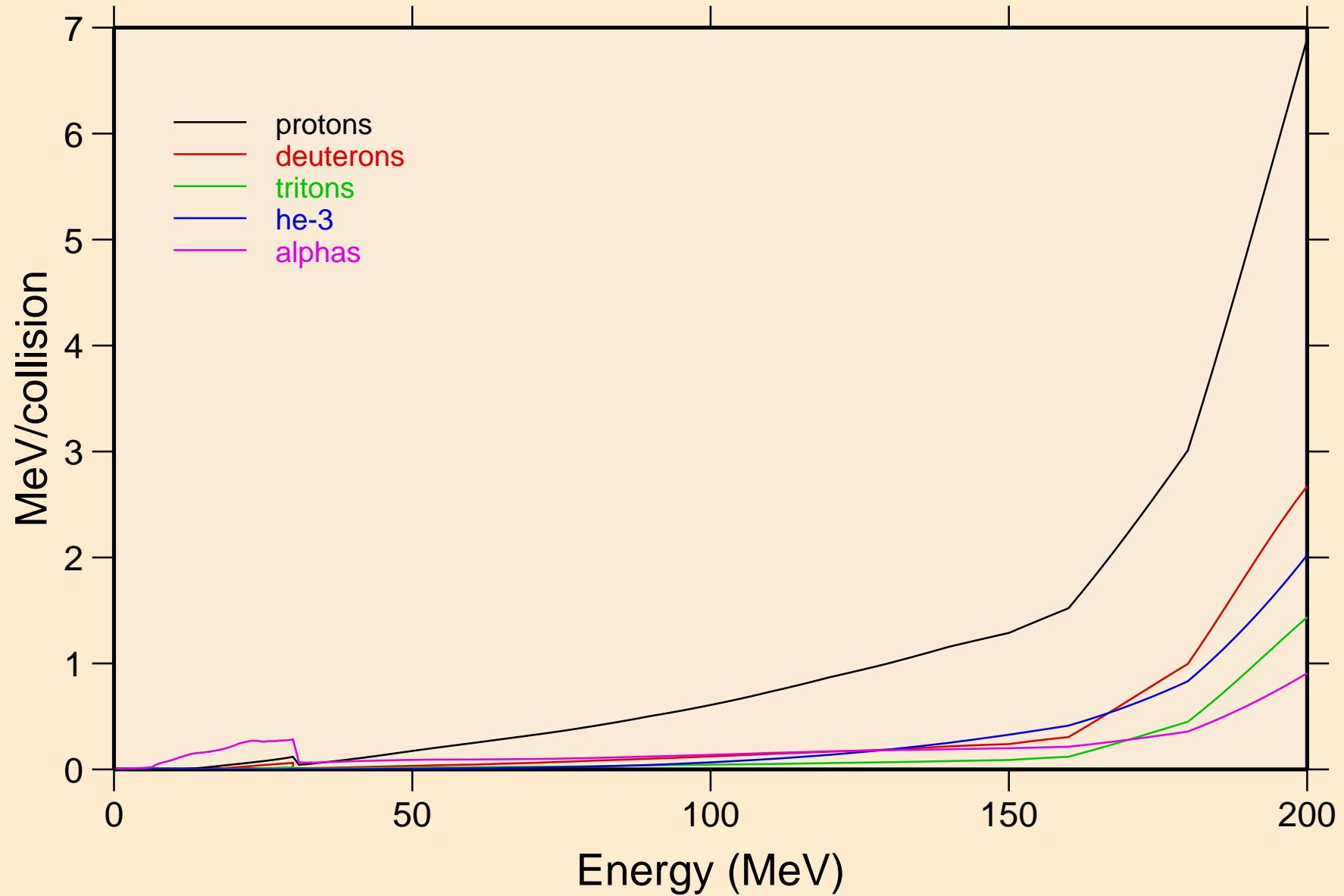

SG265 NRG TENDL-2015, AKONING

Recoil Heating

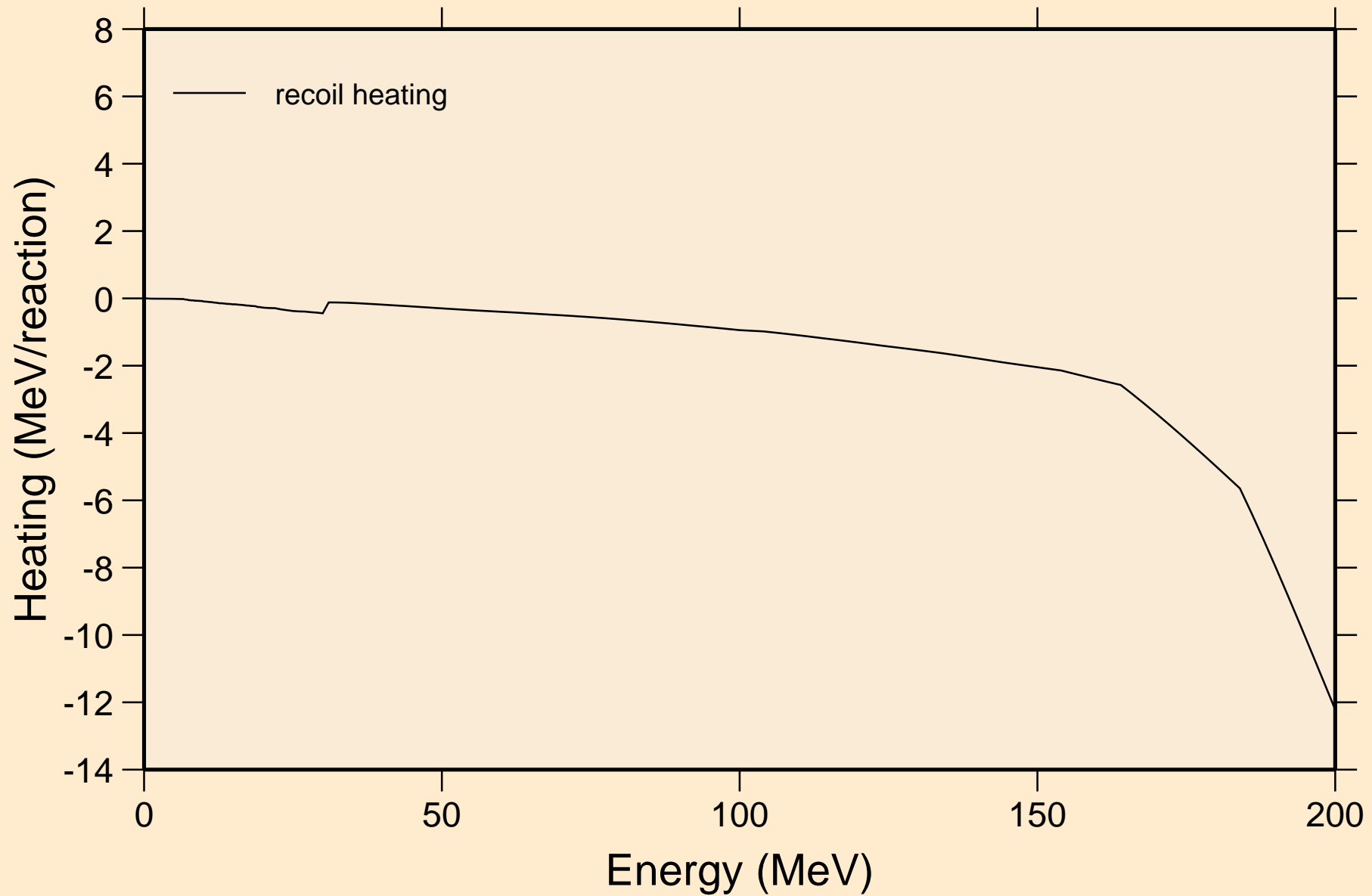

SG265 NRG TENDL-2015, AKONING

Particle production cross sections

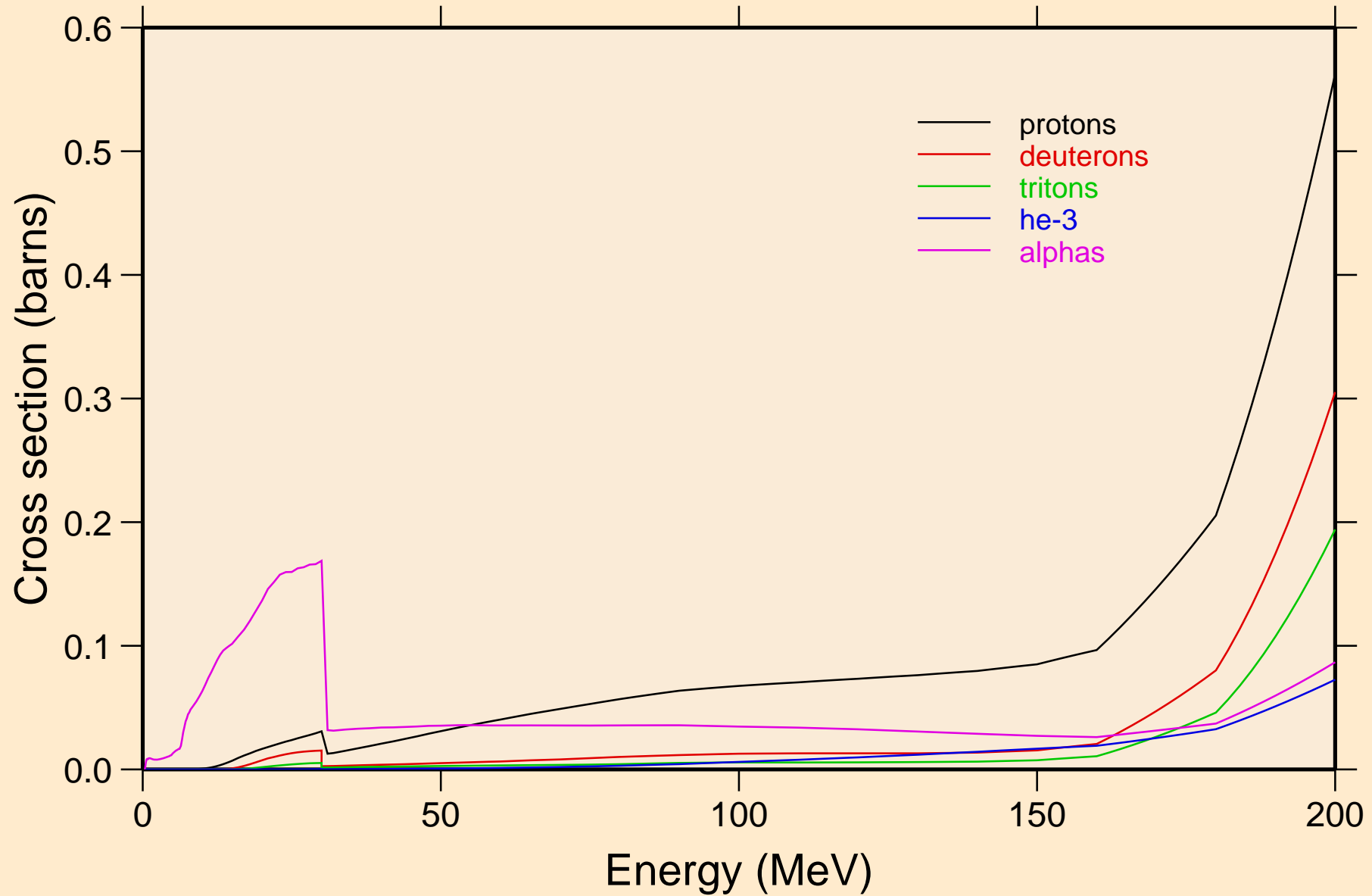

SG265 NRG TENDL-2015, AKONING
protons from (n,x)

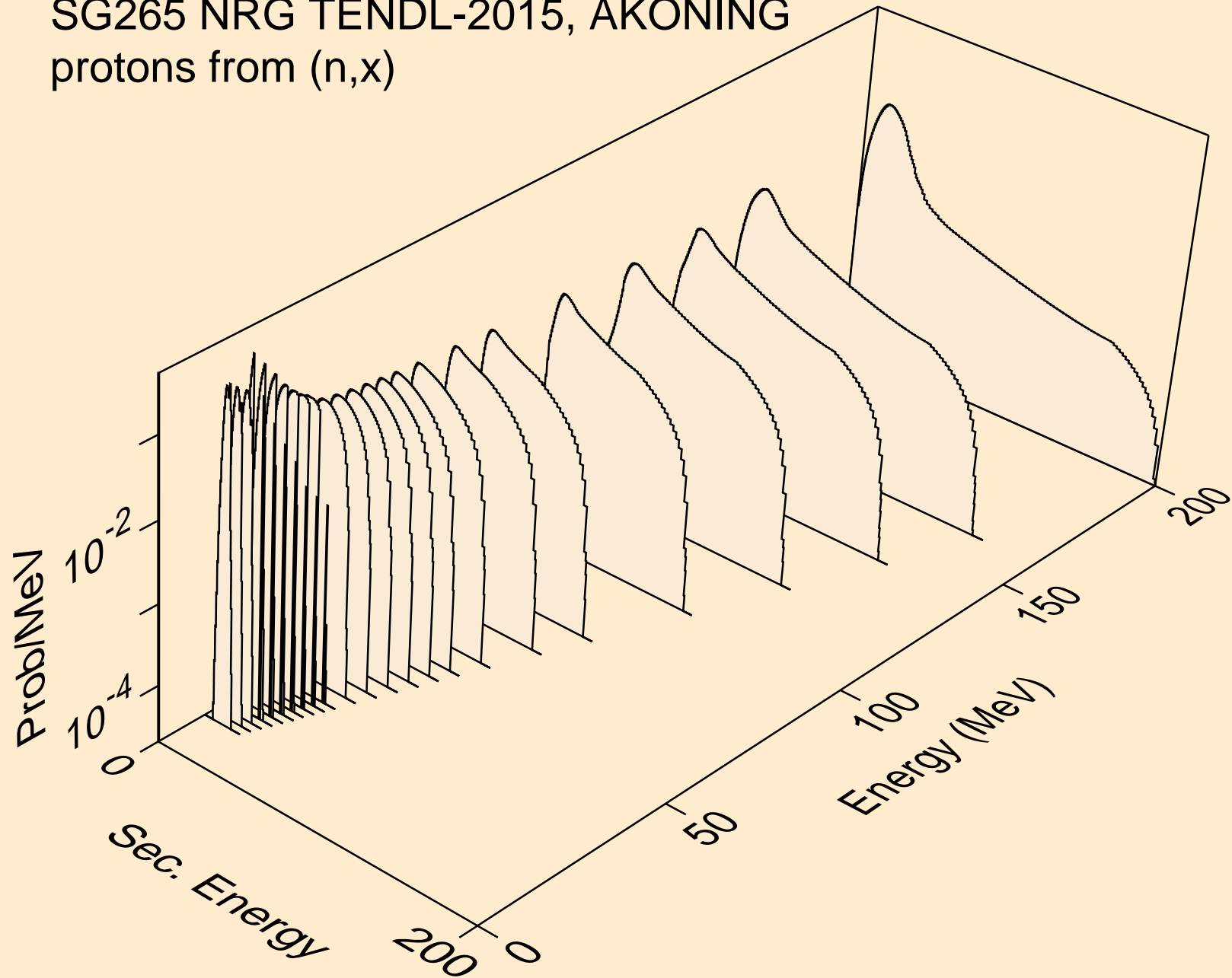

SG265 NRG TENDL-2015, AKONING
protons from (n,n*)p

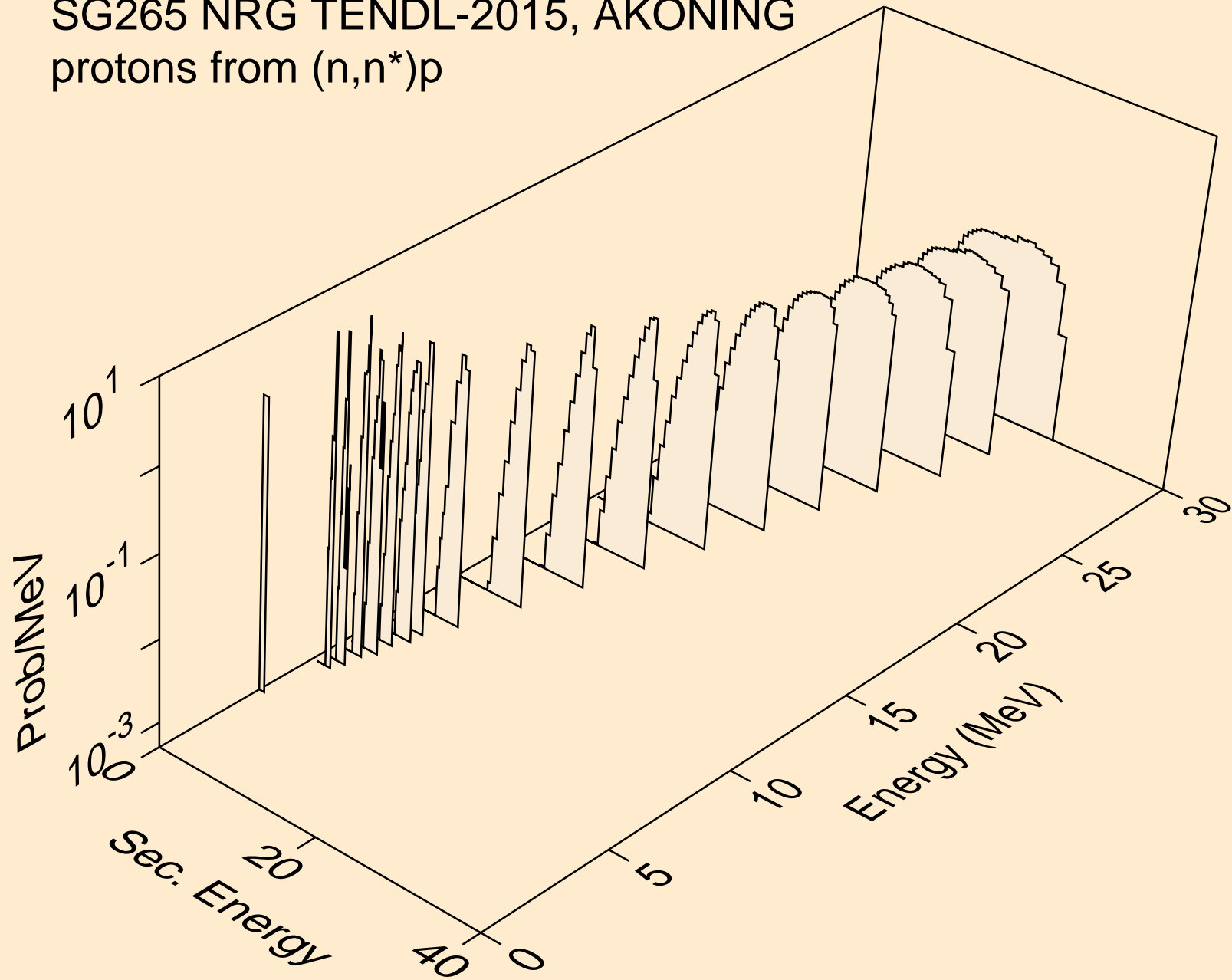

SG265 NRG TENDL-2015, AKONING
protons from (n,2np)

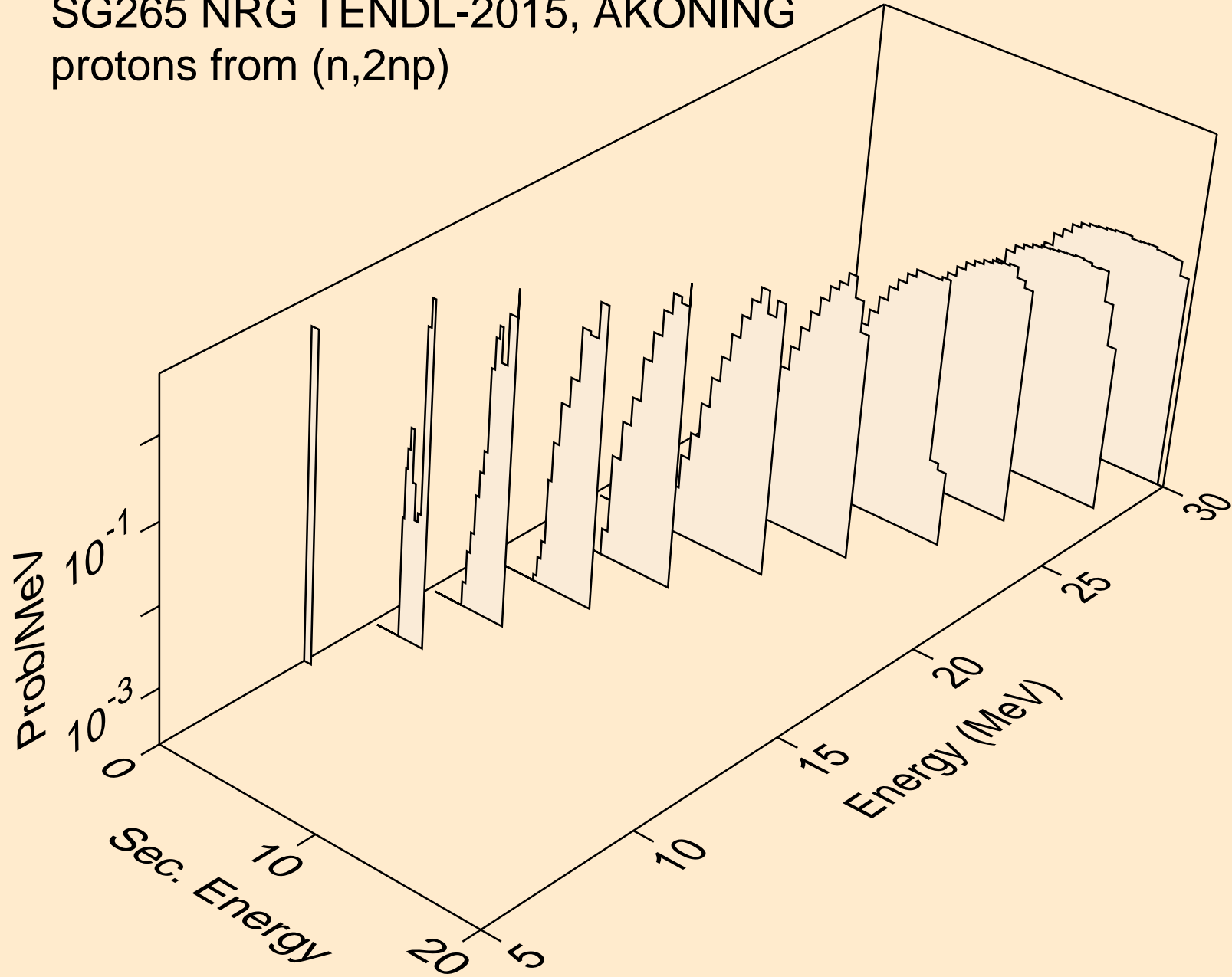

SG265 NRG TENDL-2015, AKONING
protons from (n,3np)

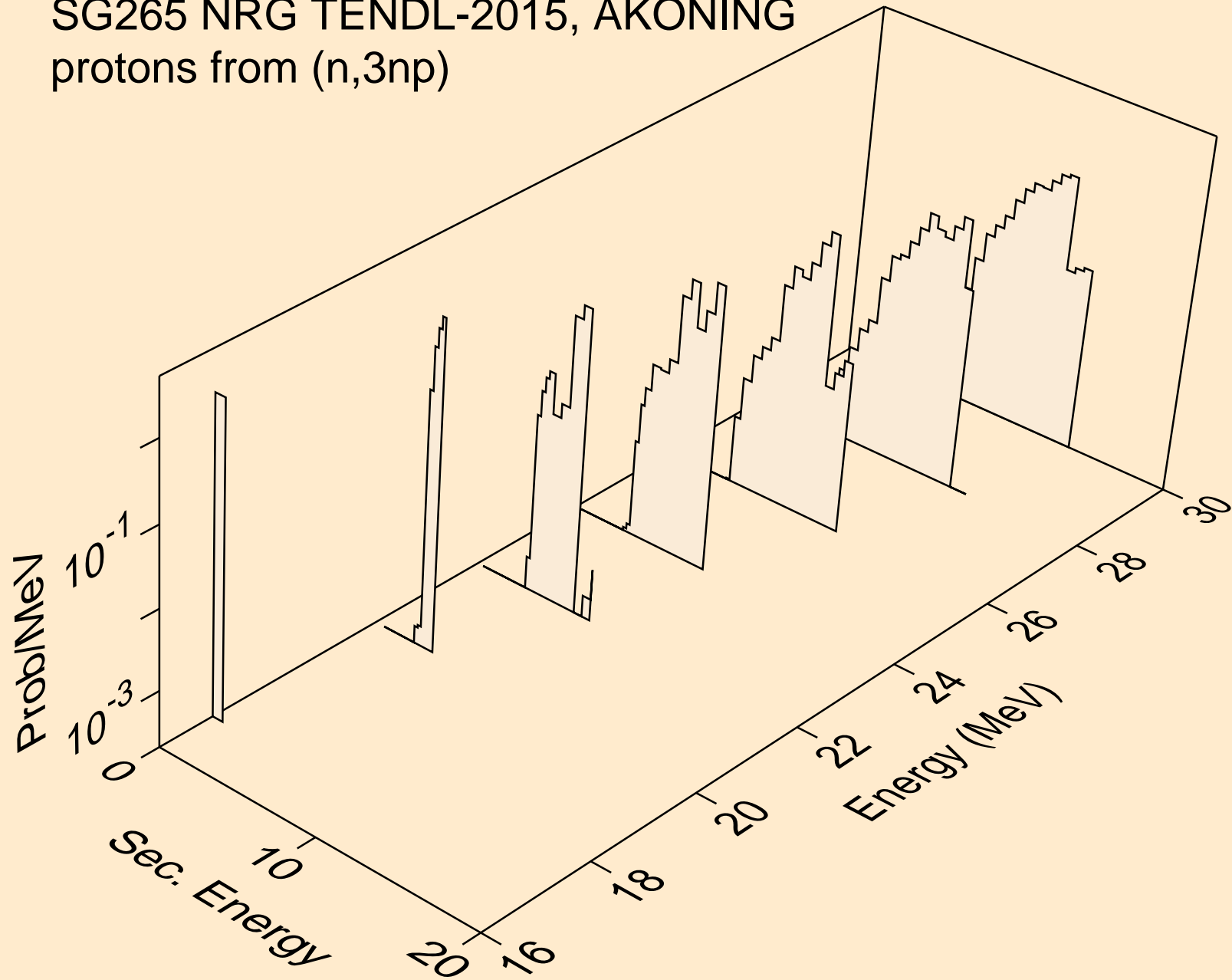

SG265 NRG TENDL-2015, AKONING
protons from (n,2np)

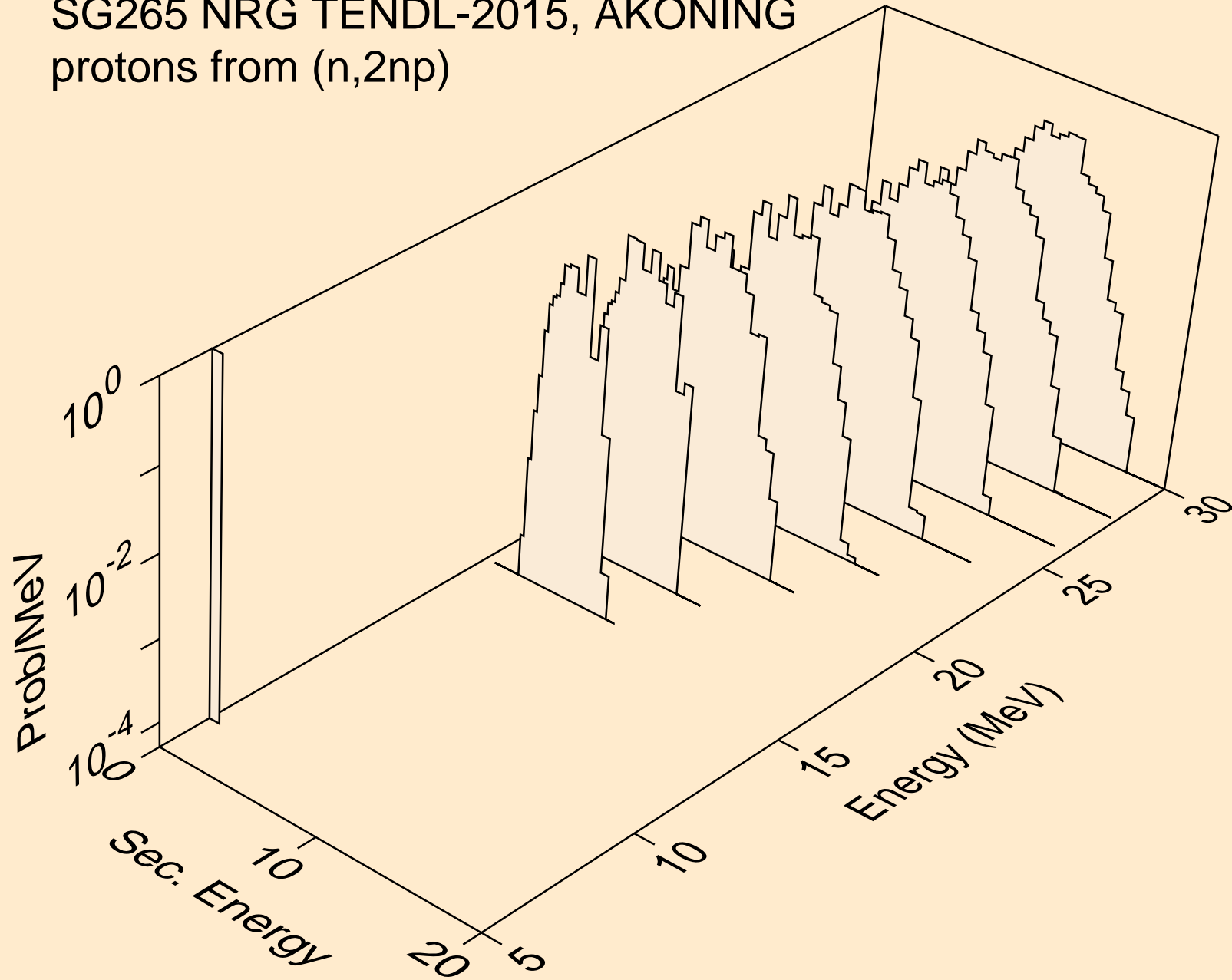

SG265 NRG TENDL-2015, AKONING
protons from (n,npa)

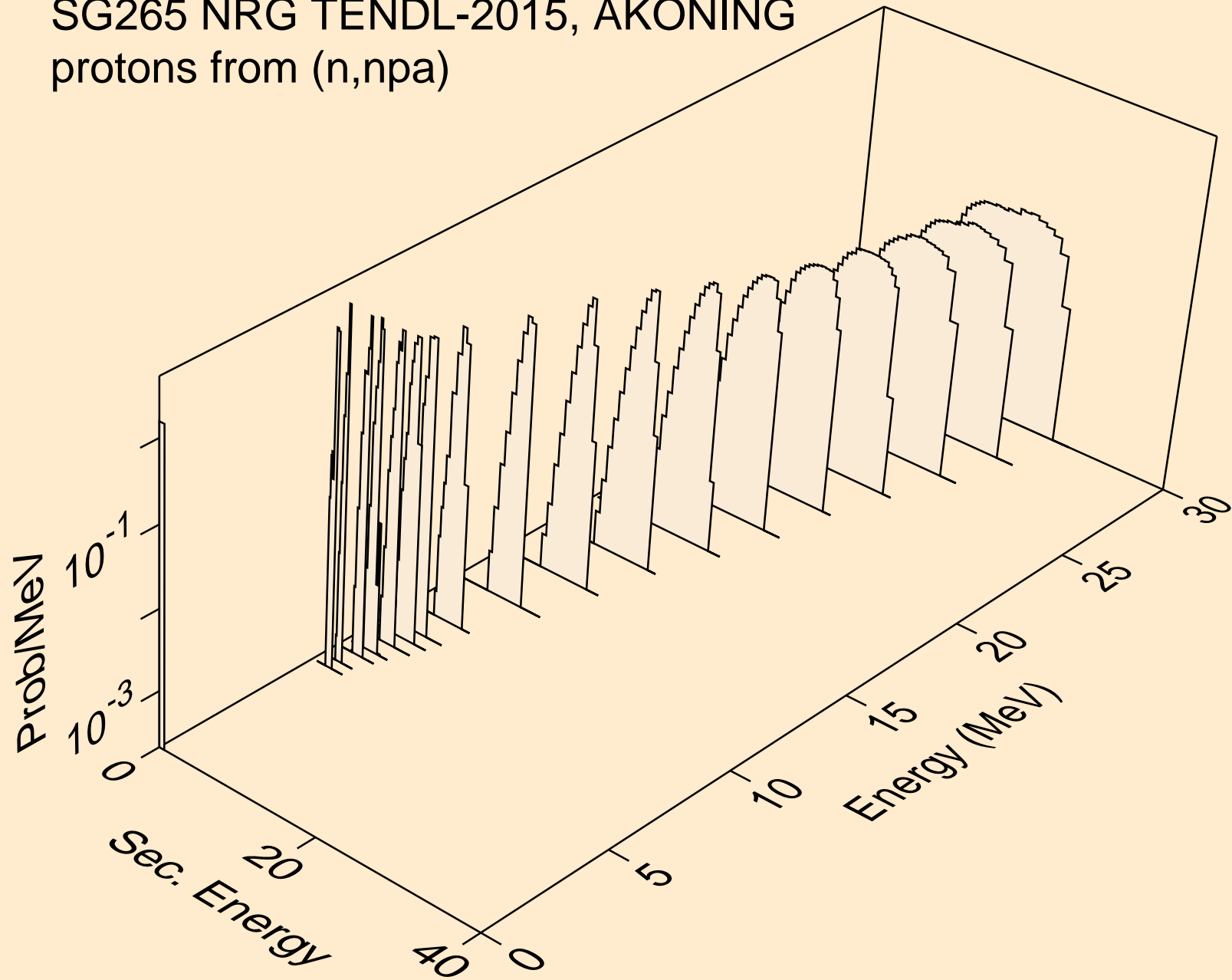

SG265 NRG TENDL-2015, AKONING
protons from (n,p)

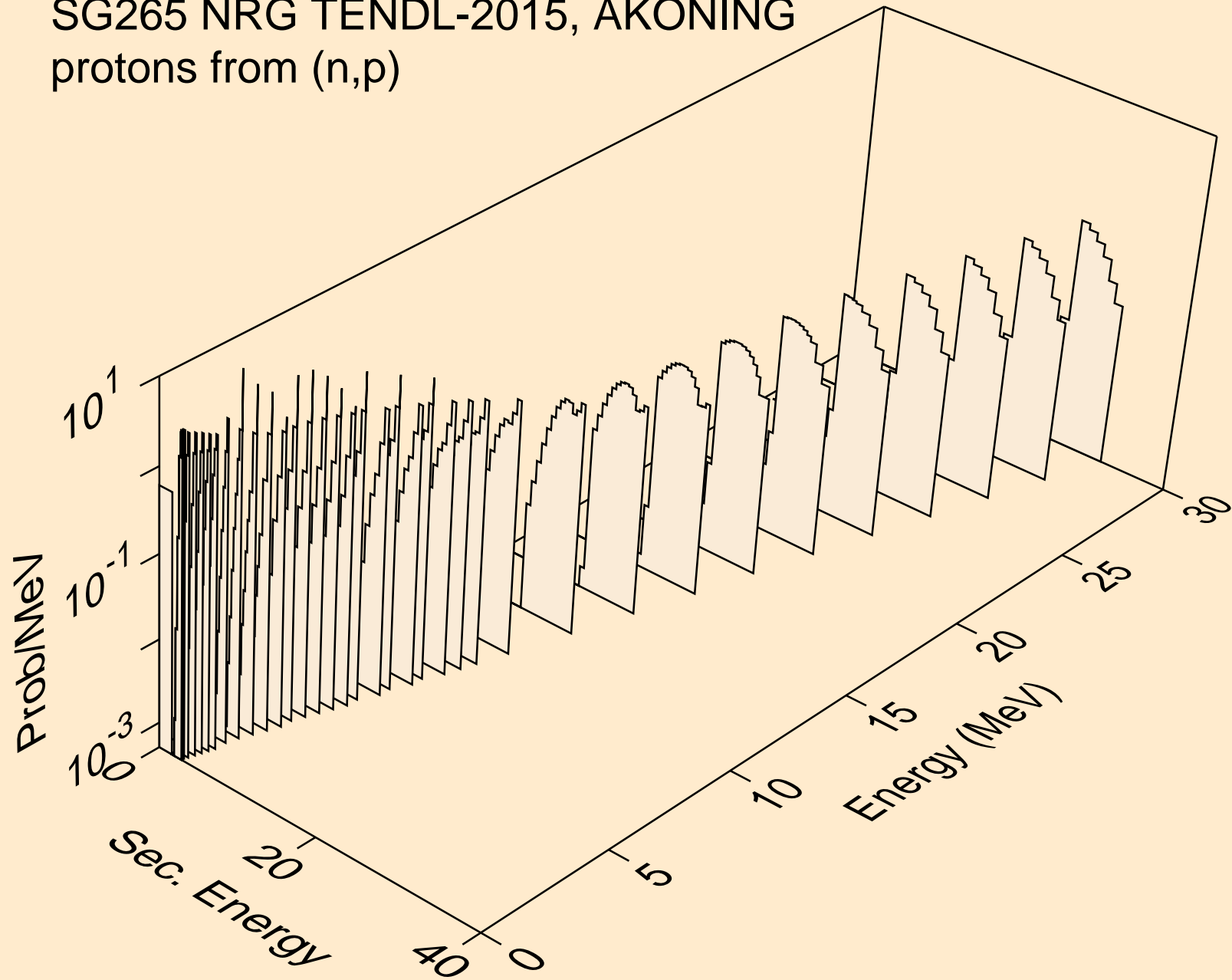

SG265 NRG TENDL-2015, AKONING
protons from (n,2p)

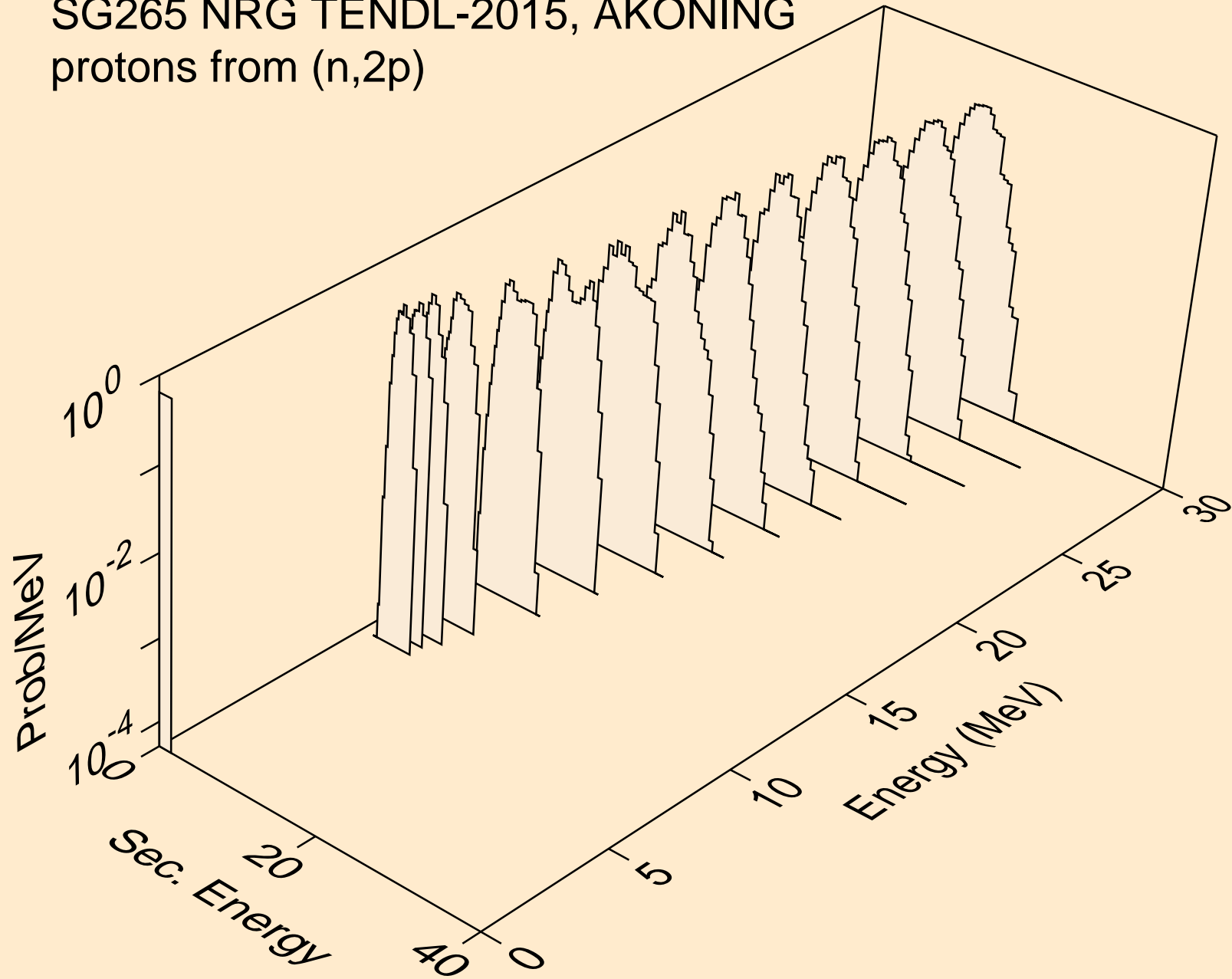

SG265 NRG TENDL-2015, AKONING
protons from (n,pa)

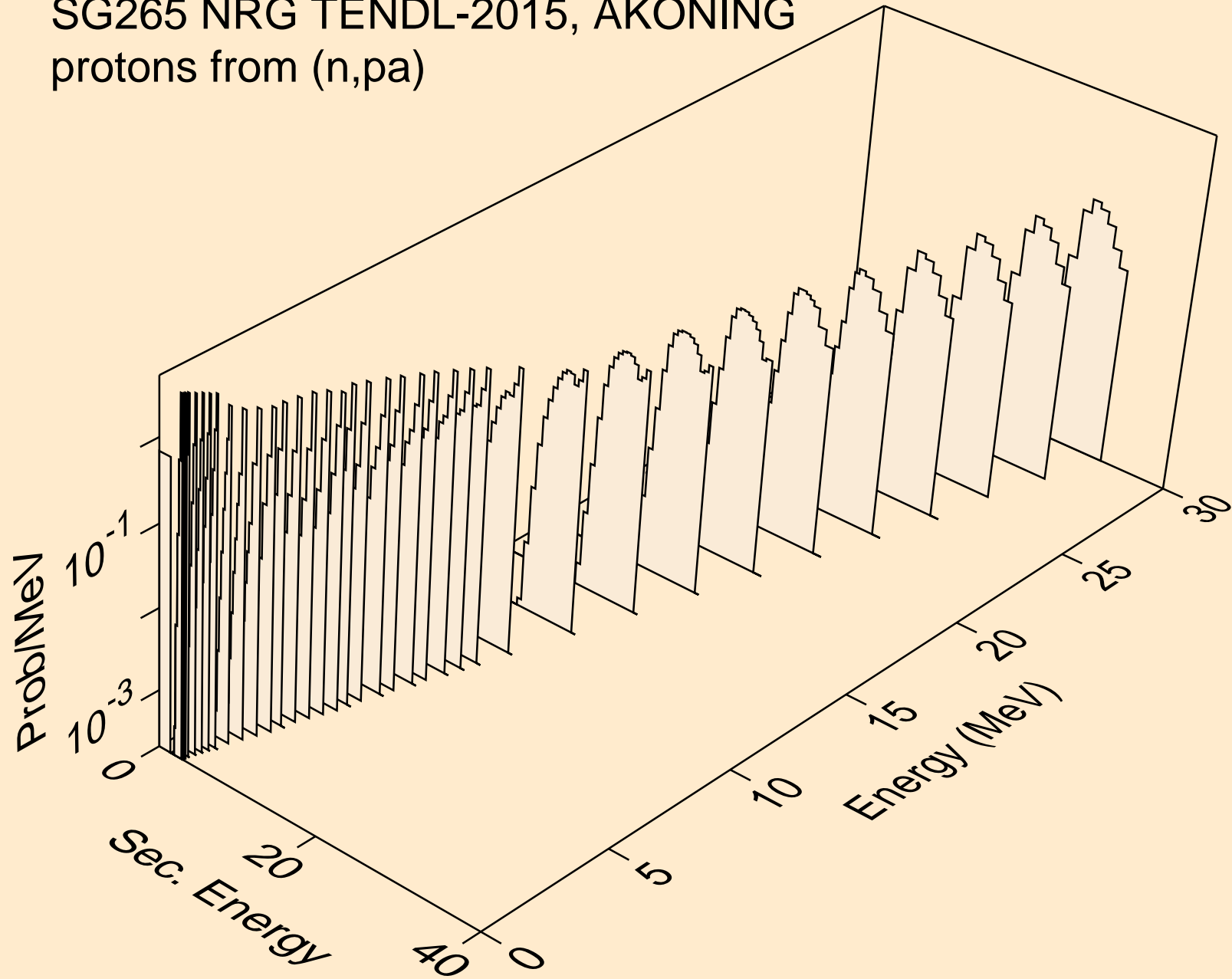

SG265 NRG TENDL-2015, AKONING
protons from (n,pd)

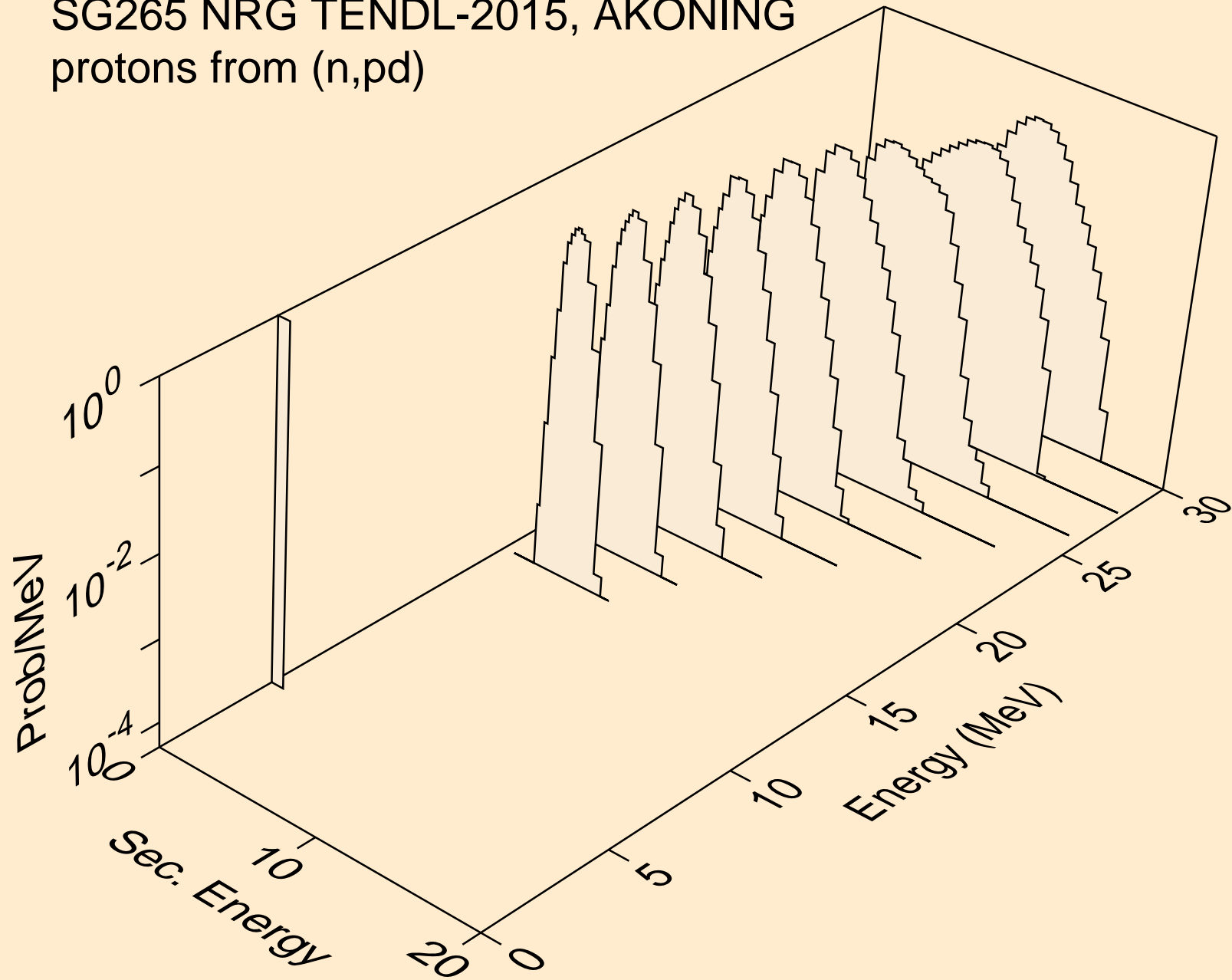

SG265 NRG TENDL-2015, AKONING
deuterons from (n,x)

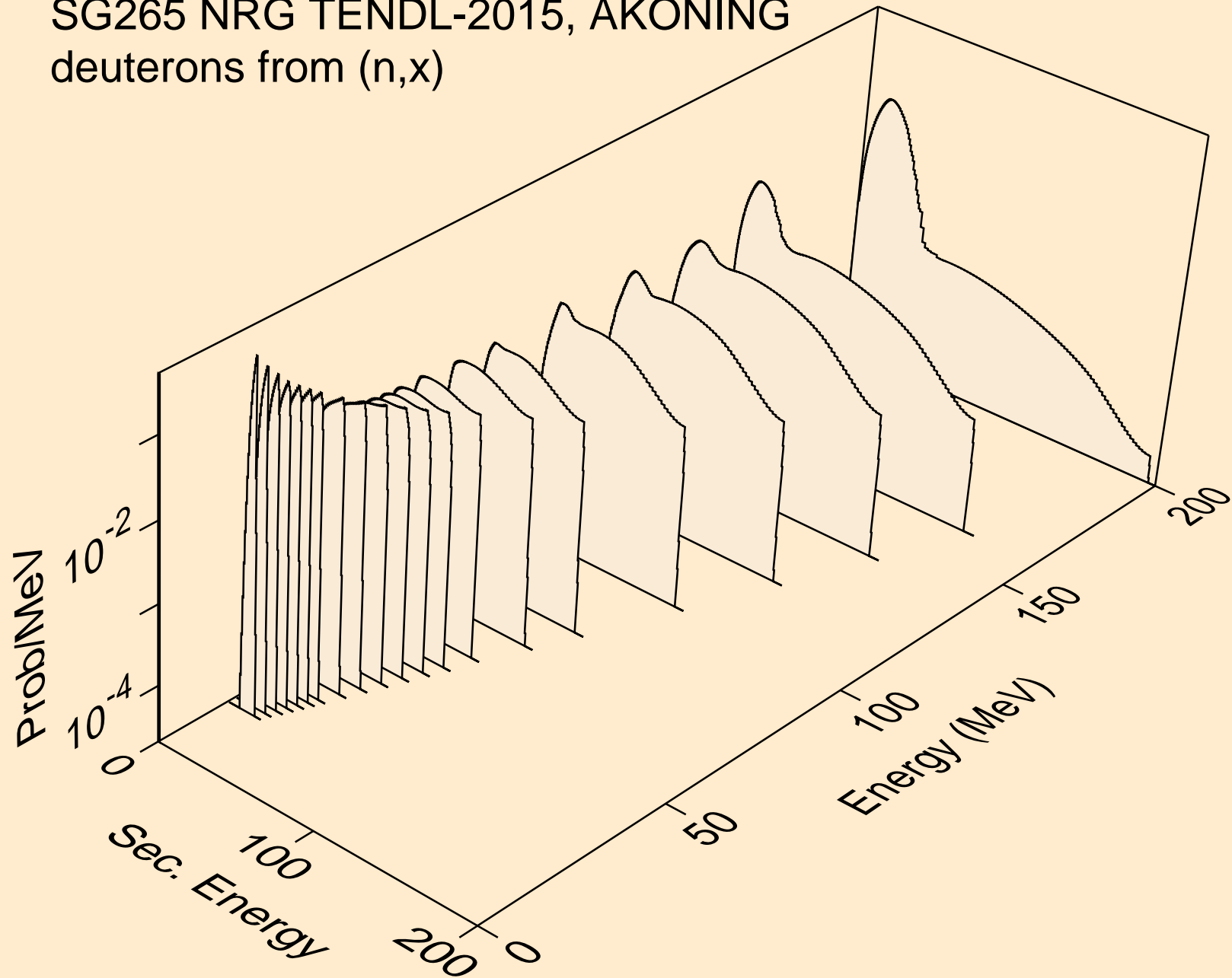

SG265 NRG TENDL-2015, AKONING
deuterons from (n,2nd)

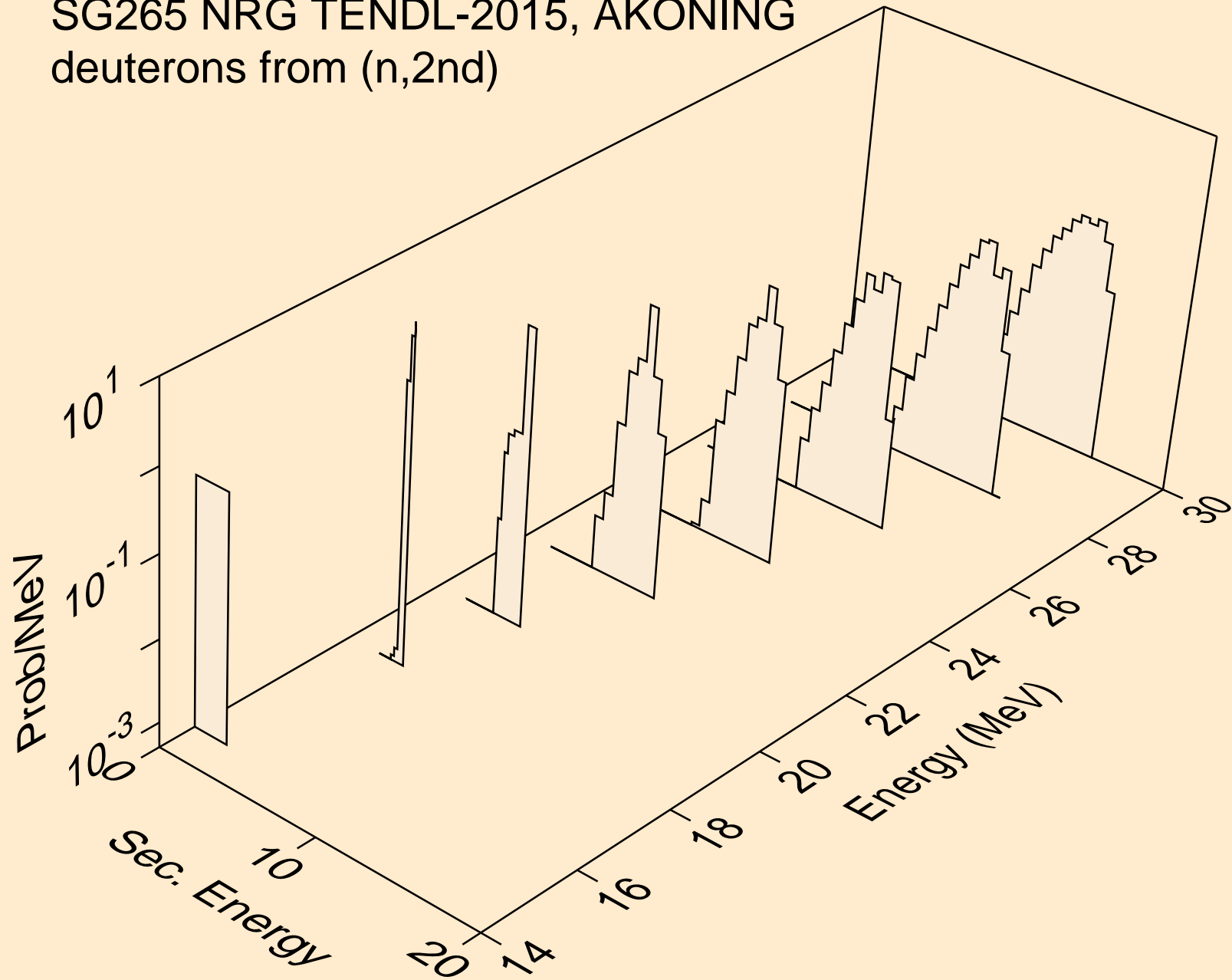

SG265 NRG TENDL-2015, AKONING
deuterons from (n,n*)d

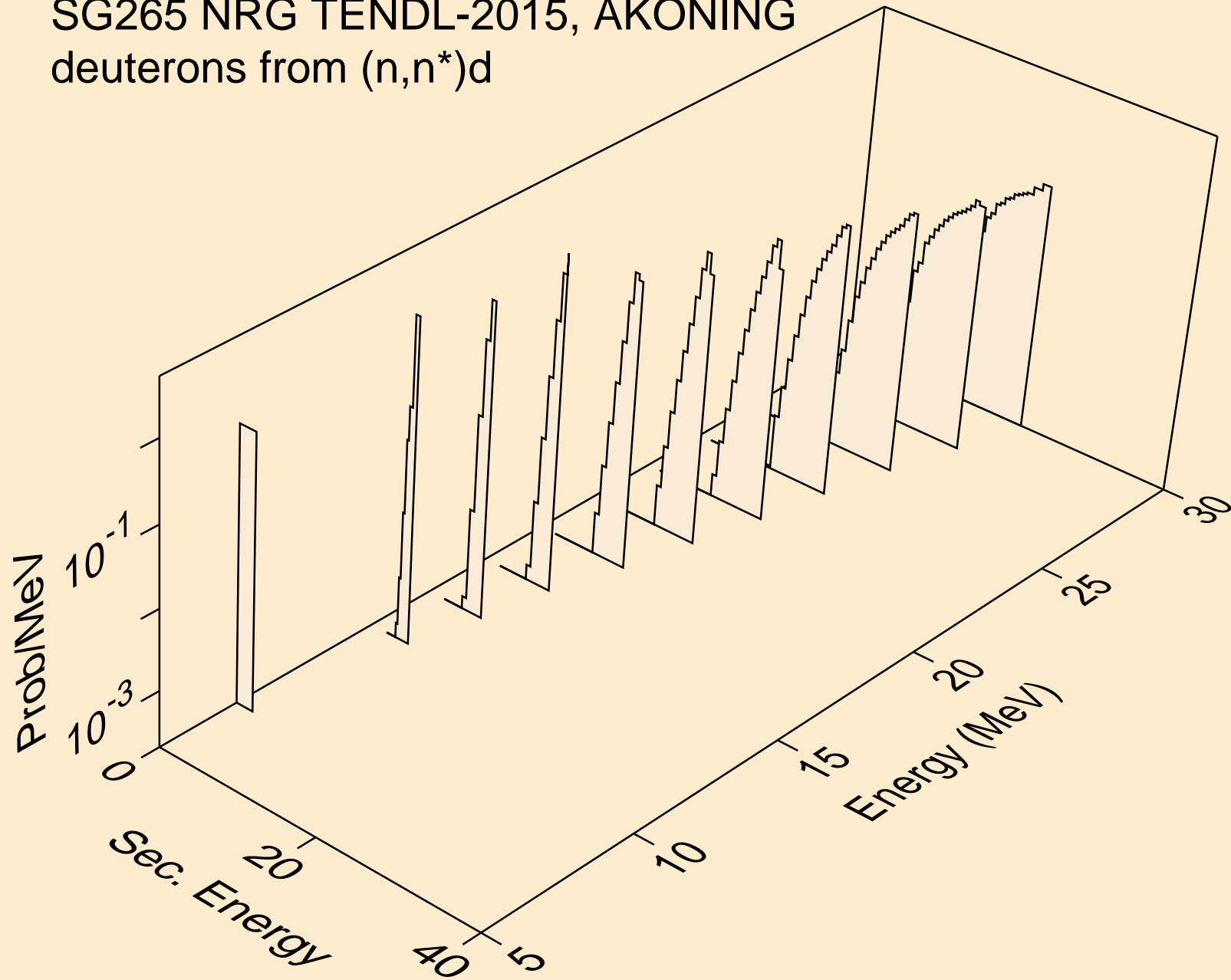

SG265 NRG TENDL-2015, AKONING
deuterons from (n,n*)d2a

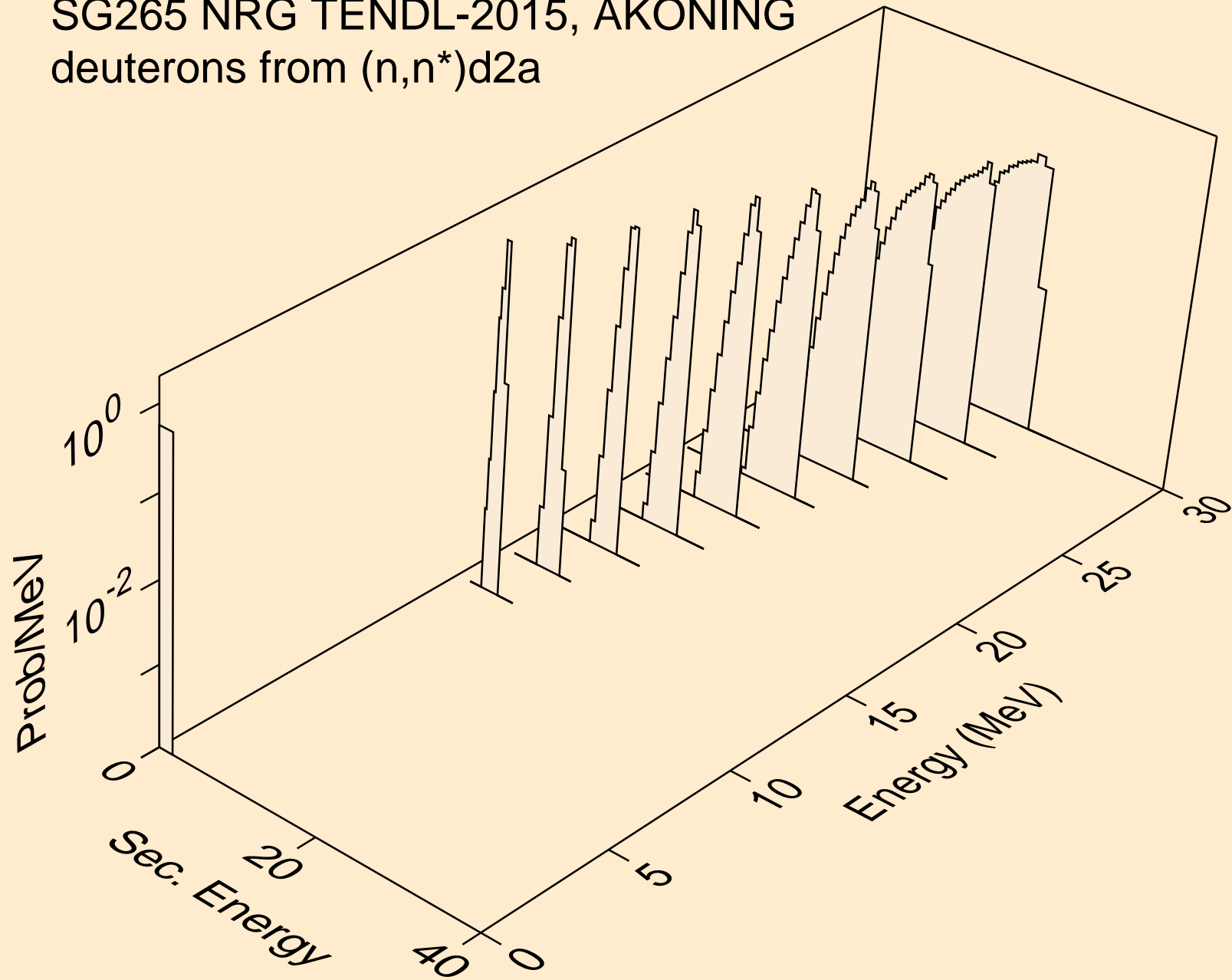

SG265 NRG TENDL-2015, AKONING
deuterons from (n,d)

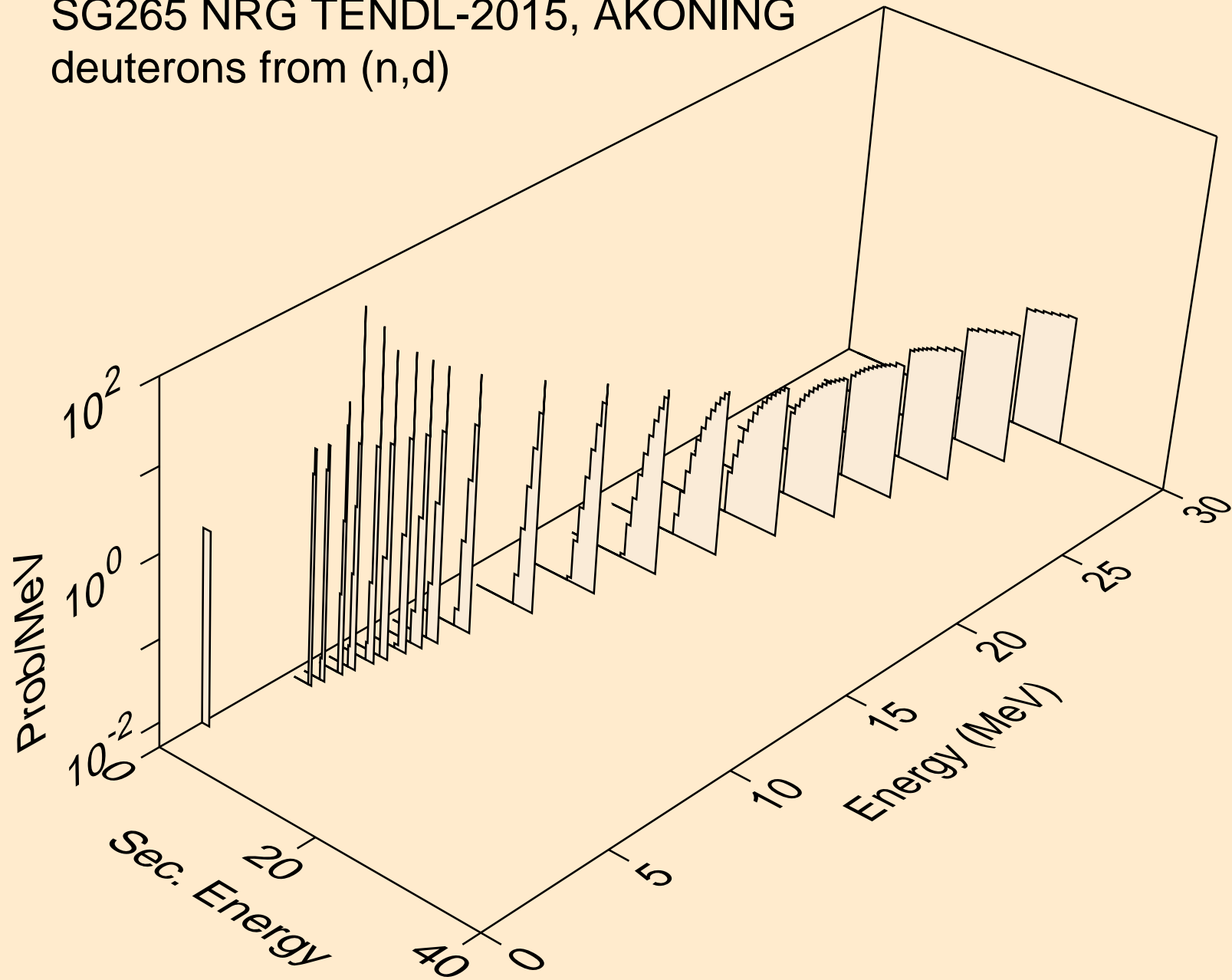

SG265 NRG TENDL-2015, AKONING
deuterons from (n,d2a)

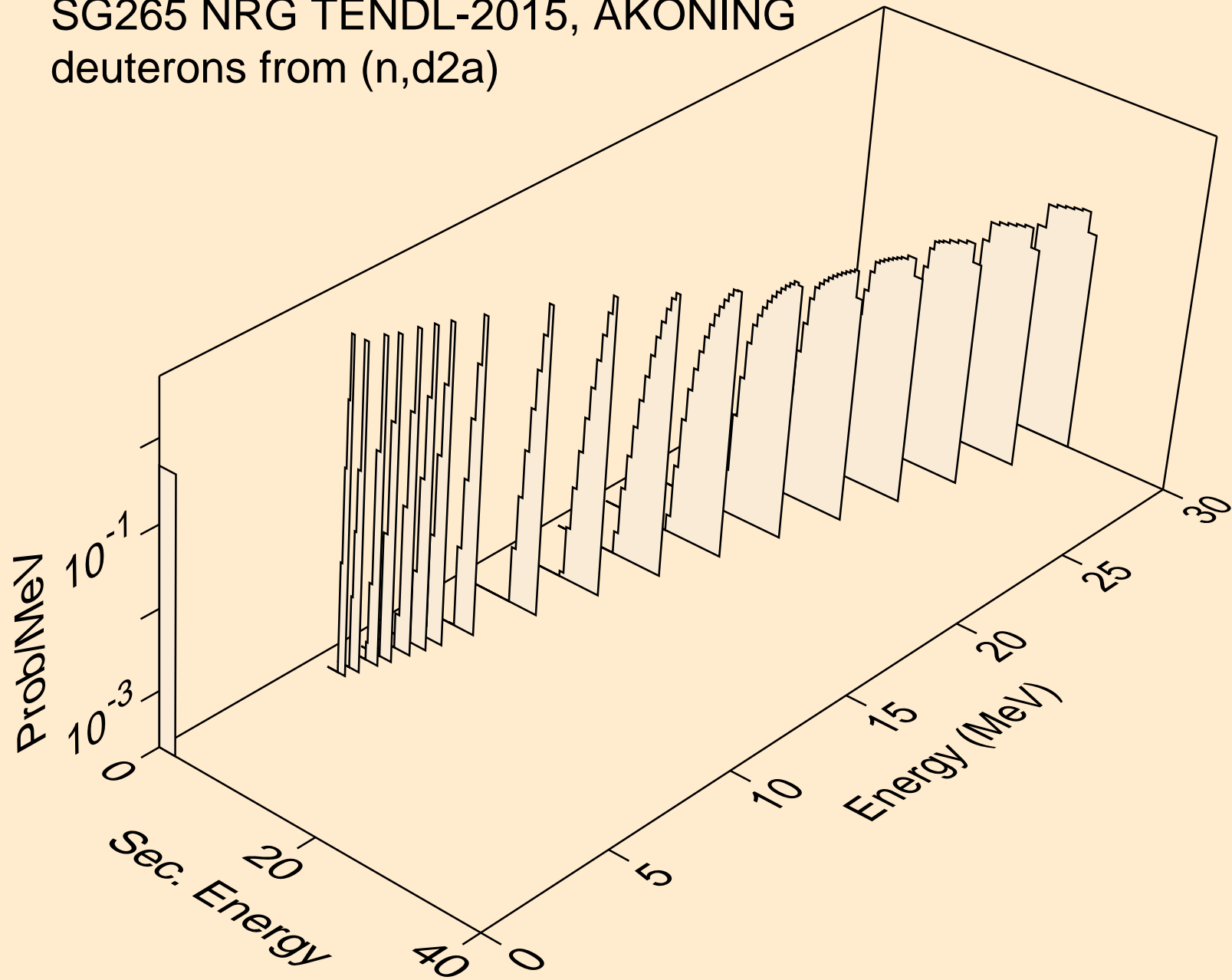

SG265 NRG TENDL-2015, AKONING
deuterons from (n,pd)

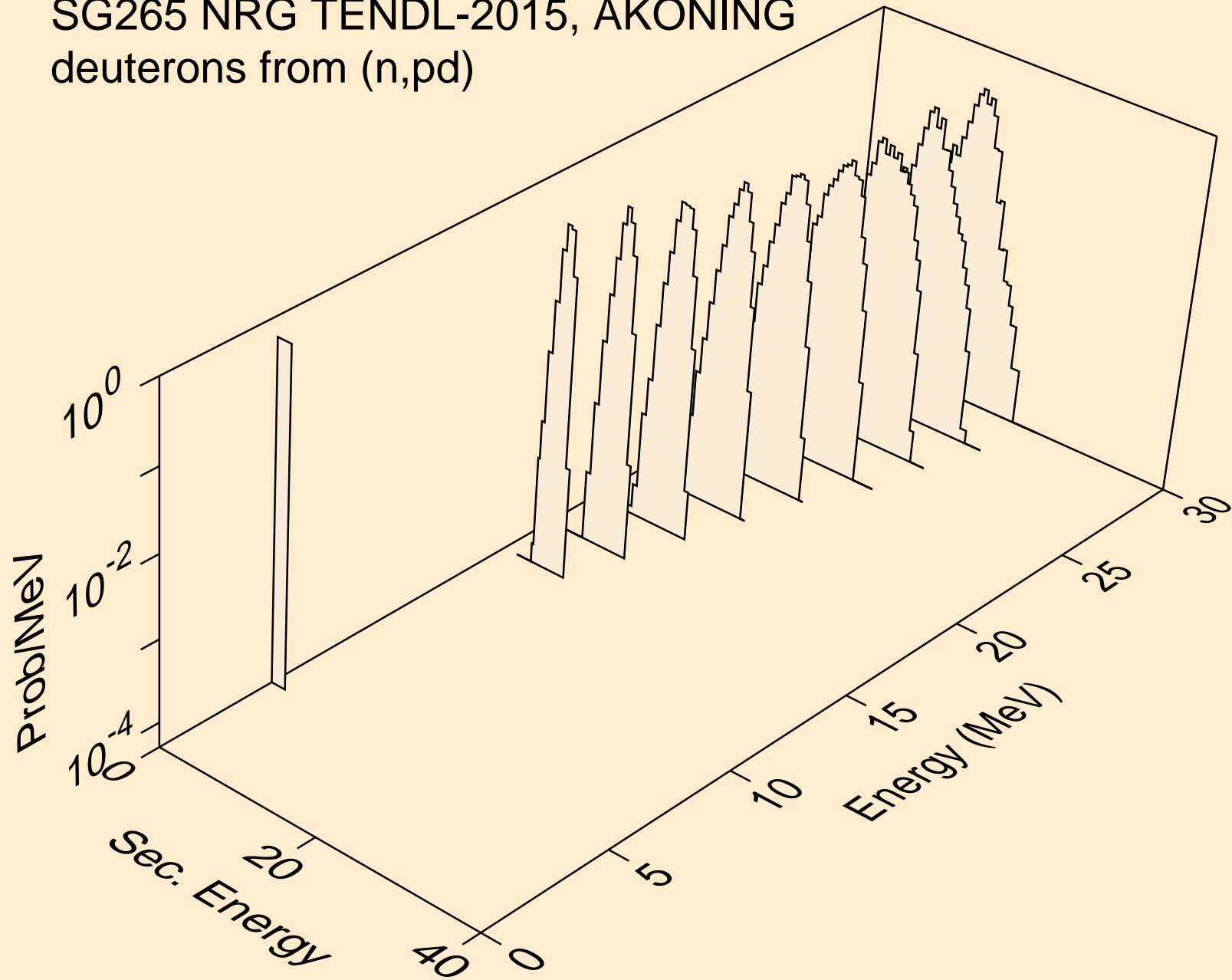

SG265 NRG TENDL-2015, AKONING
deuterons from (n,da)

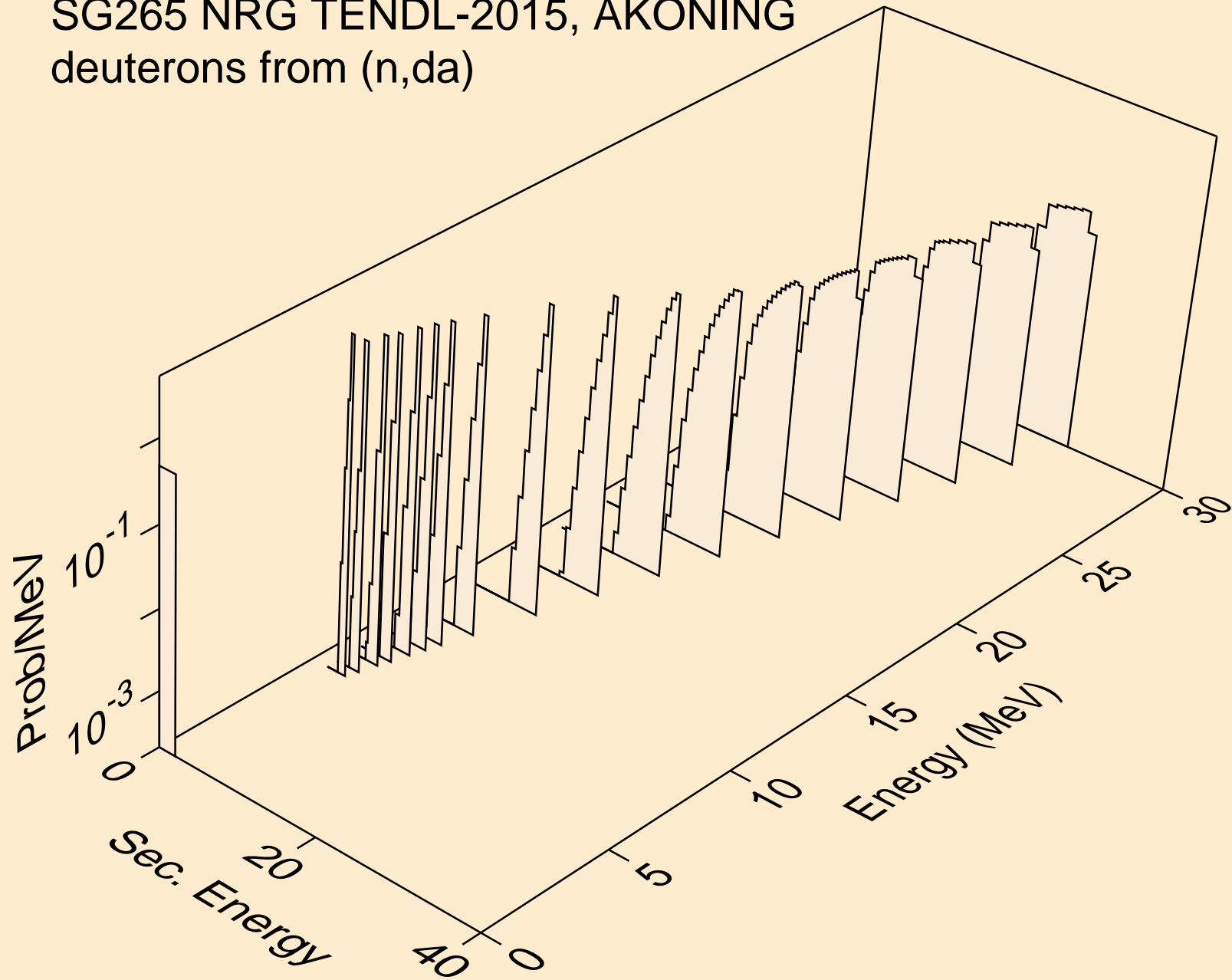

SG265 NRG TENDL-2015, AKONING
tritons from (n,x)

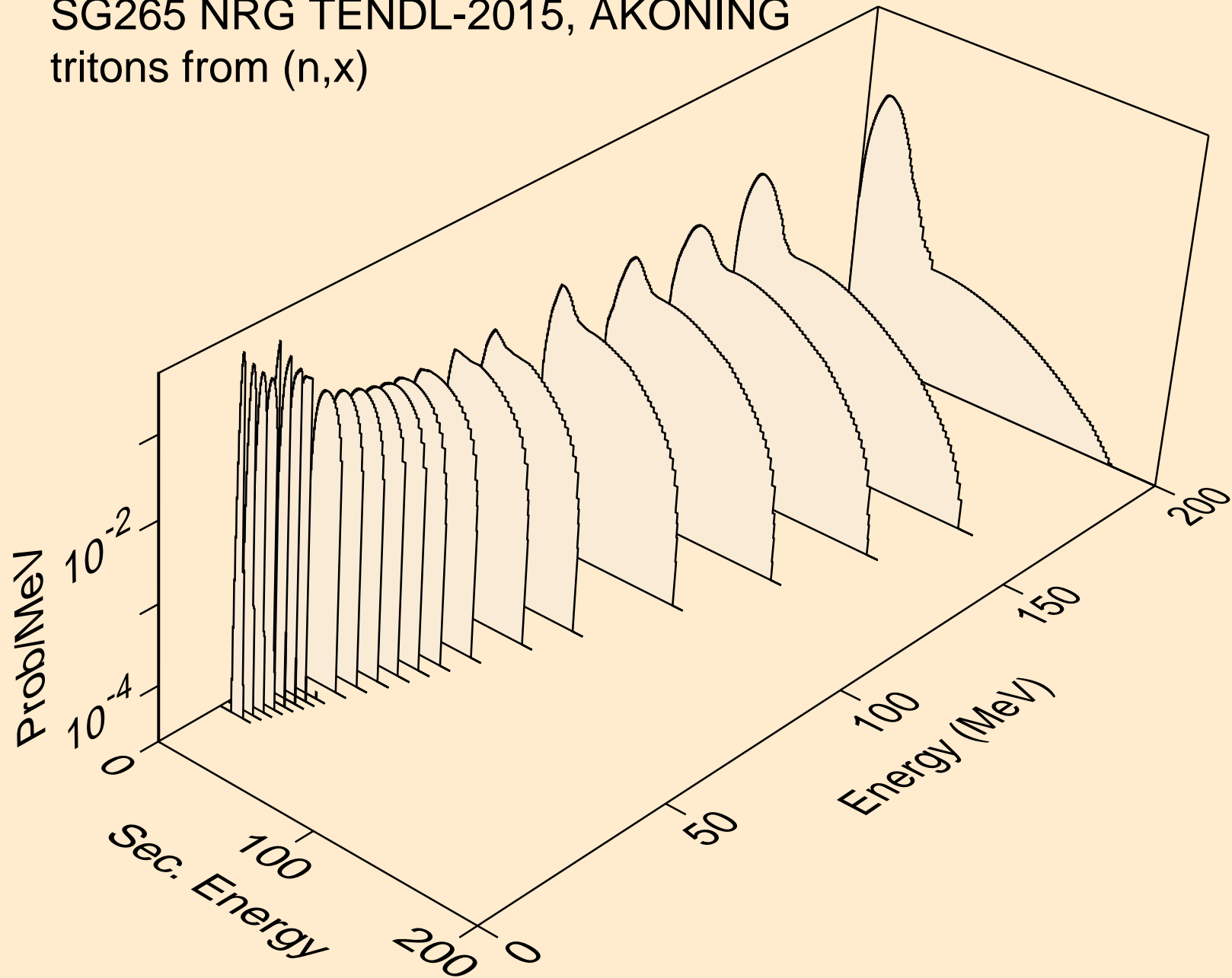

SG265 NRG TENDL-2015, AKONING
tritons from (n,n*)t

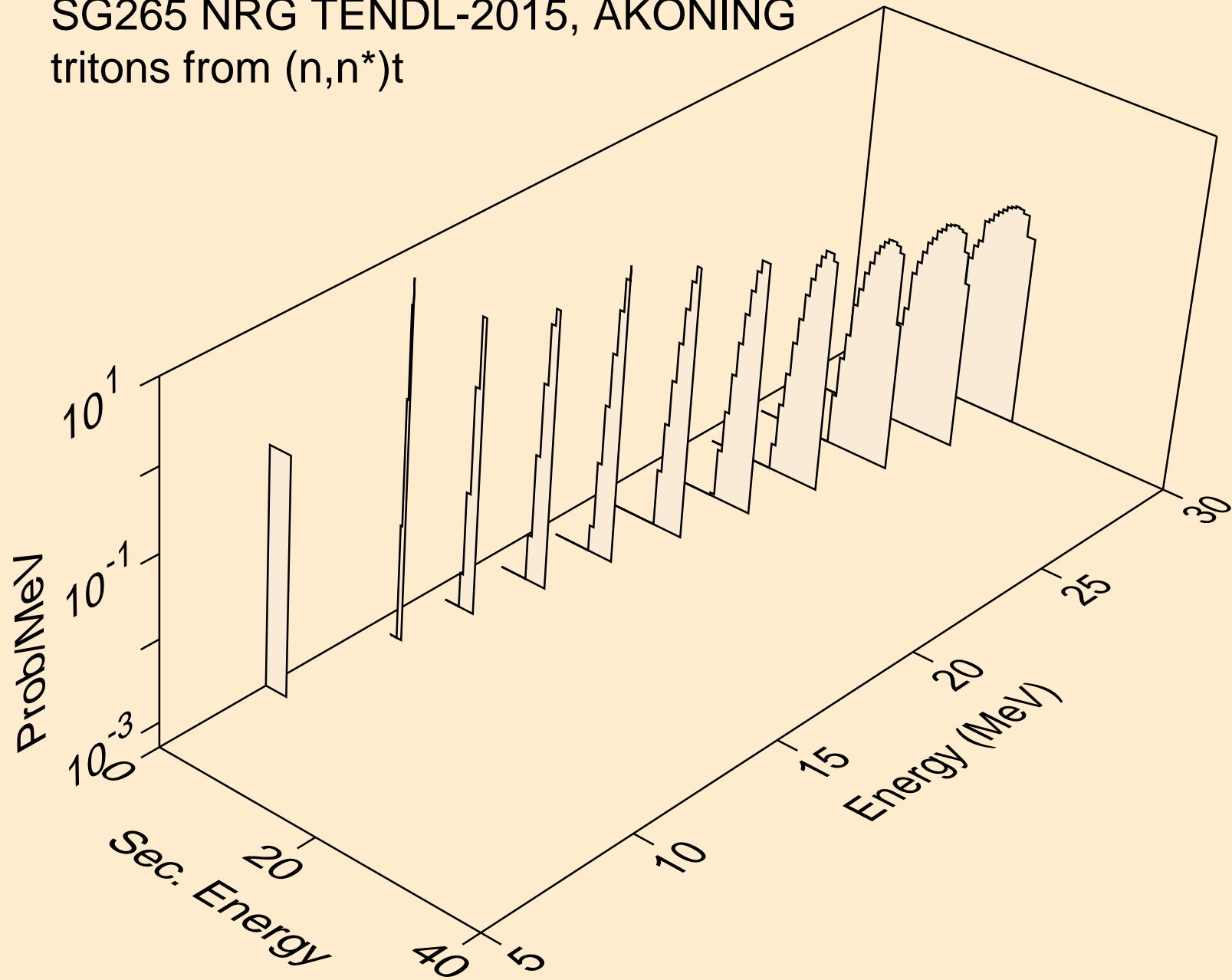

SG265 NRG TENDL-2015, AKONING
tritons from (n,n*)t2a

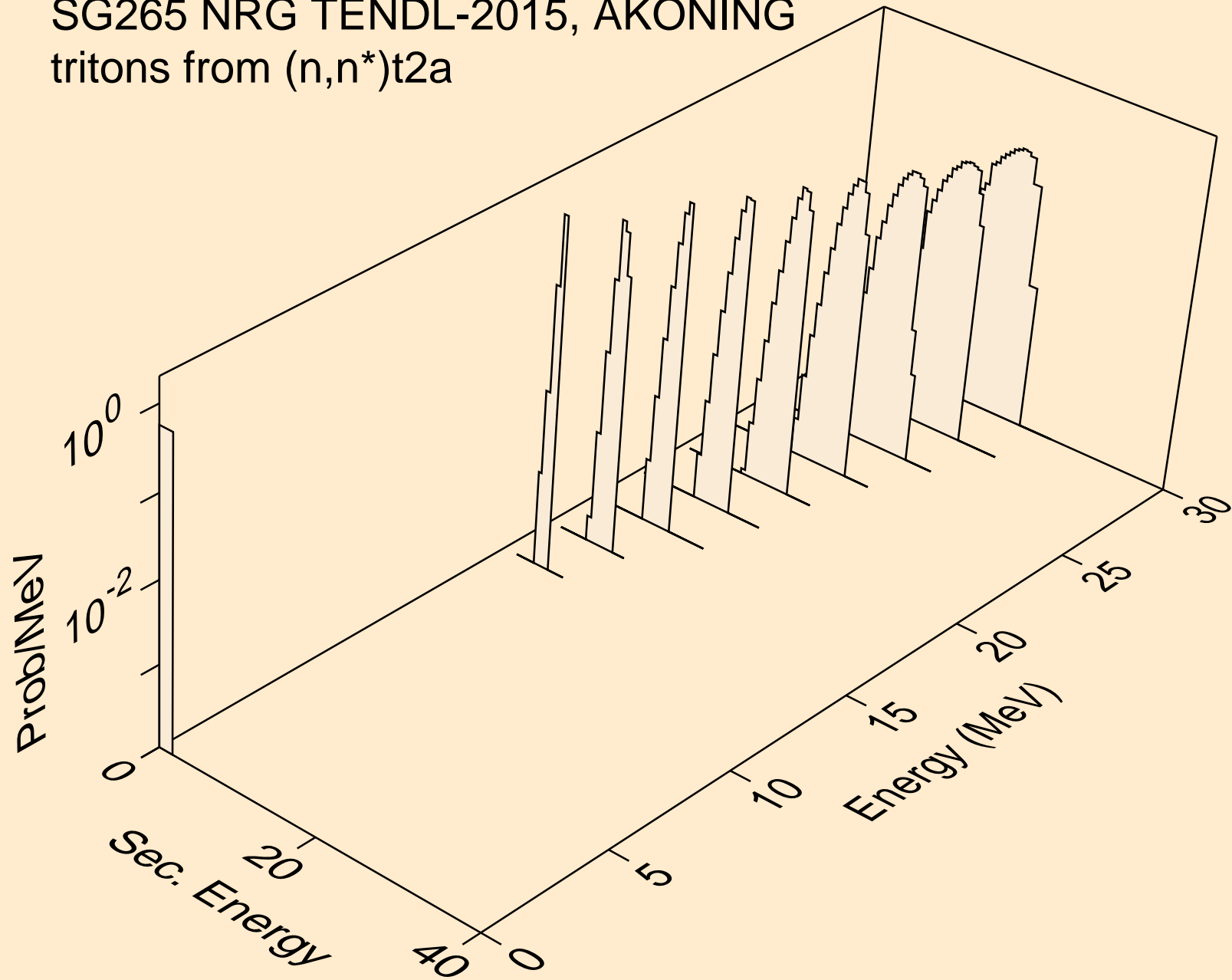

SG265 NRG TENDL-2015, AKONING
tritons from (n,t)

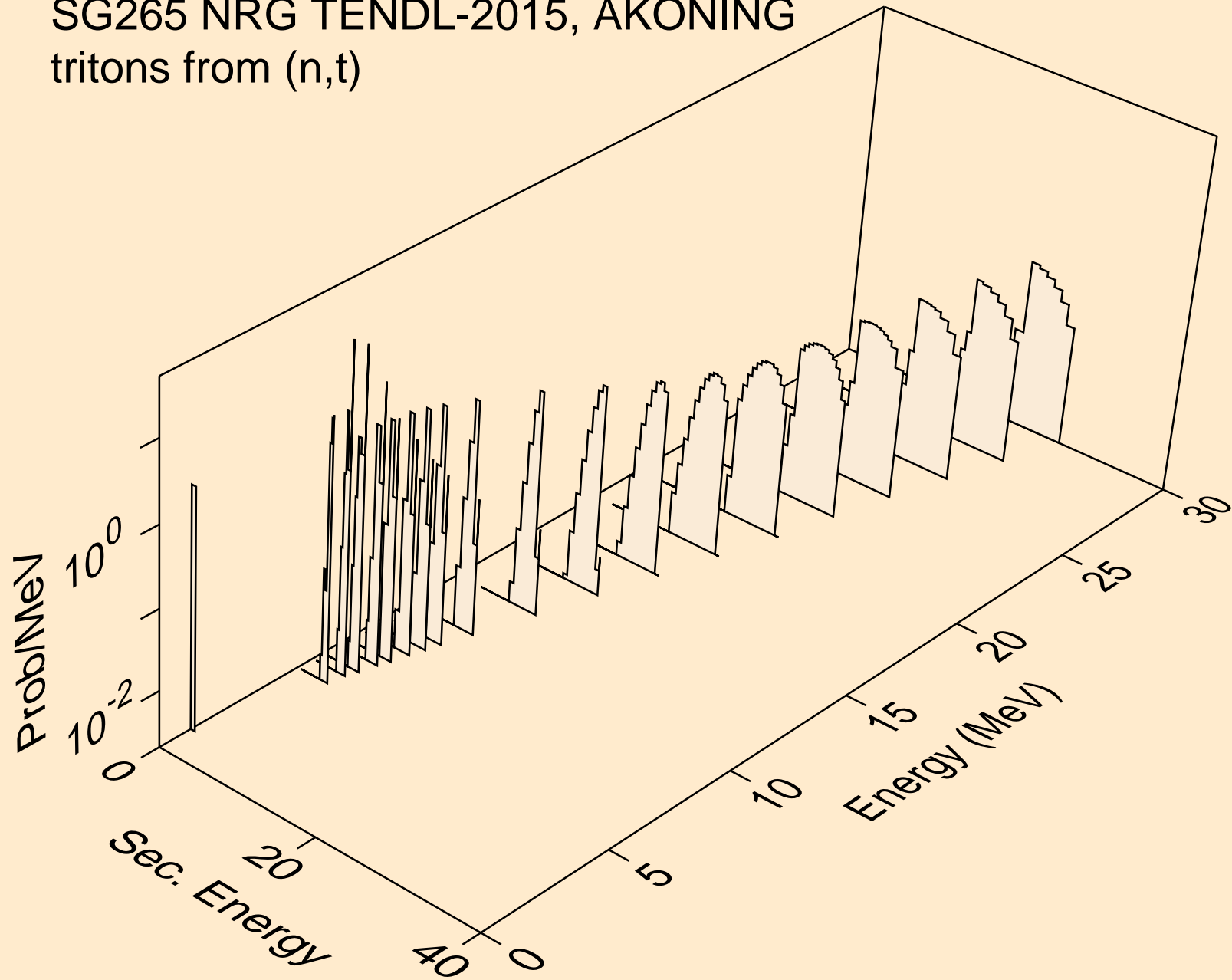

SG265 NRG TENDL-2015, AKONING
tritons from (n,t2a)

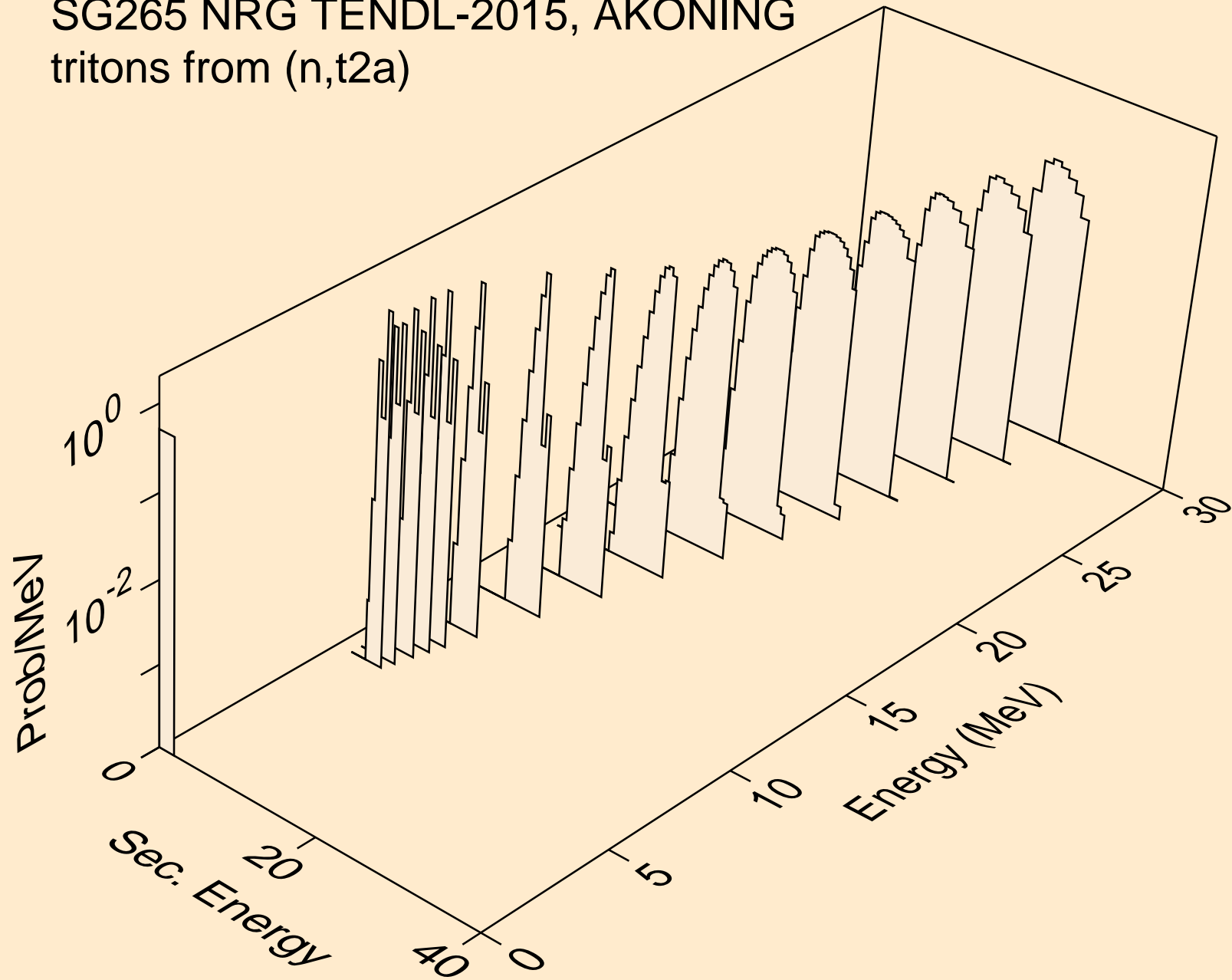

SG265 NRG TENDL-2015, AKONING
he3s from (n,x)

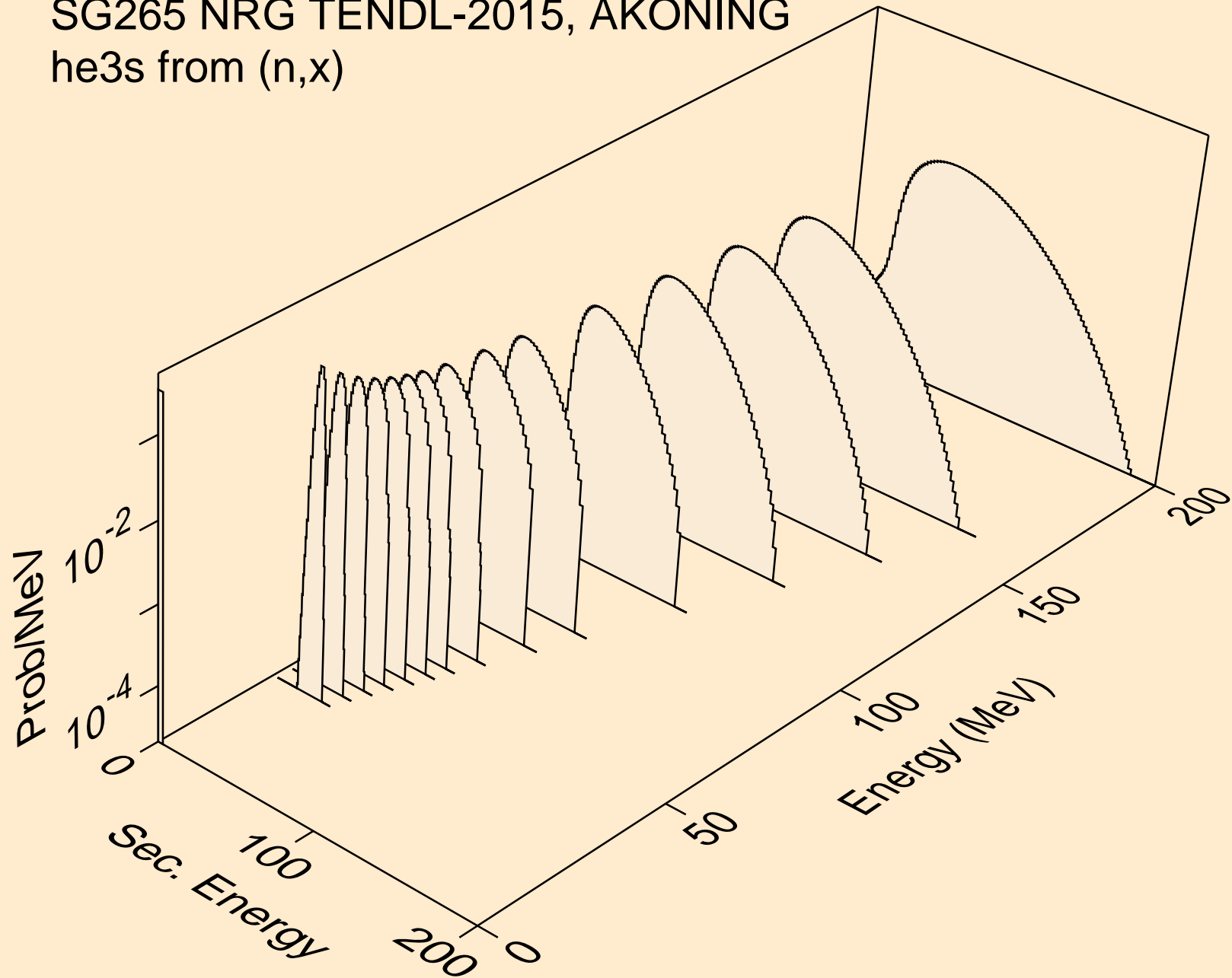

SG265 NRG TENDL-2015, AKONING
he3s from (n,n*)he3

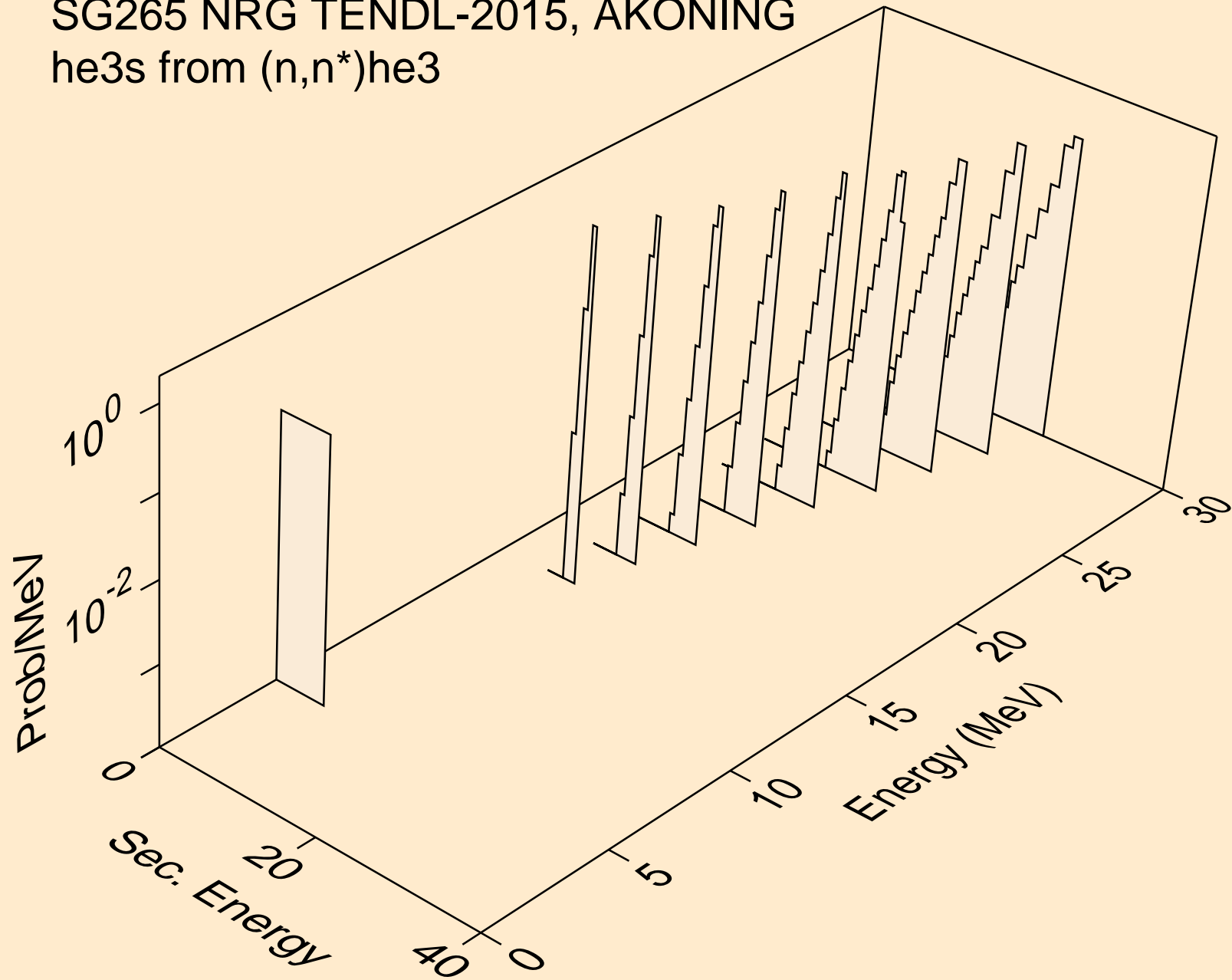

SG265 NRG TENDL-2015, AKONING
he3s from (n,he3)

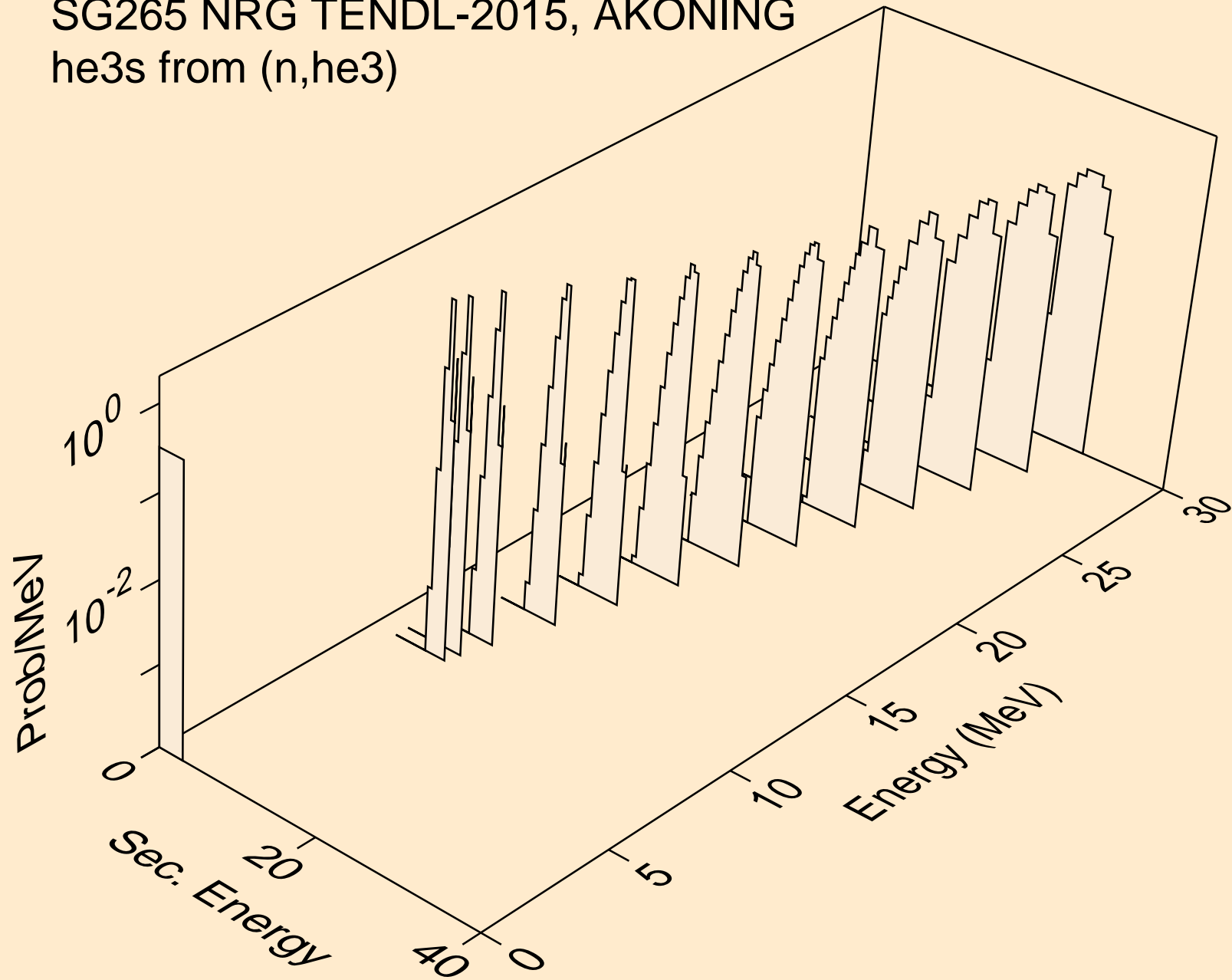

SG265 NRG TENDL-2015, AKONING
alphas from (n,x)

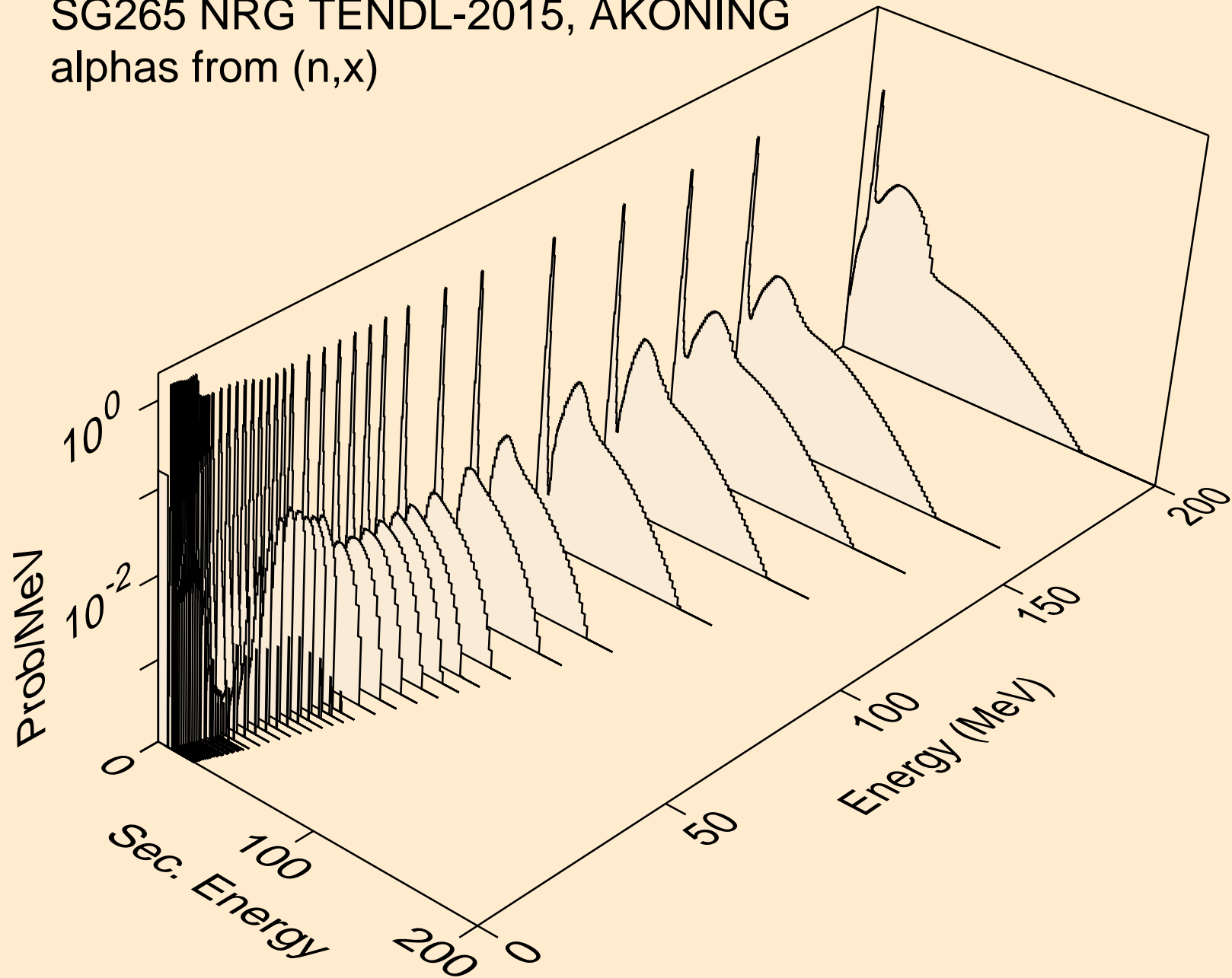

SG265 NRG TENDL-2015, AKONING
alphas from (n,n*)a

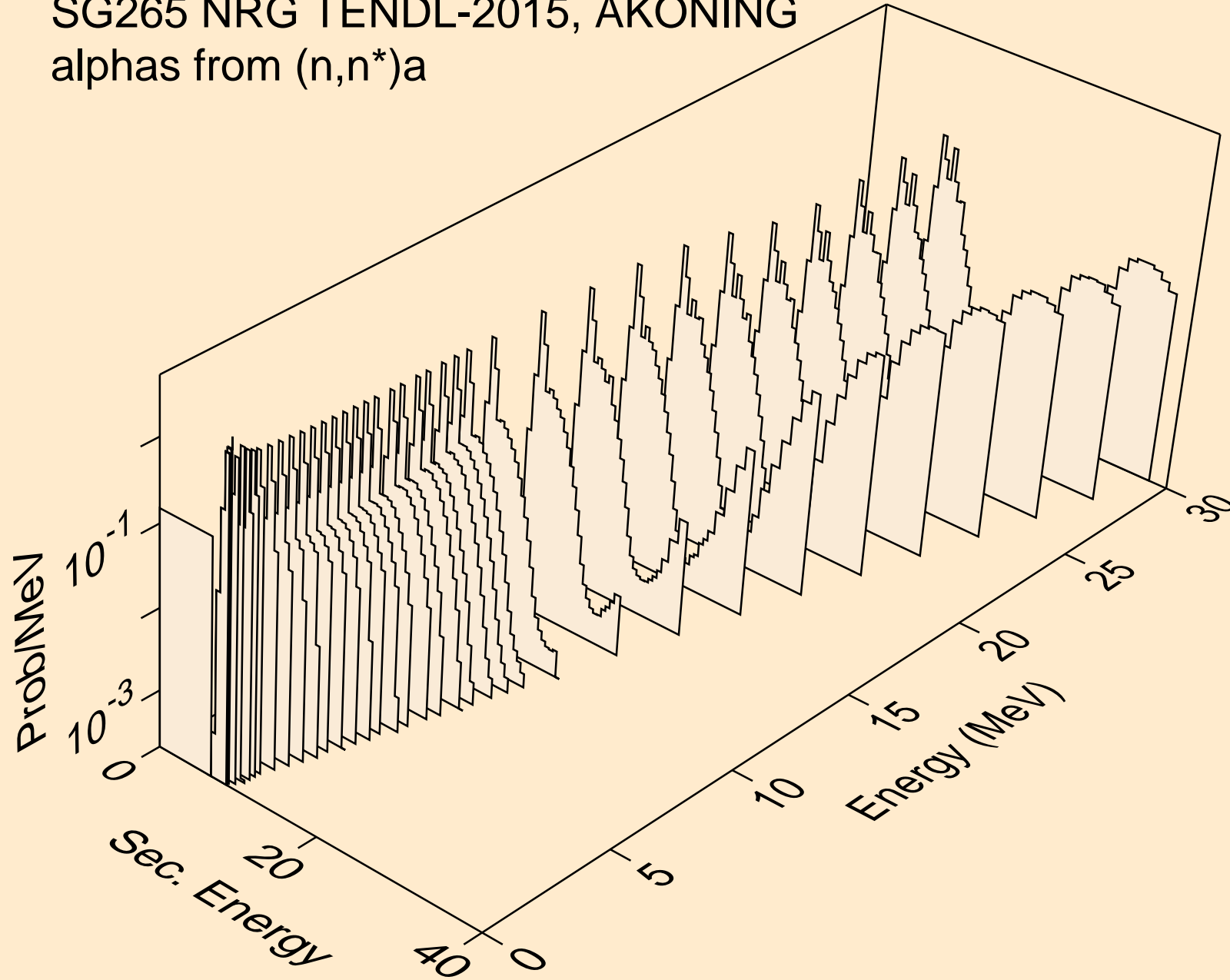

SG265 NRG TENDL-2015, AKONING
alphas from (n,n*)3a

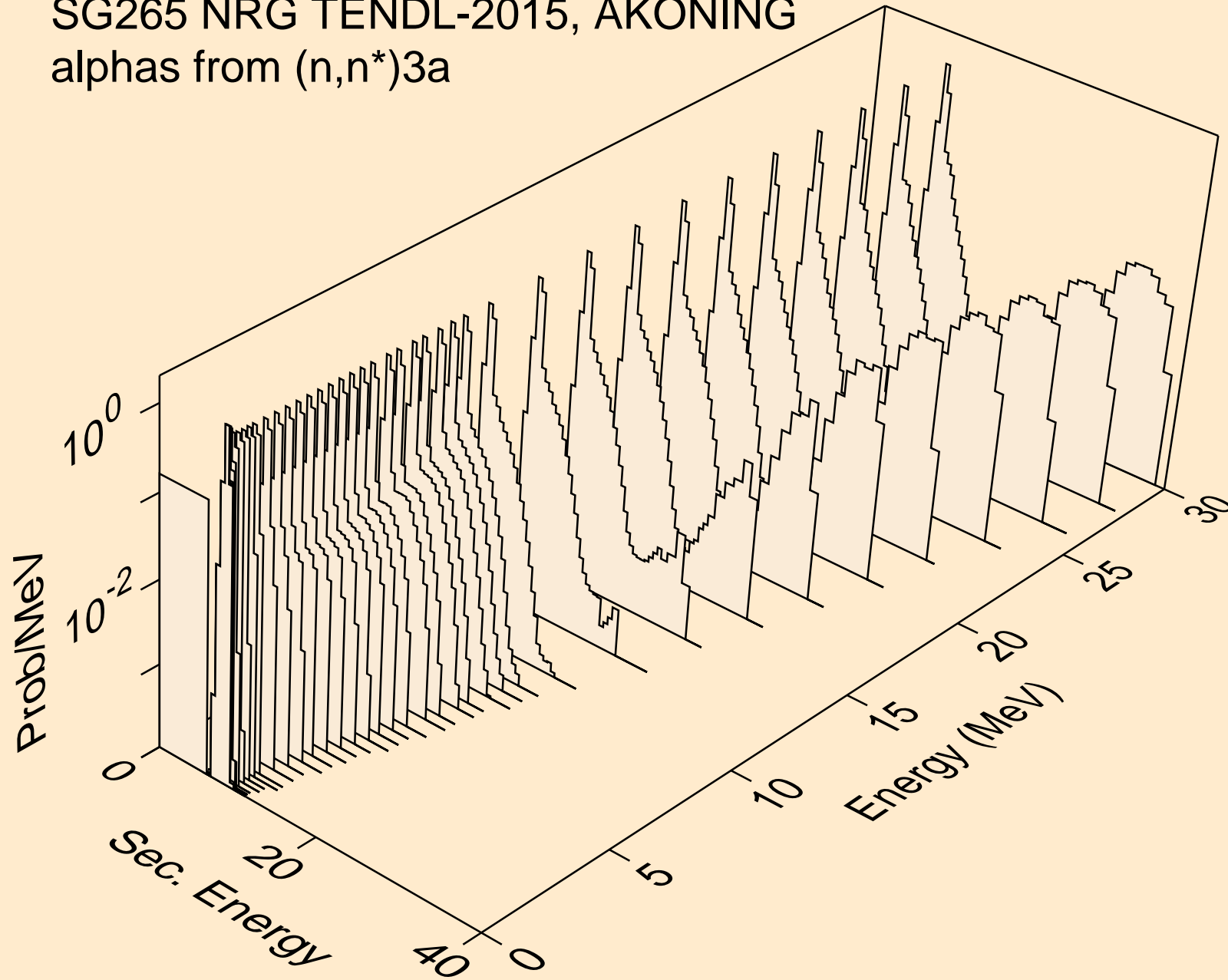

SG265 NRG TENDL-2015, AKONING
alphas from (n,2n)a

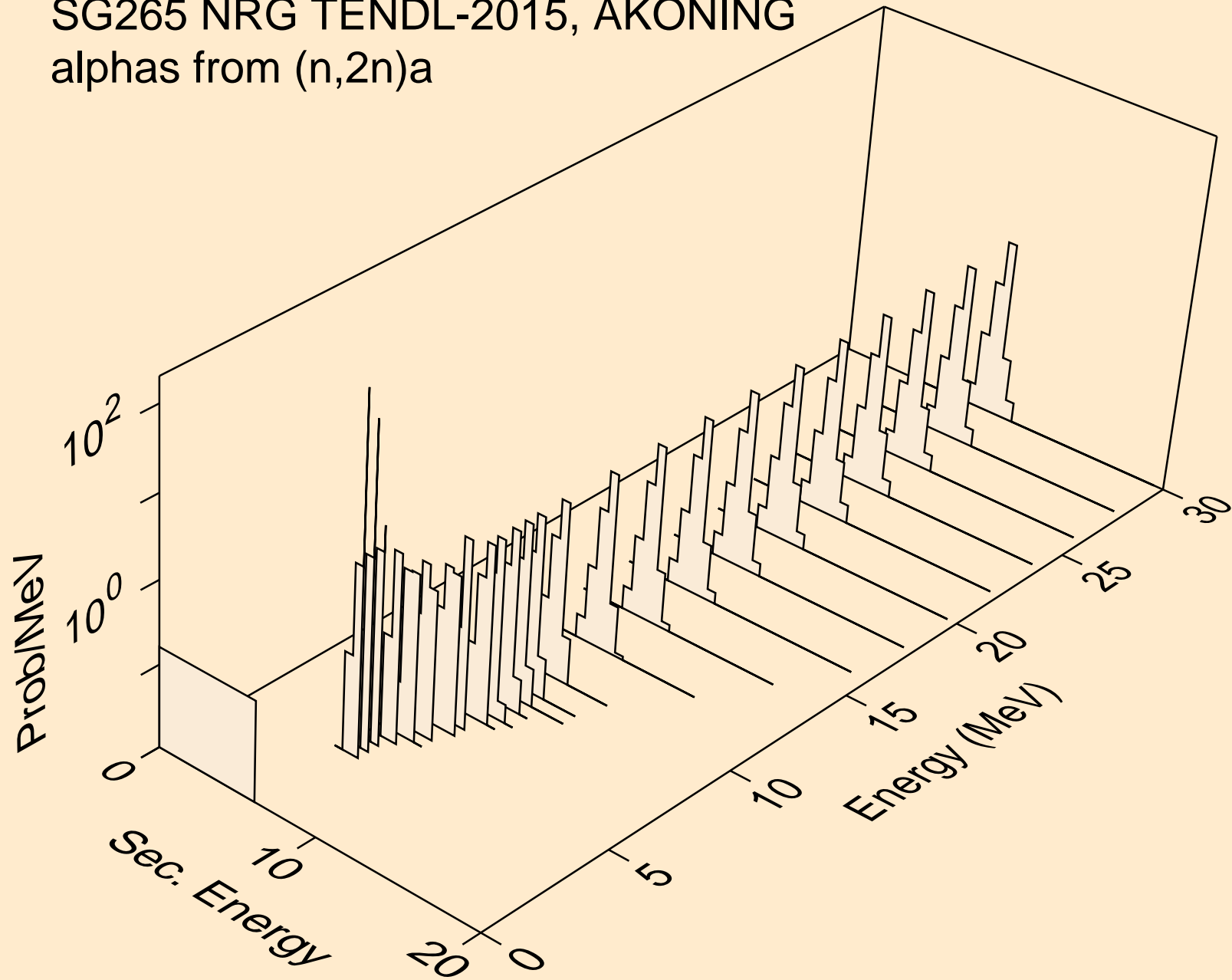

SG265 NRG TENDL-2015, AKONING
alphas from (n,3n)a

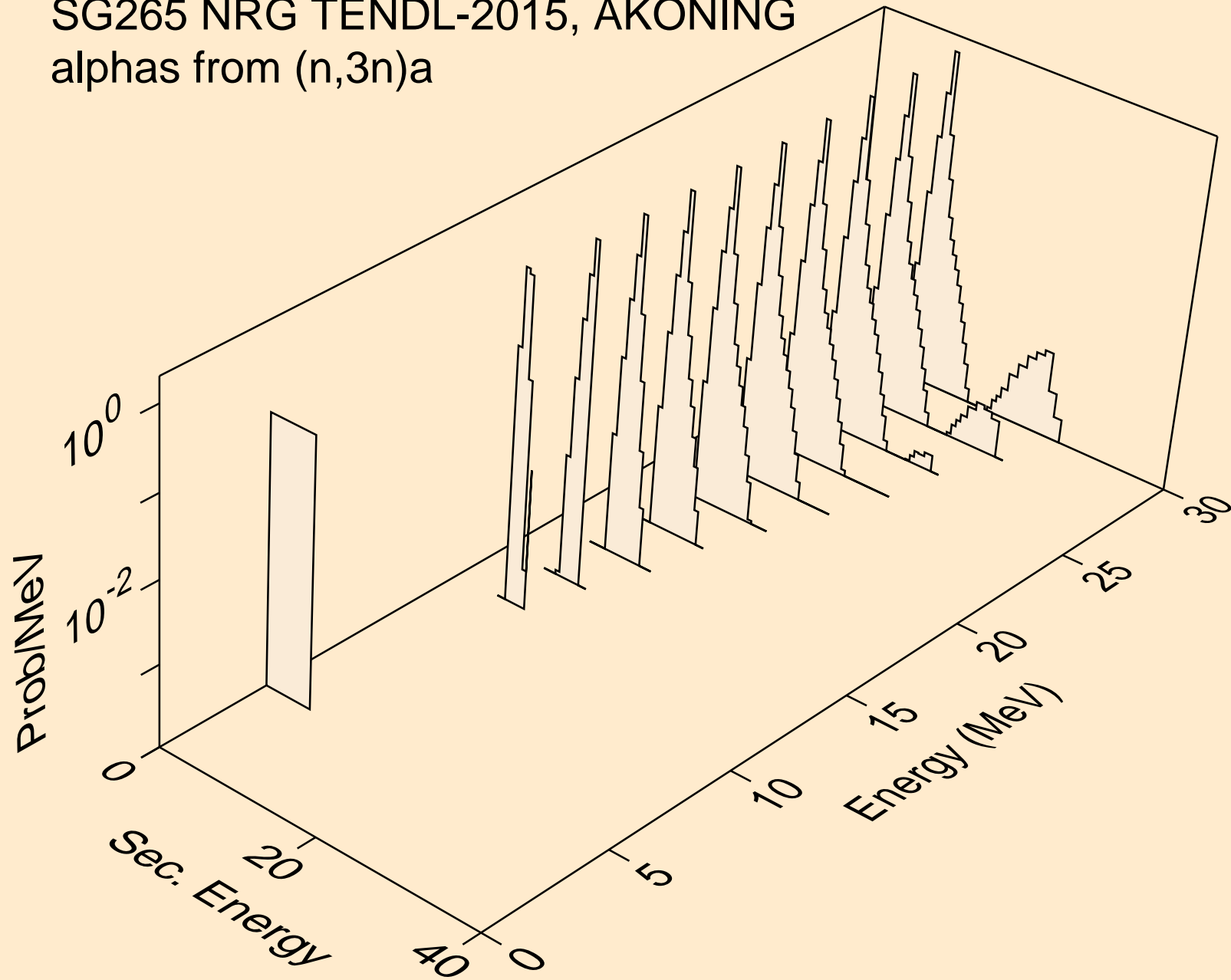

SG265 NRG TENDL-2015, AKONING
alphas from (n,n*)2a

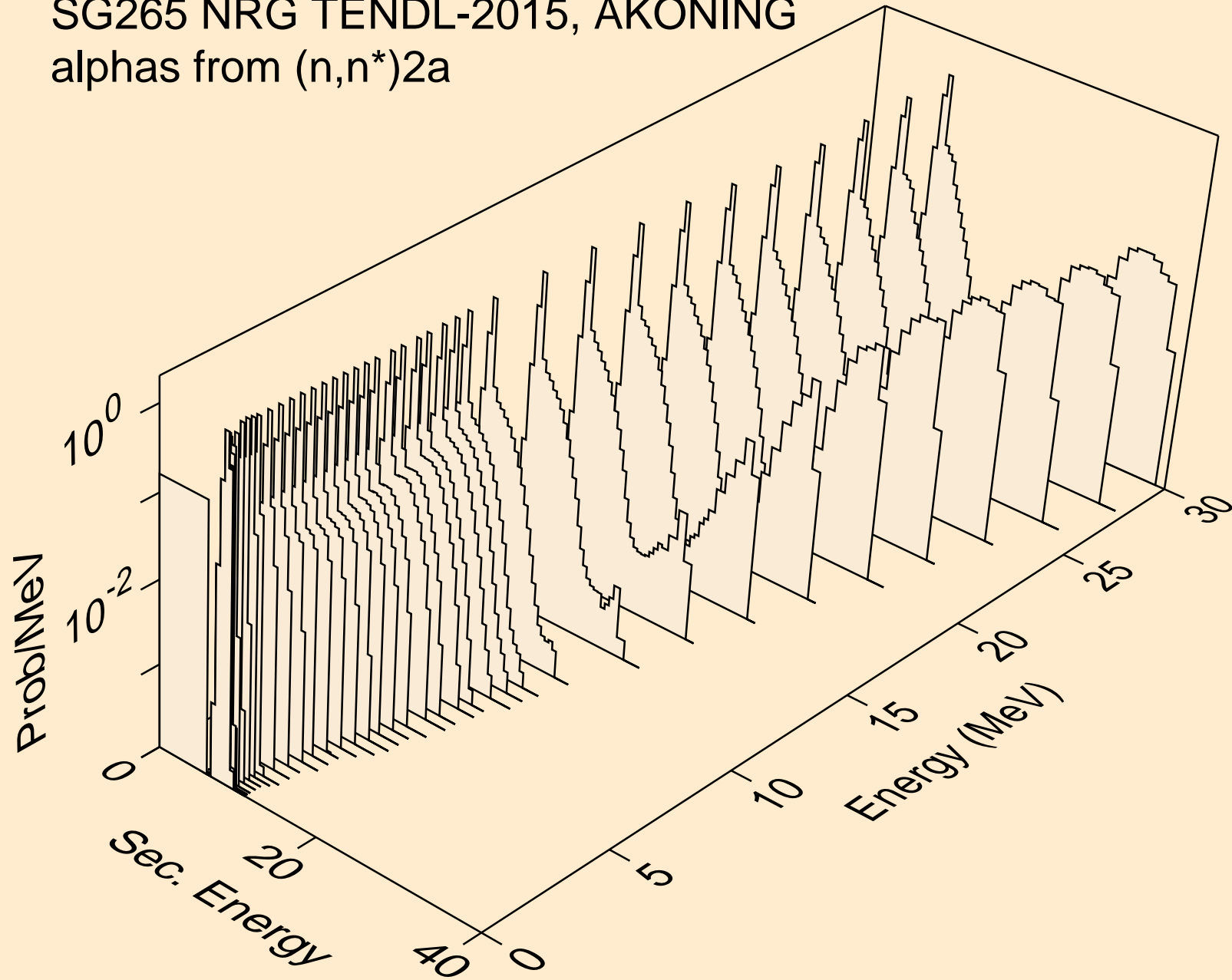

SG265 NRG TENDL-2015, AKONING
alphas from (n,2n)2a

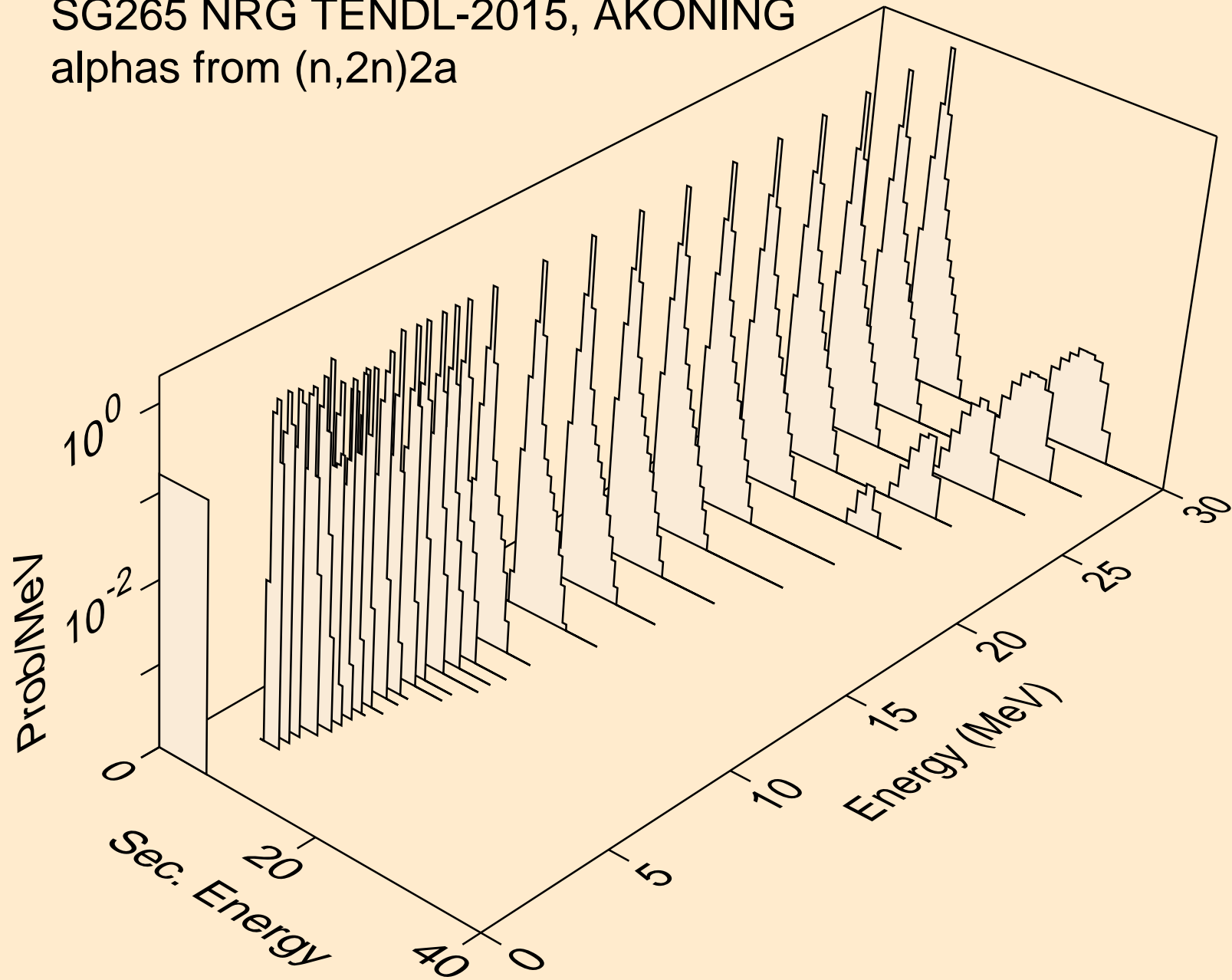

SG265 NRG TENDL-2015, AKONING
alphas from (n,n*)d2a

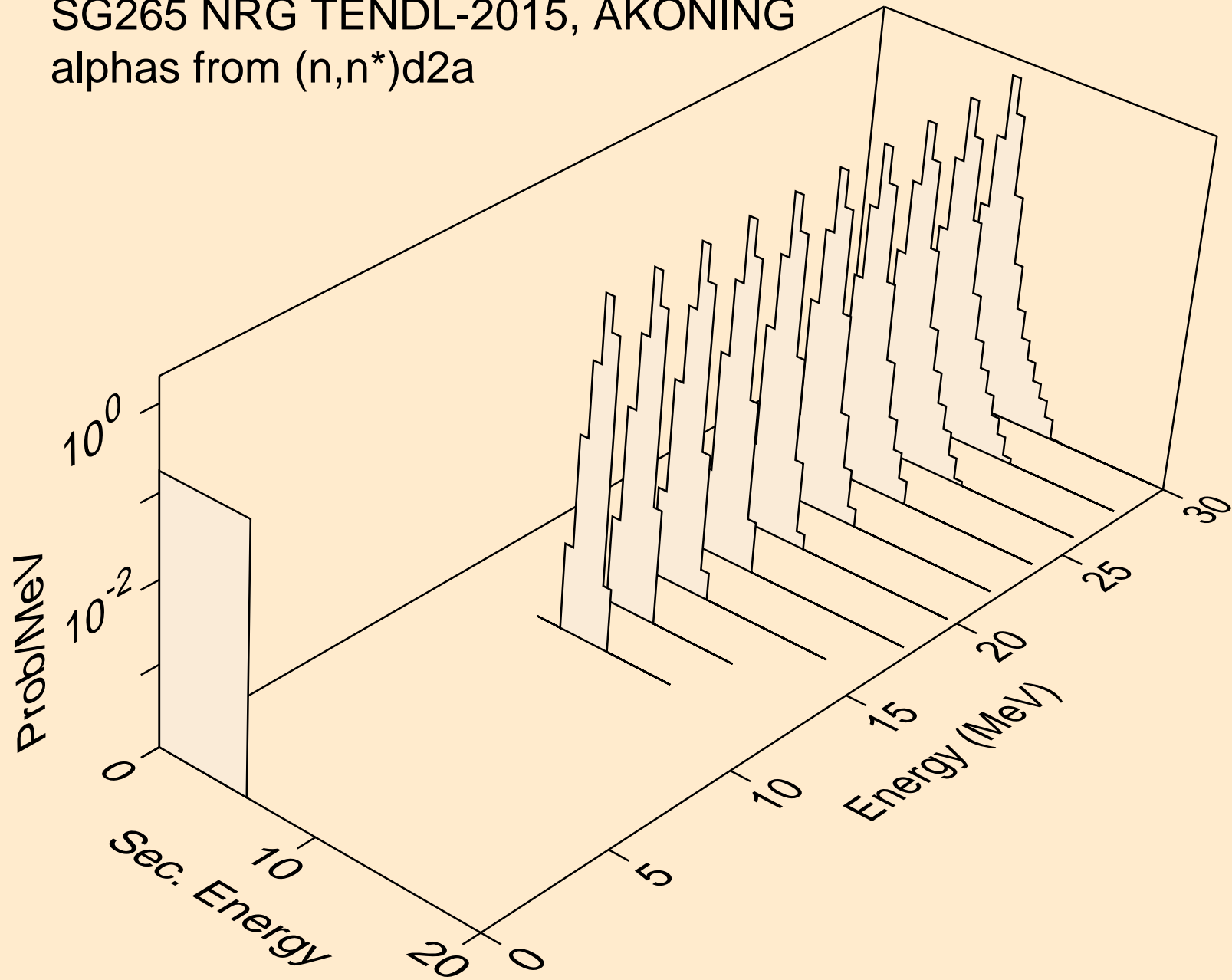

SG265 NRG TENDL-2015, AKONING
alphas from (n,n*)t2a

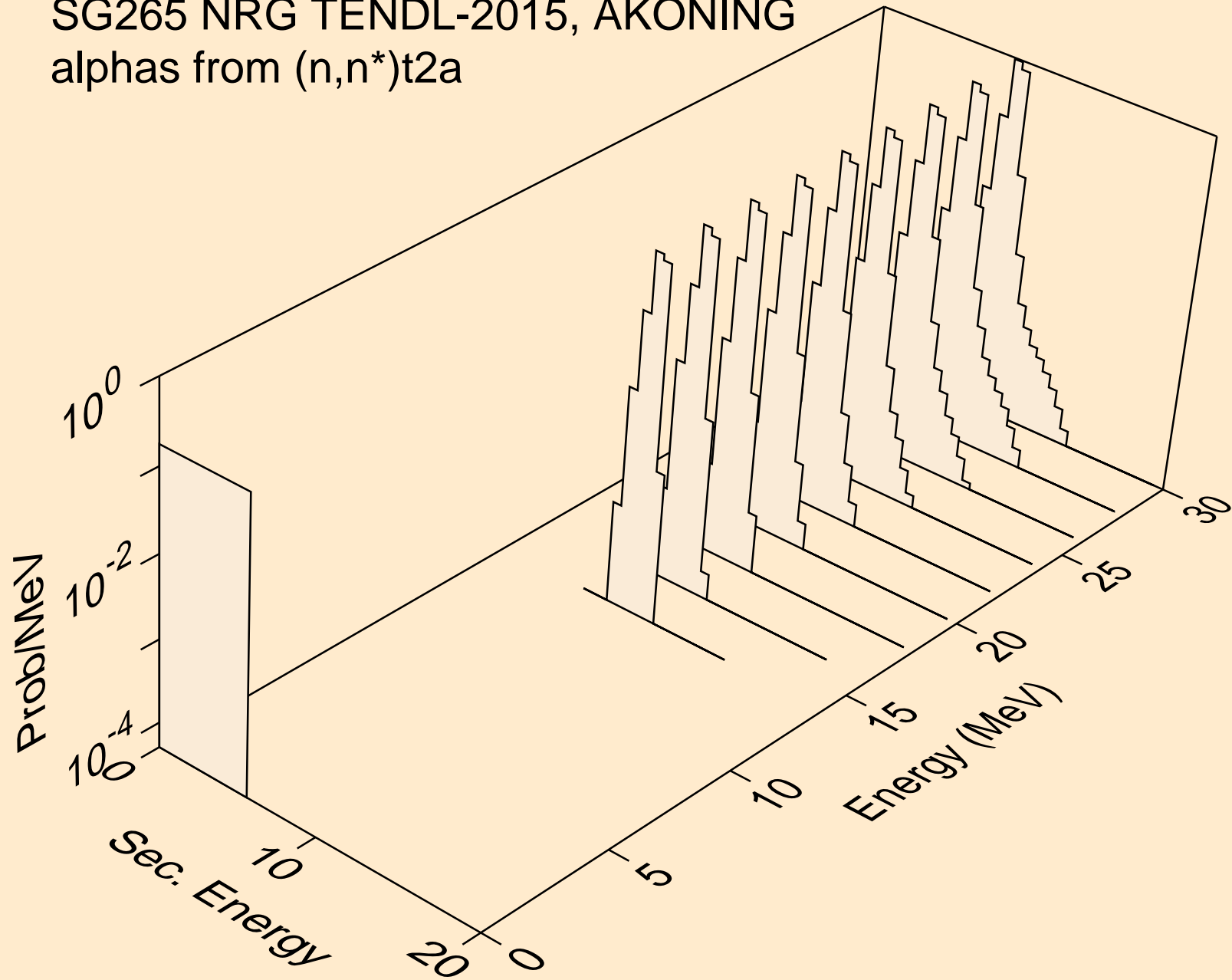

SG265 NRG TENDL-2015, AKONING
alphas from (n,npa)

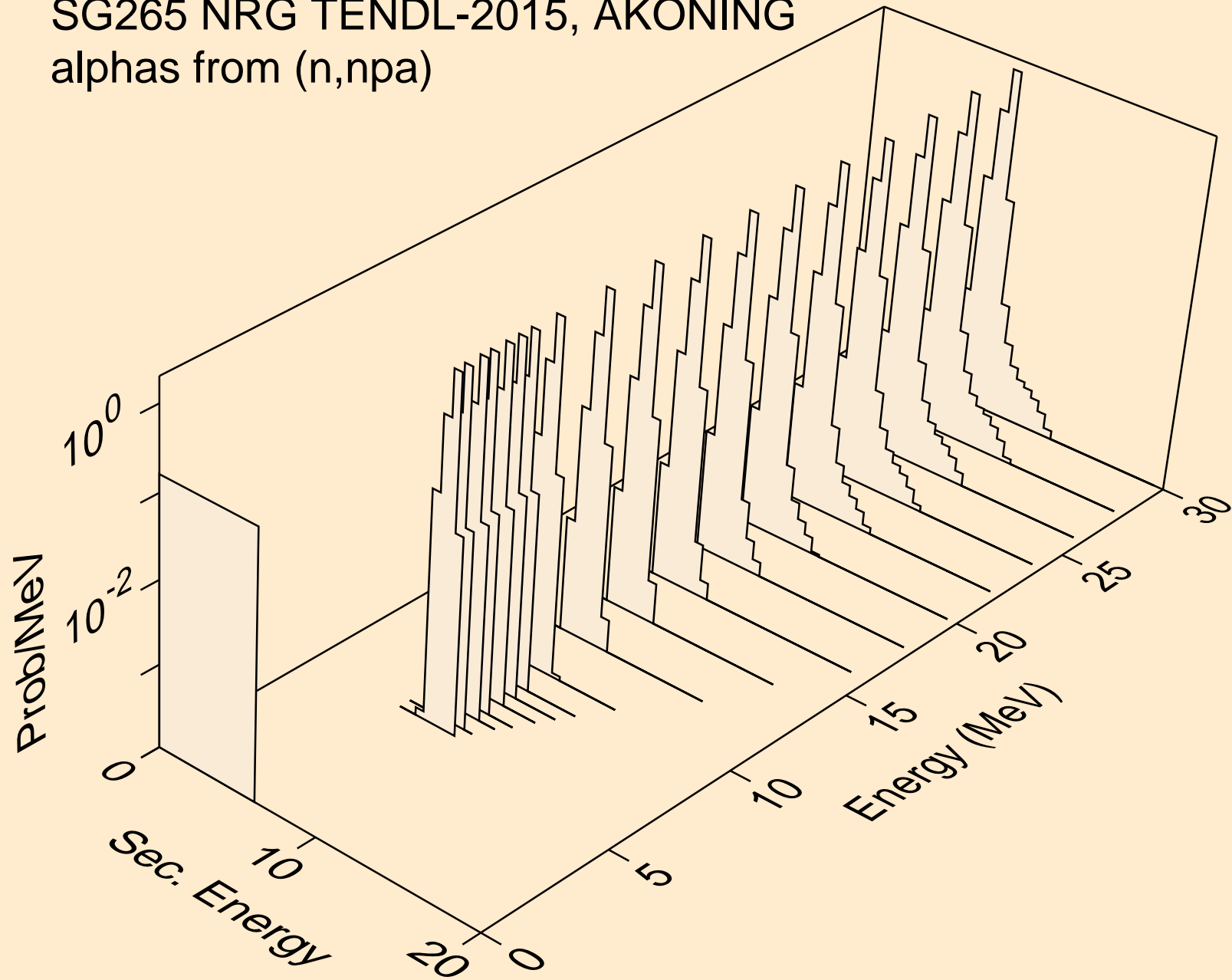

SG265 NRG TENDL-2015, AKONING
alphas from (n,a)

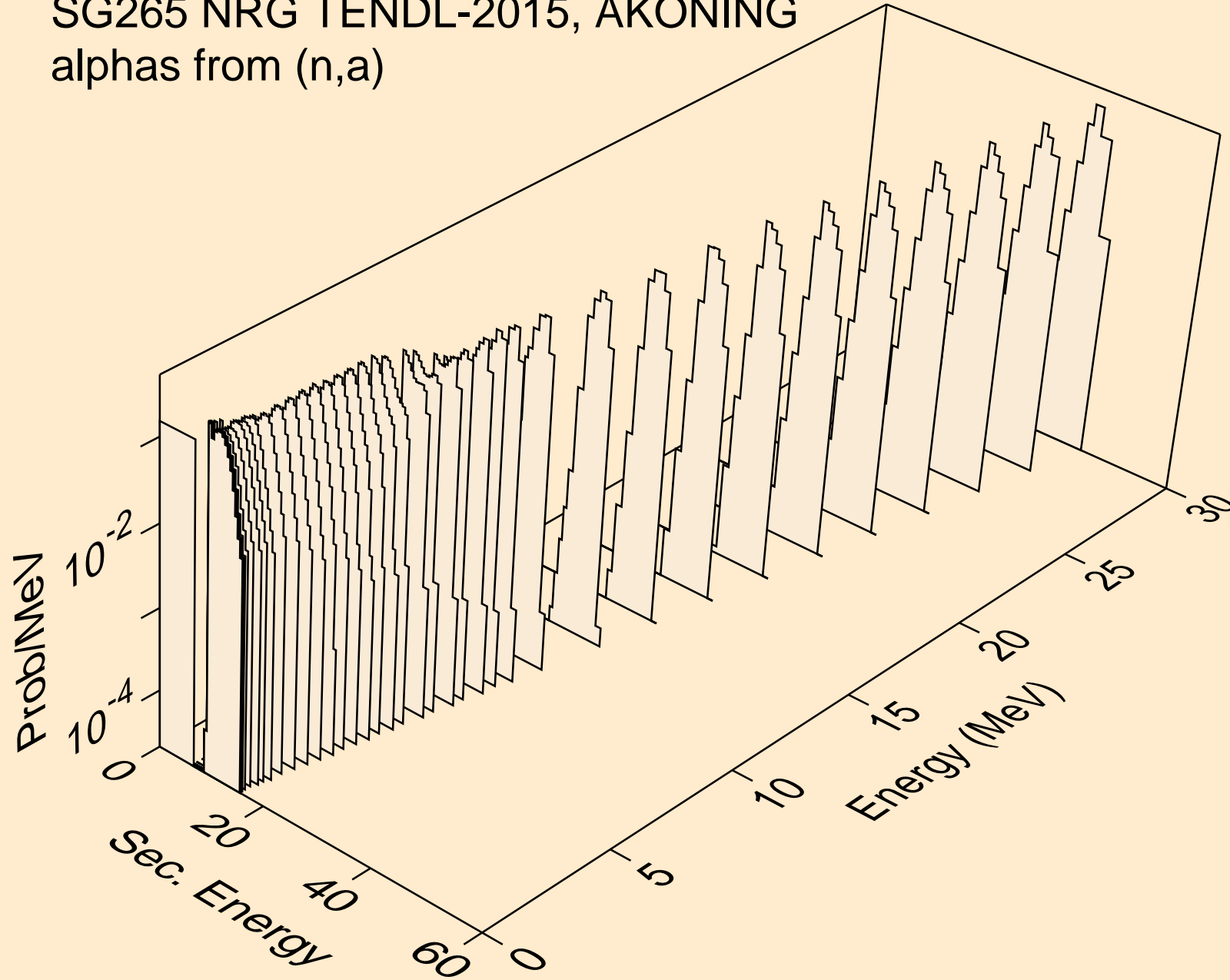

SG265 NRG TENDL-2015, AKONING
alphas from (n,2a)

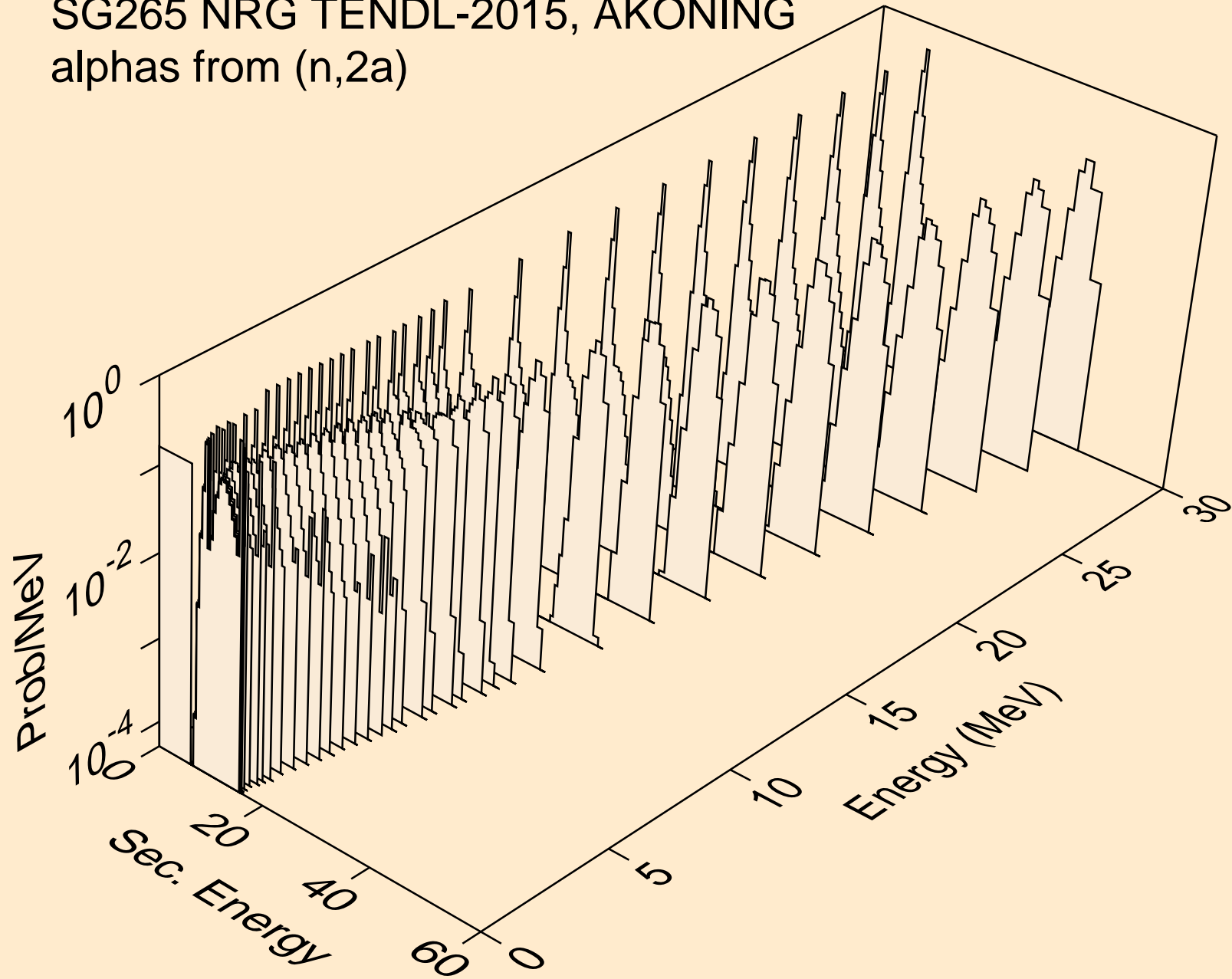

SG265 NRG TENDL-2015, AKONING
alphas from (n,3a)

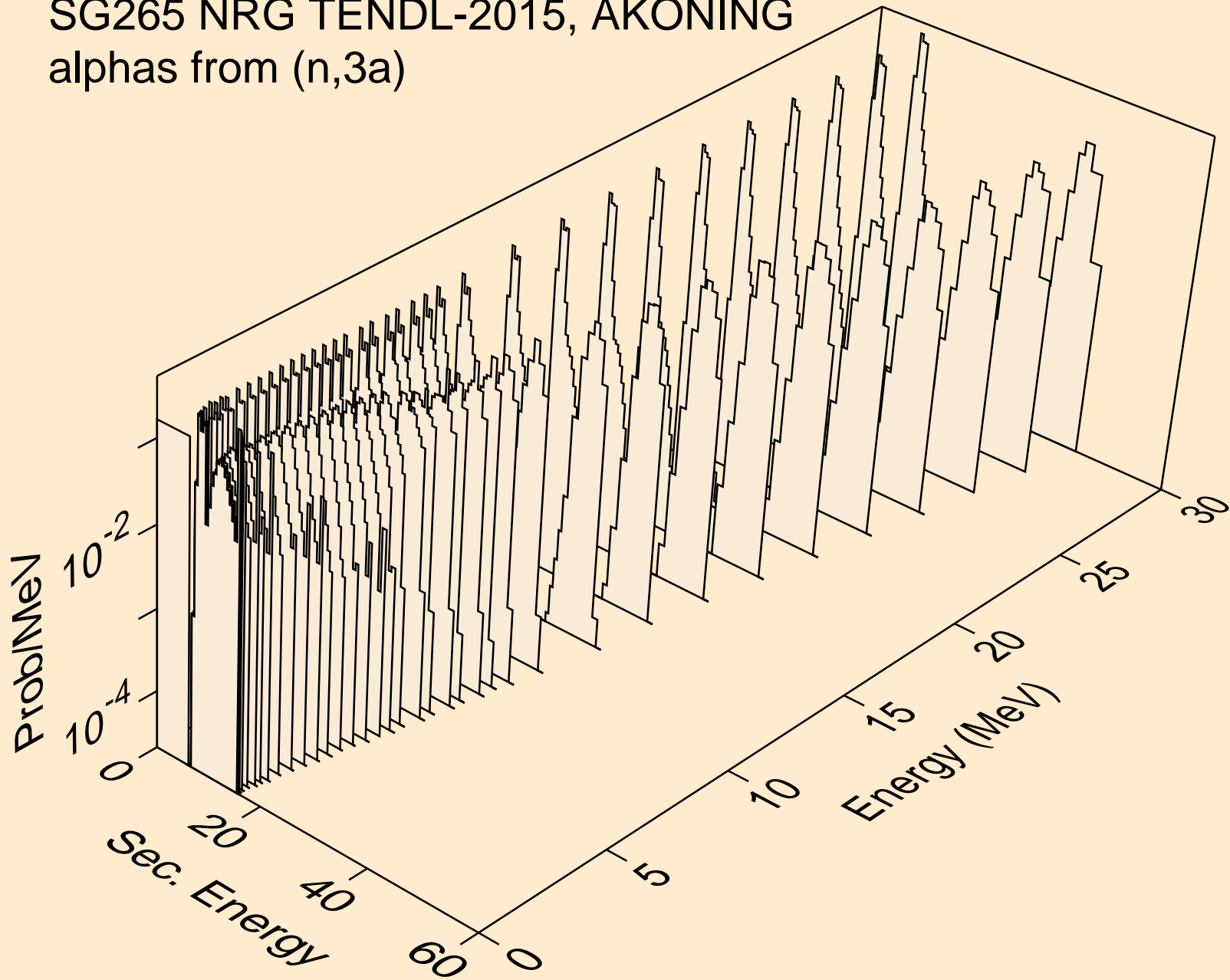

SG265 NRG TENDL-2015, AKONING
alphas from (n,pa)

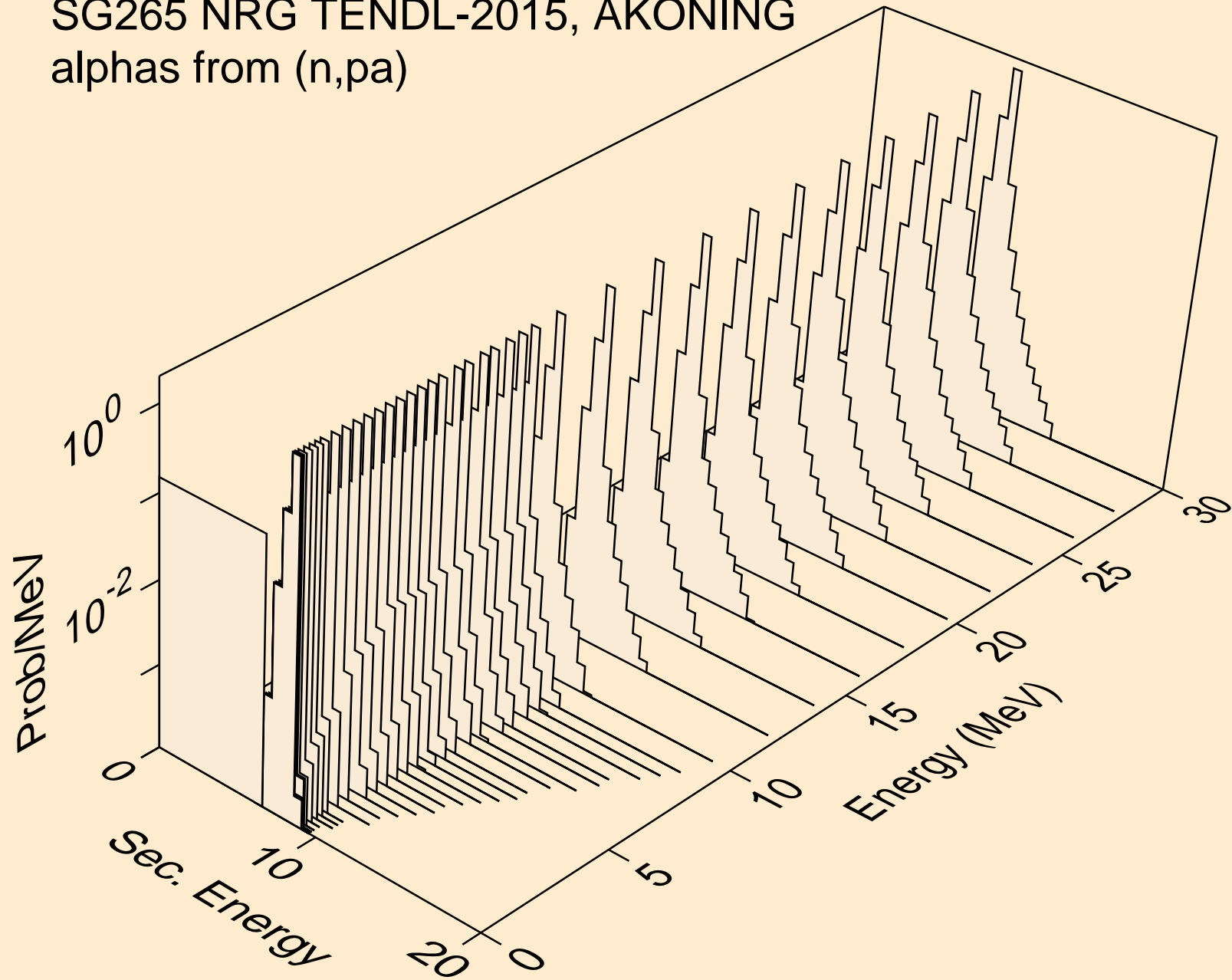

SG265 NRG TENDL-2015, AKONING
alphas from (n,t2a)

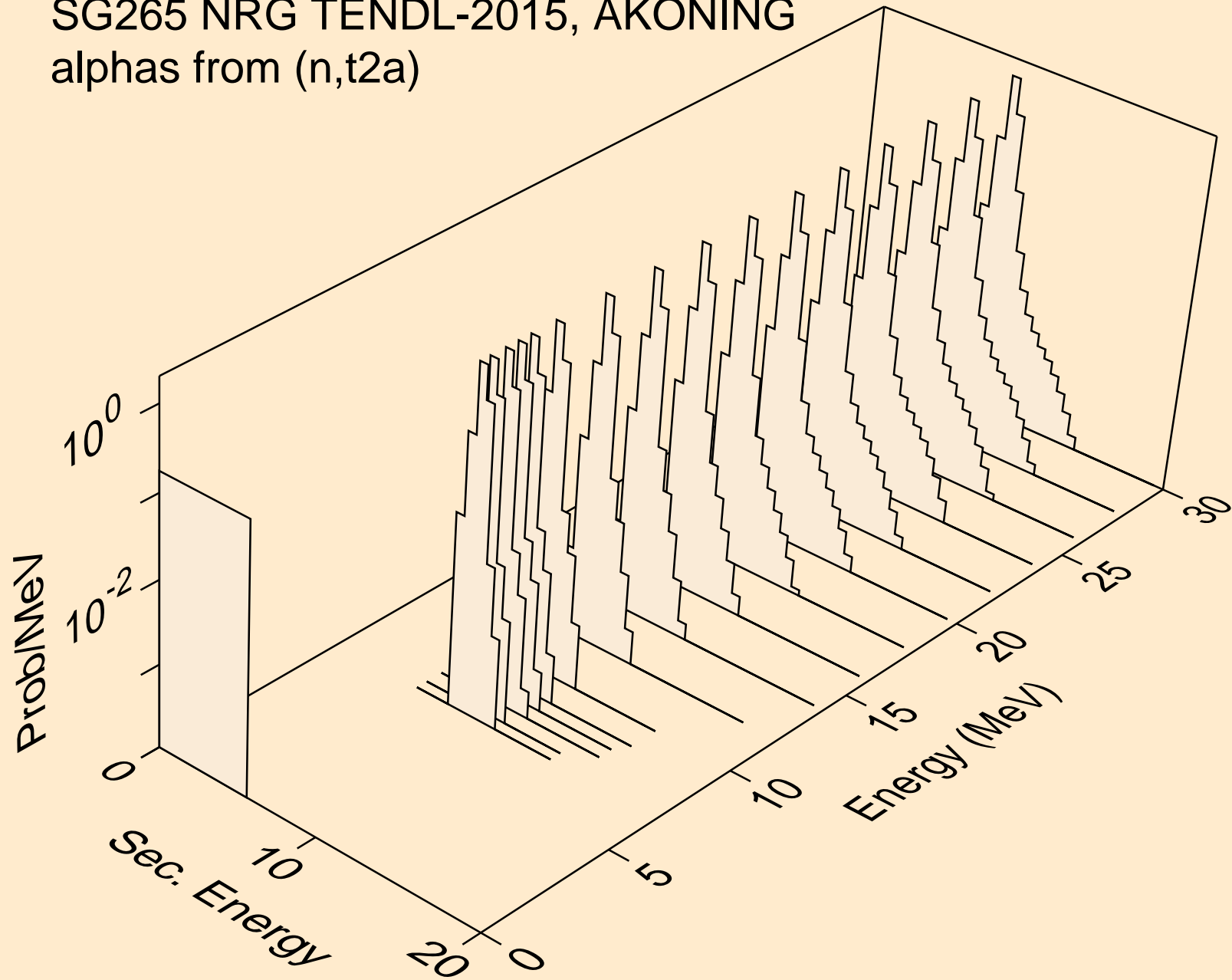

SG265 NRG TENDL-2015, AKONING
alphas from (n,d2a)

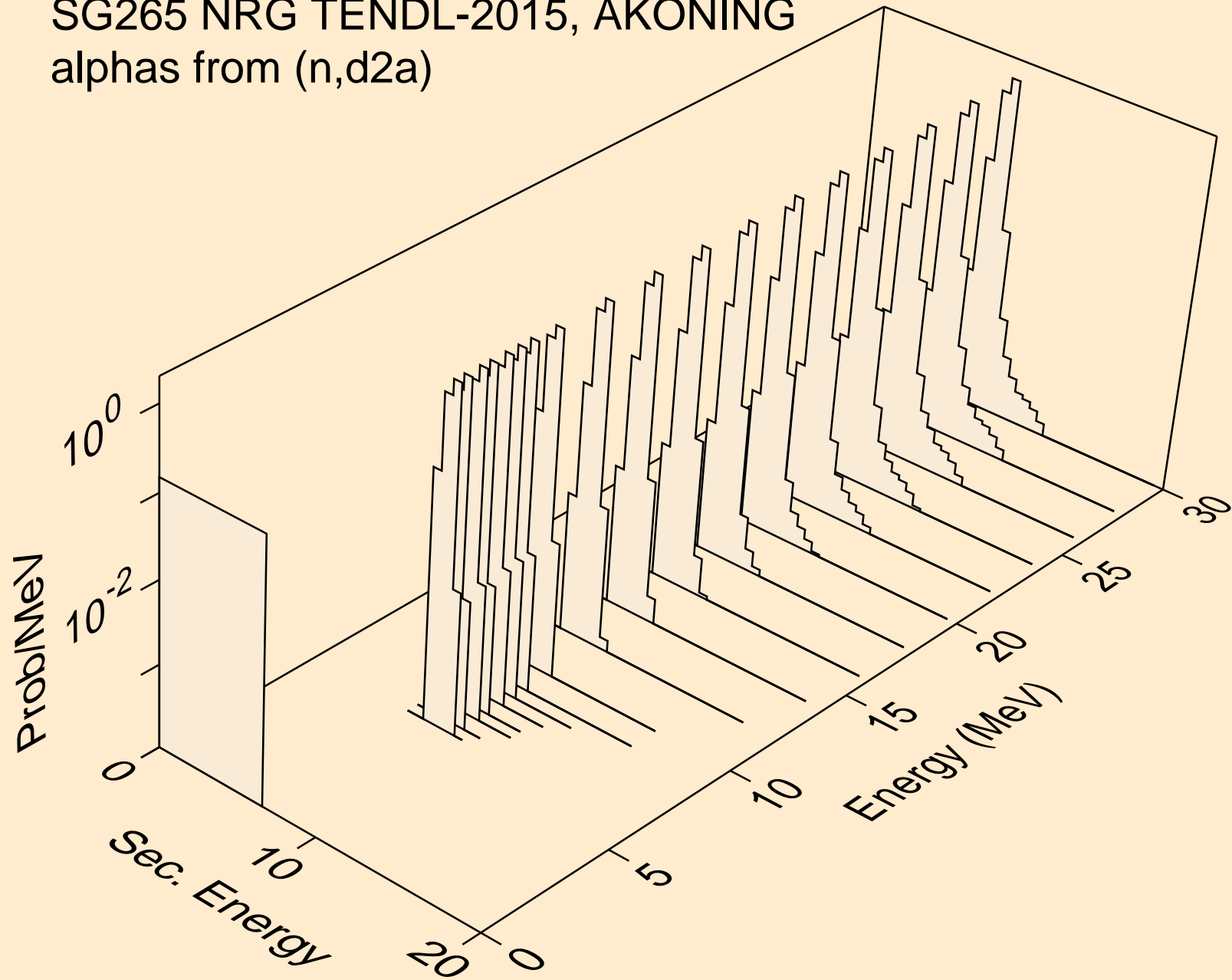

SG265 NRG TENDL-2015, AKONING
alphas from (n,da)

