

# SG267 NRG TENDL-2015, AKONING

## Principal cross sections

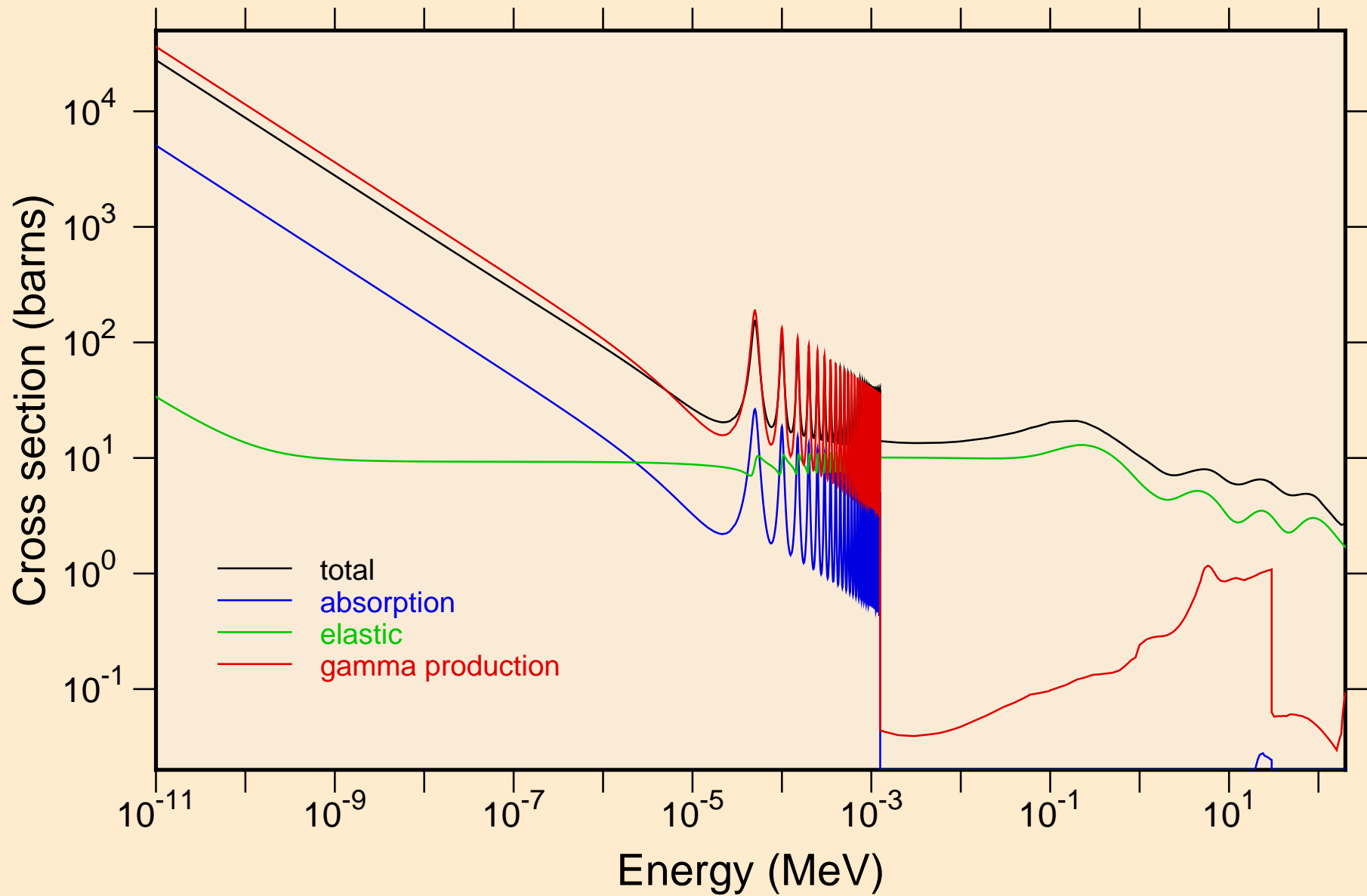

# SG267 NRG TENDL-2015, AKONING

## Non-threshold reactions

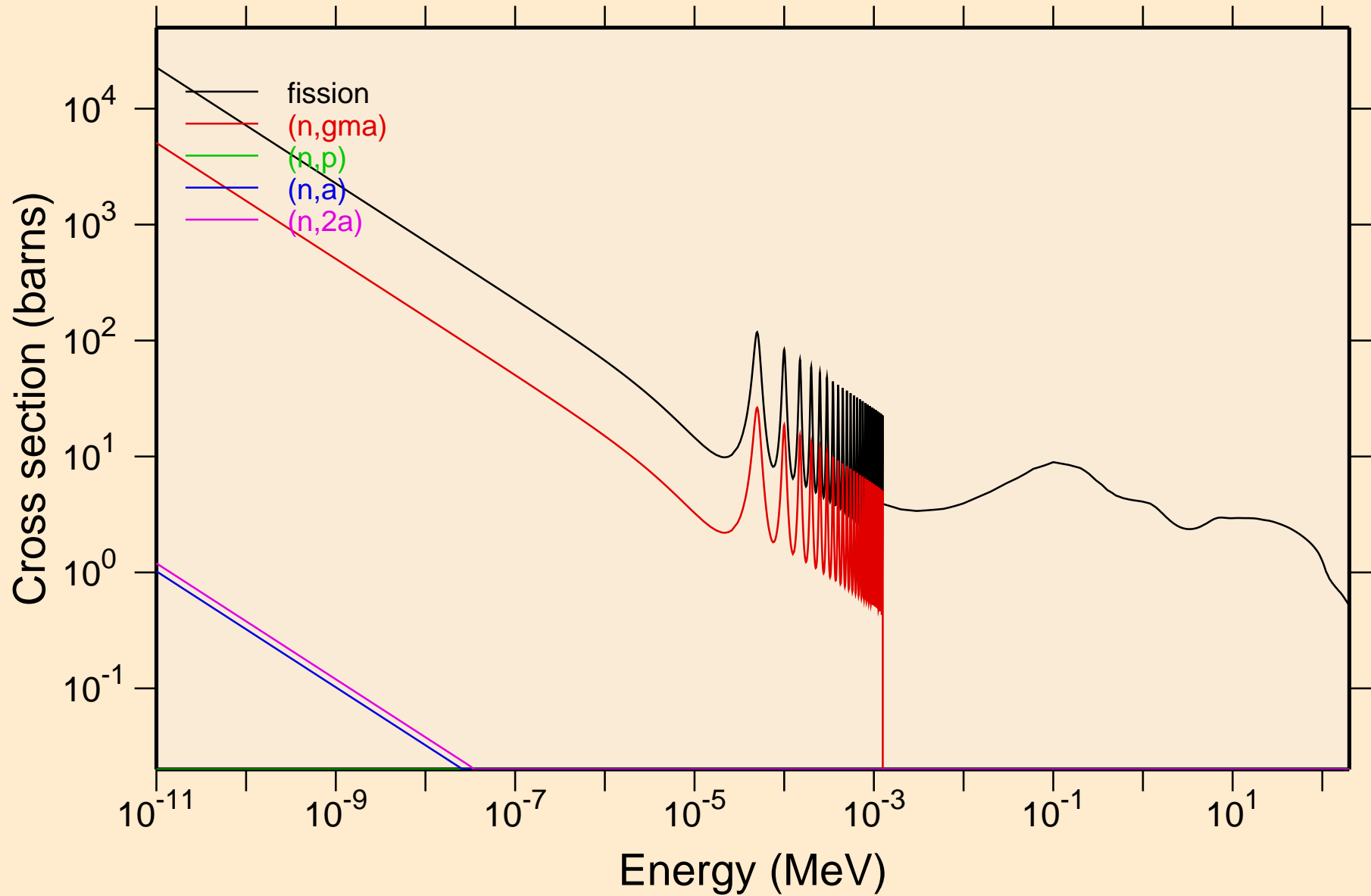

# SG267 NRG TENDL-2015, AKONING

## Non-threshold reactions

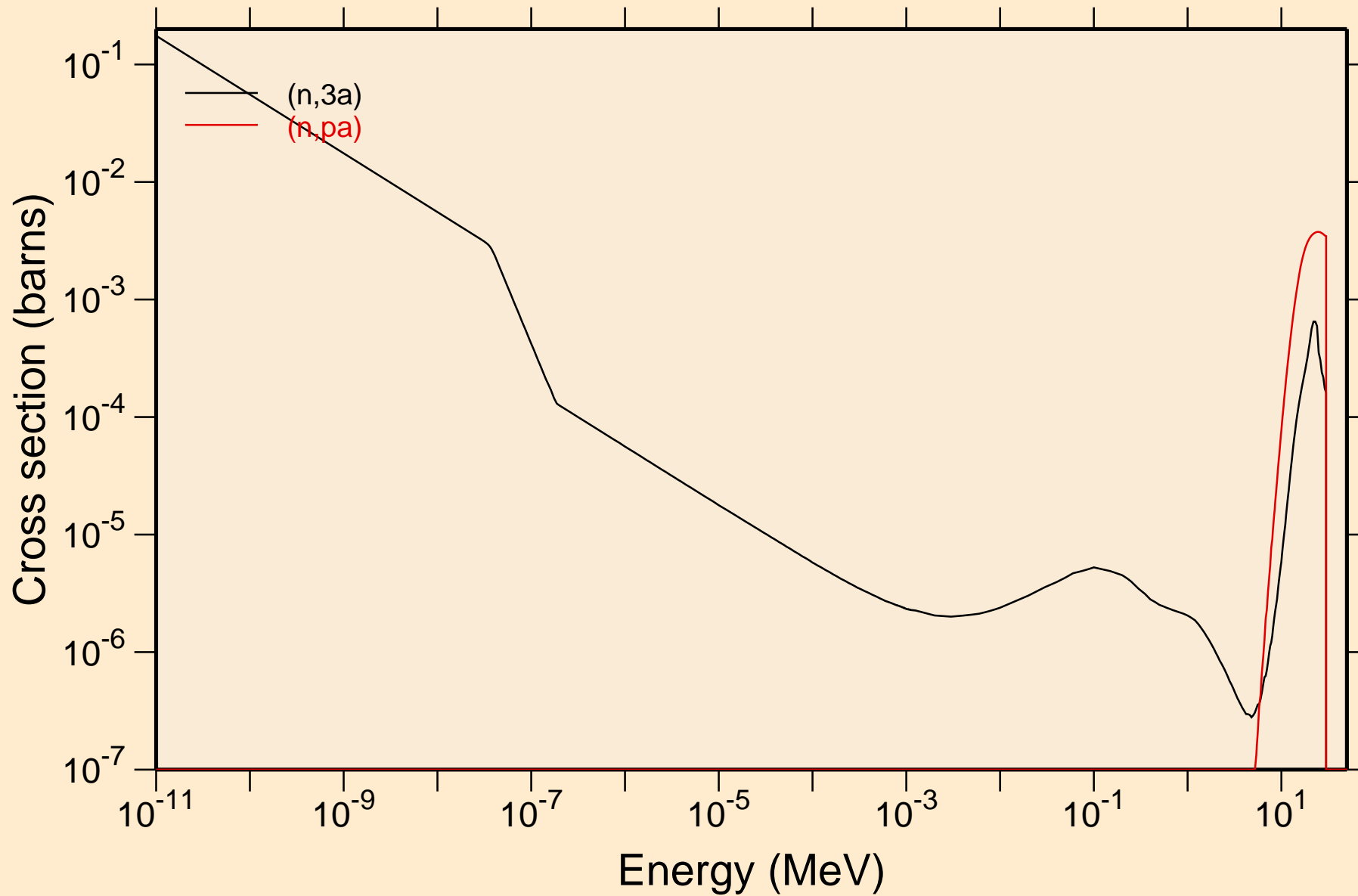

# SG267 NRG TENDL-2015, AKONING

## Principal cross sections

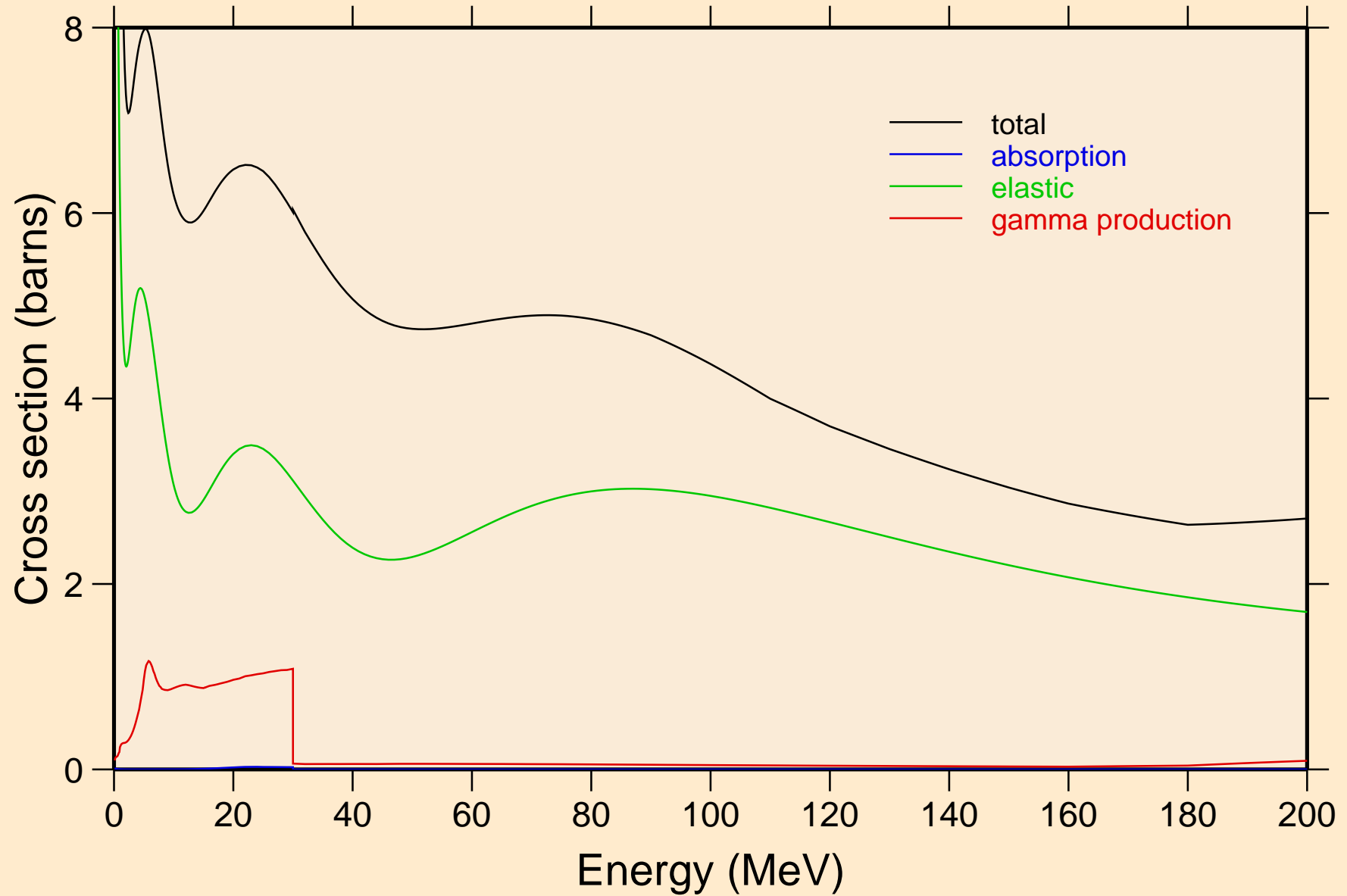

# SG267 NRG TENDL-2015, AKONING

## Non-threshold reactions

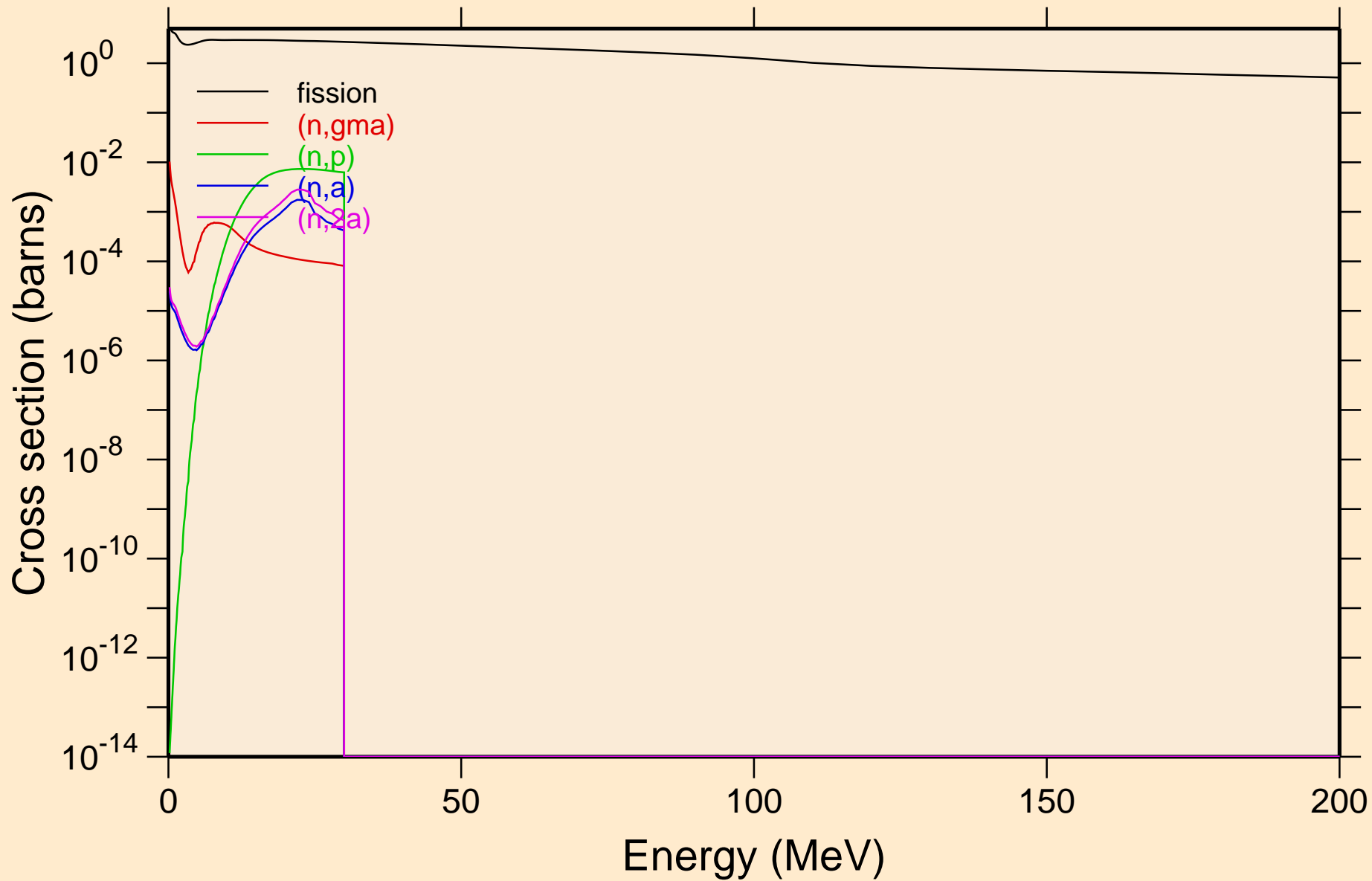

# SG267 NRG TENDL-2015, AKONING

## Non-threshold reactions

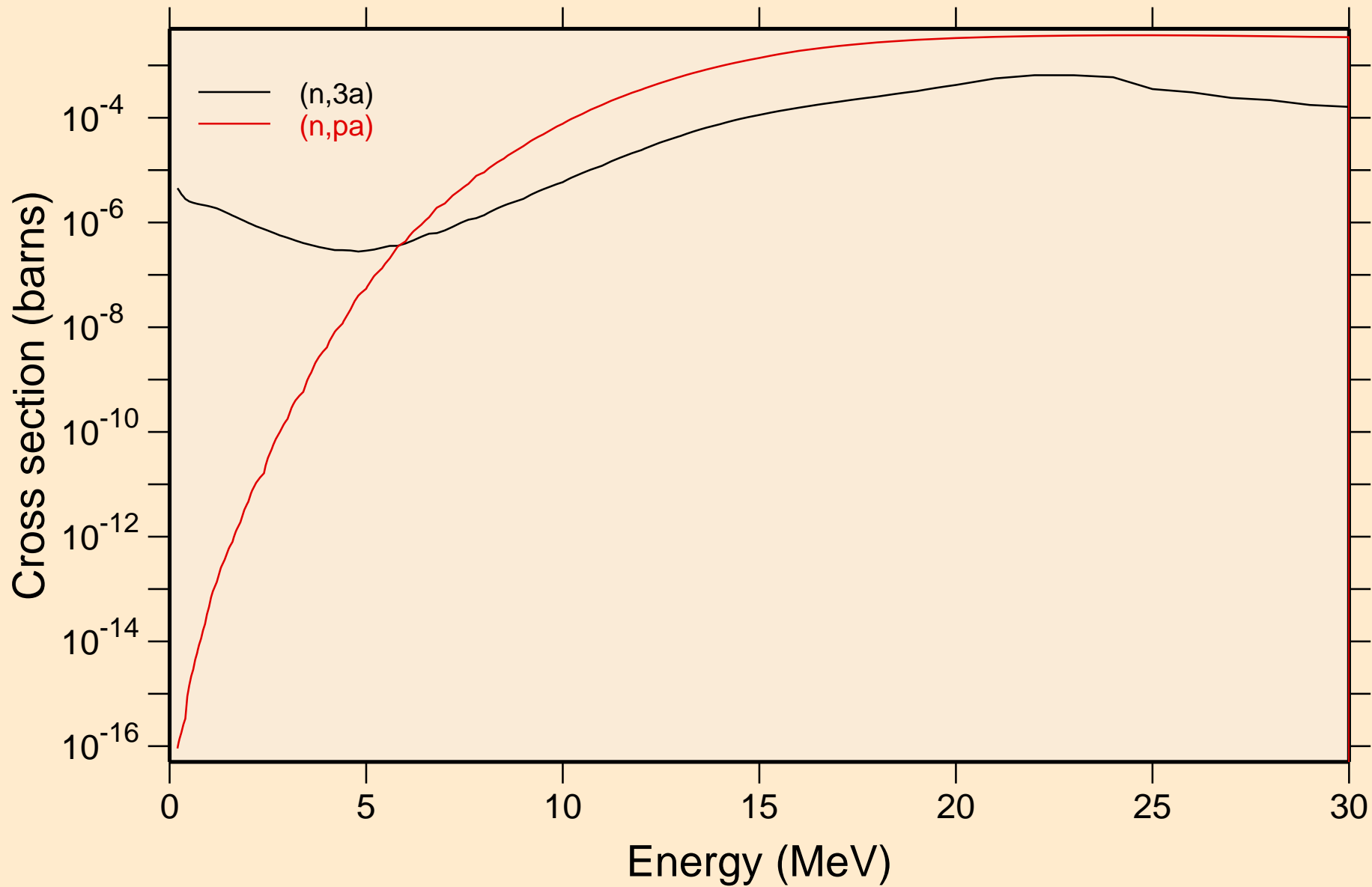

# SG267 NRG TENDL-2015, AKONING

## Inelastic levels

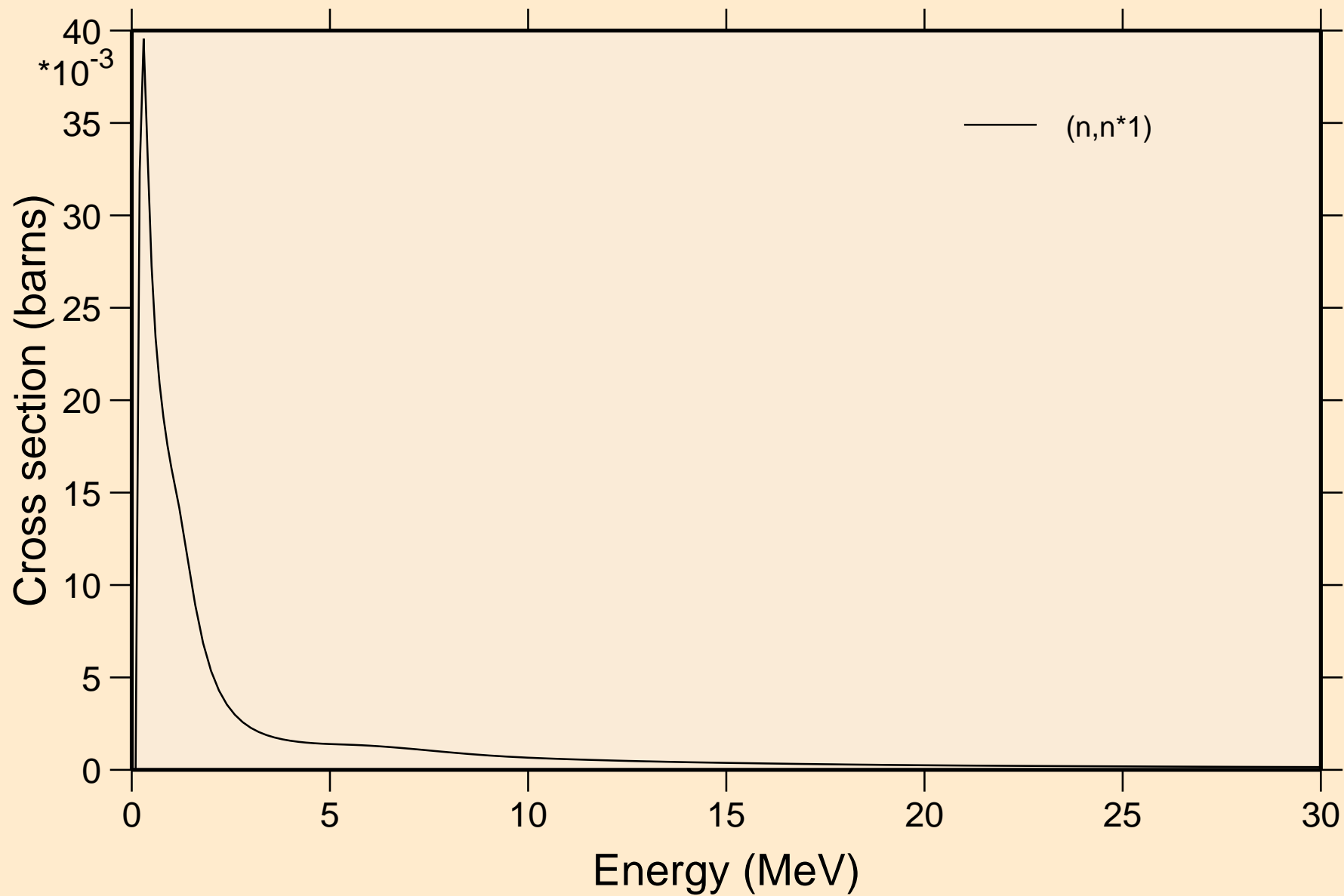

# SG267 NRG TENDL-2015, AKONING

## Threshold reactions

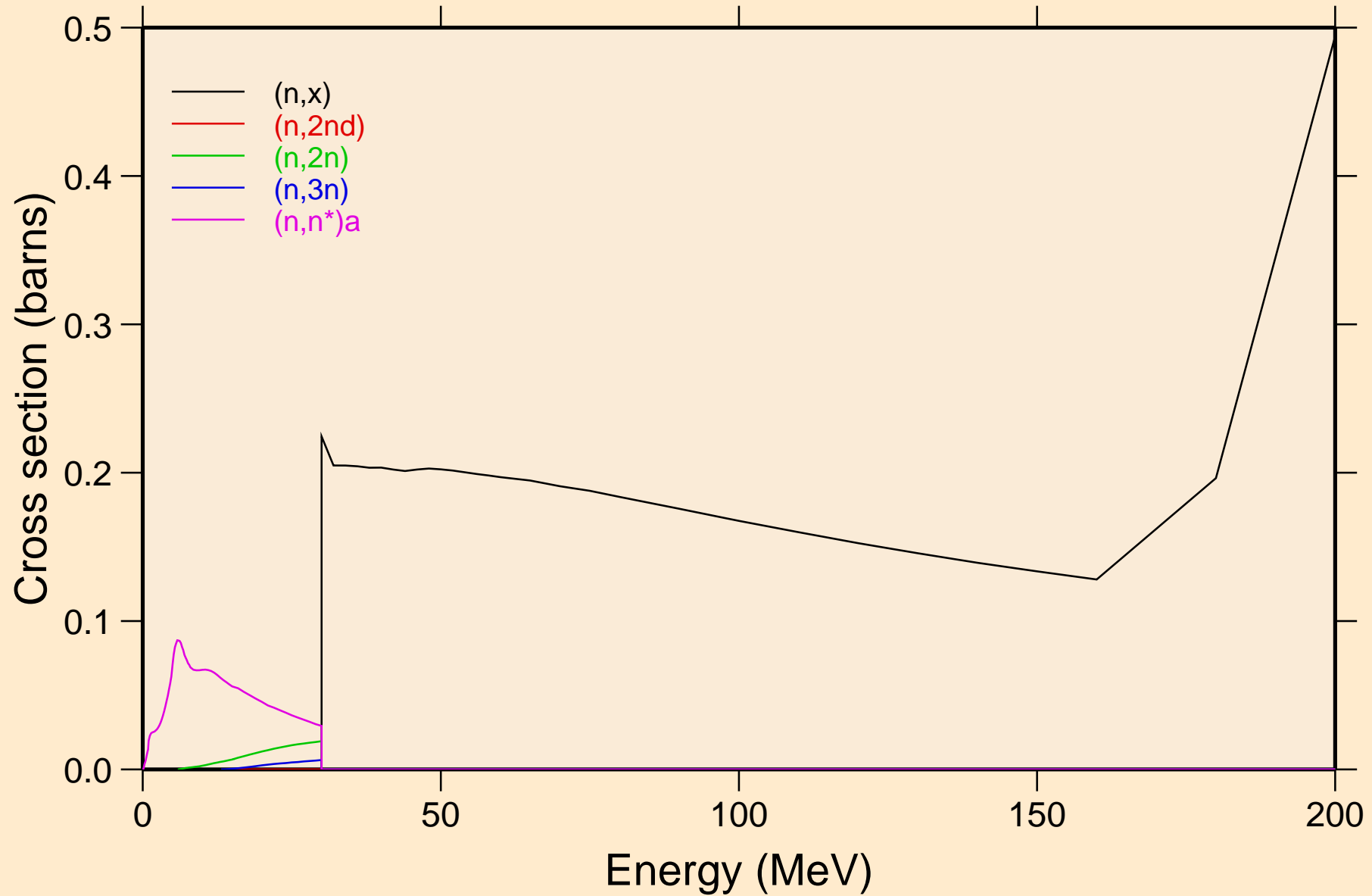



# SG267 NRG TENDL-2015, AKONING

## Threshold reactions

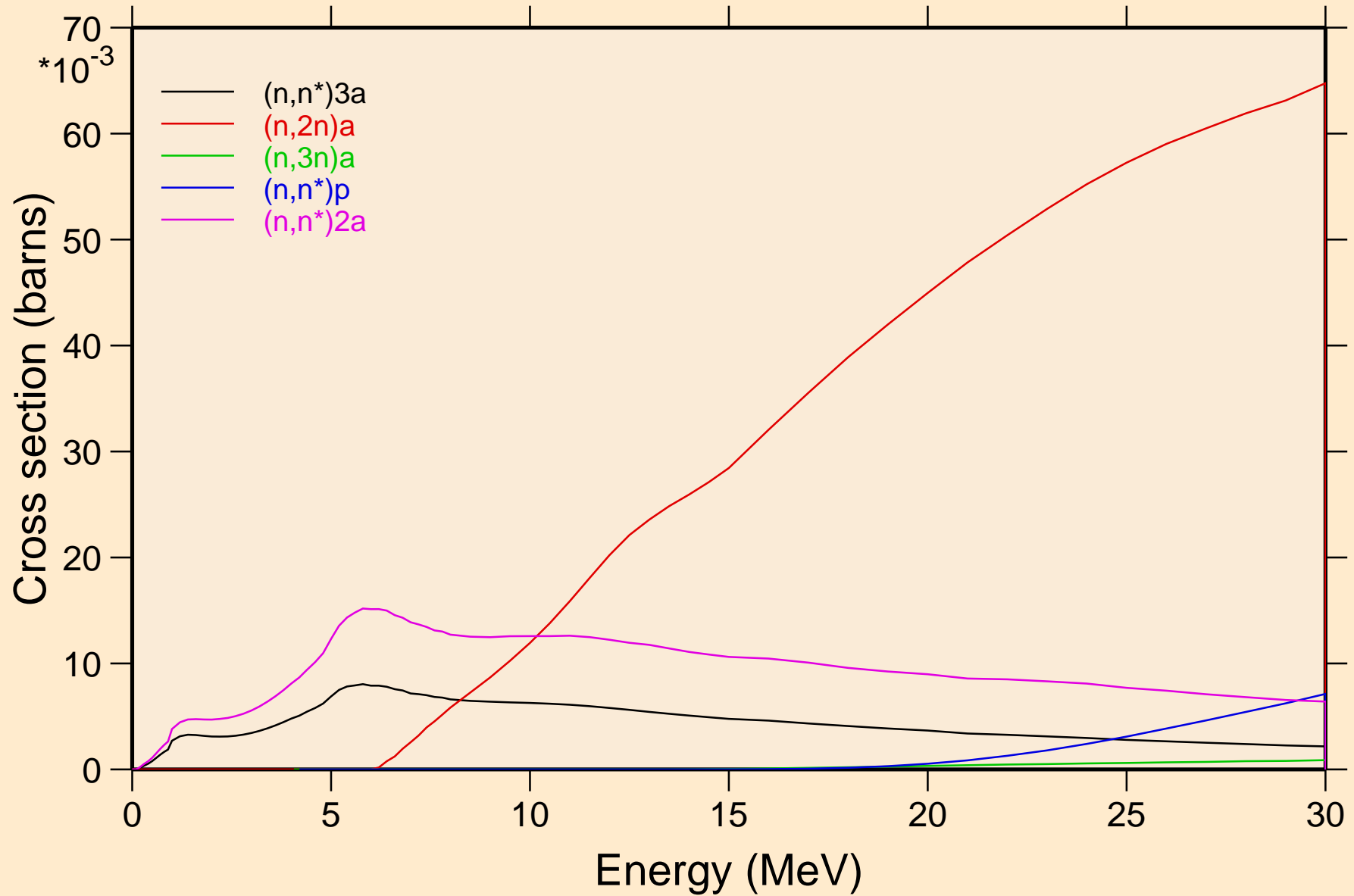

# SG267 NRG TENDL-2015, AKONING

## Threshold reactions

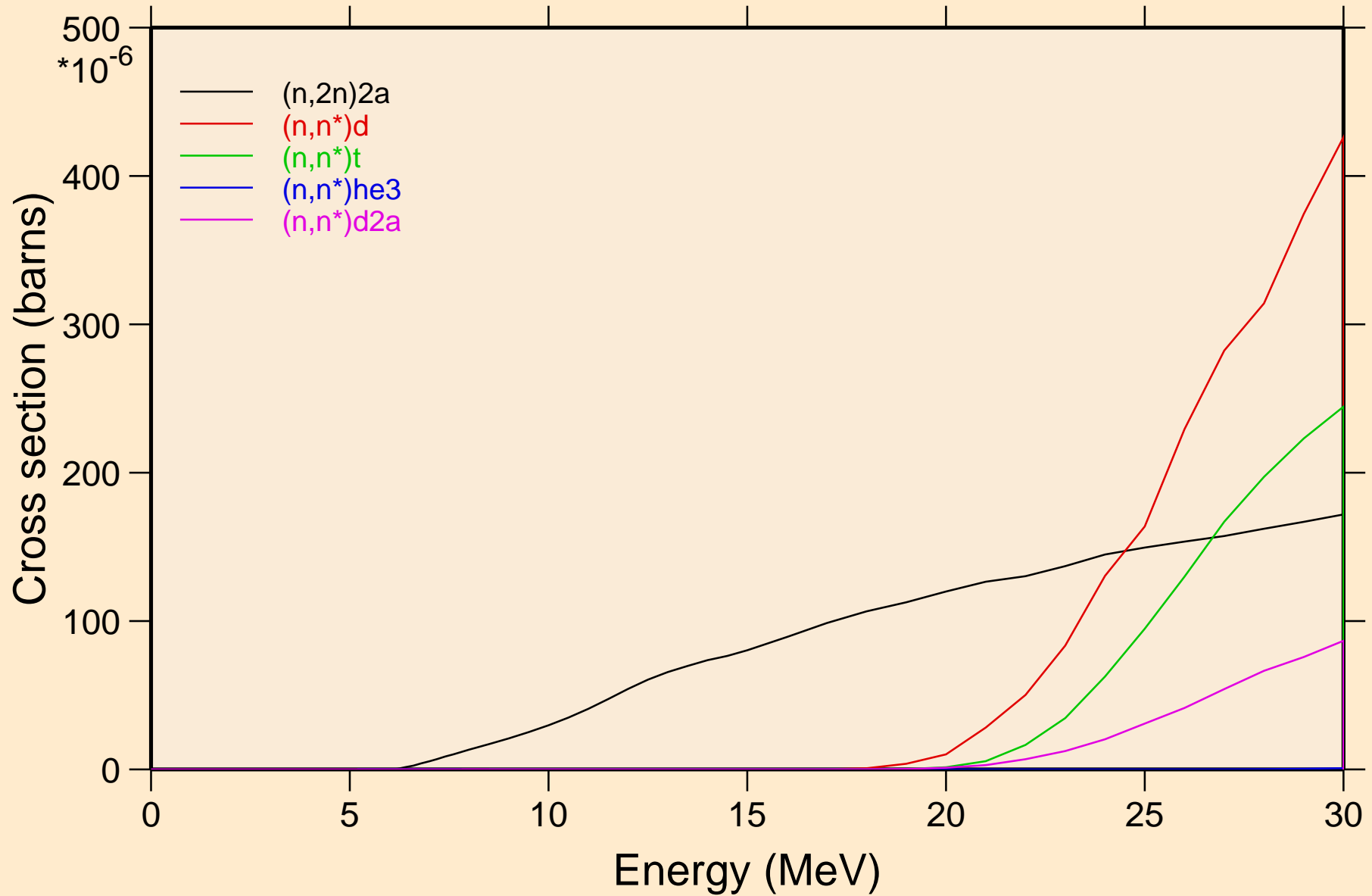

# SG267 NRG TENDL-2015, AKONING

## Threshold reactions

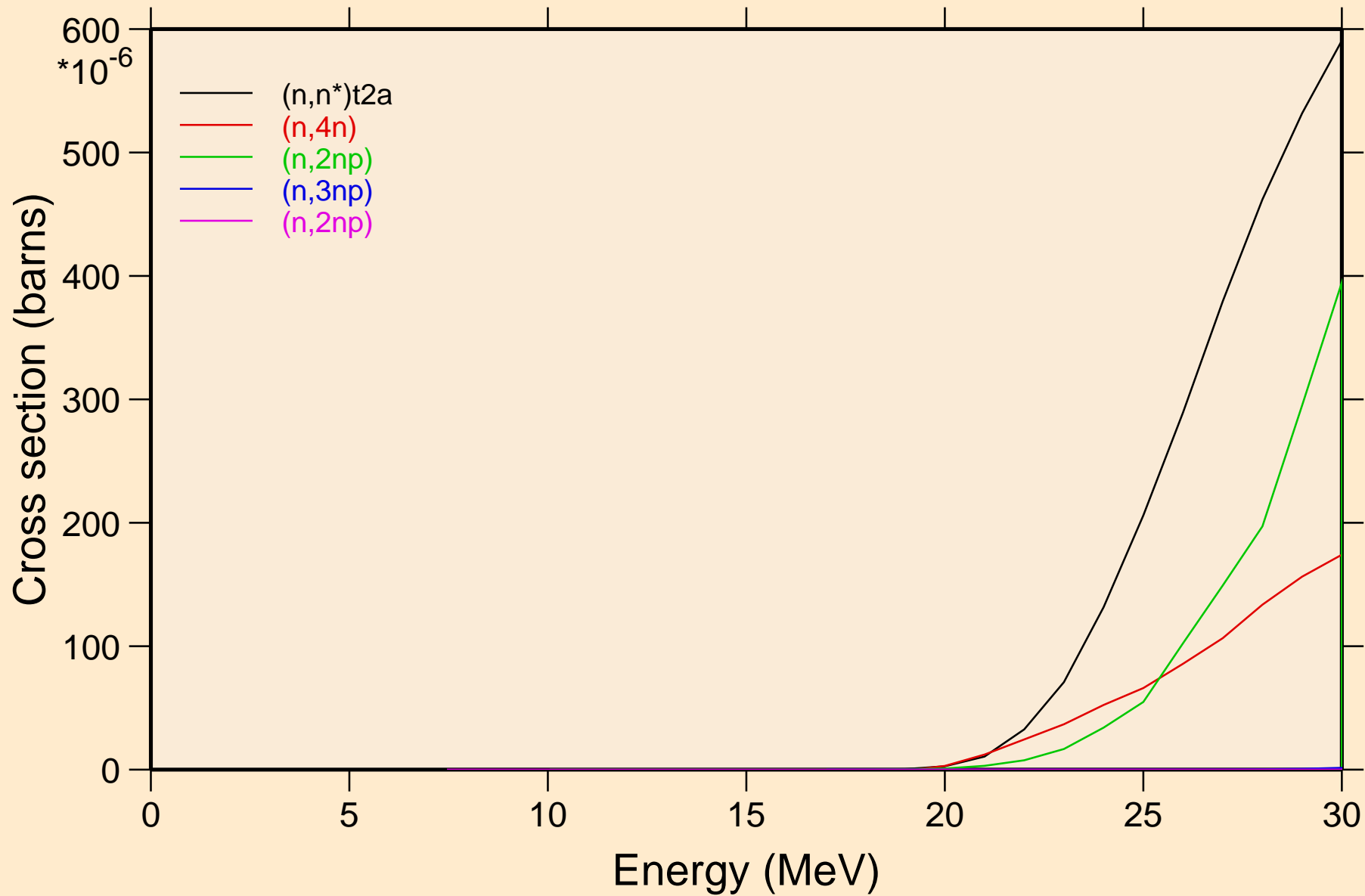

# SG267 NRG TENDL-2015, AKONING

## Threshold reactions

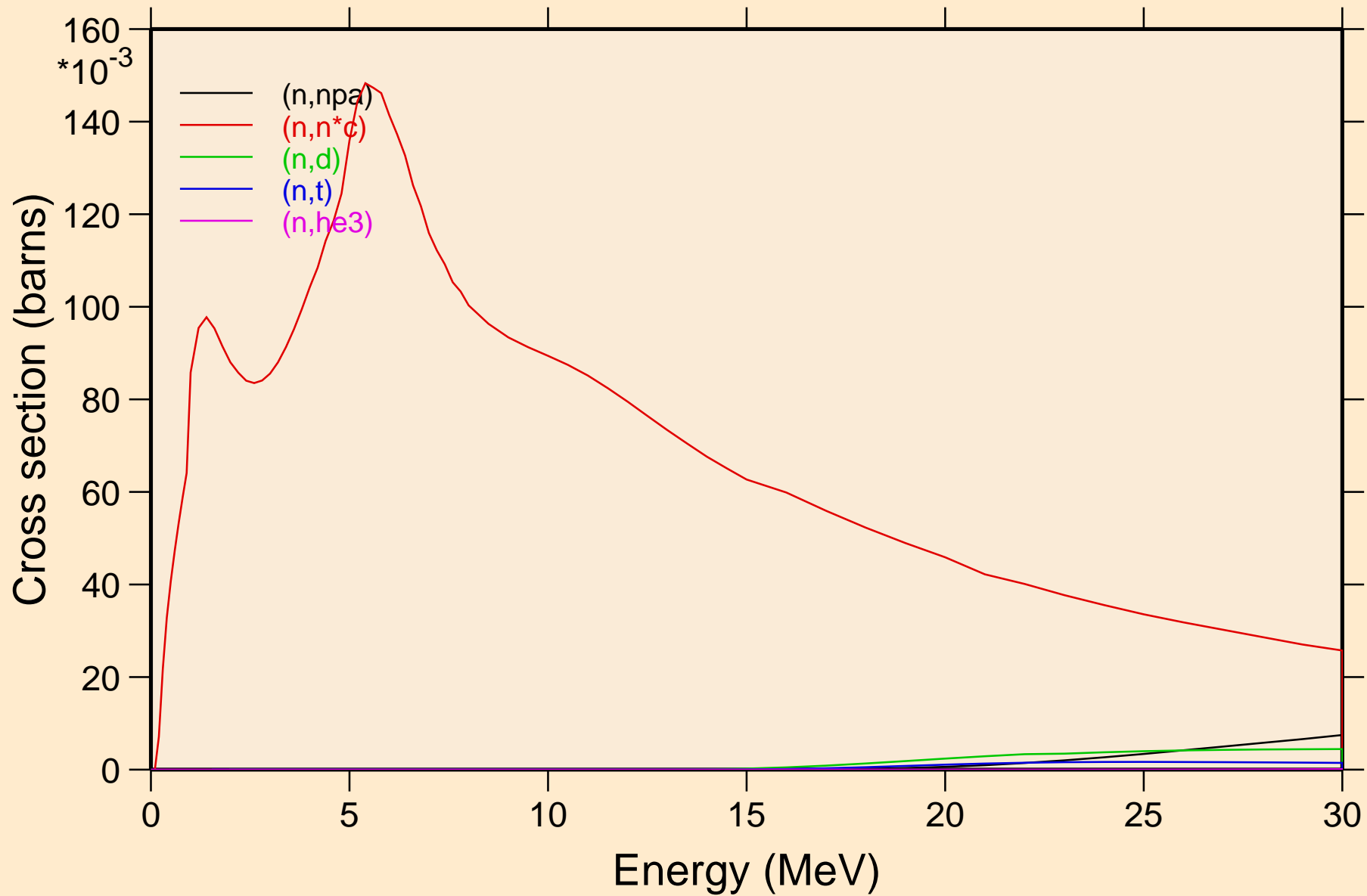

# SG267 NRG TENDL-2015, AKONING

## Threshold reactions

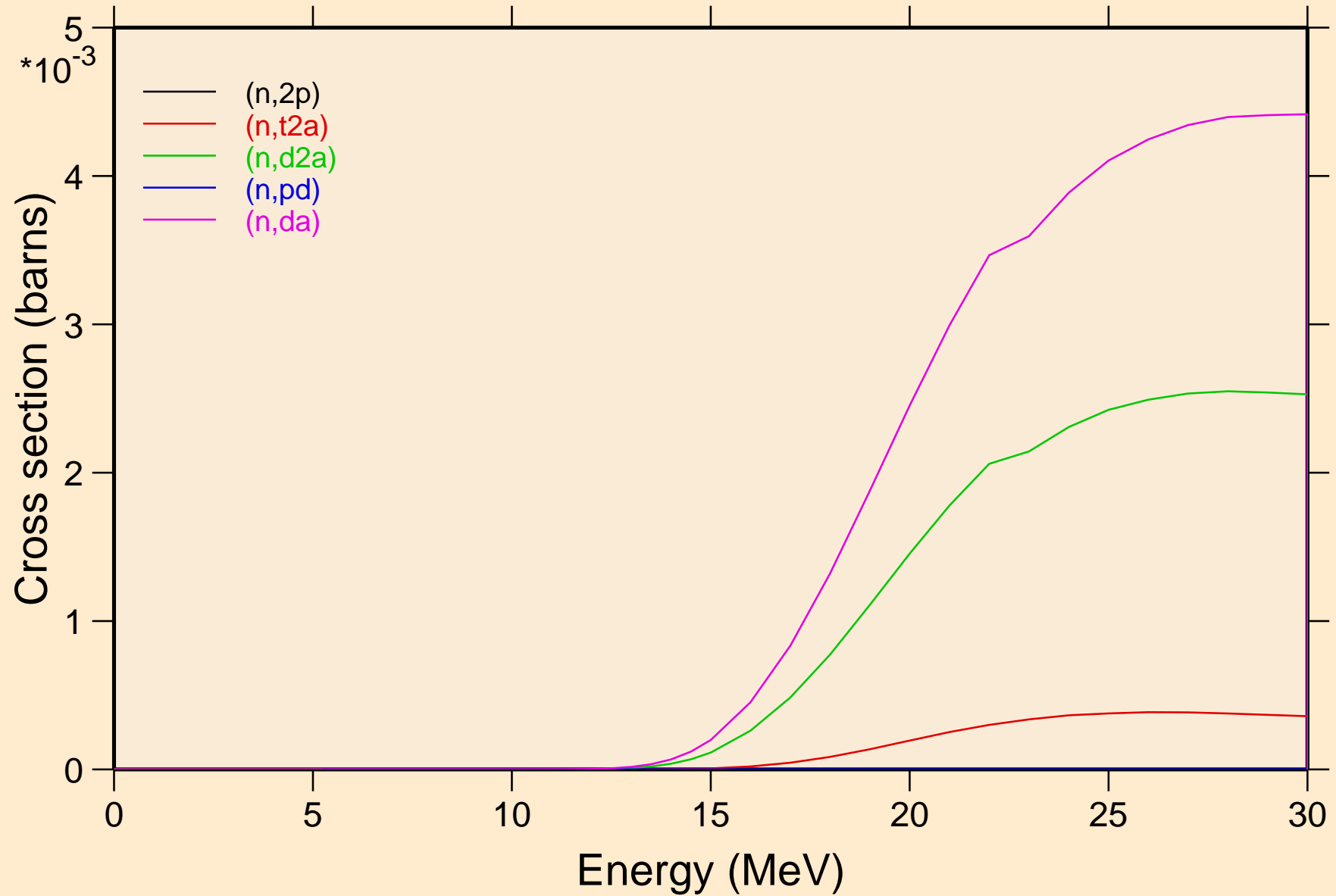

SG267 NRG TENDL-2015, AKONING  
angular distribution for elastic

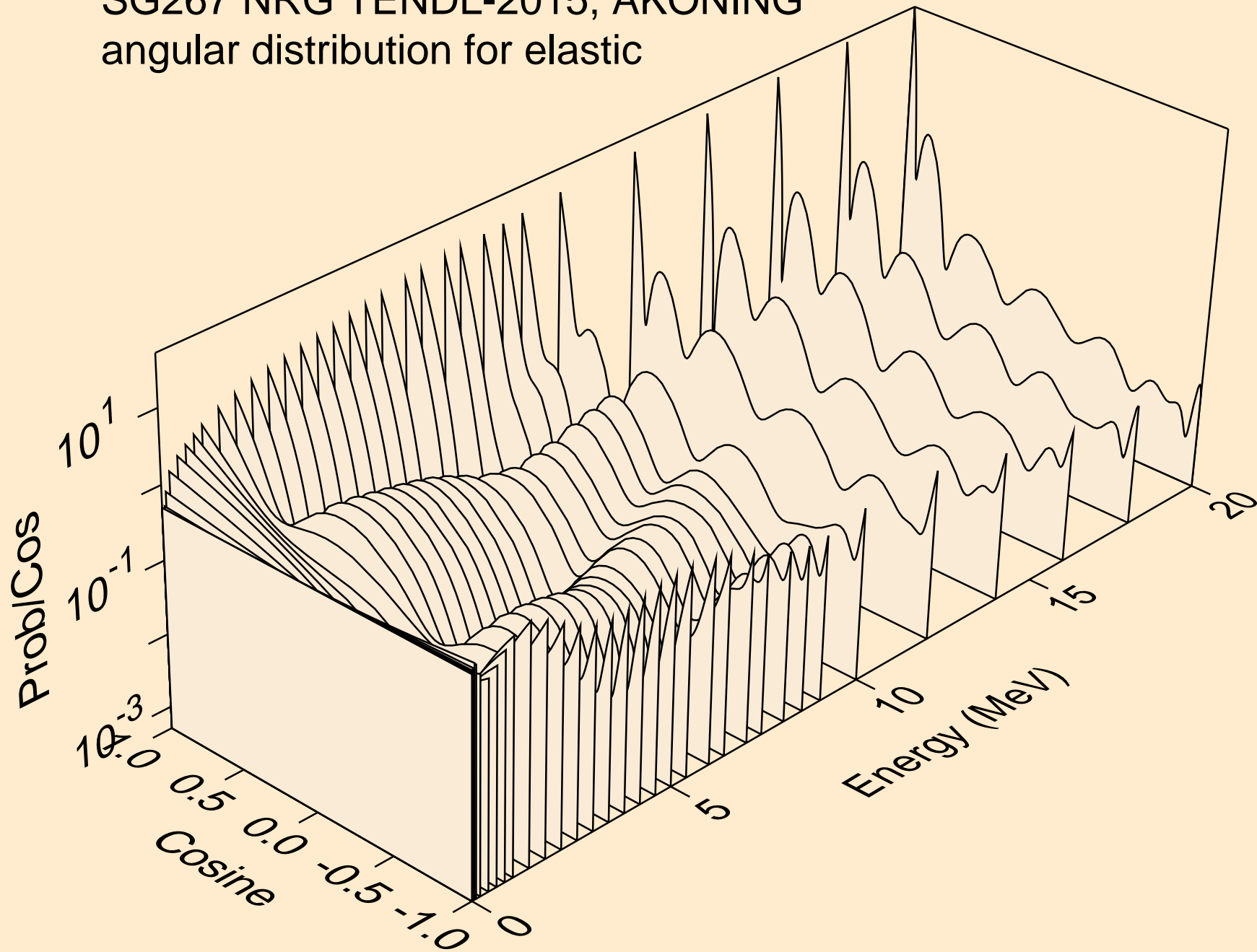

SG267 NRG TENDL-2015, AKONING  
angular distribution for elastic

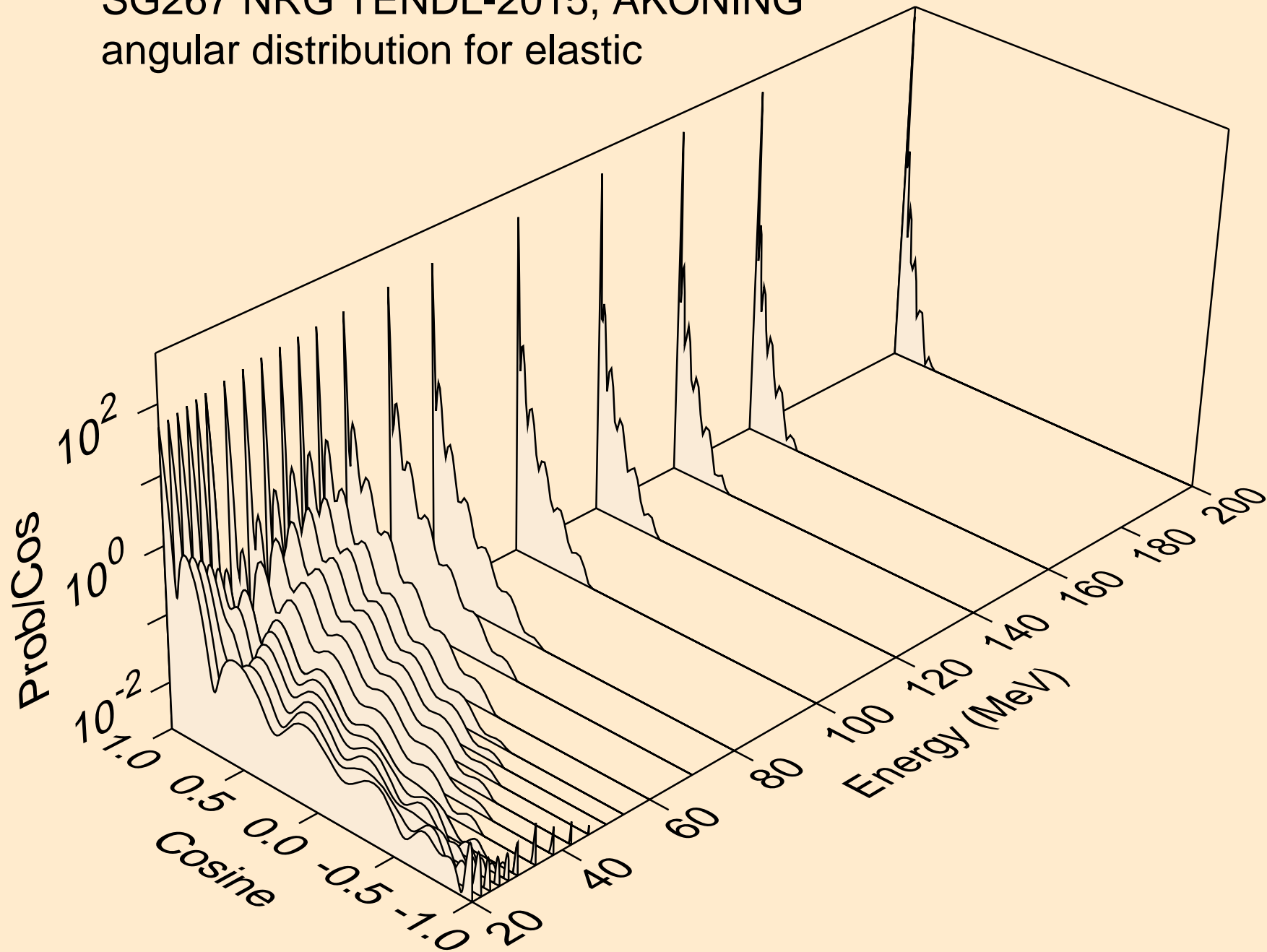

SG267 NRG TENDL-2015, AKONING  
angular distribution for (n,n\*1)

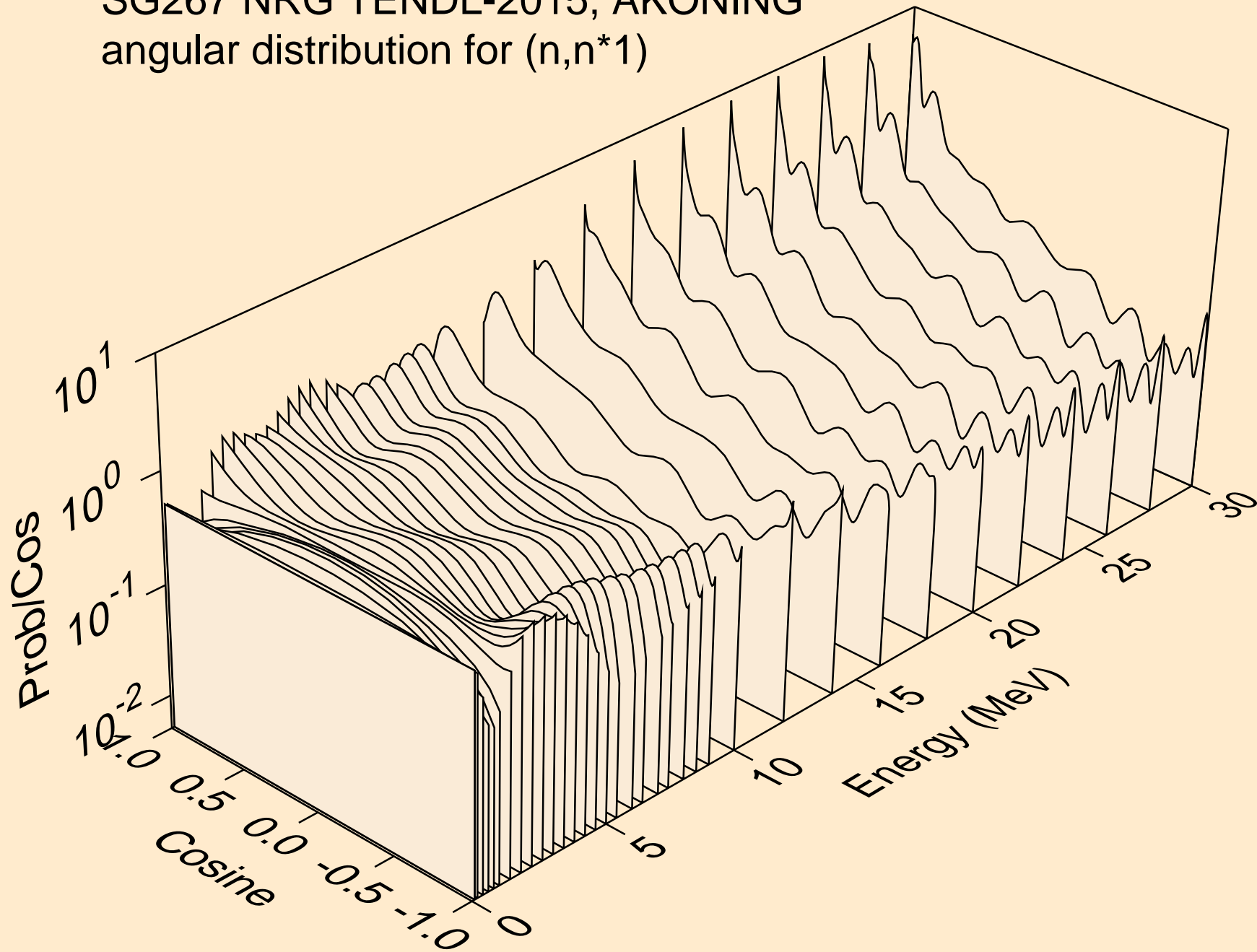



# SG267 NRG TENDL-2015, AKONING

Total fission nubar

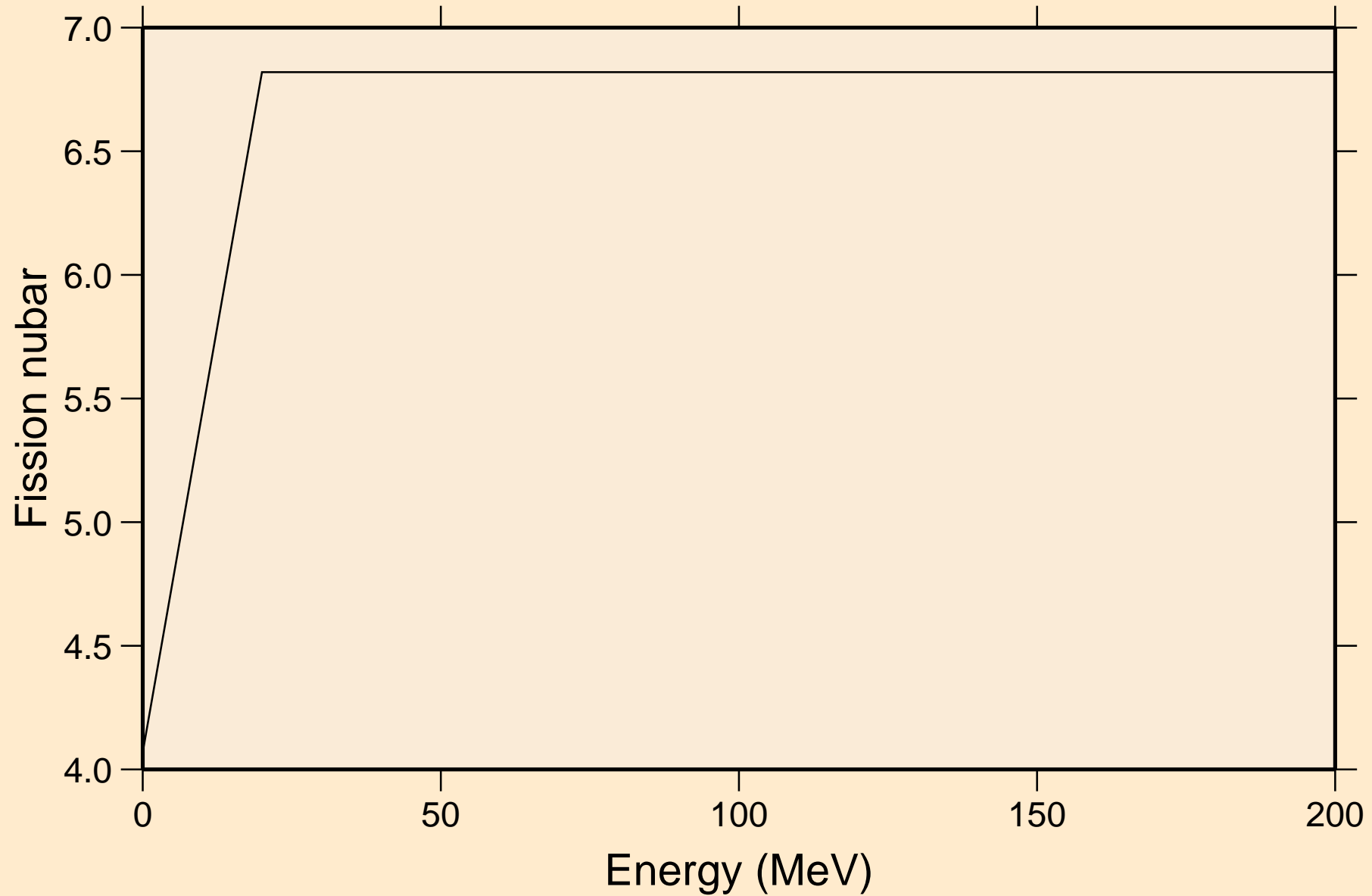

SG267 NRG TENDL-2015, AKONING  
Neutron emission for (n,x)

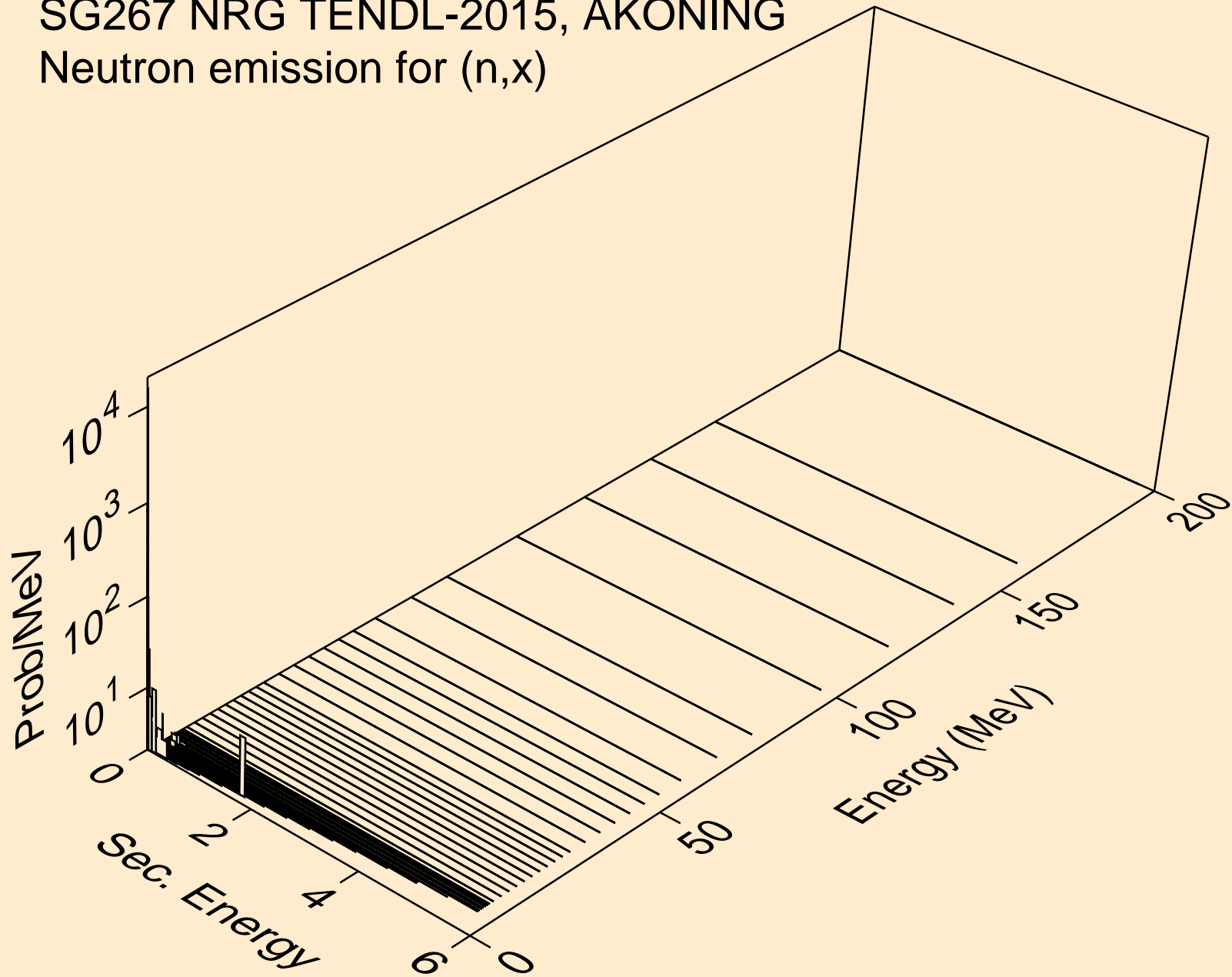

SG267 NRG TENDL-2015, AKONING  
Neutron emission for (n,2nd)

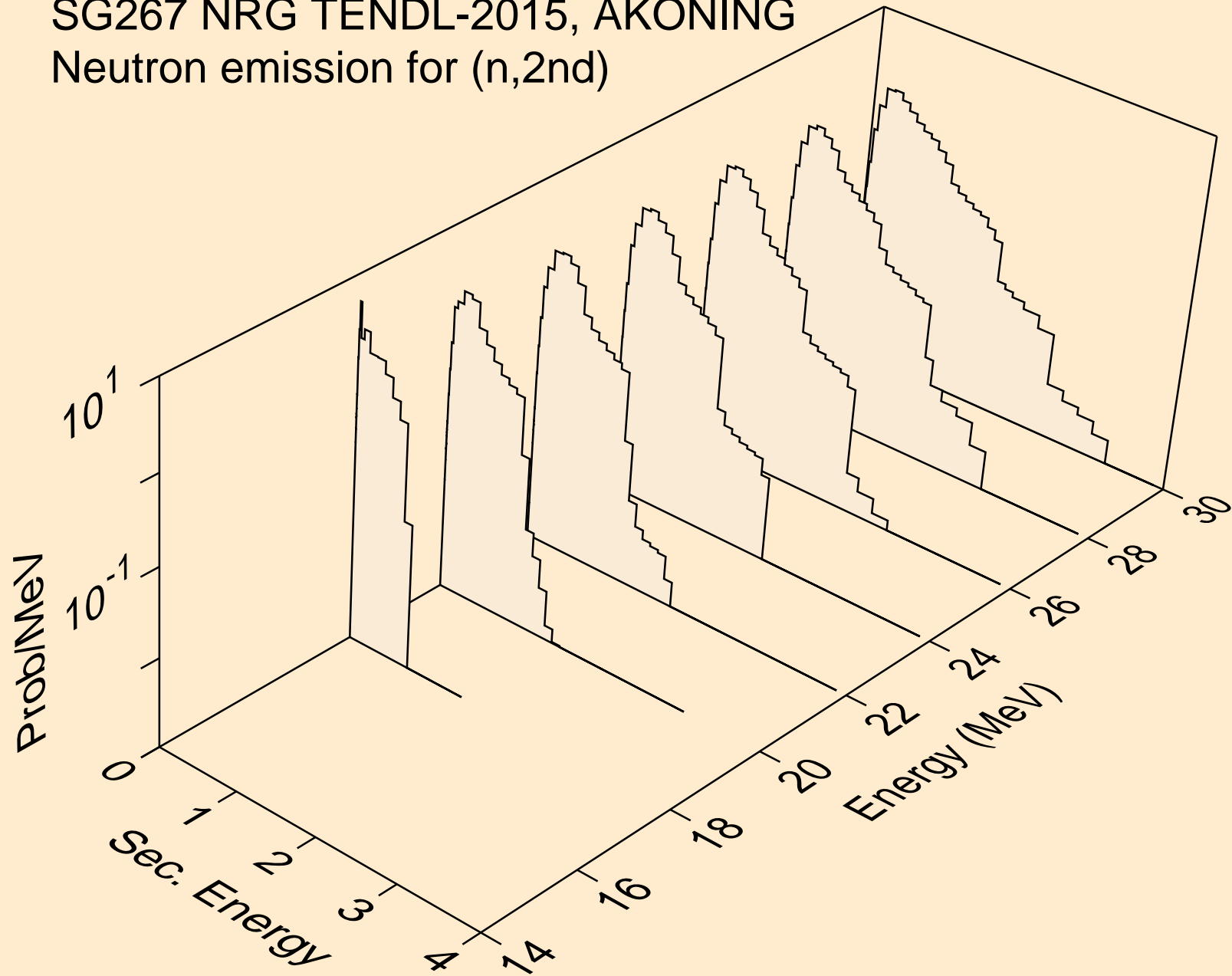

SG267 NRG TENDL-2015, AKONING  
Neutron emission for (n,2n)

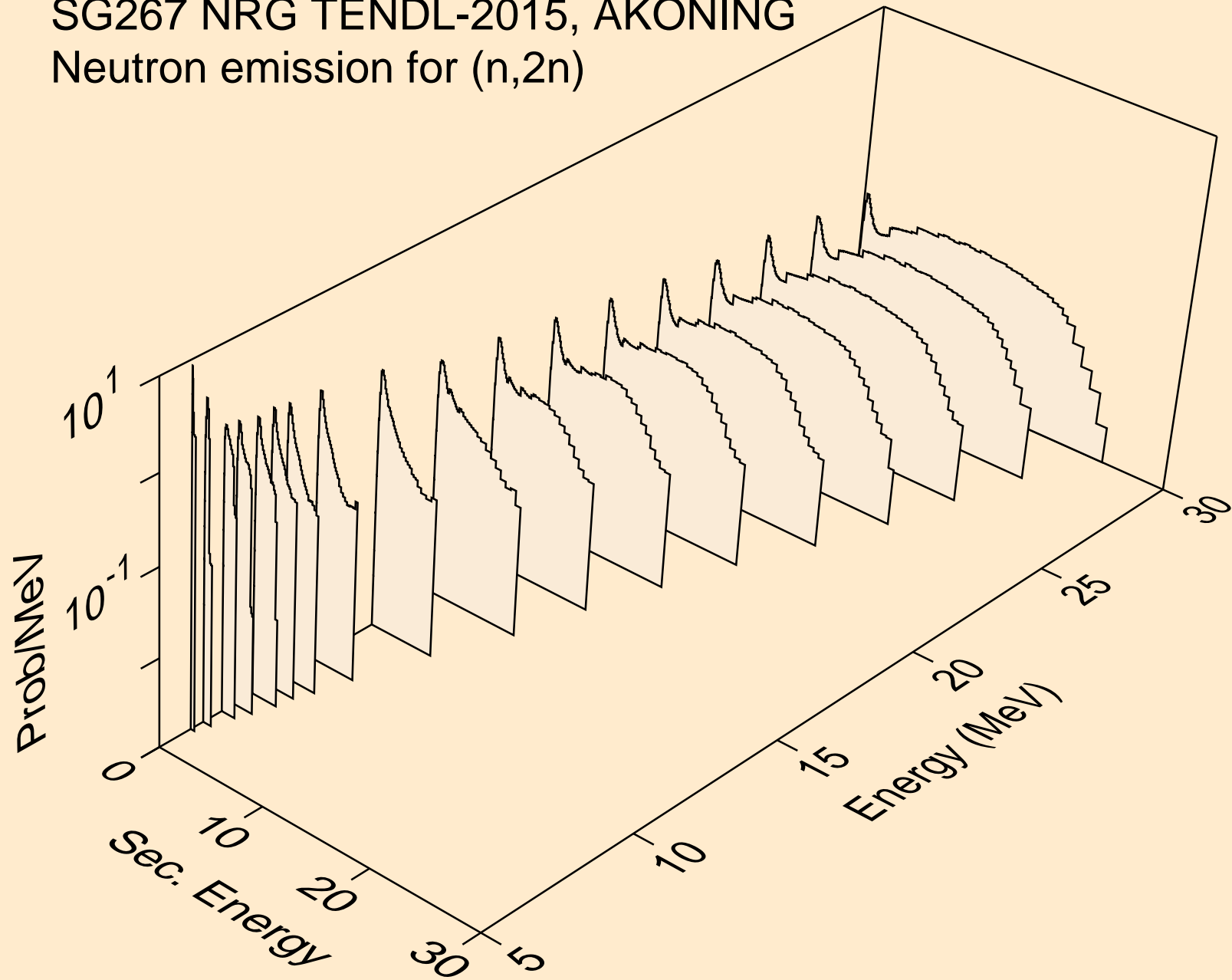

SG267 NRG TENDL-2015, AKONING  
Neutron emission for (n,3n)

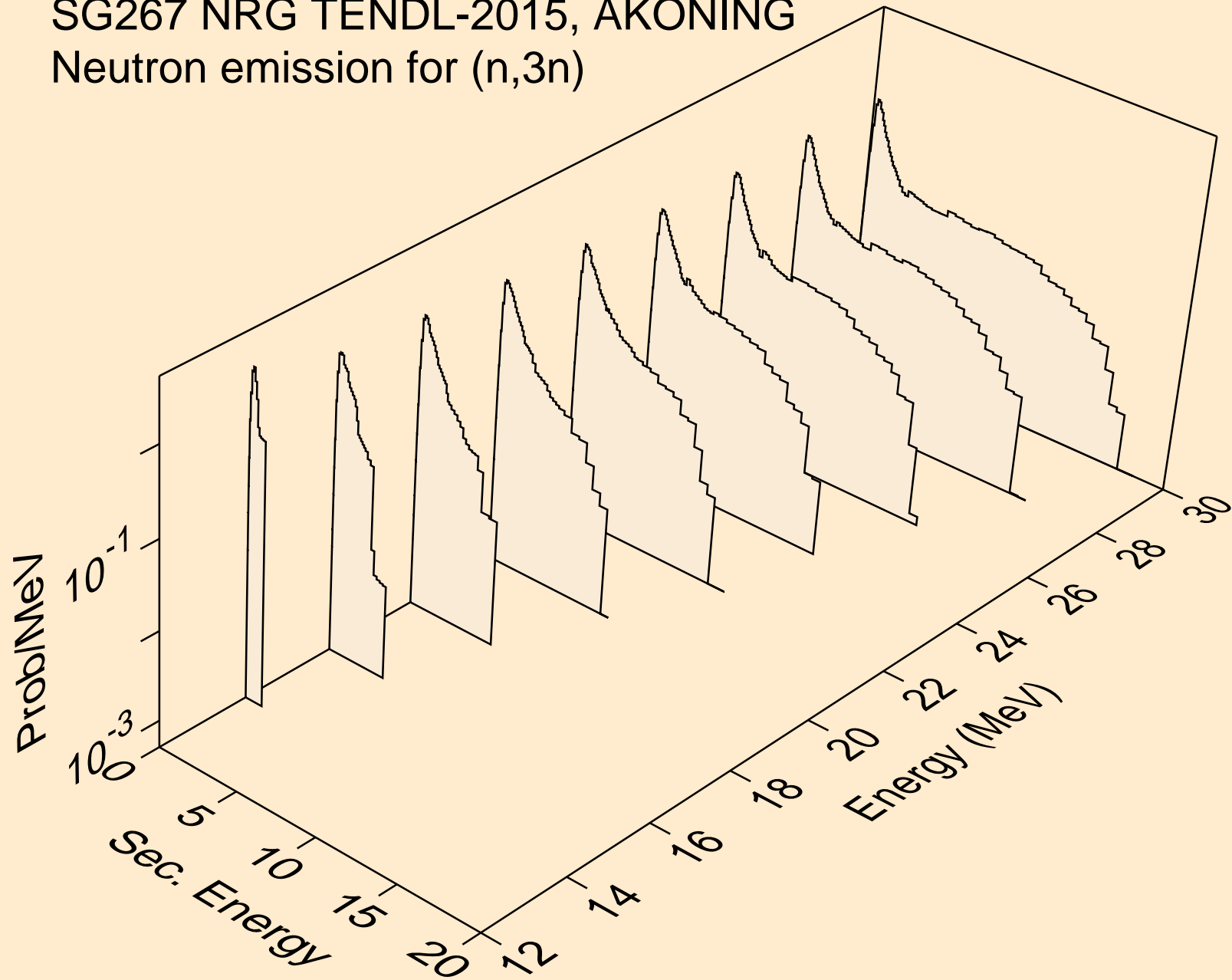

SG267 NRG TENDL-2015, AKONING  
Neutron emission for fission

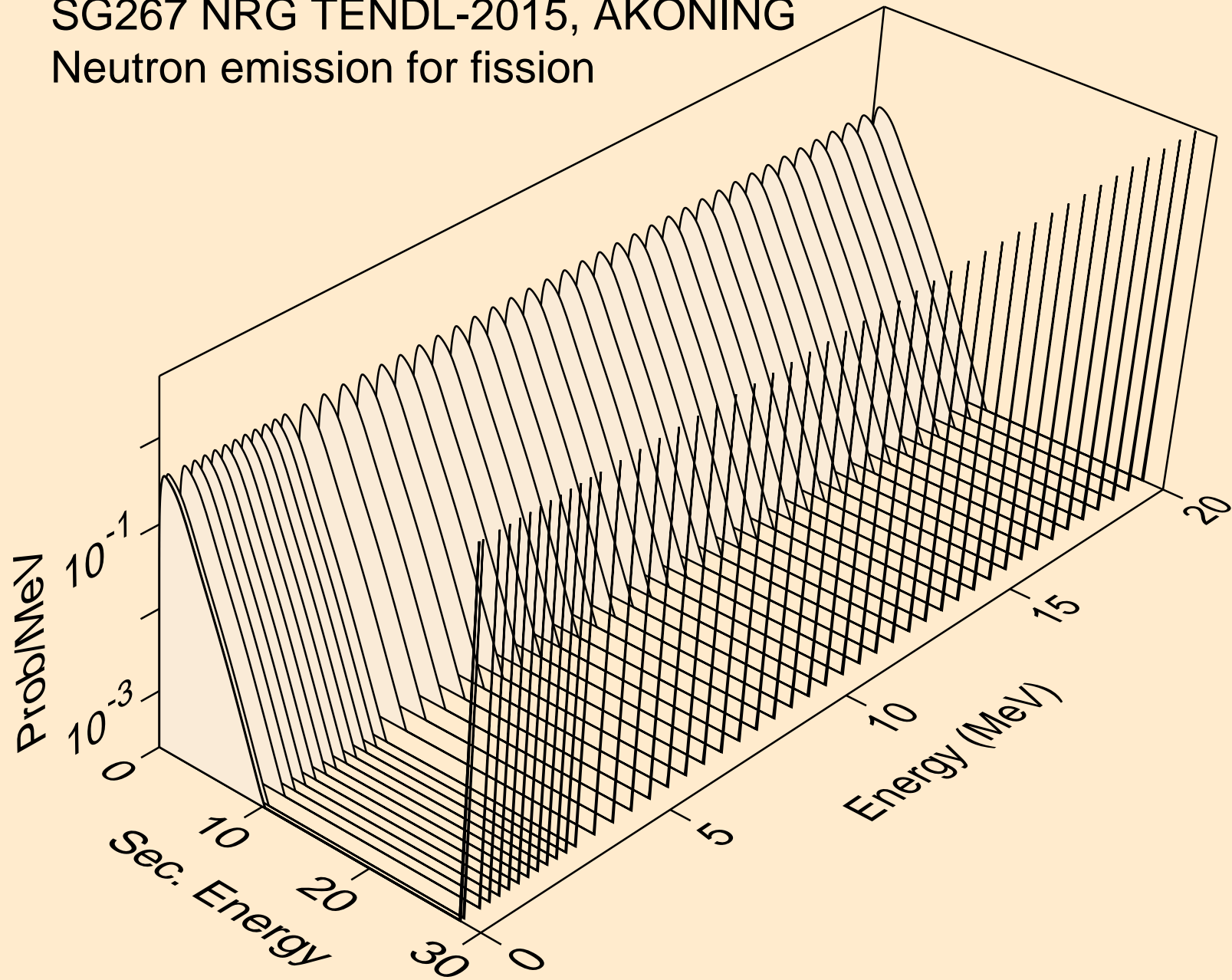

SG267 NRG TENDL-2015, AKONING  
Neutron emission for (n,n\*)a

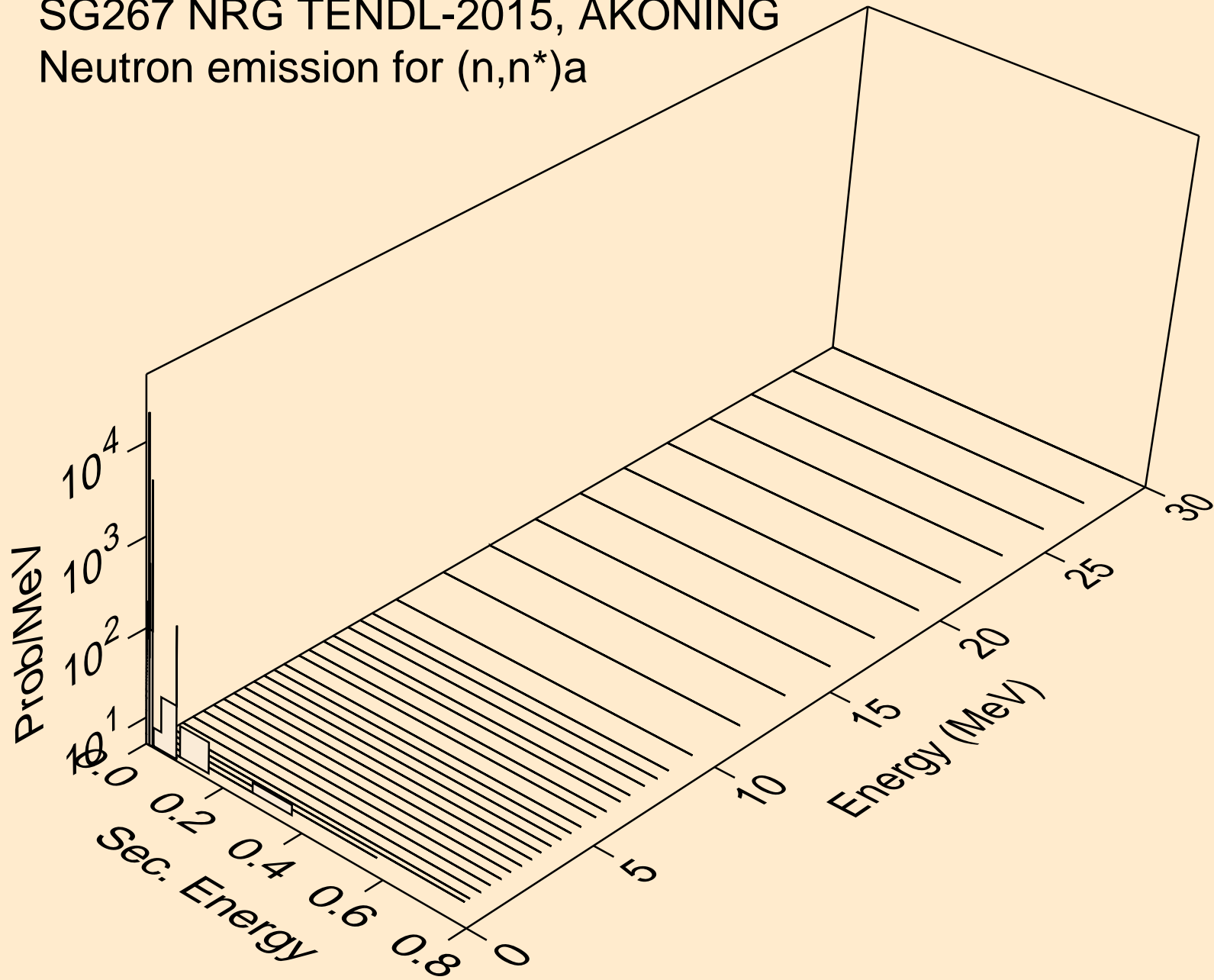

SG267 NRG TENDL-2015, AKONING  
Neutron emission for (n,n\*)3a

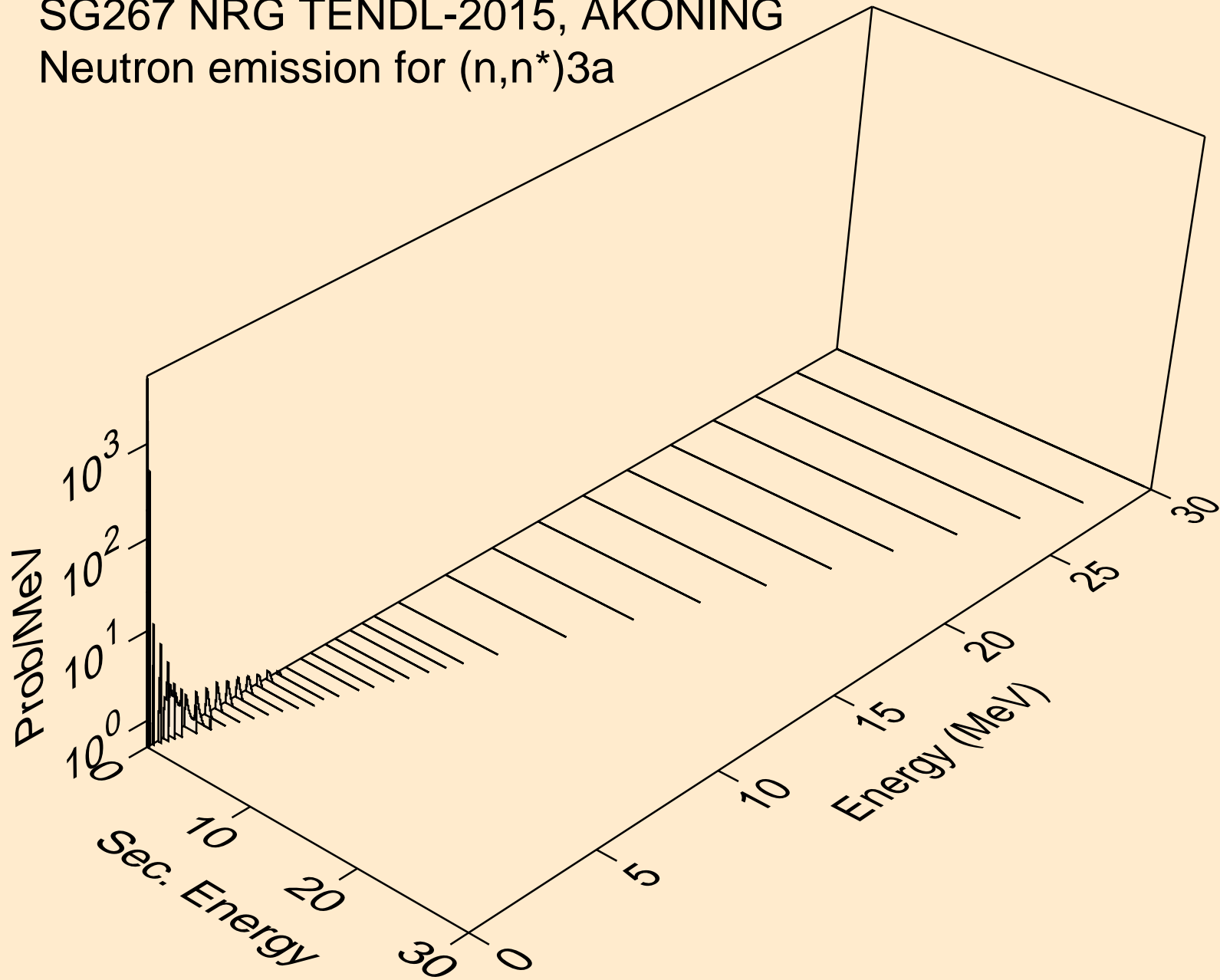



SG267 NRG TENDL-2015, AKONING  
Neutron emission for (n,2n)a

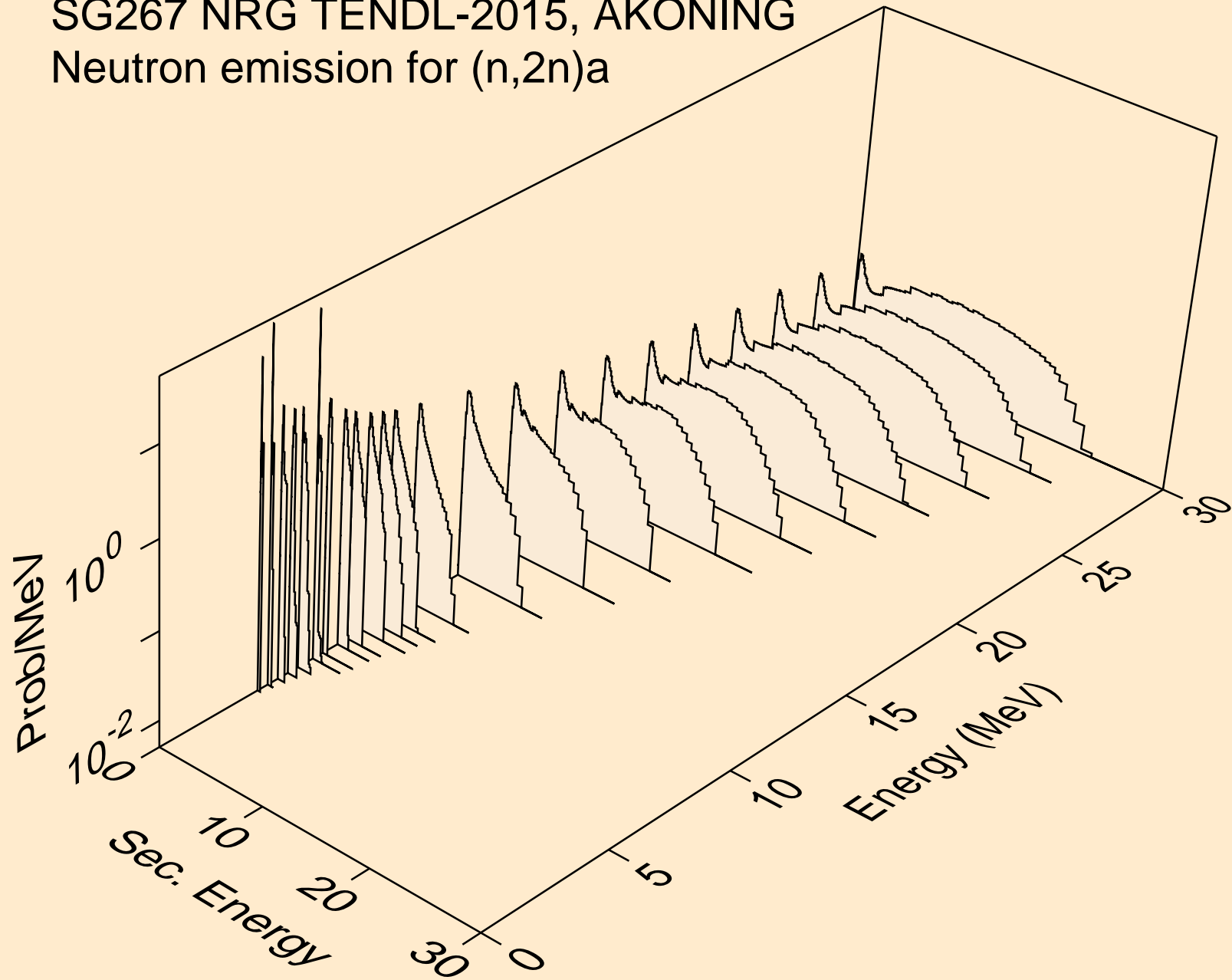

SG267 NRG TENDL-2015, AKONING  
Neutron emission for (n,3n)a

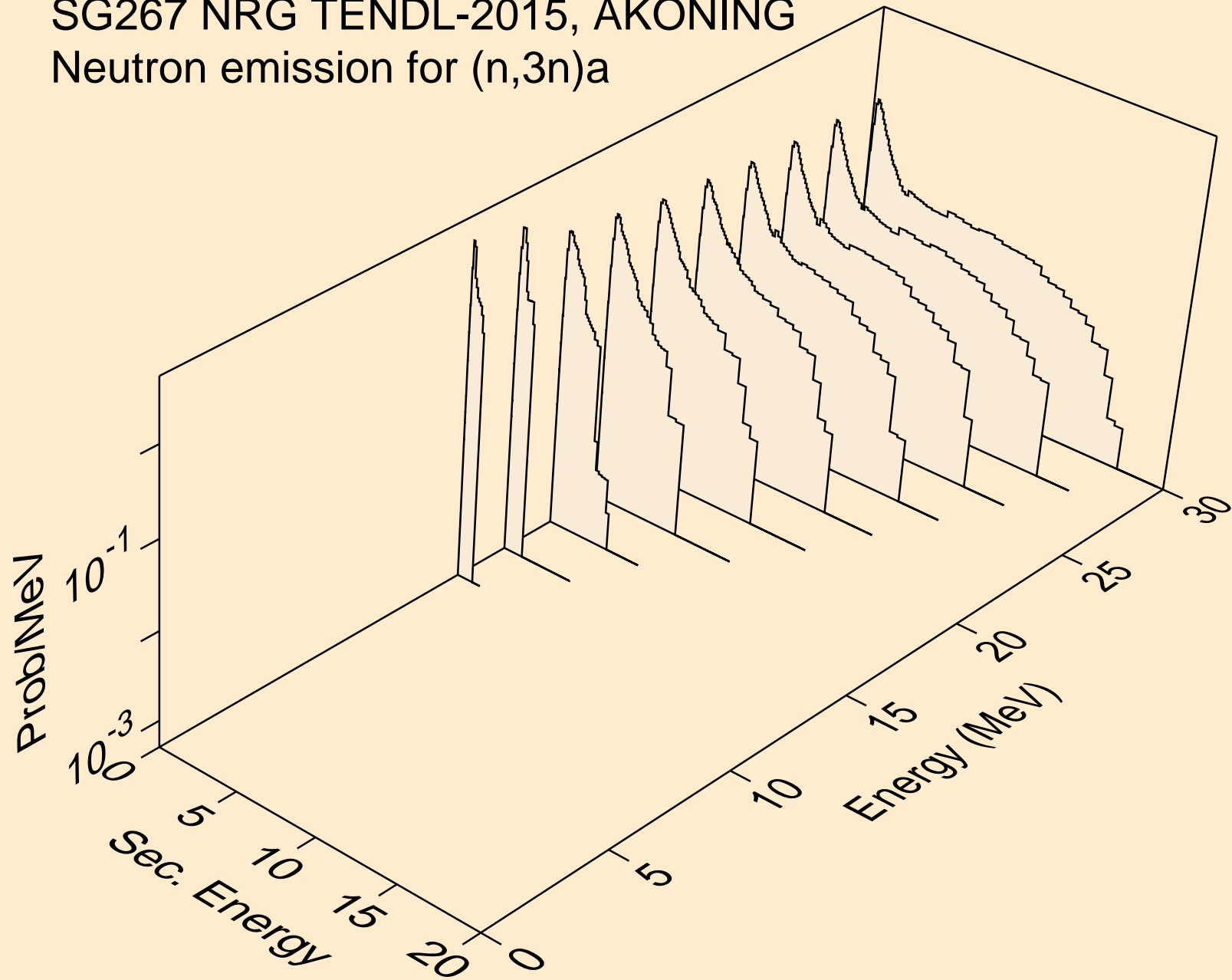

SG267 NRG TENDL-2015, AKONING  
Neutron emission for (n,n\*)p

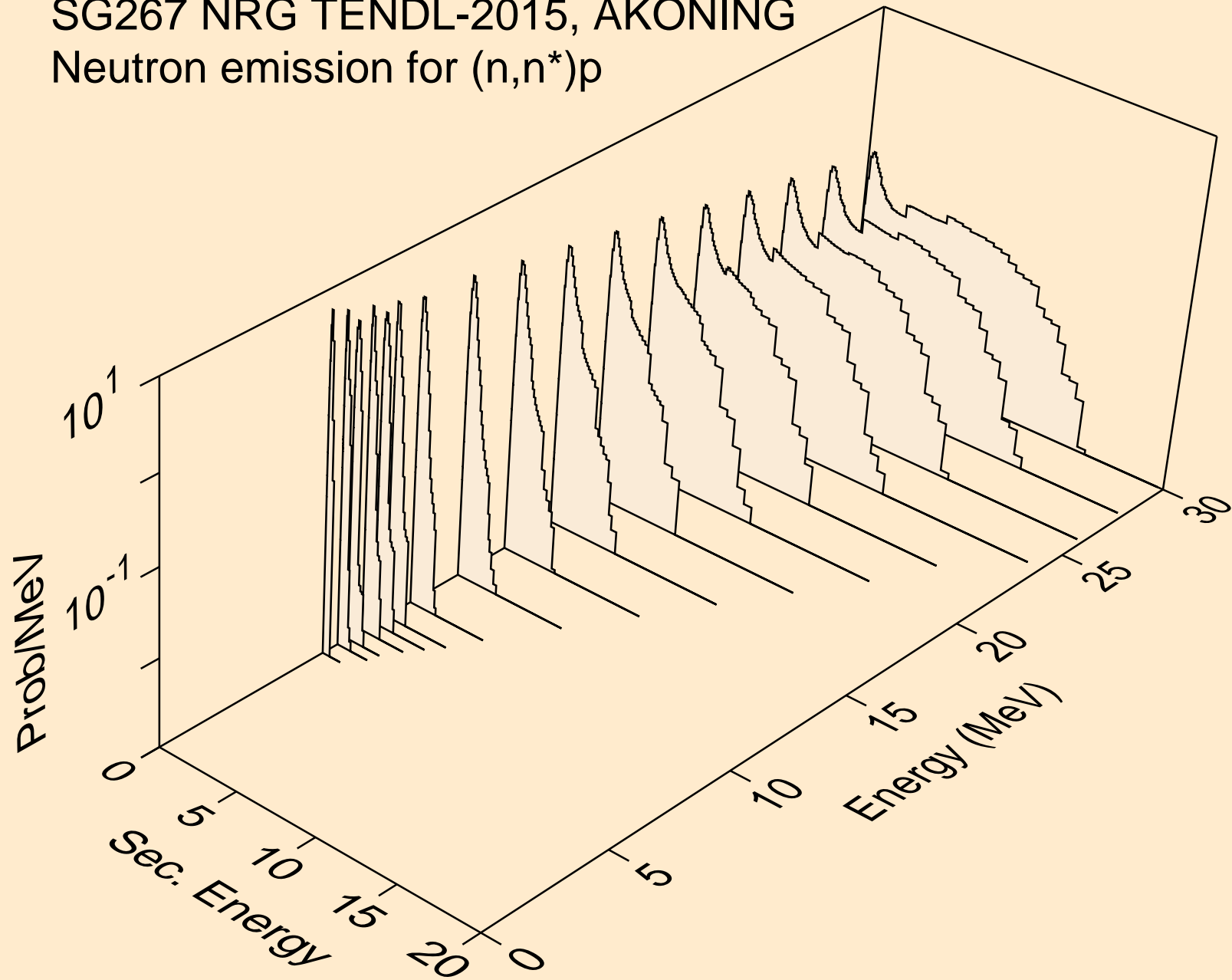

SG267 NRG TENDL-2015, AKONING  
Neutron emission for (n,n\*)2a

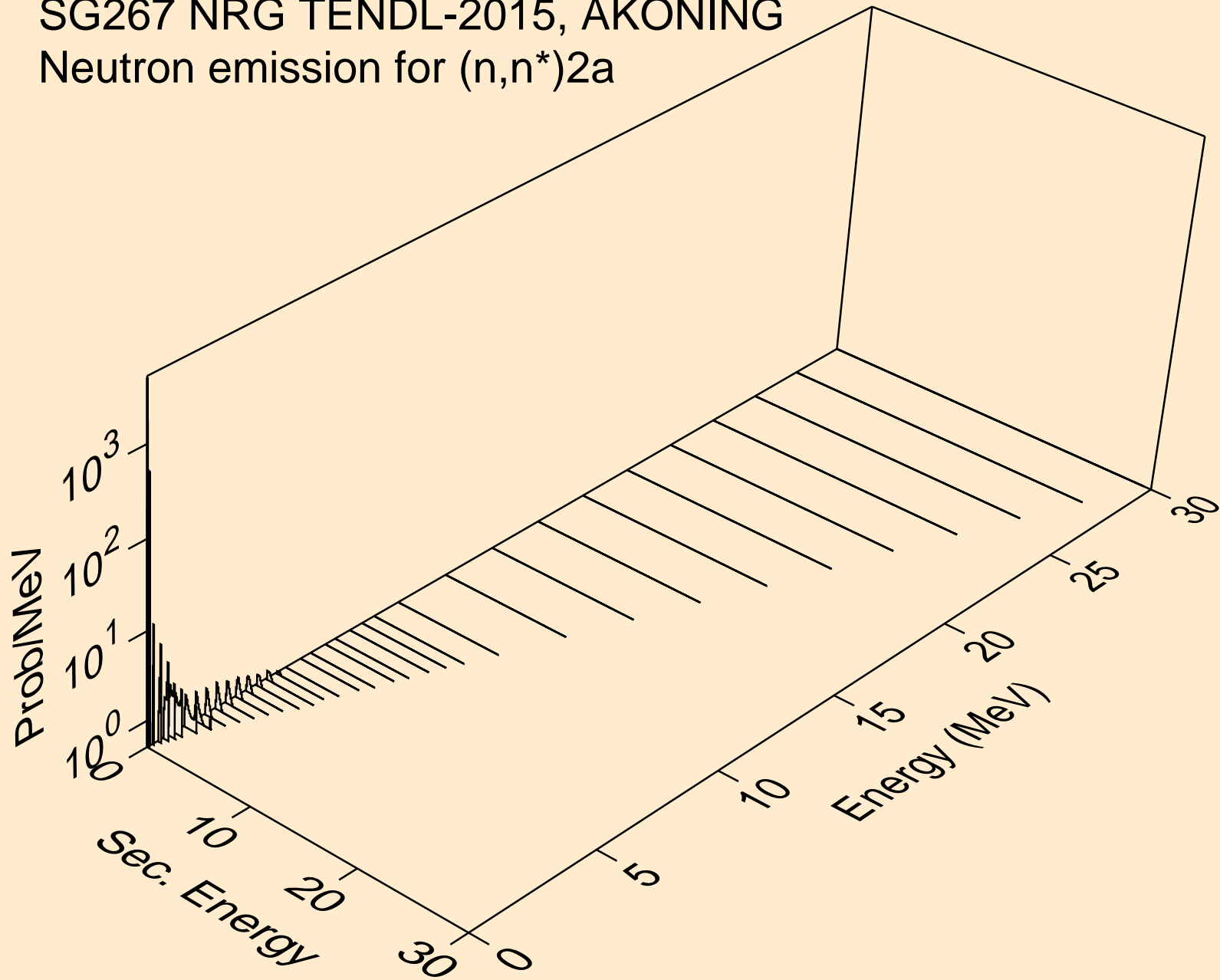

SG267 NRG TENDL-2015, AKONING  
Neutron emission for (n,2n)2a

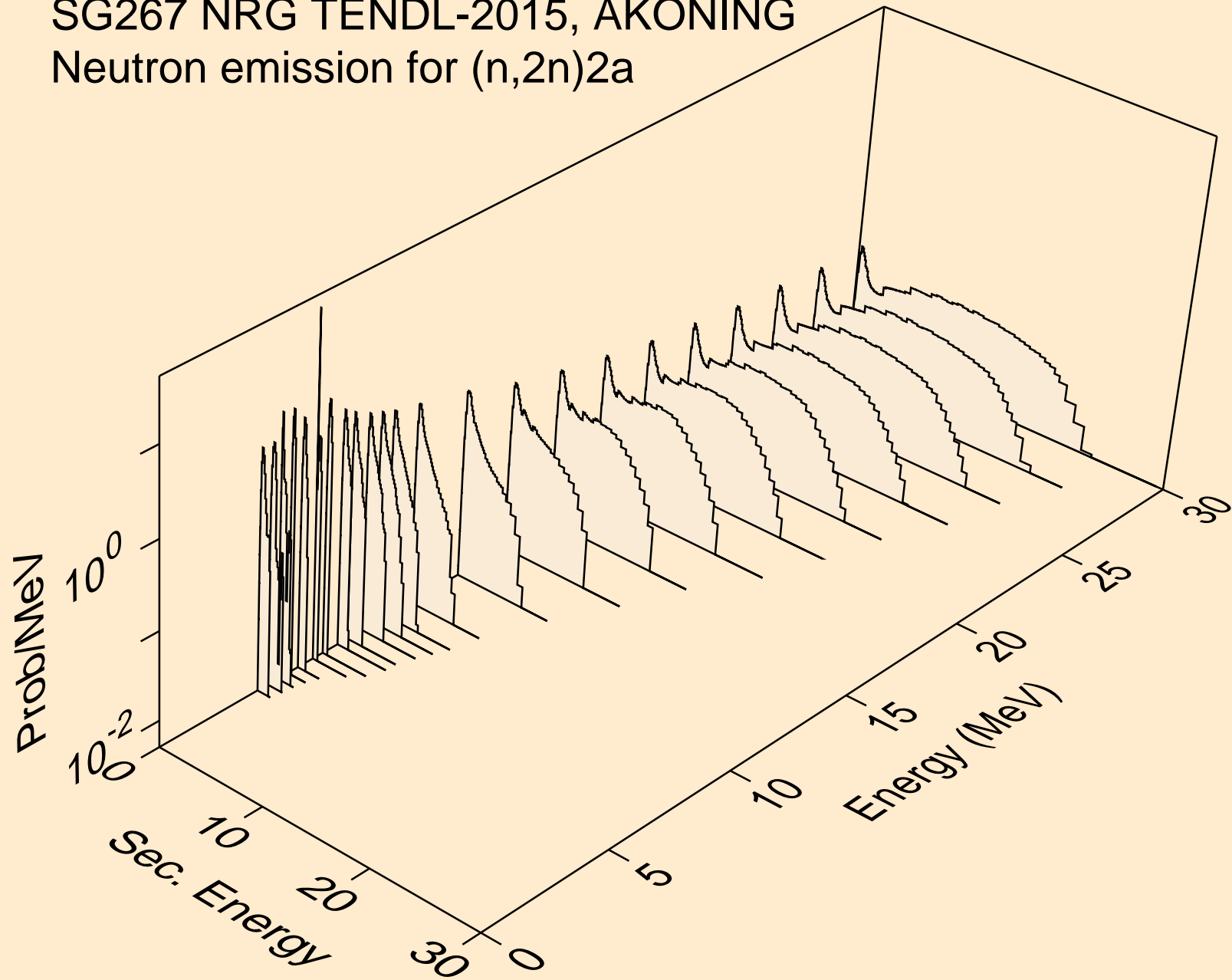

SG267 NRG TENDL-2015, AKONING  
Neutron emission for (n,n\*)d

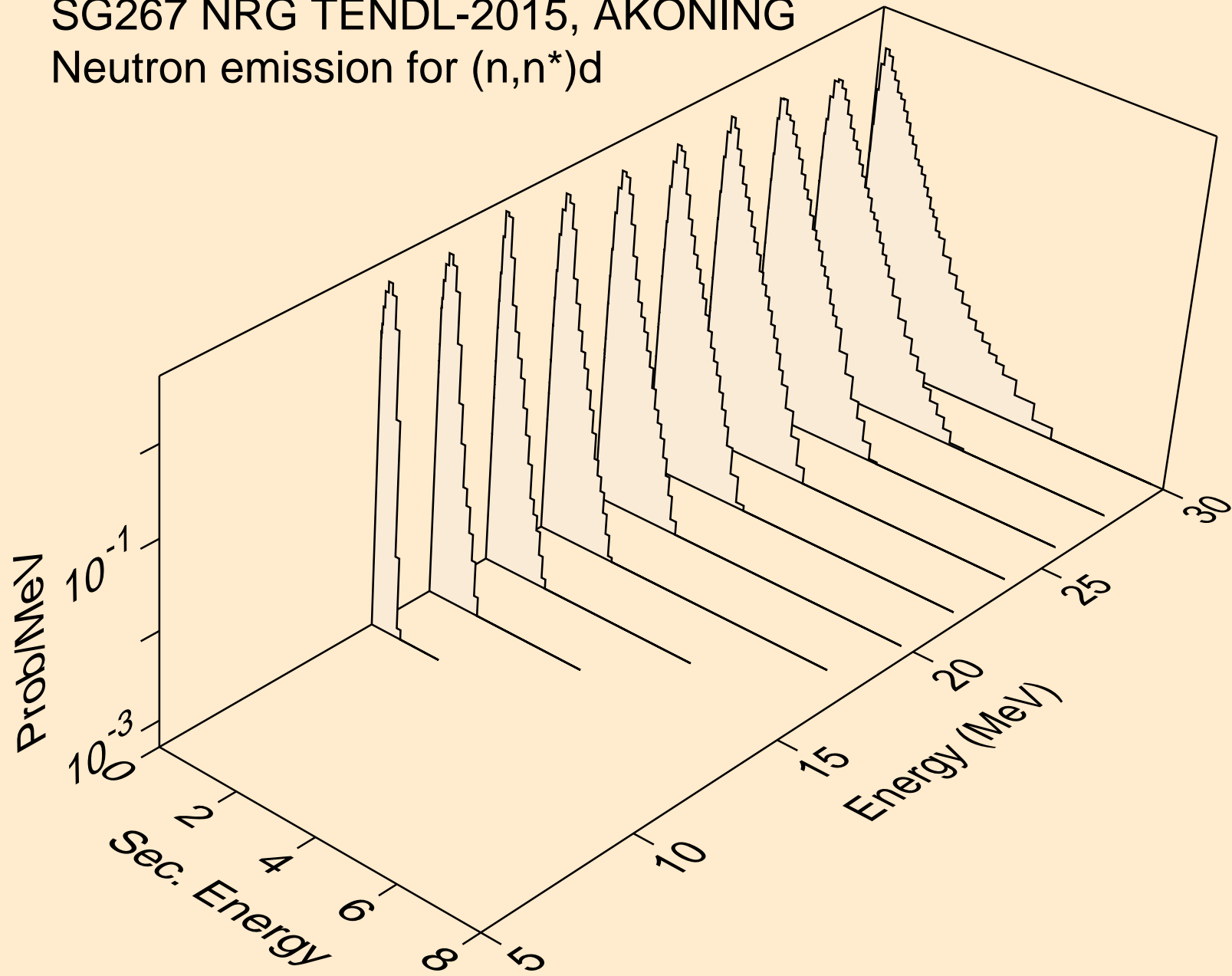

SG267 NRG TENDL-2015, AKONING  
Neutron emission for (n,n\*)t

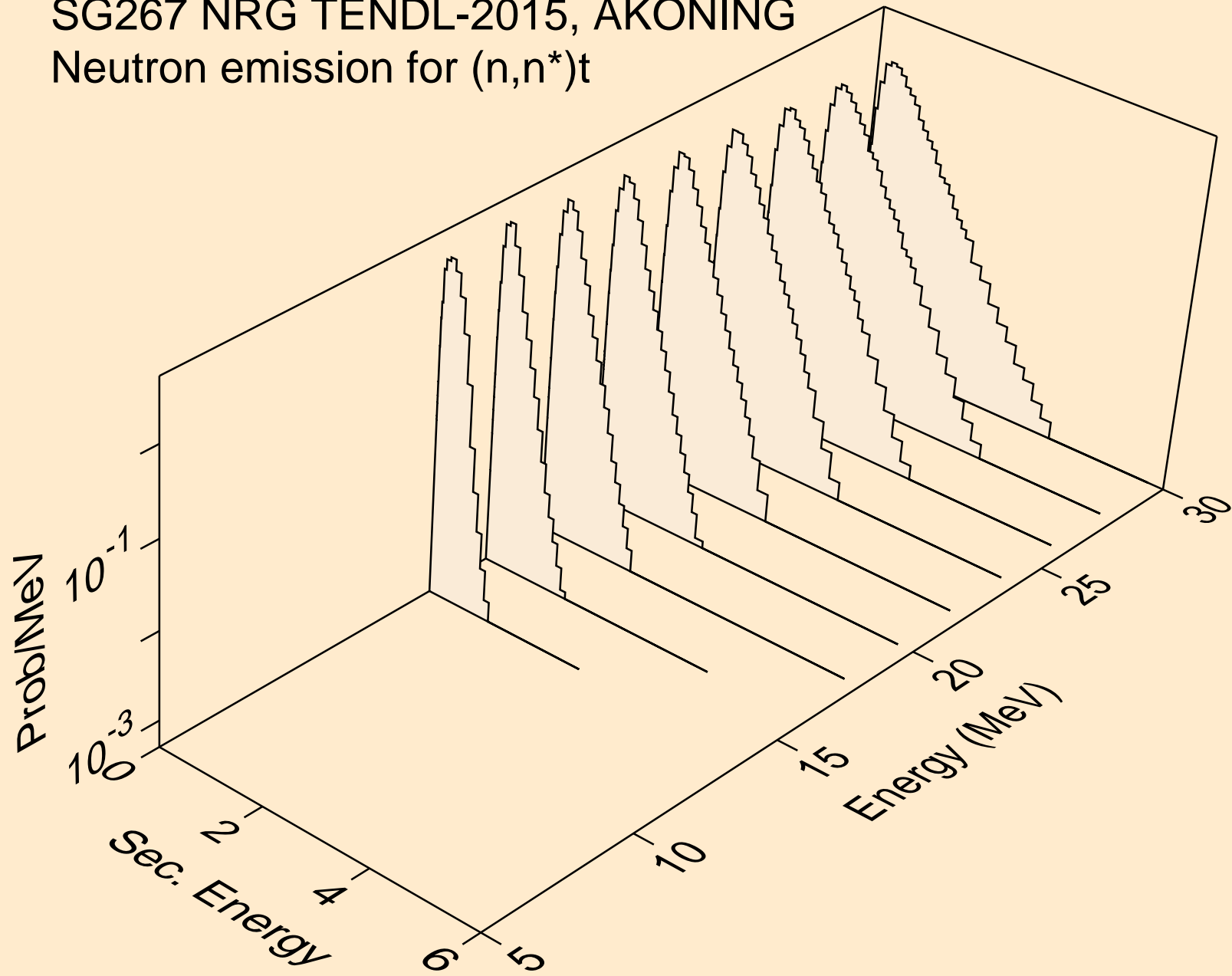

SG267 NRG TENDL-2015, AKONING  
Neutron emission for (n,n\*)he3

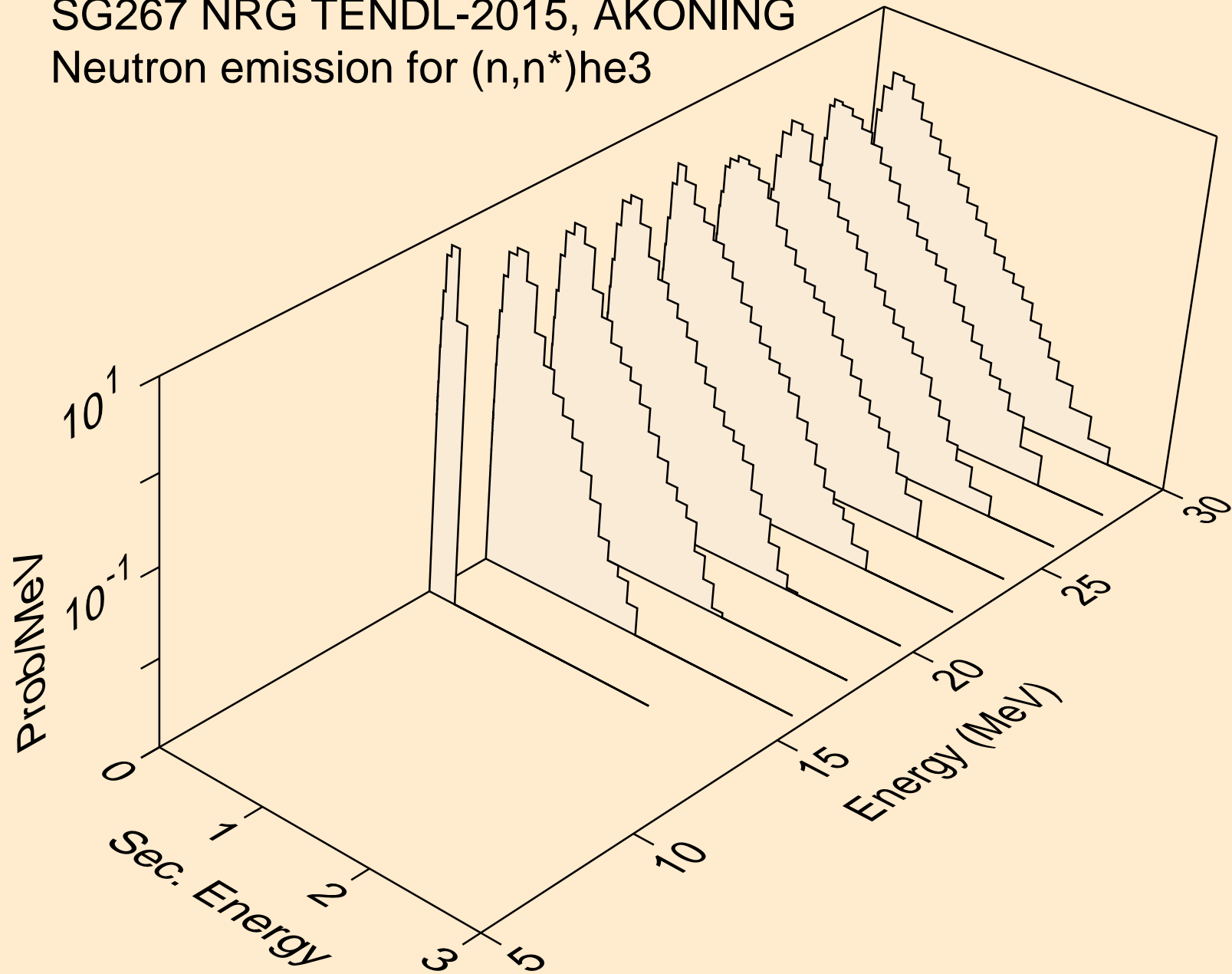



SG267 NRG TENDL-2015, AKONING  
Neutron emission for (n,n\*)d2a

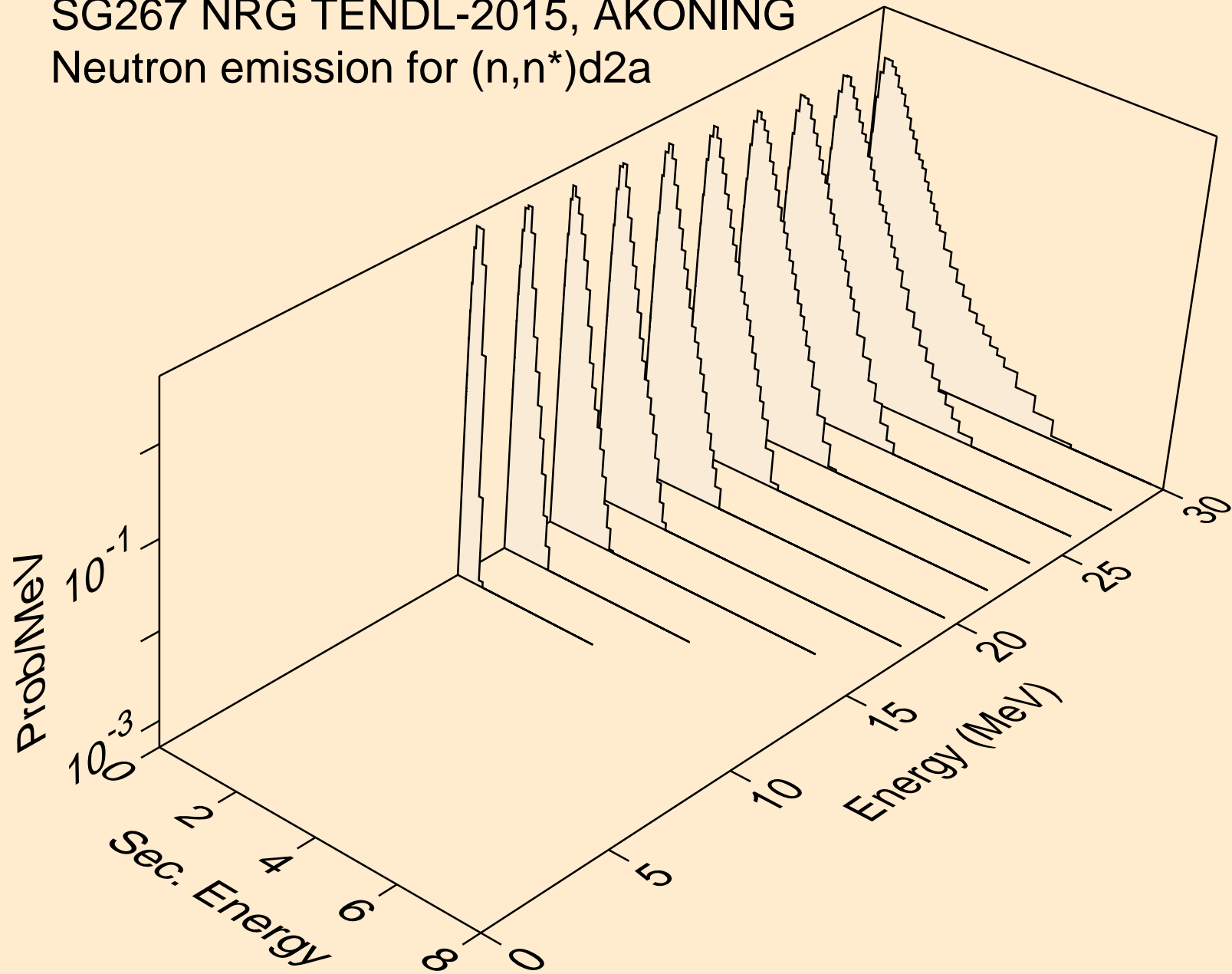

SG267 NRG TENDL-2015, AKONING  
Neutron emission for (n,n\*)t2a

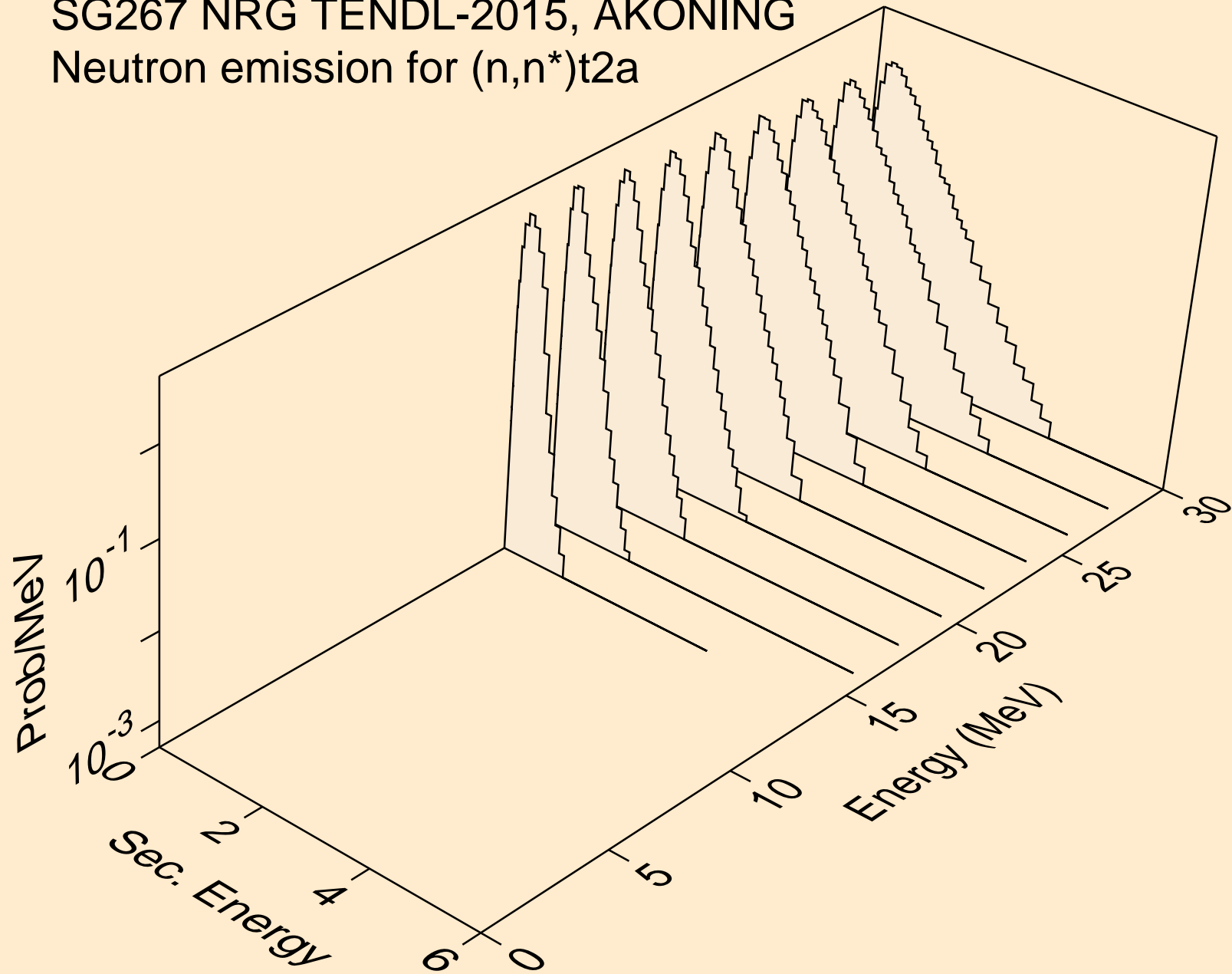

SG267 NRG TENDL-2015, AKONING  
Neutron emission for (n,4n)

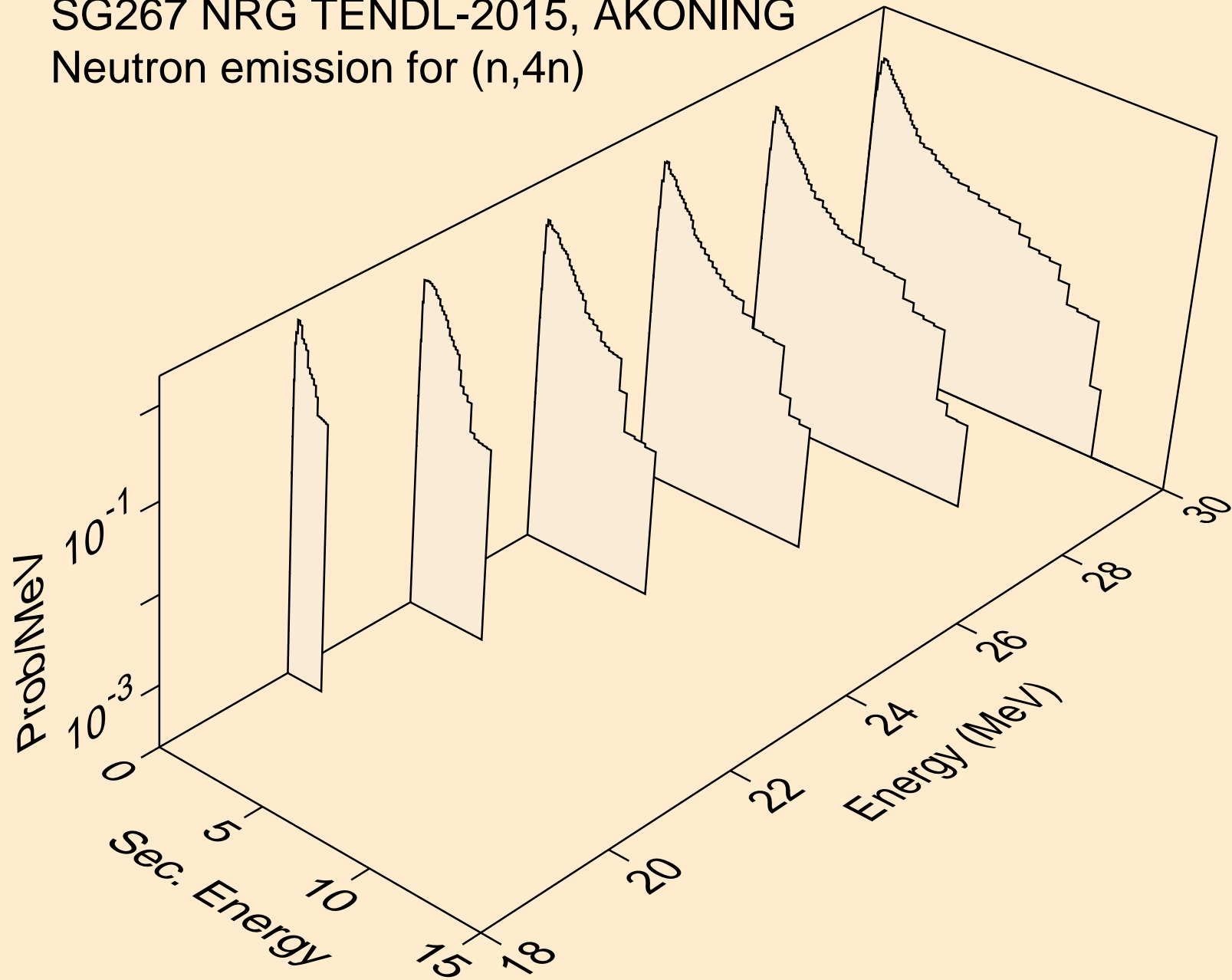

SG267 NRG TENDL-2015, AKONING  
Neutron emission for (n,2np)

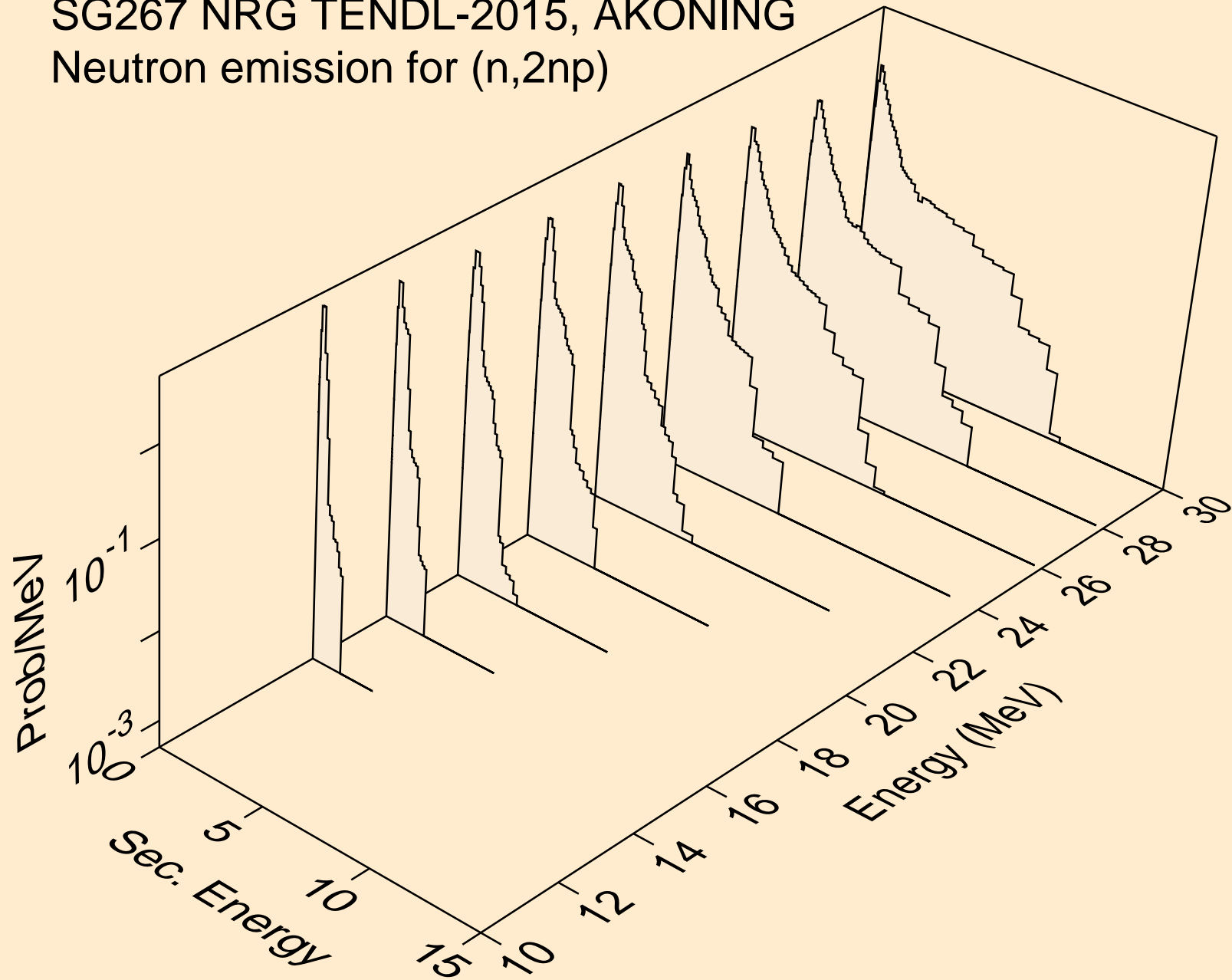

SG267 NRG TENDL-2015, AKONING  
Neutron emission for (n,3np)

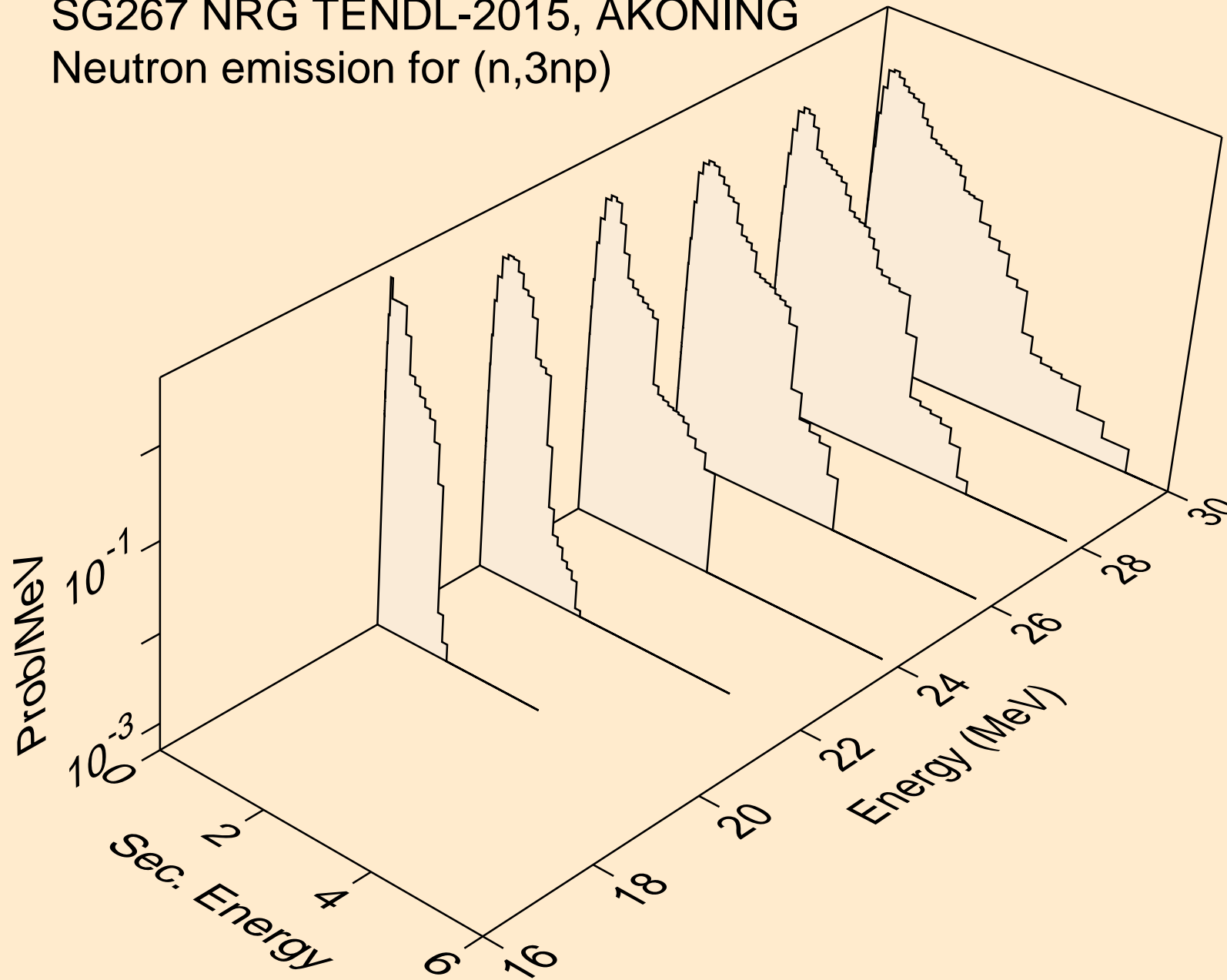

SG267 NRG TENDL-2015, AKONING  
Neutron emission for (n,2np)

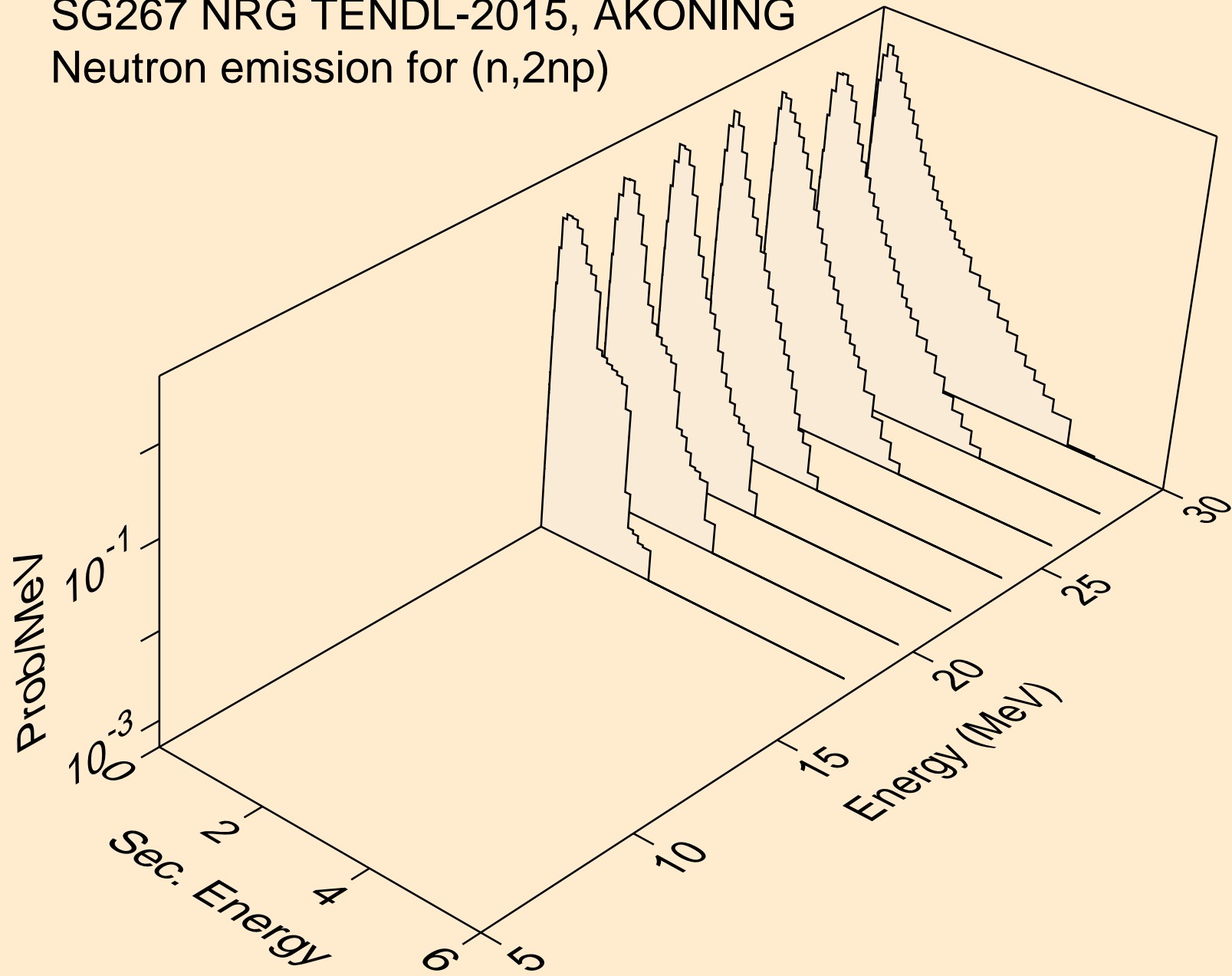

SG267 NRG TENDL-2015, AKONING  
Neutron emission for (n,npa)

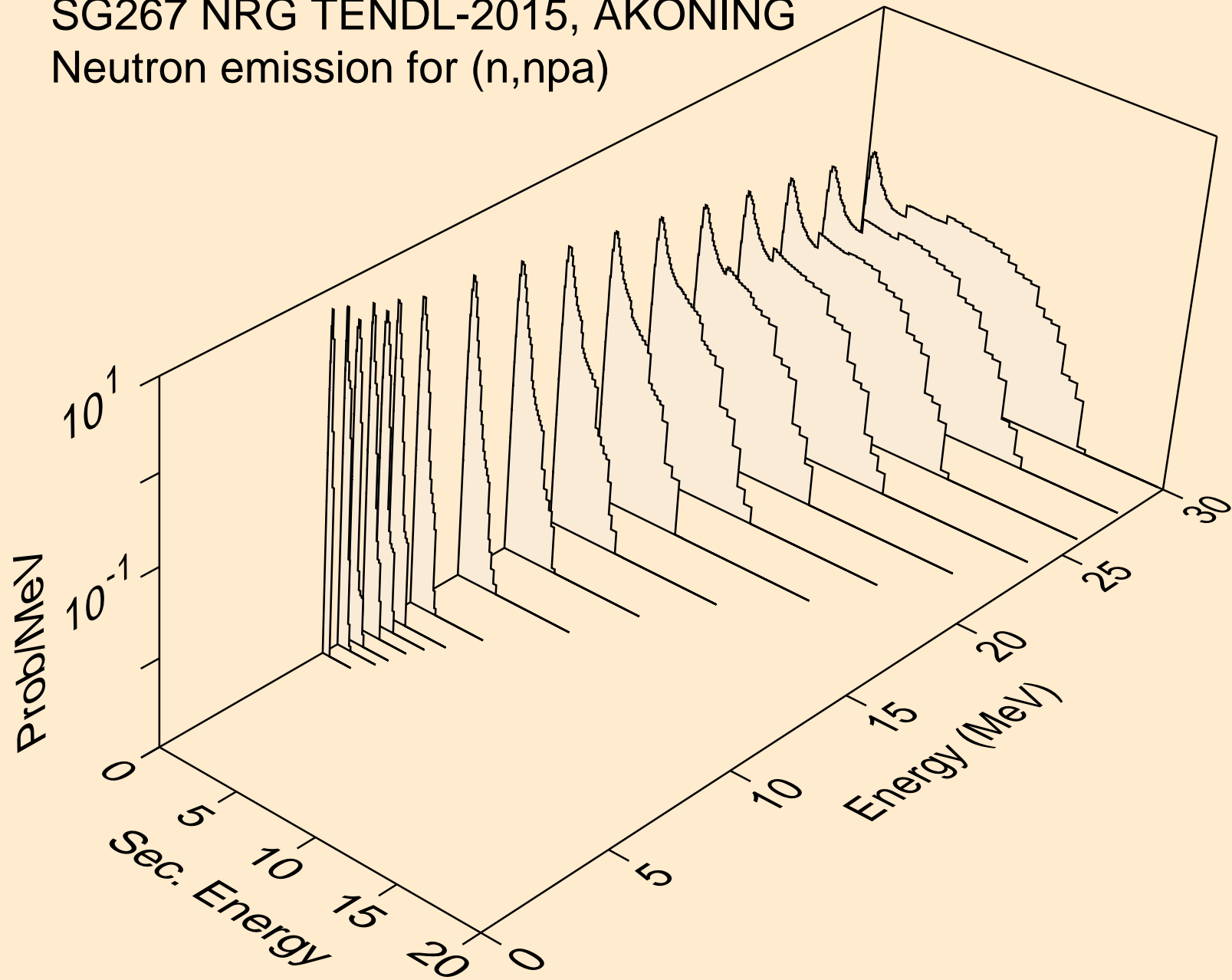

SG267 NRG TENDL-2015, AKONING  
Neutron emission for (n,n\*c)

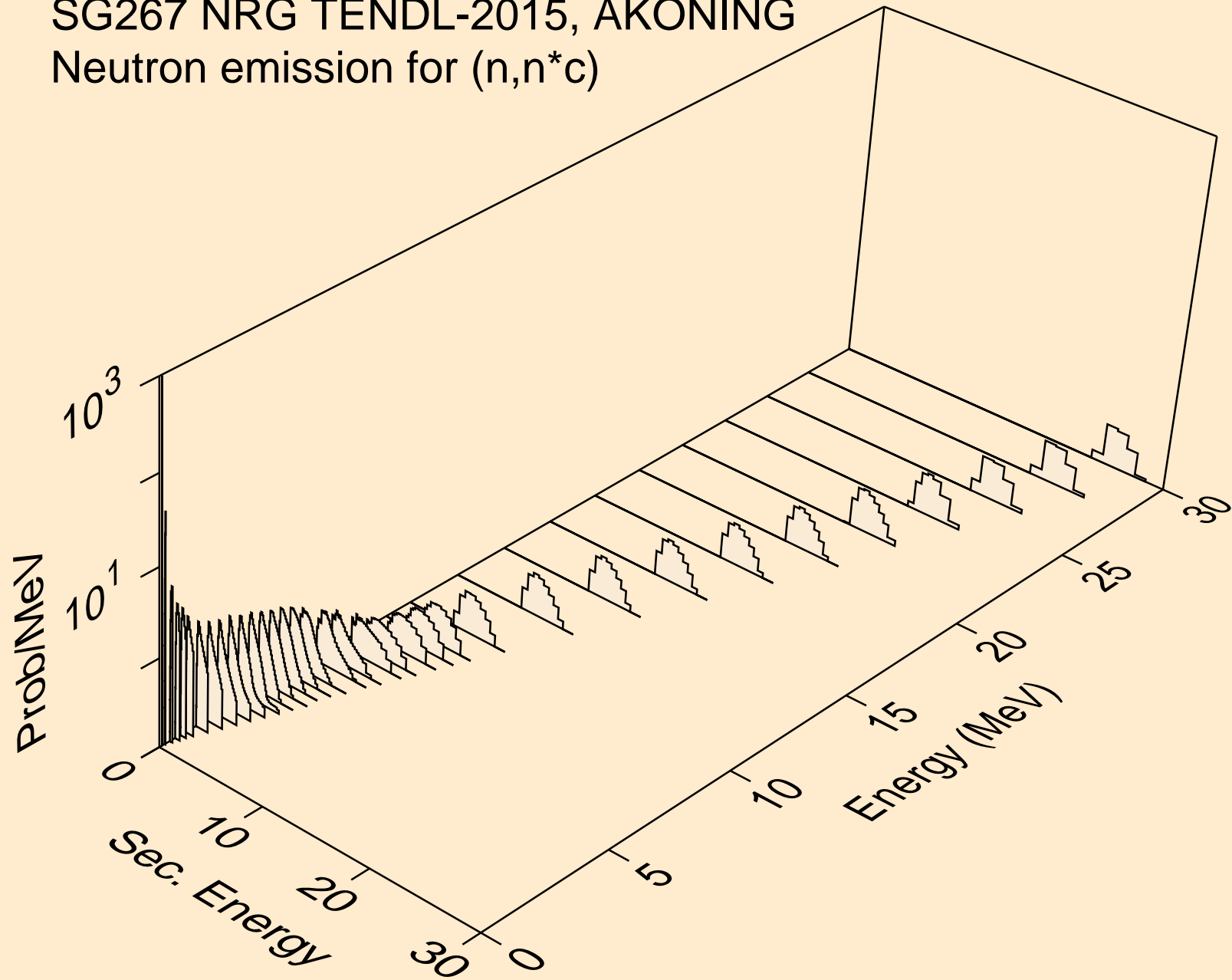



# SG267 NRG TENDL-2015, AKONING

## Delayed nubar

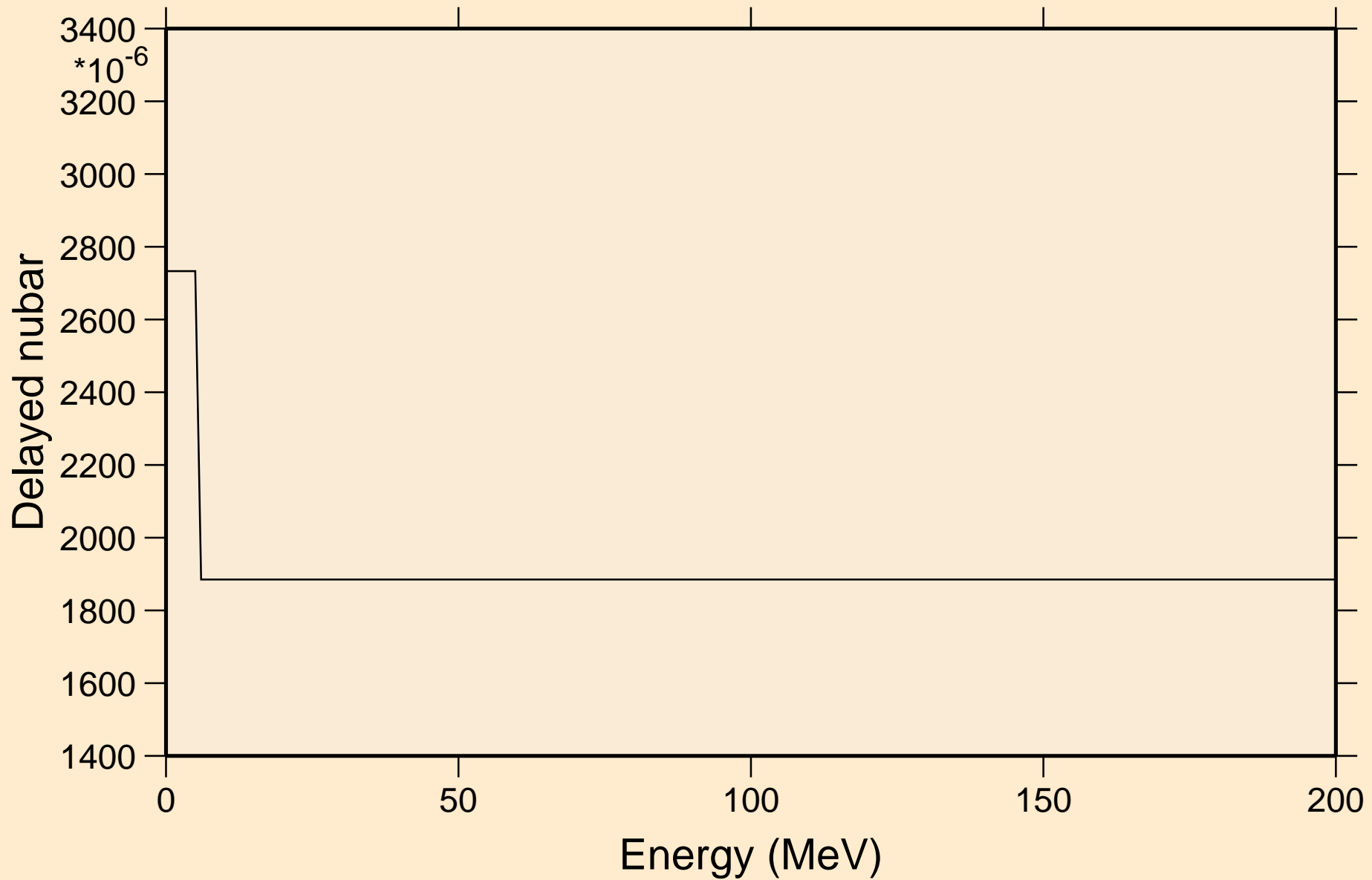

# SG267 NRG TENDL-2015, AKONING

## Delayed neutron spectra

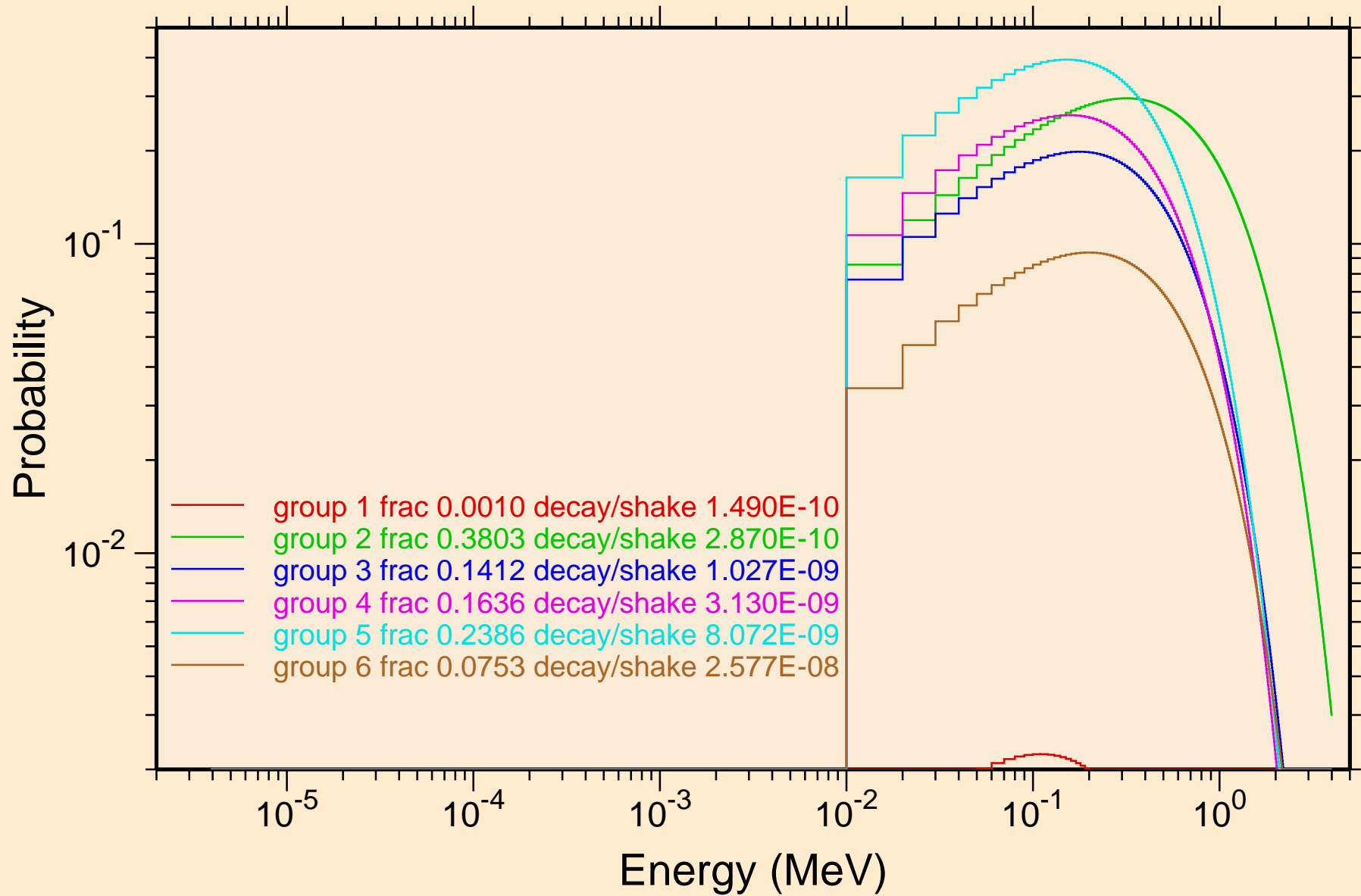

SG267 NRG TENDL-2015, AKONING  
Photon emission for (n,x)

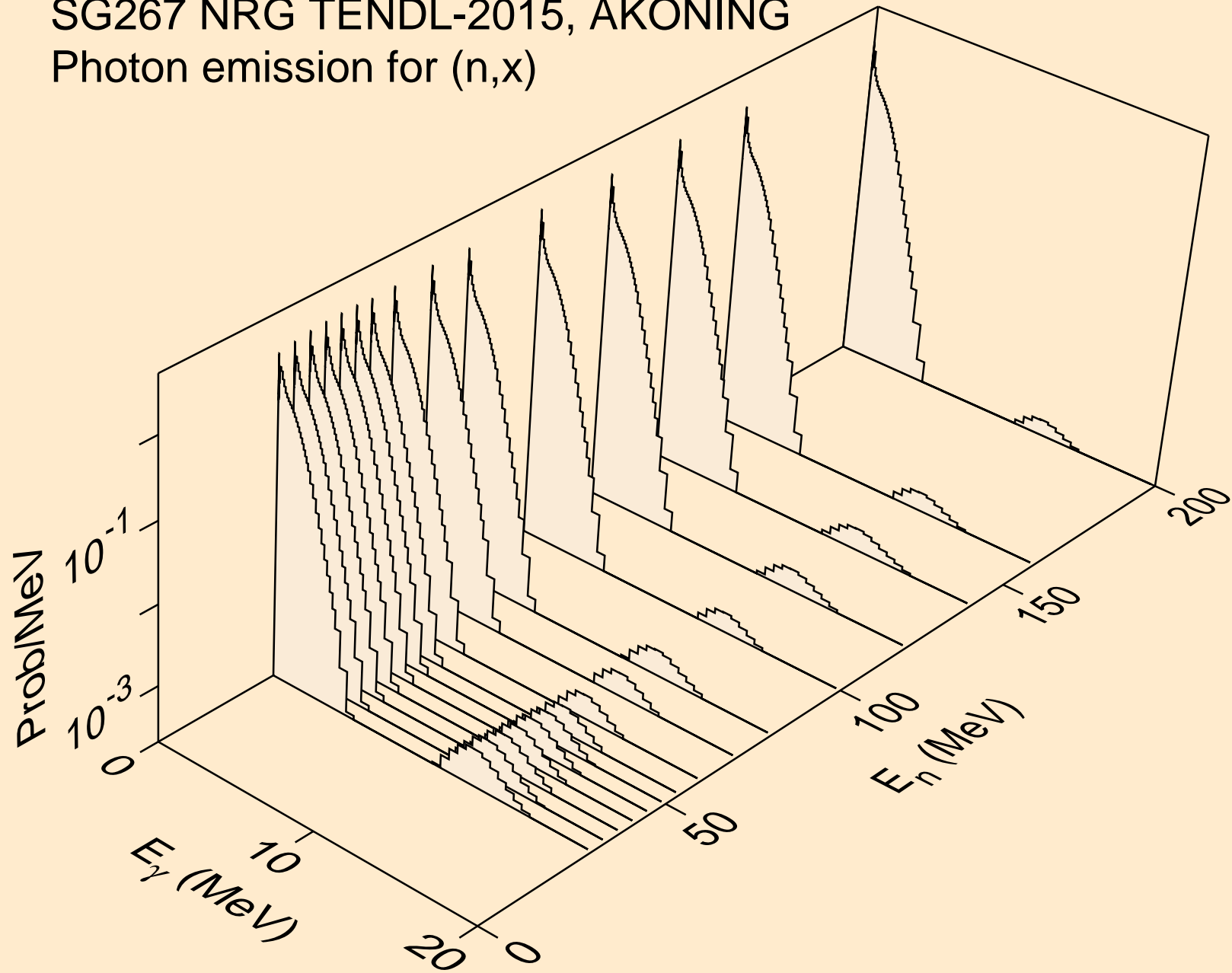

SG267 NRG TENDL-2015, AKONING  
Photon emission for (n,2nd)

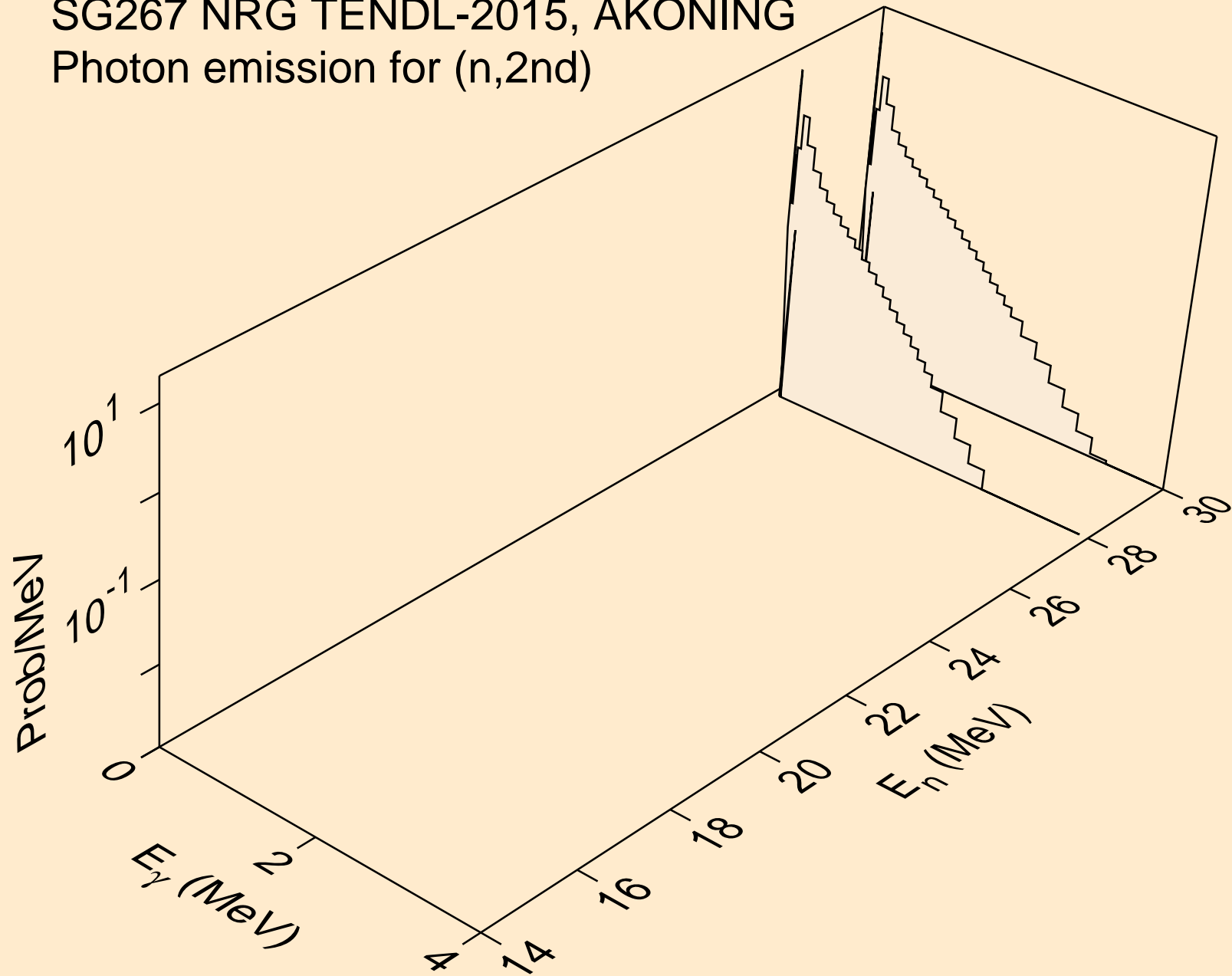

SG267 NRG TENDL-2015, AKONING  
Photon emission for (n,2n)

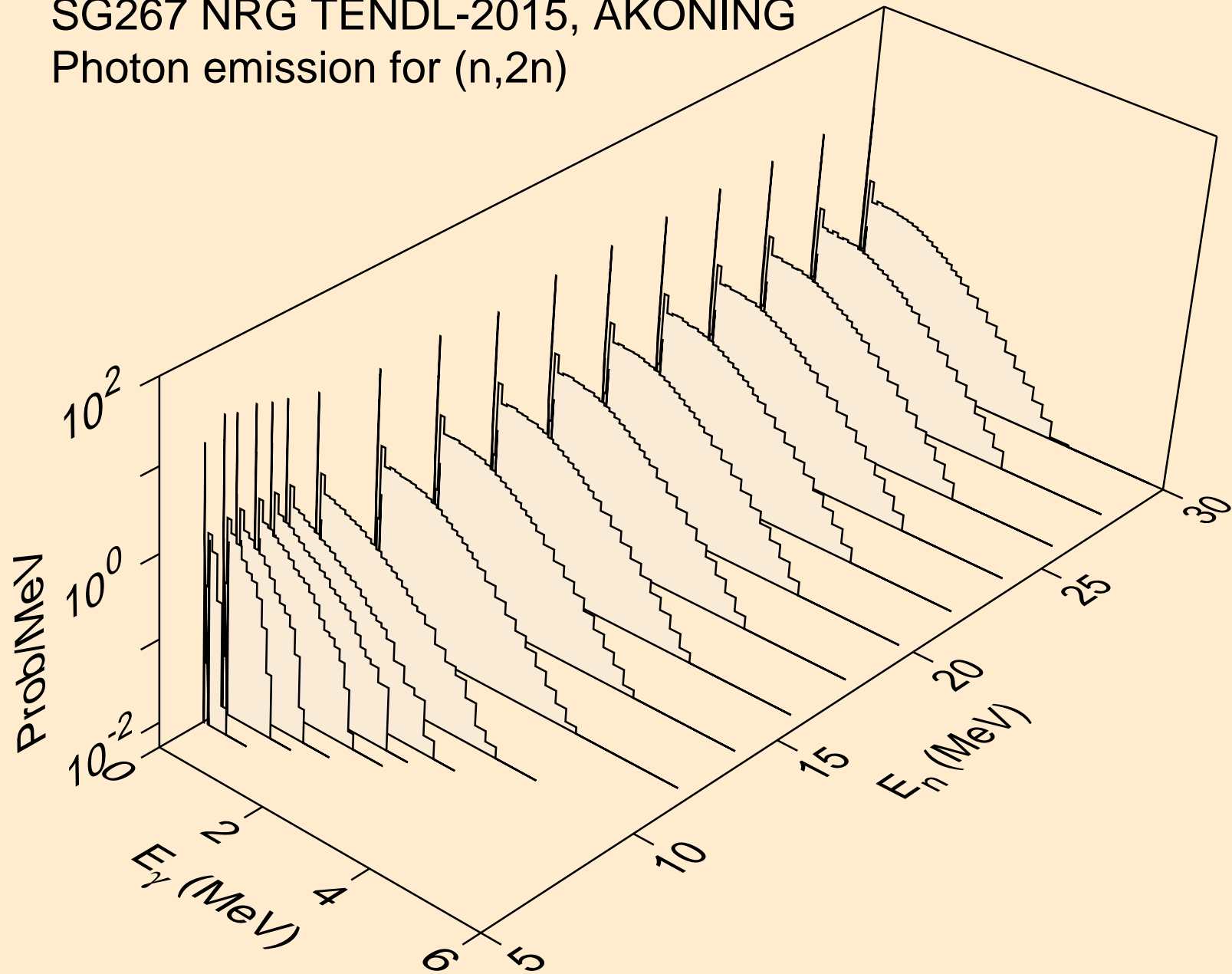

SG267 NRG TENDL-2015, AKONING  
Photon emission for (n,3n)

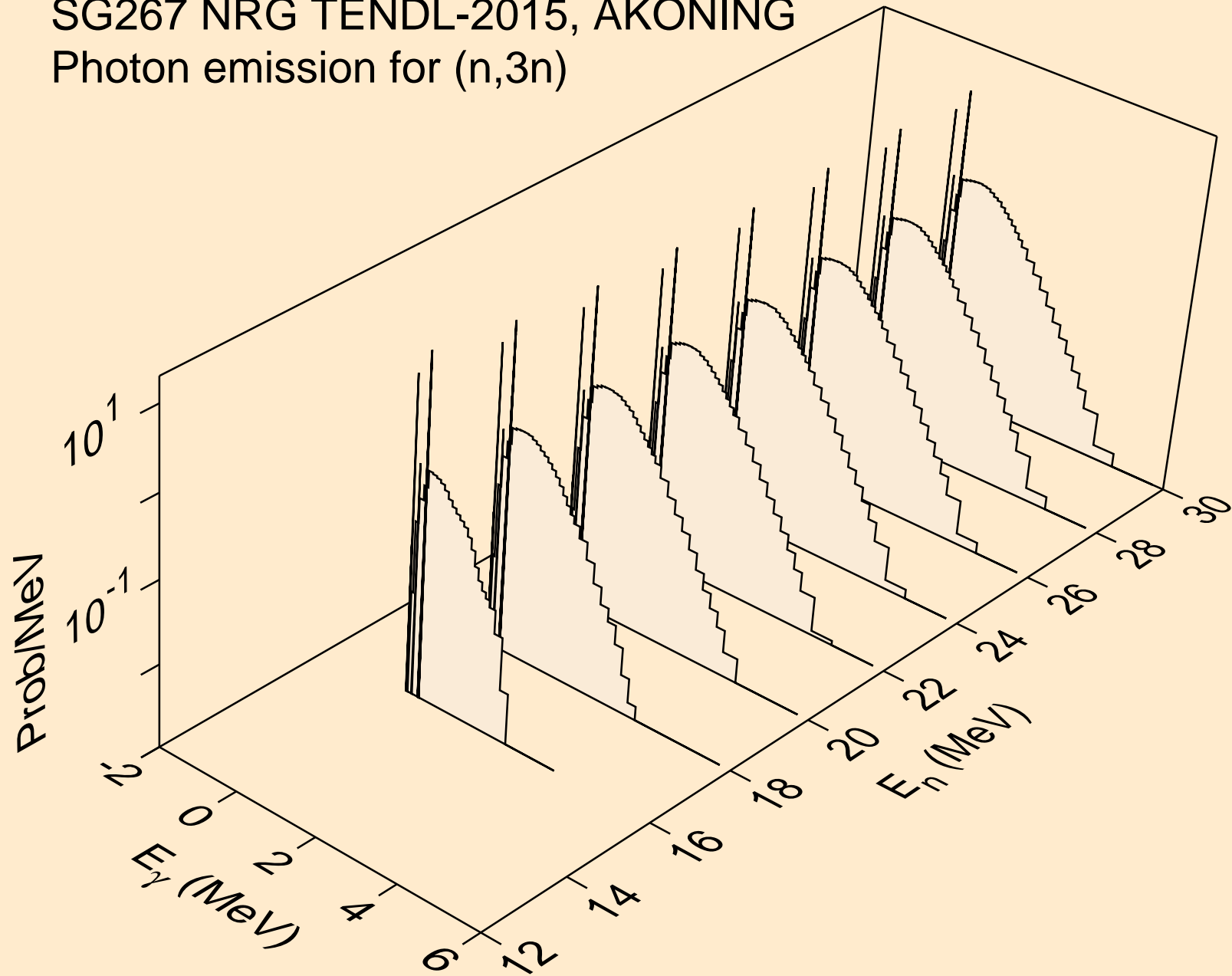

SG267 NRG TENDL-2015, AKONING  
Photon emission for (n,n\*)a

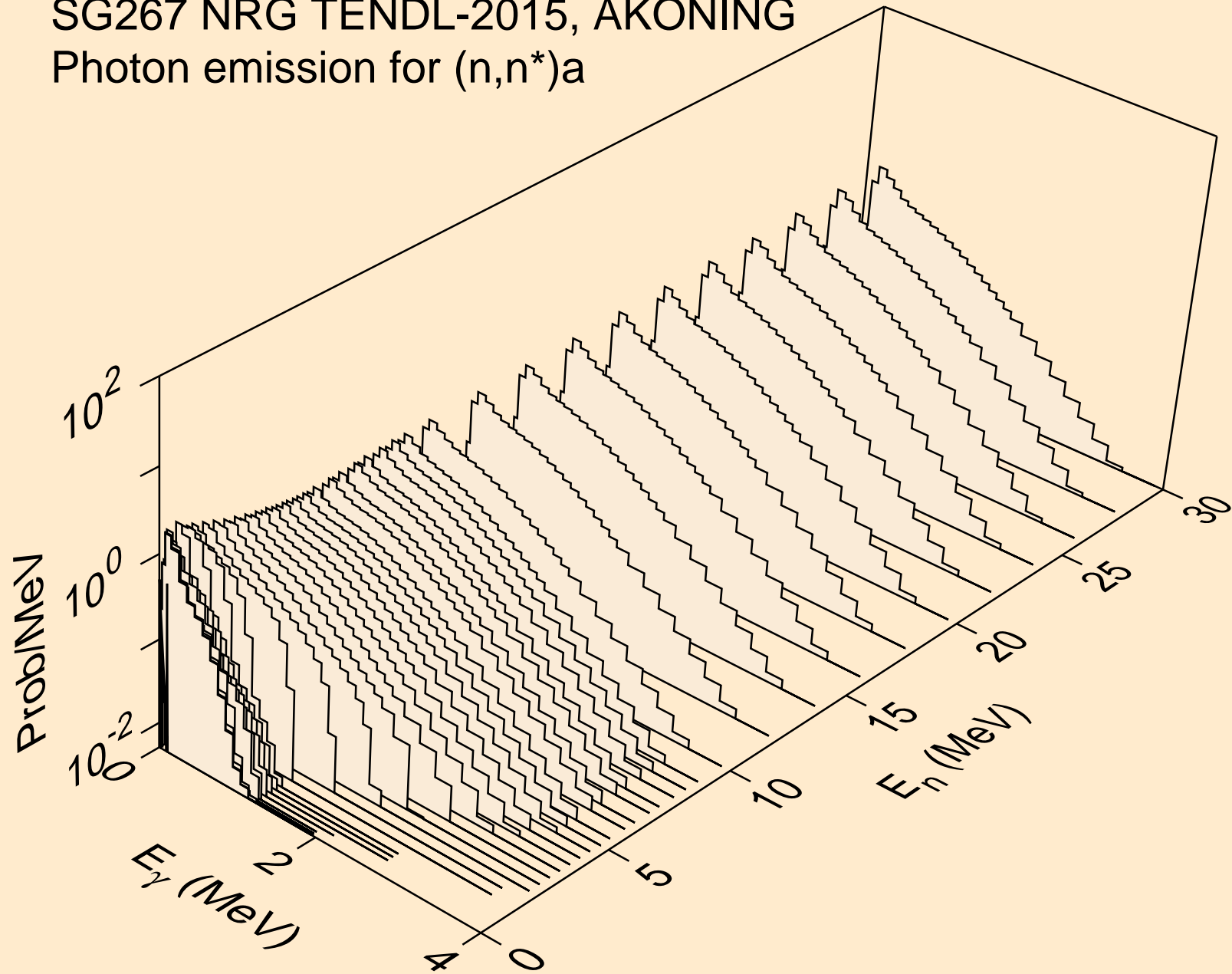

SG267 NRG TENDL-2015, AKONING  
Photon emission for (n,n\*)3a

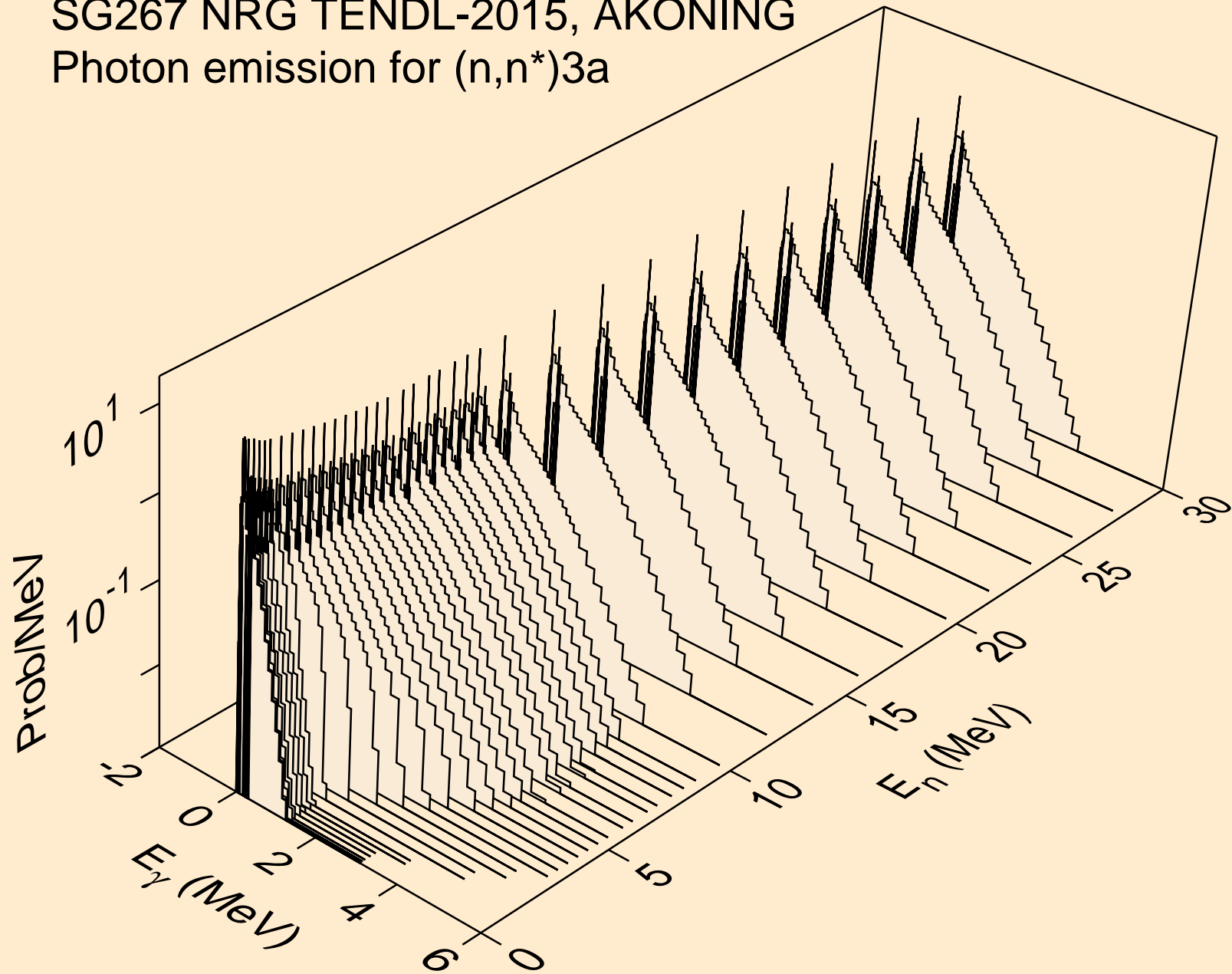



SG267 NRG TENDL-2015, AKONING  
Photon emission for (n,2n)a

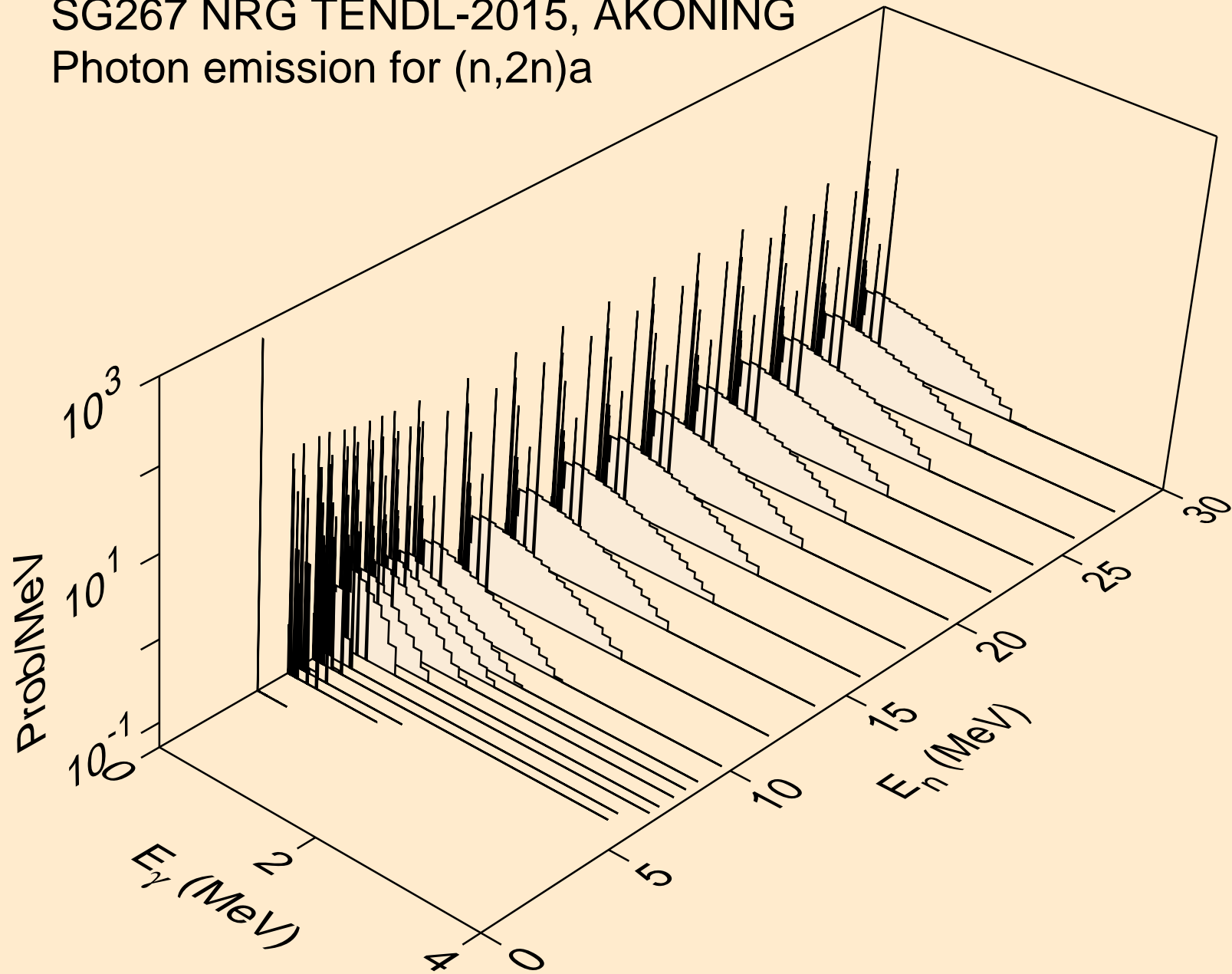

SG267 NRG TENDL-2015, AKONING  
Photon emission for (n,3n)a

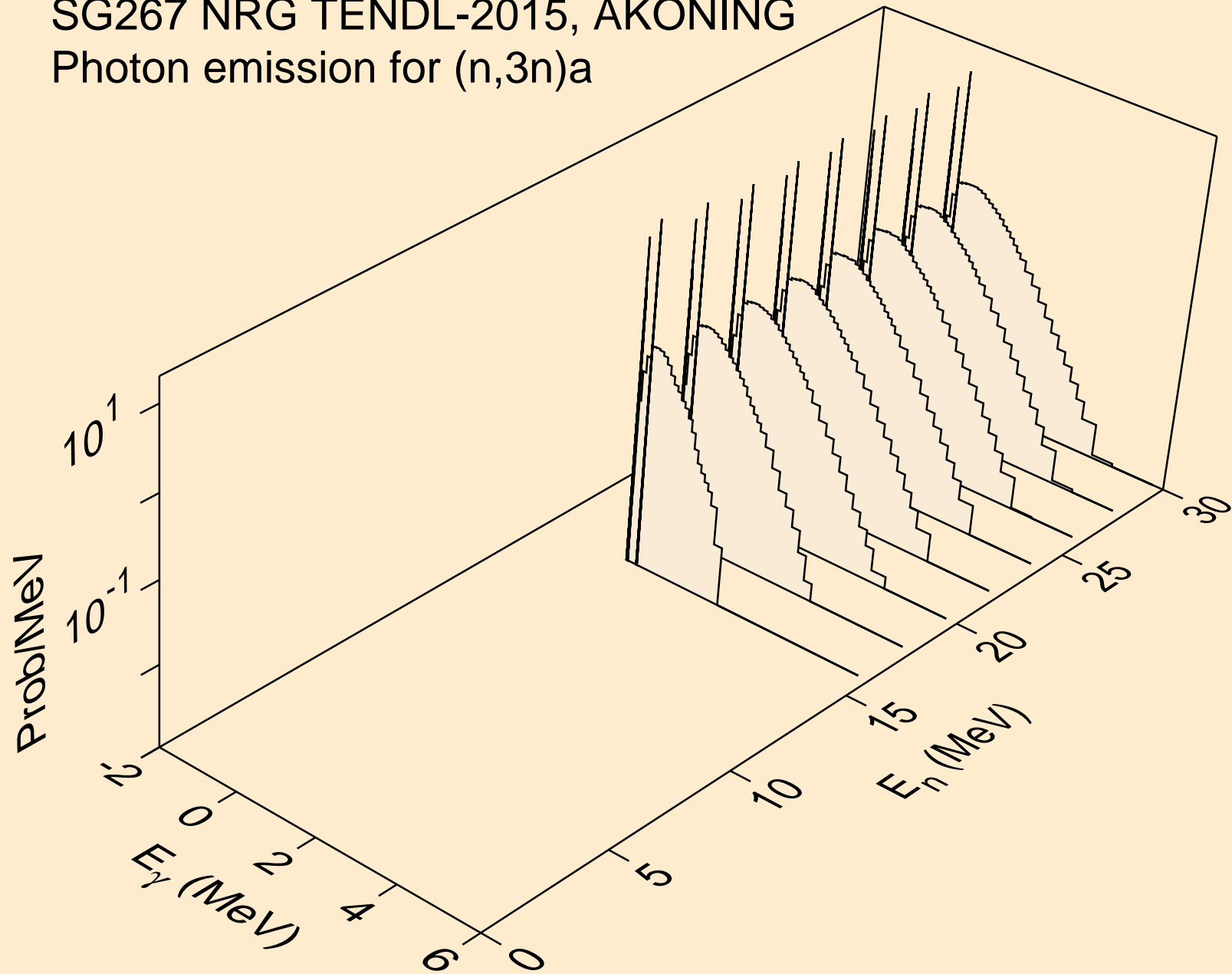

SG267 NRG TENDL-2015, AKONING  
Photon emission for (n,n\*)p

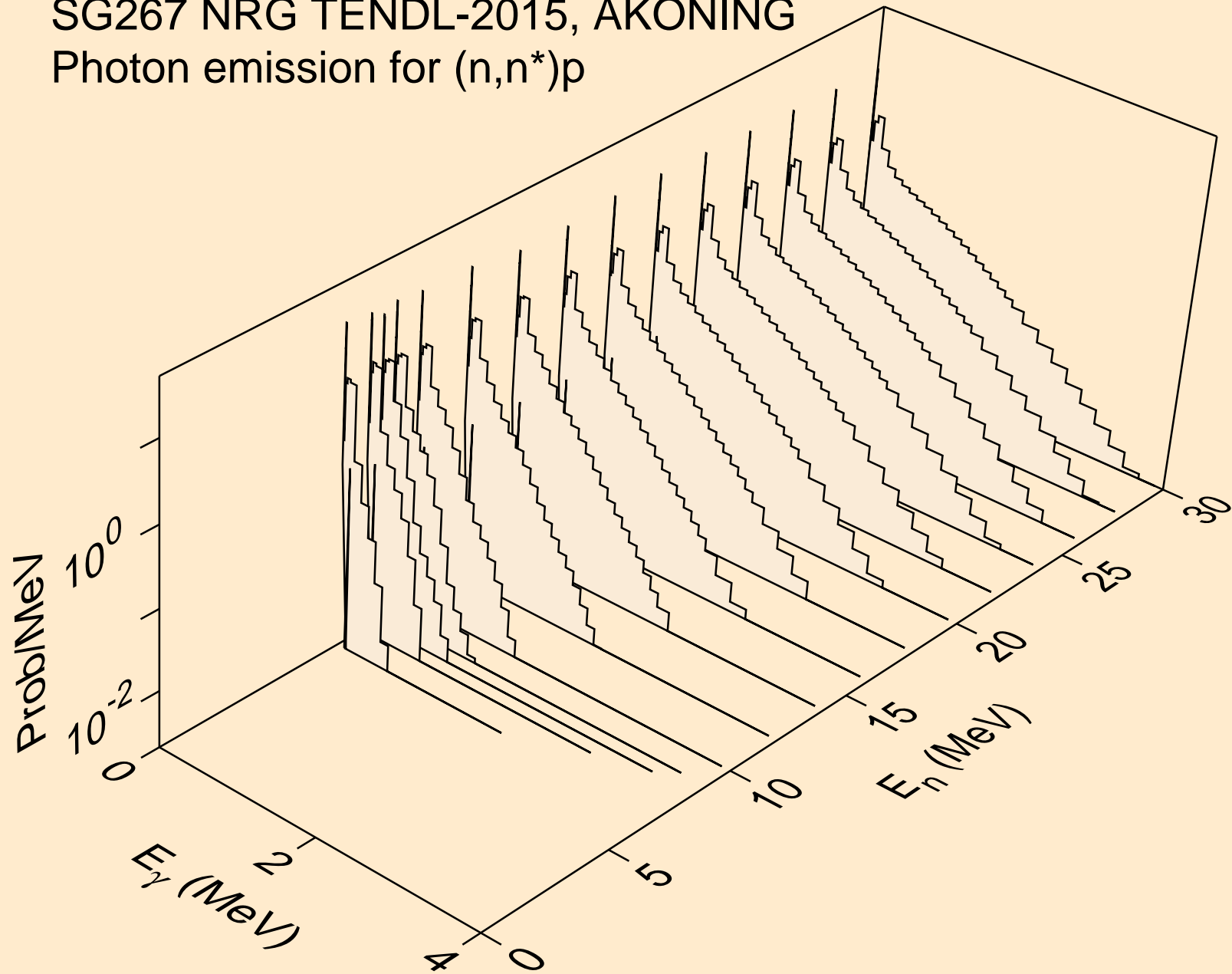

SG267 NRG TENDL-2015, AKONING  
Photon emission for (n,n\*)2a

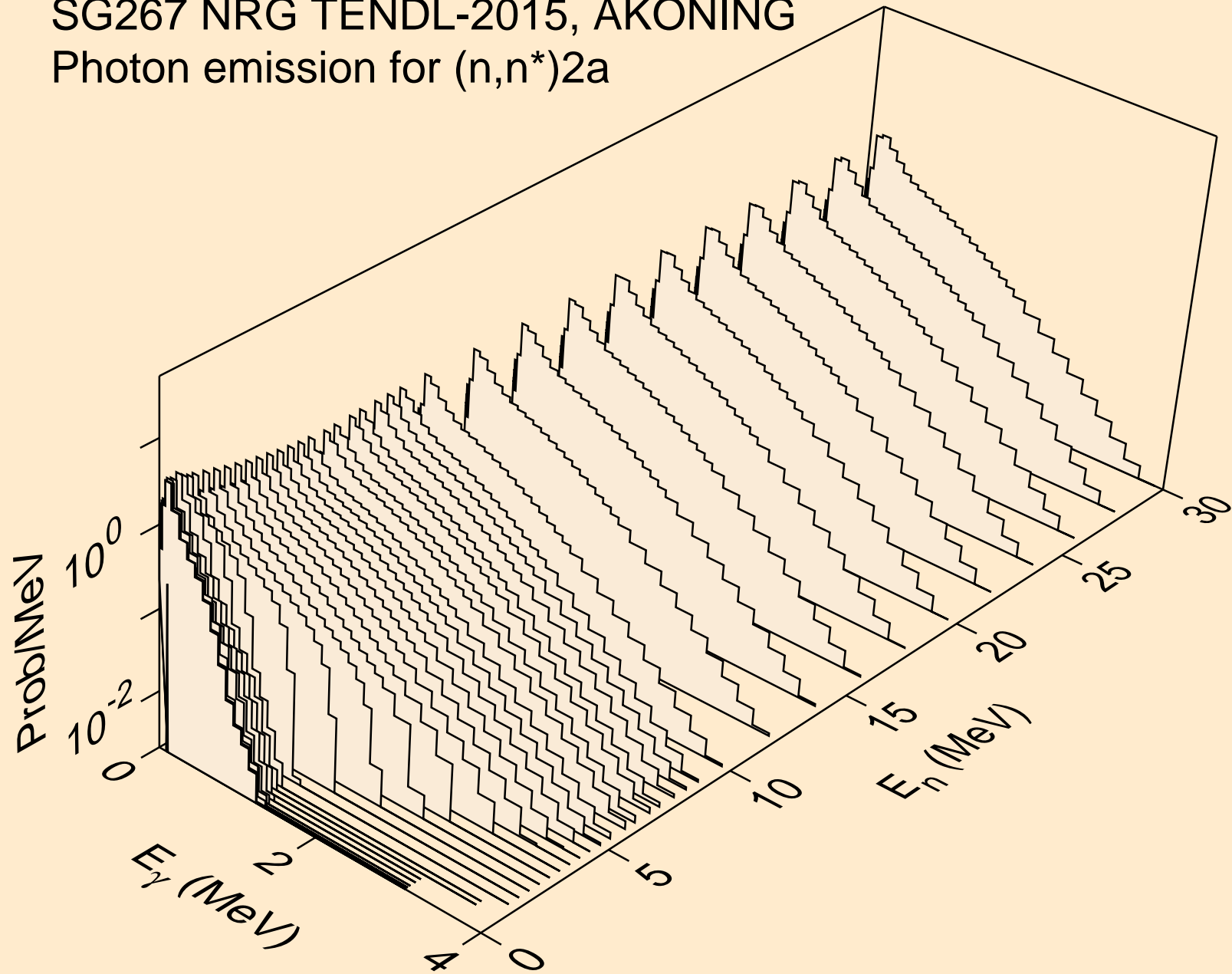

SG267 NRG TENDL-2015, AKONING  
Photon emission for (n,2n)2a

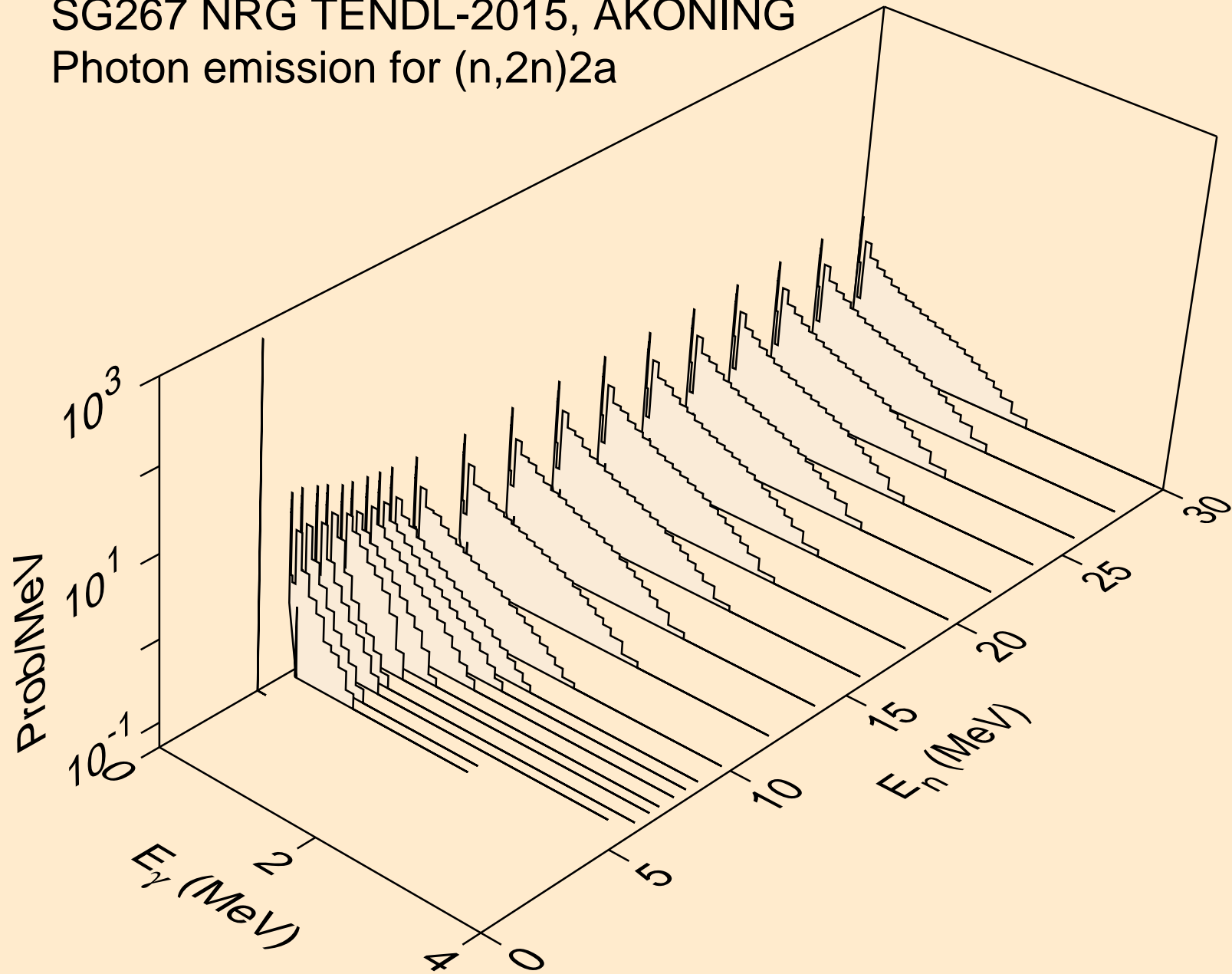

SG267 NRG TENDL-2015, AKONING  
Photon emission for (n,n\*)d

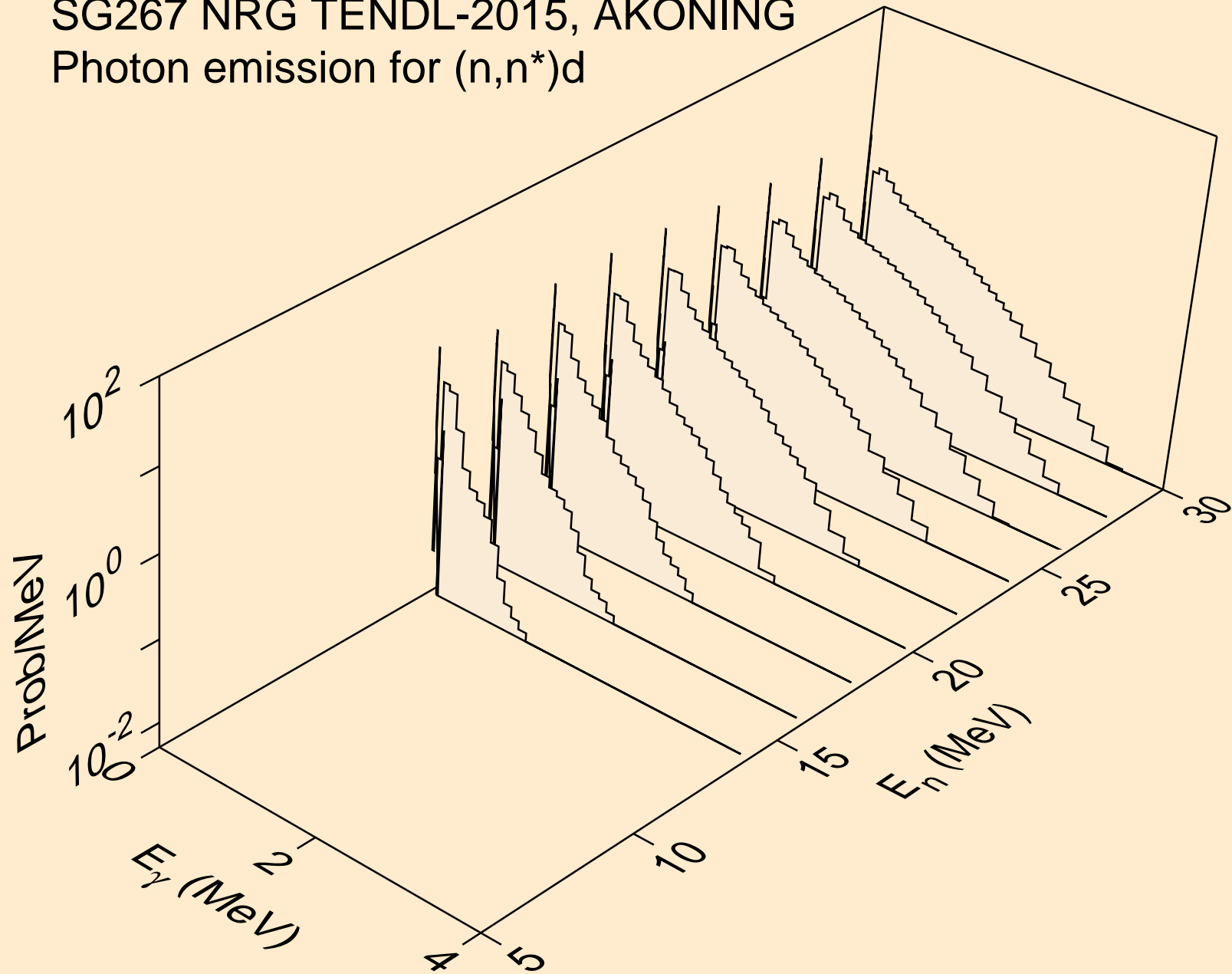

SG267 NRG TENDL-2015, AKONING  
Photon emission for (n,n\*)t

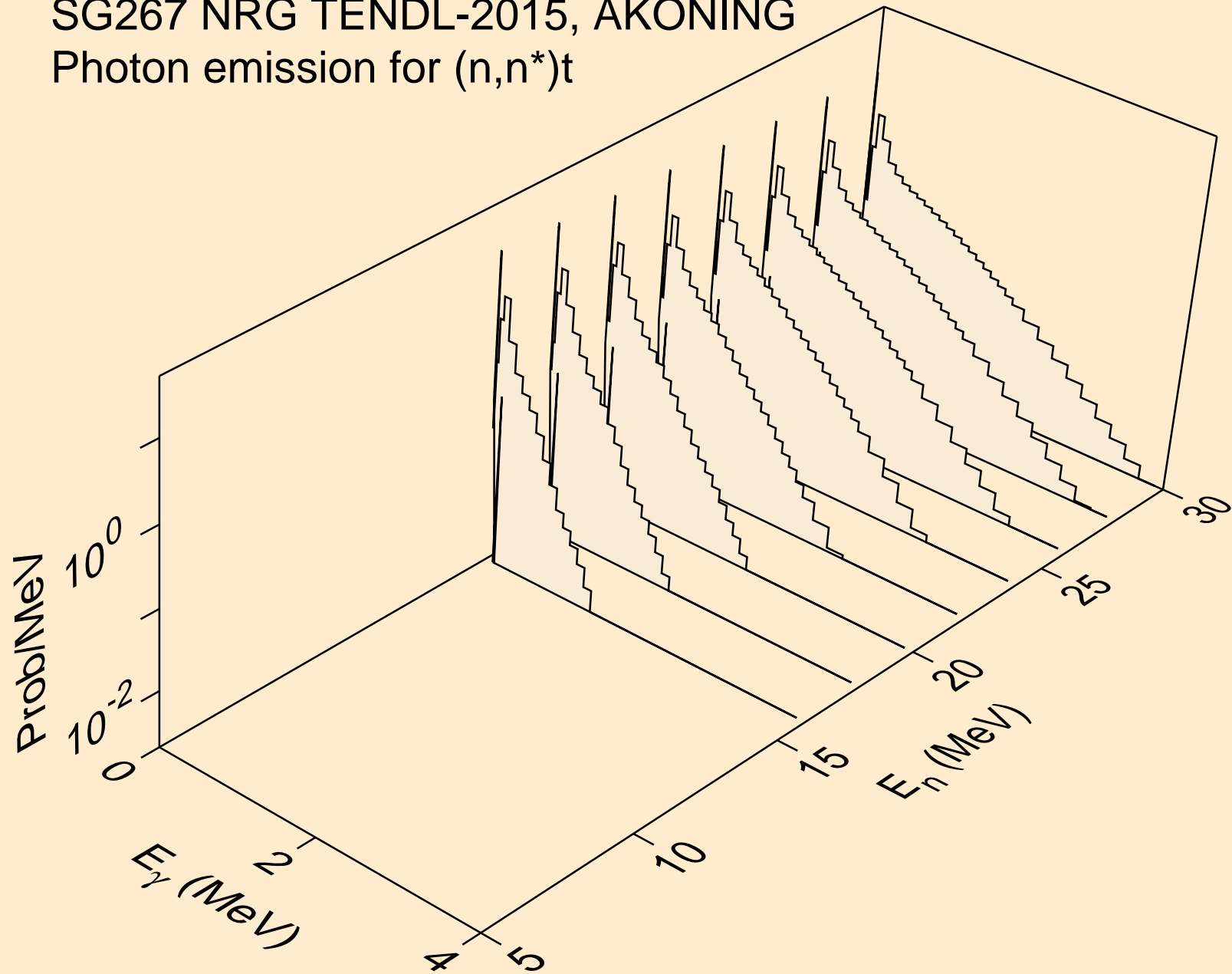

SG267 NRG TENDL-2015, AKONING  
Photon emission for (n,n\*)he3

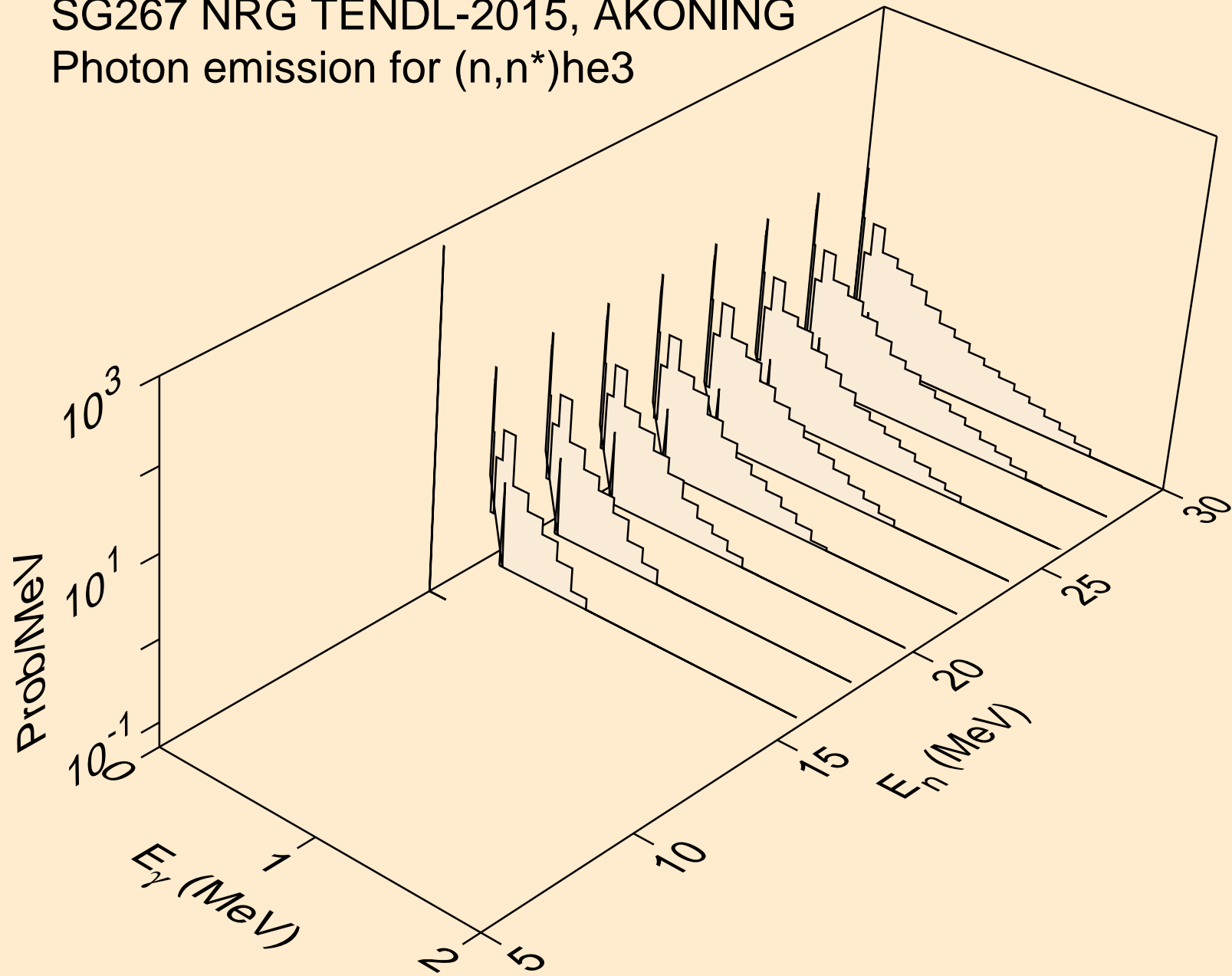



SG267 NRG TENDL-2015, AKONING  
Photon emission for (n,n\*)d2a

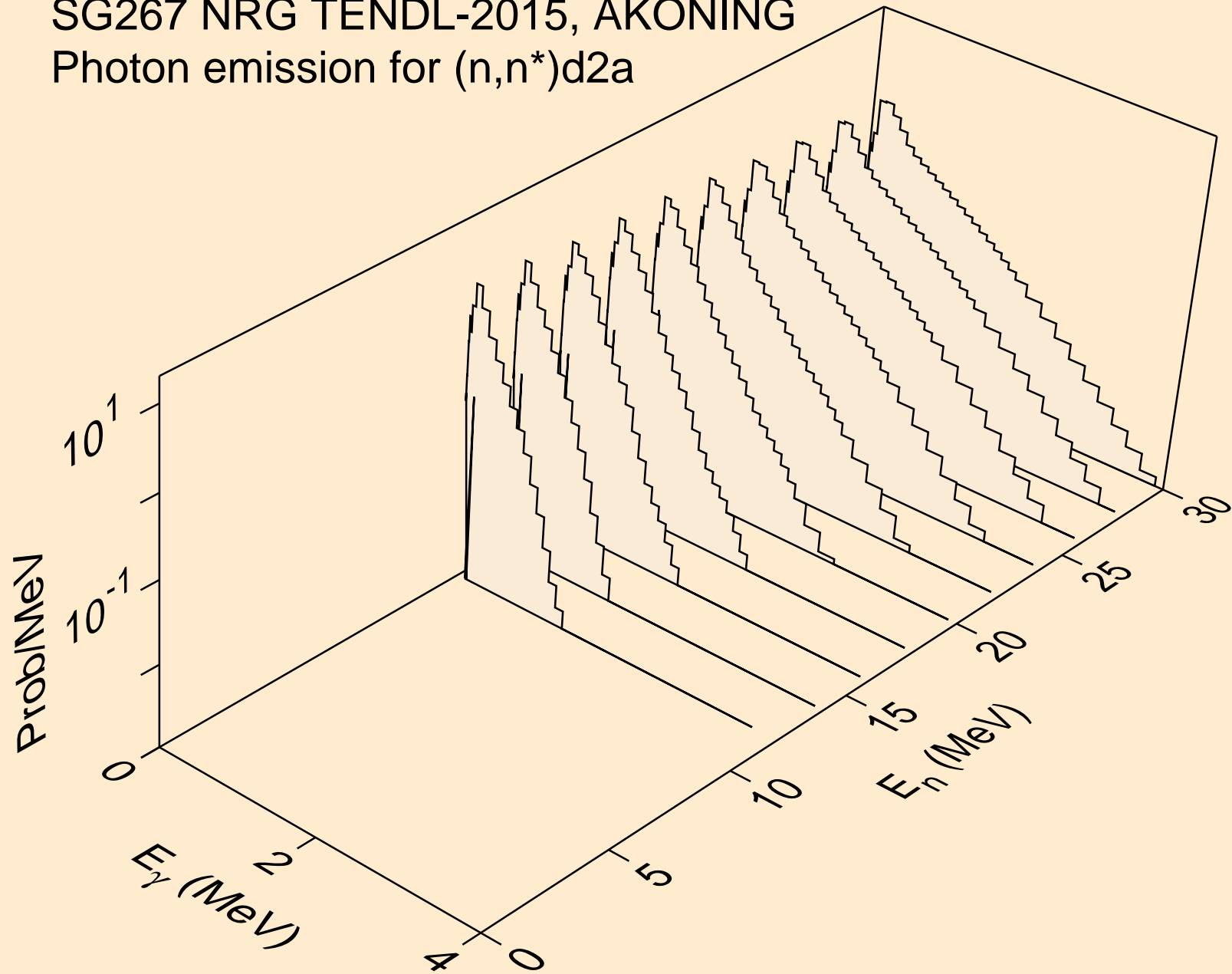

SG267 NRG TENDL-2015, AKONING  
Photon emission for (n,n\*)t2a

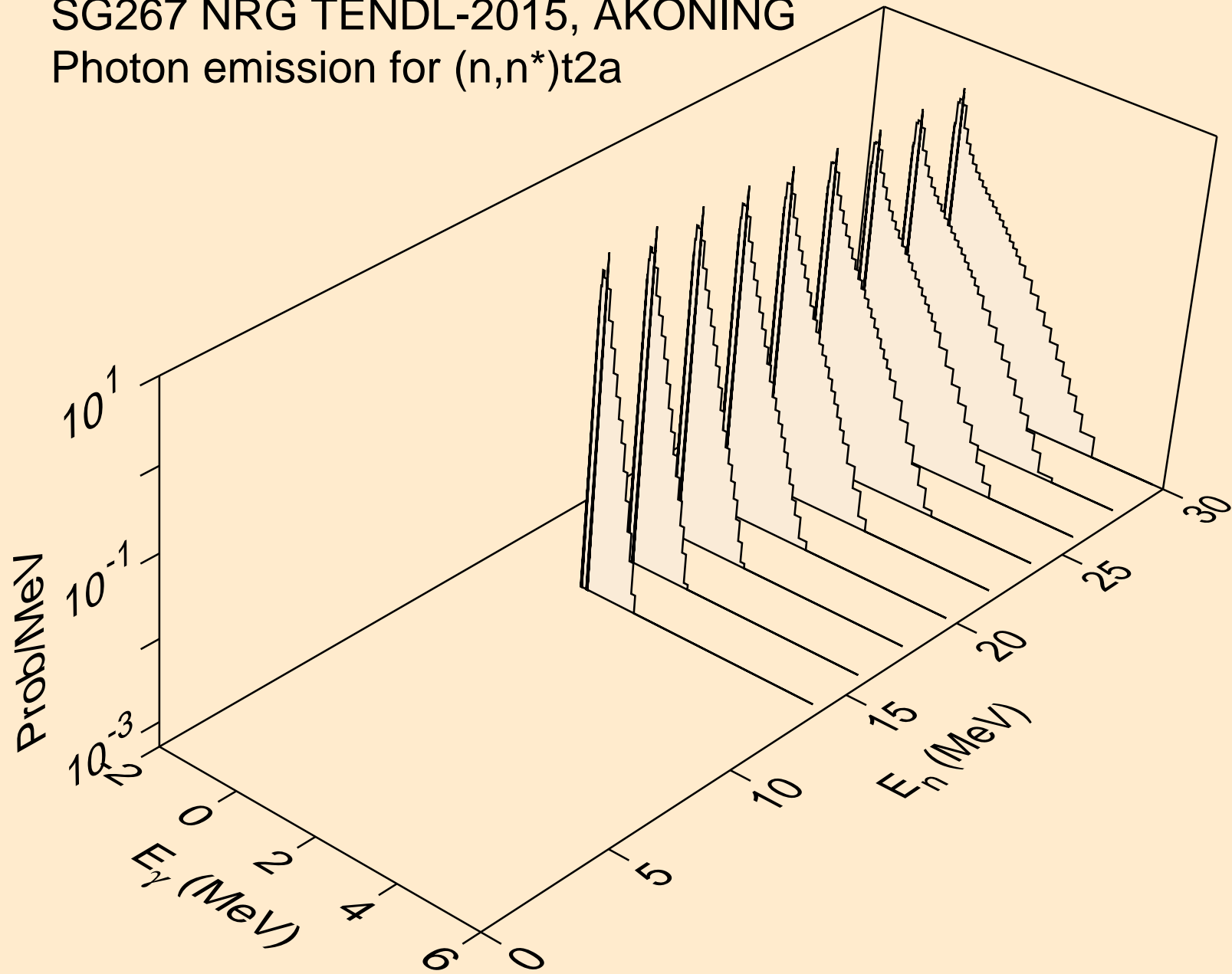

SG267 NRG TENDL-2015, AKONING  
Photon emission for (n,4n)

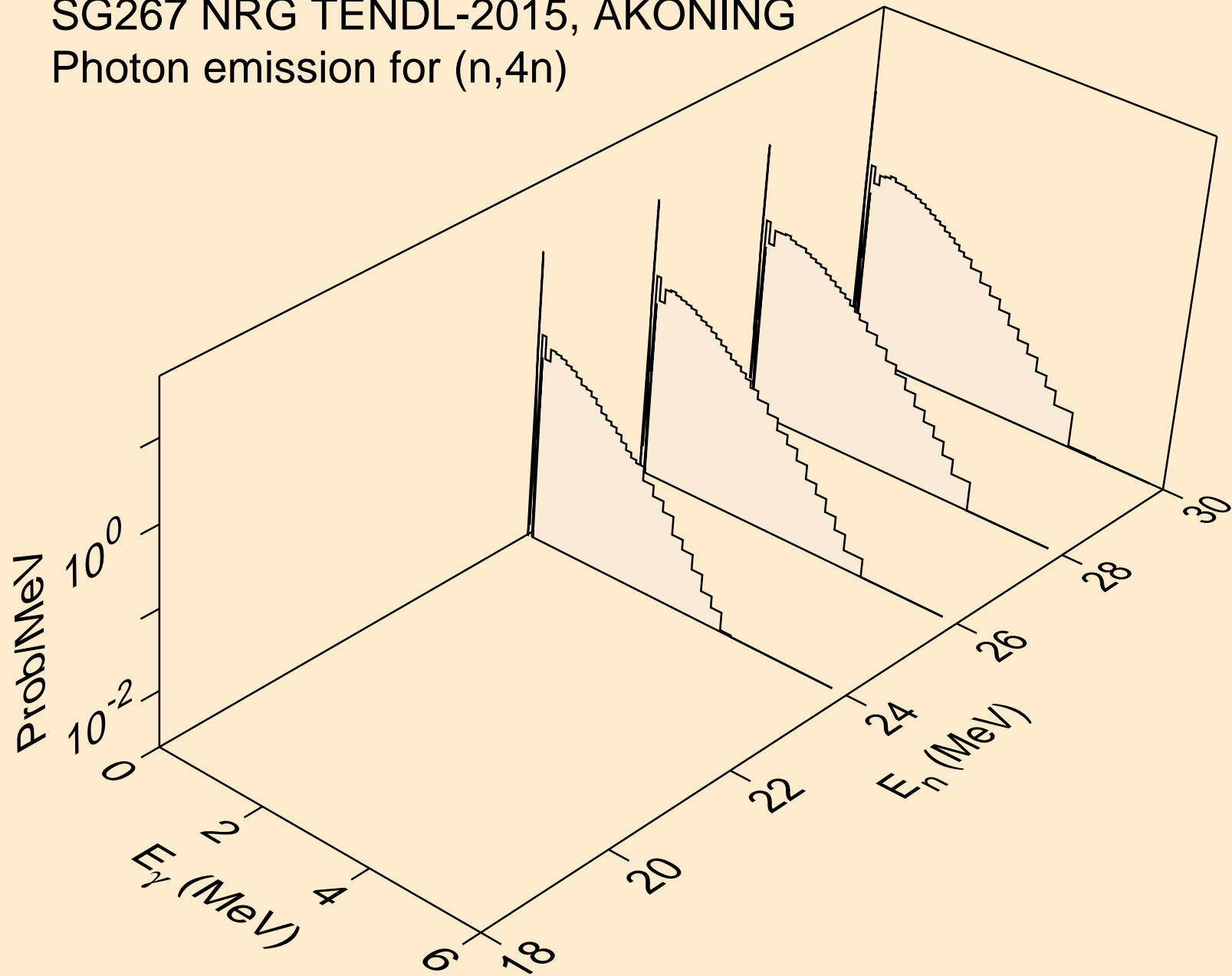

SG267 NRG TENDL-2015, AKONING  
Photon emission for (n,2np)

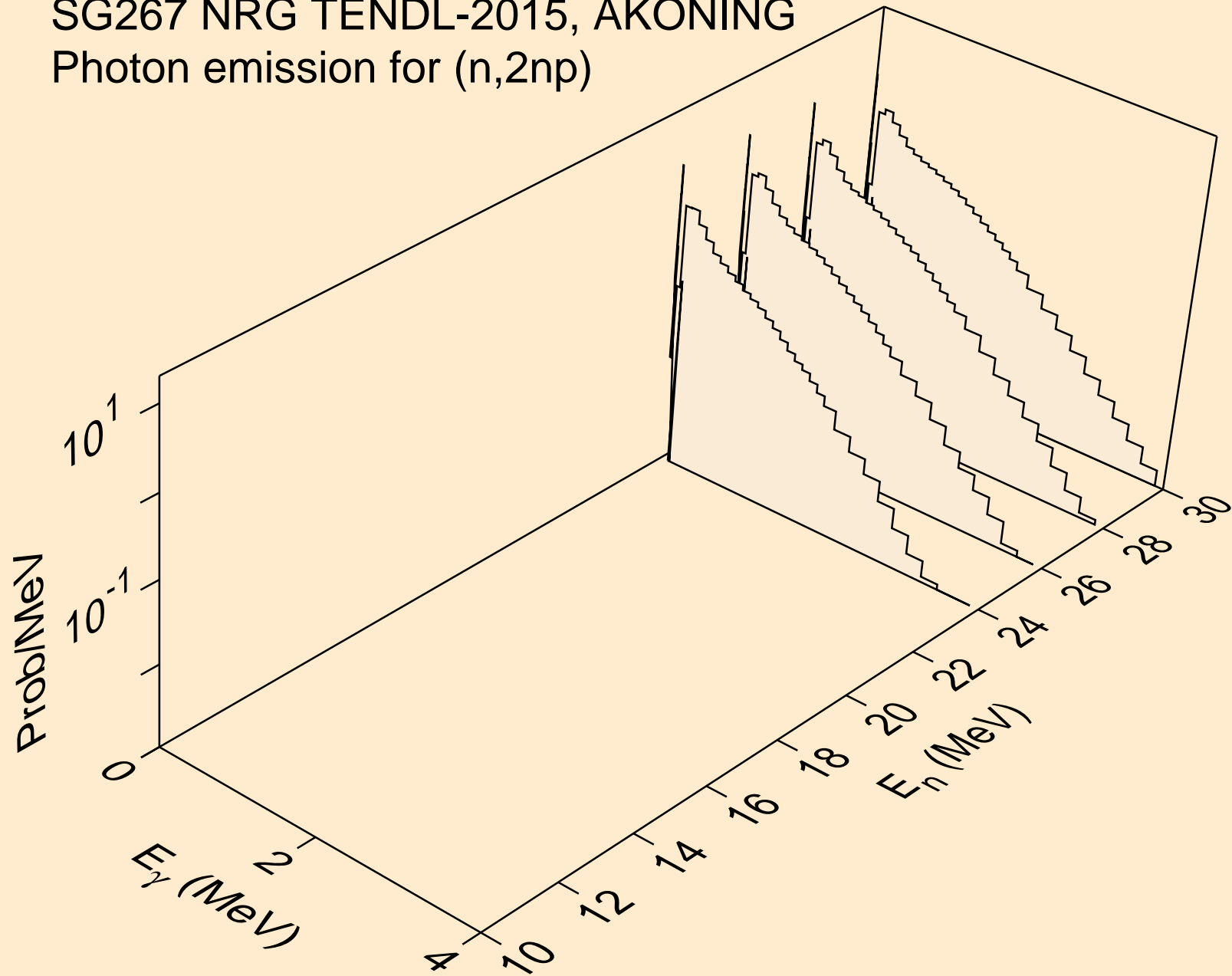

SG267 NRG TENDL-2015, AKONING  
Photon emission for (n,3np)

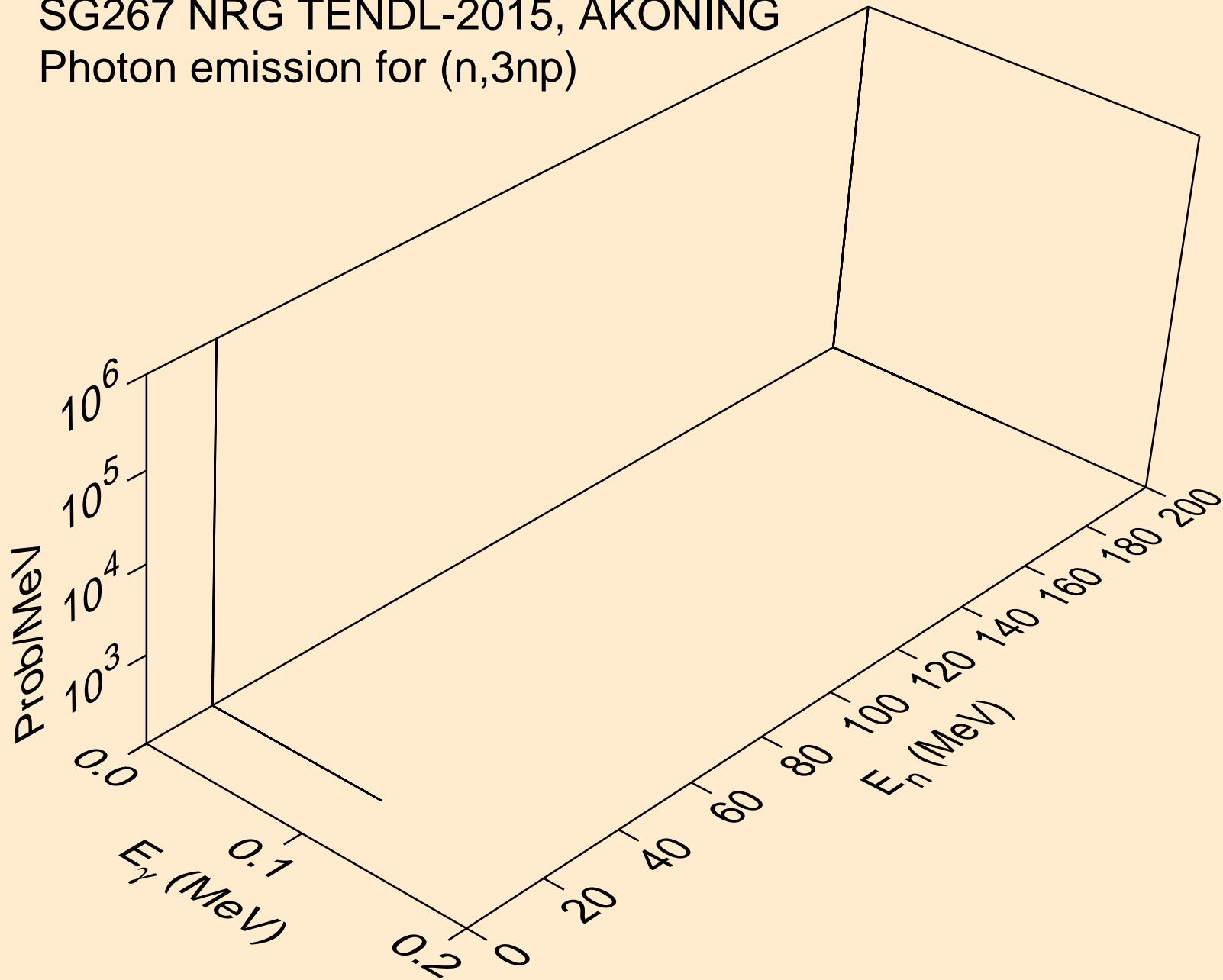

SG267 NRG TENDL-2015, AKONING  
Photon emission for (n,2np)

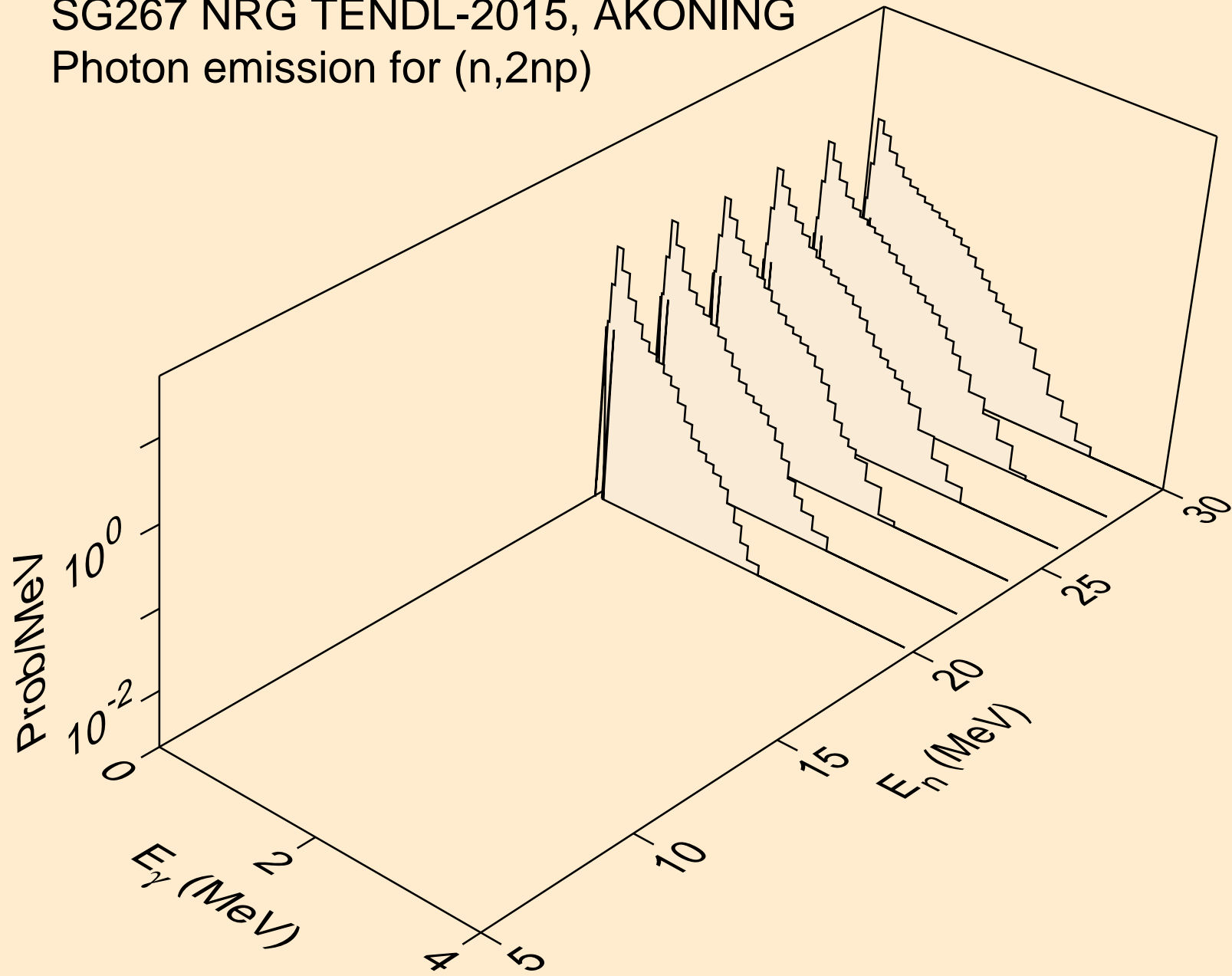

SG267 NRG TENDL-2015, AKONING  
Photon emission for (n,npa)

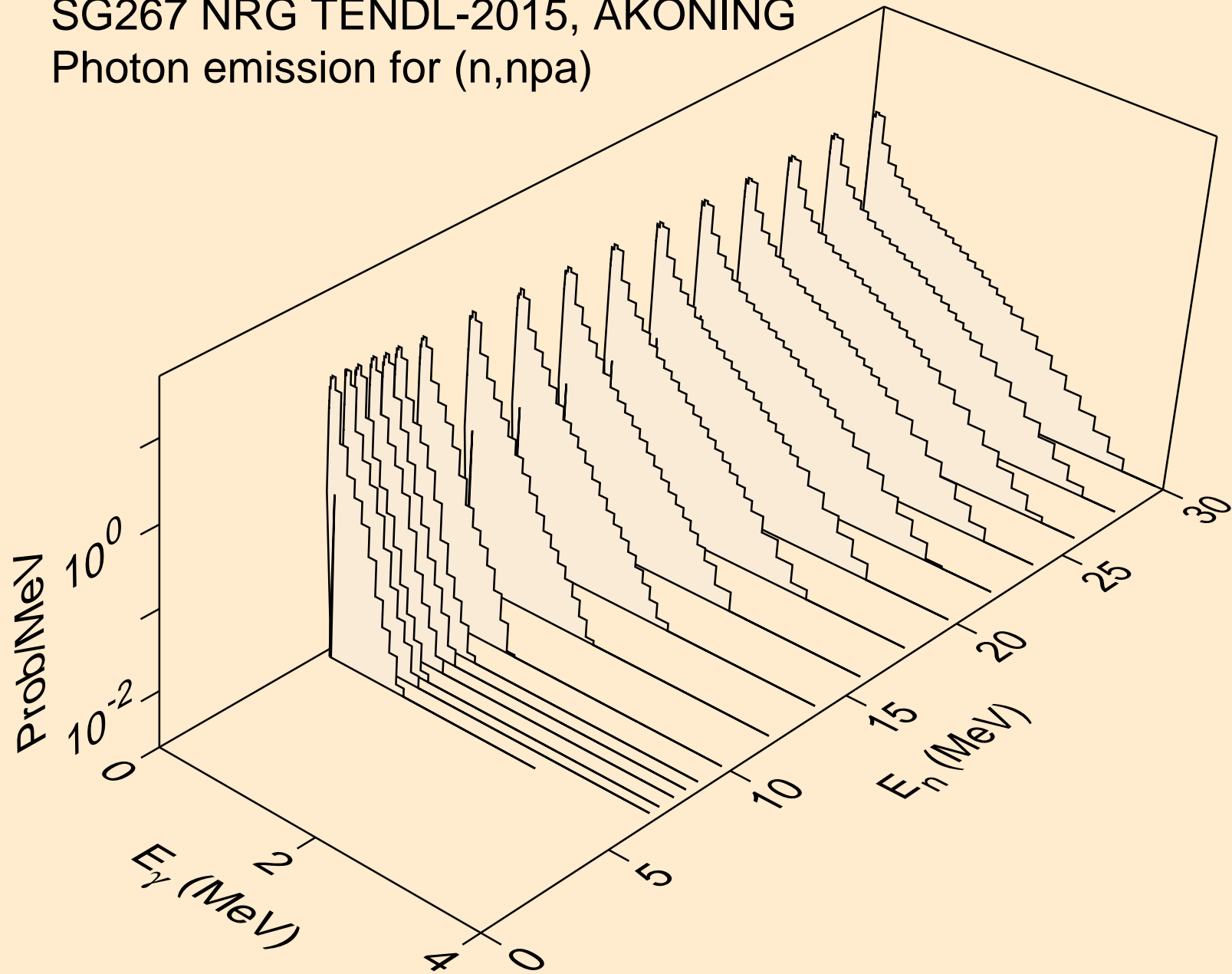

SG267 NRG TENDL-2015, AKONING  
Photon emission for (n,n\*c)

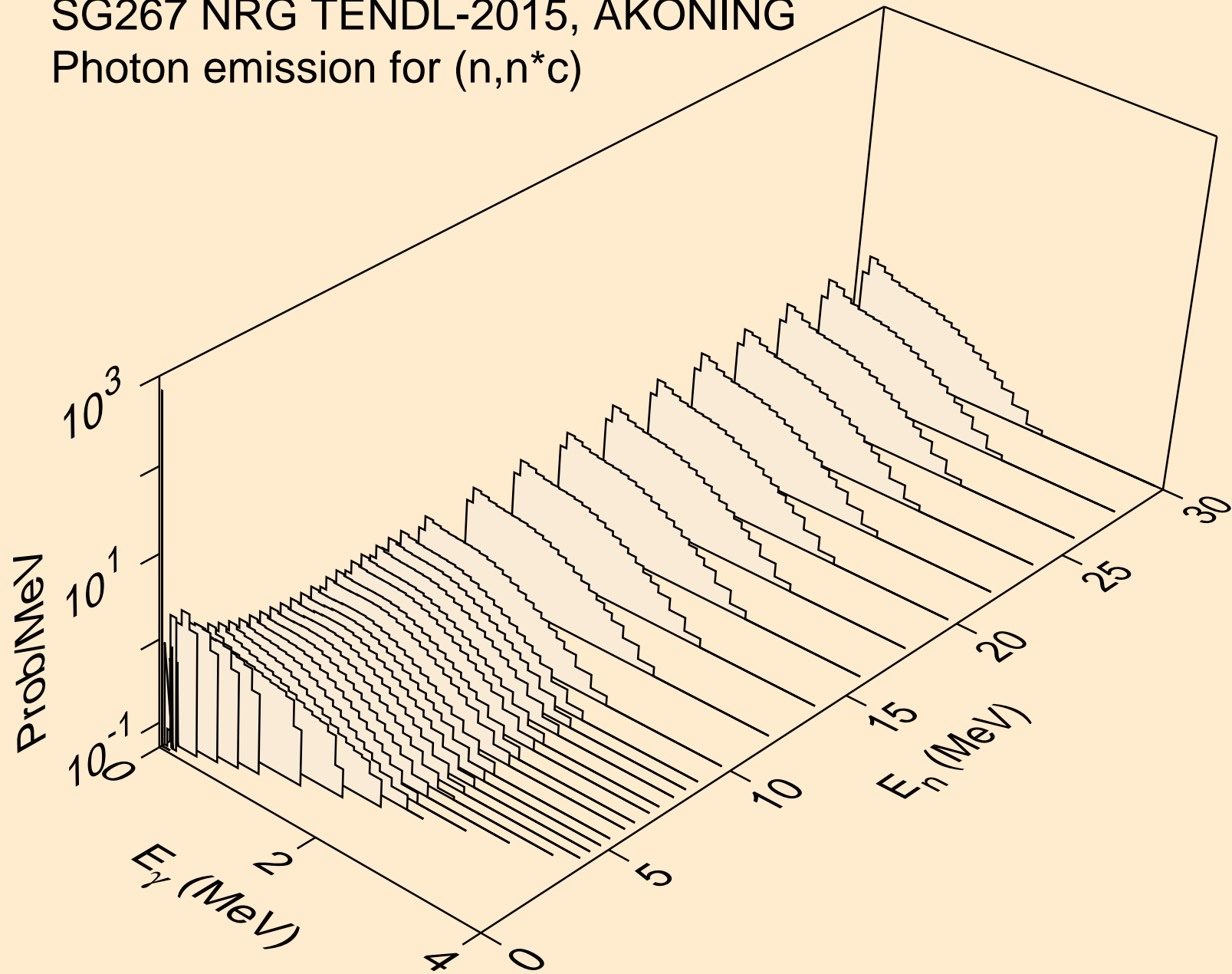



SG267 NRG TENDL-2015, AKONING  
Photon emission for (n,gma)

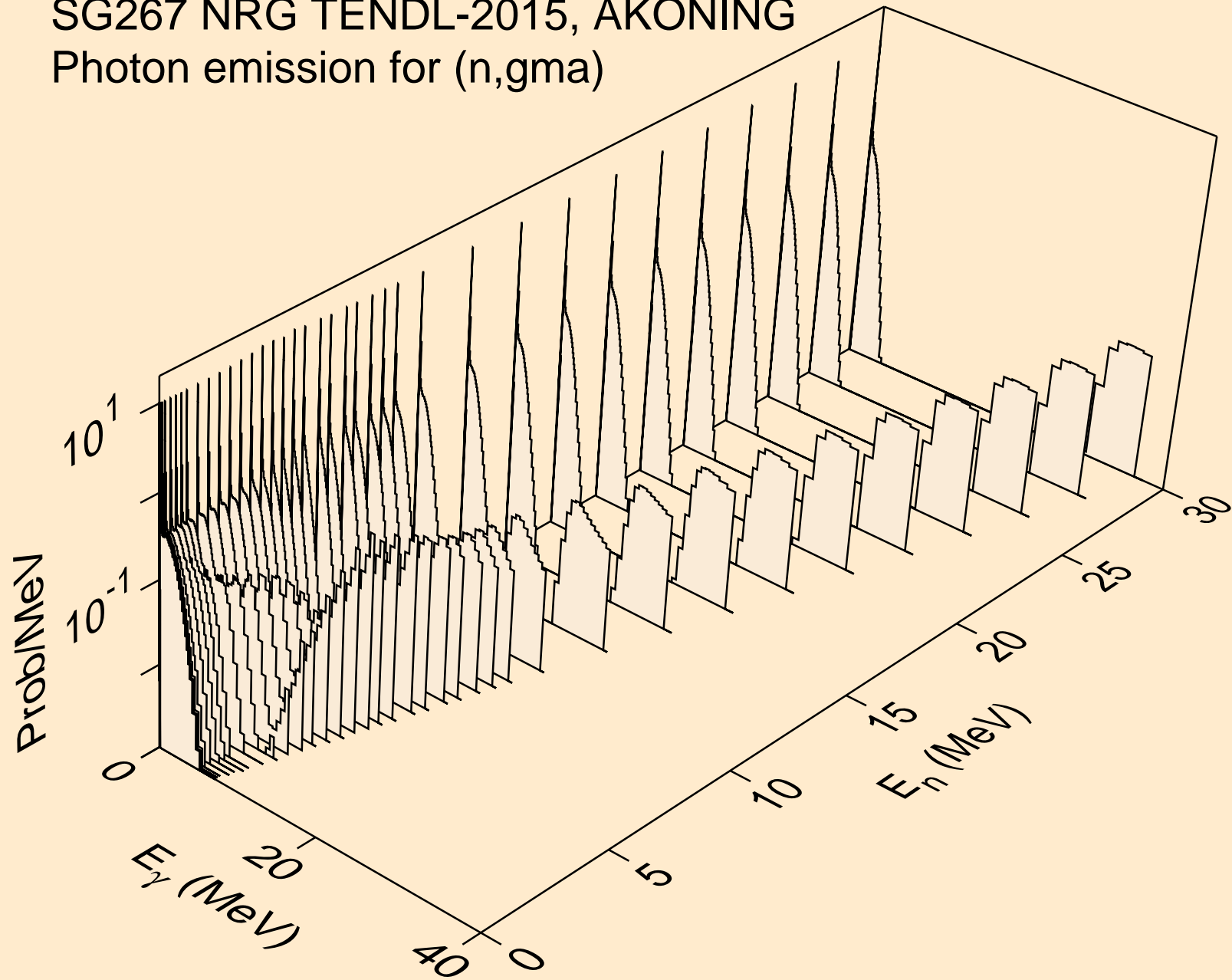

SG267 NRG TENDL-2015, AKONING  
Photon emission for (n,p)

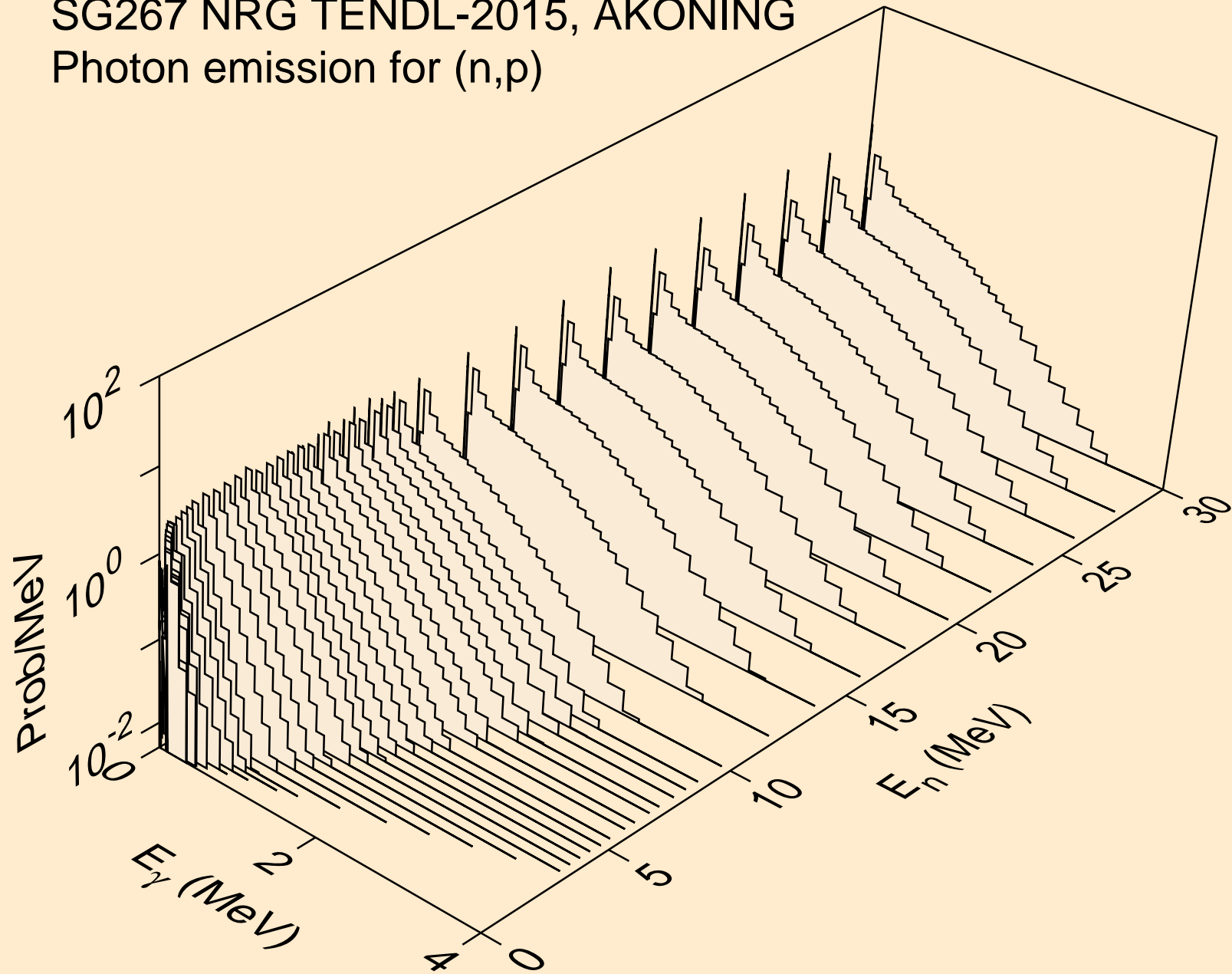

SG267 NRG TENDL-2015, AKONING  
Photon emission for (n,d)

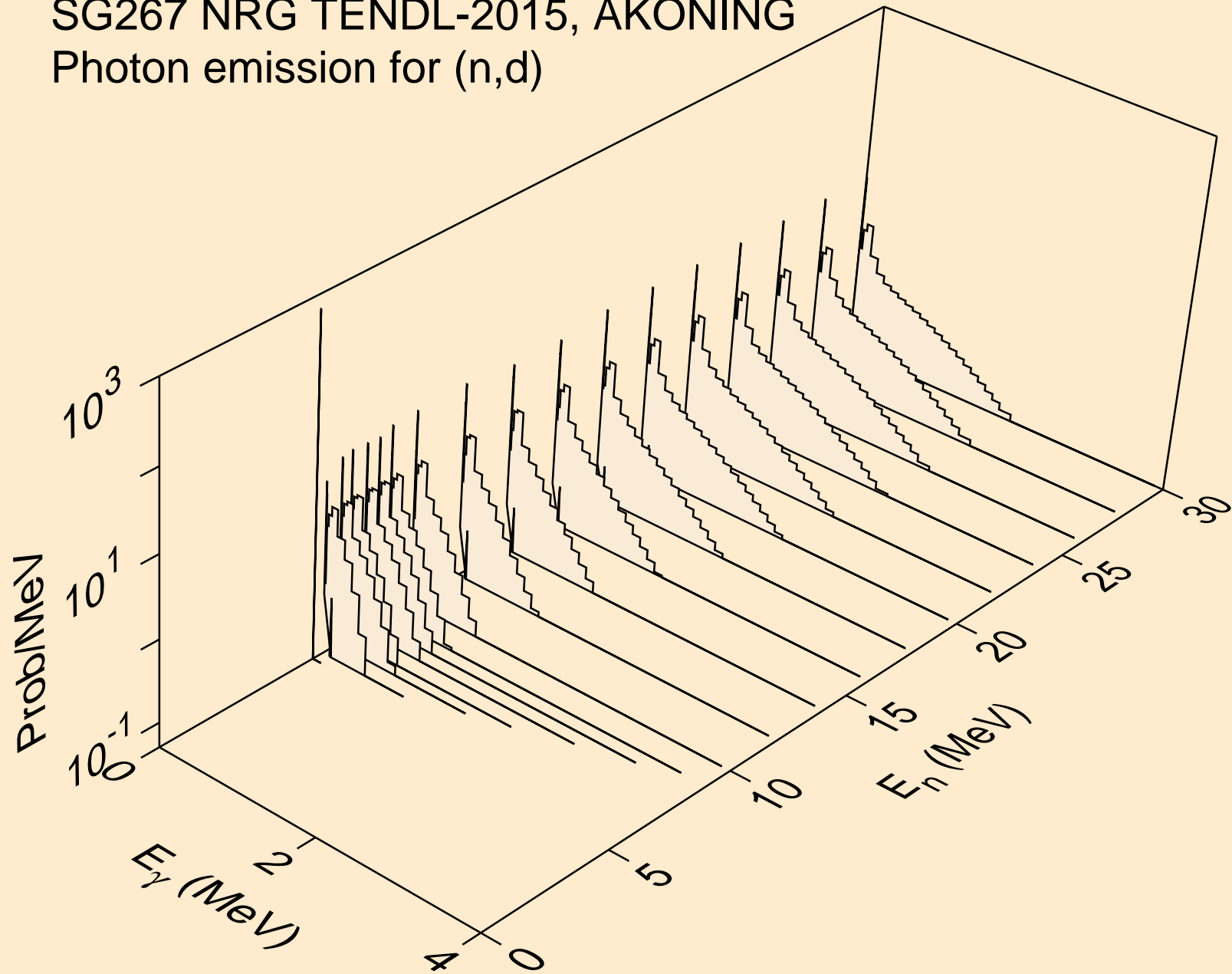

SG267 NRG TENDL-2015, AKONING  
Photon emission for (n,t)

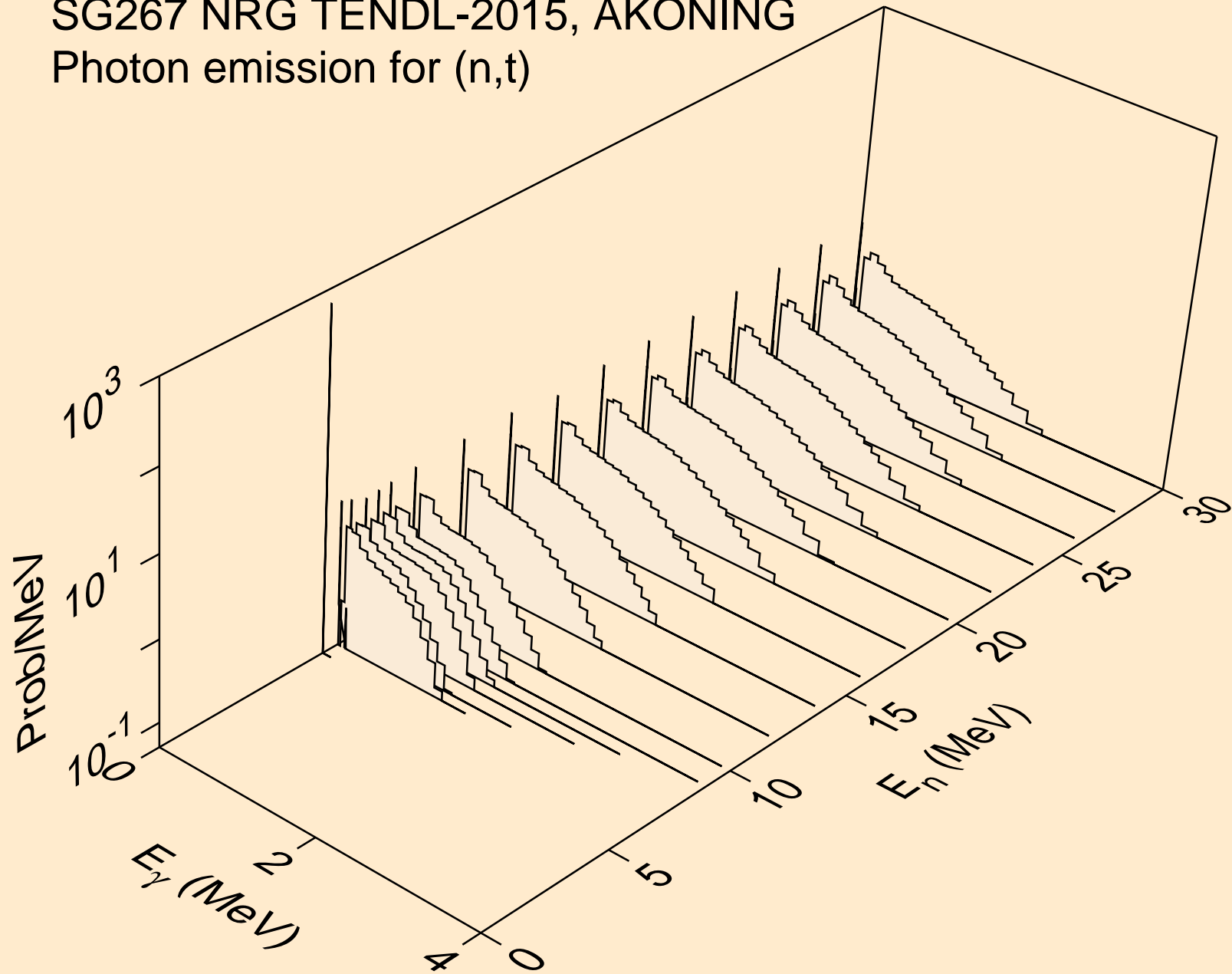

SG267 NRG TENDL-2015, AKONING  
Photon emission for (n,he3)

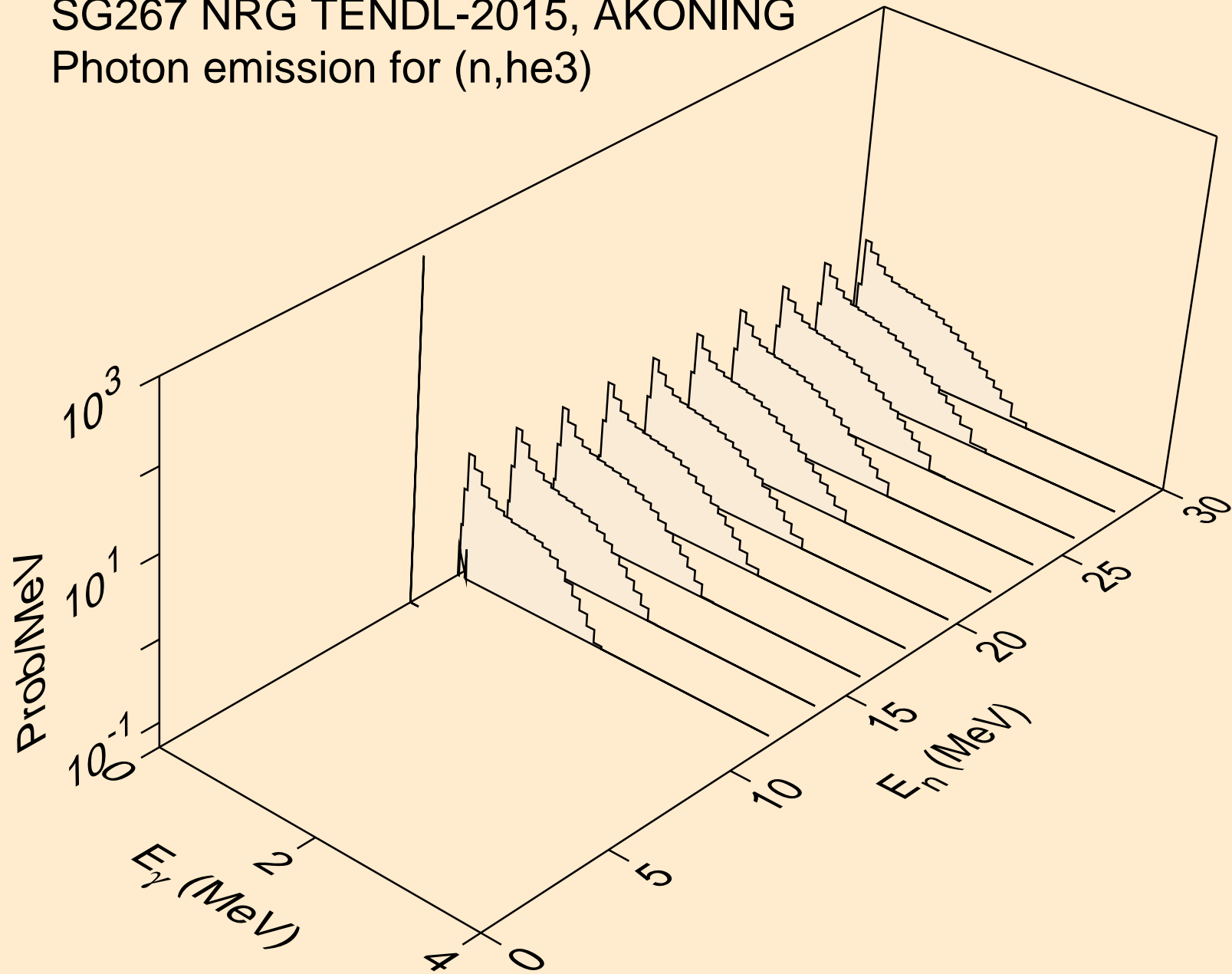

SG267 NRG TENDL-2015, AKONING  
Photon emission for (n,a)

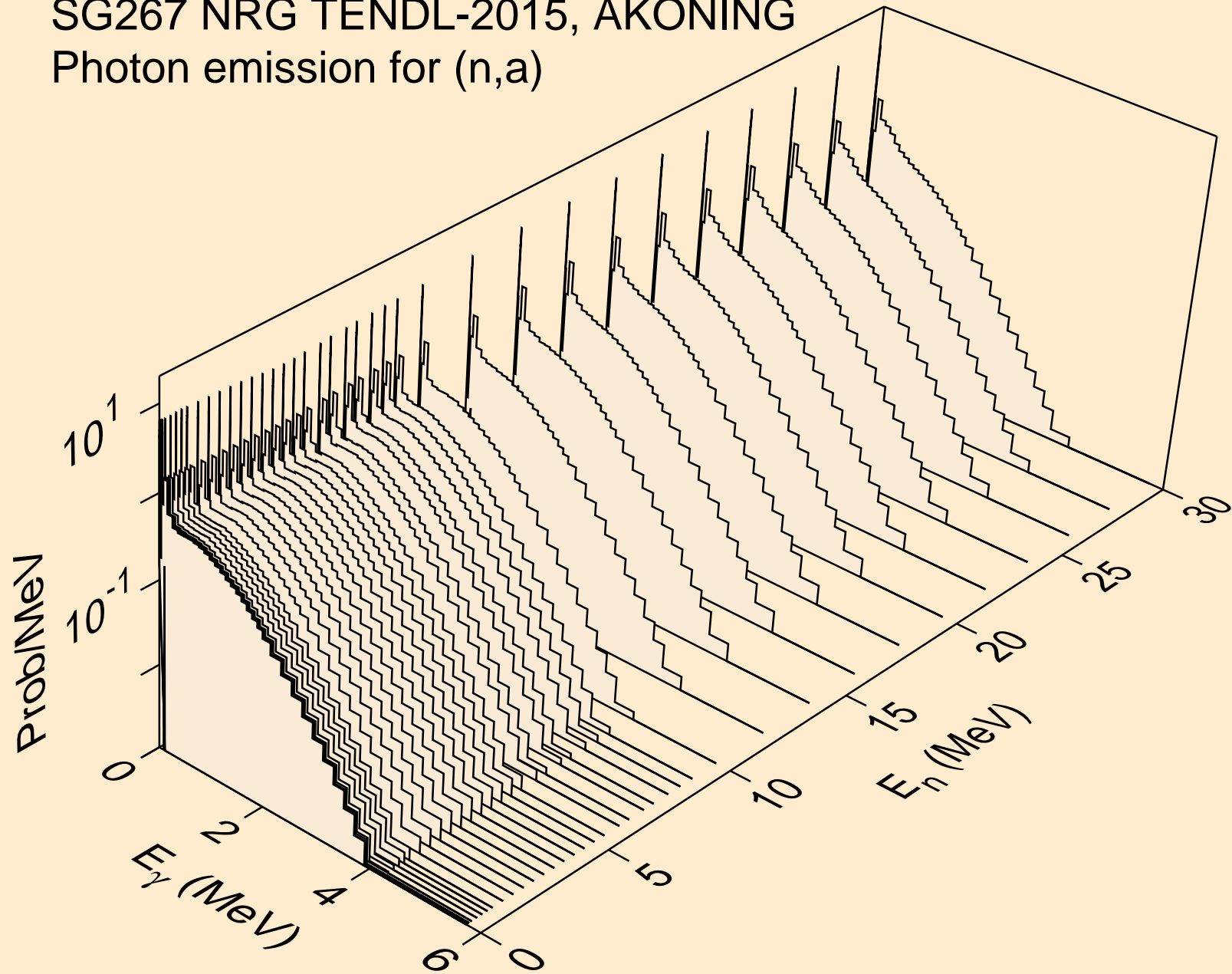

SG267 NRG TENDL-2015, AKONING  
Photon emission for (n,2a)

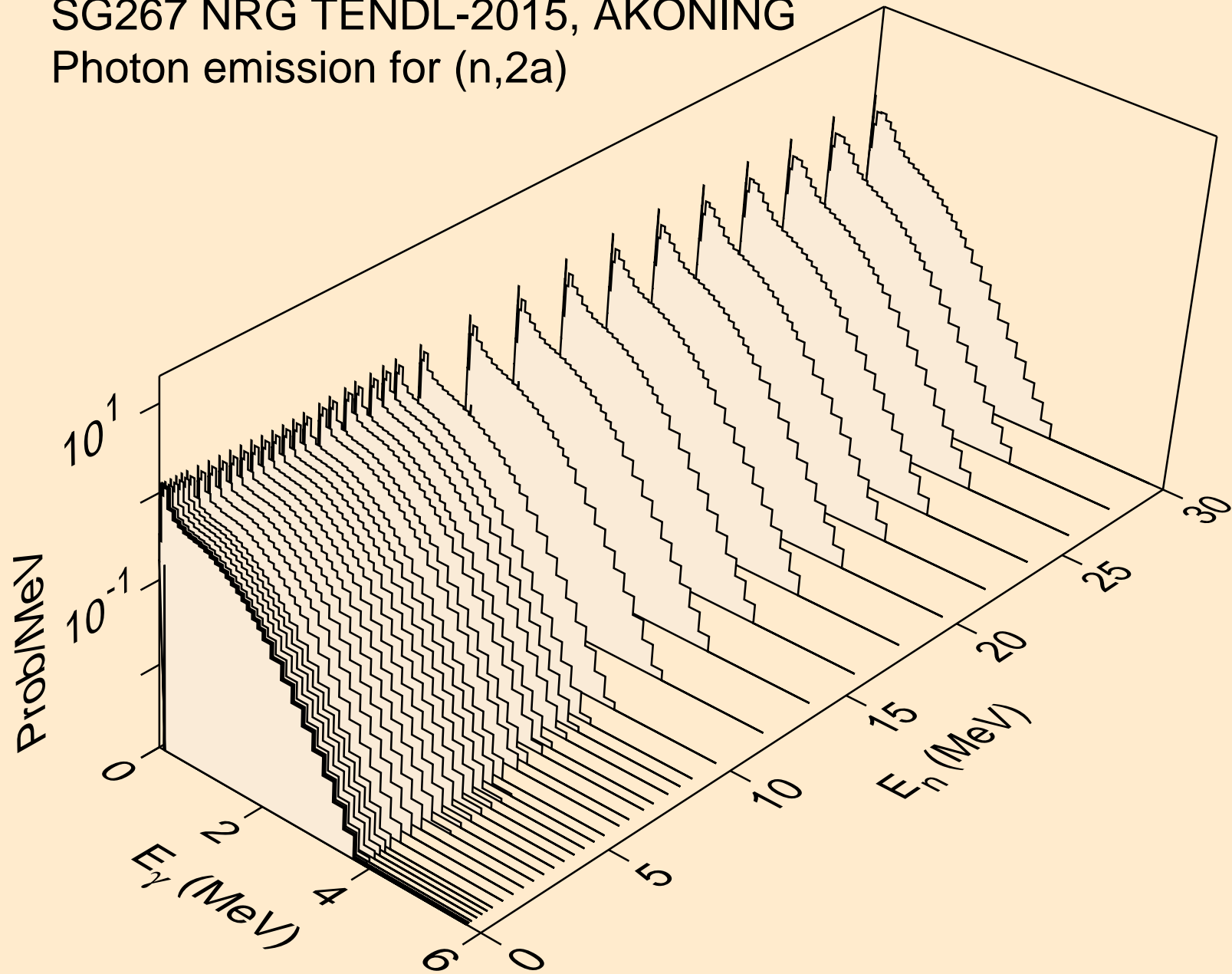

SG267 NRG TENDL-2015, AKONING  
Photon emission for (n,3a)

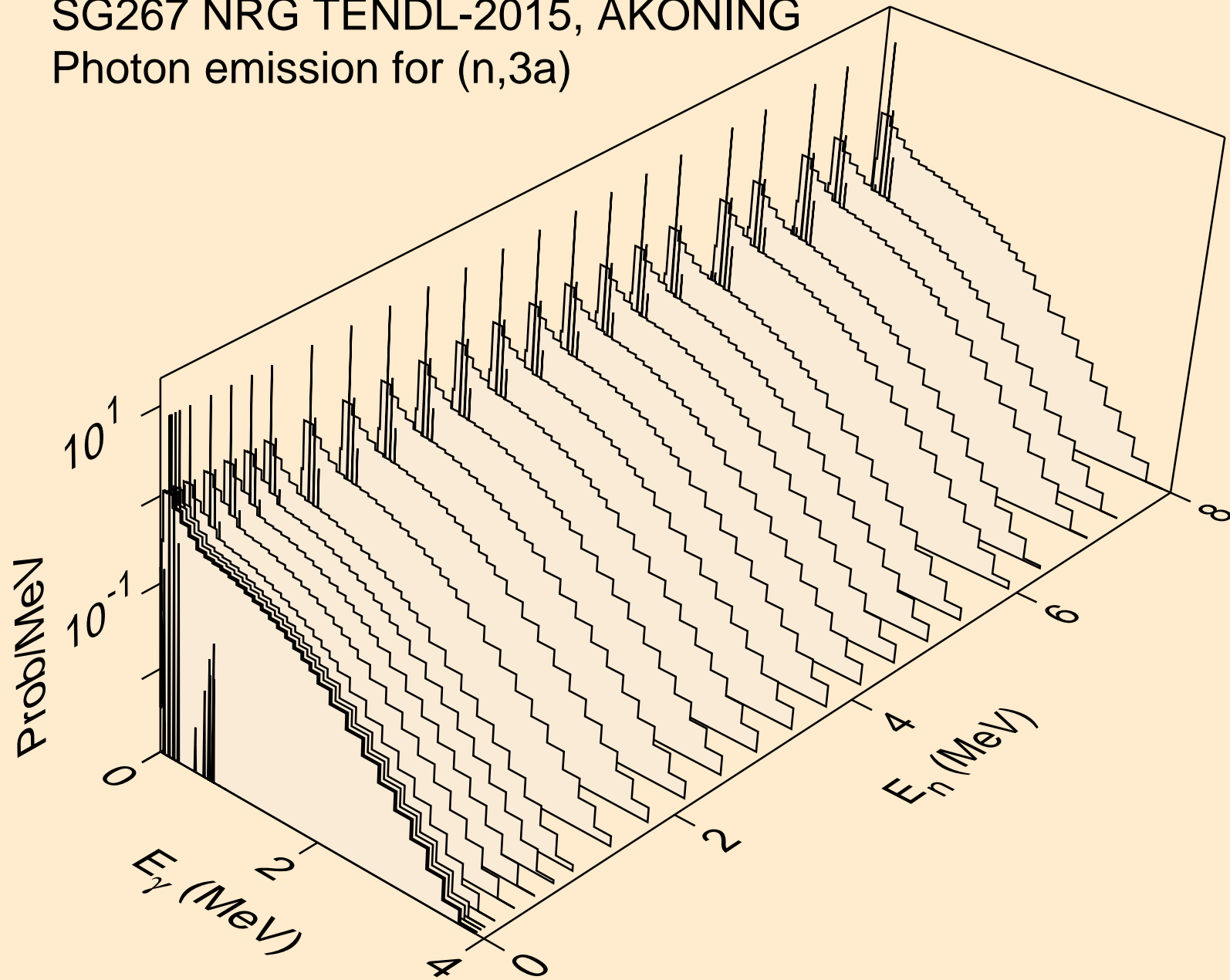



SG267 NRG TENDL-2015, AKONING  
Photon emission for (n,2p)

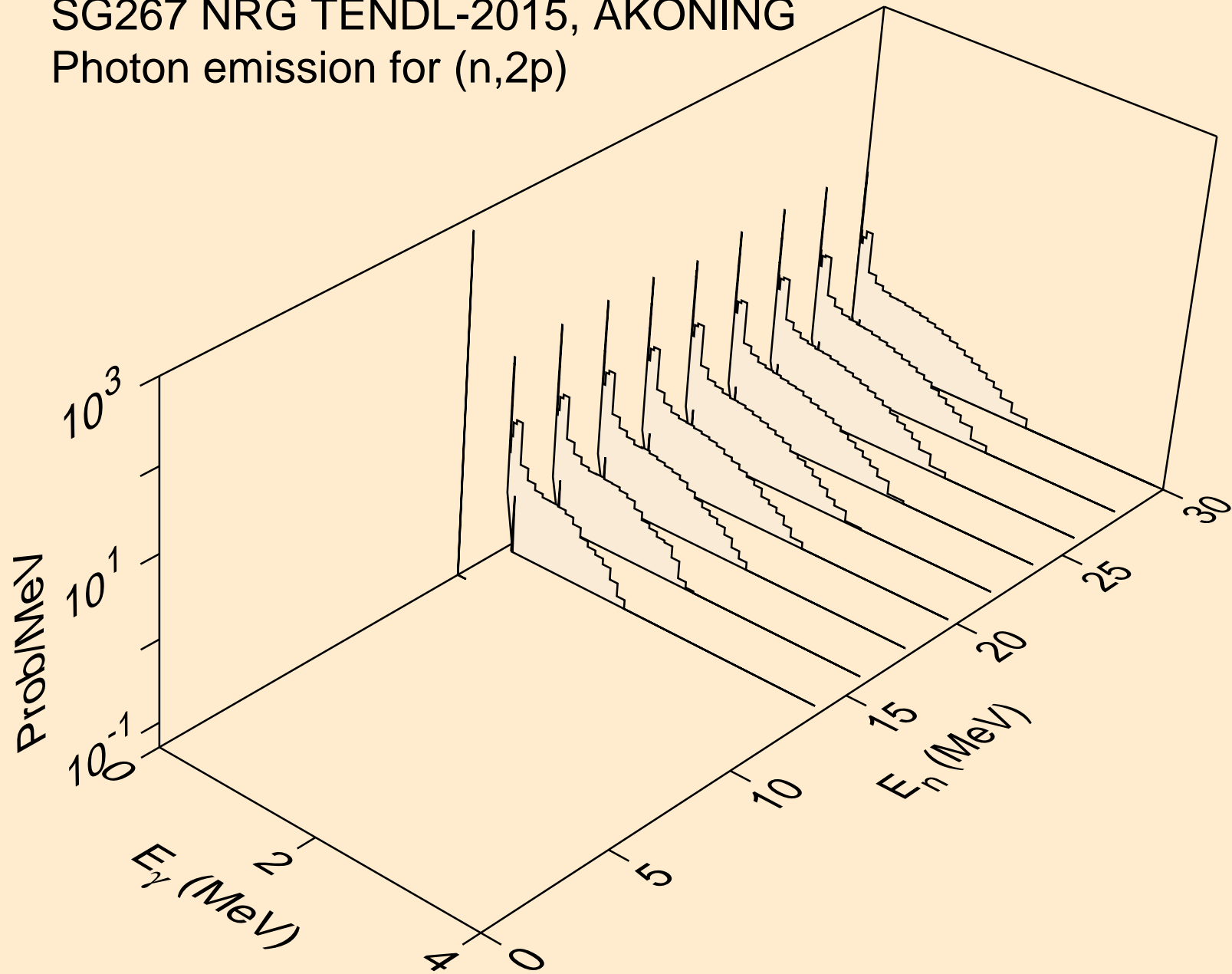

SG267 NRG TENDL-2015, AKONING  
Photon emission for (n,p)

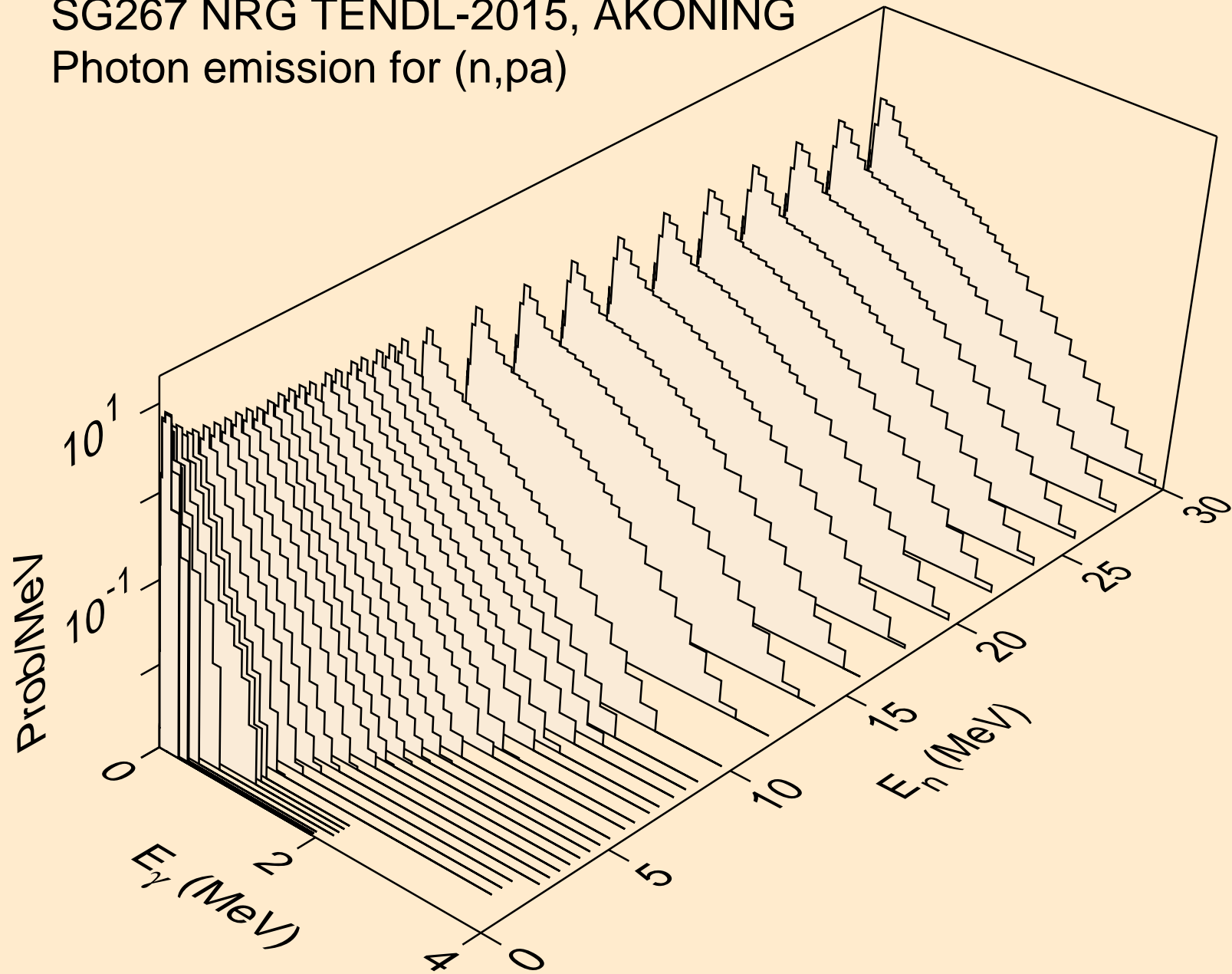

SG267 NRG TENDL-2015, AKONING  
Photon emission for (n,t2a)

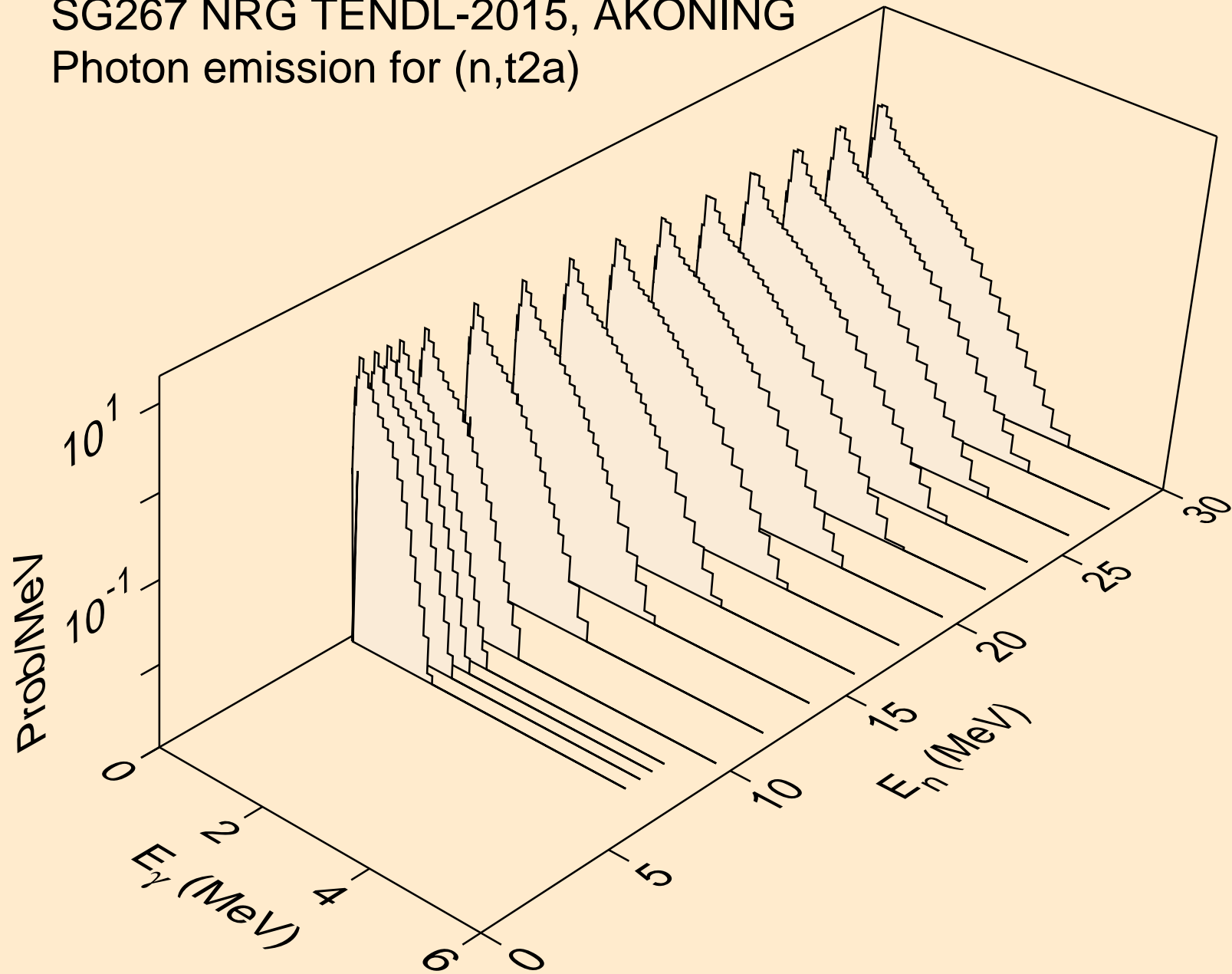

SG267 NRG TENDL-2015, AKONING  
Photon emission for (n,d2a)

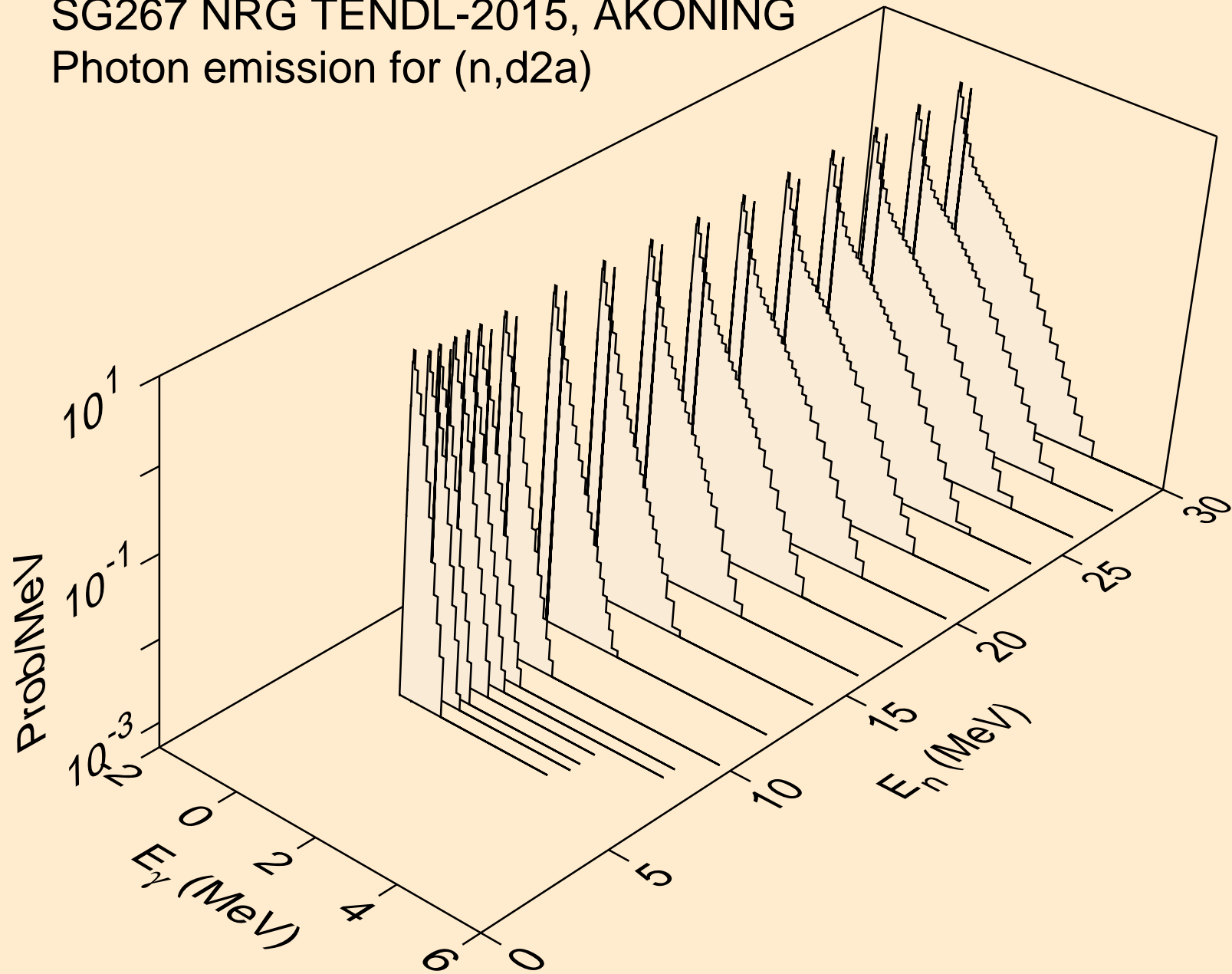

SG267 NRG TENDL-2015, AKONING  
Photon emission for (n,pd)

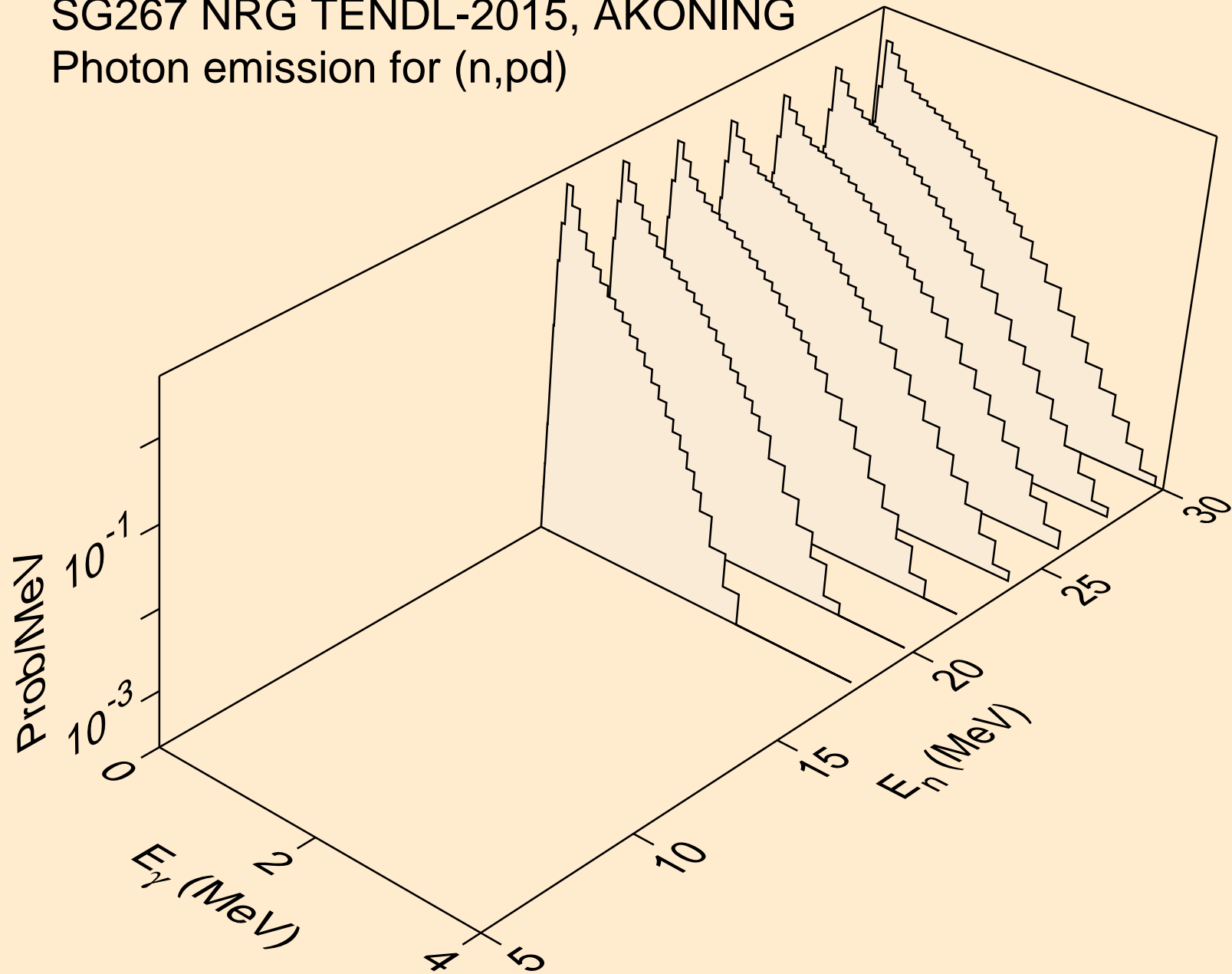

SG267 NRG TENDL-2015, AKONING  
Photon emission for (n,da)

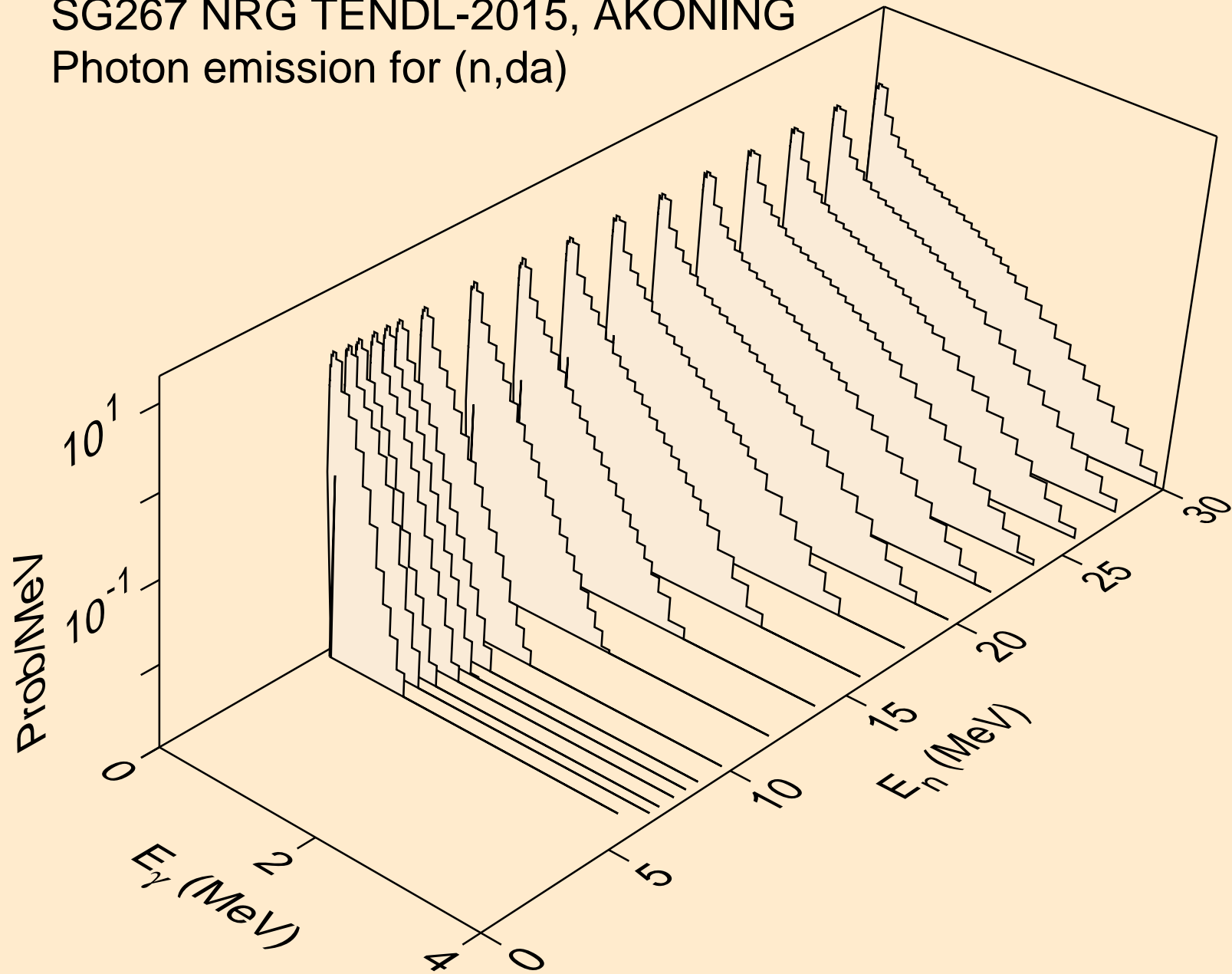

SG267 NRG TENDL-2015, AKONING  
thermal capture photon spectrum

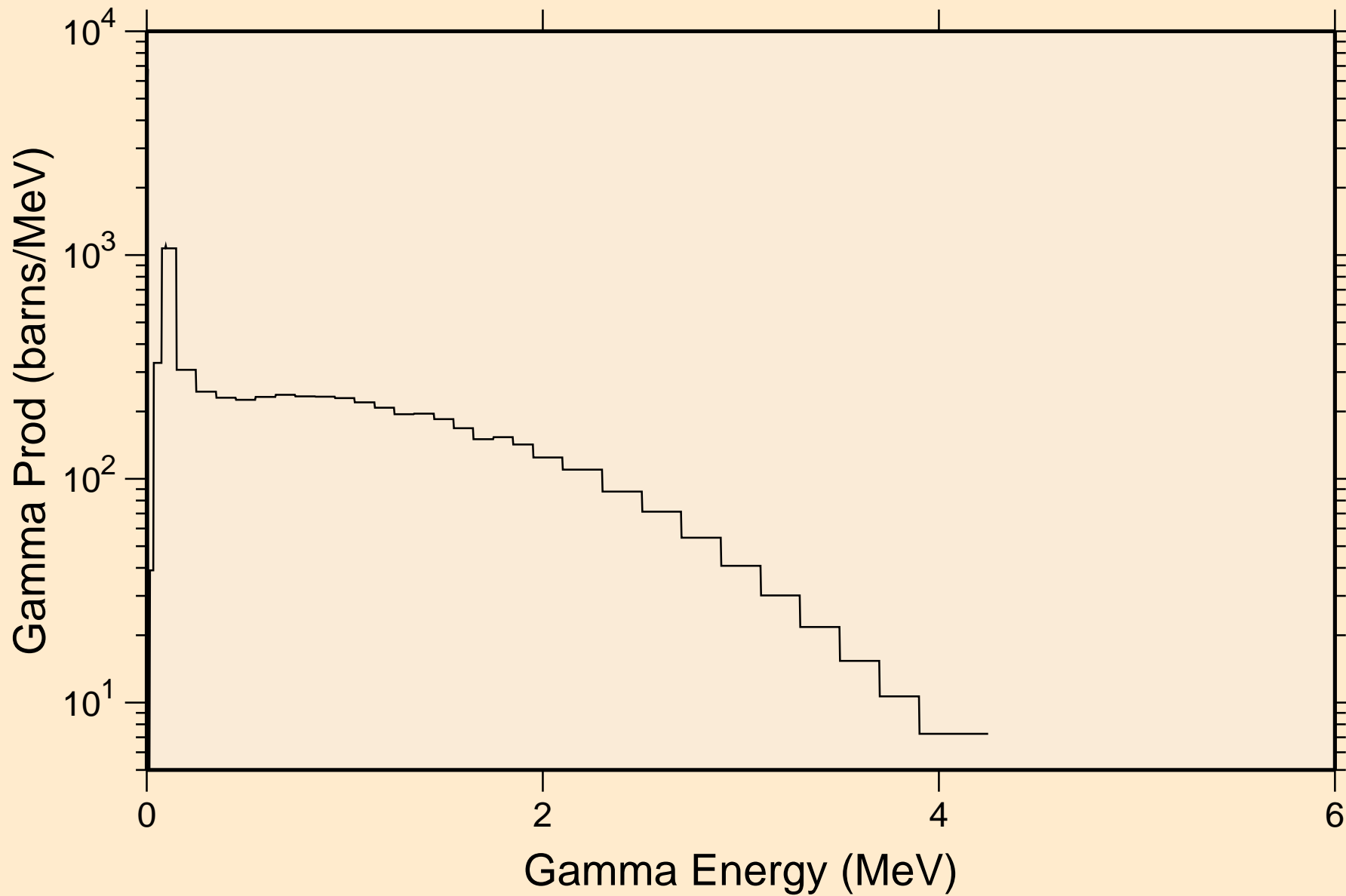

SG267 NRG TENDL-2015, AKONING  
14 MeV photon spectrum

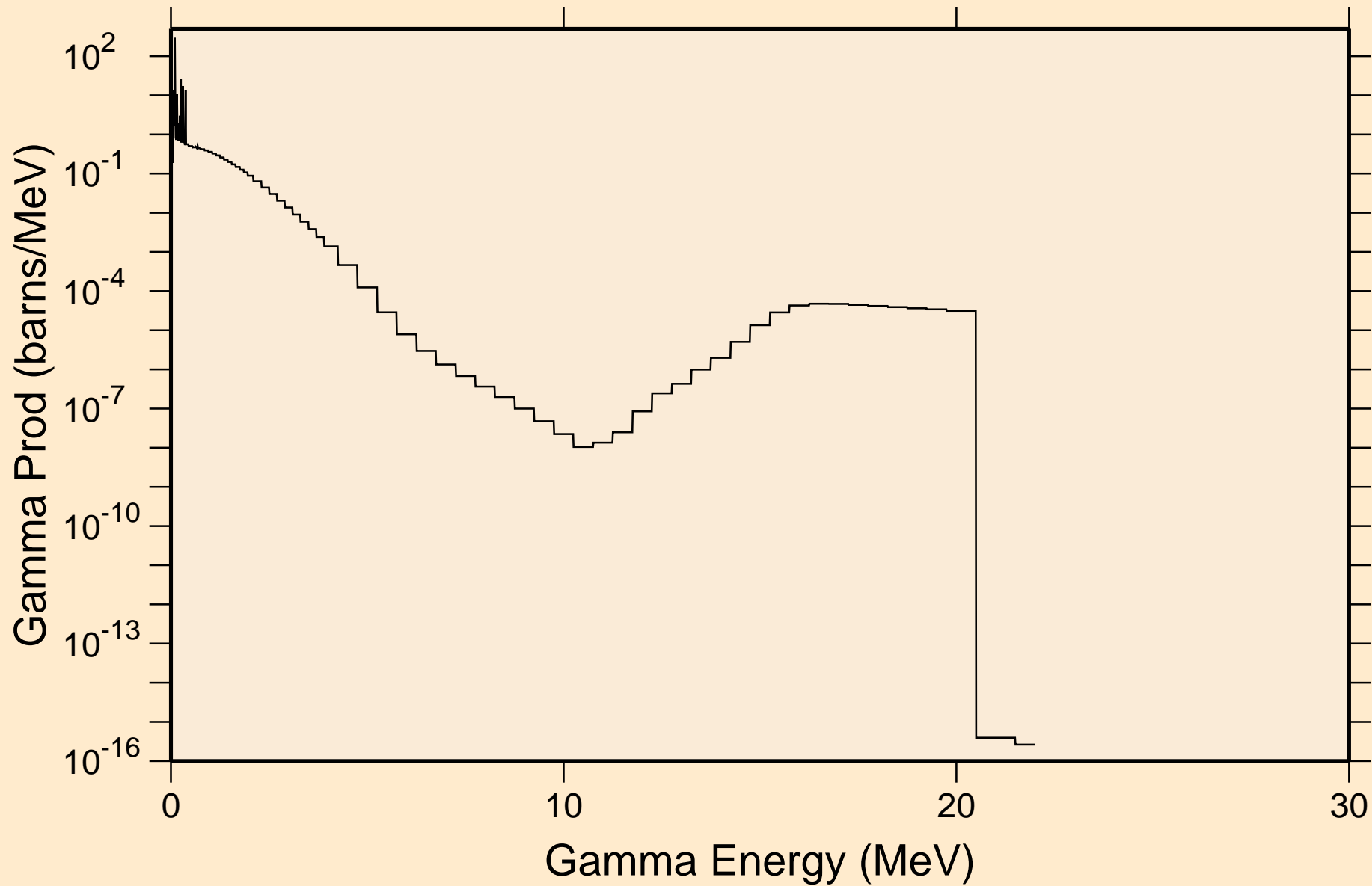



# SG267 NRG TENDL-2015, AKONING

## Particle heating contributions

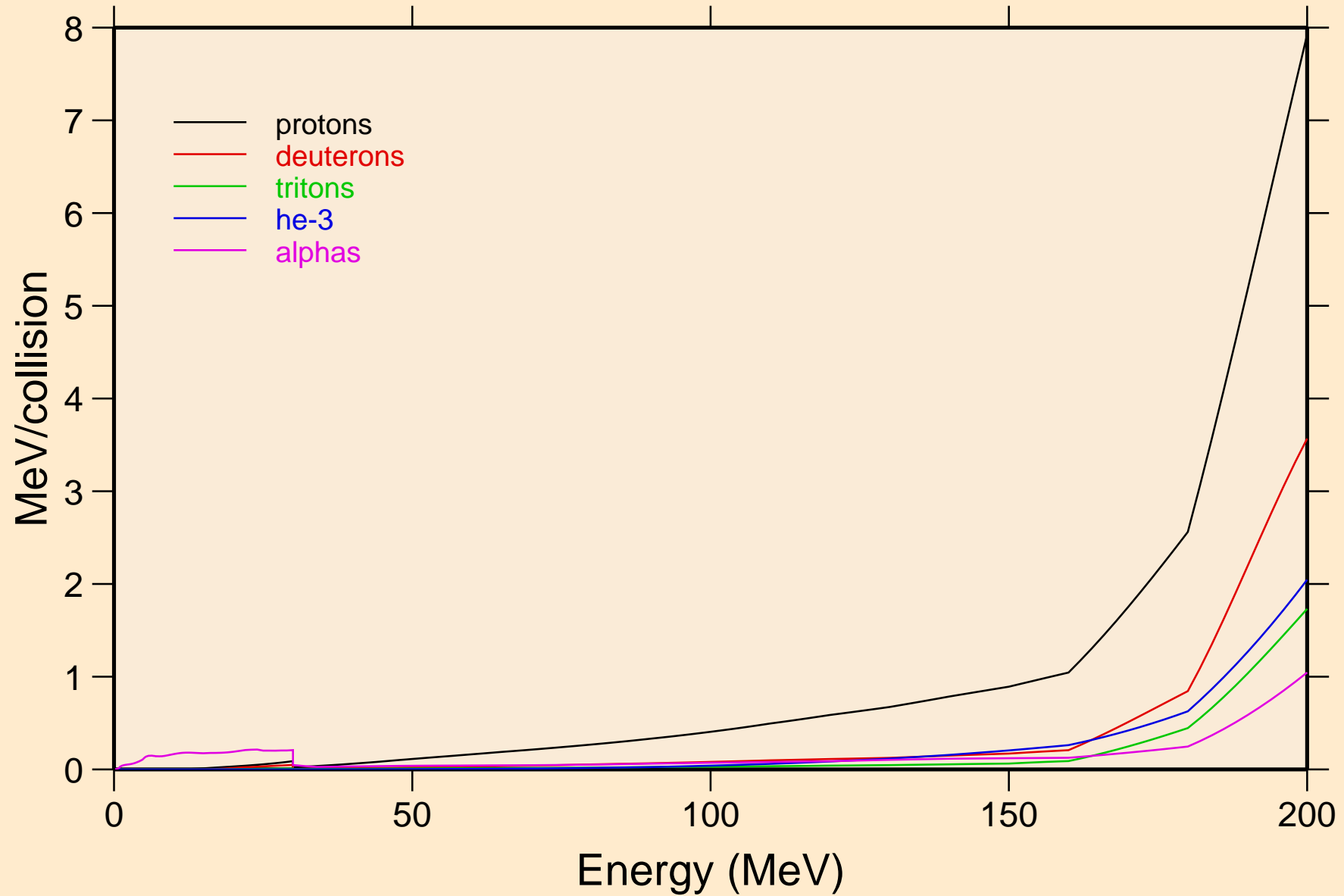

# SG267 NRG TENDL-2015, AKONING

## Recoil Heating

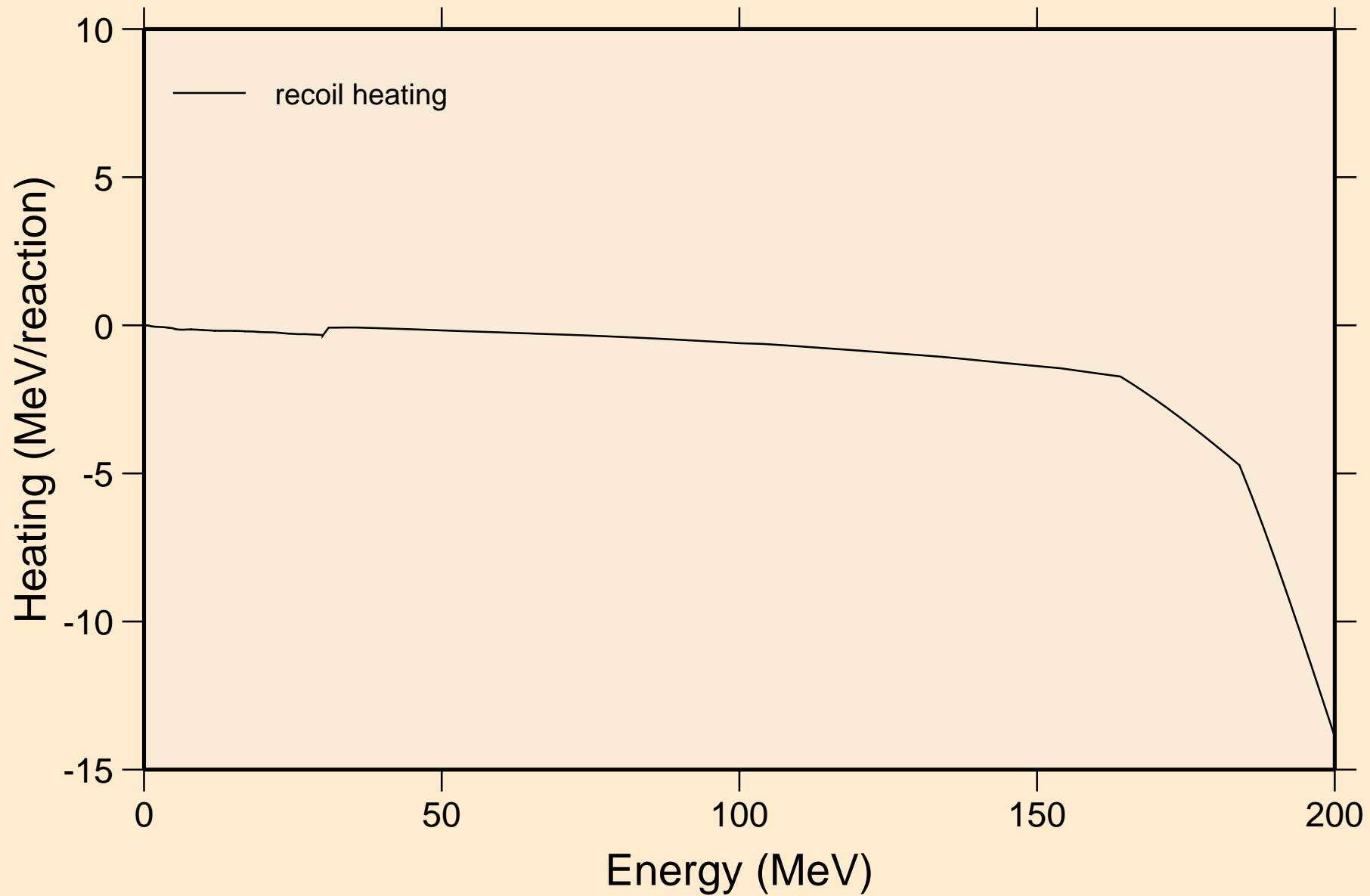

# SG267 NRG TENDL-2015, AKONING

## Particle production cross sections

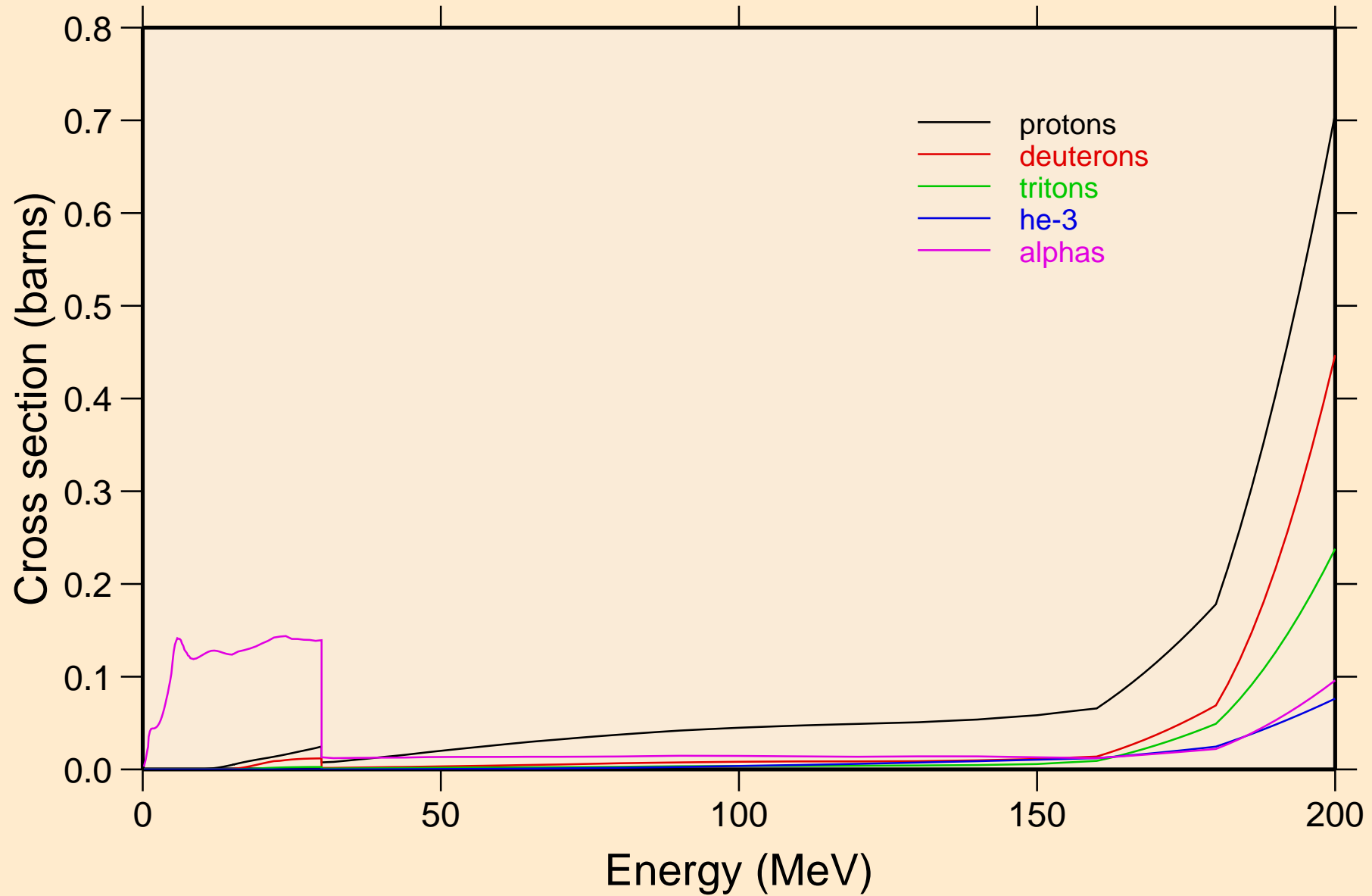

SG267 NRG TENDL-2015, AKONING  
protons from (n,x)

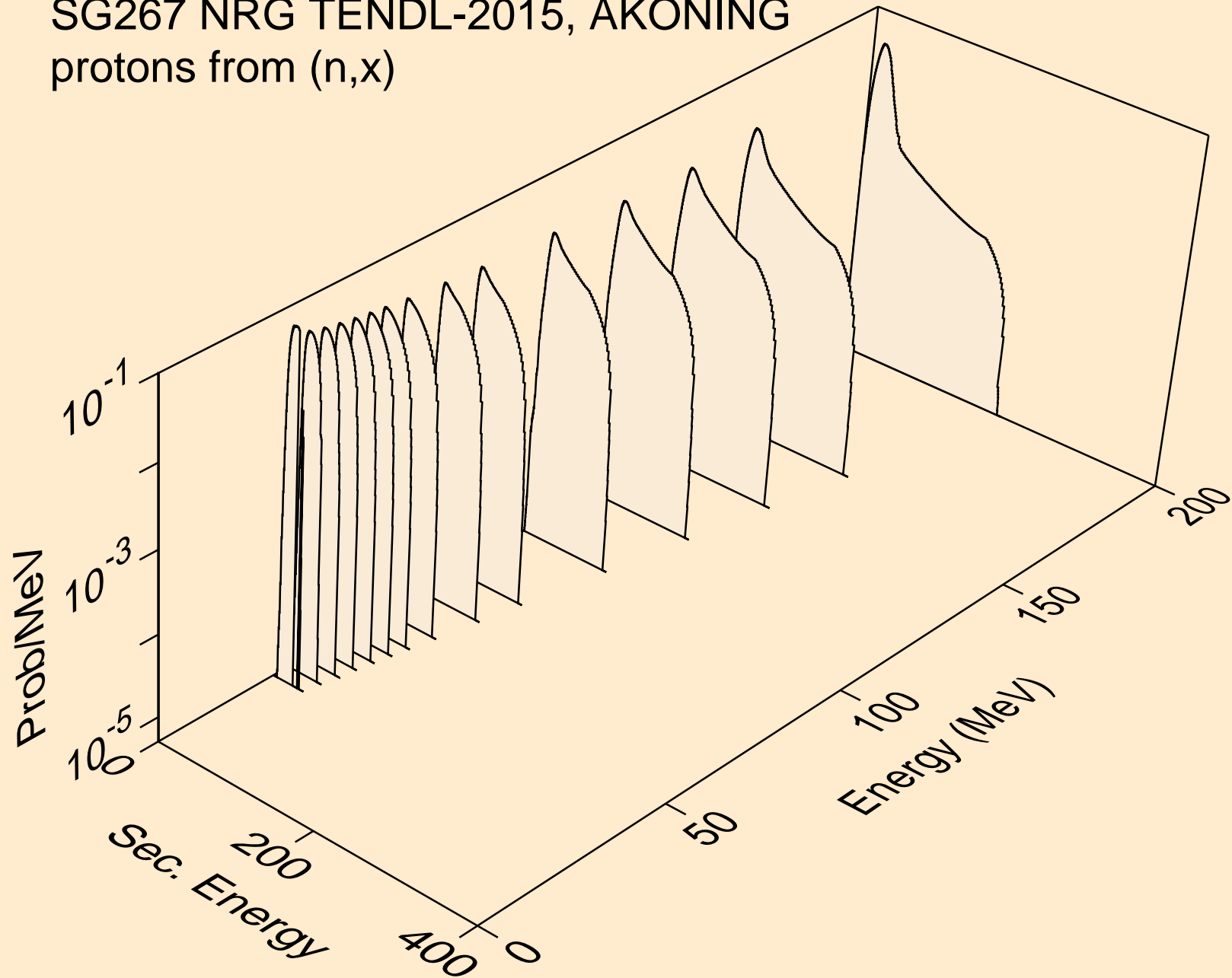

SG267 NRG TENDL-2015, AKONING  
protons from (n,n\*)p

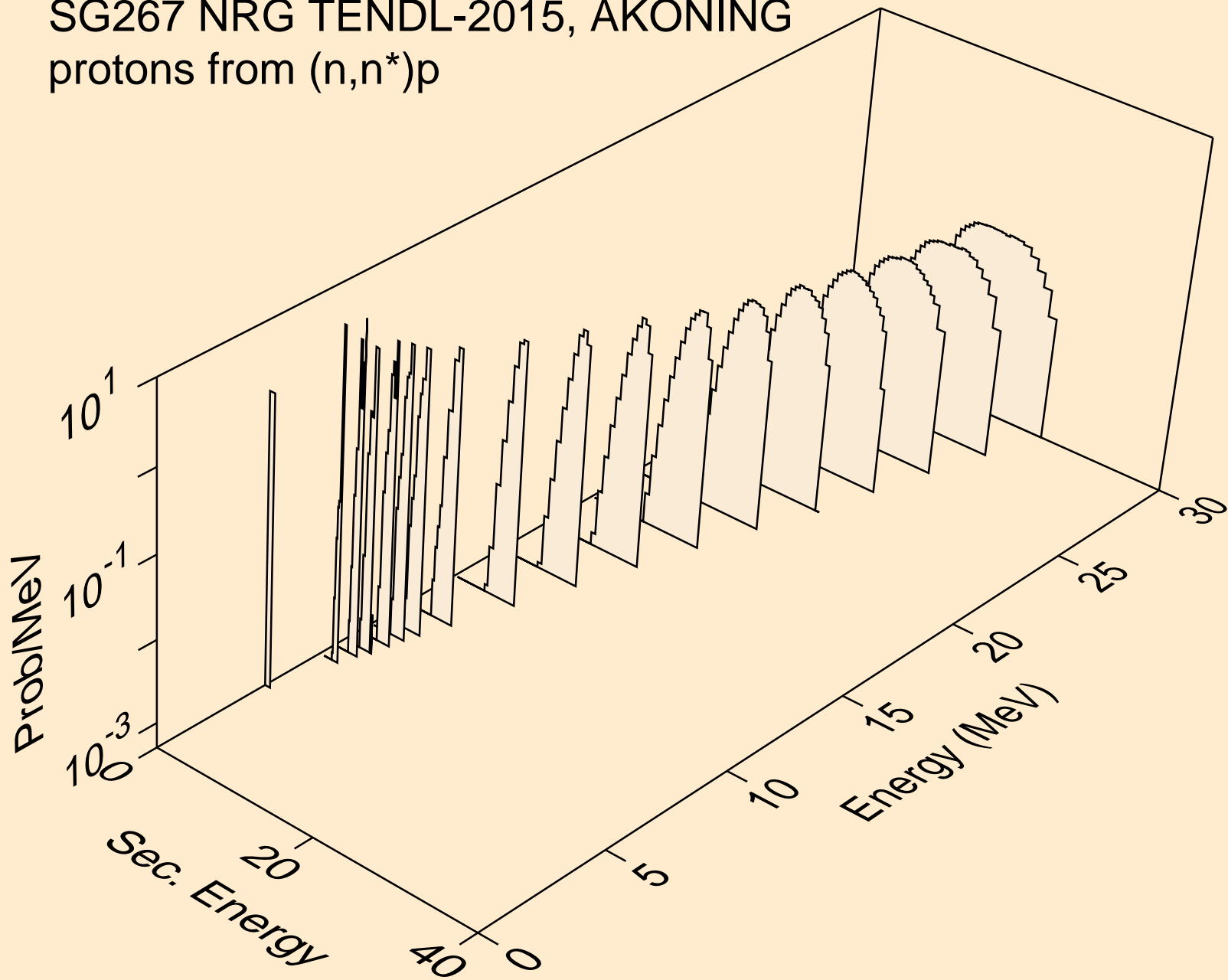

SG267 NRG TENDL-2015, AKONING  
protons from (n,2np)

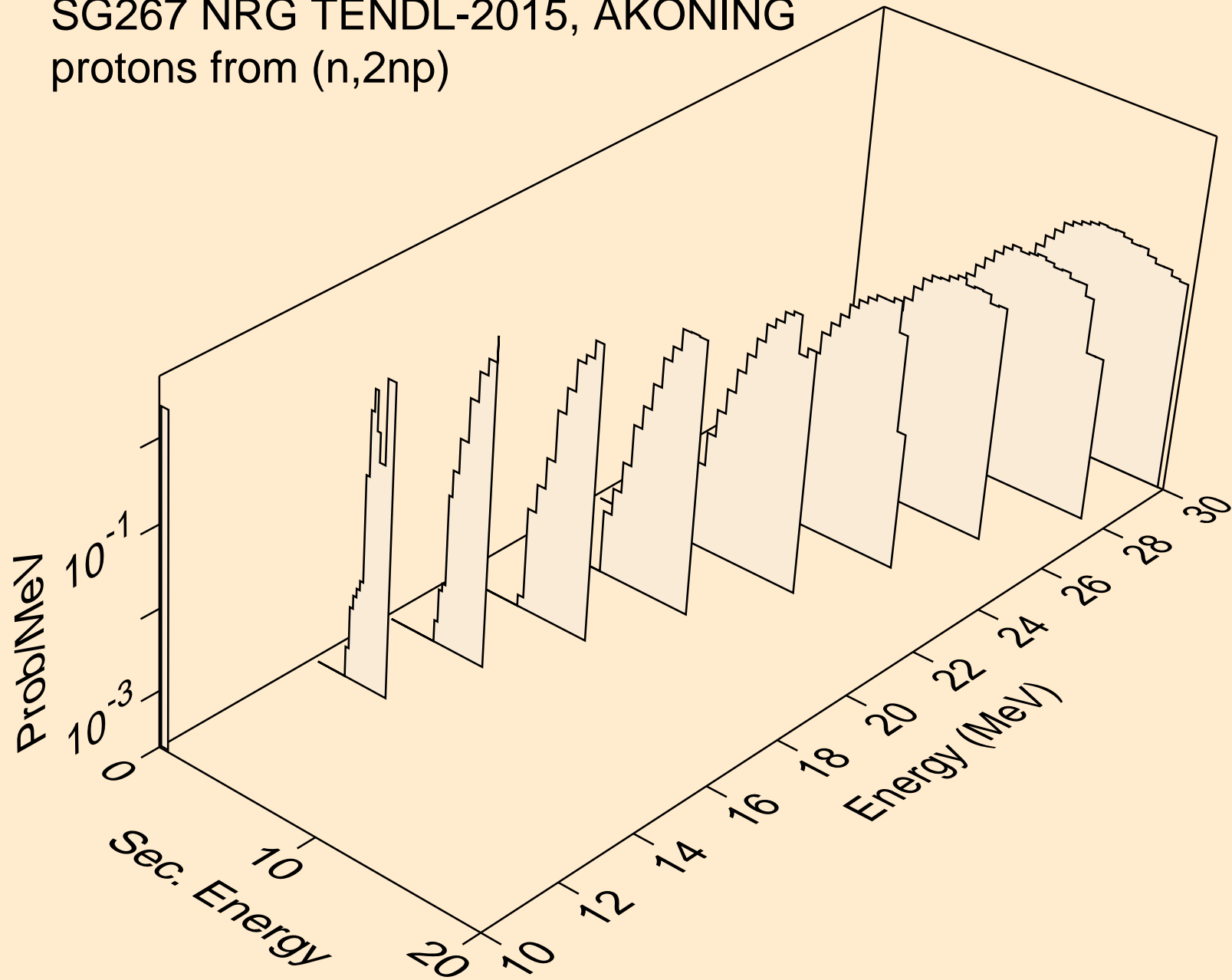

SG267 NRG TENDL-2015, AKONING  
protons from (n,3np)

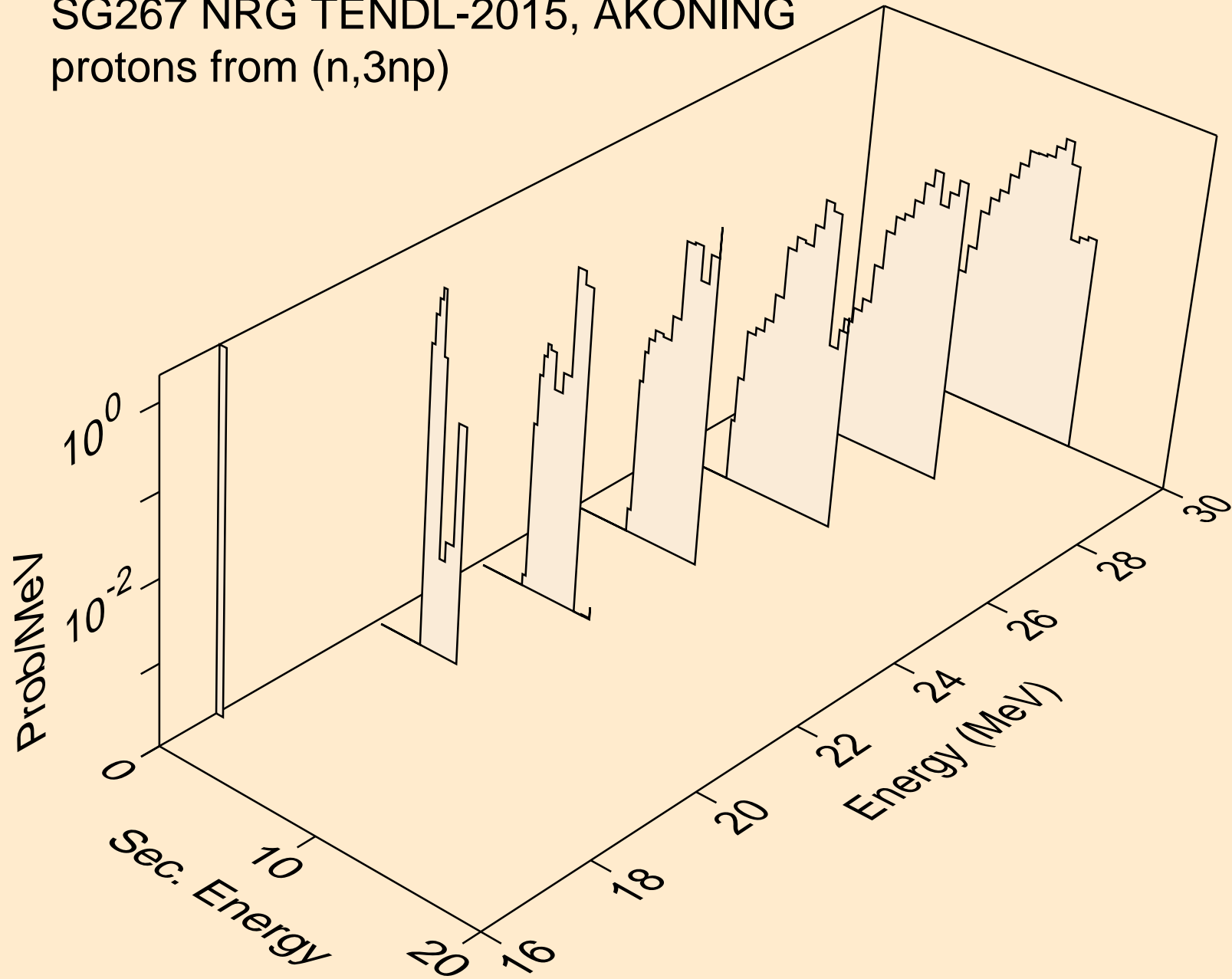

SG267 NRG TENDL-2015, AKONING  
protons from (n,2np)

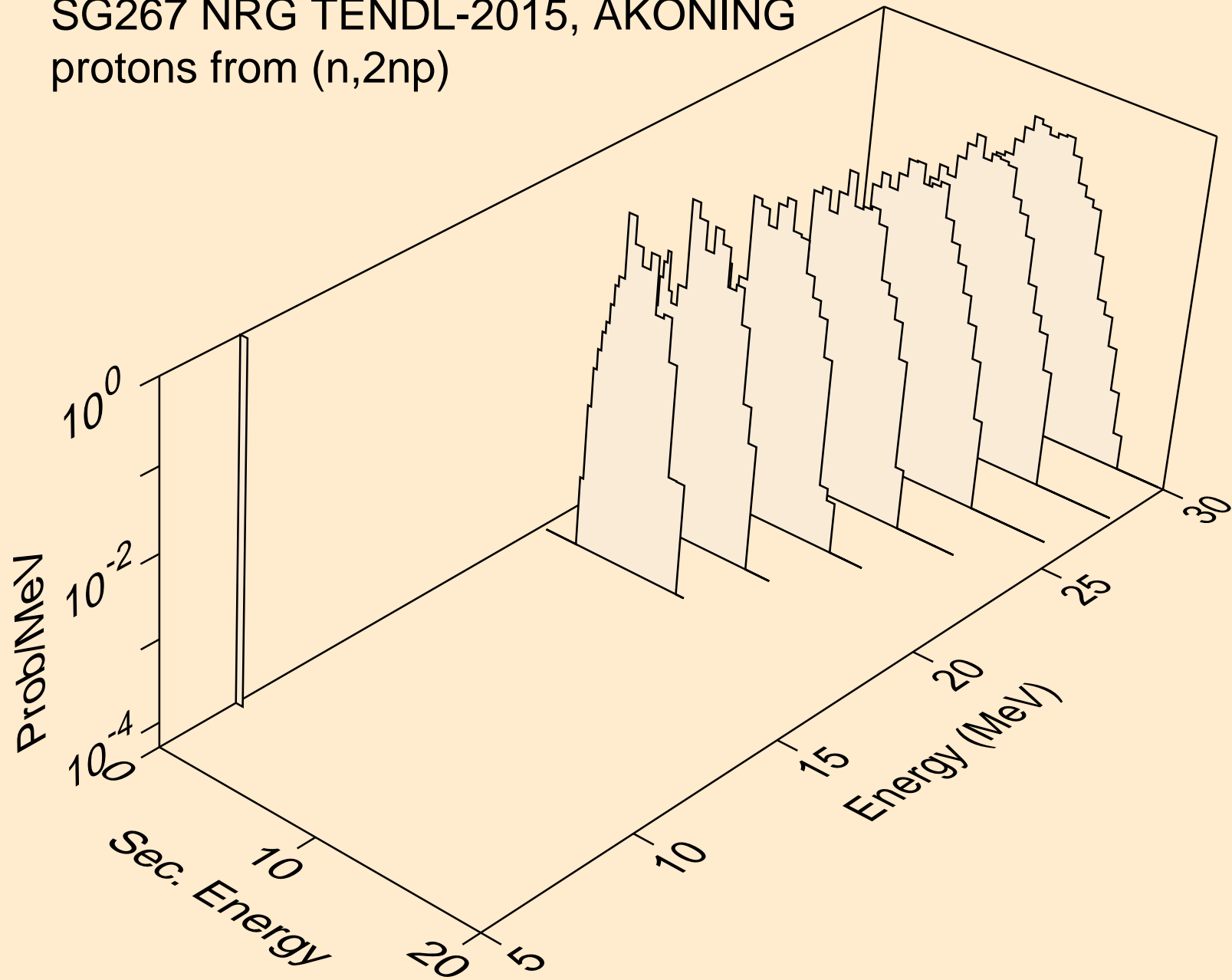



SG267 NRG TENDL-2015, AKONING  
protons from (n,npa)

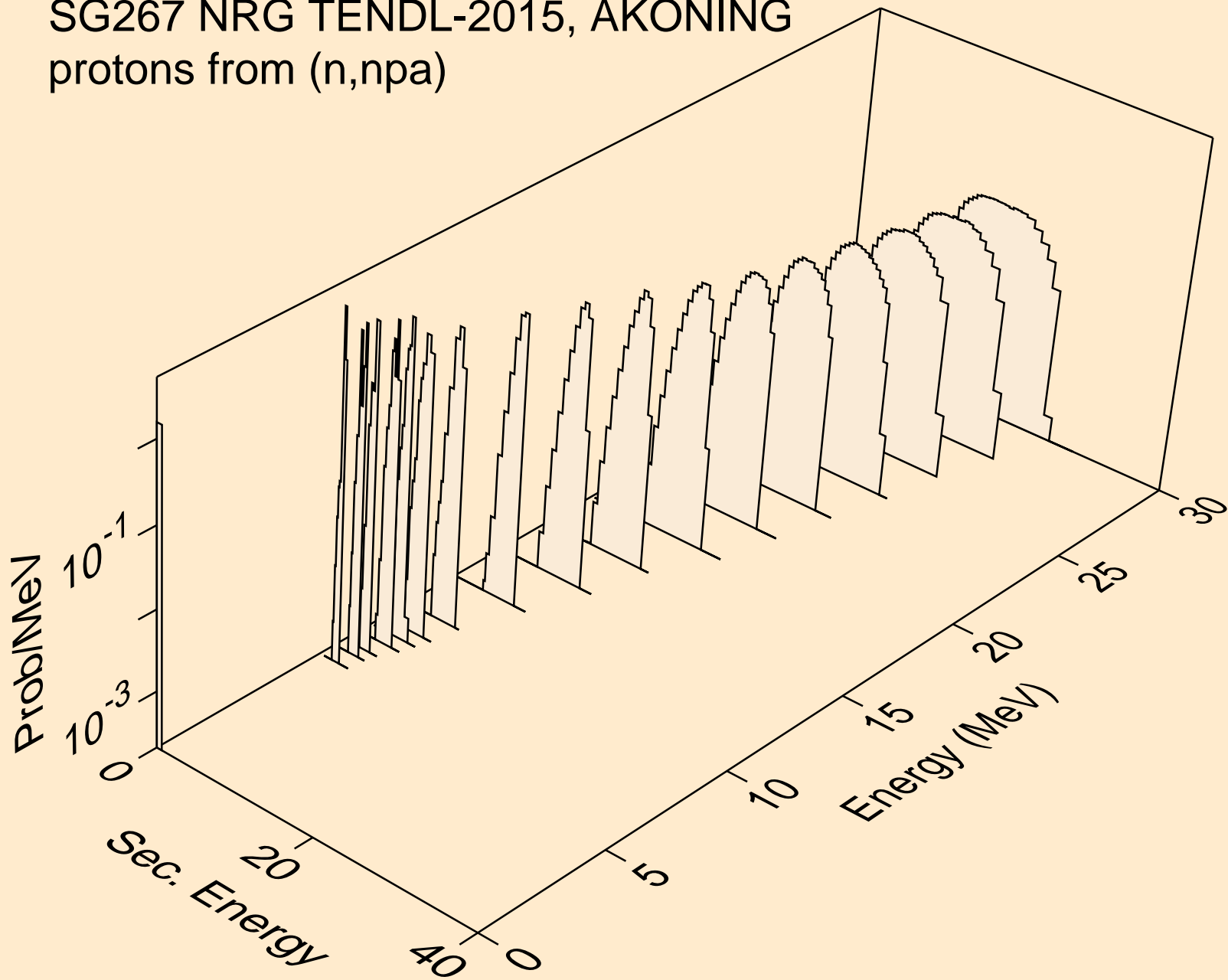

SG267 NRG TENDL-2015, AKONING  
protons from (n,p)

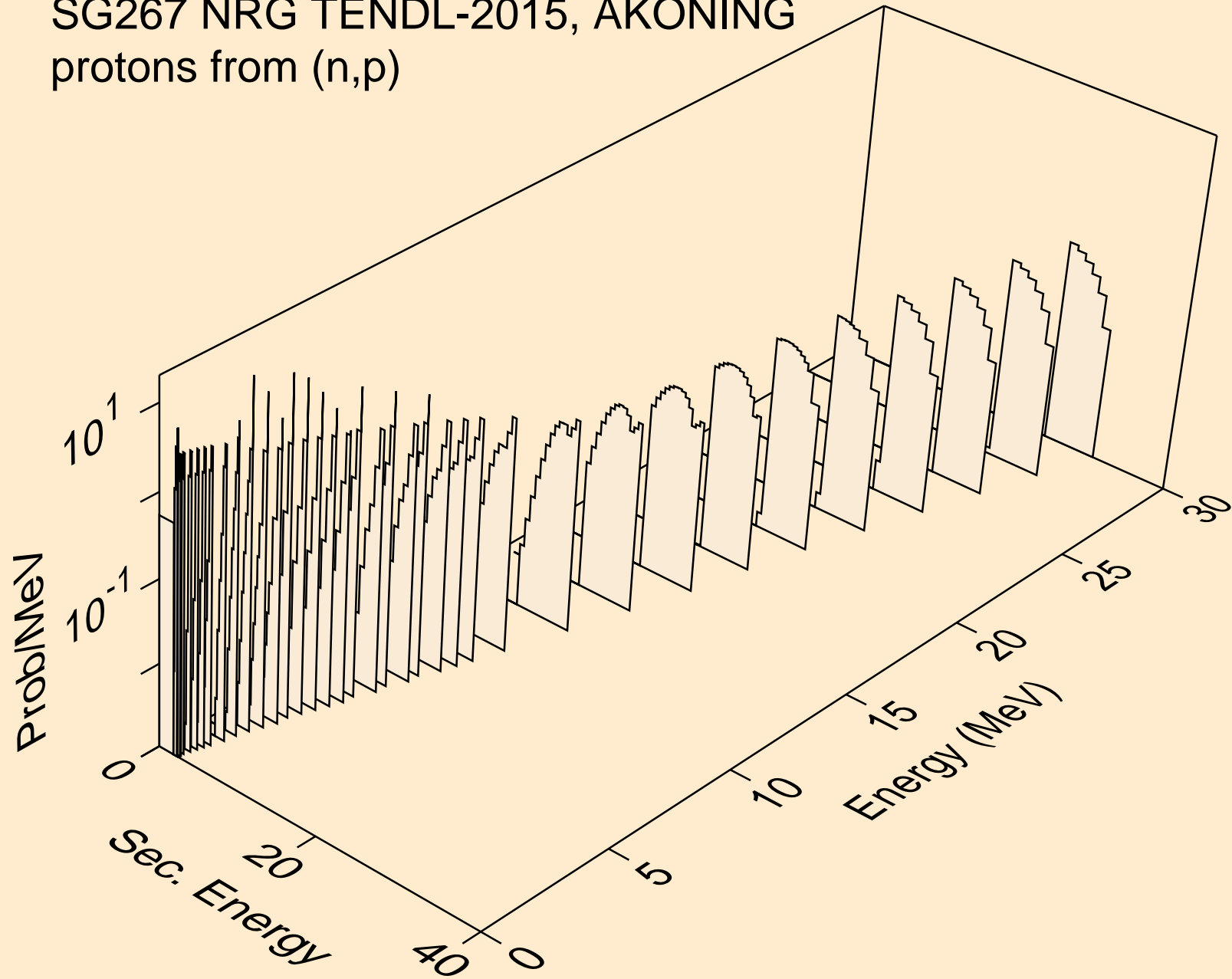

SG267 NRG TENDL-2015, AKONING  
protons from (n,2p)

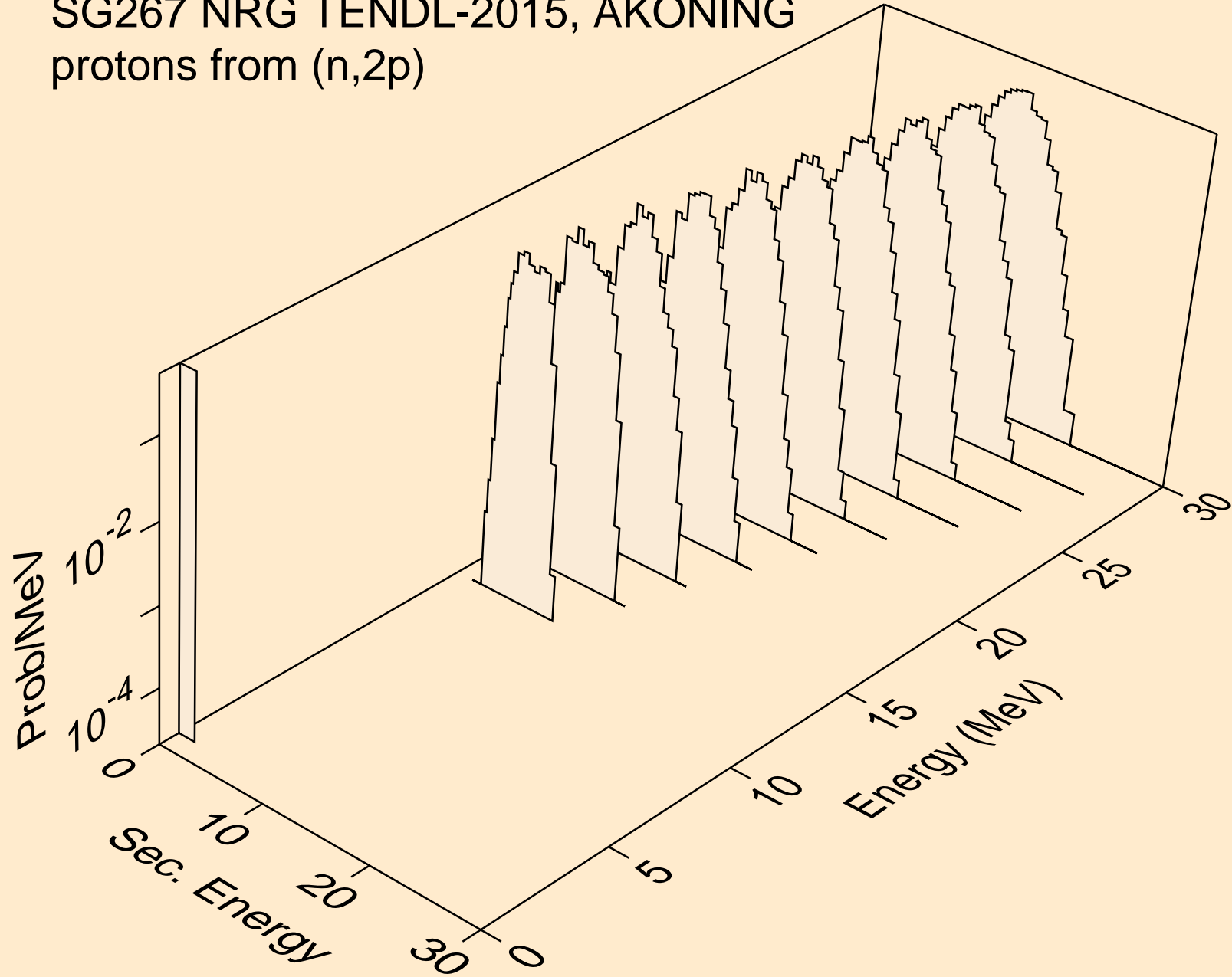

SG267 NRG TENDL-2015, AKONING  
protons from (n,pa)

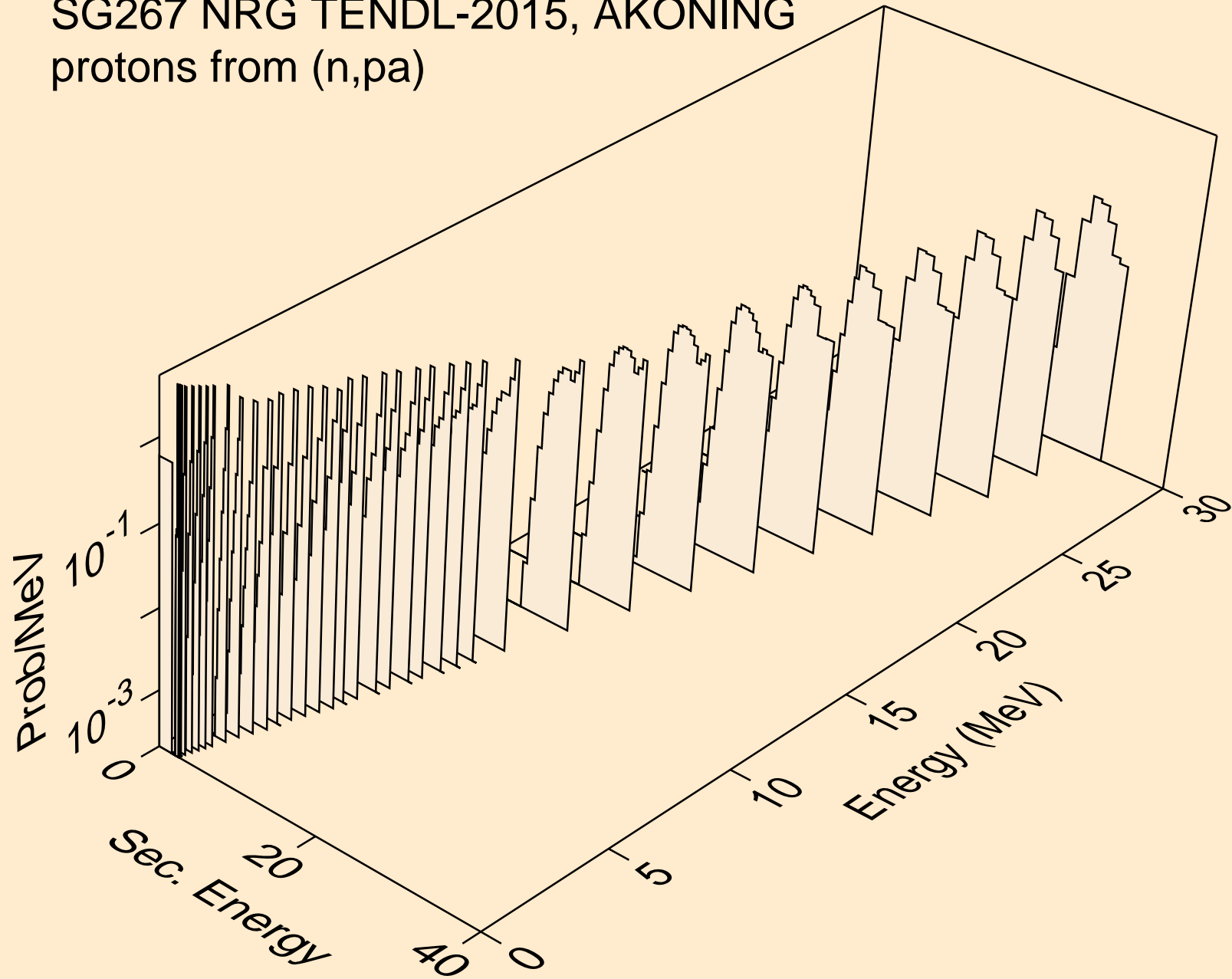

SG267 NRG TENDL-2015, AKONING  
protons from (n,pd)

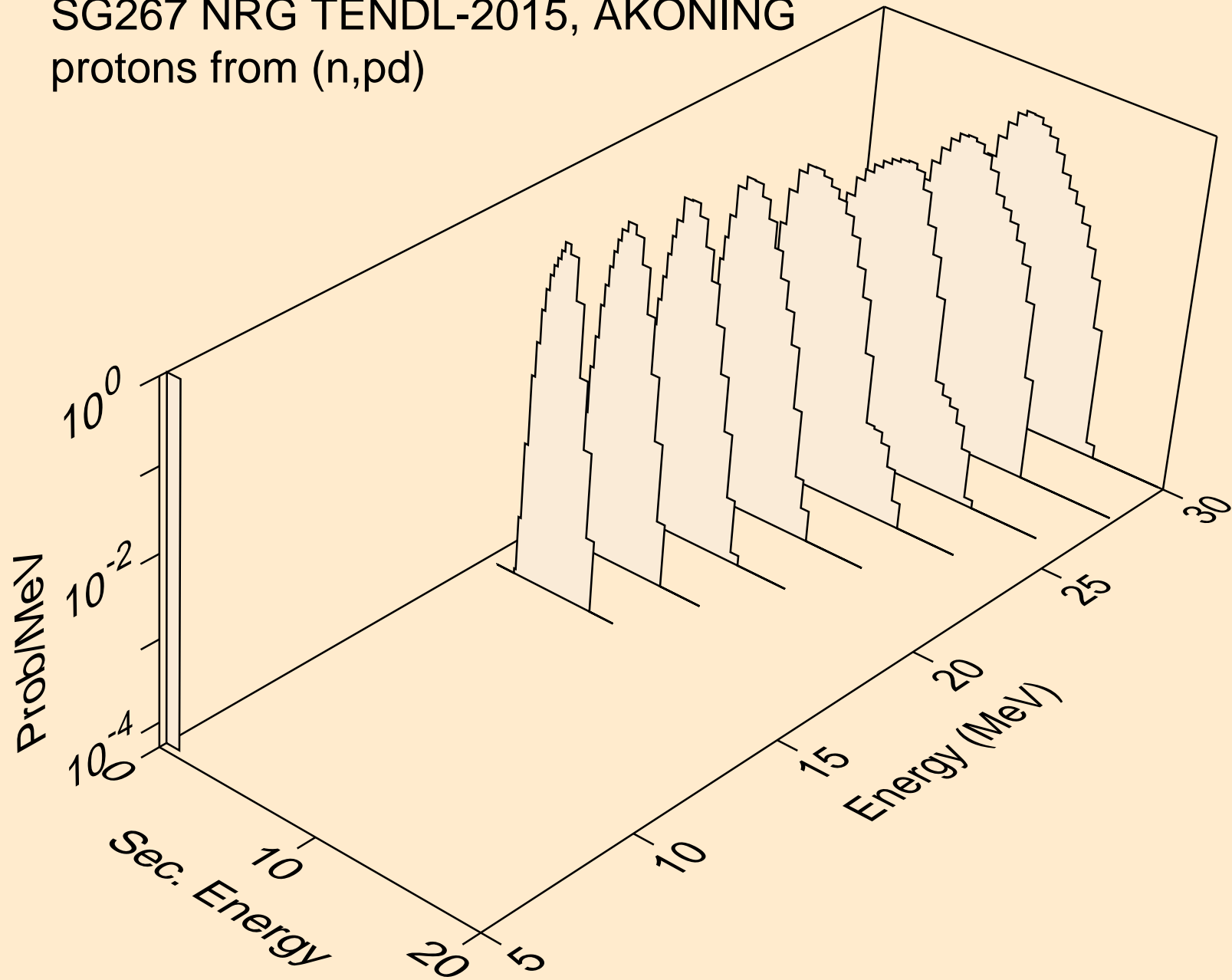

SG267 NRG TENDL-2015, AKONING  
deuterons from (n,x)

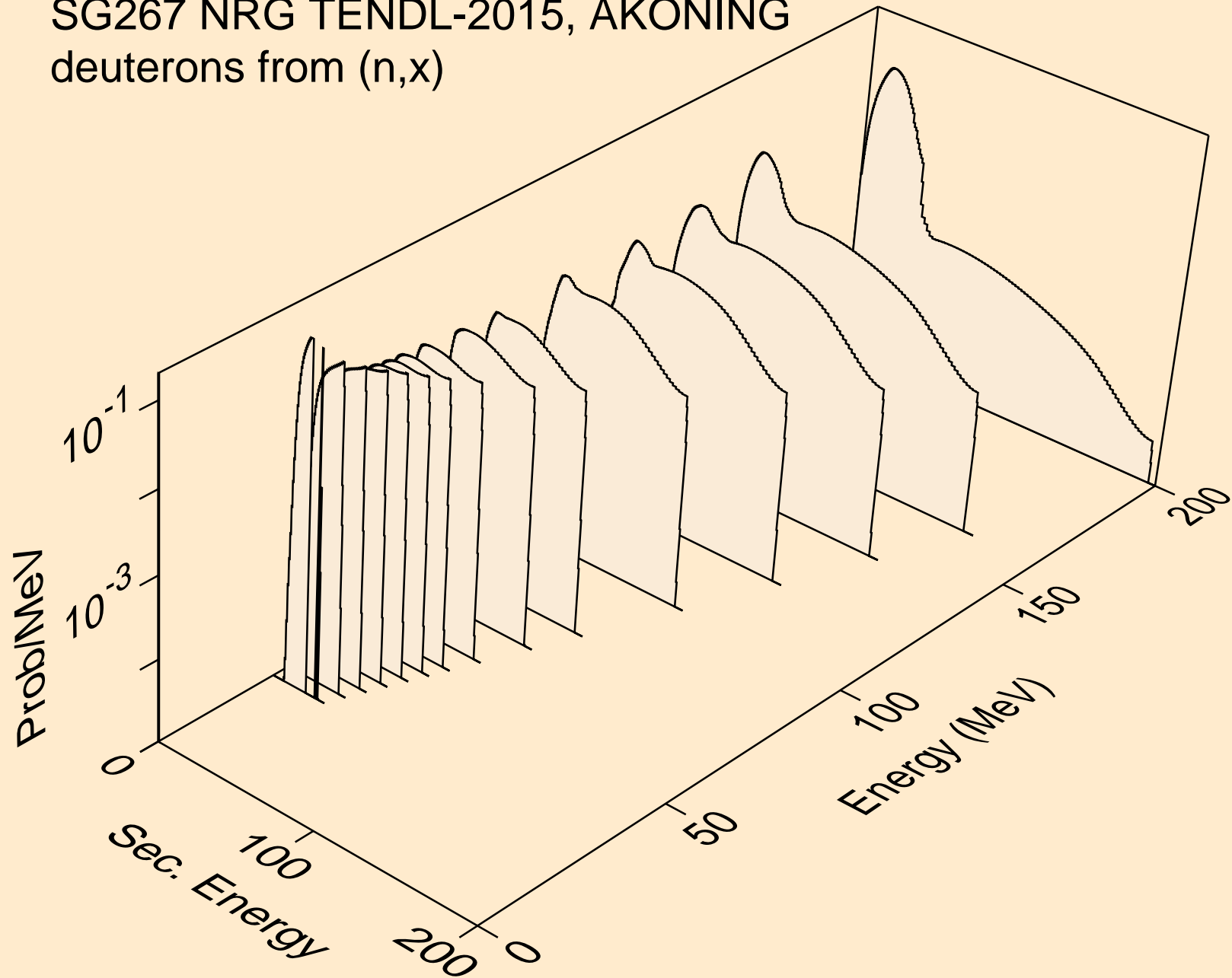

SG267 NRG TENDL-2015, AKONING  
deuterons from (n,2nd)

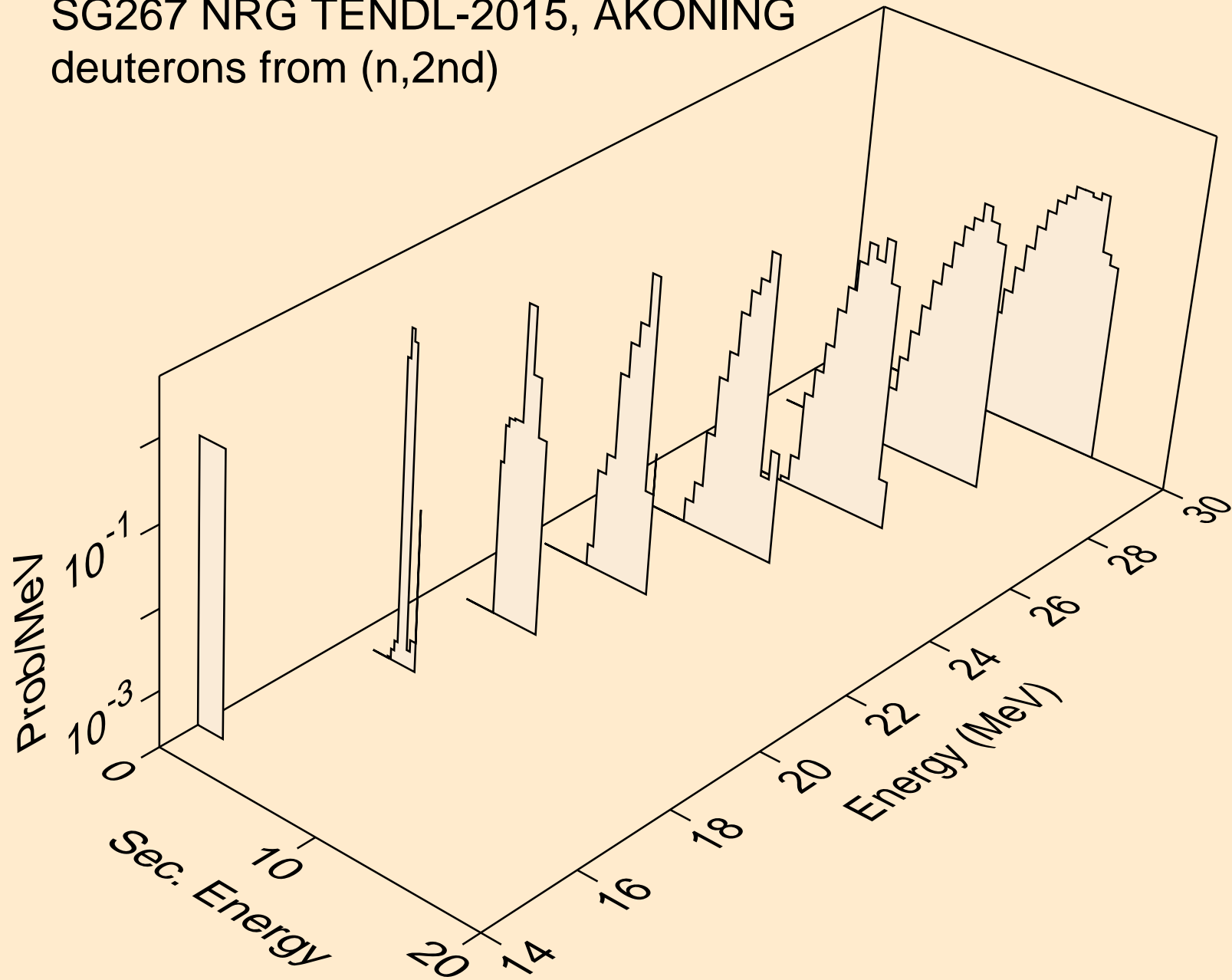

SG267 NRG TENDL-2015, AKONING  
deuterons from (n,n\*)d

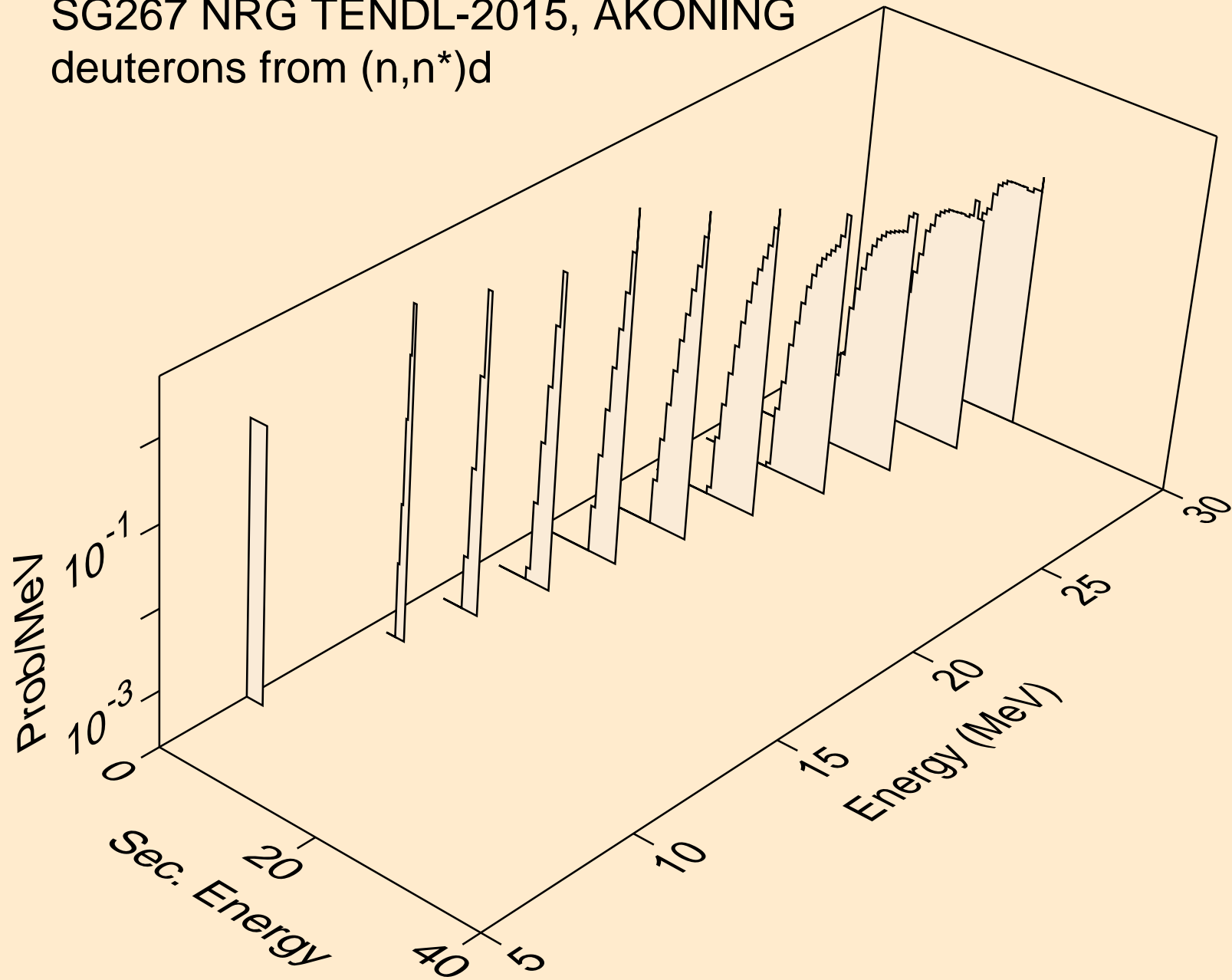



SG267 NRG TENDL-2015, AKONING  
deuterons from (n,n\*)d2a

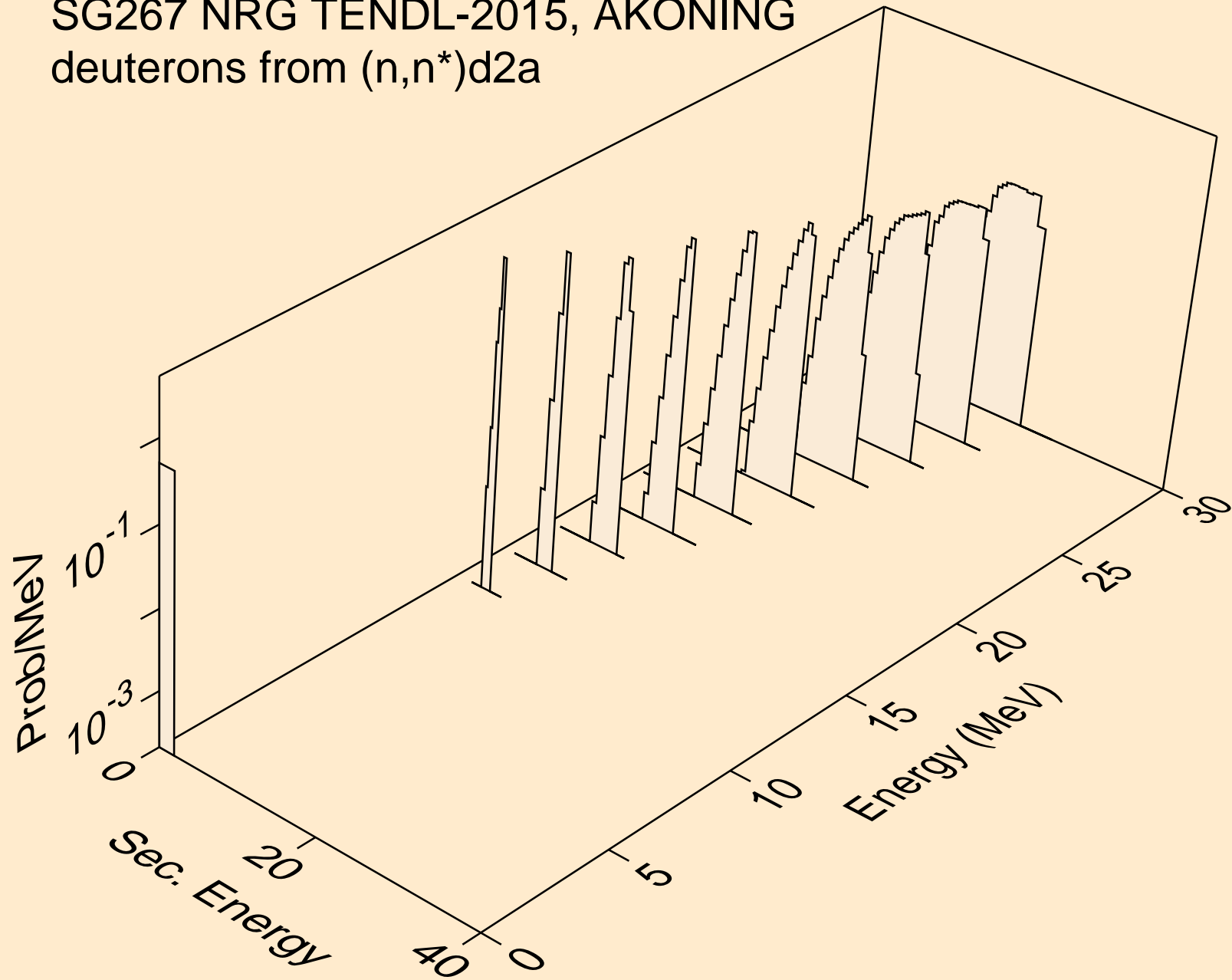

SG267 NRG TENDL-2015, AKONING  
deuterons from (n,d)

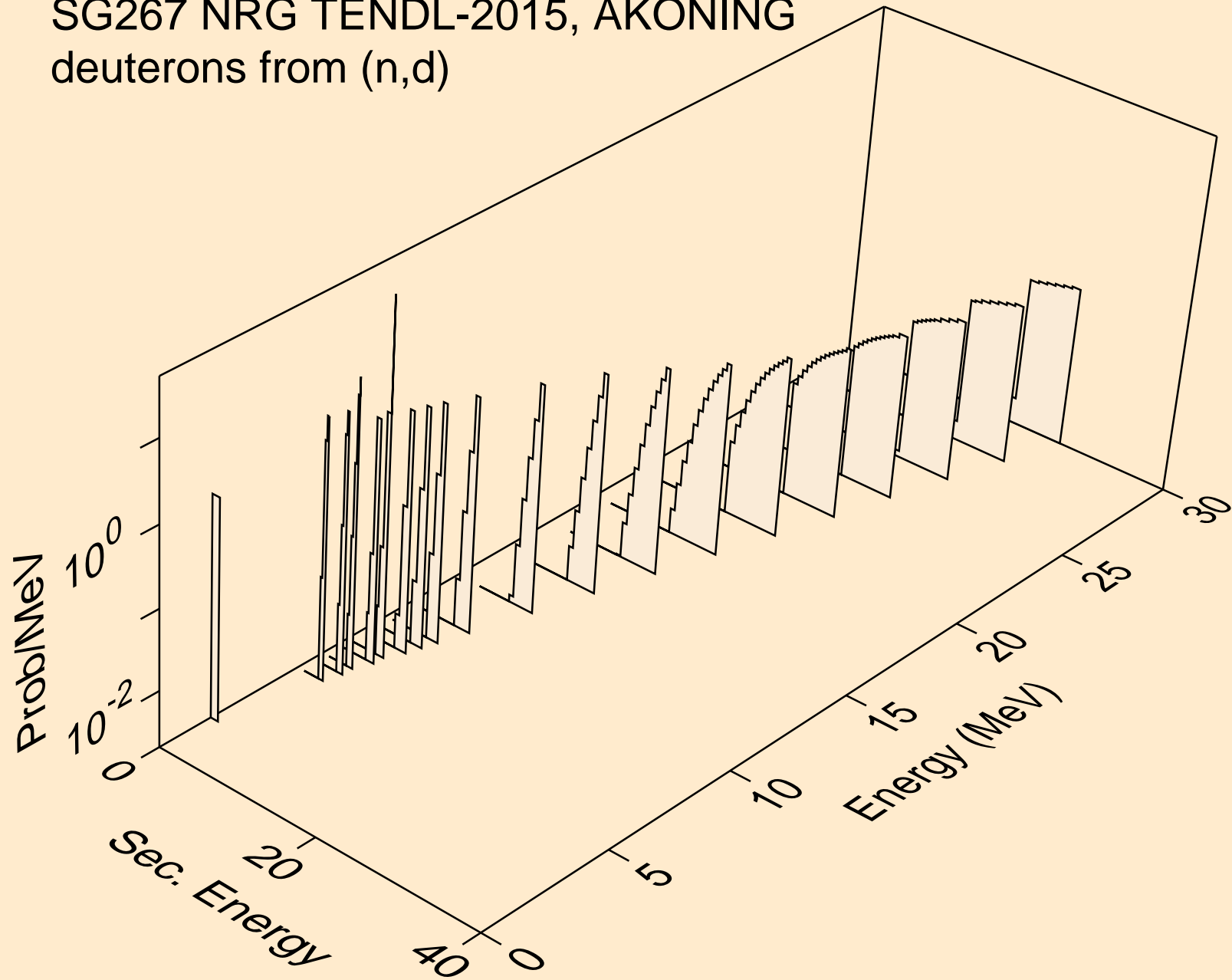

SG267 NRG TENDL-2015, AKONING  
deuterons from (n,d2a)

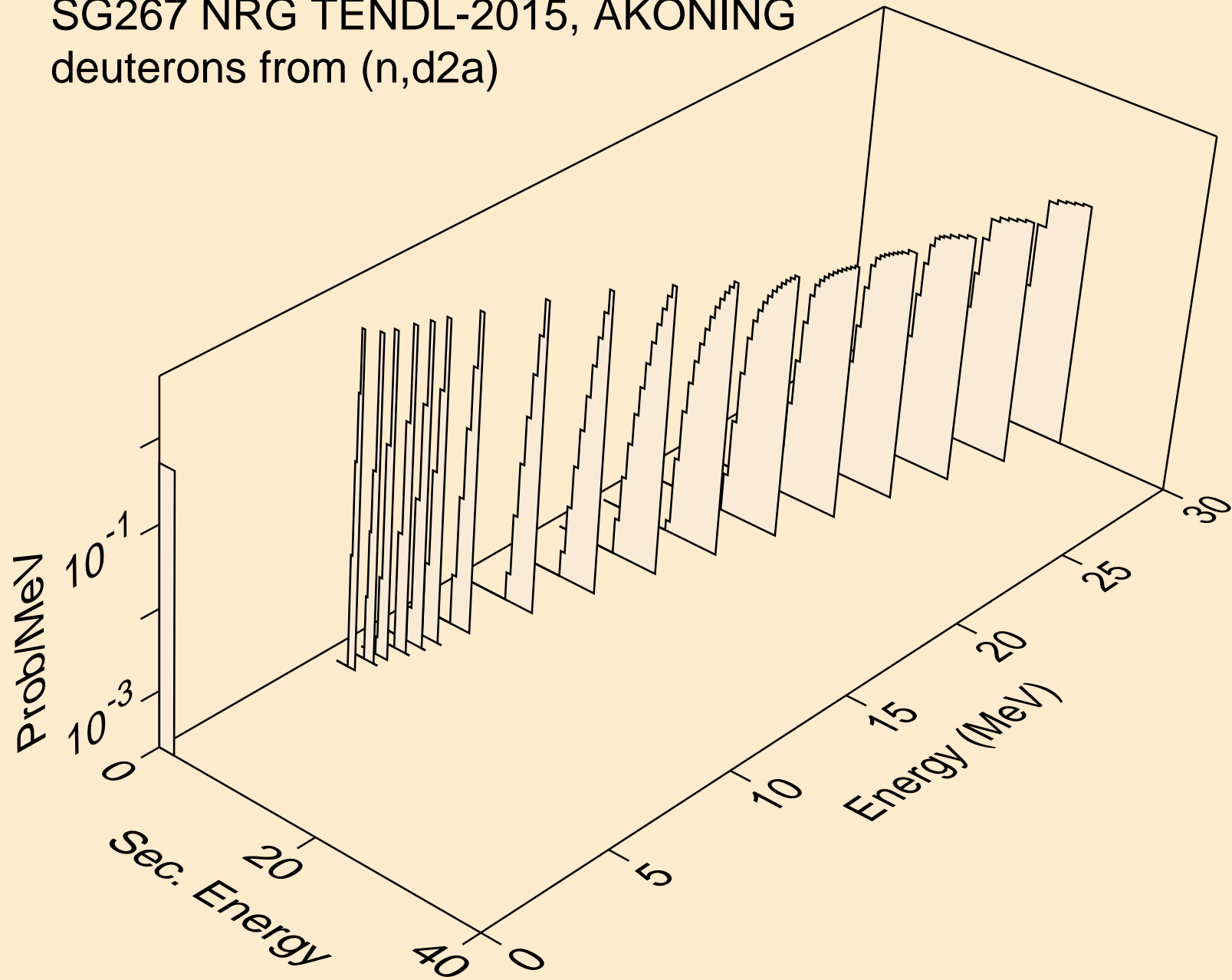

SG267 NRG TENDL-2015, AKONING  
deuterons from (n,pd)

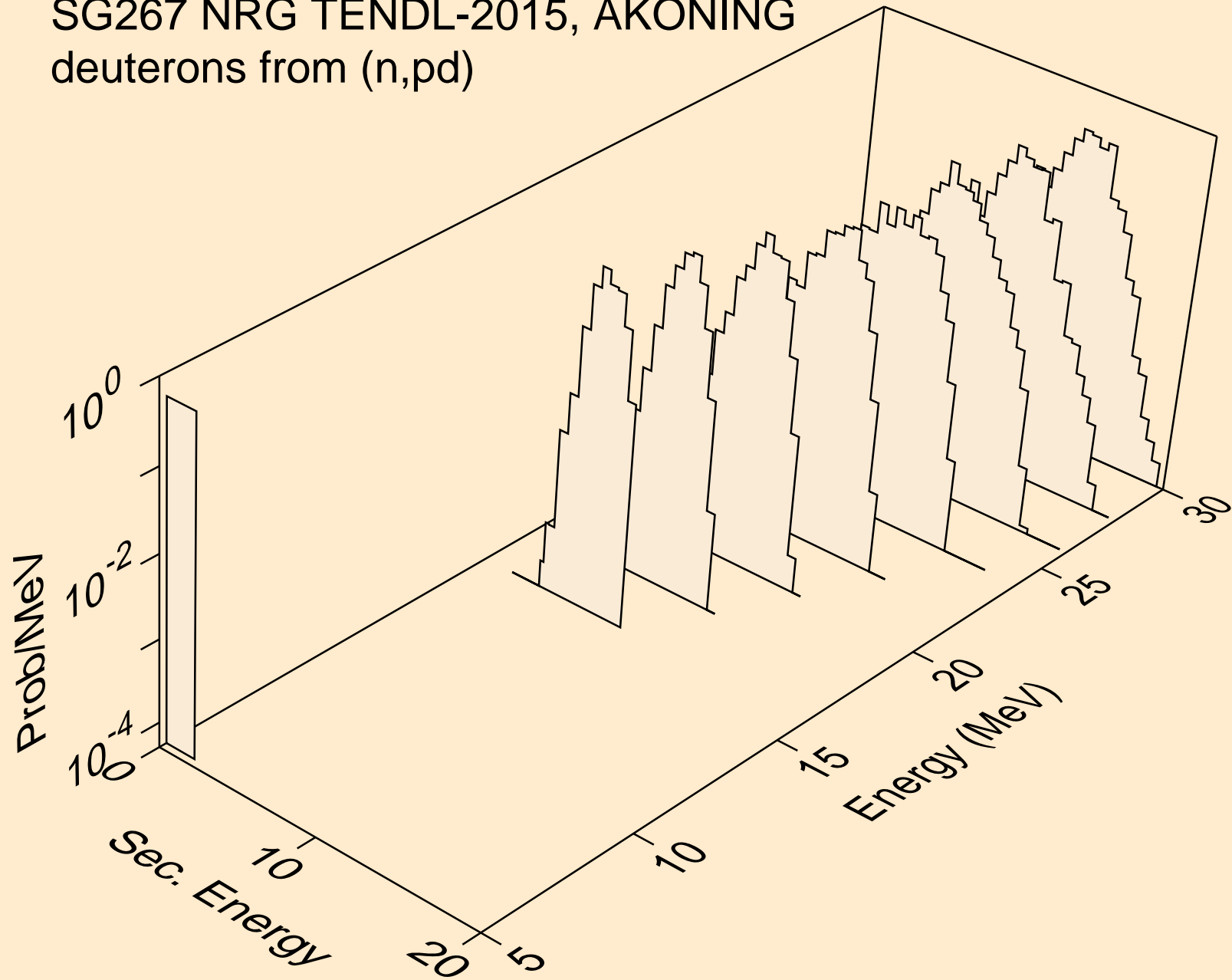

SG267 NRG TENDL-2015, AKONING  
deuterons from (n,da)

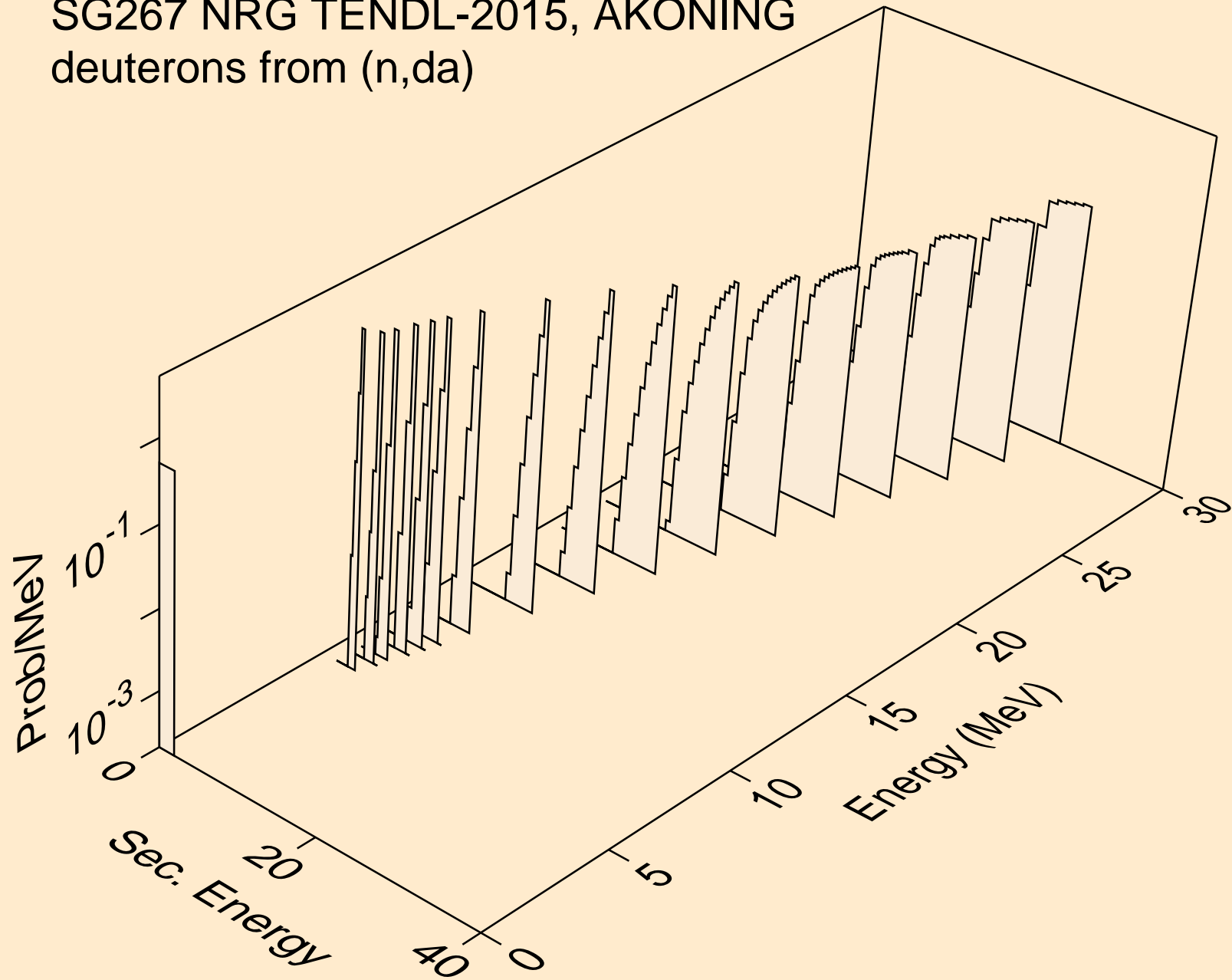

SG267 NRG TENDL-2015, AKONING  
tritons from (n,x)

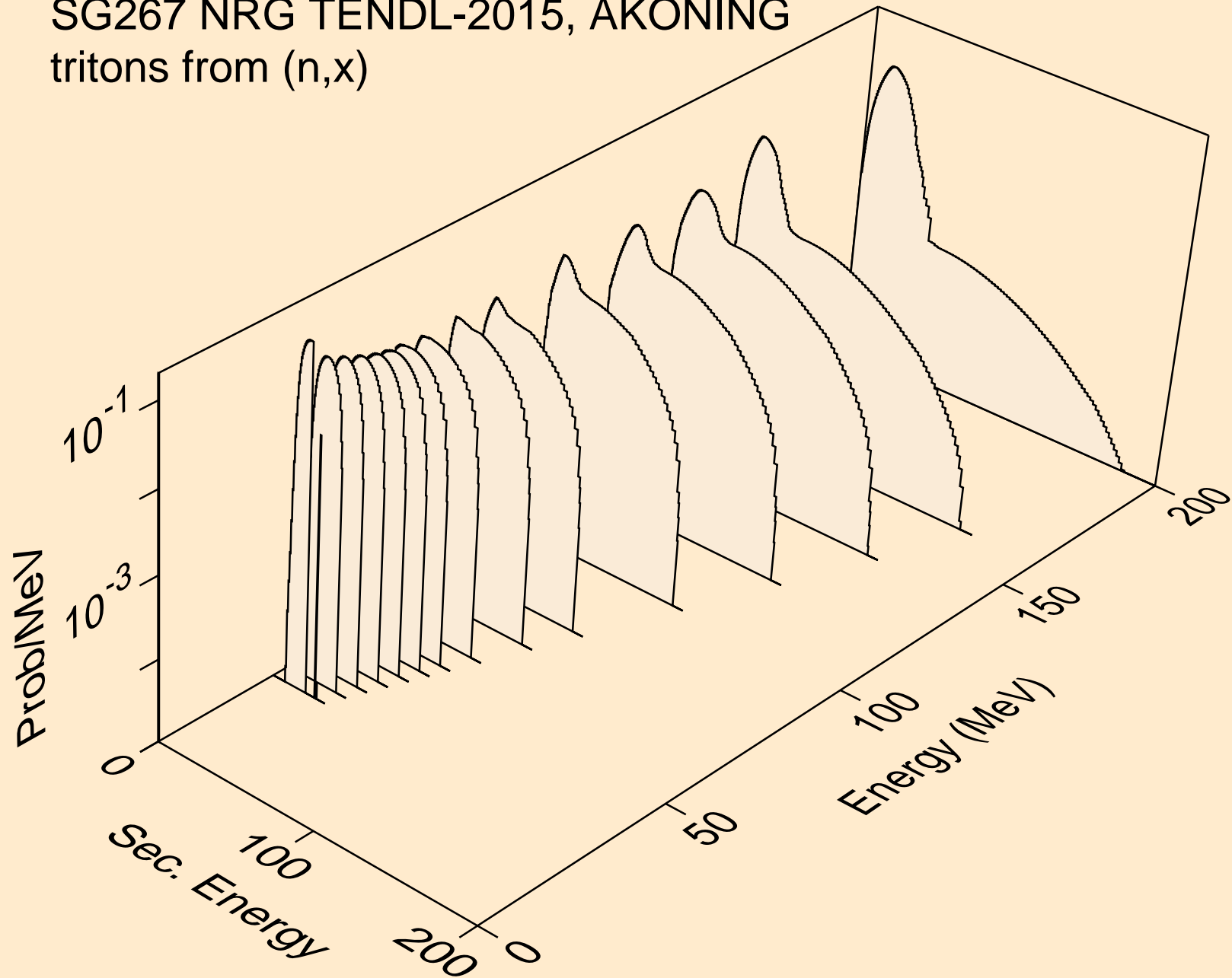

SG267 NRG TENDL-2015, AKONING  
tritons from (n,n\*)t

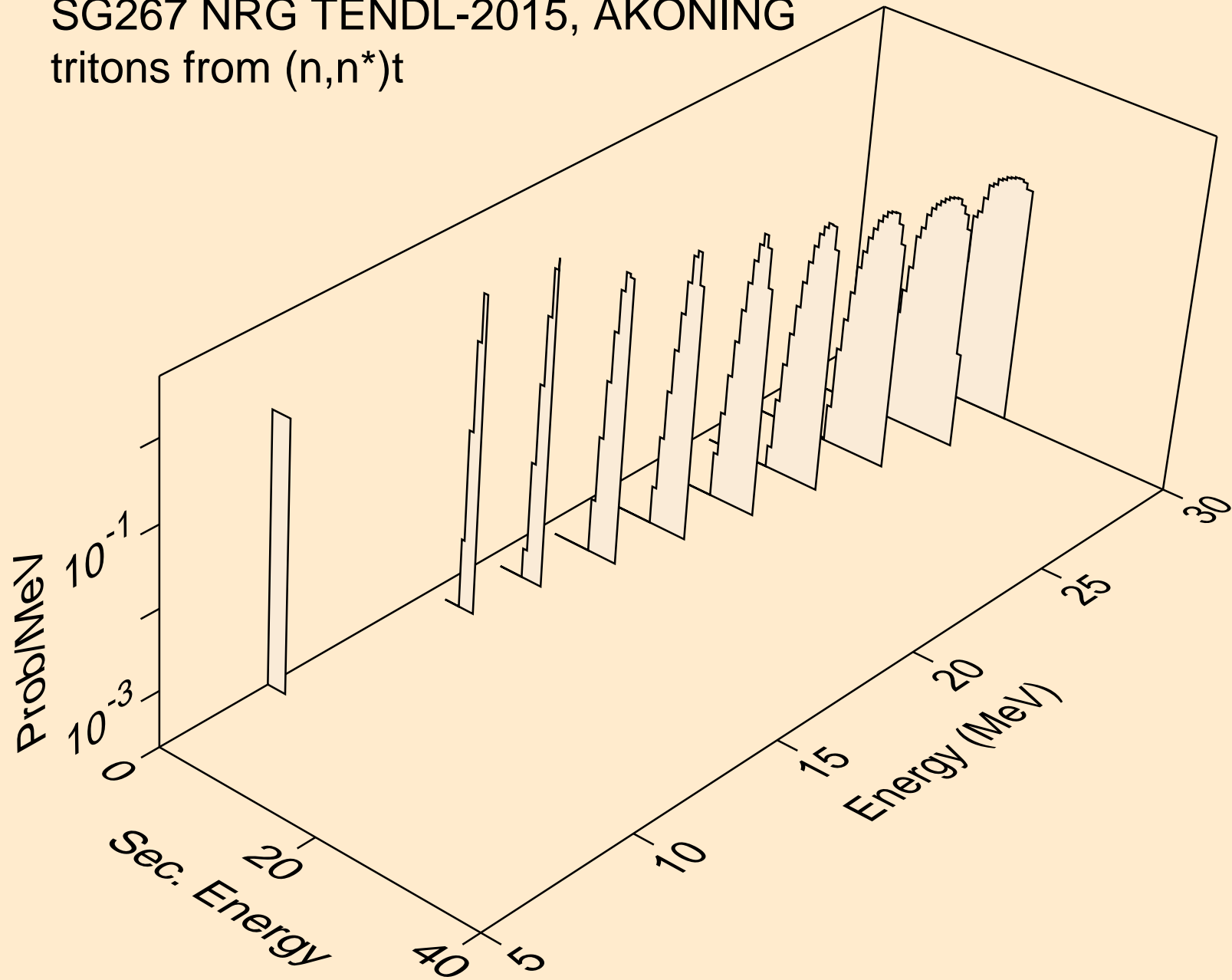

SG267 NRG TENDL-2015, AKONING  
tritons from (n,n\*)t2a

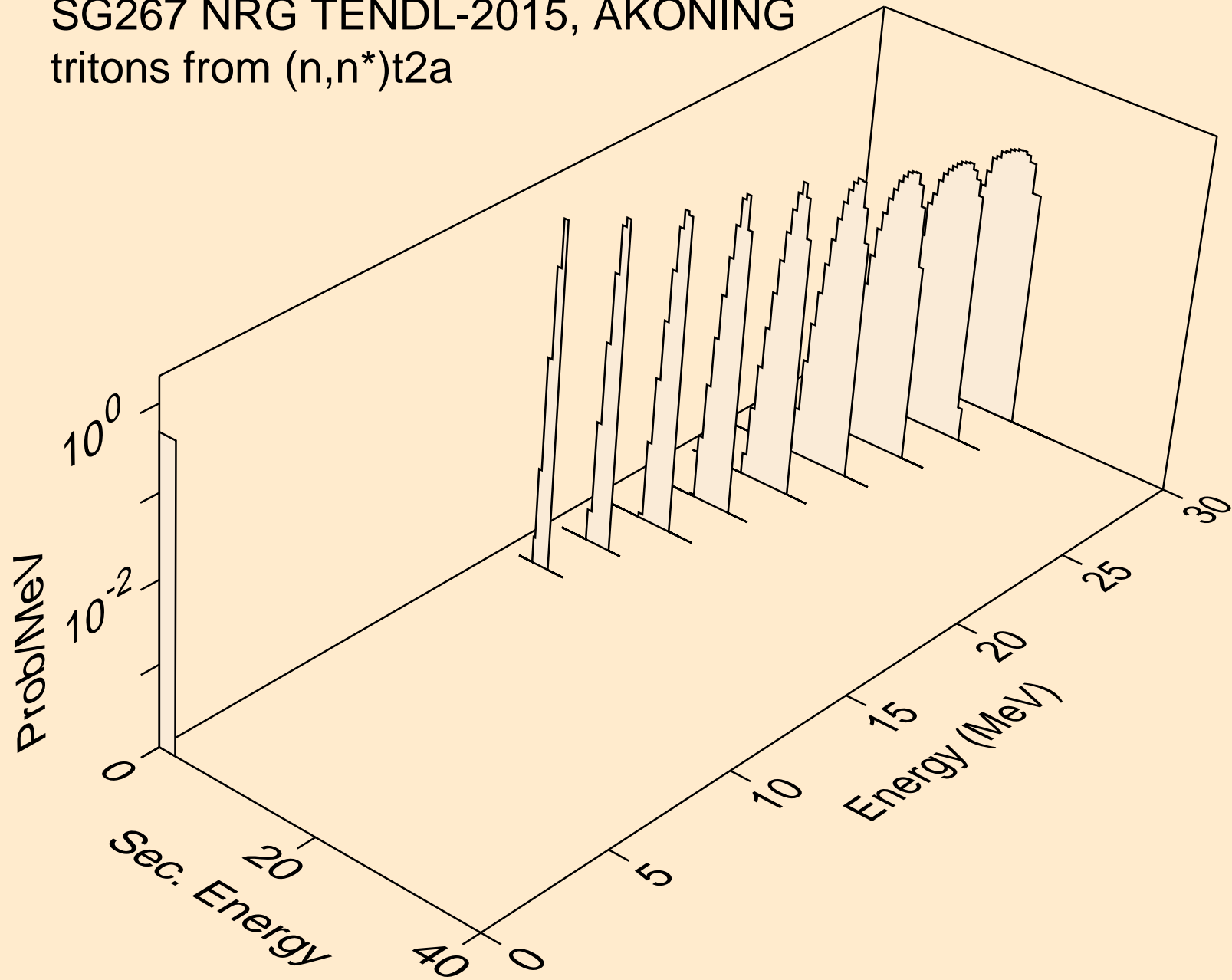



SG267 NRG TENDL-2015, AKONING  
tritons from (n,t)

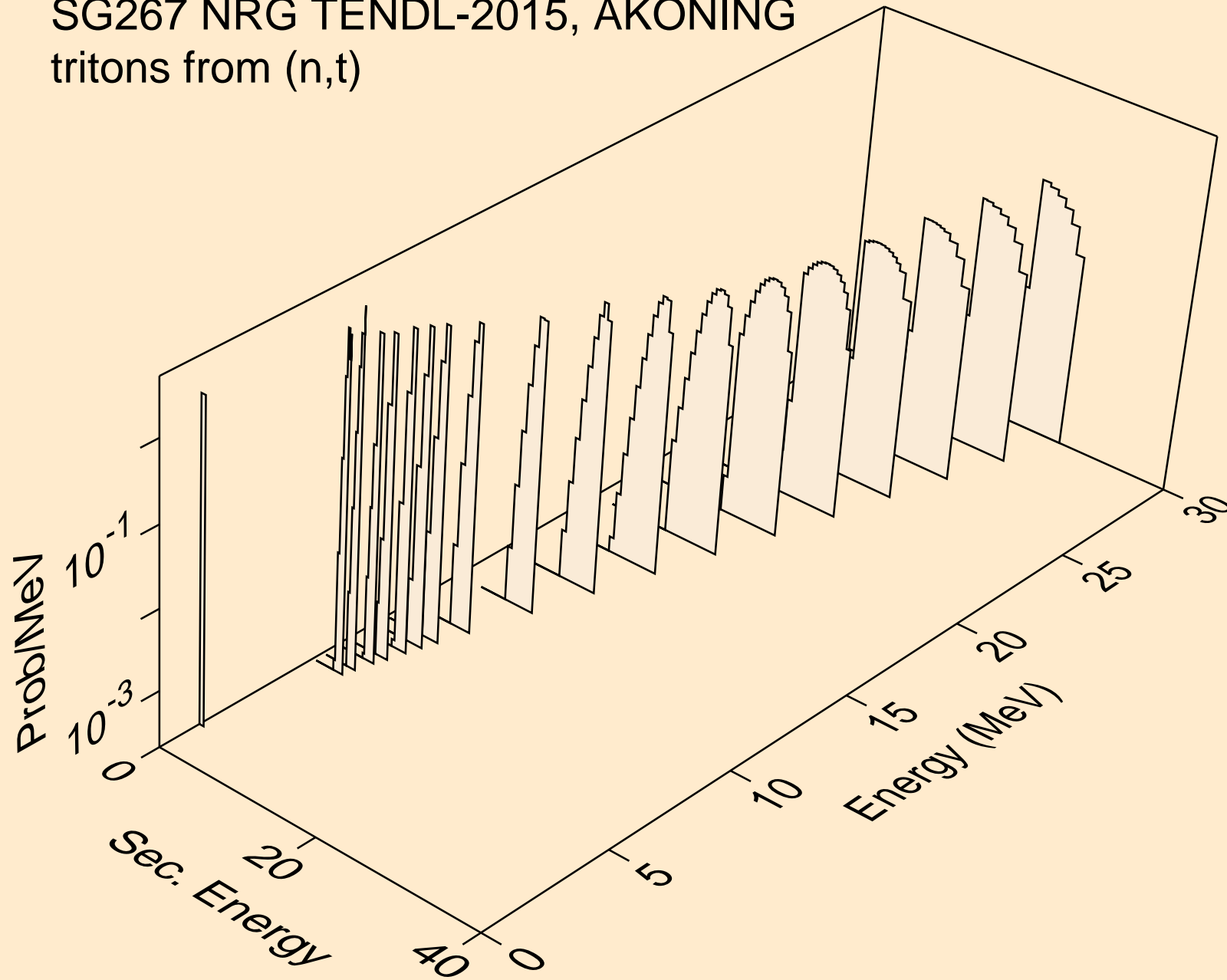

SG267 NRG TENDL-2015, AKONING  
tritons from (n,t2a)

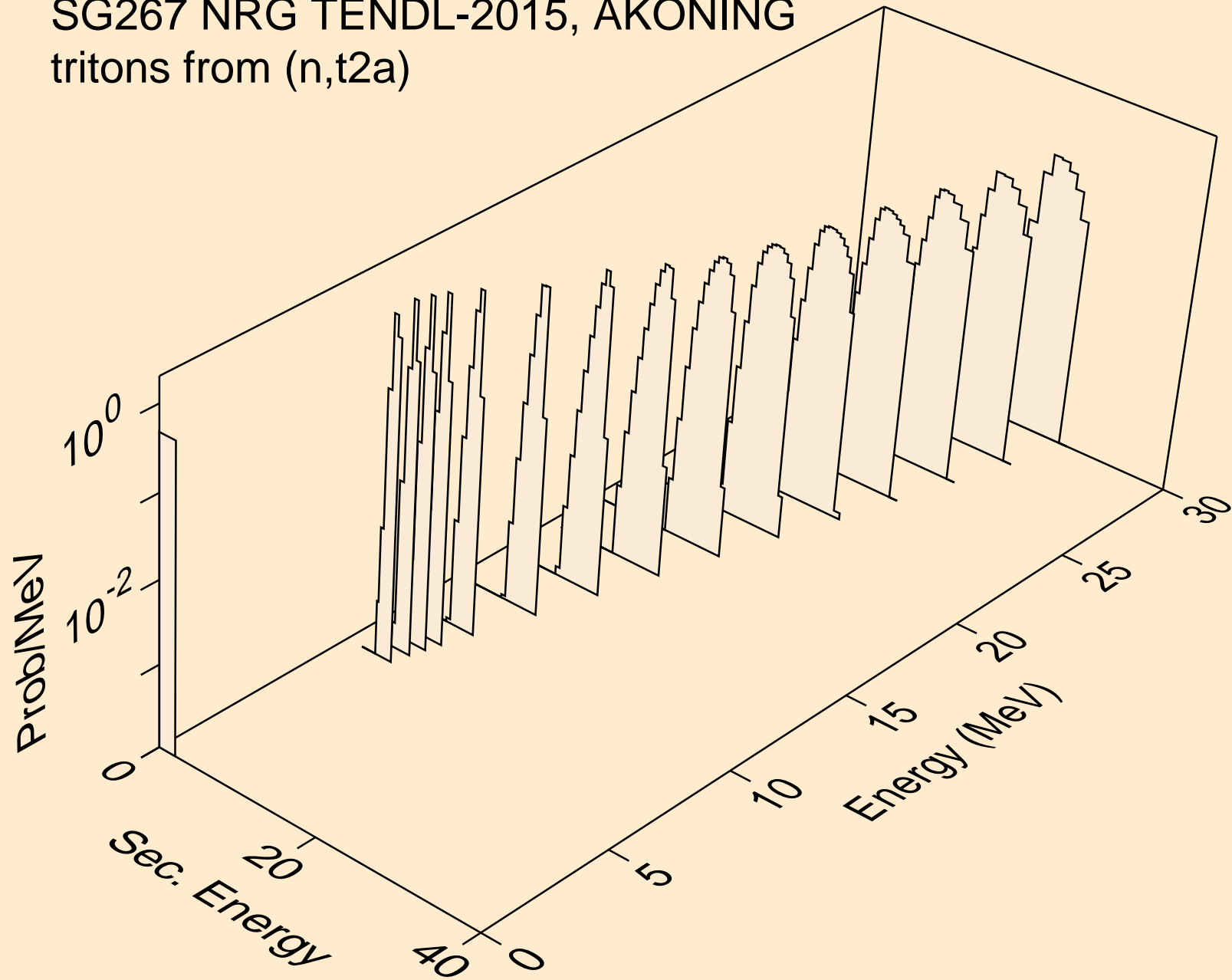

SG267 NRG TENDL-2015, AKONING  
he3s from (n,x)

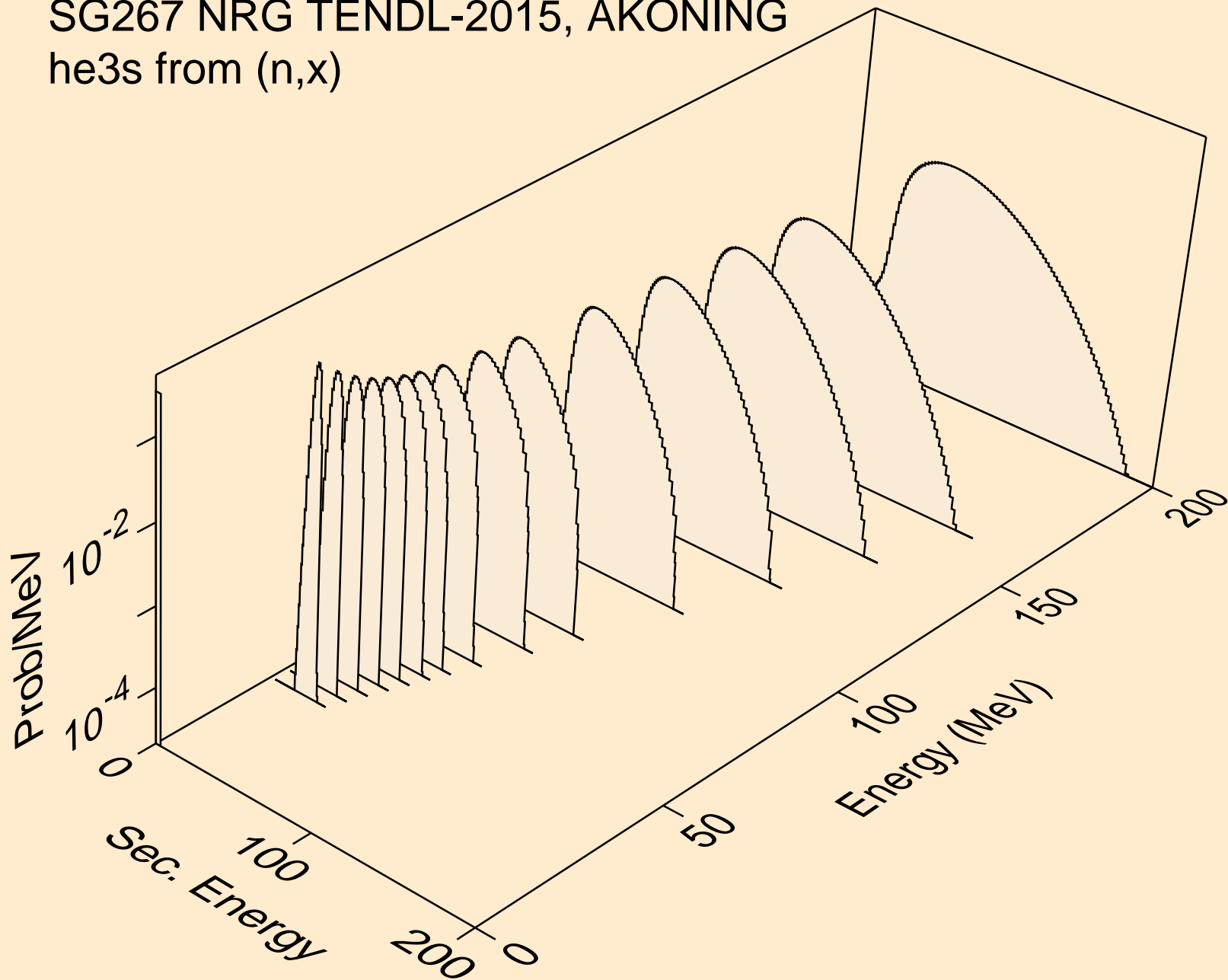

SG267 NRG TENDL-2015, AKONING  
he3s from (n,n\*)he3

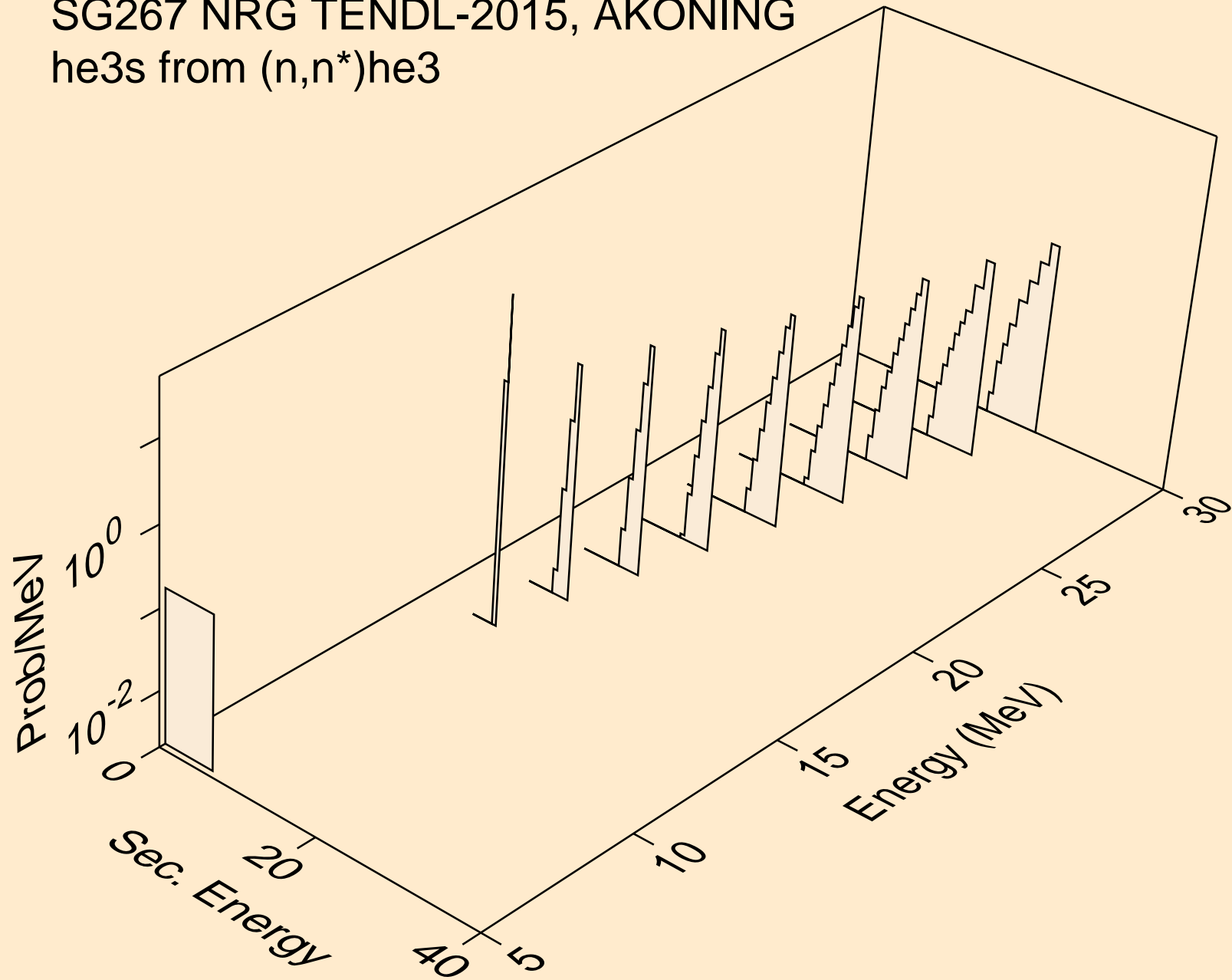

SG267 NRG TENDL-2015, AKONING  
he3s from (n,he3)

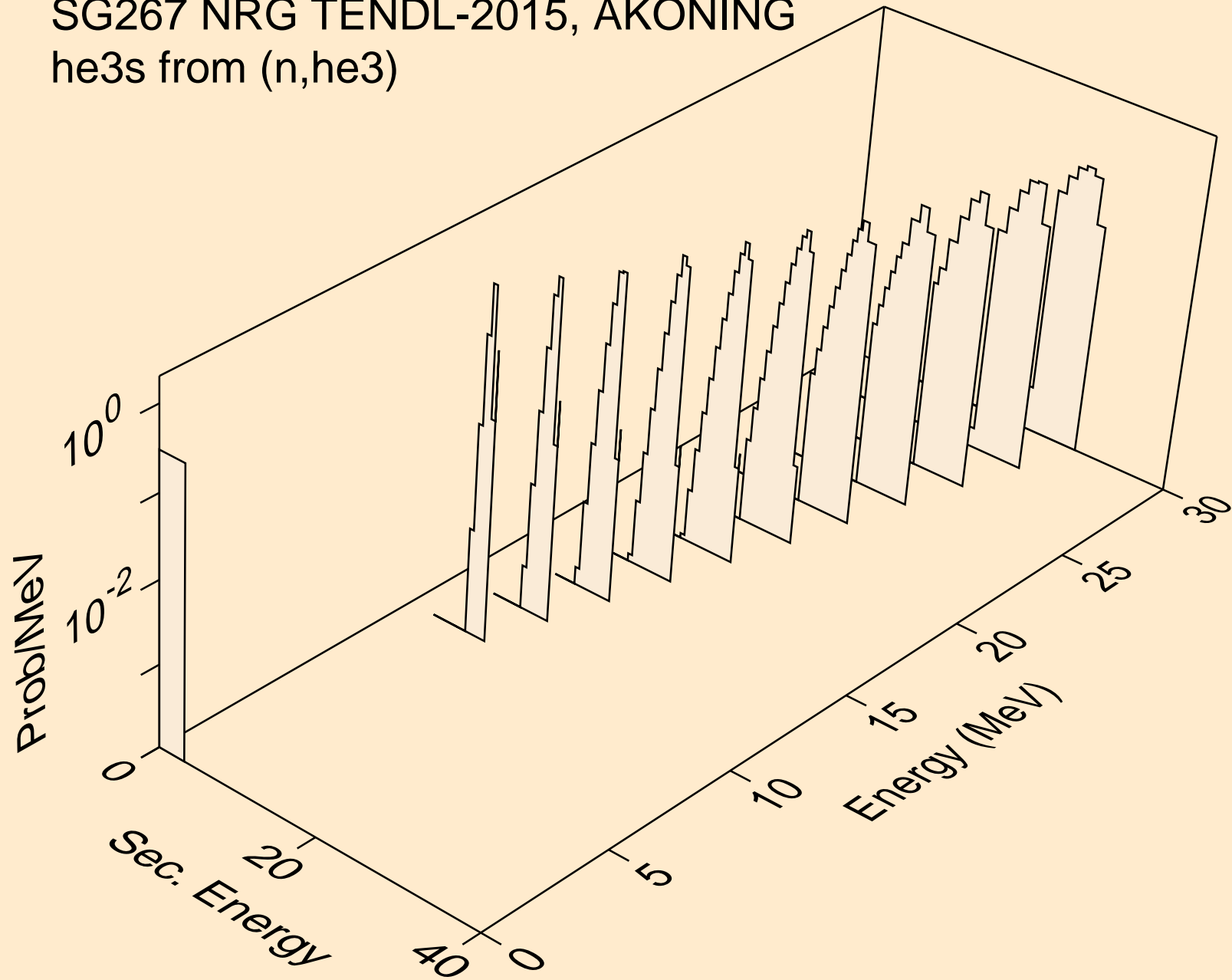

SG267 NRG TENDL-2015, AKONING  
alphas from (n,x)

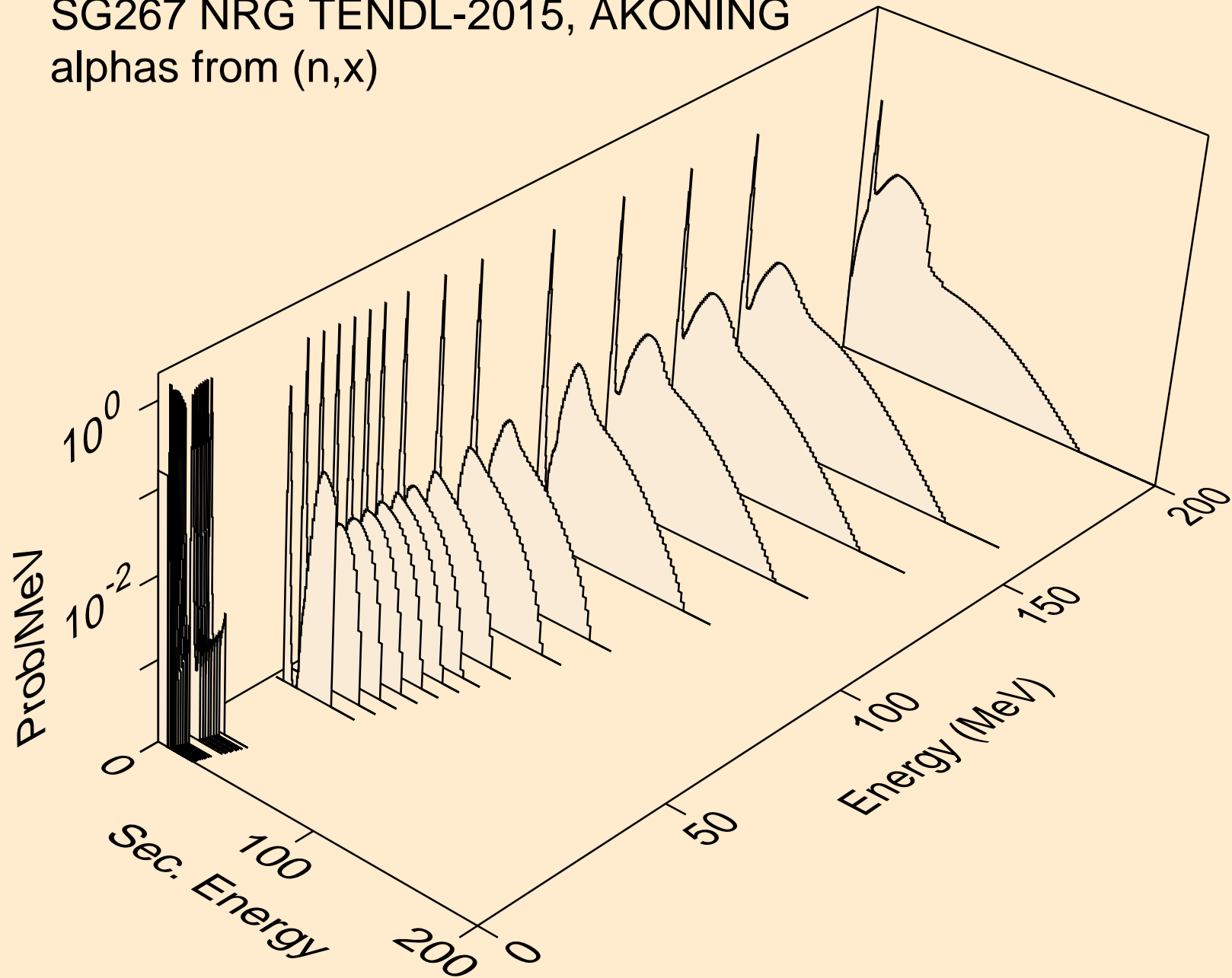

SG267 NRG TENDL-2015, AKONING  
alphas from (n,n\*)a

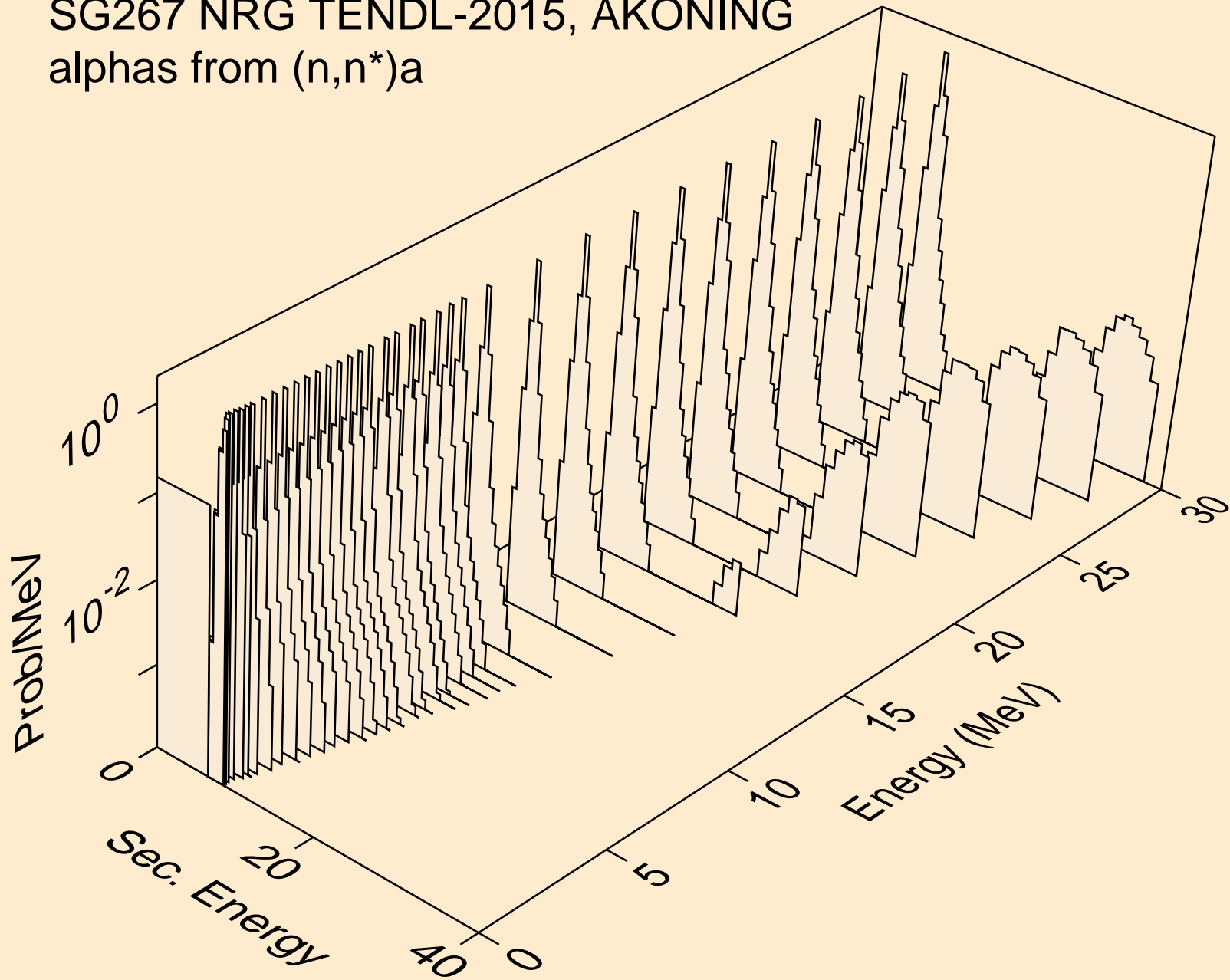

SG267 NRG TENDL-2015, AKONING  
alphas from (n,n\*)3a

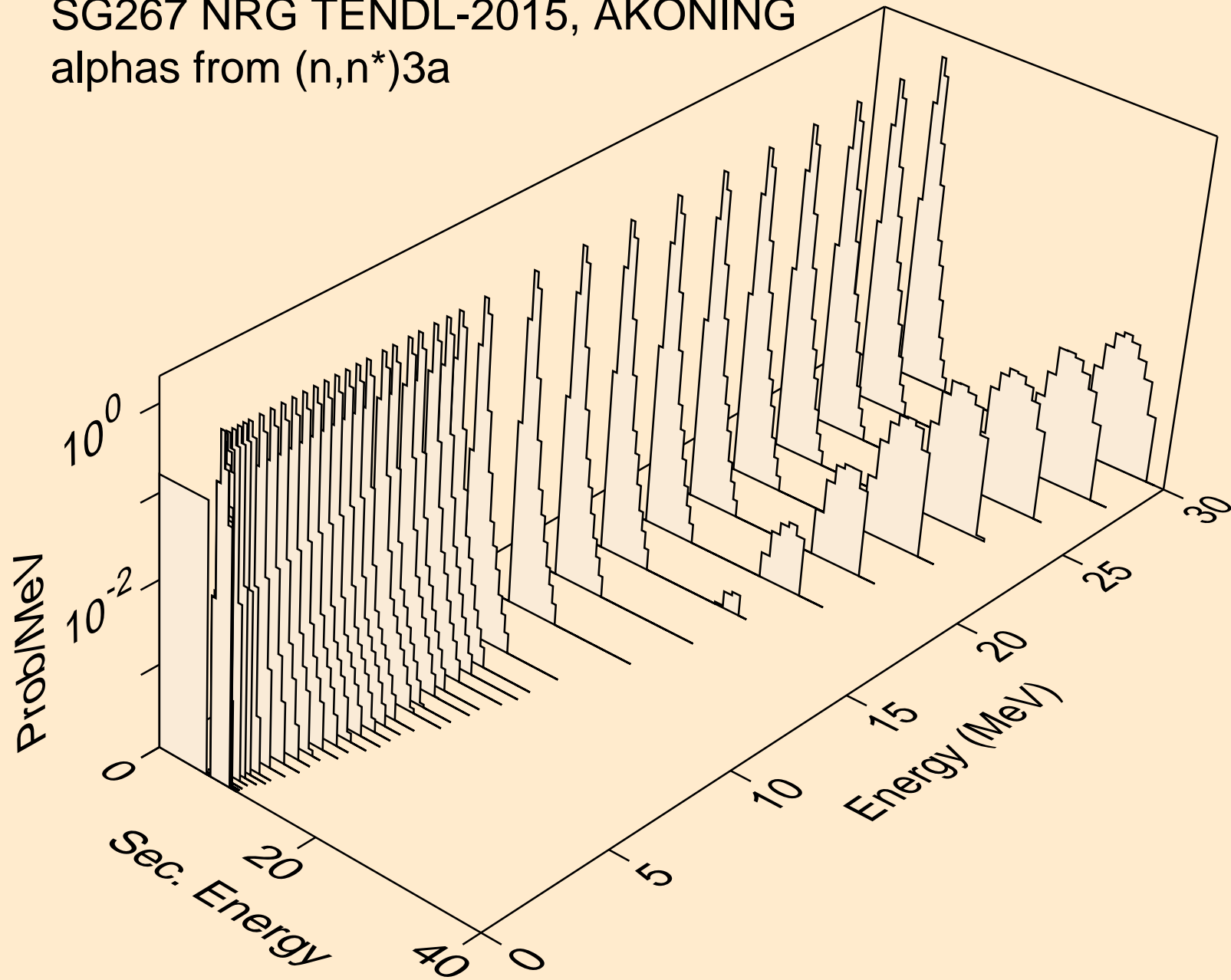



SG267 NRG TENDL-2015, AKONING  
alphas from (n,2n)a

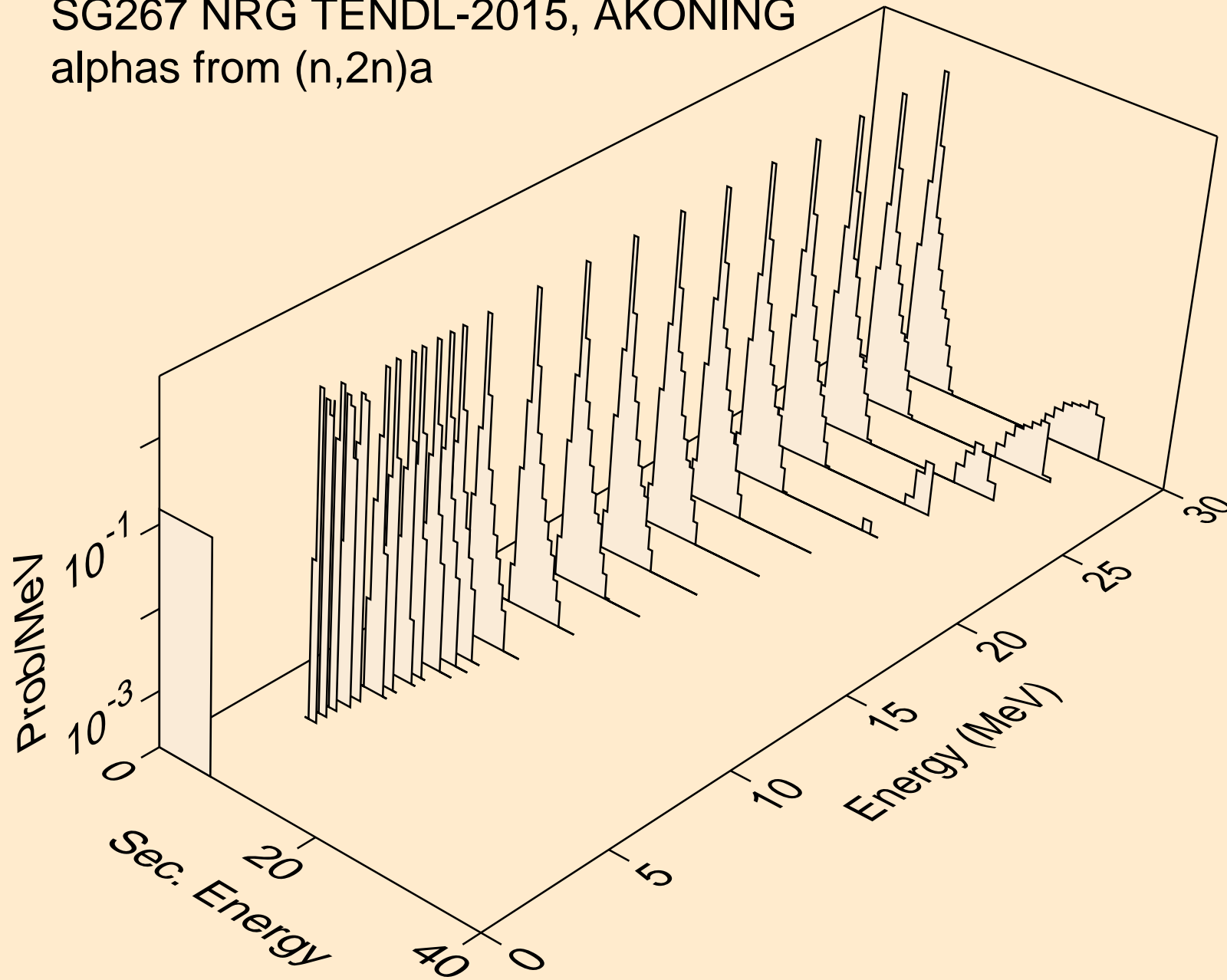

SG267 NRG TENDL-2015, AKONING  
alphas from (n,3n)a

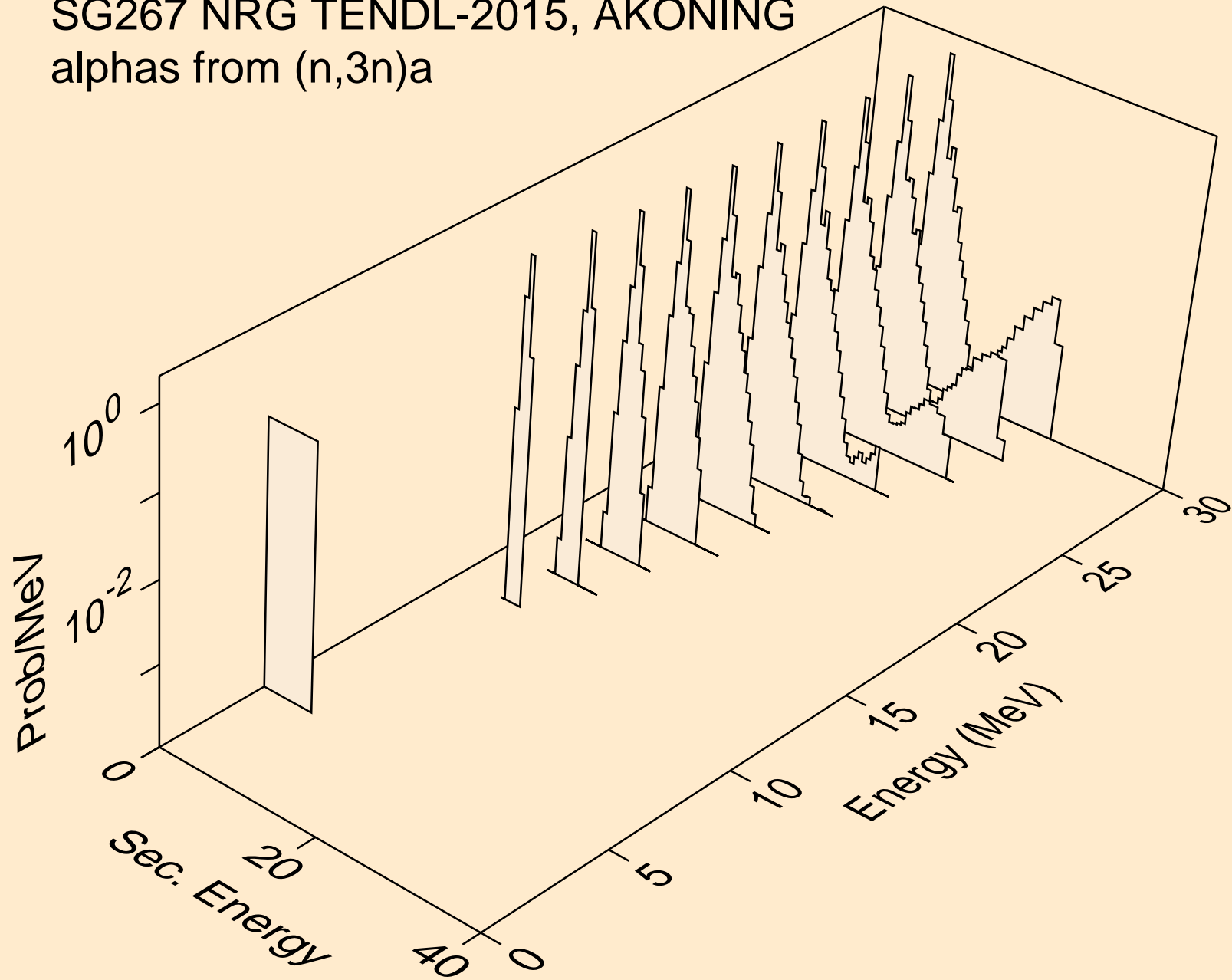

SG267 NRG TENDL-2015, AKONING  
alphas from (n,n\*)2a

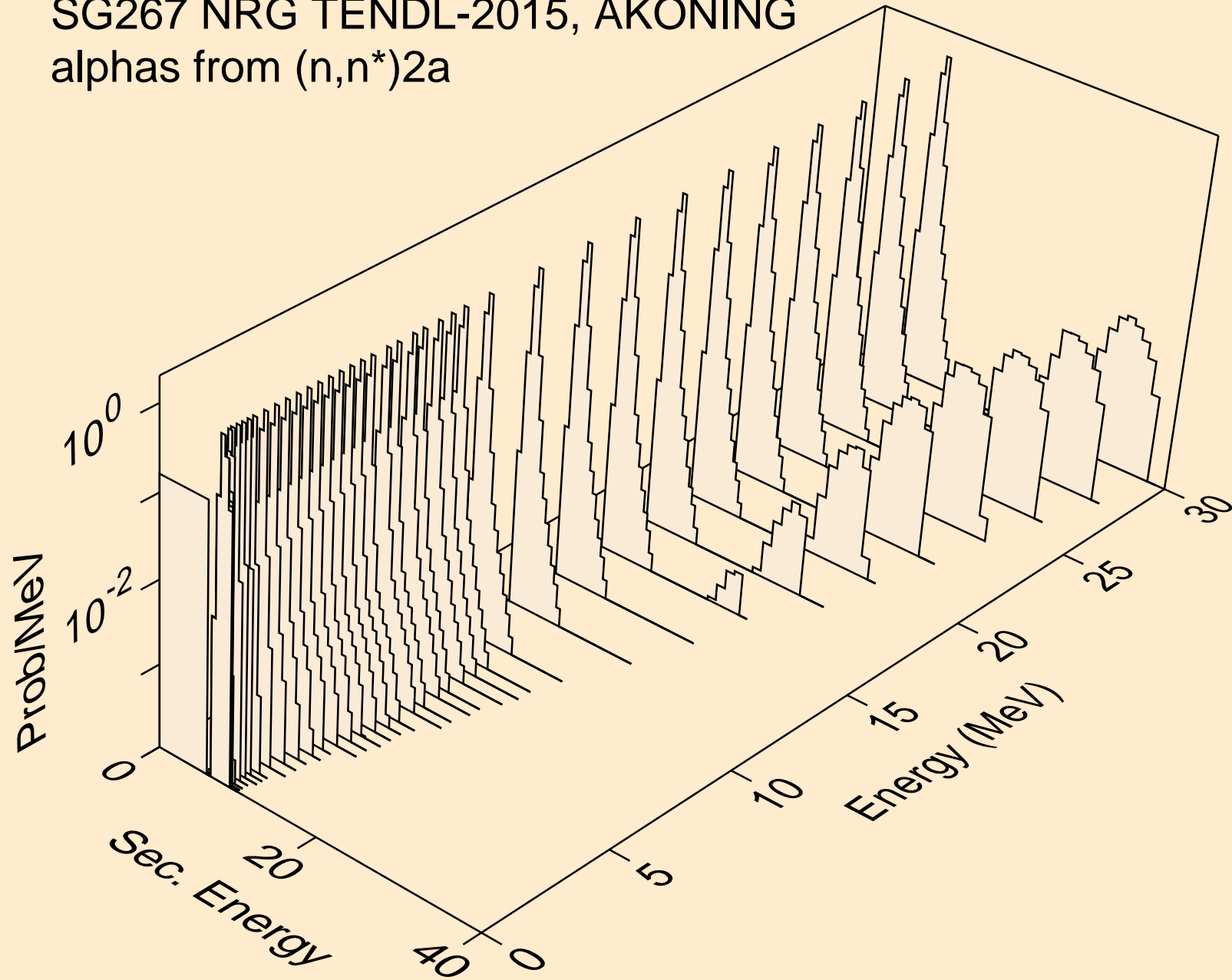

SG267 NRG TENDL-2015, AKONING  
alphas from (n,2n)2a

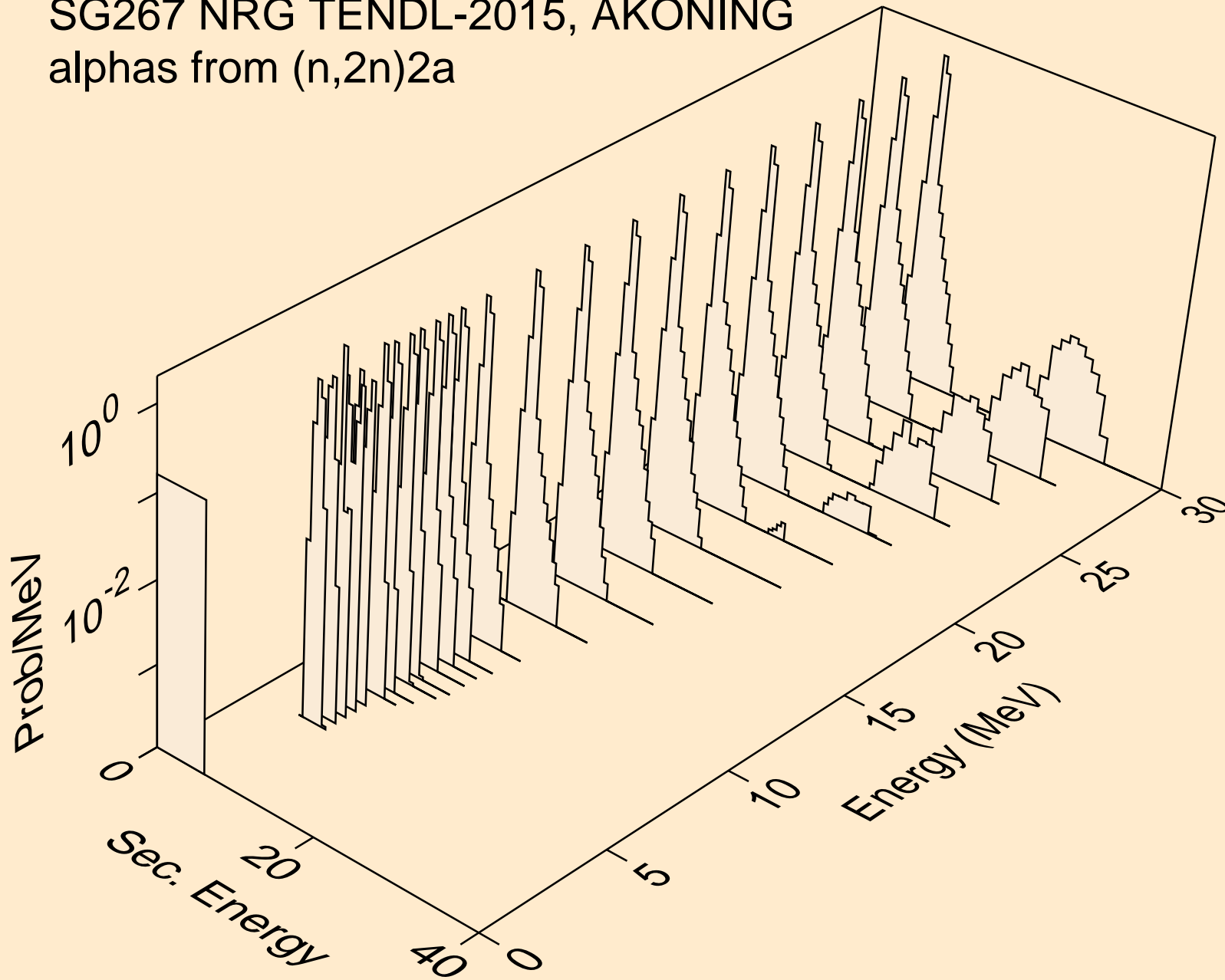

SG267 NRG TENDL-2015, AKONING  
alphas from (n,n\*)d2a

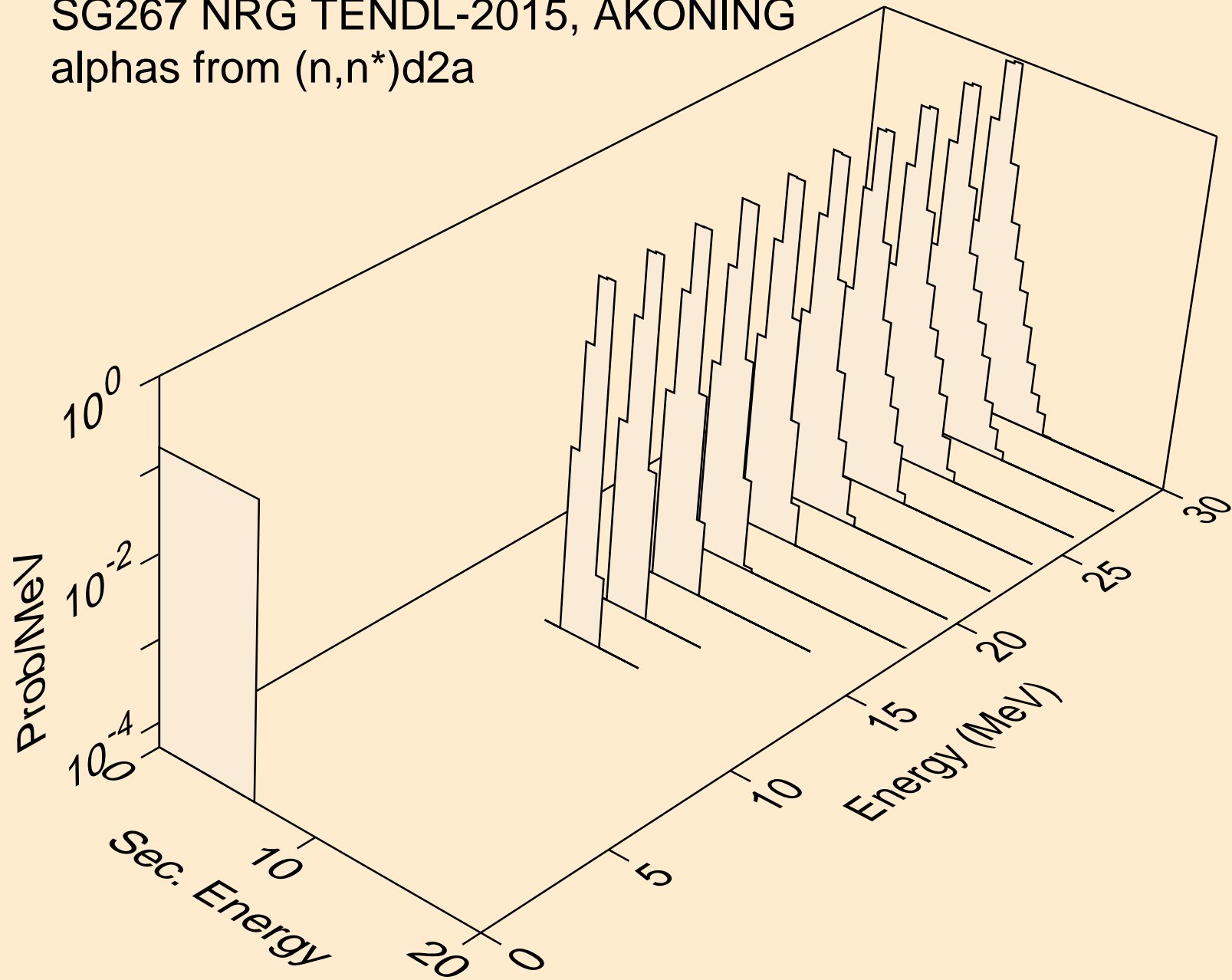

SG267 NRG TENDL-2015, AKONING  
alphas from (n,n\*)t2a

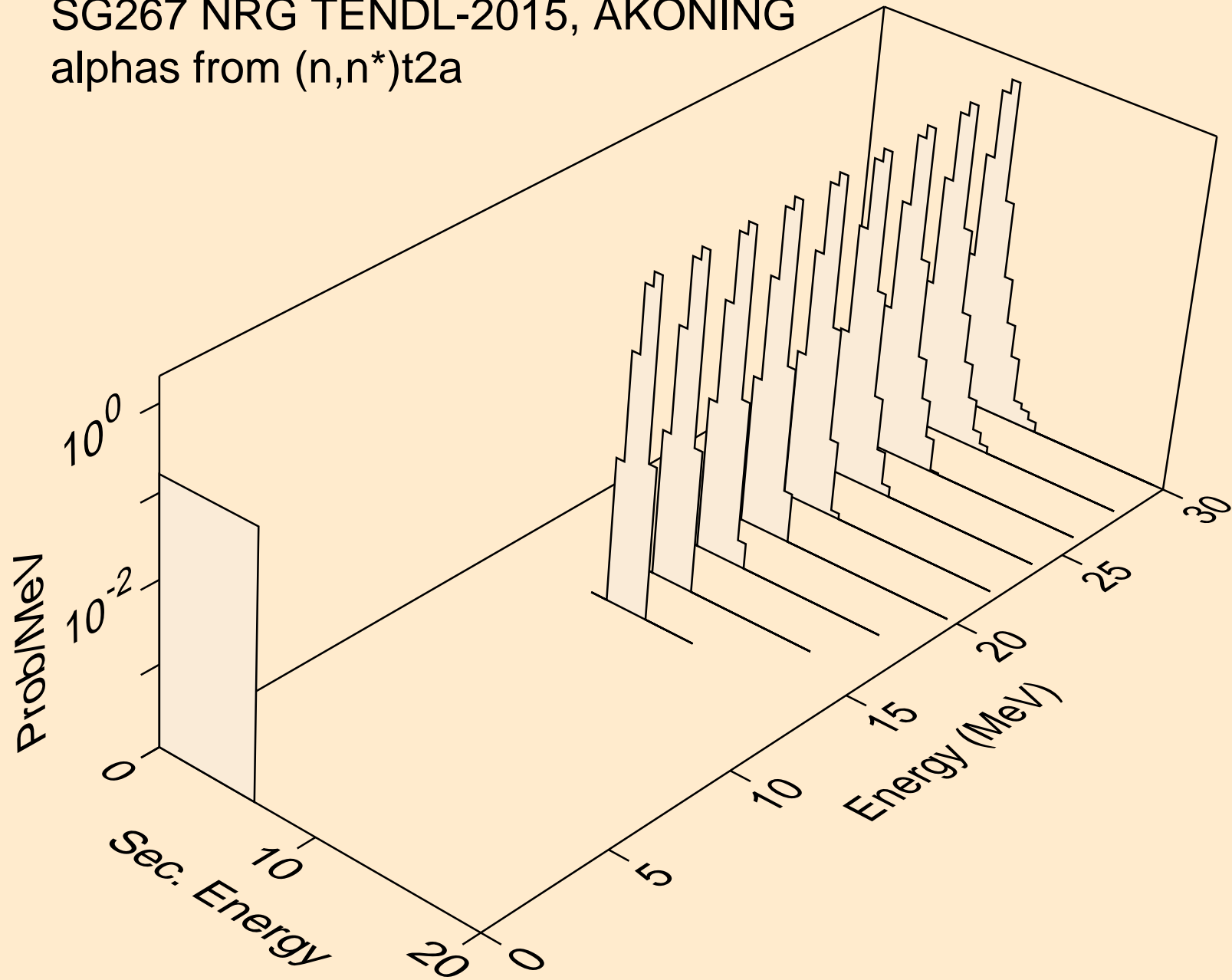

SG267 NRG TENDL-2015, AKONING  
alphas from (n,npa)

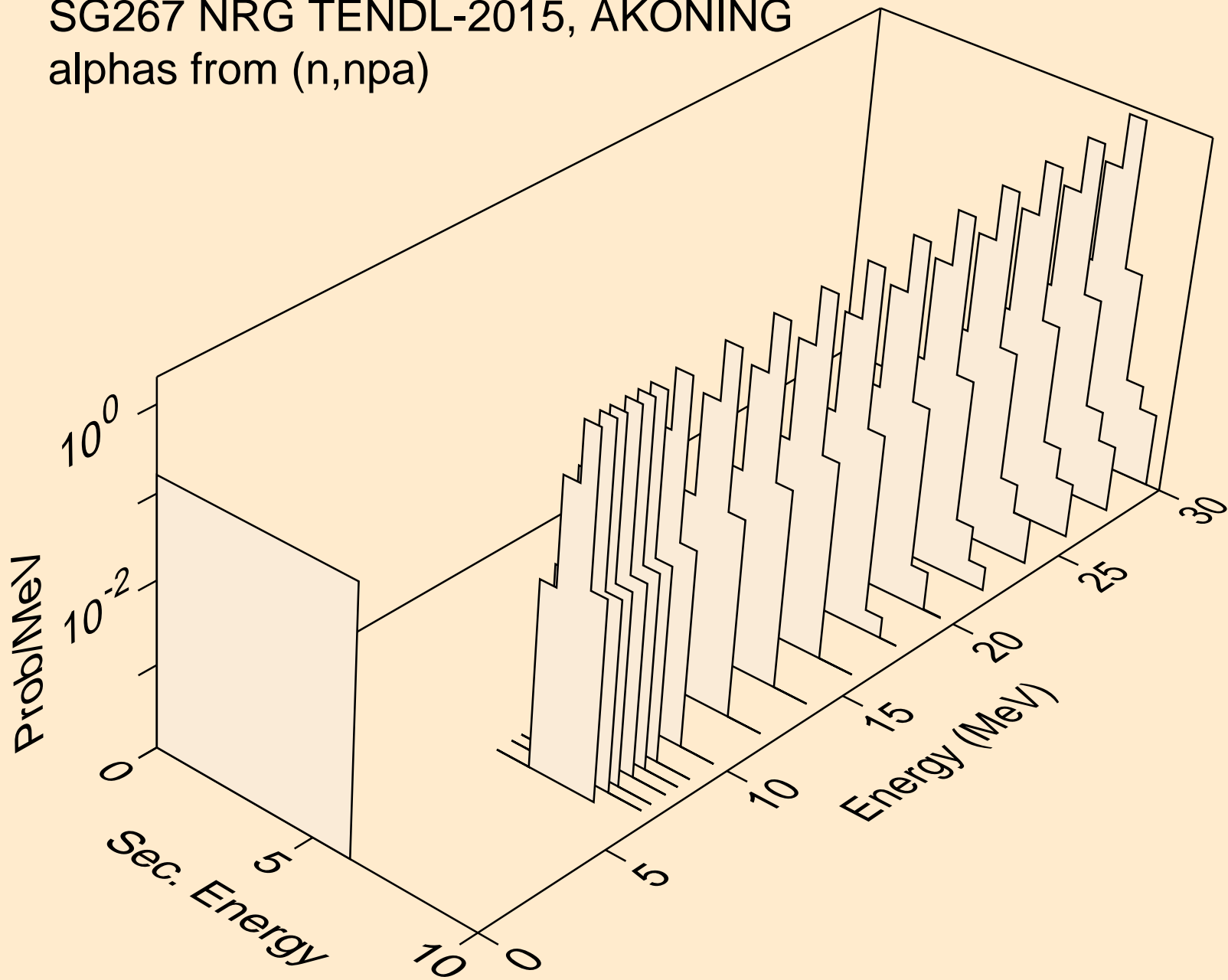

SG267 NRG TENDL-2015, AKONING  
alphas from (n,a)

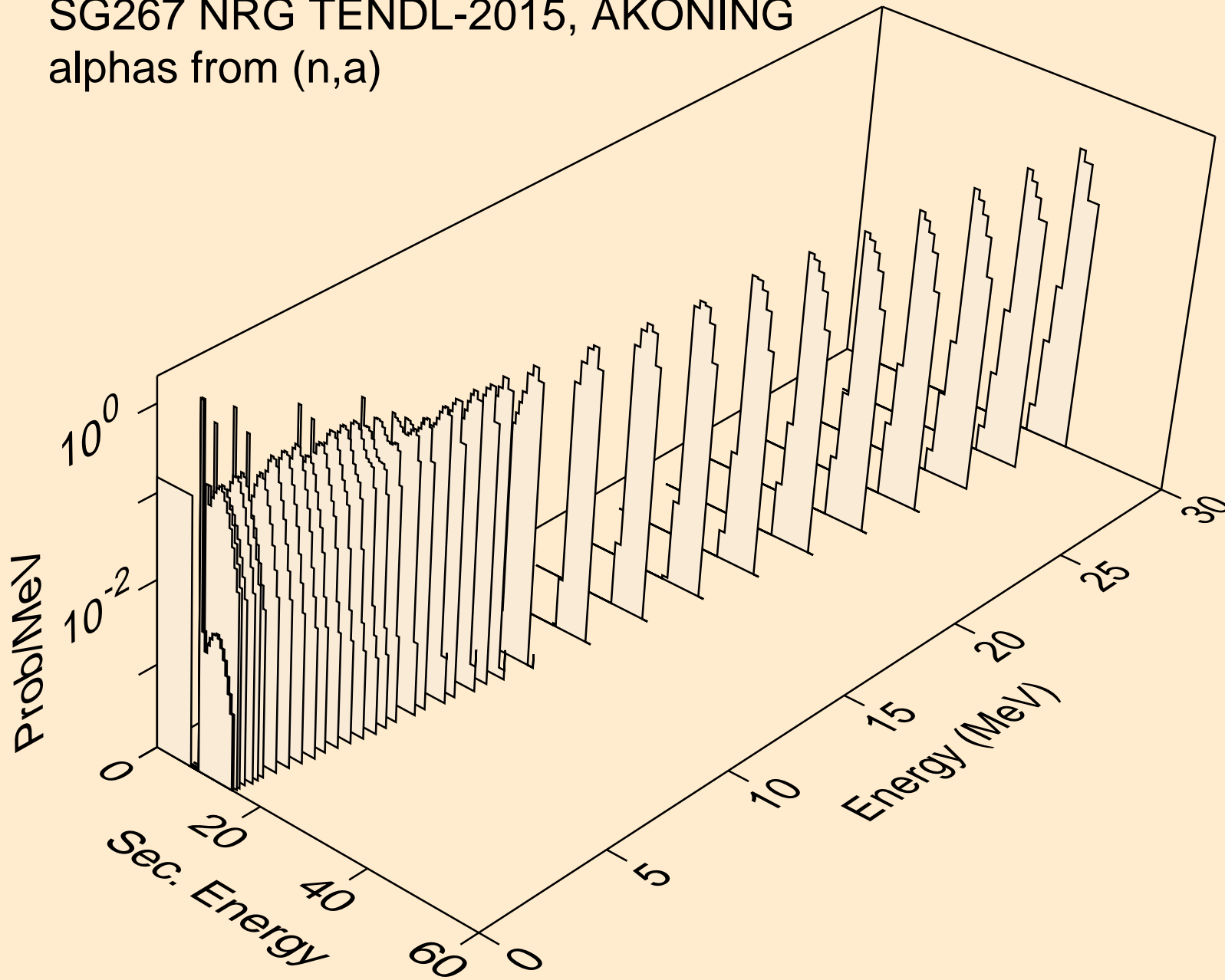



SG267 NRG TENDL-2015, AKONING  
alphas from (n,2a)

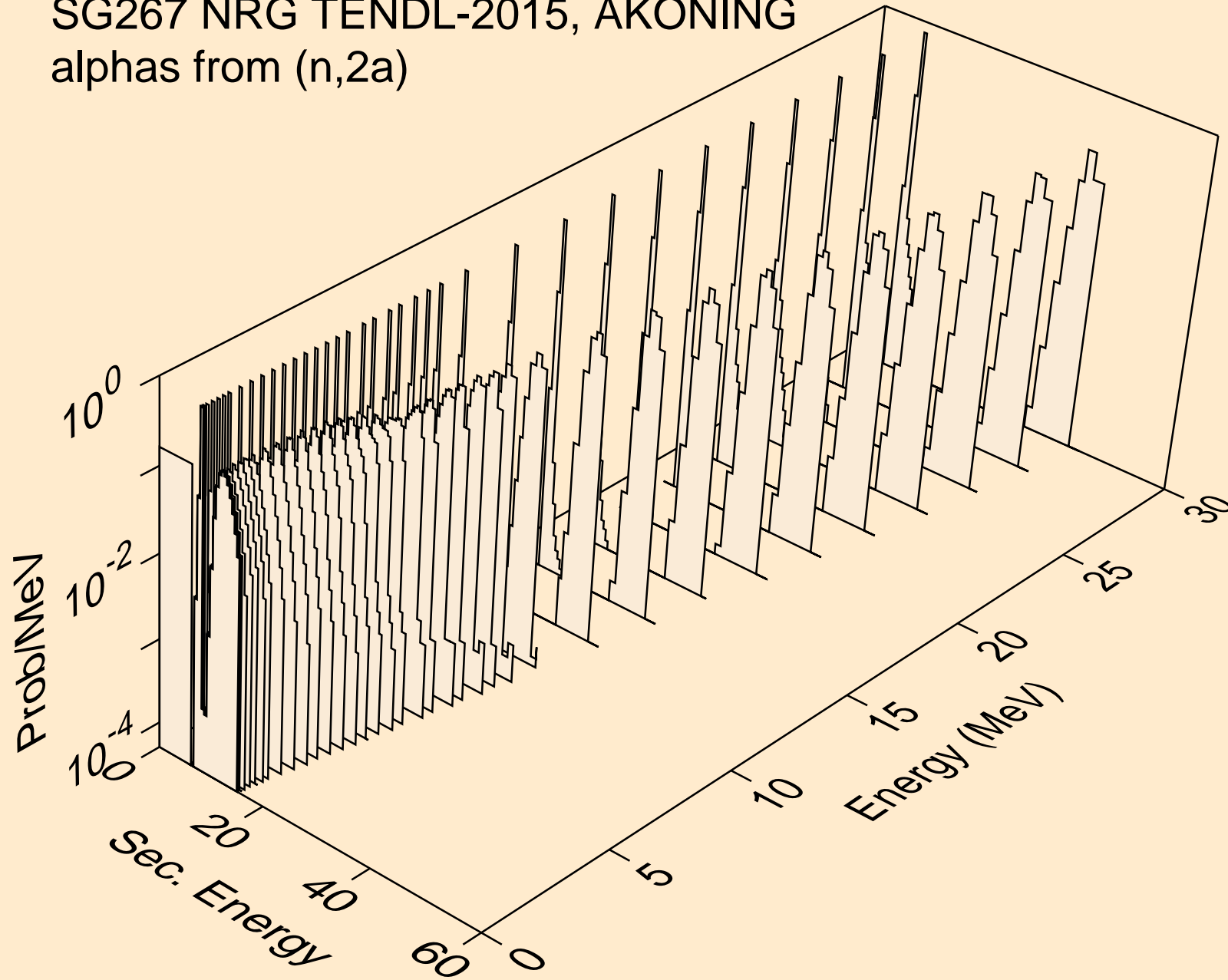

SG267 NRG TENDL-2015, AKONING  
alphas from (n,3a)

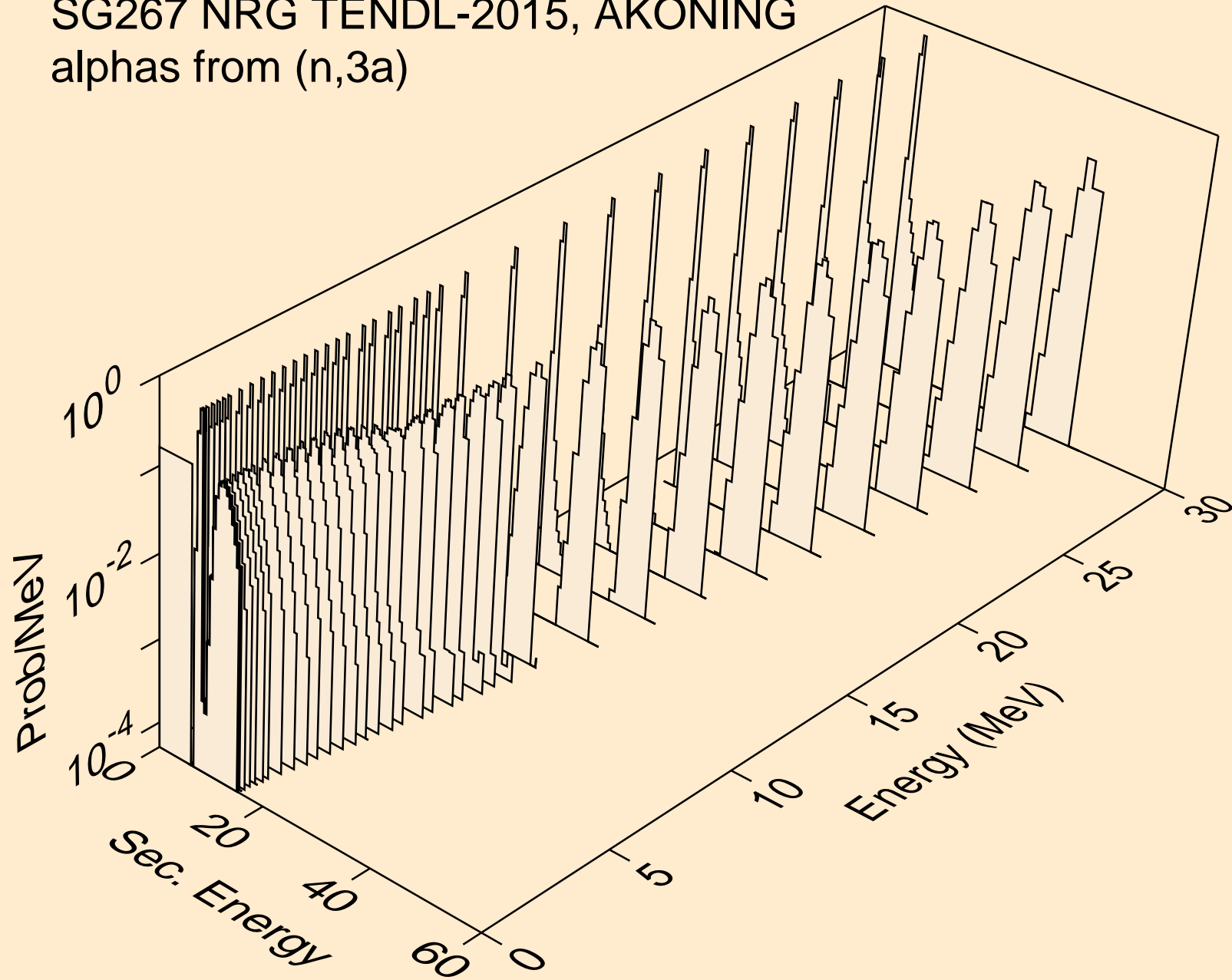

SG267 NRG TENDL-2015, AKONING  
alphas from (n,pa)

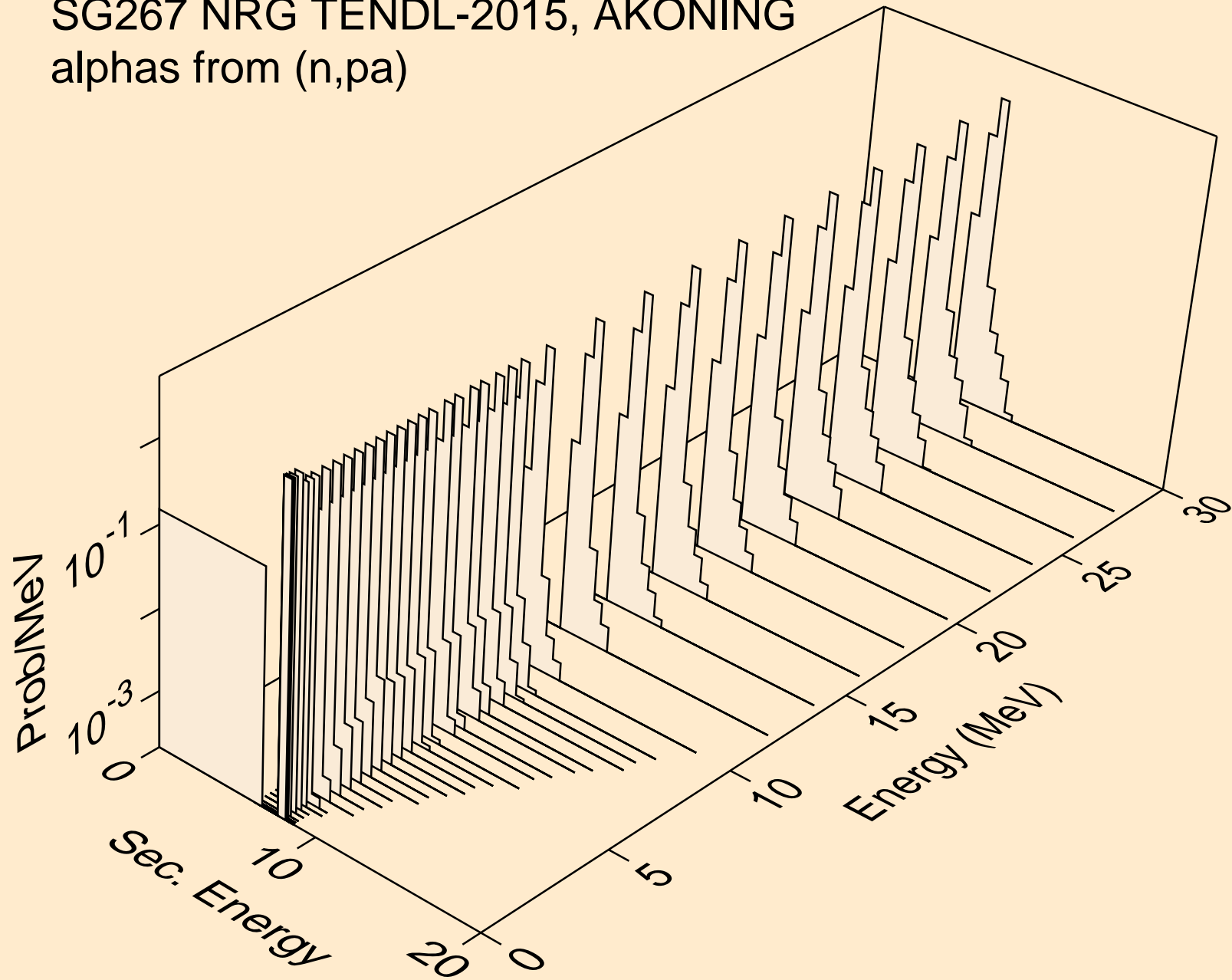

SG267 NRG TENDL-2015, AKONING  
alphas from (n,t2a)

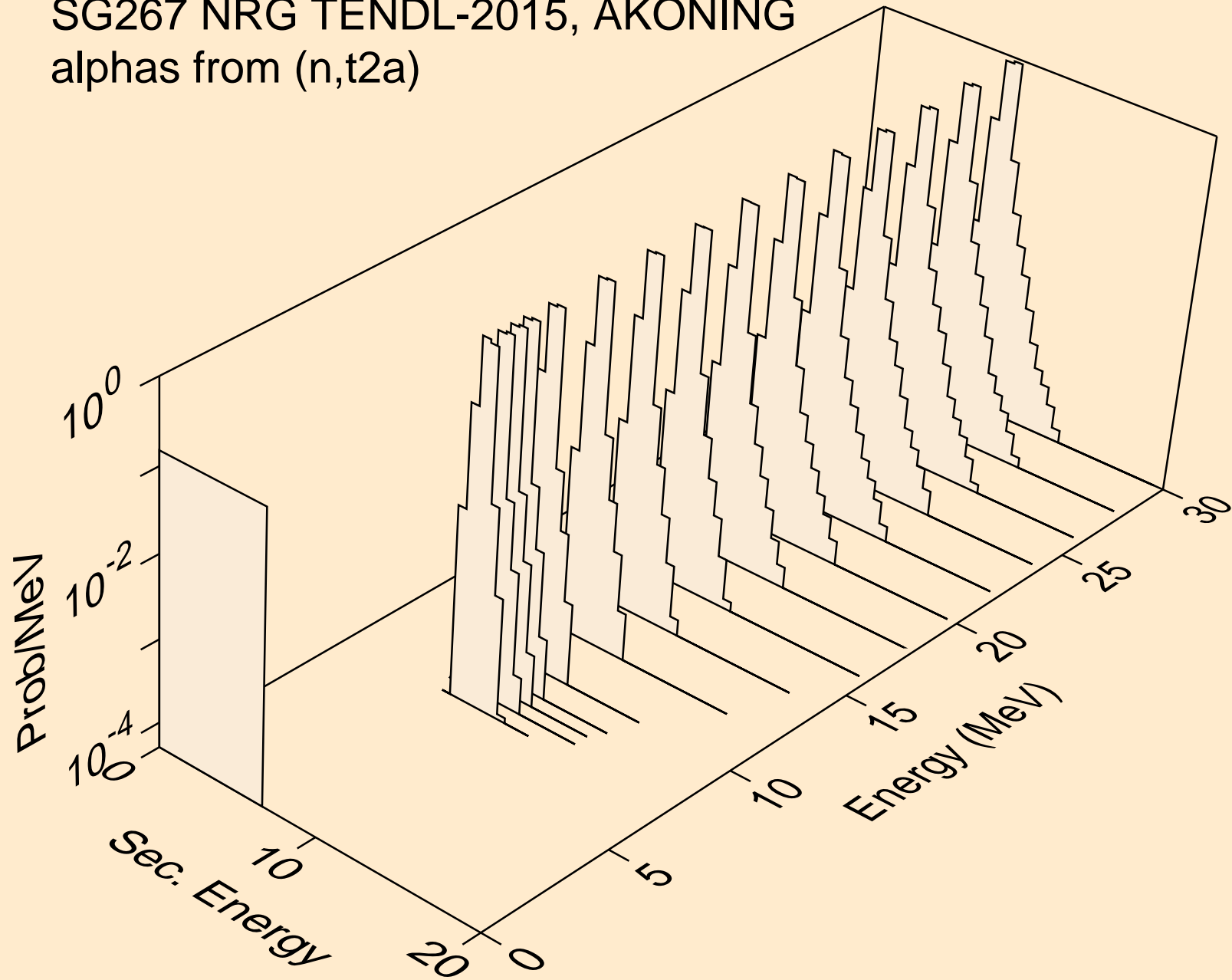

SG267 NRG TENDL-2015, AKONING  
alphas from (n,d2a)

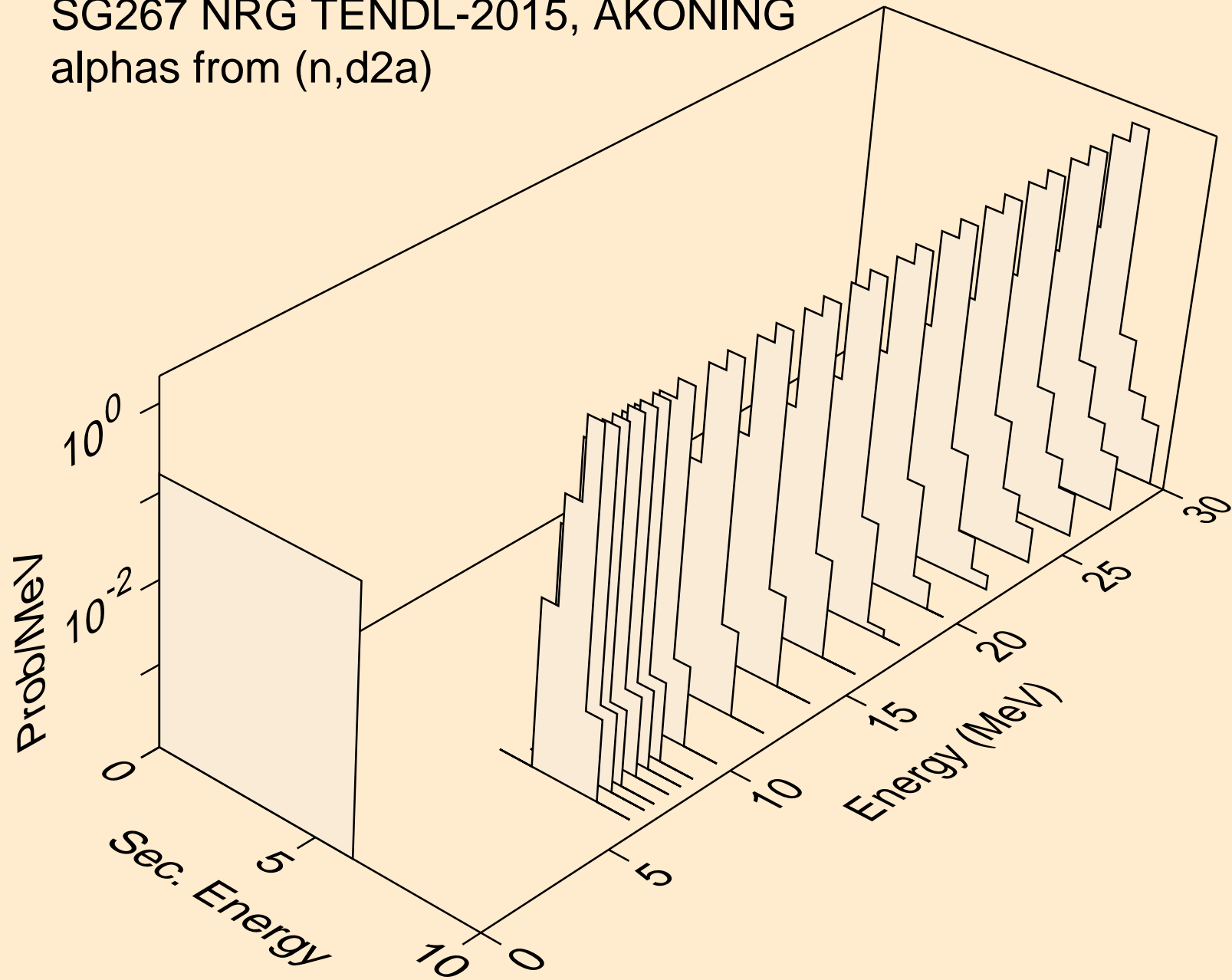

SG267 NRG TENDL-2015, AKONING  
alphas from (n,da)

