

SG271 NRG TENDL-2015, AKONING

Principal cross sections

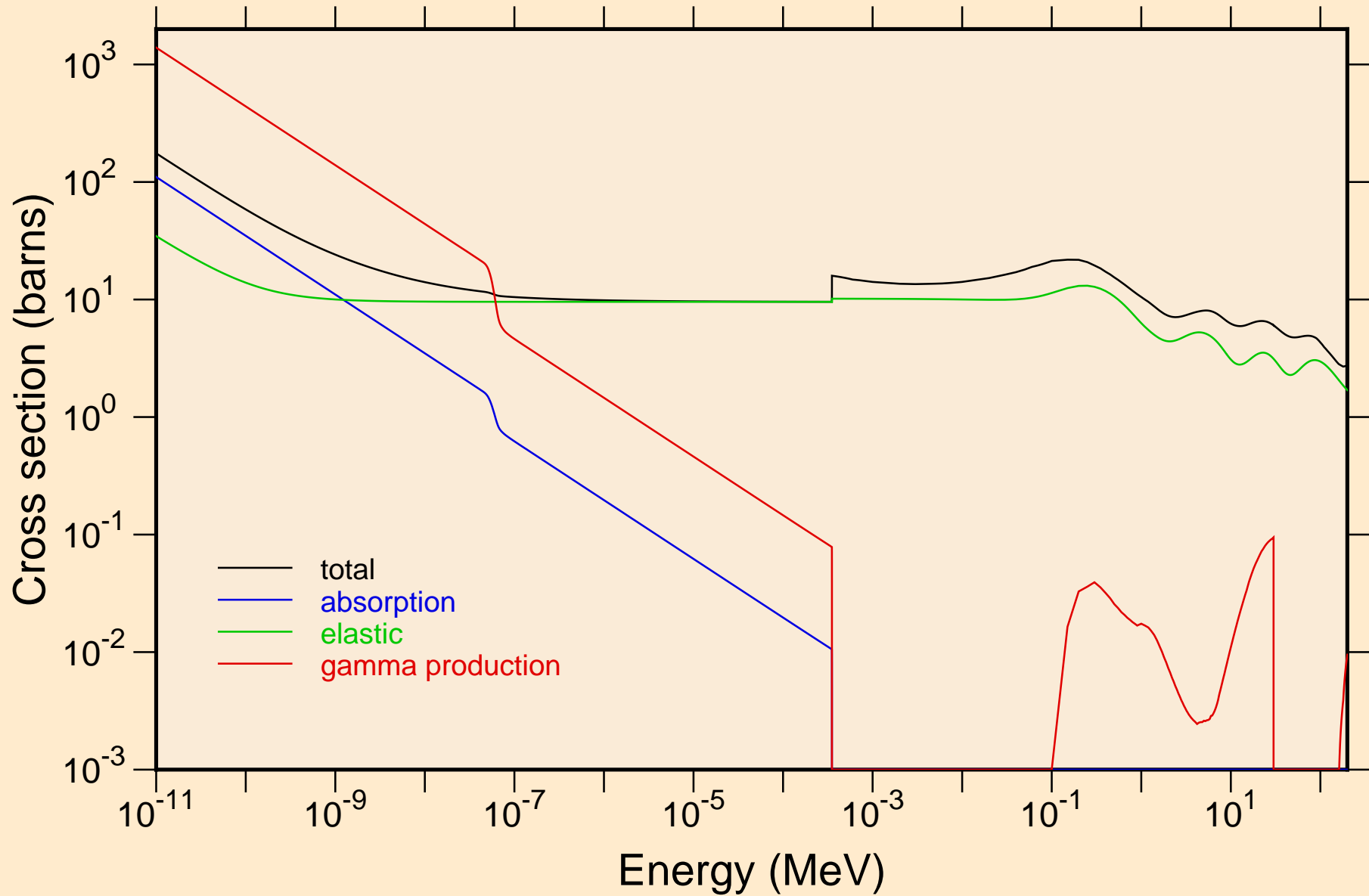

SG271 NRG TENDL-2015, AKONING

Non-threshold reactions

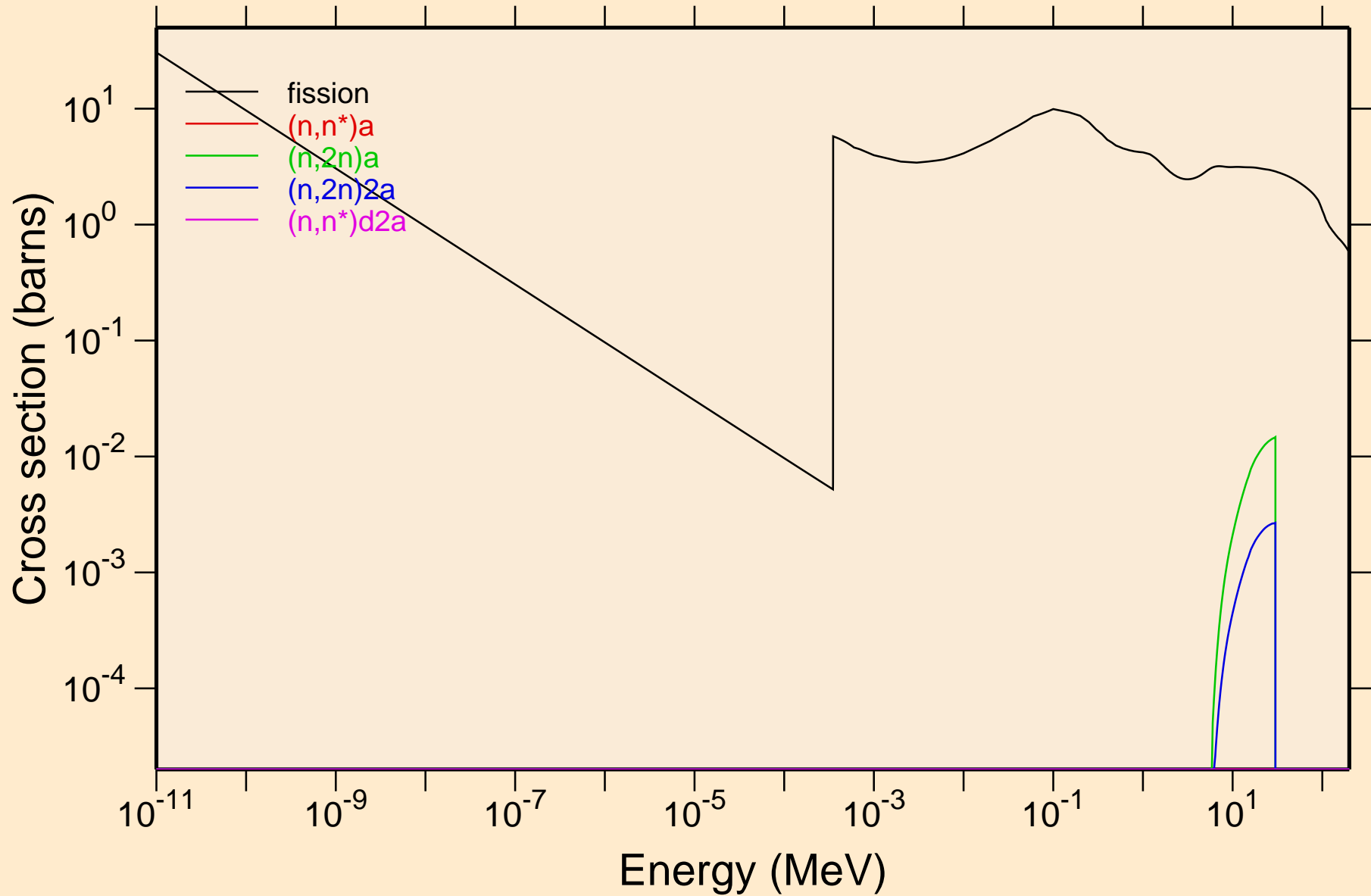

SG271 NRG TENDL-2015, AKONING

Non-threshold reactions

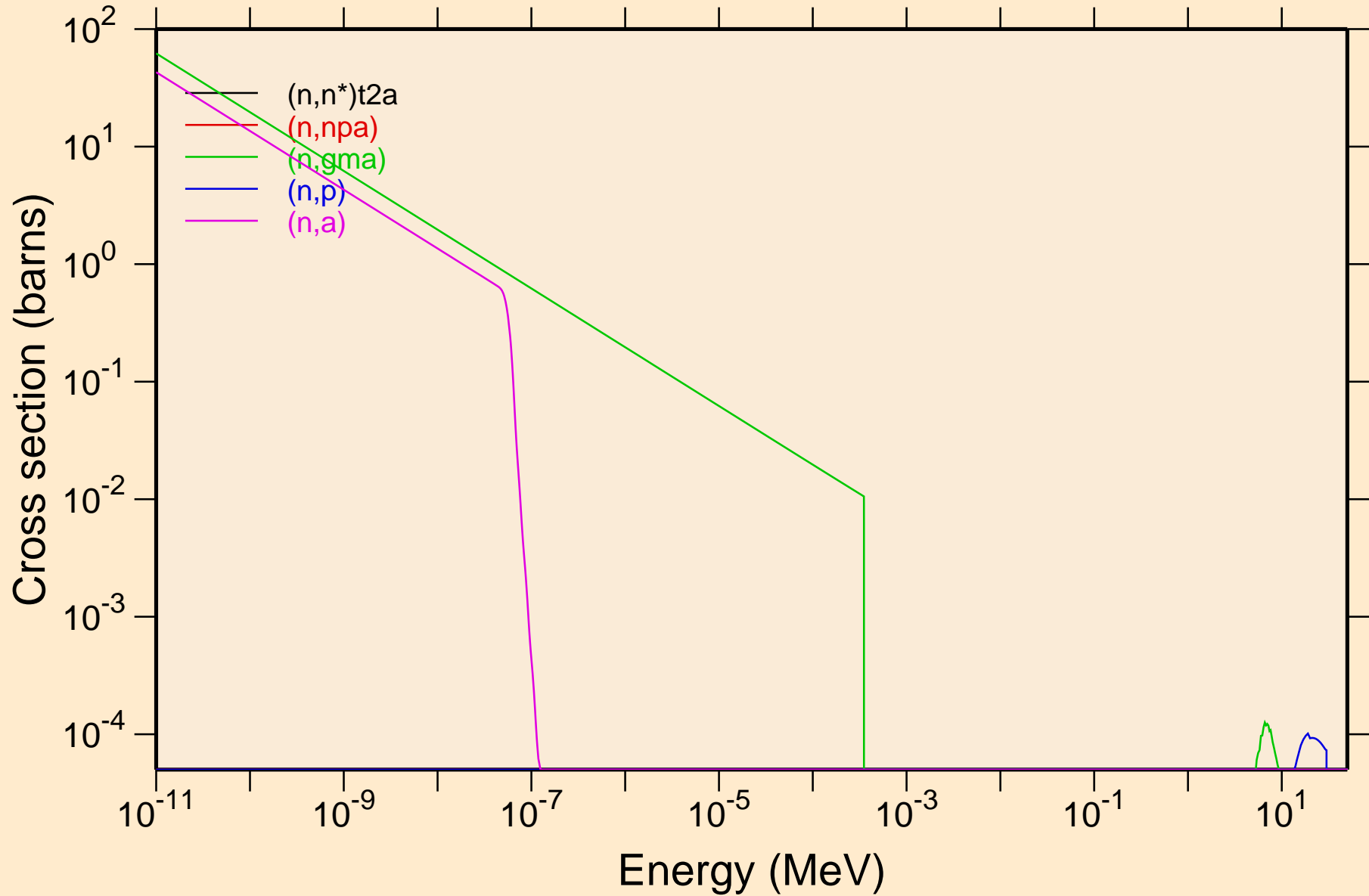

SG271 NRG TENDL-2015, AKONING

Non-threshold reactions

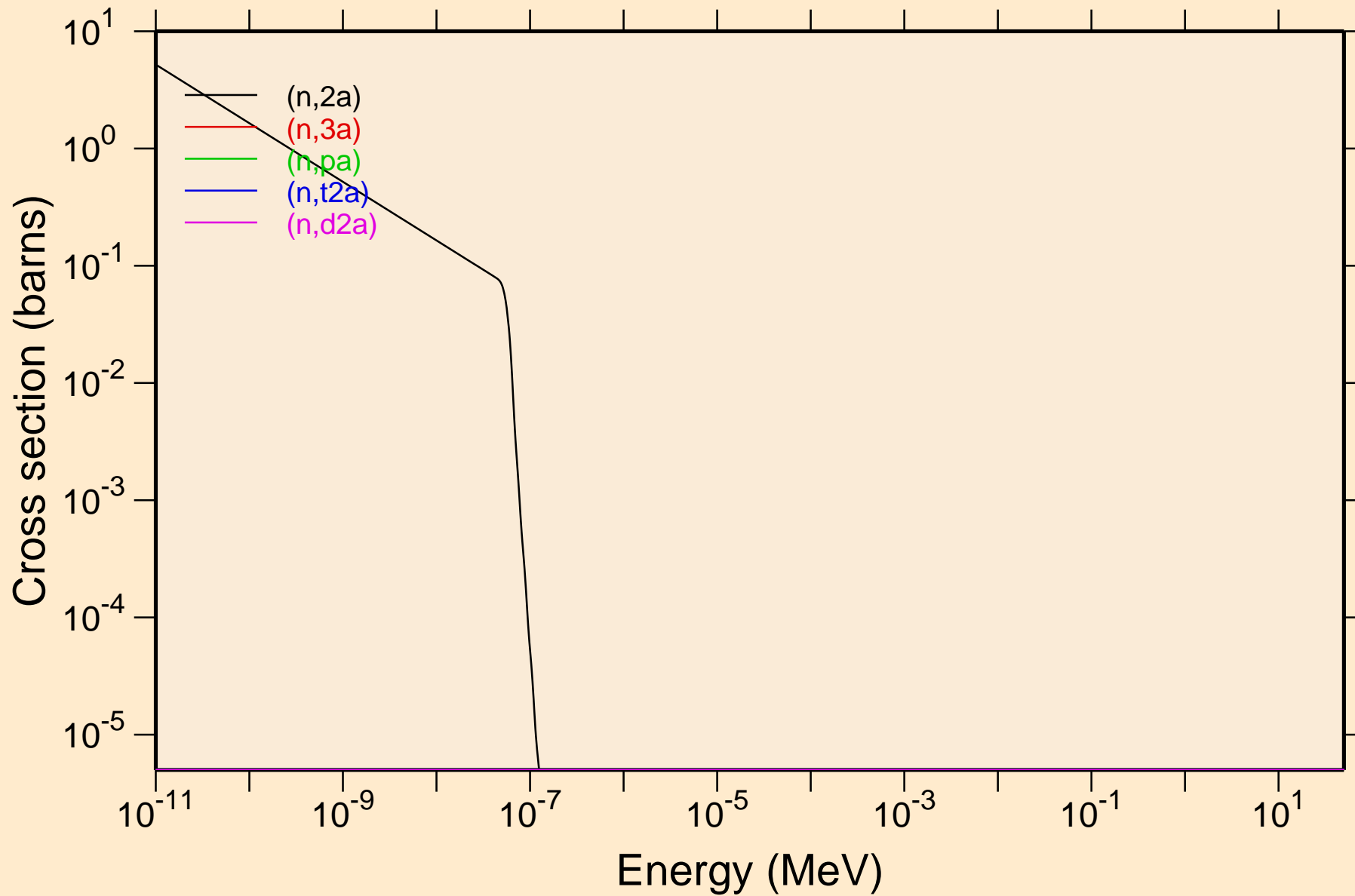

SG271 NRG TENDL-2015, AKONING
Non-threshold reactions

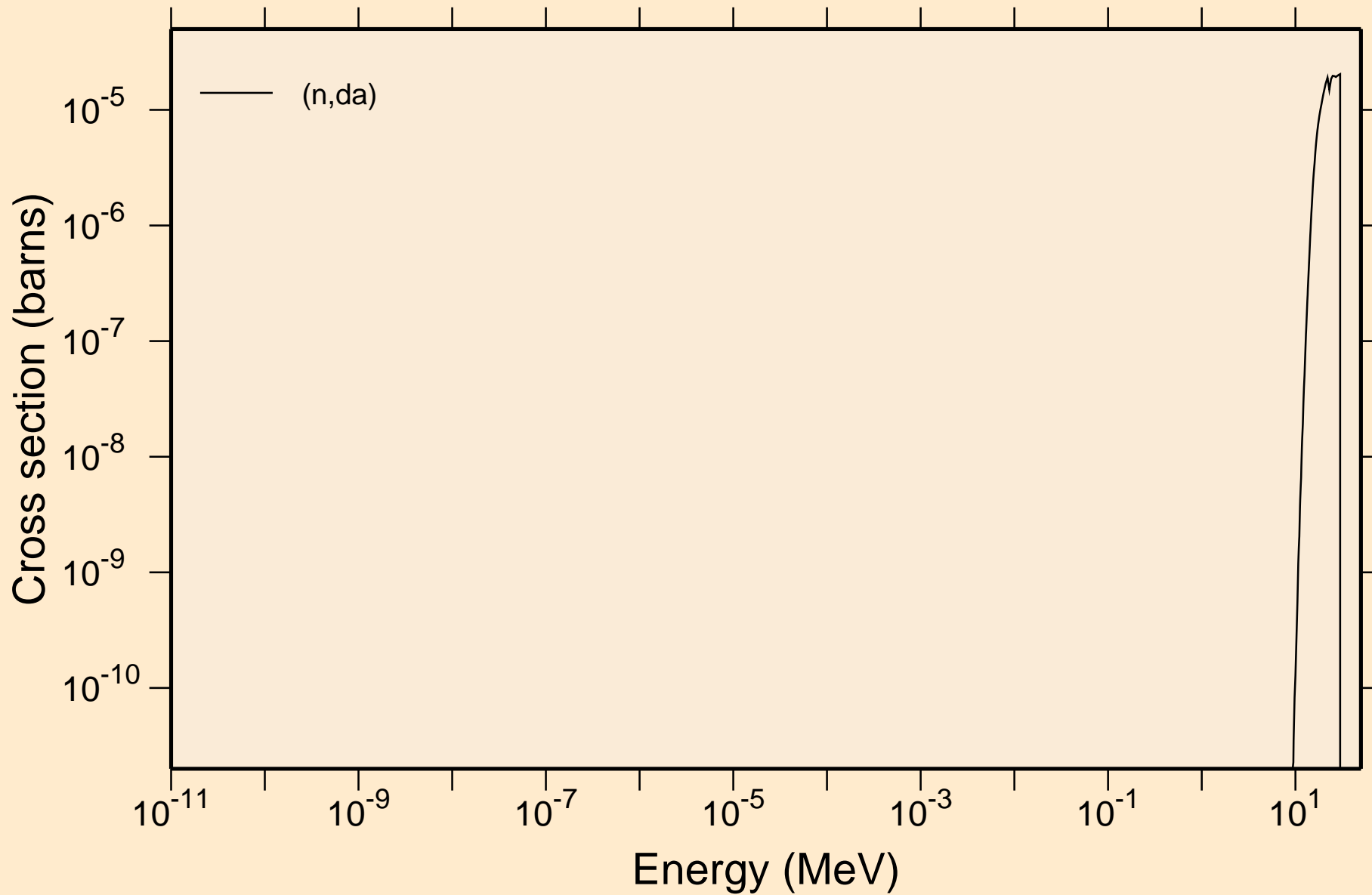

SG271 NRG TENDL-2015, AKONING

Principal cross sections

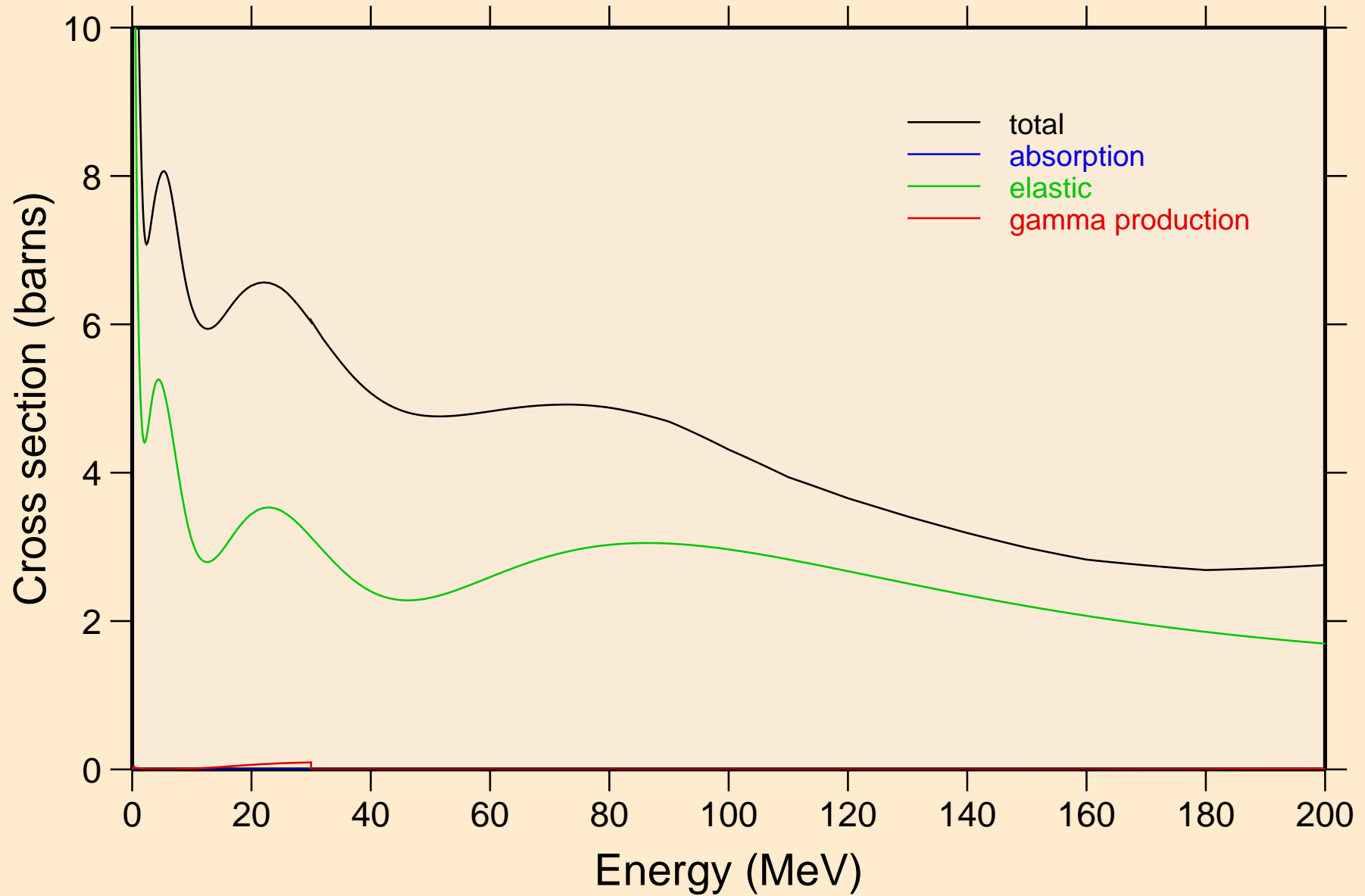

SG271 NRG TENDL-2015, AKONING

Non-threshold reactions

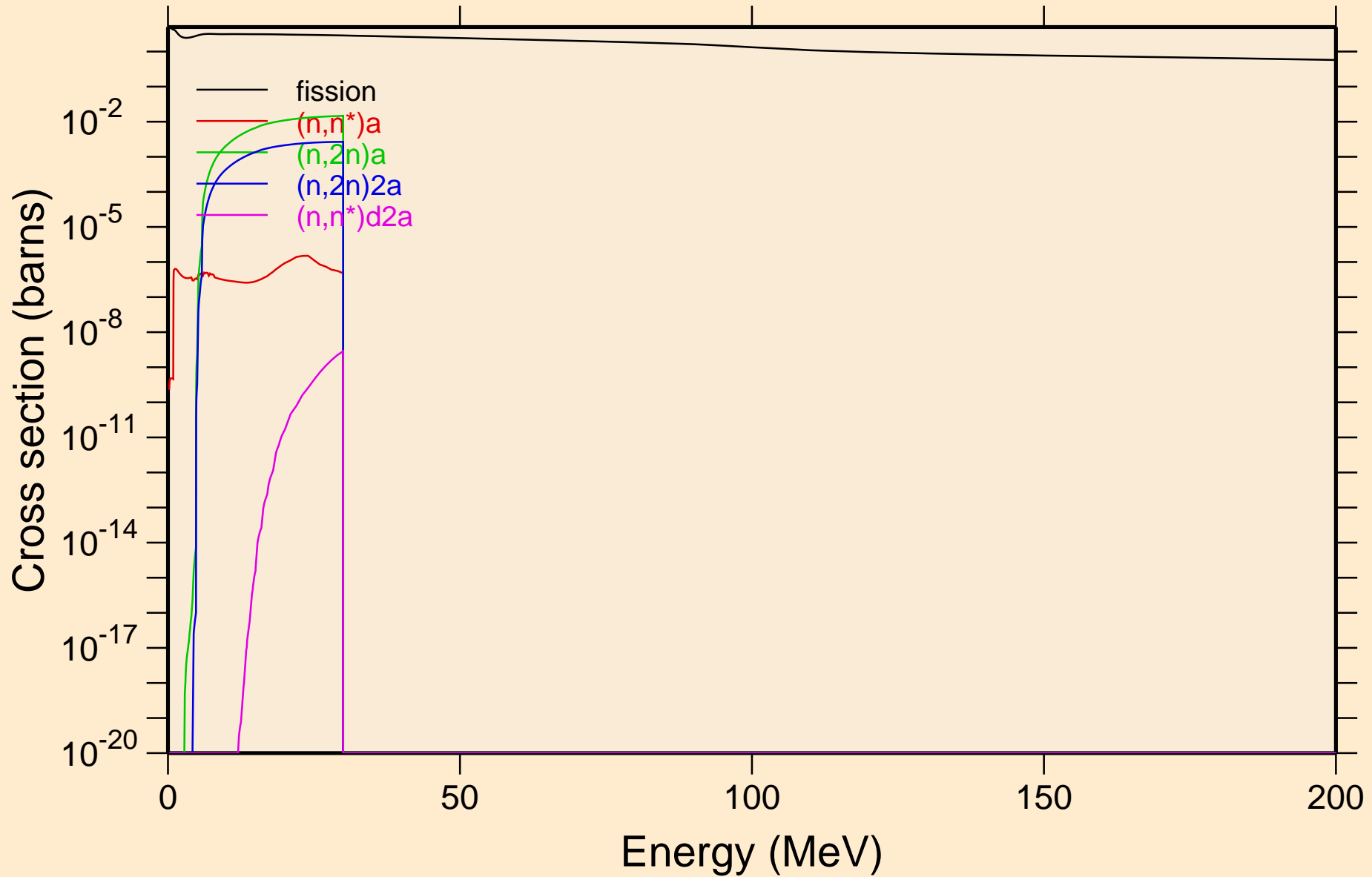

SG271 NRG TENDL-2015, AKONING

Non-threshold reactions

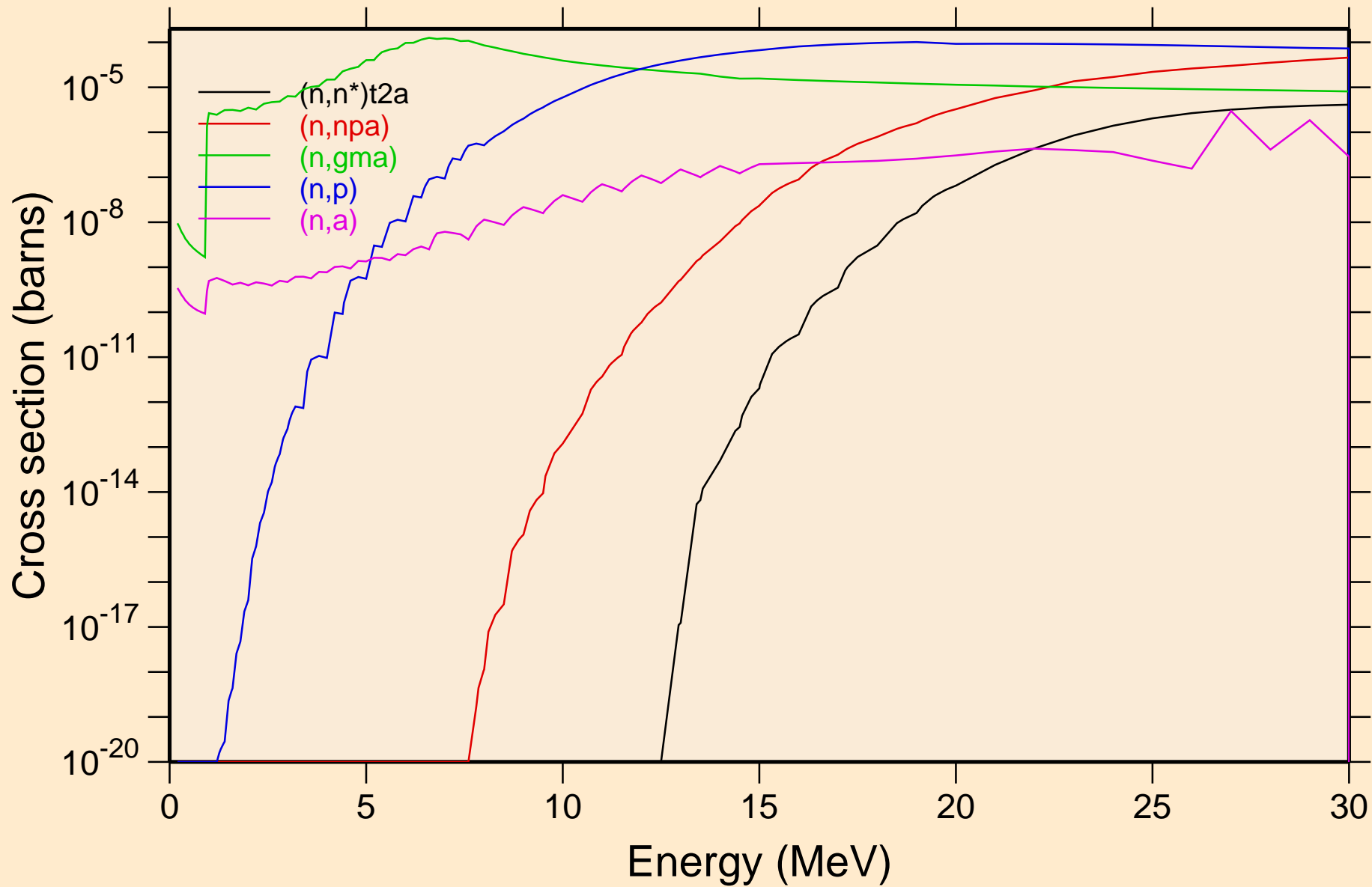

SG271 NRG TENDL-2015, AKONING

Non-threshold reactions

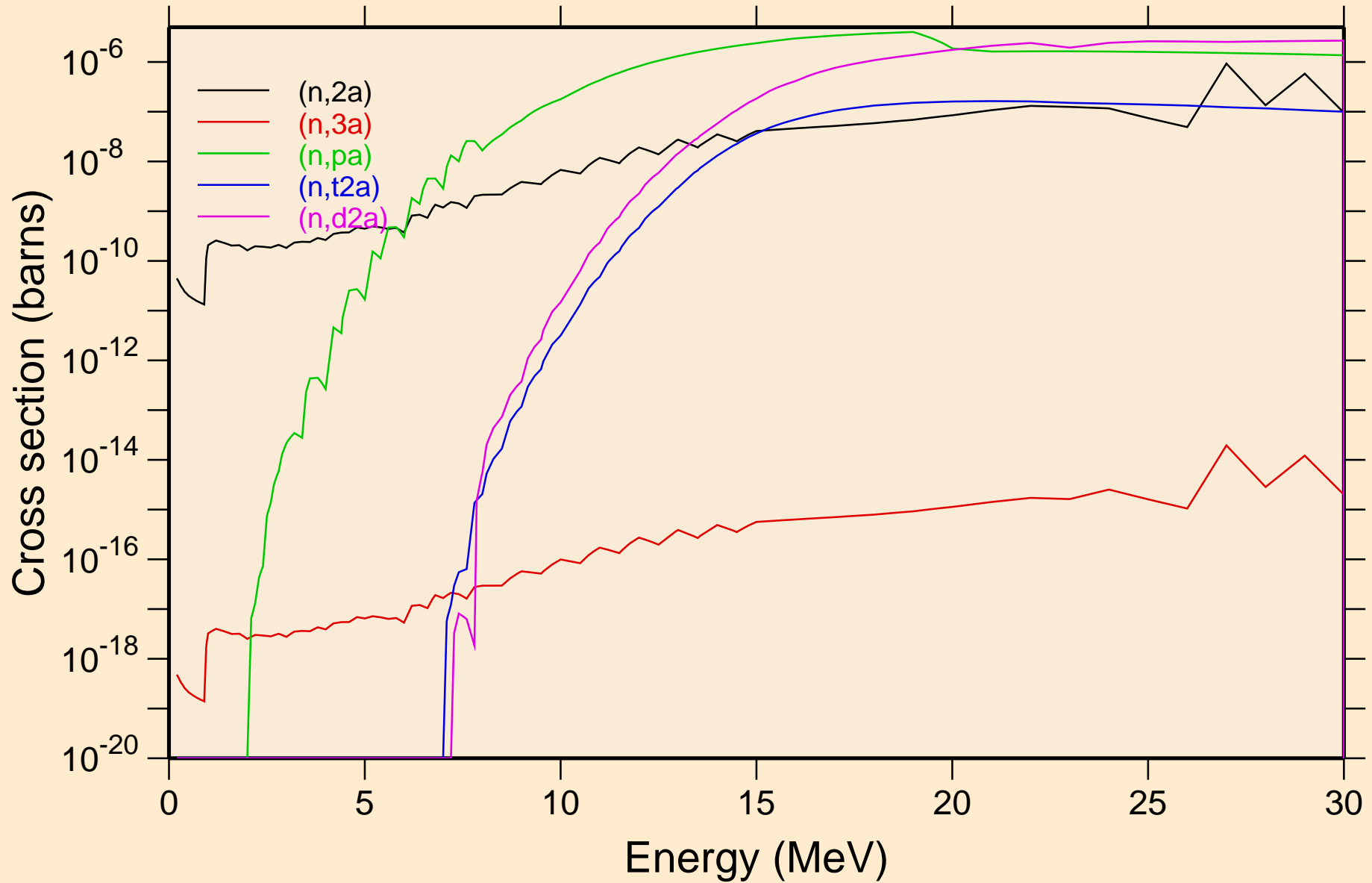

SG271 NRG TENDL-2015, AKONING

Non-threshold reactions

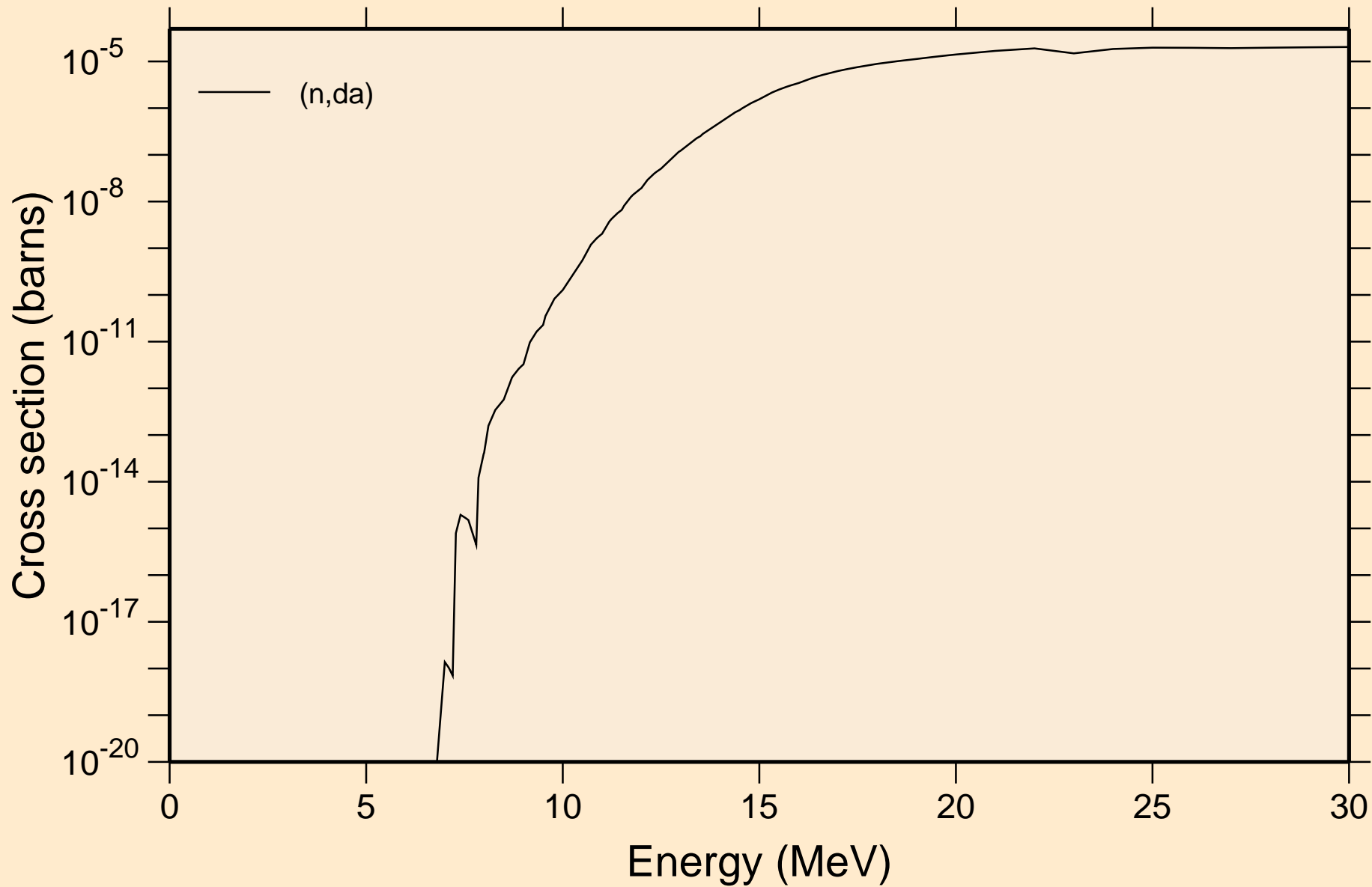

SG271 NRG TENDL-2015, AKONING

Inelastic levels

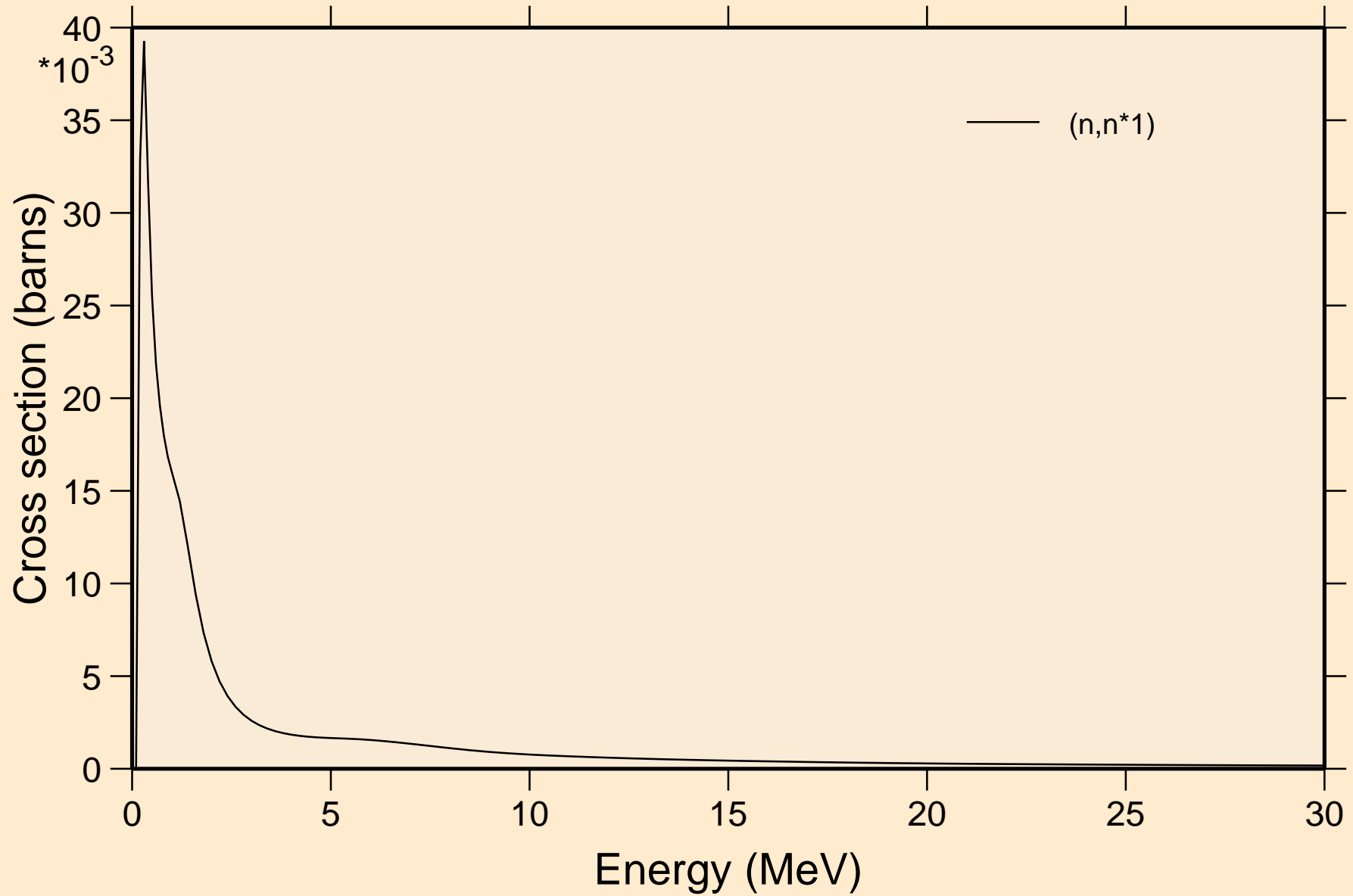

SG271 NRG TENDL-2015, AKONING

Threshold reactions

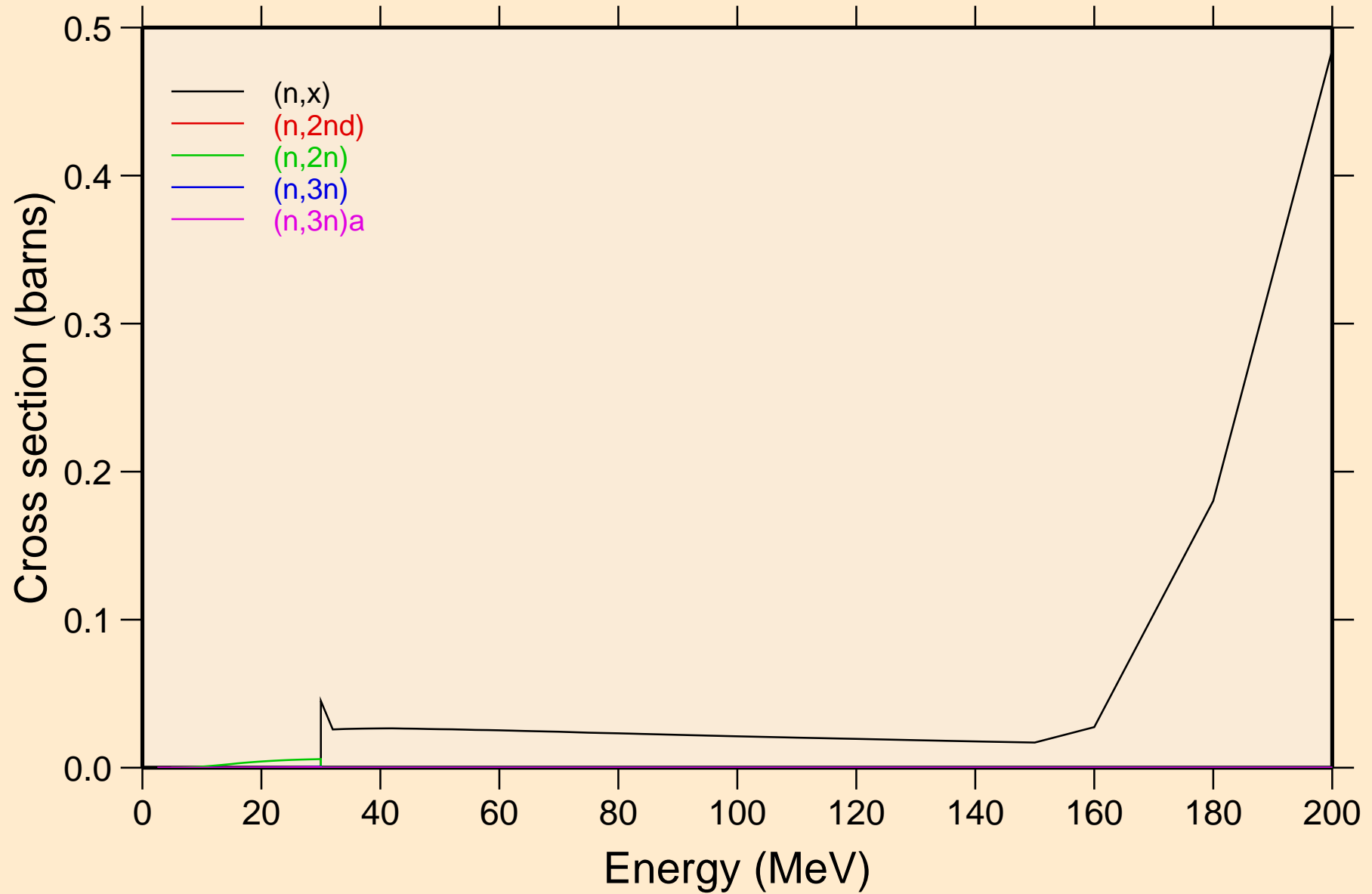

SG271 NRG TENDL-2015, AKONING

Threshold reactions

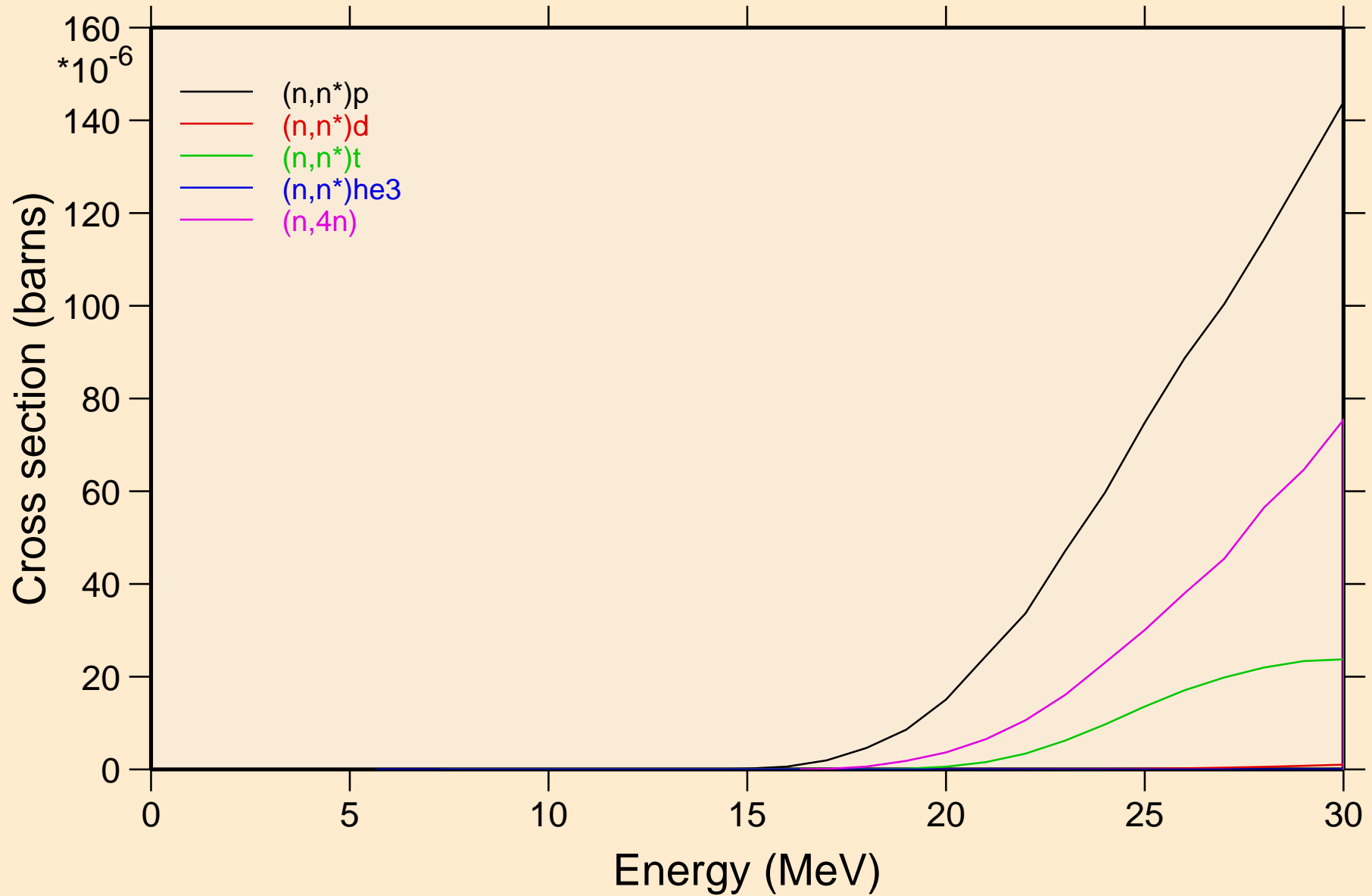

SG271 NRG TENDL-2015, AKONING

Threshold reactions

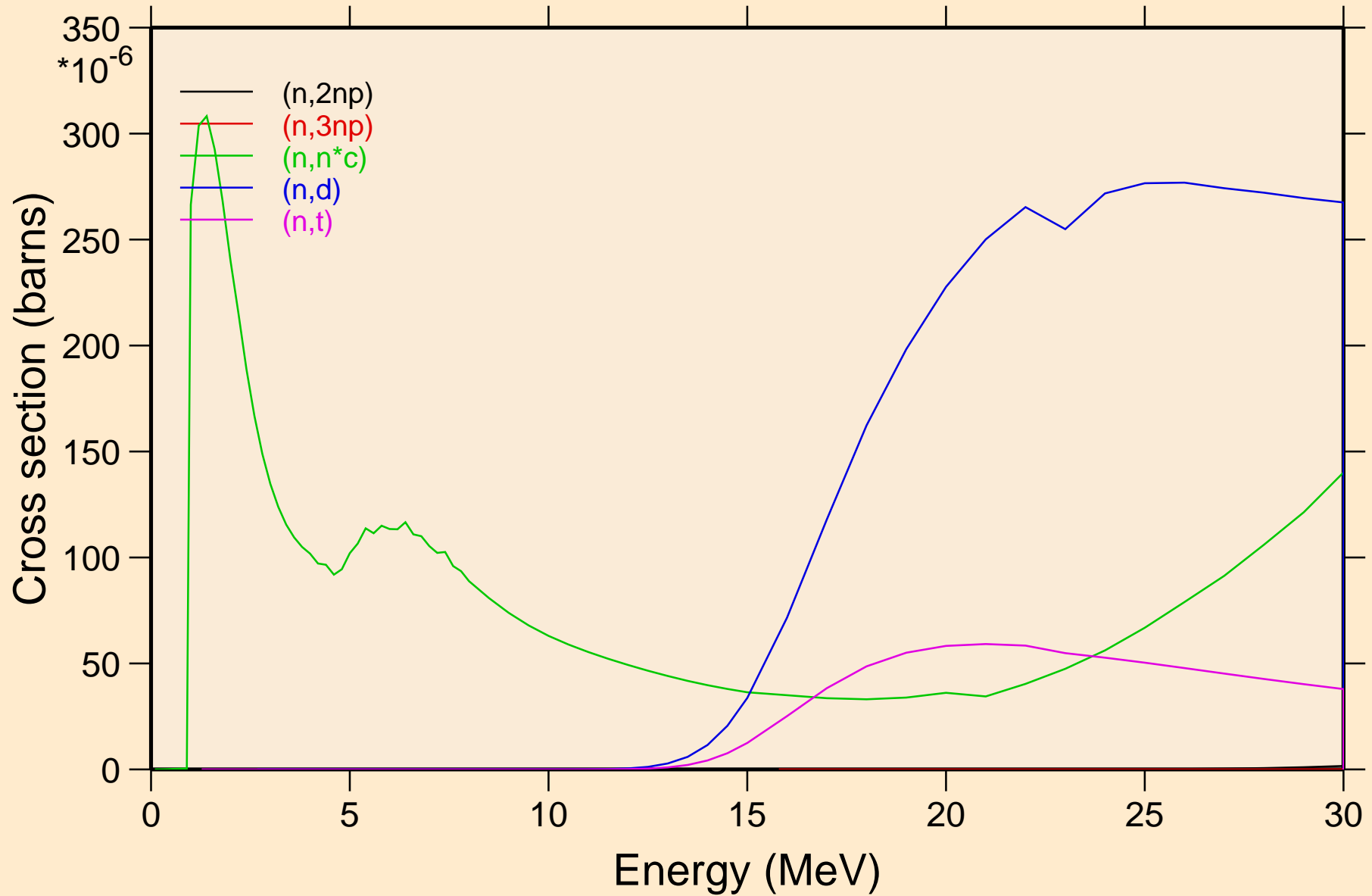

SG271 NRG TENDL-2015, AKONING

Threshold reactions

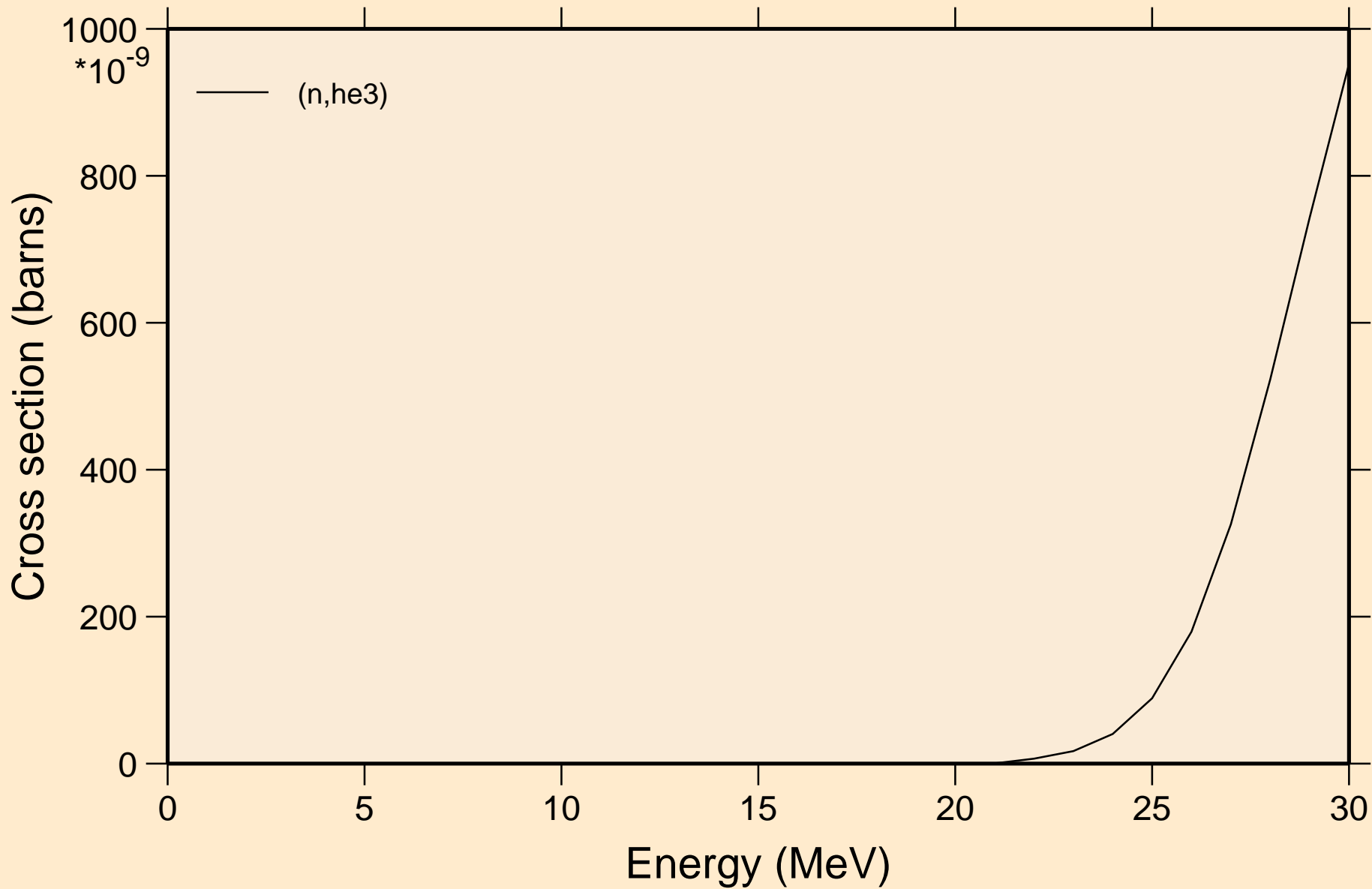

SG271 NRG TENDL-2015, AKONING
angular distribution for elastic

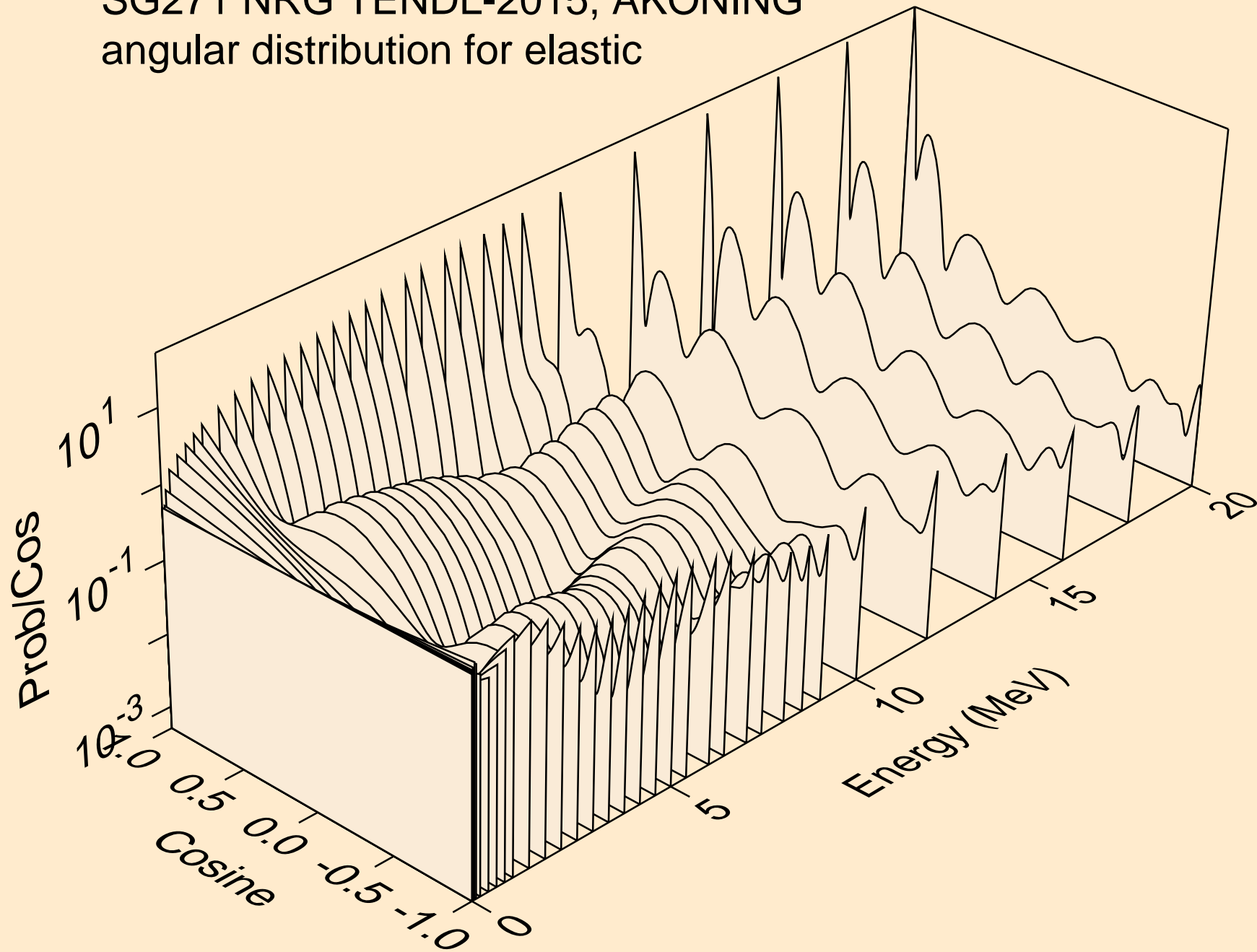

SG271 NRG TENDL-2015, AKONING
angular distribution for elastic

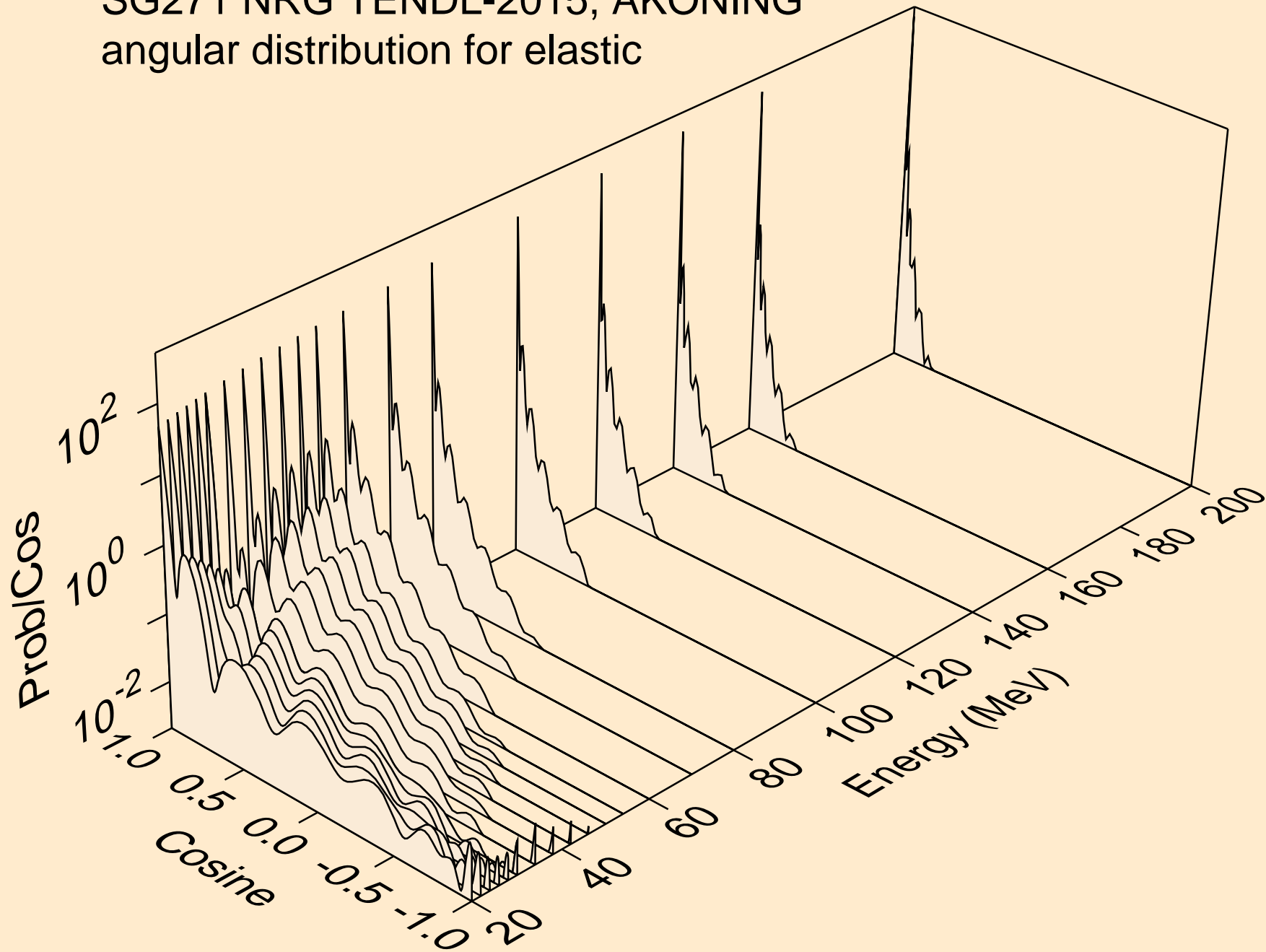

SG271 NRG TENDL-2015, AKONING
angular distribution for (n,n*1)

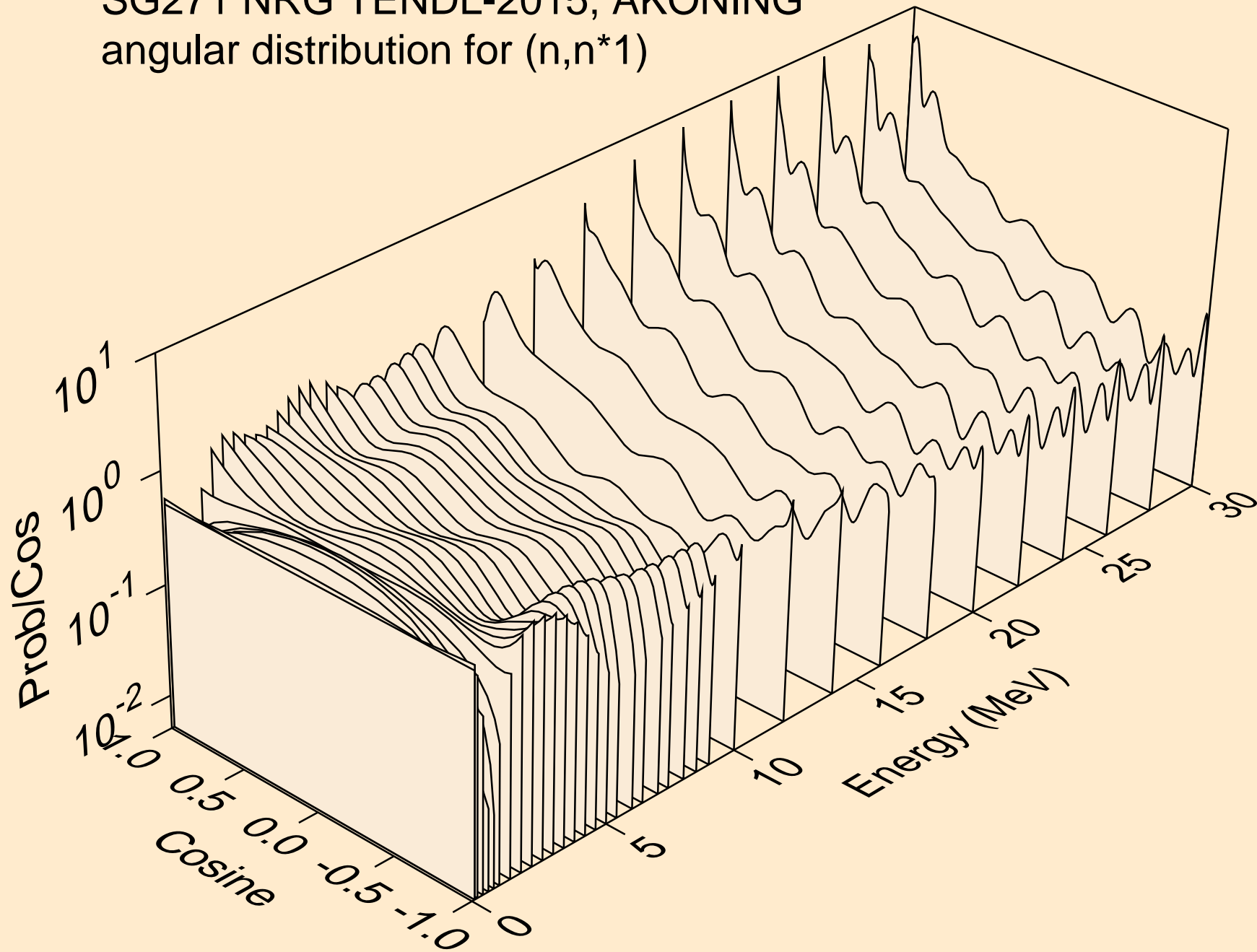

SG271 NRG TENDL-2015, AKONING

Total fission nubar

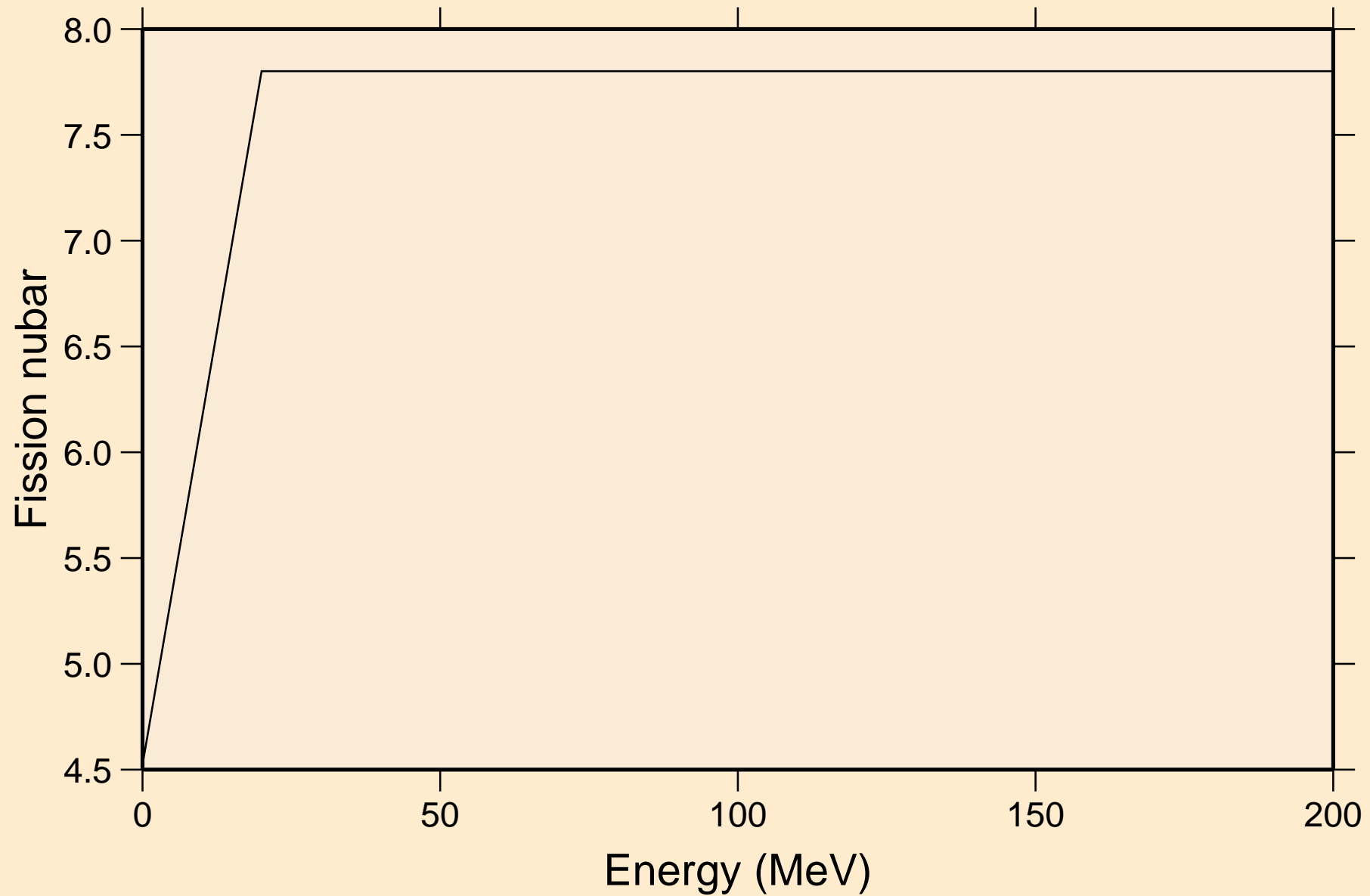

SG271 NRG TENDL-2015, AKONING
Neutron emission for (n,x)

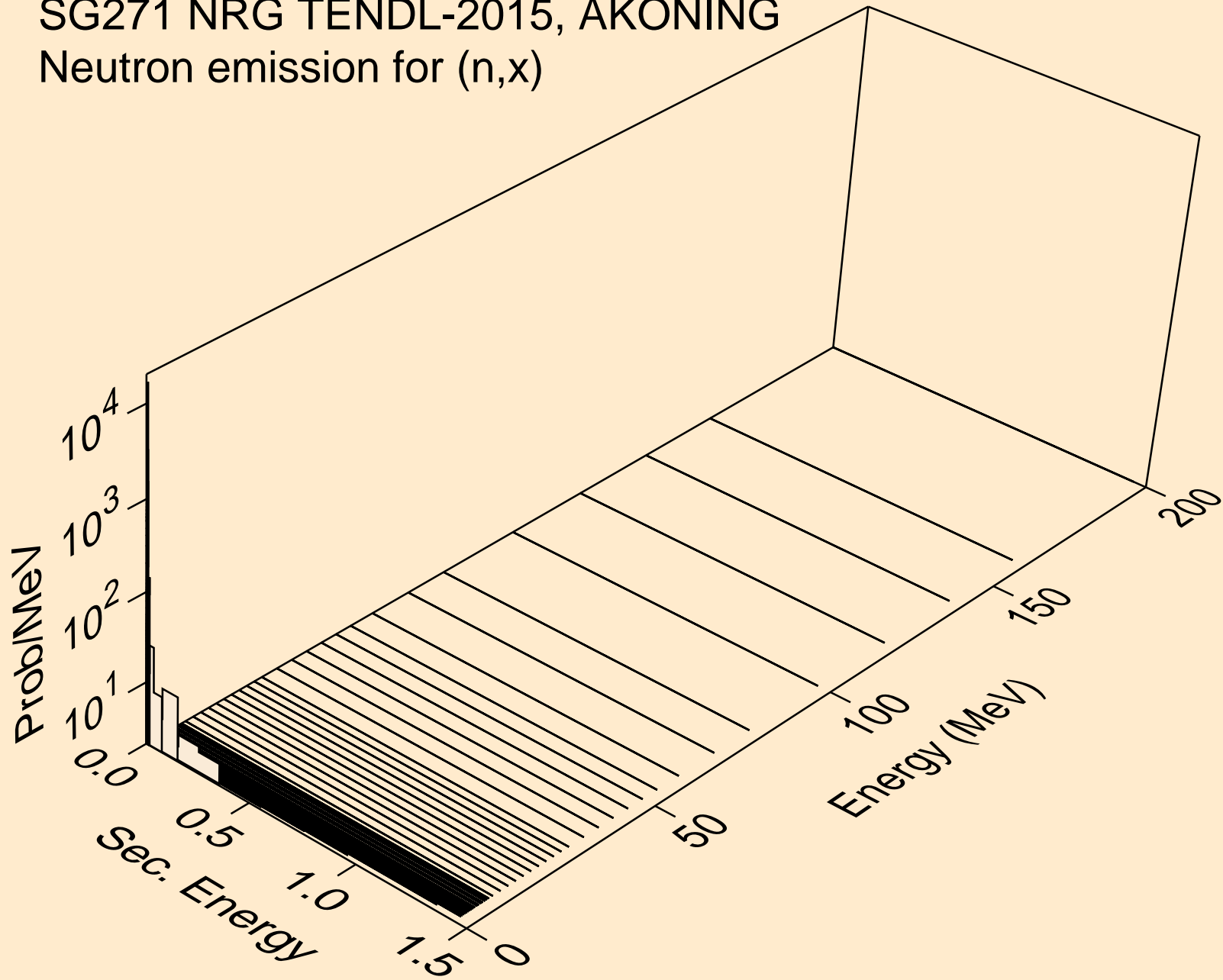

SG271 NRG TENDL-2015, AKONING
Neutron emission for (n,2nd)

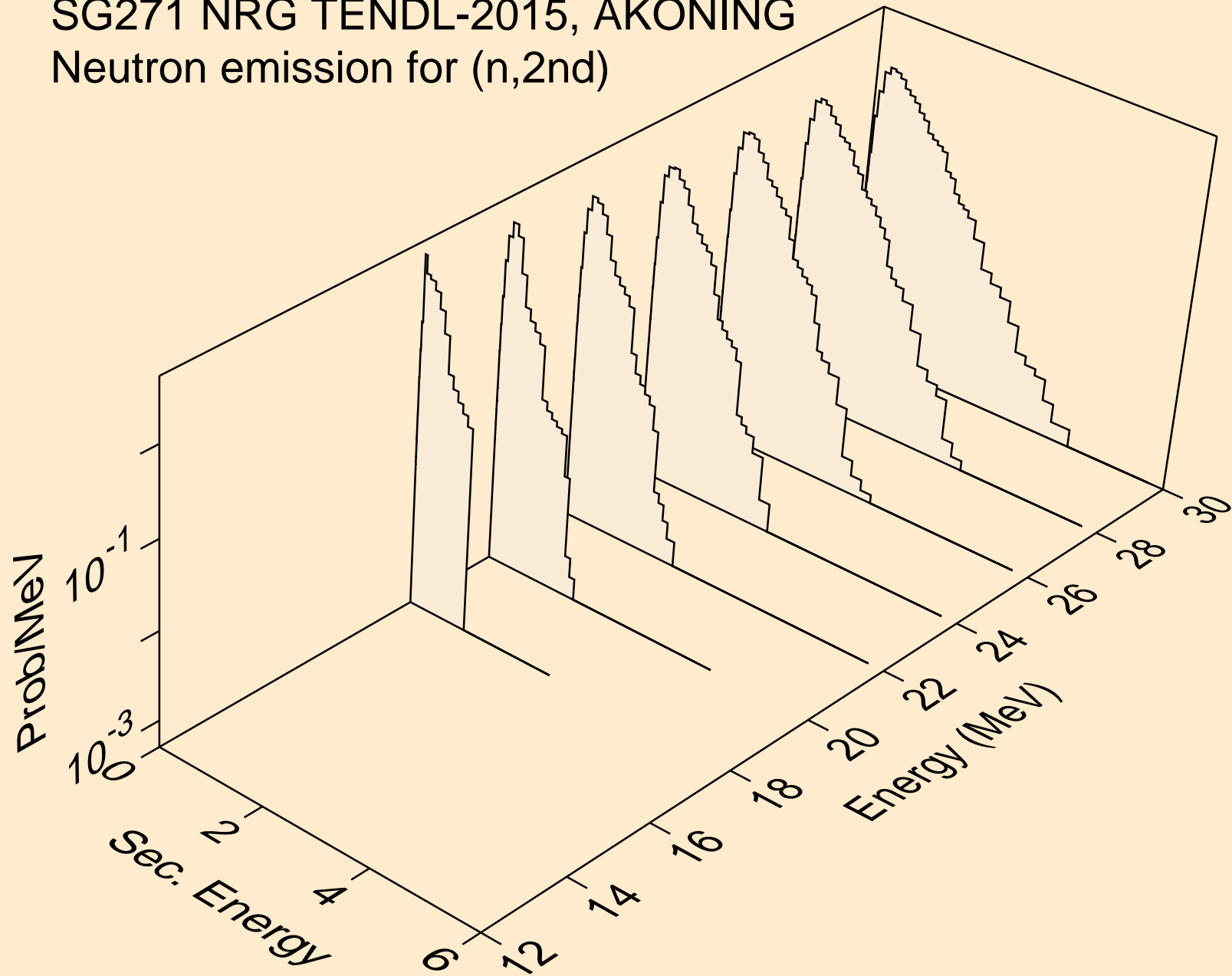

SG271 NRG TENDL-2015, AKONING
Neutron emission for (n,2n)

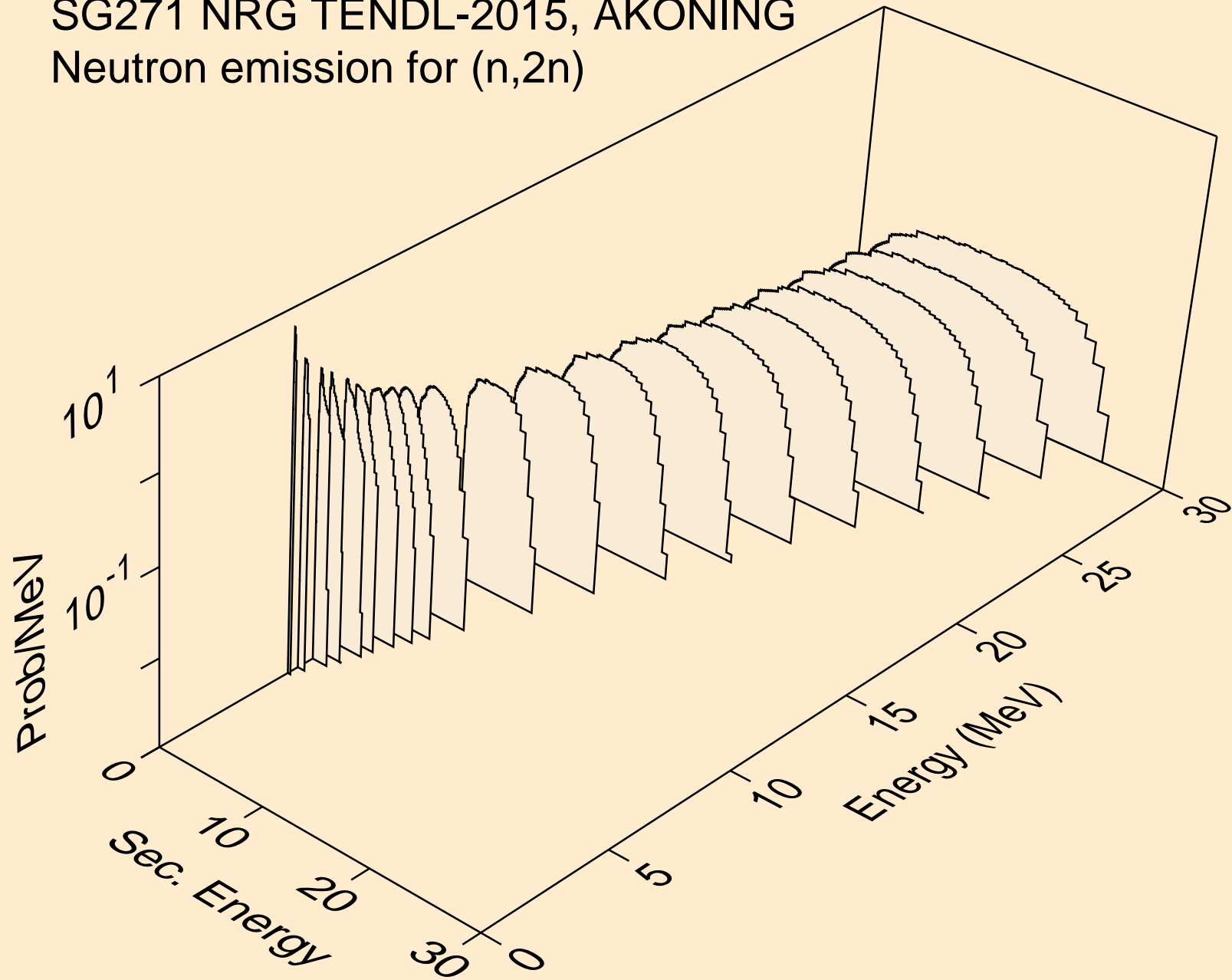

SG271 NRG TENDL-2015, AKONING
Neutron emission for (n,3n)

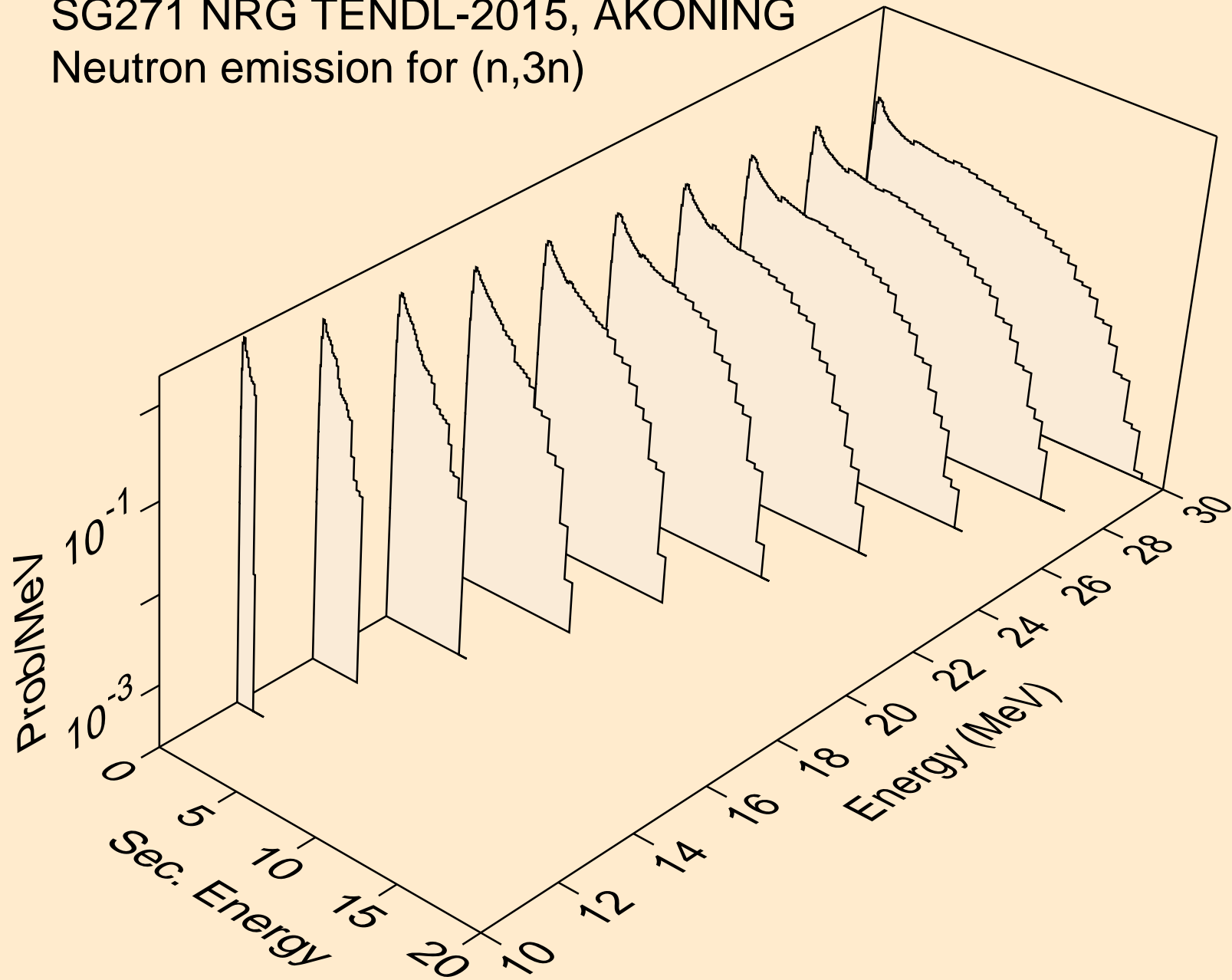

SG271 NRG TENDL-2015, AKONING
Neutron emission for fission

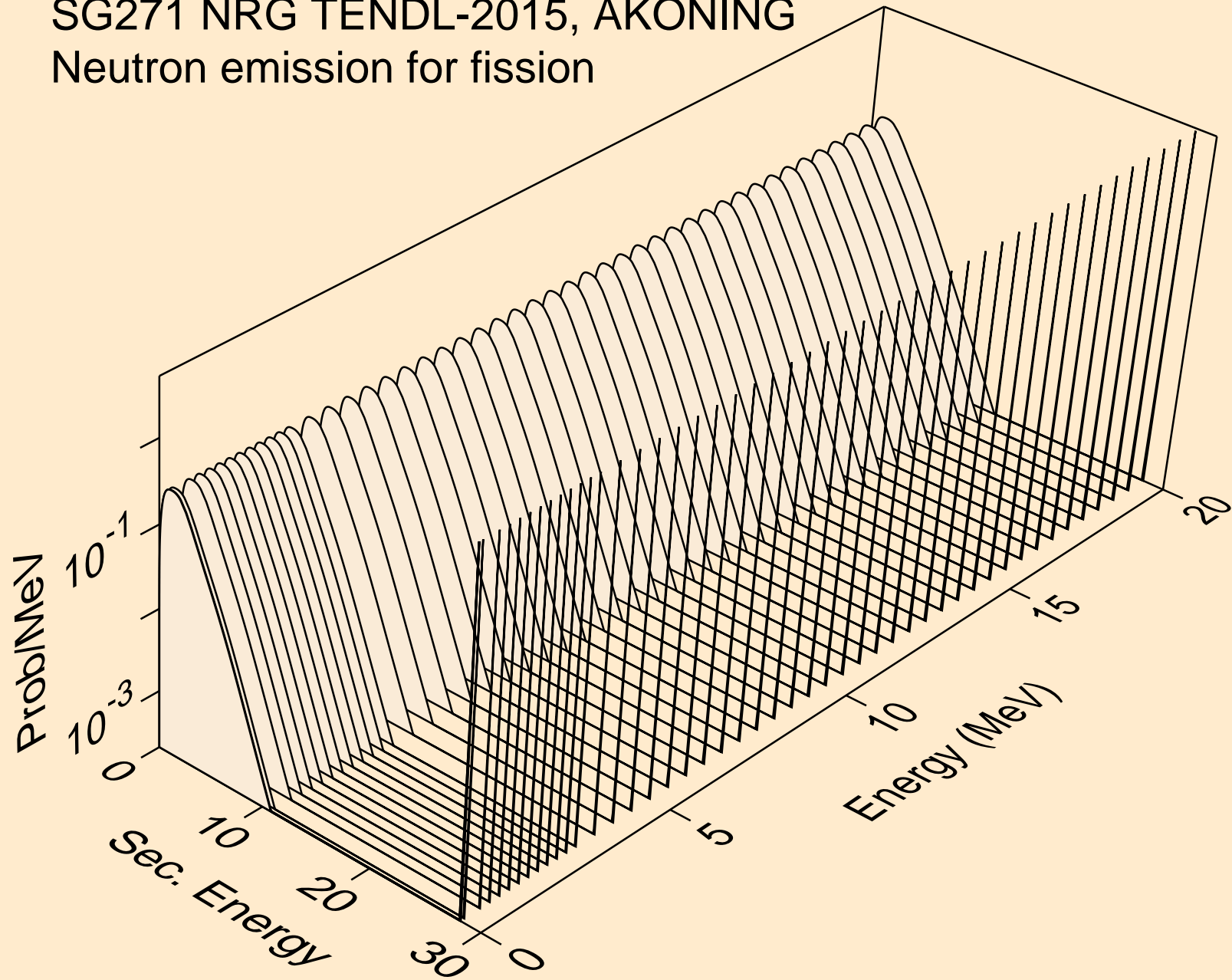

SG271 NRG TENDL-2015, AKONING
Neutron emission for (n,n*)a

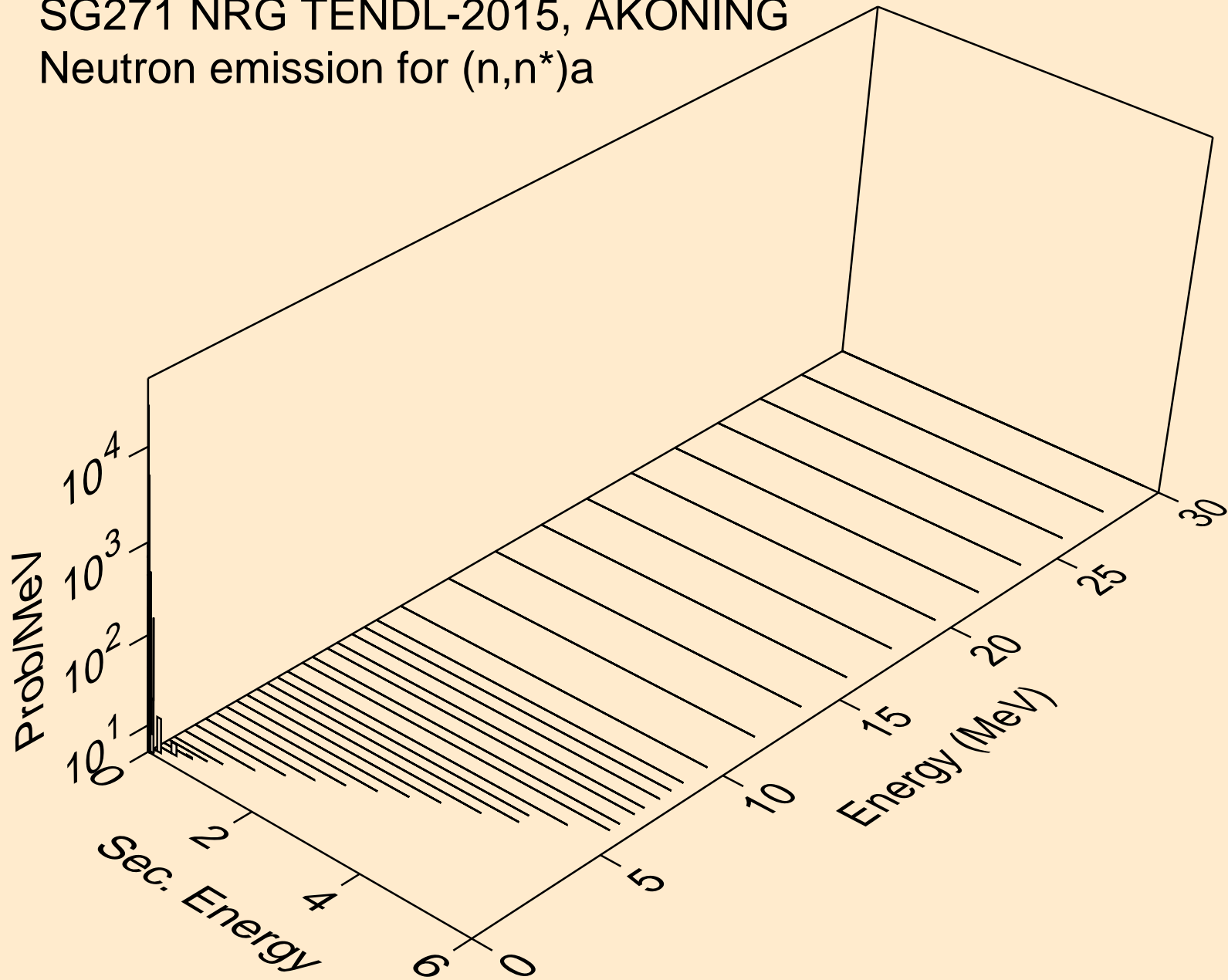

SG271 NRG TENDL-2015, AKONING
Neutron emission for (n,2n)a

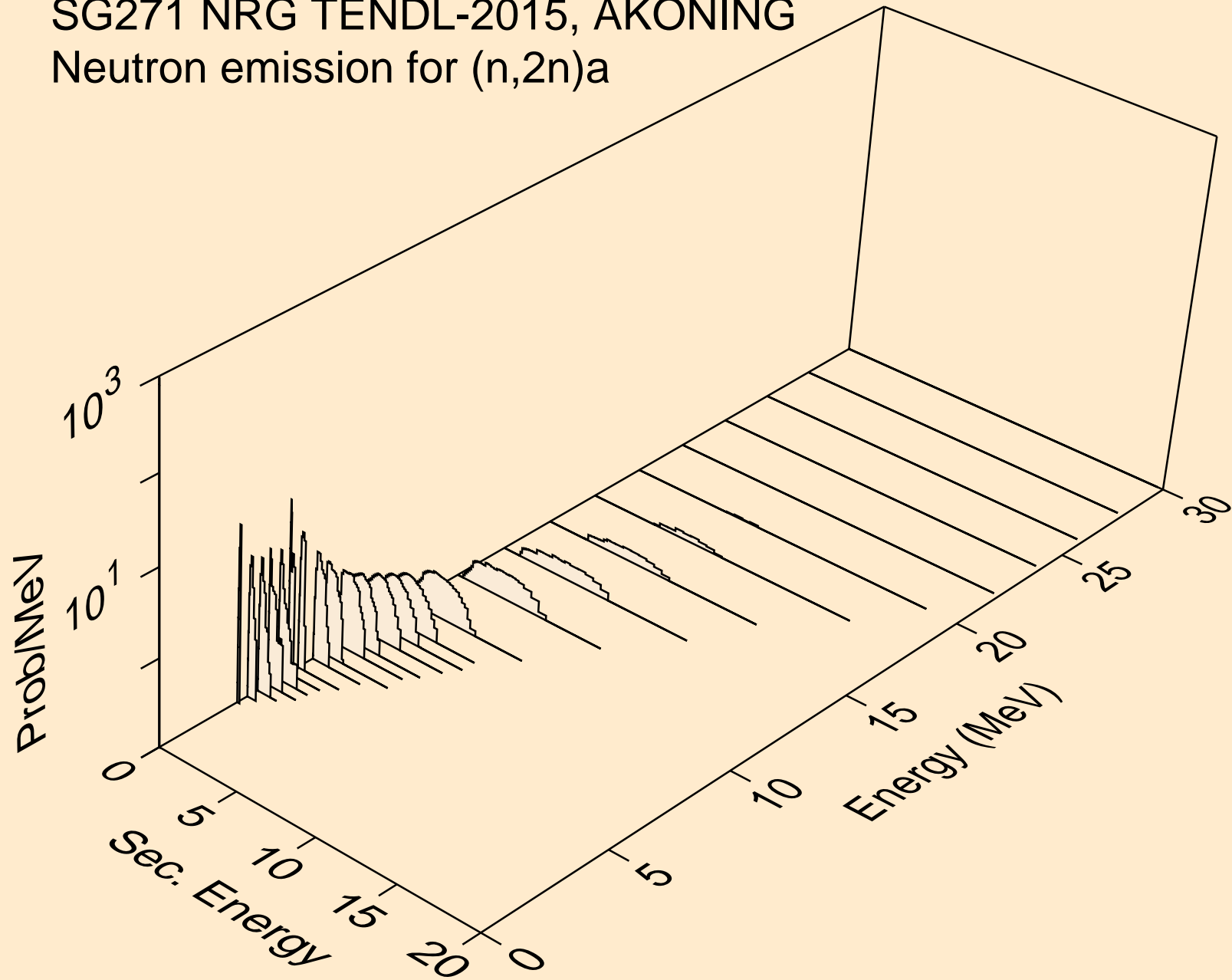

SG271 NRG TENDL-2015, AKONING
Neutron emission for (n,3n)a

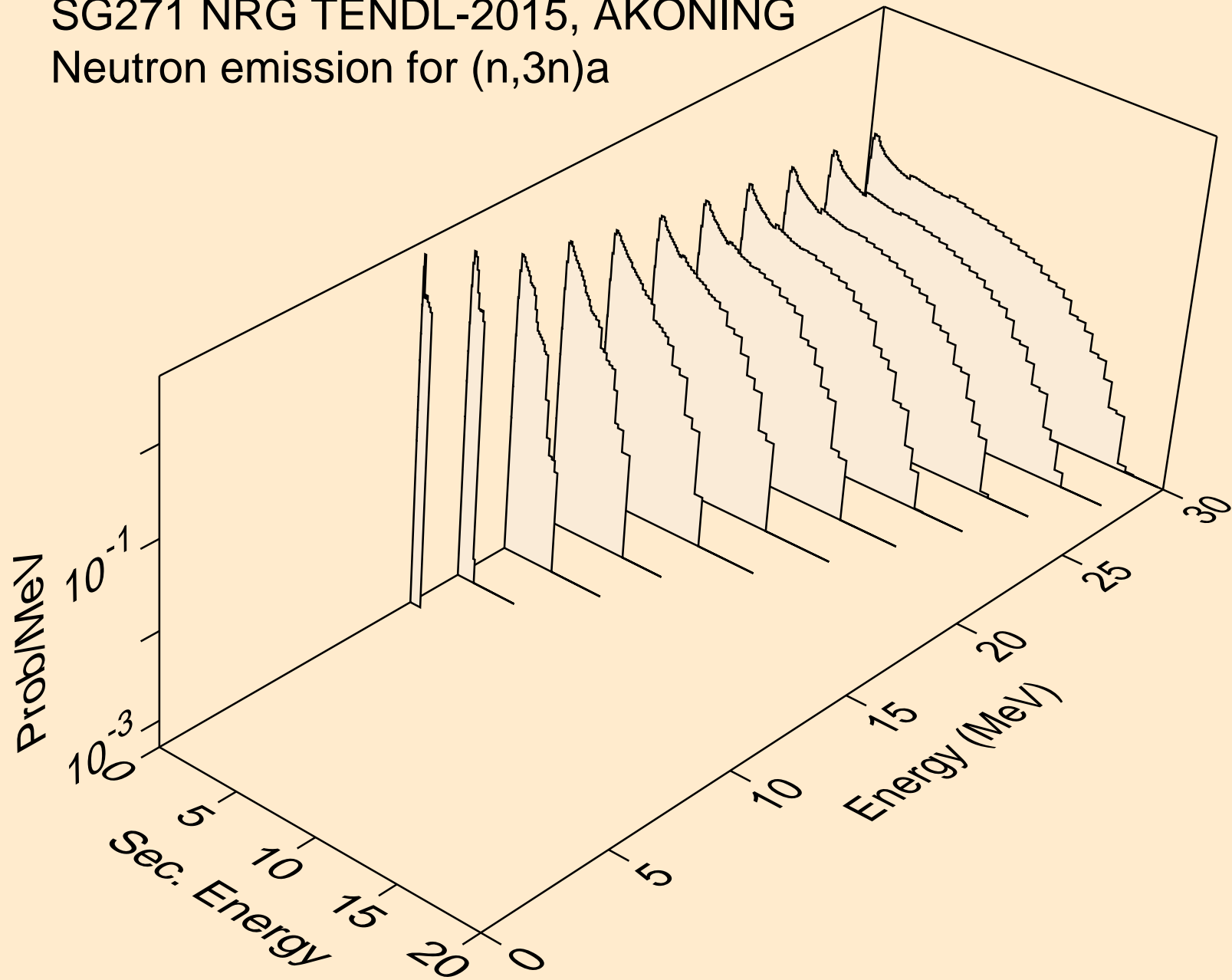

SG271 NRG TENDL-2015, AKONING
Neutron emission for (n,n*)p

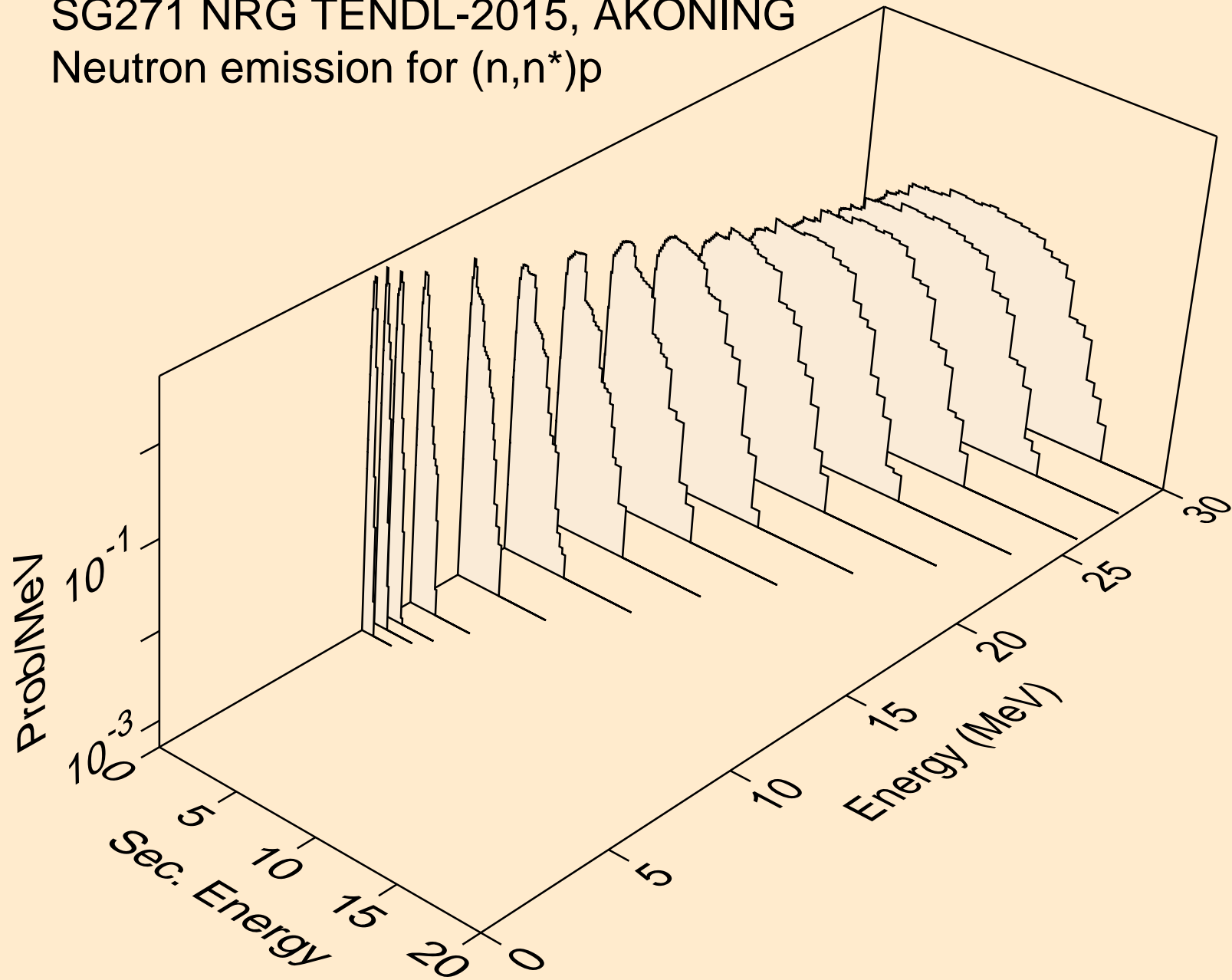

SG271 NRG TENDL-2015, AKONING
Neutron emission for (n,2n)2a

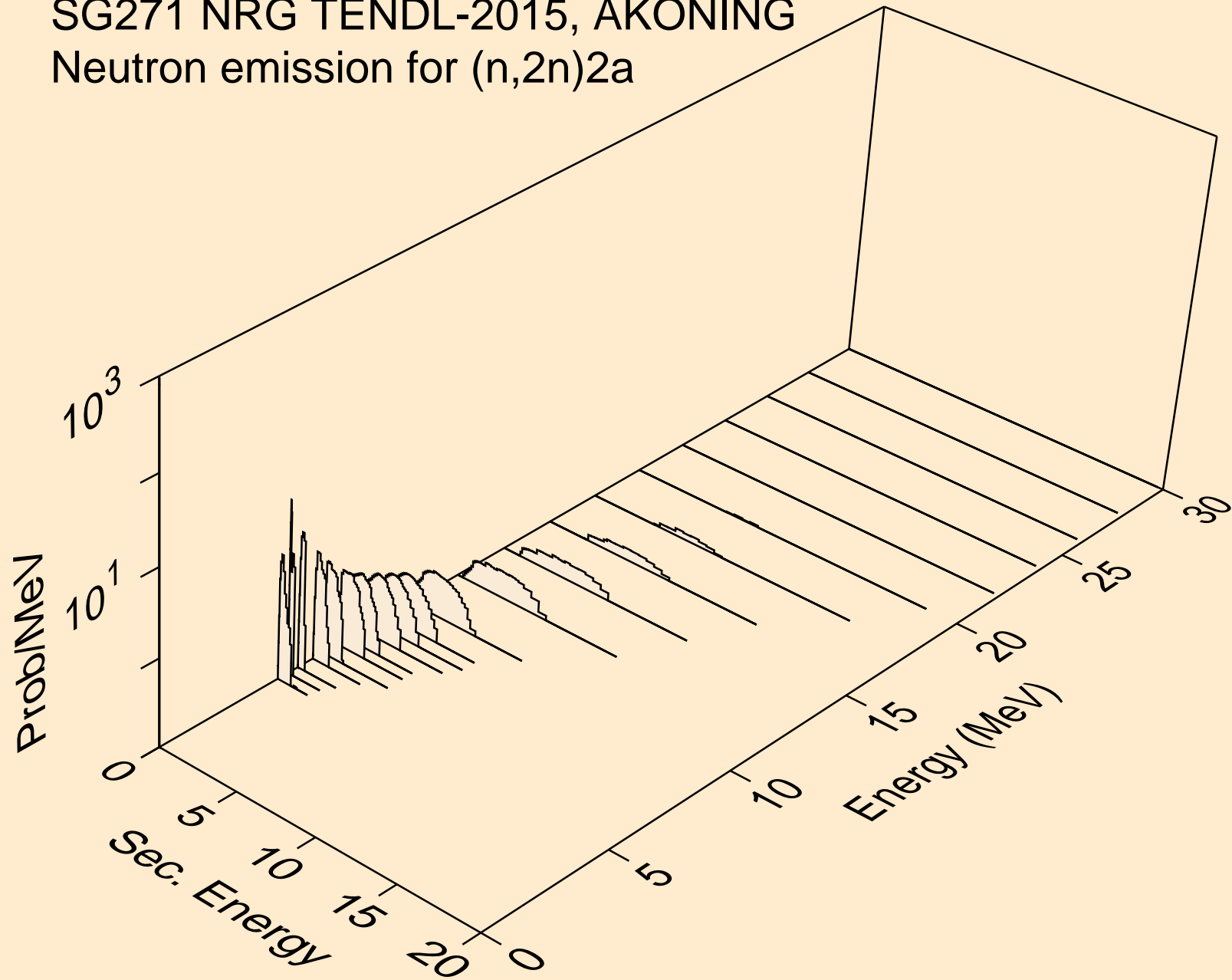

SG271 NRG TENDL-2015, AKONING
Neutron emission for (n,n*)d

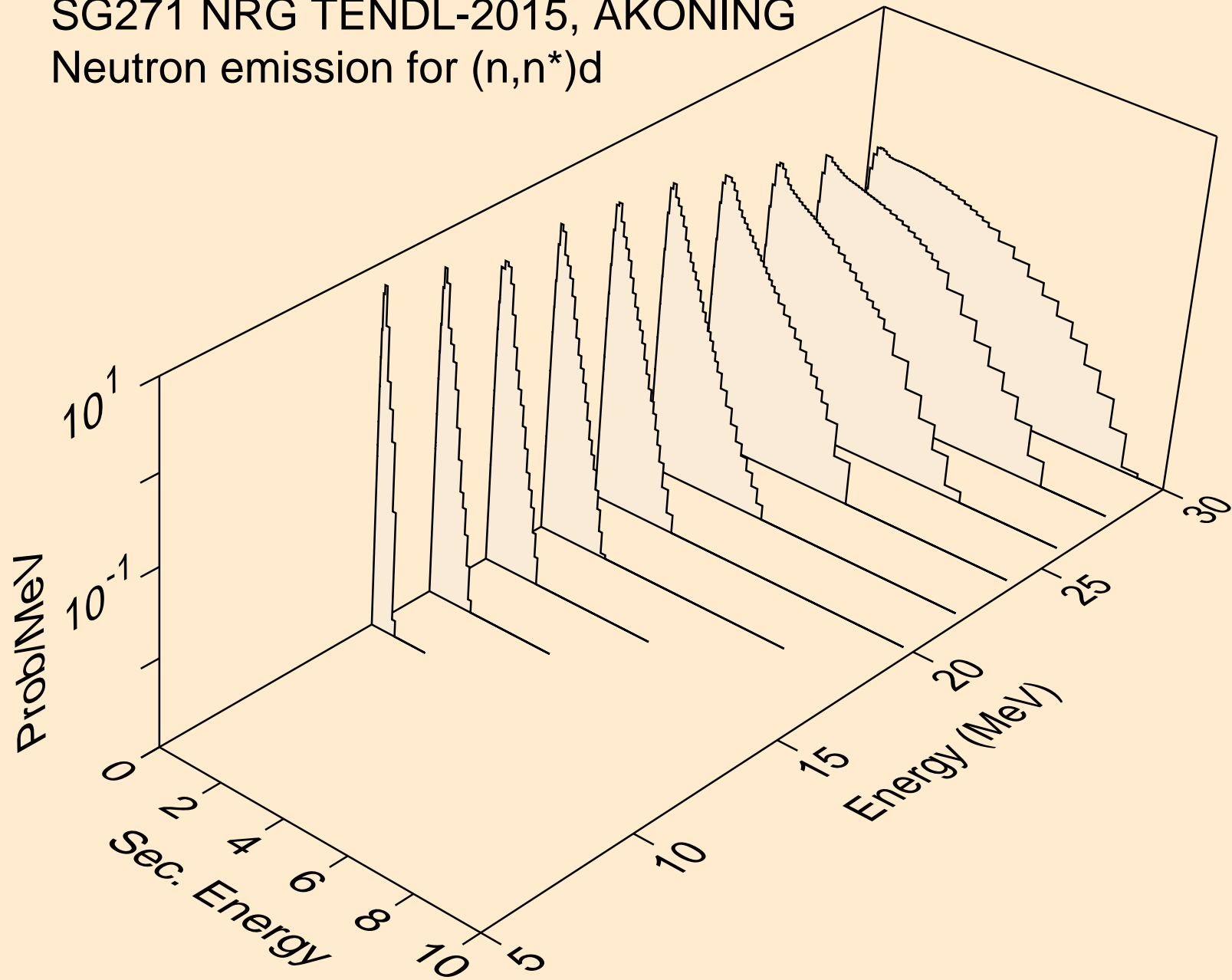

SG271 NRG TENDL-2015, AKONING
Neutron emission for (n,n*)t

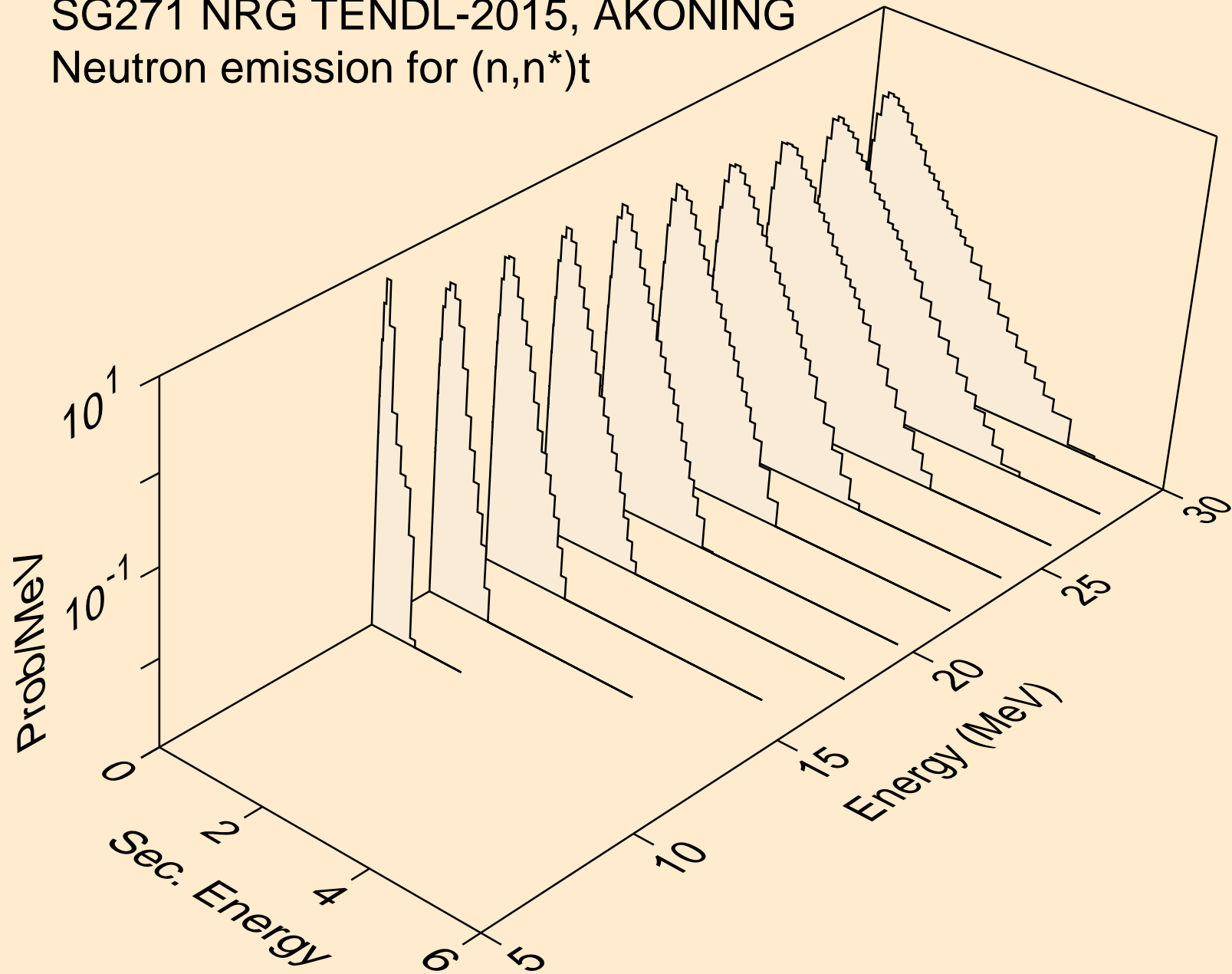

SG271 NRG TENDL-2015, AKONING
Neutron emission for (n,n*)he3

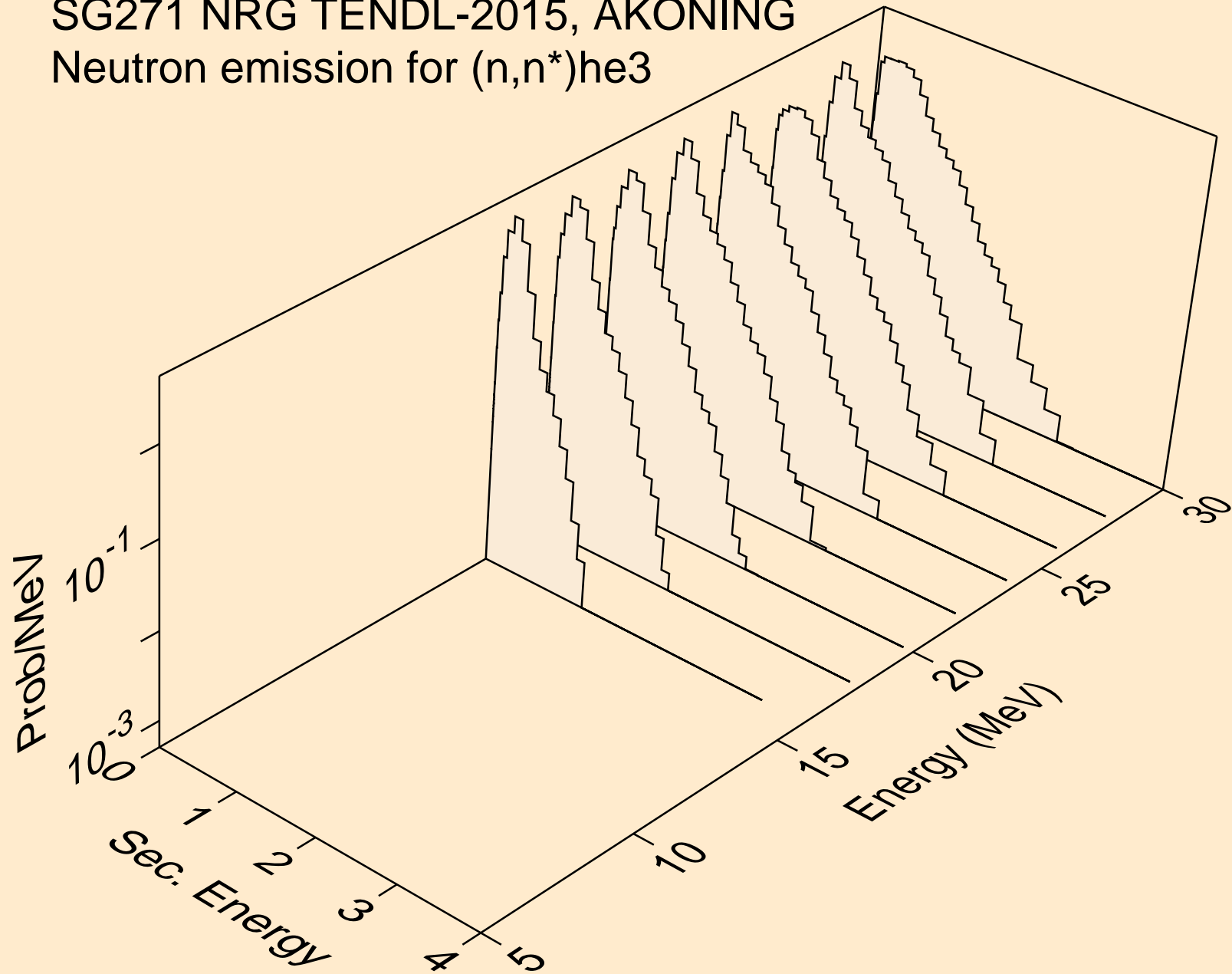

SG271 NRG TENDL-2015, AKONING
Neutron emission for (n,n*)d2a

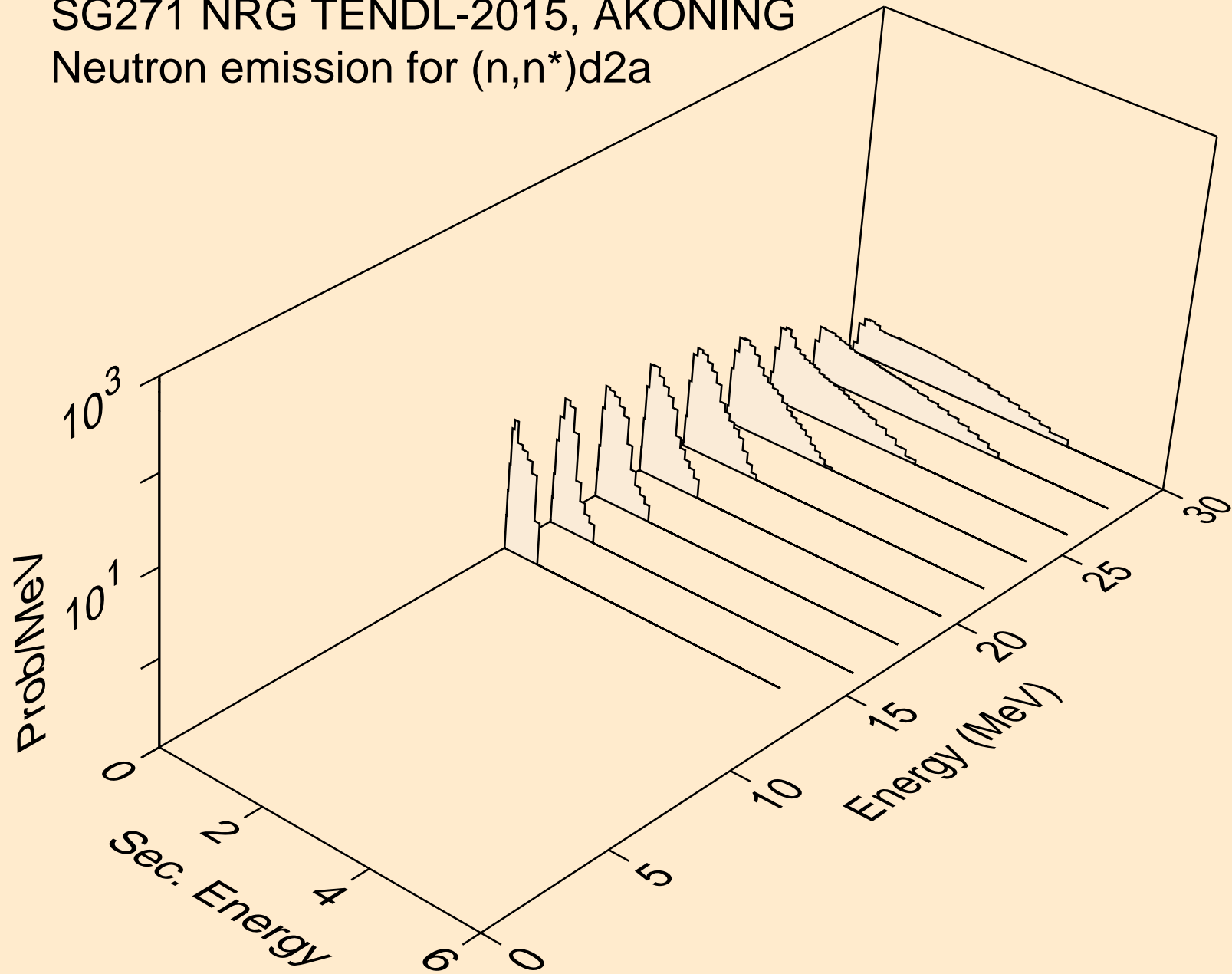

SG271 NRG TENDL-2015, AKONING
Neutron emission for (n,n*)t2a

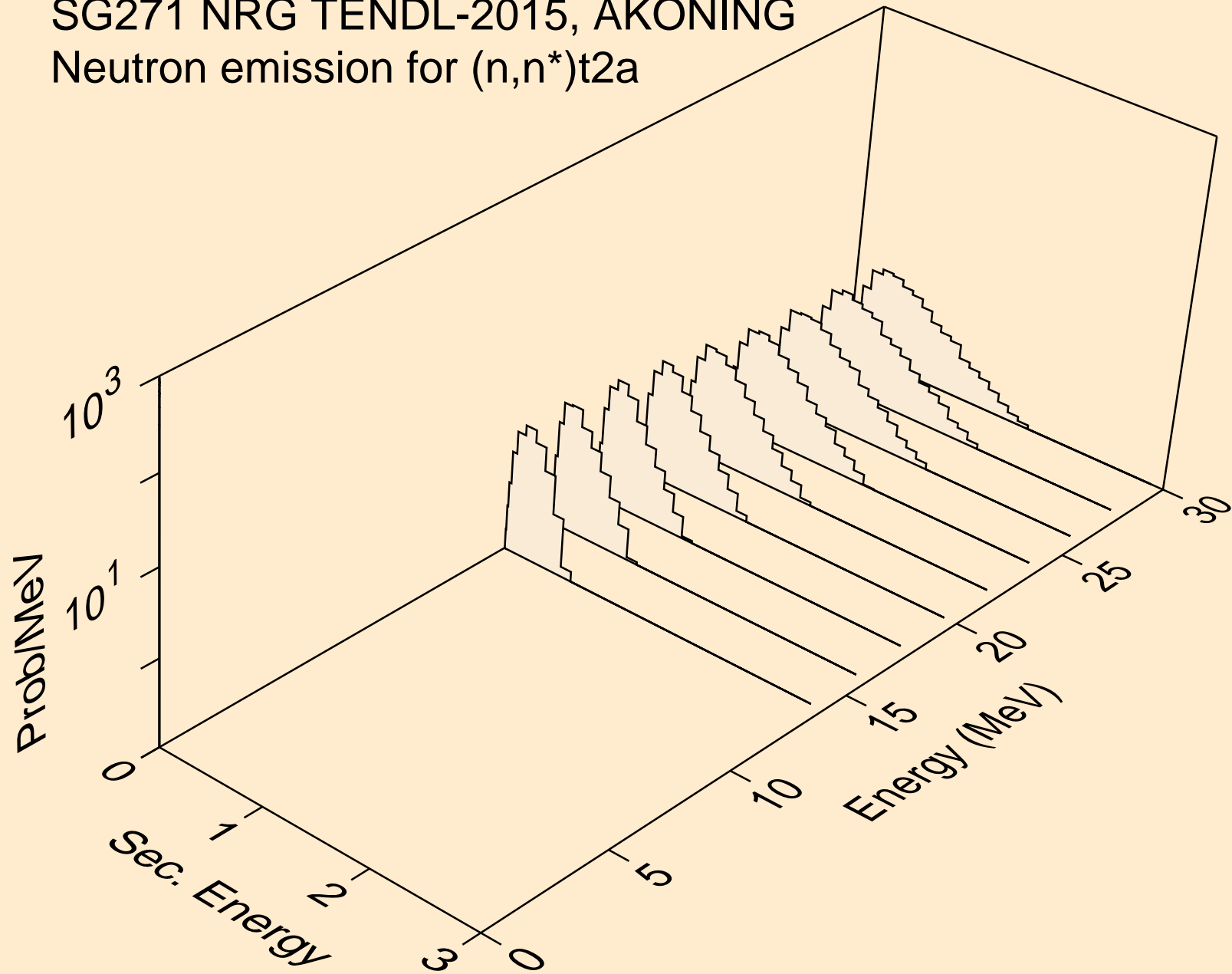

SG271 NRG TENDL-2015, AKONING
Neutron emission for (n,4n)

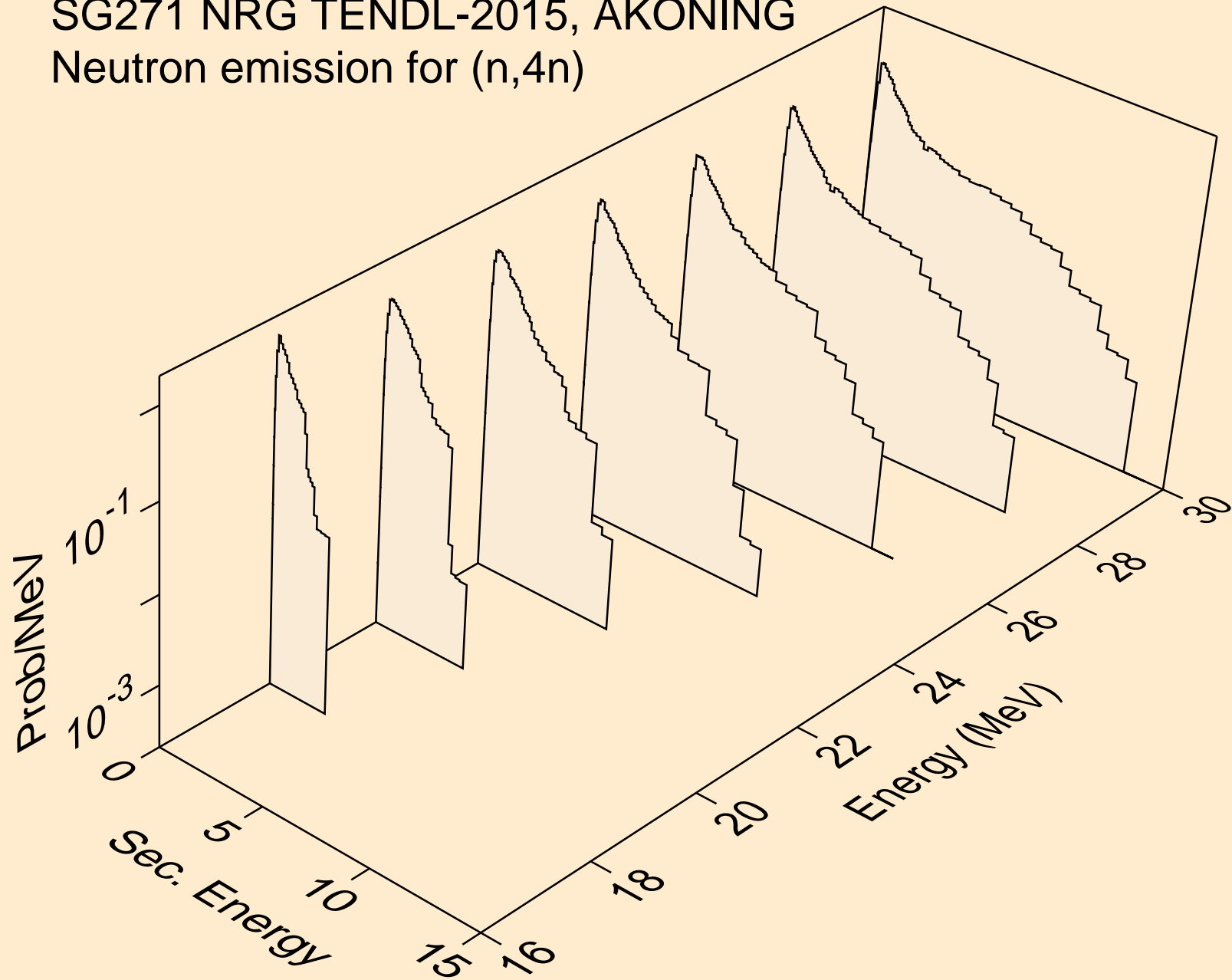

SG271 NRG TENDL-2015, AKONING
Neutron emission for (n,2np)

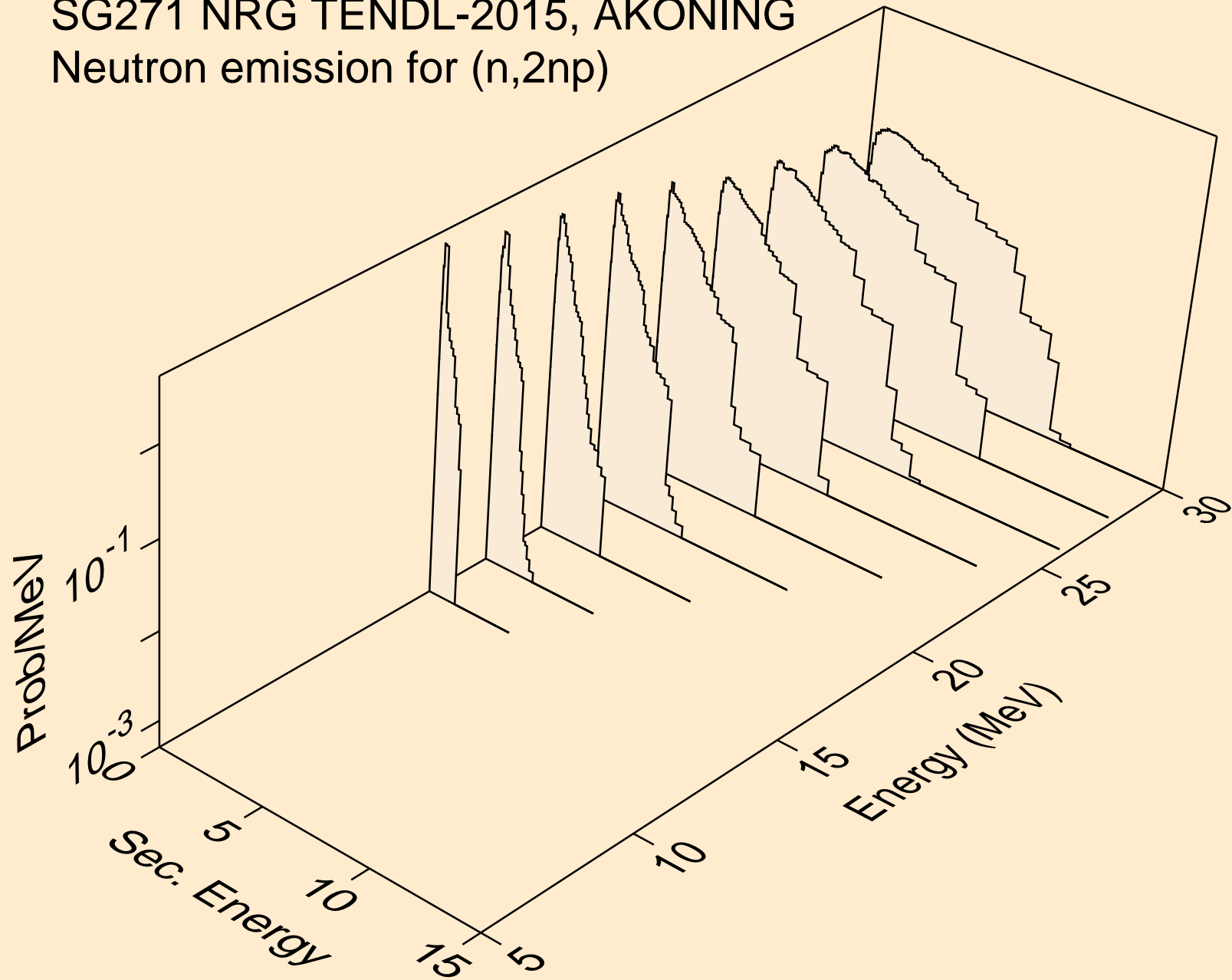

SG271 NRG TENDL-2015, AKONING
Neutron emission for (n,3np)

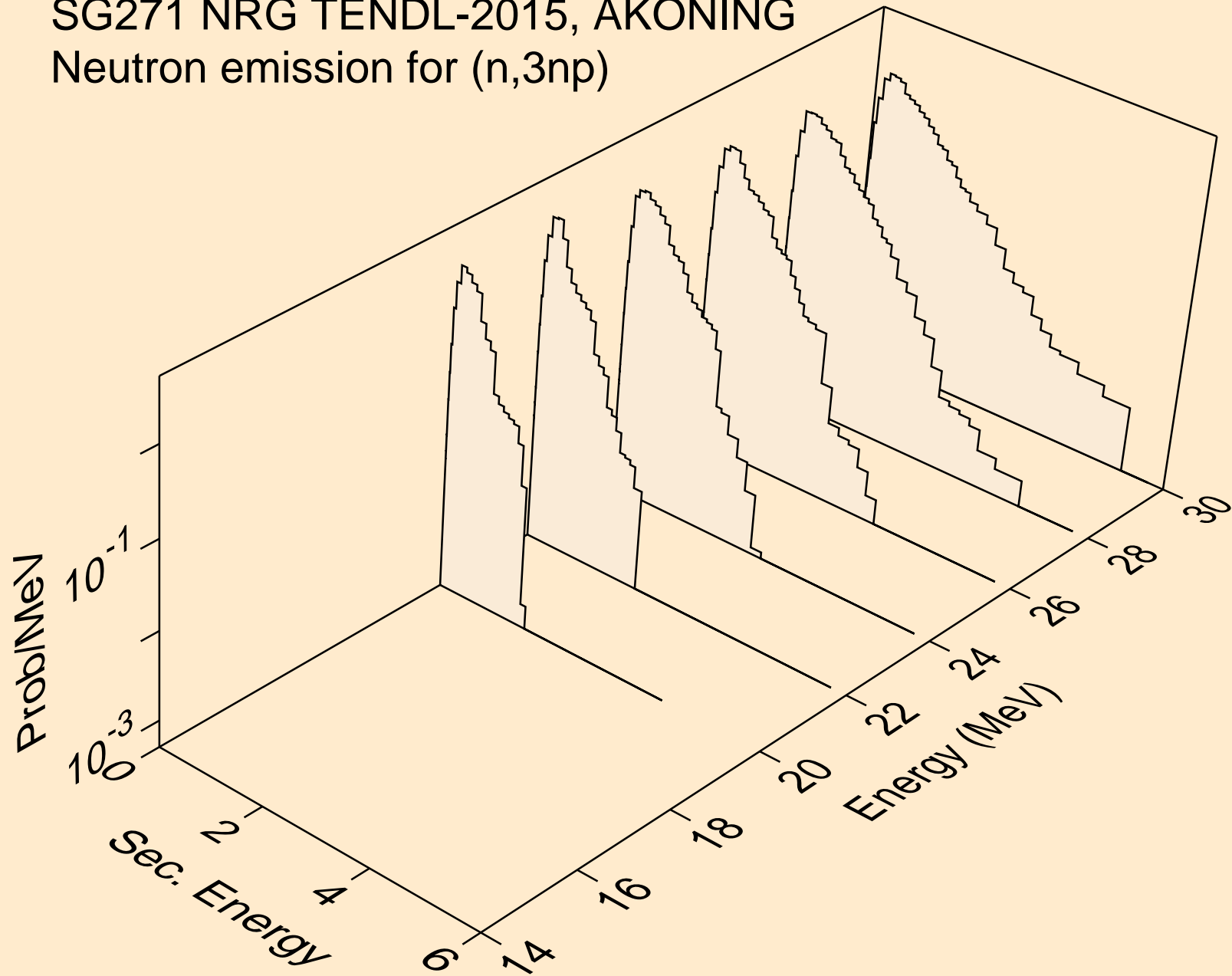

SG271 NRG TENDL-2015, AKONING
Neutron emission for (n,npa)

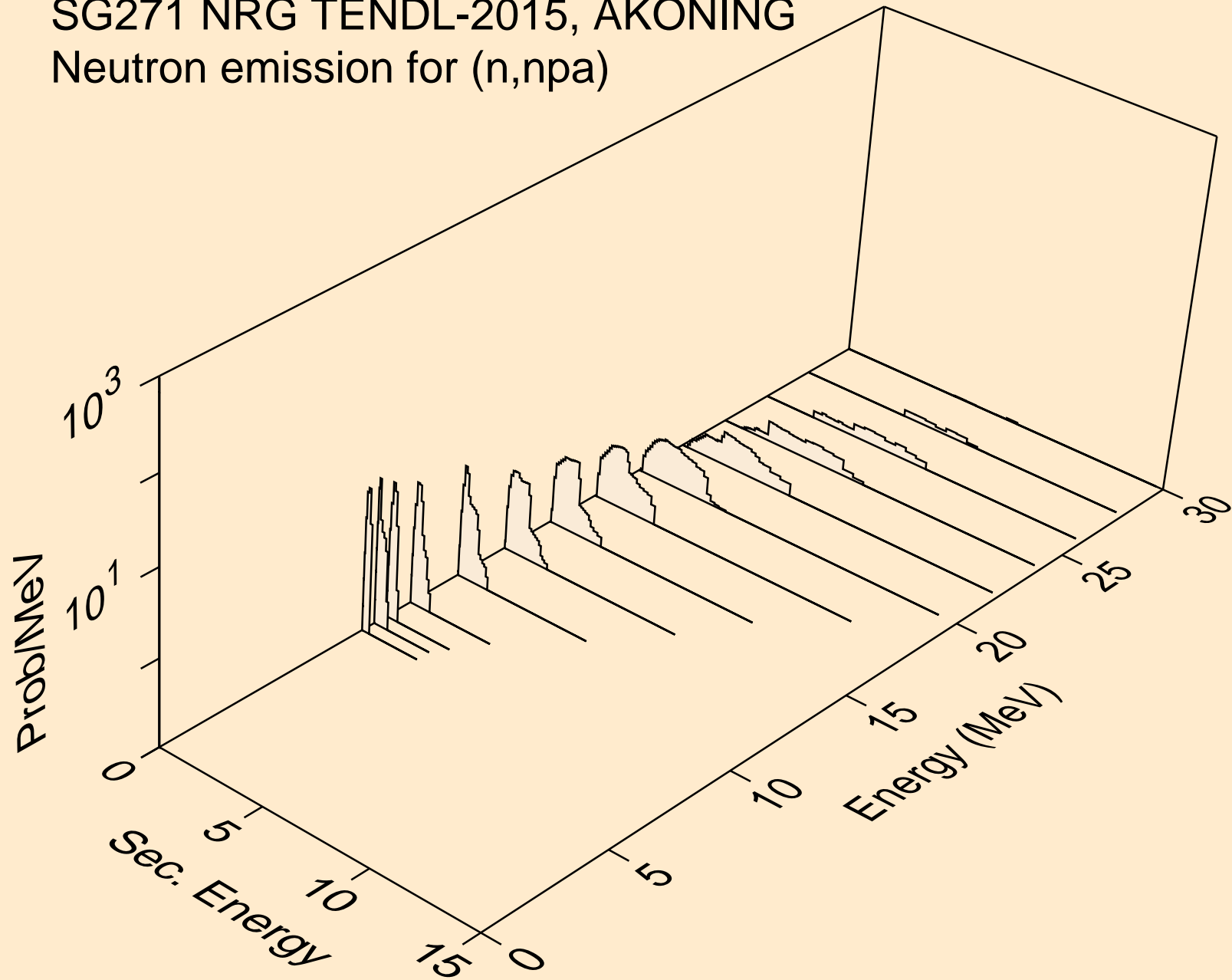

SG271 NRG TENDL-2015, AKONING
Neutron emission for (n,n*c)

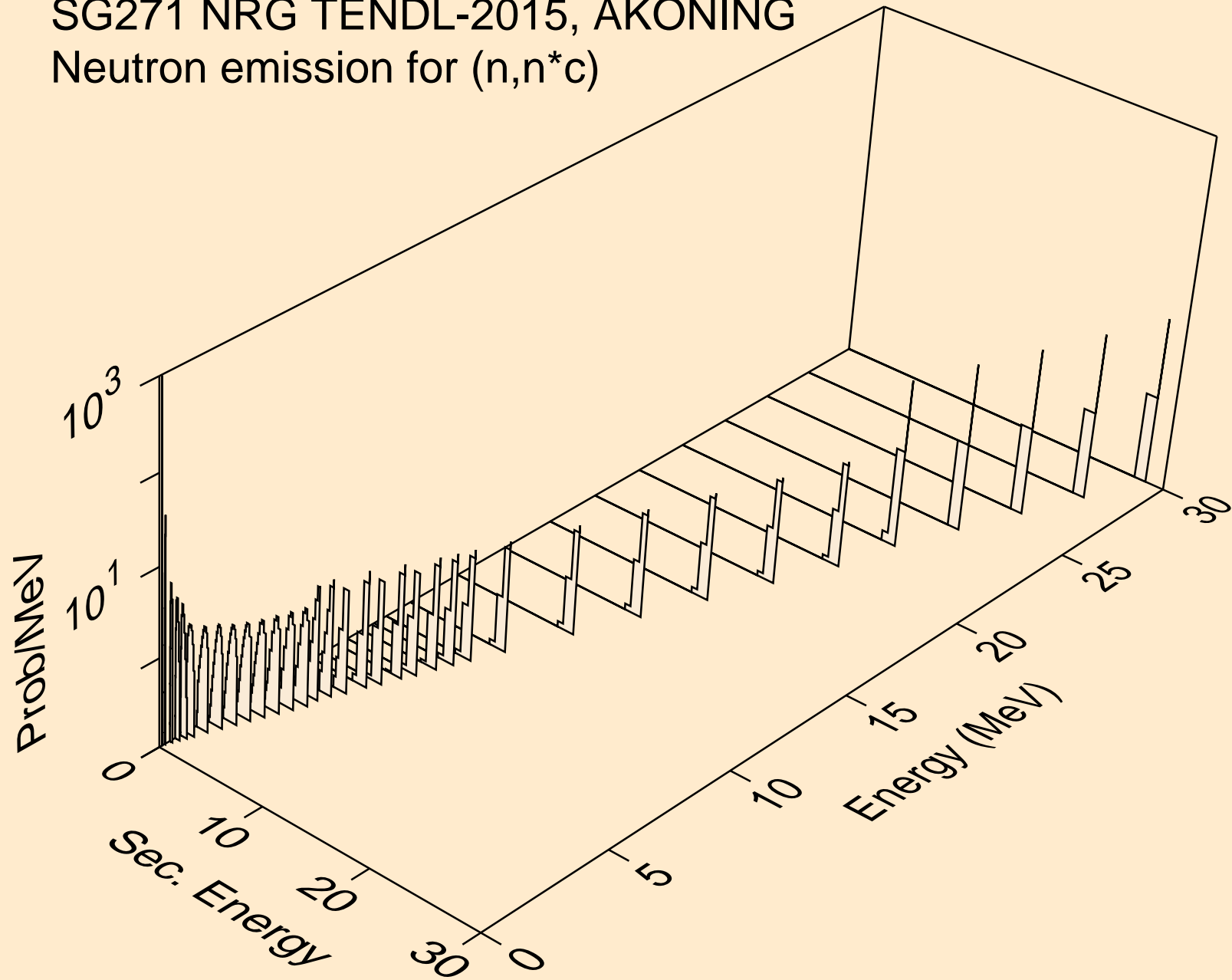

SG271 NRG TENDL-2015, AKONING

Delayed nubar

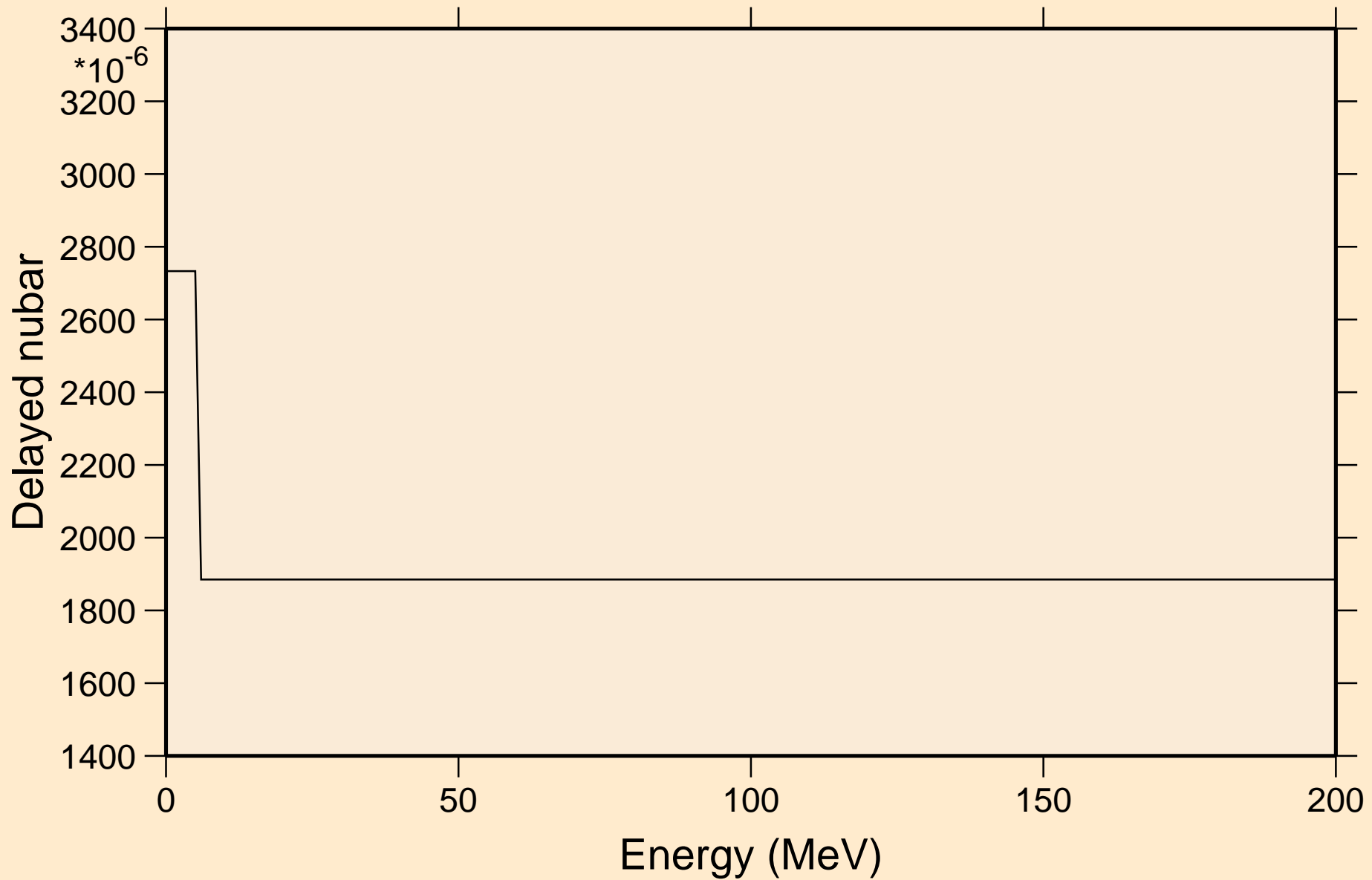

SG271 NRG TENDL-2015, AKONING

Delayed neutron spectra

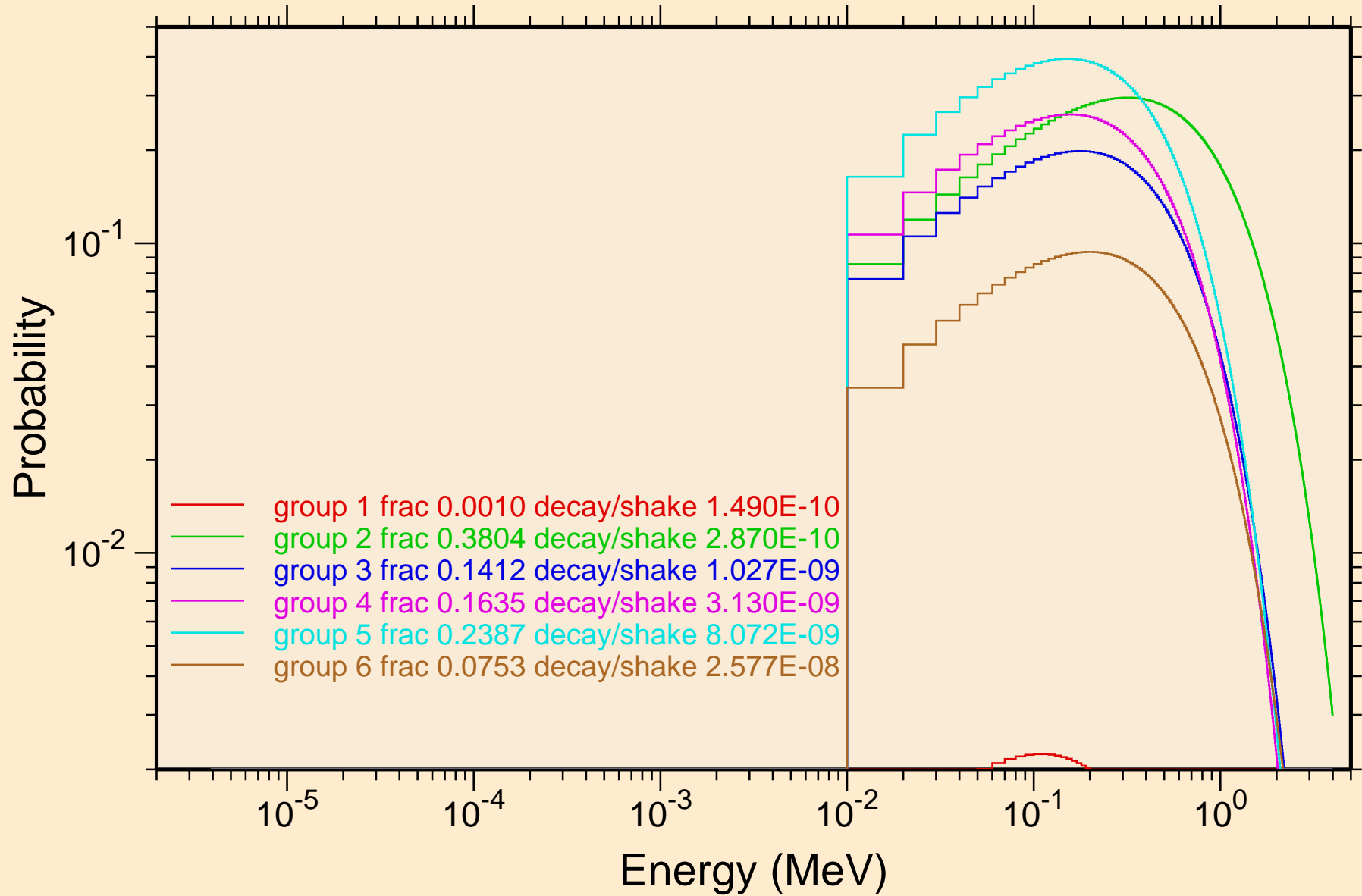

SG271 NRG TENDL-2015, AKONING
Photon emission for (n,x)

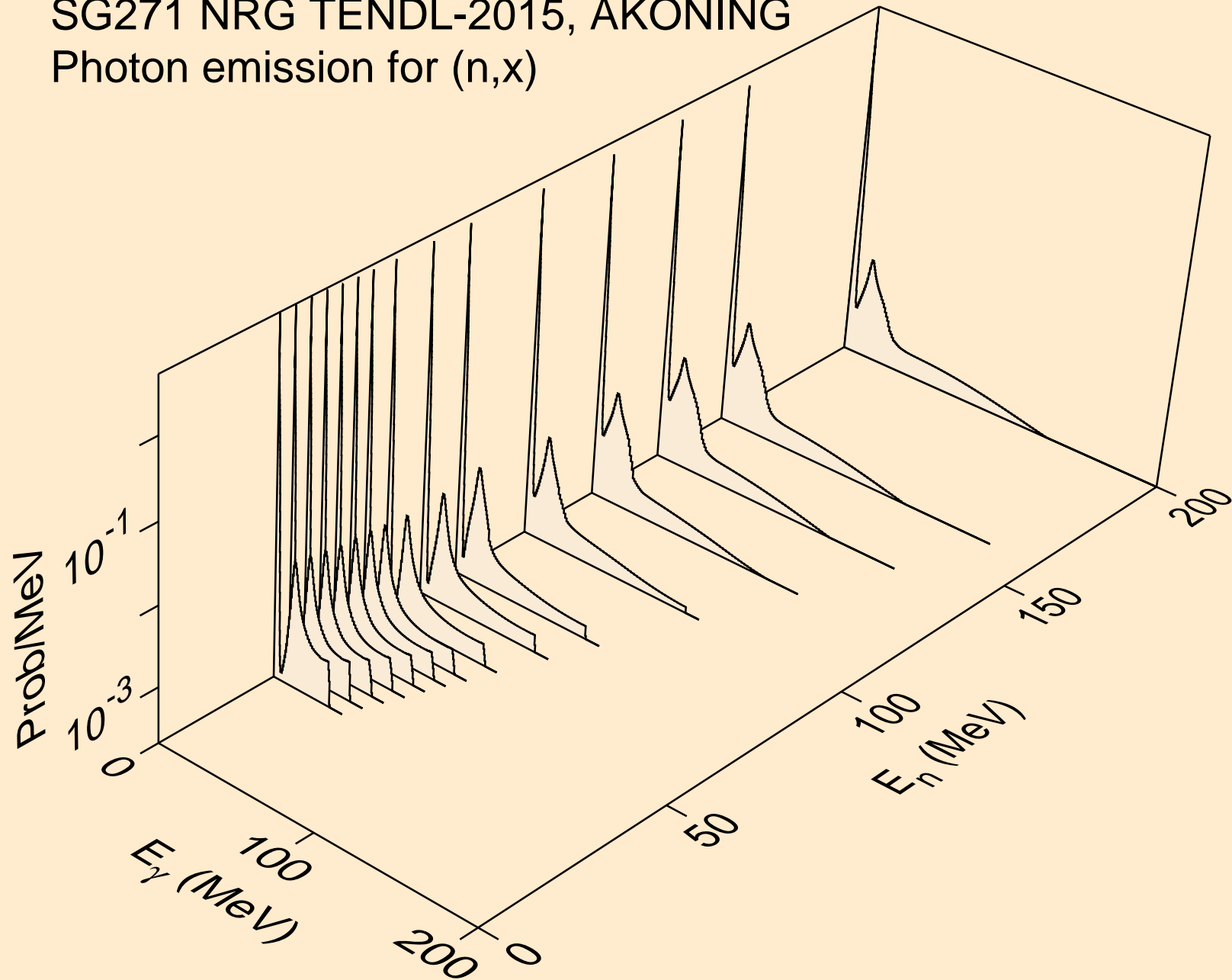

SG271 NRG TENDL-2015, AKONING
Photon emission for (n,2nd)

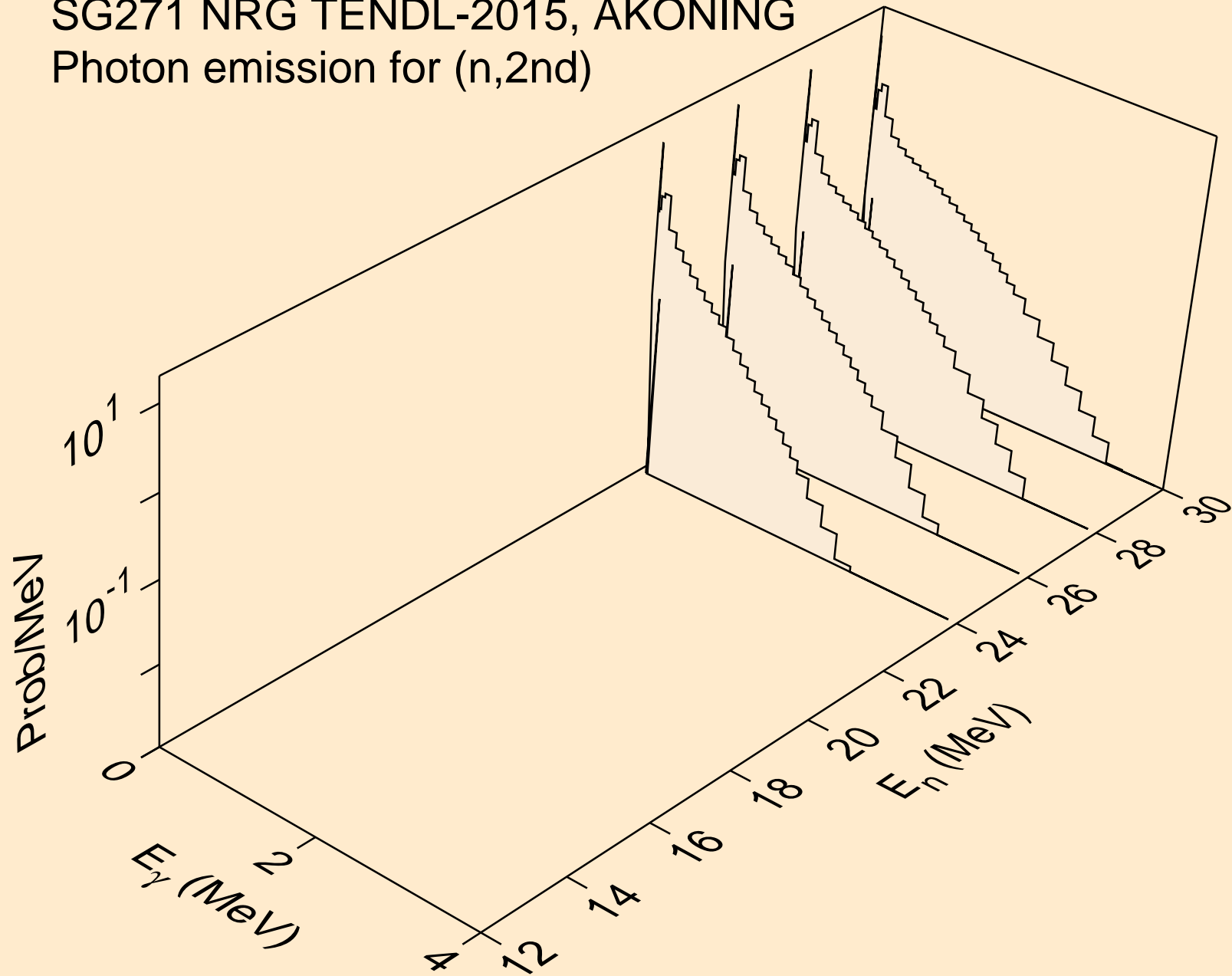

SG271 NRG TENDL-2015, AKONING
Photon emission for (n,2n)

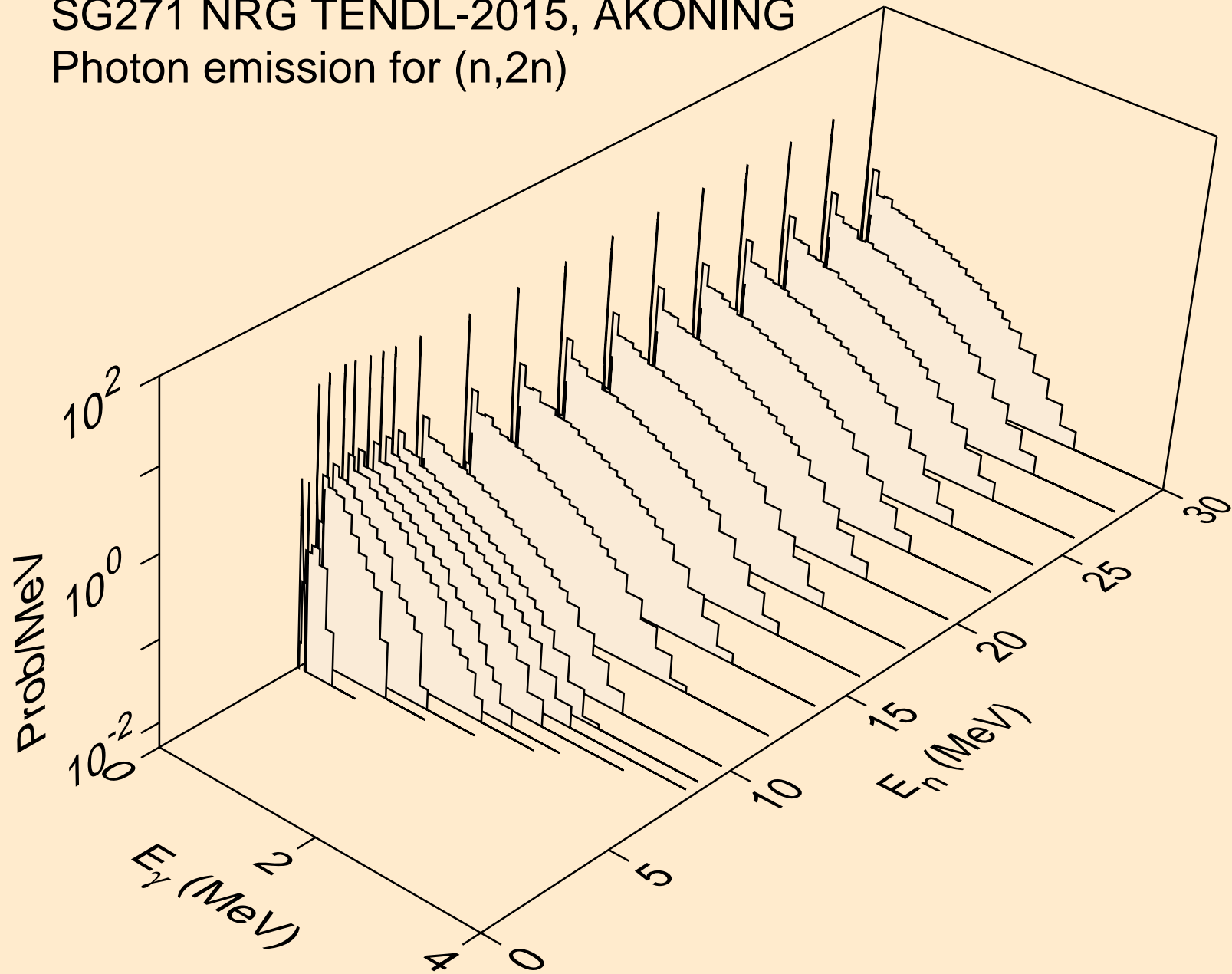

SG271 NRG TENDL-2015, AKONING
Photon emission for (n,3n)

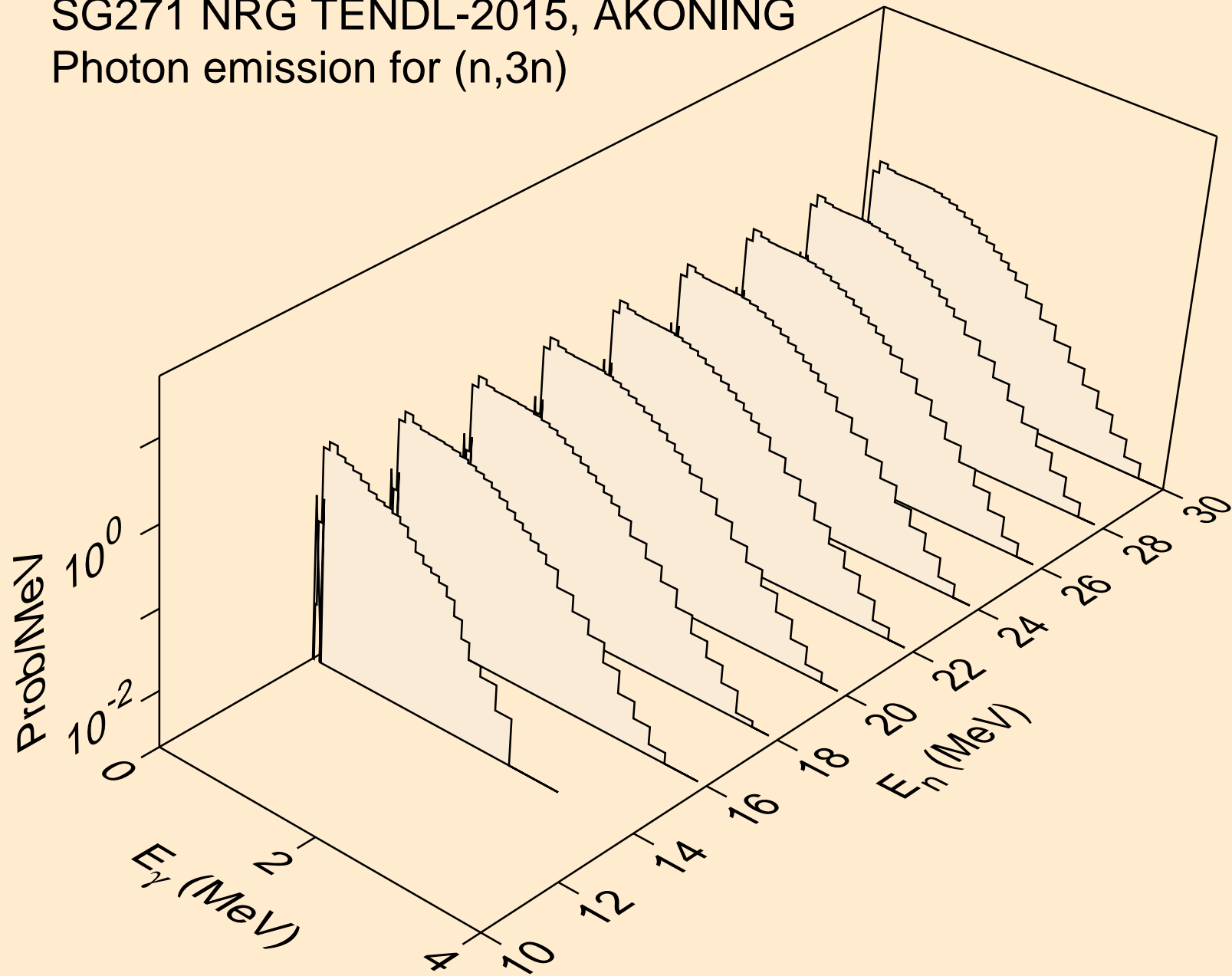

SG271 NRG TENDL-2015, AKONING
Photon emission for (n,n*)a

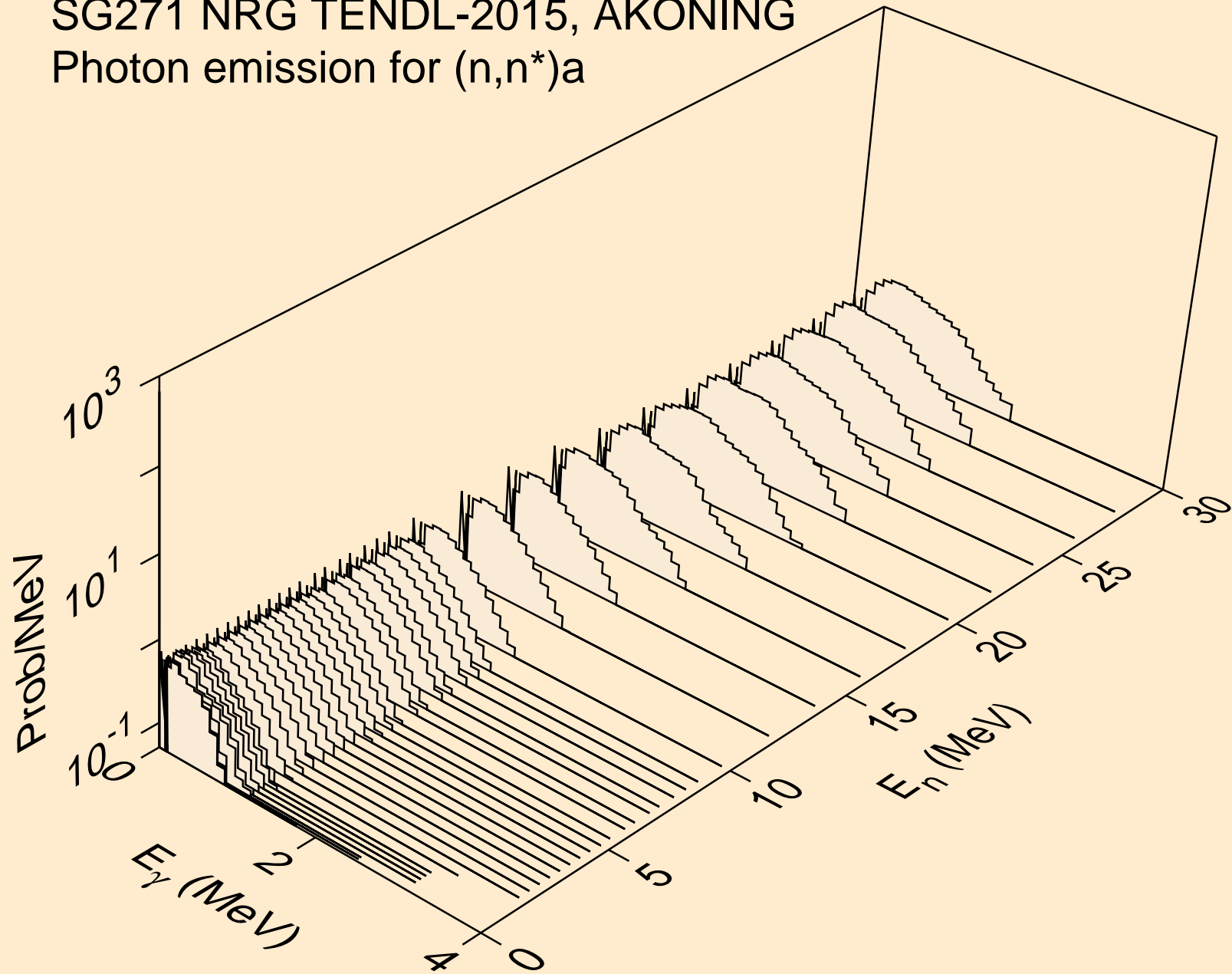

SG271 NRG TENDL-2015, AKONING
Photon emission for (n,2n)a

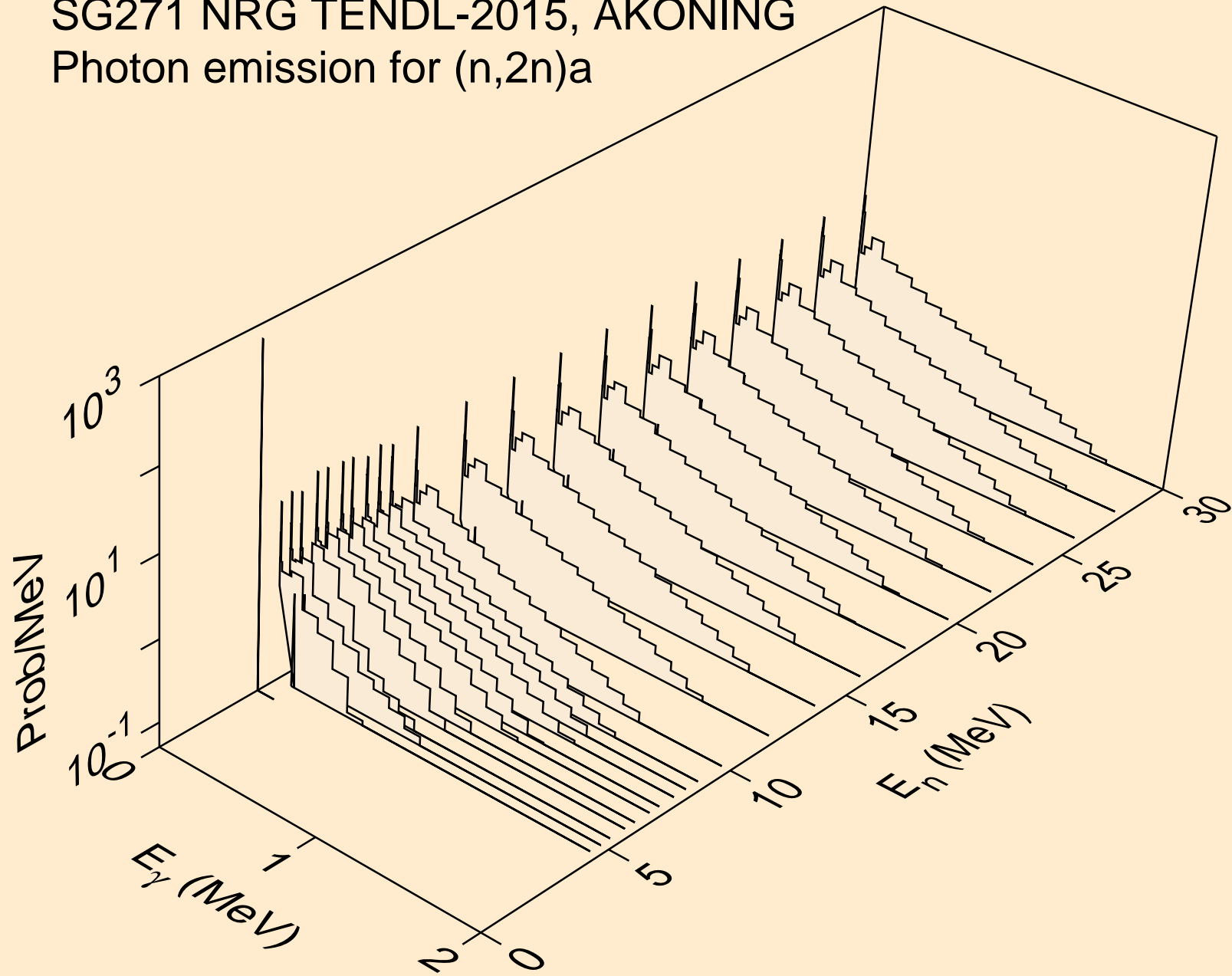

SG271 NRG TENDL-2015, AKONING
Photon emission for (n,3n)a

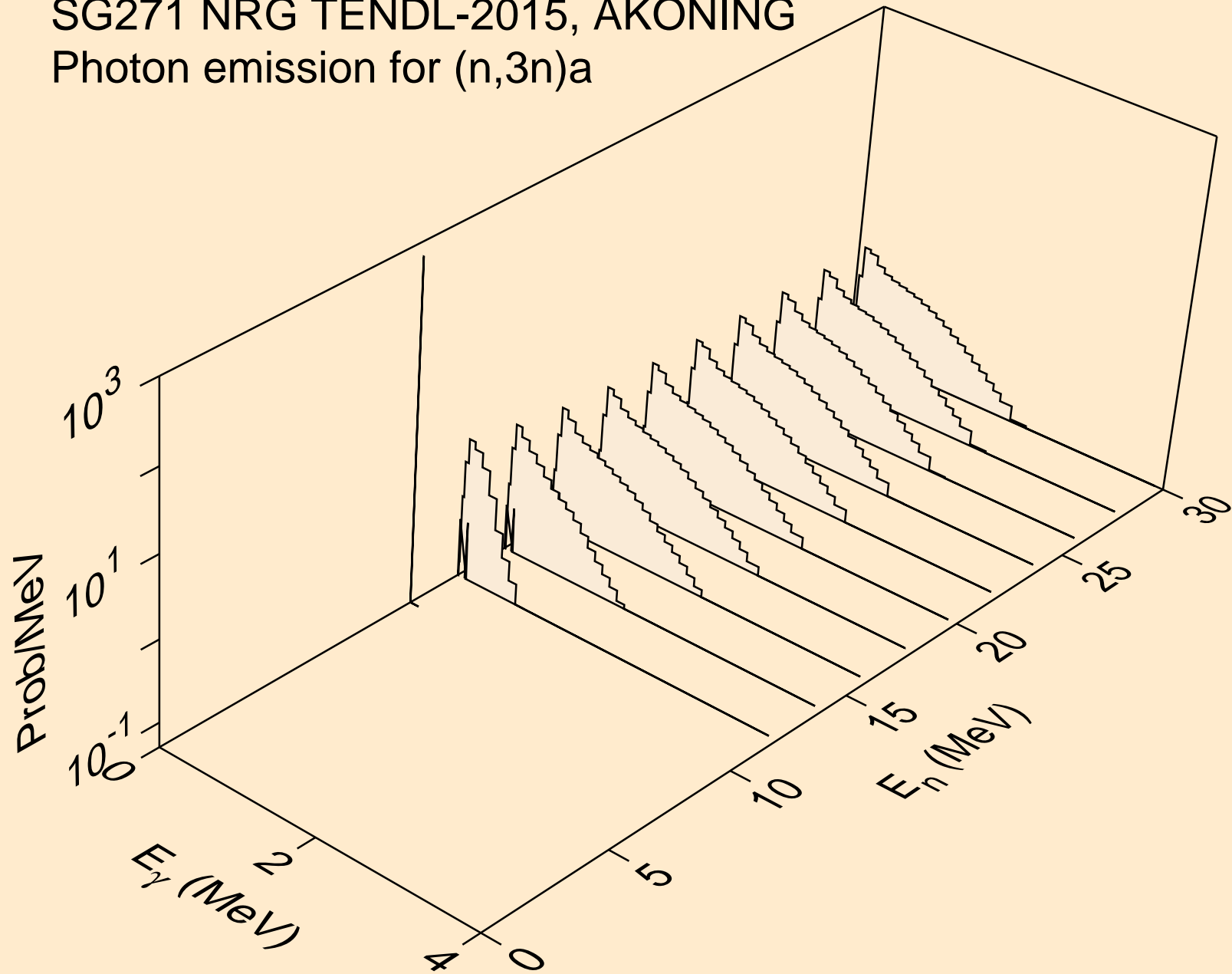

SG271 NRG TENDL-2015, AKONING
Photon emission for (n,n*)p

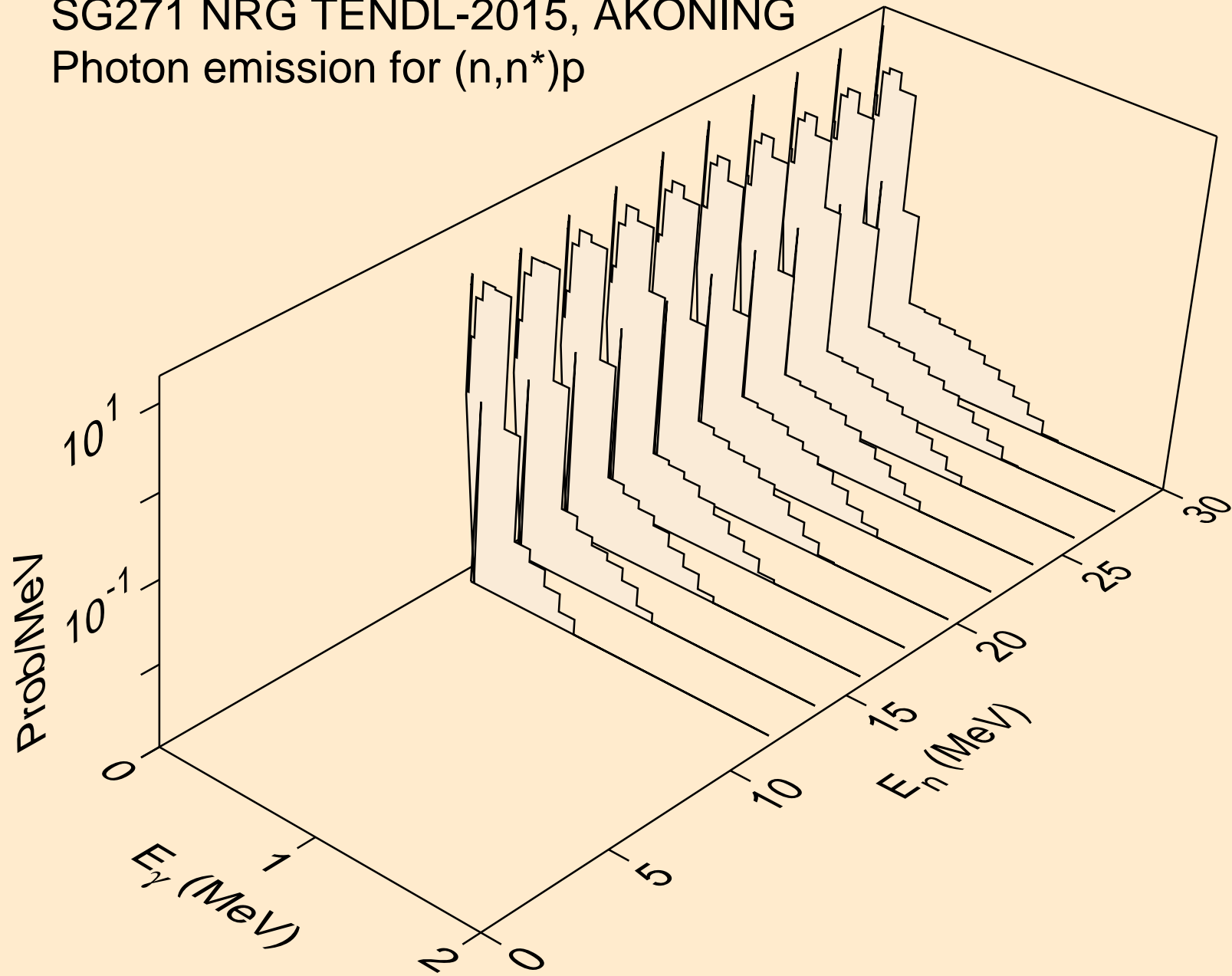

SG271 NRG TENDL-2015, AKONING
Photon emission for (n,2n)2a

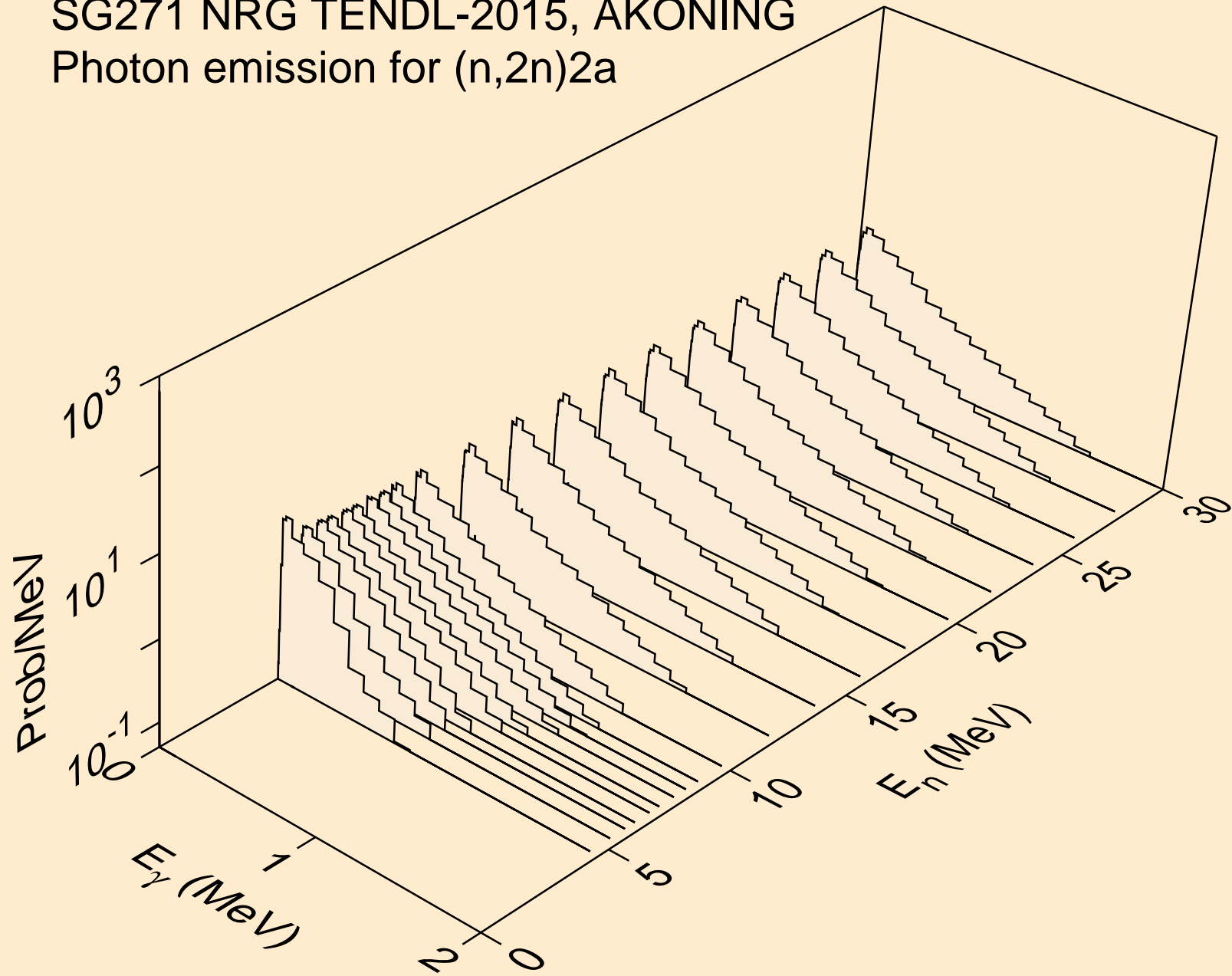

SG271 NRG TENDL-2015, AKONING
Photon emission for (n,n*)d

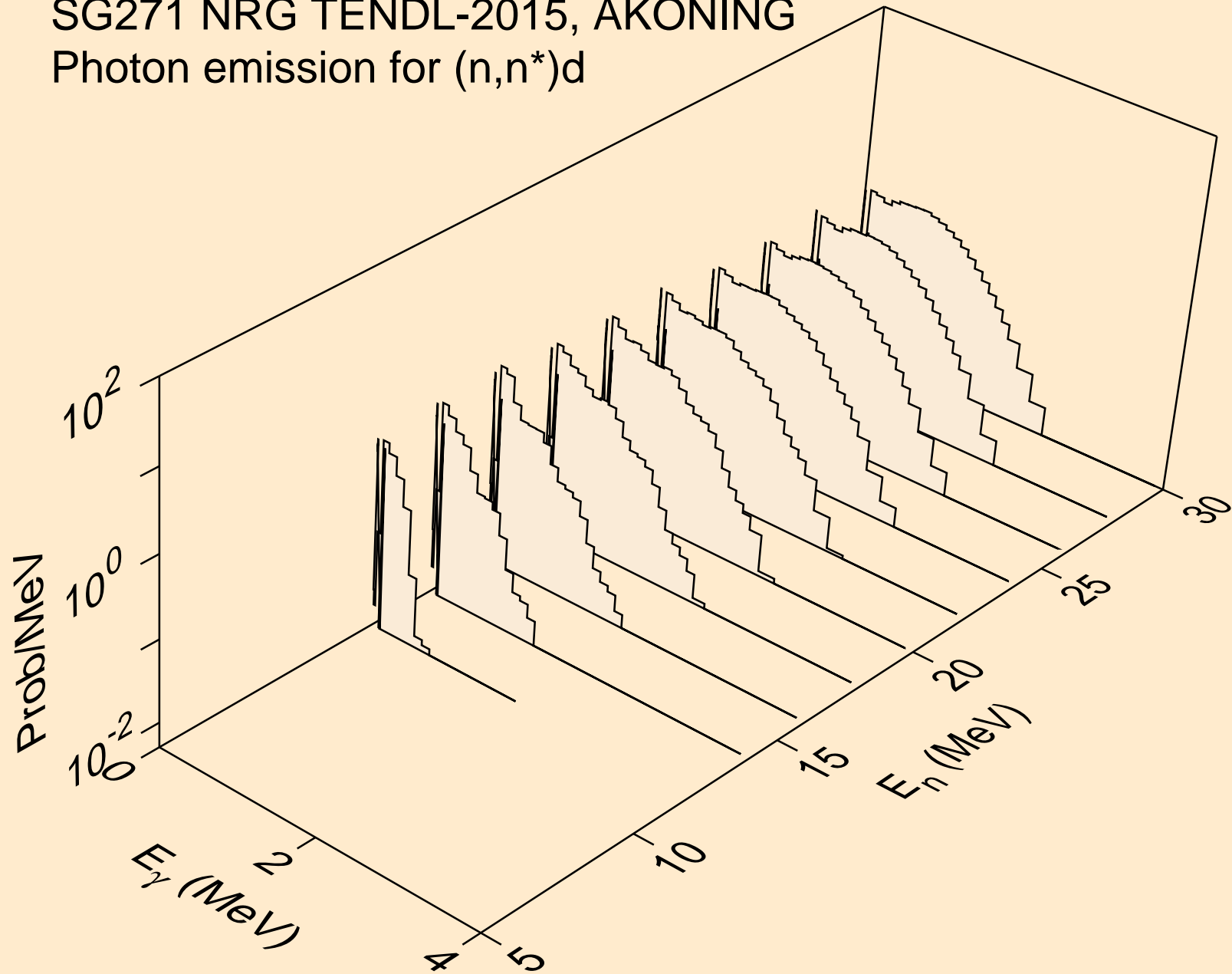

SG271 NRG TENDL-2015, AKONING
Photon emission for (n,n*)t

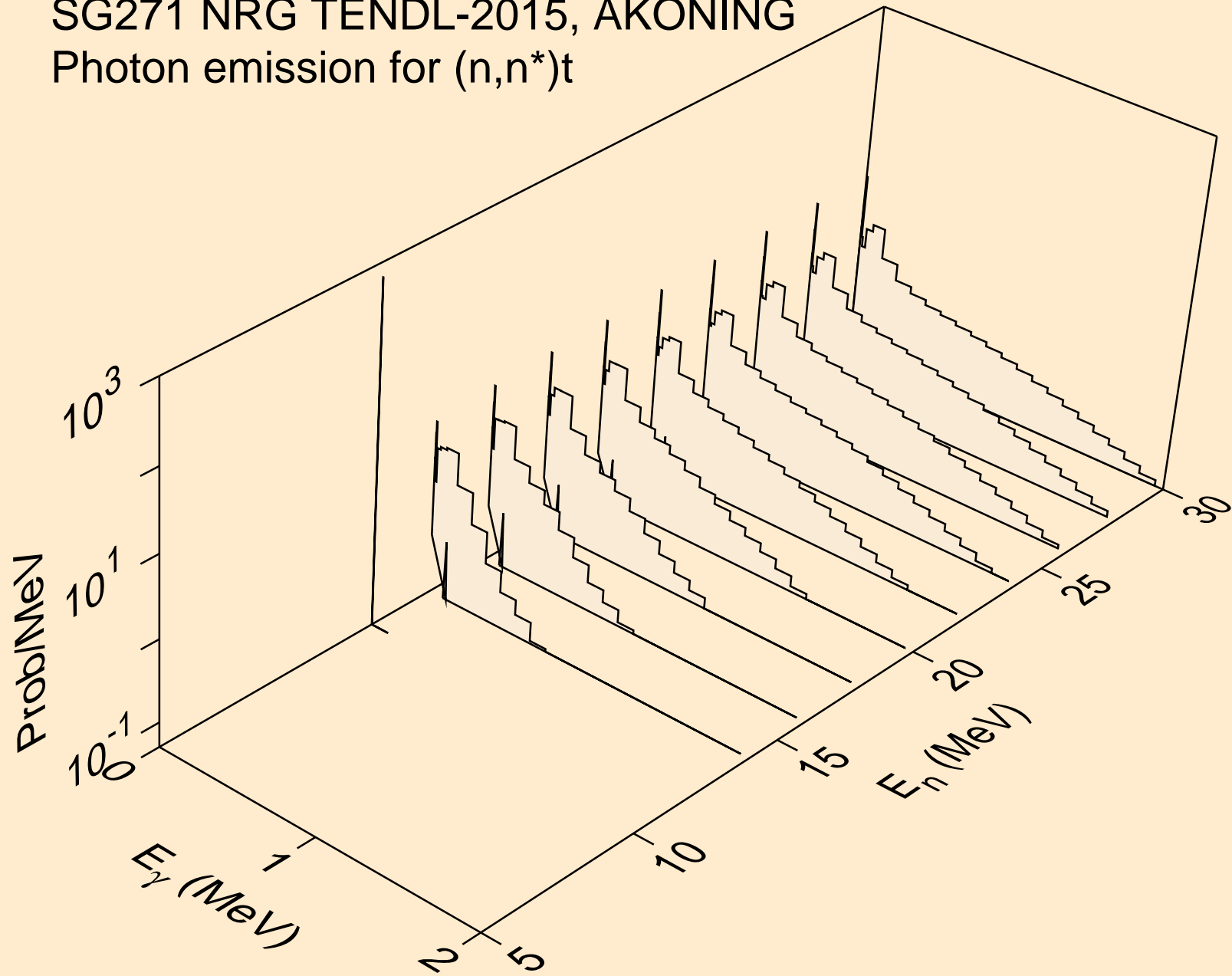

SG271 NRG TENDL-2015, AKONING
Photon emission for (n,n*)he3

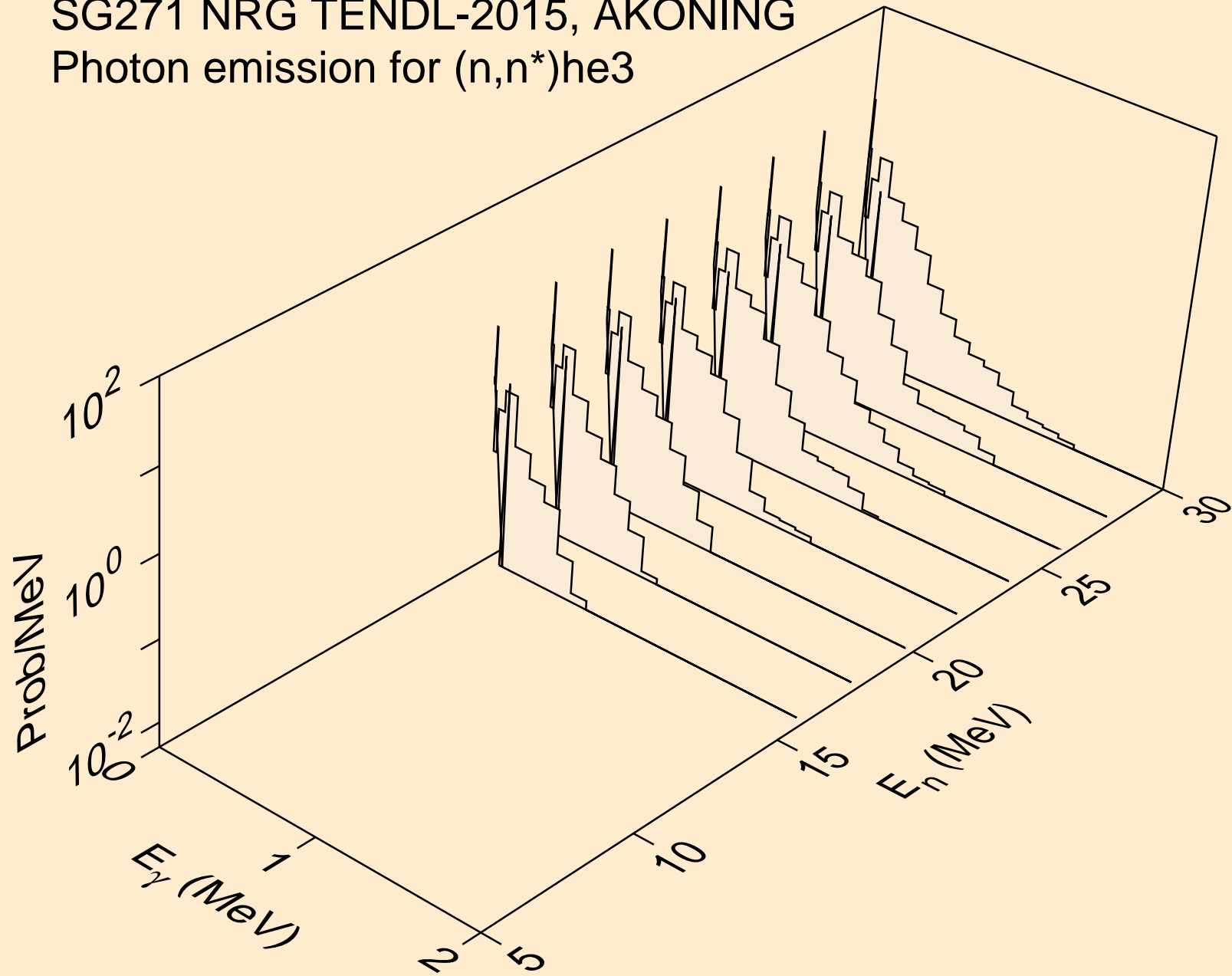

SG271 NRG TENDL-2015, AKONING
Photon emission for (n,n*)d2a

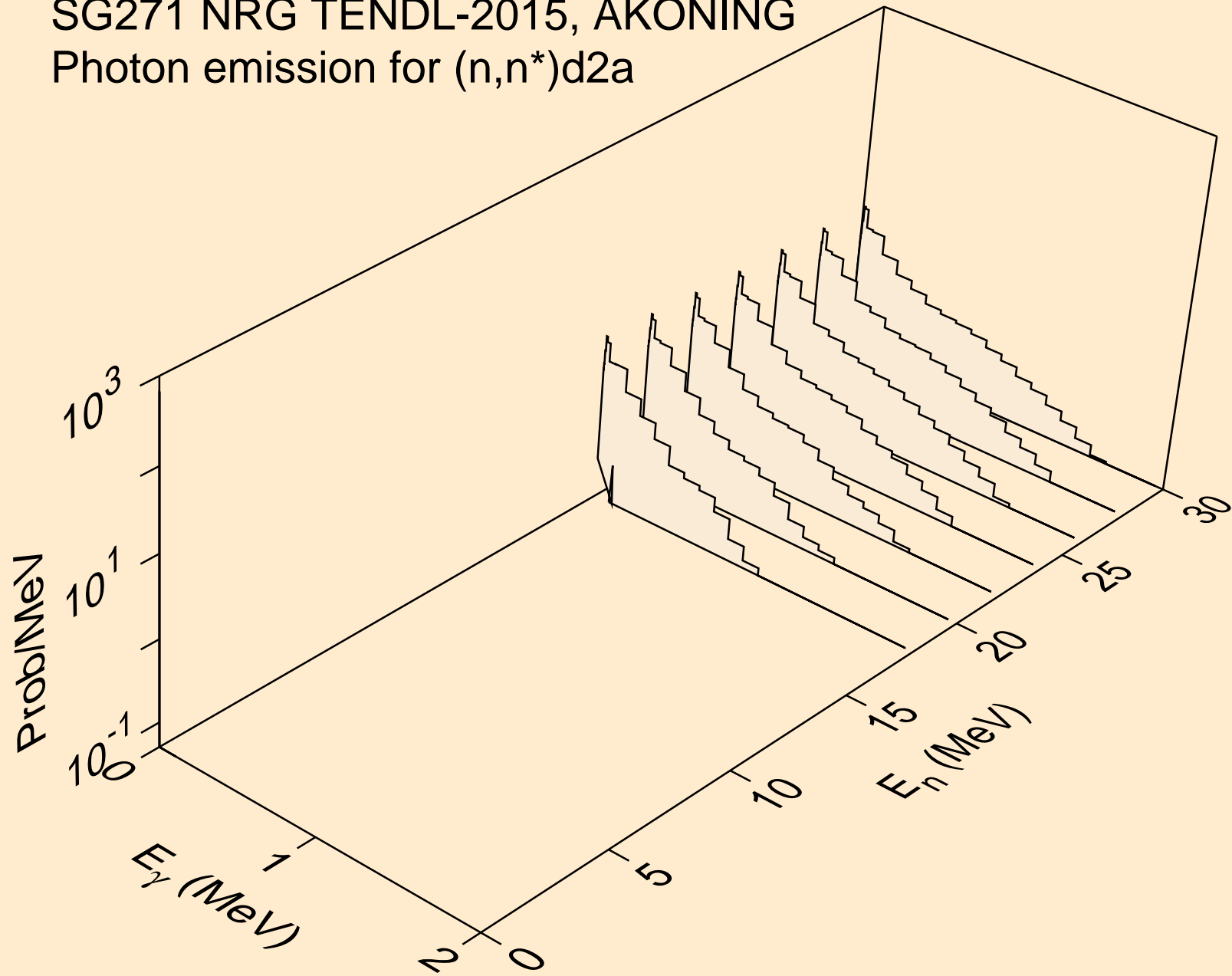

SG271 NRG TENDL-2015, AKONING
Photon emission for (n,n*)t2a

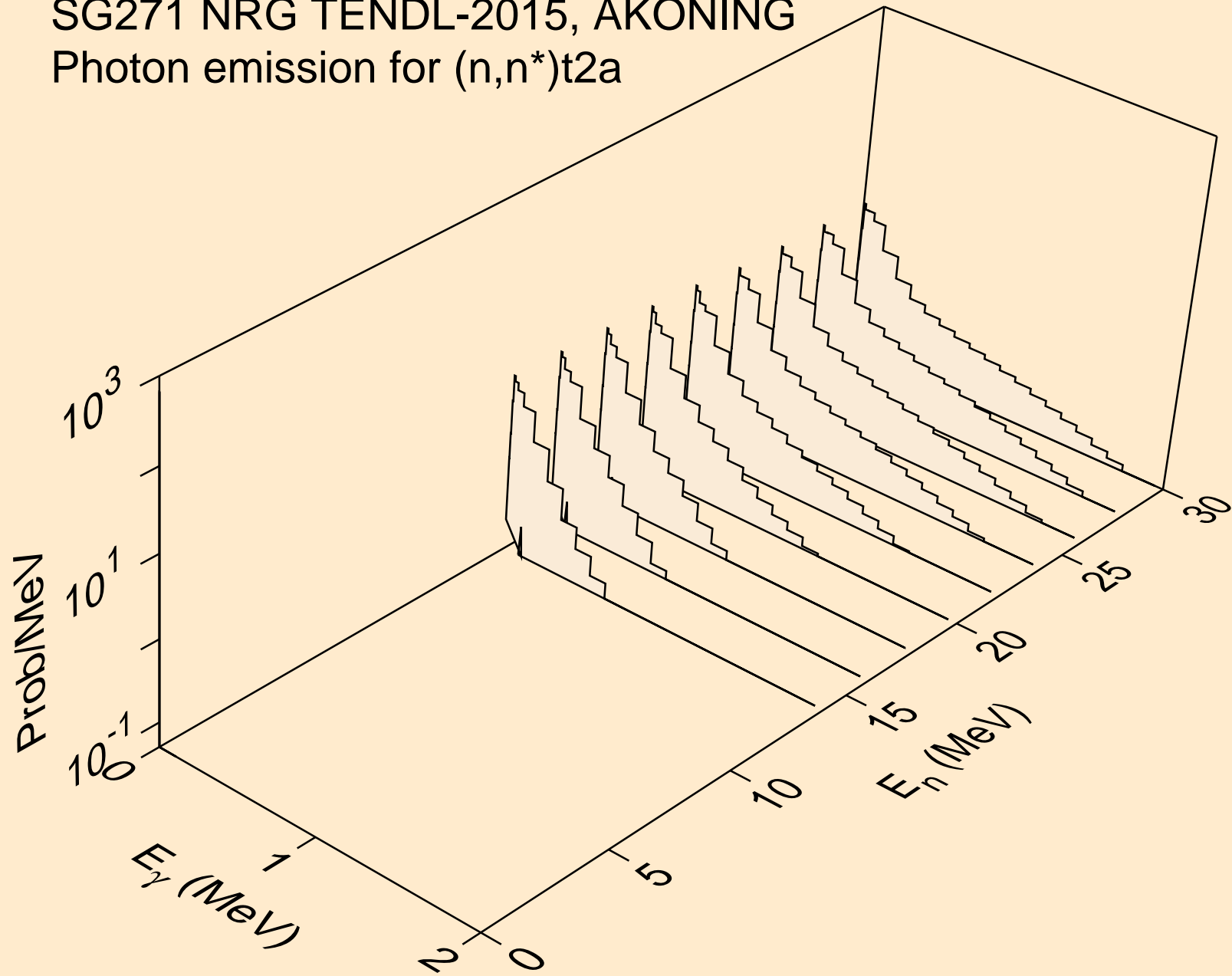

SG271 NRG TENDL-2015, AKONING
Photon emission for (n,4n)

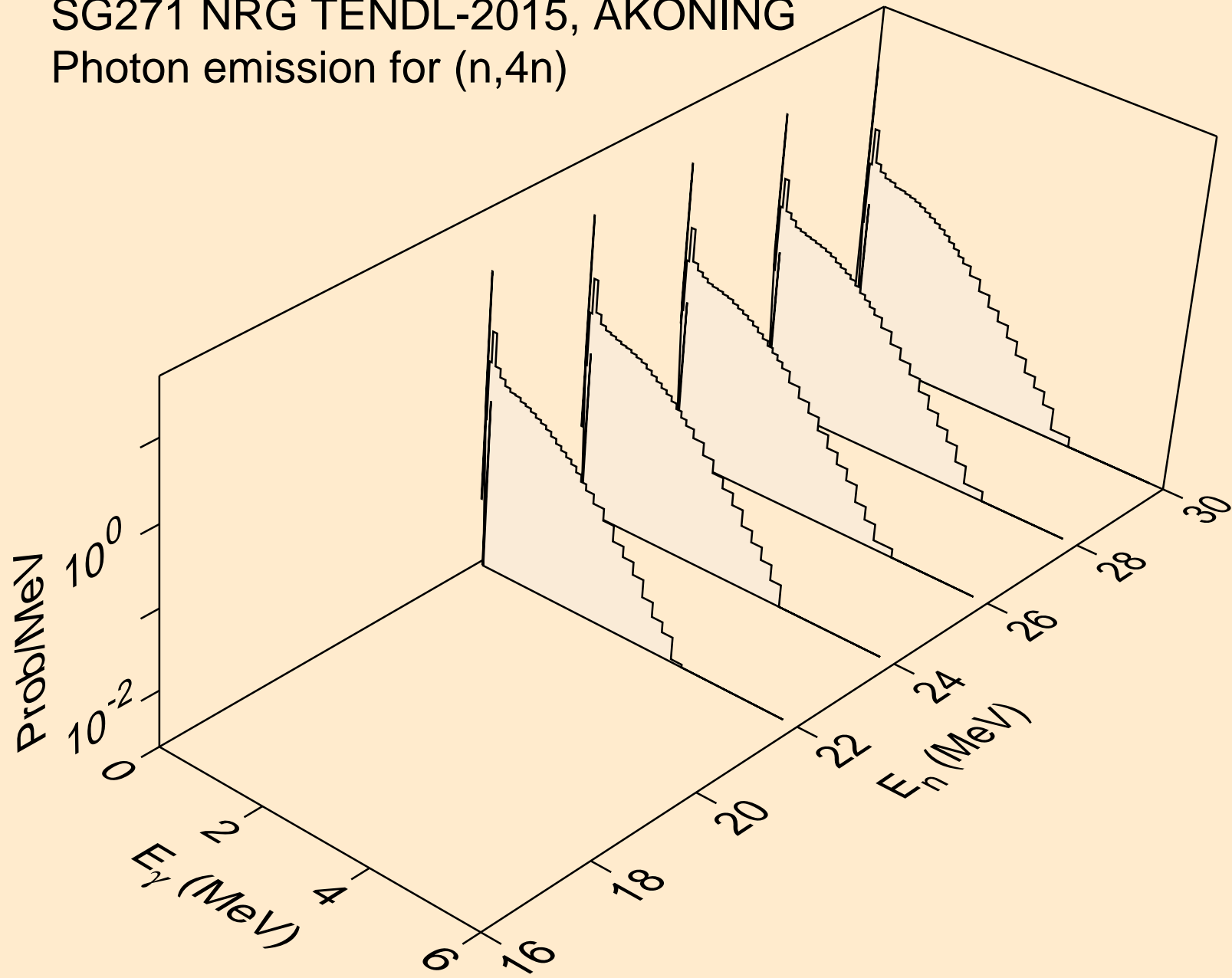

SG271 NRG TENDL-2015, AKONING
Photon emission for (n,2np)

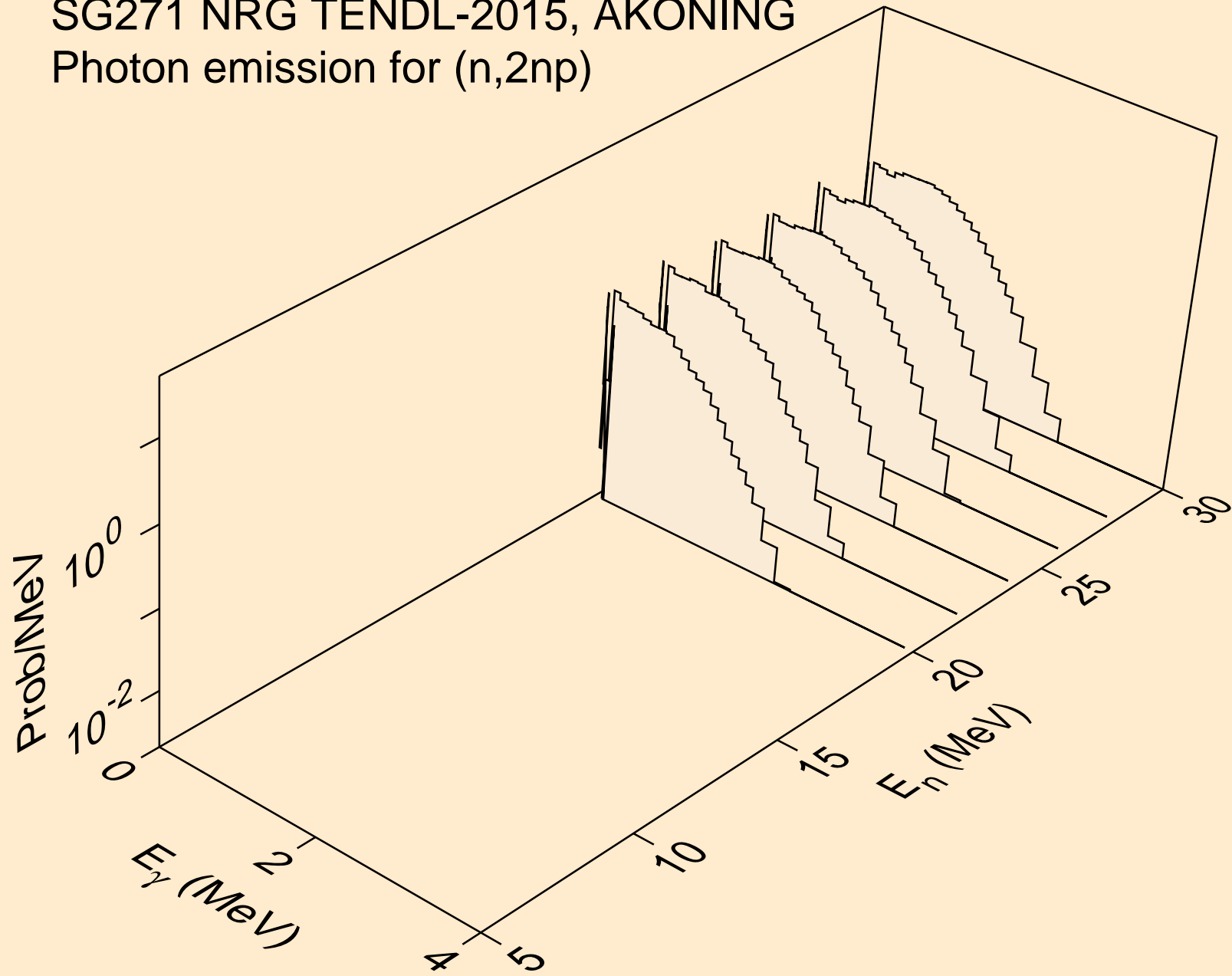

SG271 NRG TENDL-2015, AKONING
Photon emission for (n,3np)

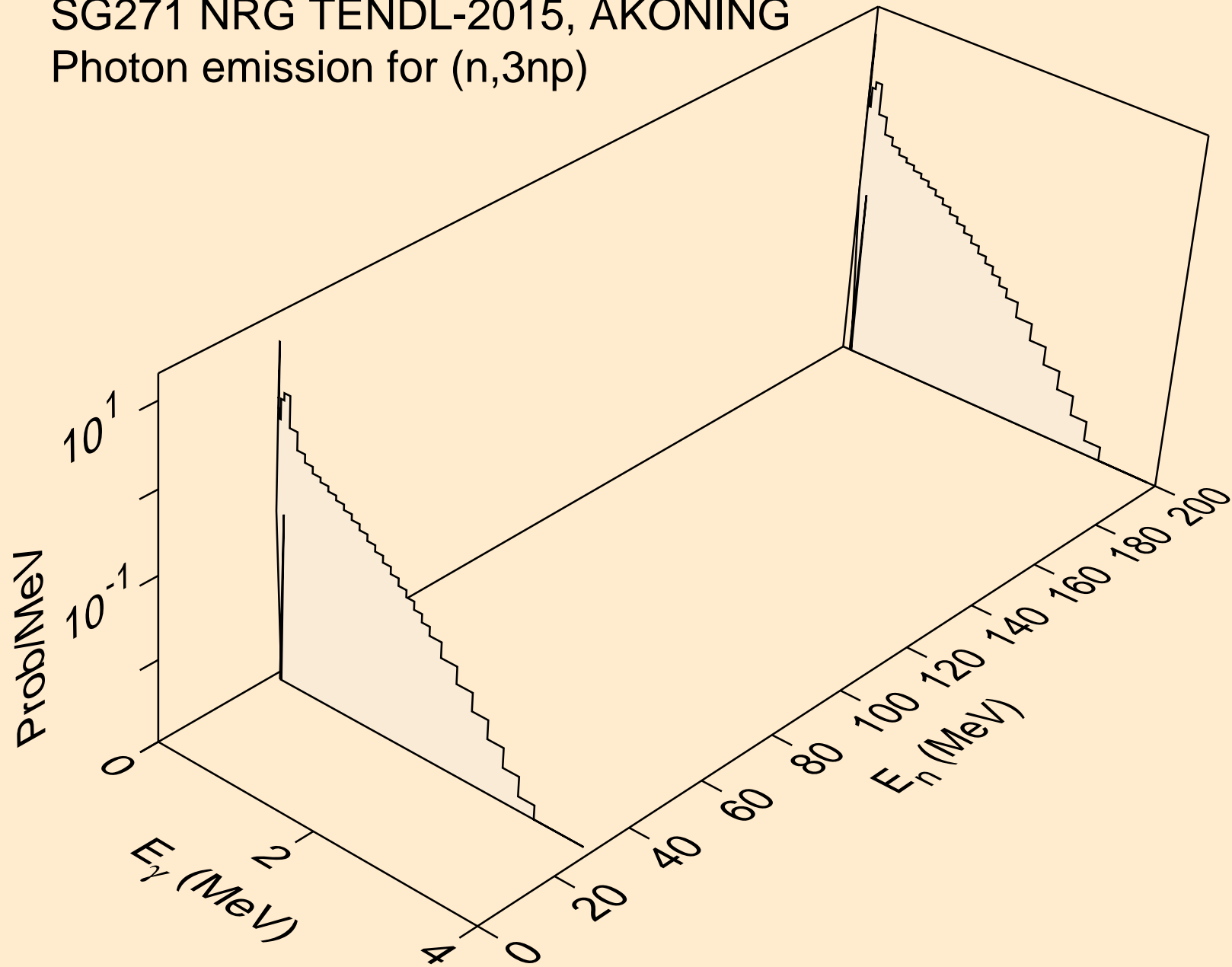

SG271 NRG TENDL-2015, AKONING
Photon emission for (n,npa)

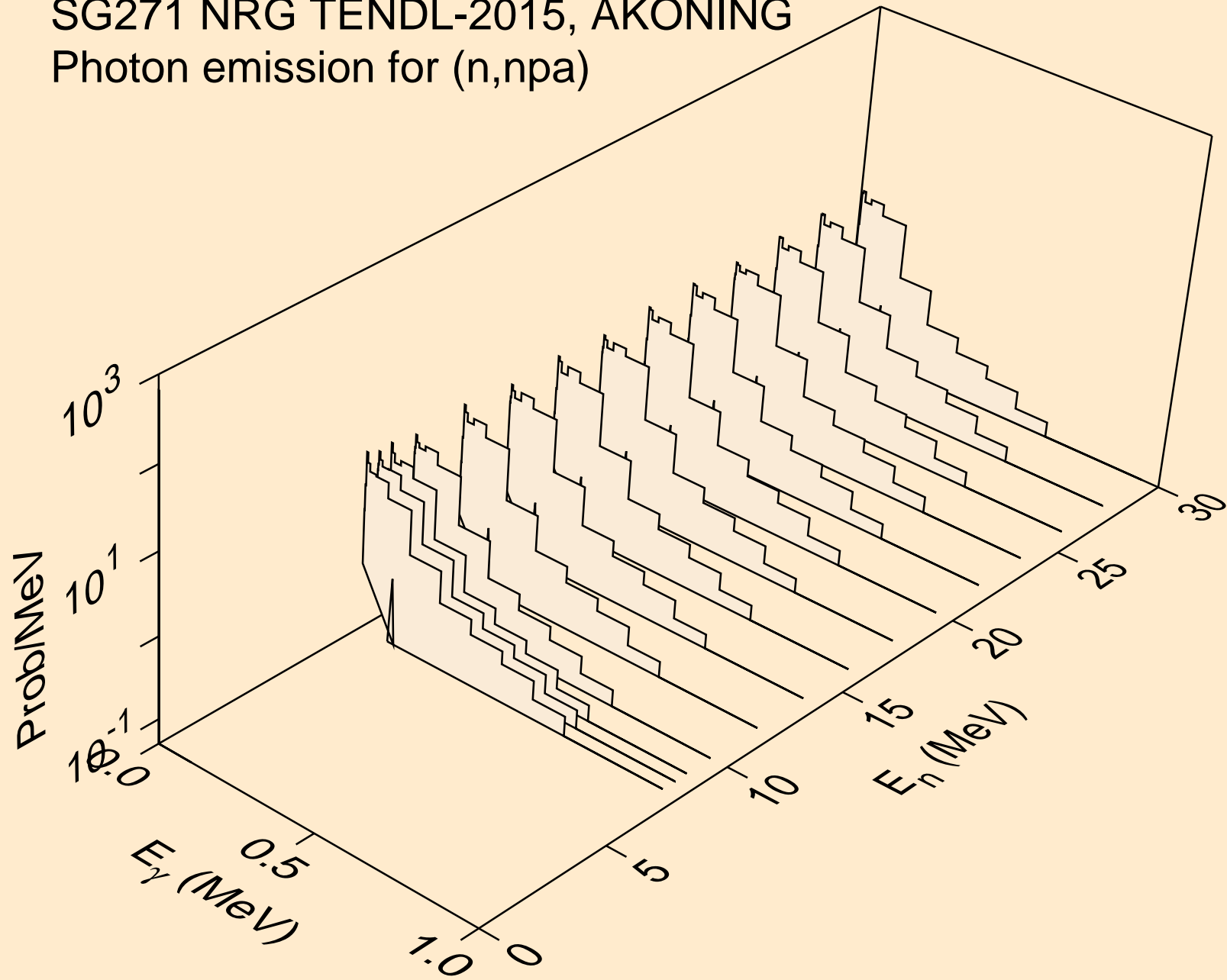

SG271 NRG TENDL-2015, AKONING
Photon emission for (n,n*c)

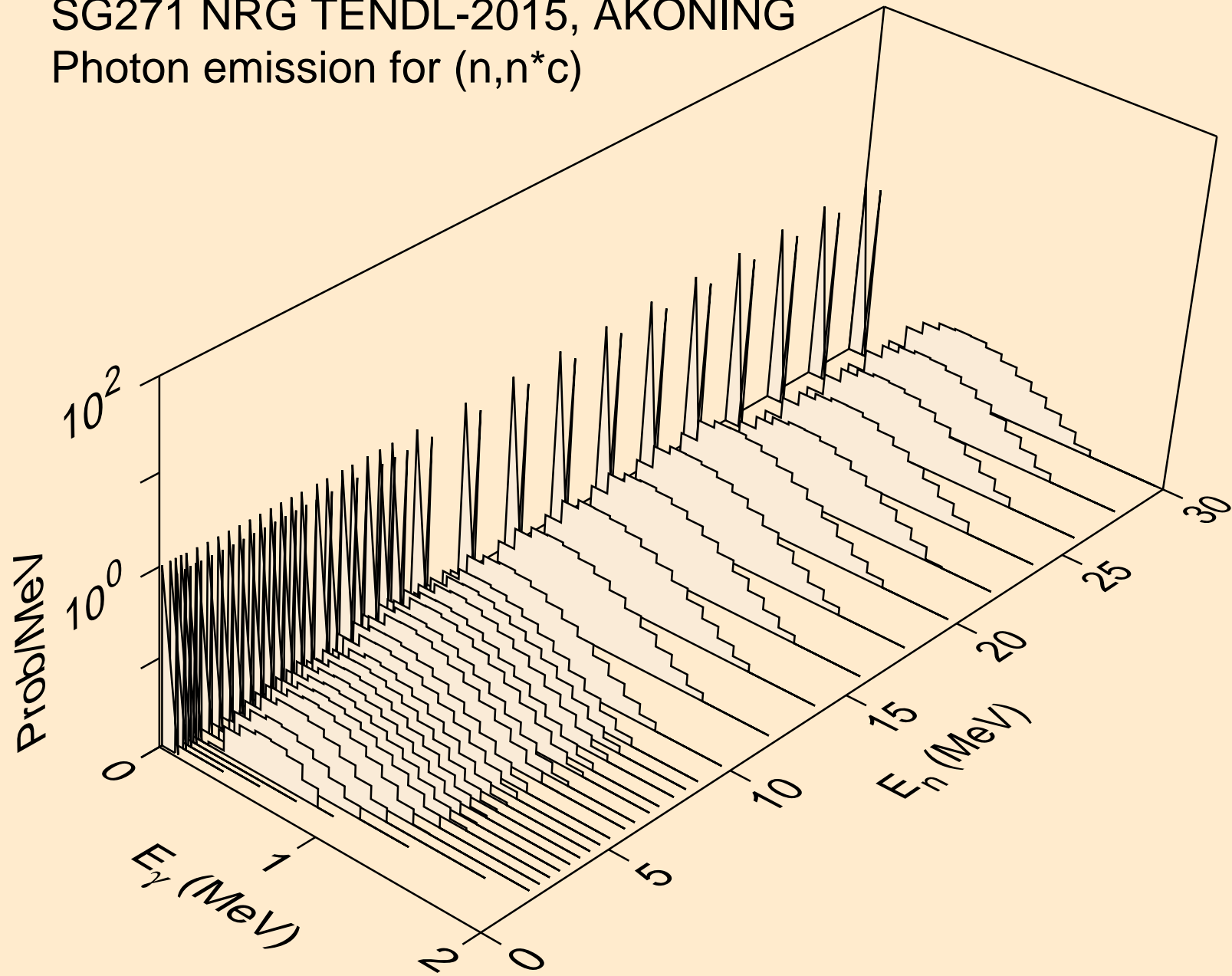

SG271 NRG TENDL-2015, AKONING
Photon emission for (n,gma)

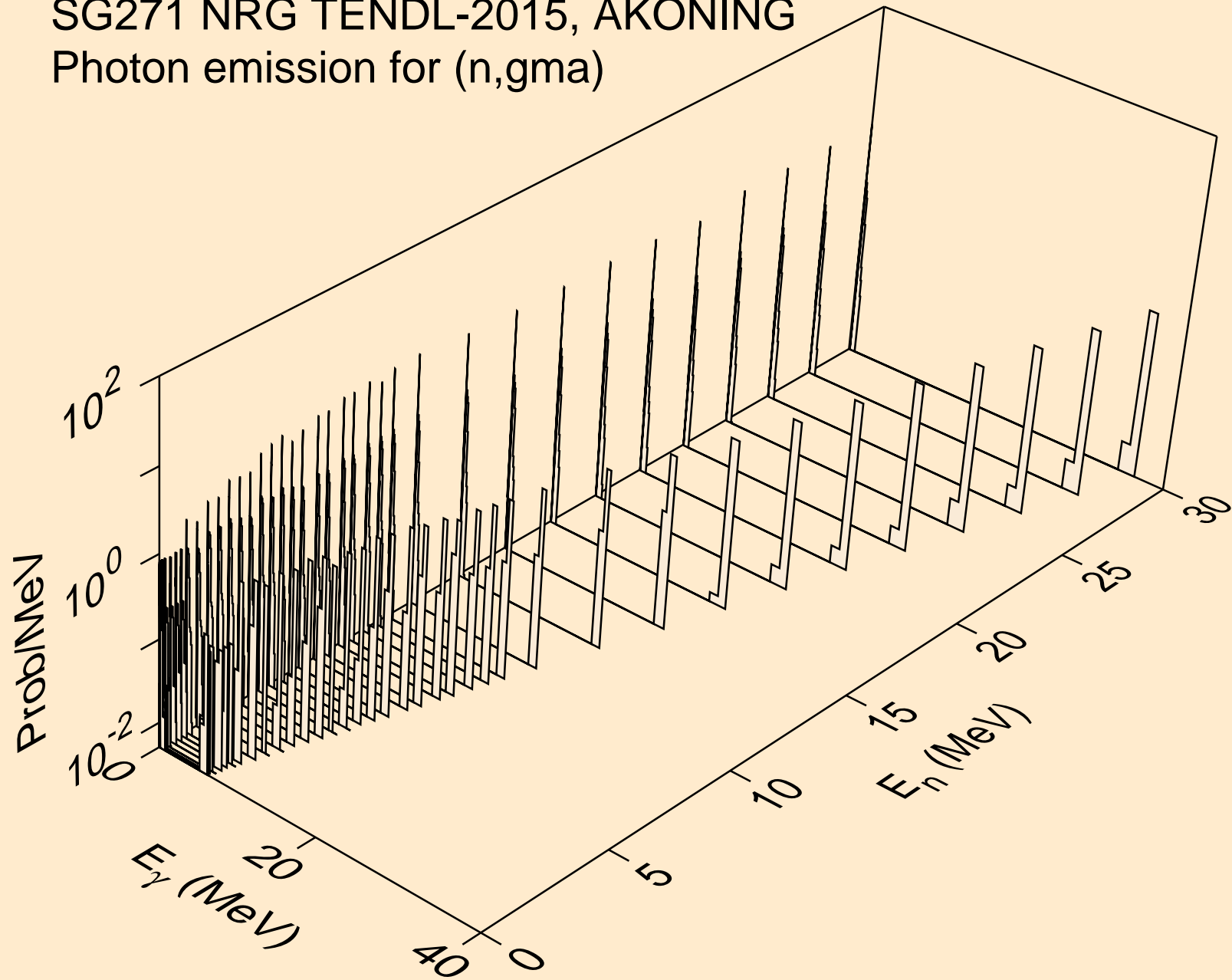

SG271 NRG TENDL-2015, AKONING
Photon emission for (n,p)

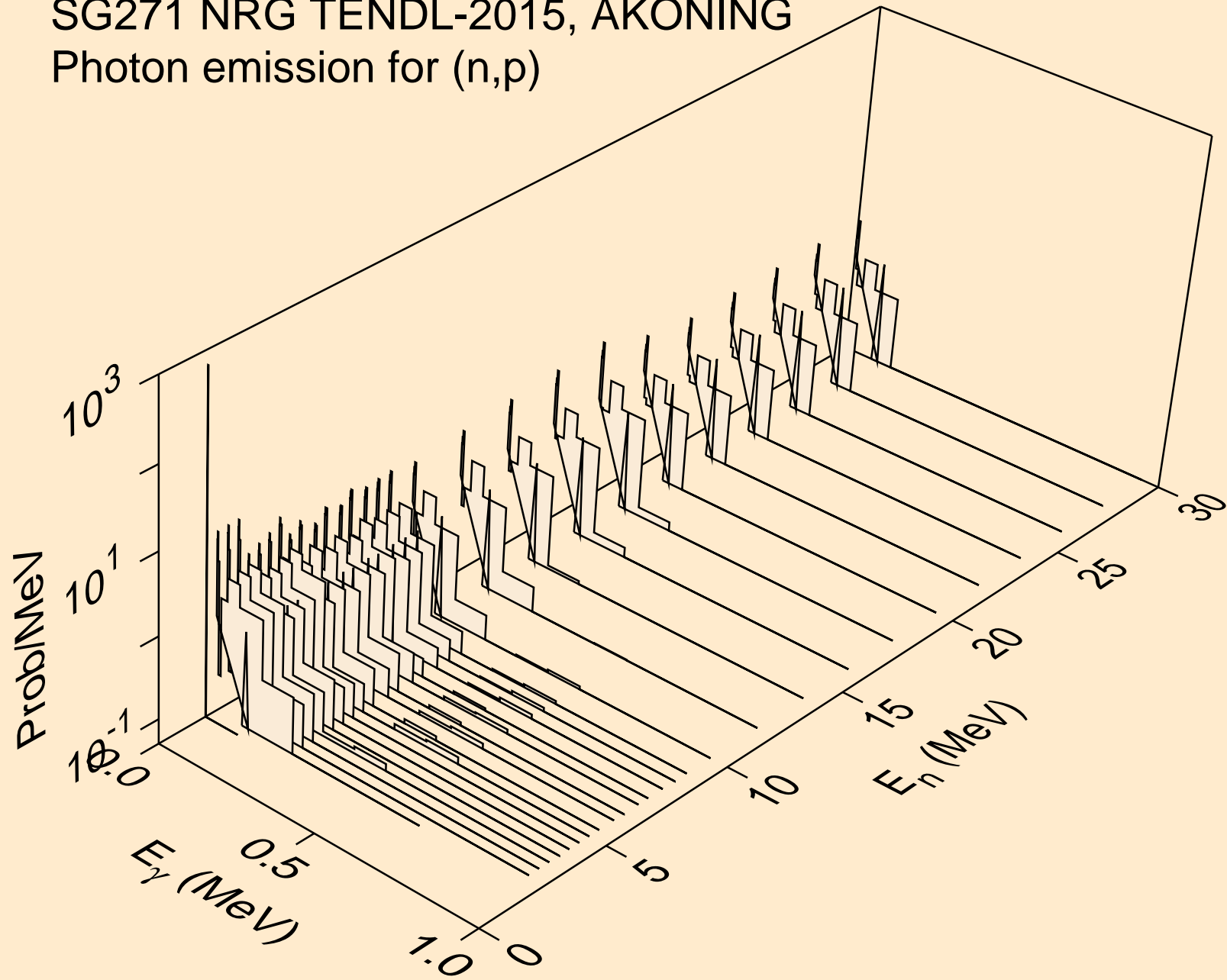

SG271 NRG TENDL-2015, AKONING
Photon emission for (n,d)

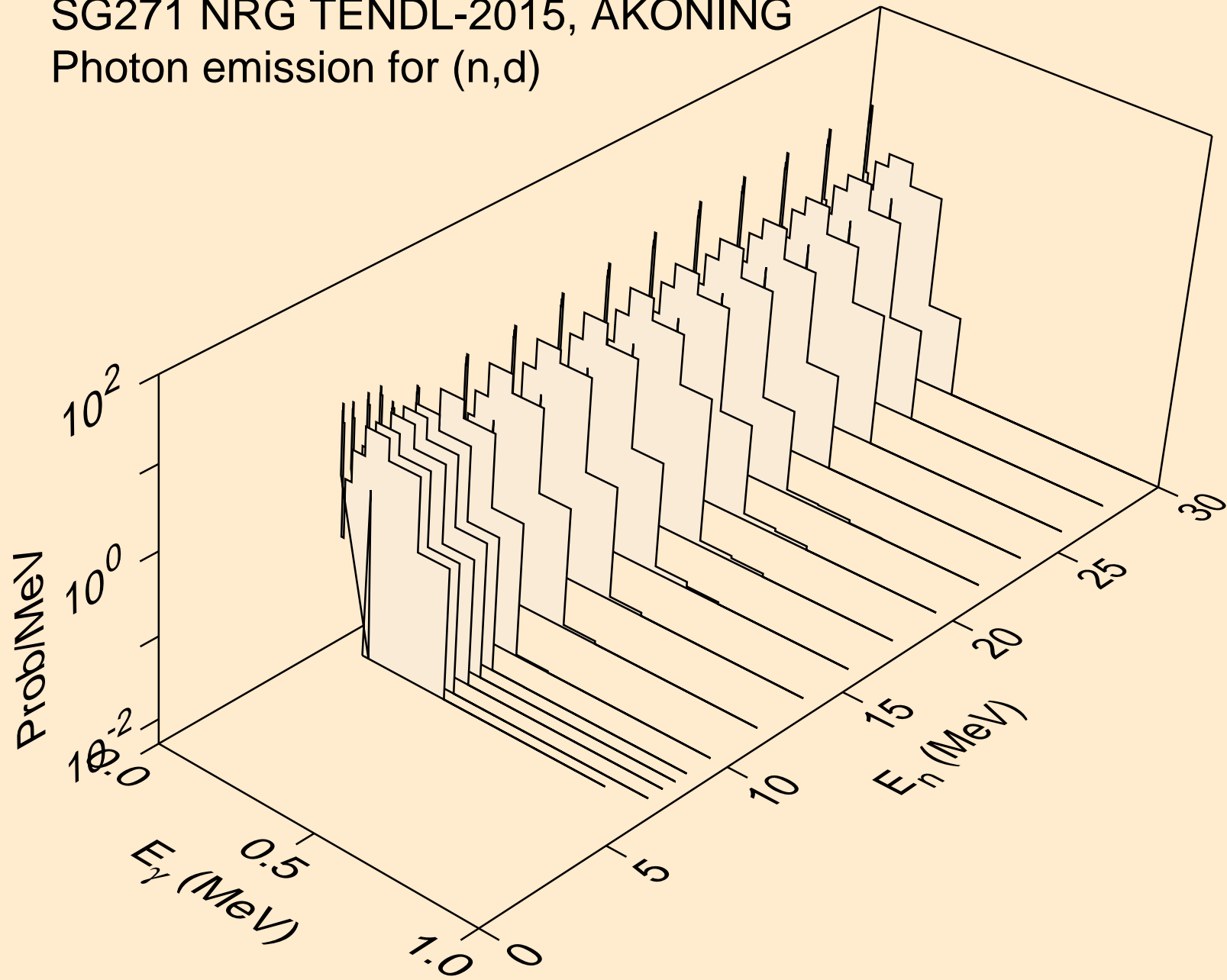

SG271 NRG TENDL-2015, AKONING
Photon emission for (n,t)

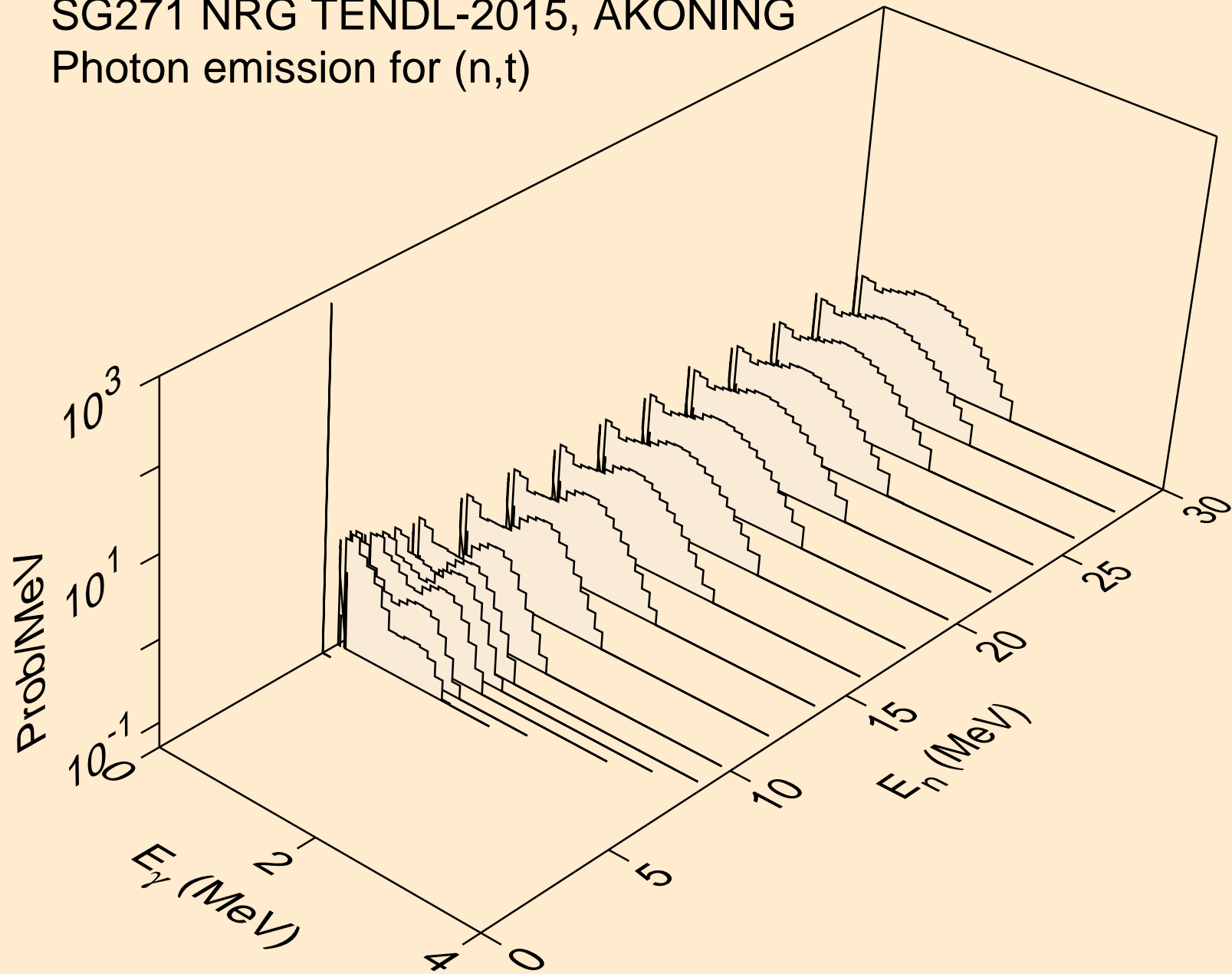

SG271 NRG TENDL-2015, AKONING
Photon emission for (n,he3)

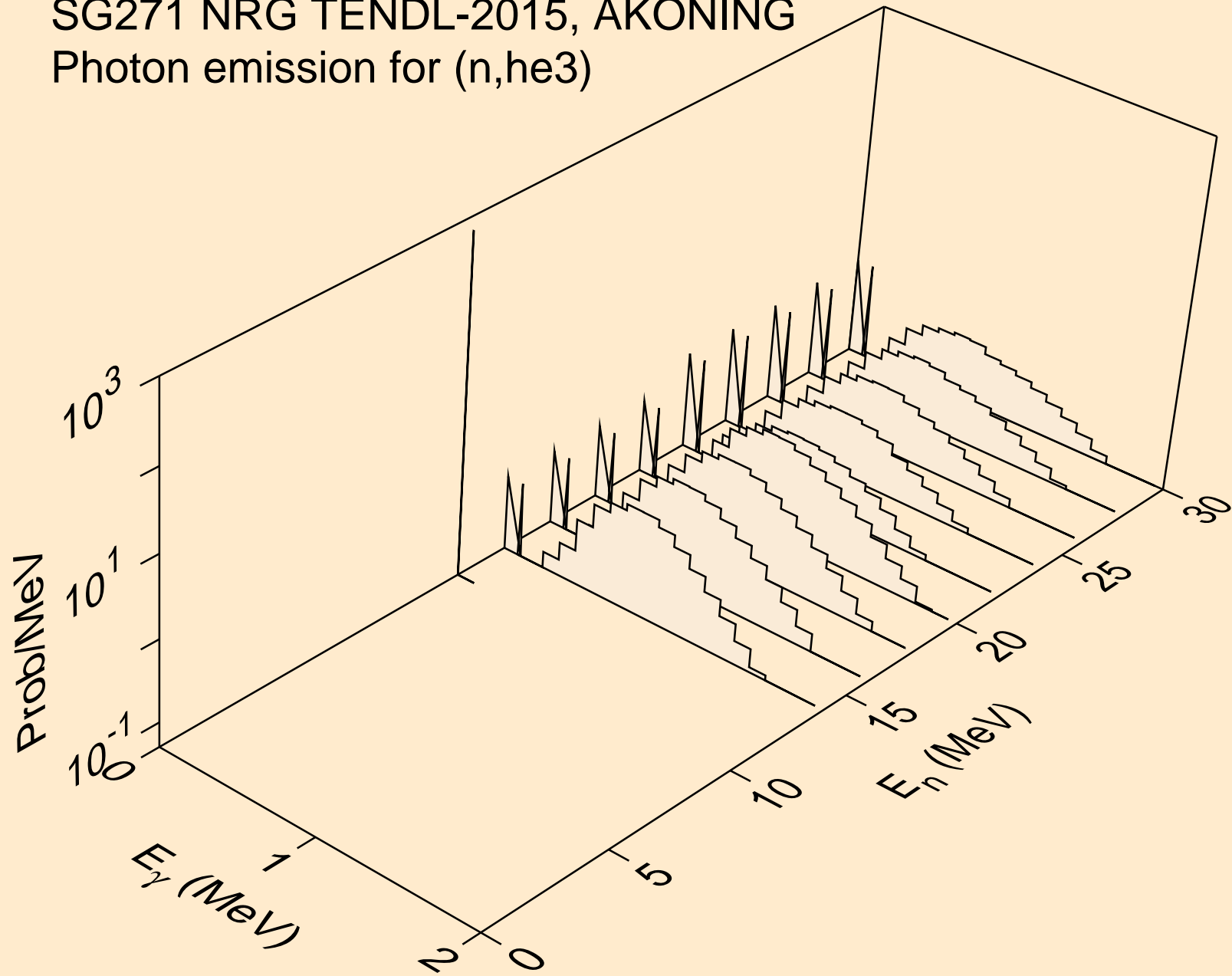

SG271 NRG TENDL-2015, AKONING
Photon emission for (n,a)

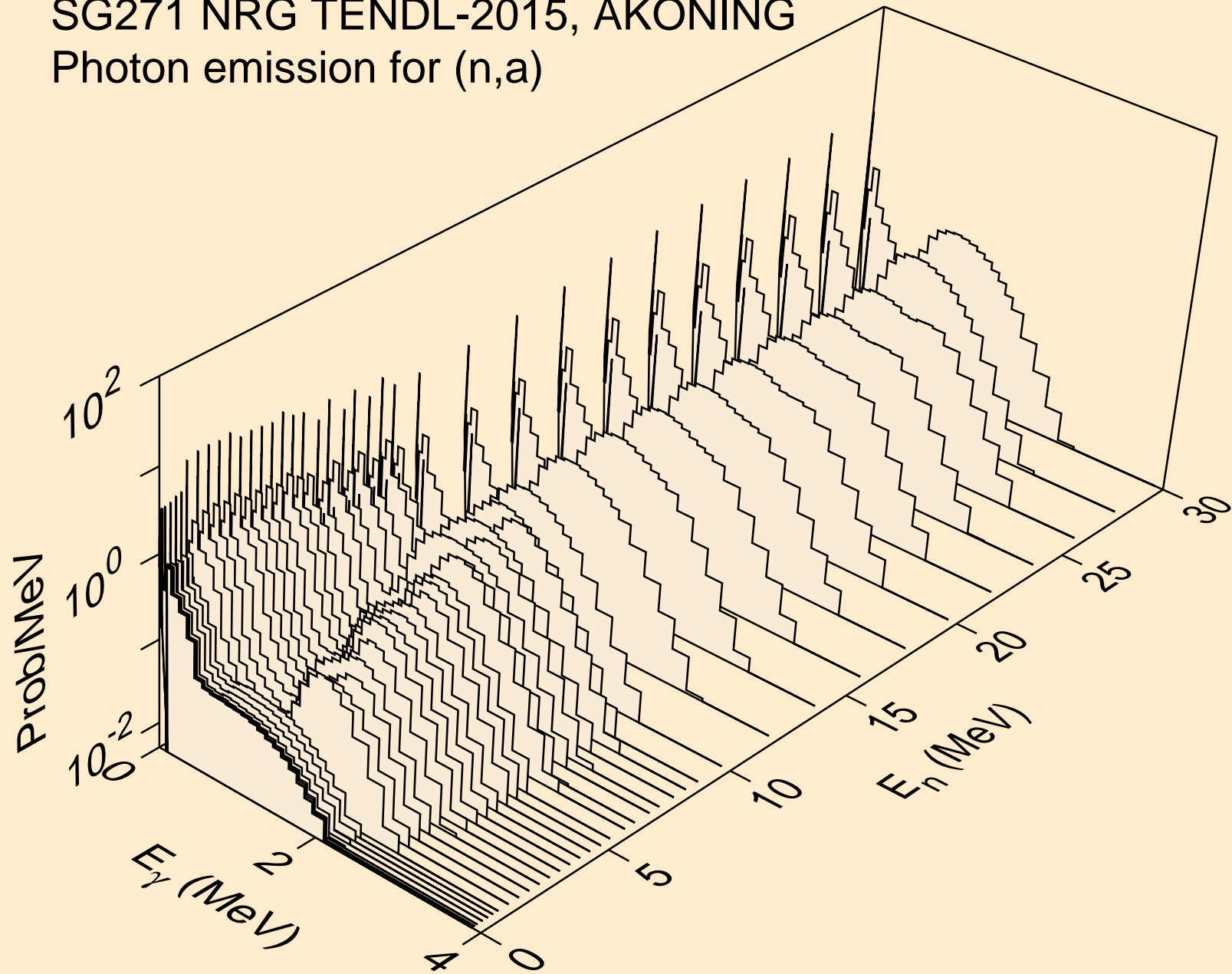

SG271 NRG TENDL-2015, AKONING
Photon emission for (n,2a)

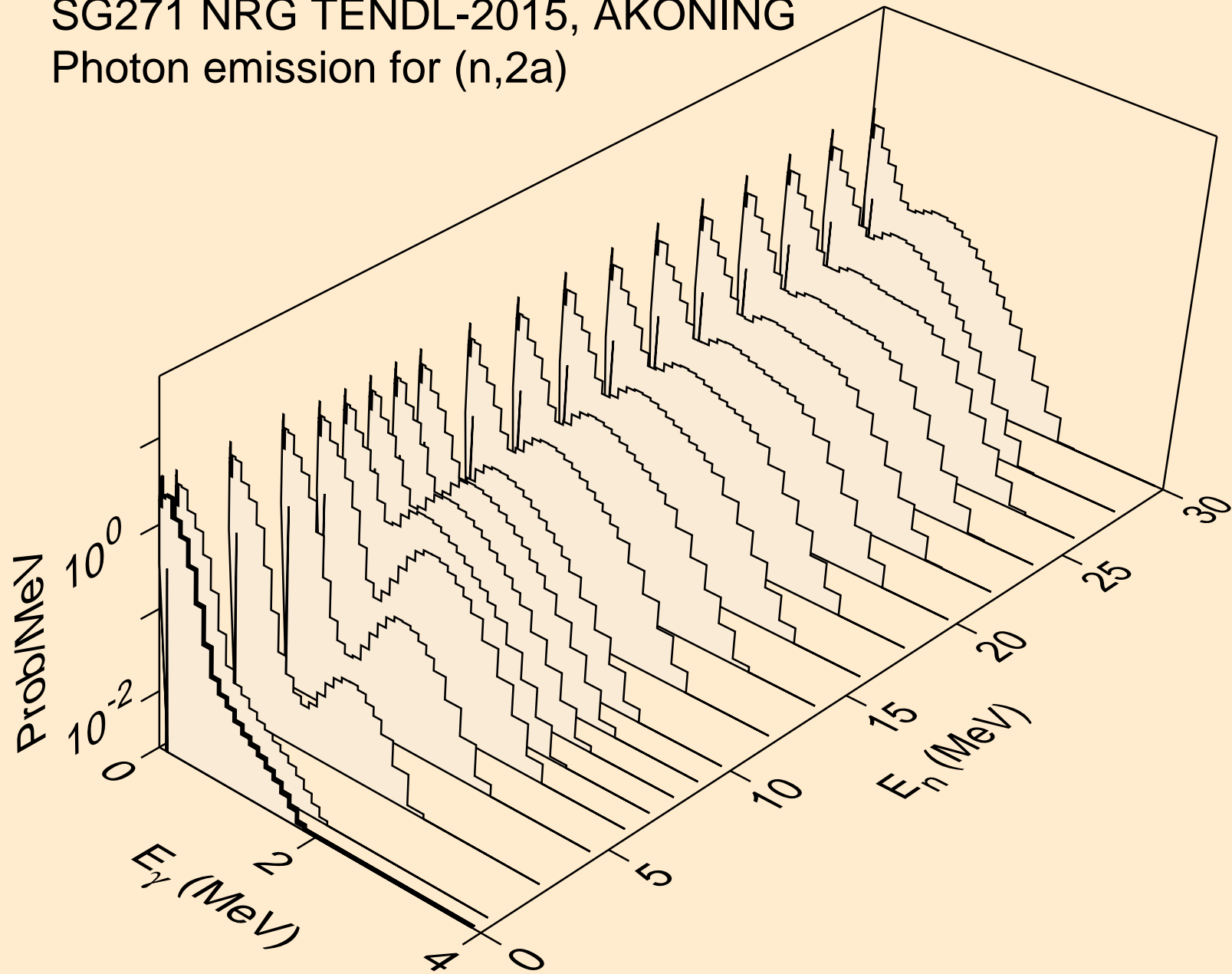

SG271 NRG TENDL-2015, AKONING
Photon emission for (n,3a)

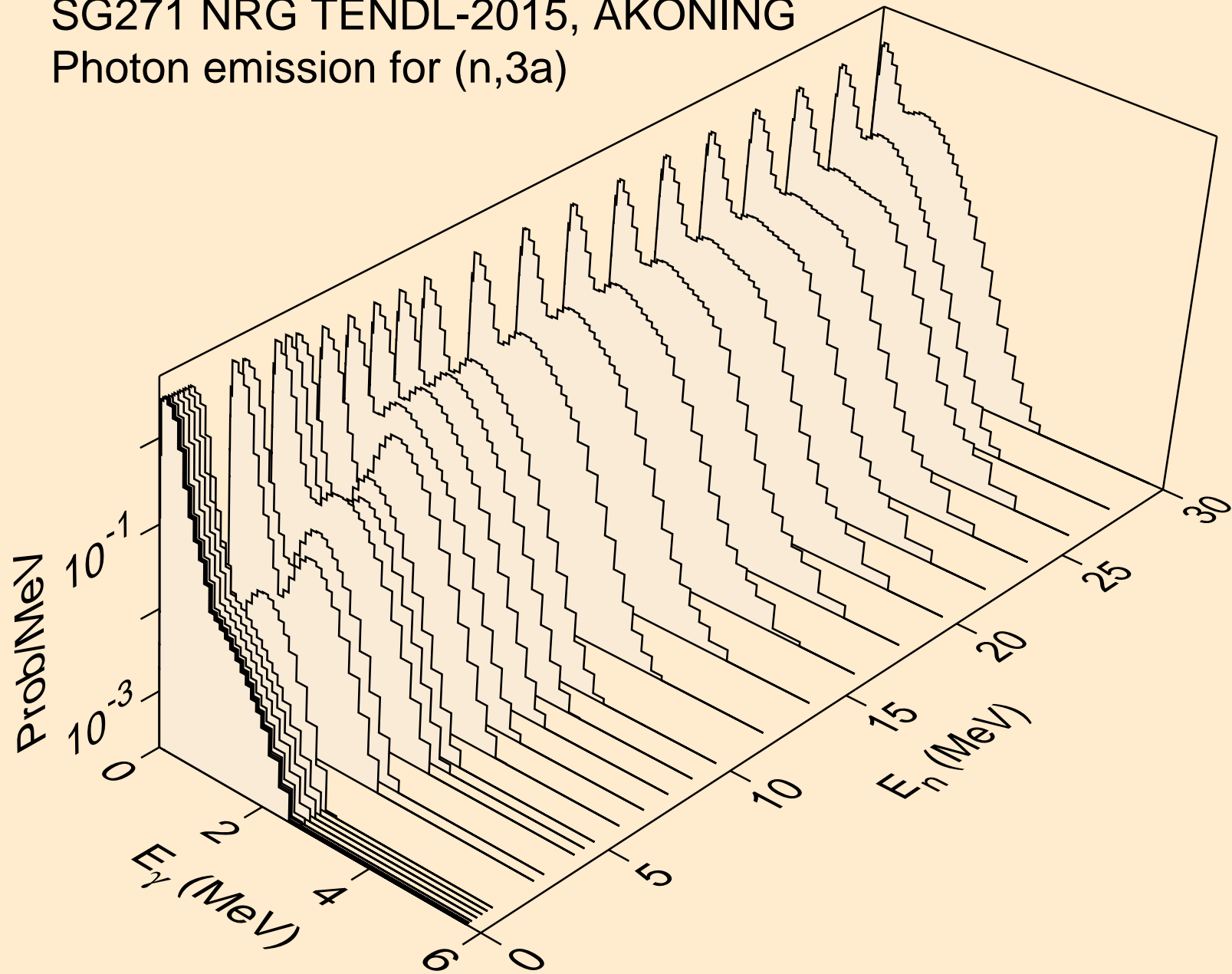

SG271 NRG TENDL-2015, AKONING
Photon emission for (n,p)

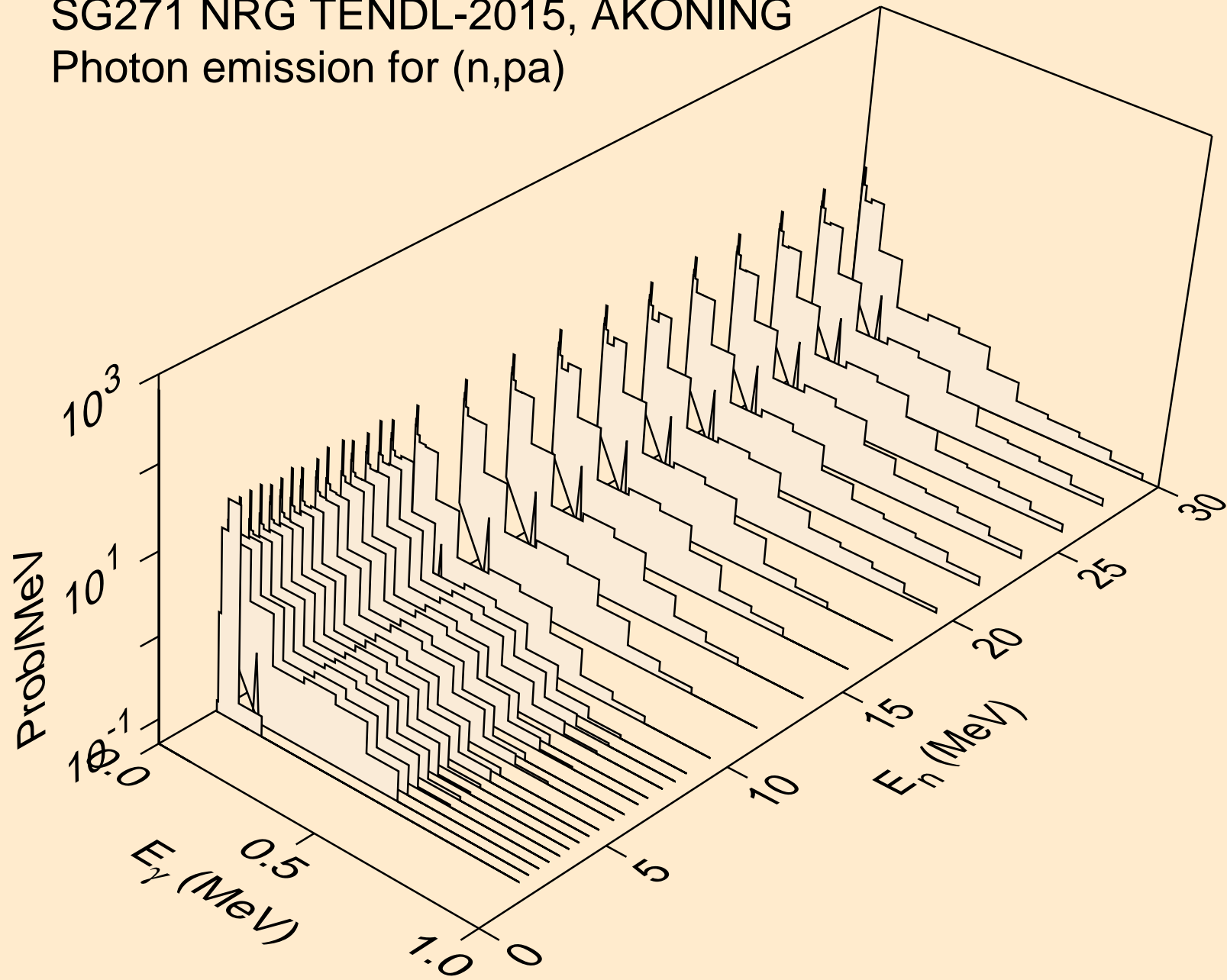

SG271 NRG TENDL-2015, AKONING
Photon emission for (n,t2a)

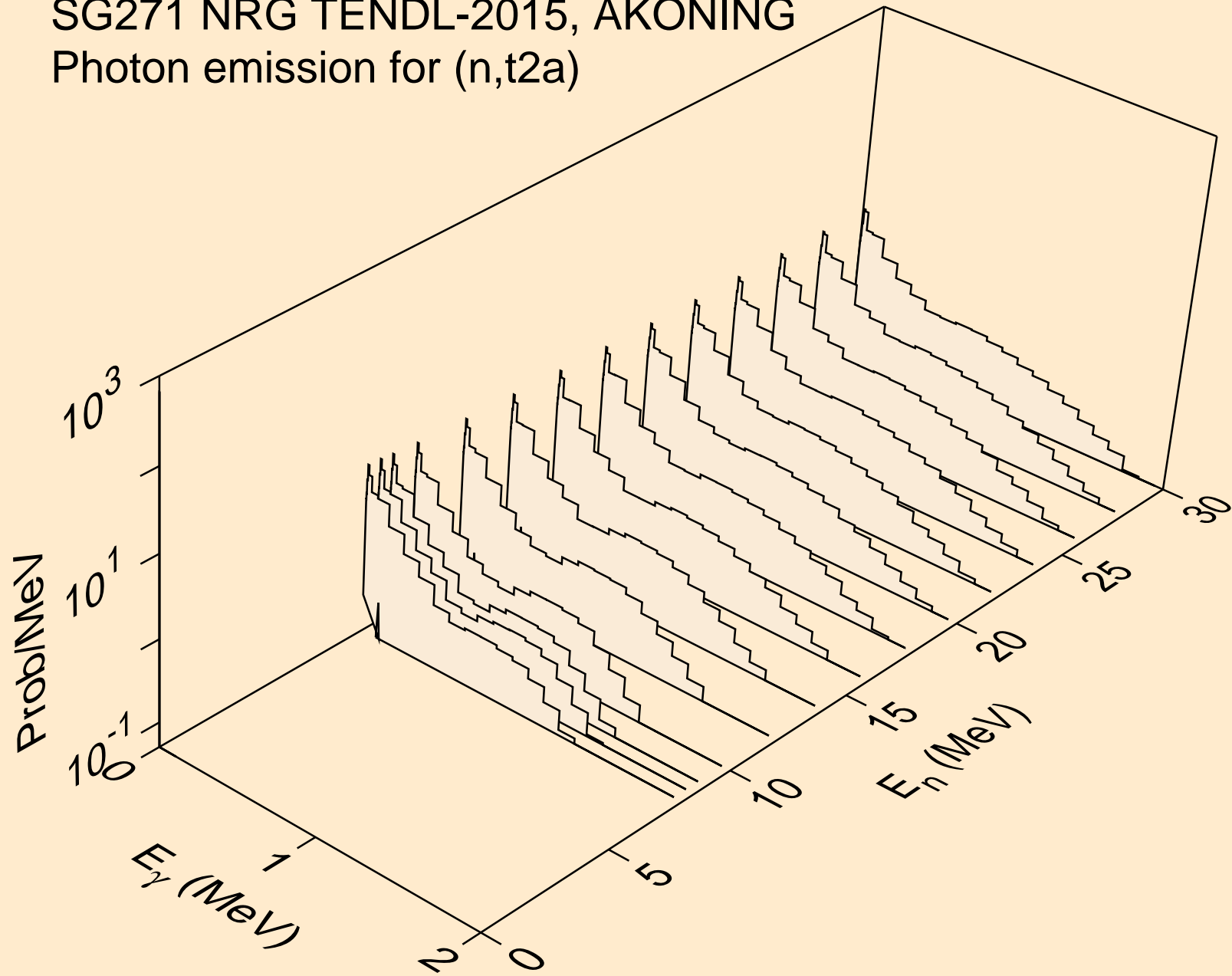

SG271 NRG TENDL-2015, AKONING
Photon emission for (n,d2a)

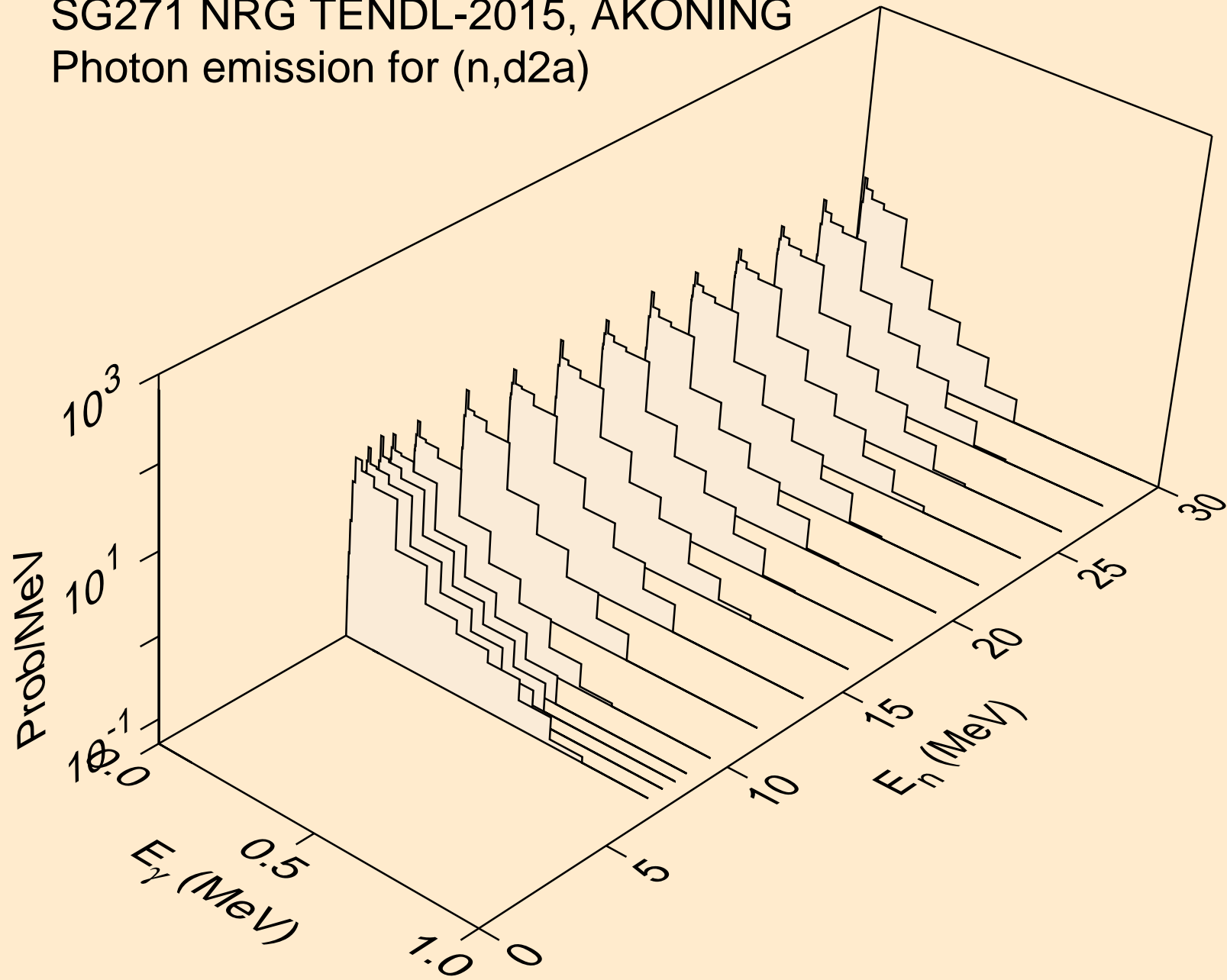

SG271 NRG TENDL-2015, AKONING
Photon emission for (n,da)

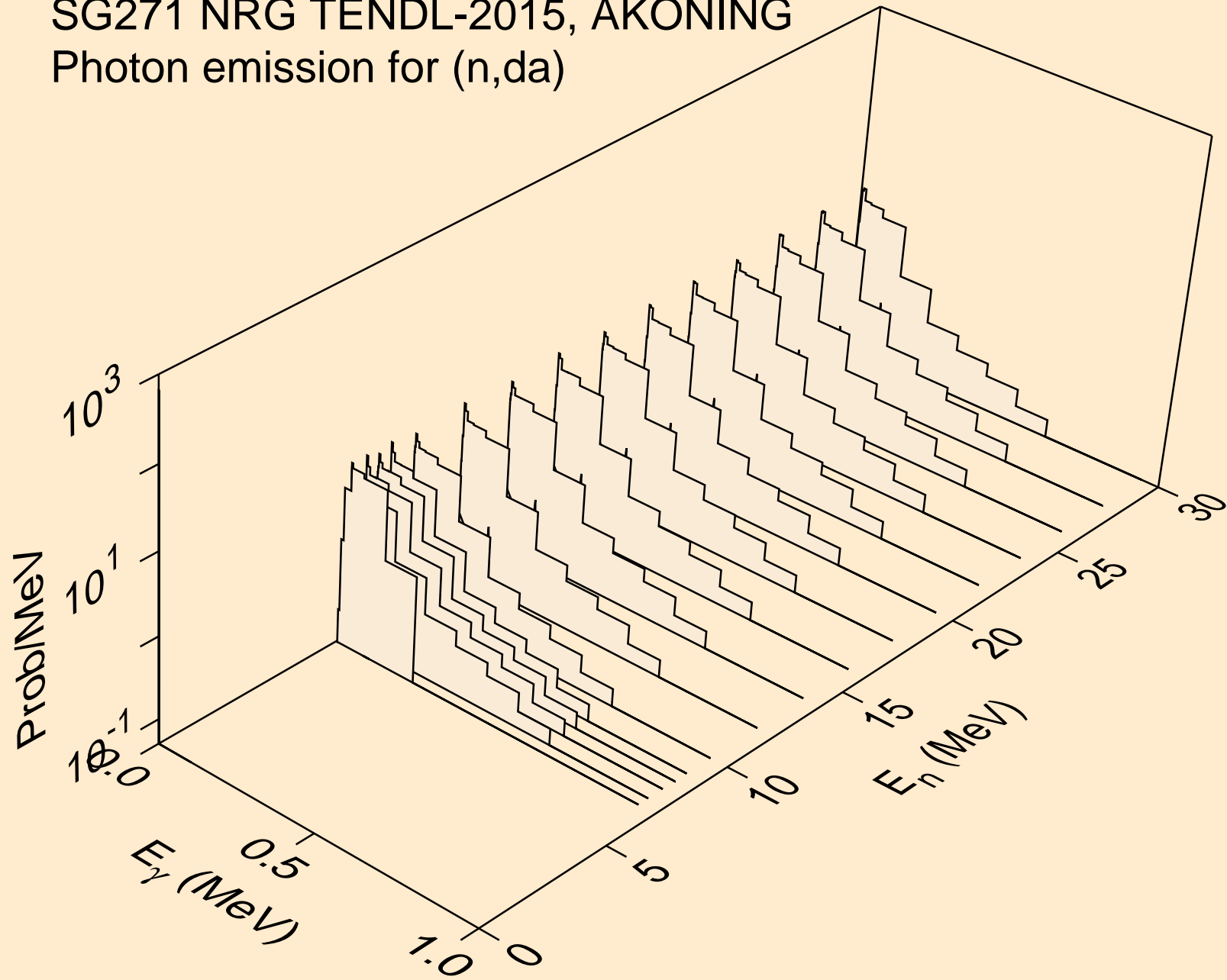

SG271 NRG TENDL-2015, AKONING
thermal capture photon spectrum

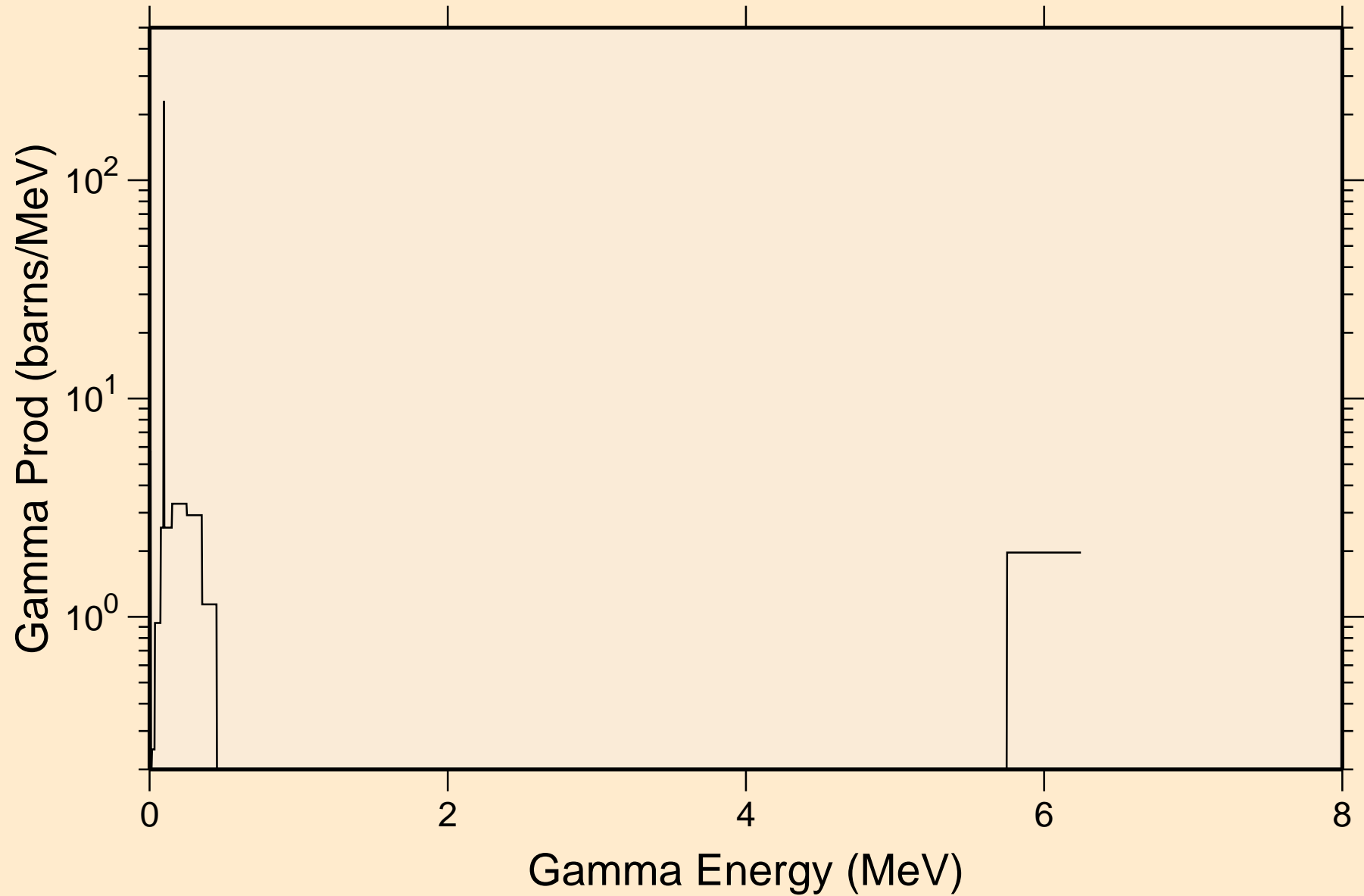

SG271 NRG TENDL-2015, AKONING
14 MeV photon spectrum

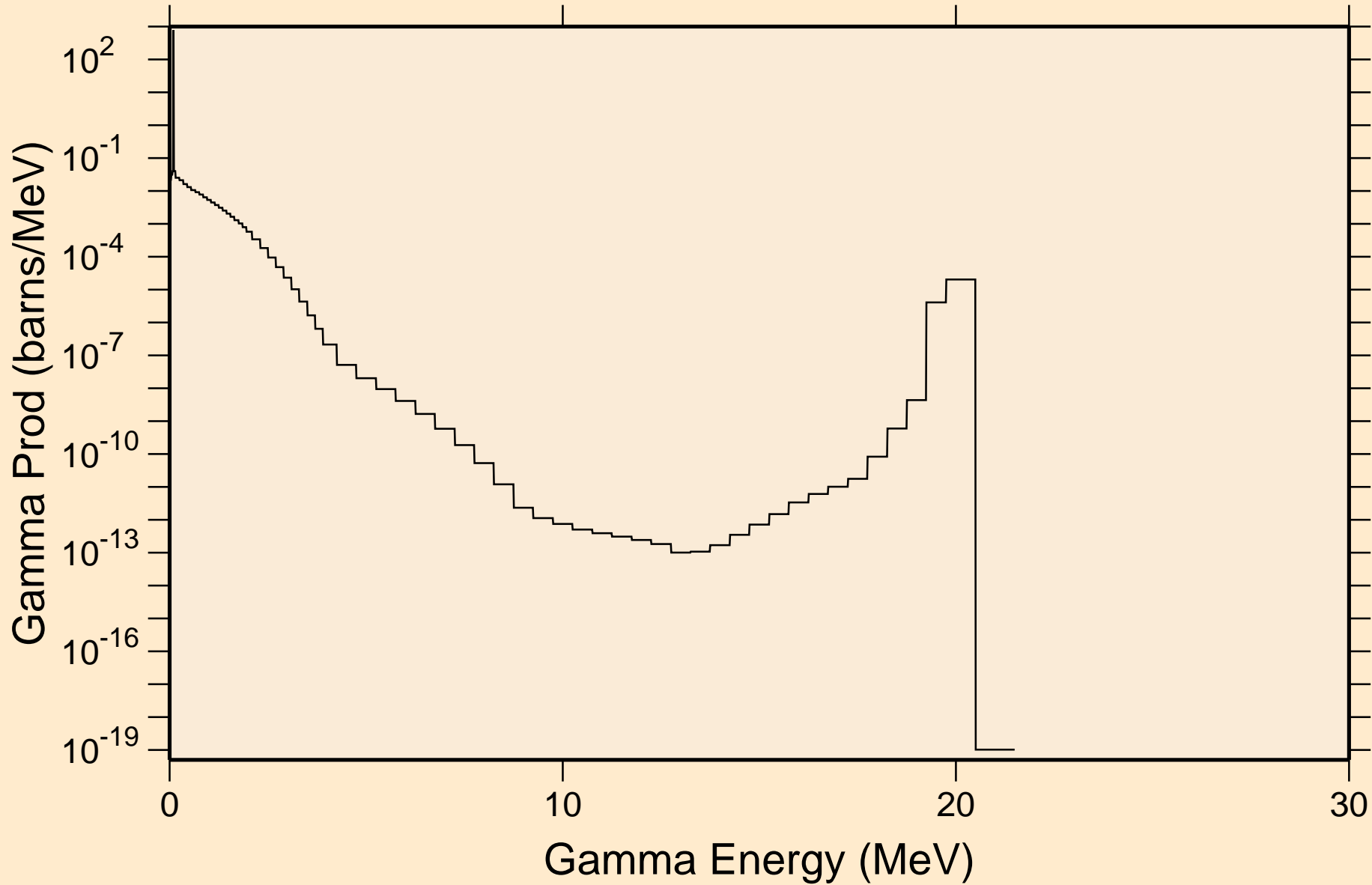

SG271 NRG TENDL-2015, AKONING

Particle heating contributions

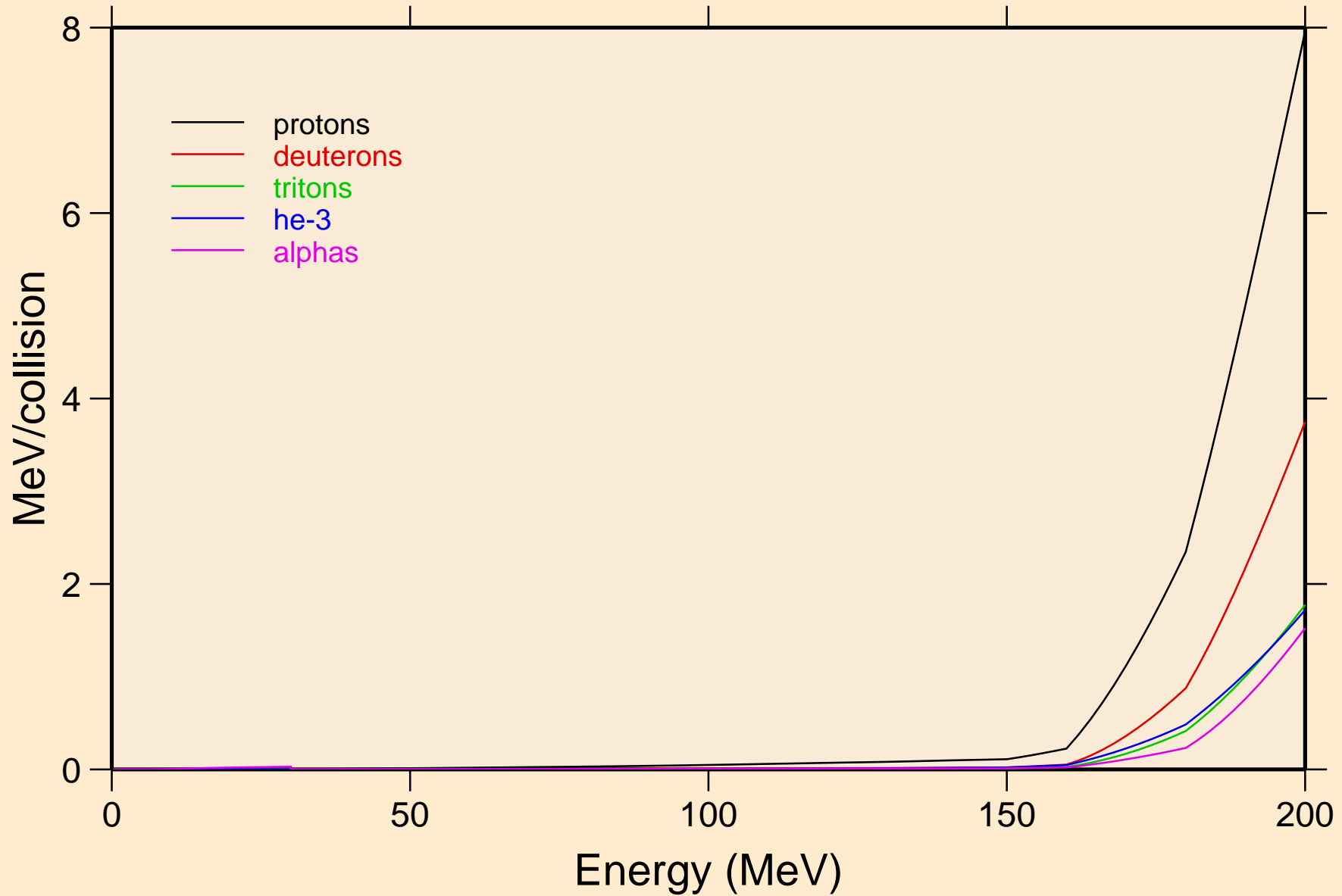

SG271 NRG TENDL-2015, AKONING

Recoil Heating

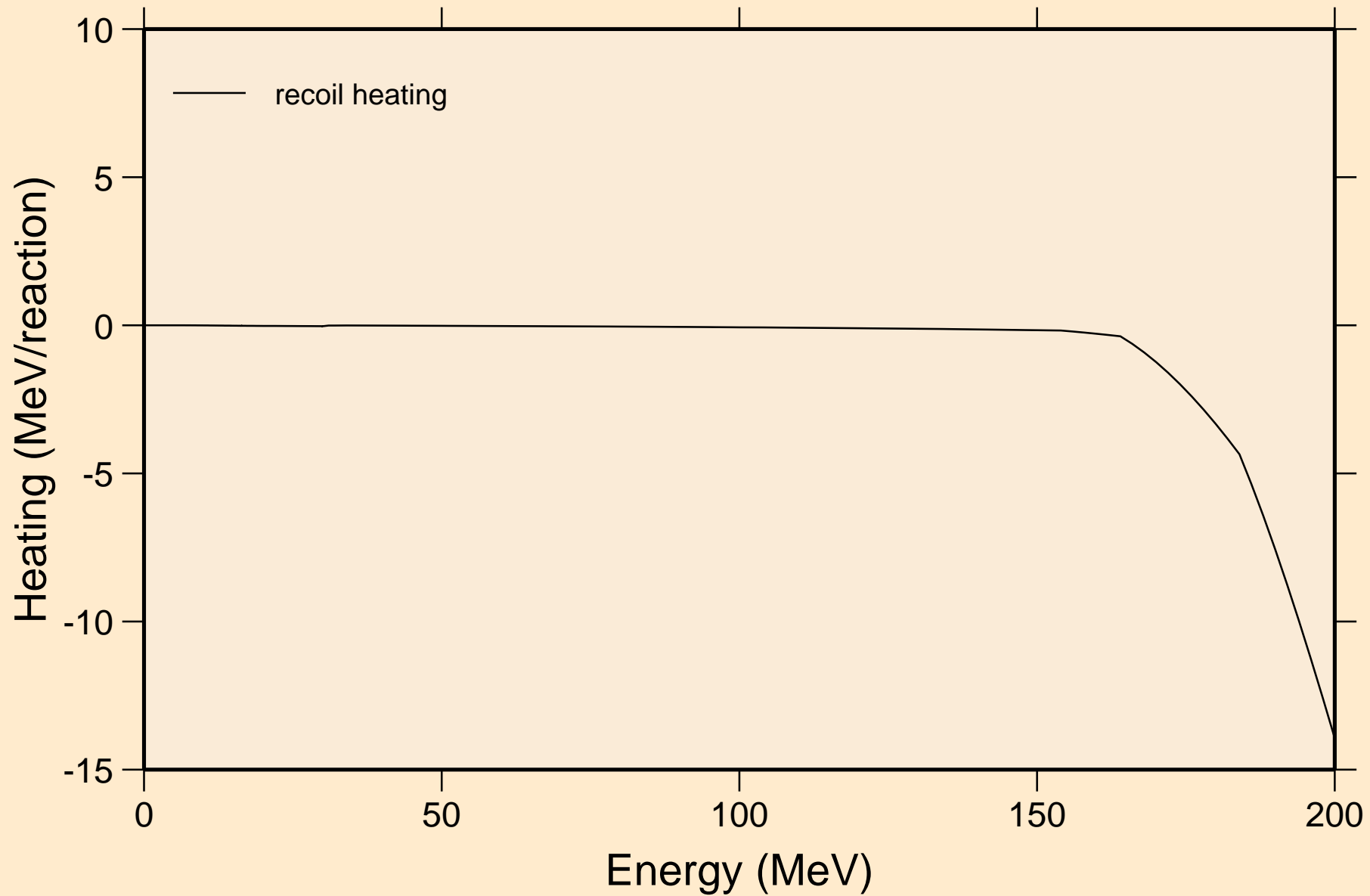

SG271 NRG TENDL-2015, AKONING

Particle production cross sections

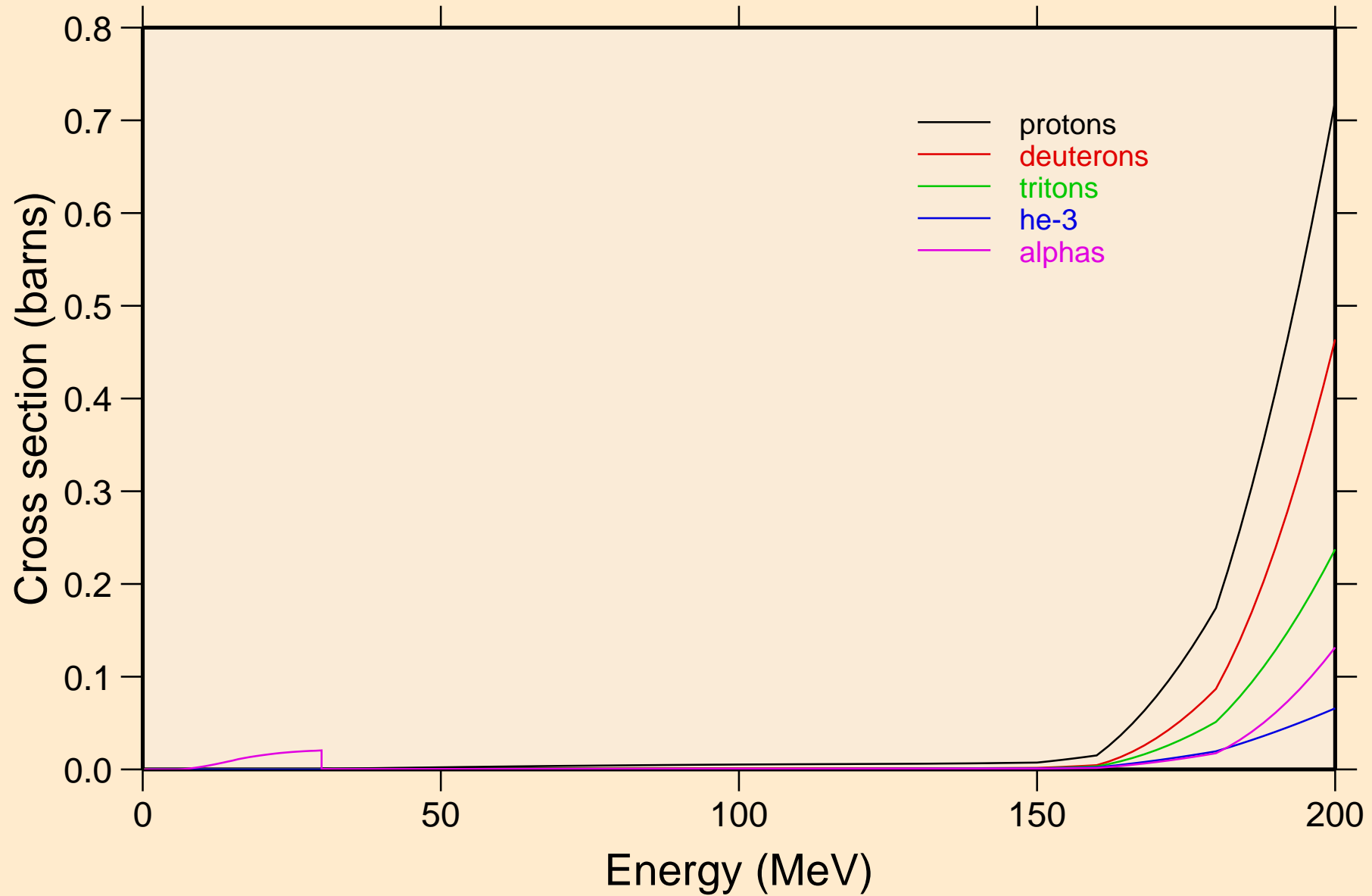

SG271 NRG TENDL-2015, AKONING
protons from (n,x)

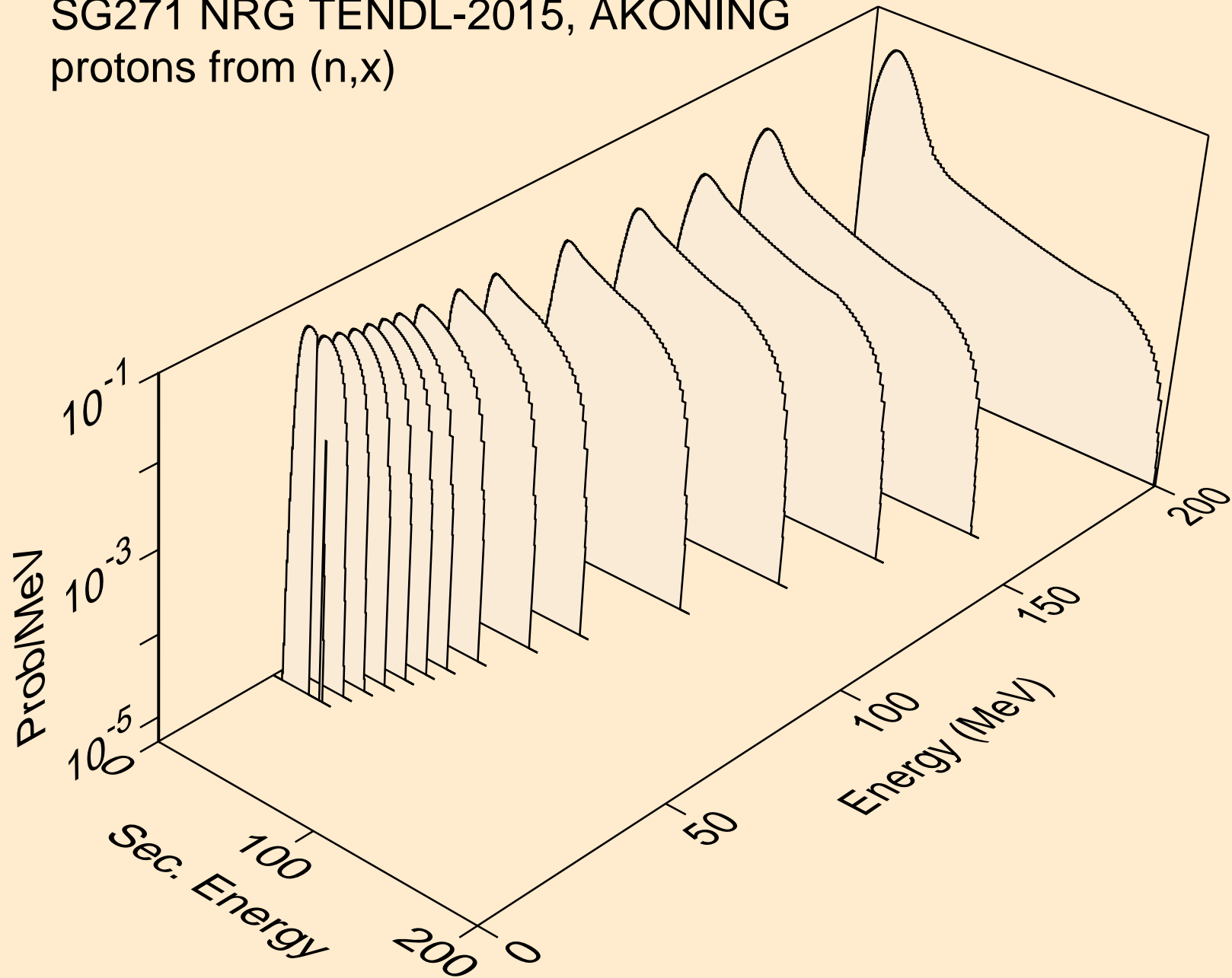

SG271 NRG TENDL-2015, AKONING
protons from (n,n*)p

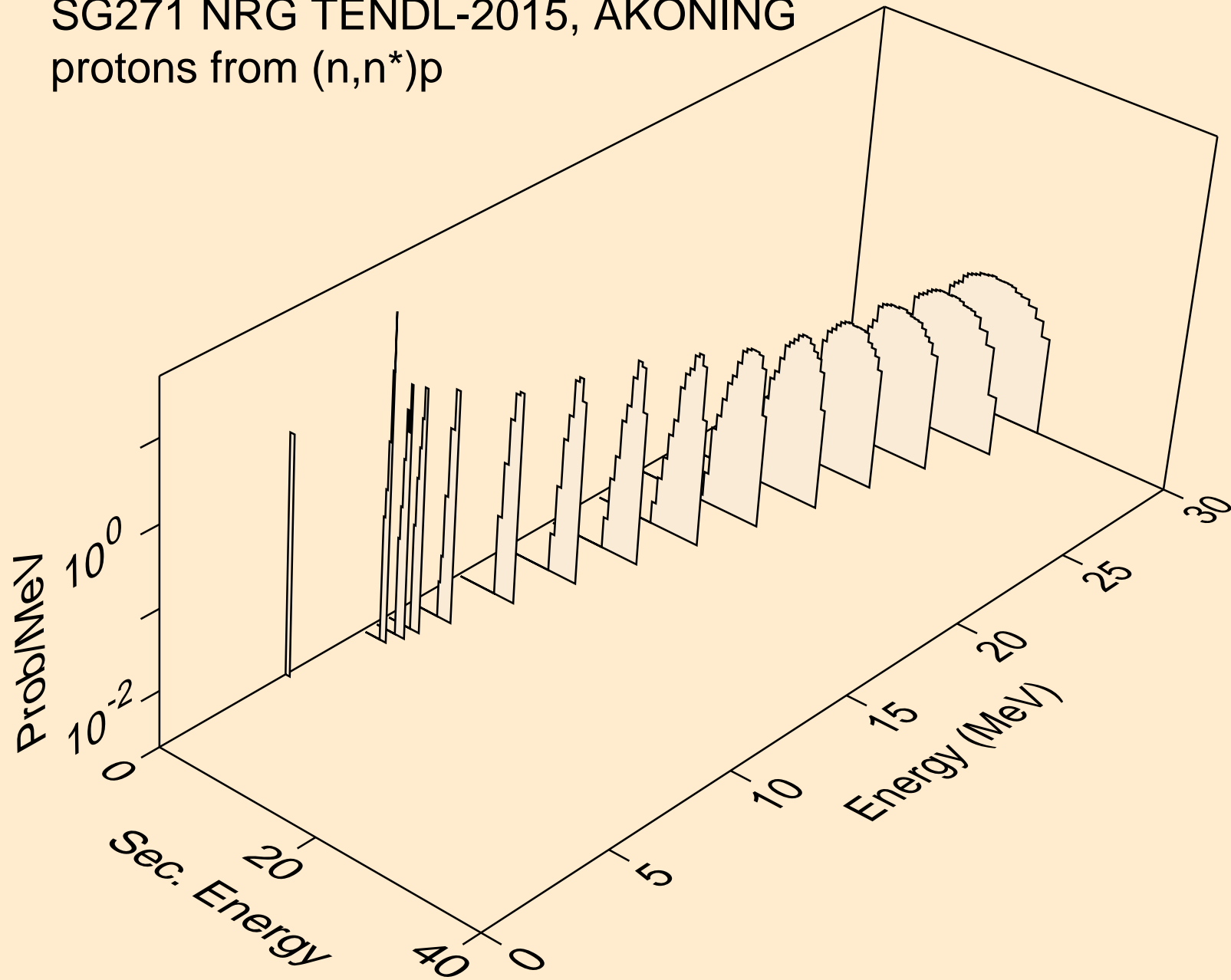

SG271 NRG TENDL-2015, AKONING
protons from (n,2np)

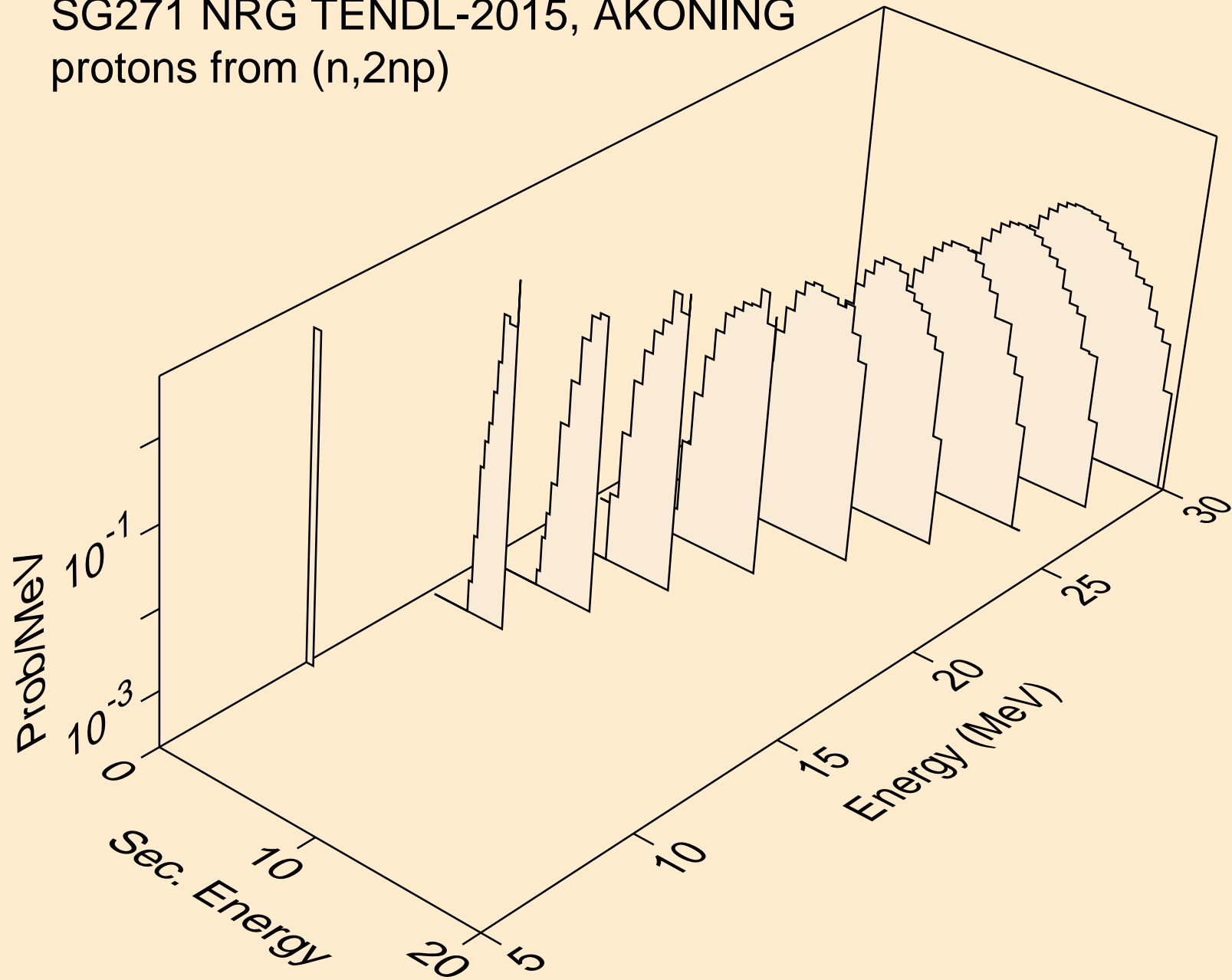

SG271 NRG TENDL-2015, AKONING
protons from (n,3np)

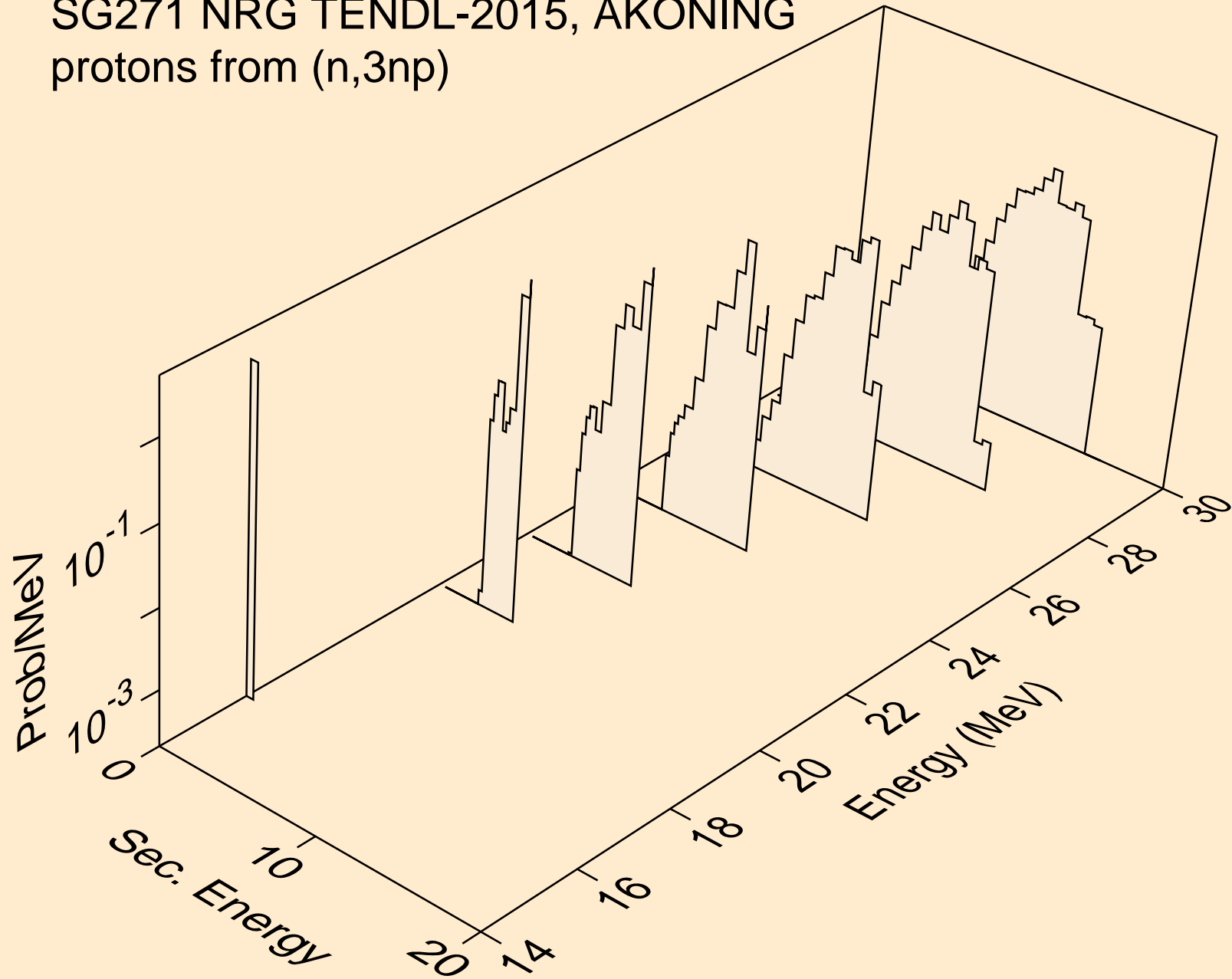

SG271 NRG TENDL-2015, AKONING
protons from (n,npa)

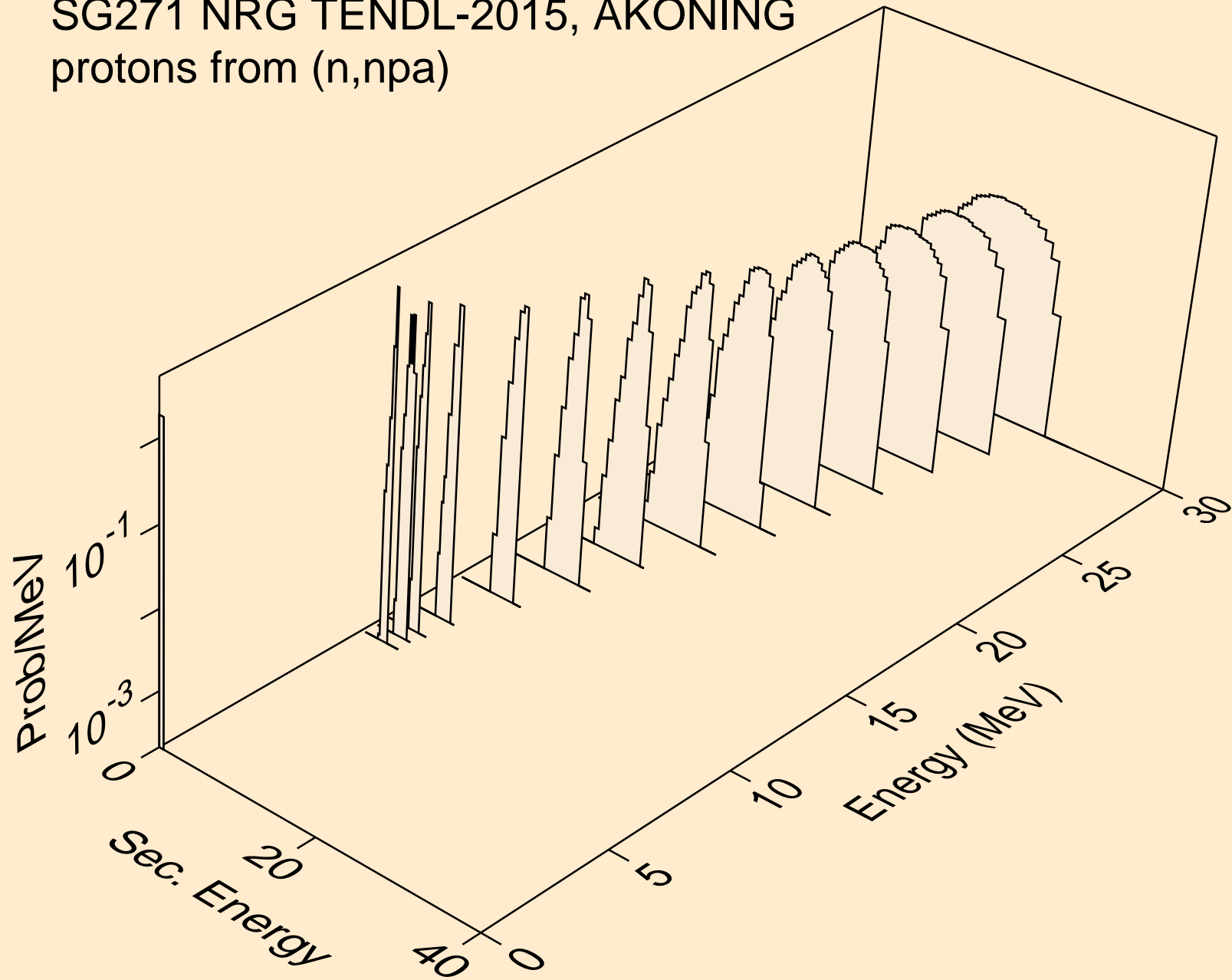

SG271 NRG TENDL-2015, AKONING
protons from (n,p)

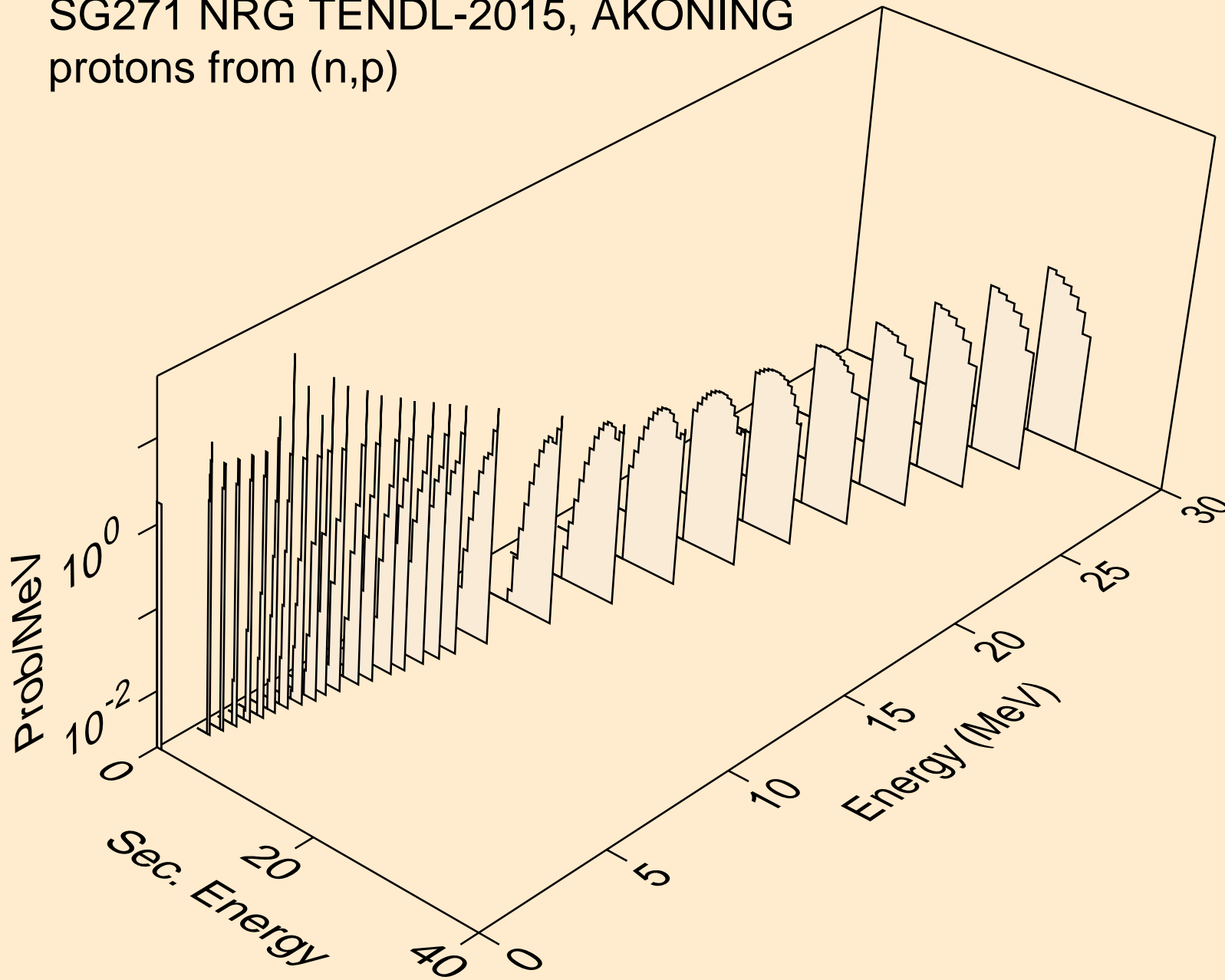

SG271 NRG TENDL-2015, AKONING
protons from (n,pa)

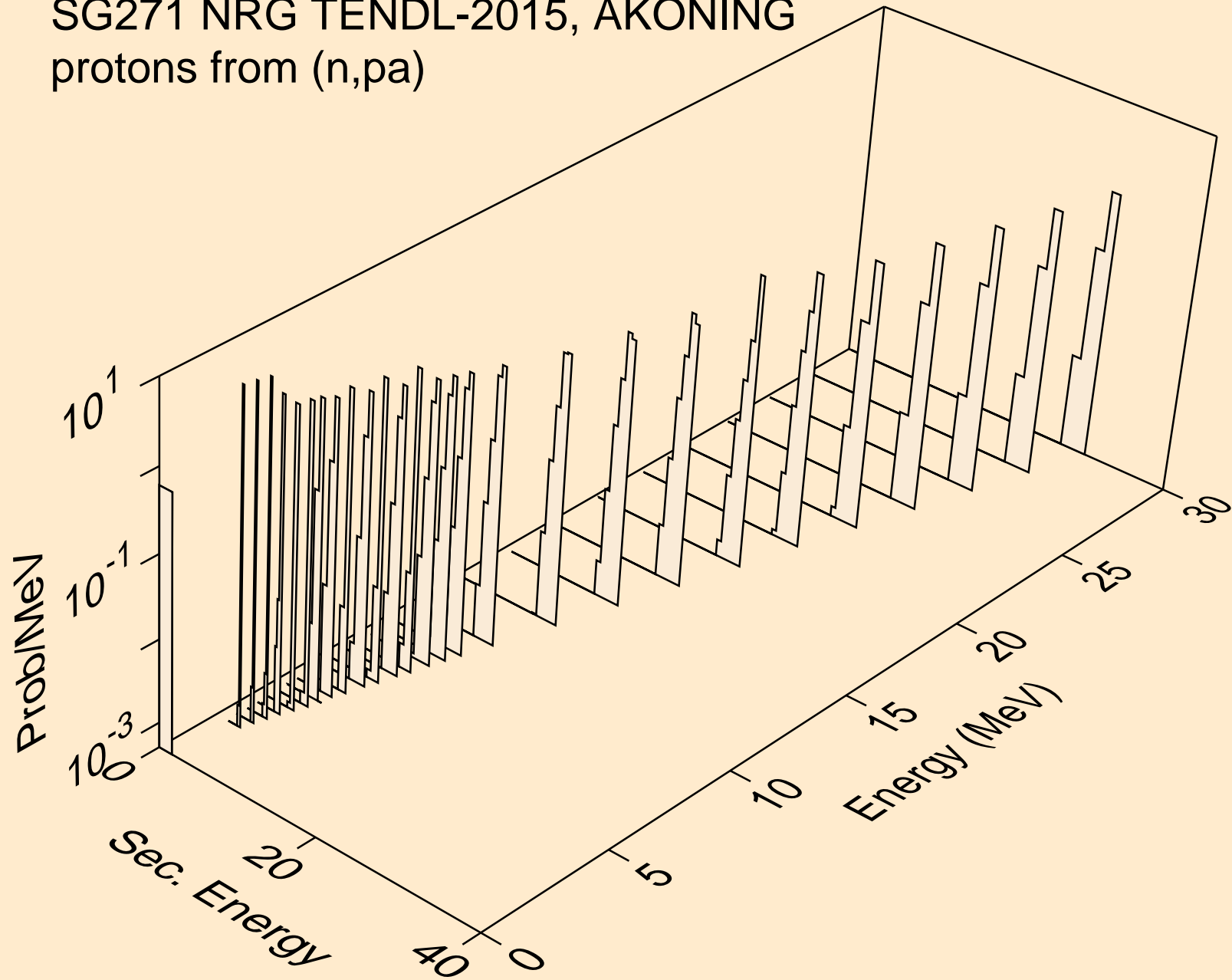

SG271 NRG TENDL-2015, AKONING
deuterons from (n,x)

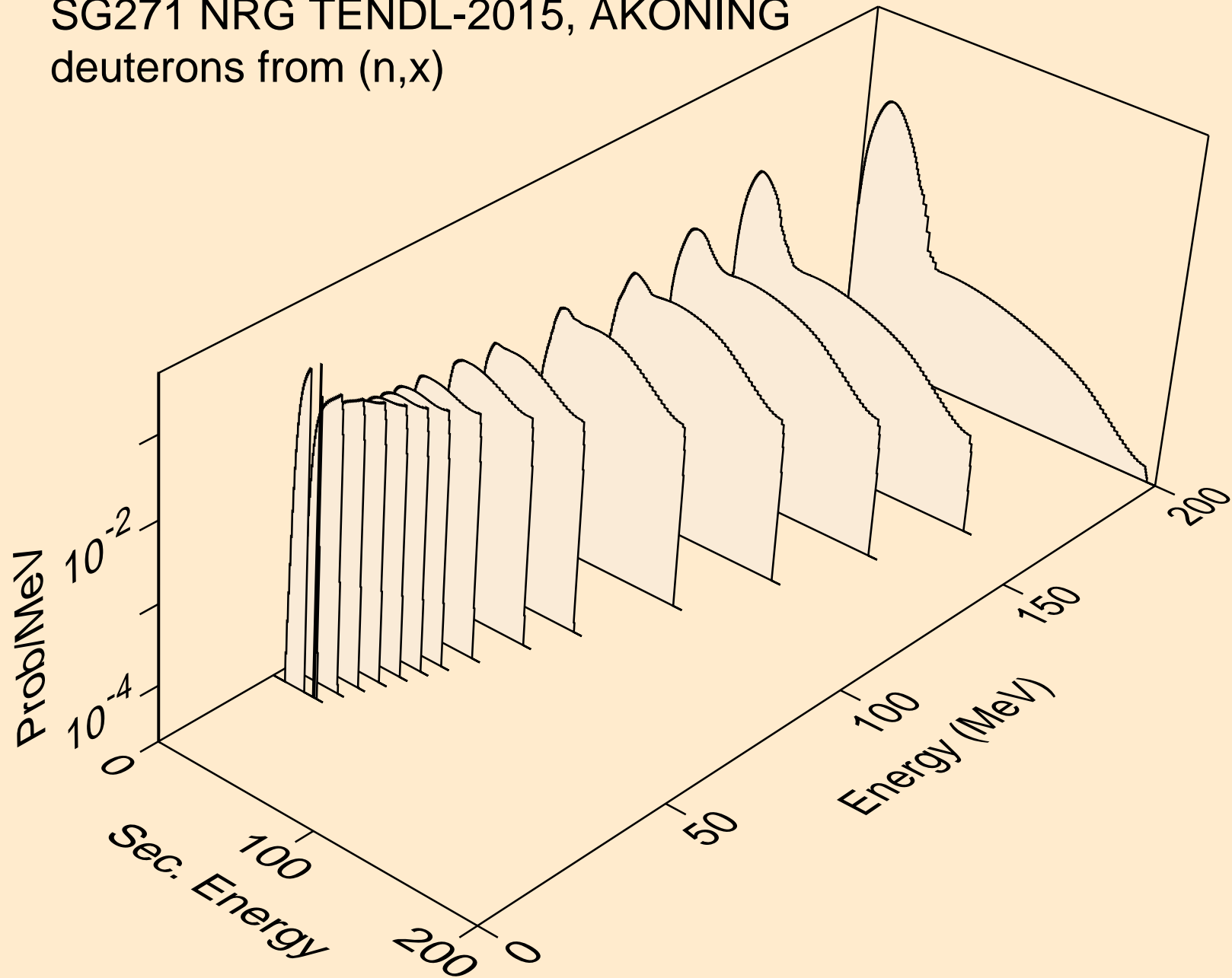

SG271 NRG TENDL-2015, AKONING
deuterons from (n,2nd)

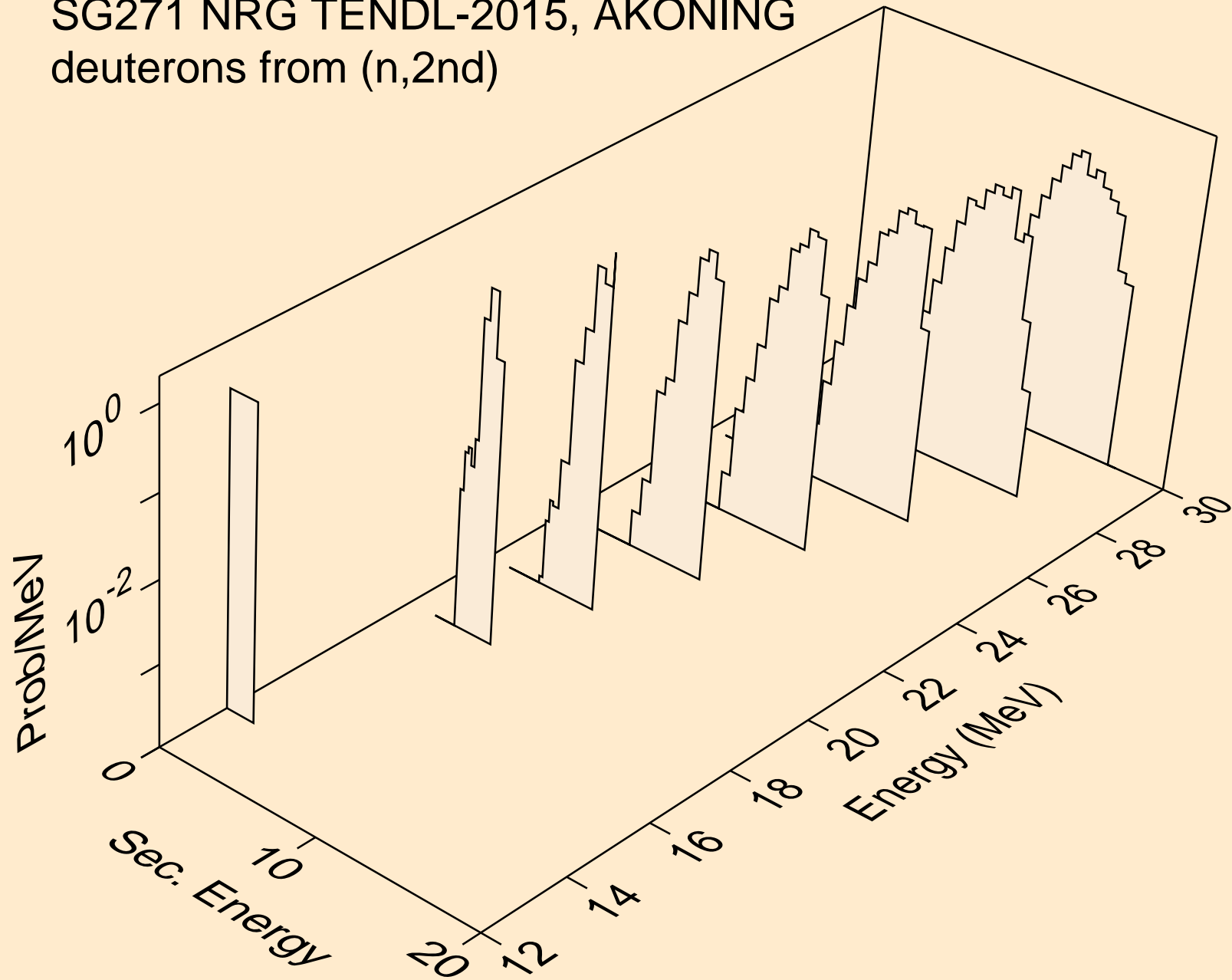

SG271 NRG TENDL-2015, AKONING
deuterons from (n,n*)d

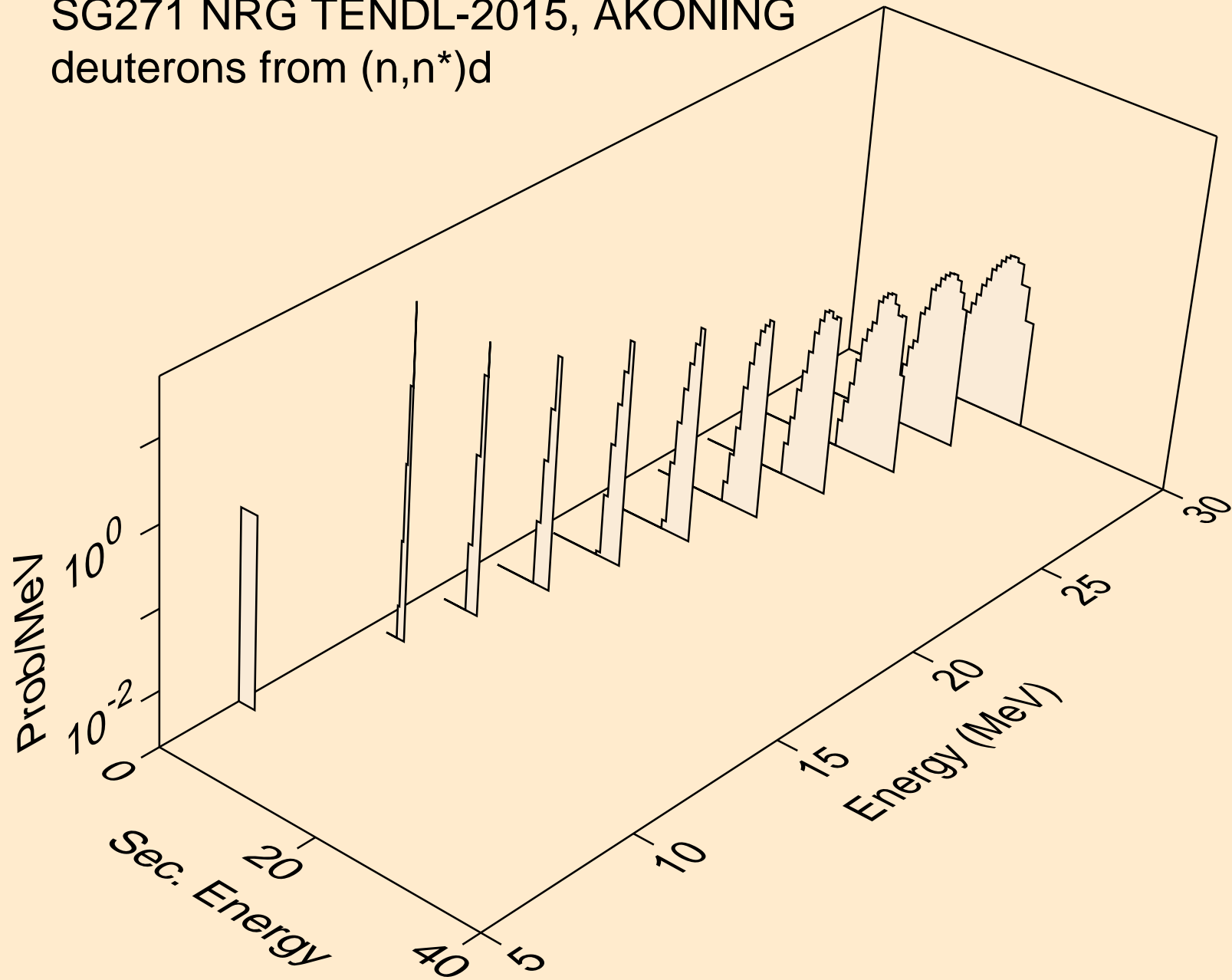

SG271 NRG TENDL-2015, AKONING
deuterons from (n,n*)d2a

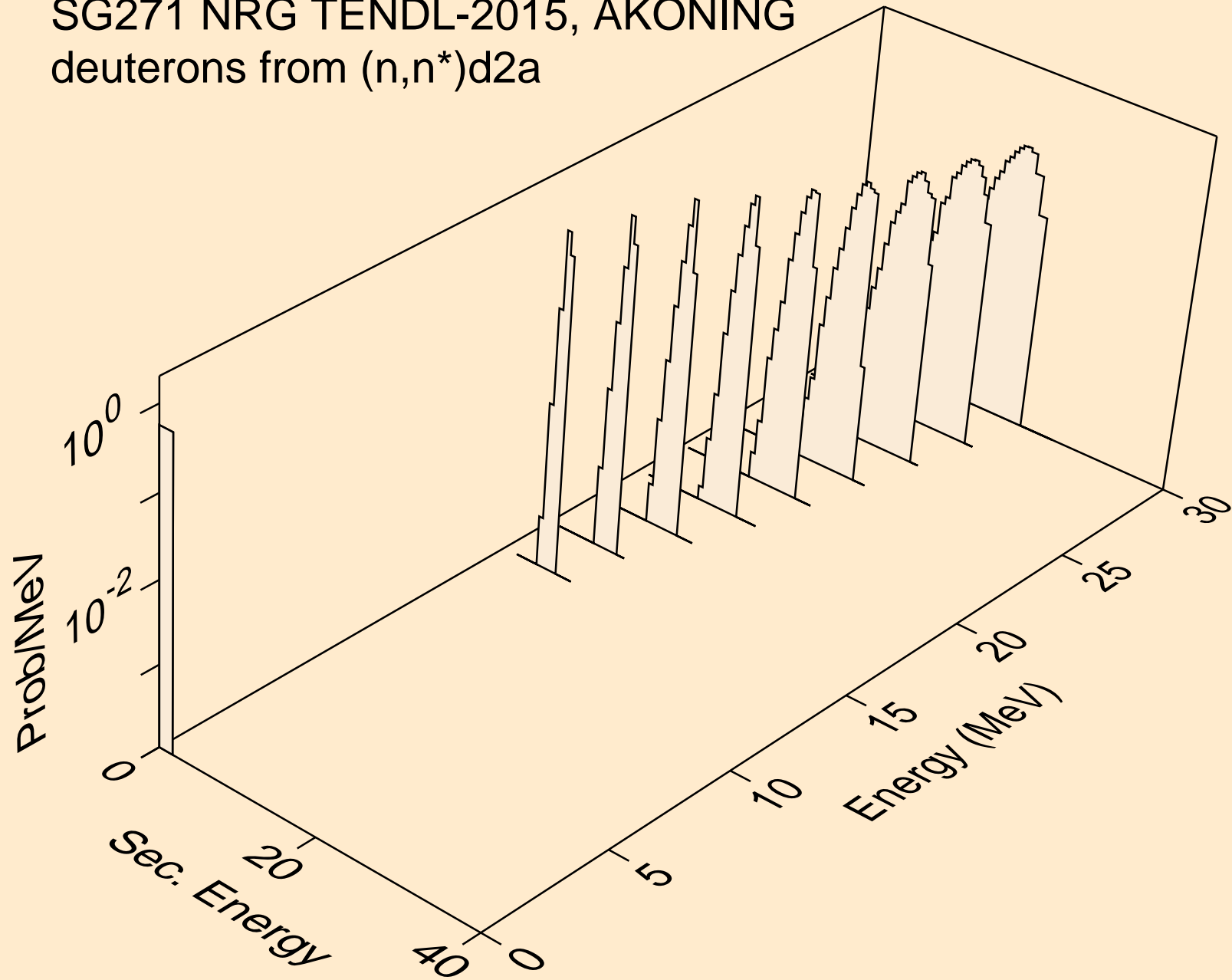

SG271 NRG TENDL-2015, AKONING
deuterons from (n,d)

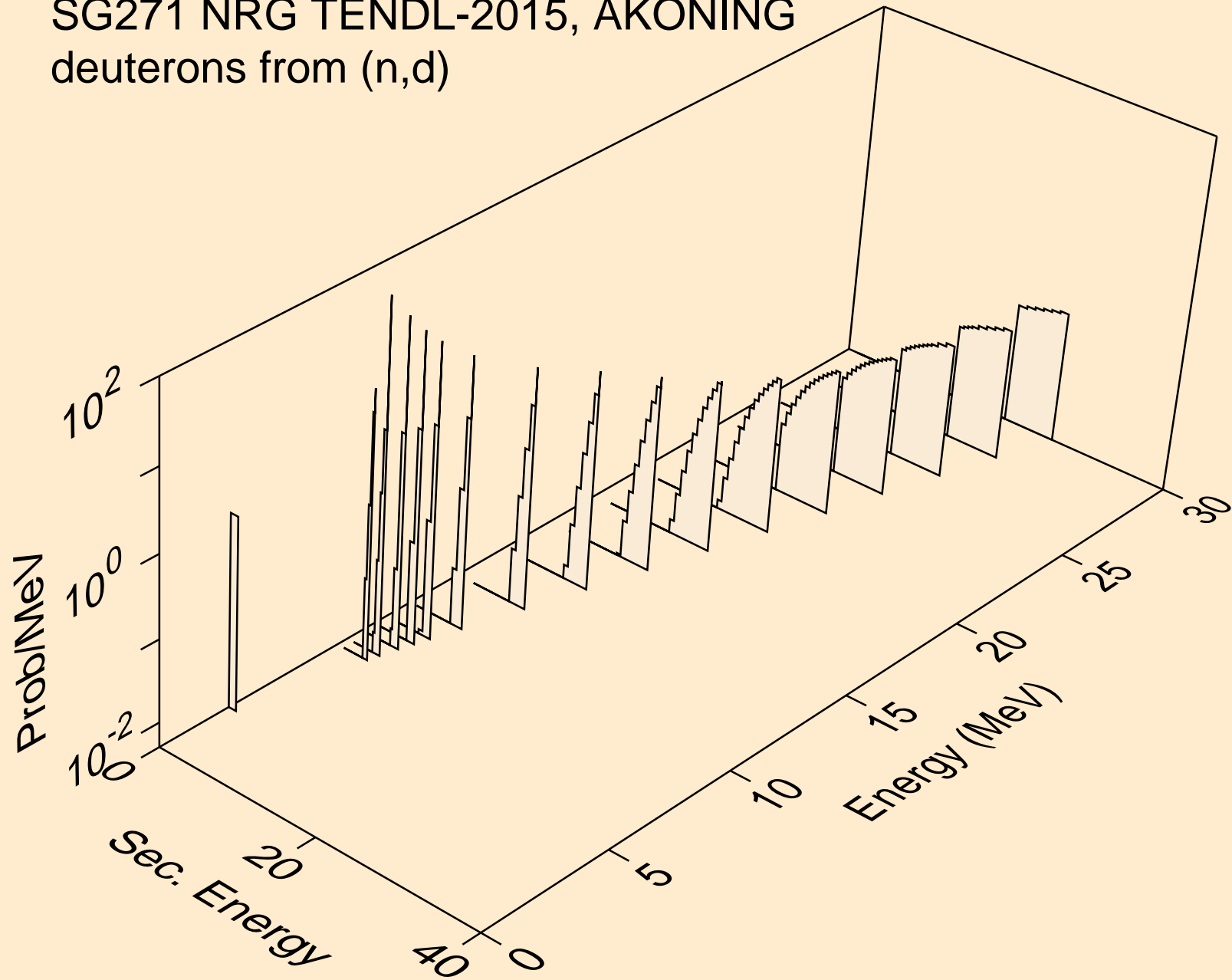

SG271 NRG TENDL-2015, AKONING
deuterons from (n,d2a)

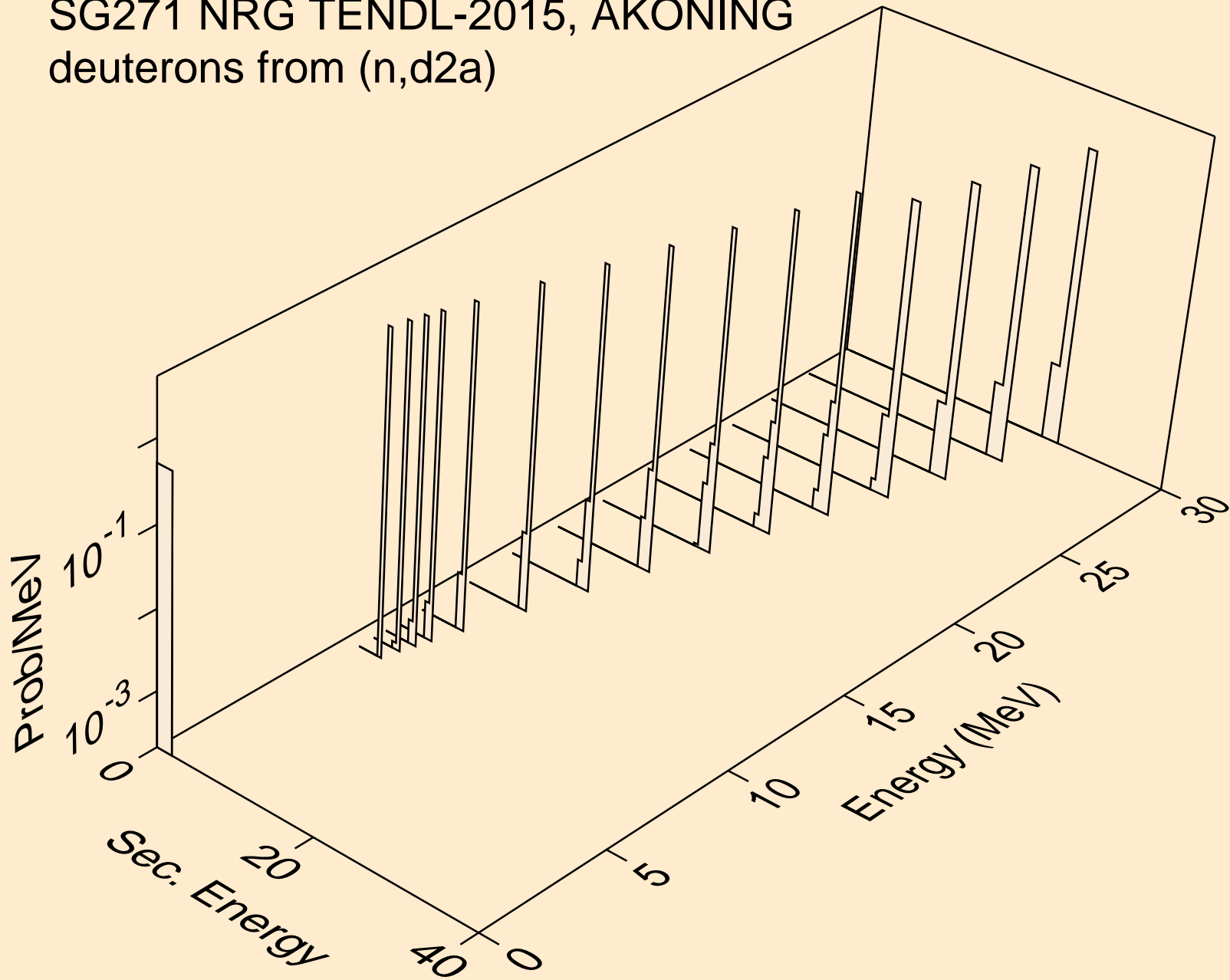

SG271 NRG TENDL-2015, AKONING
deuterons from (n,da)

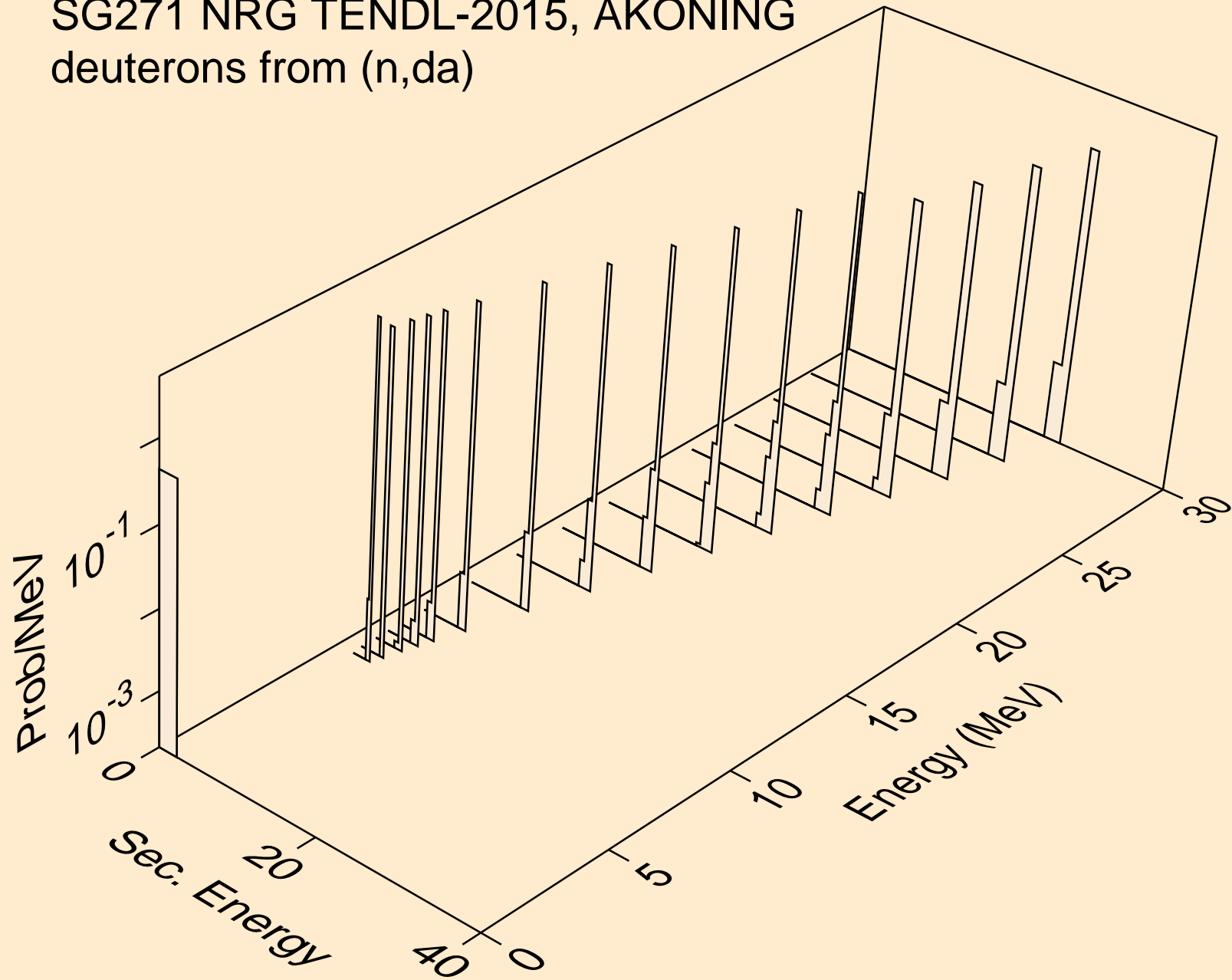

SG271 NRG TENDL-2015, AKONING
tritons from (n,x)

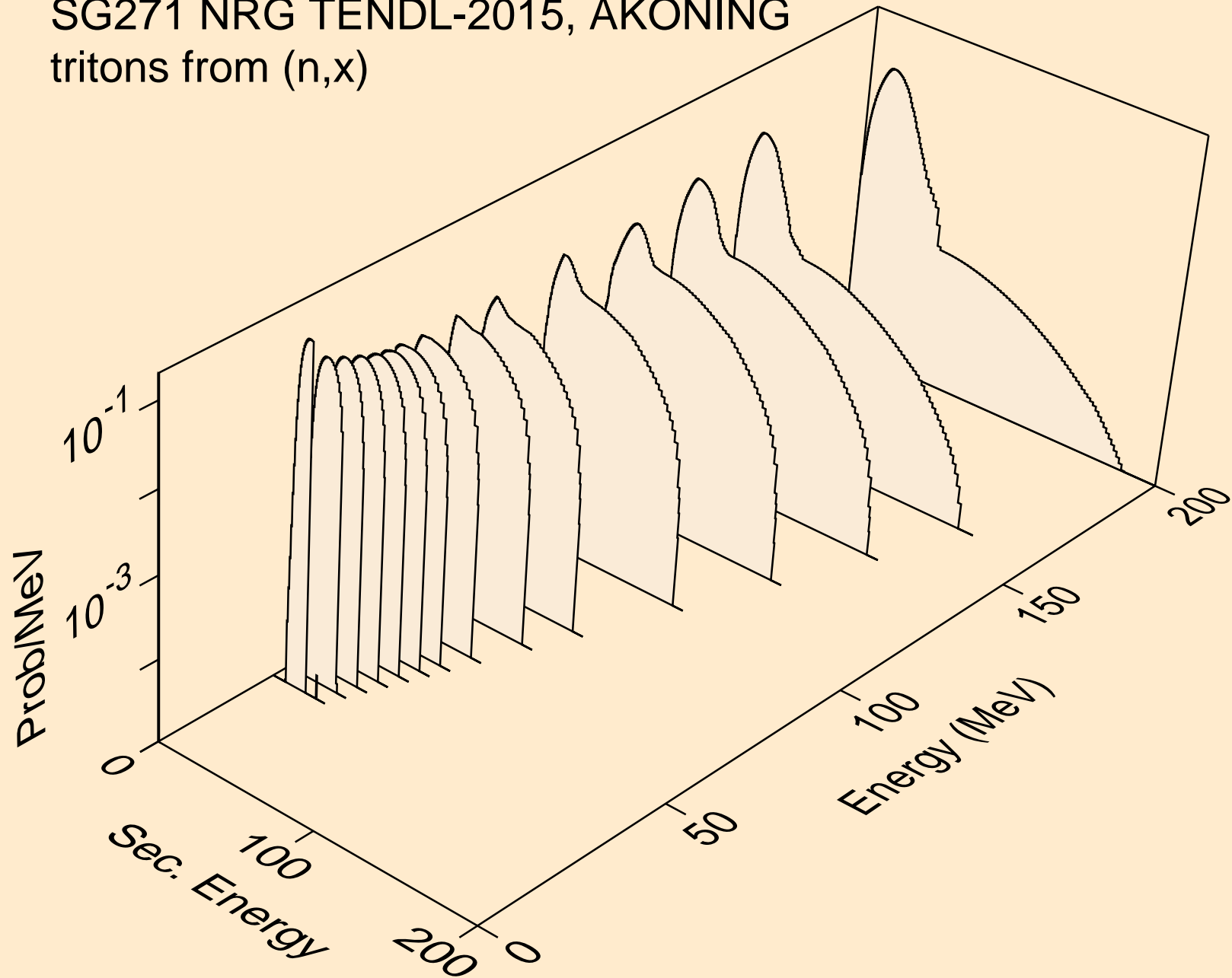

SG271 NRG TENDL-2015, AKONING
tritons from (n,n*)t

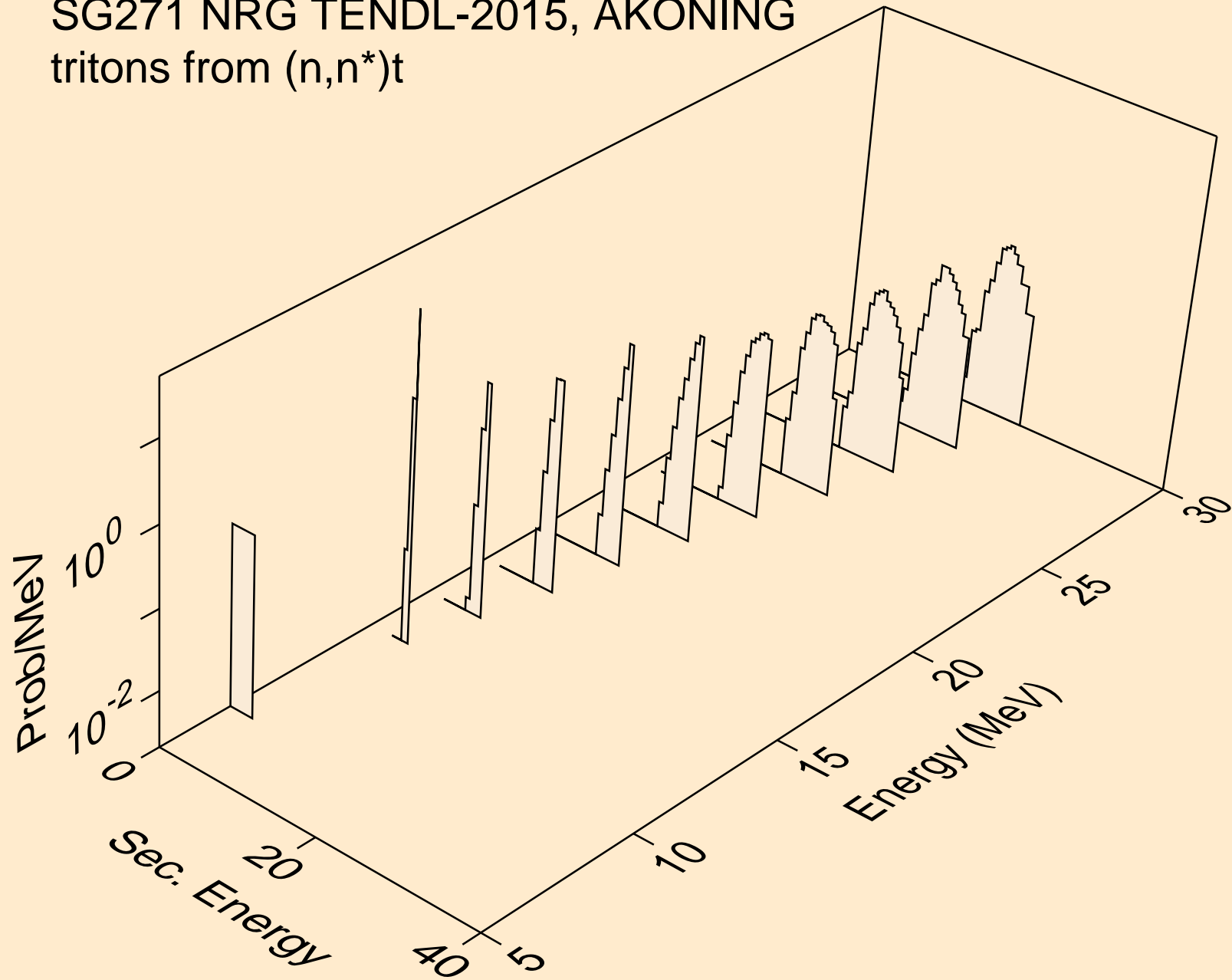

SG271 NRG TENDL-2015, AKONING
tritons from (n,n*)t2a

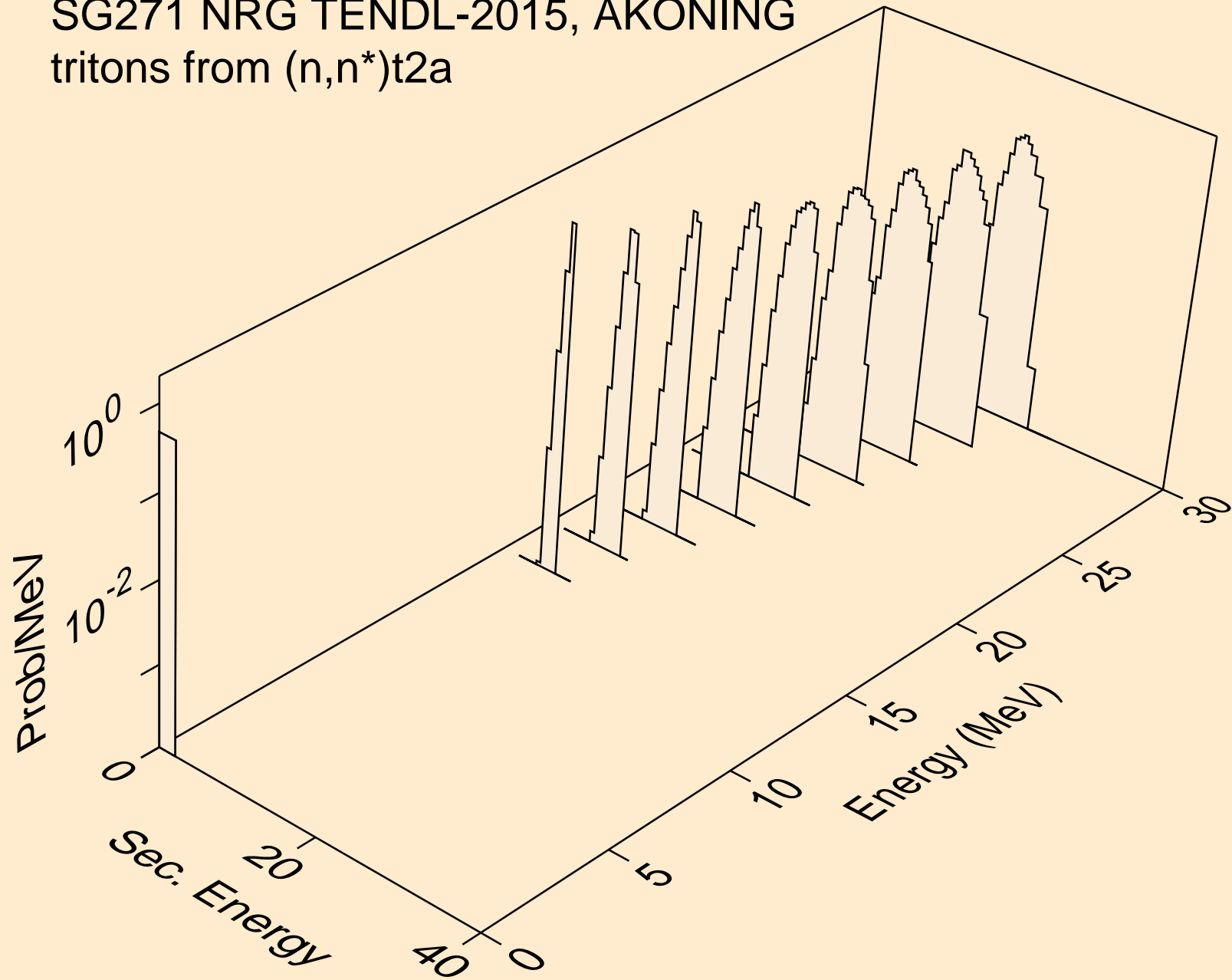

SG271 NRG TENDL-2015, AKONING
tritons from (n,t)

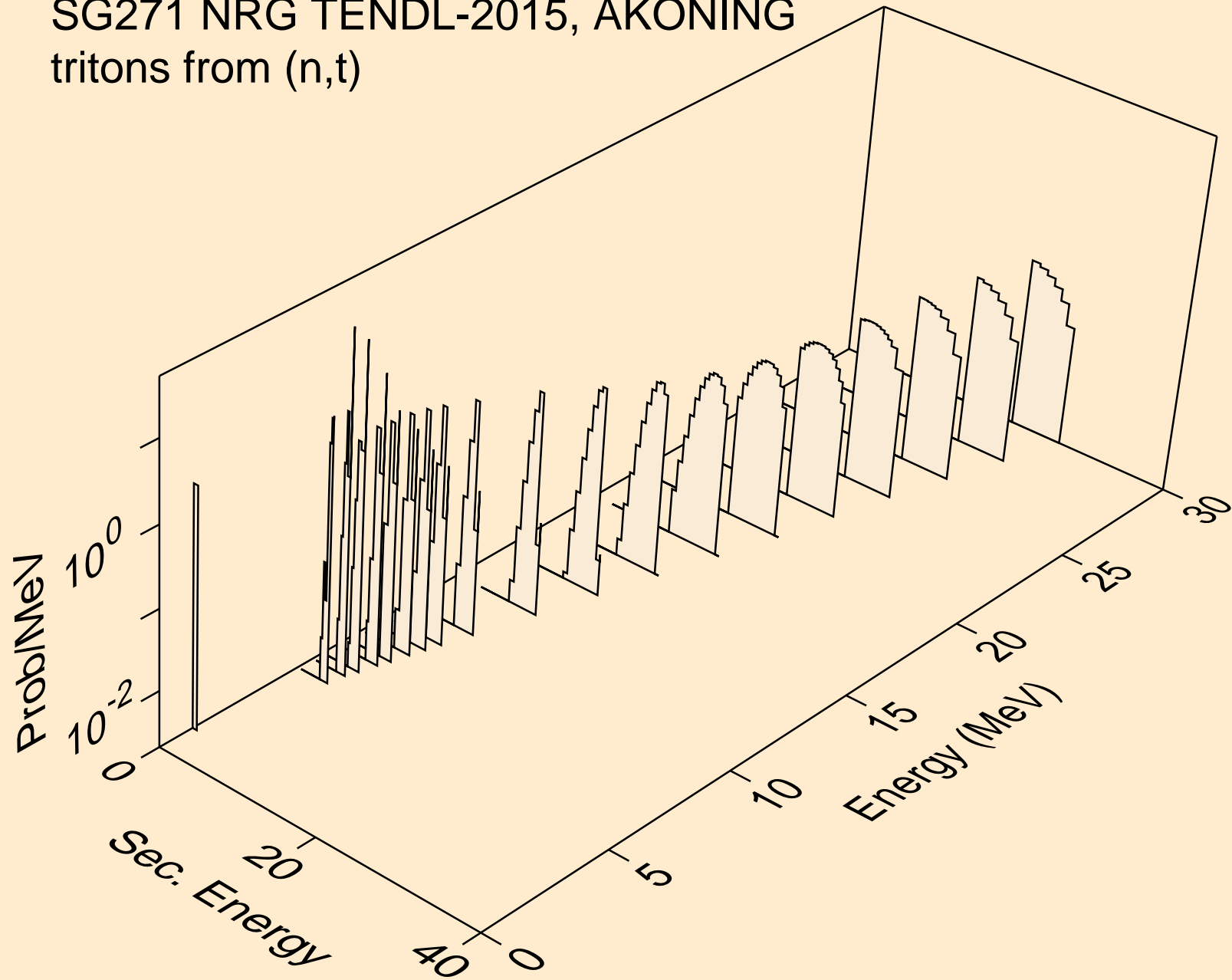

SG271 NRG TENDL-2015, AKONING
tritons from (n,t2a)

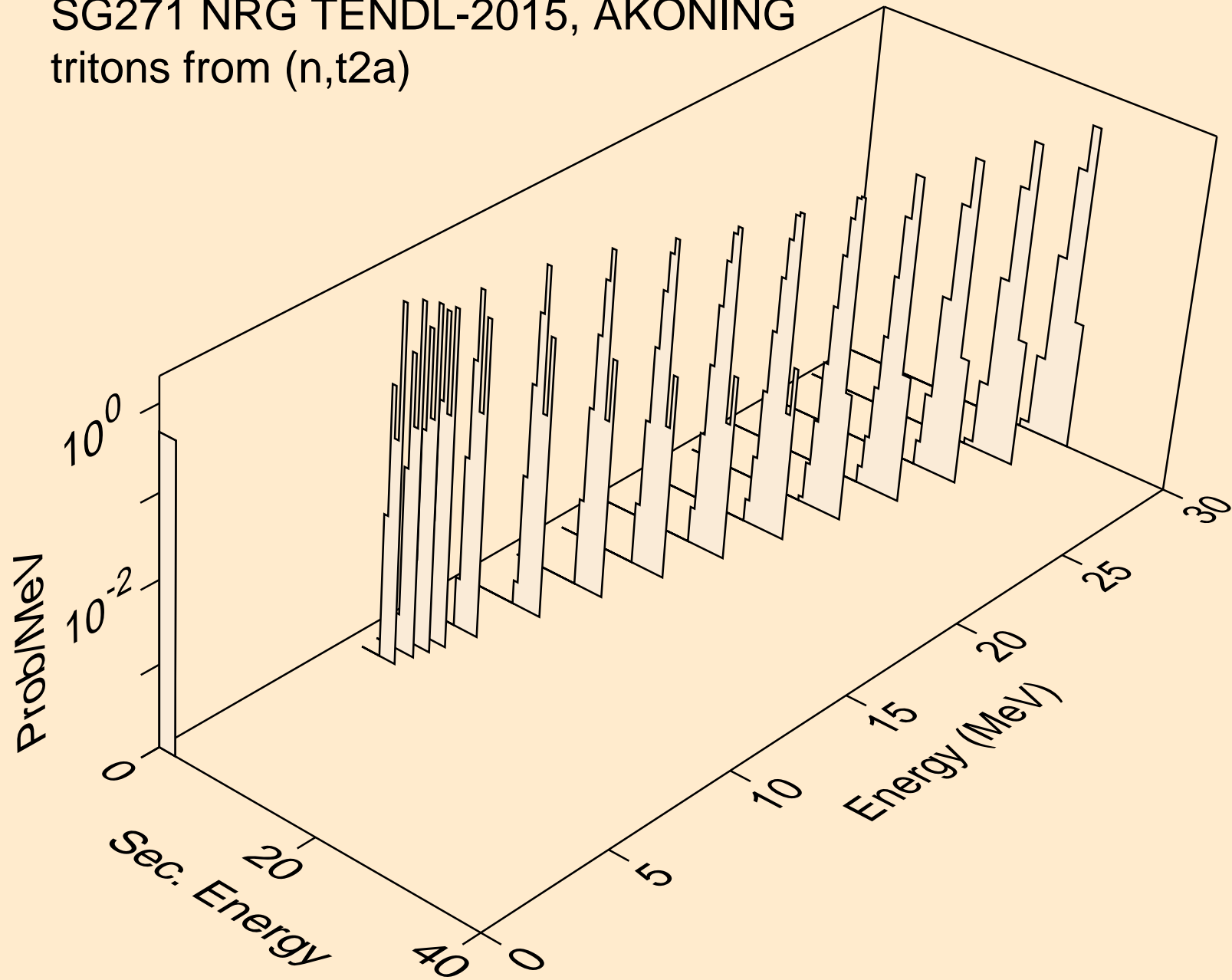

SG271 NRG TENDL-2015, AKONING
he3s from (n,x)

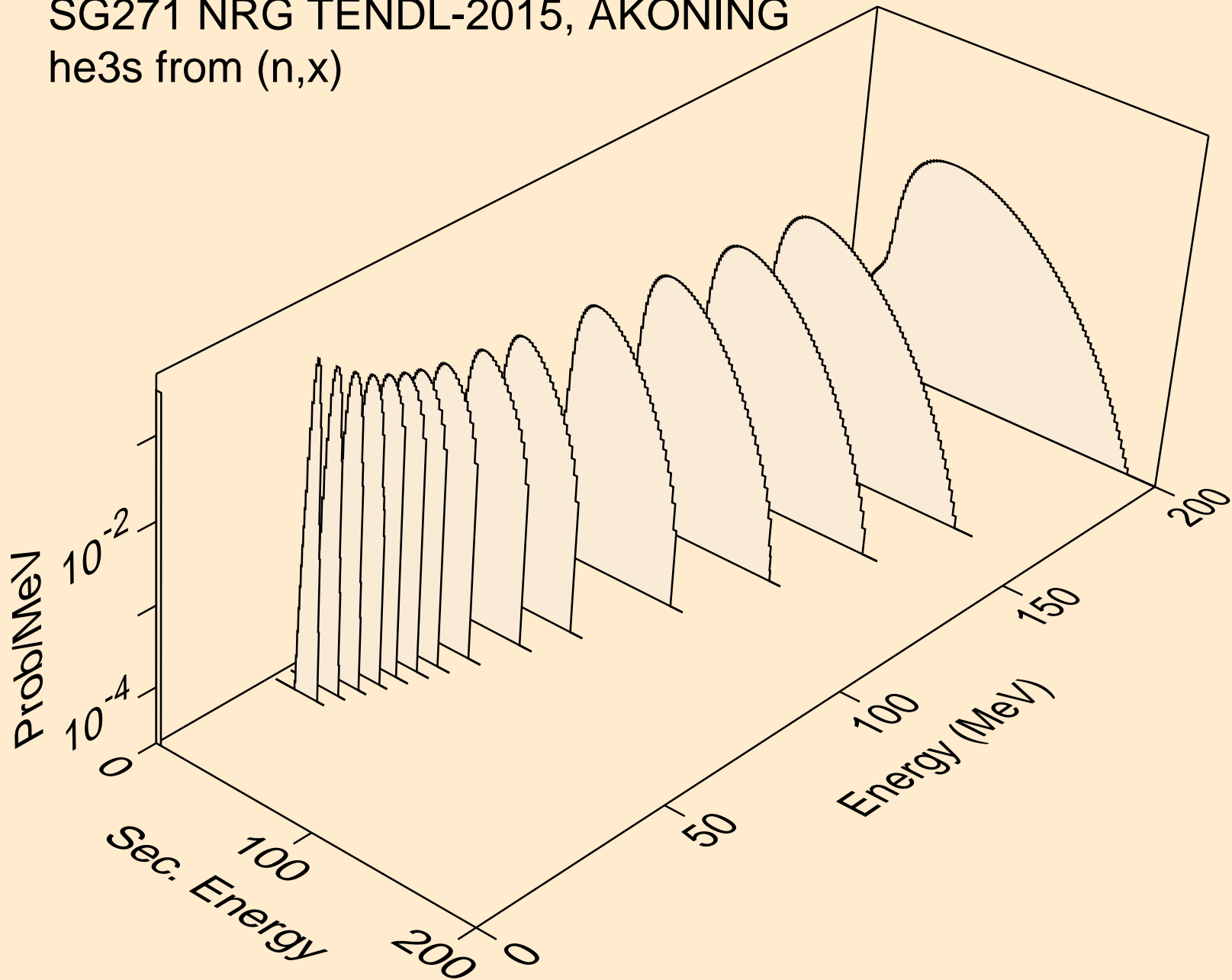

SG271 NRG TENDL-2015, AKONING
he3s from (n,n*)he3

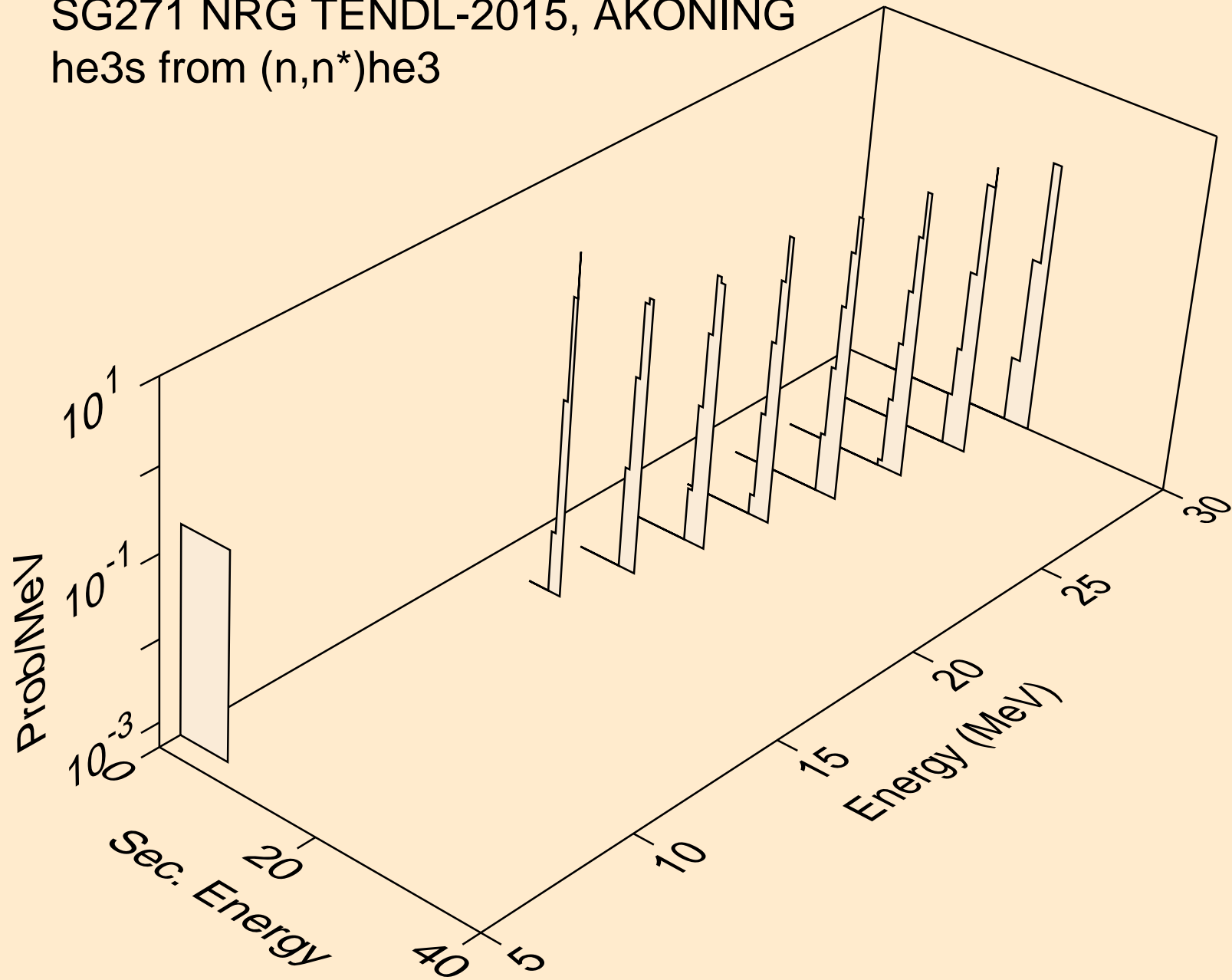

SG271 NRG TENDL-2015, AKONING
he3s from (n,he3)

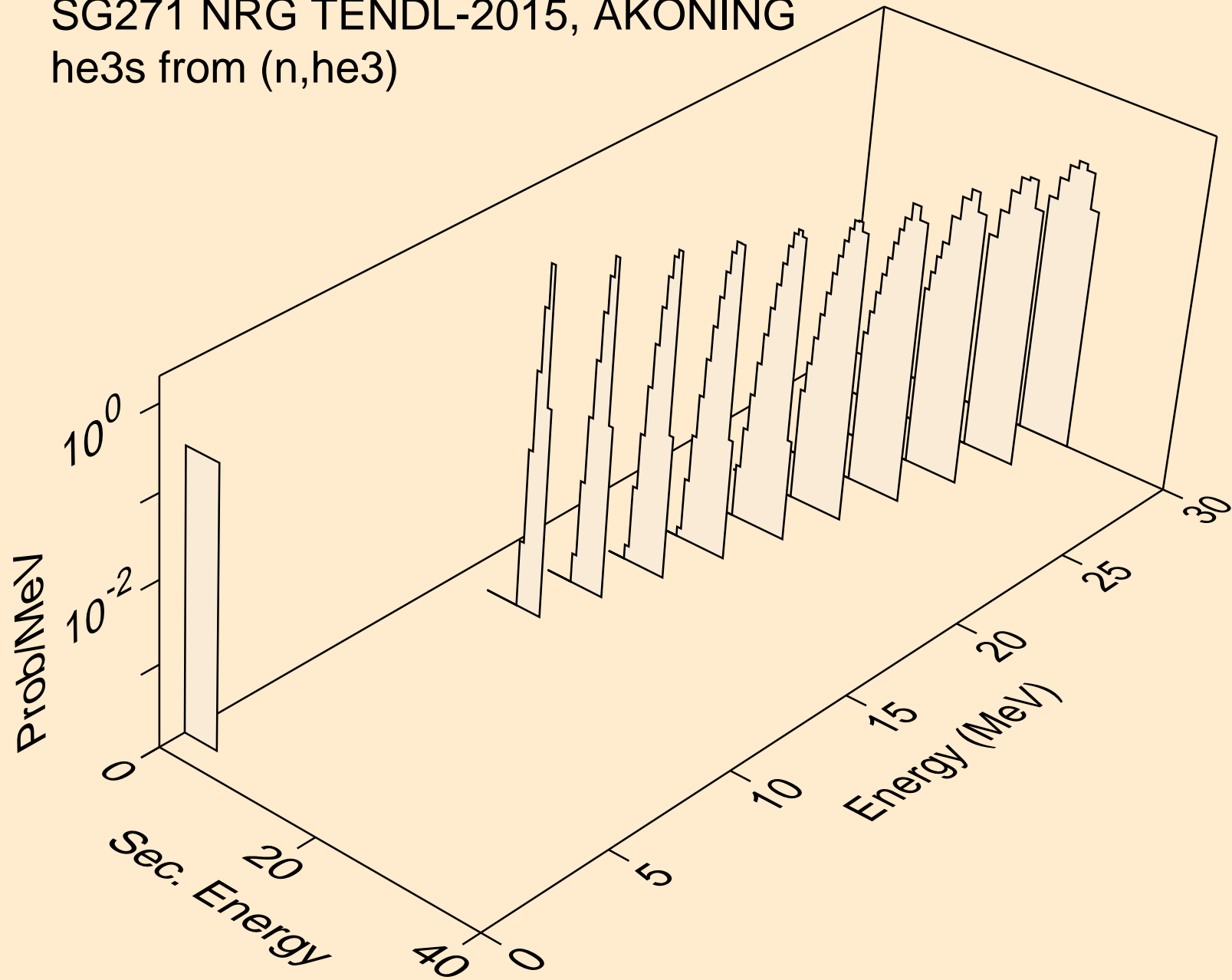

SG271 NRG TENDL-2015, AKONING
alphas from (n,x)

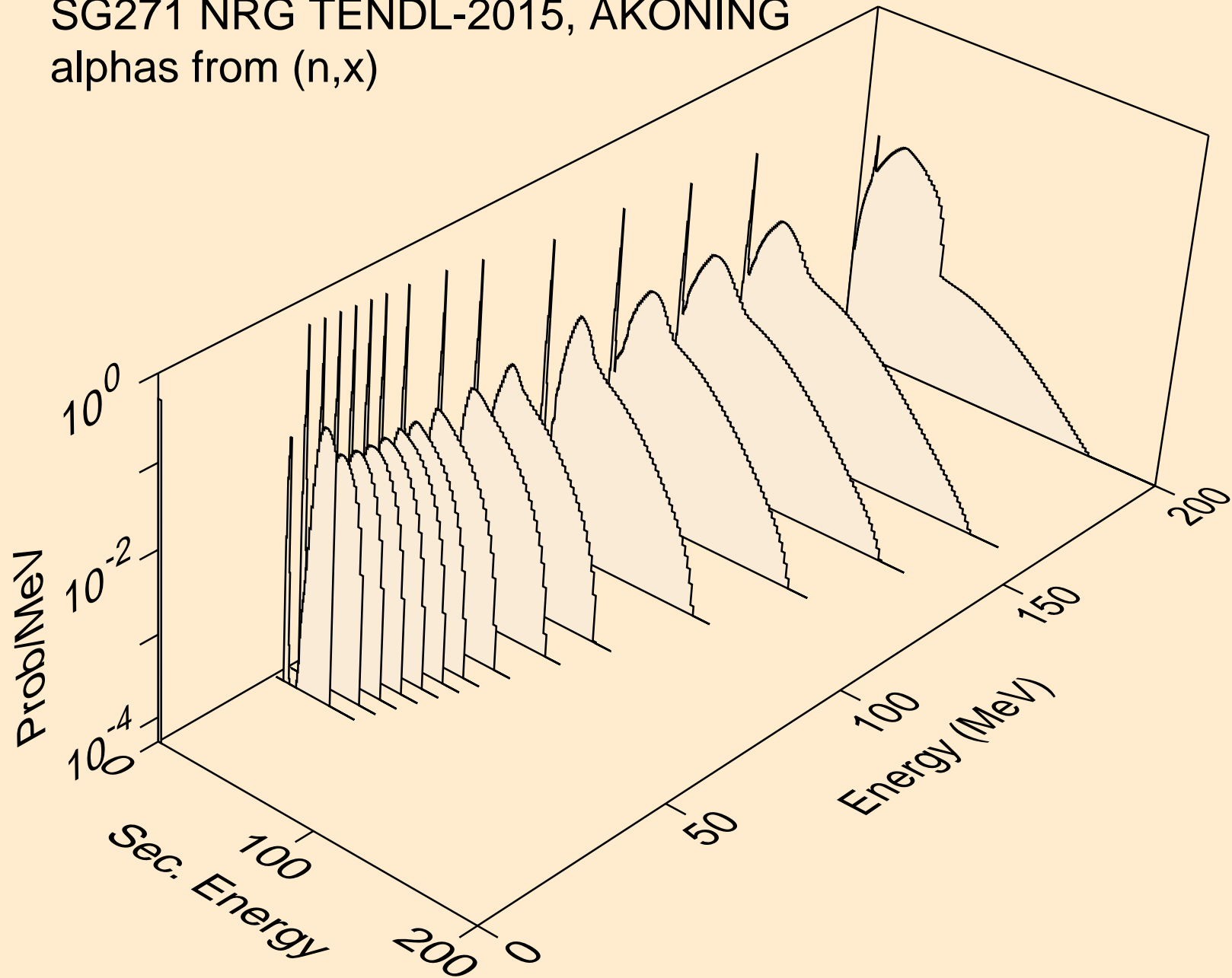

SG271 NRG TENDL-2015, AKONING
alphas from (n,n*)a

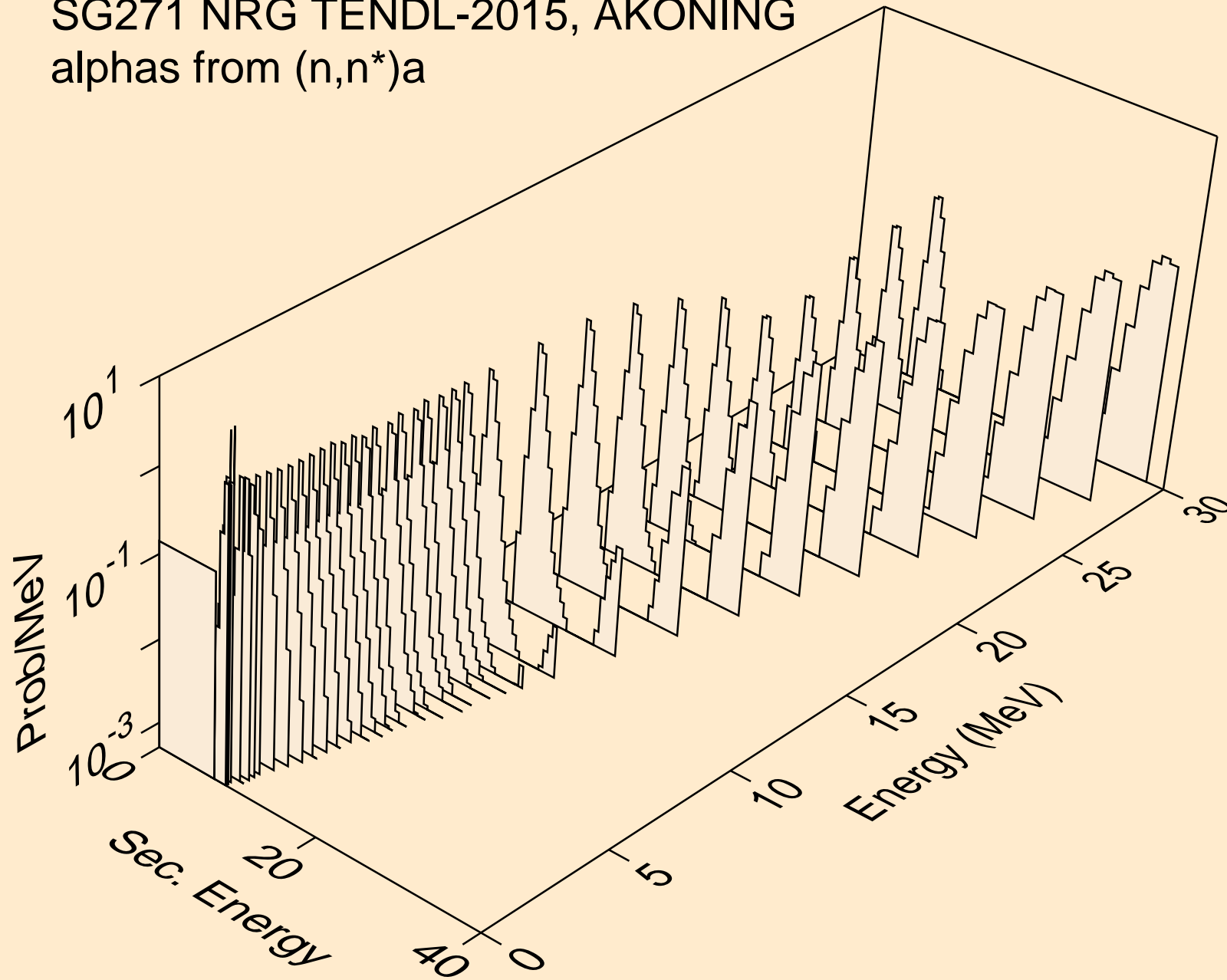

SG271 NRG TENDL-2015, AKONING
alphas from (n,2n)a

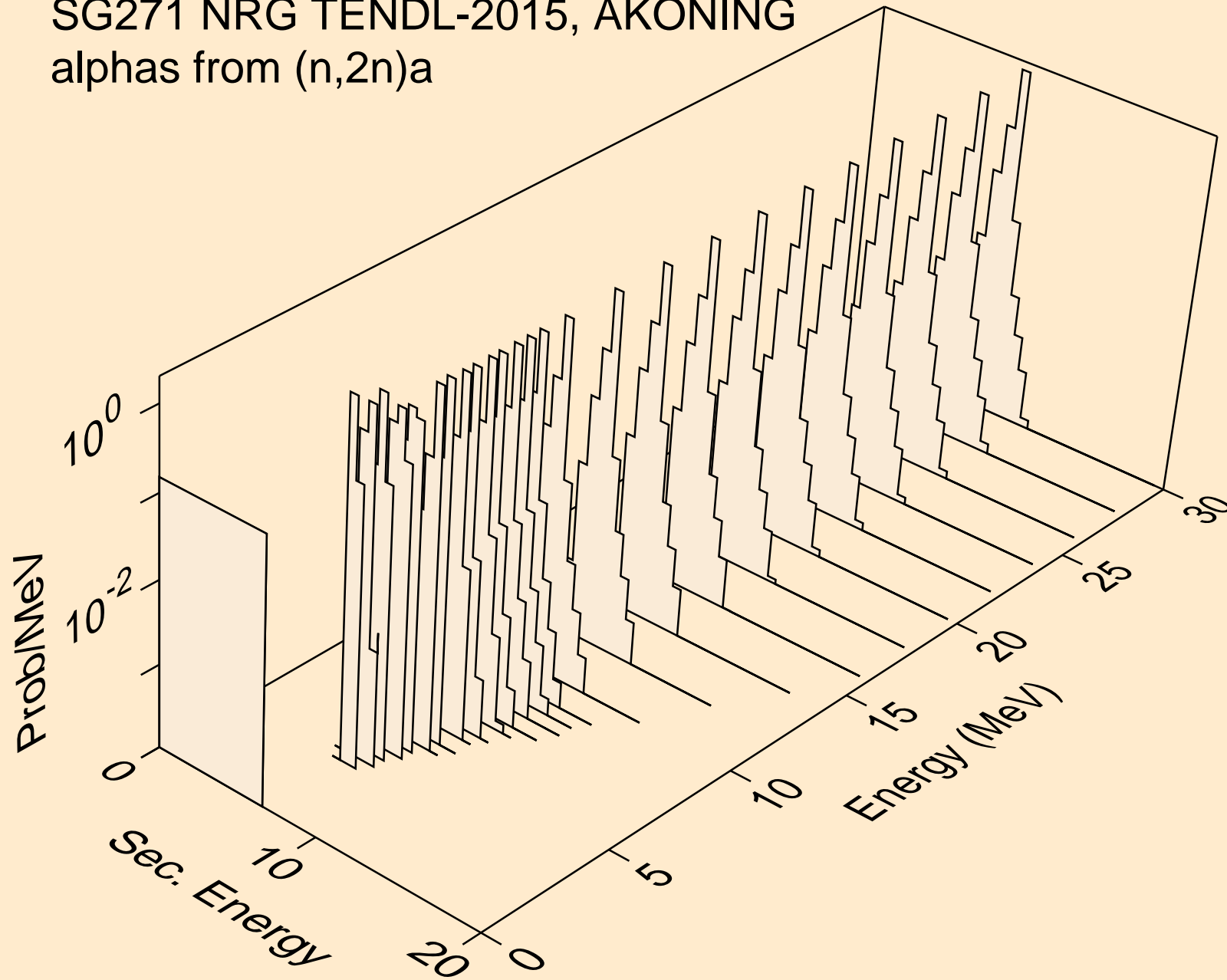

SG271 NRG TENDL-2015, AKONING
alphas from (n,3n)a

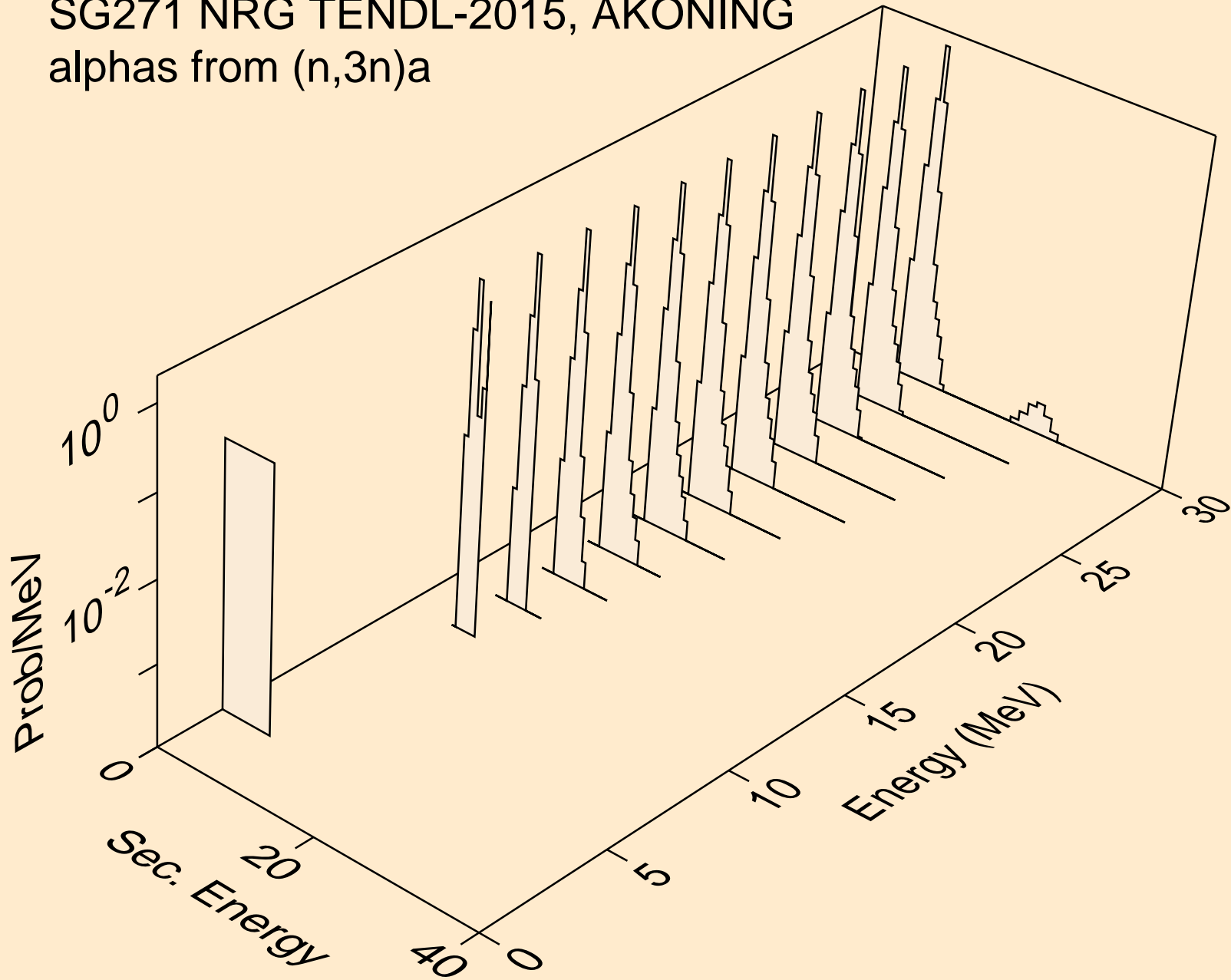

SG271 NRG TENDL-2015, AKONING
alphas from (n,2n)2a

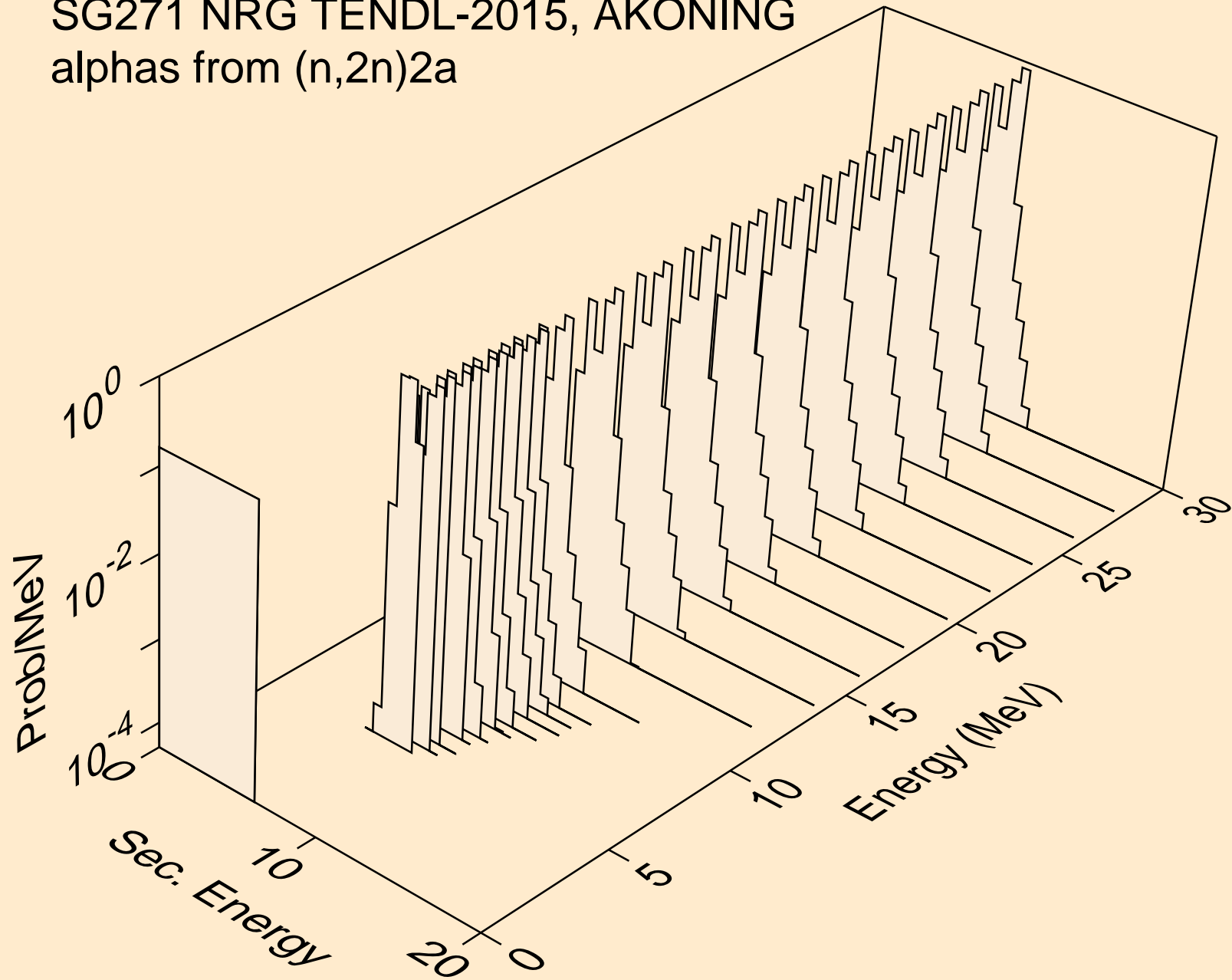

SG271 NRG TENDL-2015, AKONING
alphas from (n,n*)d2a

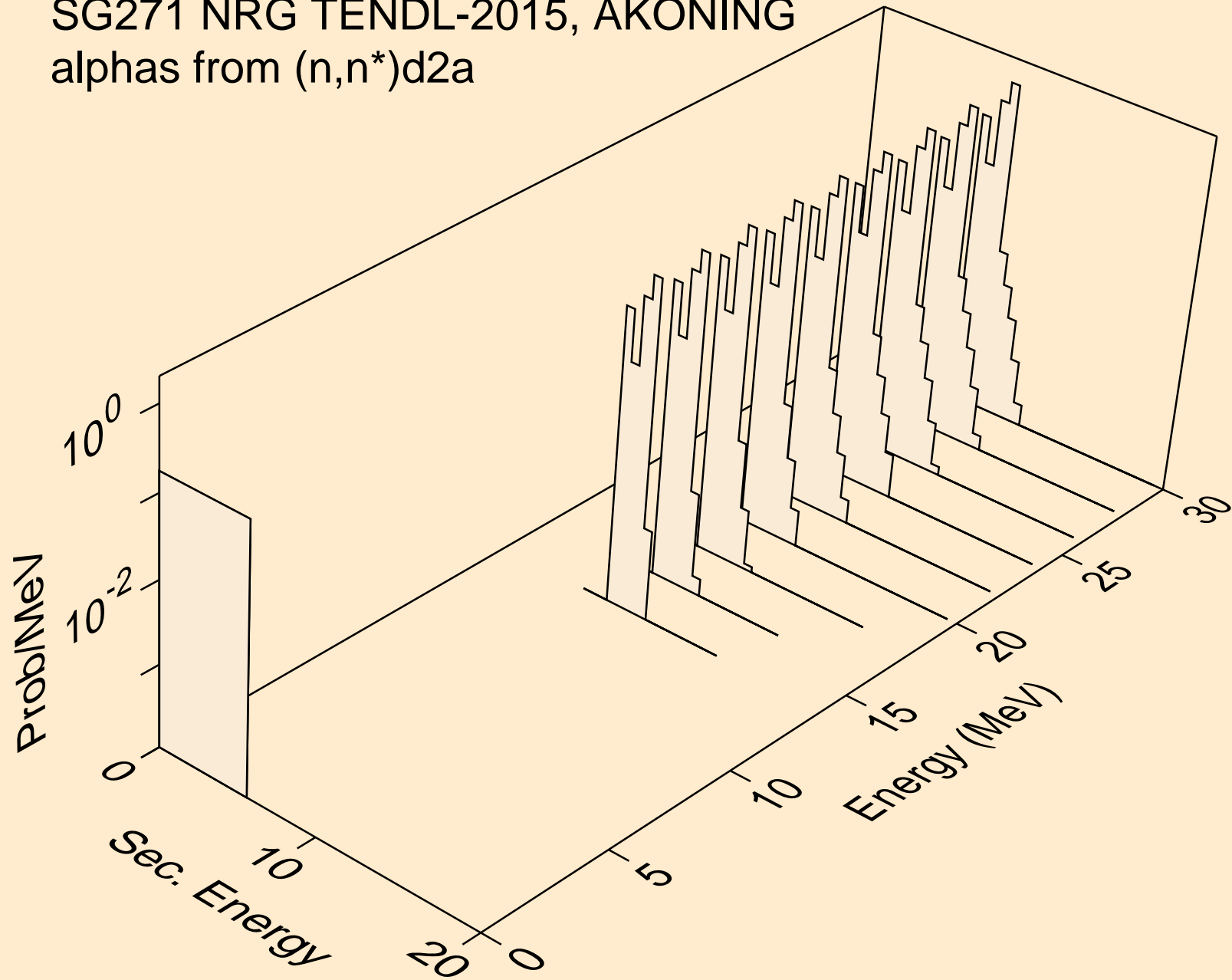

SG271 NRG TENDL-2015, AKONING
alphas from (n,n*)t2a

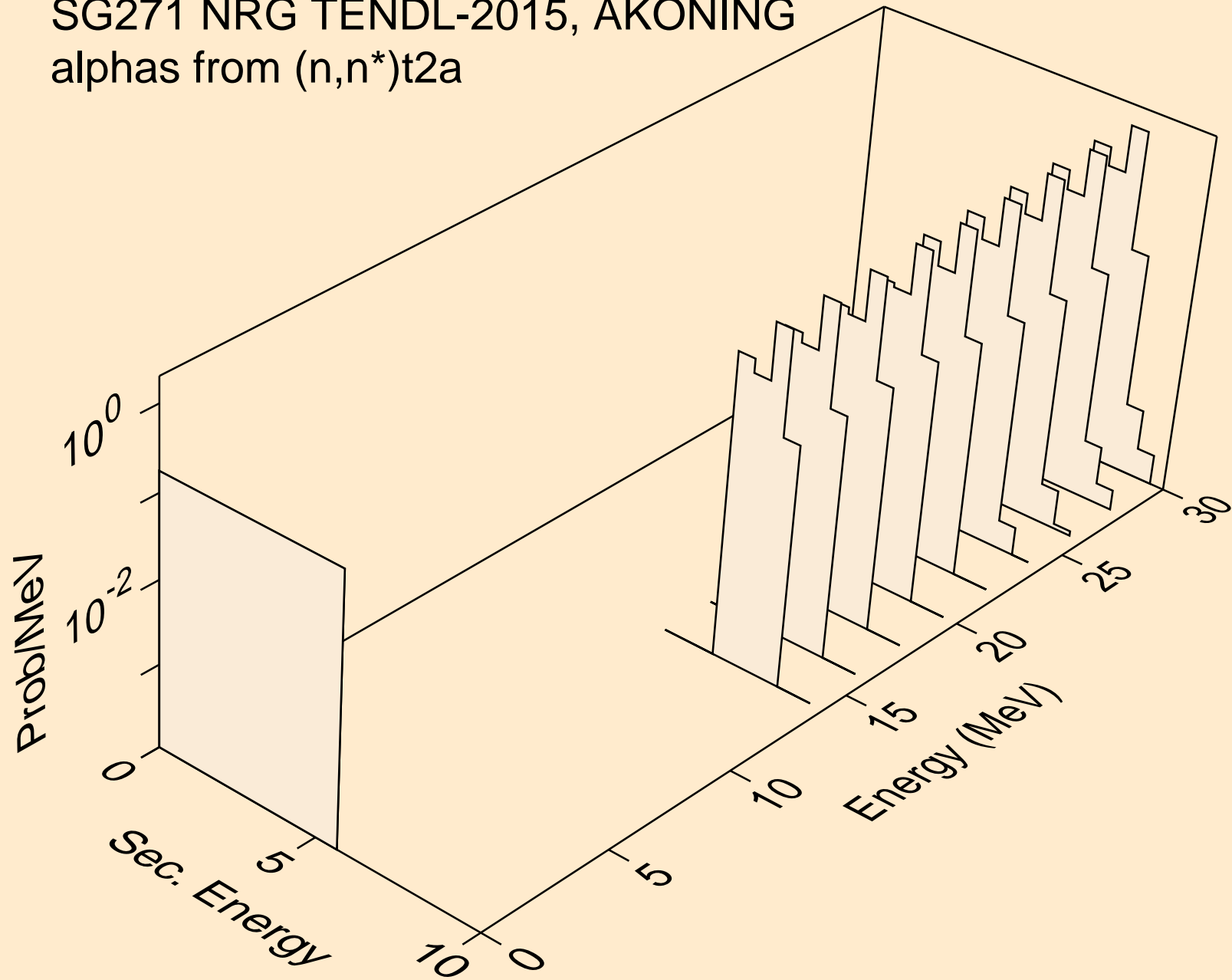

SG271 NRG TENDL-2015, AKONING
alphas from (n,npa)

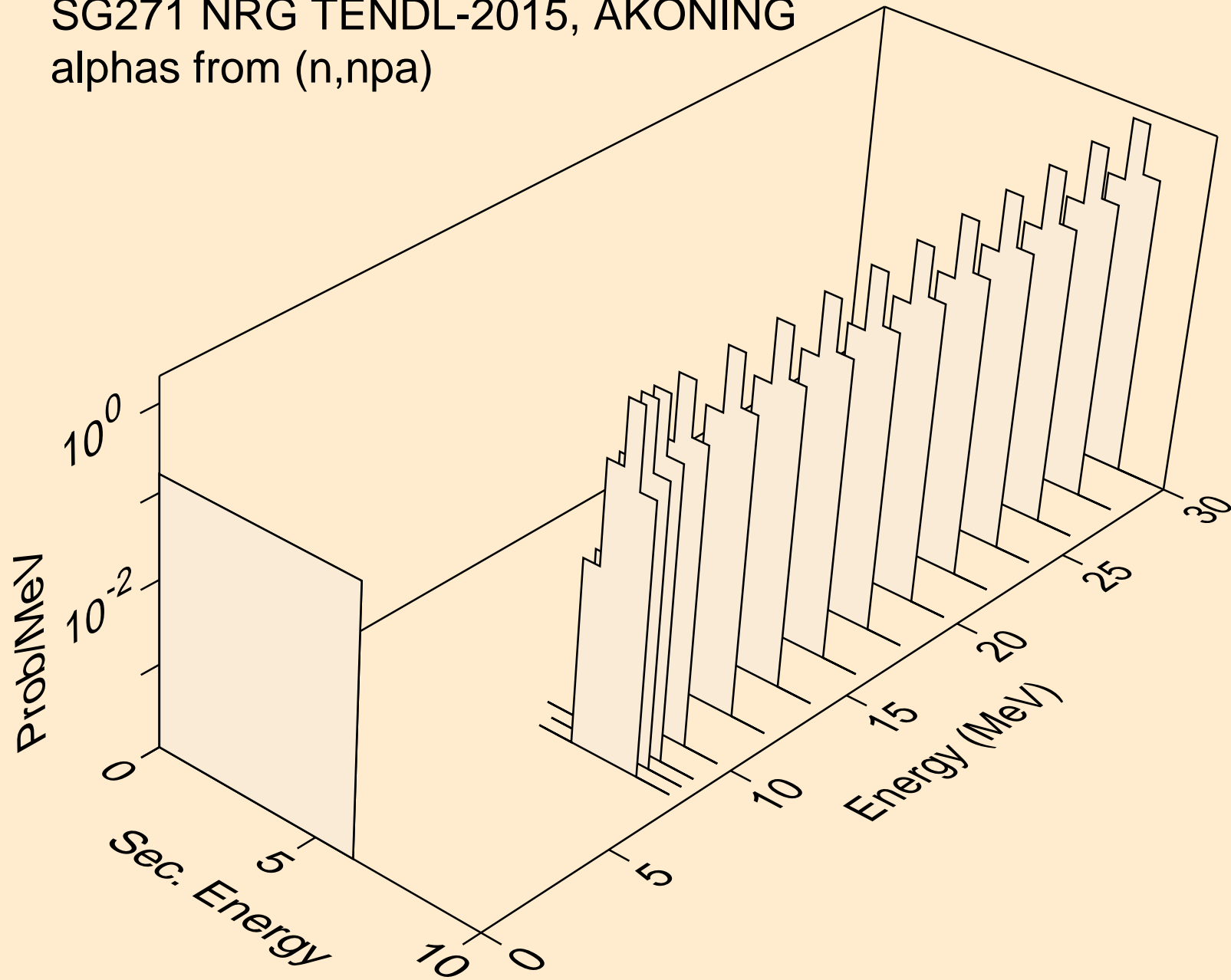

SG271 NRG TENDL-2015, AKONING
alphas from (n,a)

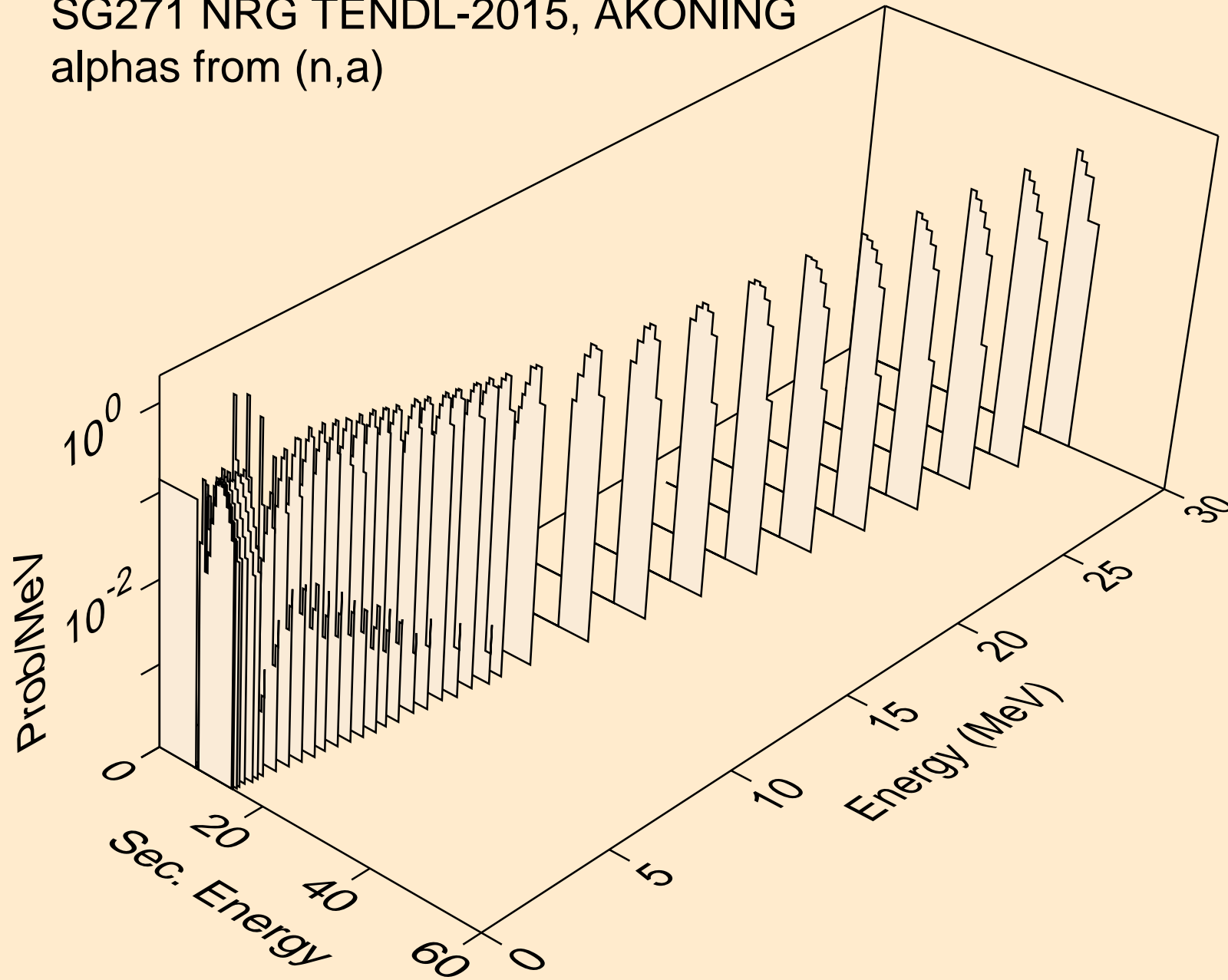

SG271 NRG TENDL-2015, AKONING
alphas from (n,2a)

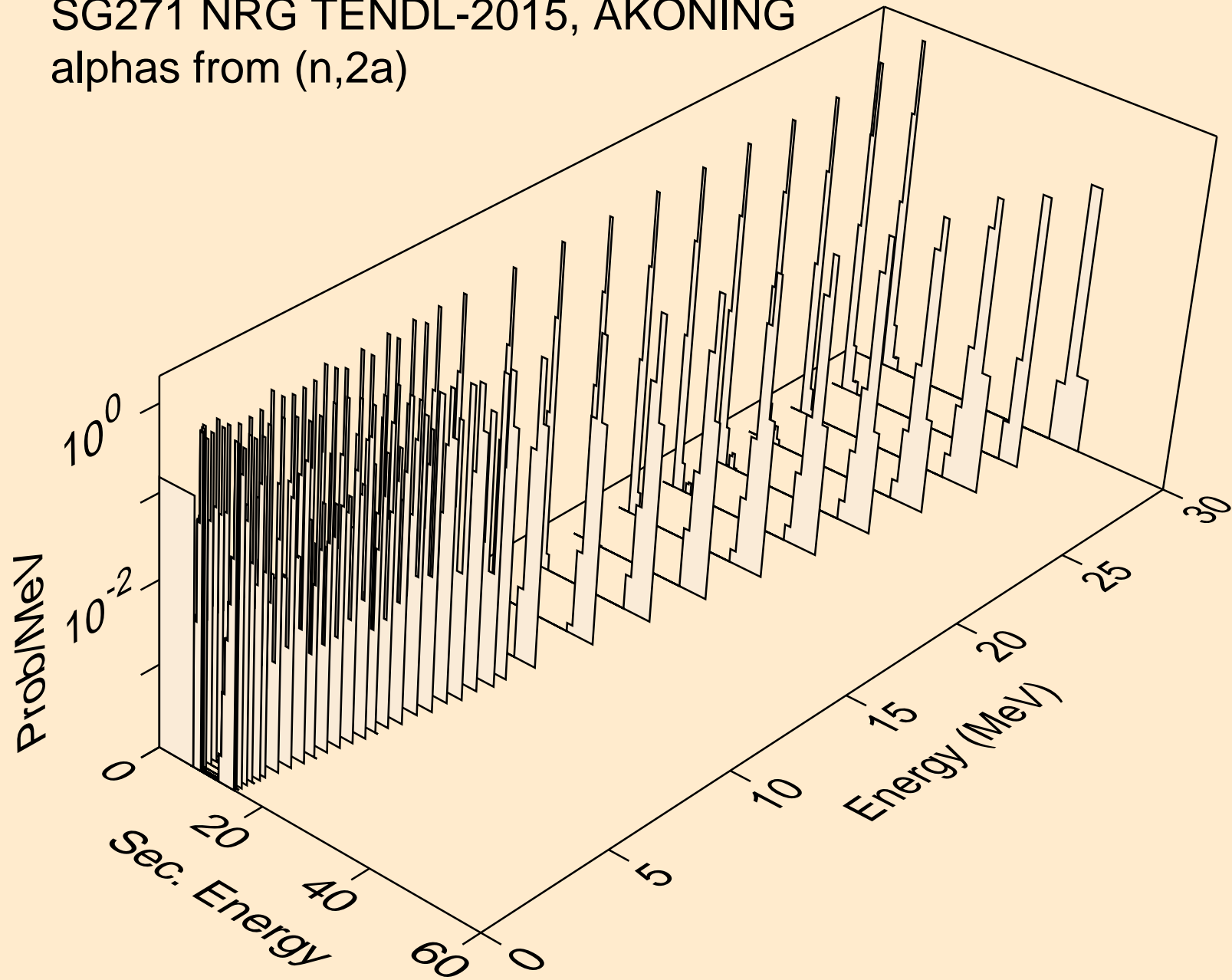

SG271 NRG TENDL-2015, AKONING
alphas from (n,3a)

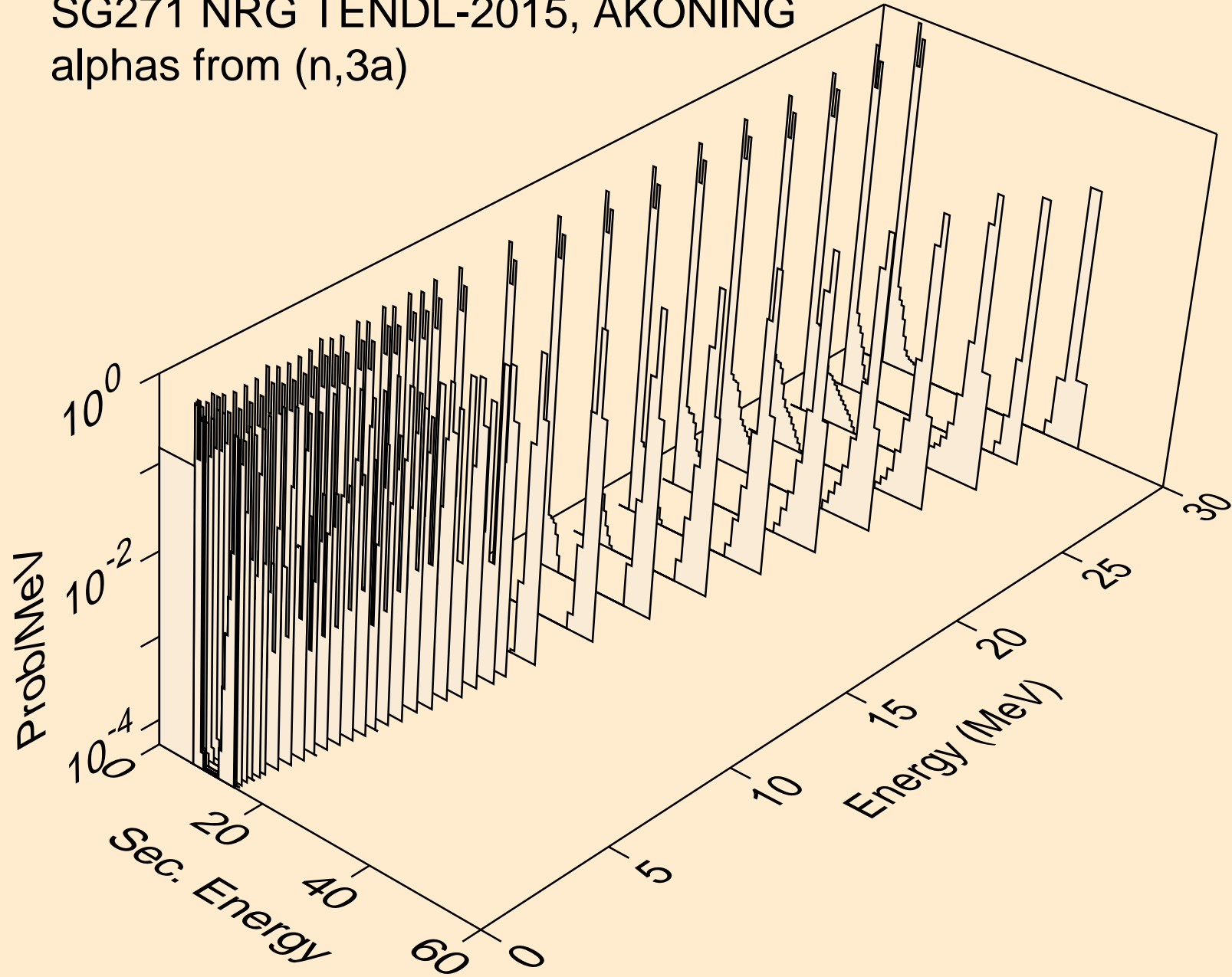

SG271 NRG TENDL-2015, AKONING
alphas from (n,pa)

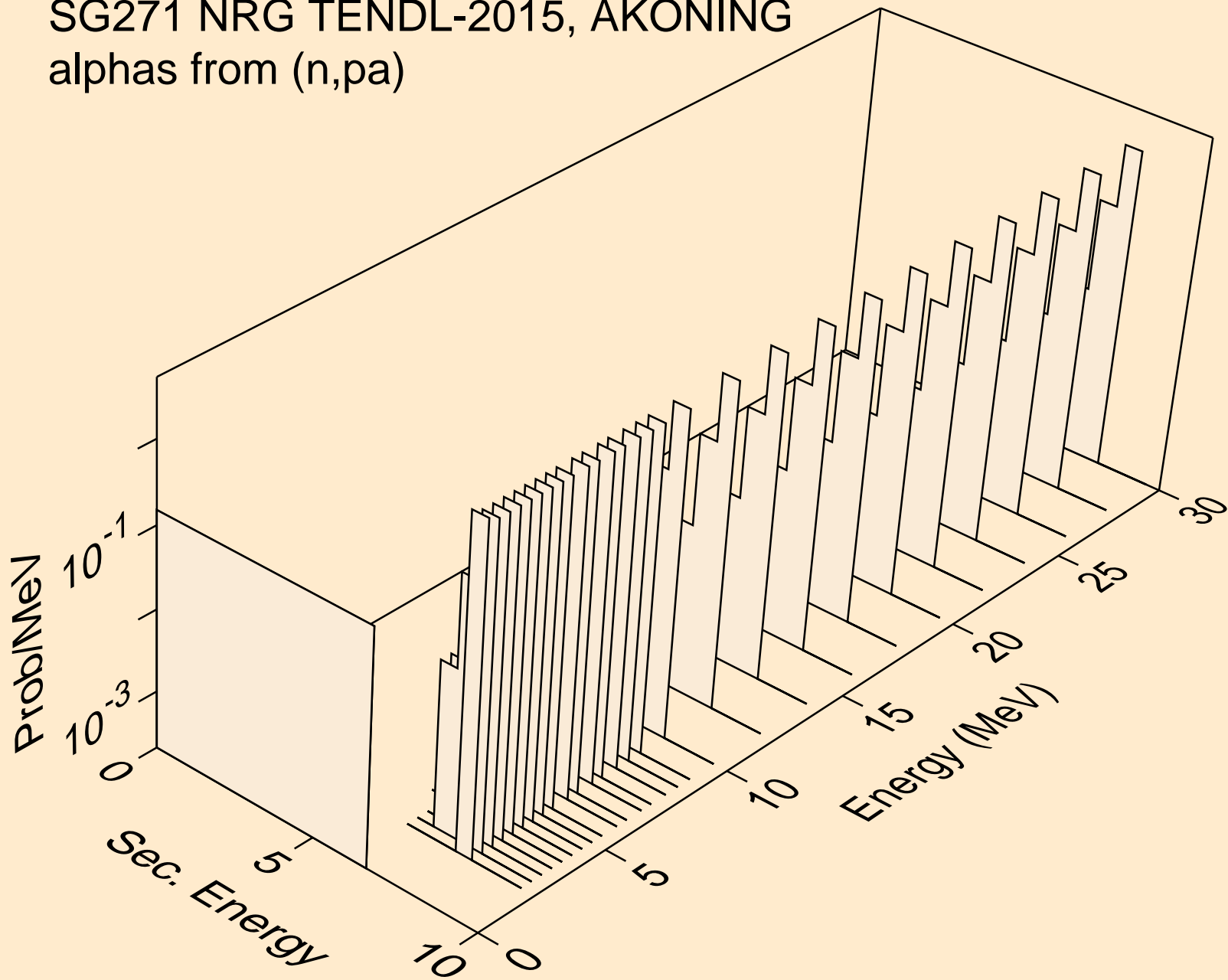

SG271 NRG TENDL-2015, AKONING
alphas from (n,t2a)

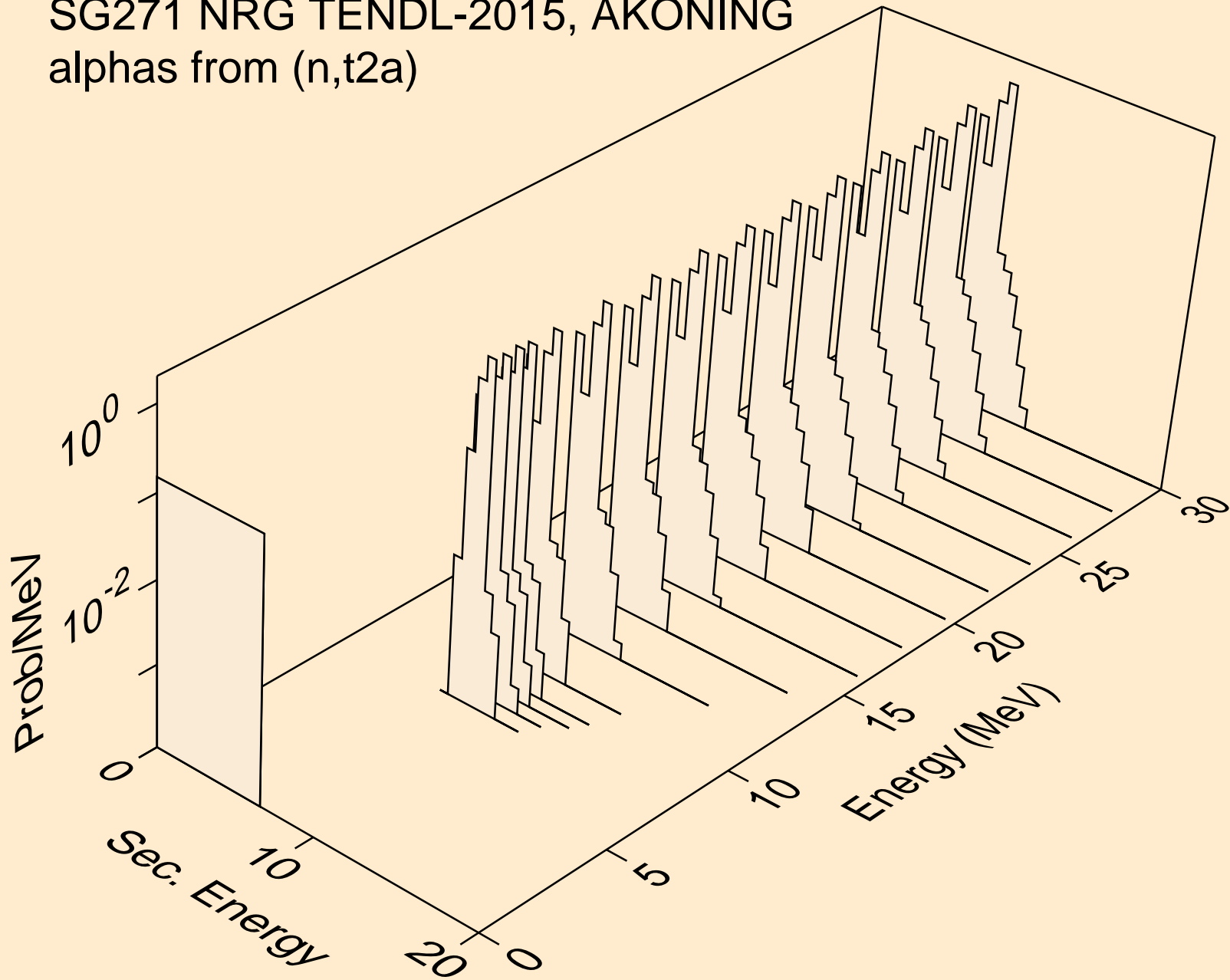

SG271 NRG TENDL-2015, AKONING
alphas from (n,d2a)

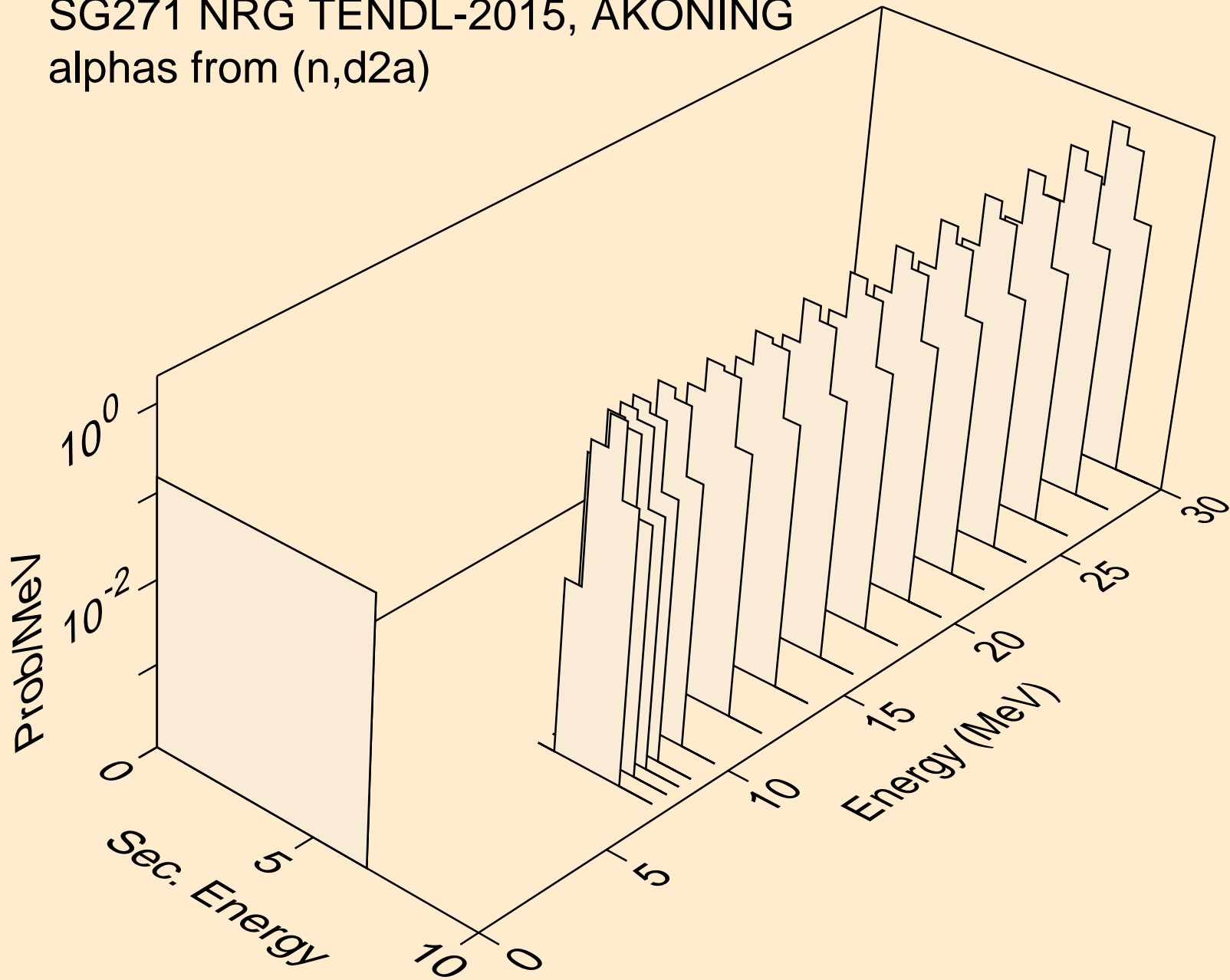

SG271 NRG TENDL-2015, AKONING
alphas from (n,da)

