

SG272 NRG TENDL-2015, AKONING

Principal cross sections

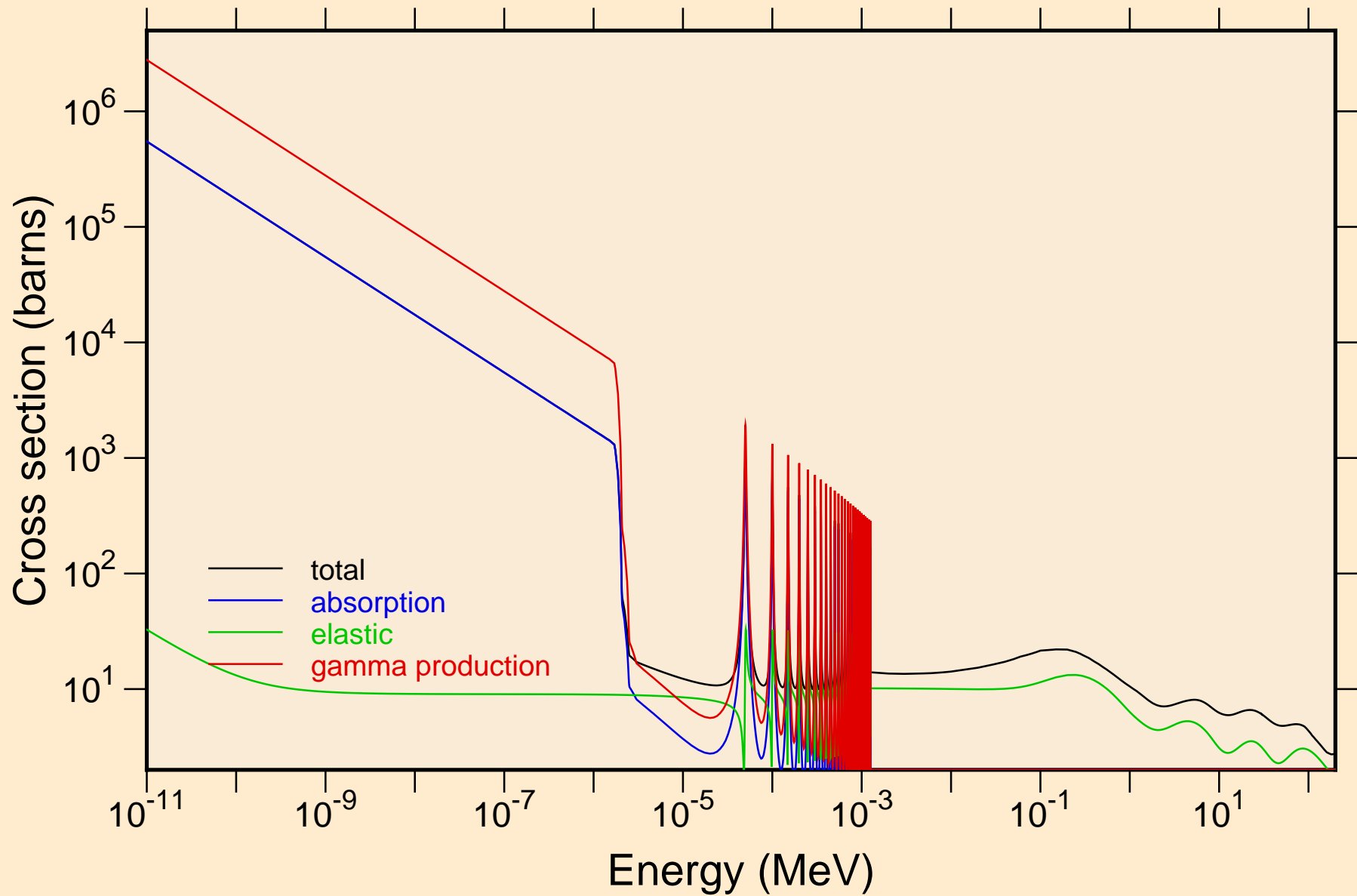

SG272 NRG TENDL-2015, AKONING
resonance total cross section

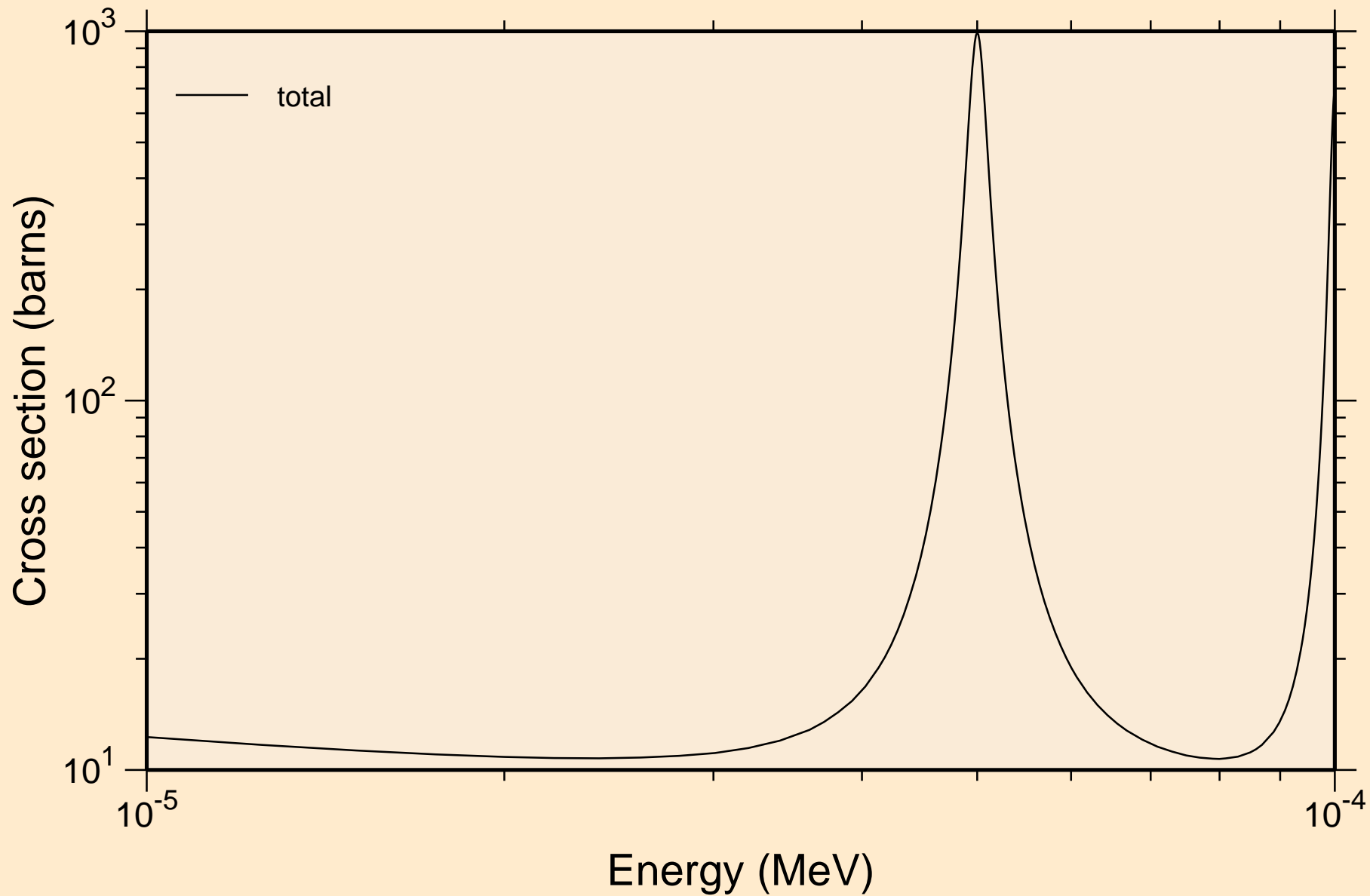

SG272 NRG TENDL-2015, AKONING

resonance total cross section

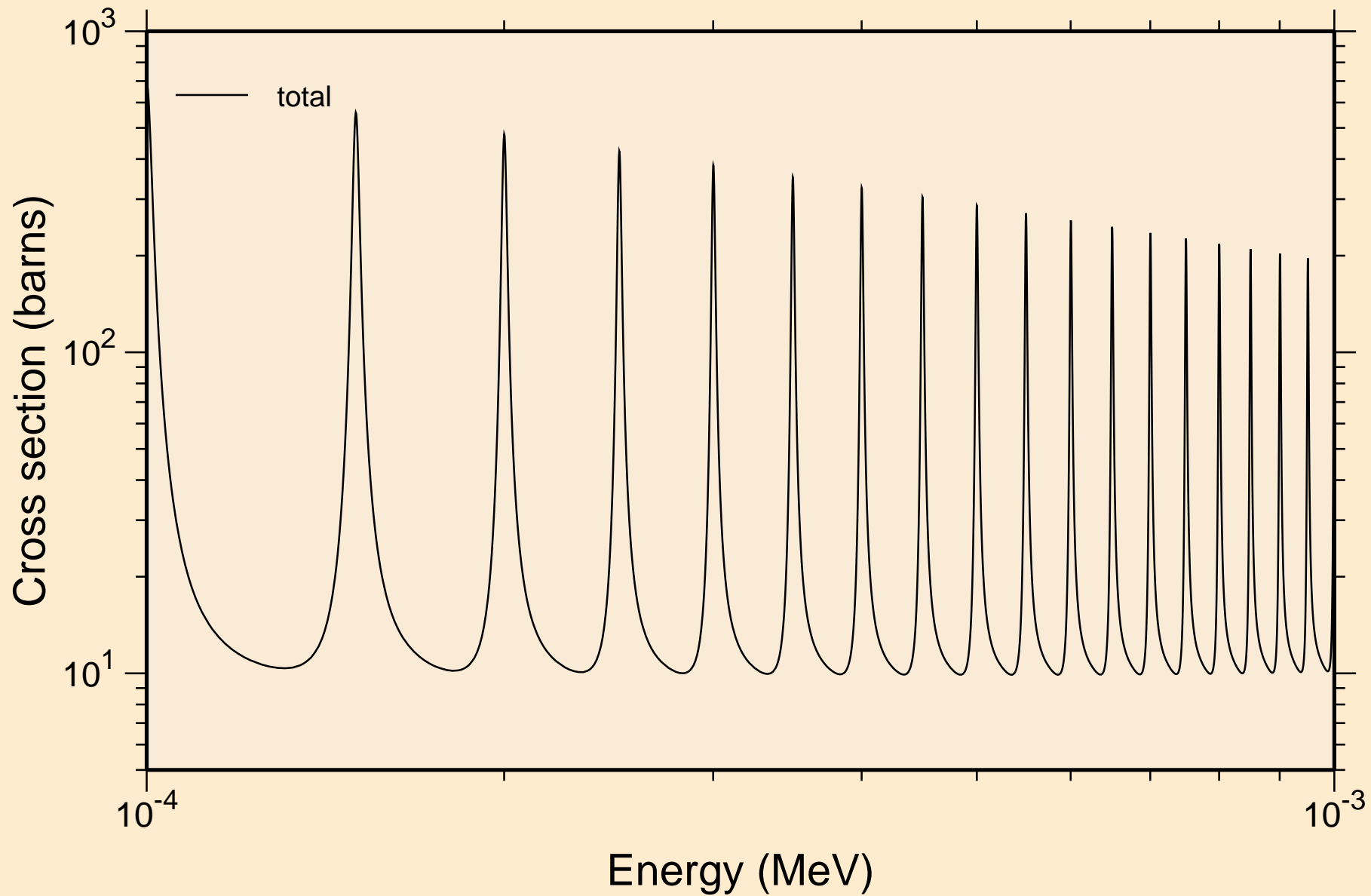

SG272 NRG TENDL-2015, AKONING
resonance total cross section

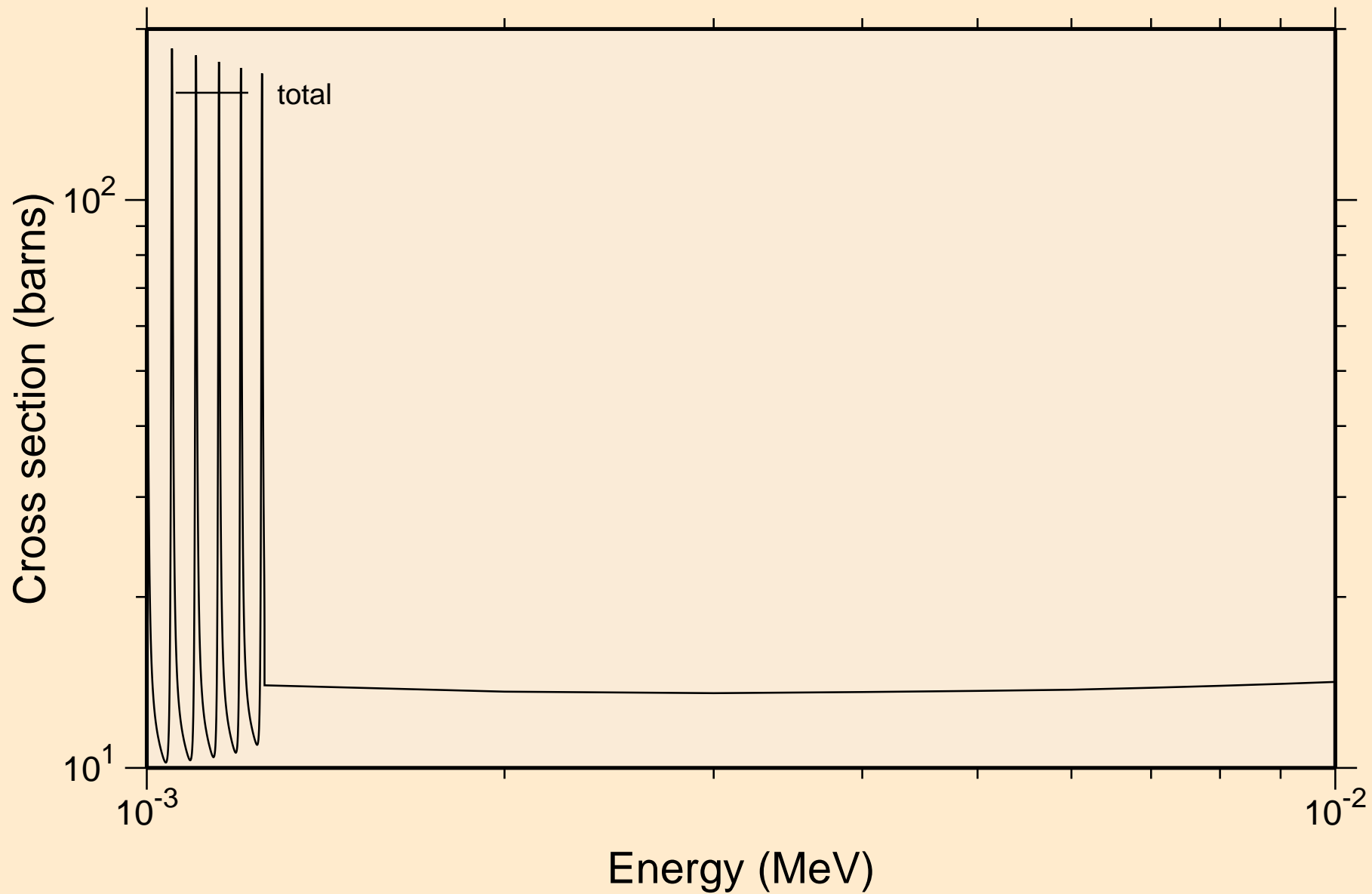

SG272 NRG TENDL-2015, AKONING
resonance total cross section

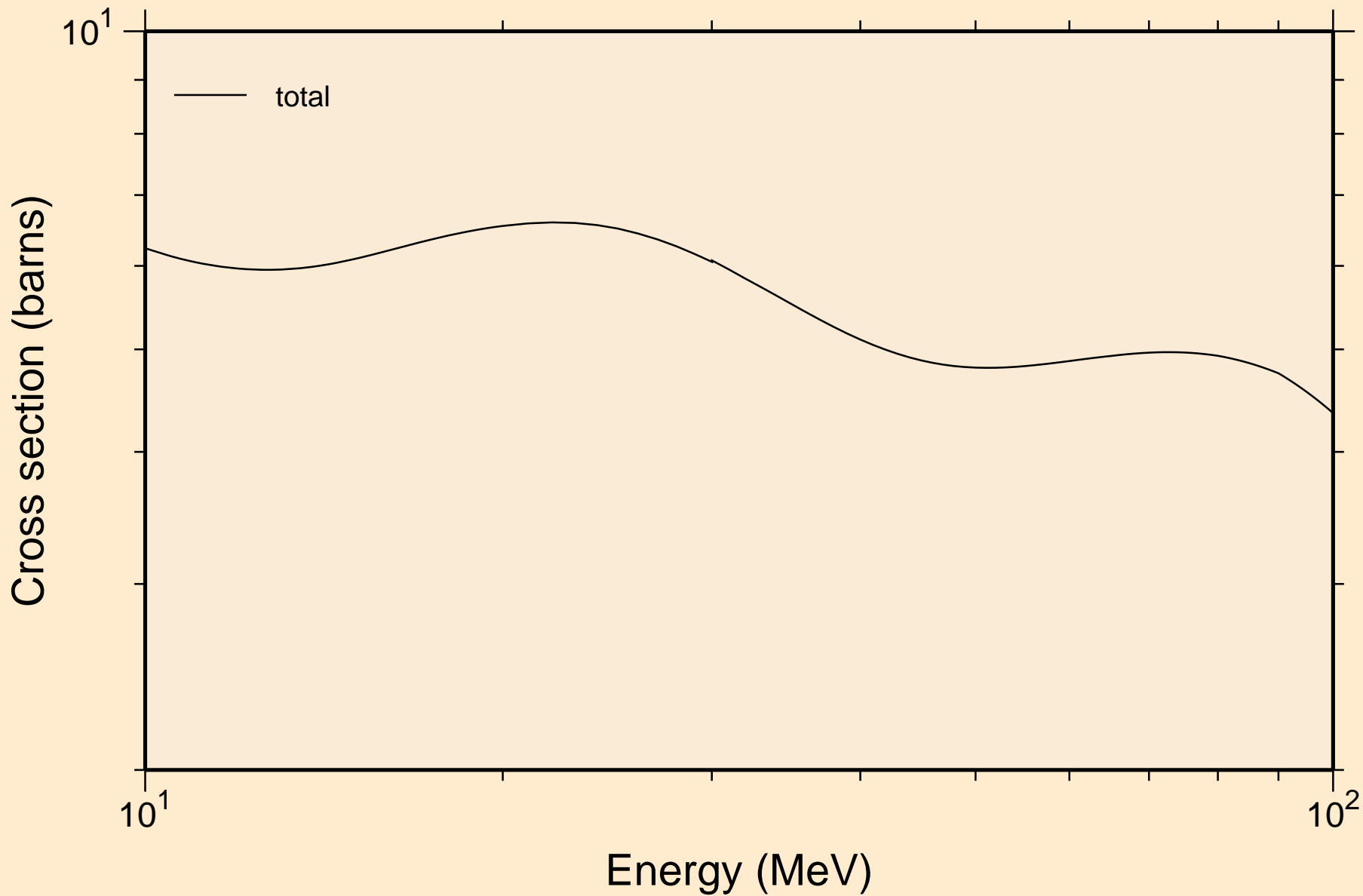

SG272 NRG TENDL-2015, AKONING

resonance absorption cross sections

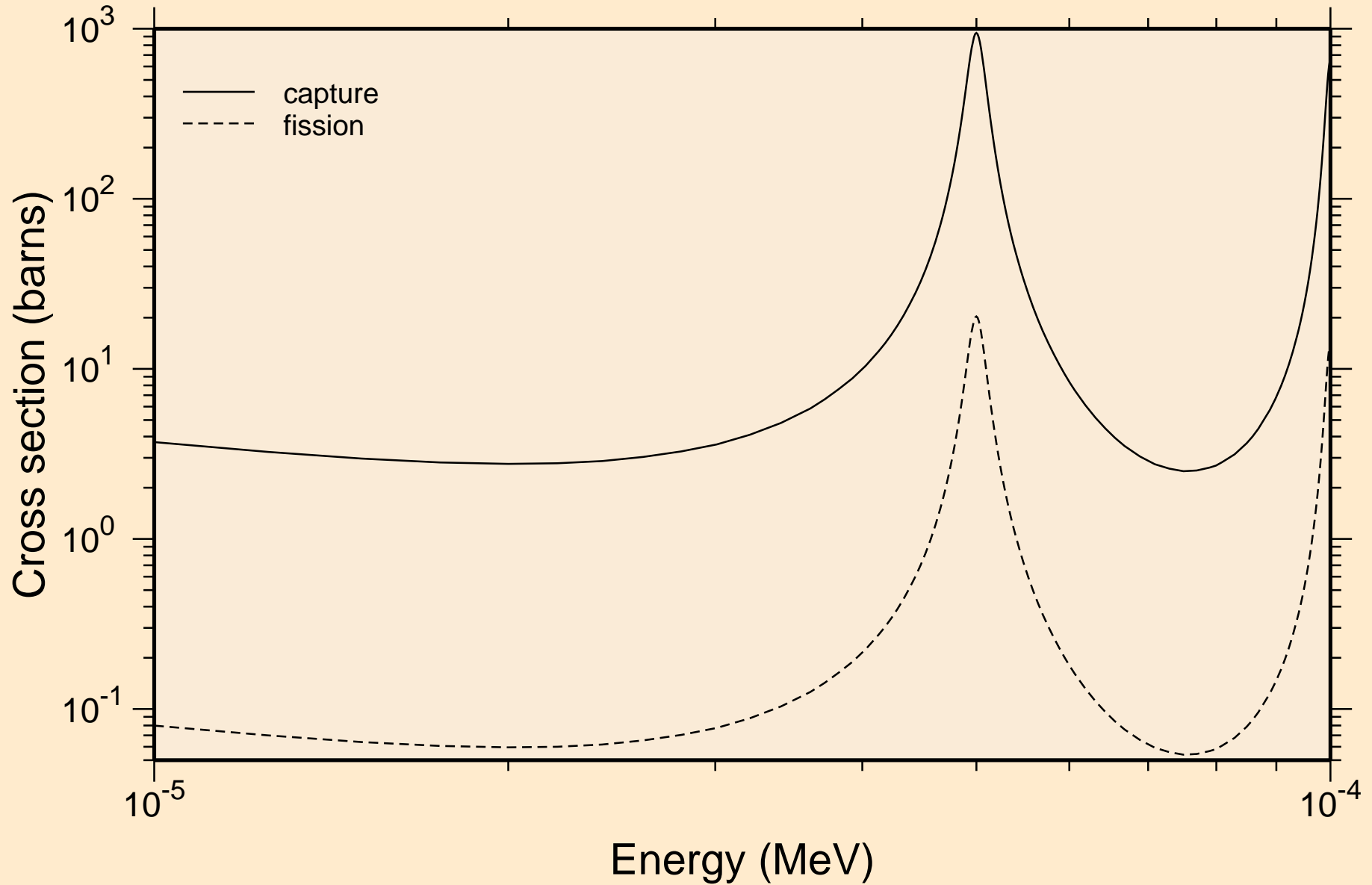

SG272 NRG TENDL-2015, AKONING resonance absorption cross sections

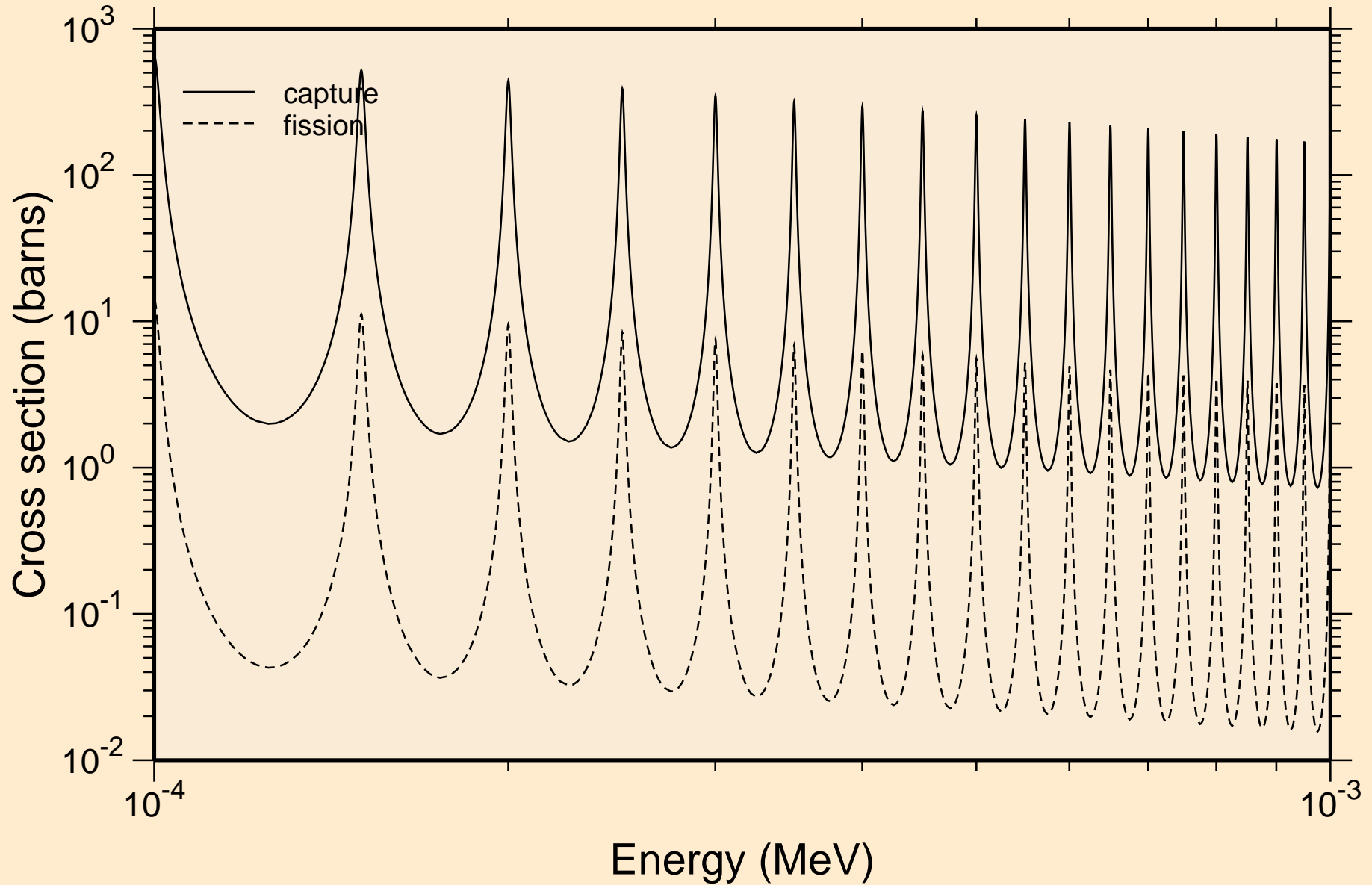

SG272 NRG TENDL-2015, AKONING resonance absorption cross sections

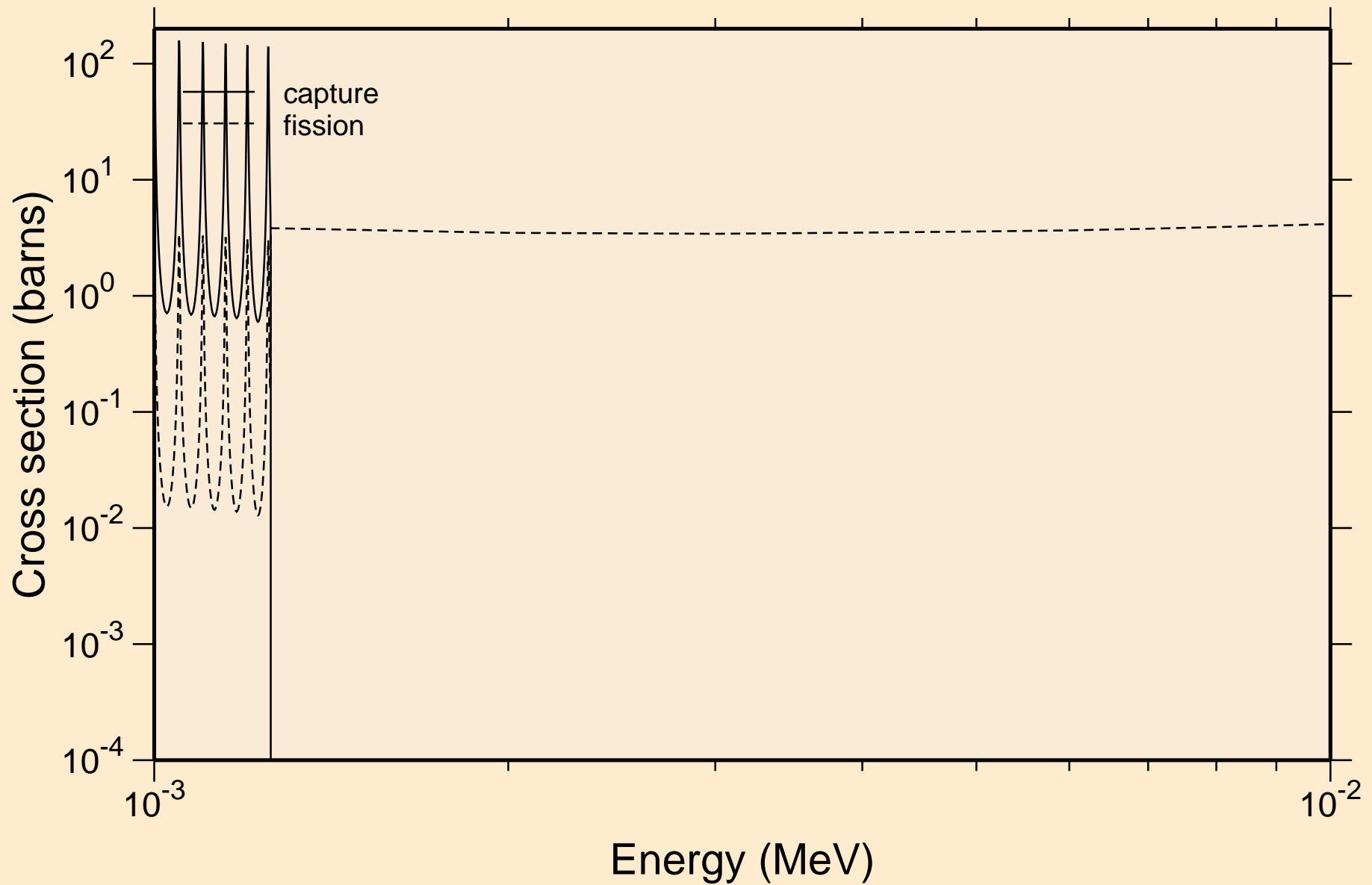

SG272 NRG TENDL-2015, AKONING

resonance absorption cross sections

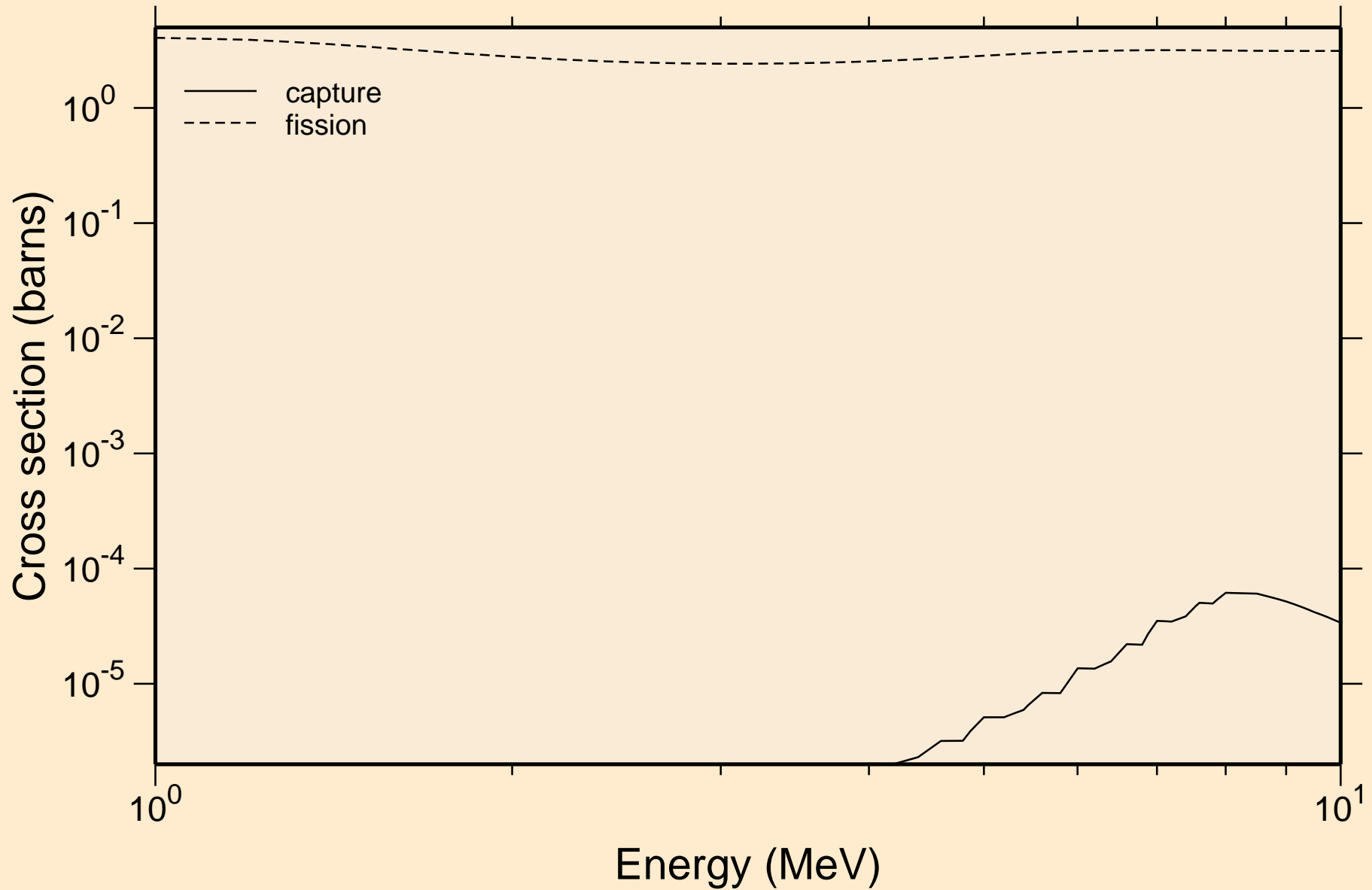

SG272 NRG TENDL-2015, AKONING

Non-threshold reactions

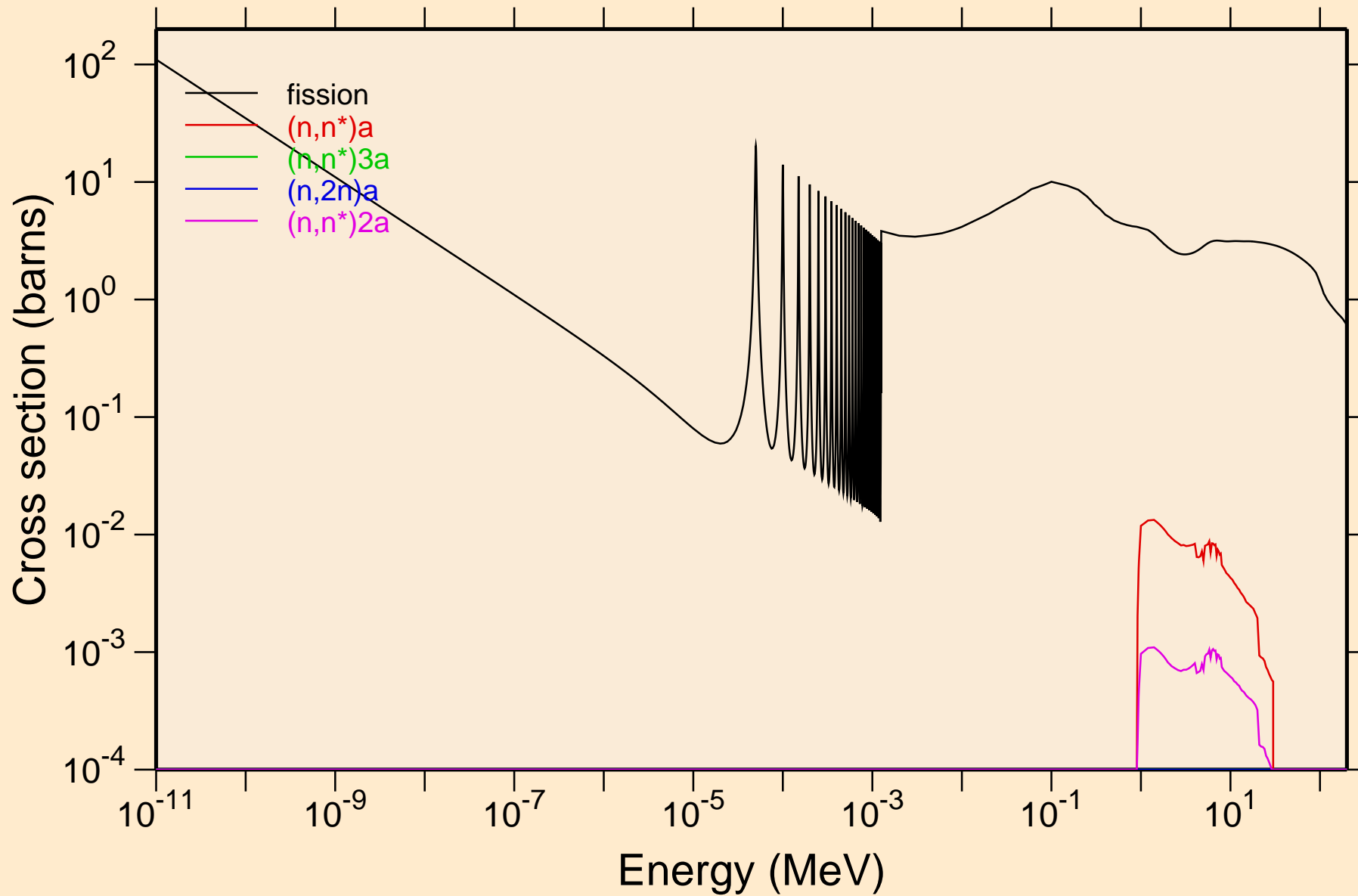

SG272 NRG TENDL-2015, AKONING

Non-threshold reactions

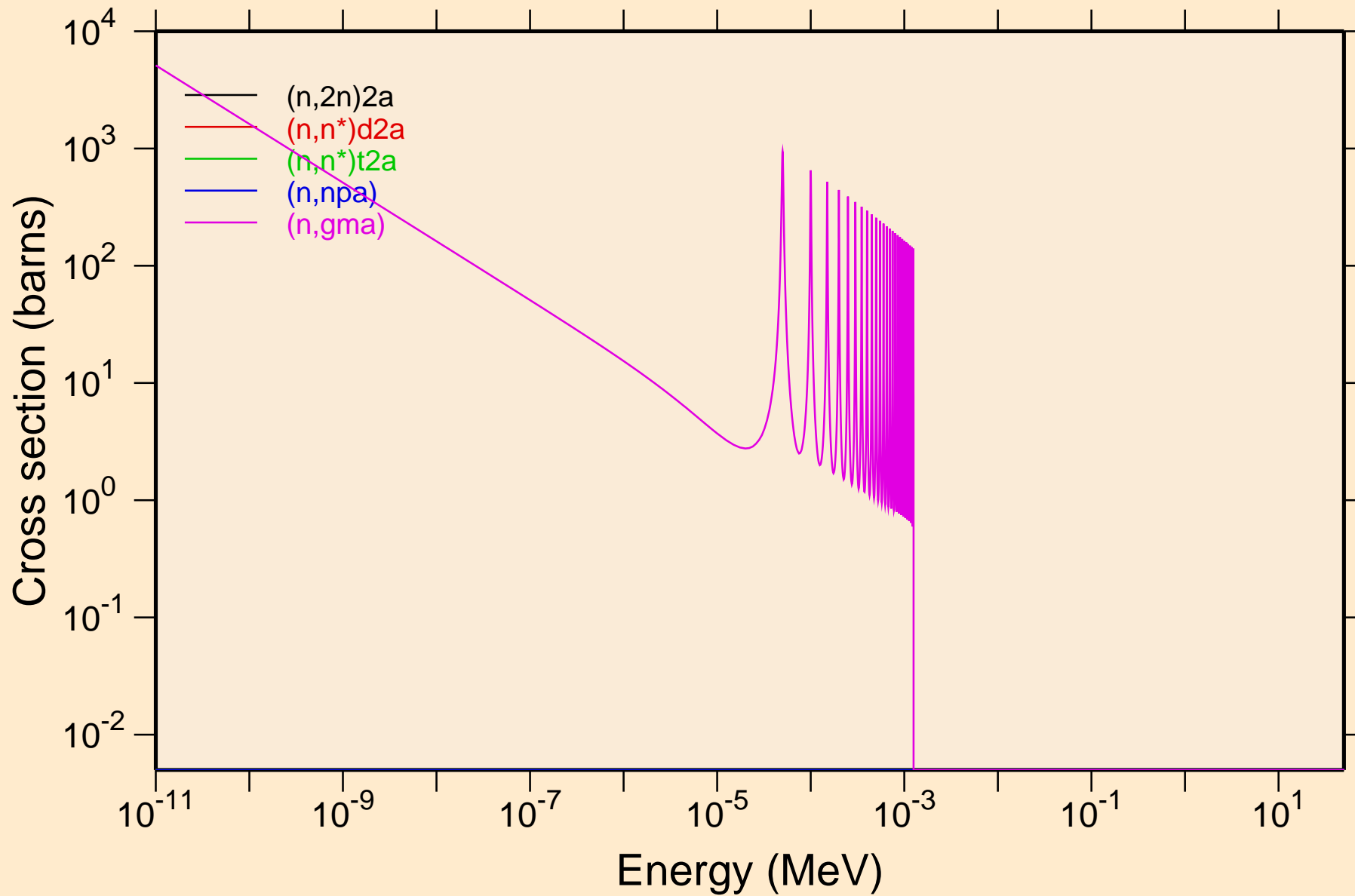

SG272 NRG TENDL-2015, AKONING

Non-threshold reactions

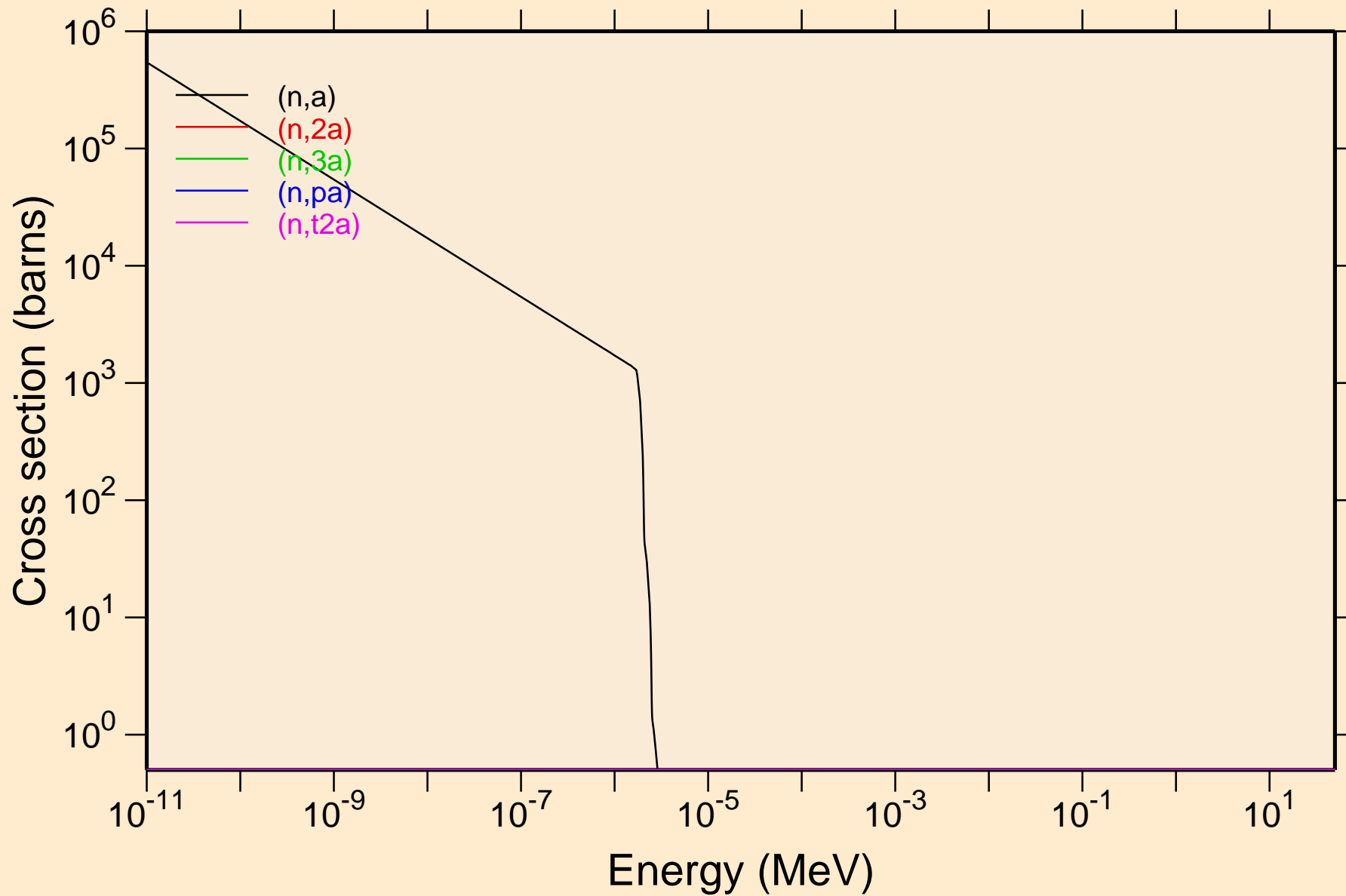

SG272 NRG TENDL-2015, AKONING

Non-threshold reactions

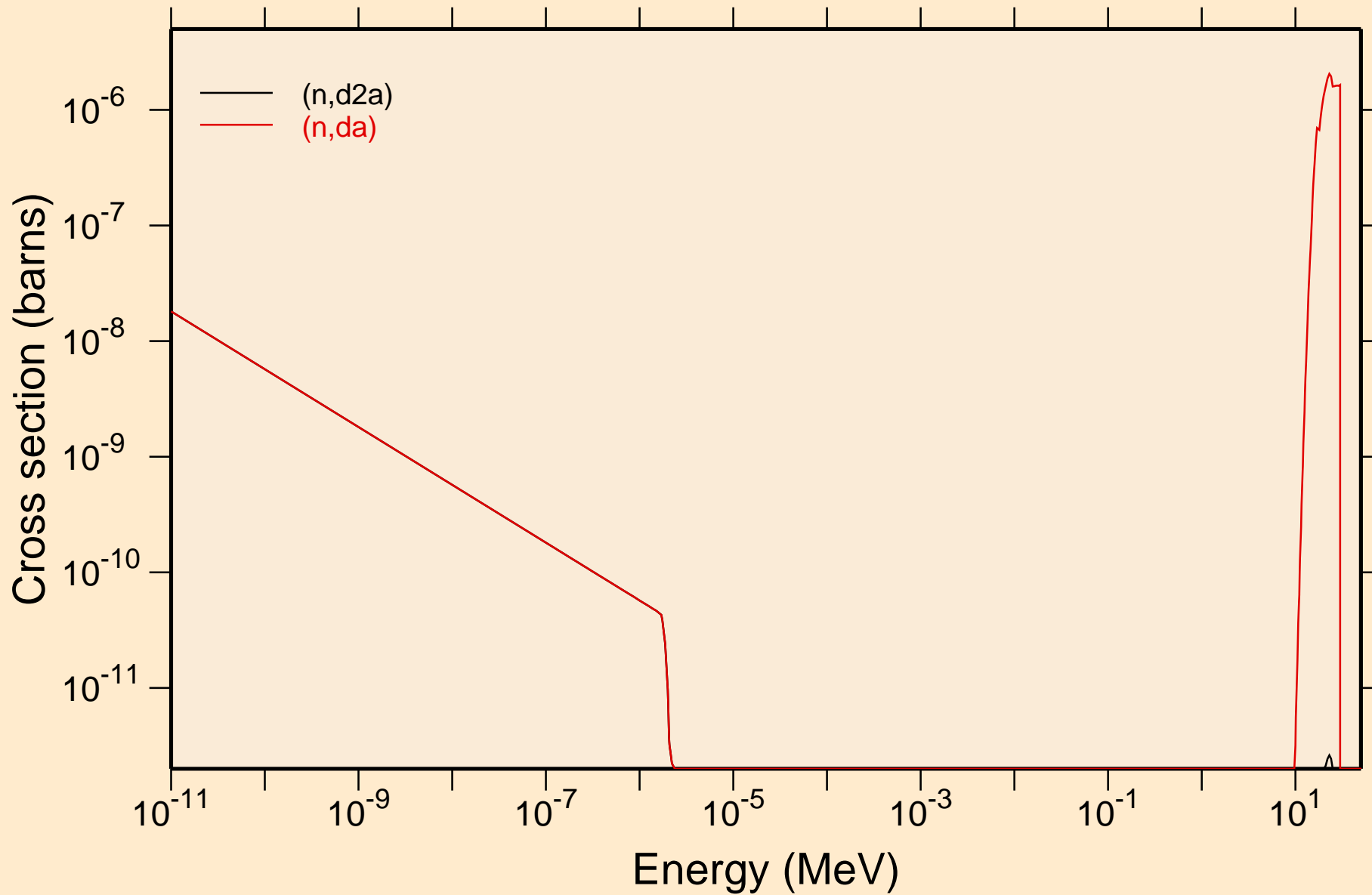

SG272 NRG TENDL-2015, AKONING

Principal cross sections

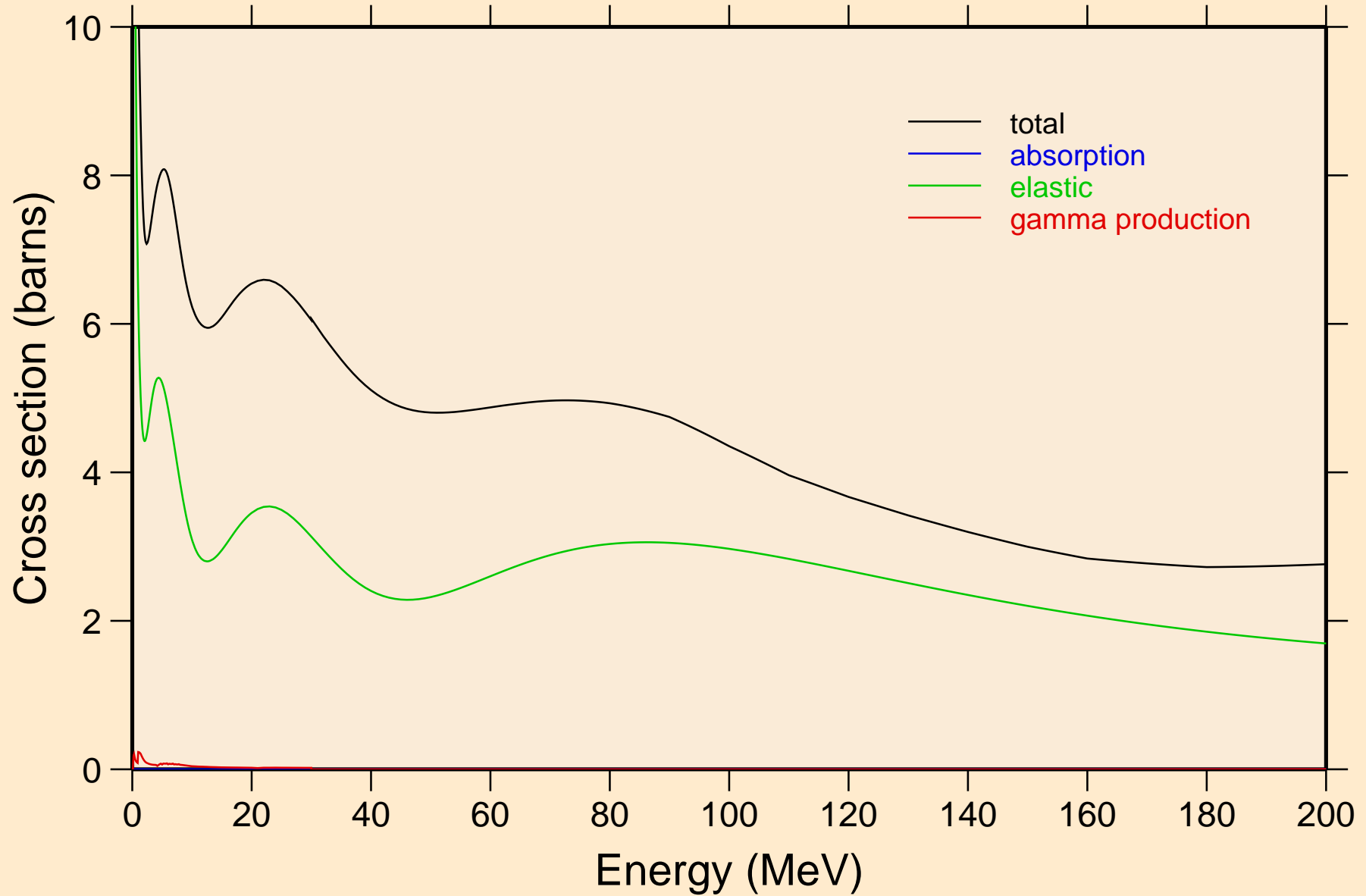

SG272 NRG TENDL-2015, AKONING

Non-threshold reactions

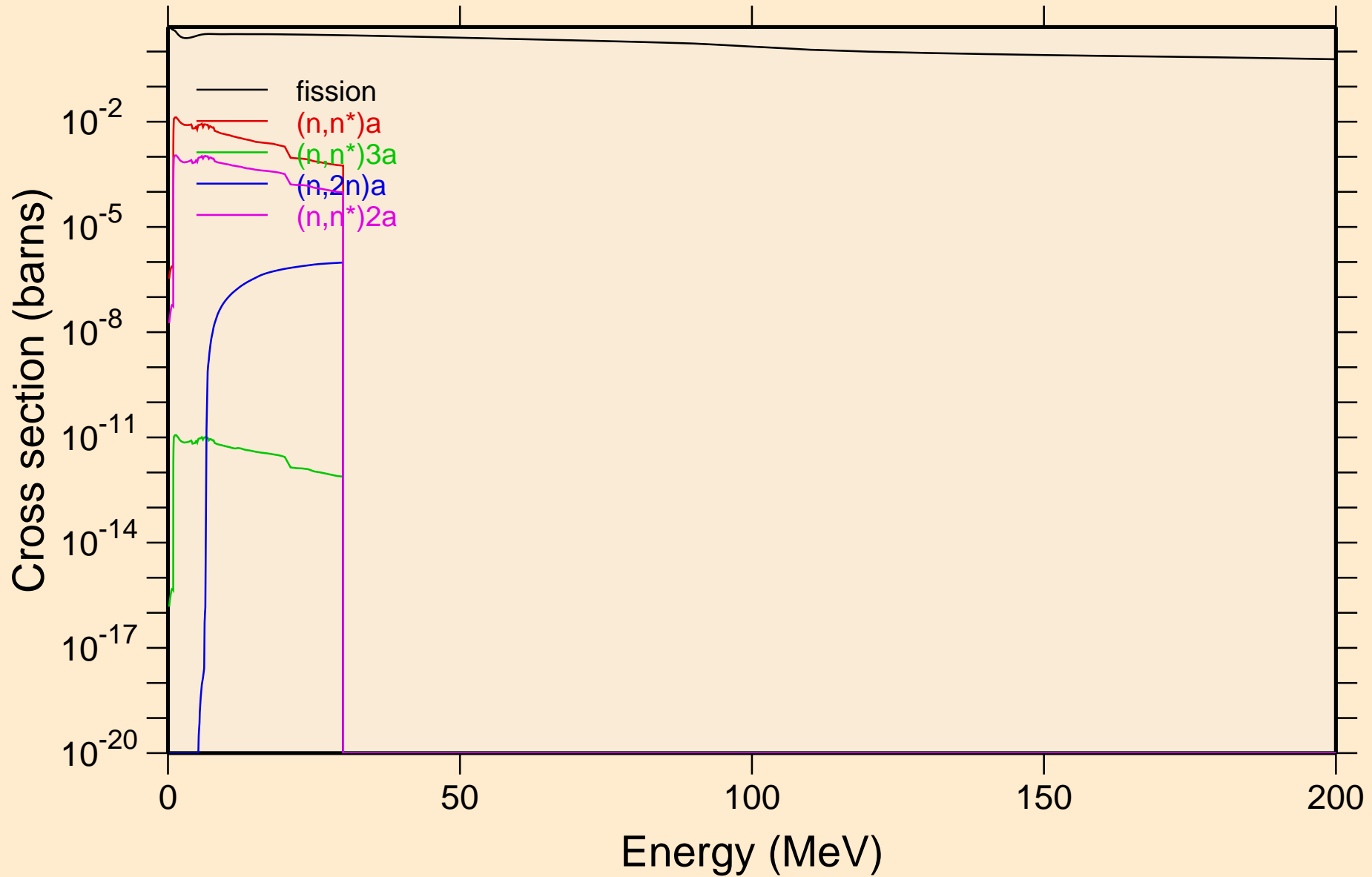

SG272 NRG TENDL-2015, AKONING

Non-threshold reactions

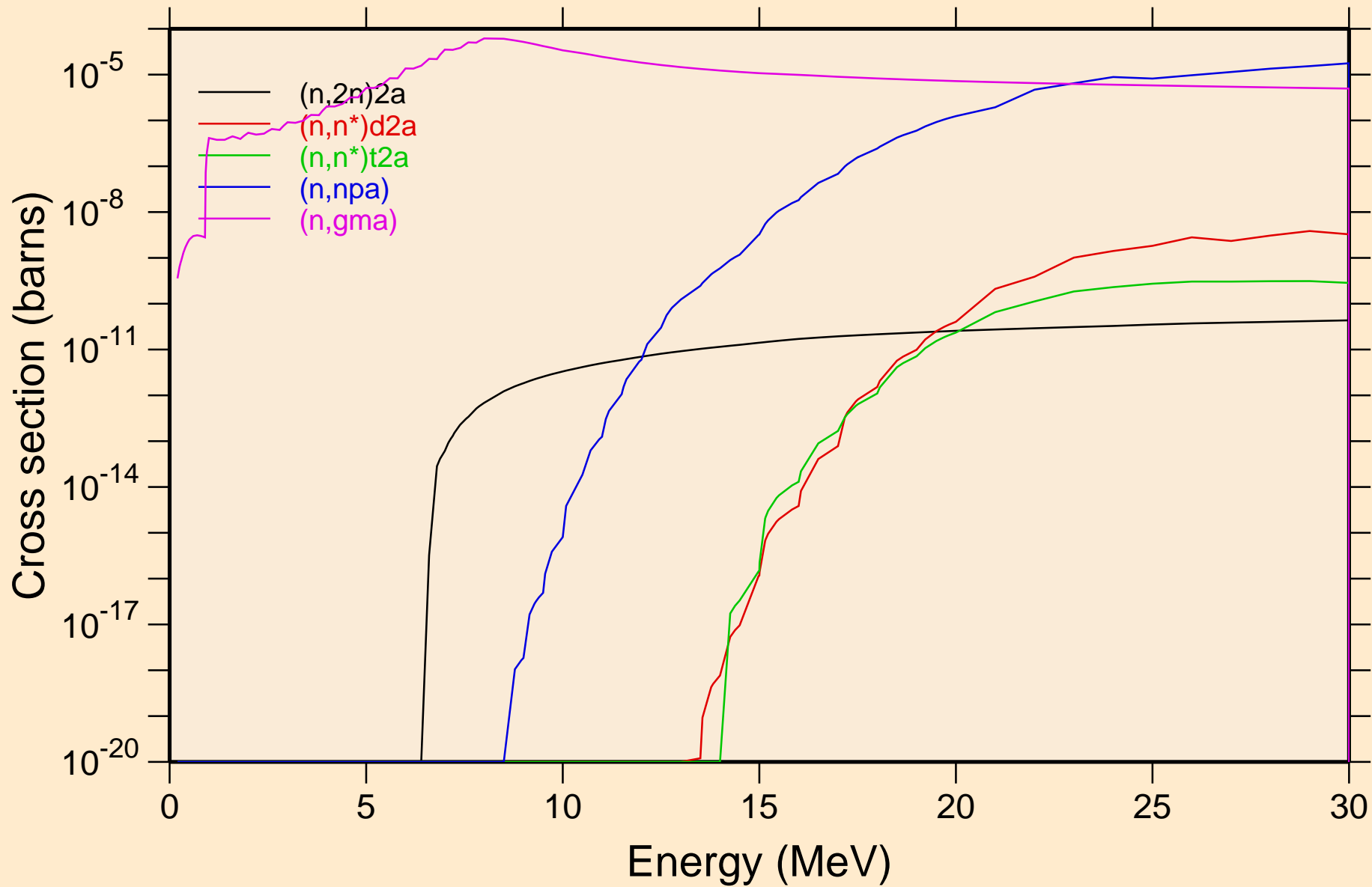

SG272 NRG TENDL-2015, AKONING

Non-threshold reactions

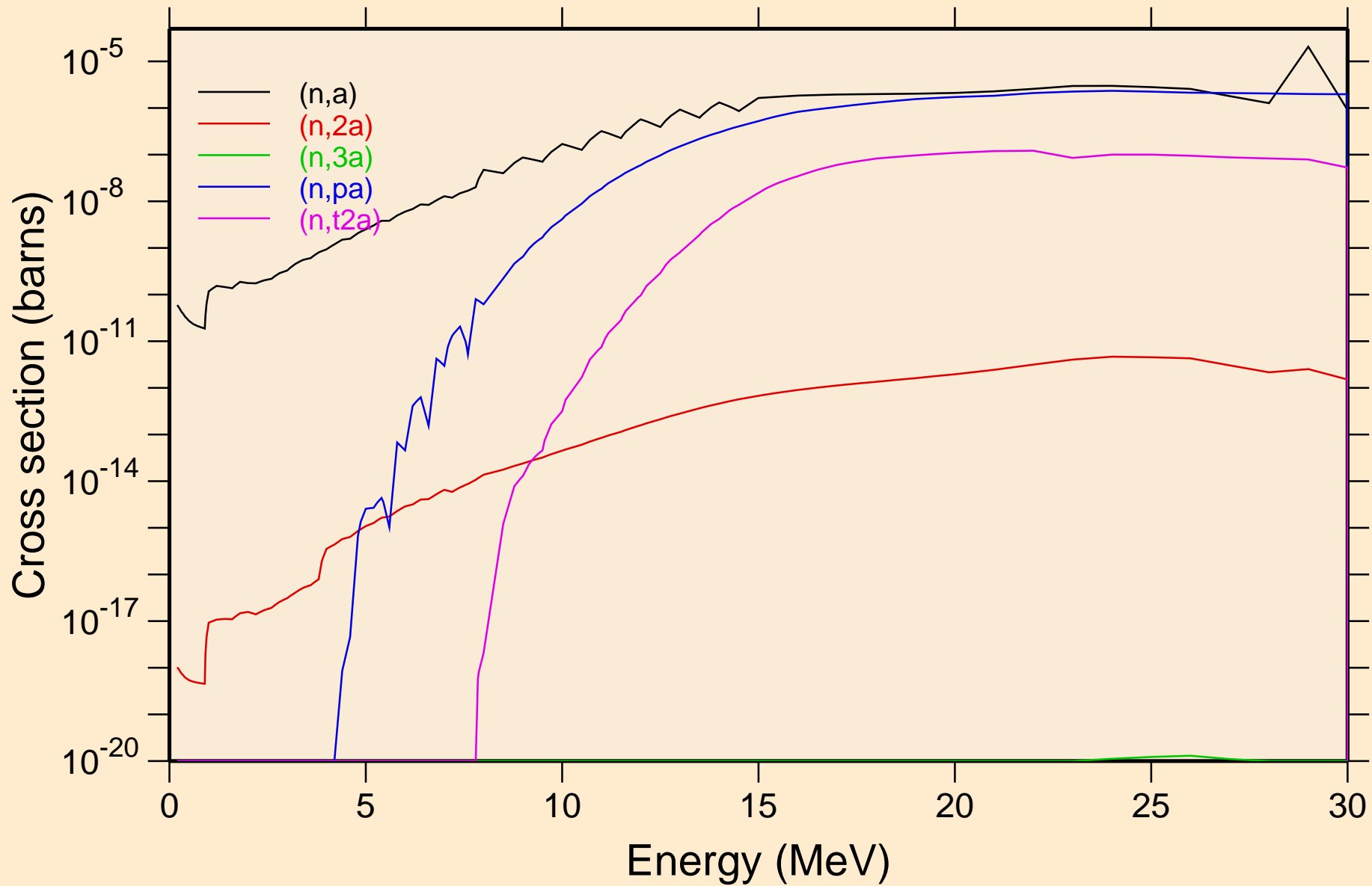

SG272 NRG TENDL-2015, AKONING

Non-threshold reactions

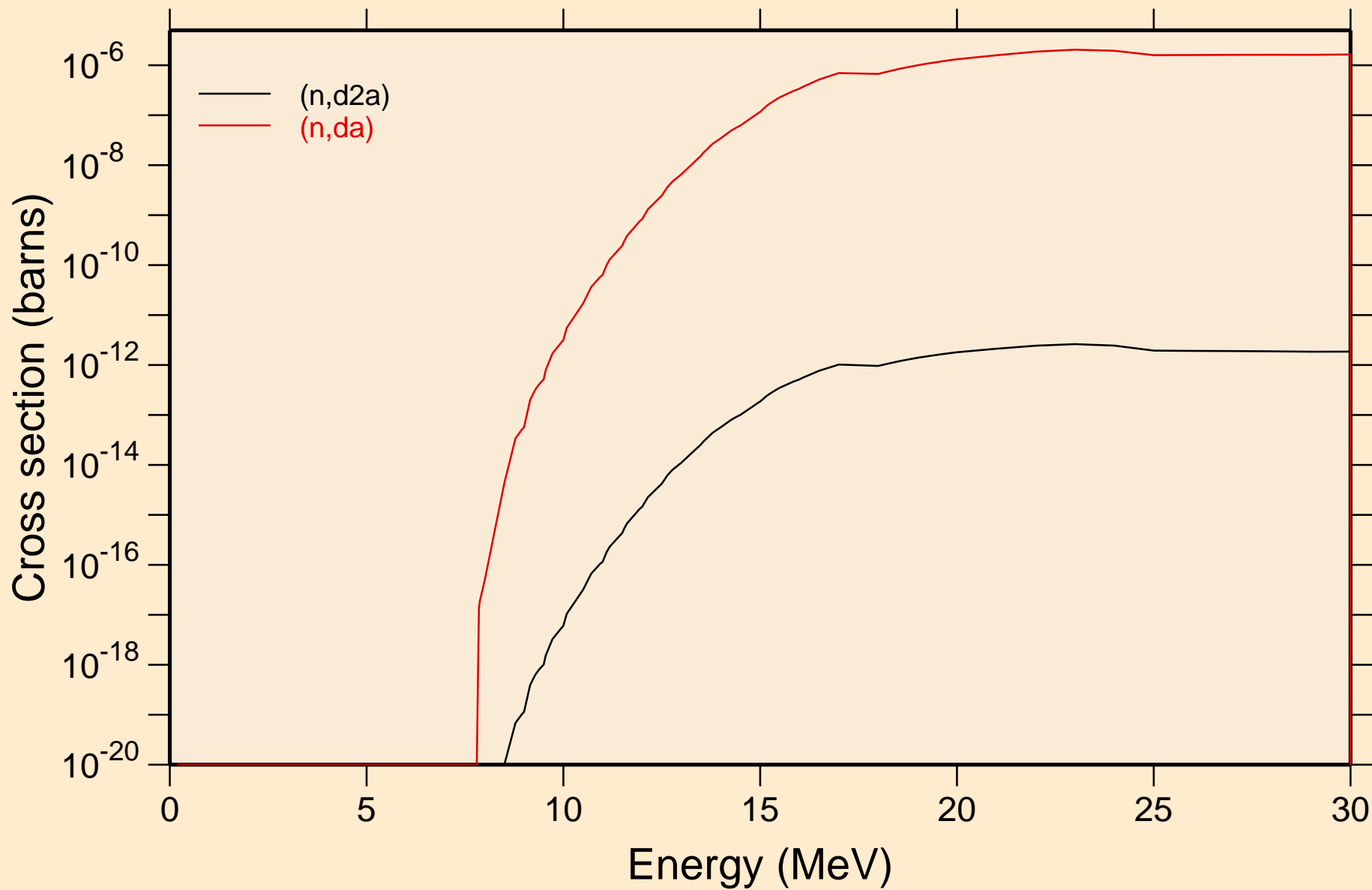

SG272 NRG TENDL-2015, AKONING
Inelastic levels

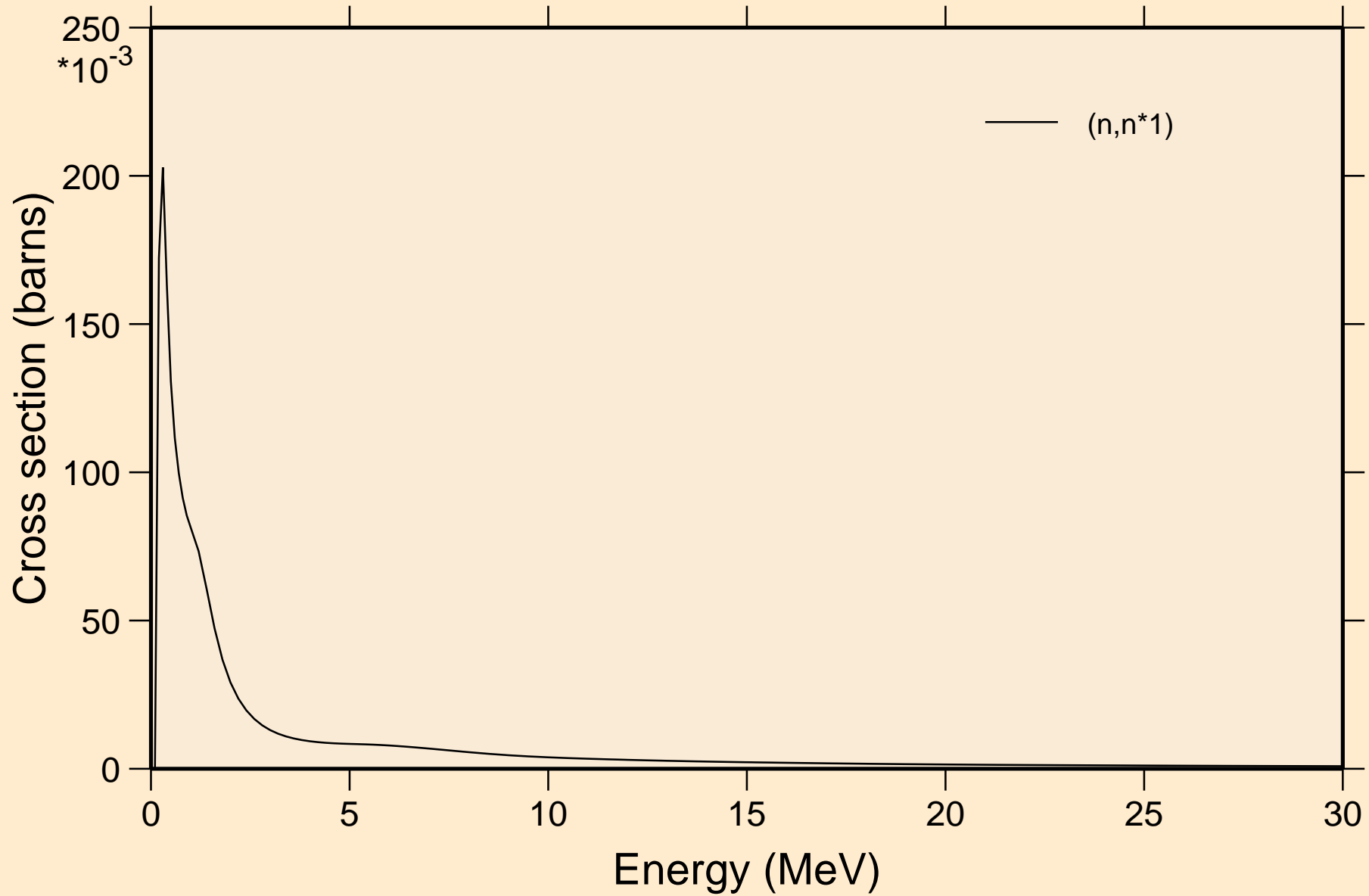

SG272 NRG TENDL-2015, AKONING

Threshold reactions

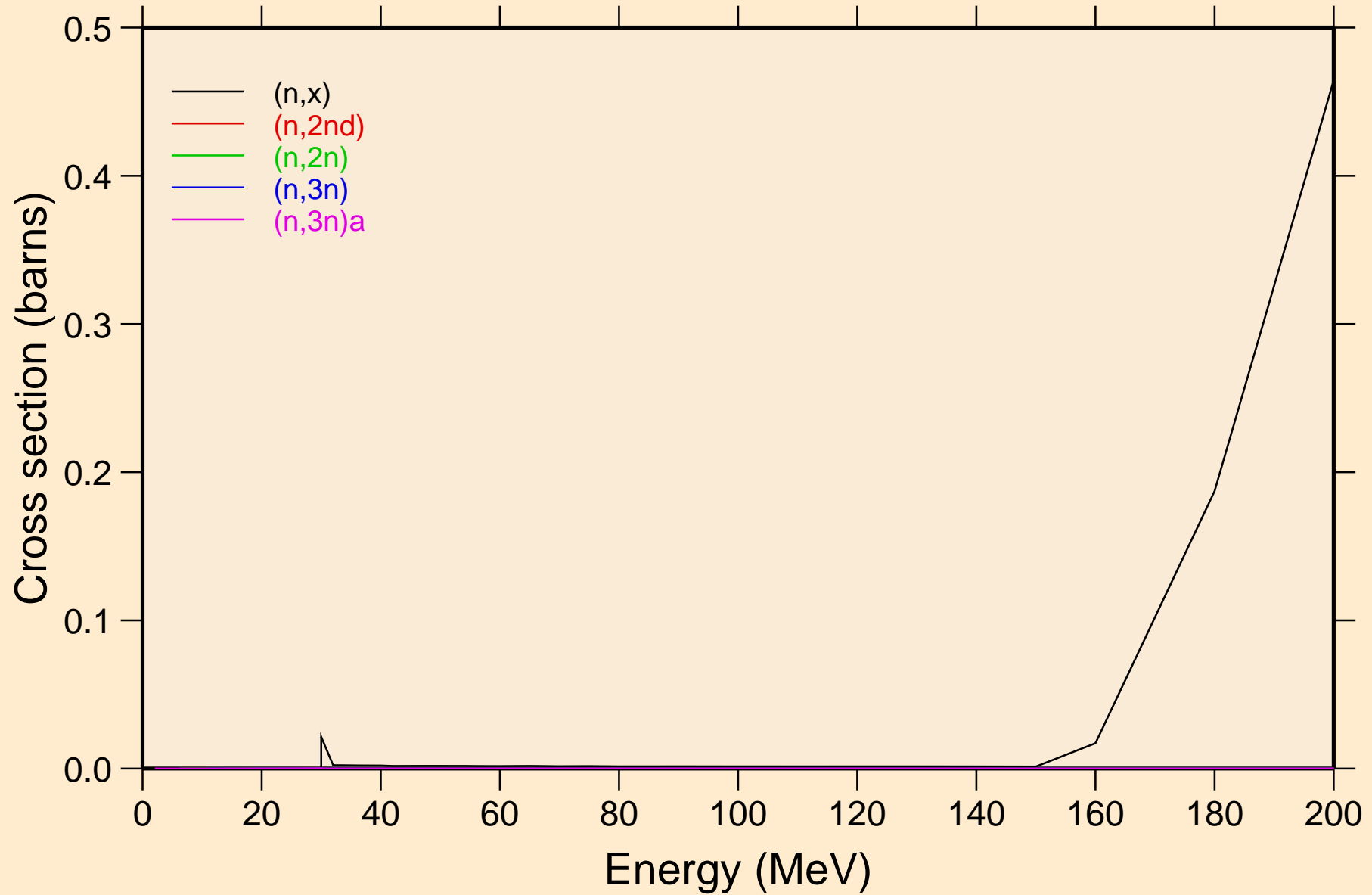

SG272 NRG TENDL-2015, AKONING

Threshold reactions

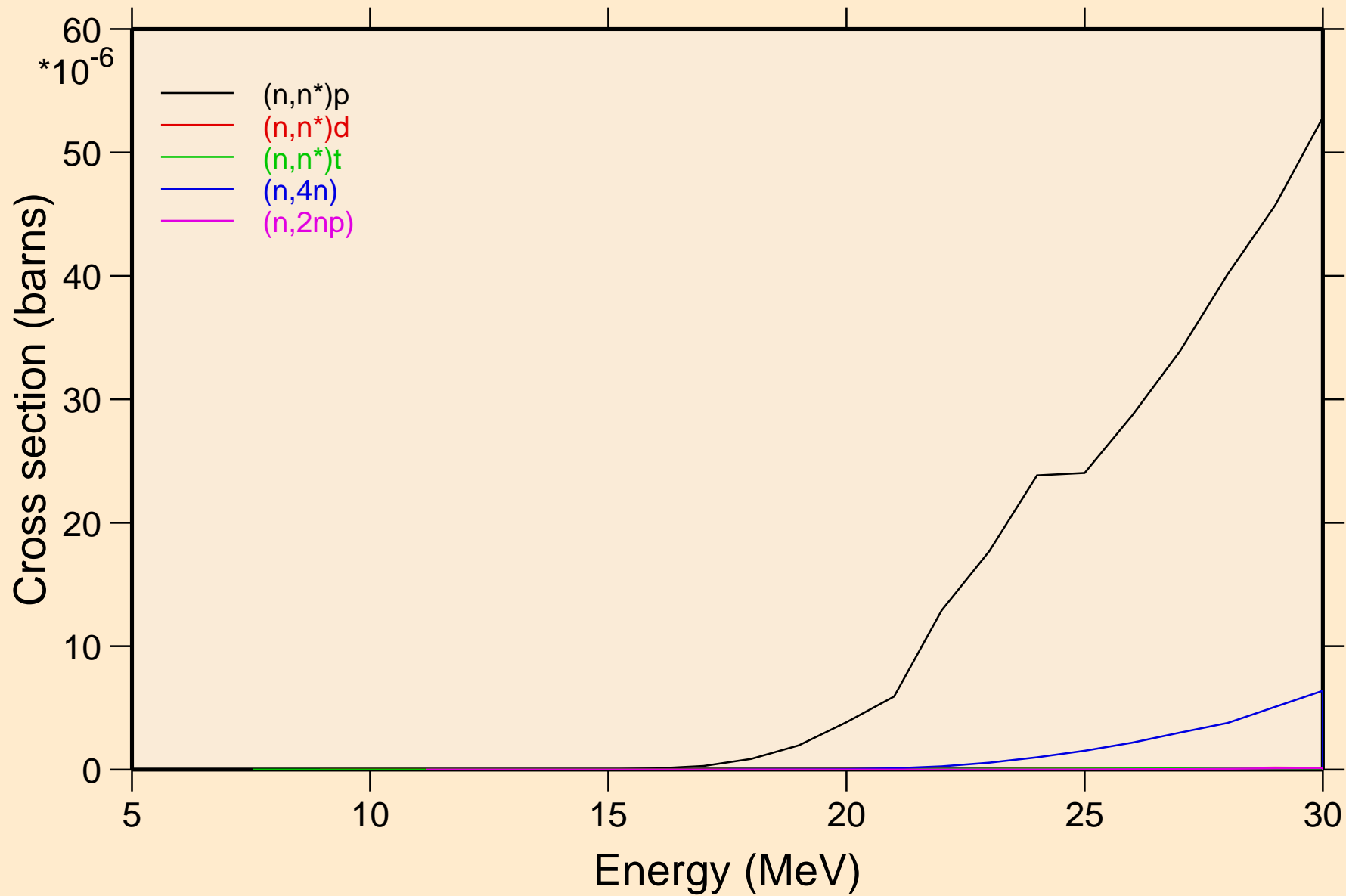

SG272 NRG TENDL-2015, AKONING

Threshold reactions

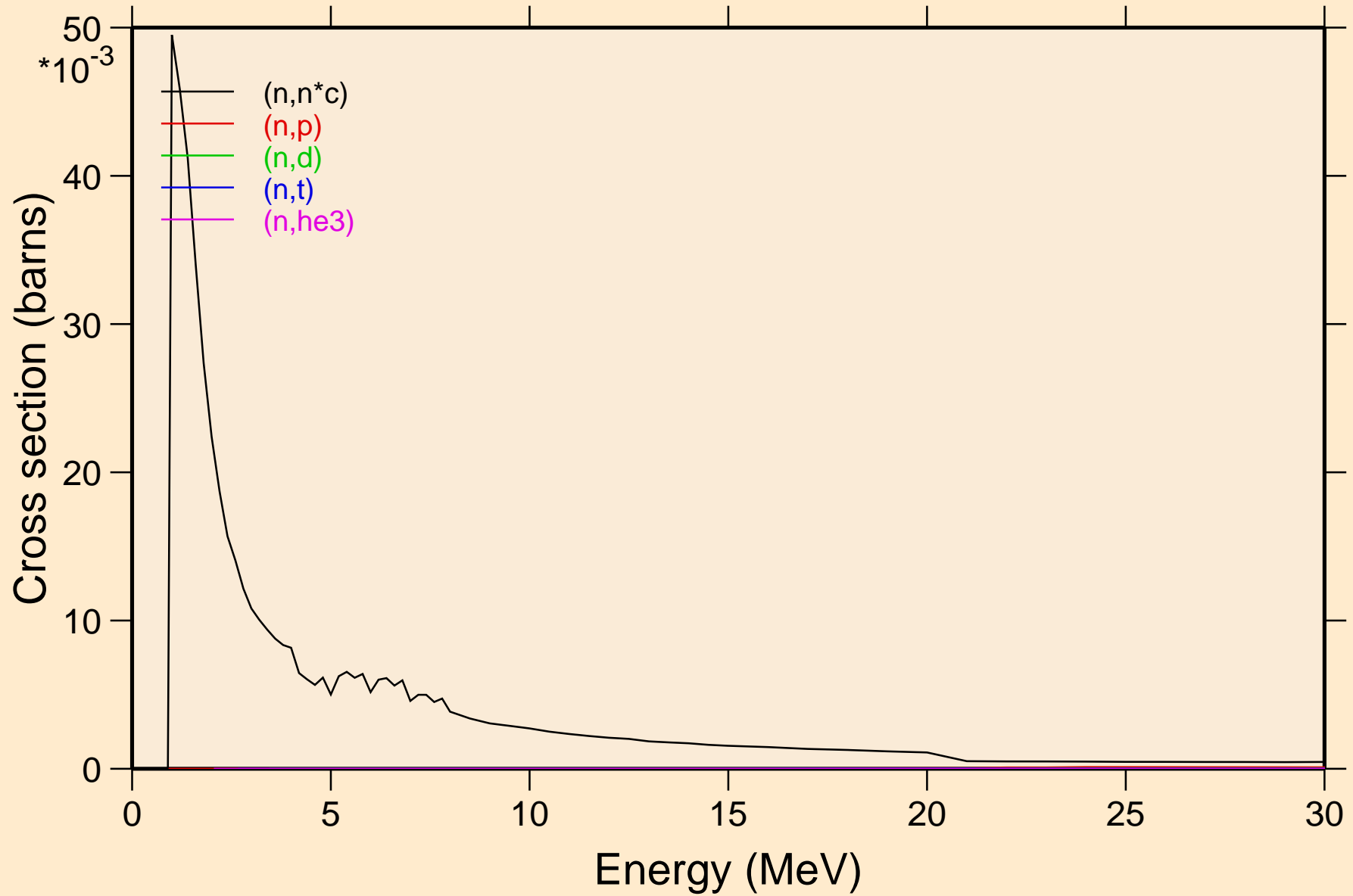

SG272 NRG TENDL-2015, AKONING
angular distribution for elastic

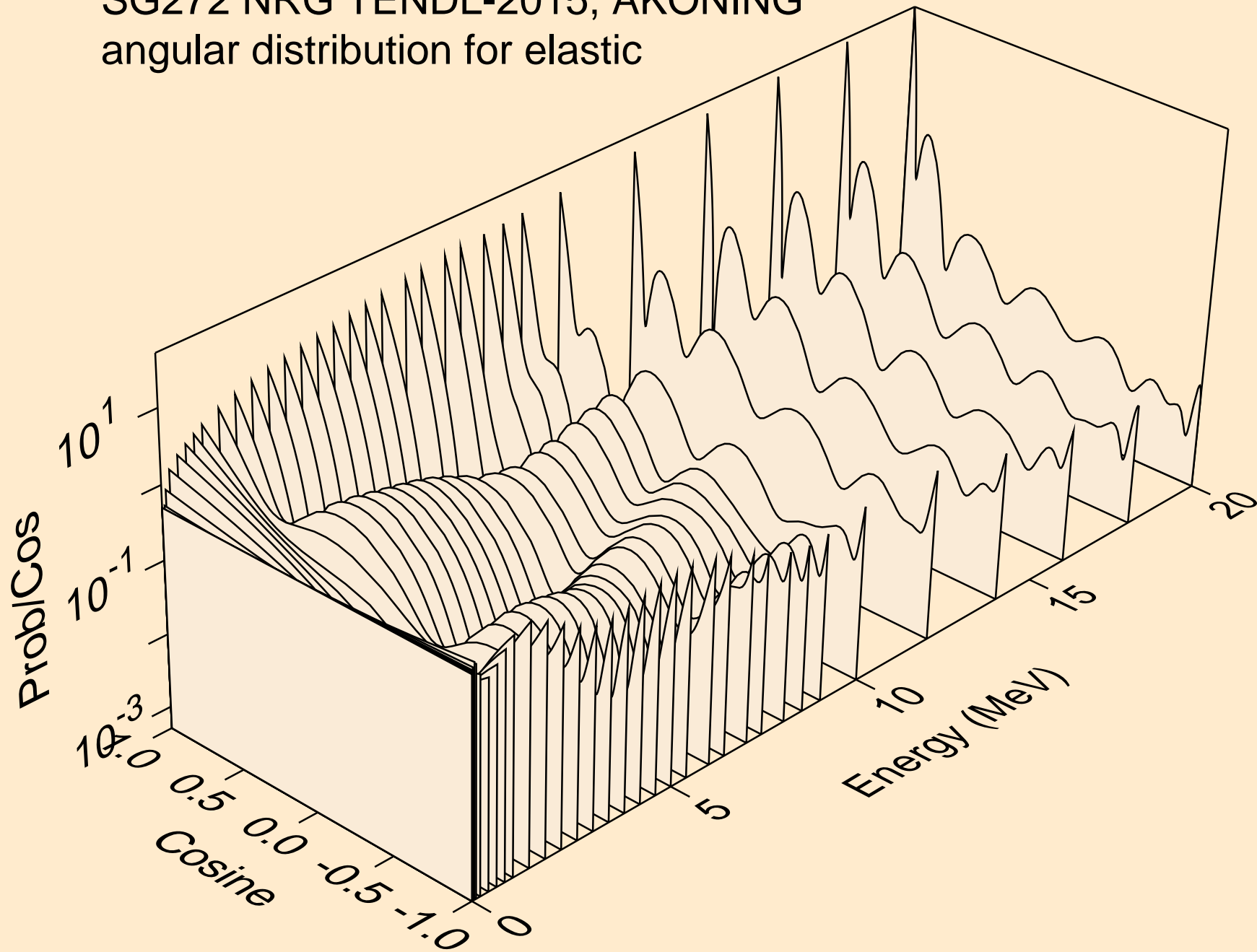

SG272 NRG TENDL-2015, AKONING
angular distribution for elastic

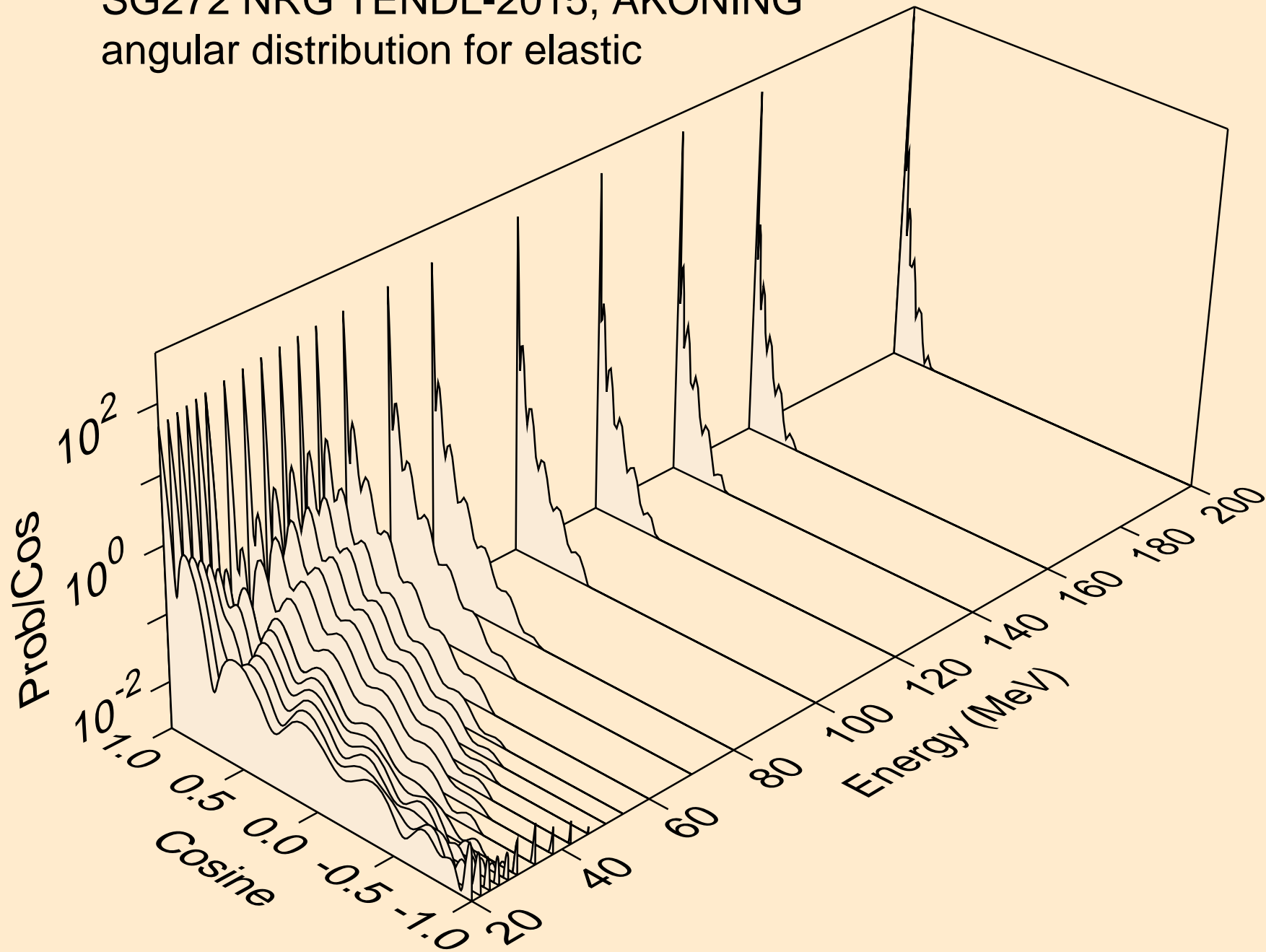

SG272 NRG TENDL-2015, AKONING
angular distribution for (n,n*1)

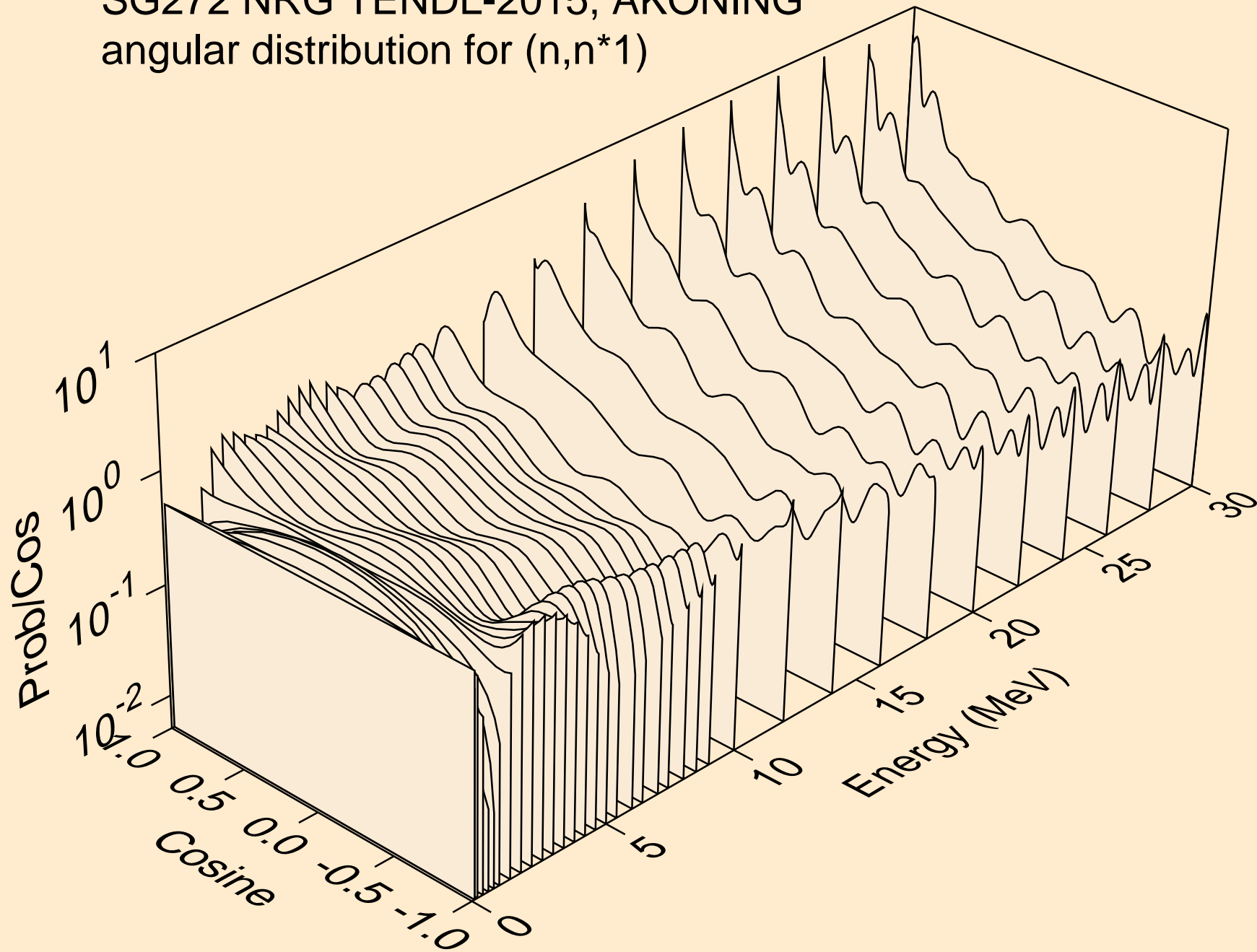

SG272 NRG TENDL-2015, AKONING

Total fission nubar

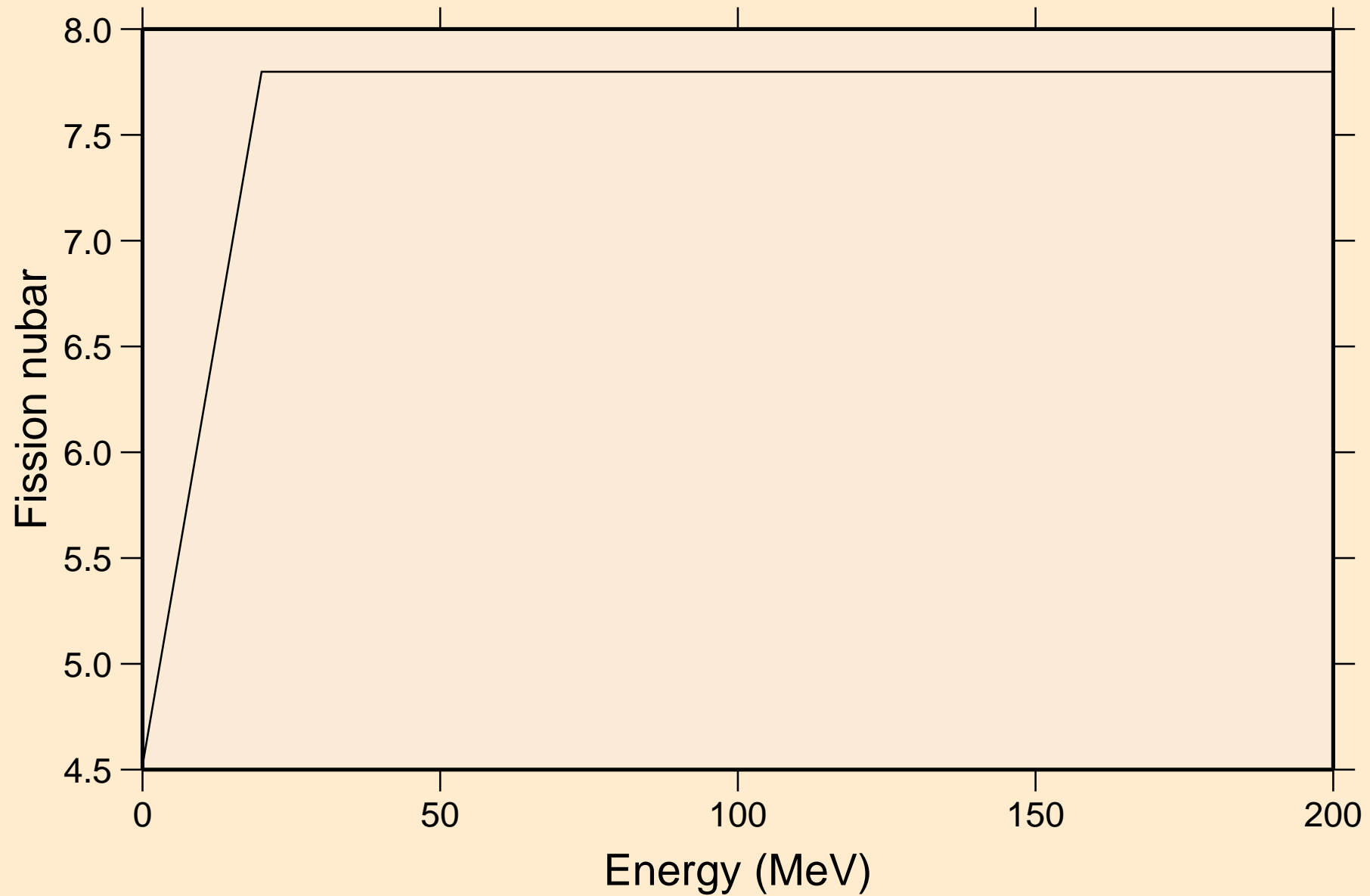

SG272 NRG TENDL-2015, AKONING
Neutron emission for (n,x)

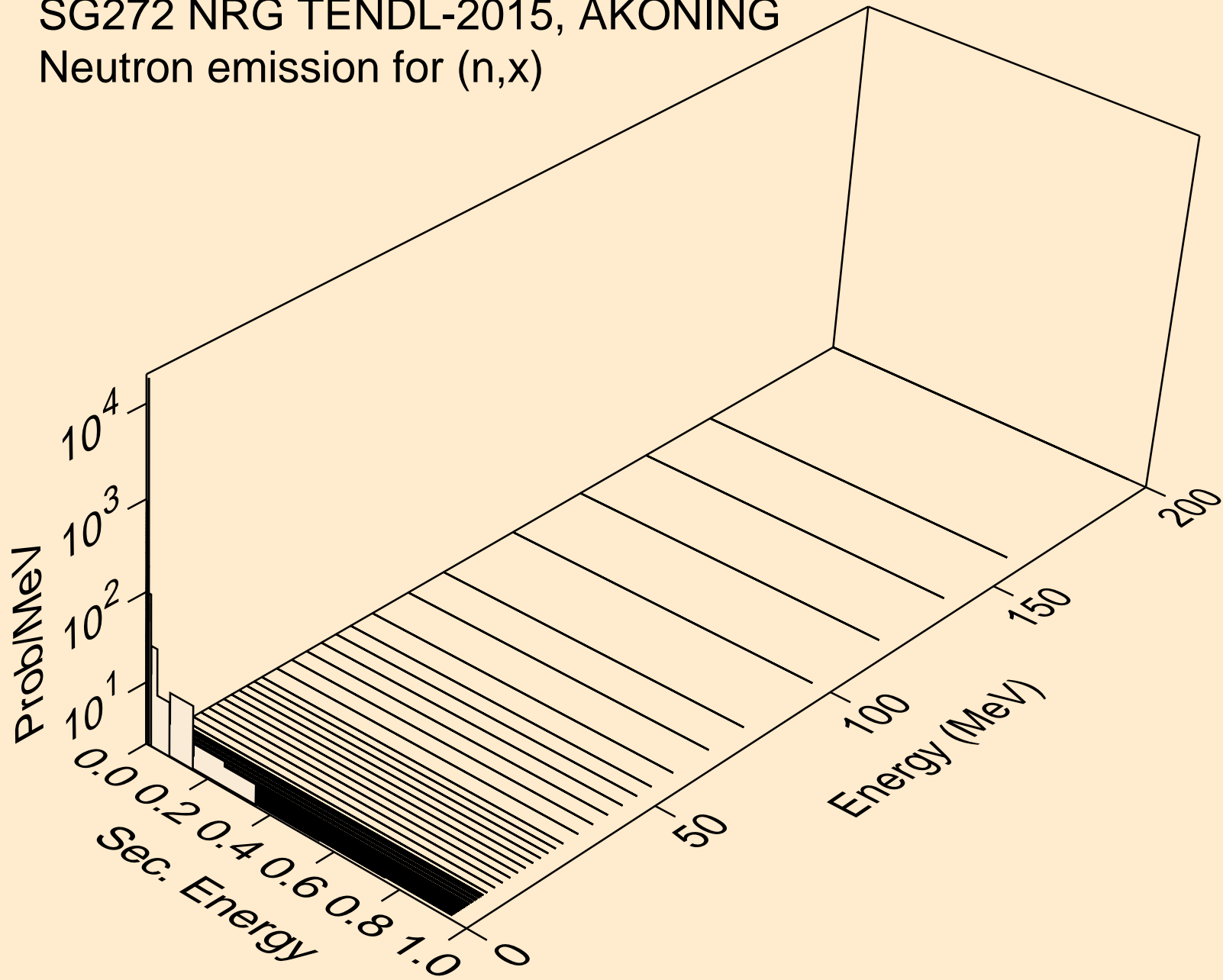

SG272 NRG TENDL-2015, AKONING
Neutron emission for (n,2nd)

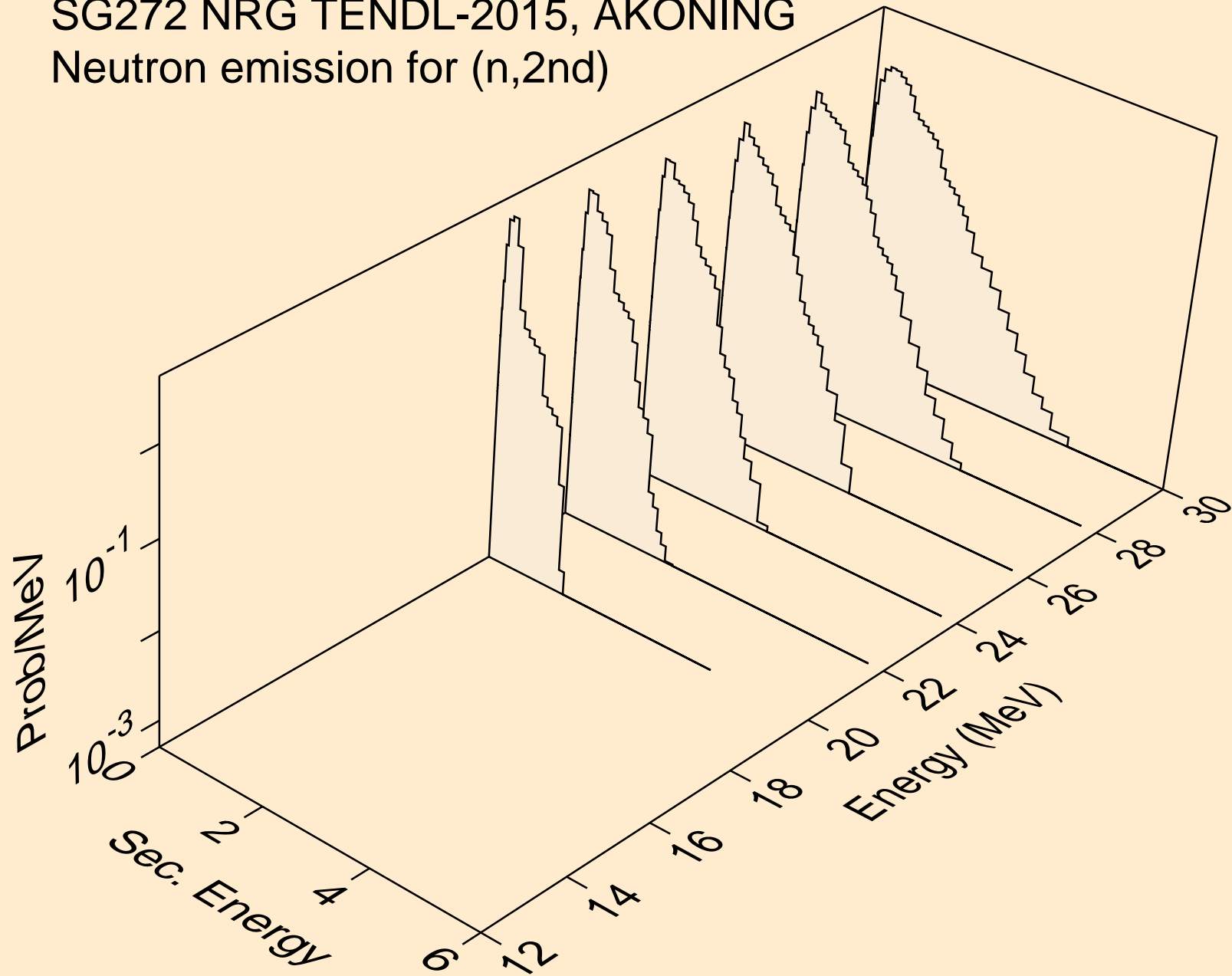

SG272 NRG TENDL-2015, AKONING
Neutron emission for (n,2n)

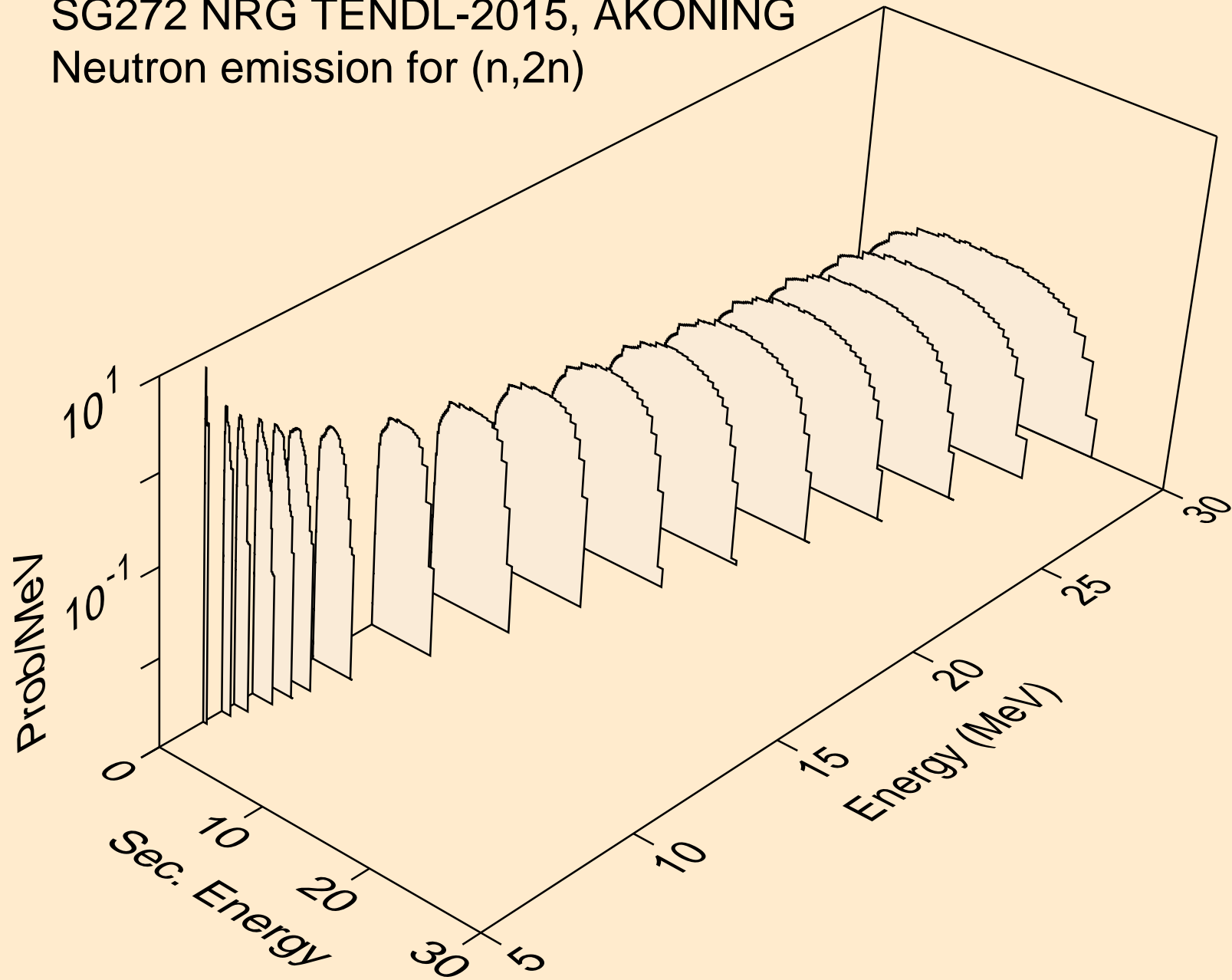

SG272 NRG TENDL-2015, AKONING
Neutron emission for (n,3n)

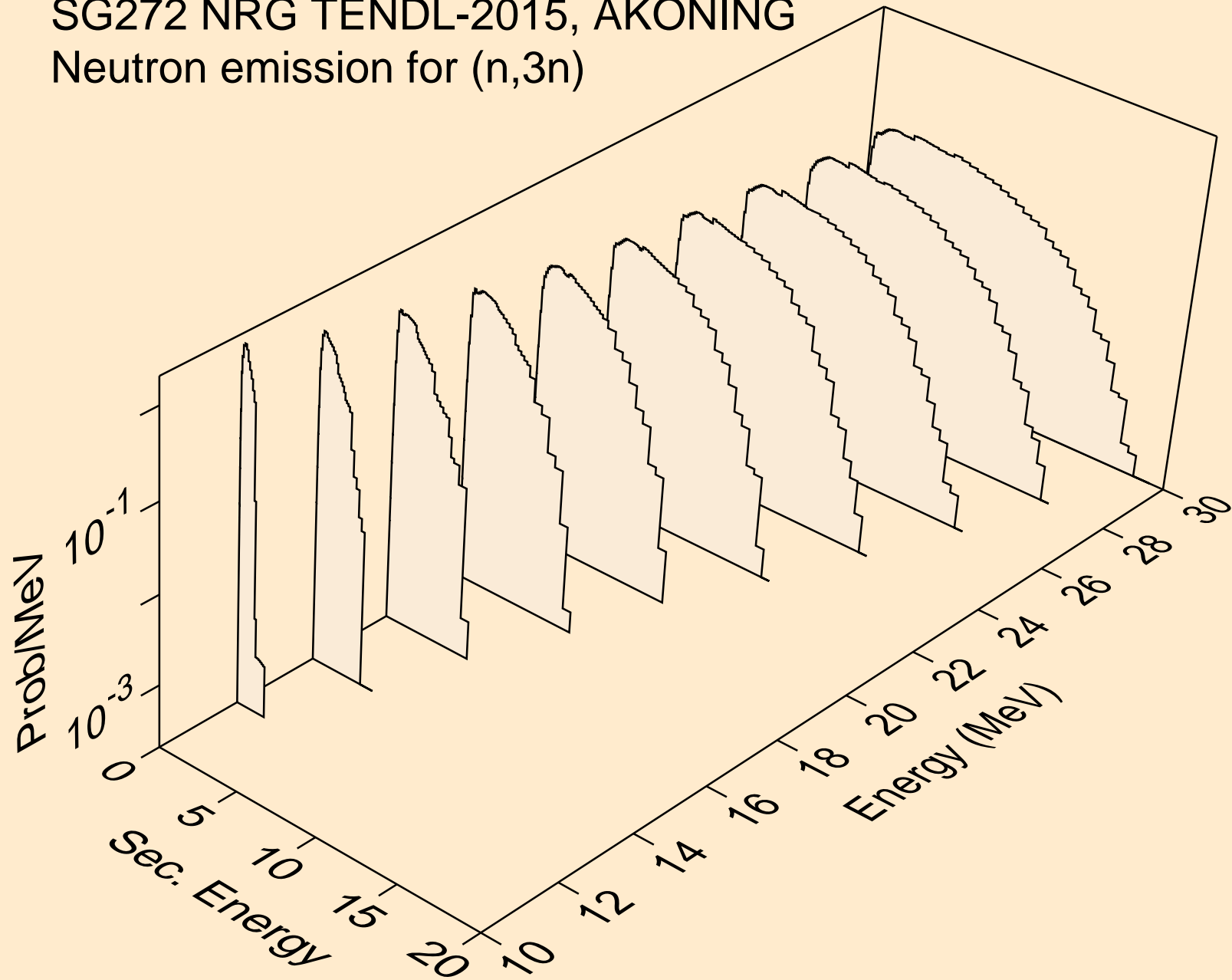

SG272 NRG TENDL-2015, AKONING
Neutron emission for fission

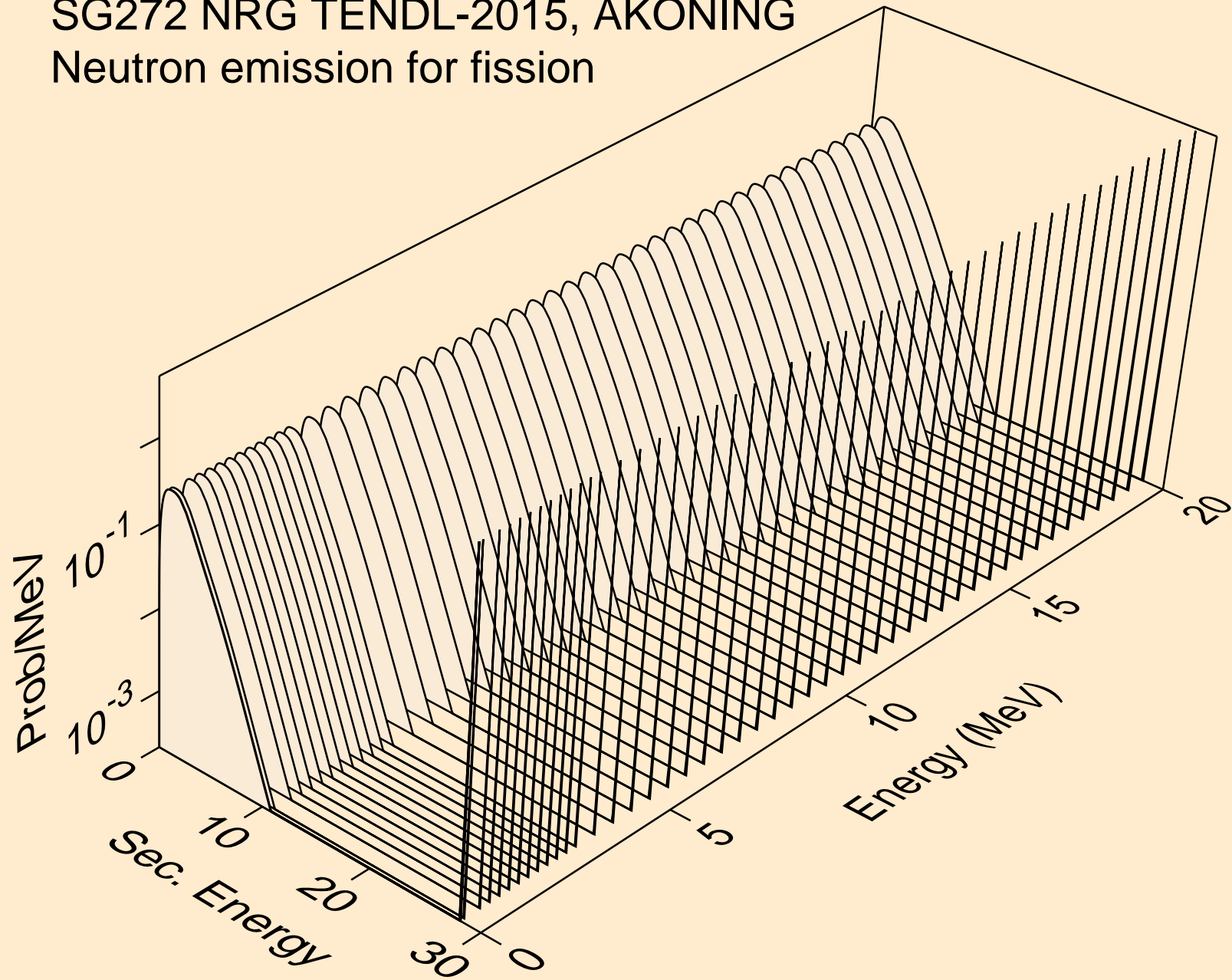

SG272 NRG TENDL-2015, AKONING
Neutron emission for (n,n*)a

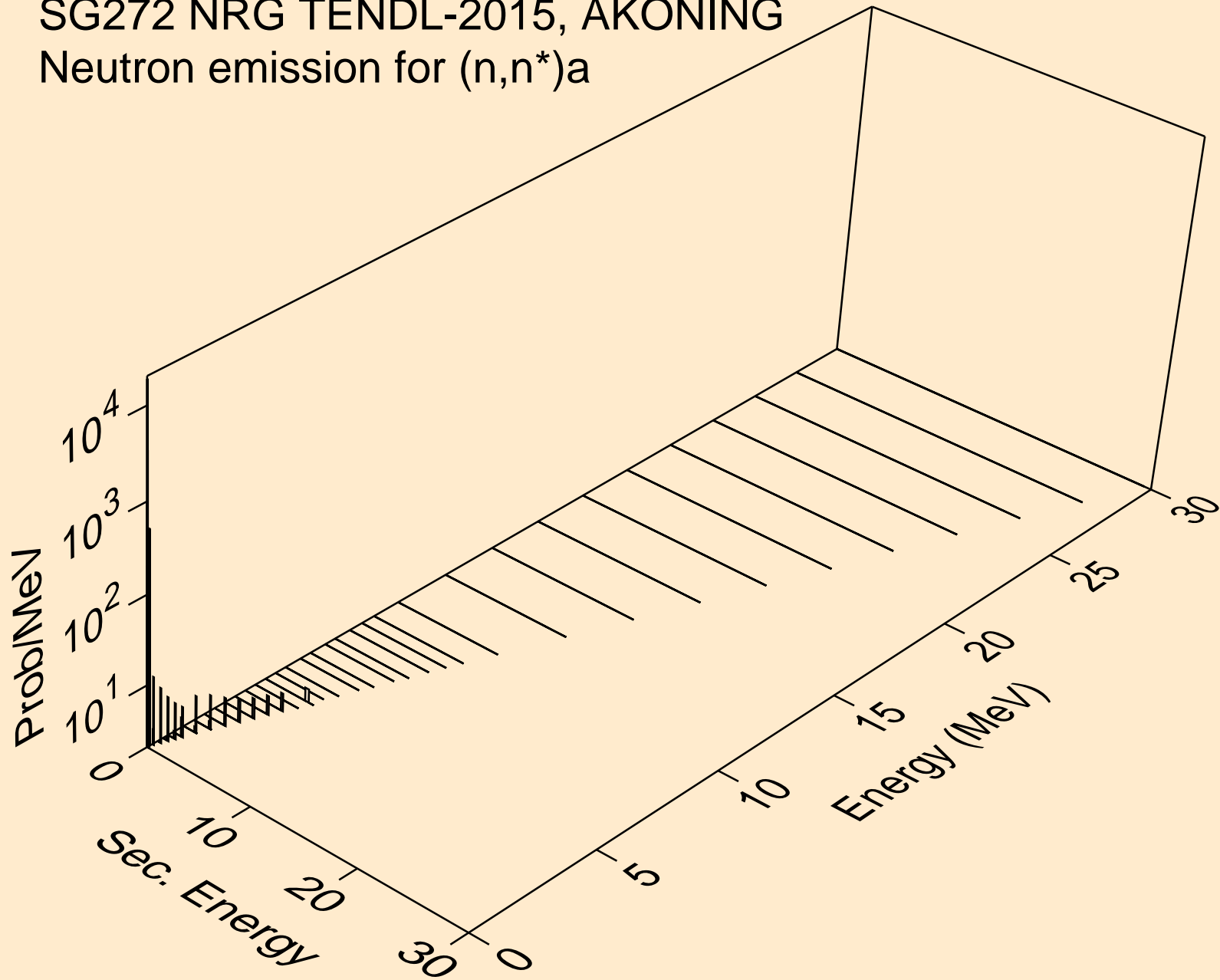

SG272 NRG TENDL-2015, AKONING
Neutron emission for (n,n*)3a

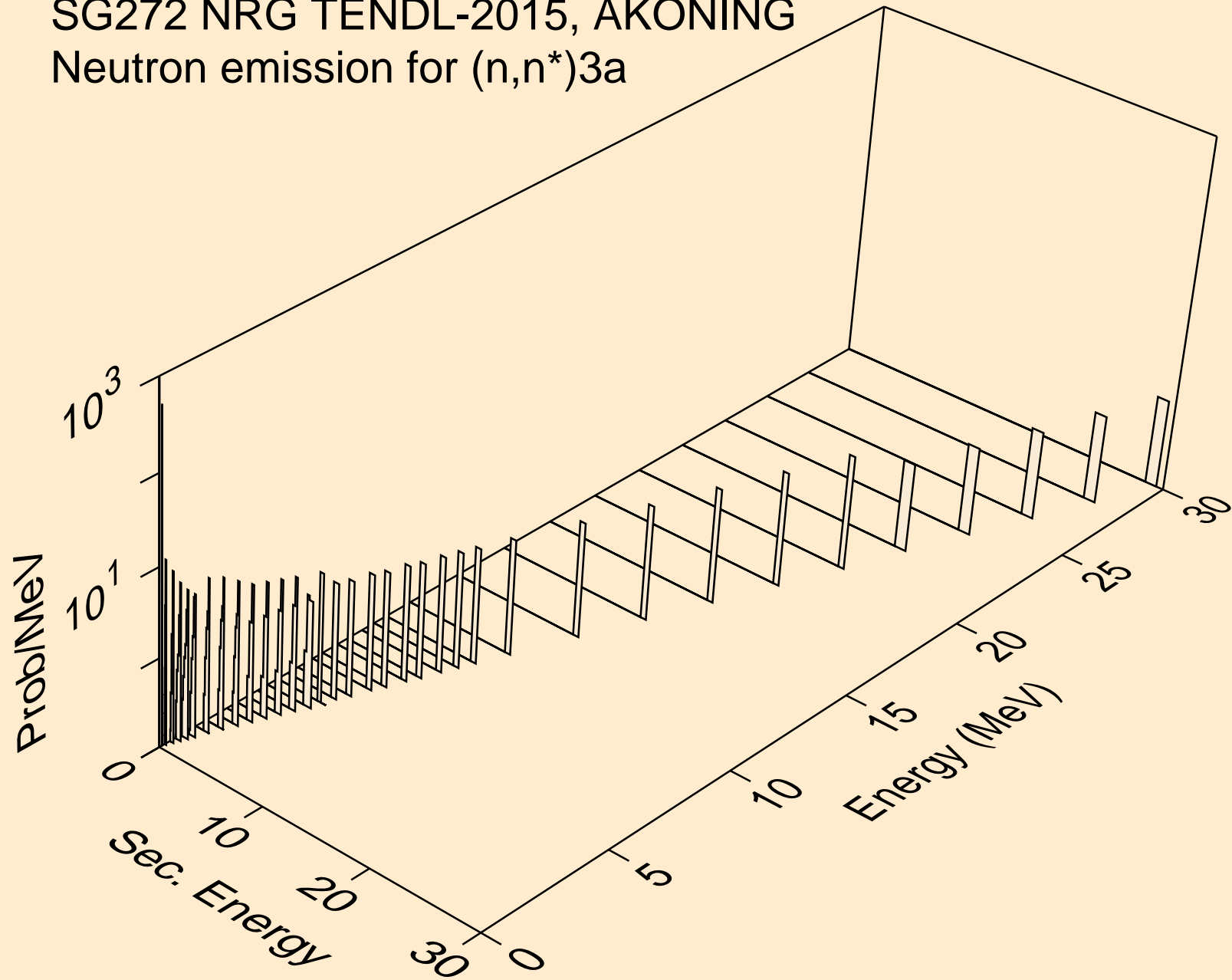

SG272 NRG TENDL-2015, AKONING
Neutron emission for (n,2n)a

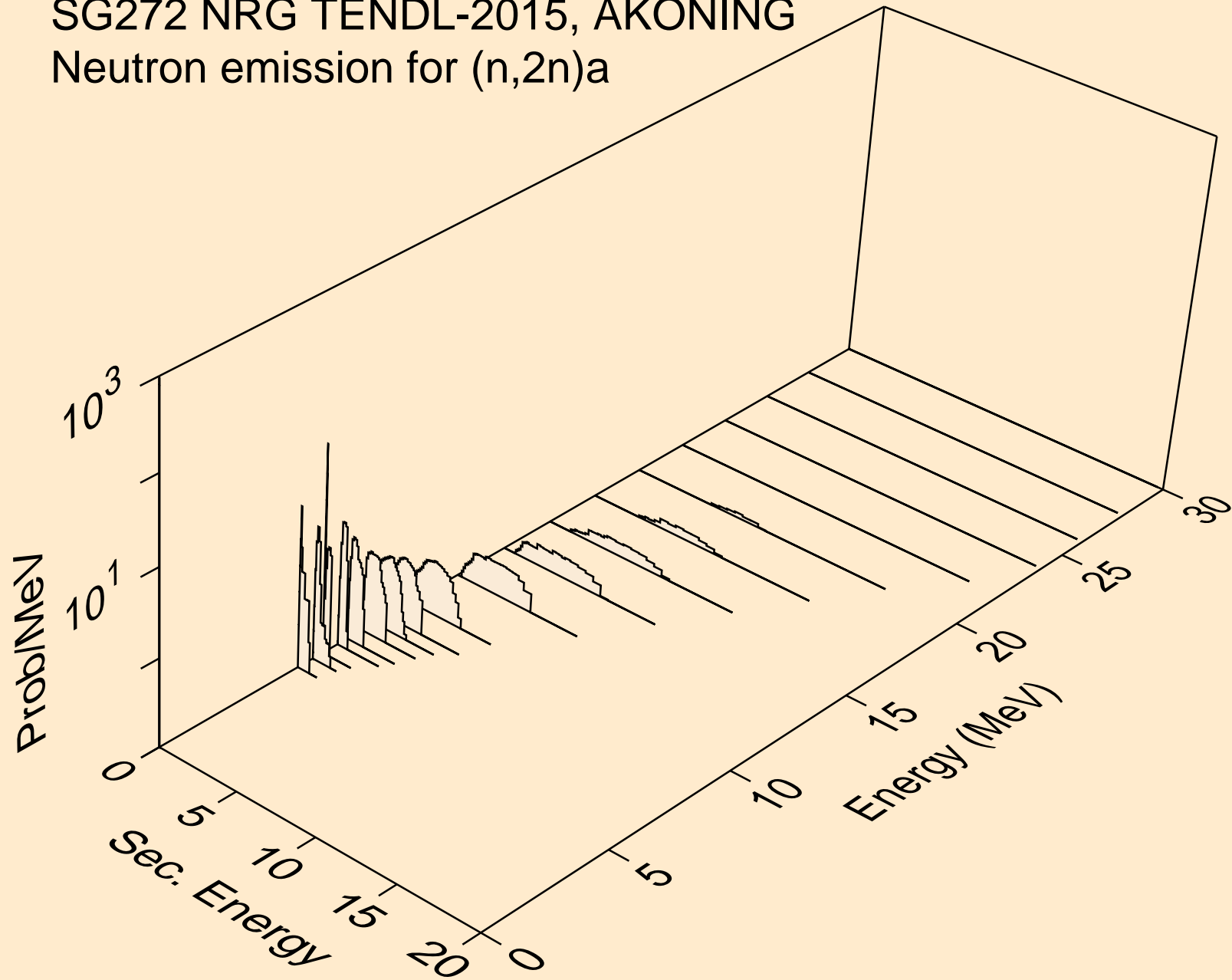

SG272 NRG TENDL-2015, AKONING
Neutron emission for (n,3n)a

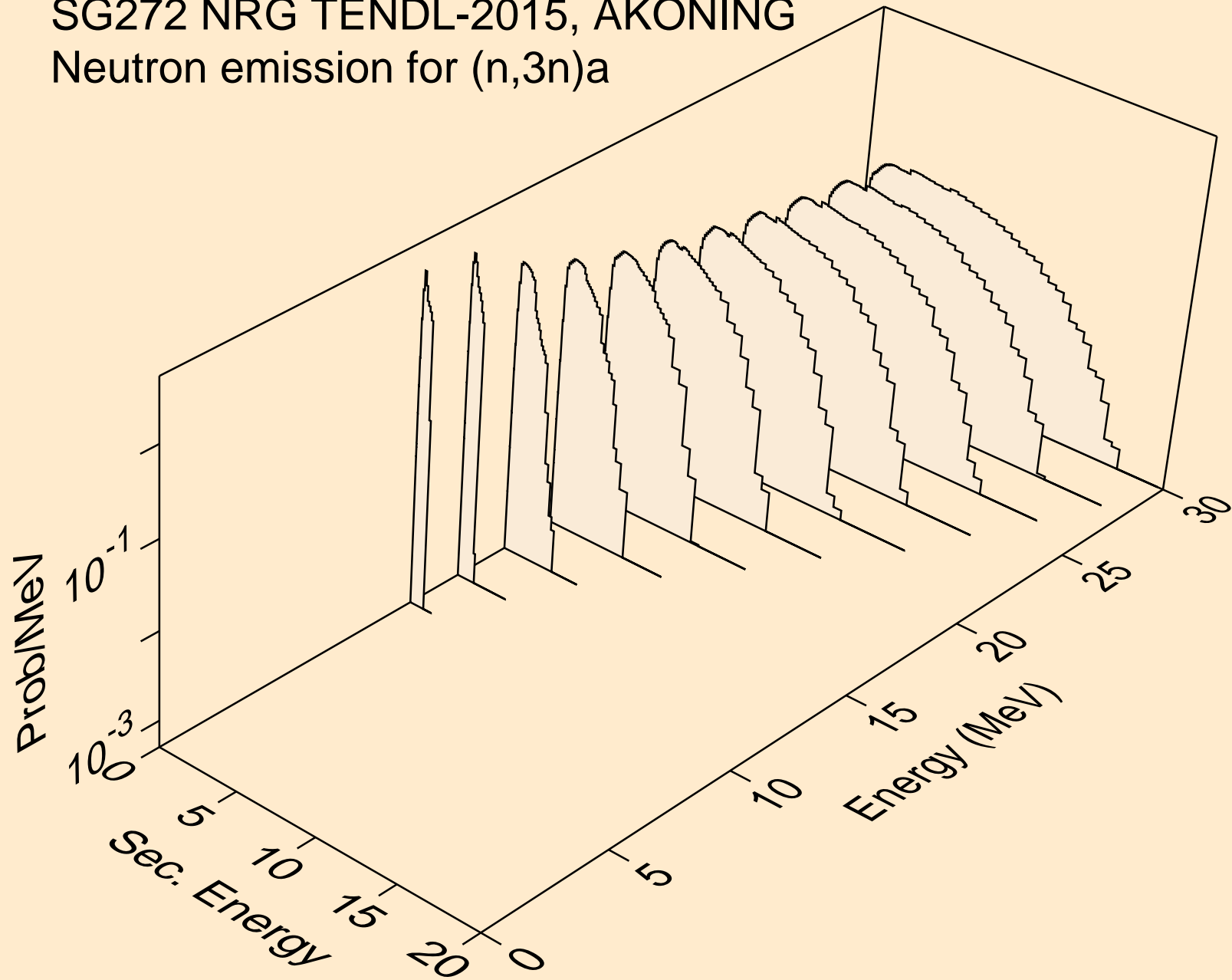

SG272 NRG TENDL-2015, AKONING
Neutron emission for (n,n*)p

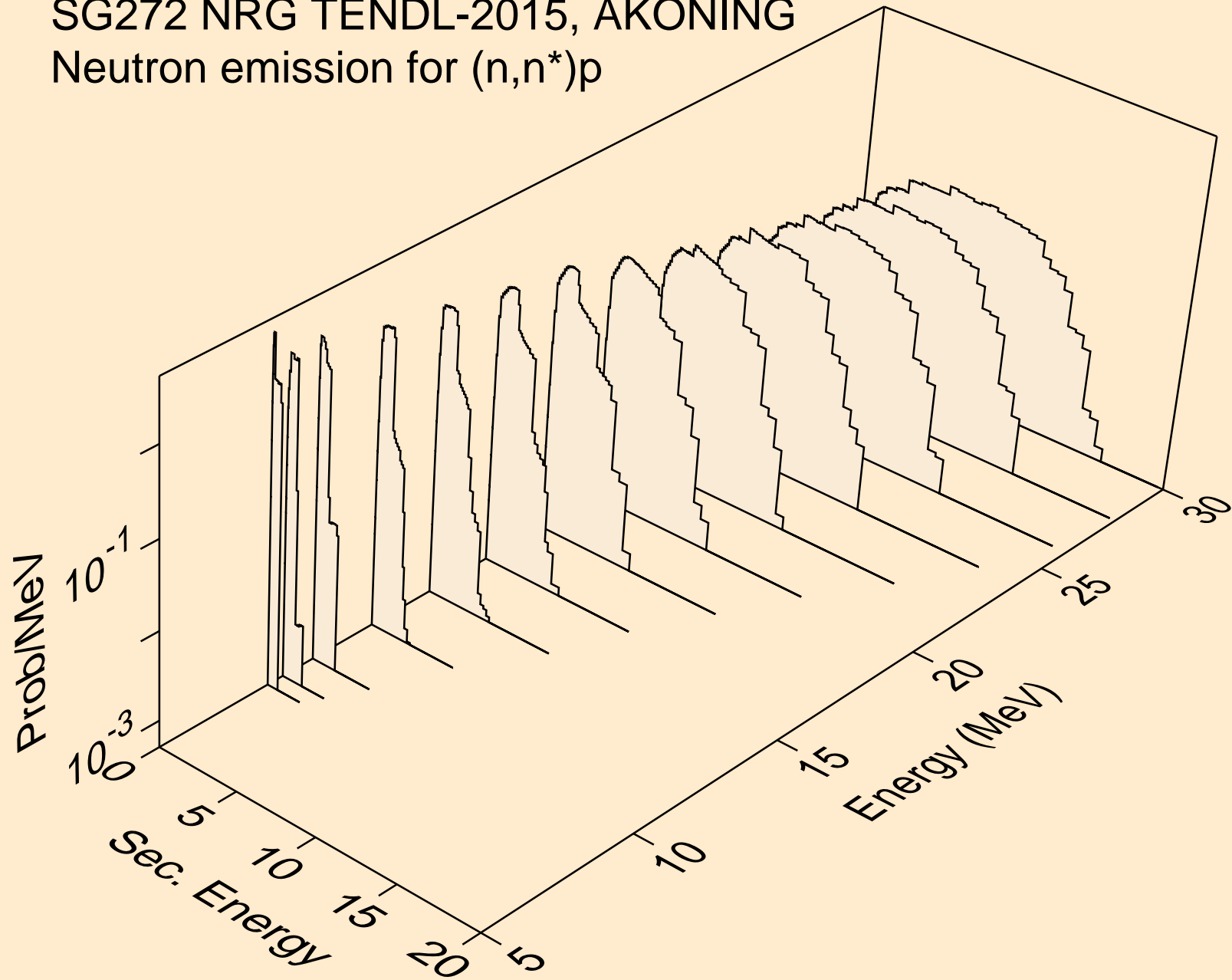

SG272 NRG TENDL-2015, AKONING
Neutron emission for (n,n*)2a

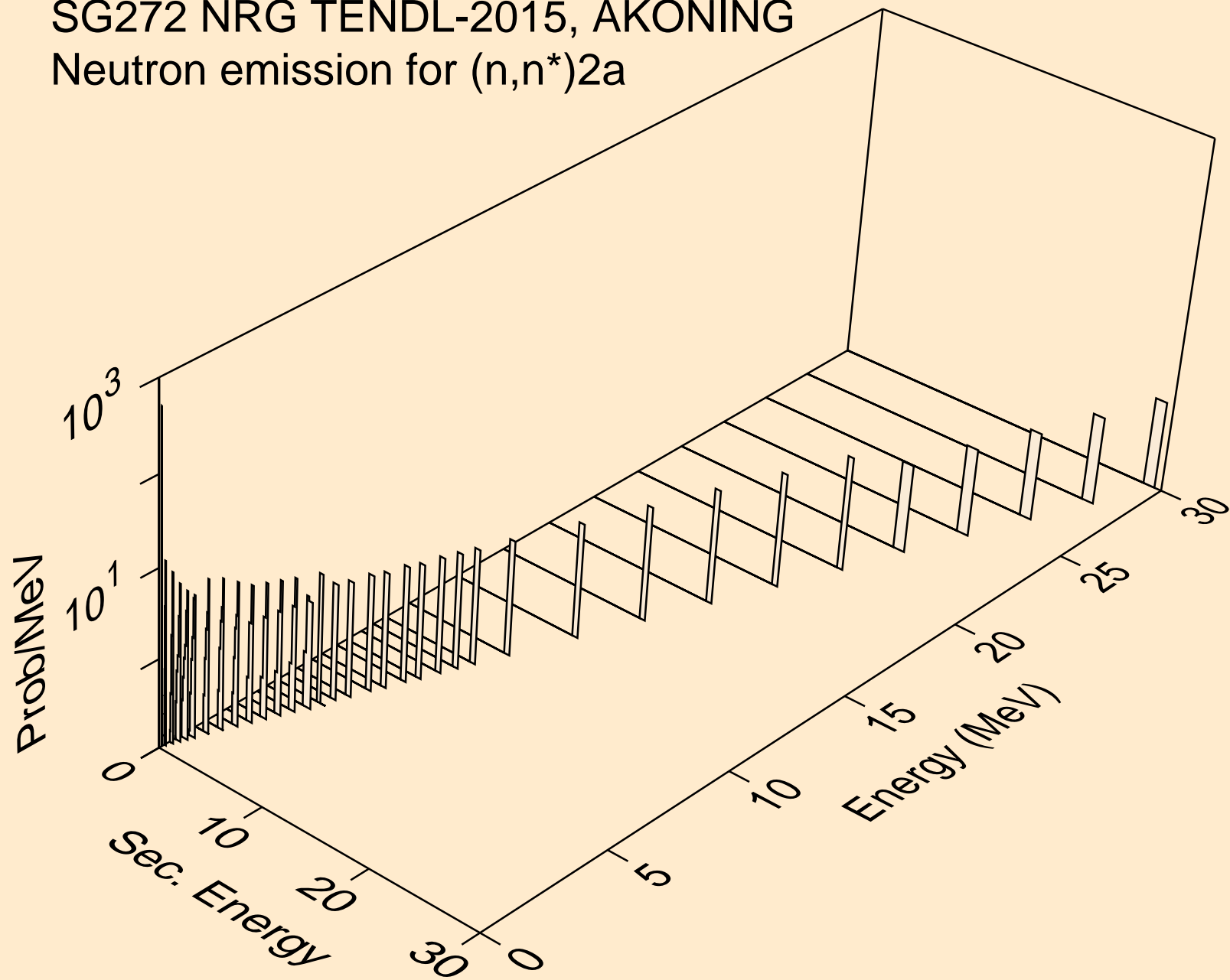

SG272 NRG TENDL-2015, AKONING
Neutron emission for (n,2n)2a

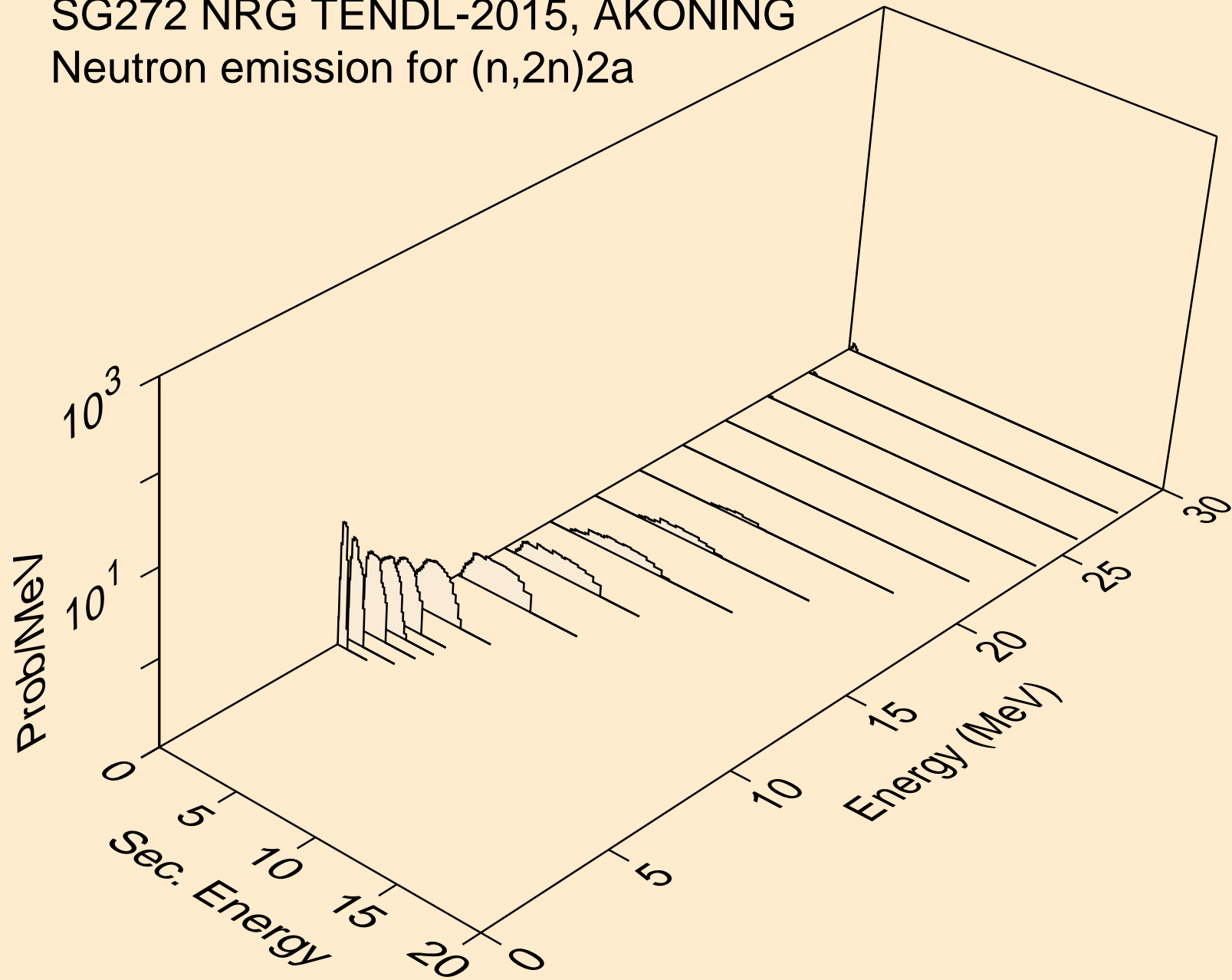

SG272 NRG TENDL-2015, AKONING
Neutron emission for (n,n*)d

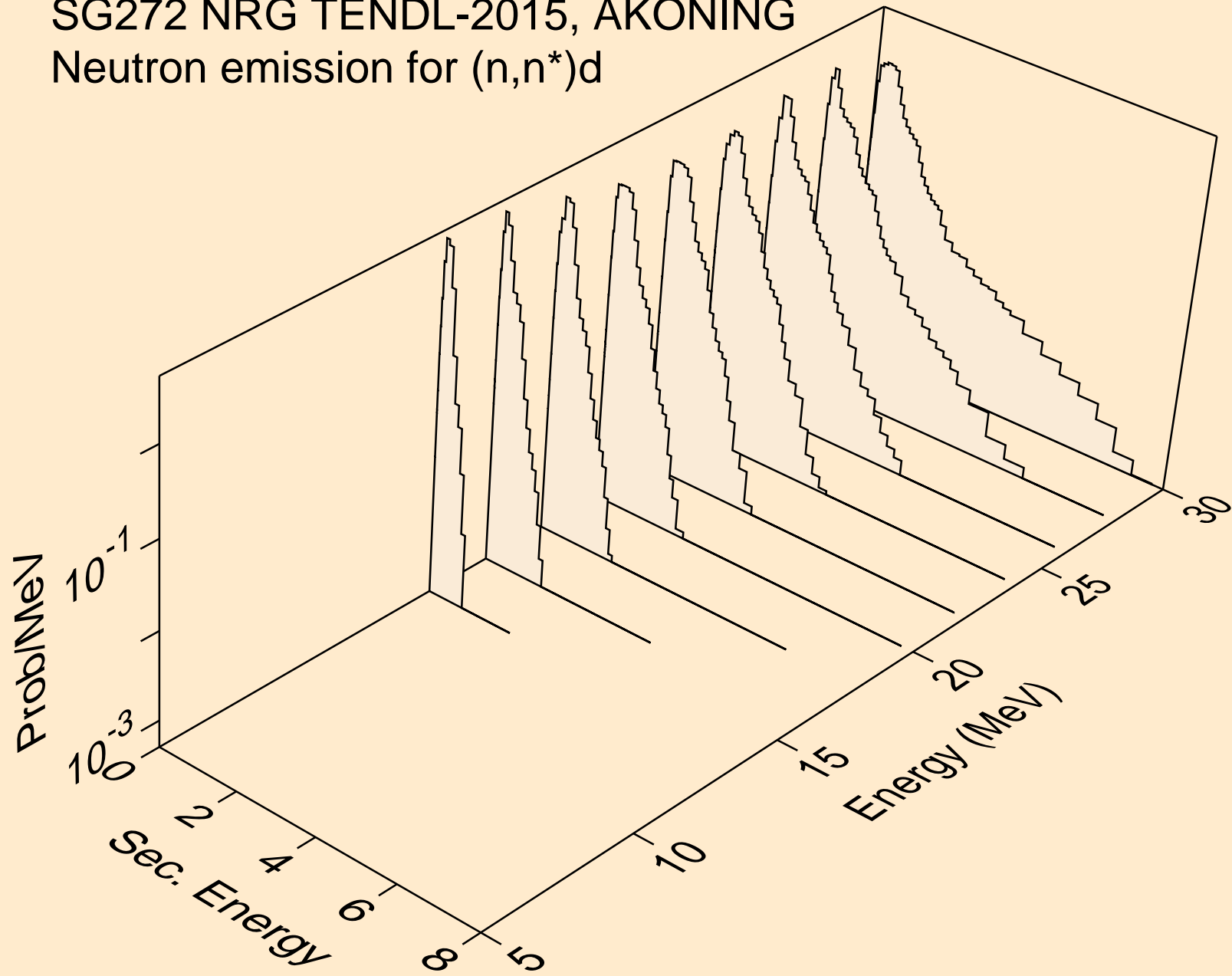

SG272 NRG TENDL-2015, AKONING
Neutron emission for (n,n*)t

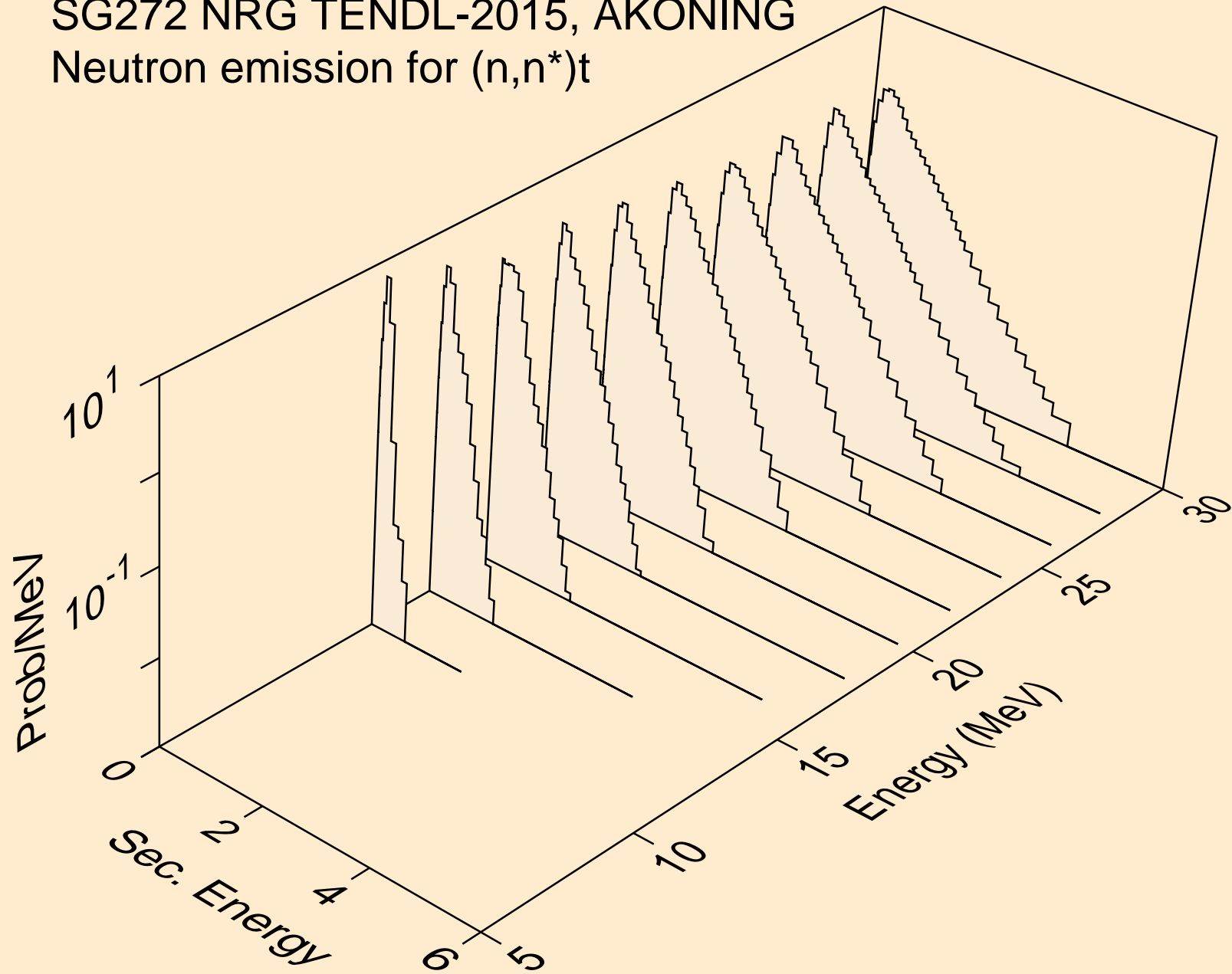

SG272 NRG TENDL-2015, AKONING
Neutron emission for (n,n*)d2a

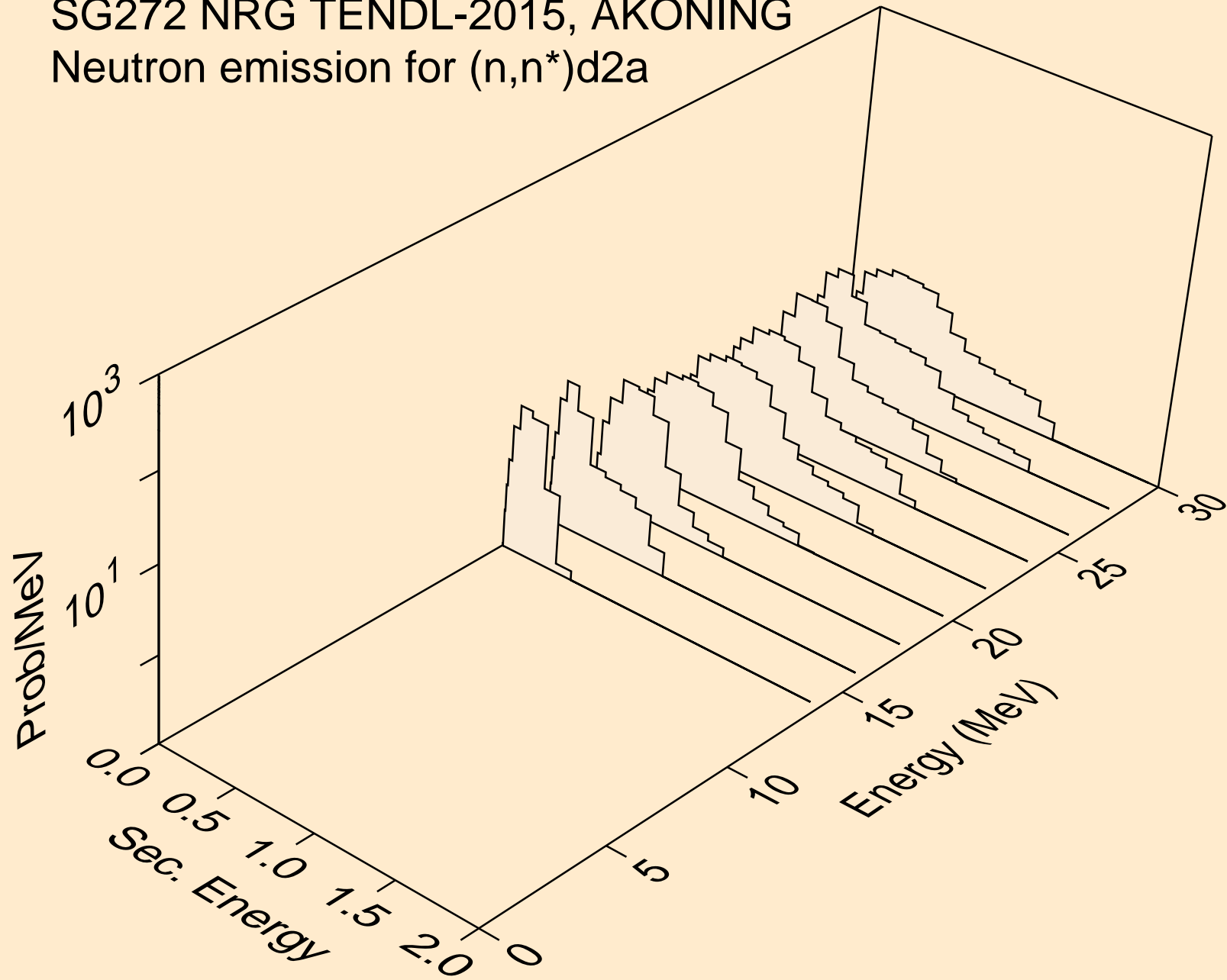

SG272 NRG TENDL-2015, AKONING
Neutron emission for (n,n*)t2a

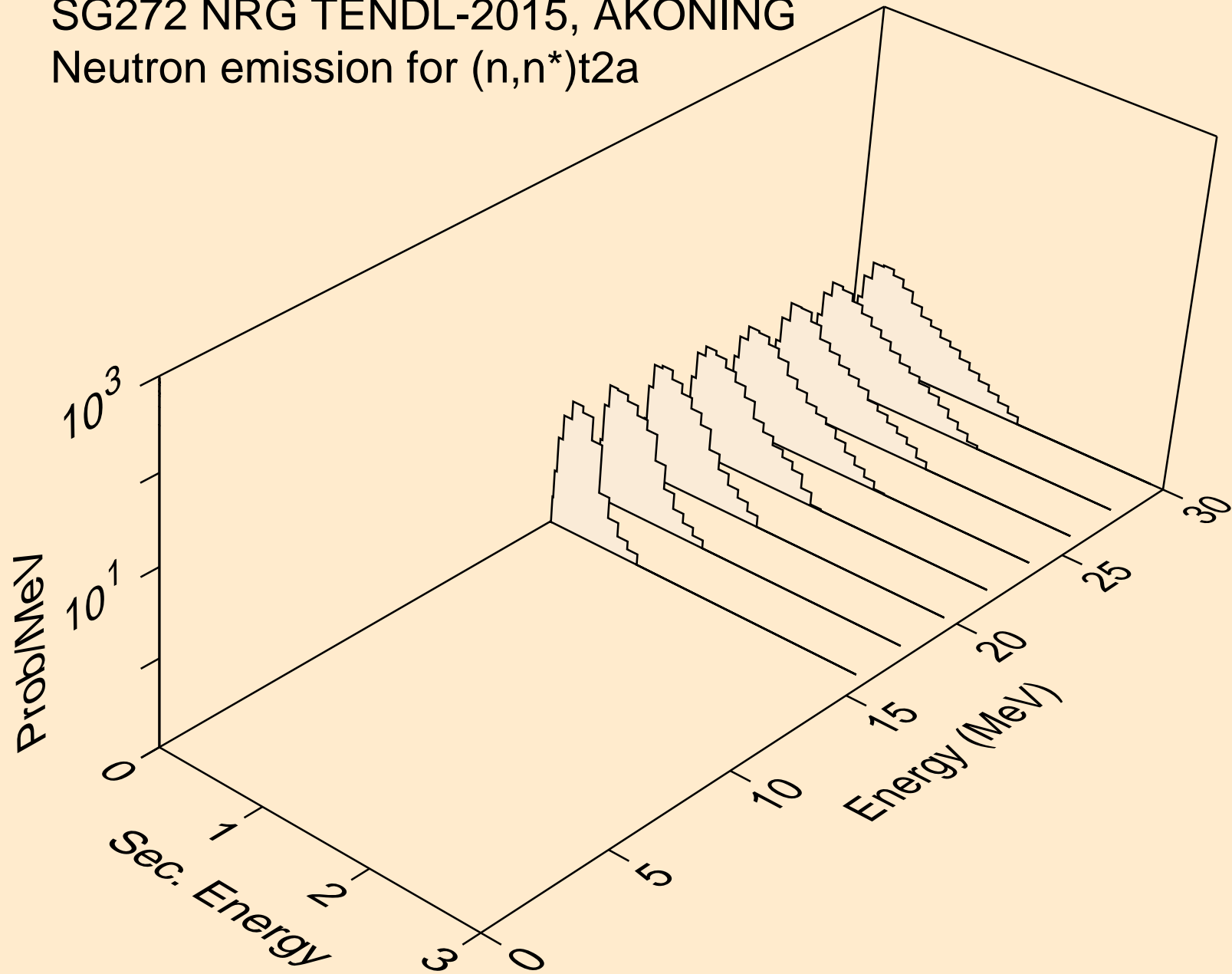

SG272 NRG TENDL-2015, AKONING
Neutron emission for (n,4n)

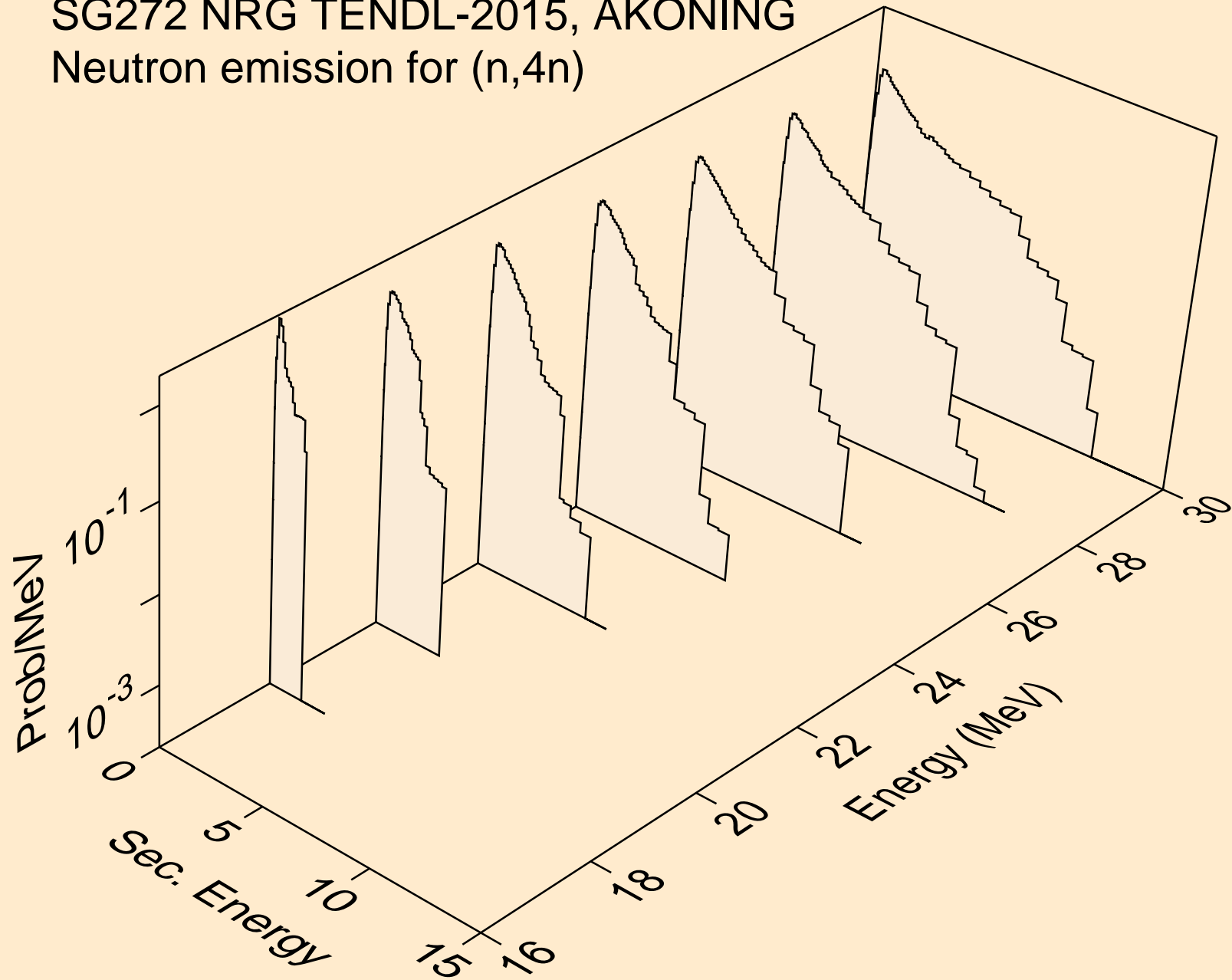

SG272 NRG TENDL-2015, AKONING
Neutron emission for (n,2np)

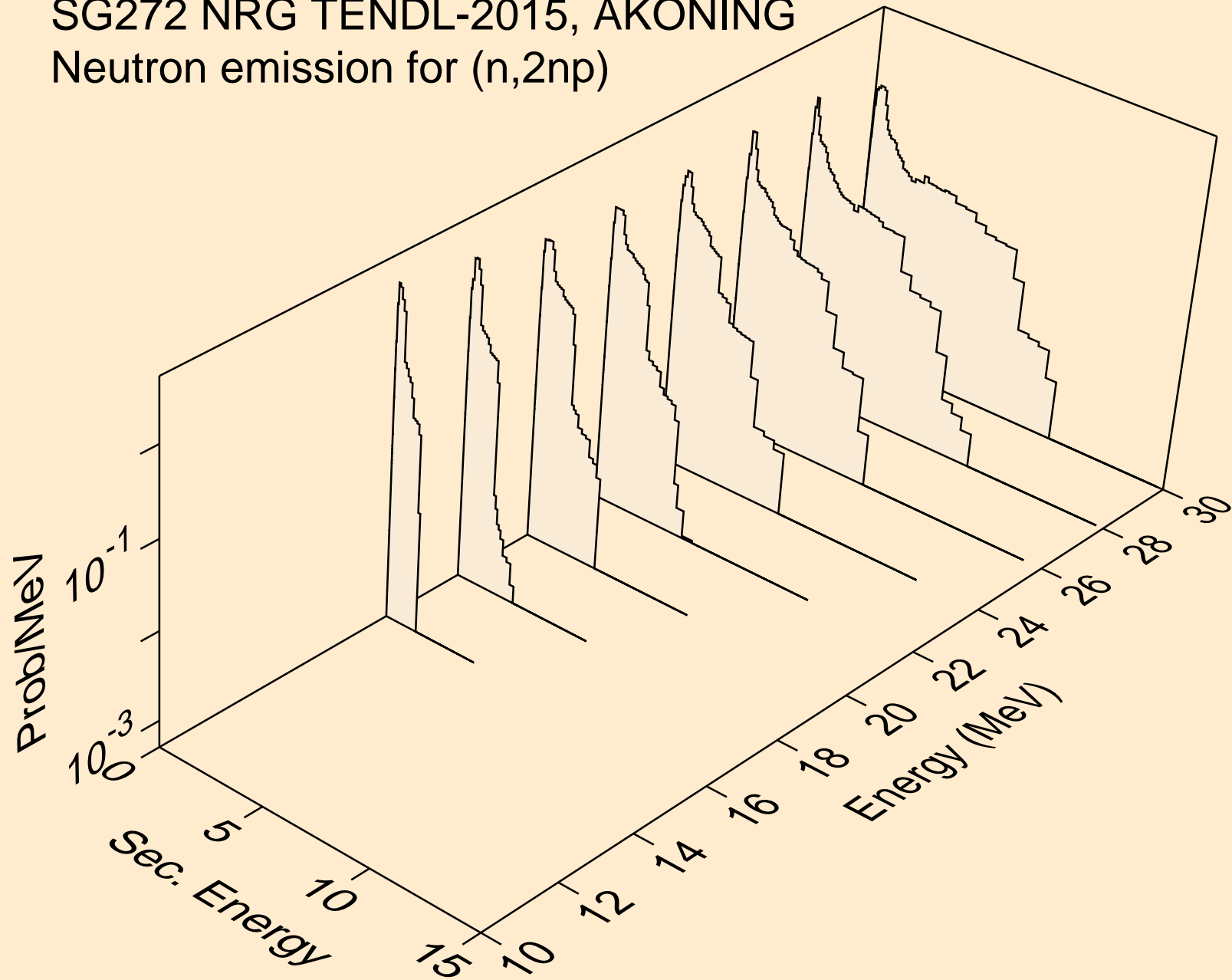

SG272 NRG TENDL-2015, AKONING
Neutron emission for (n,npa)

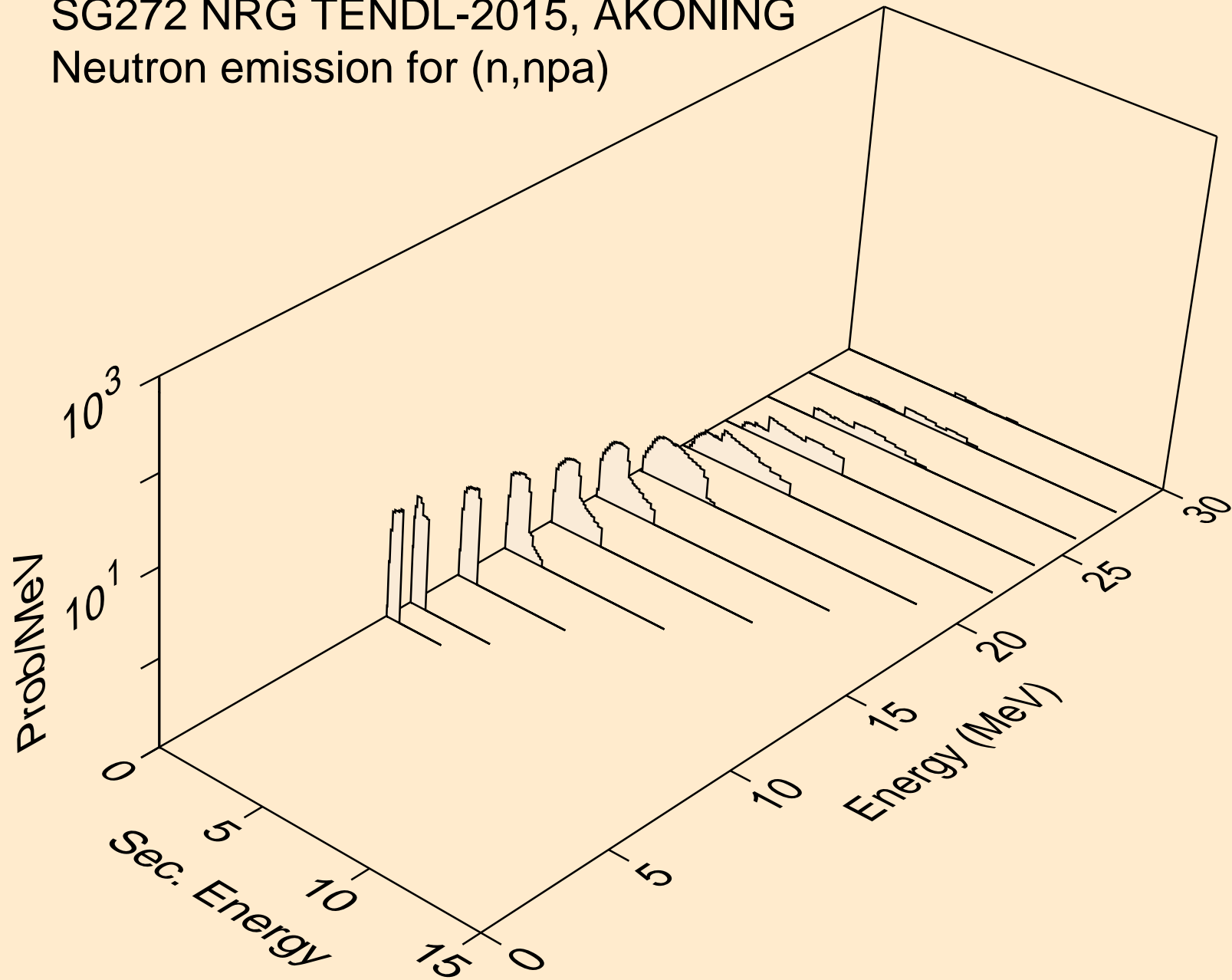

SG272 NRG TENDL-2015, AKONING
Neutron emission for (n,n*c)

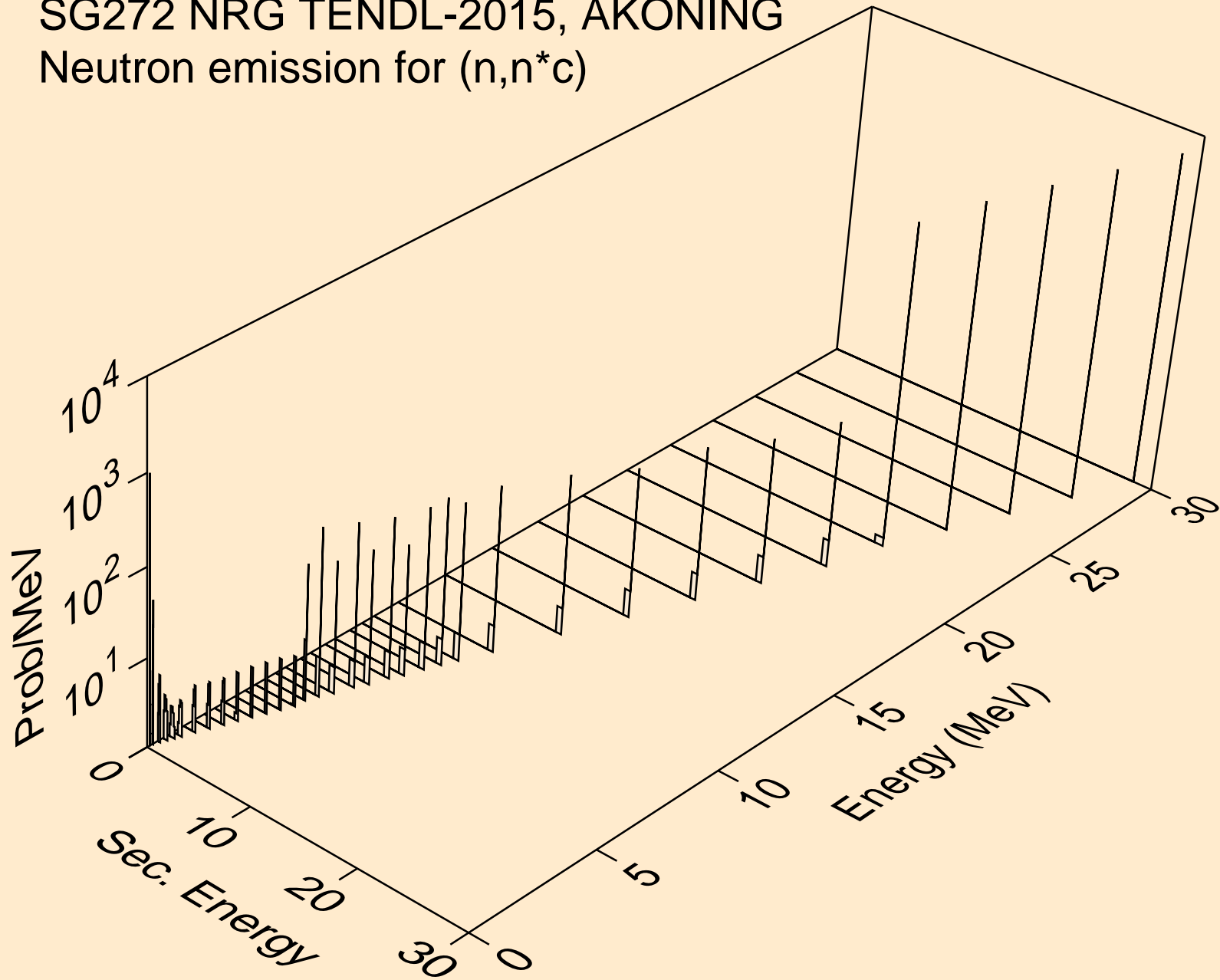

SG272 NRG TENDL-2015, AKONING

Delayed nubar

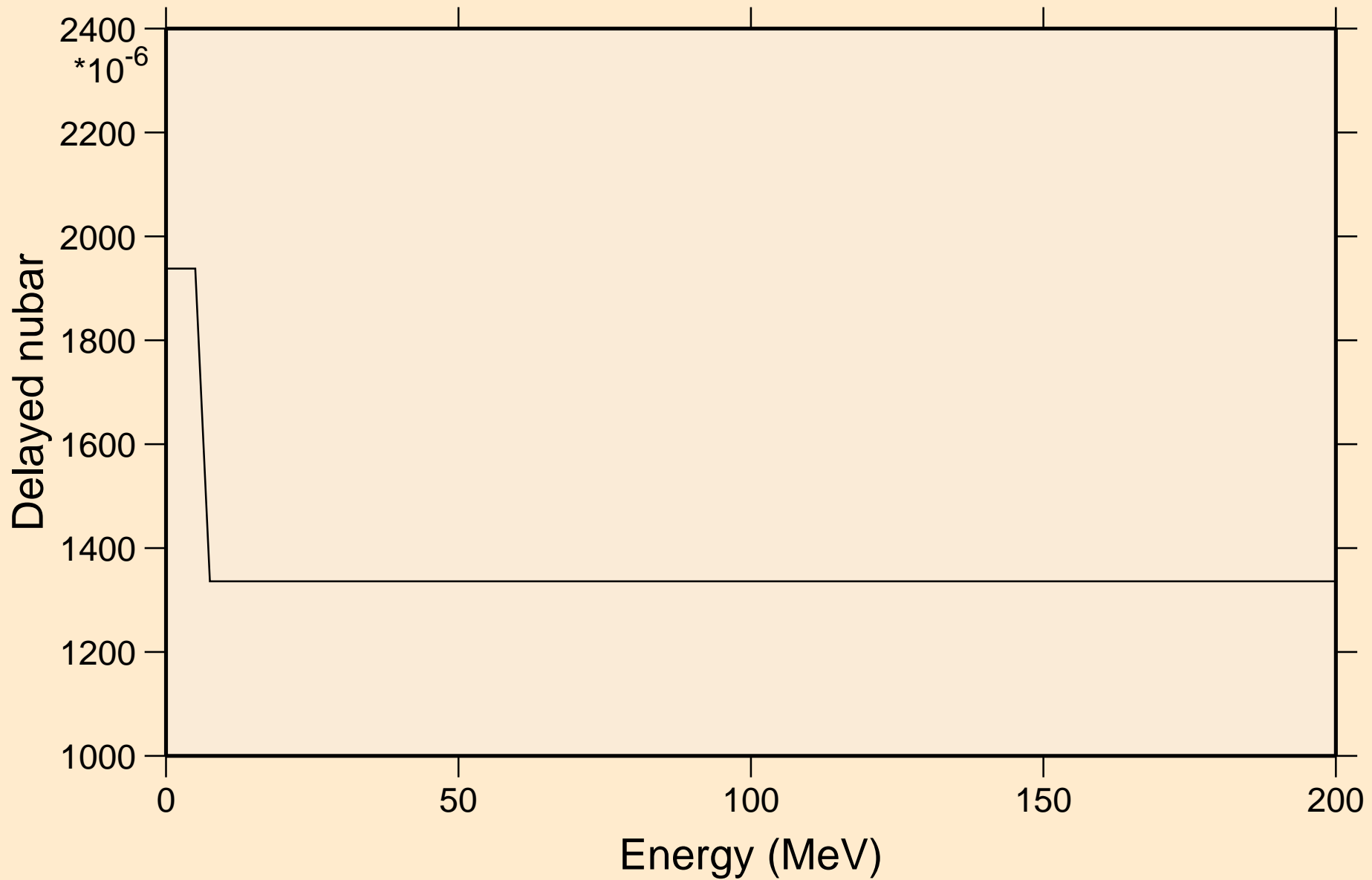

SG272 NRG TENDL-2015, AKONING

Delayed neutron spectra

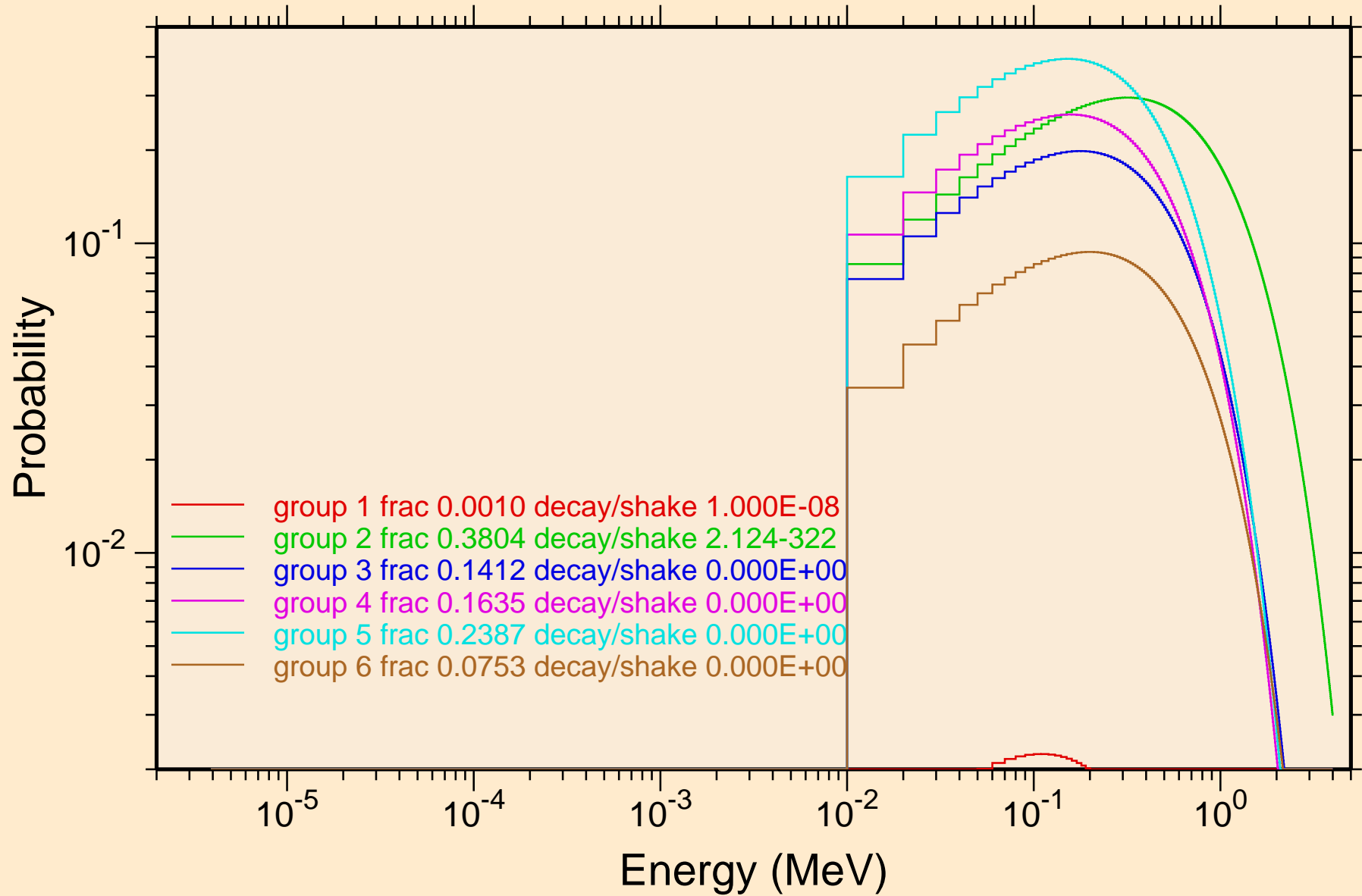

SG272 NRG TENDL-2015, AKONING
Photon emission for (n,x)

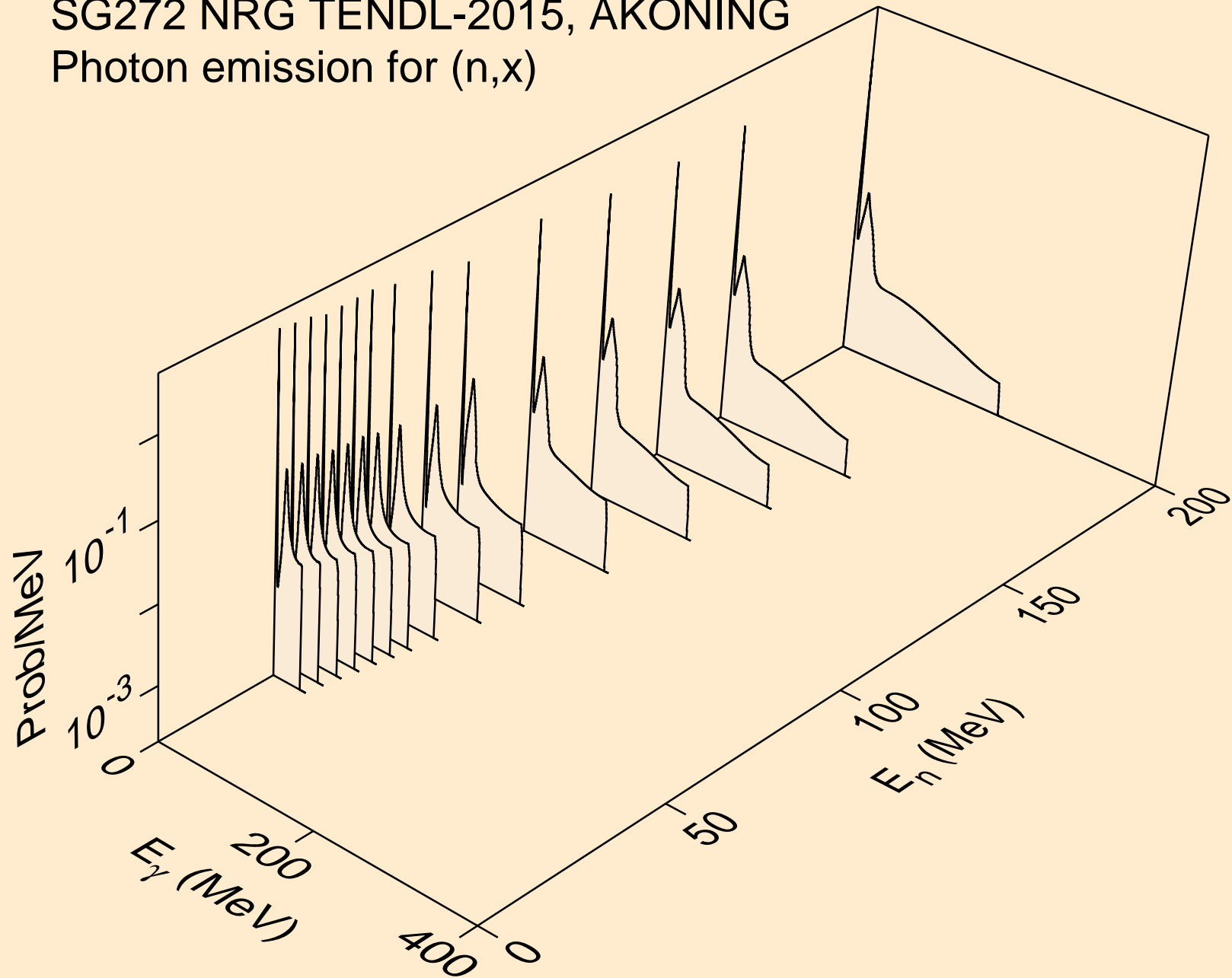

SG272 NRG TENDL-2015, AKONING
Photon emission for (n,2nd)

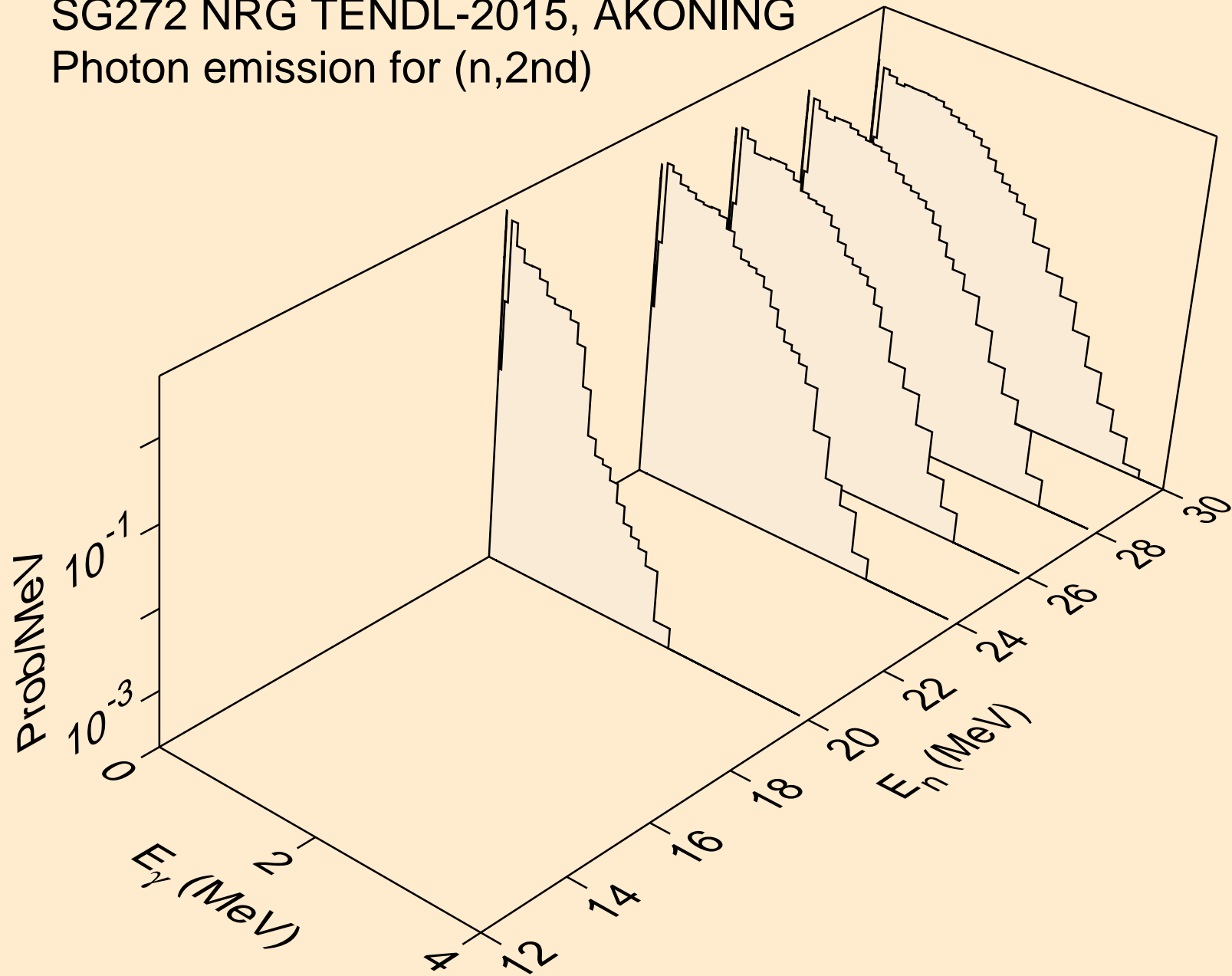

SG272 NRG TENDL-2015, AKONING
Photon emission for (n,2n)

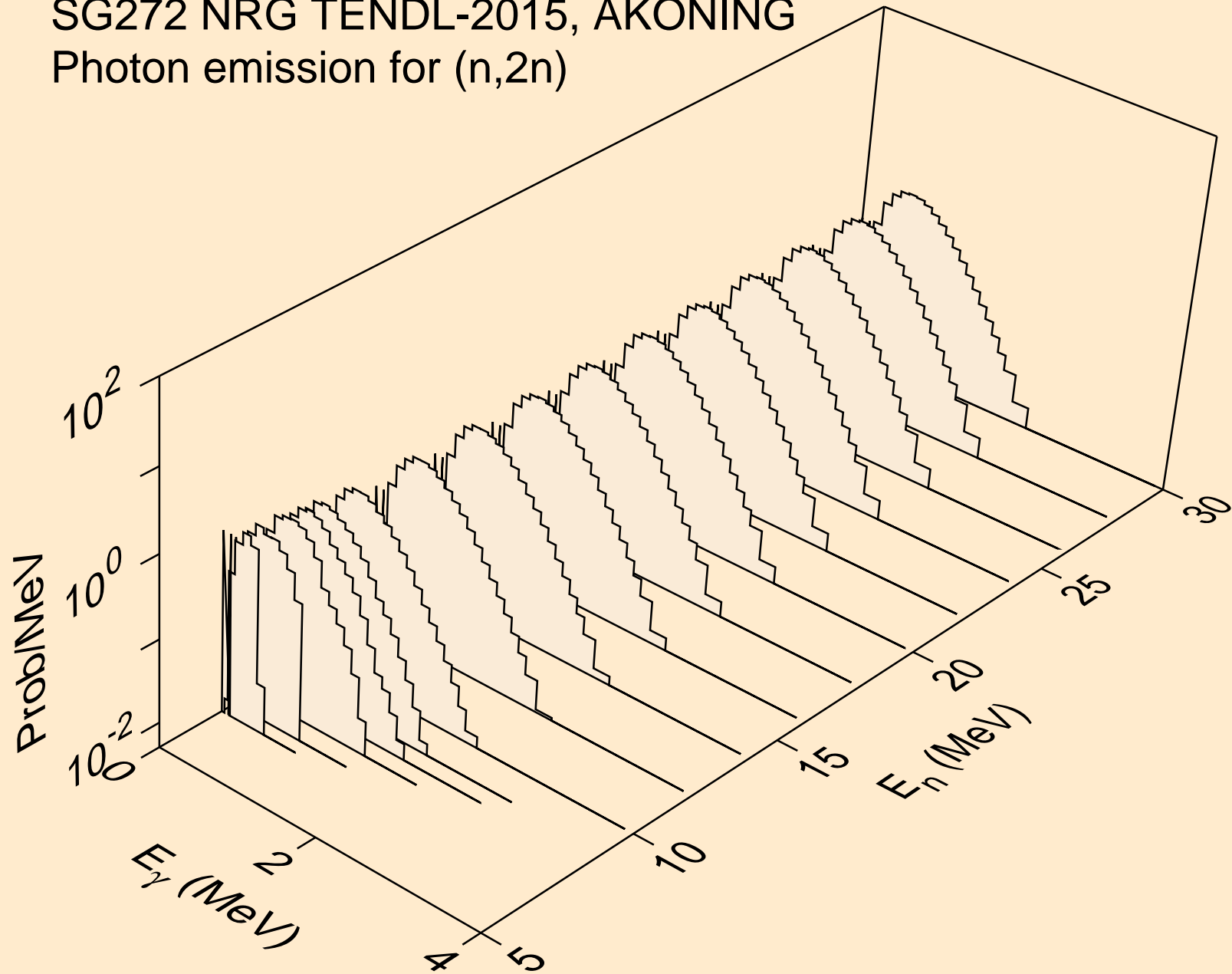

SG272 NRG TENDL-2015, AKONING
Photon emission for (n,3n)

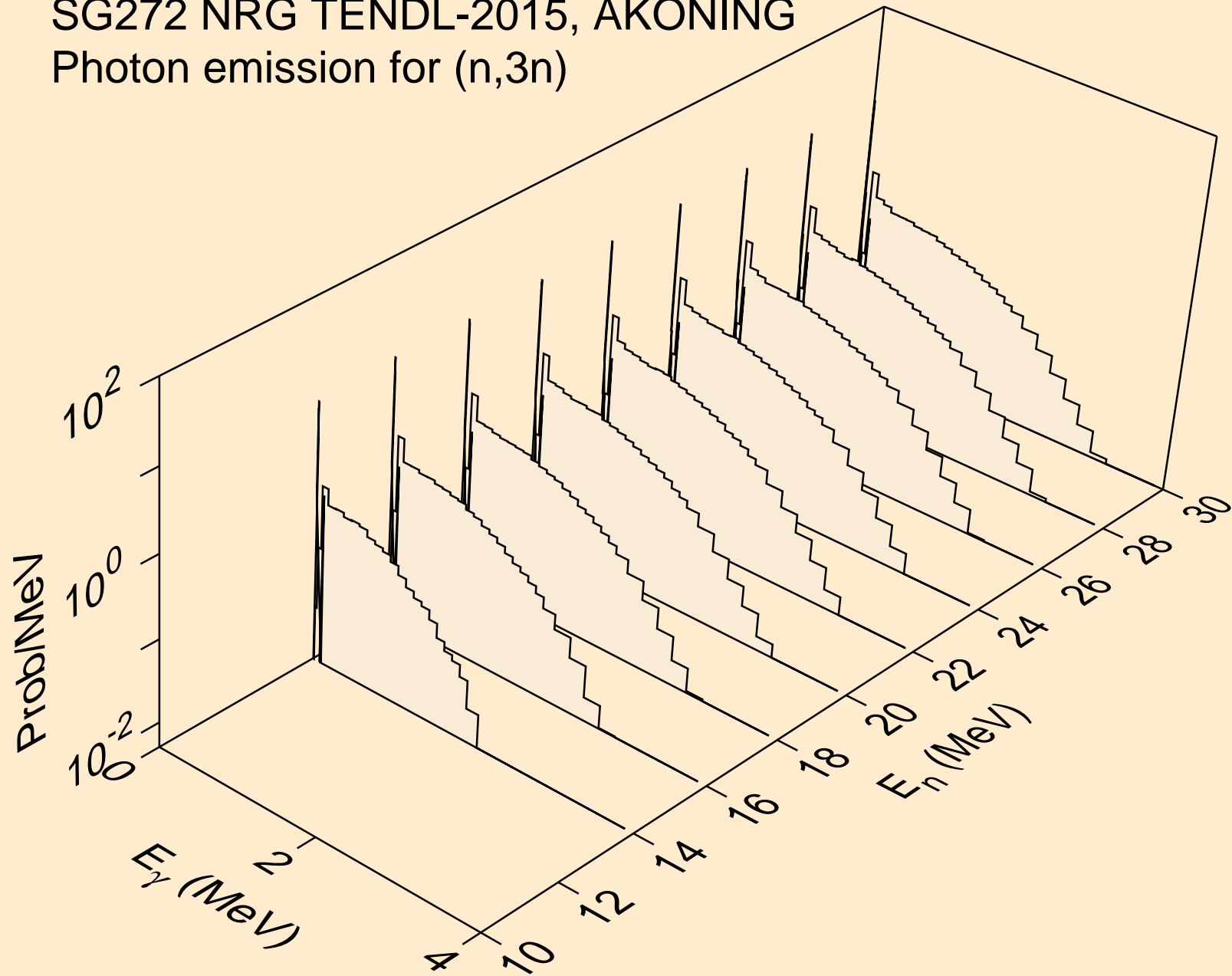

SG272 NRG TENDL-2015, AKONING
Photon emission for (n,n*)a

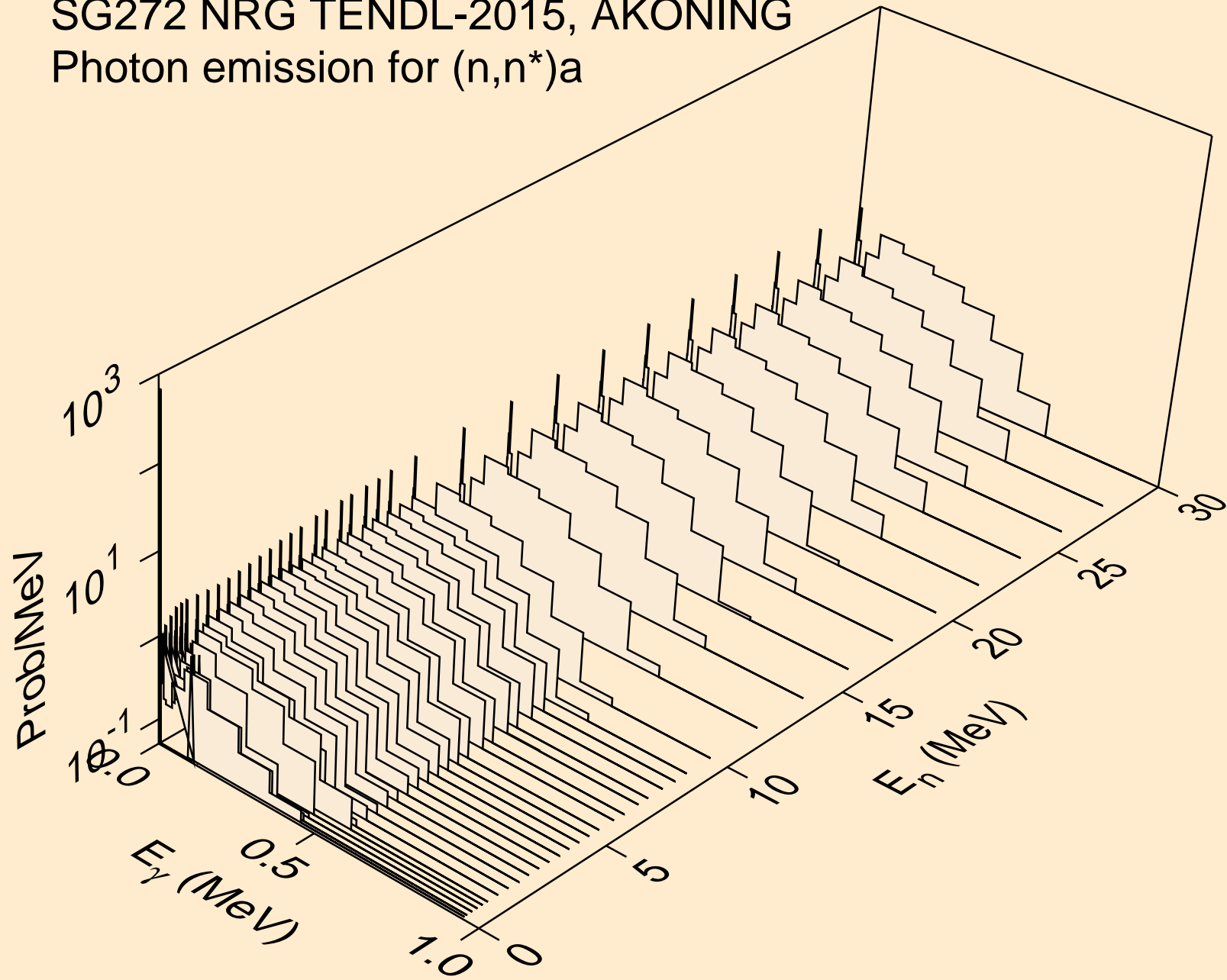

SG272 NRG TENDL-2015, AKONING
Photon emission for (n,n*)3a

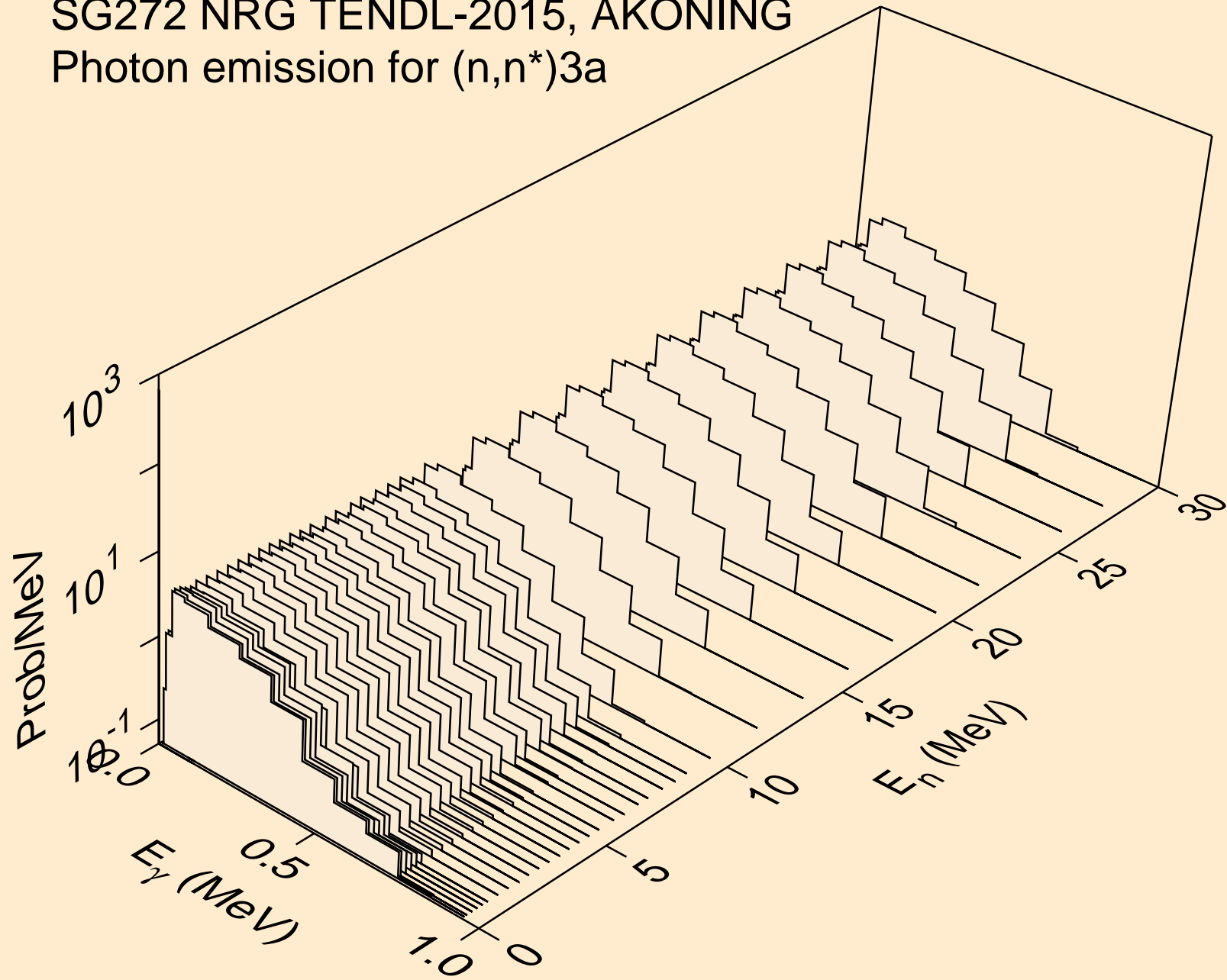

SG272 NRG TENDL-2015, AKONING
Photon emission for (n,2n)a

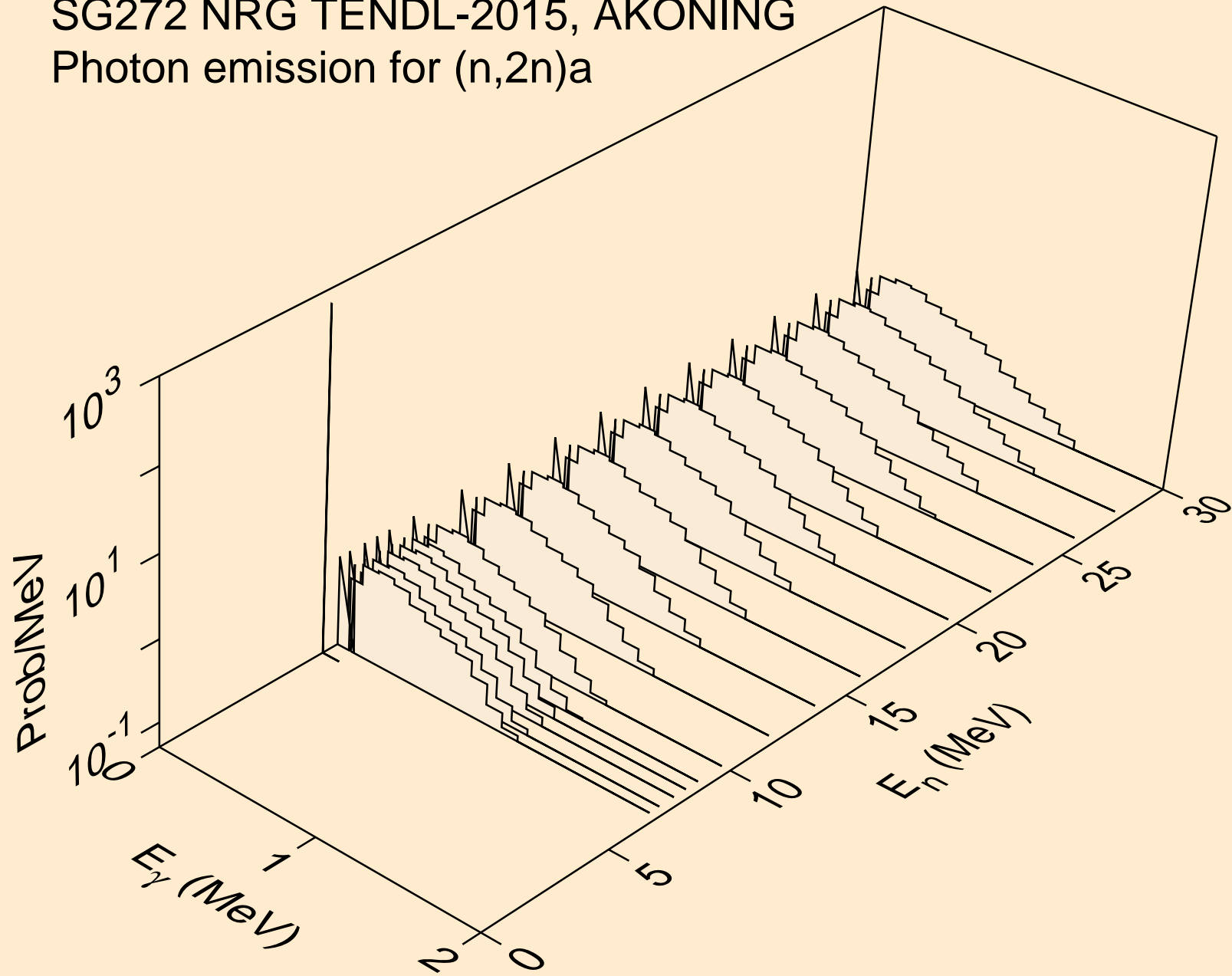

SG272 NRG TENDL-2015, AKONING
Photon emission for (n,3n)a

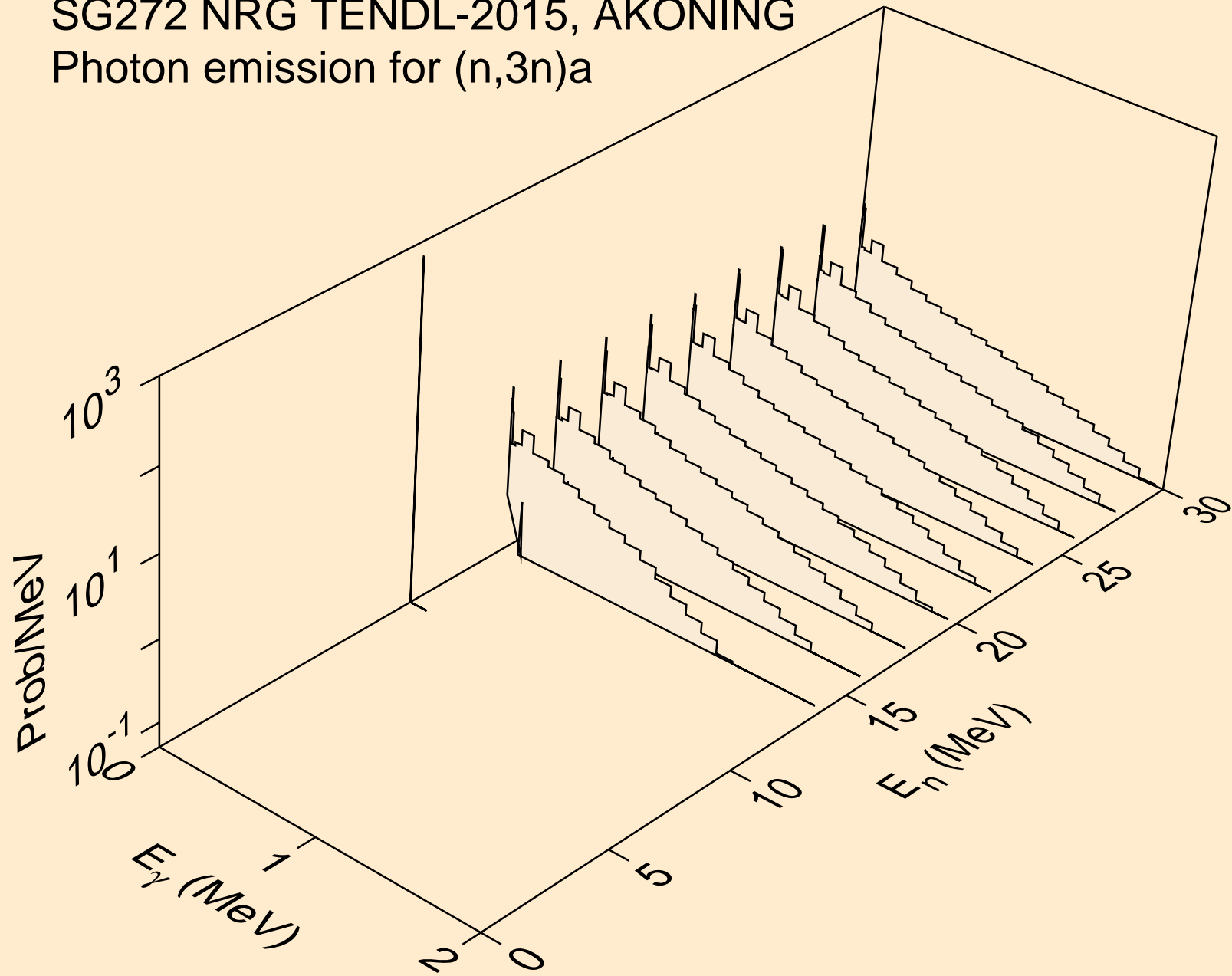

SG272 NRG TENDL-2015, AKONING

Photon emission for $(n,n^*)p$

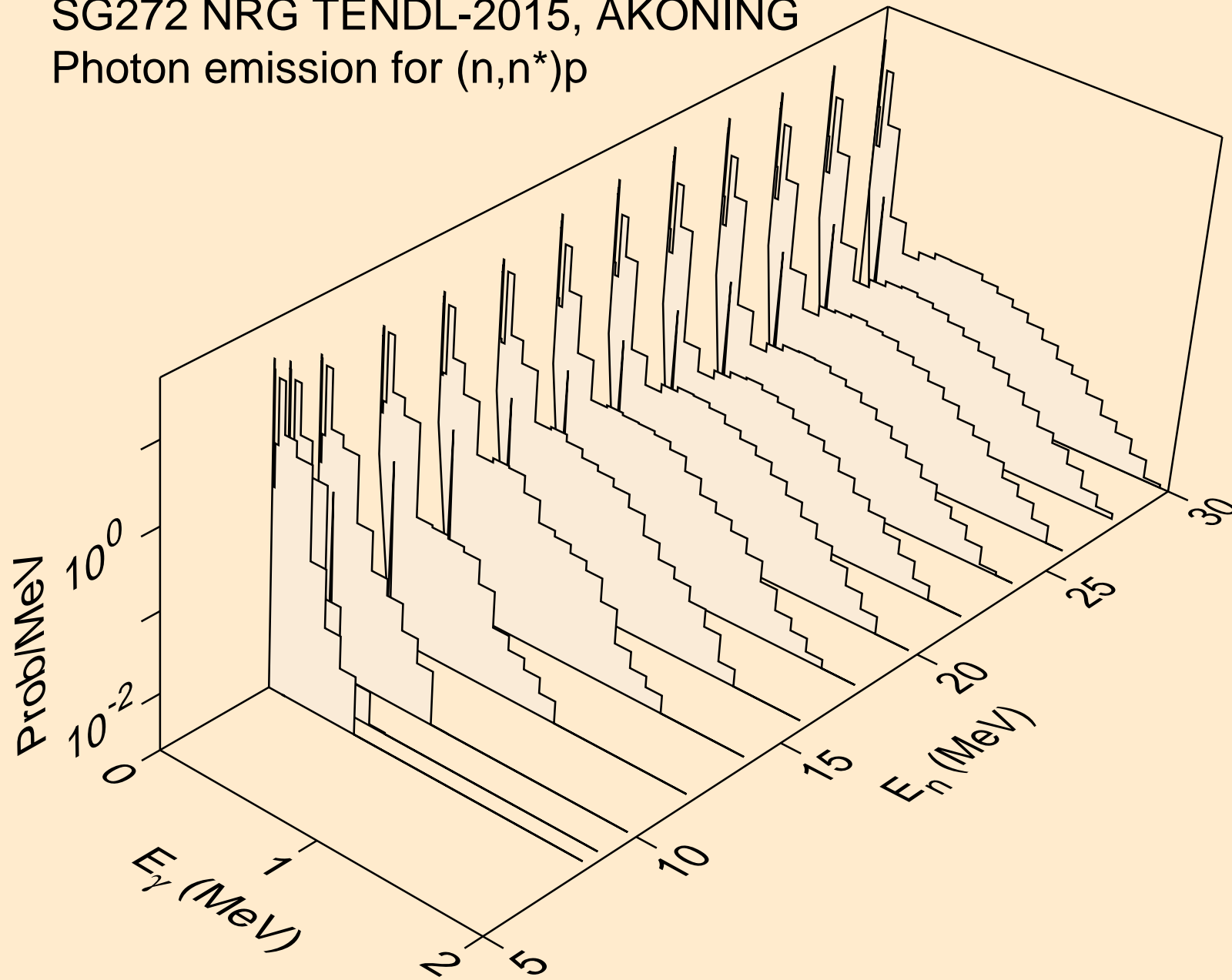

SG272 NRG TENDL-2015, AKONING
Photon emission for (n,n*)2a

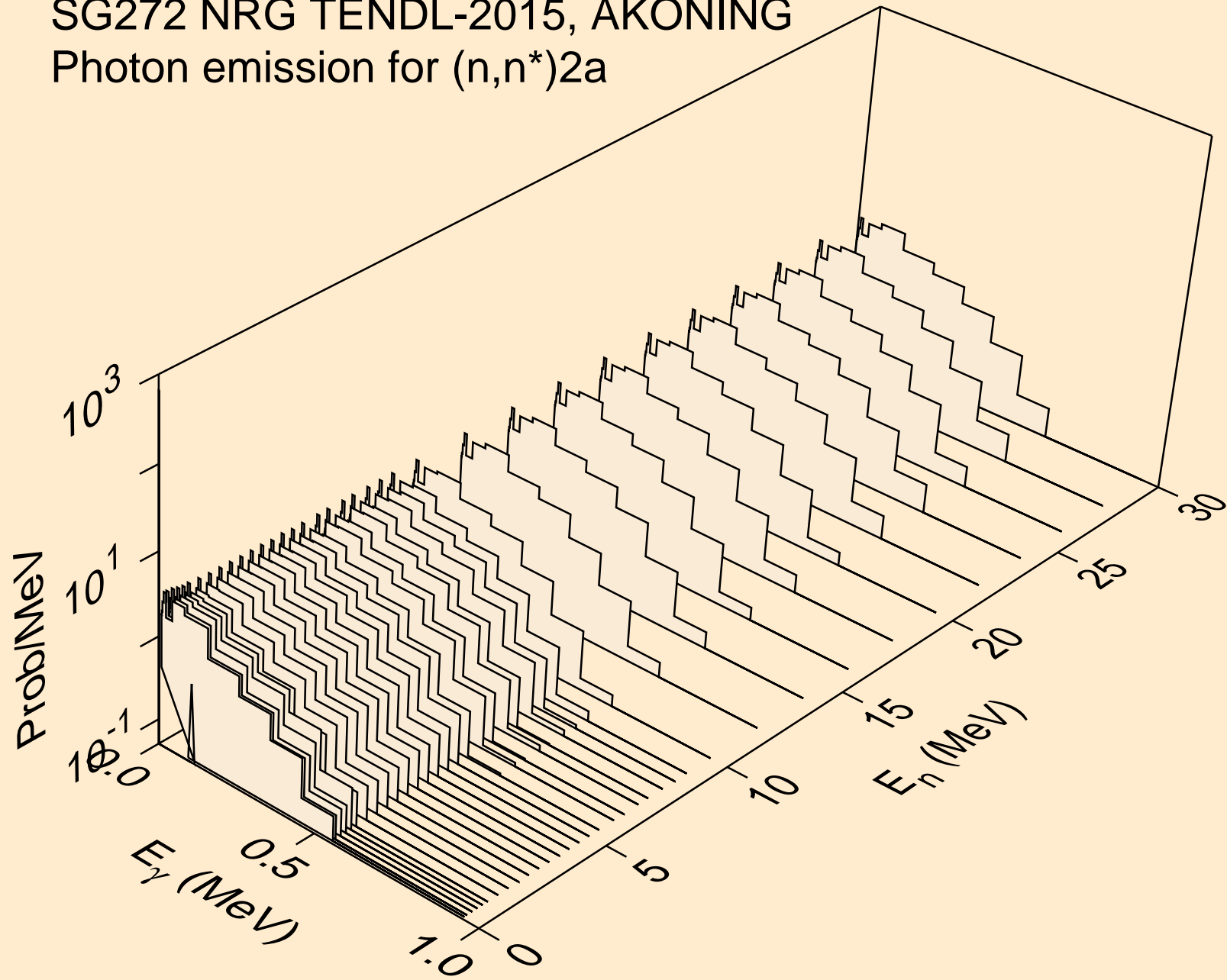

SG272 NRG TENDL-2015, AKONING
Photon emission for (n,2n)2a

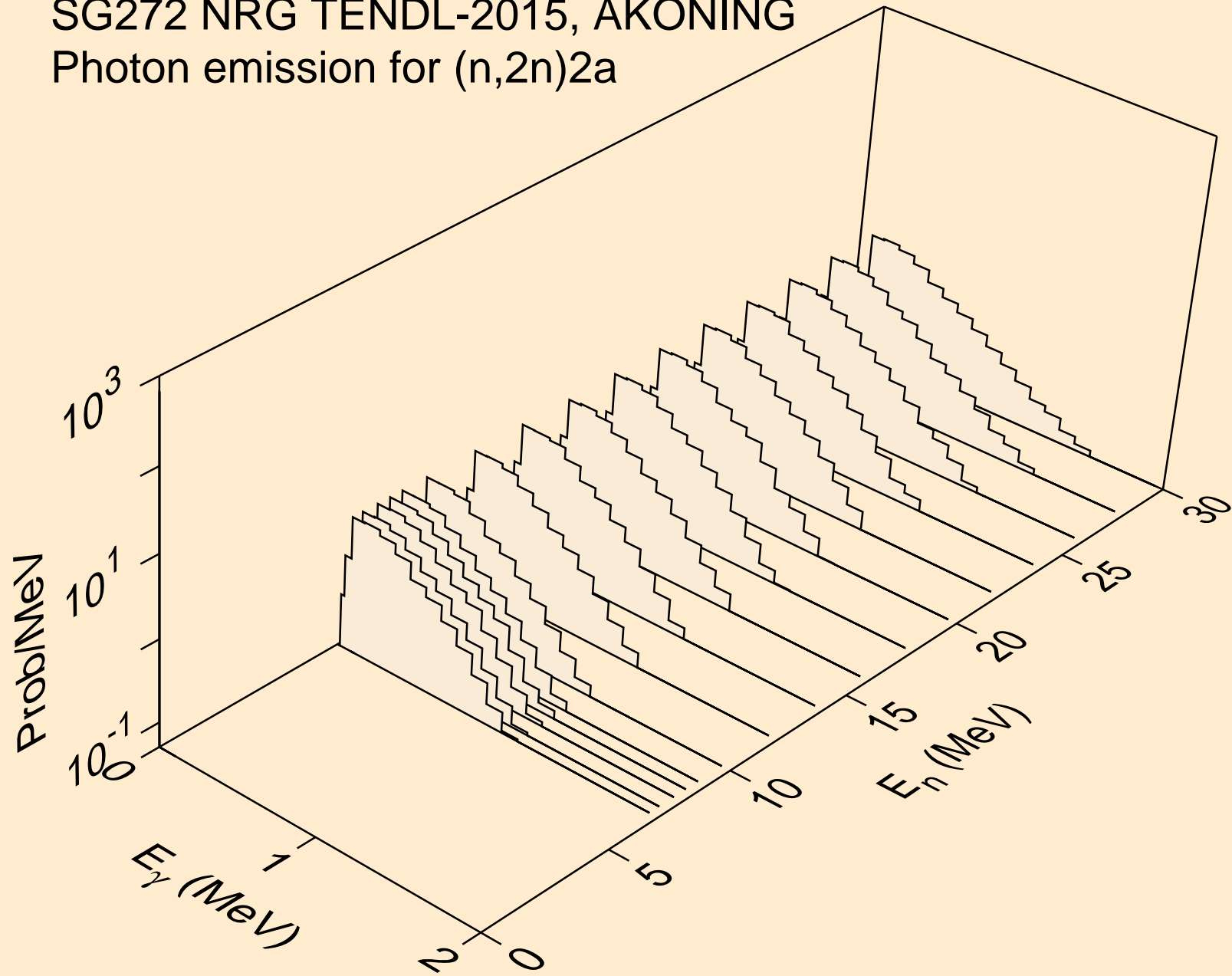

SG272 NRG TENDL-2015, AKONING
Photon emission for (n,n*)d

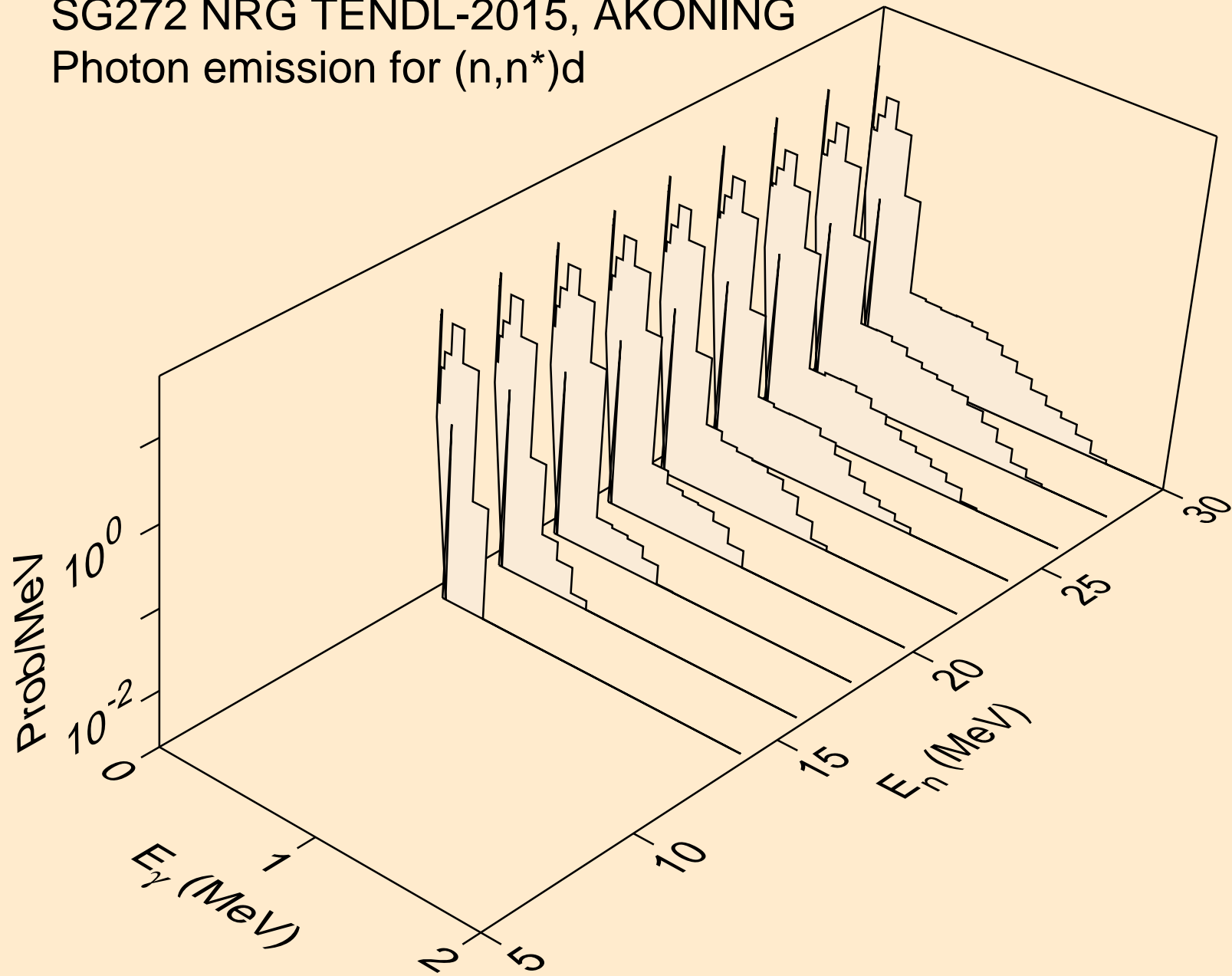

SG272 NRG TENDL-2015, AKONING
Photon emission for (n,n*)t

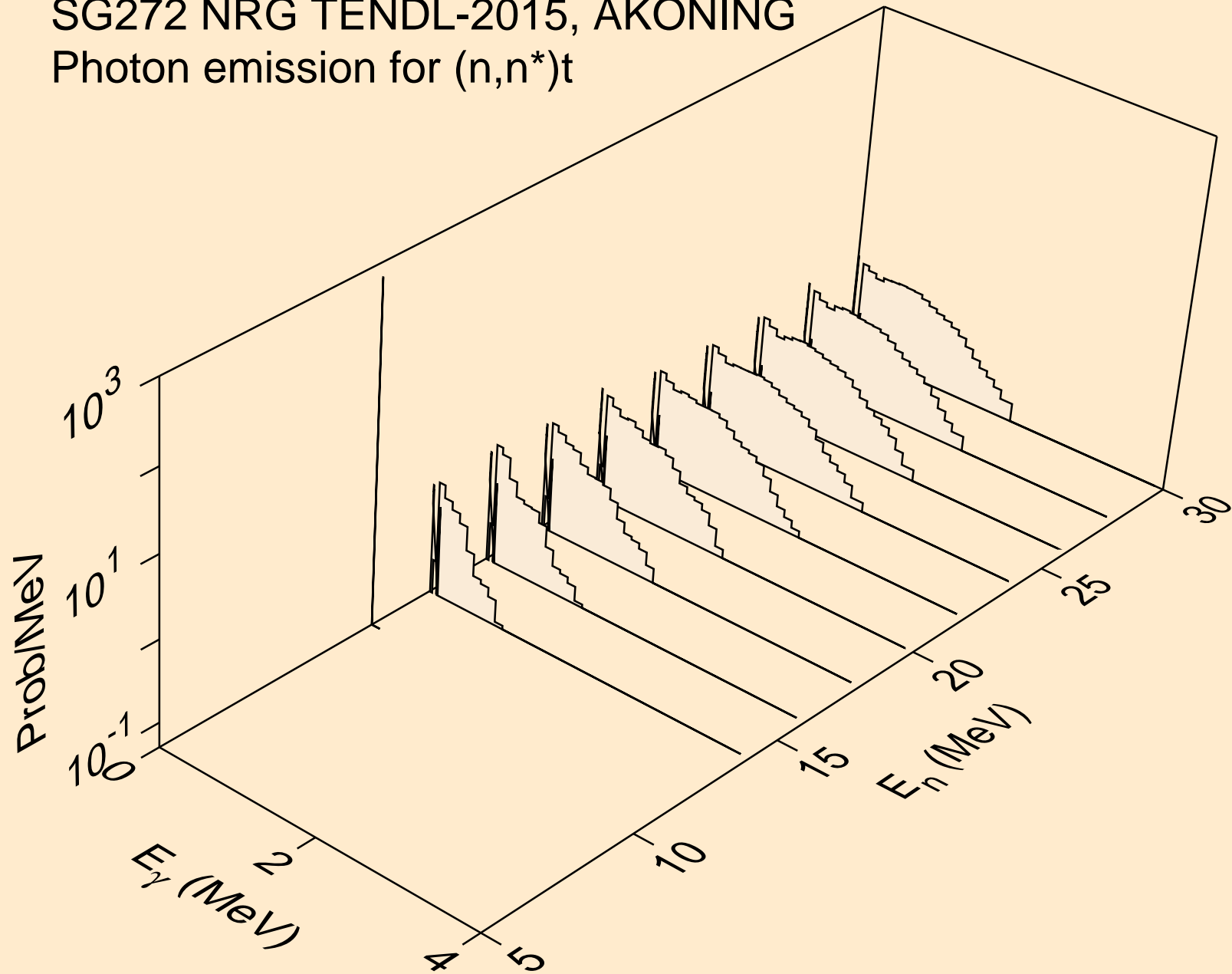

SG272 NRG TENDL-2015, AKONING
Photon emission for (n,n*)d2a

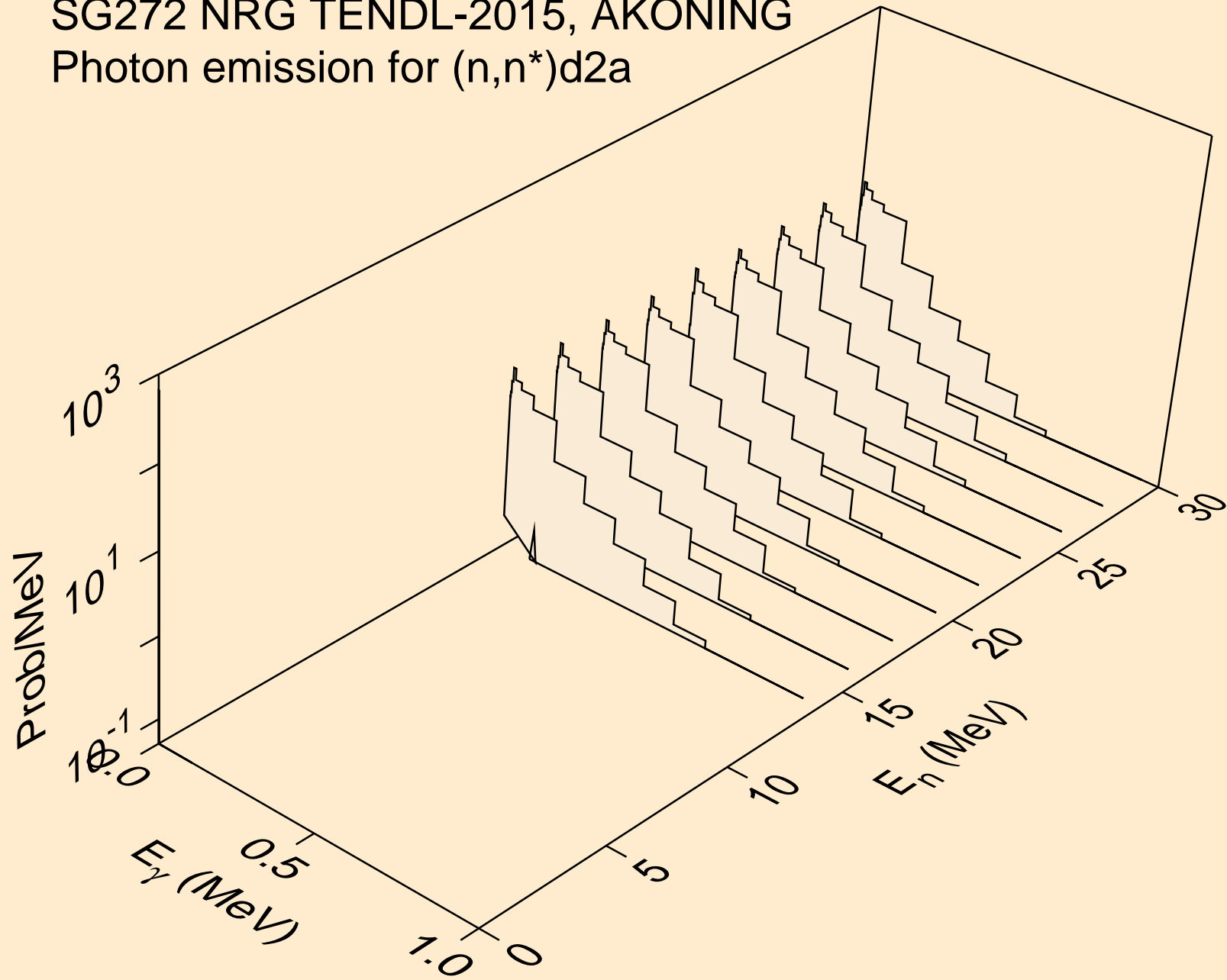

SG272 NRG TENDL-2015, AKONING
Photon emission for (n,n*)t2a

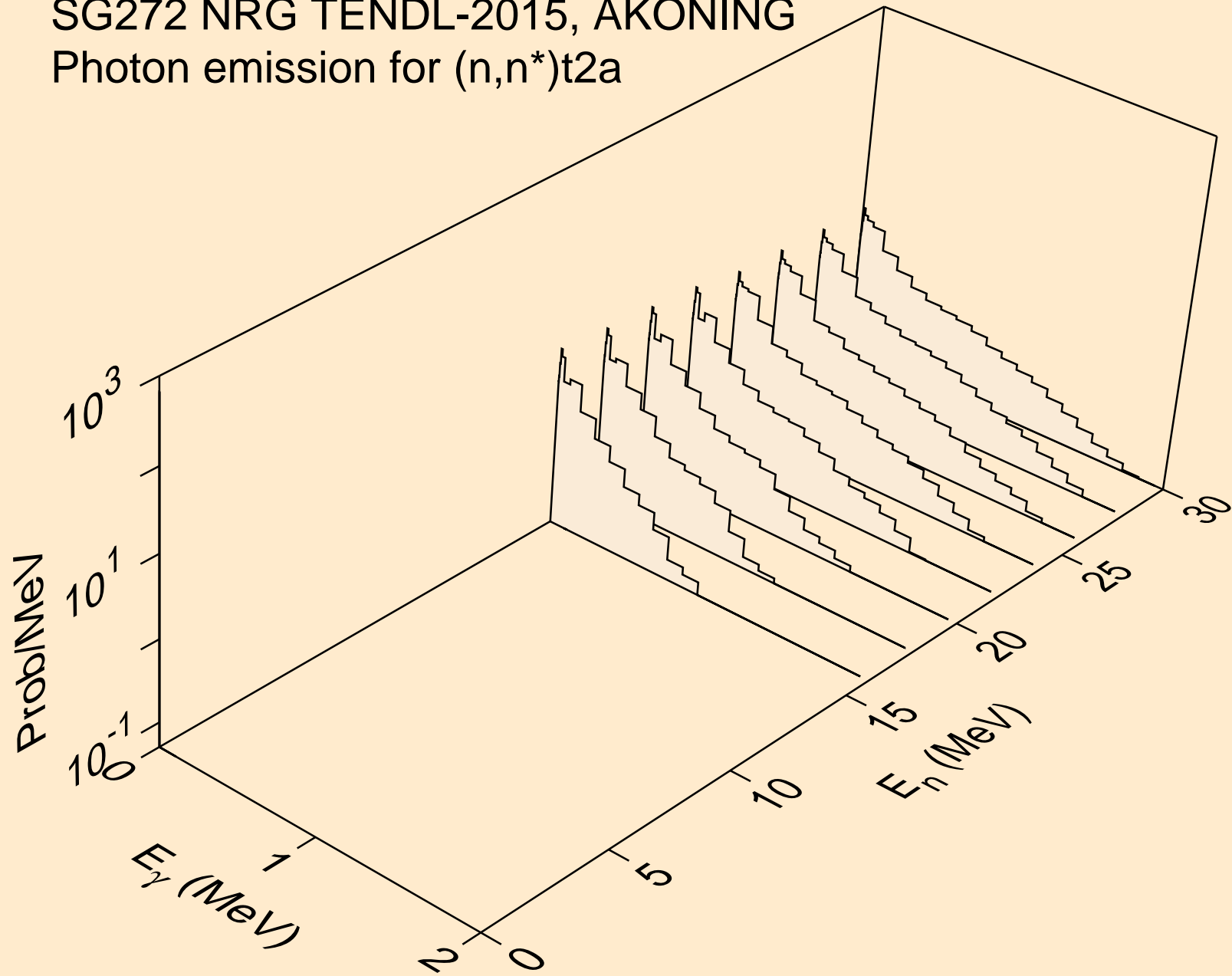

SG272 NRG TENDL-2015, AKONING
Photon emission for (n,4n)

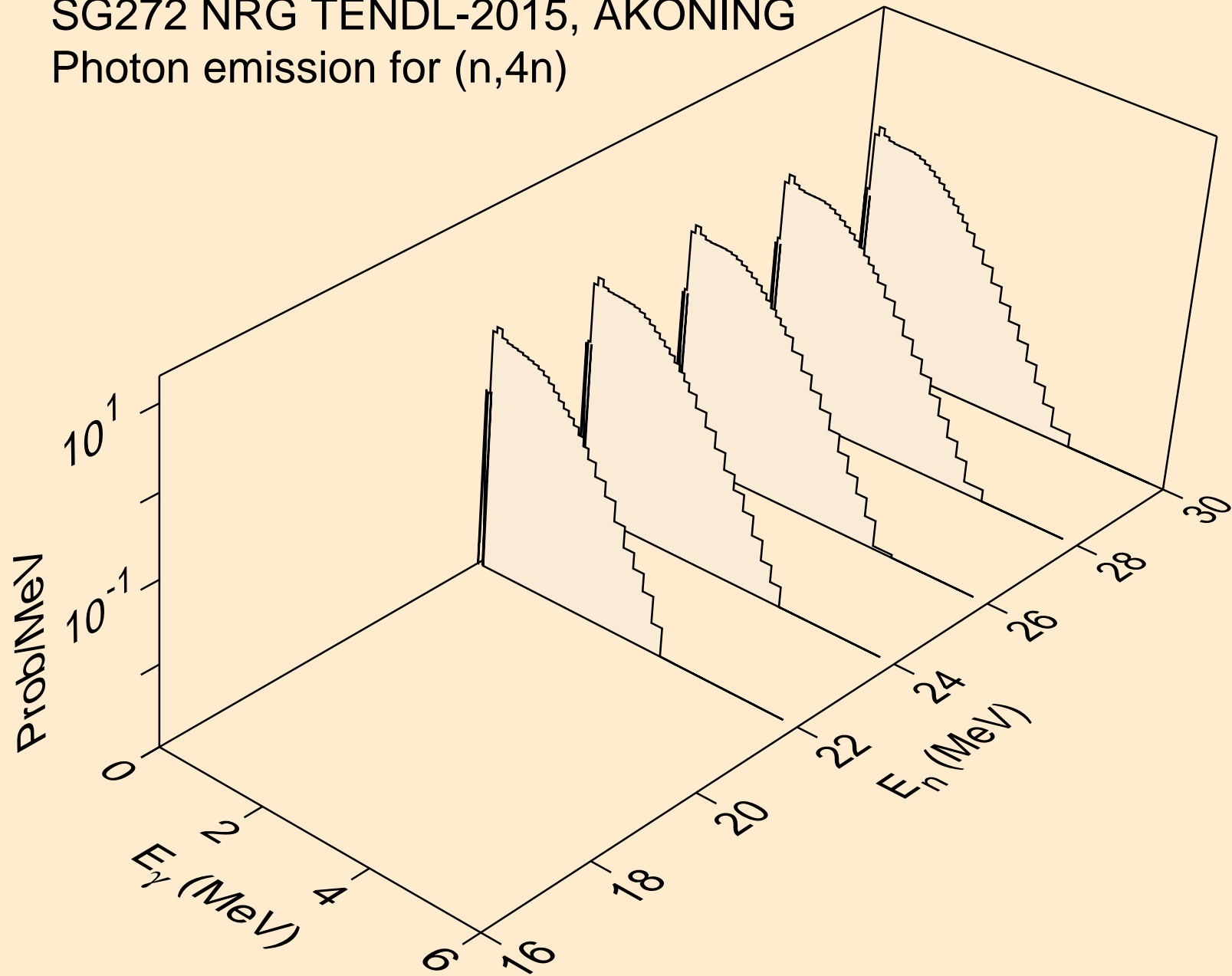

SG272 NRG TENDL-2015, AKONING
Photon emission for (n,2np)

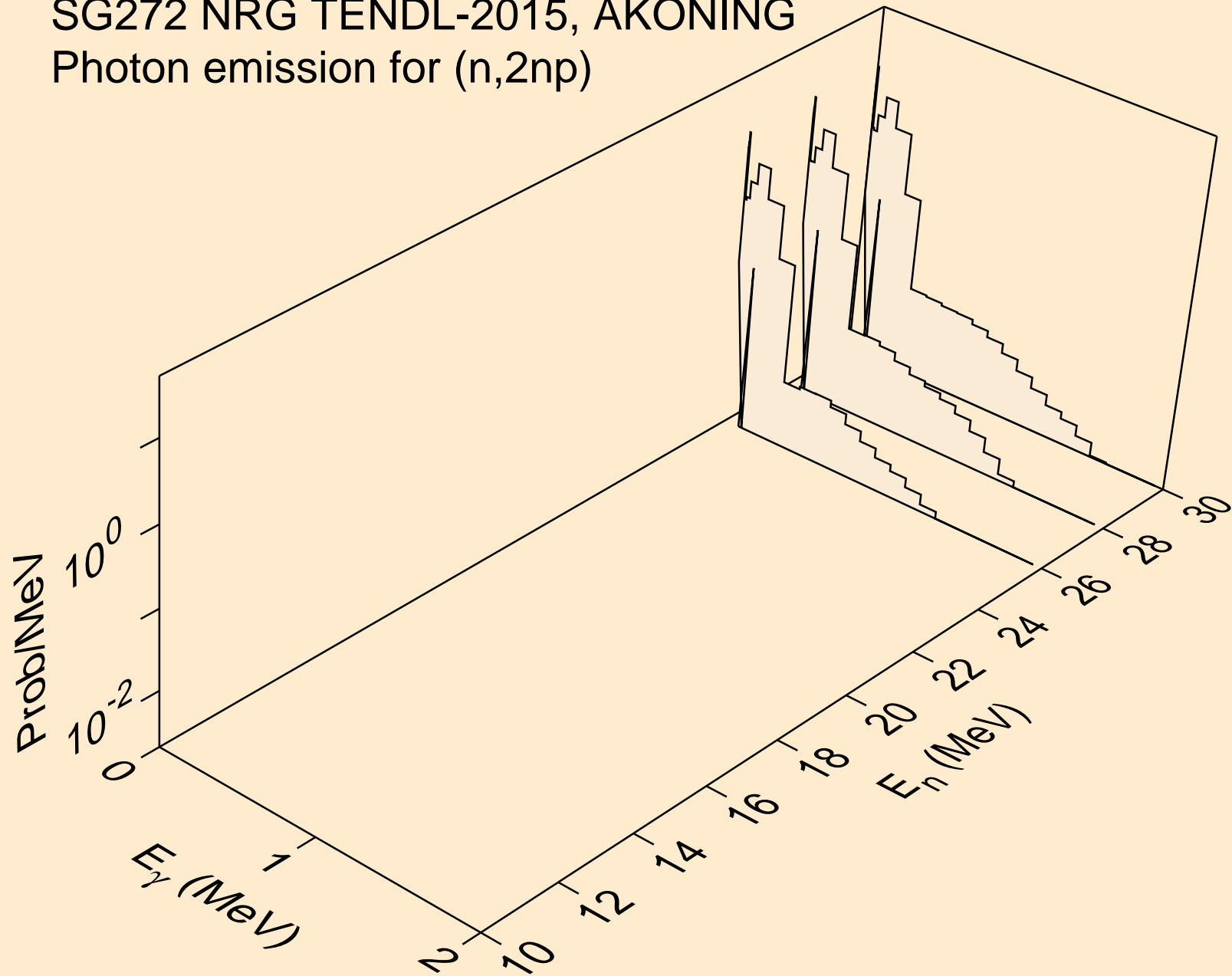

SG272 NRG TENDL-2015, AKONING
Photon emission for (n,npa)

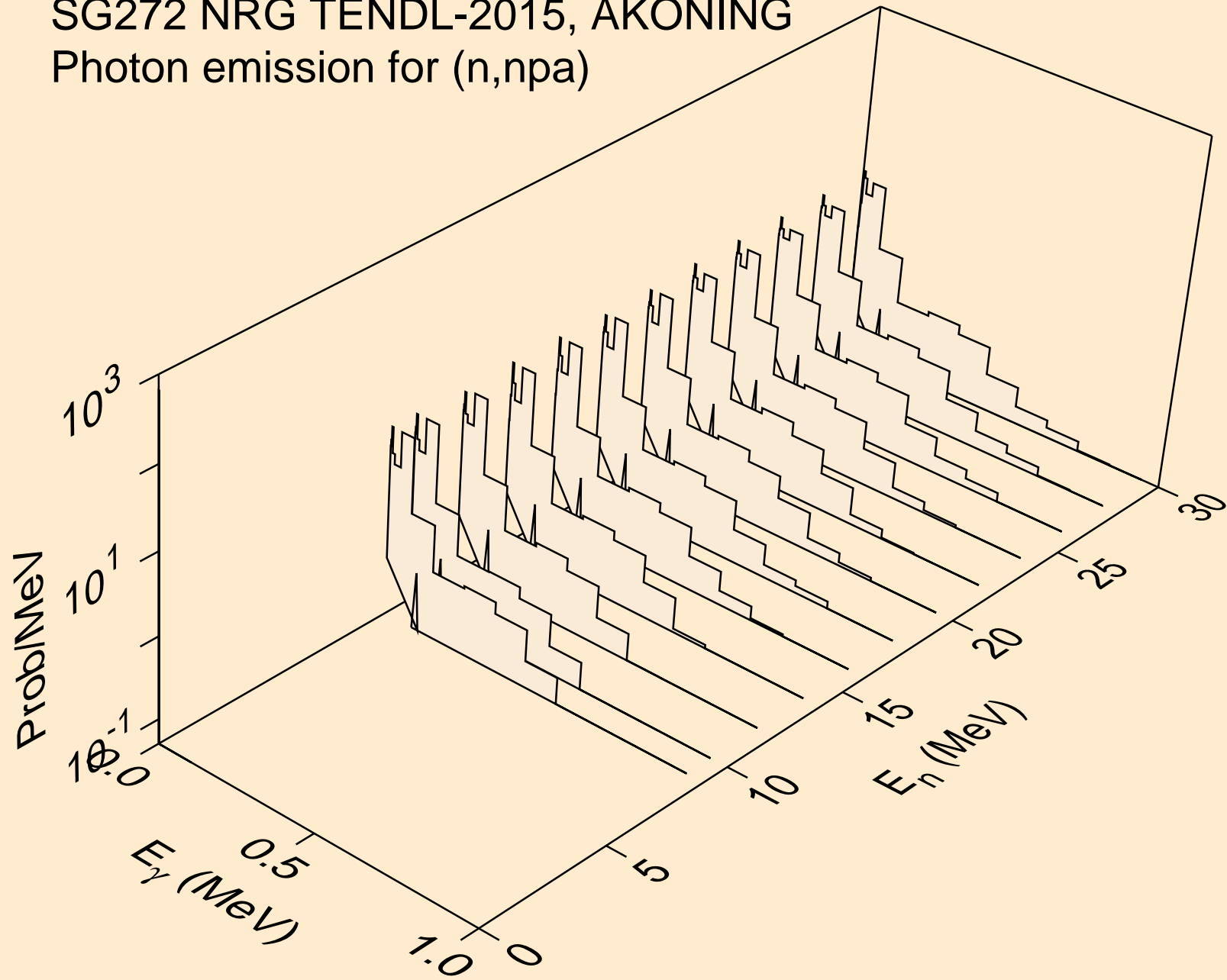

SG272 NRG TENDL-2015, AKONING
Photon emission for (n,n*c)

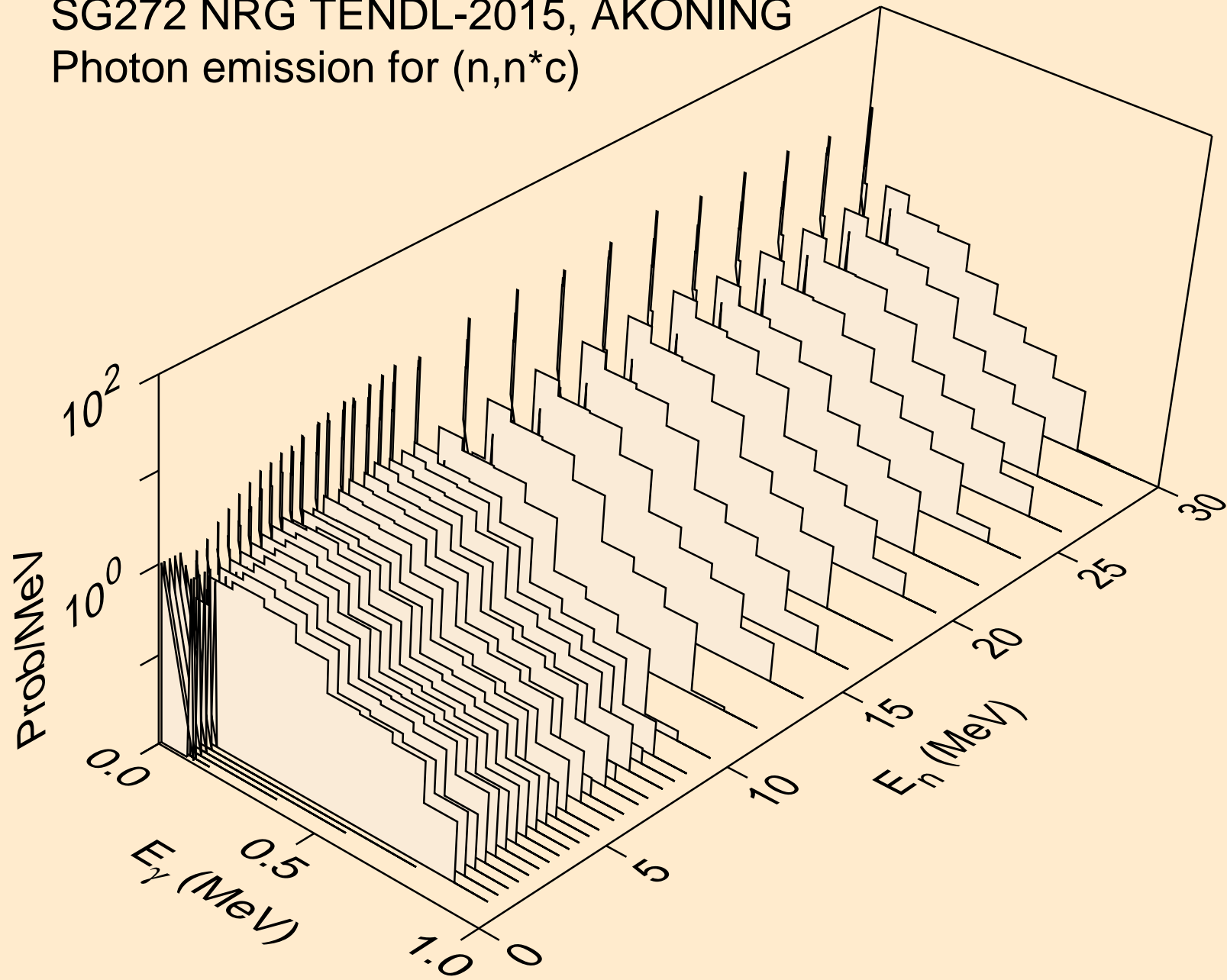

SG272 NRG TENDL-2015, AKONING
Photon emission for (n,gma)

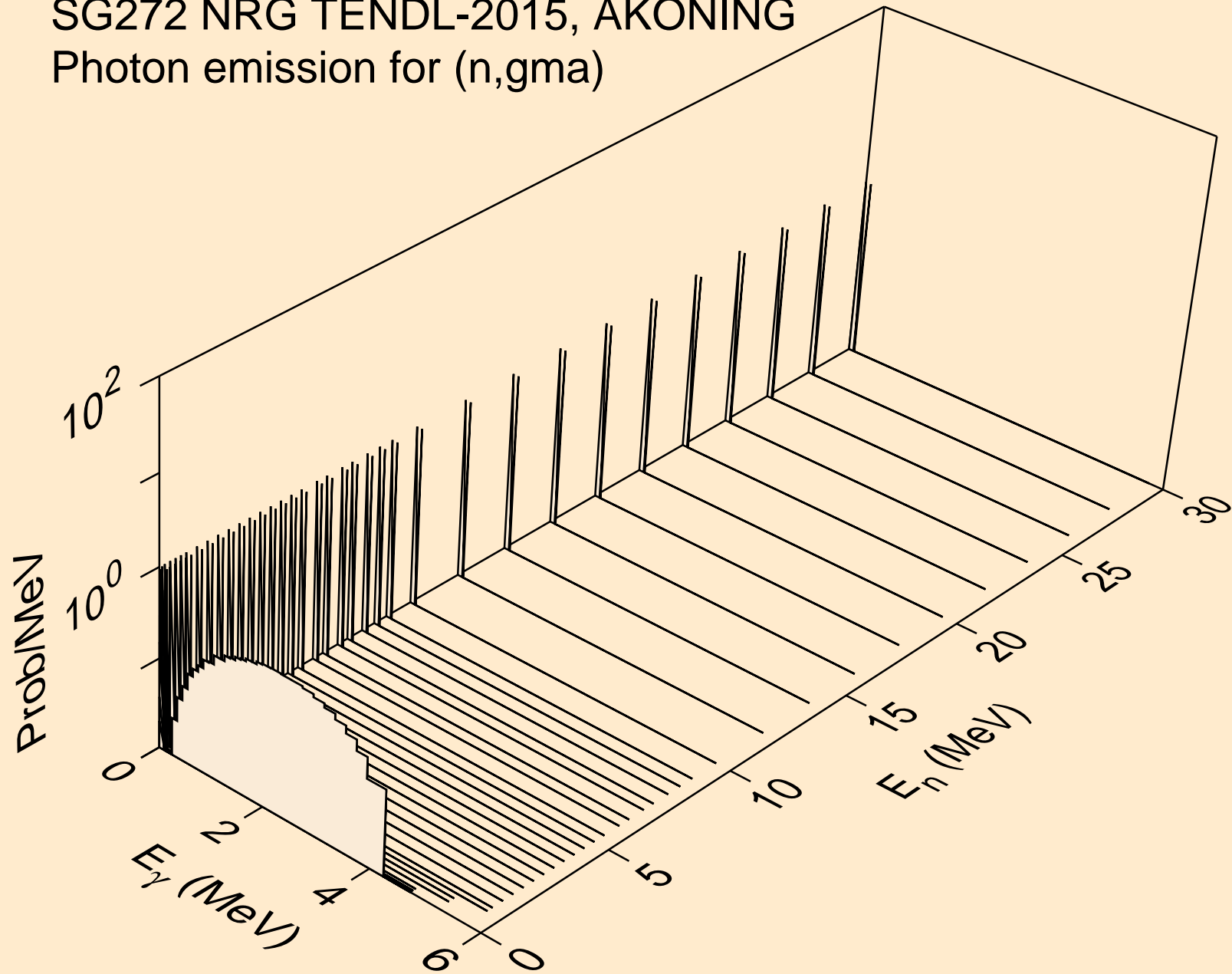

SG272 NRG TENDL-2015, AKONING
Photon emission for (n,p)

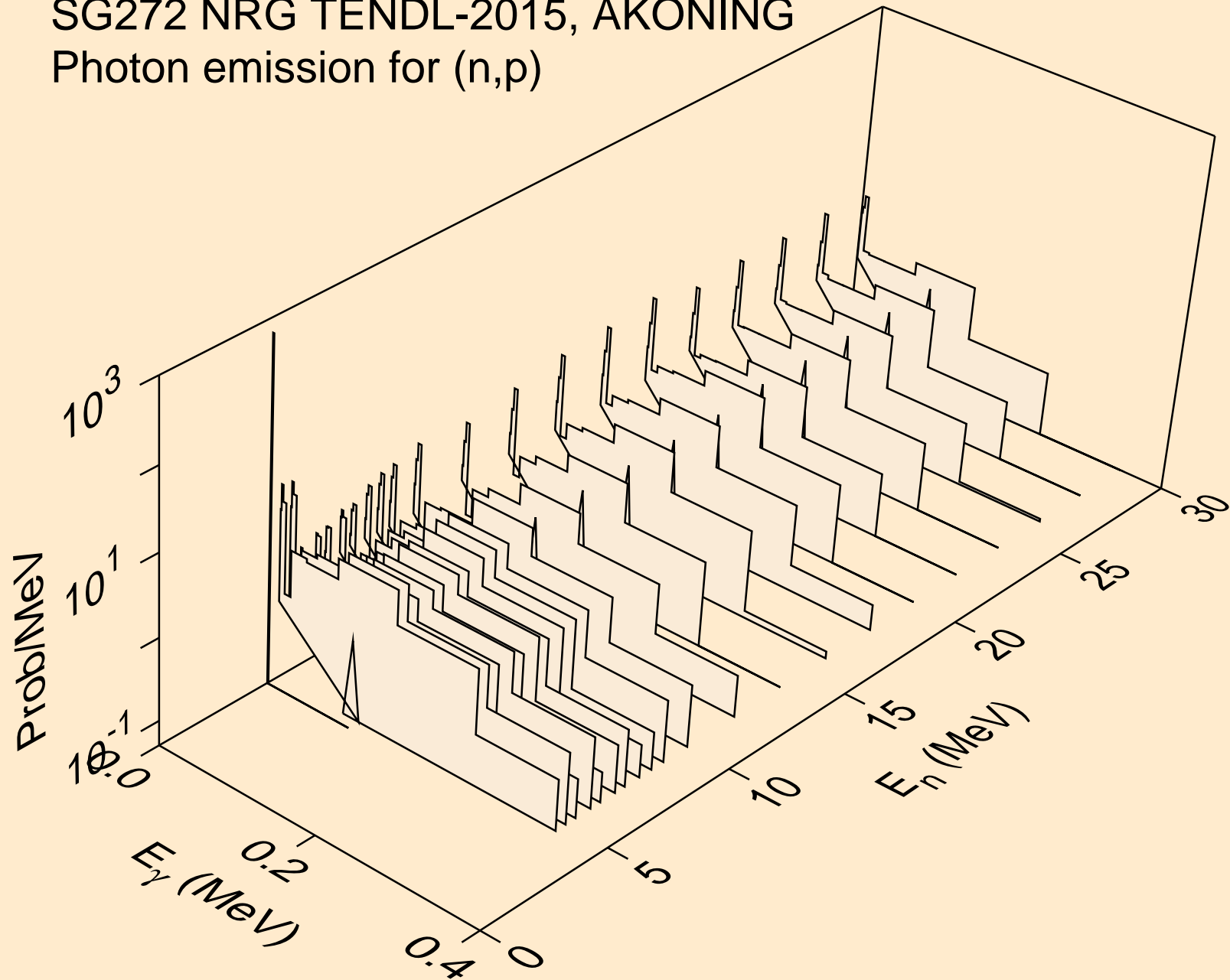

SG272 NRG TENDL-2015, AKONING
Photon emission for (n,d)

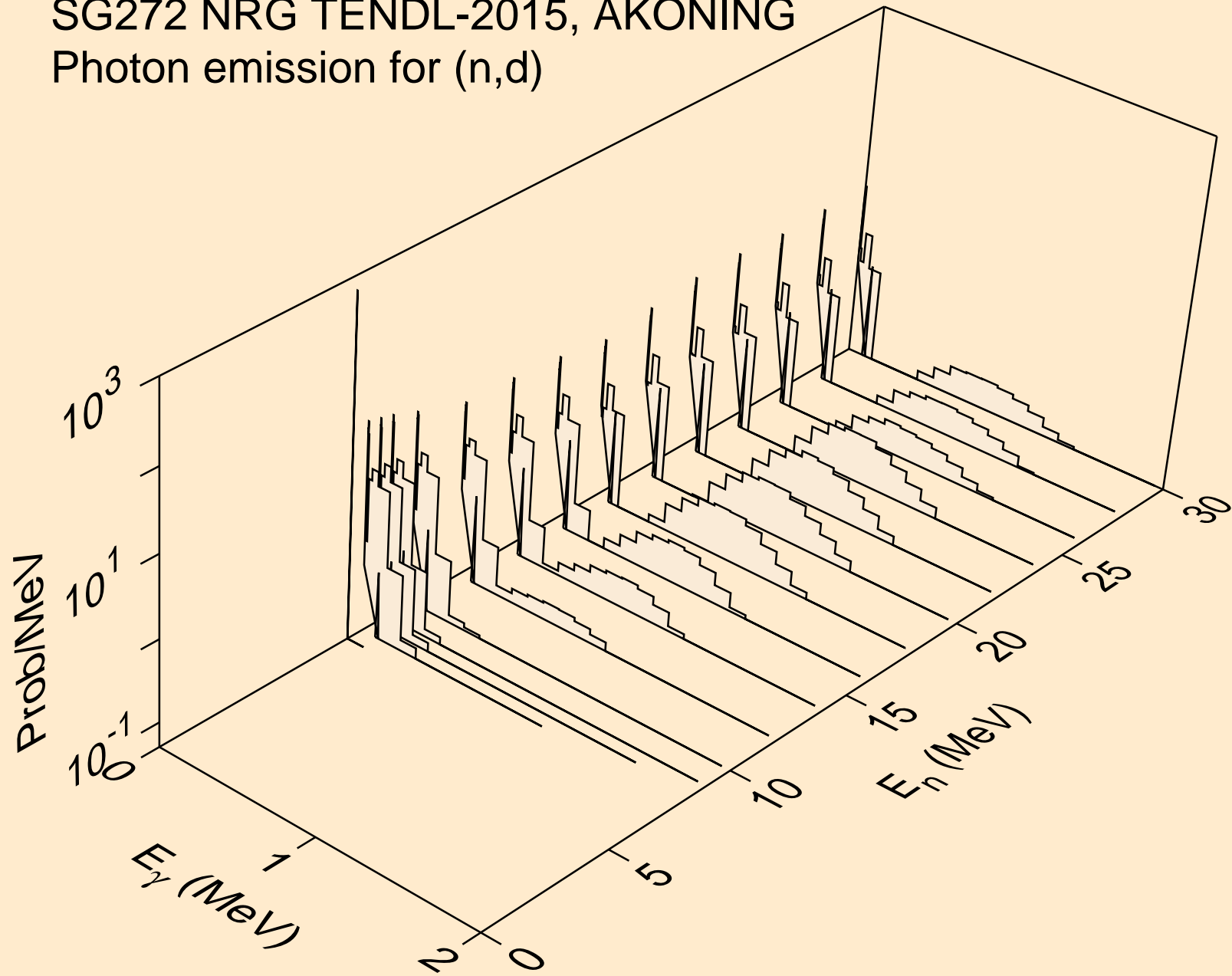

SG272 NRG TENDL-2015, AKONING
Photon emission for (n,t)

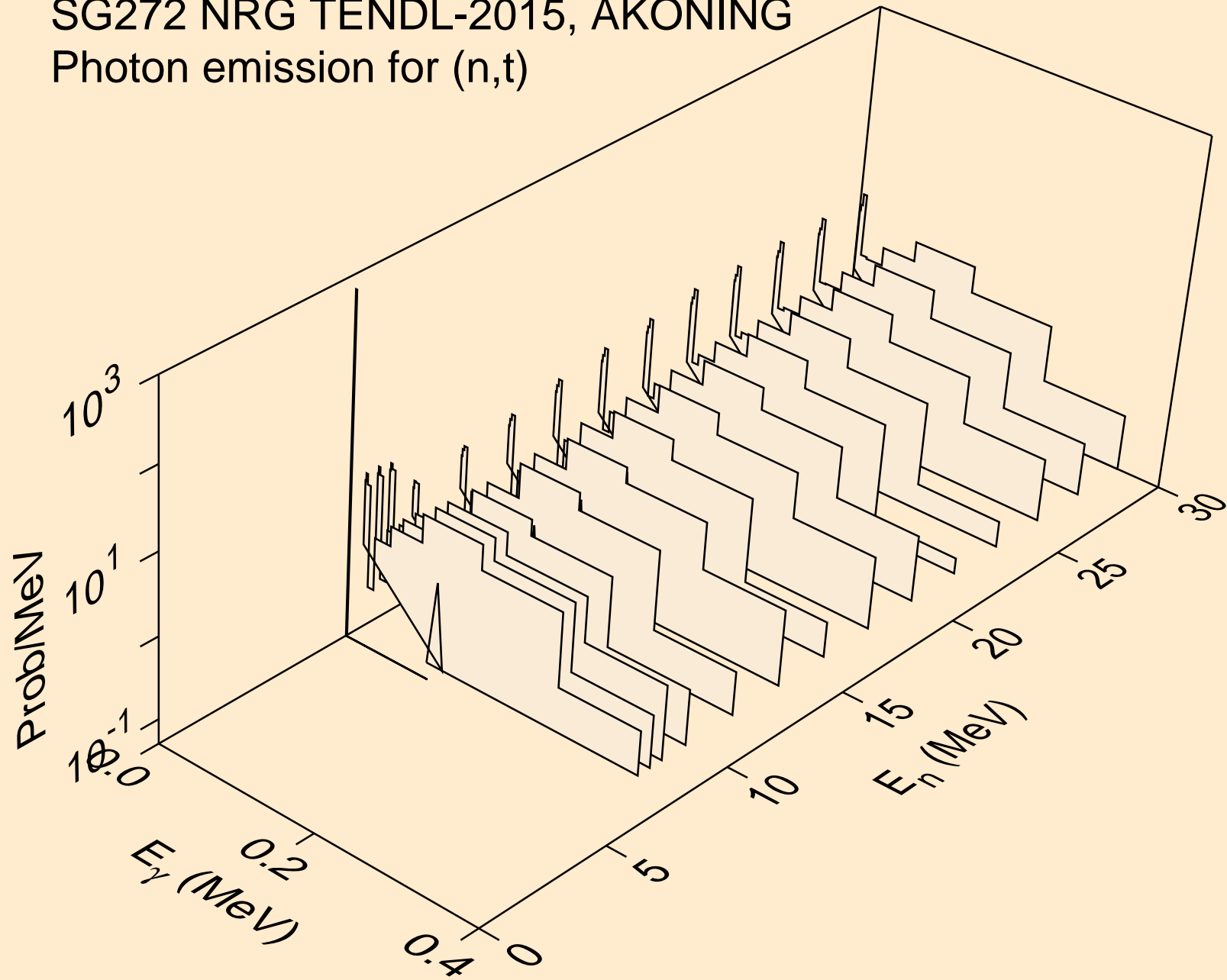

SG272 NRG TENDL-2015, AKONING
Photon emission for (n,he3)

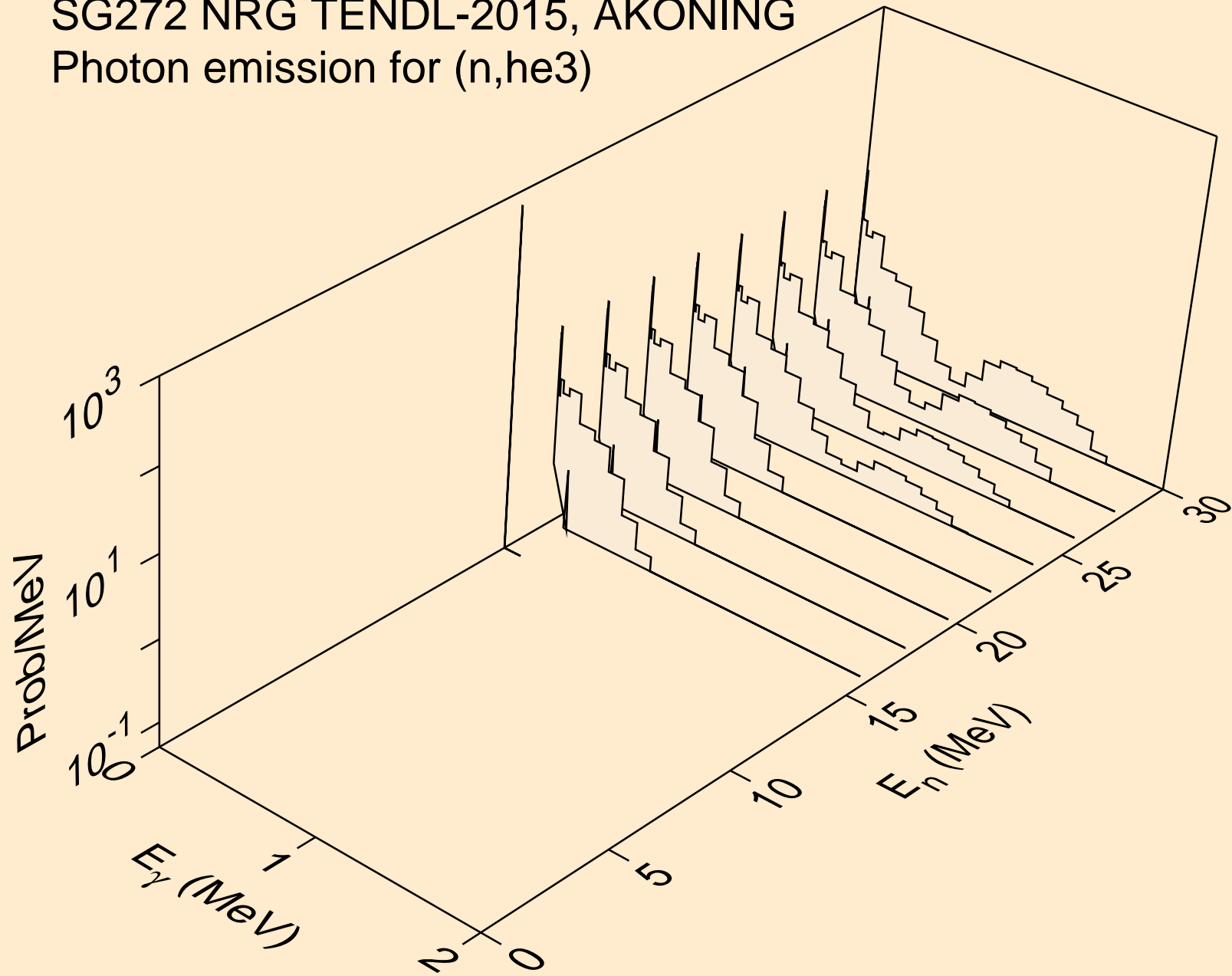

SG272 NRG TENDL-2015, AKONING
Photon emission for (n,a)

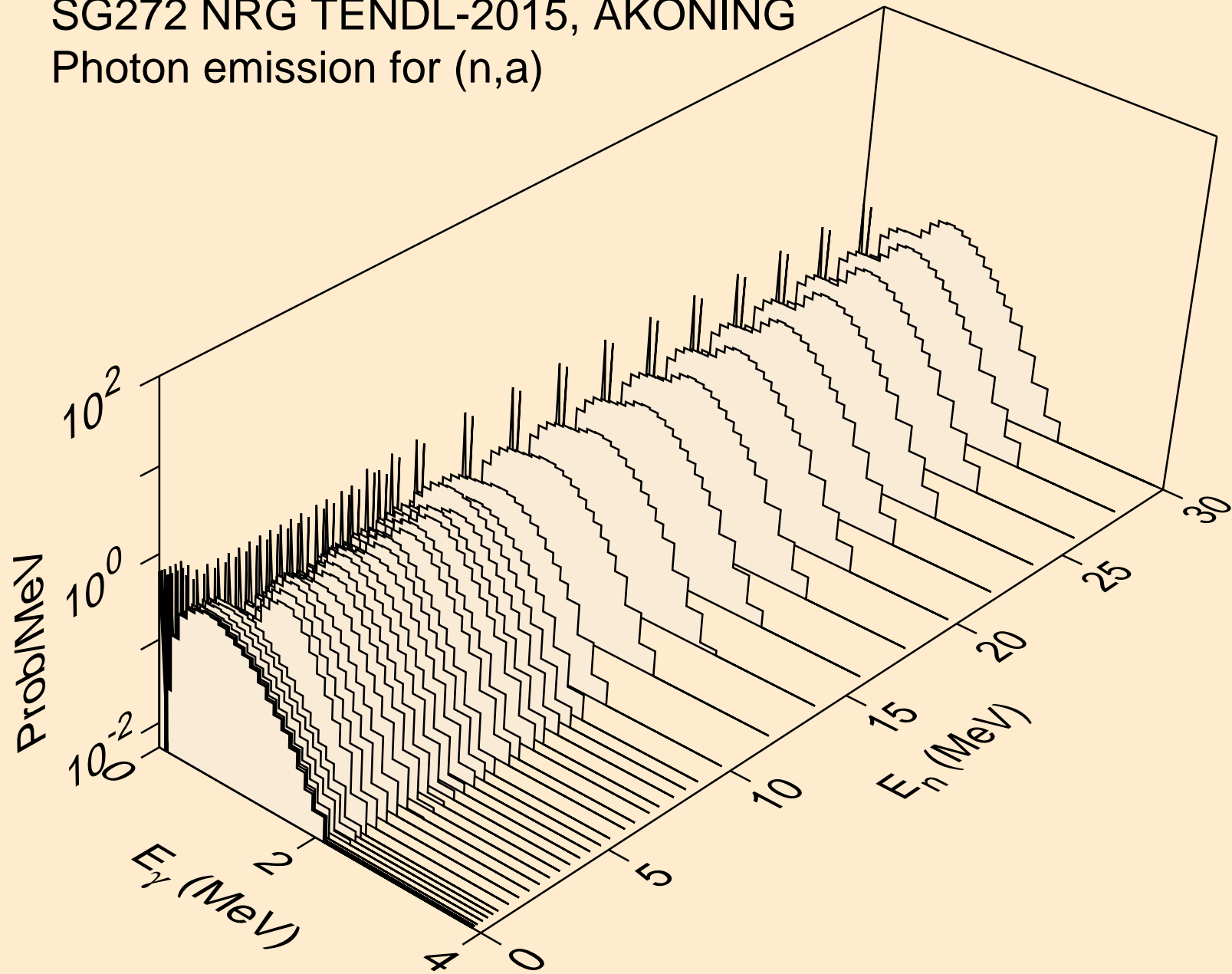

SG272 NRG TENDL-2015, AKONING
Photon emission for (n,2a)

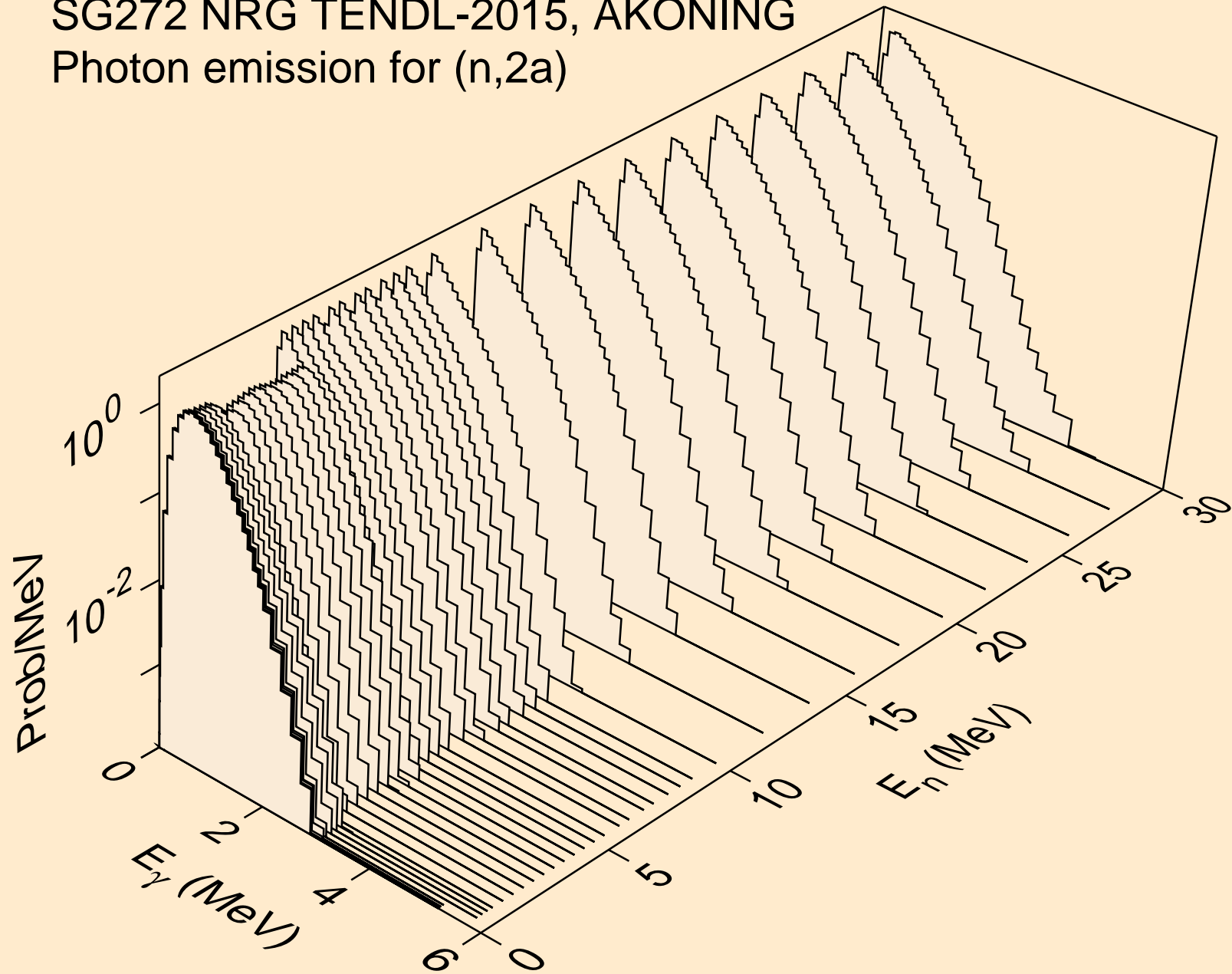

SG272 NRG TENDL-2015, AKONING
Photon emission for (n,p α)

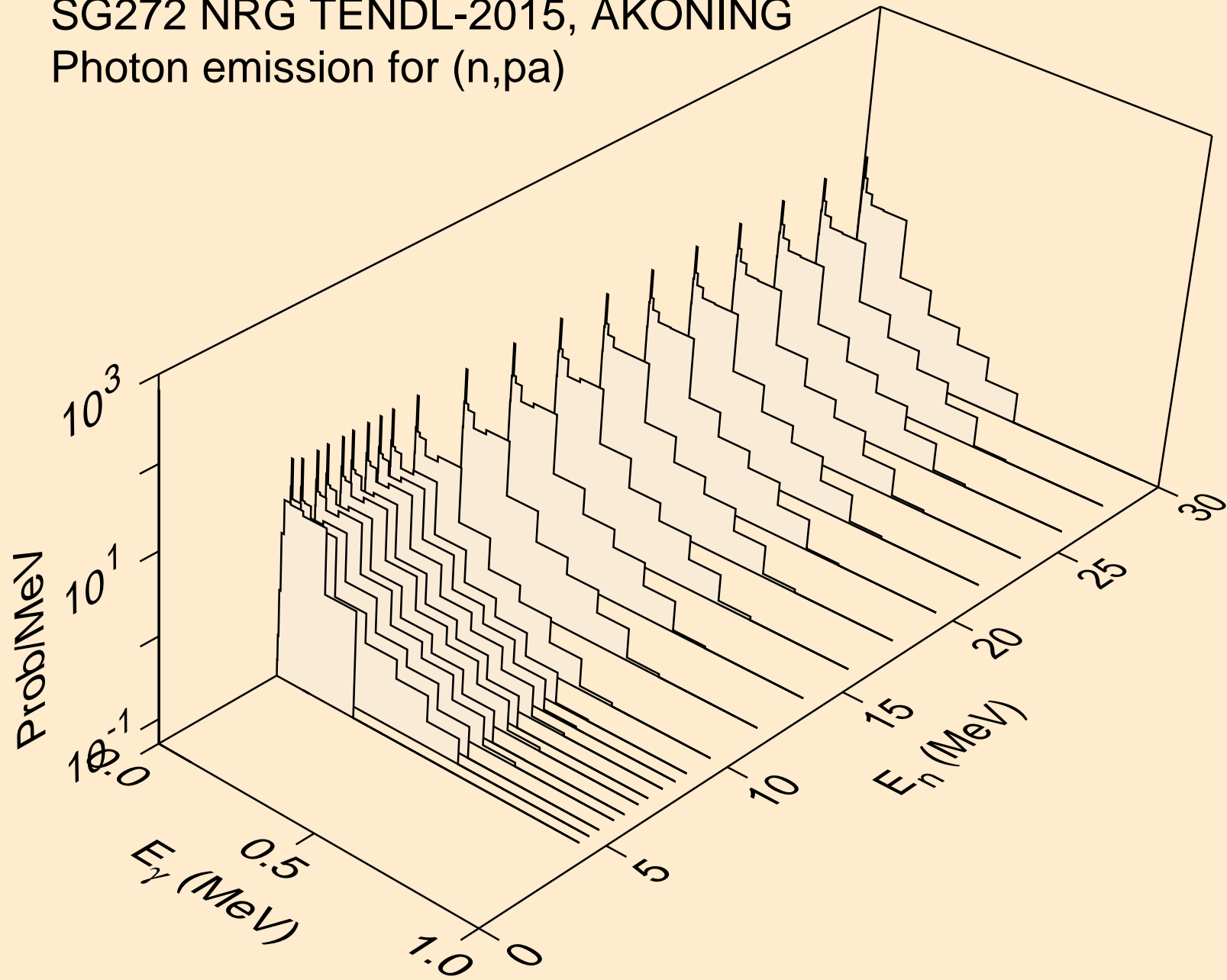

SG272 NRG TENDL-2015, AKONING
Photon emission for (n,t2a)

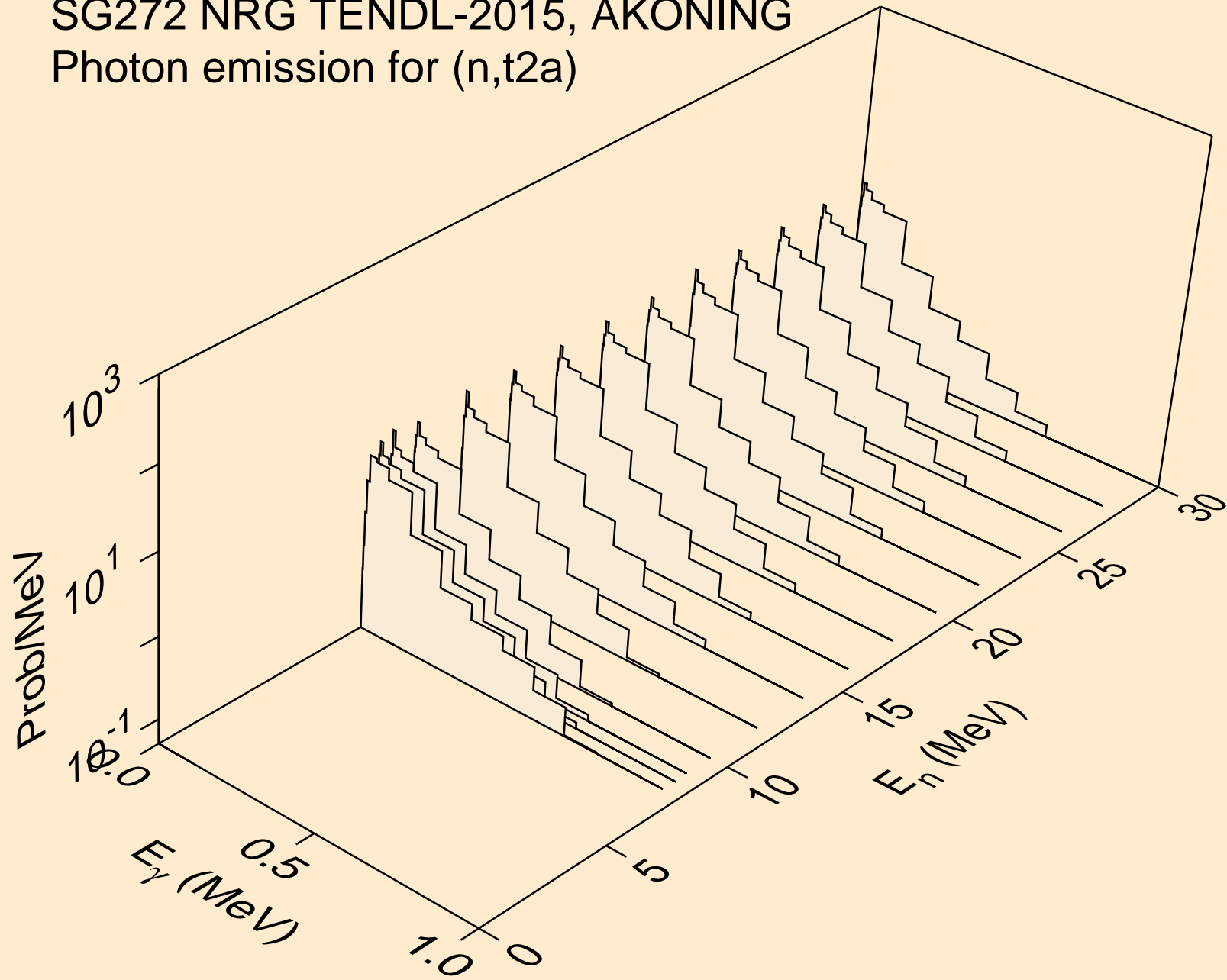

SG272 NRG TENDL-2015, AKONING
Photon emission for (n,d2a)

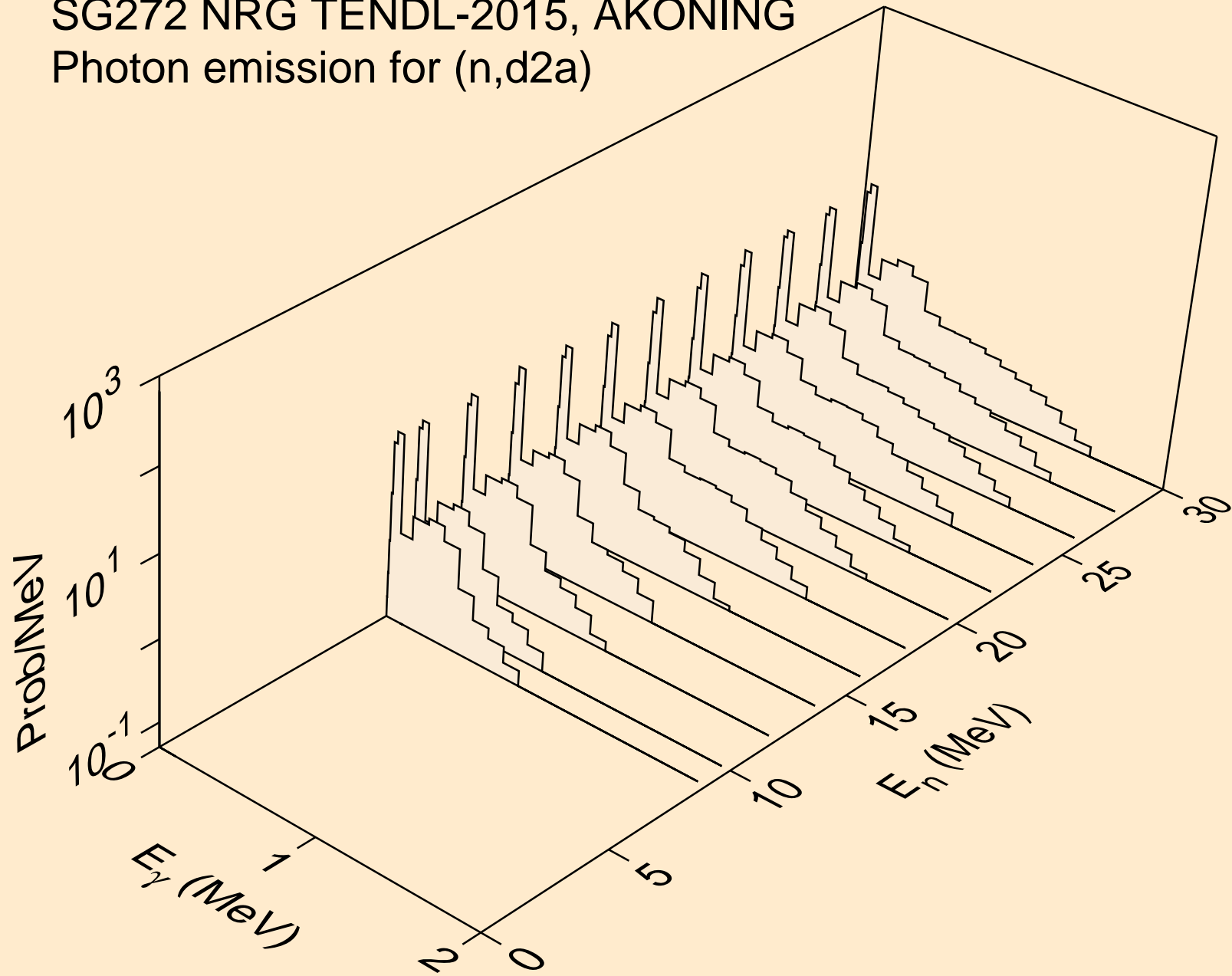

SG272 NRG TENDL-2015, AKONING
Photon emission for (n,da)

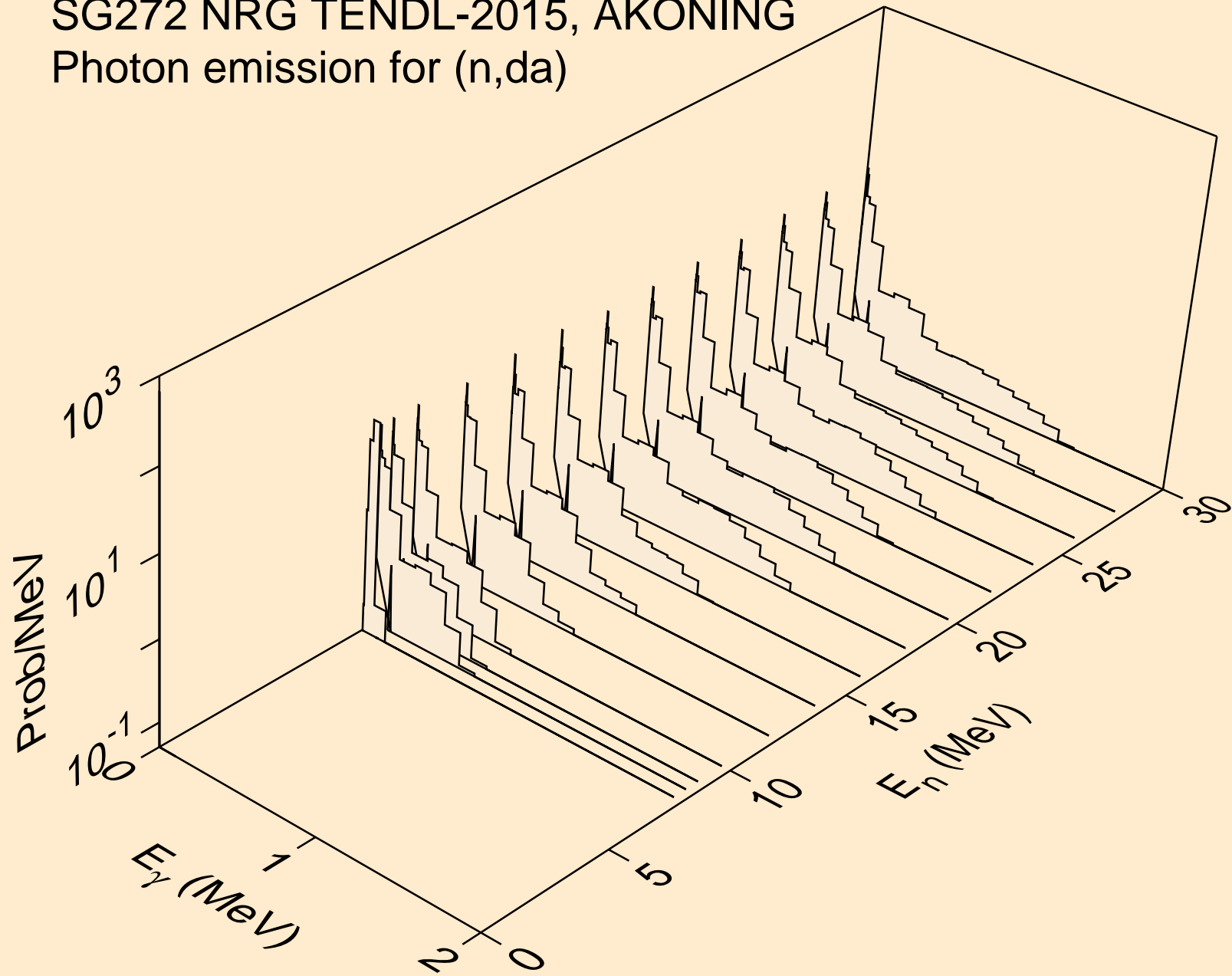

SG272 NRG TENDL-2015, AKONING
thermal capture photon spectrum

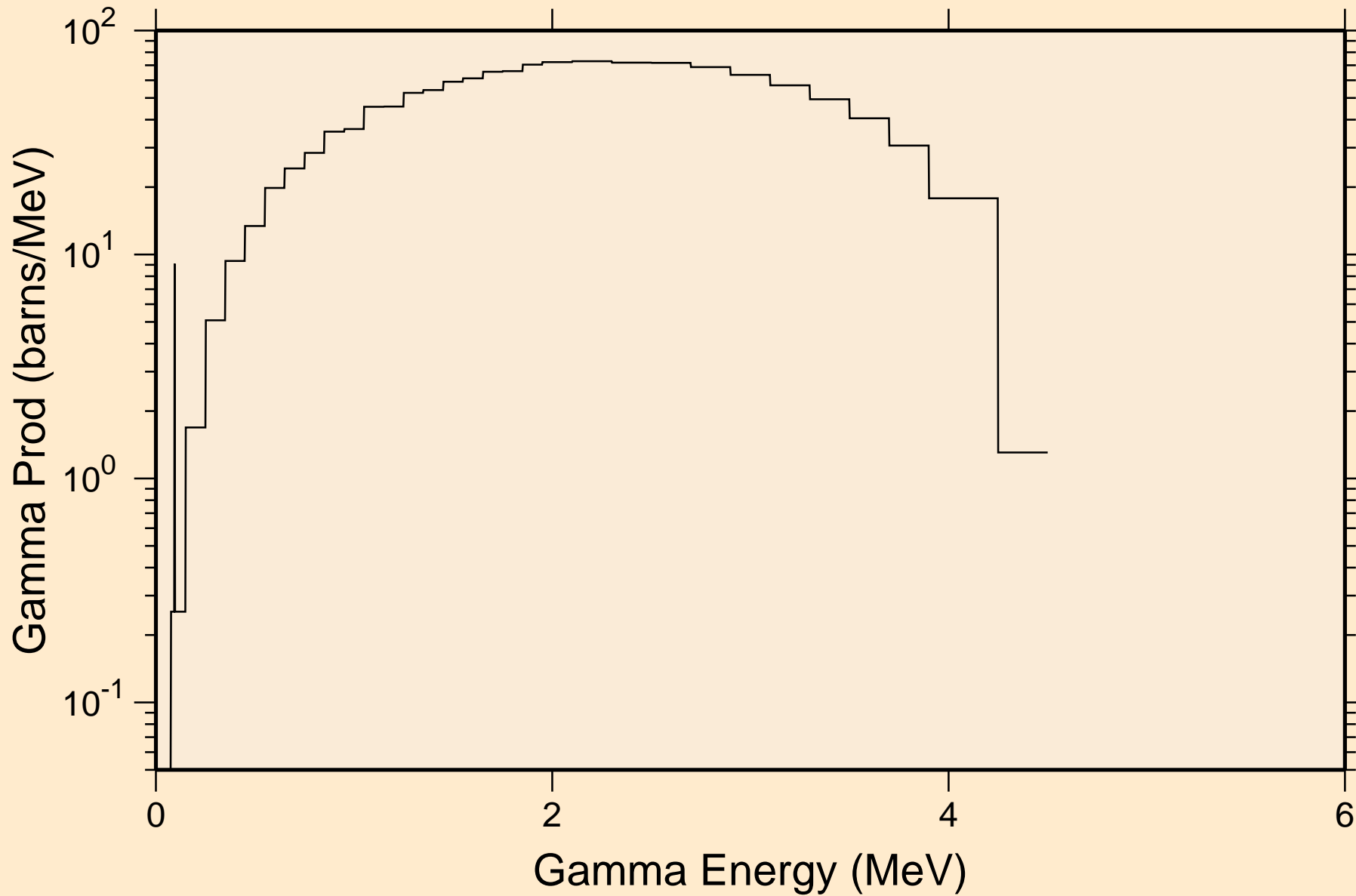

SG272 NRG TENDL-2015, AKONING
14 MeV photon spectrum

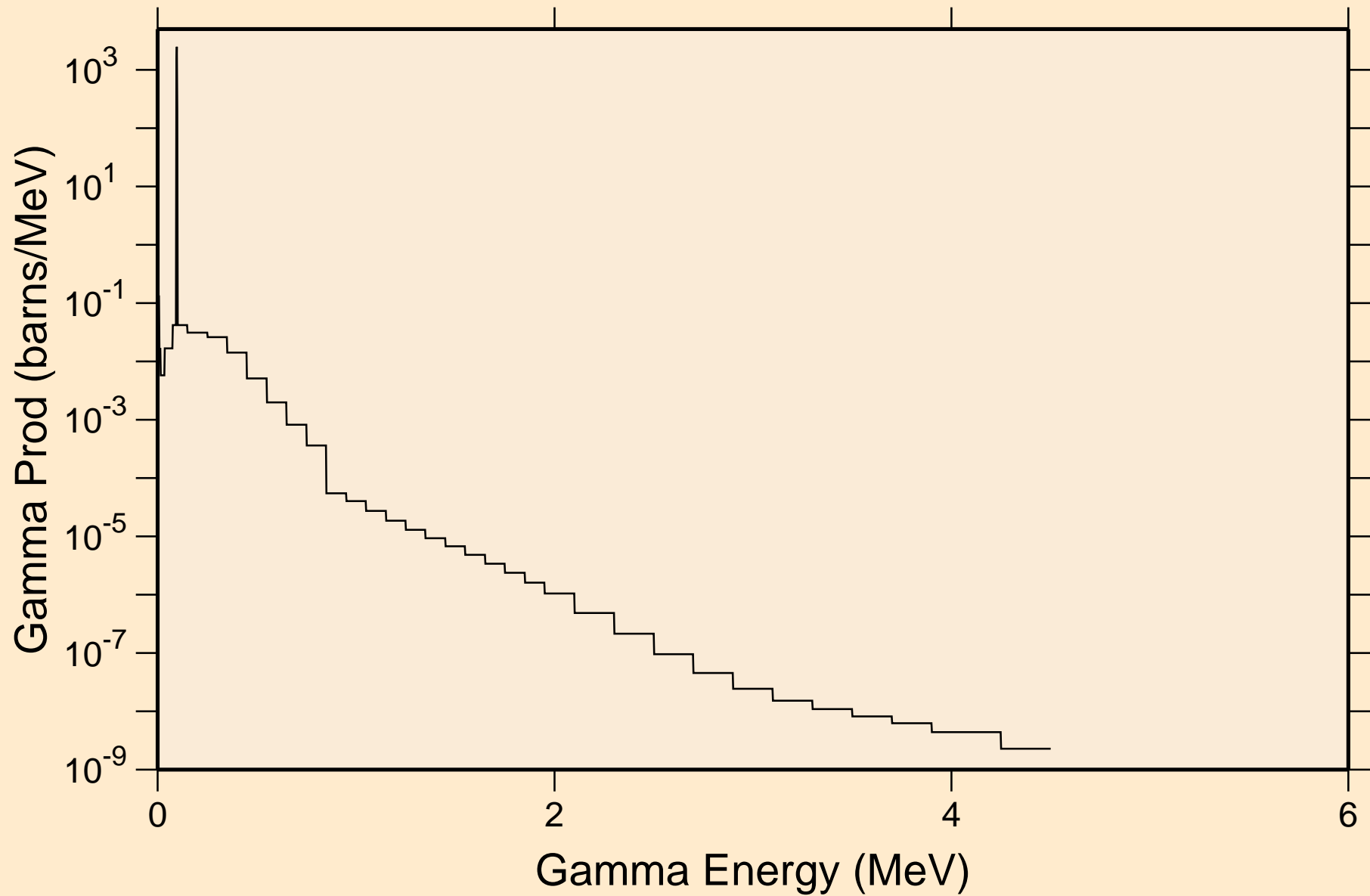

SG272 NRG TENDL-2015, AKONING

Particle heating contributions

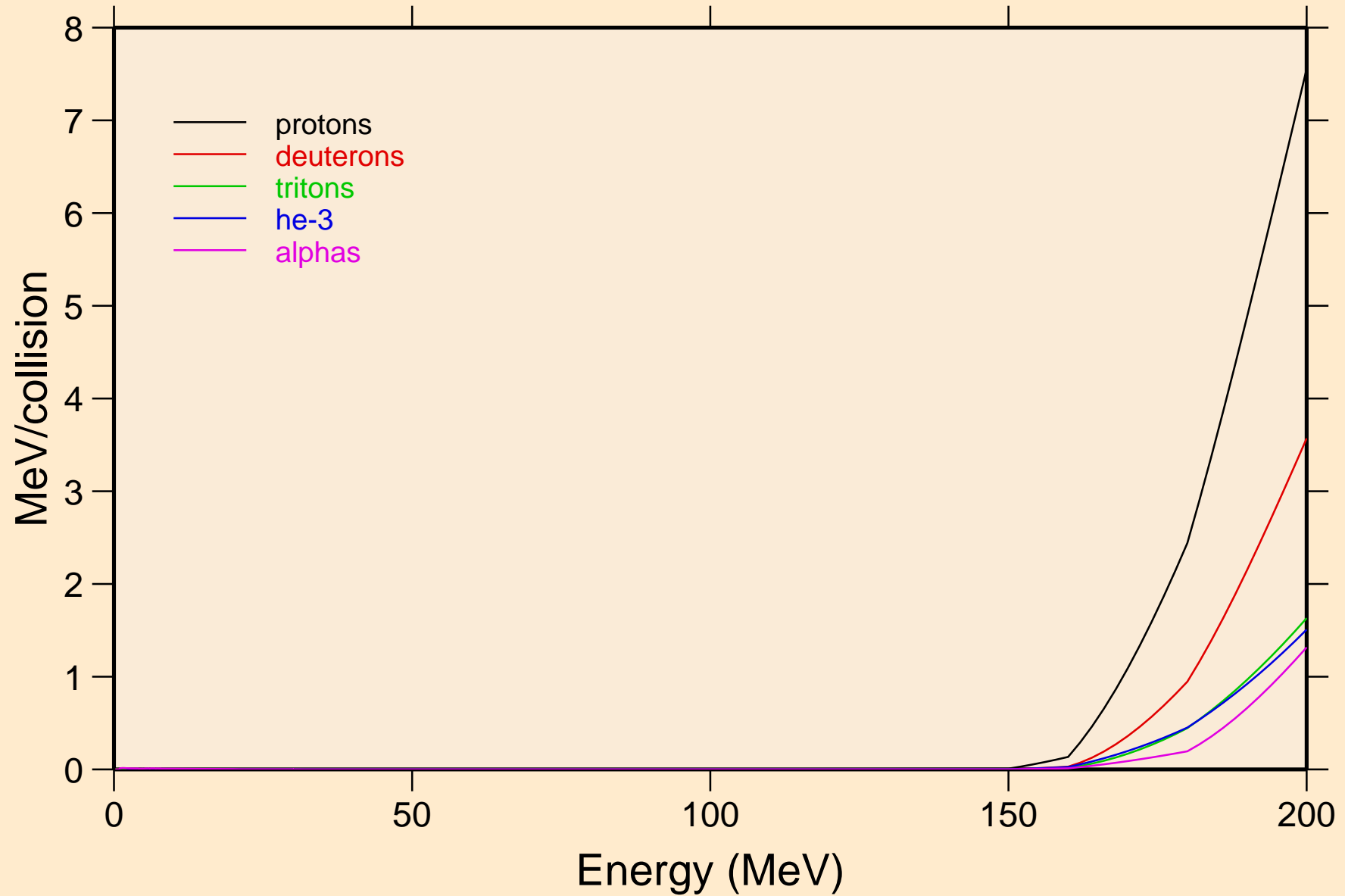

SG272 NRG TENDL-2015, AKONING

Recoil Heating

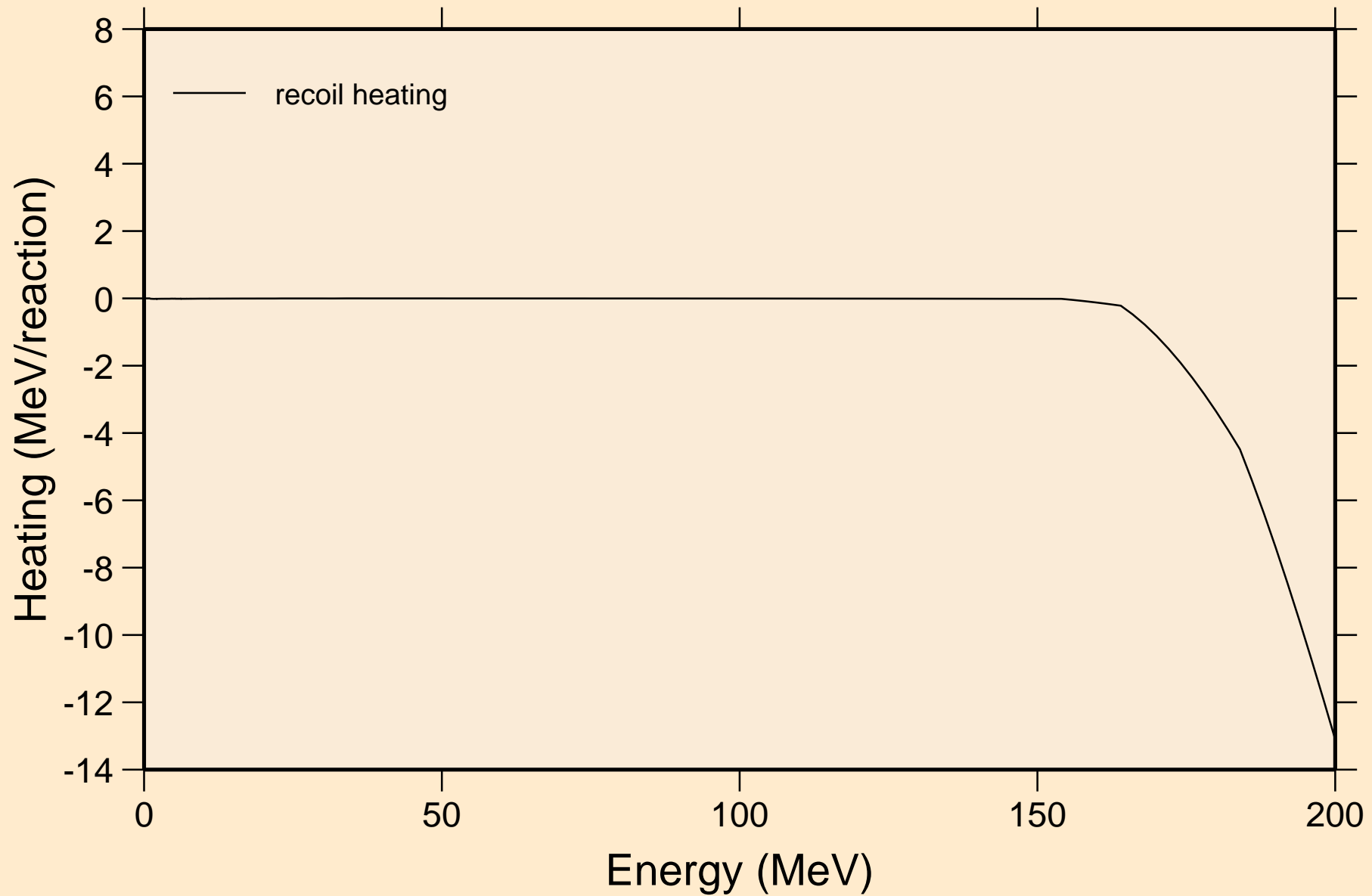

SG272 NRG TENDL-2015, AKONING

Particle production cross sections

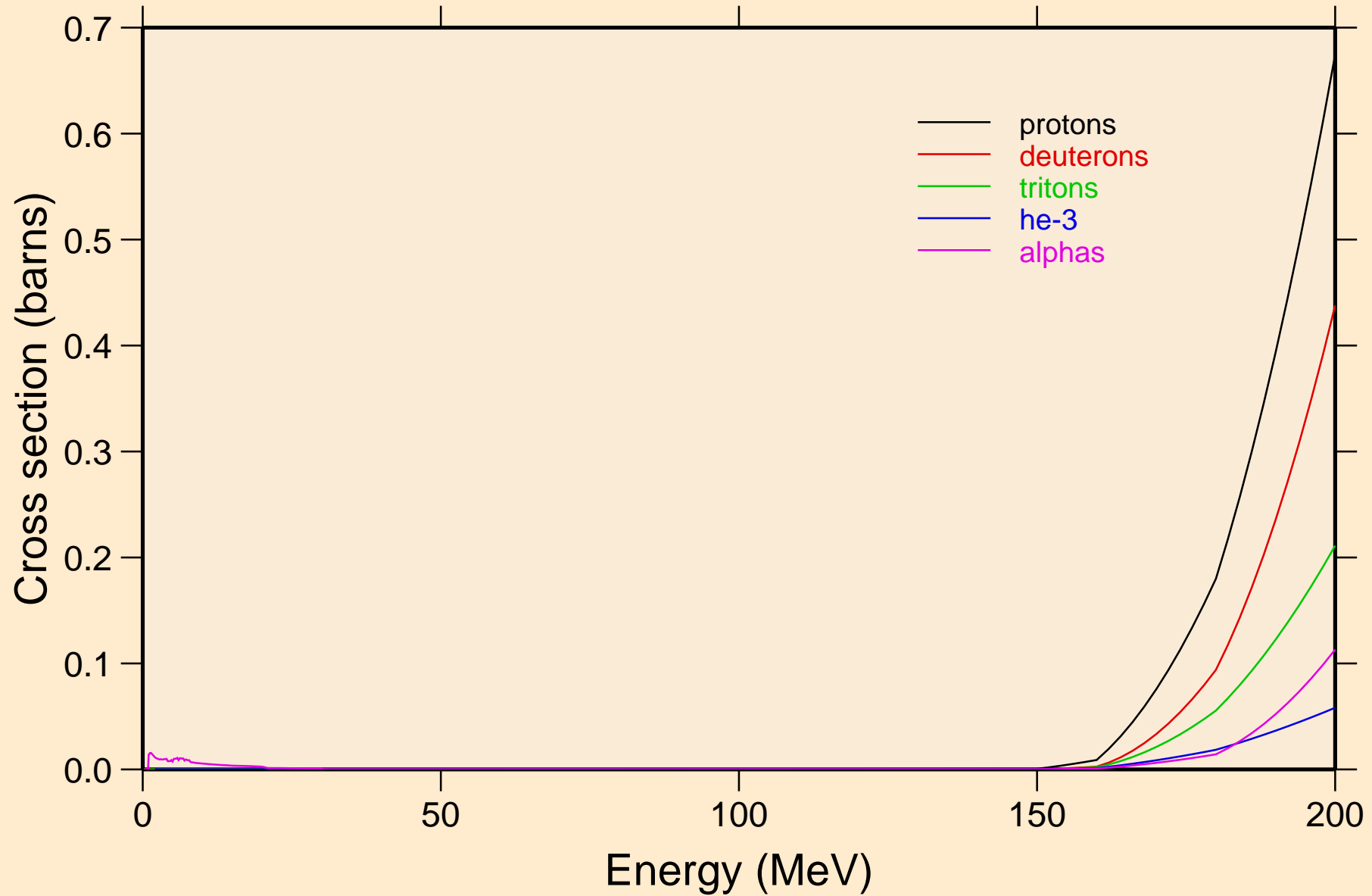

SG272 NRG TENDL-2015, AKONING
protons from (n,x)

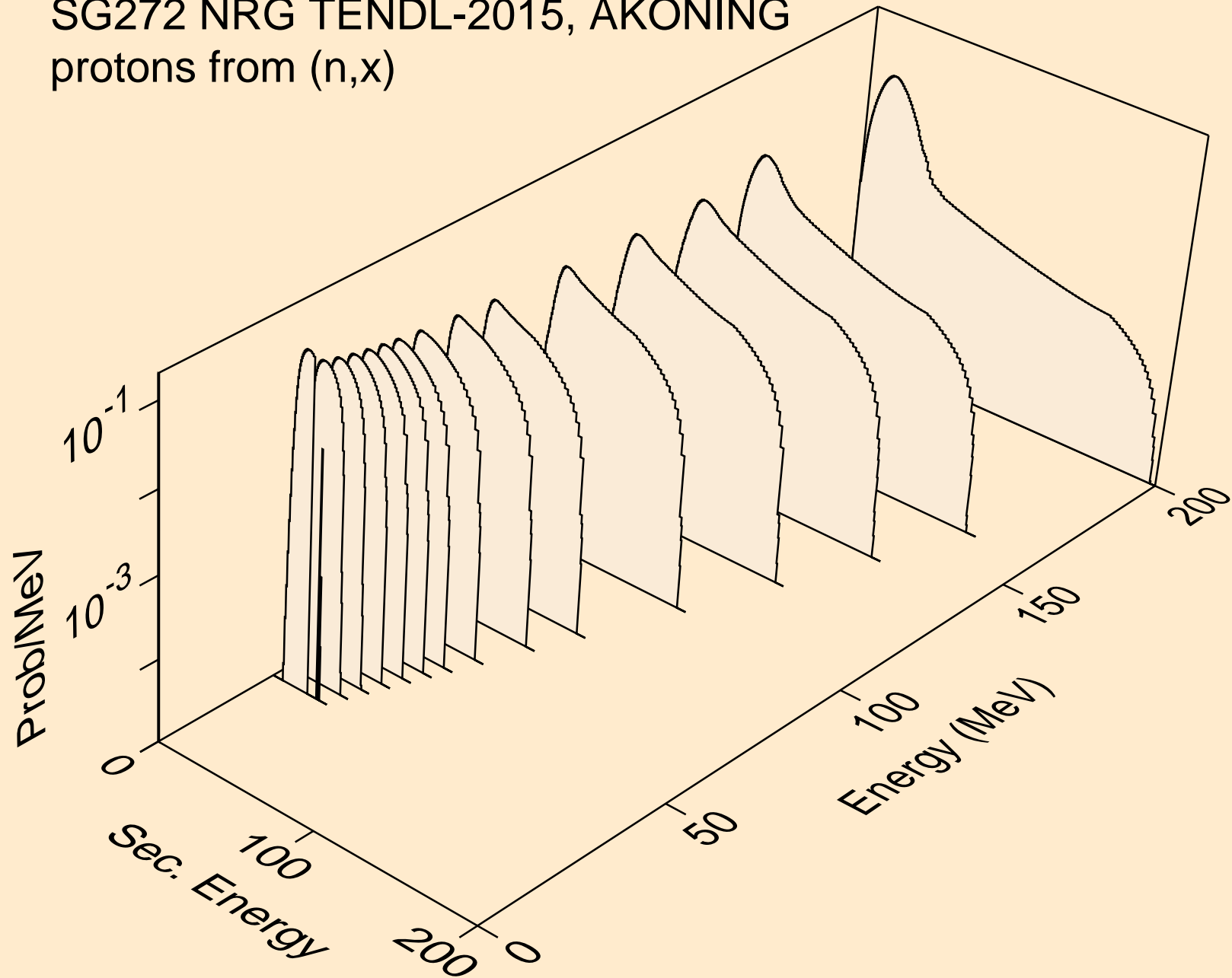

SG272 NRG TENDL-2015, AKONING
protons from (n,n*)p

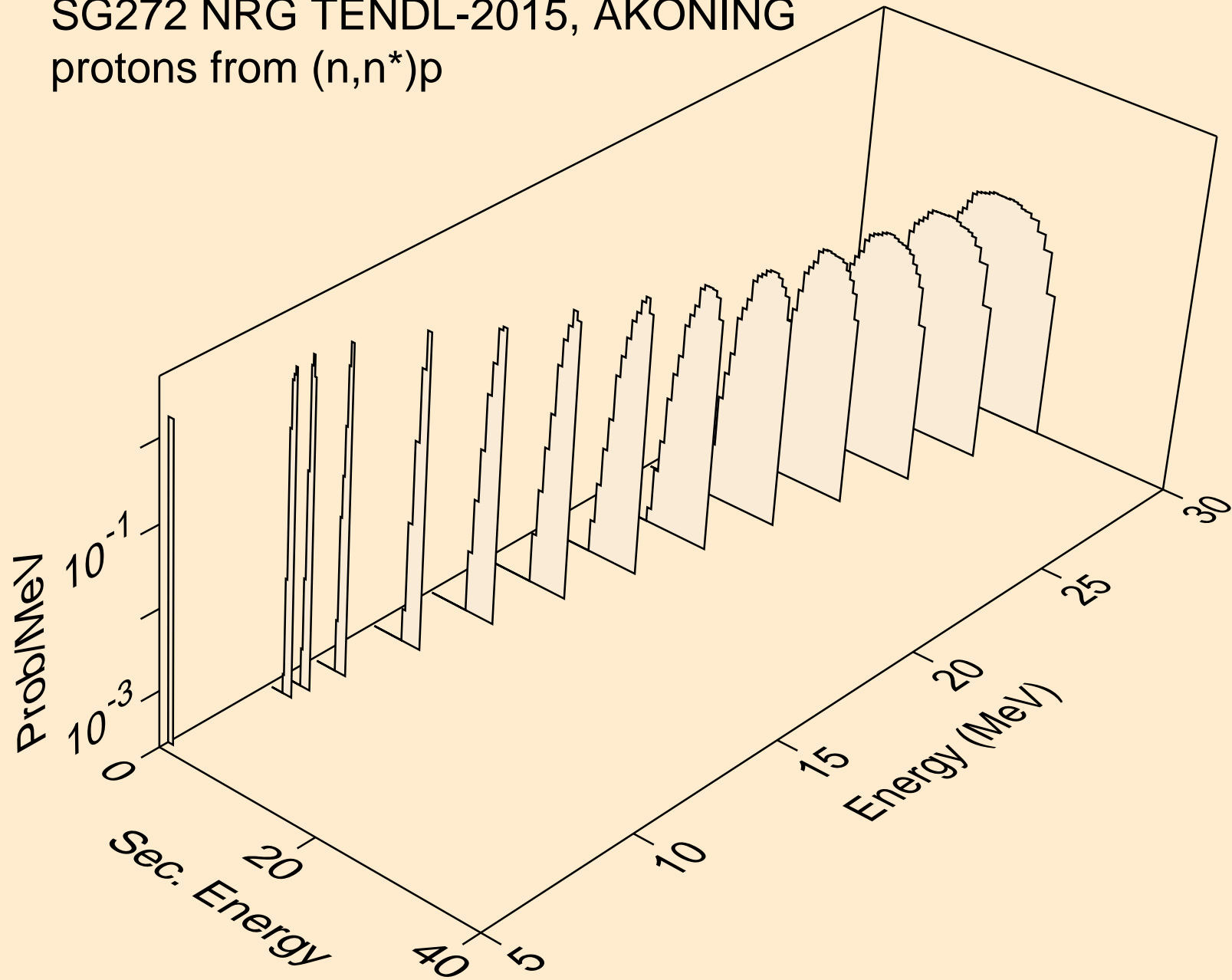

SG272 NRG TENDL-2015, AKONING
protons from (n,2np)

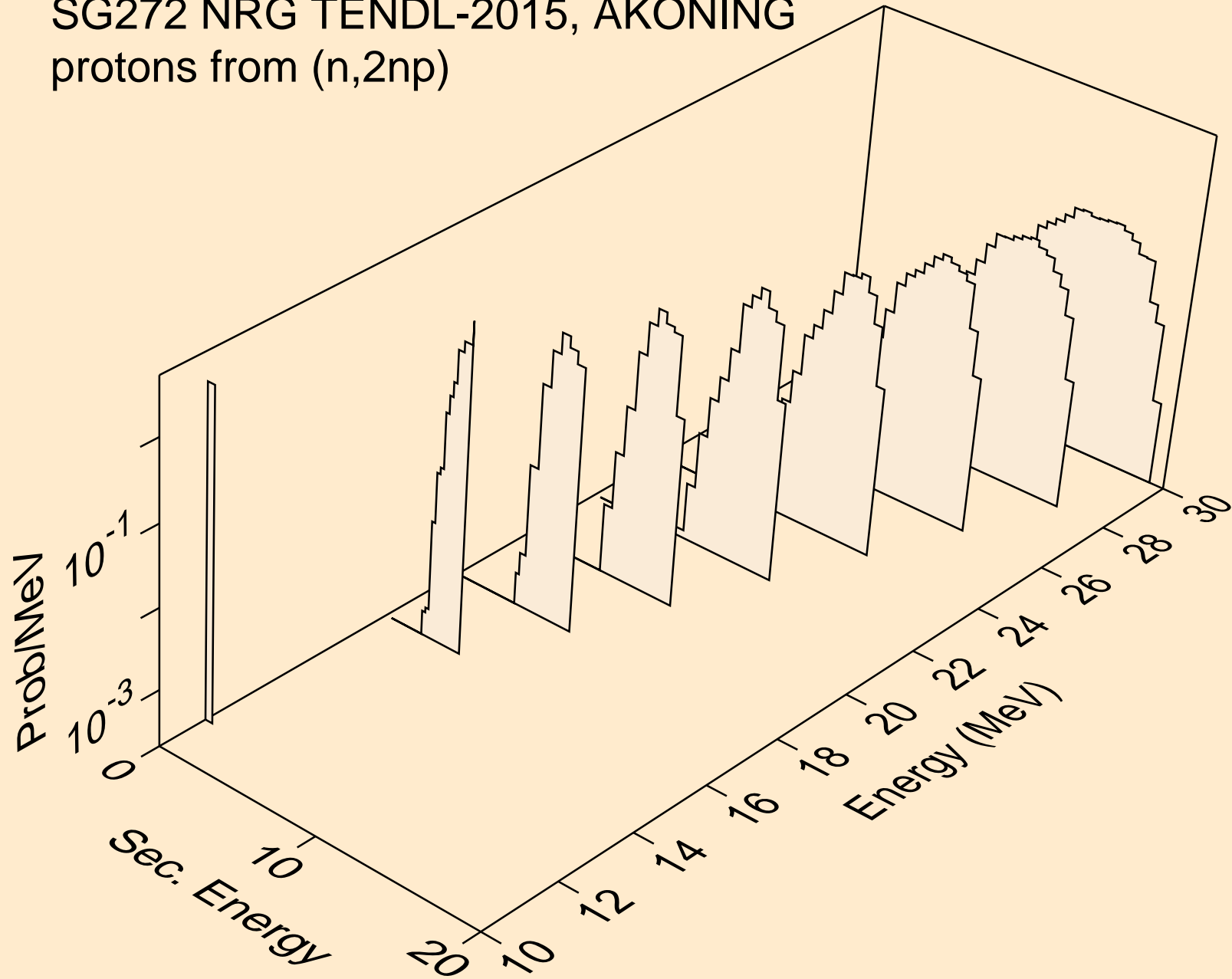

SG272 NRG TENDL-2015, AKONING
protons from (n,npa)

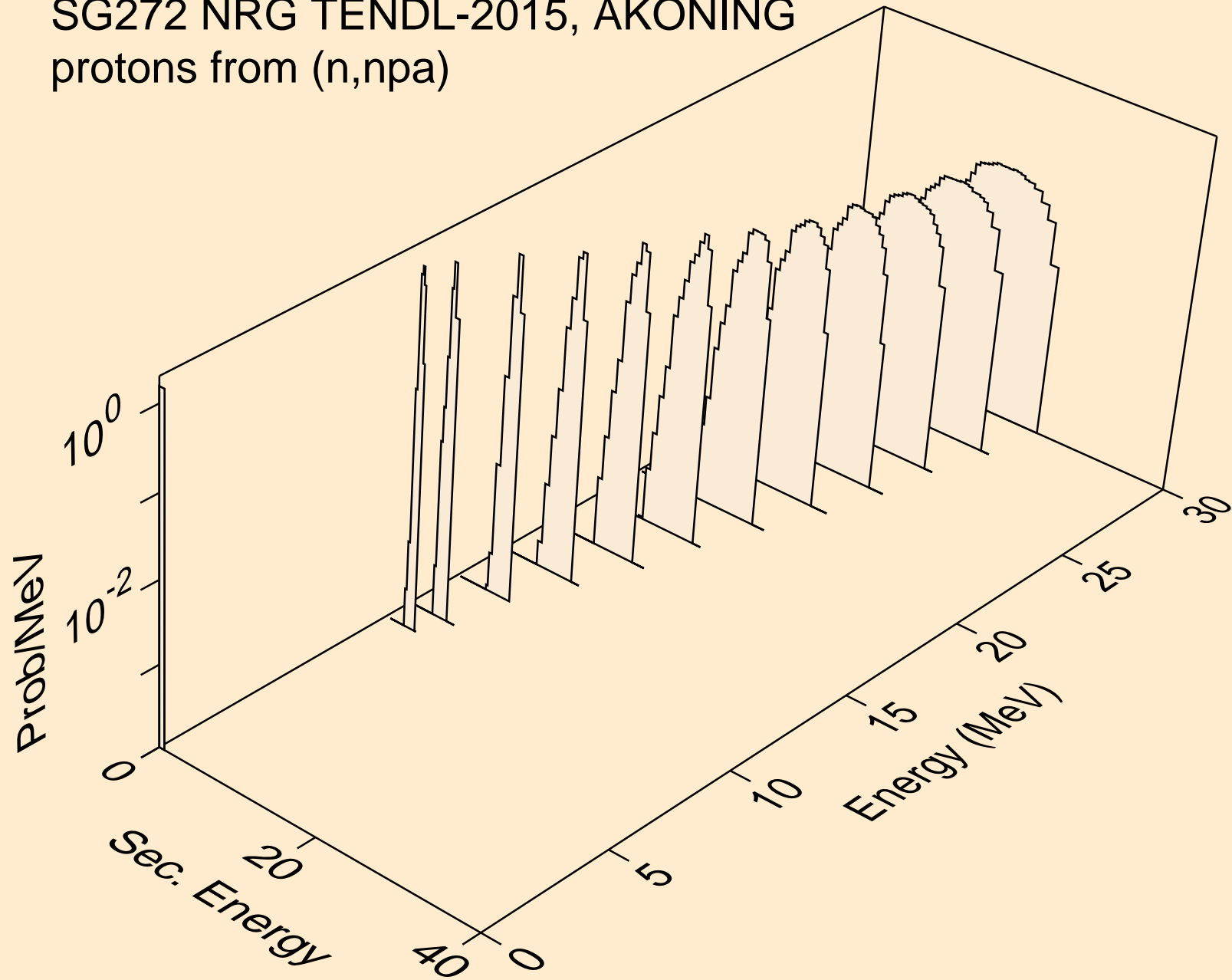

SG272 NRG TENDL-2015, AKONING
protons from (n,p)

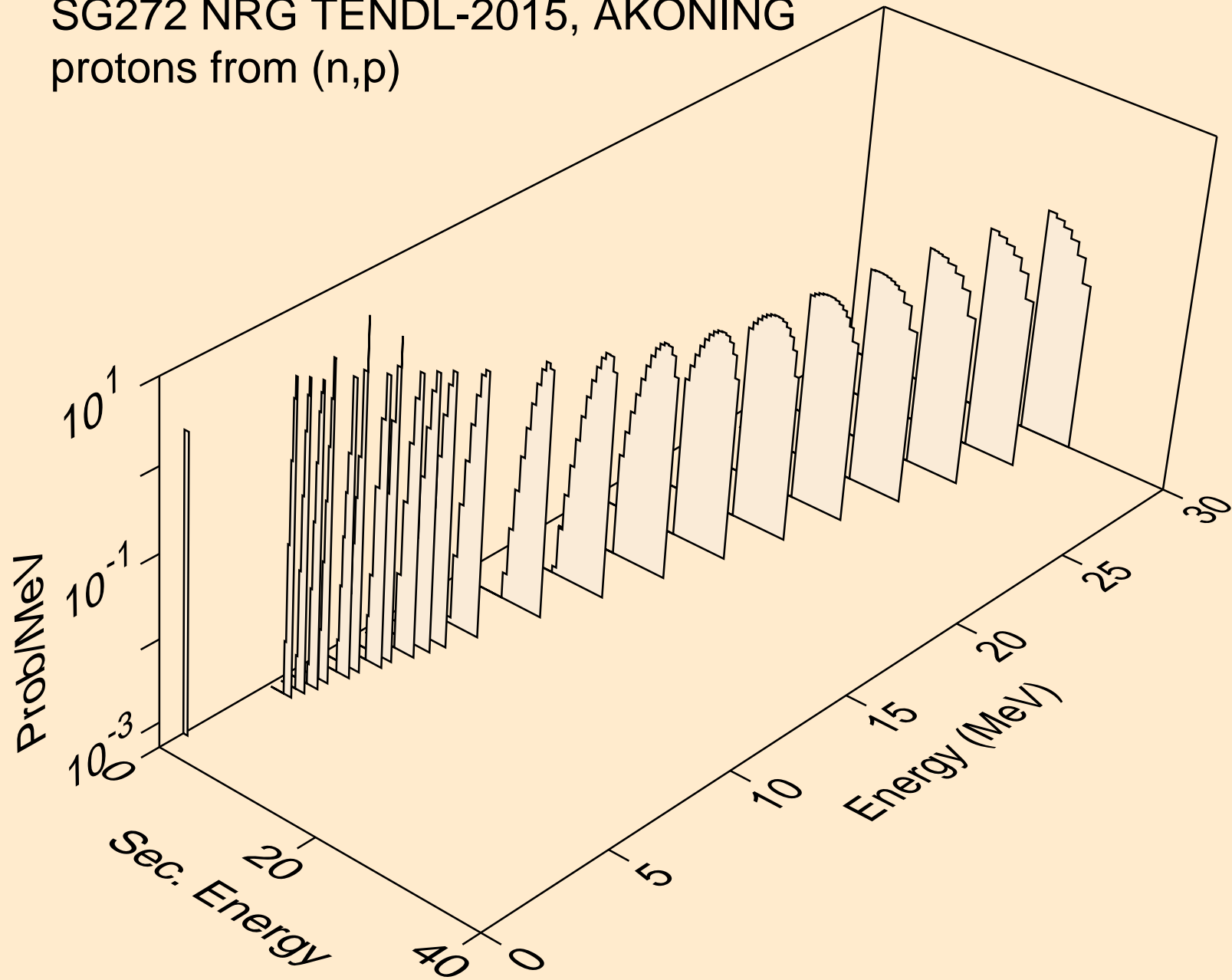

SG272 NRG TENDL-2015, AKONING
protons from (n,pa)

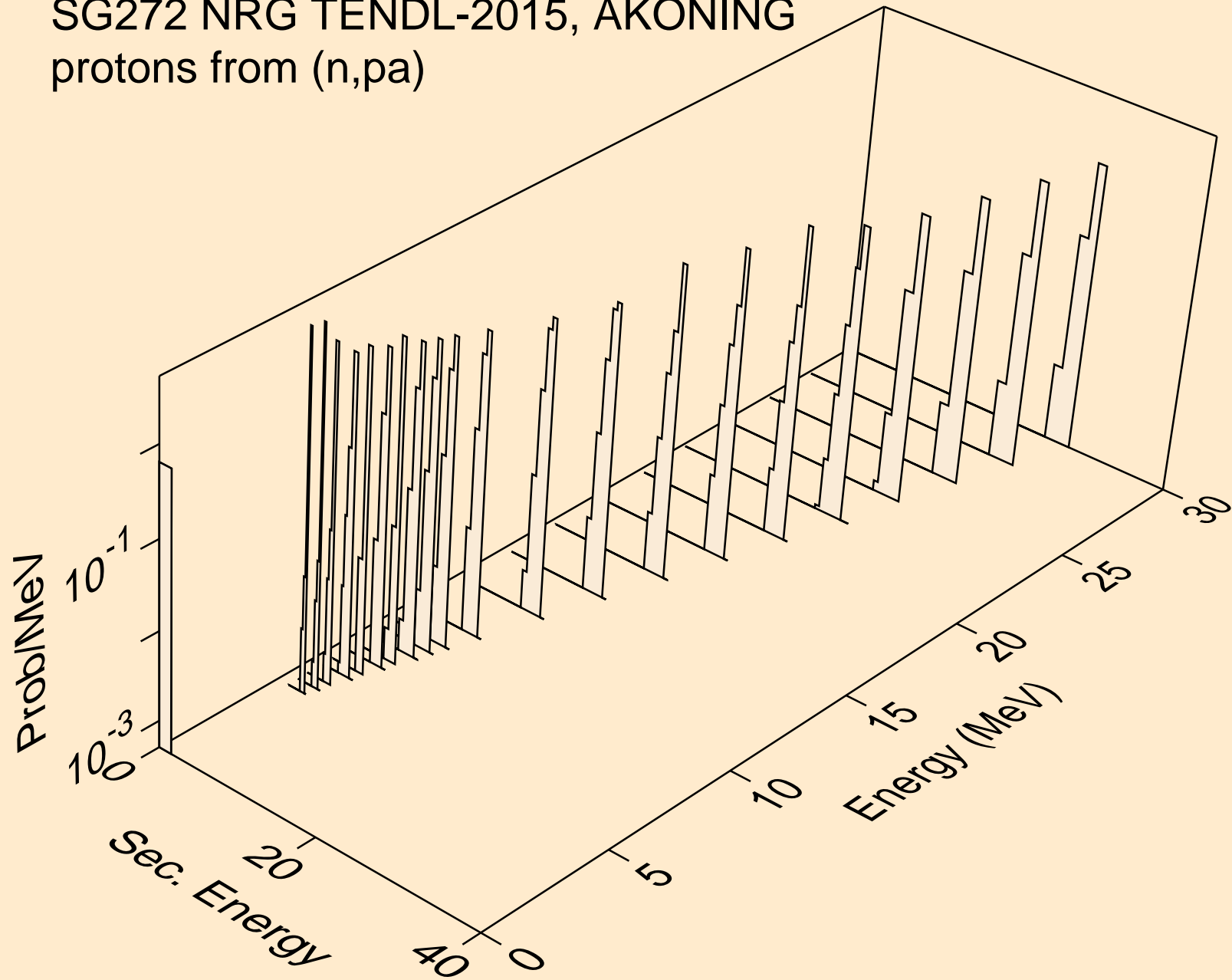

SG272 NRG TENDL-2015, AKONING
deuterons from (n,x)

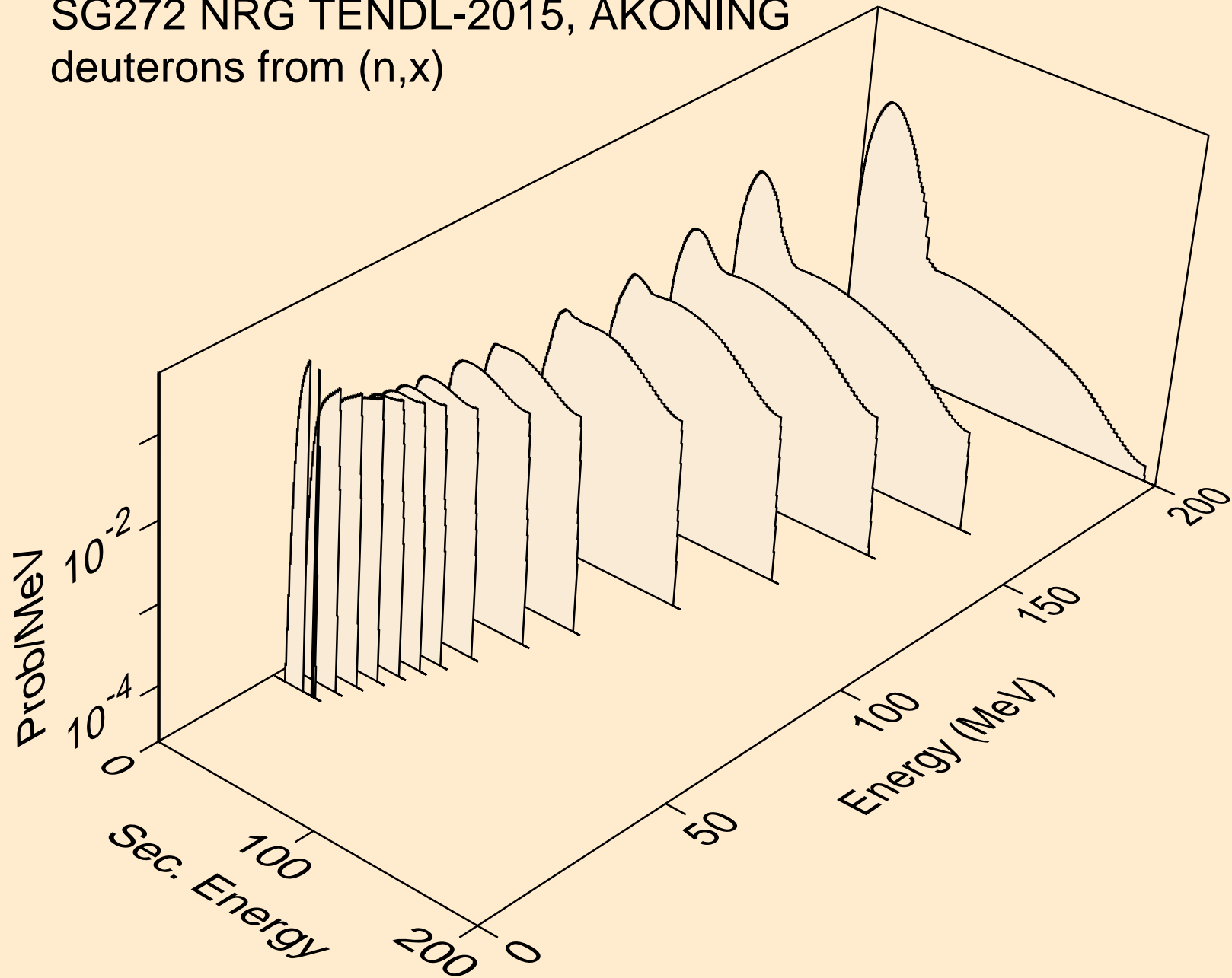

SG272 NRG TENDL-2015, AKONING
deuterons from (n,2nd)

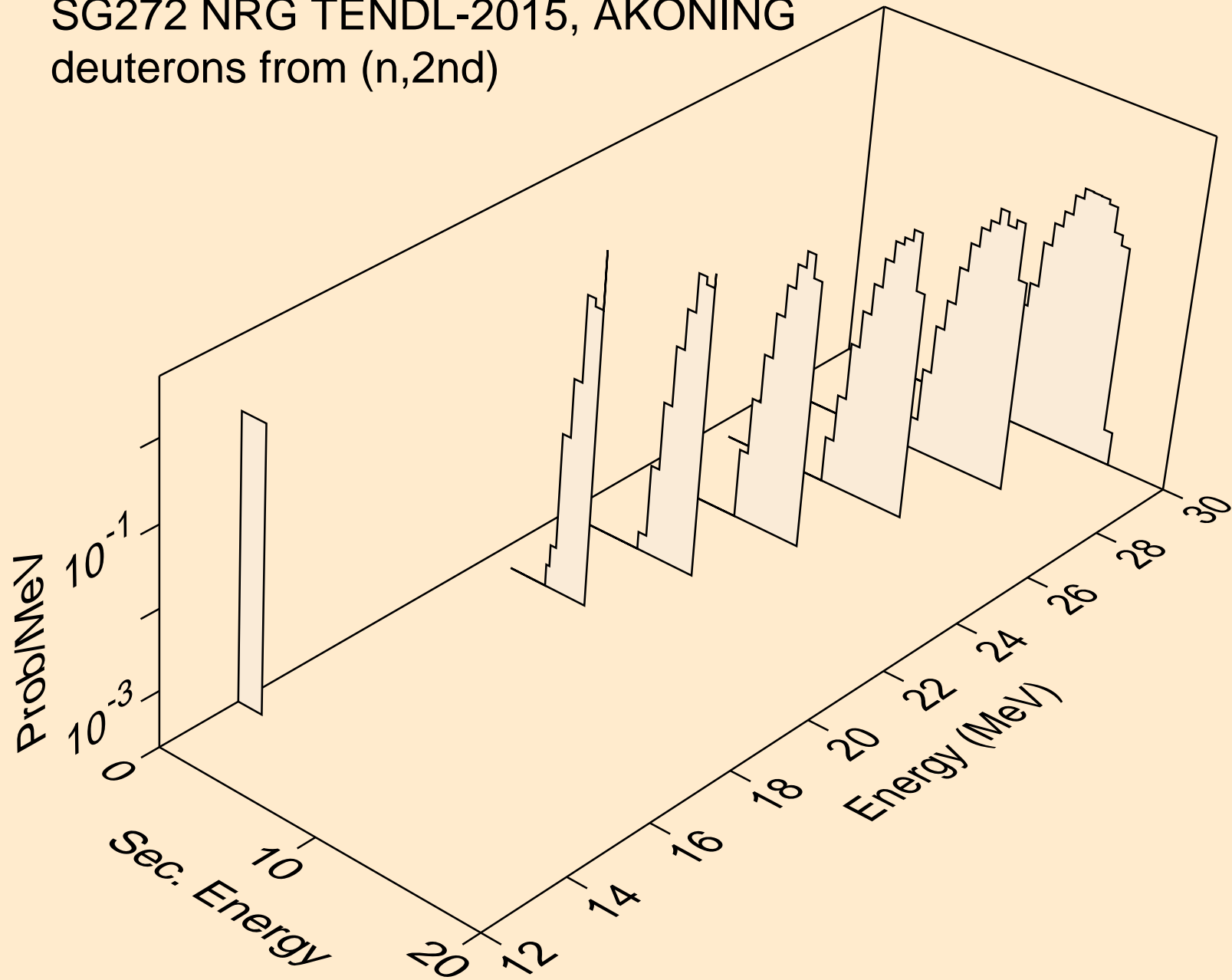

SG272 NRG TENDL-2015, AKONING
deuterons from (n,n*)d

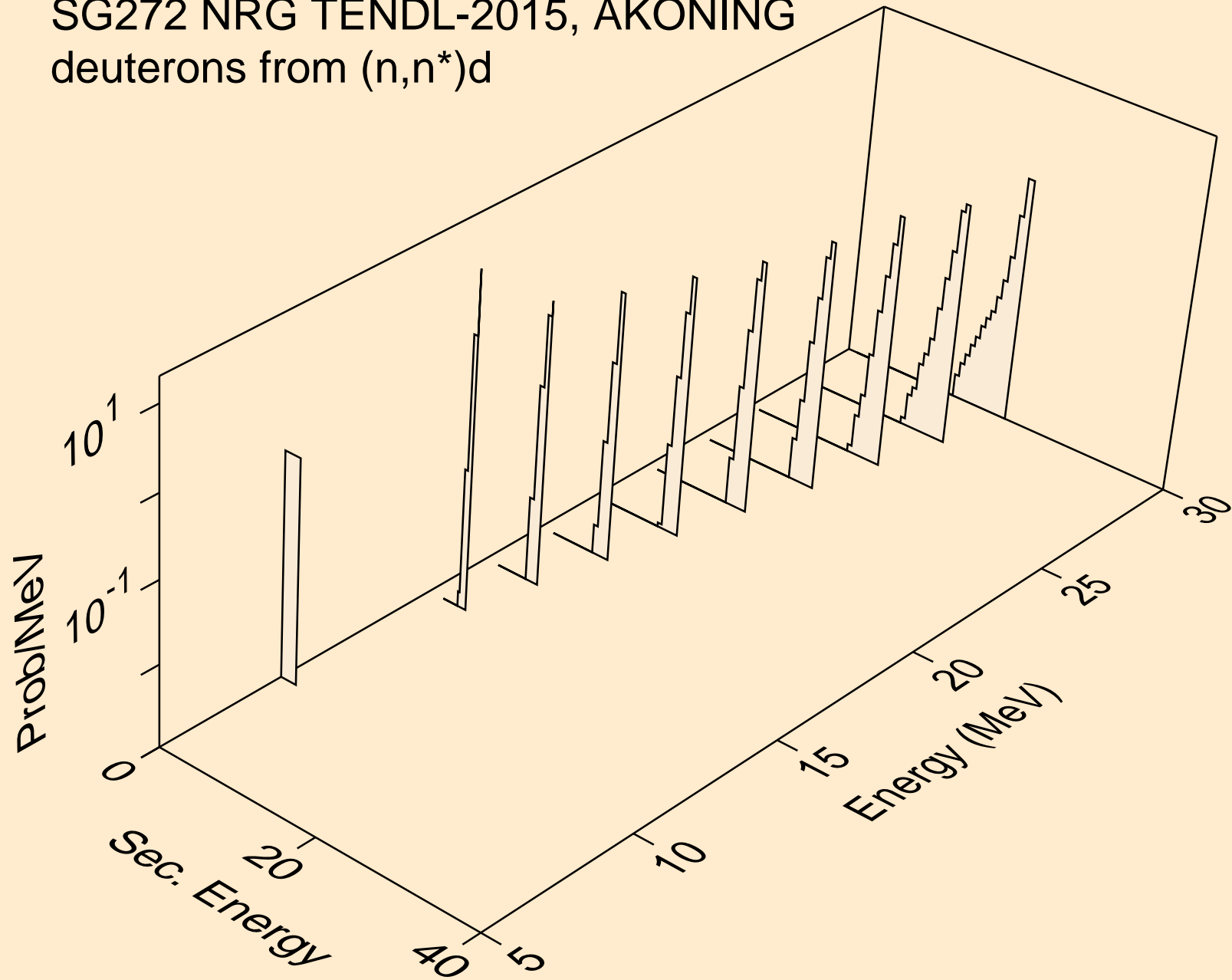

SG272 NRG TENDL-2015, AKONING
deuterons from (n,n*)d2a

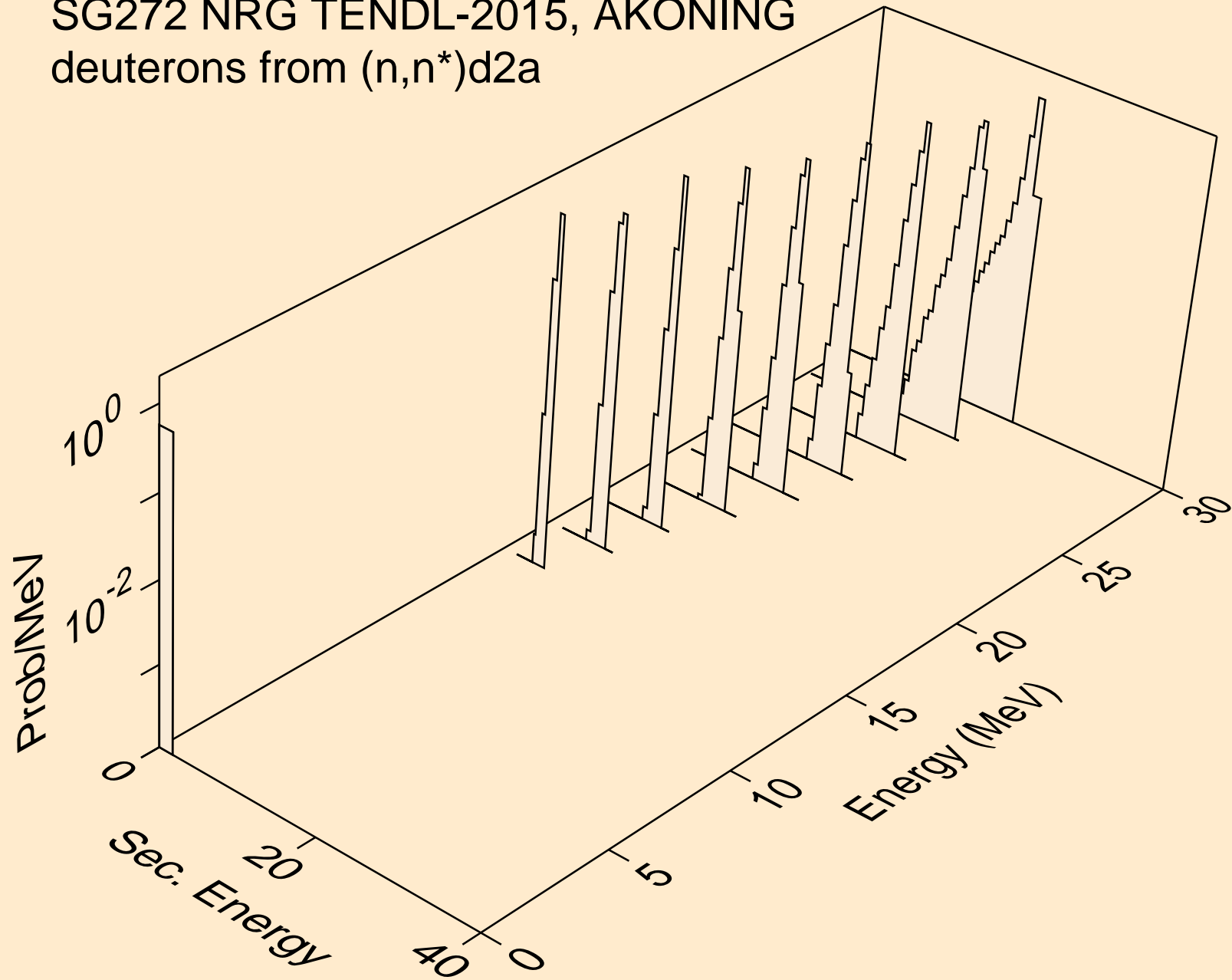

SG272 NRG TENDL-2015, AKONING
deuterons from (n,d)

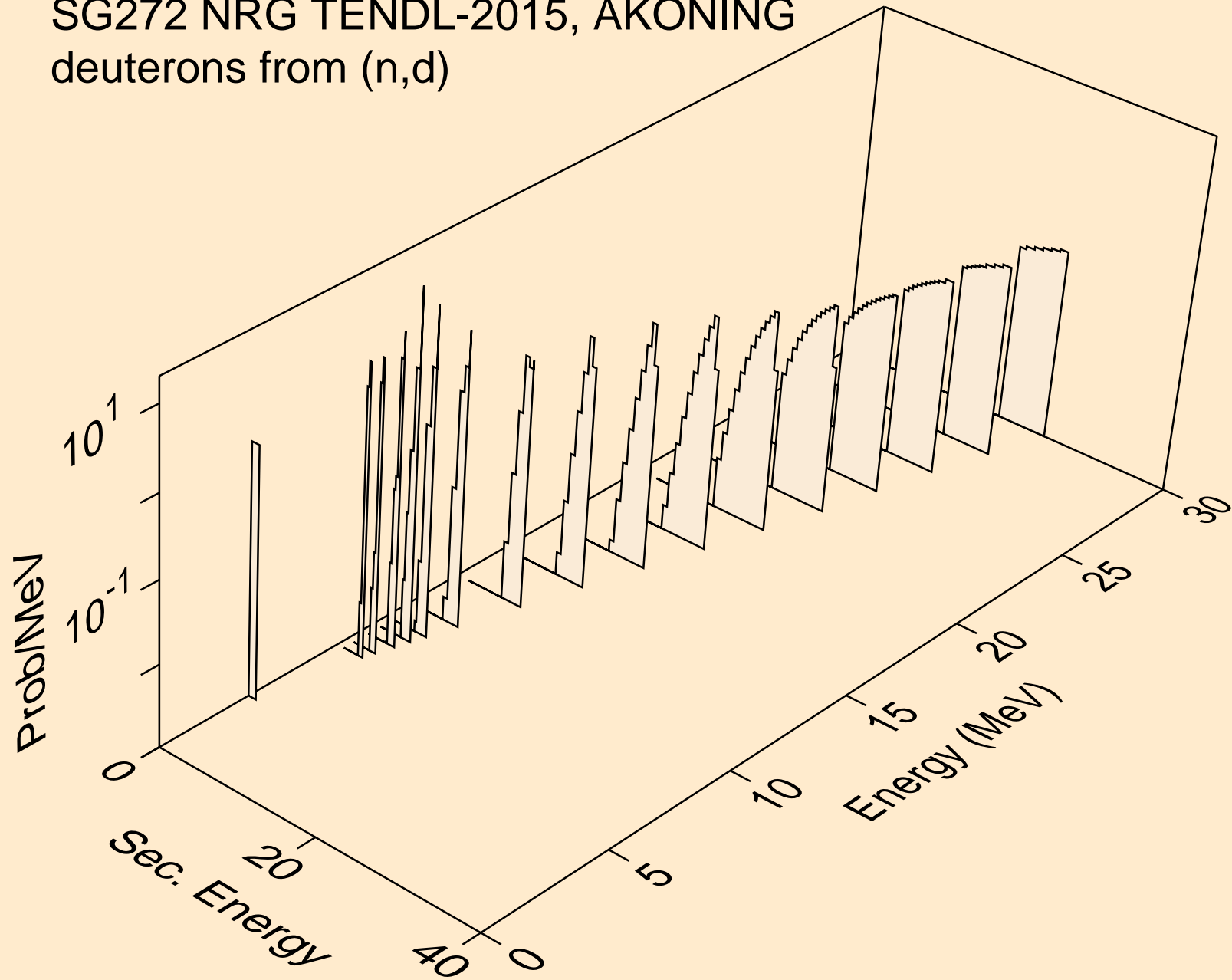

SG272 NRG TENDL-2015, AKONING
deuterons from (n,d2a)

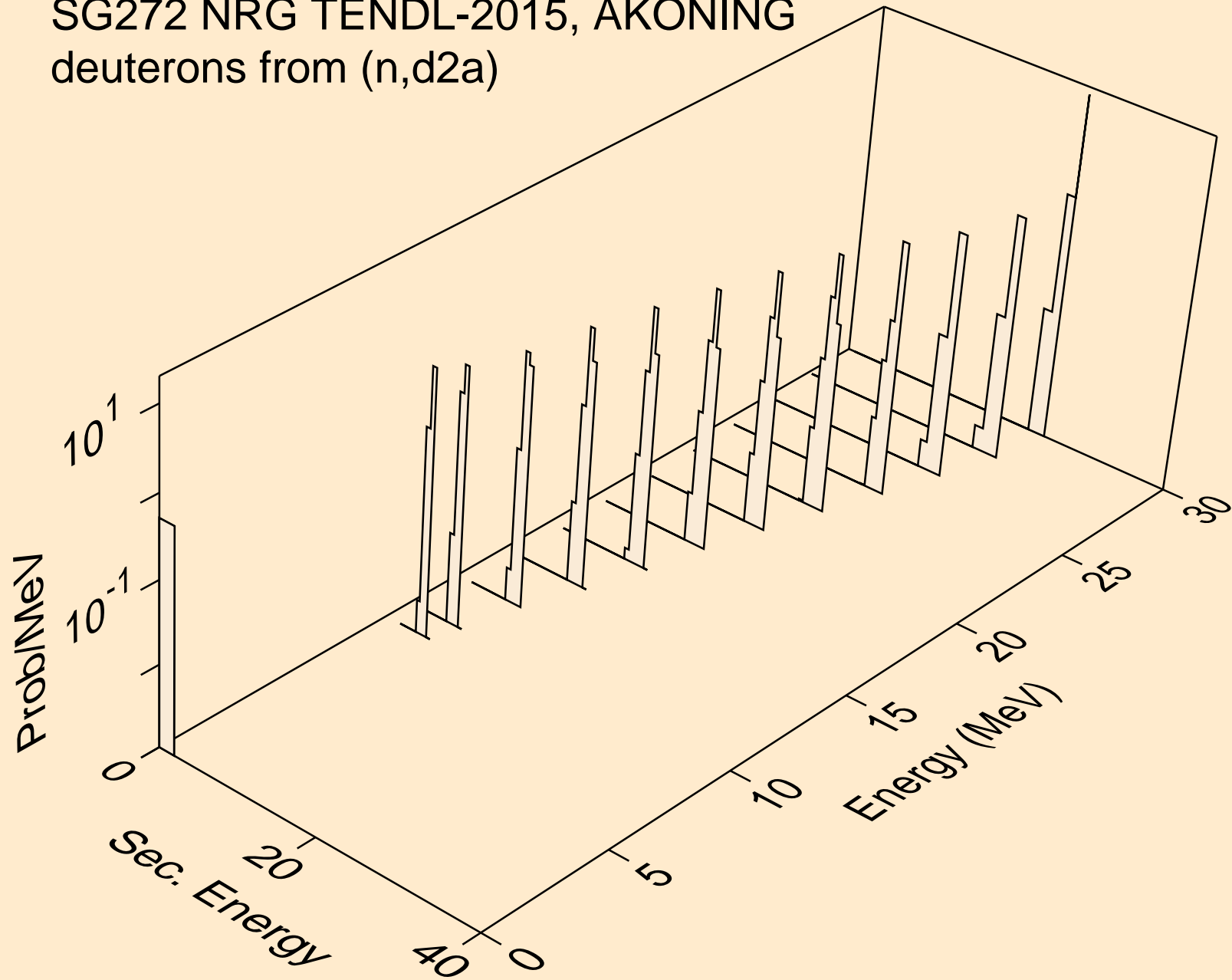

SG272 NRG TENDL-2015, AKONING
deuterons from (n,da)

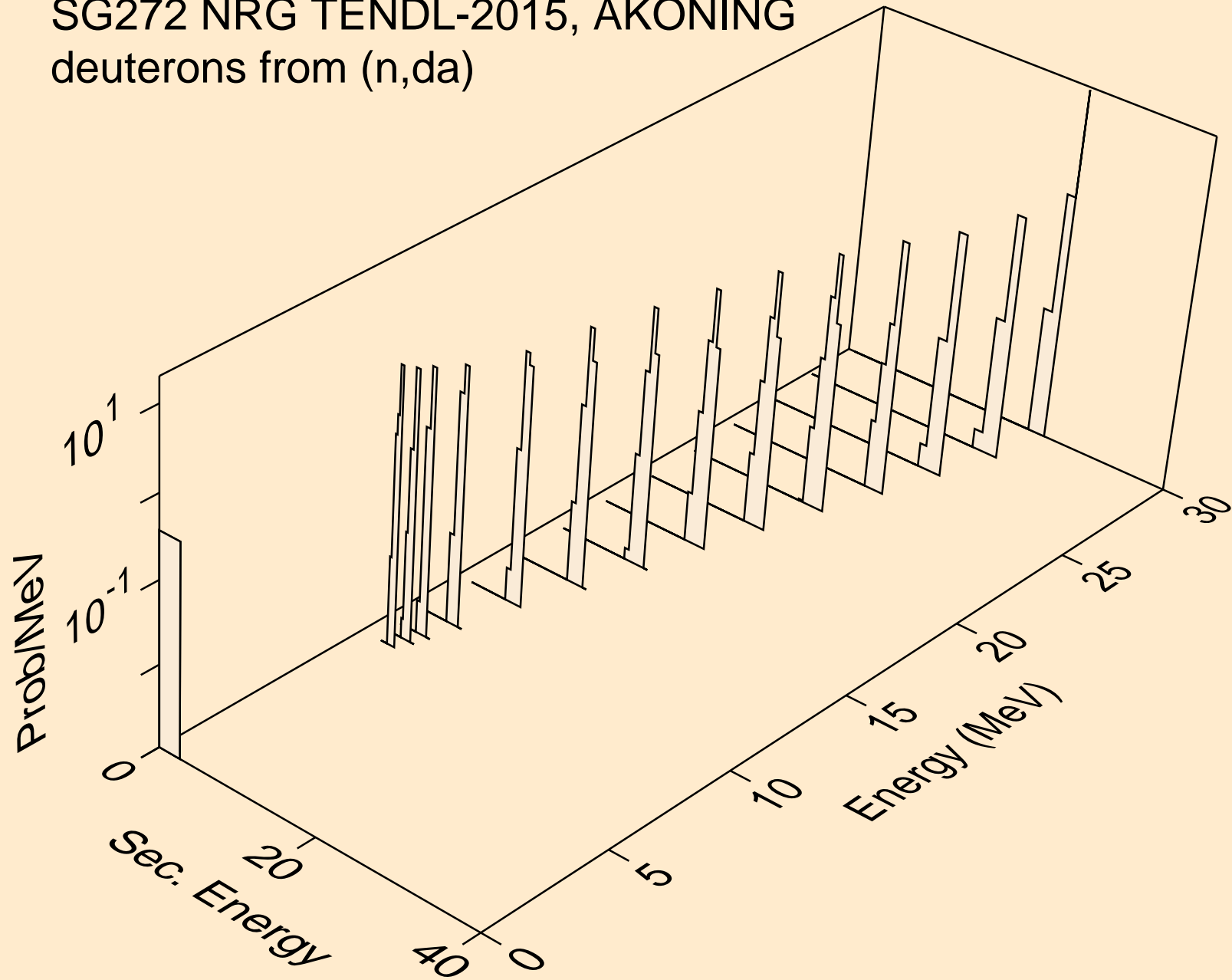

SG272 NRG TENDL-2015, AKONING
tritons from (n,x)

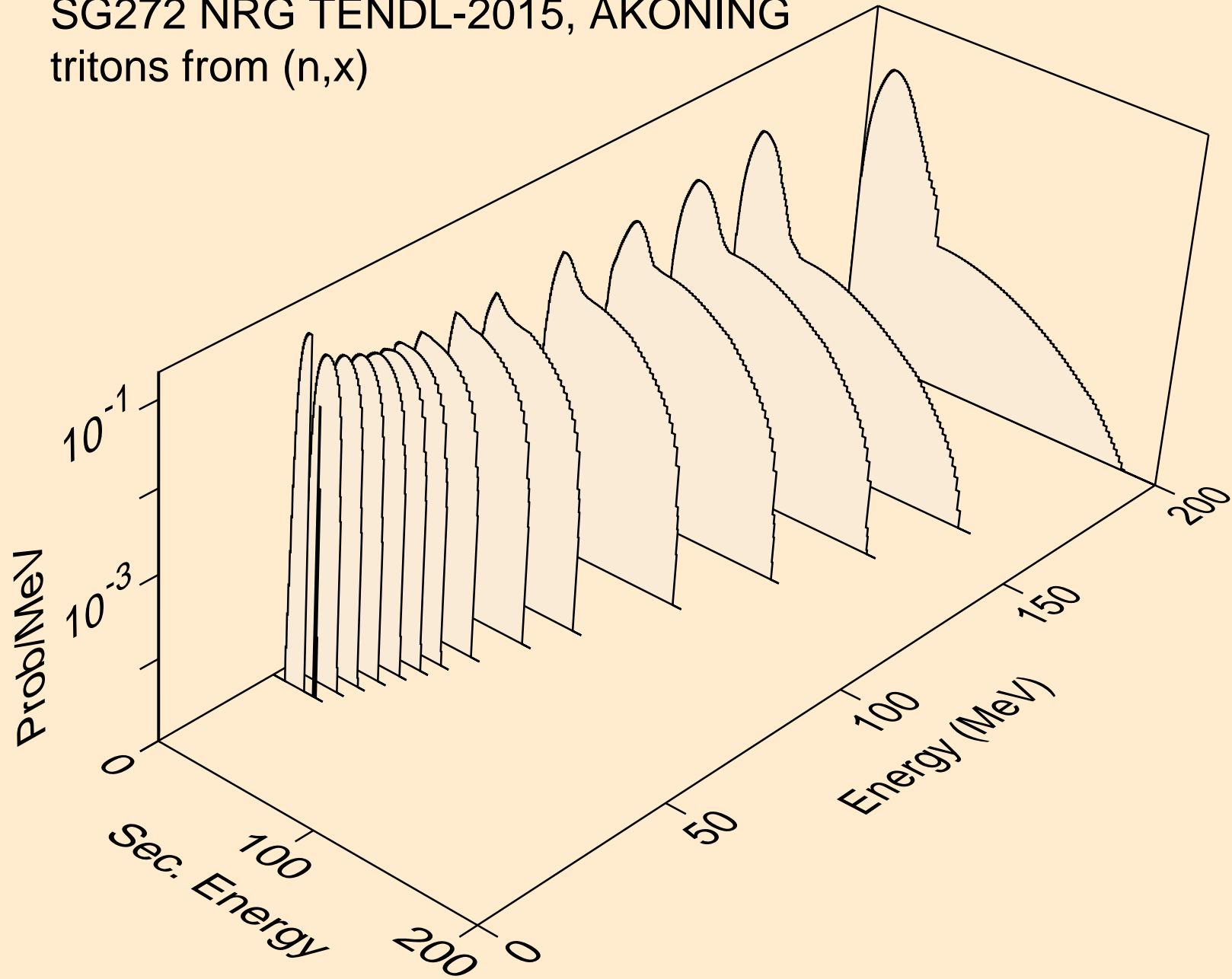

SG272 NRG TENDL-2015, AKONING
tritons from (n,n*)t

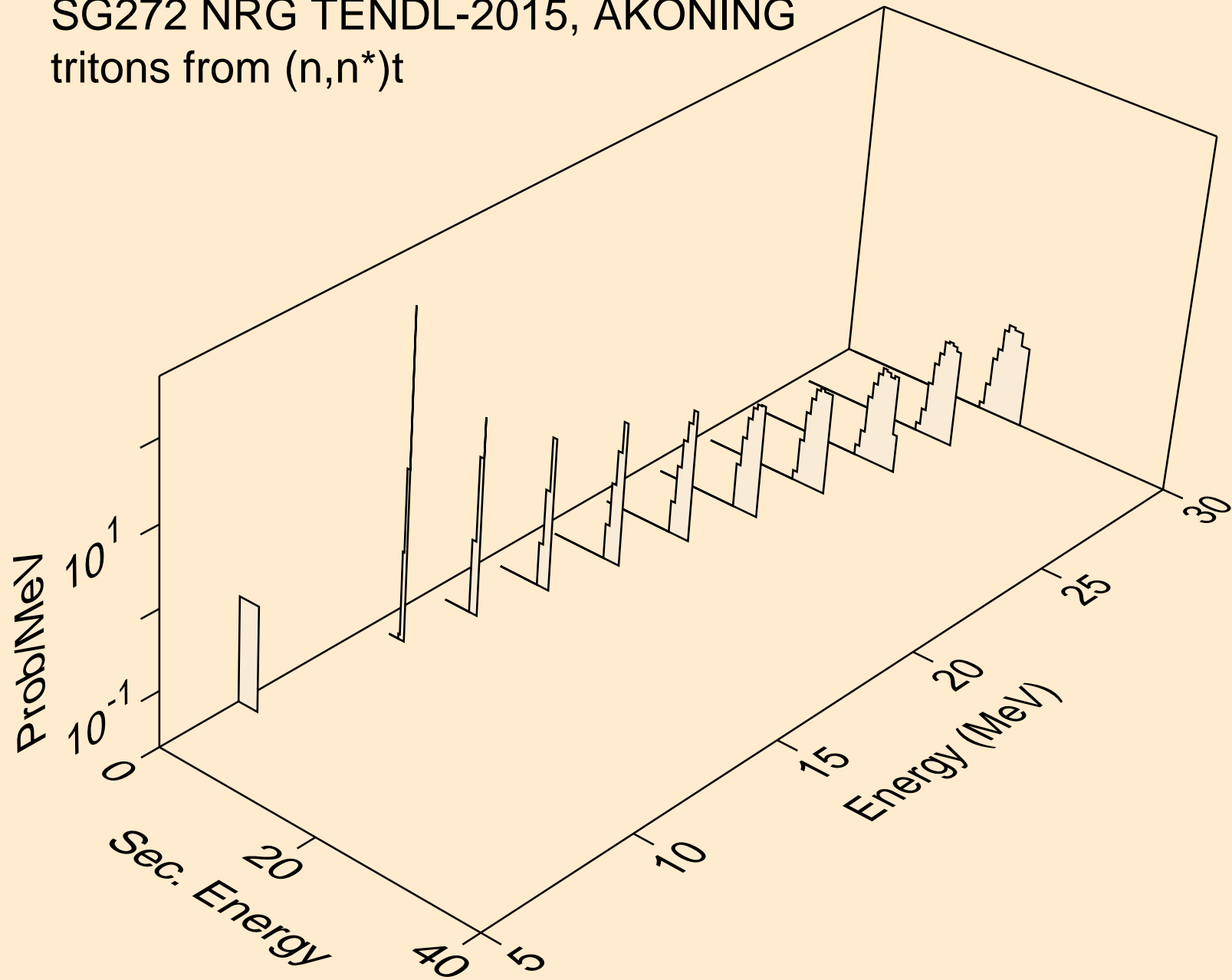

SG272 NRG TENDL-2015, AKONING
tritons from (n,n*)t2a

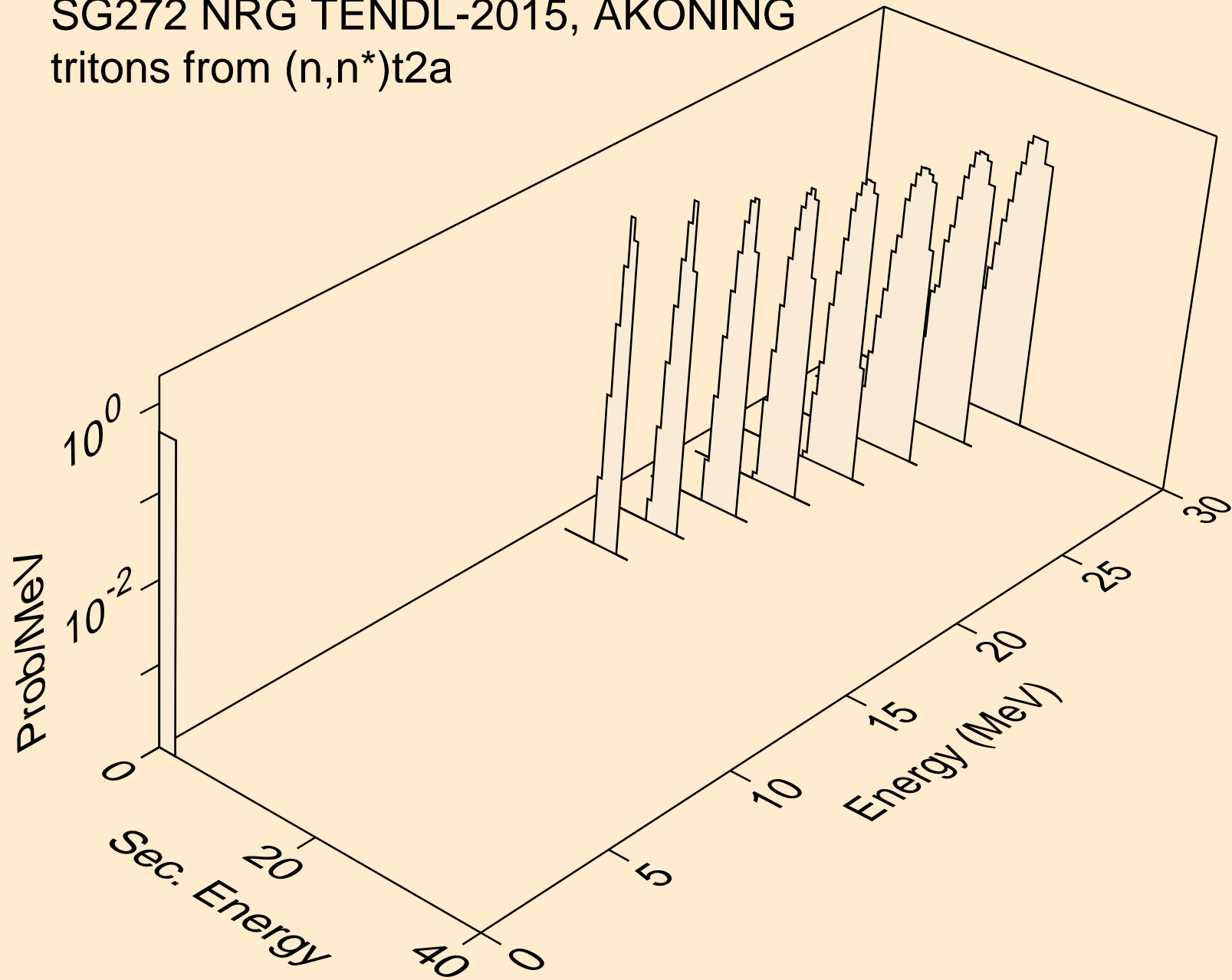

SG272 NRG TENDL-2015, AKONING
tritons from (n,t)

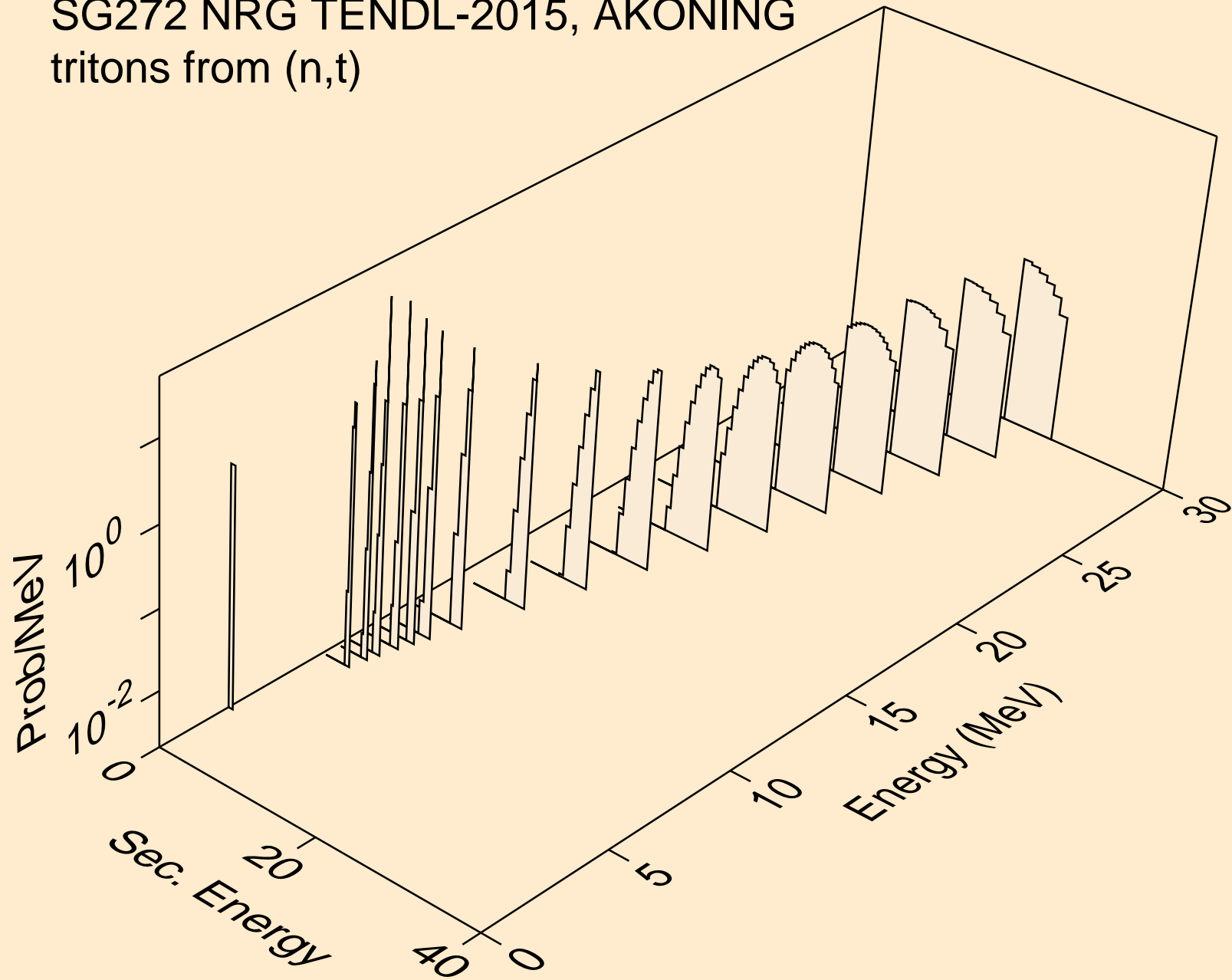

SG272 NRG TENDL-2015, AKONING
tritons from (n,t2a)

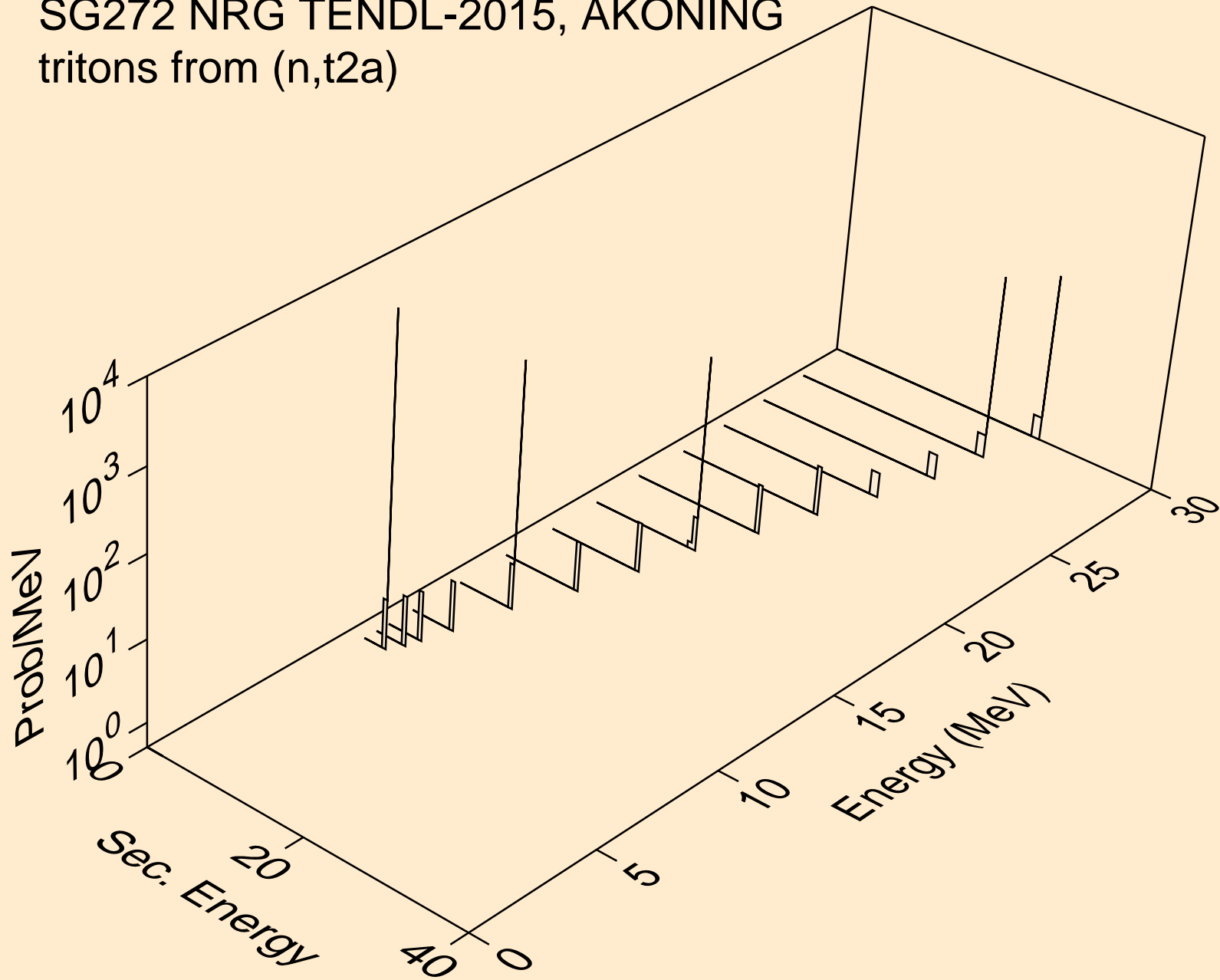

SG272 NRG TENDL-2015, AKONING
he3s from (n,x)

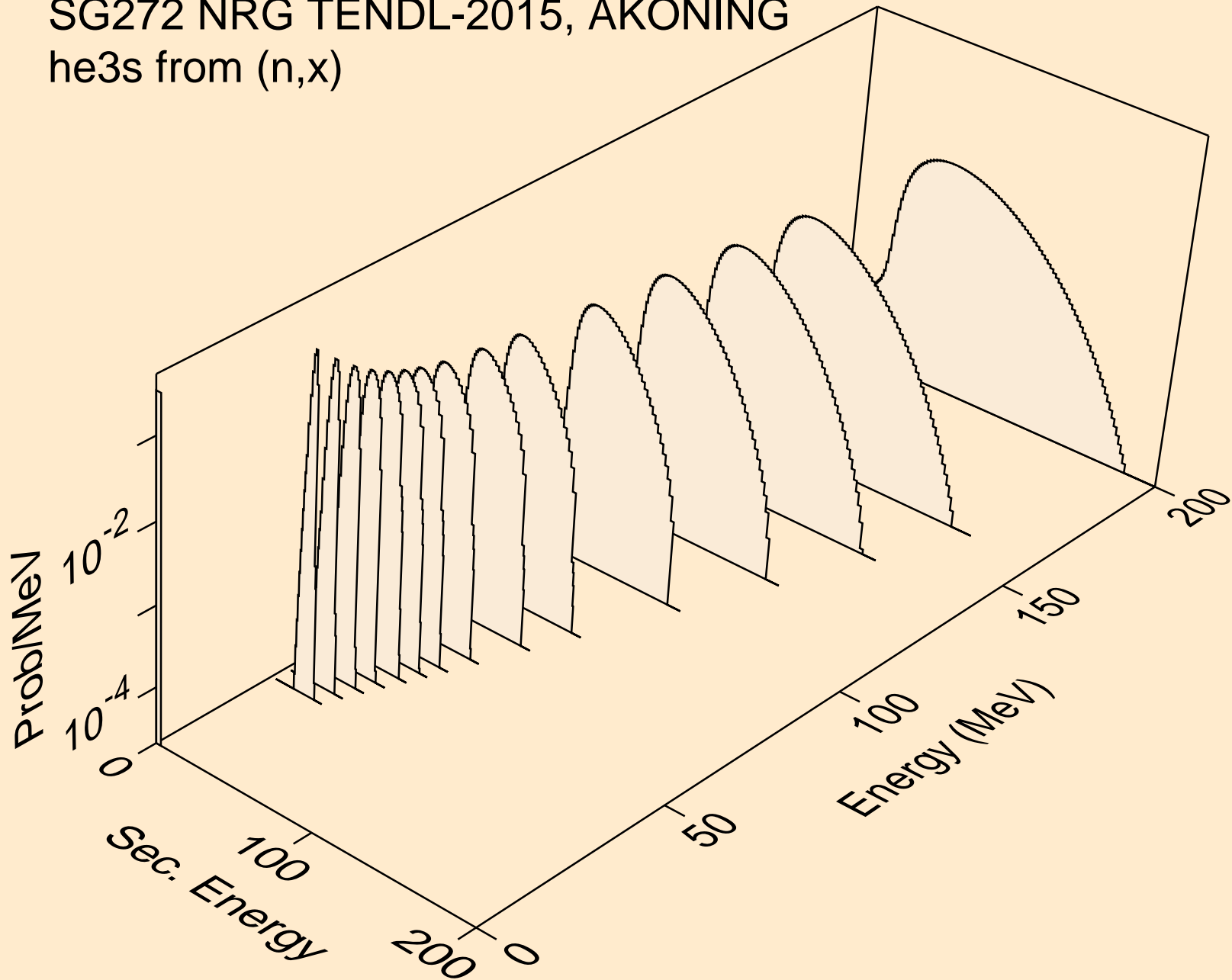

SG272 NRG TENDL-2015, AKONING
he3s from (n,he3)

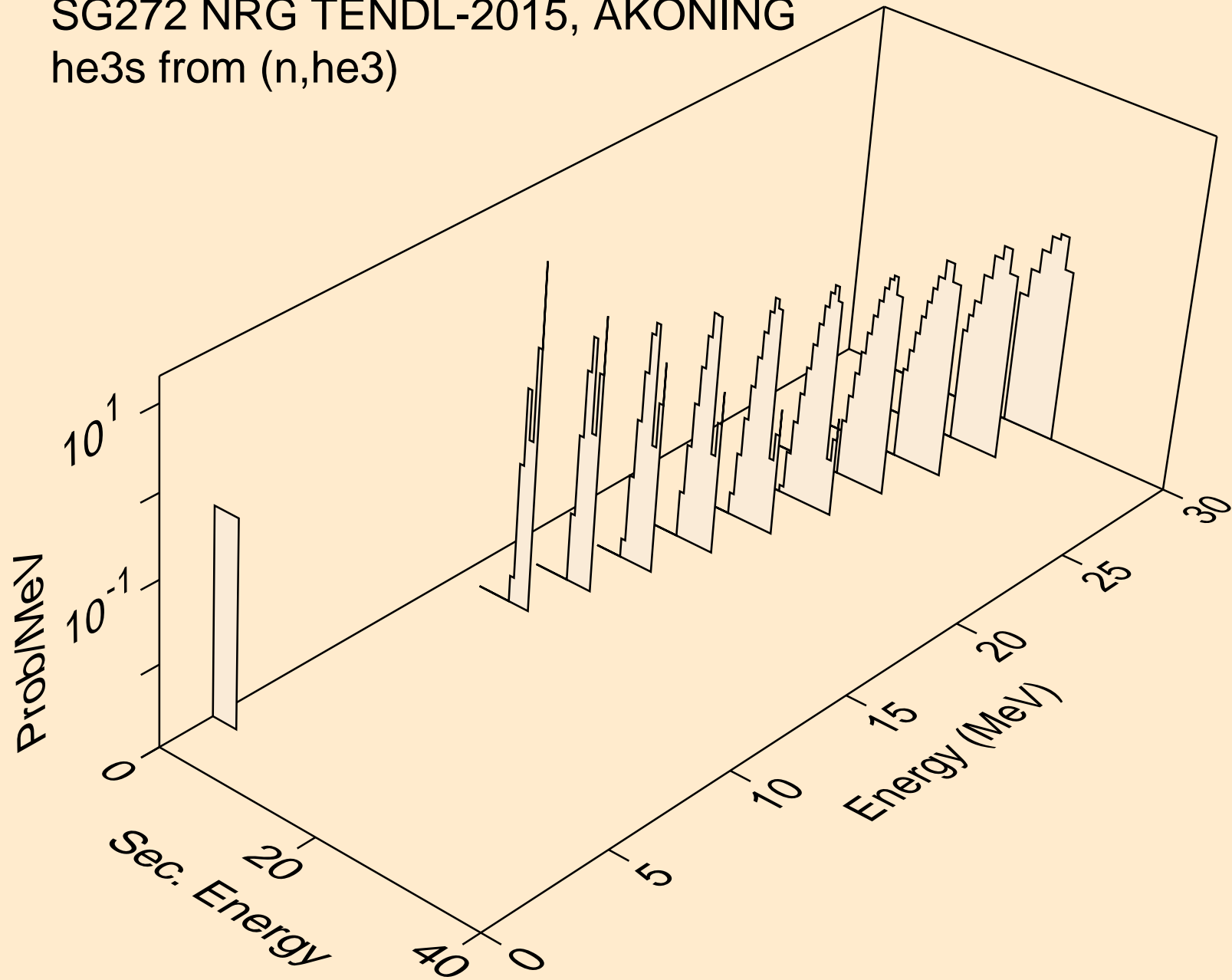

SG272 NRG TENDL-2015, AKONING
alphas from (n,x)

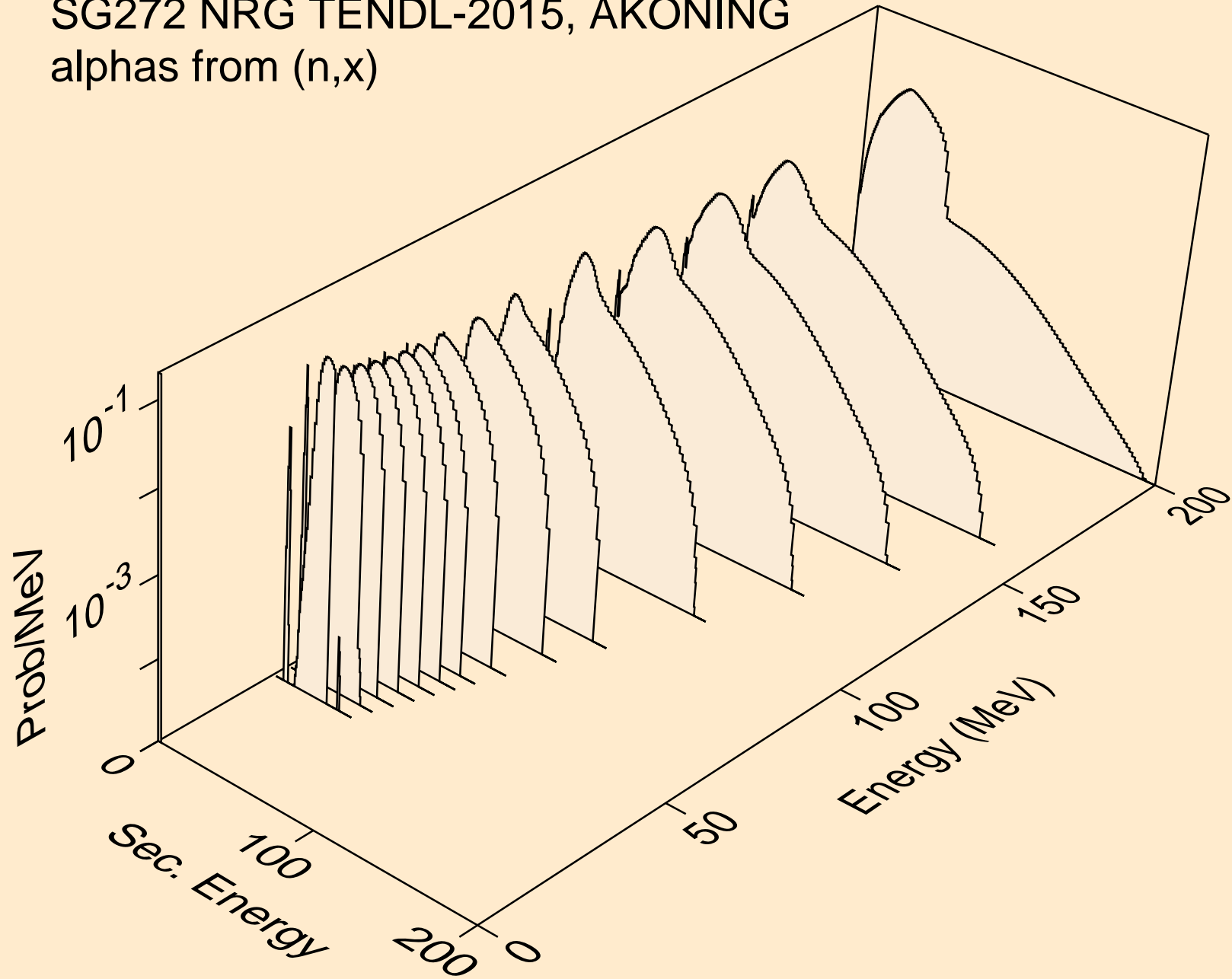

SG272 NRG TENDL-2015, AKONING
alphas from (n,n*)a

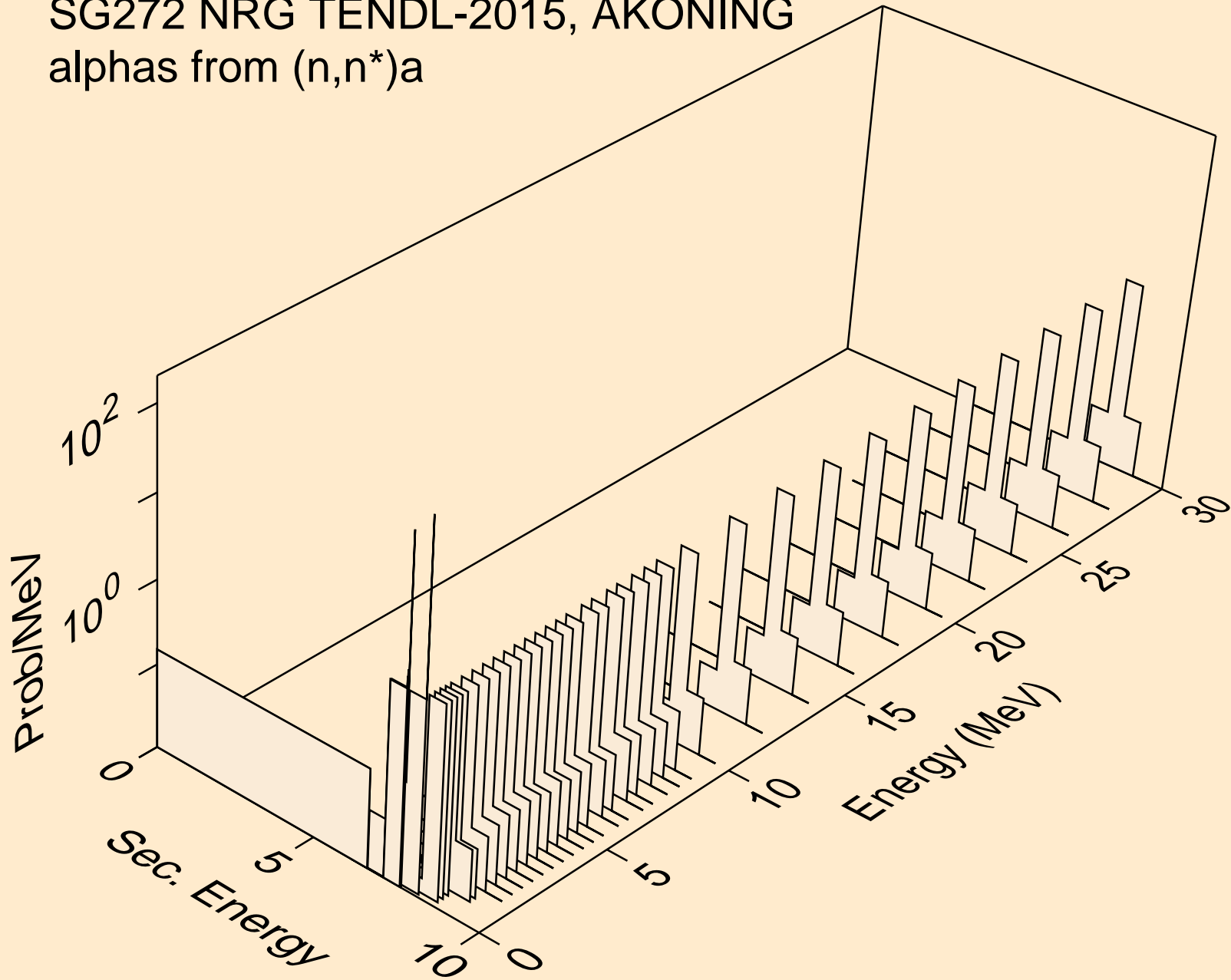

SG272 NRG TENDL-2015, AKONING
alphas from (n,n*)3a

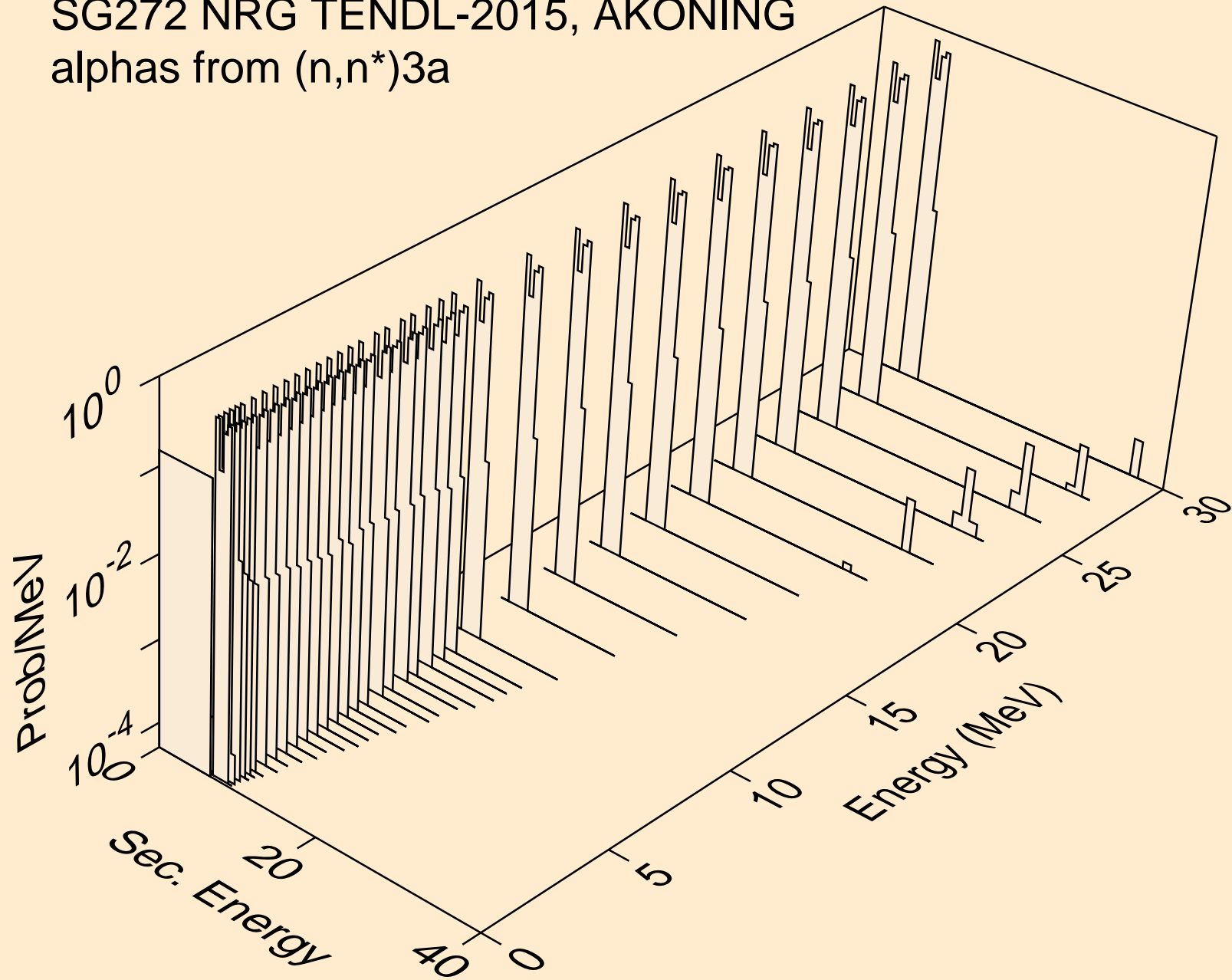

SG272 NRG TENDL-2015, AKONING
alphas from (n,2n)a

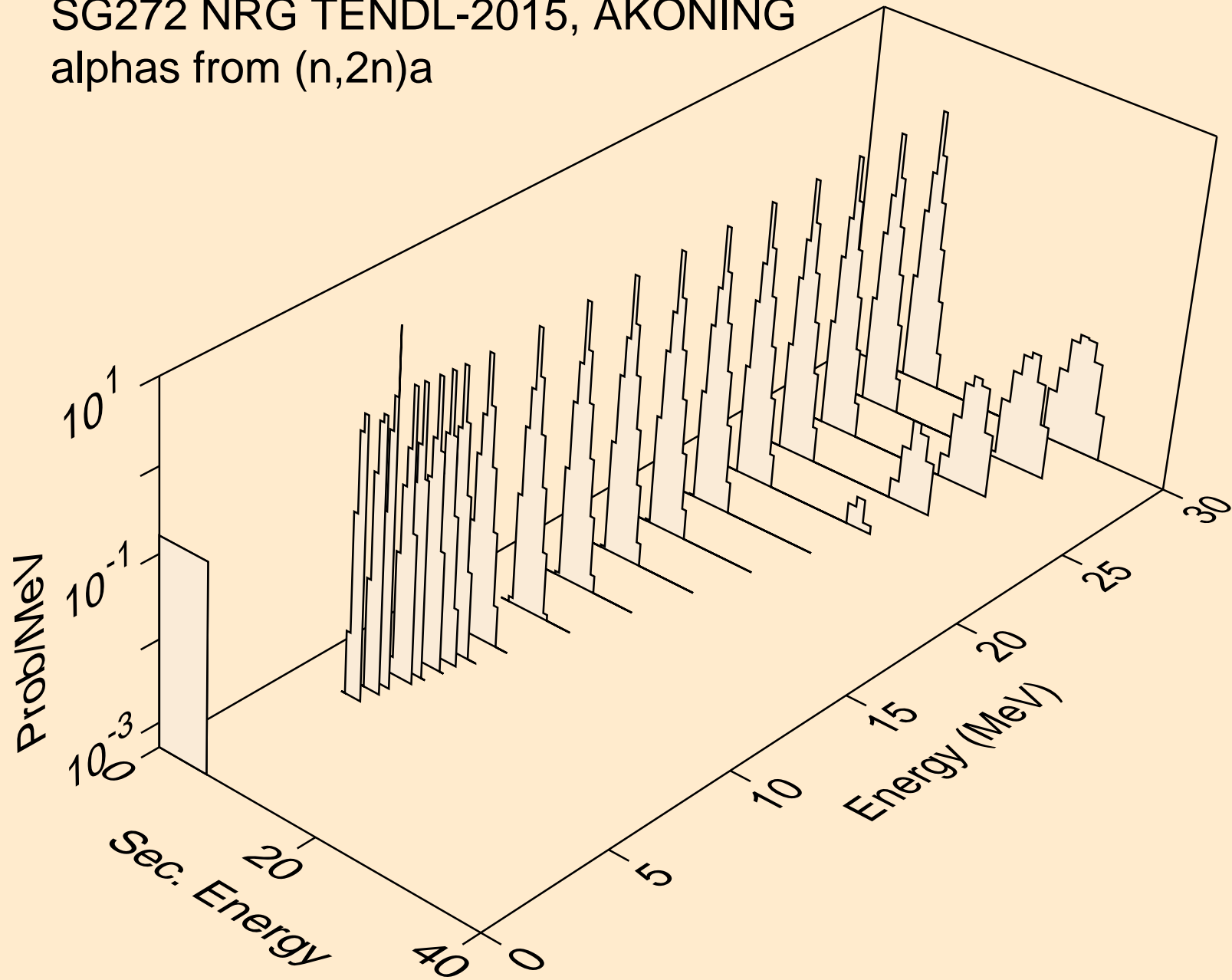

SG272 NRG TENDL-2015, AKONING
alphas from (n,3n)a

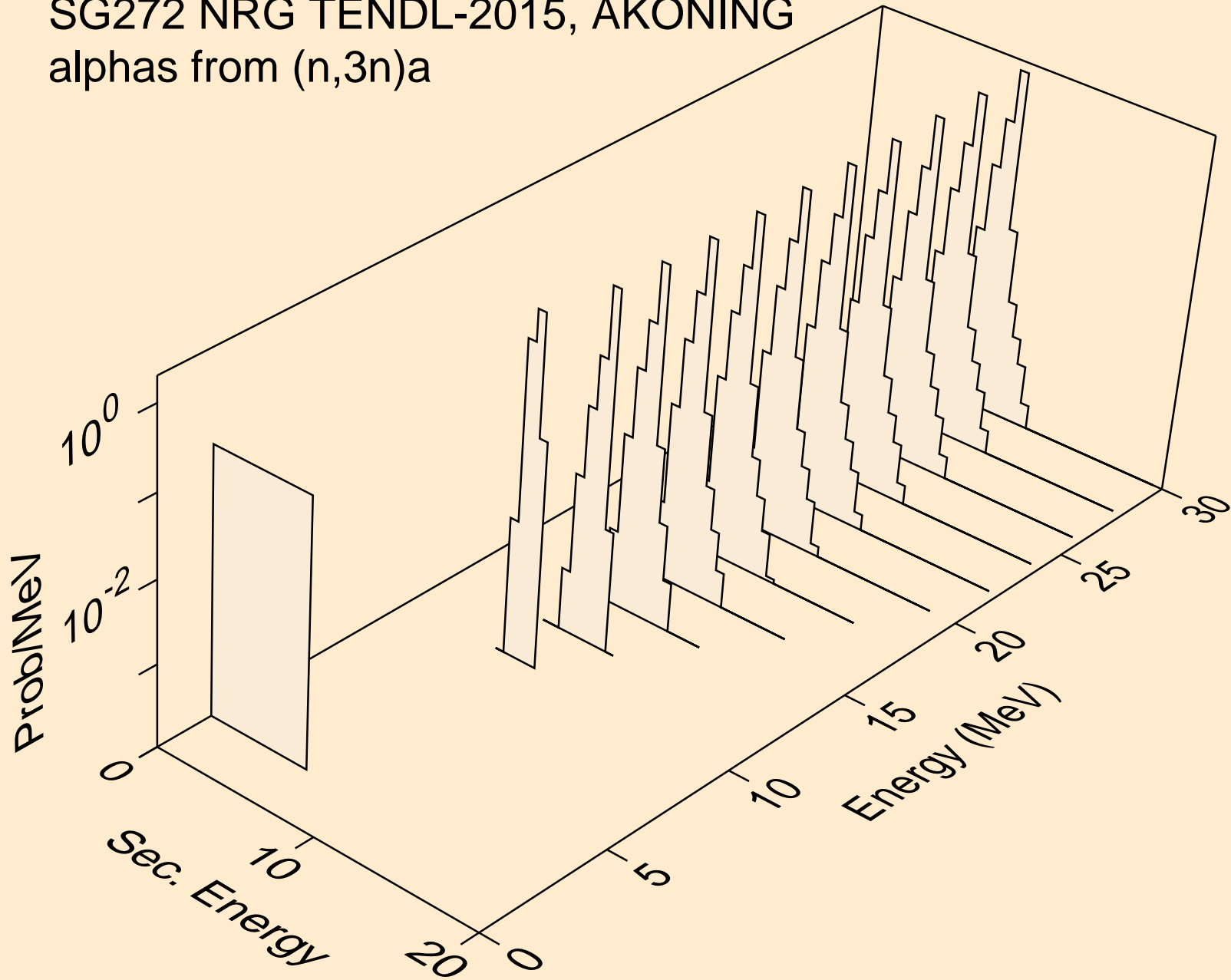

SG272 NRG TENDL-2015, AKONING
alphas from (n,n*)2a

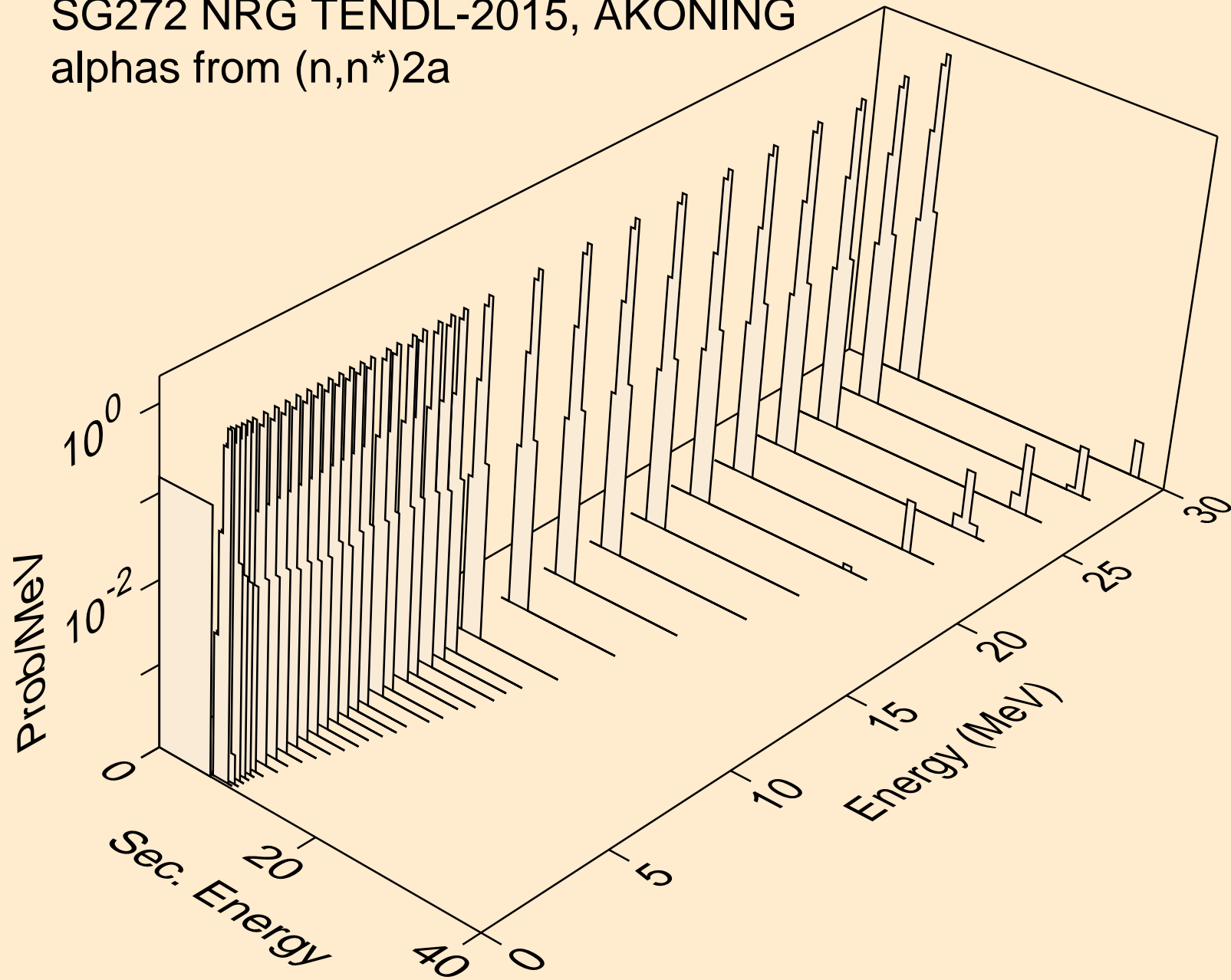

SG272 NRG TENDL-2015, AKONING
alphas from (n,2n)2a

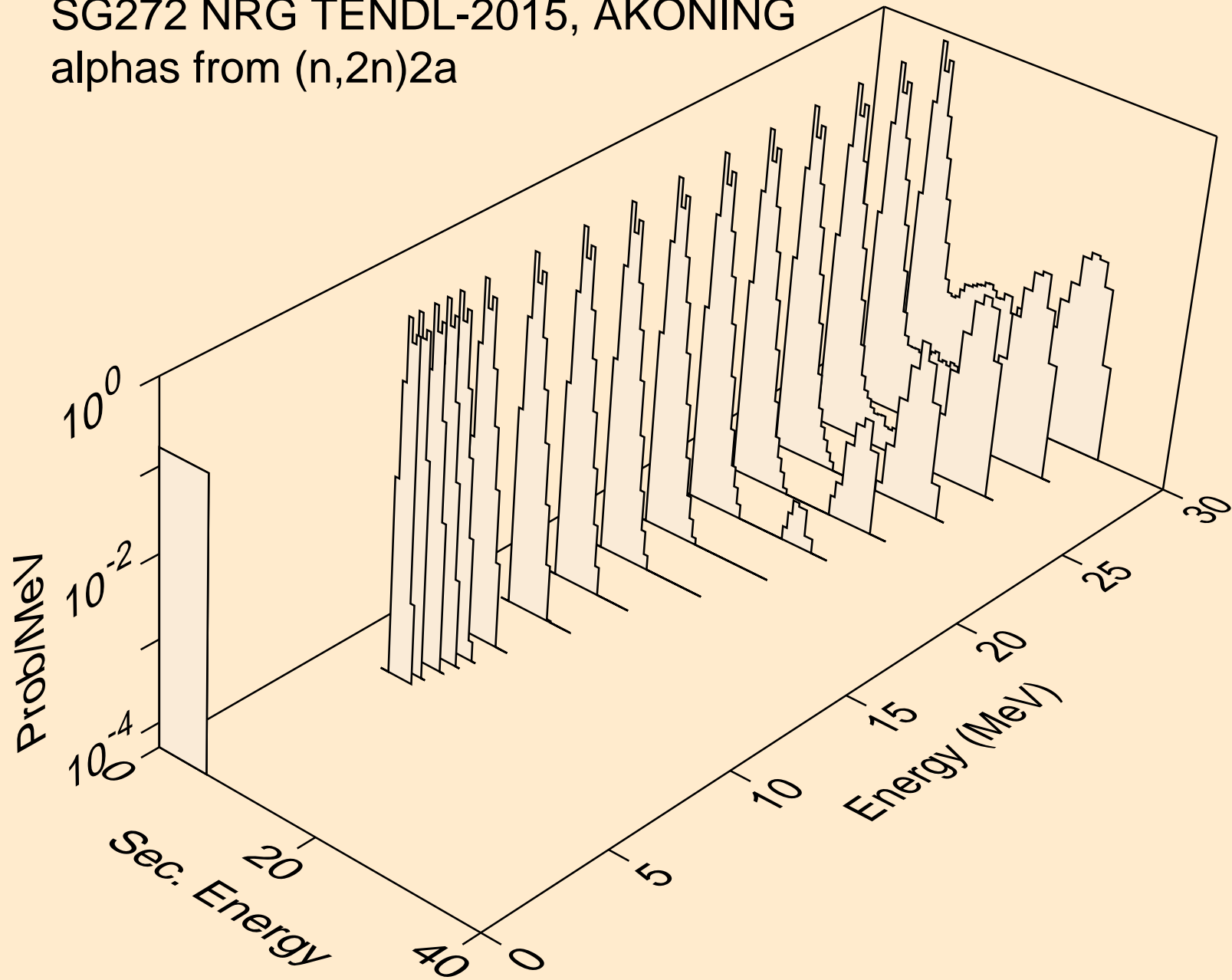

SG272 NRG TENDL-2015, AKONING
alphas from (n,n*)d2a

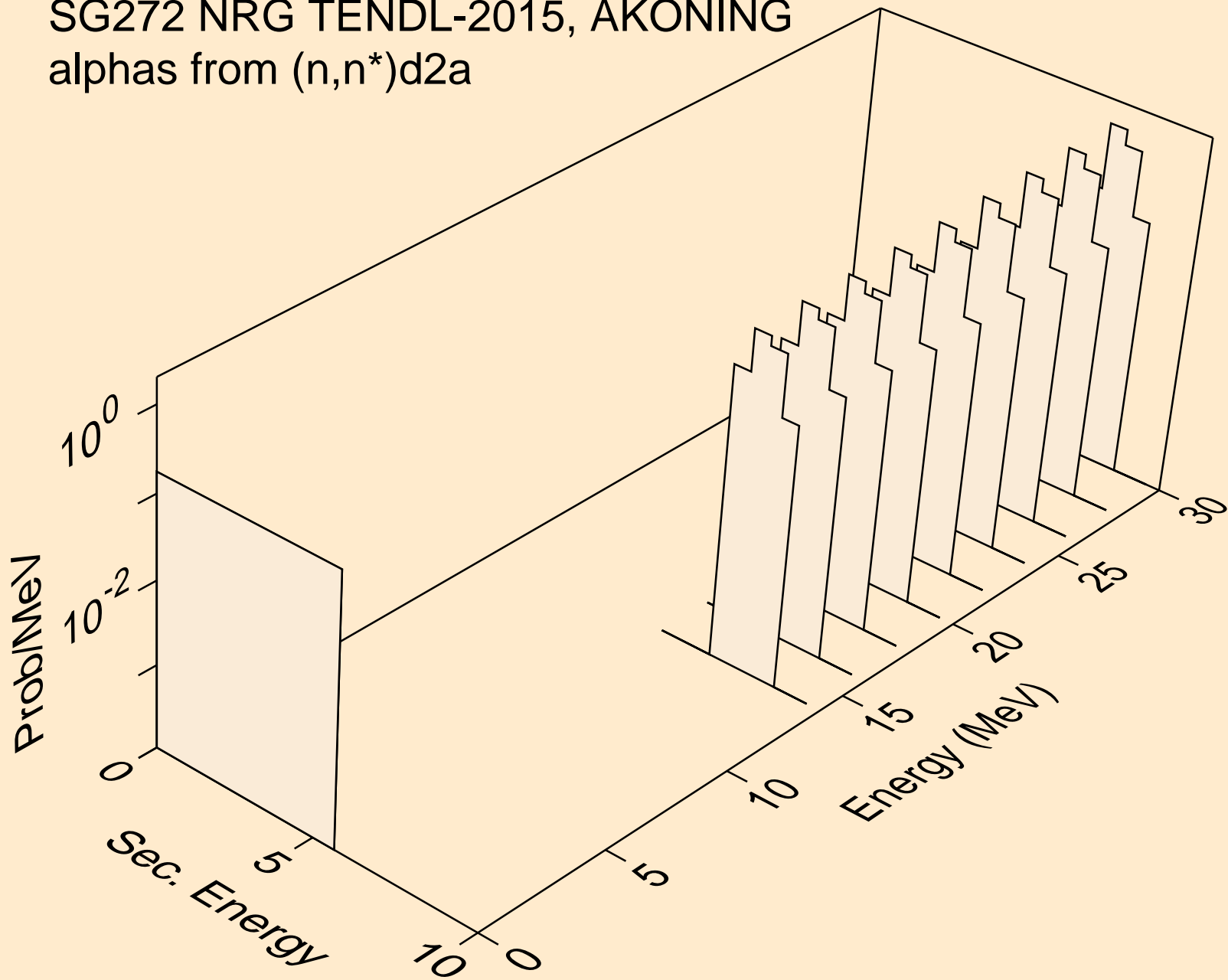

SG272 NRG TENDL-2015, AKONING
alphas from (n,n*)t2a

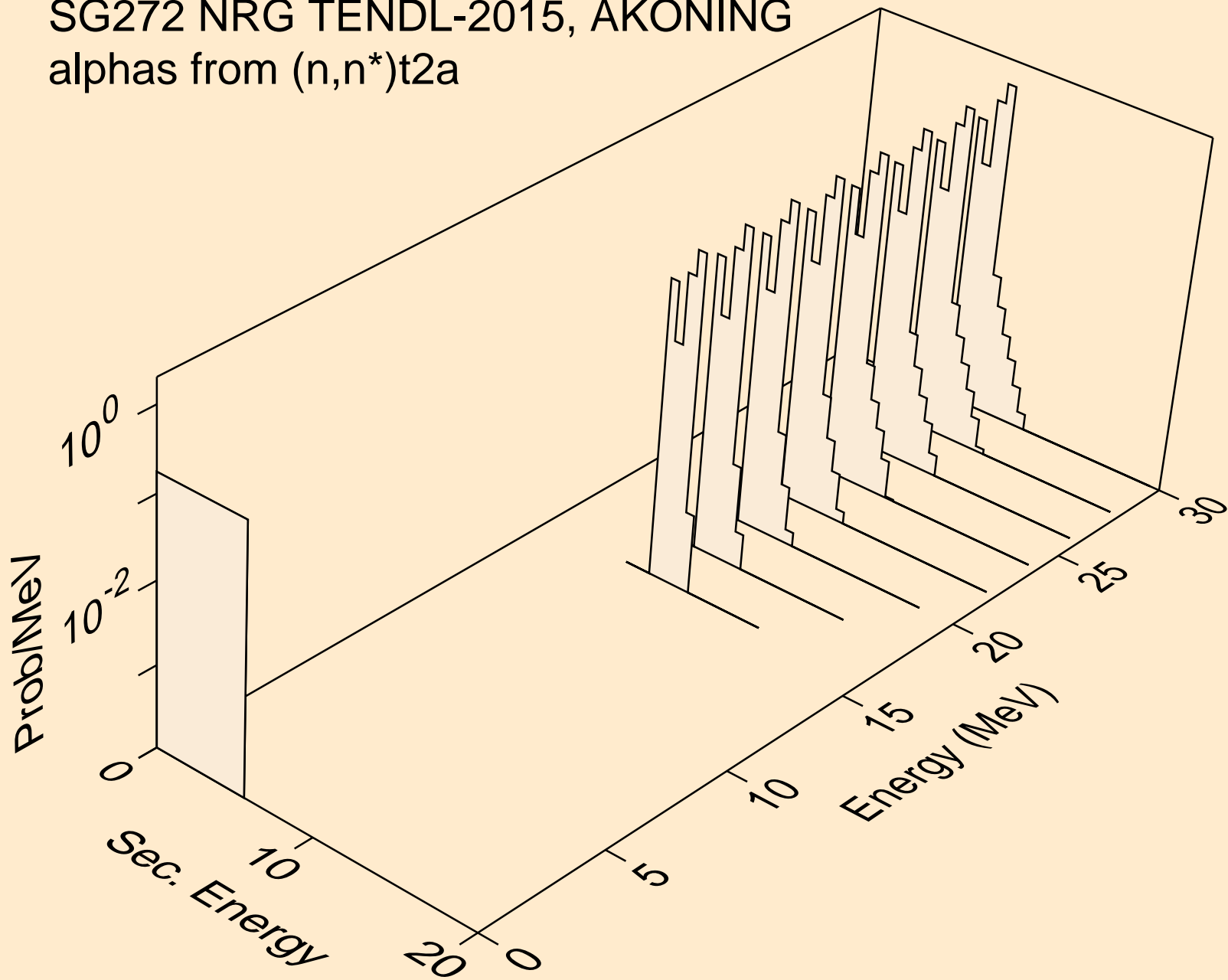

SG272 NRG TENDL-2015, AKONING
alphas from (n,npa)

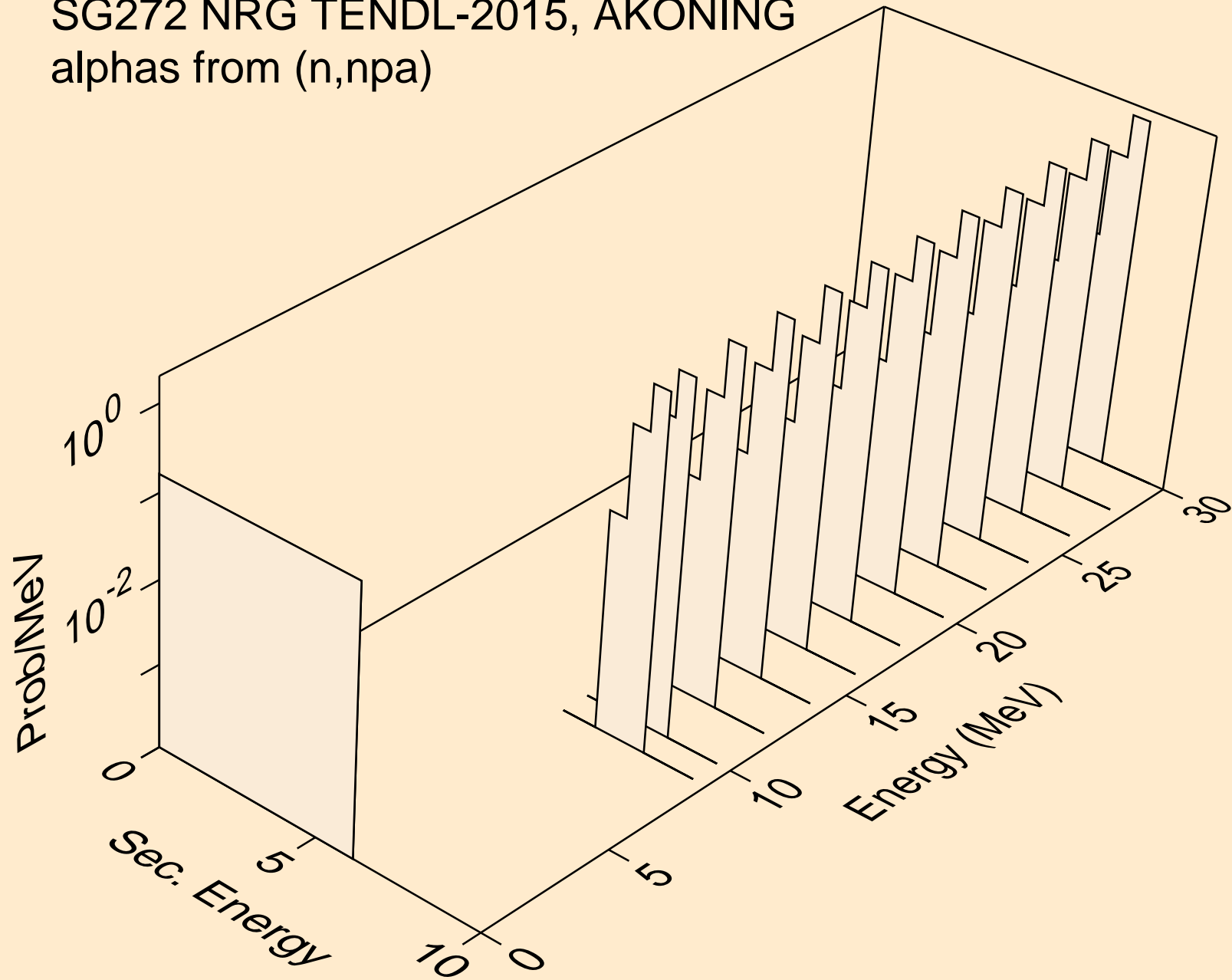

SG272 NRG TENDL-2015, AKONING
alphas from (n,a)

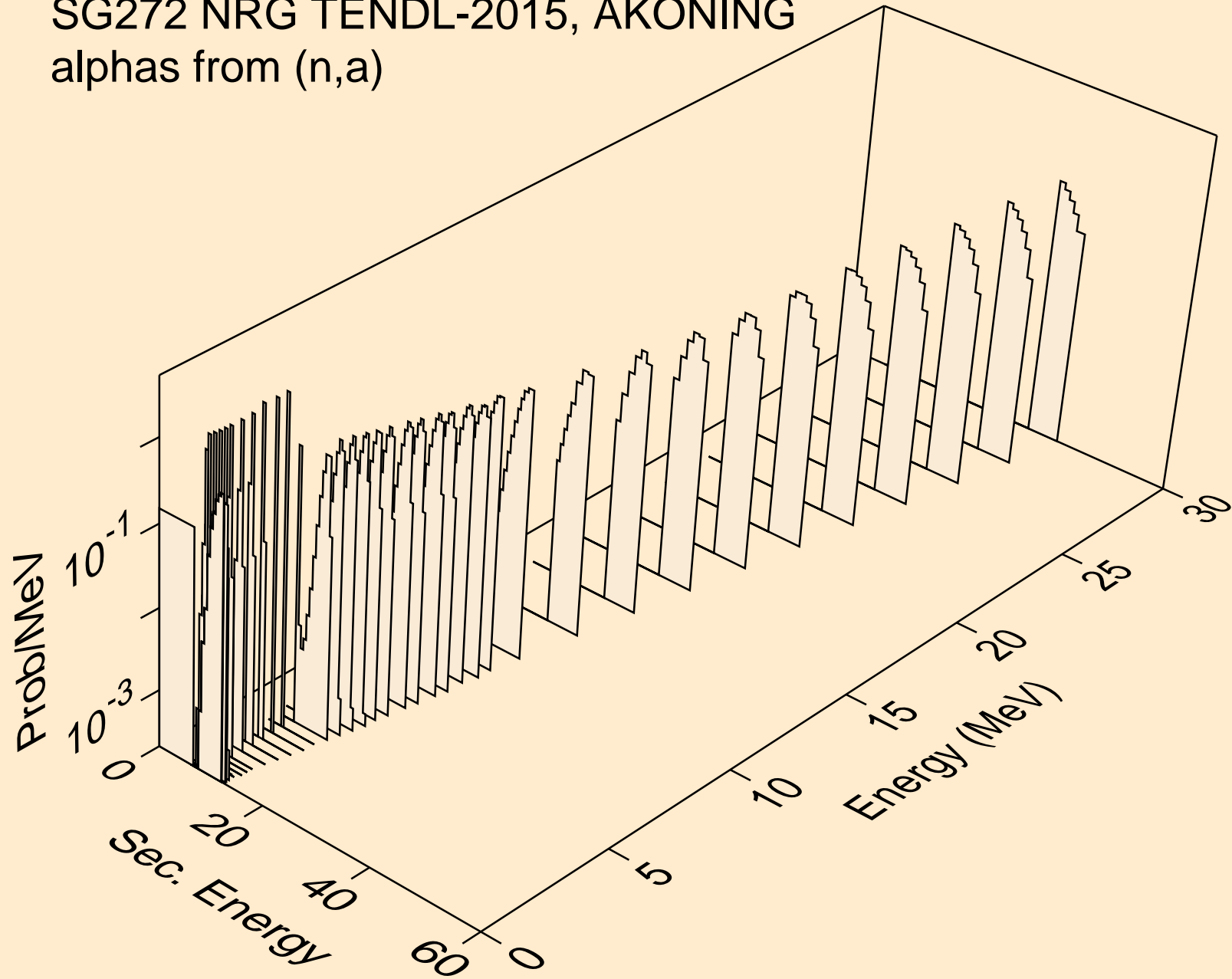

SG272 NRG TENDL-2015, AKONING
alphas from (n,2a)

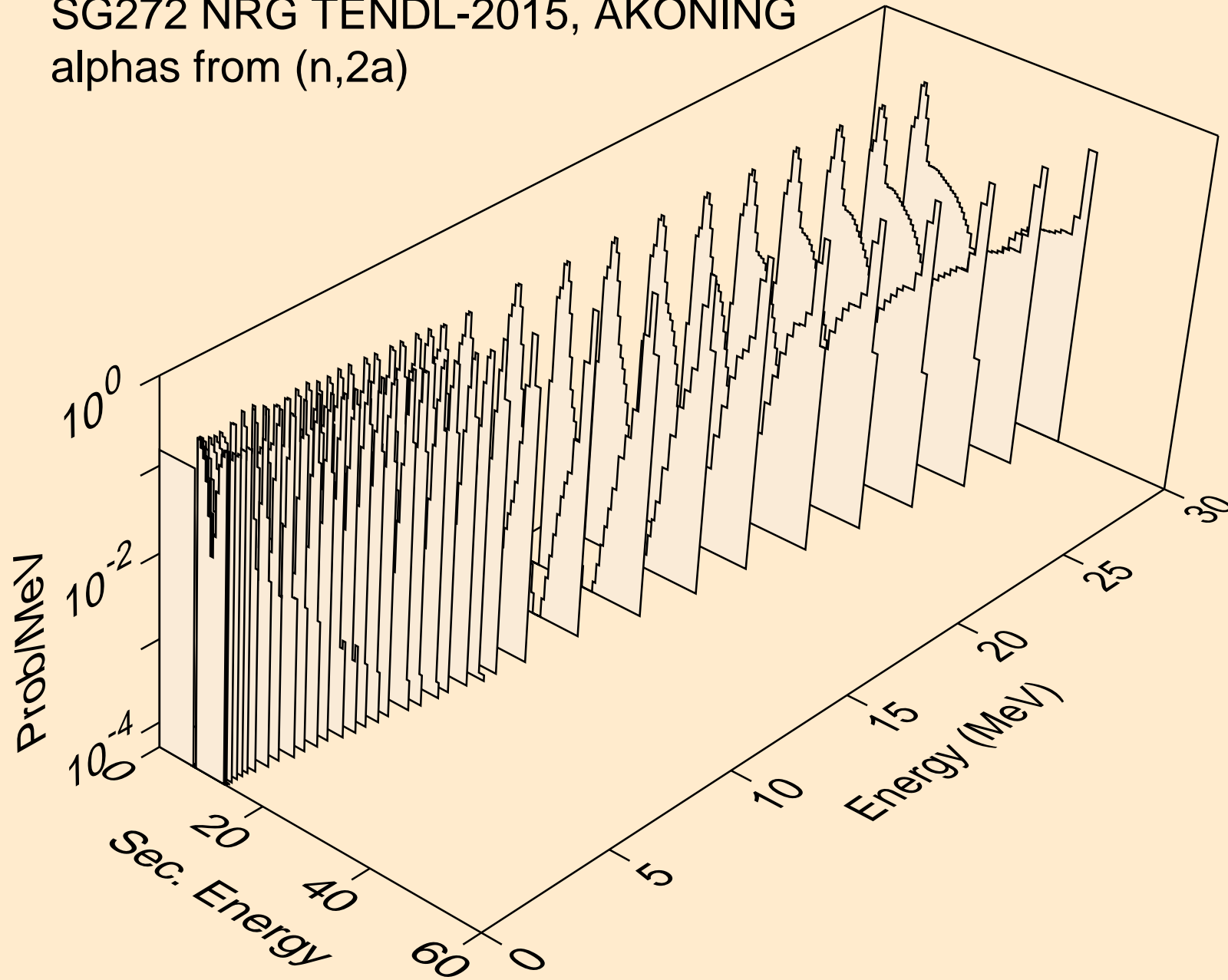

SG272 NRG TENDL-2015, AKONING
alphas from (n,3a)

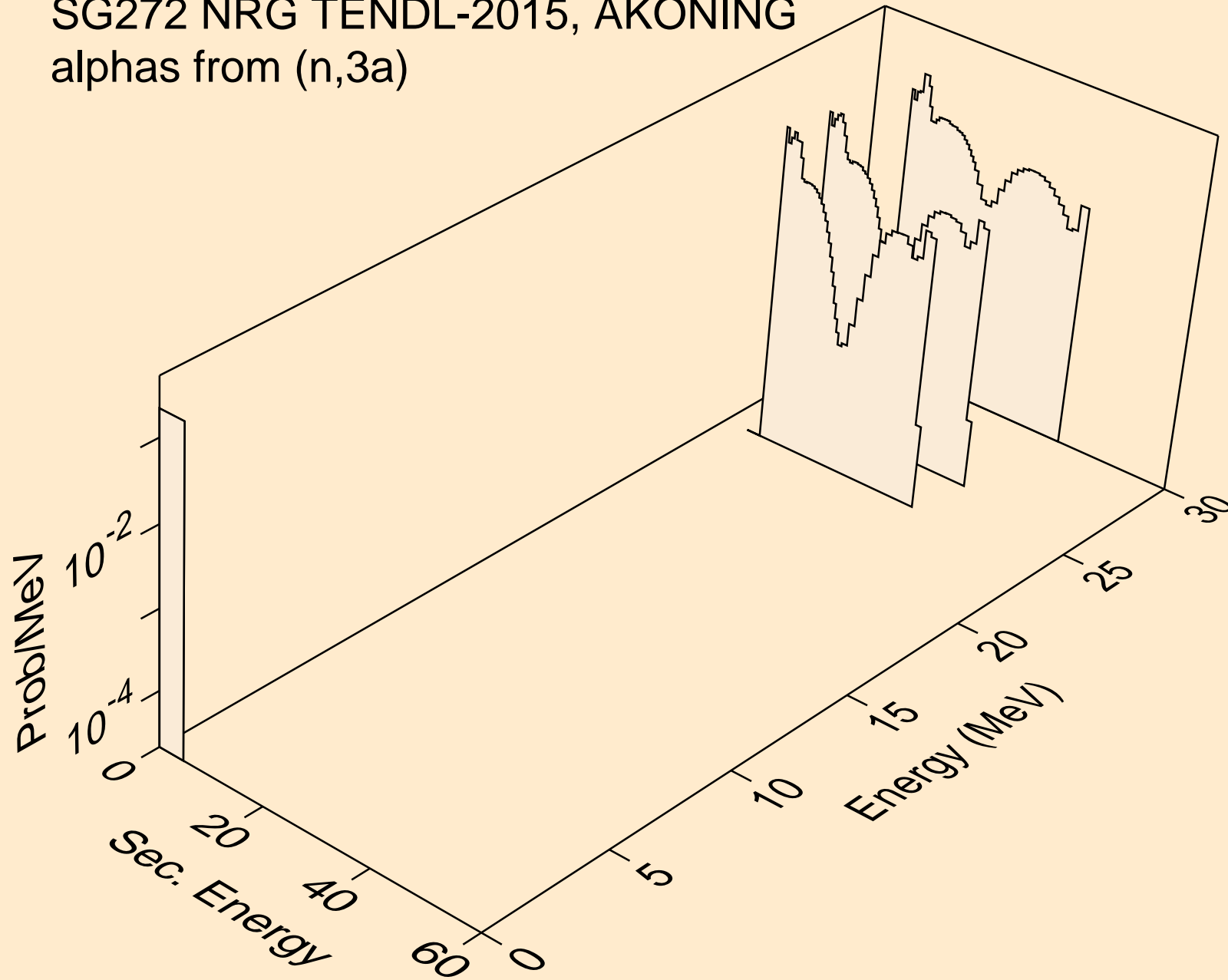

SG272 NRG TENDL-2015, AKONING
alphas from (n,pa)

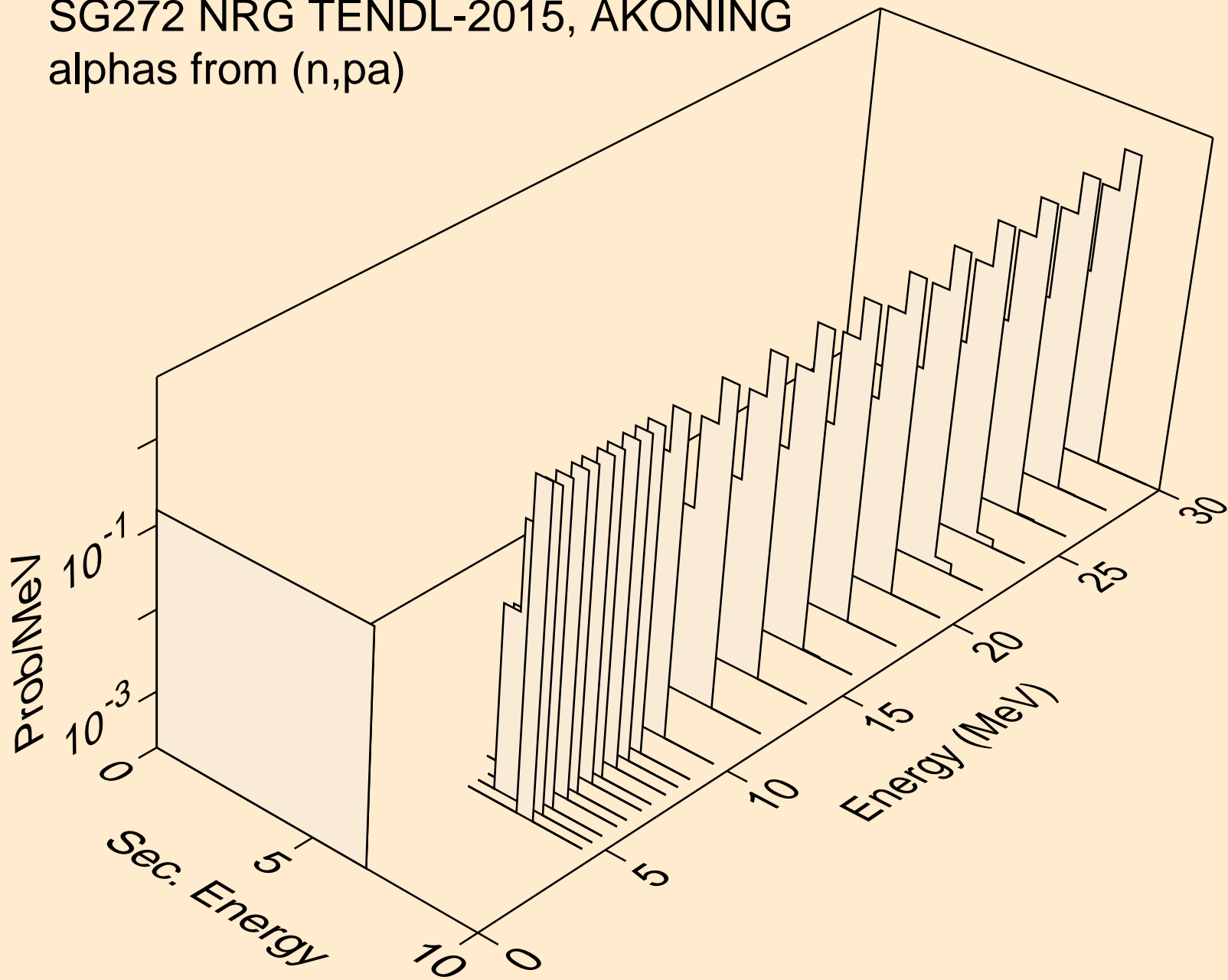

SG272 NRG TENDL-2015, AKONING
alphas from (n,t2a)

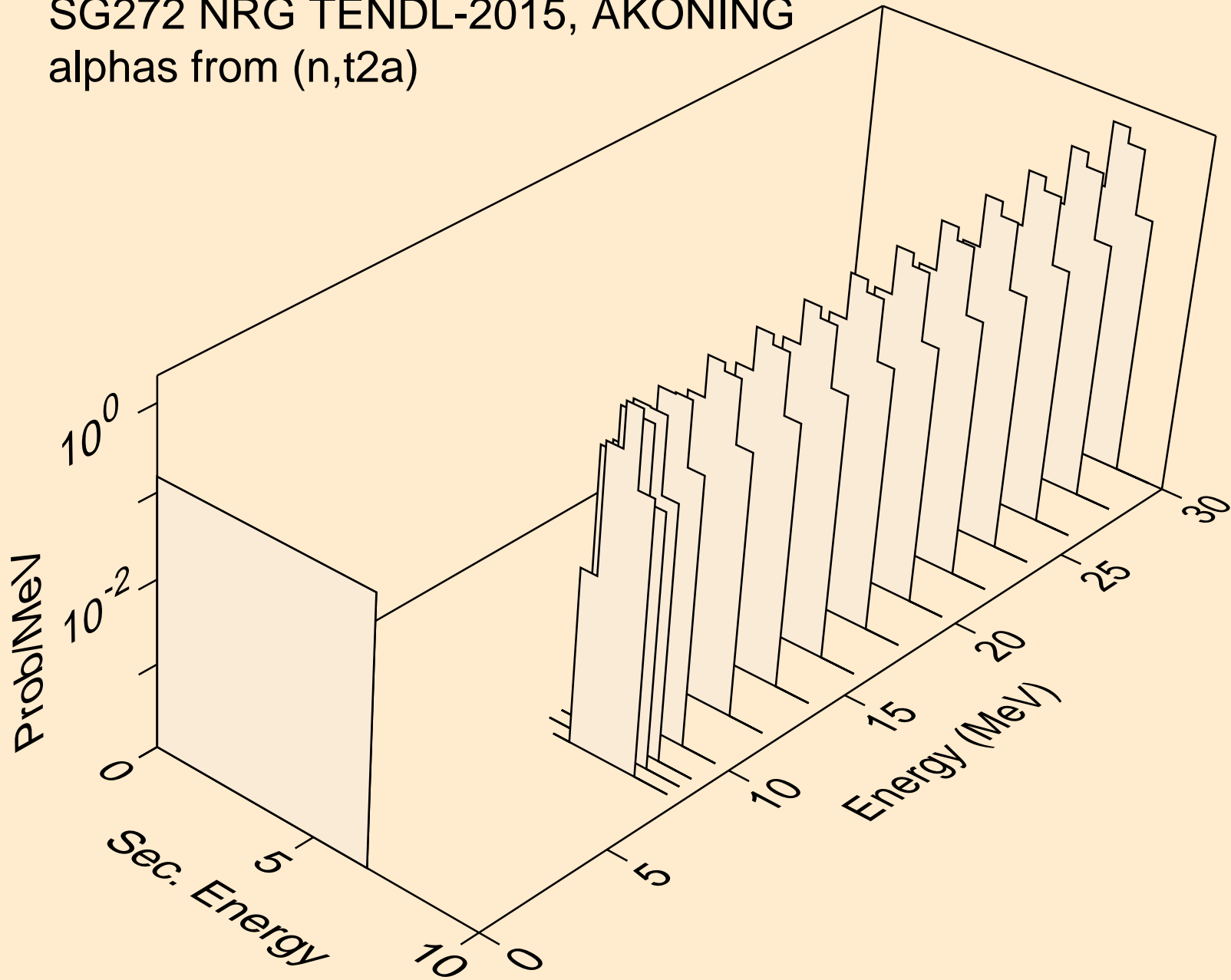

SG272 NRG TENDL-2015, AKONING
alphas from (n,d2a)

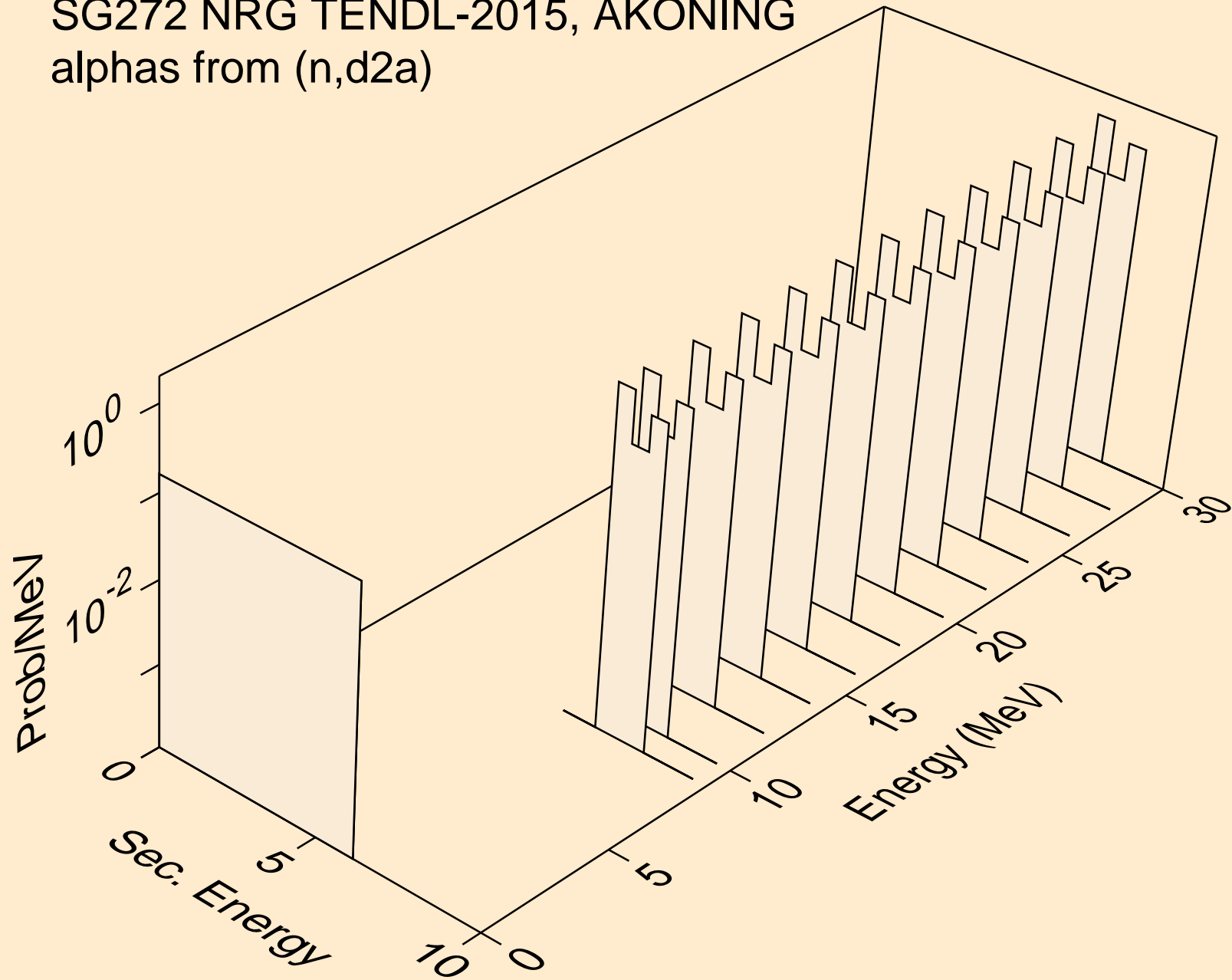

SG272 NRG TENDL-2015, AKONING
alphas from (n,da)

