

# SG273 NRG TENDL-2015, AKONING

## Principal cross sections

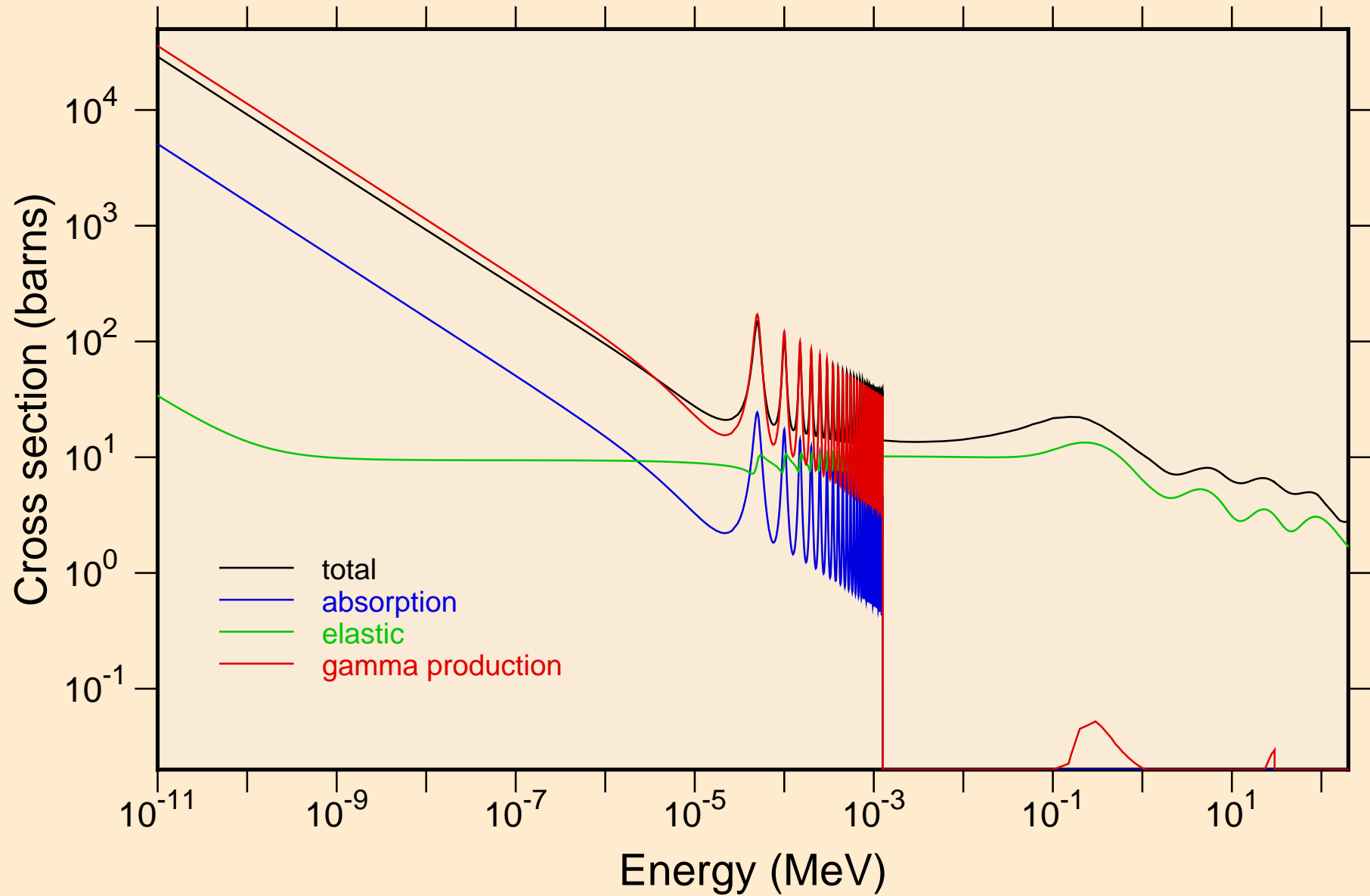

# SG273 NRG TENDL-2015, AKONING

## Non-threshold reactions

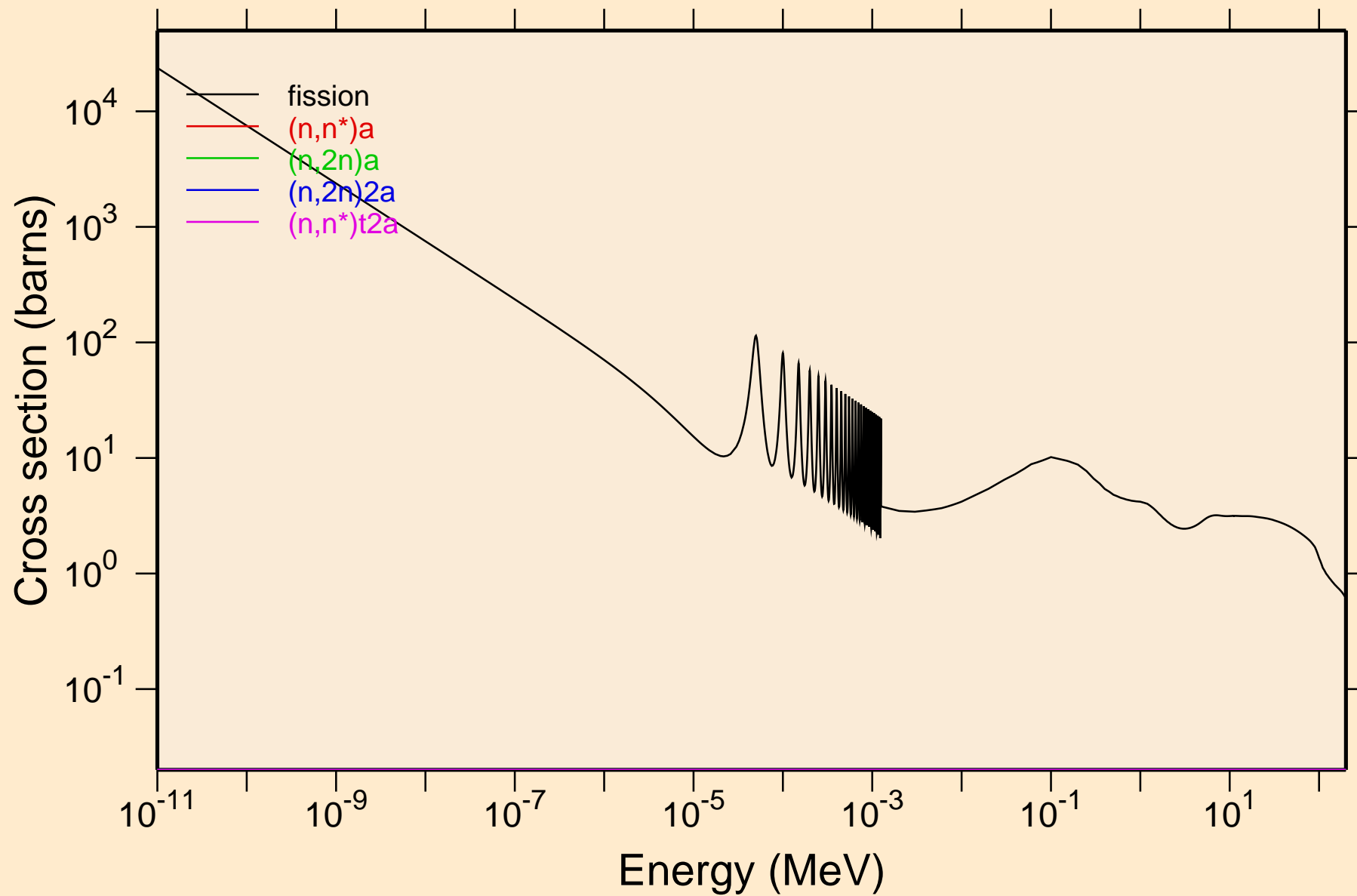

# SG273 NRG TENDL-2015, AKONING

## Non-threshold reactions

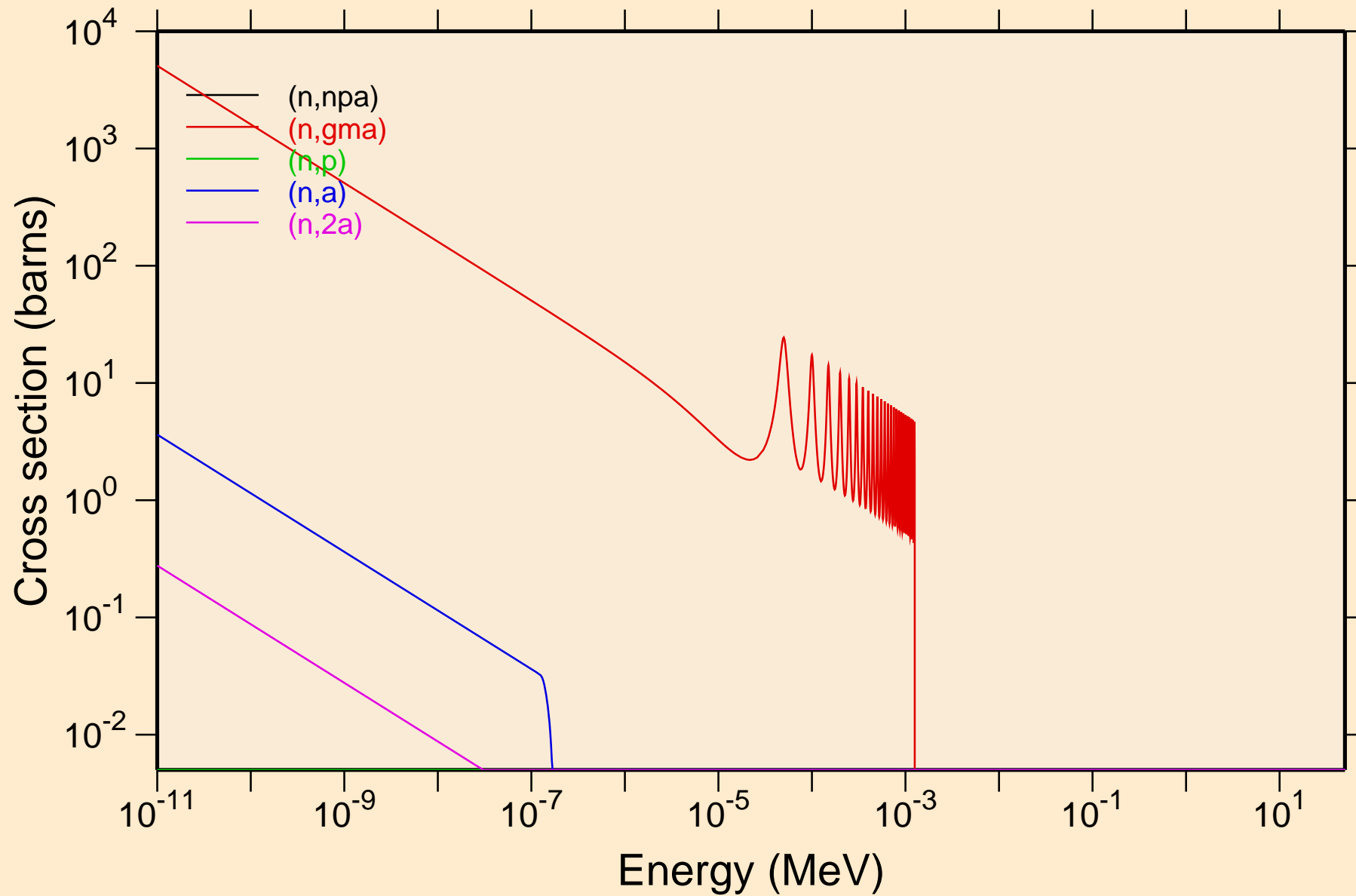

# SG273 NRG TENDL-2015, AKONING

## Non-threshold reactions

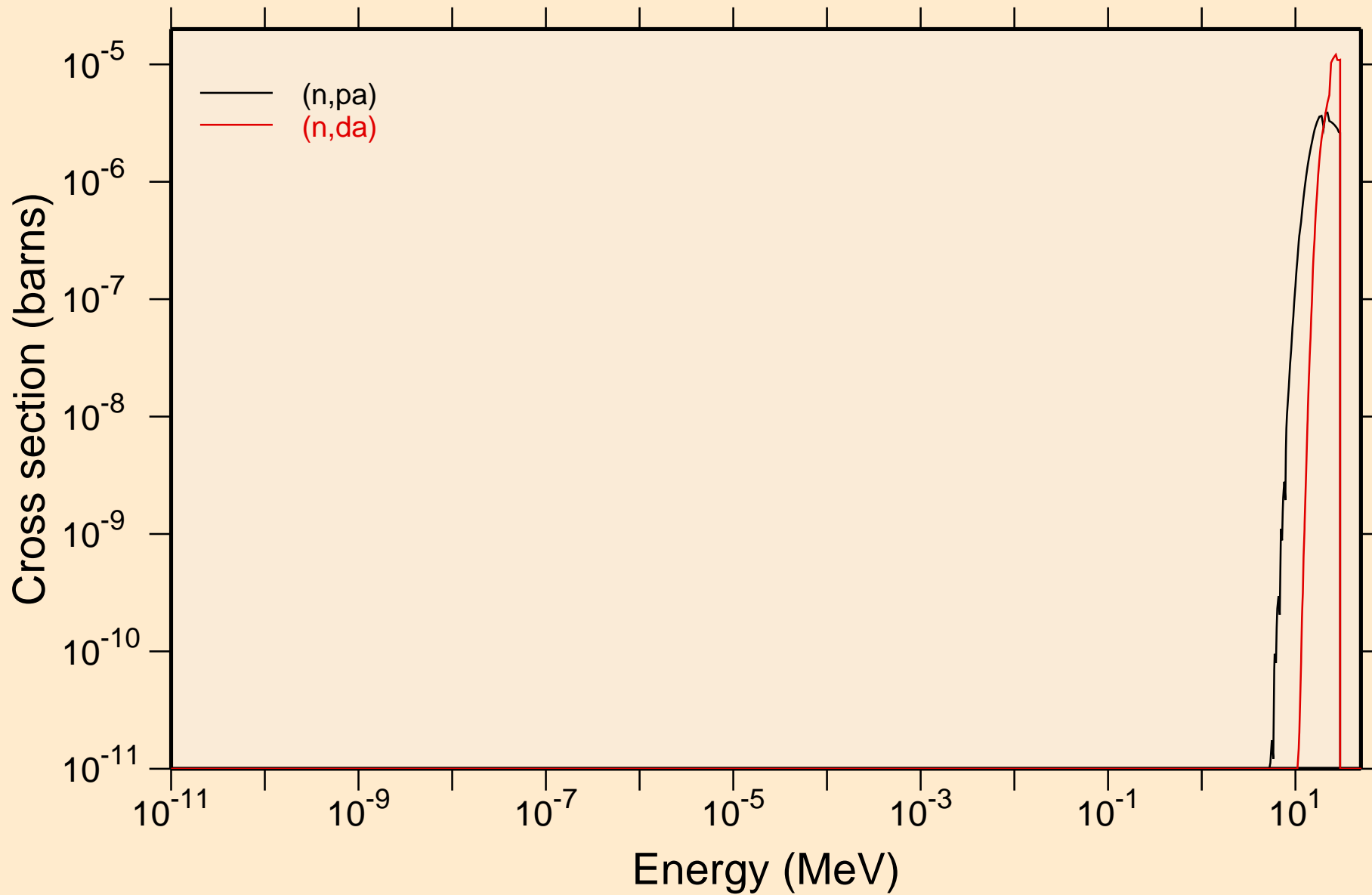

# SG273 NRG TENDL-2015, AKONING

## Principal cross sections

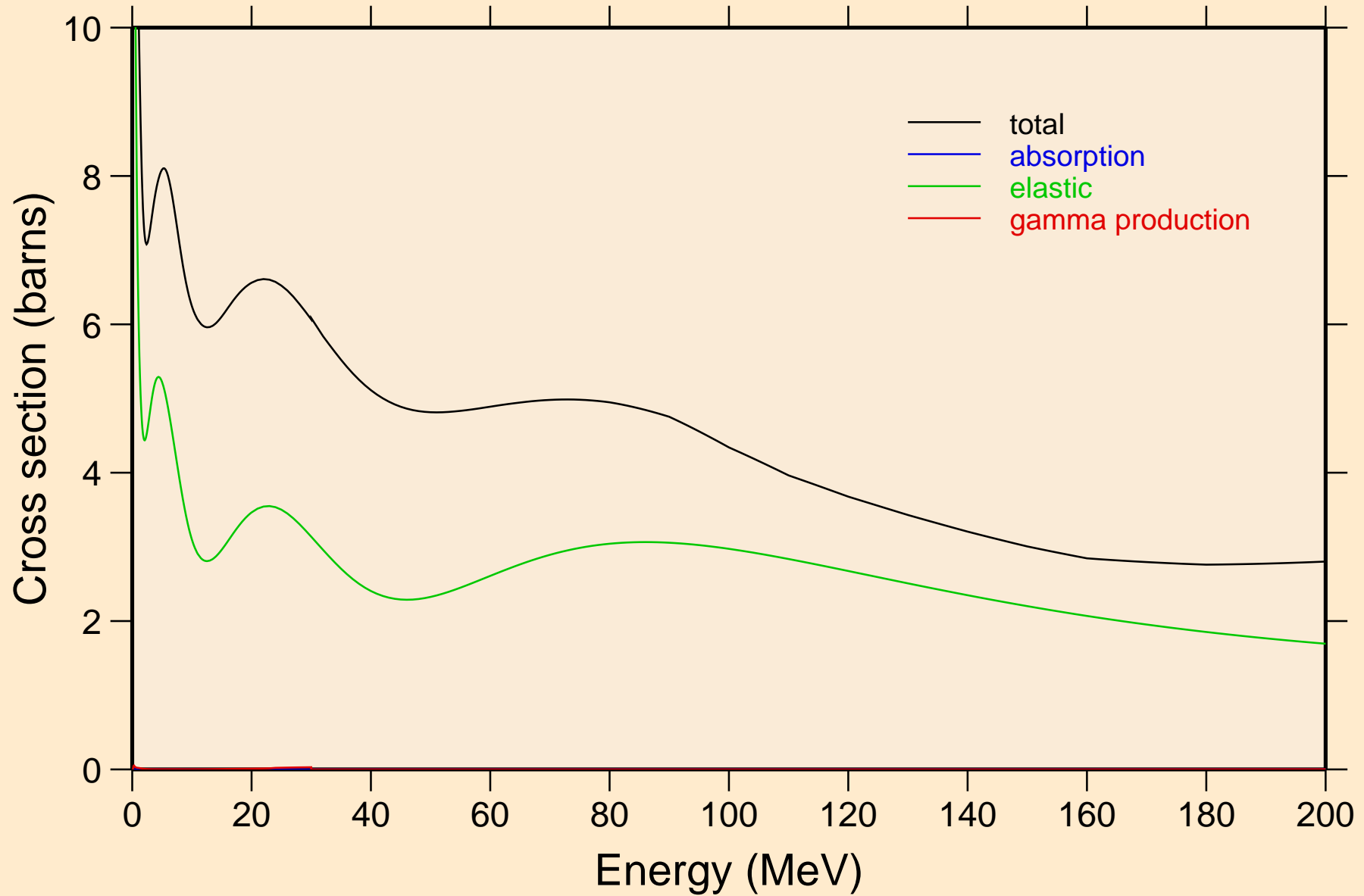

# SG273 NRG TENDL-2015, AKONING

## Non-threshold reactions

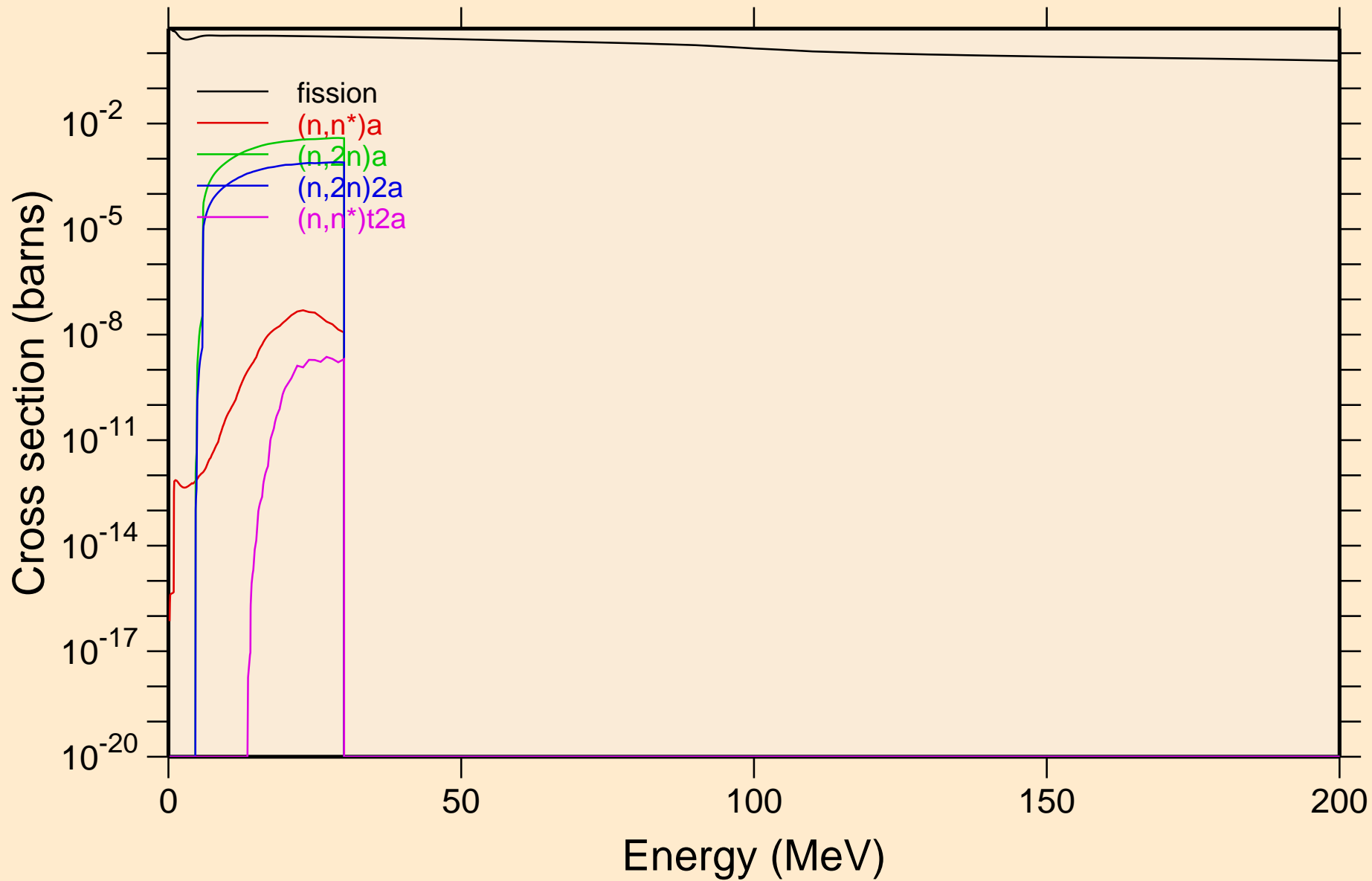

# SG273 NRG TENDL-2015, AKONING

## Non-threshold reactions

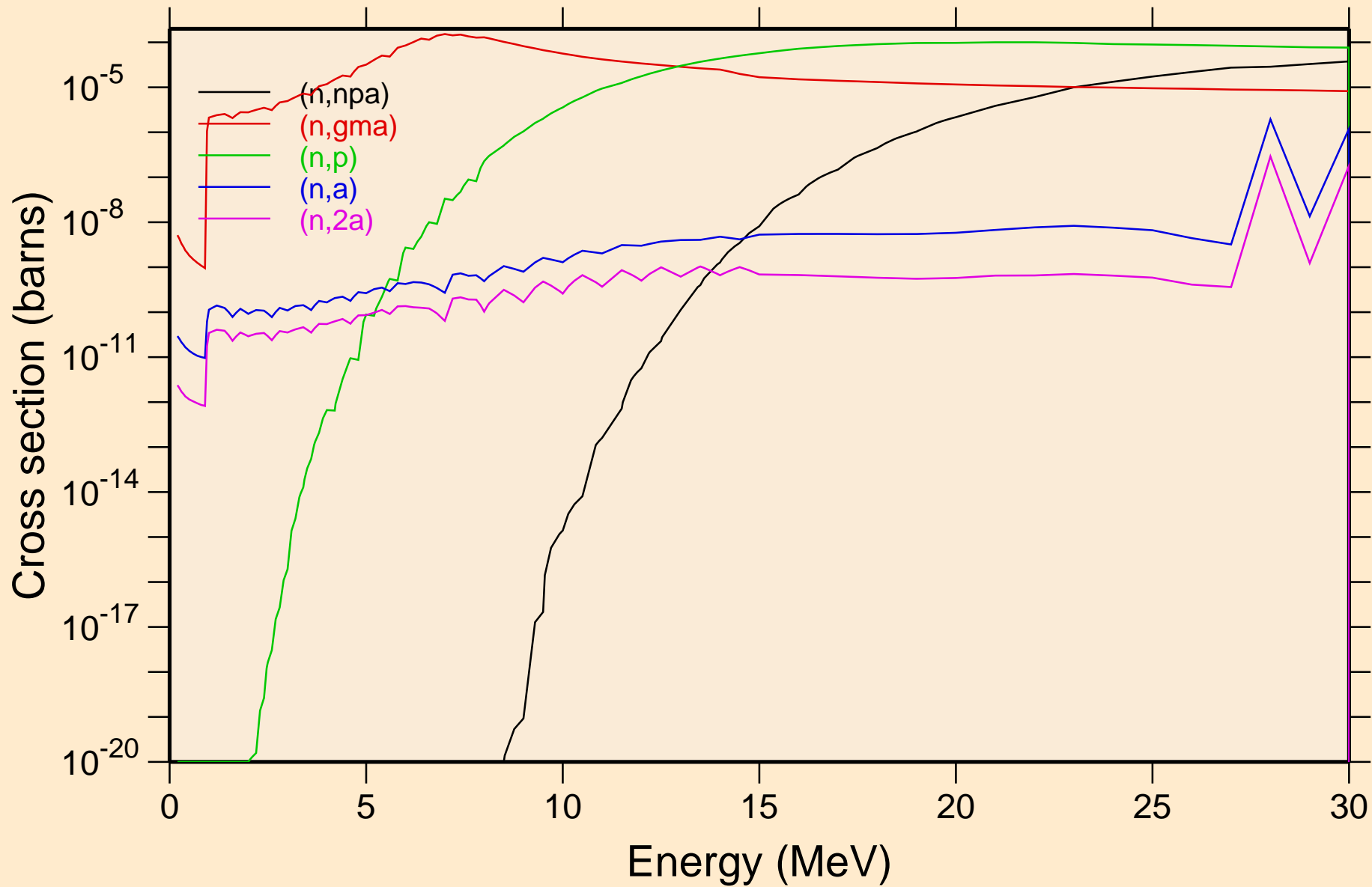

# SG273 NRG TENDL-2015, AKONING

## Non-threshold reactions

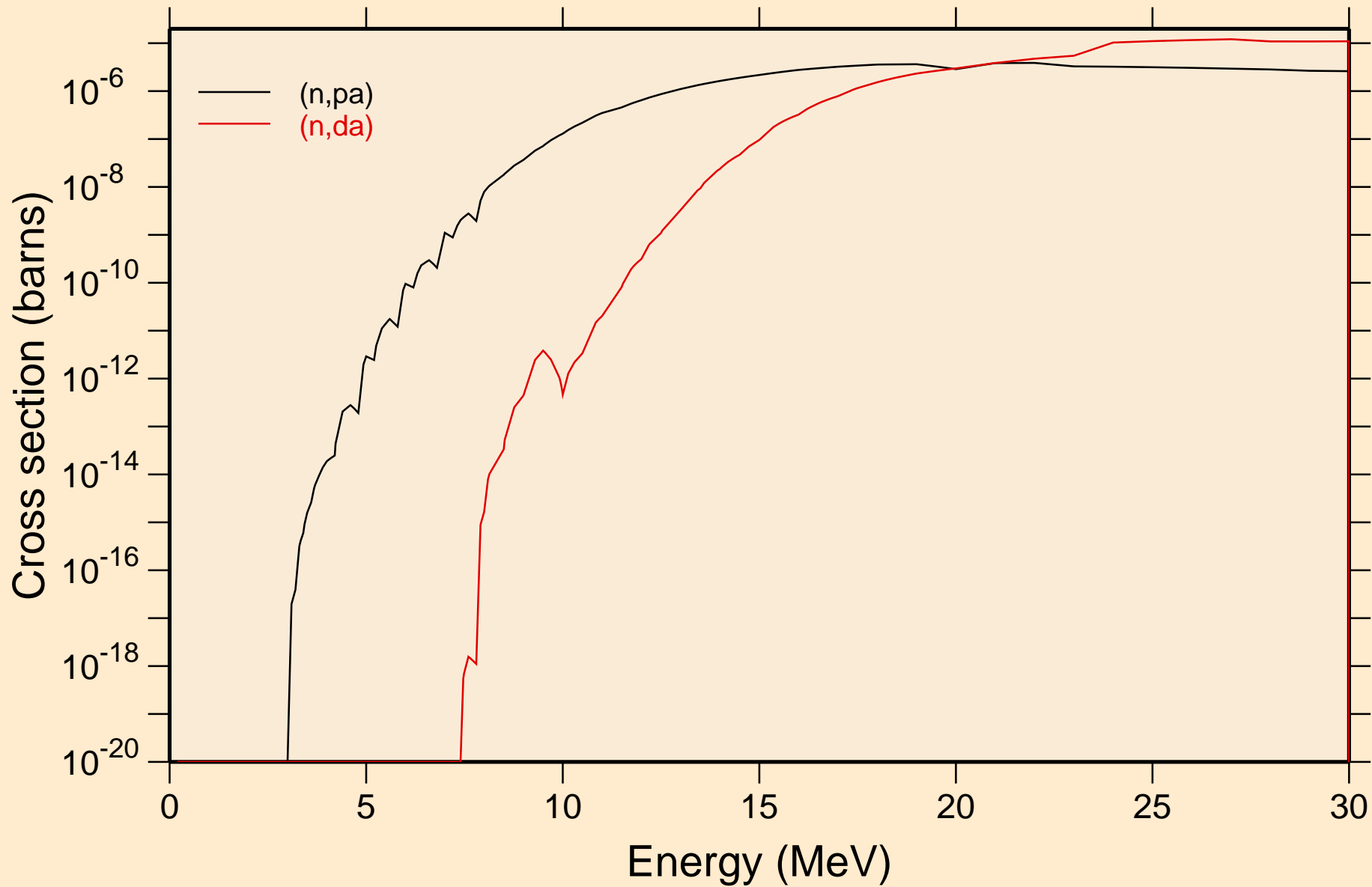



SG273 NRG TENDL-2015, AKONING  
Inelastic levels

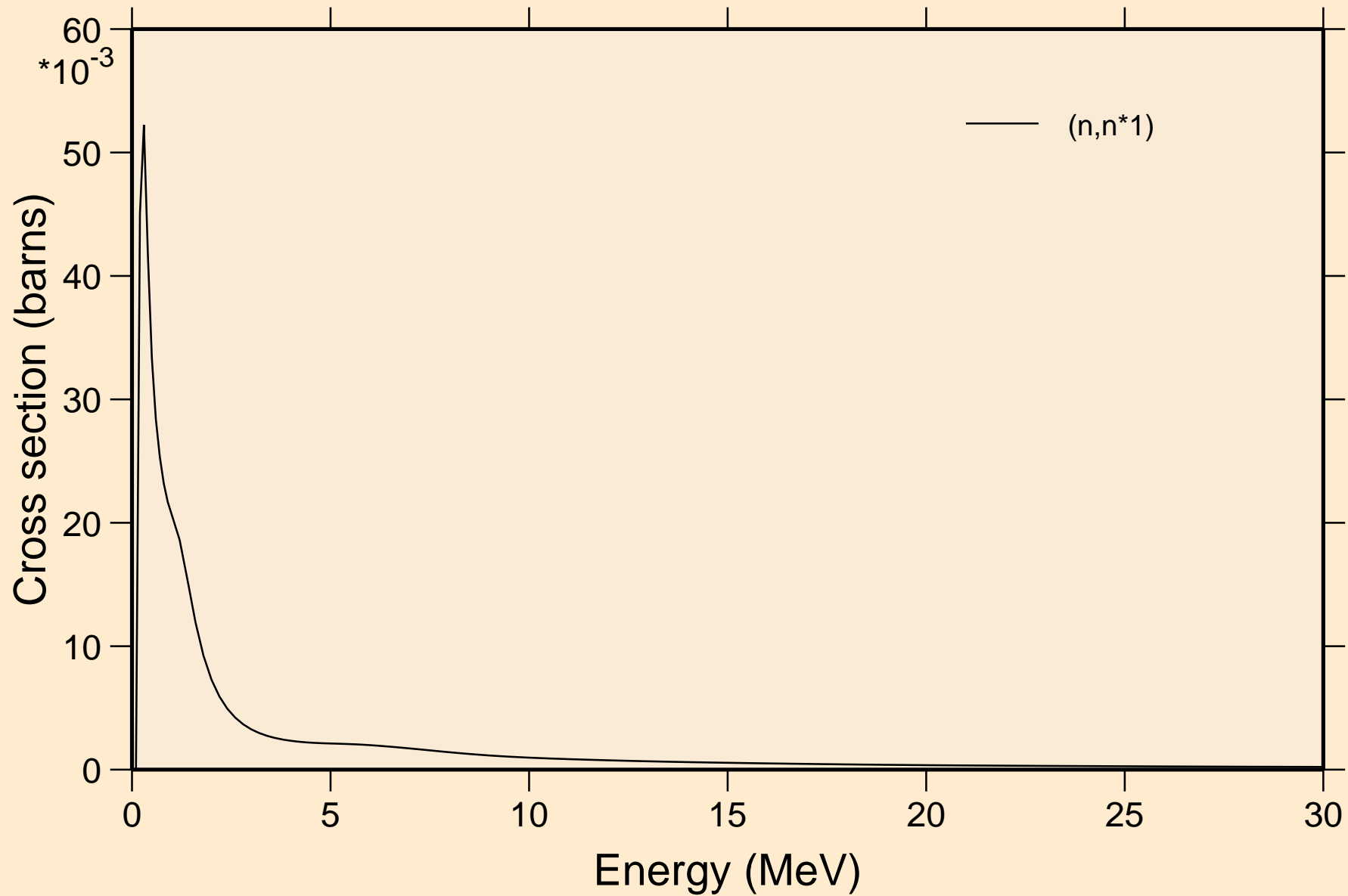

# SG273 NRG TENDL-2015, AKONING

## Threshold reactions

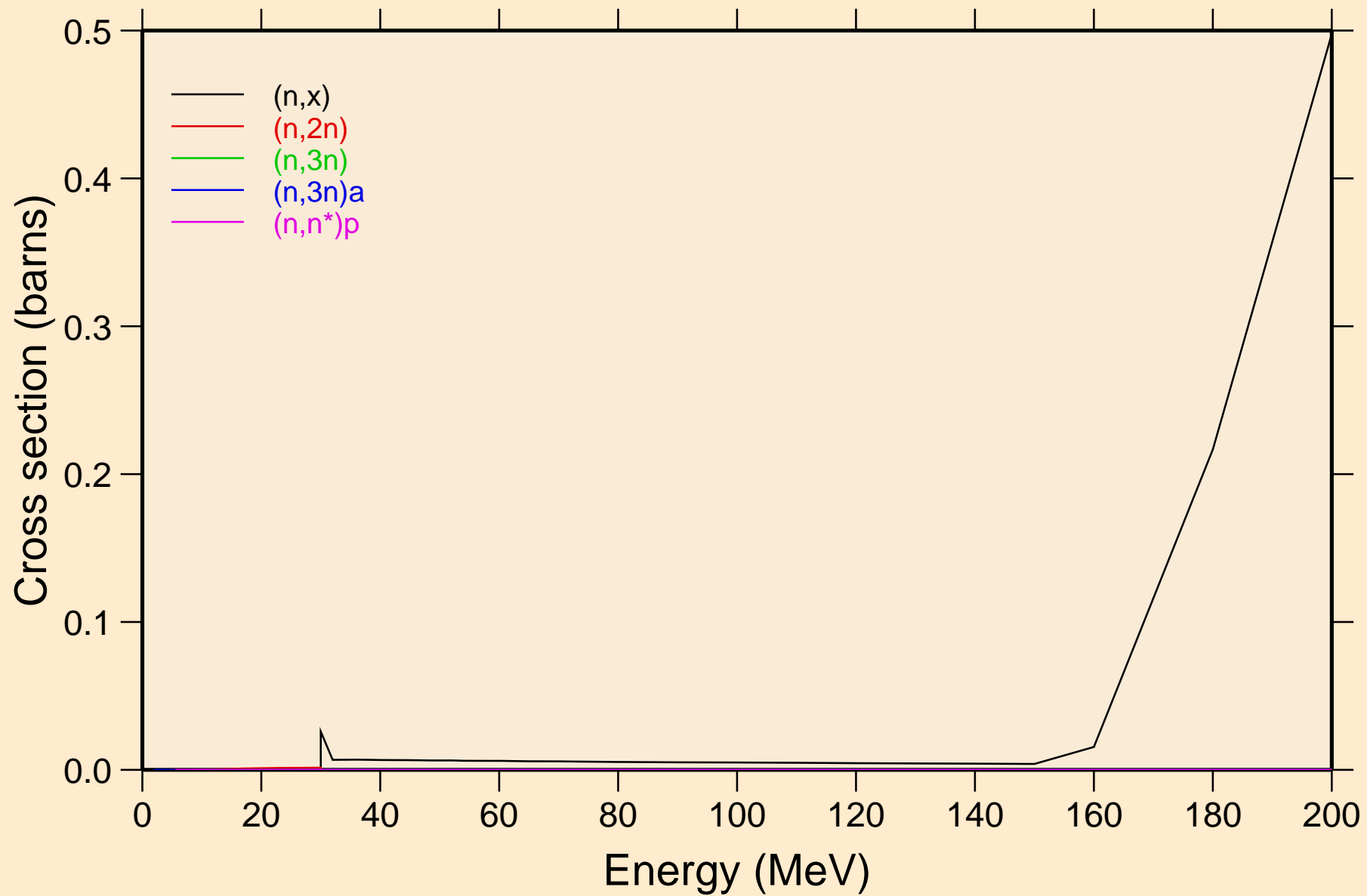

# SG273 NRG TENDL-2015, AKONING

## Threshold reactions

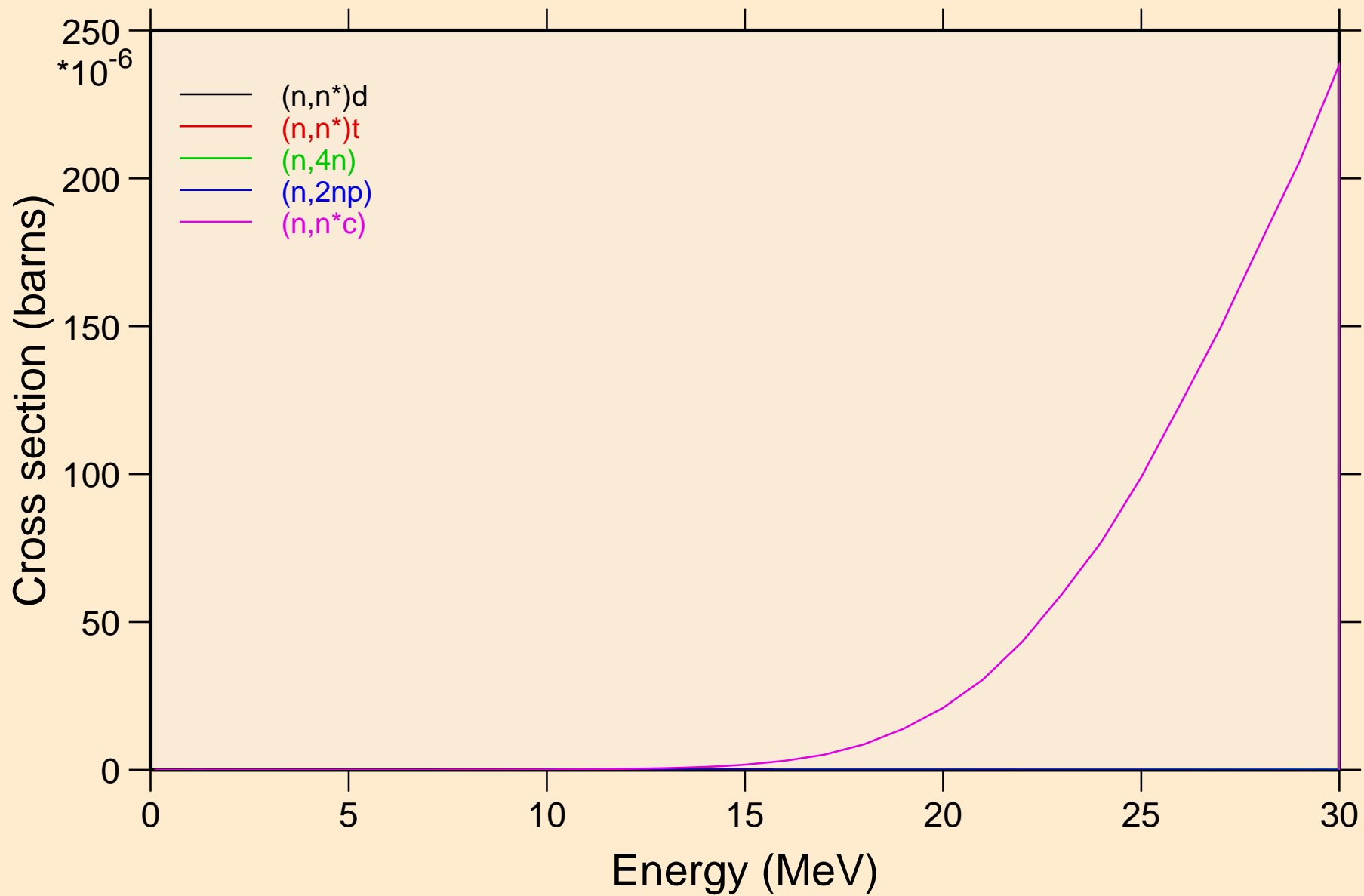

# SG273 NRG TENDL-2015, AKONING

## Threshold reactions

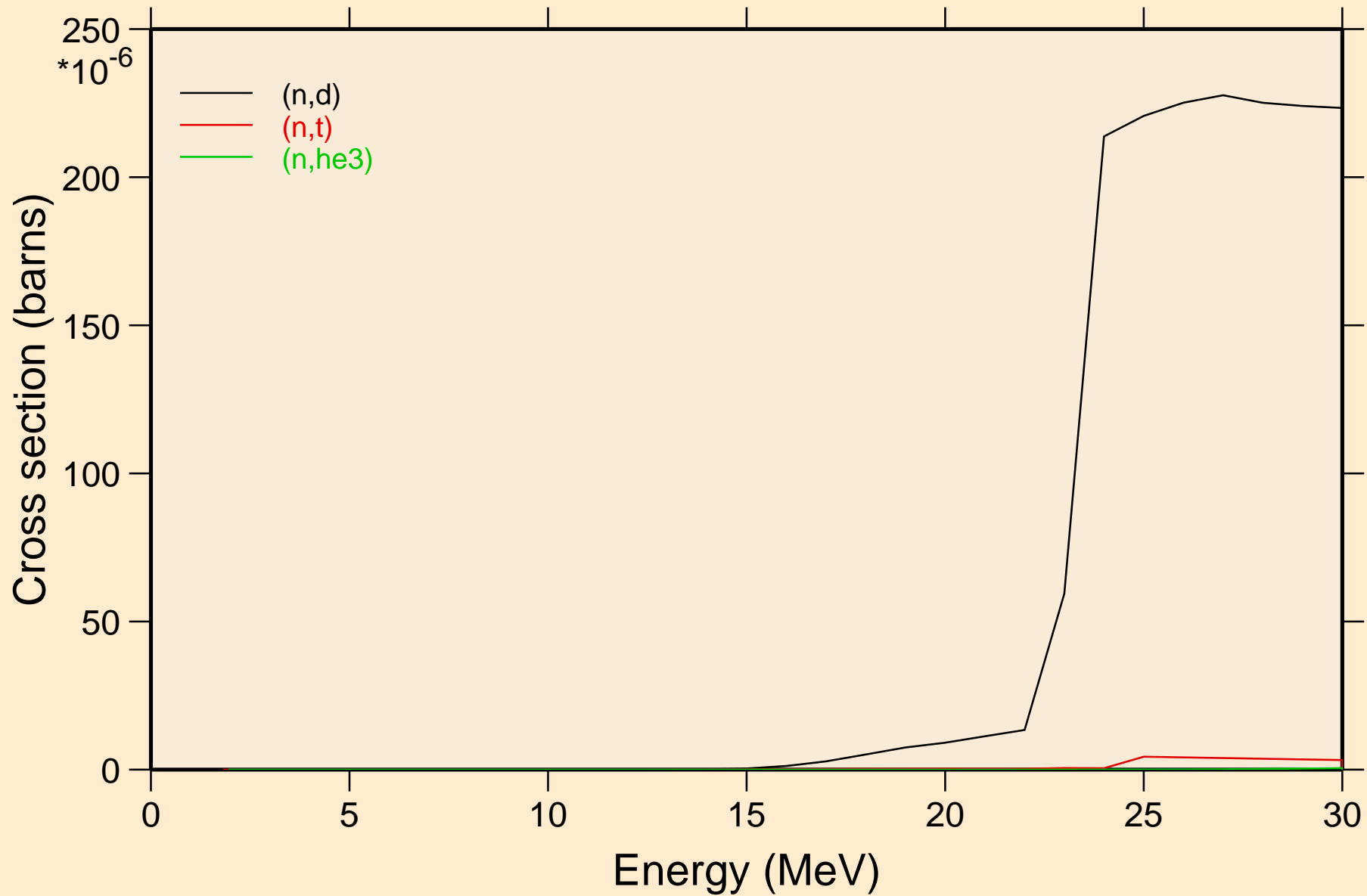

SG273 NRG TENDL-2015, AKONING  
angular distribution for elastic

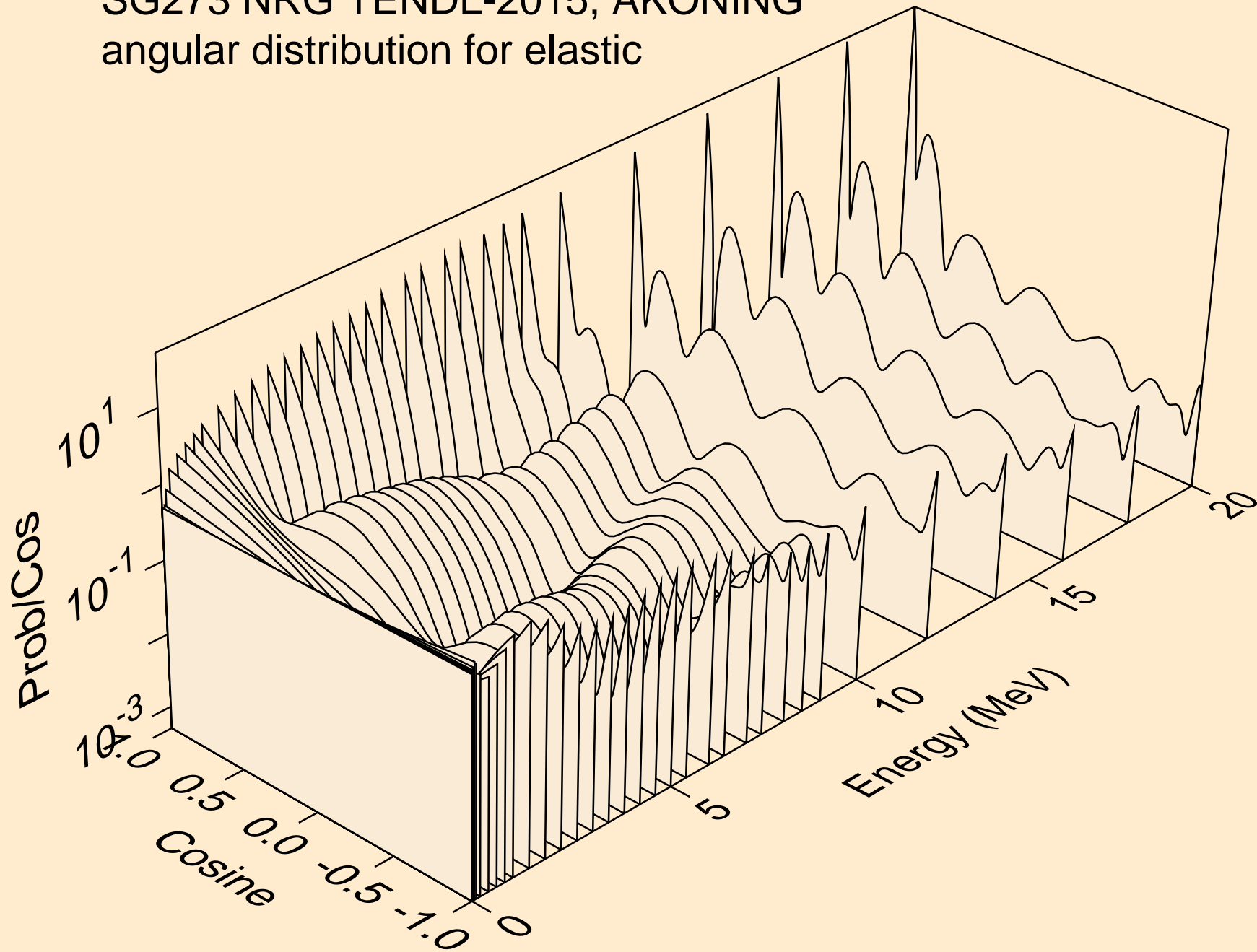

SG273 NRG TENDL-2015, AKONING  
angular distribution for elastic

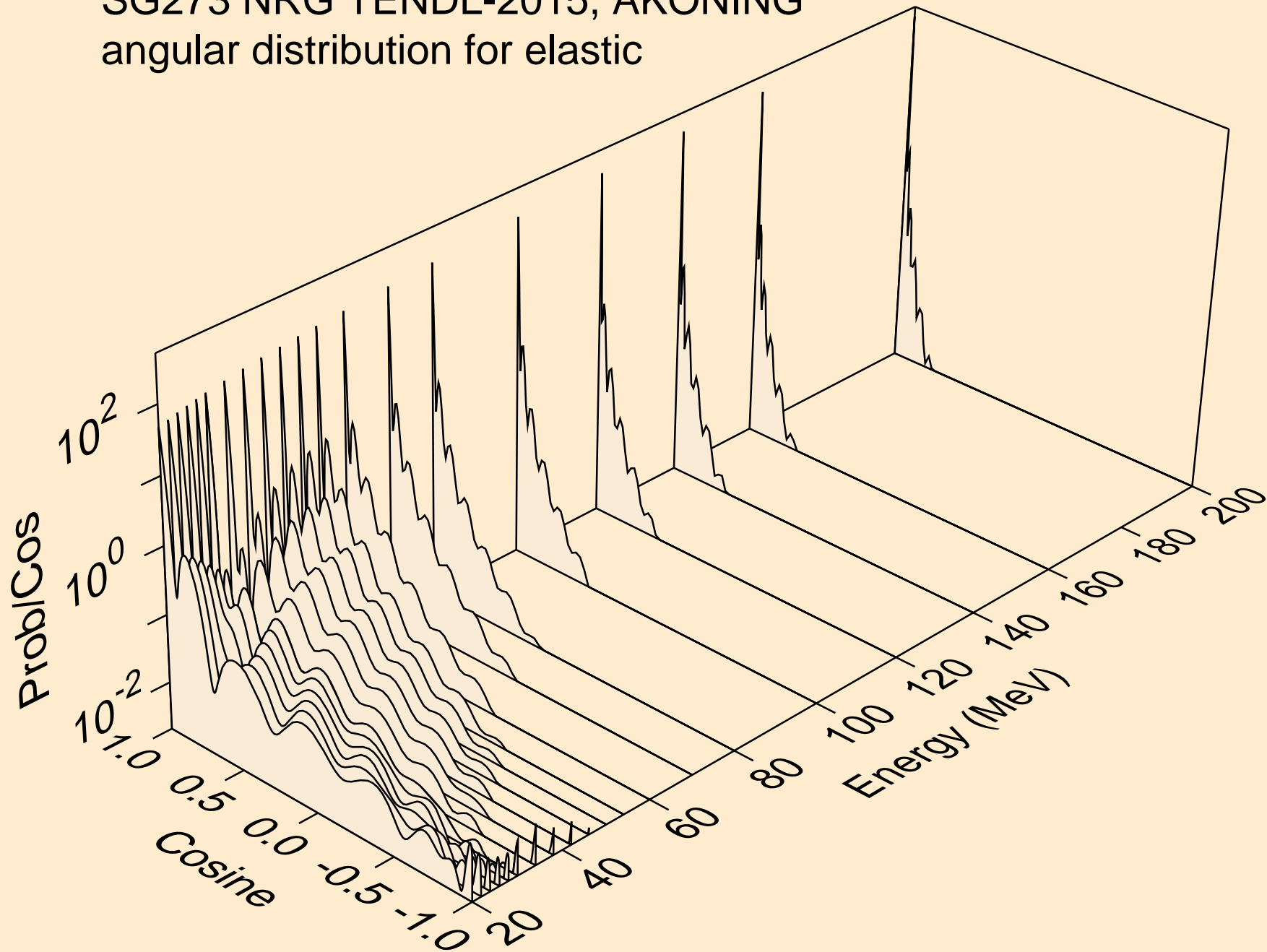

SG273 NRG TENDL-2015, AKONING  
angular distribution for (n,n\*1)

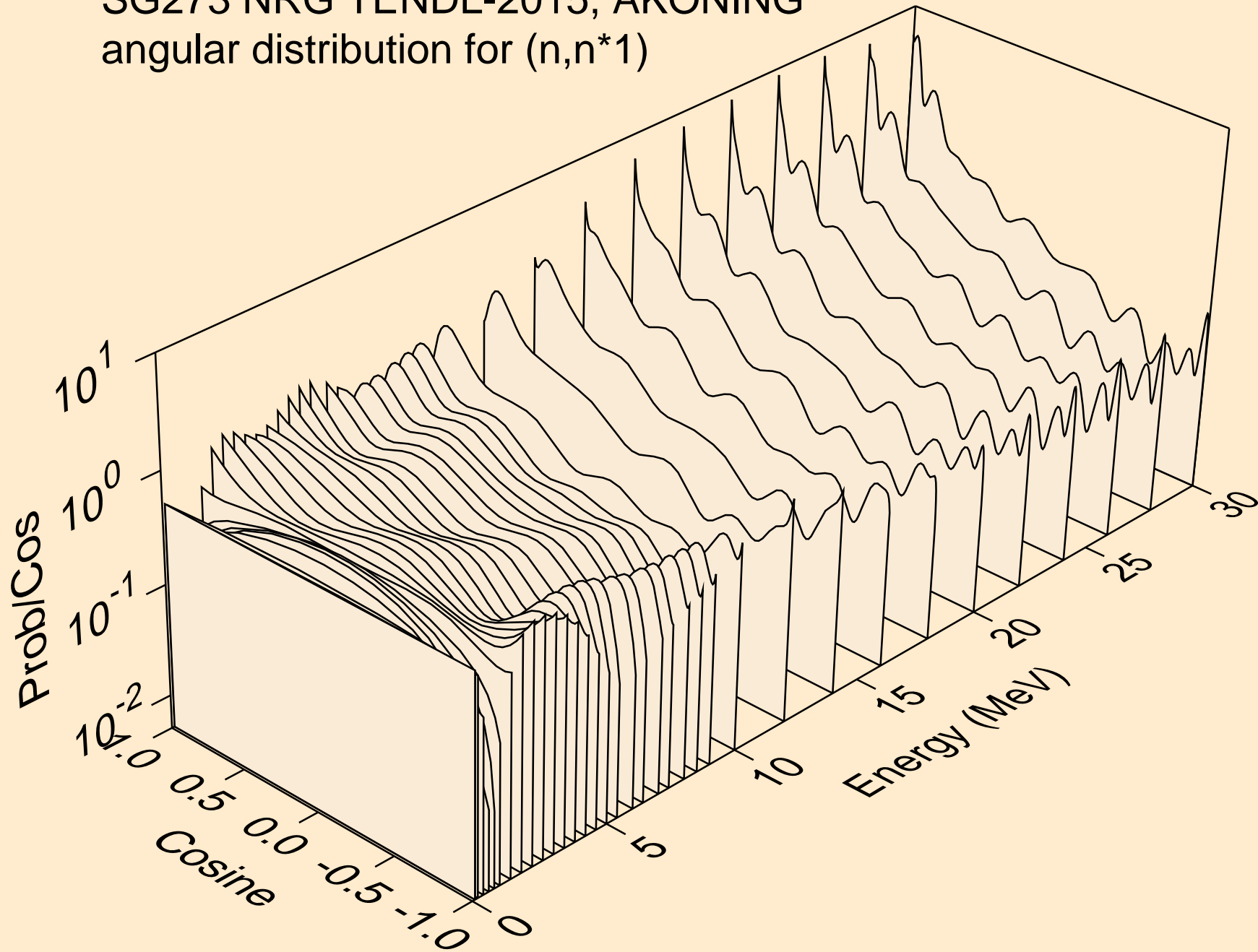

# SG273 NRG TENDL-2015, AKONING

Total fission nubar

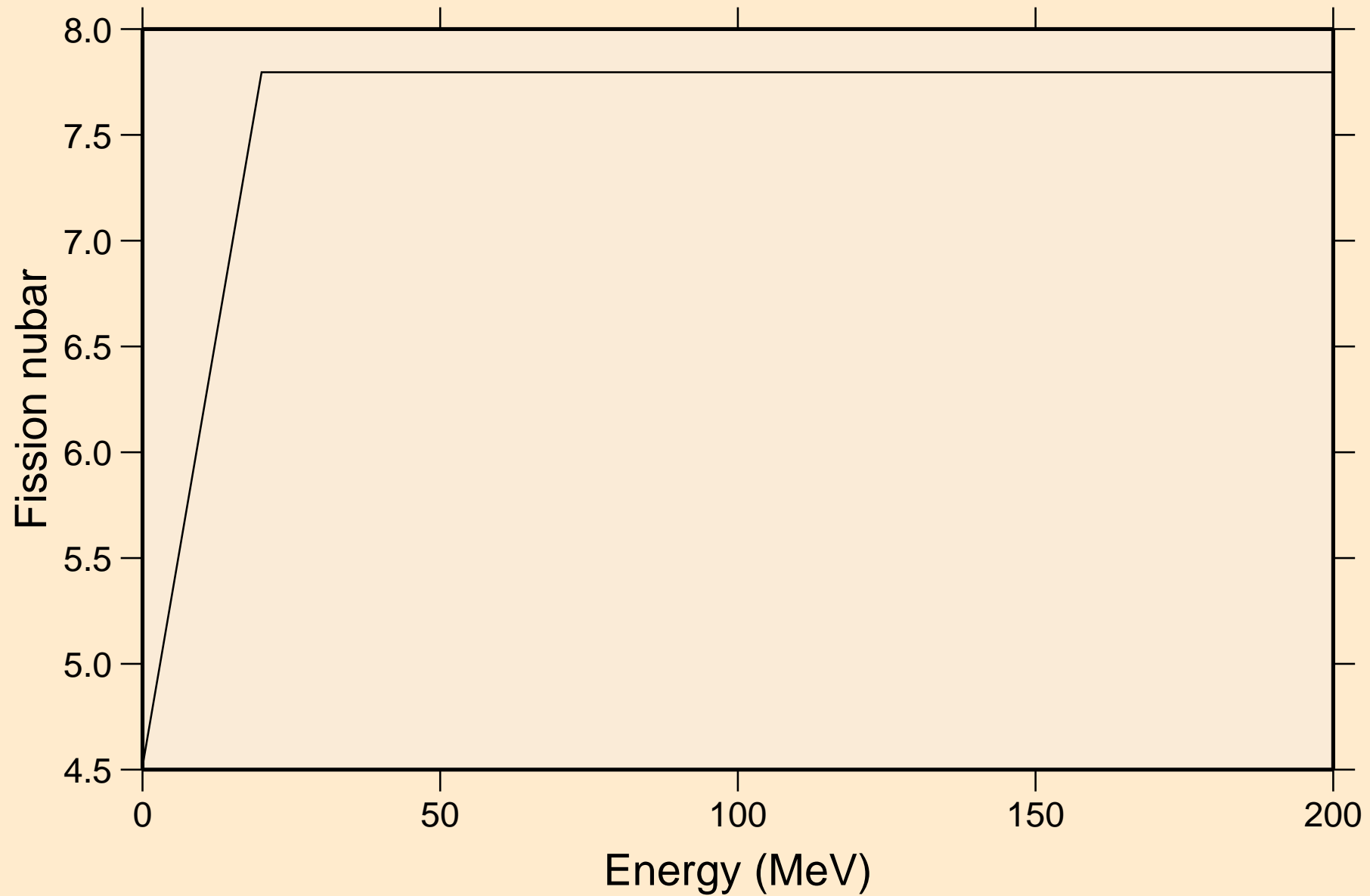



SG273 NRG TENDL-2015, AKONING  
Neutron emission for (n,x)

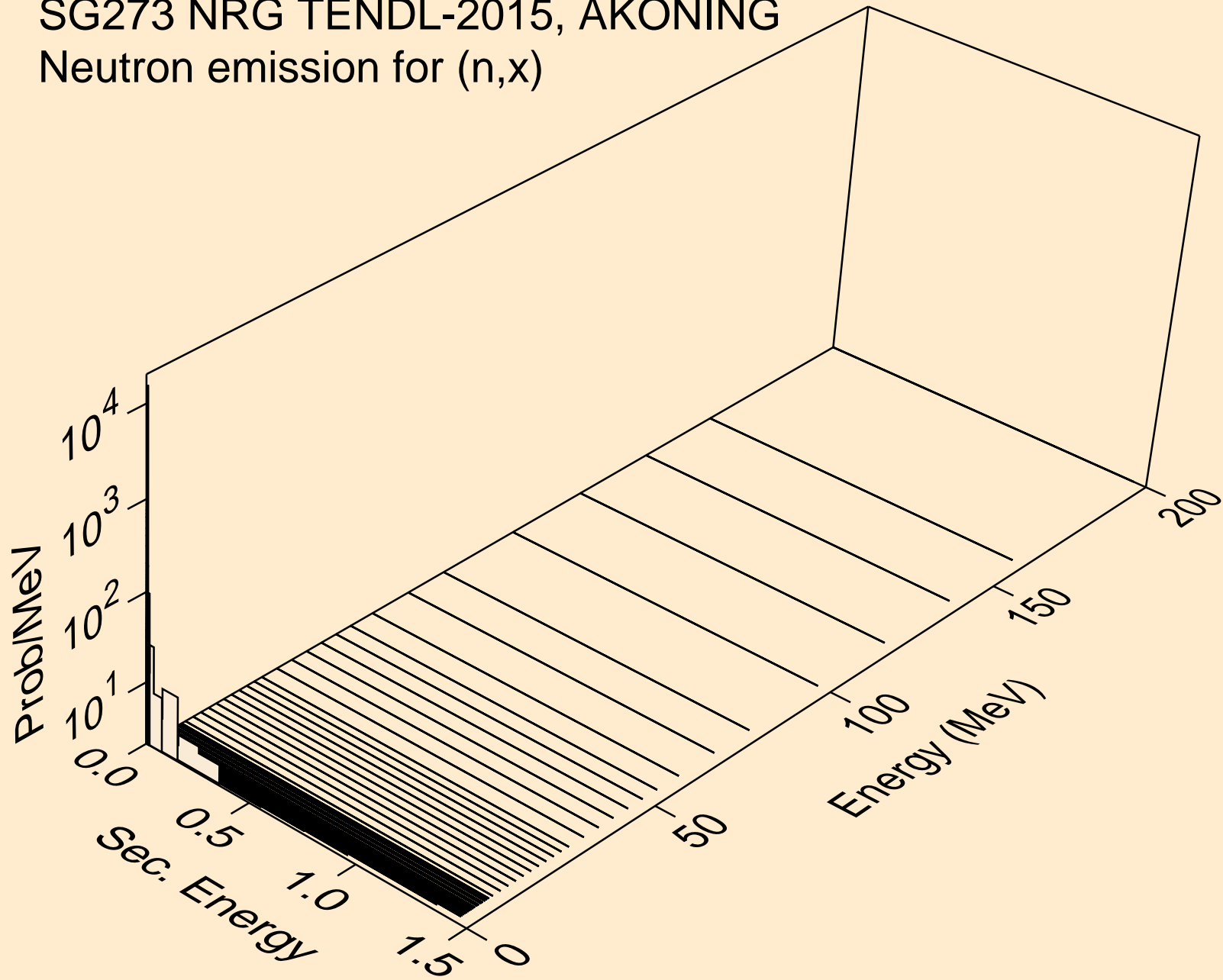

SG273 NRG TENDL-2015, AKONING  
Neutron emission for (n,2n)

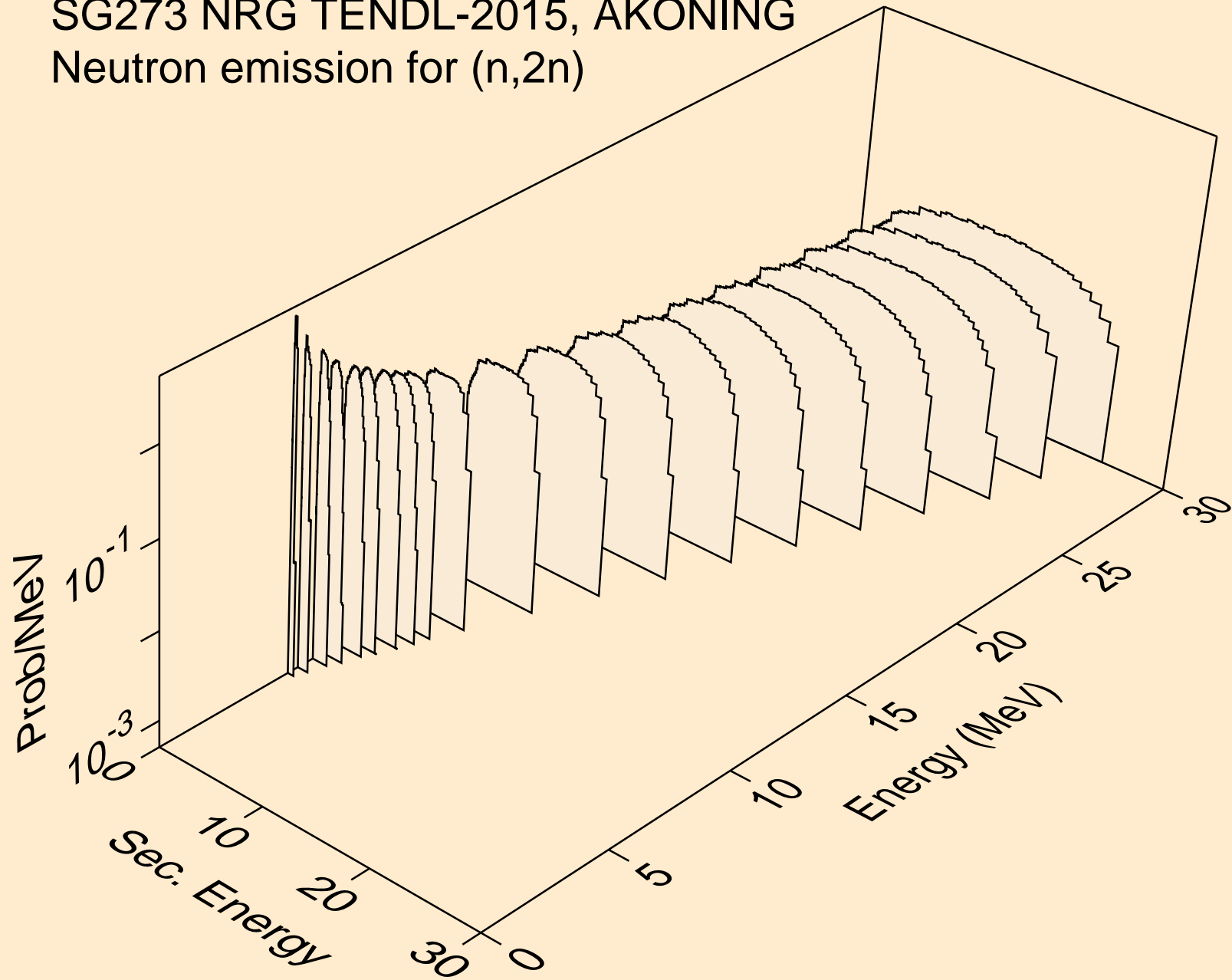

SG273 NRG TENDL-2015, AKONING  
Neutron emission for (n,3n)

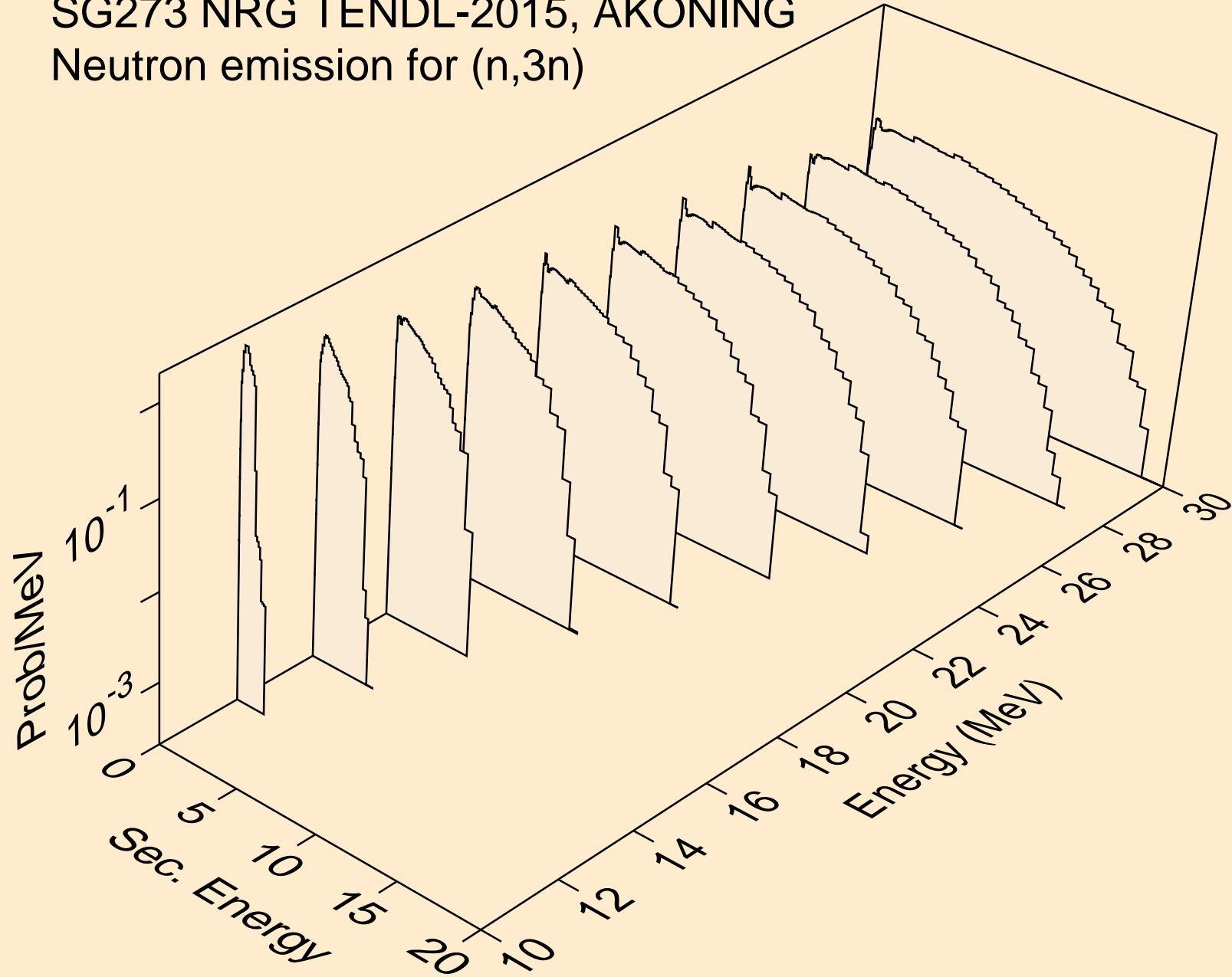

SG273 NRG TENDL-2015, AKONING  
Neutron emission for fission

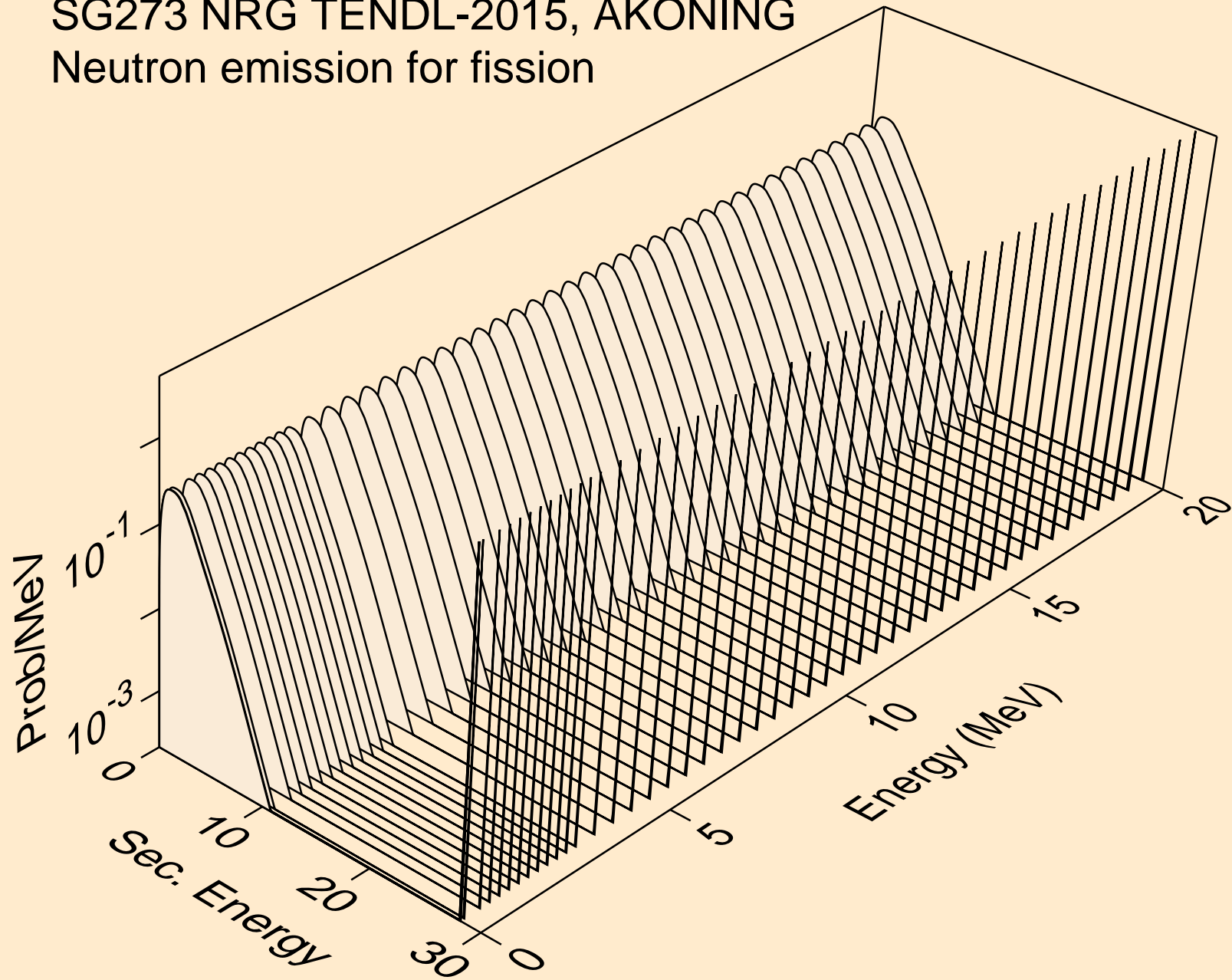

SG273 NRG TENDL-2015, AKONING  
Neutron emission for (n,n\*)a

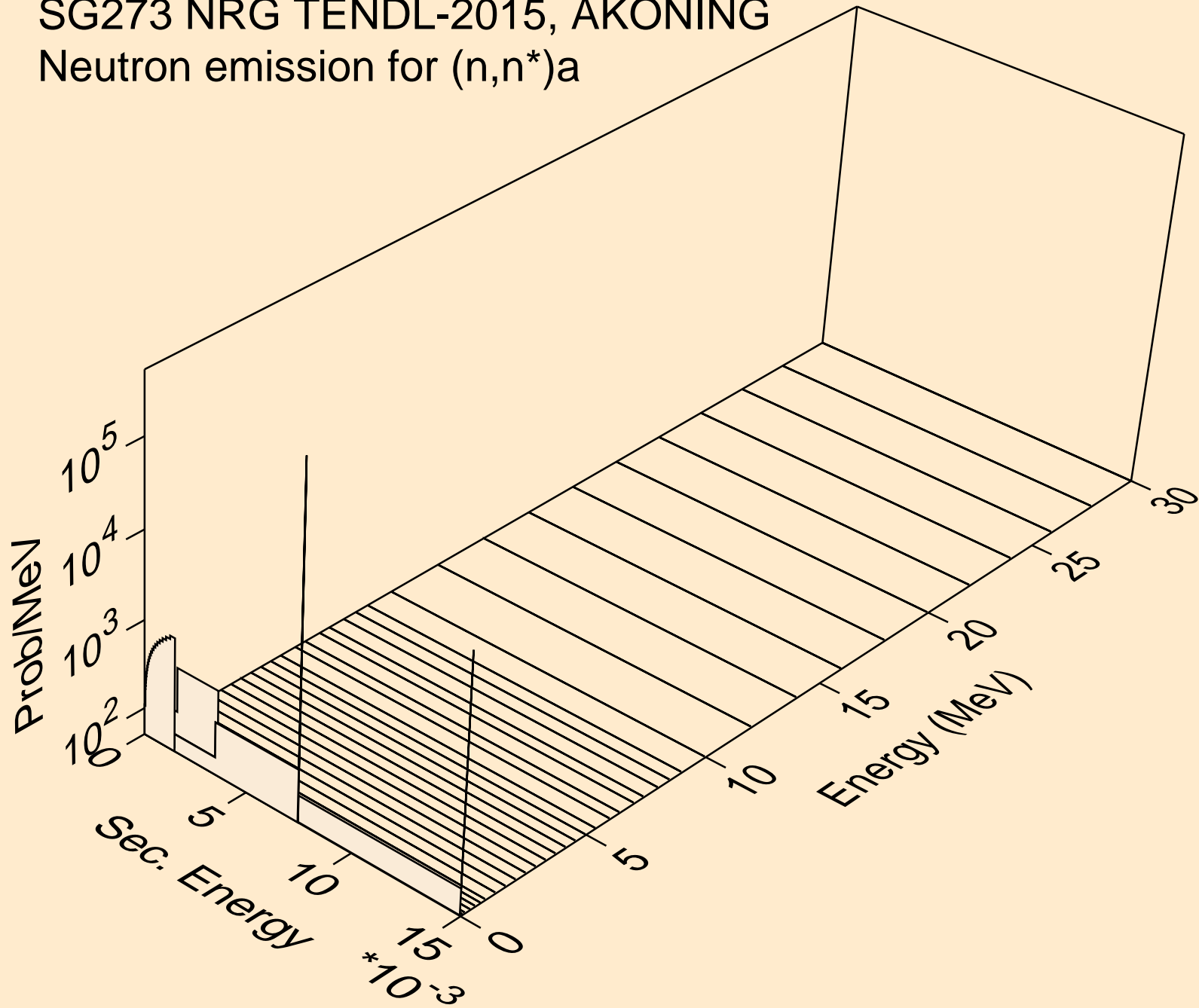

SG273 NRG TENDL-2015, AKONING  
Neutron emission for (n,2n)a

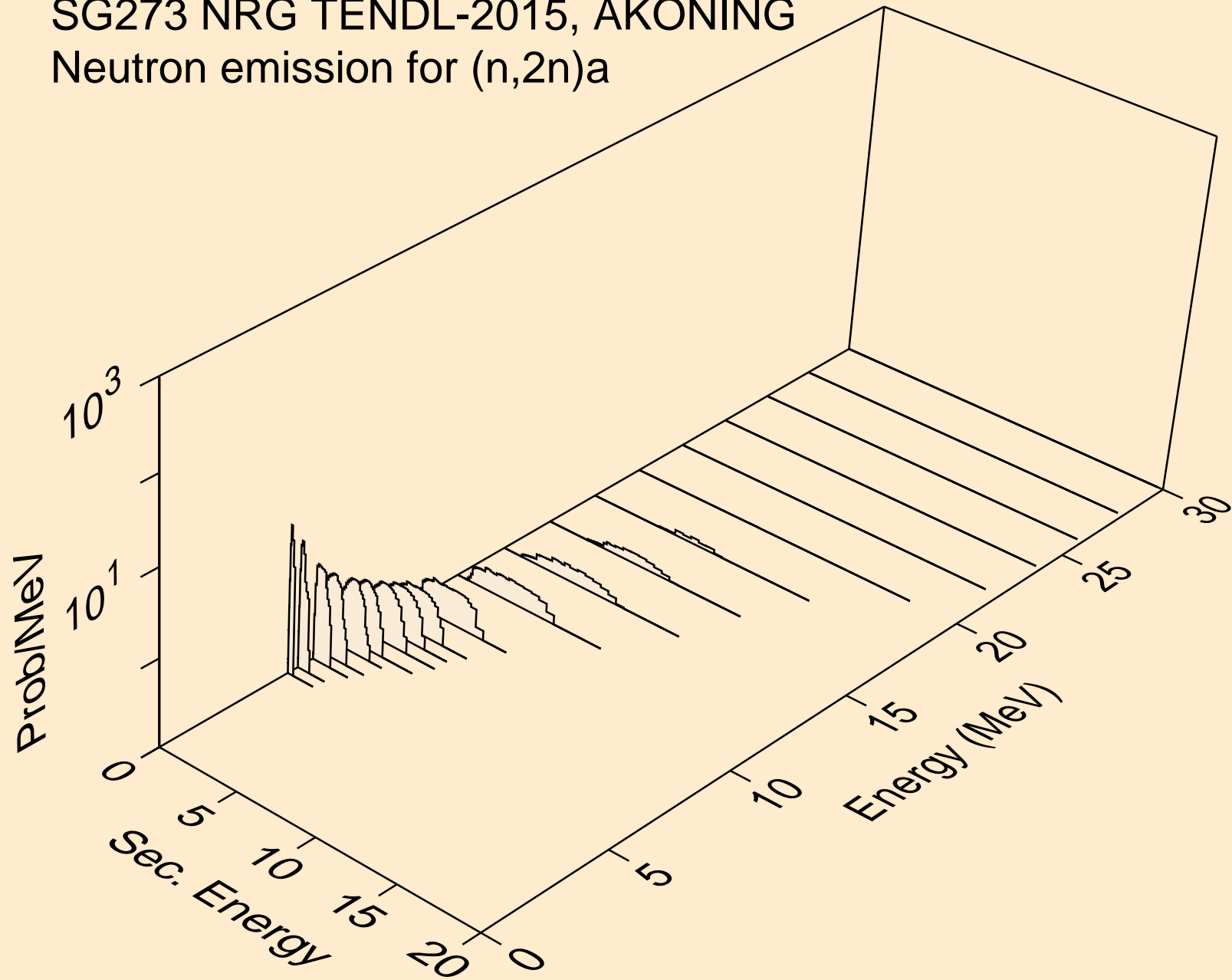

SG273 NRG TENDL-2015, AKONING  
Neutron emission for (n,3n)a

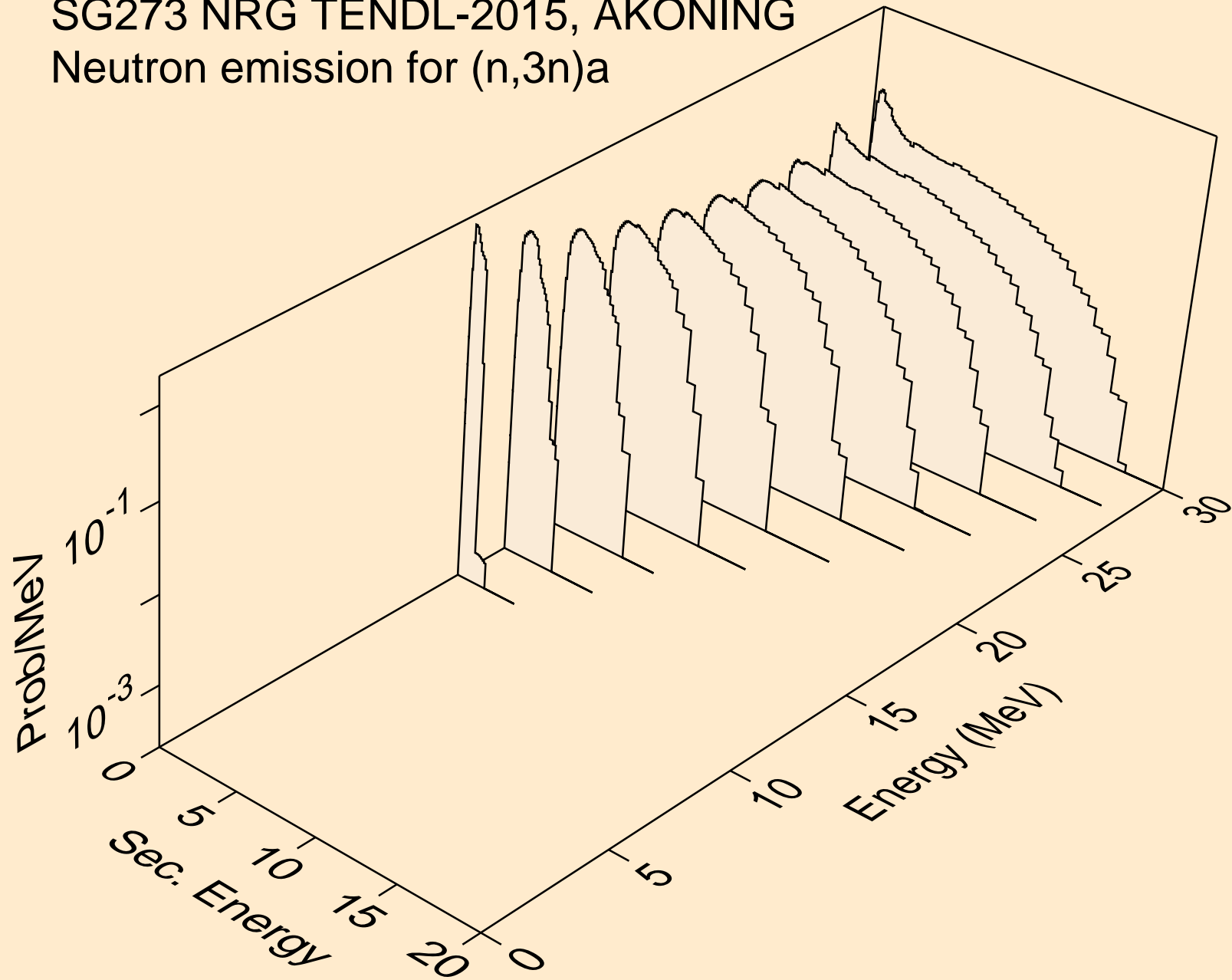

SG273 NRG TENDL-2015, AKONING  
Neutron emission for (n,n\*)p

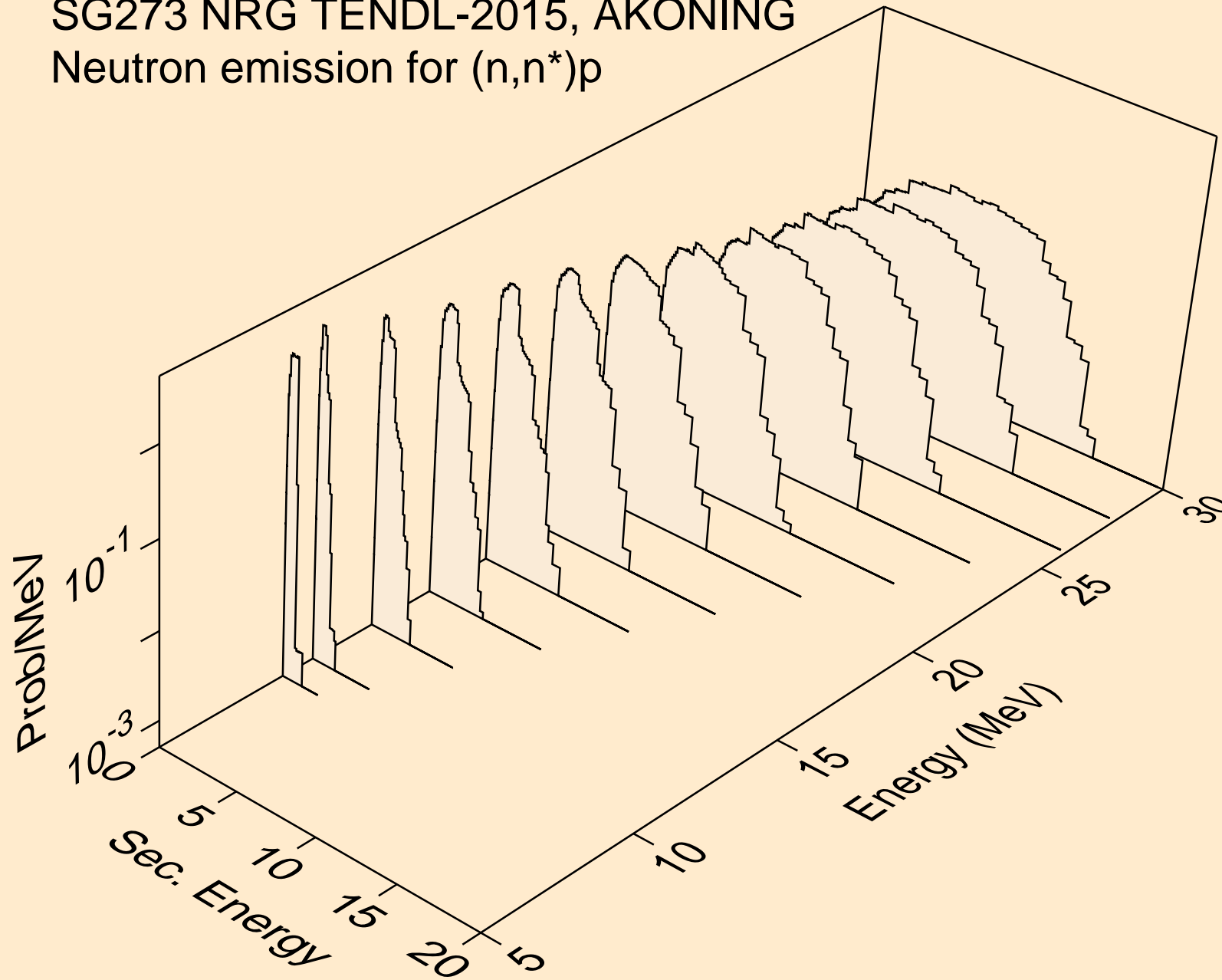



SG273 NRG TENDL-2015, AKONING  
Neutron emission for (n,2n)2a

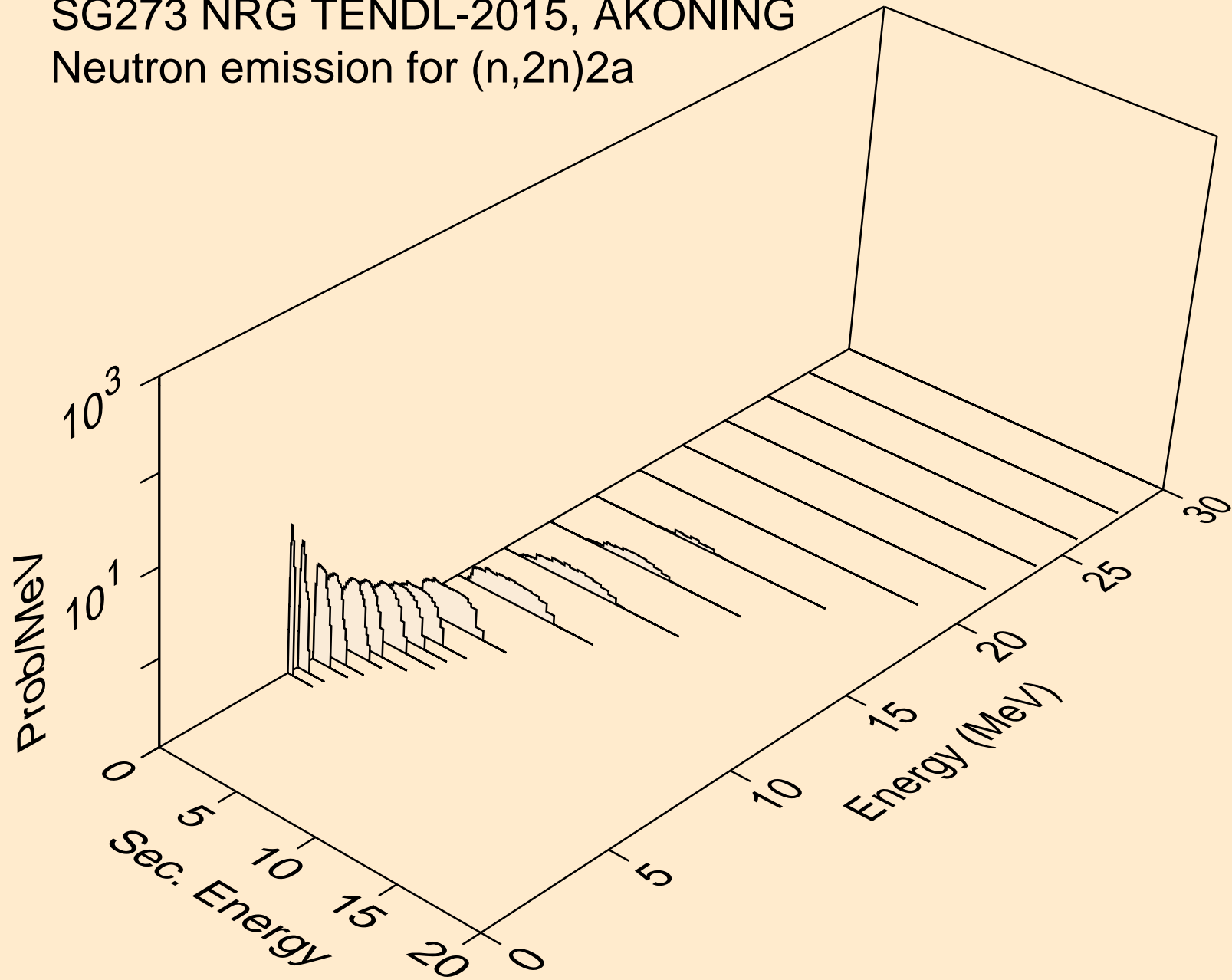

SG273 NRG TENDL-2015, AKONING  
Neutron emission for (n,n\*)d

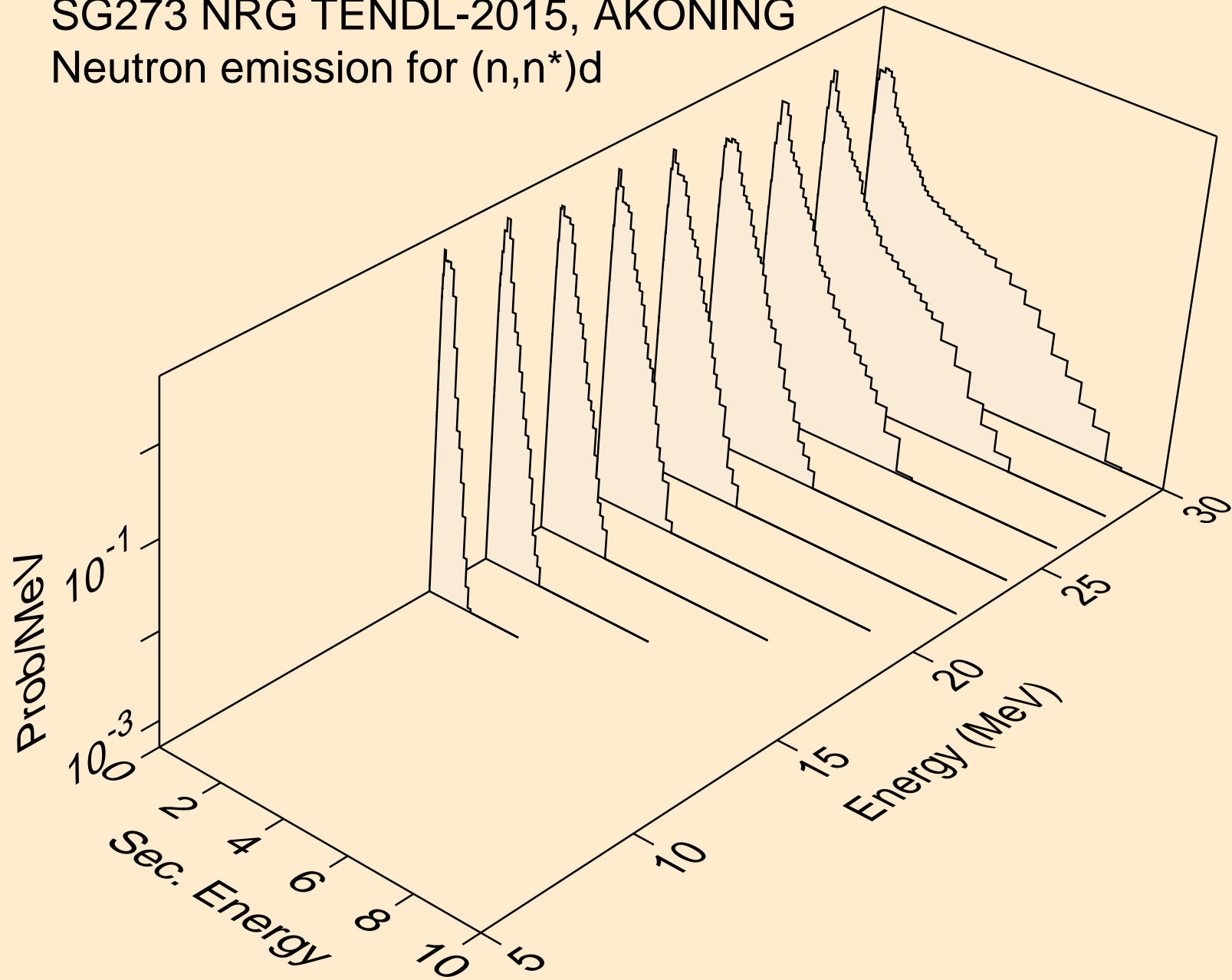

SG273 NRG TENDL-2015, AKONING  
Neutron emission for (n,n\*)t

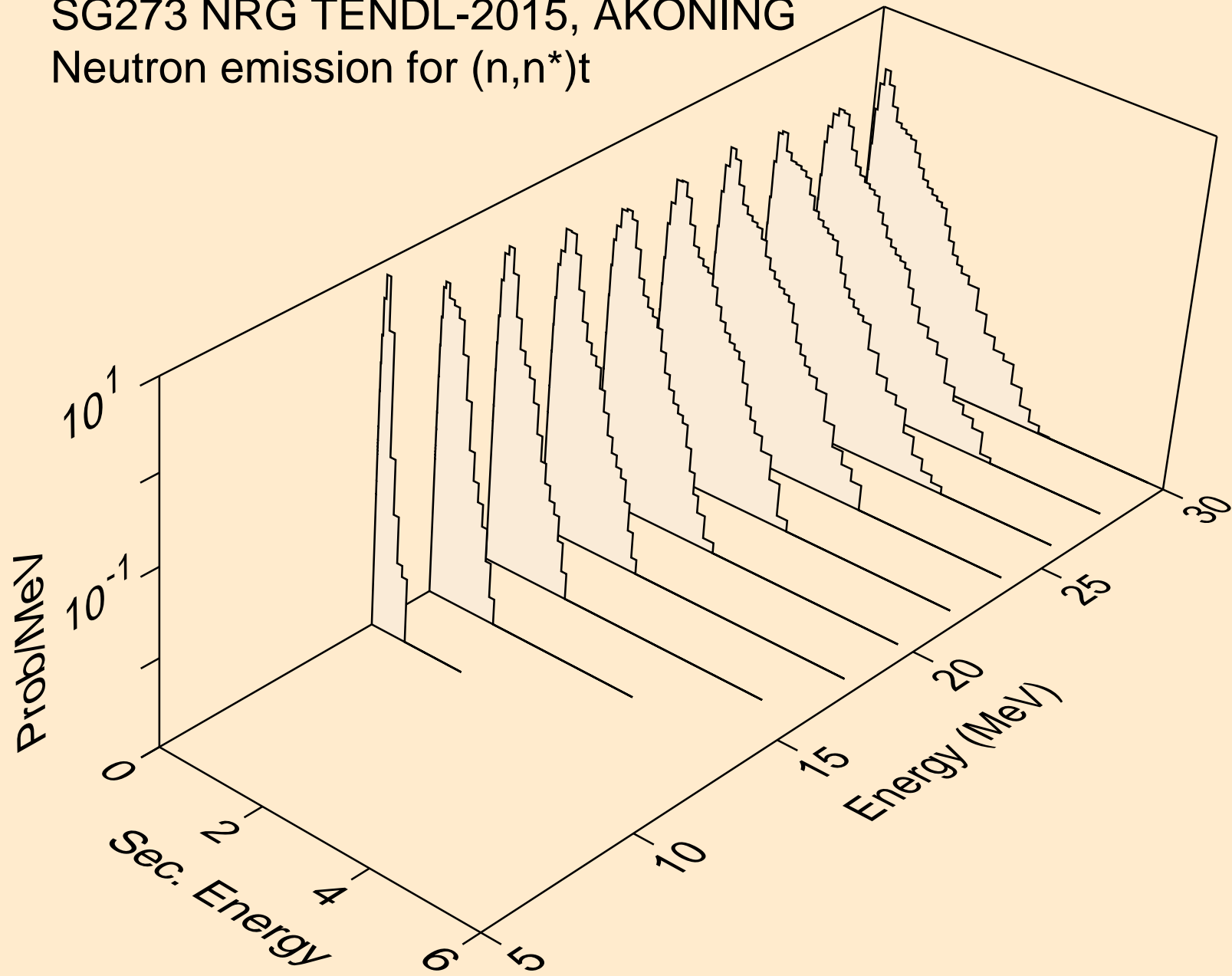

SG273 NRG TENDL-2015, AKONING  
Neutron emission for (n,n\*)t2a

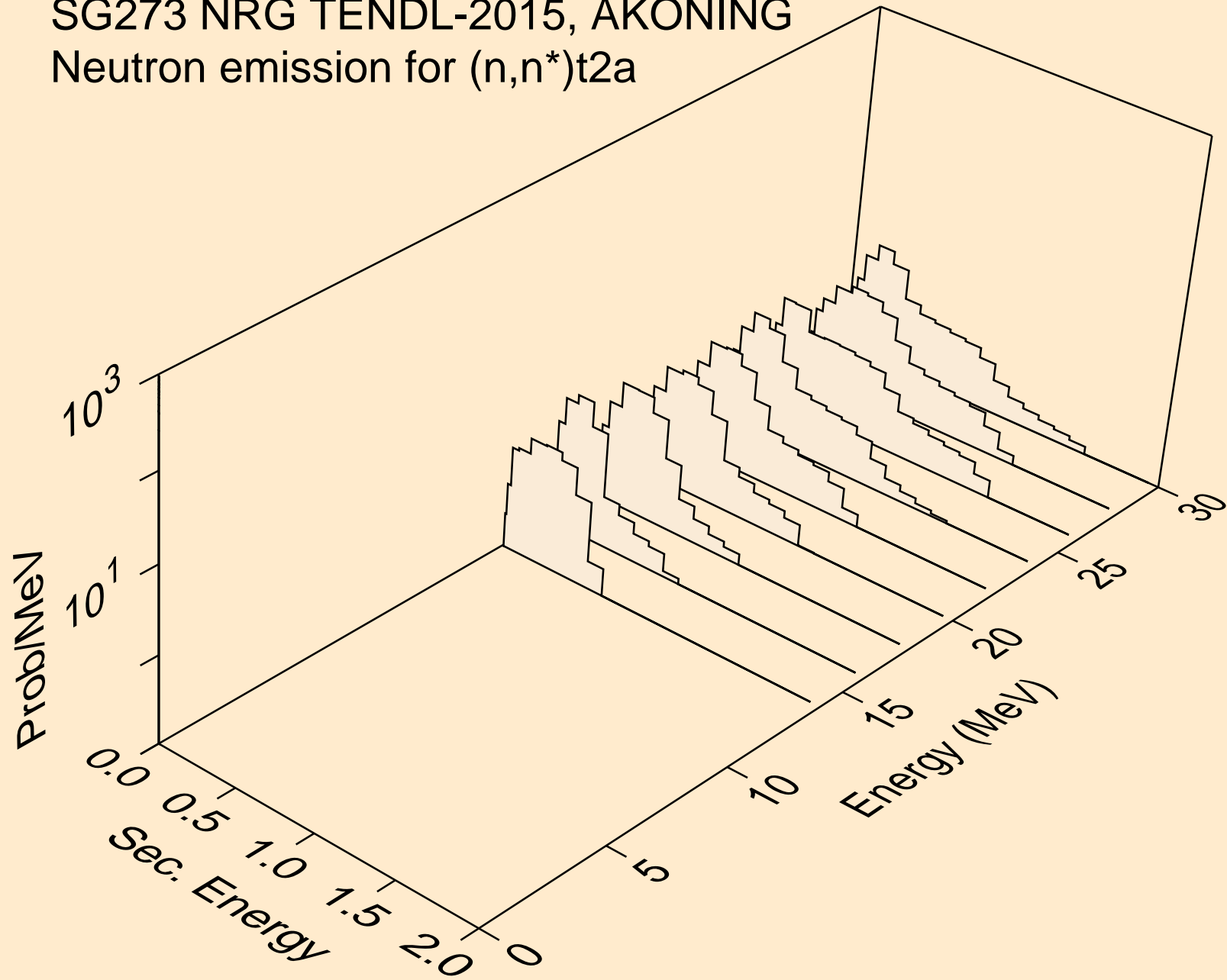

SG273 NRG TENDL-2015, AKONING  
Neutron emission for (n,4n)

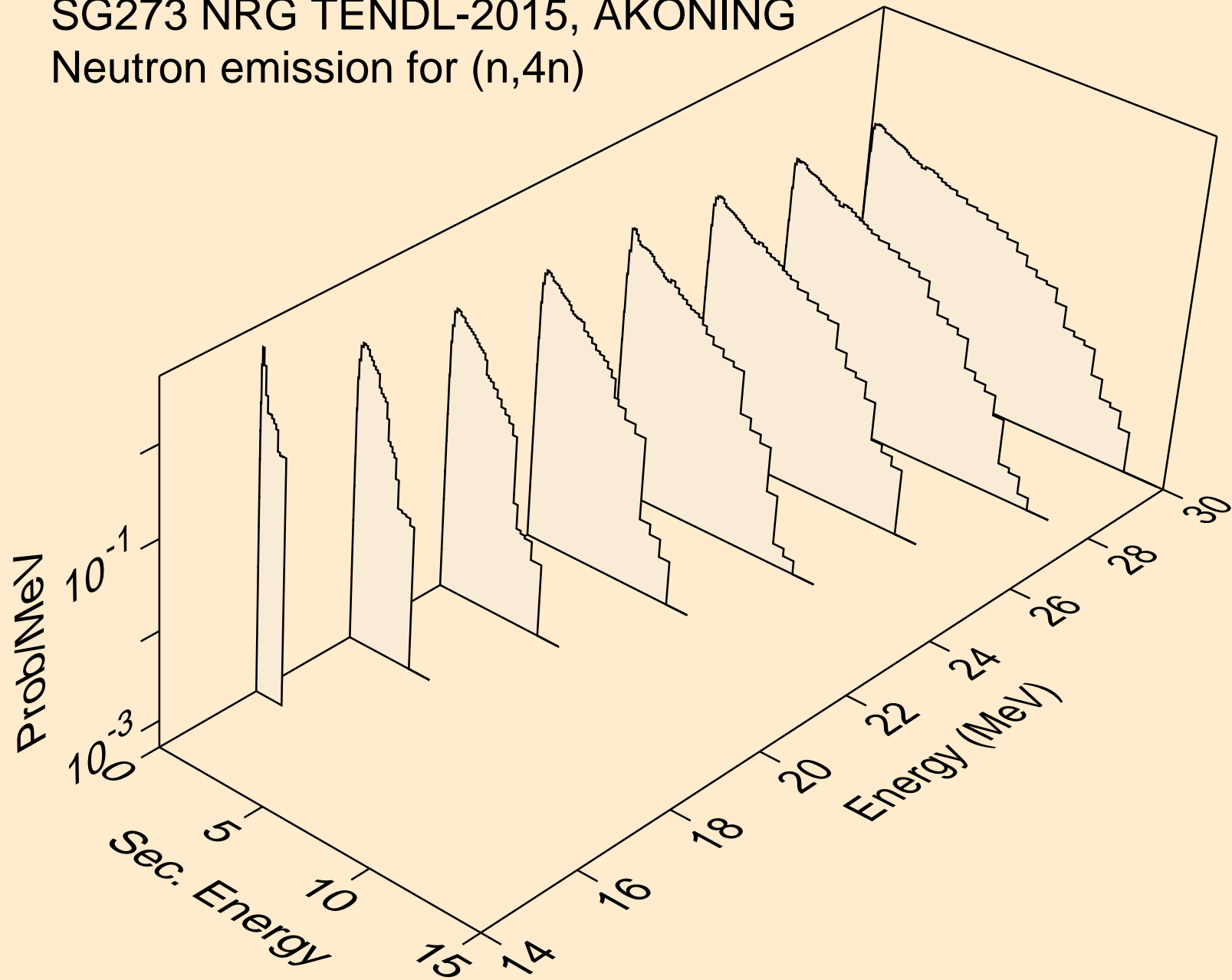

SG273 NRG TENDL-2015, AKONING  
Neutron emission for (n,2np)

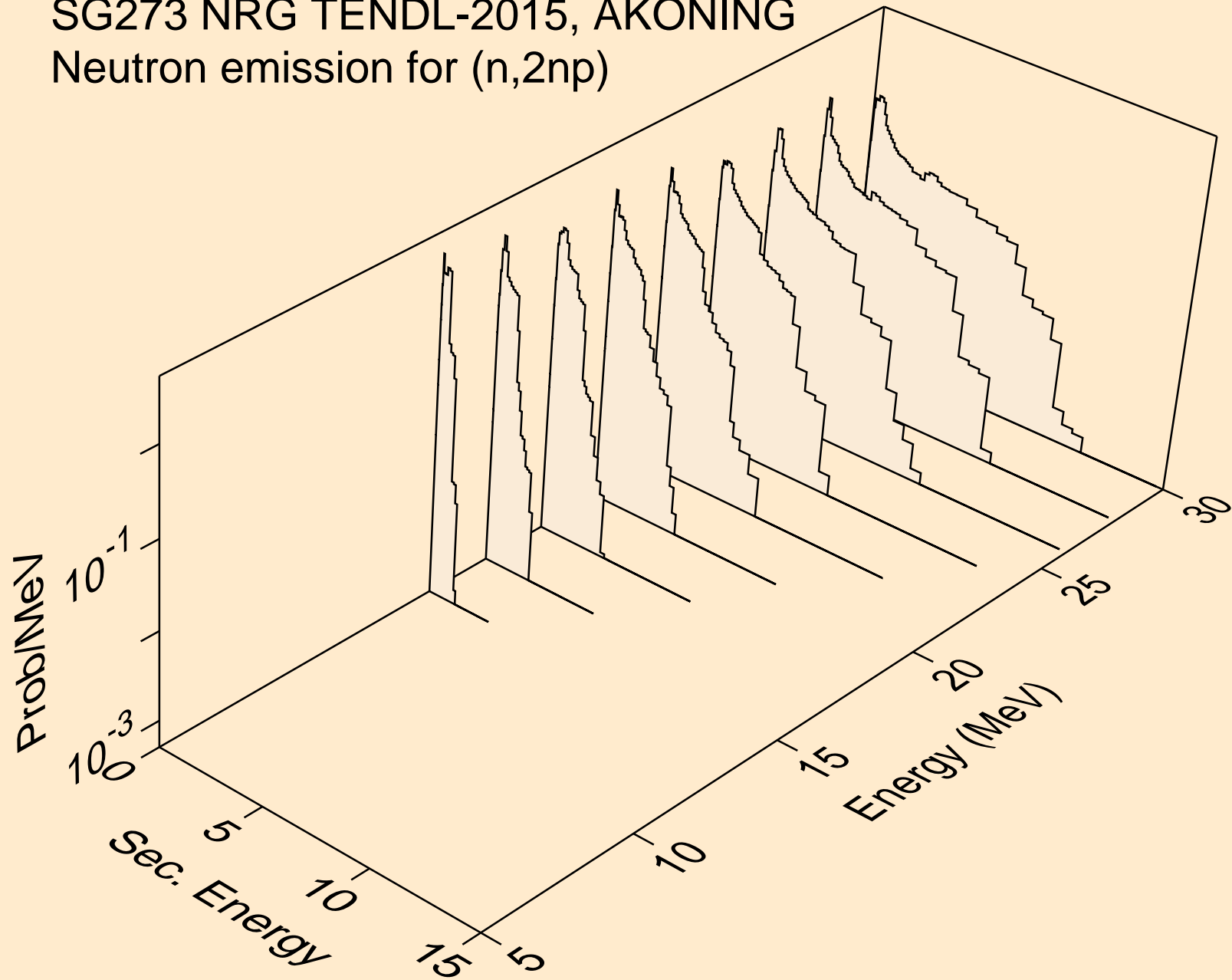

SG273 NRG TENDL-2015, AKONING  
Neutron emission for (n,npa)

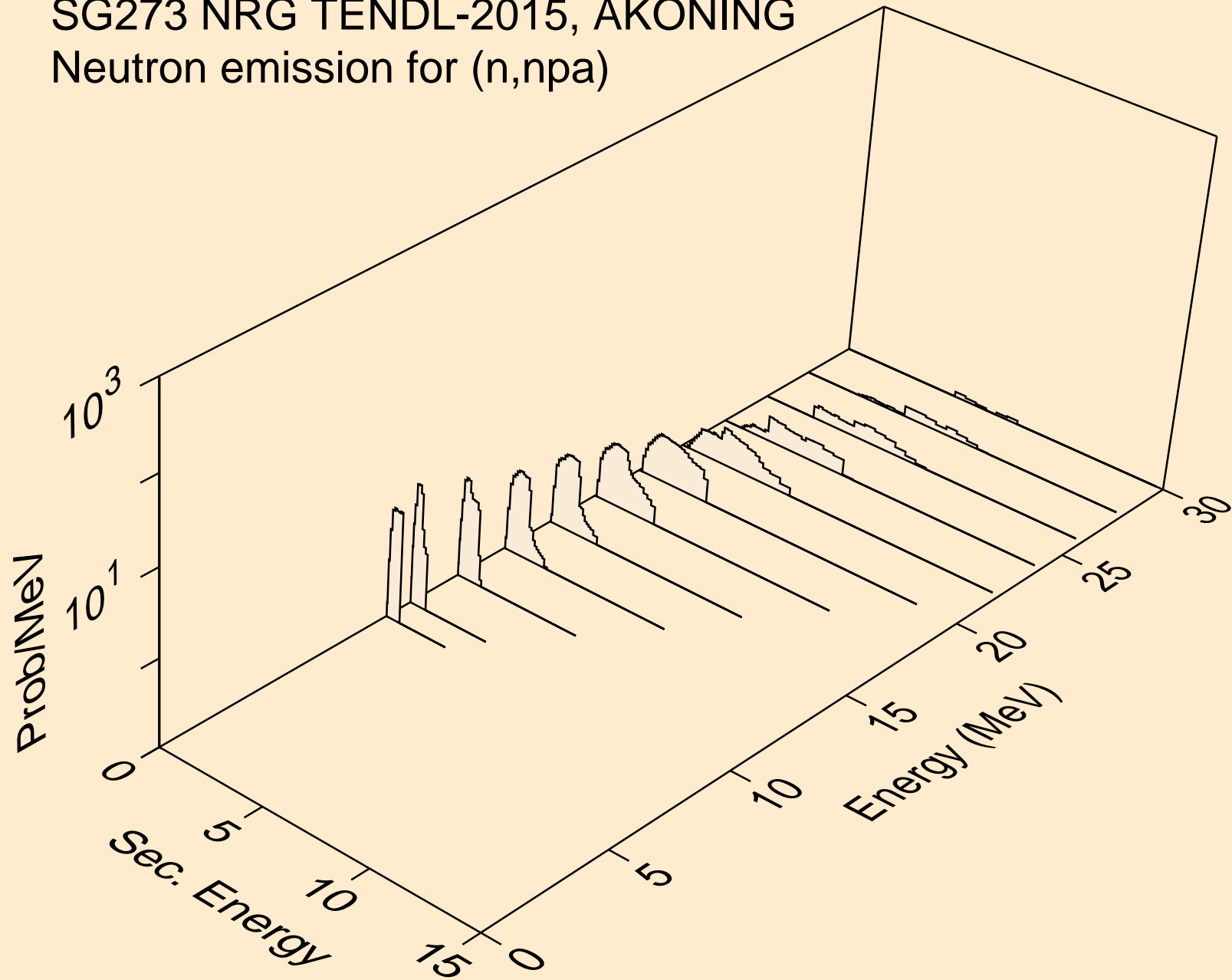

SG273 NRG TENDL-2015, AKONING  
Neutron emission for (n,n\*c)

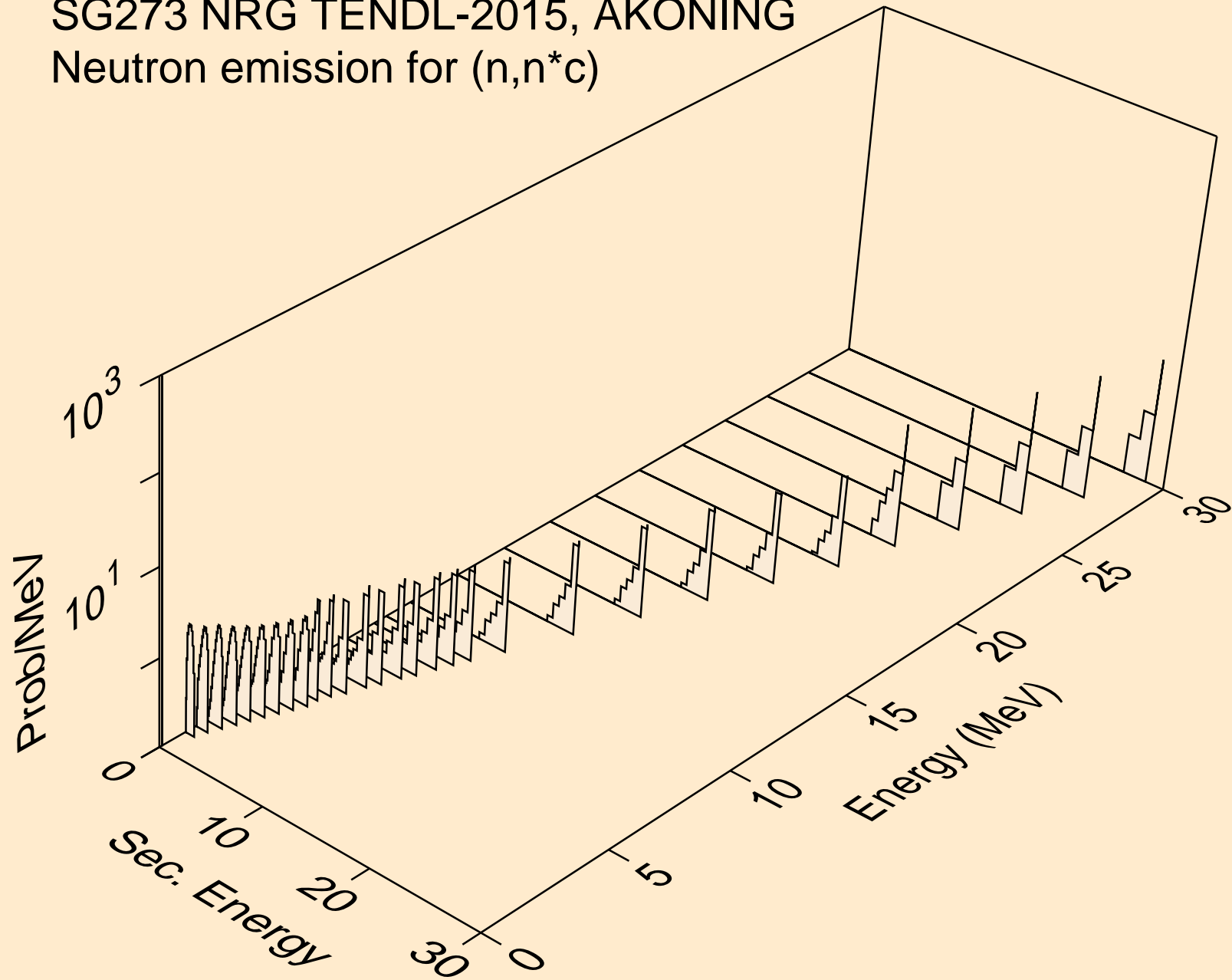



# SG273 NRG TENDL-2015, AKONING

## Delayed nubar

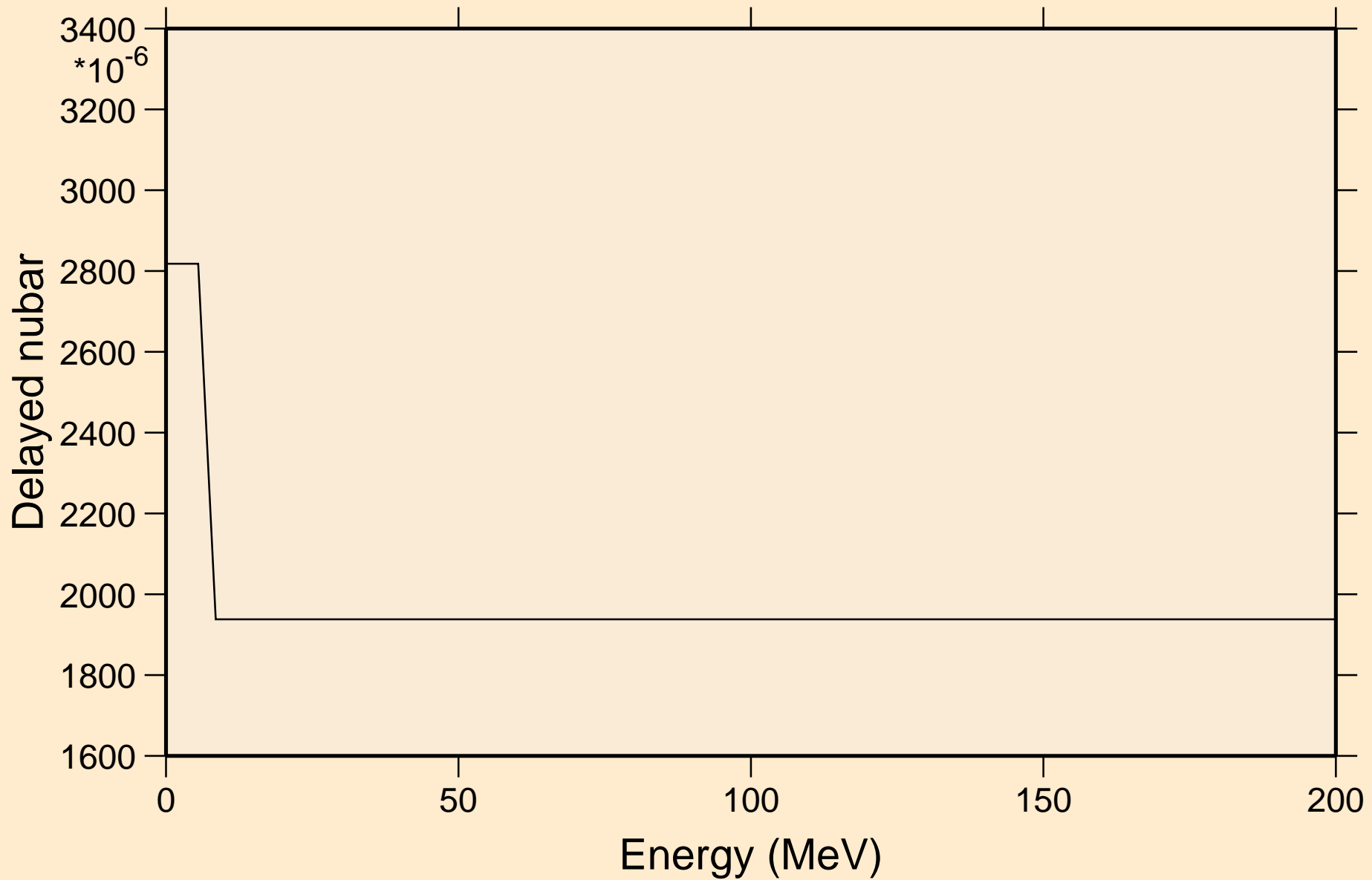

# SG273 NRG TENDL-2015, AKONING

## Delayed neutron spectra

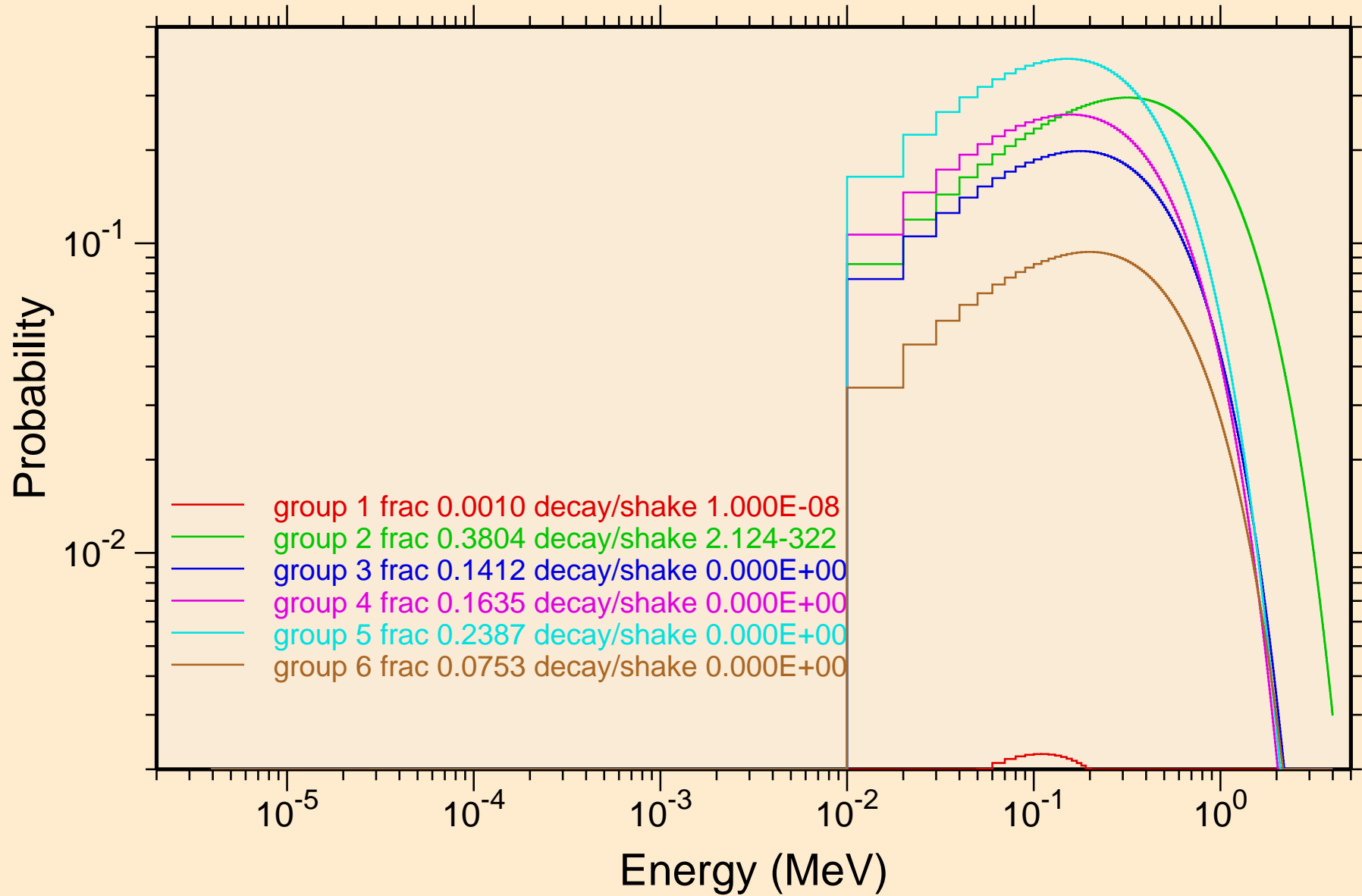

SG273 NRG TENDL-2015, AKONING  
Photon emission for (n,x)

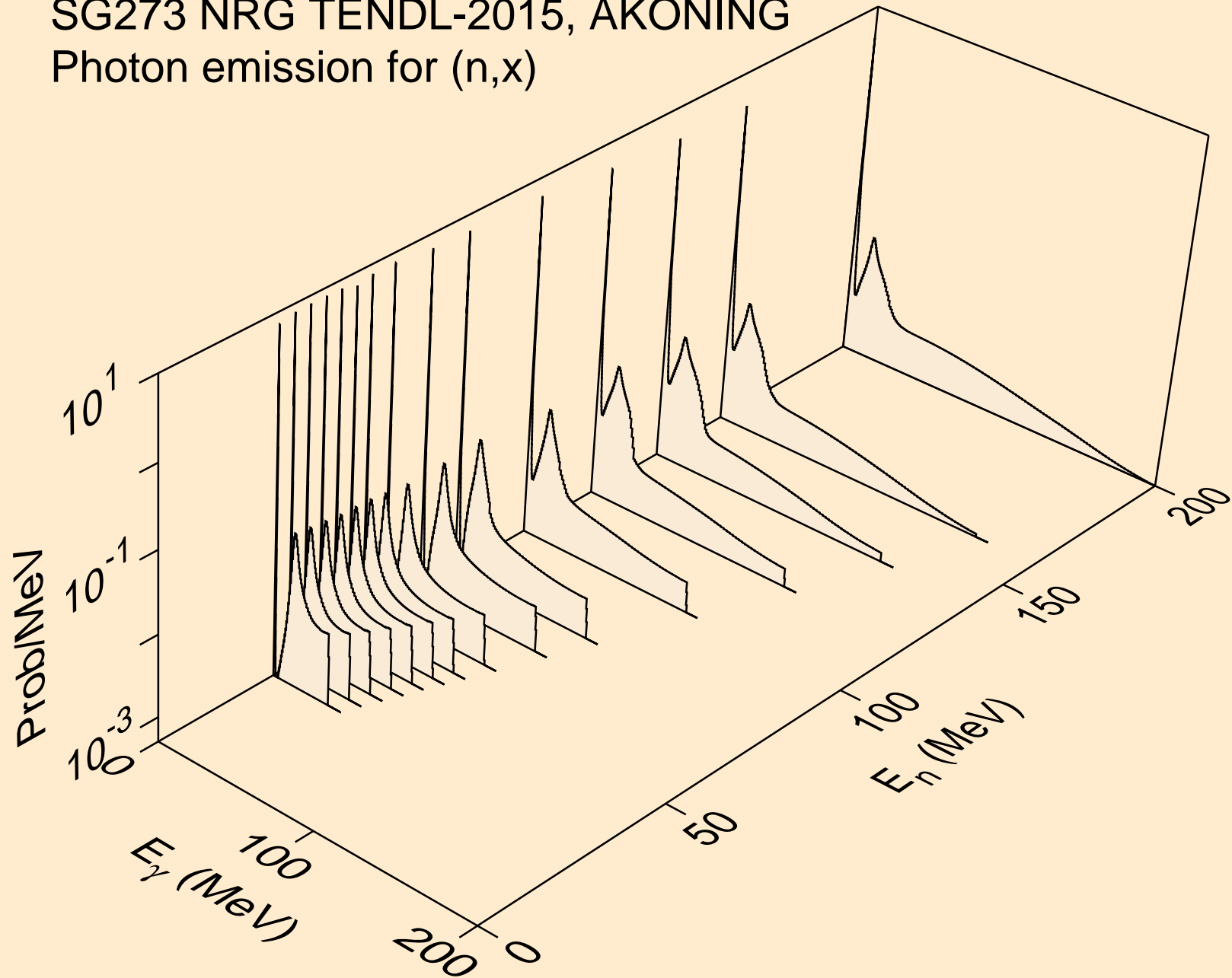

SG273 NRG TENDL-2015, AKONING  
Photon emission for (n,2n)

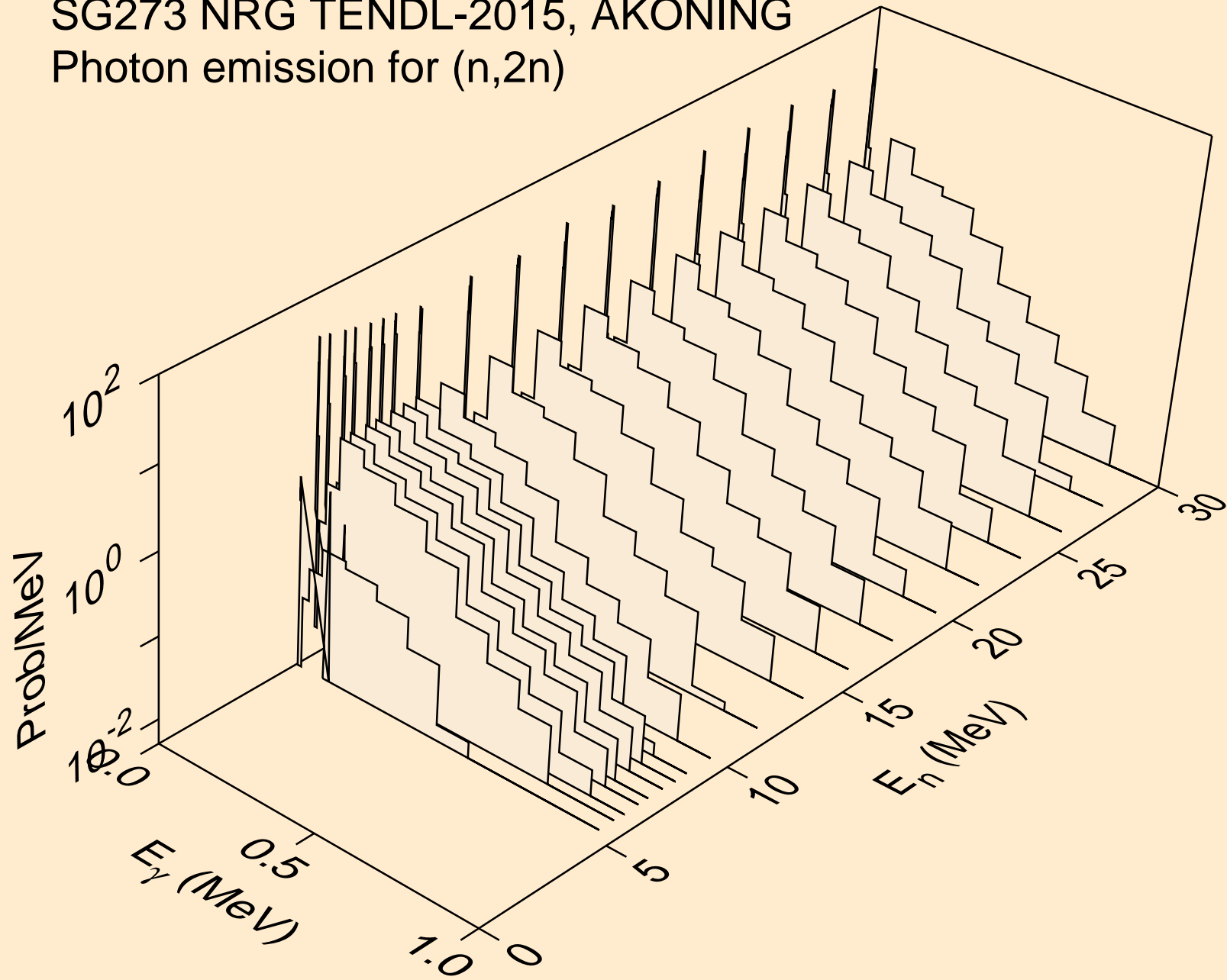

SG273 NRG TENDL-2015, AKONING  
Photon emission for (n,3n)

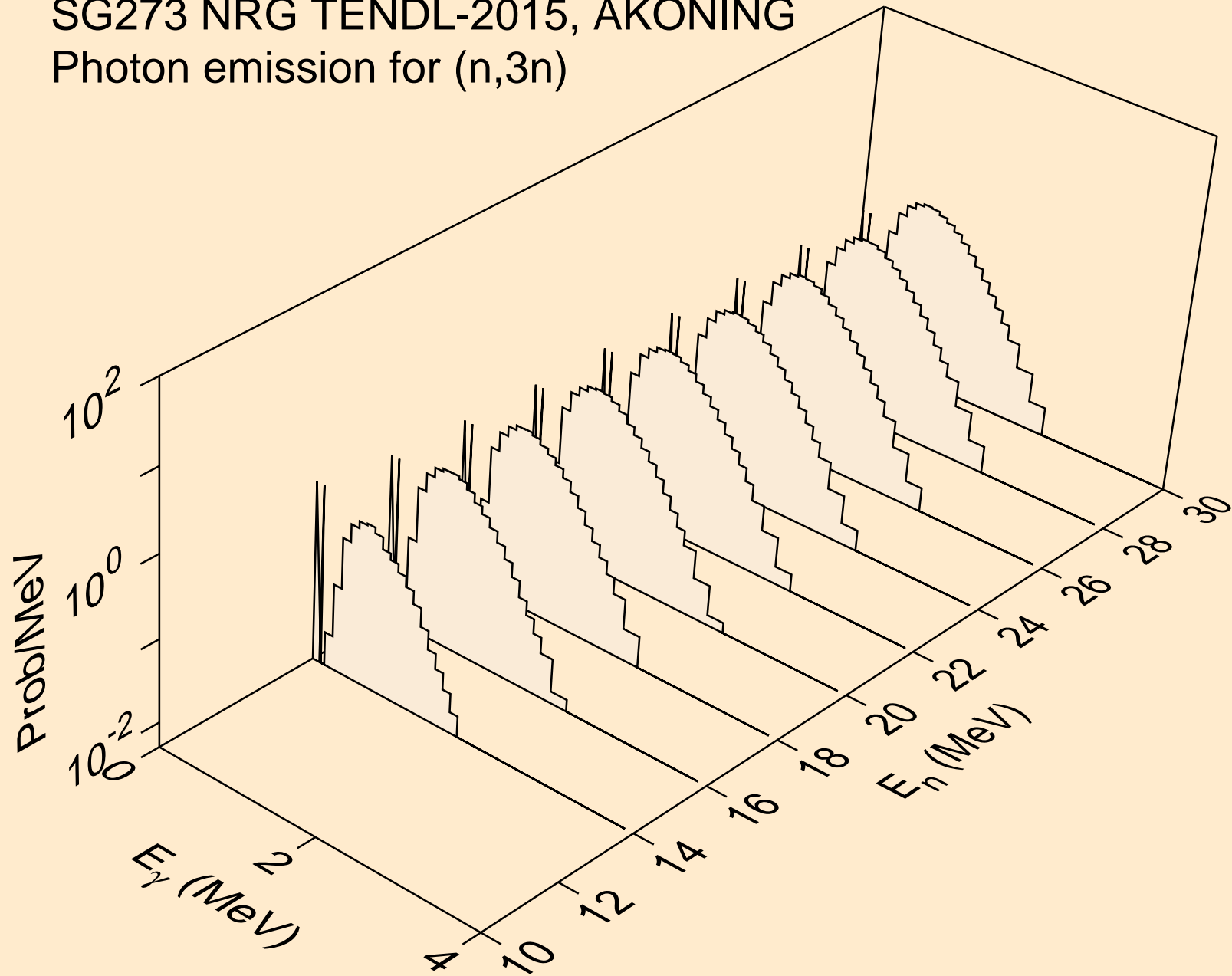

SG273 NRG TENDL-2015, AKONING  
Photon emission for (n,n\*)a

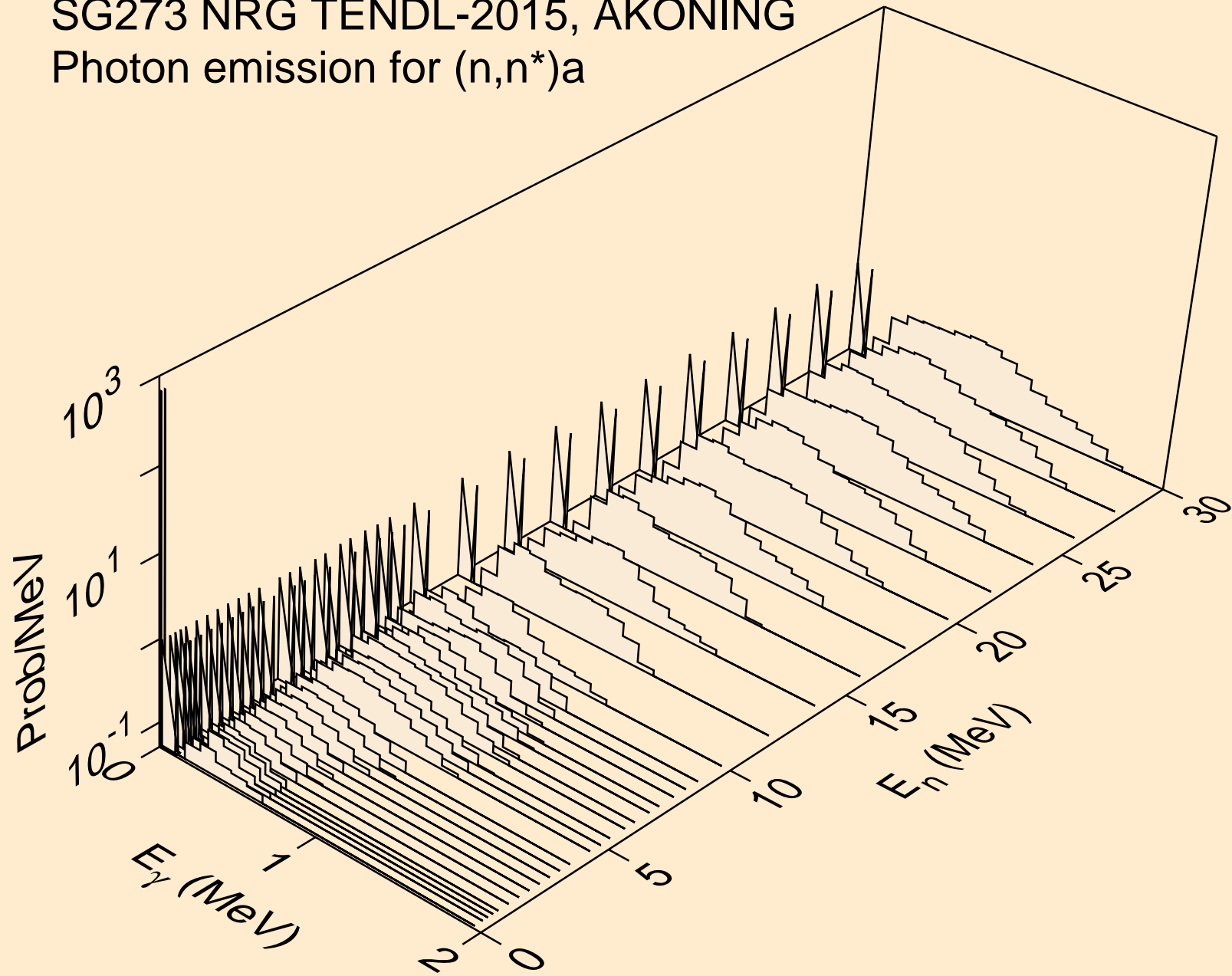

SG273 NRG TENDL-2015, AKONING  
Photon emission for (n,2n)a

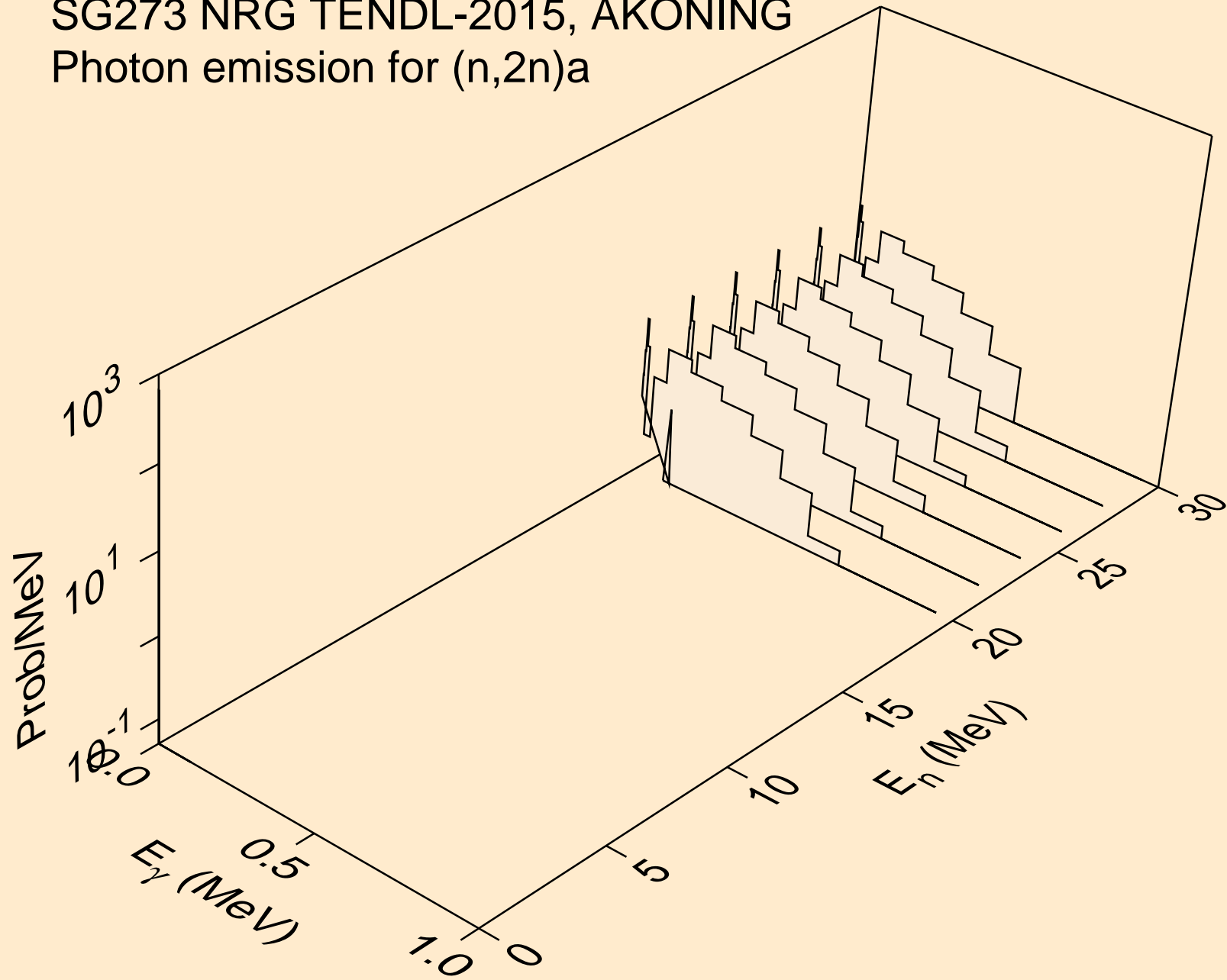

SG273 NRG TENDL-2015, AKONING  
Photon emission for (n,3n)a

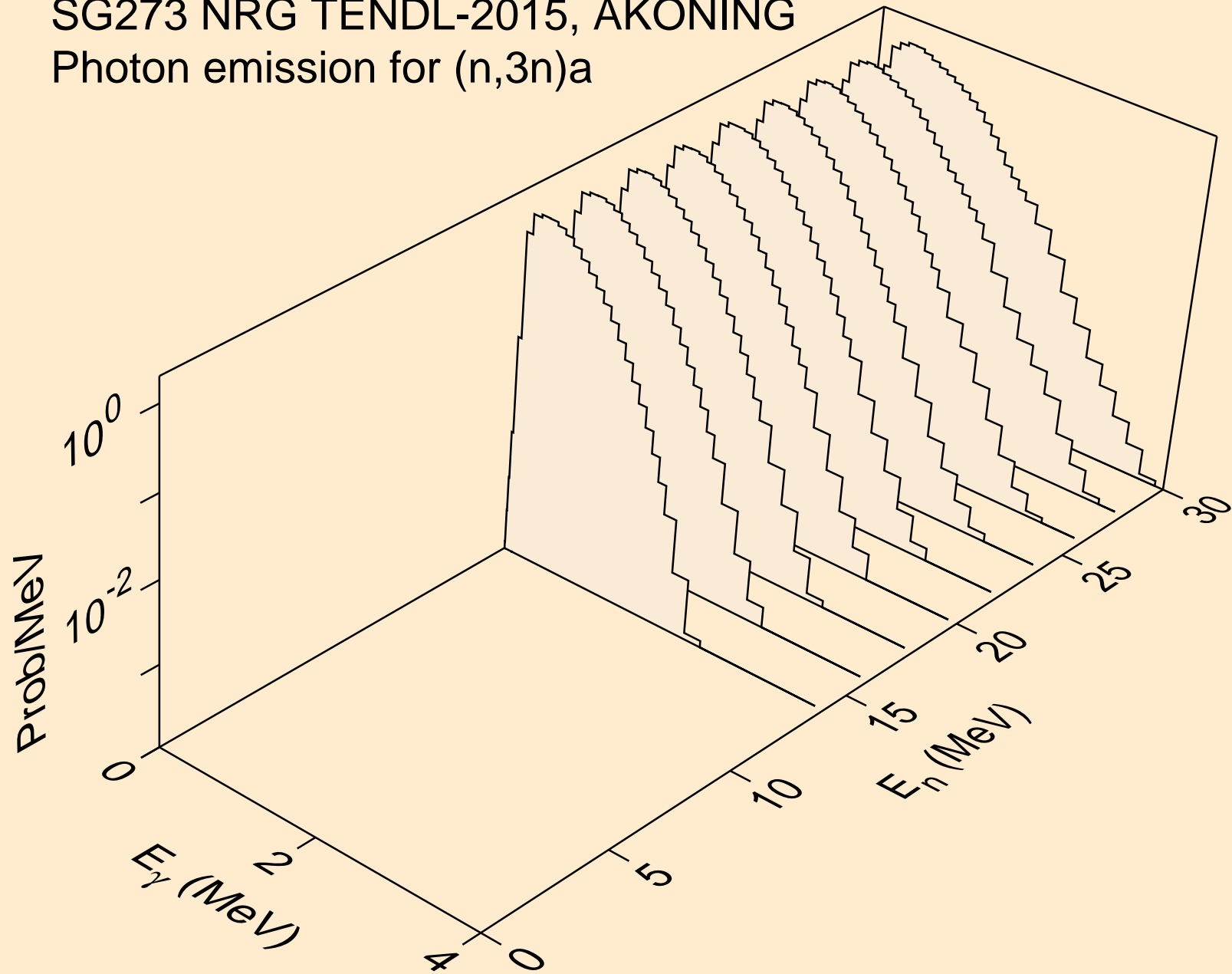



SG273 NRG TENDL-2015, AKONING  
Photon emission for (n,n\*)p

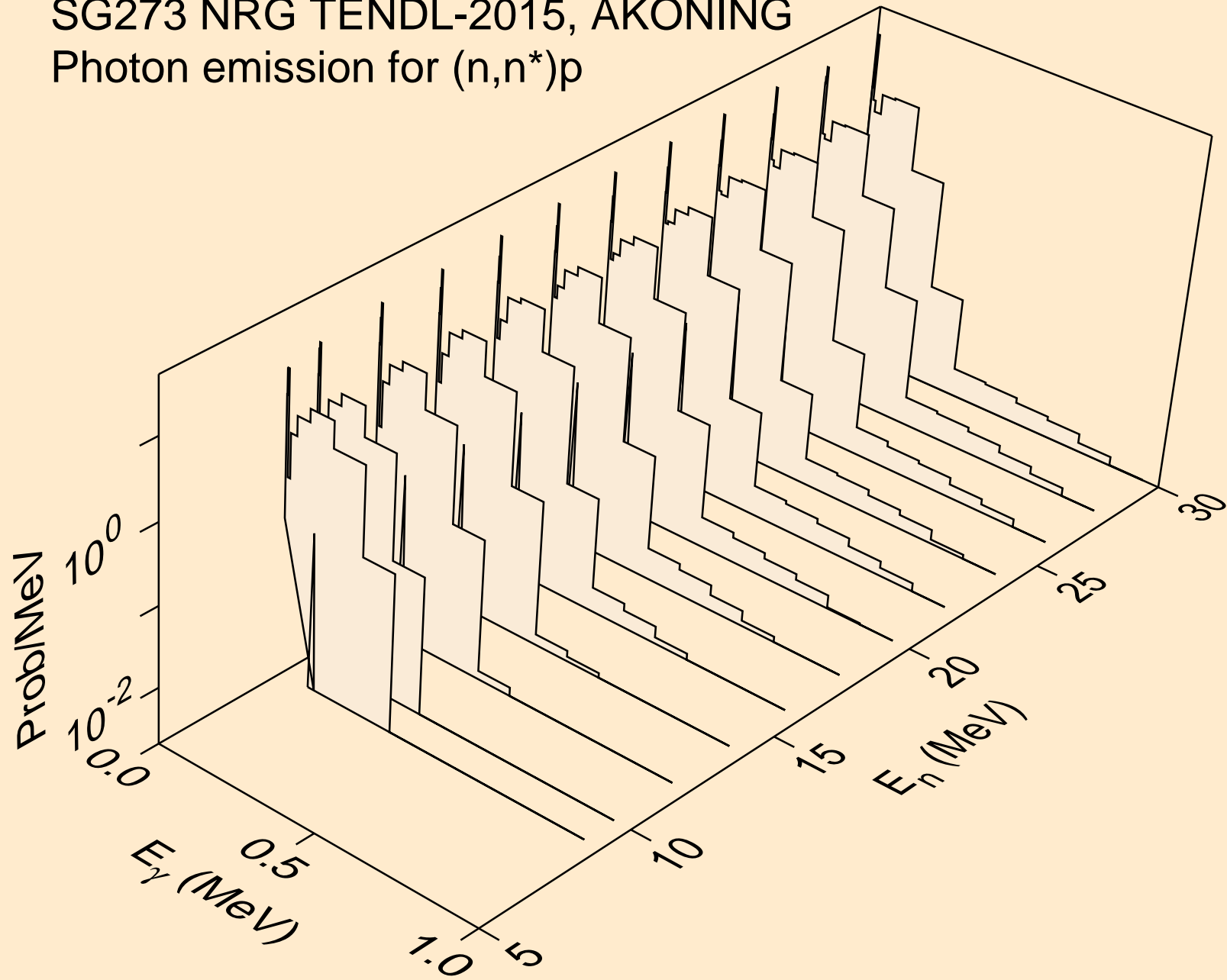

SG273 NRG TENDL-2015, AKONING  
Photon emission for (n,2n)2a

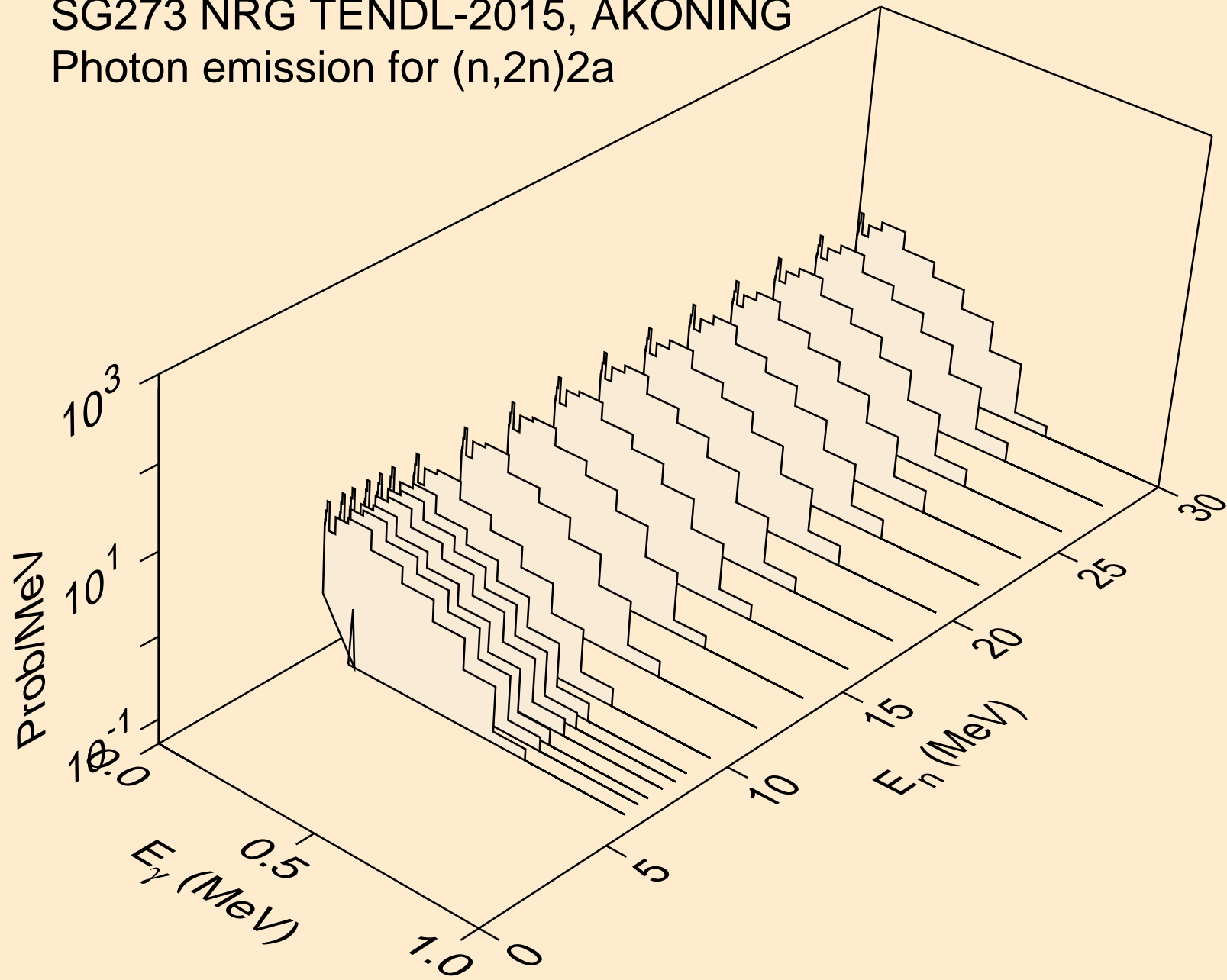

SG273 NRG TENDL-2015, AKONING  
Photon emission for (n,n\*)d

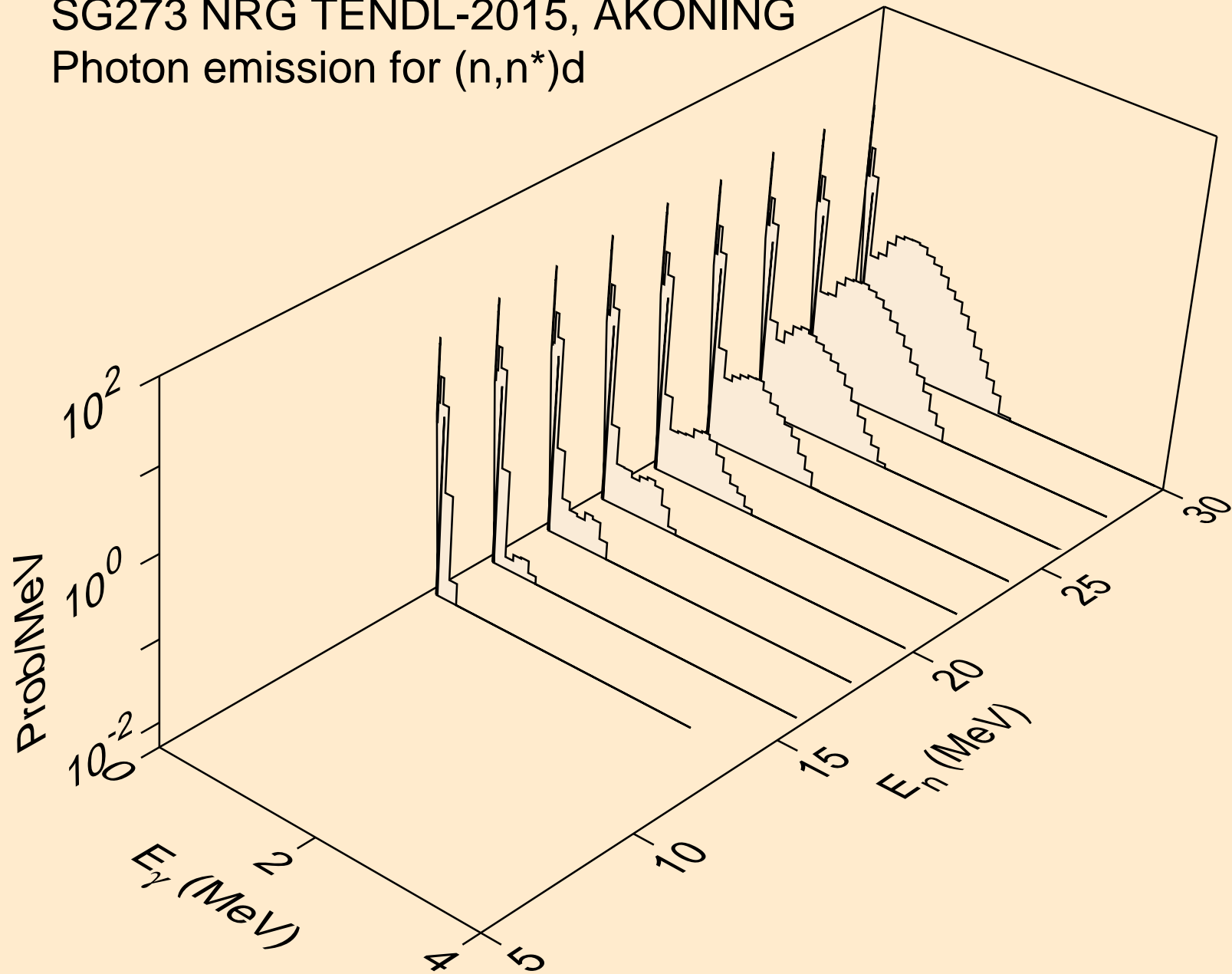

SG273 NRG TENDL-2015, AKONING  
Photon emission for (n,n\*)t

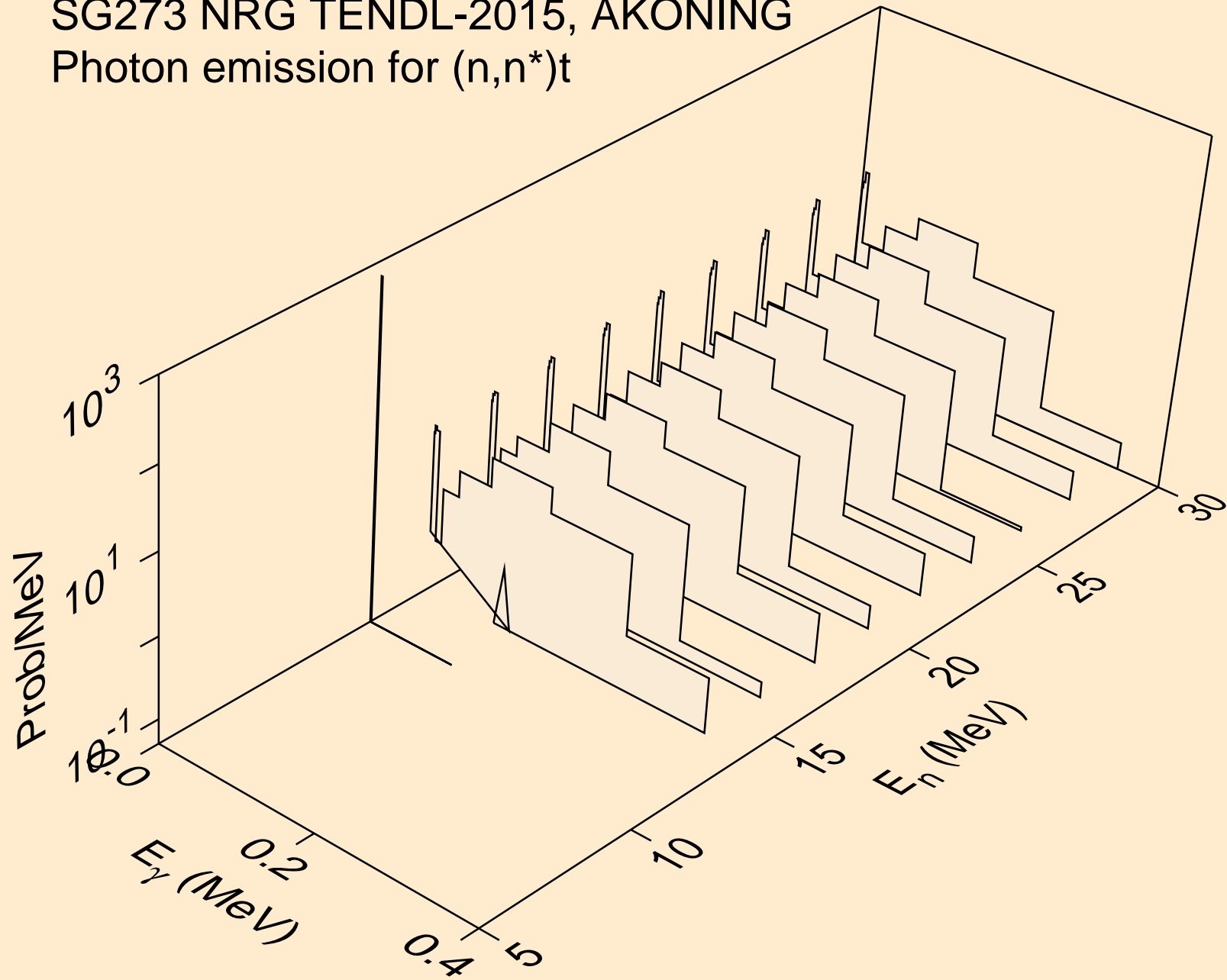

SG273 NRG TENDL-2015, AKONING  
Photon emission for (n,n\*)t2a

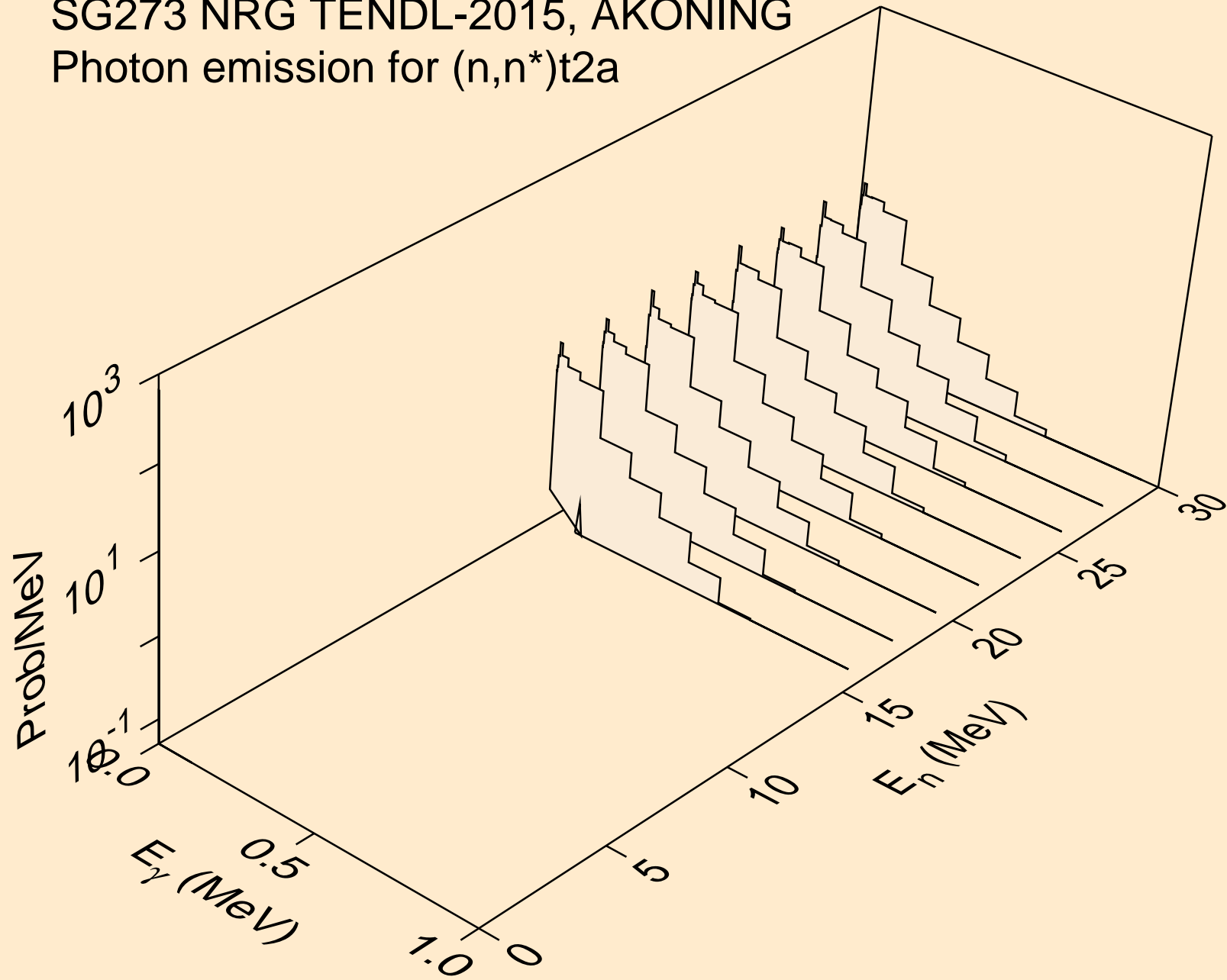

SG273 NRG TENDL-2015, AKONING  
Photon emission for (n,4n)

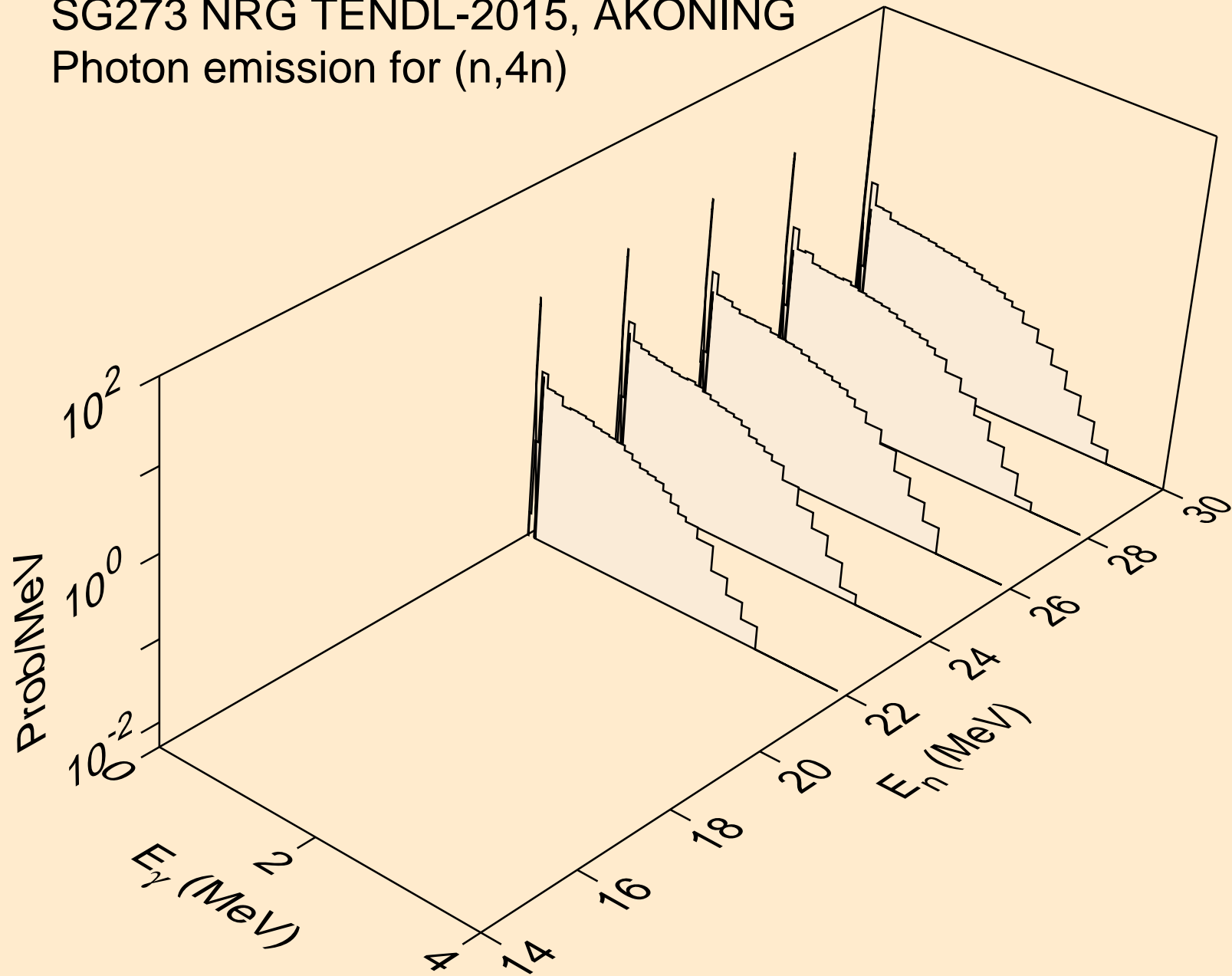

SG273 NRG TENDL-2015, AKONING  
Photon emission for (n,2np)

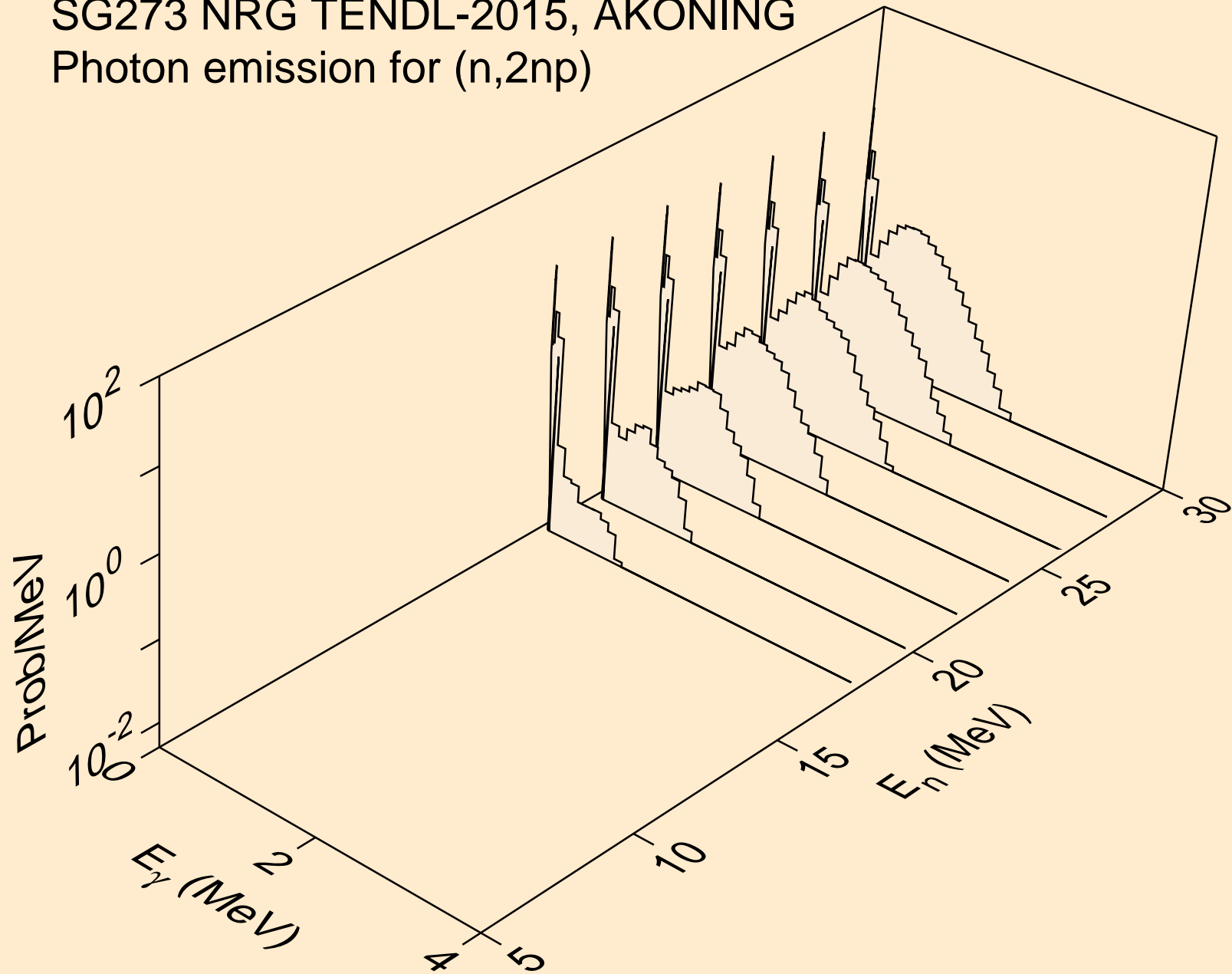

SG273 NRG TENDL-2015, AKONING  
Photon emission for (n,npa)

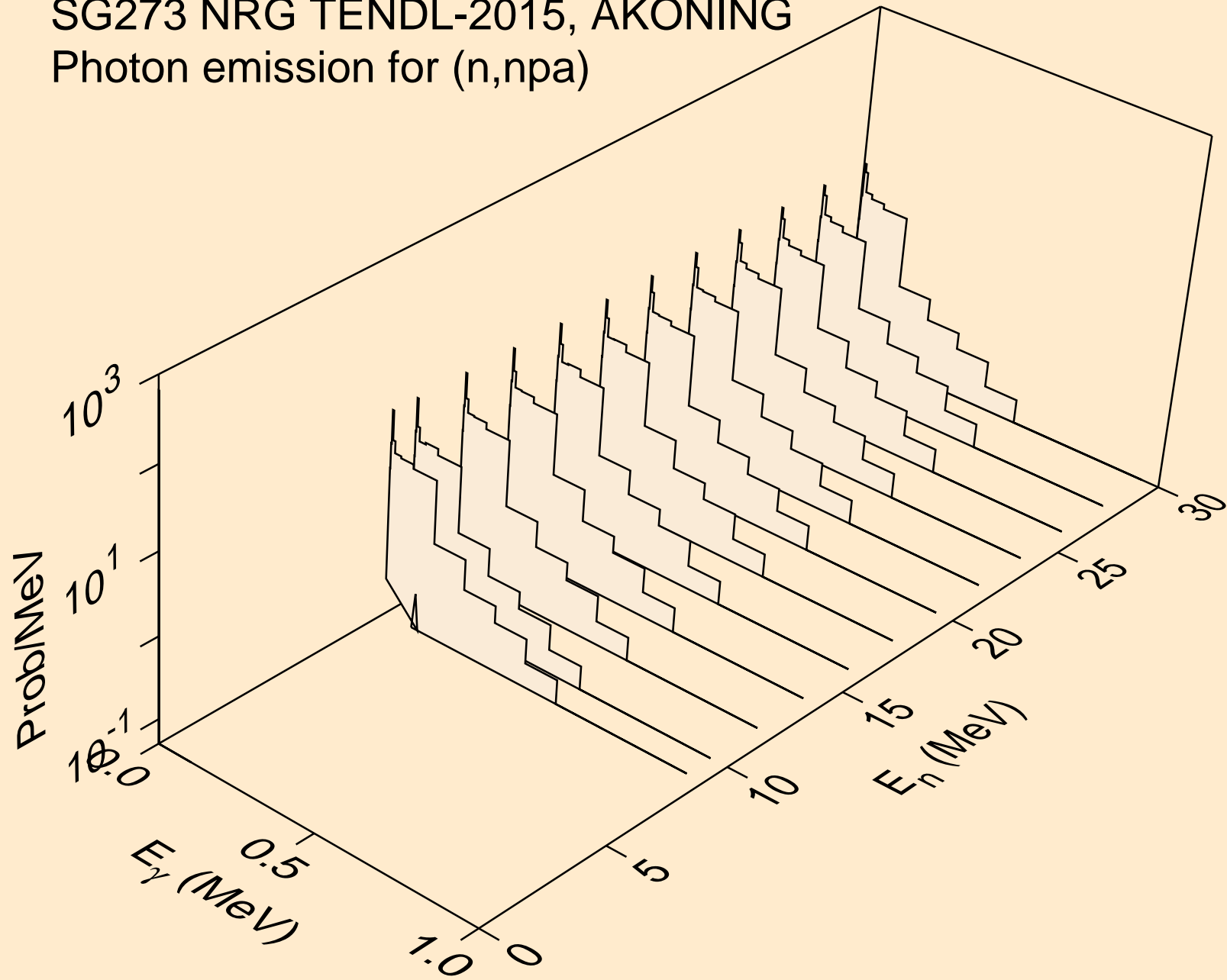



SG273 NRG TENDL-2015, AKONING  
Photon emission for (n,n\*c)

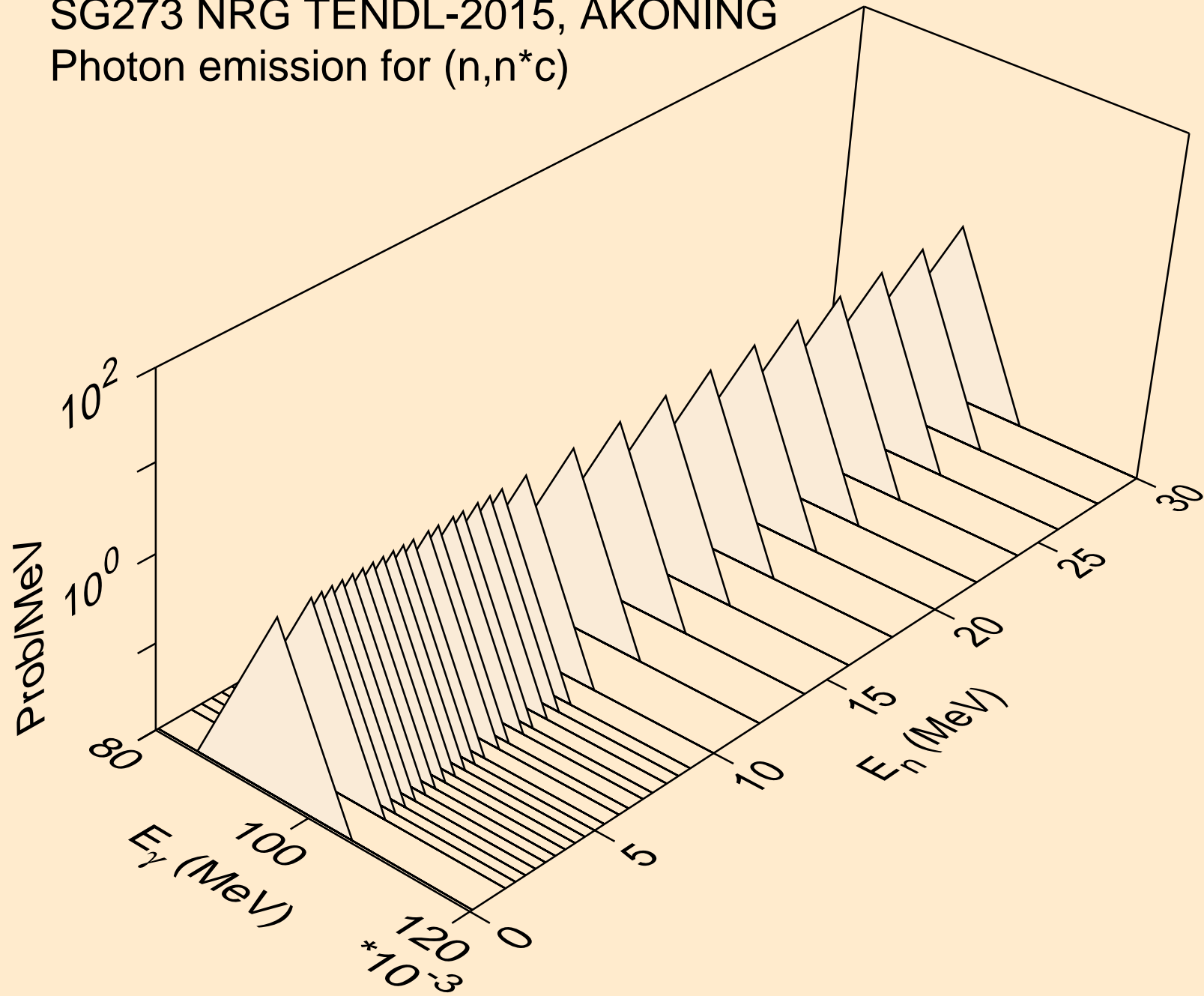

SG273 NRG TENDL-2015, AKONING  
Photon emission for (n,gma)

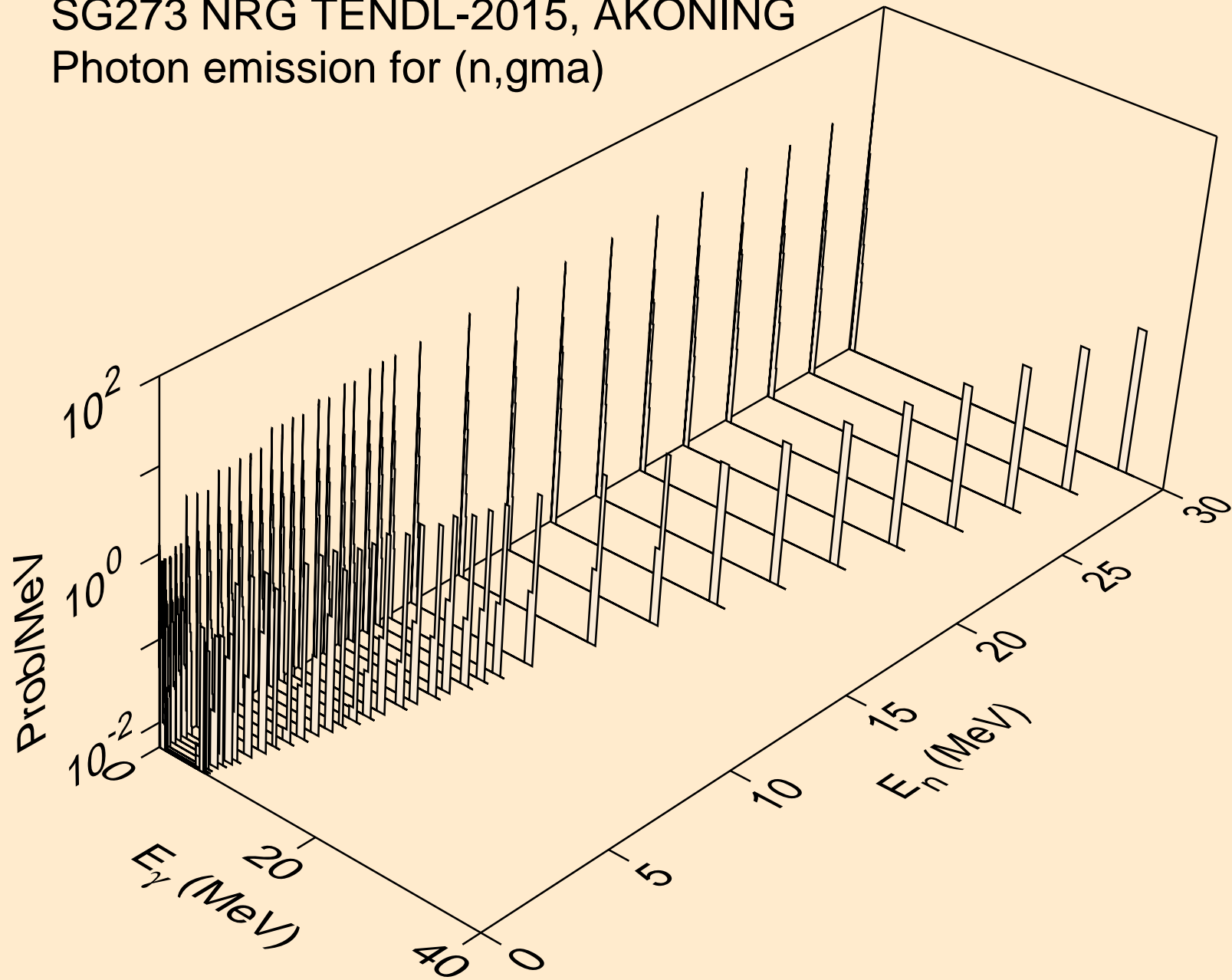

SG273 NRG TENDL-2015, AKONING  
Photon emission for (n,p)

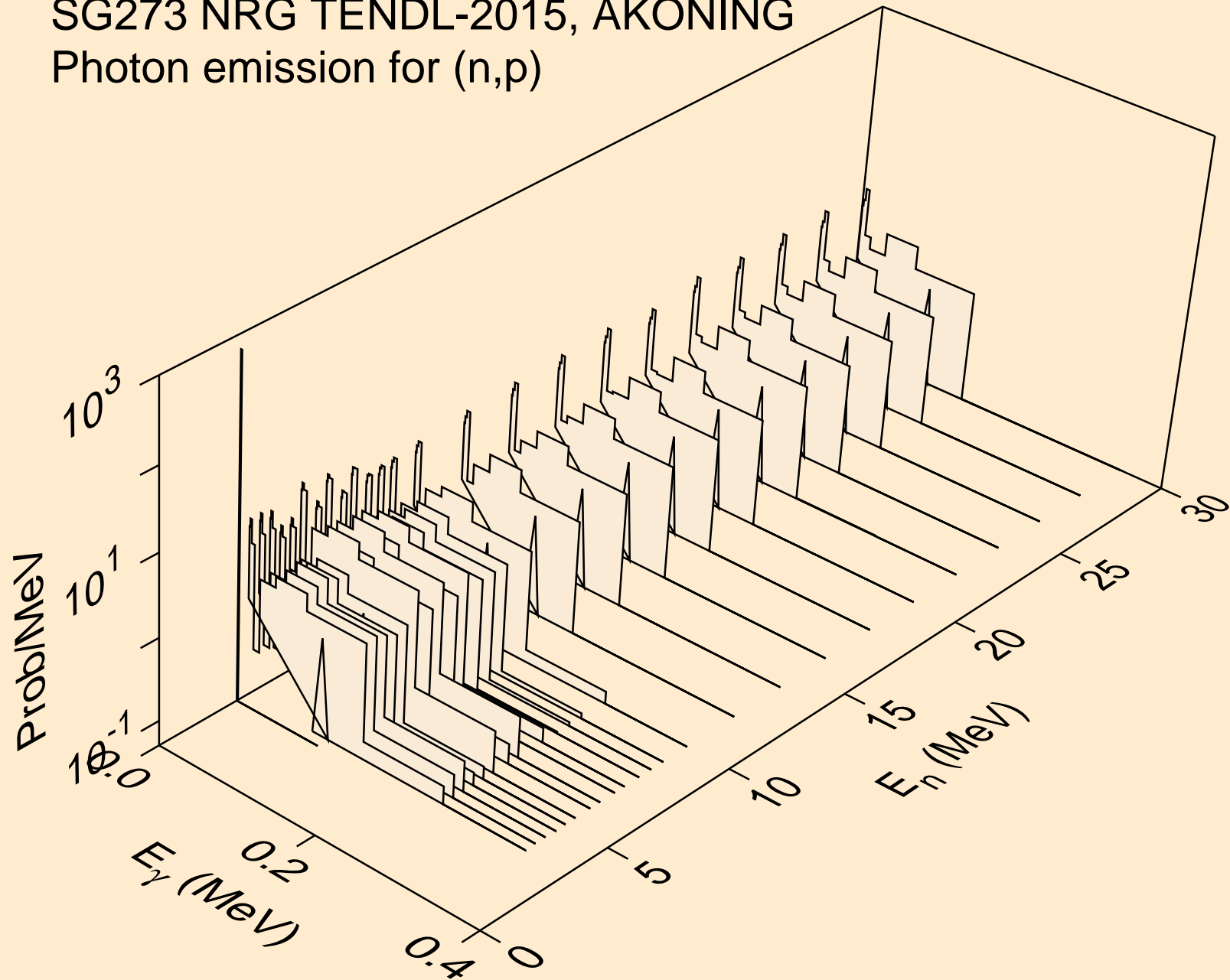

SG273 NRG TENDL-2015, AKONING  
Photon emission for (n,d)

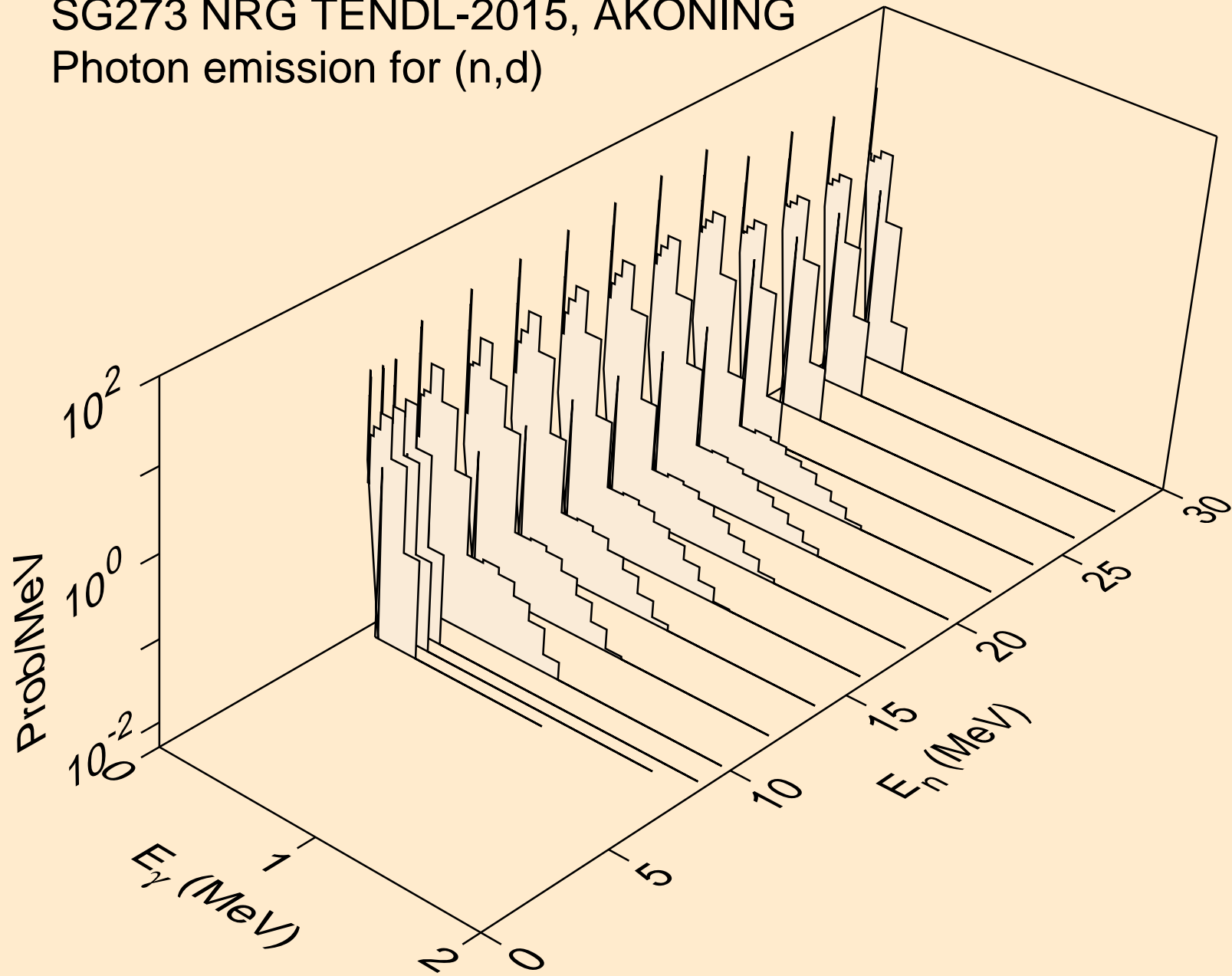

SG273 NRG TENDL-2015, AKONING  
Photon emission for (n,t)

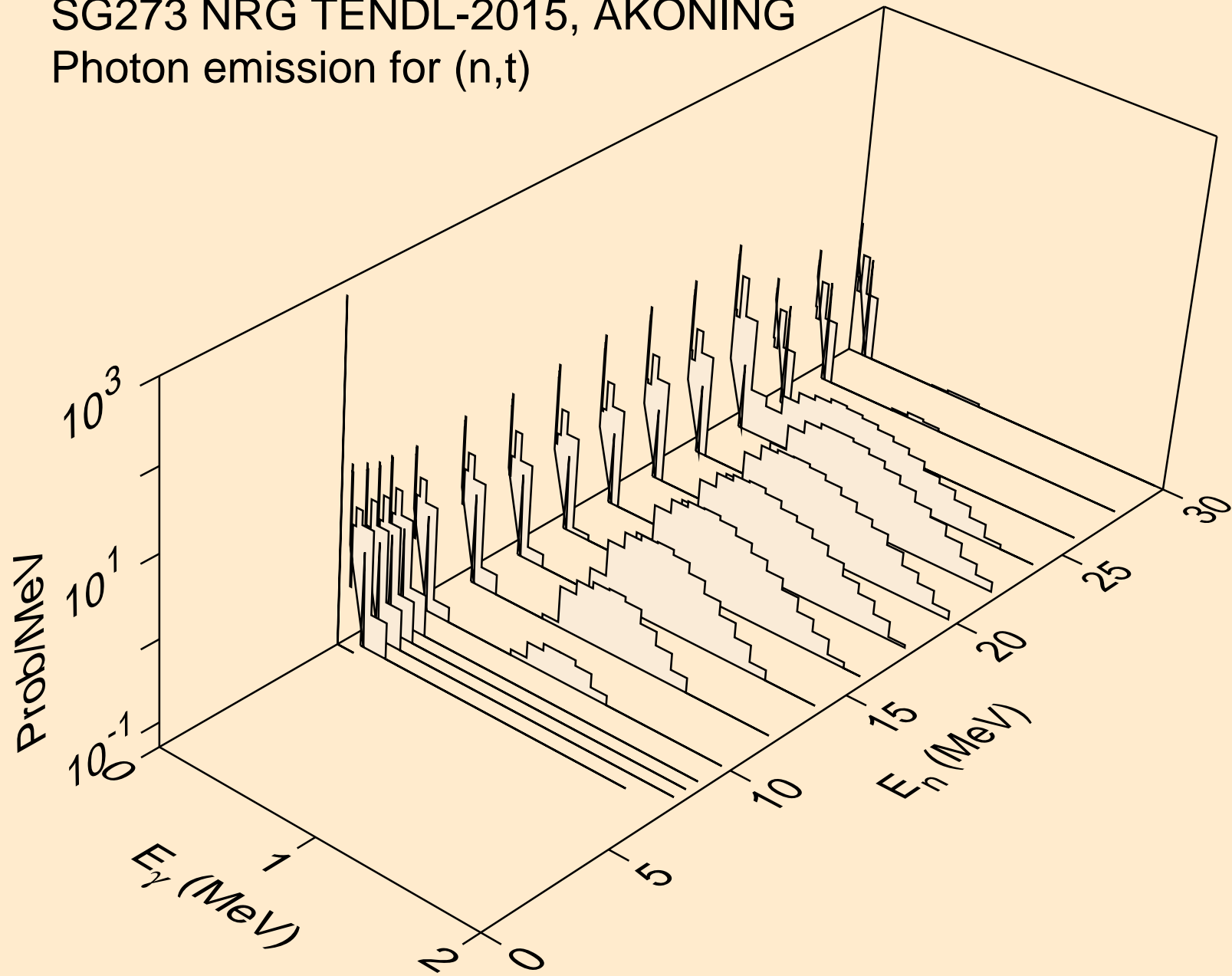

SG273 NRG TENDL-2015, AKONING  
Photon emission for (n,he3)

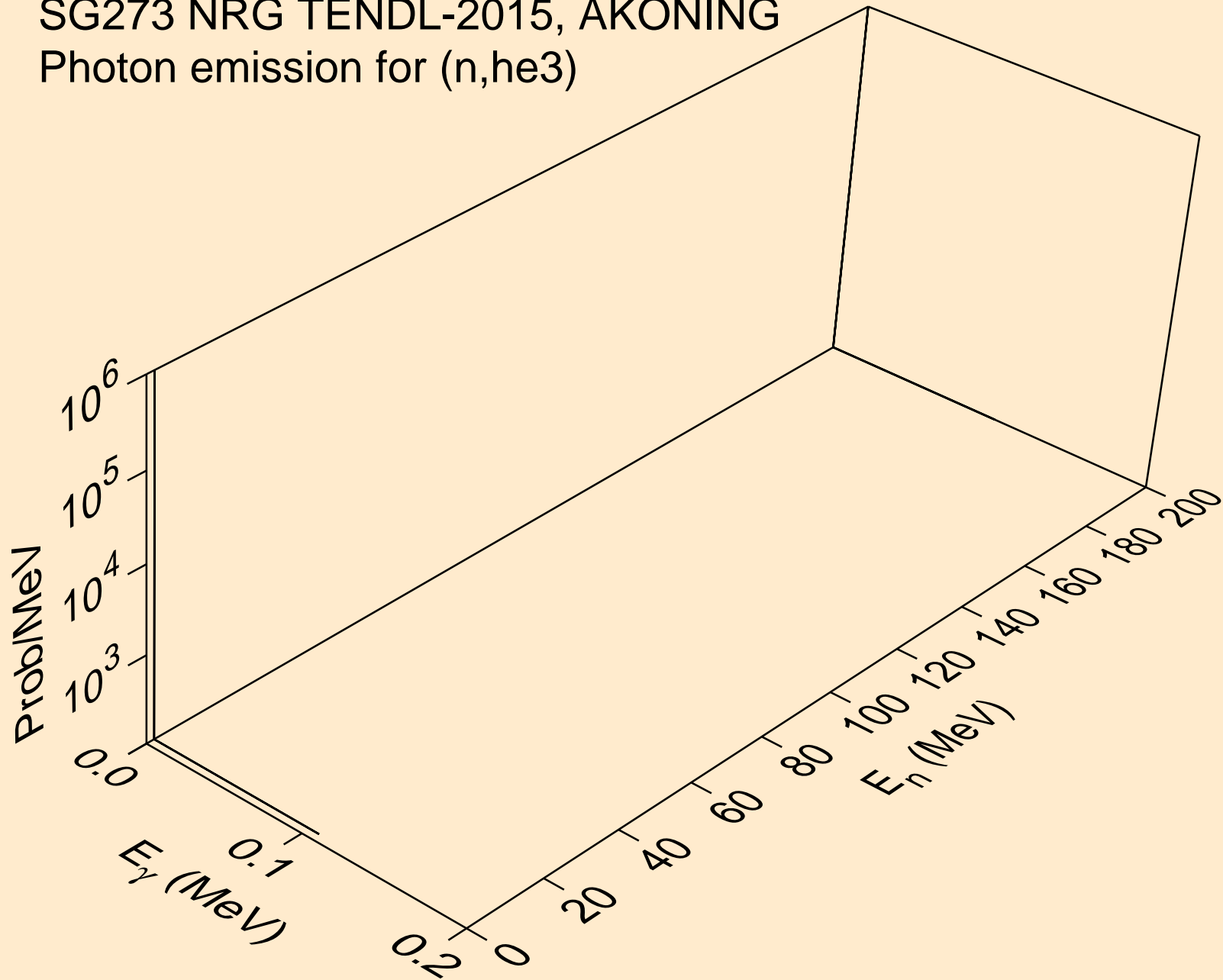

SG273 NRG TENDL-2015, AKONING  
Photon emission for (n,a)

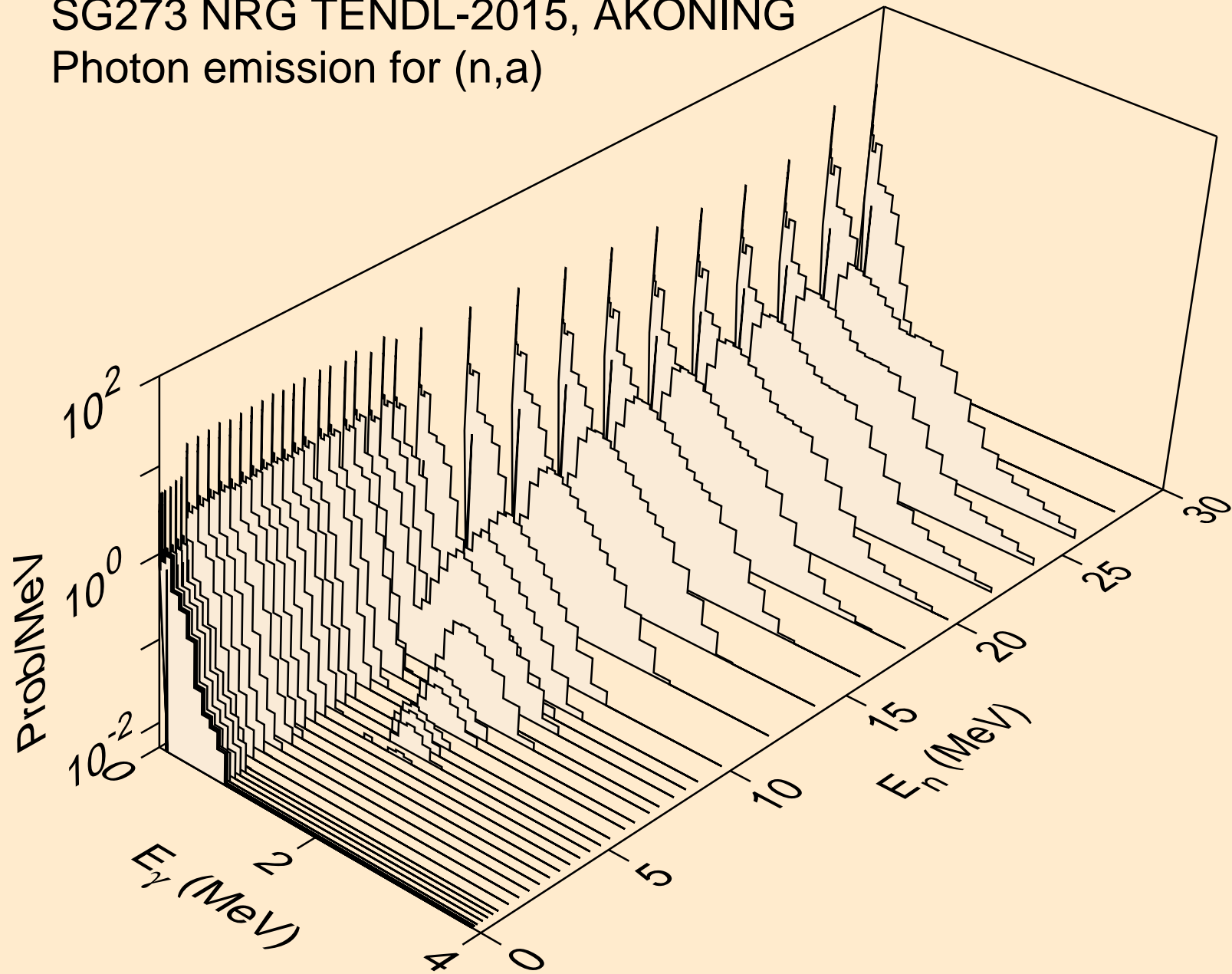

SG273 NRG TENDL-2015, AKONING  
Photon emission for (n,2a)

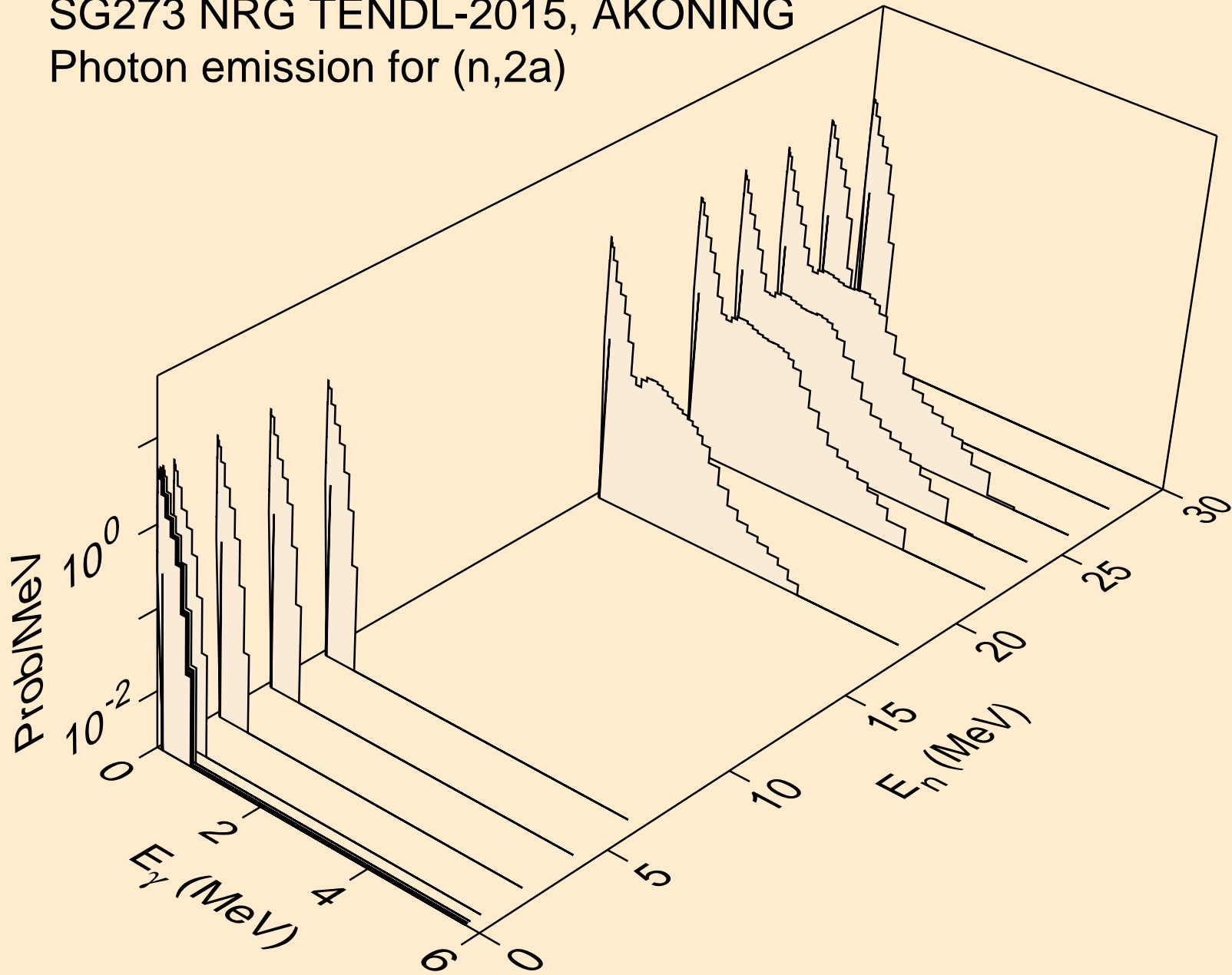



SG273 NRG TENDL-2015, AKONING  
Photon emission for (n,p $\alpha$ )

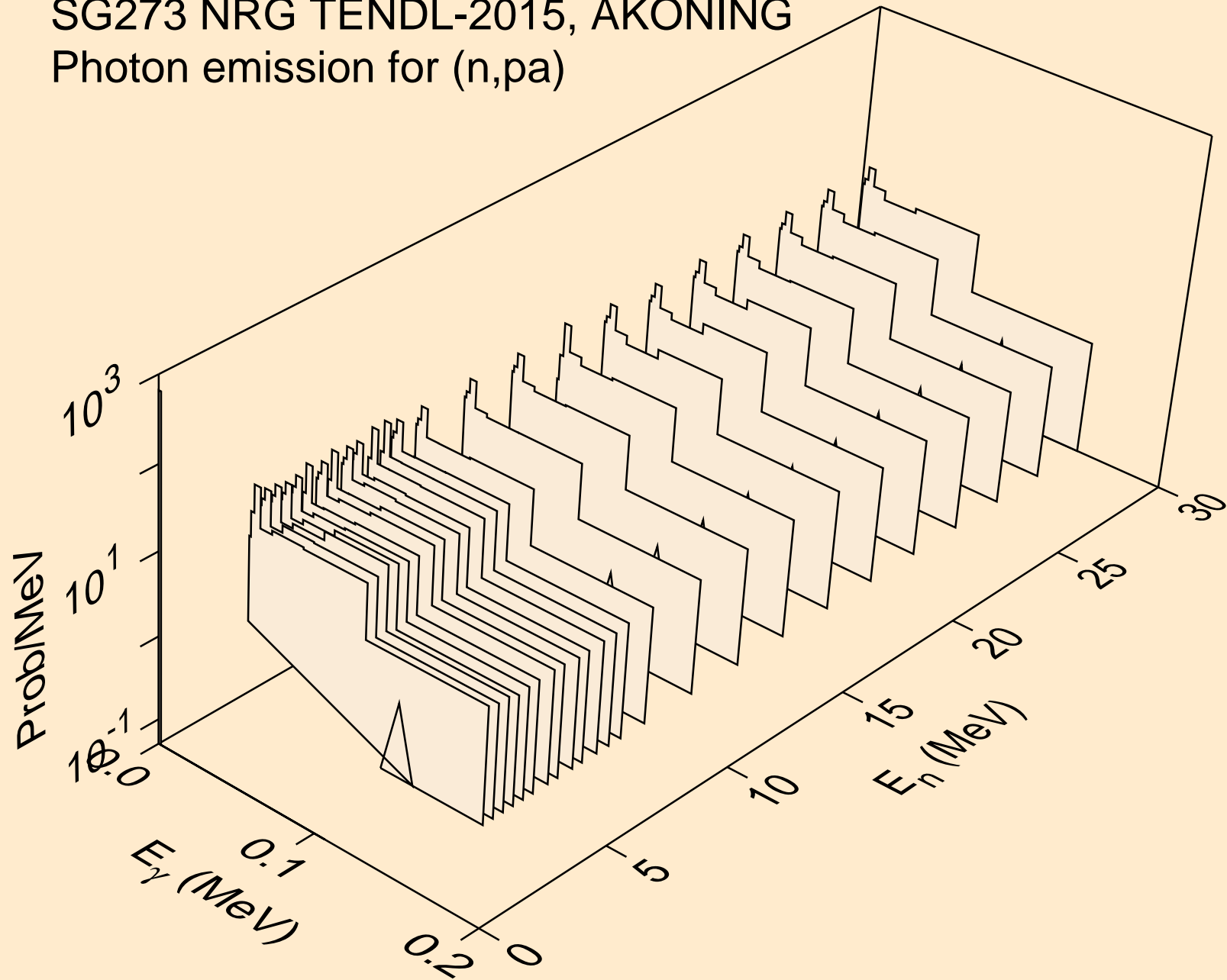

SG273 NRG TENDL-2015, AKONING  
Photon emission for (n,da)

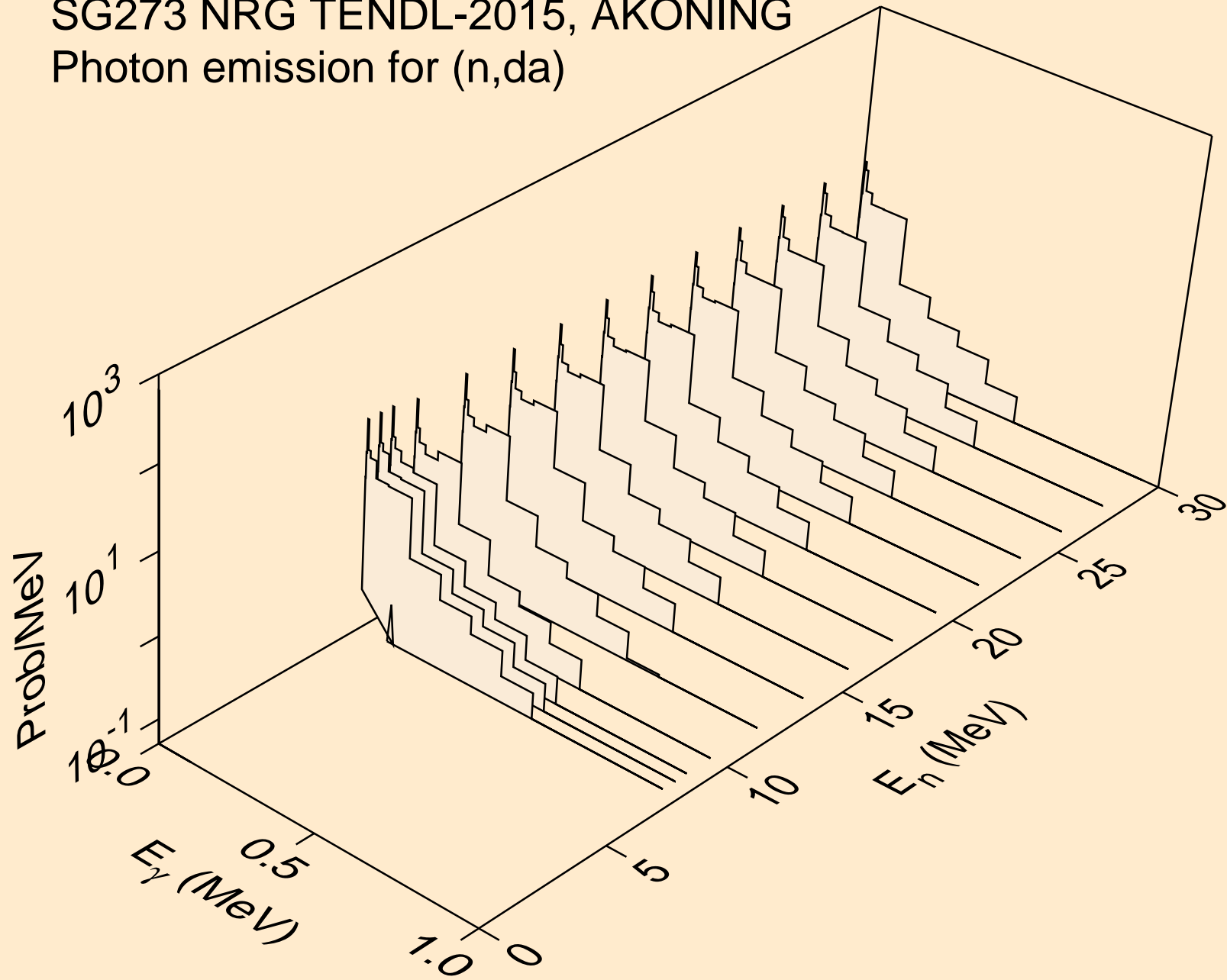

SG273 NRG TENDL-2015, AKONING  
thermal capture photon spectrum

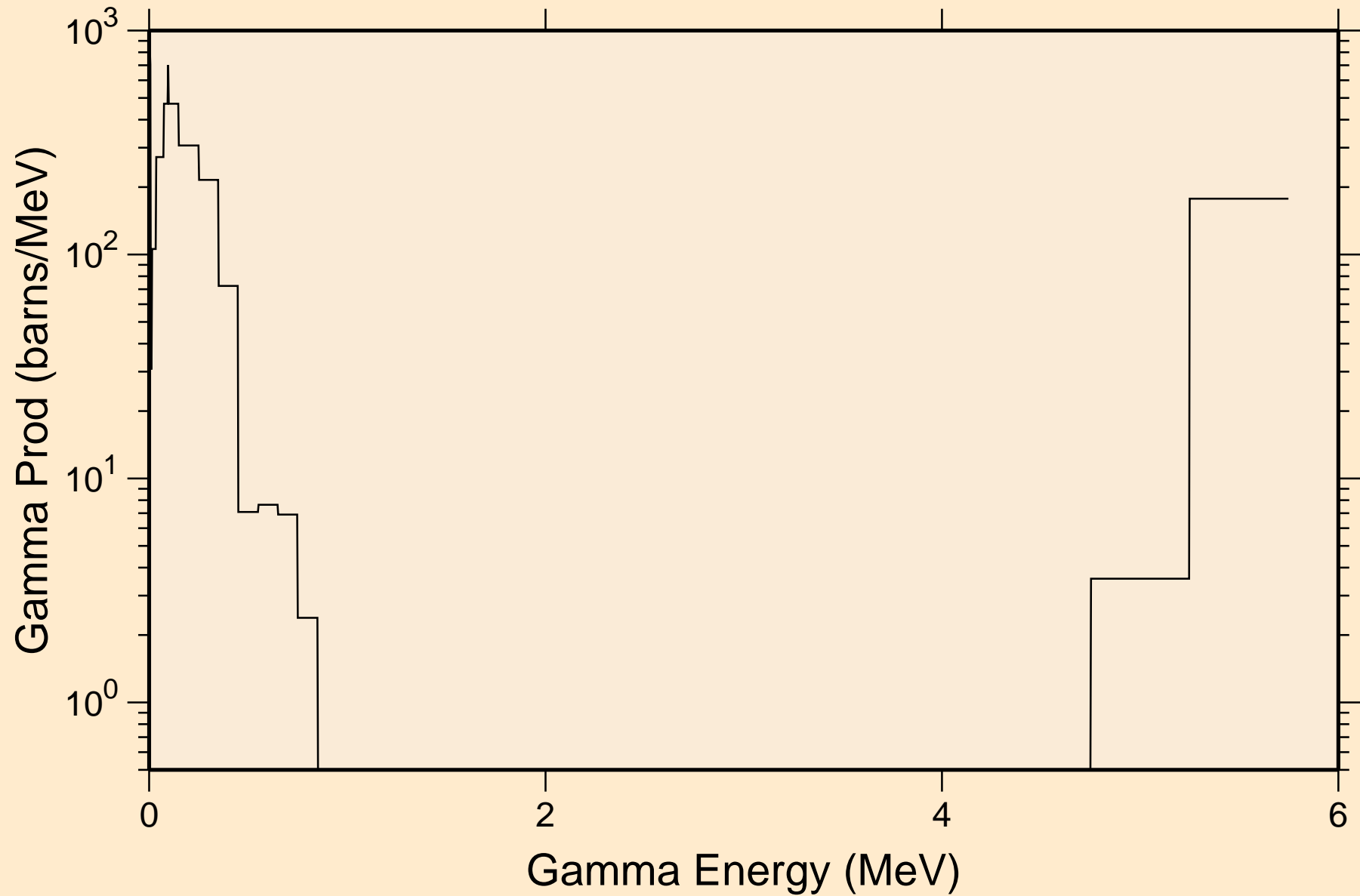

SG273 NRG TENDL-2015, AKONING  
14 MeV photon spectrum

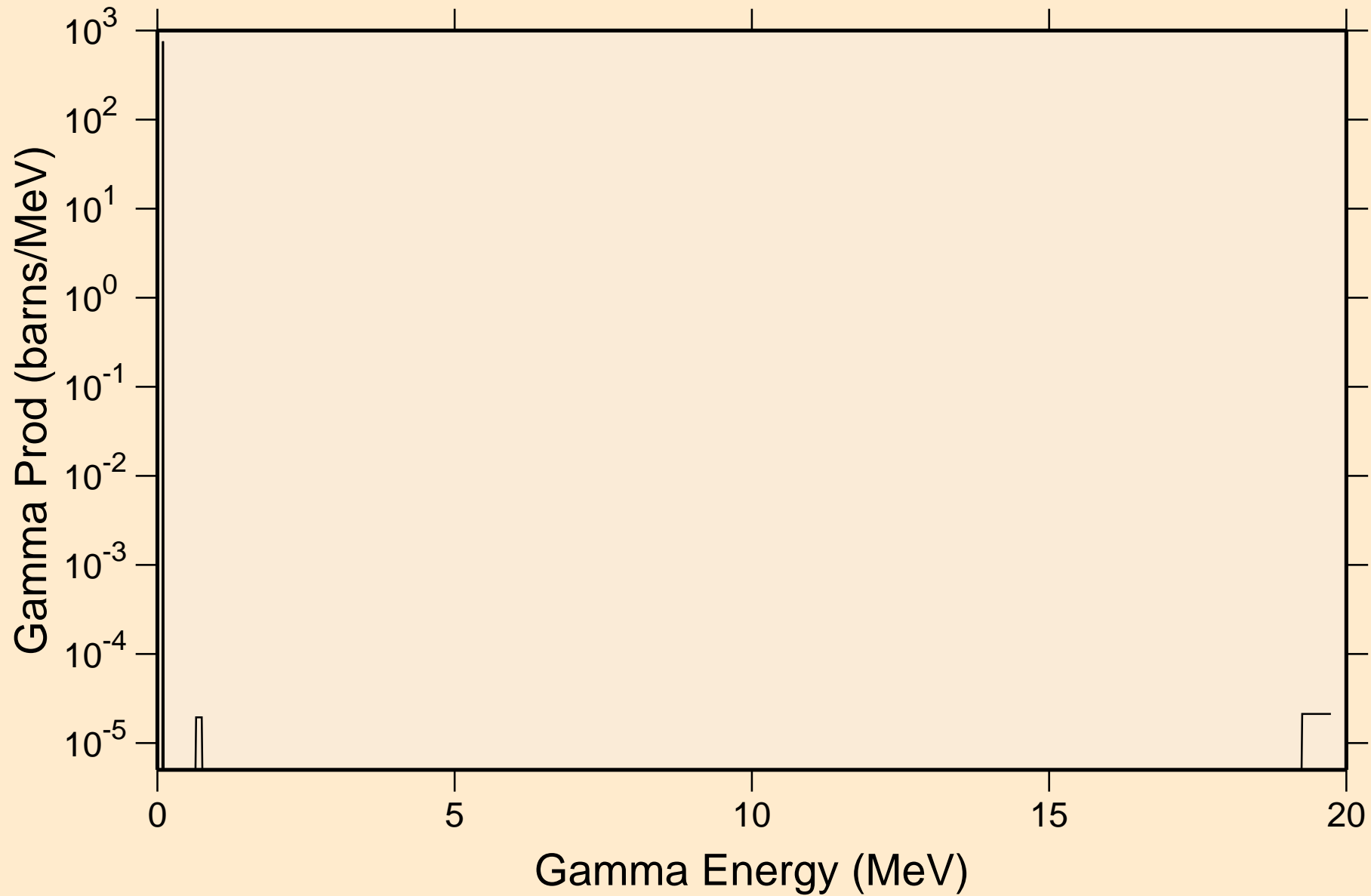

# SG273 NRG TENDL-2015, AKONING

## Particle heating contributions

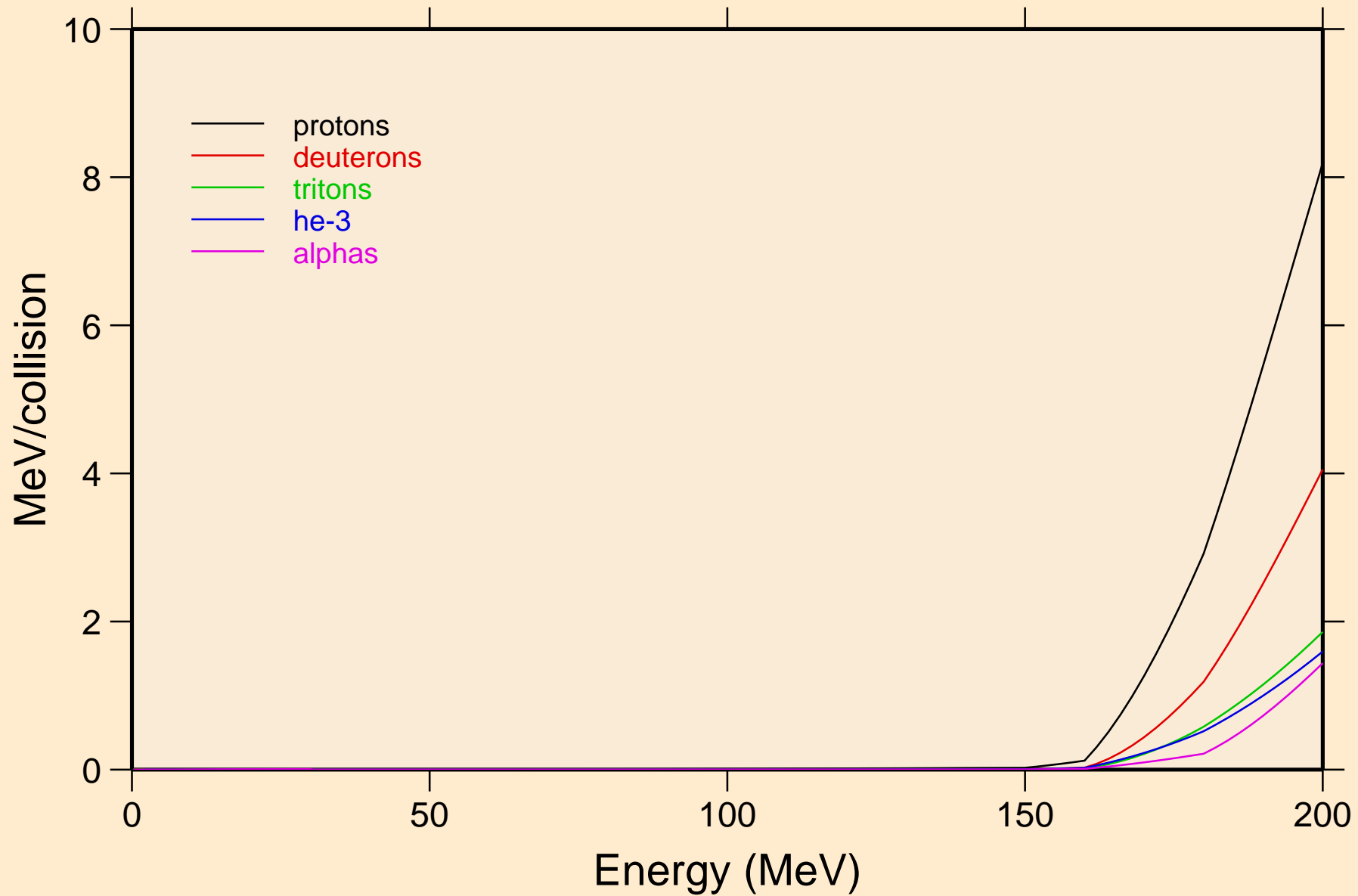

# SG273 NRG TENDL-2015, AKONING

## Recoil Heating

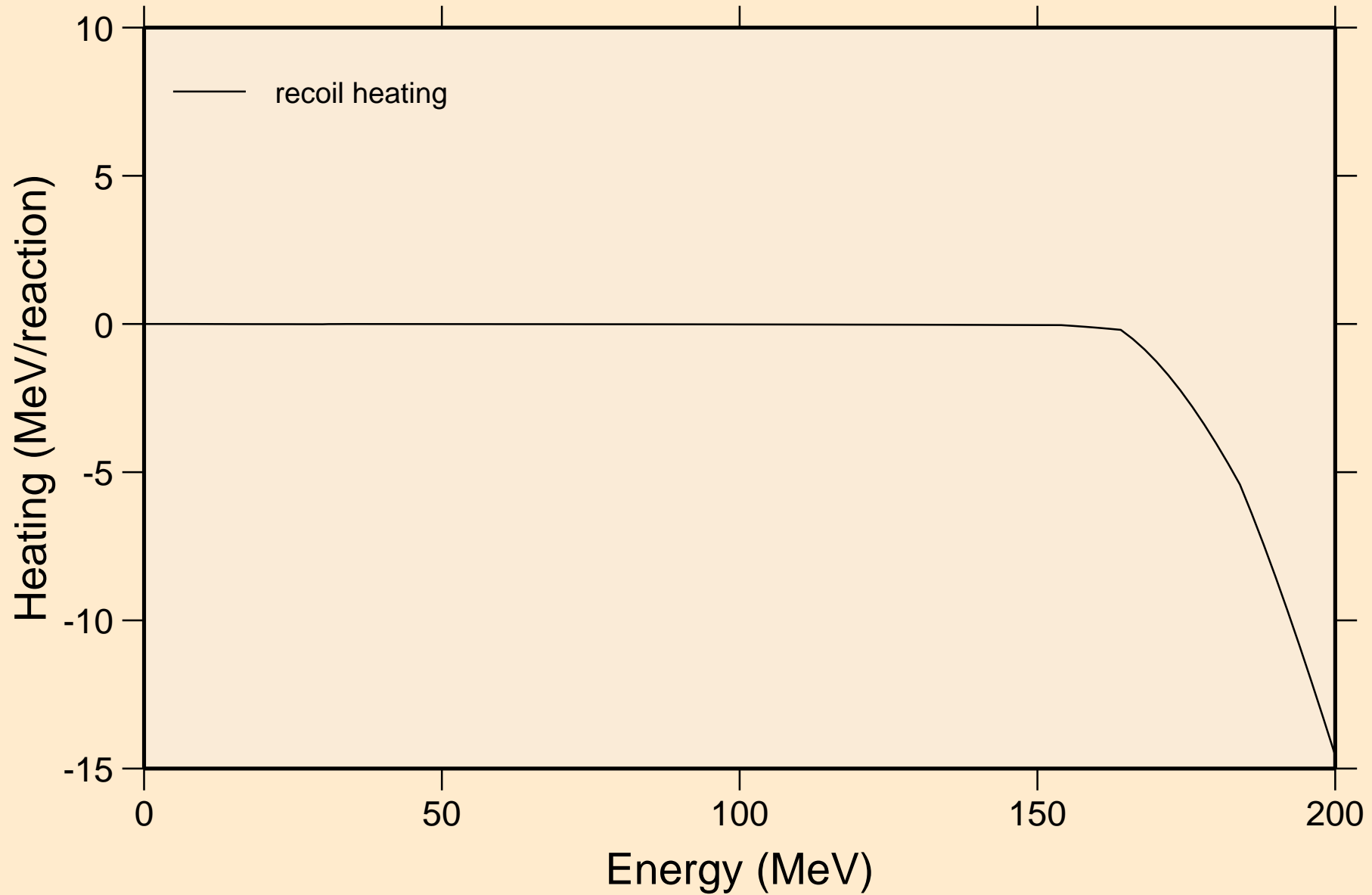

# SG273 NRG TENDL-2015, AKONING

## Particle production cross sections

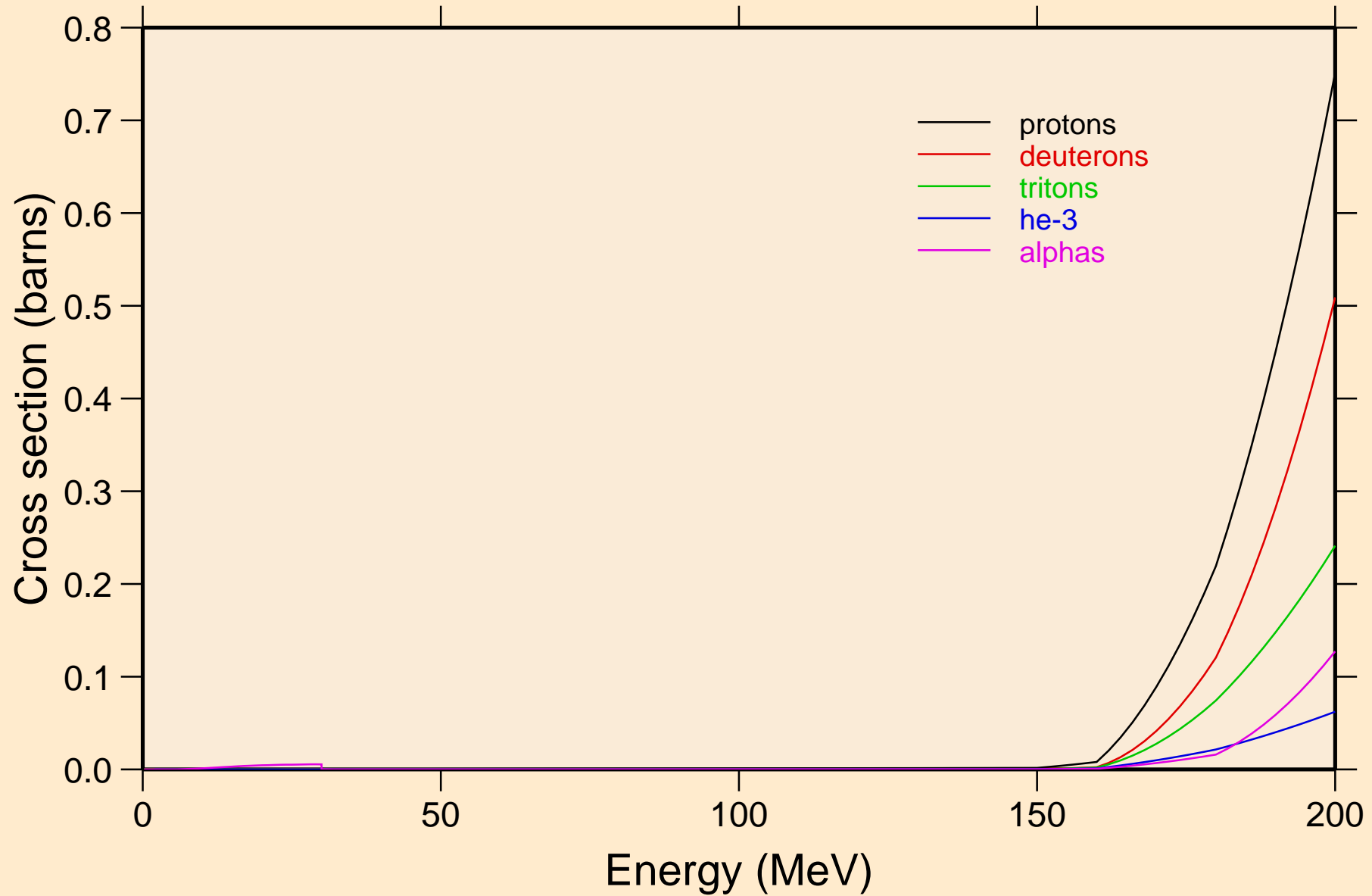

SG273 NRG TENDL-2015, AKONING  
protons from (n,x)

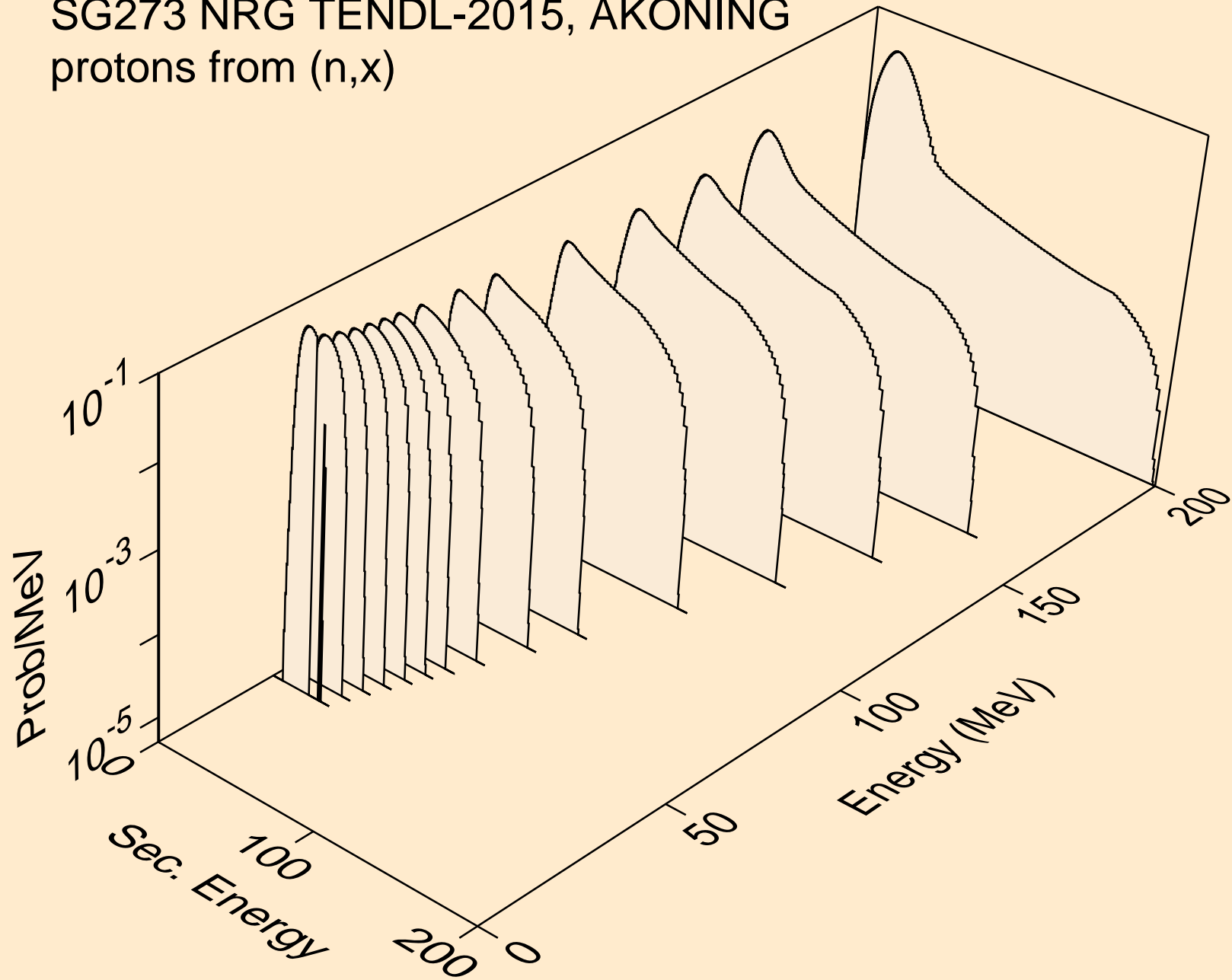



SG273 NRG TENDL-2015, AKONING  
protons from (n,n\*)p

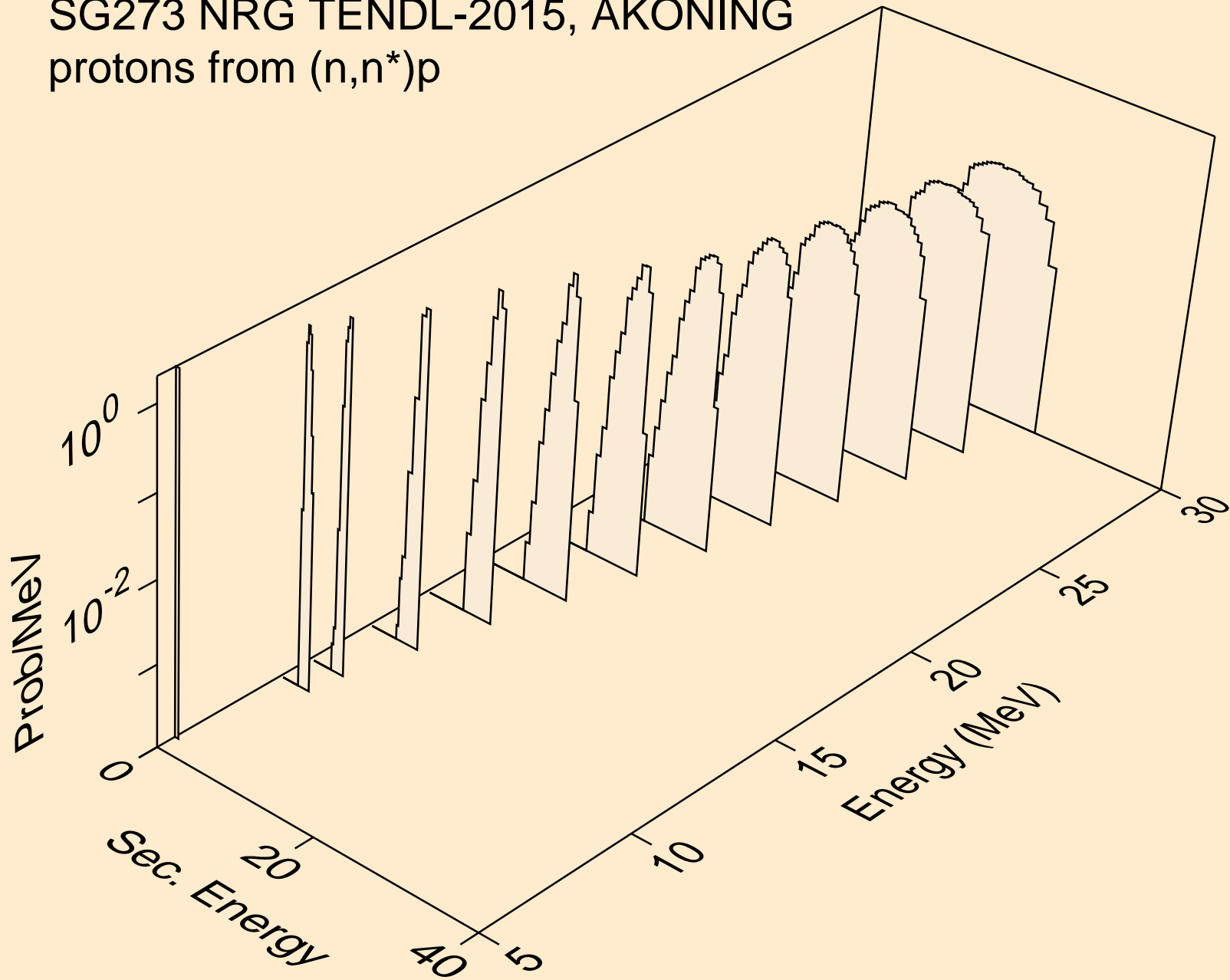

SG273 NRG TENDL-2015, AKONING  
protons from (n,2np)

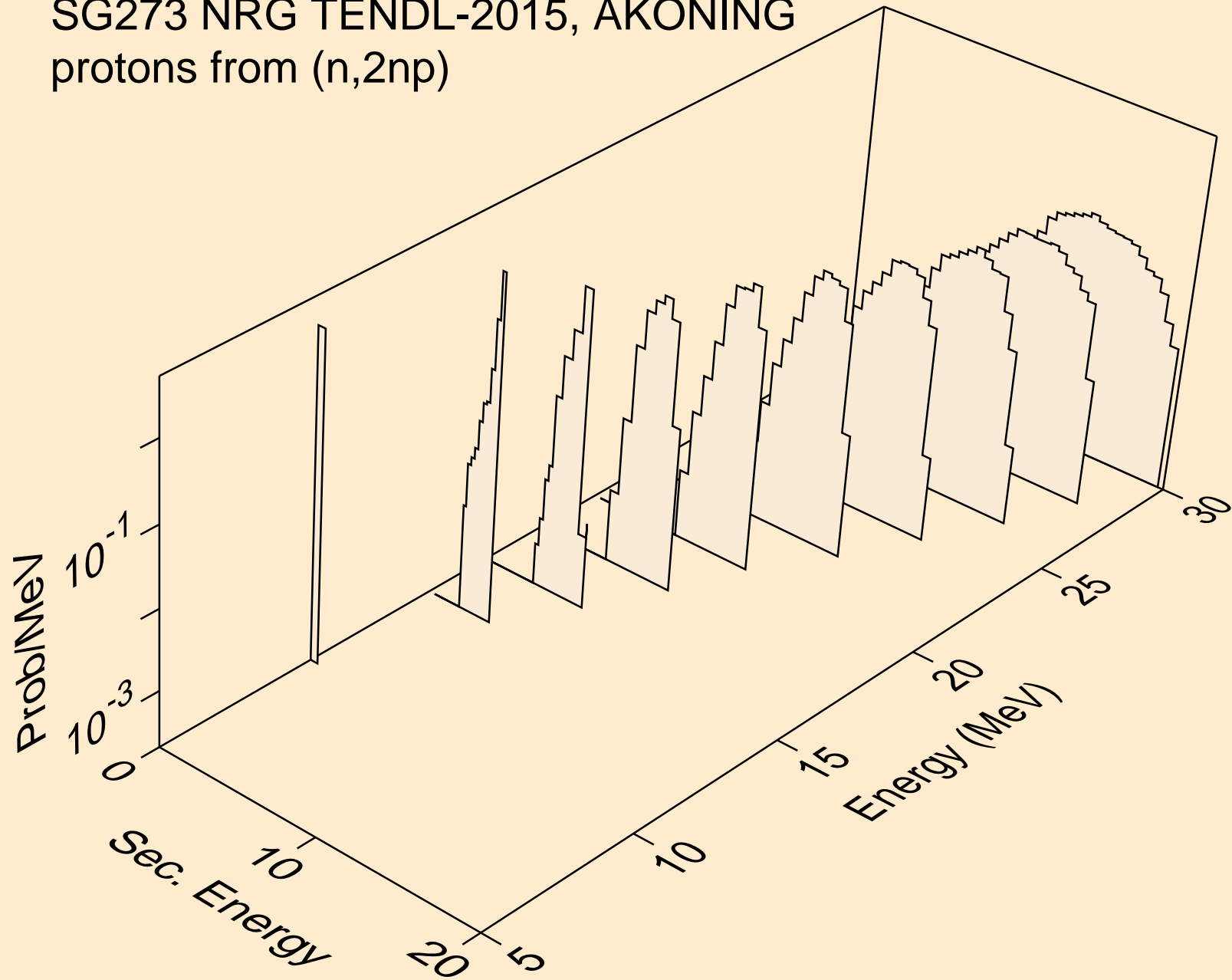

SG273 NRG TENDL-2015, AKONING  
protons from (n,npa)

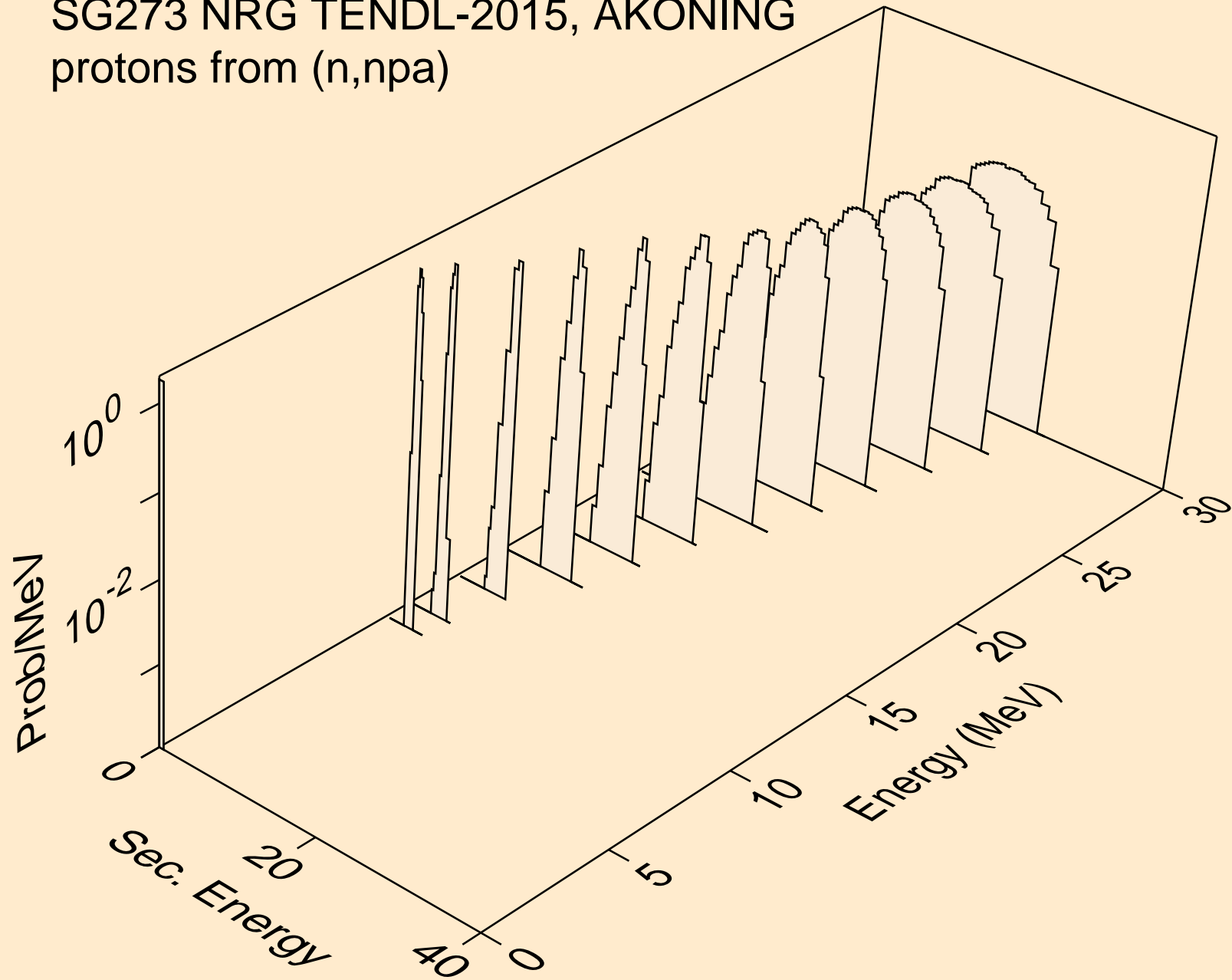

SG273 NRG TENDL-2015, AKONING  
protons from (n,p)

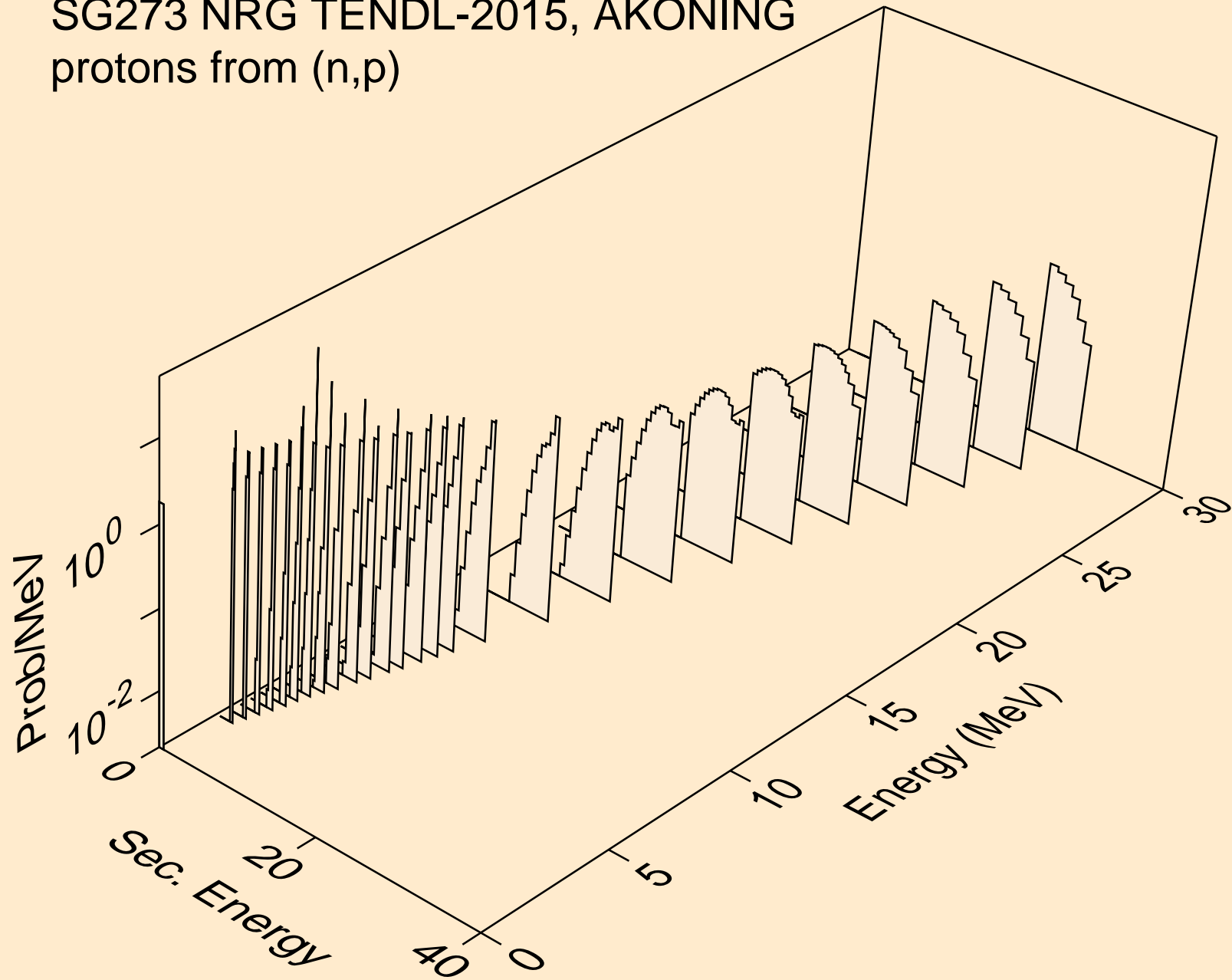

SG273 NRG TENDL-2015, AKONING  
protons from (n,pa)

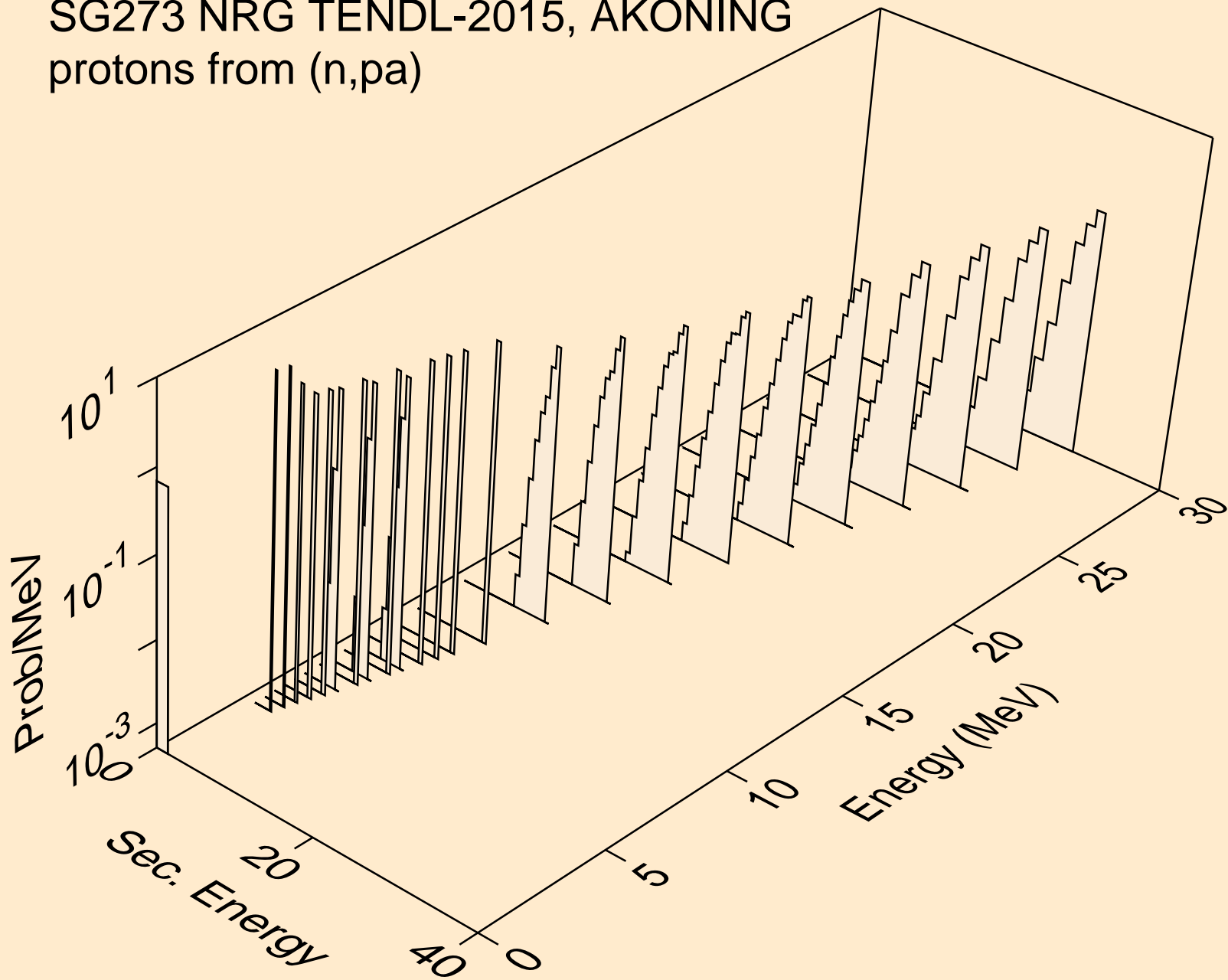

SG273 NRG TENDL-2015, AKONING  
deuterons from (n,x)

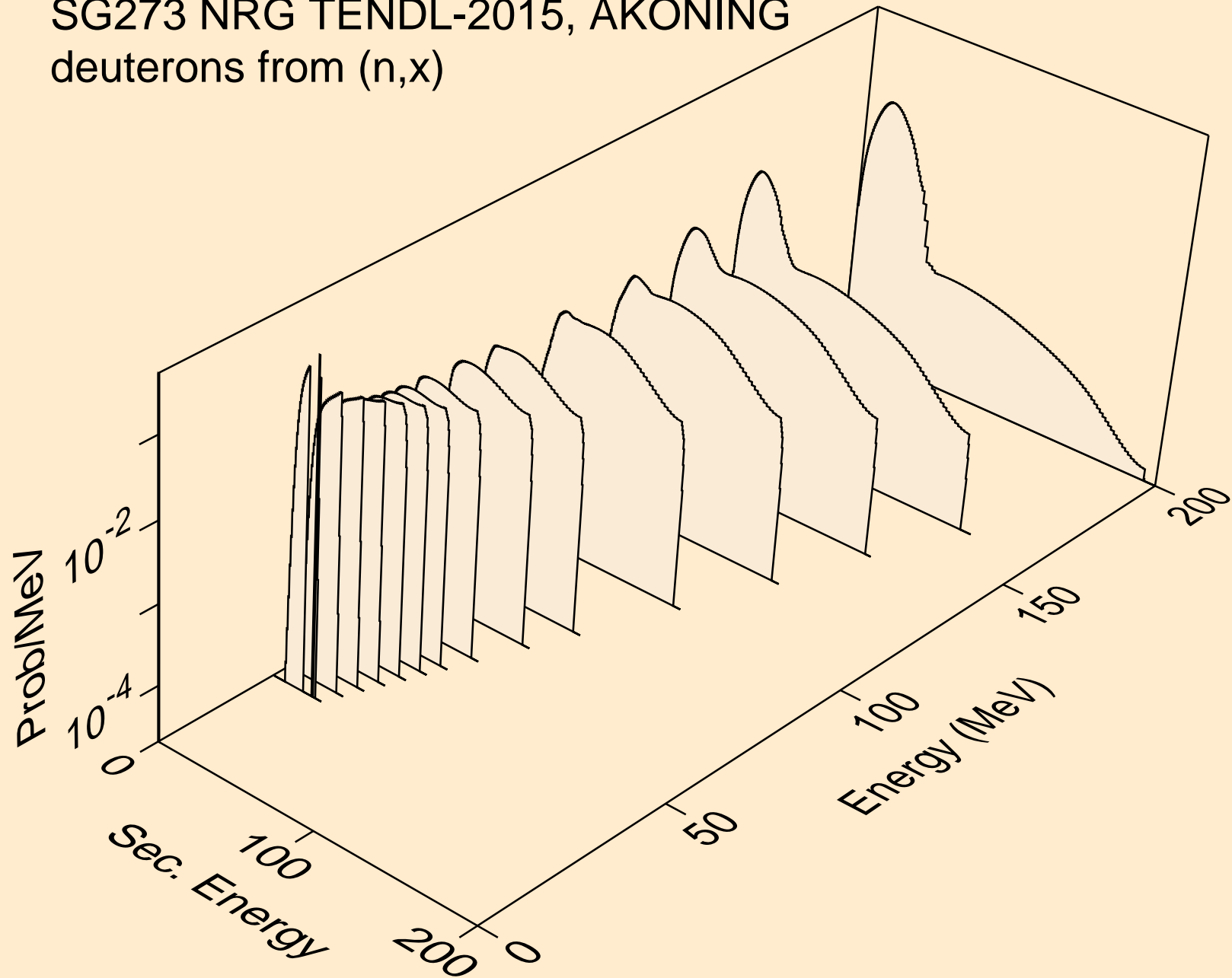

SG273 NRG TENDL-2015, AKONING  
deuterons from (n,n\*)d

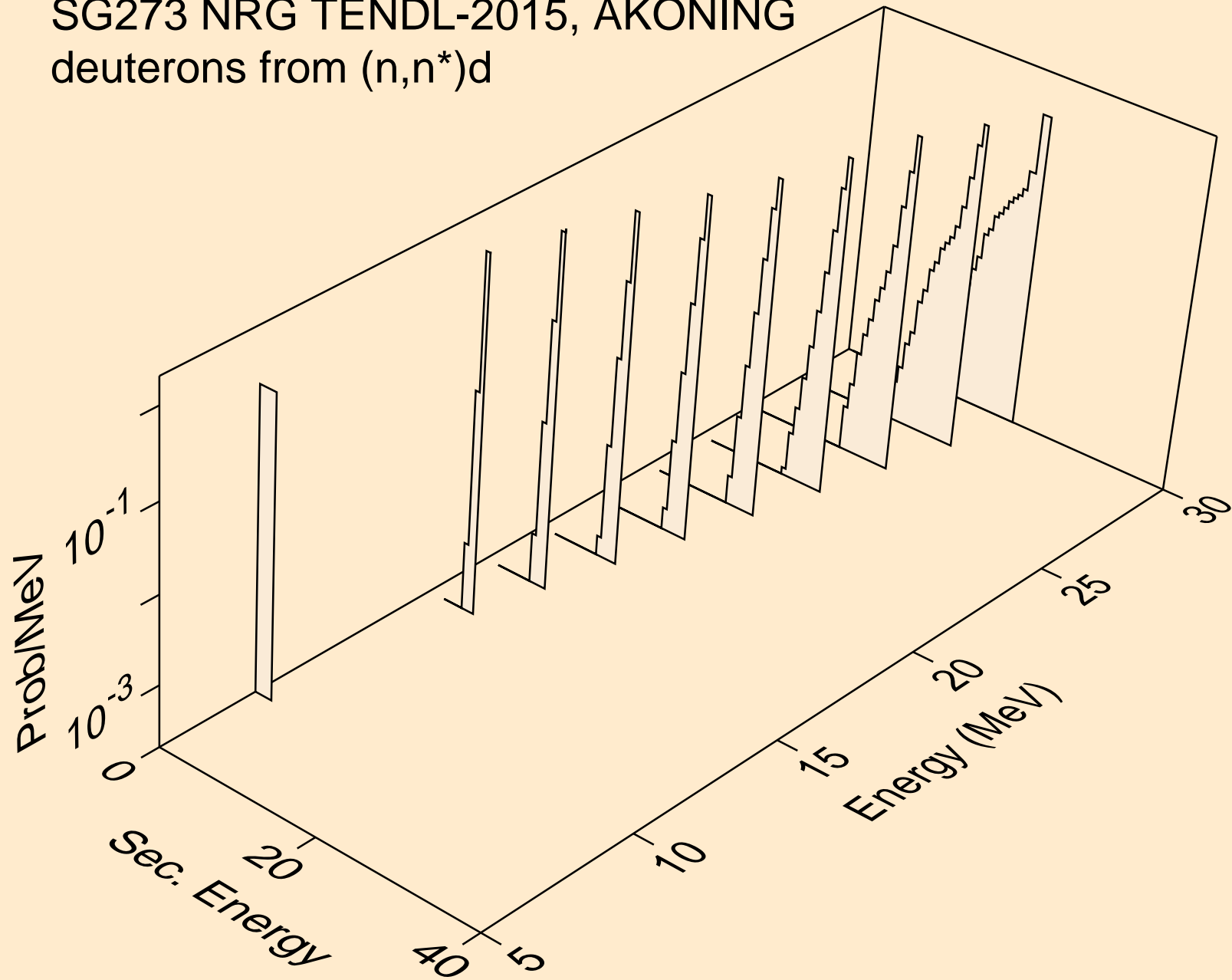

SG273 NRG TENDL-2015, AKONING  
deuterons from (n,d)

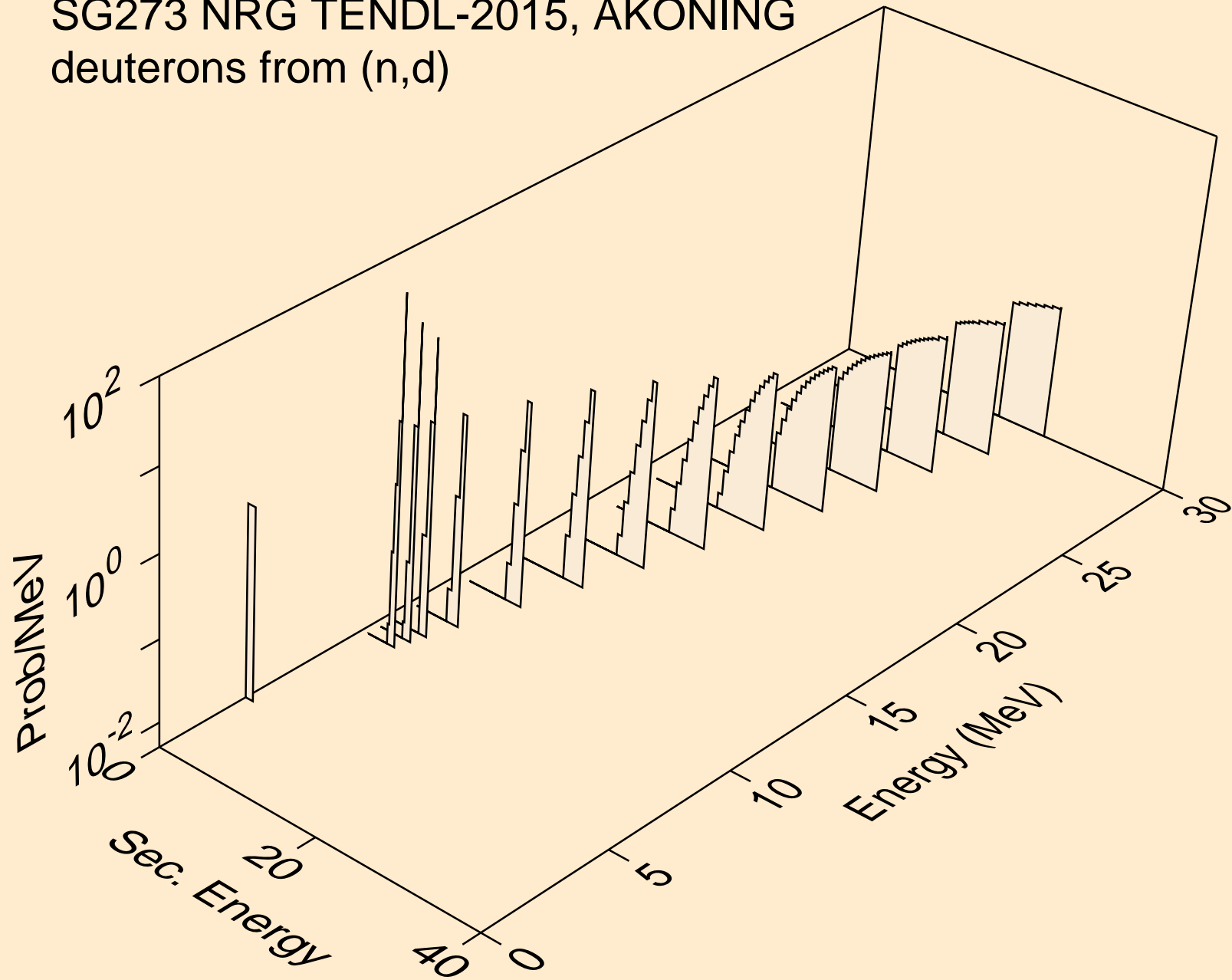



SG273 NRG TENDL-2015, AKONING  
deuterons from (n,da)

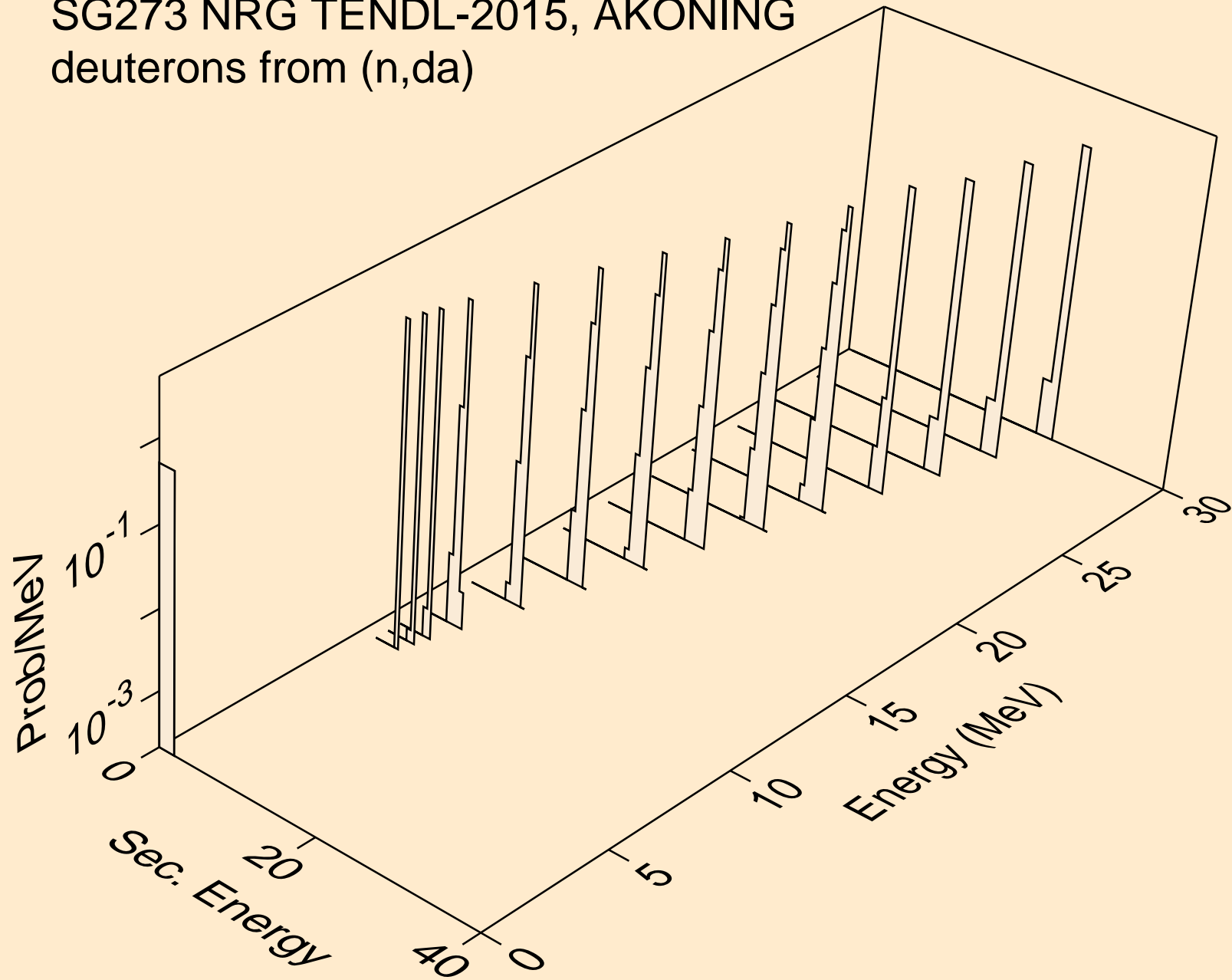

SG273 NRG TENDL-2015, AKONING  
tritons from (n,x)

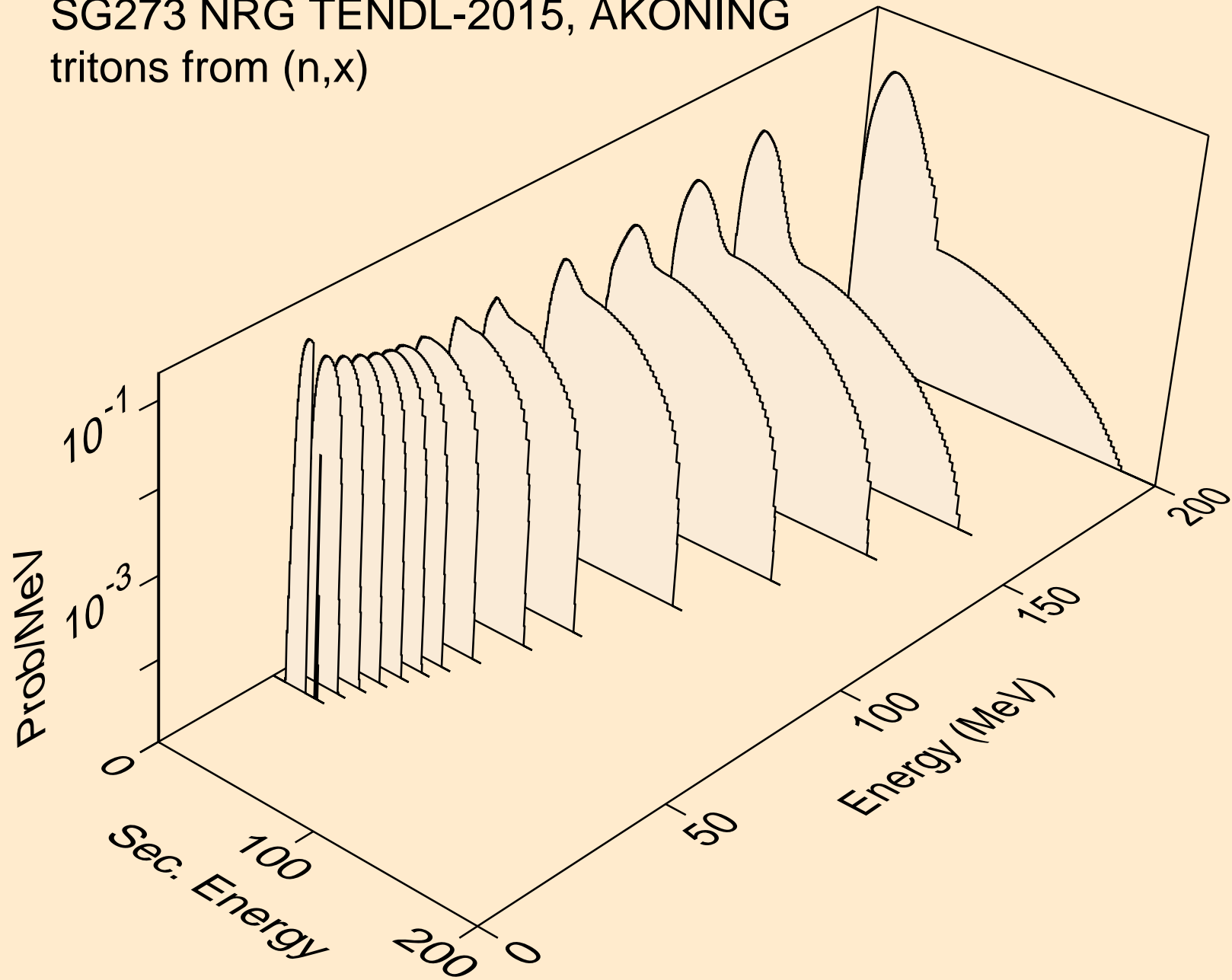

SG273 NRG TENDL-2015, AKONING  
tritons from (n,n\*)t

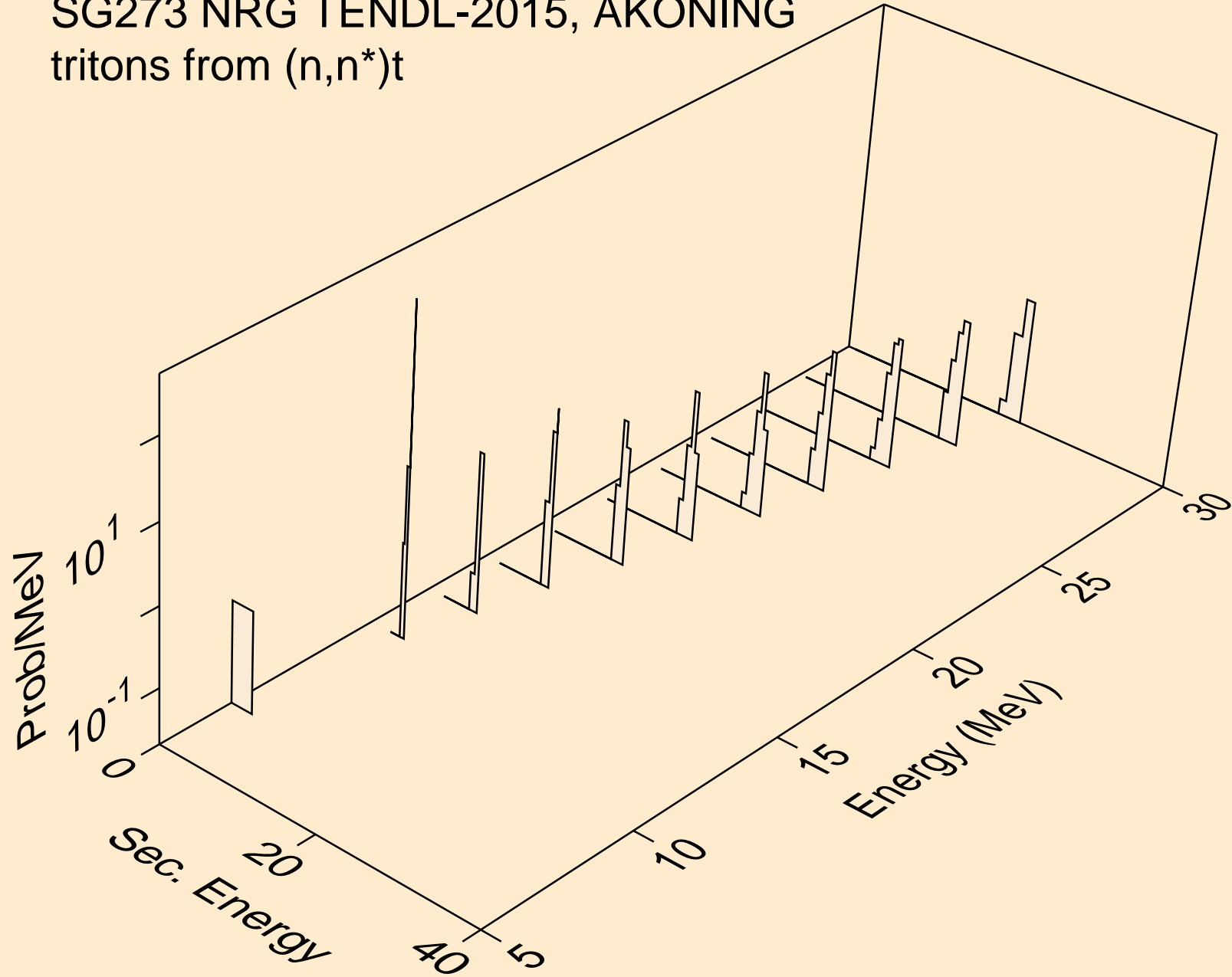

SG273 NRG TENDL-2015, AKONING  
tritons from (n,n\*)t2a

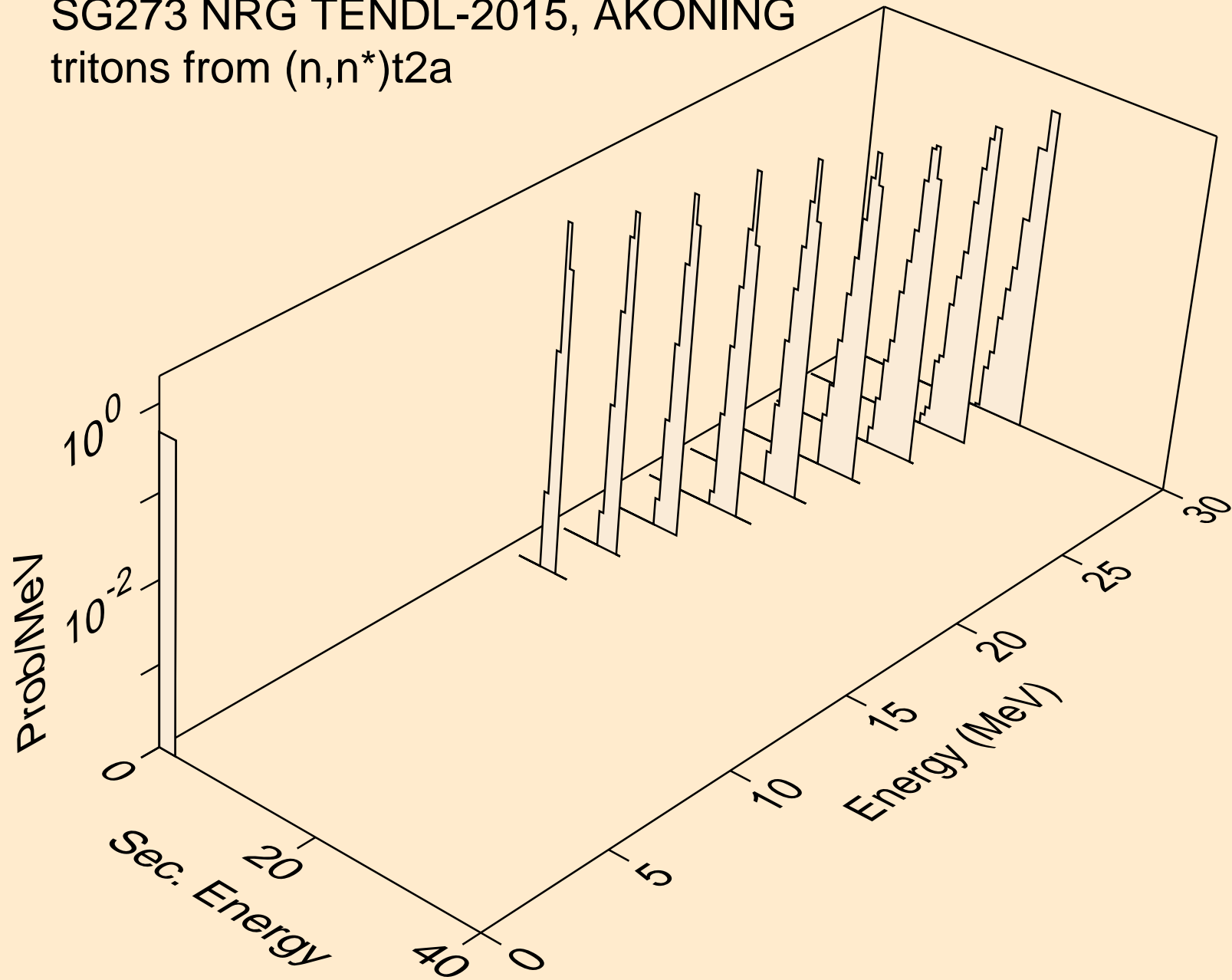

SG273 NRG TENDL-2015, AKONING  
tritons from (n,t)

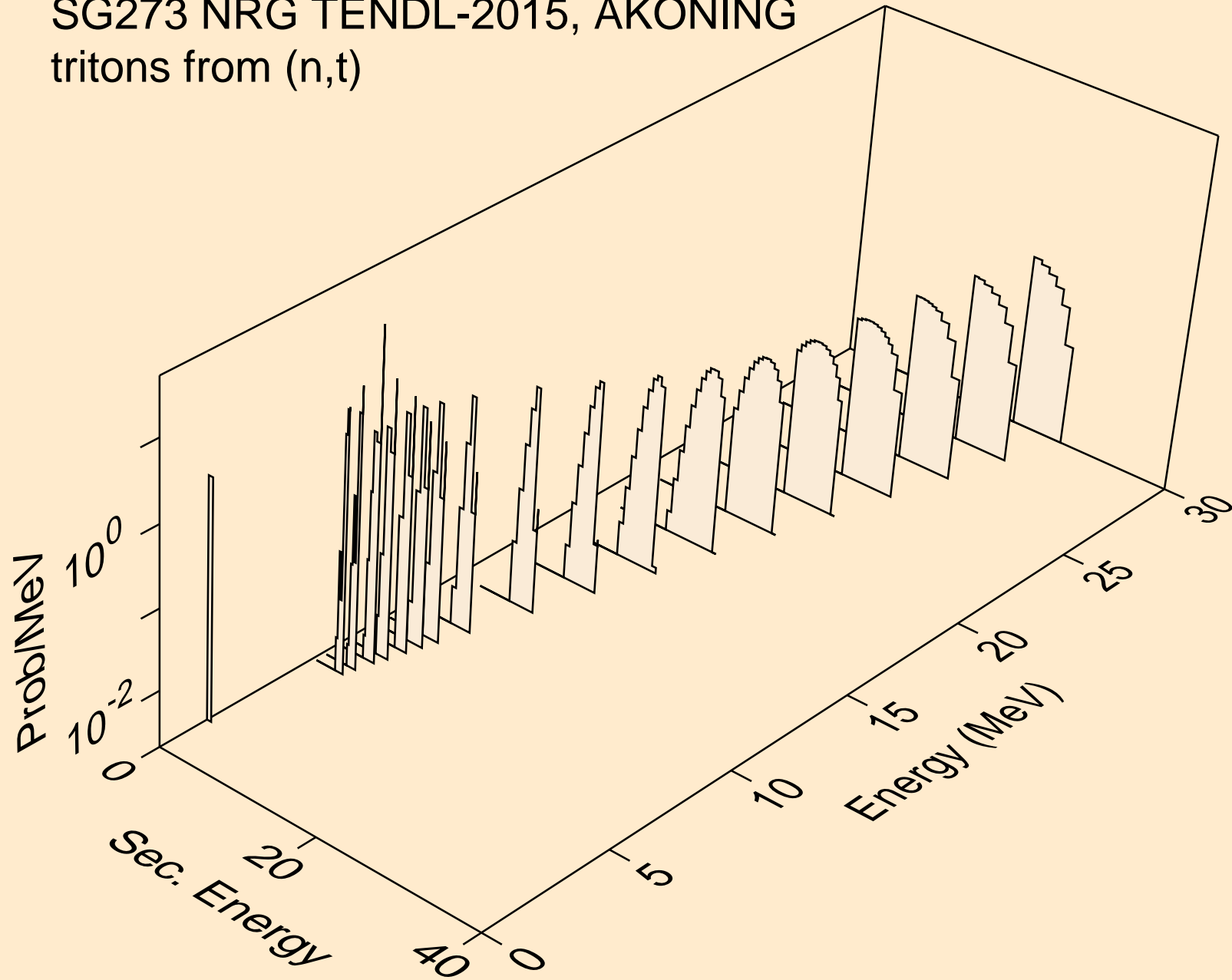

SG273 NRG TENDL-2015, AKONING  
he3s from (n,x)

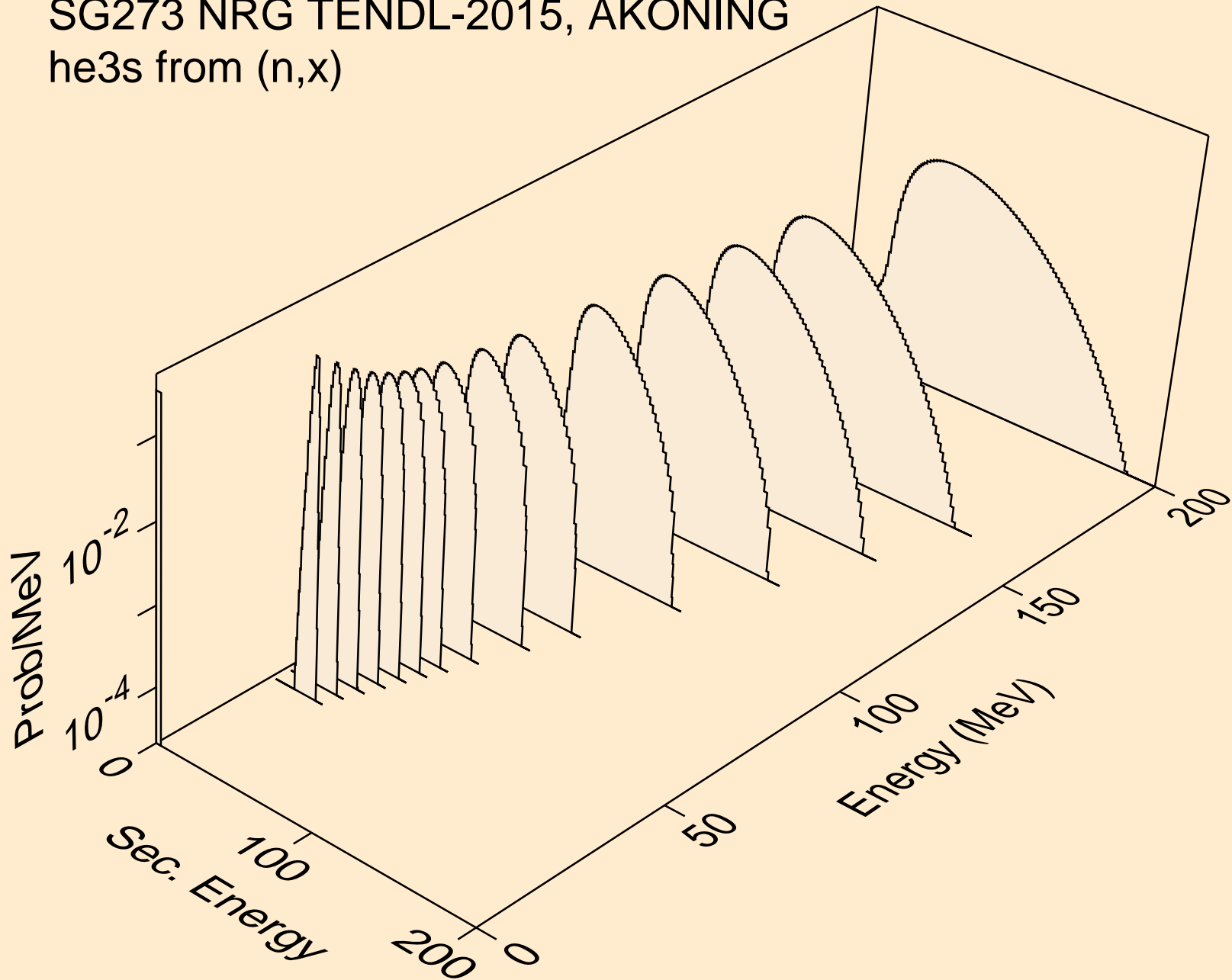

SG273 NRG TENDL-2015, AKONING  
he3s from (n,he3)

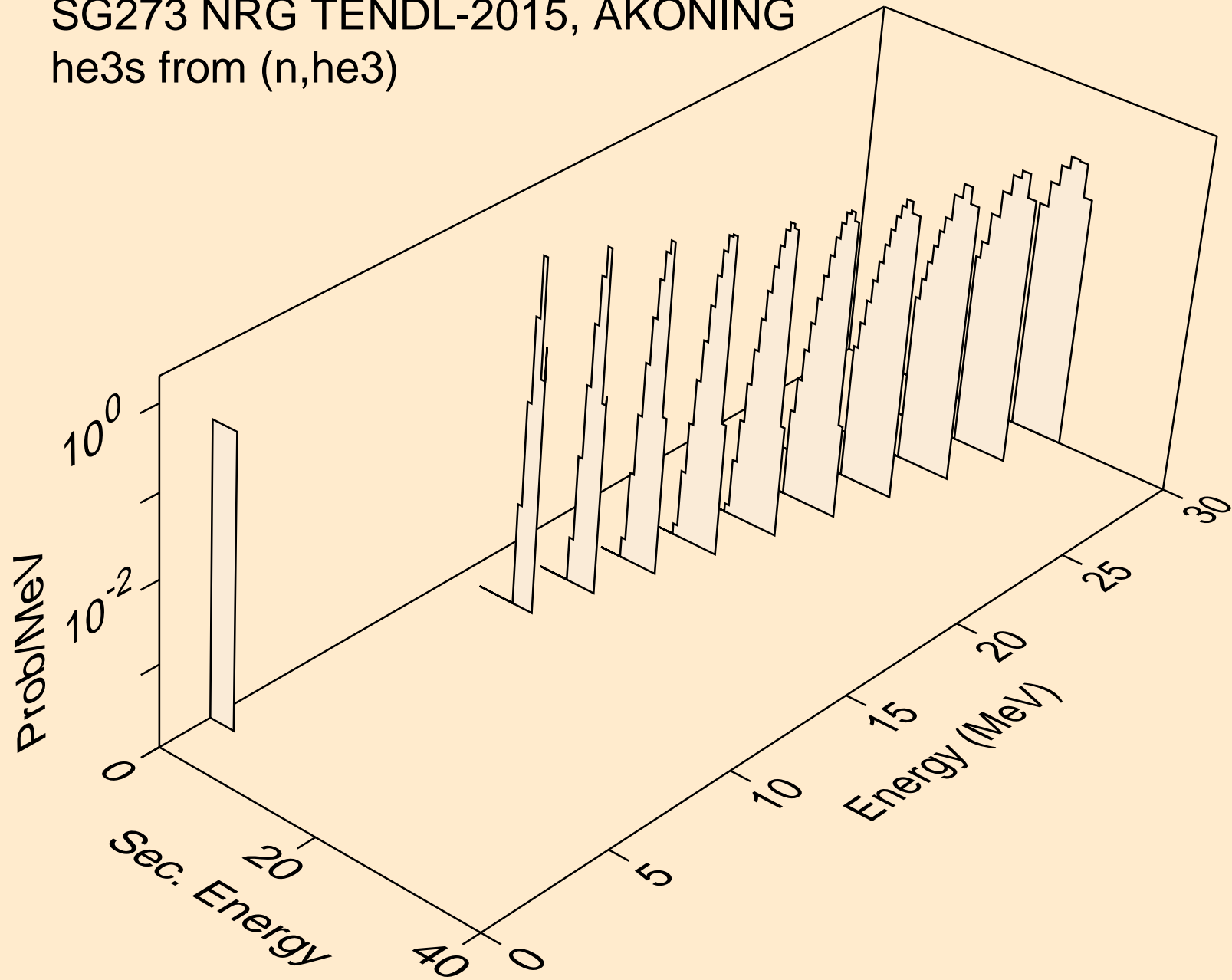

SG273 NRG TENDL-2015, AKONING  
alphas from (n,x)

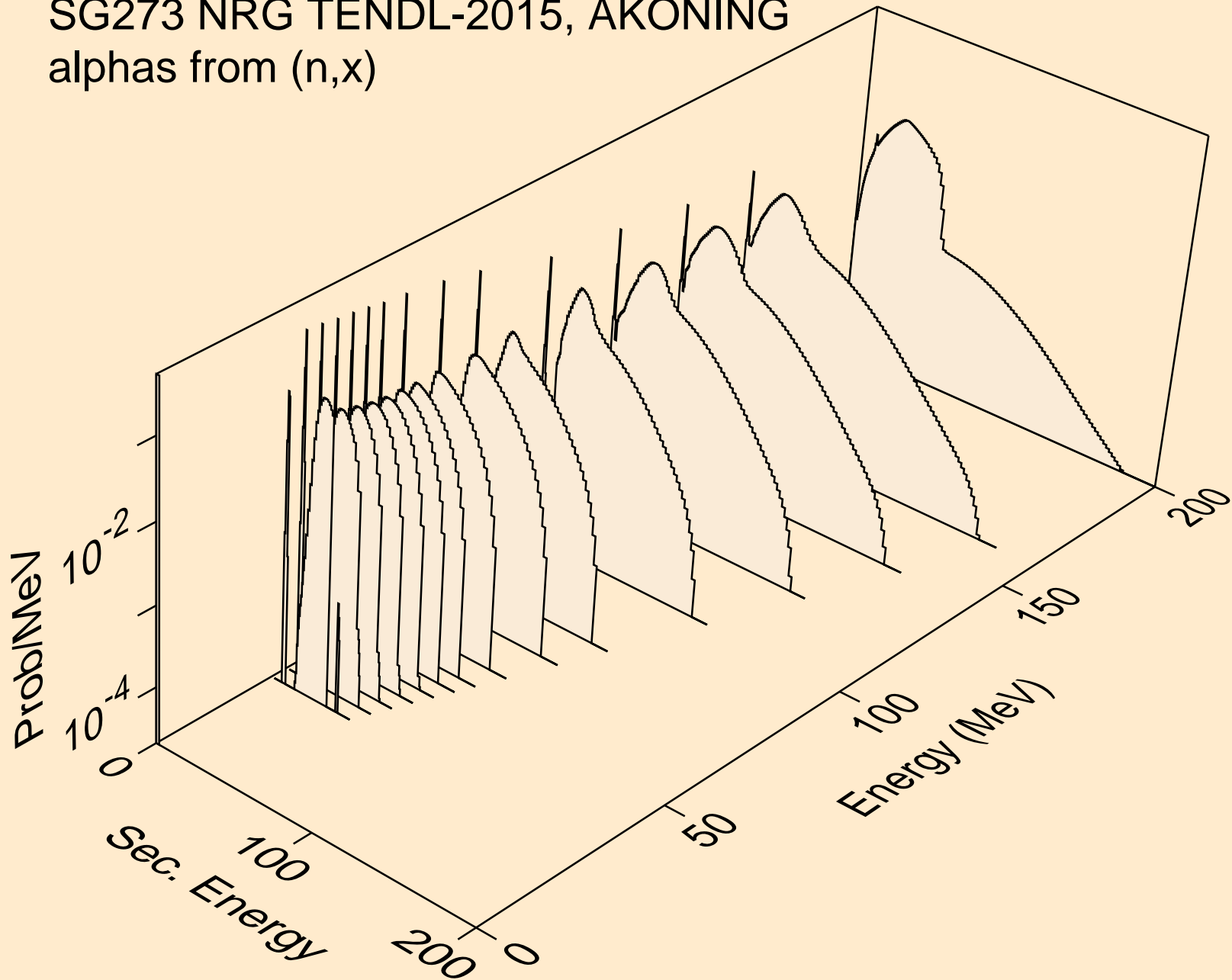



SG273 NRG TENDL-2015, AKONING  
alphas from (n,n\*)a

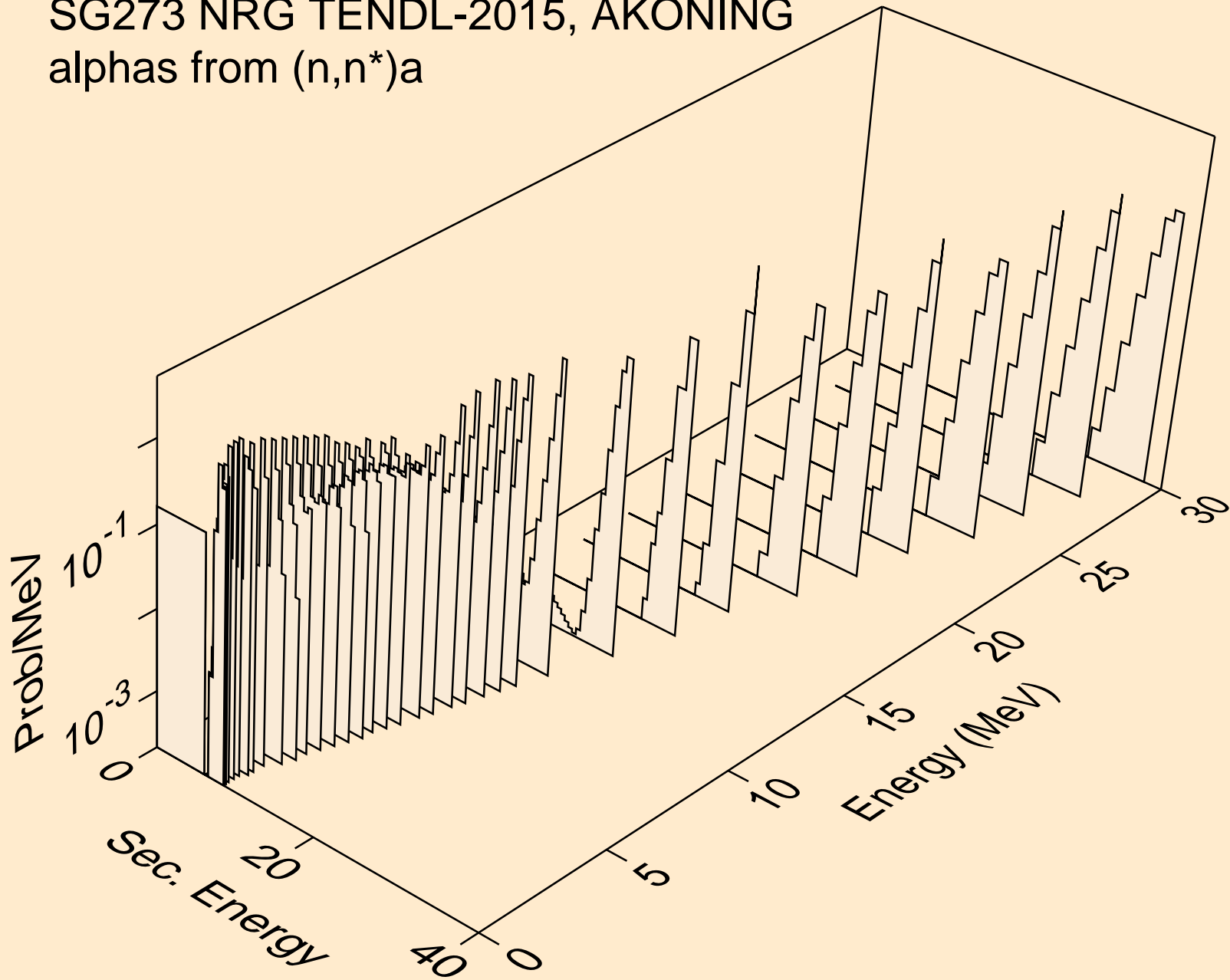

SG273 NRG TENDL-2015, AKONING  
alphas from (n,2n)a

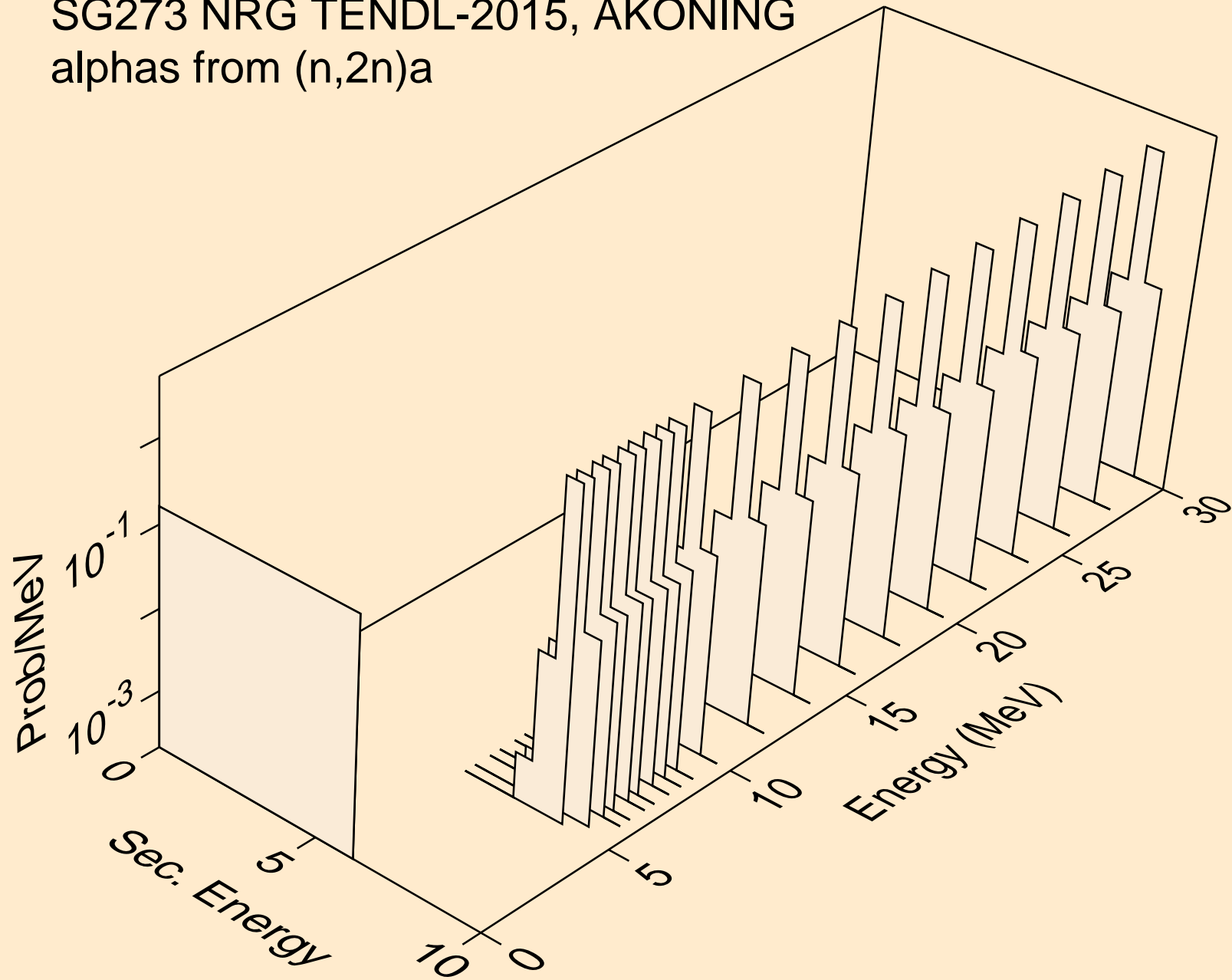

SG273 NRG TENDL-2015, AKONING  
alphas from (n,3n)a

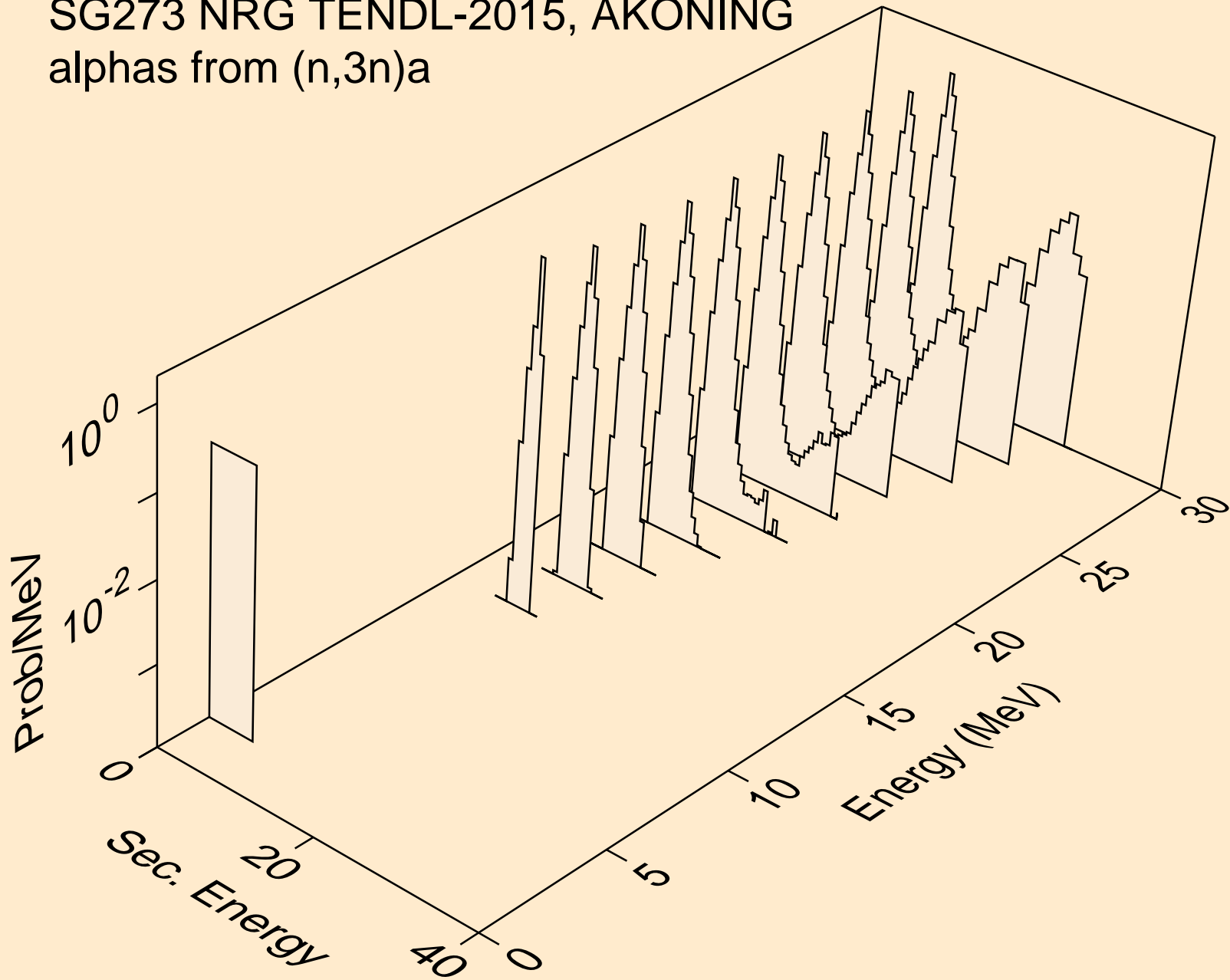

SG273 NRG TENDL-2015, AKONING  
alphas from (n,2n)2a

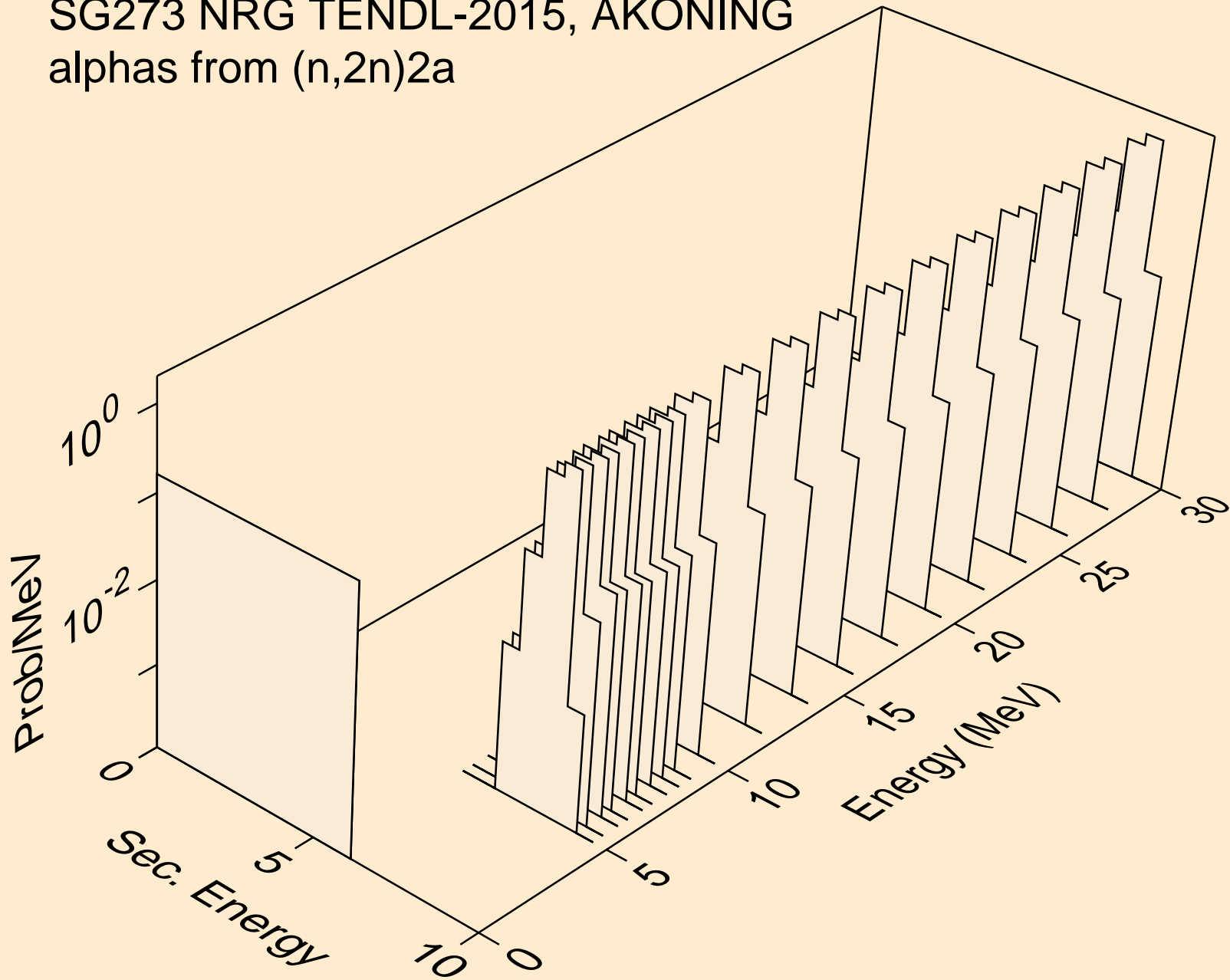

SG273 NRG TENDL-2015, AKONING  
alphas from (n,n\*)t2a

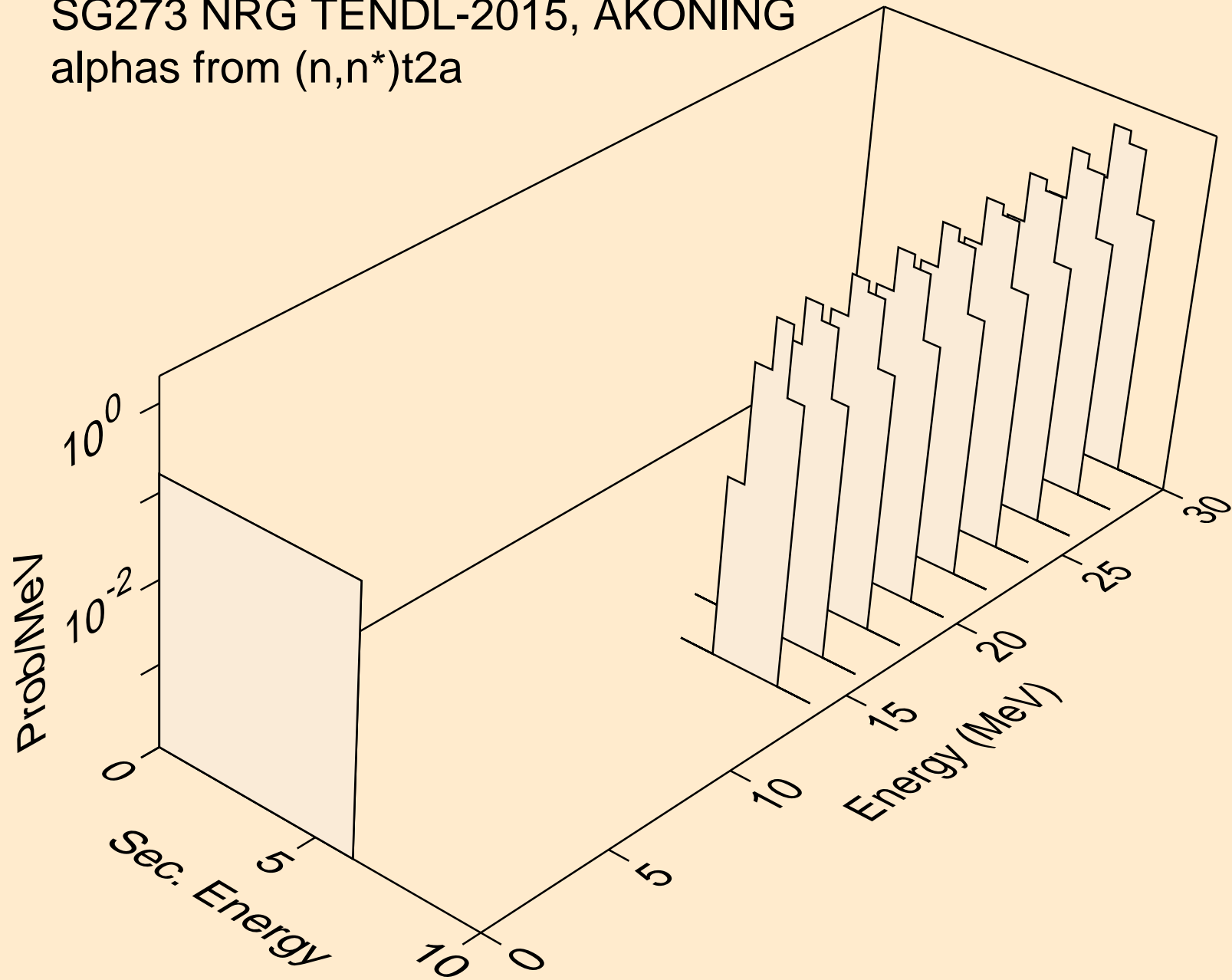

SG273 NRG TENDL-2015, AKONING  
alphas from (n,npa)

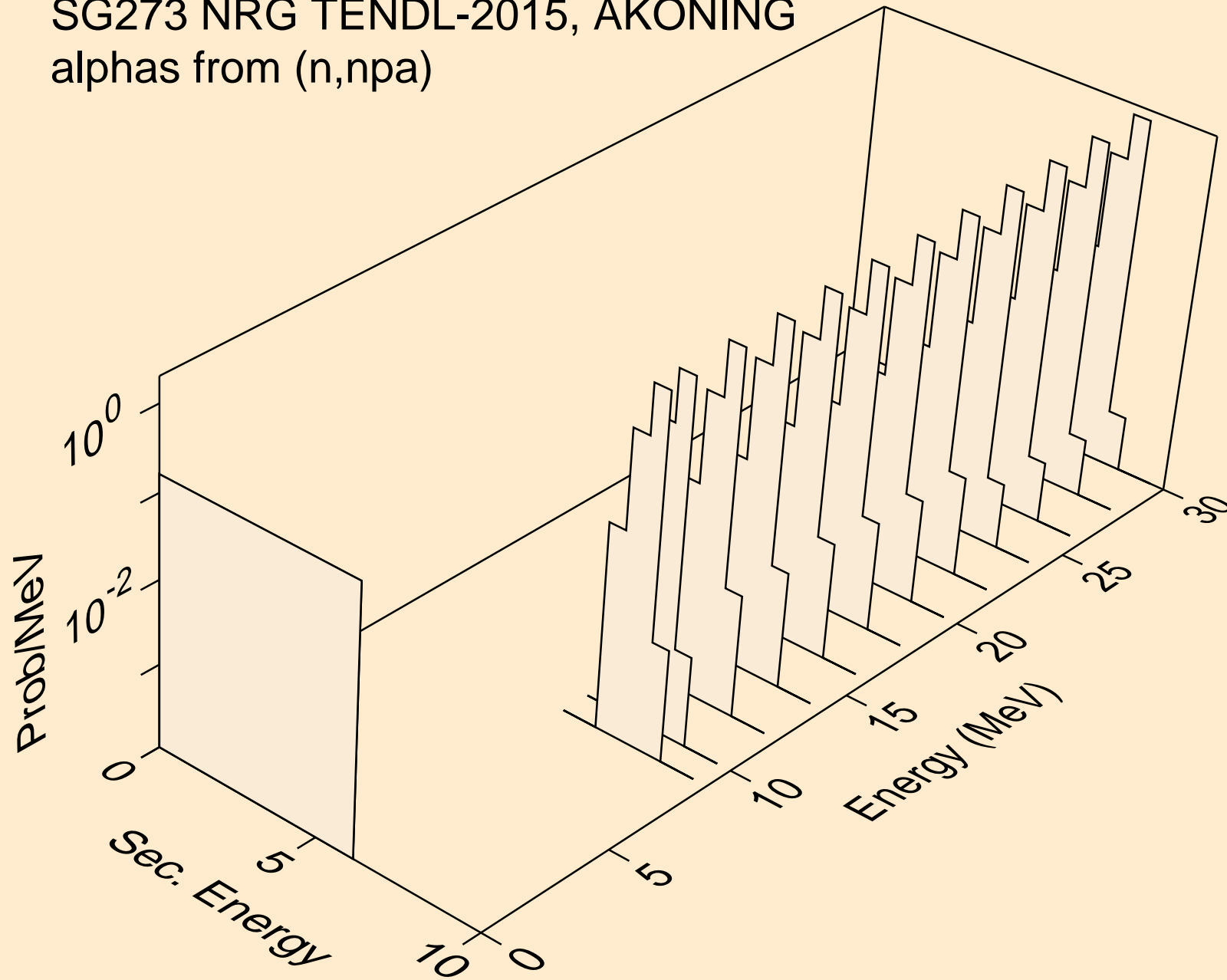

SG273 NRG TENDL-2015, AKONING  
alphas from (n,a)

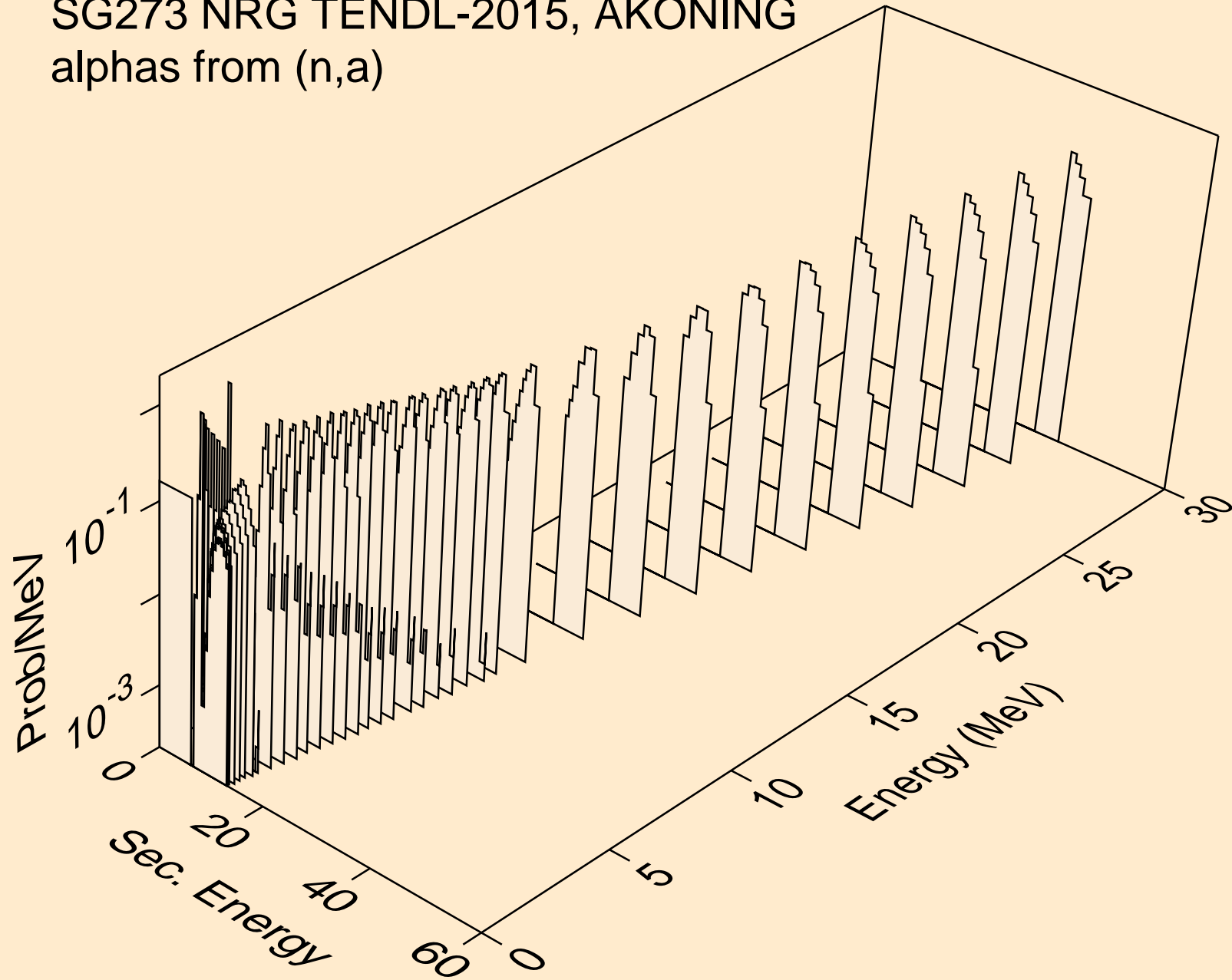

SG273 NRG TENDL-2015, AKONING  
alphas from (n,2a)

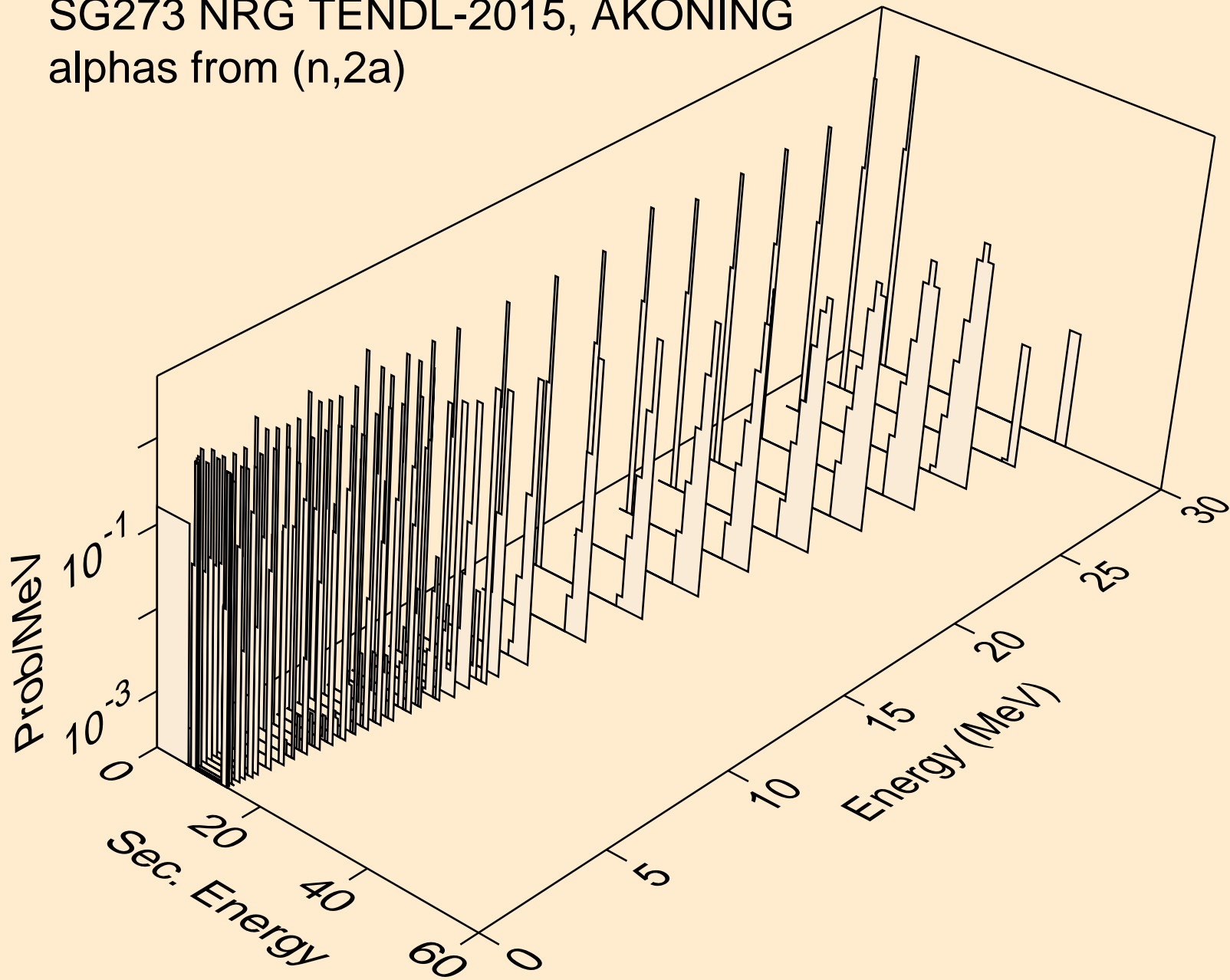



SG273 NRG TENDL-2015, AKONING  
alphas from (n,pa)

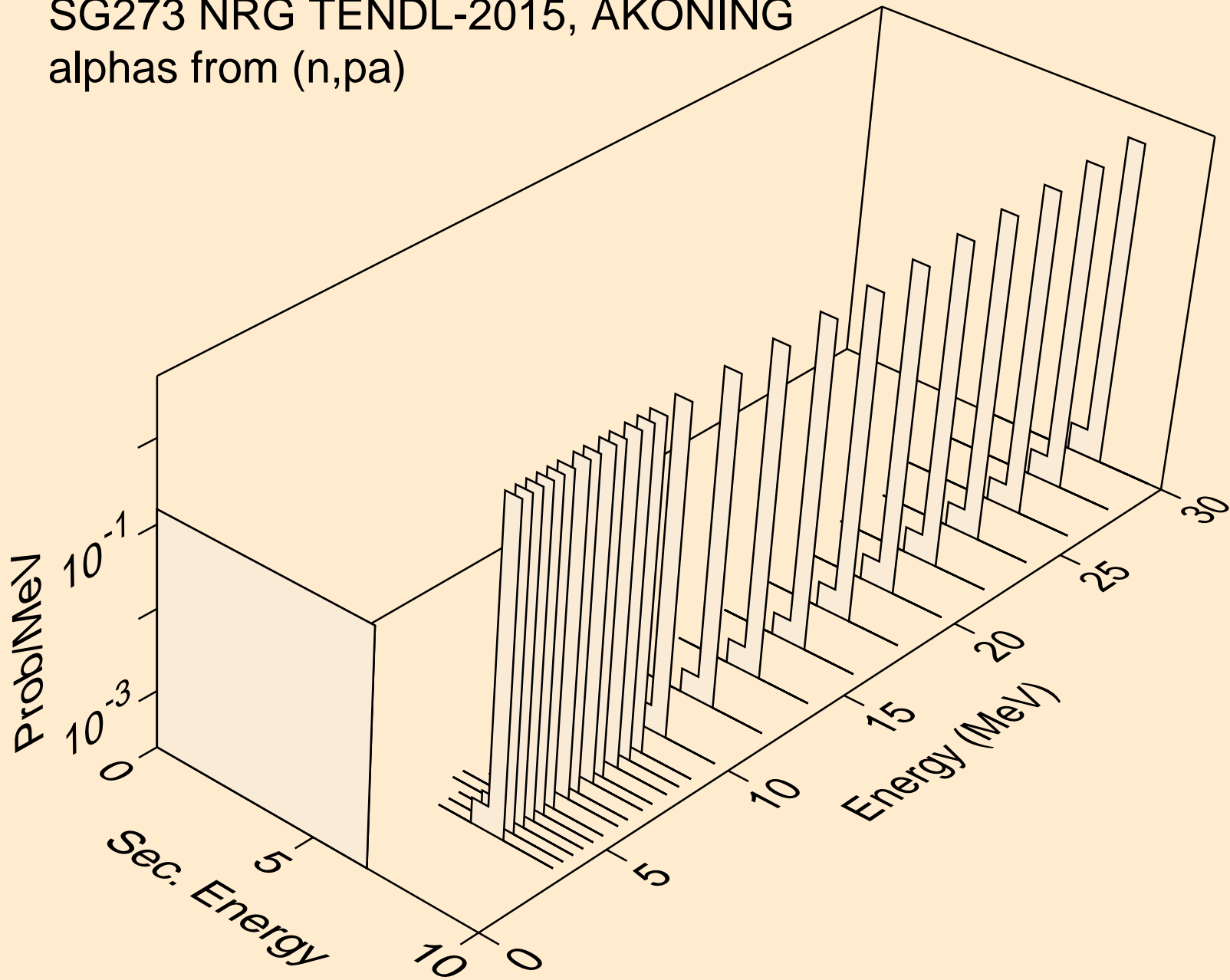

SG273 NRG TENDL-2015, AKONING  
alphas from (n,da)

