

SN132 NRG TENDL-2015, AKONING

Principal cross sections

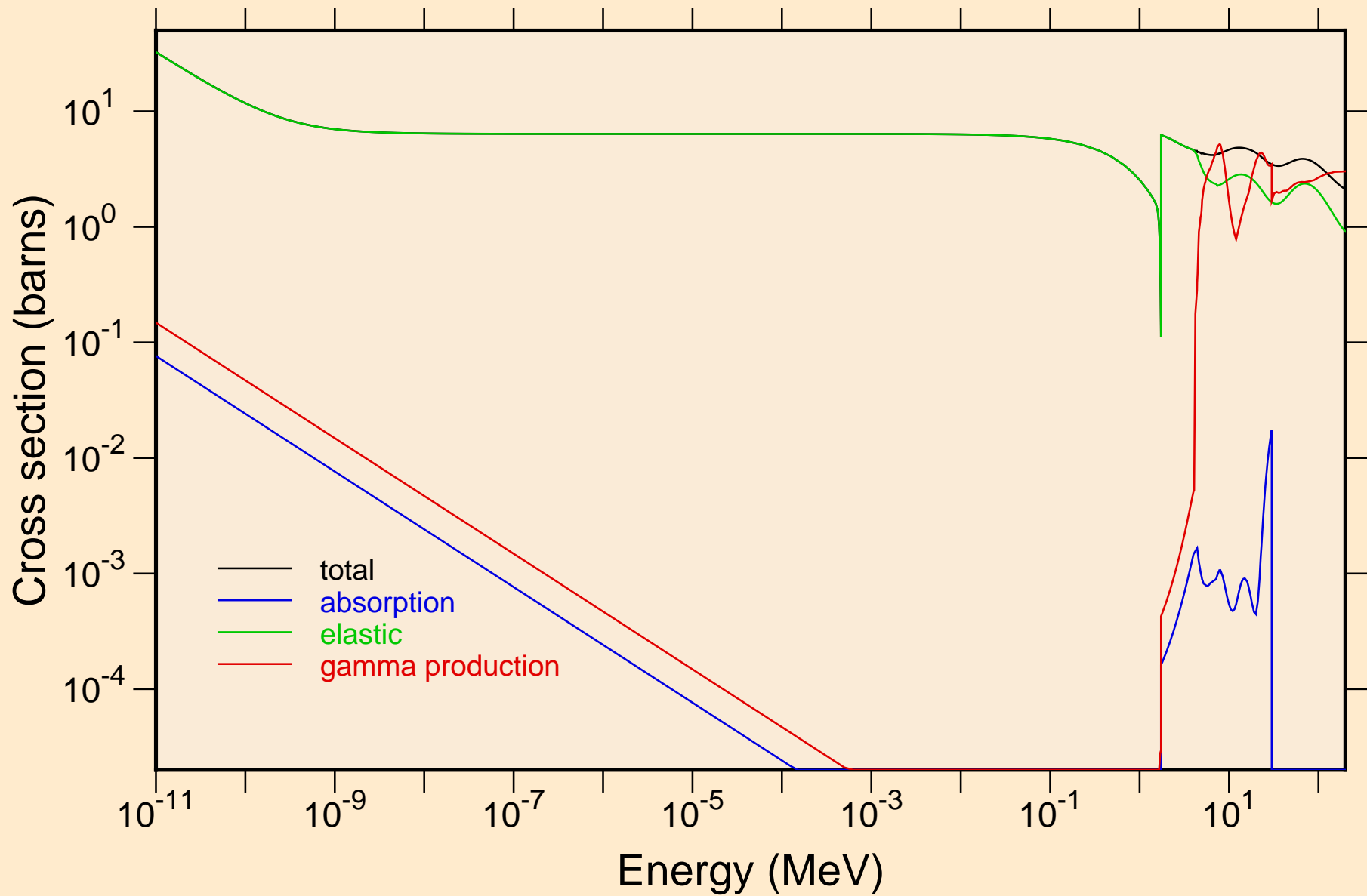

SN132 NRG TENDL-2015, AKONING

Non-threshold reactions

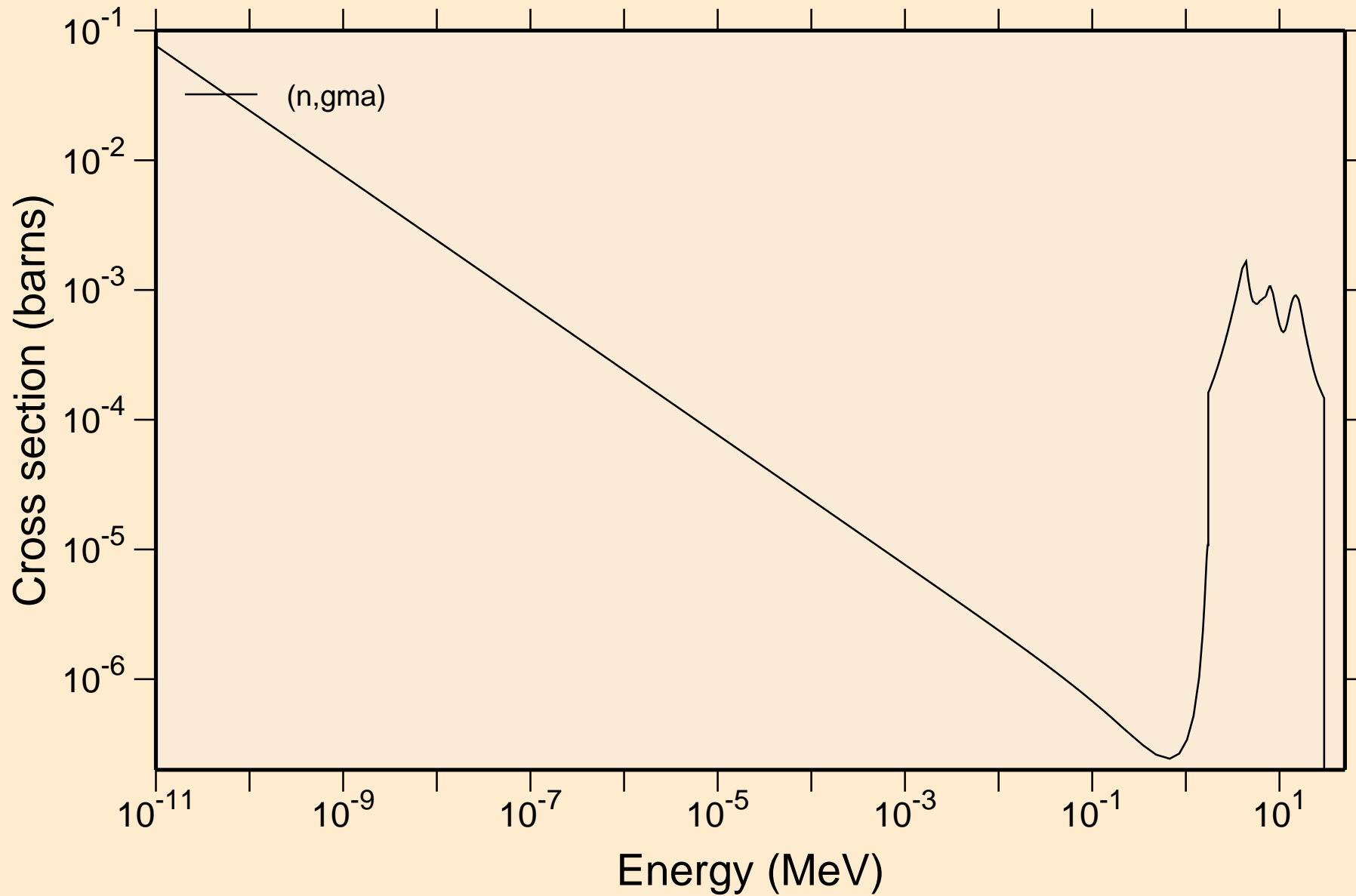

SN132 NRG TENDL-2015, AKONING

Principal cross sections

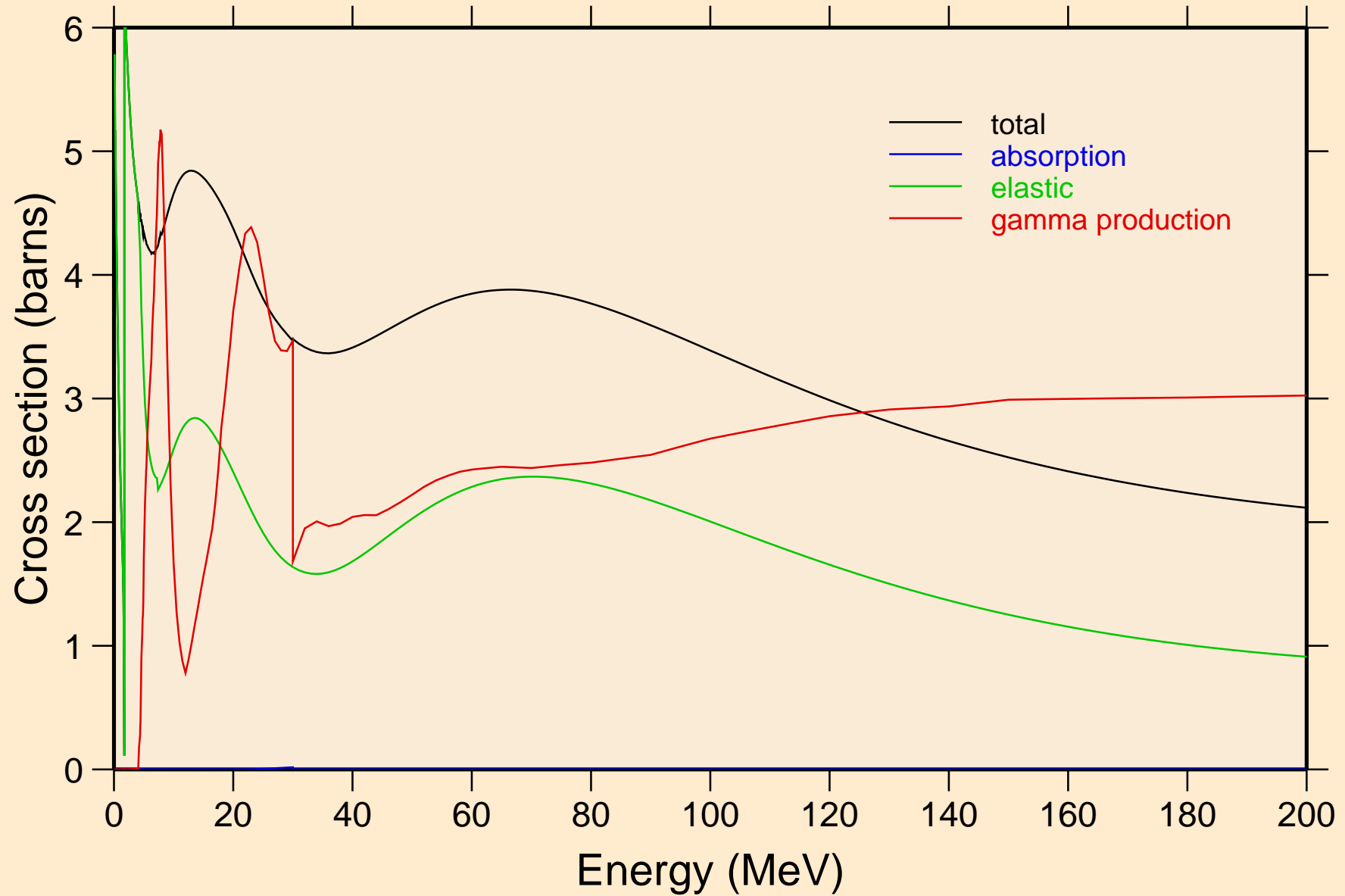

SN132 NRG TENDL-2015, AKONING

Non-threshold reactions

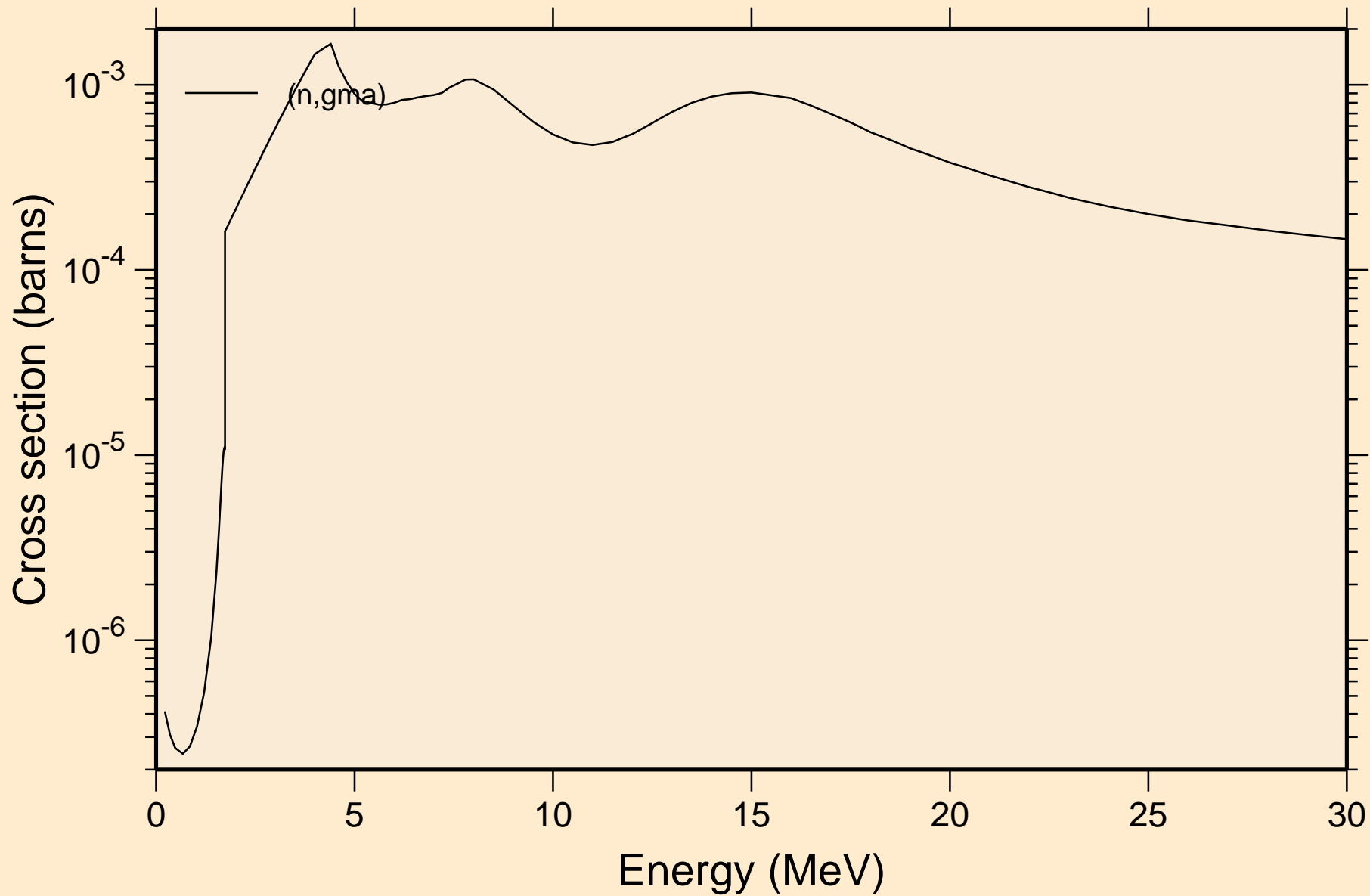

SN132 NRG TENDL-2015, AKONING

Inelastic levels

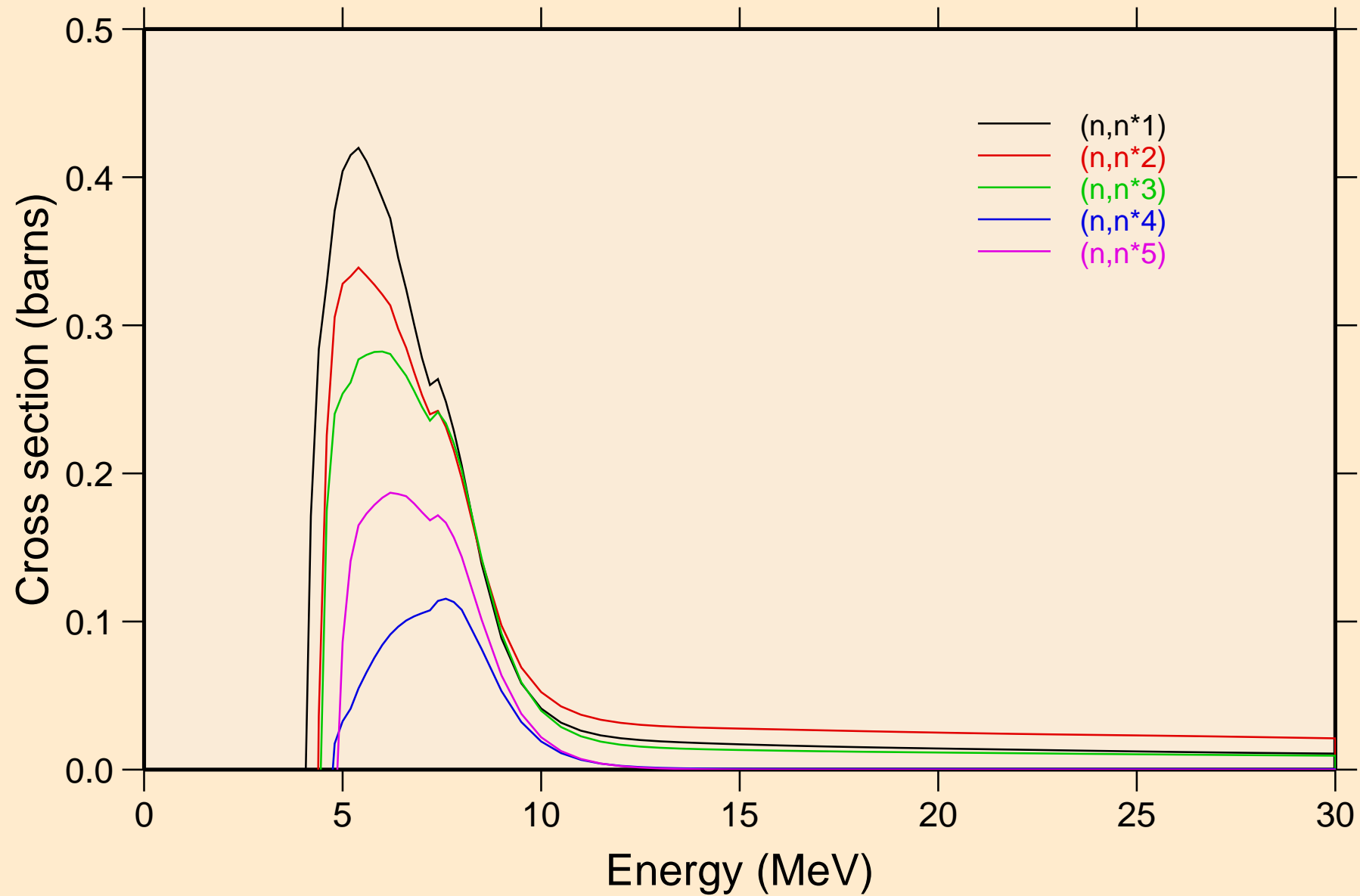

SN132 NRG TENDL-2015, AKONING

Inelastic levels

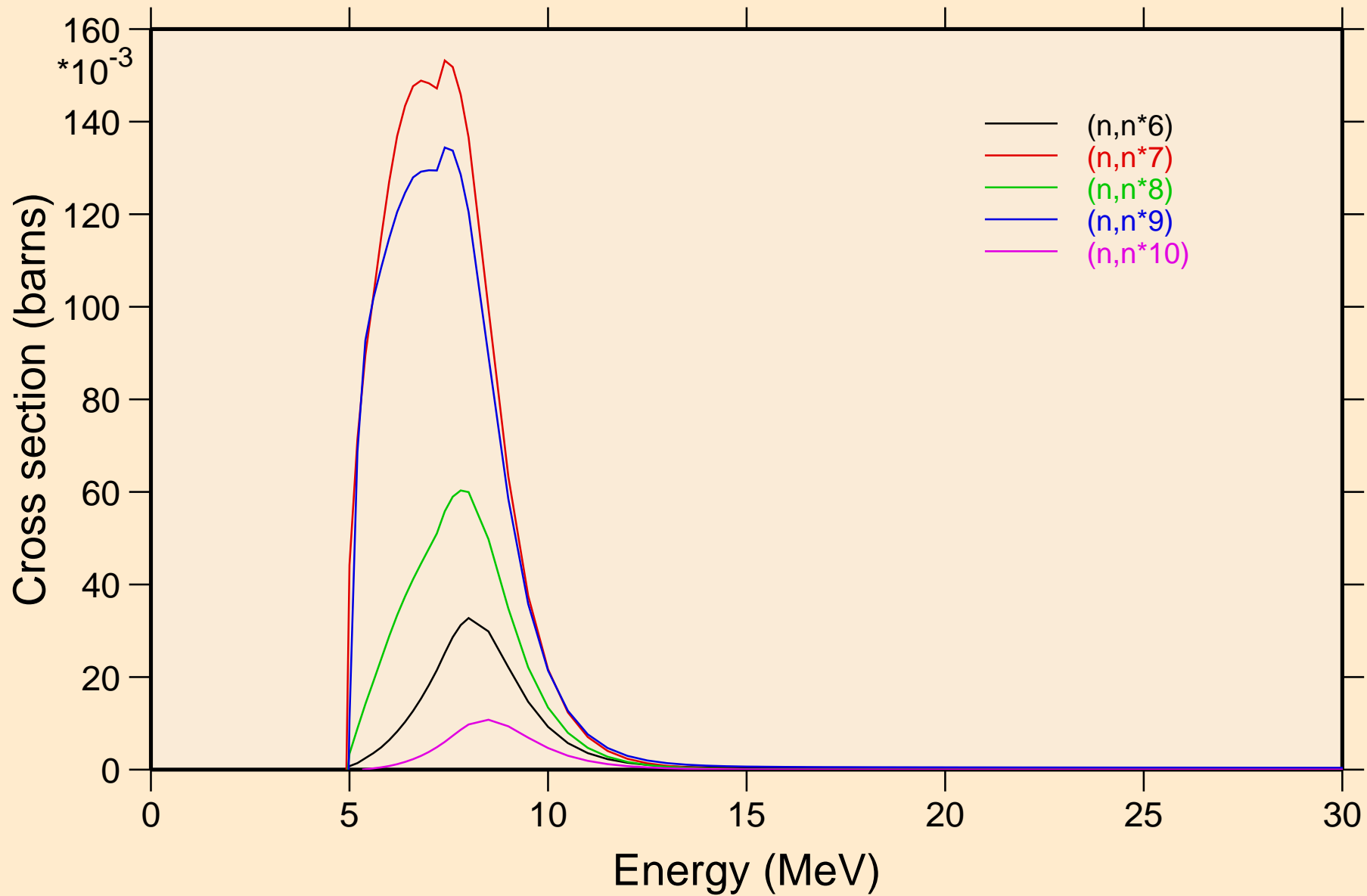

SN132 NRG TENDL-2015, AKONING

Inelastic levels

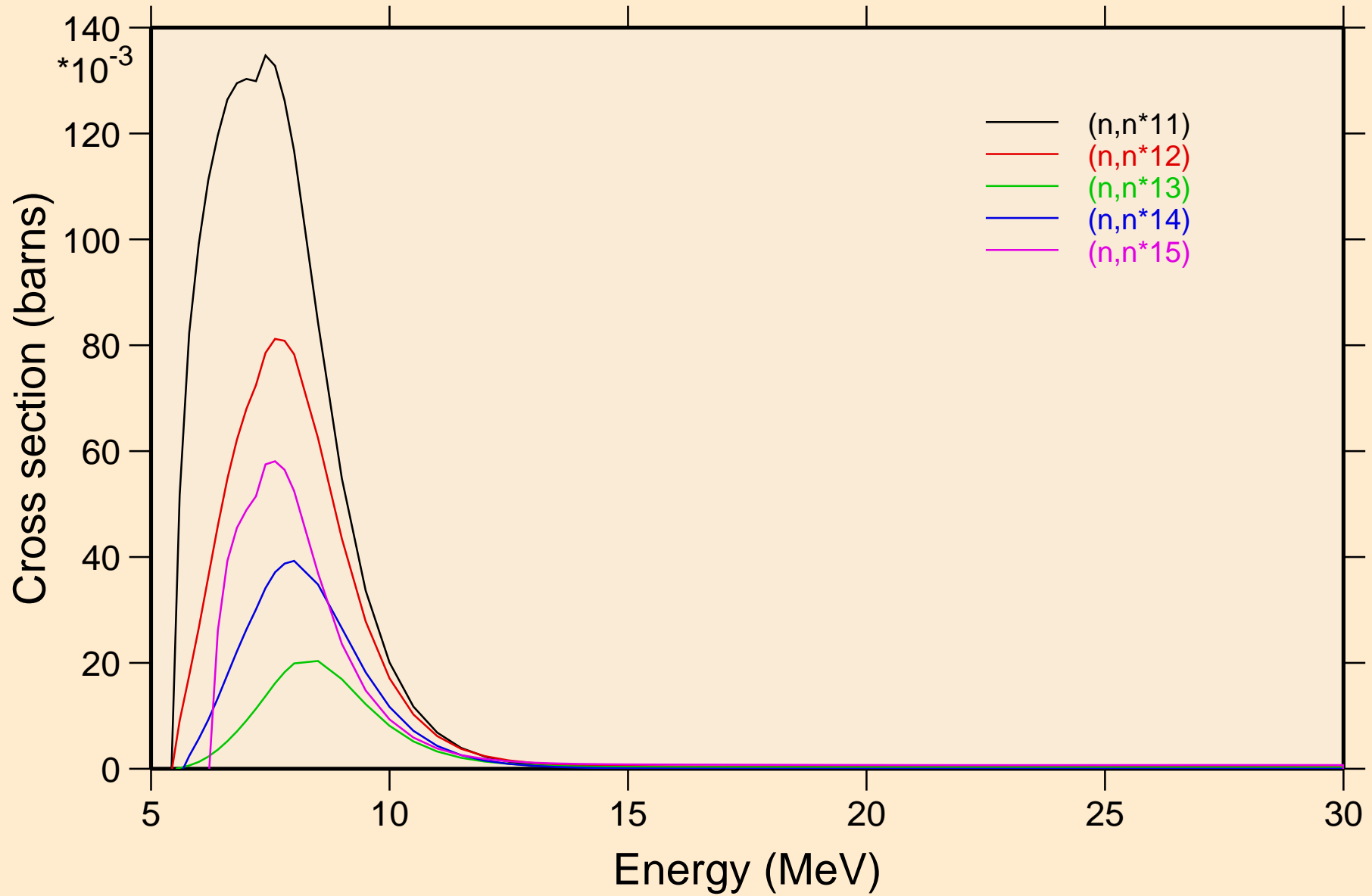

SN132 NRG TENDL-2015, AKONING

Inelastic levels

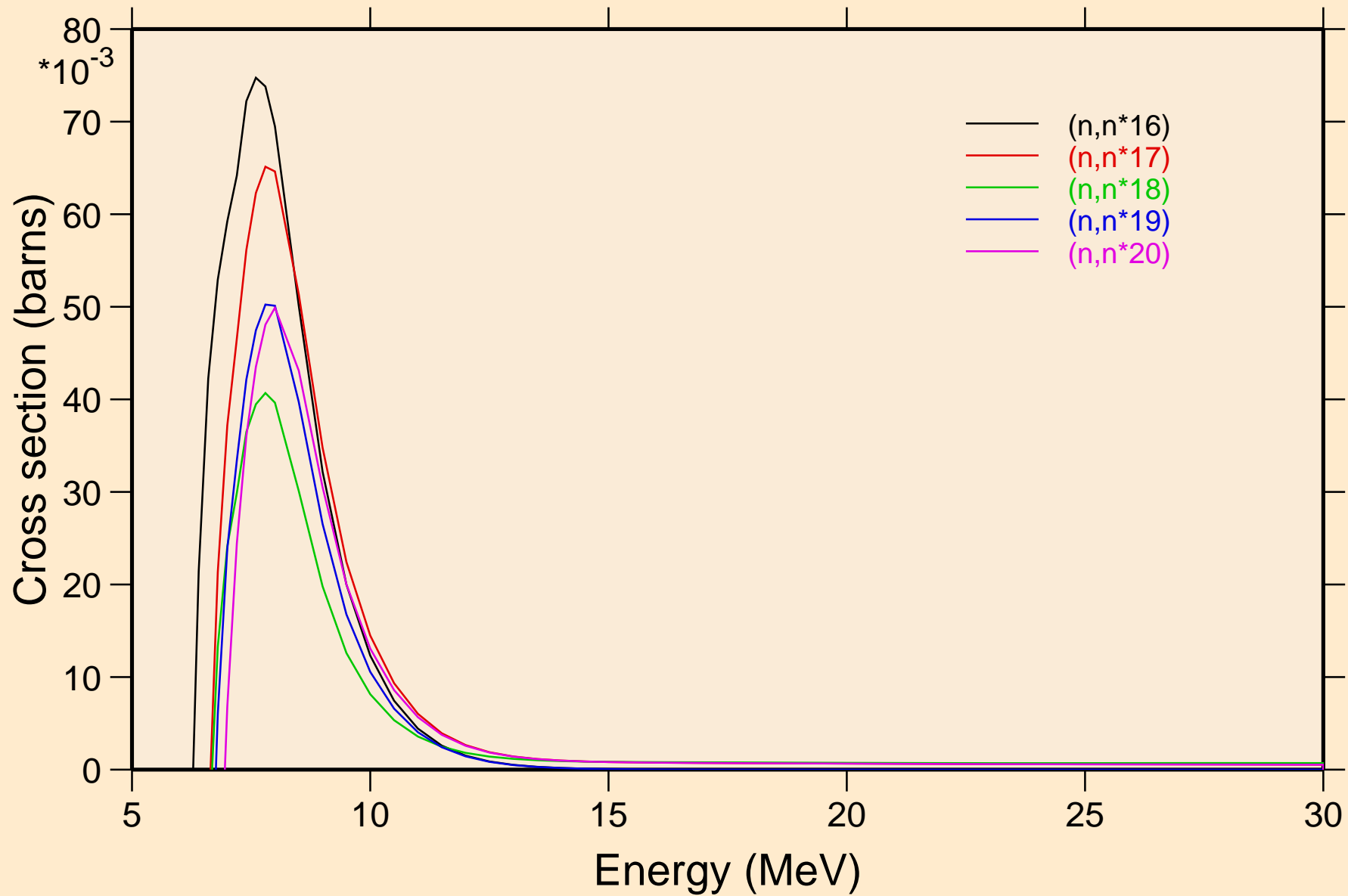

SN132 NRG TENDL-2015, AKONING

Inelastic levels

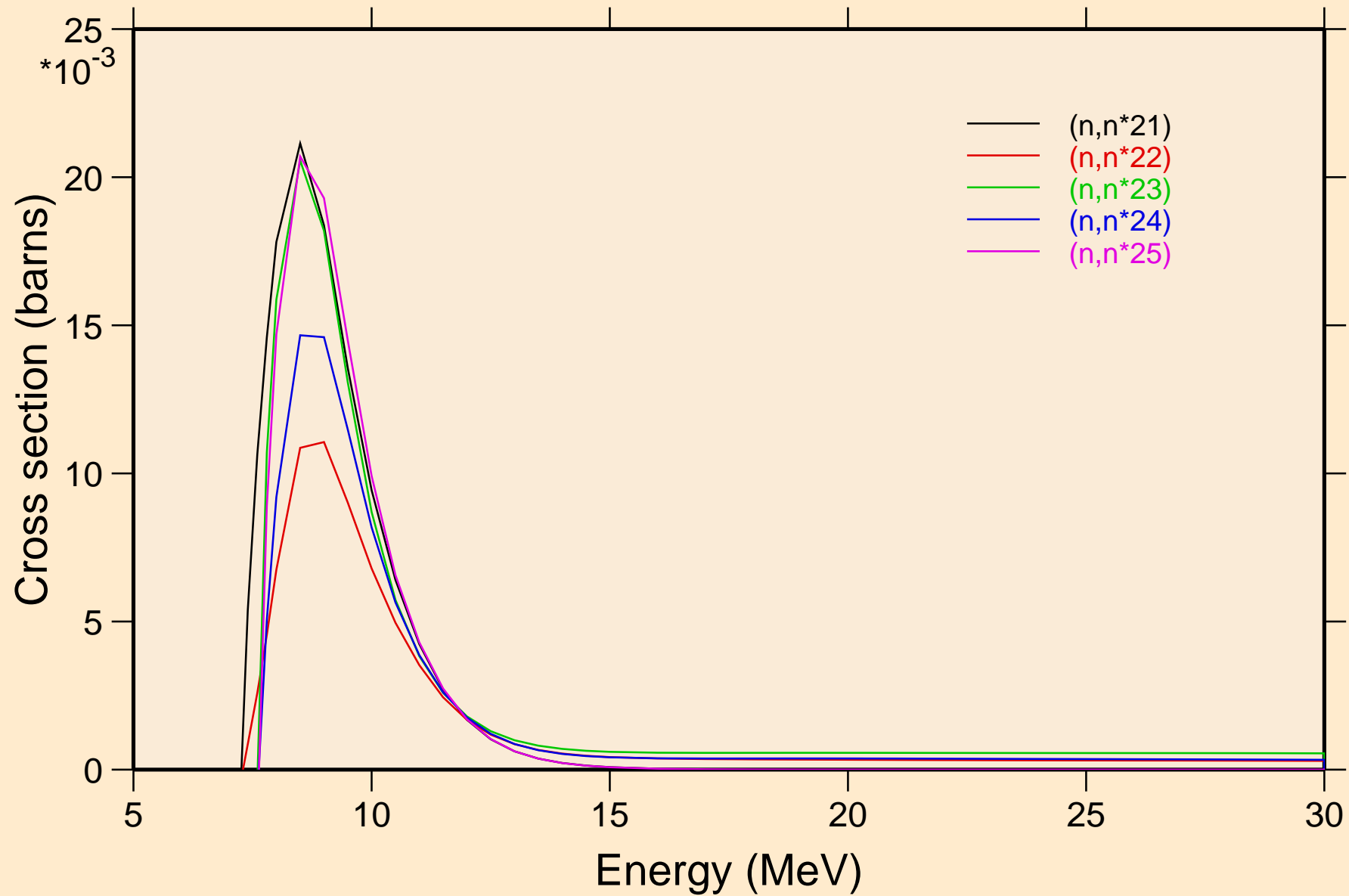

SN132 NRG TENDL-2015, AKONING

Inelastic levels

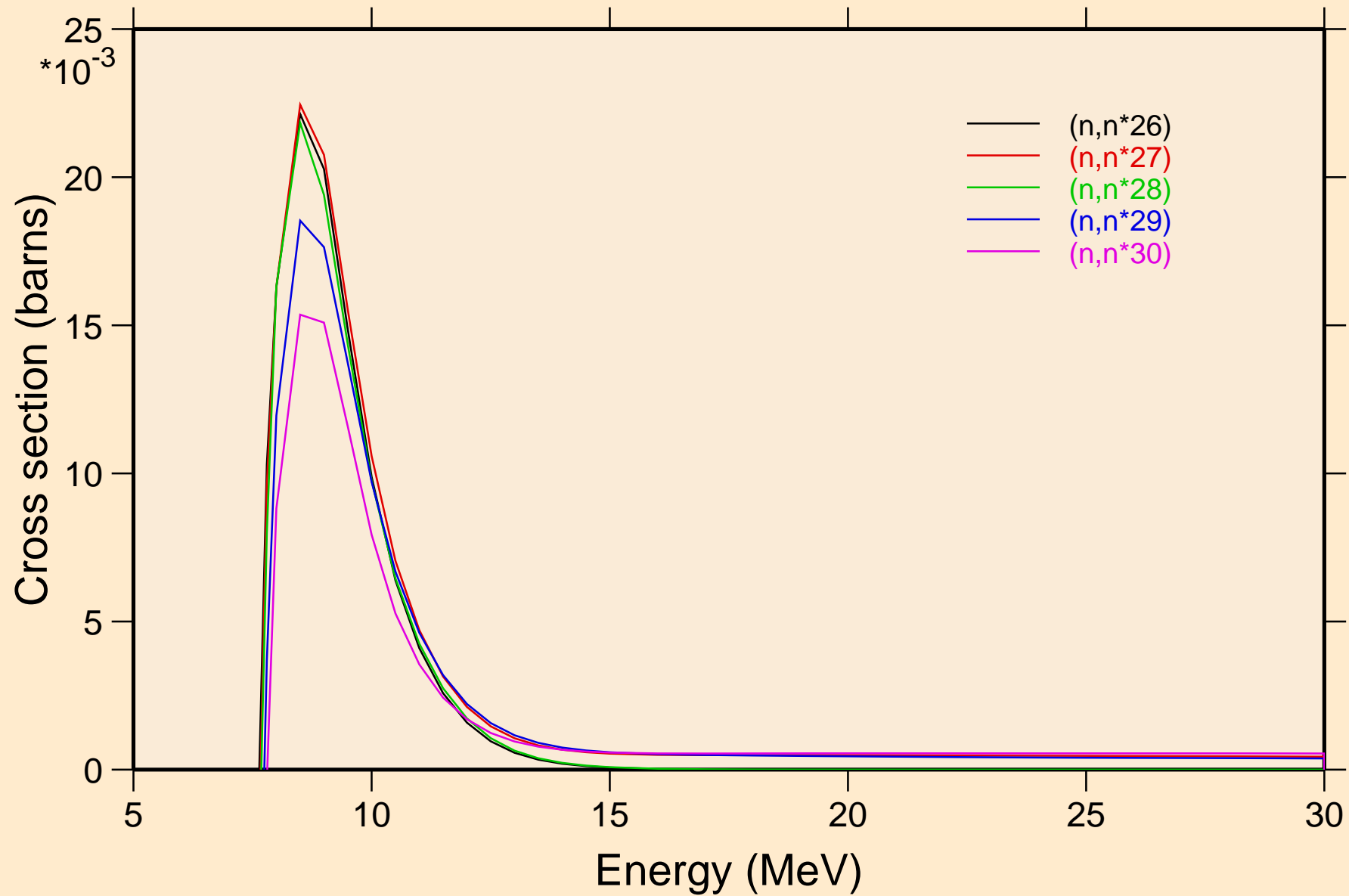

SN132 NRG TENDL-2015, AKONING

Threshold reactions

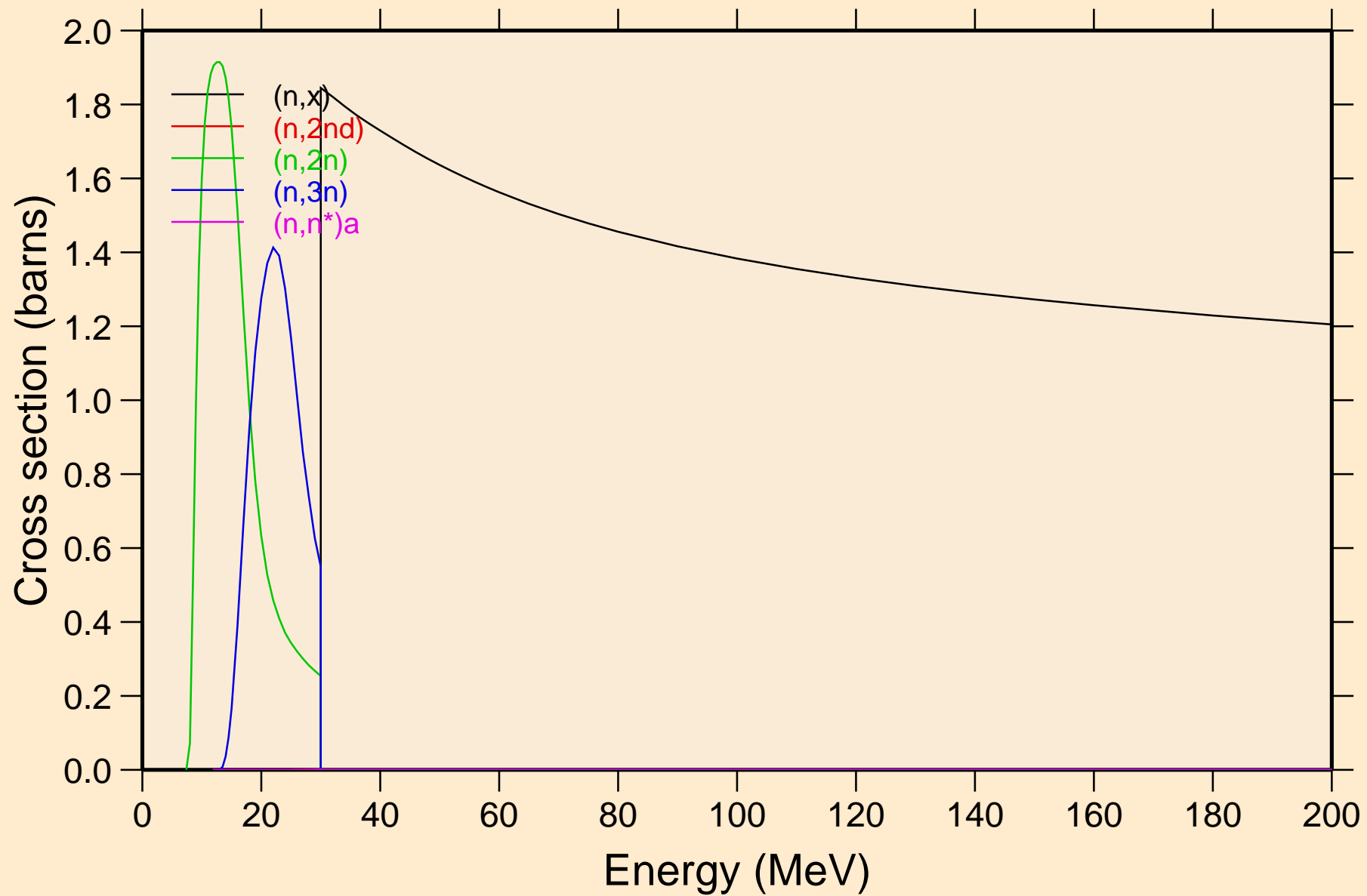

SN132 NRG TENDL-2015, AKONING

Threshold reactions

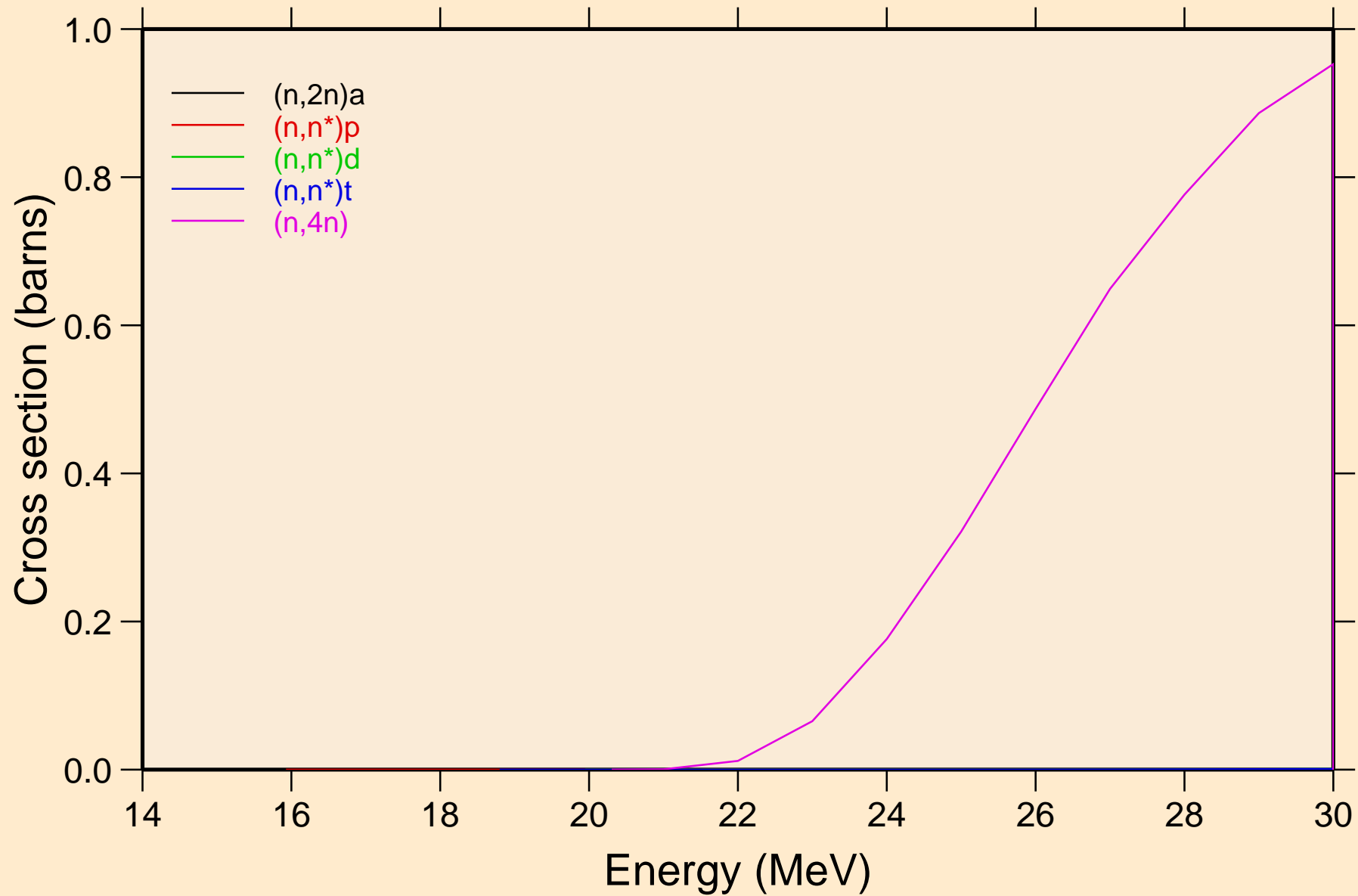

SN132 NRG TENDL-2015, AKONING

Threshold reactions

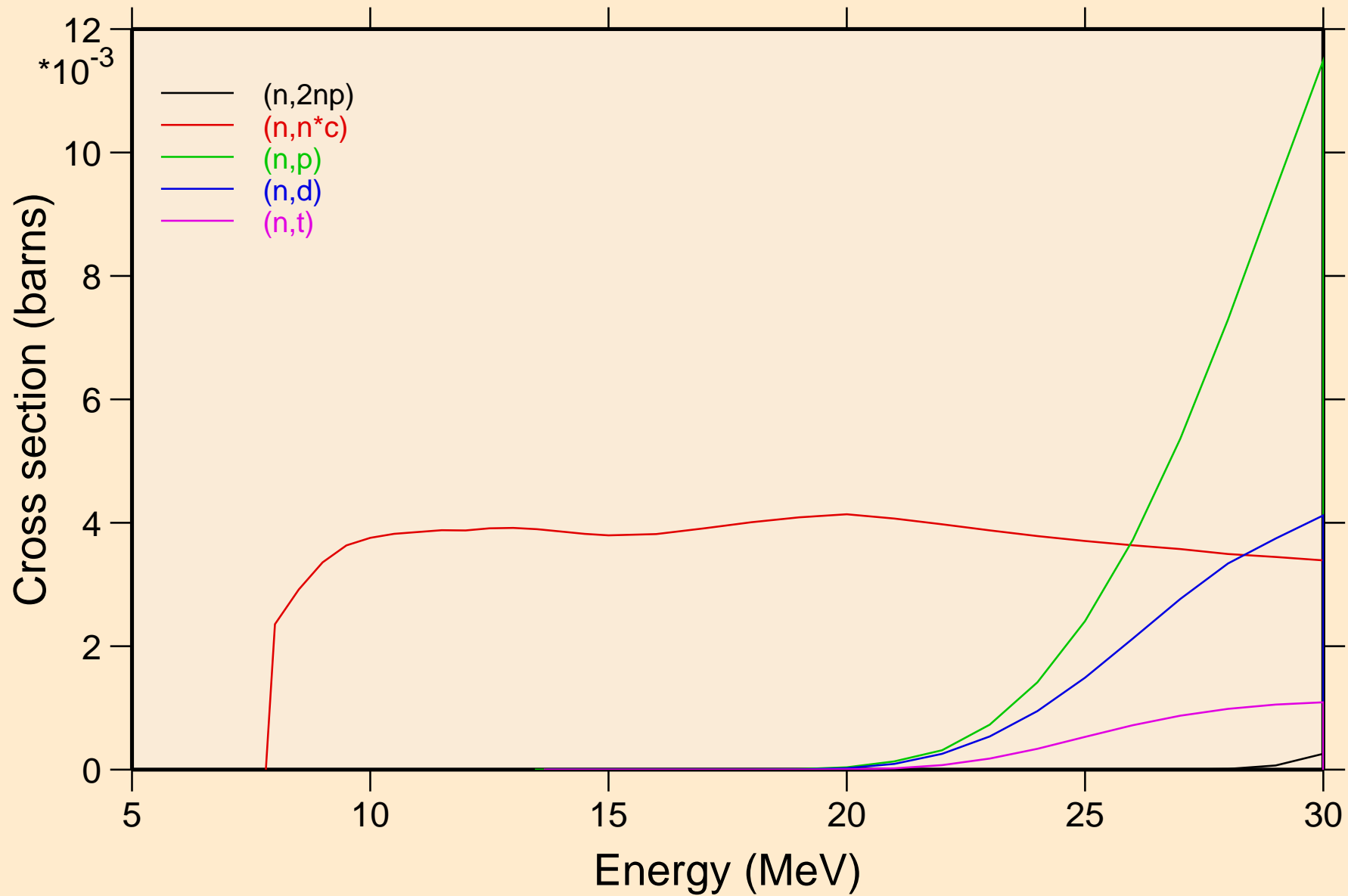

SN132 NRG TENDL-2015, AKONING

Threshold reactions

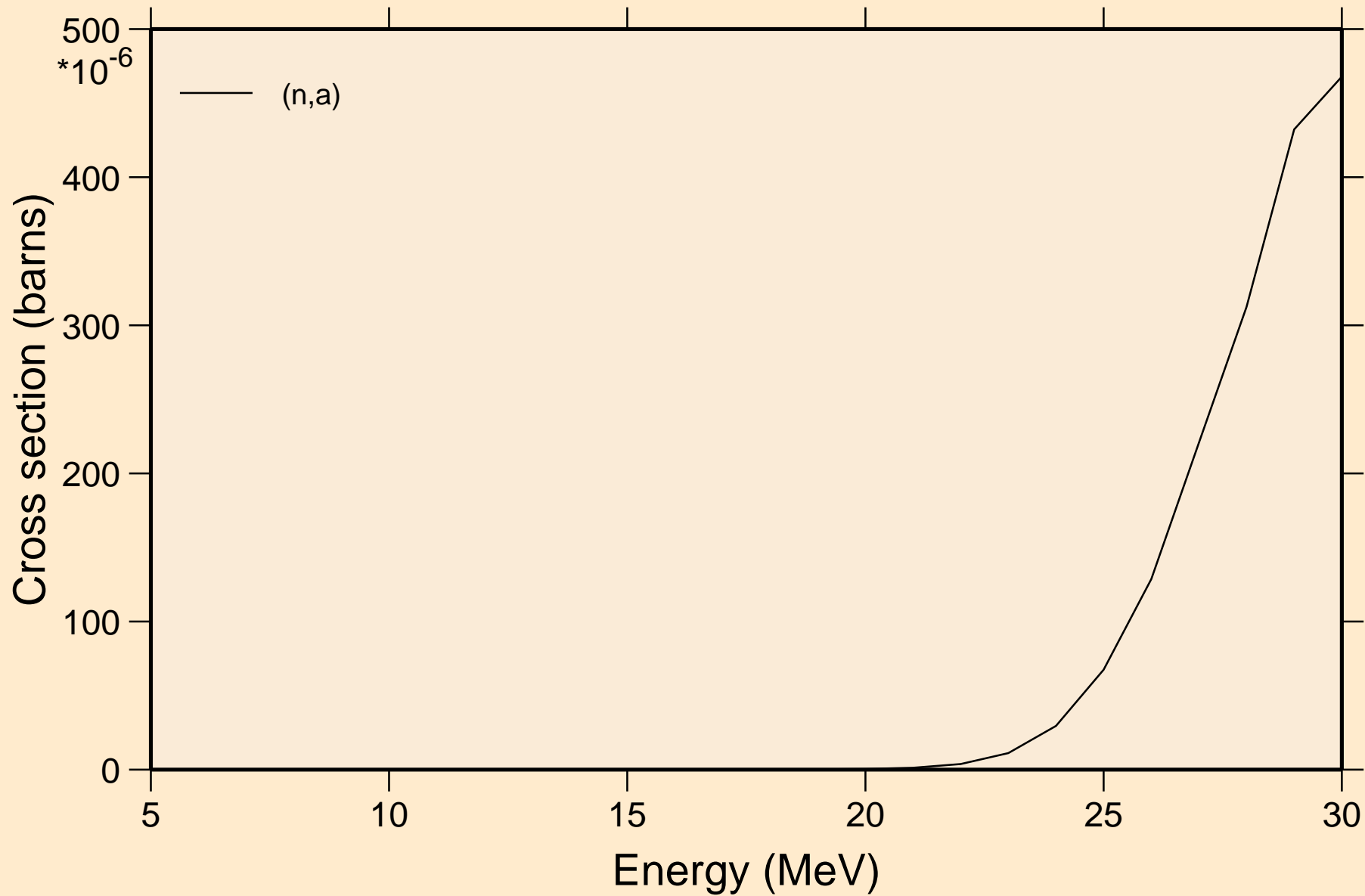

SN132 NRG TENDL-2015, AKONING
angular distribution for elastic

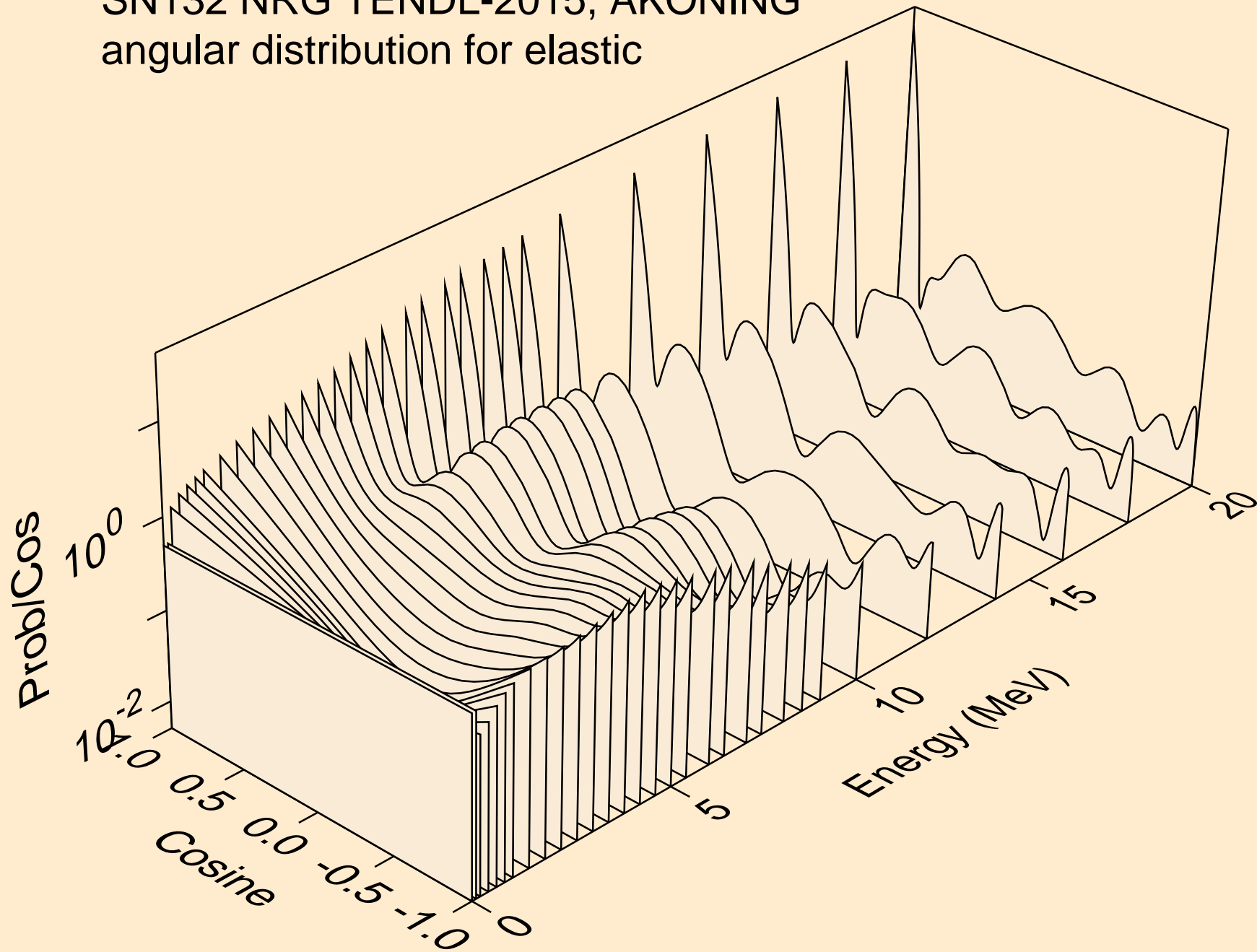

SN132 NRG TENDL-2015, AKONING
angular distribution for elastic

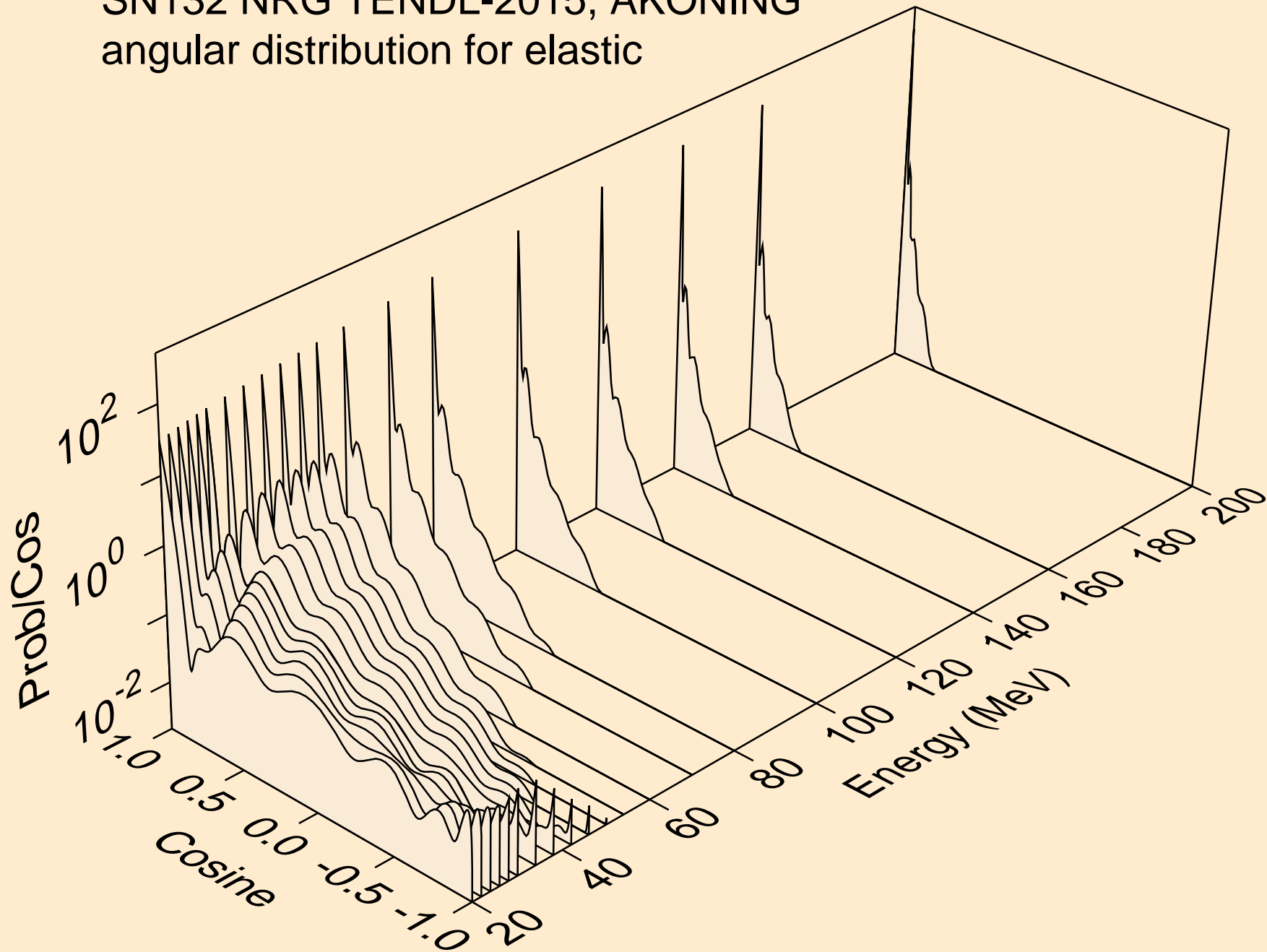

SN132 NRG TENDL-2015, AKONING
angular distribution for (n,n*1)

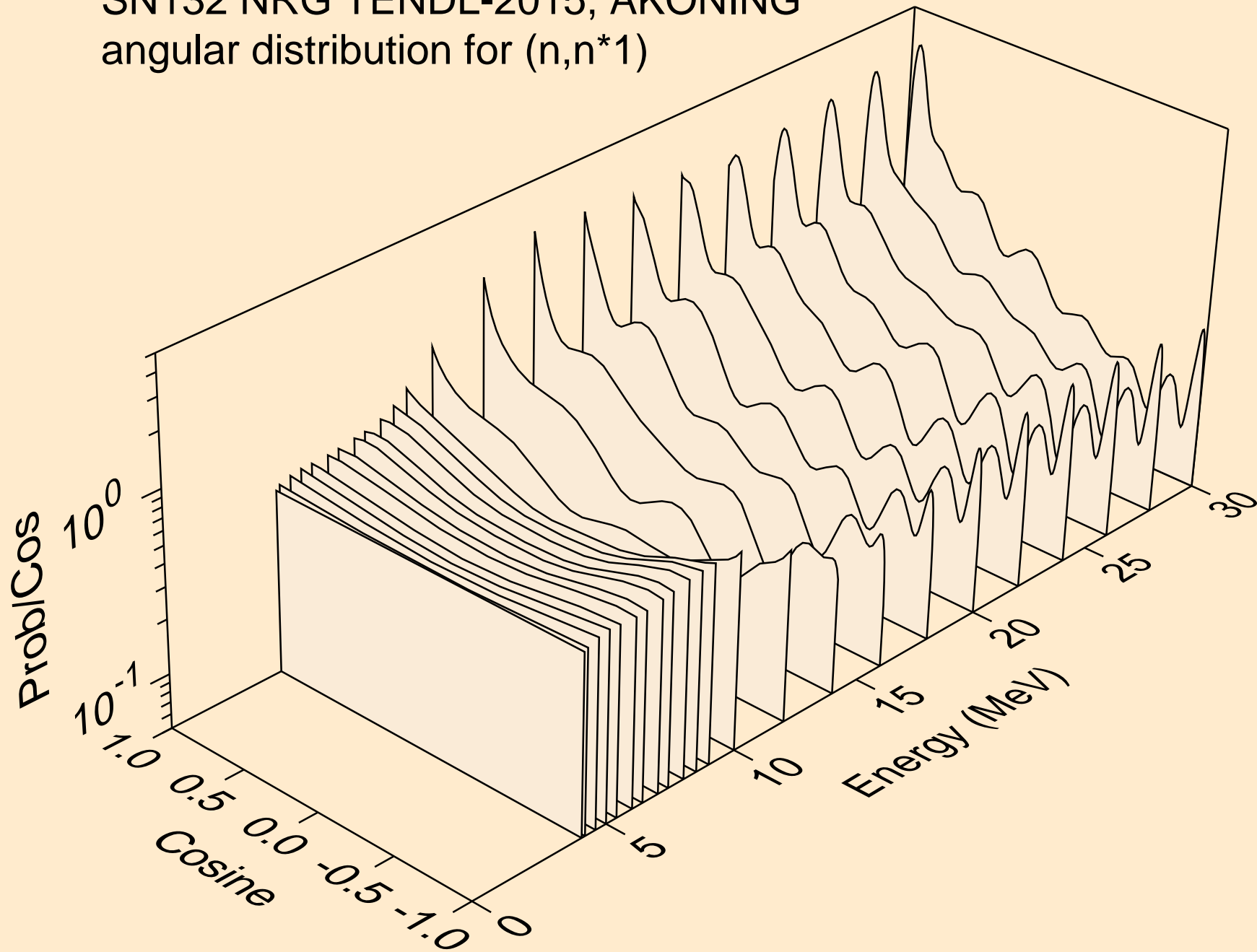

SN132 NRG TENDL-2015, AKONING
angular distribution for (n,n*2)

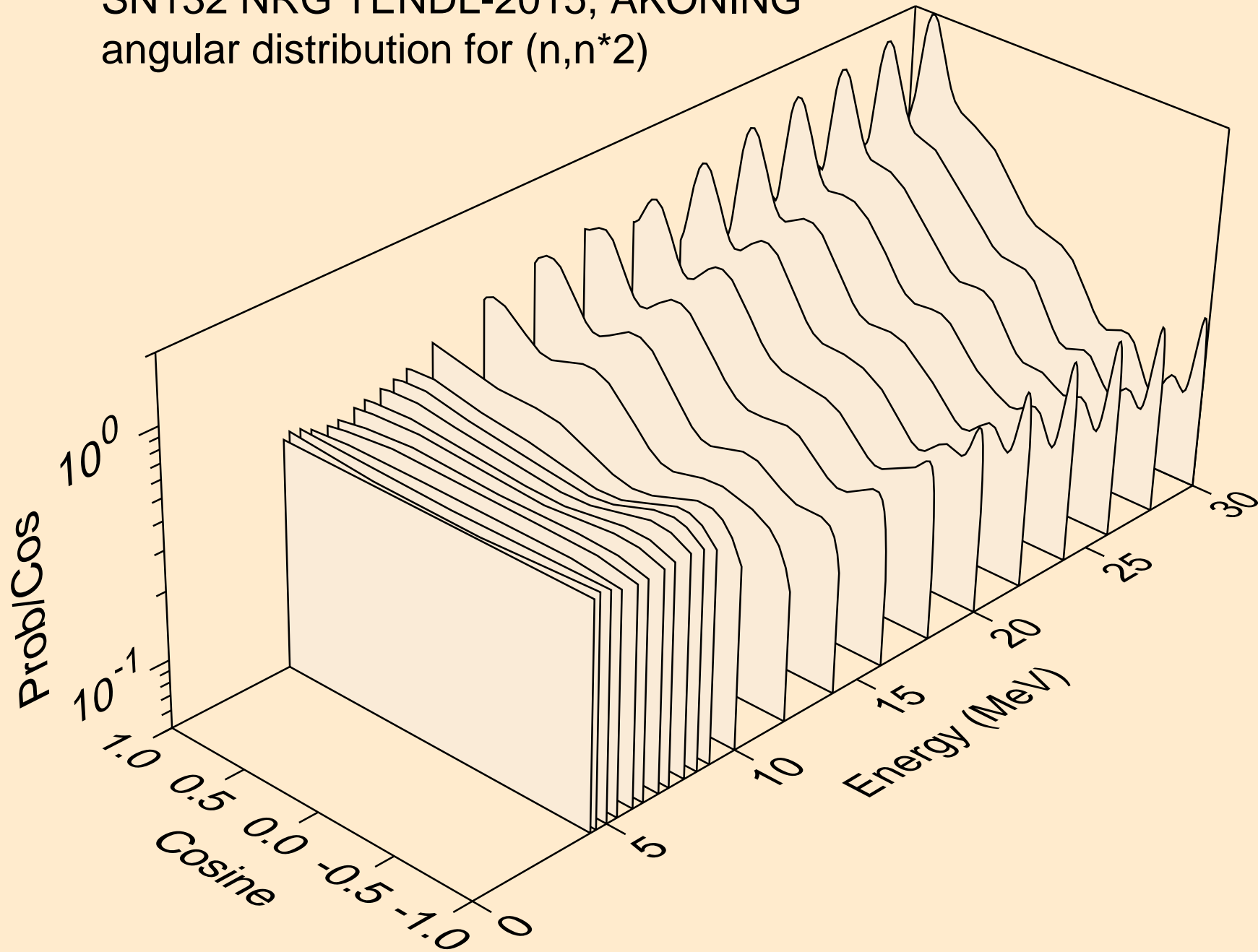

SN132 NRG TENDL-2015, AKONING
angular distribution for (n,n*3)

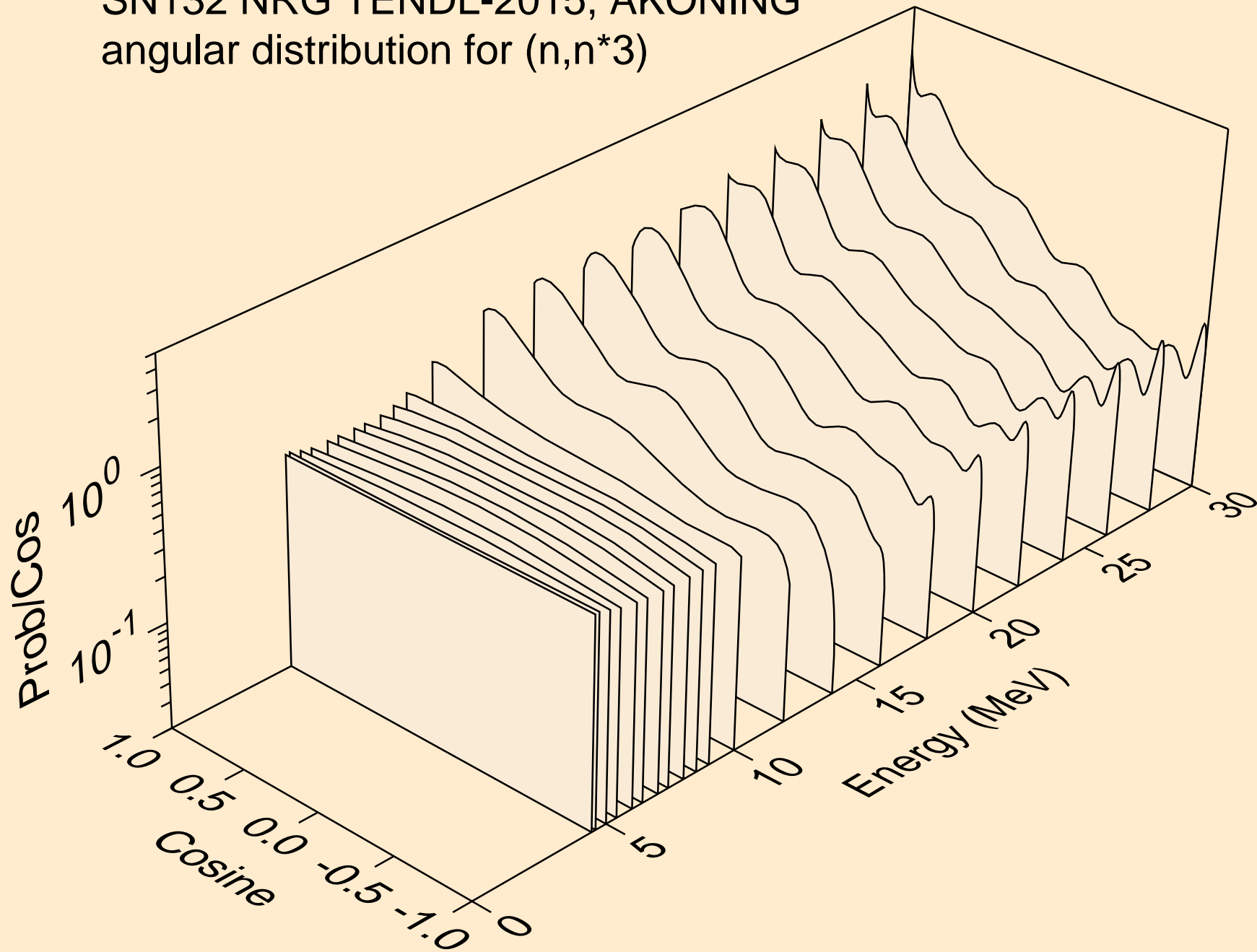

SN132 NRG TENDL-2015, AKONING
angular distribution for (n,n*4)

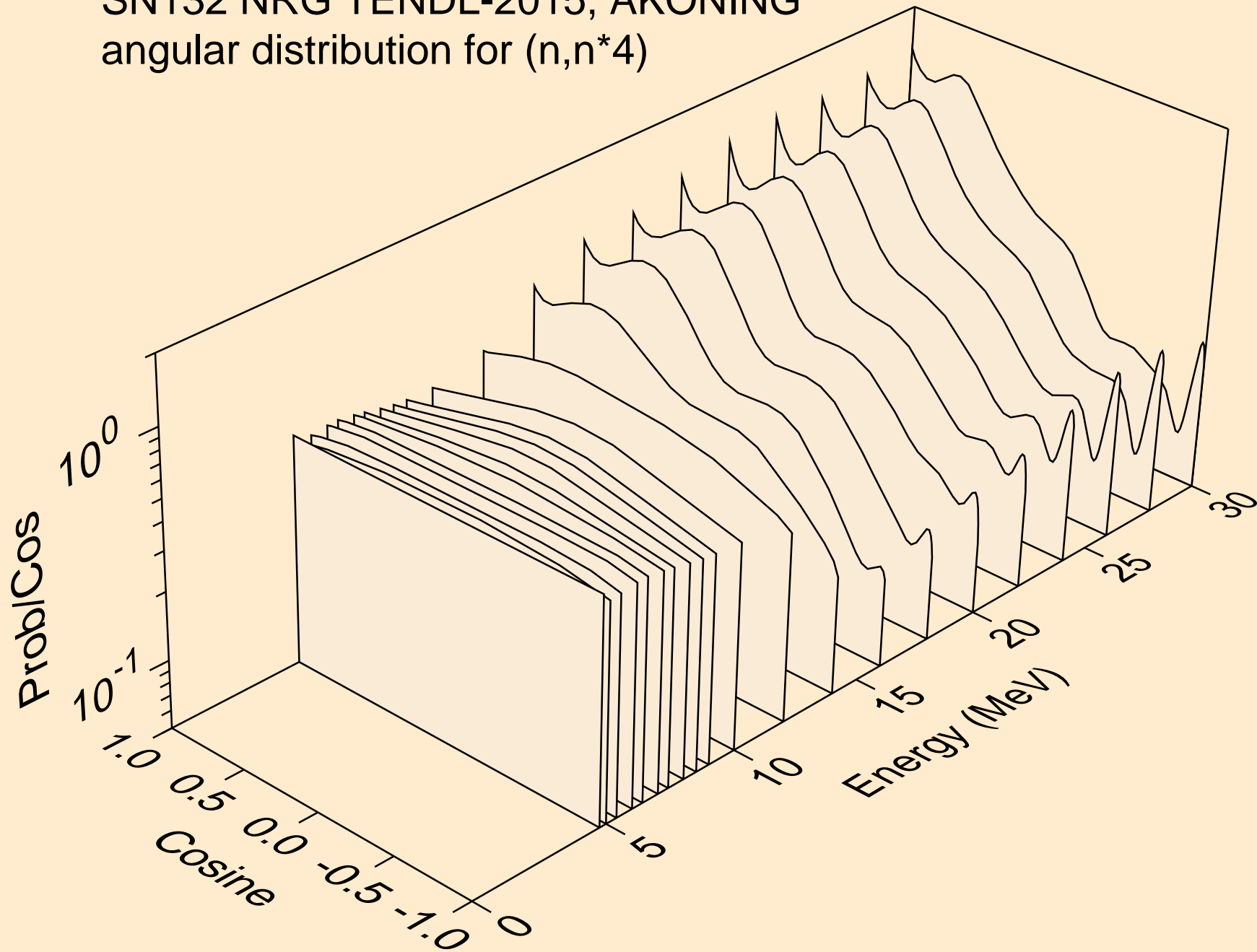

SN132 NRG TENDL-2015, AKONING
angular distribution for (n,n*5)

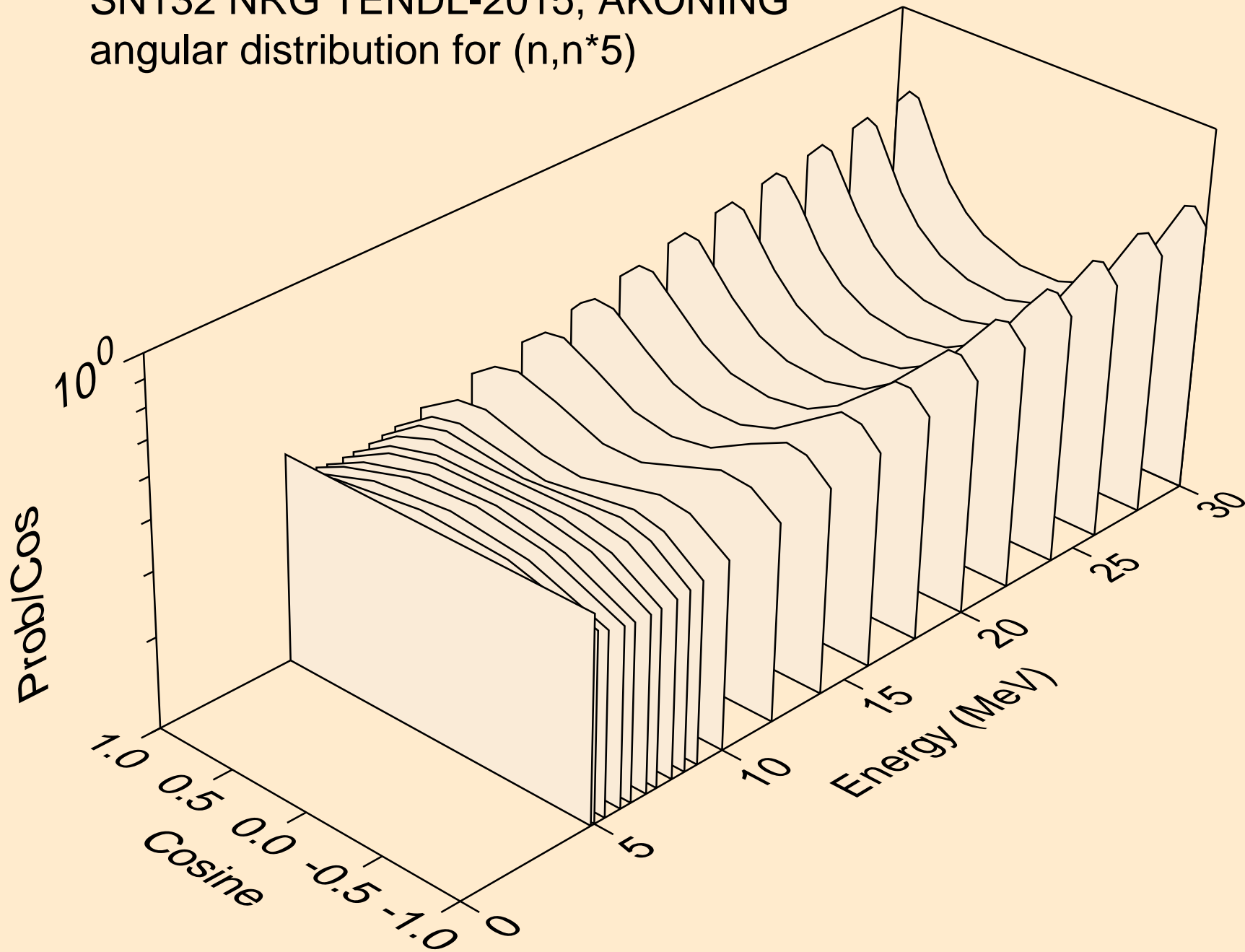

SN132 NRG TENDL-2015, AKONING
angular distribution for (n,n*6)

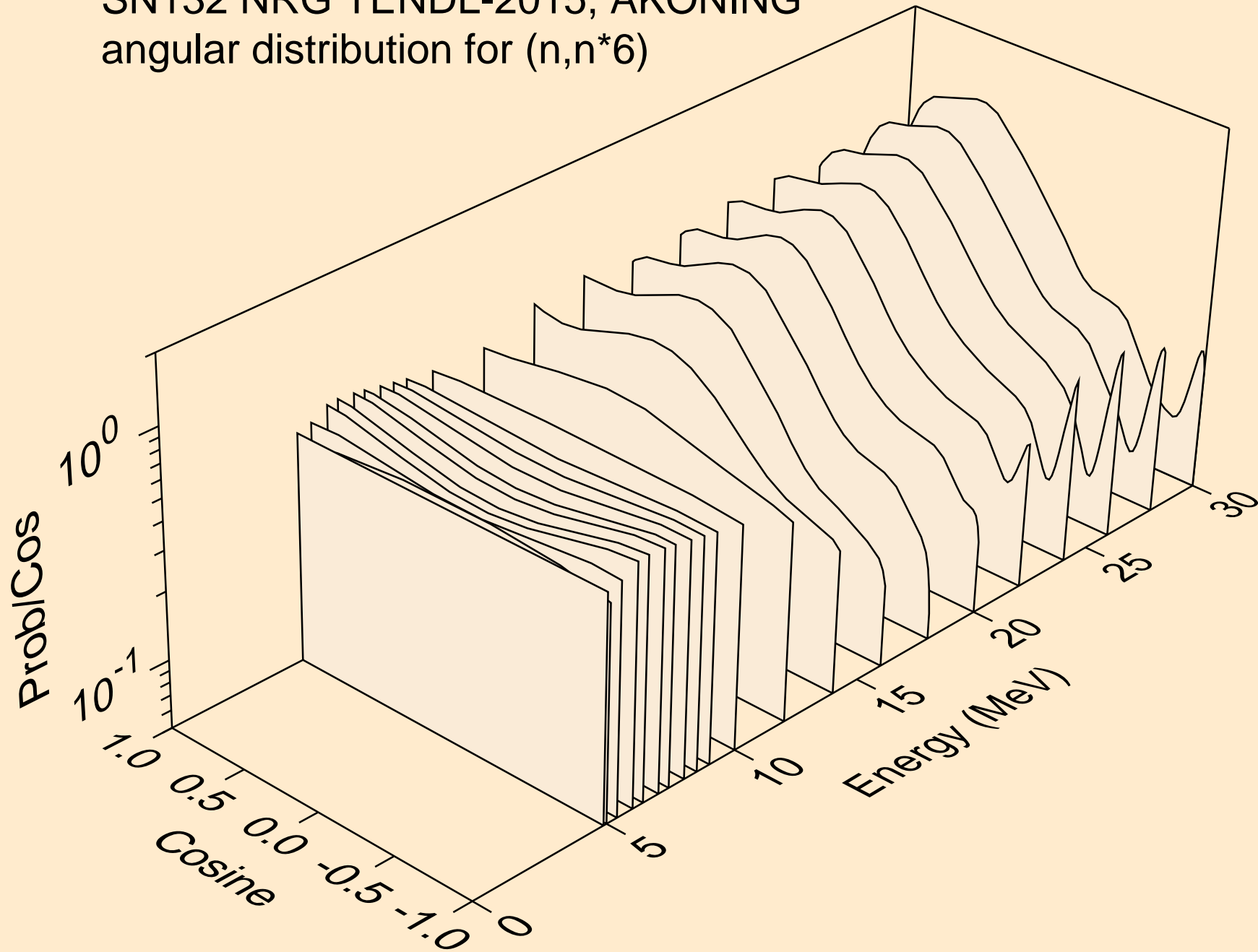

SN132 NRG TENDL-2015, AKONING
angular distribution for (n,n*7)

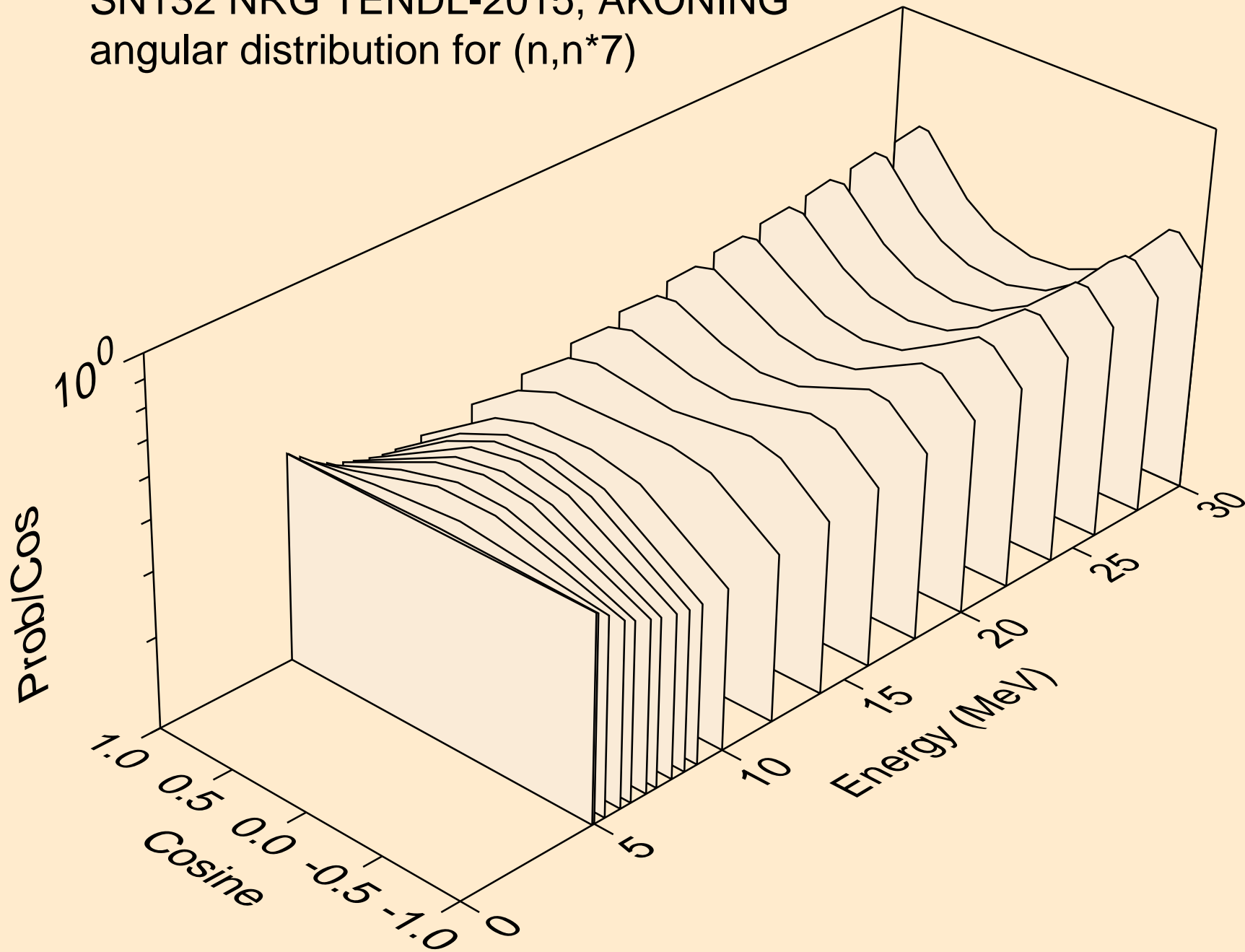

SN132 NRG TENDL-2015, AKONING
angular distribution for (n,n*8)

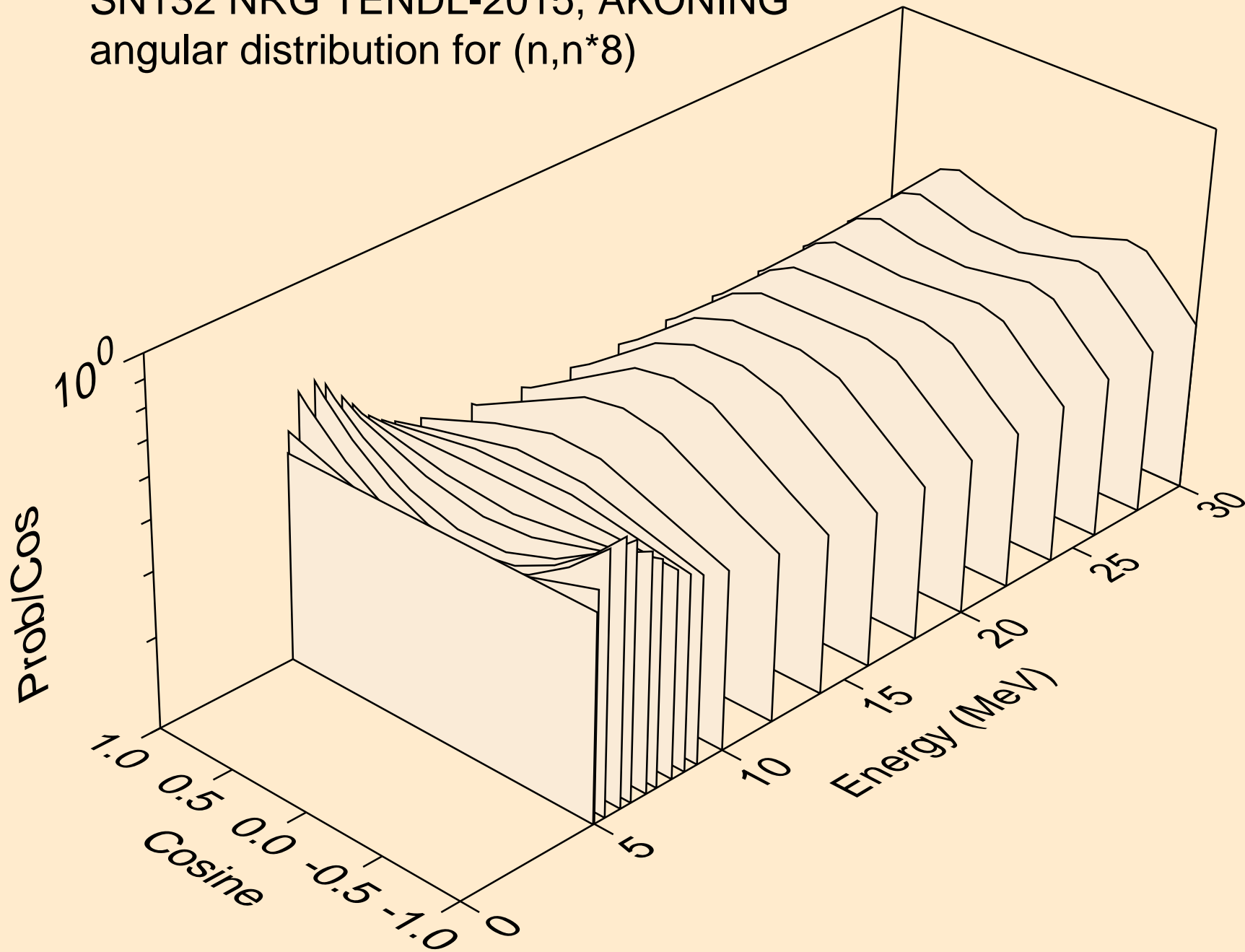

SN132 NRG TENDL-2015, AKONING
angular distribution for (n,n*9)

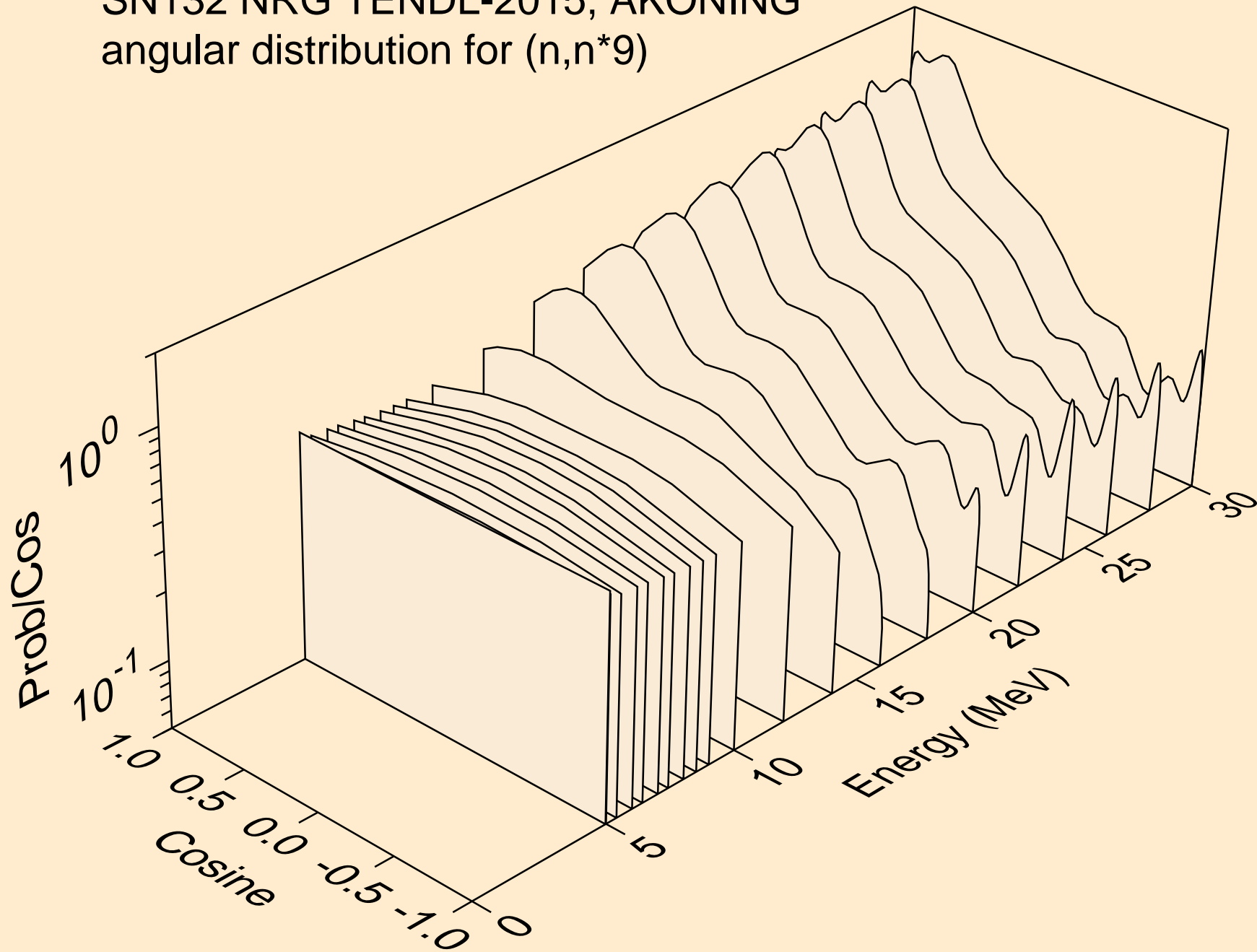

SN132 NRG TENDL-2015, AKONING
angular distribution for (n,n*10)

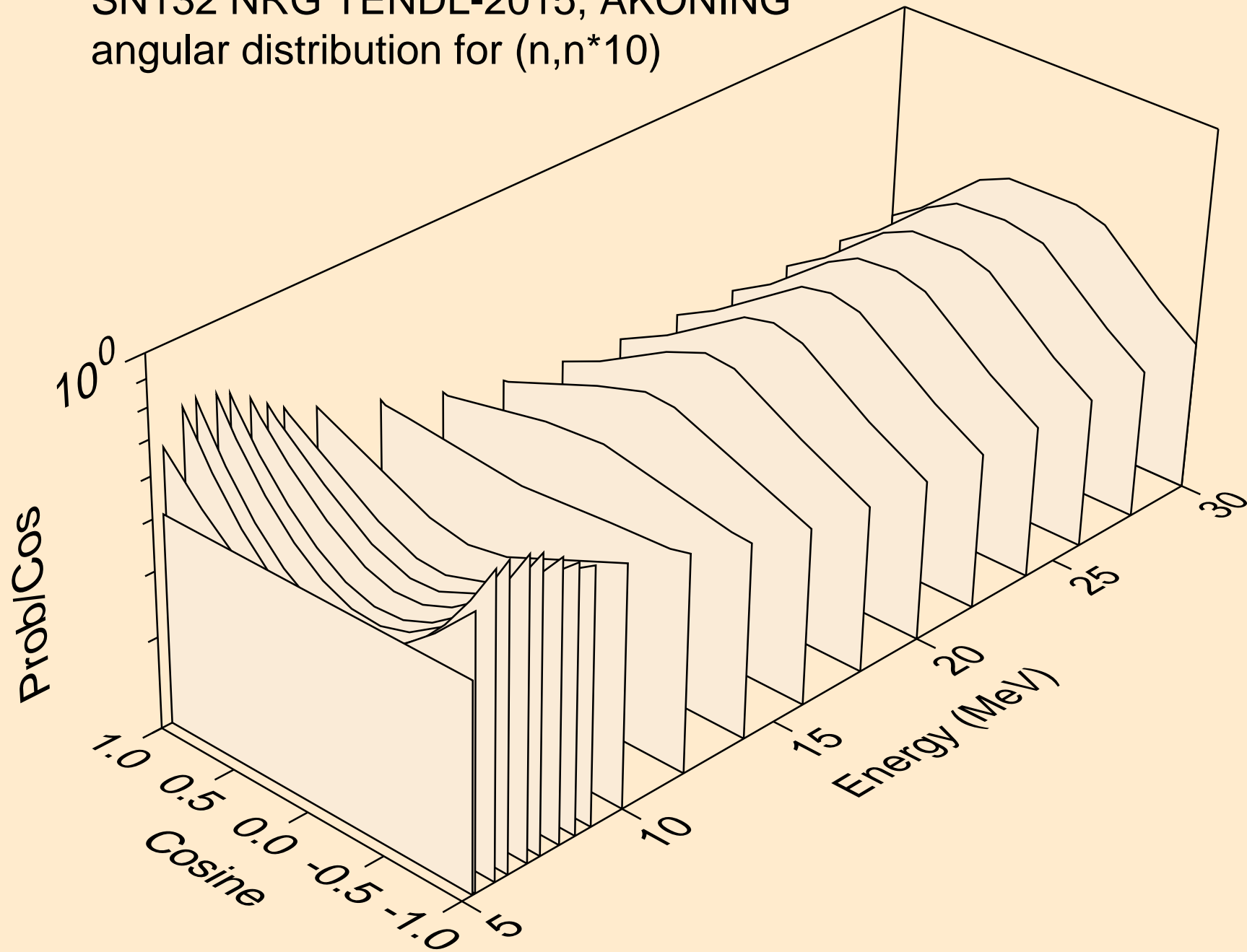

SN132 NRG TENDL-2015, AKONING
angular distribution for (n,n*11)

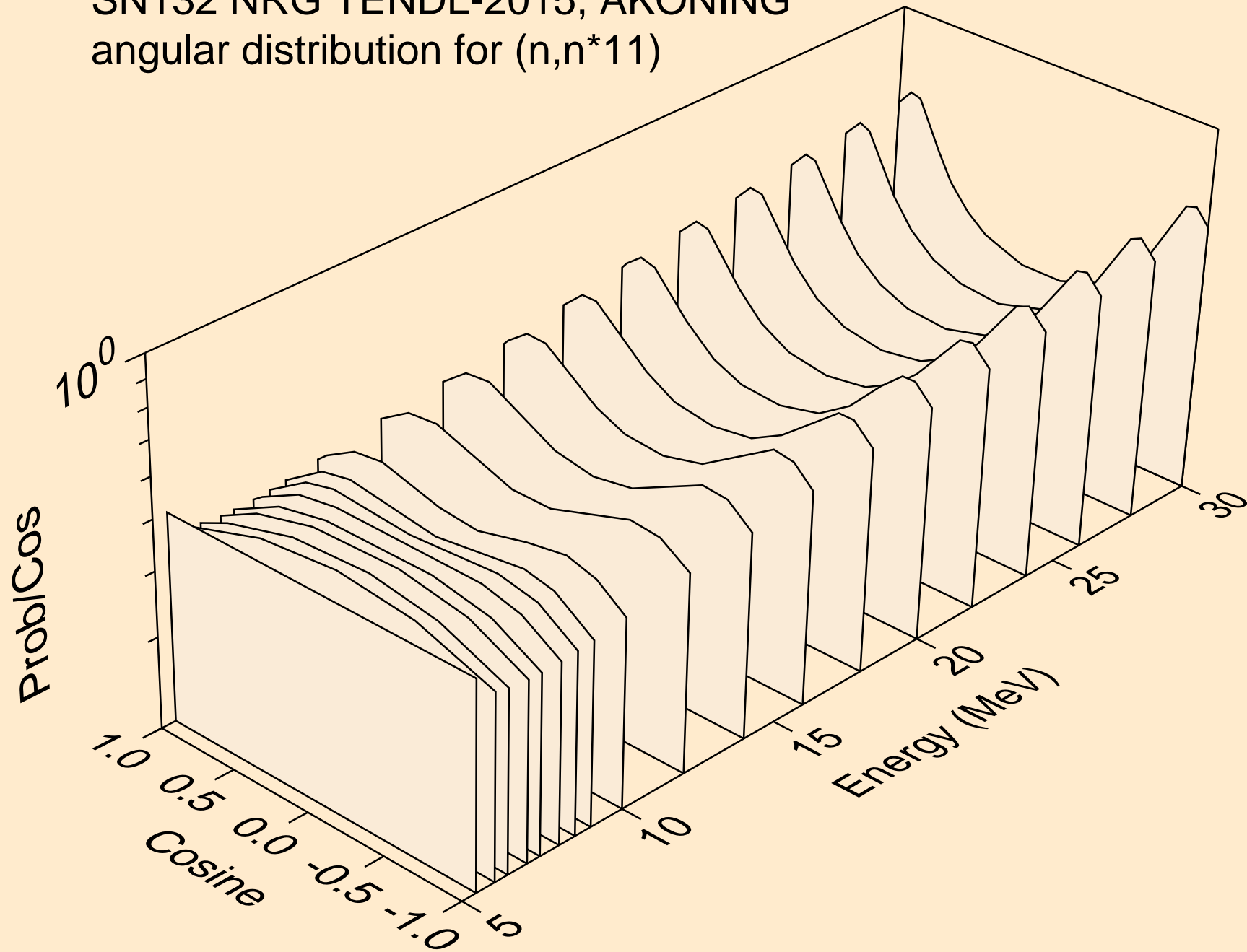

SN132 NRG TENDL-2015, AKONING
angular distribution for (n,n*12)

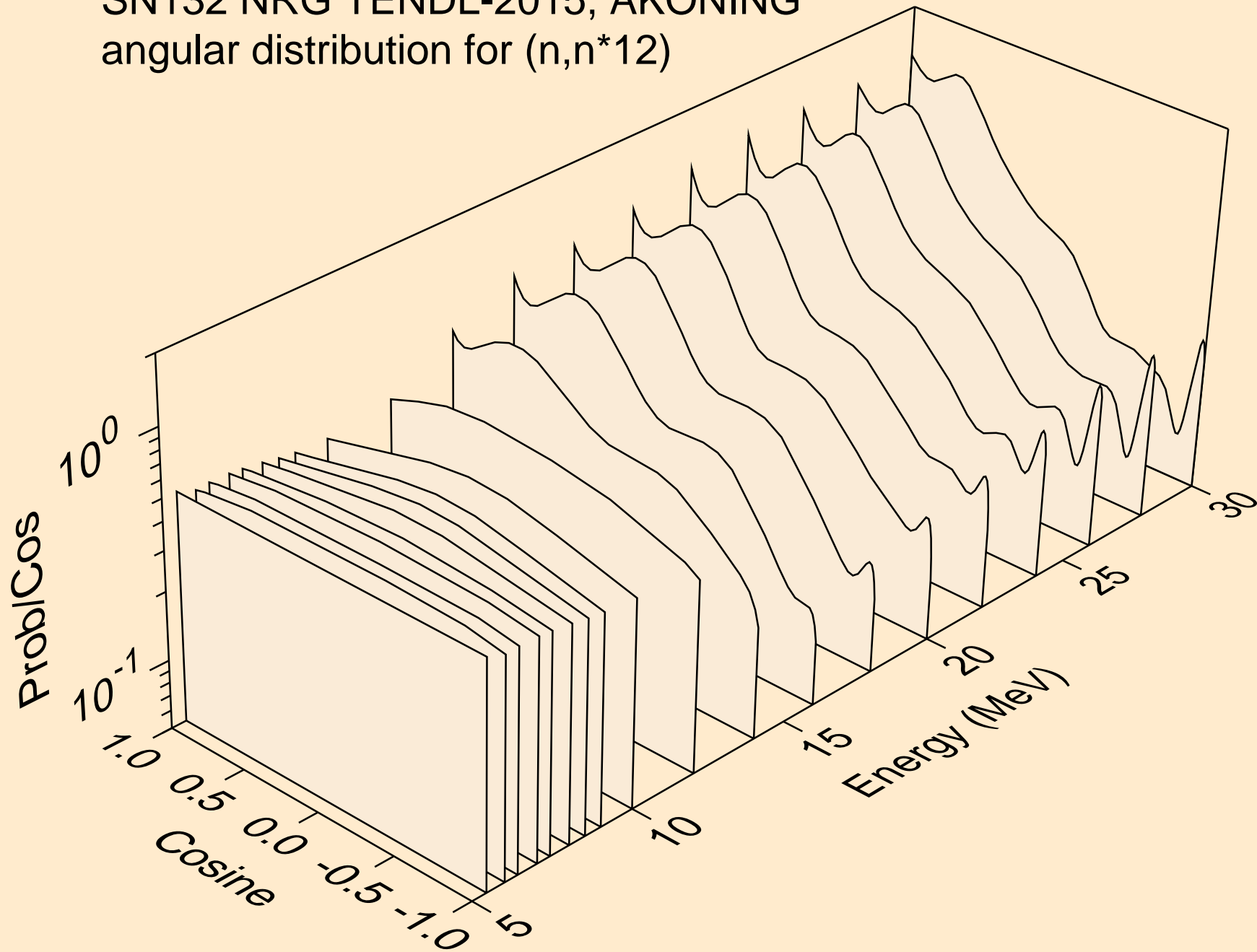

SN132 NRG TENDL-2015, AKONING
angular distribution for (n,n*13)

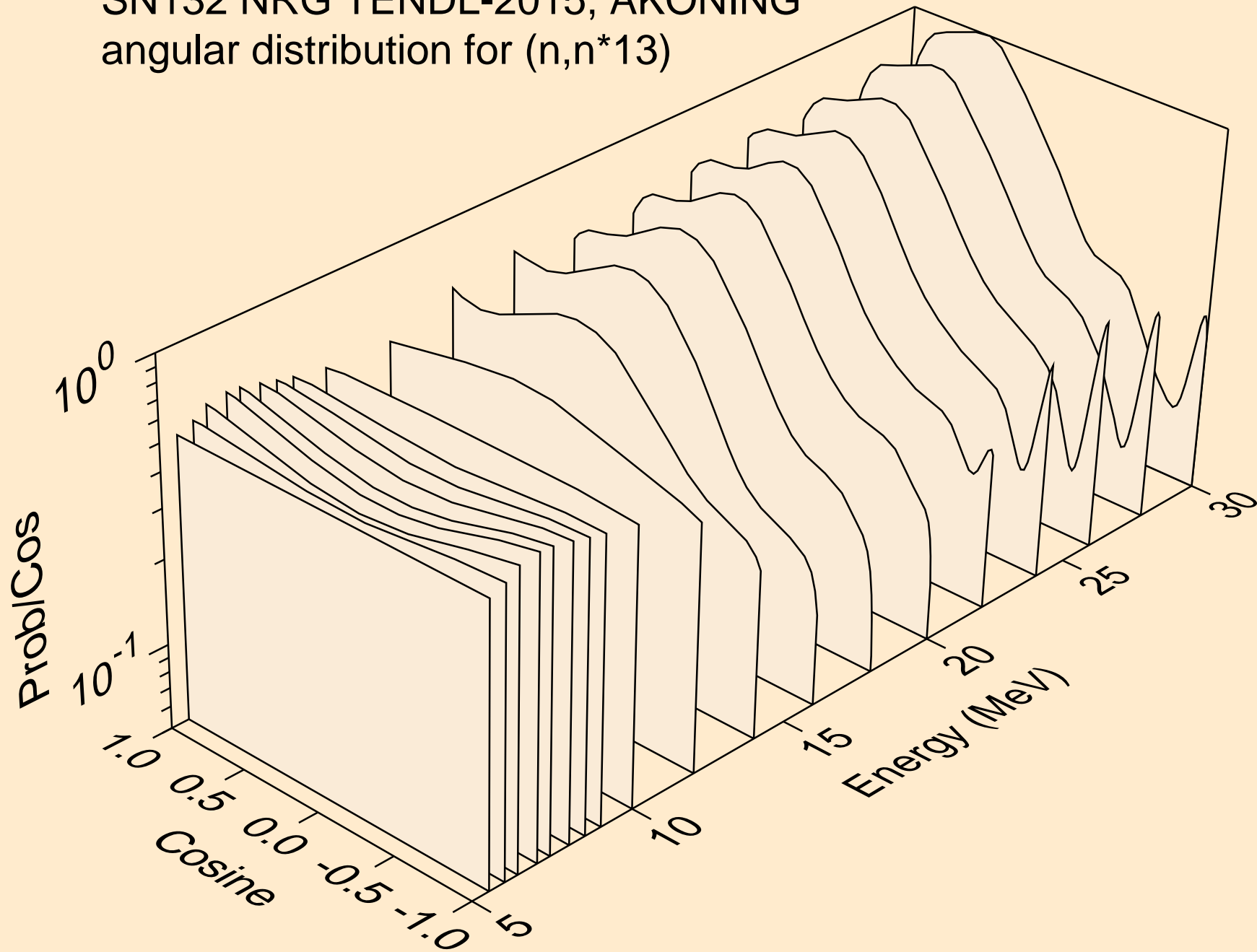

SN132 NRG TENDL-2015, AKONING
angular distribution for (n,n*14)

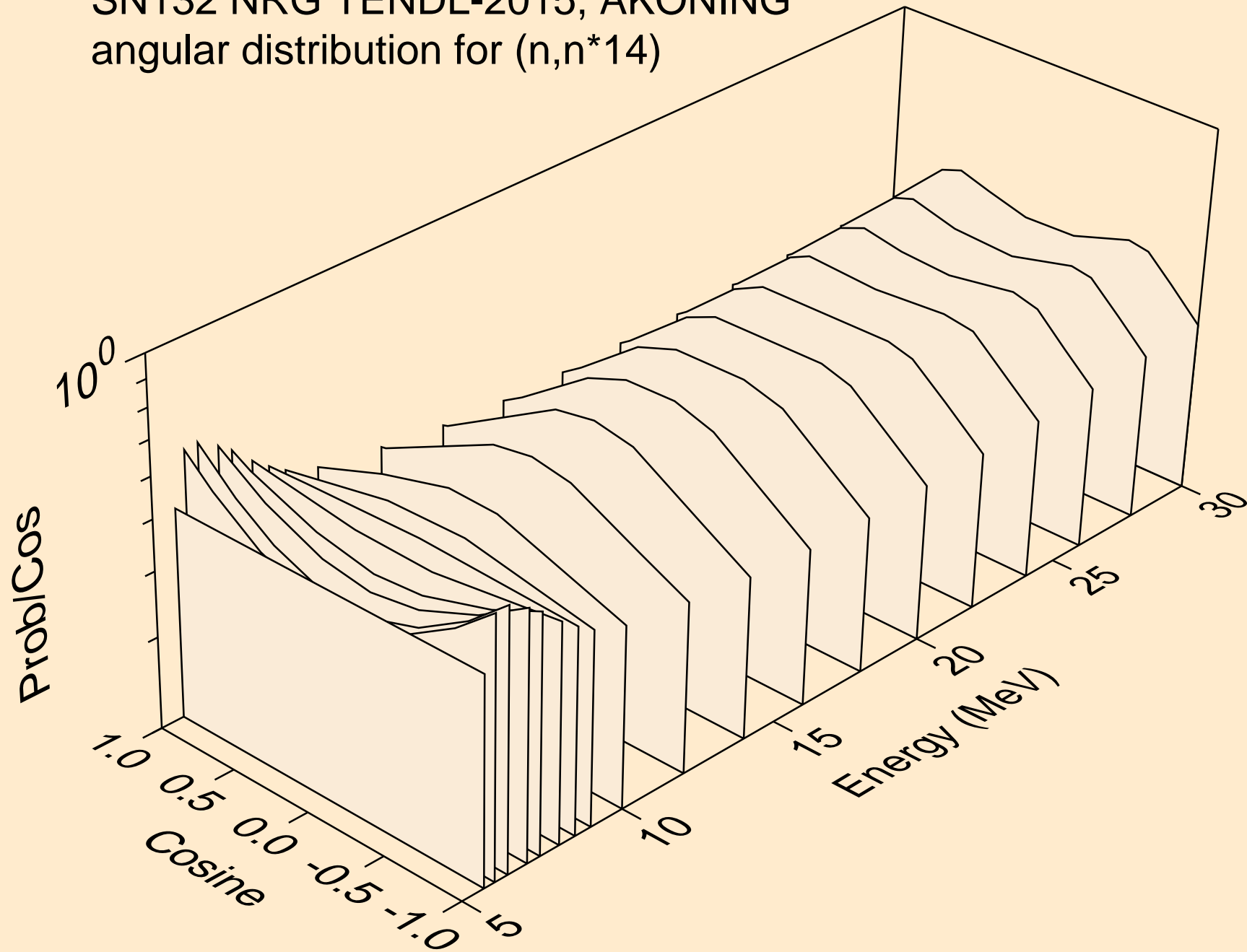

SN132 NRG TENDL-2015, AKONING
angular distribution for (n,n*15)

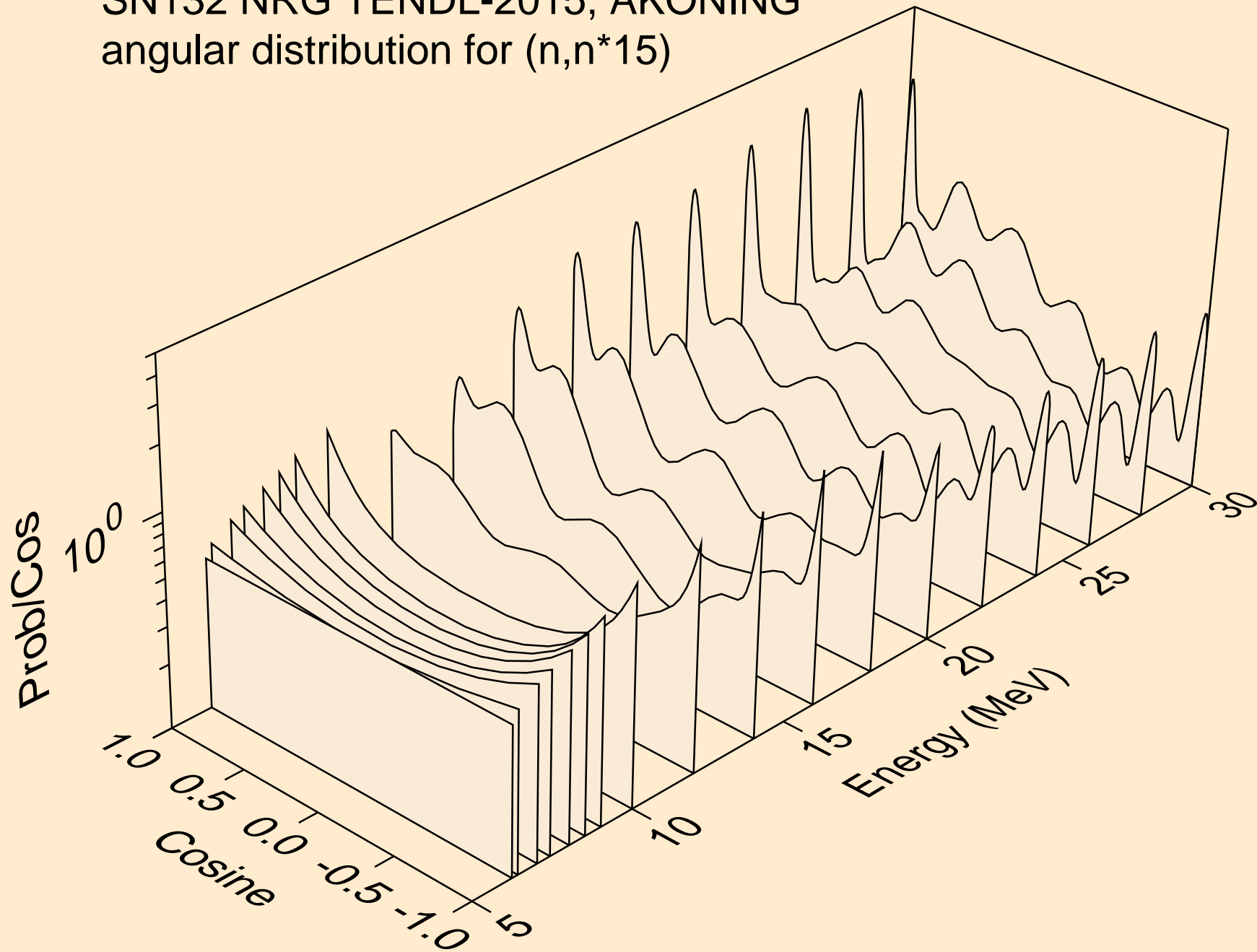

SN132 NRG TENDL-2015, AKONING
angular distribution for (n,n*16)

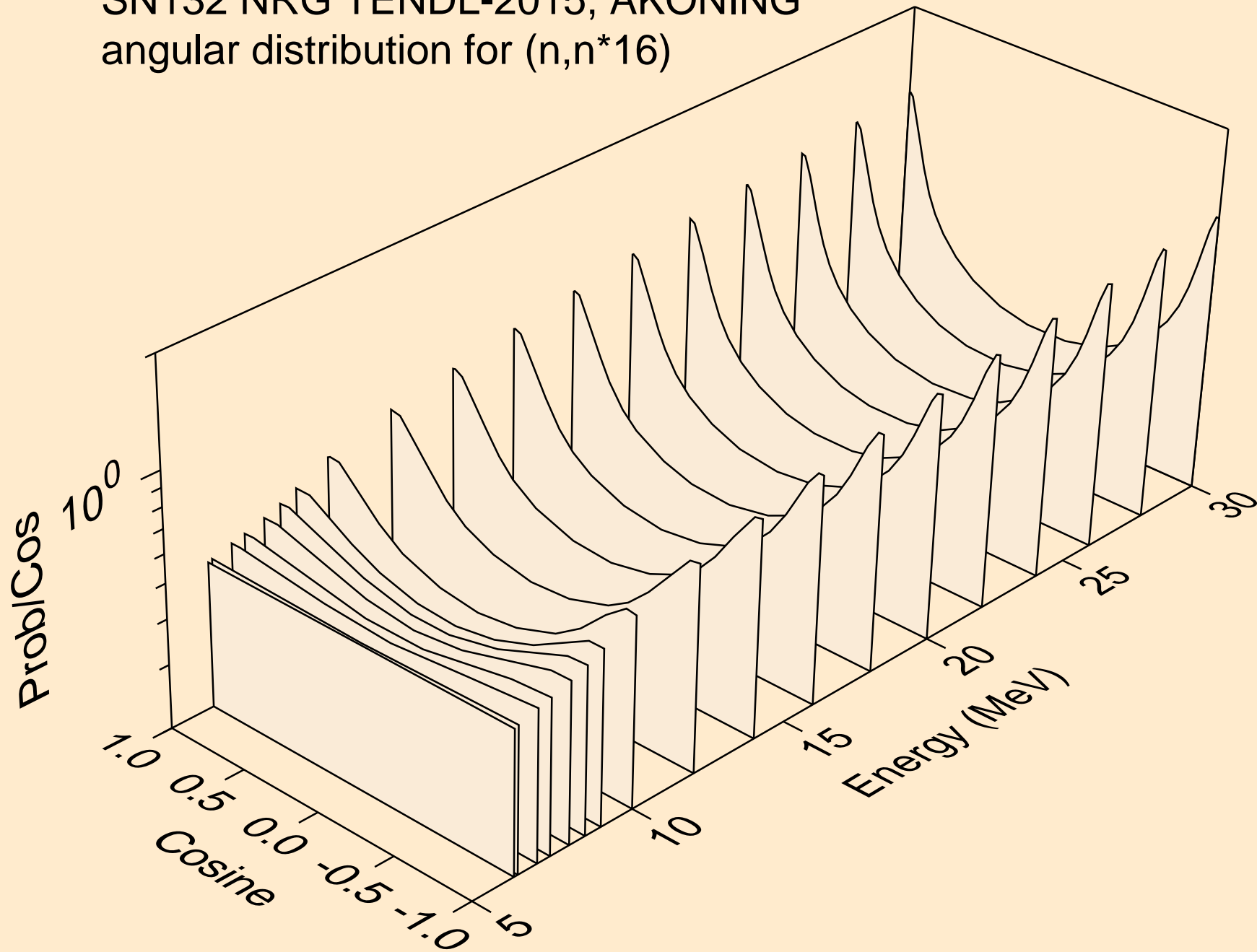

SN132 NRG TENDL-2015, AKONING
angular distribution for (n,n*17)

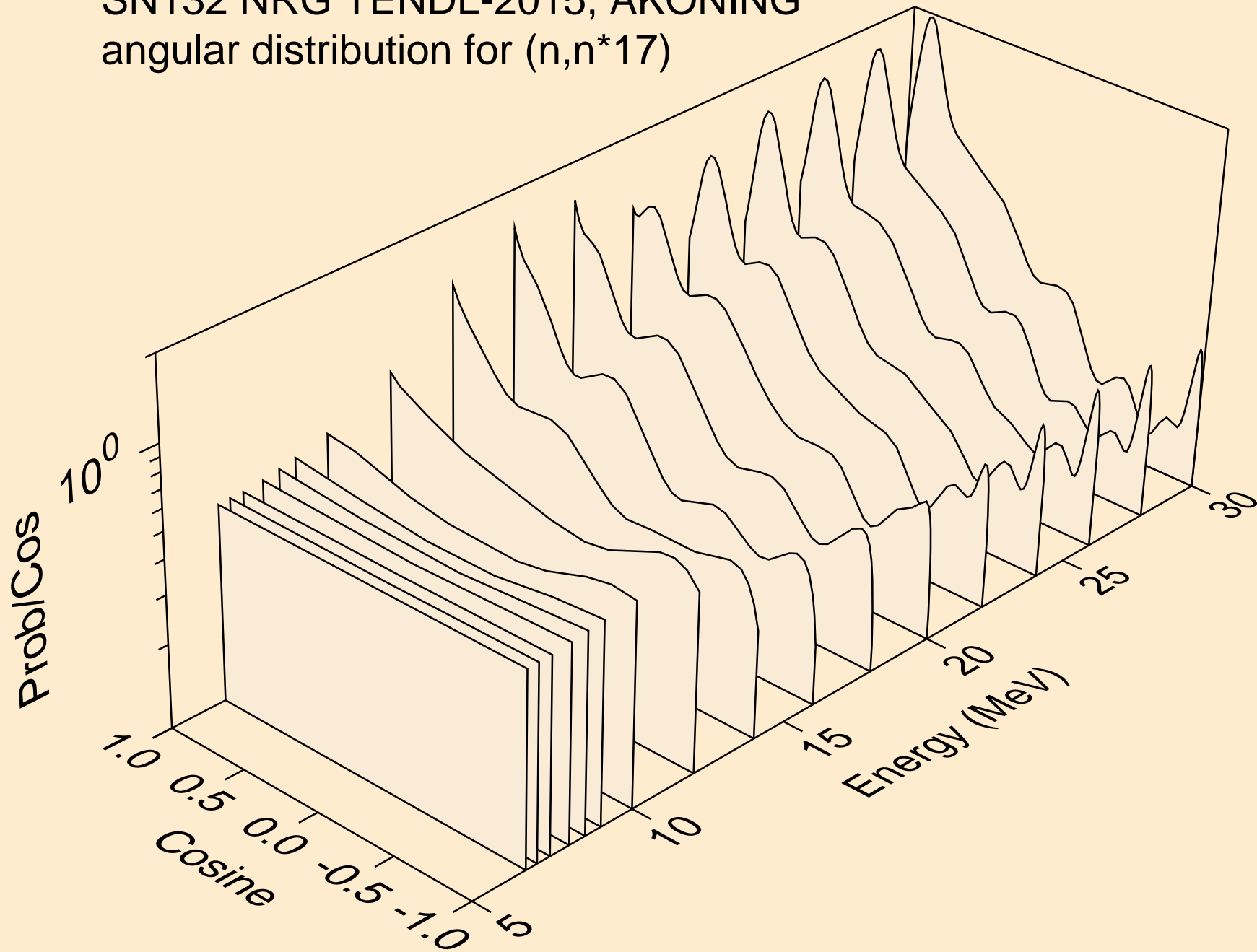

SN132 NRG TENDL-2015, AKONING
angular distribution for (n,n*18)

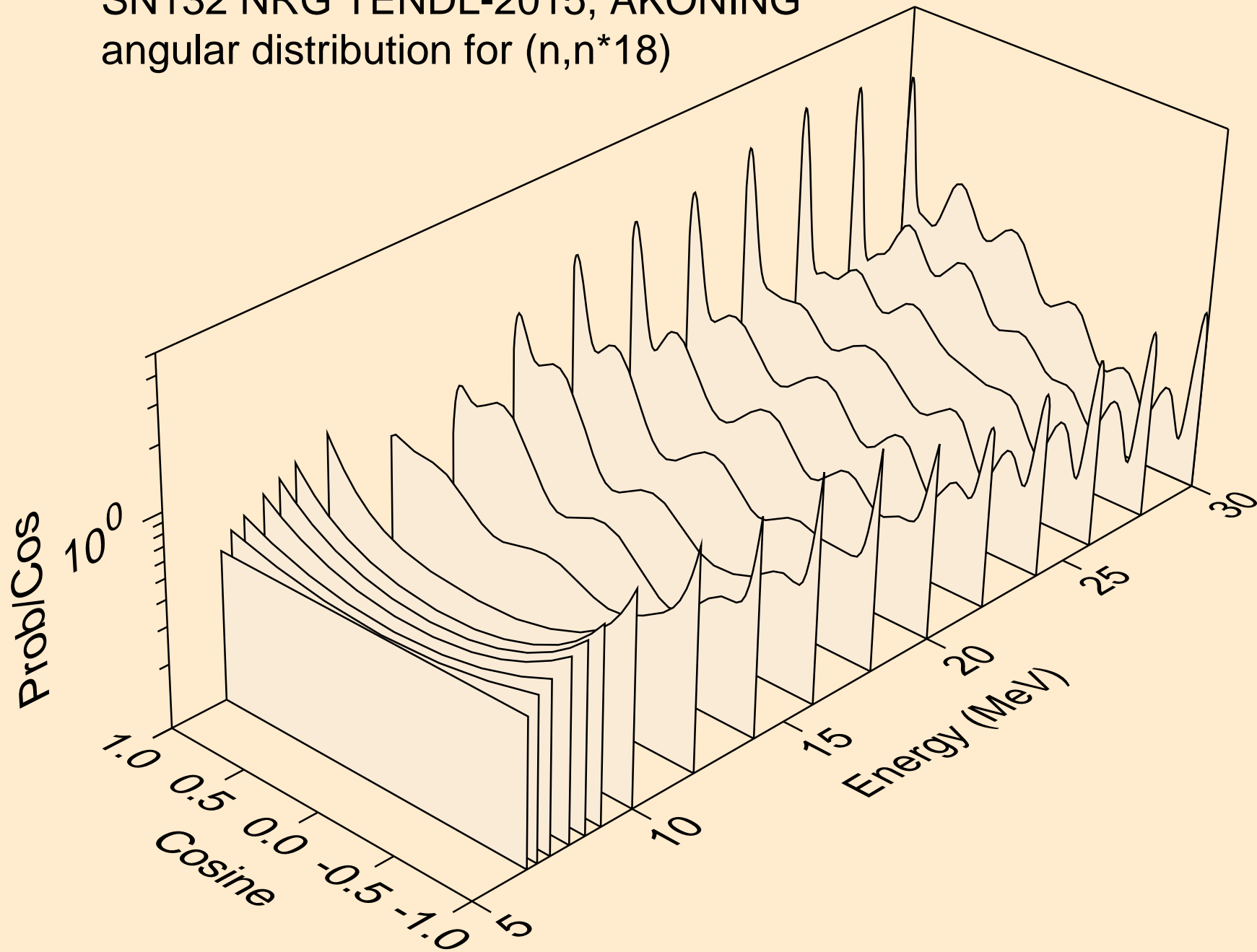

SN132 NRG TENDL-2015, AKONING
angular distribution for (n,n*19)

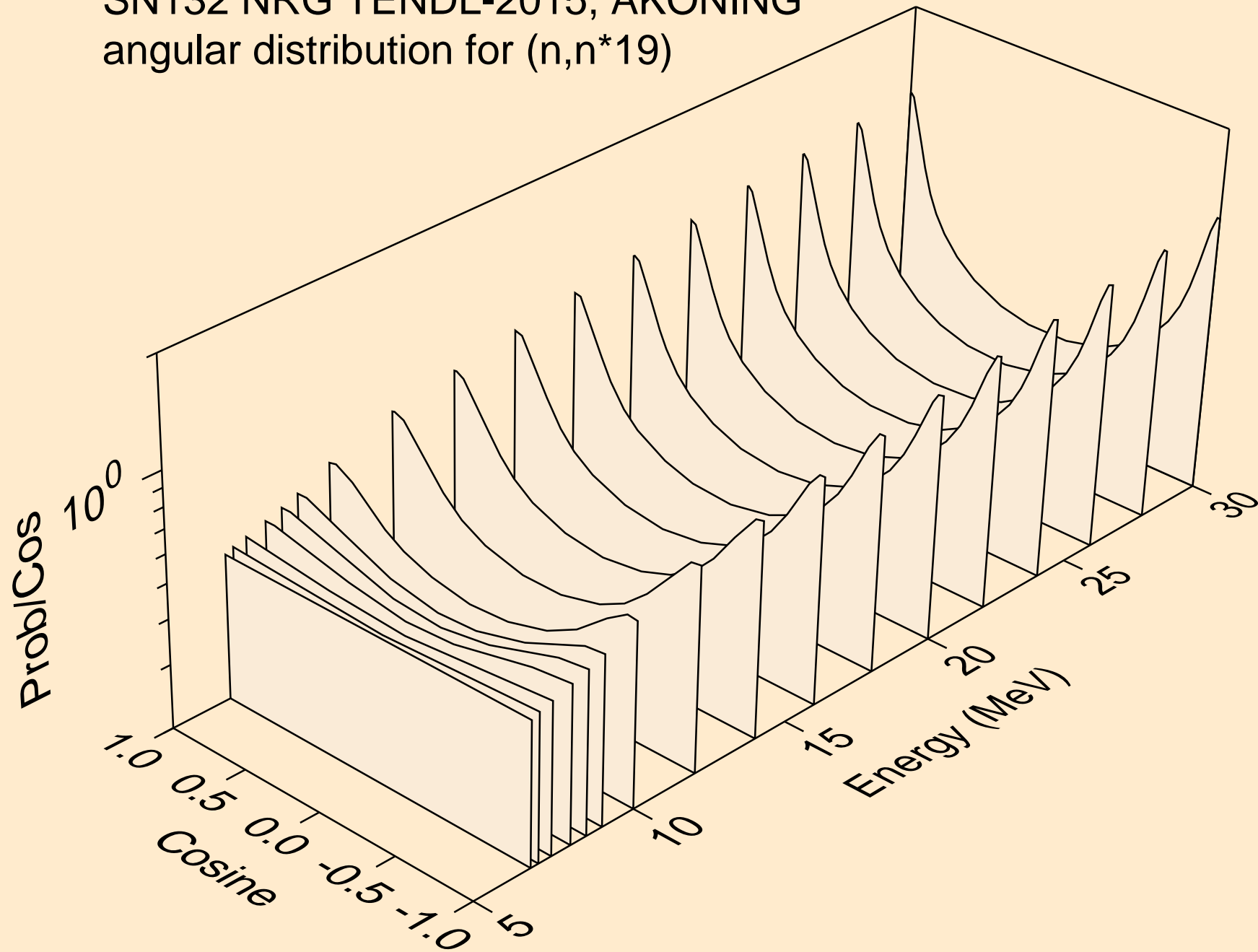

SN132 NRG TENDL-2015, AKONING
angular distribution for (n,n*20)

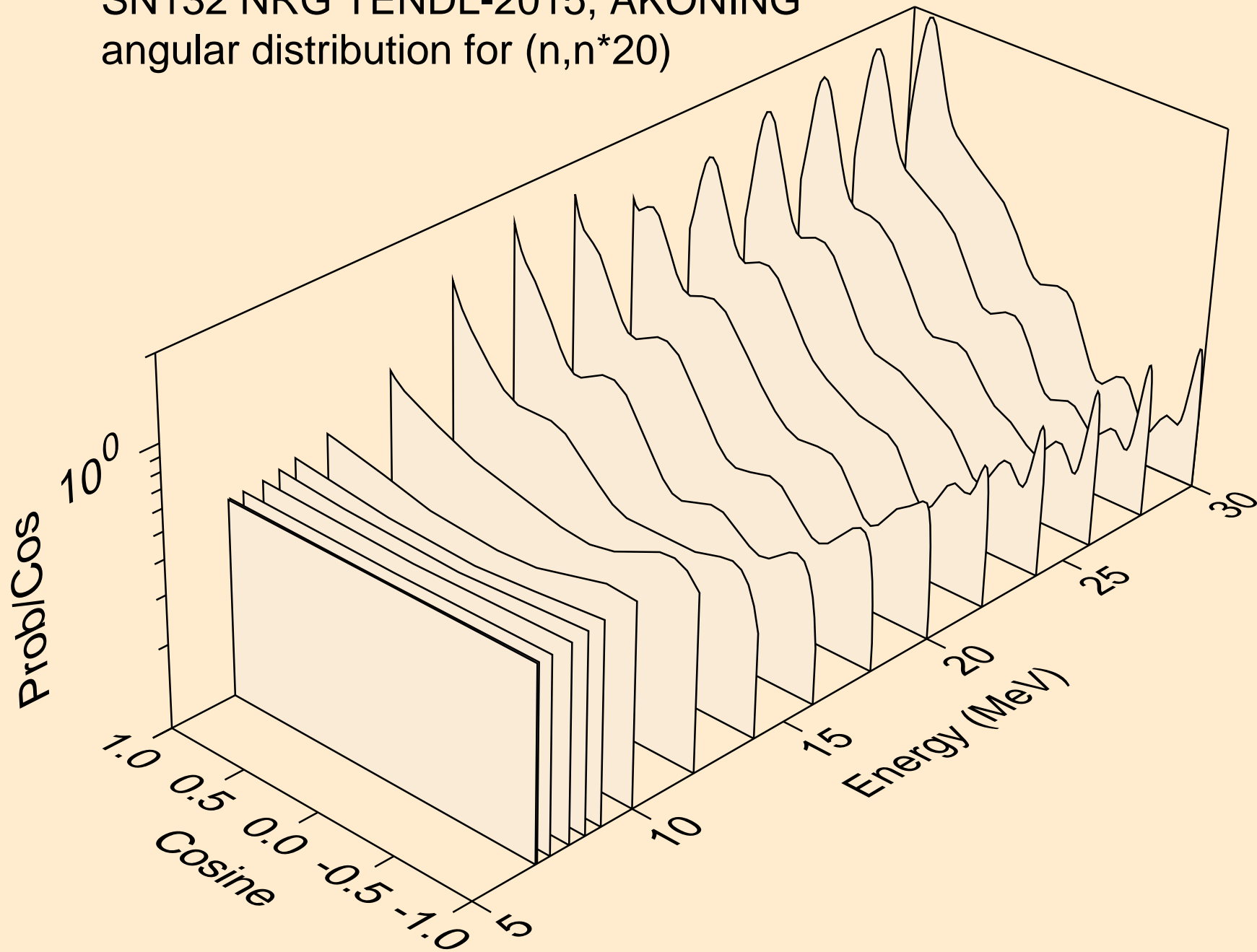

SN132 NRG TENDL-2015, AKONING
angular distribution for (n,n*21)

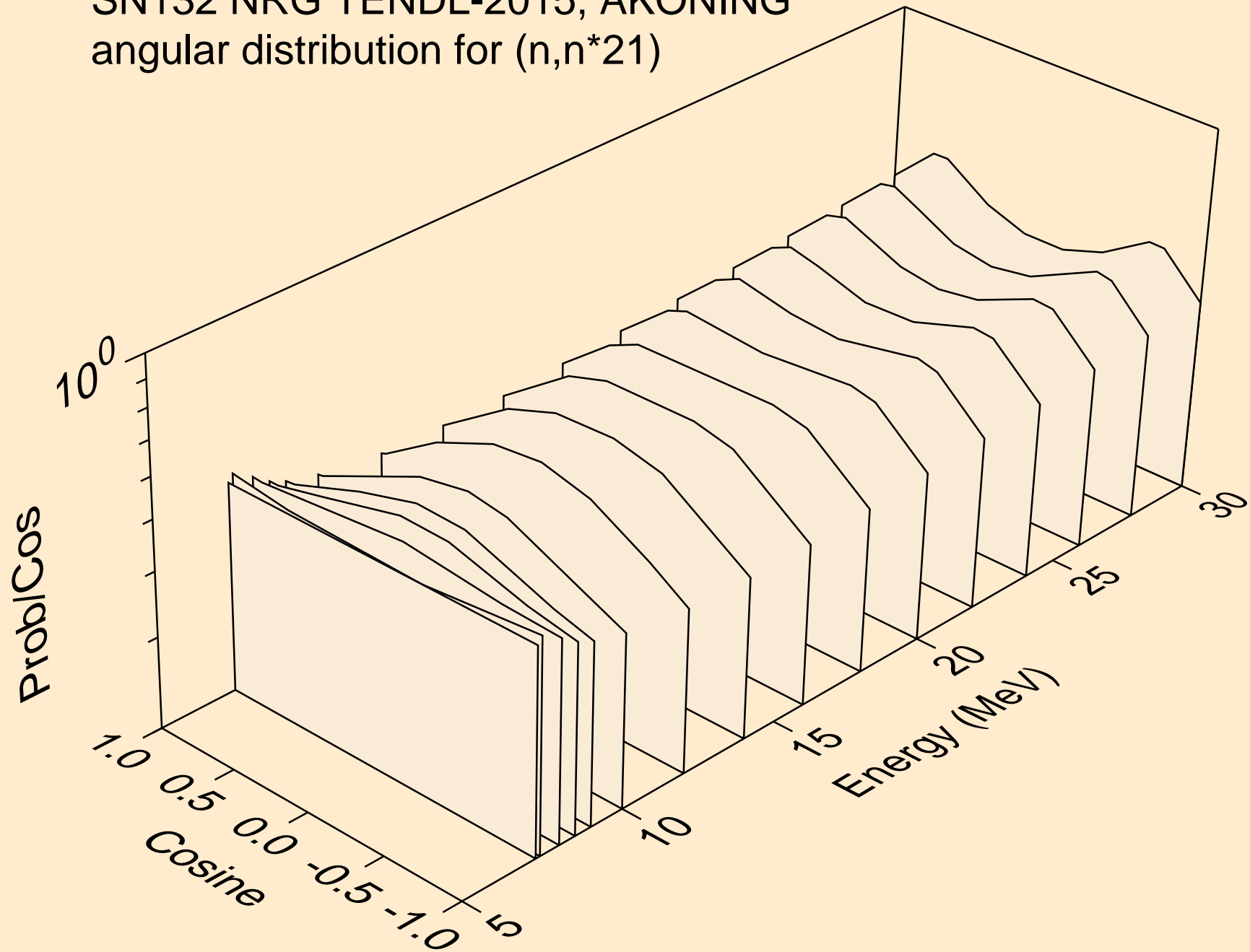

SN132 NRG TENDL-2015, AKONING
angular distribution for (n,n*22)

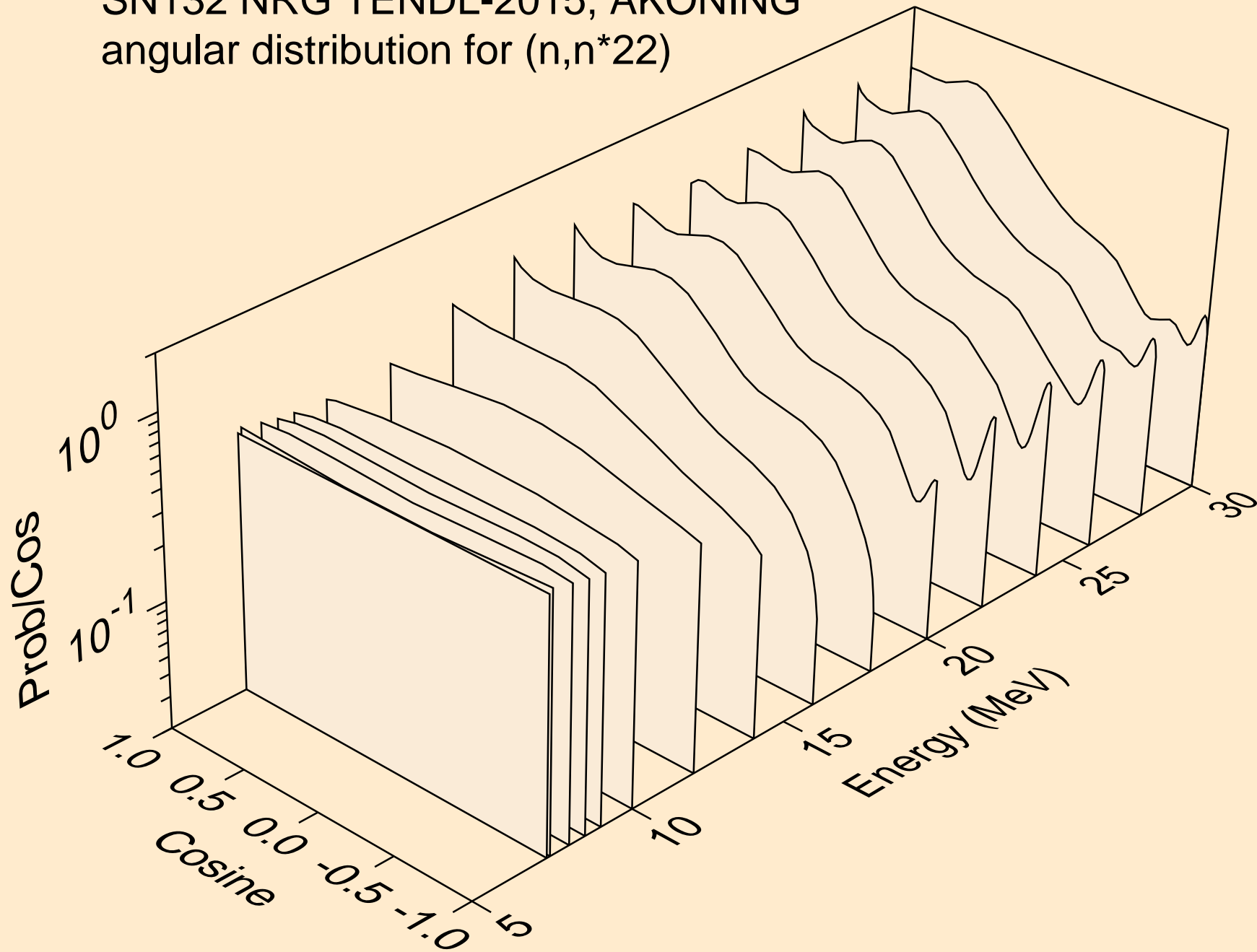

SN132 NRG TENDL-2015, AKONING
angular distribution for (n,n*23)

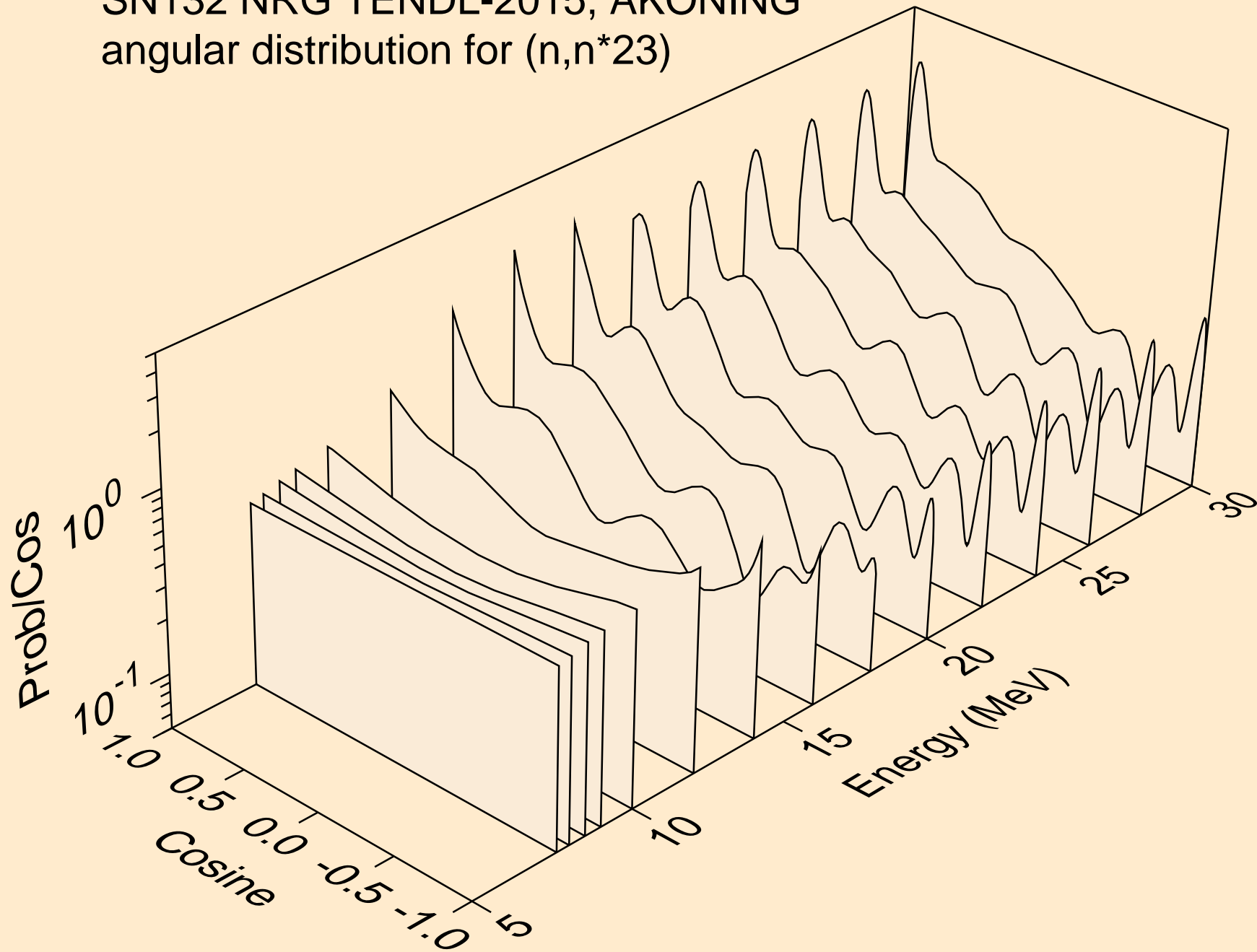

SN132 NRG TENDL-2015, AKONING
angular distribution for (n,n*24)

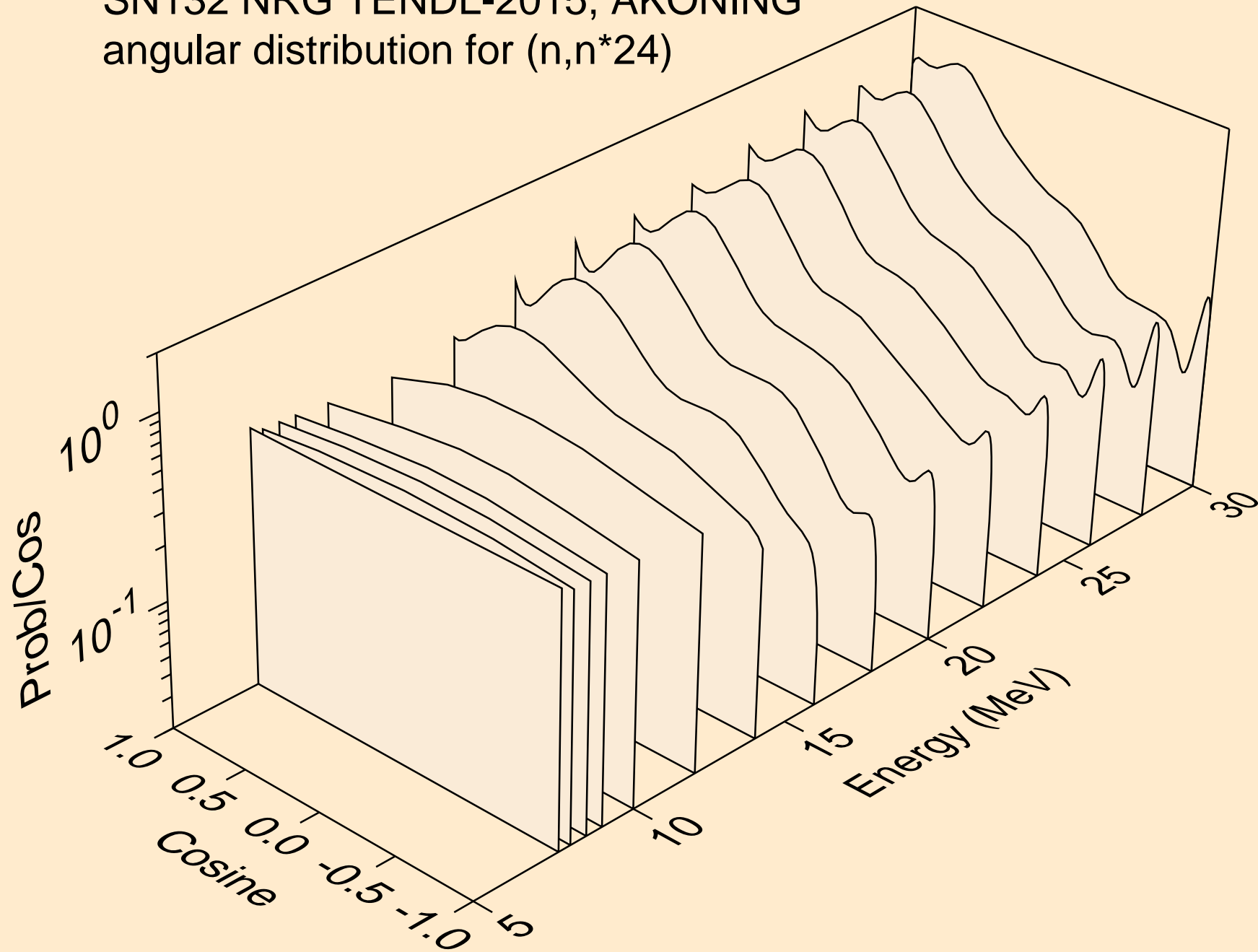

SN132 NRG TENDL-2015, AKONING
angular distribution for (n,n*25)

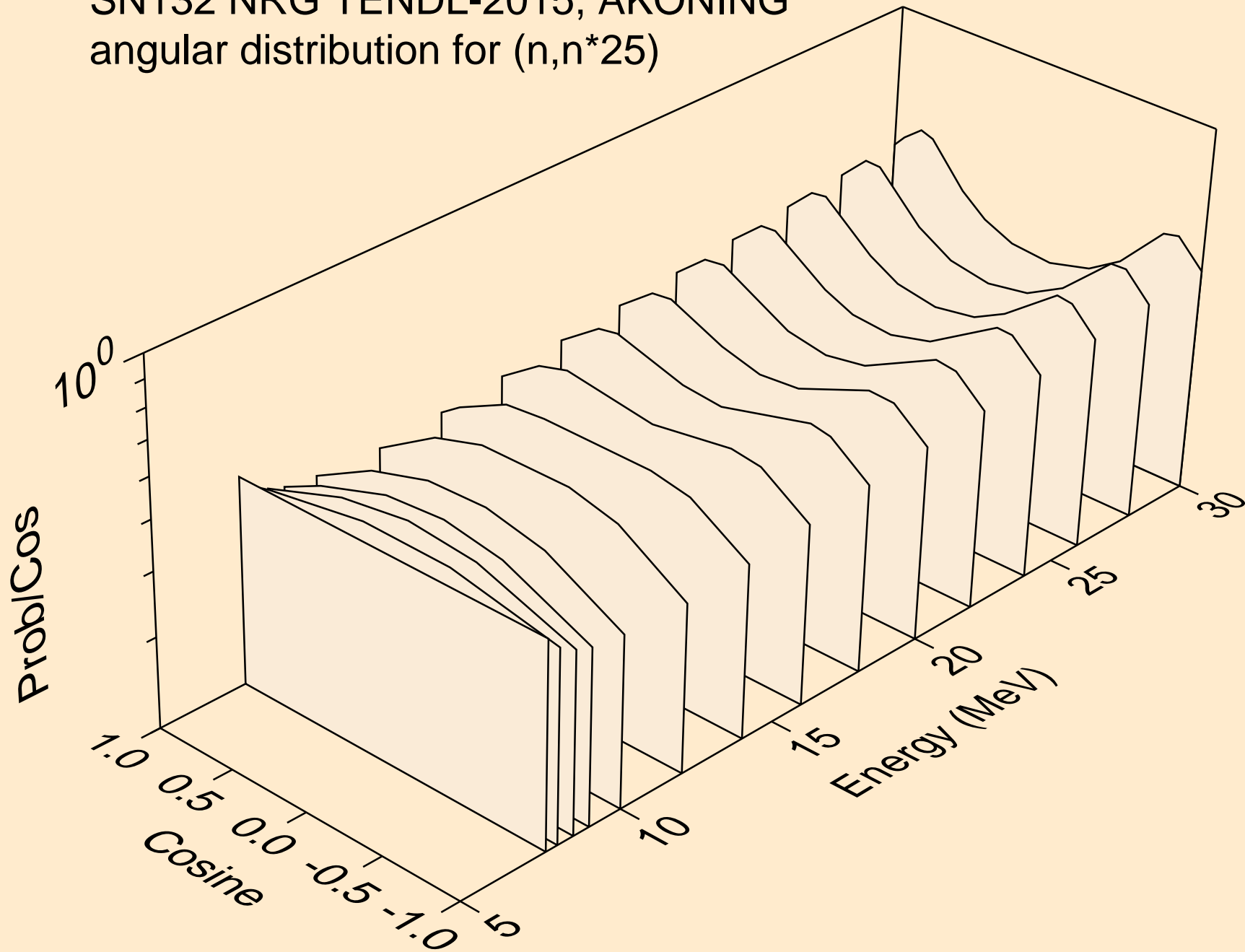

SN132 NRG TENDL-2015, AKONING
angular distribution for (n,n*26)

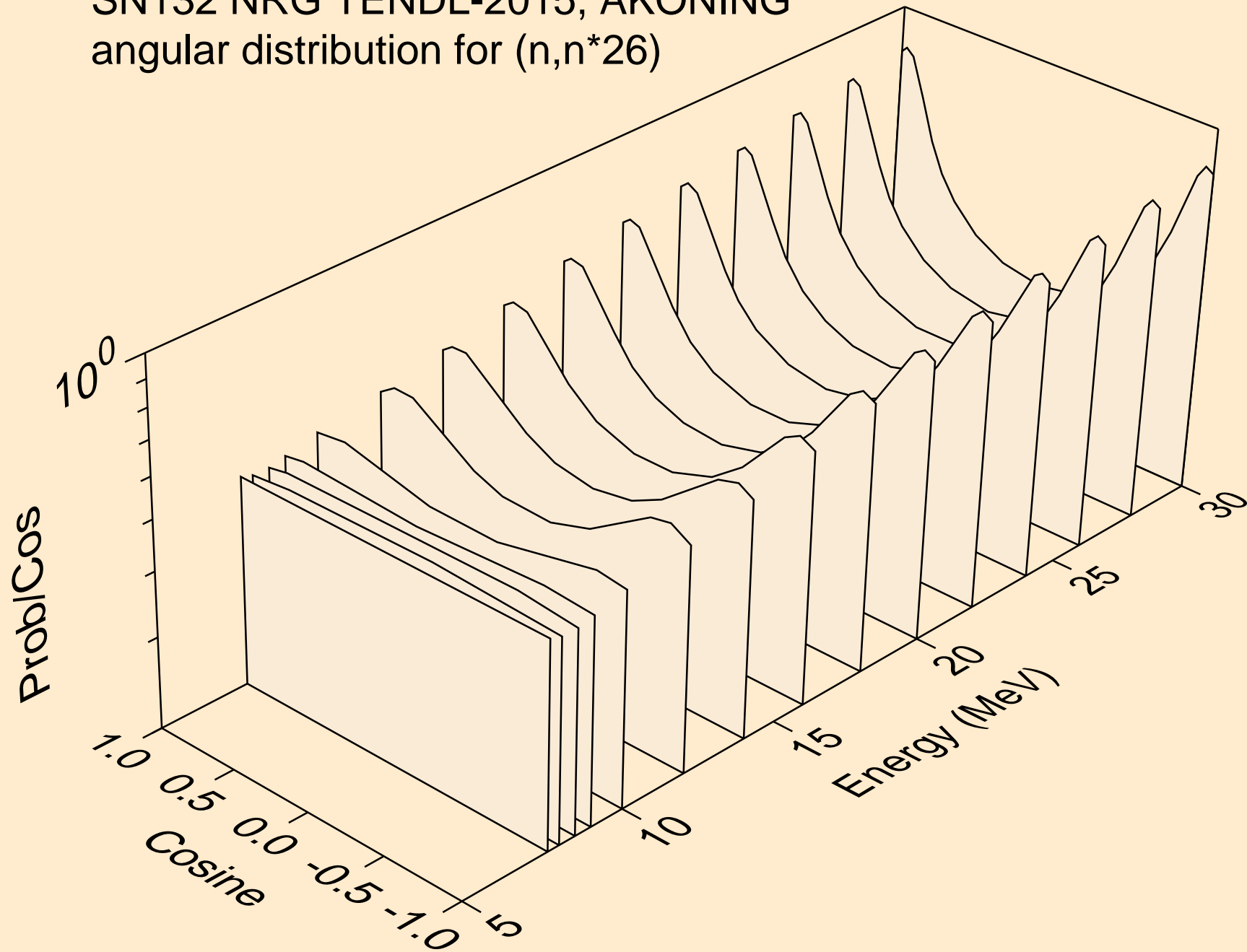

SN132 NRG TENDL-2015, AKONING
angular distribution for (n,n*27)

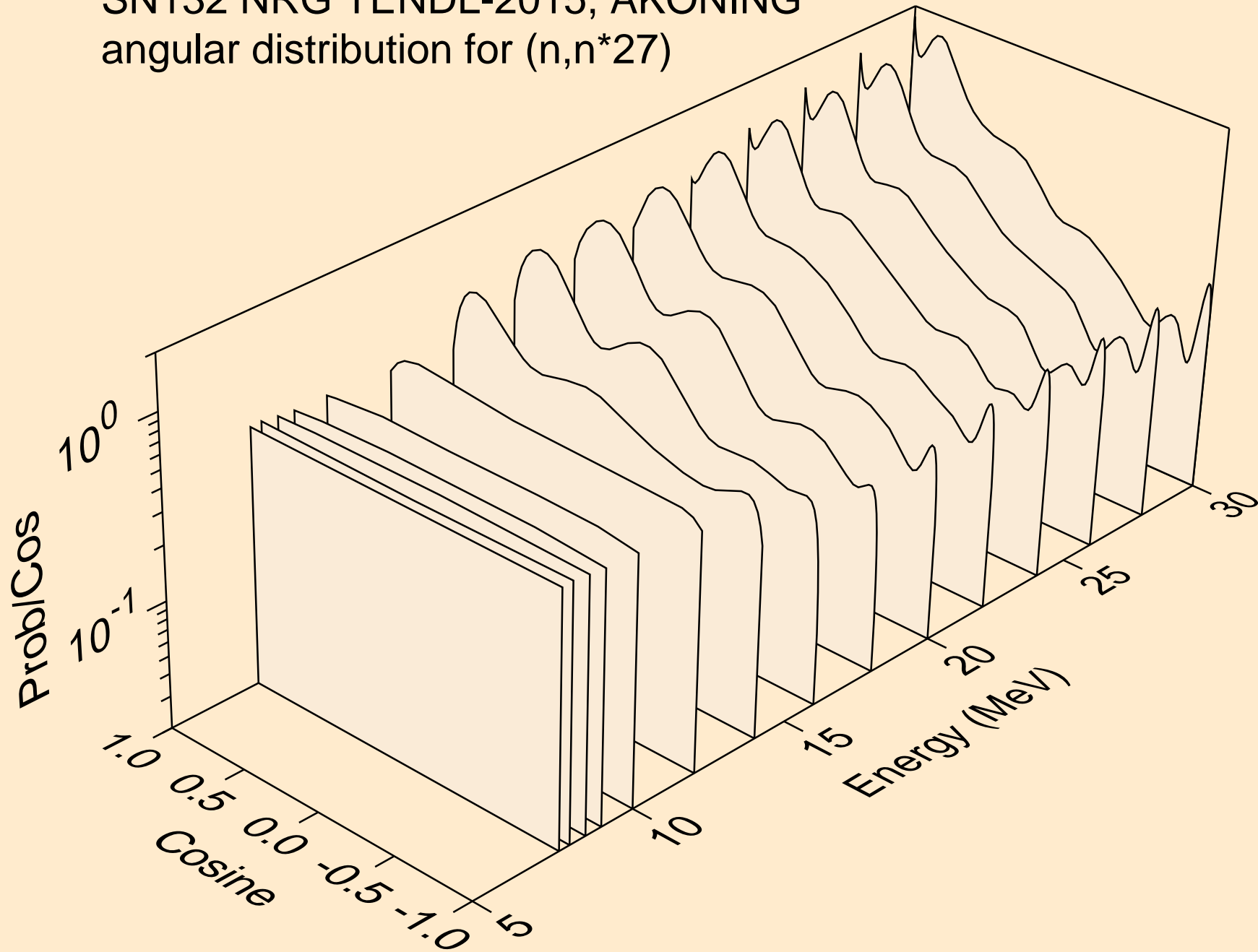

SN132 NRG TENDL-2015, AKONING
angular distribution for (n,n*28)

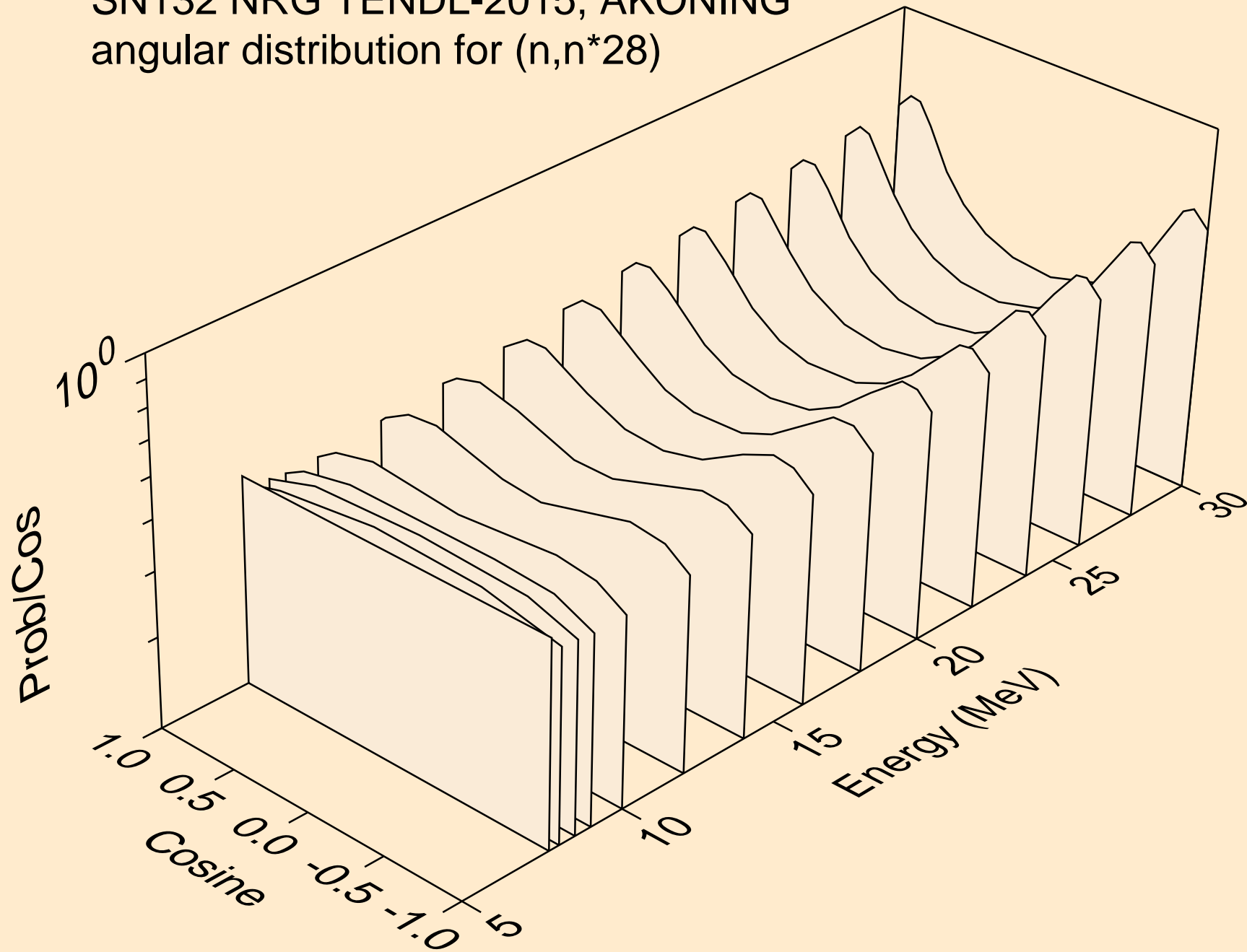

SN132 NRG TENDL-2015, AKONING
angular distribution for (n,n*29)

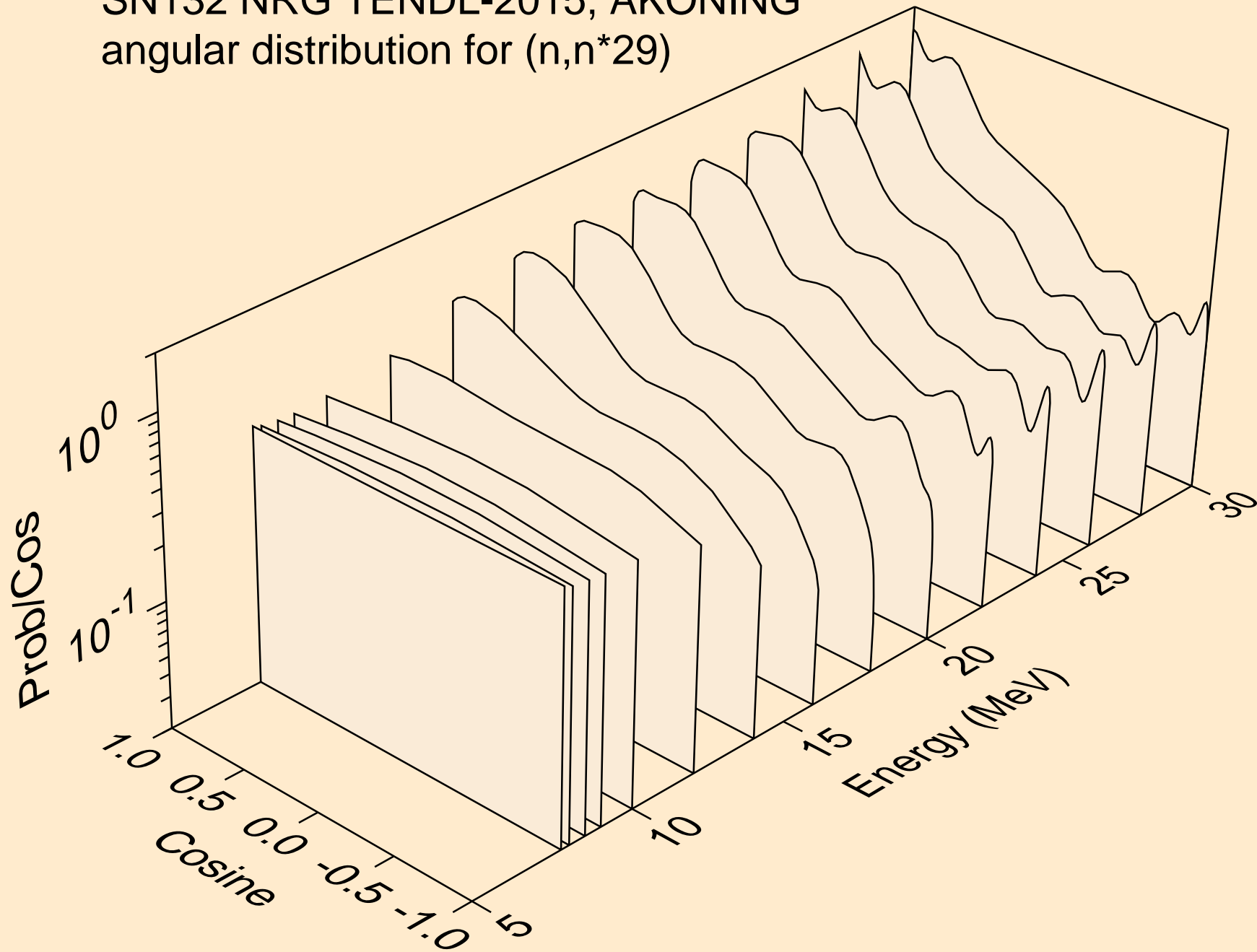

SN132 NRG TENDL-2015, AKONING
angular distribution for (n,n*30)

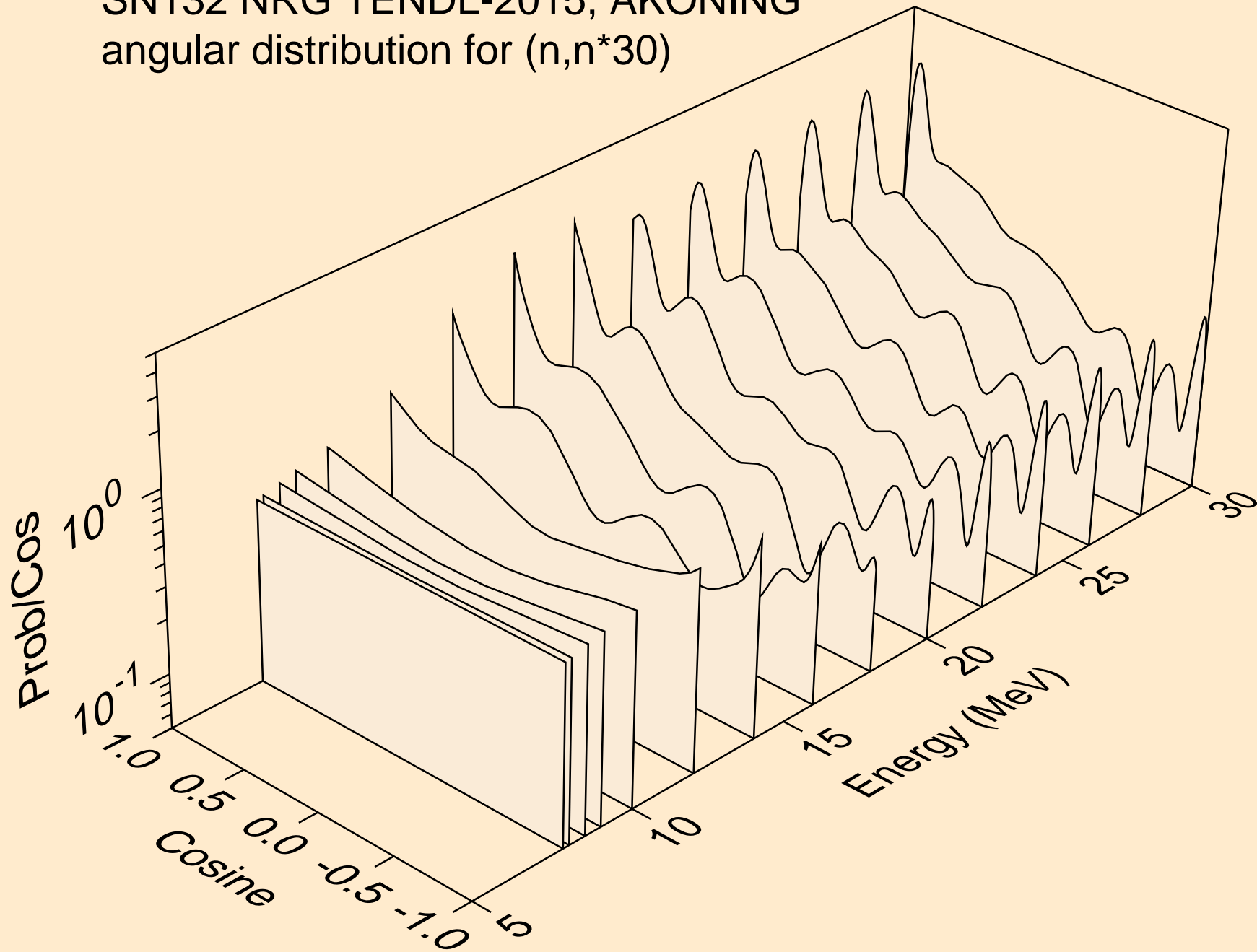

SN132 NRG TENDL-2015, AKONING
Neutron emission for (n,x)

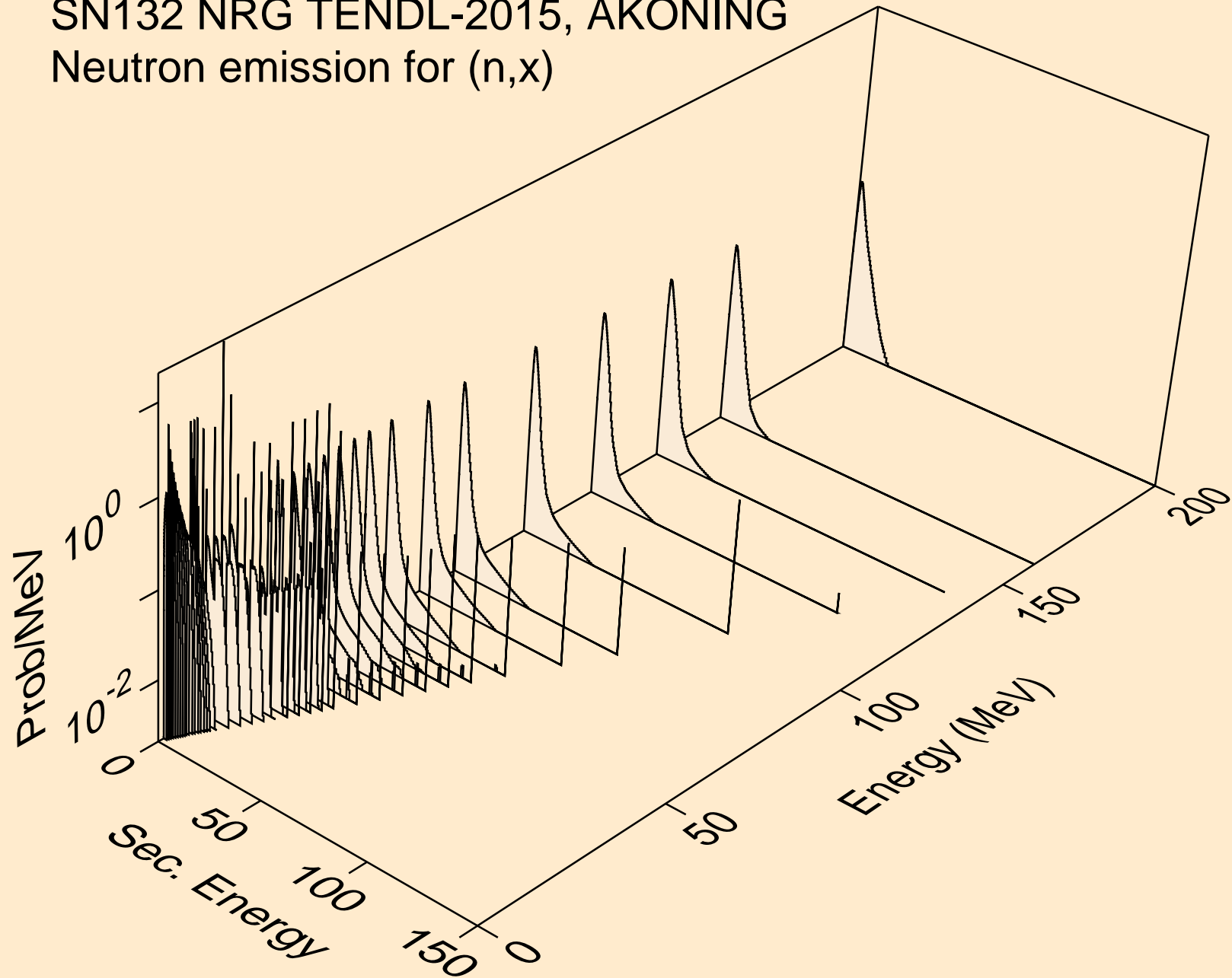

SN132 NRG TENDL-2015, AKONING
Neutron emission for (n,2nd)

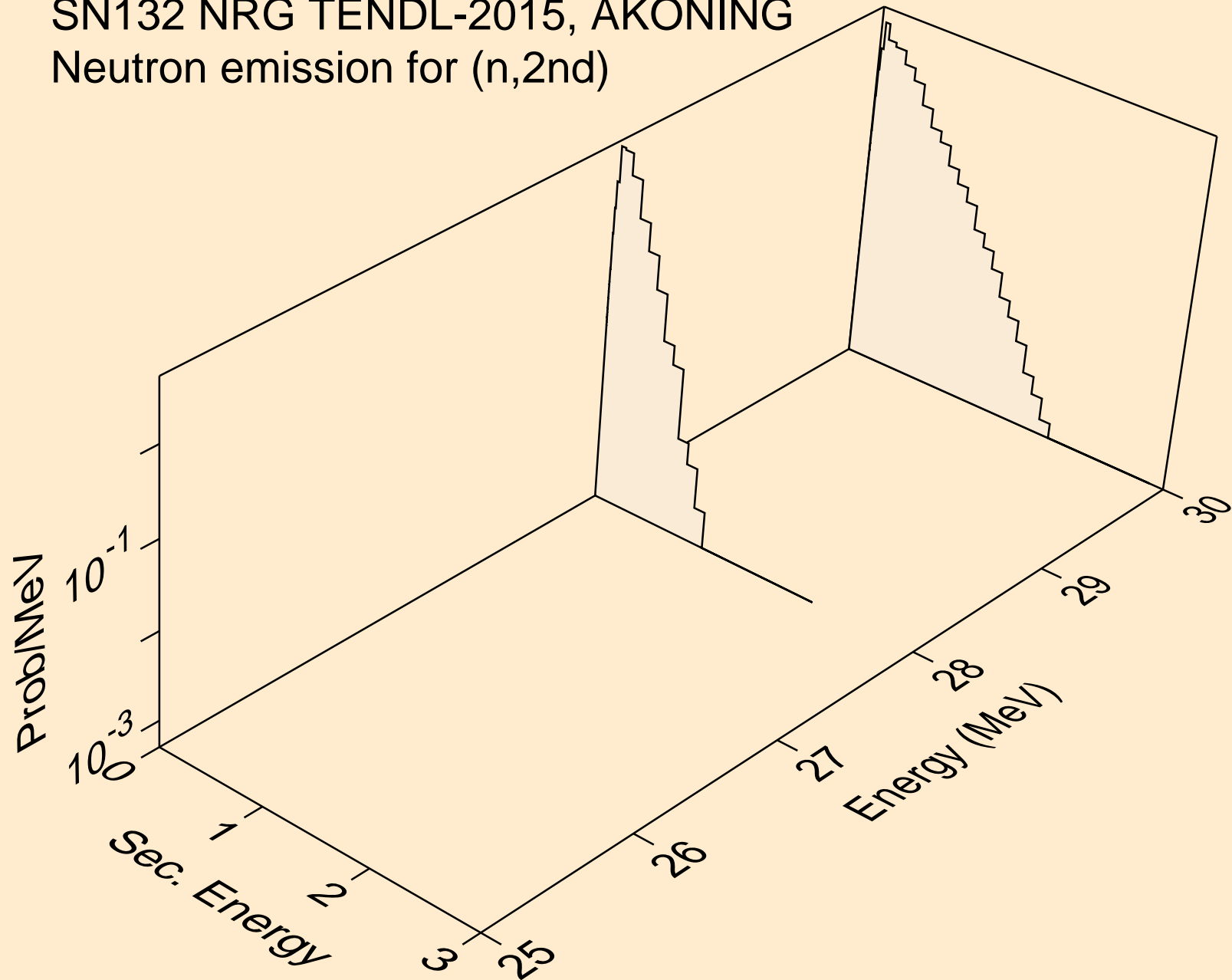

SN132 NRG TENDL-2015, AKONING
Neutron emission for (n,2n)

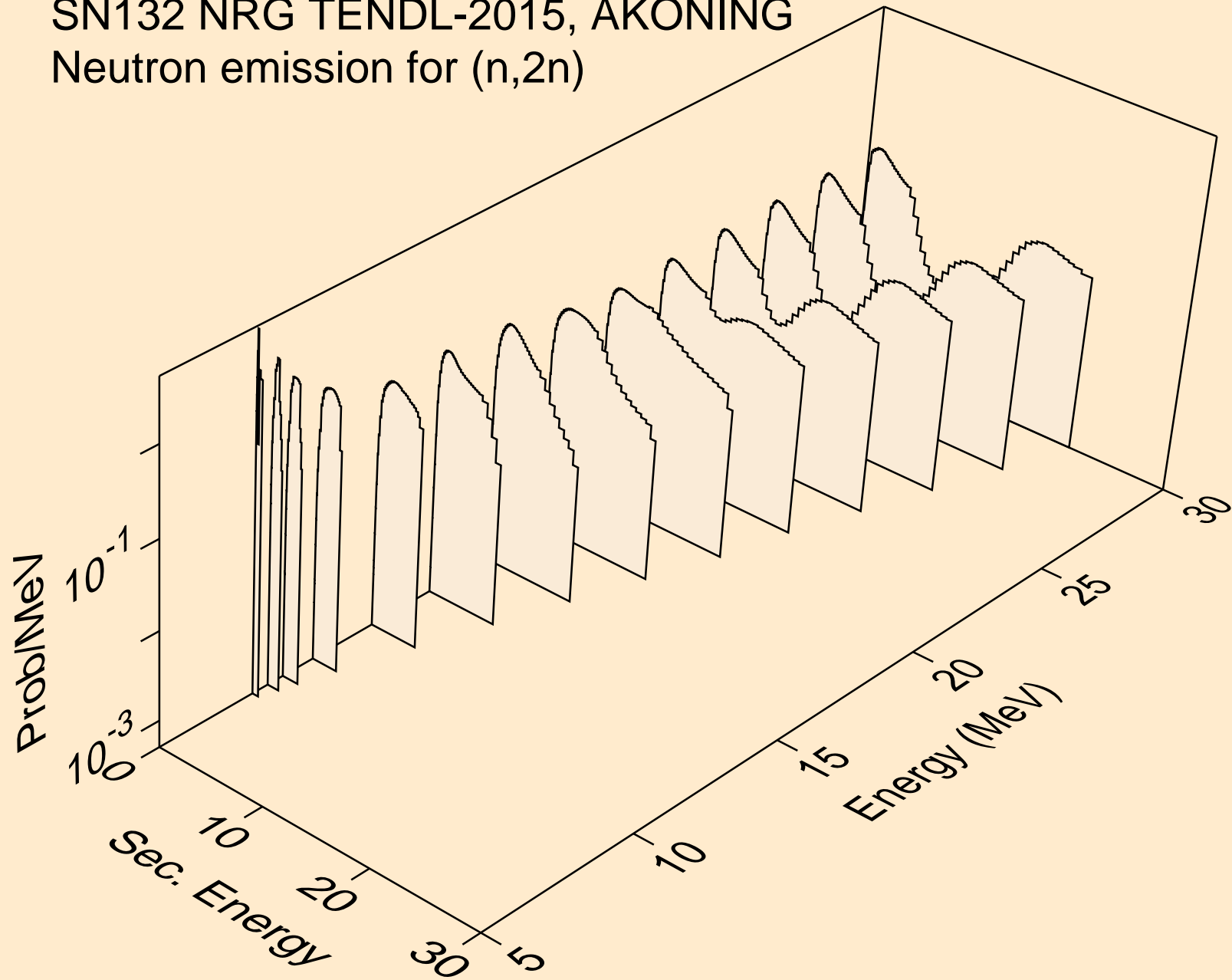

SN132 NRG TENDL-2015, AKONING
Neutron emission for (n,3n)

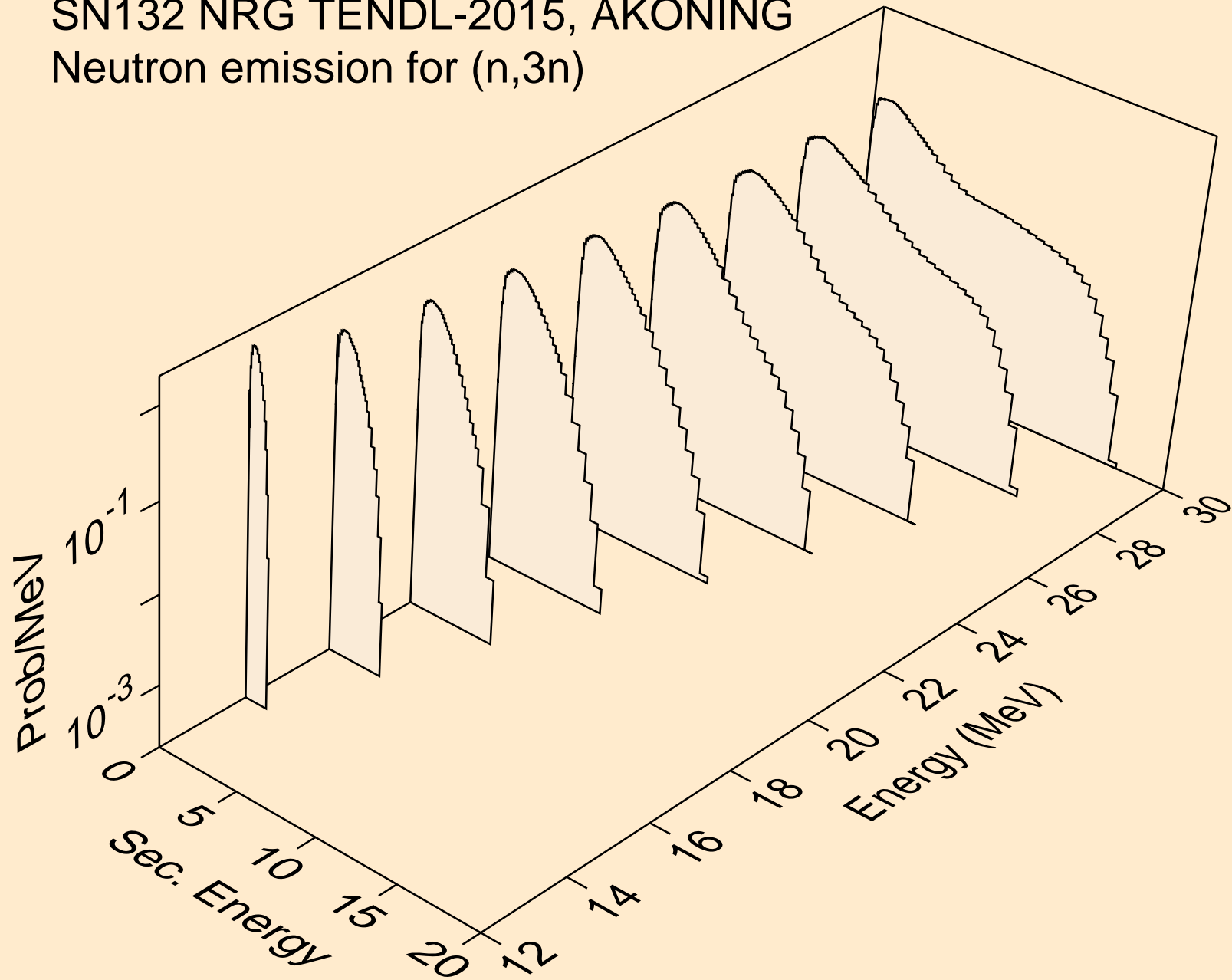

SN132 NRG TENDL-2015, AKONING
Neutron emission for (n,n*)a

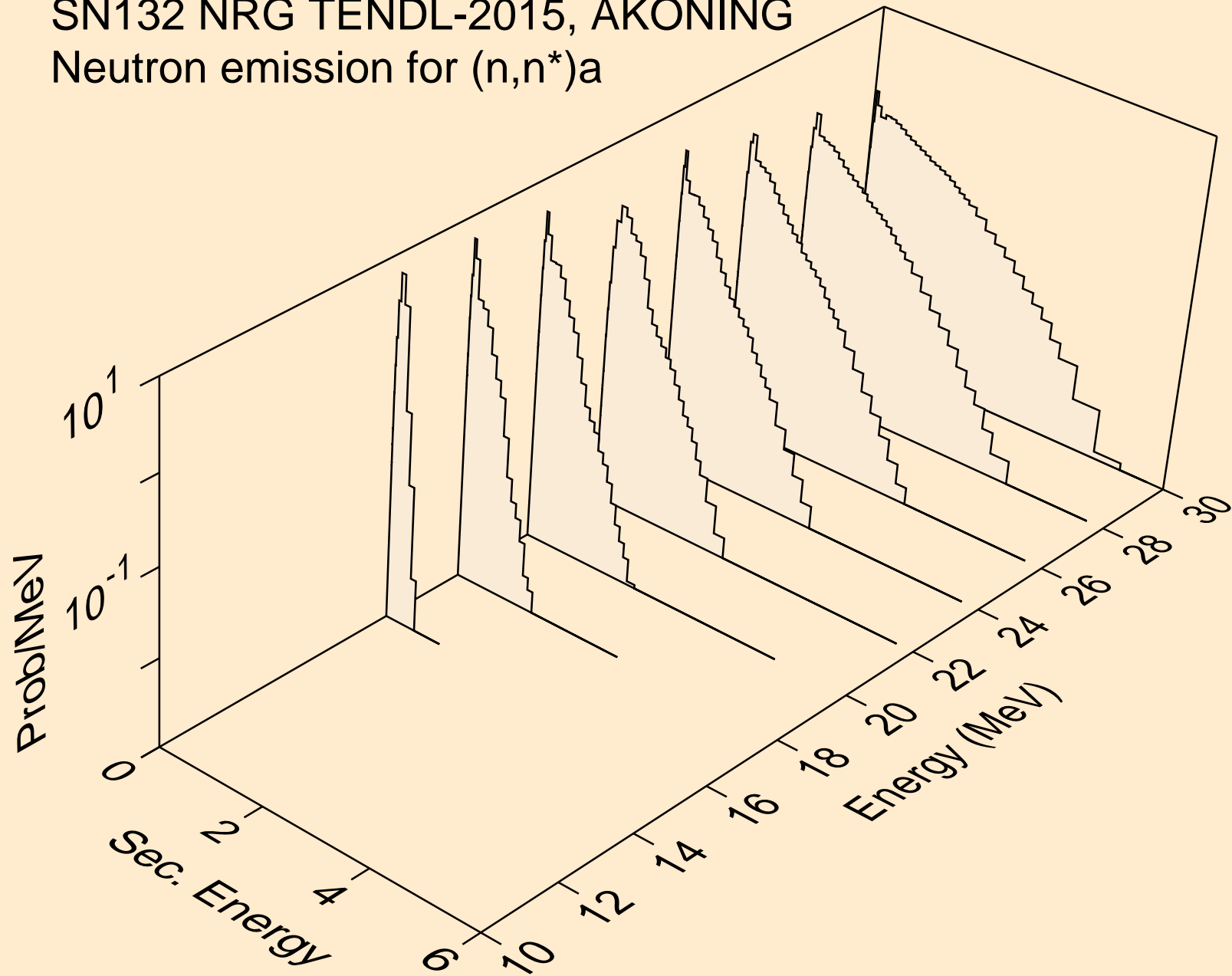

SN132 NRG TENDL-2015, AKONING
Neutron emission for (n,2n)a

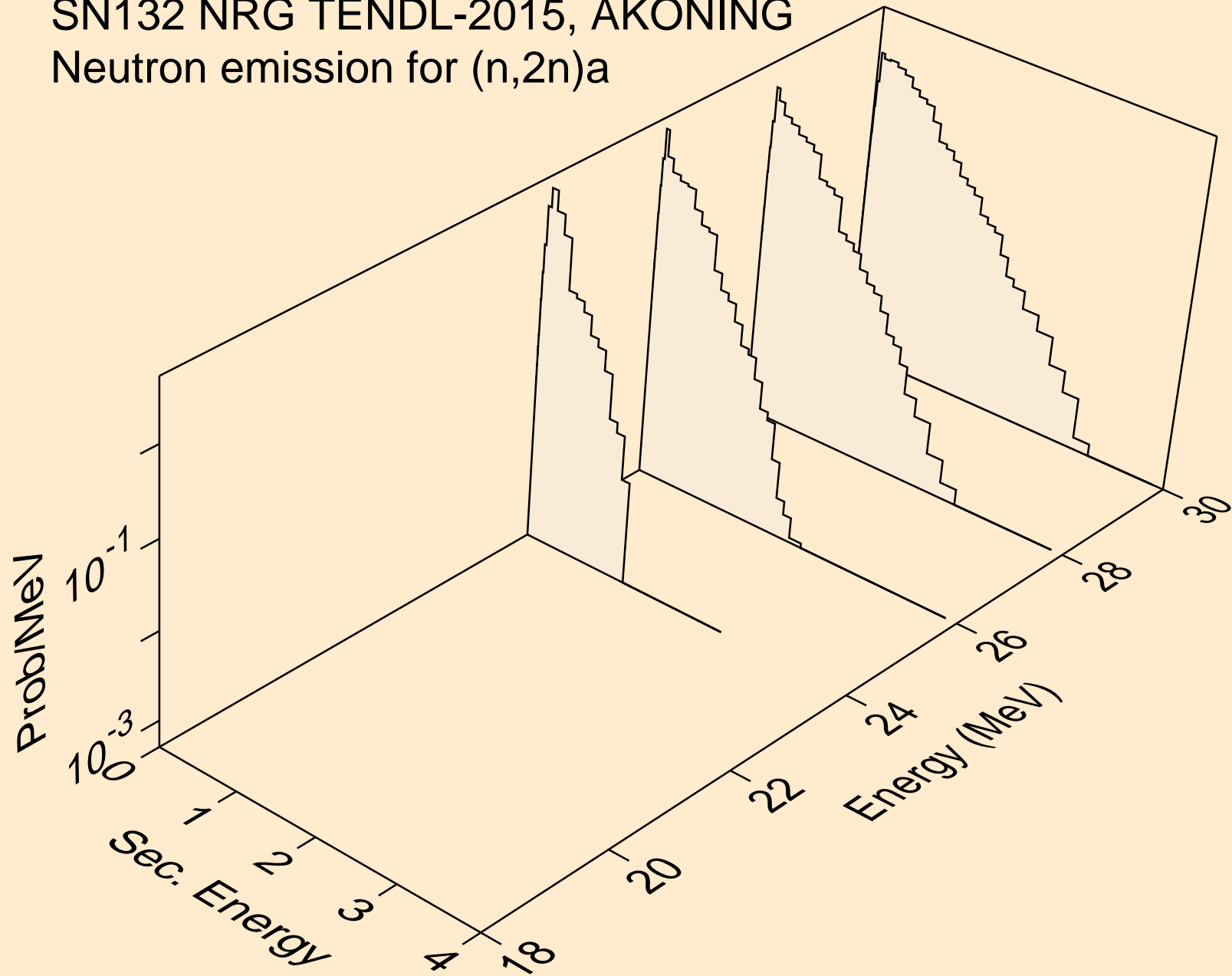

SN132 NRG TENDL-2015, AKONING
Neutron emission for (n,n*)p

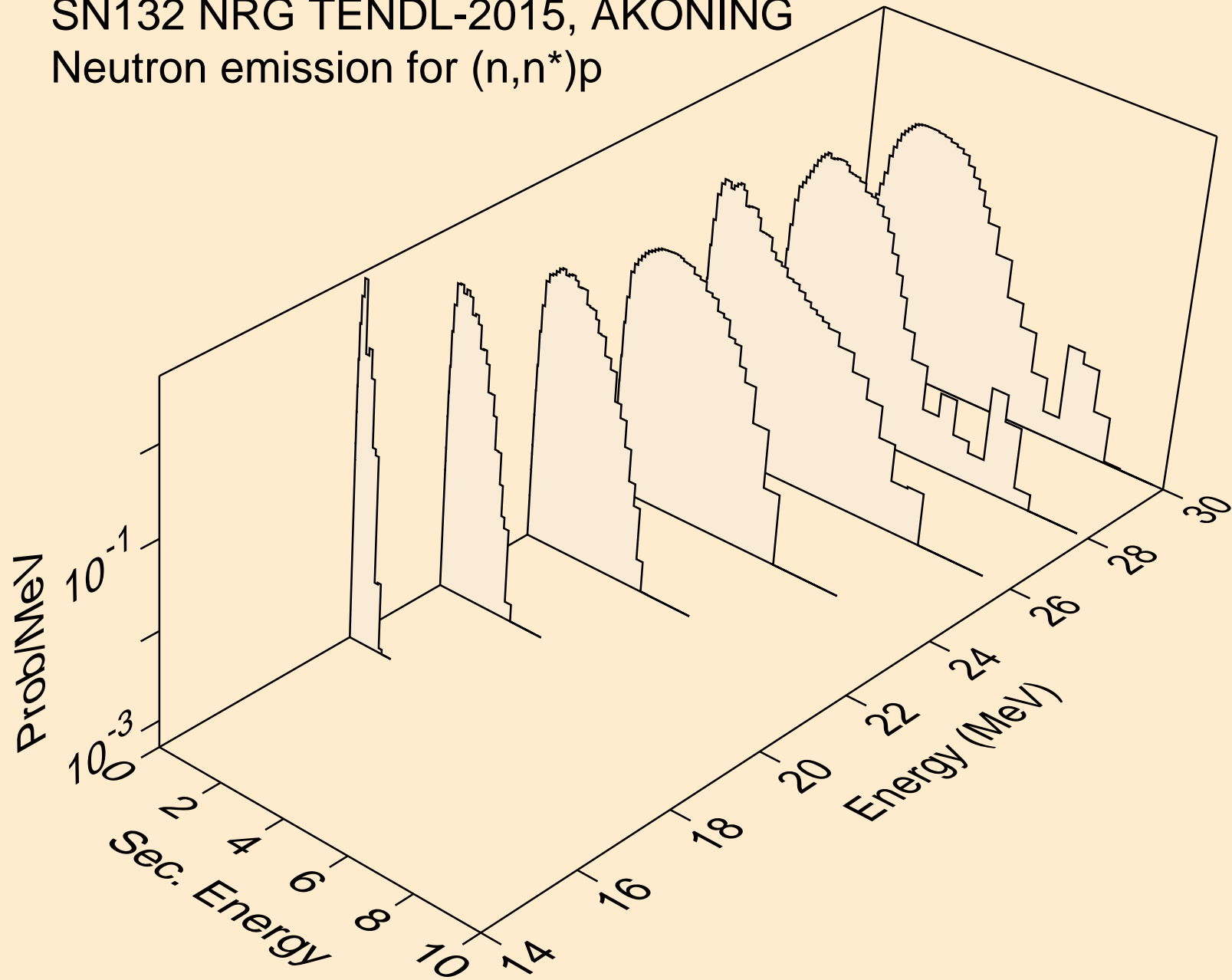

SN132 NRG TENDL-2015, AKONING
Neutron emission for (n,n*)d

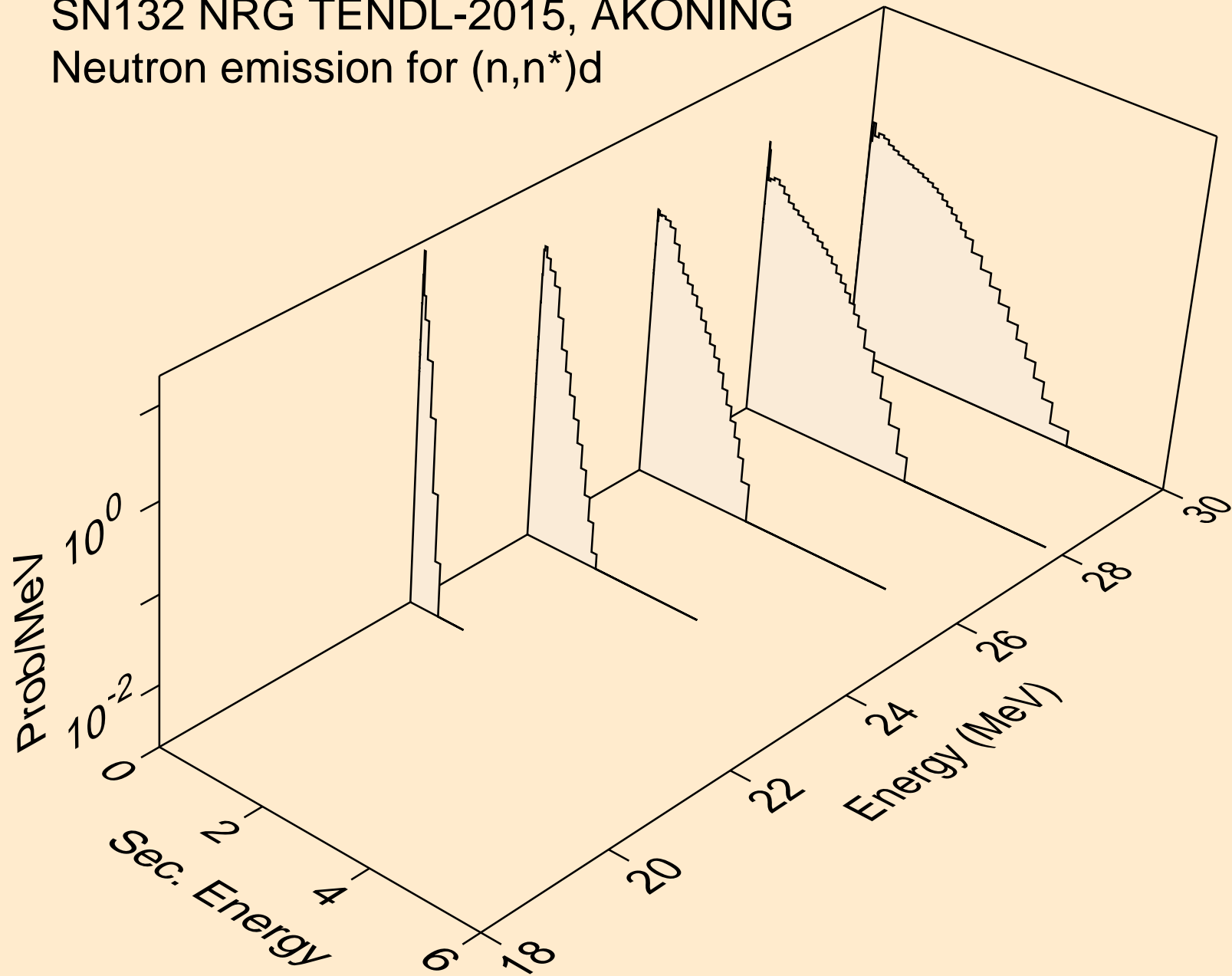

SN132 NRG TENDL-2015, AKONING
Neutron emission for (n,n*)t

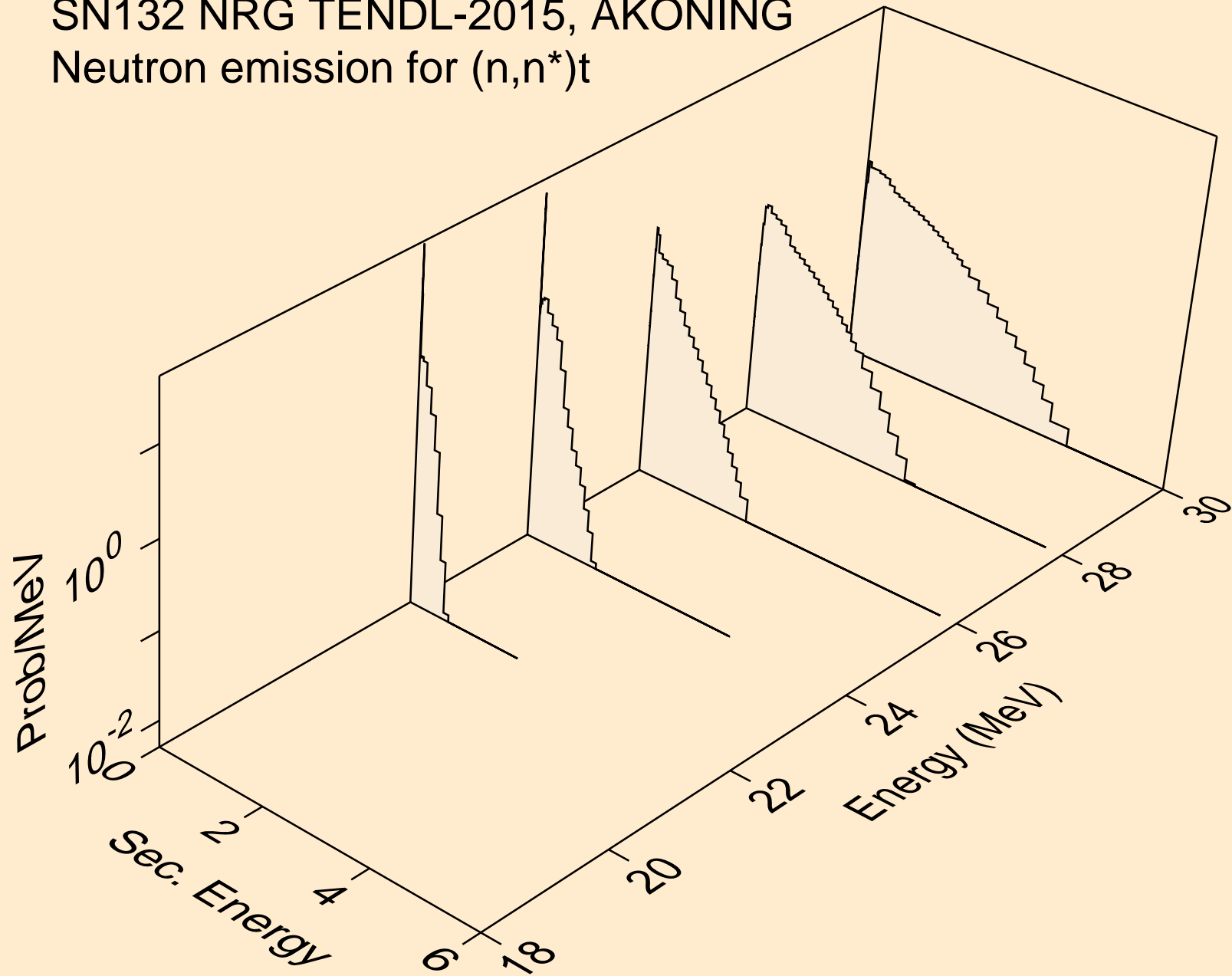

SN132 NRG TENDL-2015, AKONING
Neutron emission for (n,4n)

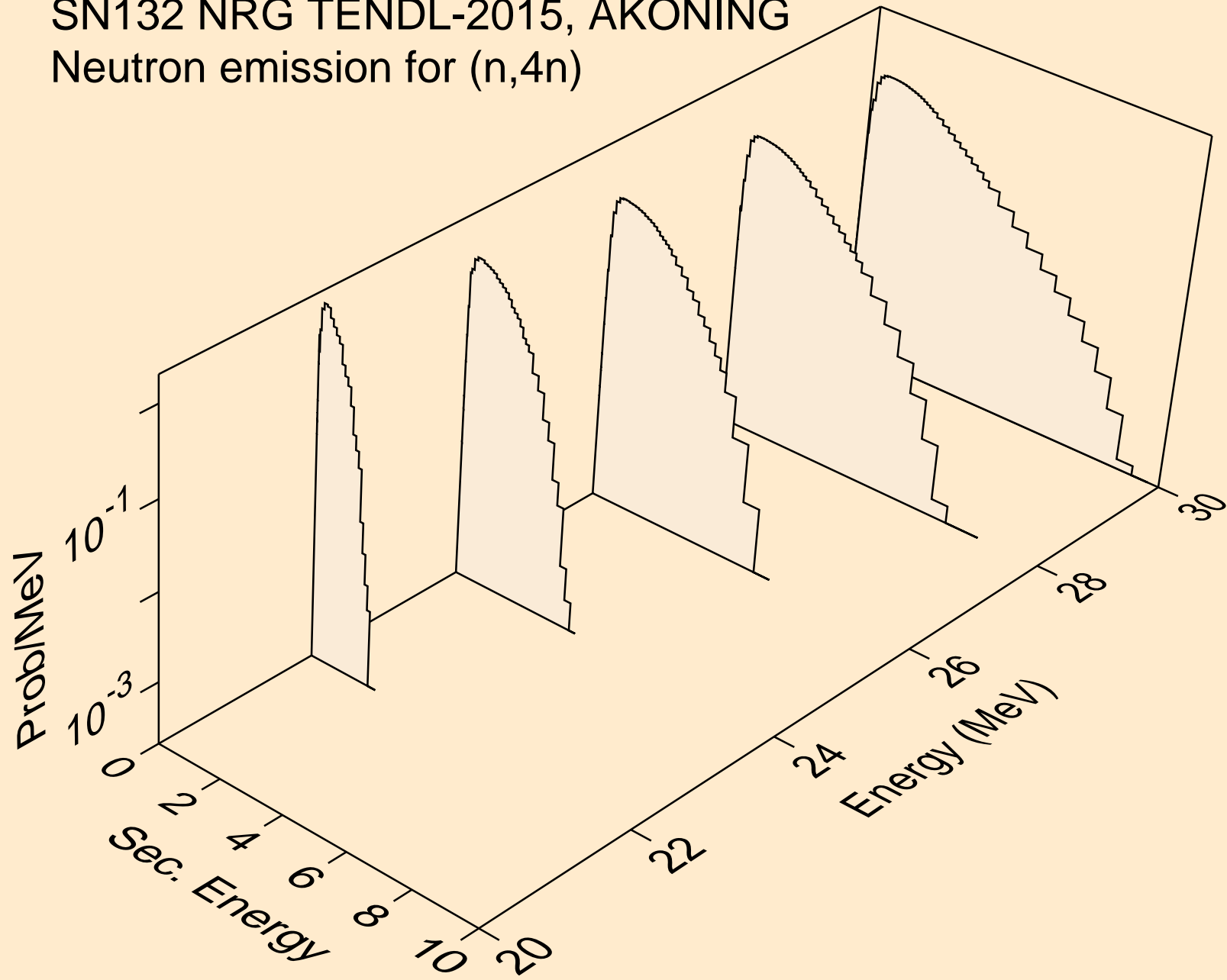

SN132 NRG TENDL-2015, AKONING
Neutron emission for (n,2np)

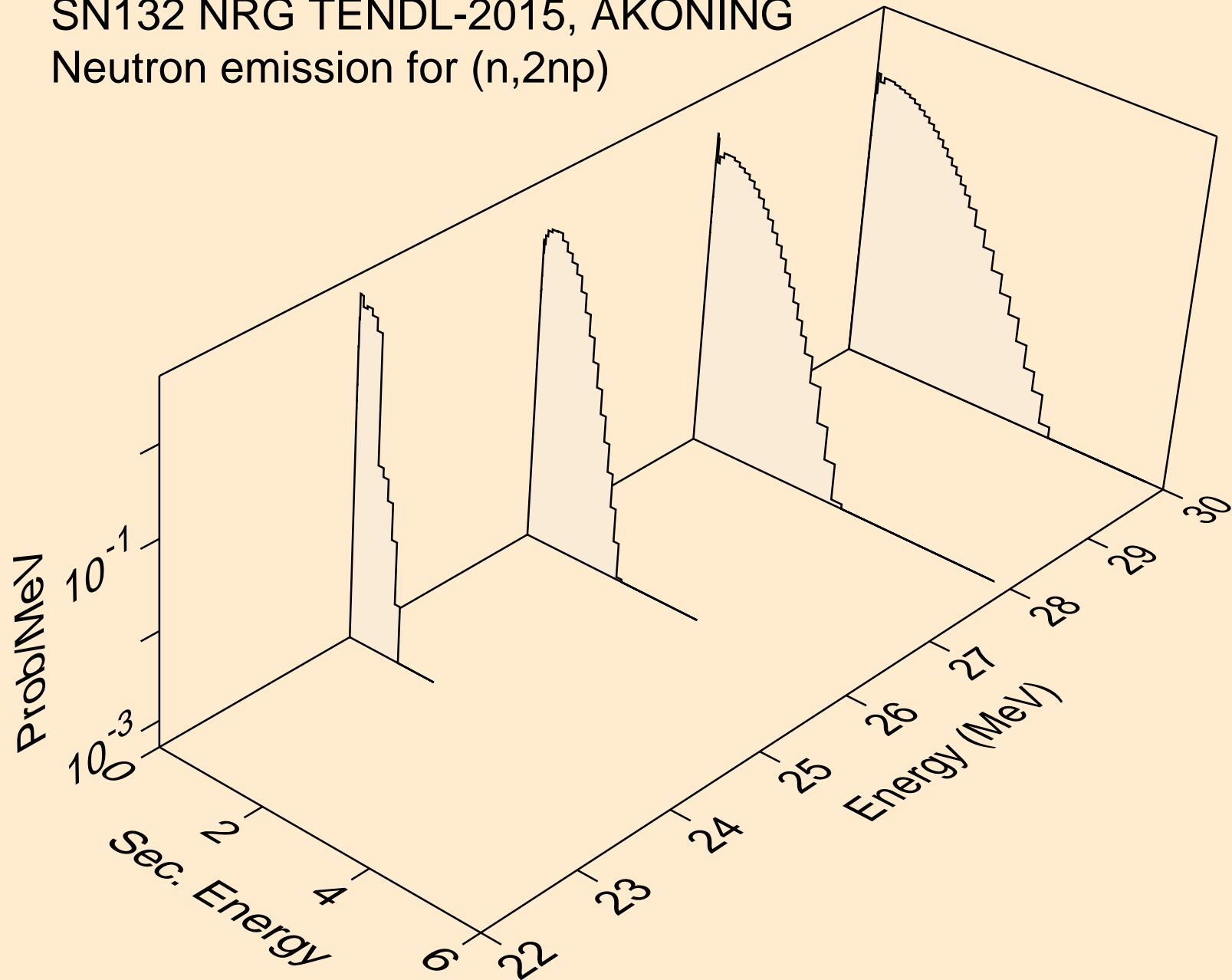

SN132 NRG TENDL-2015, AKONING
Neutron emission for (n,n*c)

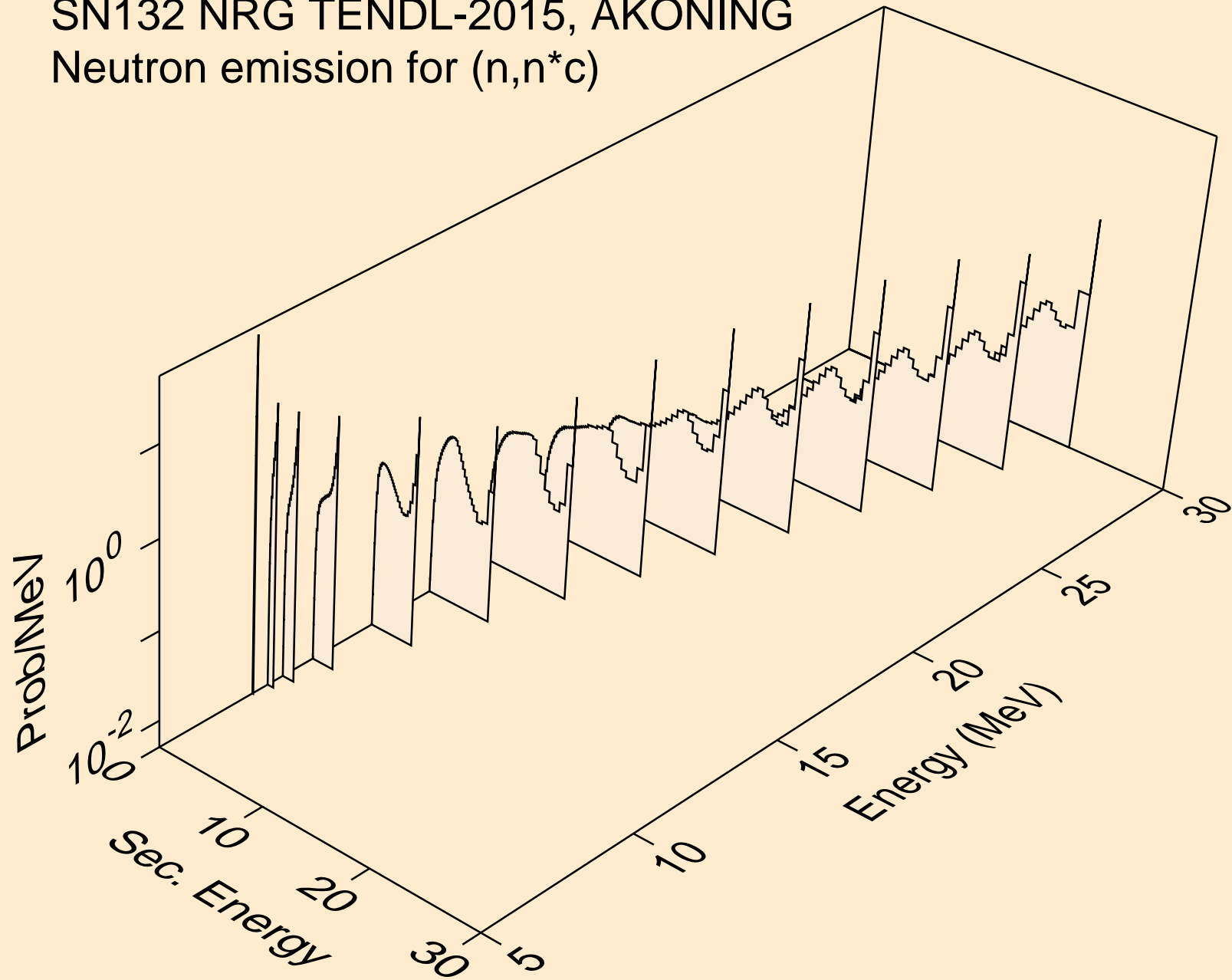

SN132 NRG TENDL-2015, AKONING
Photon emission for (n,x)

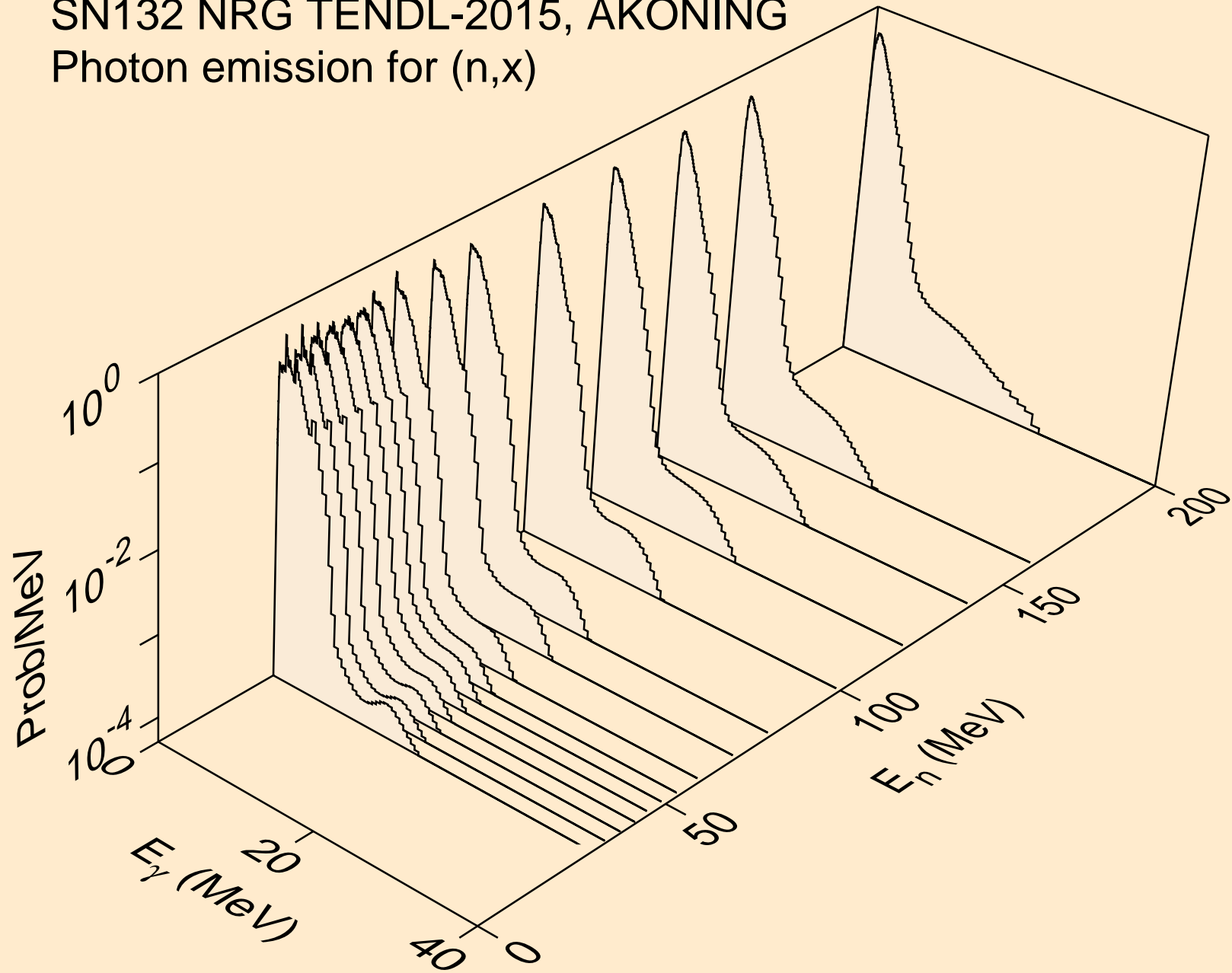

SN132 NRG TENDL-2015, AKONING
Photon emission for (n,2nd)

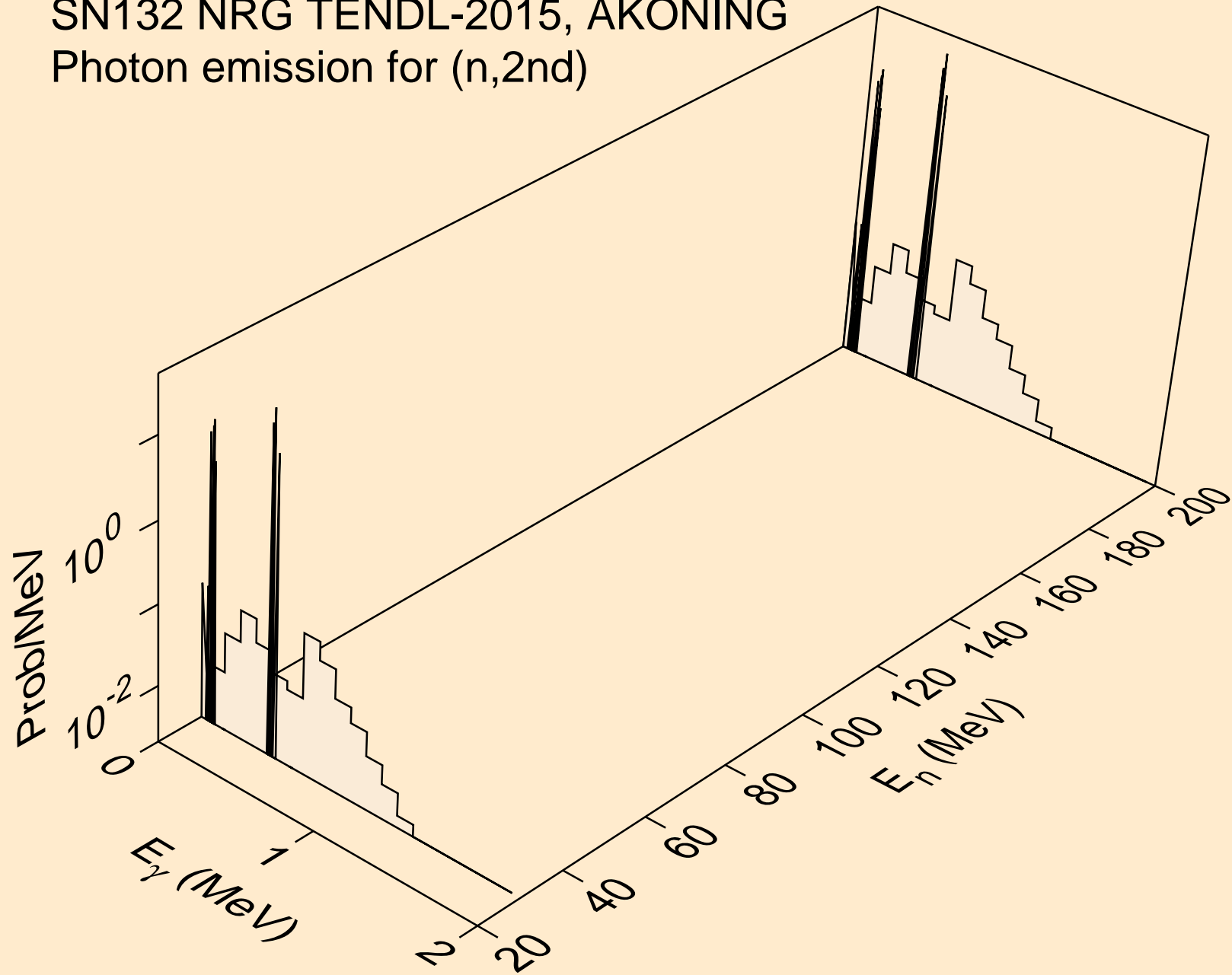

SN132 NRG TENDL-2015, AKONING
Photon emission for (n,2n)

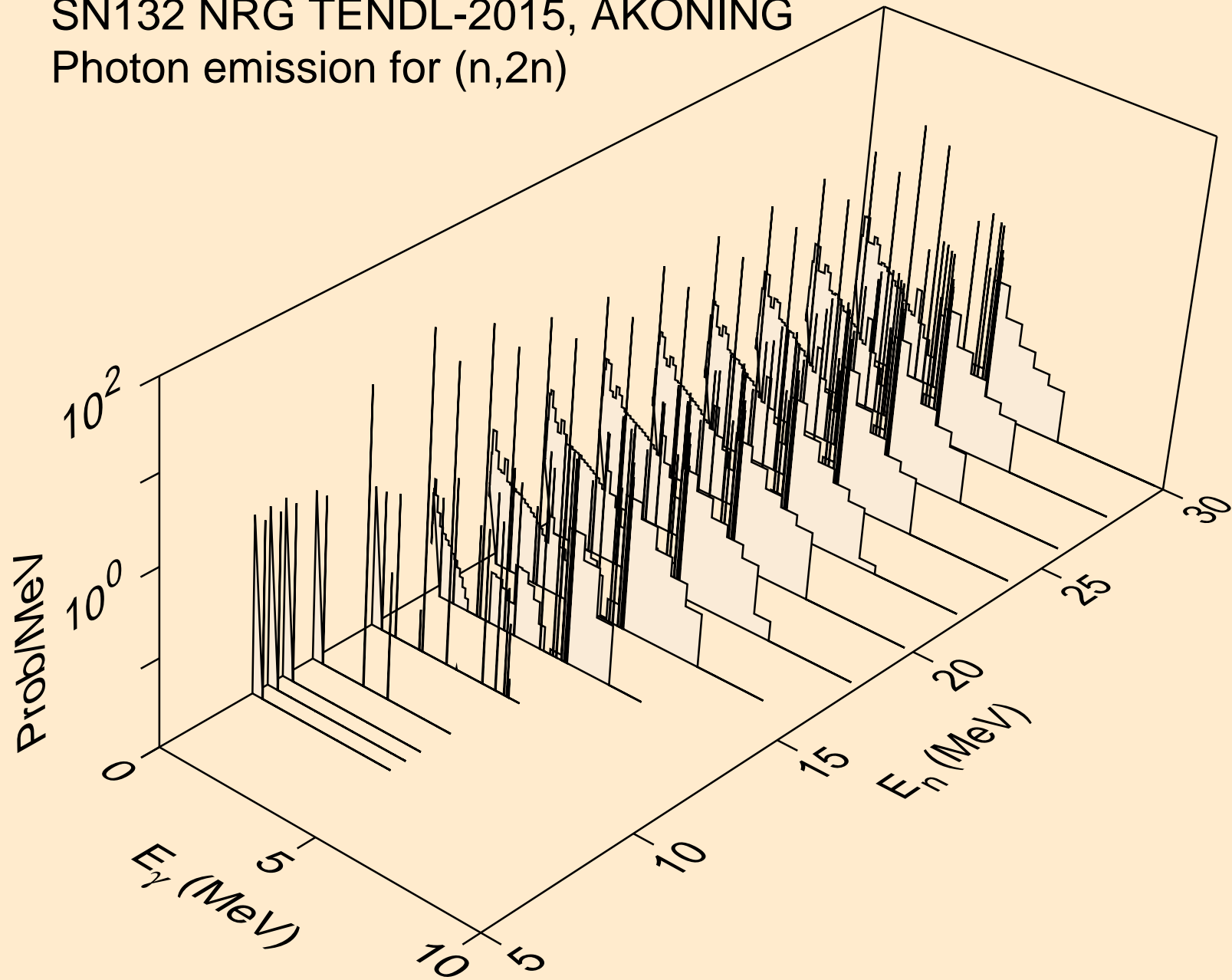

SN132 NRG TENDL-2015, AKONING
Photon emission for (n,3n)

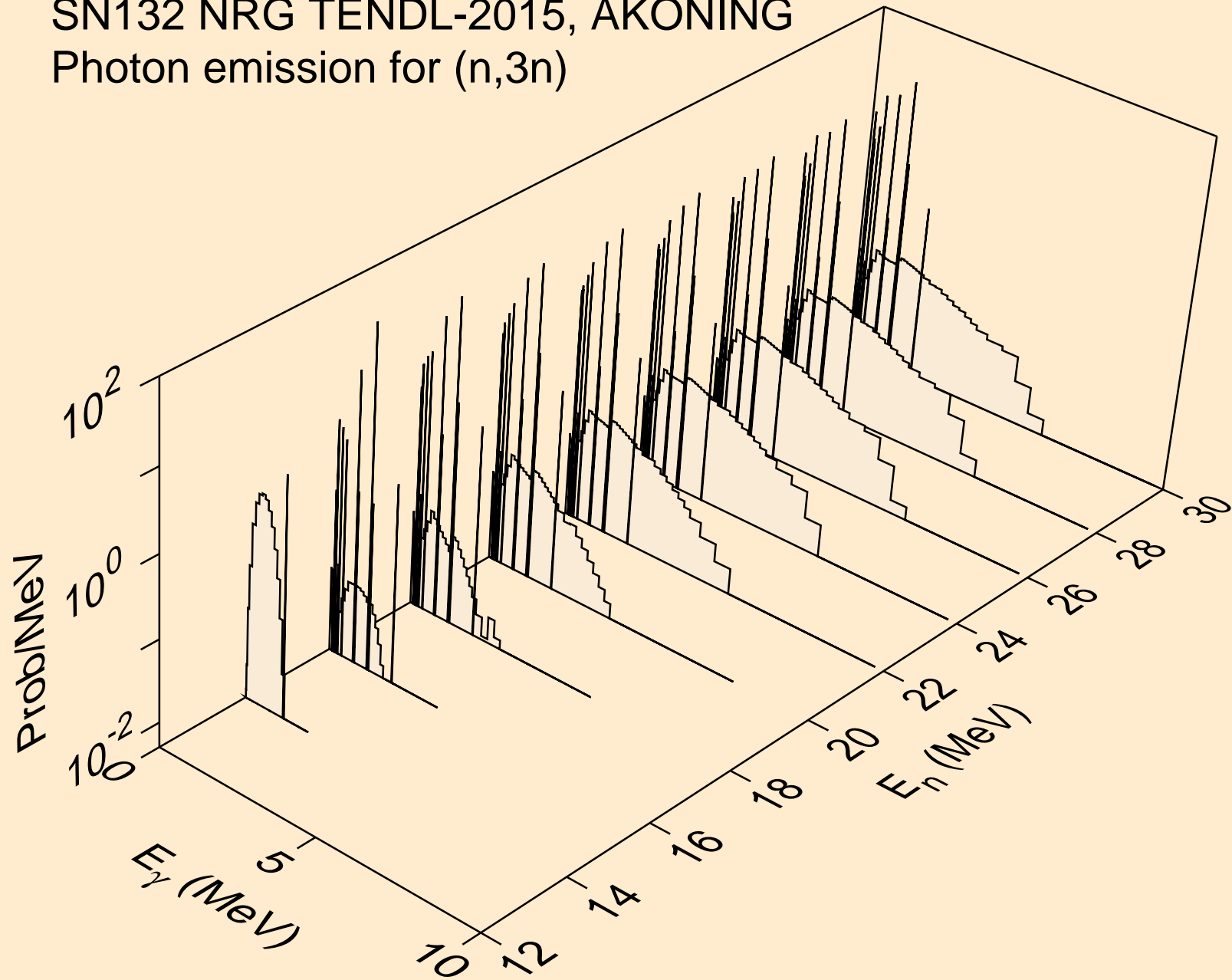

SN132 NRG TENDL-2015, AKONING
Photon emission for (n,n*)a

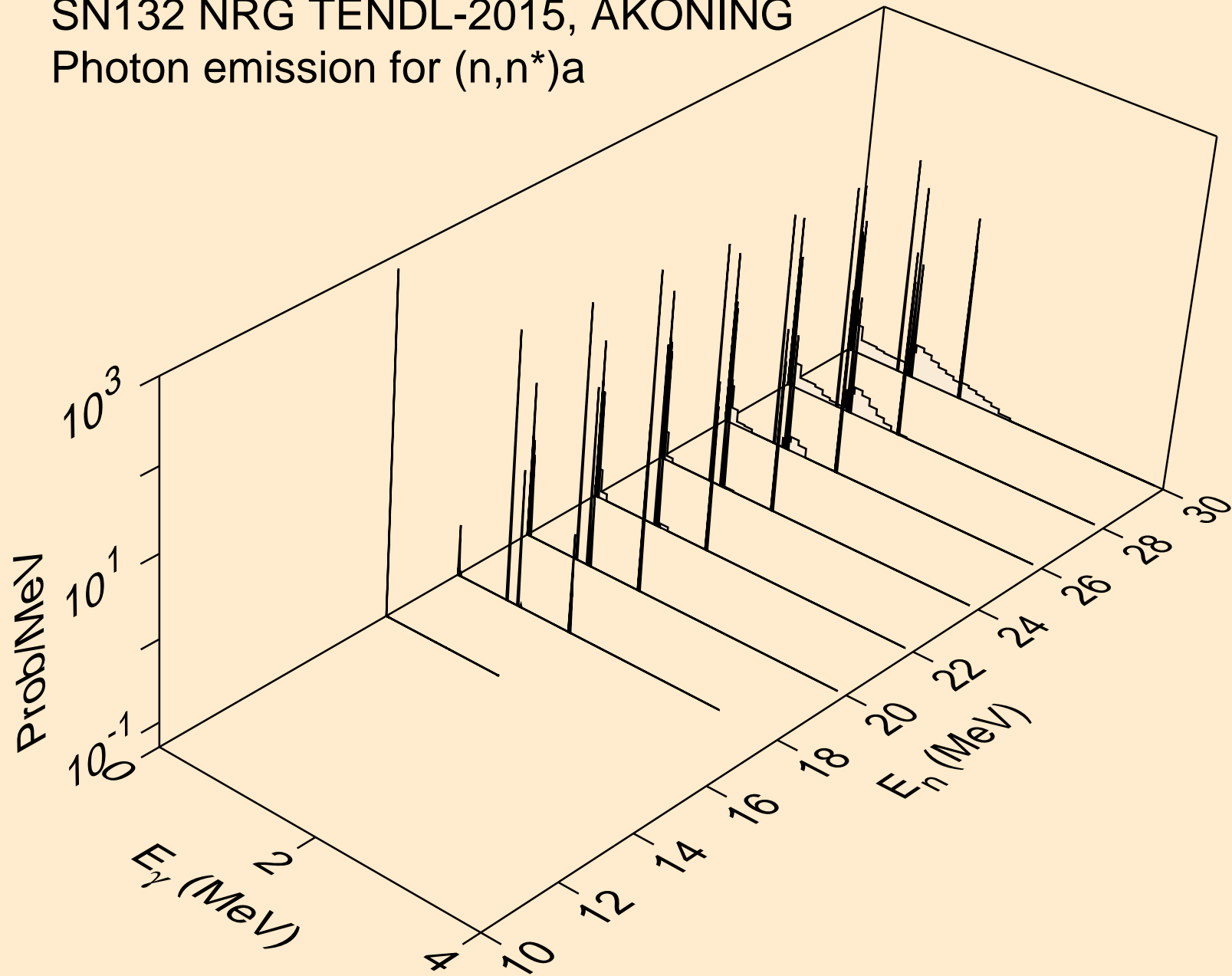

SN132 NRG TENDL-2015, AKONING
Photon emission for (n,2n)a

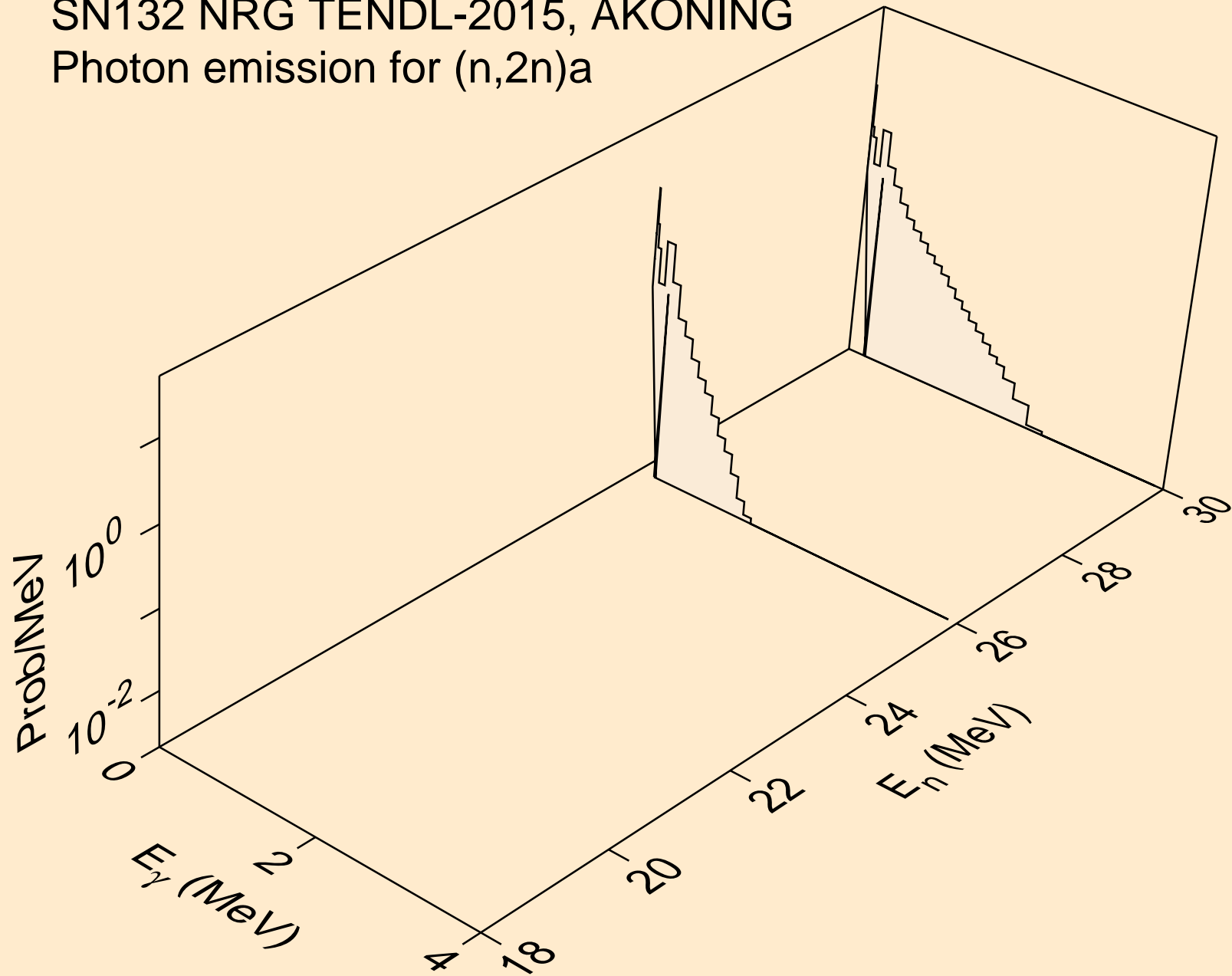

SN132 NRG TENDL-2015, AKONING
Photon emission for (n,n*)p

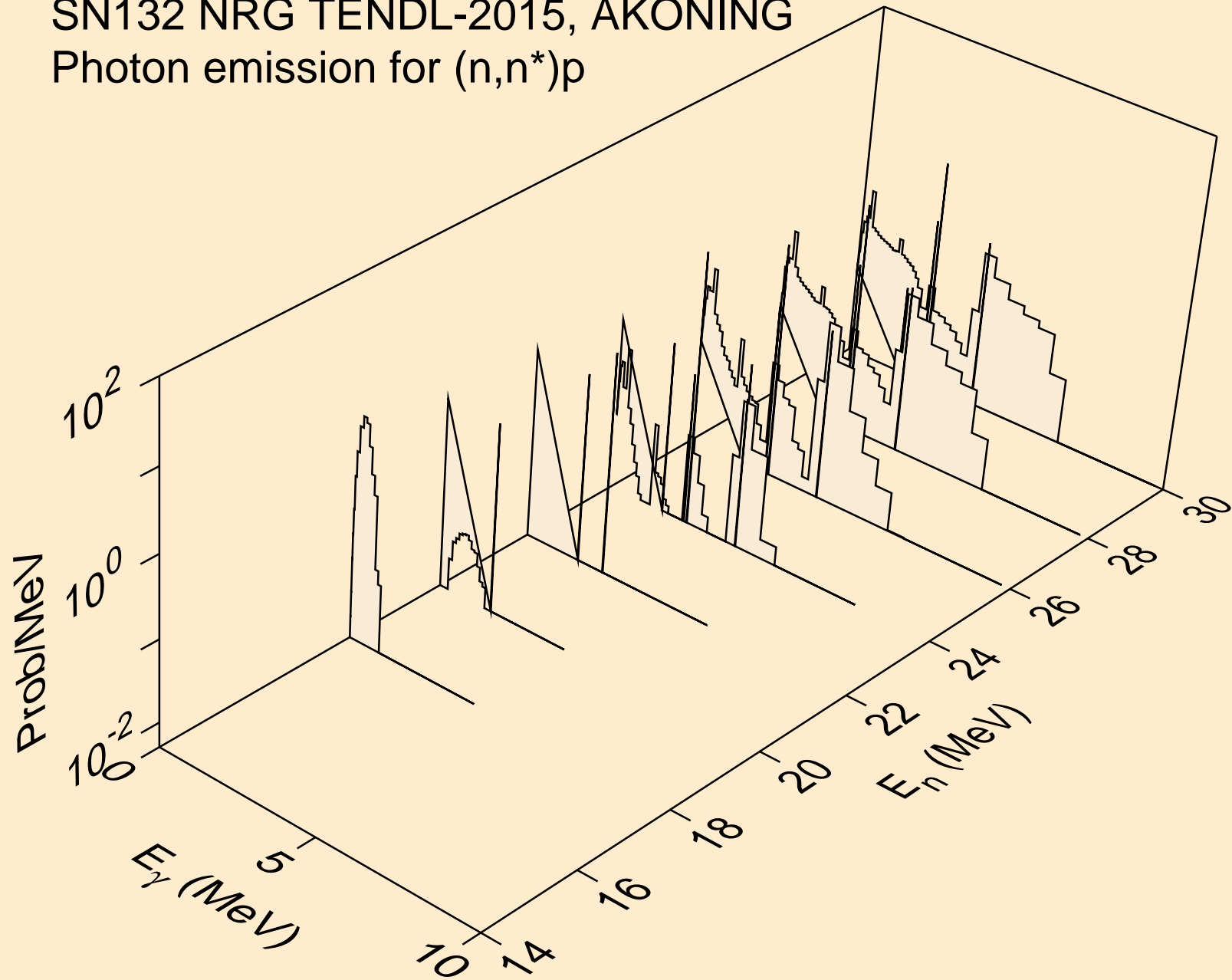

SN132 NRG TENDL-2015, AKONING
Photon emission for (n,n*)d

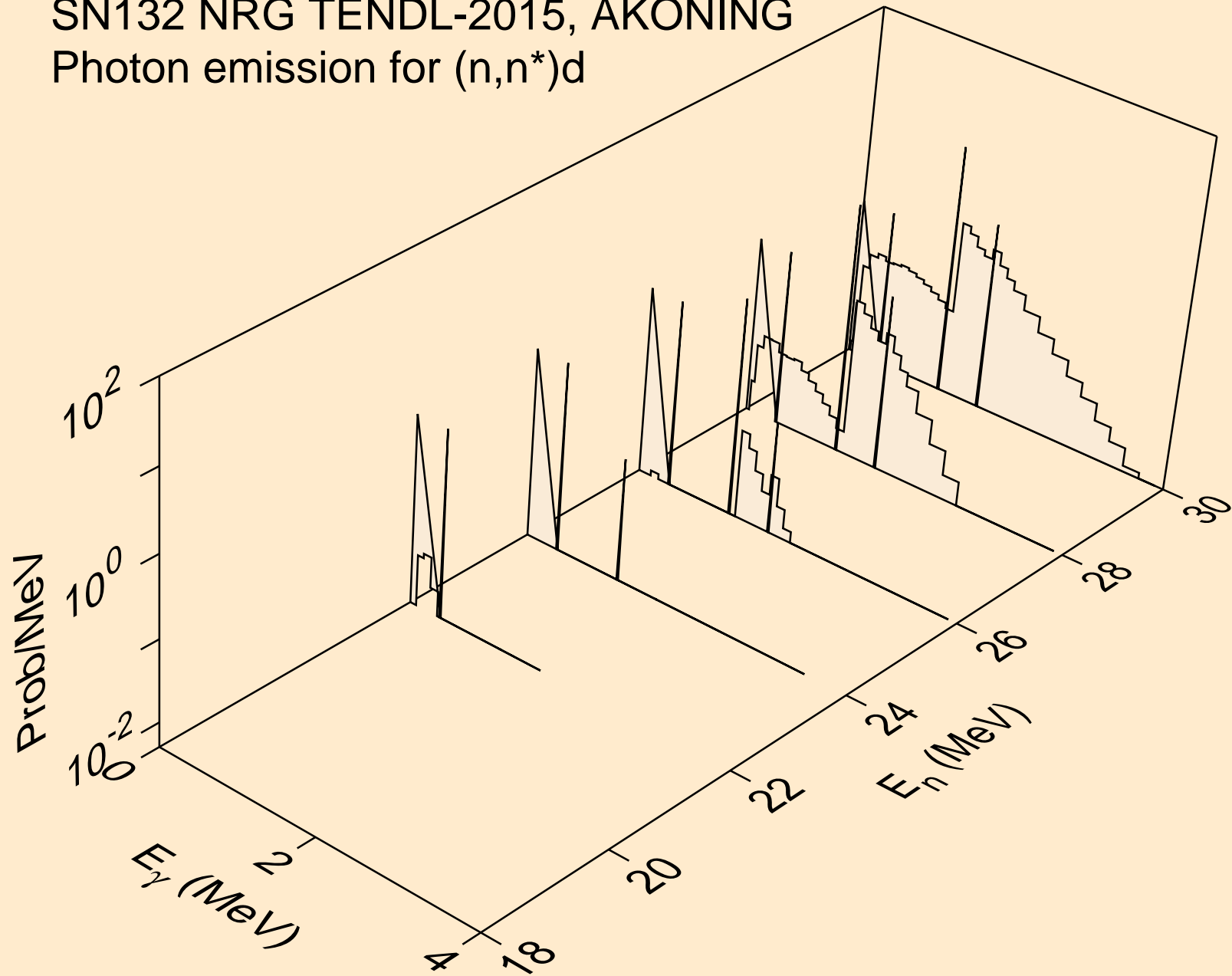

SN132 NRG TENDL-2015, AKONING
Photon emission for (n,n*)t

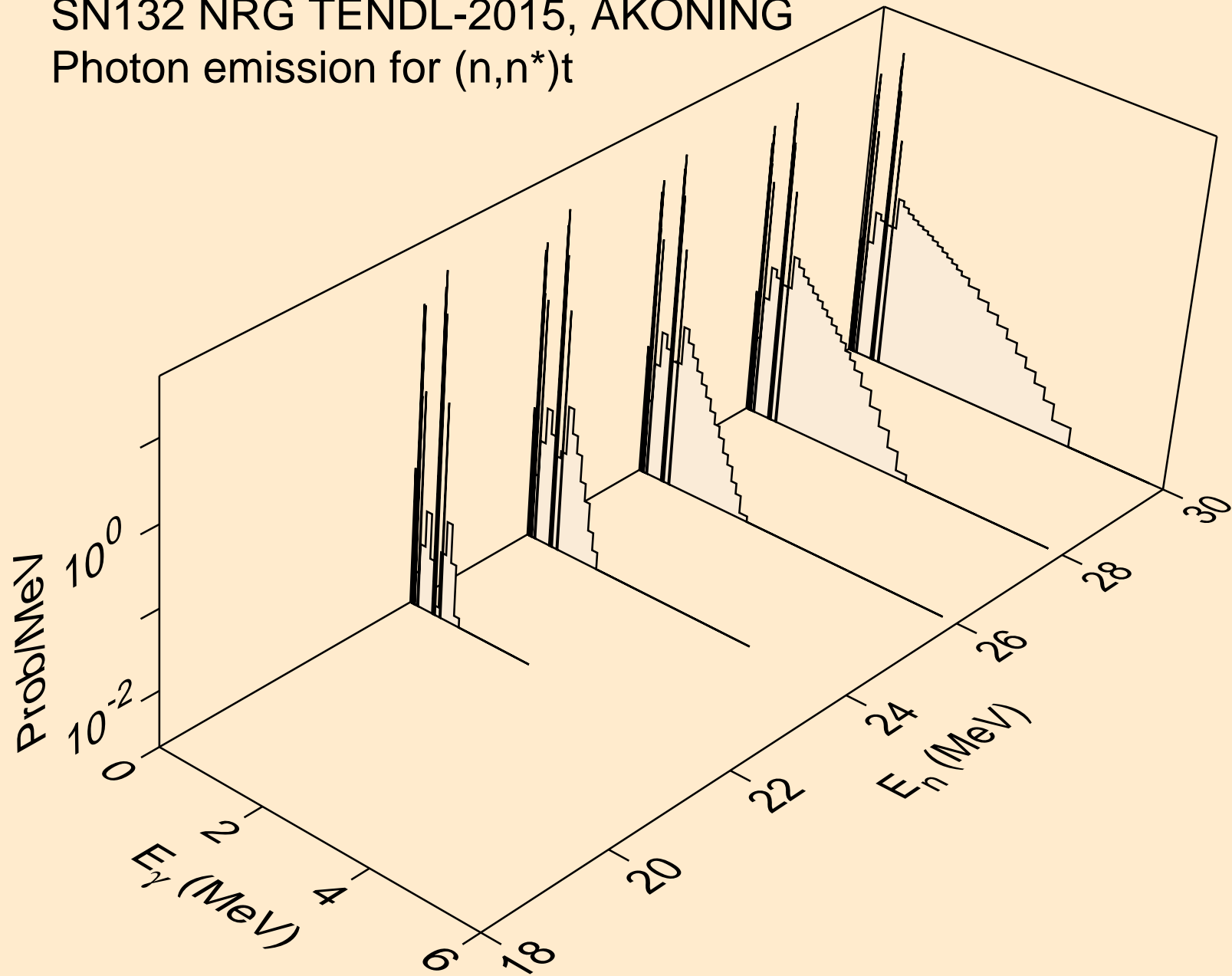

SN132 NRG TENDL-2015, AKONING
Photon emission for (n,4n)

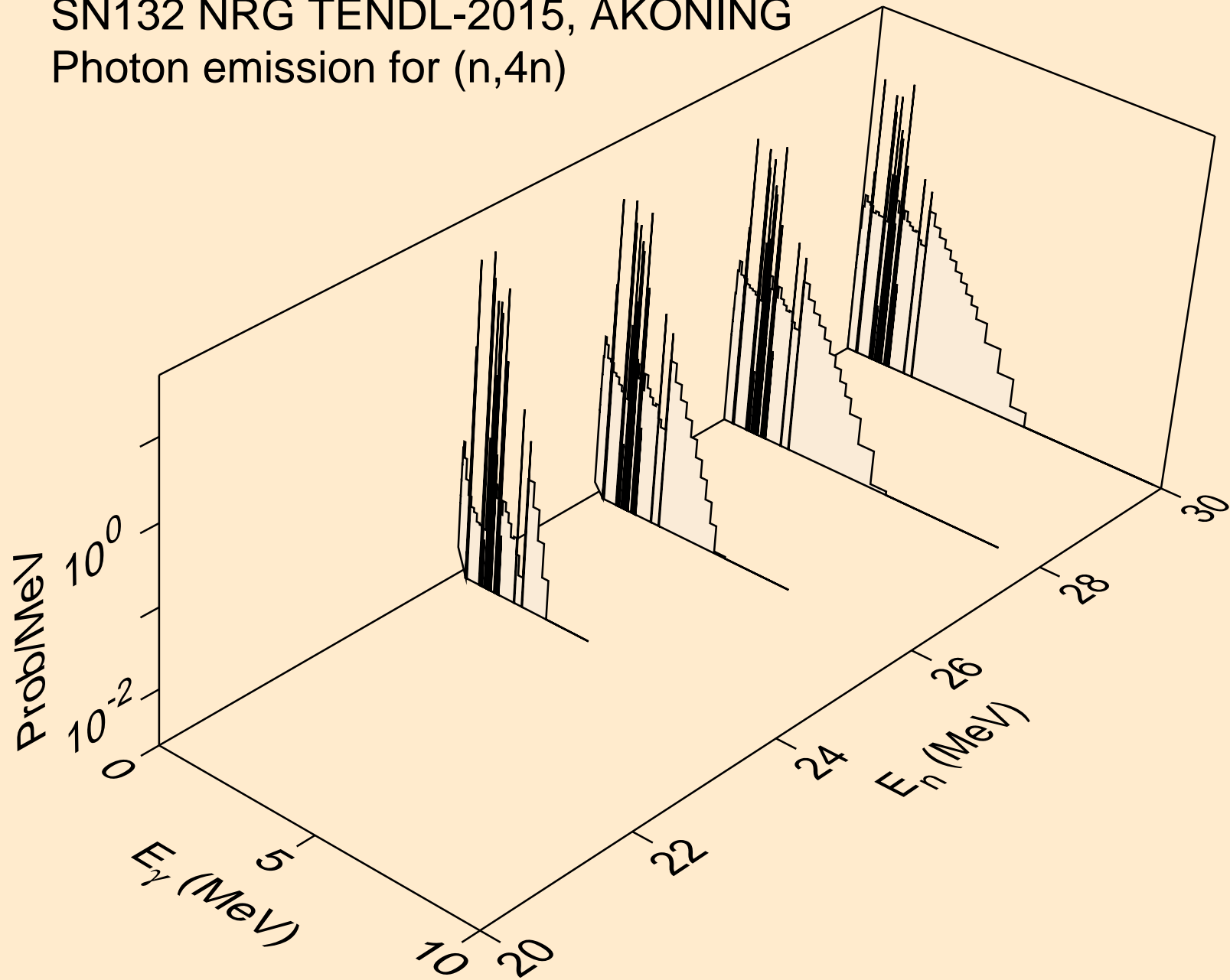

SN132 NRG TENDL-2015, AKONING
Photon emission for (n,2np)

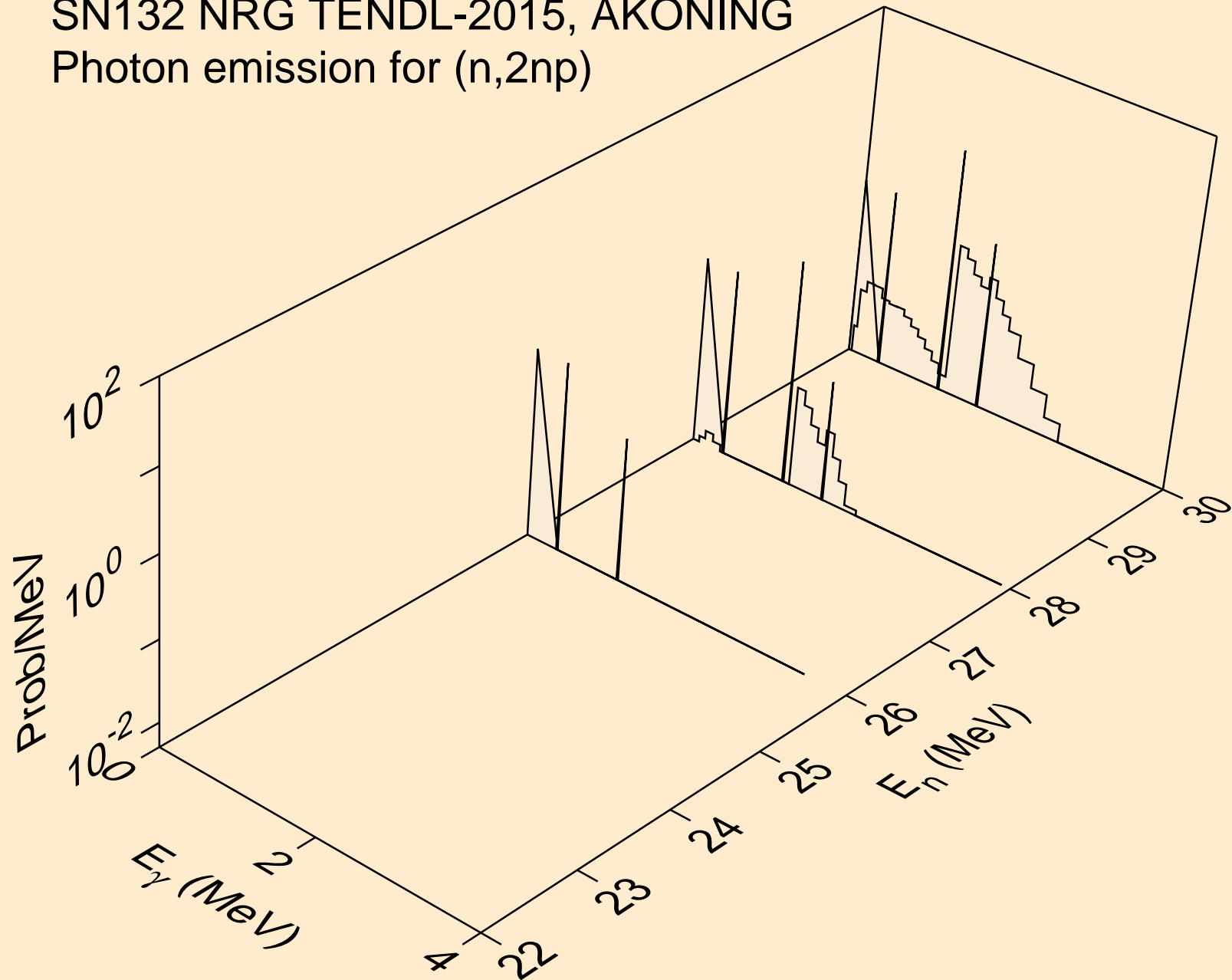

SN132 NRG TENDL-2015, AKONING
Photon emission for (n,n*c)

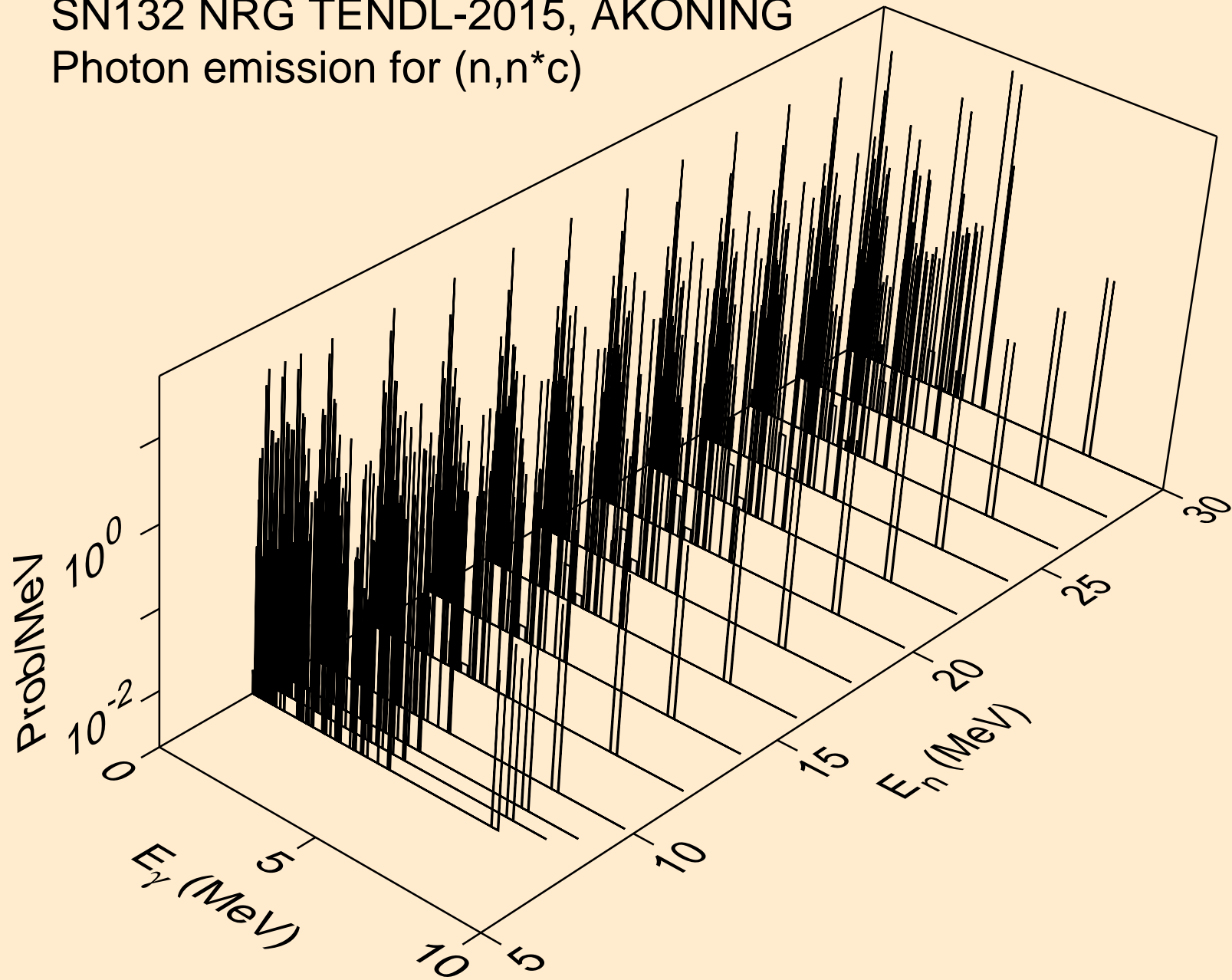

SN132 NRG TENDL-2015, AKONING
Photon emission for (n,gma)

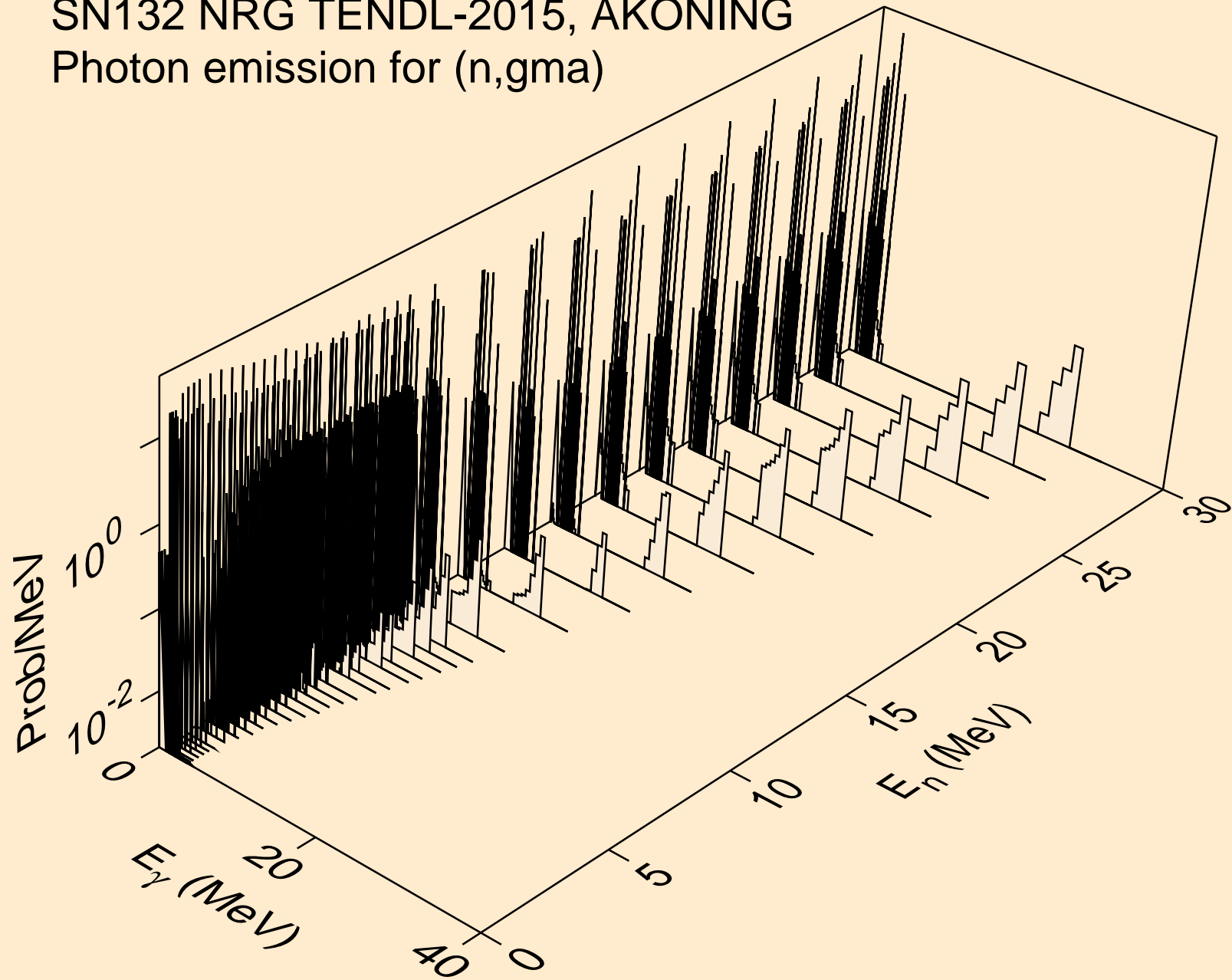

SN132 NRG TENDL-2015, AKONING
Photon emission for (n,p)

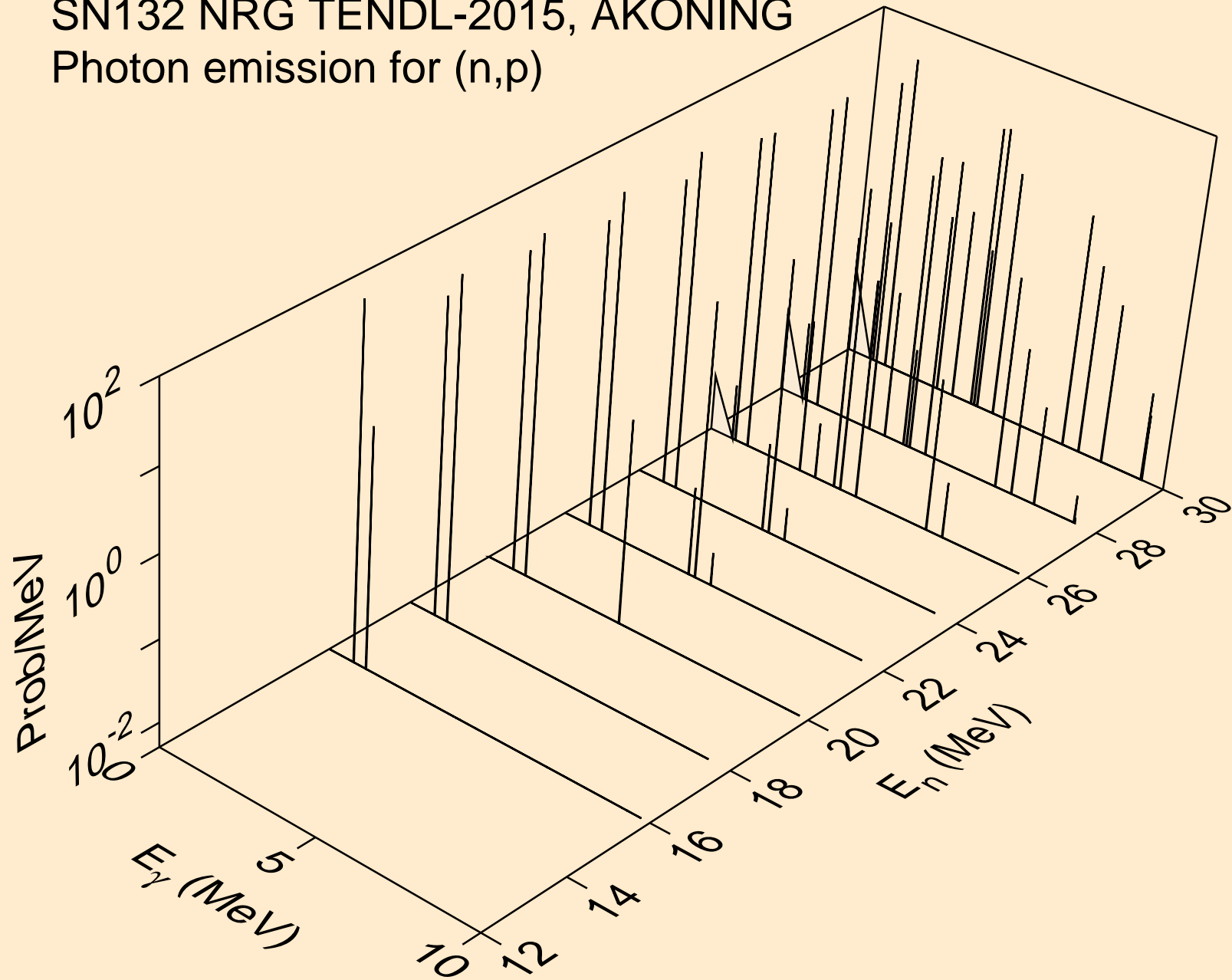

SN132 NRG TENDL-2015, AKONING
Photon emission for (n,d)

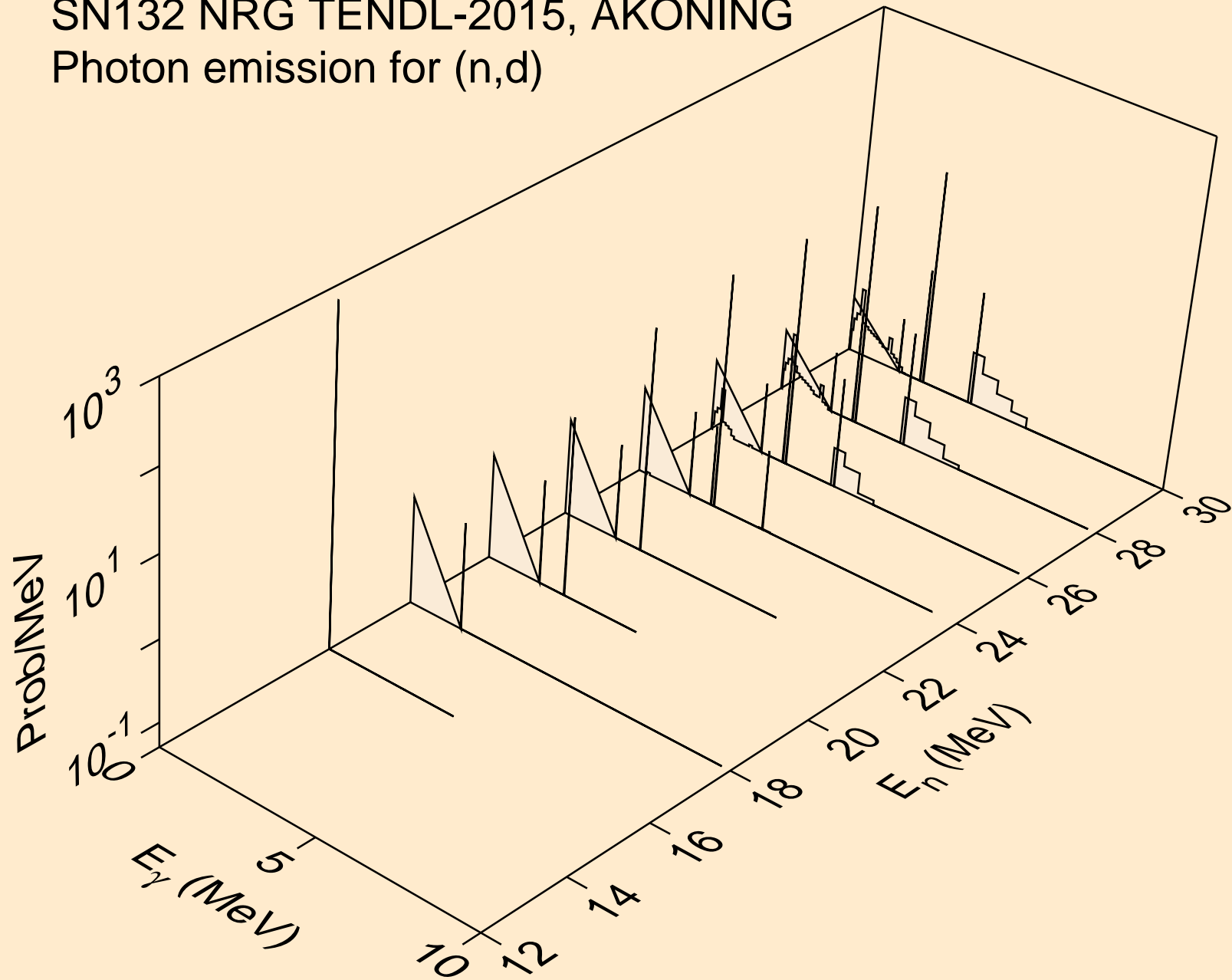

SN132 NRG TENDL-2015, AKONING
Photon emission for (n,t)

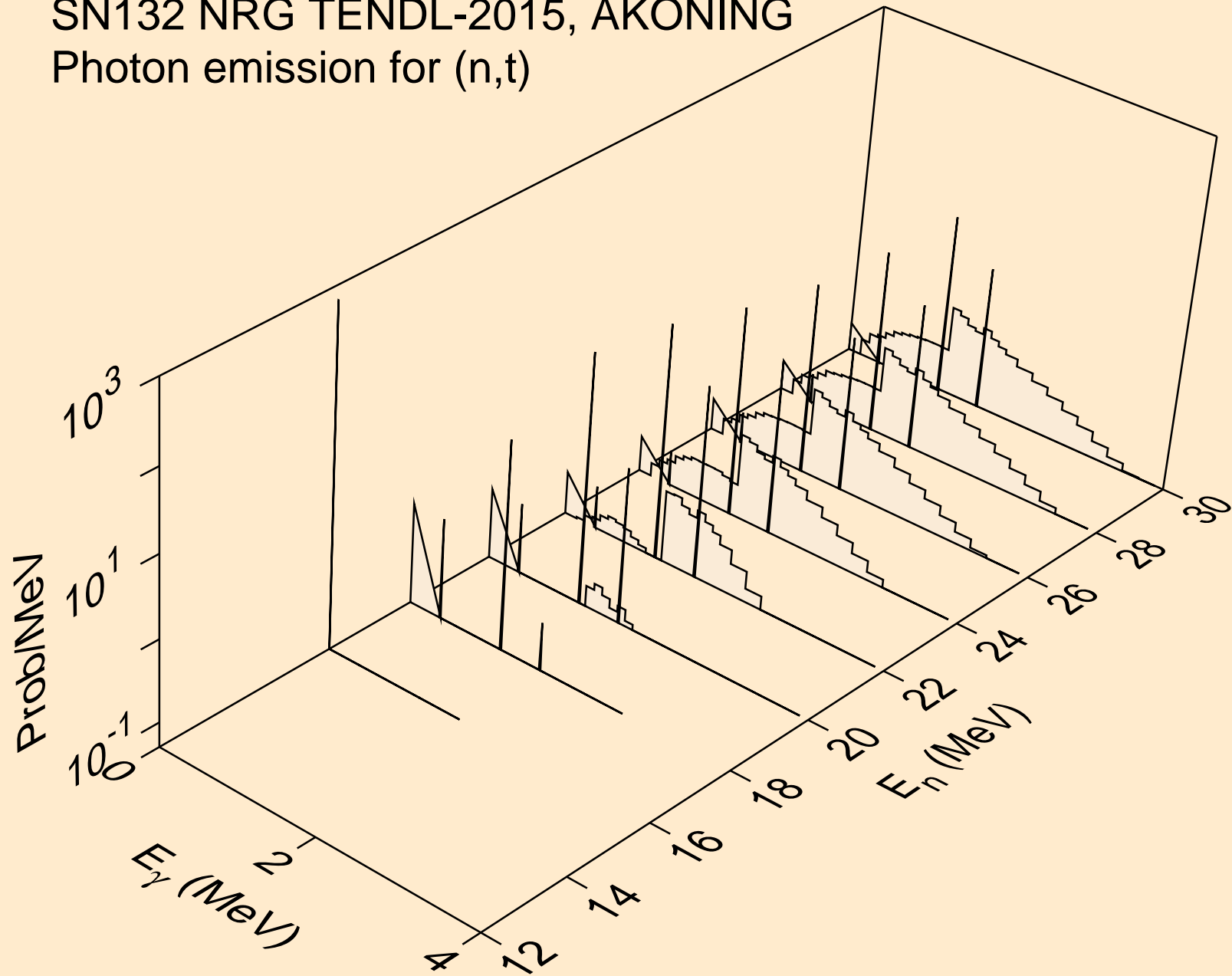

SN132 NRG TENDL-2015, AKONING
Photon emission for (n,a)

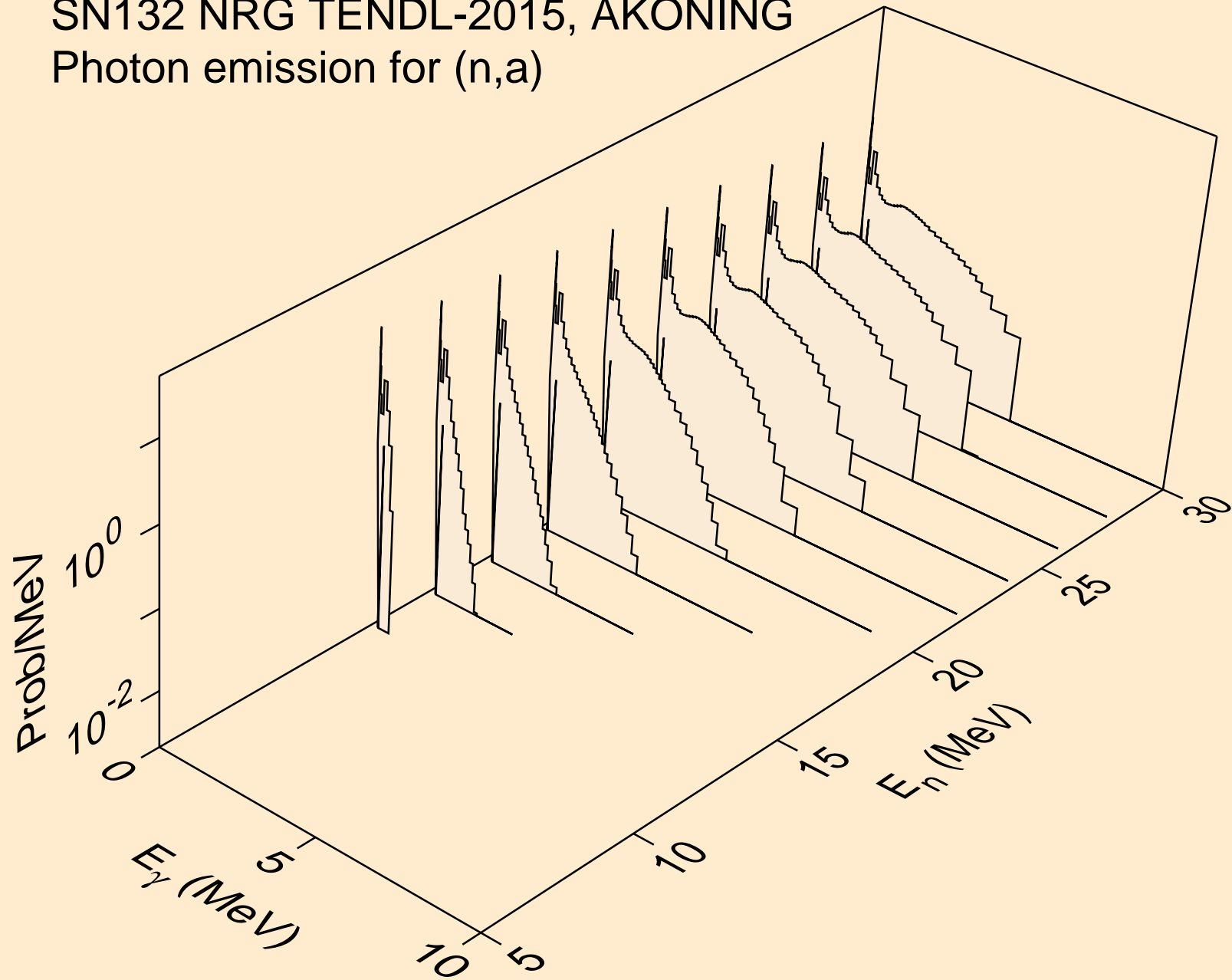

SN132 NRG TENDL-2015, AKONING
thermal capture photon spectrum

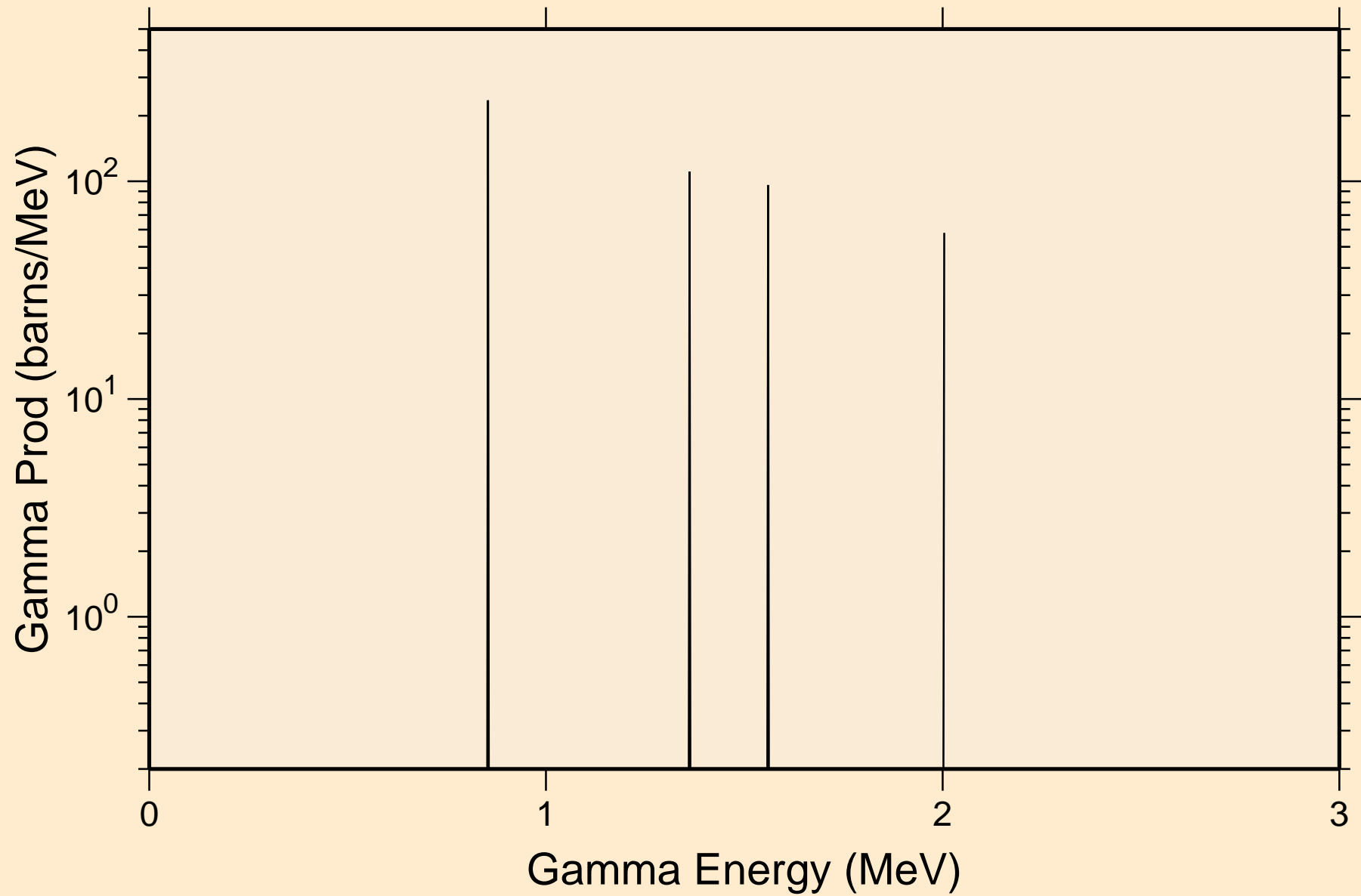

SN132 NRG TENDL-2015, AKONING

14 MeV photon spectrum

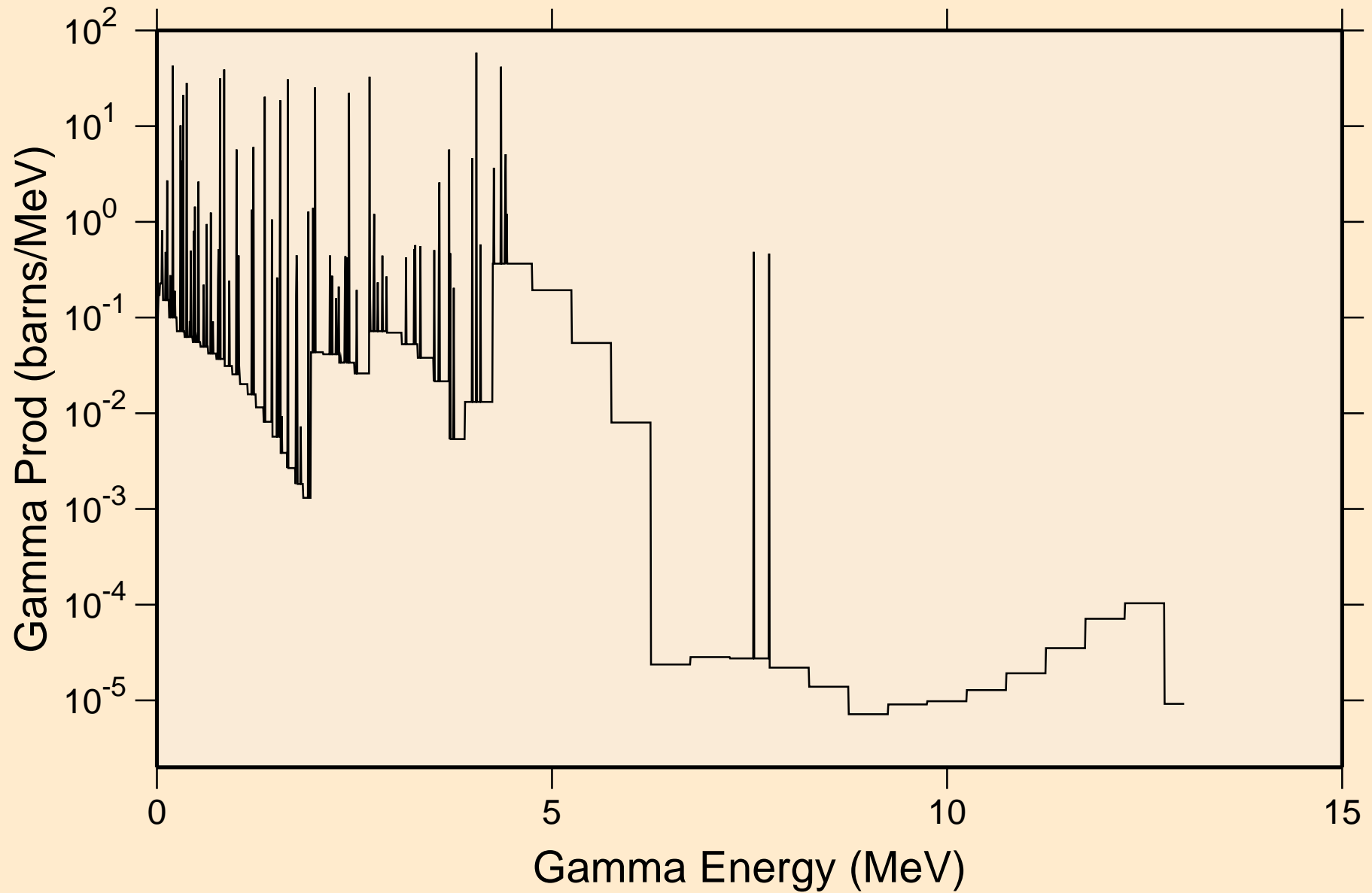

SN132 NRG TENDL-2015, AKONING

Particle heating contributions

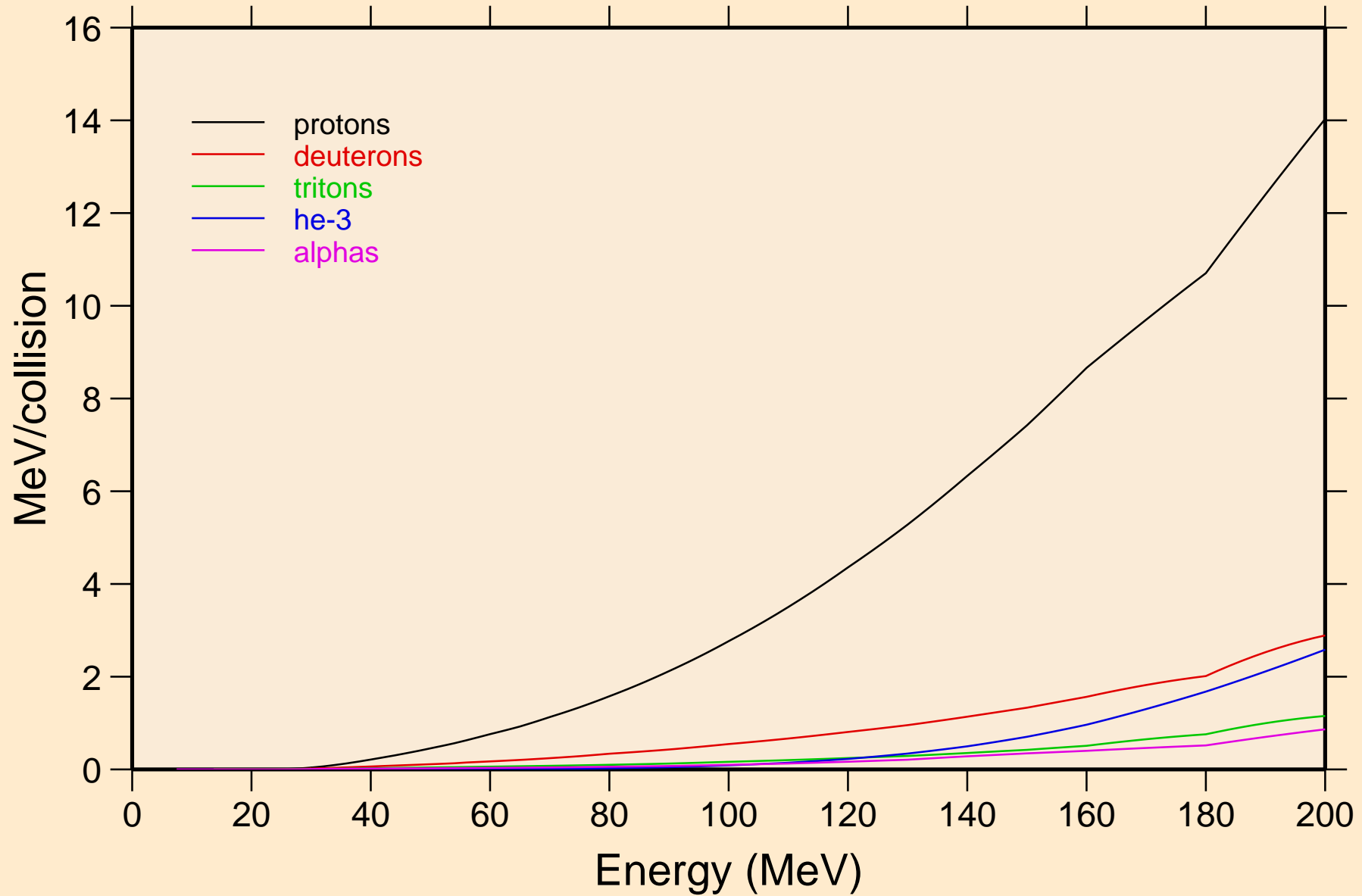

SN132 NRG TENDL-2015, AKONING

Recoil Heating

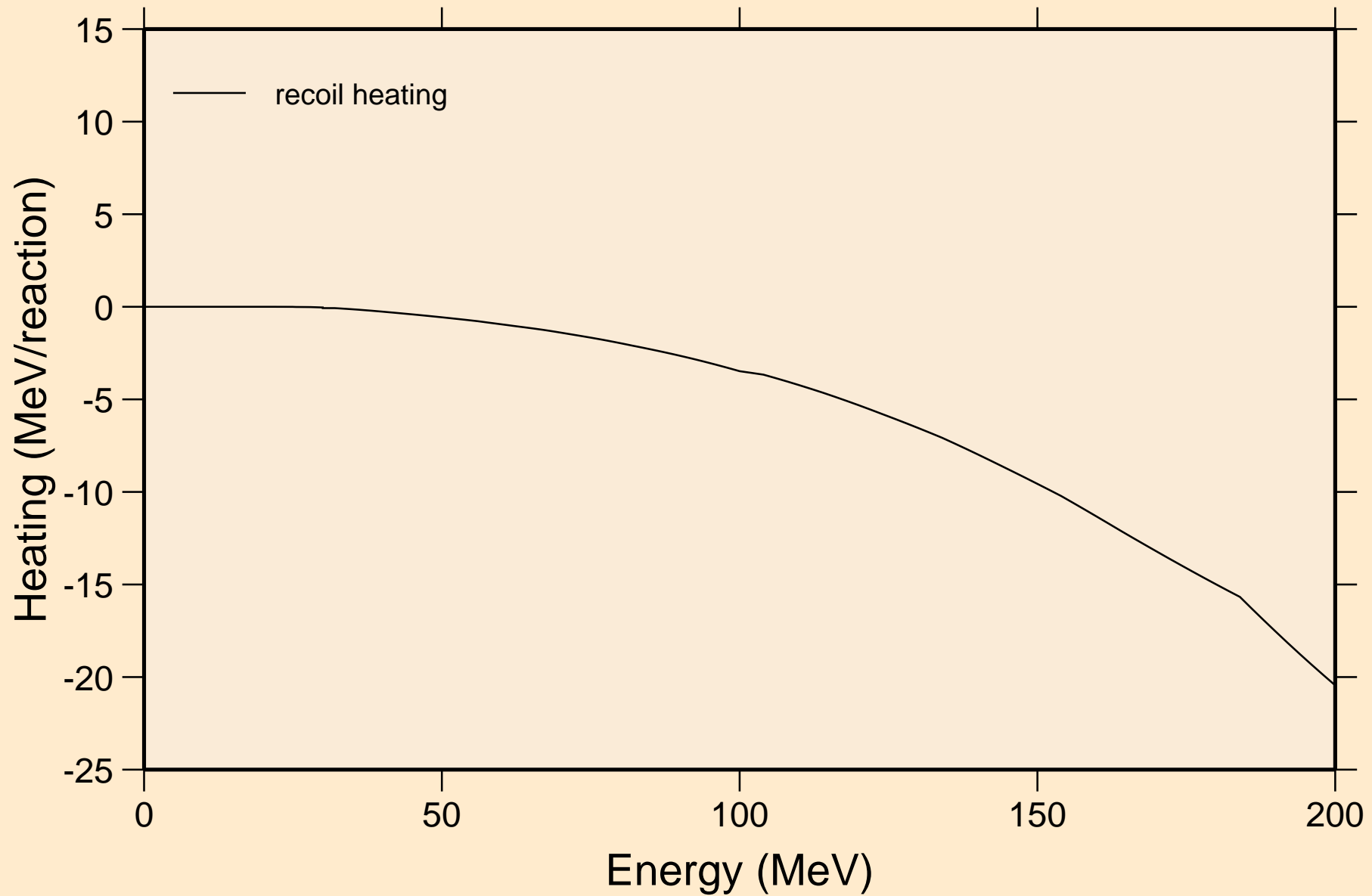

SN132 NRG TENDL-2015, AKONING

Particle production cross sections

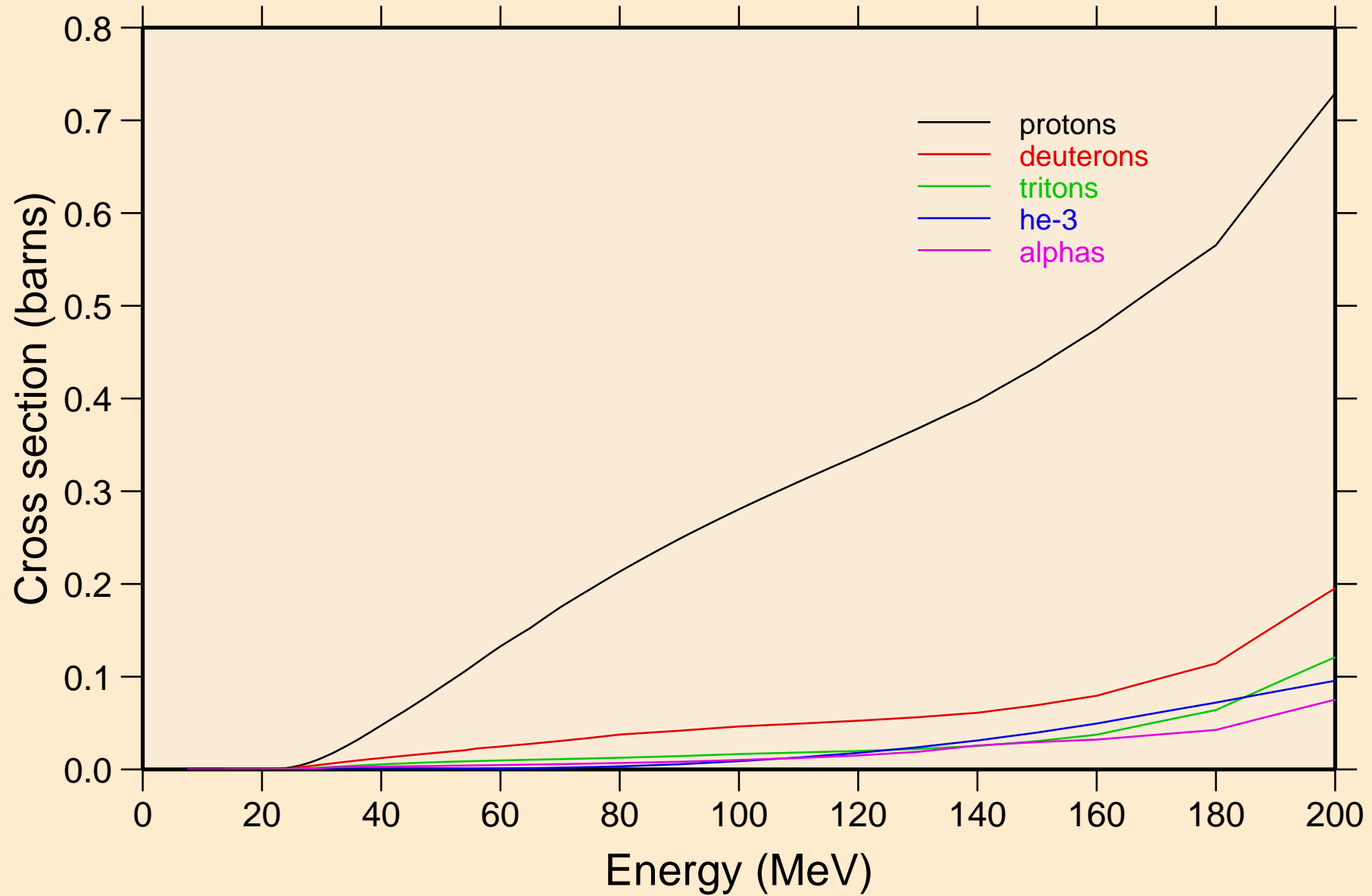

SN132 NRG TENDL-2015, AKONING
protons from (n,x)

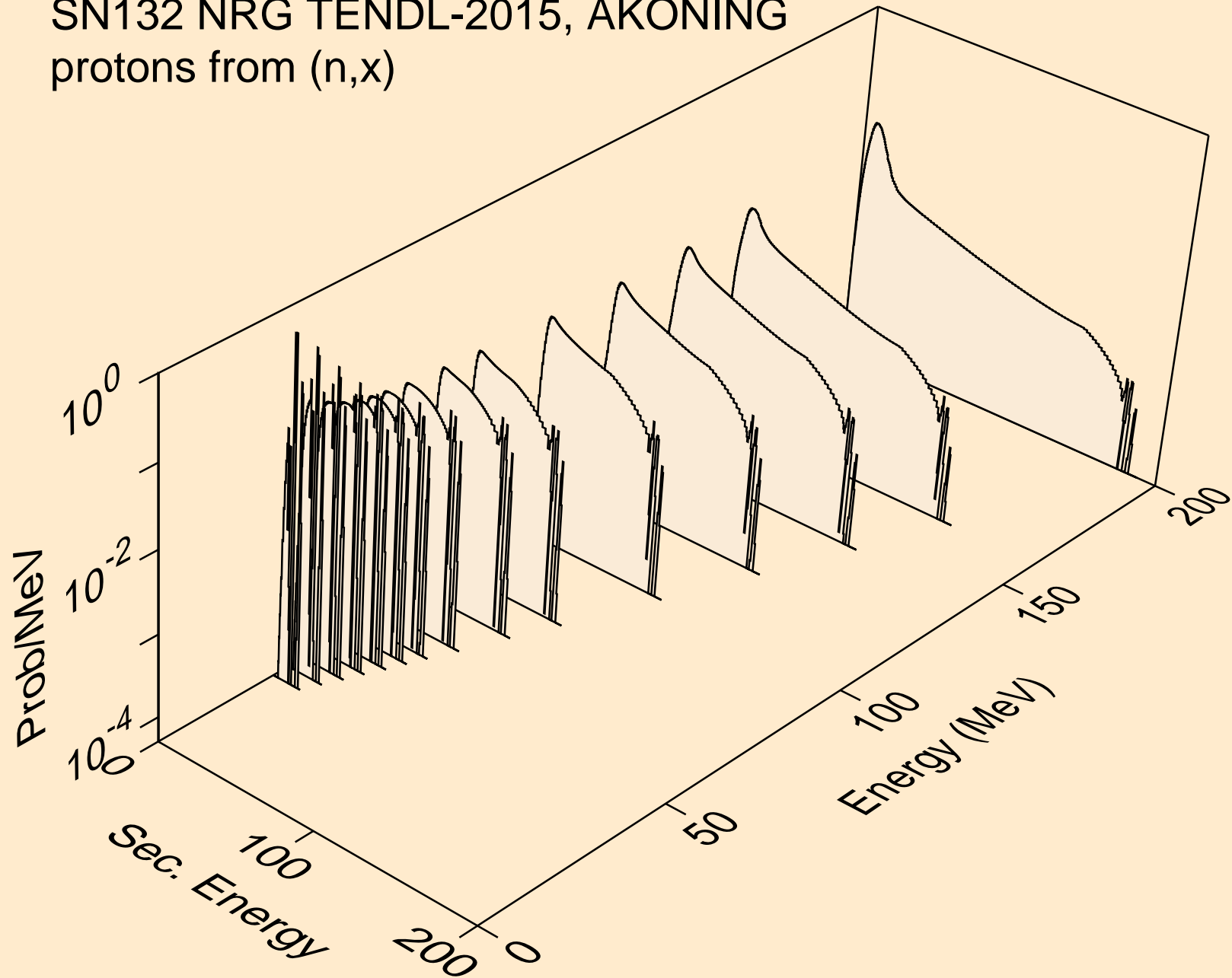

SN132 NRG TENDL-2015, AKONING
protons from (n,n*)p

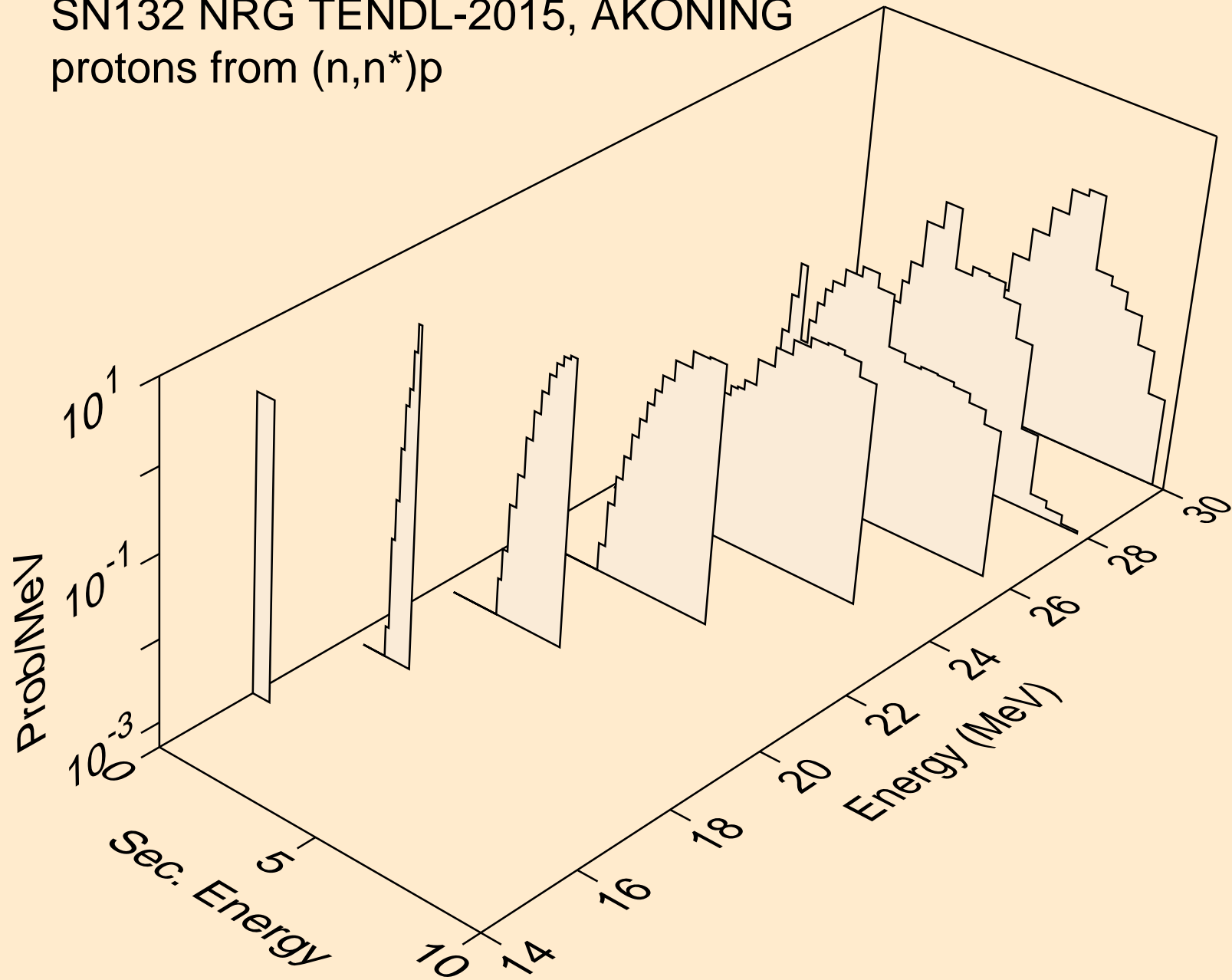

SN132 NRG TENDL-2015, AKONING
protons from (n,2np)

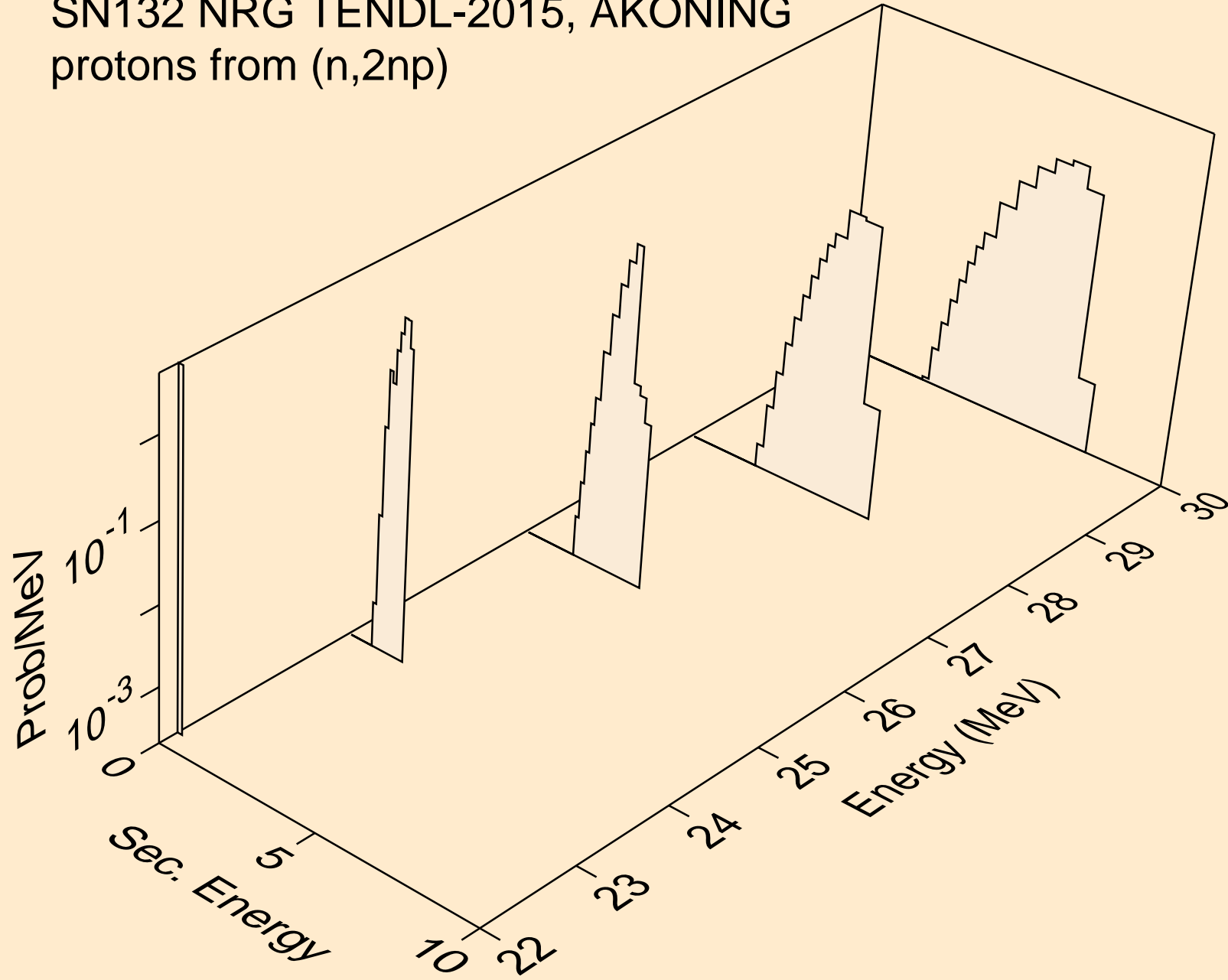

SN132 NRG TENDL-2015, AKONING
protons from (n,p)

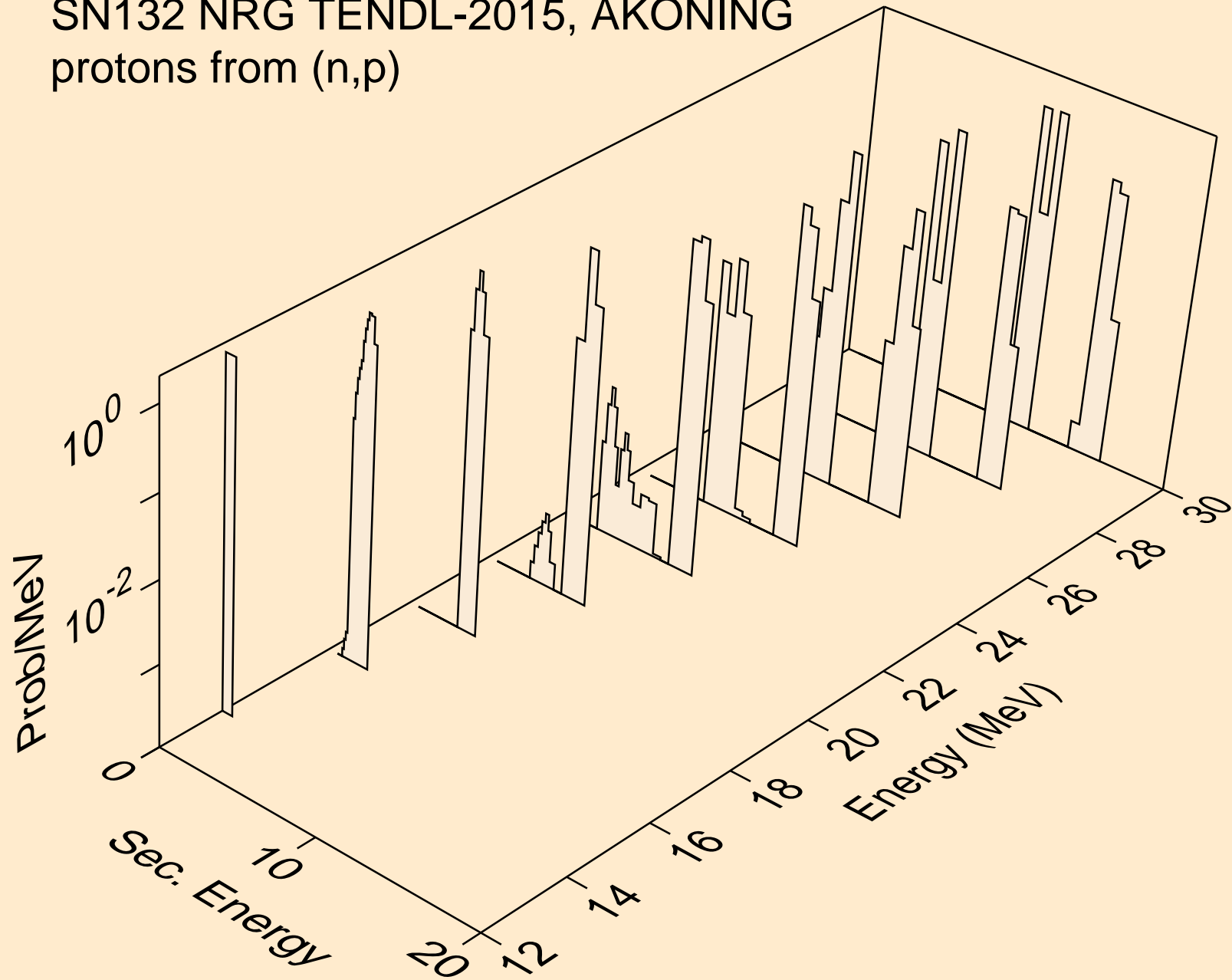

SN132 NRG TENDL-2015, AKONING
deuterons from (n,x)

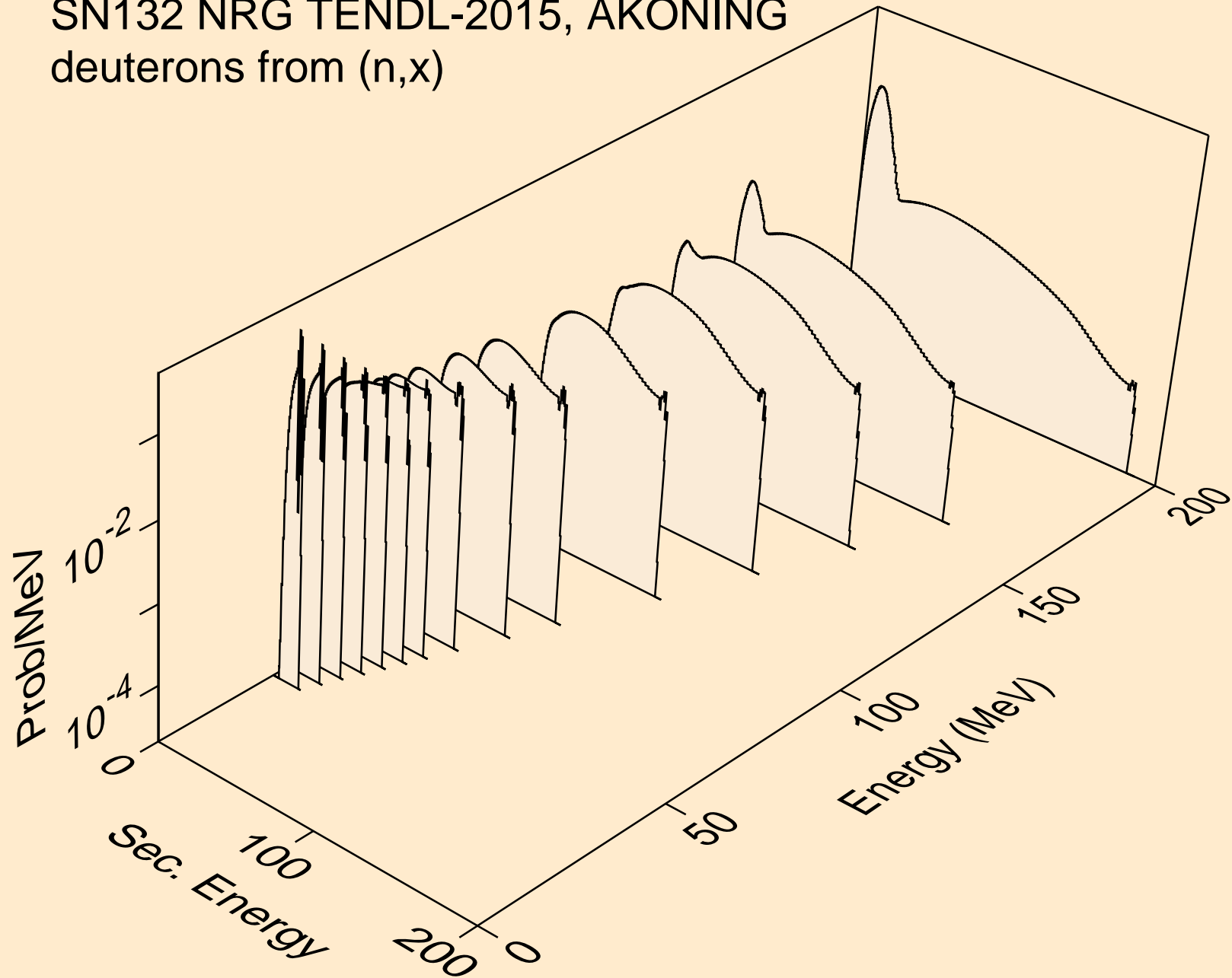

SN132 NRG TENDL-2015, AKONING
deuterons from (n,2nd)

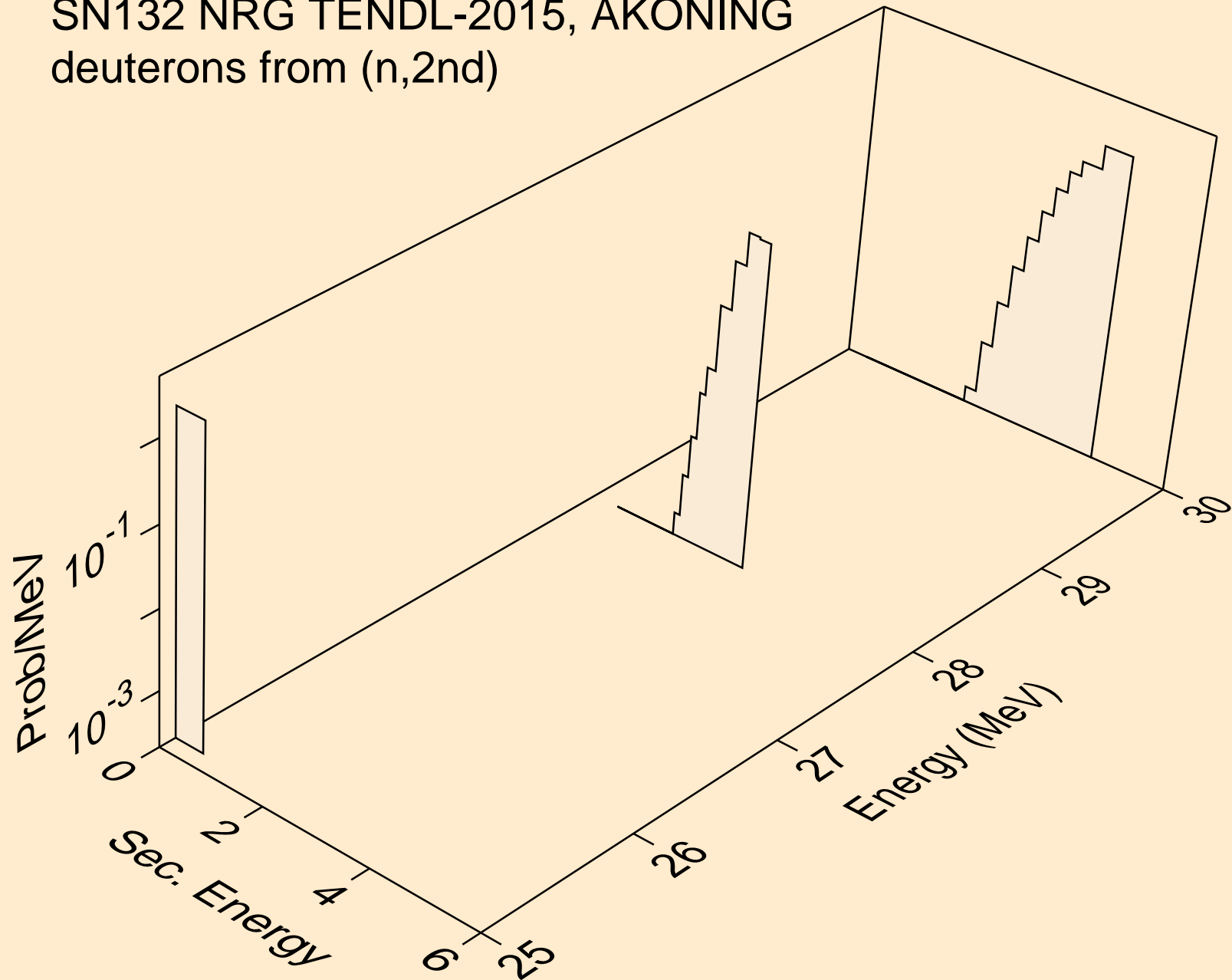

SN132 NRG TENDL-2015, AKONING
deuterons from (n,n*)d

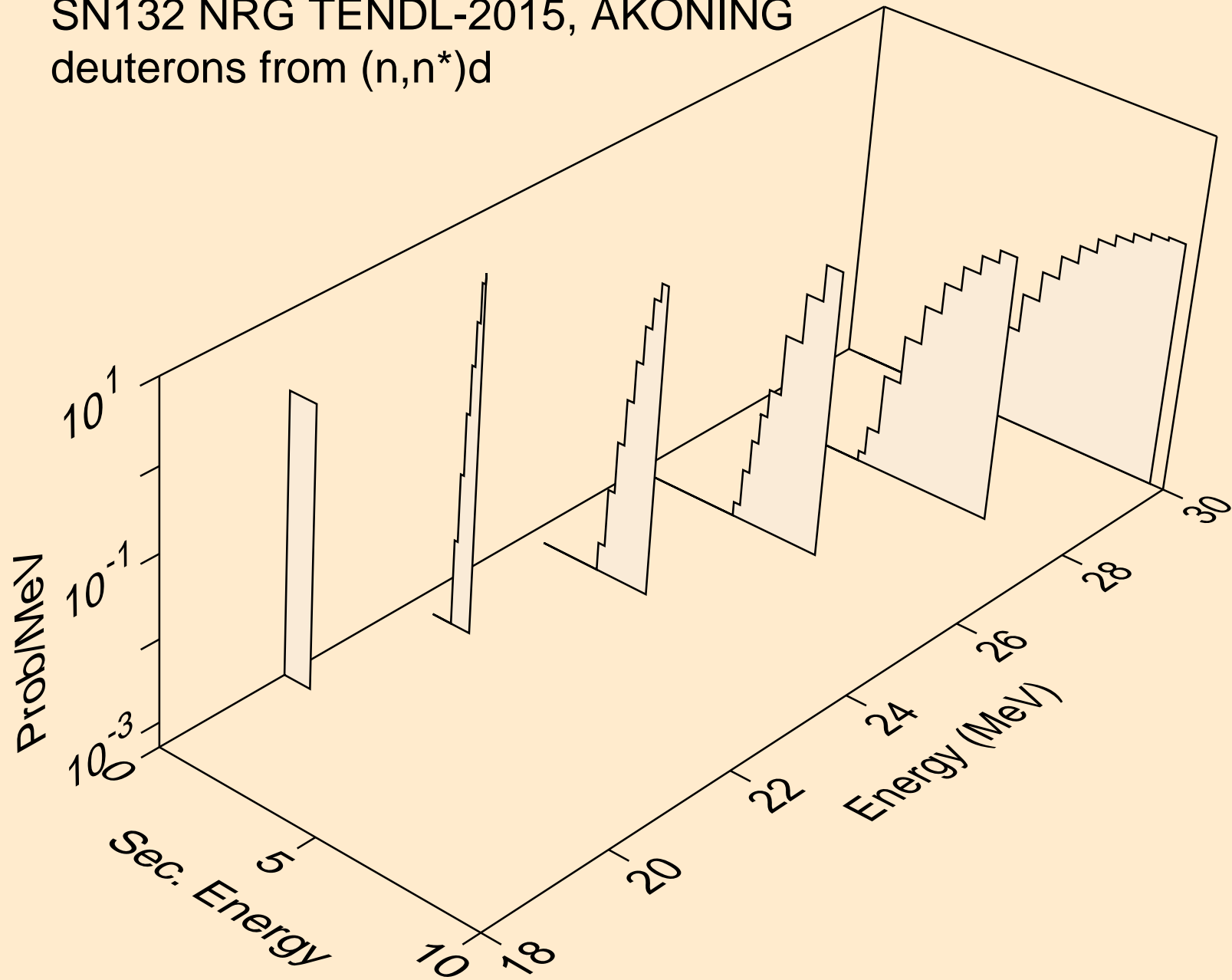

SN132 NRG TENDL-2015, AKONING
deuterons from (n,d)

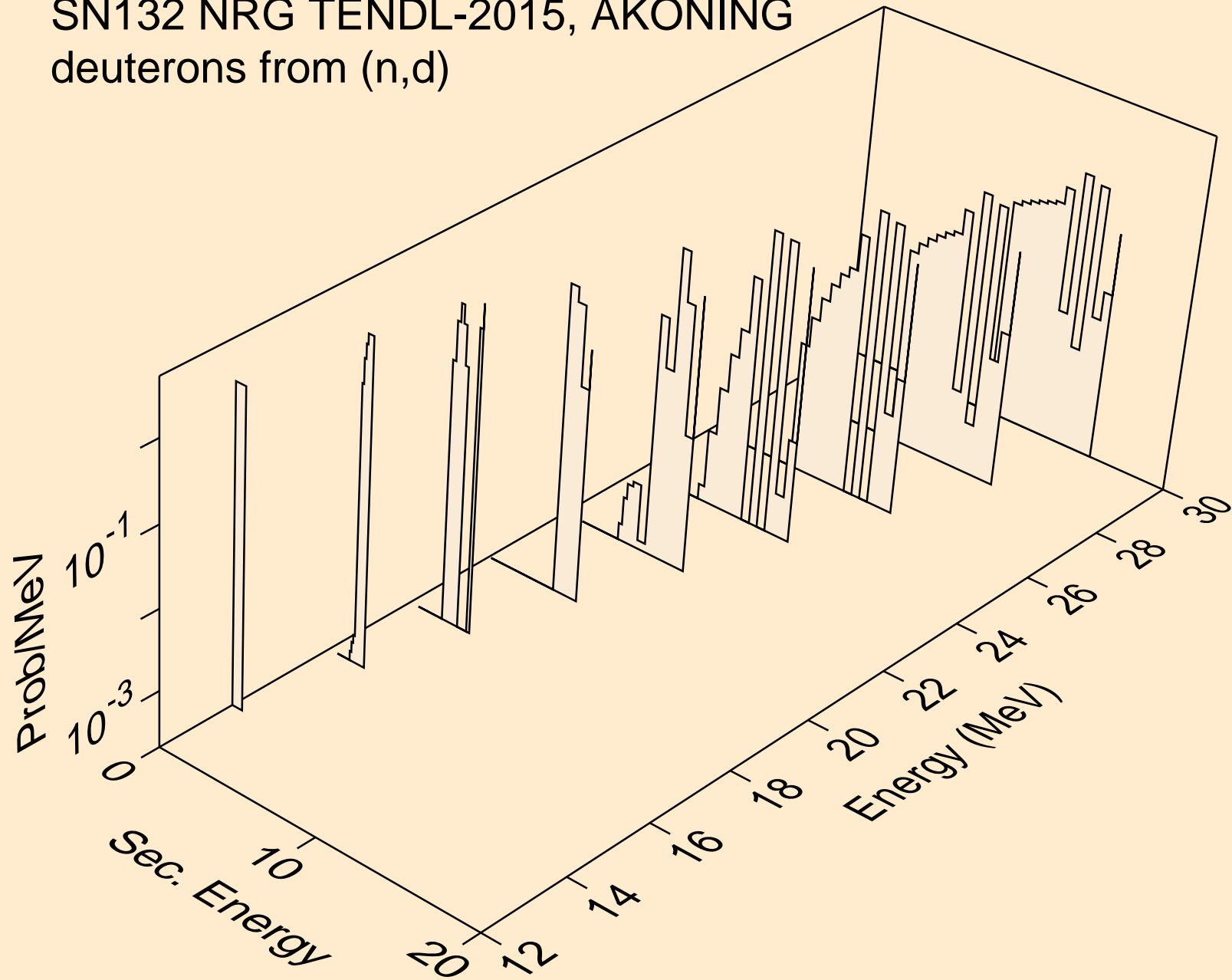

SN132 NRG TENDL-2015, AKONING
tritons from (n,x)

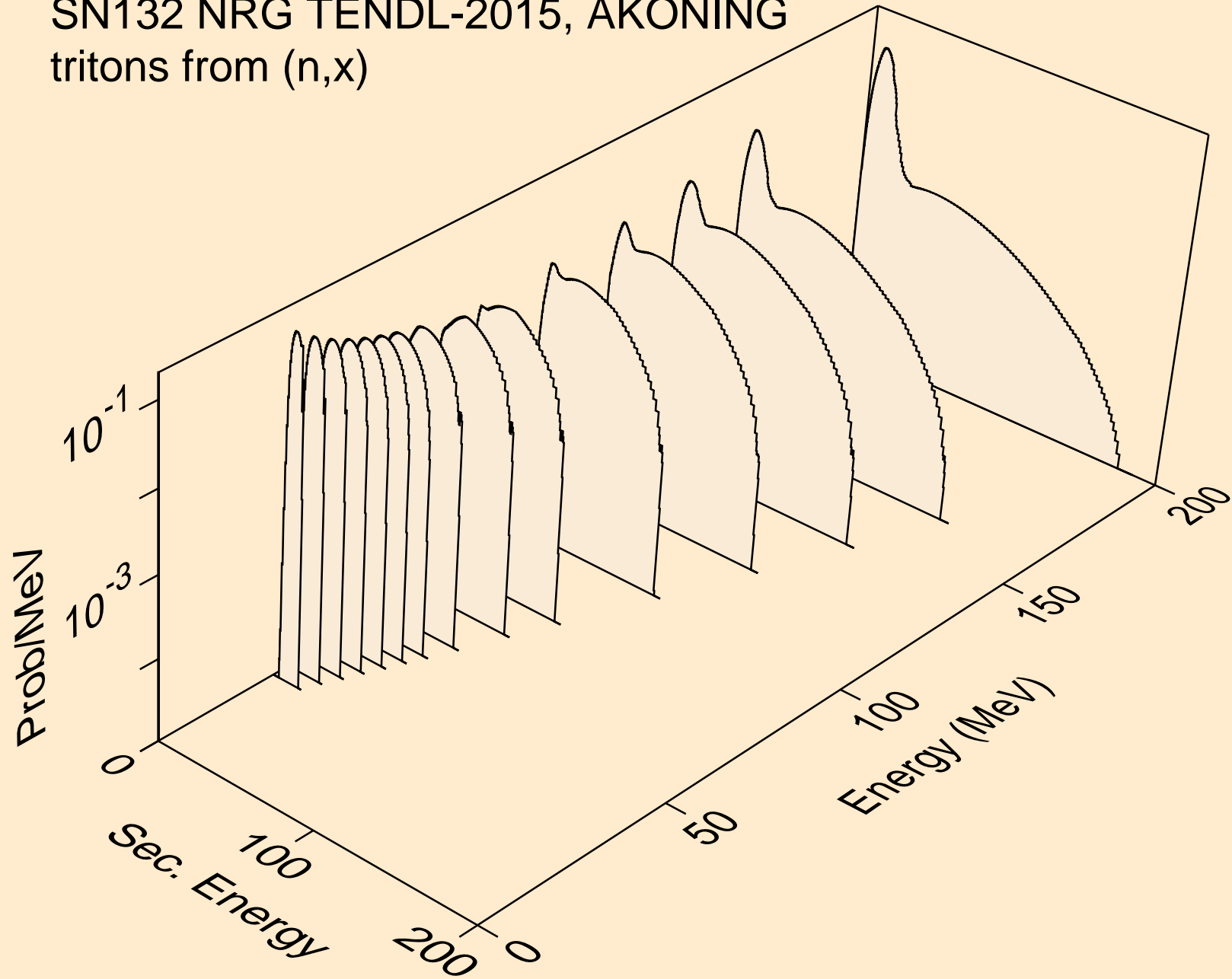

SN132 NRG TENDL-2015, AKONING
tritons from (n,n*)t

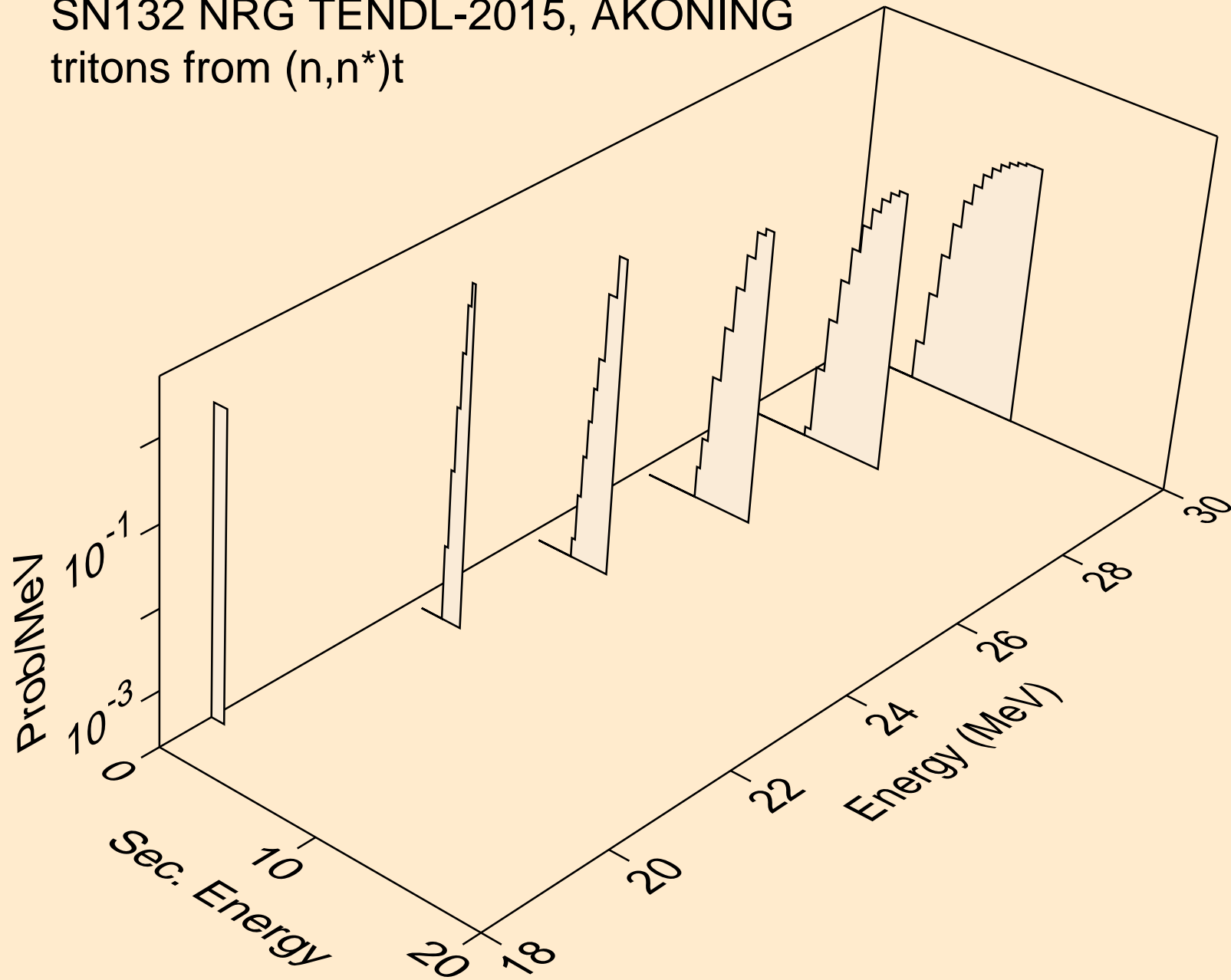

SN132 NRG TENDL-2015, AKONING
tritons from (n,t)

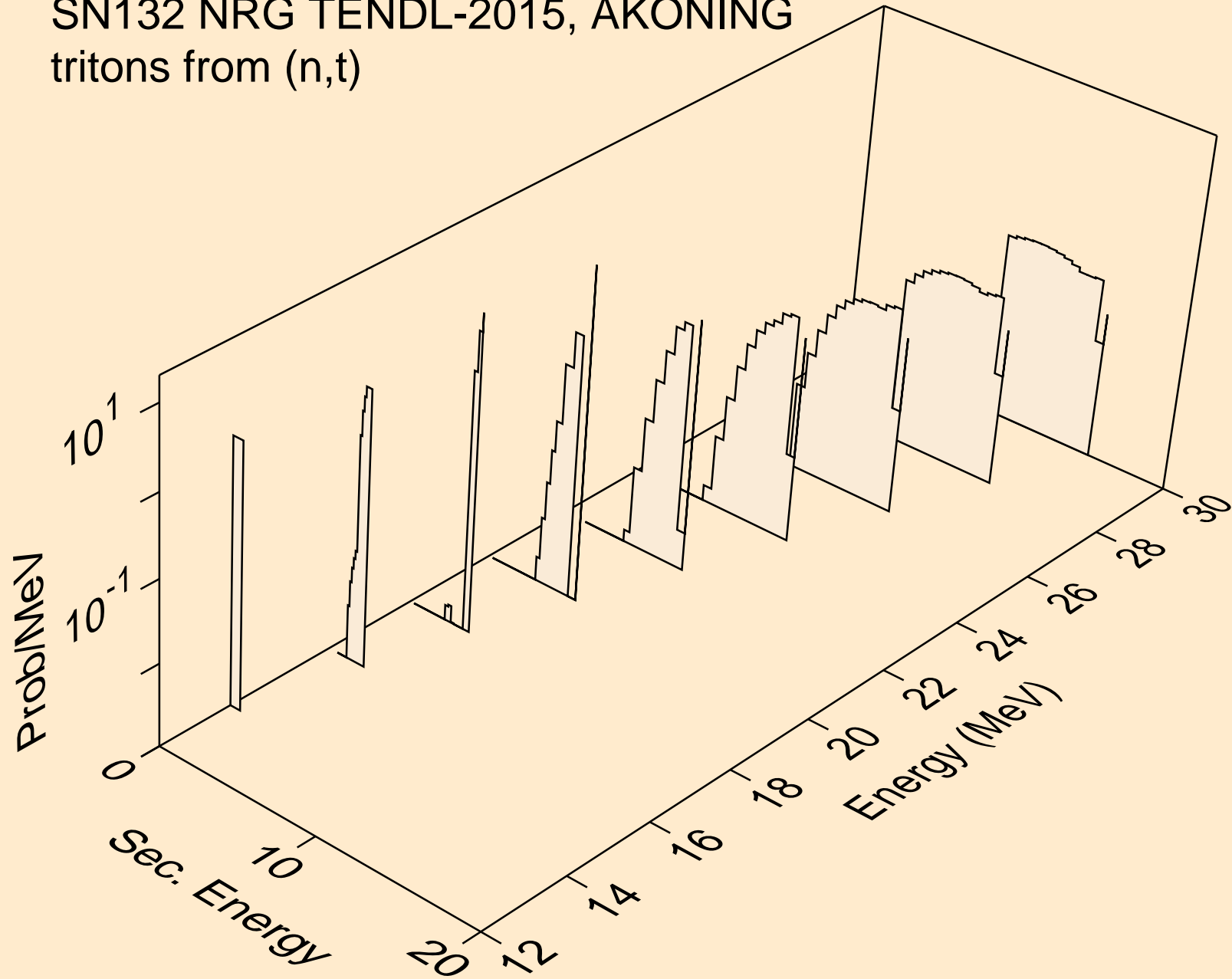

SN132 NRG TENDL-2015, AKONING
he3s from (n,x)

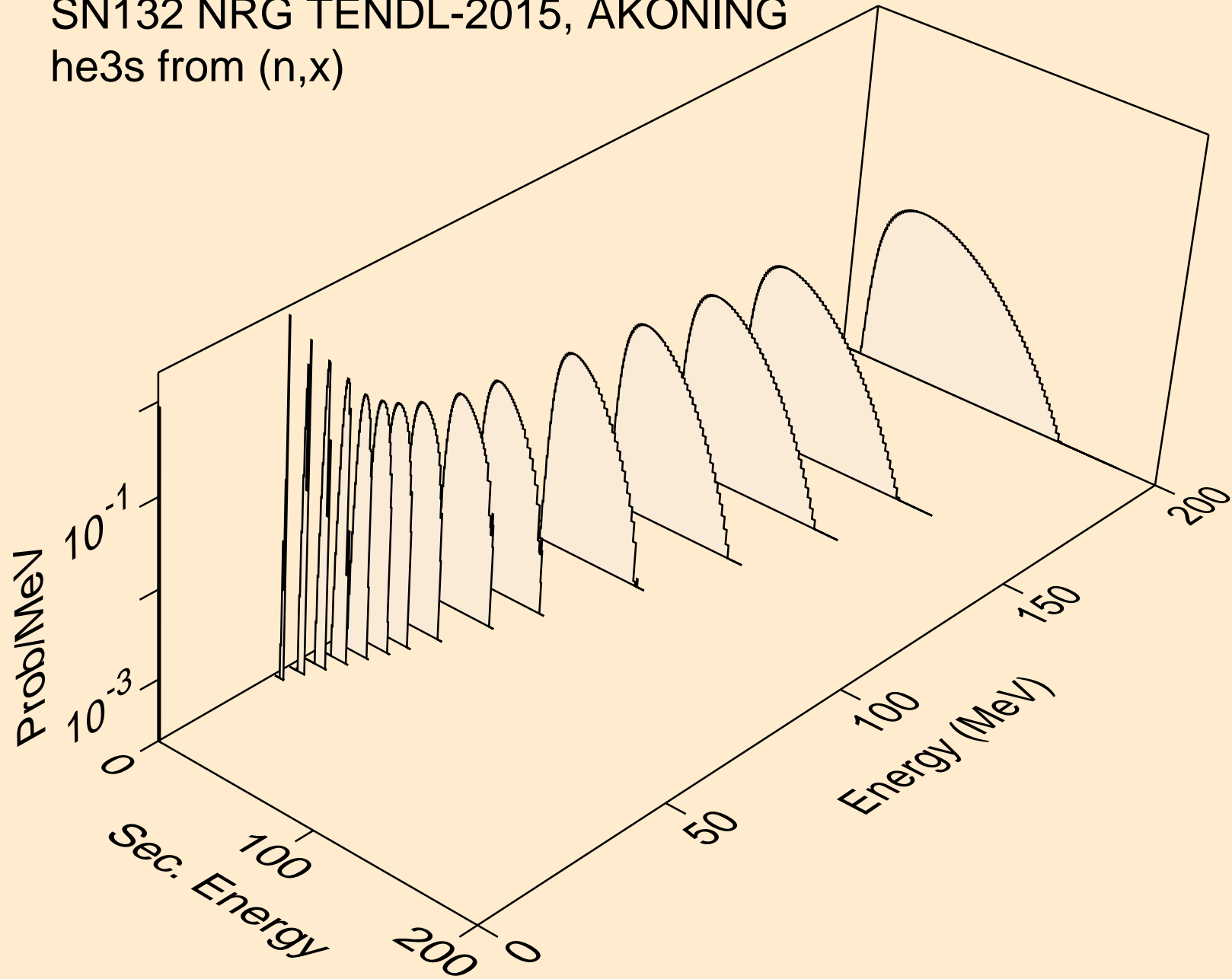

SN132 NRG TENDL-2015, AKONING
alphas from (n,x)

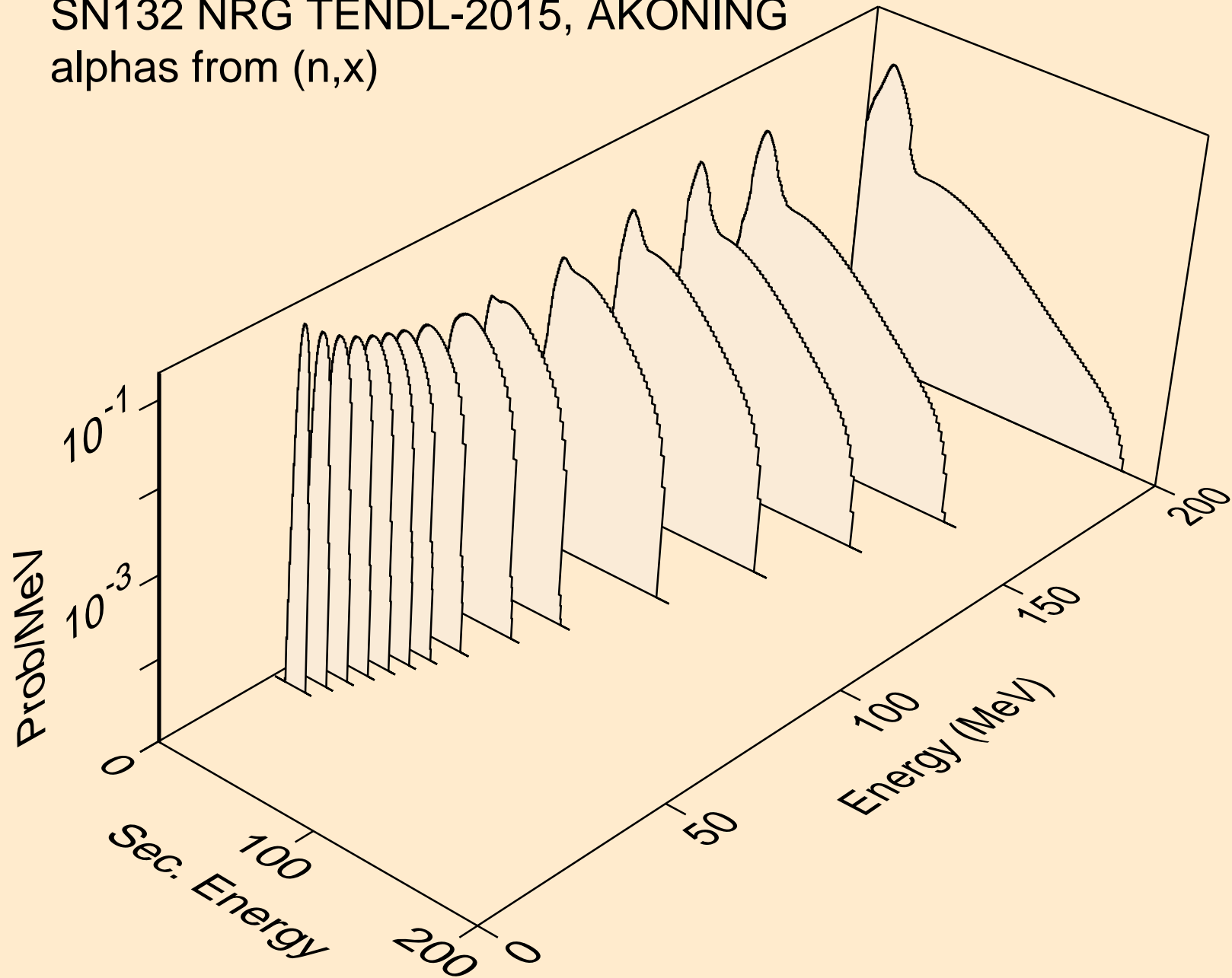

SN132 NRG TENDL-2015, AKONING
alphas from (n,n*)a

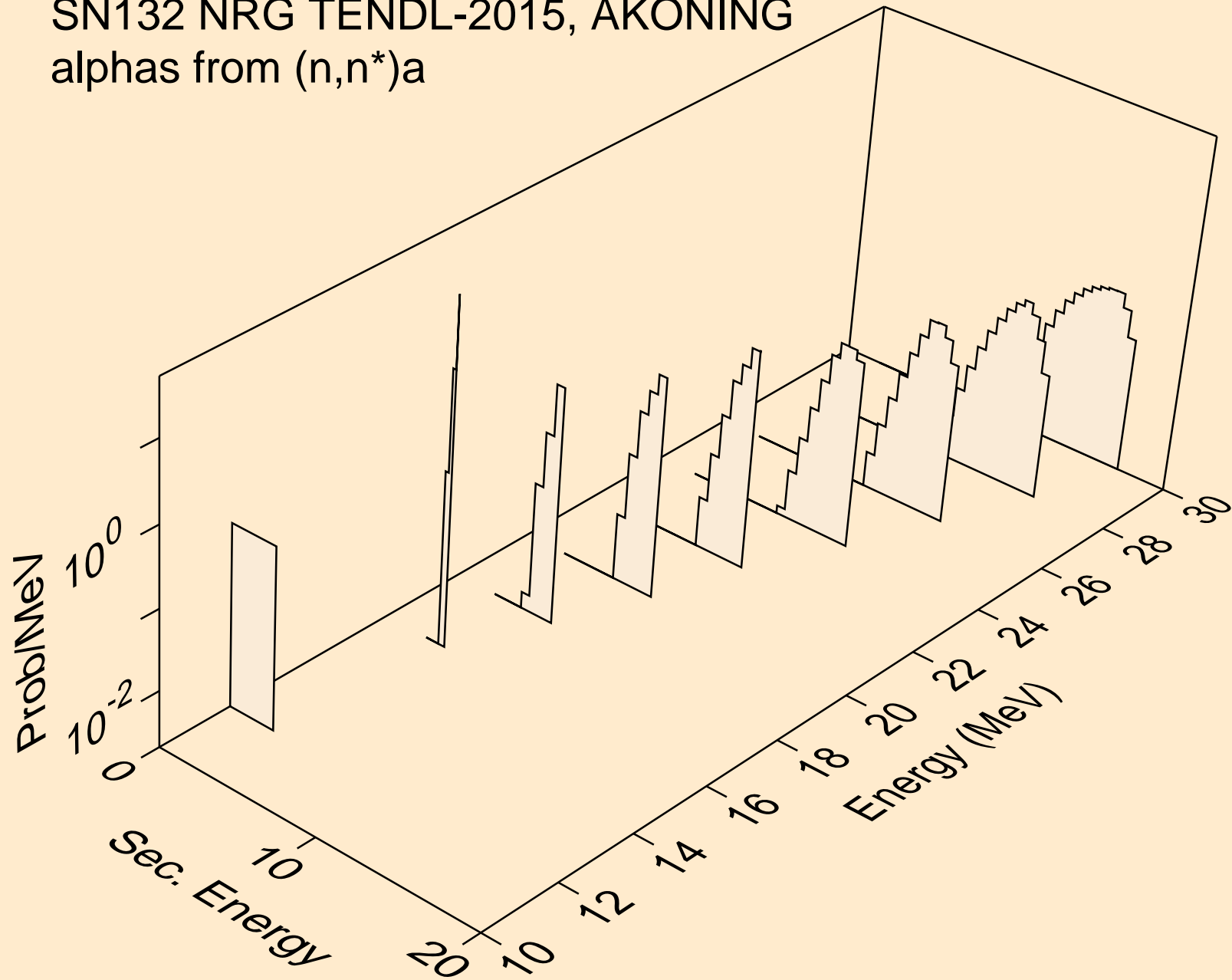

SN132 NRG TENDL-2015, AKONING
alphas from (n,2n)a

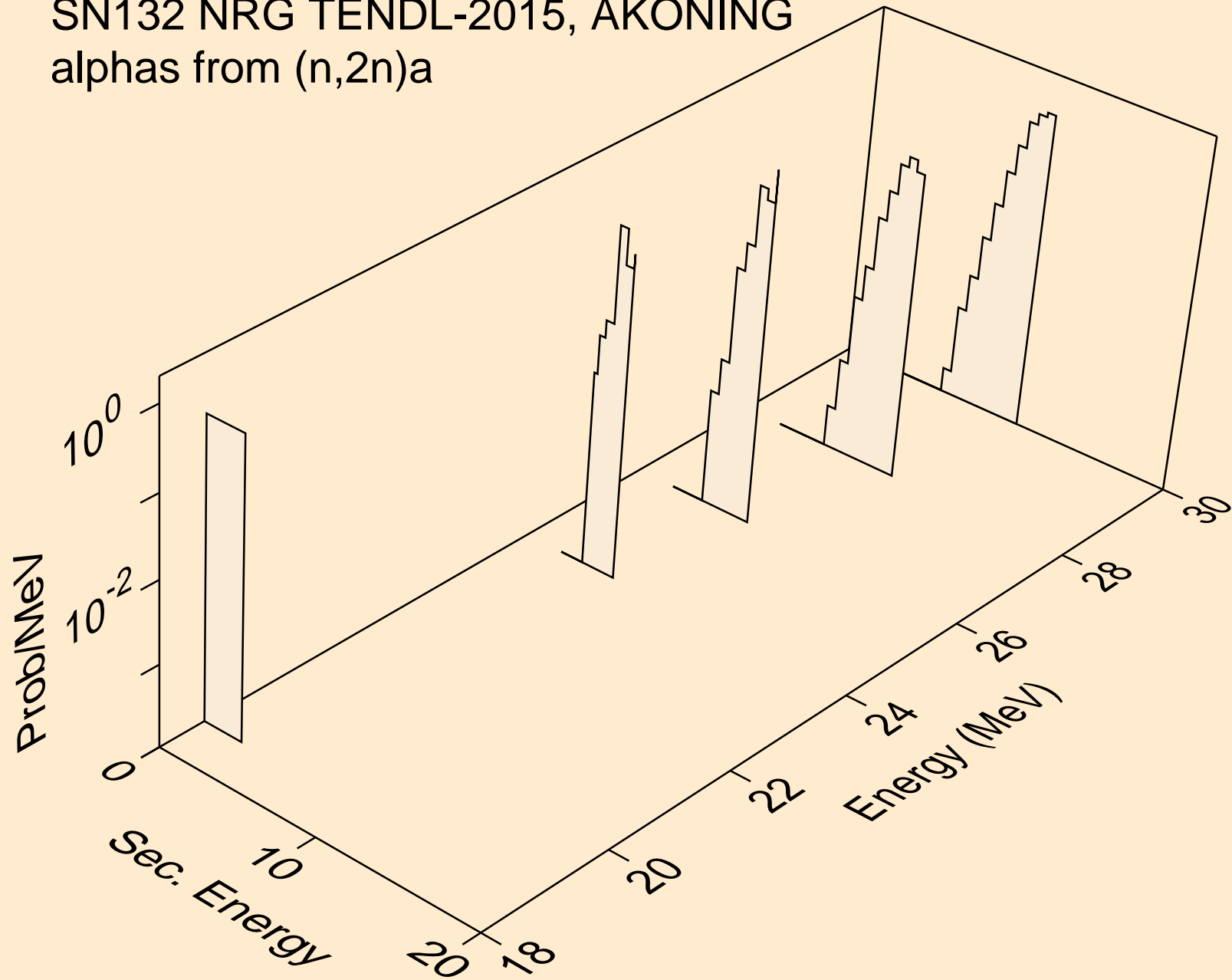

SN132 NRG TENDL-2015, AKONING
alphas from (n,a)

