

TA161 NRG TENDL-2015, AKONING

Principal cross sections

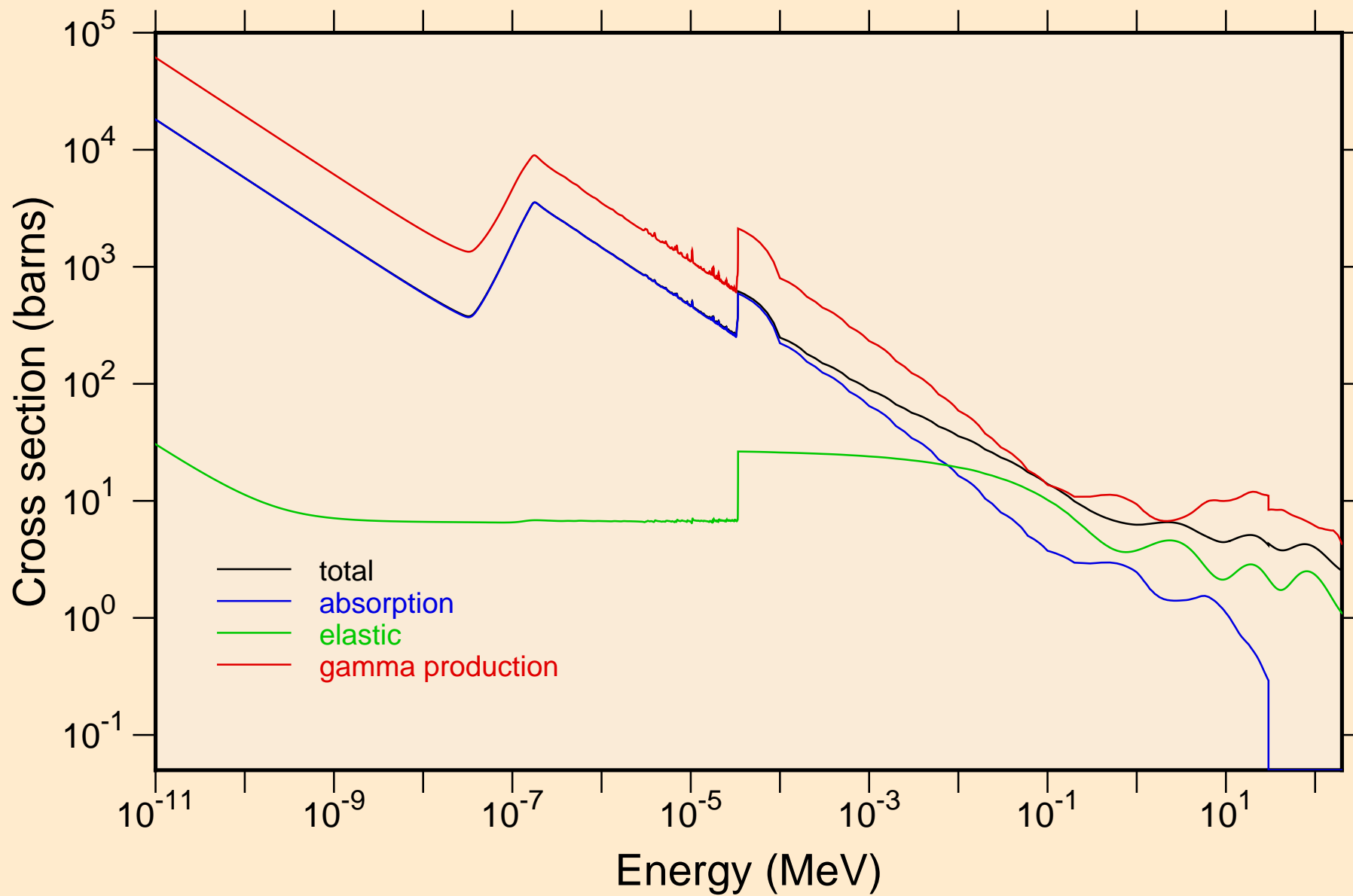

TA161 NRG TENDL-2015, AKONING
resonance total cross section

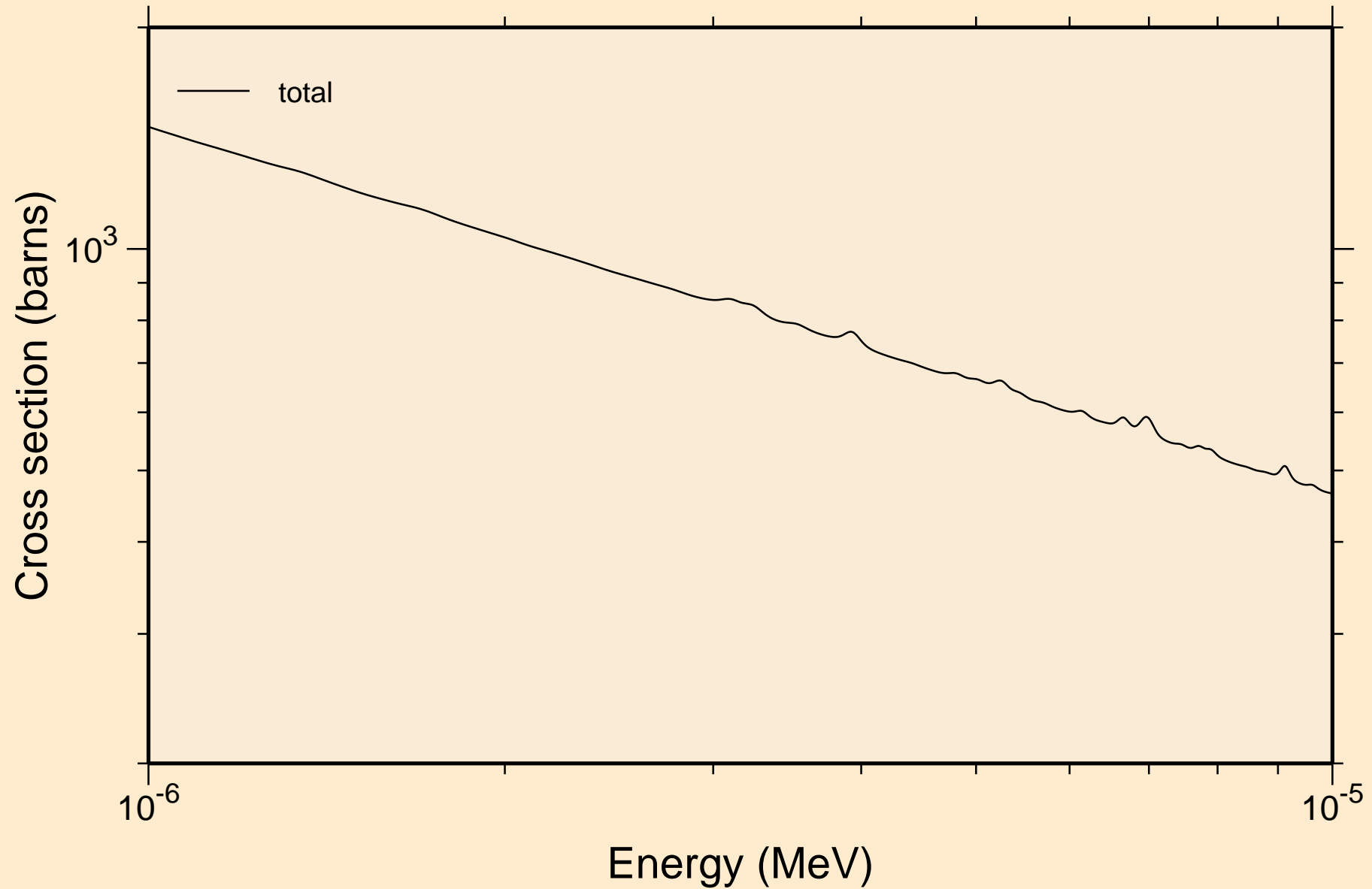

TA161 NRG TENDL-2015, AKONING
resonance total cross section

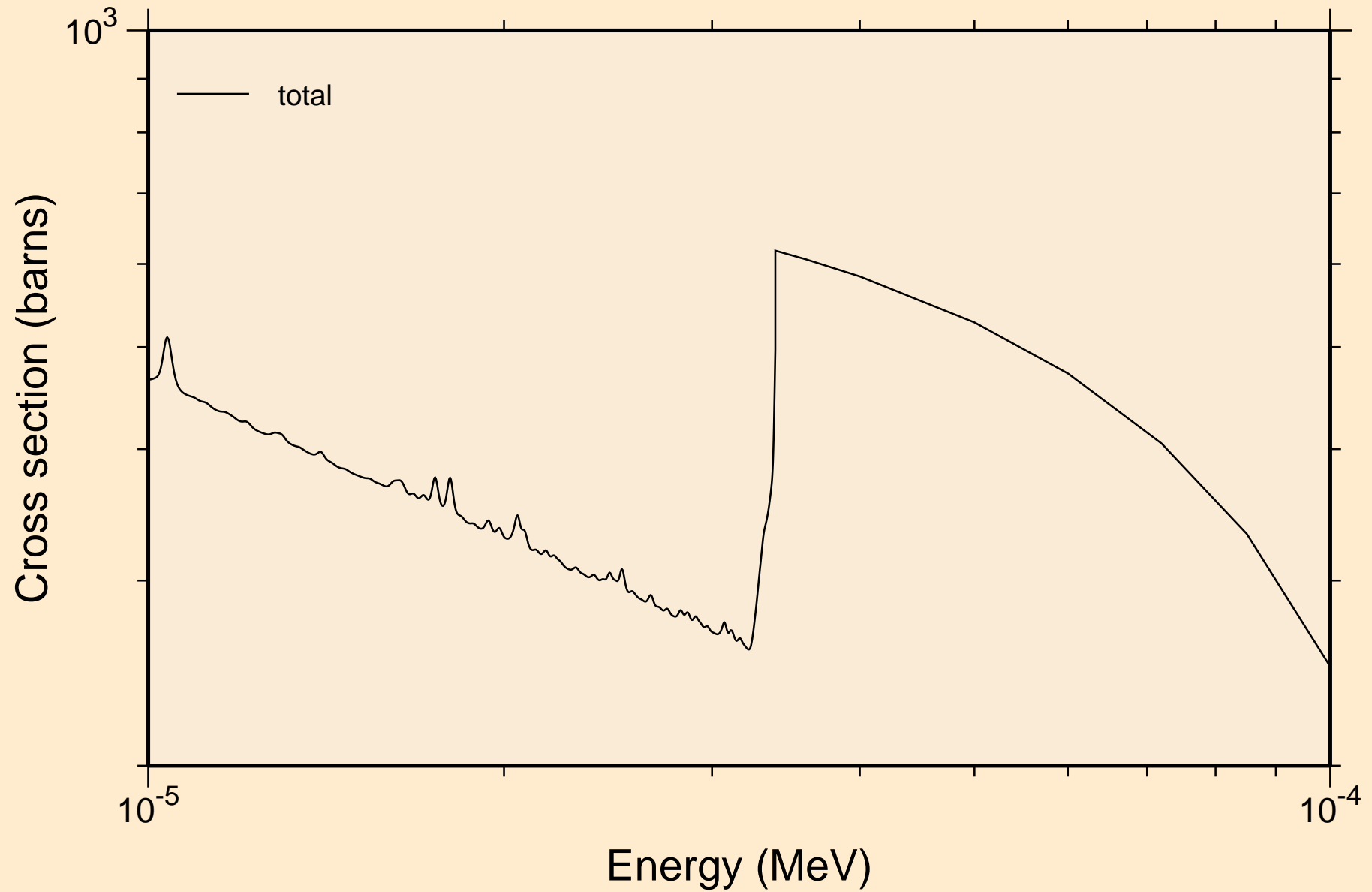

TA161 NRG TENDL-2015, AKONING
resonance total cross section

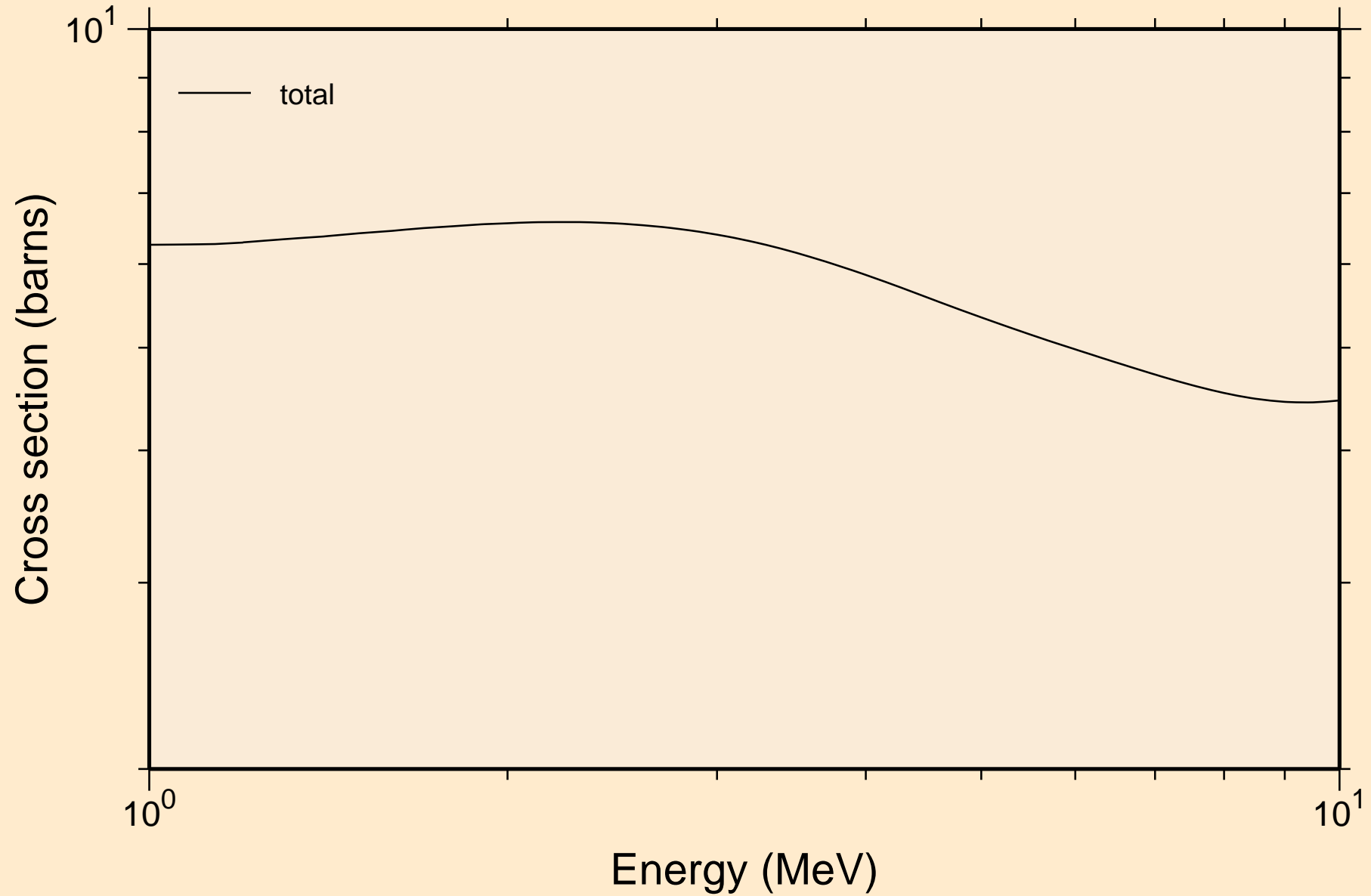

TA161 NRG TENDL-2015, AKONING
resonance absorption cross sections

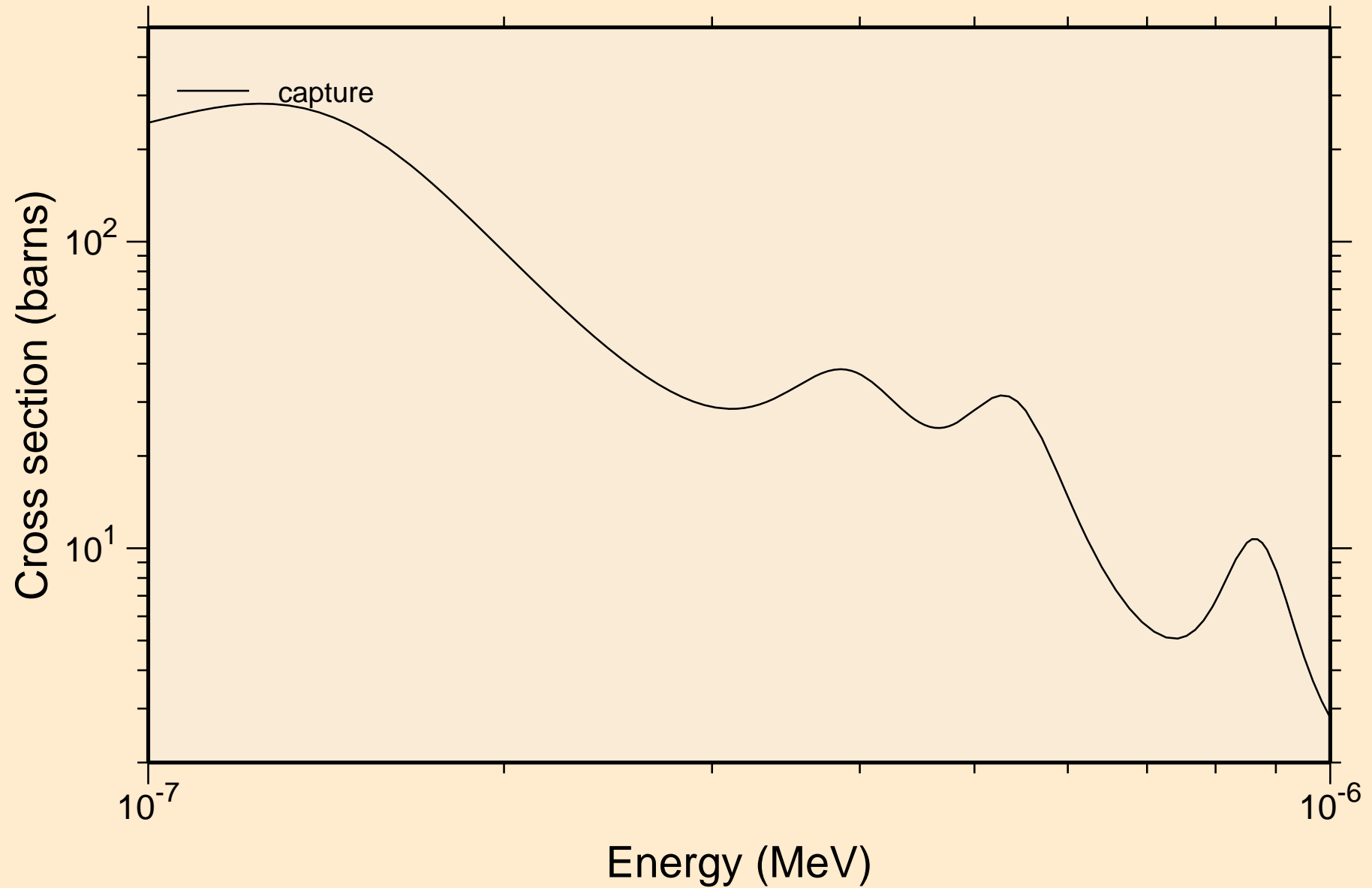

TA161 NRG TENDL-2015, AKONING
resonance absorption cross sections

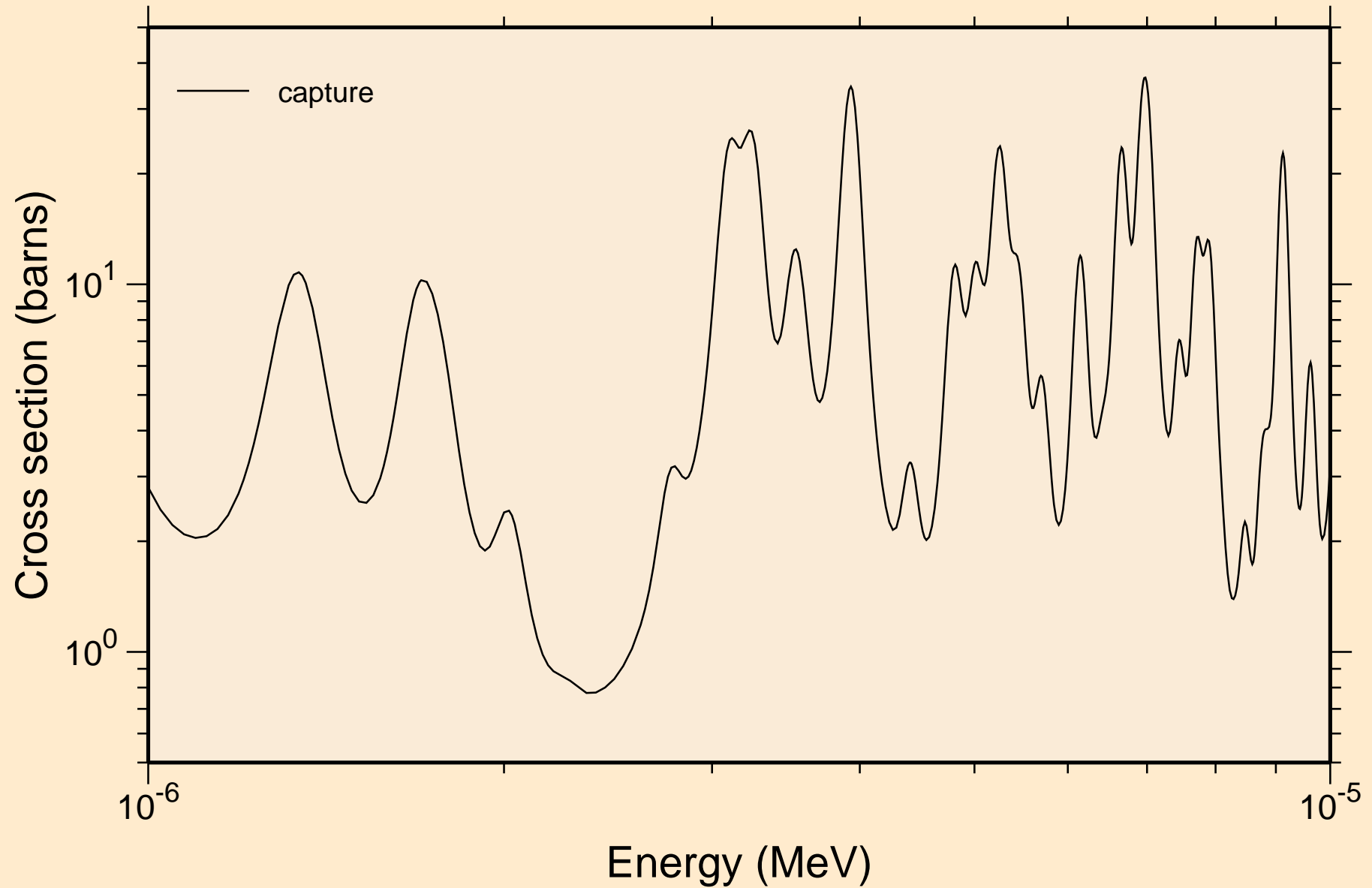

TA161 NRG TENDL-2015, AKONING
resonance absorption cross sections

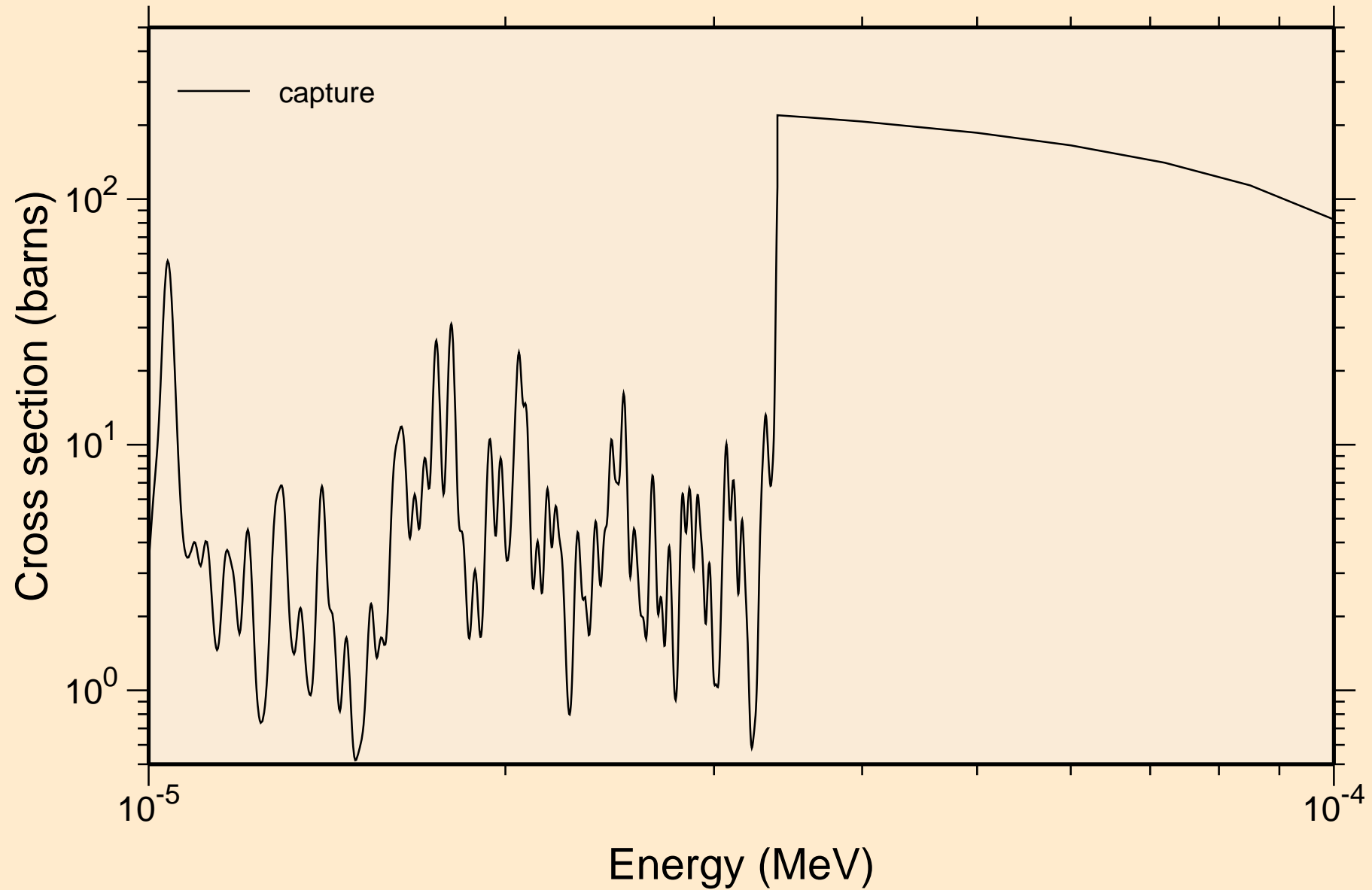

TA161 NRG TENDL-2015, AKONING
resonance absorption cross sections

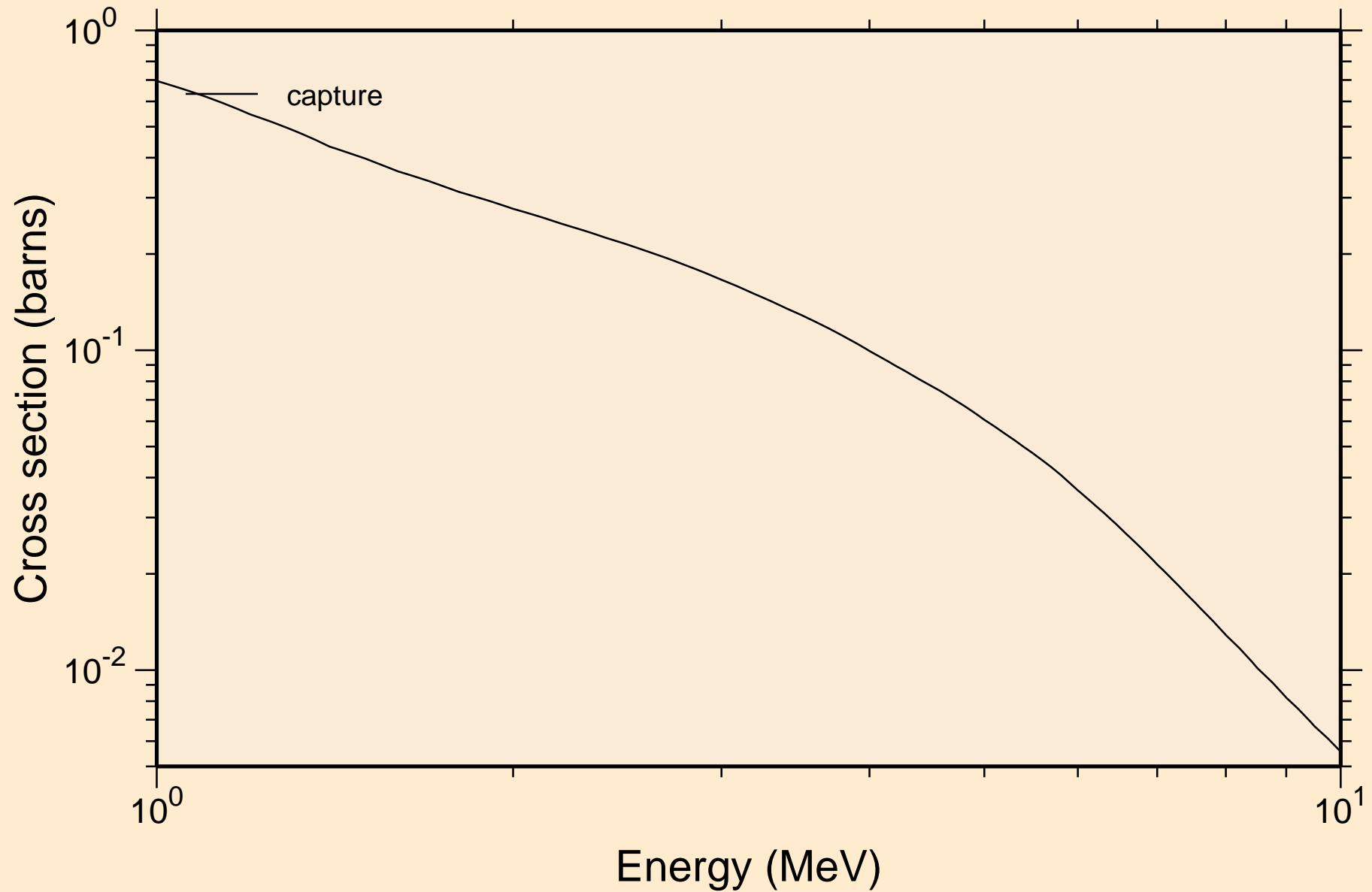

TA161 NRG TENDL-2015, AKONING
Non-threshold reactions

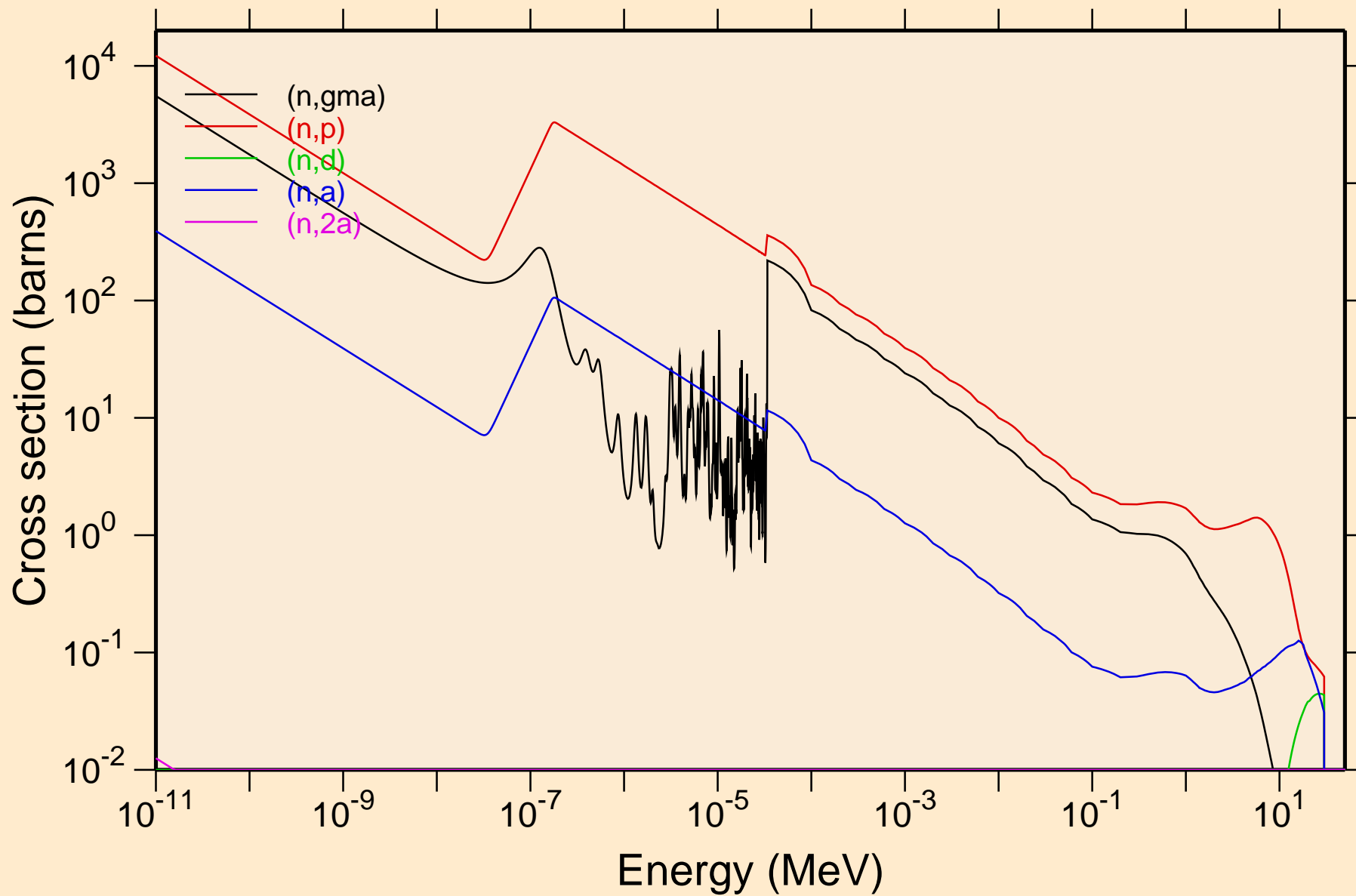

TA161 NRG TENDL-2015, AKONING

Non-threshold reactions

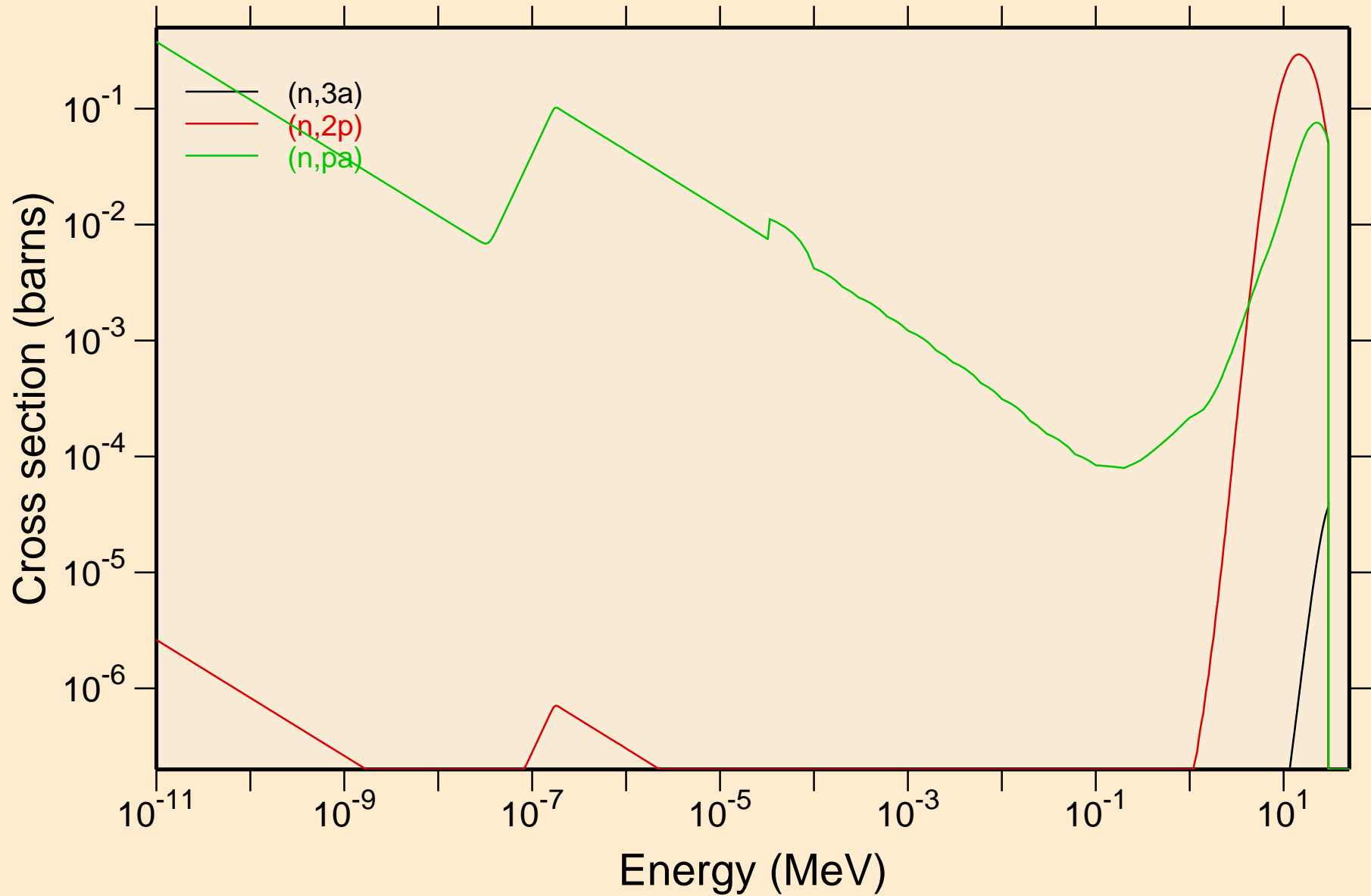

TA161 NRG TENDL-2015, AKONING

Principal cross sections

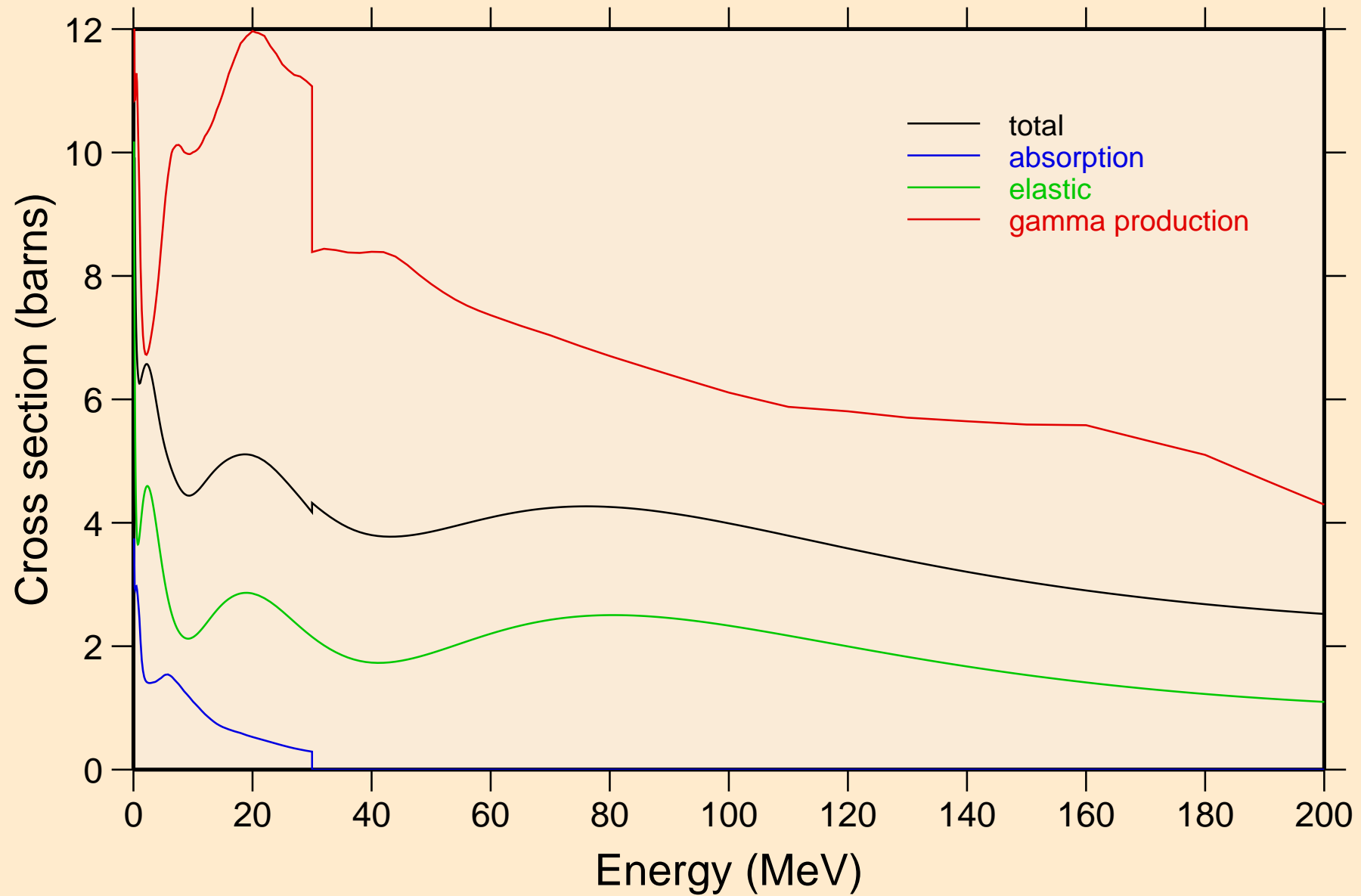

TA161 NRG TENDL-2015, AKONING

Non-threshold reactions

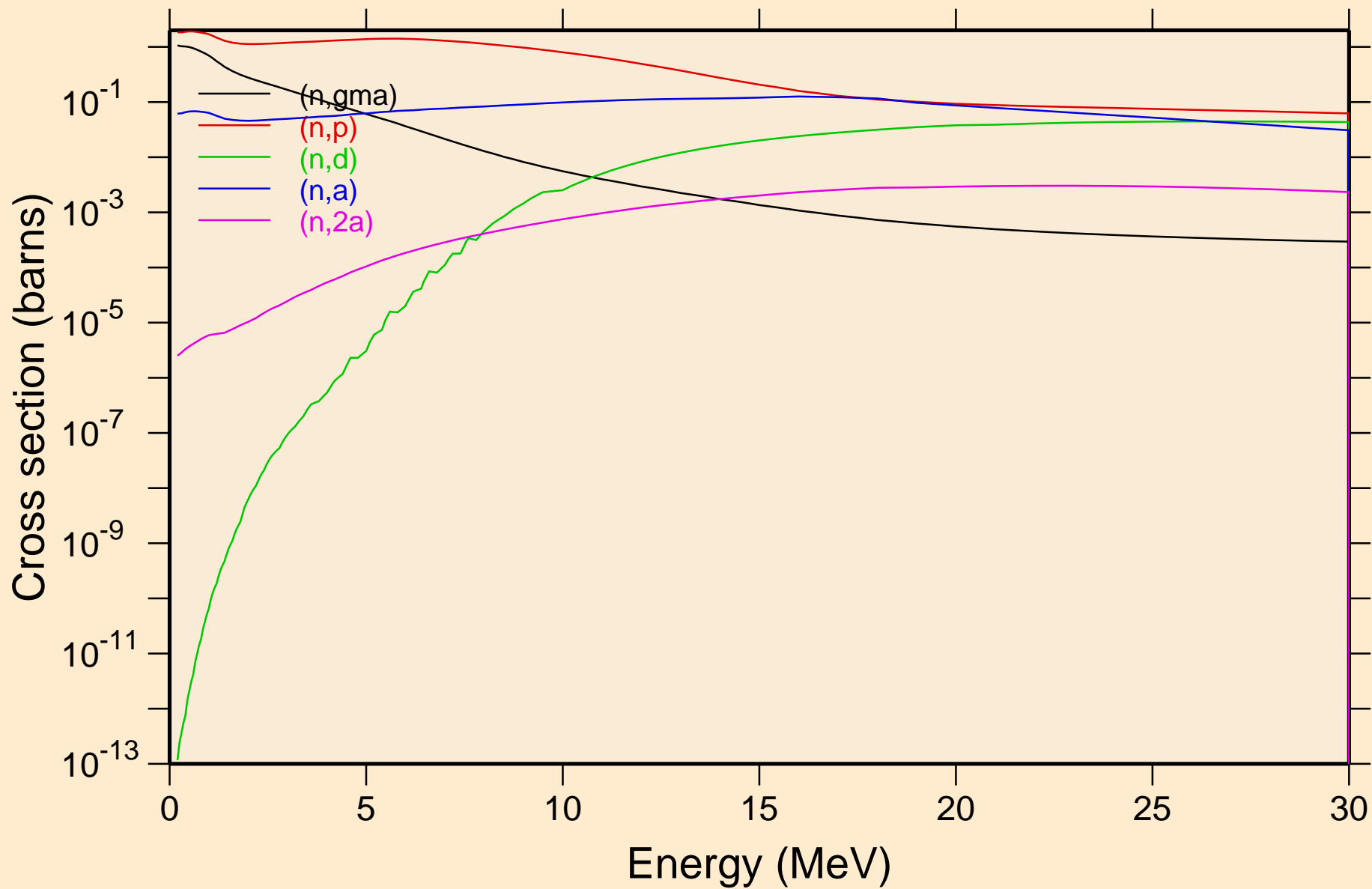

TA161 NRG TENDL-2015, AKONING
Non-threshold reactions

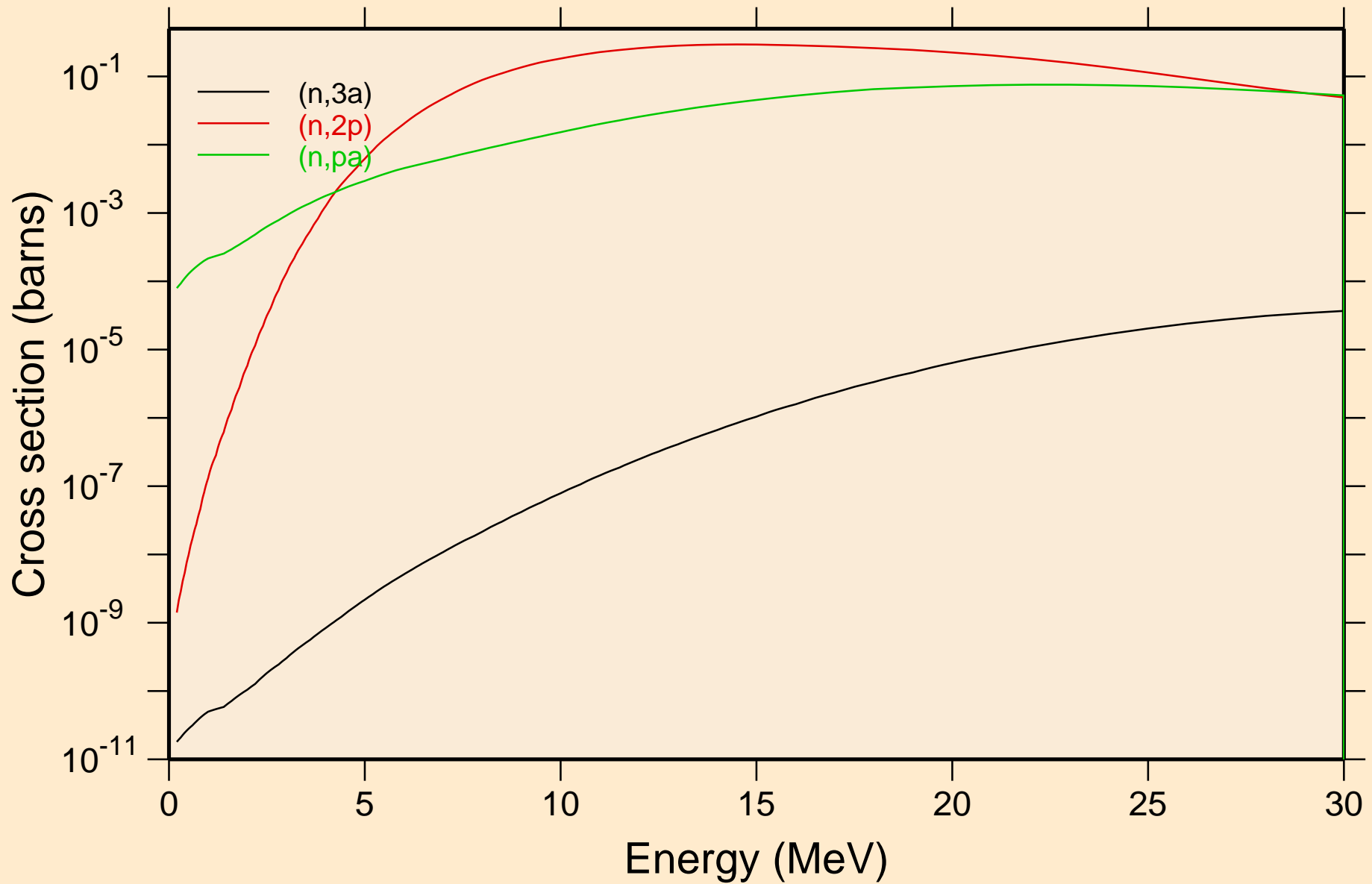

TA161 NRG TENDL-2015, AKONING

Inelastic levels

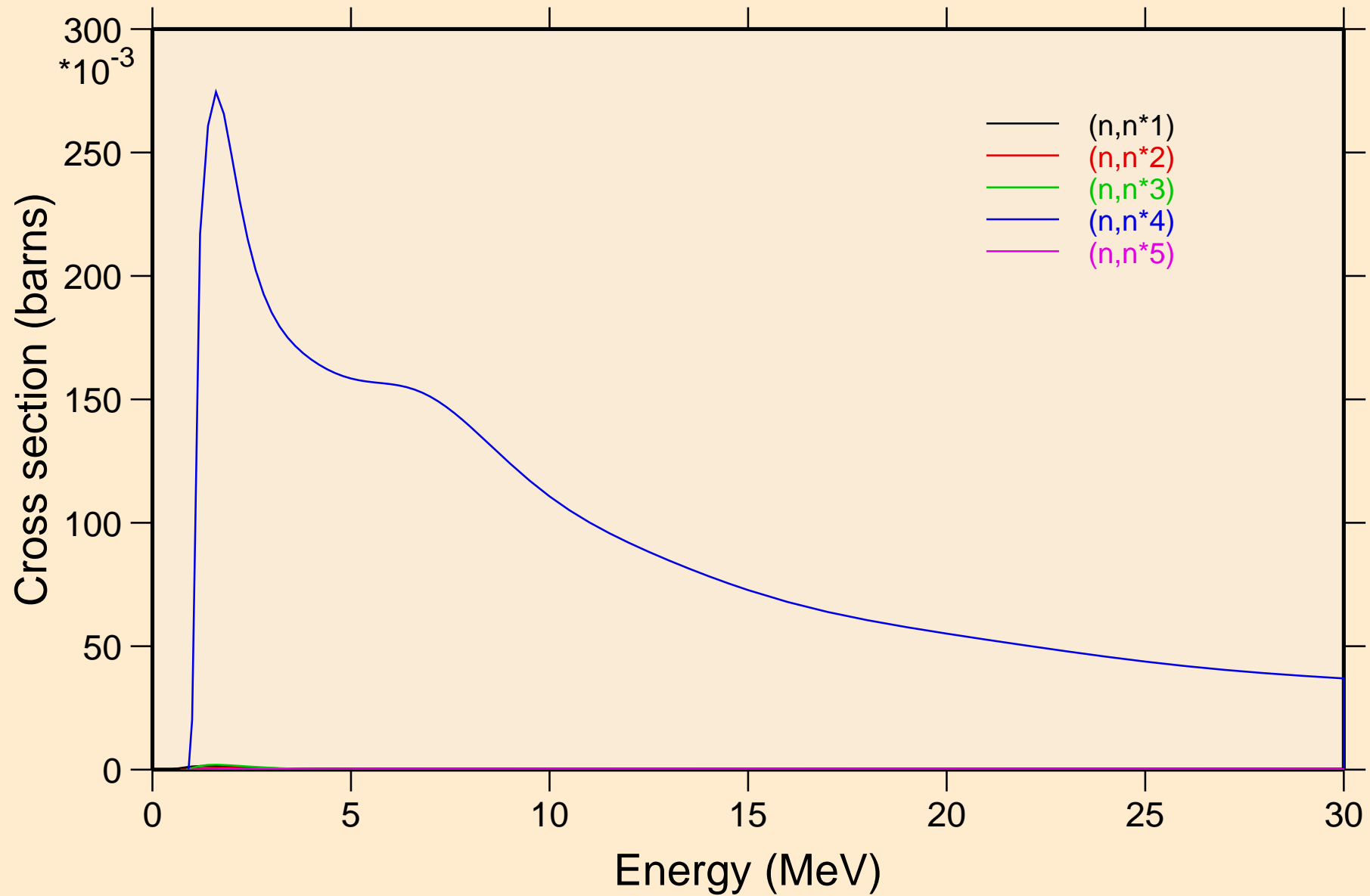

TA161 NRG TENDL-2015, AKONING

Inelastic levels

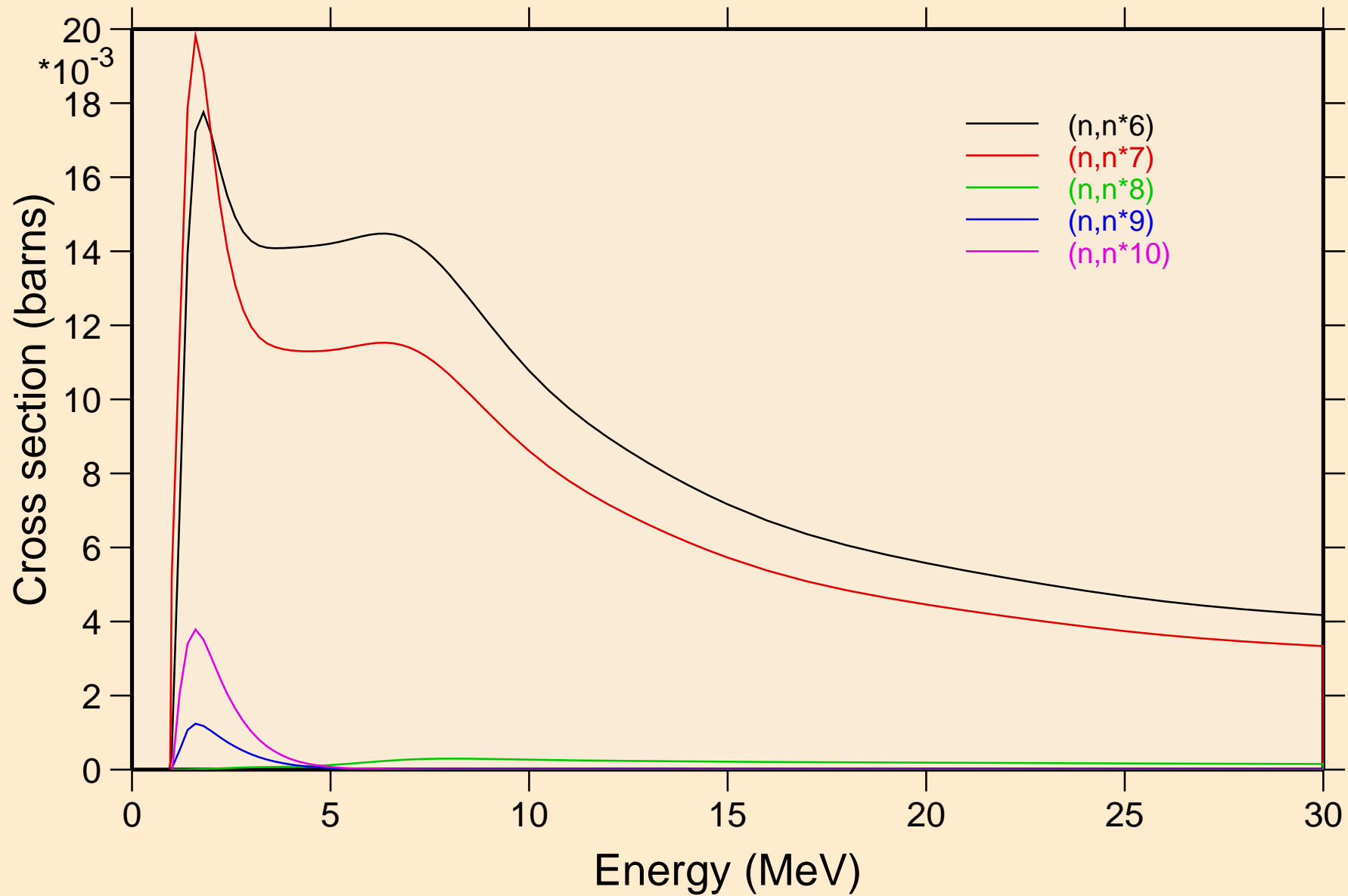

TA161 NRG TENDL-2015, AKONING

Inelastic levels

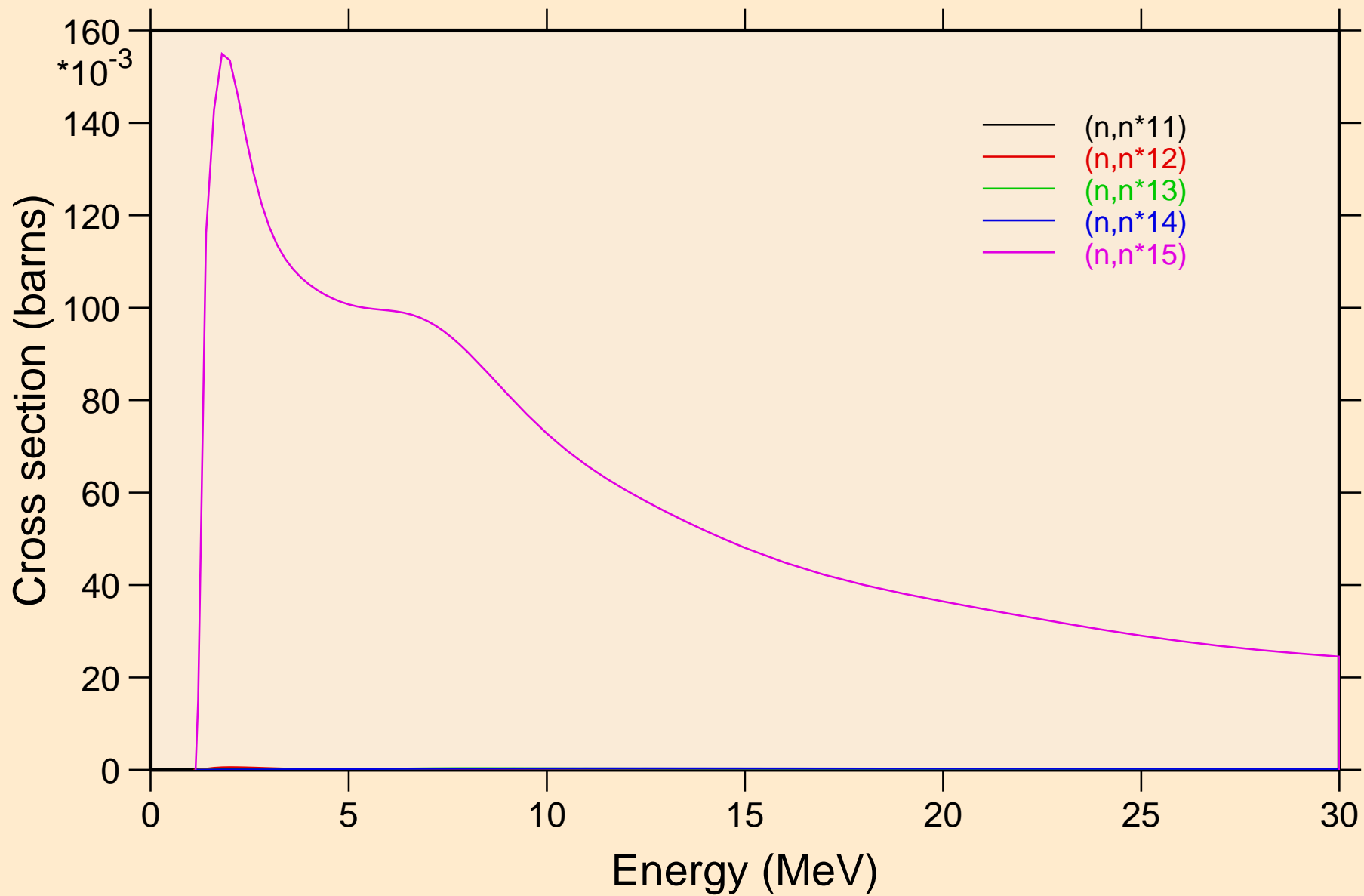

TA161 NRG TENDL-2015, AKONING
Inelastic levels

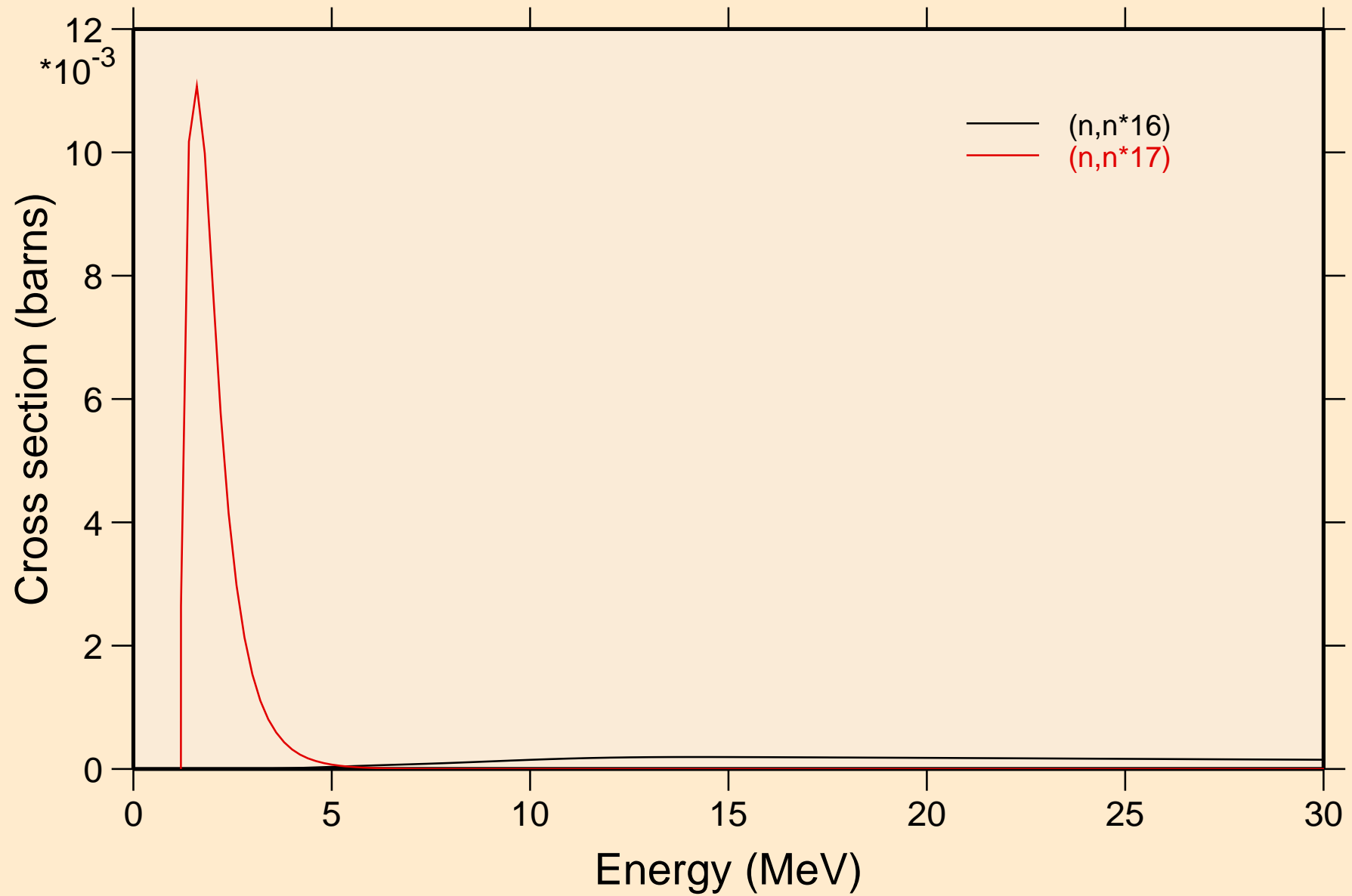

TA161 NRG TENDL-2015, AKONING

Threshold reactions

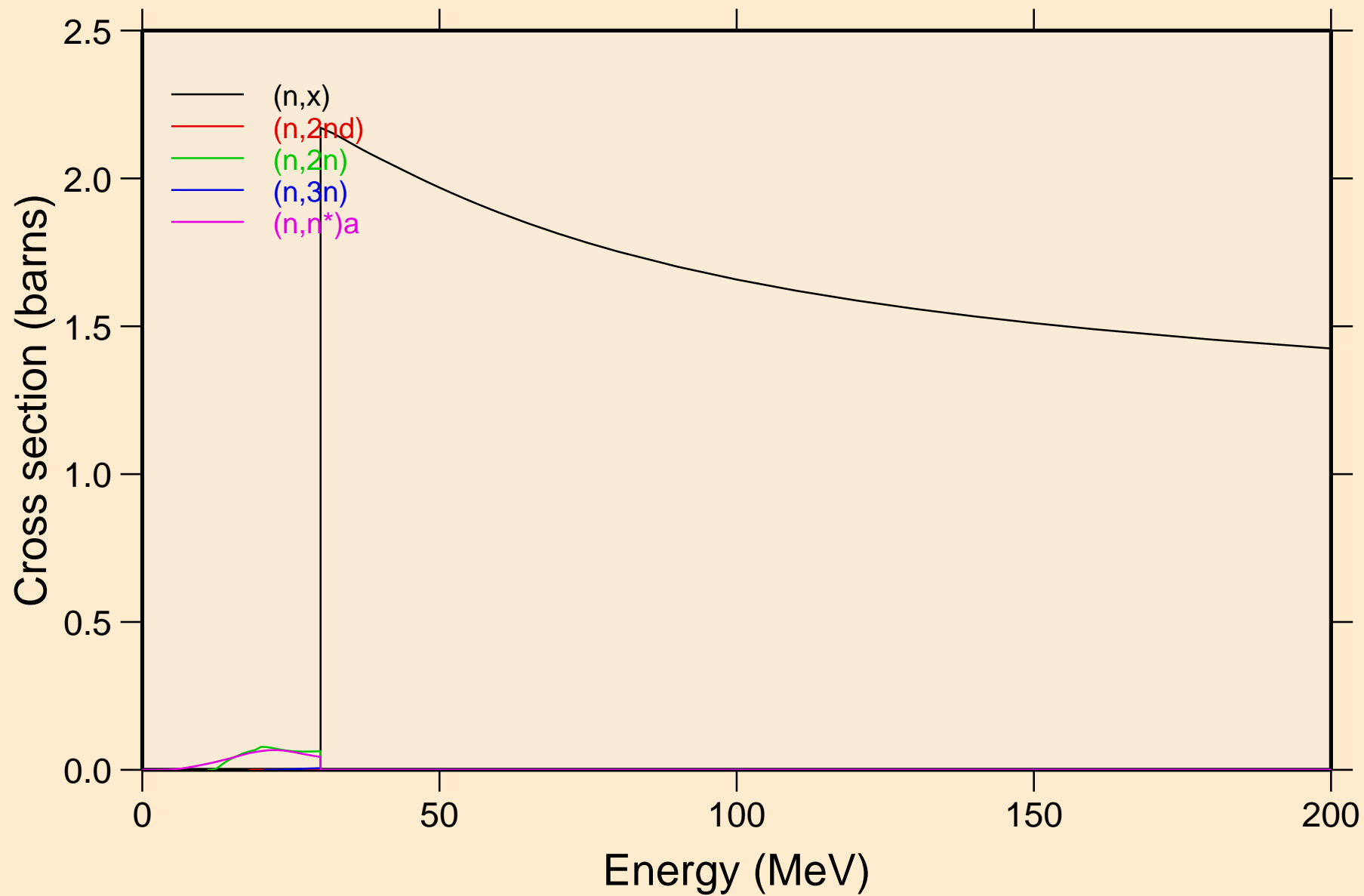

TA161 NRG TENDL-2015, AKONING

Threshold reactions

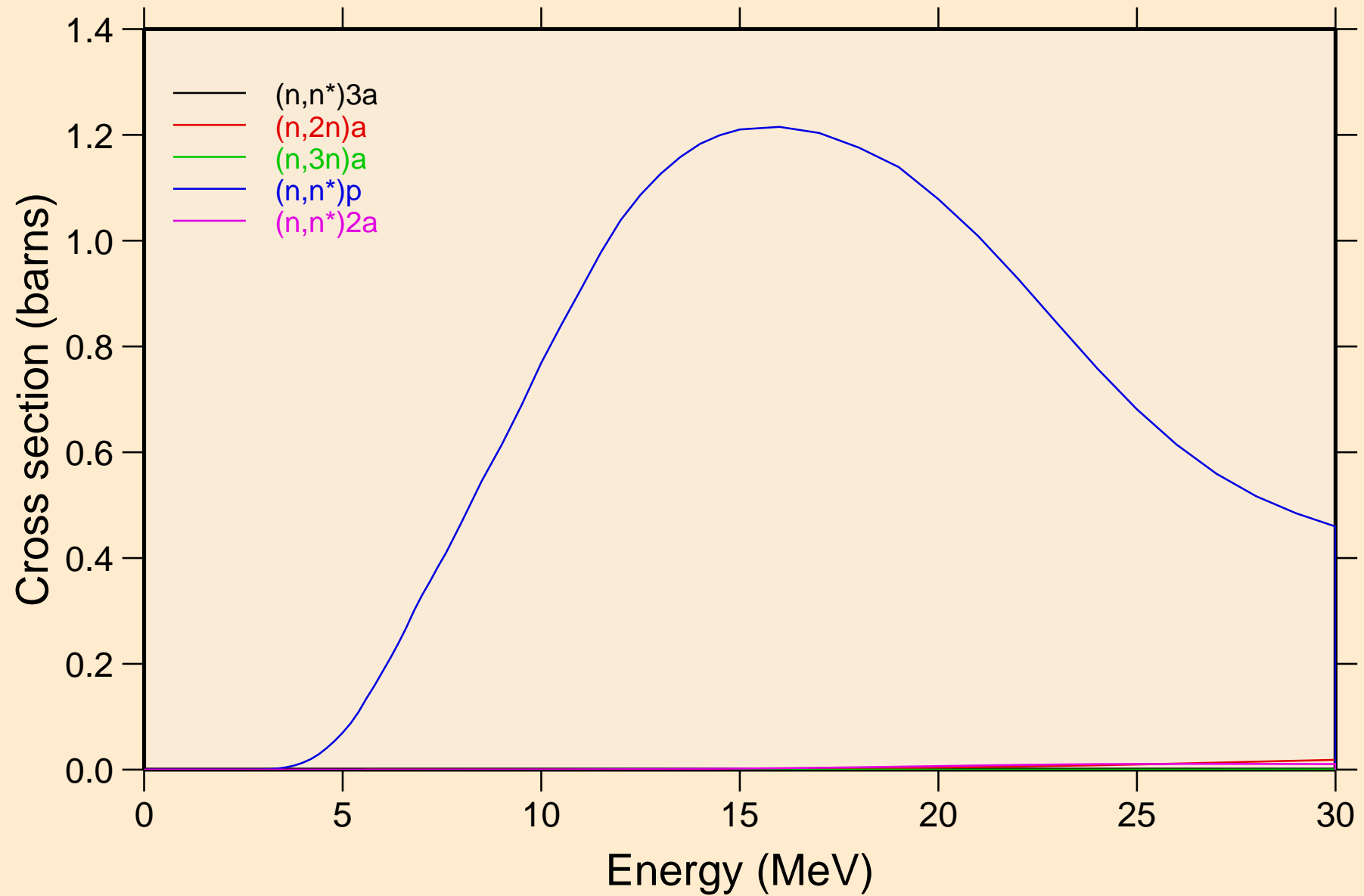

TA161 NRG TENDL-2015, AKONING

Threshold reactions

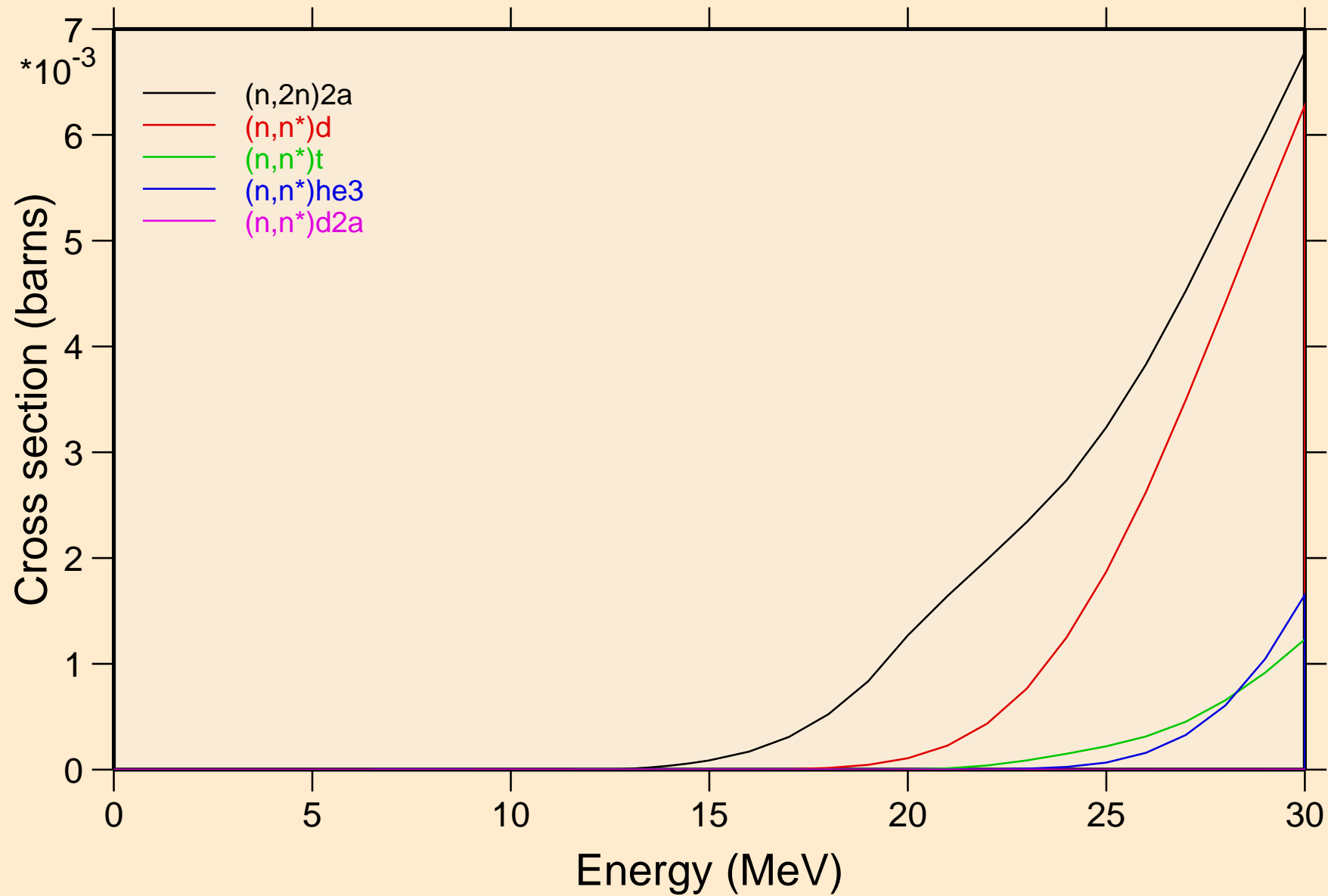

TA161 NRG TENDL-2015, AKONING

Threshold reactions

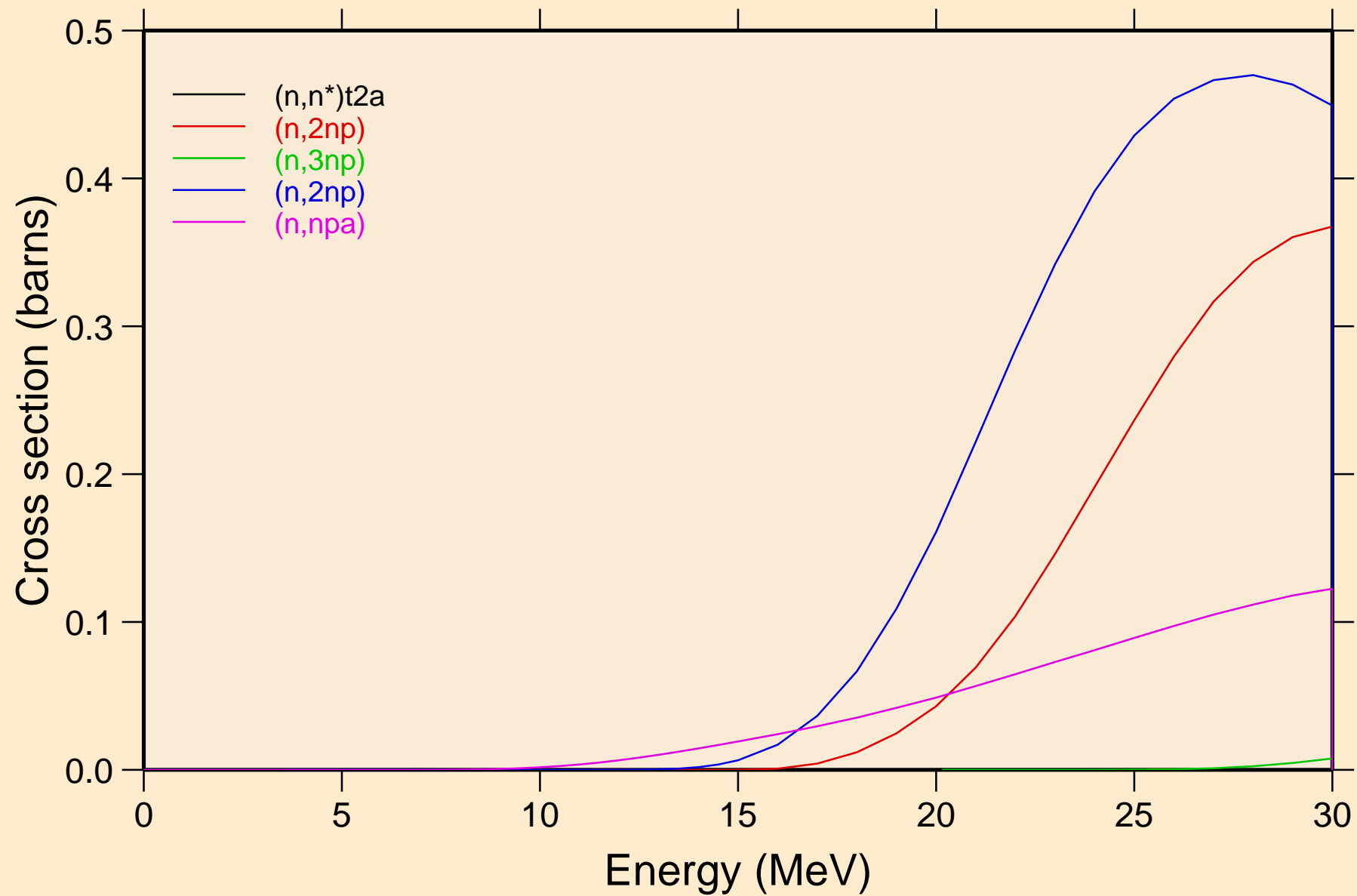

TA161 NRG TENDL-2015, AKONING

Threshold reactions

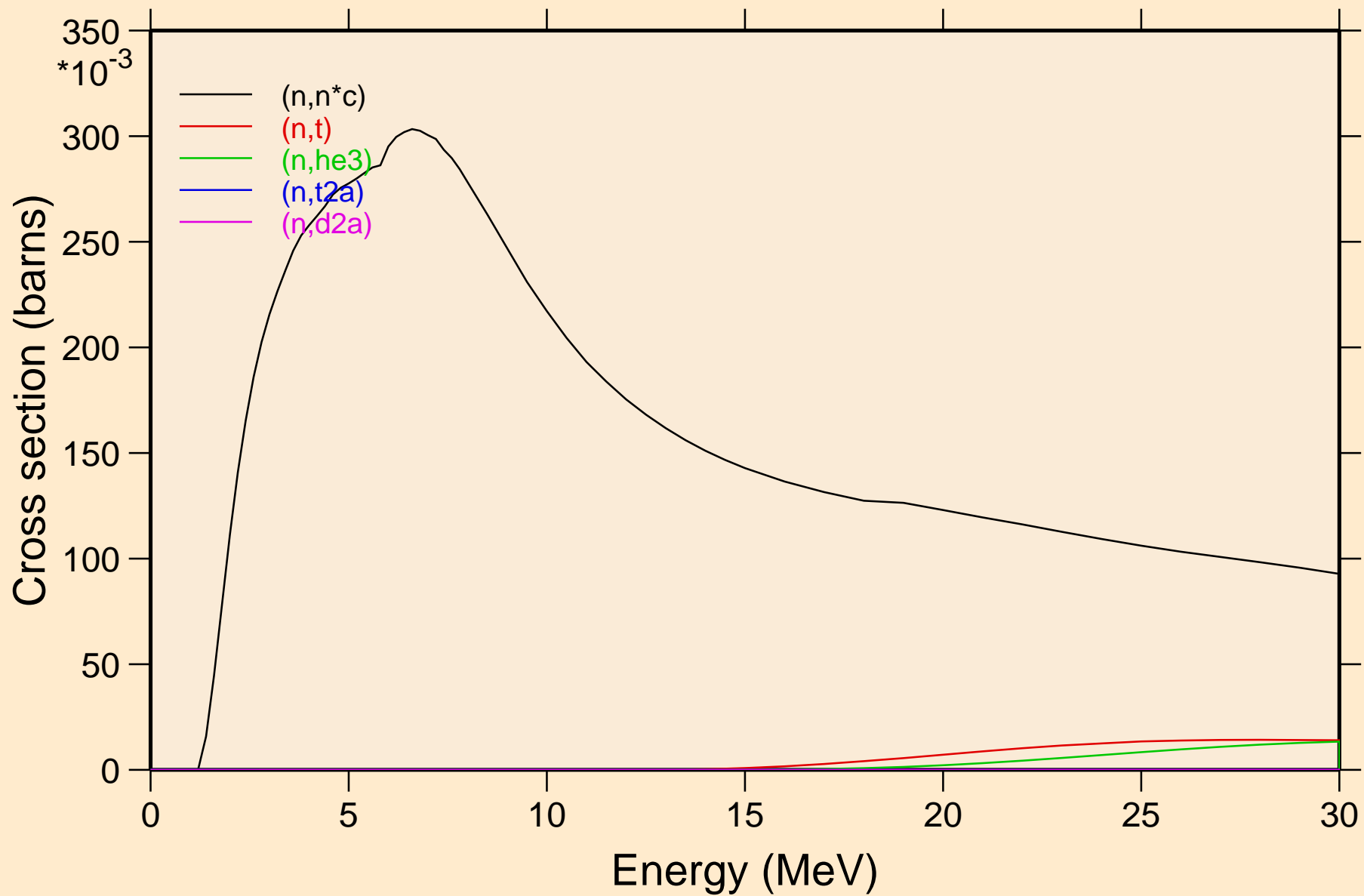

TA161 NRG TENDL-2015, AKONING

Threshold reactions

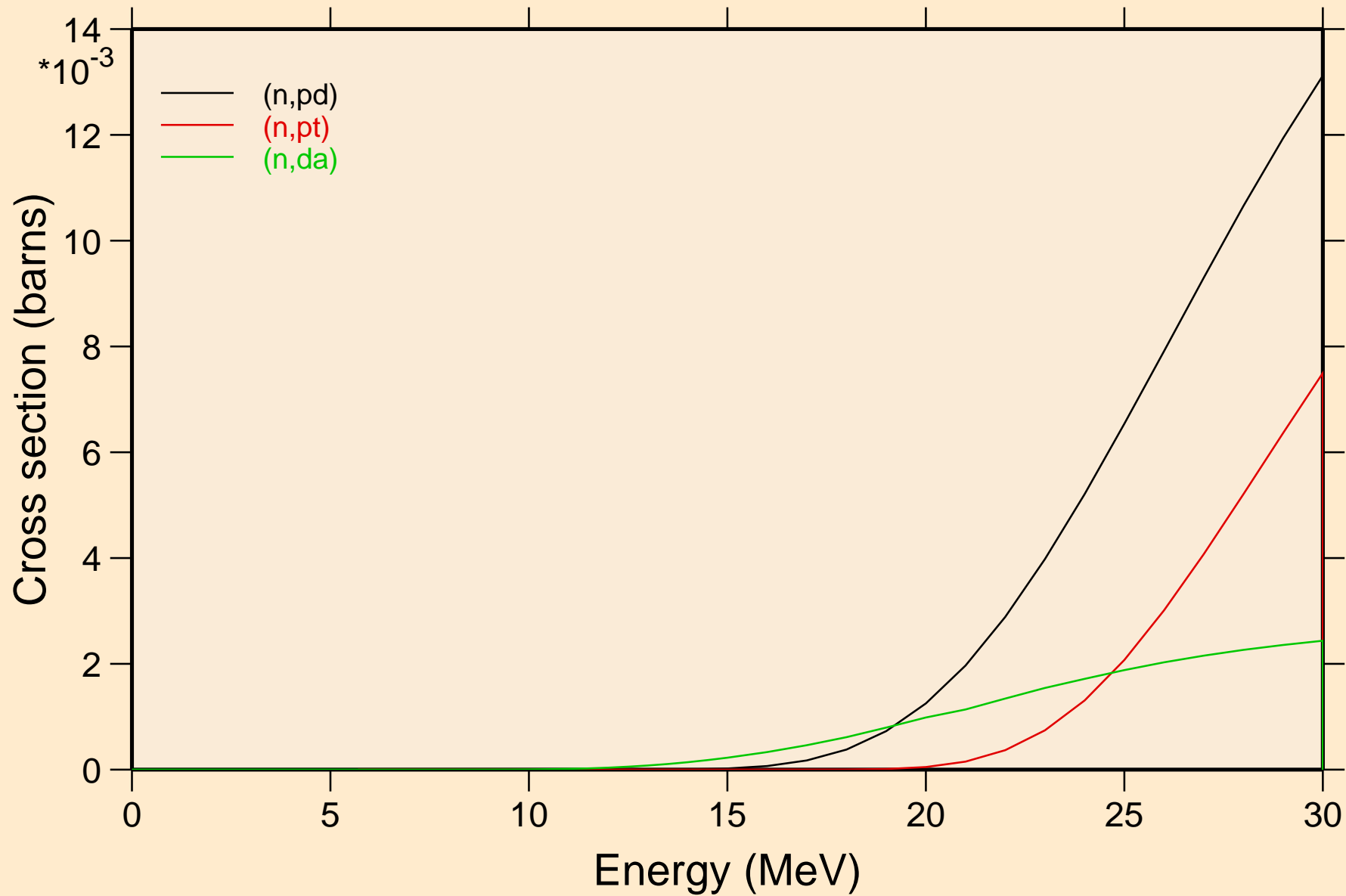

TA161 NRG TENDL-2015, AKONING
angular distribution for elastic

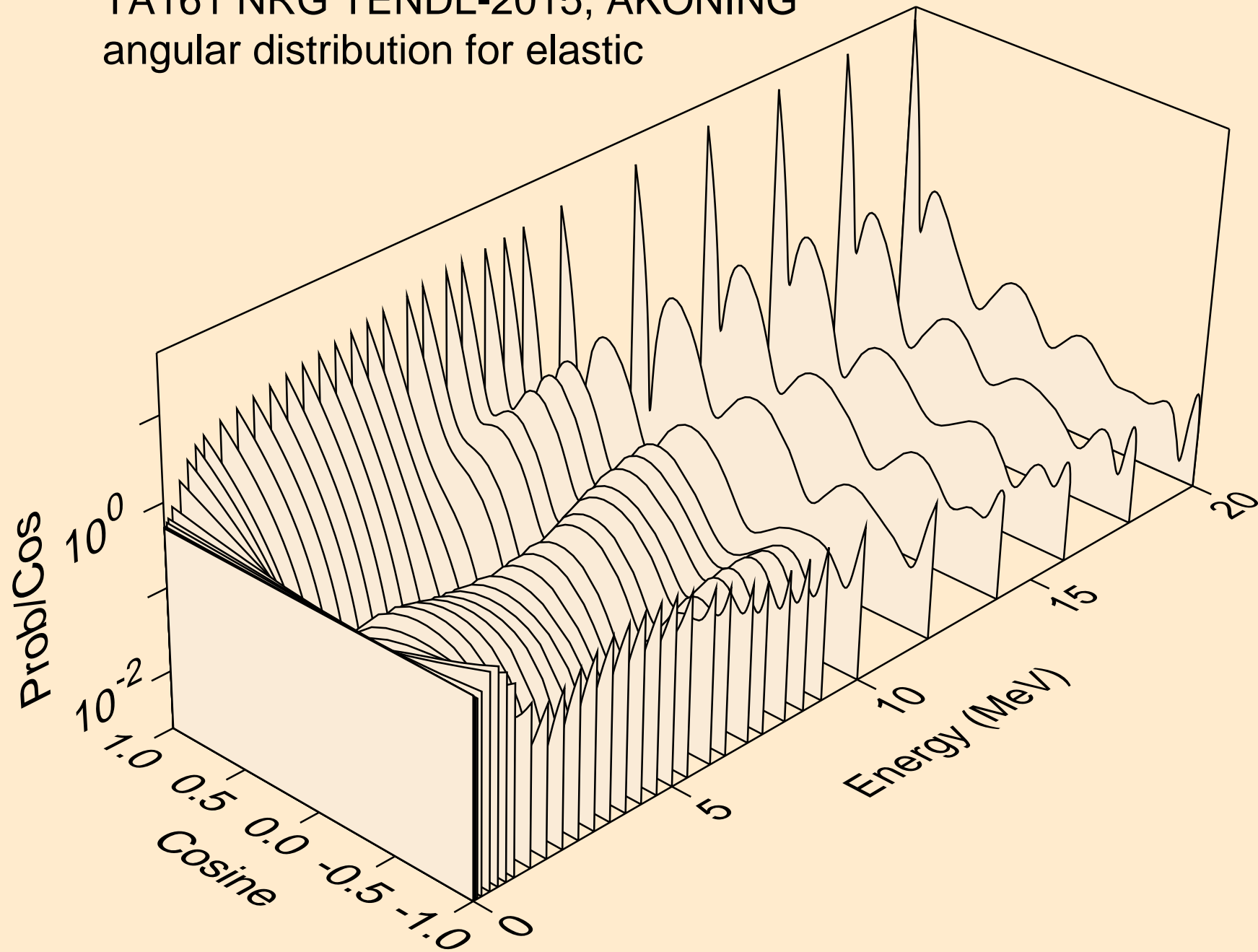

TA161 NRG TENDL-2015, AKONING
angular distribution for elastic

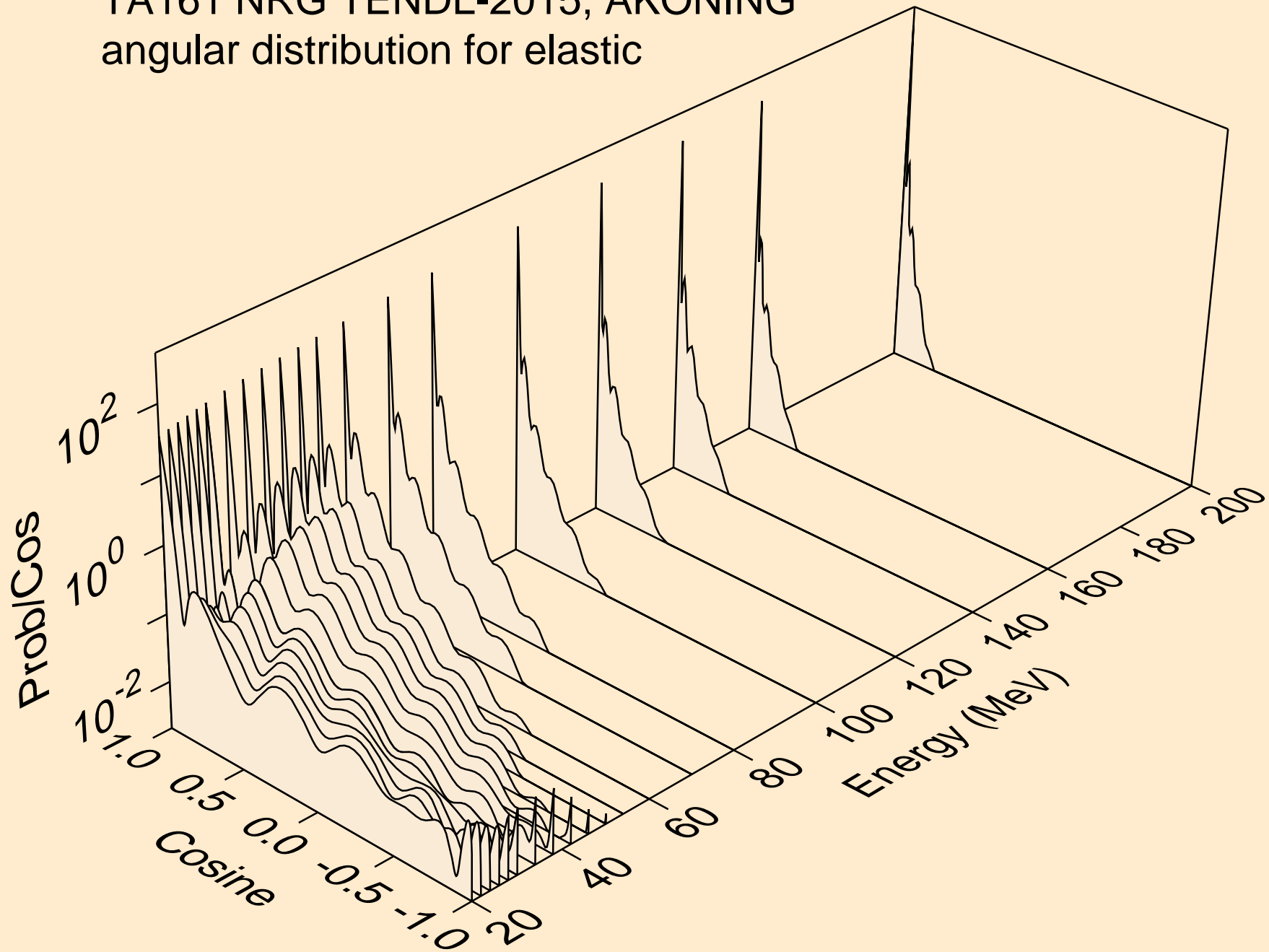

TA161 NRG TENDL-2015, AKONING
angular distribution for (n,n*1)

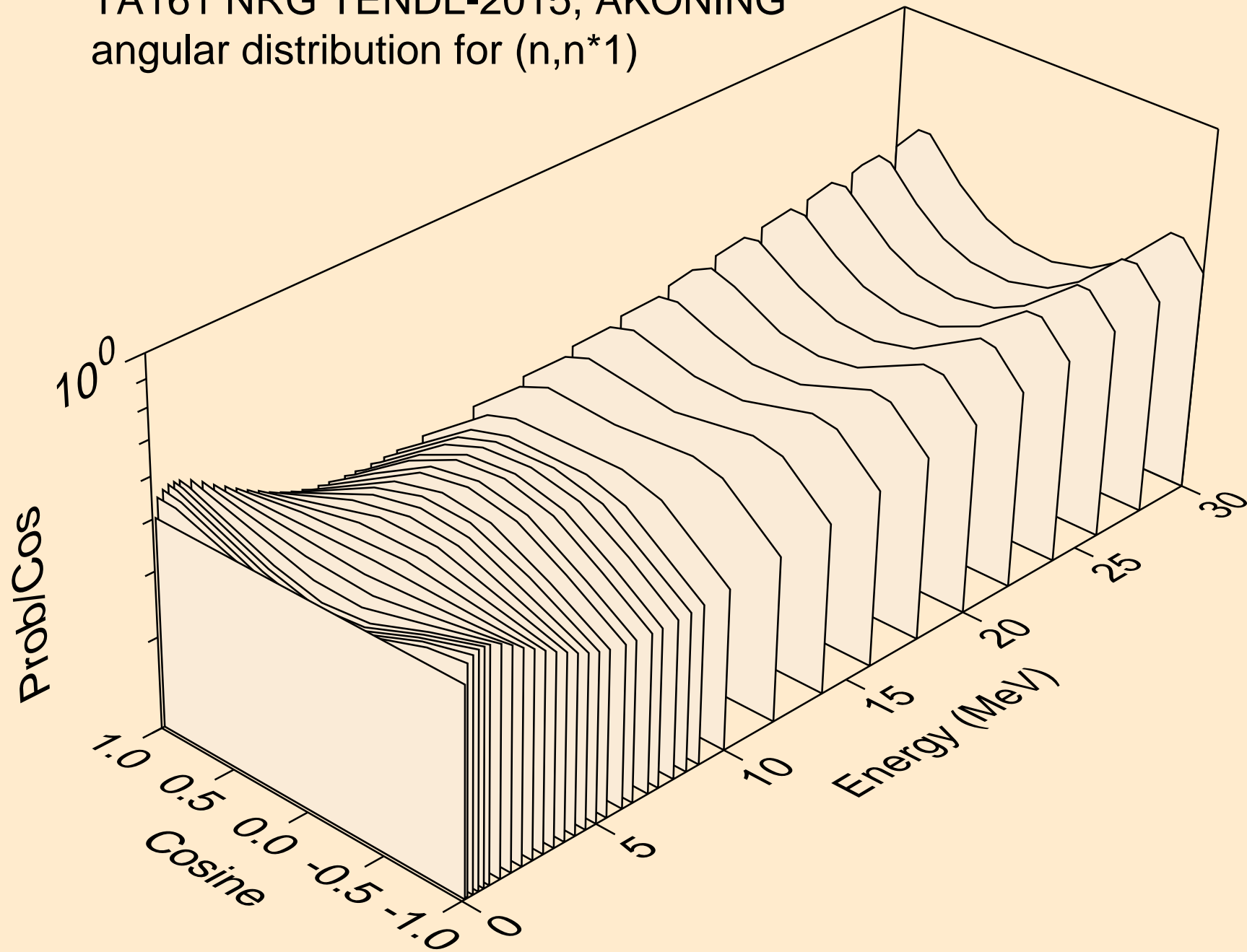

TA161 NRG TENDL-2015, AKONING
angular distribution for (n,n*2)

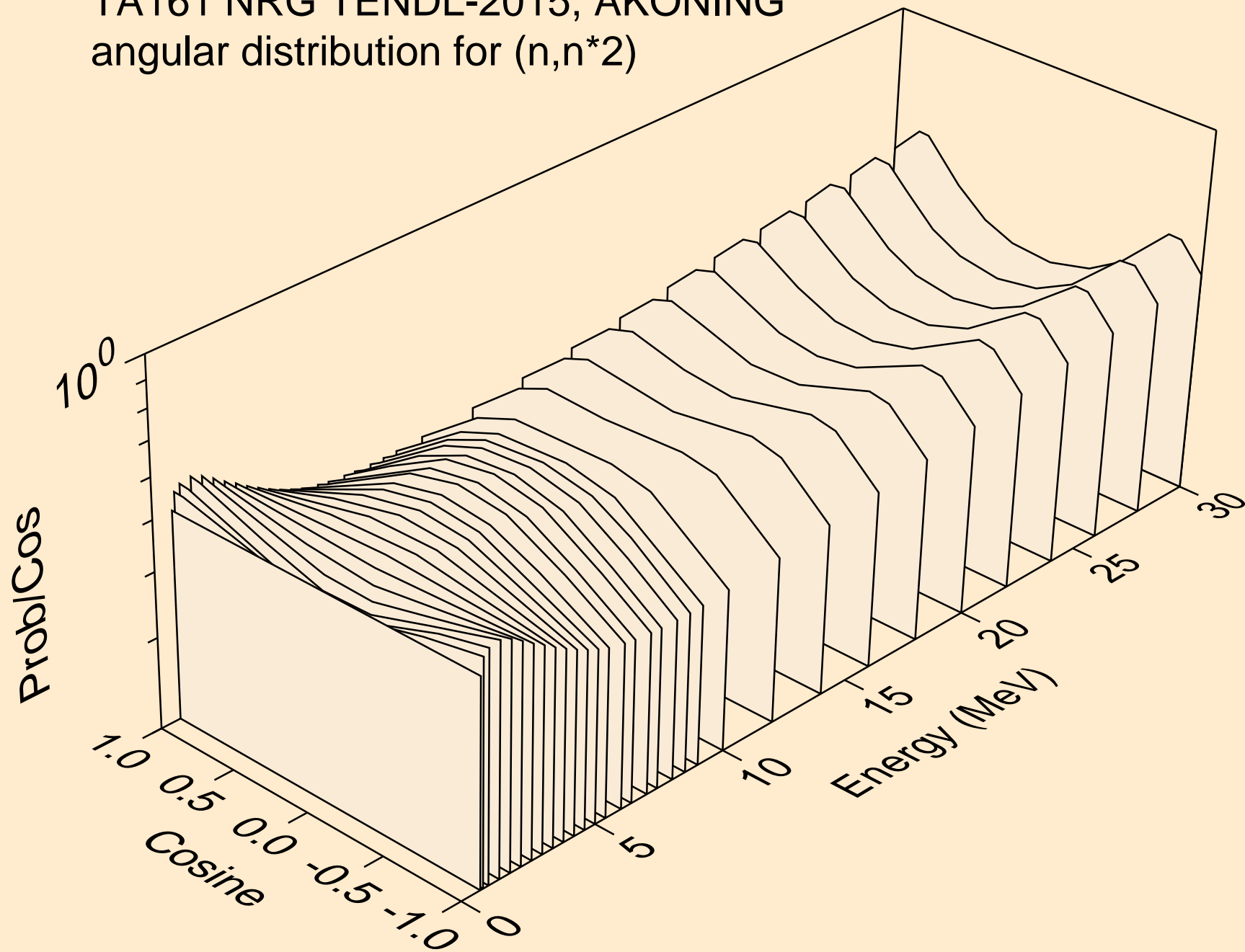

TA161 NRG TENDL-2015, AKONING
angular distribution for (n,n*3)

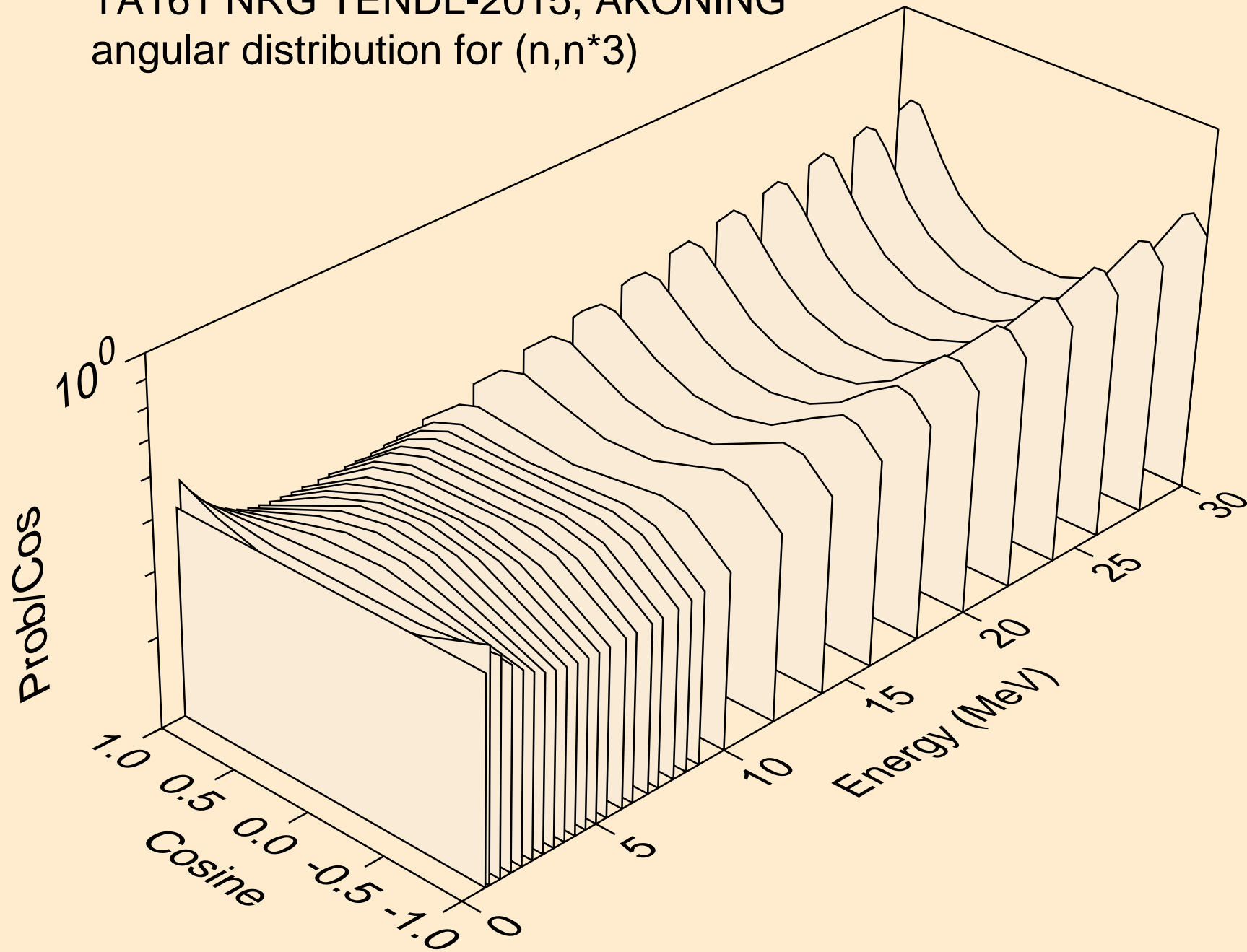

TA161 NRG TENDL-2015, AKONING
angular distribution for (n,n*4)

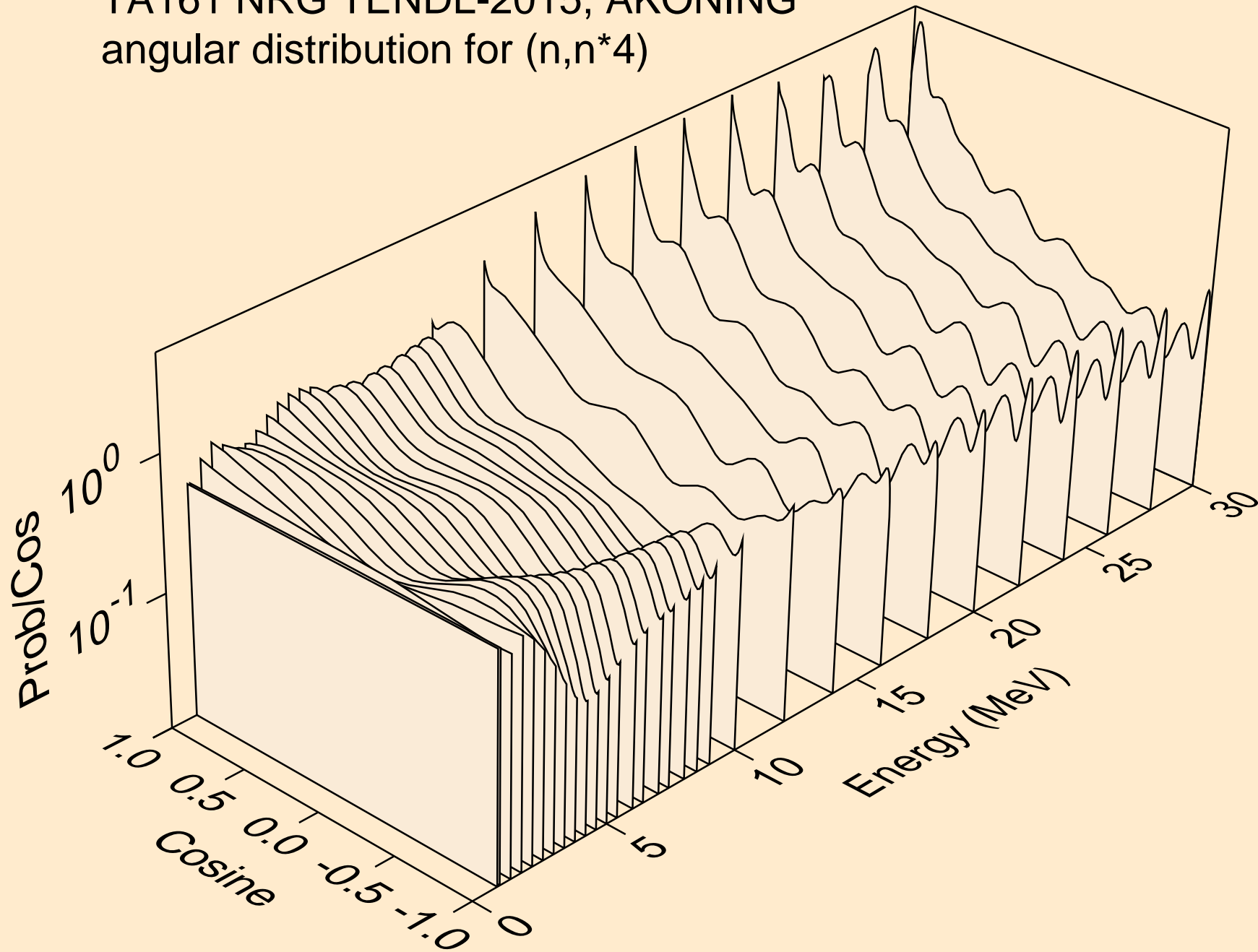

TA161 NRG TENDL-2015, AKONING
angular distribution for (n,n*5)

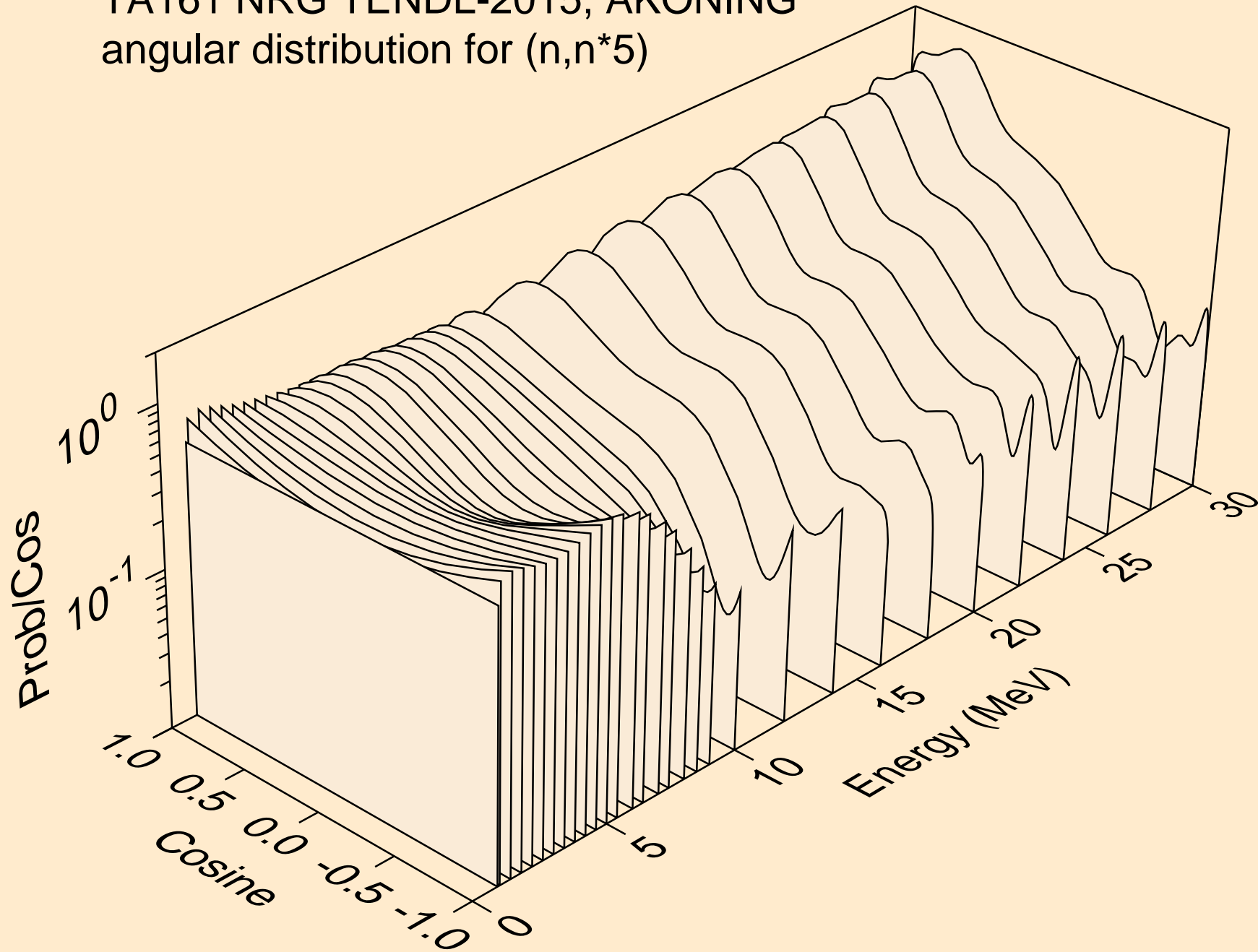

TA161 NRG TENDL-2015, AKONING
angular distribution for (n,n*6)

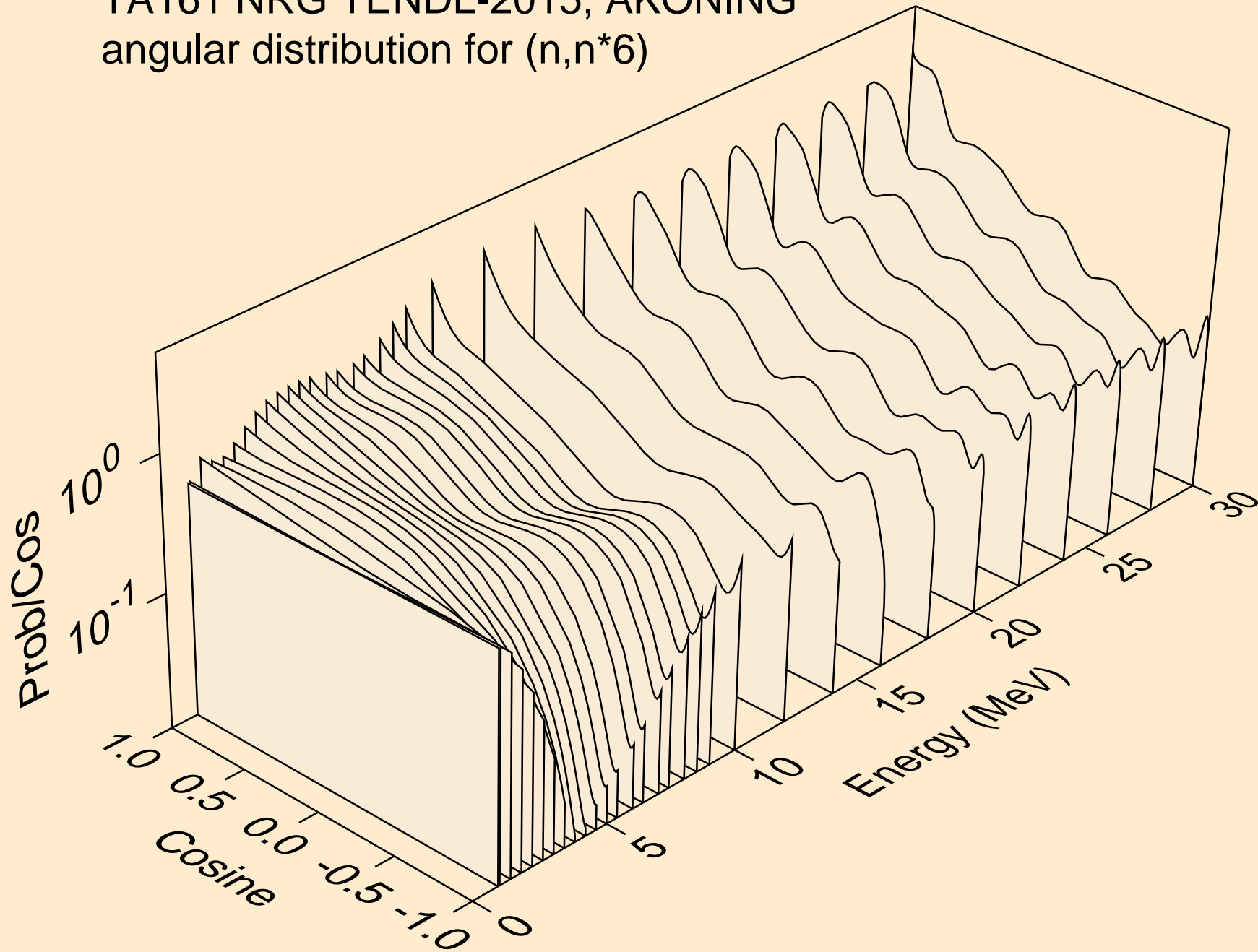

TA161 NRG TENDL-2015, AKONING
angular distribution for (n,n*7)

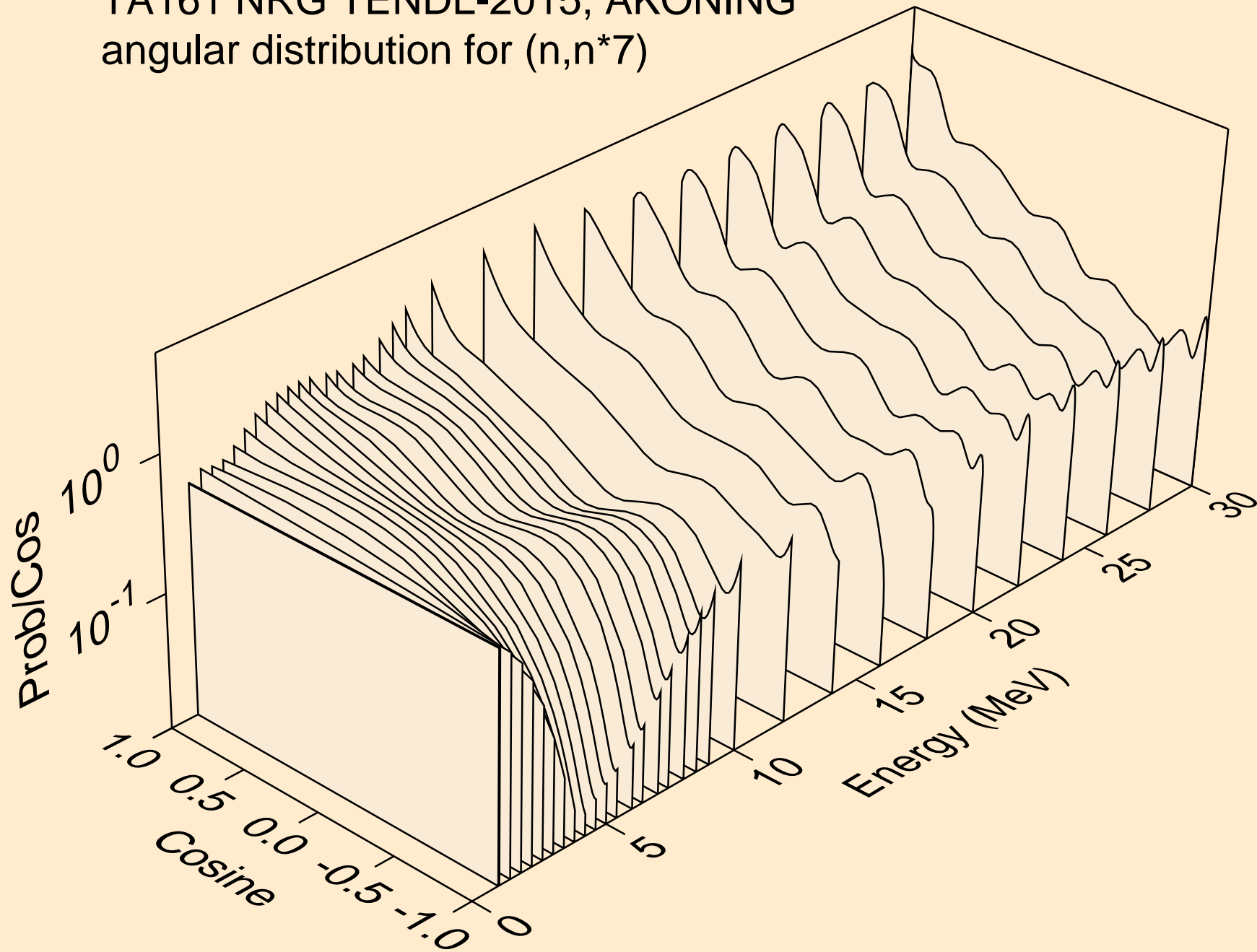

TA161 NRG TENDL-2015, AKONING
angular distribution for (n,n*8)

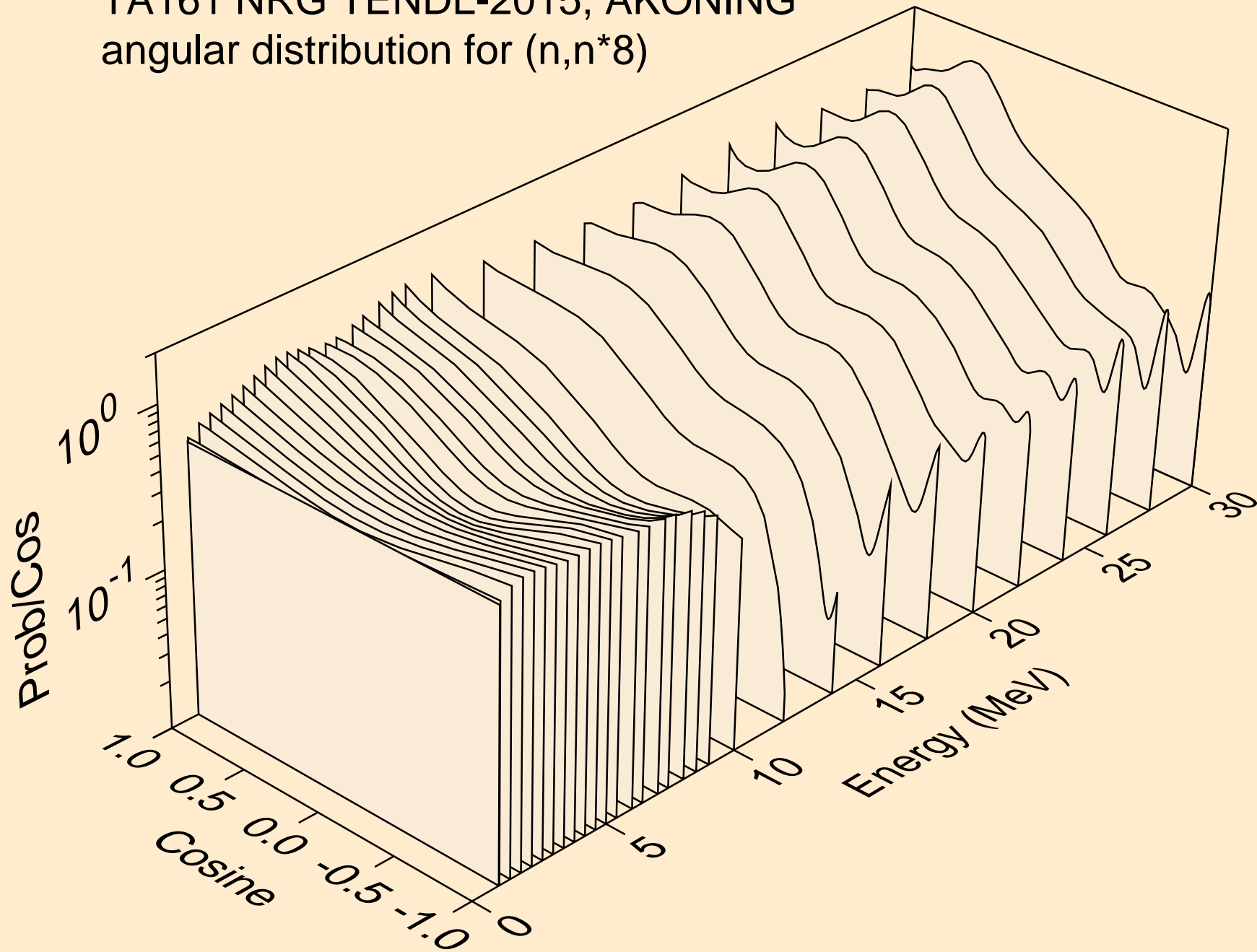

TA161 NRG TENDL-2015, AKONING
angular distribution for (n,n*9)

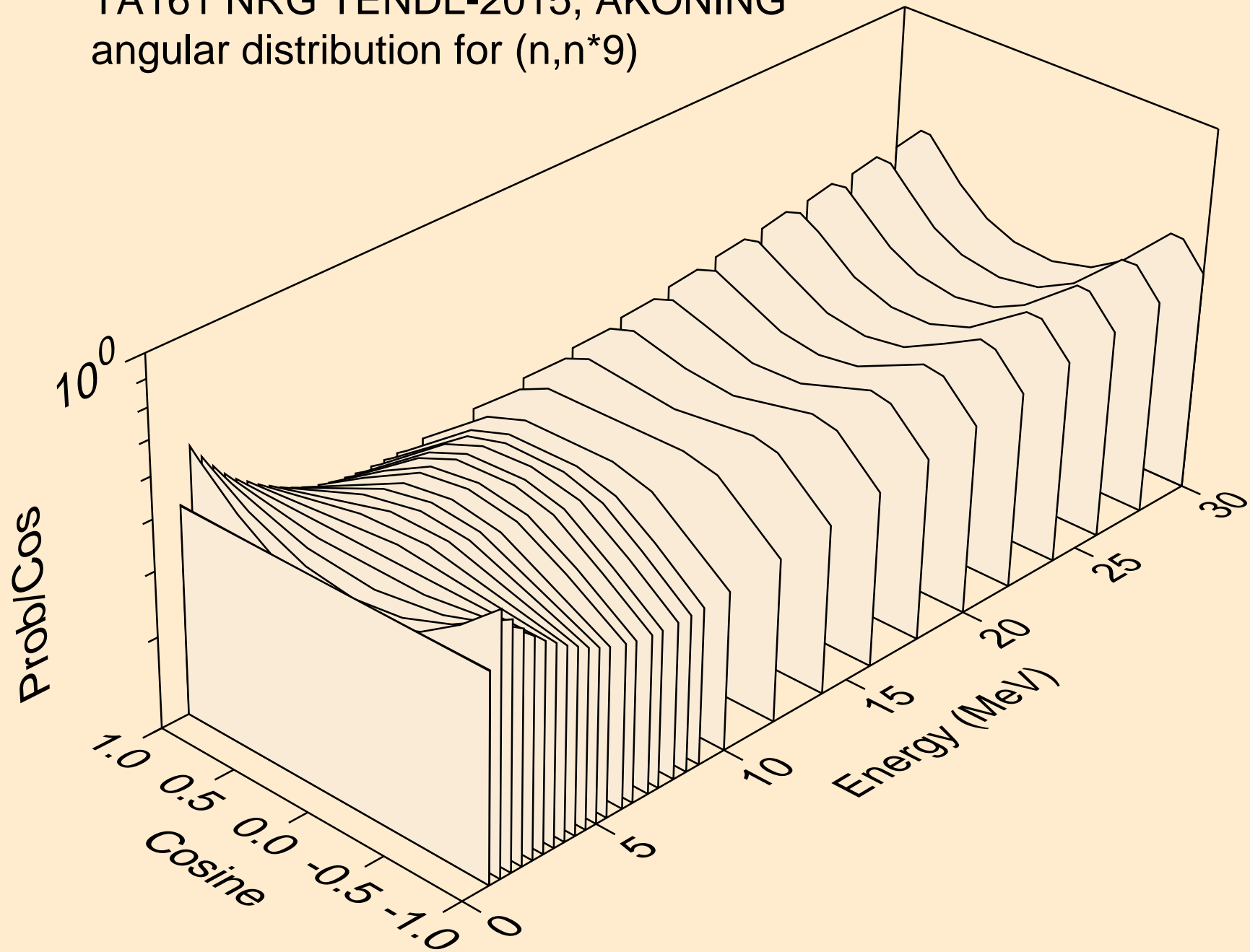

TA161 NRG TENDL-2015, AKONING
angular distribution for (n,n*10)

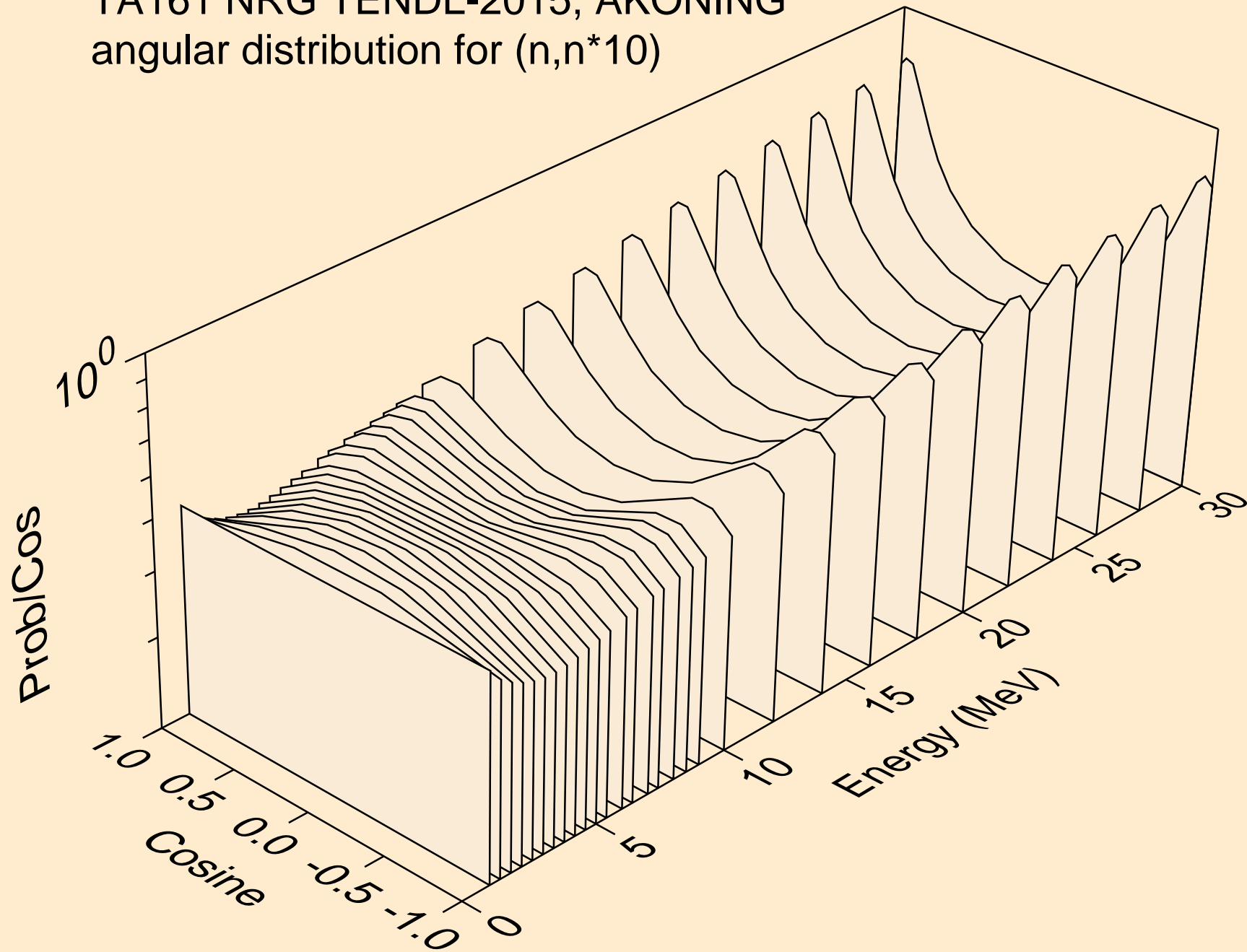

TA161 NRG TENDL-2015, AKONING
angular distribution for (n,n*11)

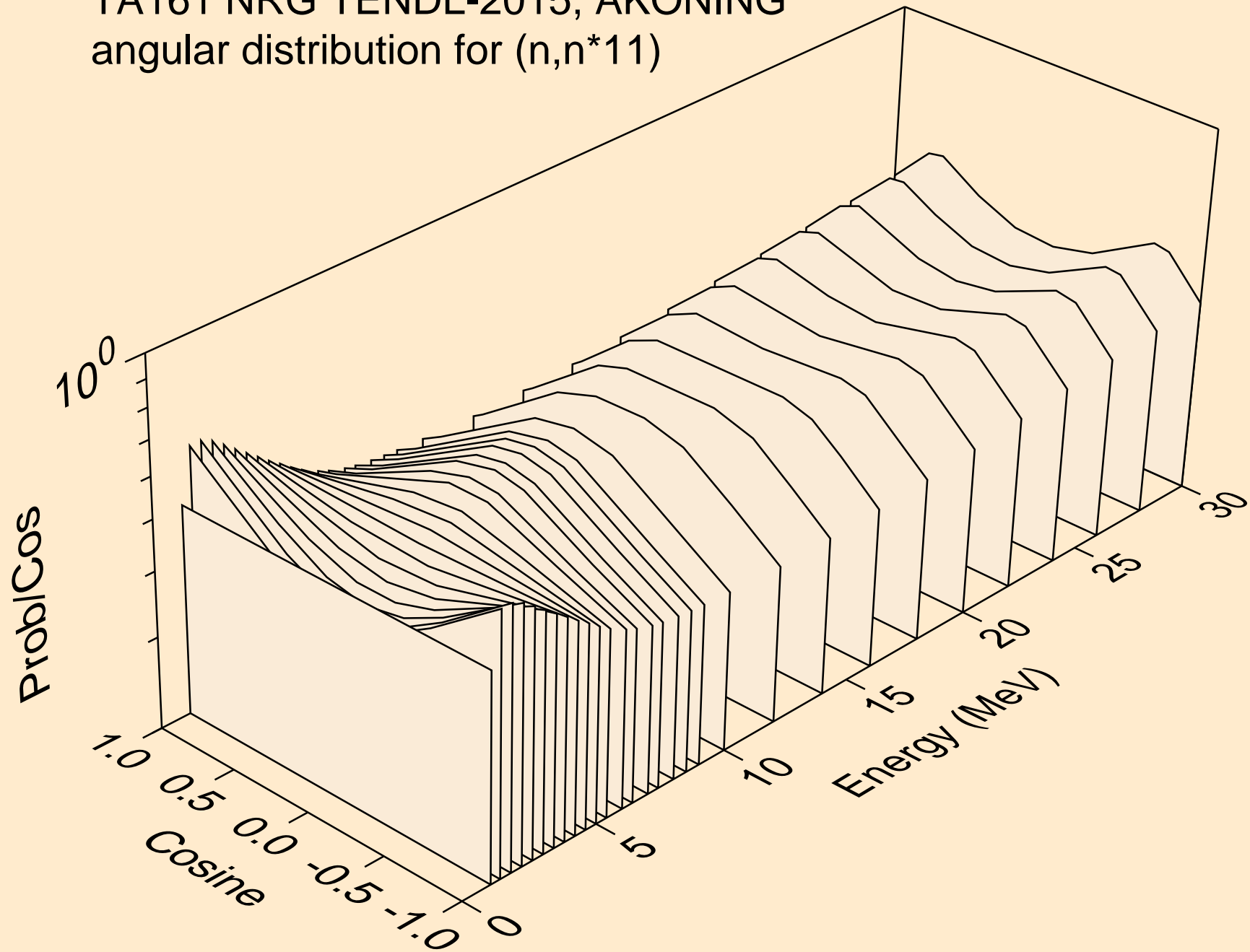

TA161 NRG TENDL-2015, AKONING
angular distribution for (n,n*12)

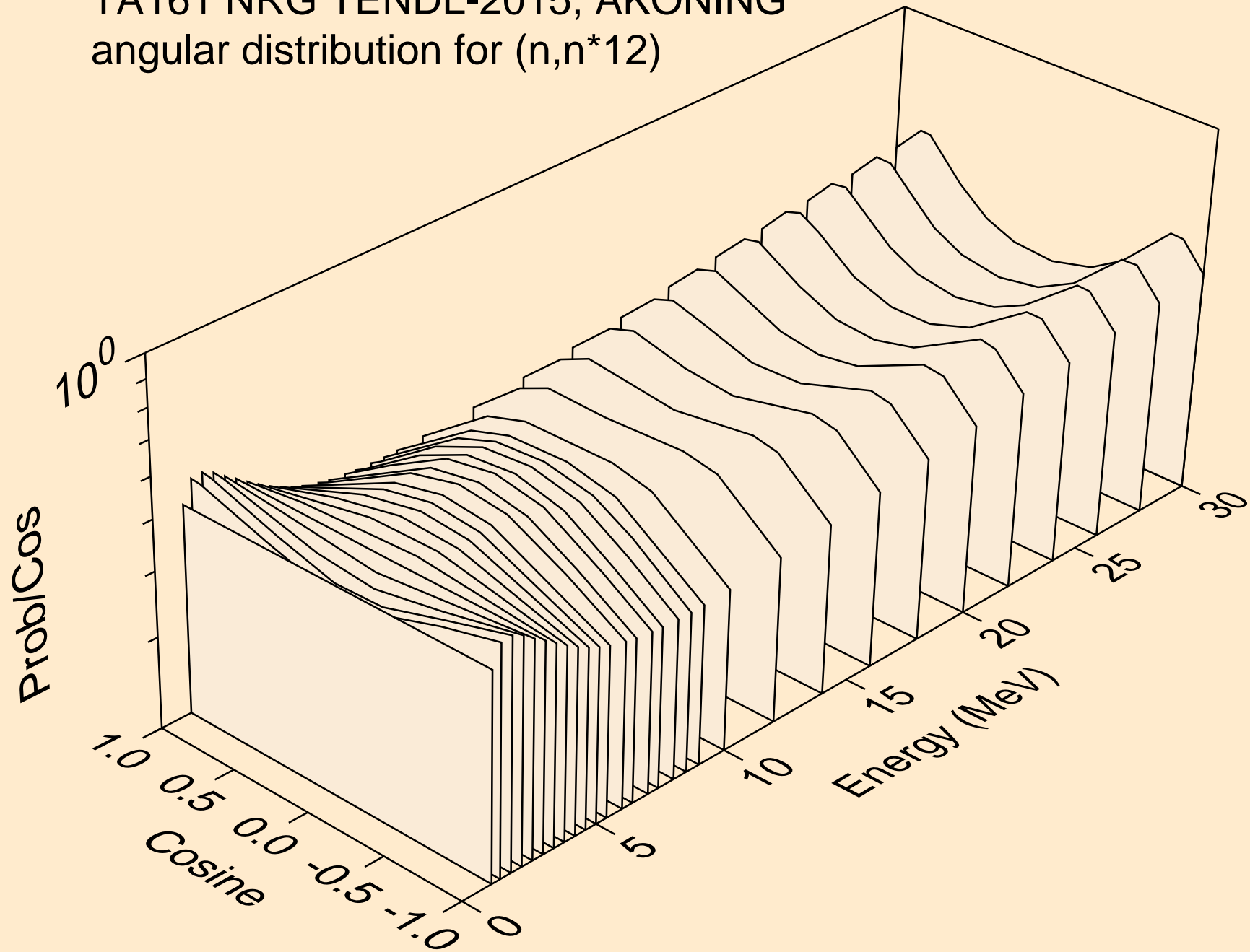

TA161 NRG TENDL-2015, AKONING
angular distribution for (n,n*13)

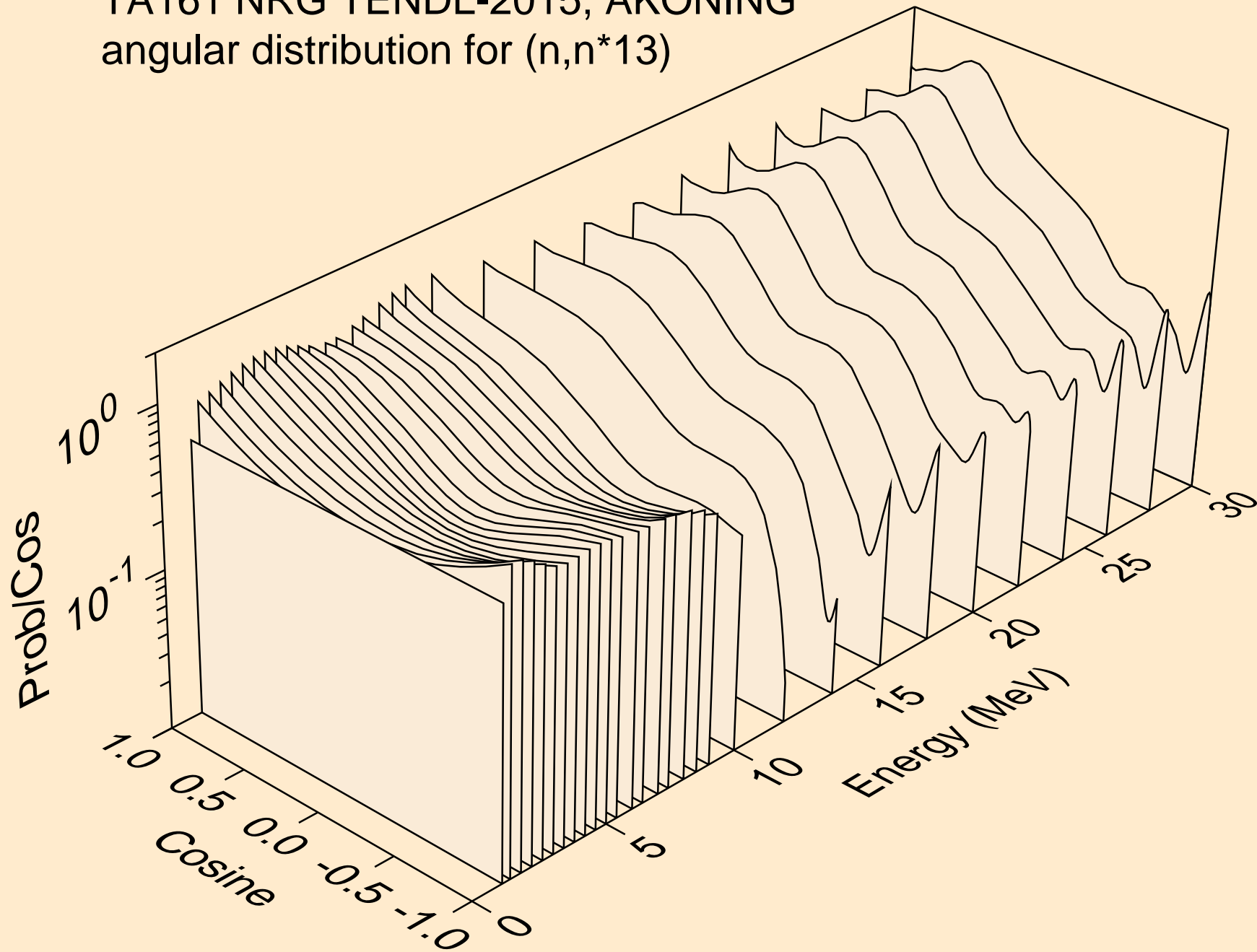

TA161 NRG TENDL-2015, AKONING
angular distribution for (n,n*14)

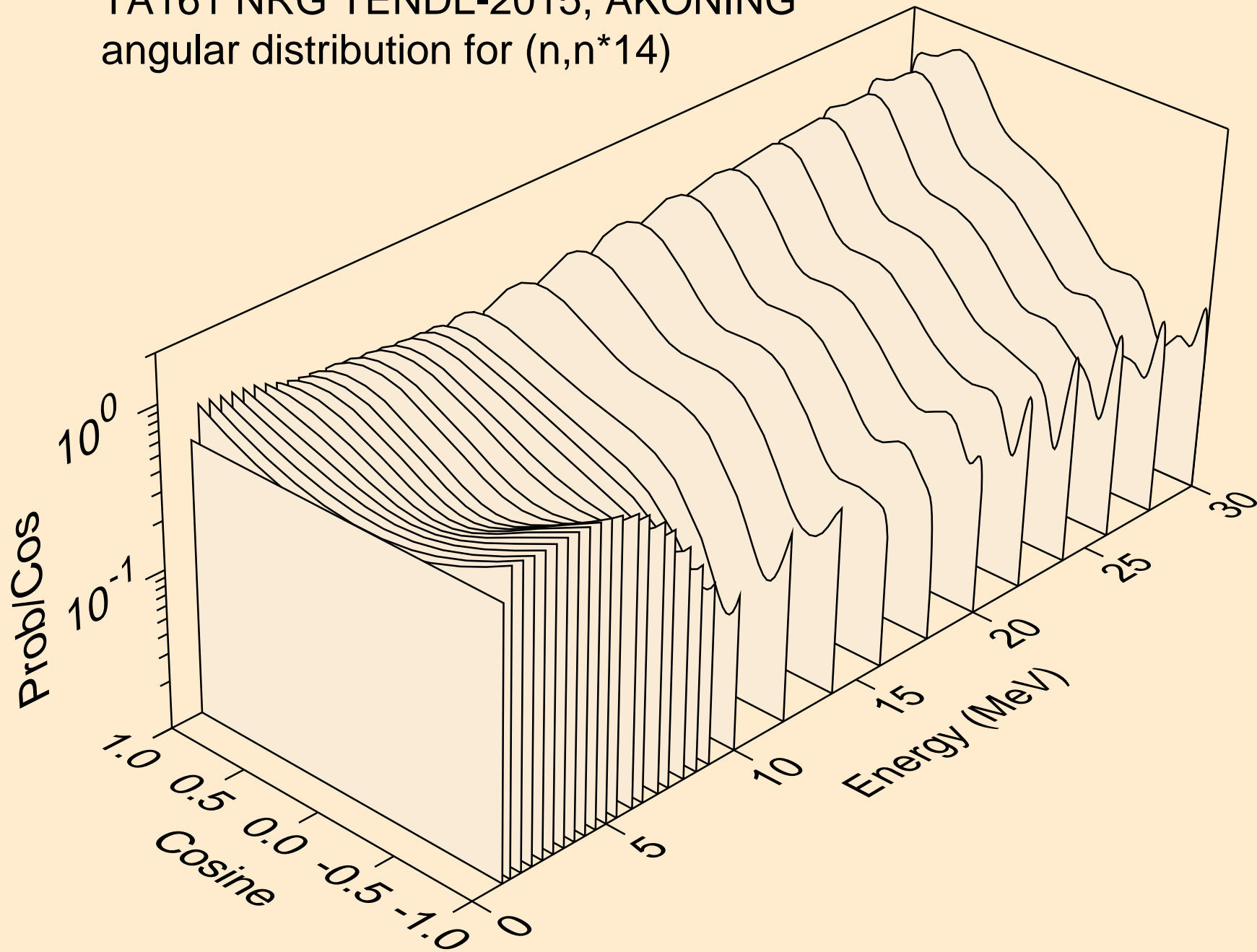

TA161 NRG TENDL-2015, AKONING
angular distribution for (n,n*15)

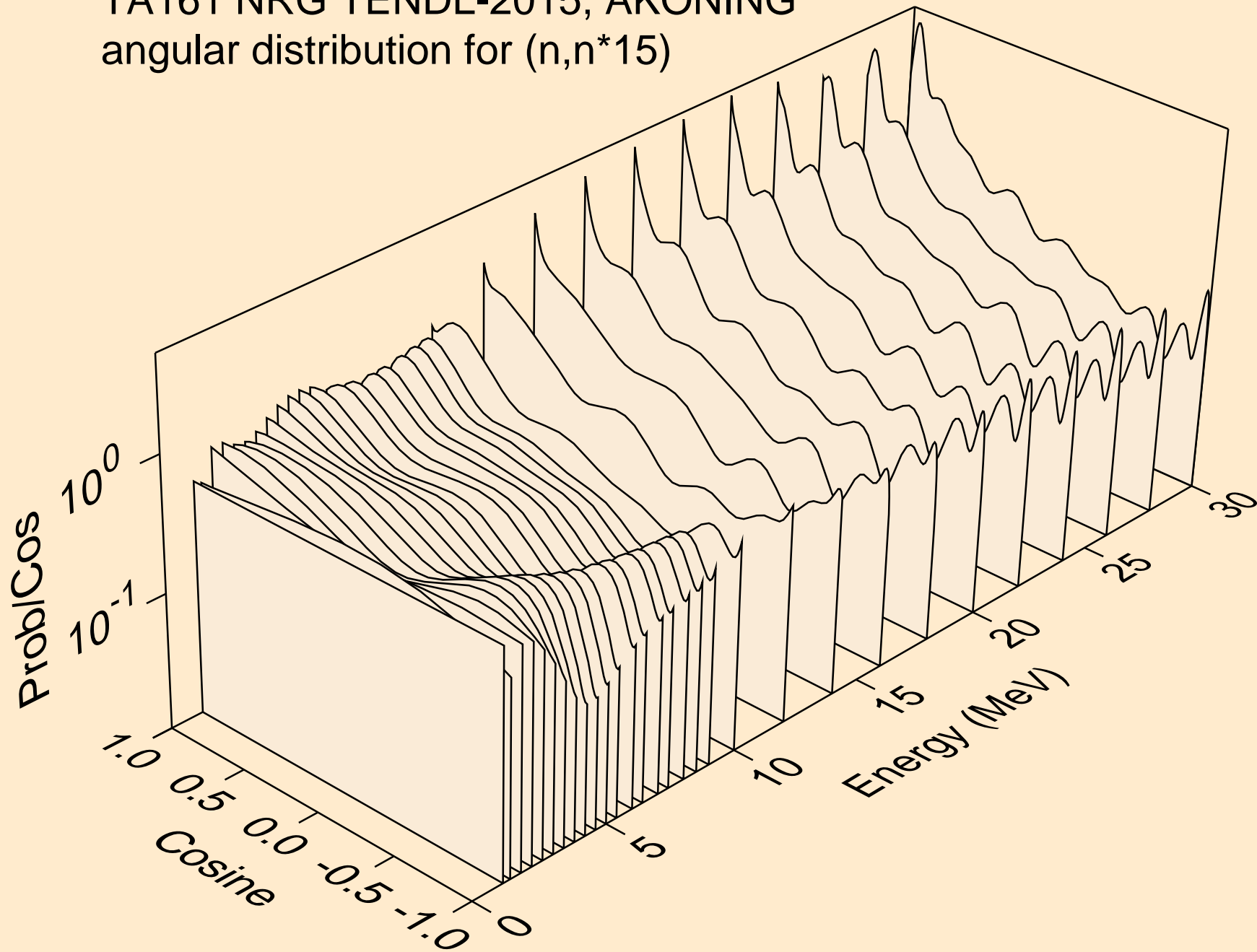

TA161 NRG TENDL-2015, AKONING
angular distribution for (n,n*16)

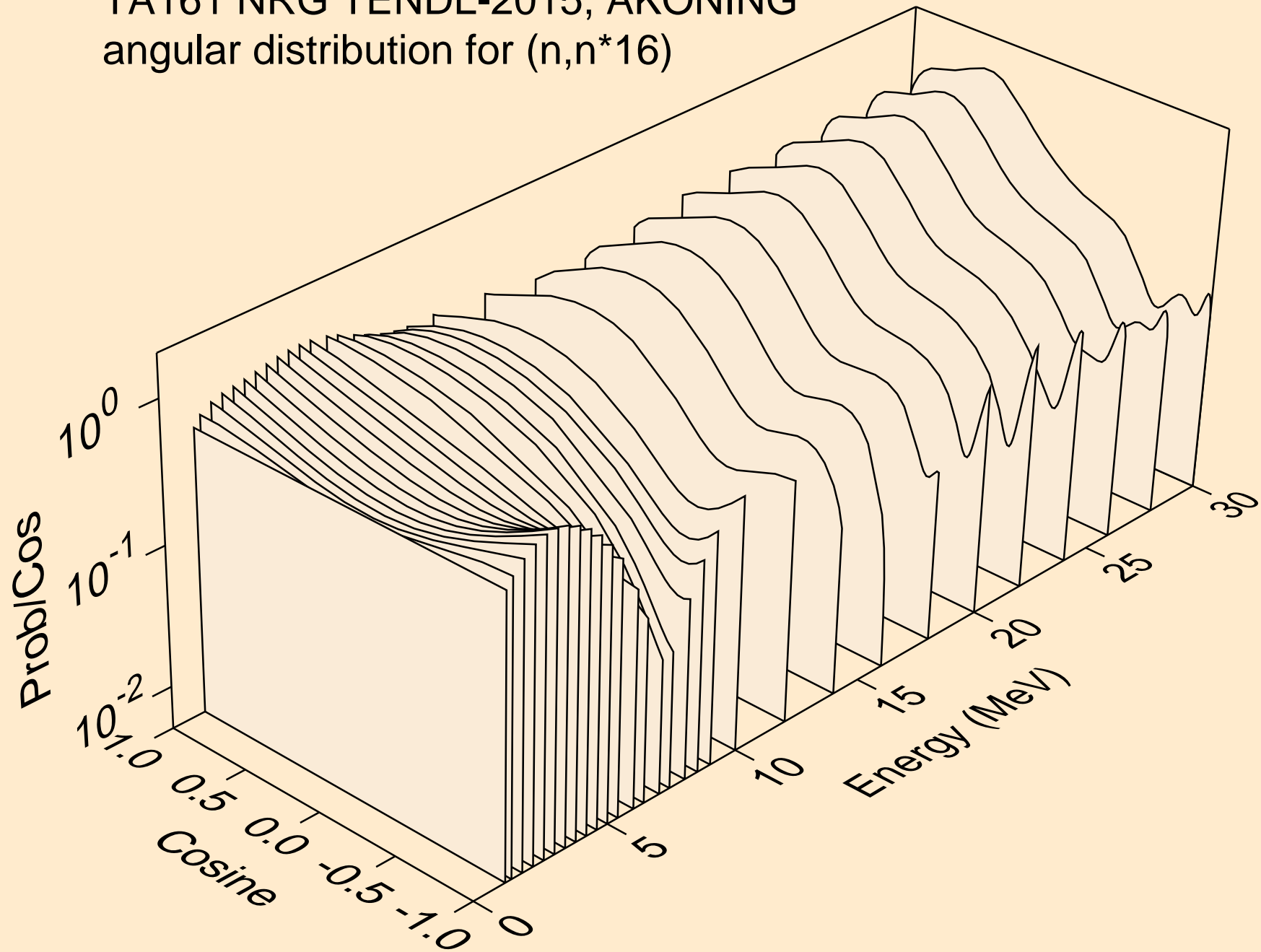

TA161 NRG TENDL-2015, AKONING
angular distribution for (n,n*17)

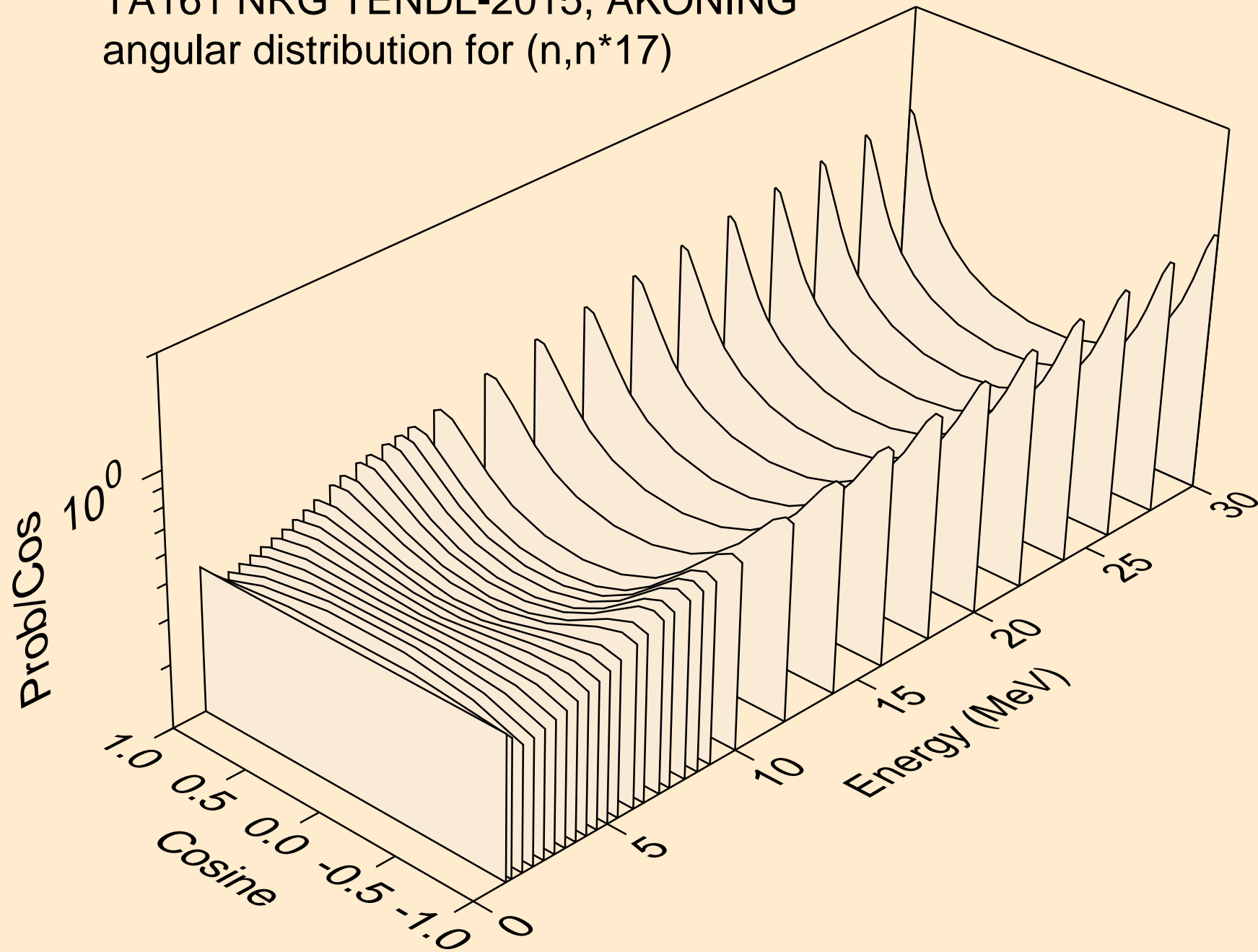

TA161 NRG TENDL-2015, AKONING
Neutron emission for (n,x)

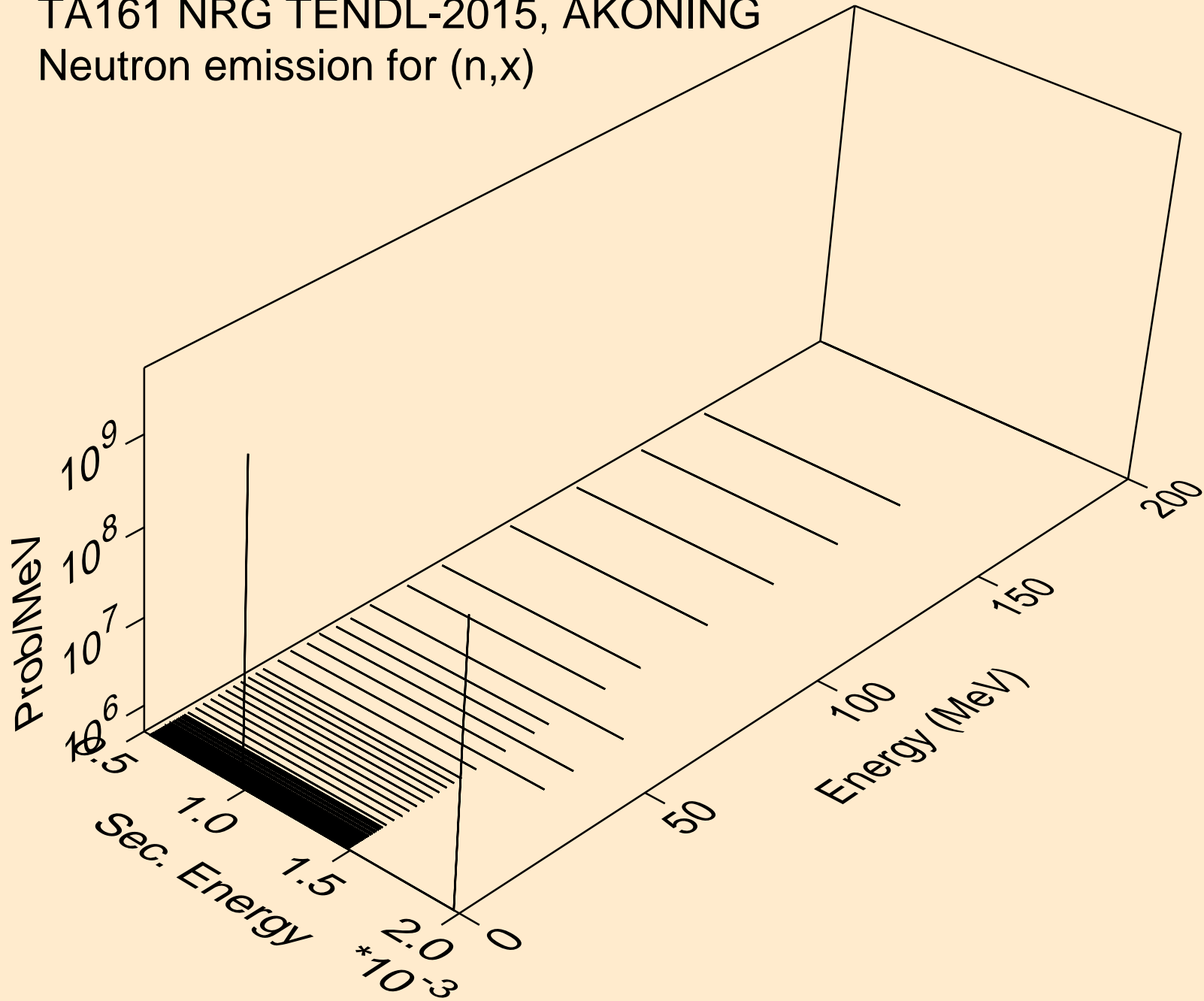

TA161 NRG TENDL-2015, AKONING
Neutron emission for (n,2nd)

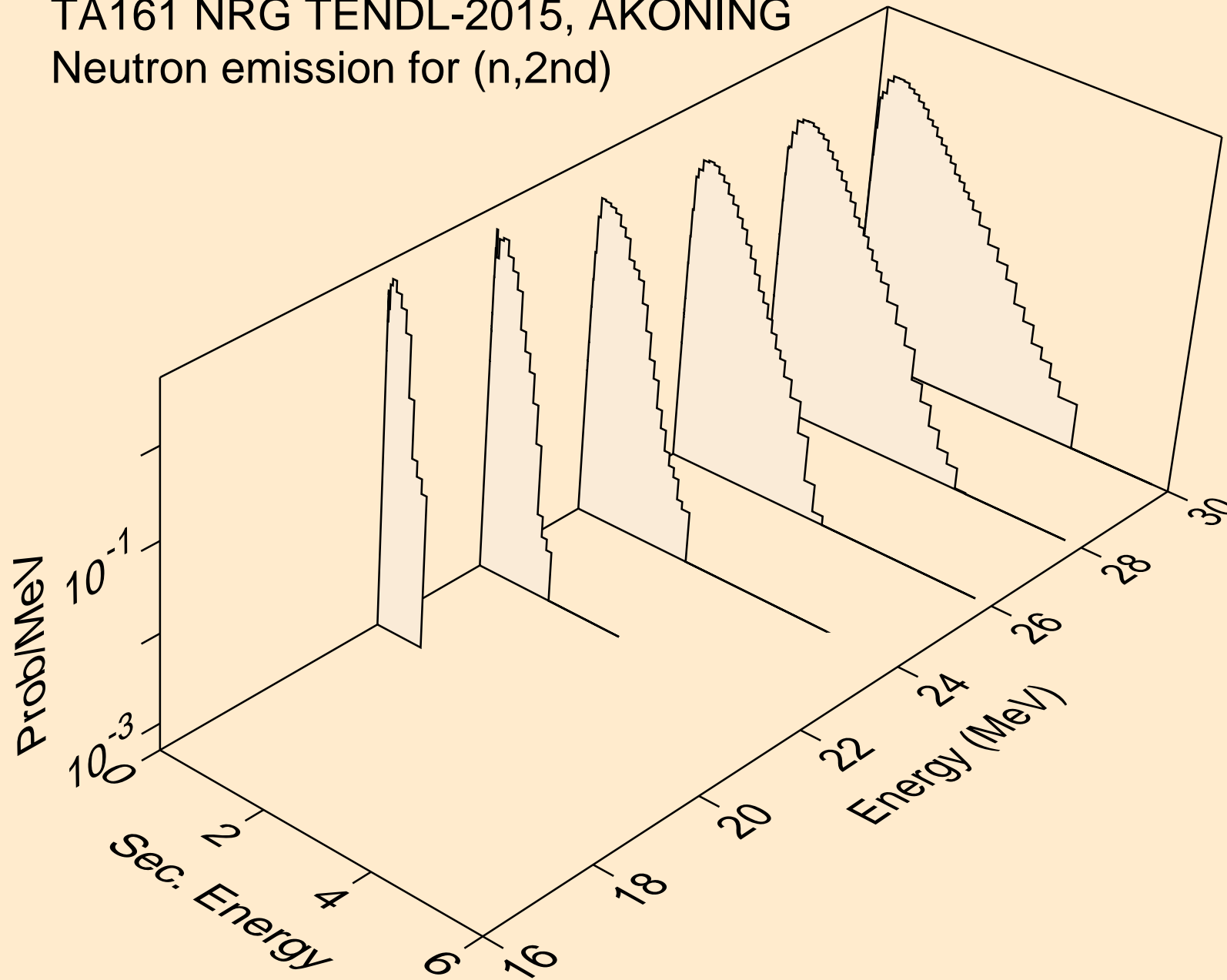

TA161 NRG TENDL-2015, AKONING
Neutron emission for (n,2n)

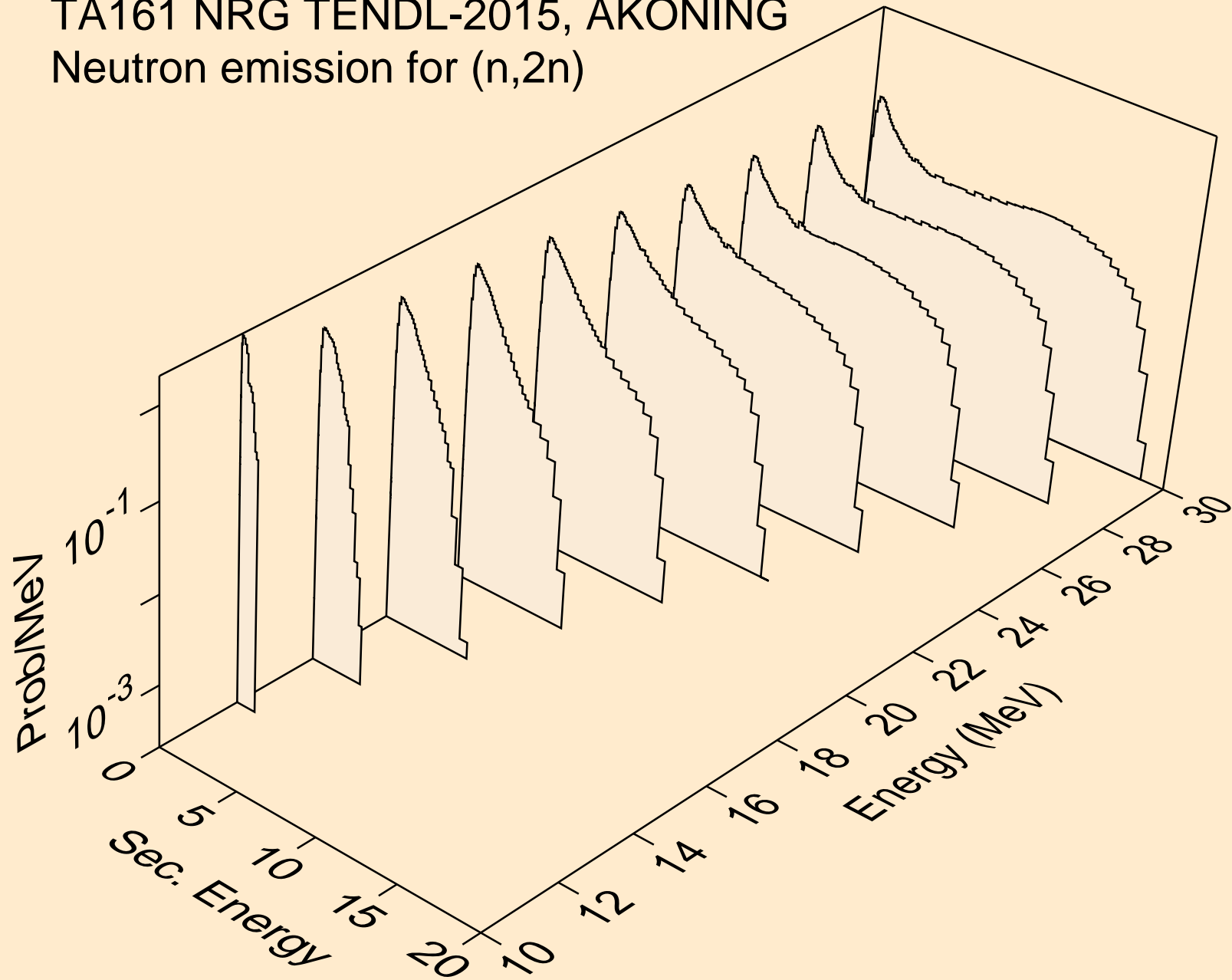

TA161 NRG TENDL-2015, AKONING
Neutron emission for (n,3n)

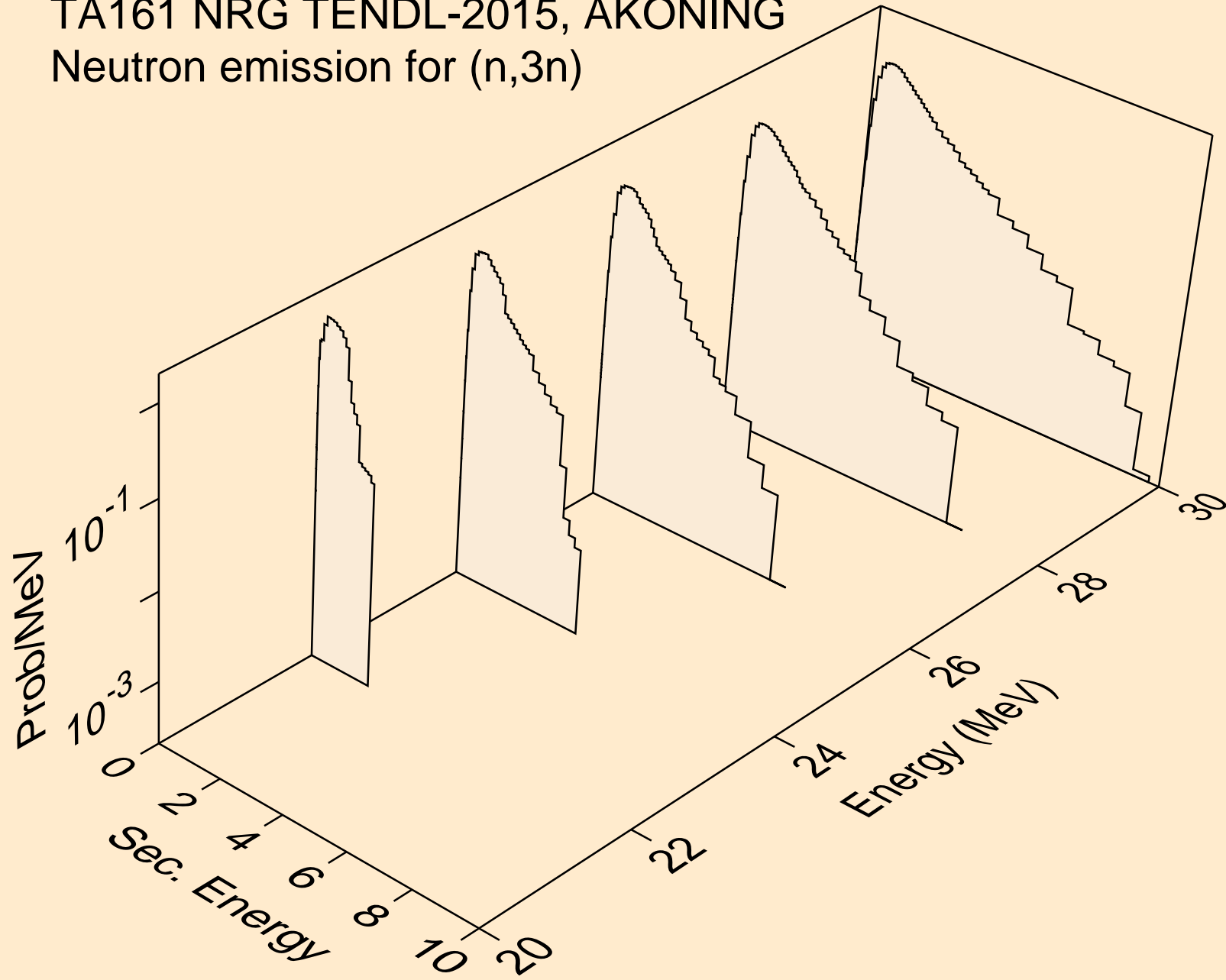

TA161 NRG TENDL-2015, AKONING
Neutron emission for (n,n*)a

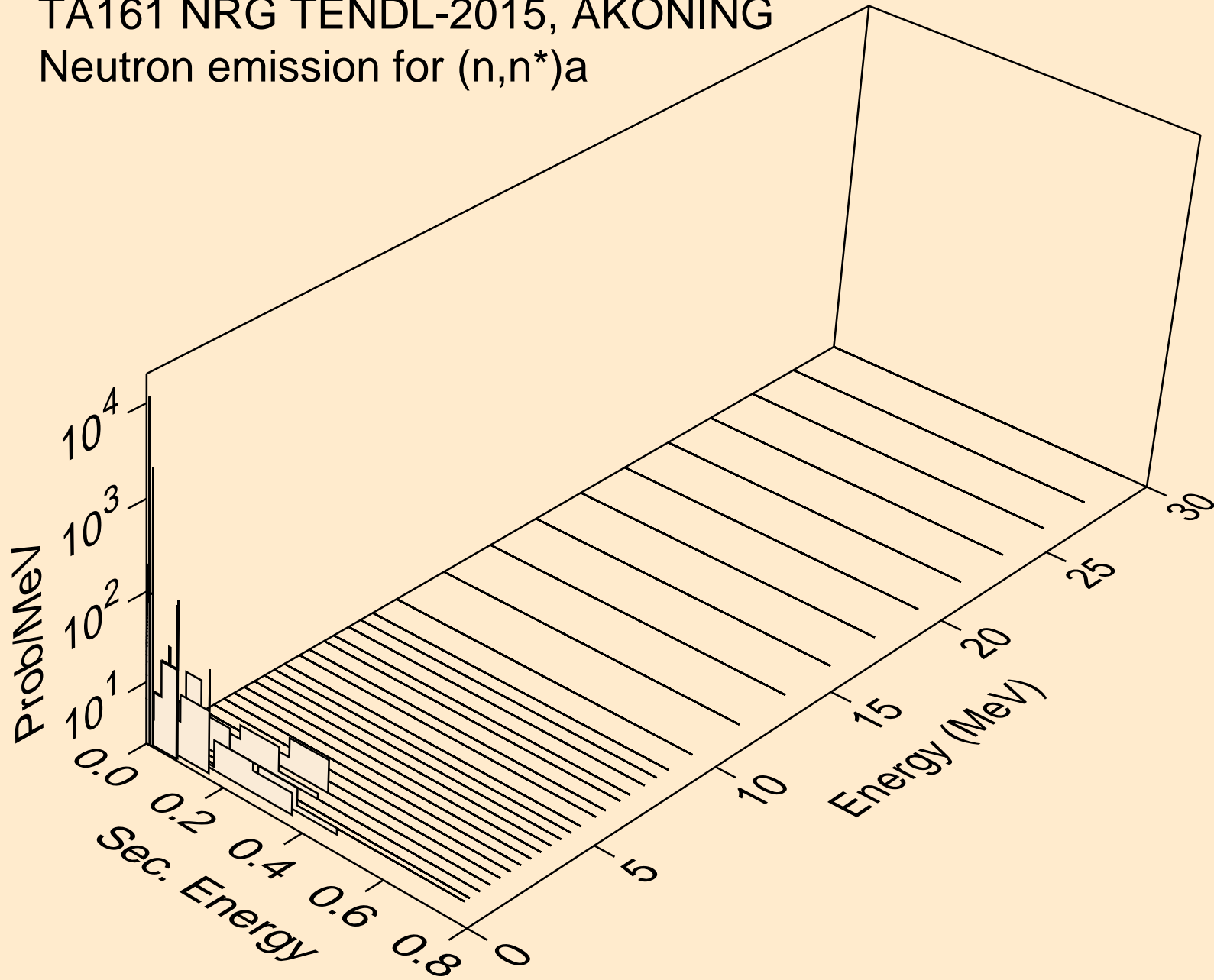

TA161 NRG TENDL-2015, AKONING
Neutron emission for (n,n*)3a

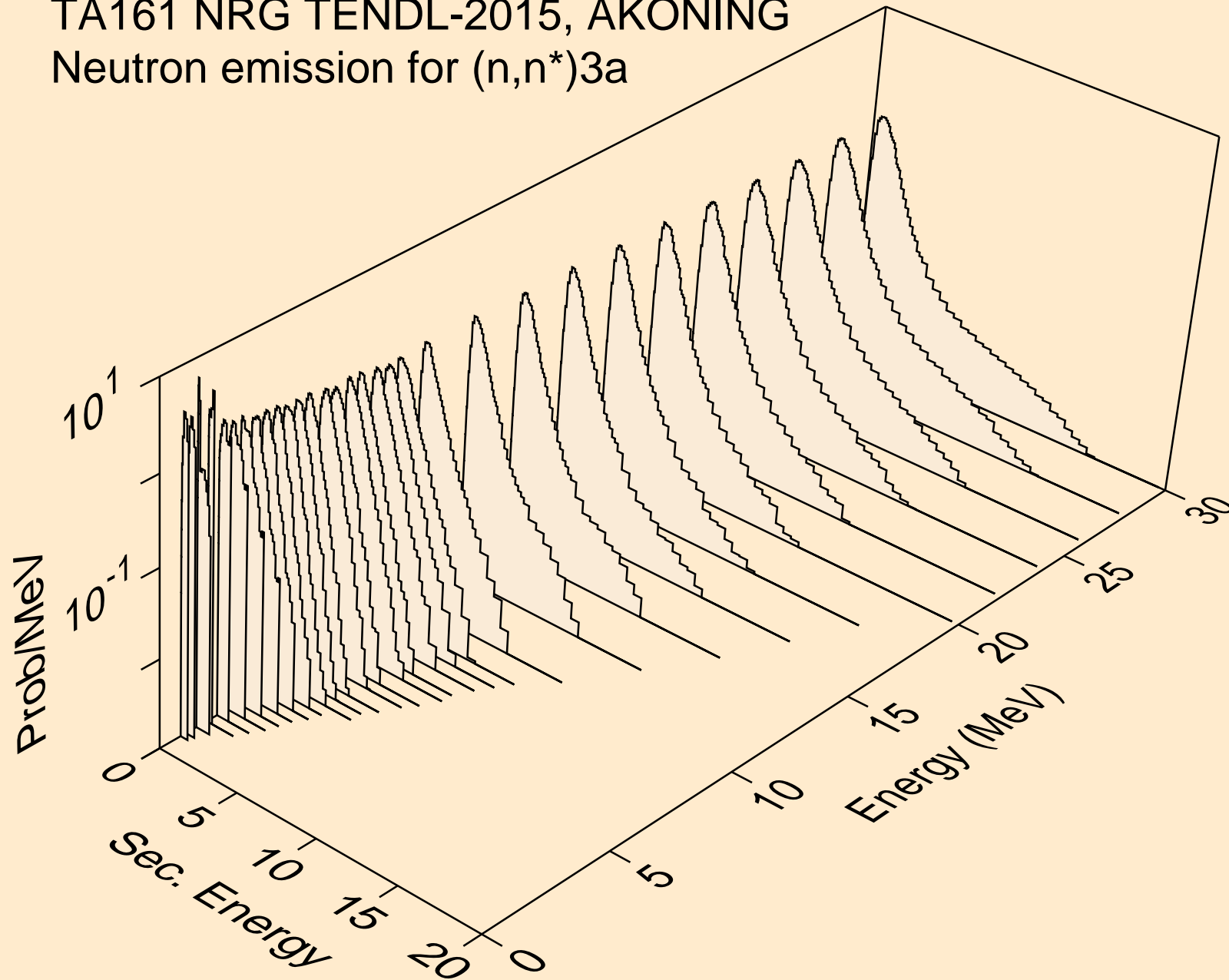

TA161 NRG TENDL-2015, AKONING
Neutron emission for (n,2n)a

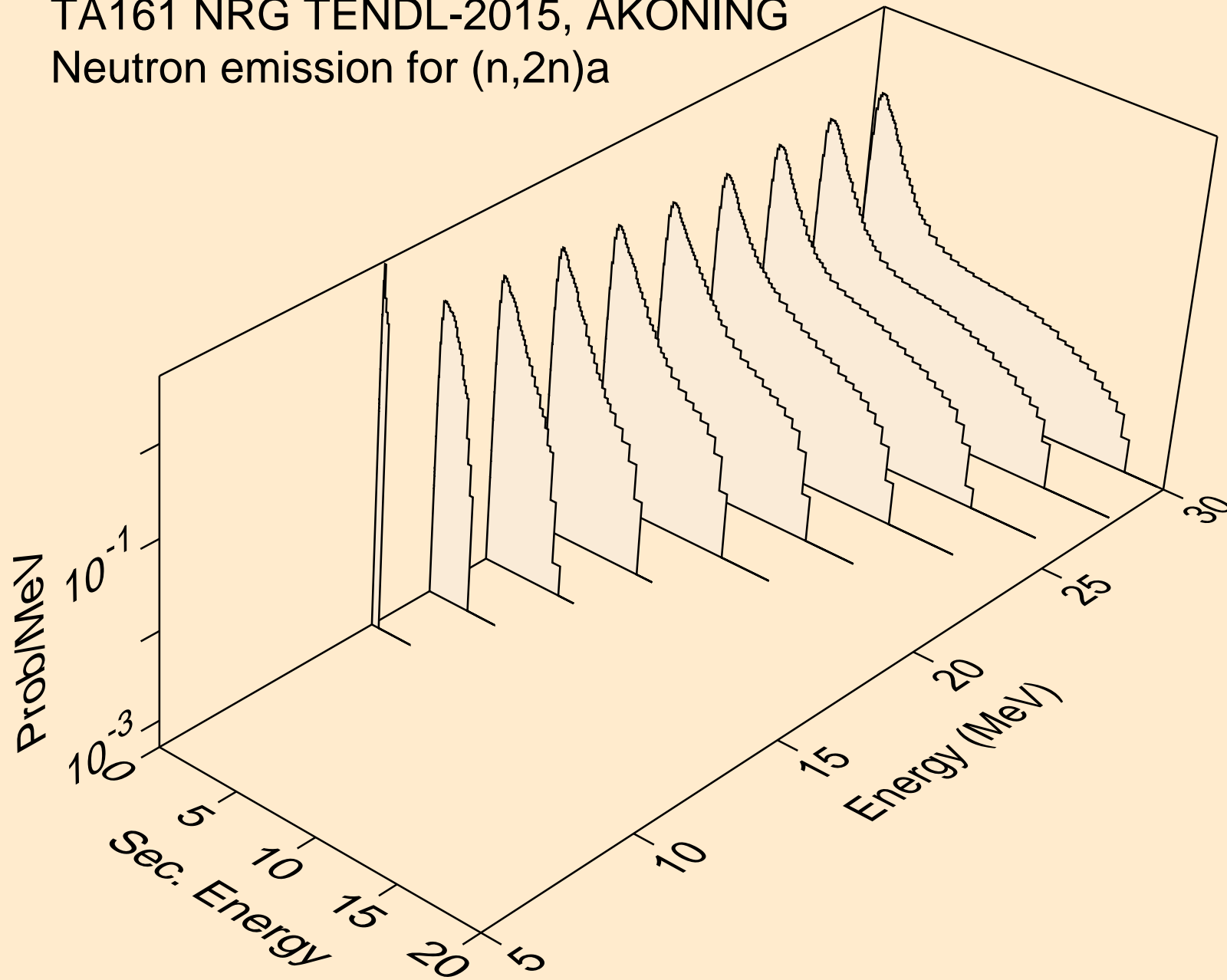

TA161 NRG TENDL-2015, AKONING
Neutron emission for (n,3n)a

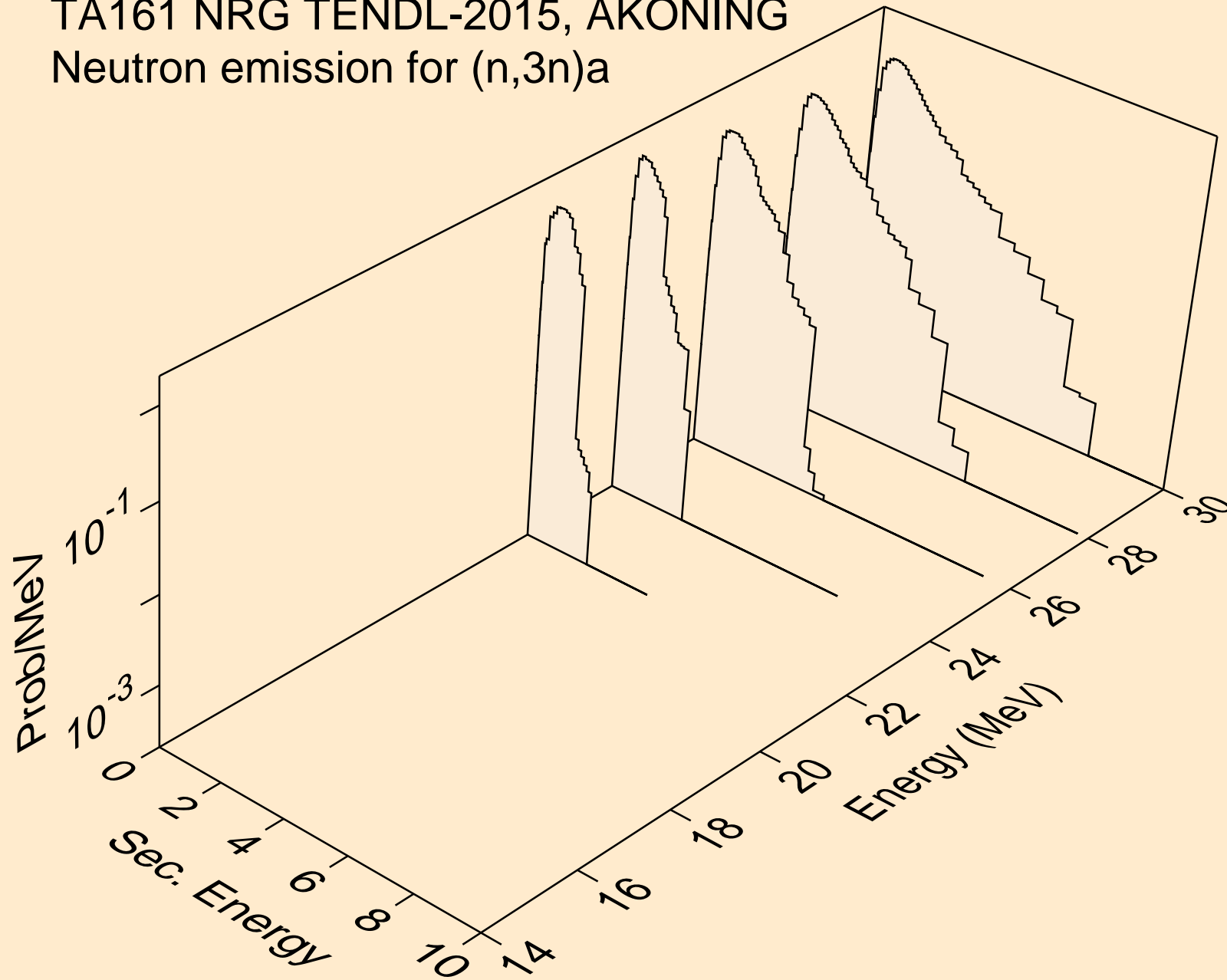

TA161 NRG TENDL-2015, AKONING
Neutron emission for (n,n*)p

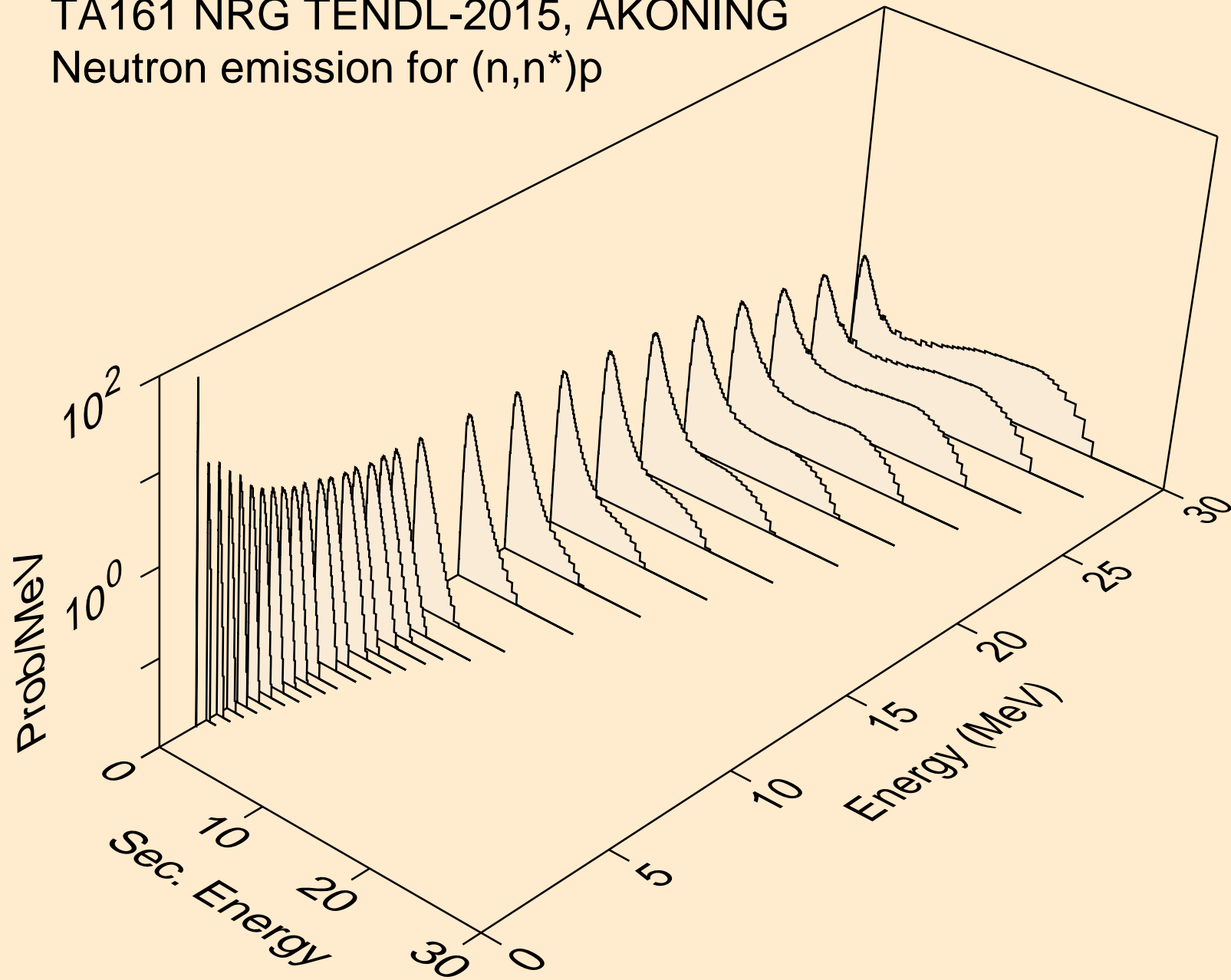

TA161 NRG TENDL-2015, AKONING
Neutron emission for (n,n*)2a

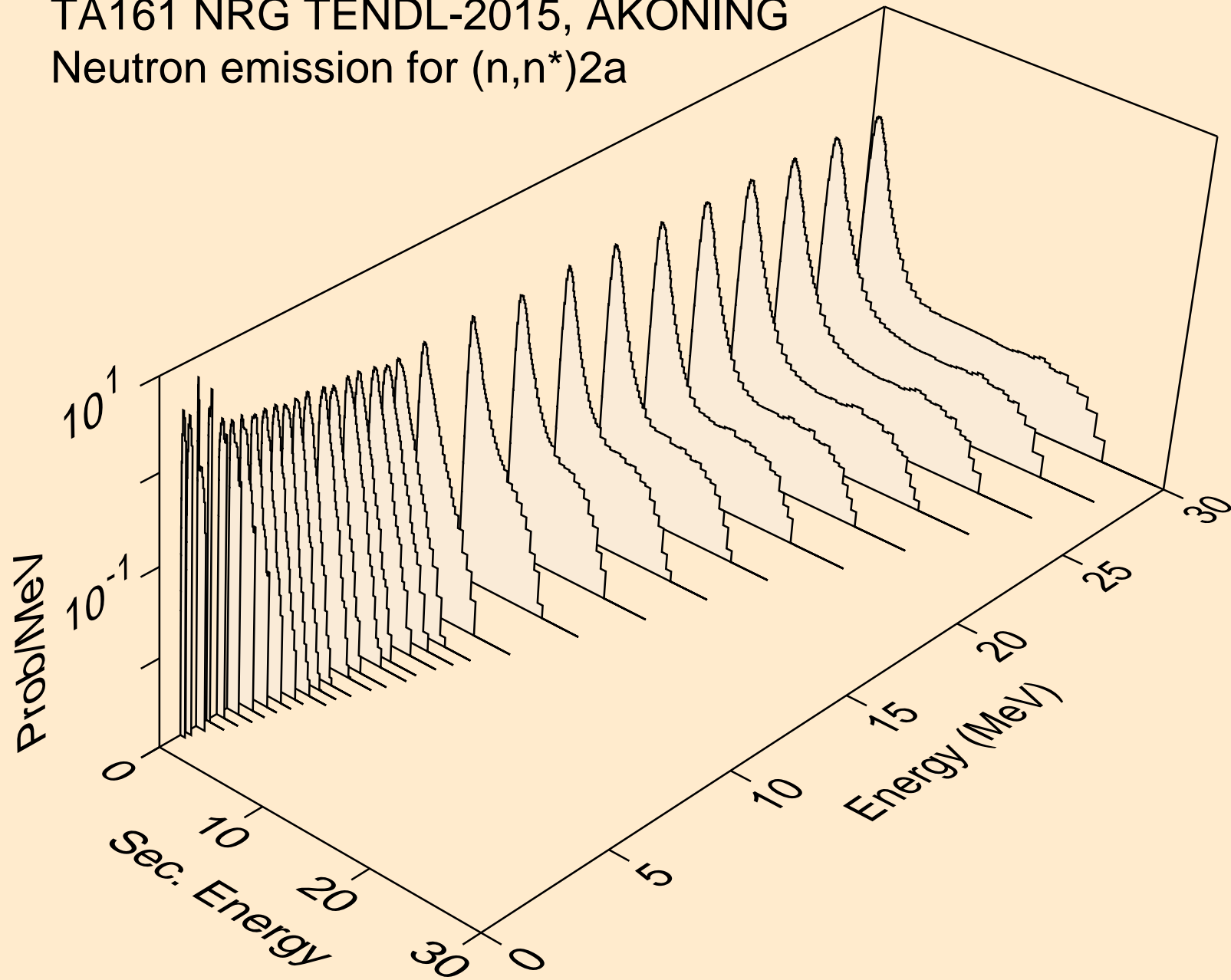

TA161 NRG TENDL-2015, AKONING
Neutron emission for (n,2n)2a

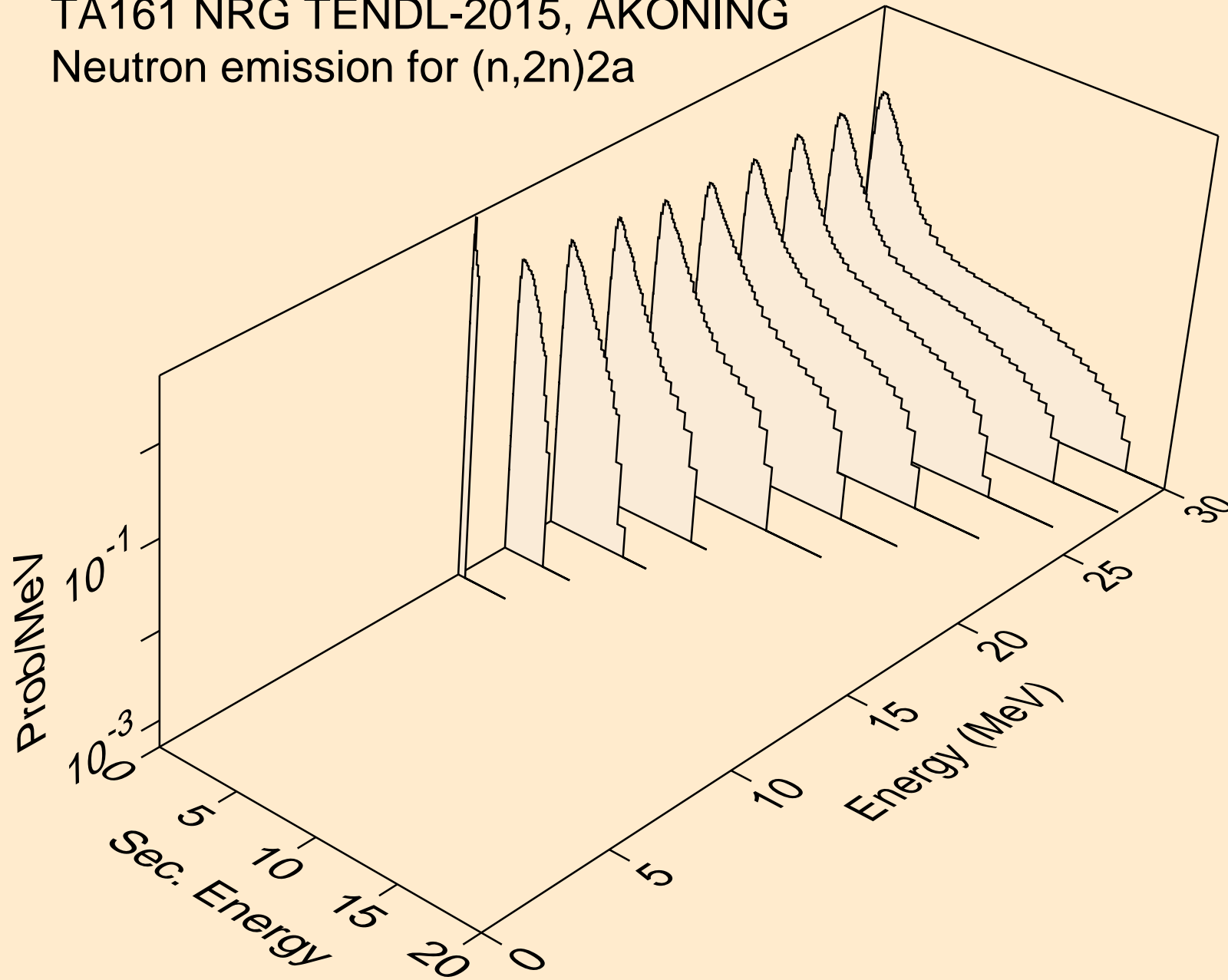

TA161 NRG TENDL-2015, AKONING
Neutron emission for (n,n*)d

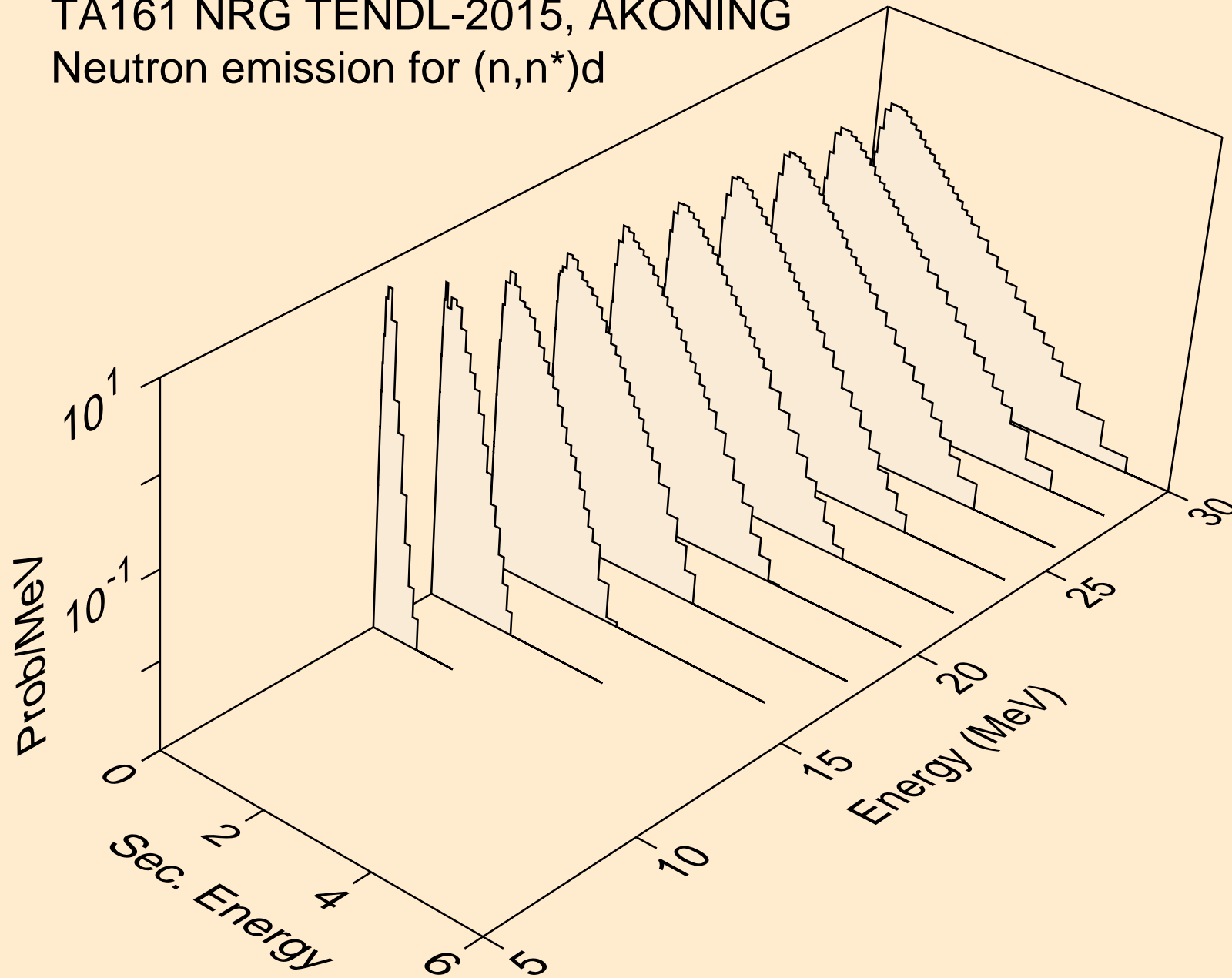

TA161 NRG TENDL-2015, AKONING
Neutron emission for (n,n*)t

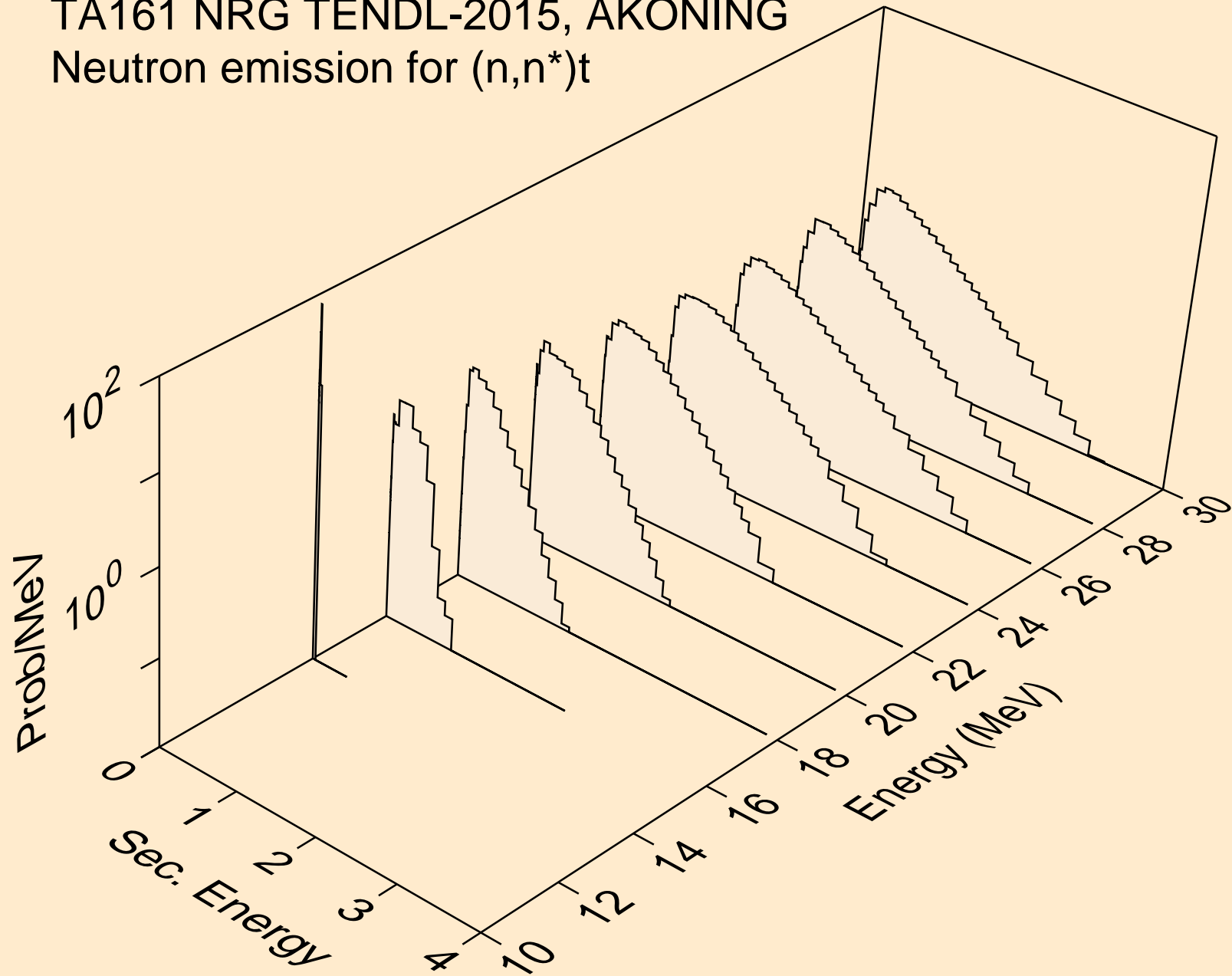

TA161 NRG TENDL-2015, AKONING
Neutron emission for (n,n*)he3

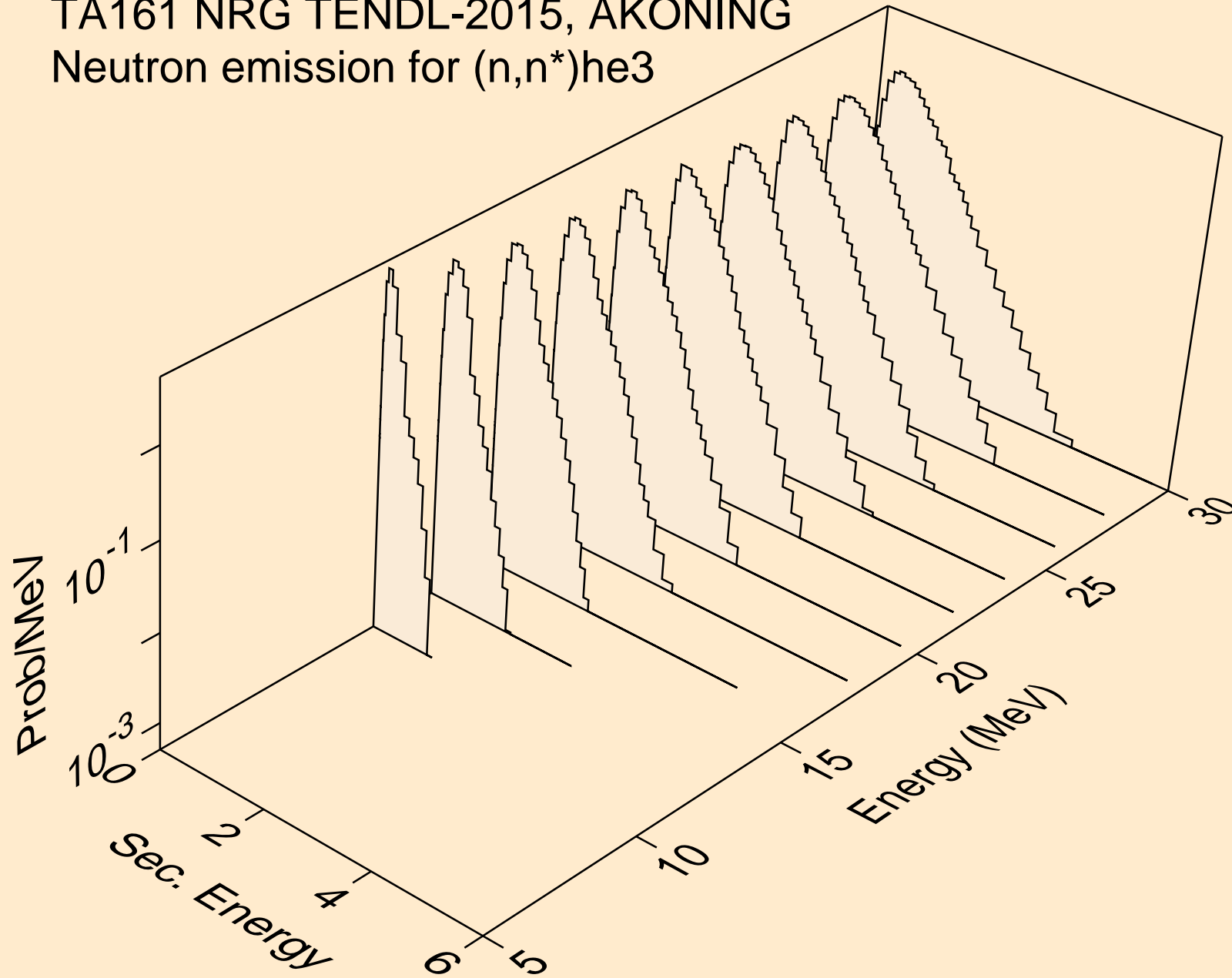

TA161 NRG TENDL-2015, AKONING
Neutron emission for (n,n*)d2a

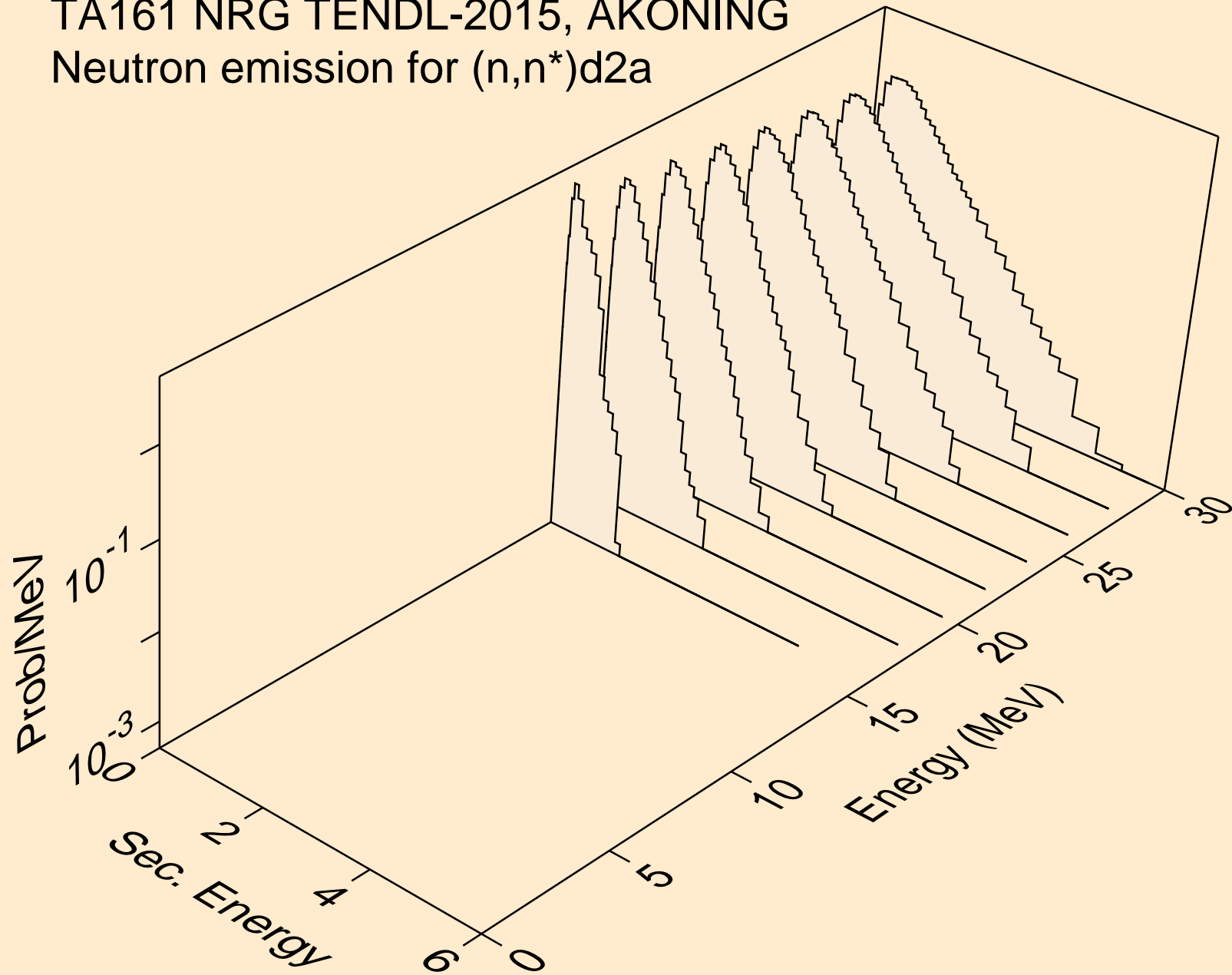

TA161 NRG TENDL-2015, AKONING
Neutron emission for (n,n*)t2a

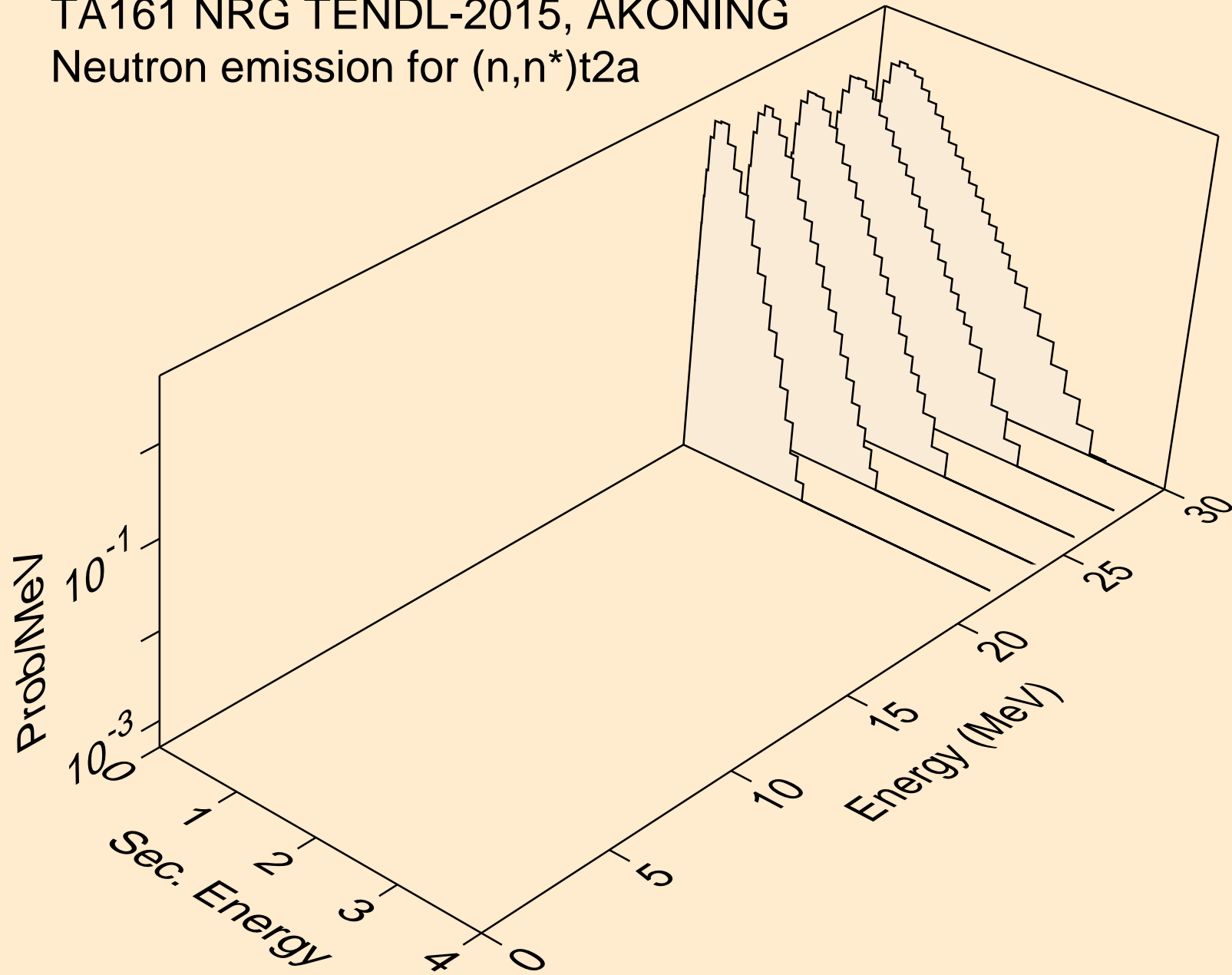

TA161 NRG TENDL-2015, AKONING
Neutron emission for (n,2np)

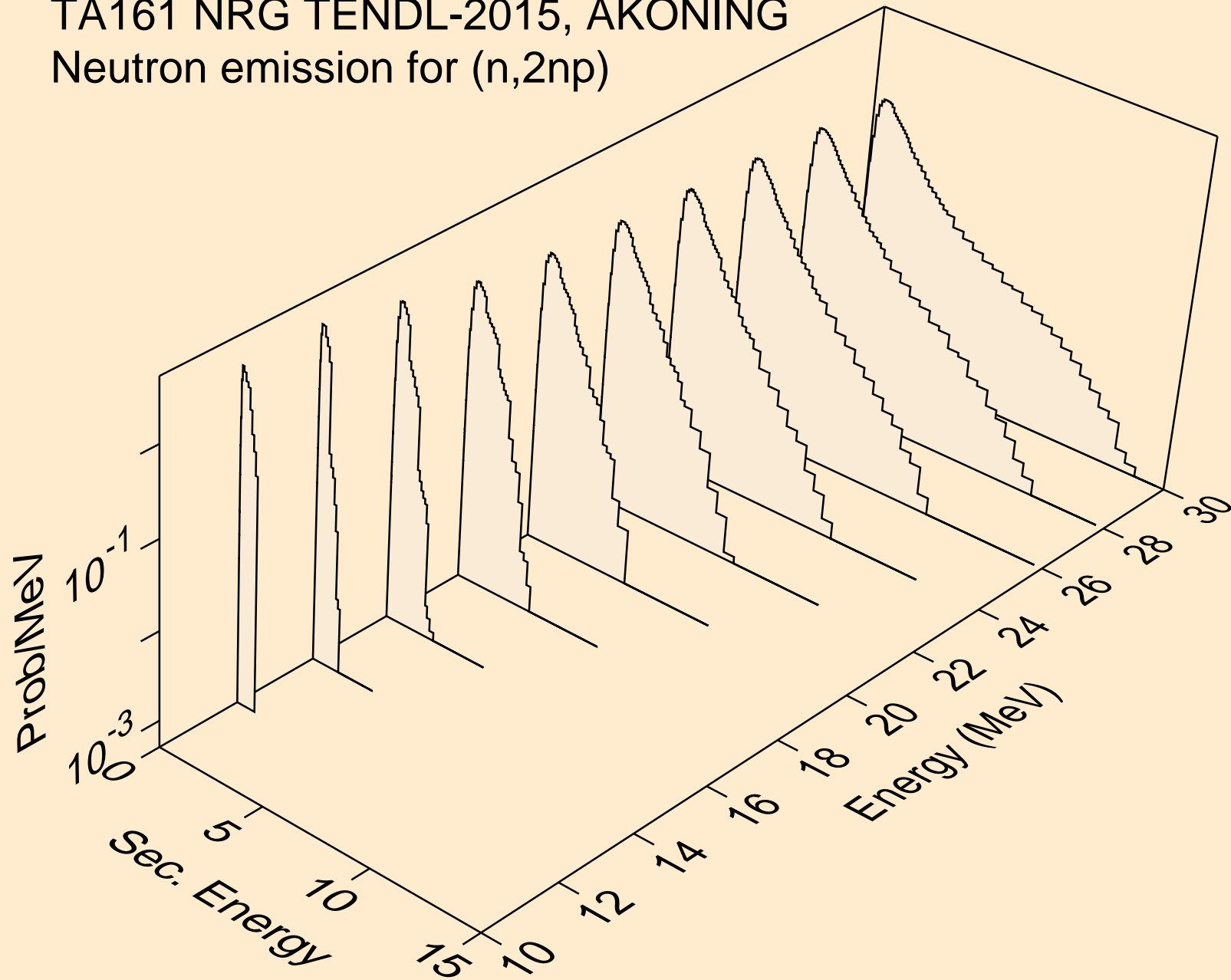

TA161 NRG TENDL-2015, AKONING
Neutron emission for (n,3np)

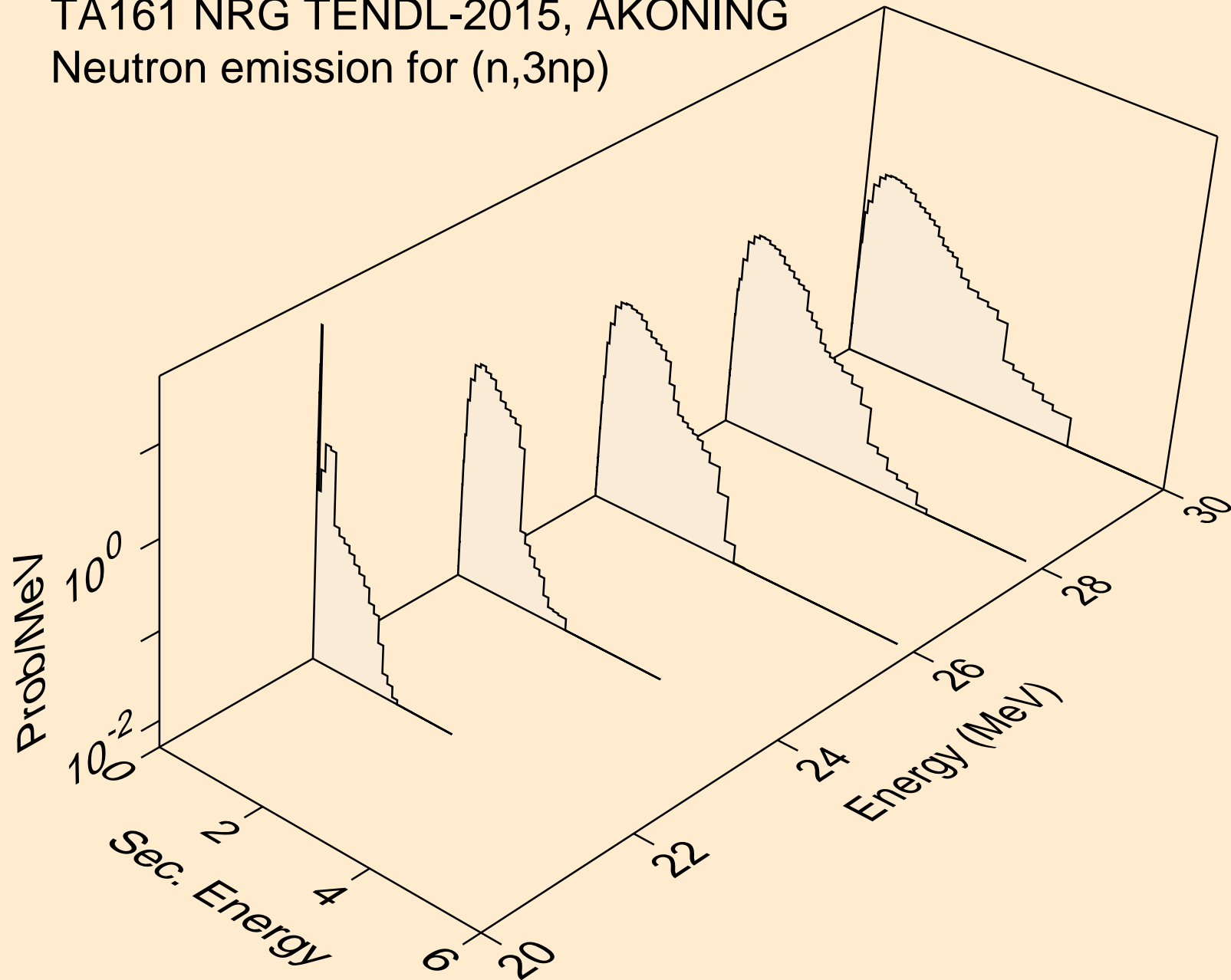

TA161 NRG TENDL-2015, AKONING
Neutron emission for (n,2np)

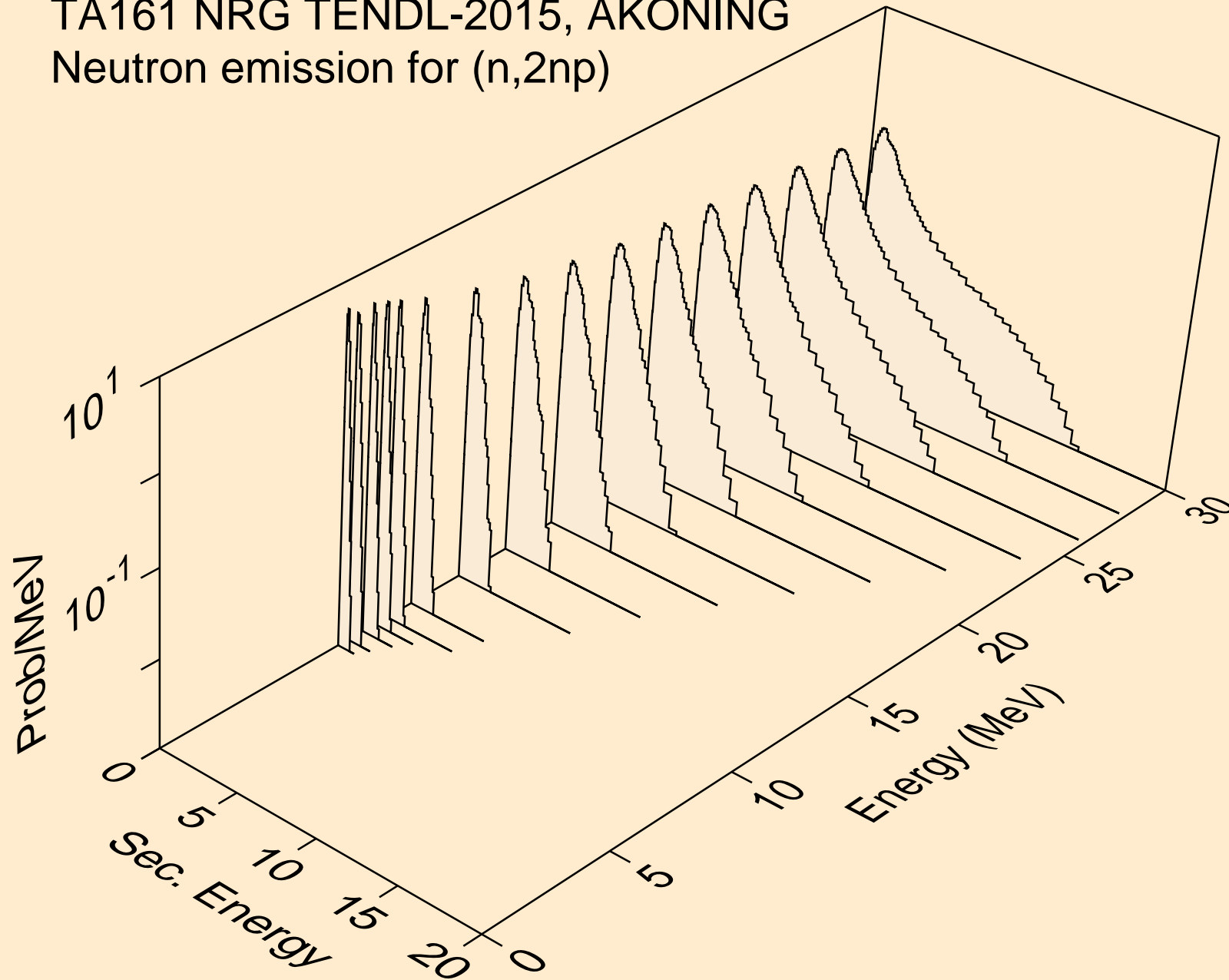

TA161 NRG TENDL-2015, AKONING
Neutron emission for (n,npa)

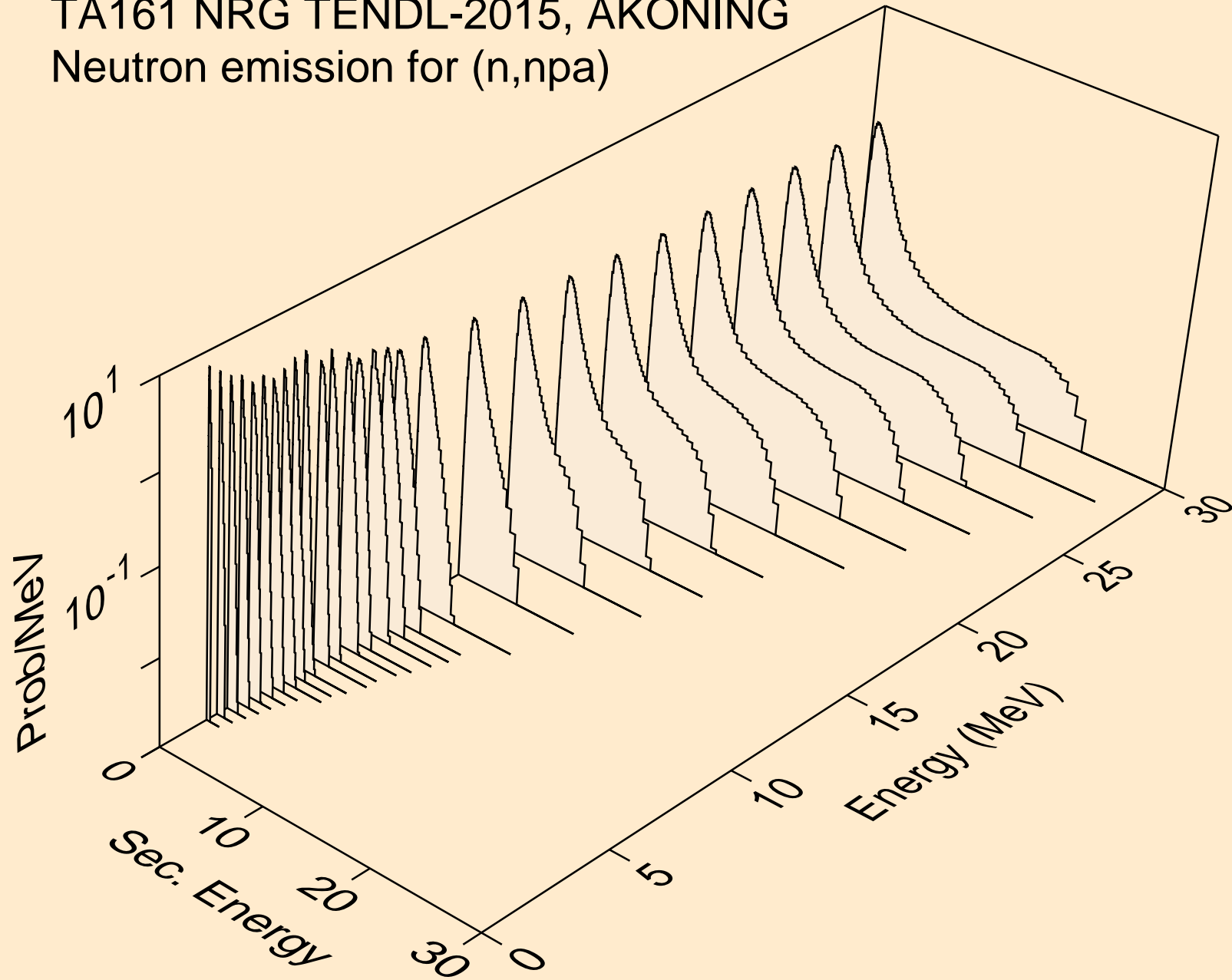

TA161 NRG TENDL-2015, AKONING
Neutron emission for (n,n*c)

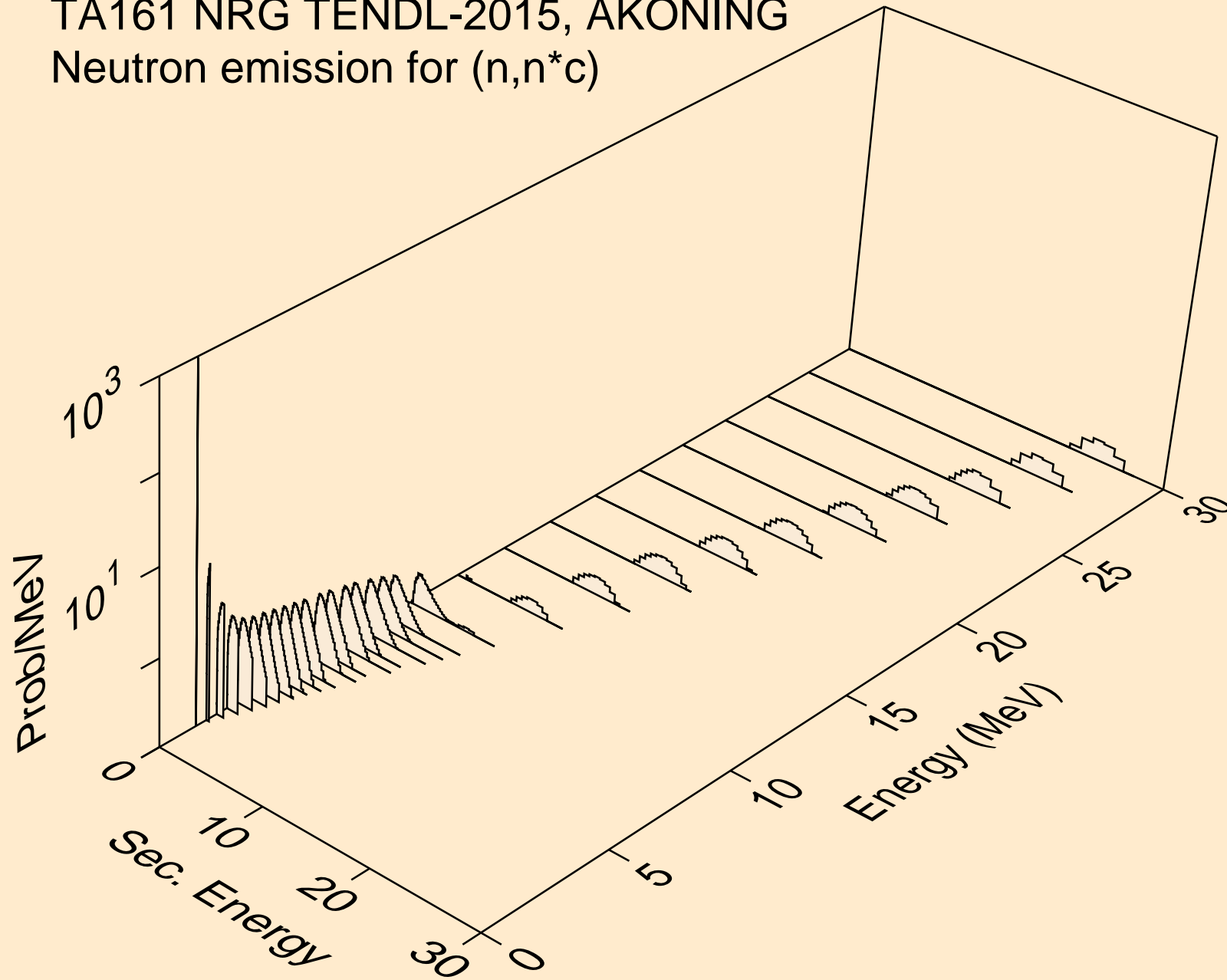

TA161 NRG TENDL-2015, AKONING
Photon emission for (n,x)

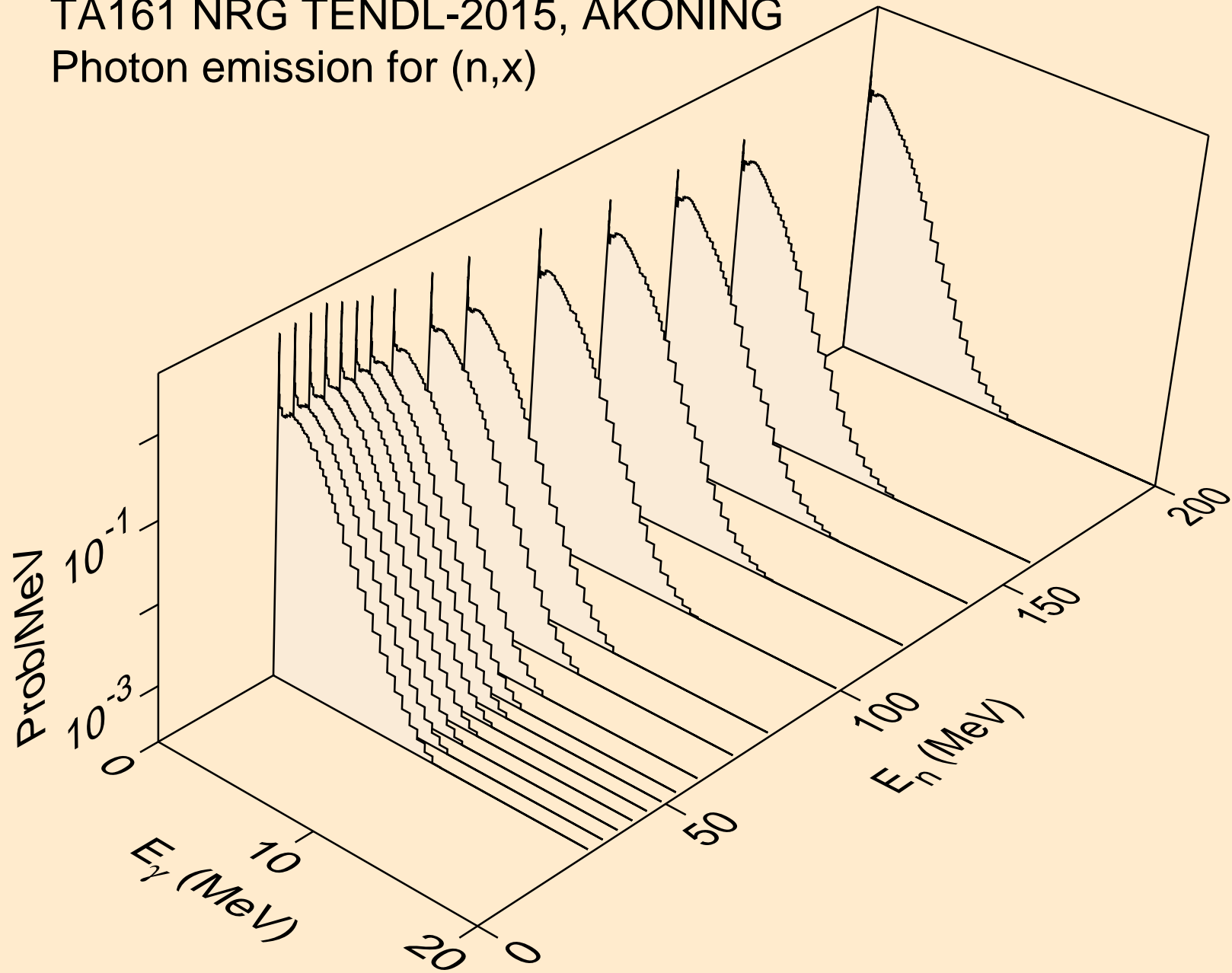

TA161 NRG TENDL-2015, AKONING
Photon emission for (n,2nd)

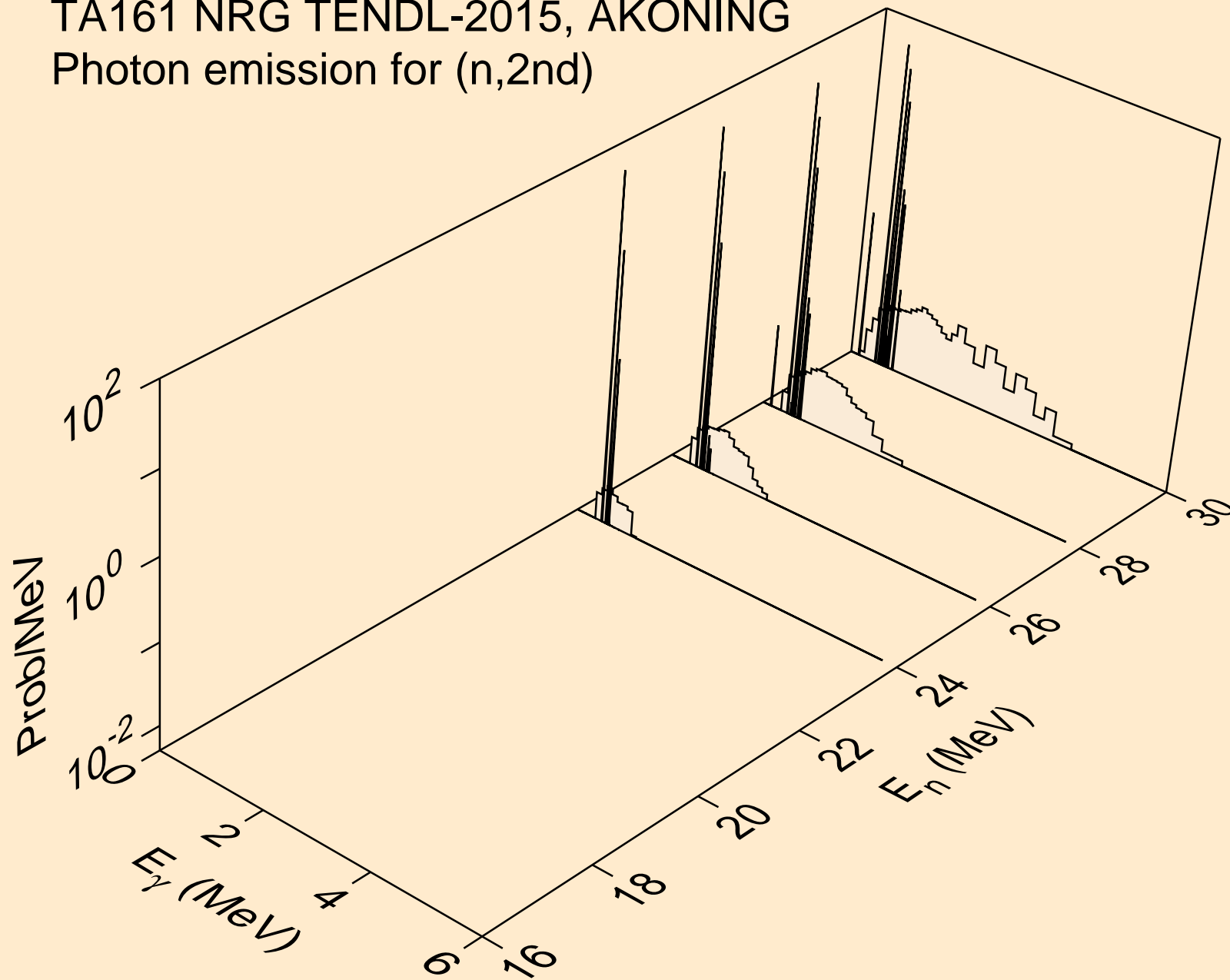

TA161 NRG TENDL-2015, AKONING
Photon emission for (n,2n)

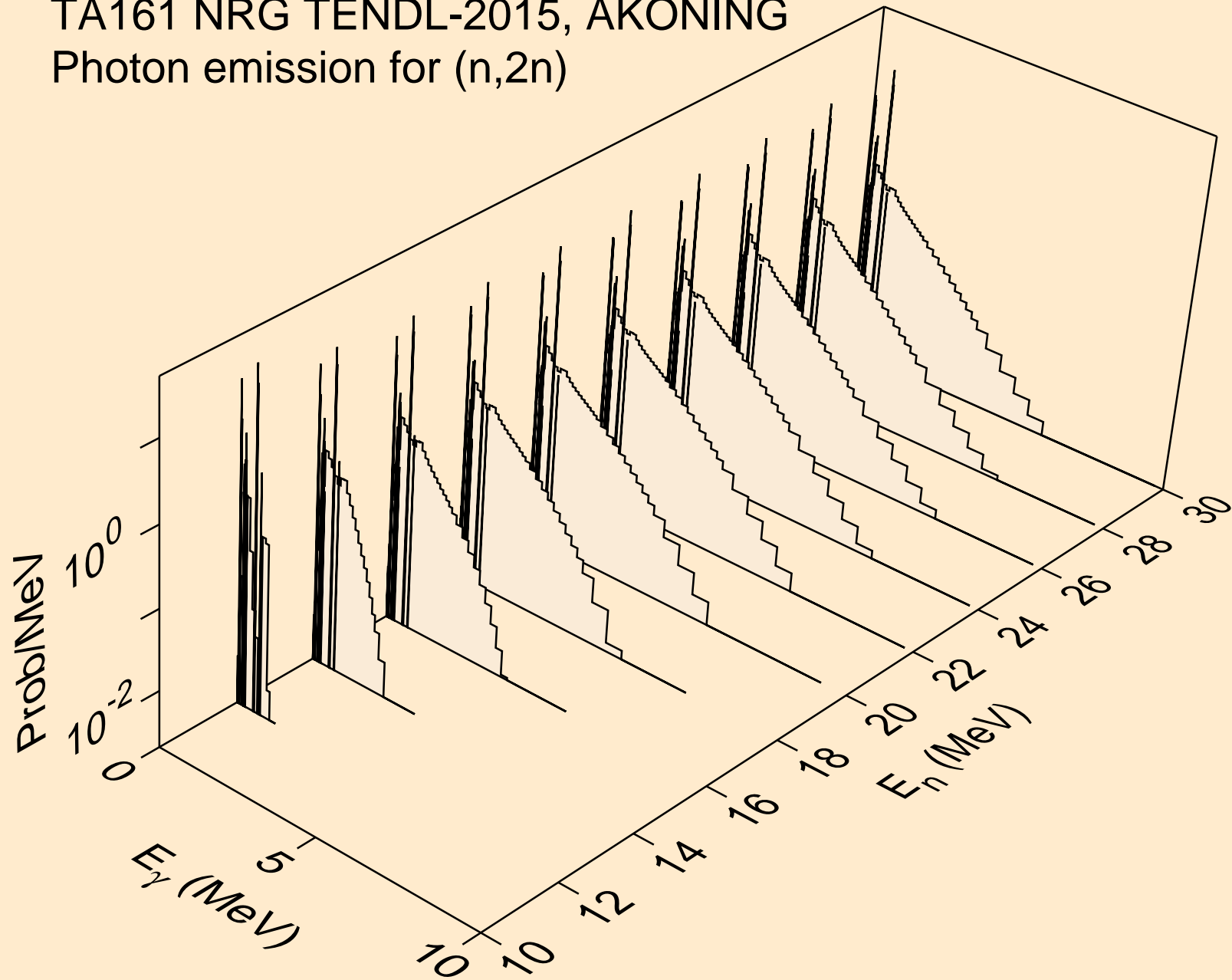

TA161 NRG TENDL-2015, AKONING
Photon emission for (n,3n)

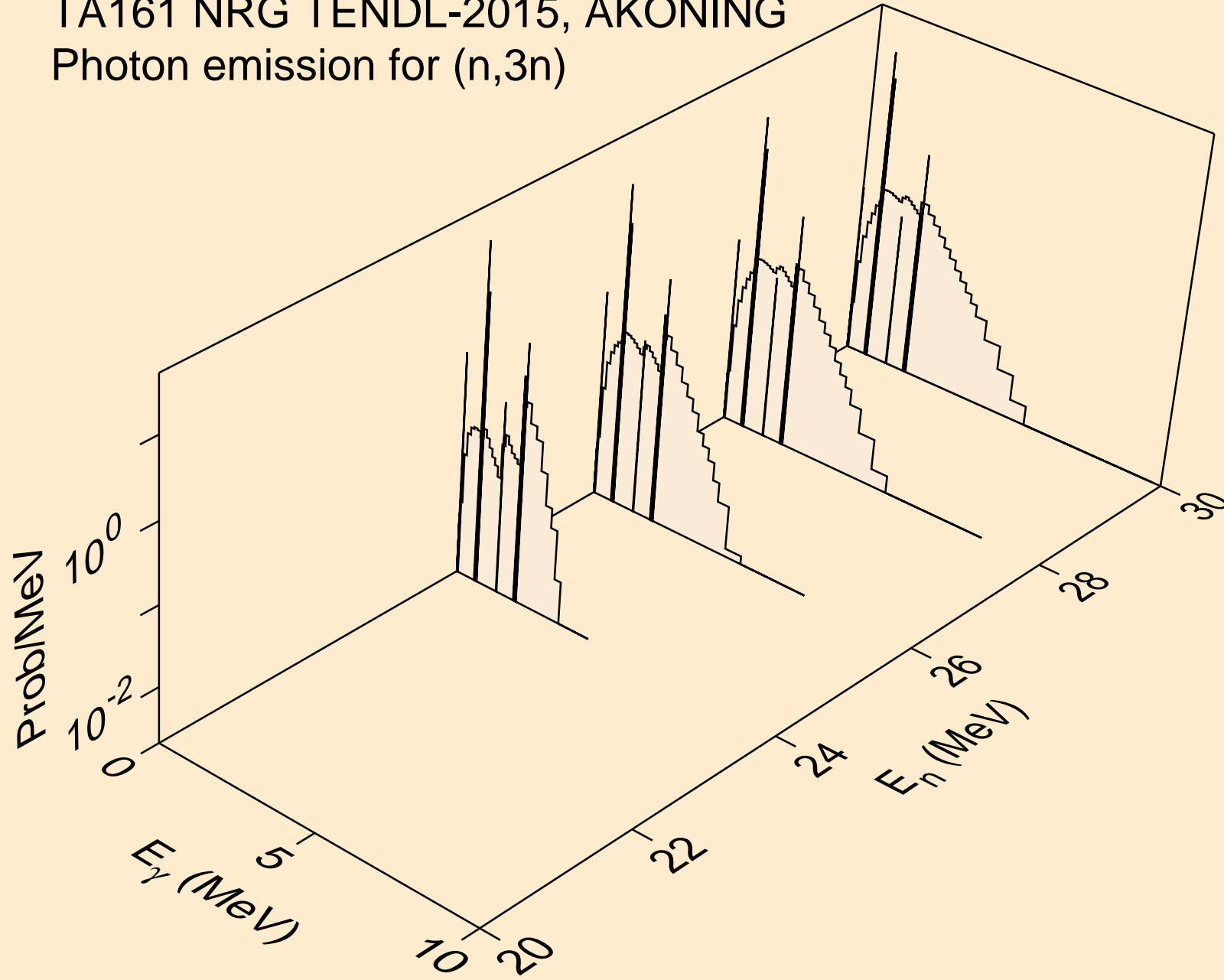

TA161 NRG TENDL-2015, AKONING
Photon emission for (n,n*)a

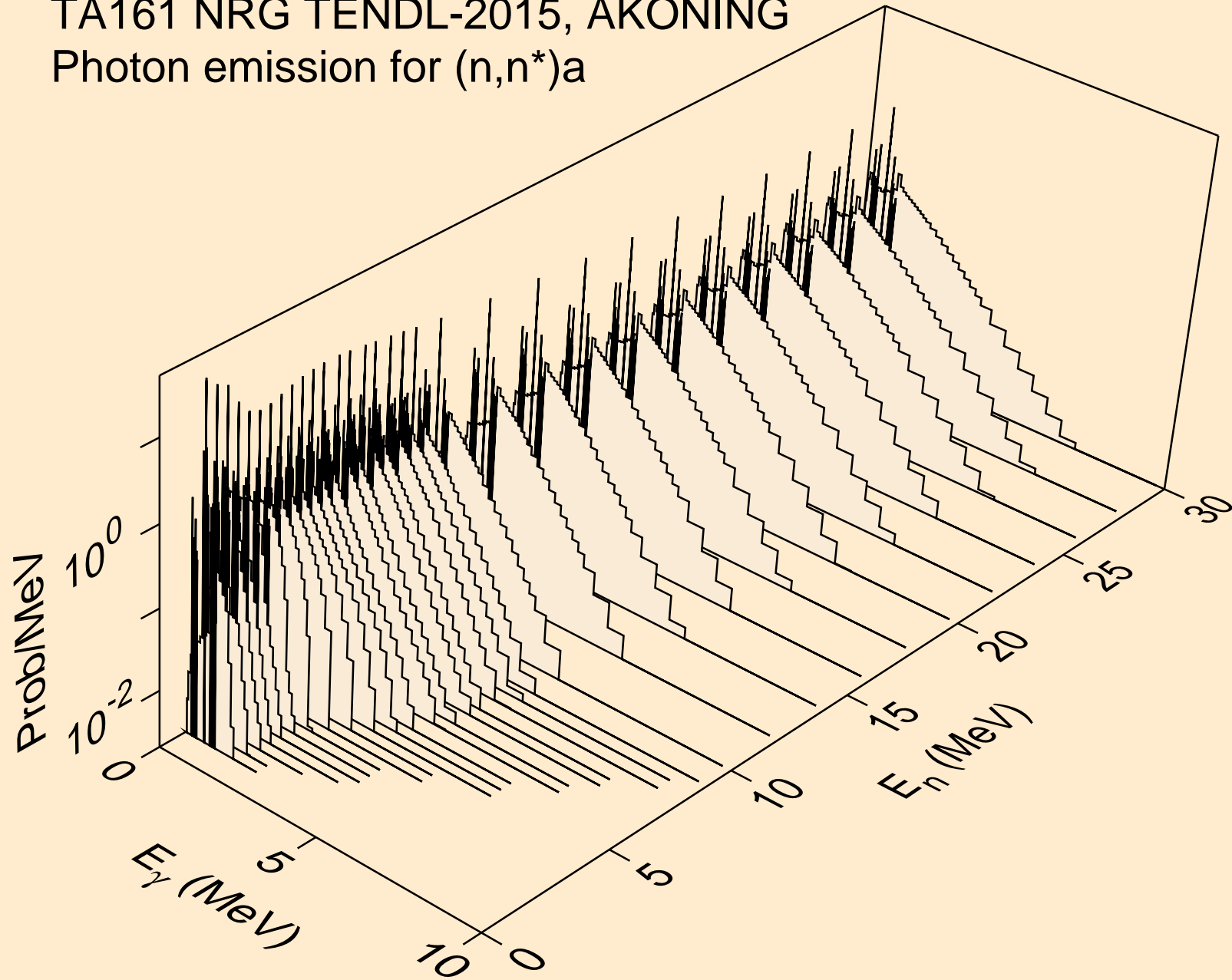

TA161 NRG TENDL-2015, AKONING
Photon emission for (n,n*)3a

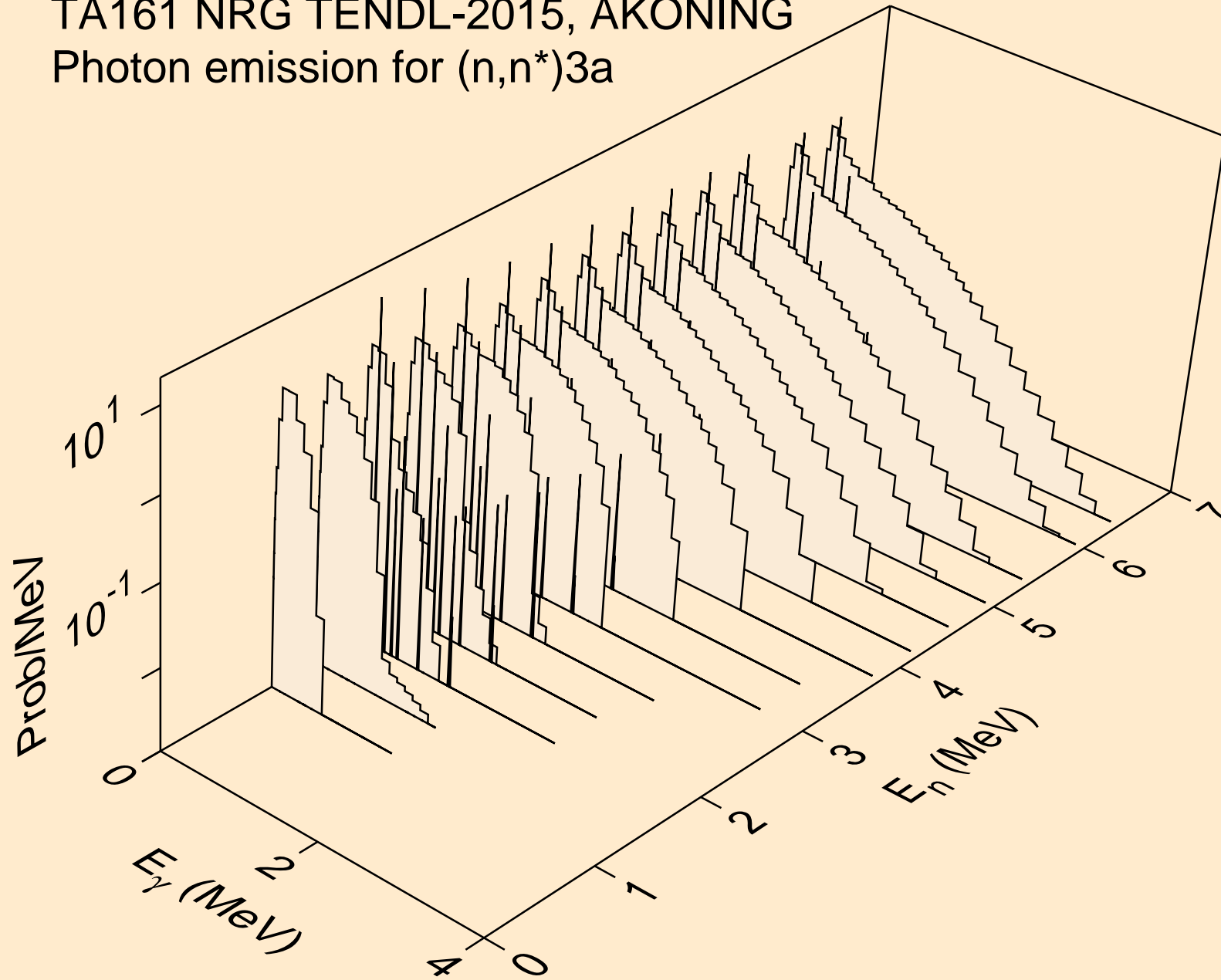

TA161 NRG TENDL-2015, AKONING
Photon emission for (n,2n)a

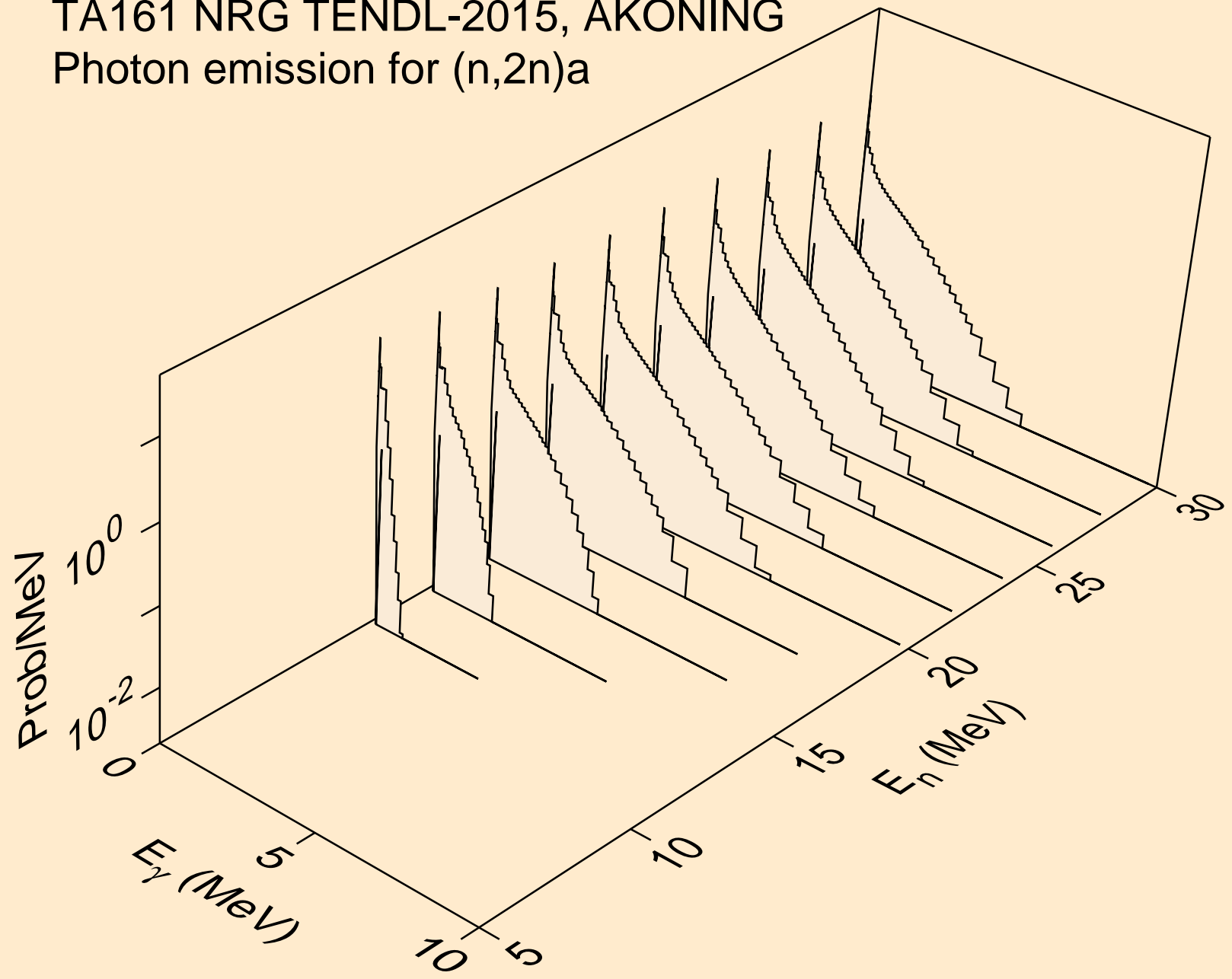

TA161 NRG TENDL-2015, AKONING
Photon emission for (n,3n)a

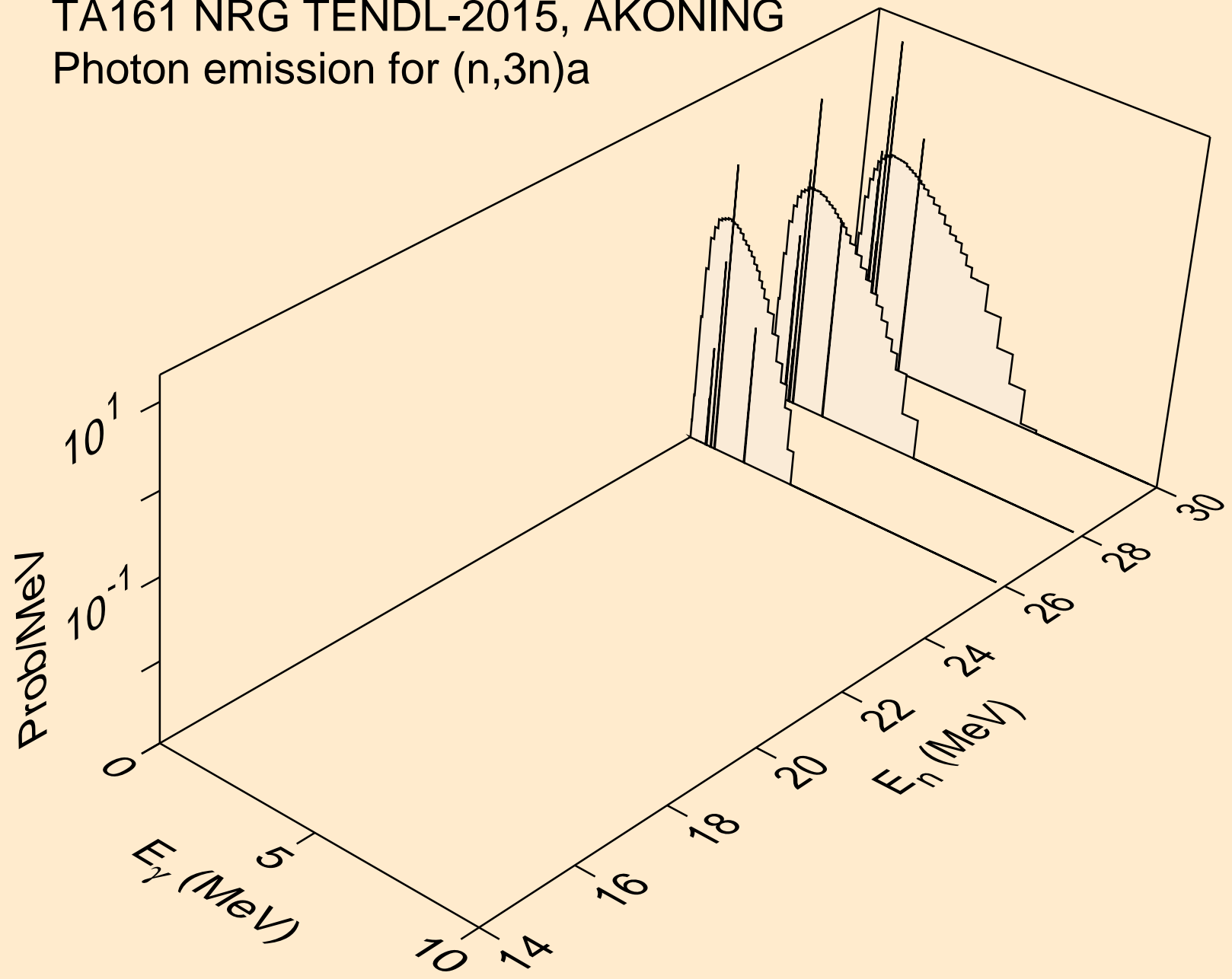

TA161 NRG TENDL-2015, AKONING
Photon emission for (n,n*)p

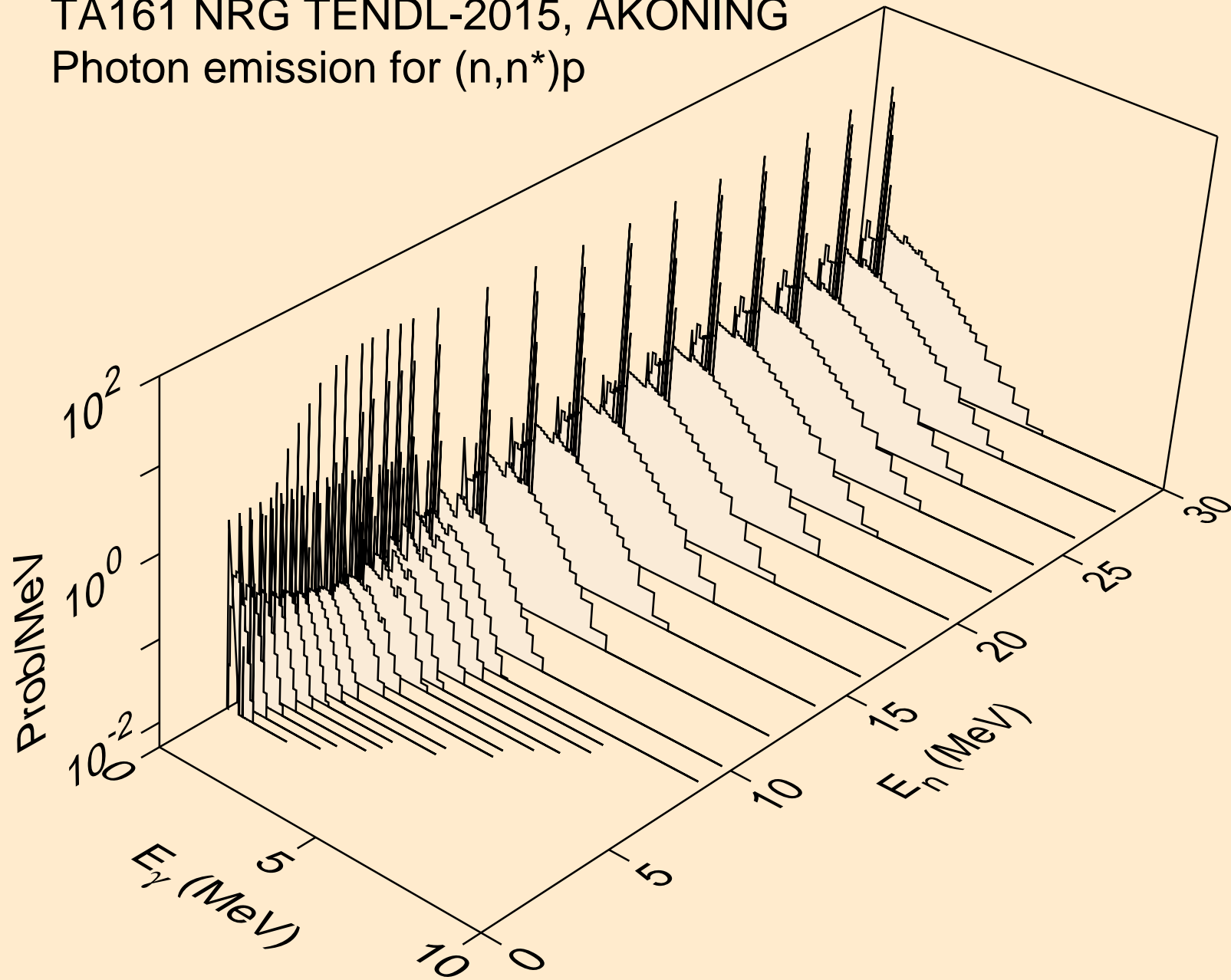

TA161 NRG TENDL-2015, AKONING
Photon emission for (n,n*)2a

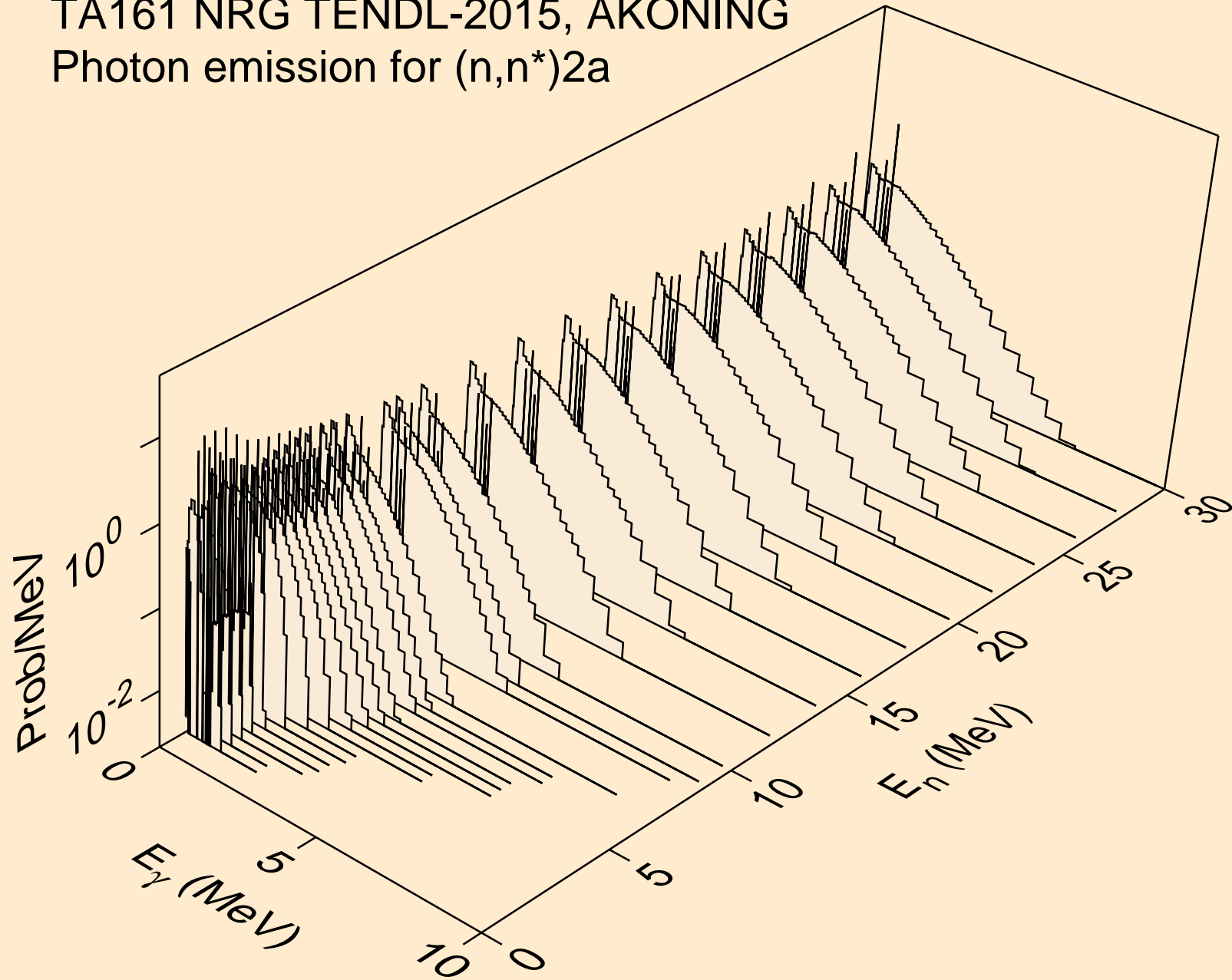

TA161 NRG TENDL-2015, AKONING
Photon emission for (n,2n)2a

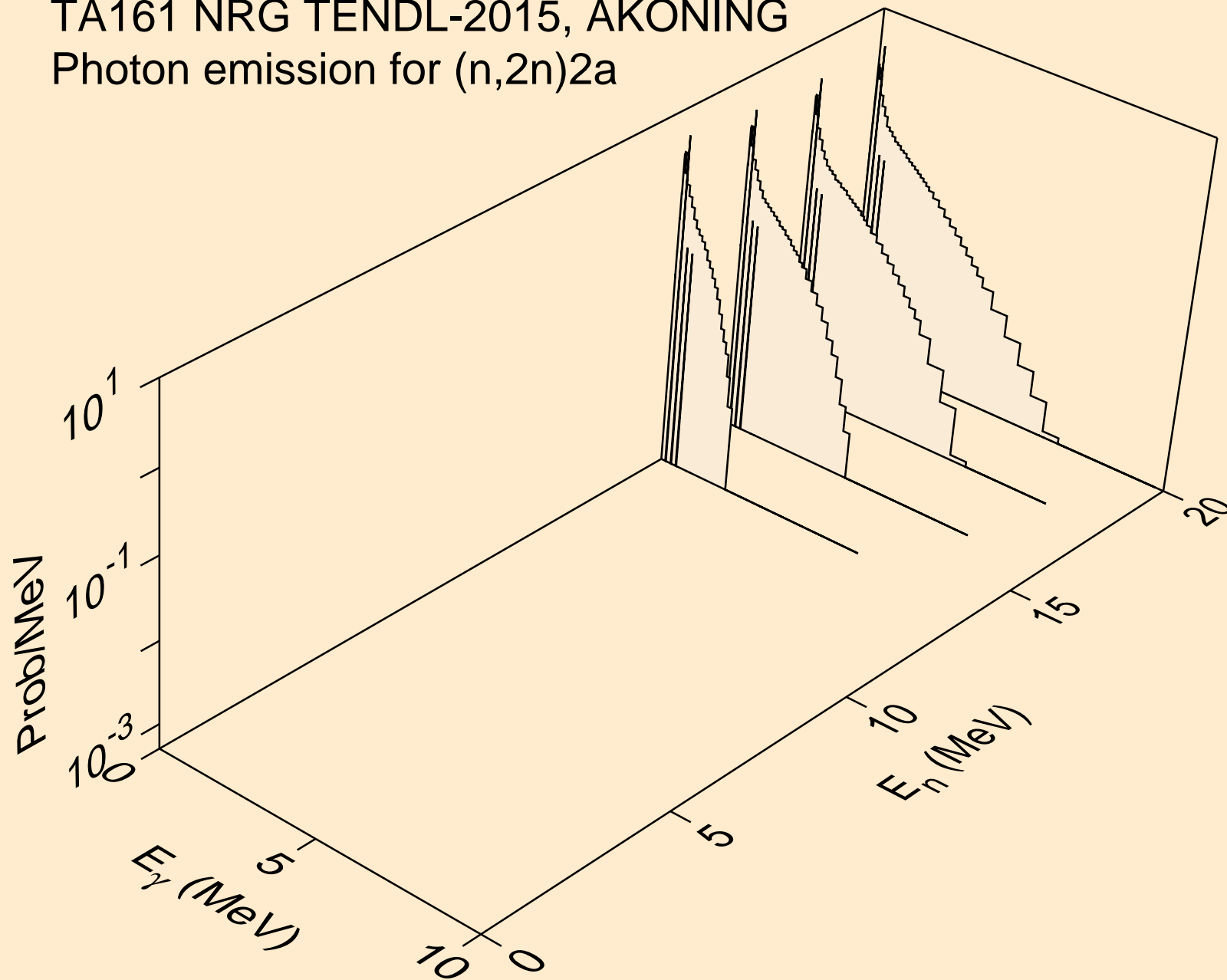

TA161 NRG TENDL-2015, AKONING
Photon emission for (n,n*)d

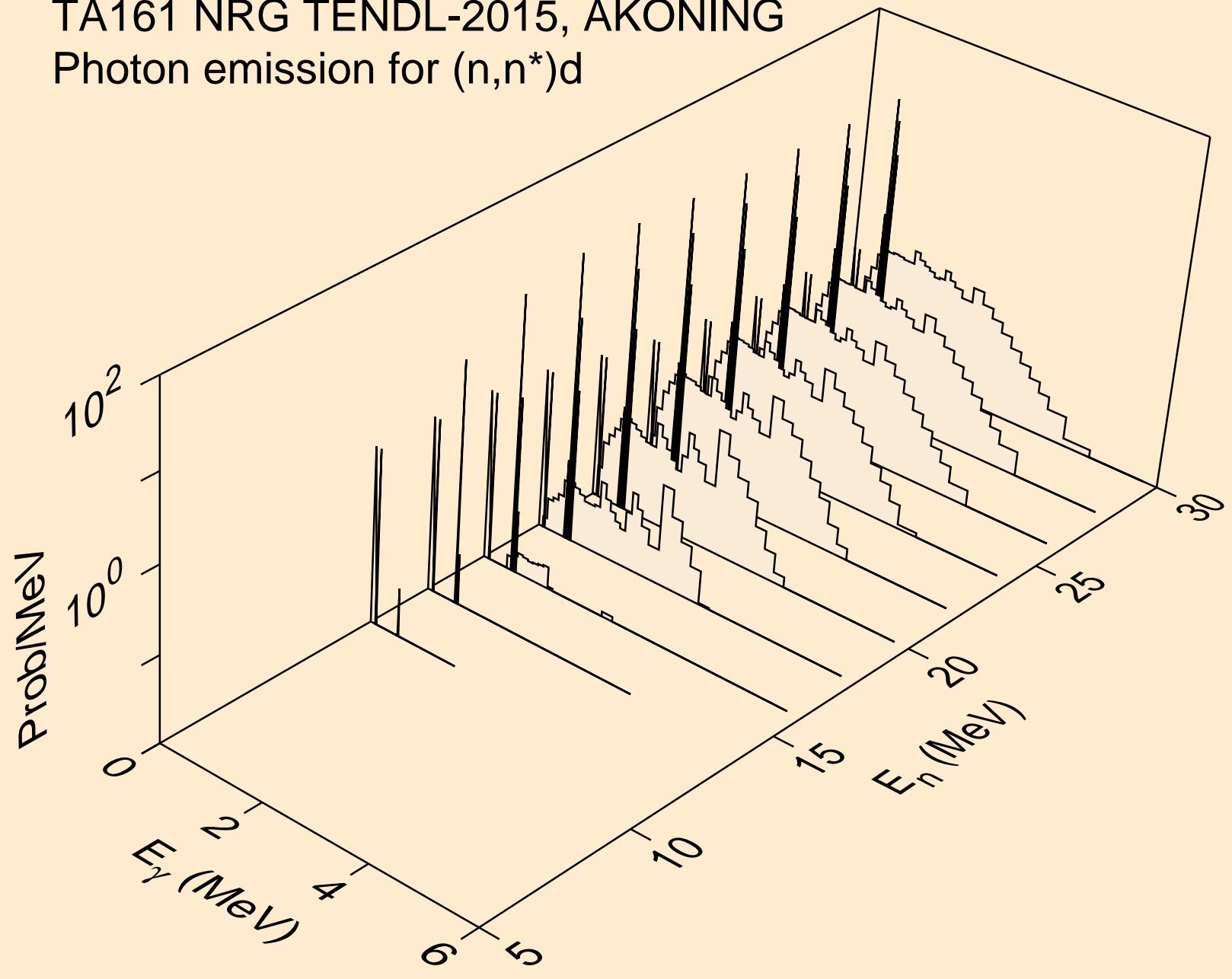

TA161 NRG TENDL-2015, AKONING
Photon emission for (n,n*)t

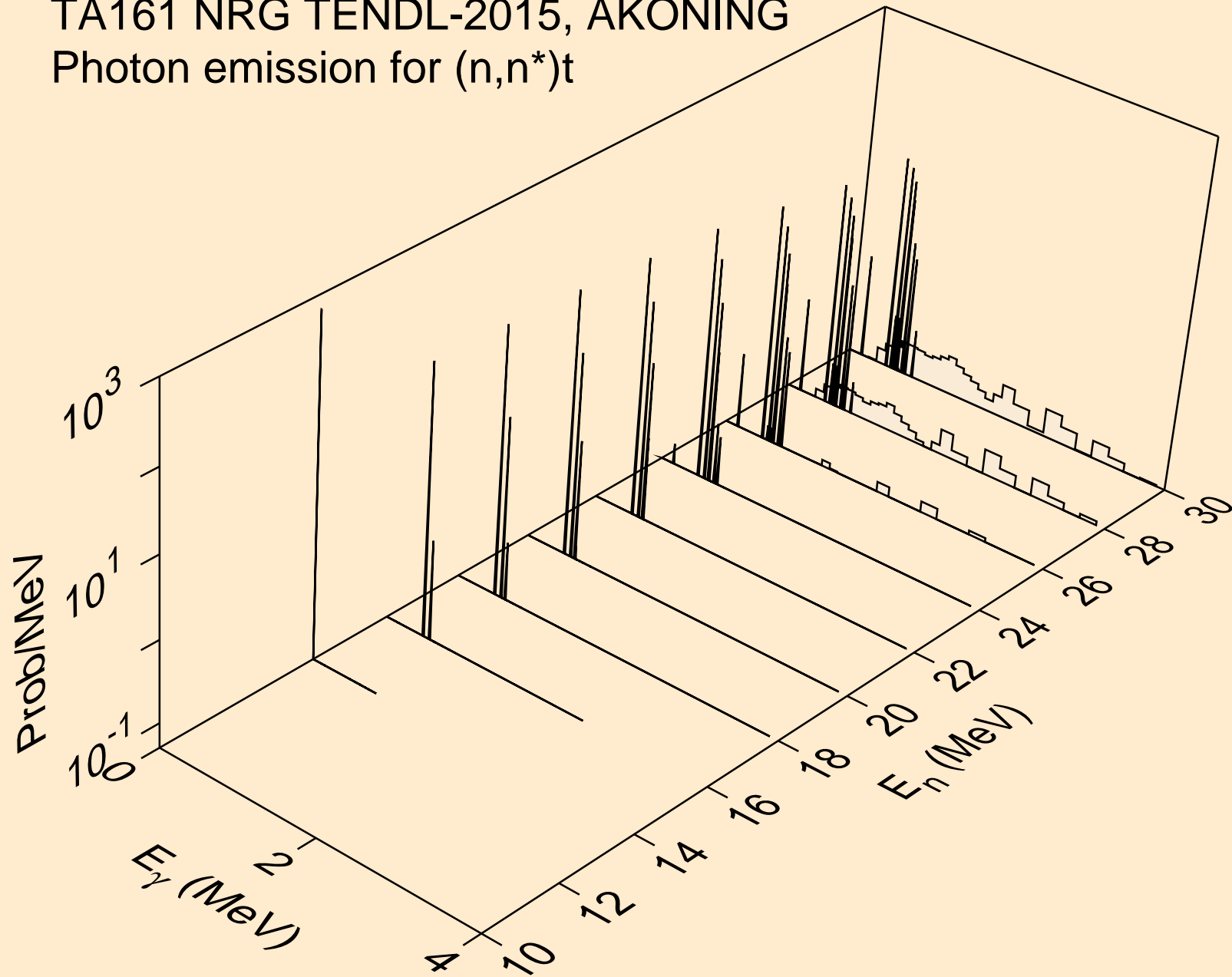

TA161 NRG TENDL-2015, AKONING
Photon emission for (n,n*)he3

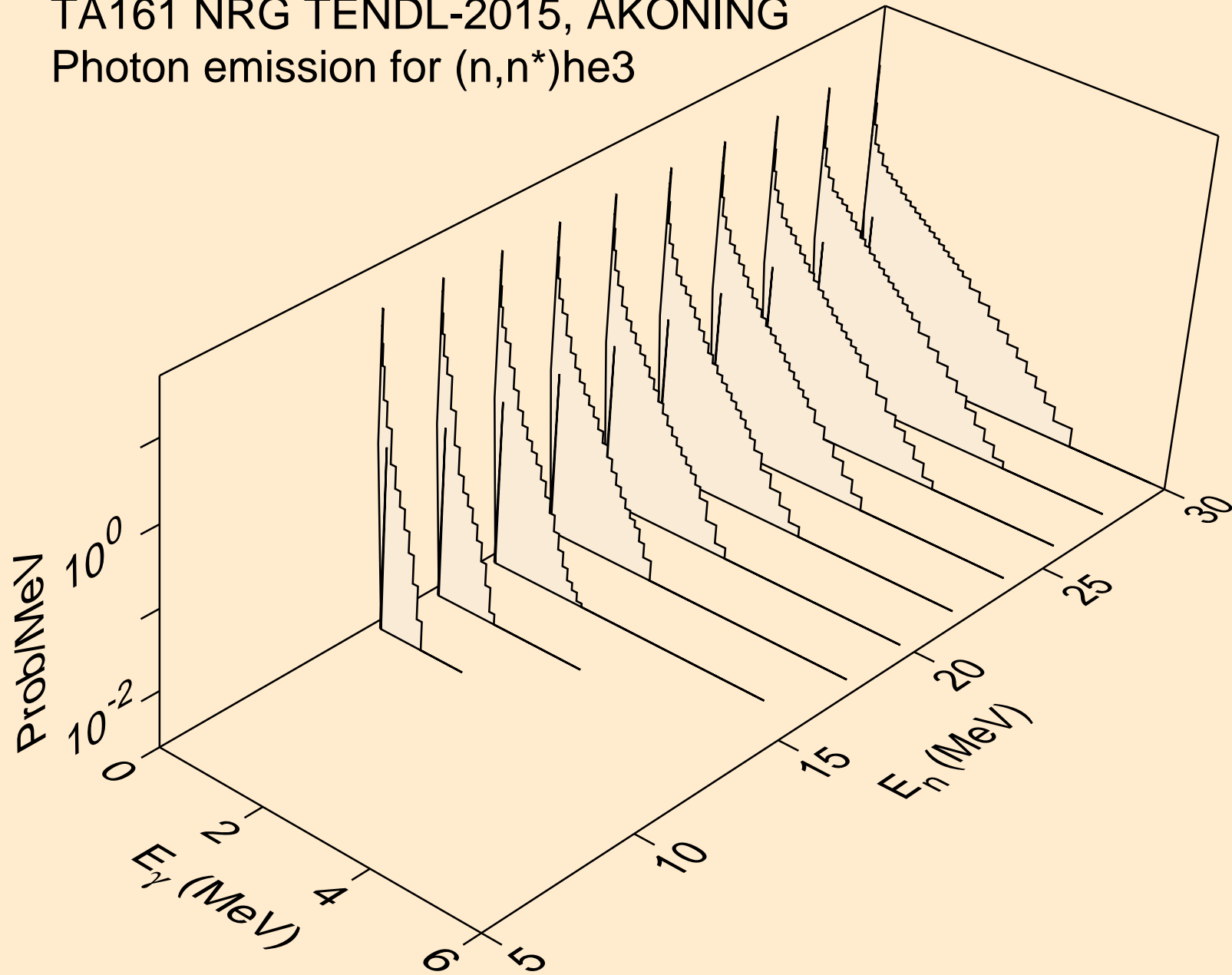

TA161 NRG TENDL-2015, AKONING
Photon emission for (n,n*)d2a

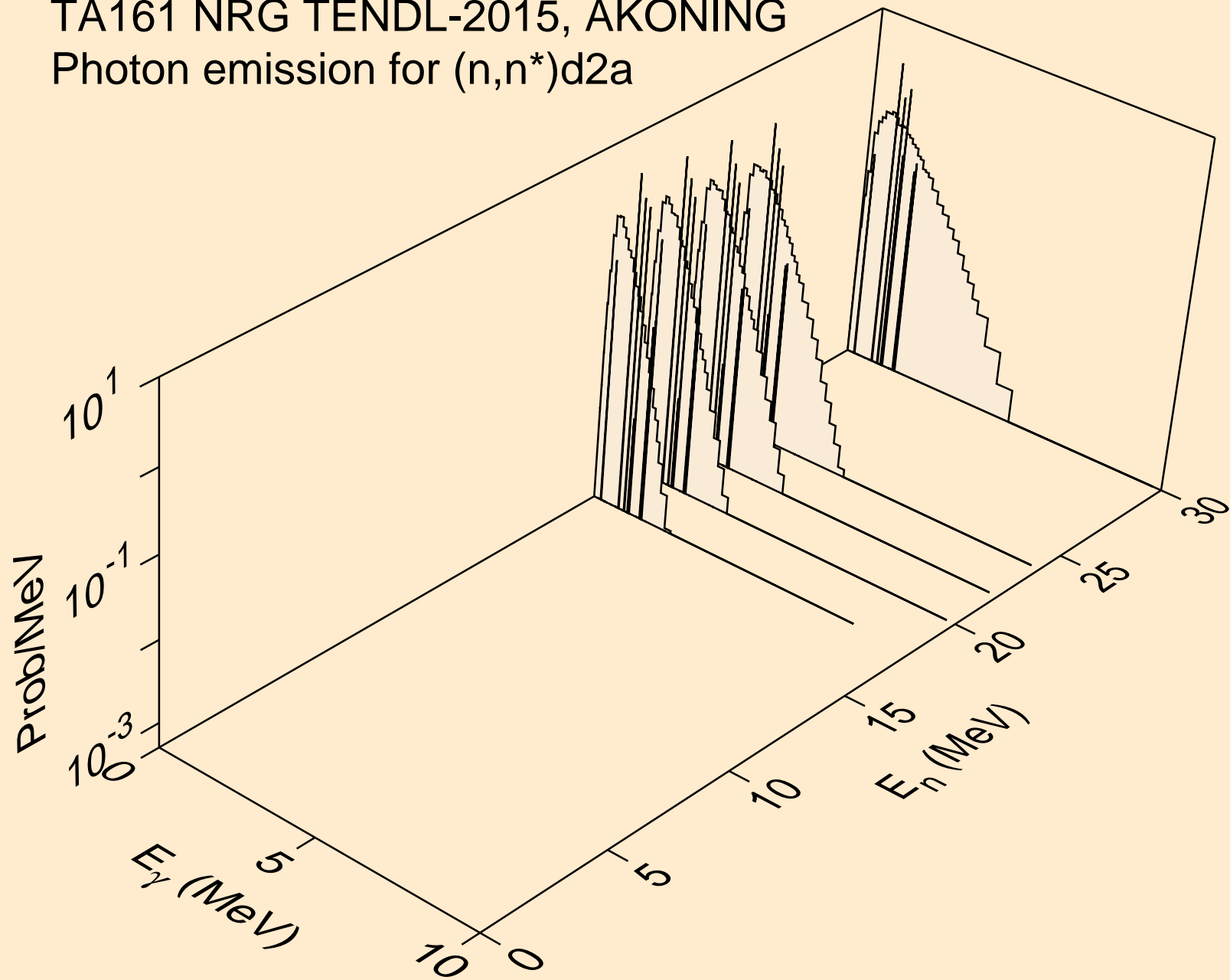

TA161 NRG TENDL-2015, AKONING
Photon emission for (n,n*)t2a

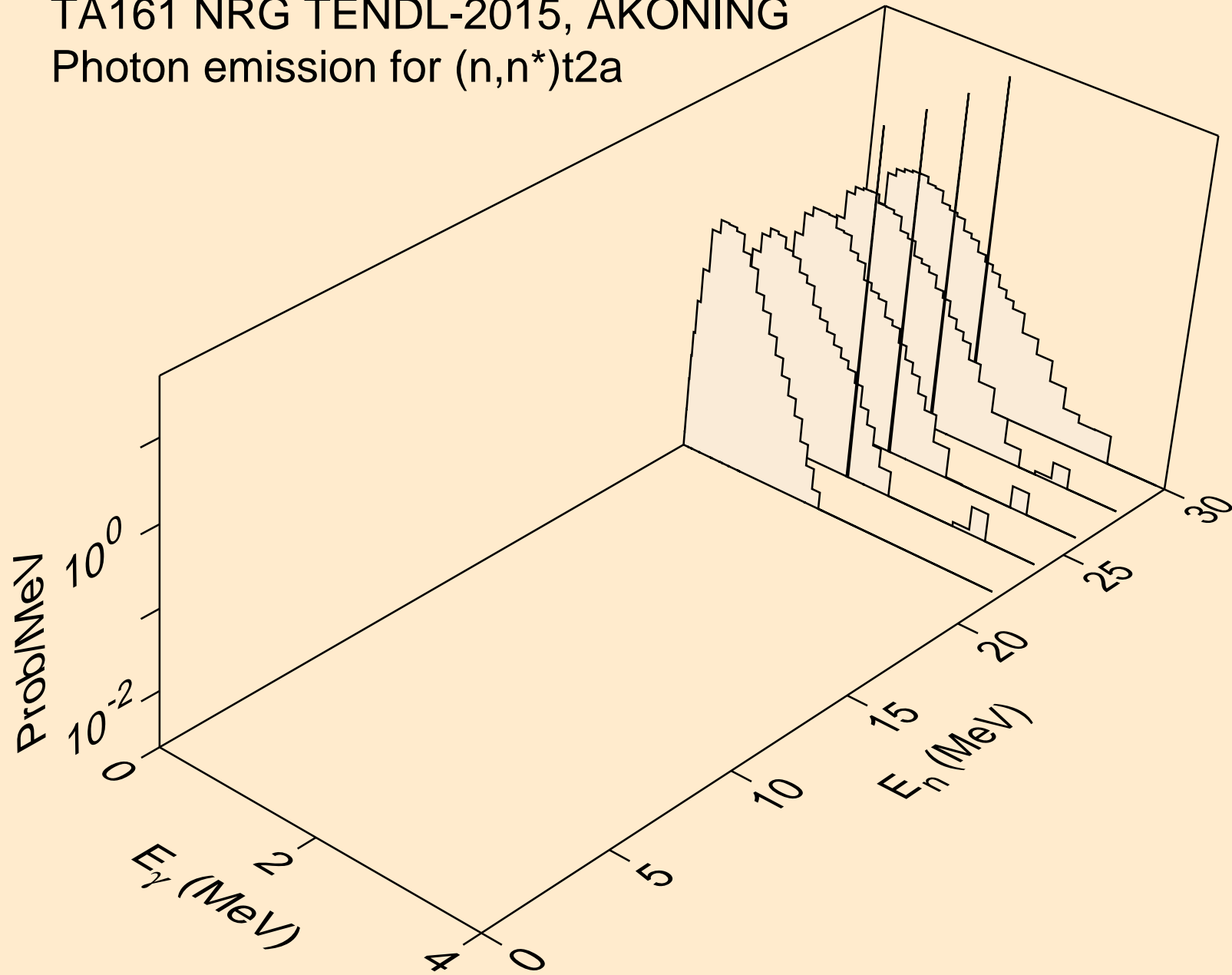

TA161 NRG TENDL-2015, AKONING
Photon emission for (n,2np)

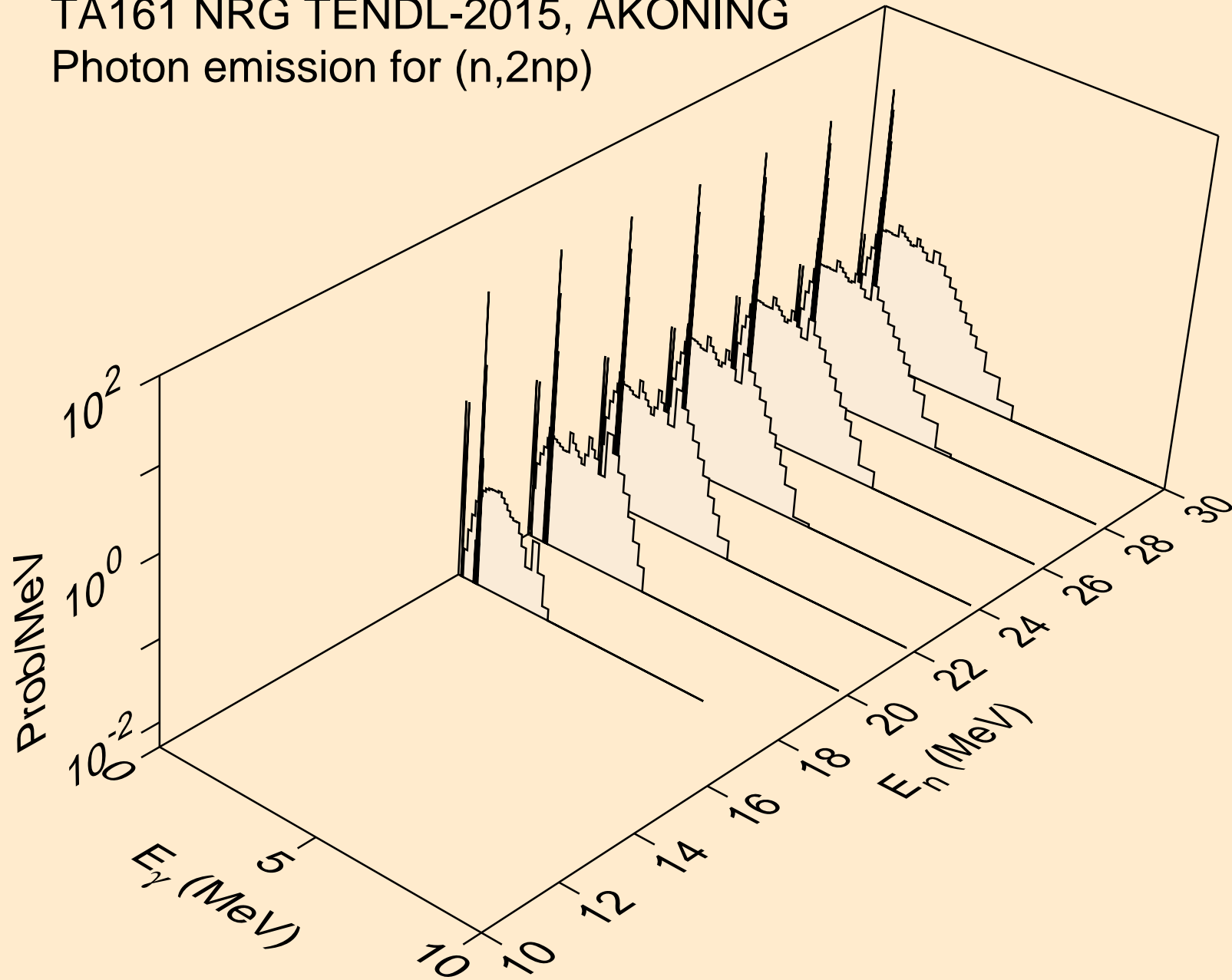

TA161 NRG TENDL-2015, AKONING
Photon emission for (n,3np)

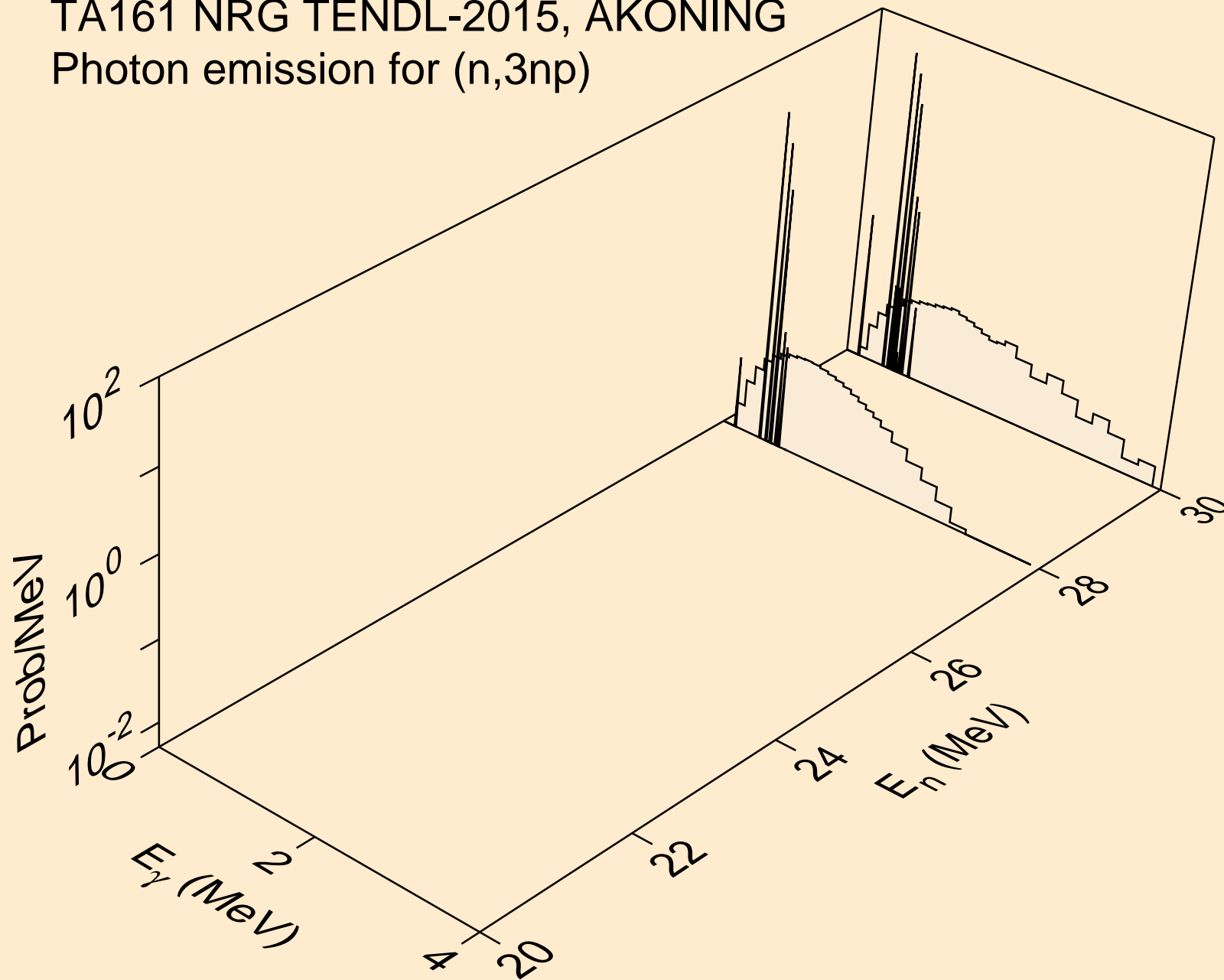

TA161 NRG TENDL-2015, AKONING
Photon emission for (n,2np)

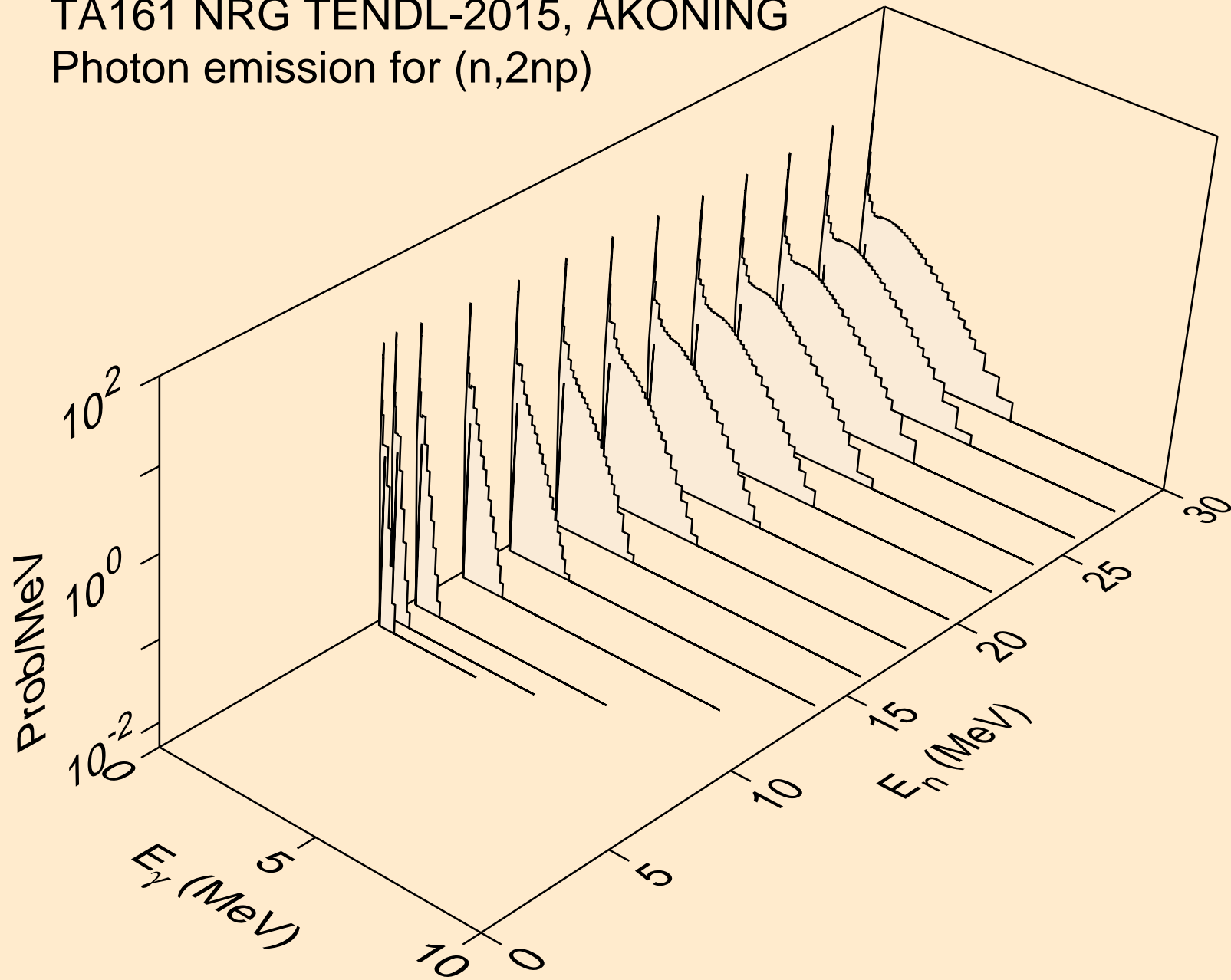

TA161 NRG TENDL-2015, AKONING
Photon emission for (n,npa)

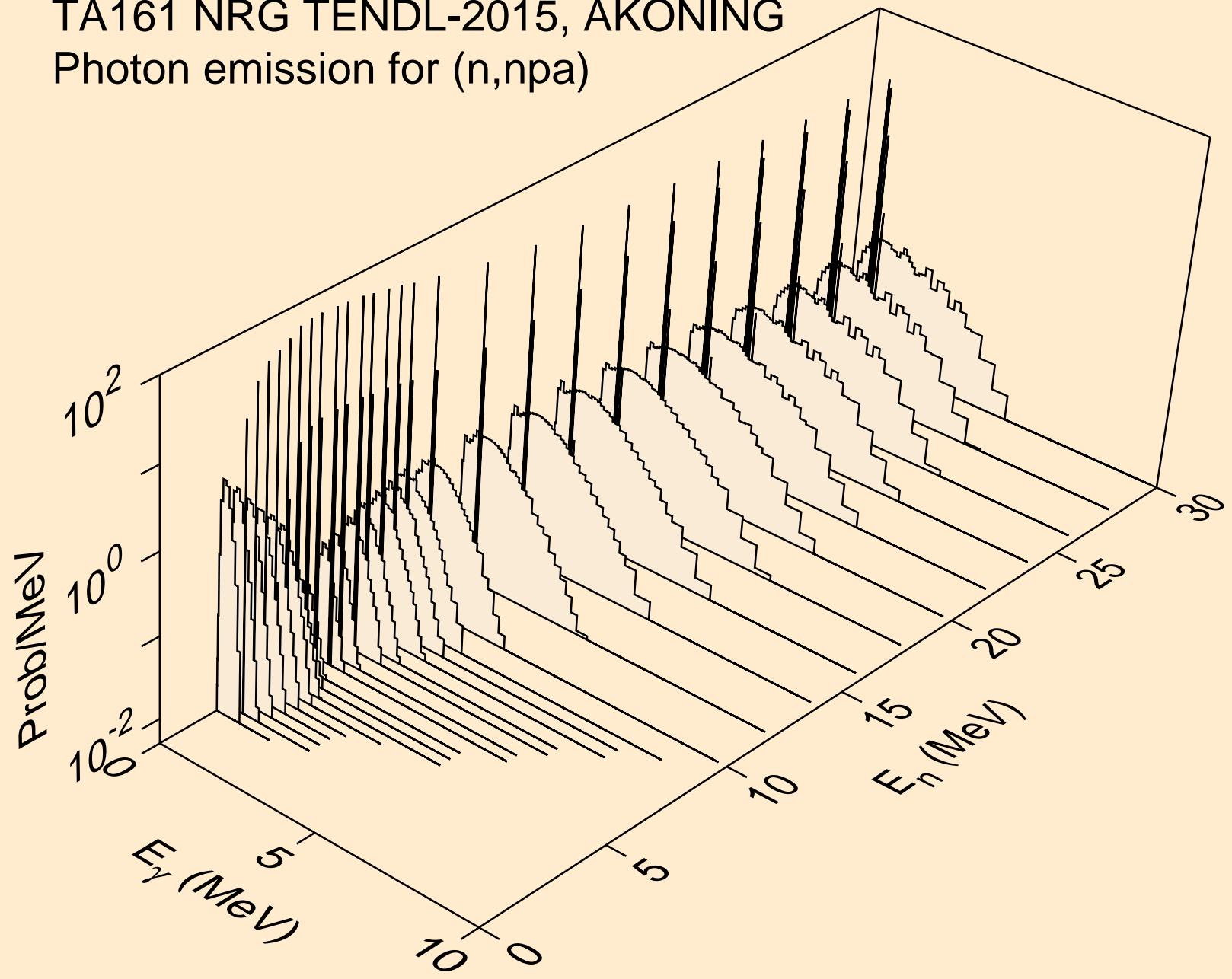

TA161 NRG TENDL-2015, AKONING
Photon emission for (n,n*c)

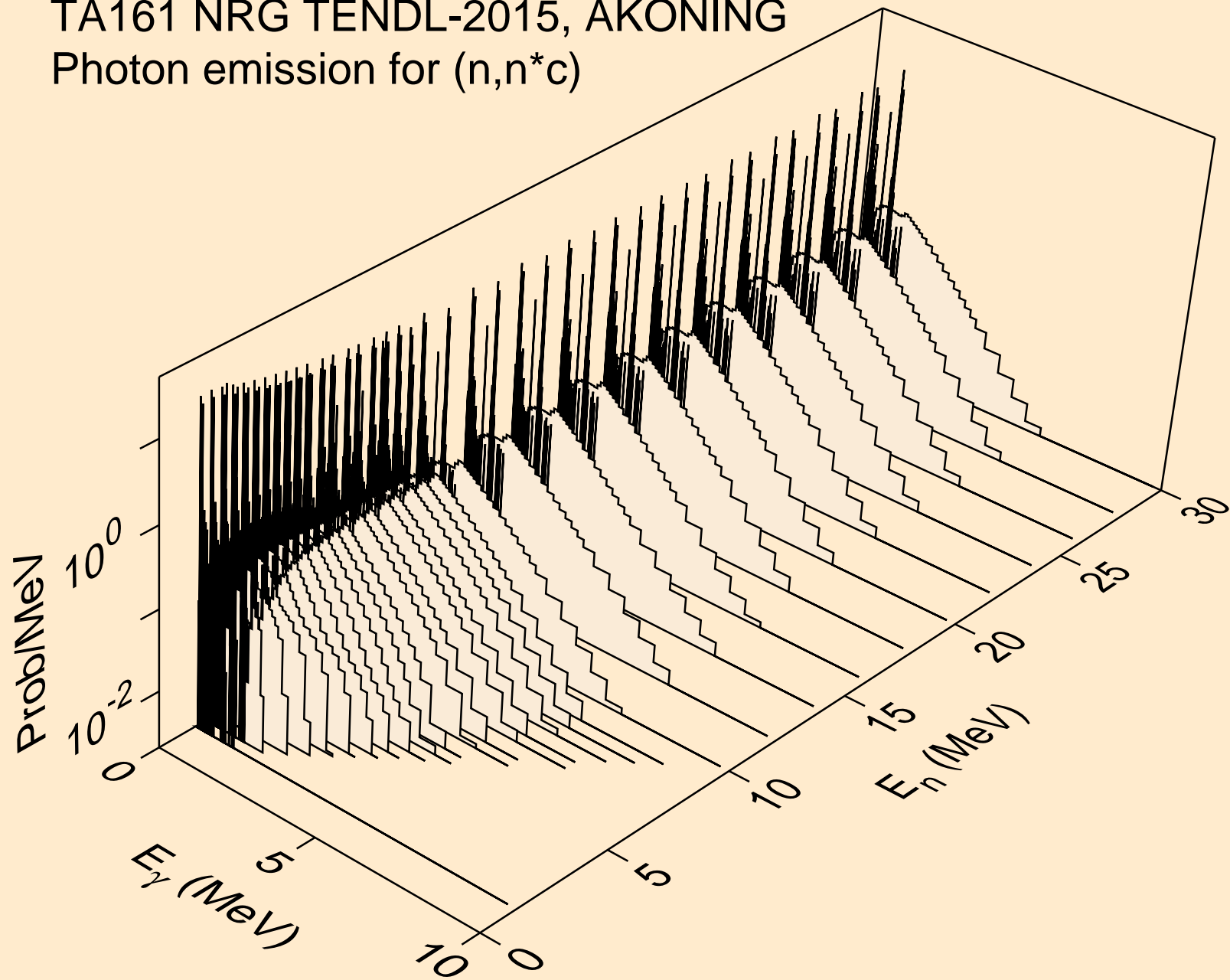

TA161 NRG TENDL-2015, AKONING
Photon emission for (n,gma)

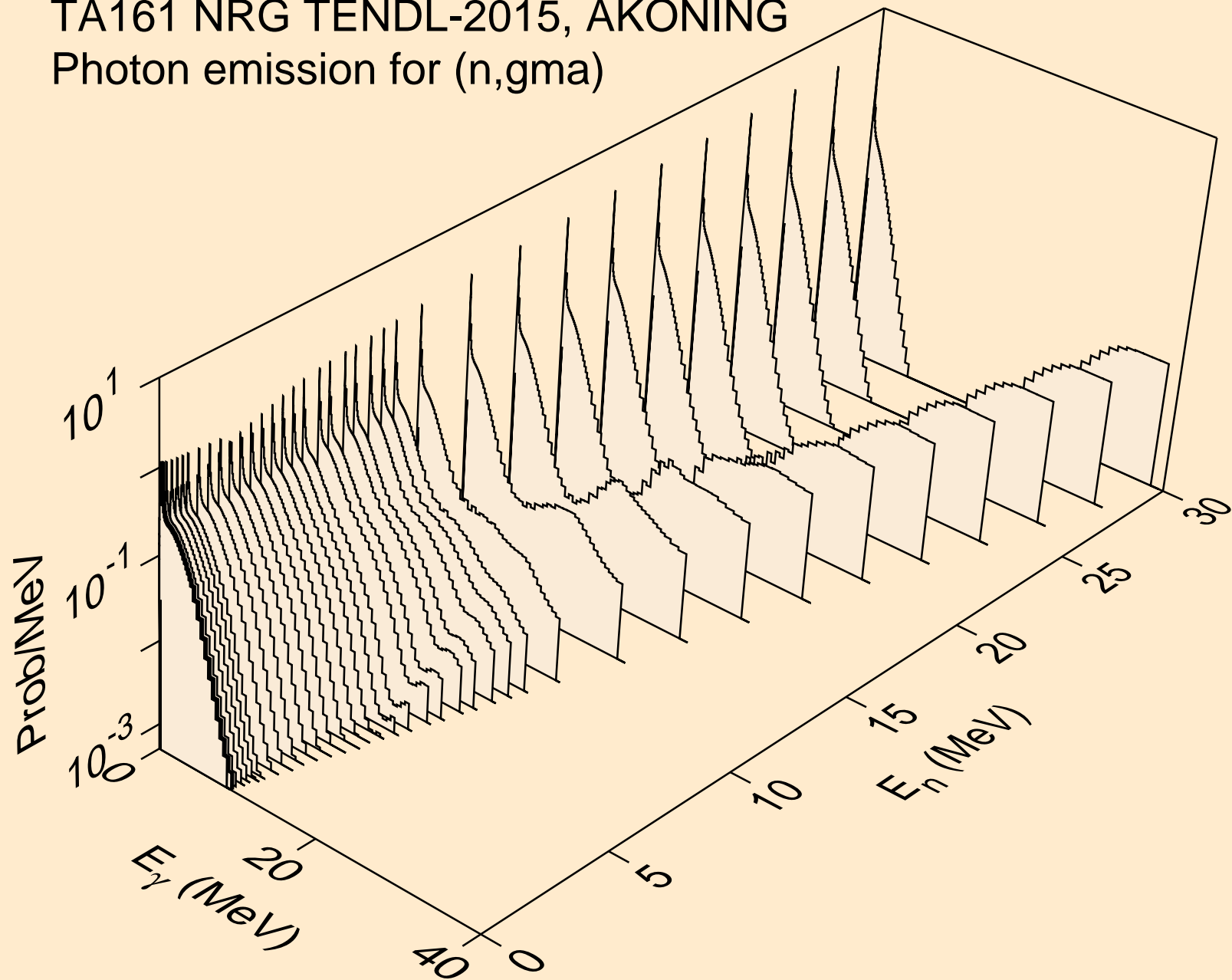

TA161 NRG TENDL-2015, AKONING
Photon emission for (n,p)

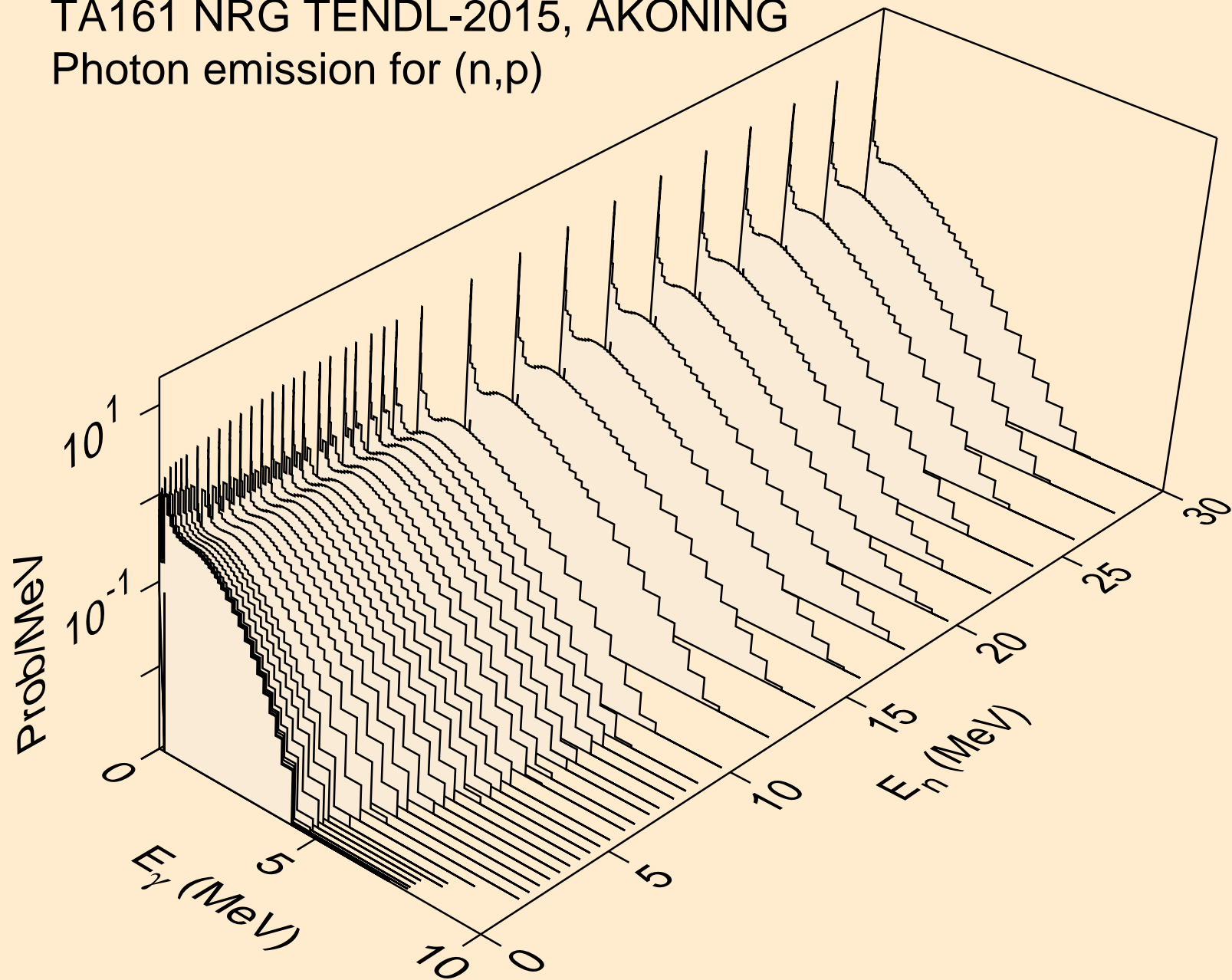

TA161 NRG TENDL-2015, AKONING
Photon emission for (n,d)

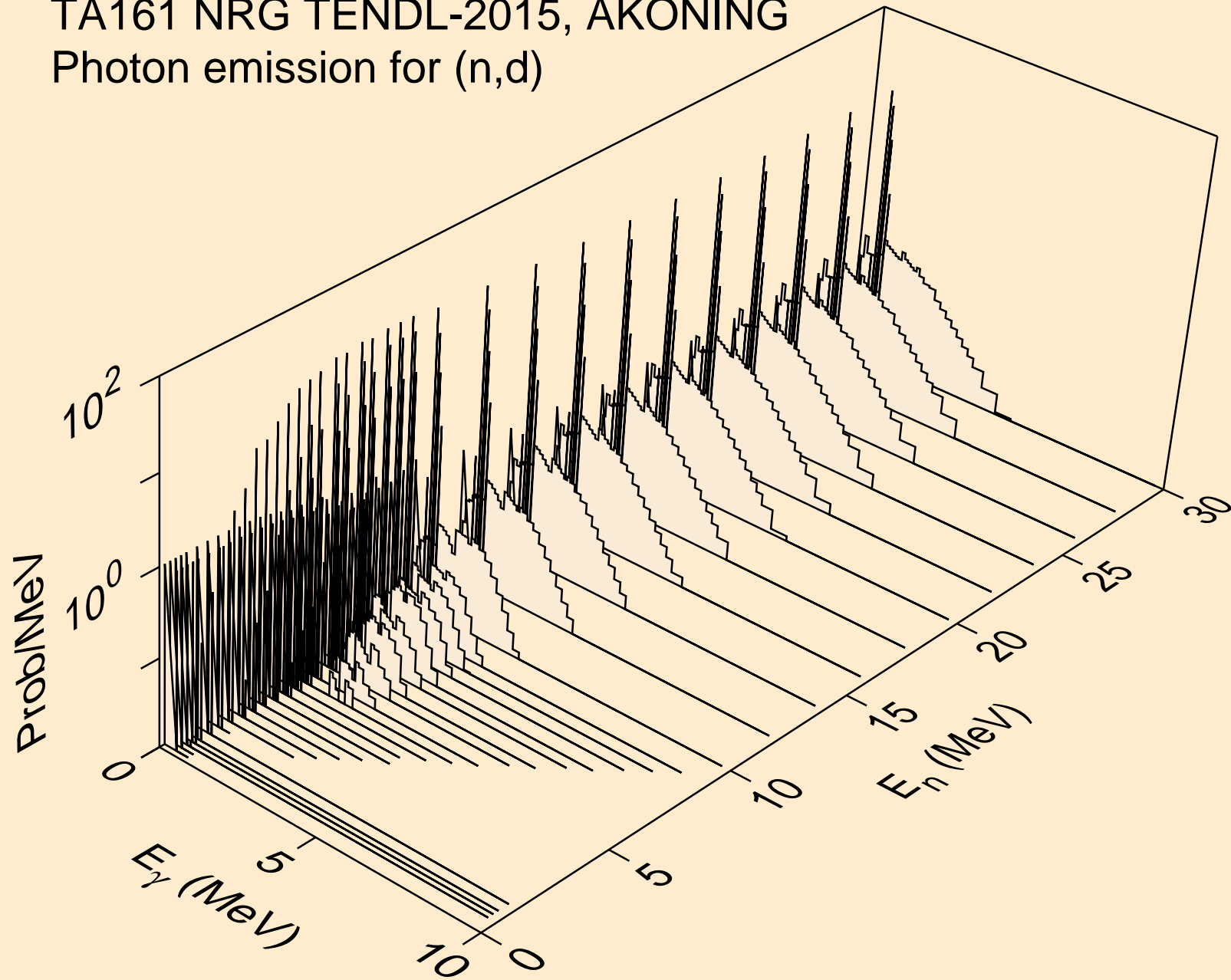

TA161 NRG TENDL-2015, AKONING
Photon emission for (n,t)

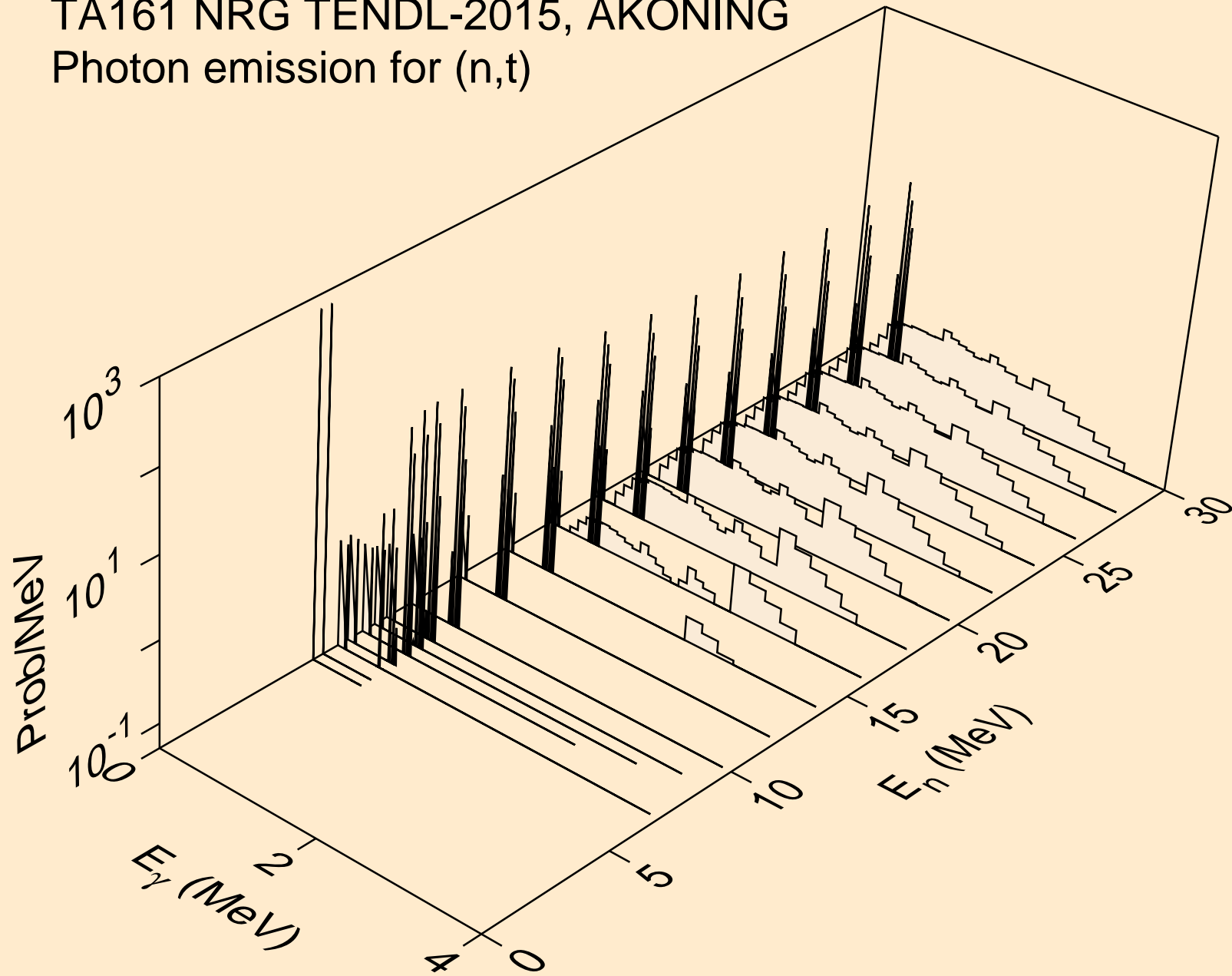

TA161 NRG TENDL-2015, AKONING
Photon emission for (n,he3)

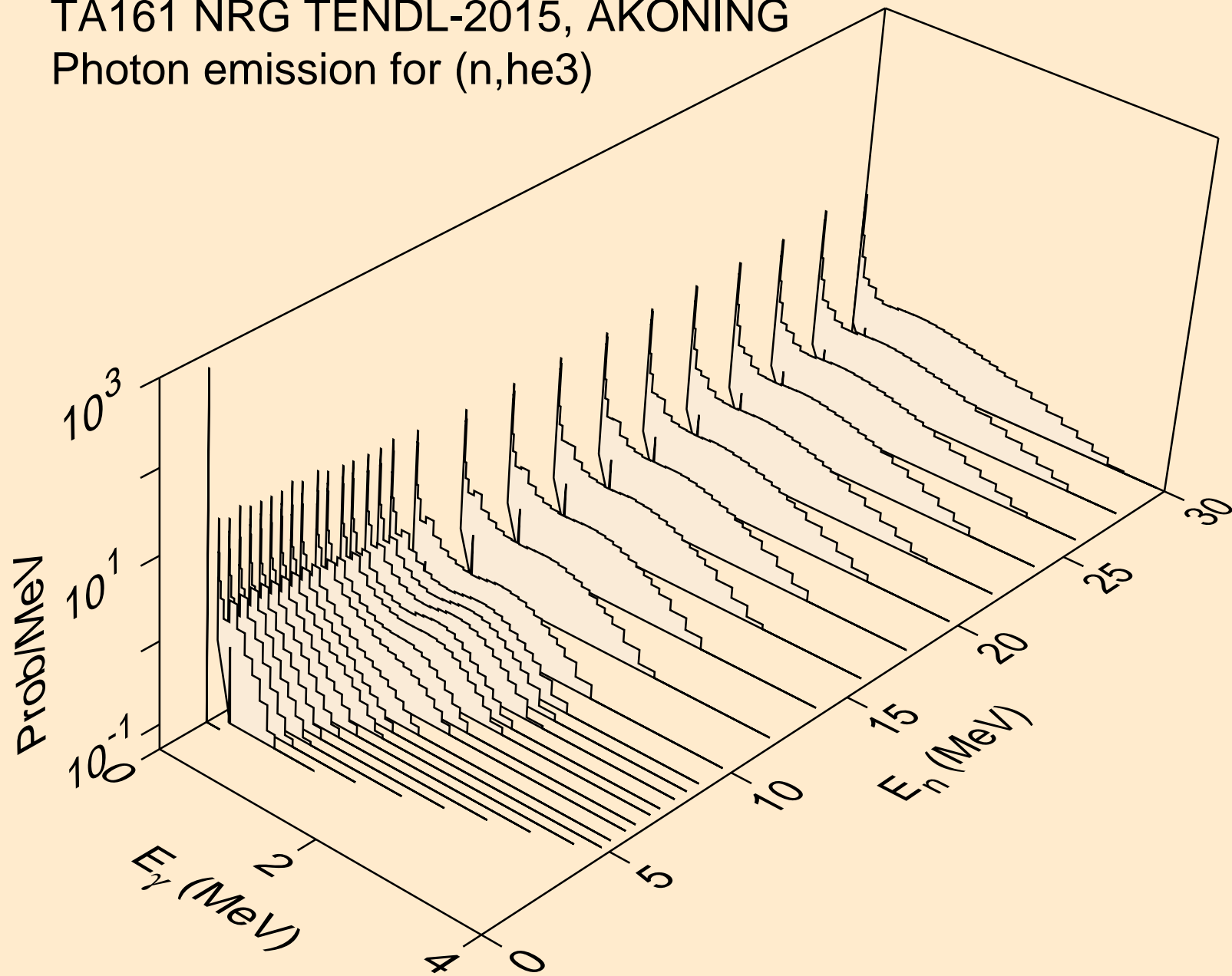

TA161 NRG TENDL-2015, AKONING
Photon emission for (n,a)

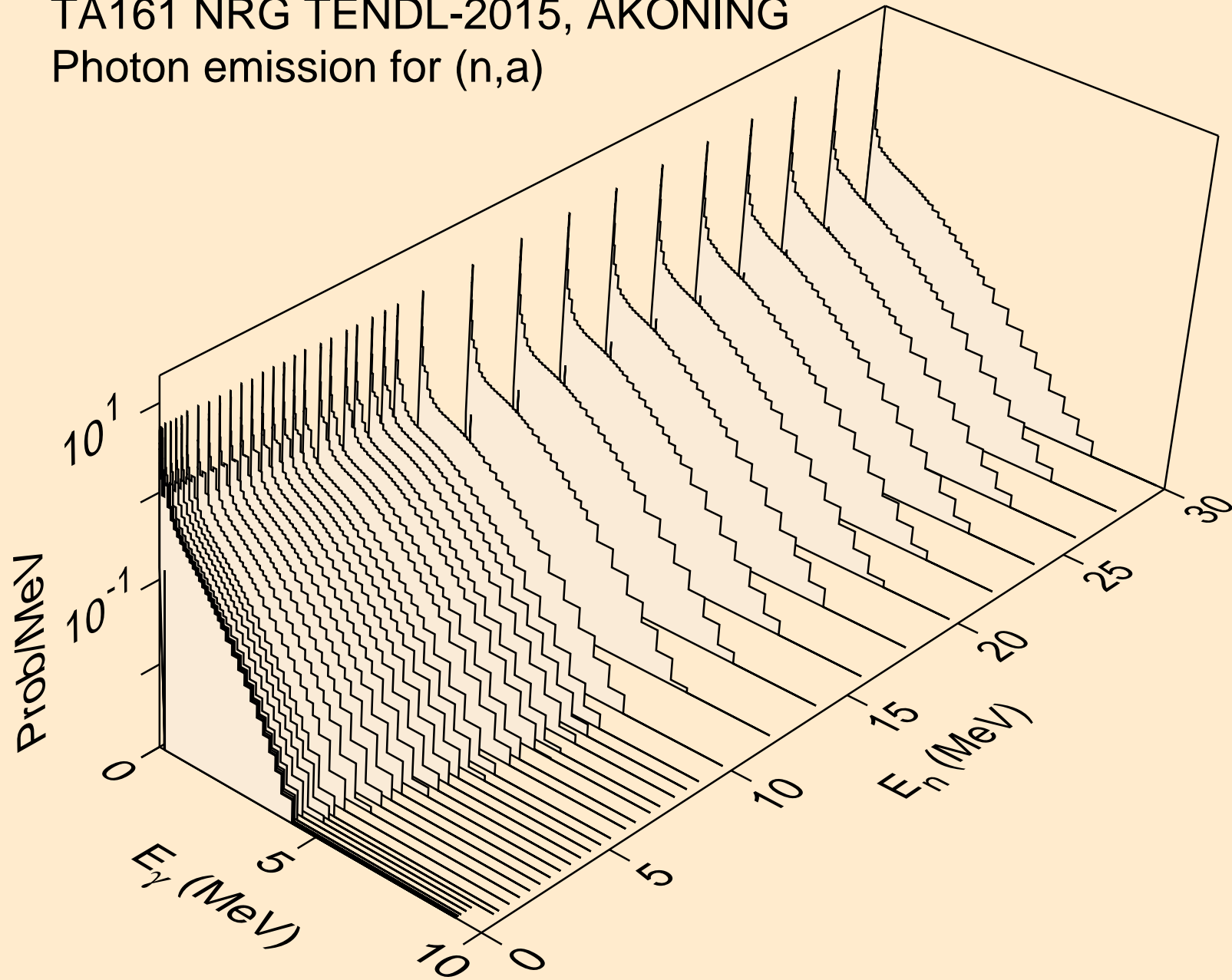

TA161 NRG TENDL-2015, AKONING
Photon emission for (n,2a)

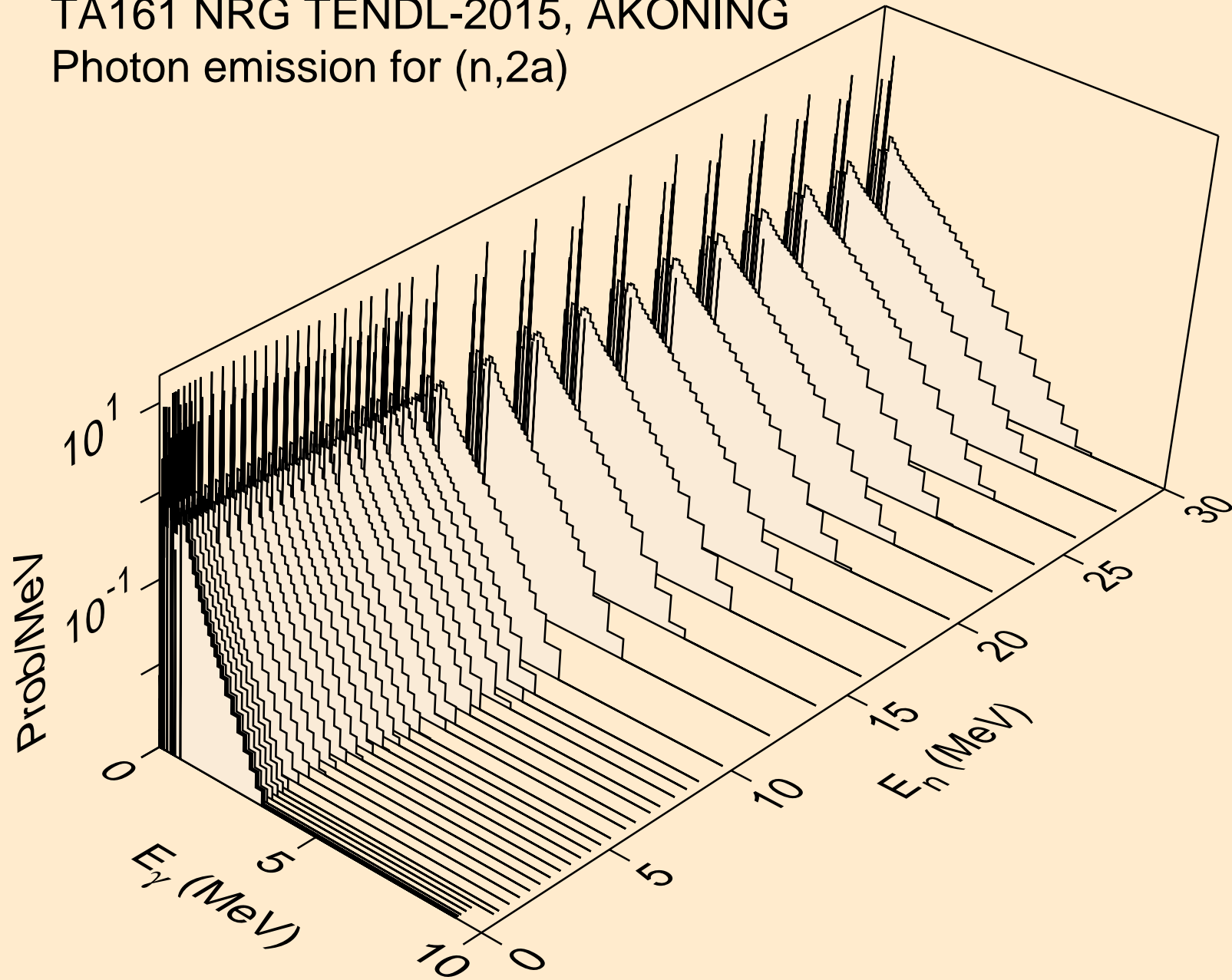

TA161 NRG TENDL-2015, AKONING
Photon emission for (n,3a)

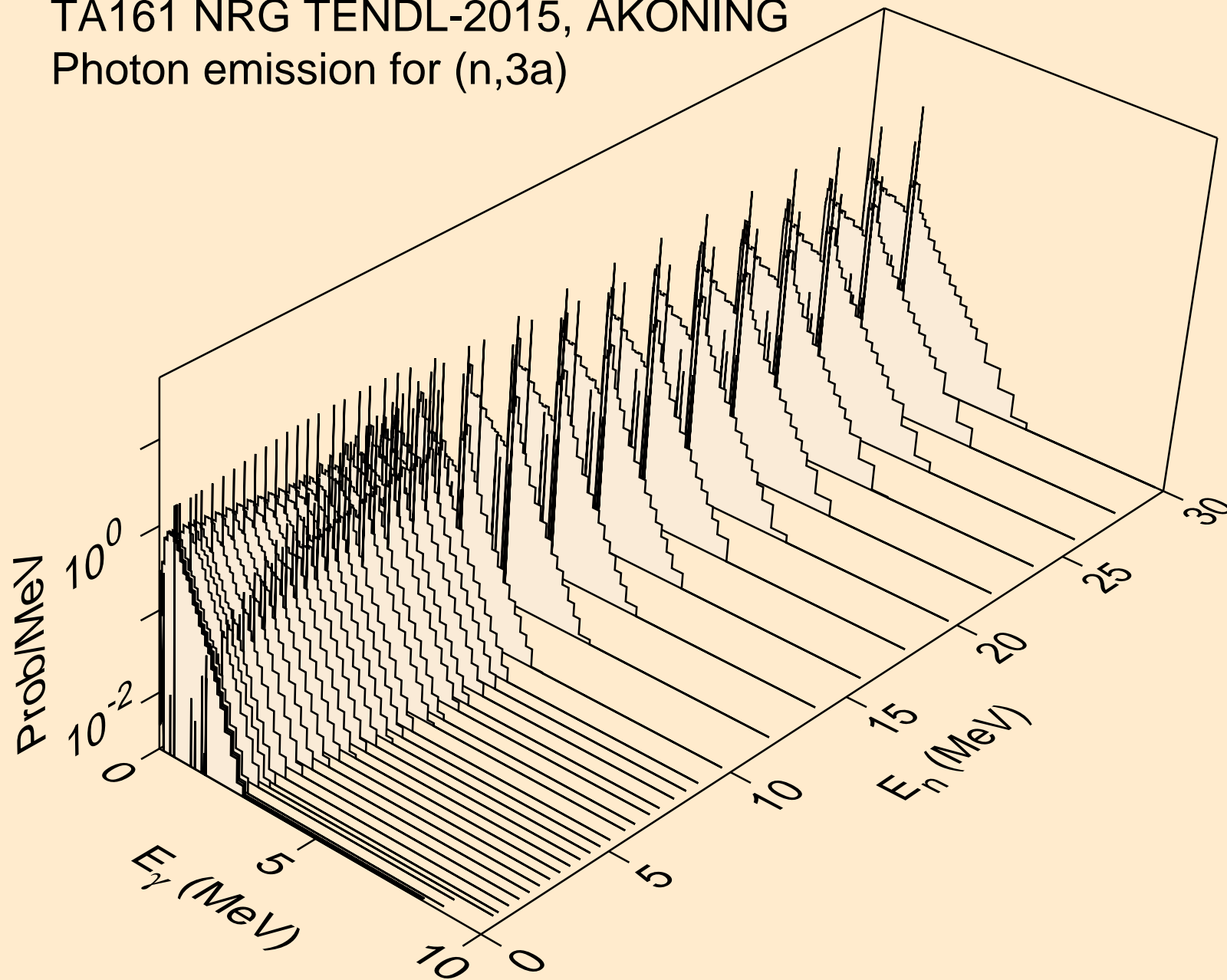

TA161 NRG TENDL-2015, AKONING
Photon emission for (n,2p)

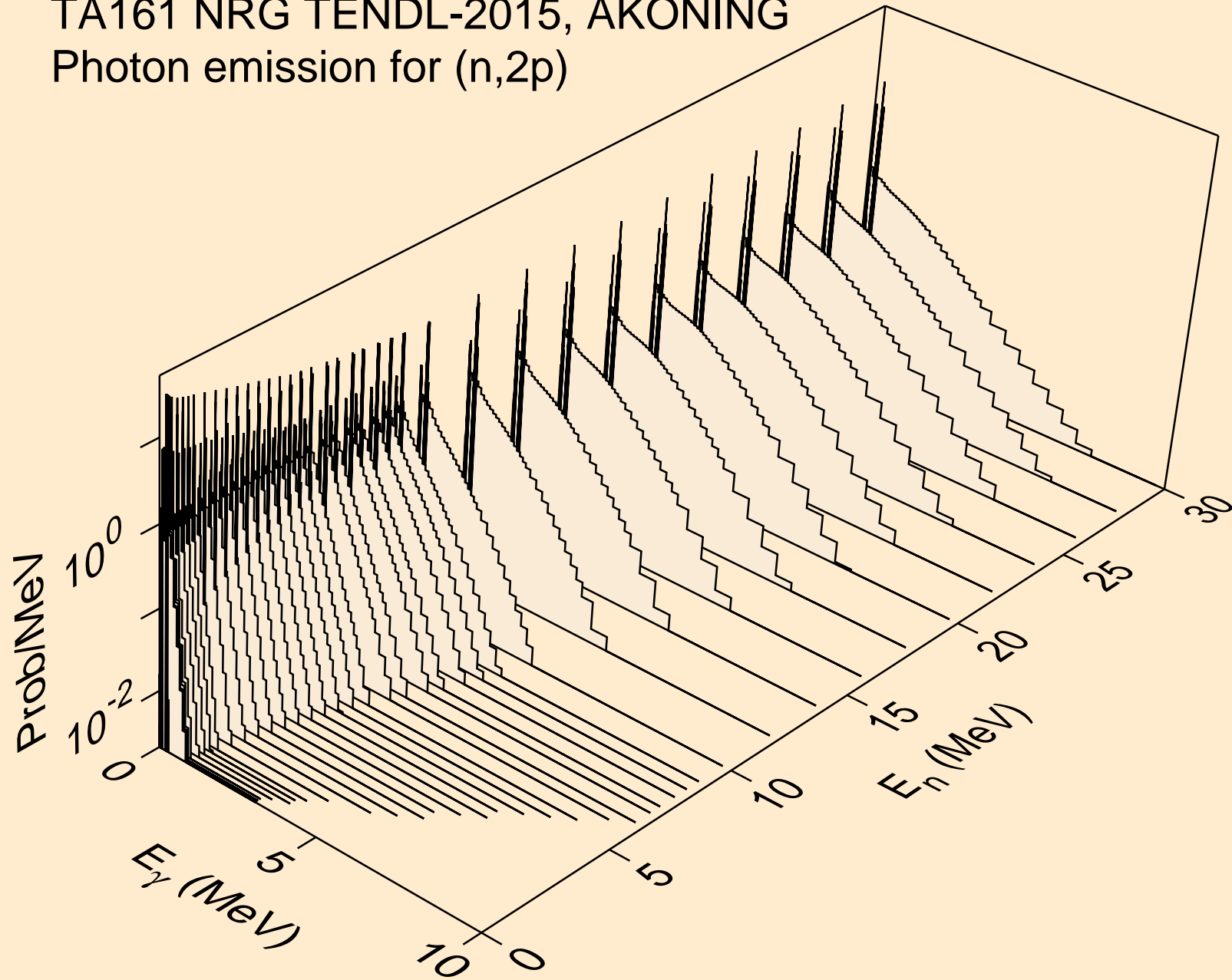

TA161 NRG TENDL-2015, AKONING
Photon emission for (n,p α)

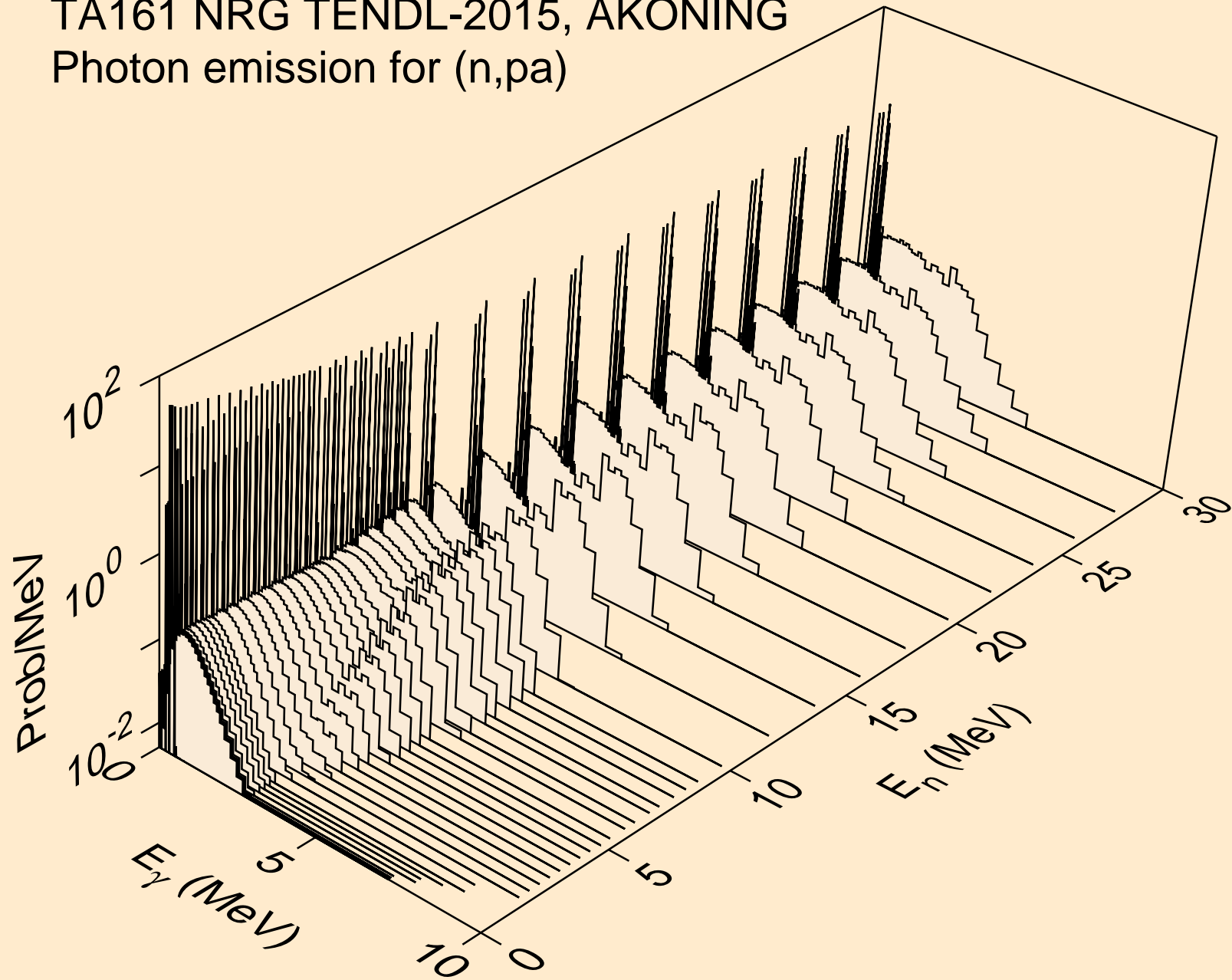

TA161 NRG TENDL-2015, AKONING
Photon emission for (n,t2a)

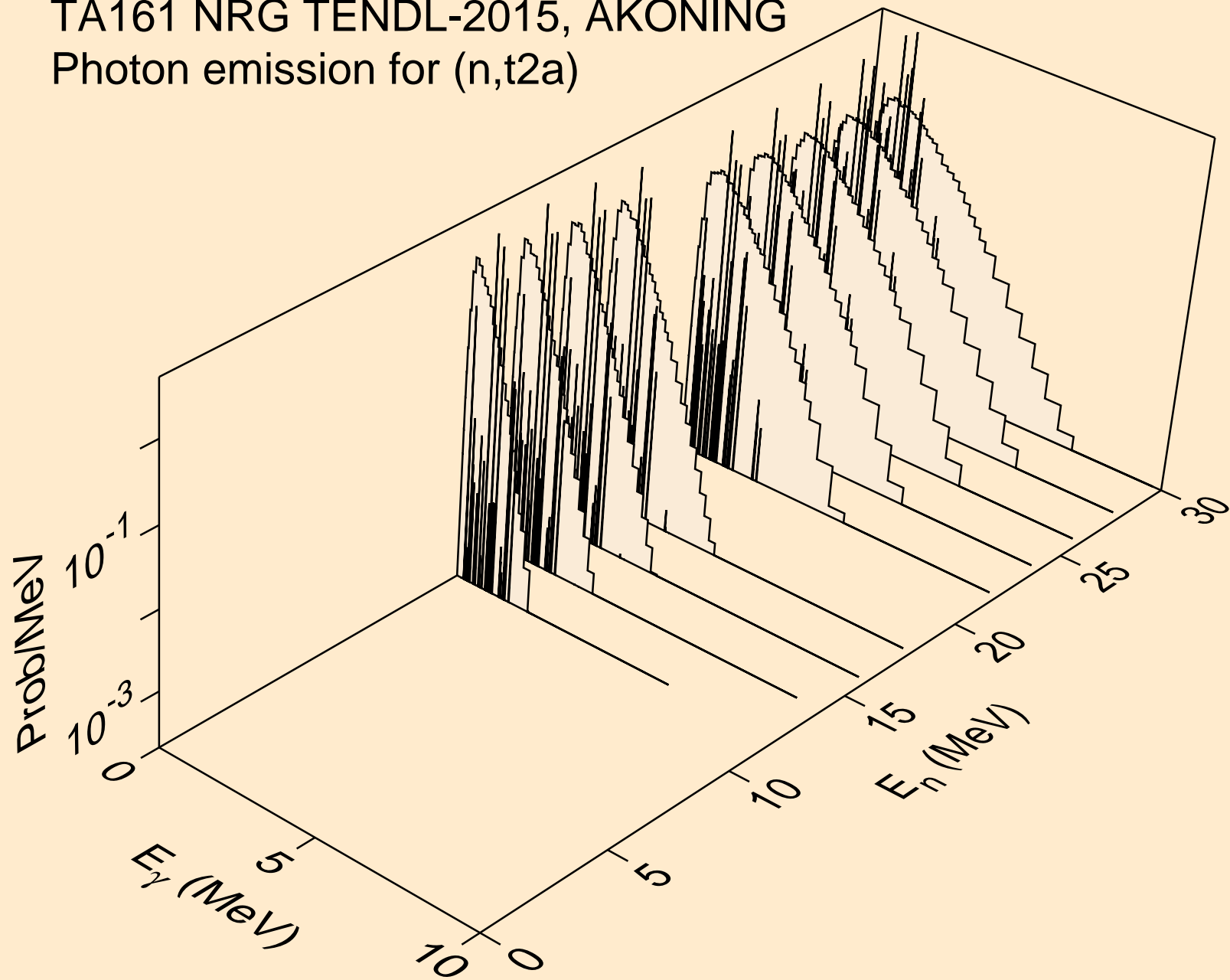

TA161 NRG TENDL-2015, AKONING
Photon emission for (n,d2a)

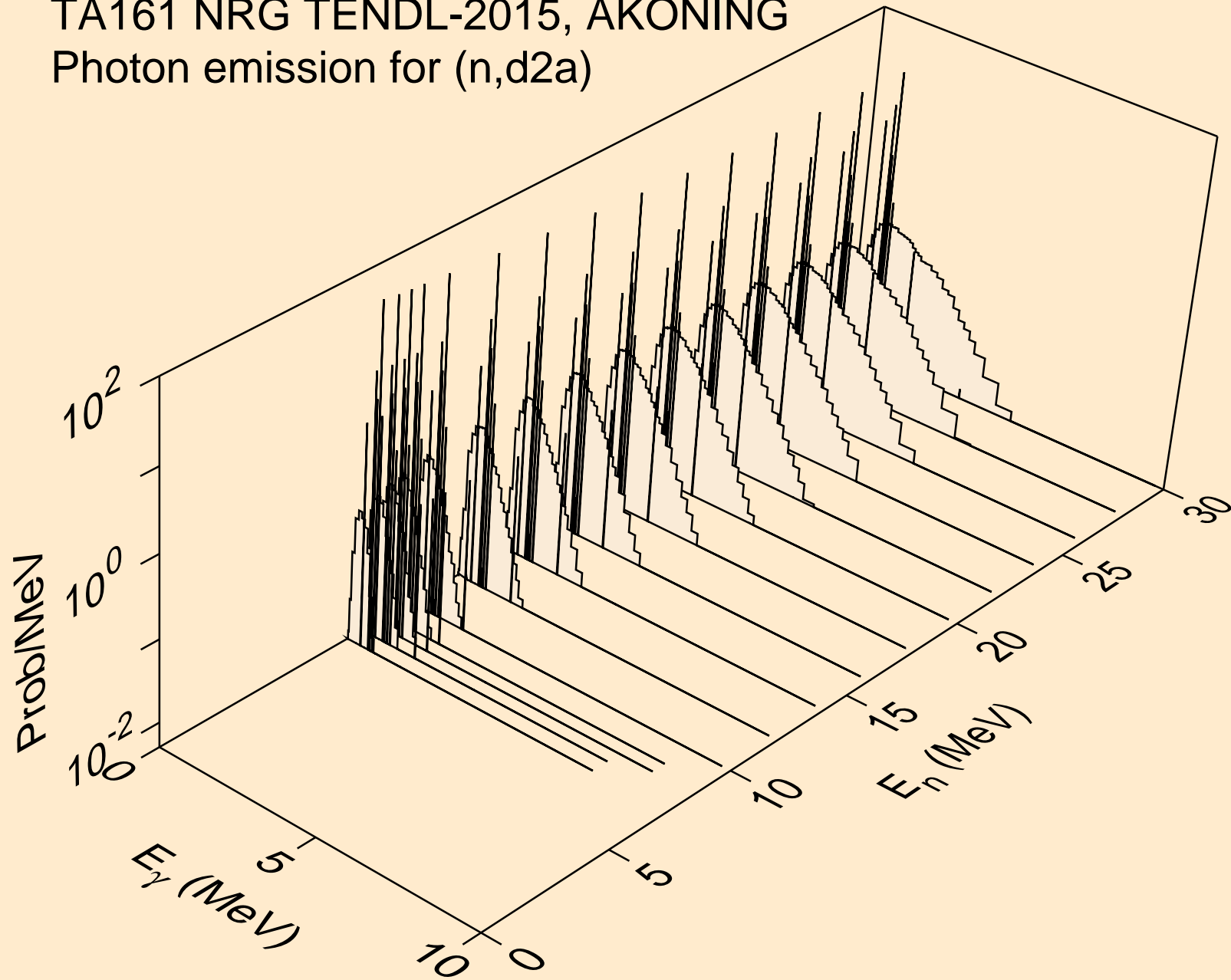

TA161 NRG TENDL-2015, AKONING
Photon emission for (n,pd)

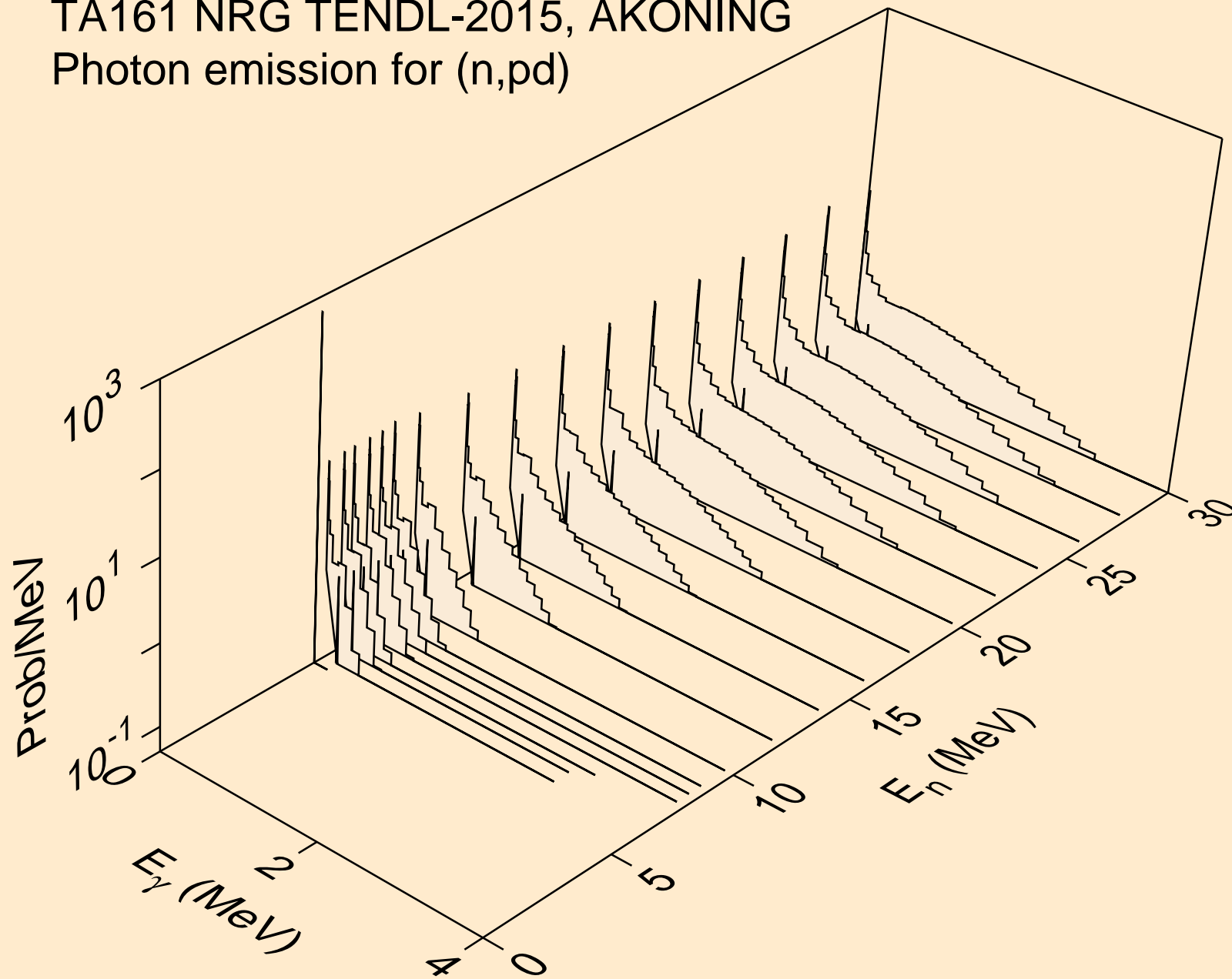

TA161 NRG TENDL-2015, AKONING
Photon emission for (n,pt)

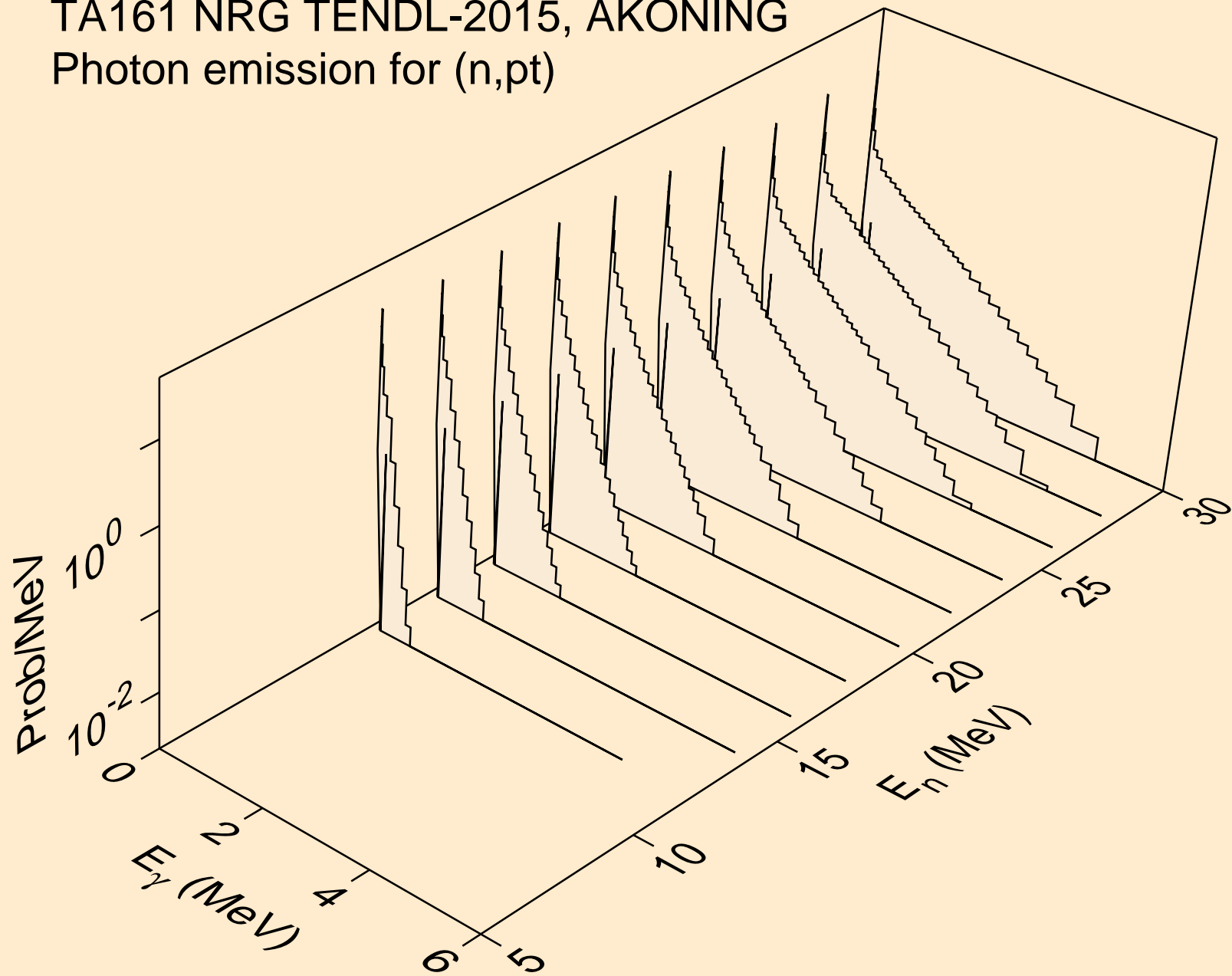

TA161 NRG TENDL-2015, AKONING
Photon emission for (n,da)

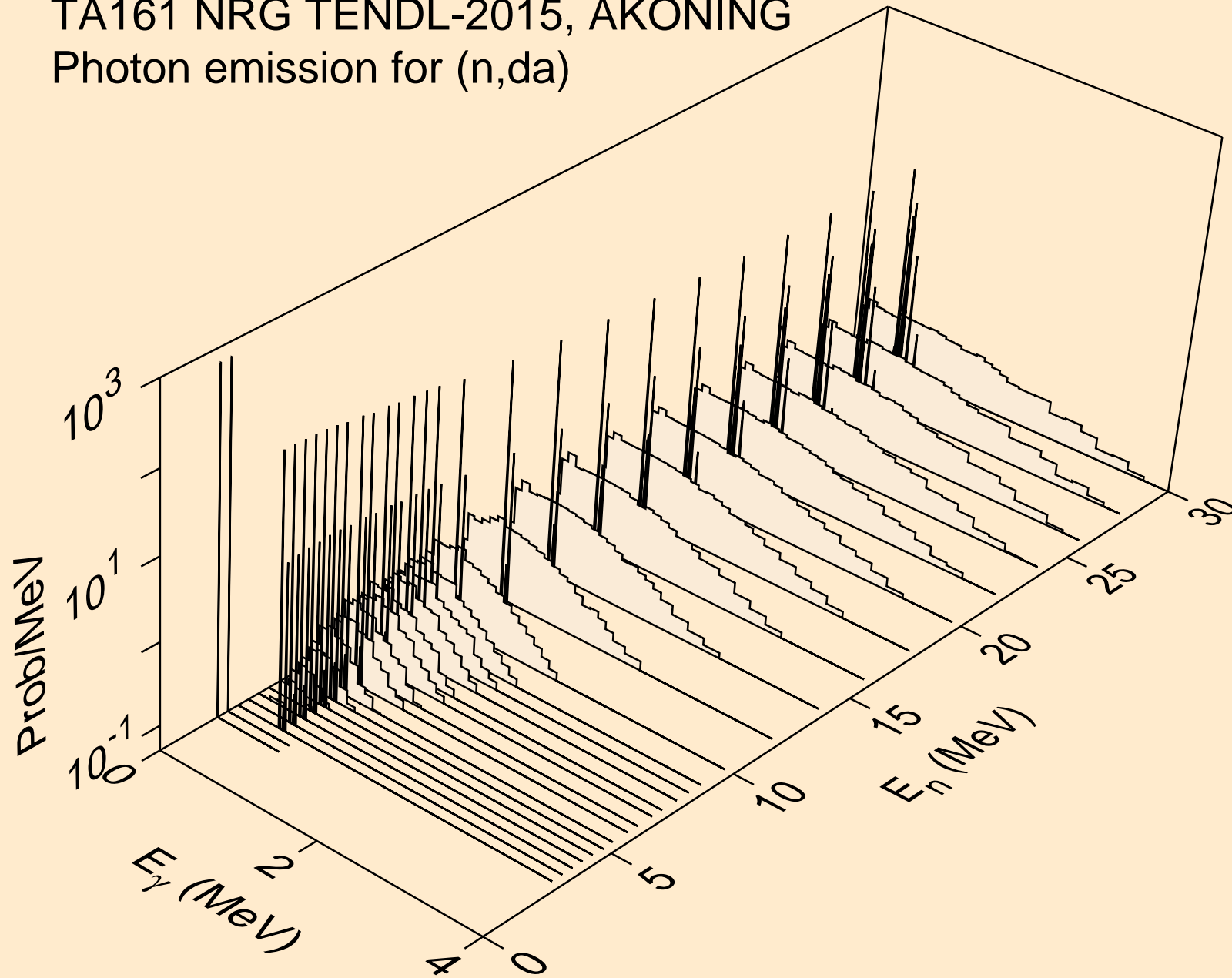

TA161 NRG TENDL-2015, AKONING
thermal capture photon spectrum

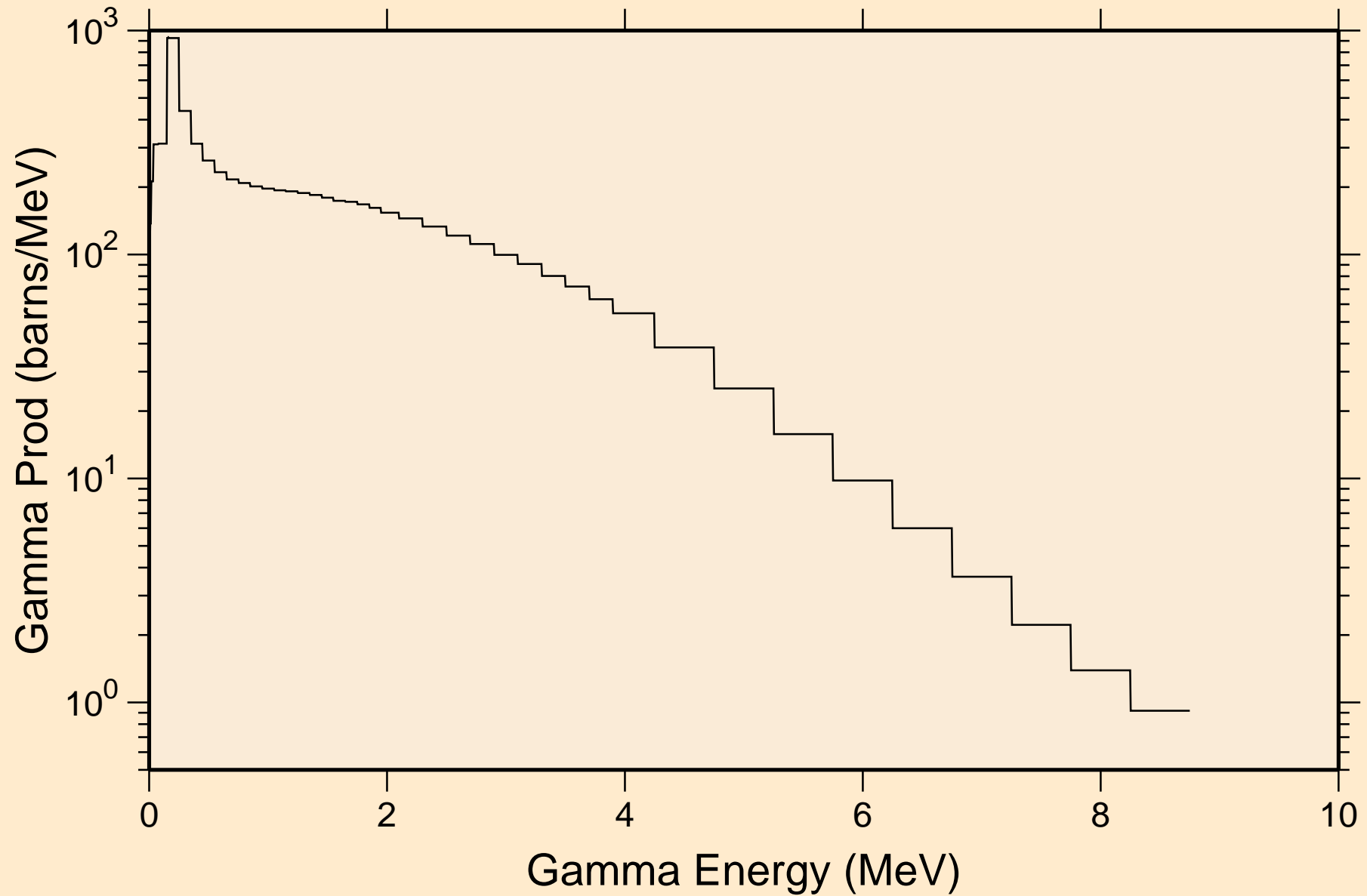

TA161 NRG TENDL-2015, AKONING
14 MeV photon spectrum

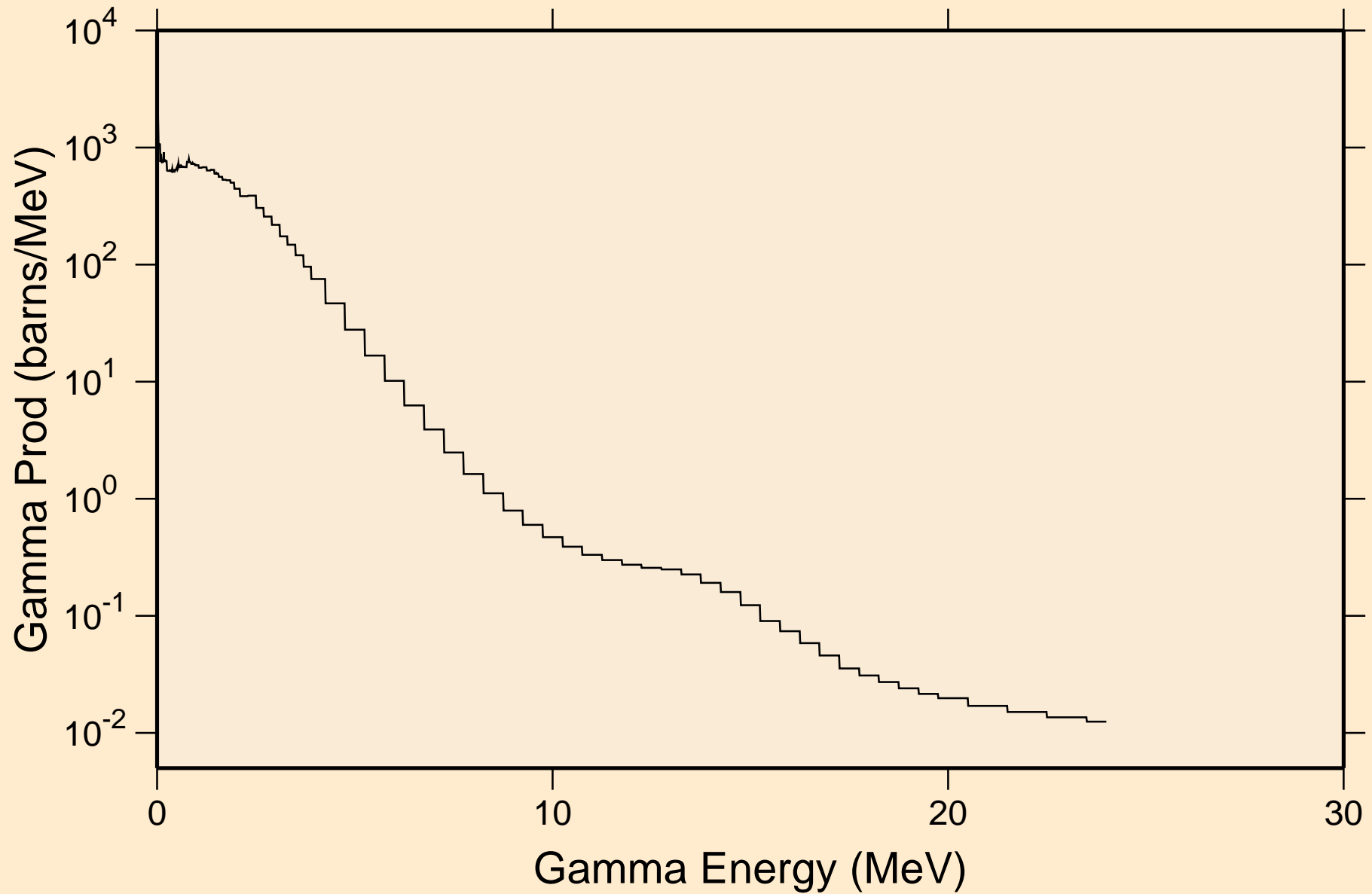

TA161 NRG TENDL-2015, AKONING

Particle heating contributions

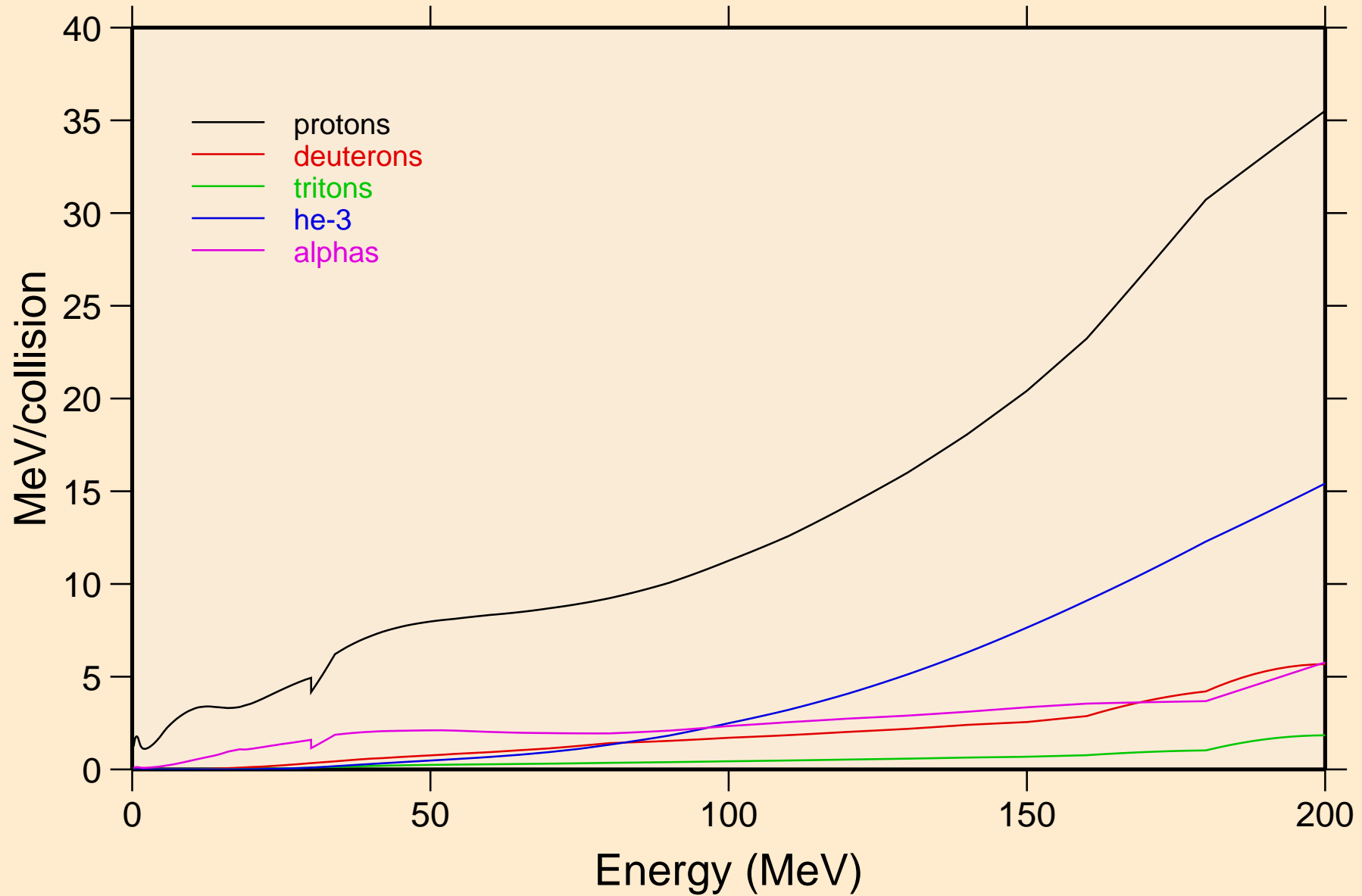

TA161 NRG TENDL-2015, AKONING

Recoil Heating

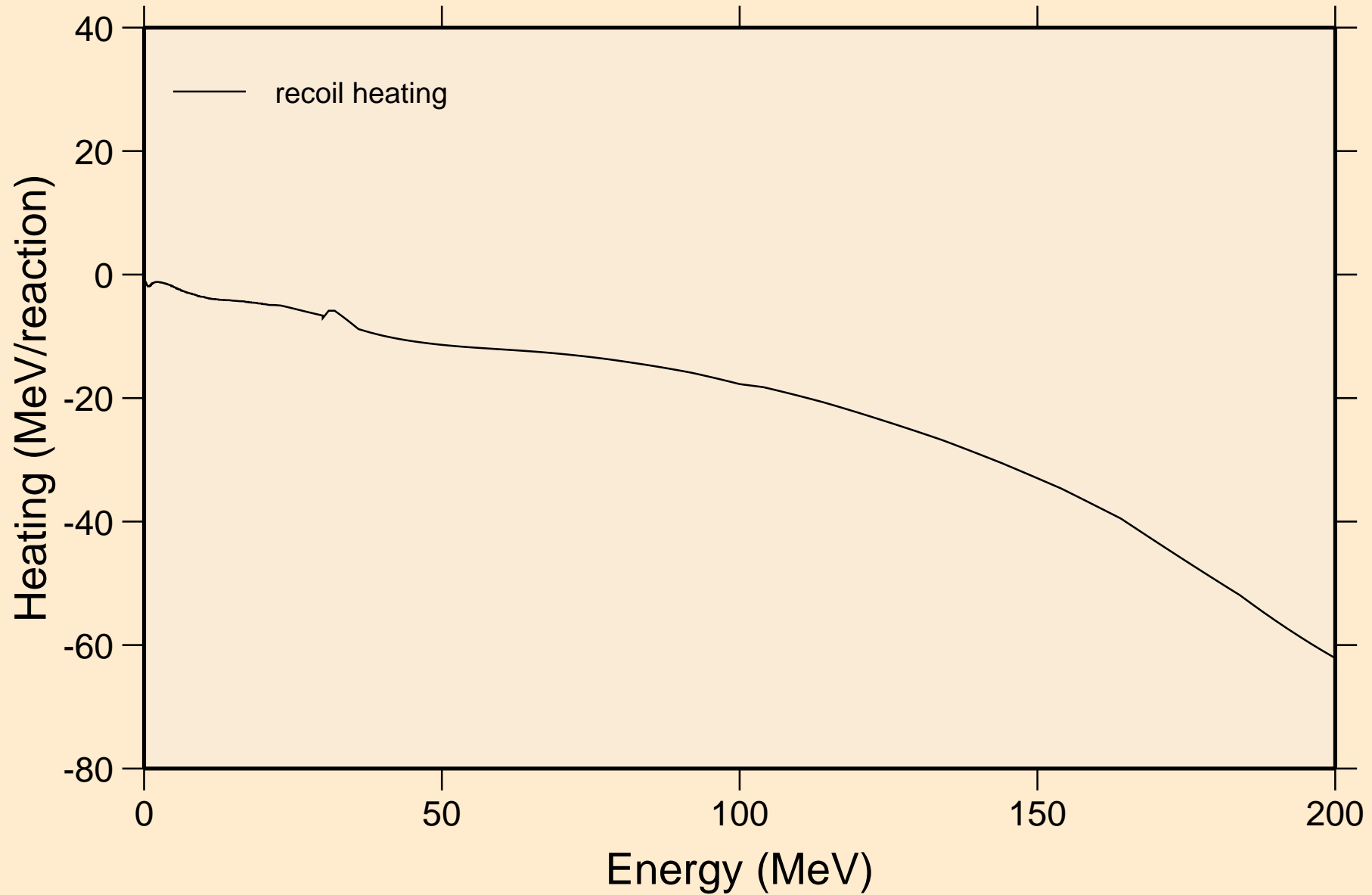

TA161 NRG TENDL-2015, AKONING

Particle production cross sections

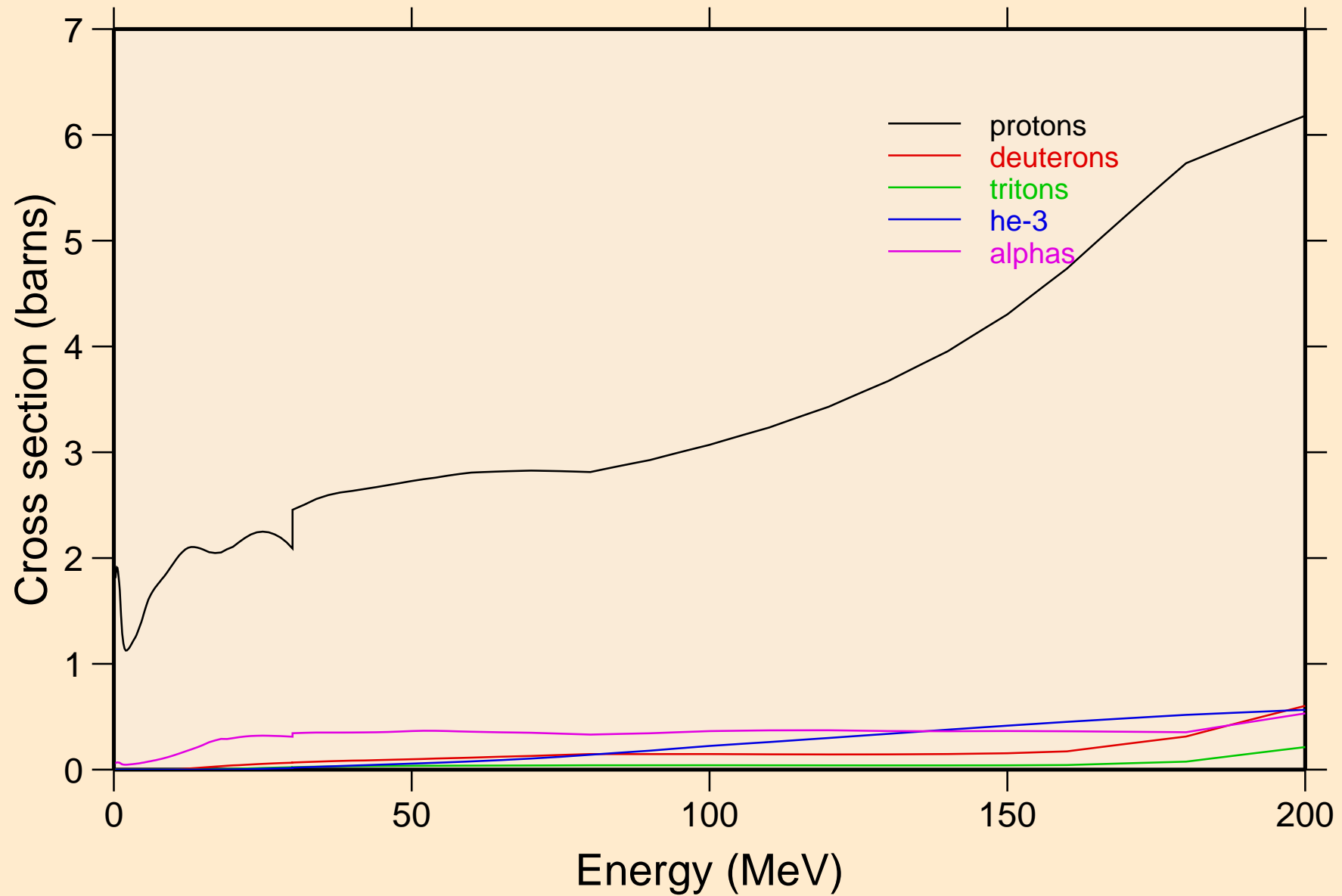

TA161 NRG TENDL-2015, AKONING
protons from (n,x)

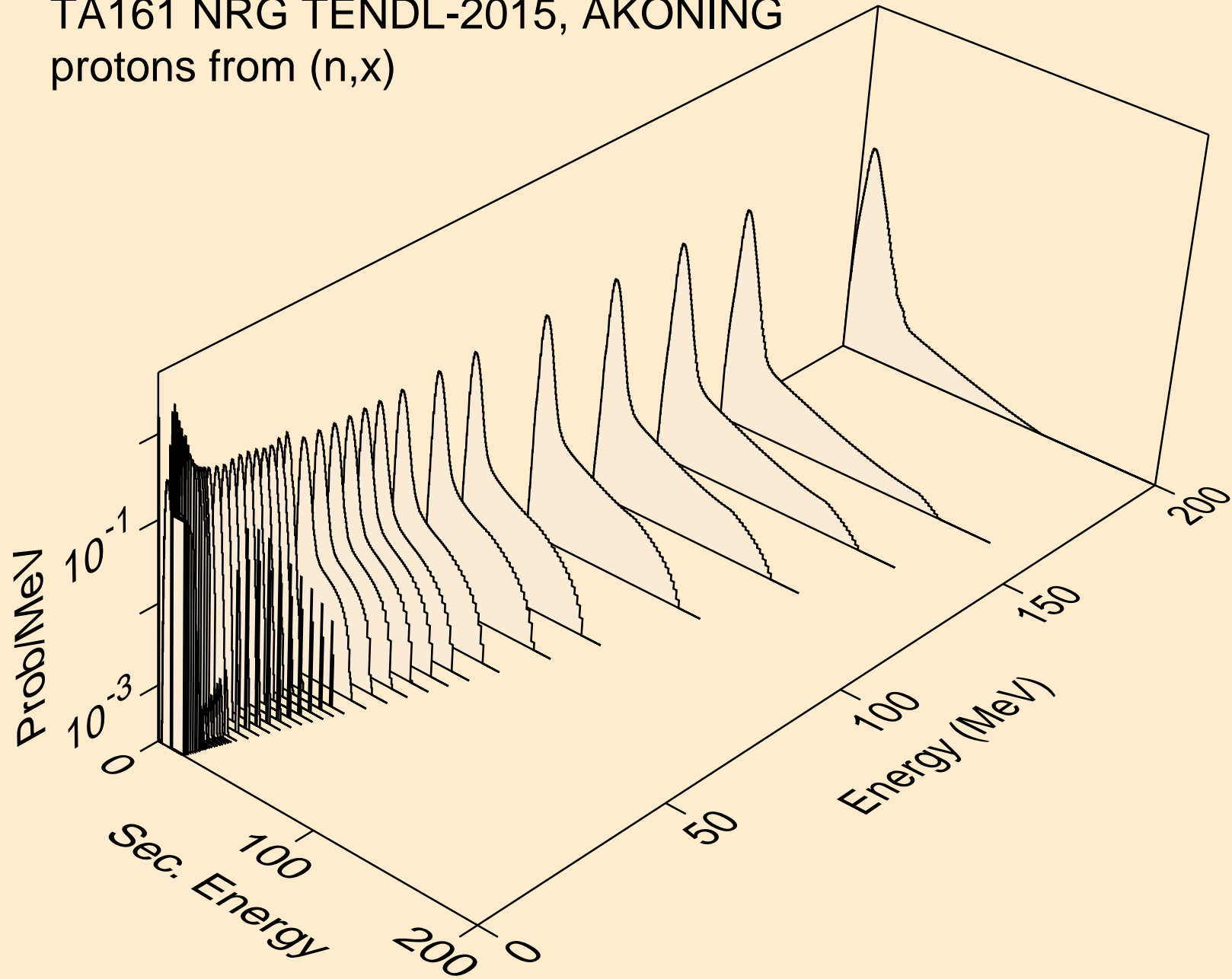

TA161 NRG TENDL-2015, AKONING
protons from (n,n*)p

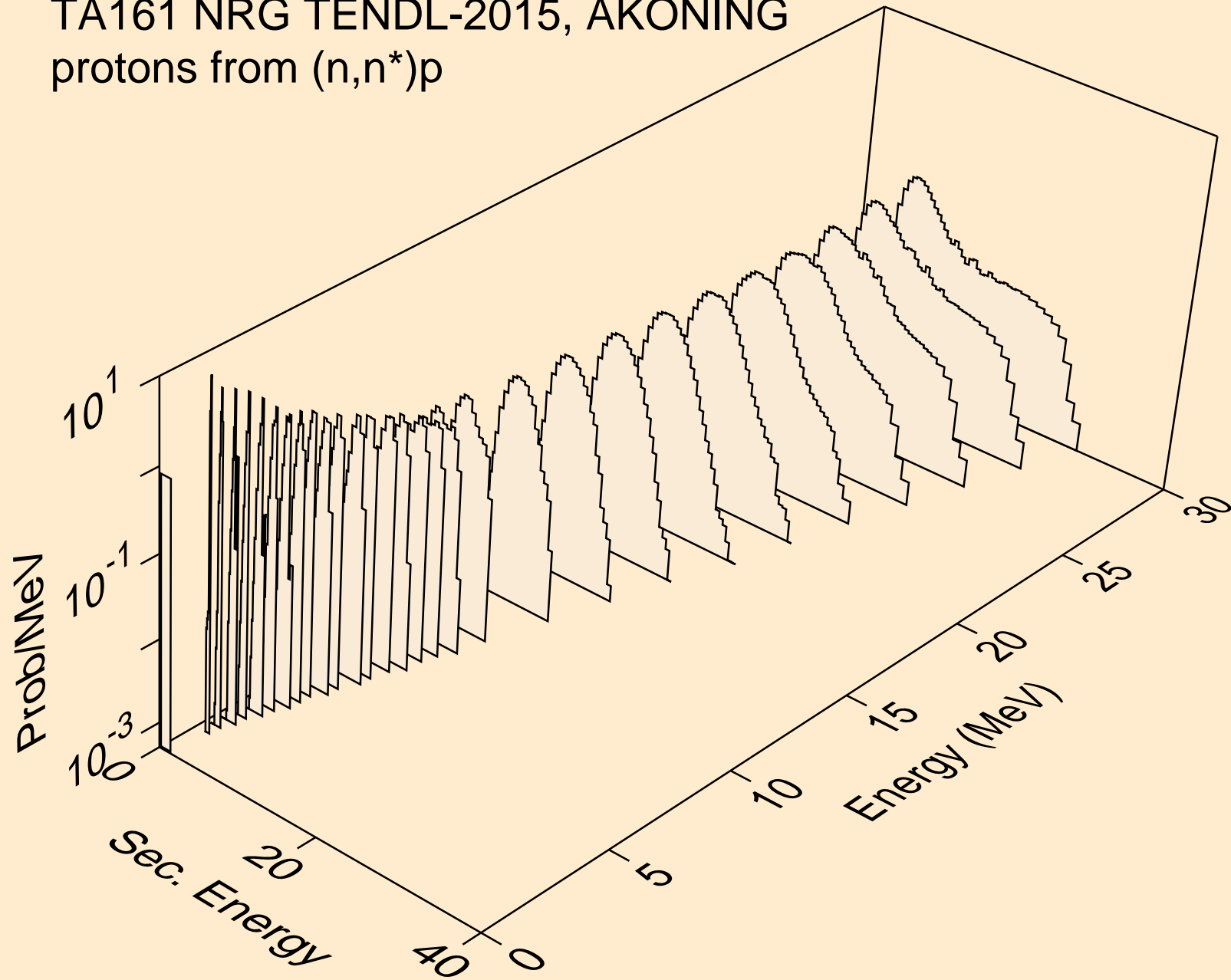

TA161 NRG TENDL-2015, AKONING
protons from (n,2np)

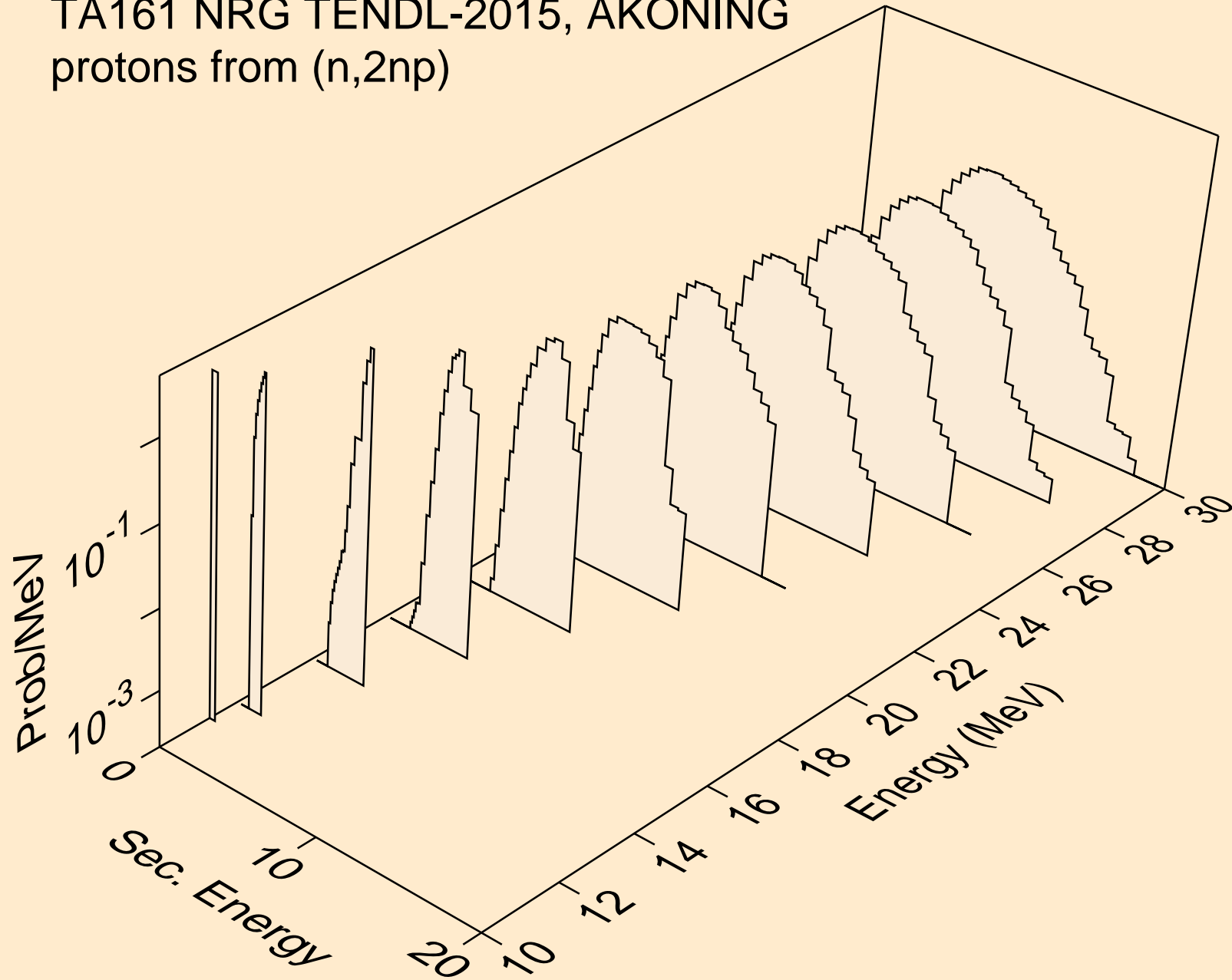

TA161 NRG TENDL-2015, AKONING
protons from (n,3np)

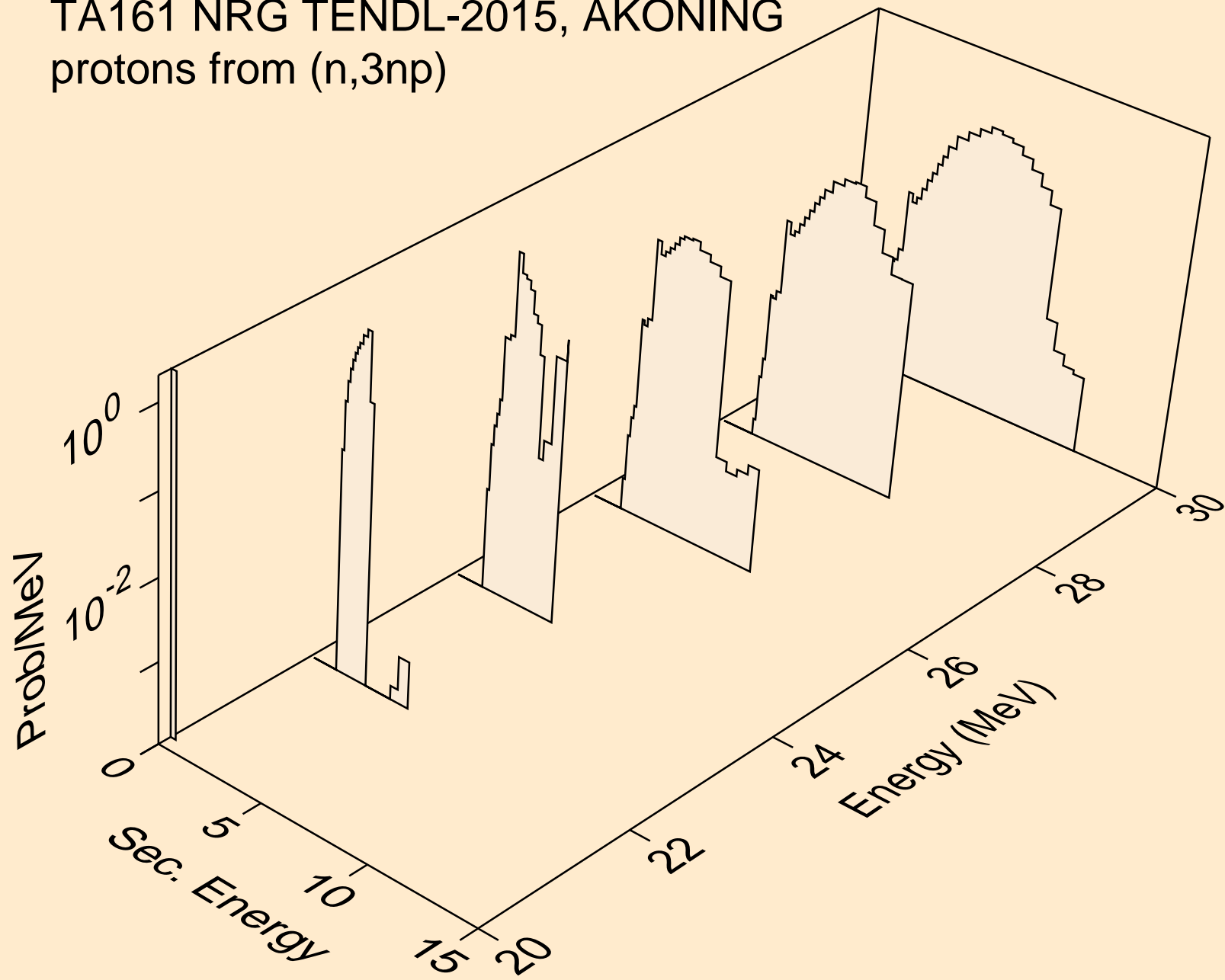

TA161 NRG TENDL-2015, AKONING
protons from (n,2np)

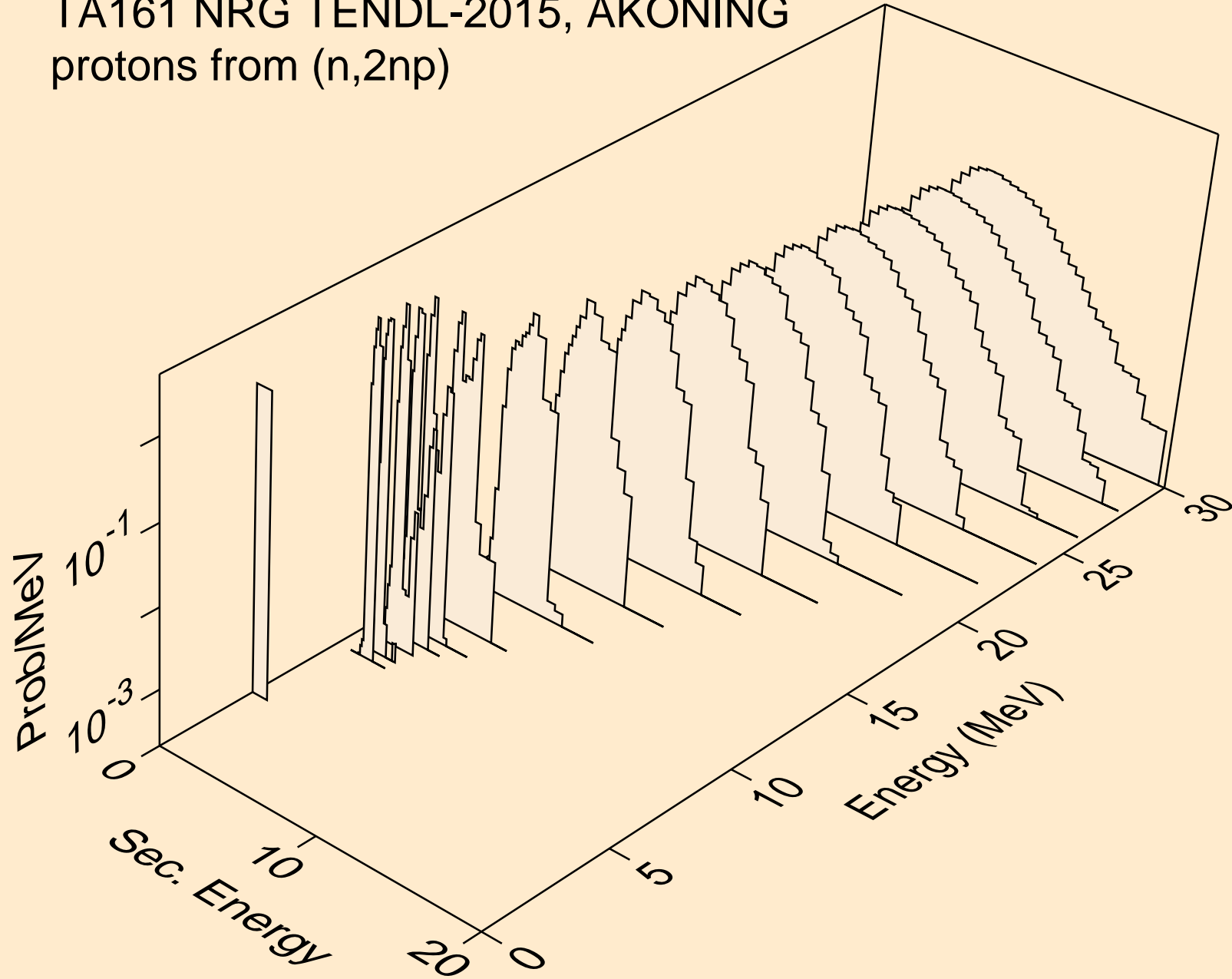

TA161 NRG TENDL-2015, AKONING
protons from (n,npa)

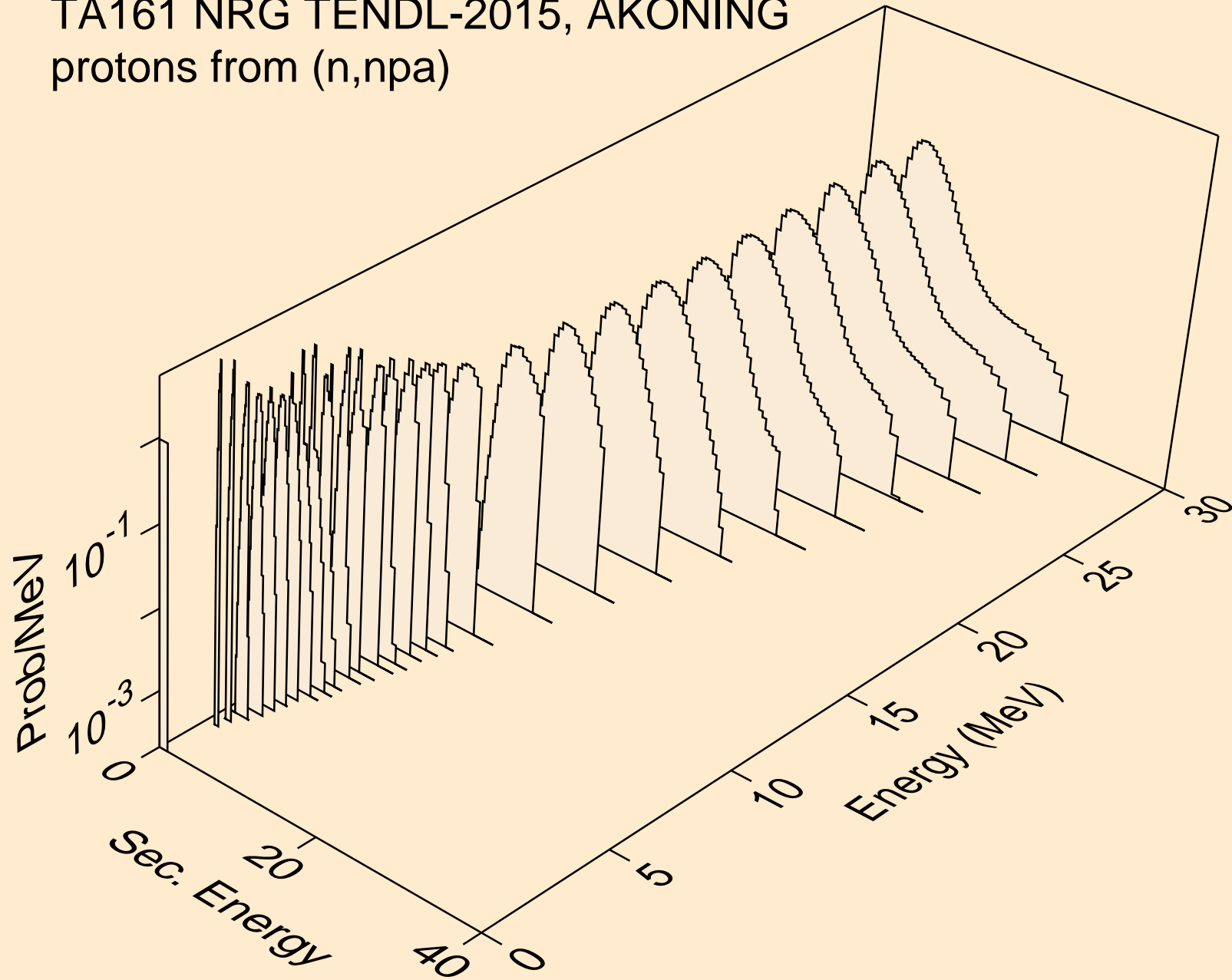

TA161 NRG TENDL-2015, AKONING
protons from (n,p)

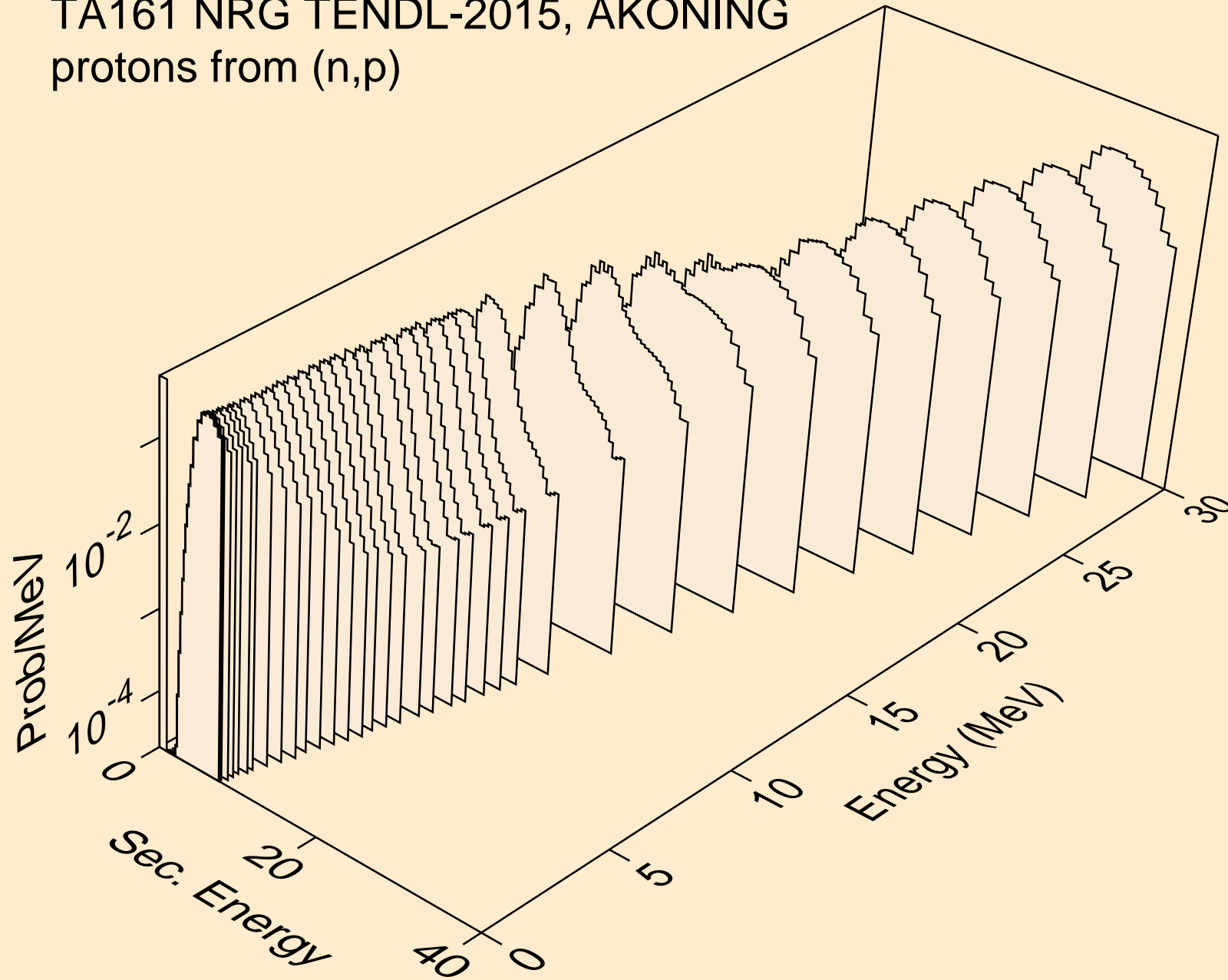

TA161 NRG TENDL-2015, AKONING
protons from (n,2p)

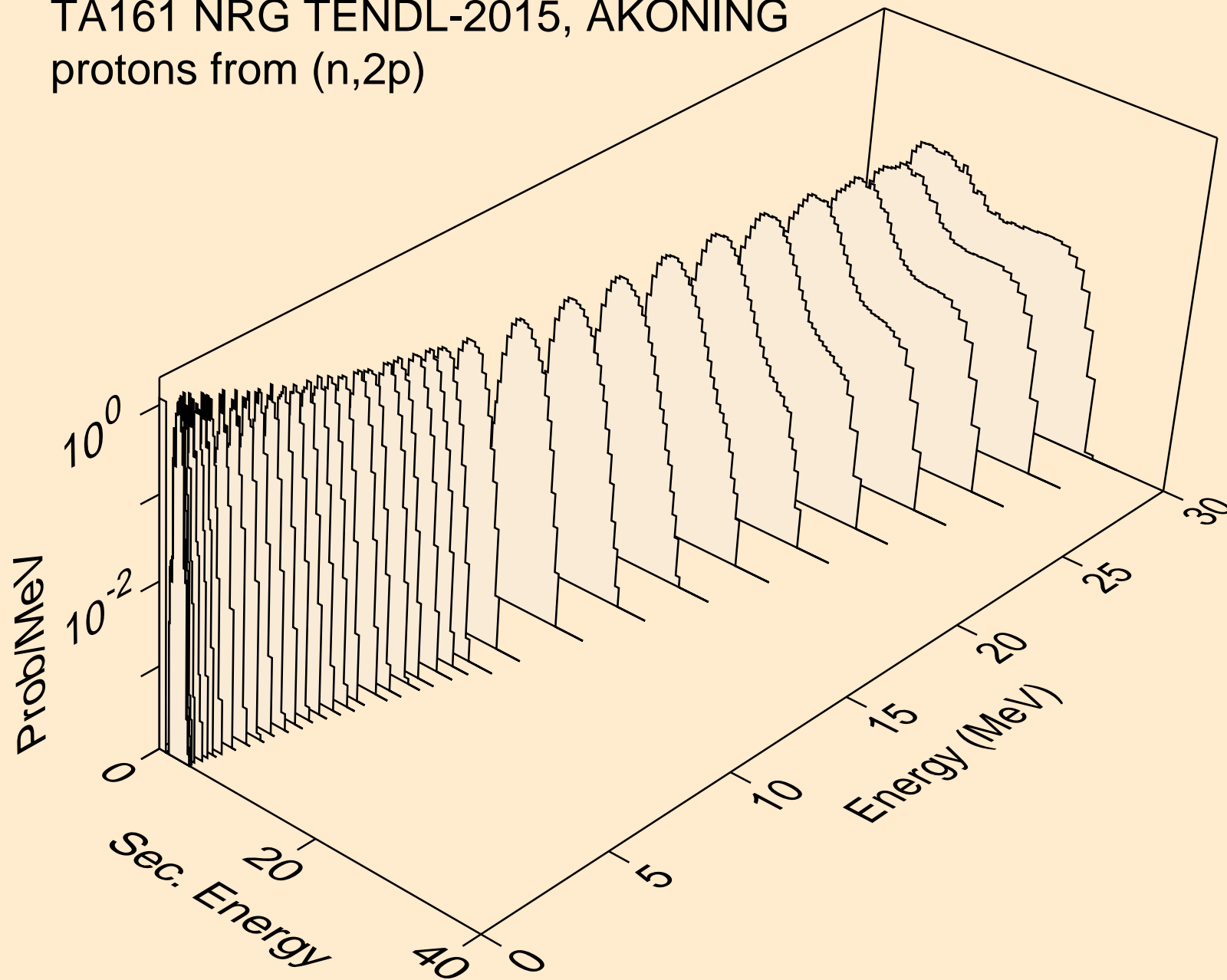

TA161 NRG TENDL-2015, AKONING
protons from (n,pa)

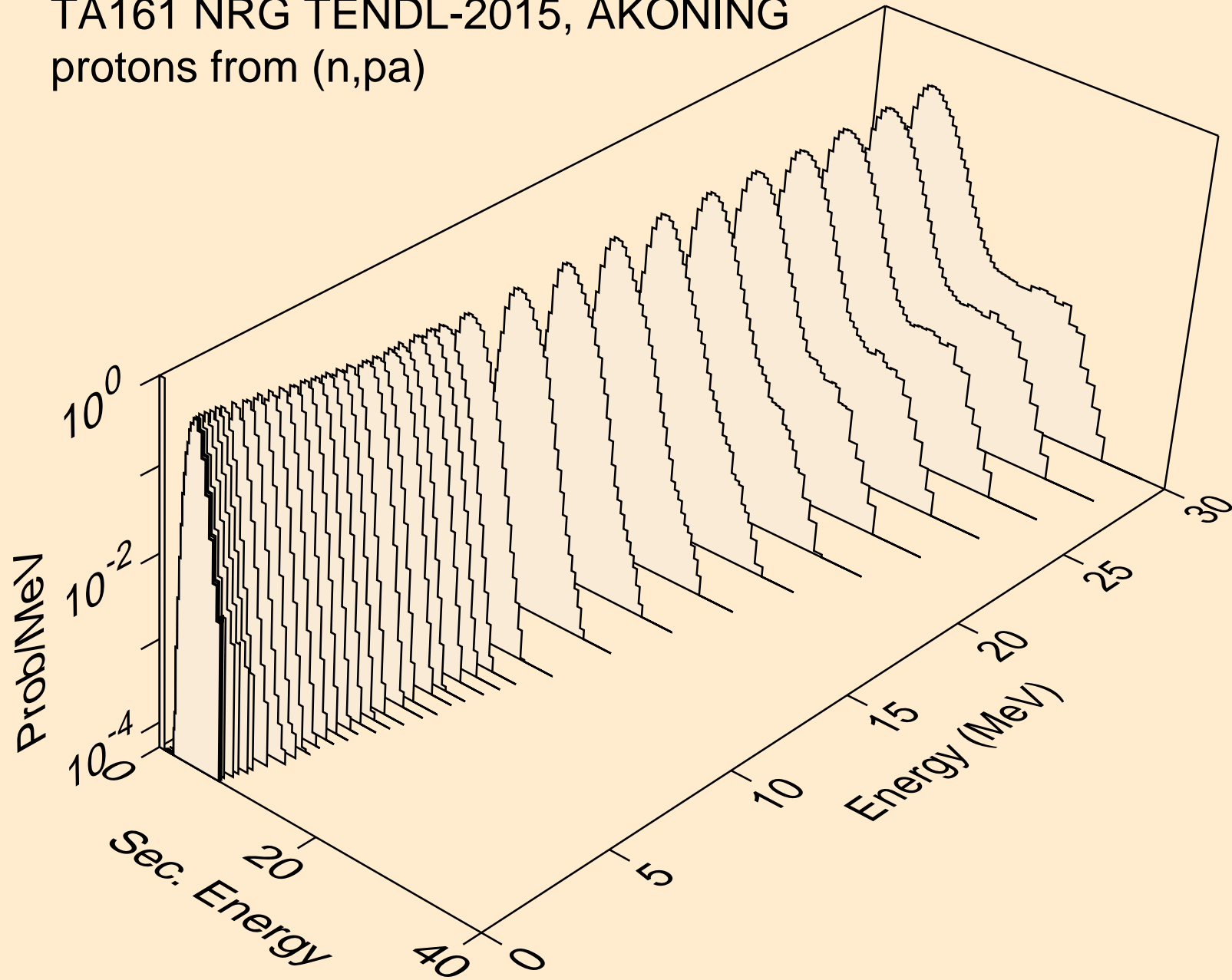

TA161 NRG TENDL-2015, AKONING
protons from (n,pd)

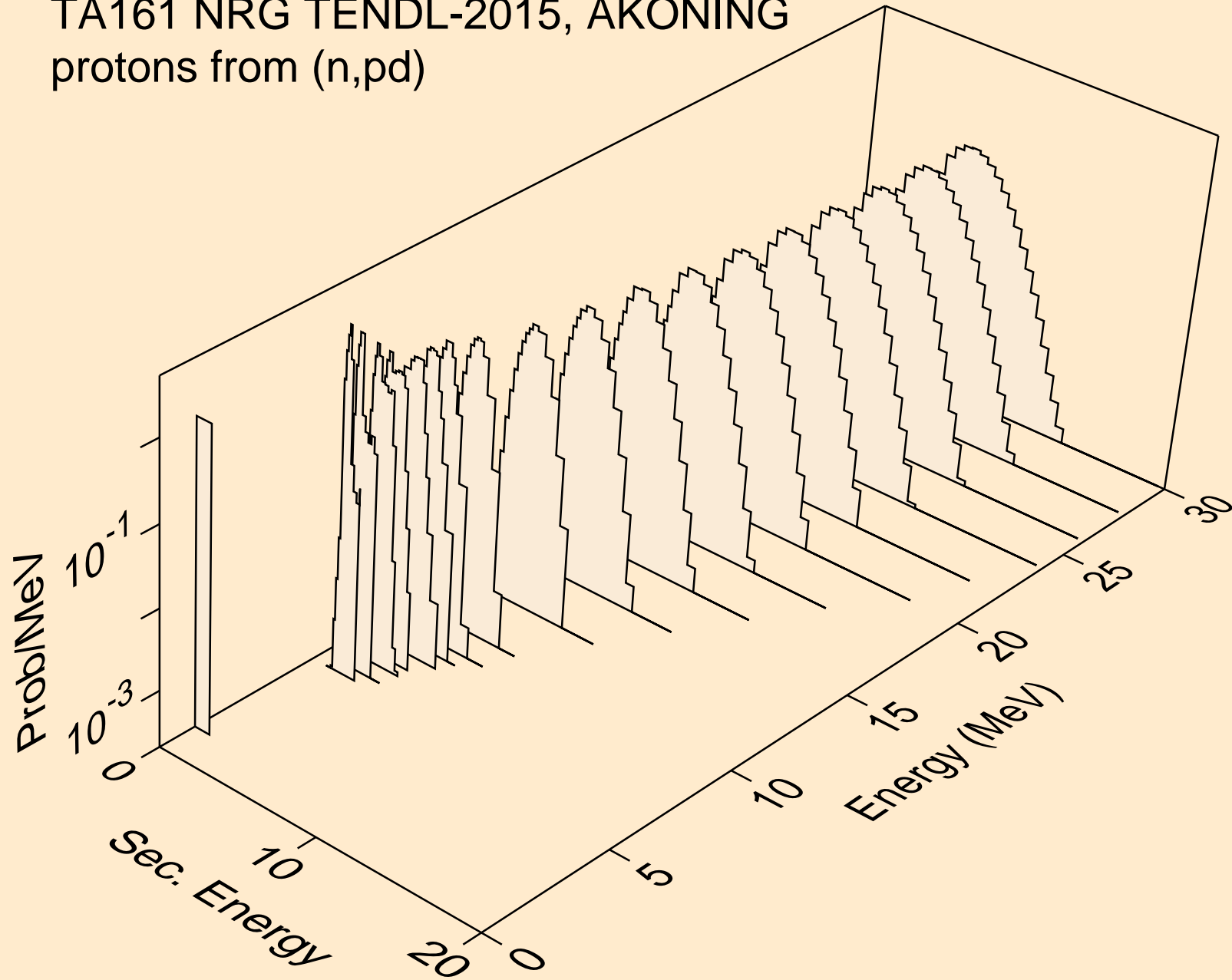

TA161 NRG TENDL-2015, AKONING
protons from (n,pt)

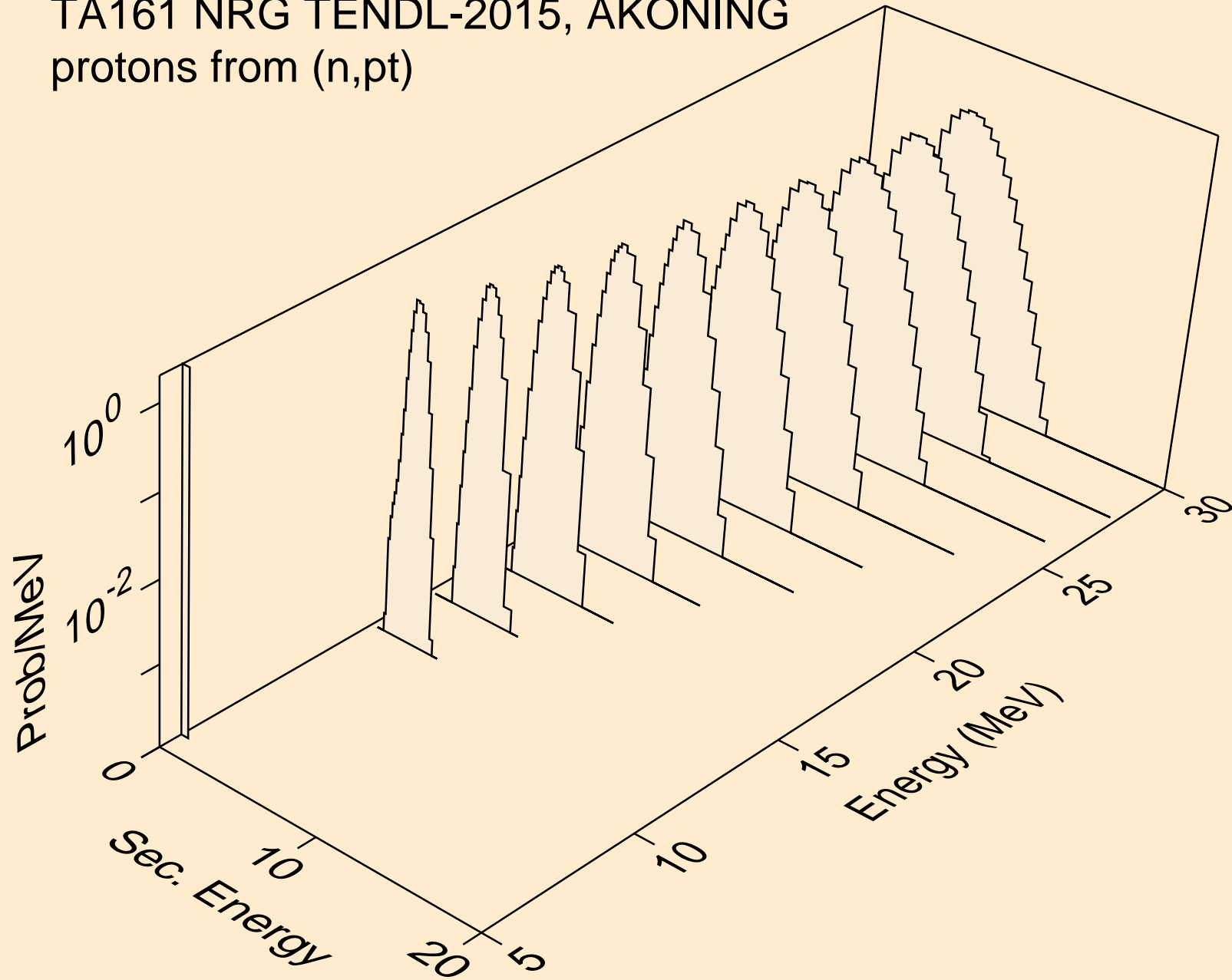

TA161 NRG TENDL-2015, AKONING
deuterons from (n,x)

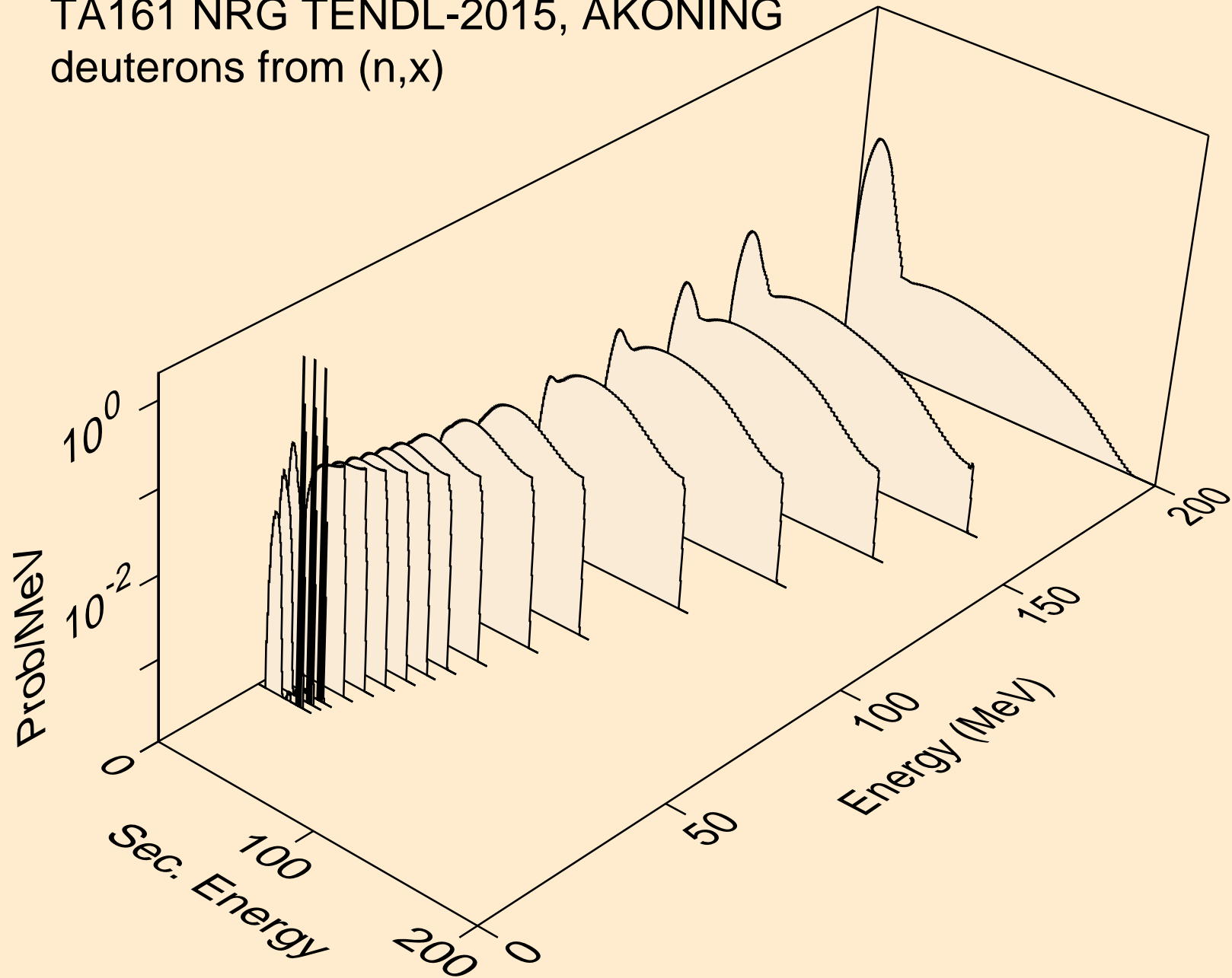

TA161 NRG TENDL-2015, AKONING
deuterons from (n,2nd)

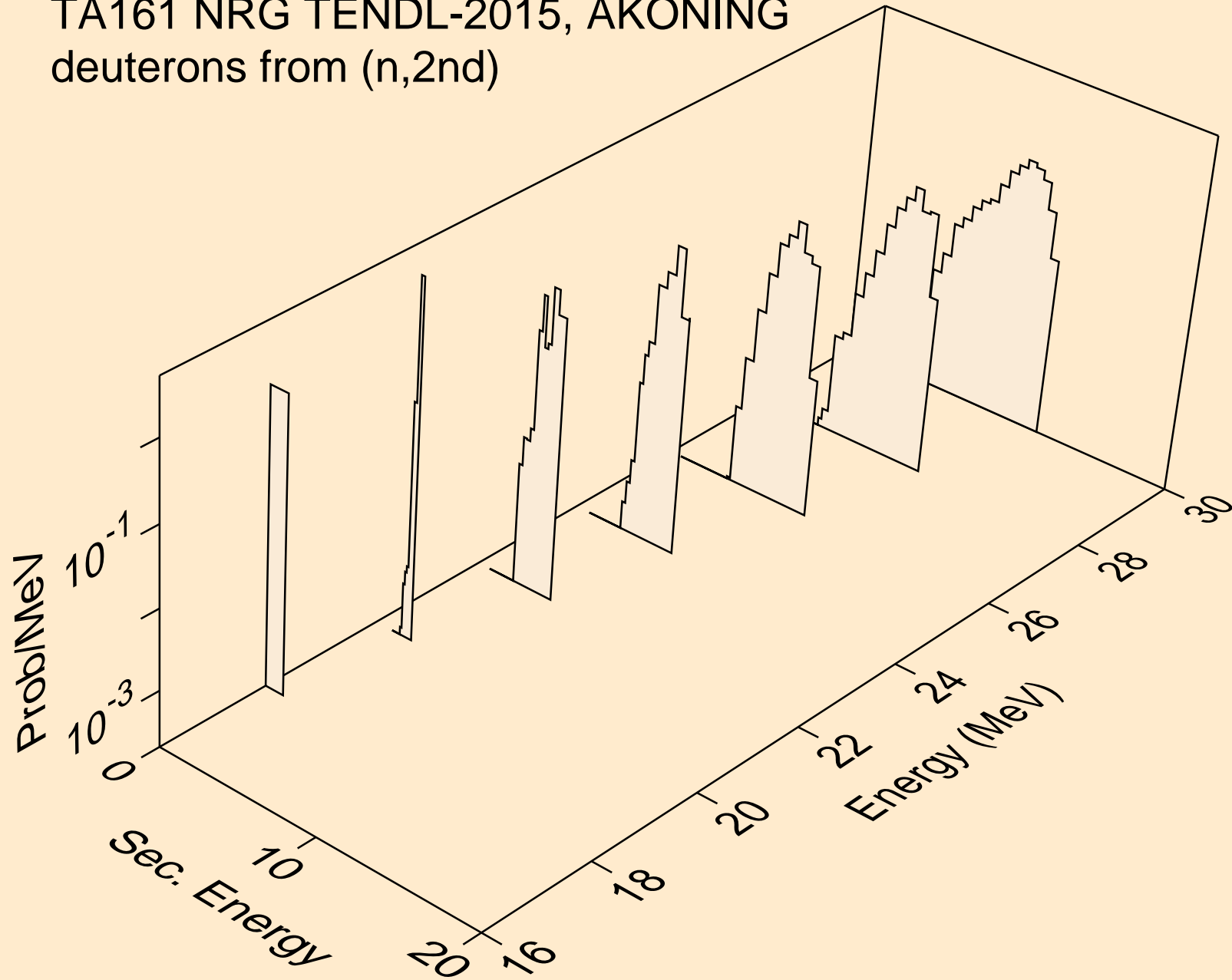

TA161 NRG TENDL-2015, AKONING
deuterons from (n,n*)d

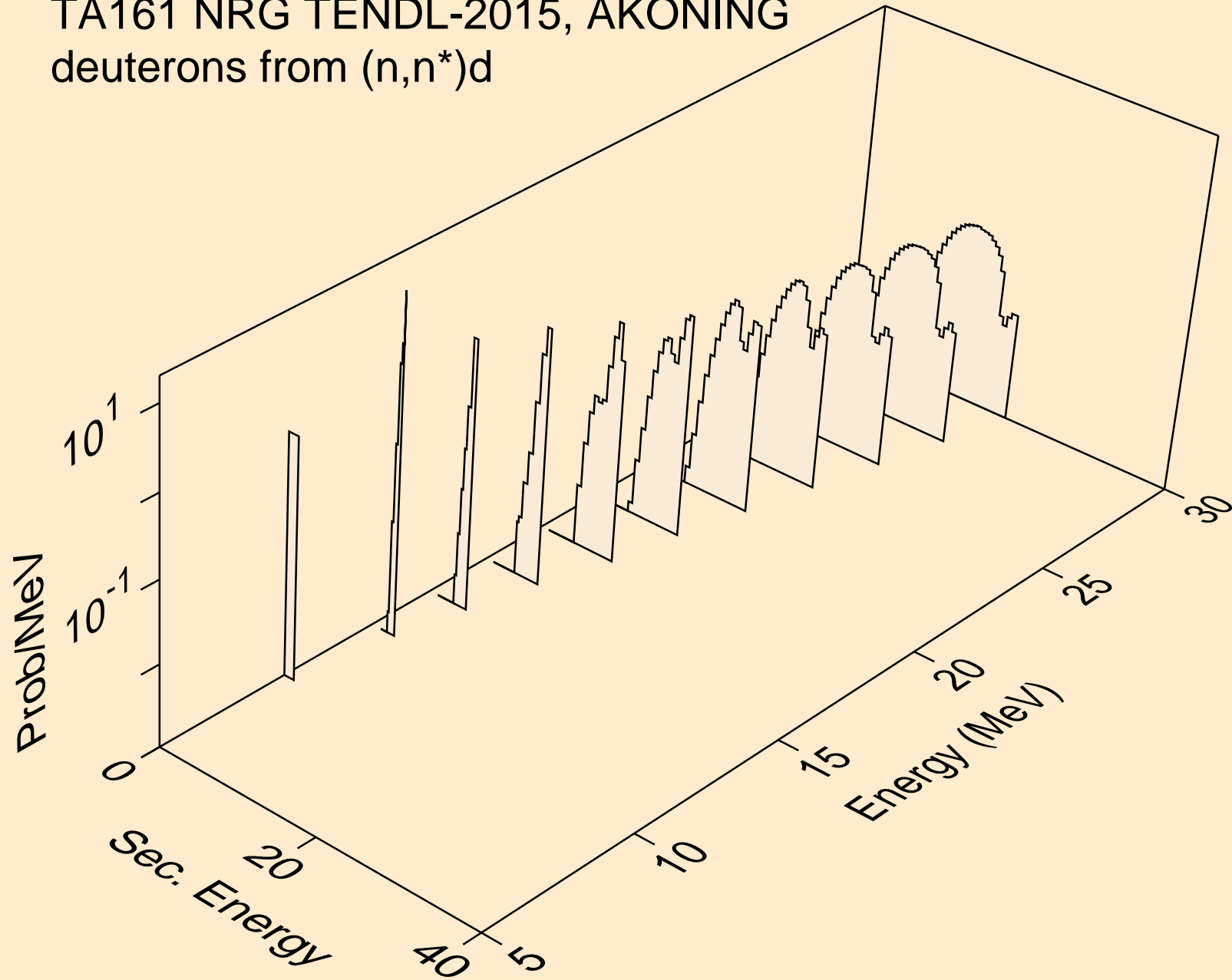

TA161 NRG TENDL-2015, AKONING
deuterons from (n,n*)d2a

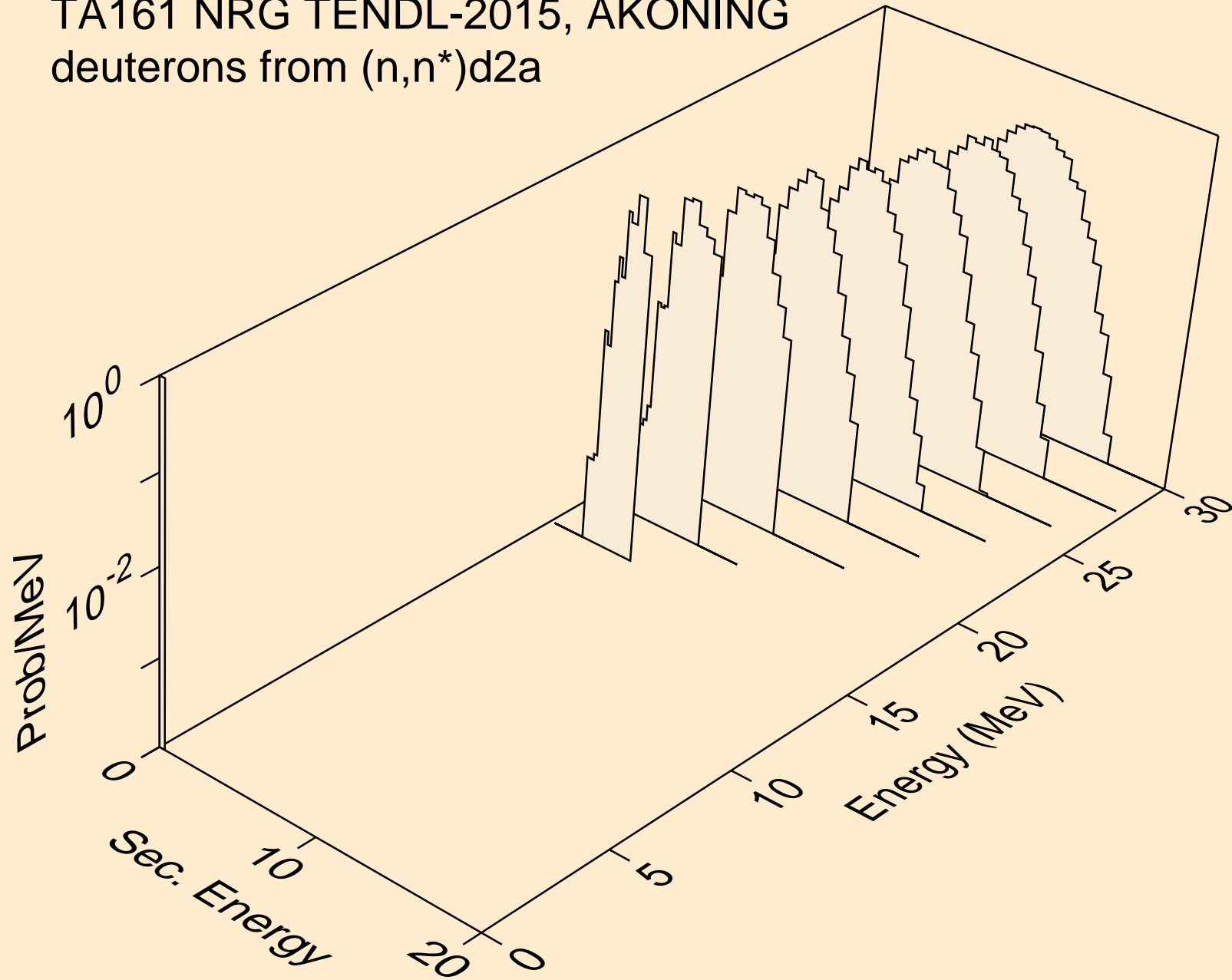

TA161 NRG TENDL-2015, AKONING
deuterons from (n,d)

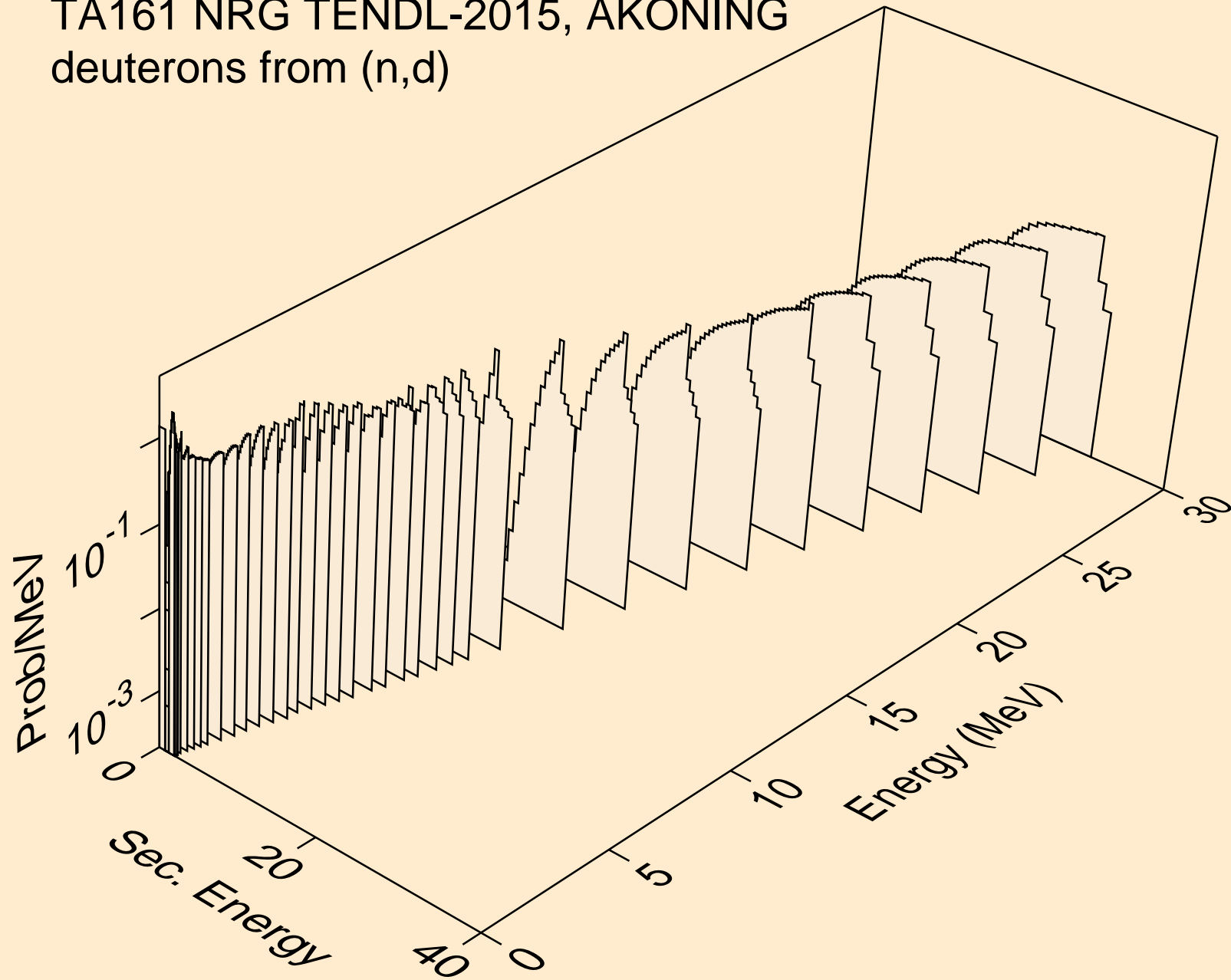

TA161 NRG TENDL-2015, AKONING
deuterons from (n,d2a)

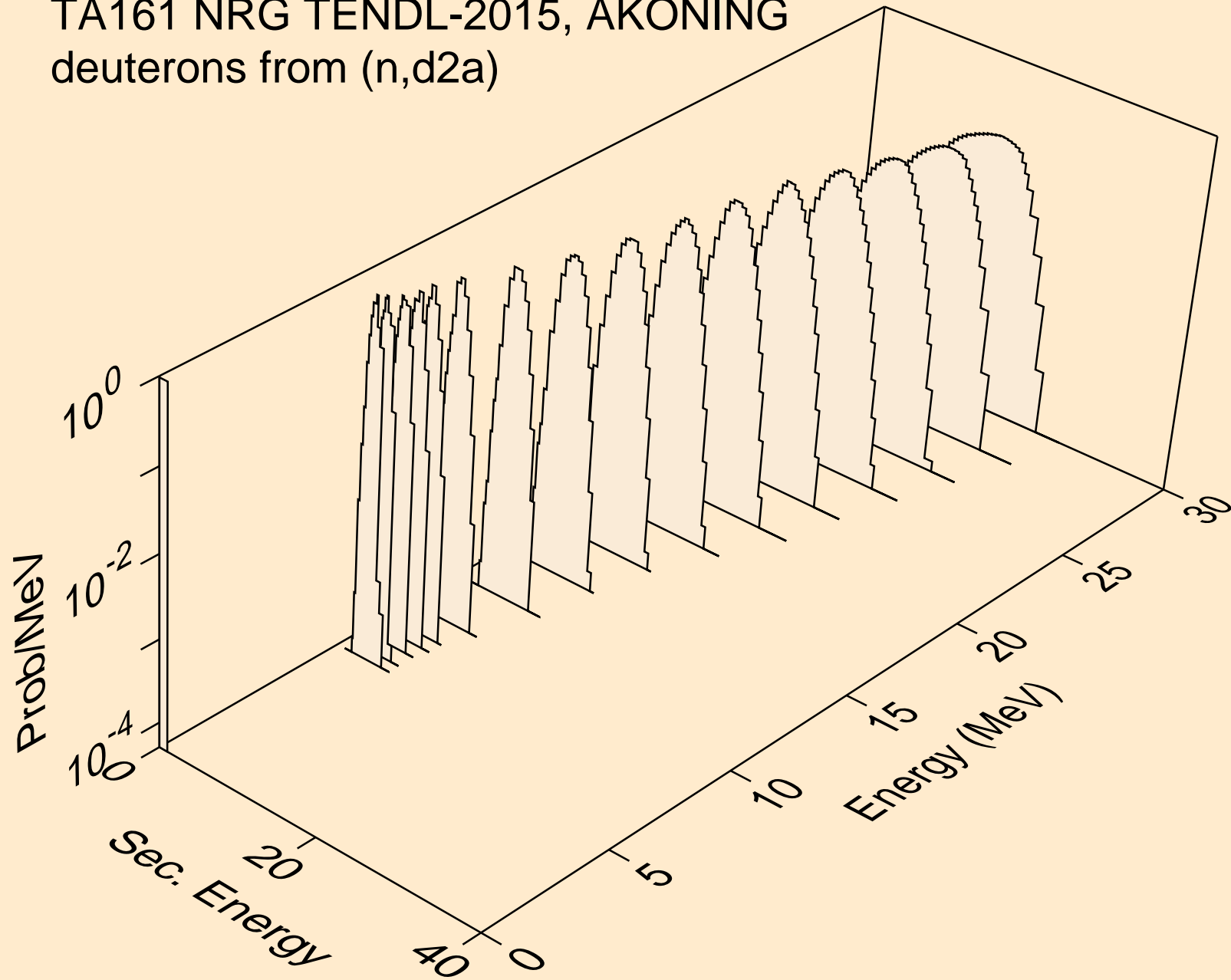

TA161 NRG TENDL-2015, AKONING
deuterons from (n,pd)

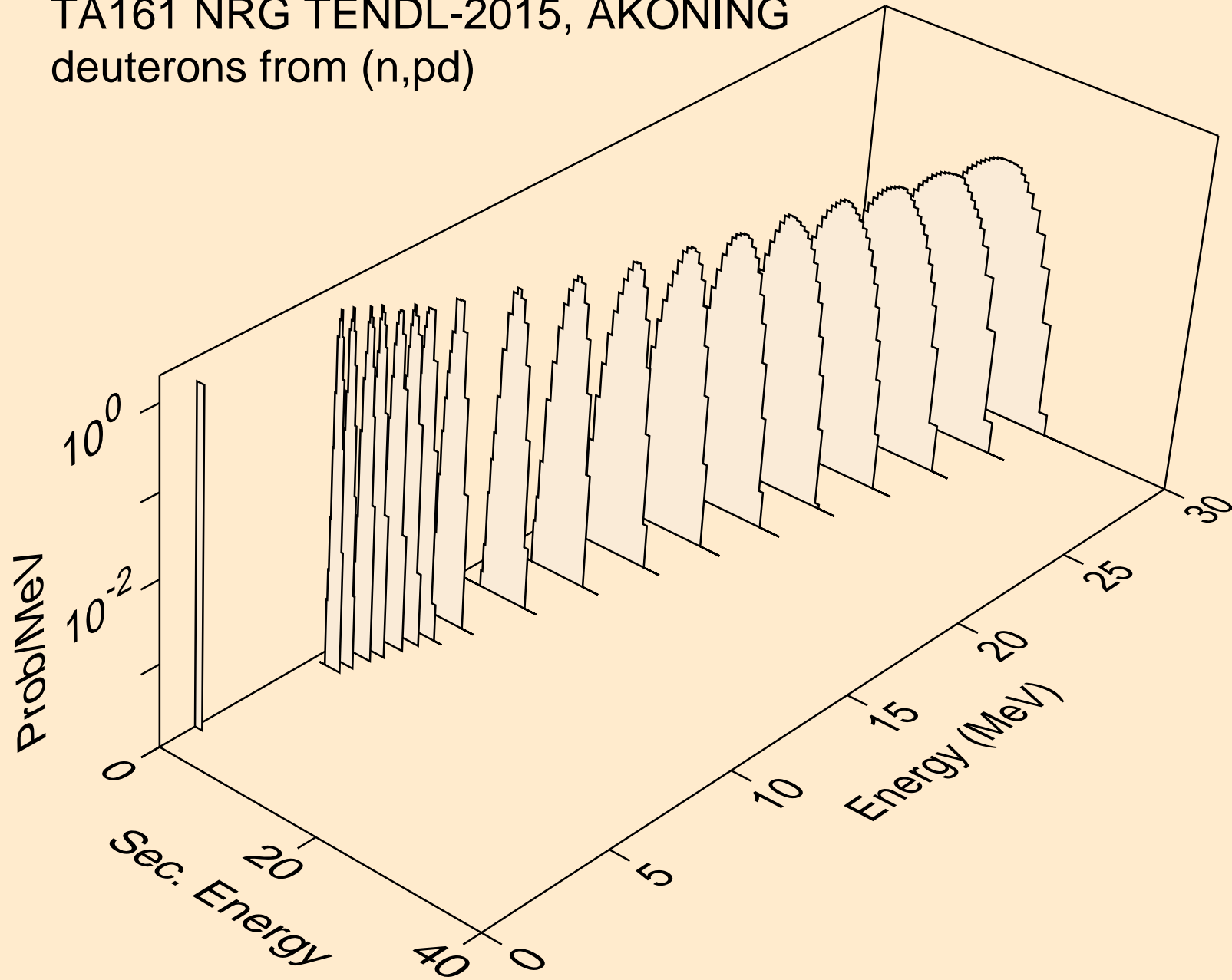

TA161 NRG TENDL-2015, AKONING
deuterons from (n,da)

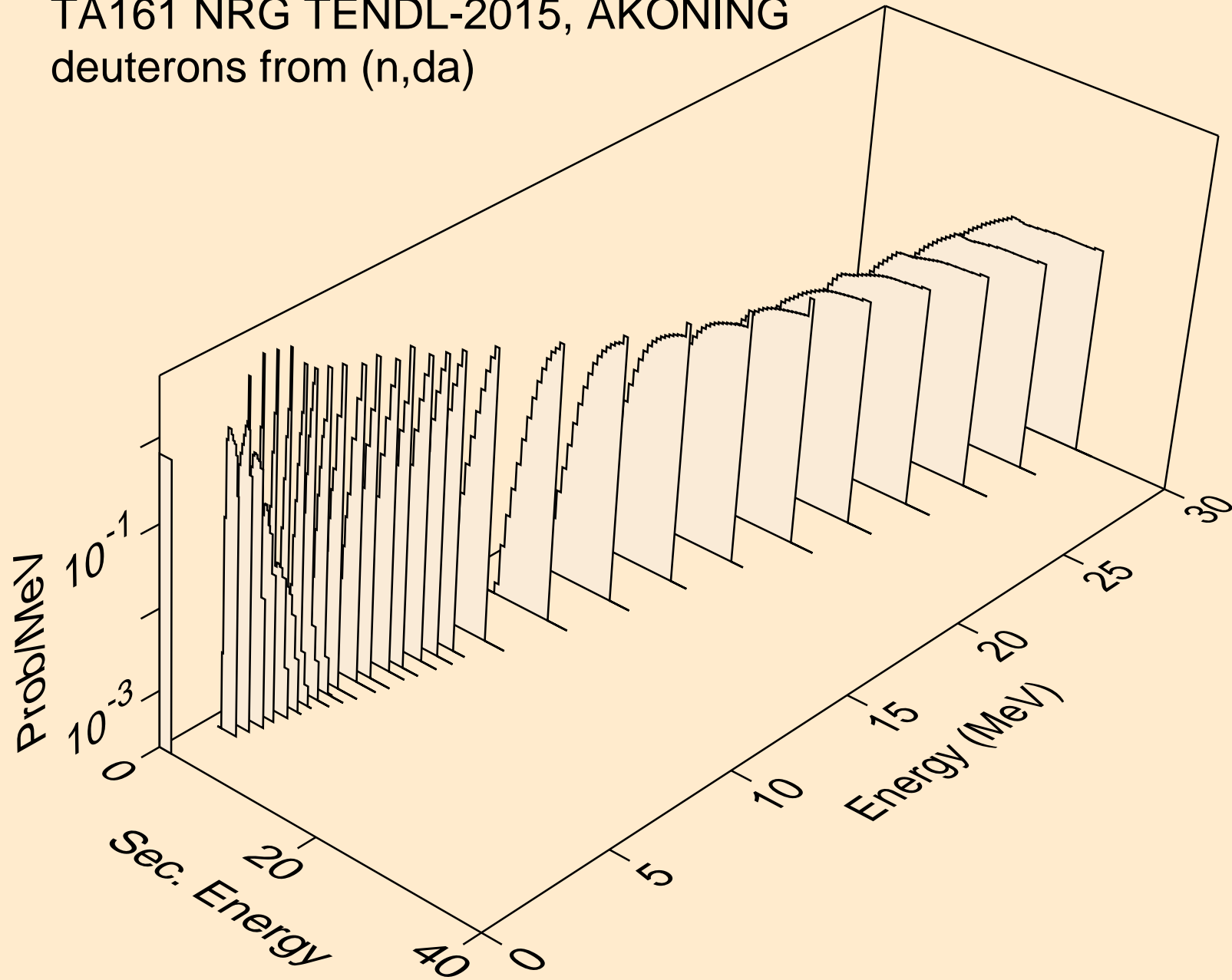

TA161 NRG TENDL-2015, AKONING
tritons from (n,x)

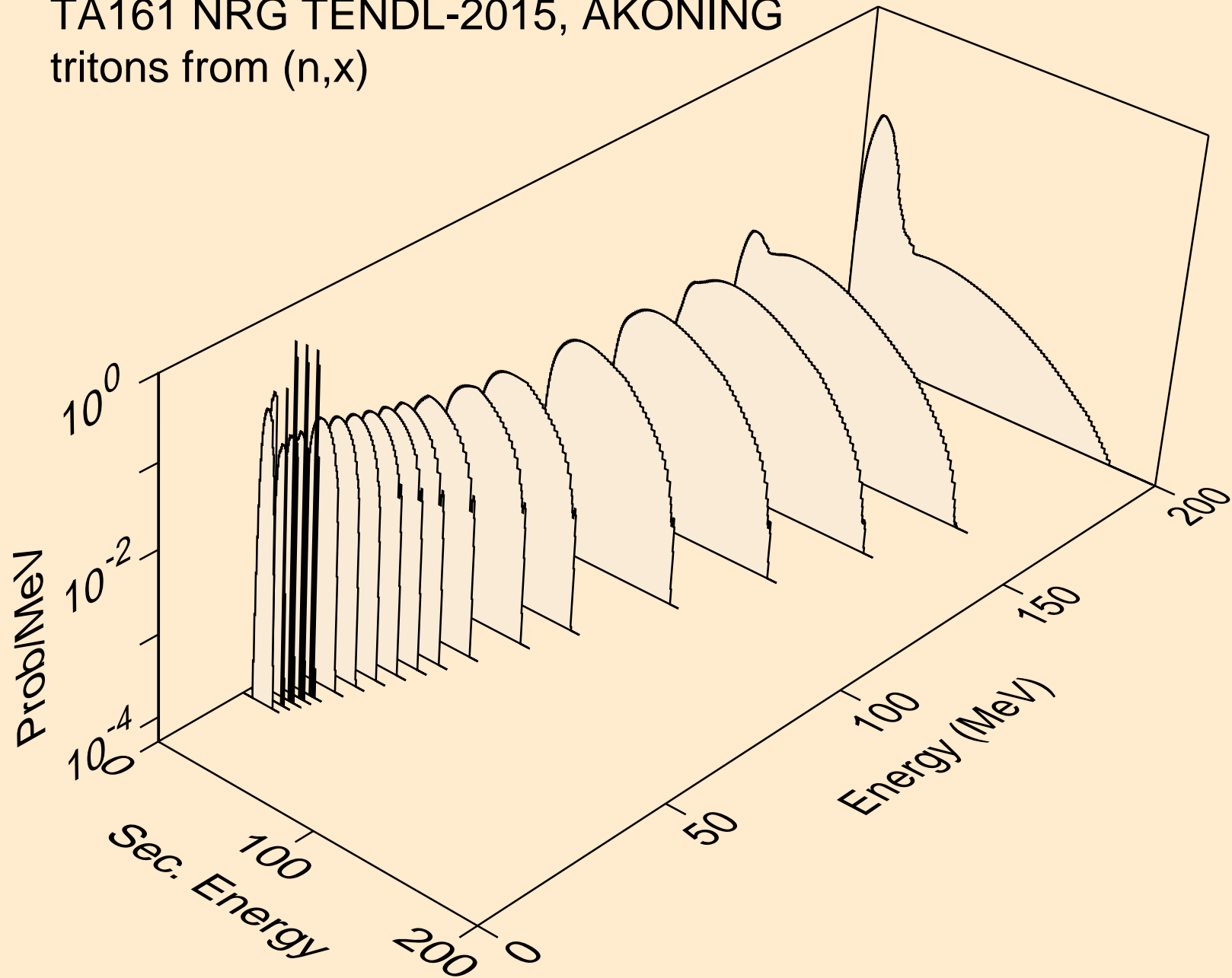

TA161 NRG TENDL-2015, AKONING
tritons from (n,n*)t

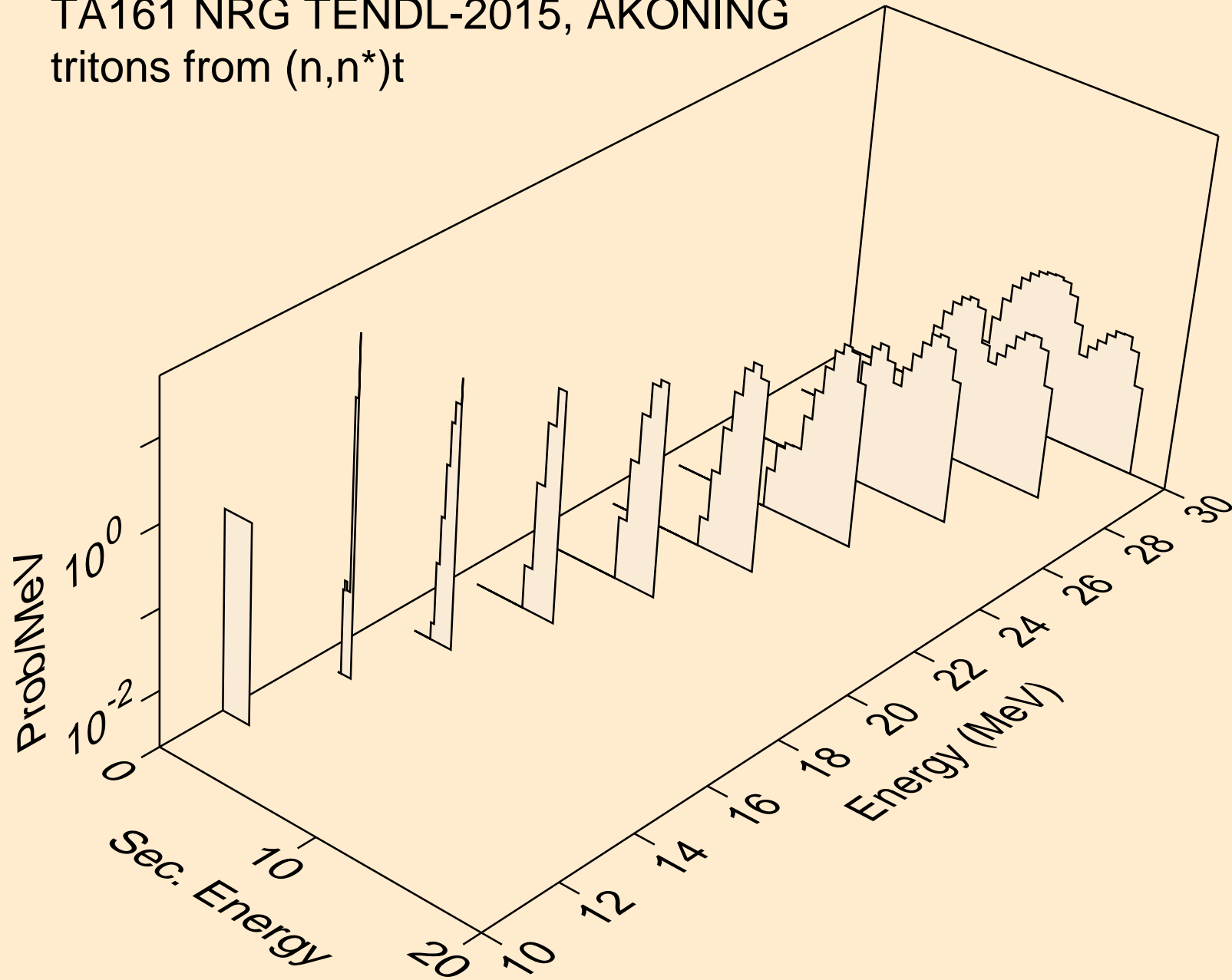

TA161 NRG TENDL-2015, AKONING
tritons from (n,n*)t2a

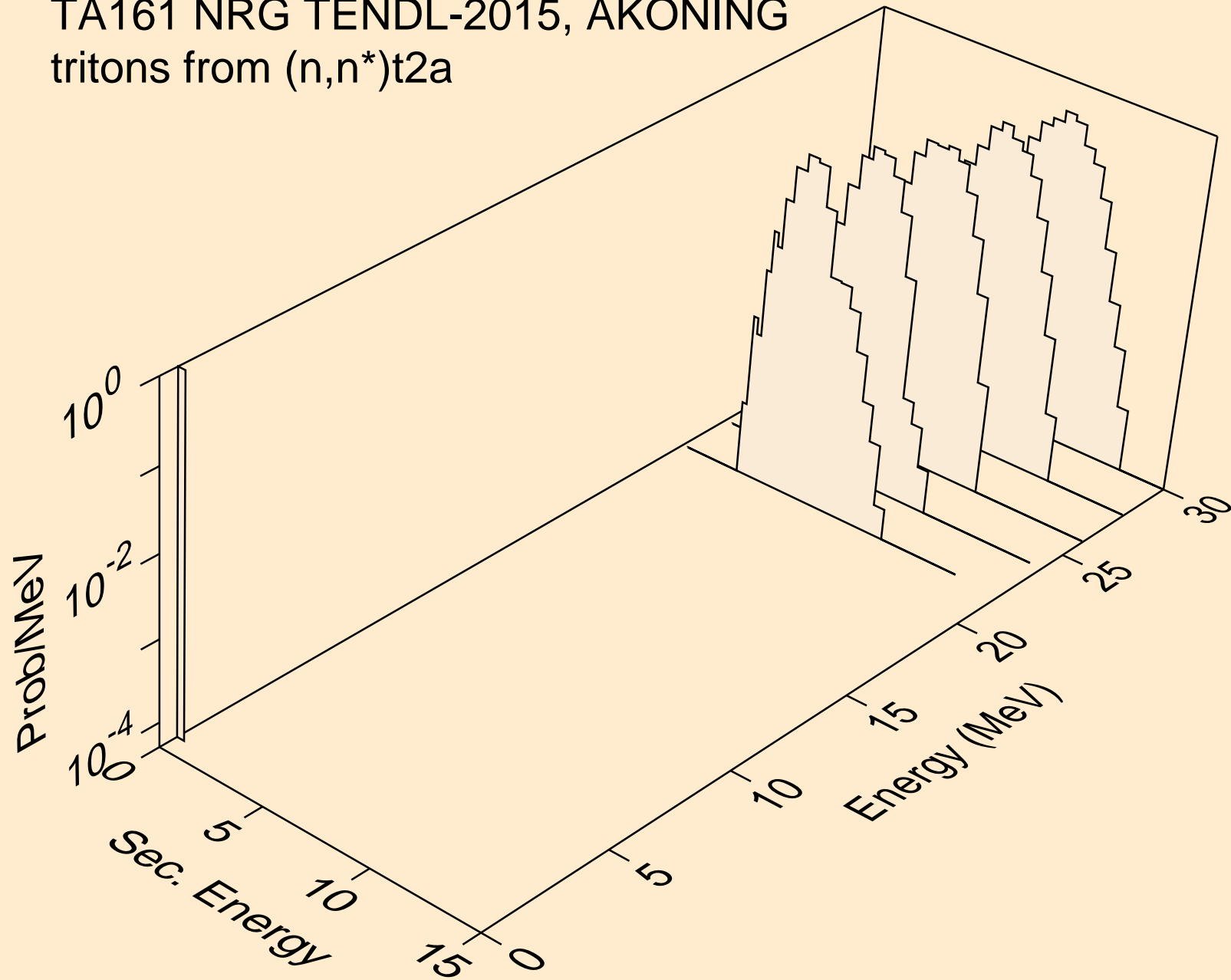

TA161 NRG TENDL-2015, AKONING
tritons from (n,t)

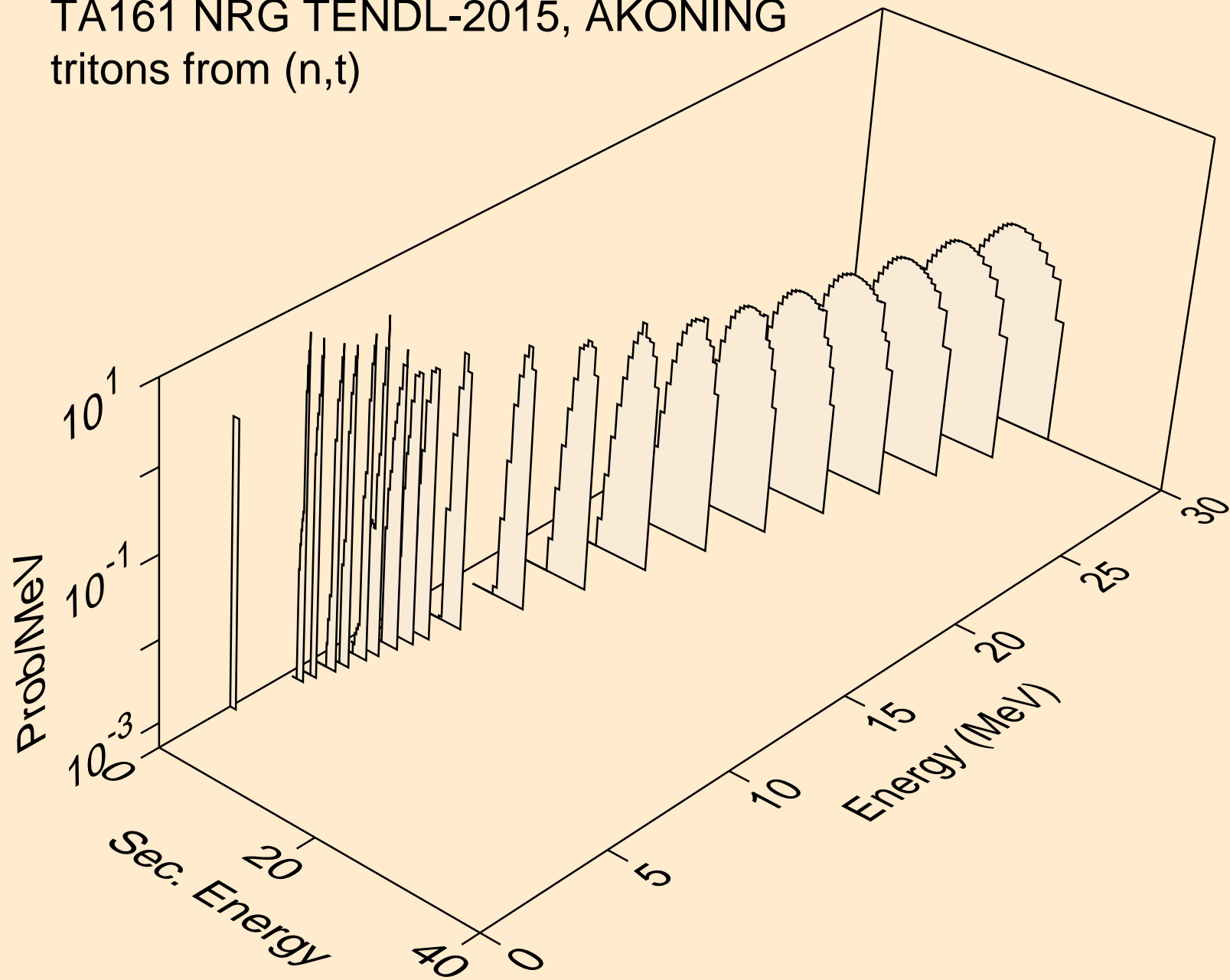

TA161 NRG TENDL-2015, AKONING
tritons from (n,t2a)

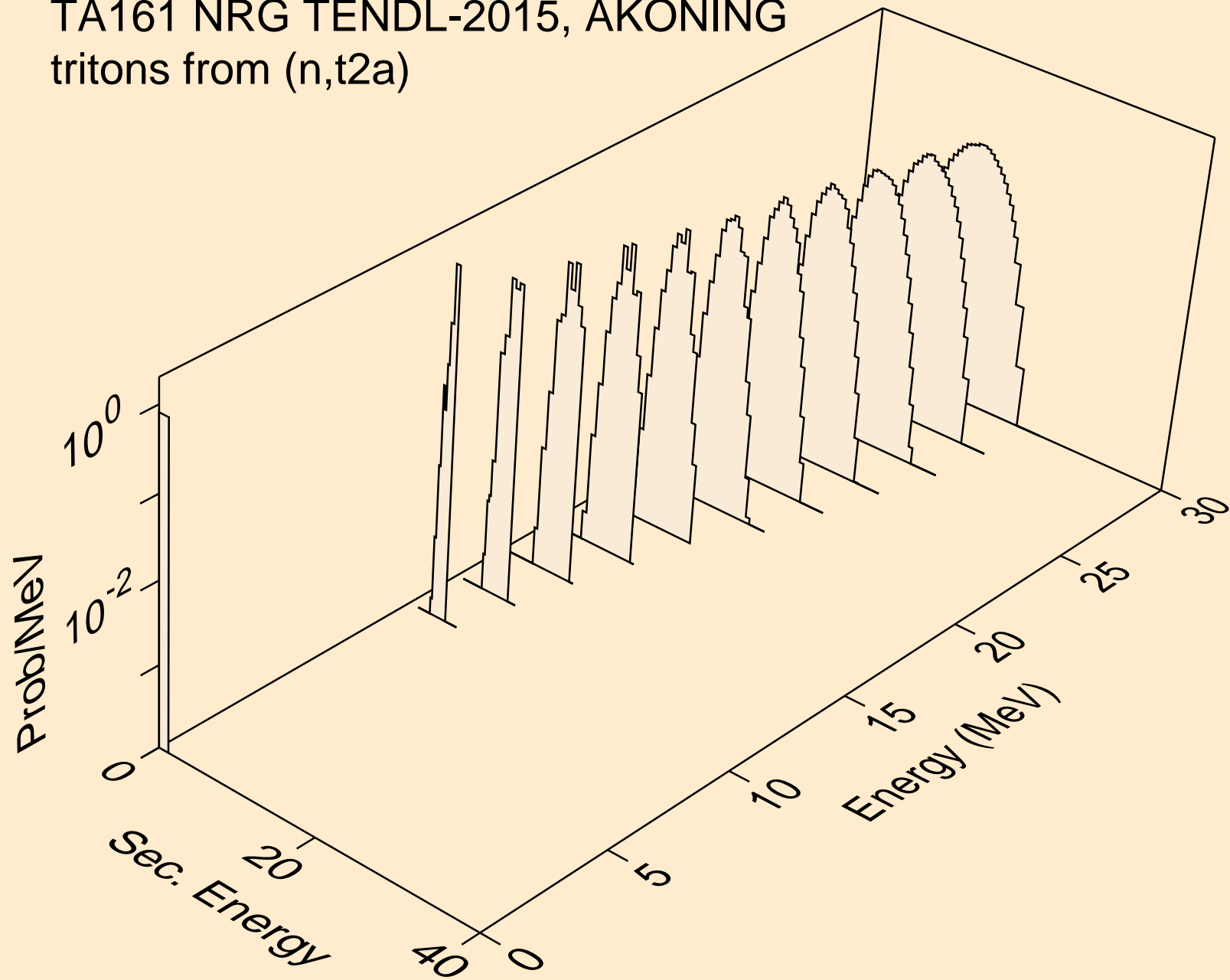

TA161 NRG TENDL-2015, AKONING
tritons from (n,pt)

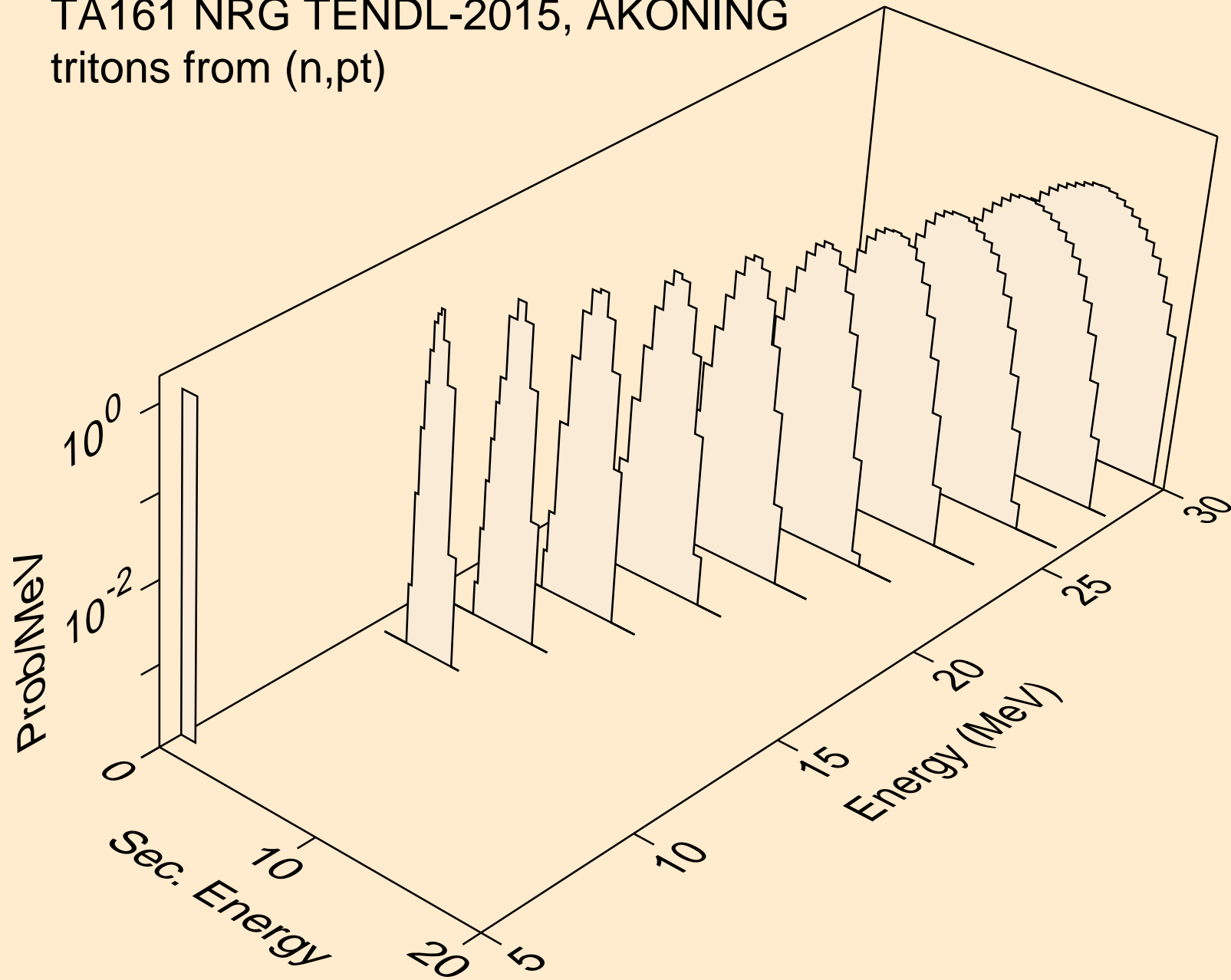

TA161 NRG TENDL-2015, AKONING
he3s from (n,x)

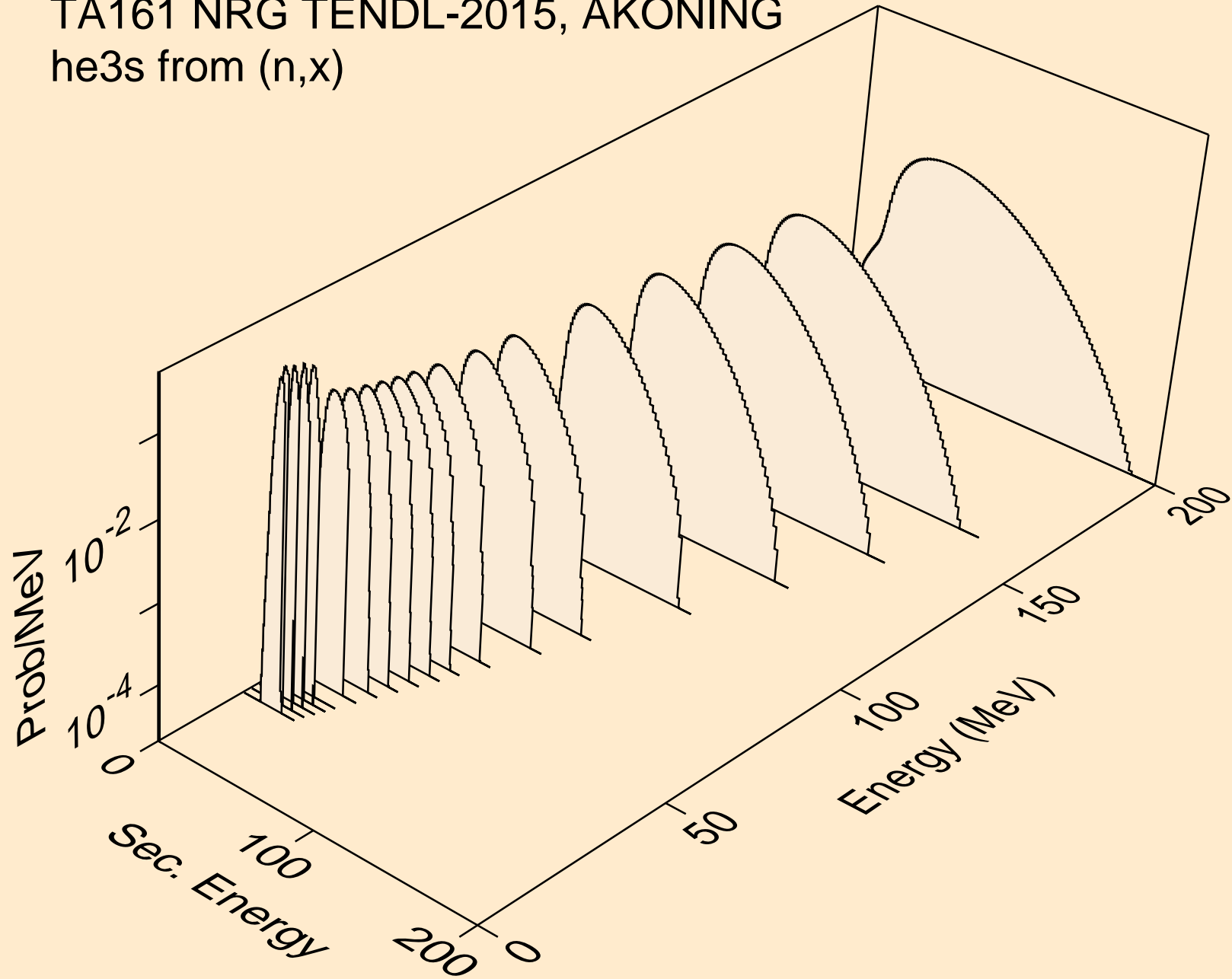

TA161 NRG TENDL-2015, AKONING
he3s from (n,n*)he3

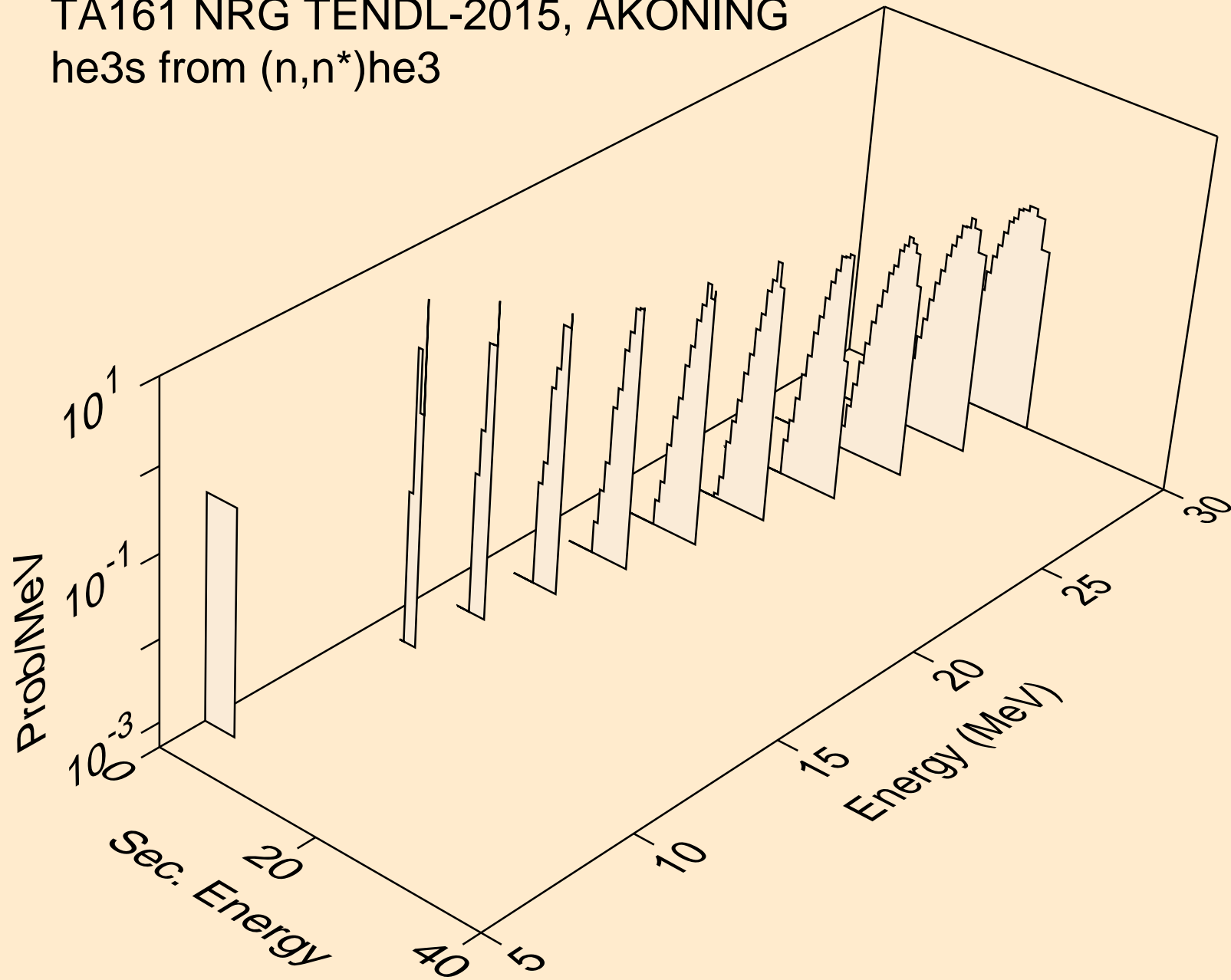

TA161 NRG TENDL-2015, AKONING
he3s from (n,he3)

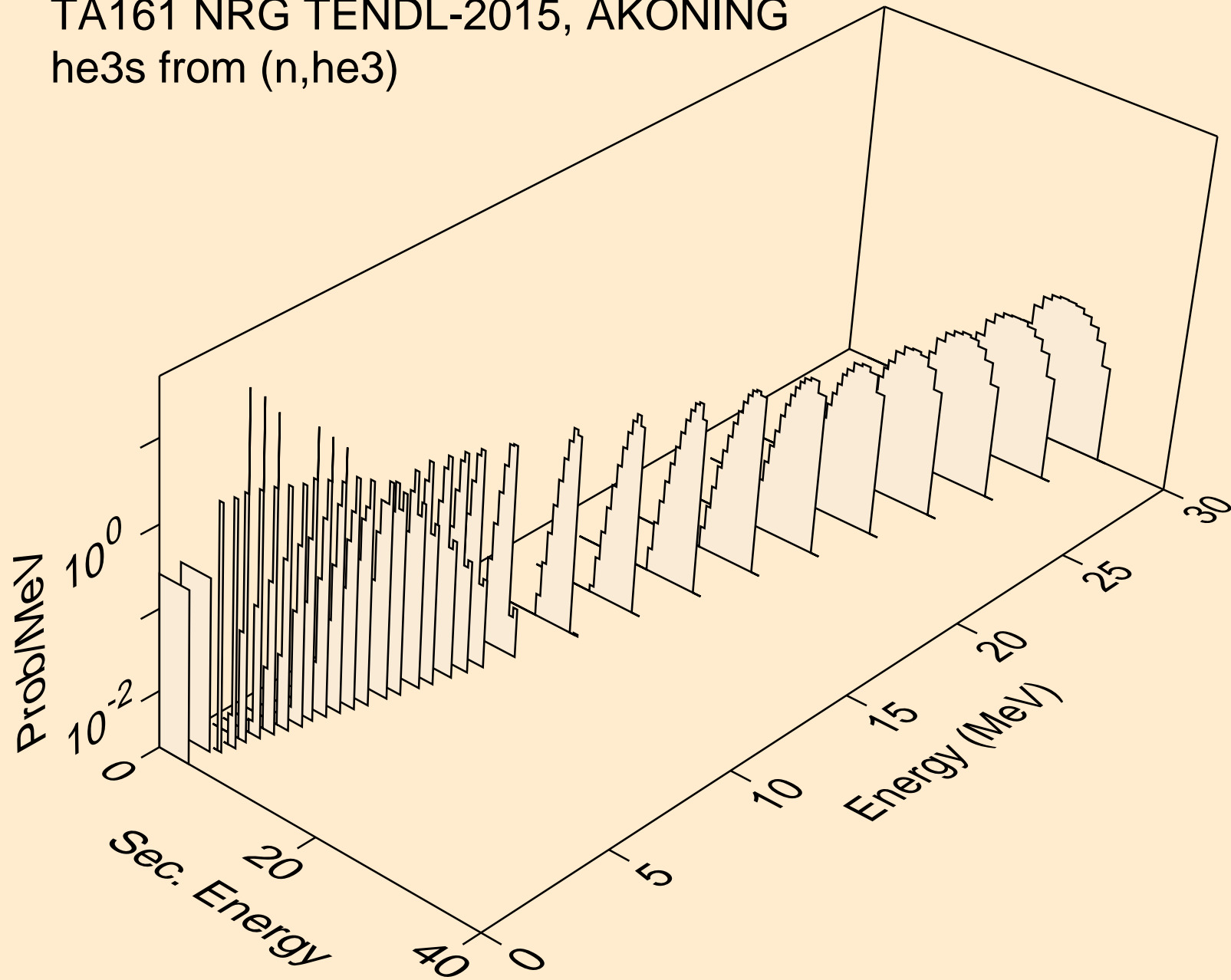

TA161 NRG TENDL-2015, AKONING
alphas from (n,x)

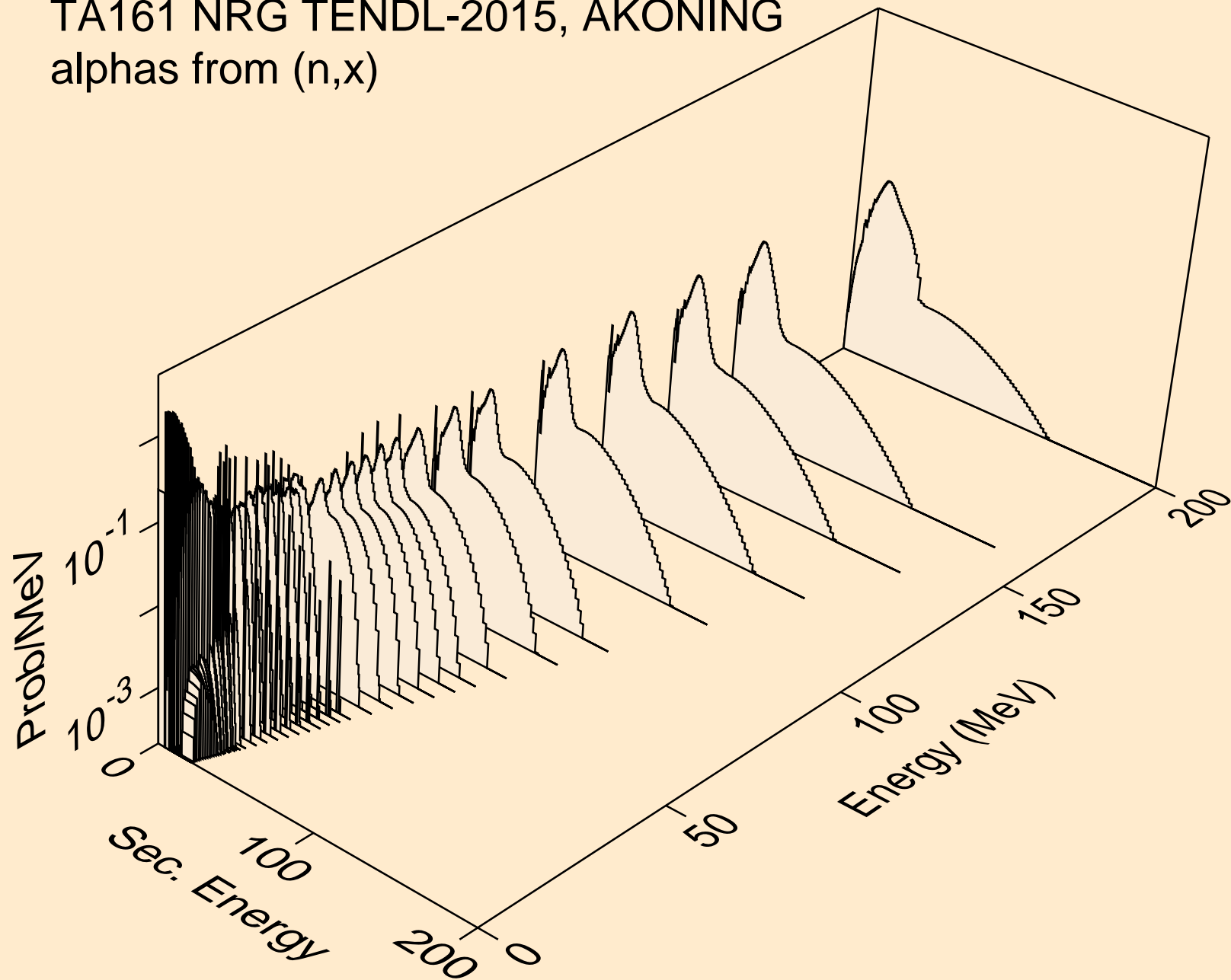

TA161 NRG TENDL-2015, AKONING
alphas from (n,n*)a

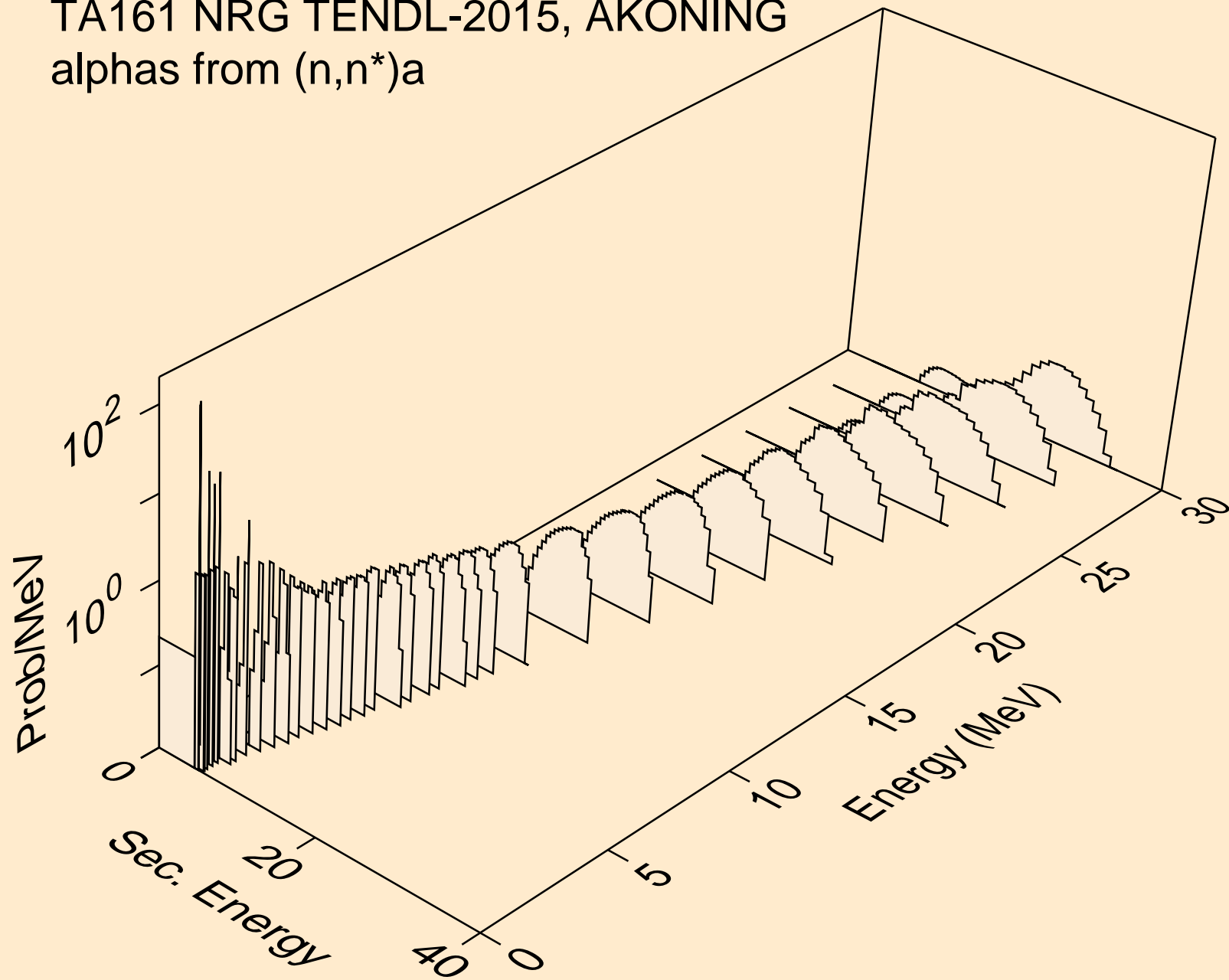

TA161 NRG TENDL-2015, AKONING
alphas from (n,n*)3a

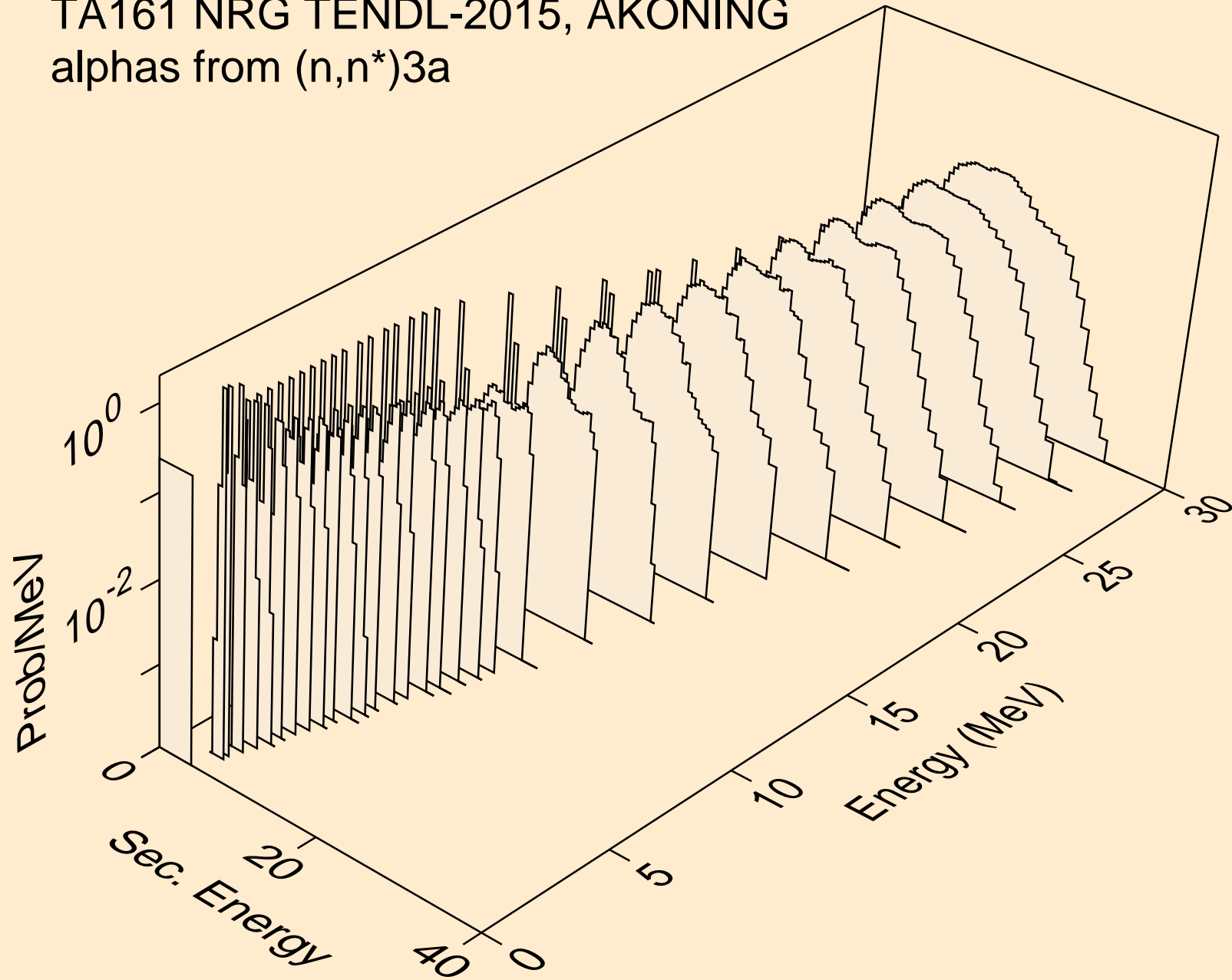

TA161 NRG TENDL-2015, AKONING
alphas from (n,2n)a

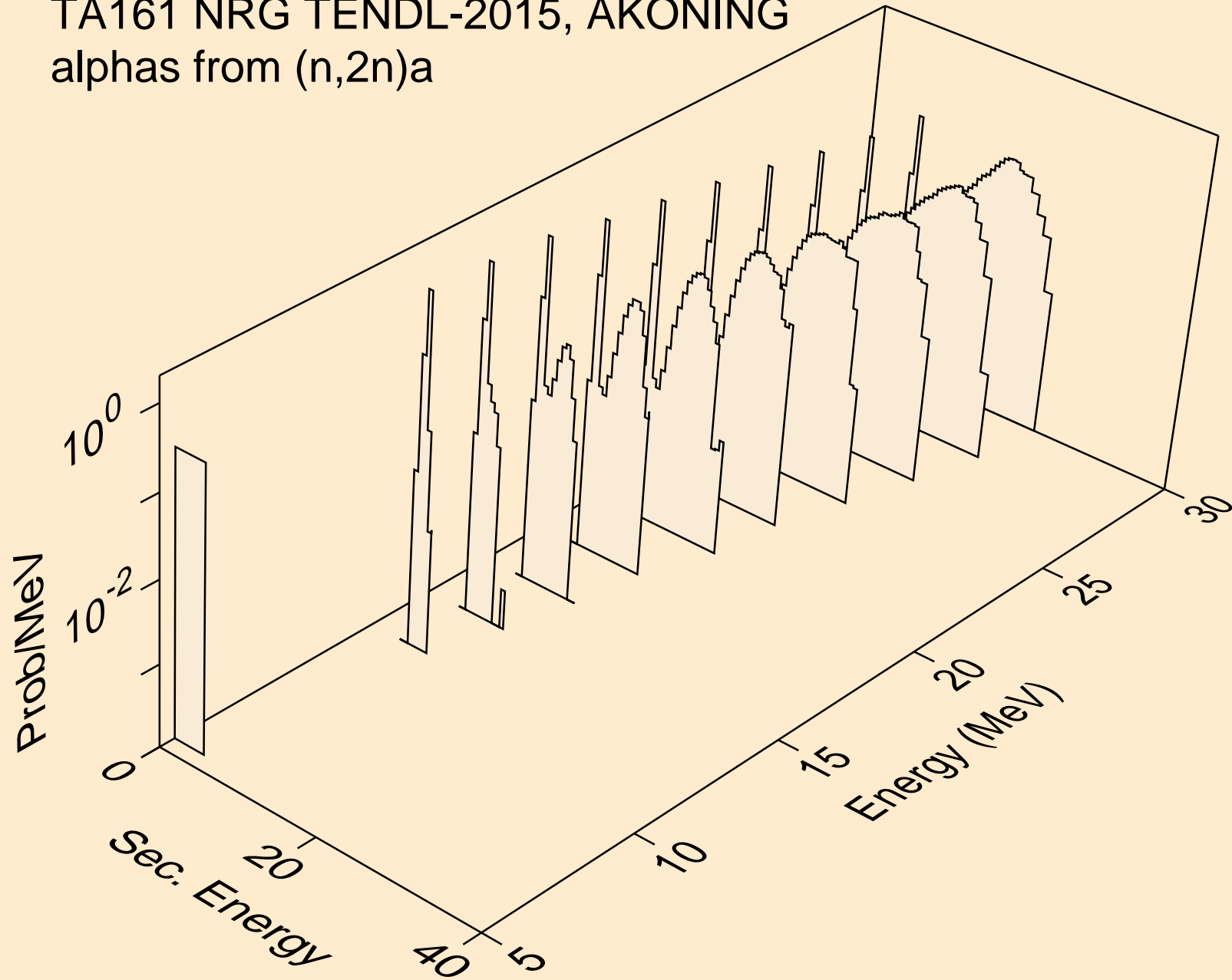

TA161 NRG TENDL-2015, AKONING
alphas from (n,3n)a

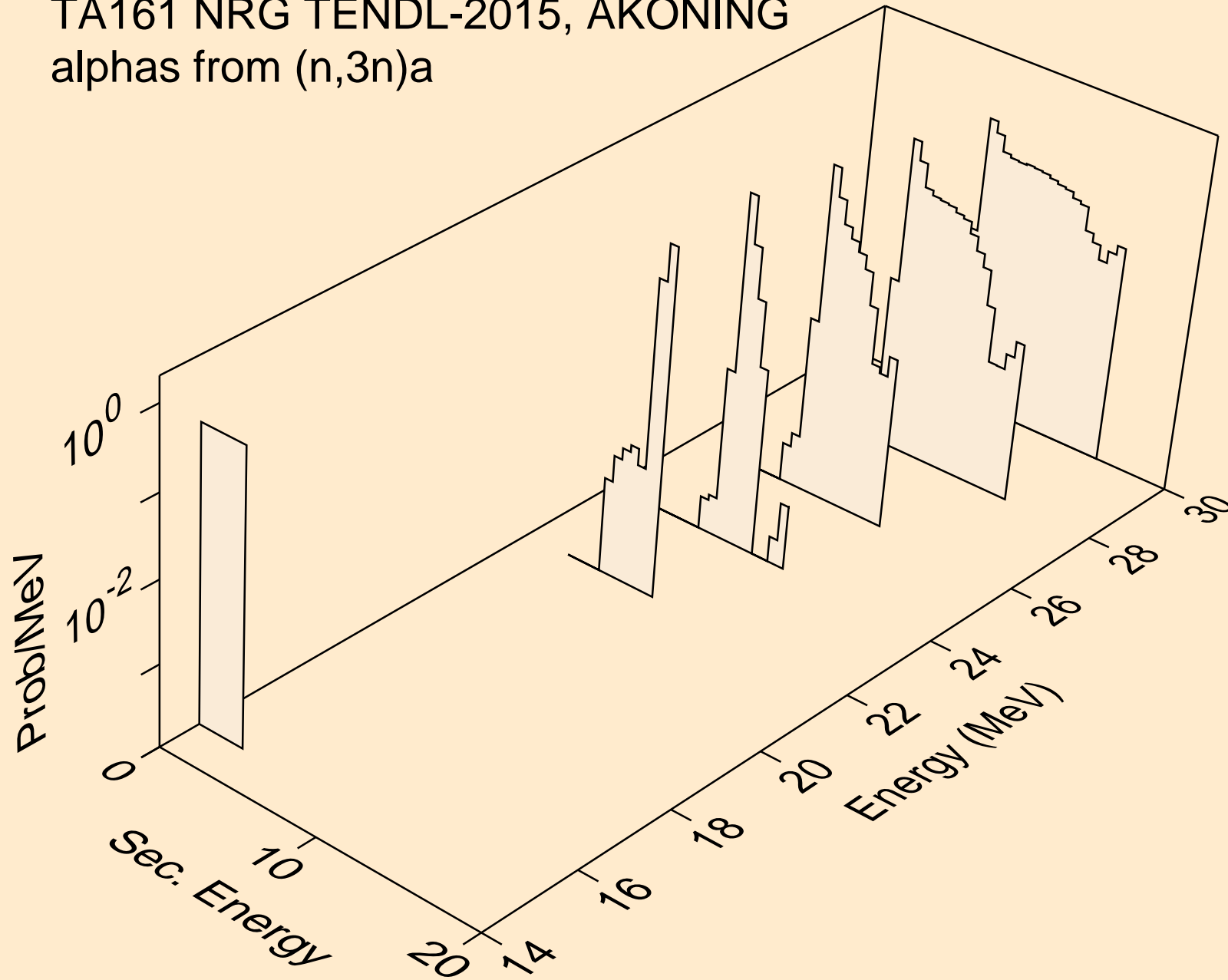

TA161 NRG TENDL-2015, AKONING
alphas from (n,n*)2a

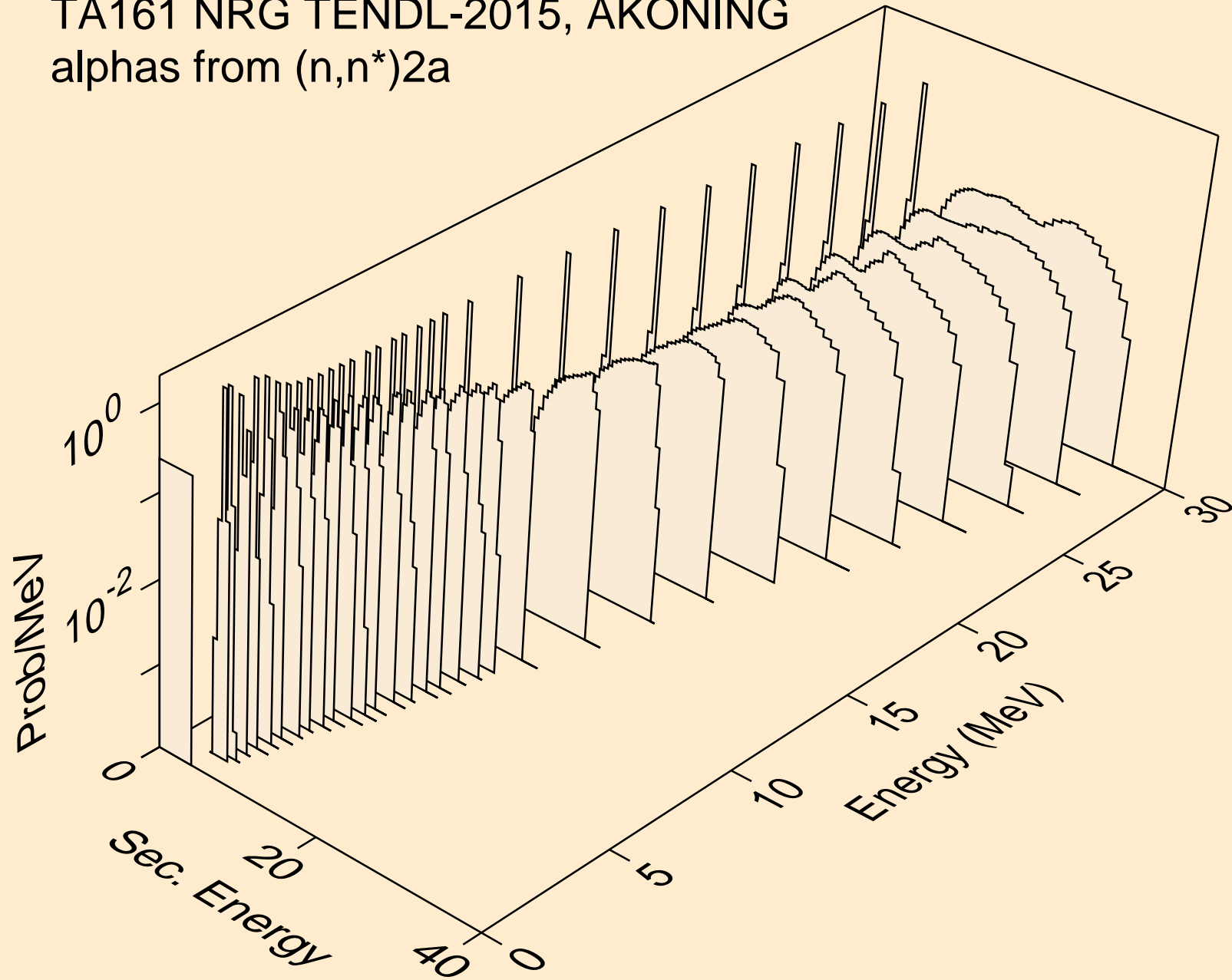

TA161 NRG TENDL-2015, AKONING
alphas from (n,2n)2a

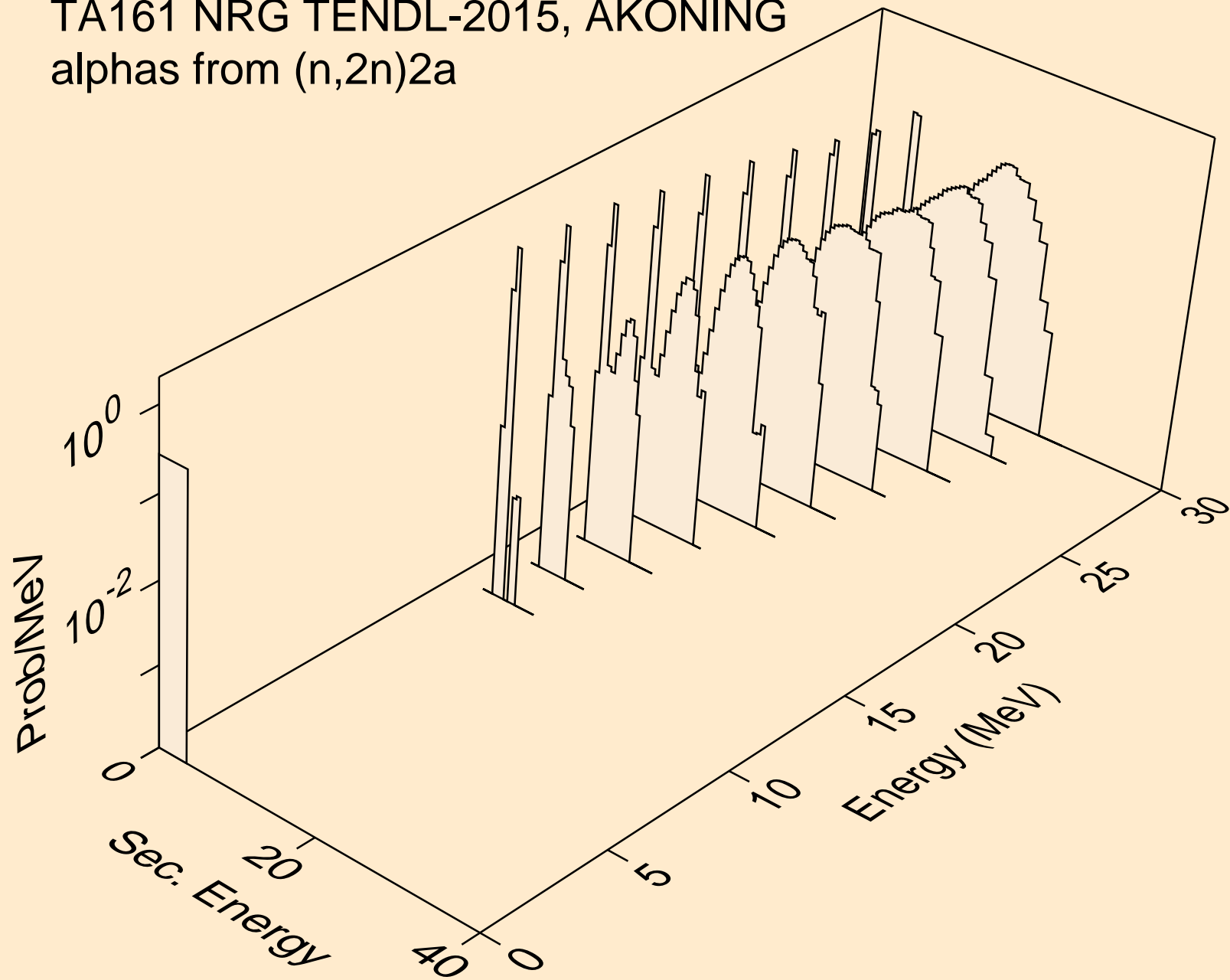

TA161 NRG TENDL-2015, AKONING
alphas from (n,n*)d2a

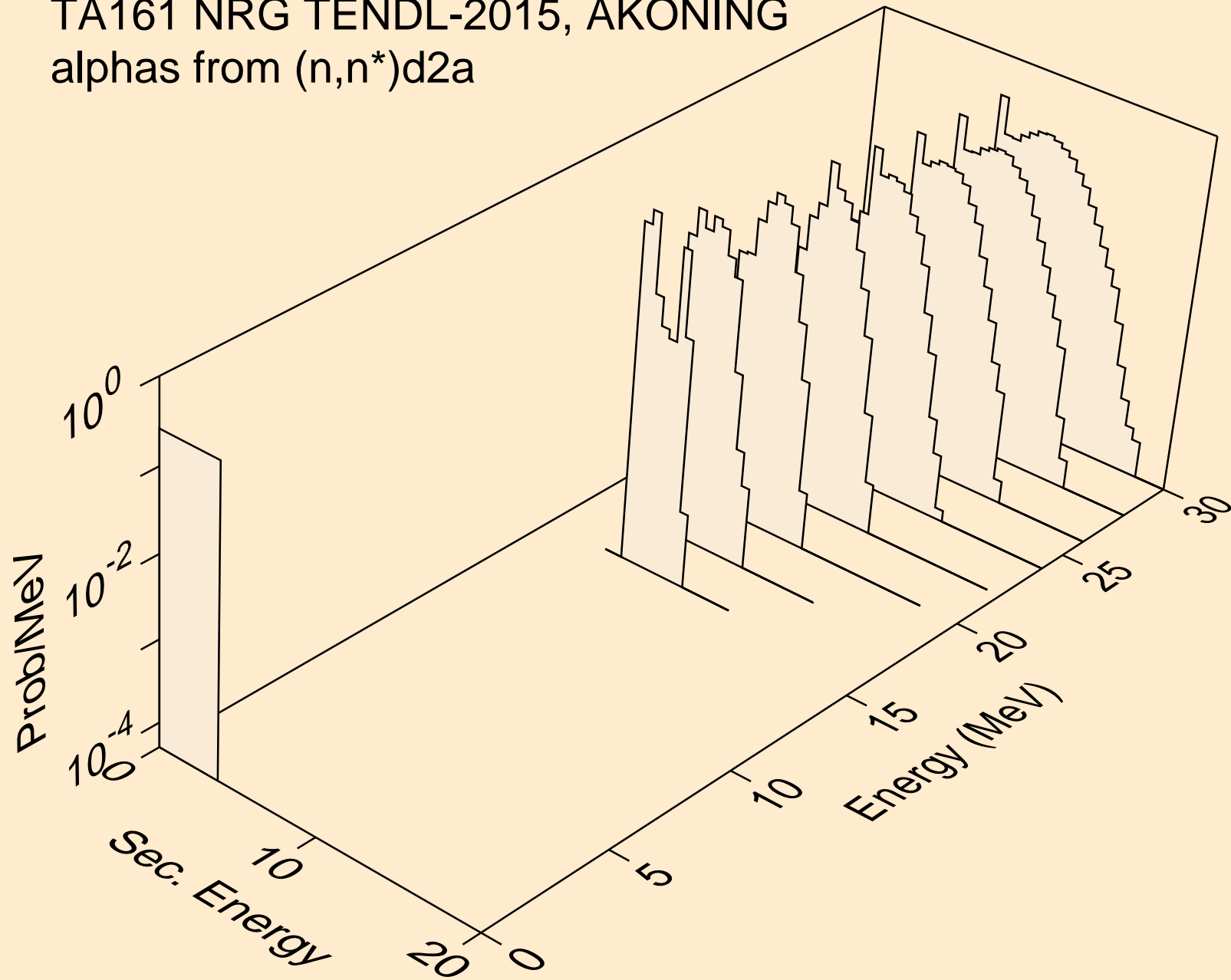

TA161 NRG TENDL-2015, AKONING
alphas from (n,n*)t2a

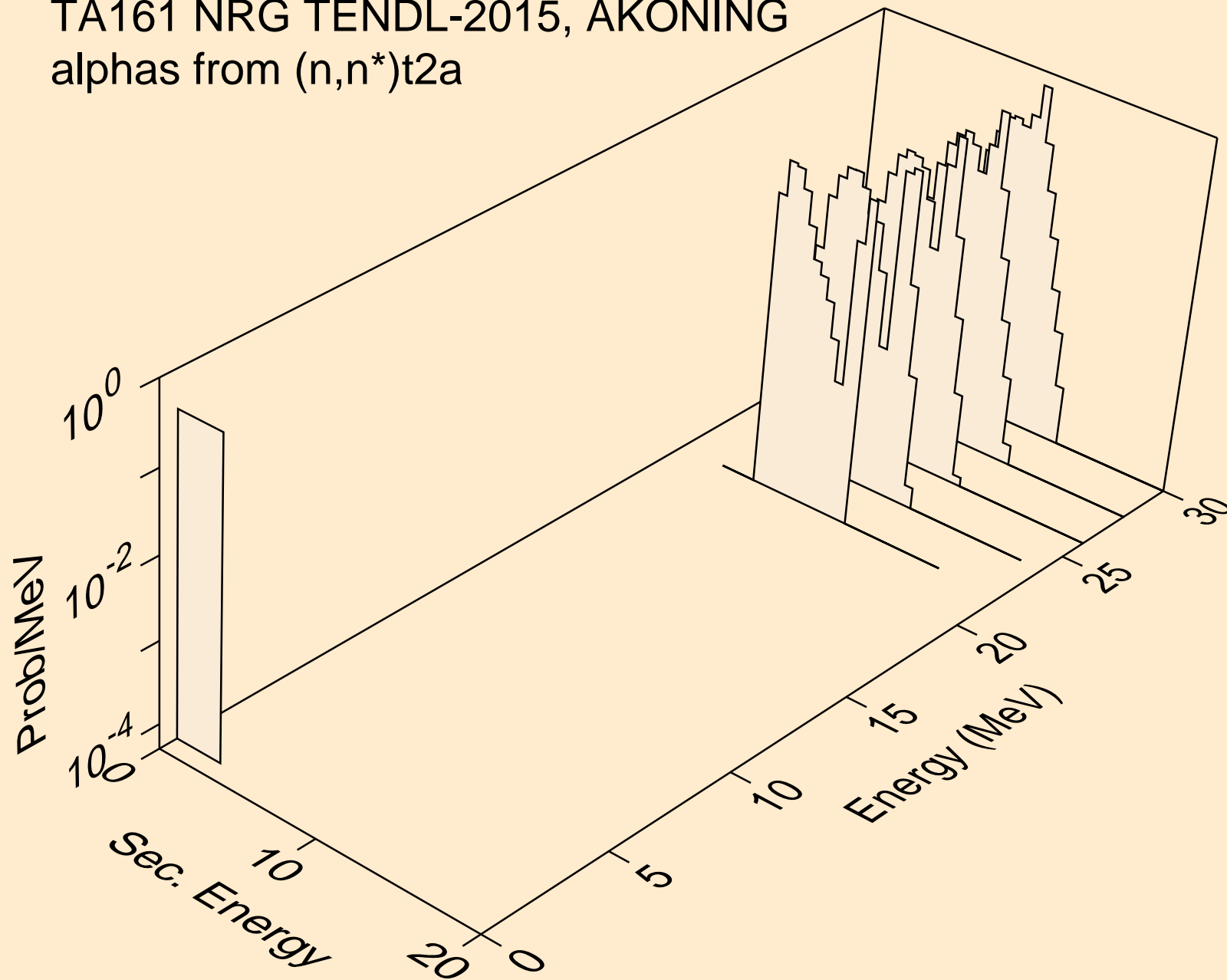

TA161 NRG TENDL-2015, AKONING
alphas from (n,npa)

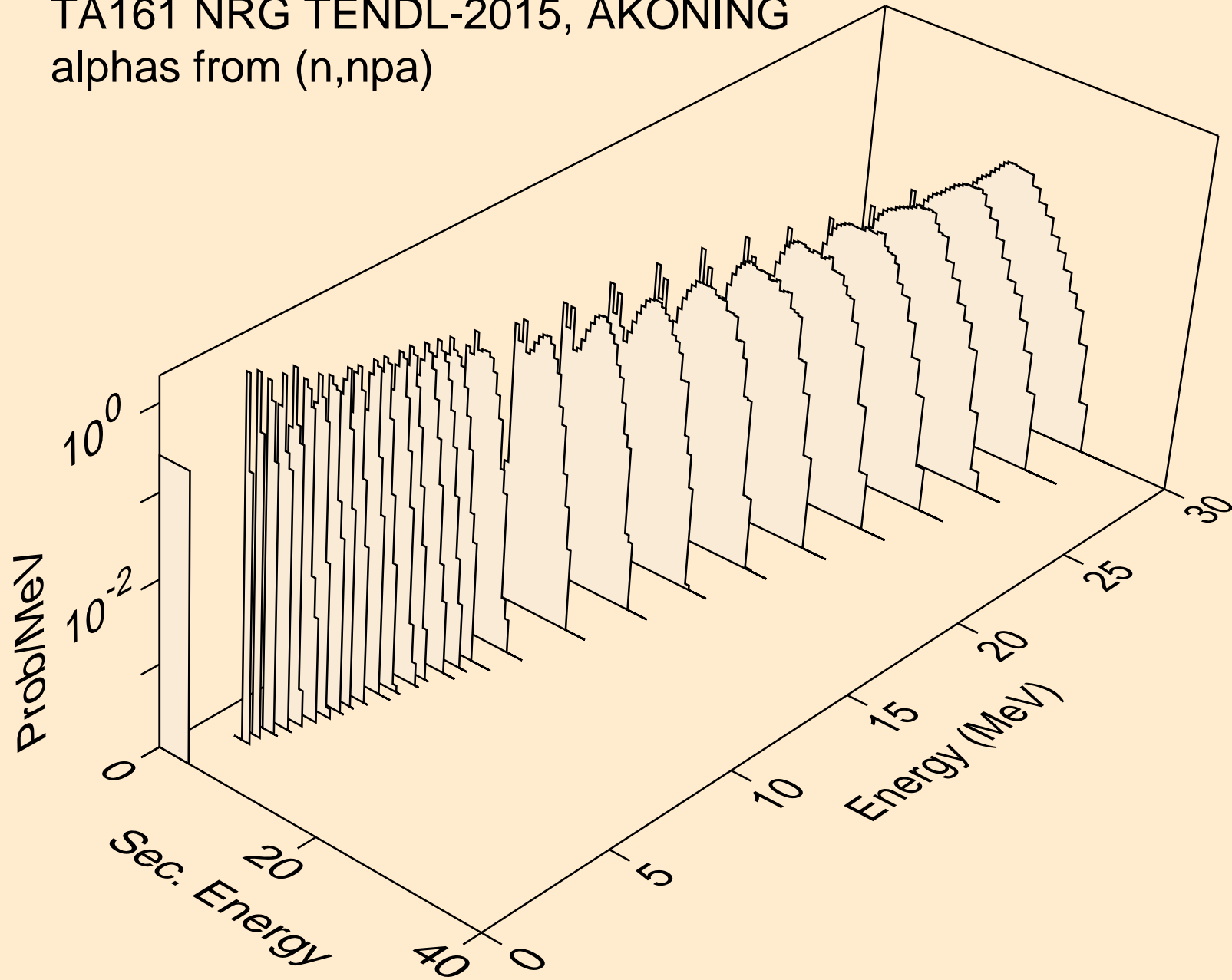

TA161 NRG TENDL-2015, AKONING
alphas from (n,a)

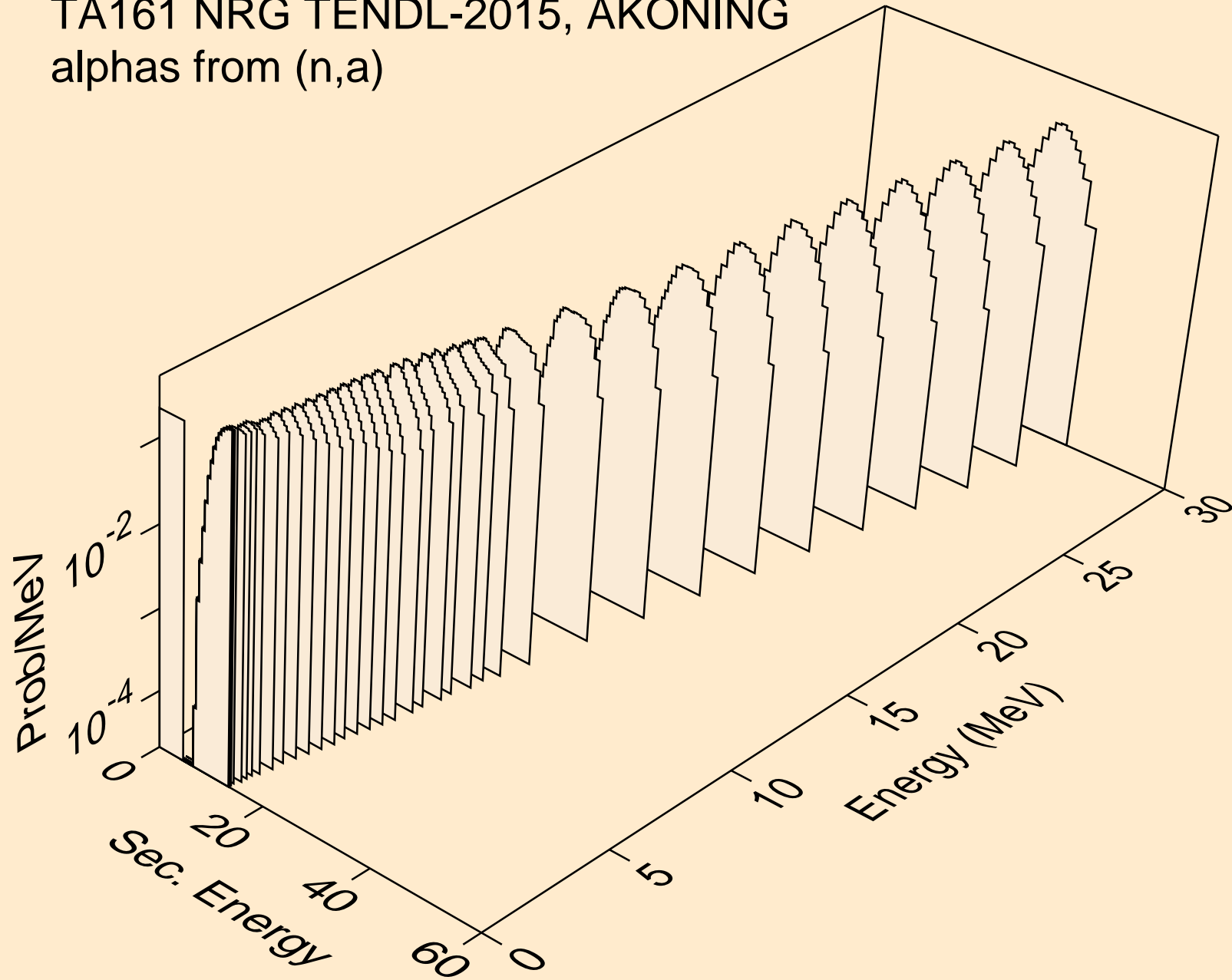

TA161 NRG TENDL-2015, AKONING
alphas from (n,2a)

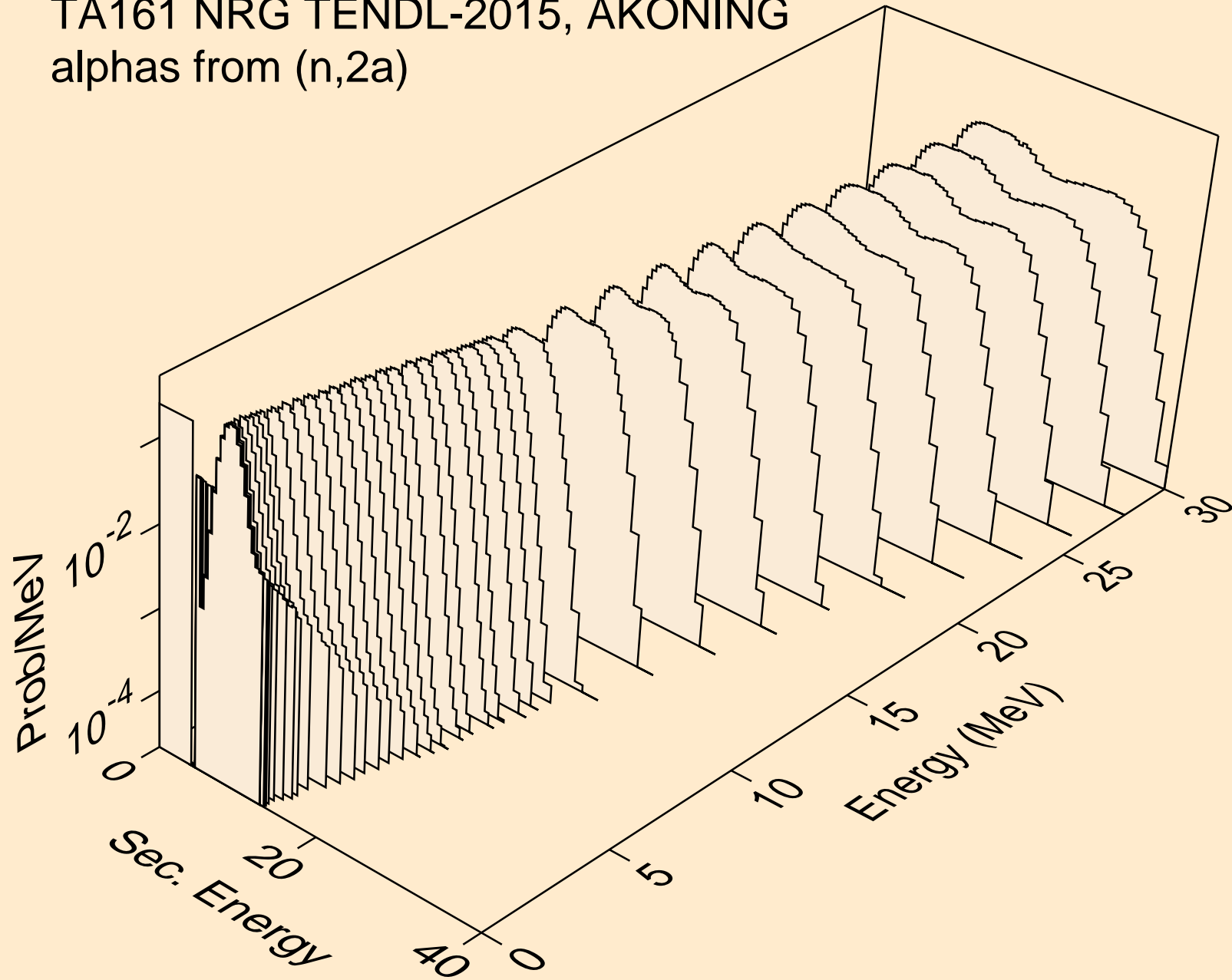

TA161 NRG TENDL-2015, AKONING
alphas from (n,3a)

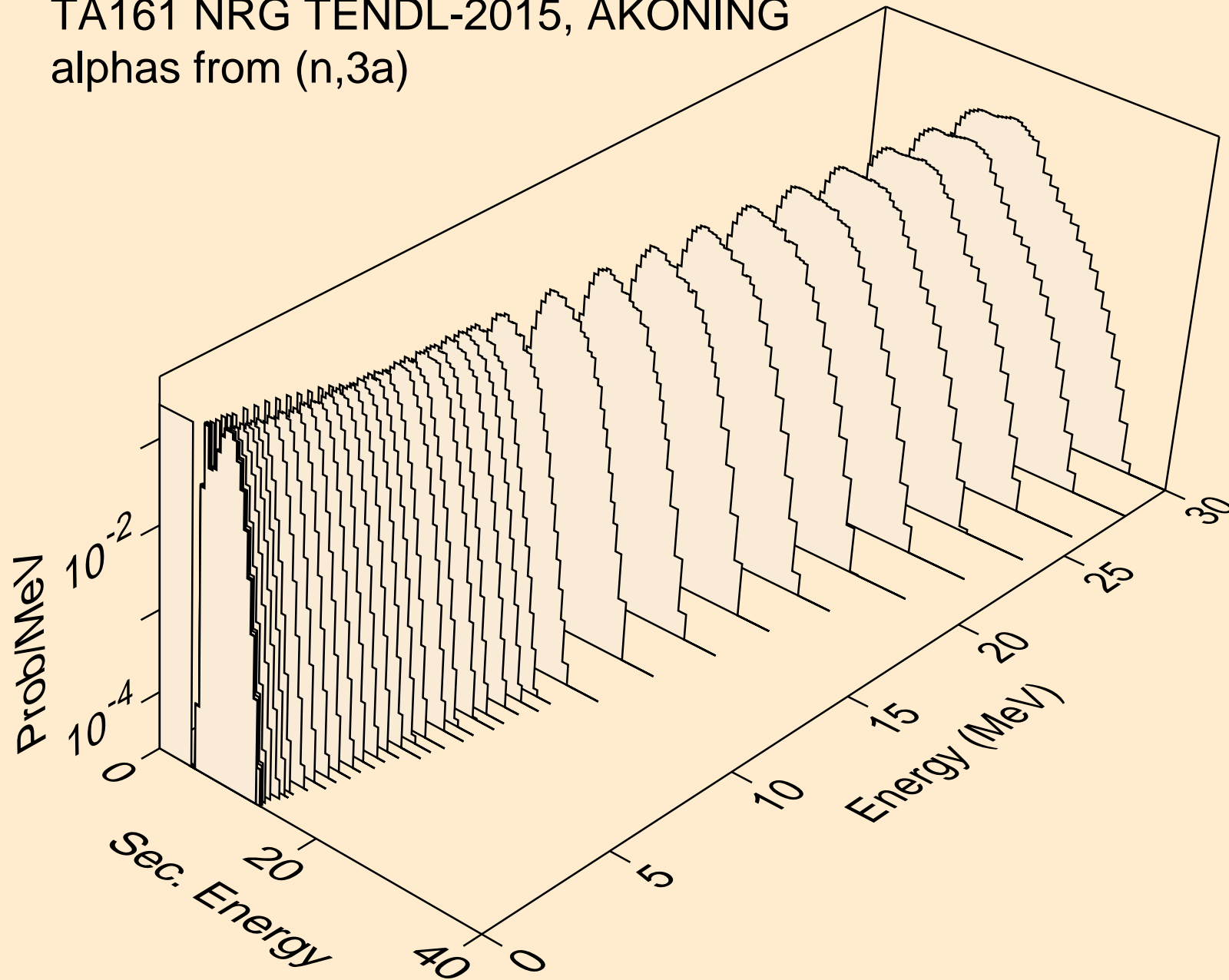

TA161 NRG TENDL-2015, AKONING
alphas from (n,pa)

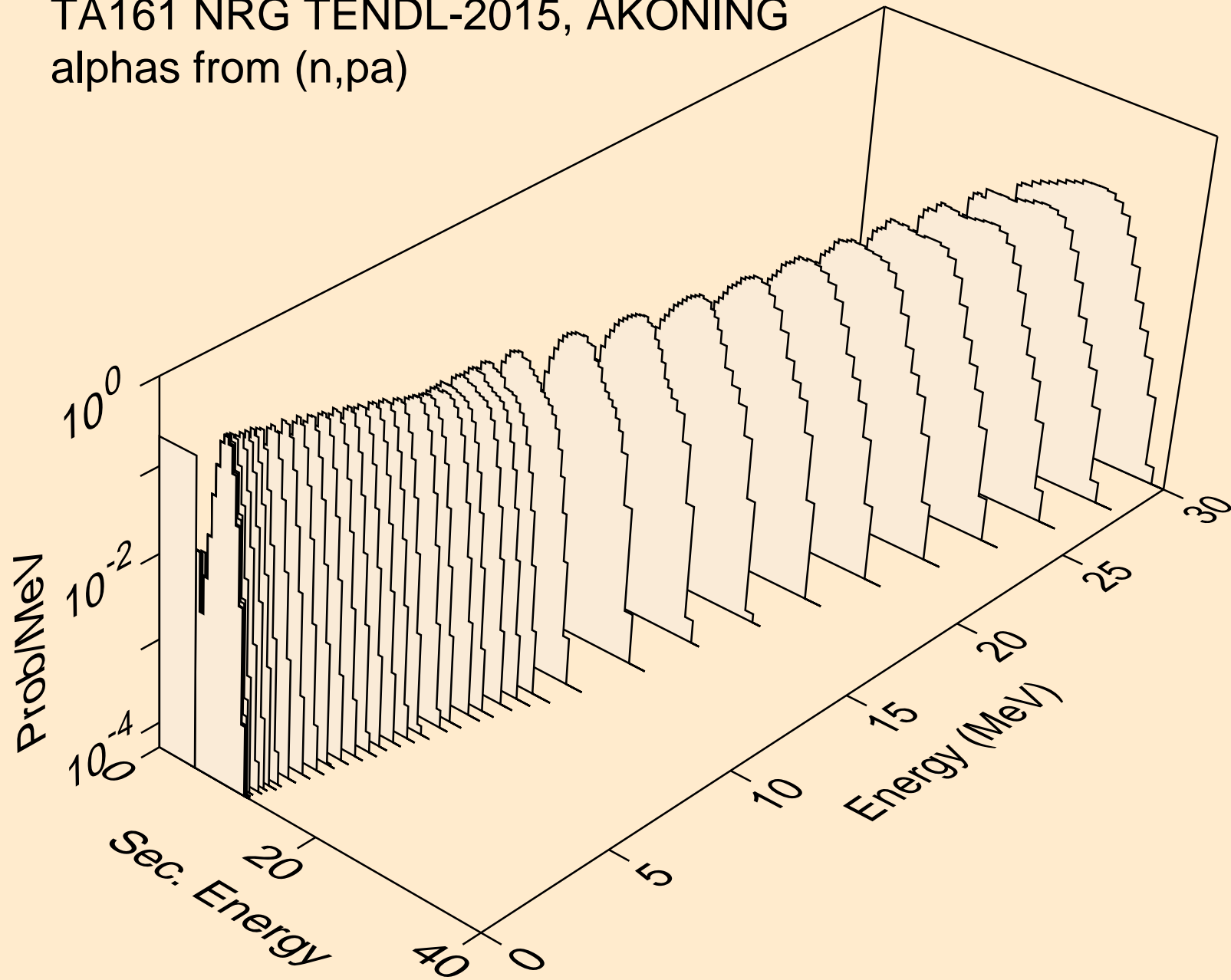

TA161 NRG TENDL-2015, AKONING
alphas from (n,t2a)

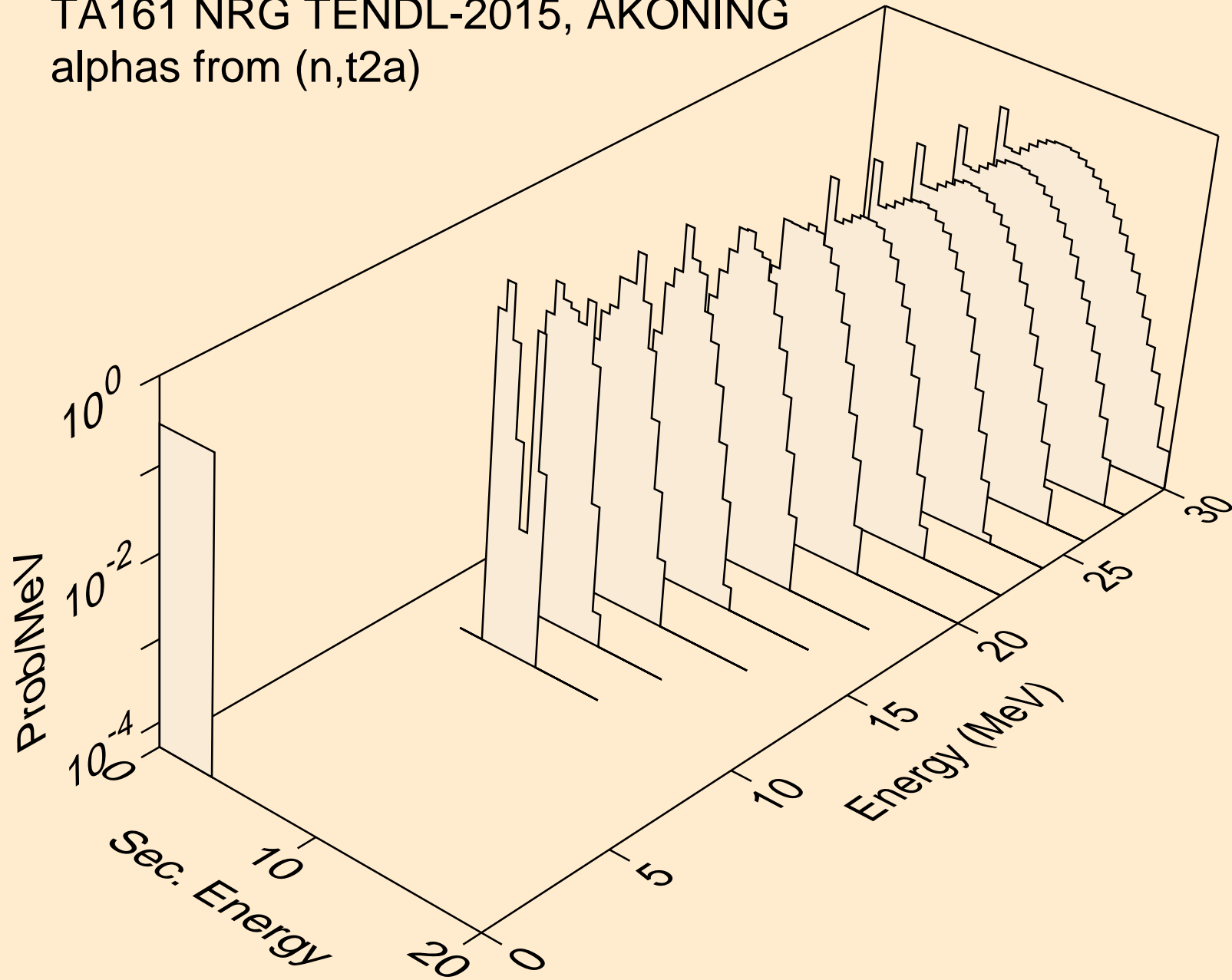

TA161 NRG TENDL-2015, AKONING
alphas from (n,d2a)

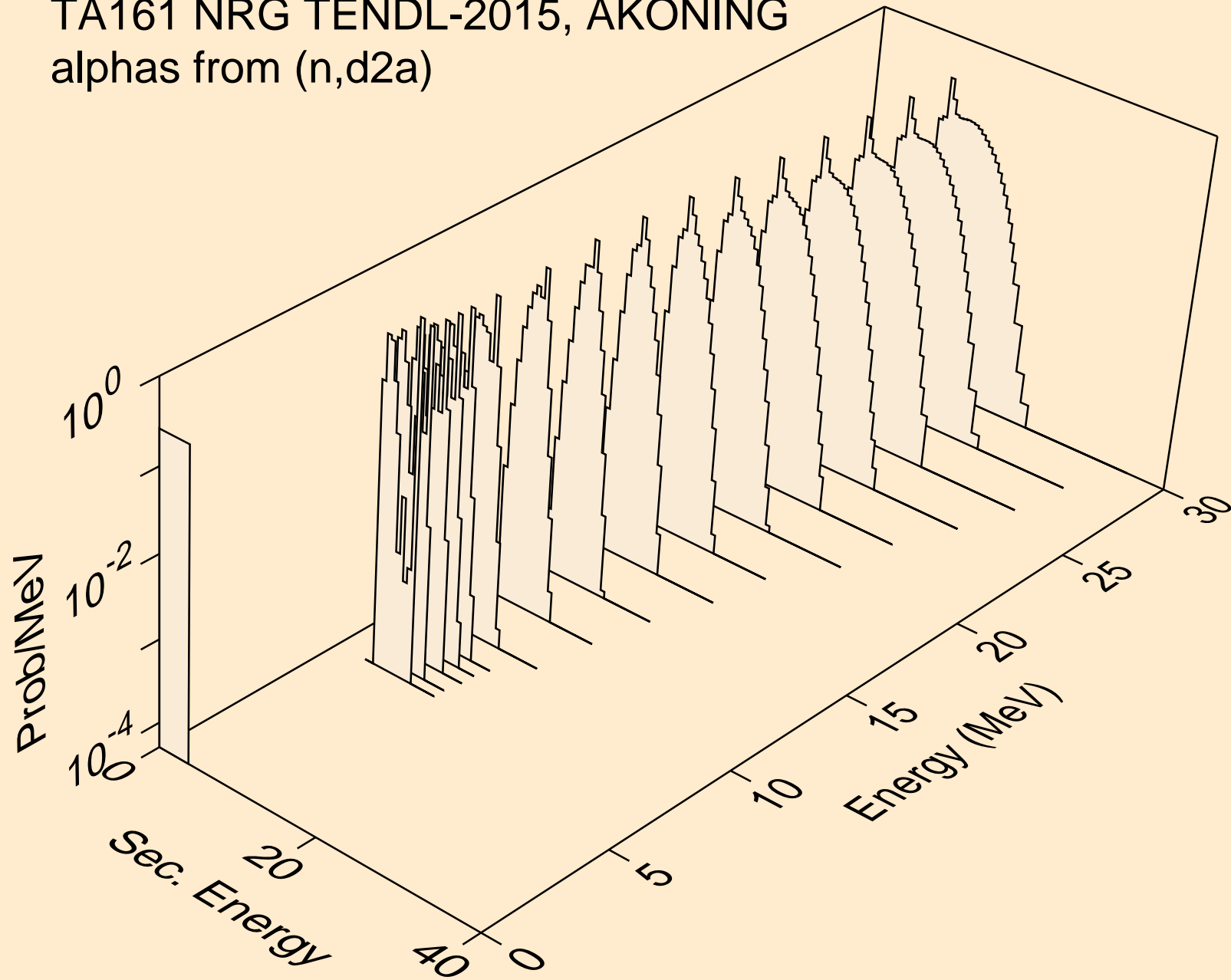

TA161 NRG TENDL-2015, AKONING
alphas from (n,da)

