

TA171 NRG TENDL-2015, AKONING

Principal cross sections

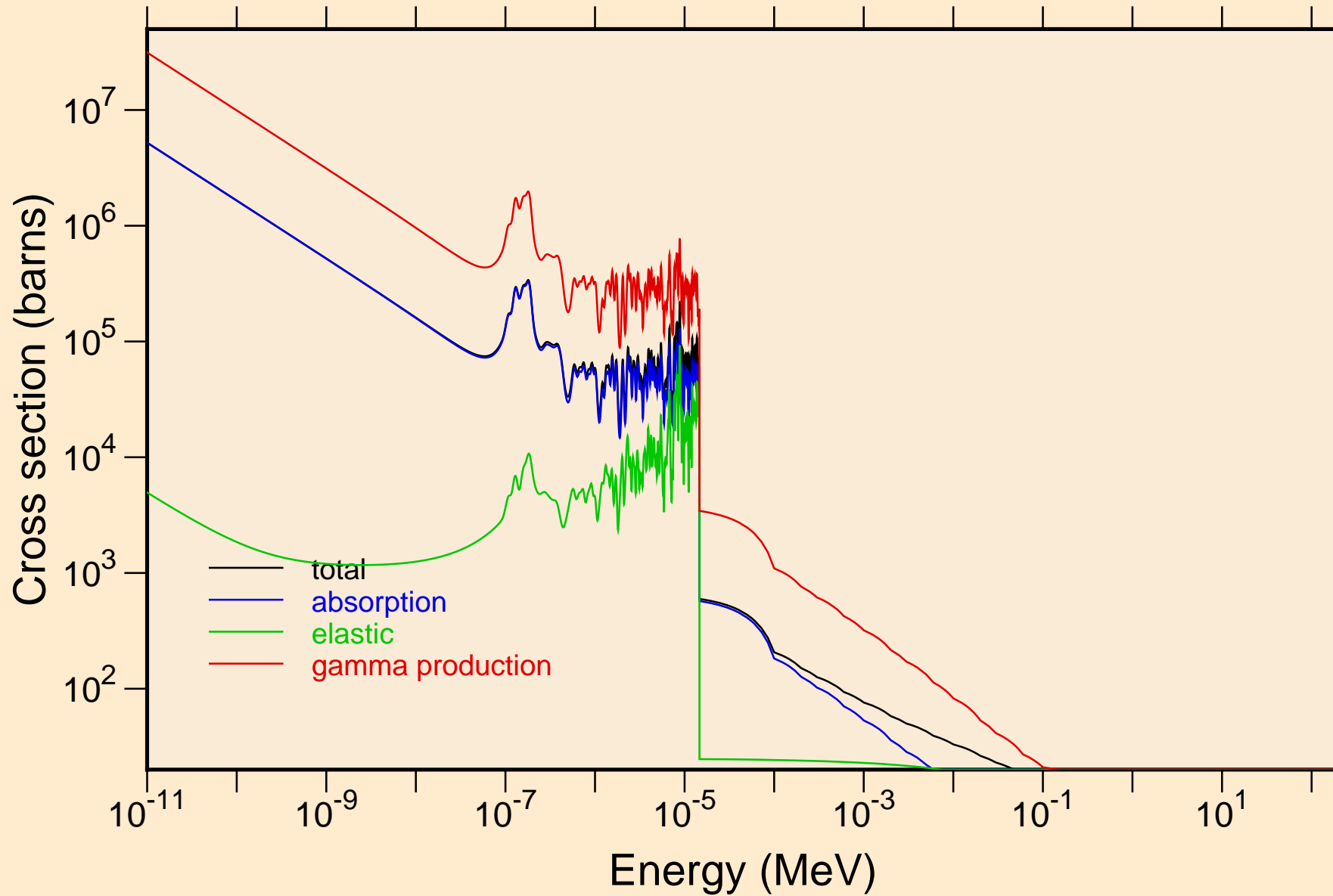

TA171 NRG TENDL-2015, AKONING
resonance total cross section

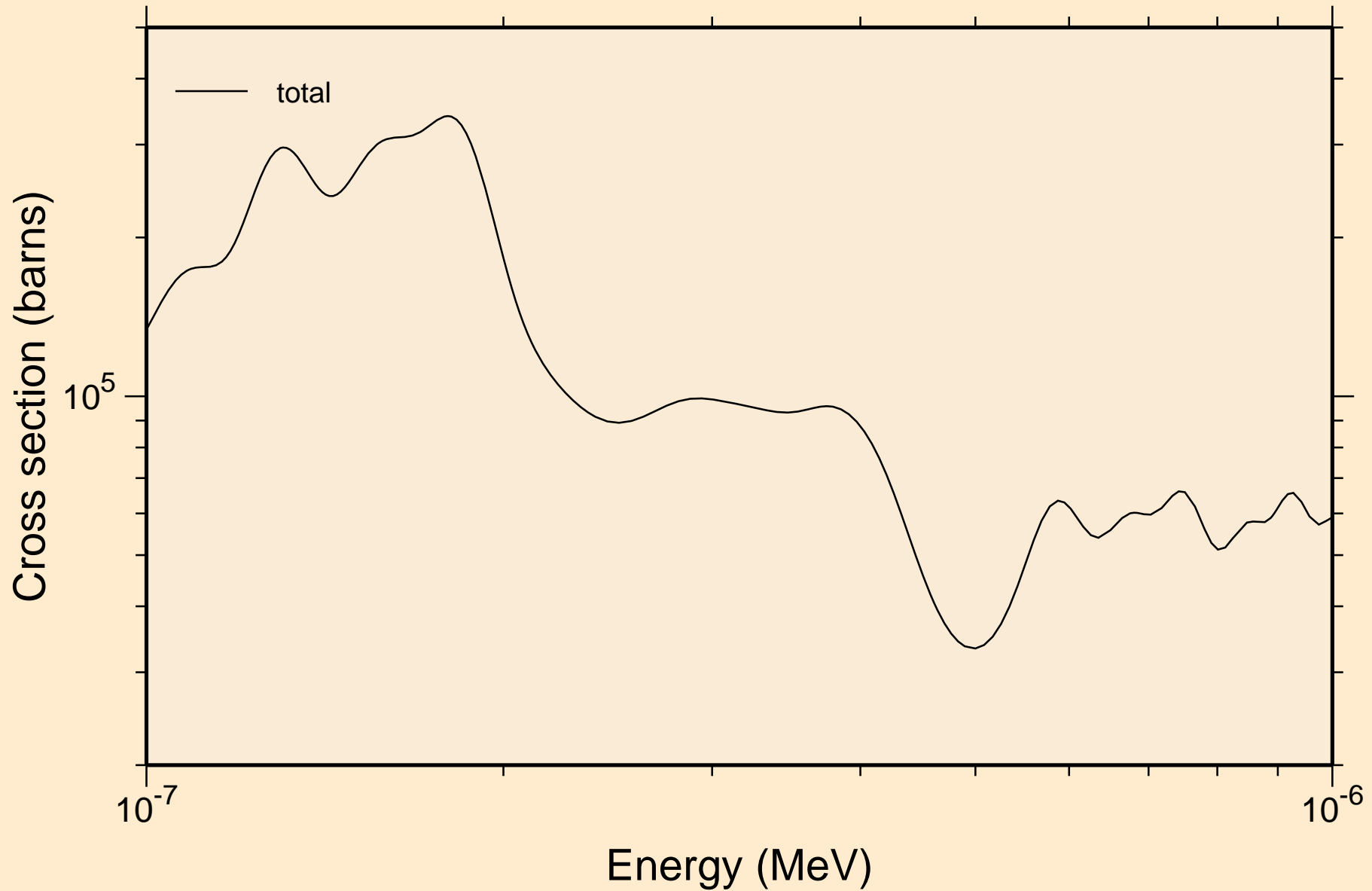

TA171 NRG TENDL-2015, AKONING
resonance total cross section

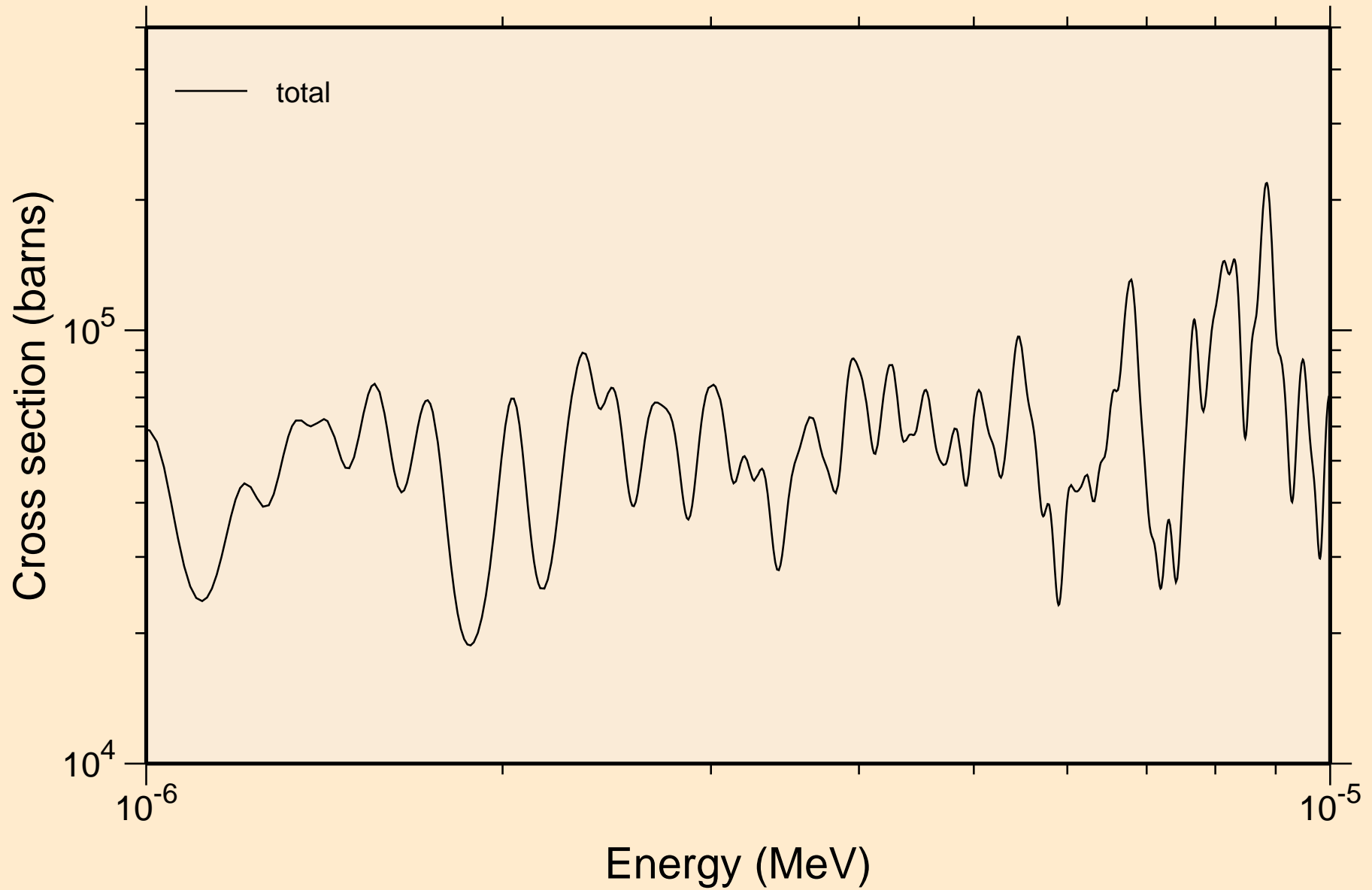

TA171 NRG TENDL-2015, AKONING
resonance total cross section

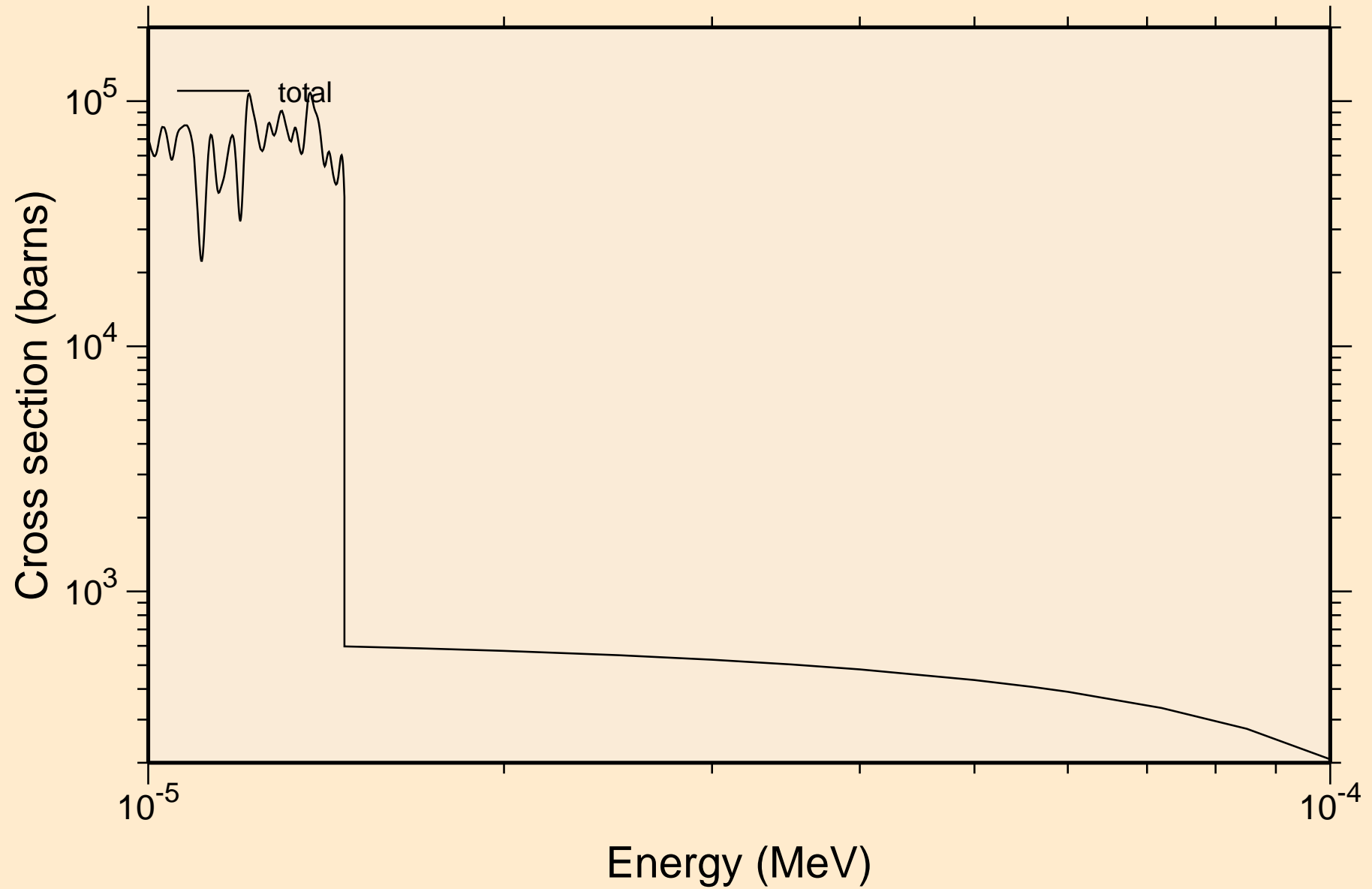

TA171 NRG TENDL-2015, AKONING
resonance total cross section

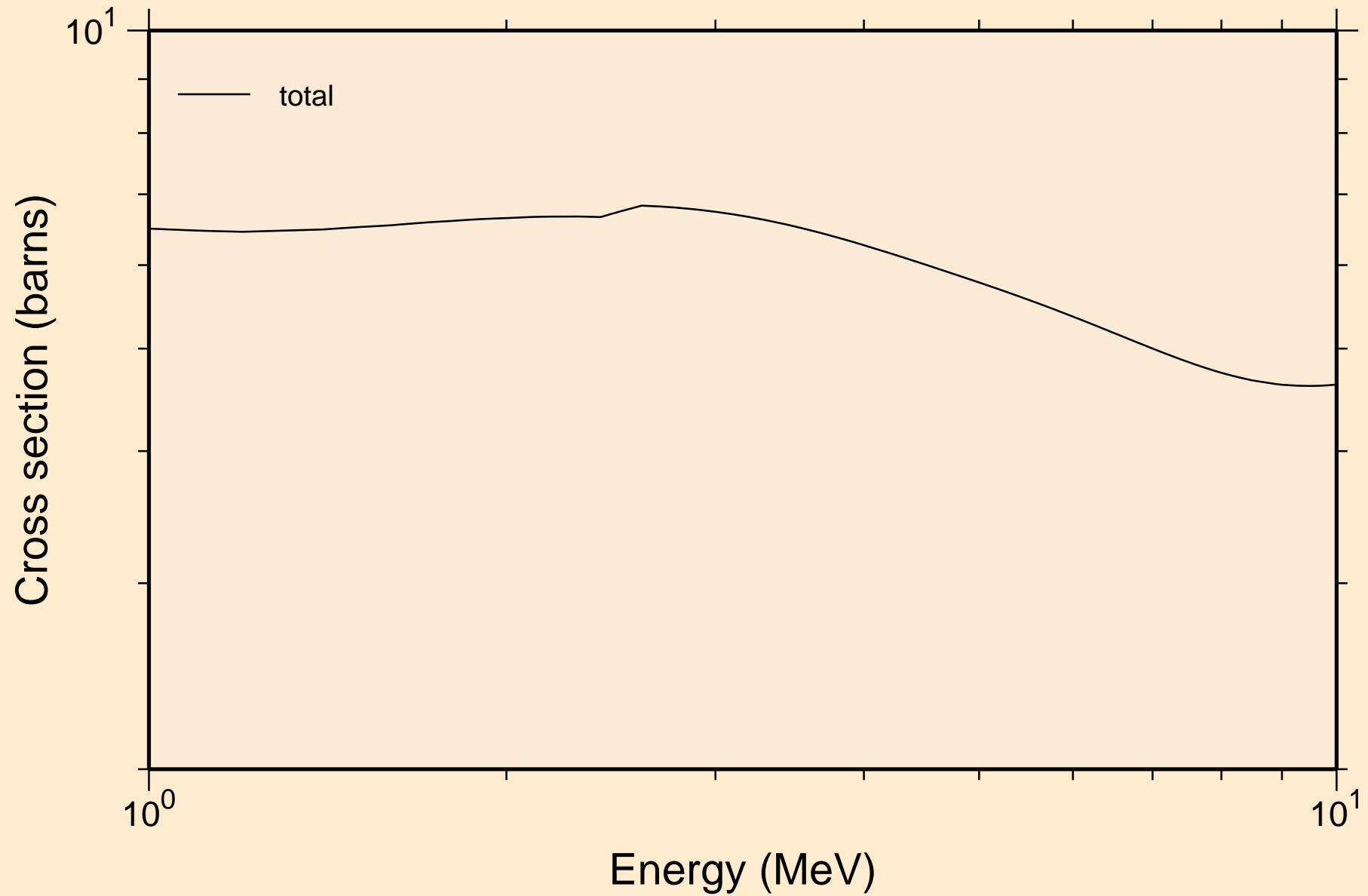

TA171 NRG TENDL-2015, AKONING
resonance absorption cross sections

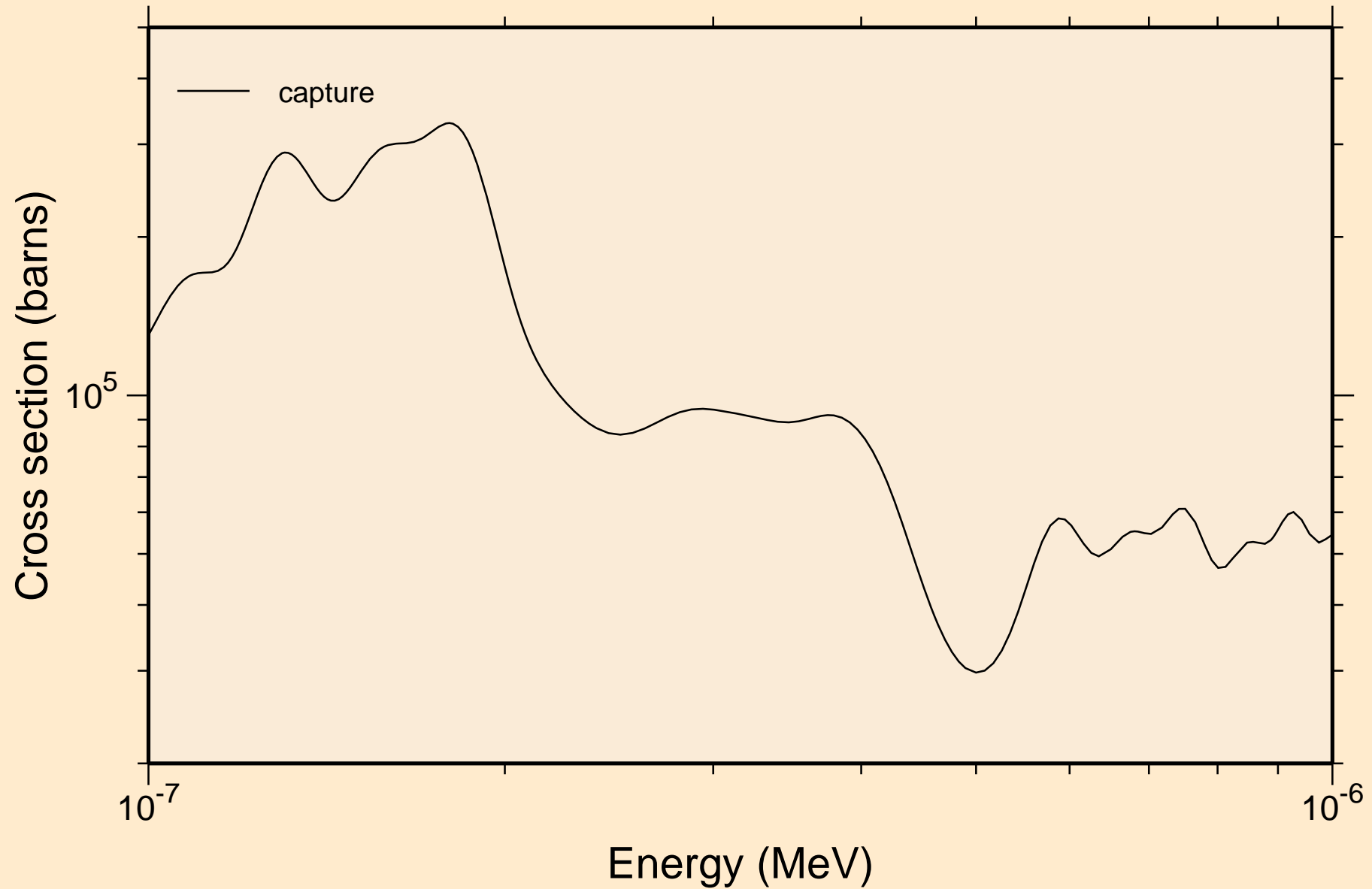

TA171 NRG TENDL-2015, AKONING
resonance absorption cross sections

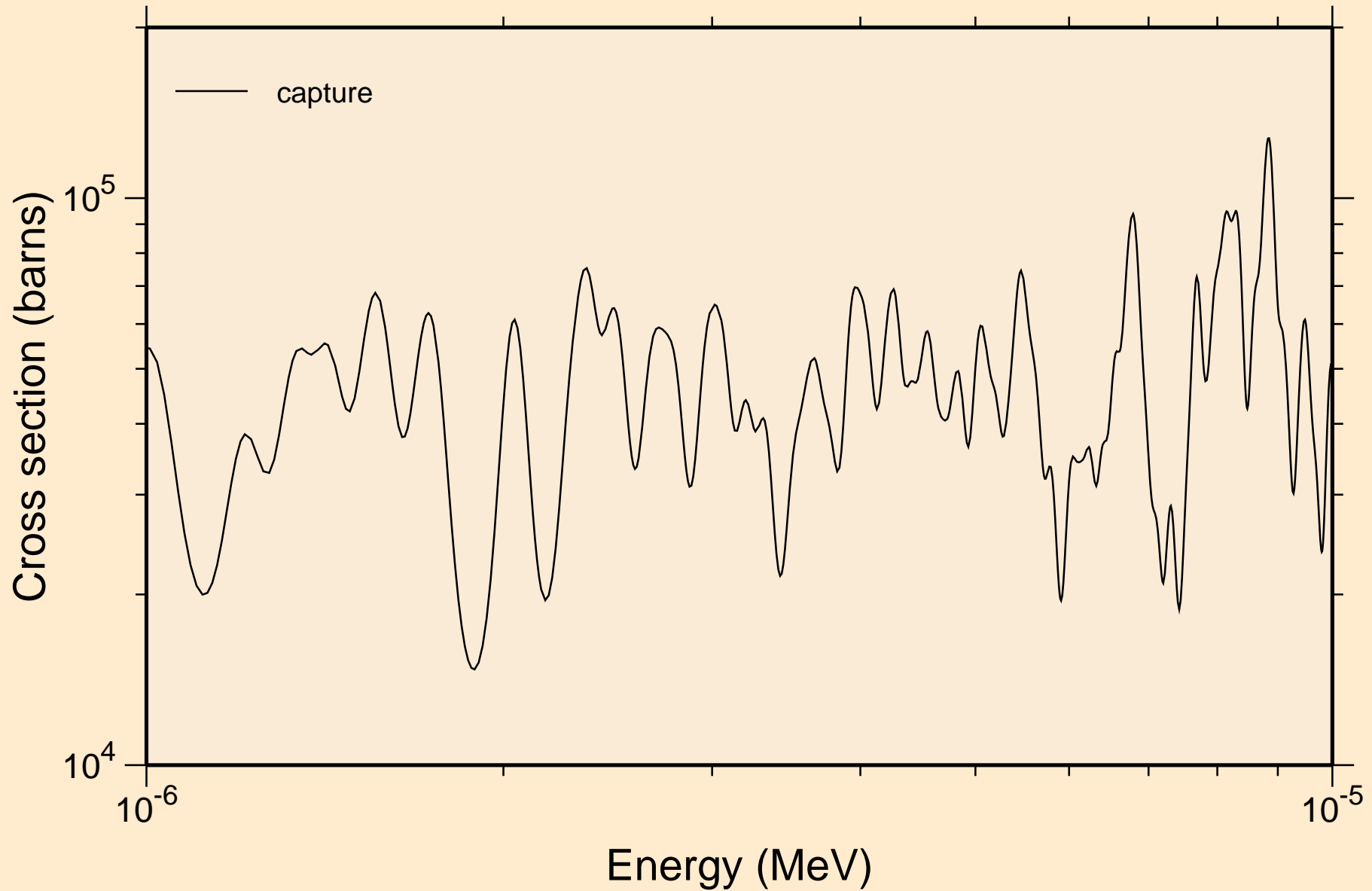

TA171 NRG TENDL-2015, AKONING
resonance absorption cross sections

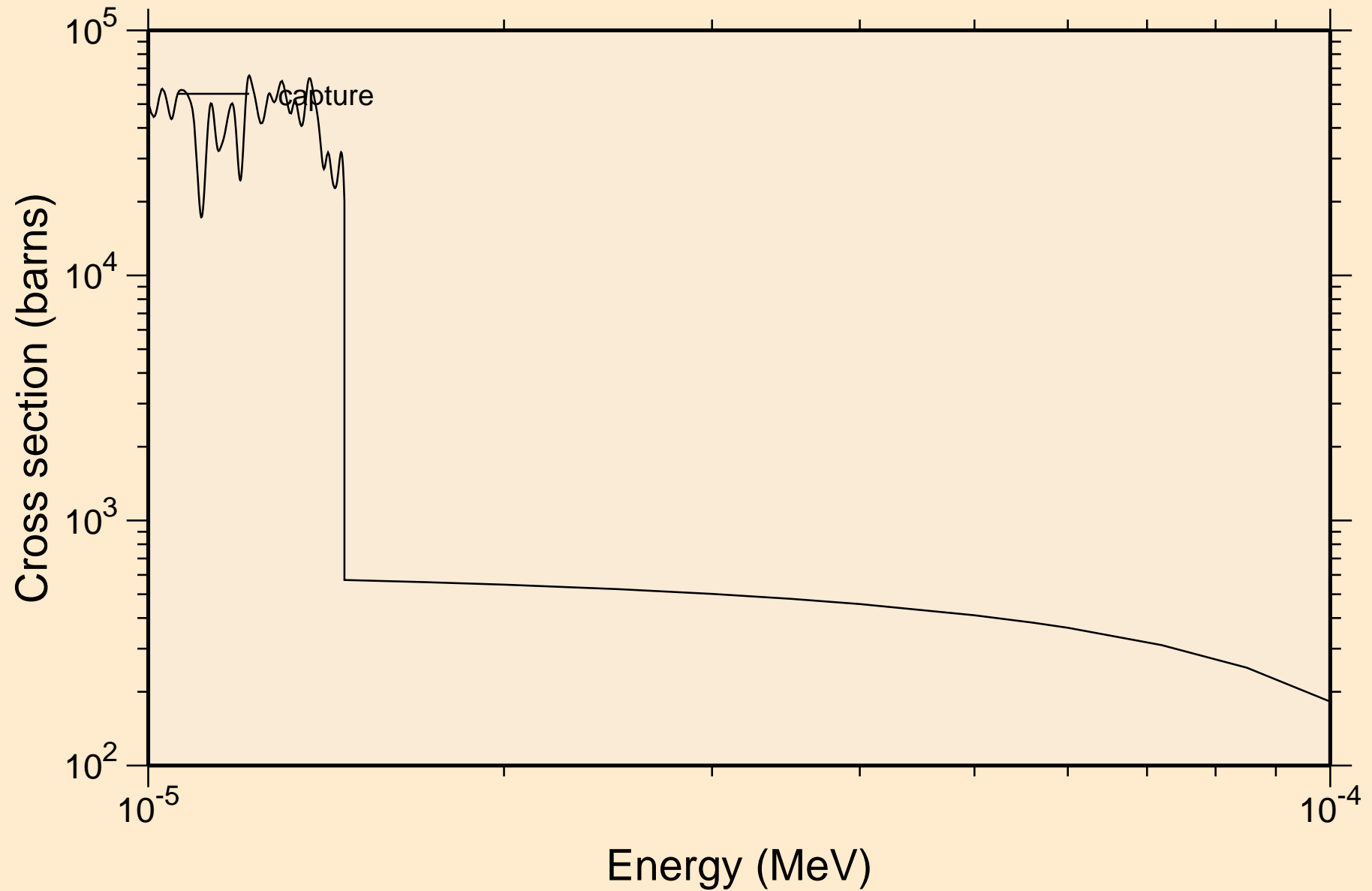

TA171 NRG TENDL-2015, AKONING
resonance absorption cross sections

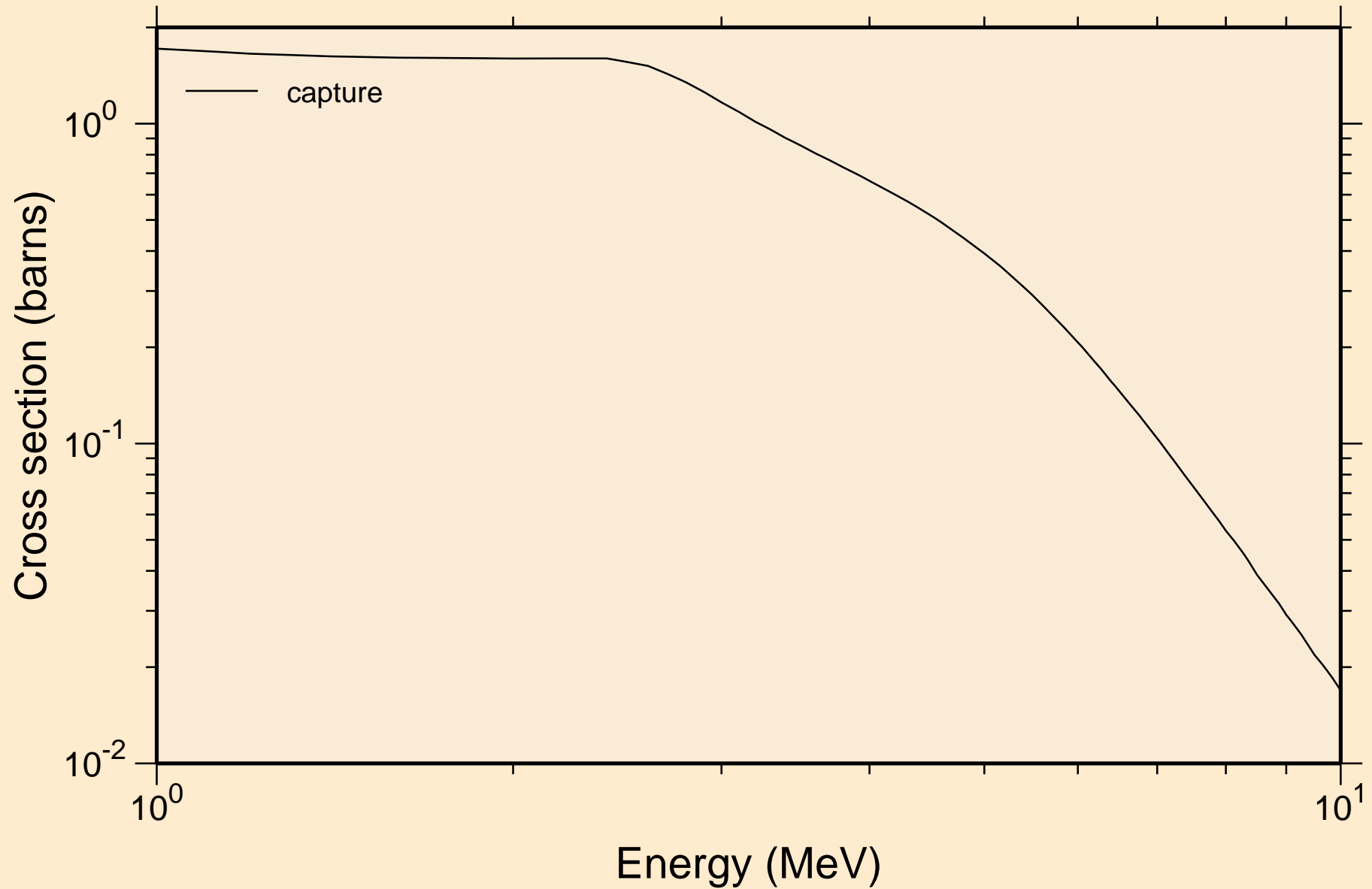

TA171 NRG TENDL-2015, AKONING
Non-threshold reactions

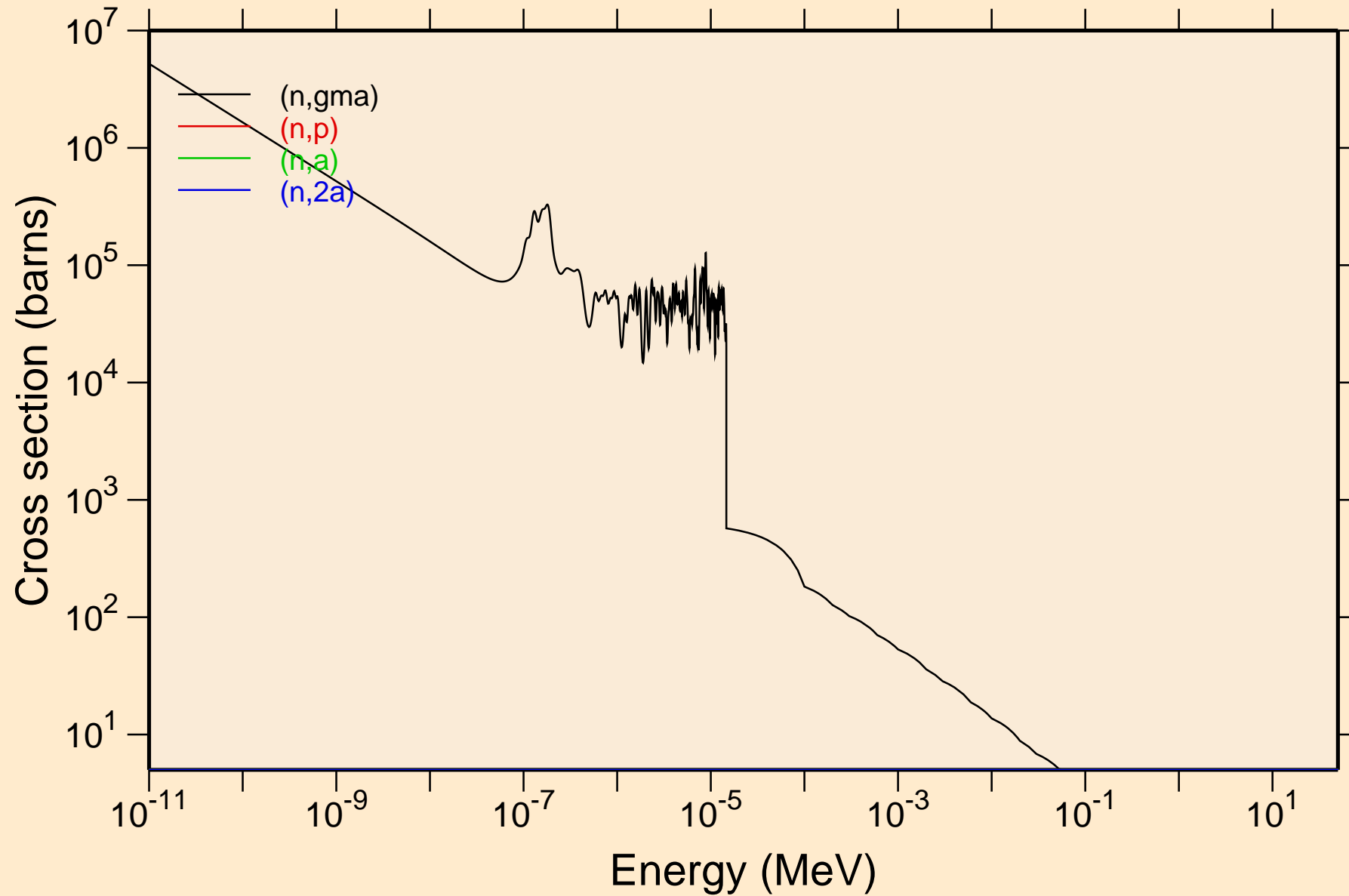

TA171 NRG TENDL-2015, AKONING

Principal cross sections

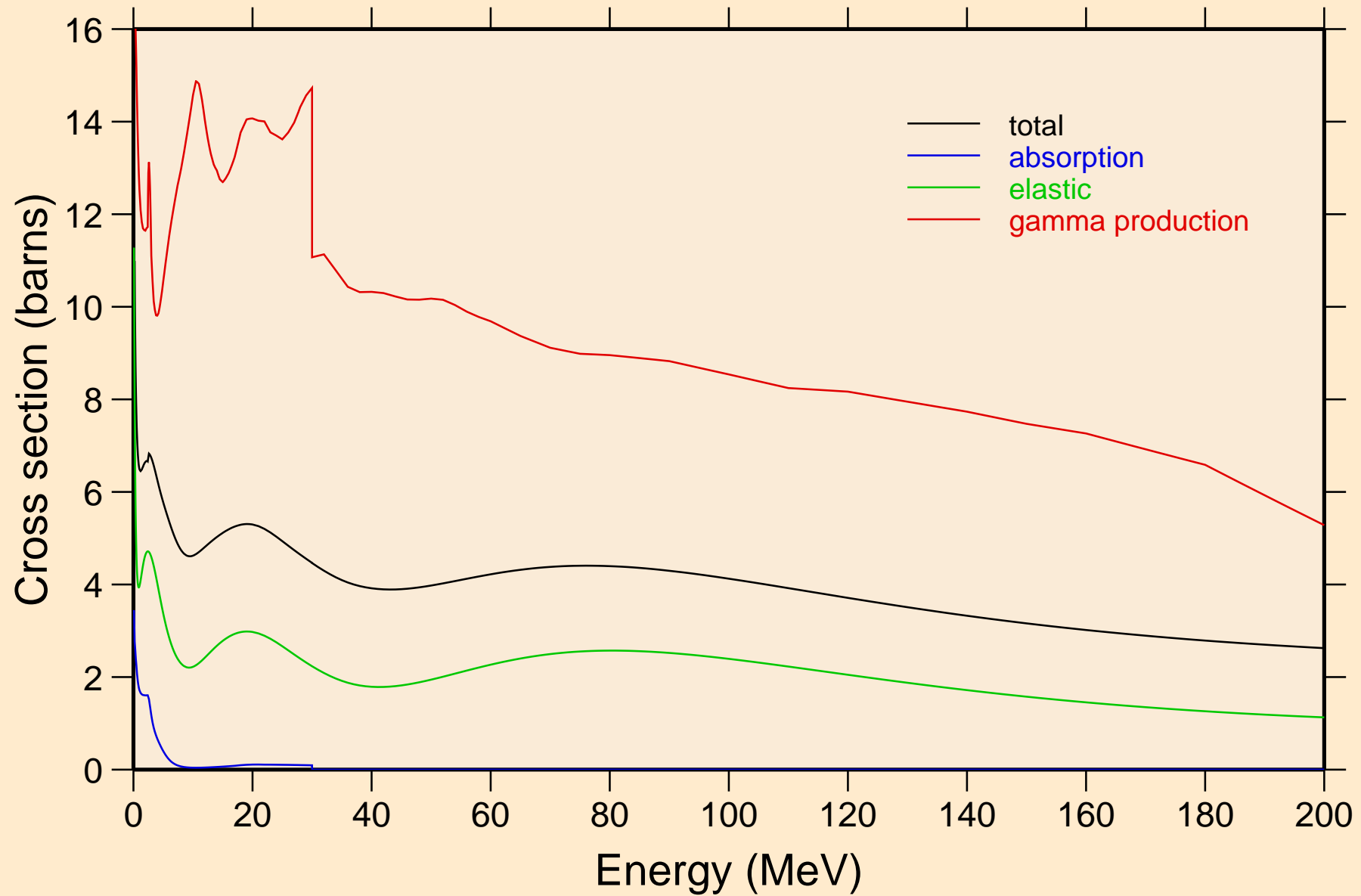

TA171 NRG TENDL-2015, AKONING
Non-threshold reactions

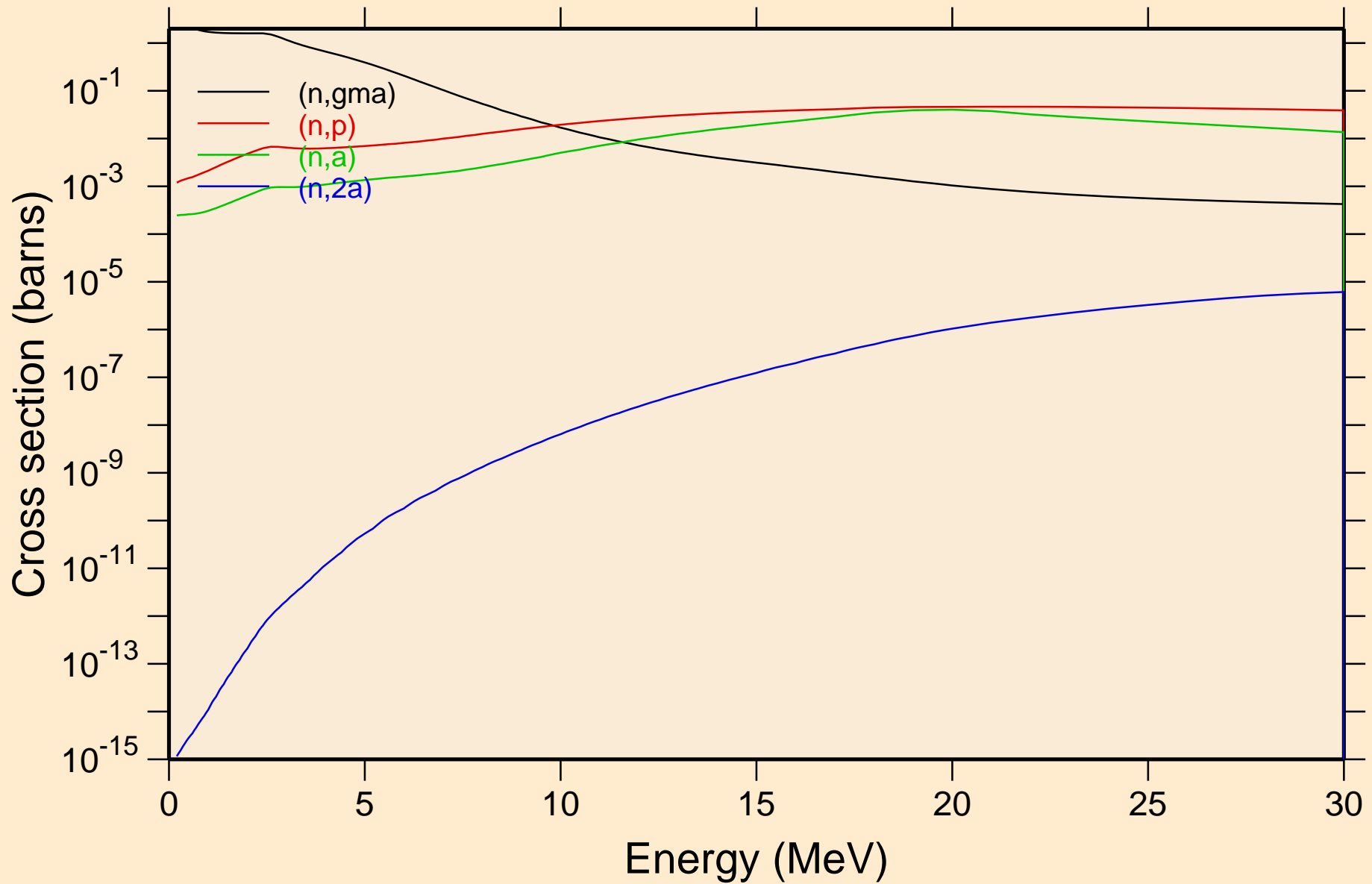

TA171 NRG TENDL-2015, AKONING

Inelastic levels

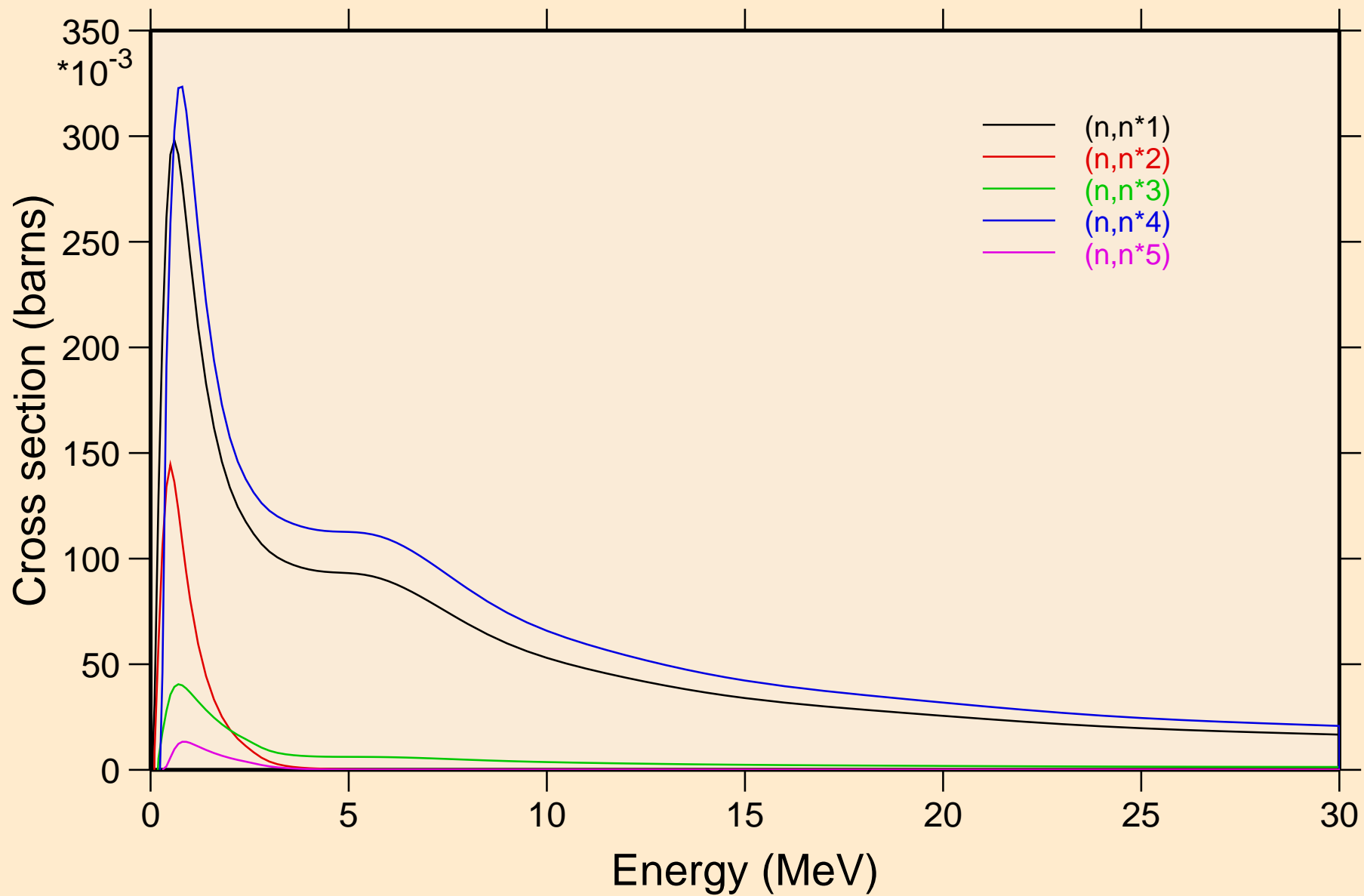

TA171 NRG TENDL-2015, AKONING

Inelastic levels

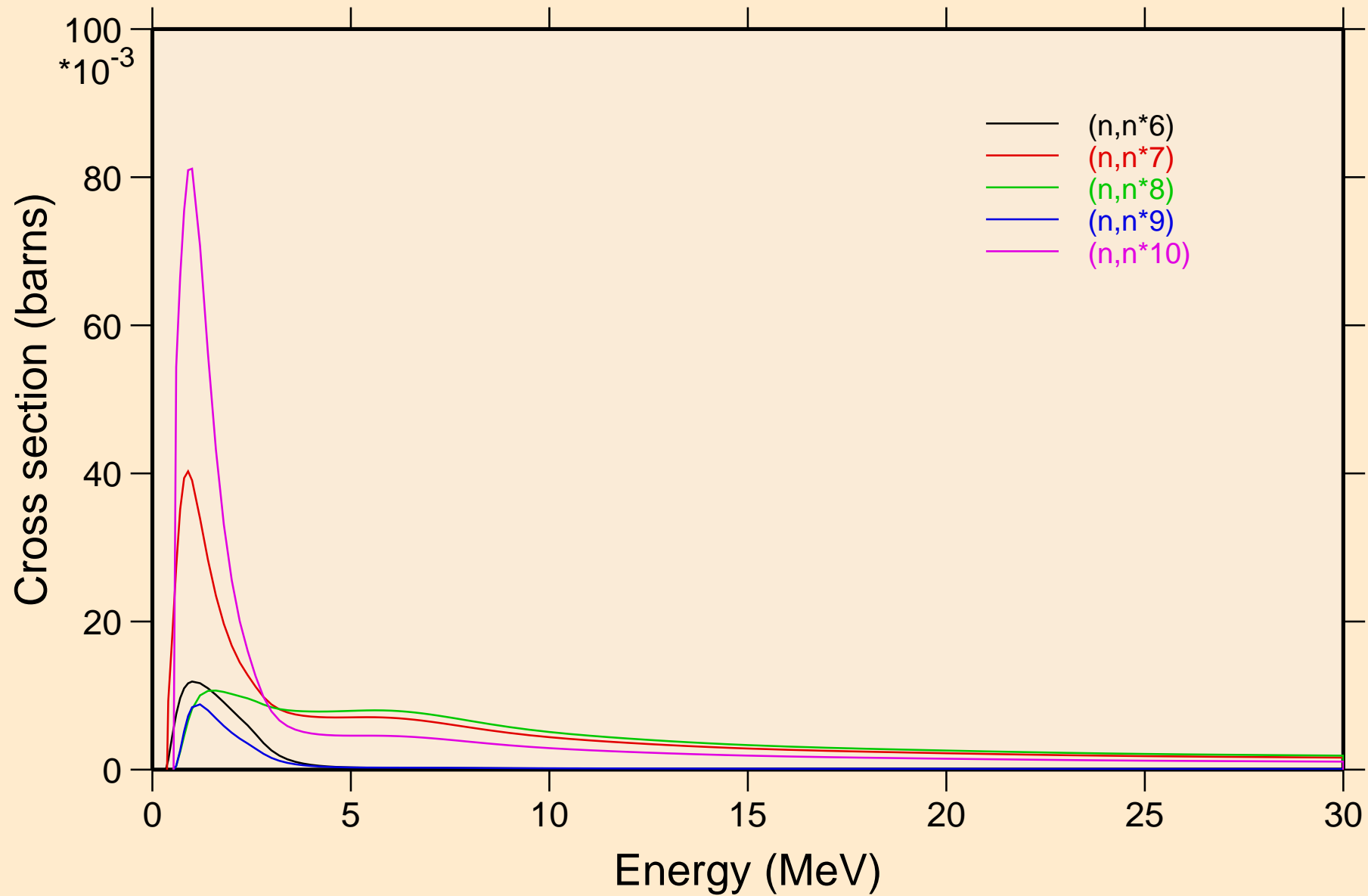

TA171 NRG TENDL-2015, AKONING

Threshold reactions

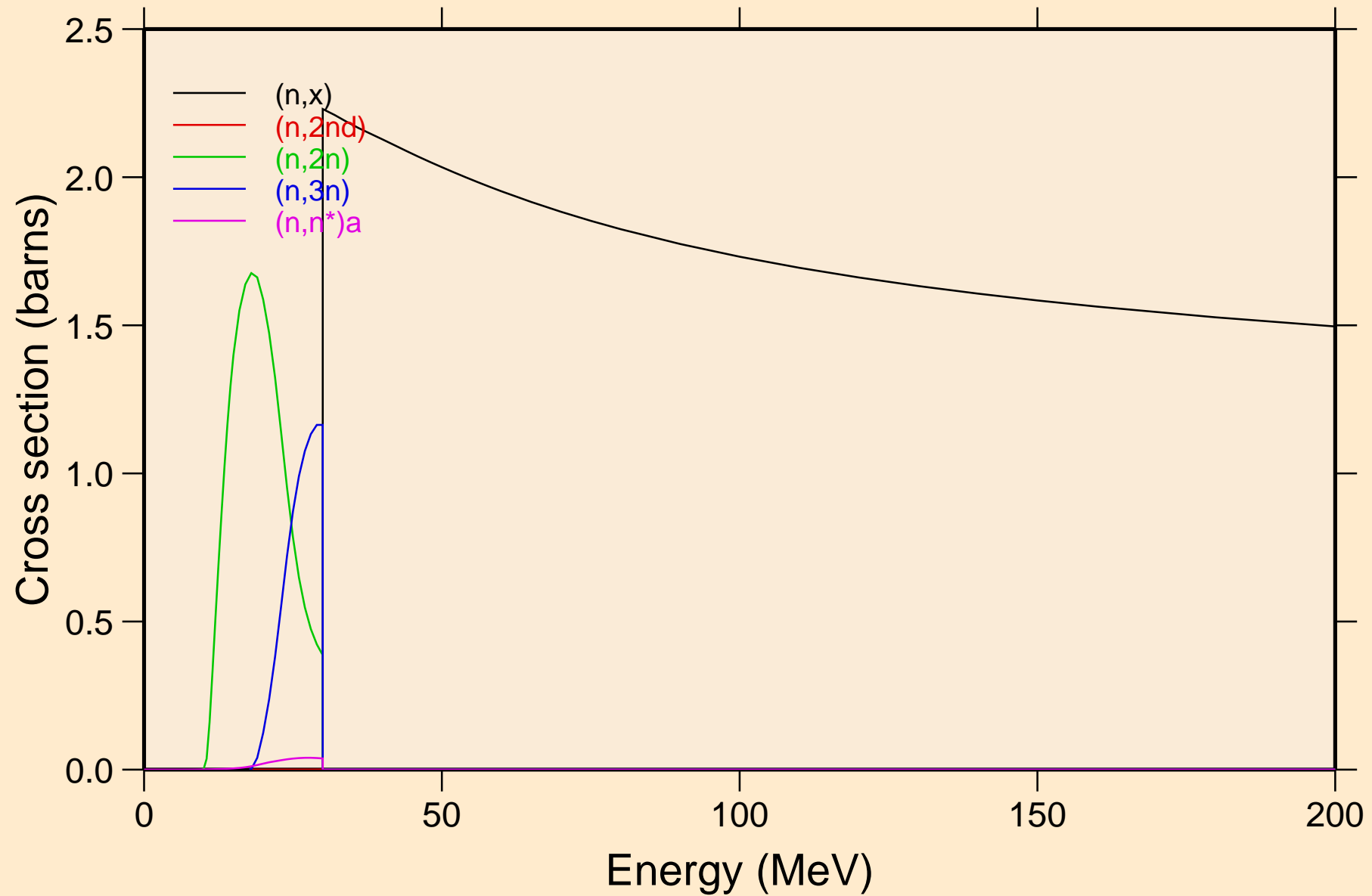

TA171 NRG TENDL-2015, AKONING

Threshold reactions

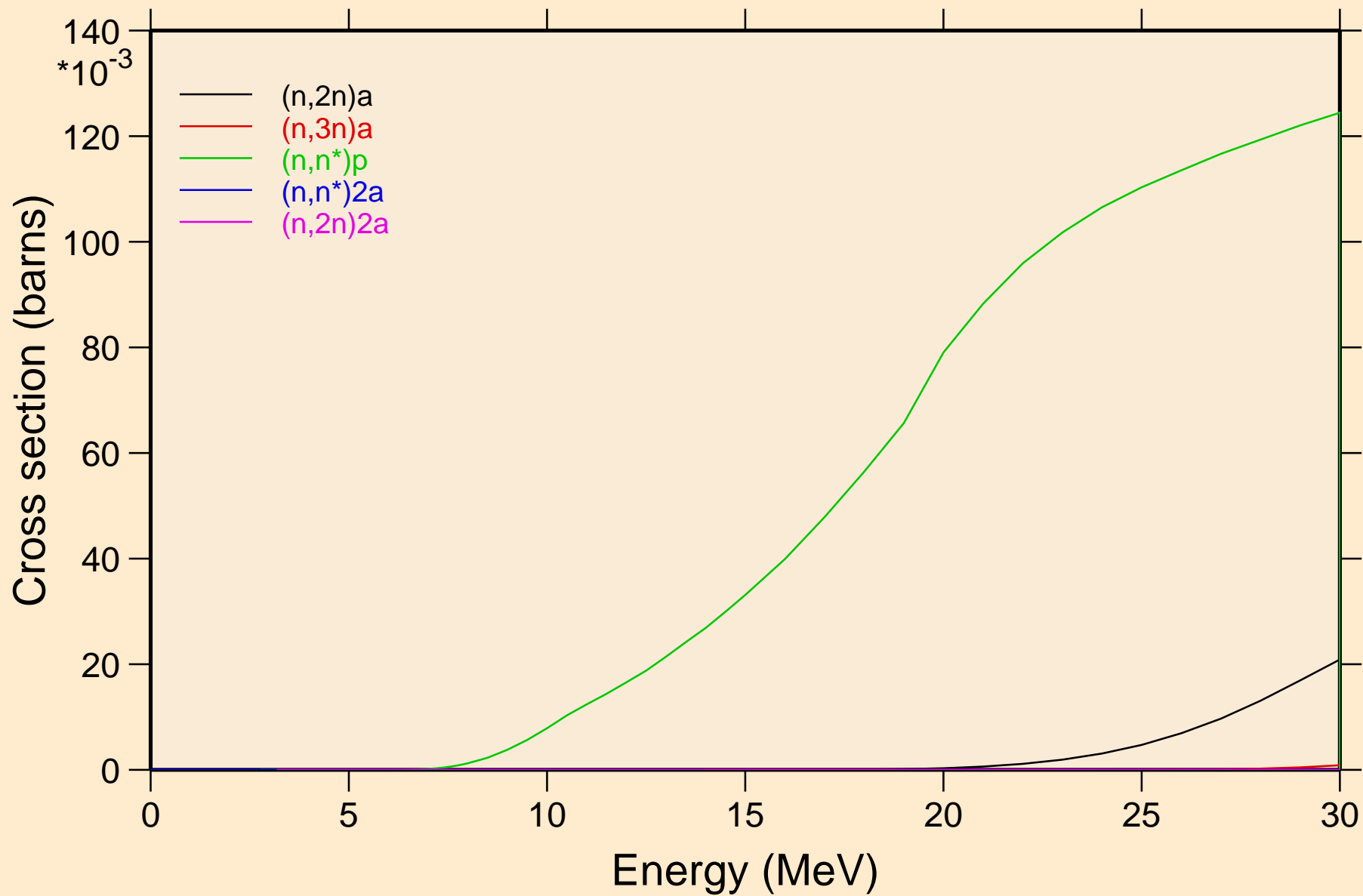

TA171 NRG TENDL-2015, AKONING

Threshold reactions

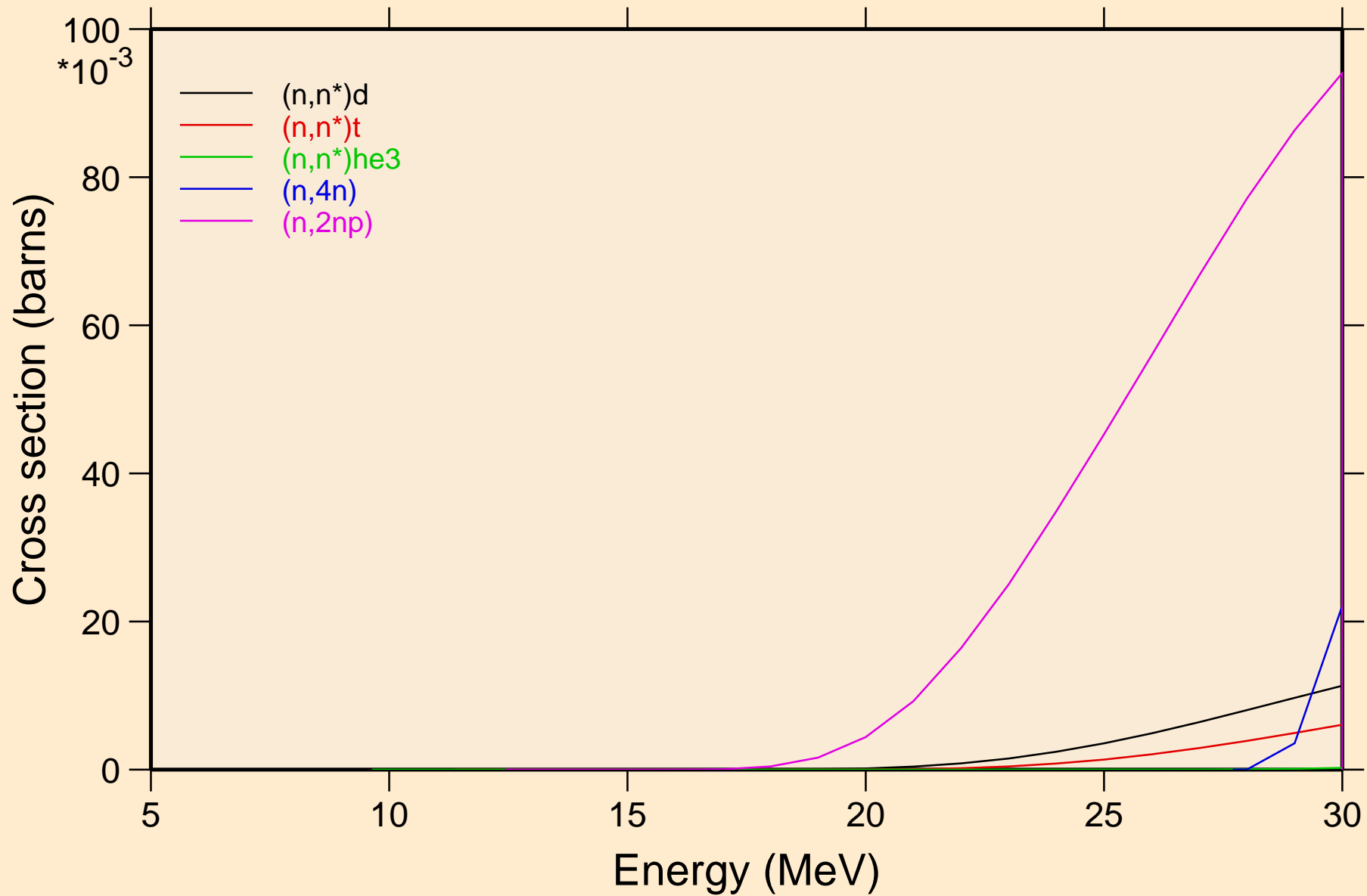

TA171 NRG TENDL-2015, AKONING

Threshold reactions

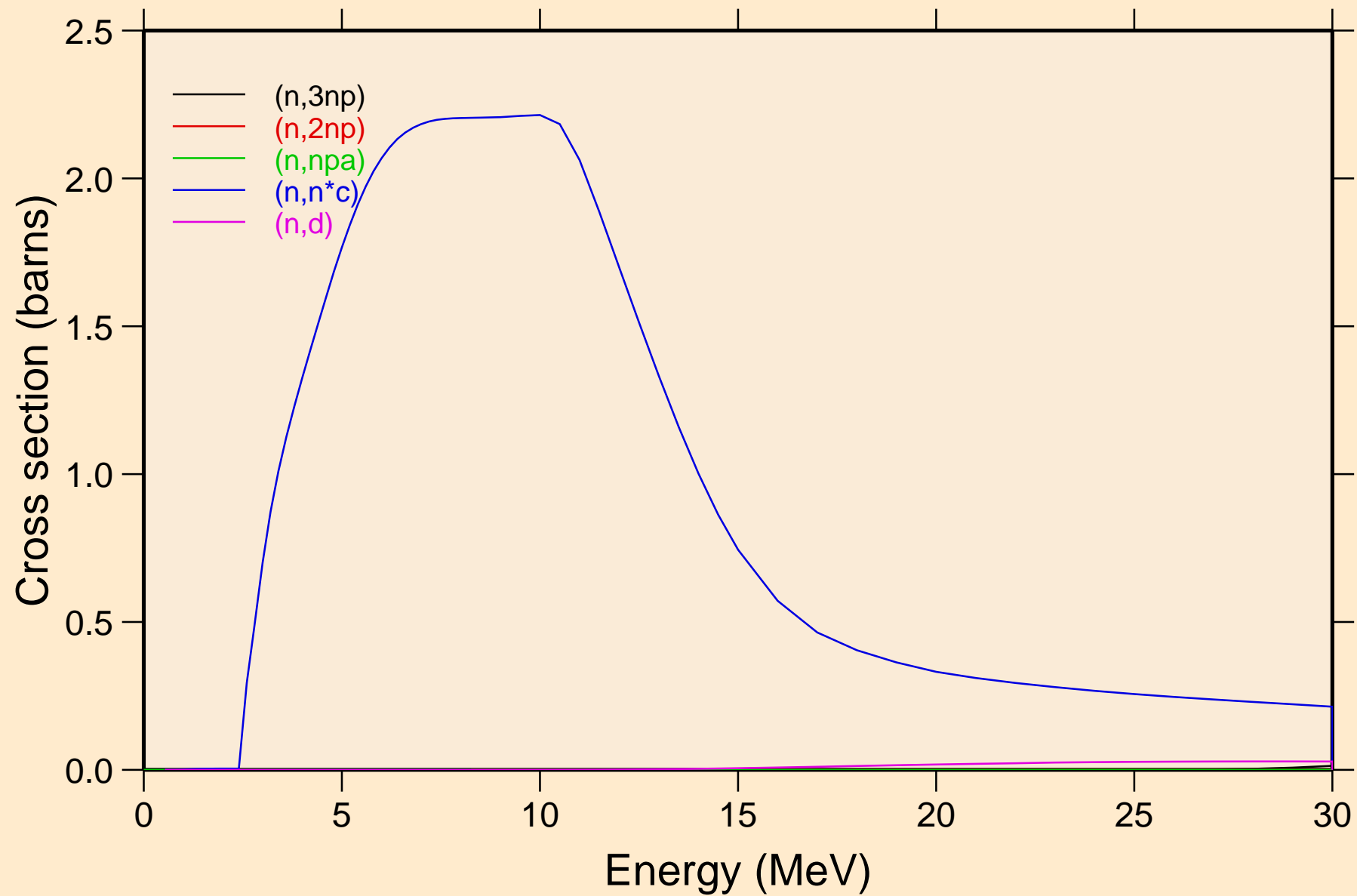

TA171 NRG TENDL-2015, AKONING

Threshold reactions

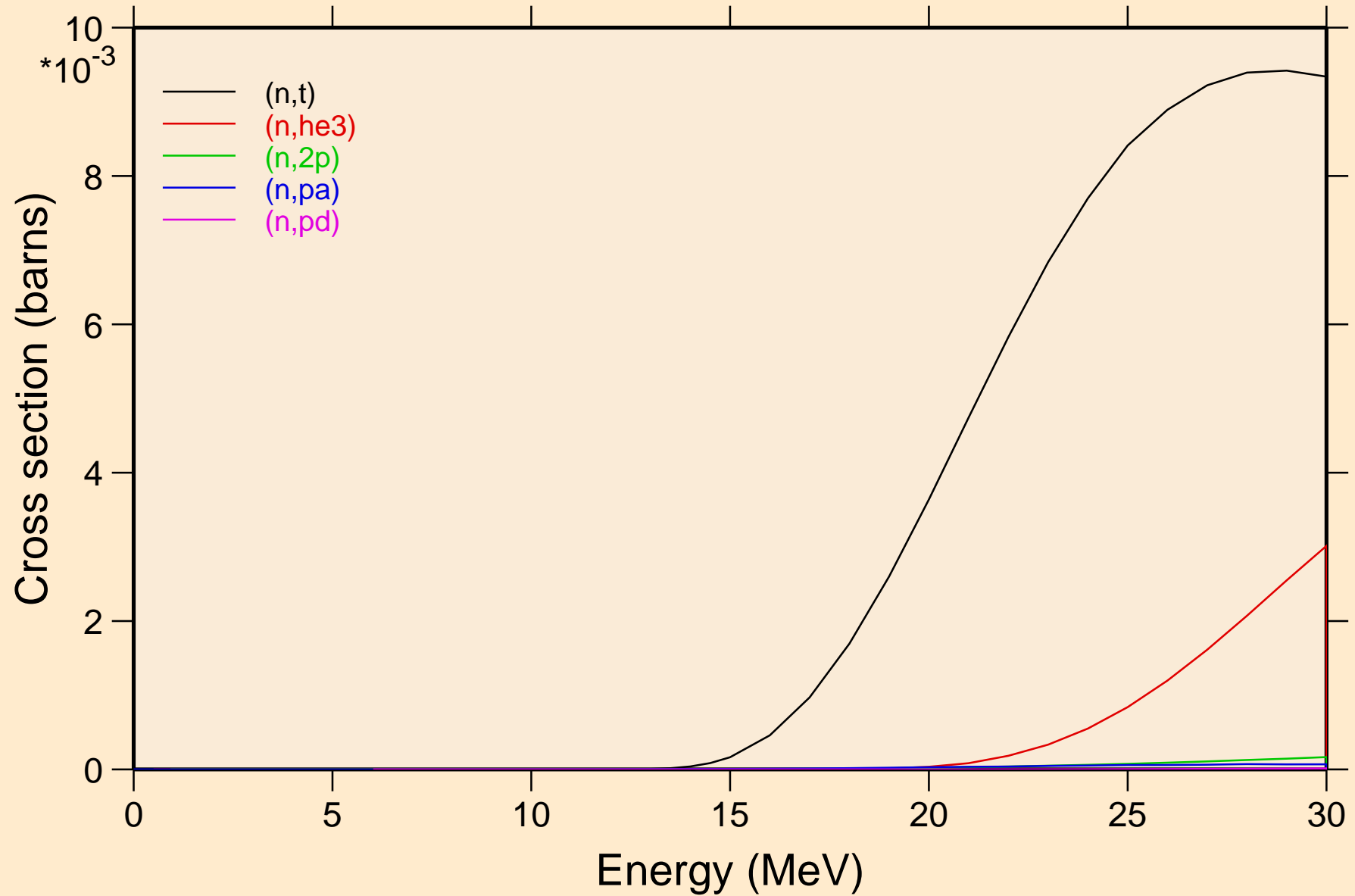

TA171 NRG TENDL-2015, AKONING

Threshold reactions

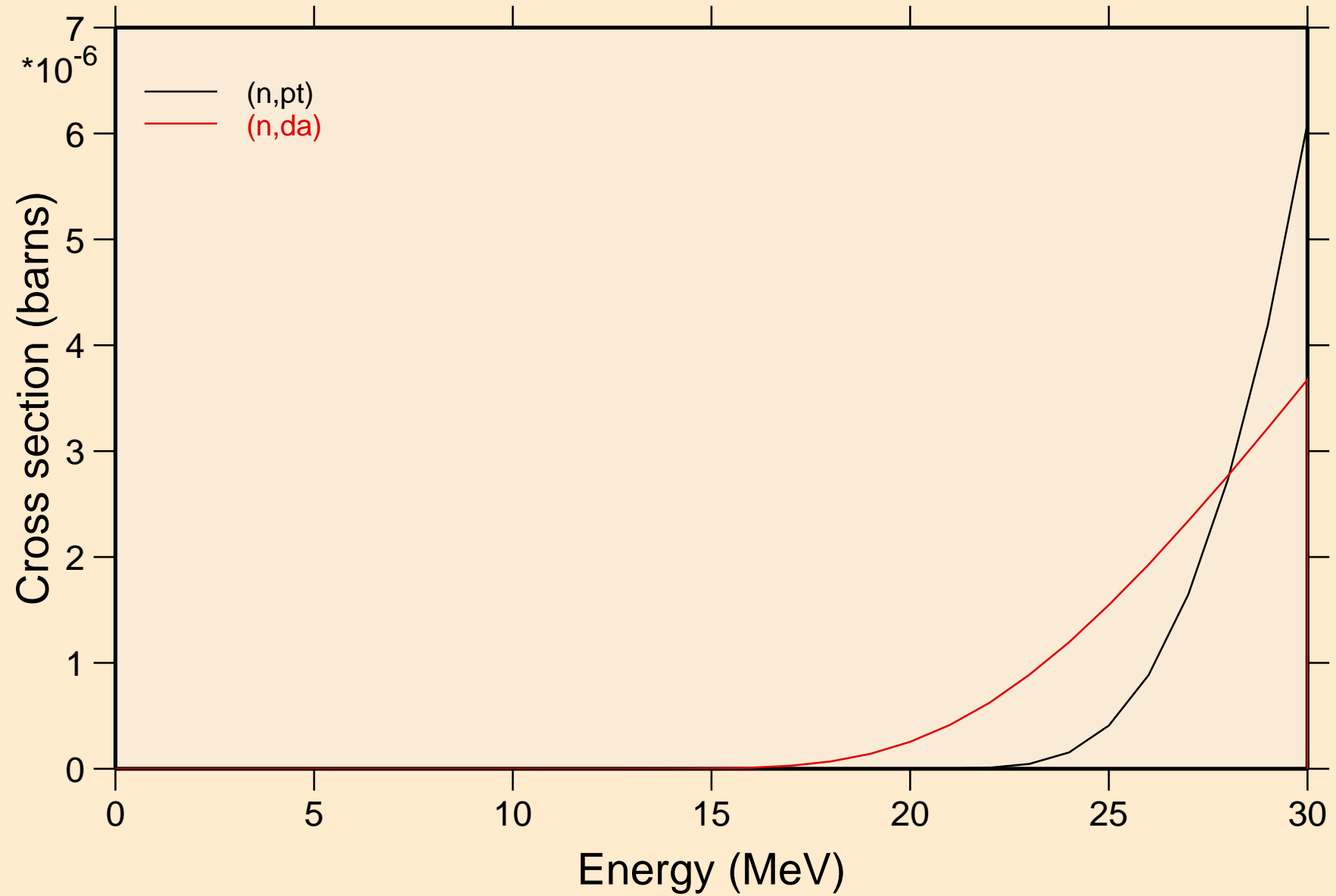

TA171 NRG TENDL-2015, AKONING
angular distribution for elastic

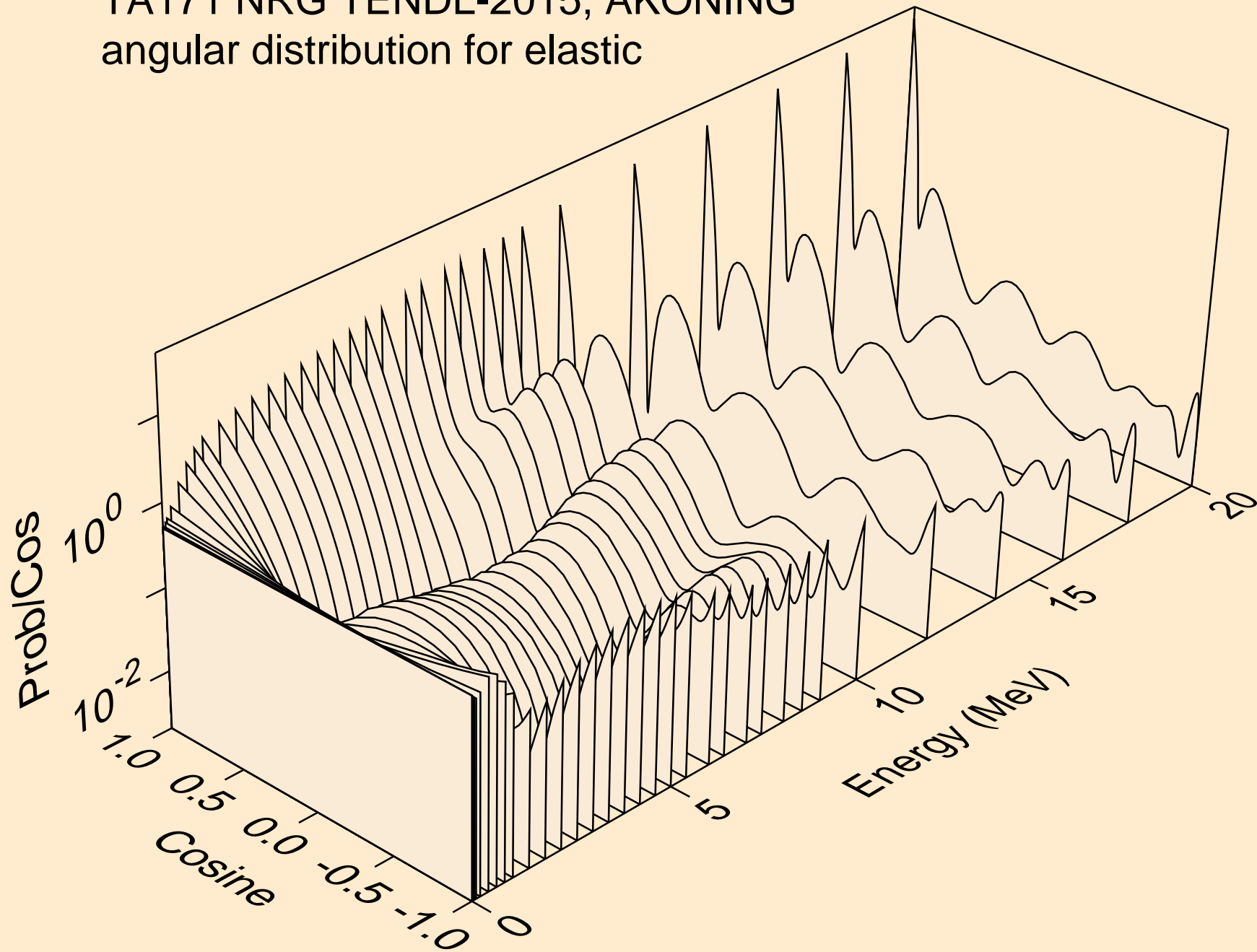

TA171 NRG TENDL-2015, AKONING
angular distribution for elastic

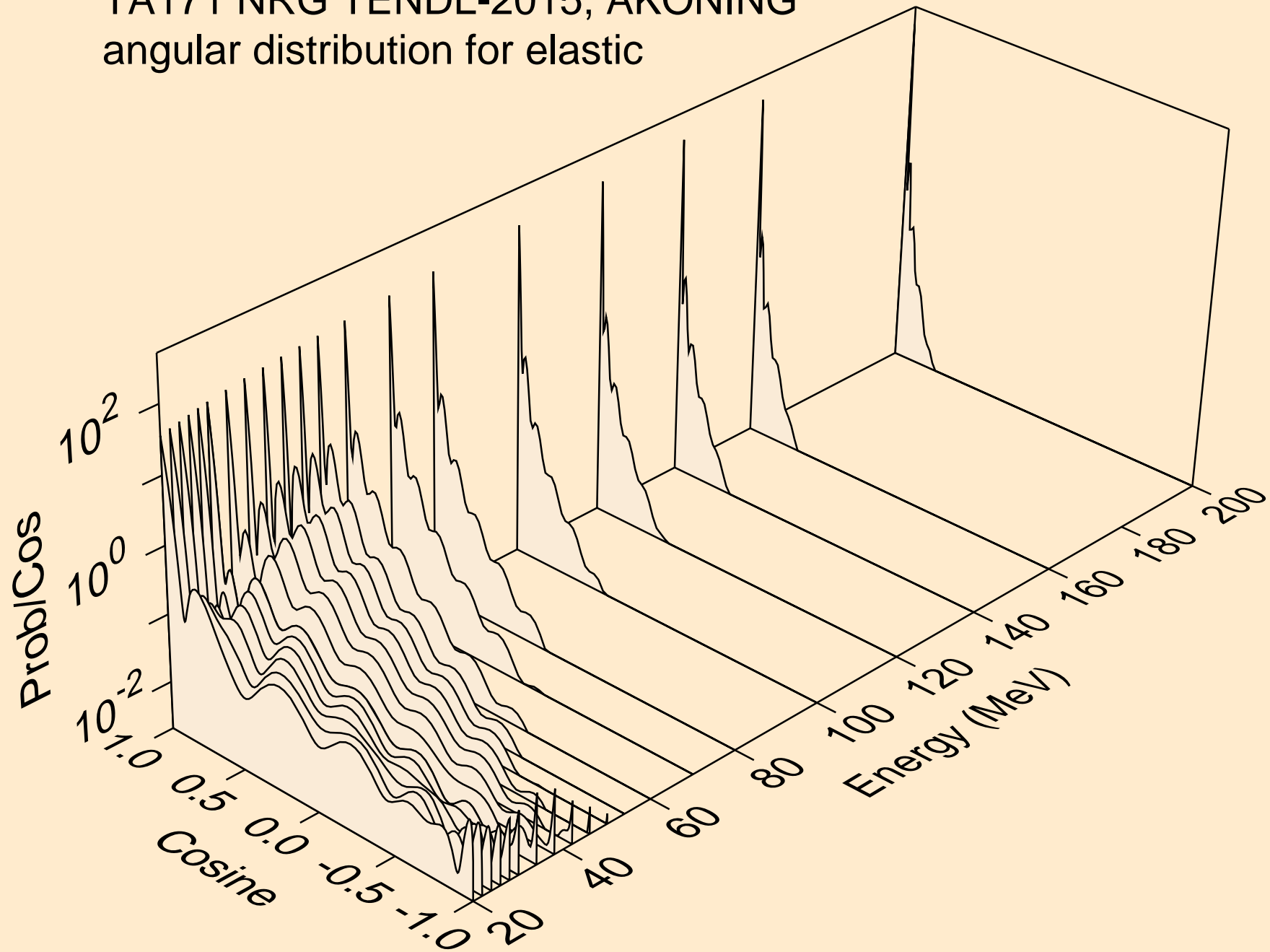

TA171 NRG TENDL-2015, AKONING
angular distribution for (n,n*1)

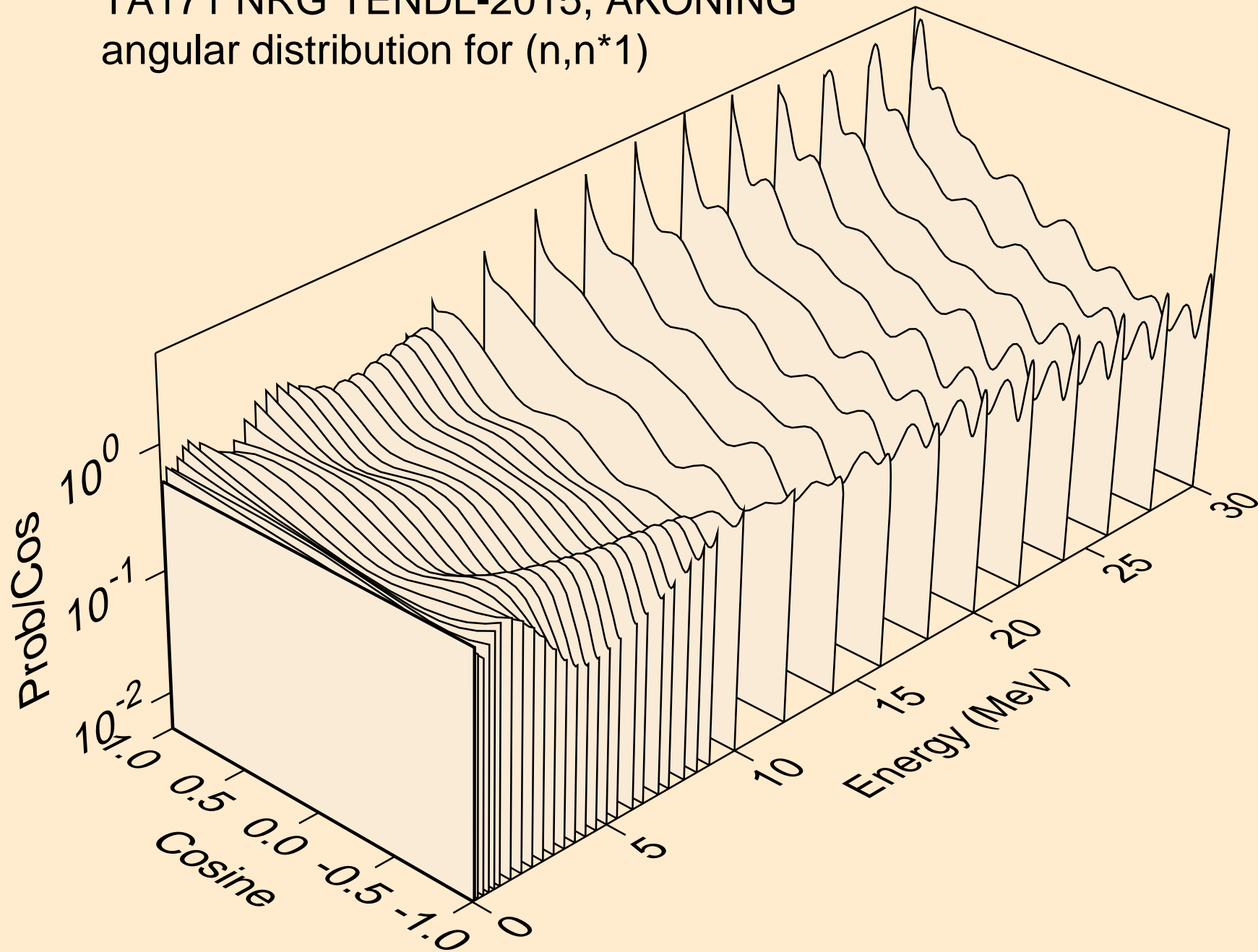

TA171 NRG TENDL-2015, AKONING
angular distribution for (n,n*2)

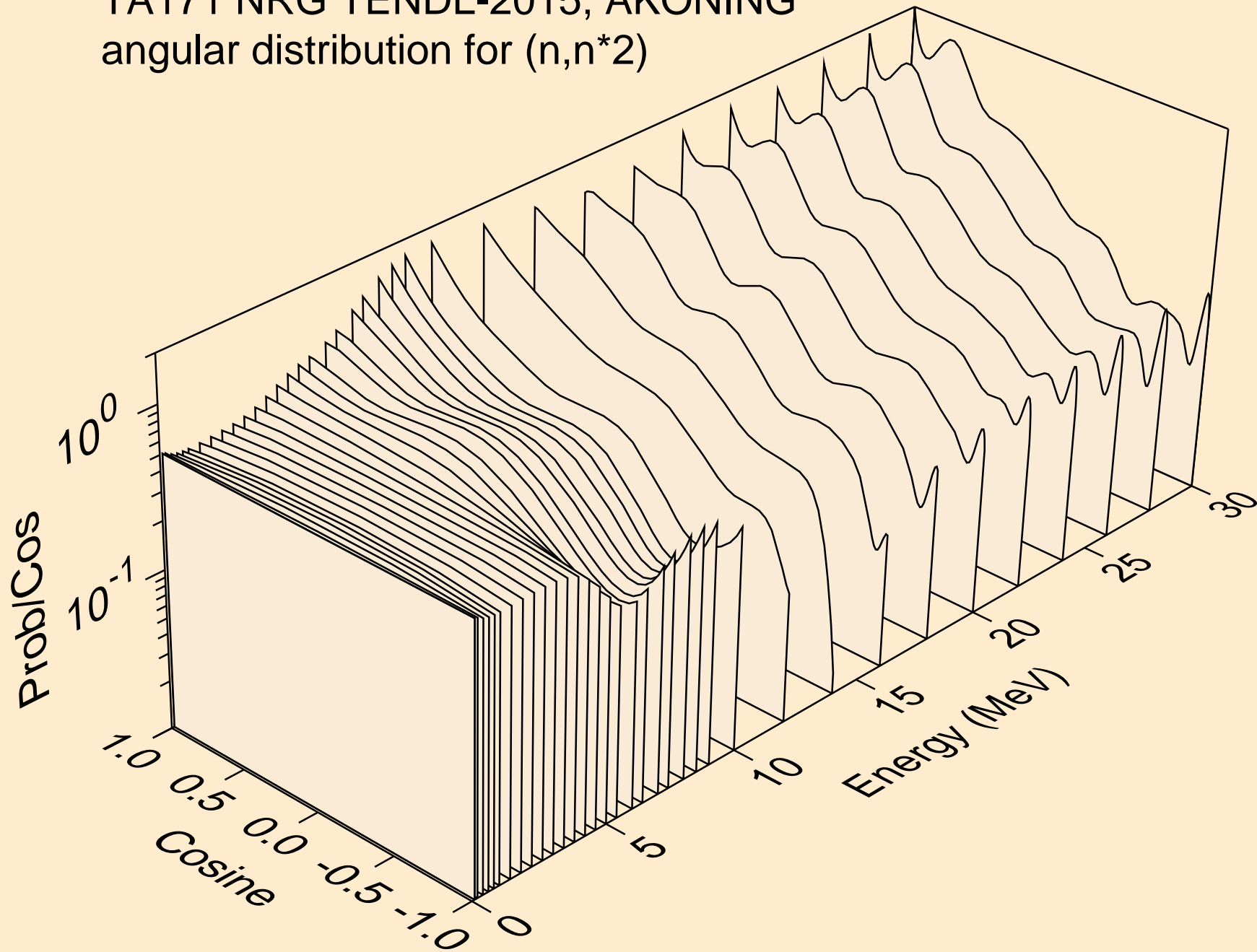

TA171 NRG TENDL-2015, AKONING
angular distribution for (n,n*3)

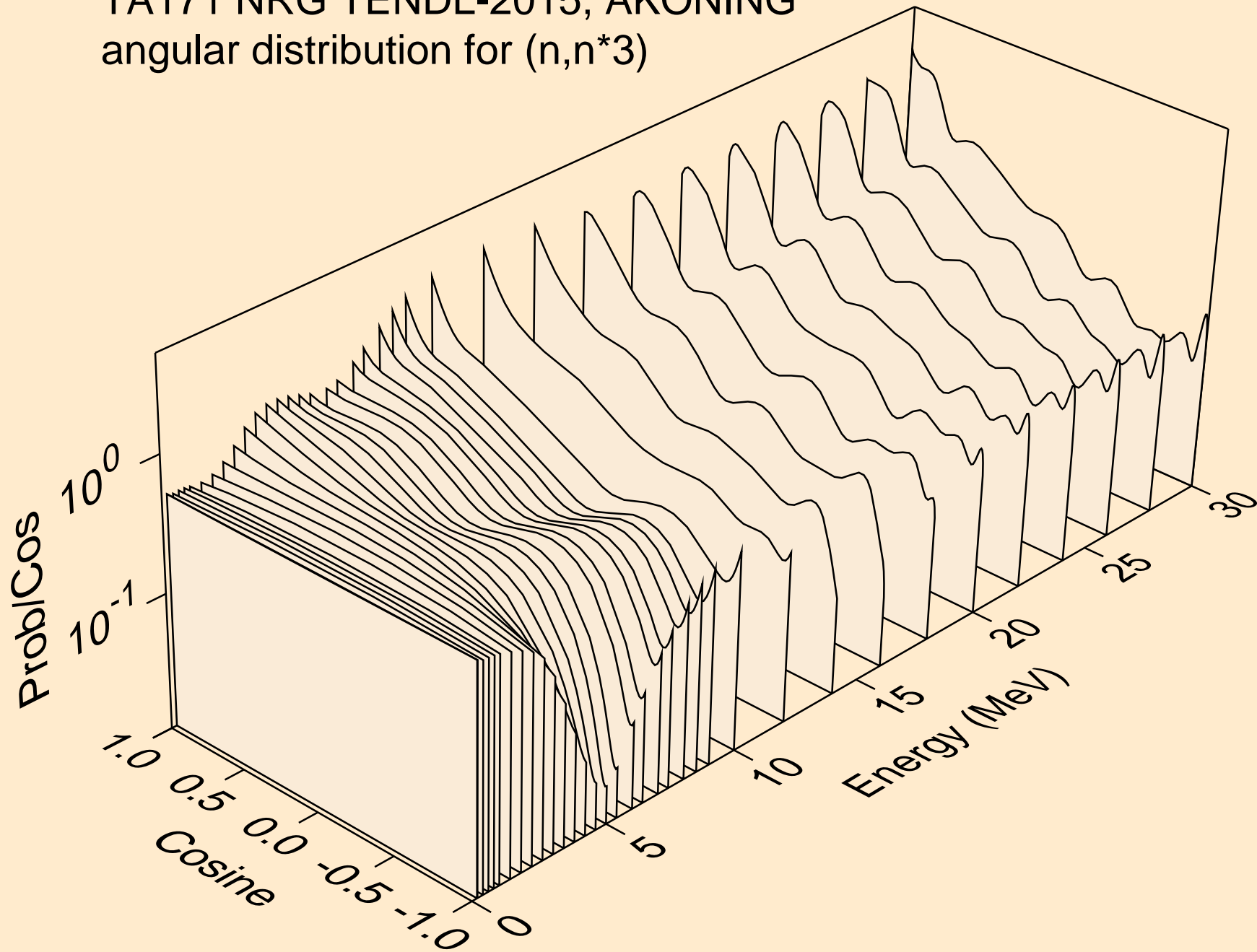

TA171 NRG TENDL-2015, AKONING
angular distribution for (n,n*4)

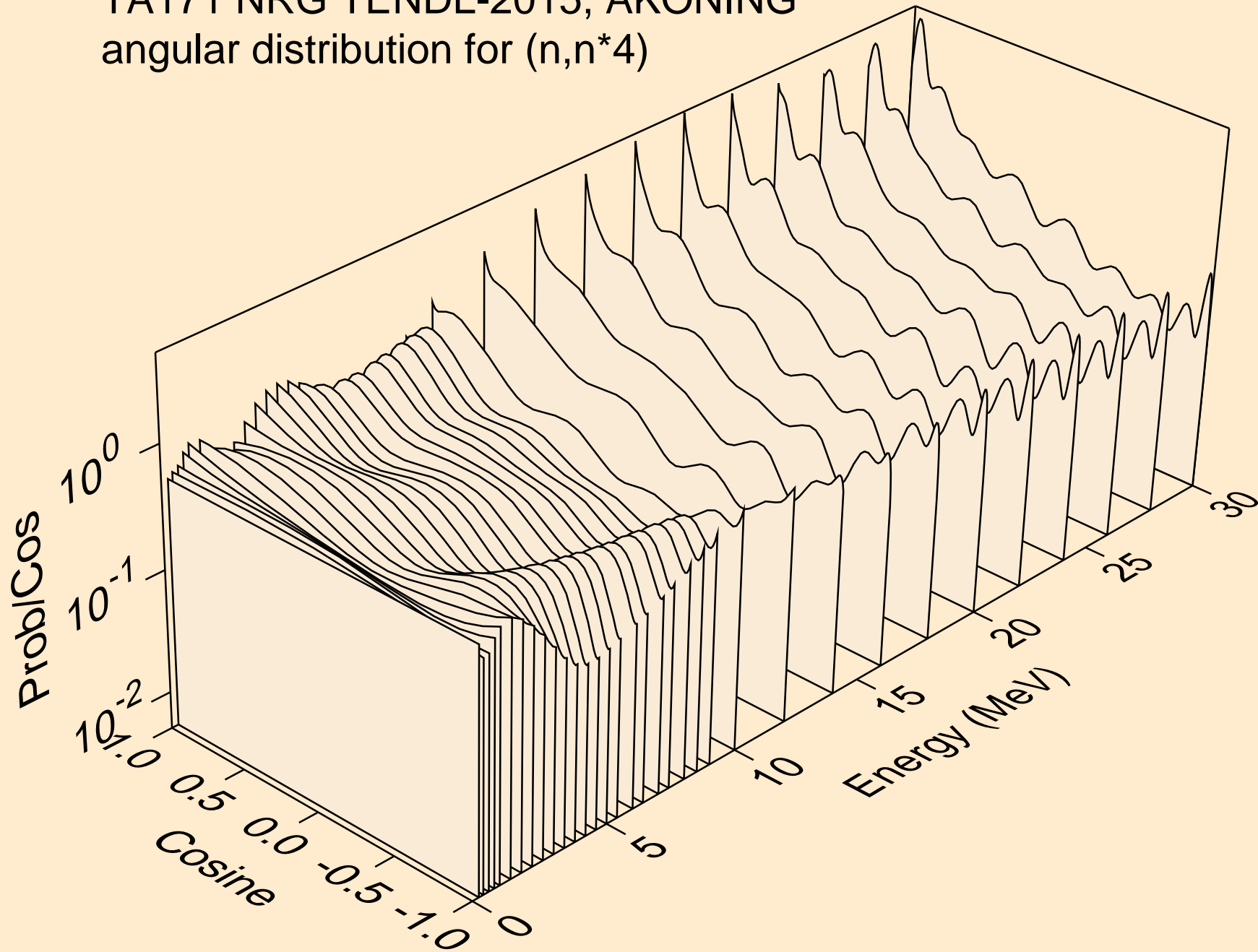

TA171 NRG TENDL-2015, AKONING
angular distribution for (n,n*5)

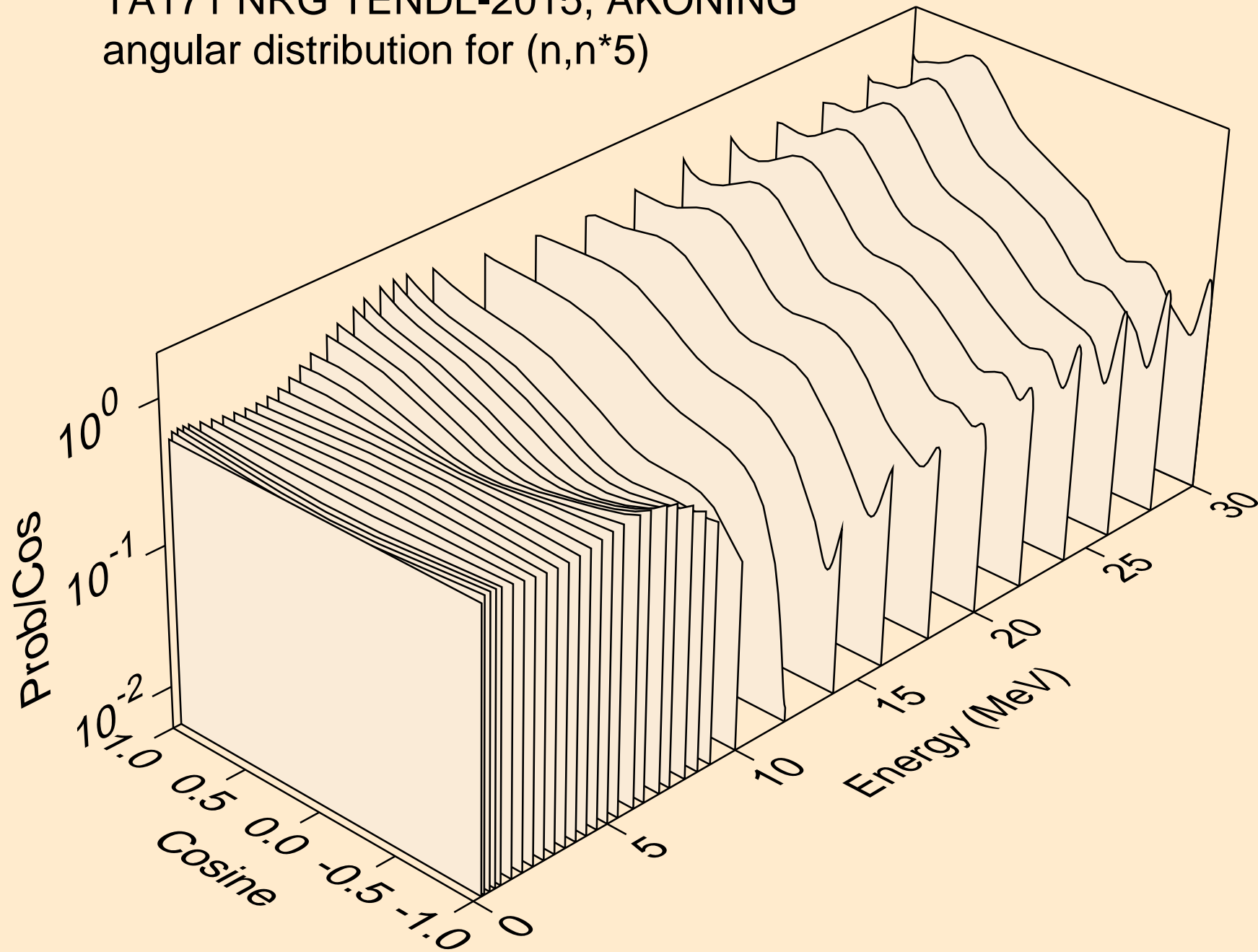

TA171 NRG TENDL-2015, AKONING
angular distribution for (n,n*6)

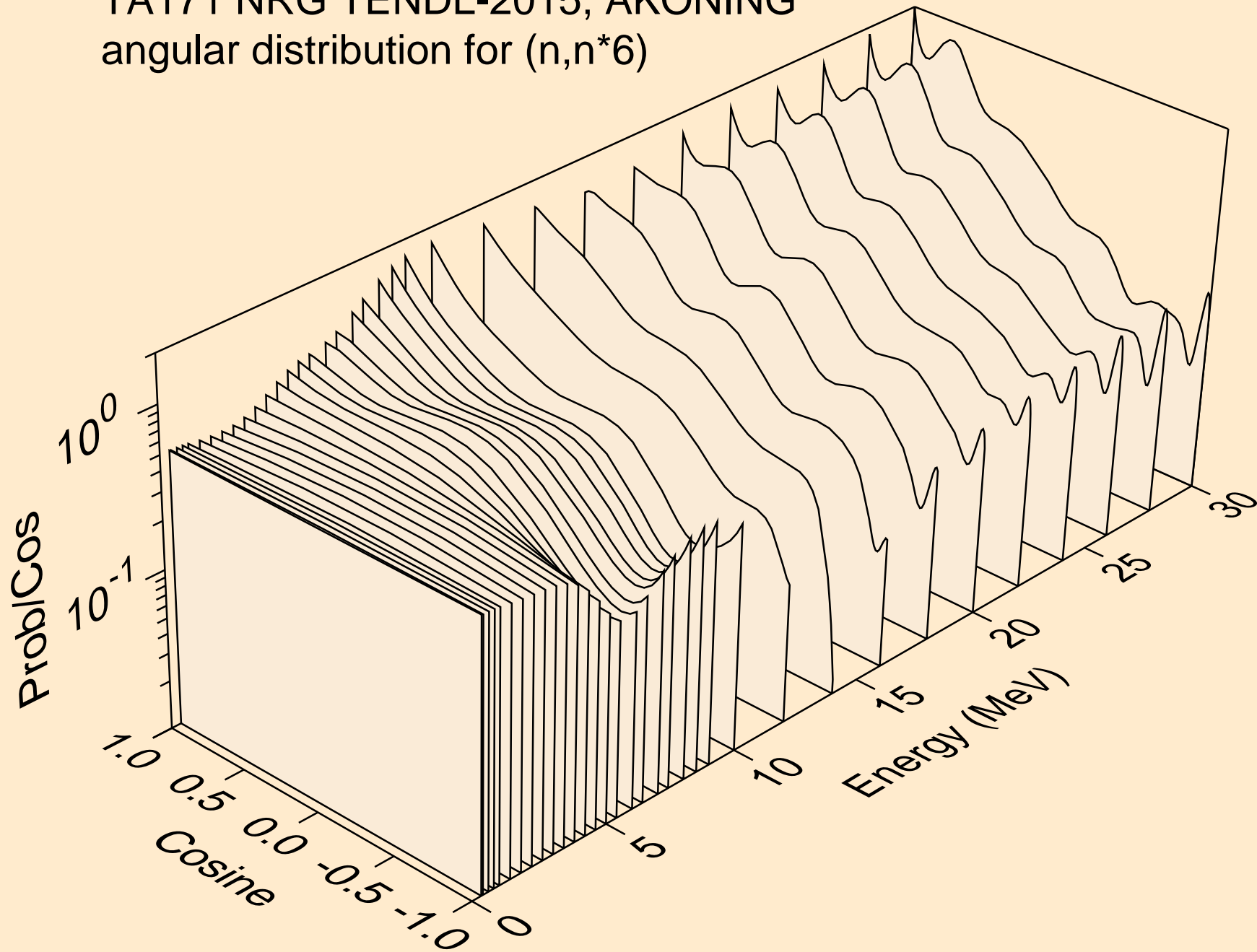

TA171 NRG TENDL-2015, AKONING
angular distribution for (n,n*7)

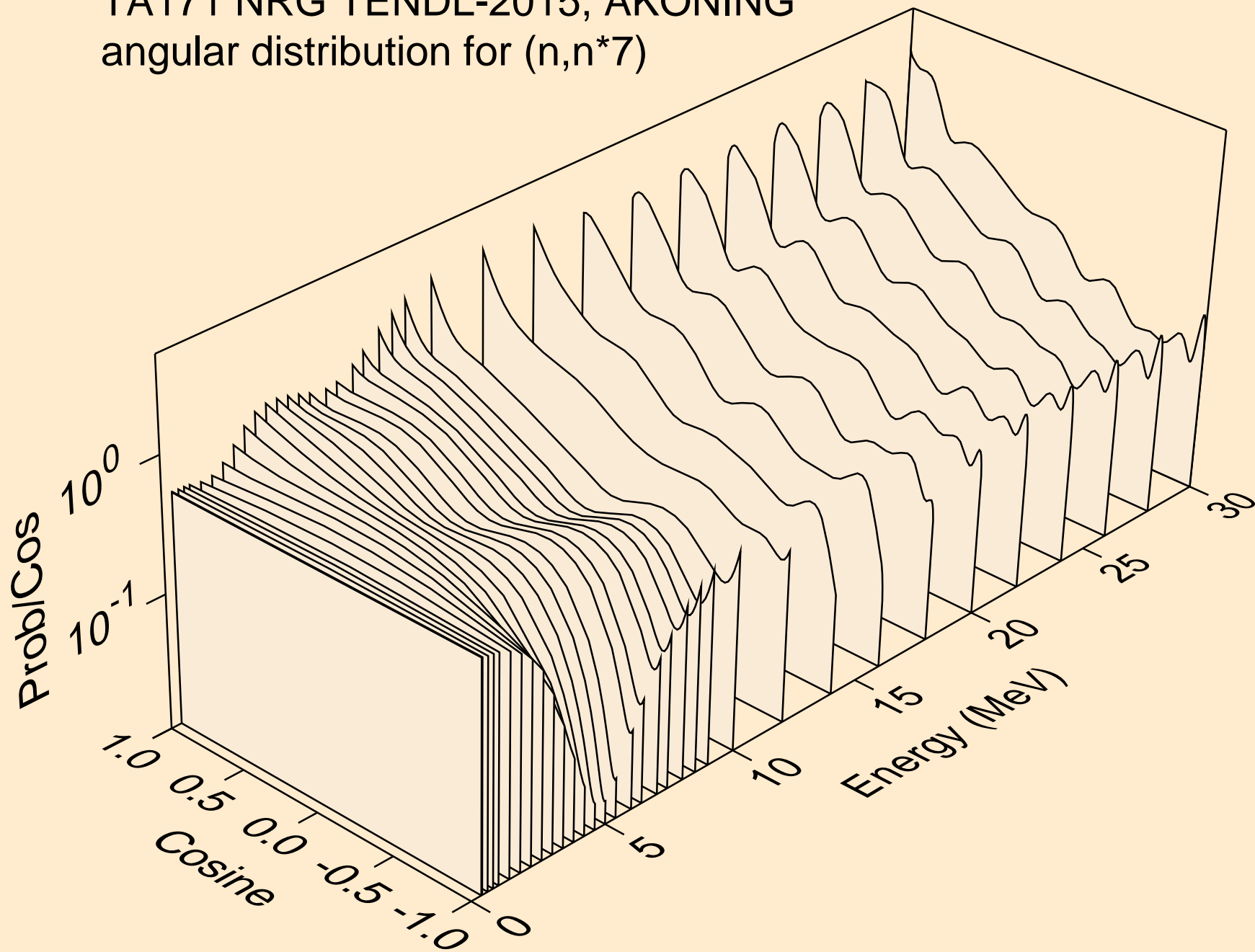

TA171 NRG TENDL-2015, AKONING
angular distribution for (n,n*8)

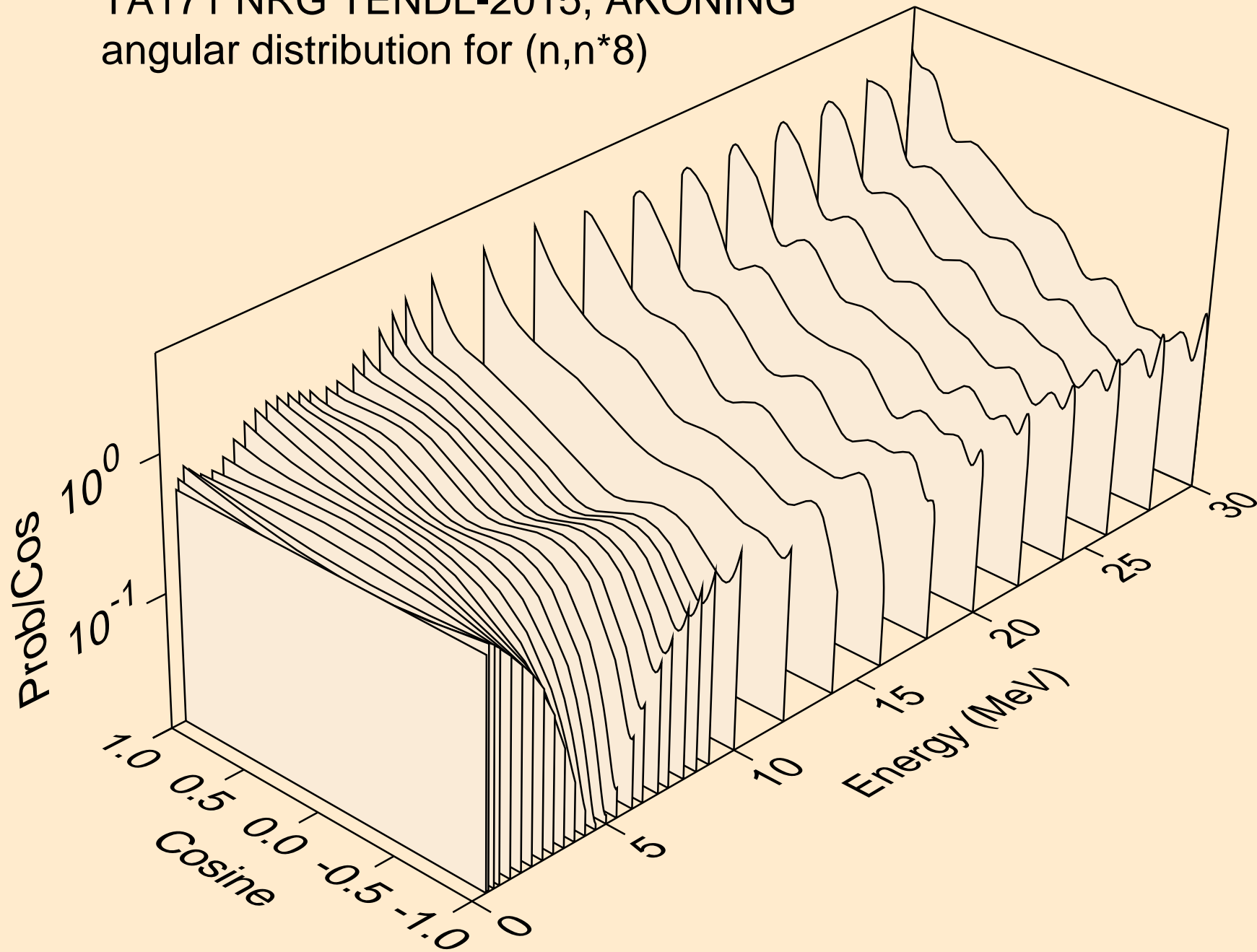

TA171 NRG TENDL-2015, AKONING
angular distribution for (n,n*9)

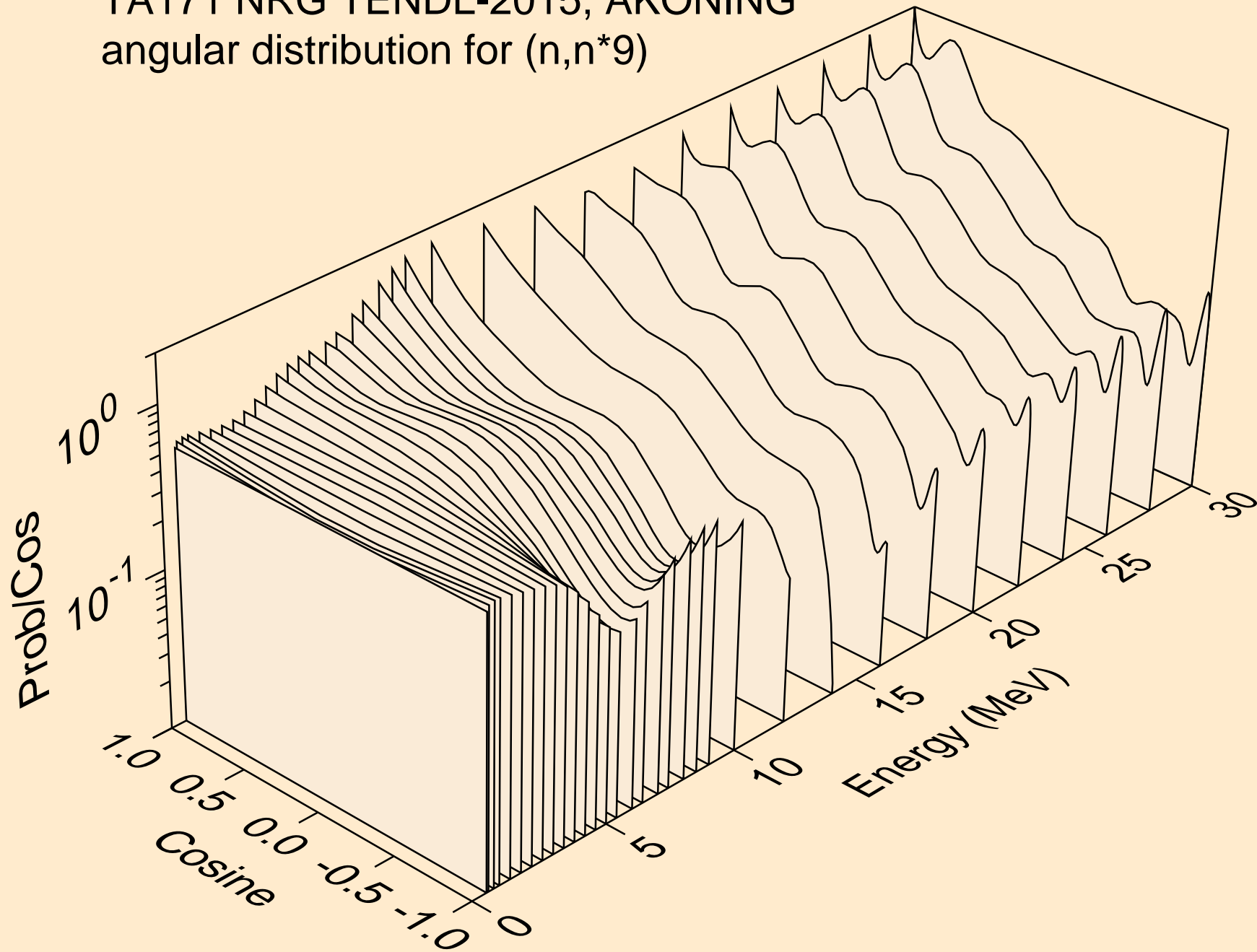

TA171 NRG TENDL-2015, AKONING
angular distribution for (n,n*10)

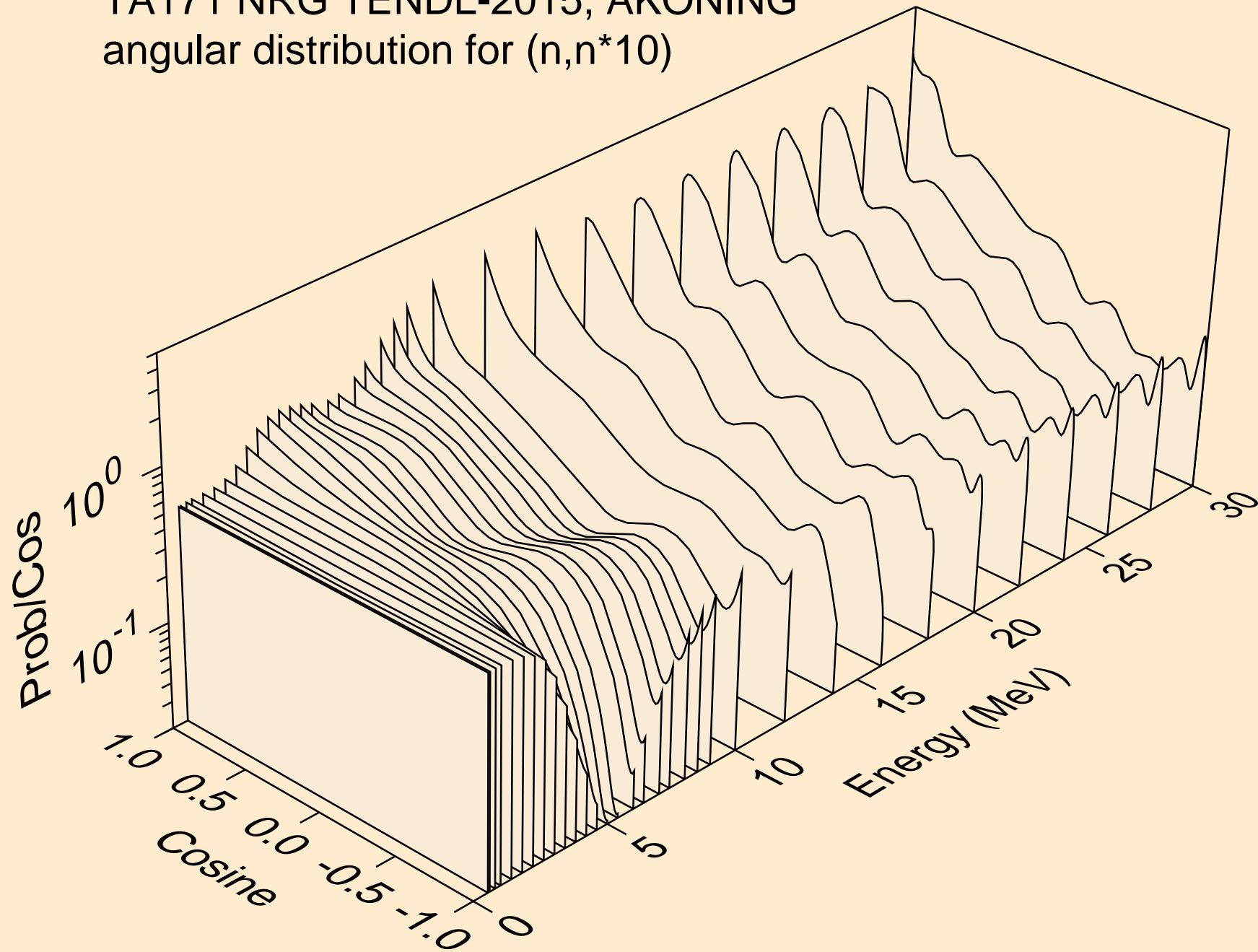

TA171 NRG TENDL-2015, AKONING
Neutron emission for (n,x)

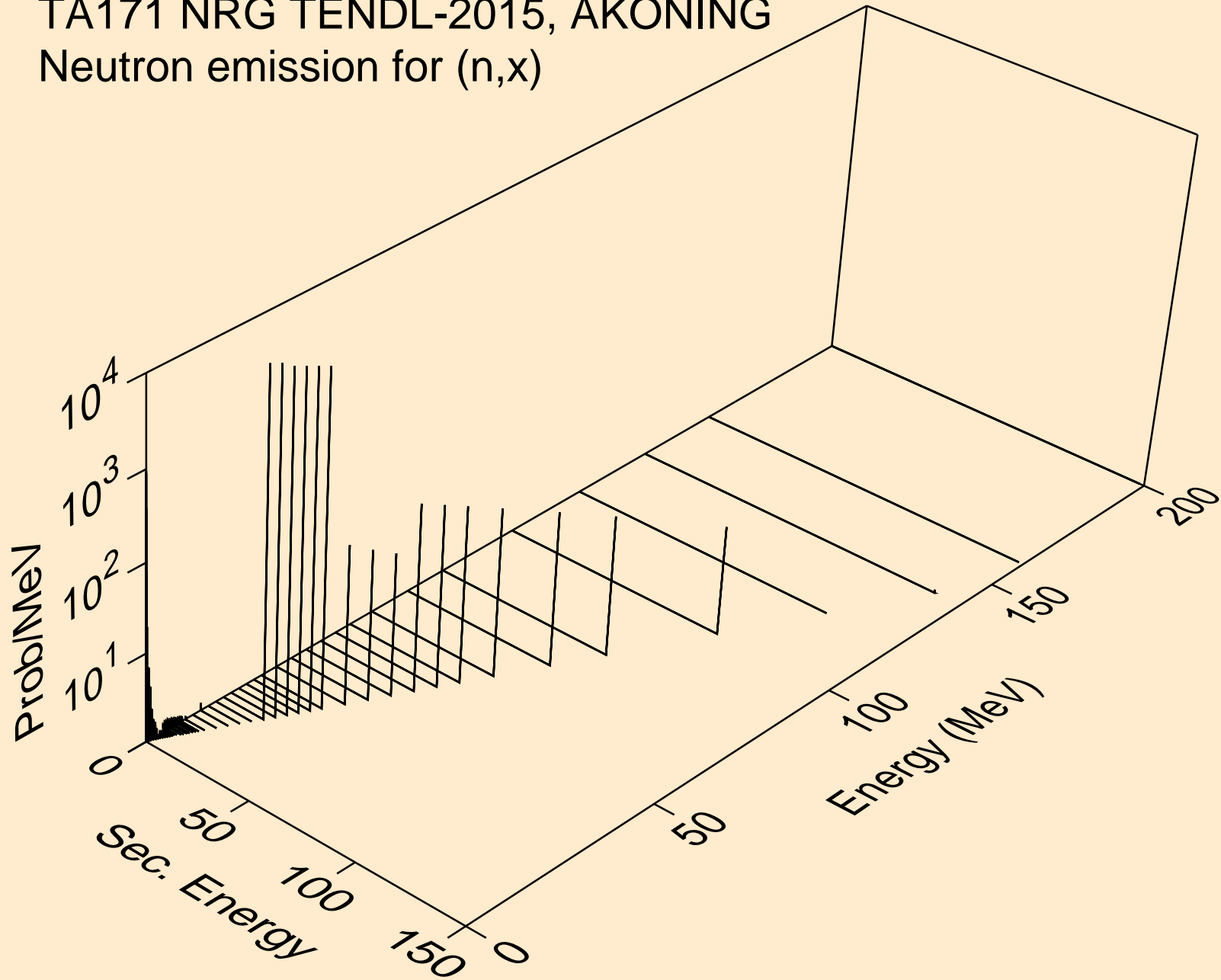

TA171 NRG TENDL-2015, AKONING
Neutron emission for (n,2nd)

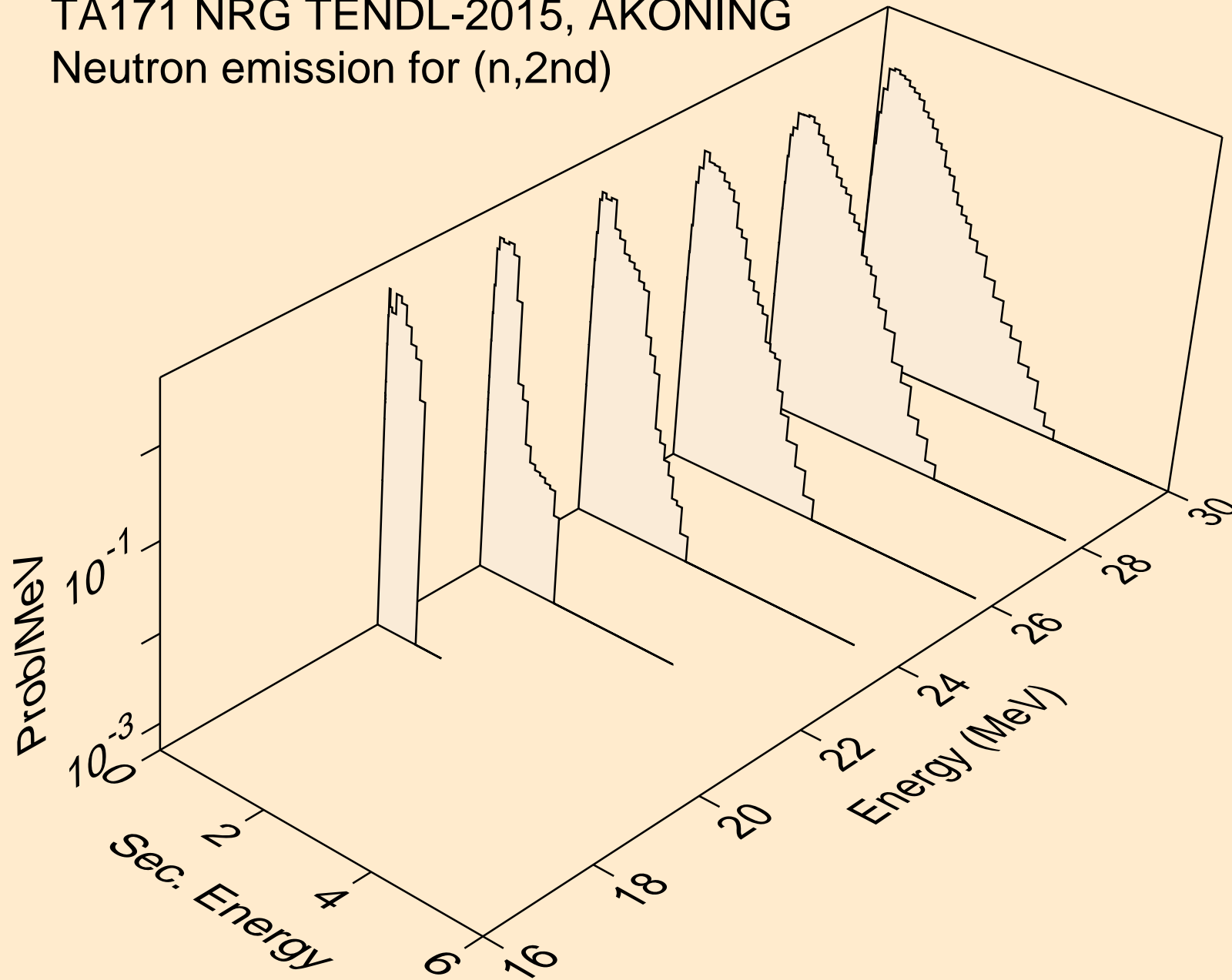

TA171 NRG TENDL-2015, AKONING
Neutron emission for (n,2n)

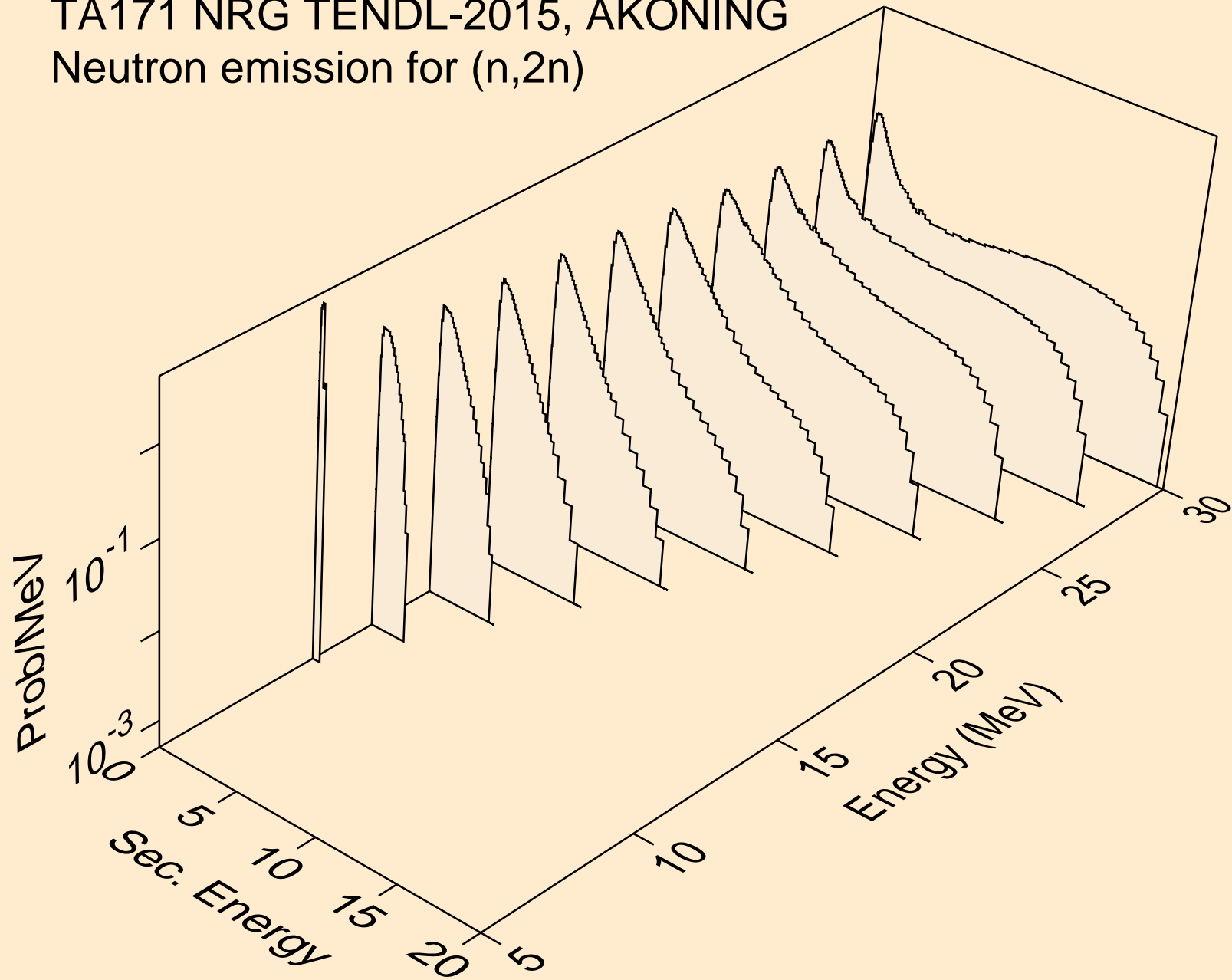

TA171 NRG TENDL-2015, AKONING
Neutron emission for (n,3n)

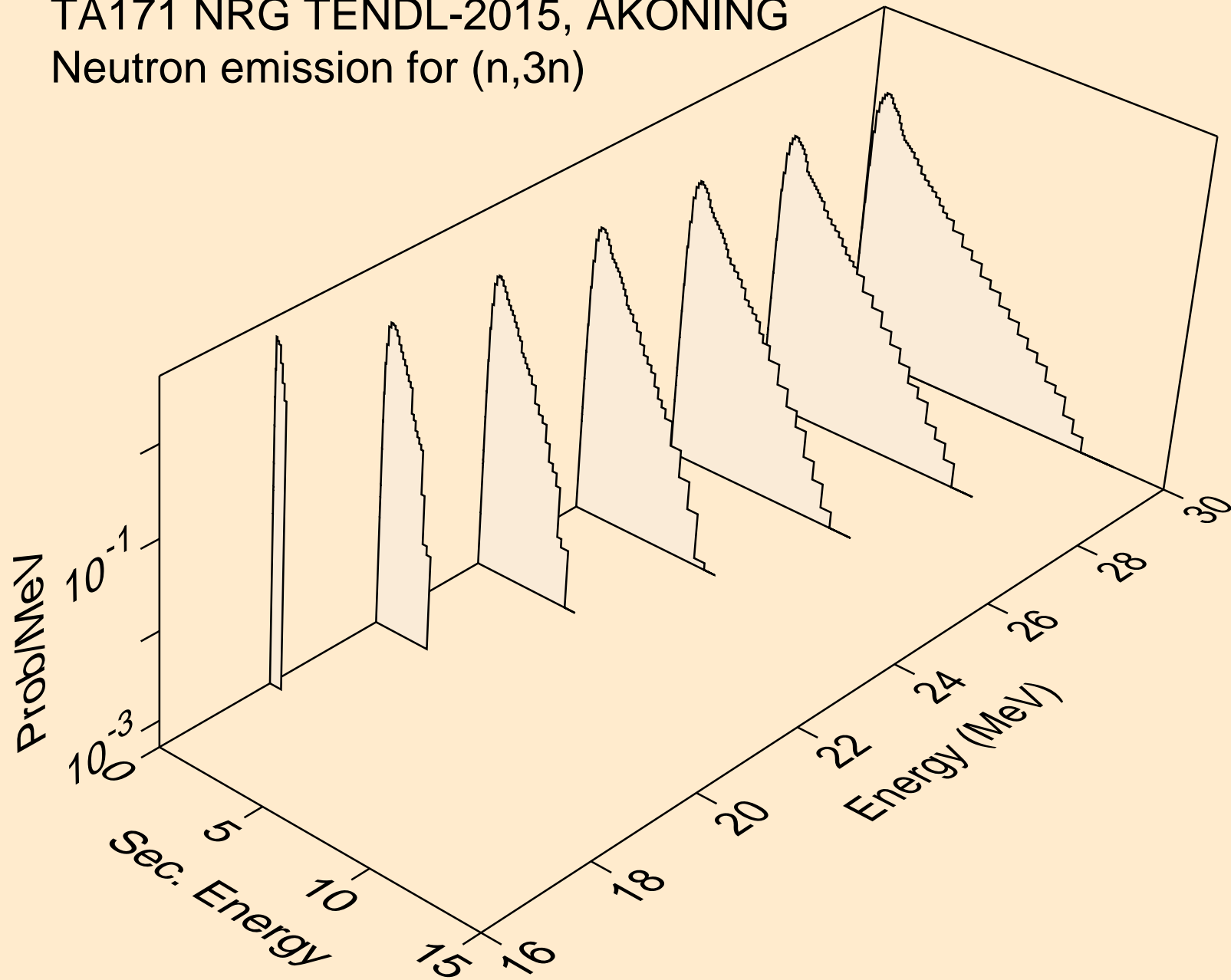

TA171 NRG TENDL-2015, AKONING
Neutron emission for (n,n*)a

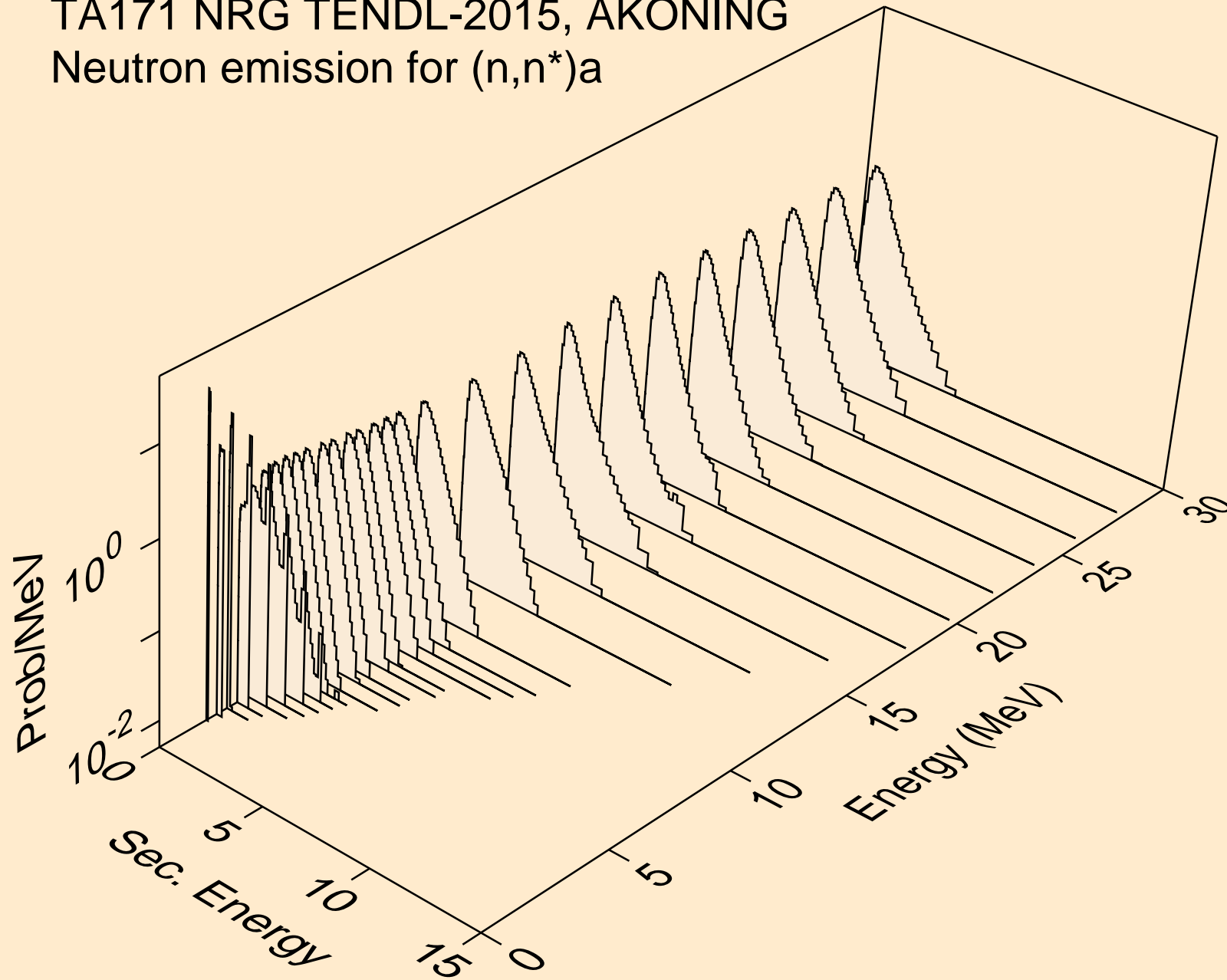

TA171 NRG TENDL-2015, AKONING
Neutron emission for (n,2n)a

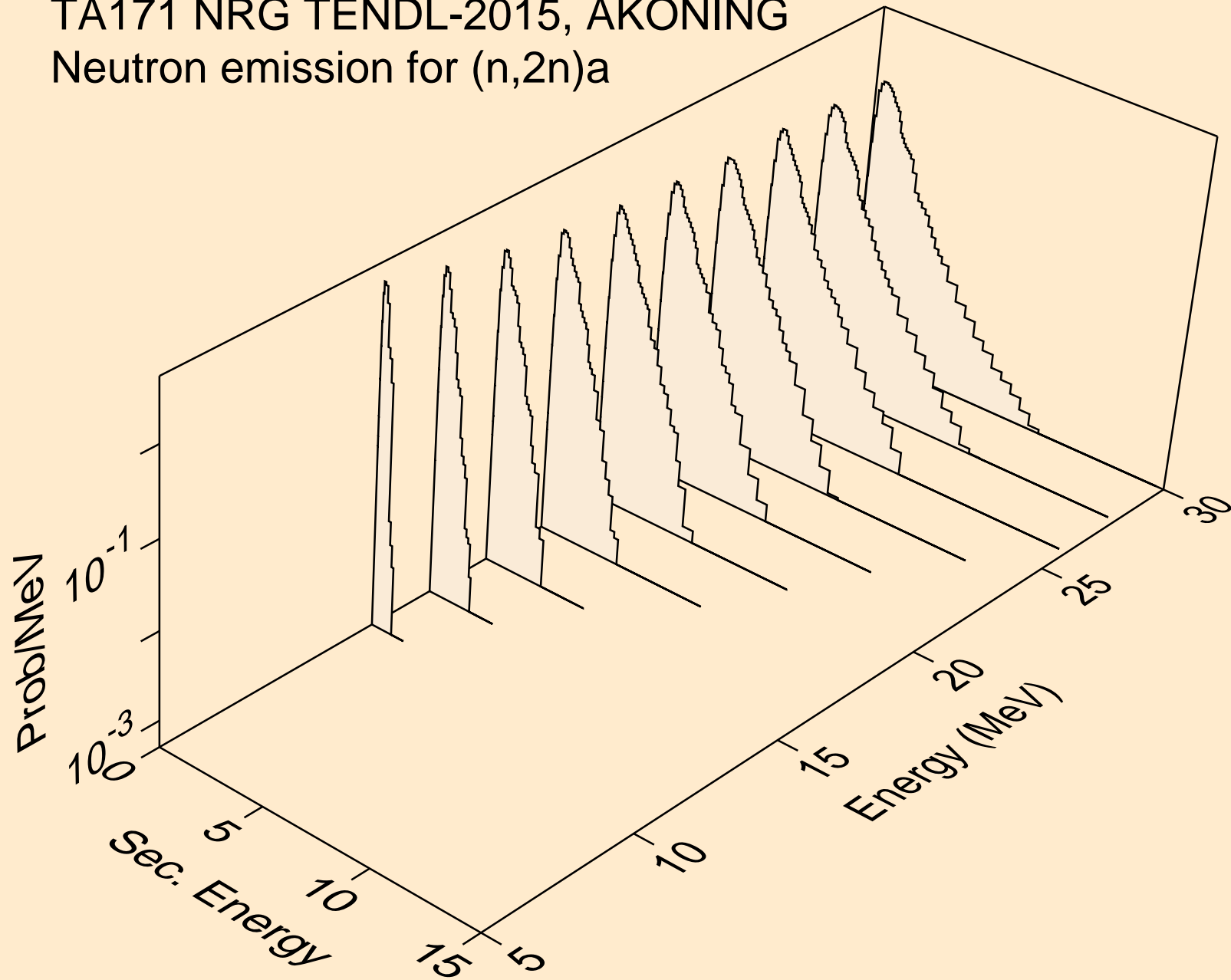

TA171 NRG TENDL-2015, AKONING
Neutron emission for (n,3n)a

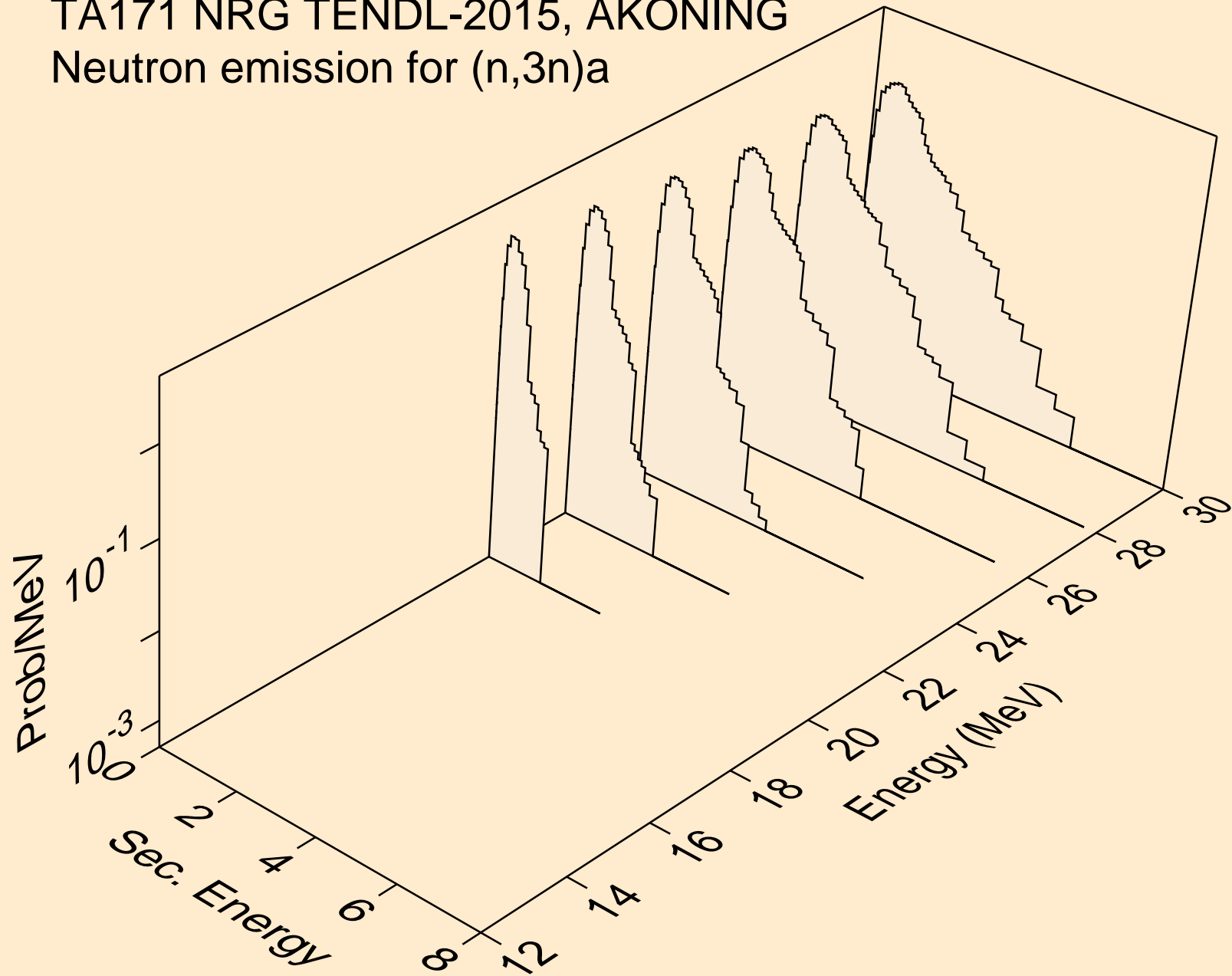

TA171 NRG TENDL-2015, AKONING
Neutron emission for (n,n*)p

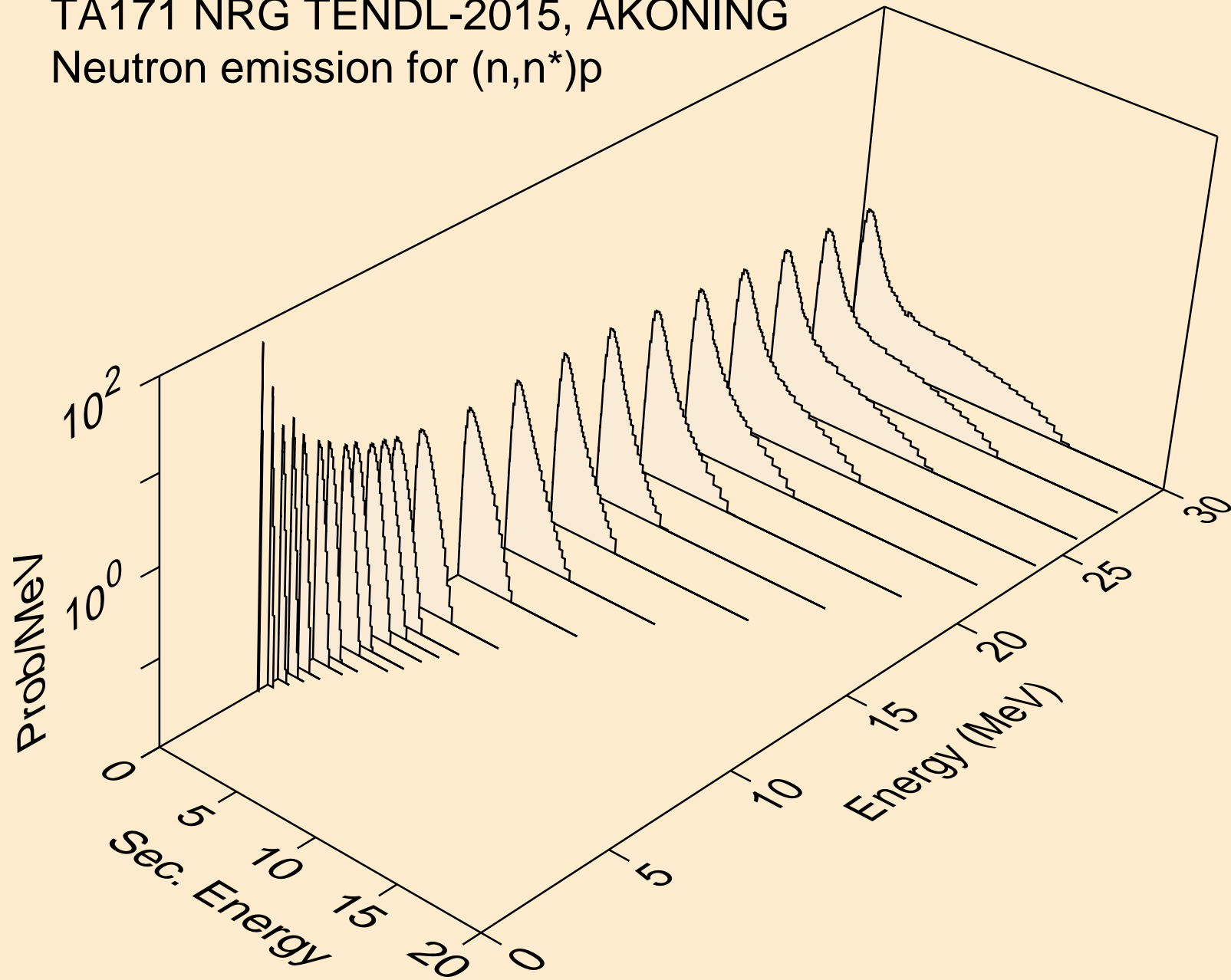

TA171 NRG TENDL-2015, AKONING
Neutron emission for (n,n*)2a

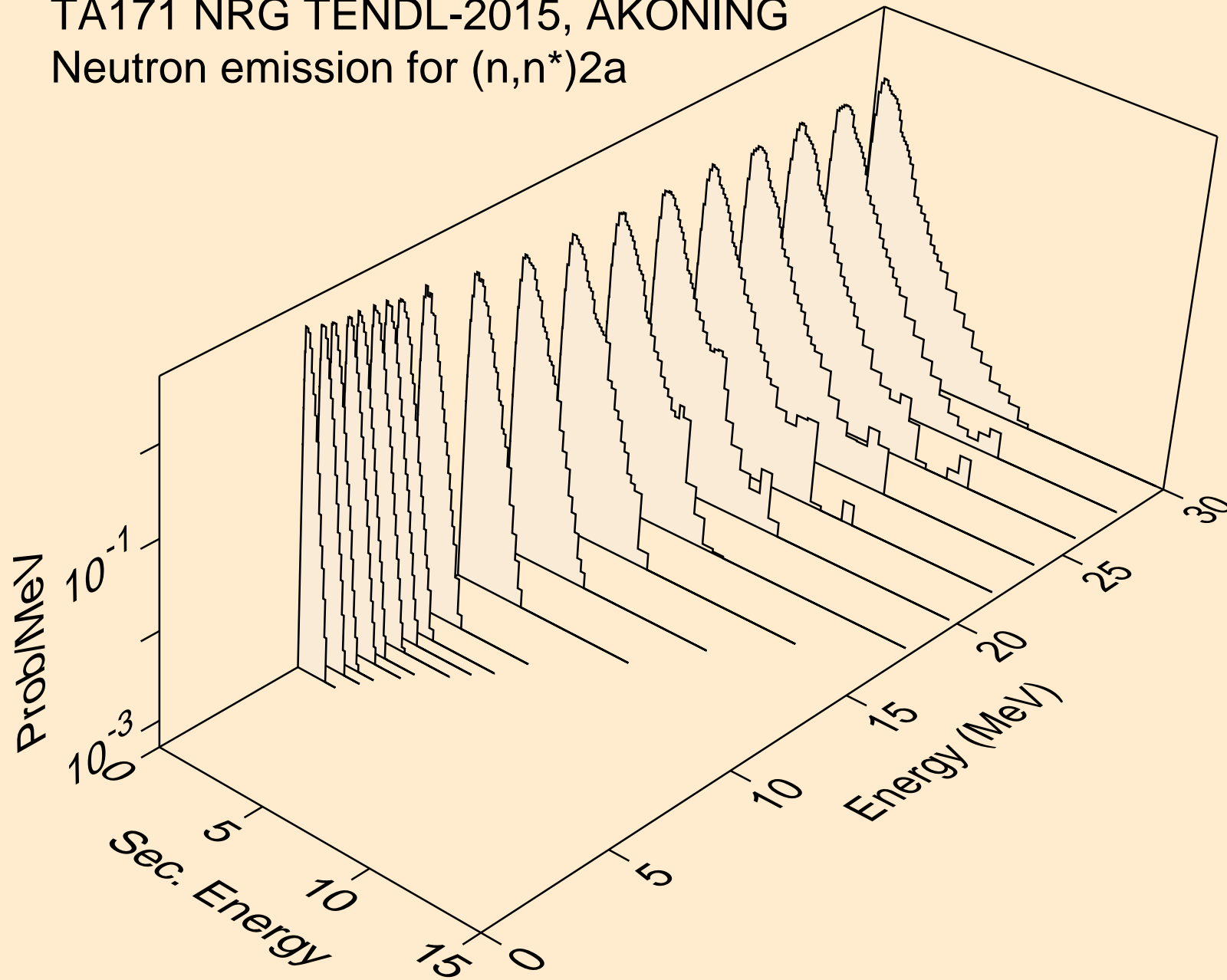

TA171 NRG TENDL-2015, AKONING
Neutron emission for (n,2n)2a

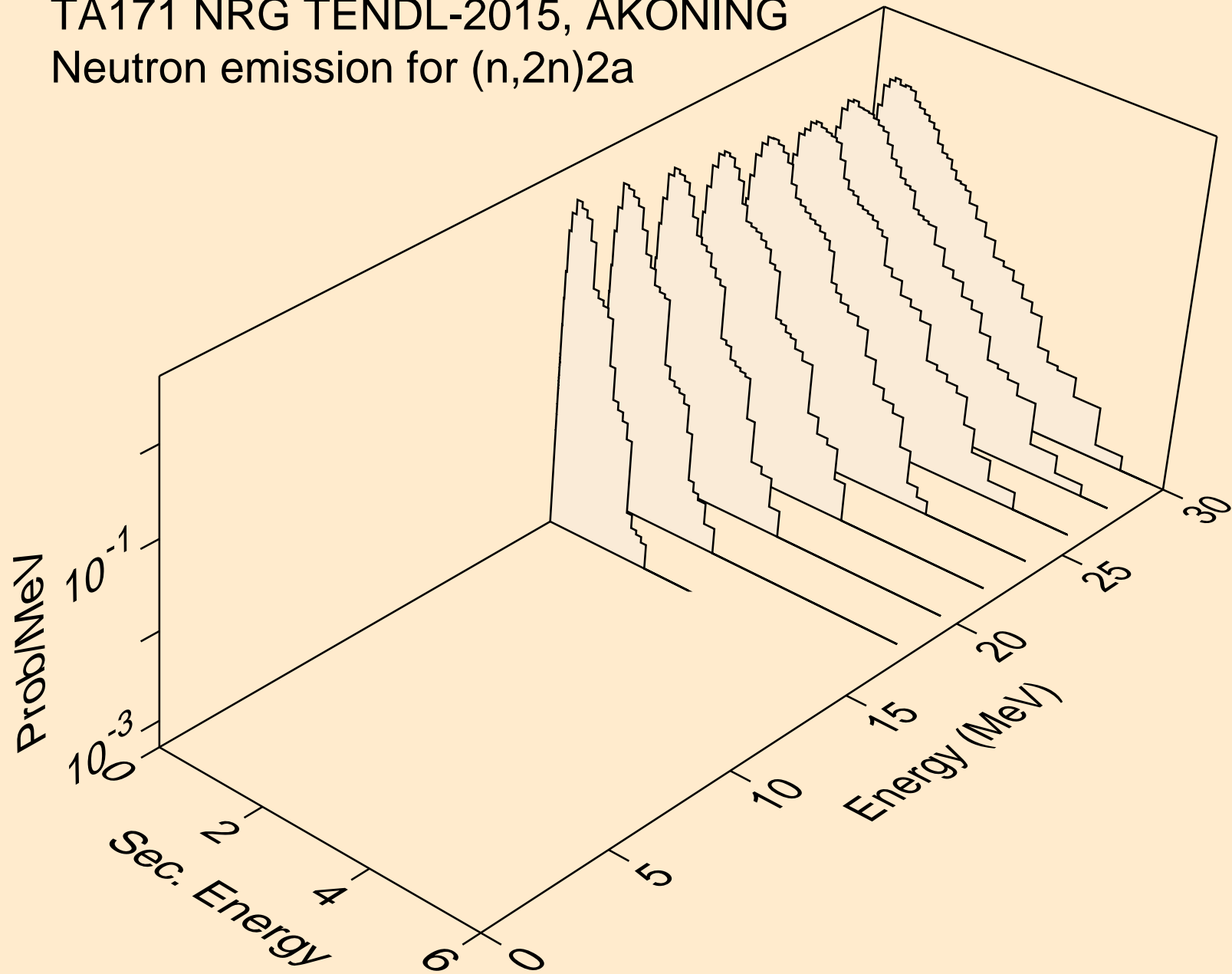

TA171 NRG TENDL-2015, AKONING
Neutron emission for (n,n*)d

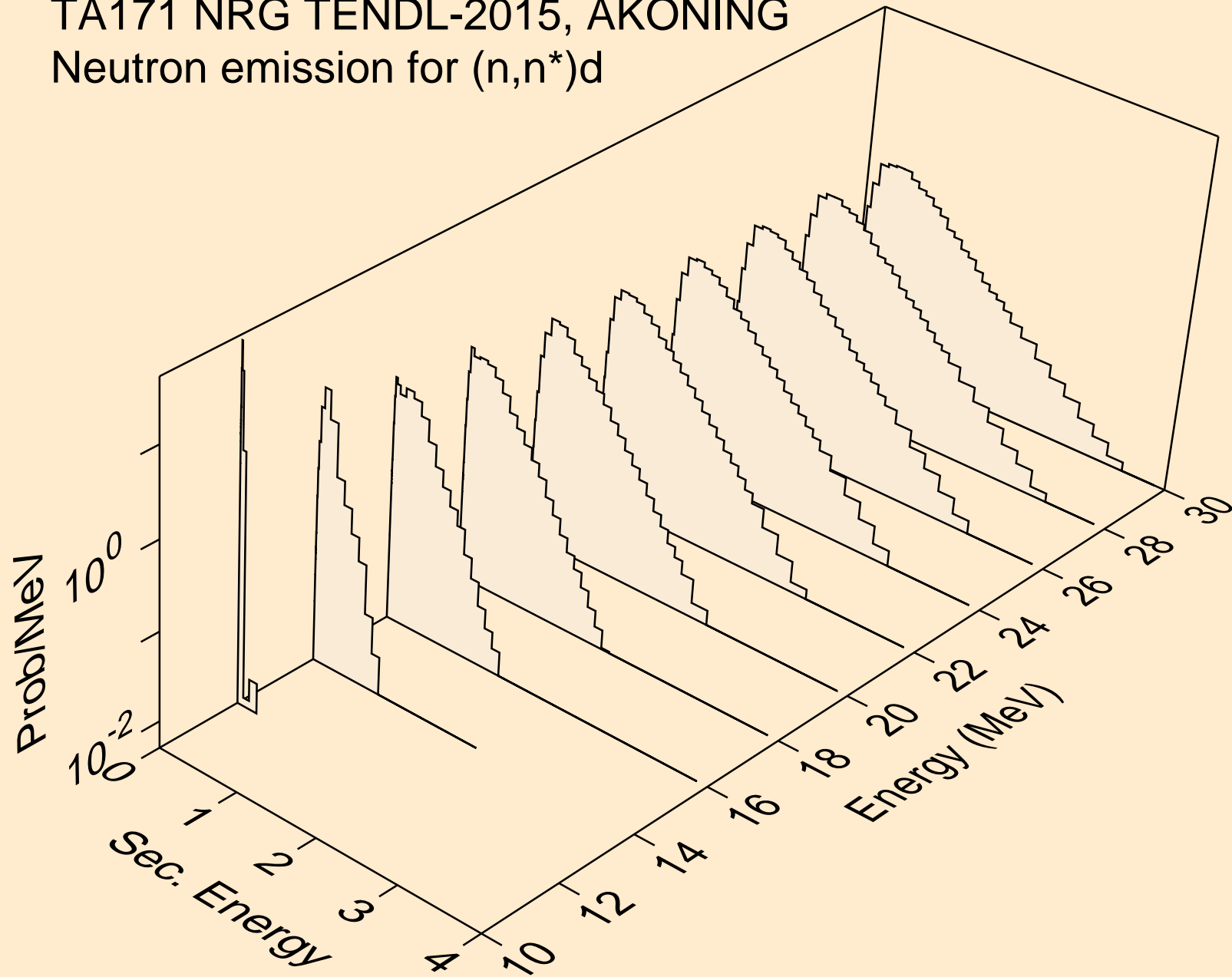

TA171 NRG TENDL-2015, AKONING
Neutron emission for (n,n*)t

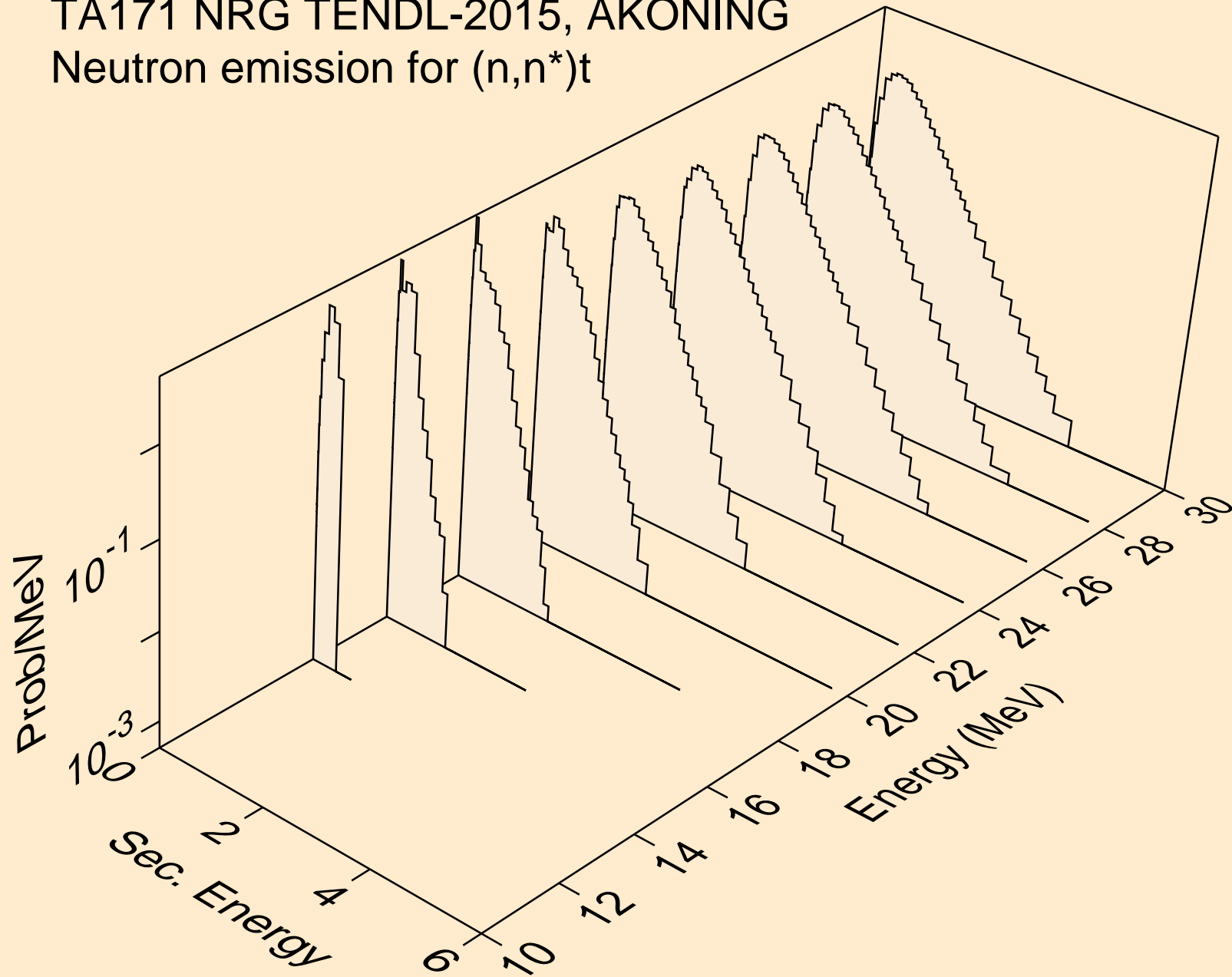

TA171 NRG TENDL-2015, AKONING
Neutron emission for (n,n*)he3

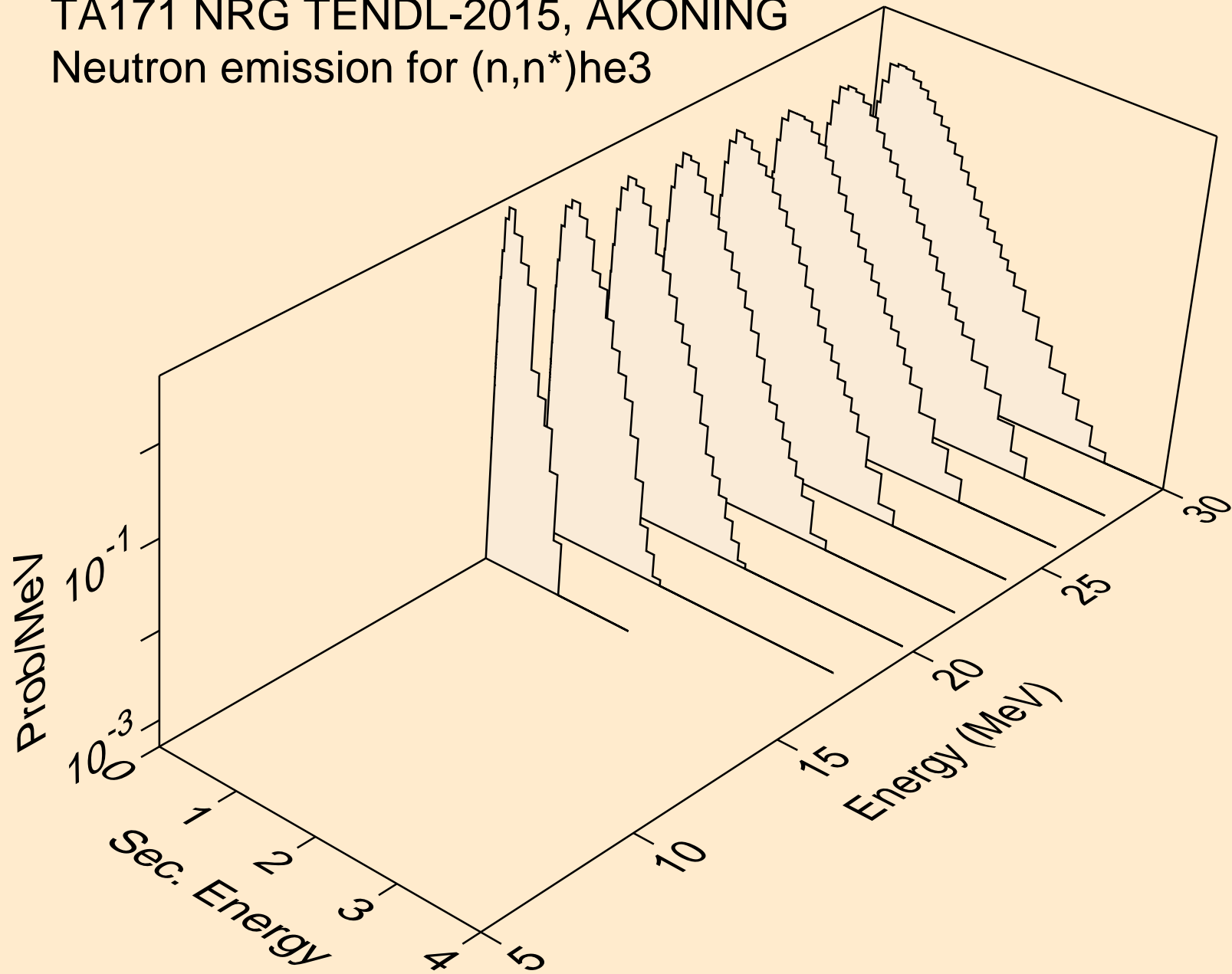

TA171 NRG TENDL-2015, AKONING
Neutron emission for (n,4n)

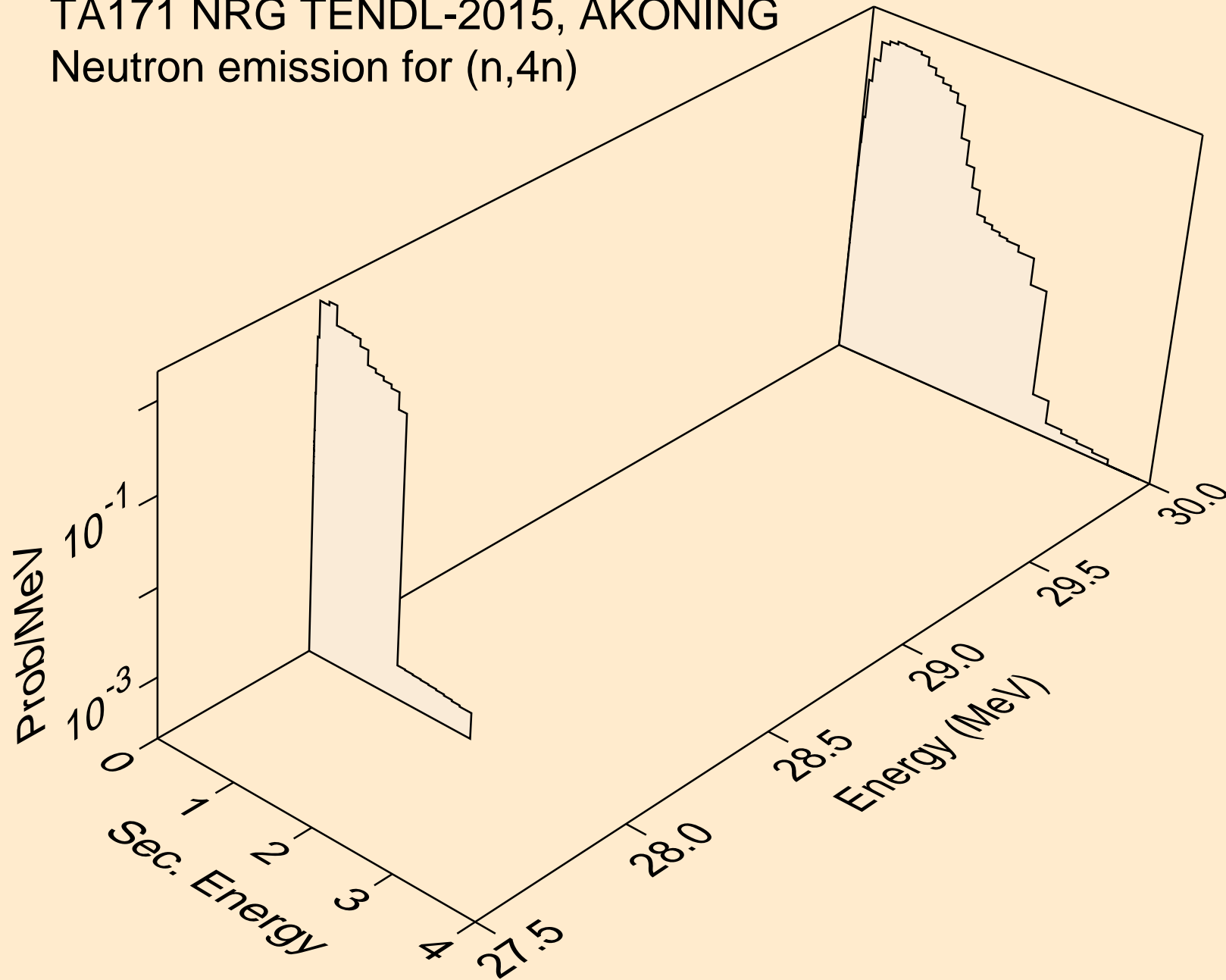

TA171 NRG TENDL-2015, AKONING
Neutron emission for (n,2np)

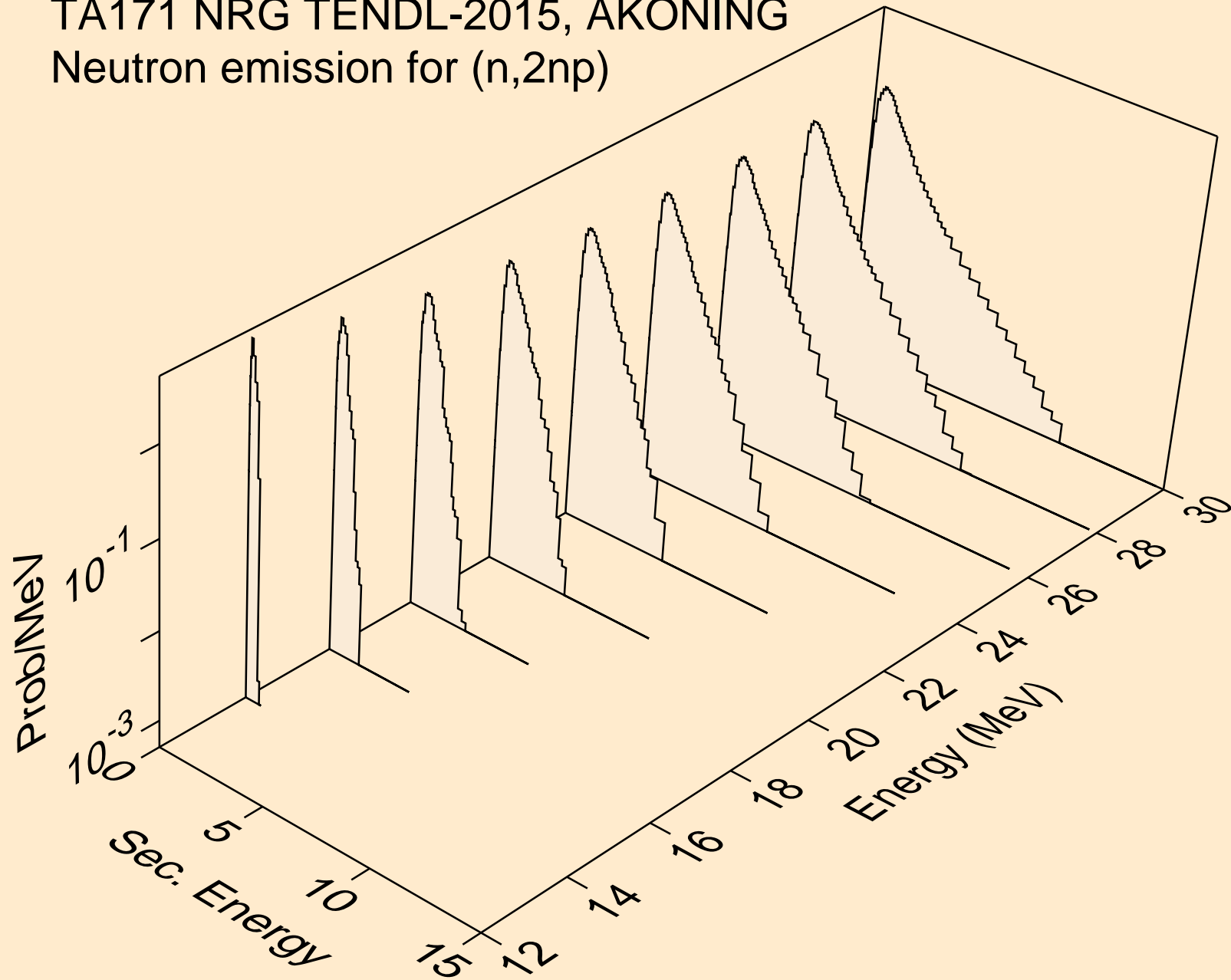

TA171 NRG TENDL-2015, AKONING
Neutron emission for (n,3np)

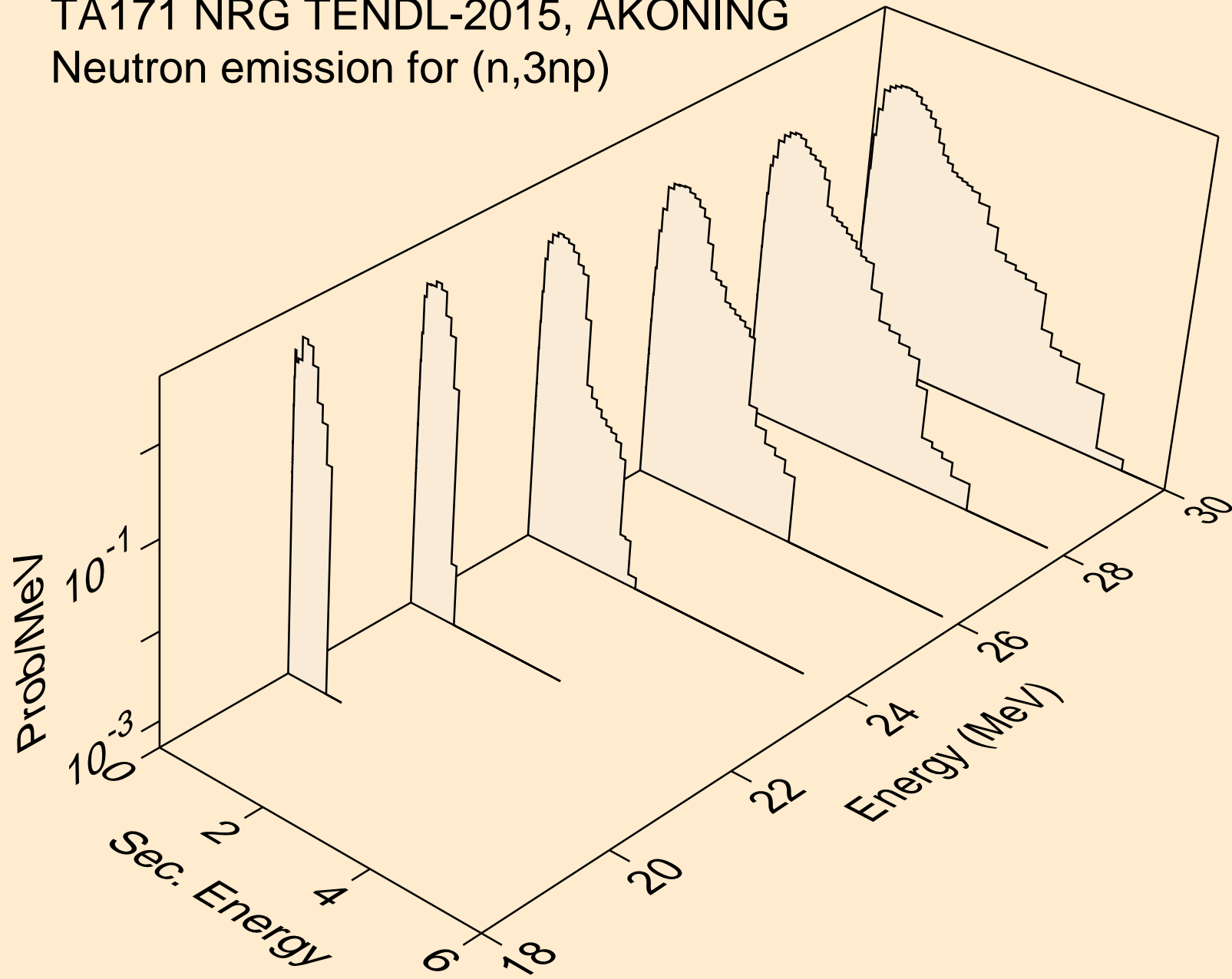

TA171 NRG TENDL-2015, AKONING
Neutron emission for (n,2np)

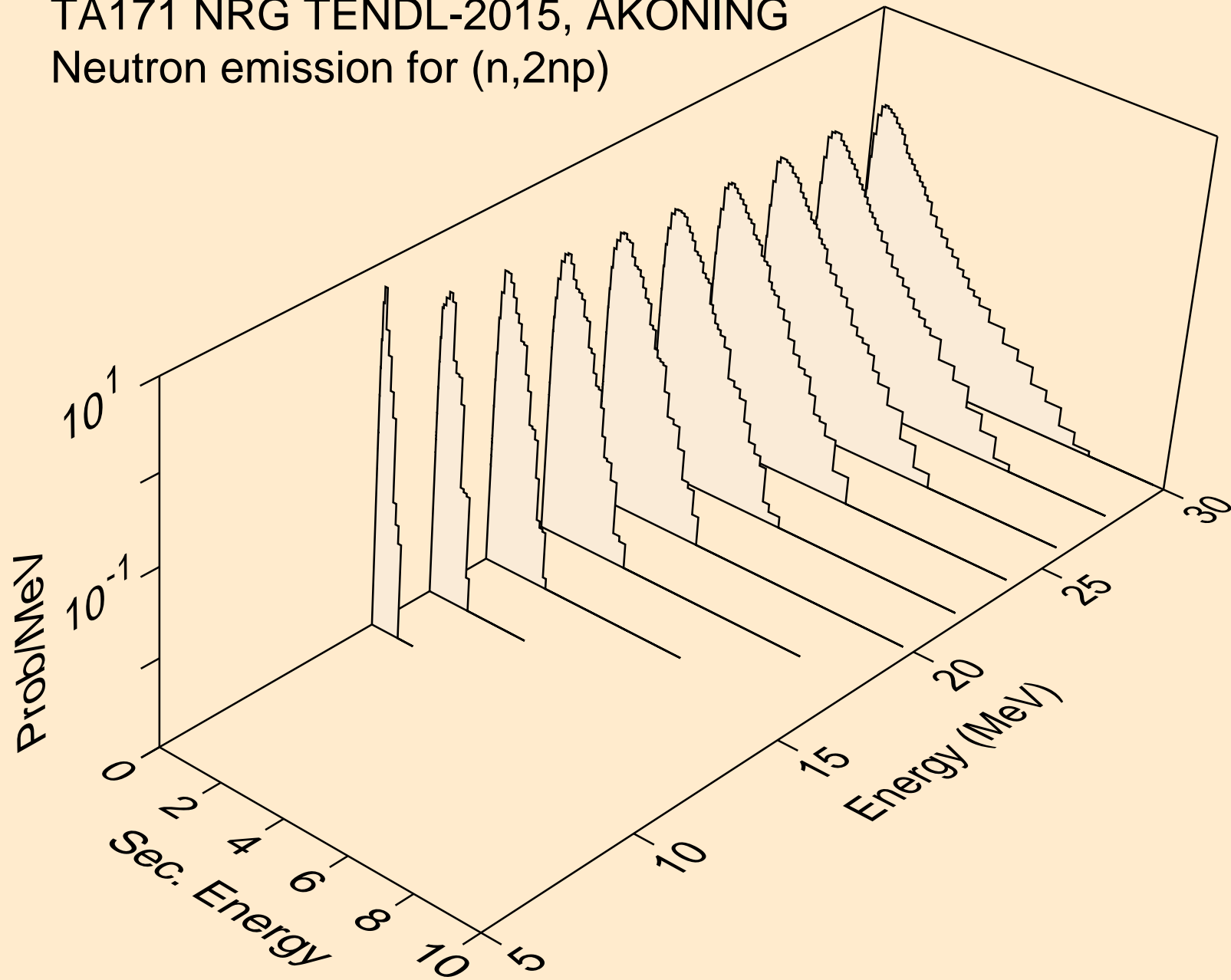

TA171 NRG TENDL-2015, AKONING
Neutron emission for (n,npa)

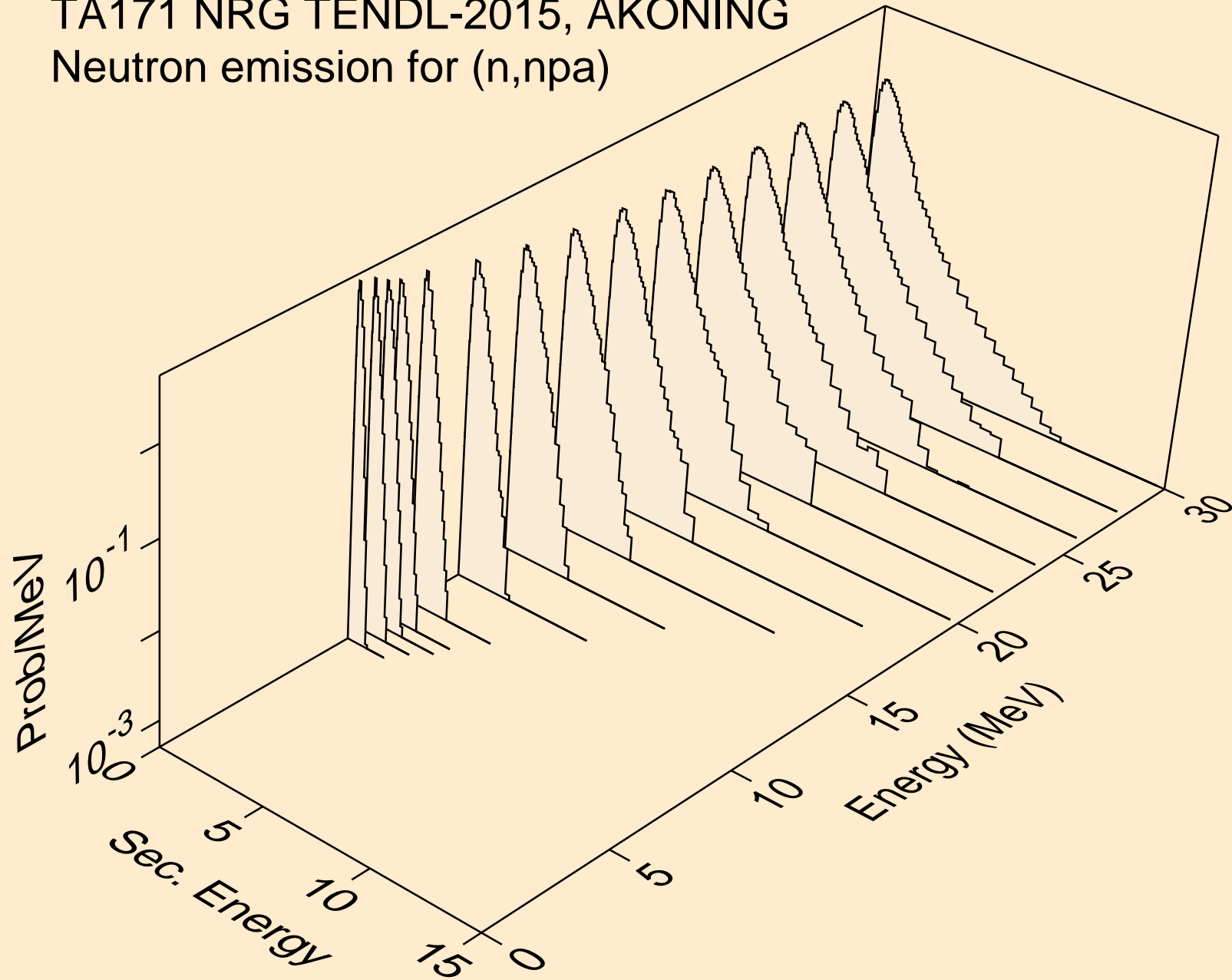

TA171 NRG TENDL-2015, AKONING
Neutron emission for (n,n*c)

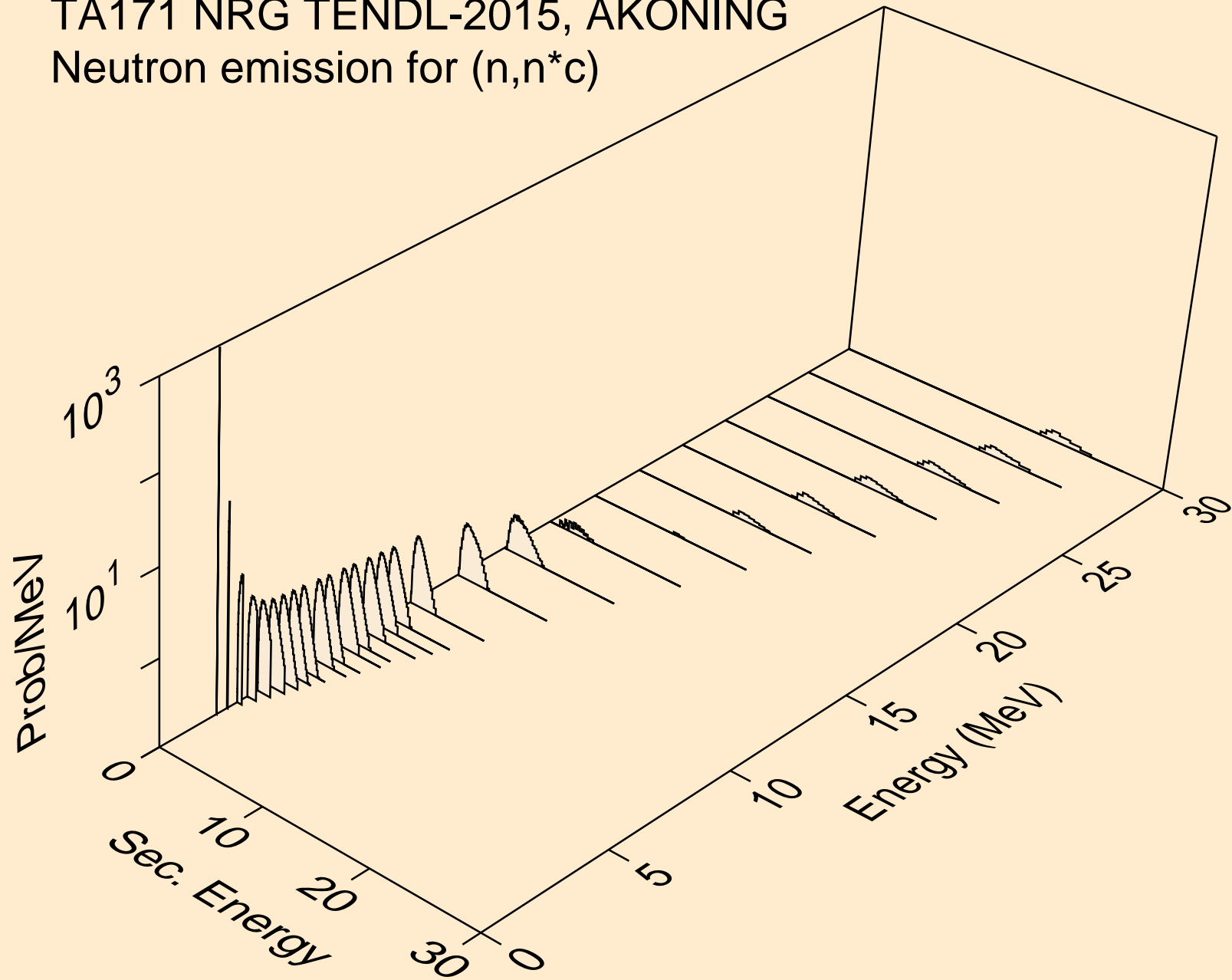

TA171 NRG TENDL-2015, AKONING
Photon emission for (n,x)

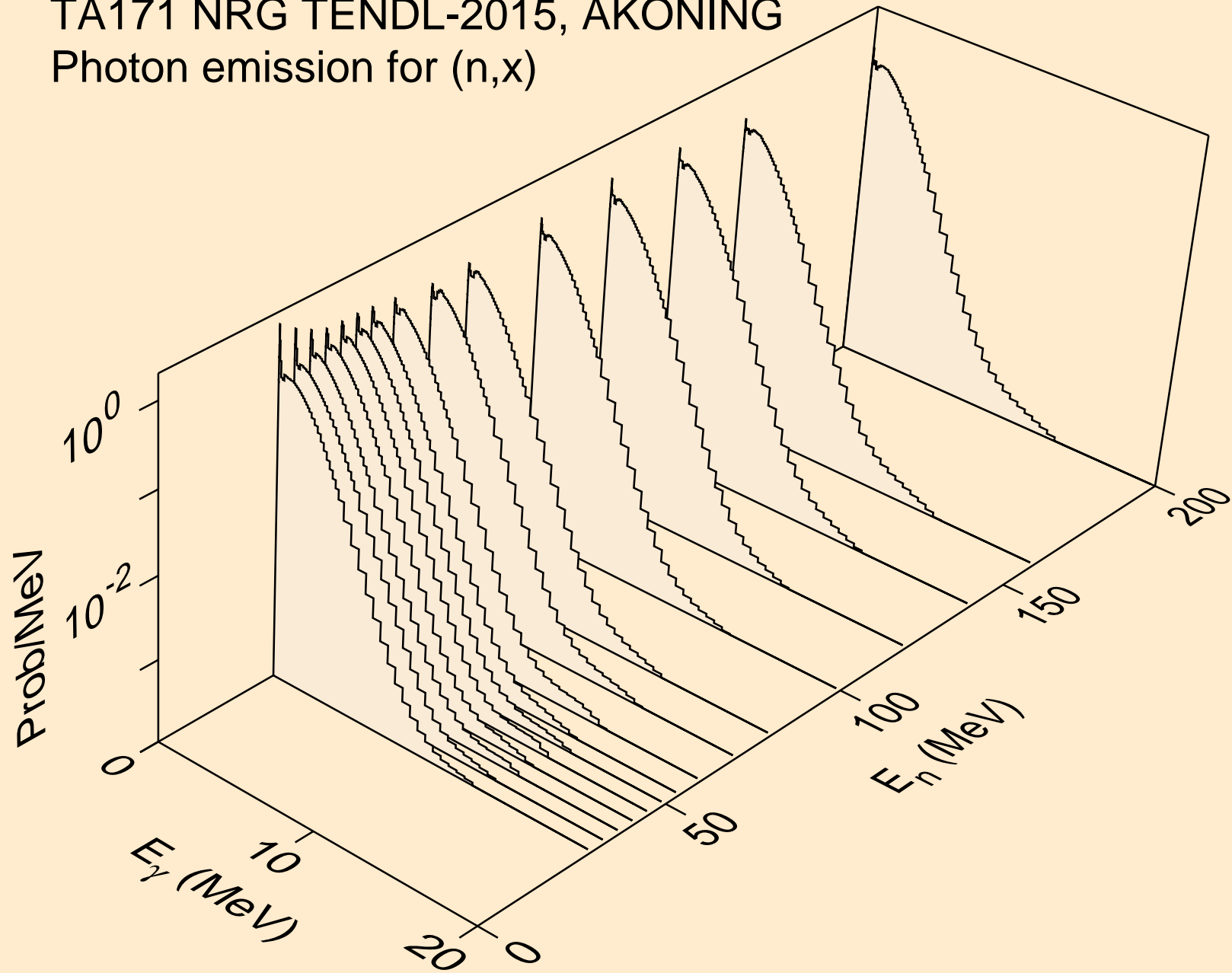

TA171 NRG TENDL-2015, AKONING
Photon emission for (n,2nd)

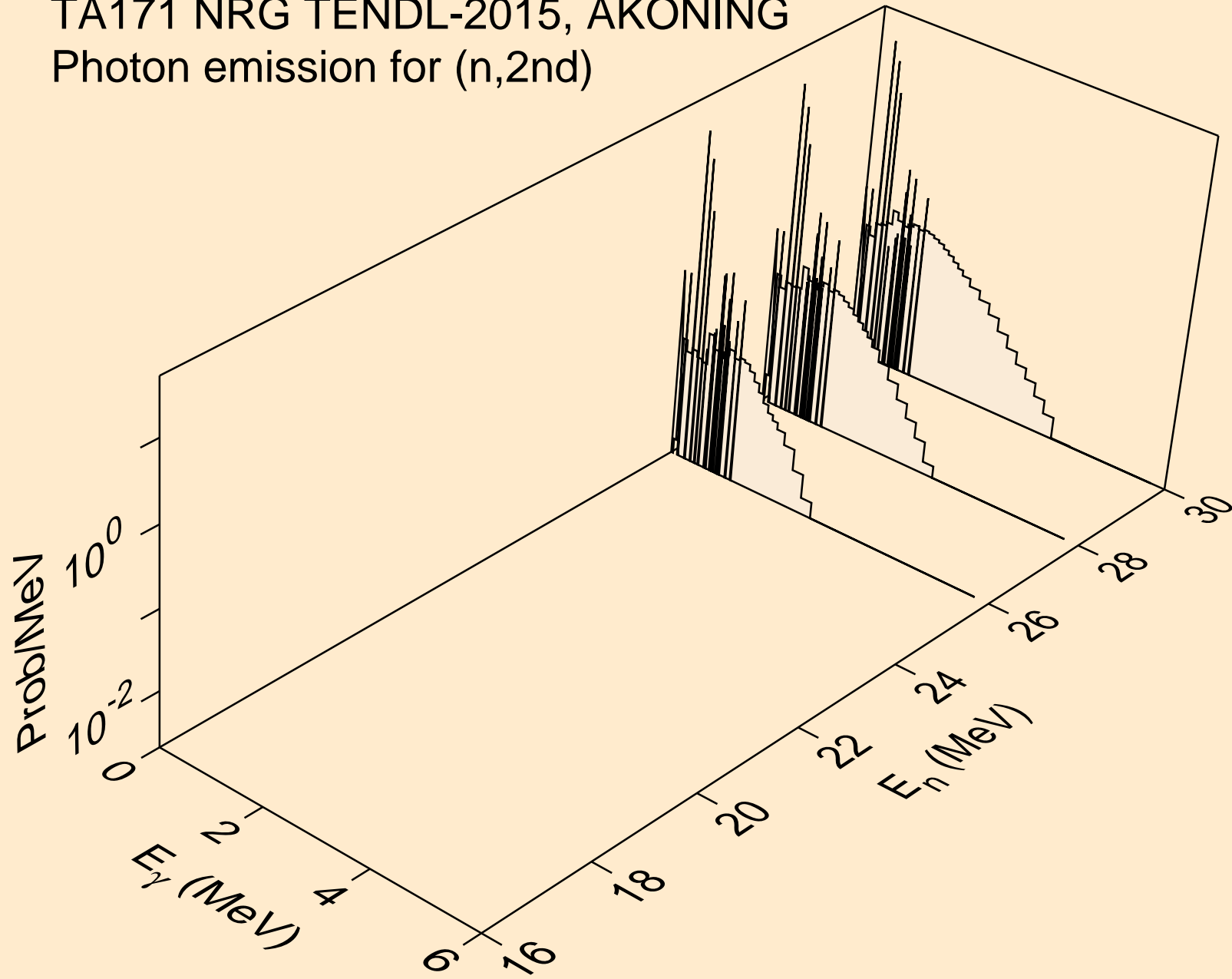

TA171 NRG TENDL-2015, AKONING
Photon emission for (n,2n)

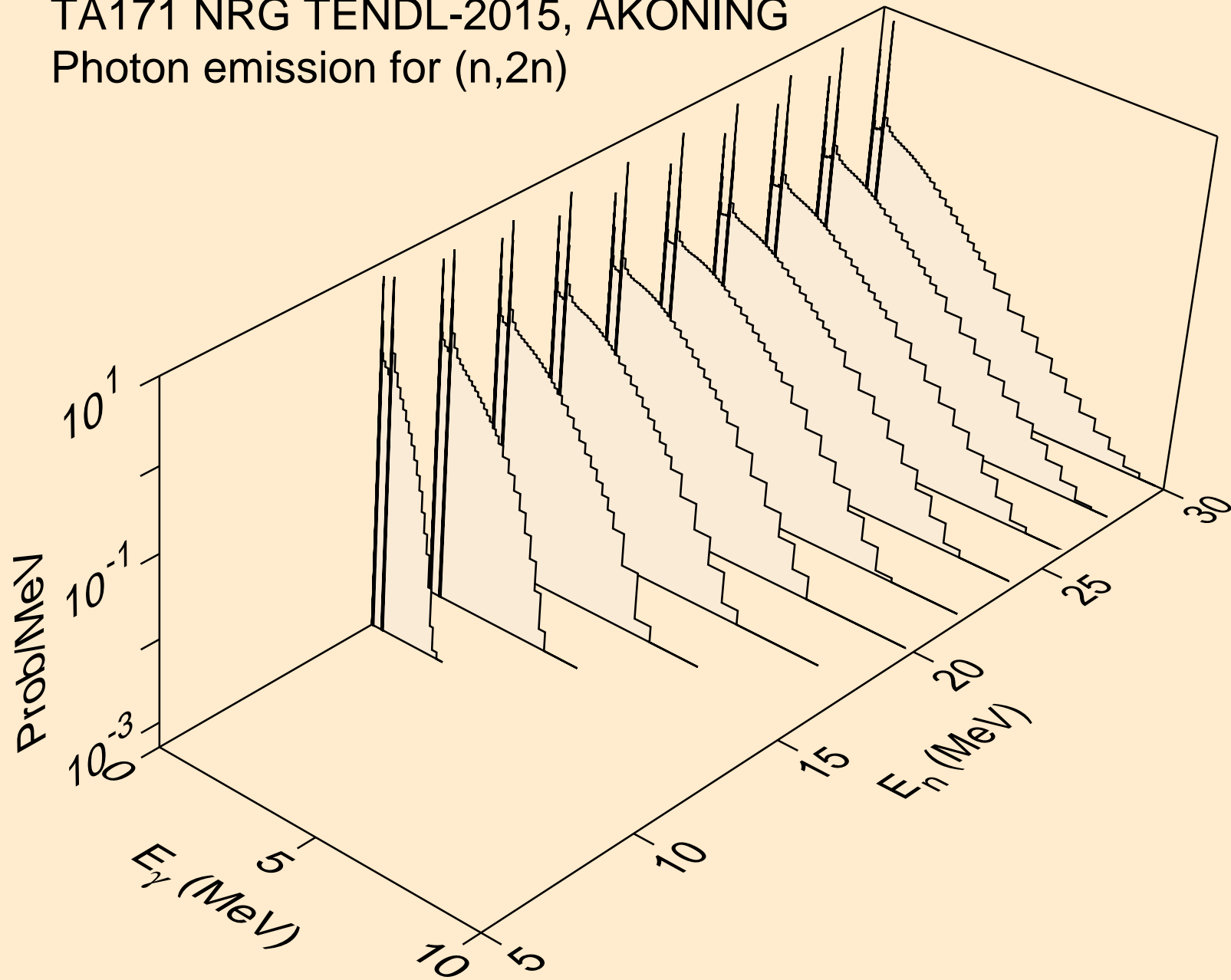

TA171 NRG TENDL-2015, AKONING
Photon emission for (n,3n)

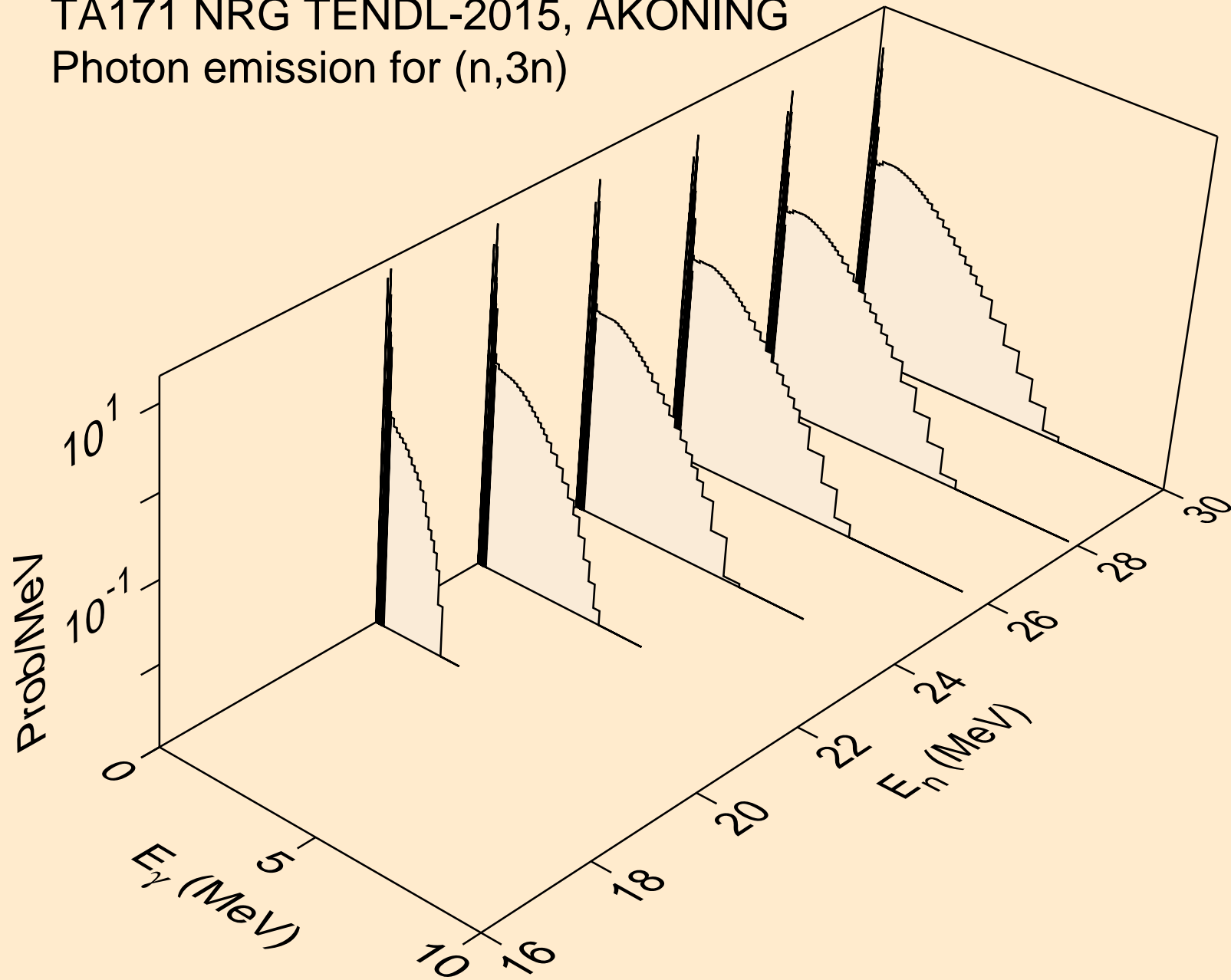

TA171 NRG TENDL-2015, AKONING
Photon emission for (n,n*)a

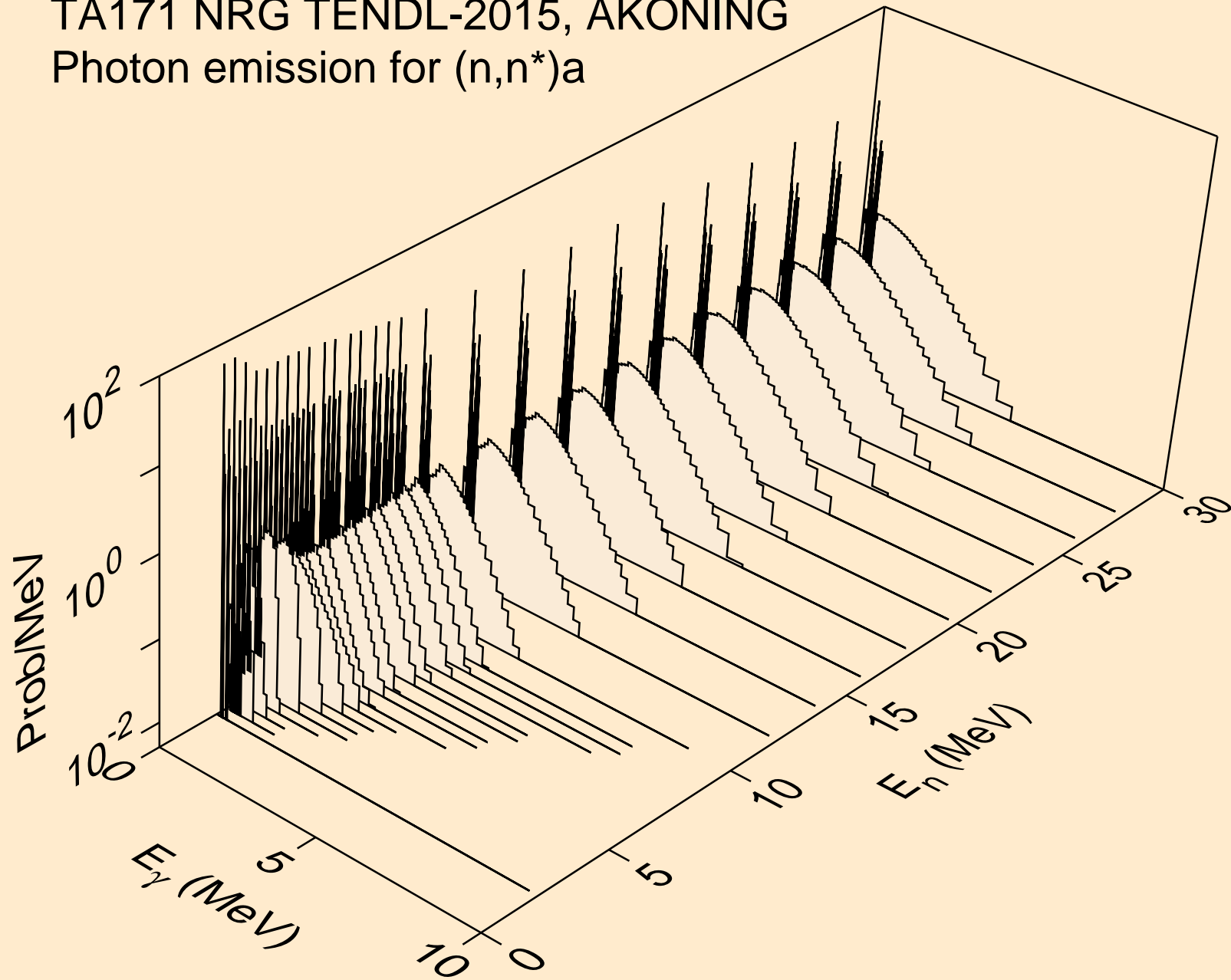

TA171 NRG TENDL-2015, AKONING
Photon emission for (n,2n)a

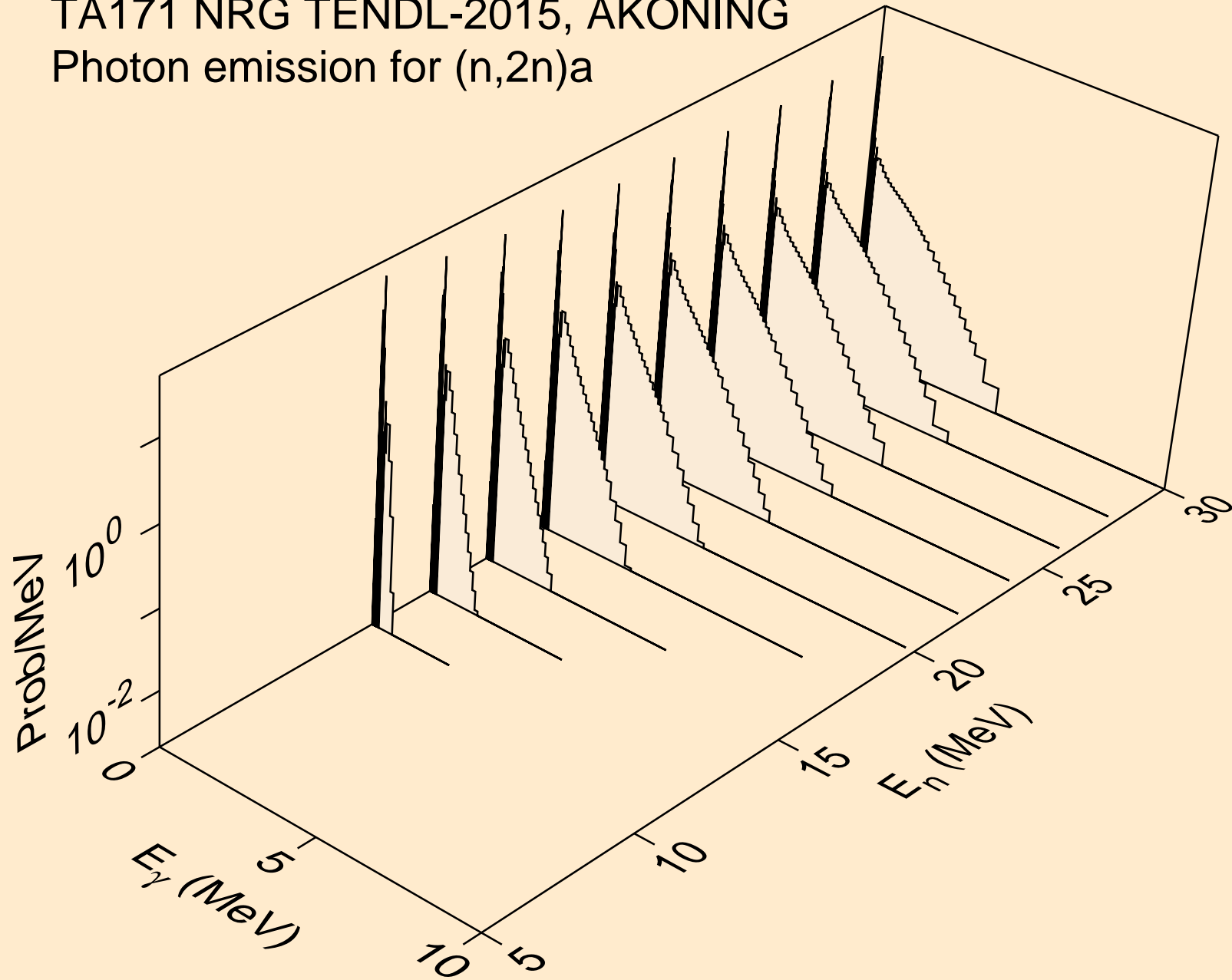

TA171 NRG TENDL-2015, AKONING
Photon emission for (n,3n)a

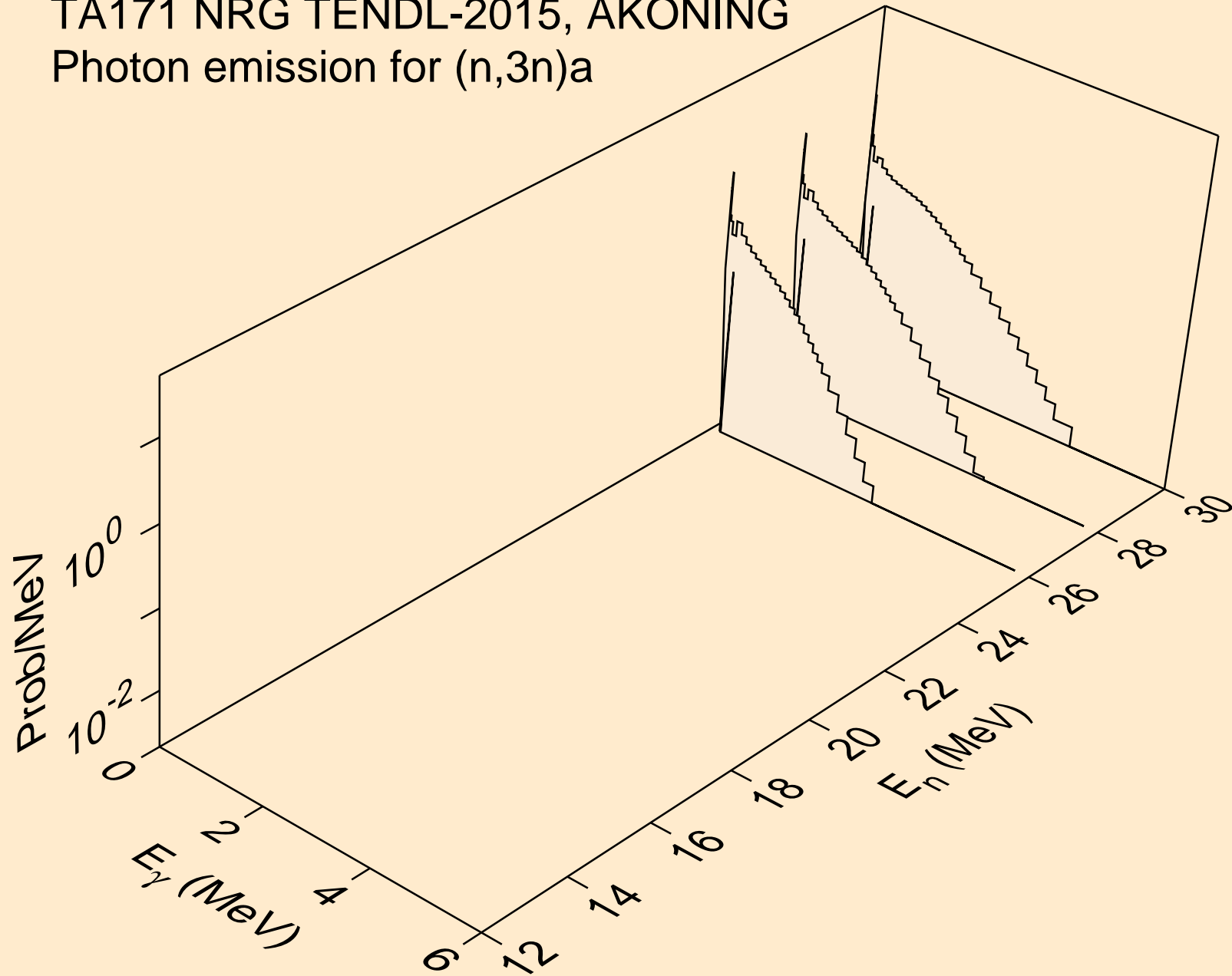

TA171 NRG TENDL-2015, AKONING
Photon emission for (n,n*)p

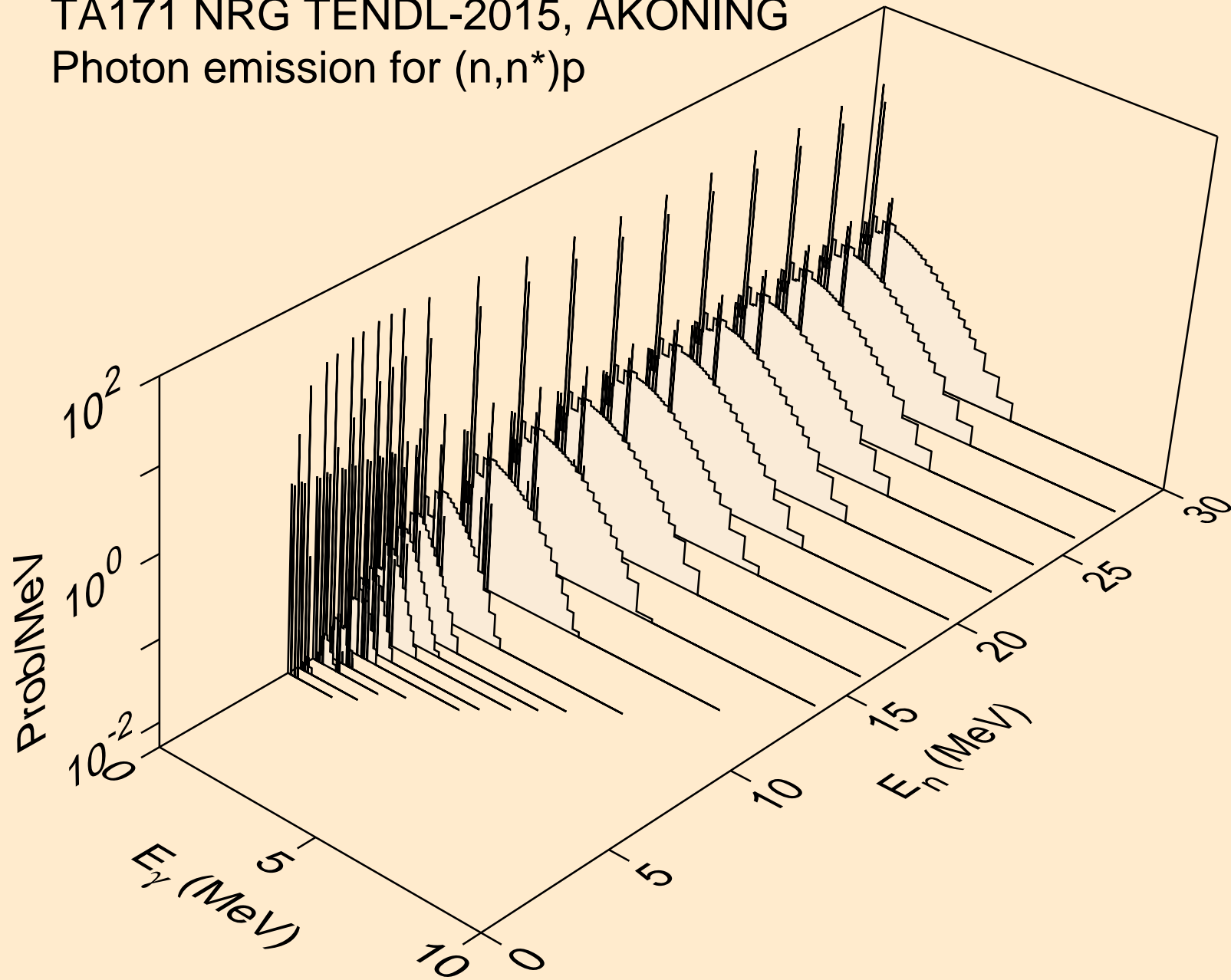

TA171 NRG TENDL-2015, AKONING
Photon emission for (n,n*)2a

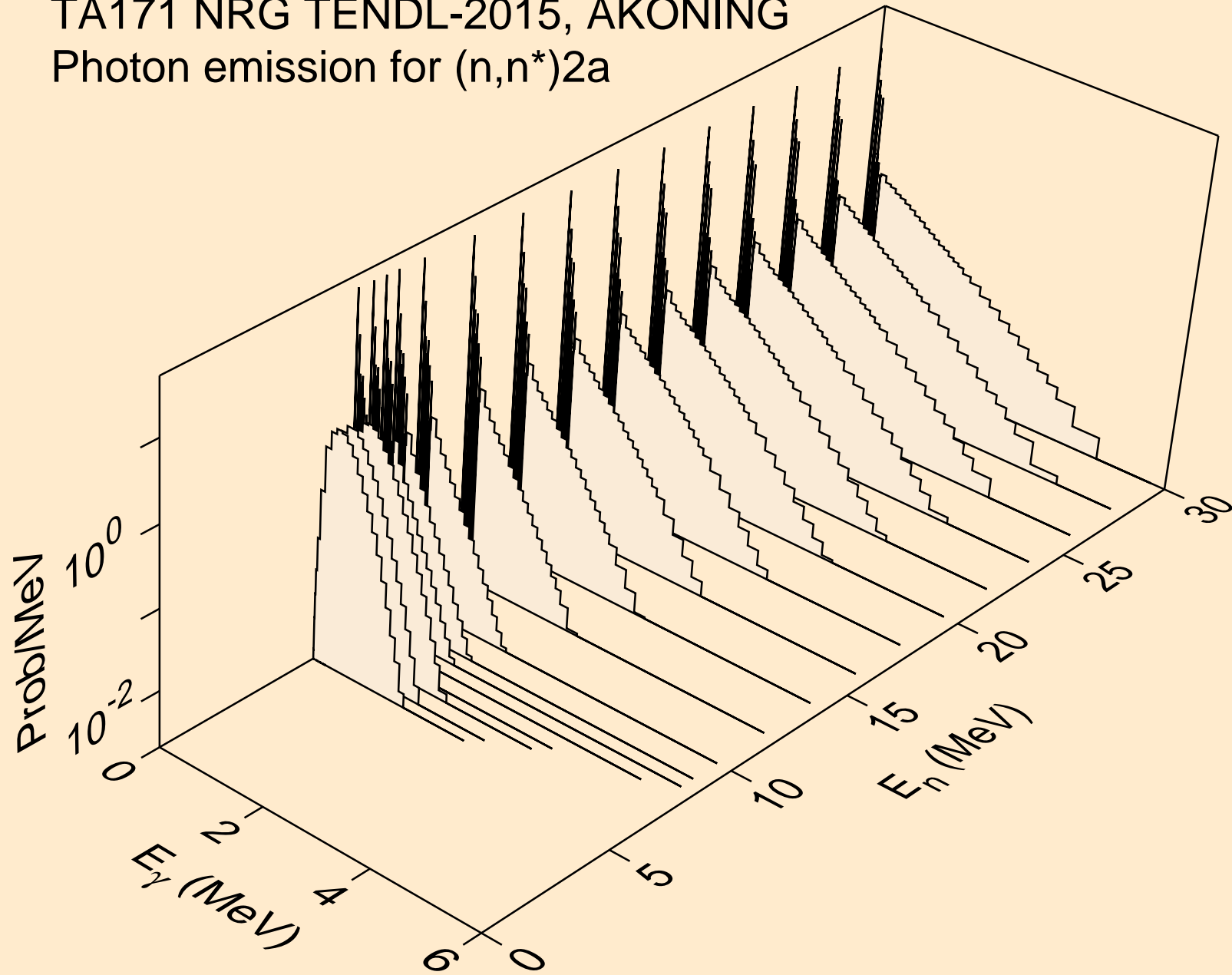

TA171 NRG TENDL-2015, AKONING
Photon emission for (n,2n)2a

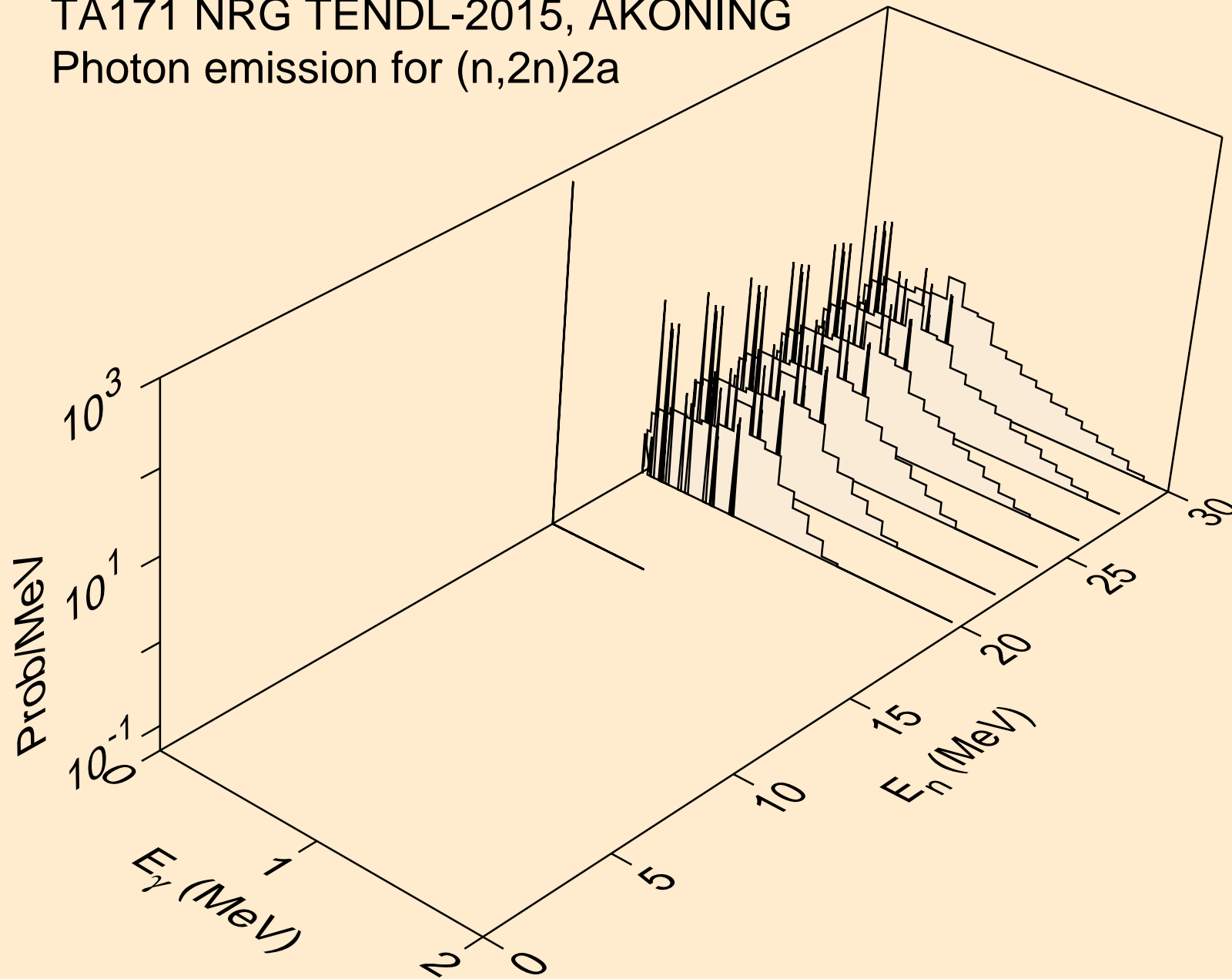

TA171 NRG TENDL-2015, AKONING
Photon emission for (n,n*)d

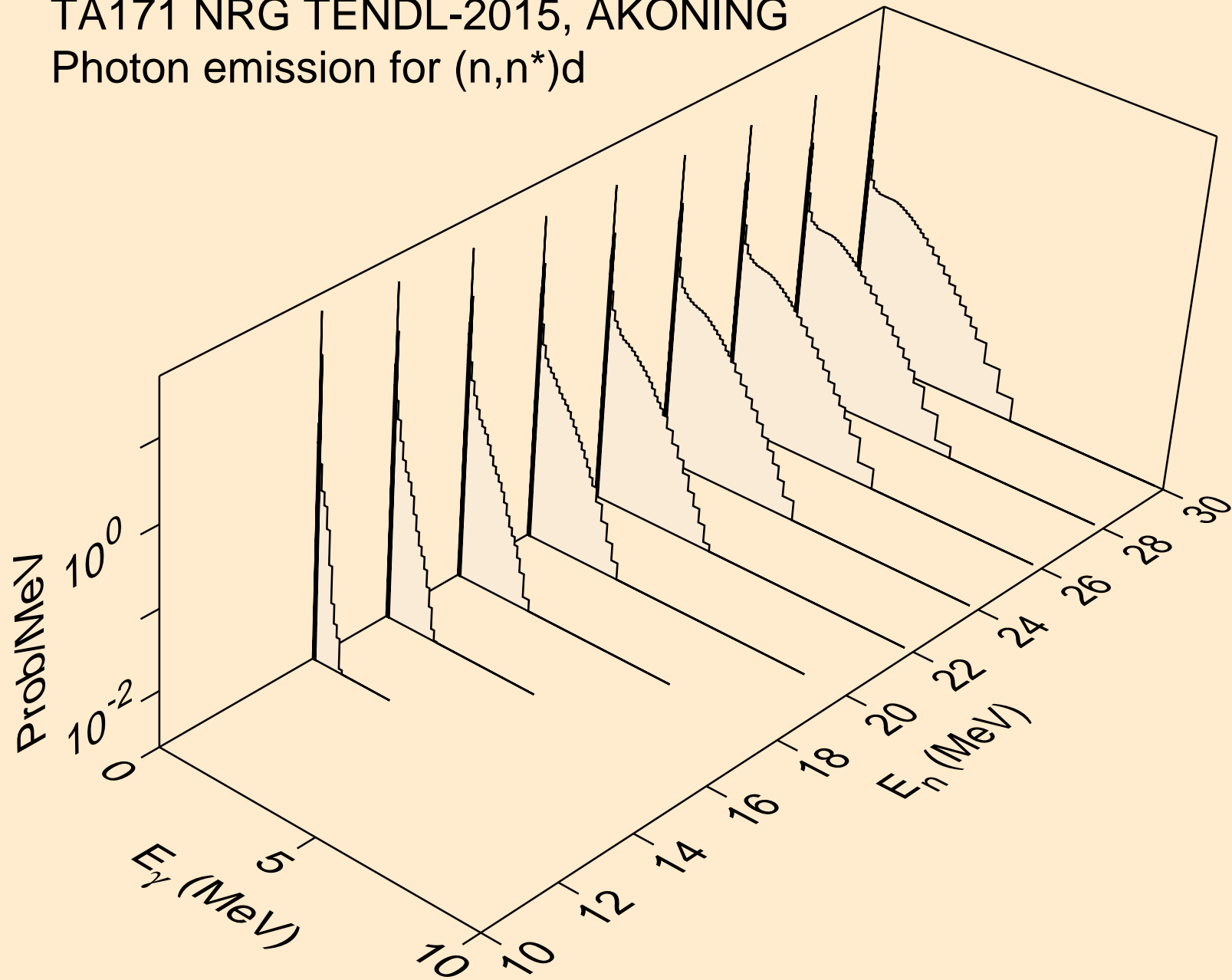

TA171 NRG TENDL-2015, AKONING
Photon emission for (n,n*)t

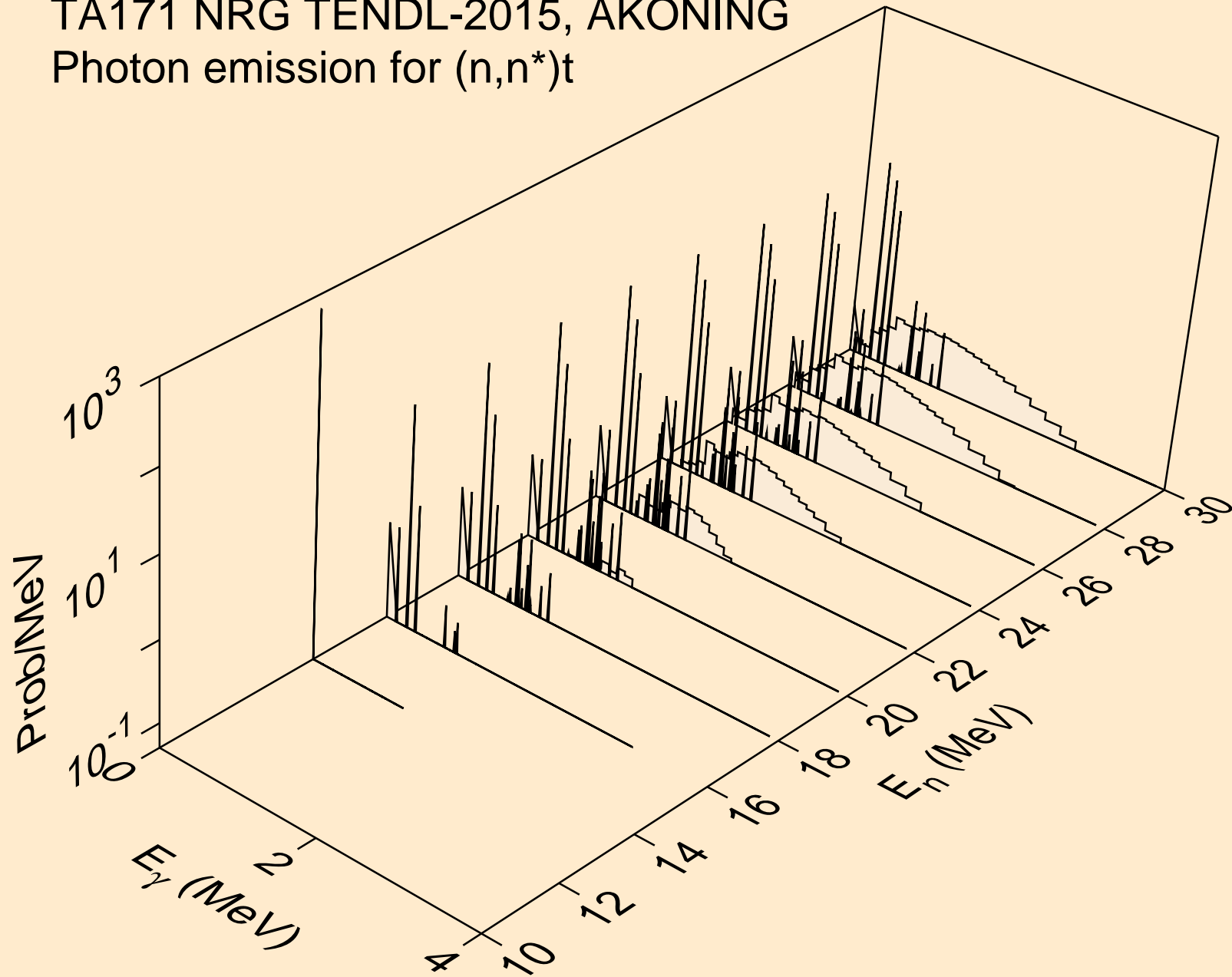

TA171 NRG TENDL-2015, AKONING
Photon emission for (n,n*)he3

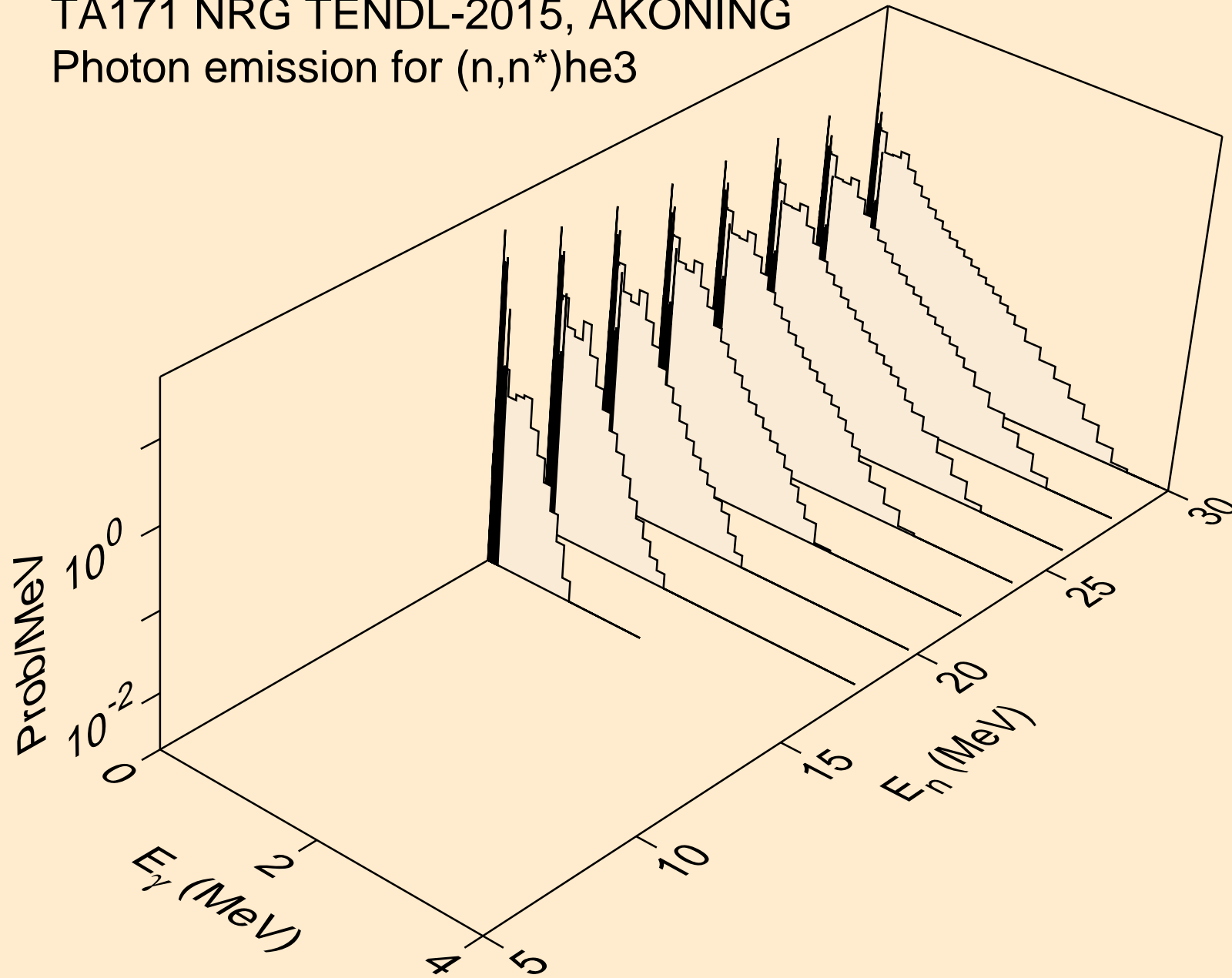

TA171 NRG TENDL-2015, AKONING
Photon emission for (n,4n)

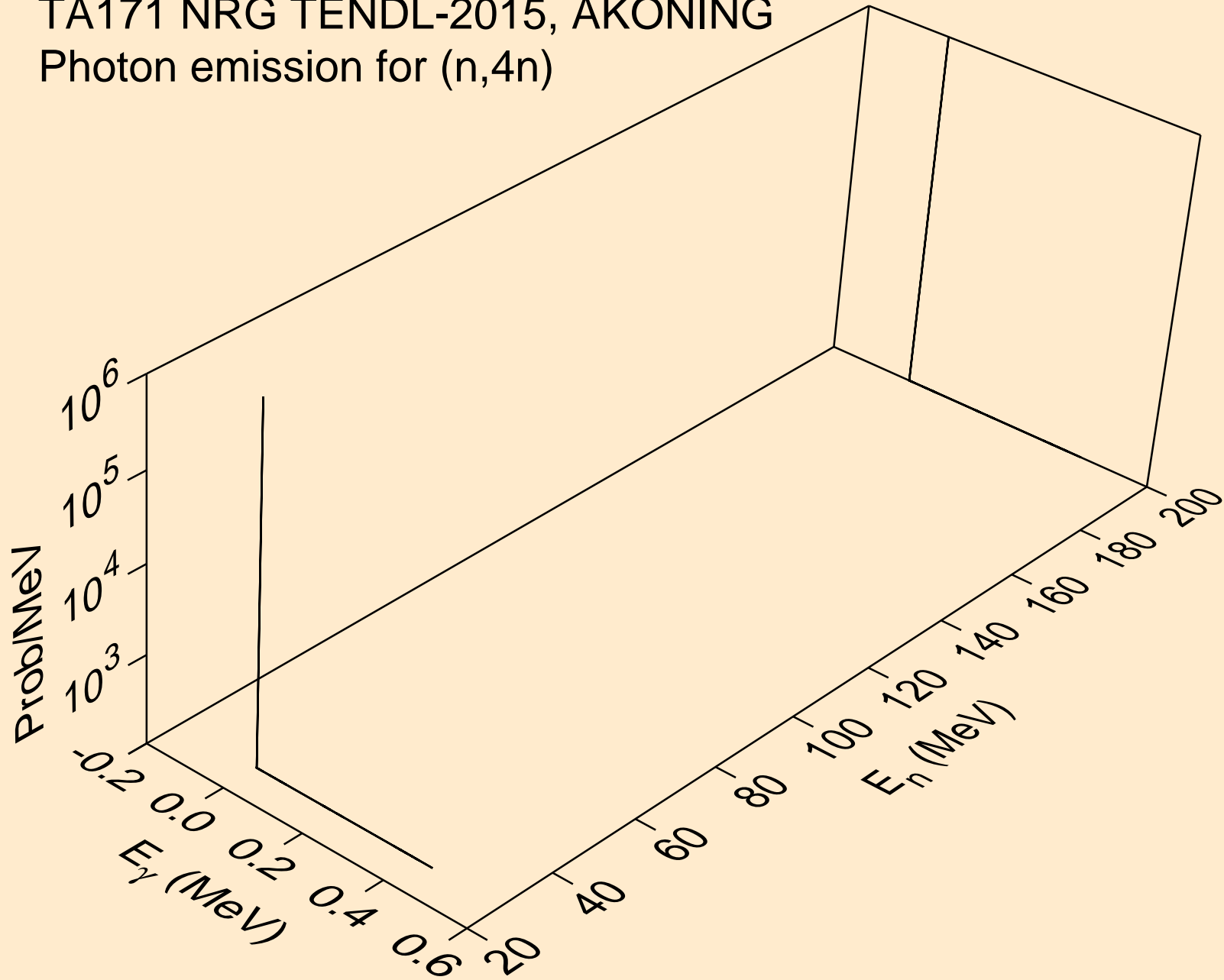

TA171 NRG TENDL-2015, AKONING
Photon emission for (n,2np)

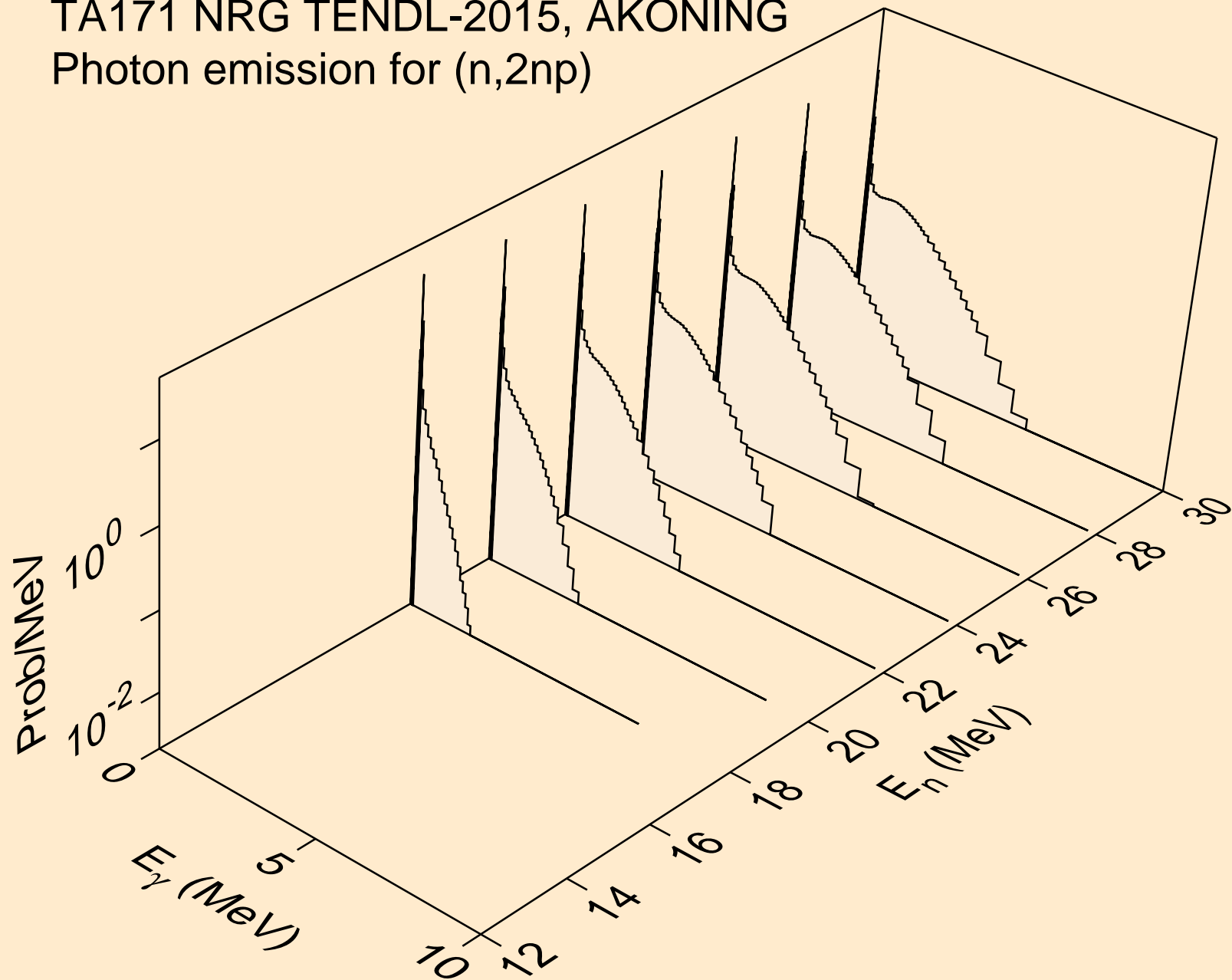

TA171 NRG TENDL-2015, AKONING
Photon emission for (n,3np)

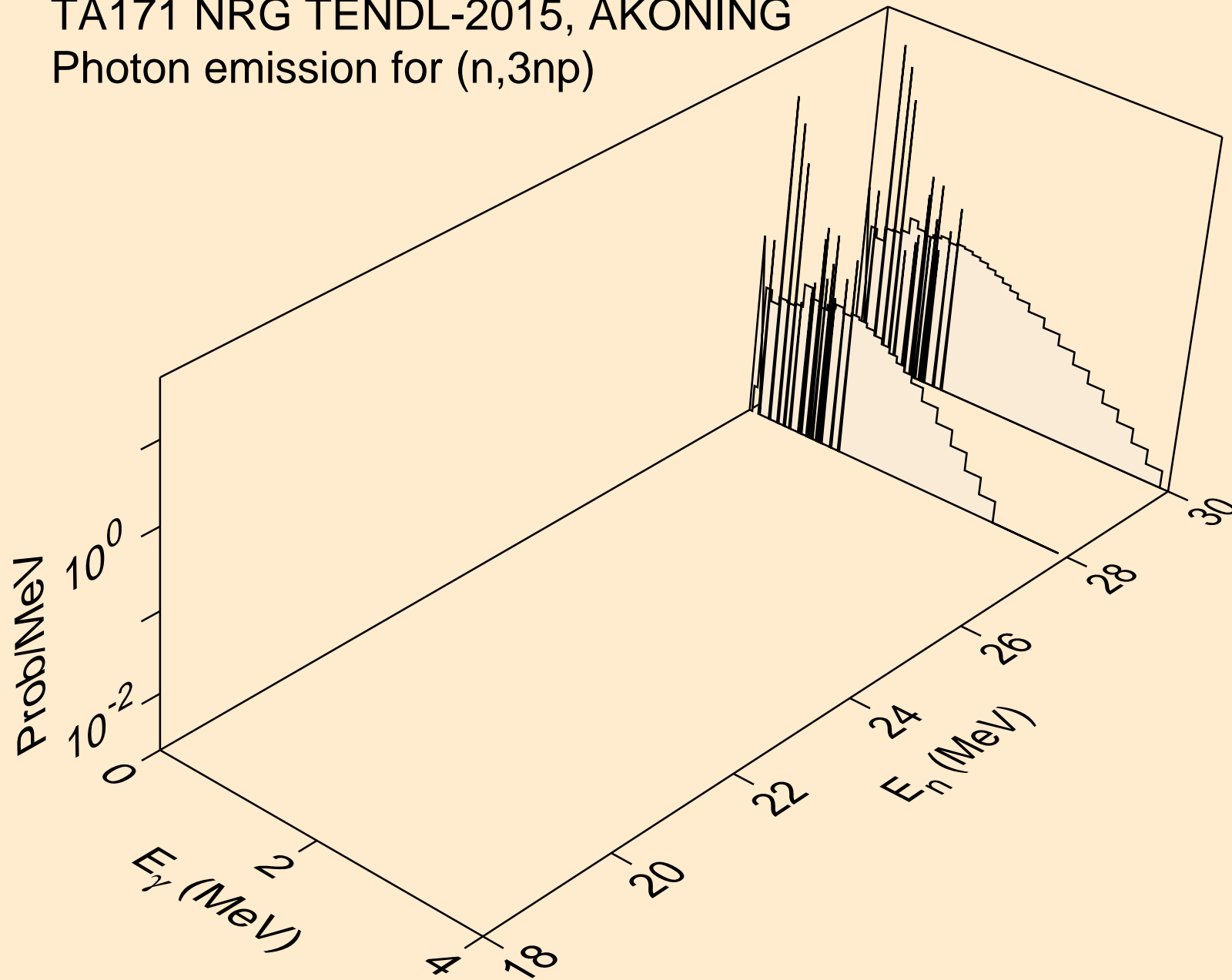

TA171 NRG TENDL-2015, AKONING
Photon emission for (n,2np)

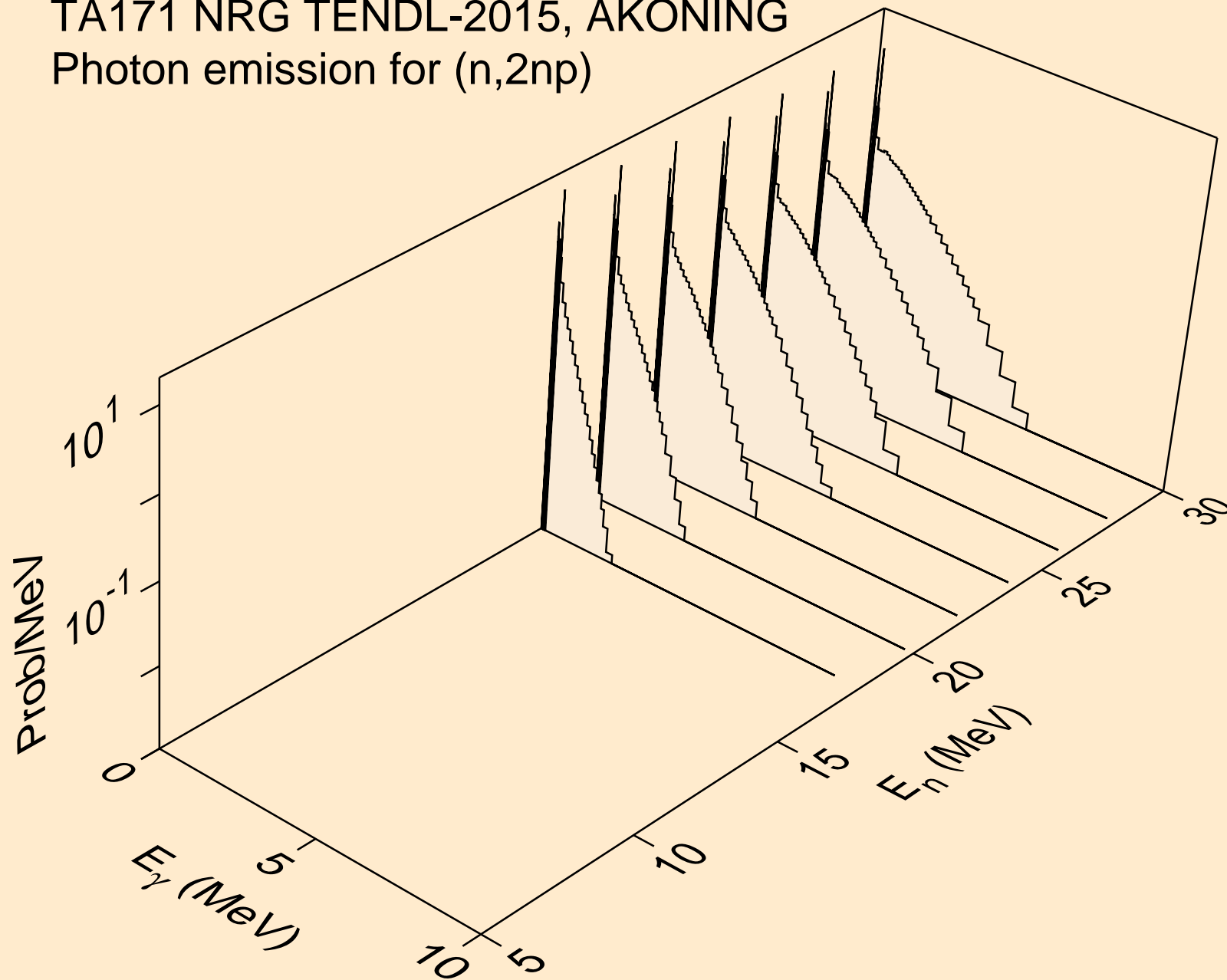

TA171 NRG TENDL-2015, AKONING
Photon emission for (n,npa)

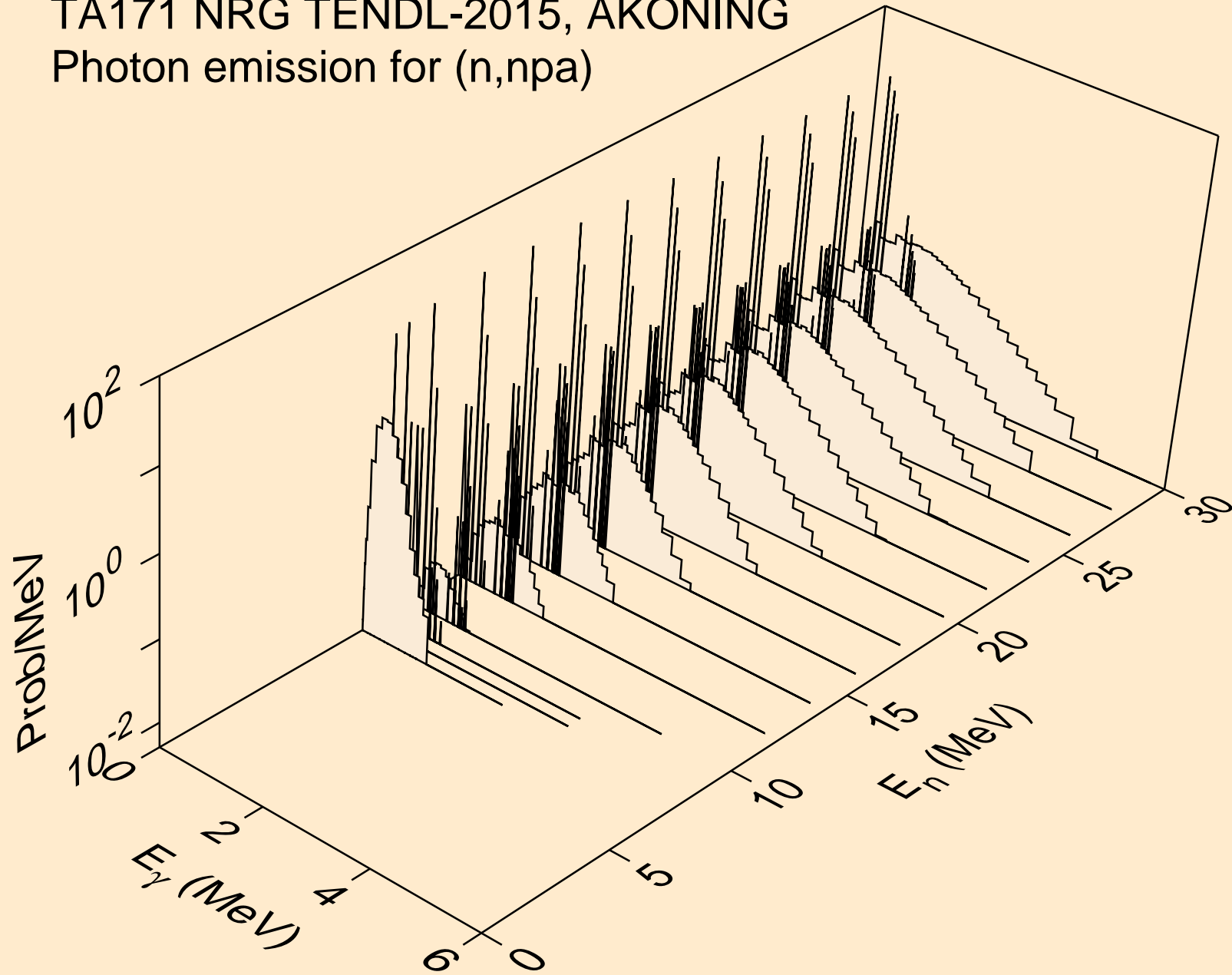

TA171 NRG TENDL-2015, AKONING
Photon emission for (n,n*c)

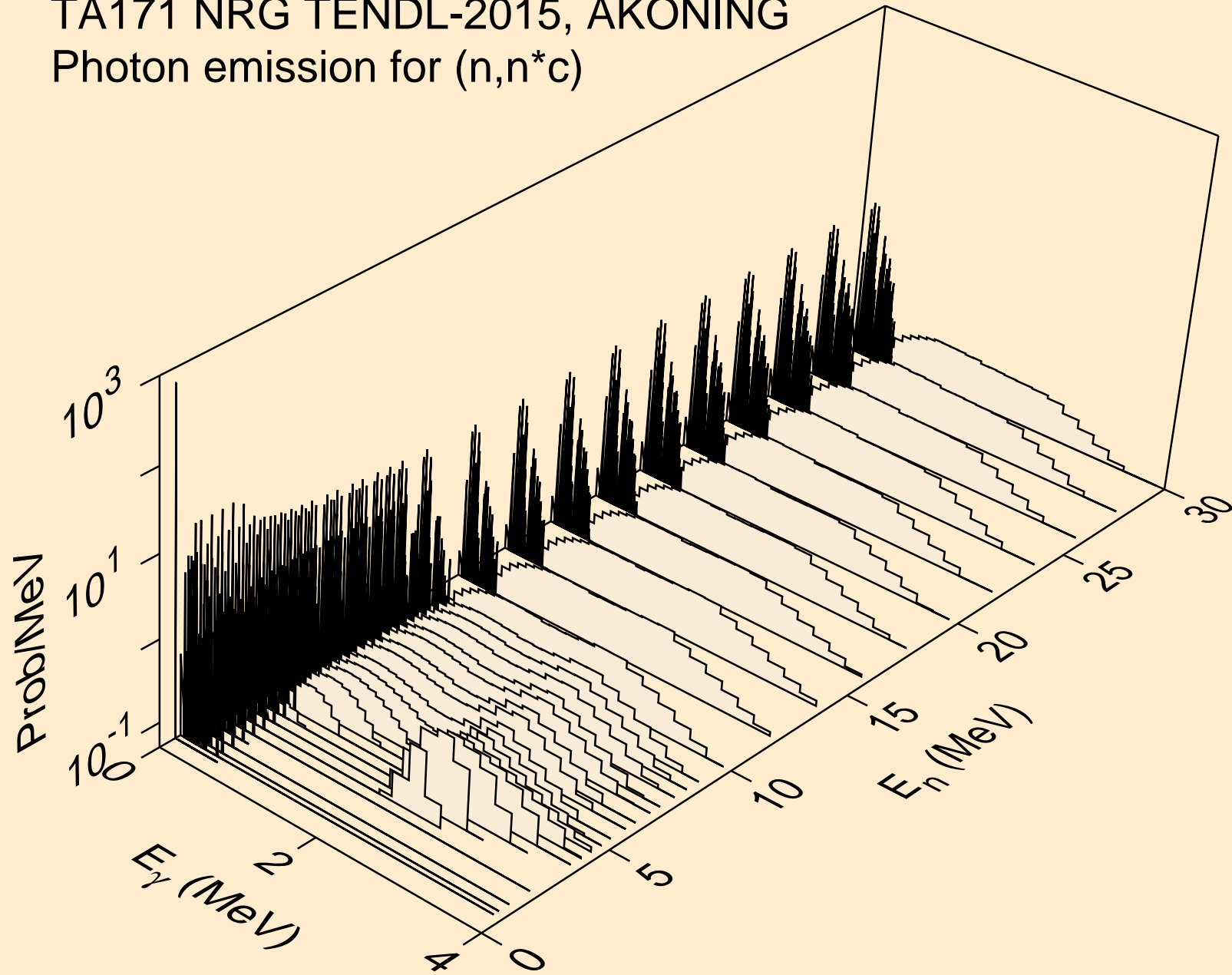

TA171 NRG TENDL-2015, AKONING
Photon emission for (n,gma)

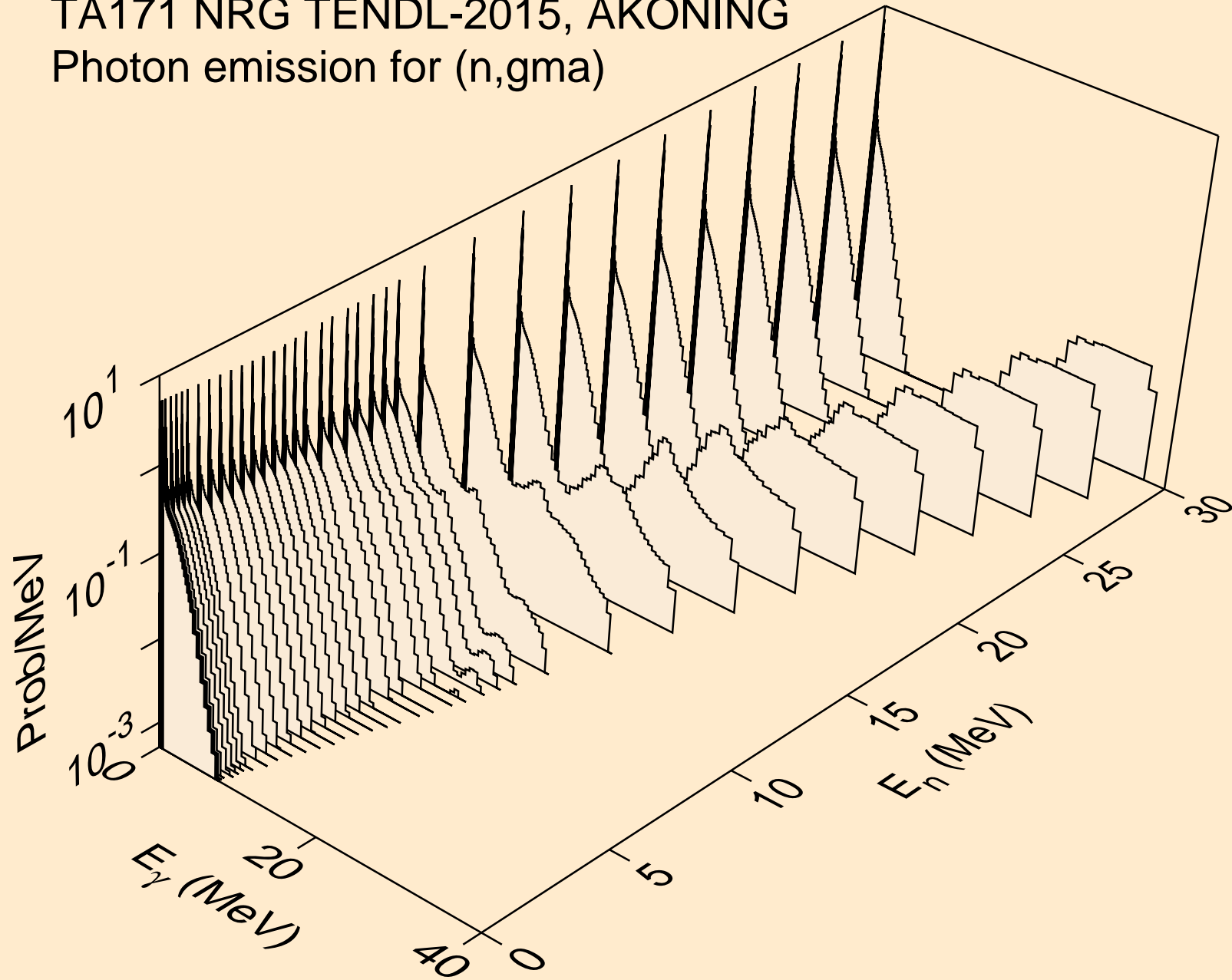

TA171 NRG TENDL-2015, AKONING
Photon emission for (n,p)

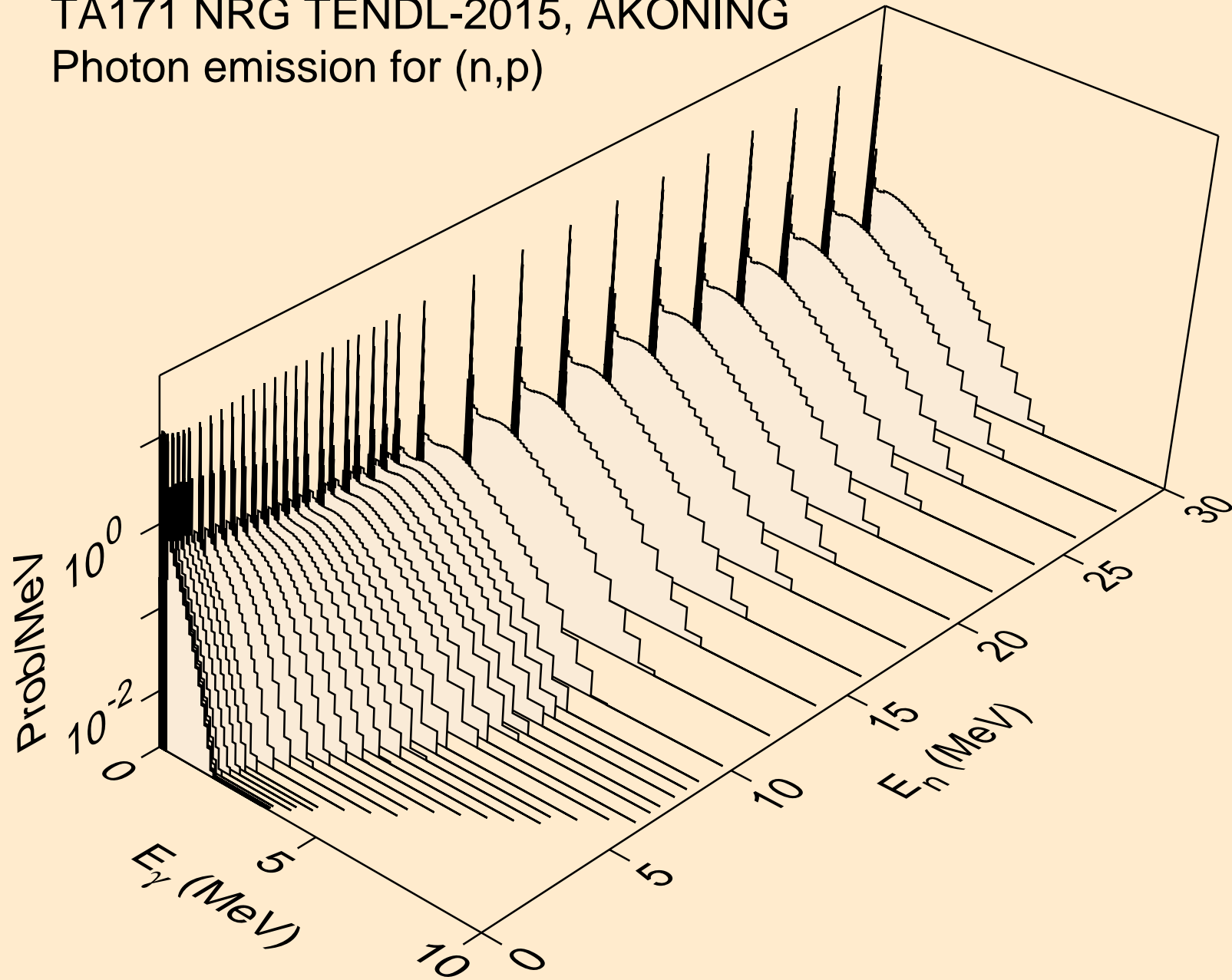

TA171 NRG TENDL-2015, AKONING
Photon emission for (n,d)

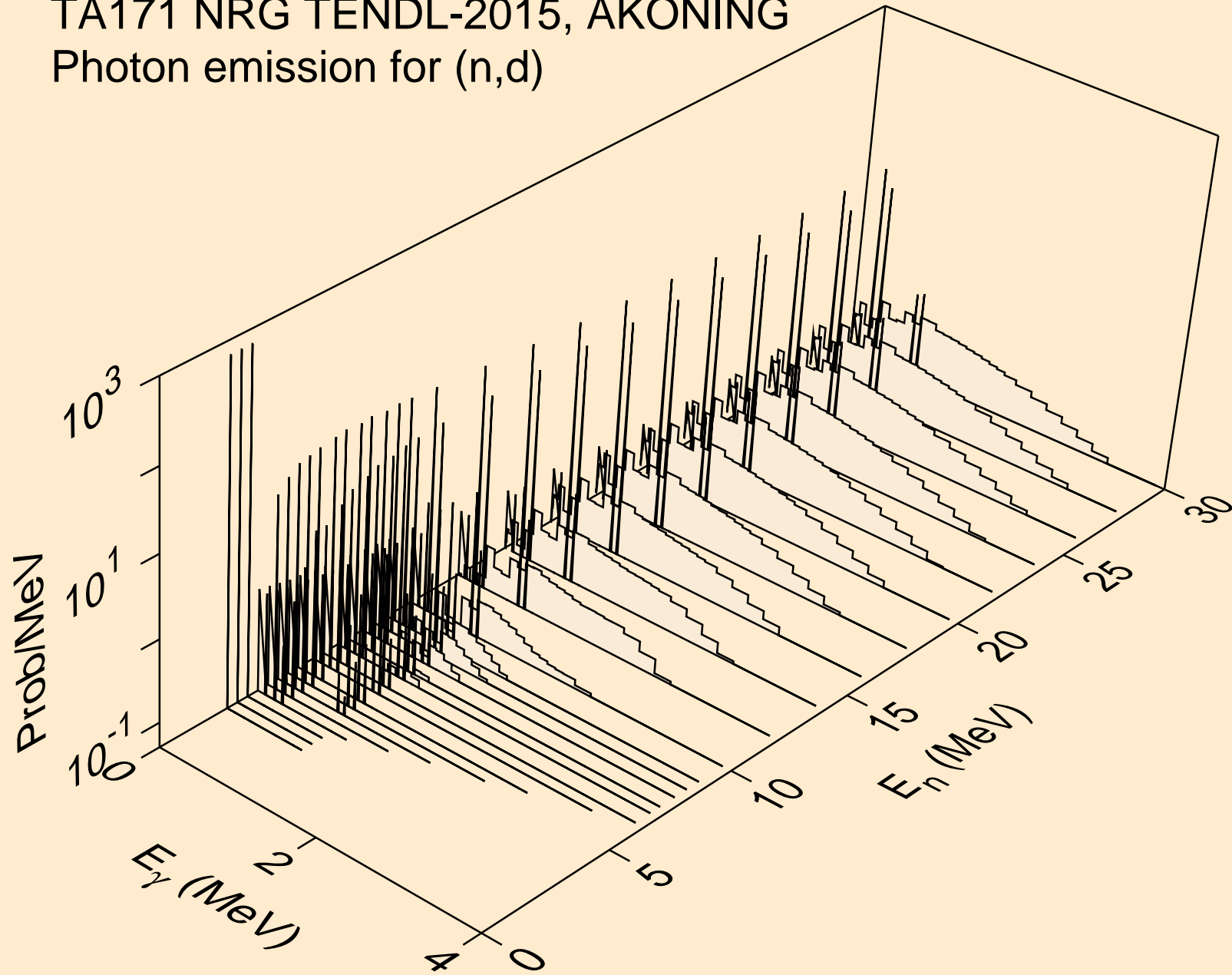

TA171 NRG TENDL-2015, AKONING
Photon emission for (n,t)

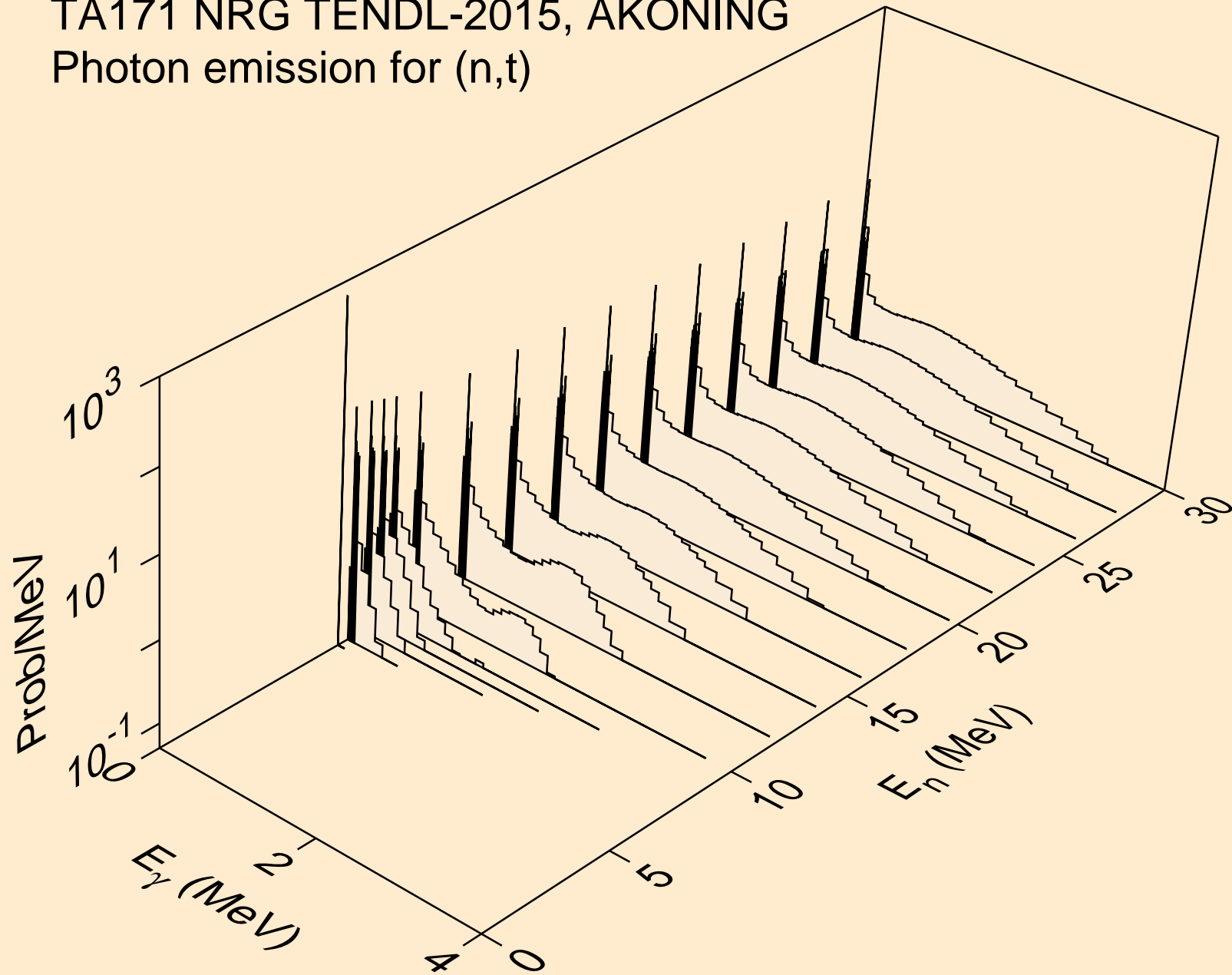

TA171 NRG TENDL-2015, AKONING
Photon emission for (n,he3)

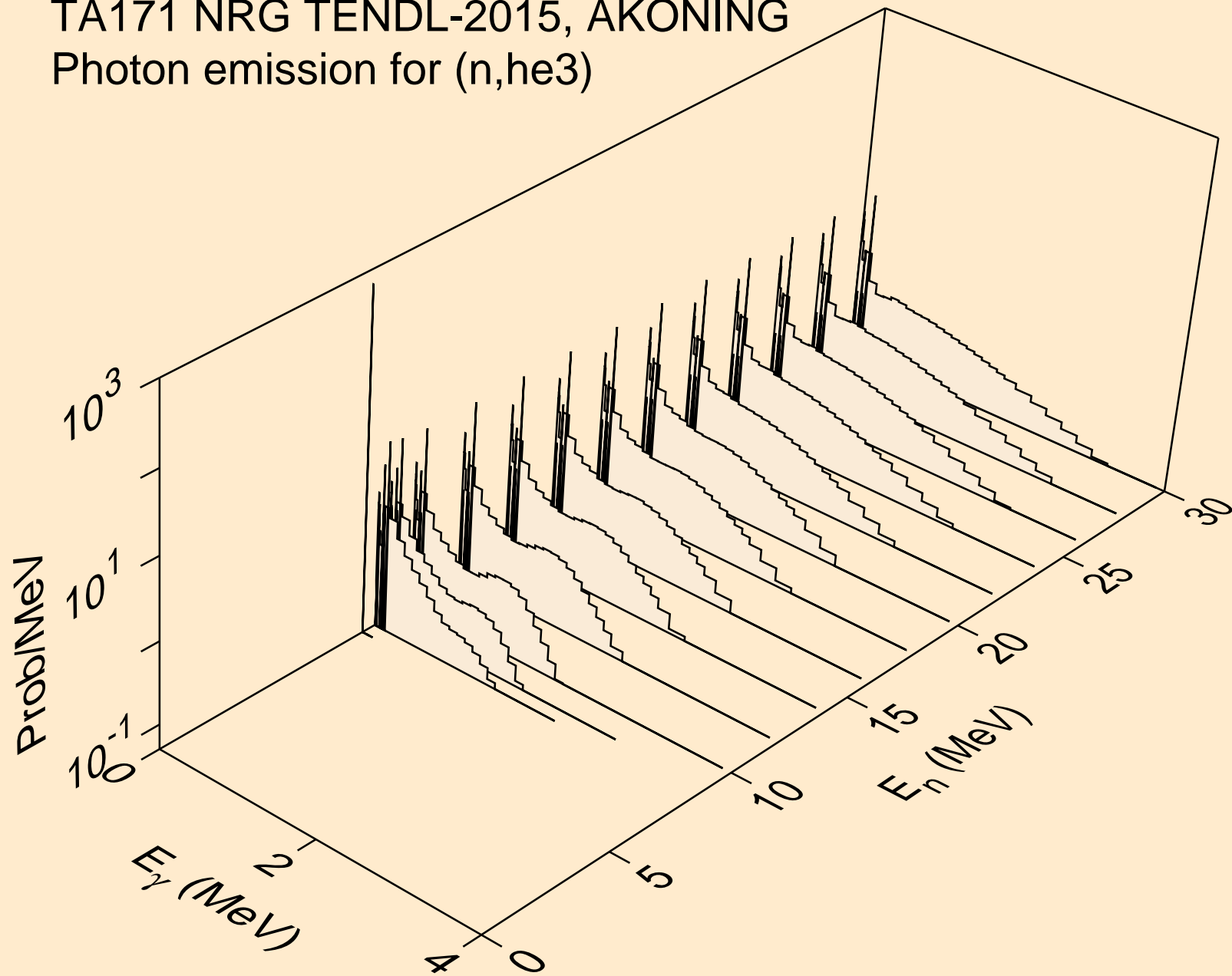

TA171 NRG TENDL-2015, AKONING
Photon emission for (n,a)

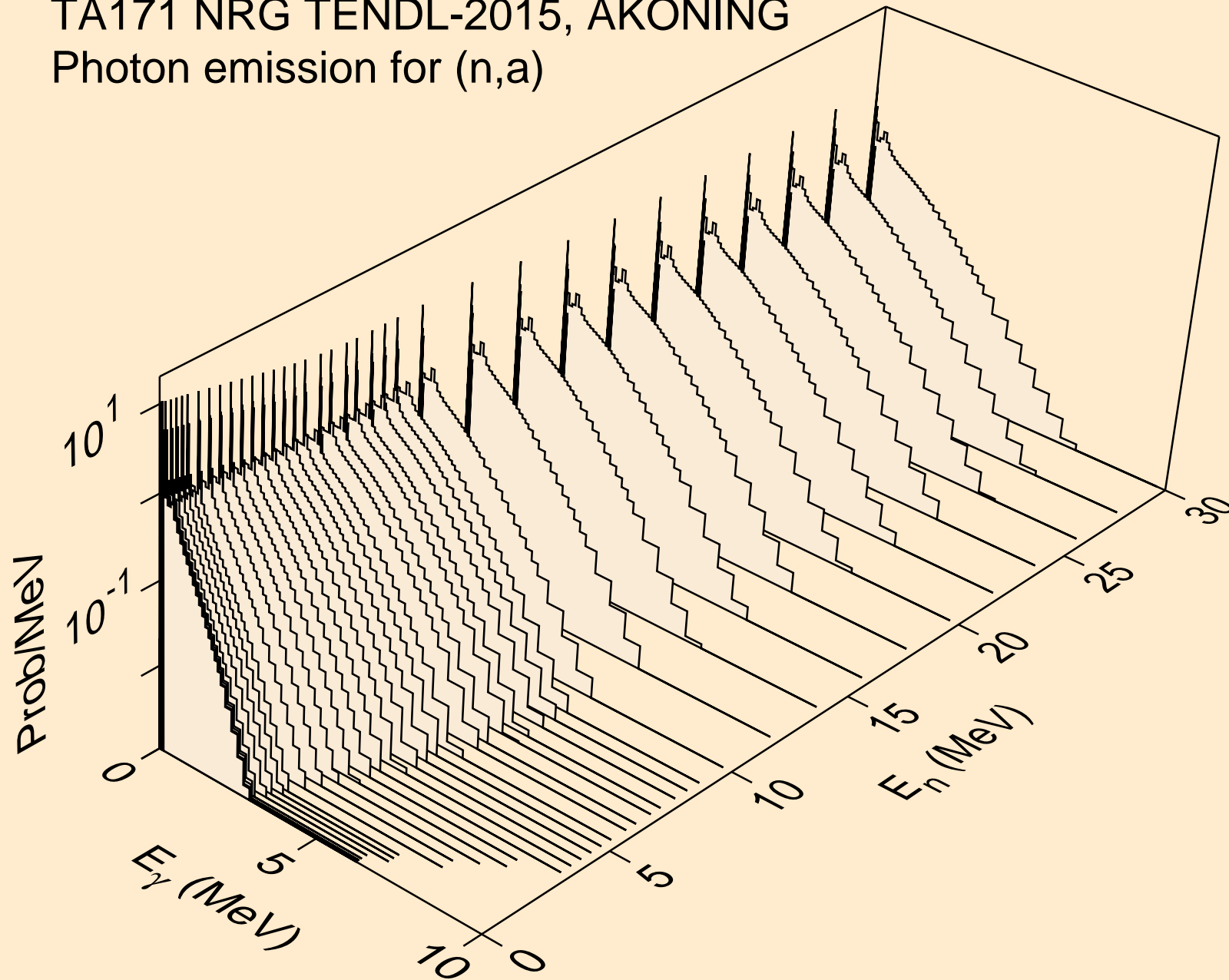

TA171 NRG TENDL-2015, AKONING
Photon emission for (n,2a)

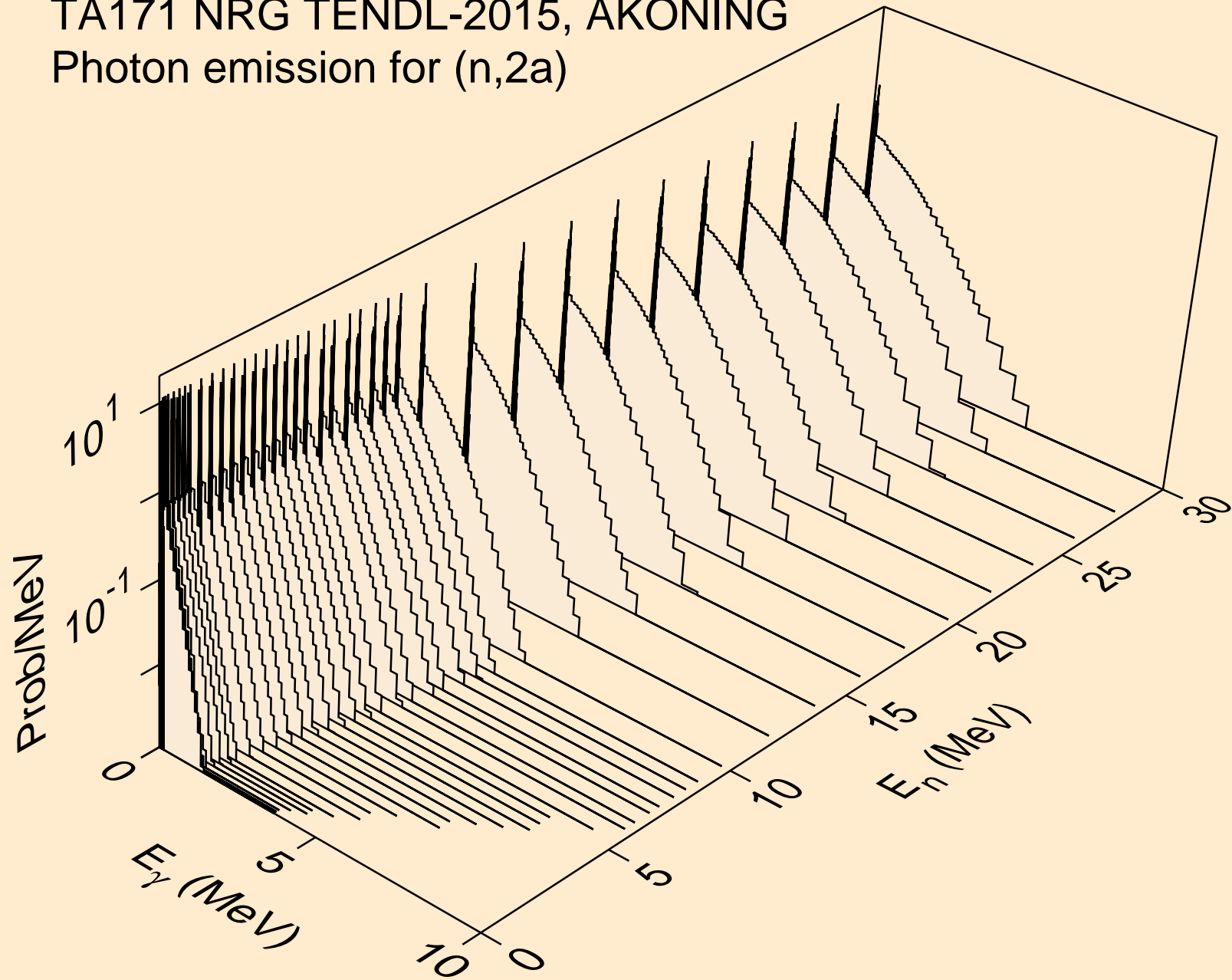

TA171 NRG TENDL-2015, AKONING
Photon emission for (n,2p)

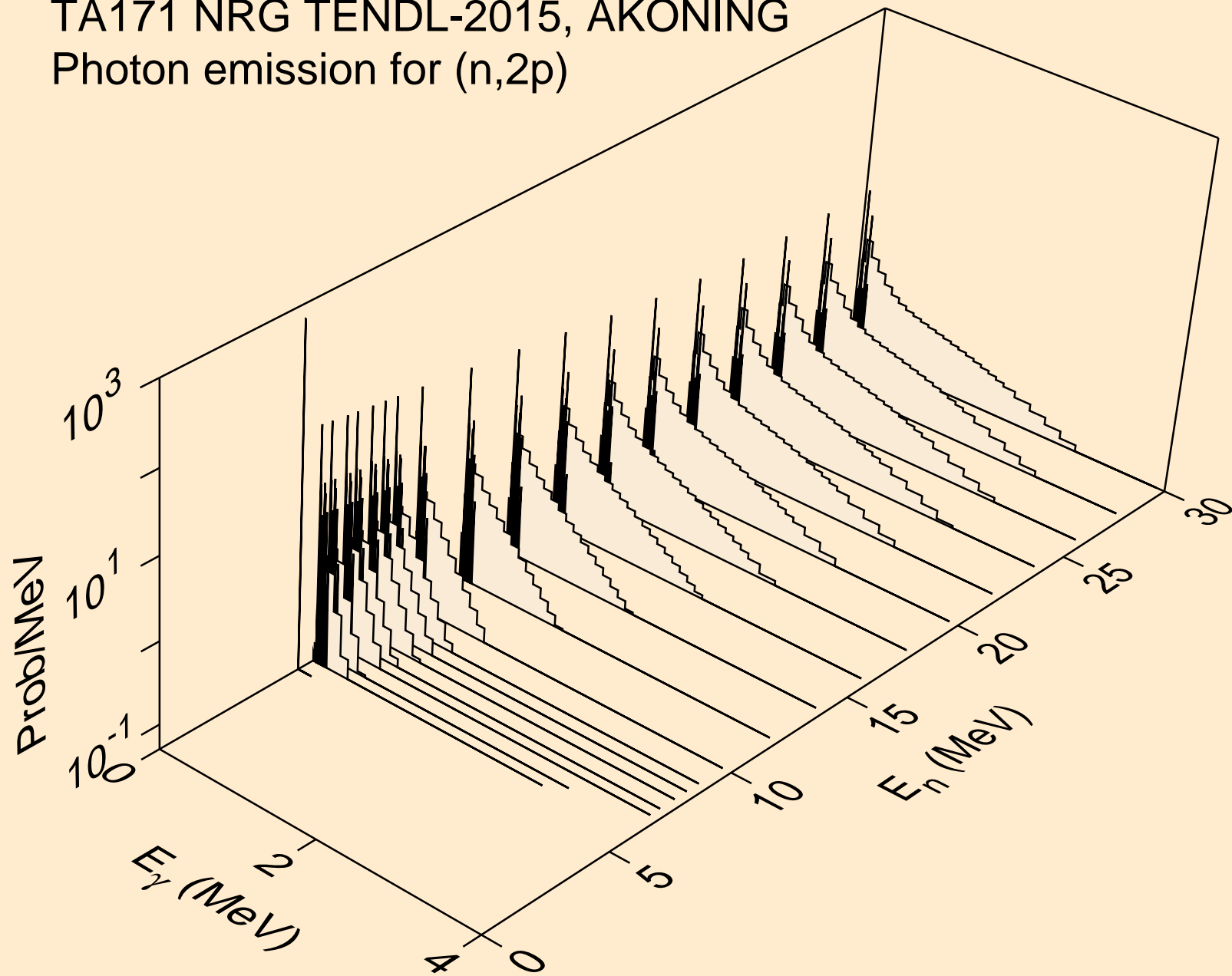

TA171 NRG TENDL-2015, AKONING
Photon emission for (n,p α)

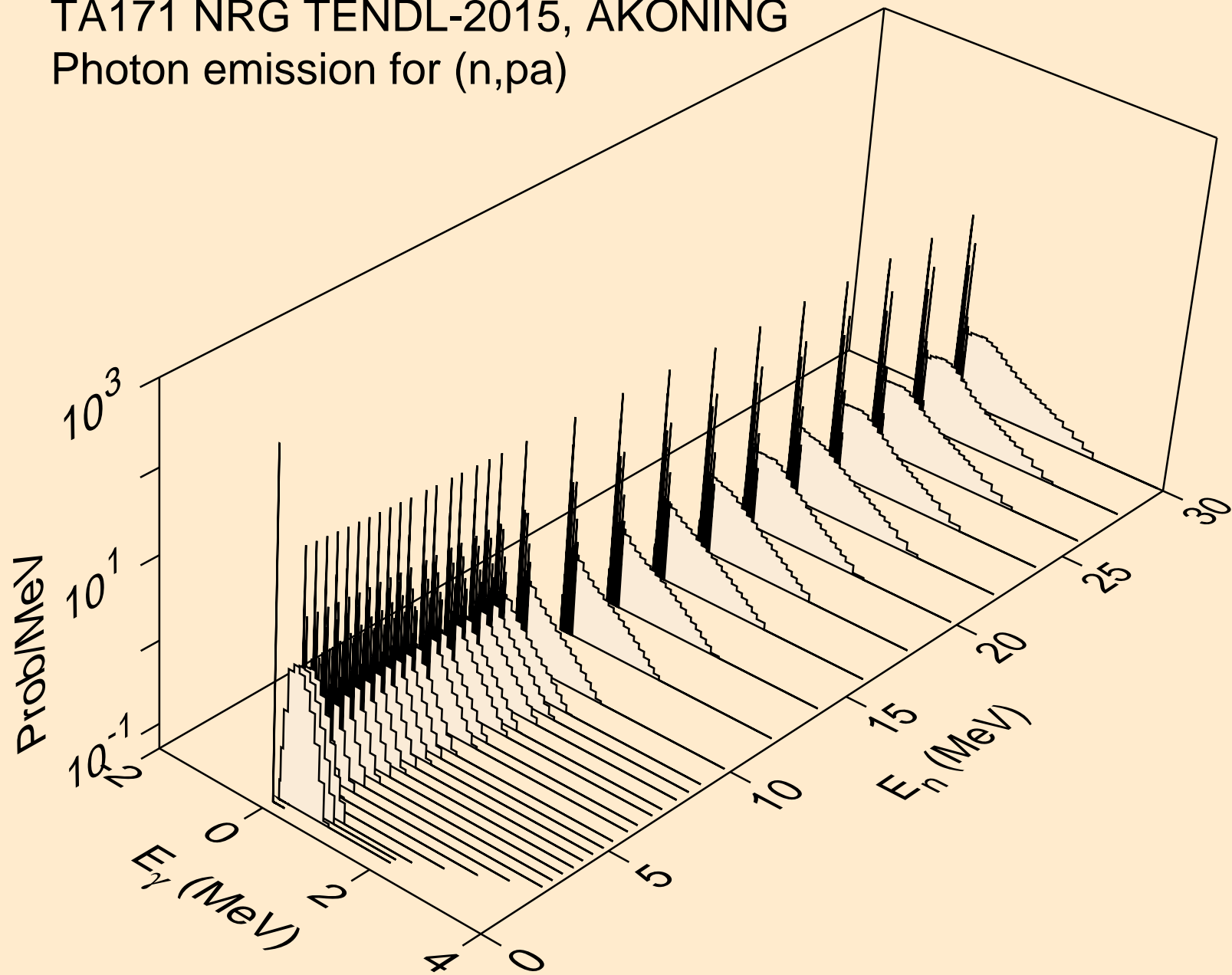

TA171 NRG TENDL-2015, AKONING
Photon emission for (n,pd)

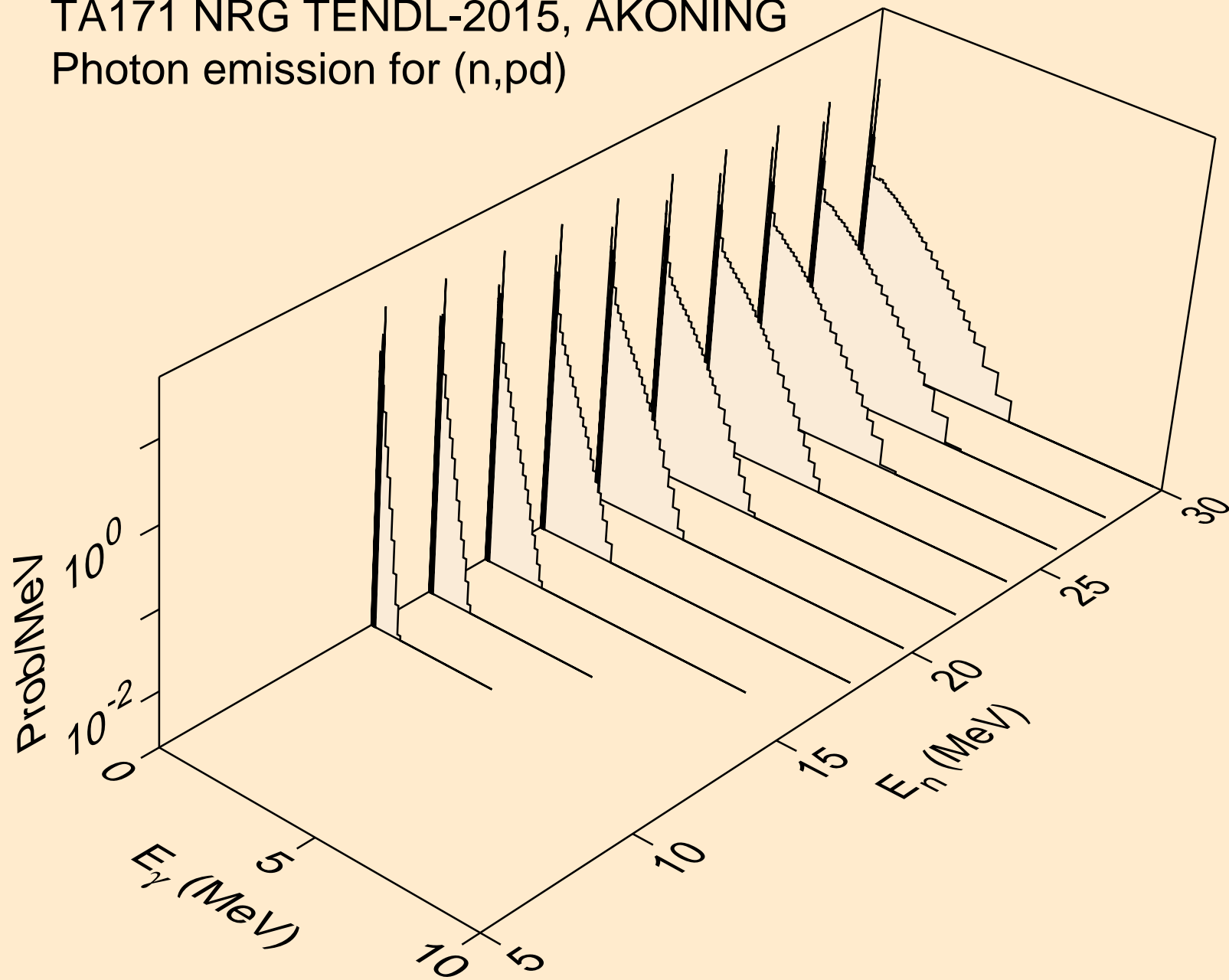

TA171 NRG TENDL-2015, AKONING
Photon emission for (n,pt)

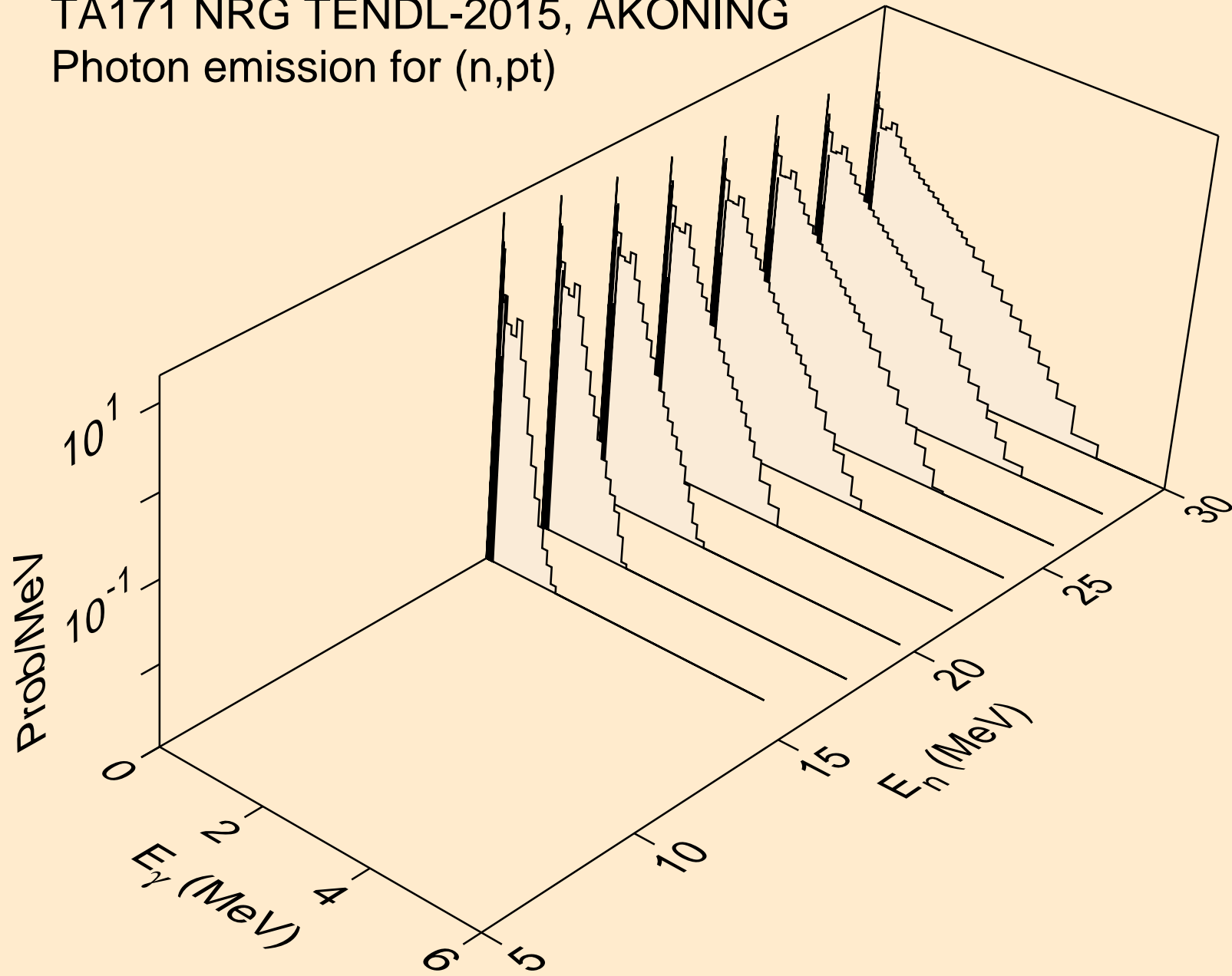

TA171 NRG TENDL-2015, AKONING
Photon emission for (n,da)

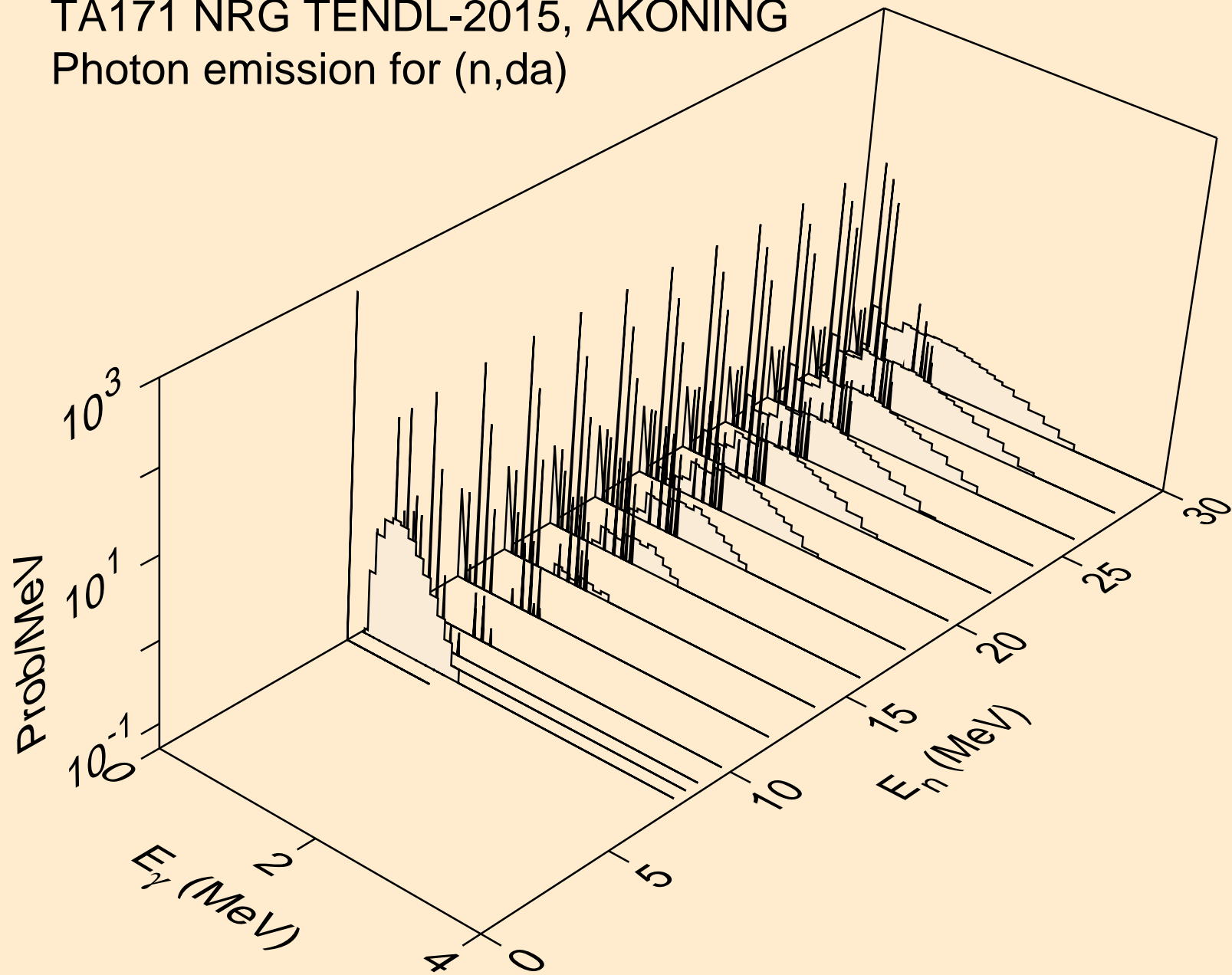

TA171 NRG TENDL-2015, AKONING
thermal capture photon spectrum

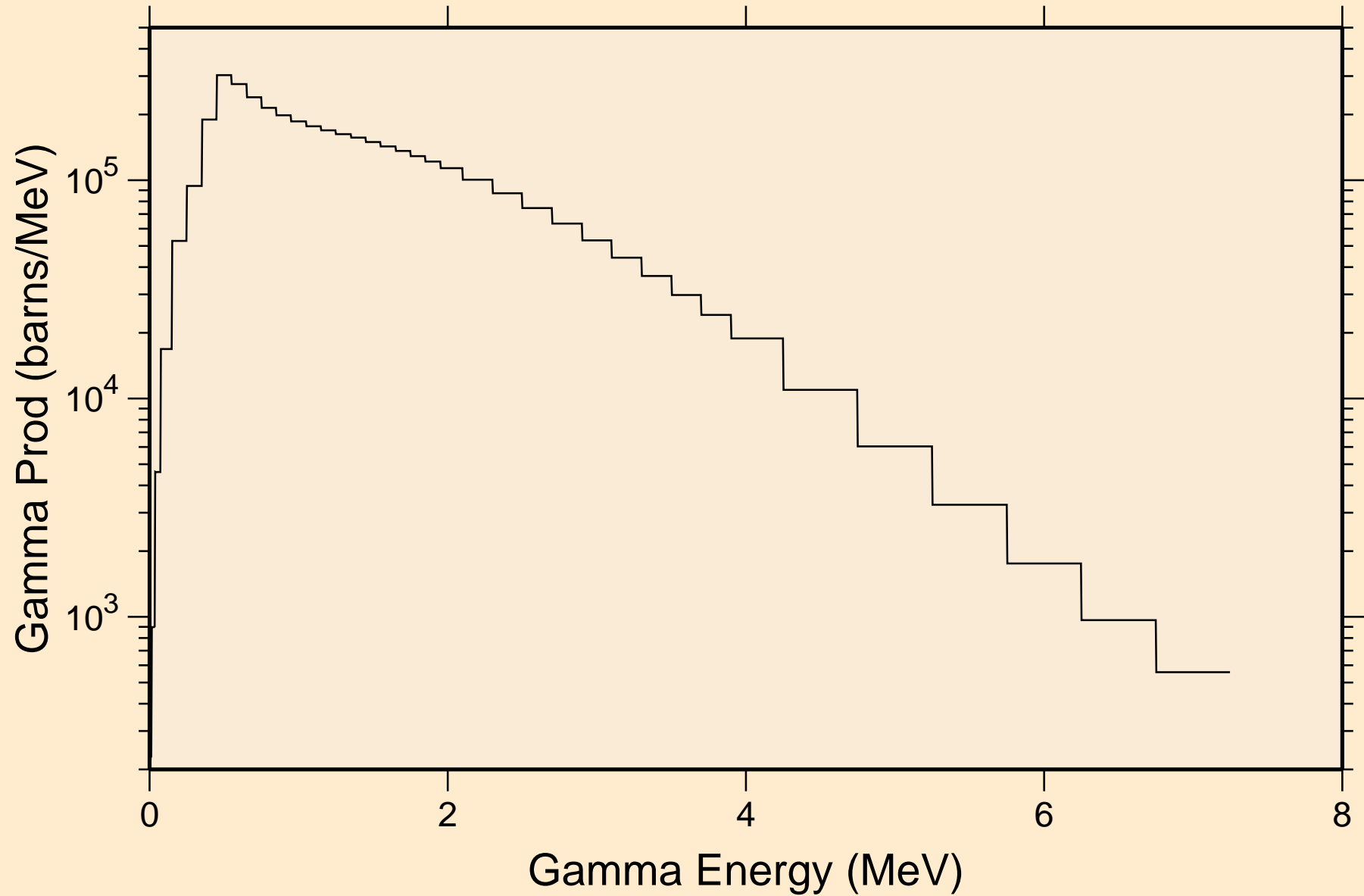

TA171 NRG TENDL-2015, AKONING
14 MeV photon spectrum

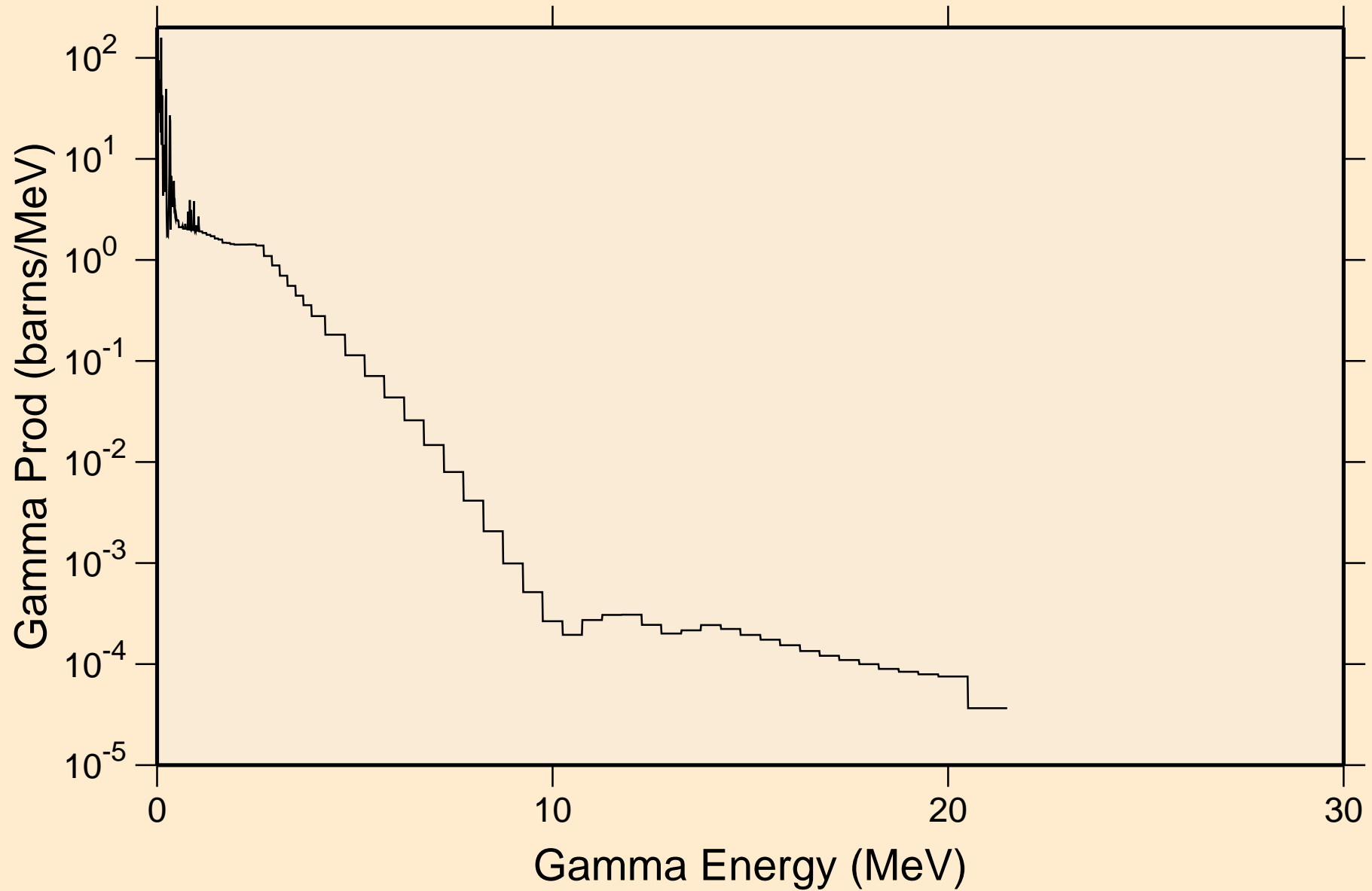

TA171 NRG TENDL-2015, AKONING

Particle heating contributions

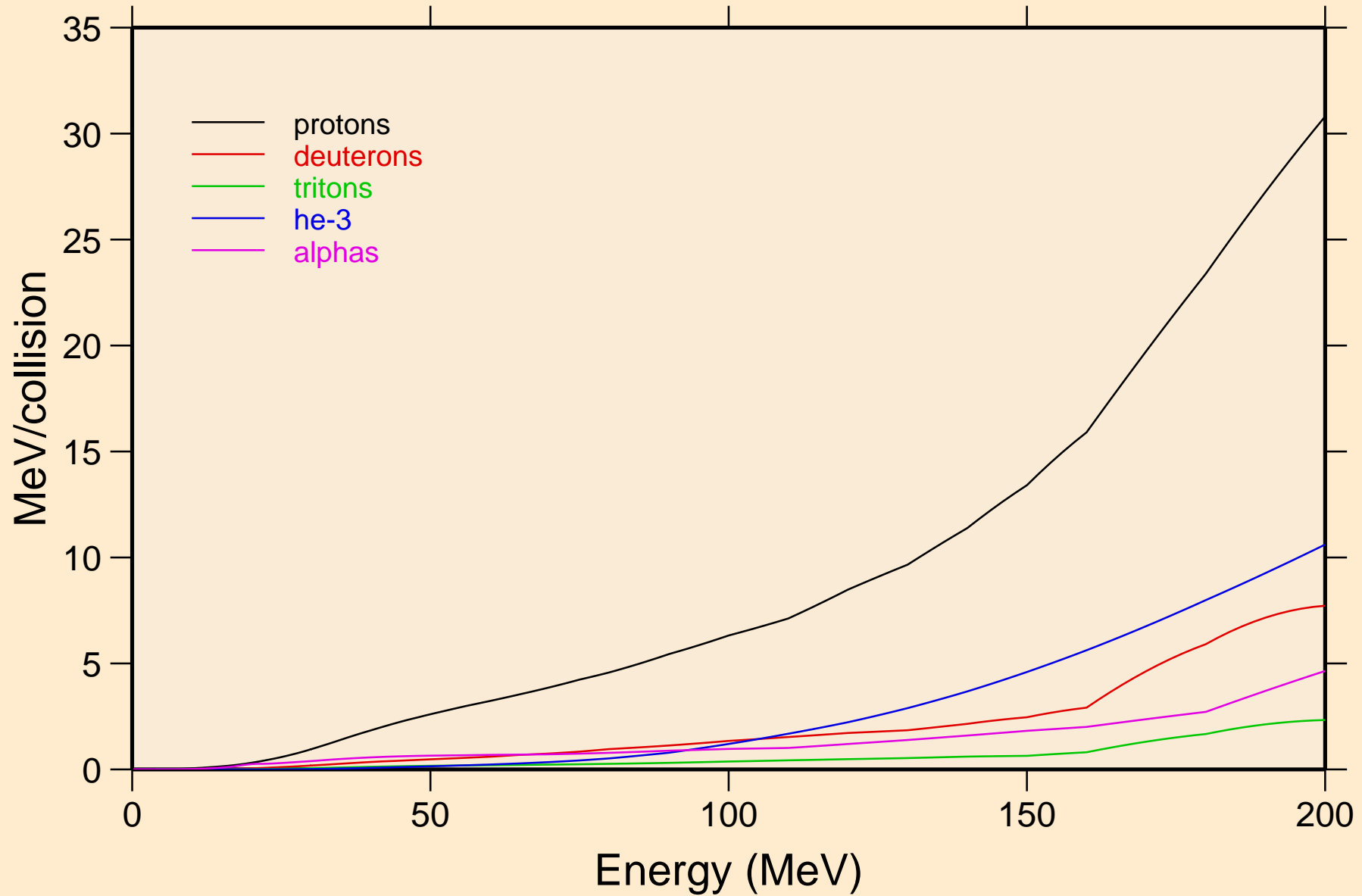

TA171 NRG TENDL-2015, AKONING

Recoil Heating

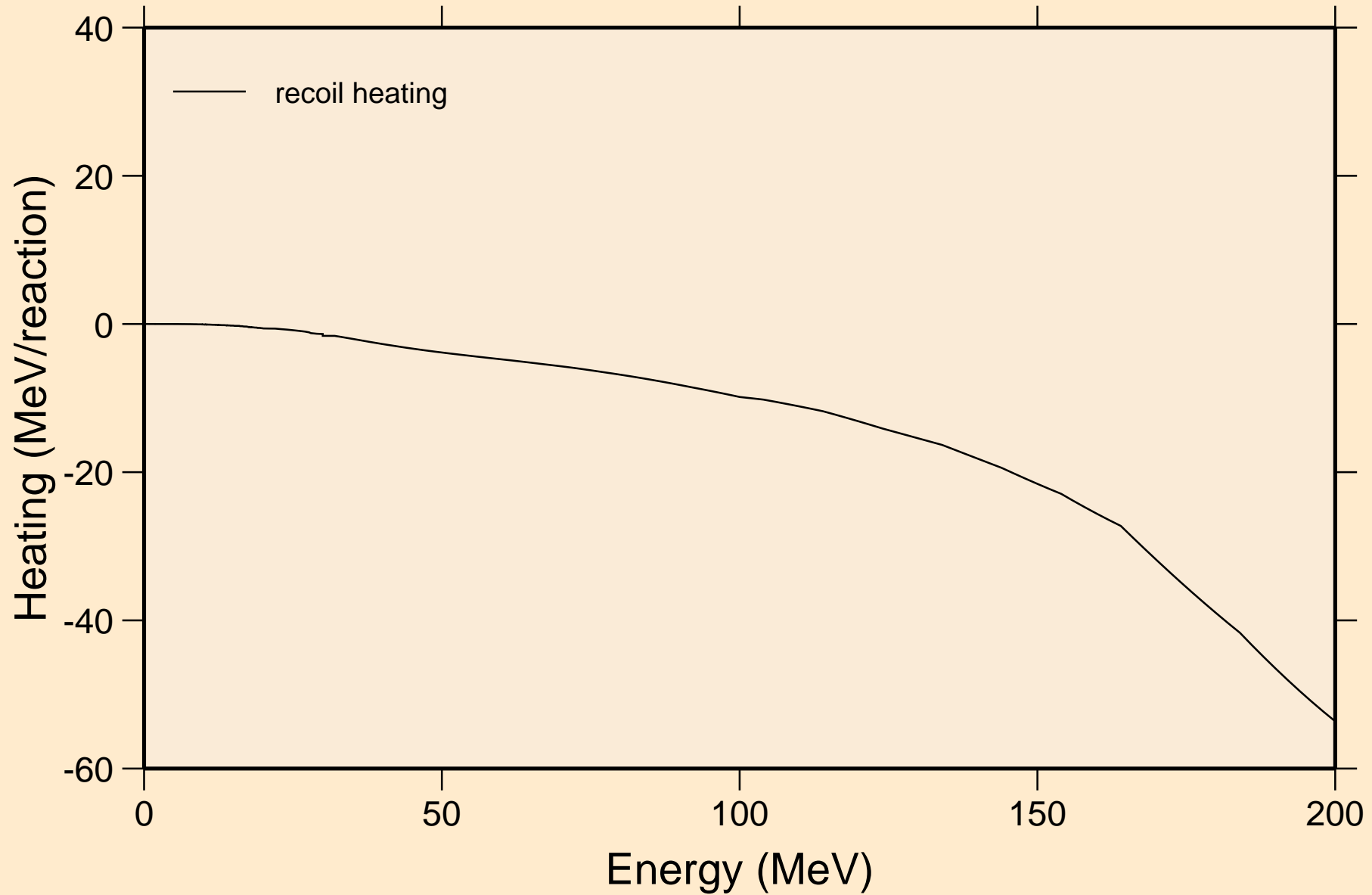

TA171 NRG TENDL-2015, AKONING

Particle production cross sections

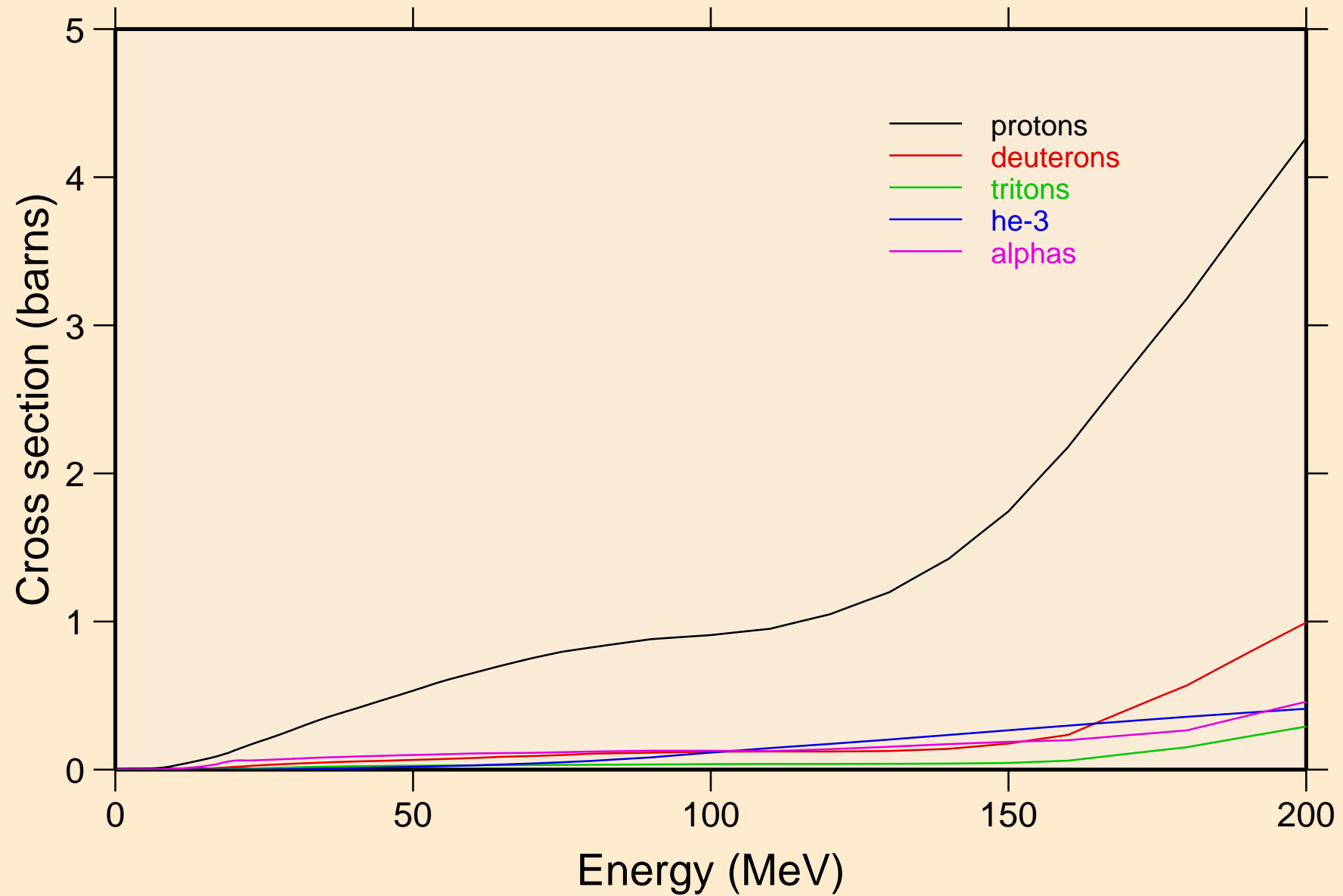

TA171 NRG TENDL-2015, AKONING
protons from (n,x)

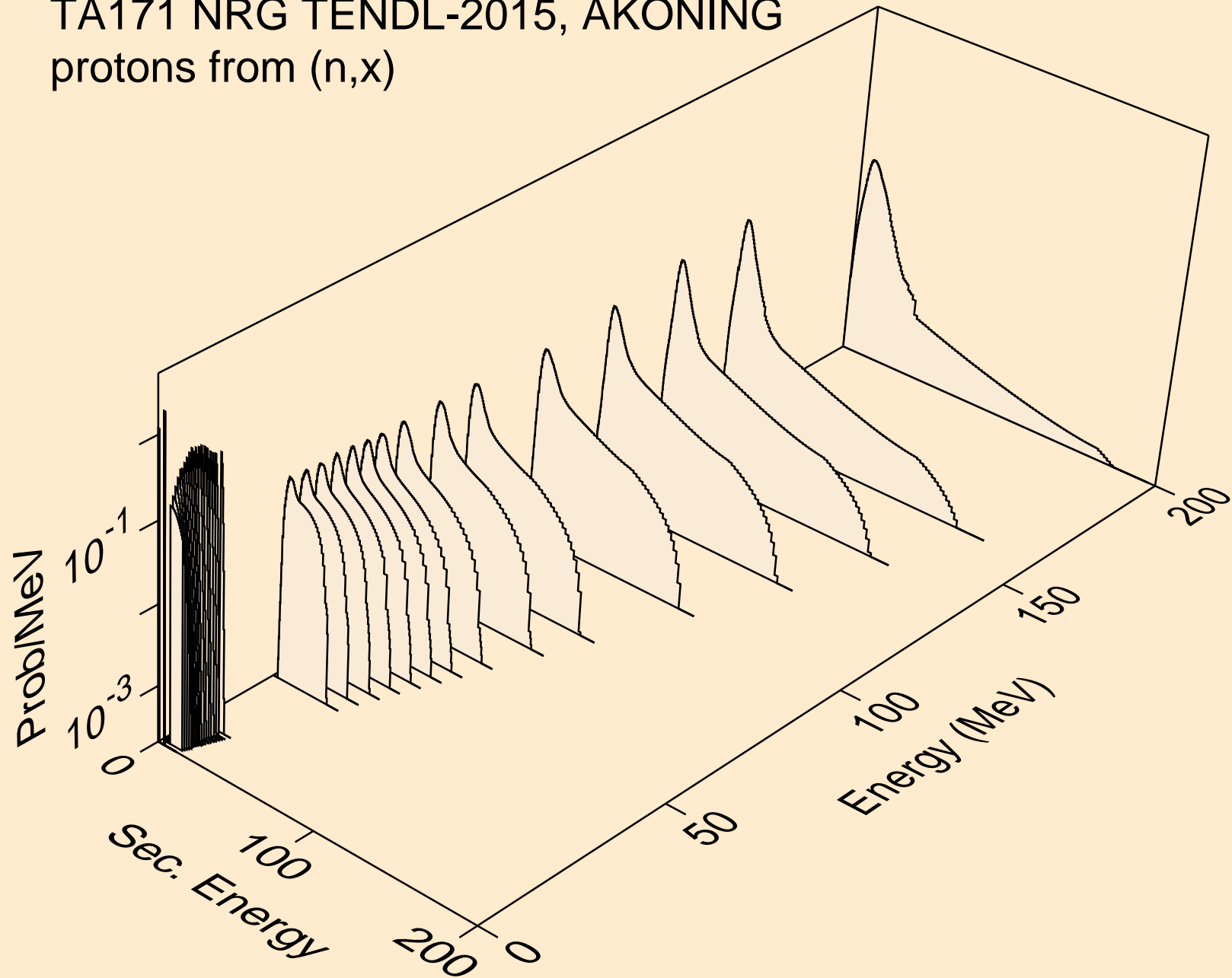

TA171 NRG TENDL-2015, AKONING
protons from (n,n*)p

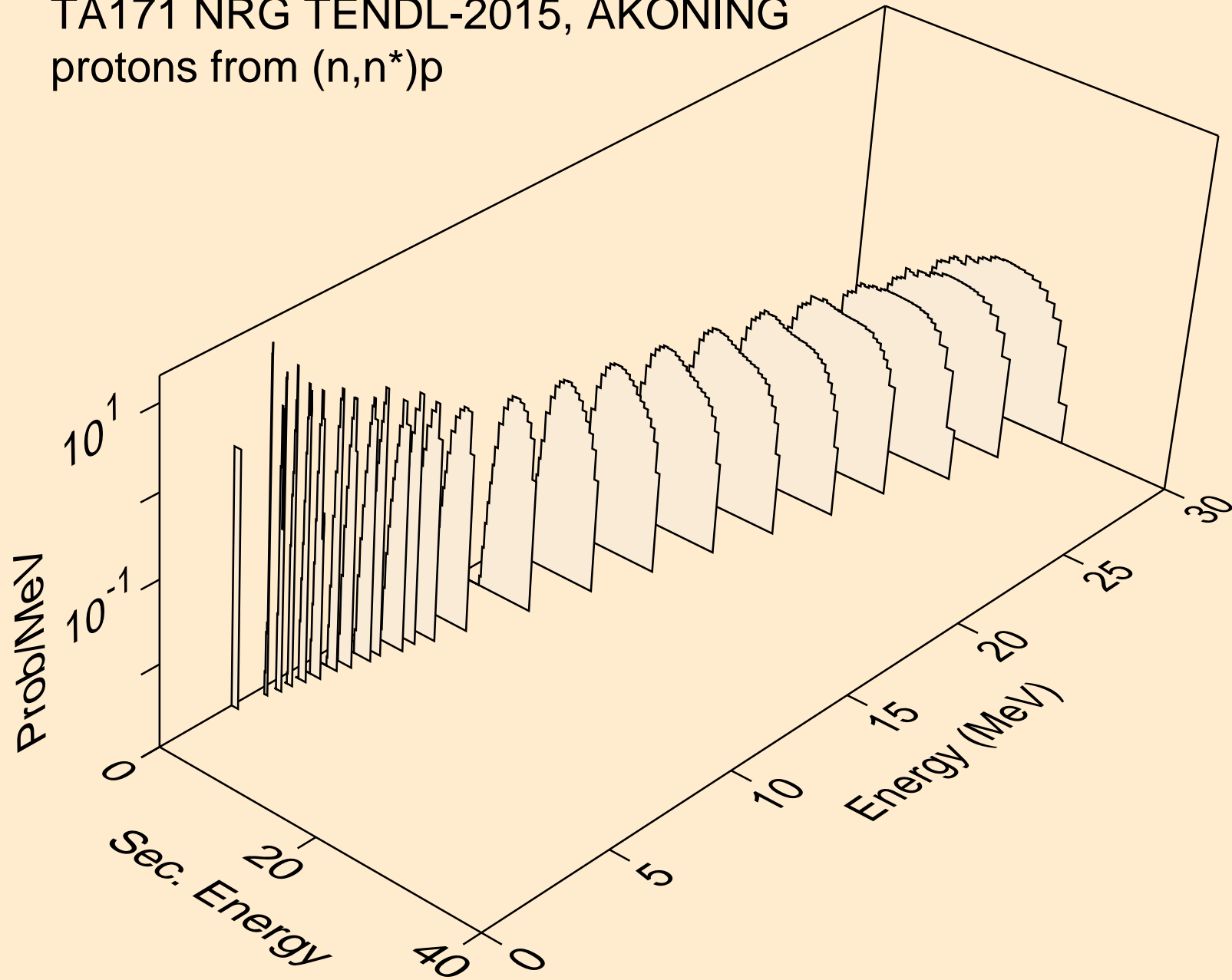

TA171 NRG TENDL-2015, AKONING
protons from (n,2np)

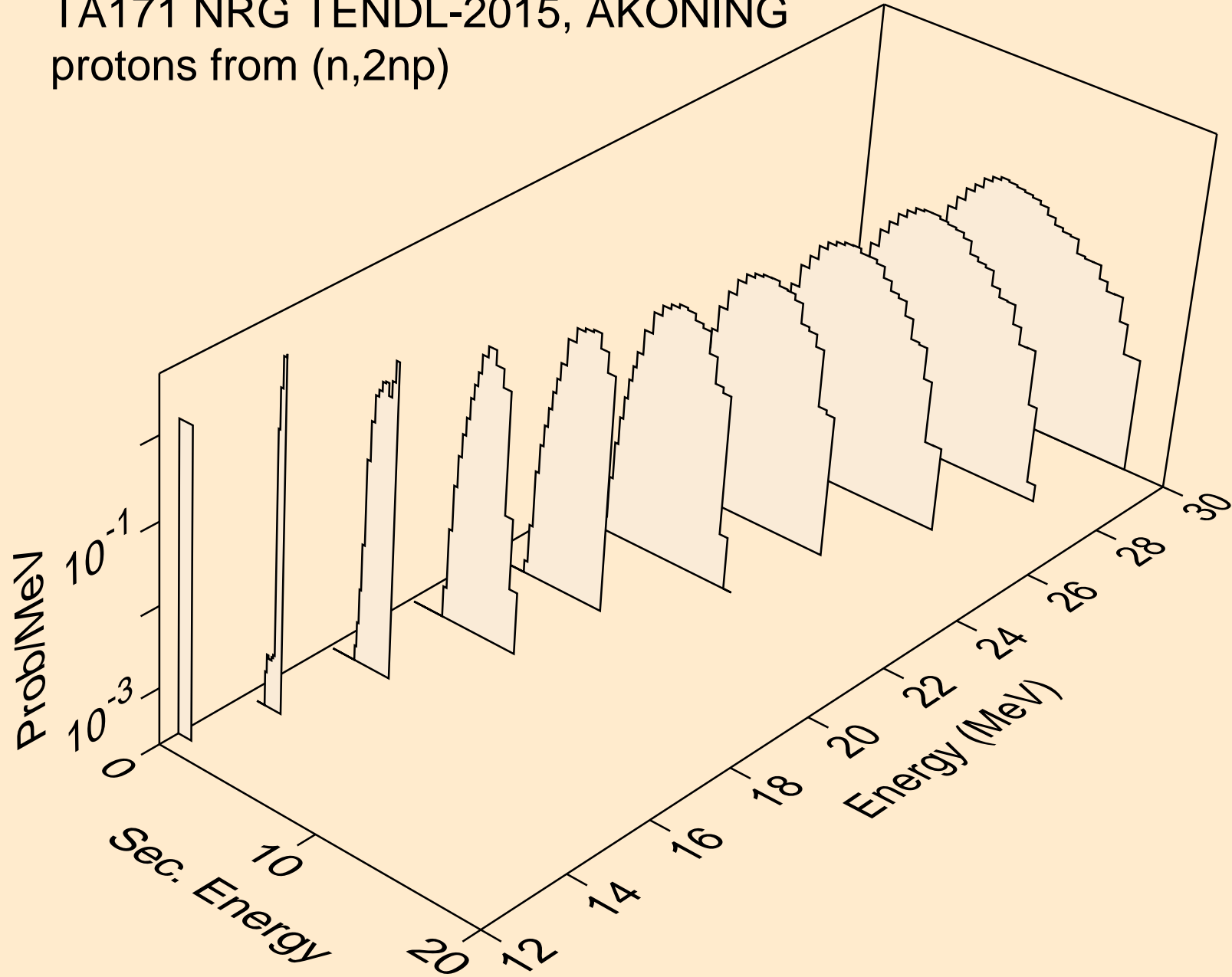

TA171 NRG TENDL-2015, AKONING
protons from (n,3np)

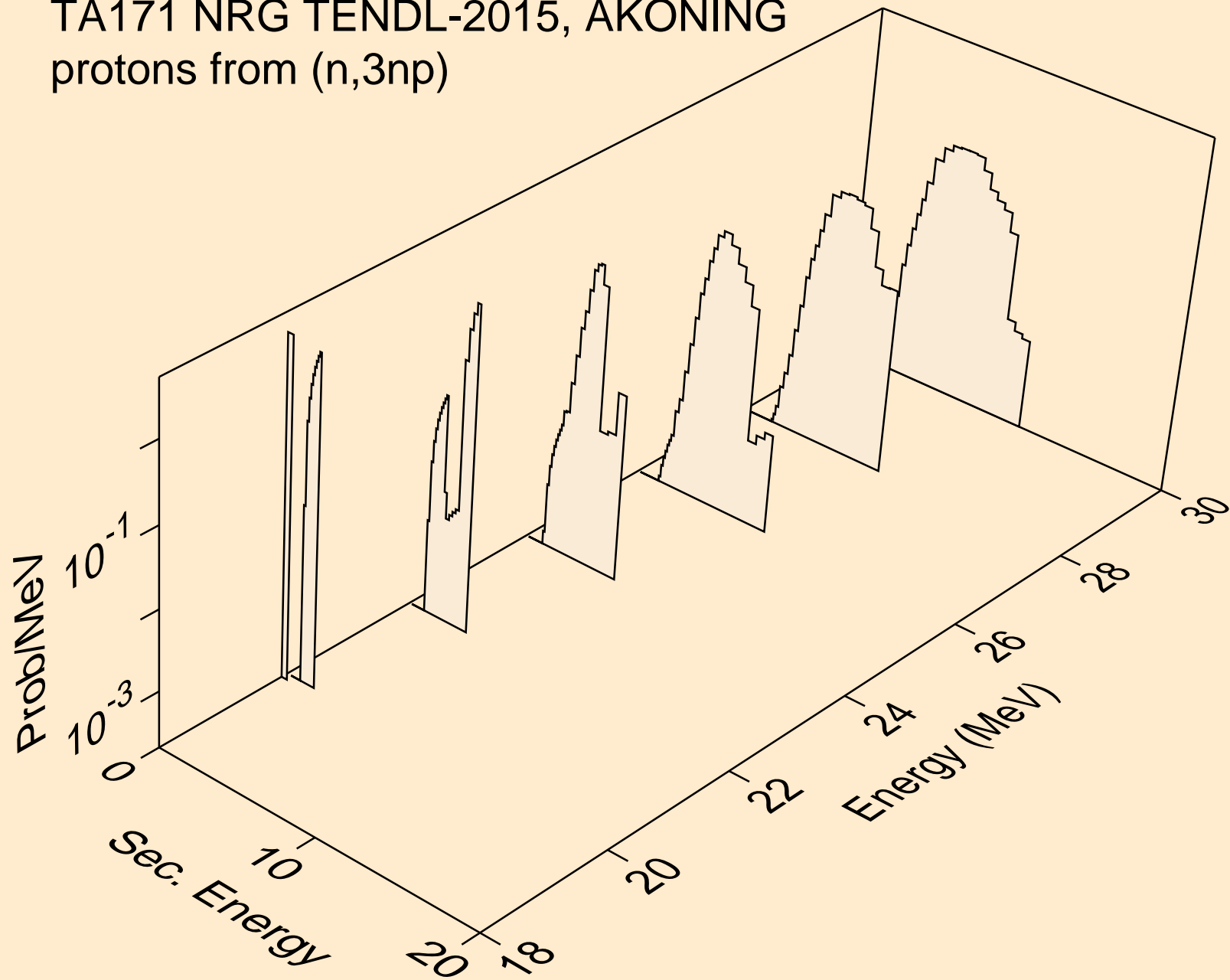

TA171 NRG TENDL-2015, AKONING
protons from (n,2np)

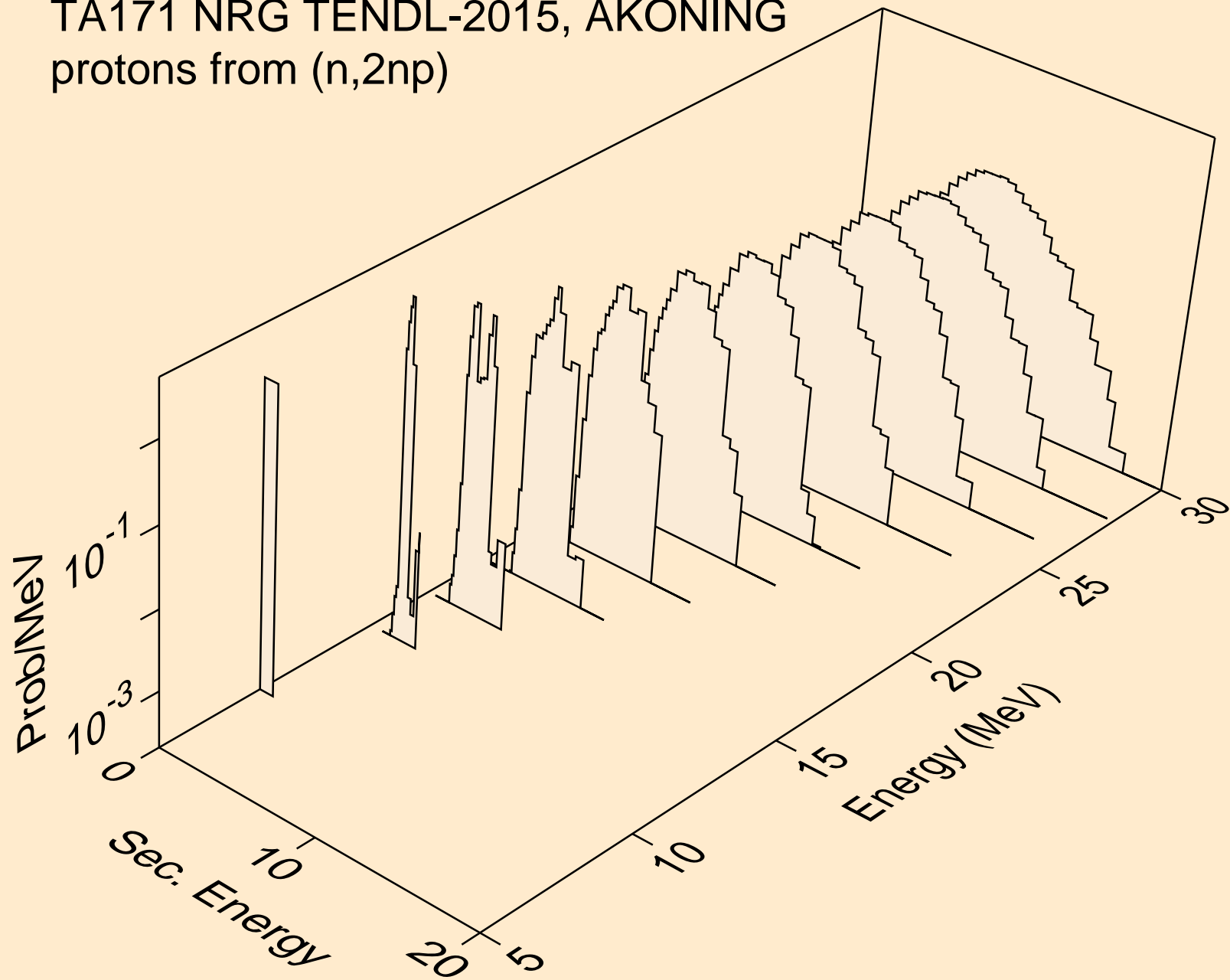

TA171 NRG TENDL-2015, AKONING
protons from (n,npa)

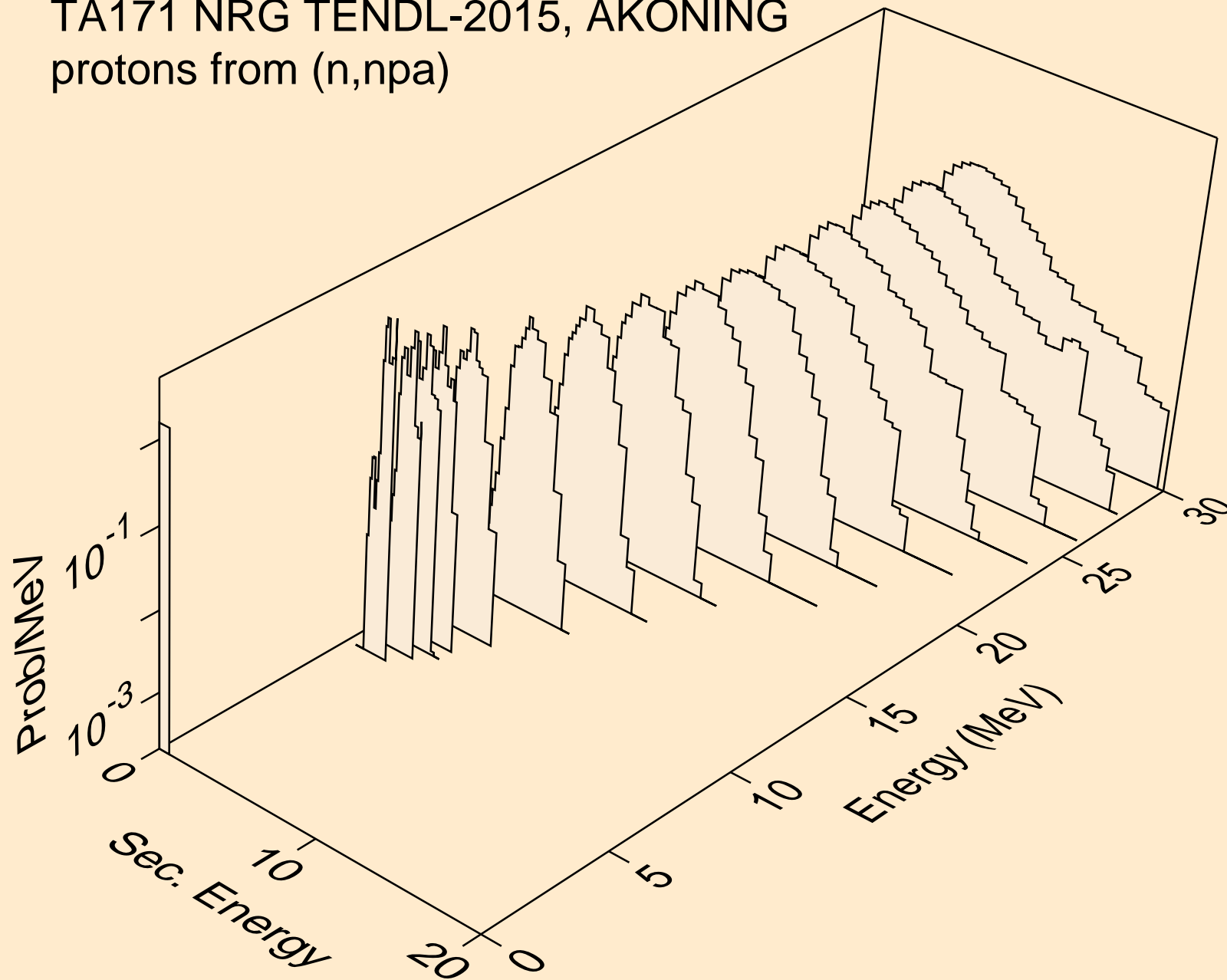

TA171 NRG TENDL-2015, AKONING
protons from (n,p)

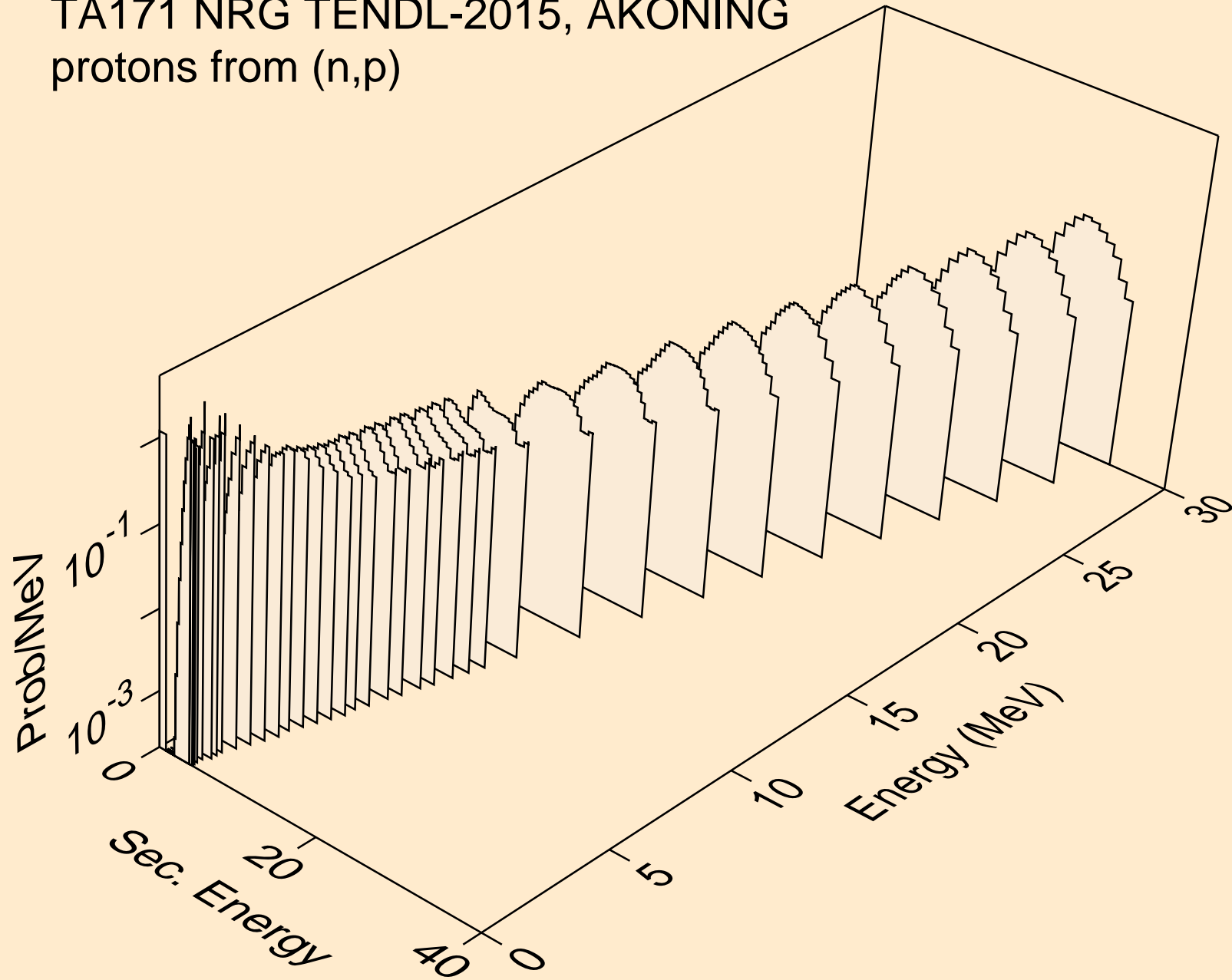

TA171 NRG TENDL-2015, AKONING
protons from (n,2p)

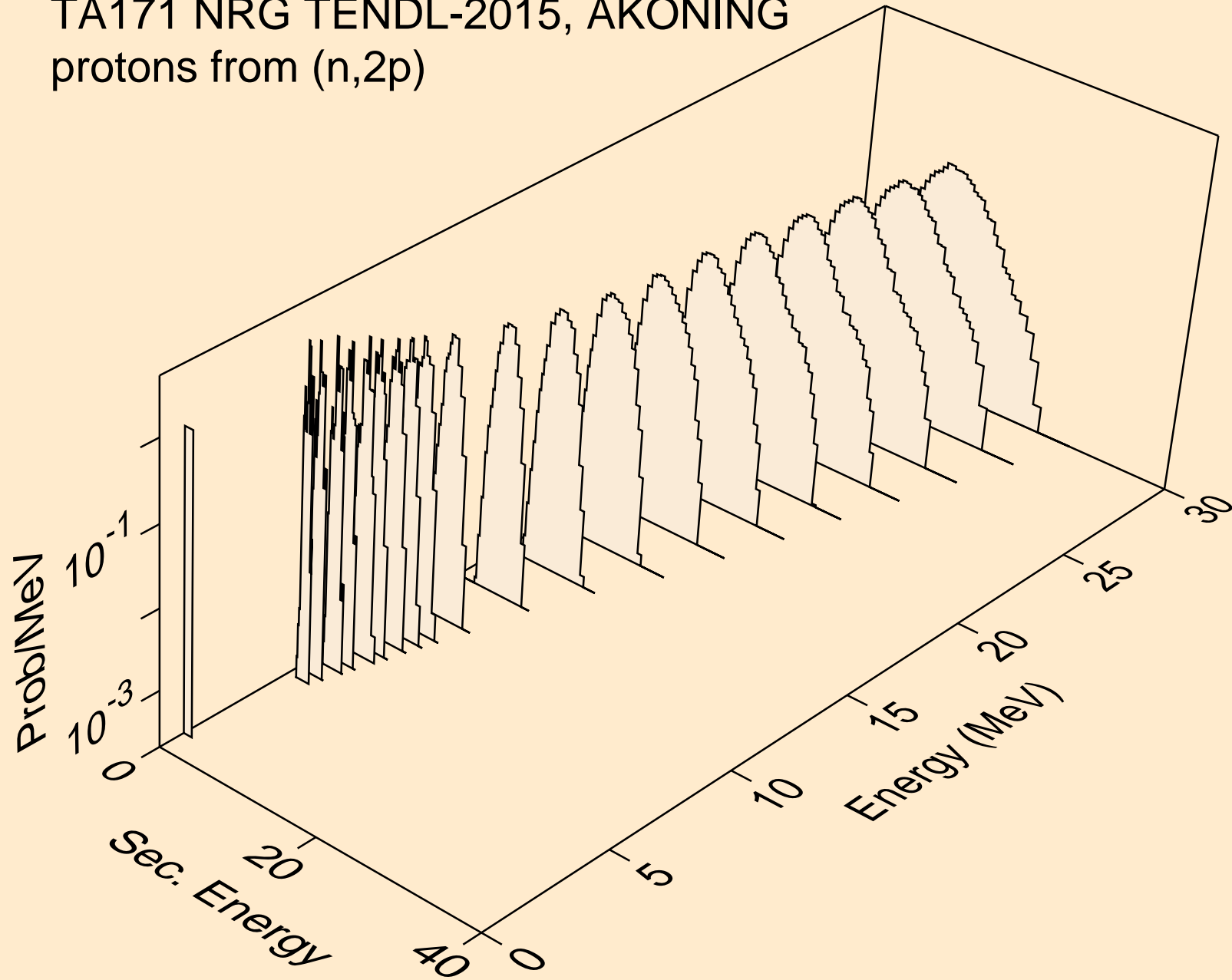

TA171 NRG TENDL-2015, AKONING
protons from (n,pa)

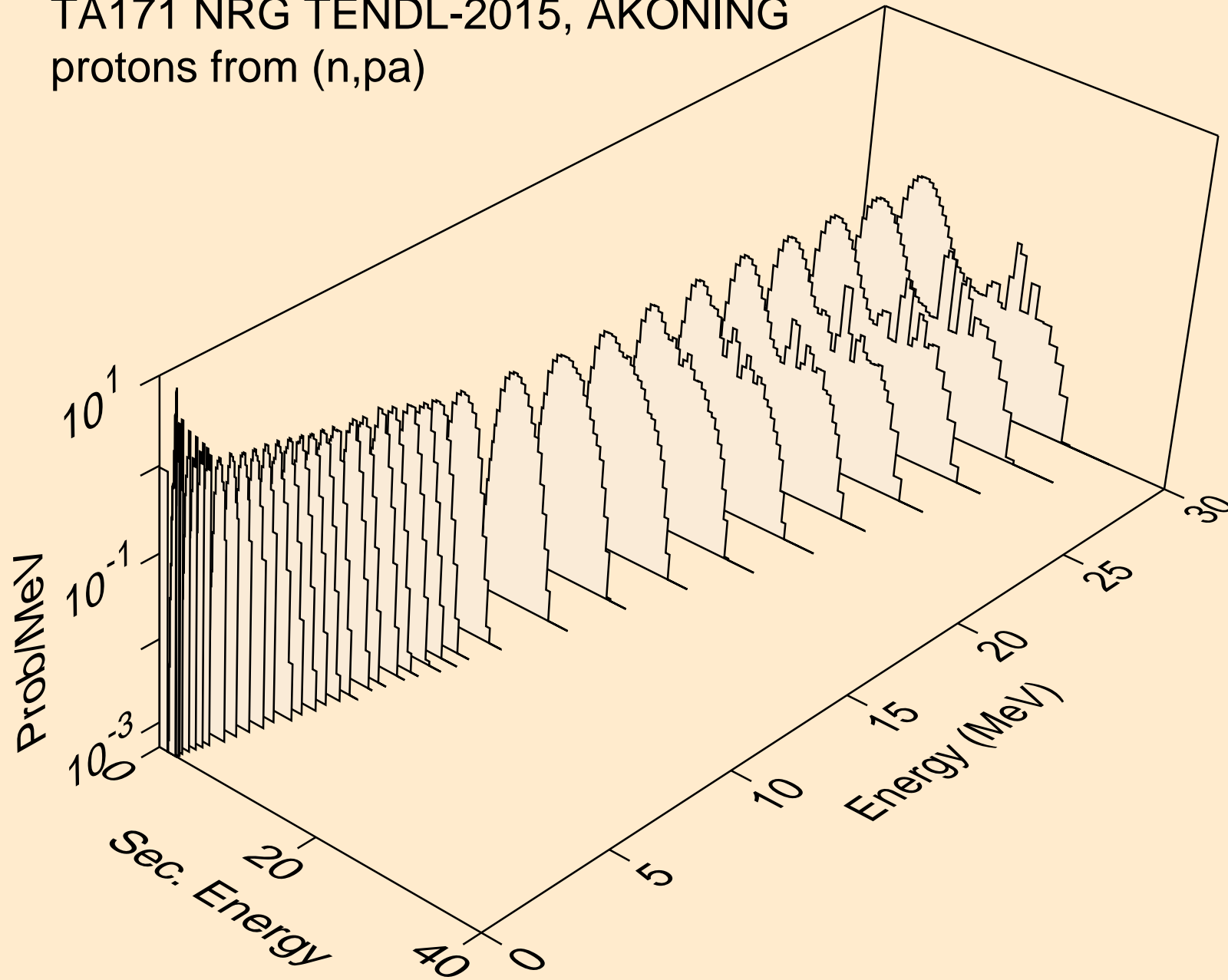

TA171 NRG TENDL-2015, AKONING
protons from (n,pd)

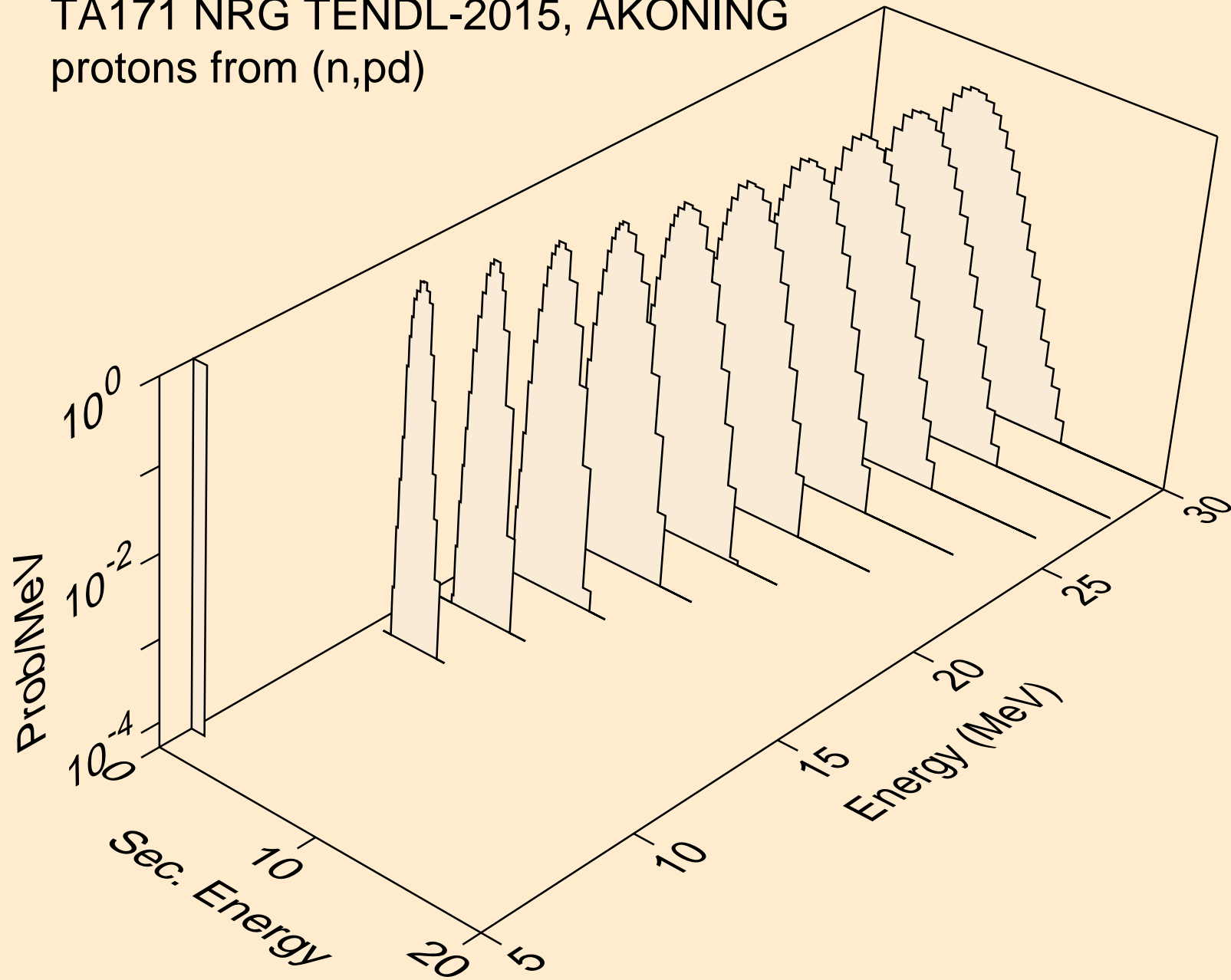

TA171 NRG TENDL-2015, AKONING
protons from (n,pt)

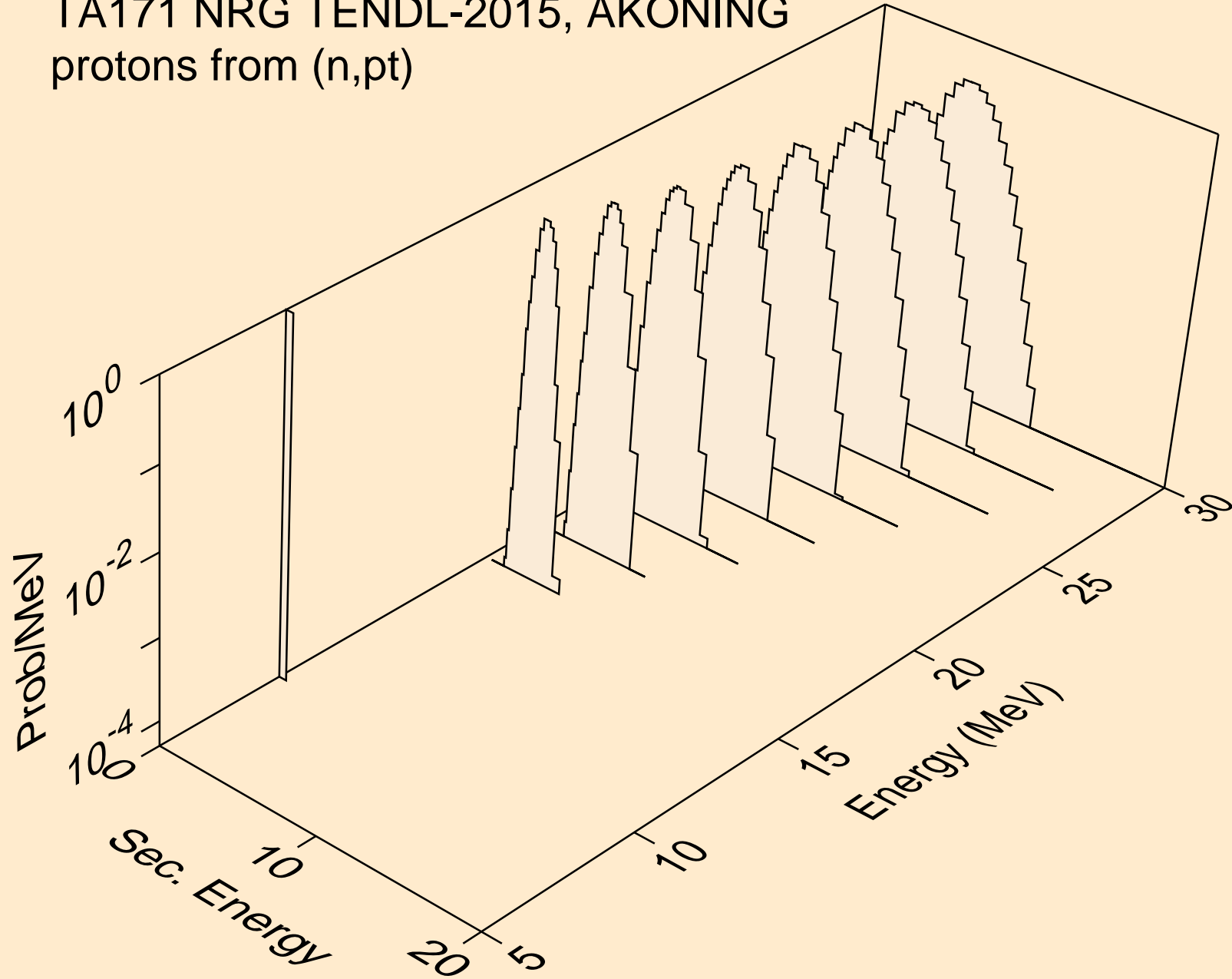

TA171 NRG TENDL-2015, AKONING
deuterons from (n,x)

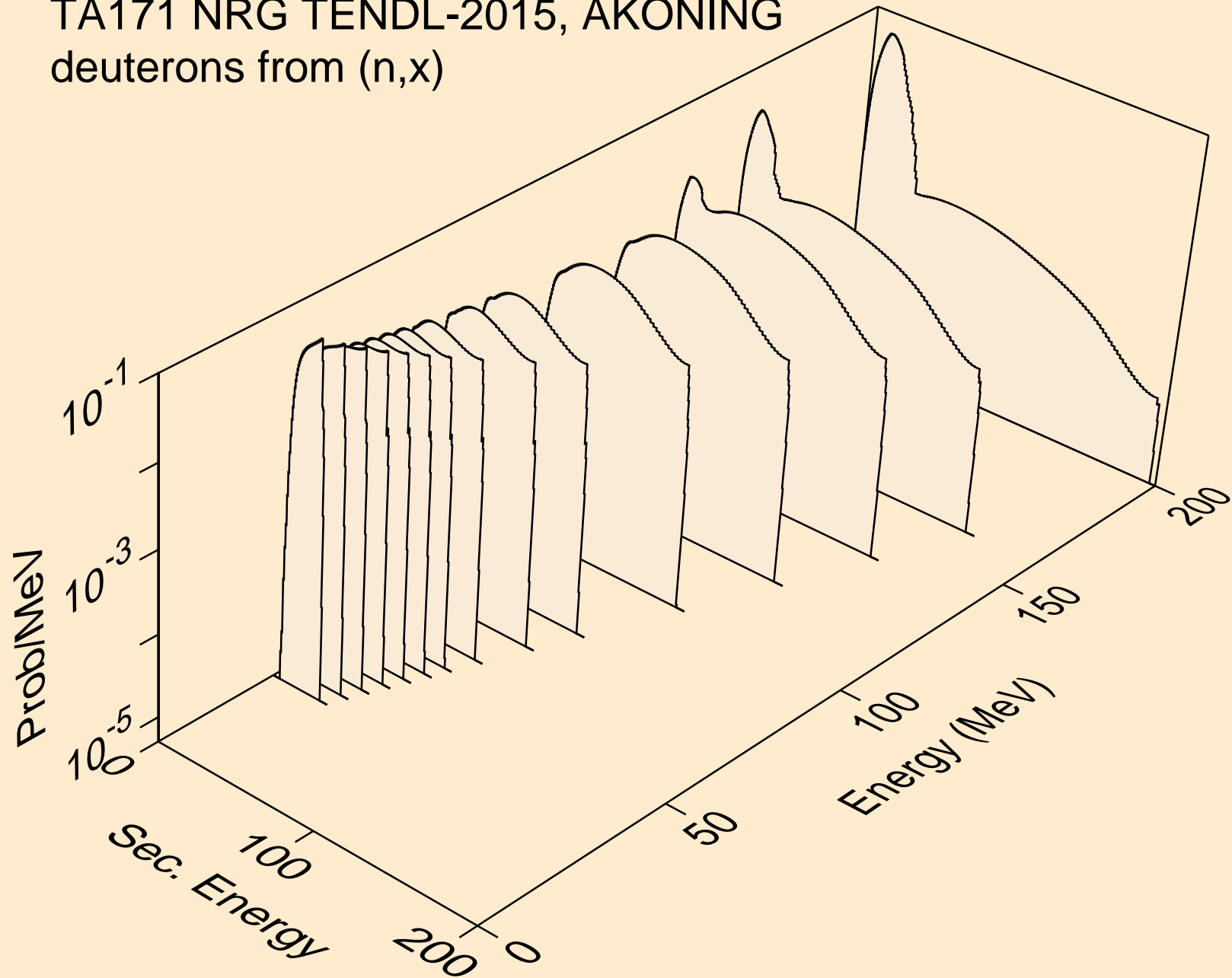

TA171 NRG TENDL-2015, AKONING
deuterons from (n,2nd)

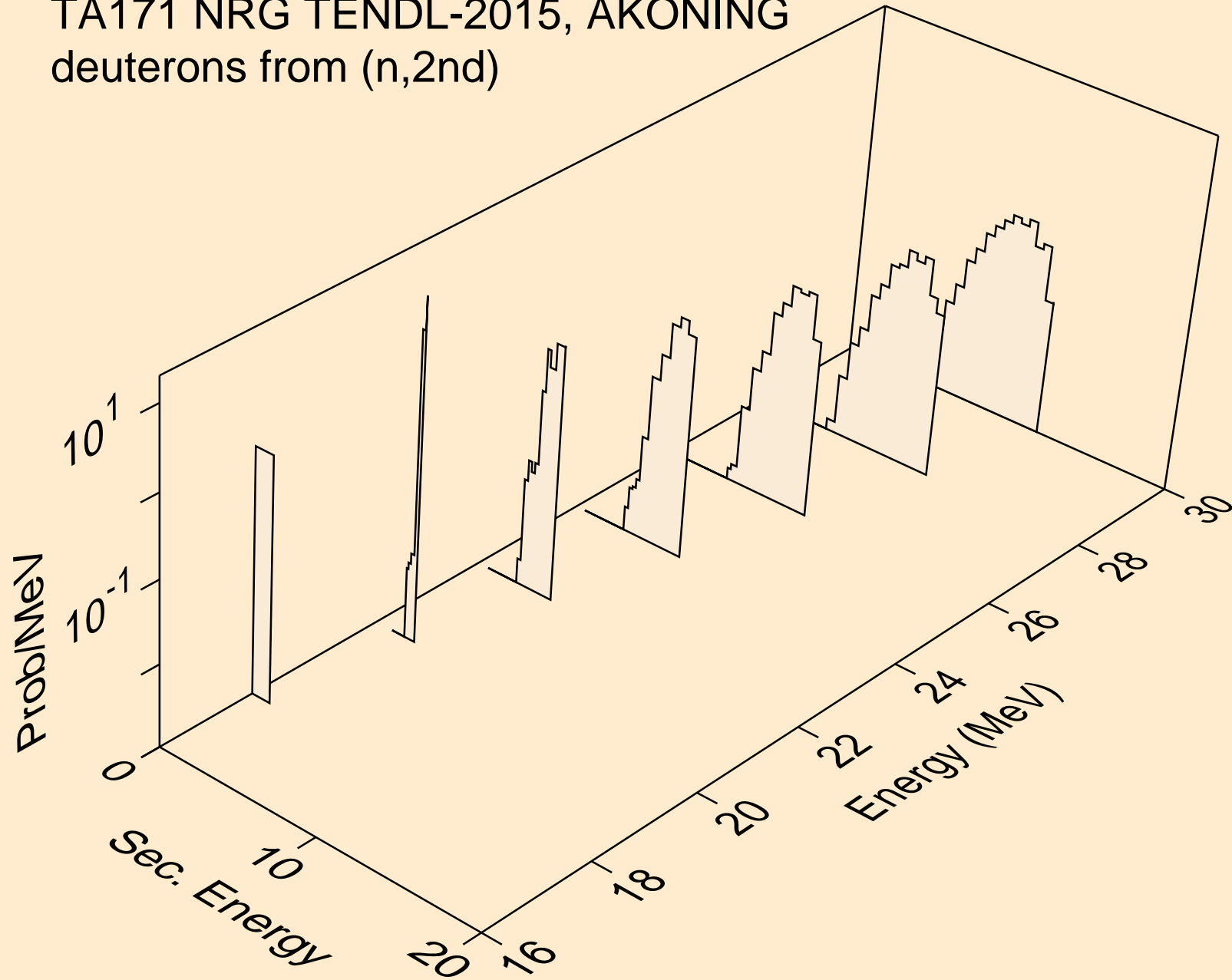

TA171 NRG TENDL-2015, AKONING
deuterons from (n,n*)d

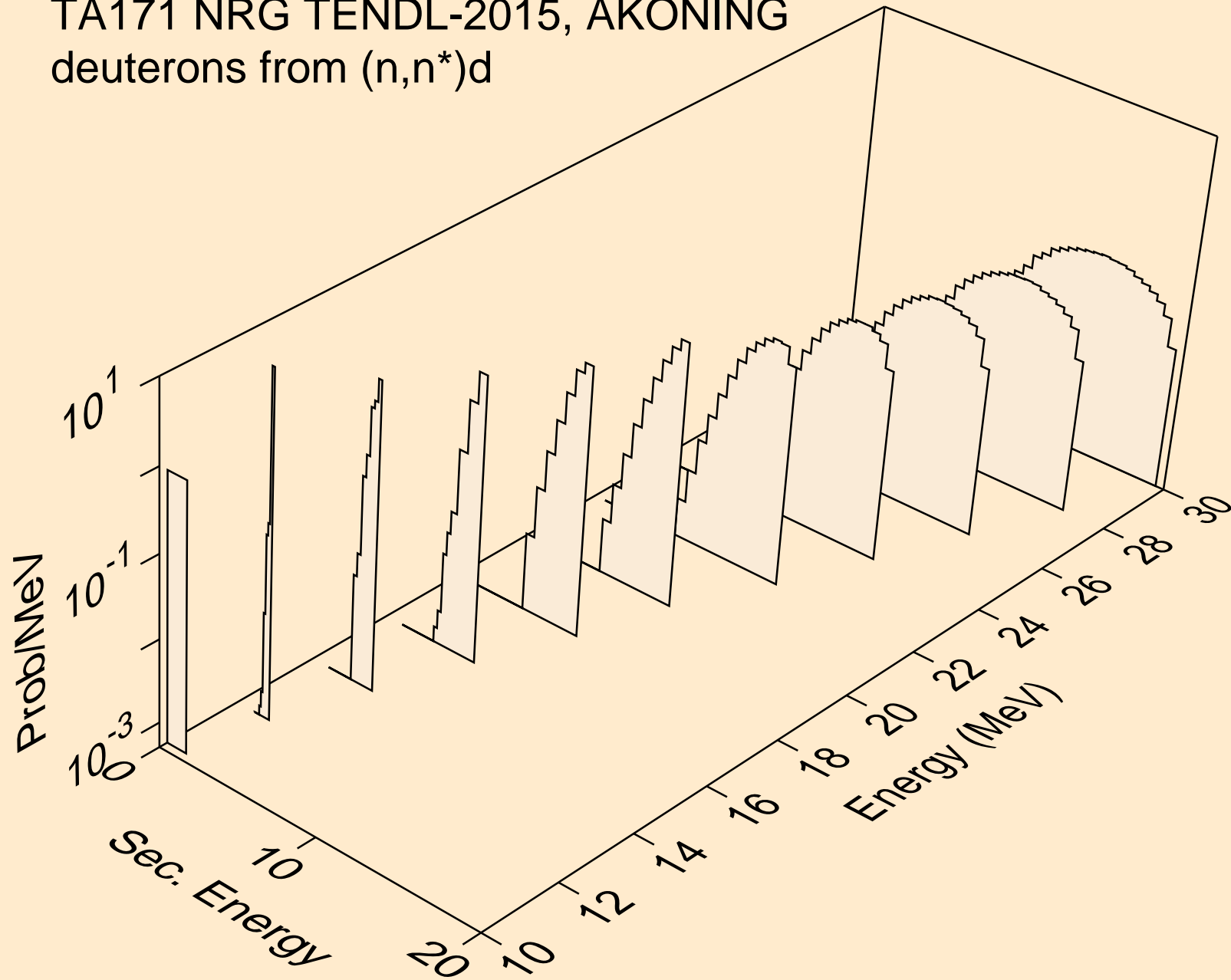

TA171 NRG TENDL-2015, AKONING
deuterons from (n,d)

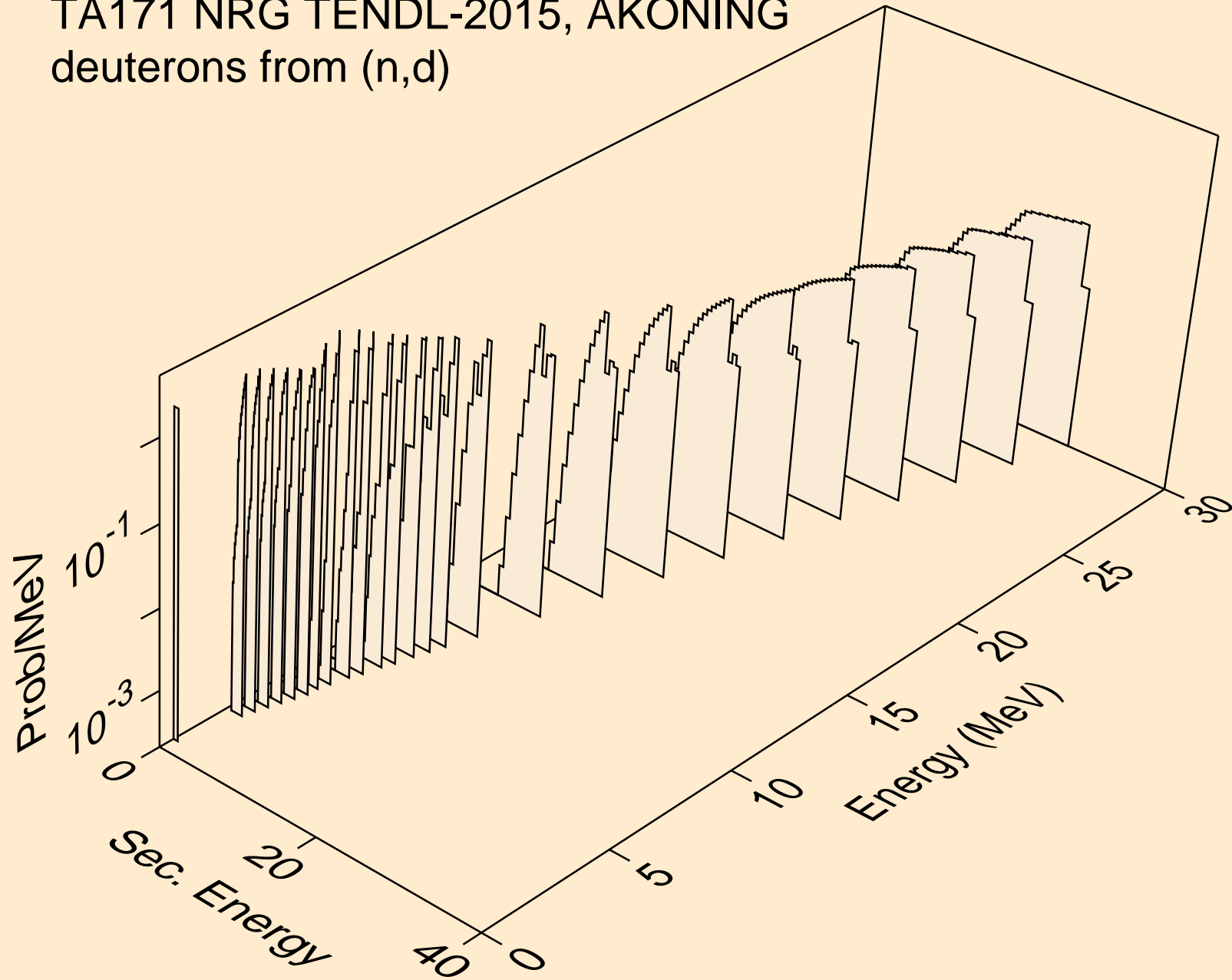

TA171 NRG TENDL-2015, AKONING
deuterons from (n,pd)

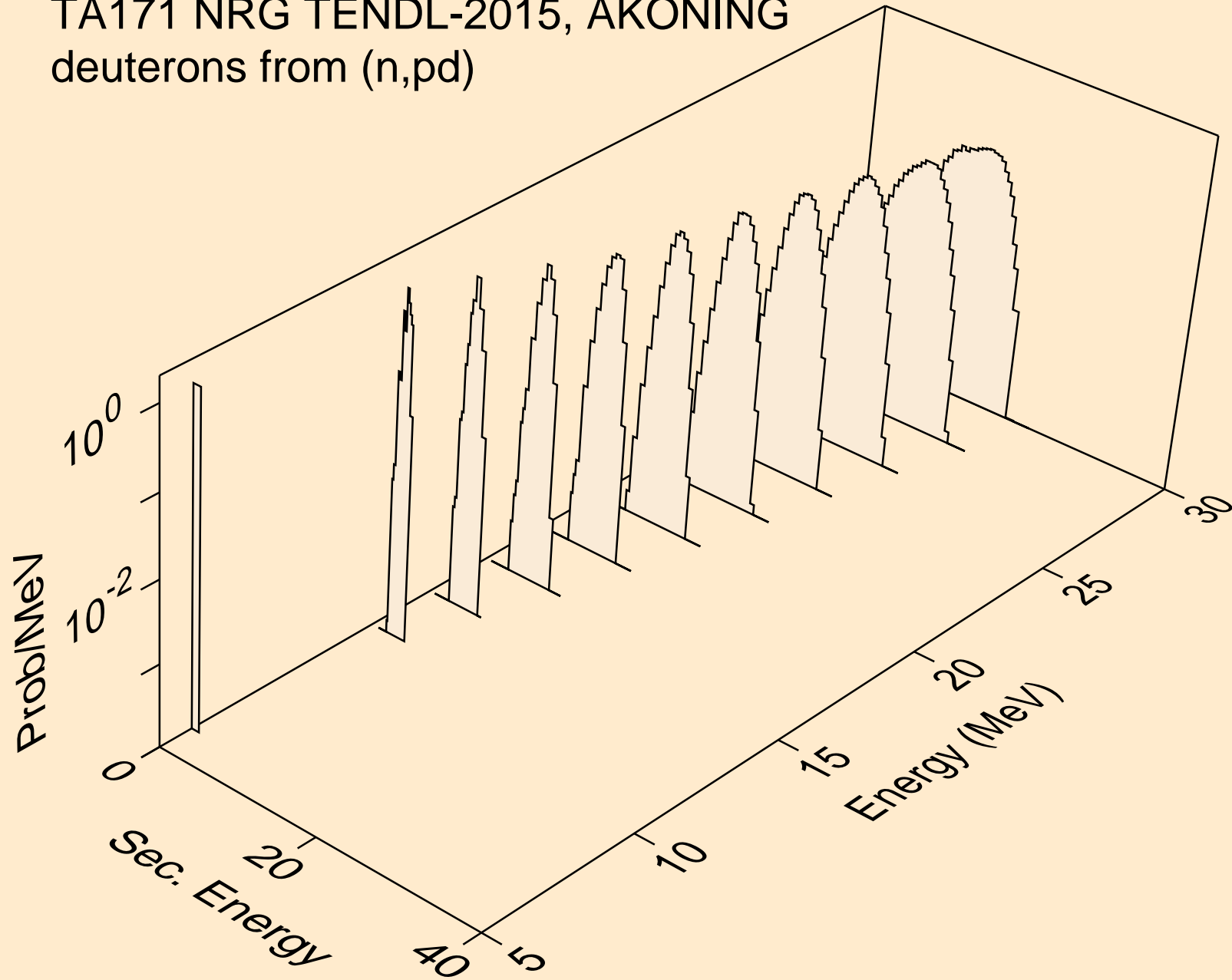

TA171 NRG TENDL-2015, AKONING
deuterons from (n,da)

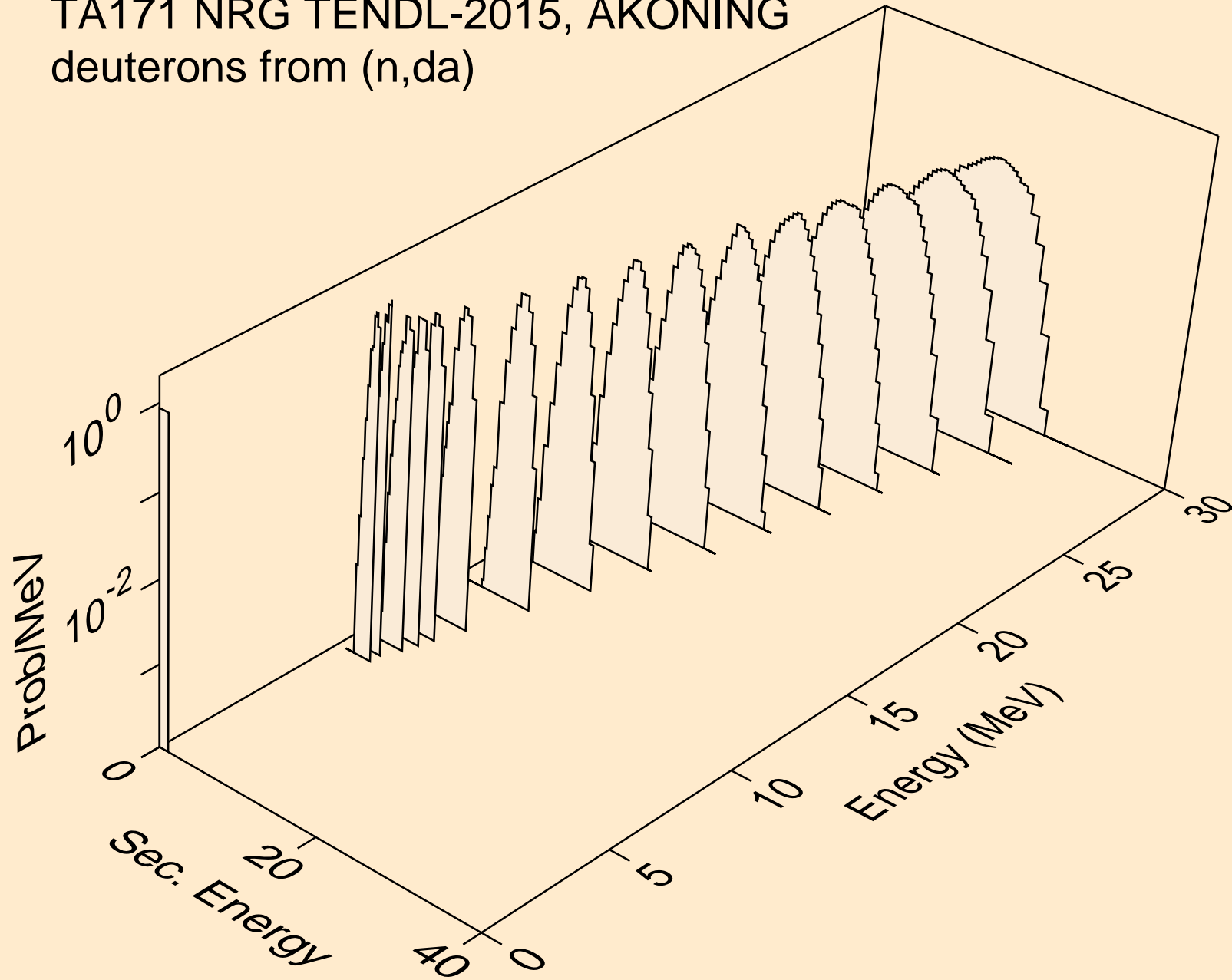

TA171 NRG TENDL-2015, AKONING
tritons from (n,x)

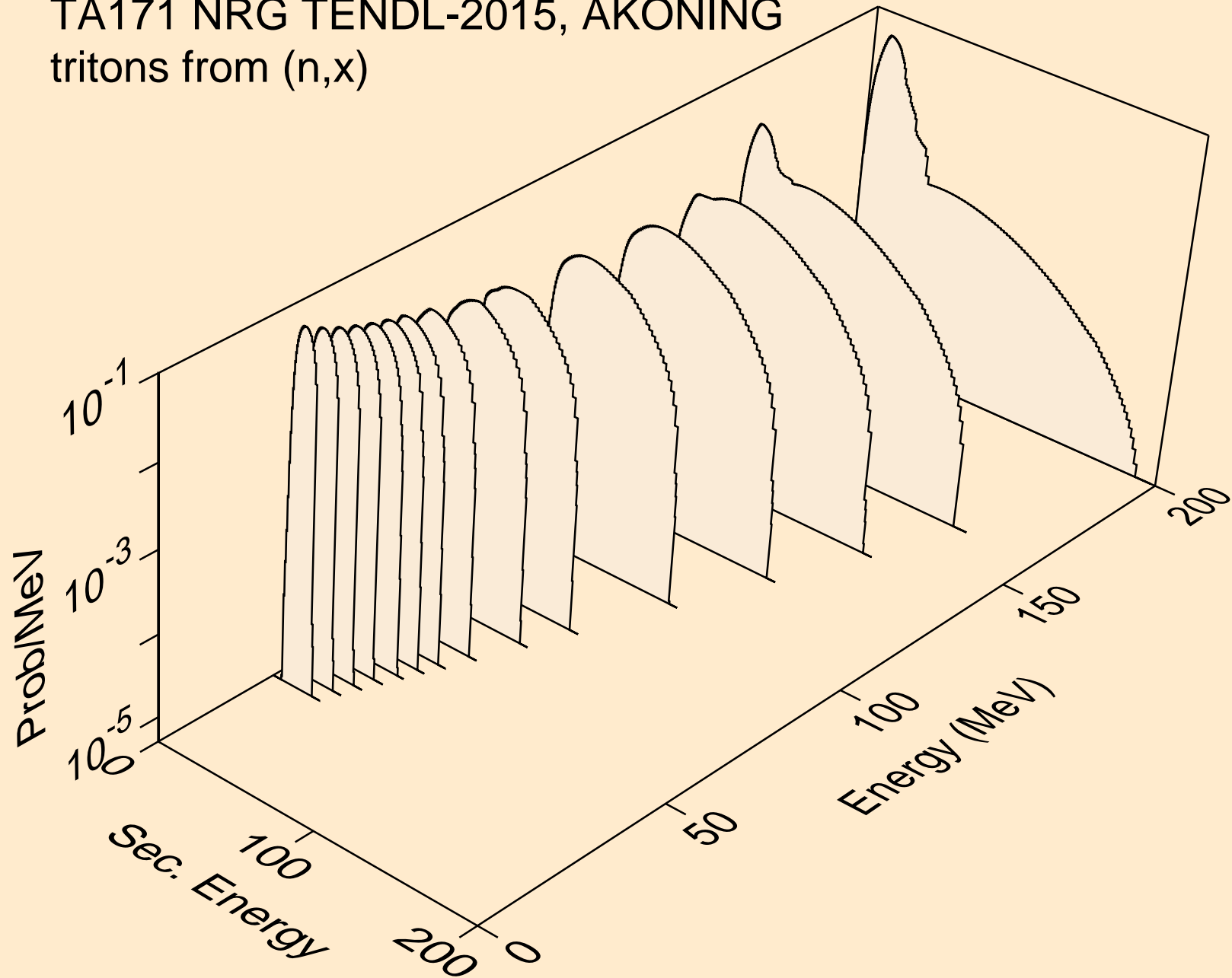

TA171 NRG TENDL-2015, AKONING
tritons from (n,n*)t

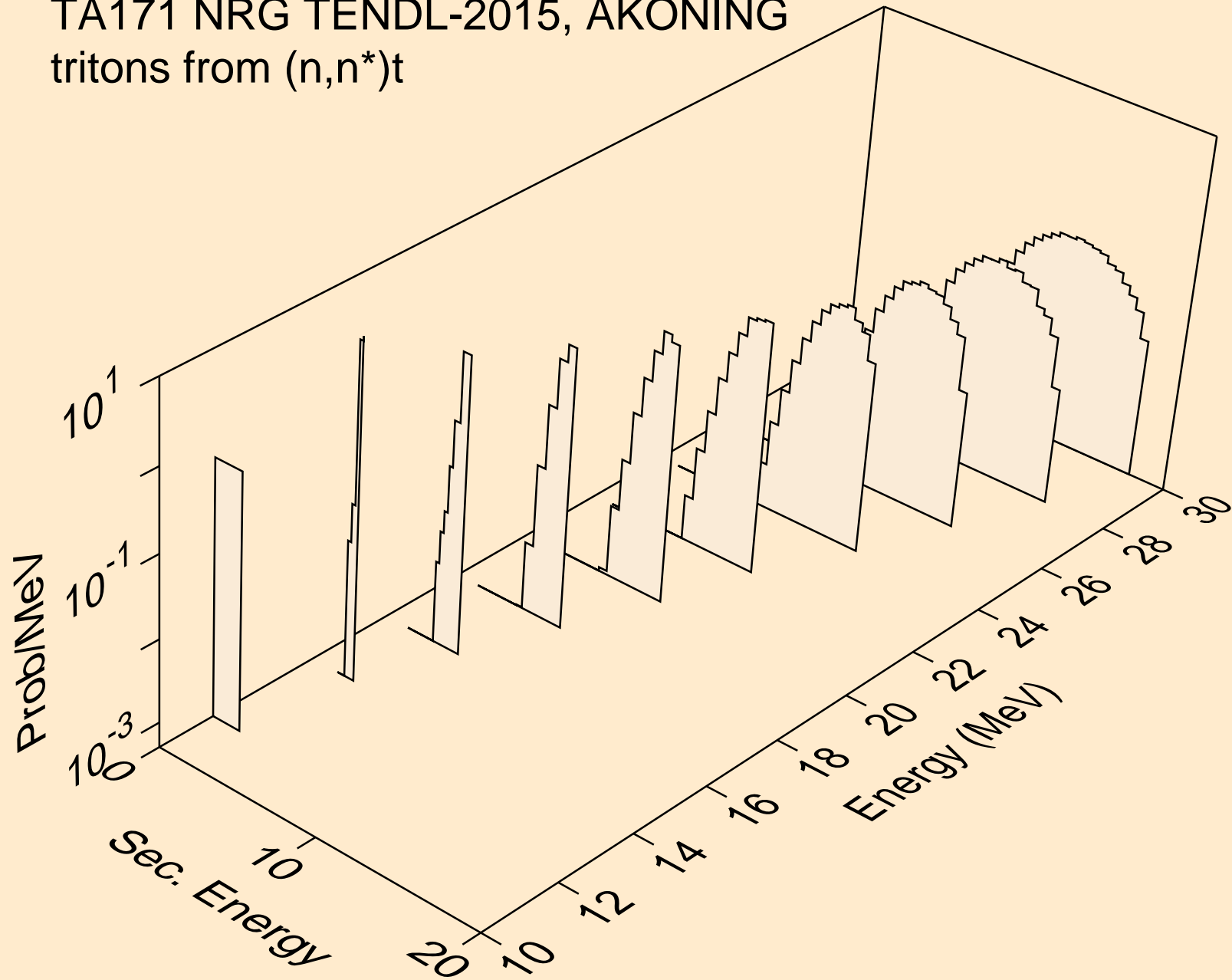

TA171 NRG TENDL-2015, AKONING
tritons from (n,t)

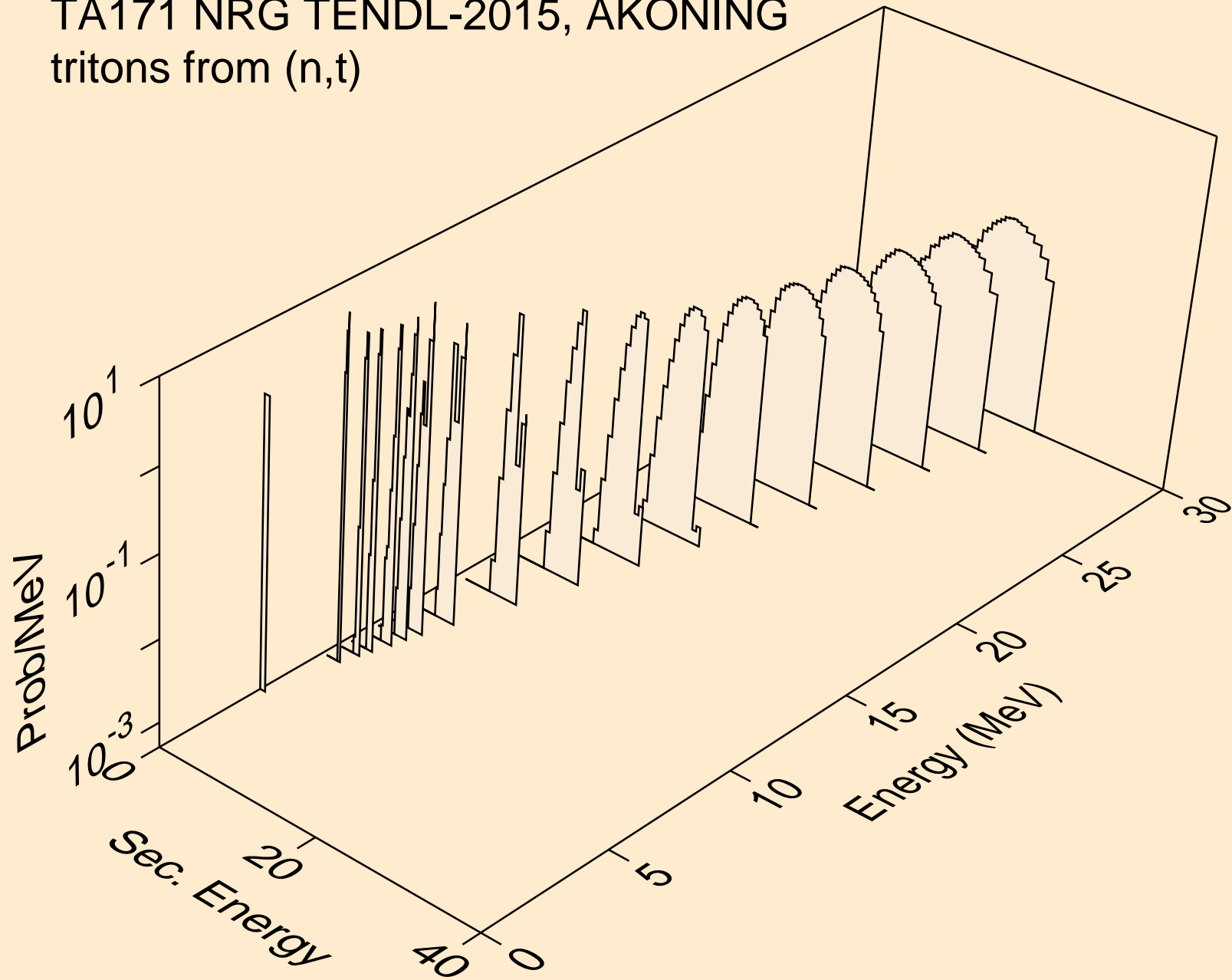

TA171 NRG TENDL-2015, AKONING
tritons from (n,pt)

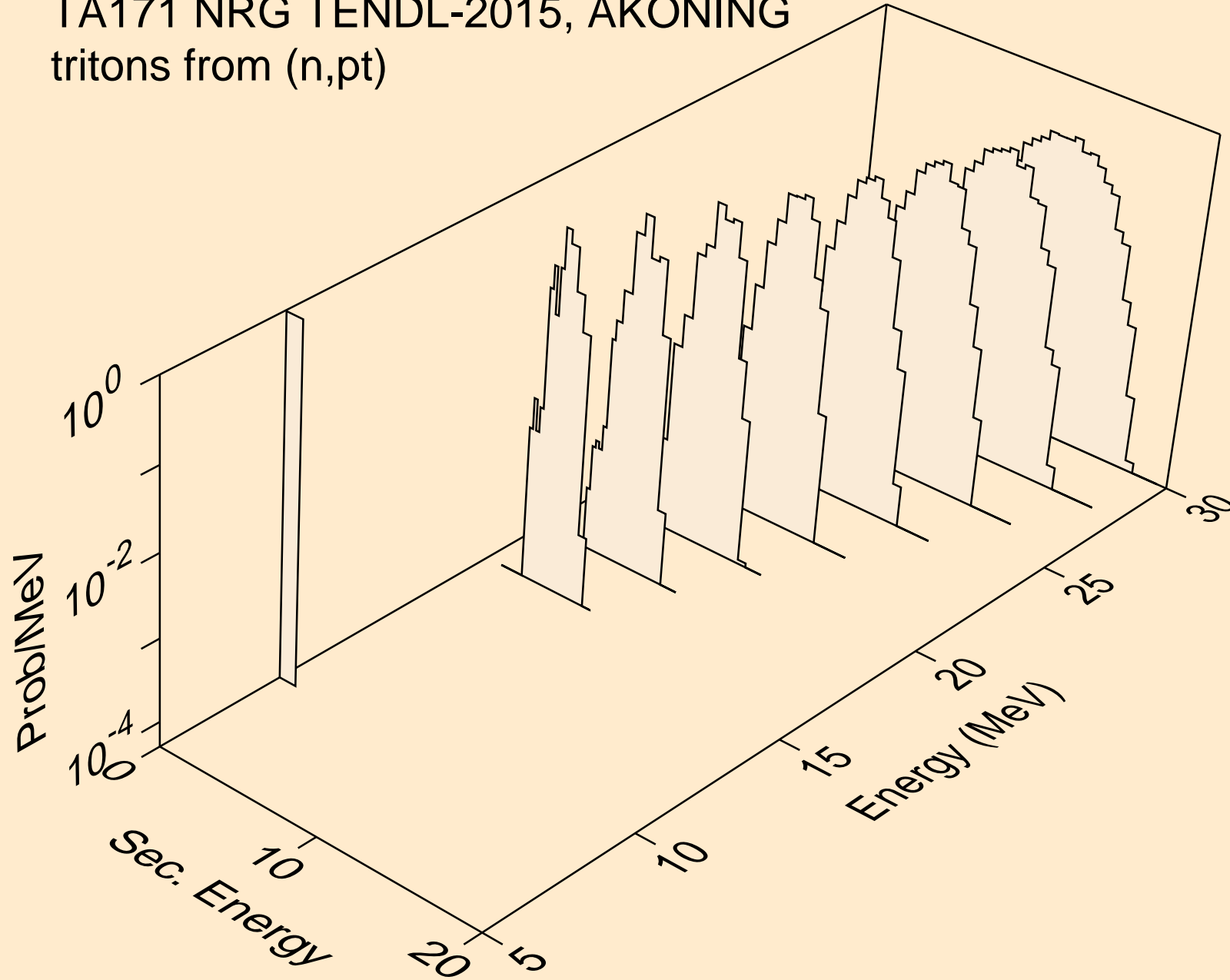

TA171 NRG TENDL-2015, AKONING
he3s from (n,x)

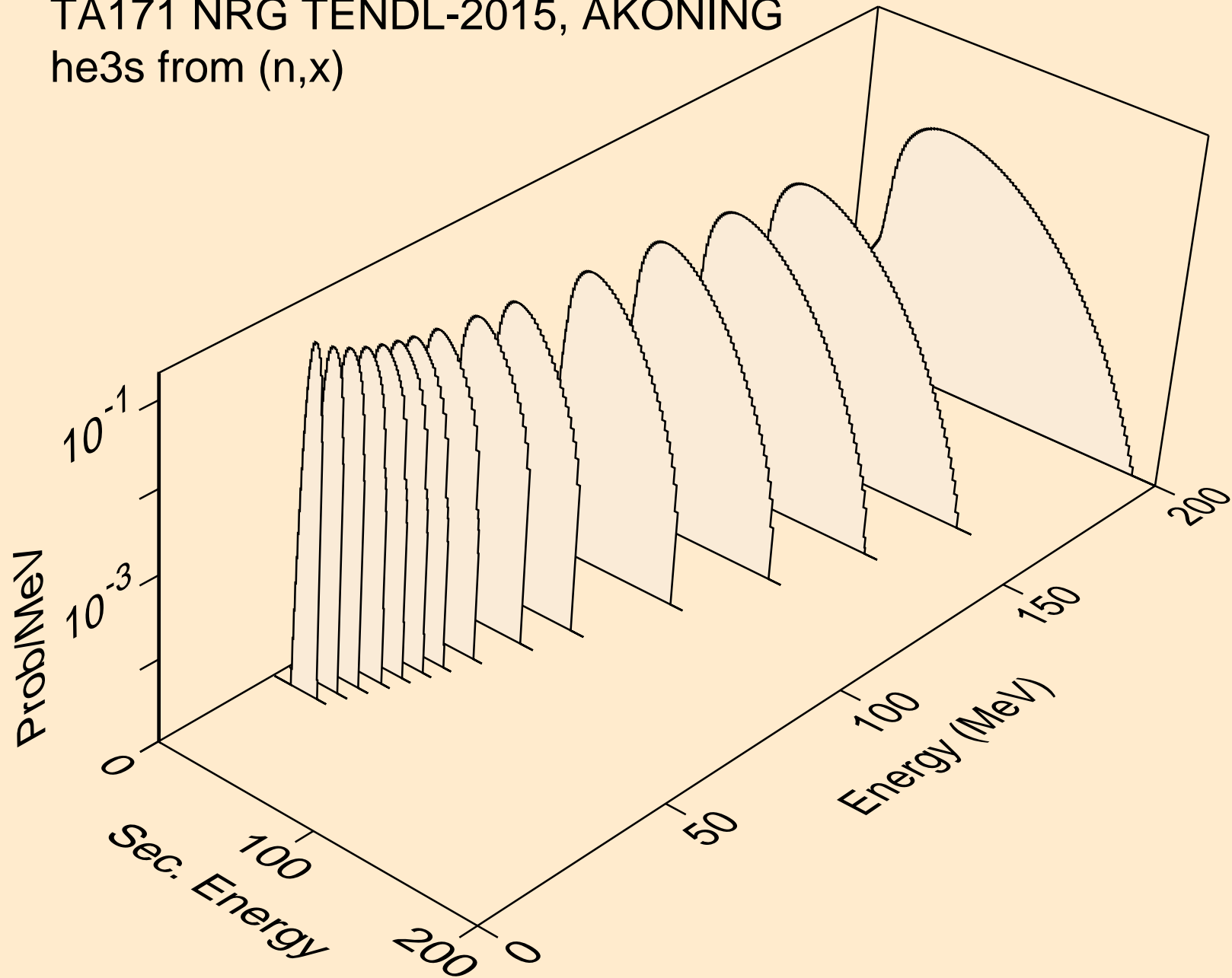

TA171 NRG TENDL-2015, AKONING
he3s from (n,n*)he3

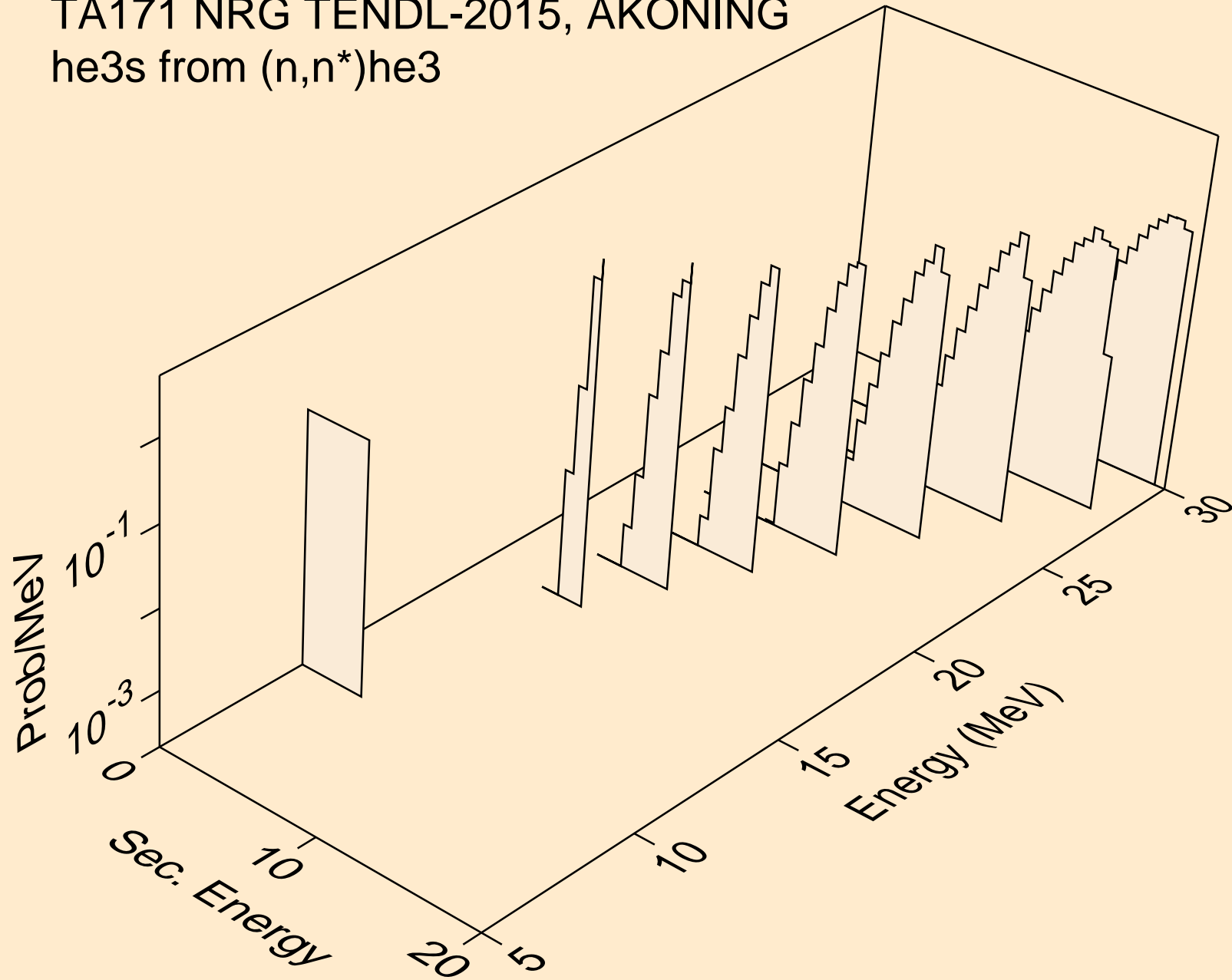

TA171 NRG TENDL-2015, AKONING
he3s from (n,he3)

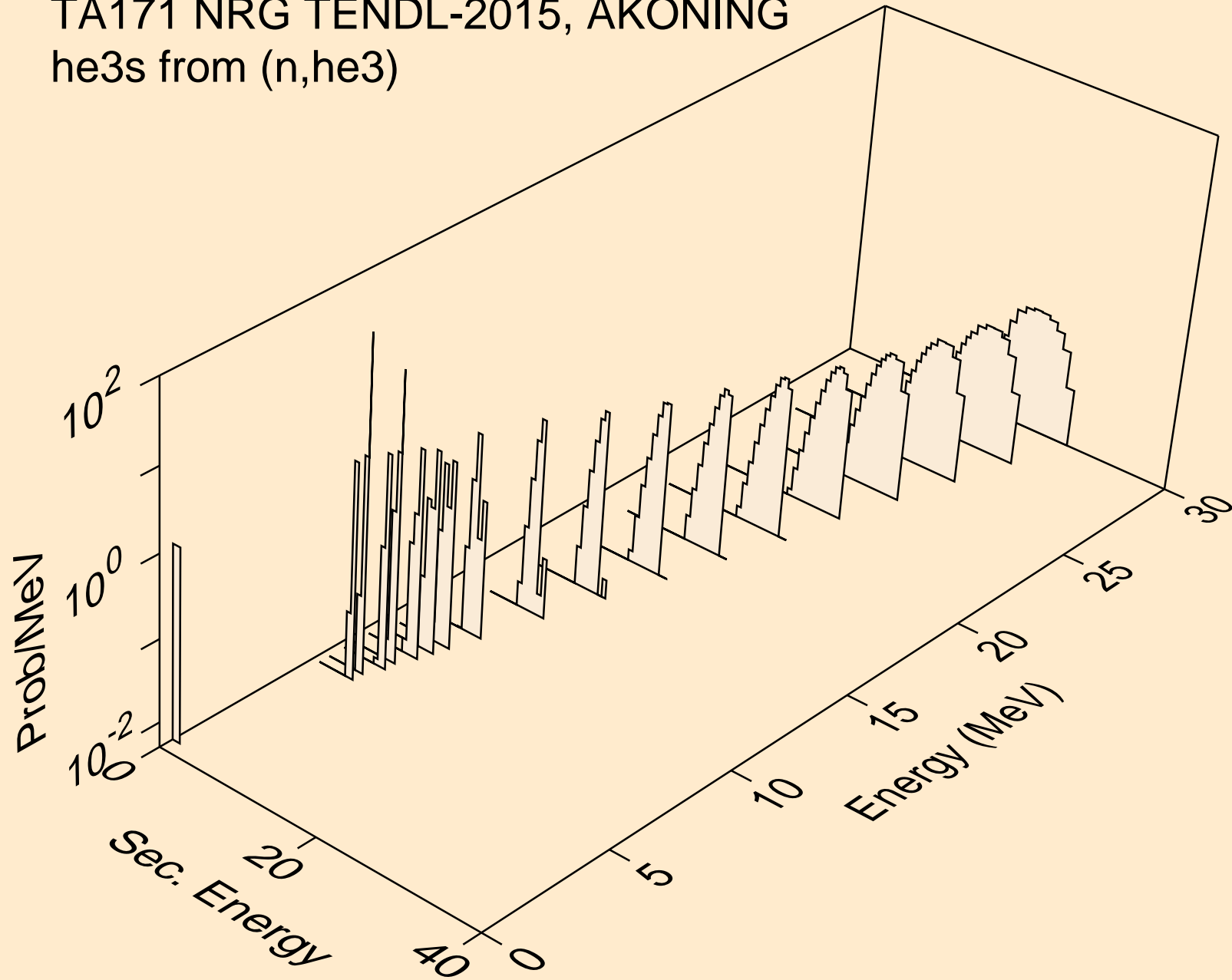

TA171 NRG TENDL-2015, AKONING
alphas from (n,x)

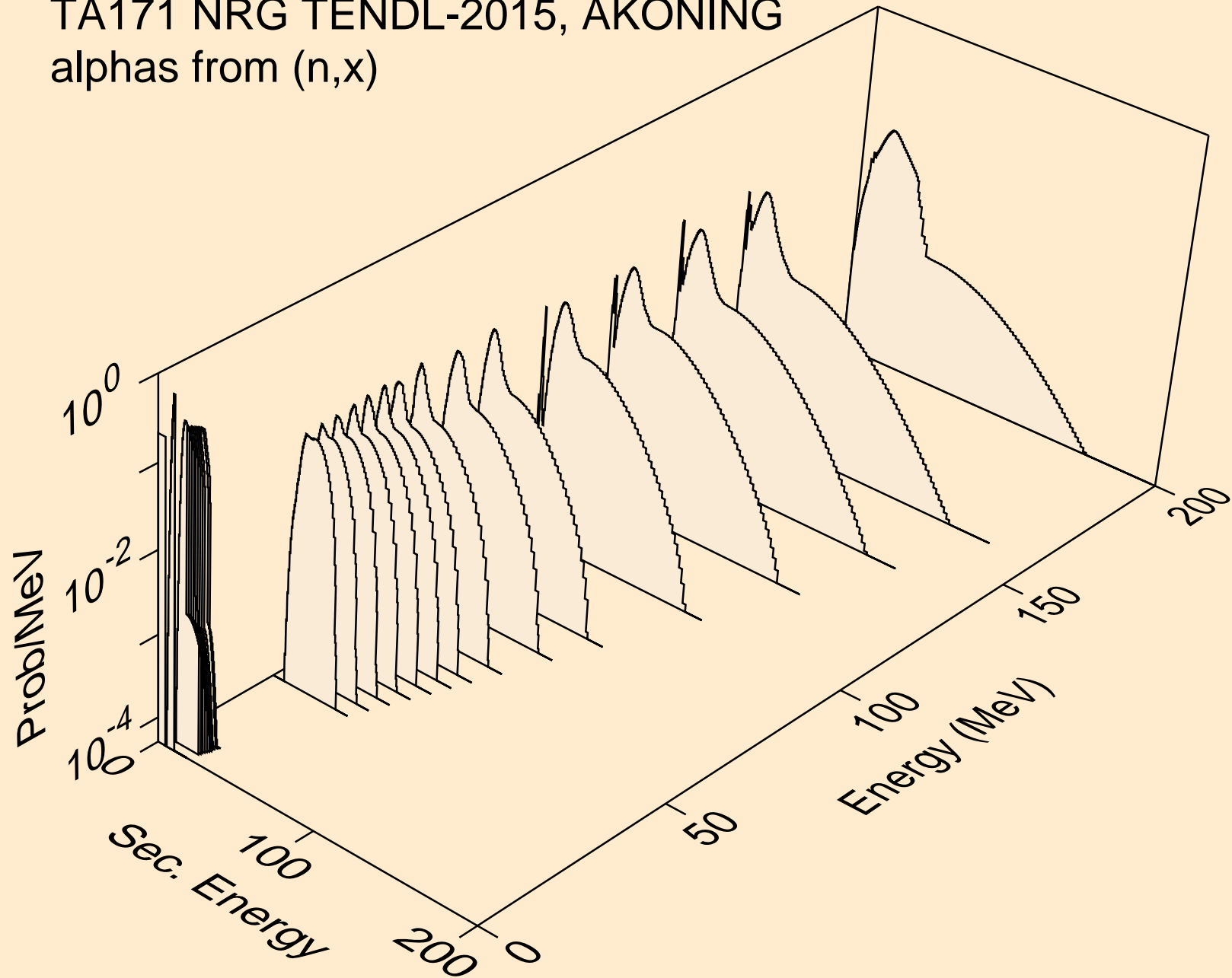

TA171 NRG TENDL-2015, AKONING
alphas from (n,n*)a

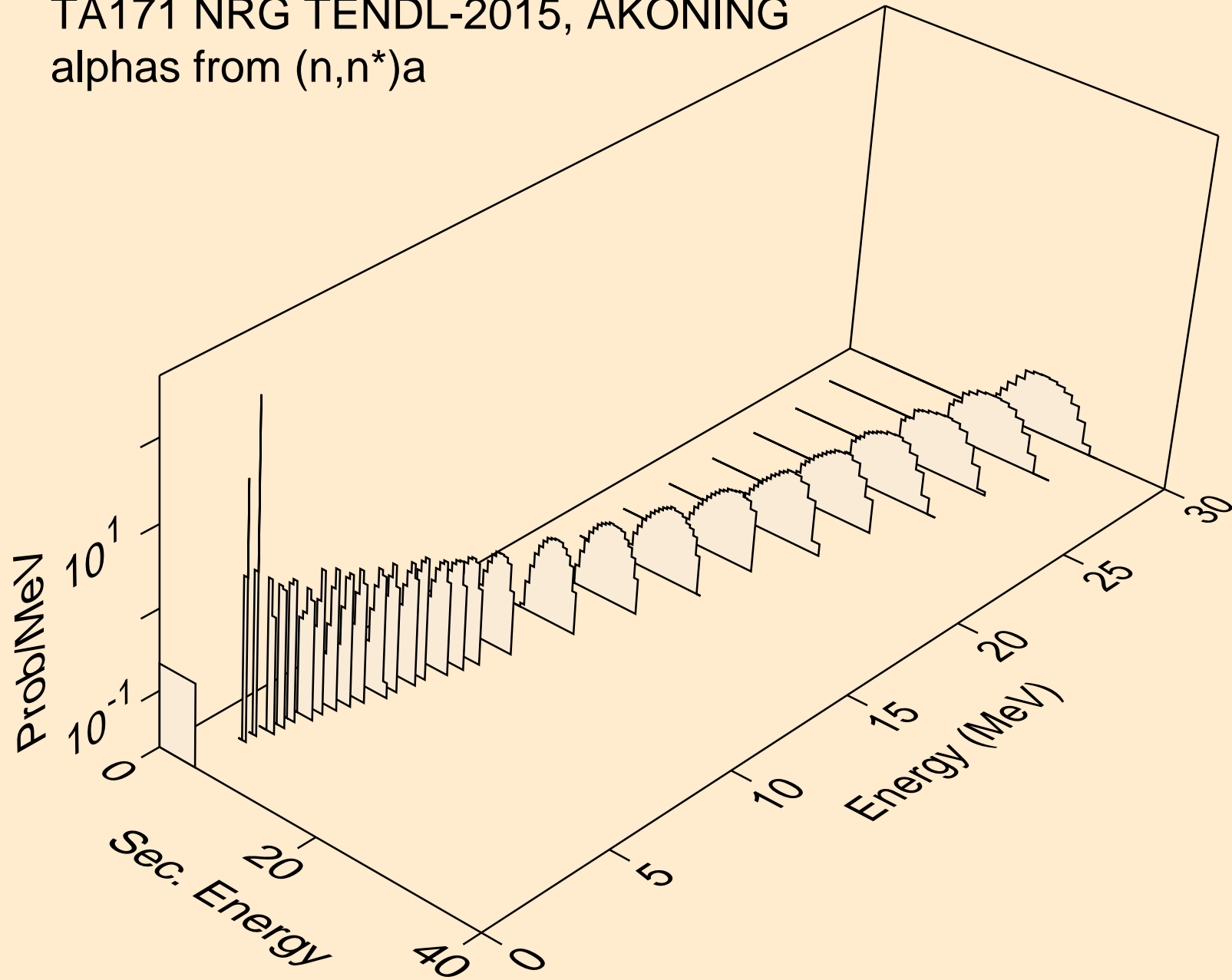

TA171 NRG TENDL-2015, AKONING
alphas from (n,2n)a

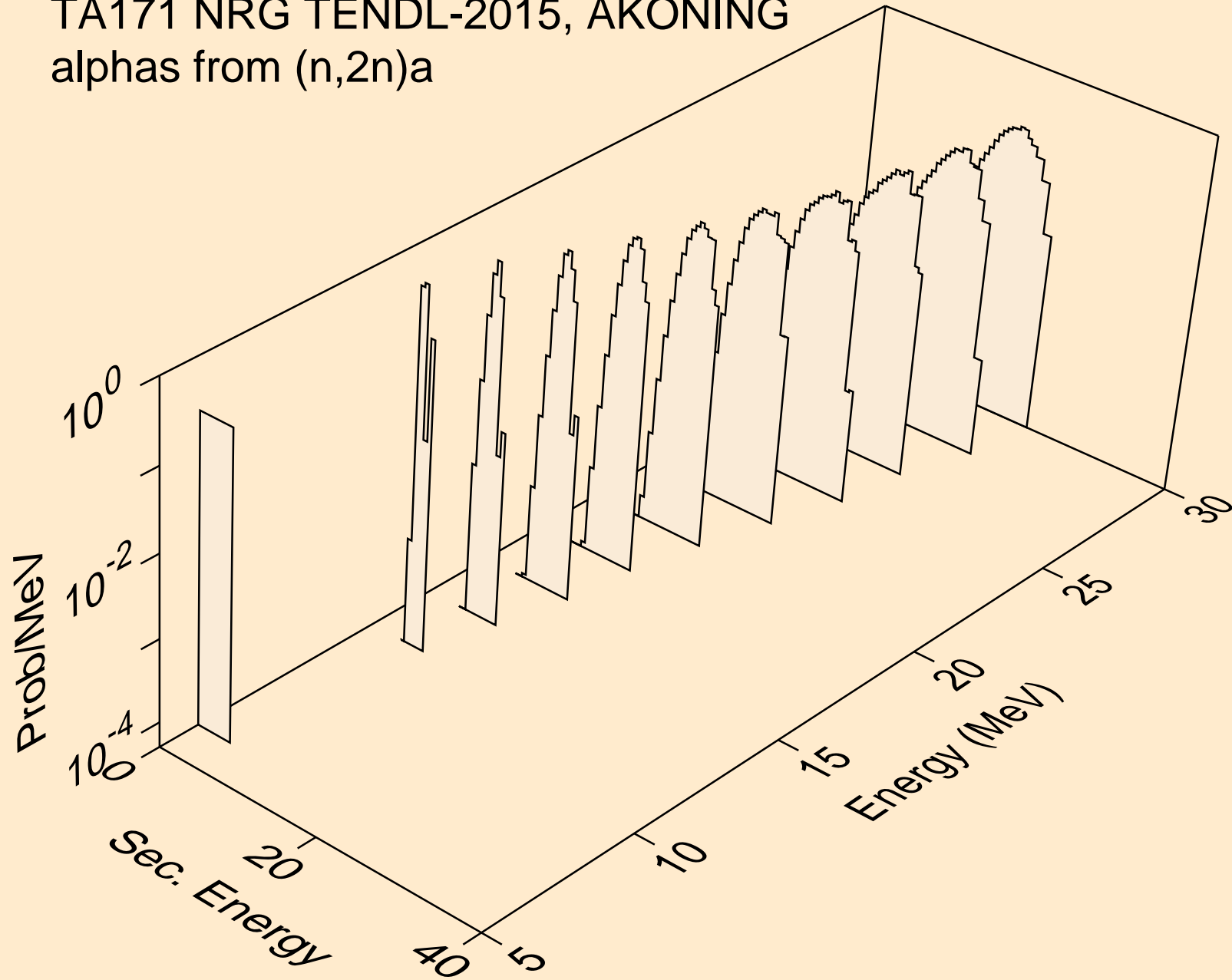

TA171 NRG TENDL-2015, AKONING
alphas from (n,3n)a

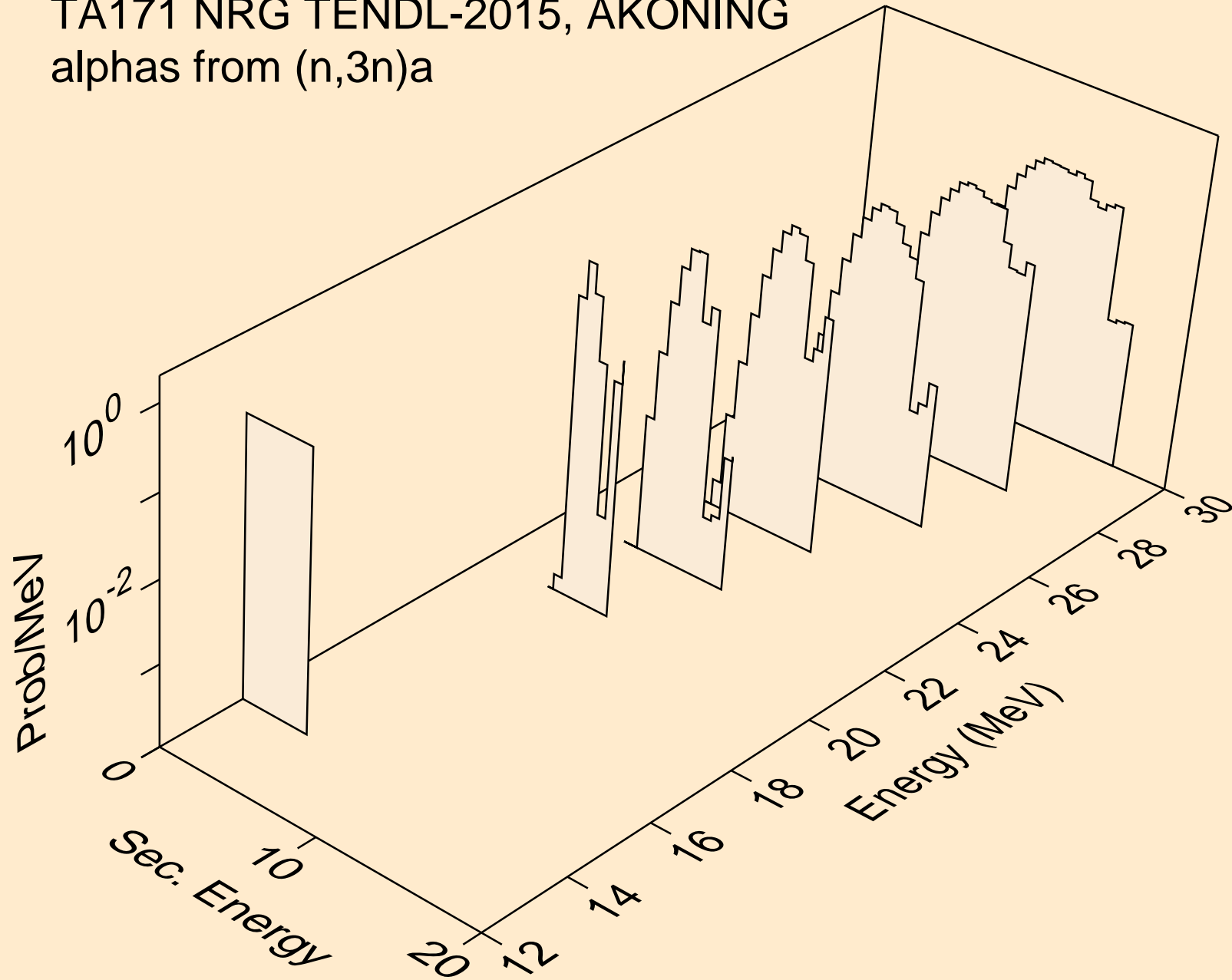

TA171 NRG TENDL-2015, AKONING
alphas from (n,n*)2a

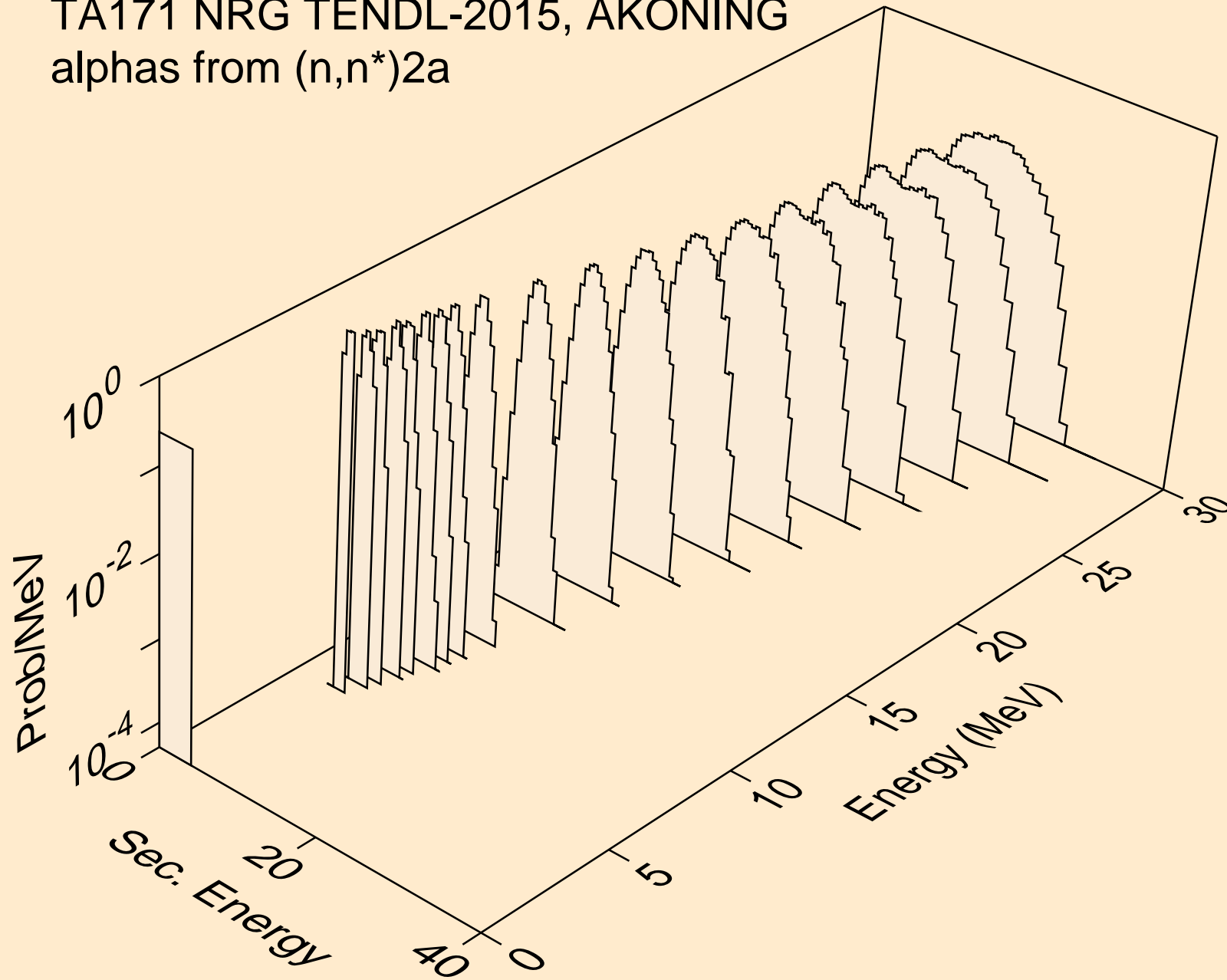

TA171 NRG TENDL-2015, AKONING
alphas from (n,2n)2a

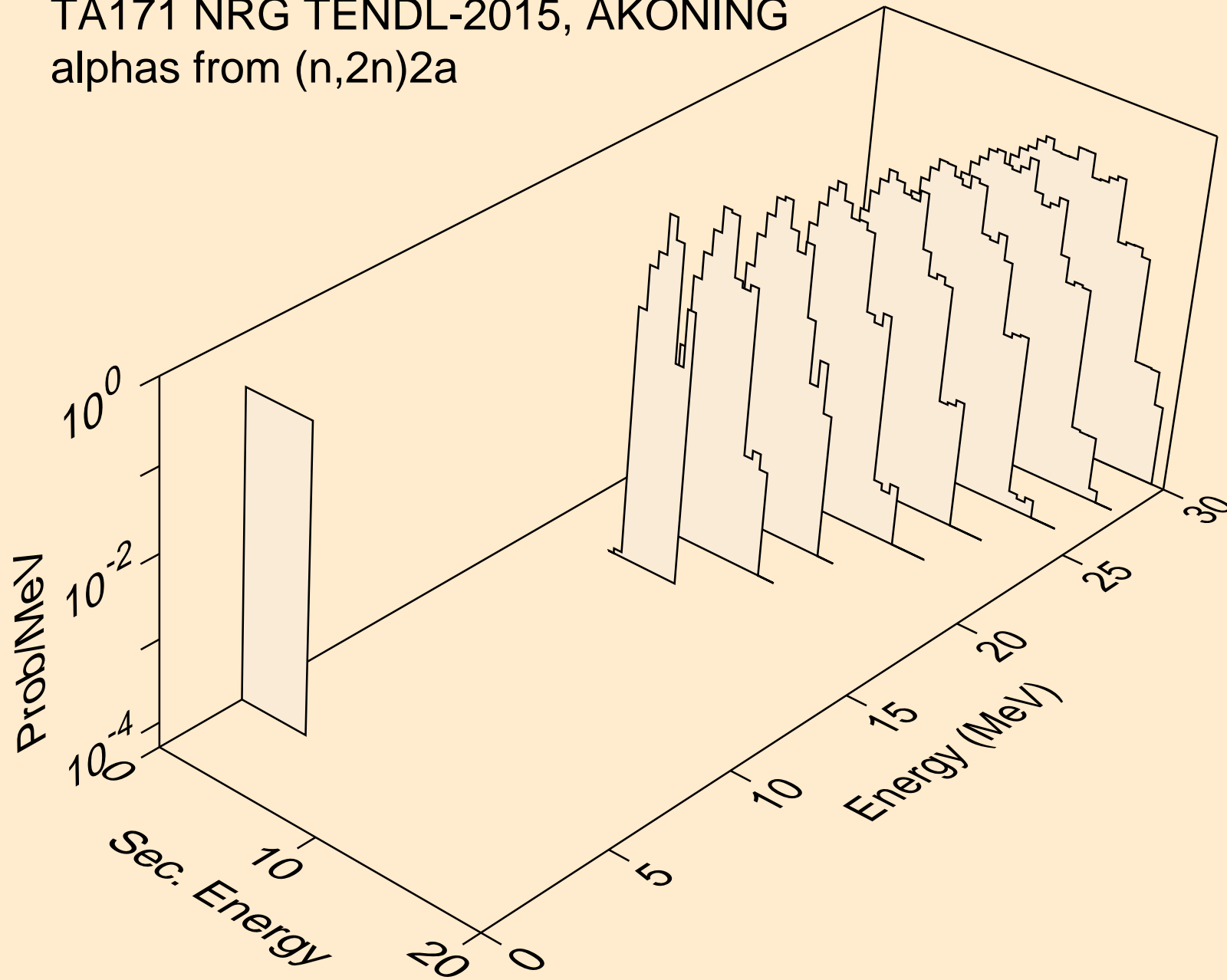

TA171 NRG TENDL-2015, AKONING
alphas from (n,npa)

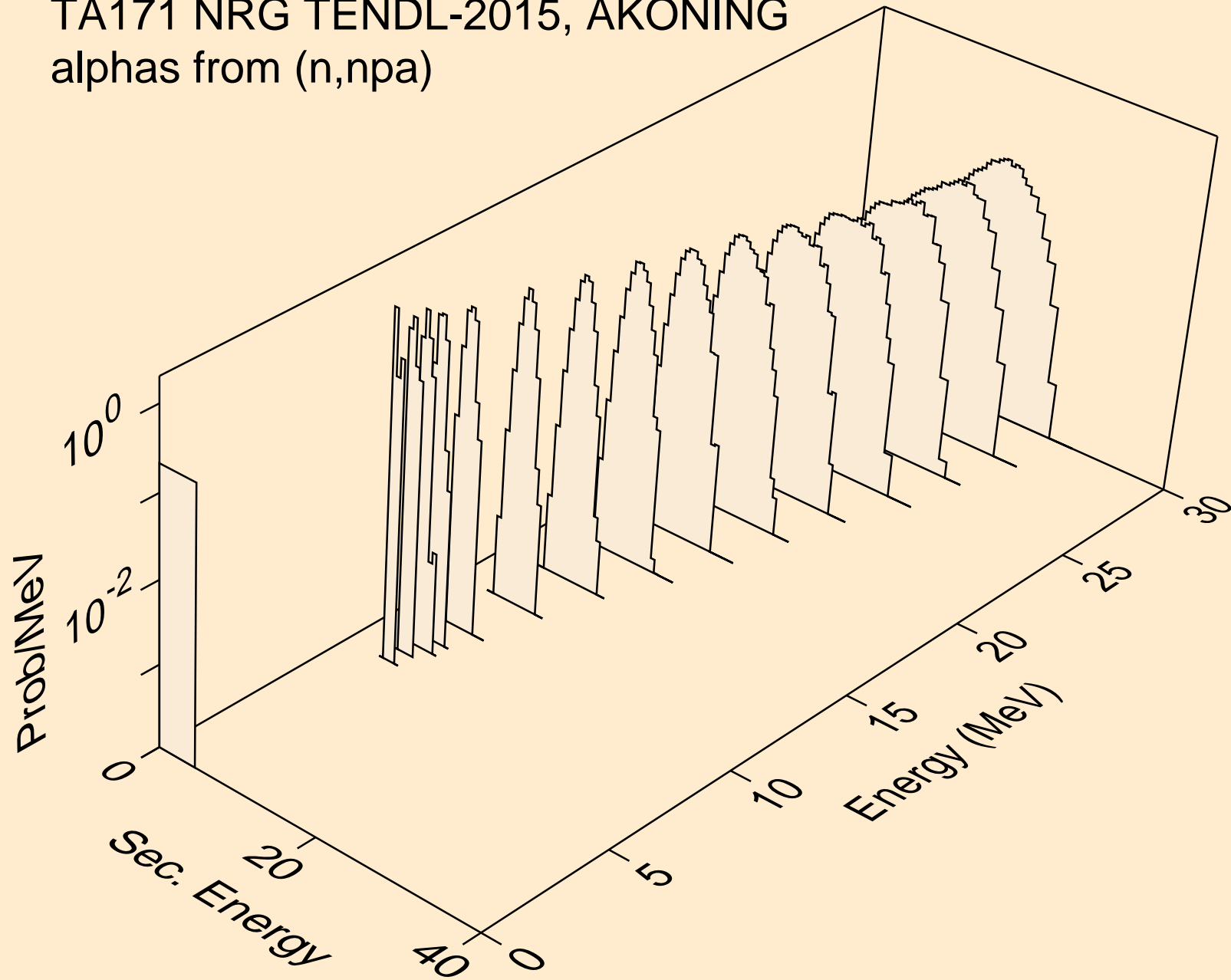

TA171 NRG TENDL-2015, AKONING
alphas from (n,a)

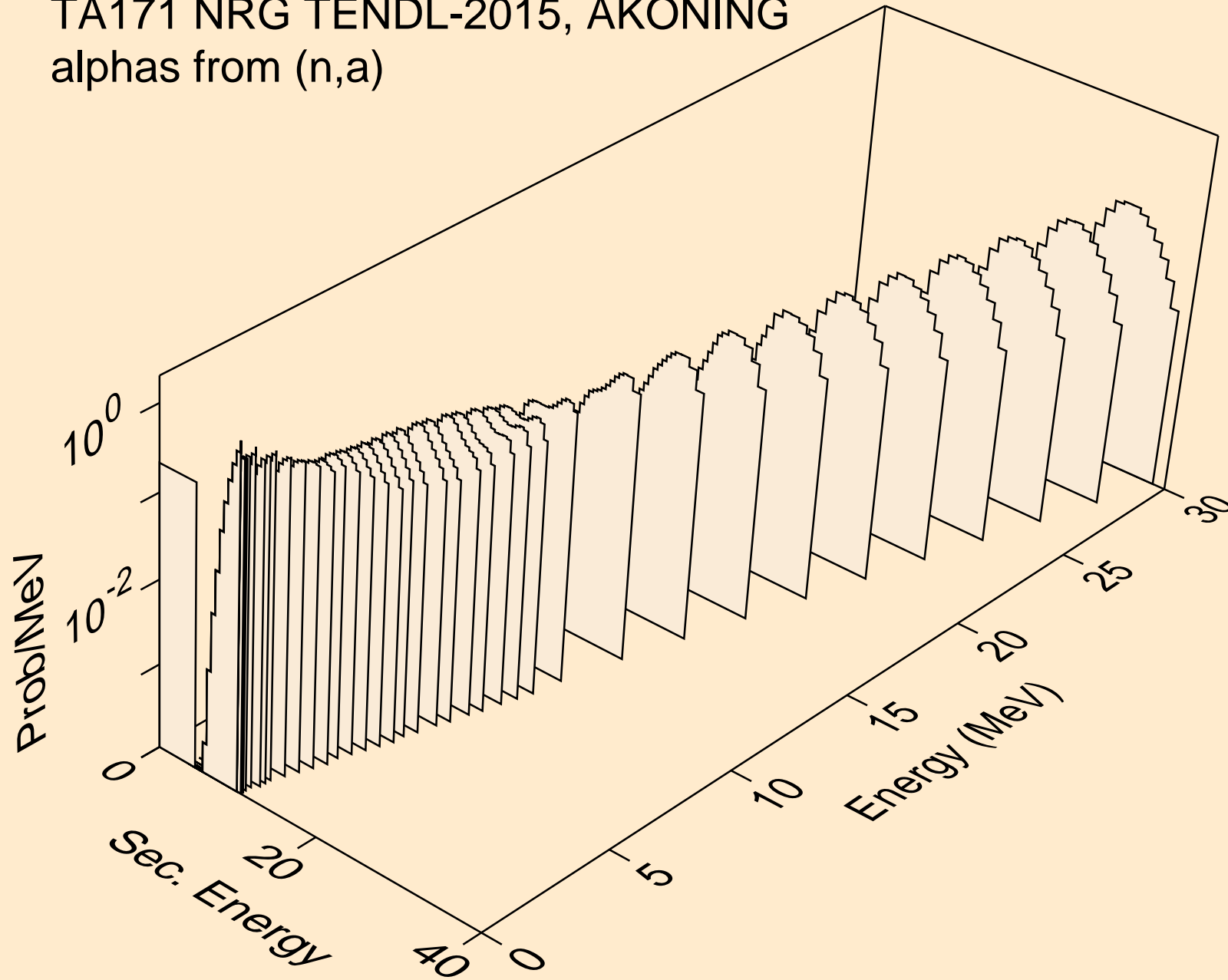

TA171 NRG TENDL-2015, AKONING
alphas from (n,2a)

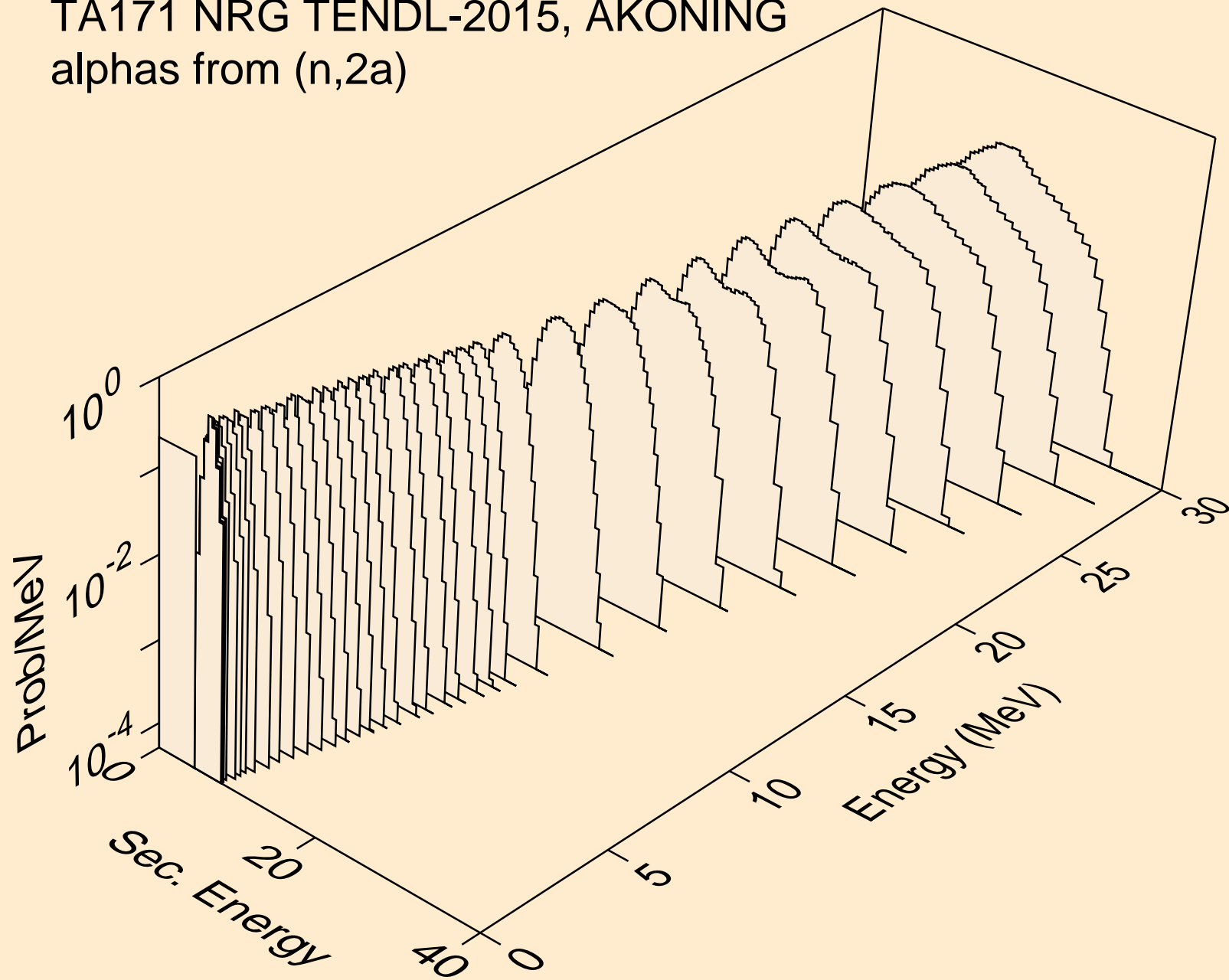

TA171 NRG TENDL-2015, AKONING
alphas from (n,pa)

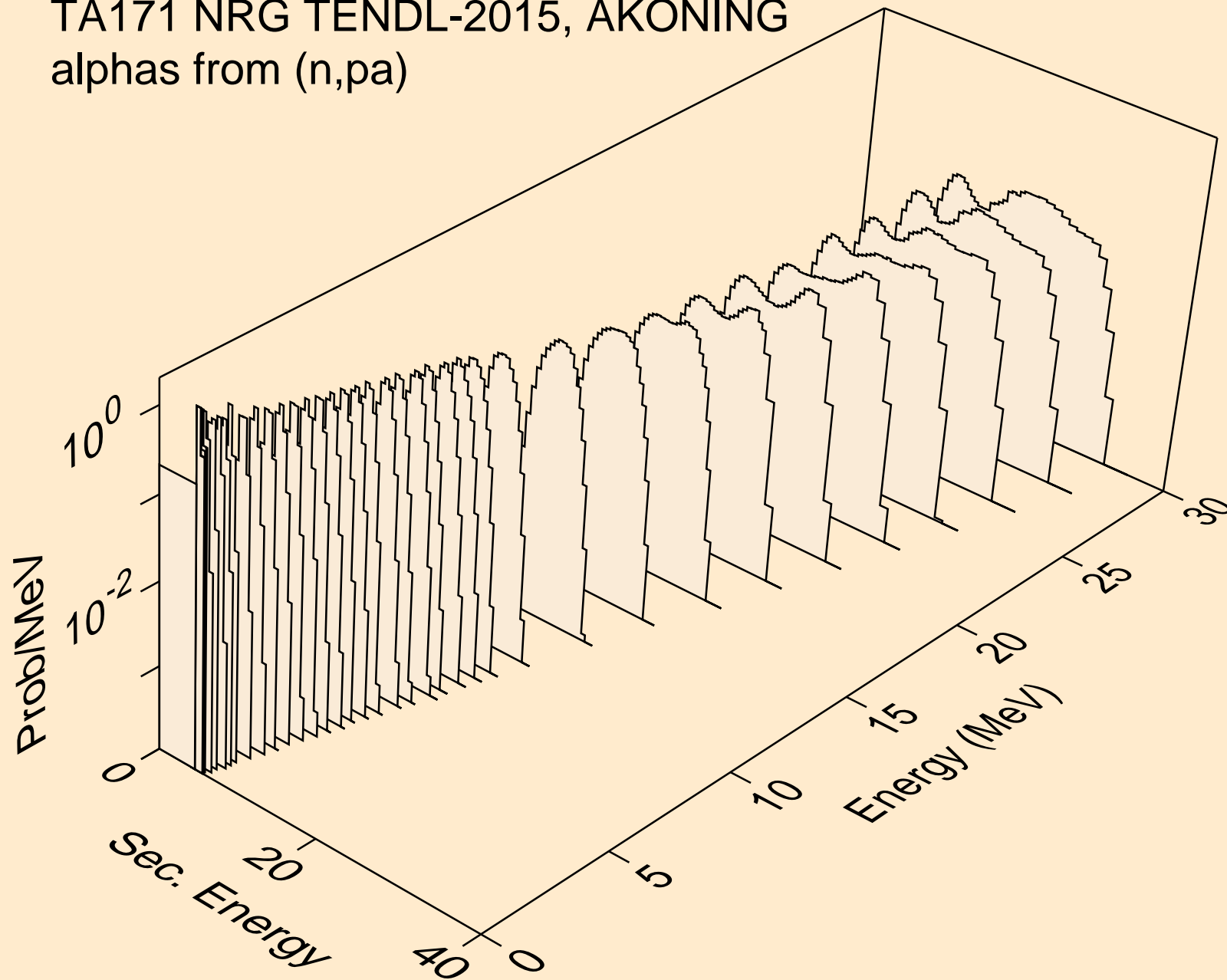

TA171 NRG TENDL-2015, AKONING
alphas from (n,da)

