

TA183 NRG TENDL-2015, AKONING

Principal cross sections

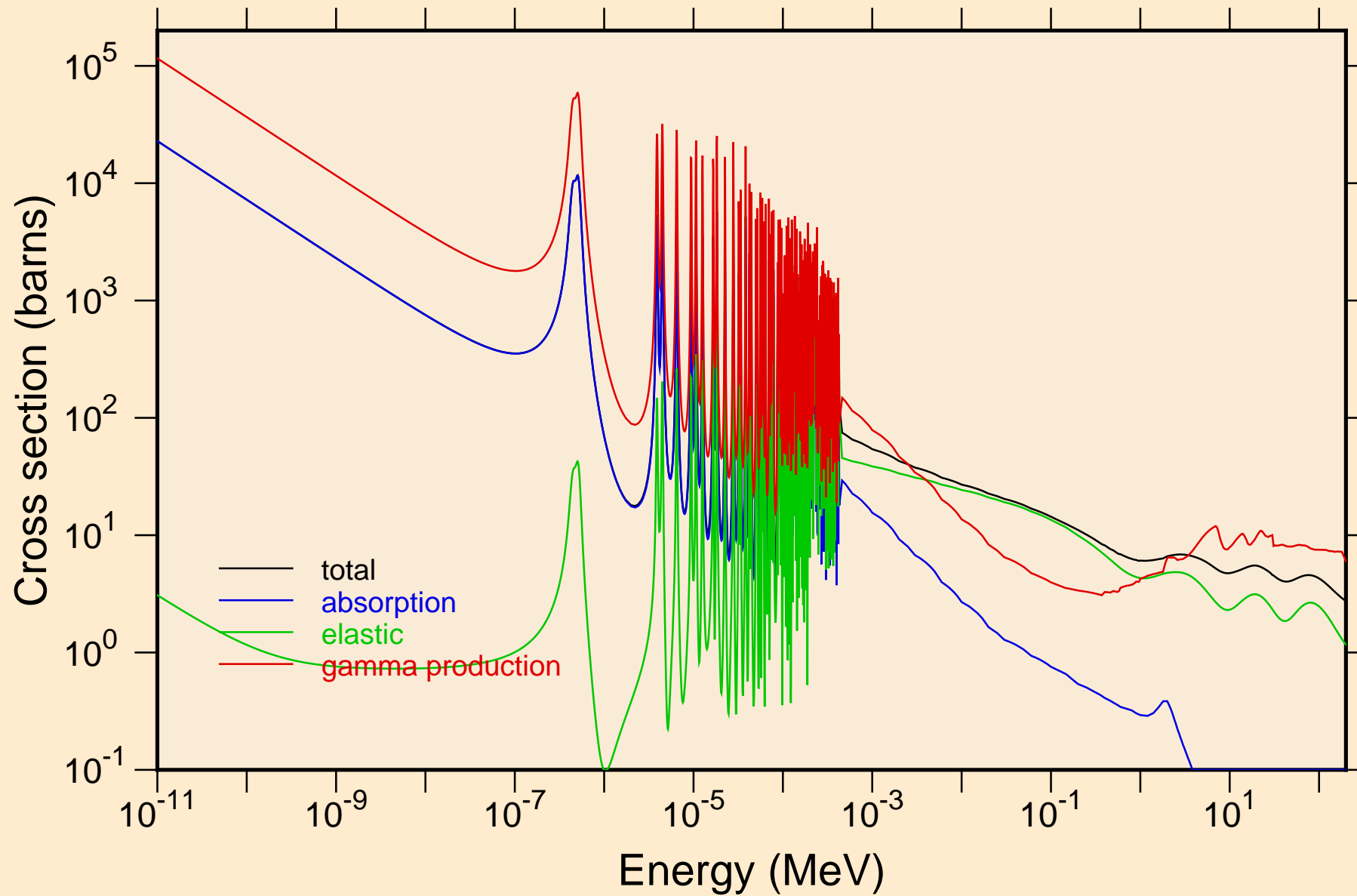

TA183 NRG TENDL-2015, AKONING
resonance total cross section

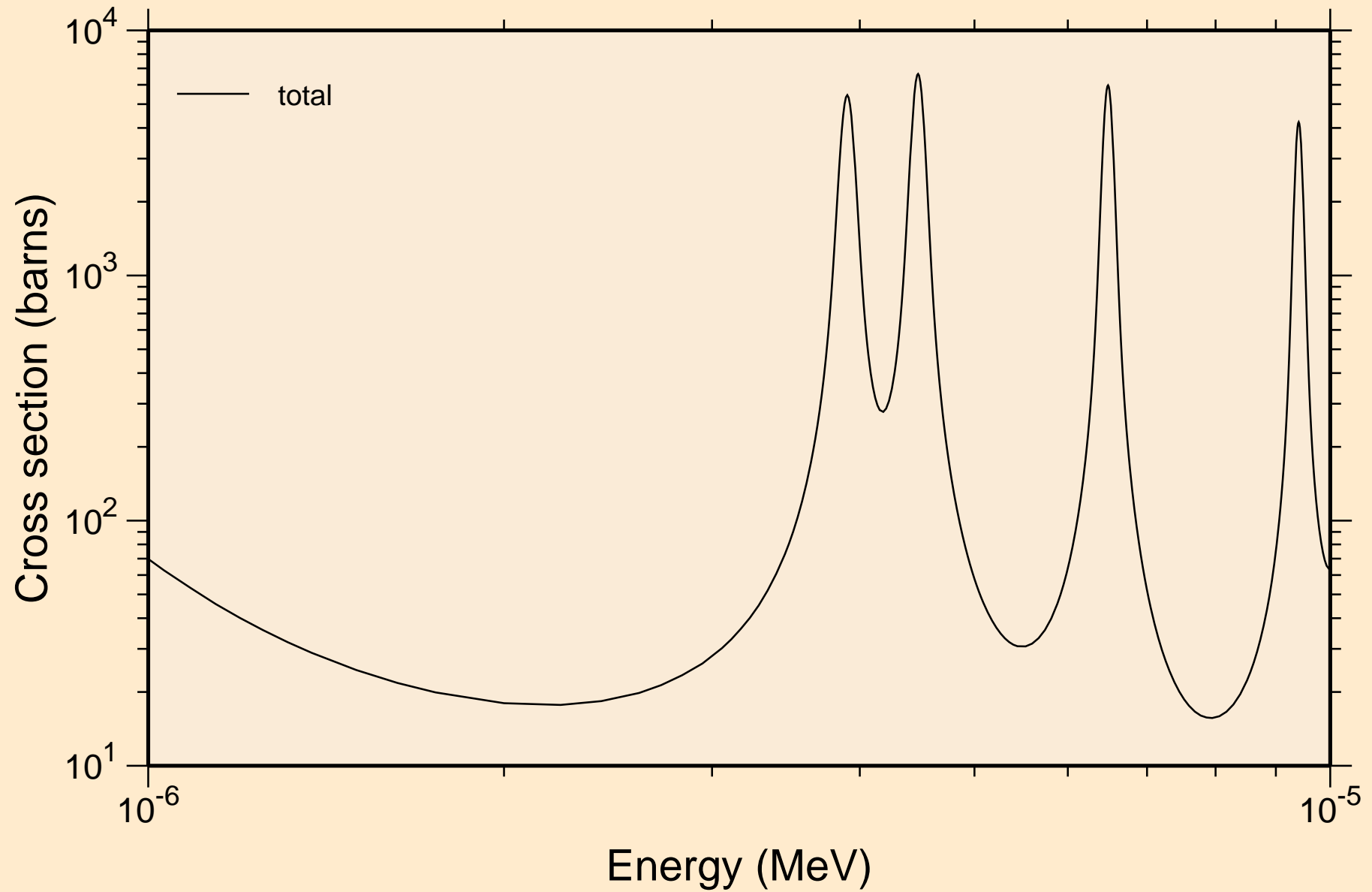

TA183 NRG TENDL-2015, AKONING
resonance total cross section

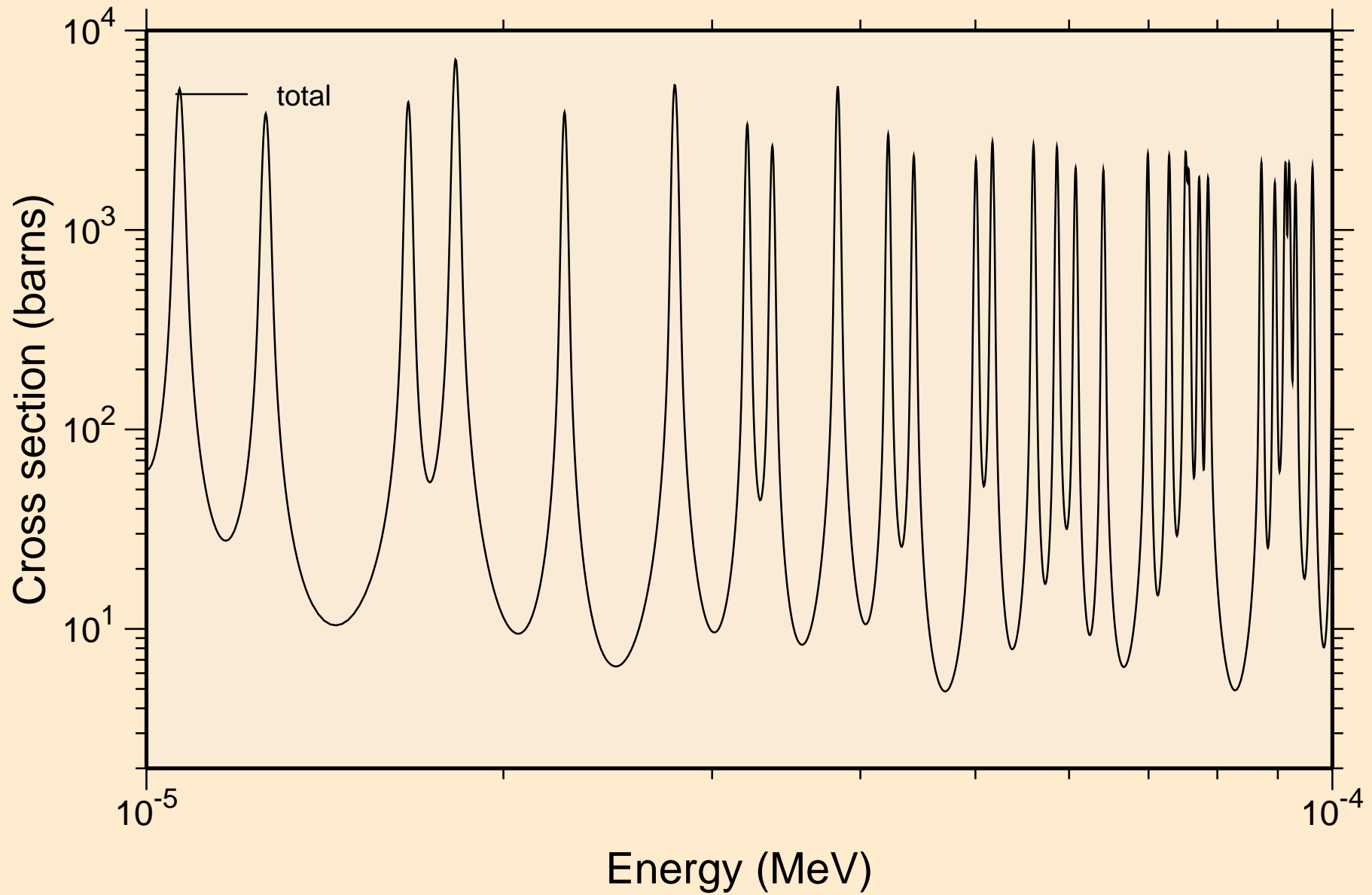

TA183 NRG TENDL-2015, AKONING
resonance total cross section

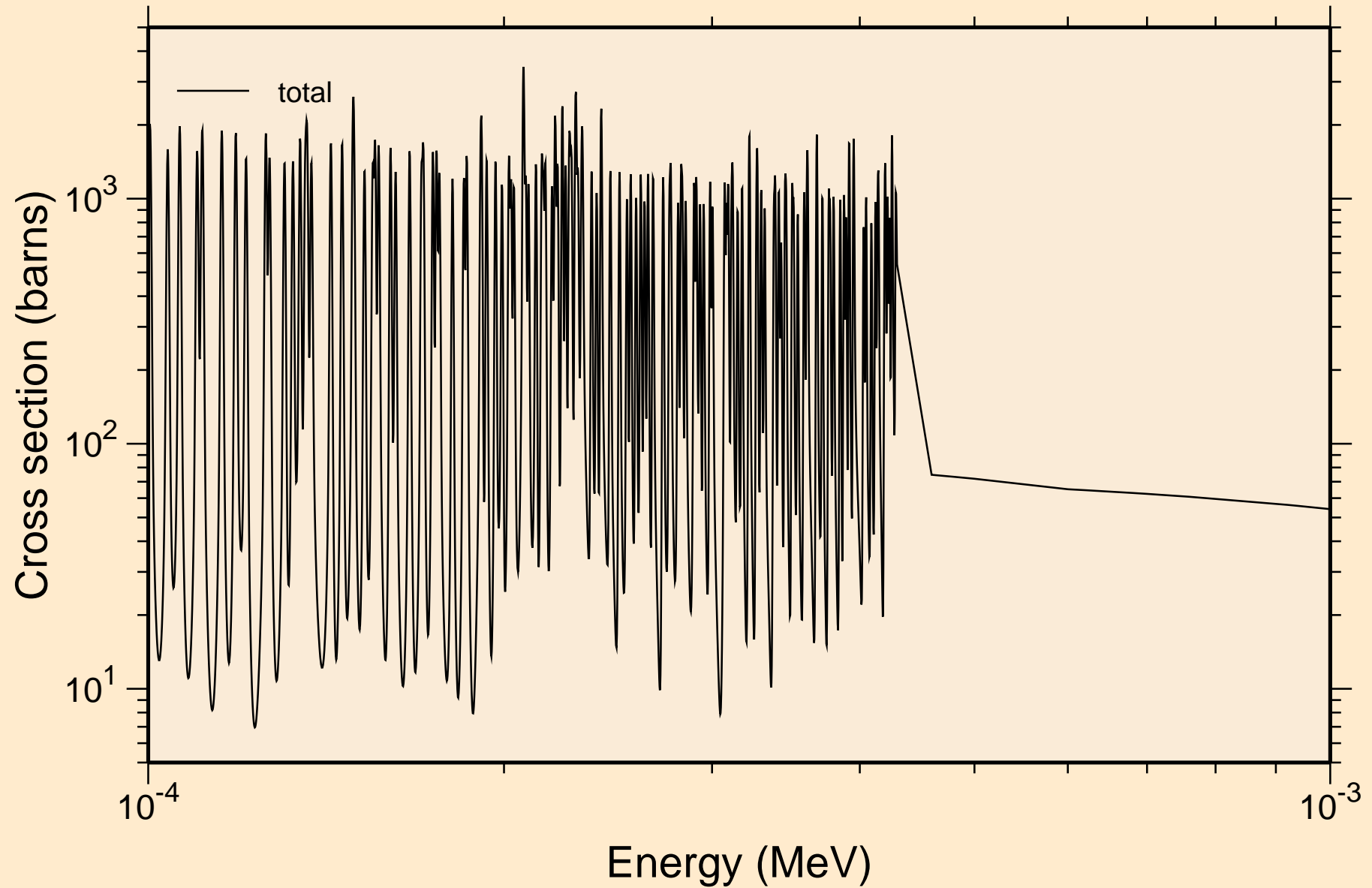

TA183 NRG TENDL-2015, AKONING
resonance total cross section

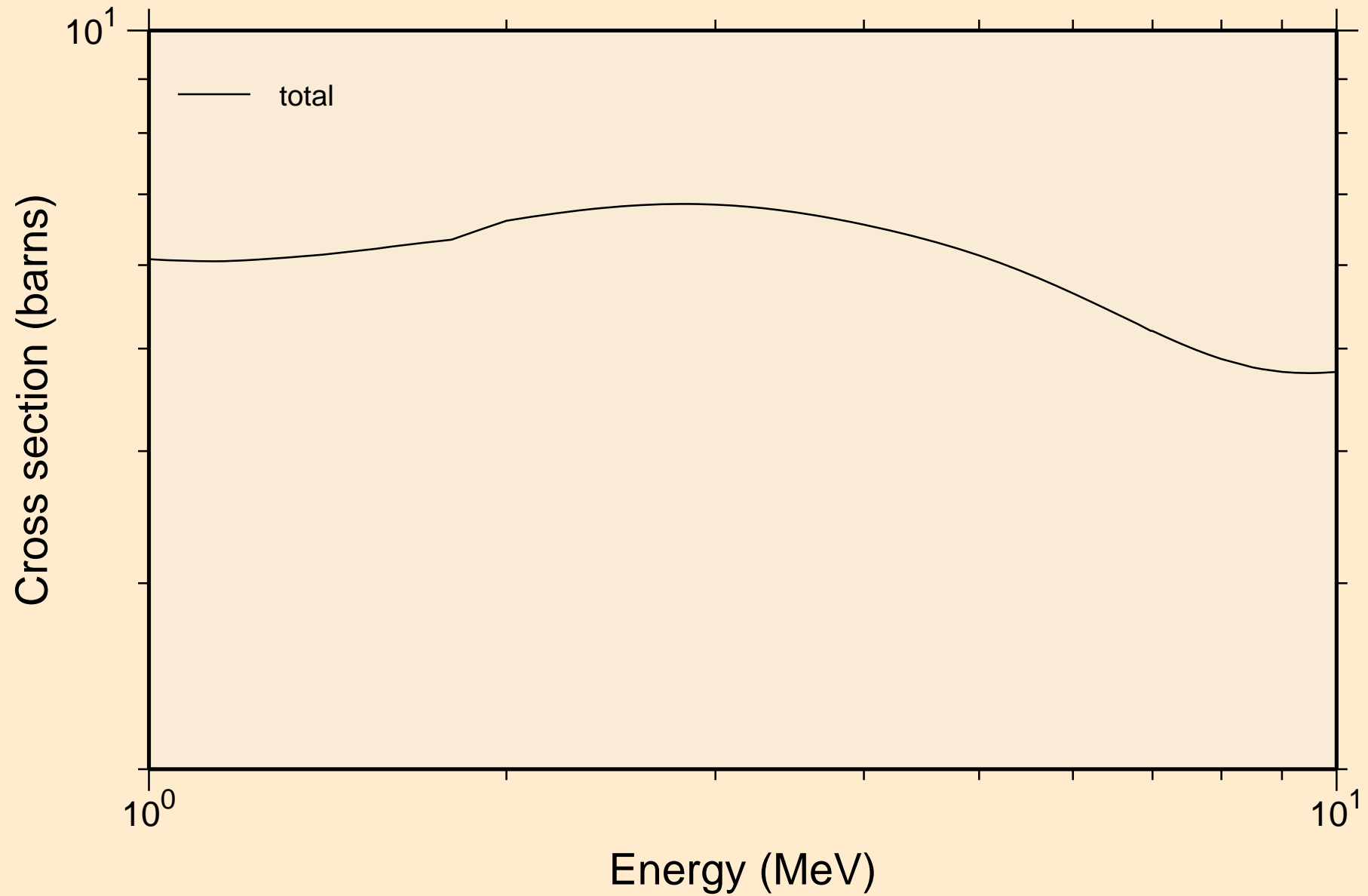

TA183 NRG TENDL-2015, AKONING
resonance absorption cross sections

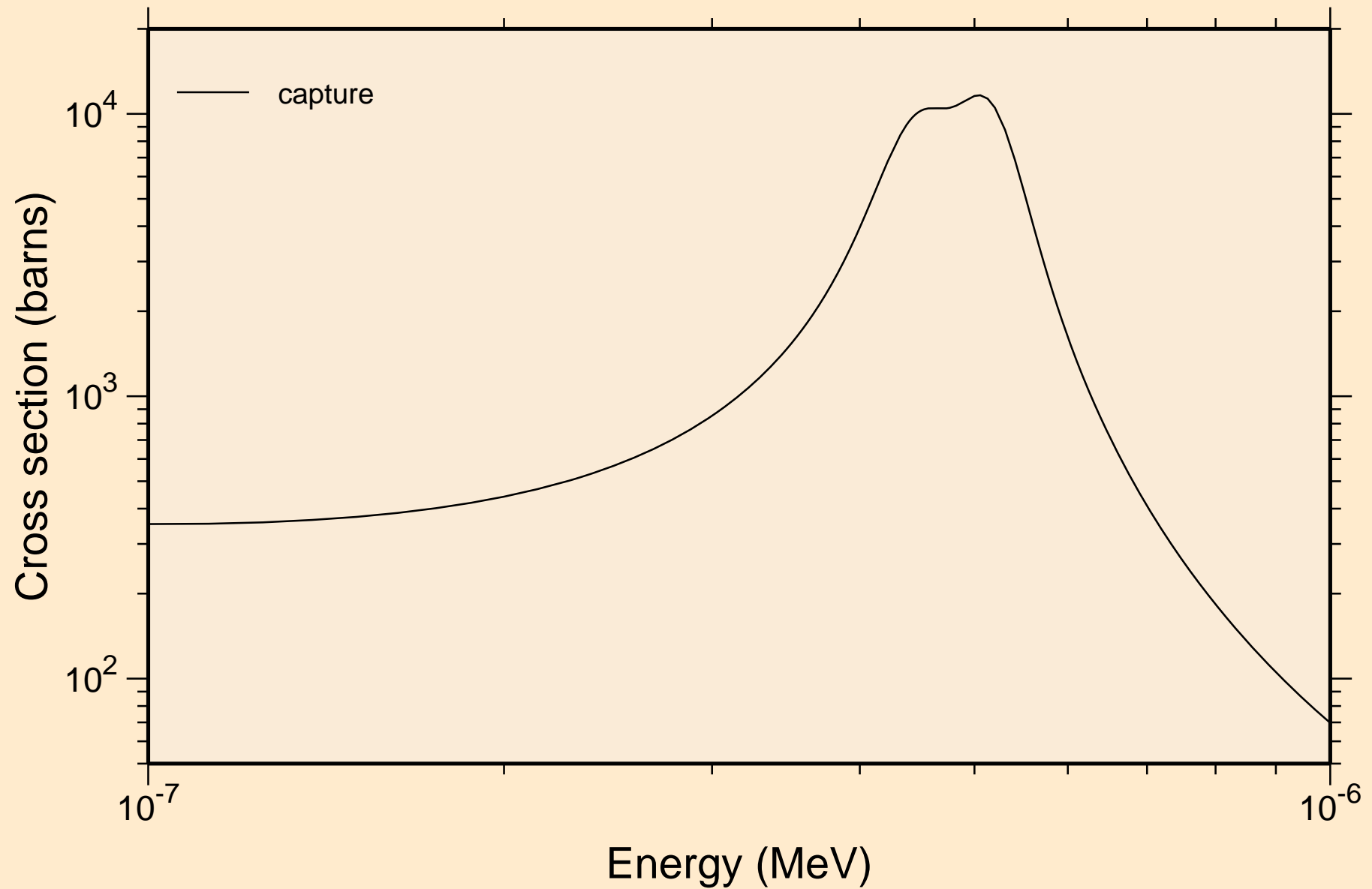

TA183 NRG TENDL-2015, AKONING
resonance absorption cross sections

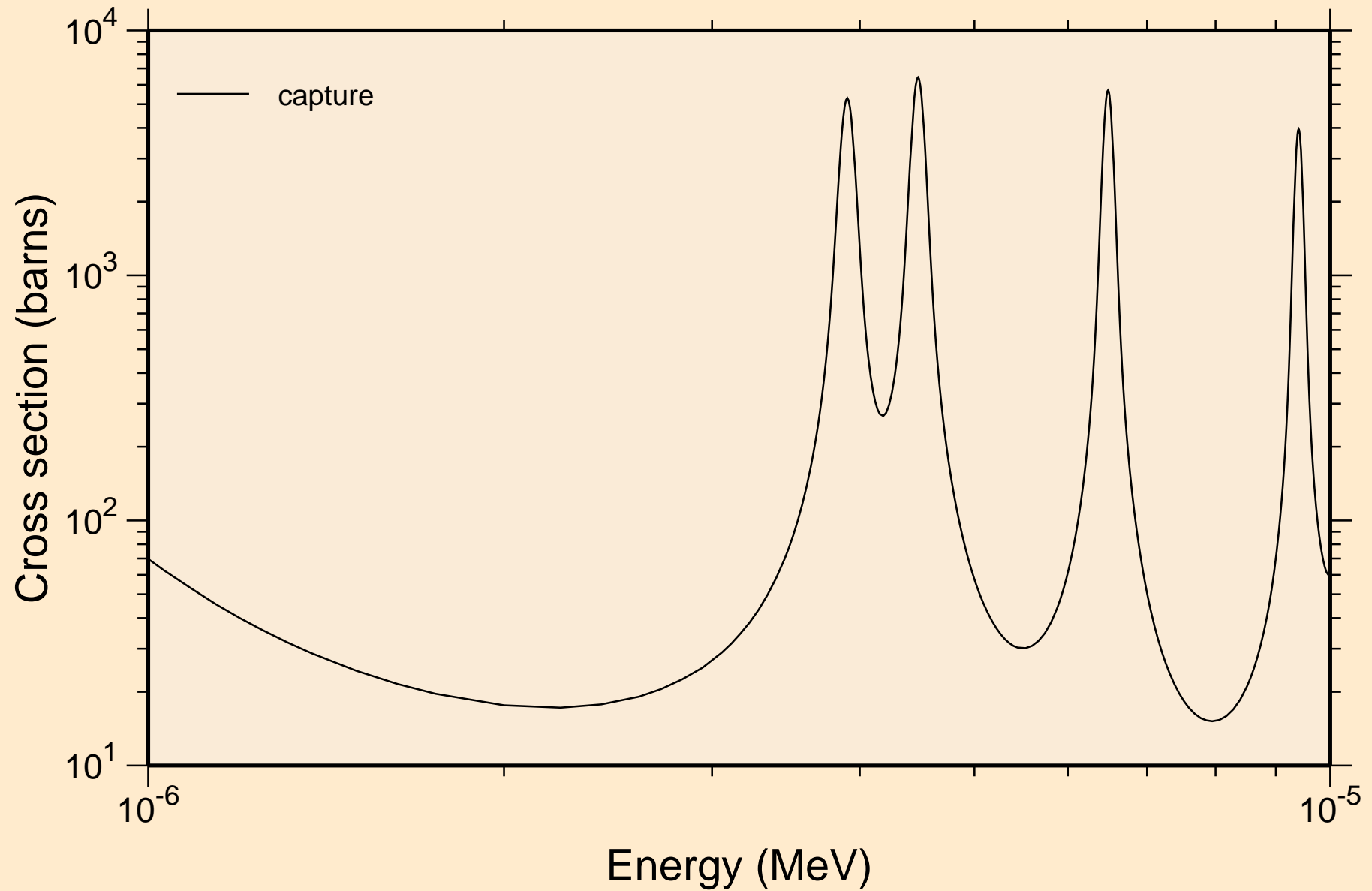

TA183 NRG TENDL-2015, AKONING
resonance absorption cross sections

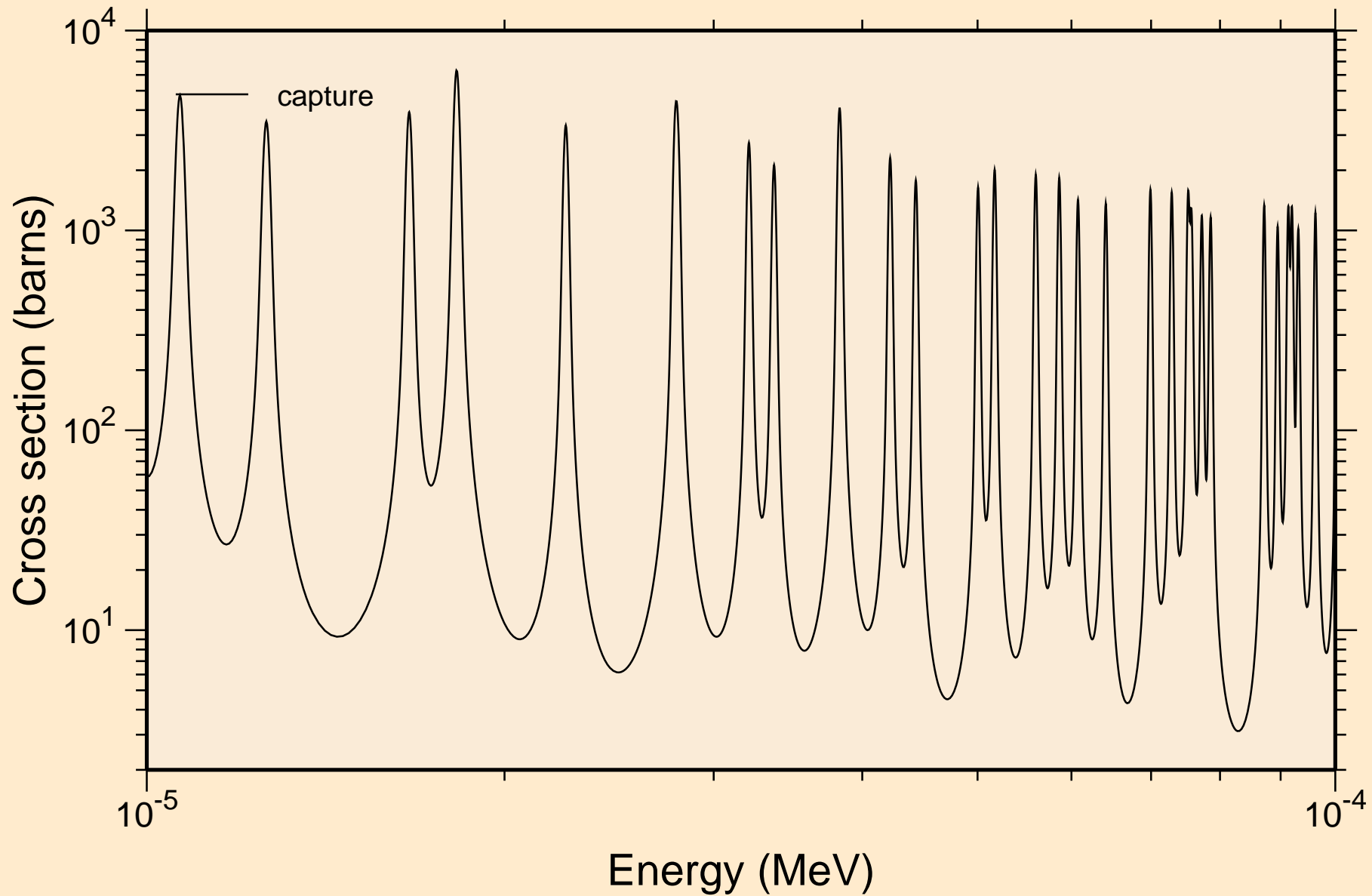

TA183 NRG TENDL-2015, AKONING
resonance absorption cross sections

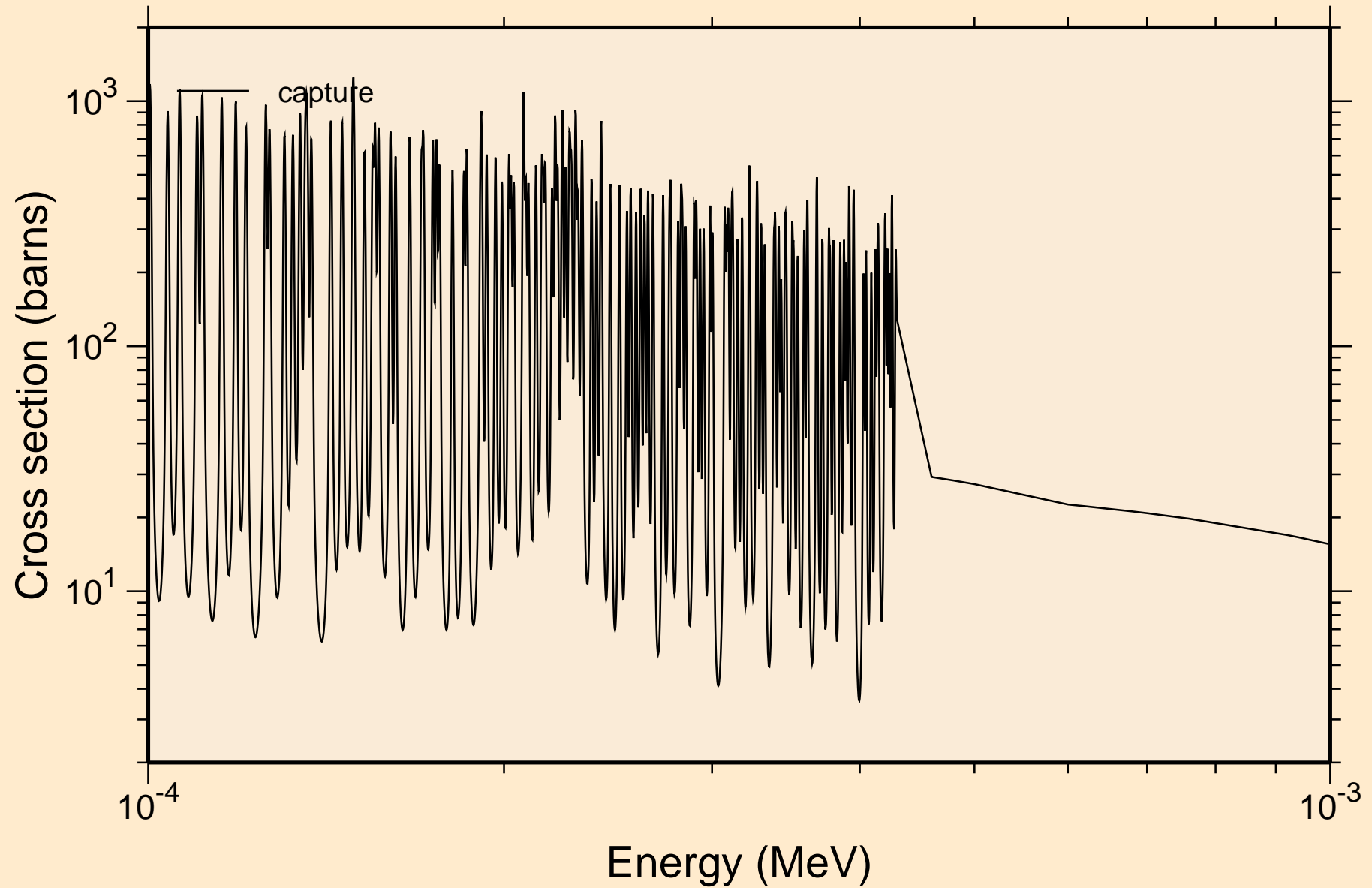

TA183 NRG TENDL-2015, AKONING
resonance absorption cross sections

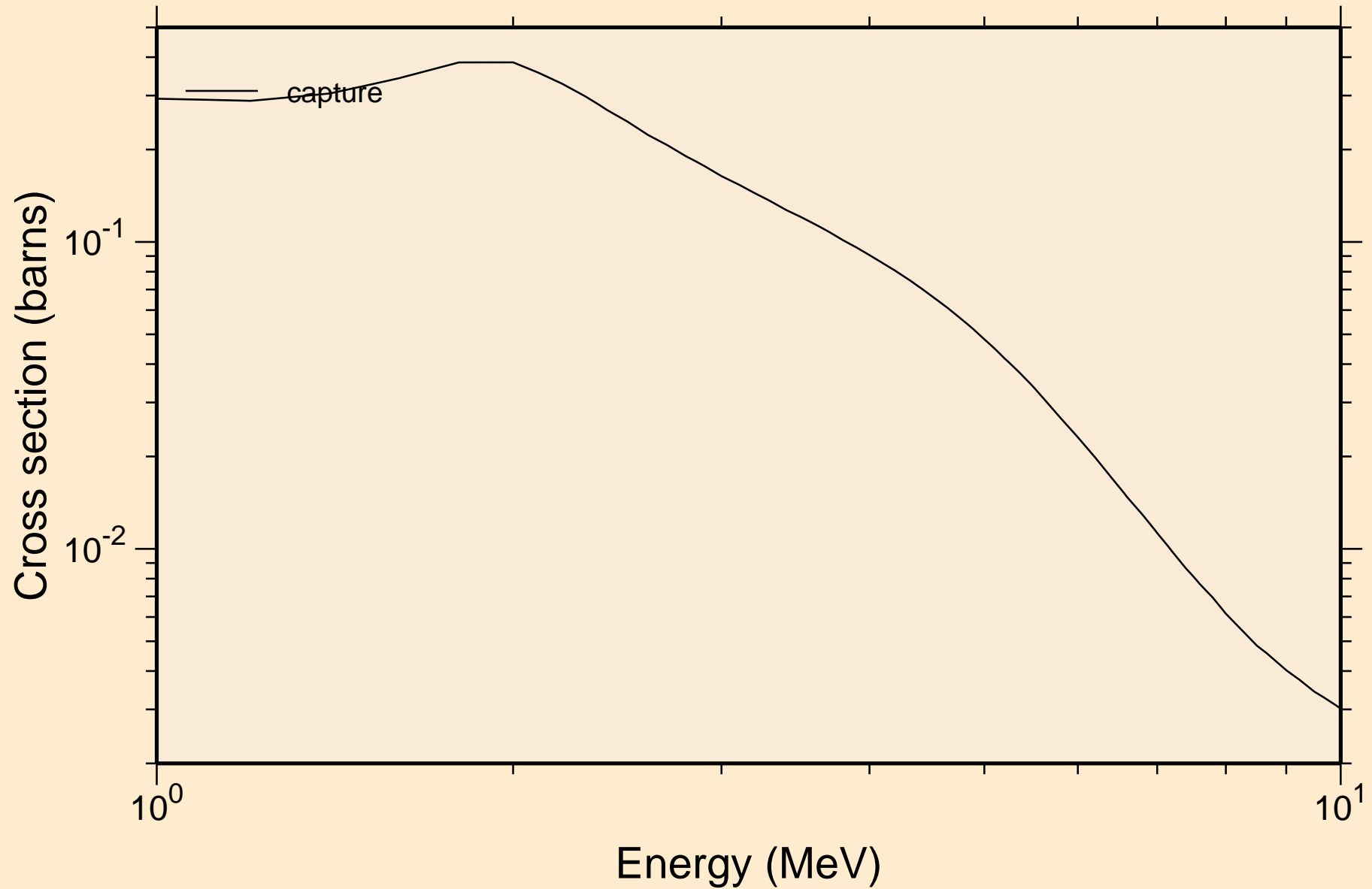

TA183 NRG TENDL-2015, AKONING
Non-threshold reactions

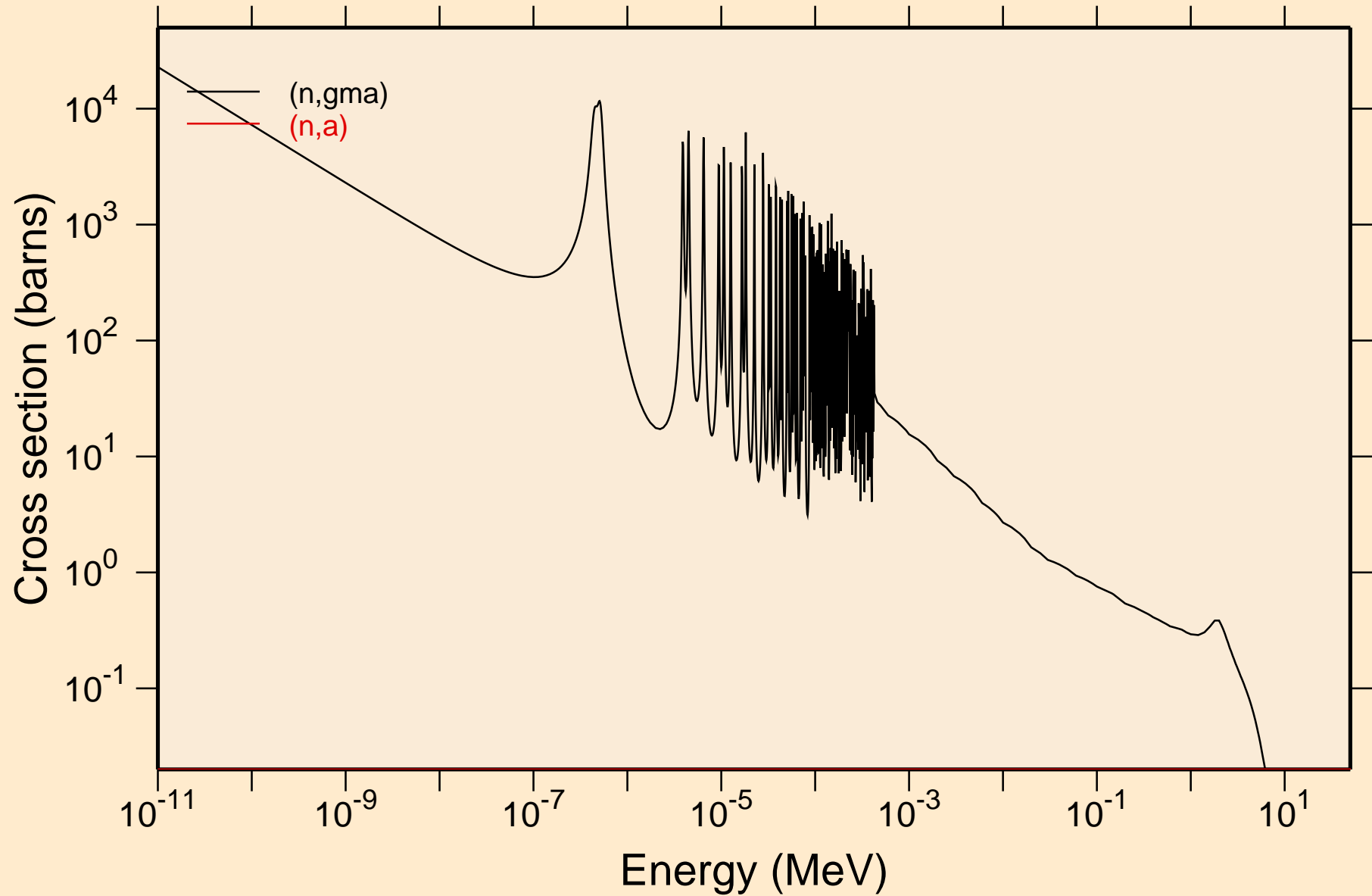

TA183 NRG TENDL-2015, AKONING

Principal cross sections

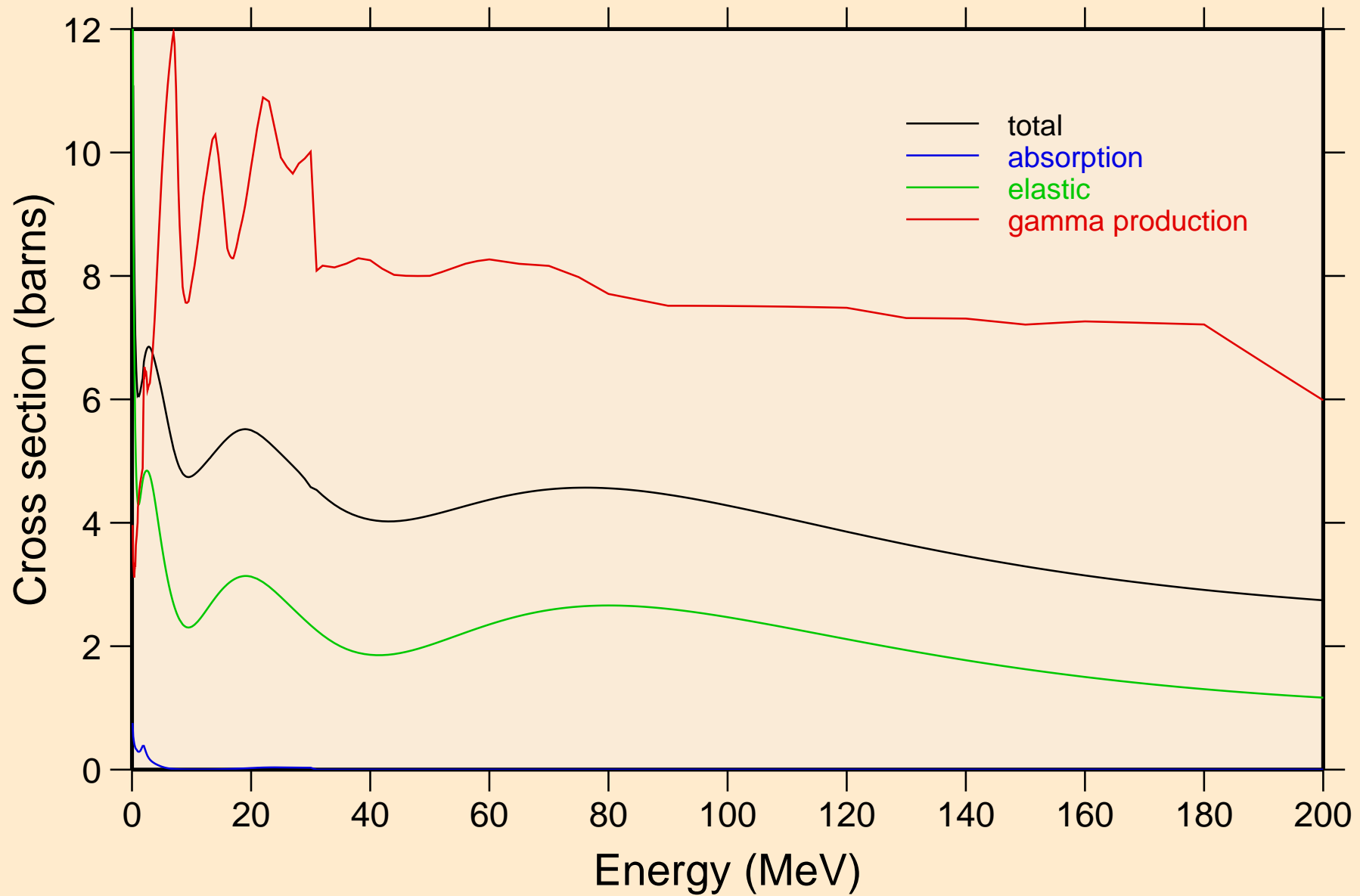

TA183 NRG TENDL-2015, AKONING
Non-threshold reactions

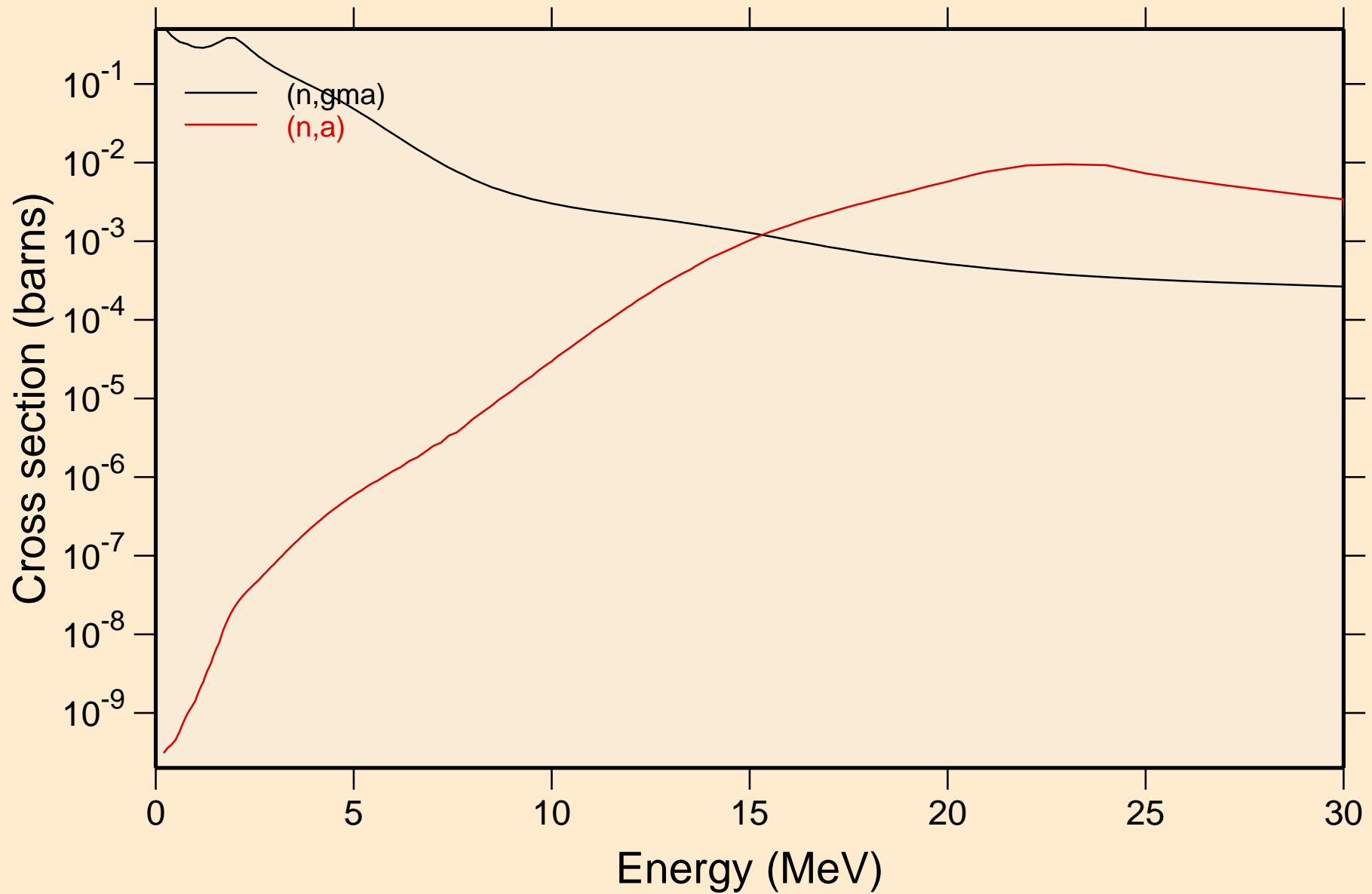

TA183 NRG TENDL-2015, AKONING

Inelastic levels

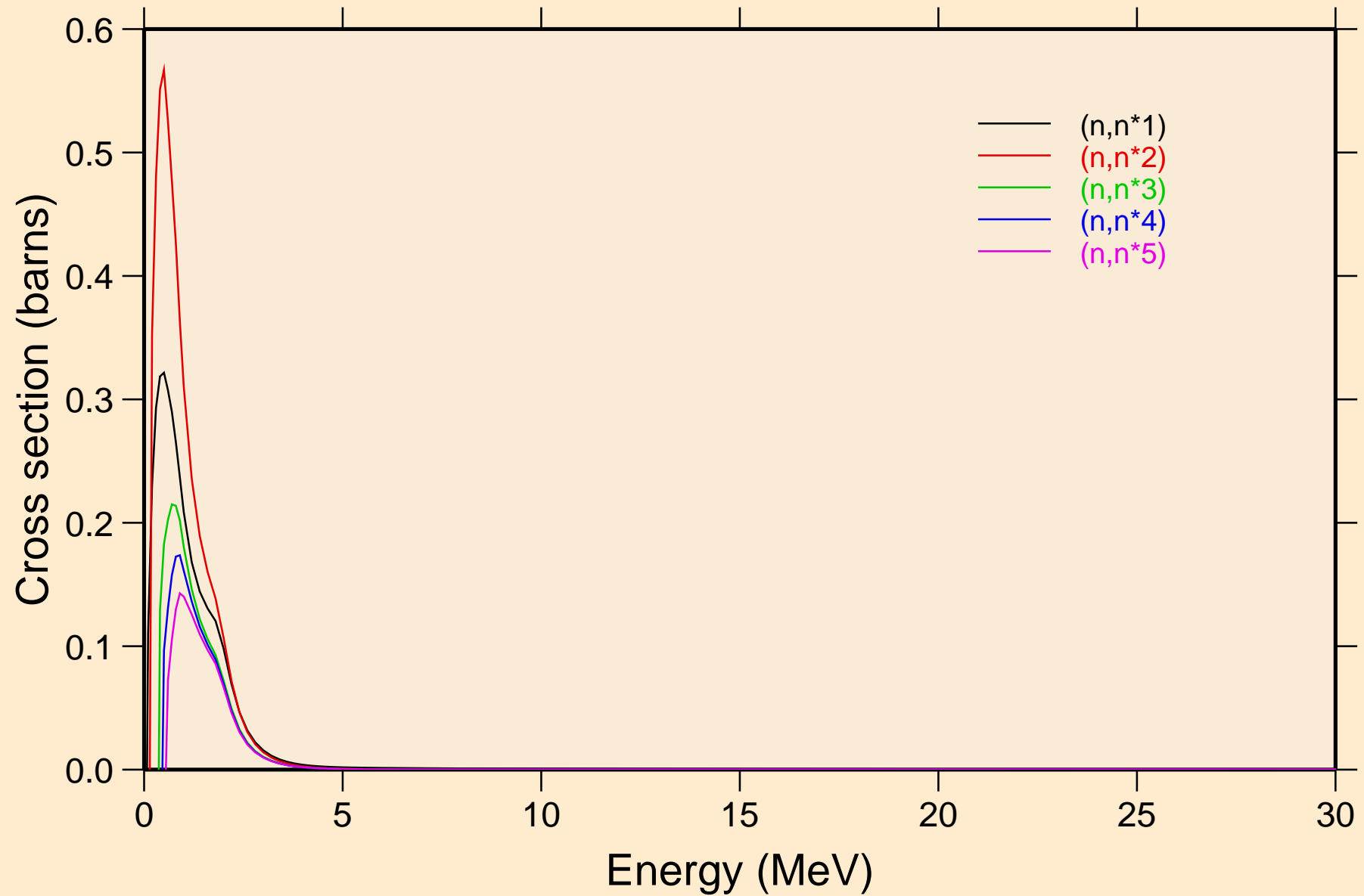

TA183 NRG TENDL-2015, AKONING

Inelastic levels

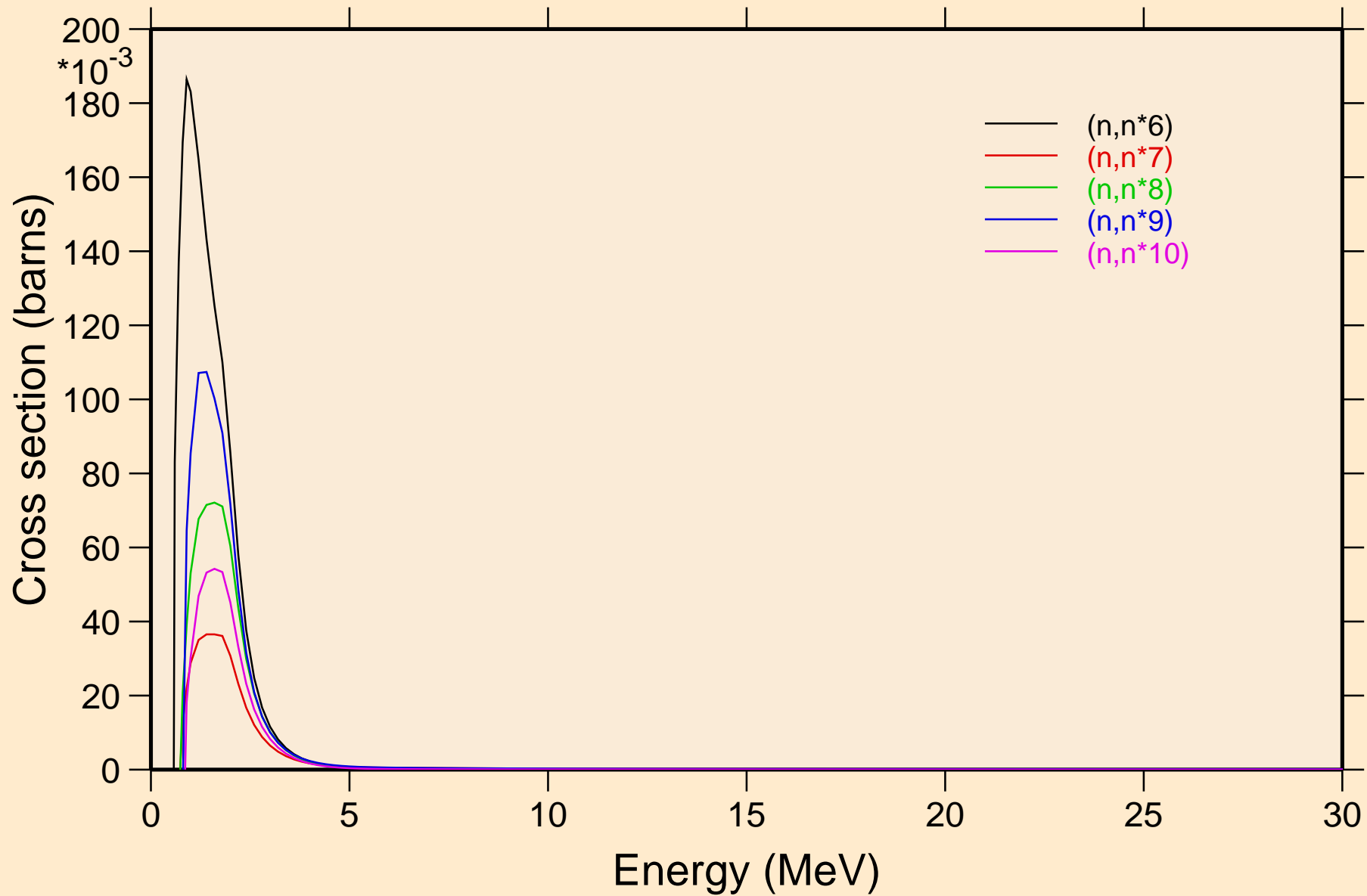

TA183 NRG TENDL-2015, AKONING

Inelastic levels

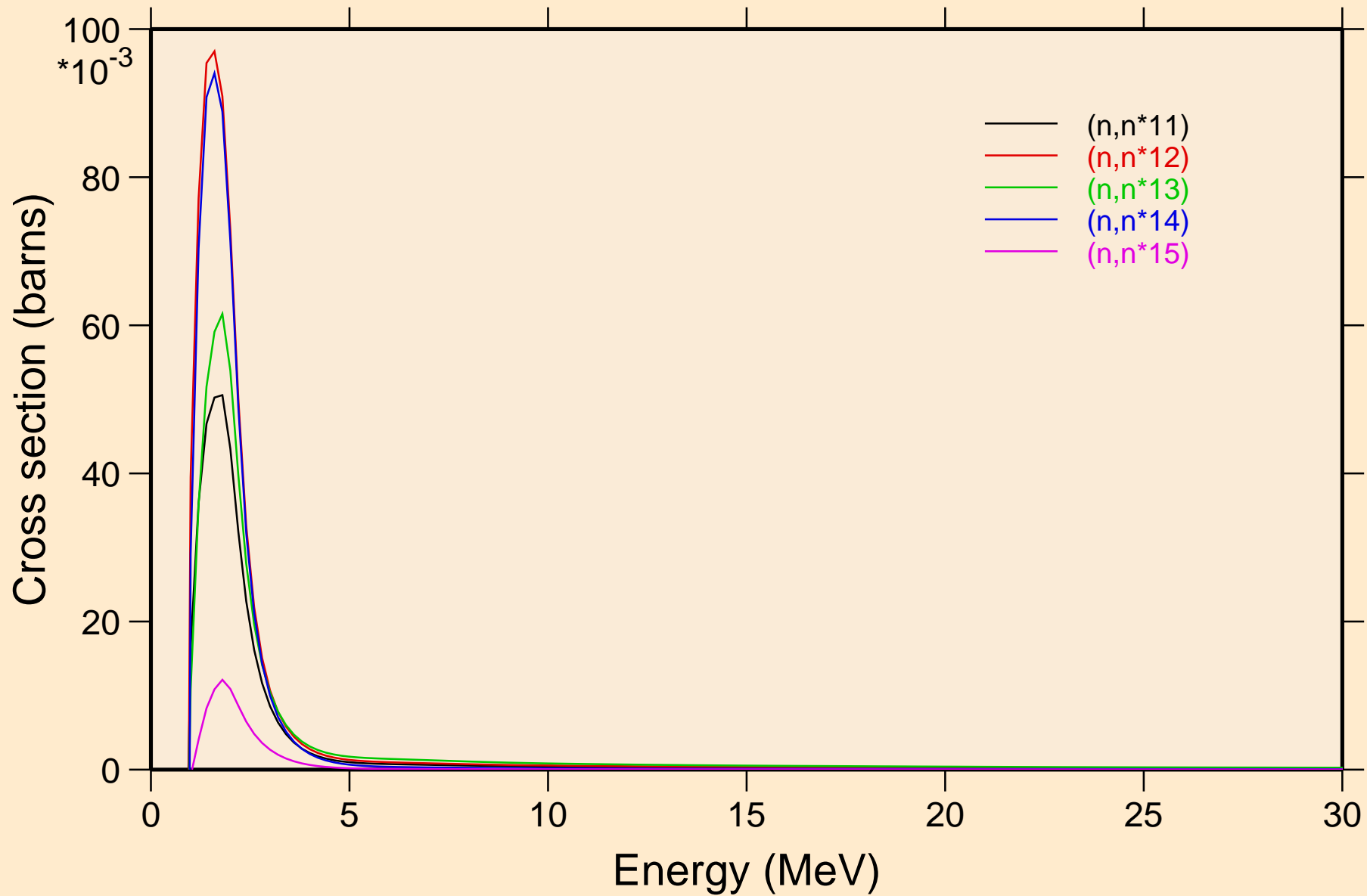

TA183 NRG TENDL-2015, AKONING

Inelastic levels

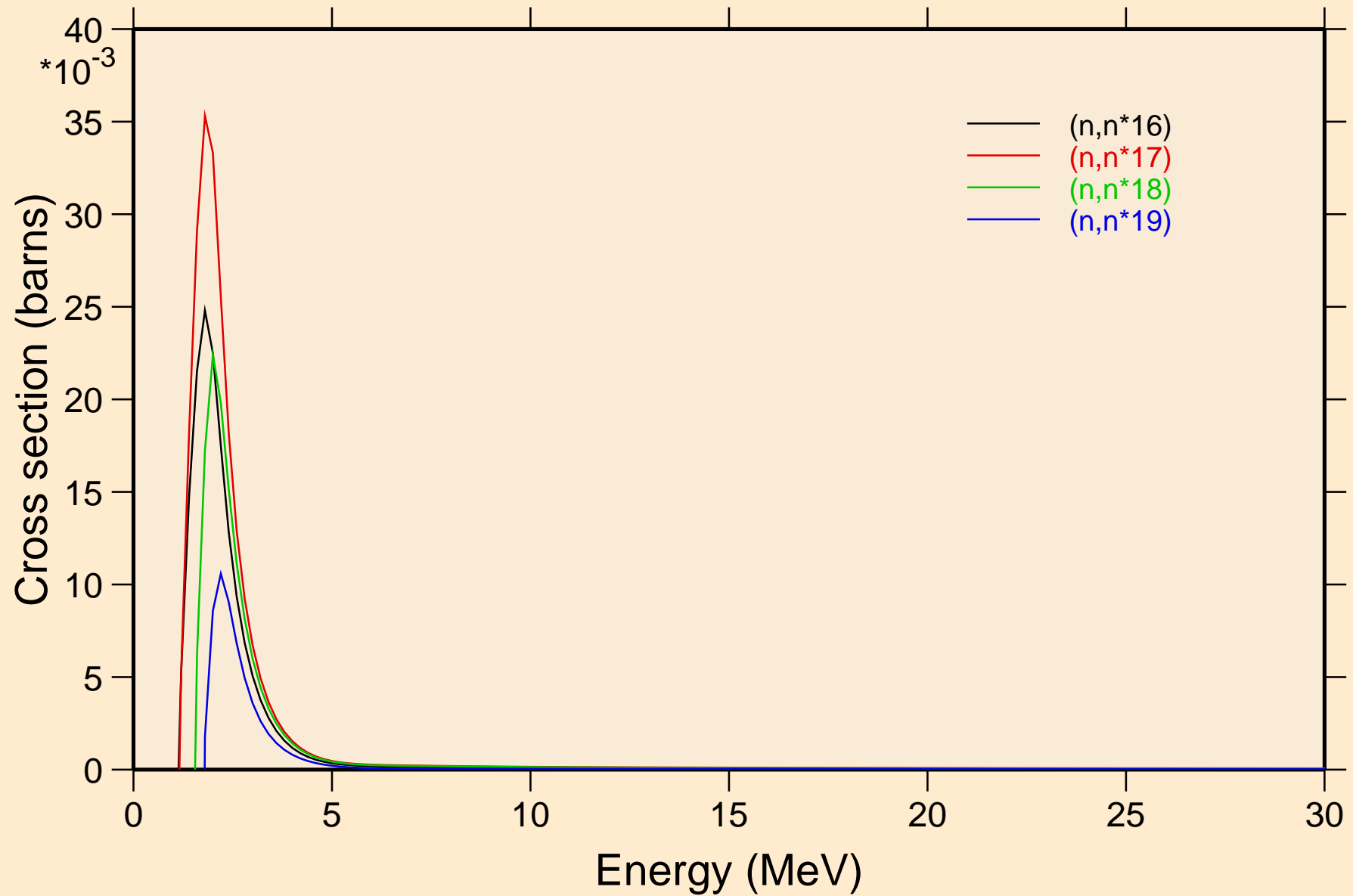

TA183 NRG TENDL-2015, AKONING

Threshold reactions

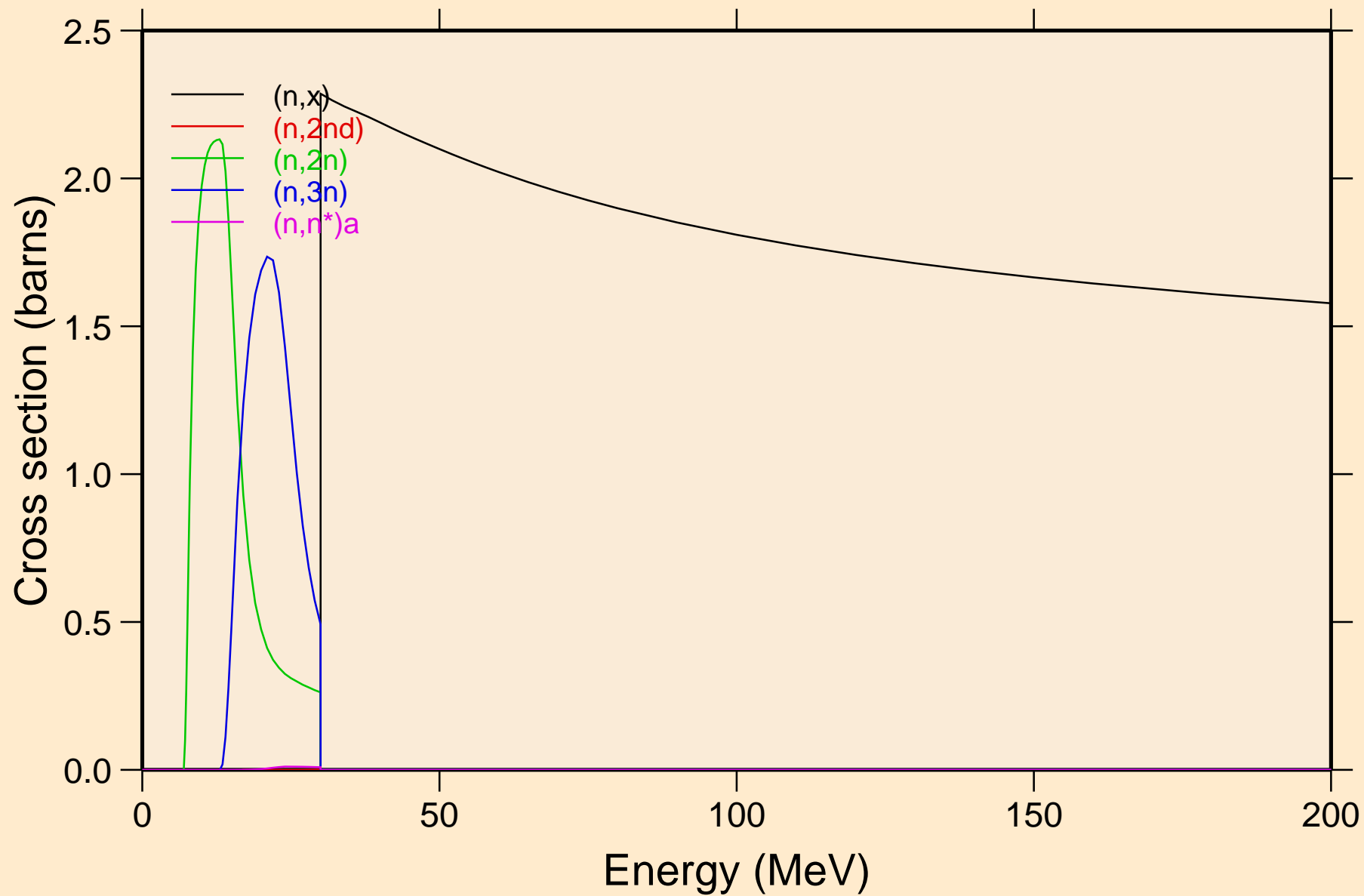

TA183 NRG TENDL-2015, AKONING

Threshold reactions

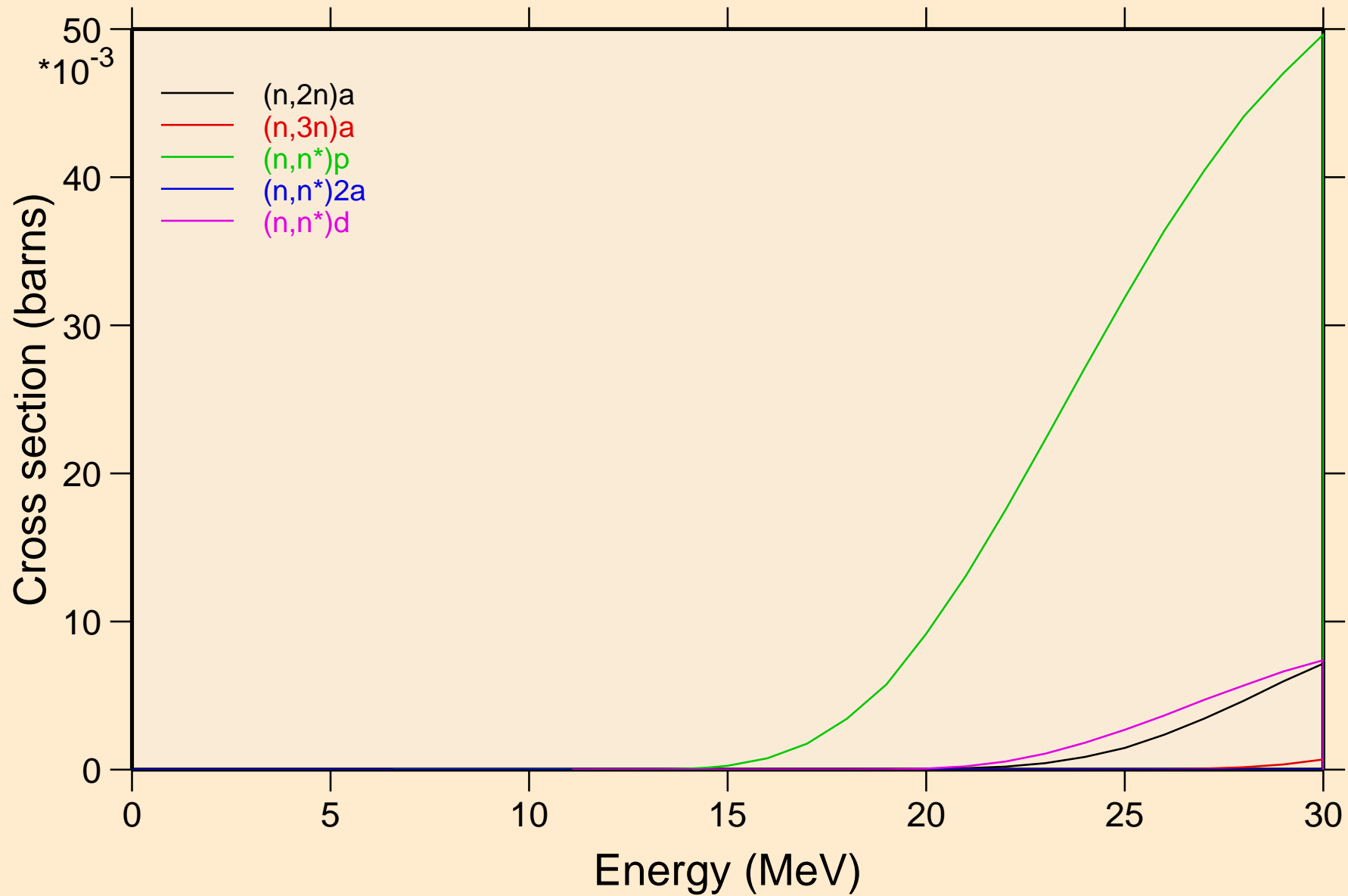

TA183 NRG TENDL-2015, AKONING

Threshold reactions

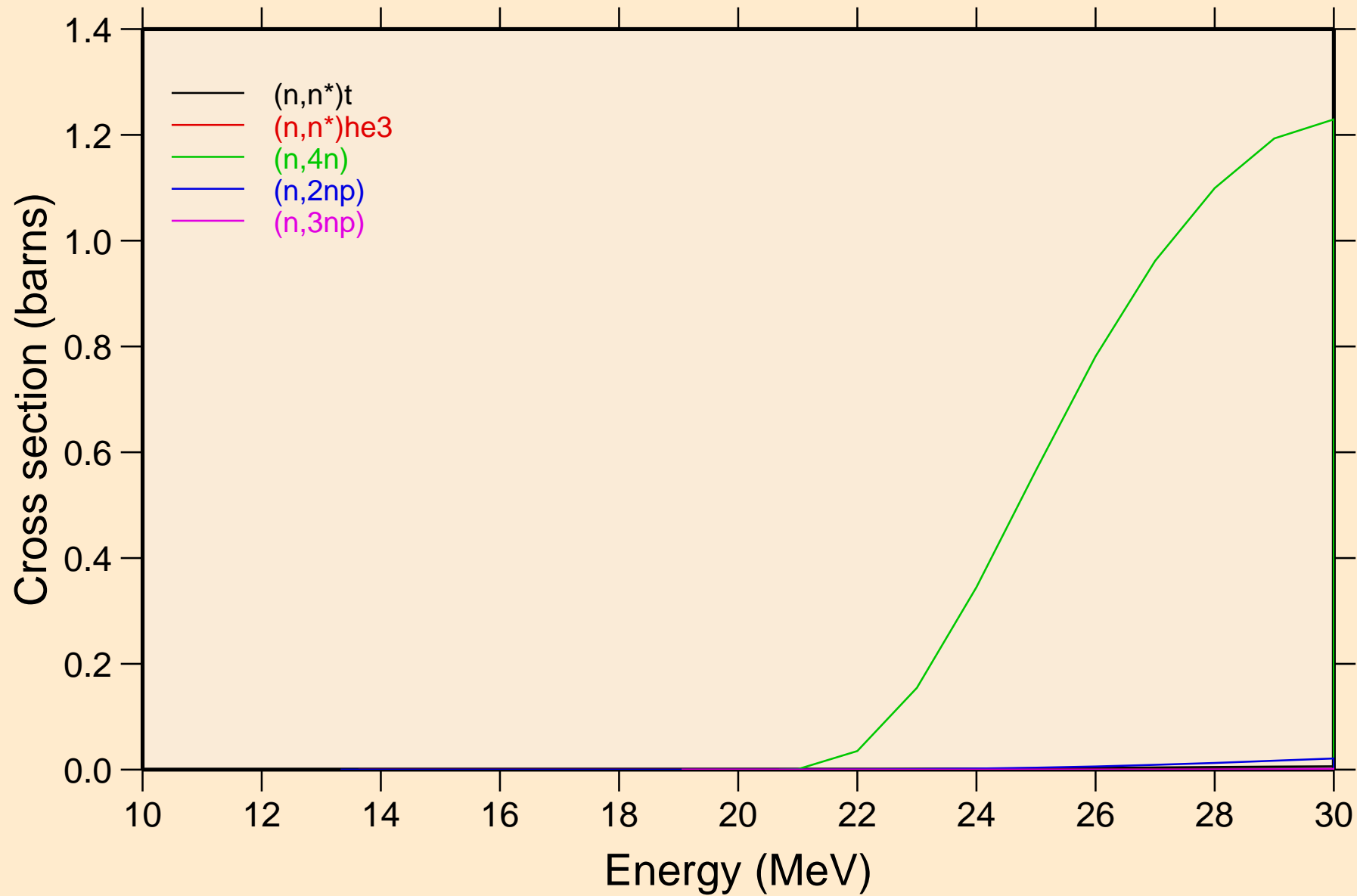

TA183 NRG TENDL-2015, AKONING

Threshold reactions

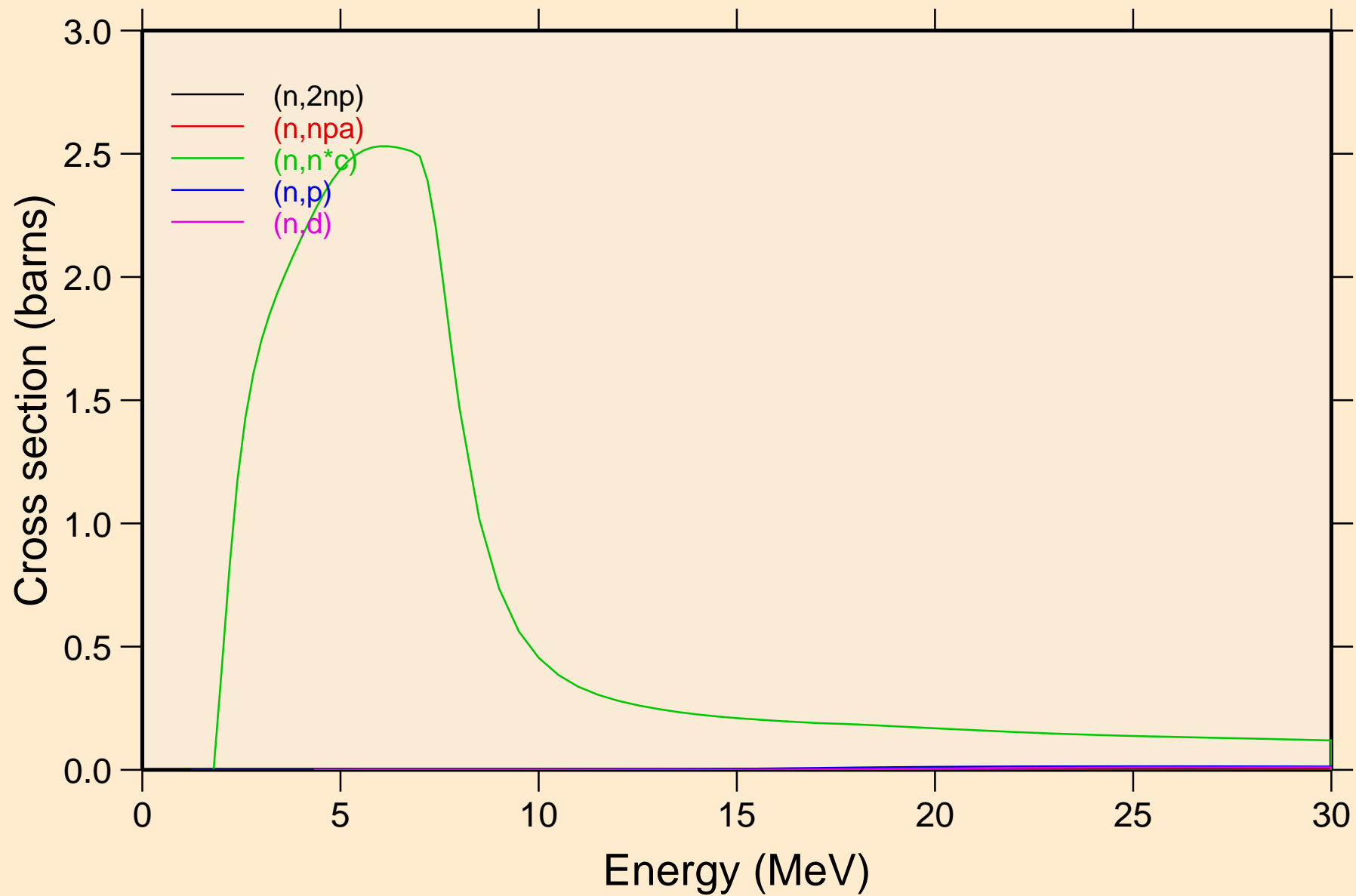

TA183 NRG TENDL-2015, AKONING

Threshold reactions

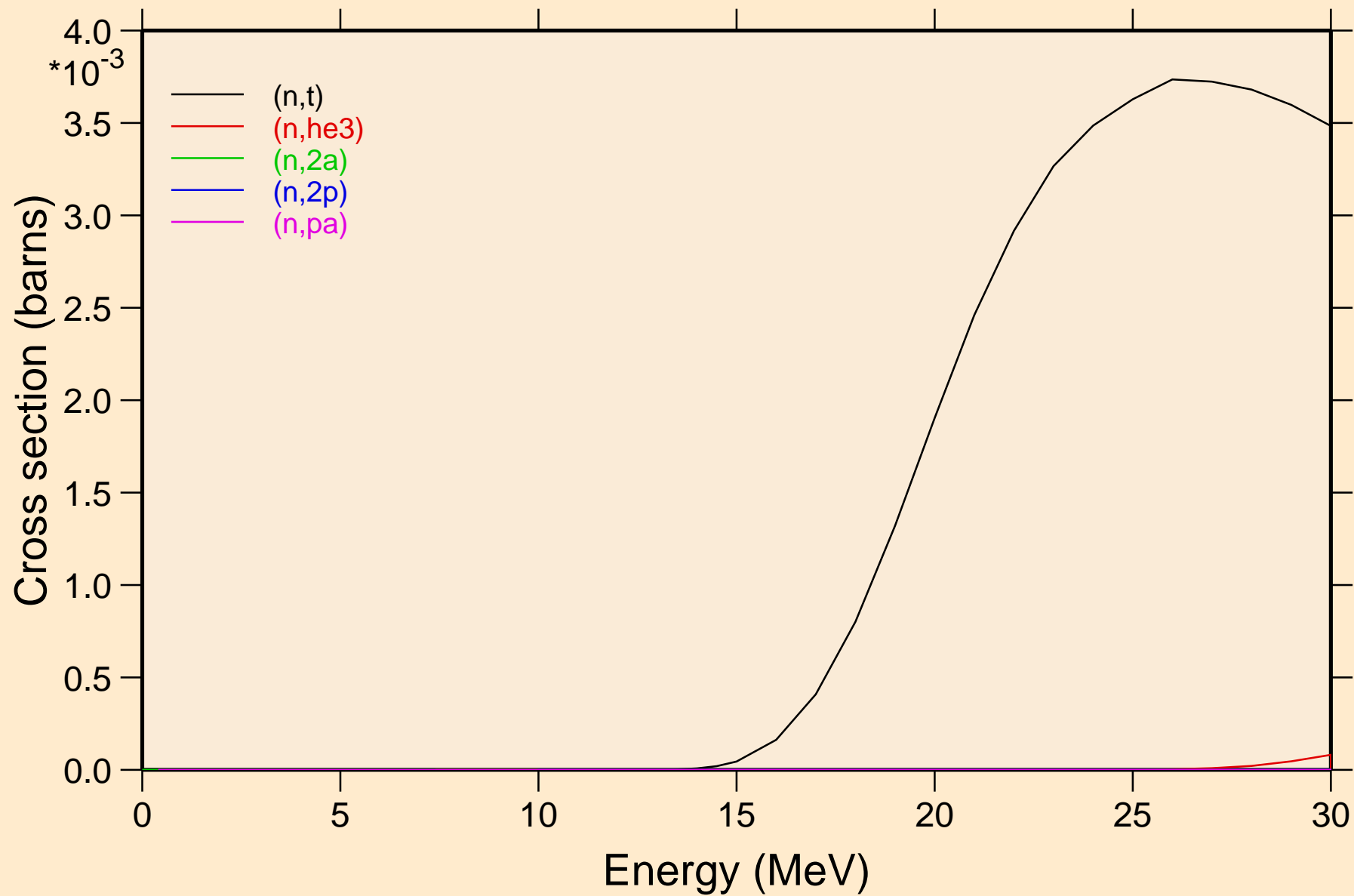

TA183 NRG TENDL-2015, AKONING
angular distribution for elastic

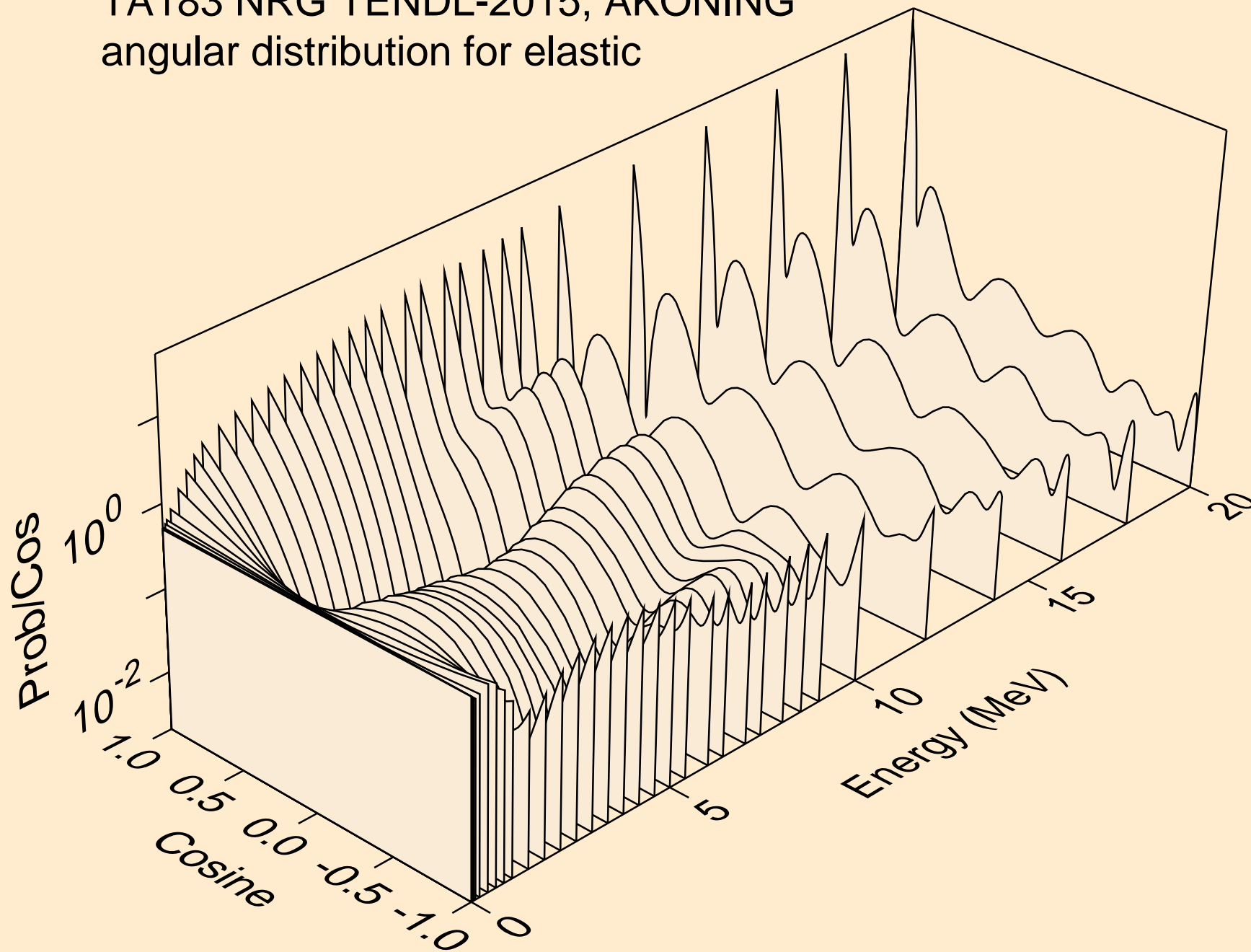

TA183 NRG TENDL-2015, AKONING
angular distribution for elastic

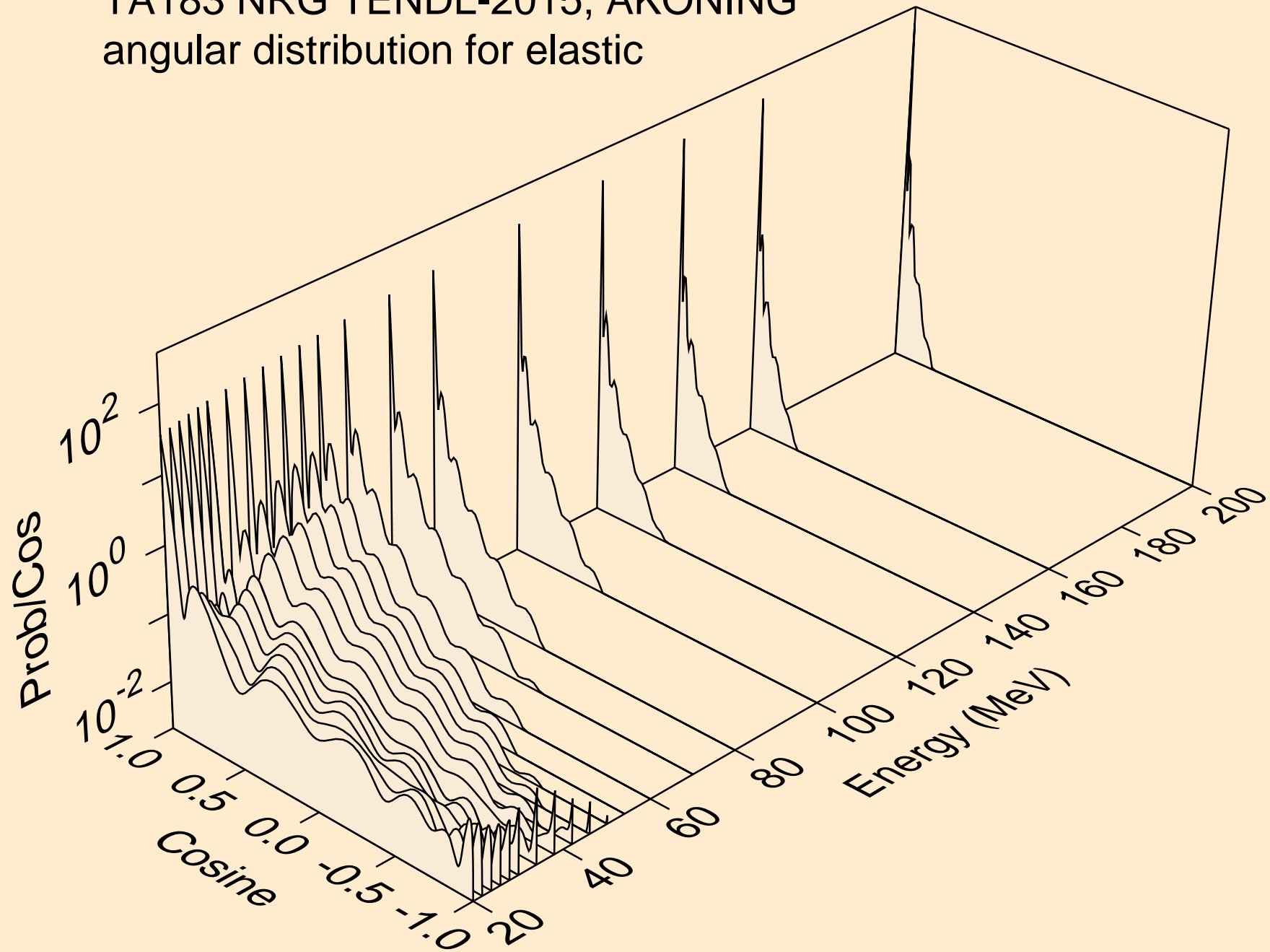

TA183 NRG TENDL-2015, AKONING
angular distribution for (n,n*1)

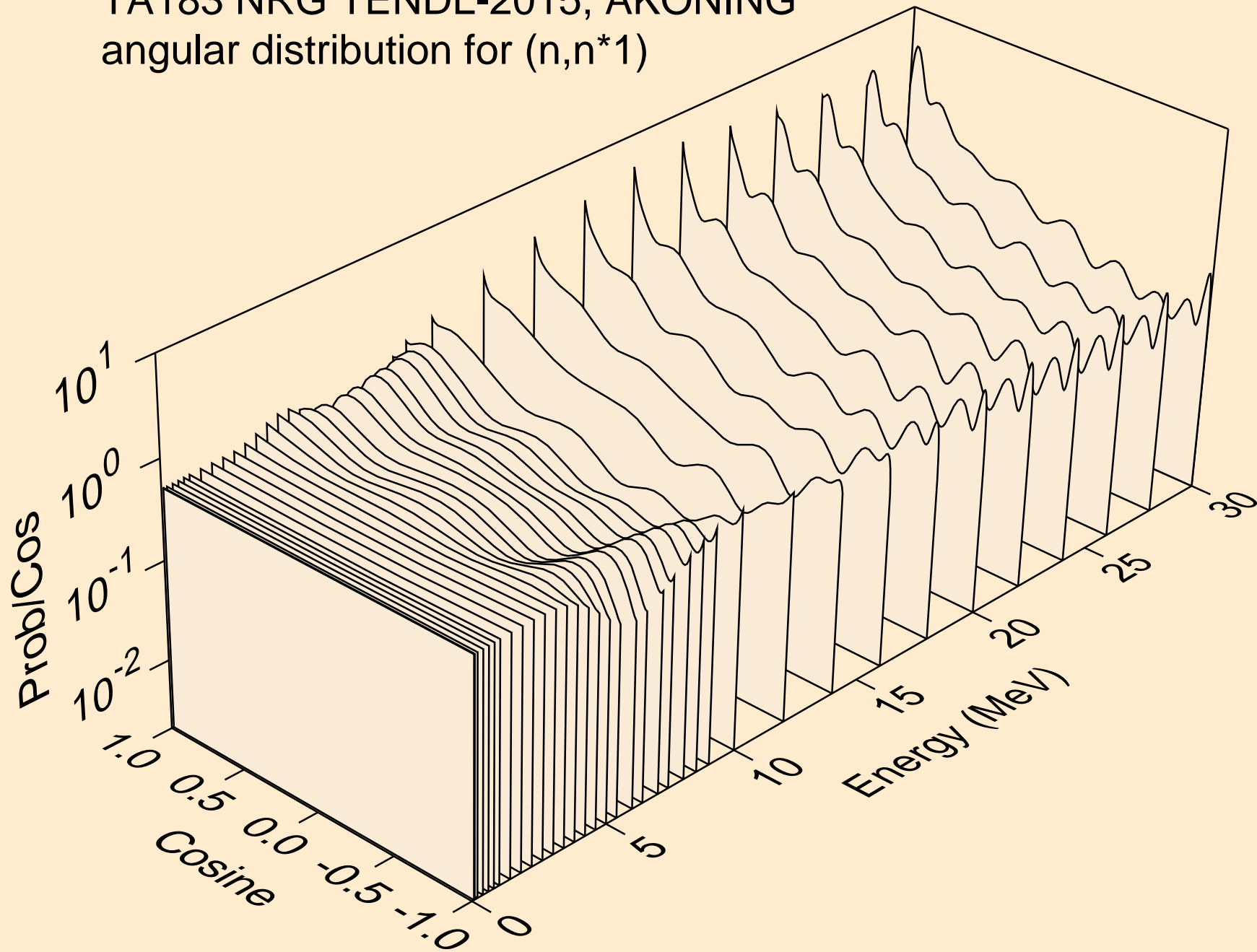

TA183 NRG TENDL-2015, AKONING
angular distribution for (n,n*2)

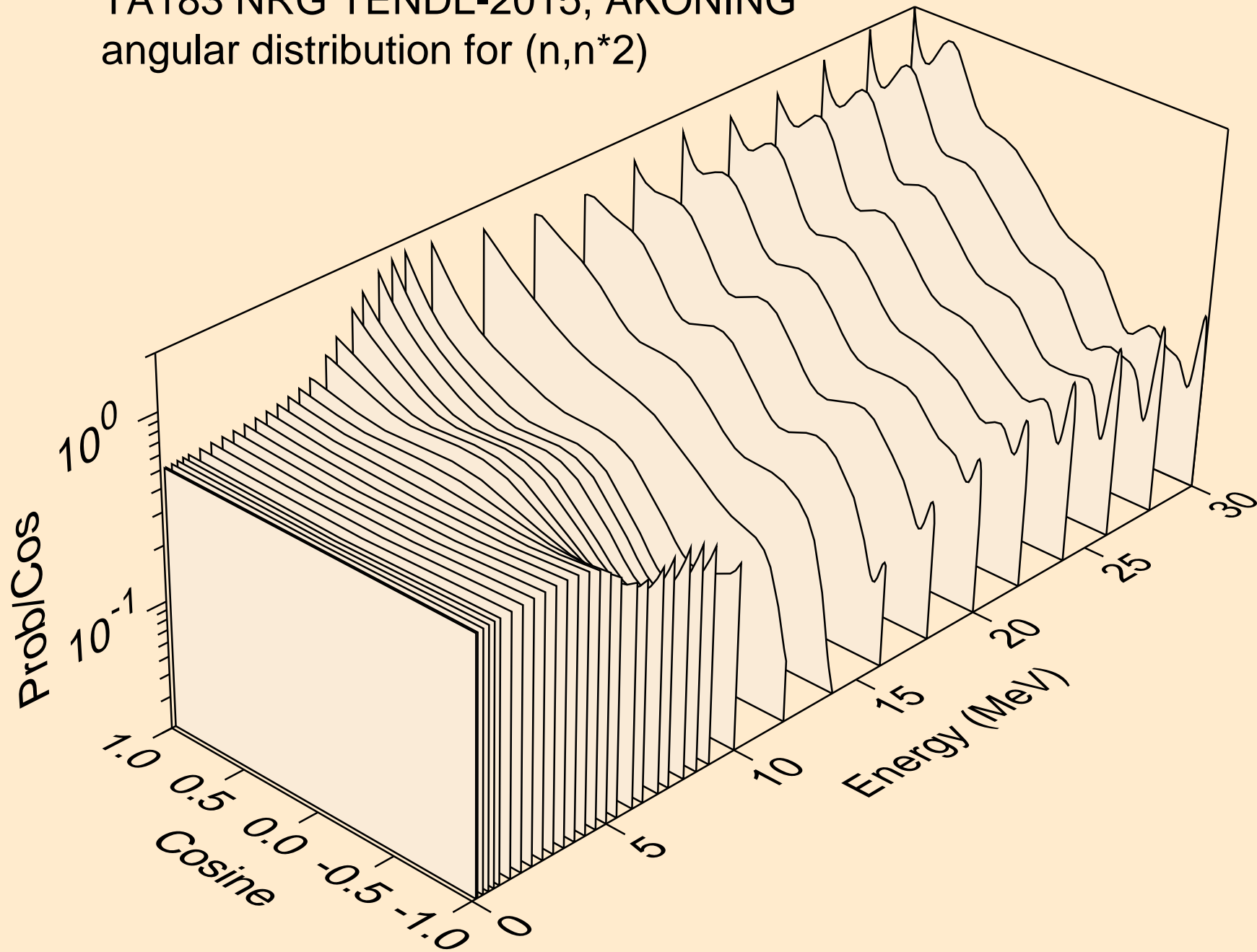

TA183 NRG TENDL-2015, AKONING
angular distribution for (n,n*3)

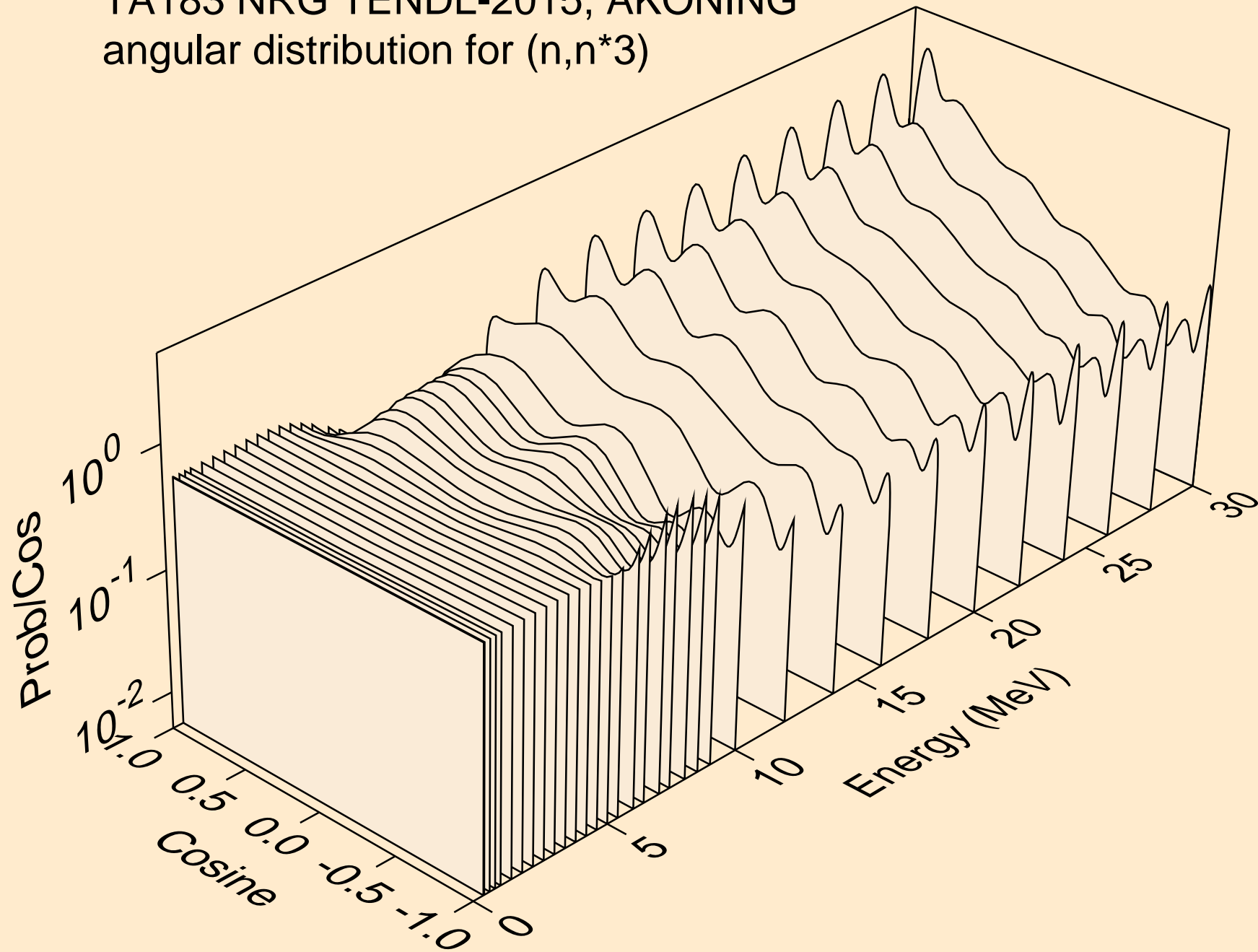

TA183 NRG TENDL-2015, AKONING
angular distribution for (n,n*4)

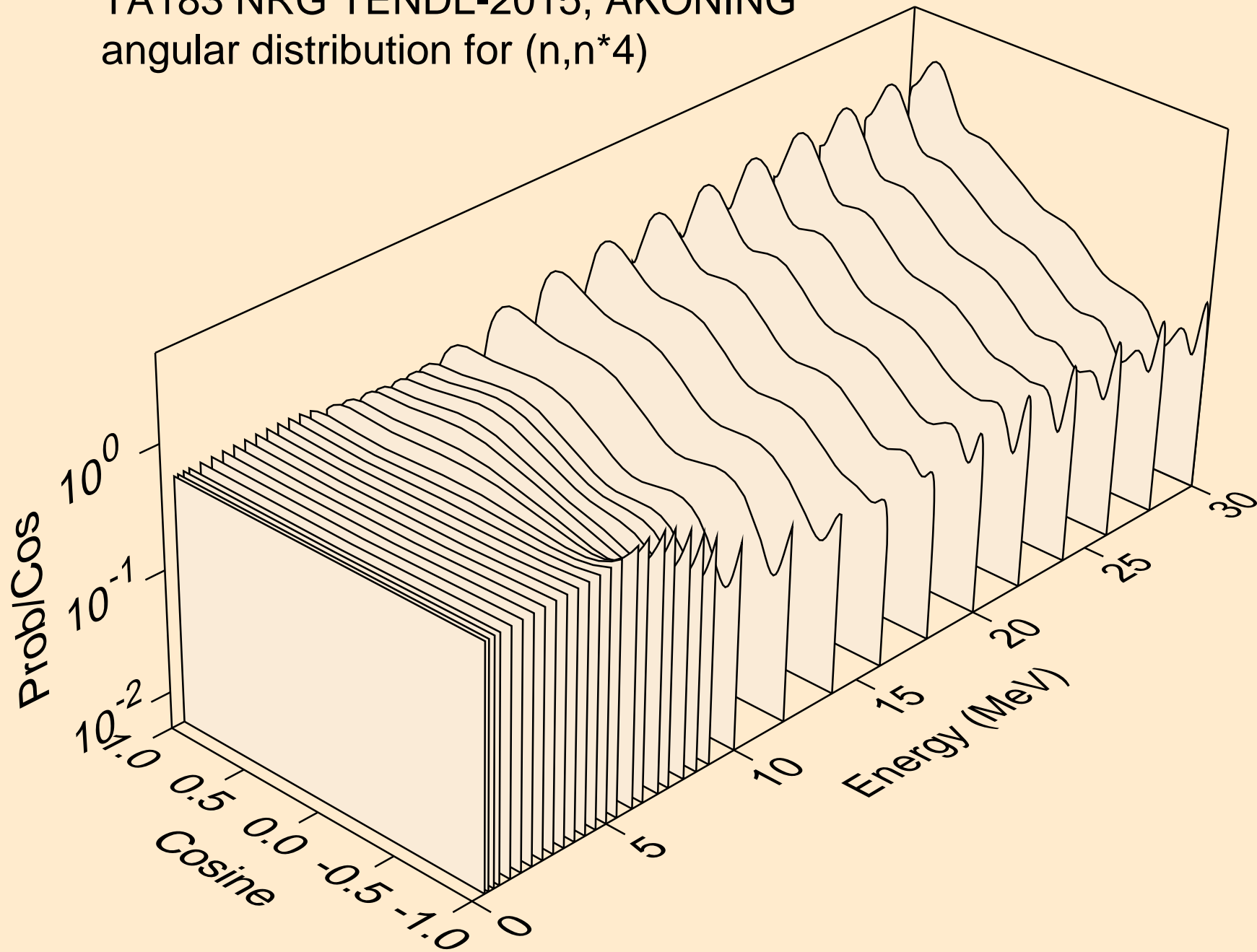

TA183 NRG TENDL-2015, AKONING
angular distribution for (n,n*5)

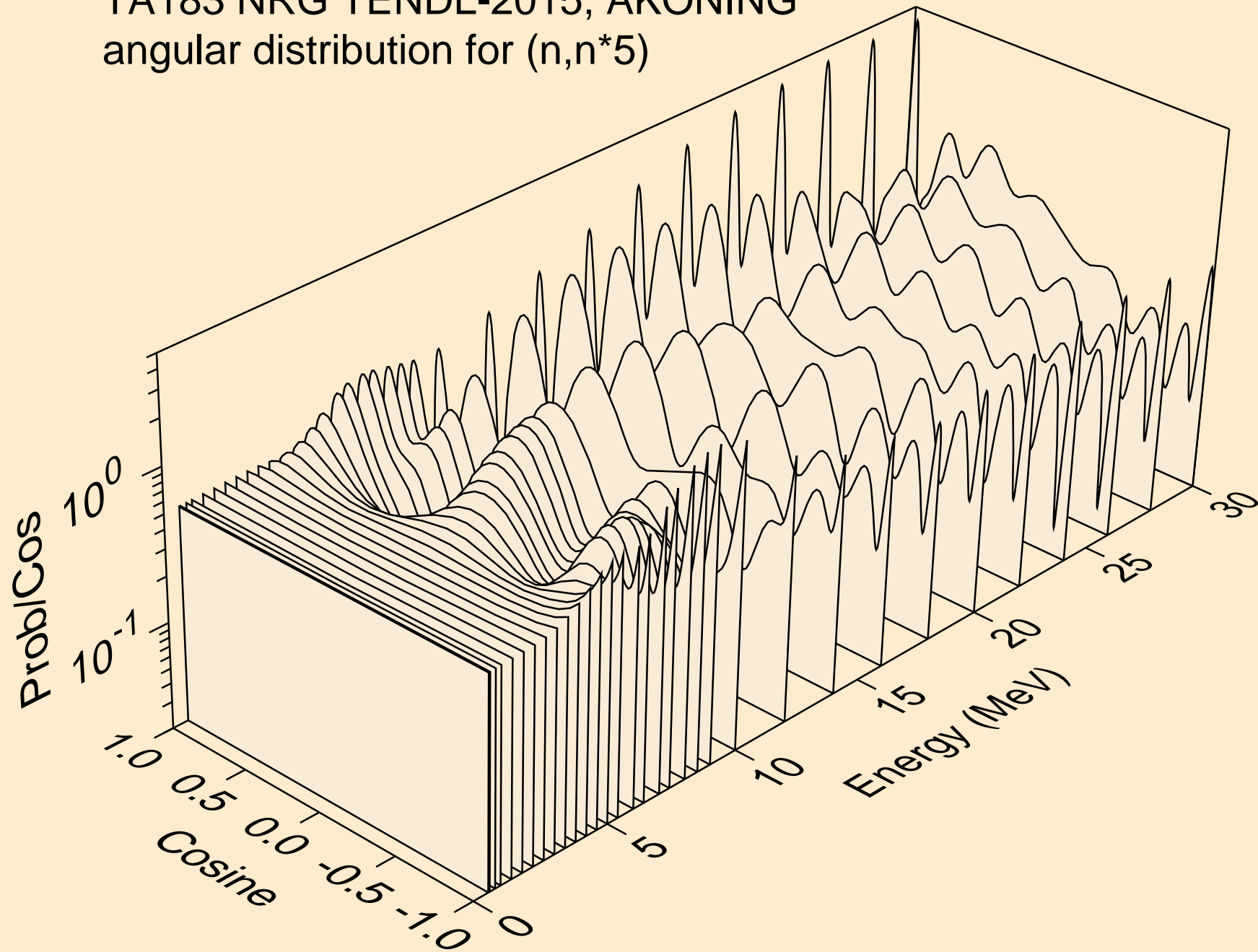

TA183 NRG TENDL-2015, AKONING
angular distribution for (n,n*6)

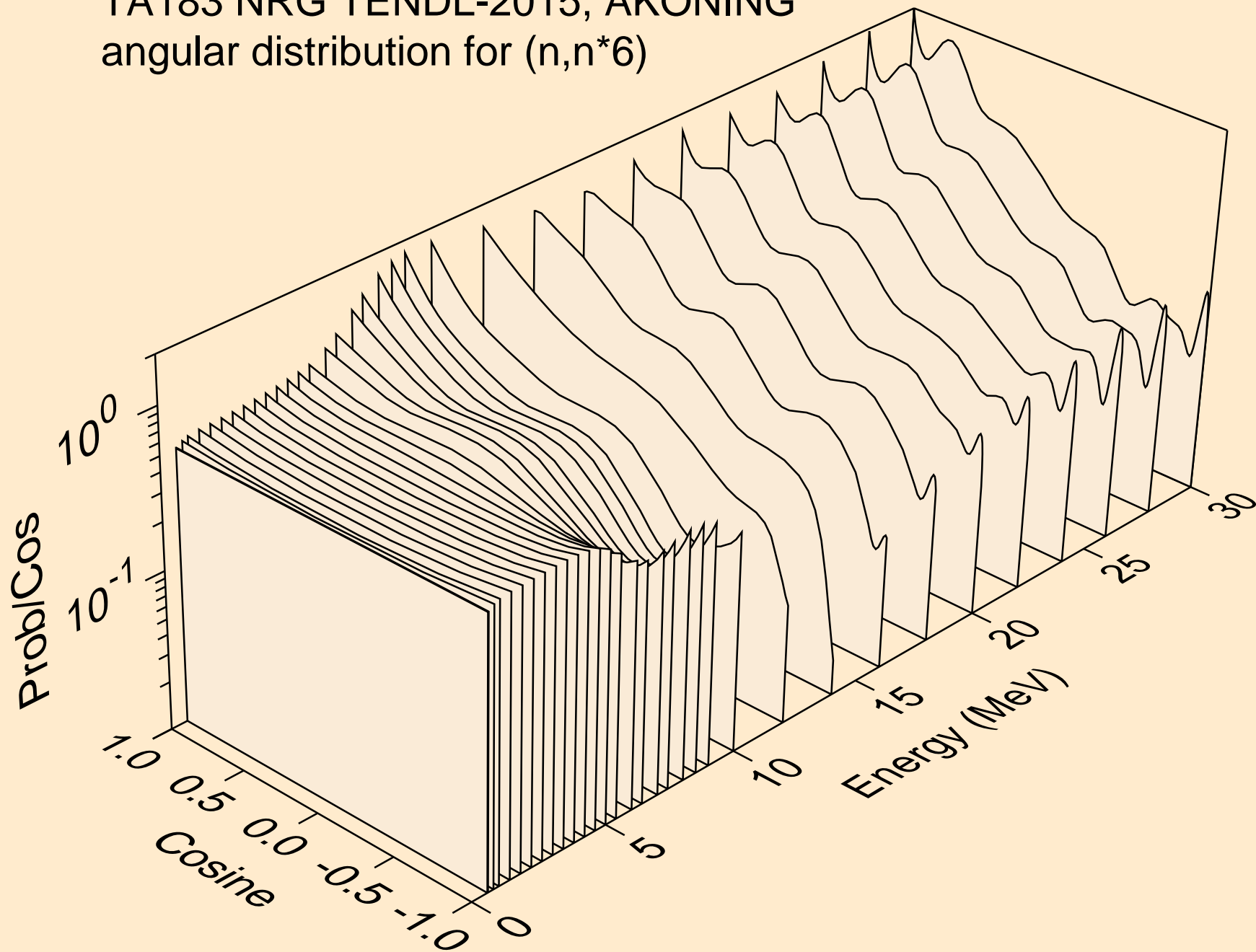

TA183 NRG TENDL-2015, AKONING
angular distribution for (n,n*7)

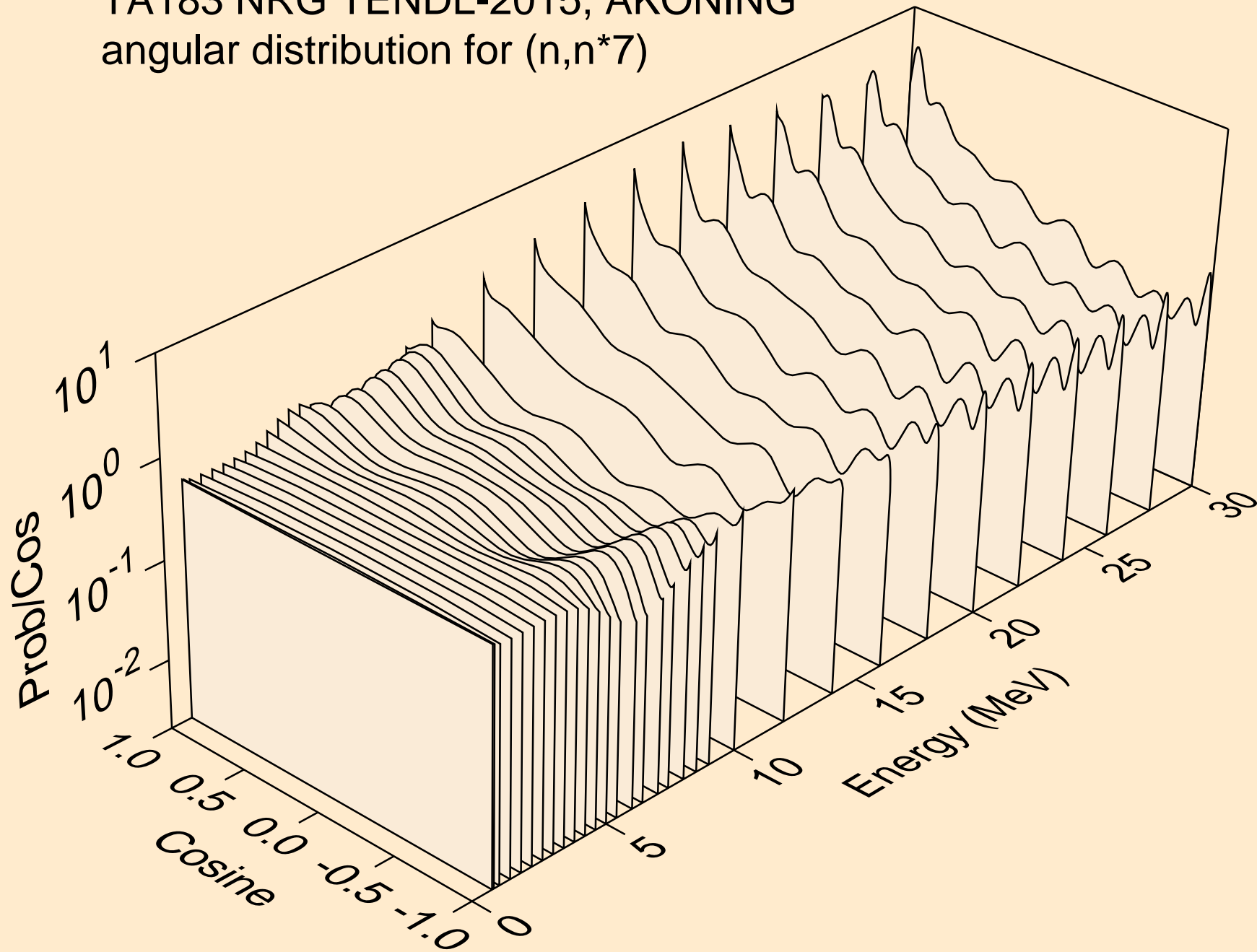

TA183 NRG TENDL-2015, AKONING
angular distribution for (n,n*8)

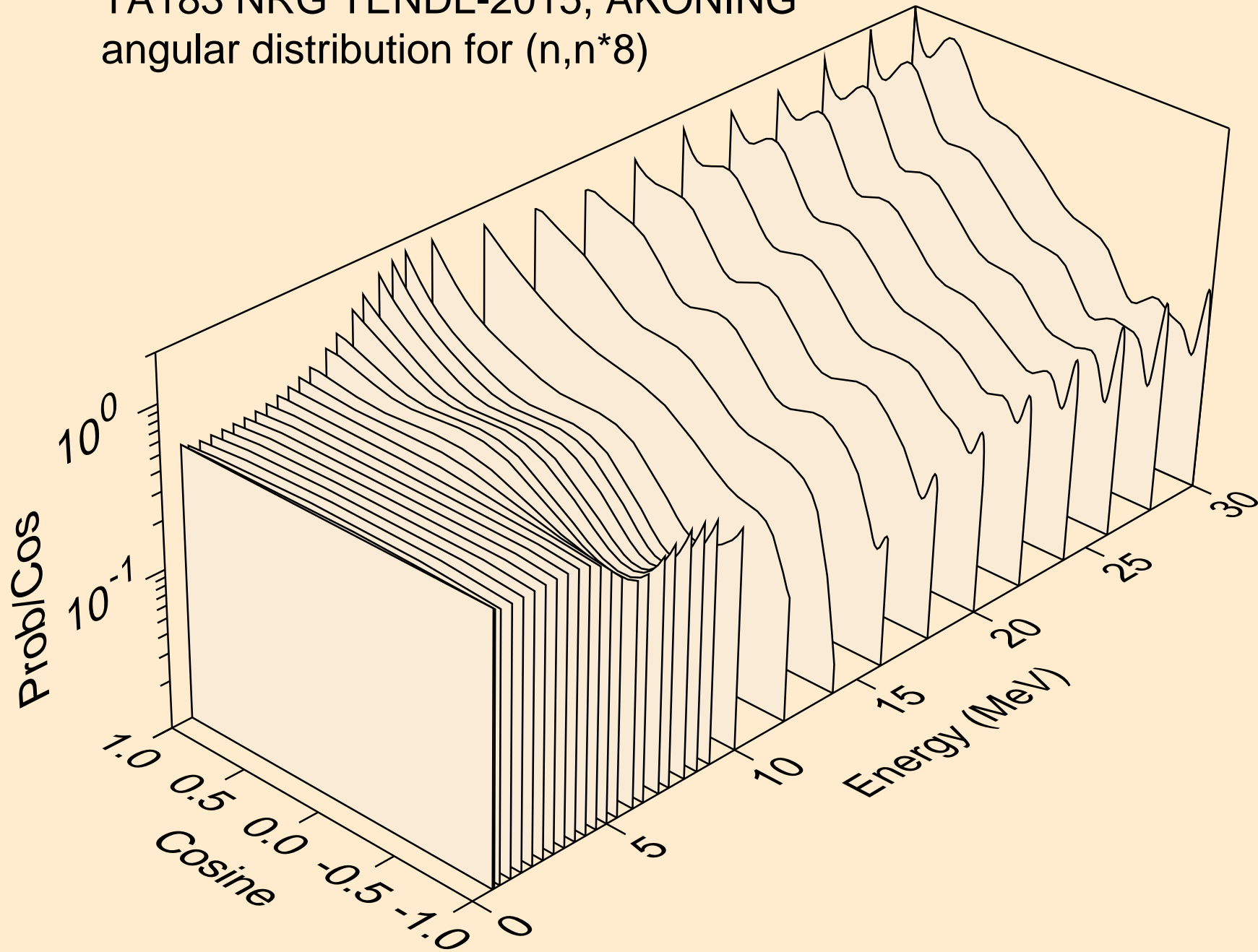

TA183 NRG TENDL-2015, AKONING
angular distribution for (n,n*9)

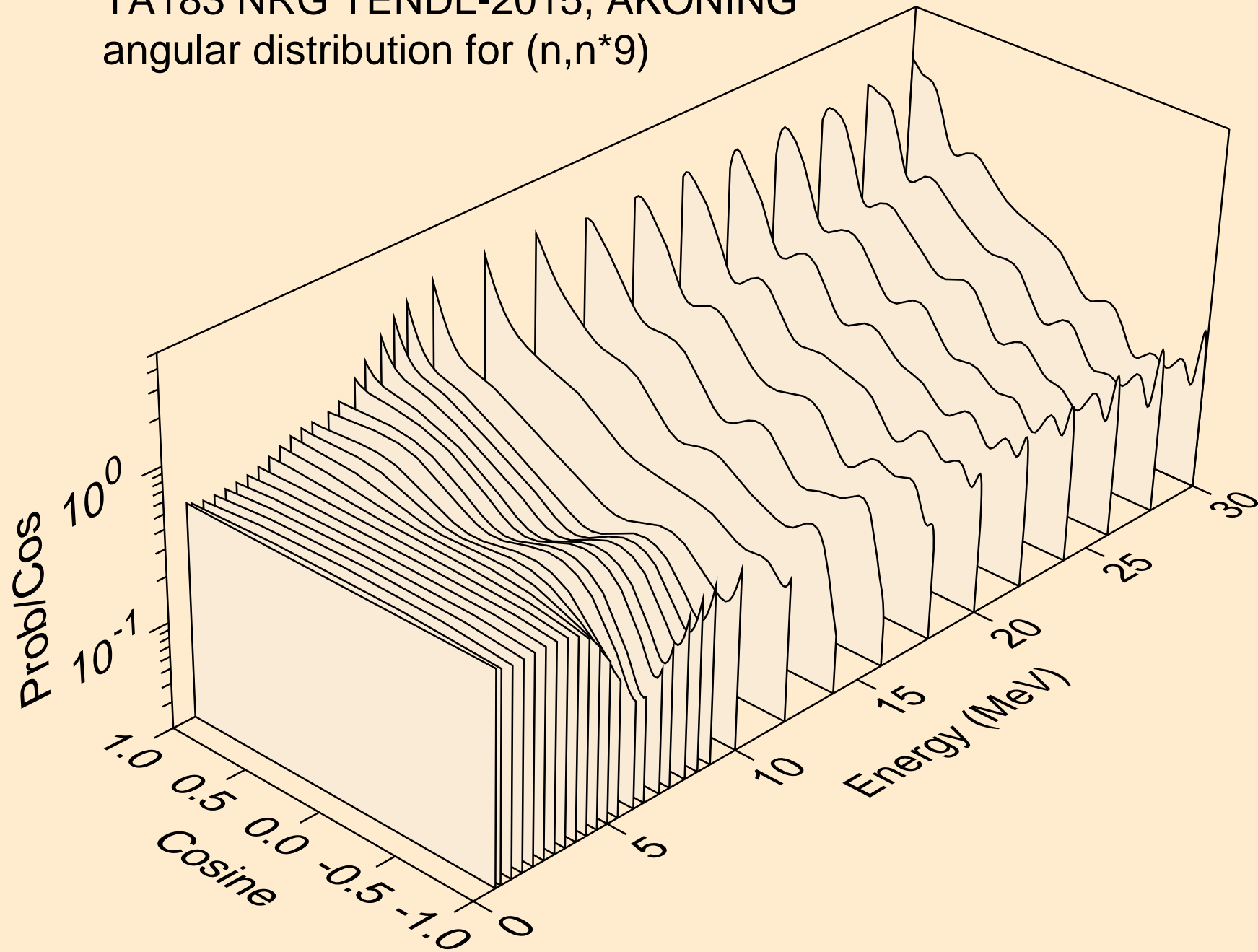

TA183 NRG TENDL-2015, AKONING
angular distribution for (n,n*10)

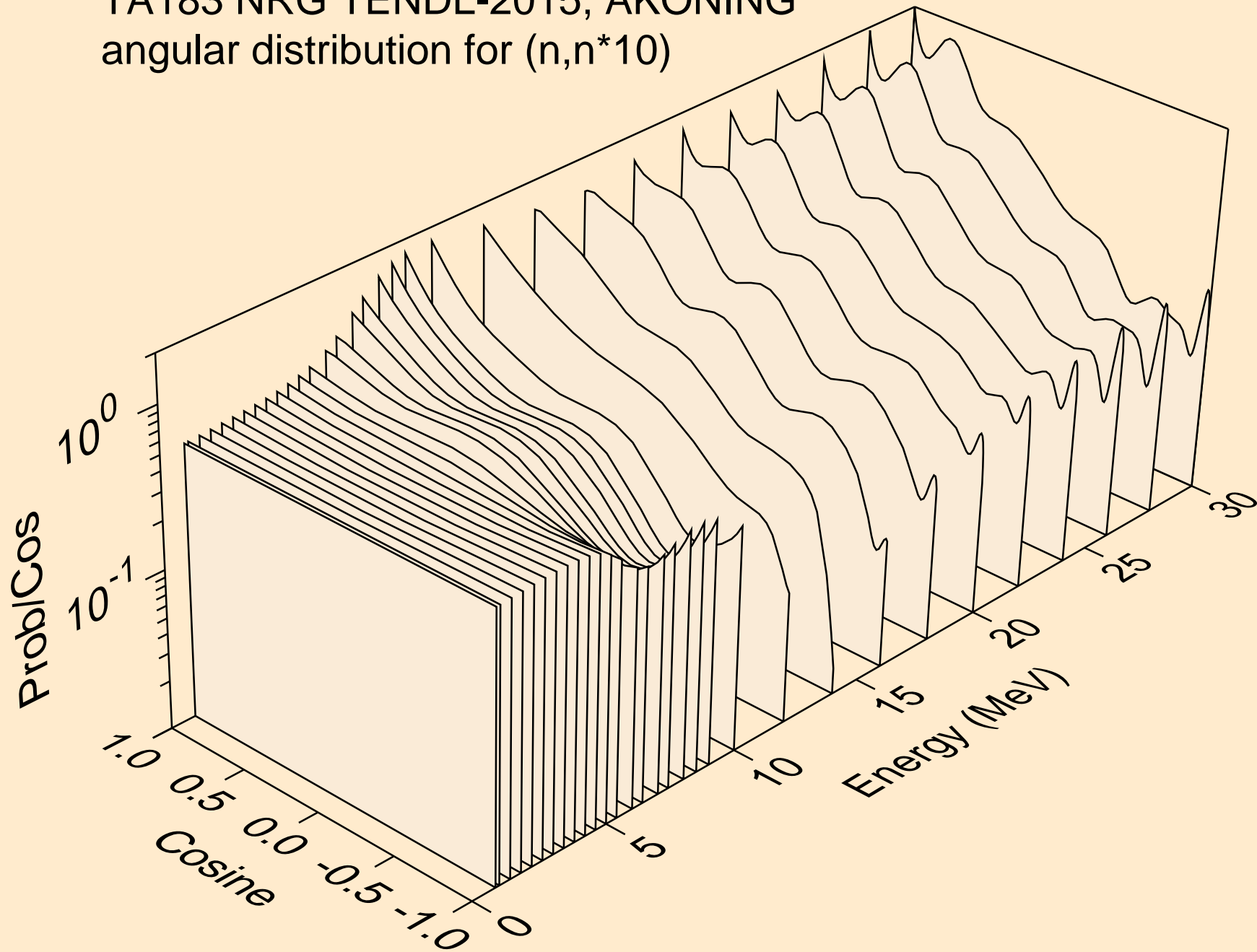

TA183 NRG TENDL-2015, AKONING
angular distribution for (n,n*11)

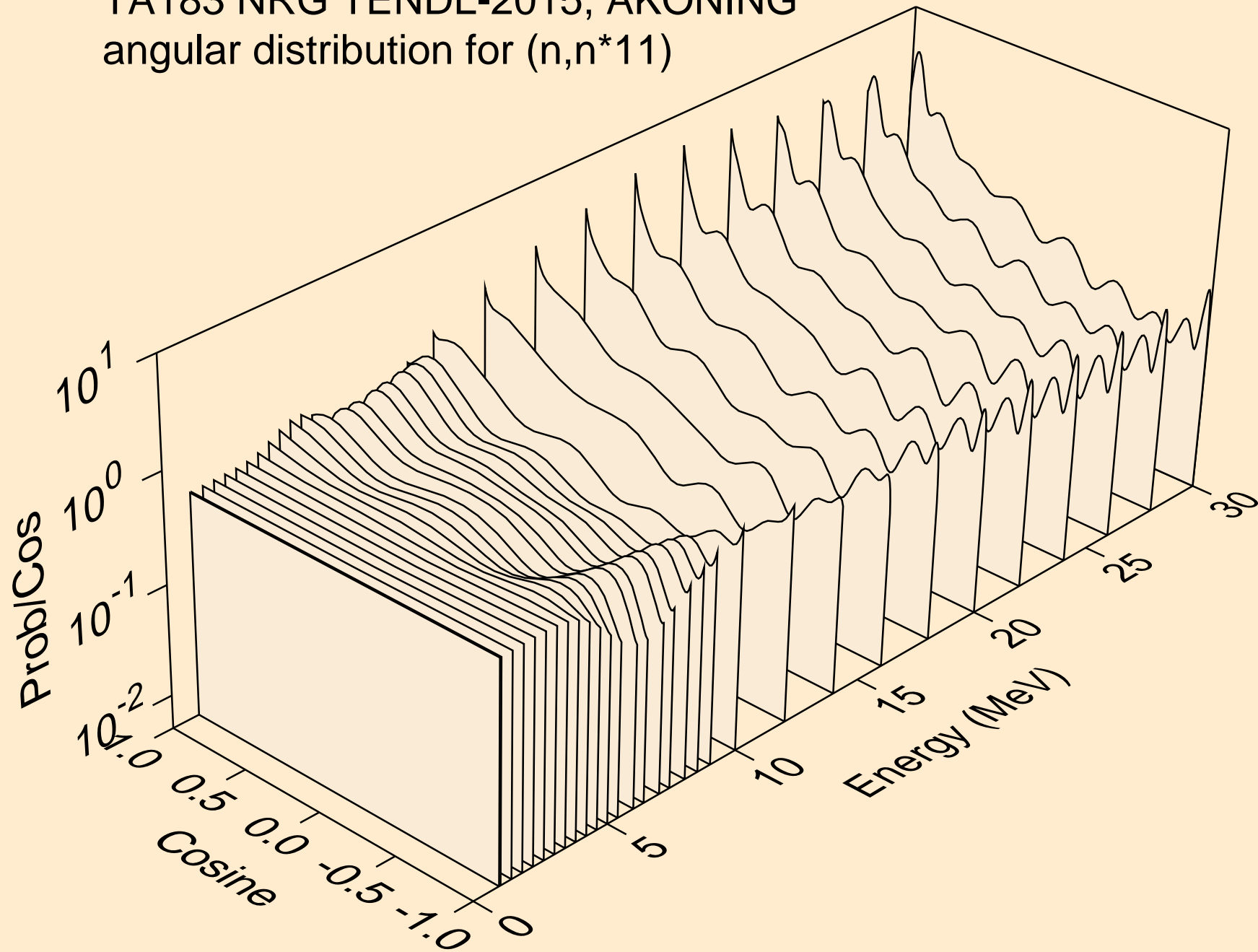

TA183 NRG TENDL-2015, AKONING
angular distribution for (n,n*12)

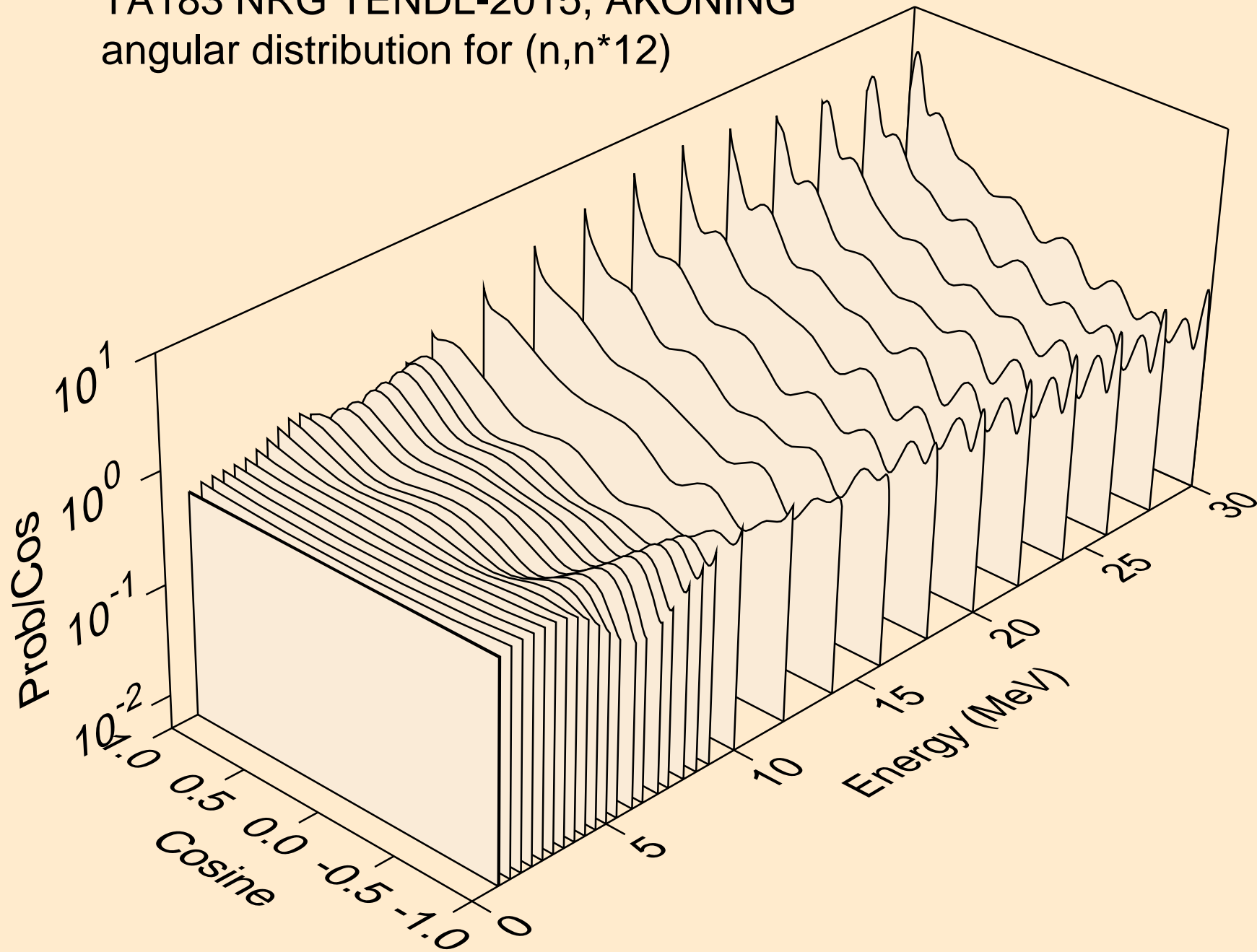

TA183 NRG TENDL-2015, AKONING
angular distribution for (n,n*13)

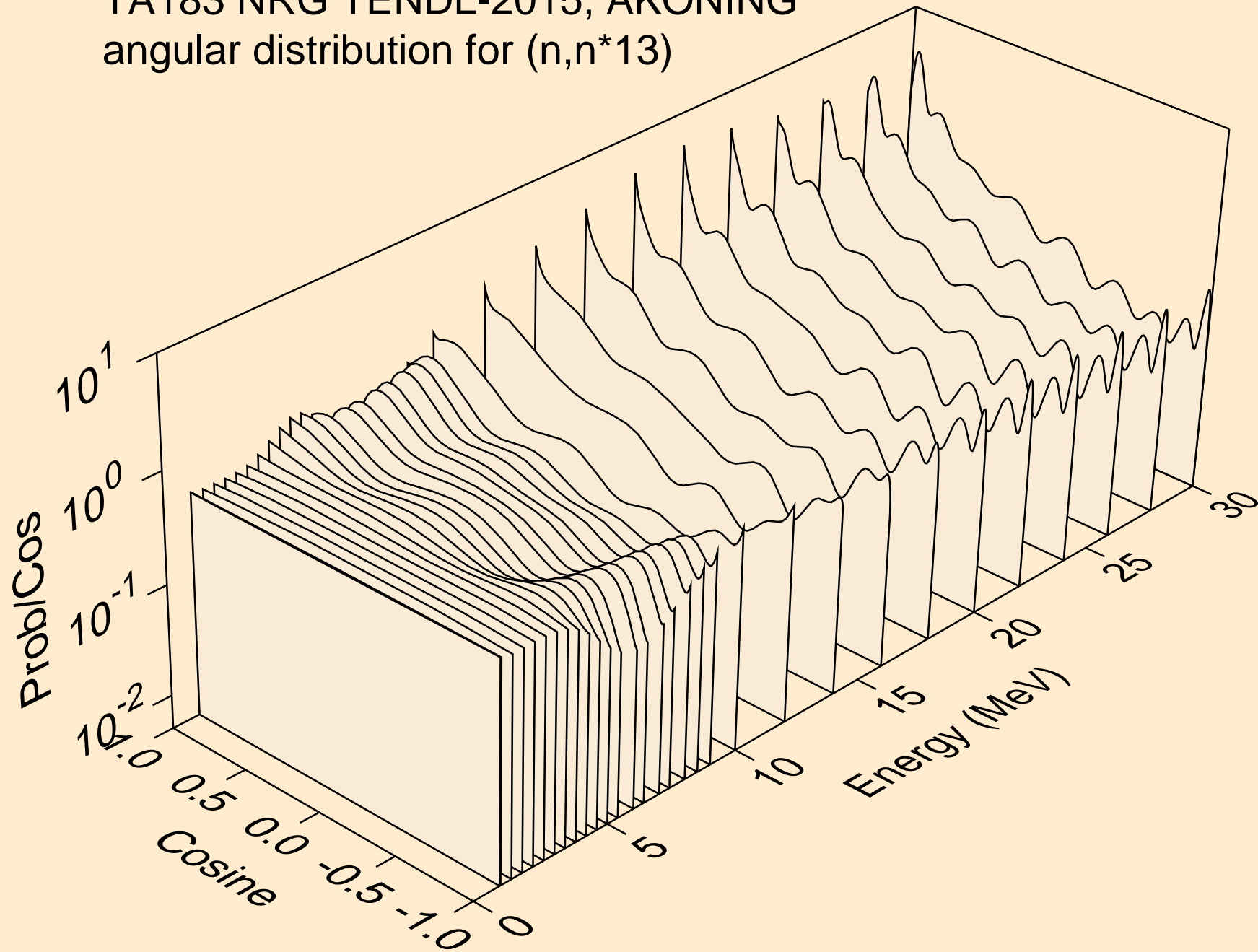

TA183 NRG TENDL-2015, AKONING
angular distribution for (n,n*14)

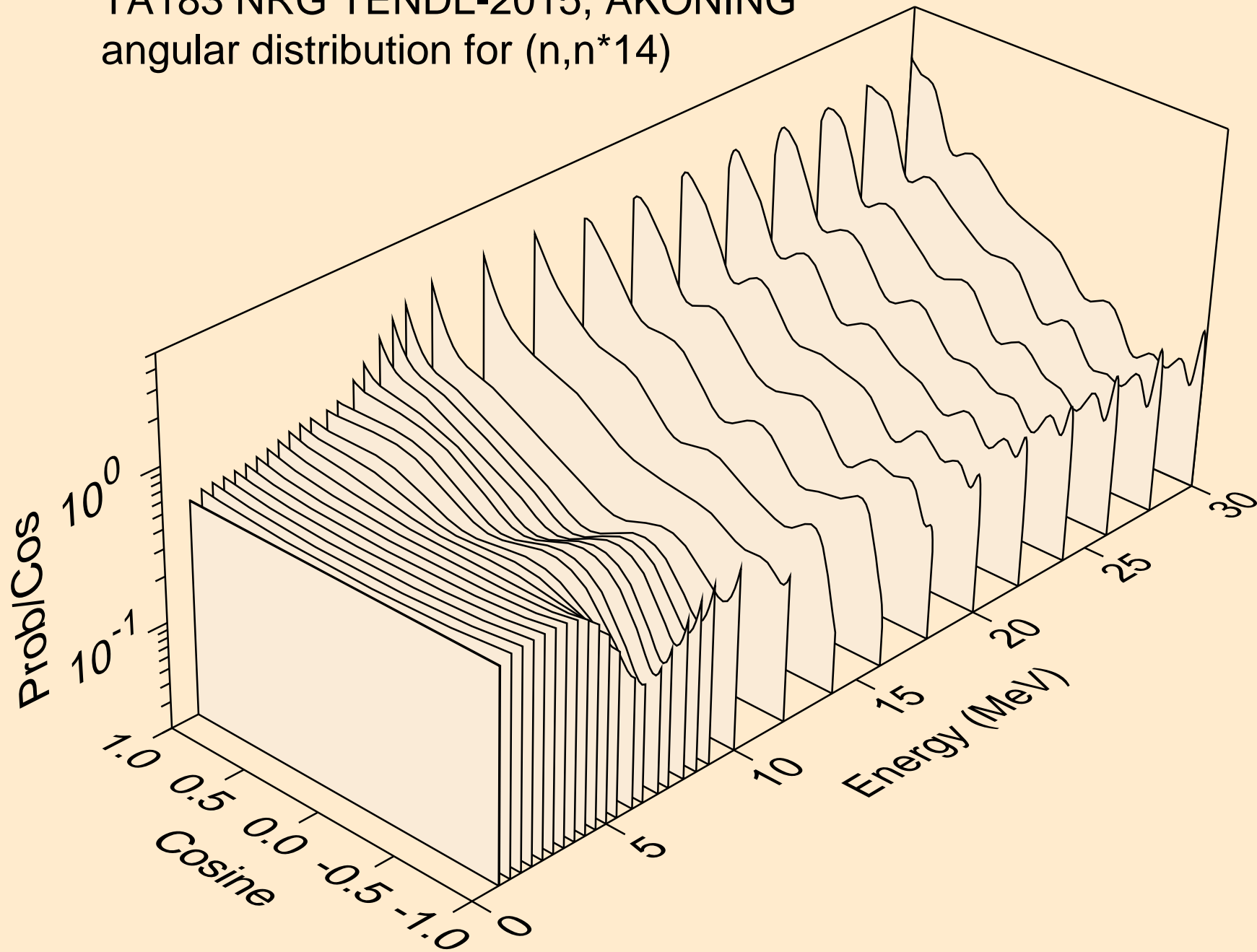

TA183 NRG TENDL-2015, AKONING
angular distribution for (n,n*15)

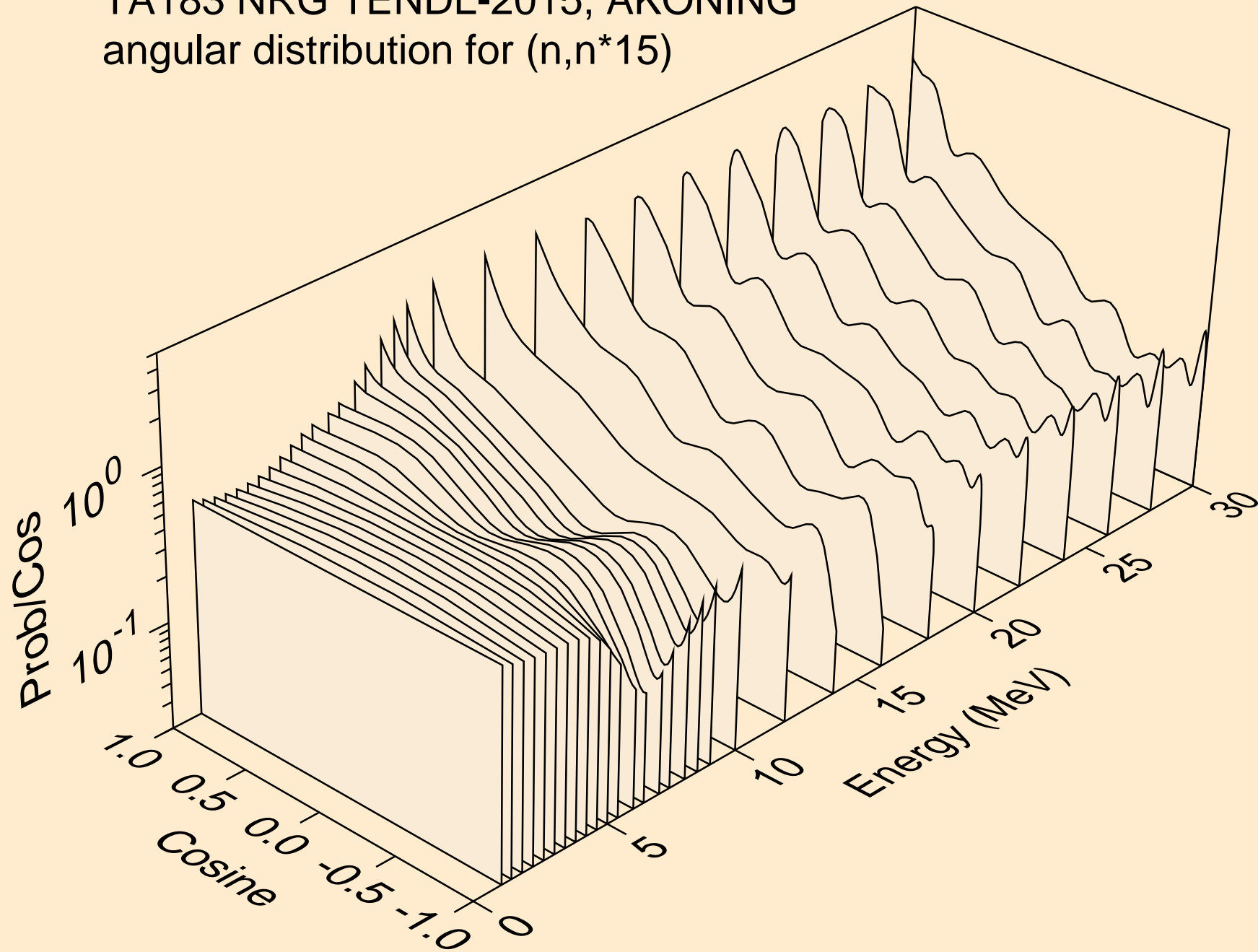

TA183 NRG TENDL-2015, AKONING
angular distribution for (n,n*16)

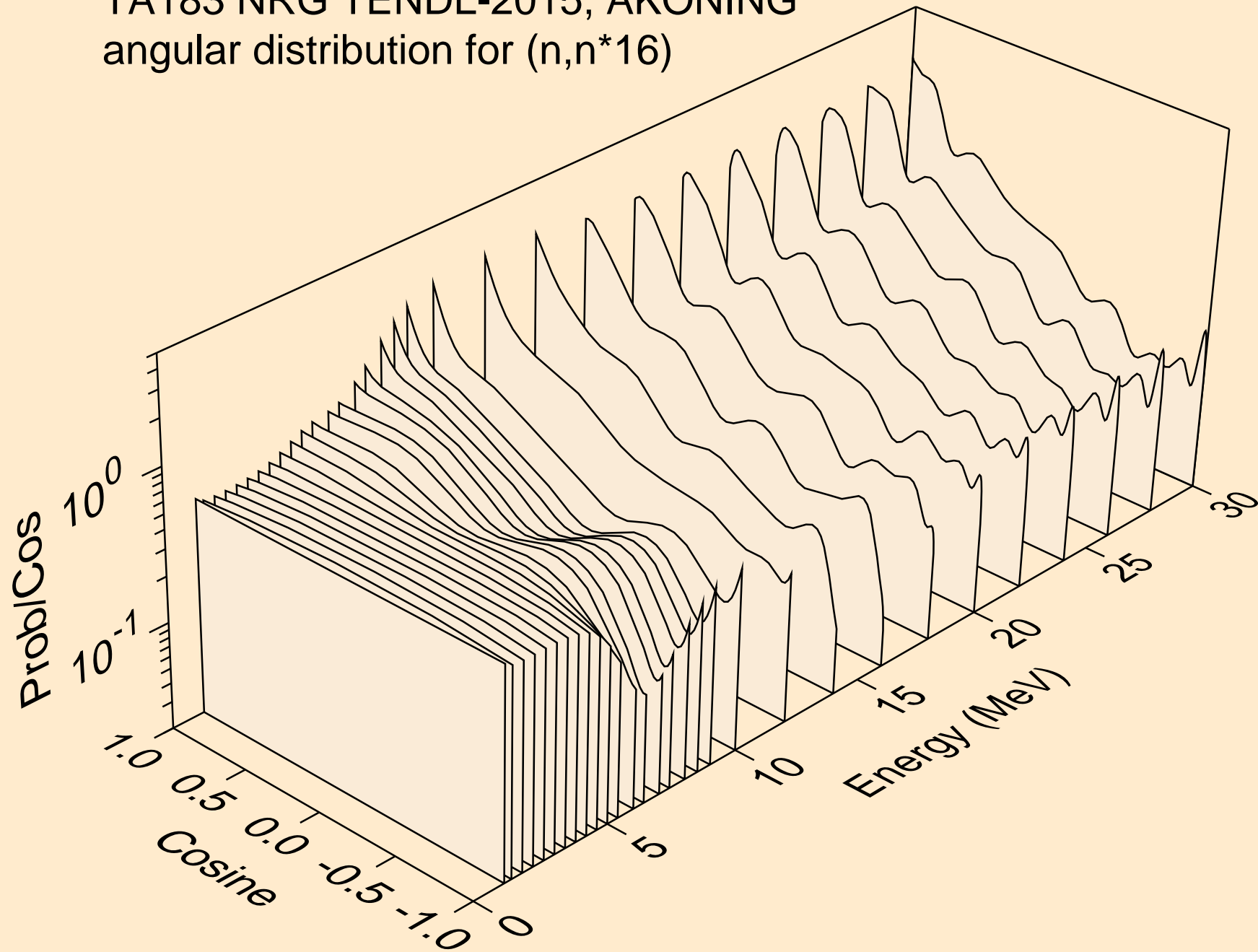

TA183 NRG TENDL-2015, AKONING
angular distribution for (n,n*17)

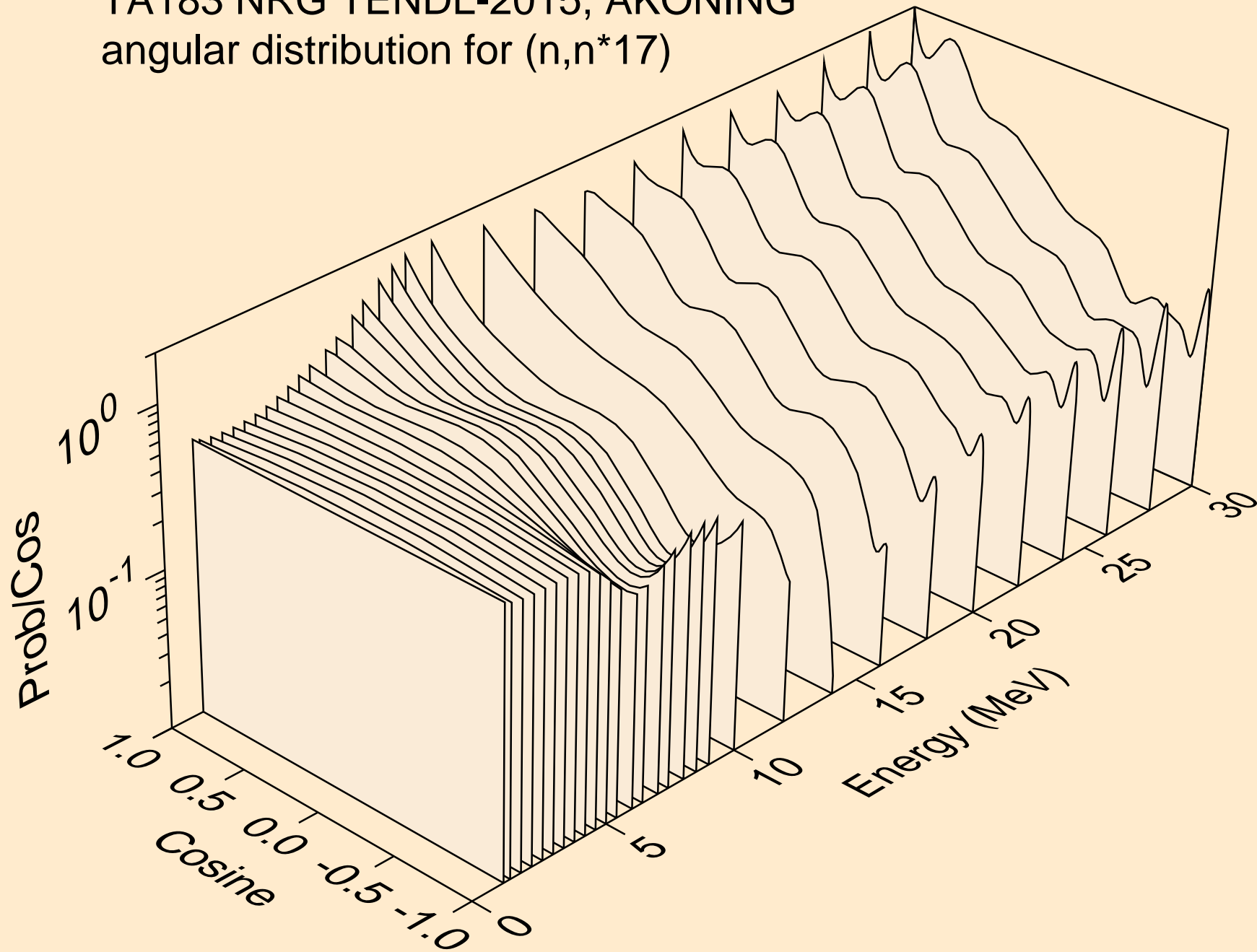

TA183 NRG TENDL-2015, AKONING
angular distribution for (n,n*18)

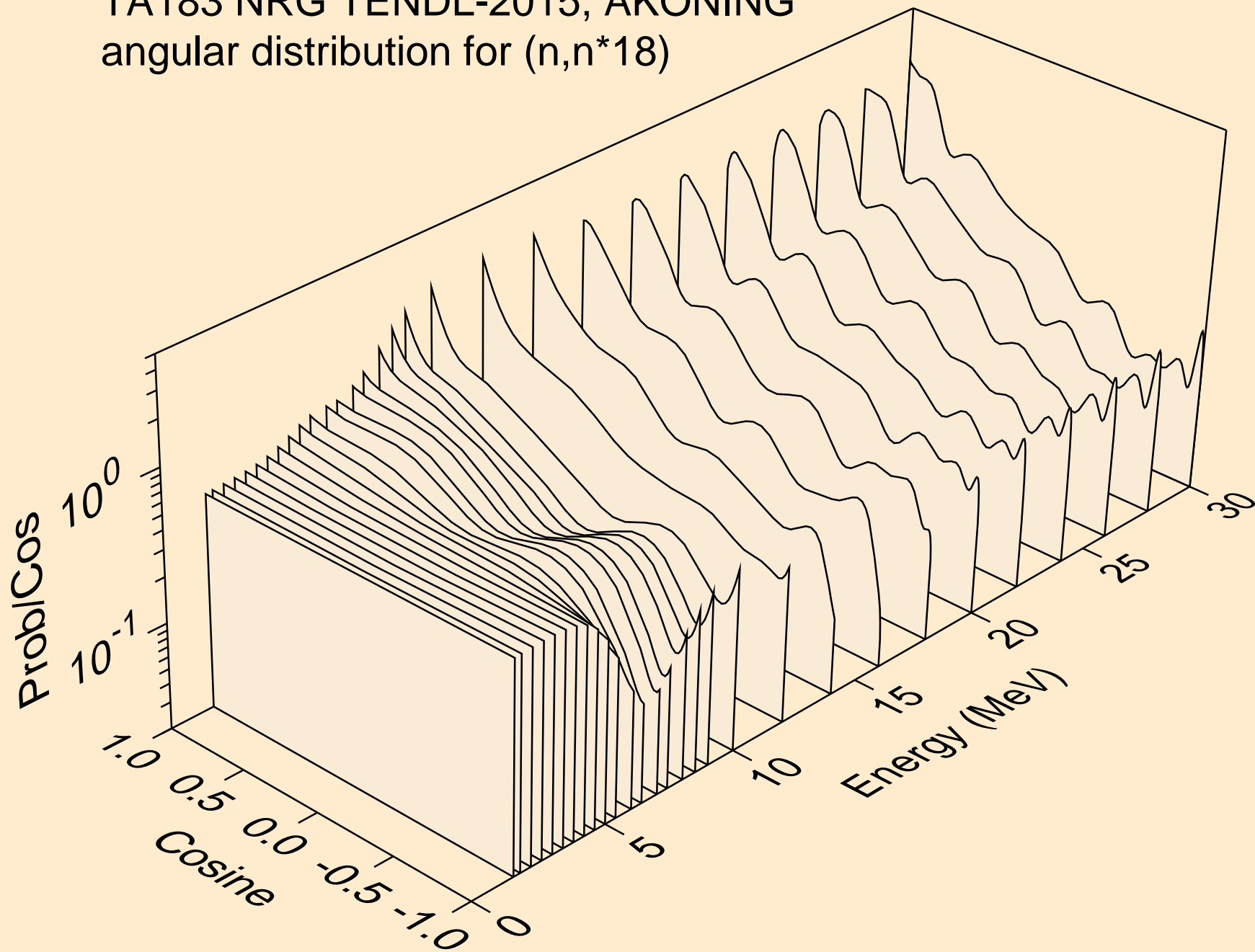

TA183 NRG TENDL-2015, AKONING
angular distribution for (n,n*19)

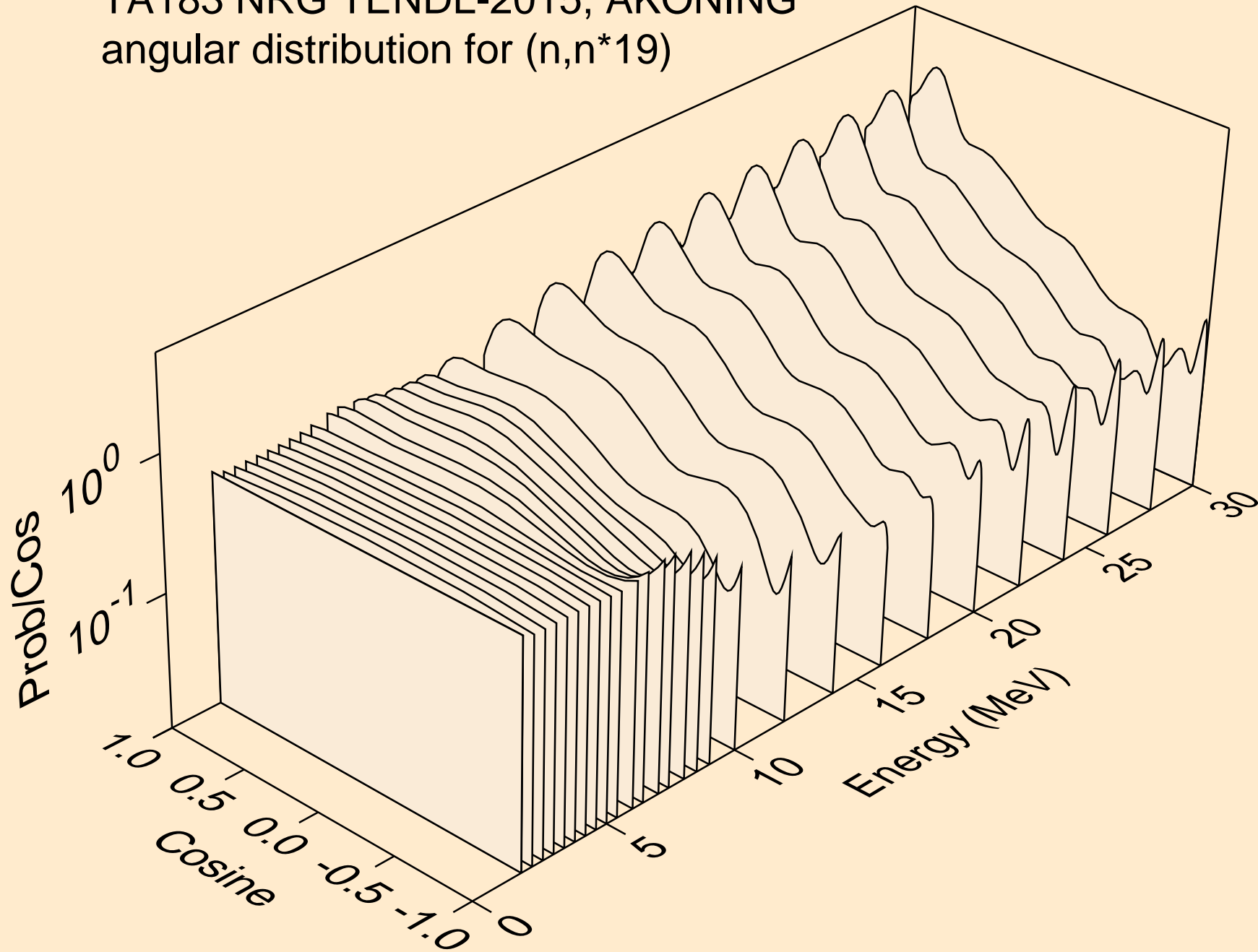

TA183 NRG TENDL-2015, AKONING
Neutron emission for (n,x)

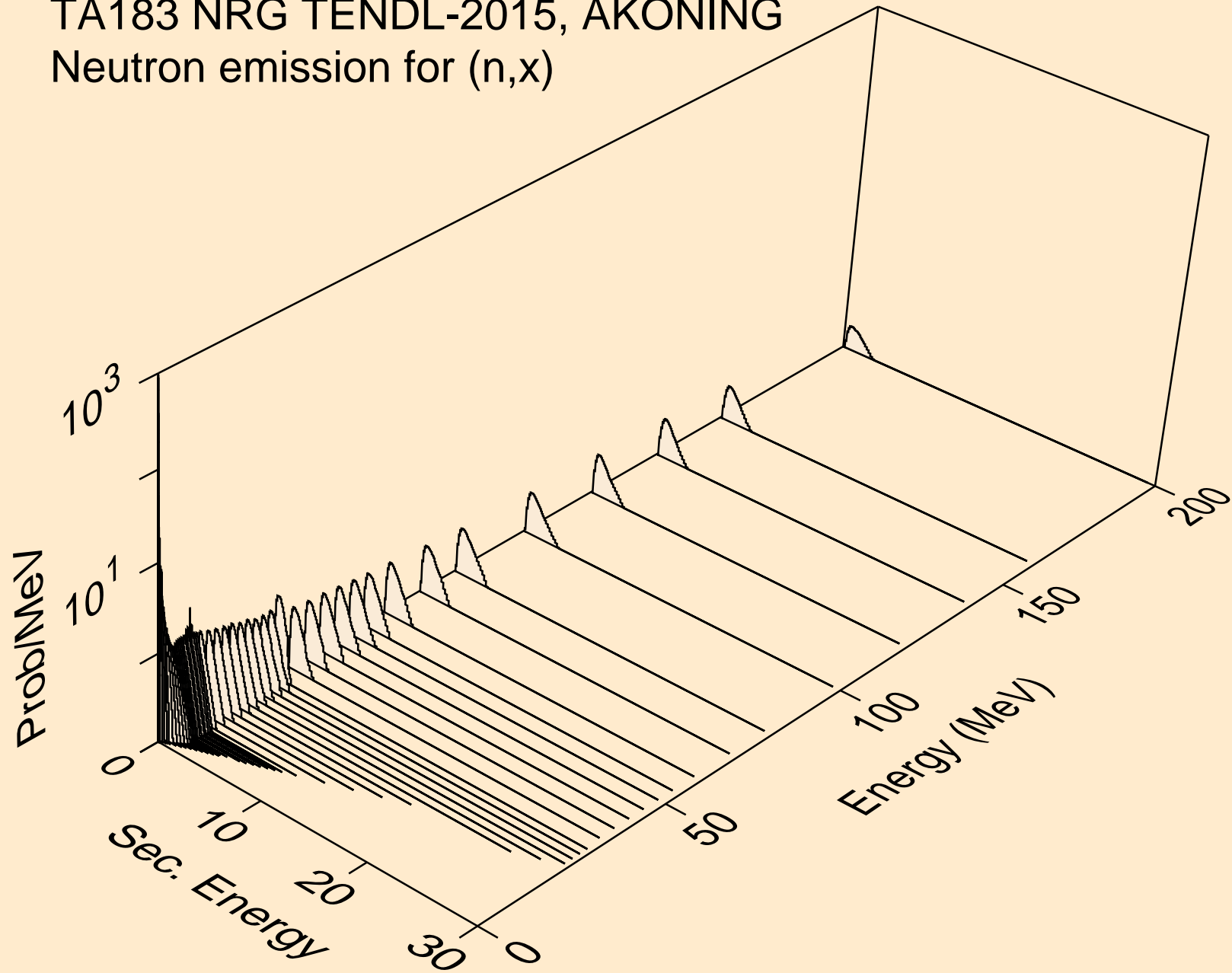

TA183 NRG TENDL-2015, AKONING
Neutron emission for (n,2nd)

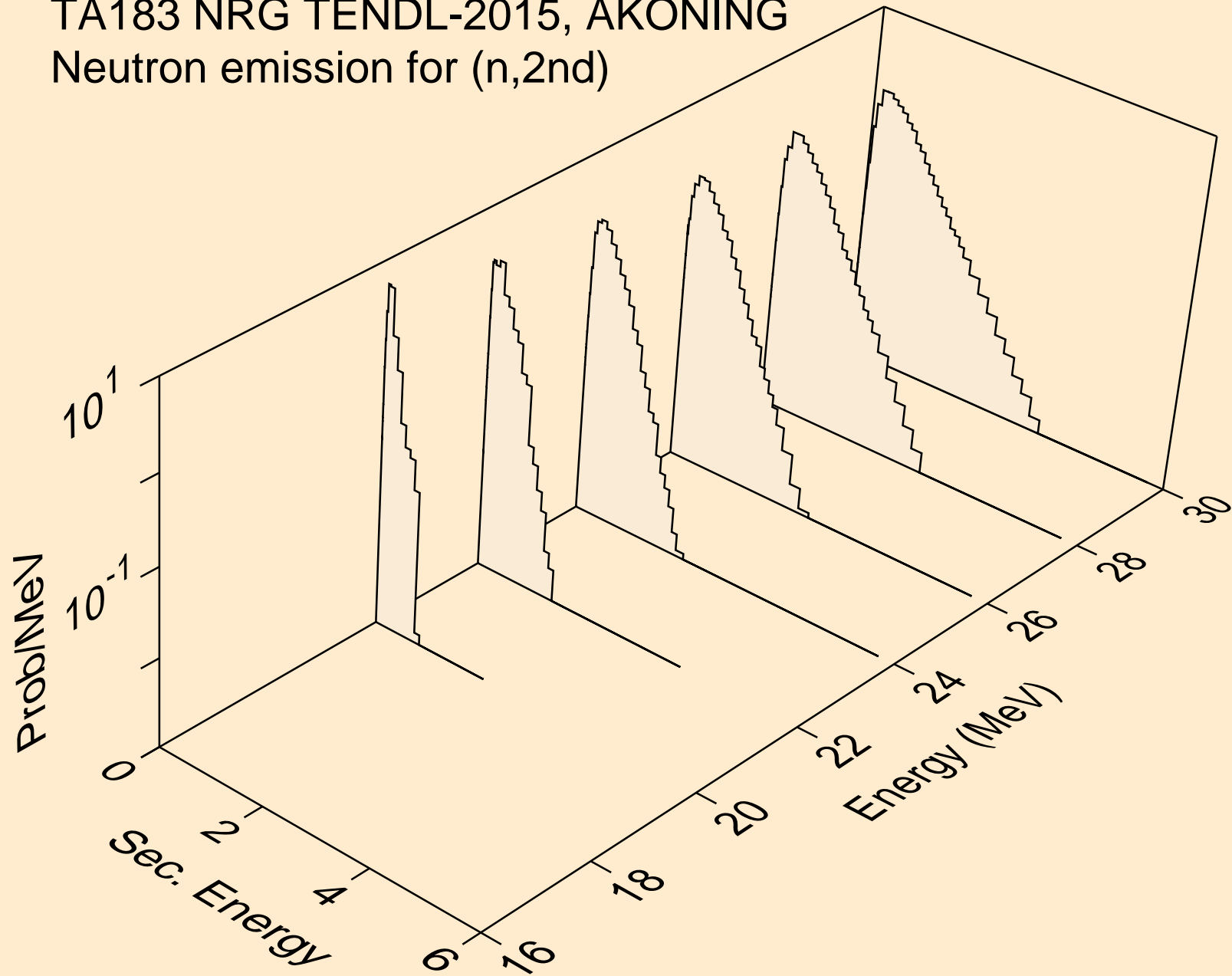

TA183 NRG TENDL-2015, AKONING
Neutron emission for (n,2n)

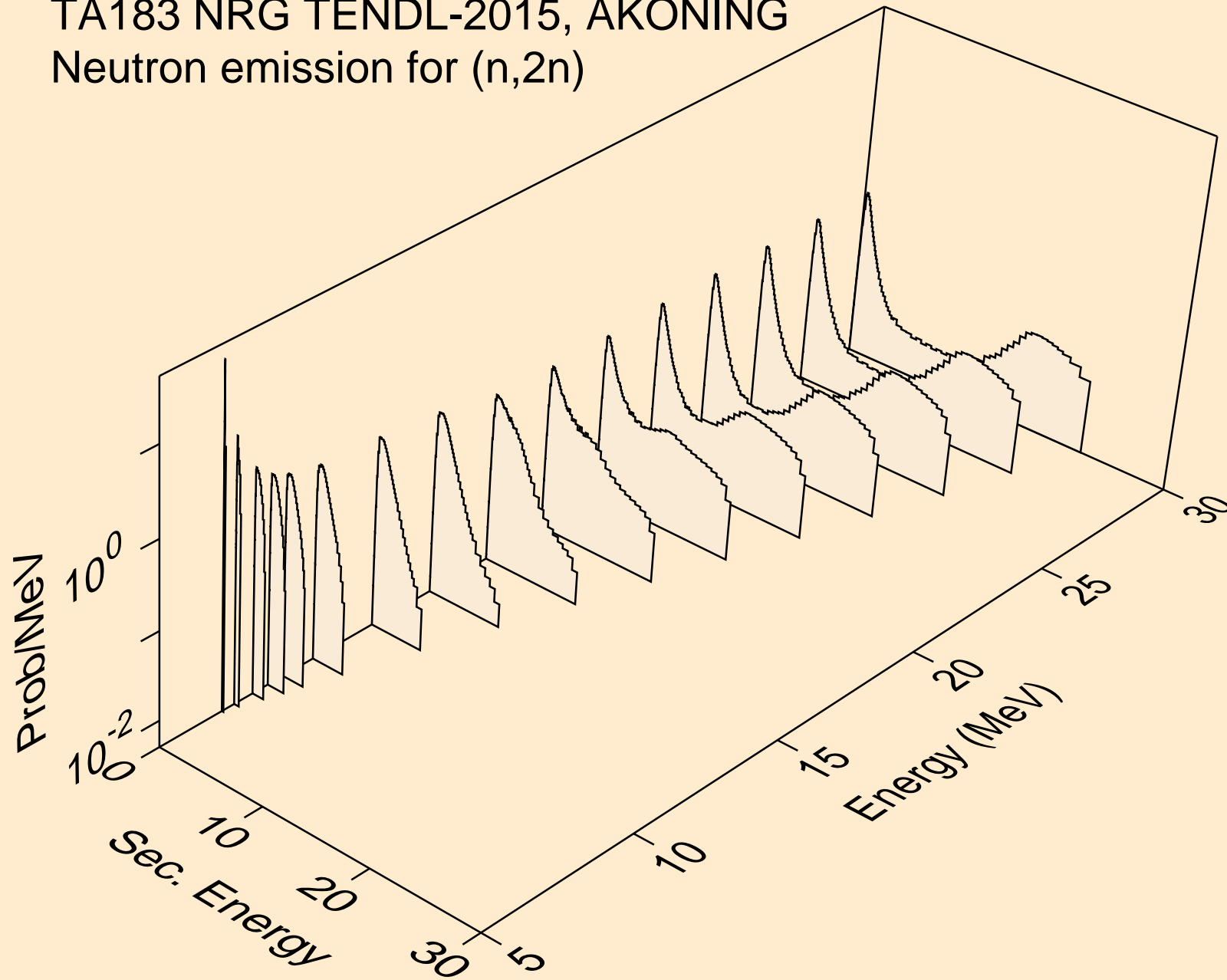

TA183 NRG TENDL-2015, AKONING
Neutron emission for (n,3n)

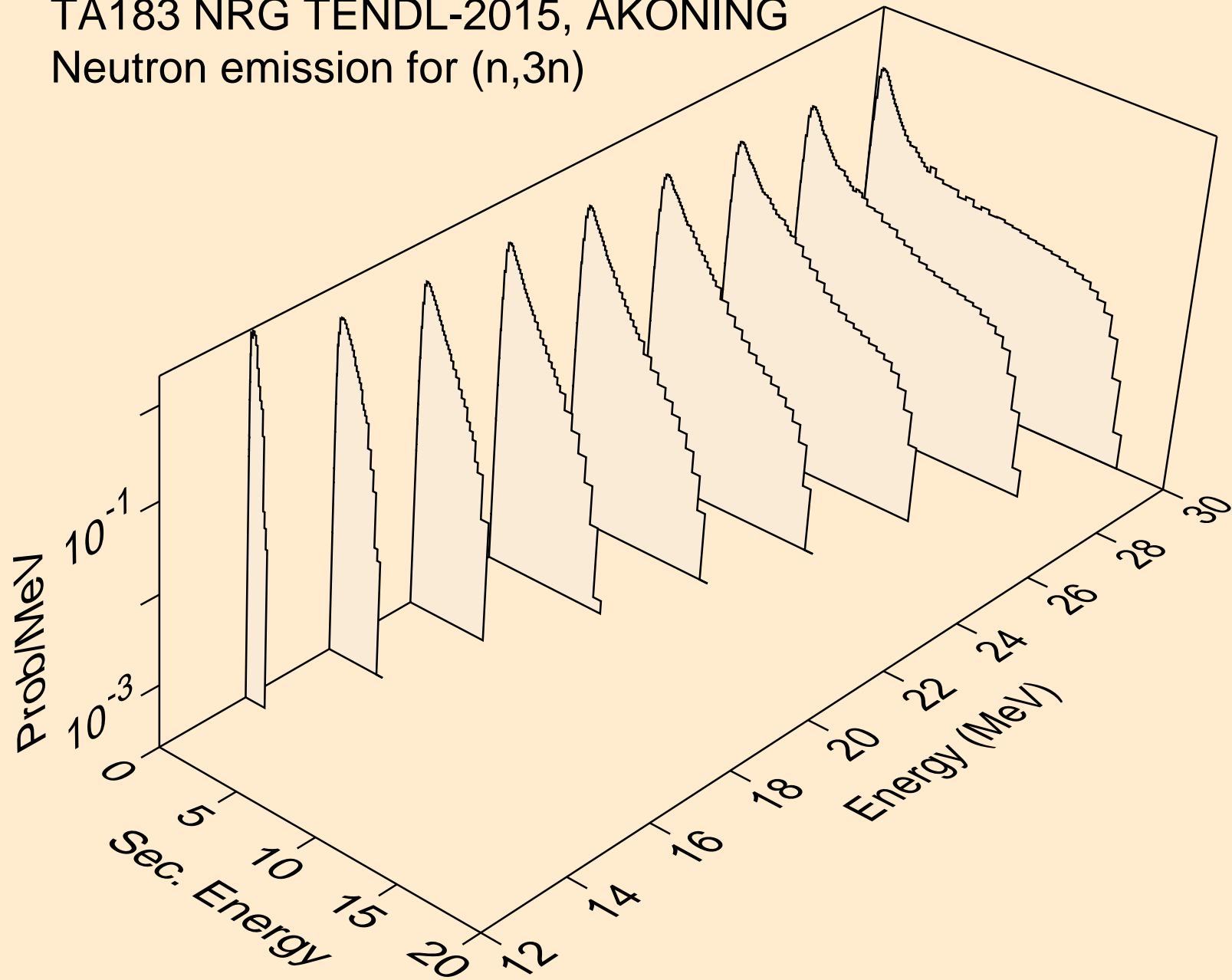

TA183 NRG TENDL-2015, AKONING
Neutron emission for (n,n*)a

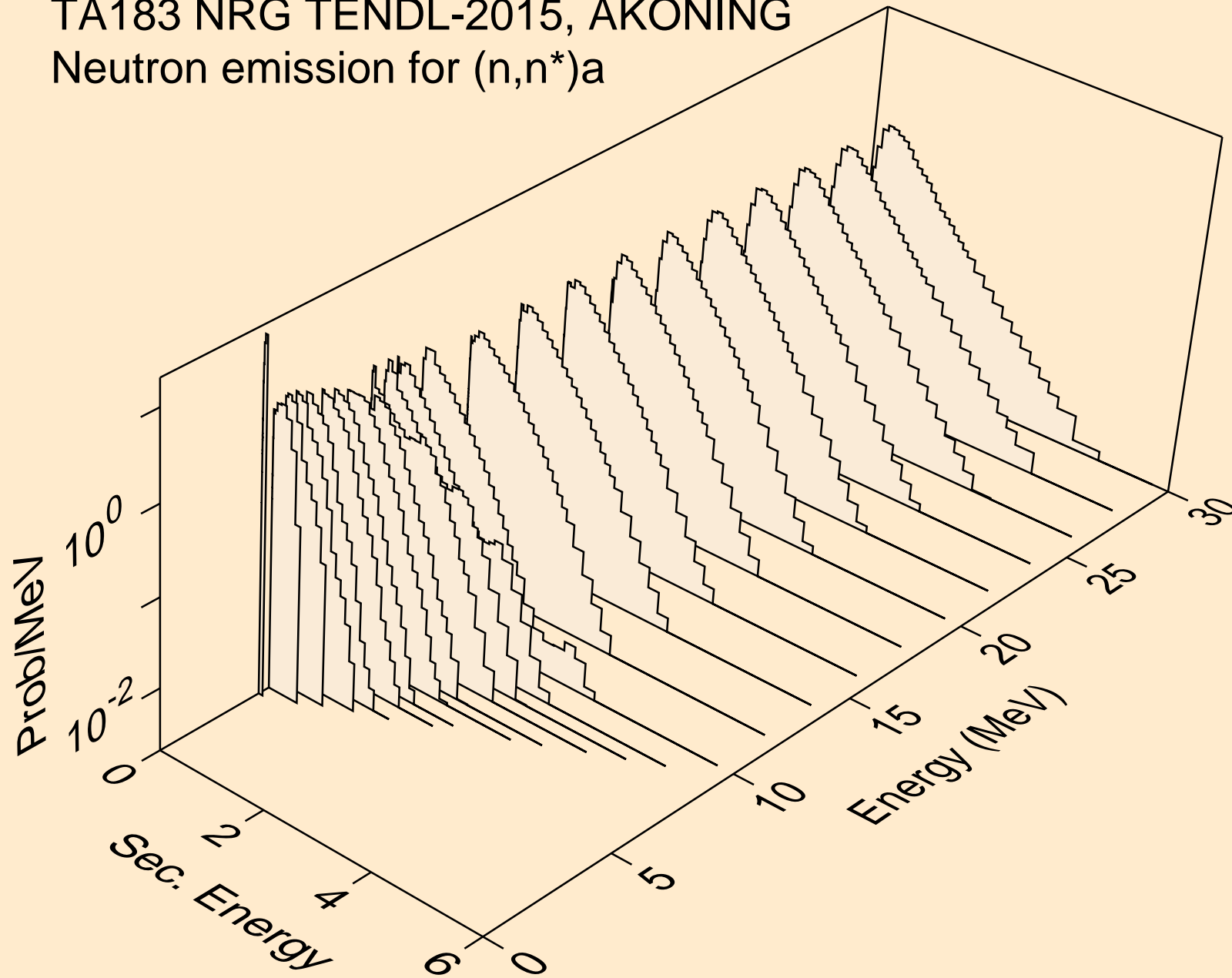

TA183 NRG TENDL-2015, AKONING
Neutron emission for (n,2n)a

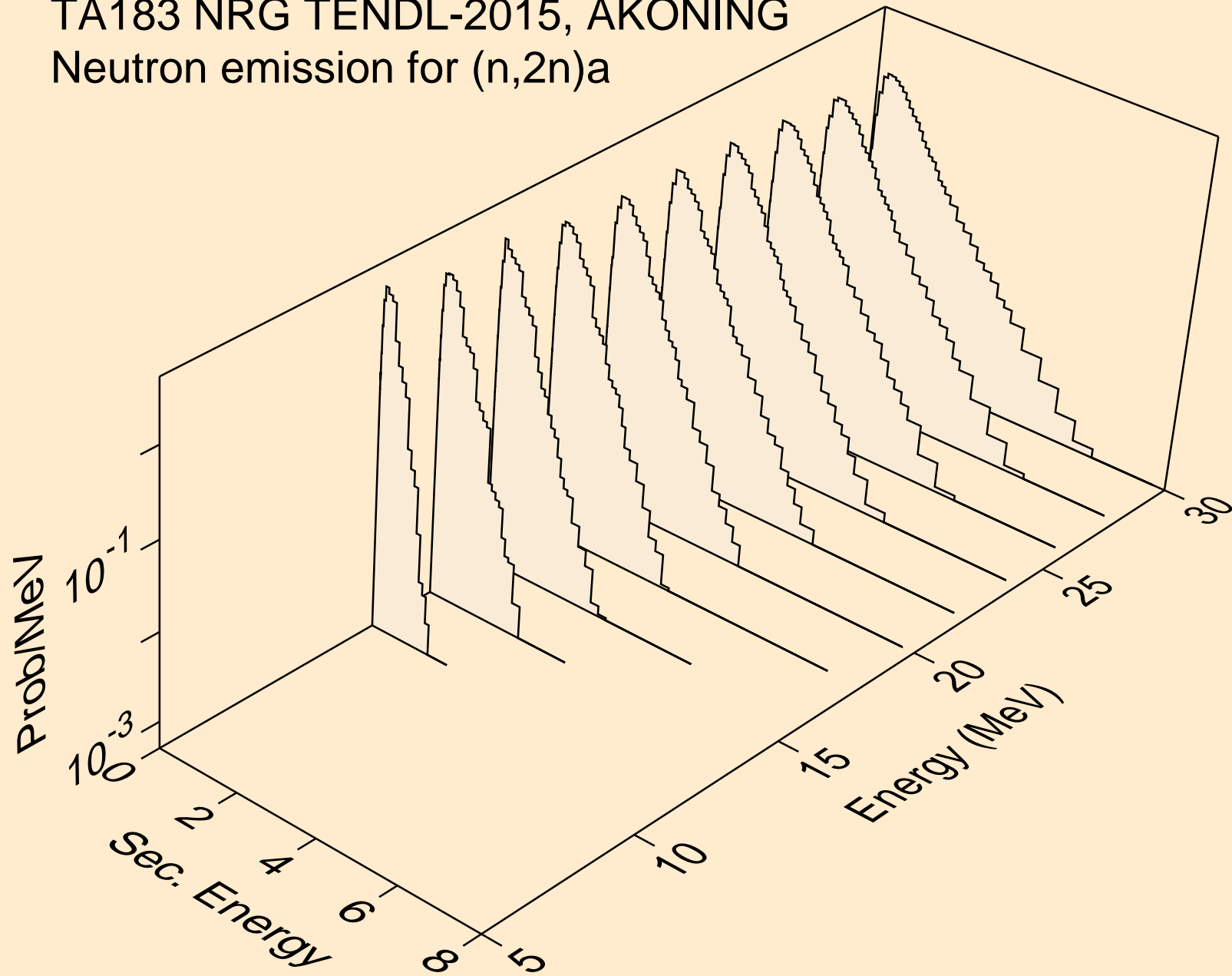

TA183 NRG TENDL-2015, AKONING
Neutron emission for (n,3n)a

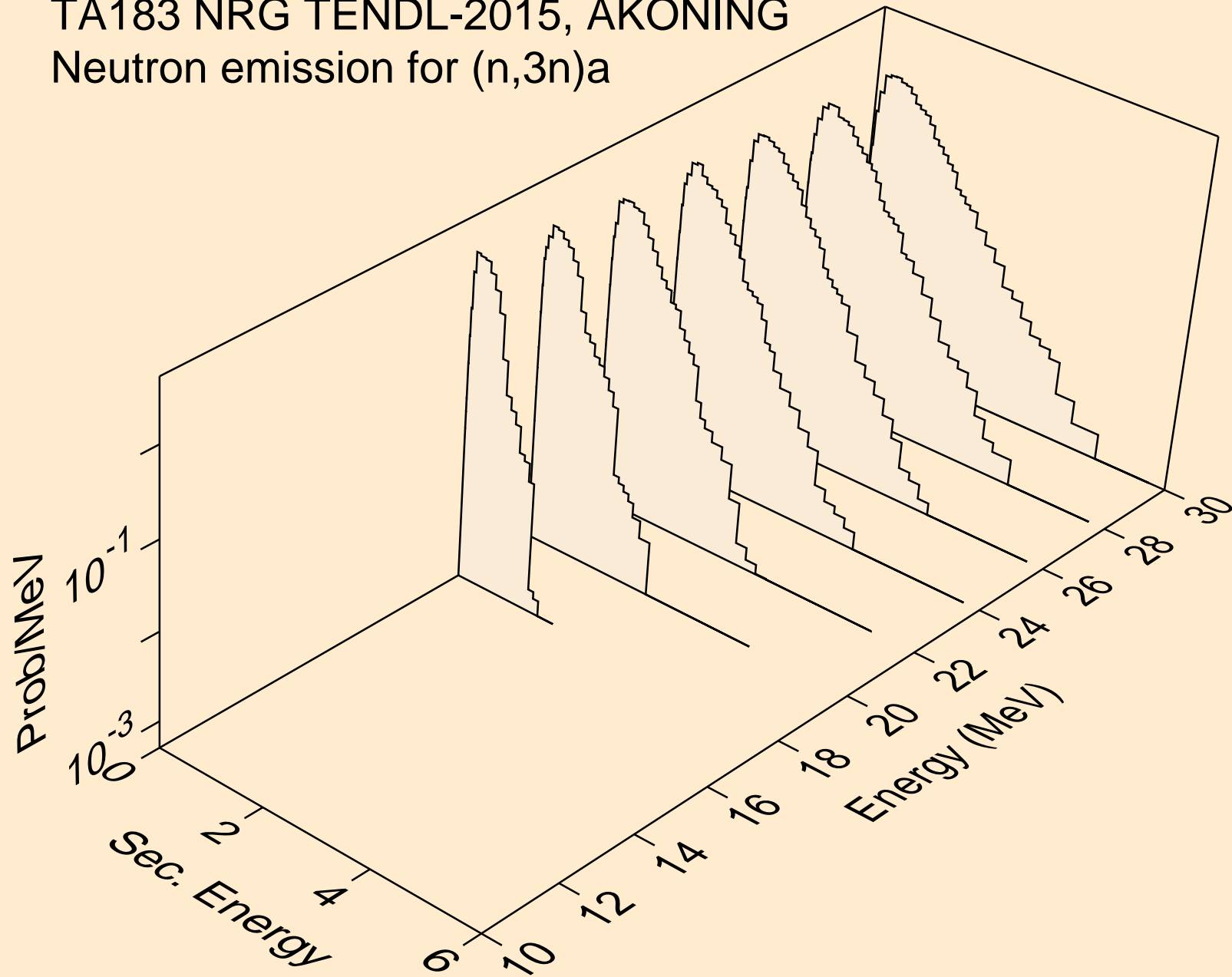

TA183 NRG TENDL-2015, AKONING
Neutron emission for (n,n*)p

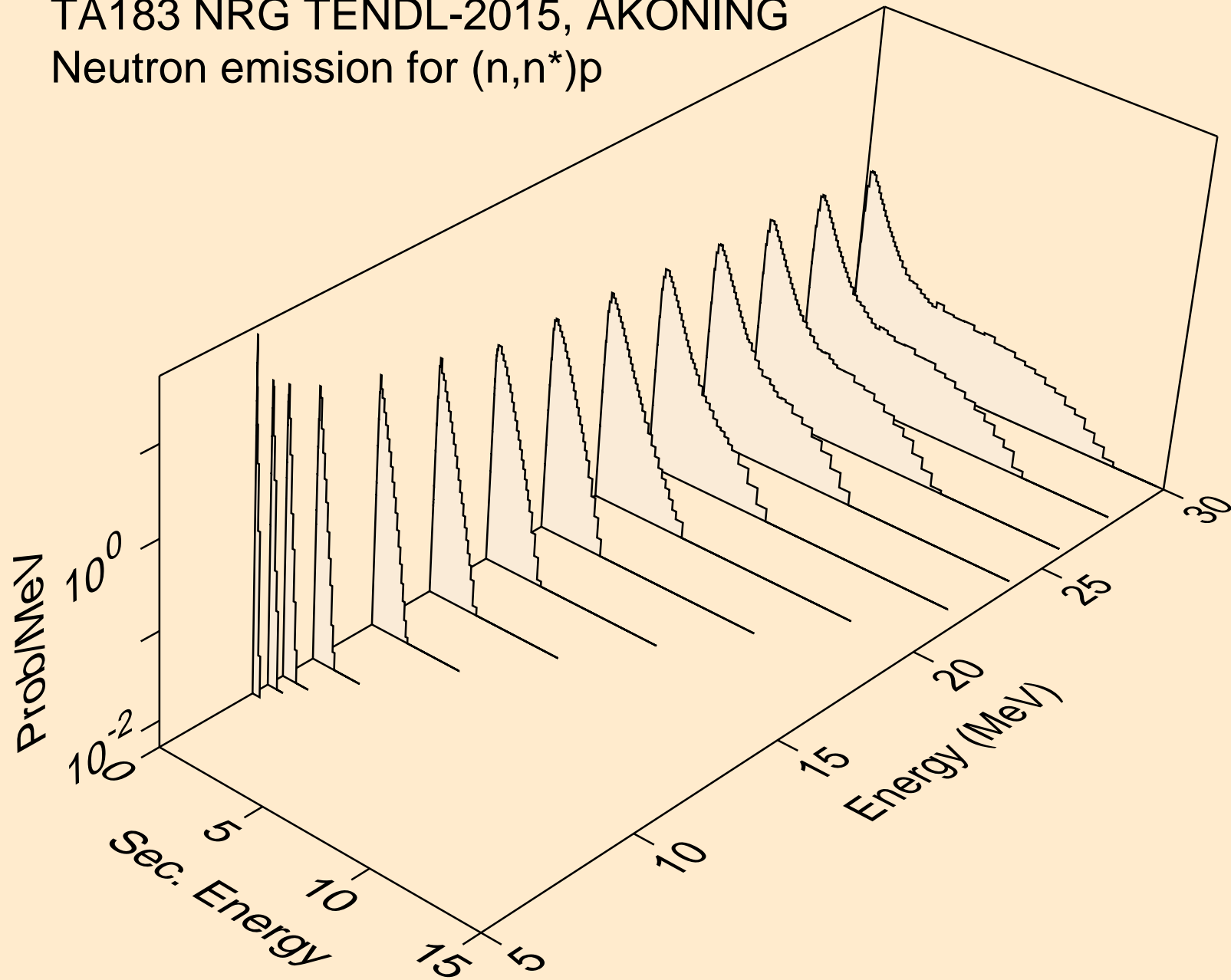

TA183 NRG TENDL-2015, AKONING
Neutron emission for (n,n*)2a

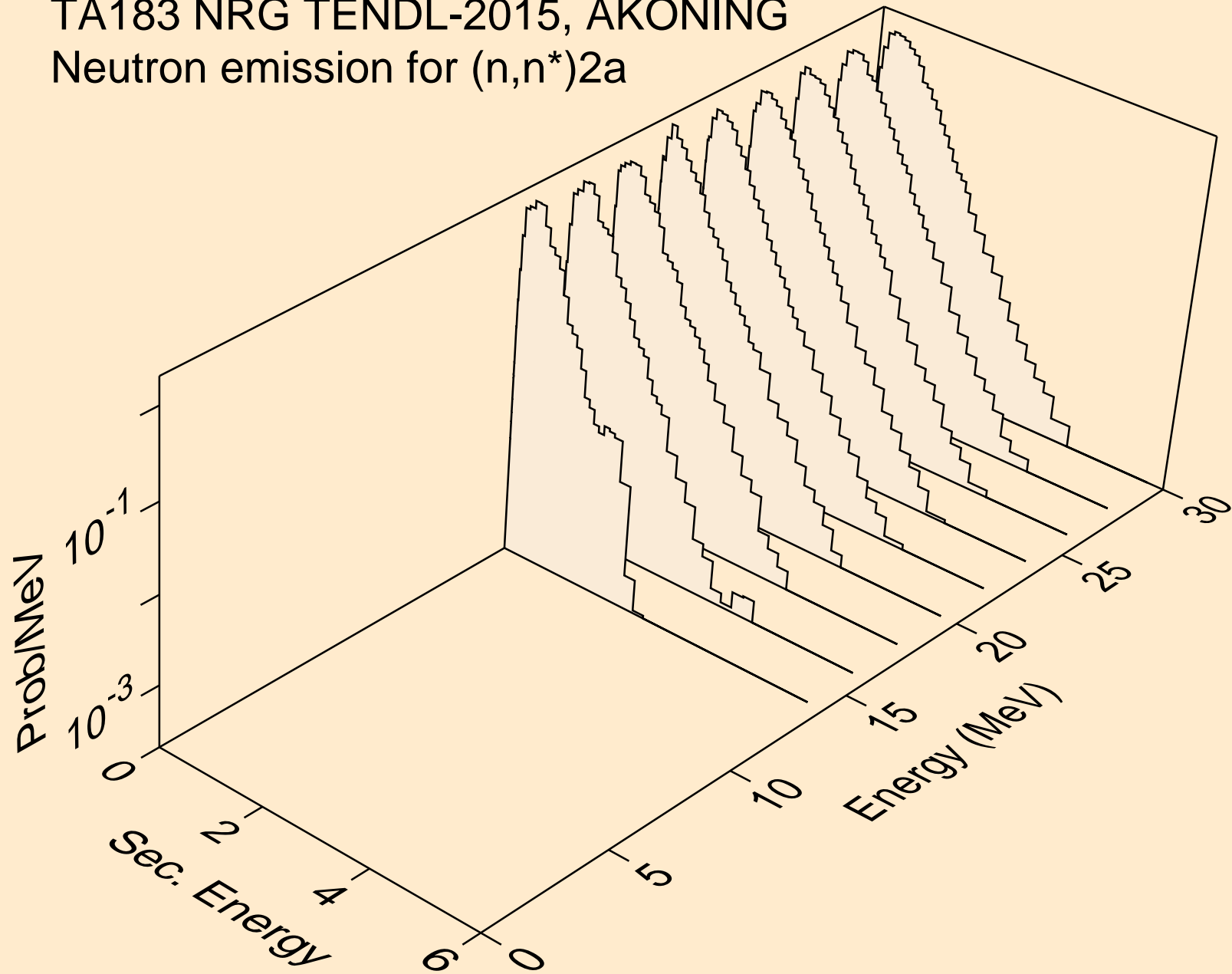

TA183 NRG TENDL-2015, AKONING
Neutron emission for (n,n*)d

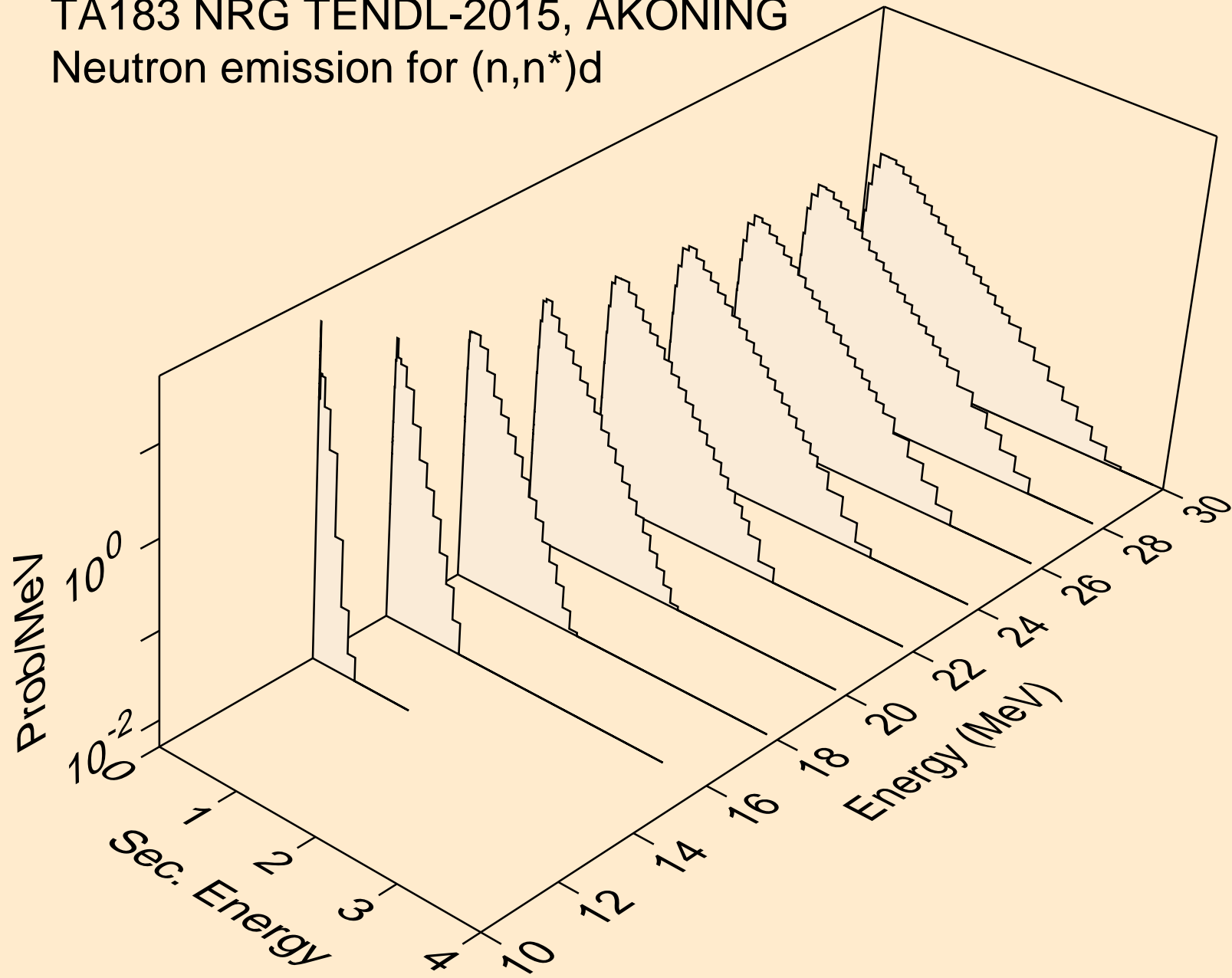

TA183 NRG TENDL-2015, AKONING
Neutron emission for (n,n*)t

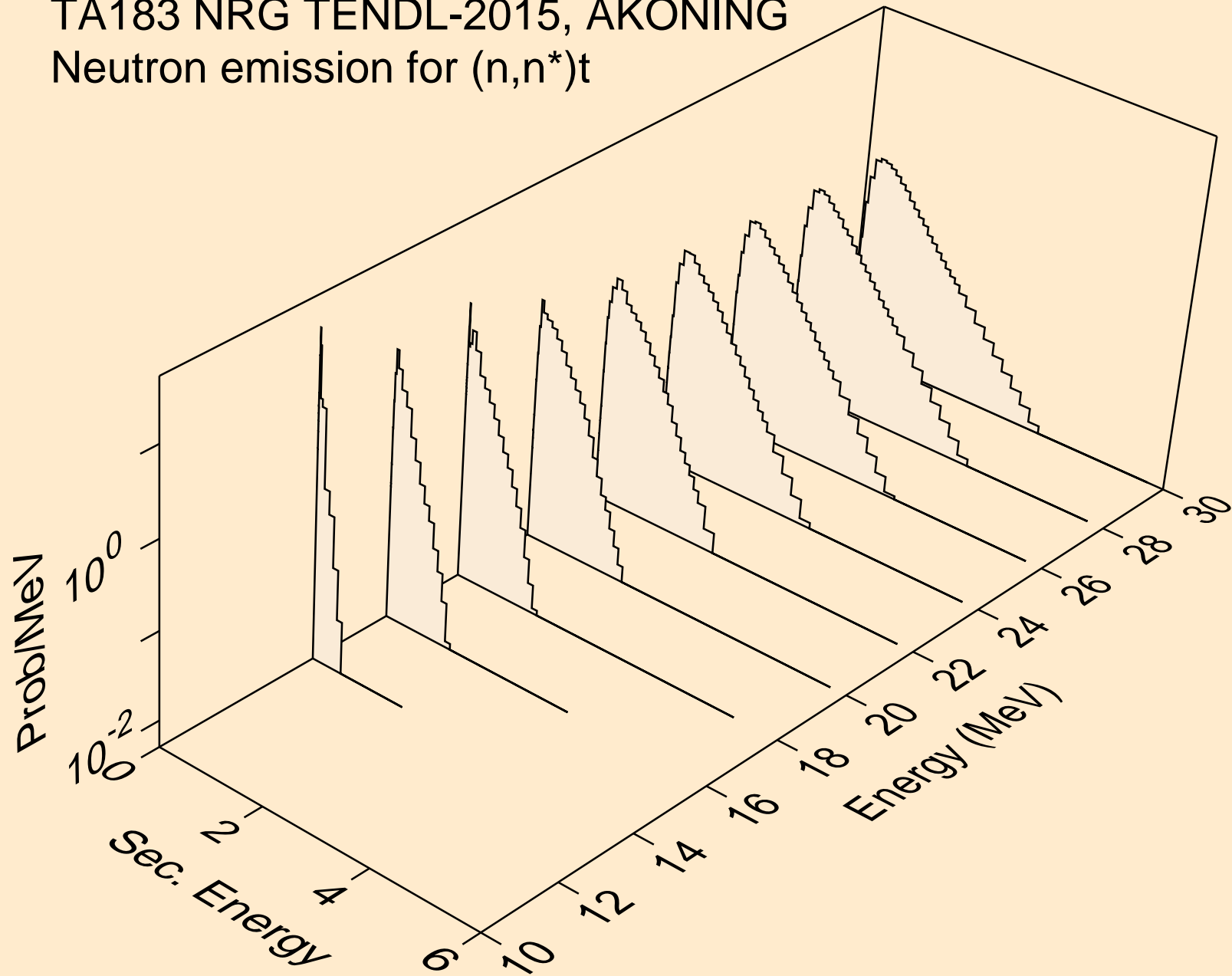

TA183 NRG TENDL-2015, AKONING
Neutron emission for (n,n*)he3

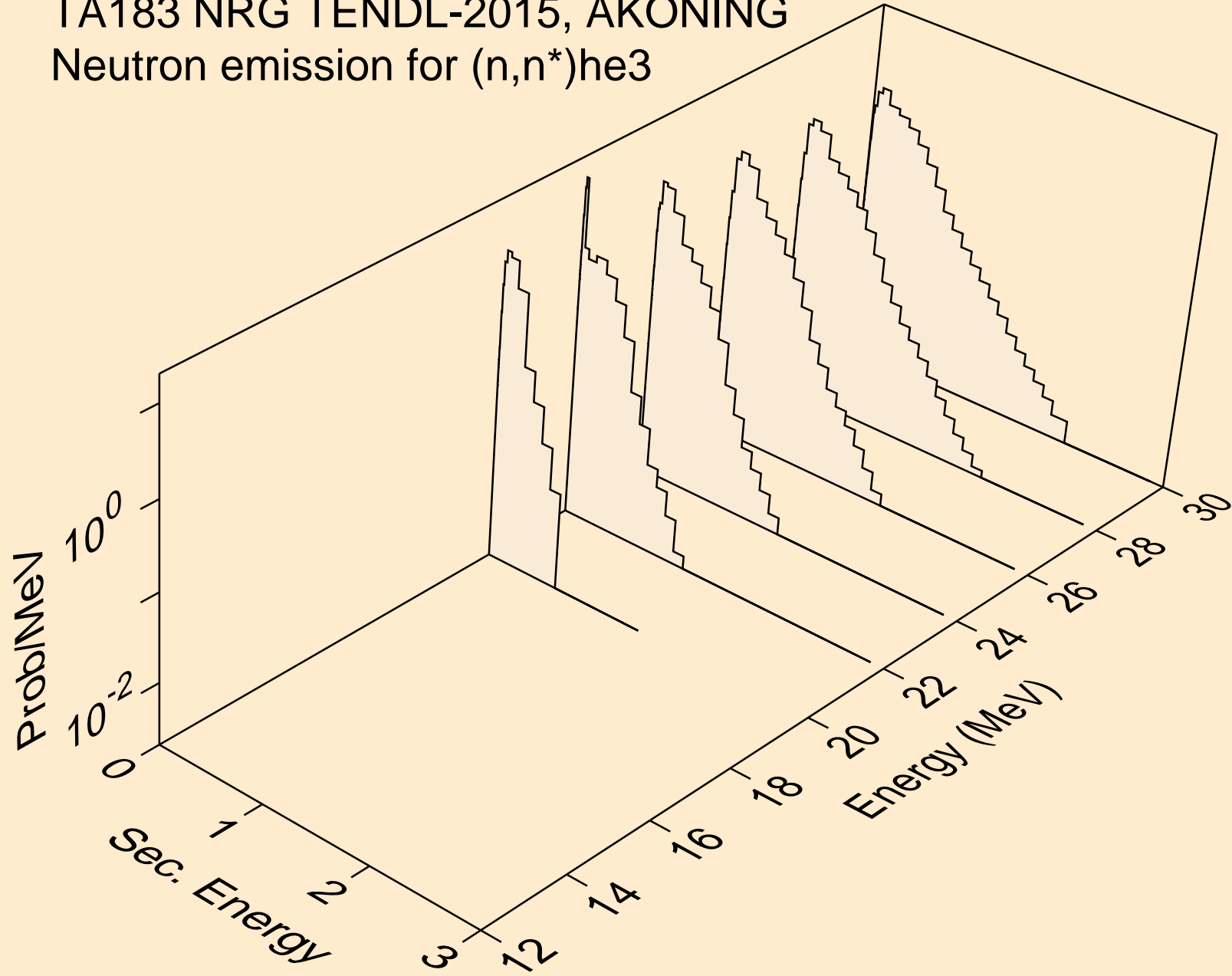

TA183 NRG TENDL-2015, AKONING
Neutron emission for (n,4n)

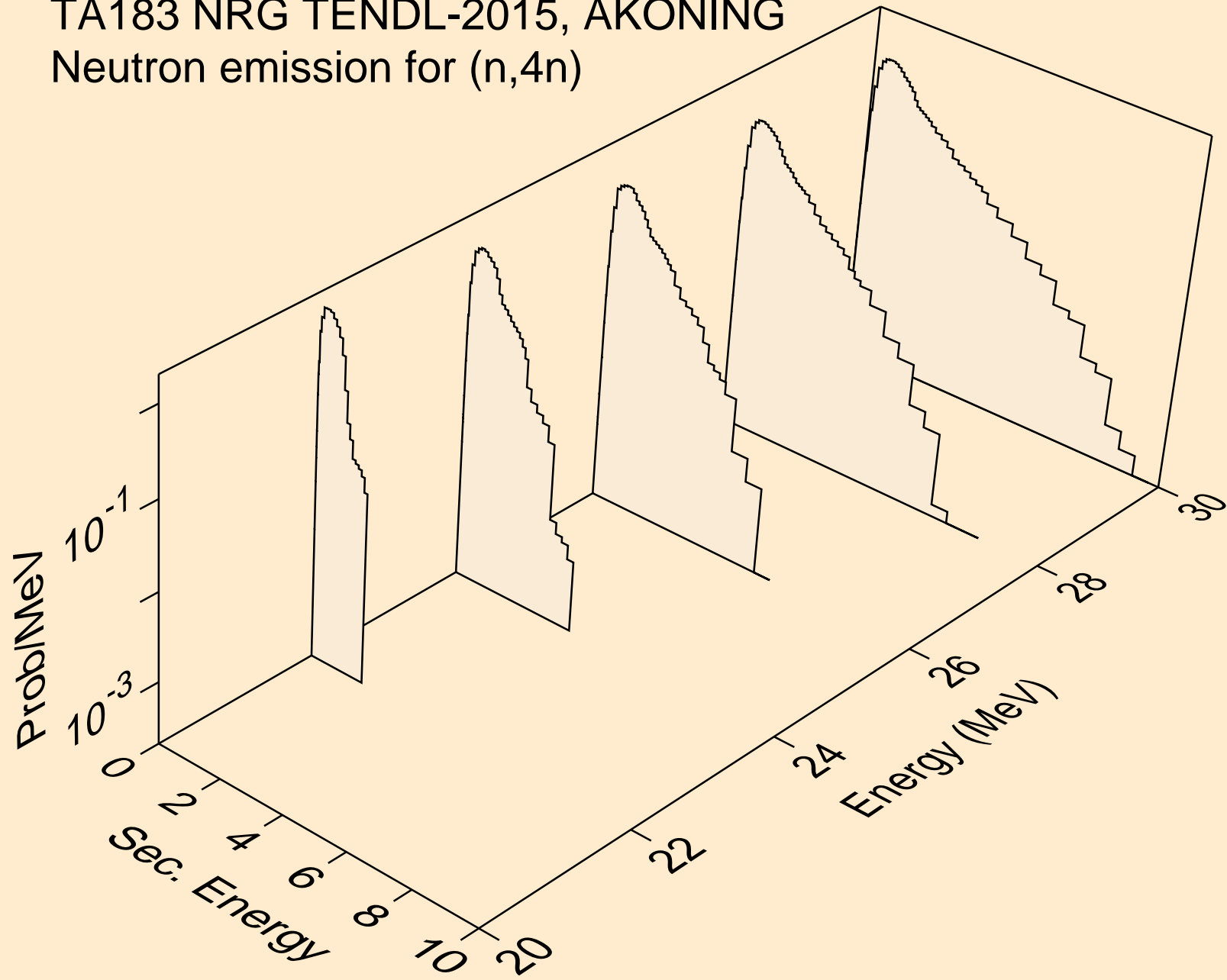

TA183 NRG TENDL-2015, AKONING
Neutron emission for (n,2np)

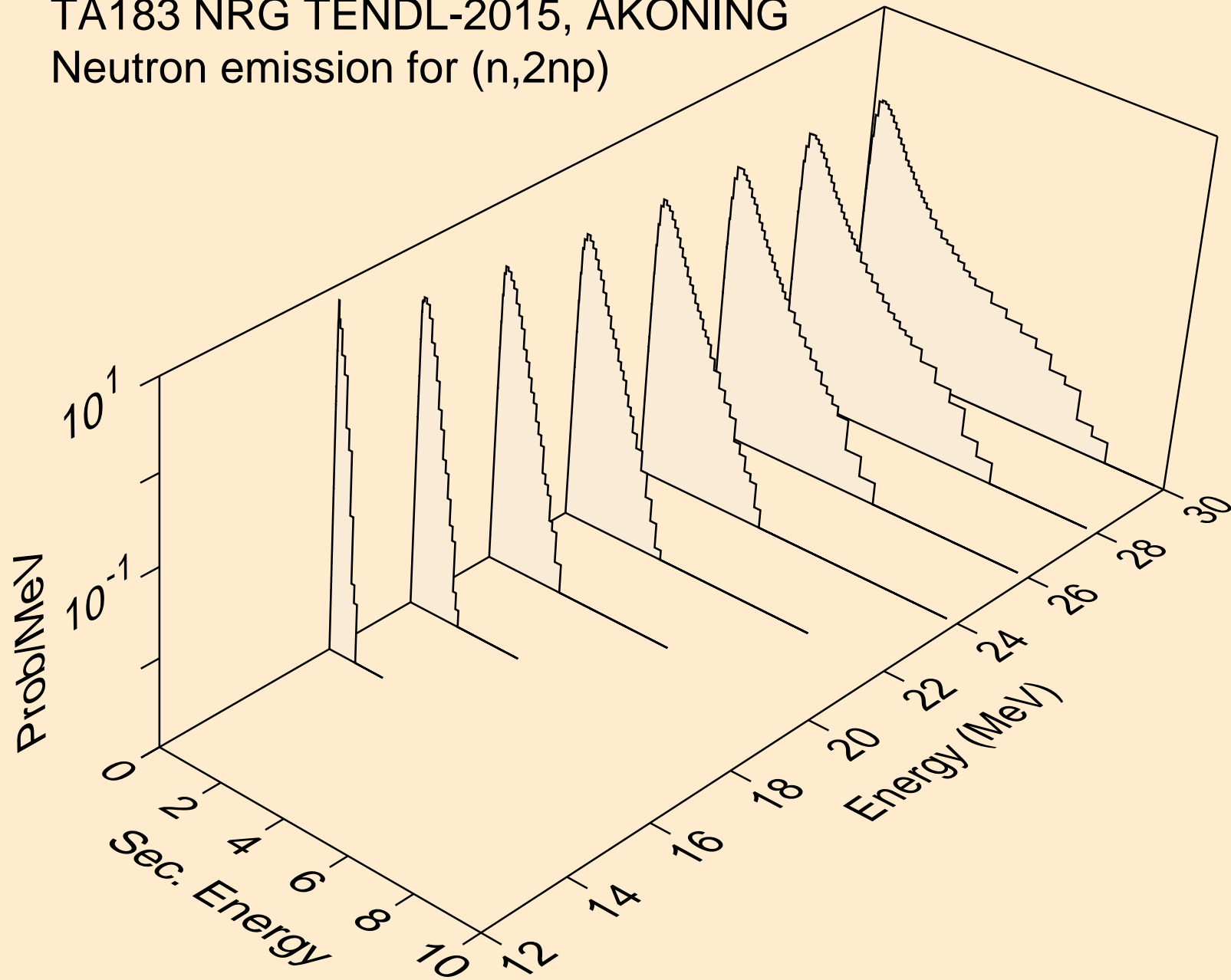

TA183 NRG TENDL-2015, AKONING
Neutron emission for (n,3np)

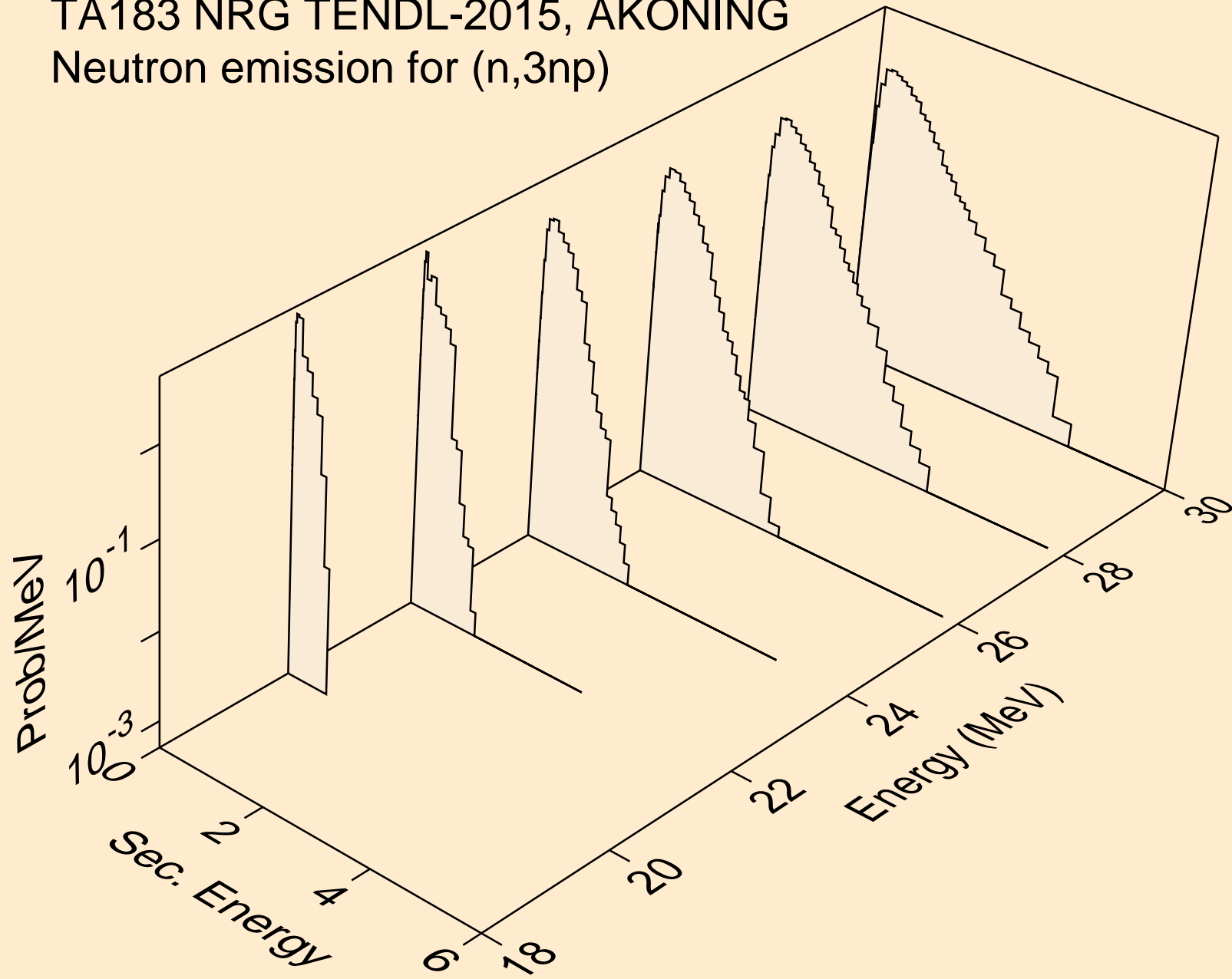

TA183 NRG TENDL-2015, AKONING
Neutron emission for (n,2np)

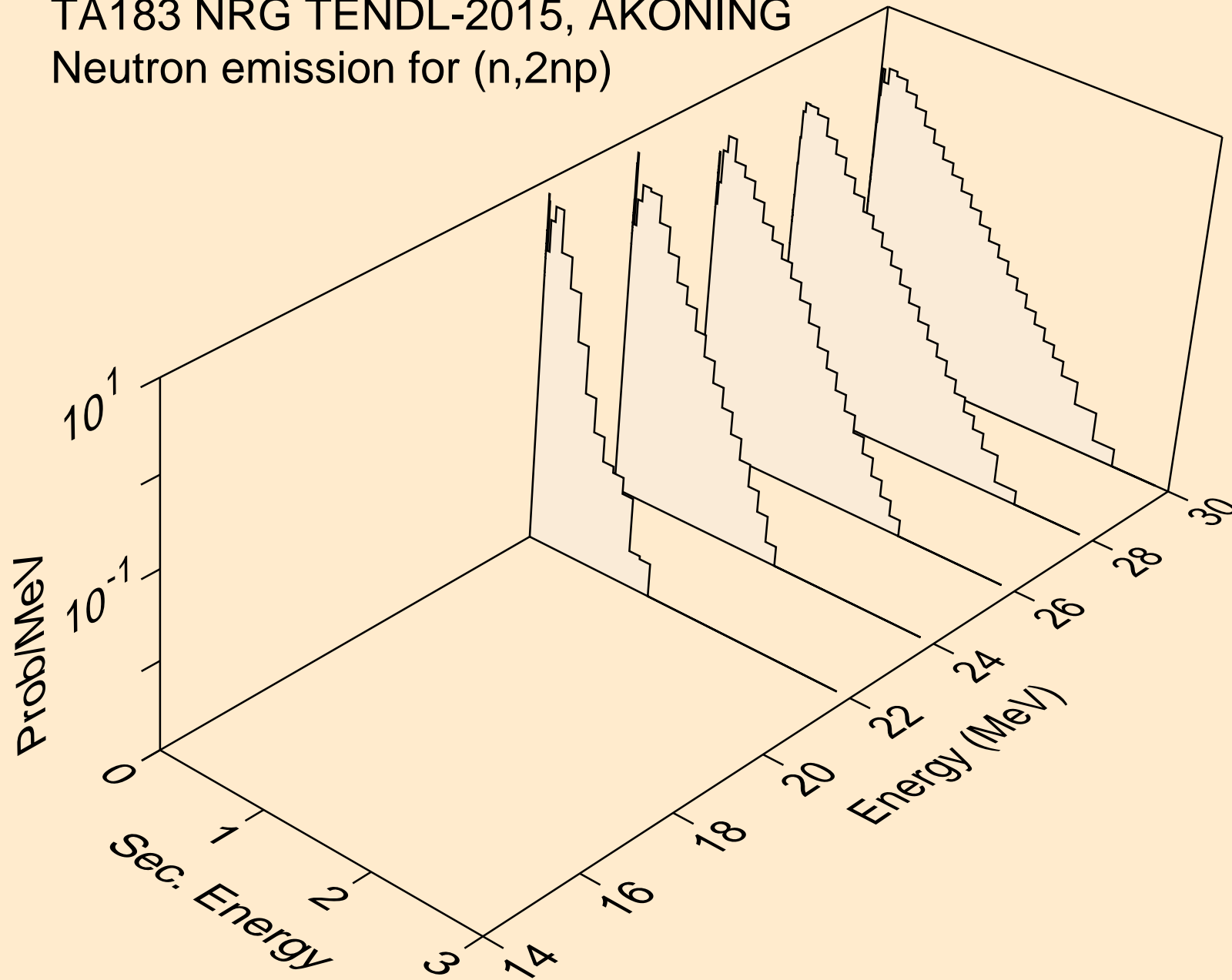

TA183 NRG TENDL-2015, AKONING
Neutron emission for (n,npa)

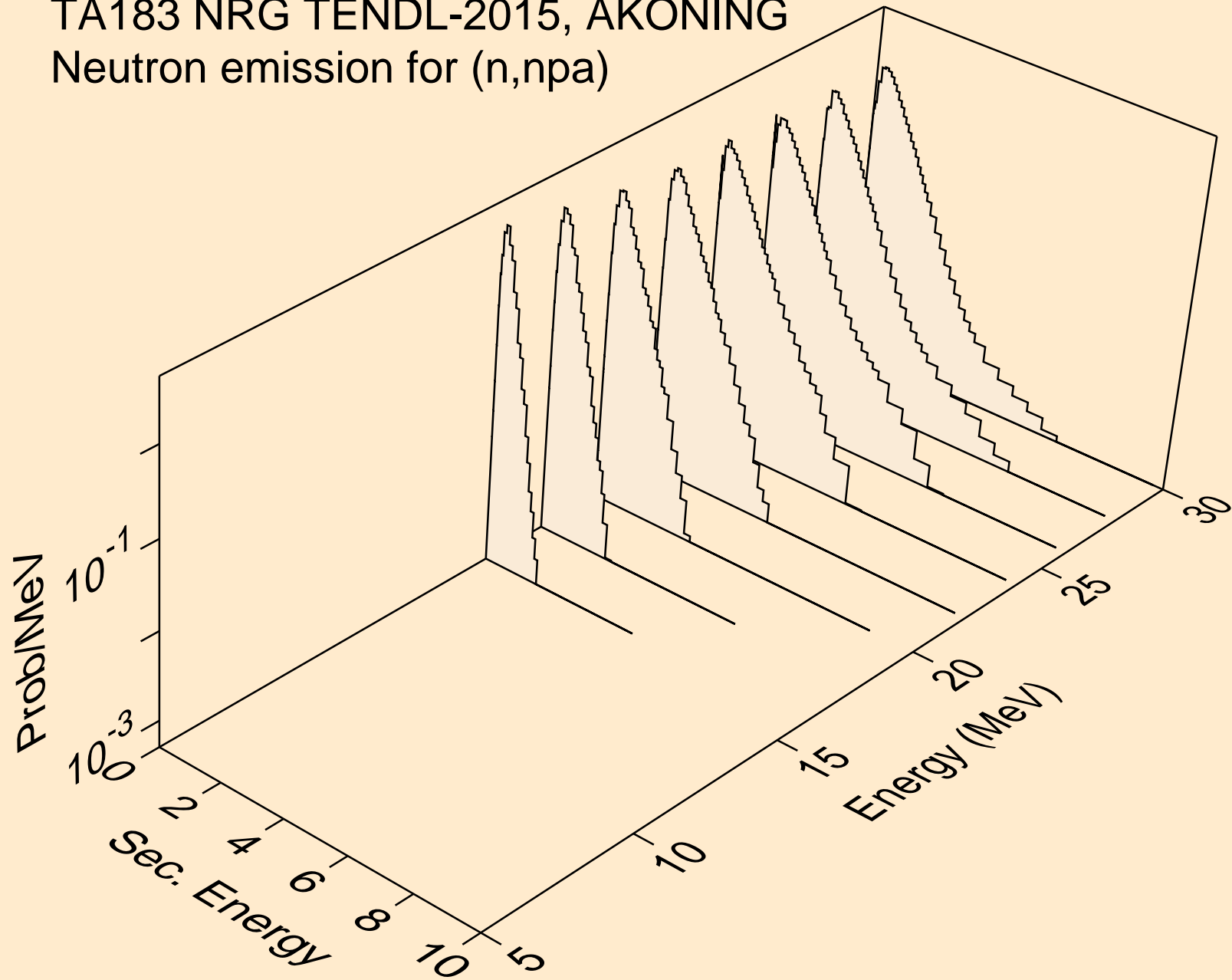

TA183 NRG TENDL-2015, AKONING
Neutron emission for (n,n*c)

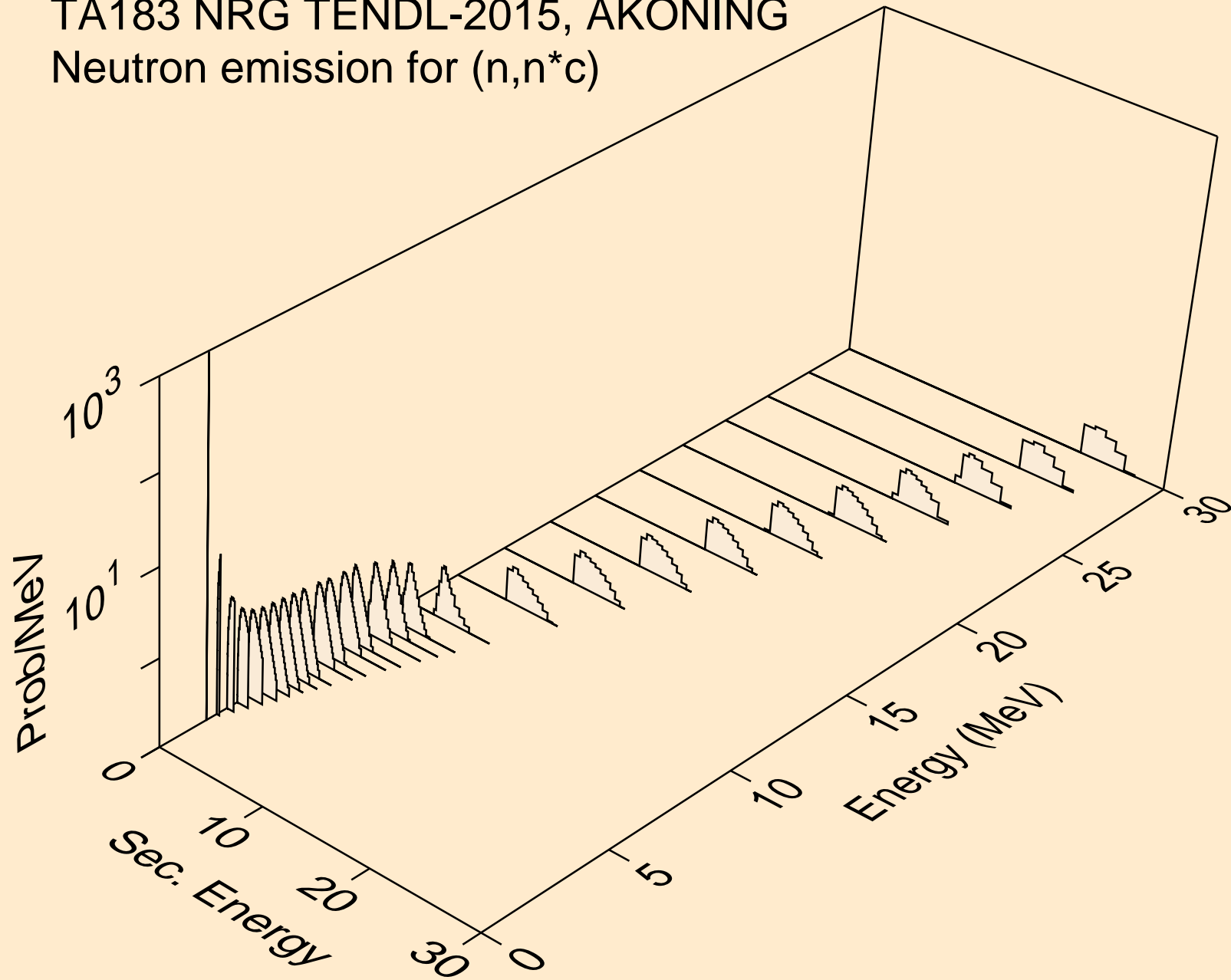

TA183 NRG TENDL-2015, AKONING
Photon emission for (n,x)

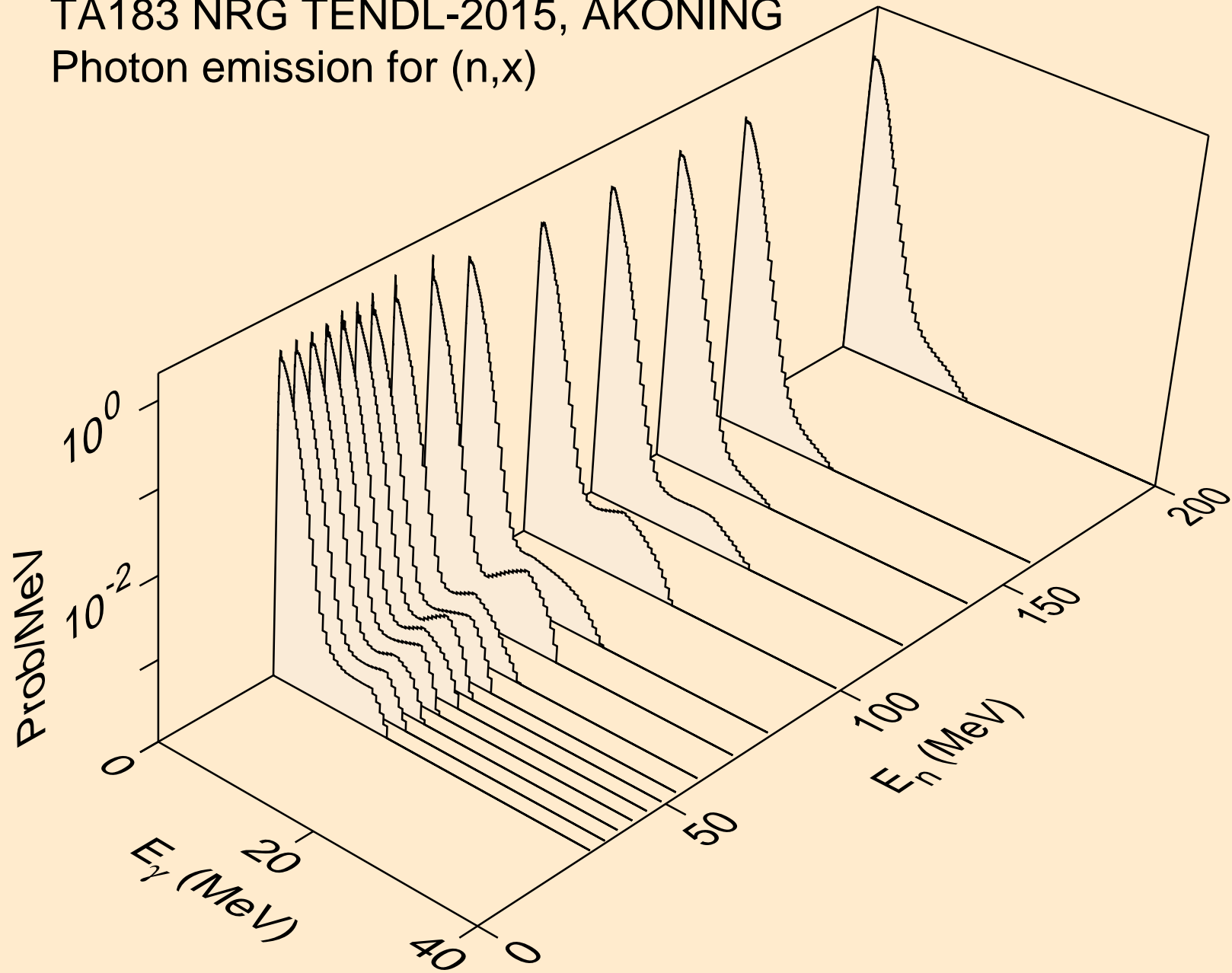

TA183 NRG TENDL-2015, AKONING
Photon emission for (n,2nd)

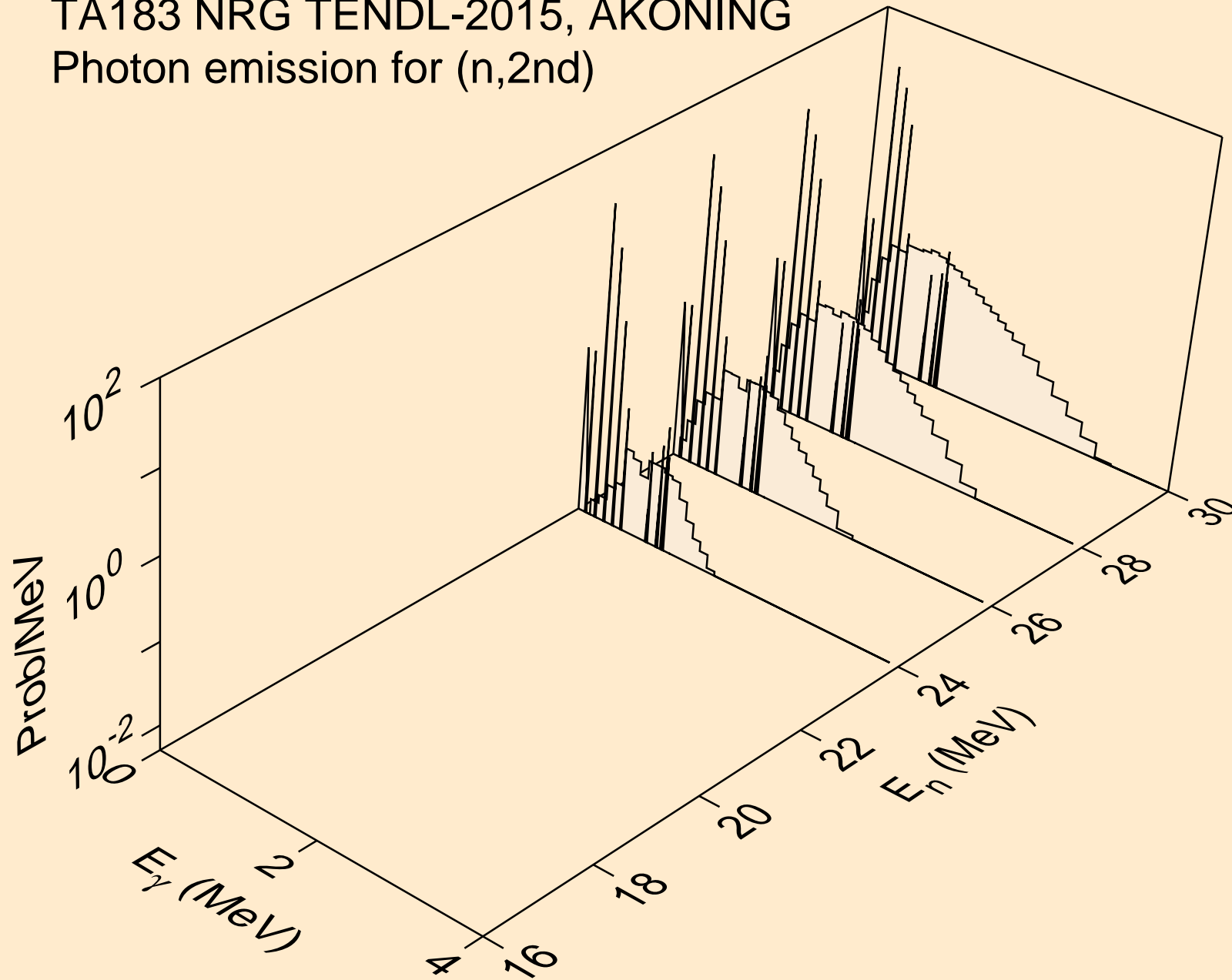

TA183 NRG TENDL-2015, AKONING
Photon emission for (n,2n)

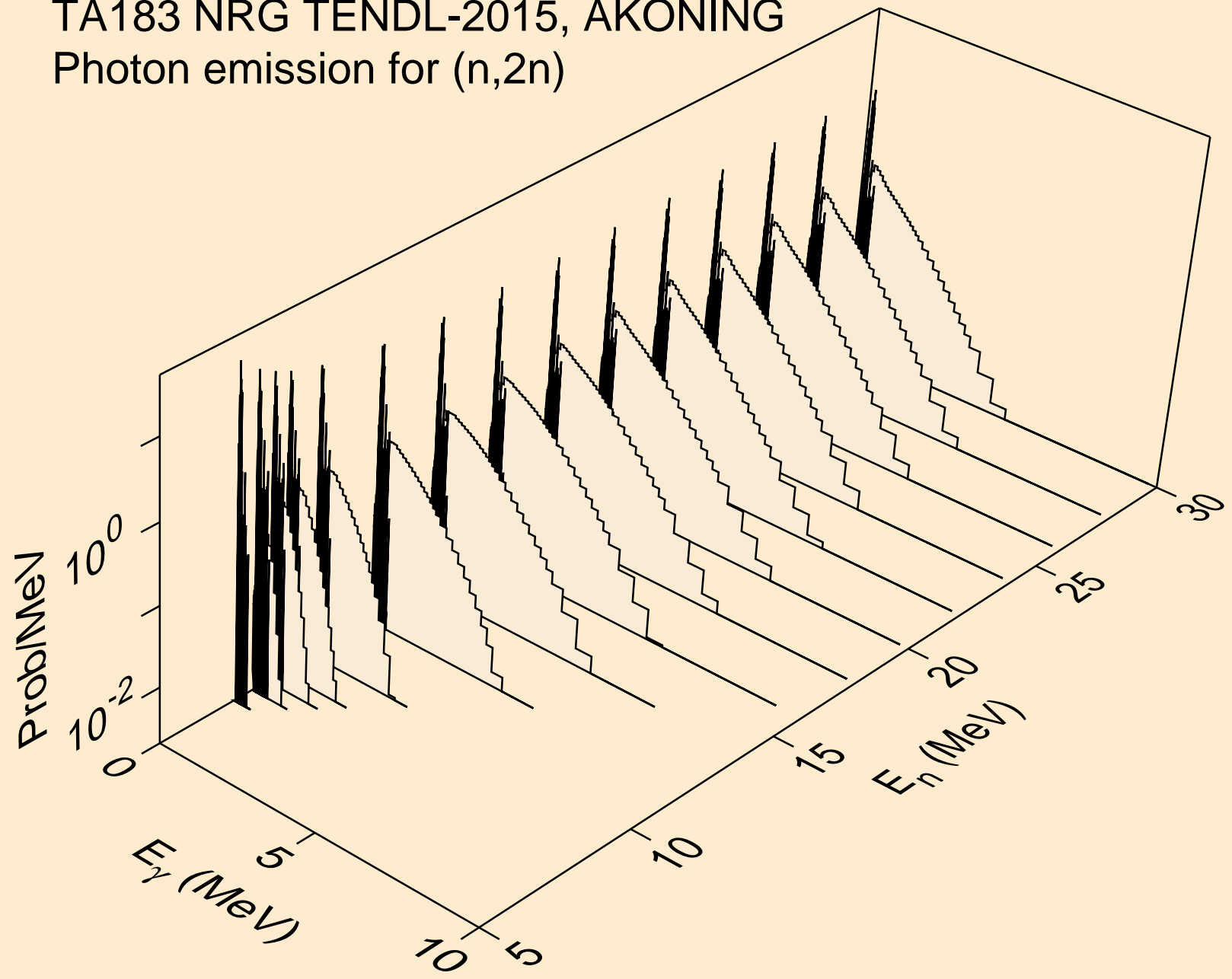

TA183 NRG TENDL-2015, AKONING
Photon emission for (n,3n)

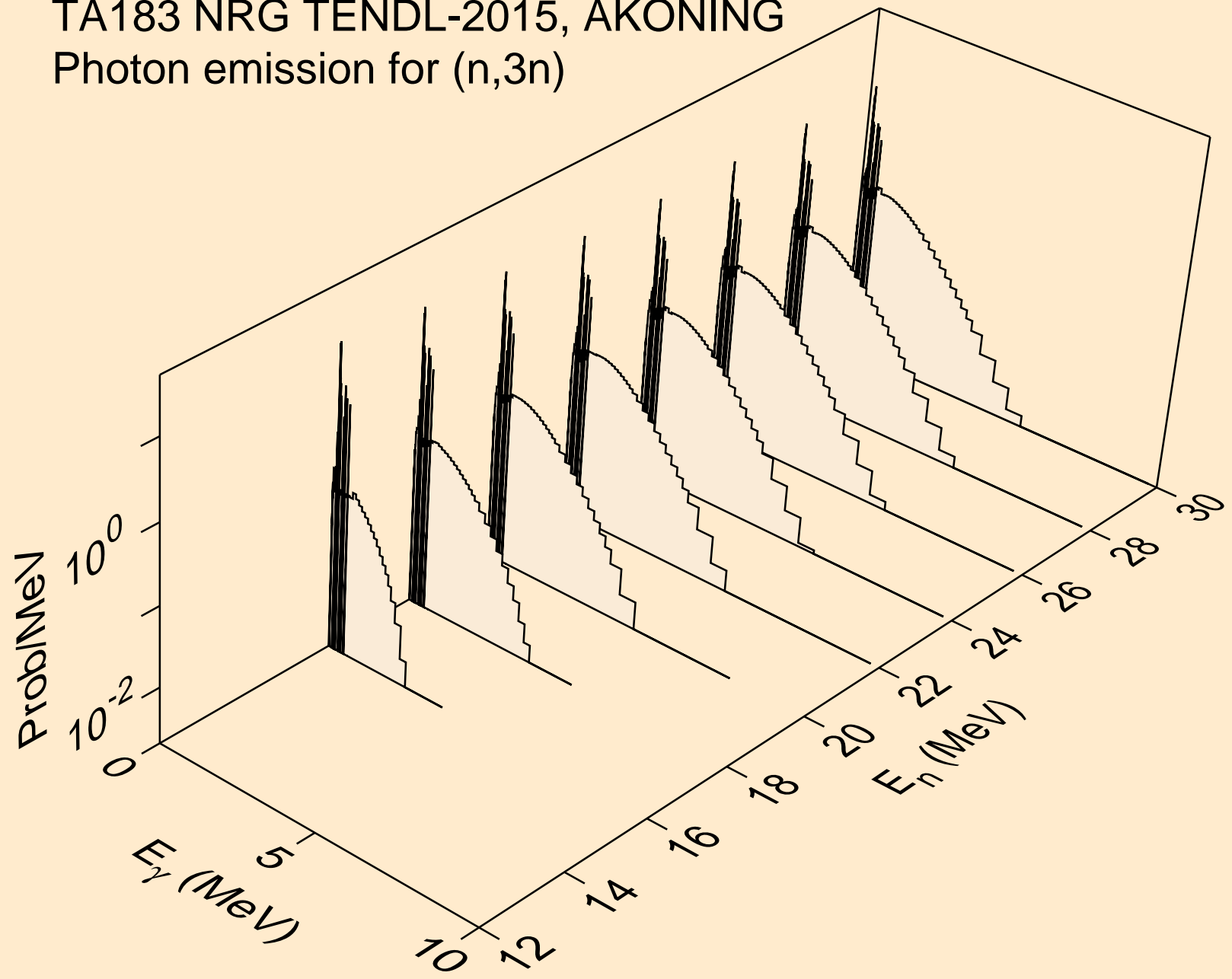

TA183 NRG TENDL-2015, AKONING
Photon emission for (n,n*)a

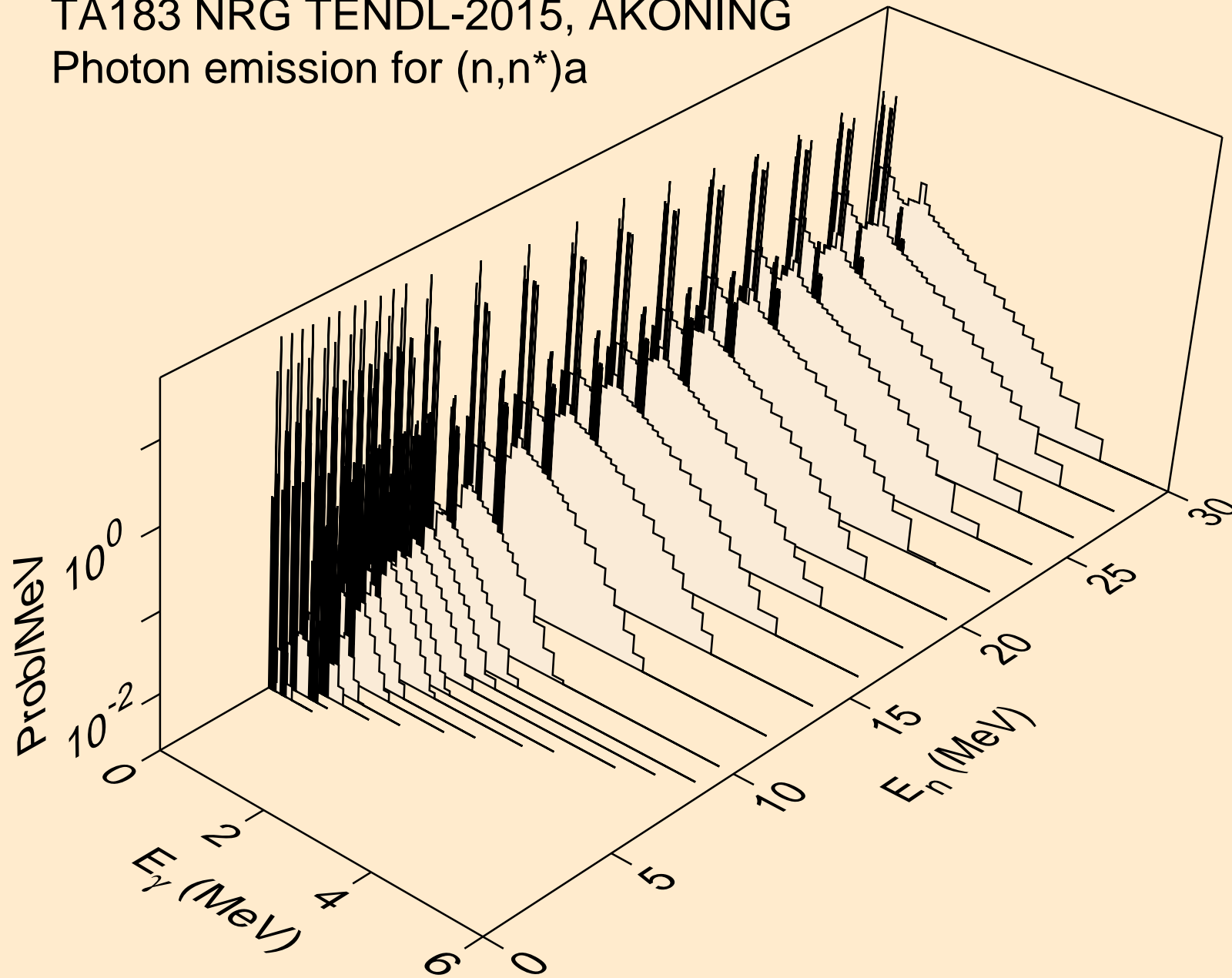

TA183 NRG TENDL-2015, AKONING
Photon emission for (n,2n)a

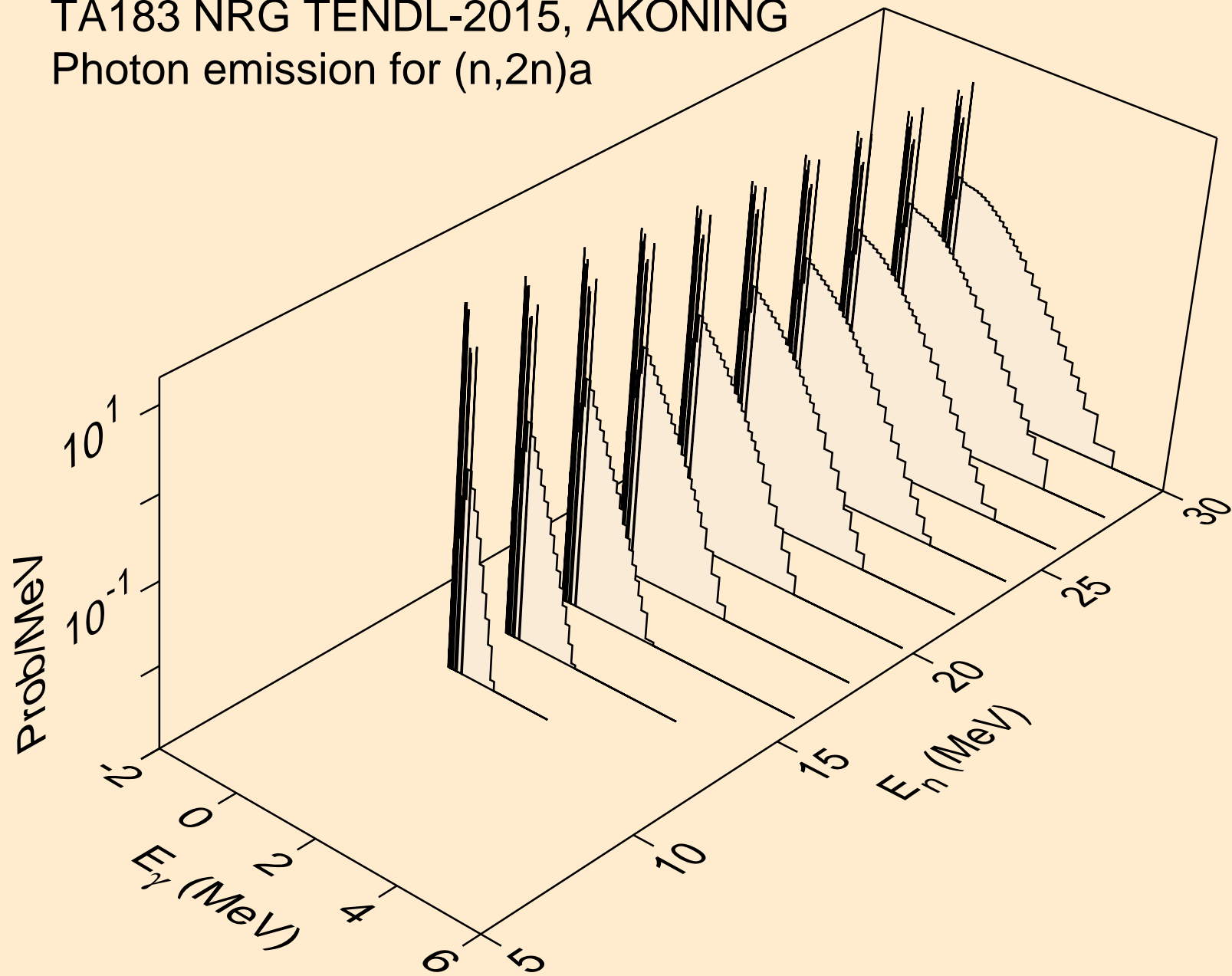

TA183 NRG TENDL-2015, AKONING
Photon emission for (n,3n)a

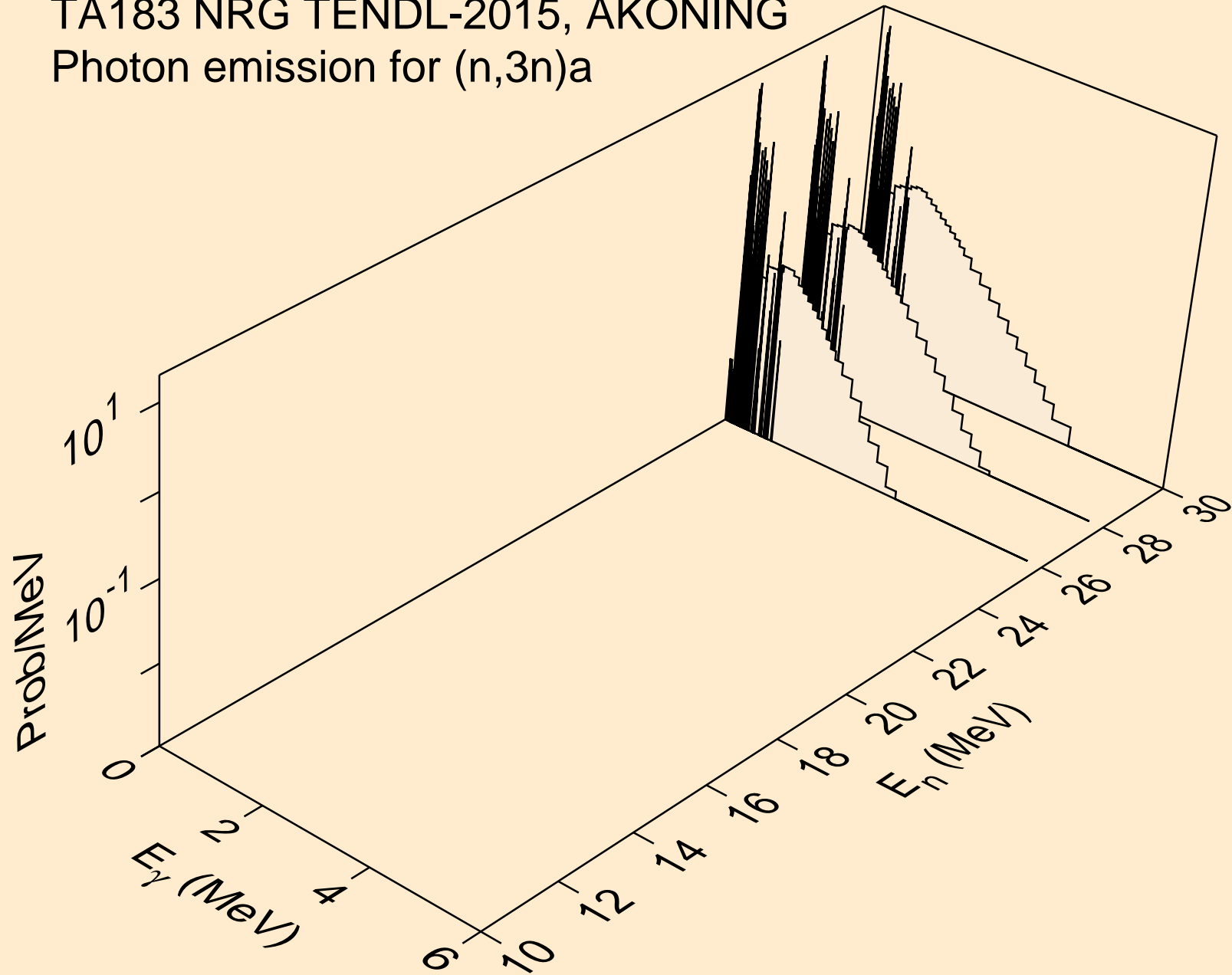

TA183 NRG TENDL-2015, AKONING
Photon emission for (n,n*)p

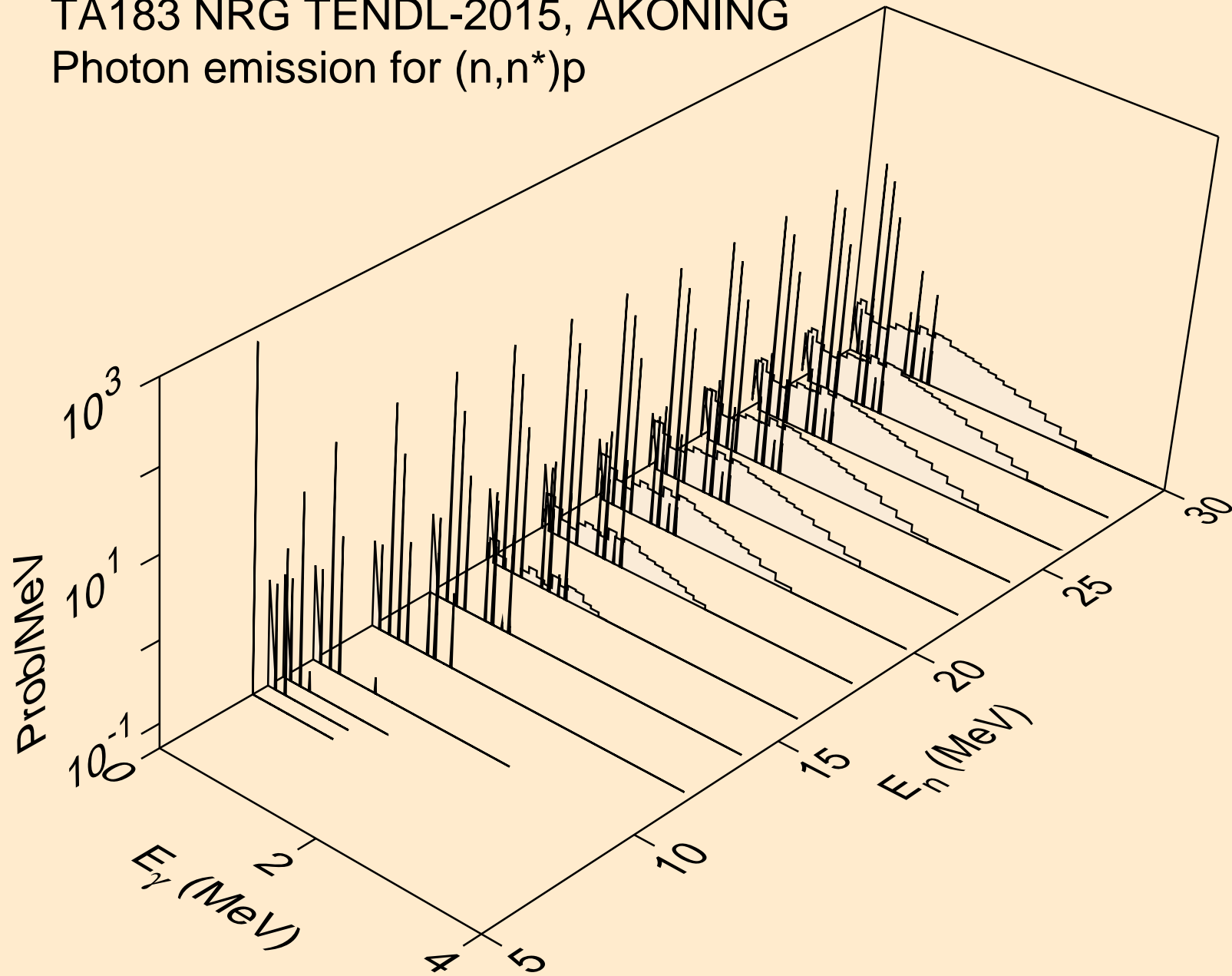

TA183 NRG TENDL-2015, AKONING
Photon emission for (n,n*)2a

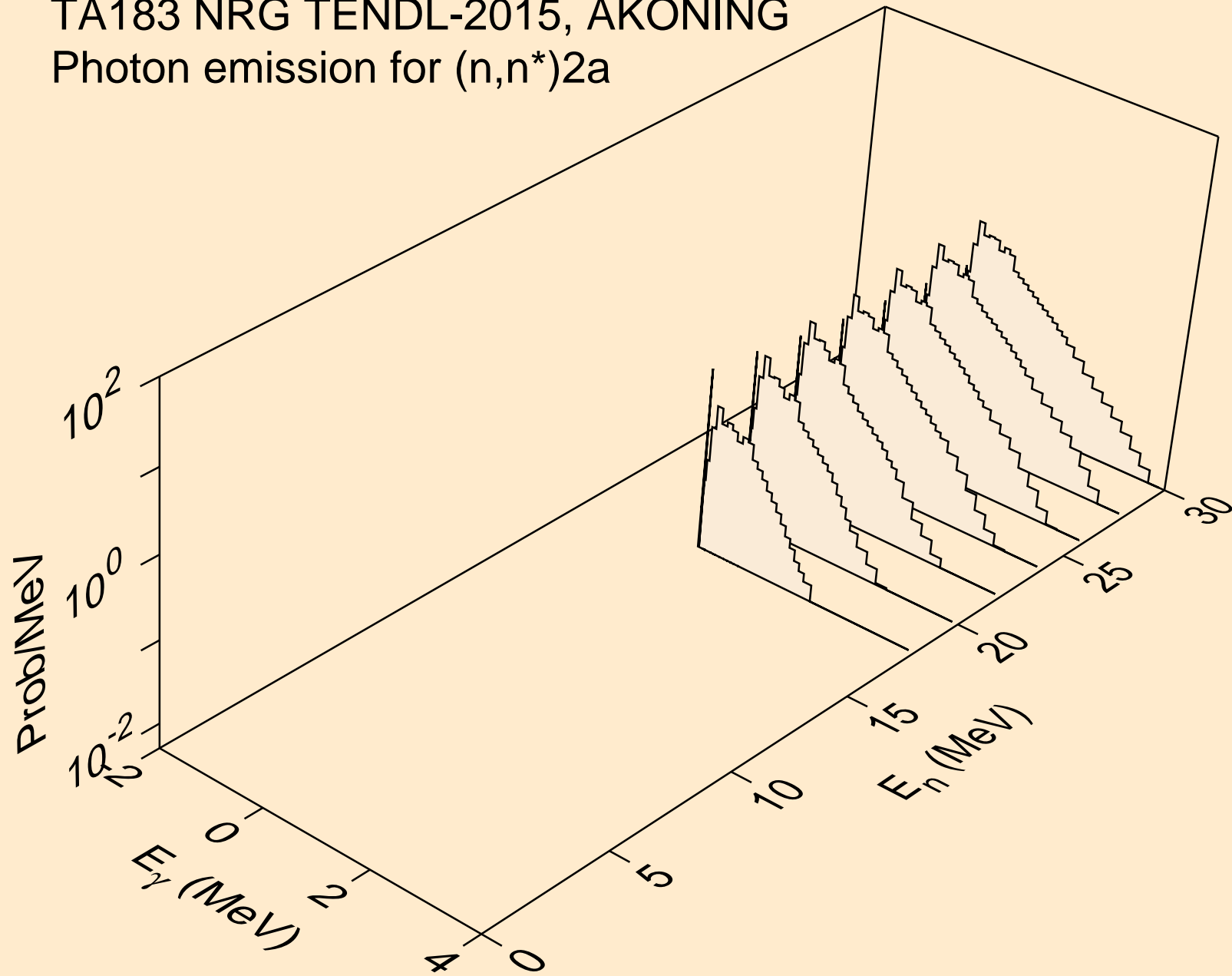

TA183 NRG TENDL-2015, AKONING
Photon emission for (n,n*)d

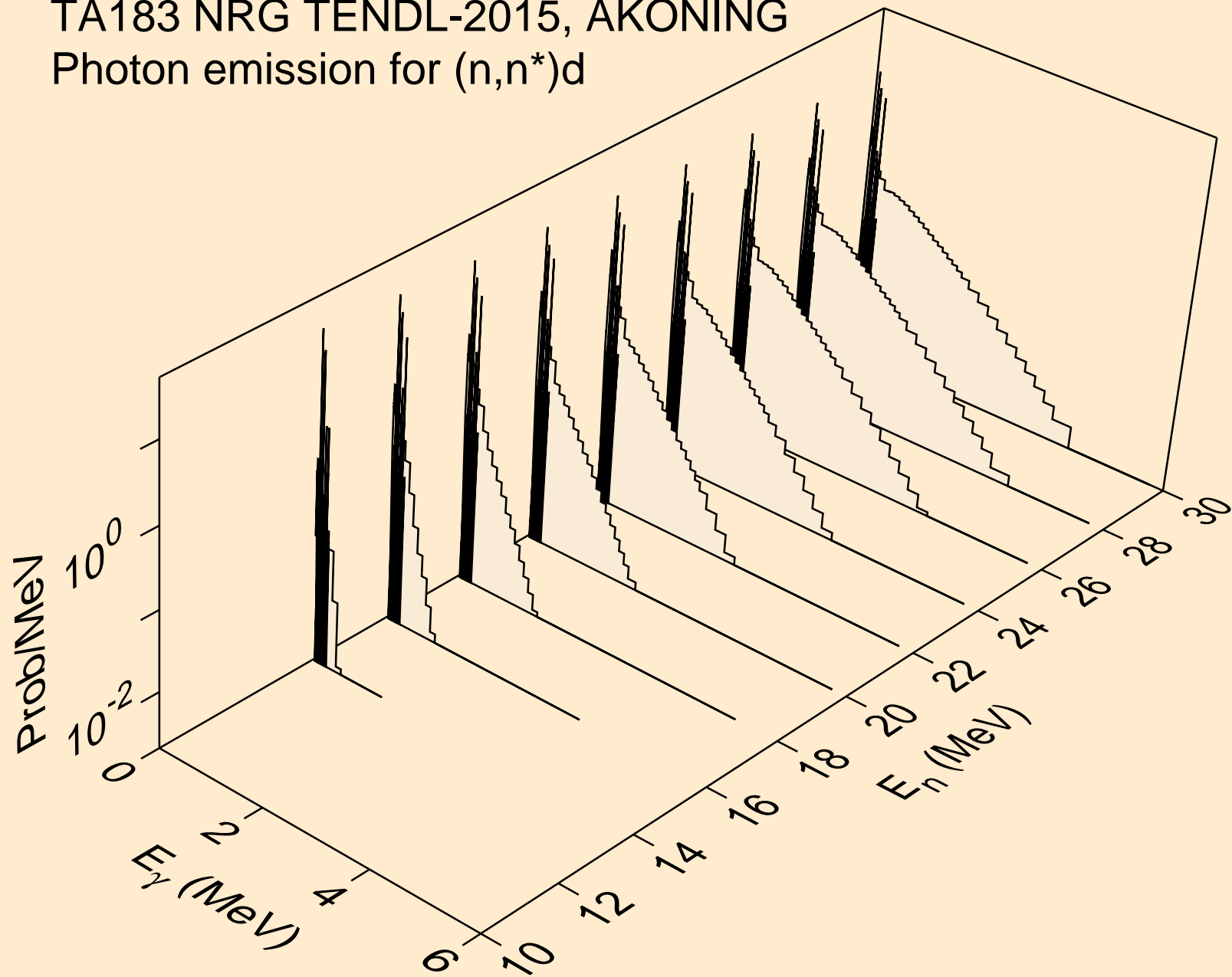

TA183 NRG TENDL-2015, AKONING
Photon emission for (n,n*)t

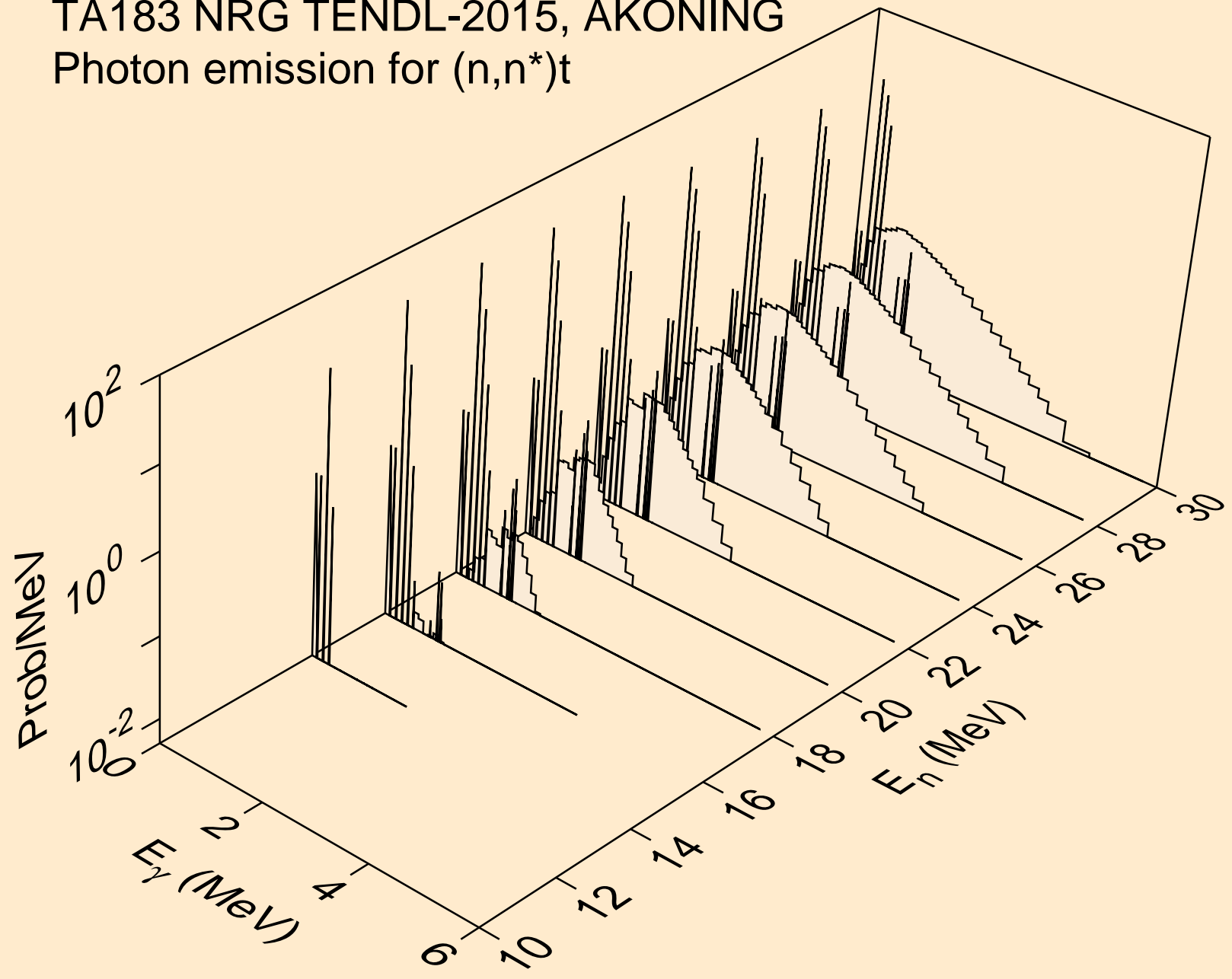

TA183 NRG TENDL-2015, AKONING
Photon emission for (n,n*)he3

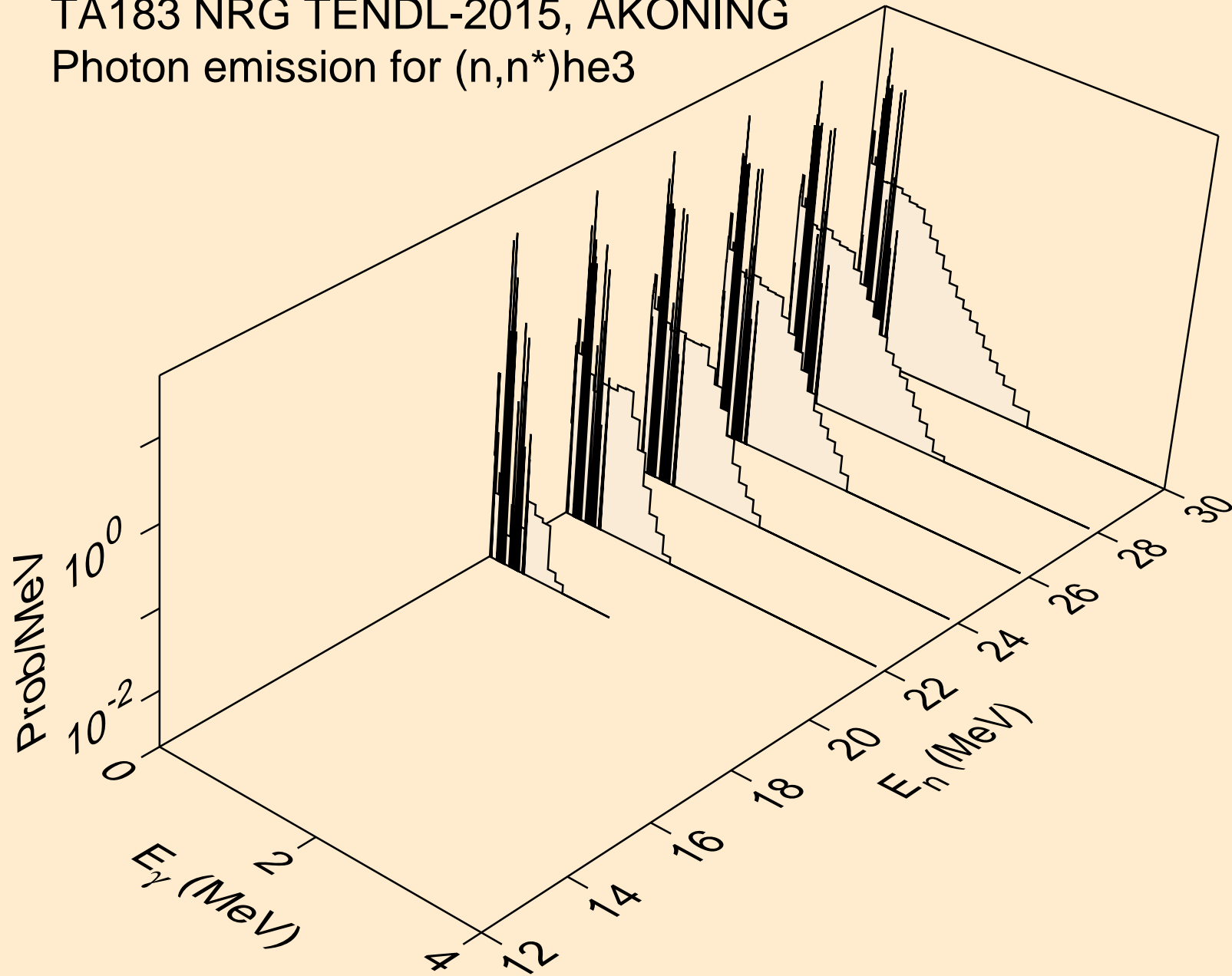

TA183 NRG TENDL-2015, AKONING
Photon emission for (n,4n)

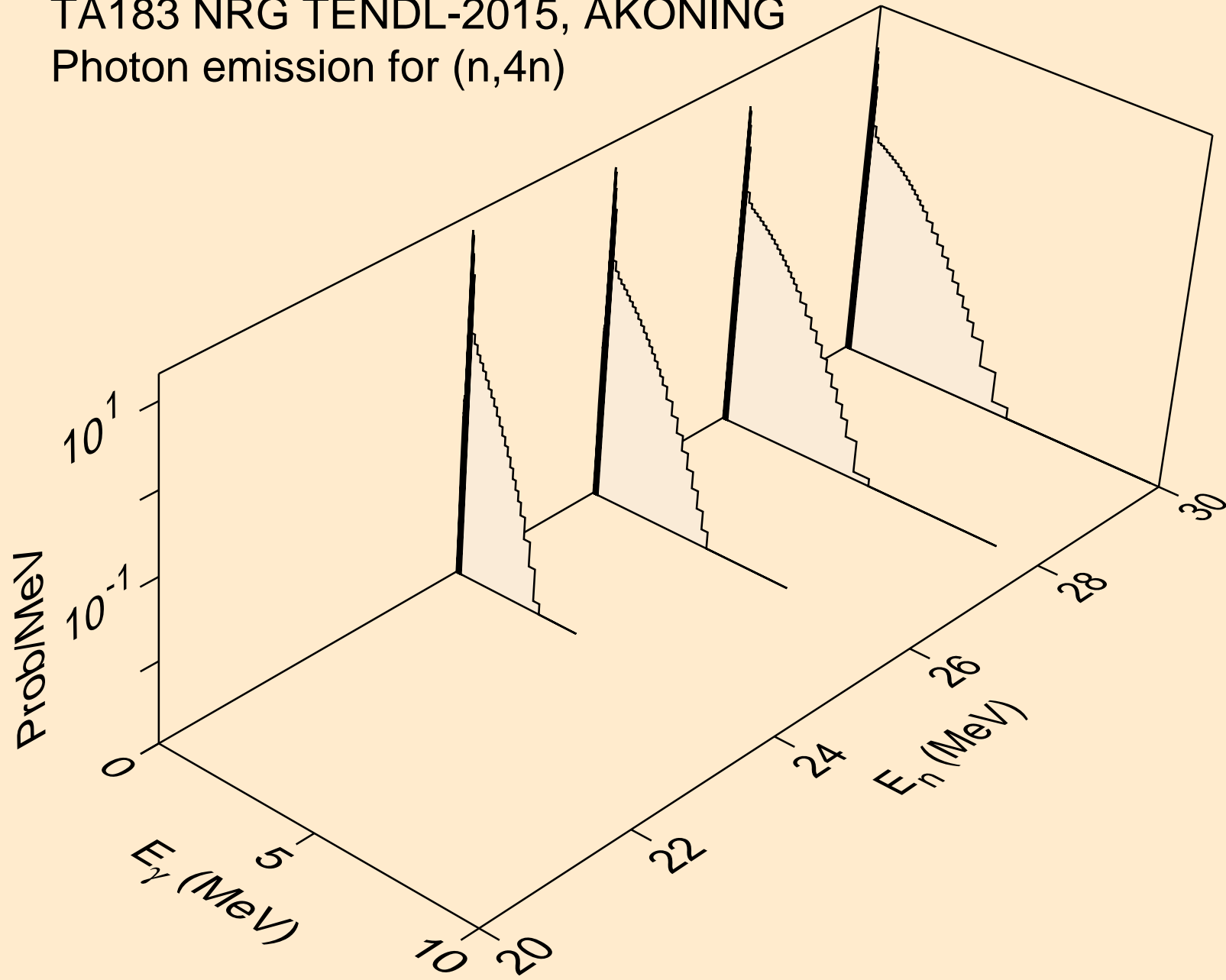

TA183 NRG TENDL-2015, AKONING
Photon emission for (n,2np)

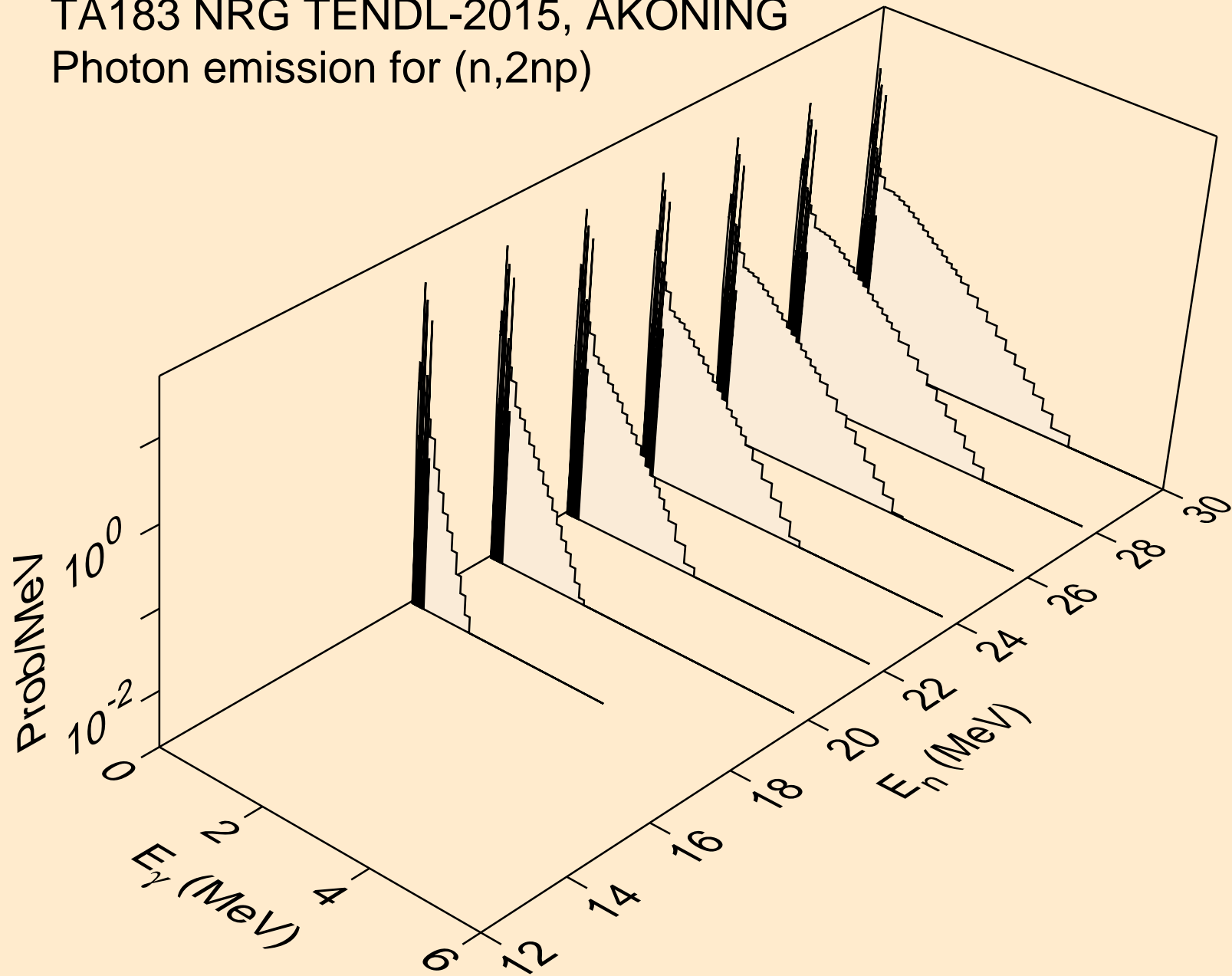

TA183 NRG TENDL-2015, AKONING
Photon emission for (n,3np)

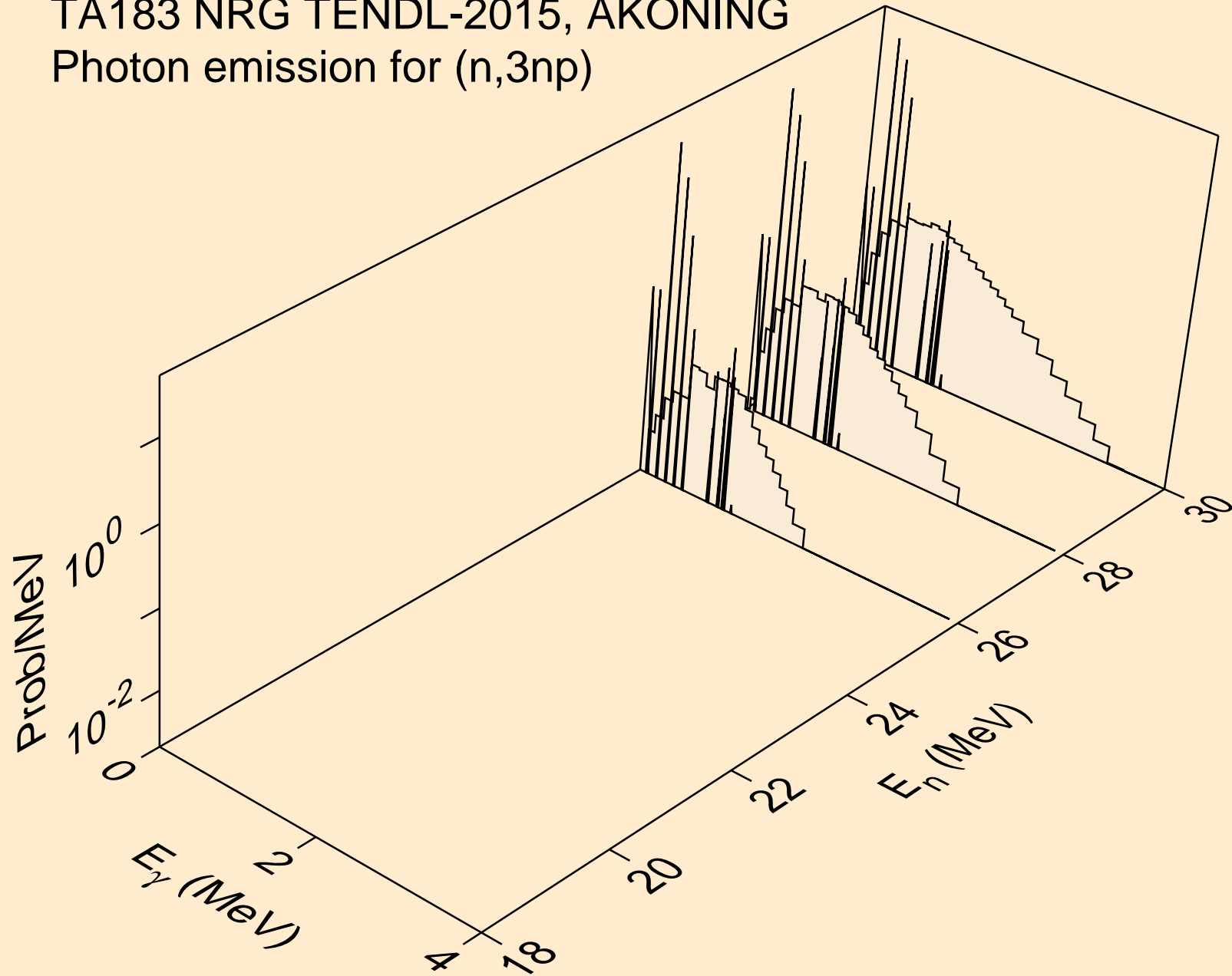

TA183 NRG TENDL-2015, AKONING
Photon emission for (n,2np)

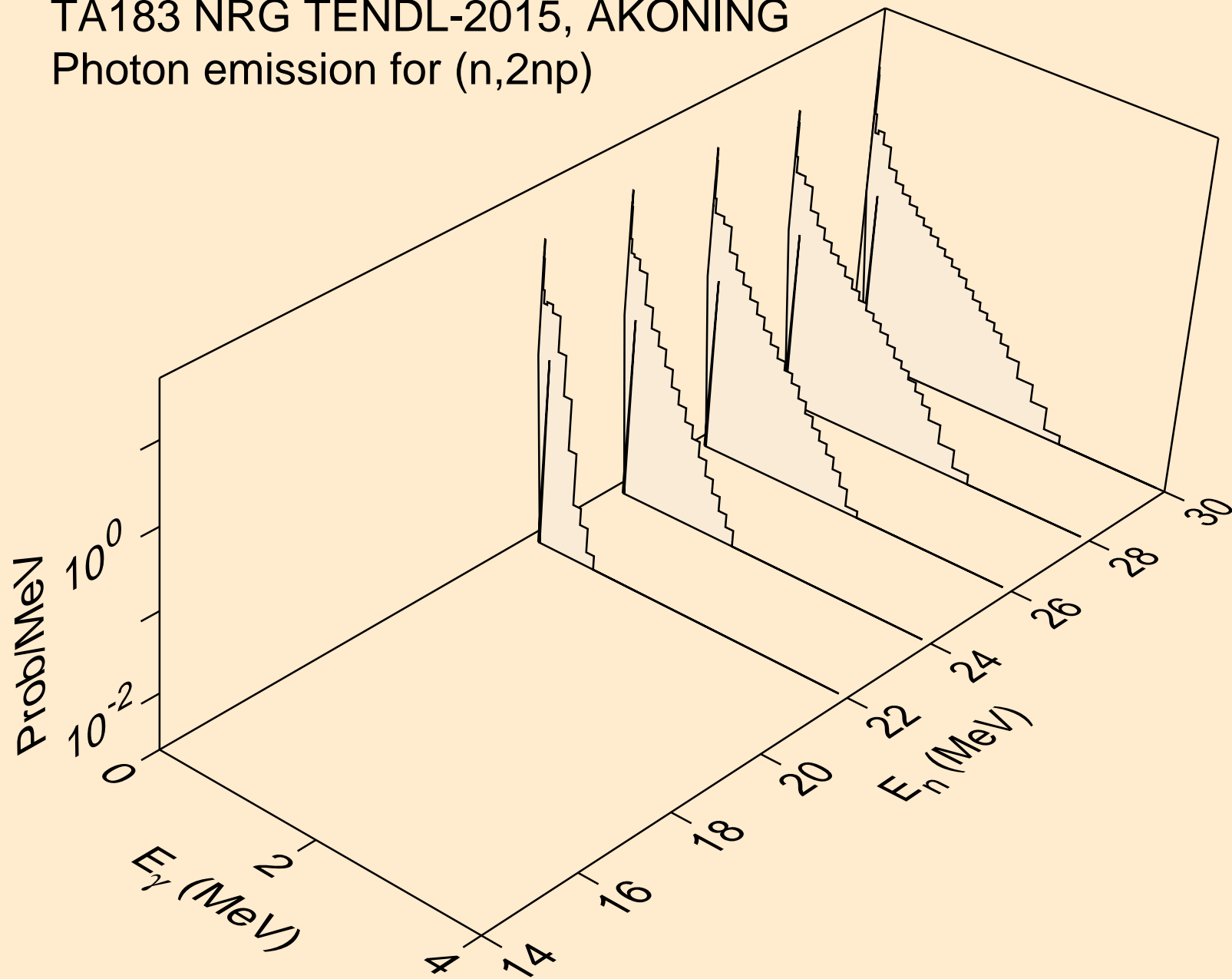

TA183 NRG TENDL-2015, AKONING
Photon emission for (n,npa)

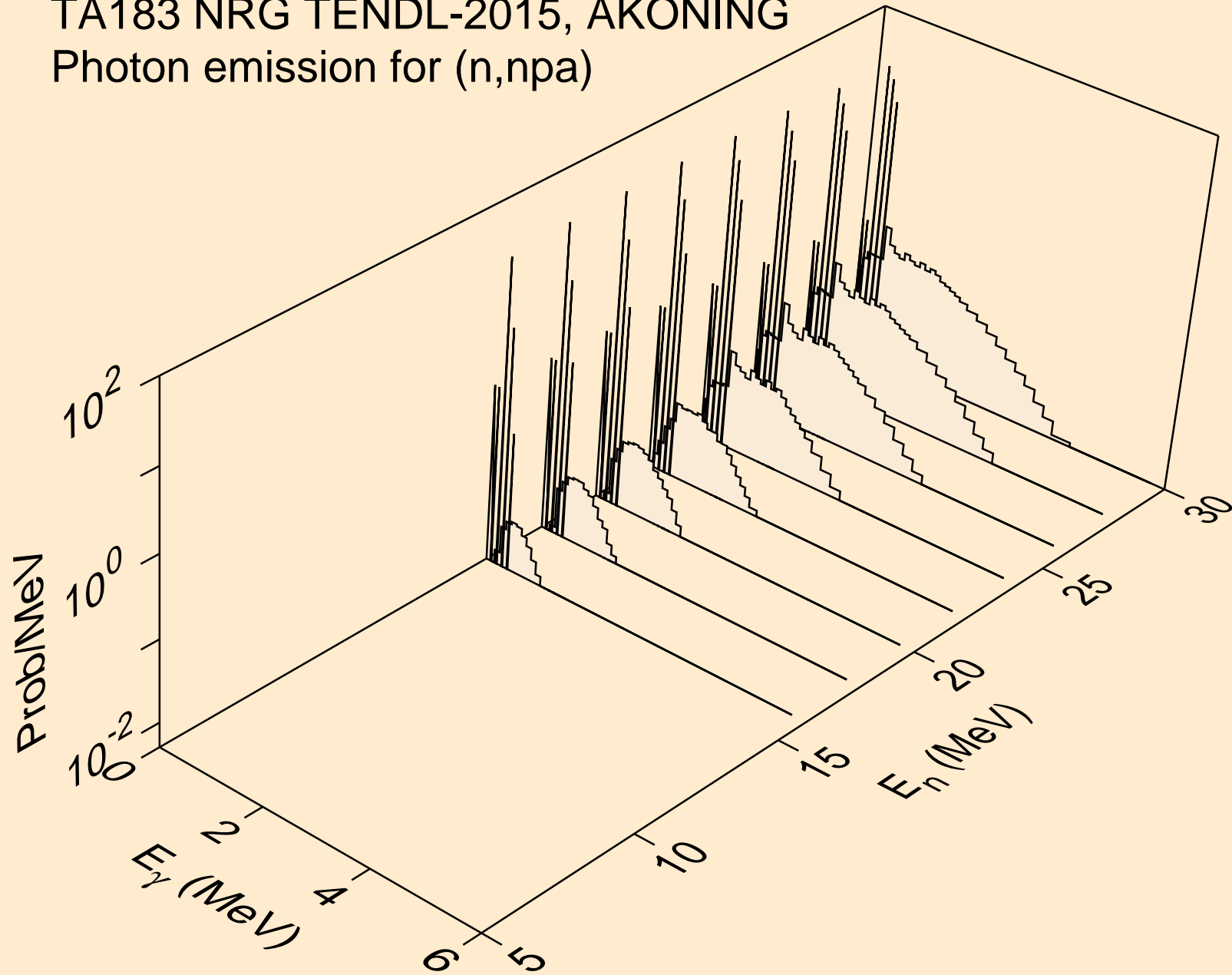

TA183 NRG TENDL-2015, AKONING
Photon emission for (n,n*c)

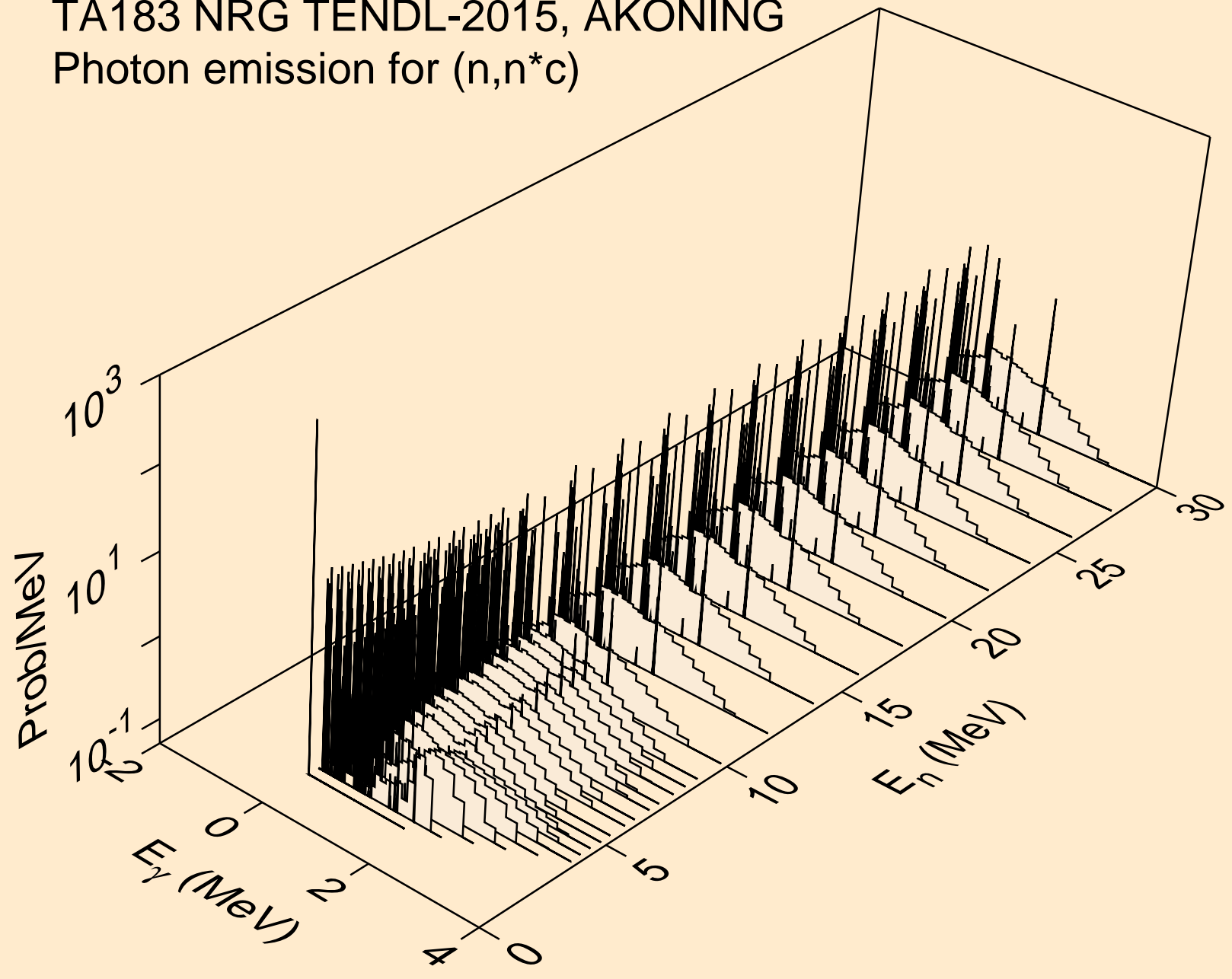

TA183 NRG TENDL-2015, AKONING
Photon emission for (n,gma)

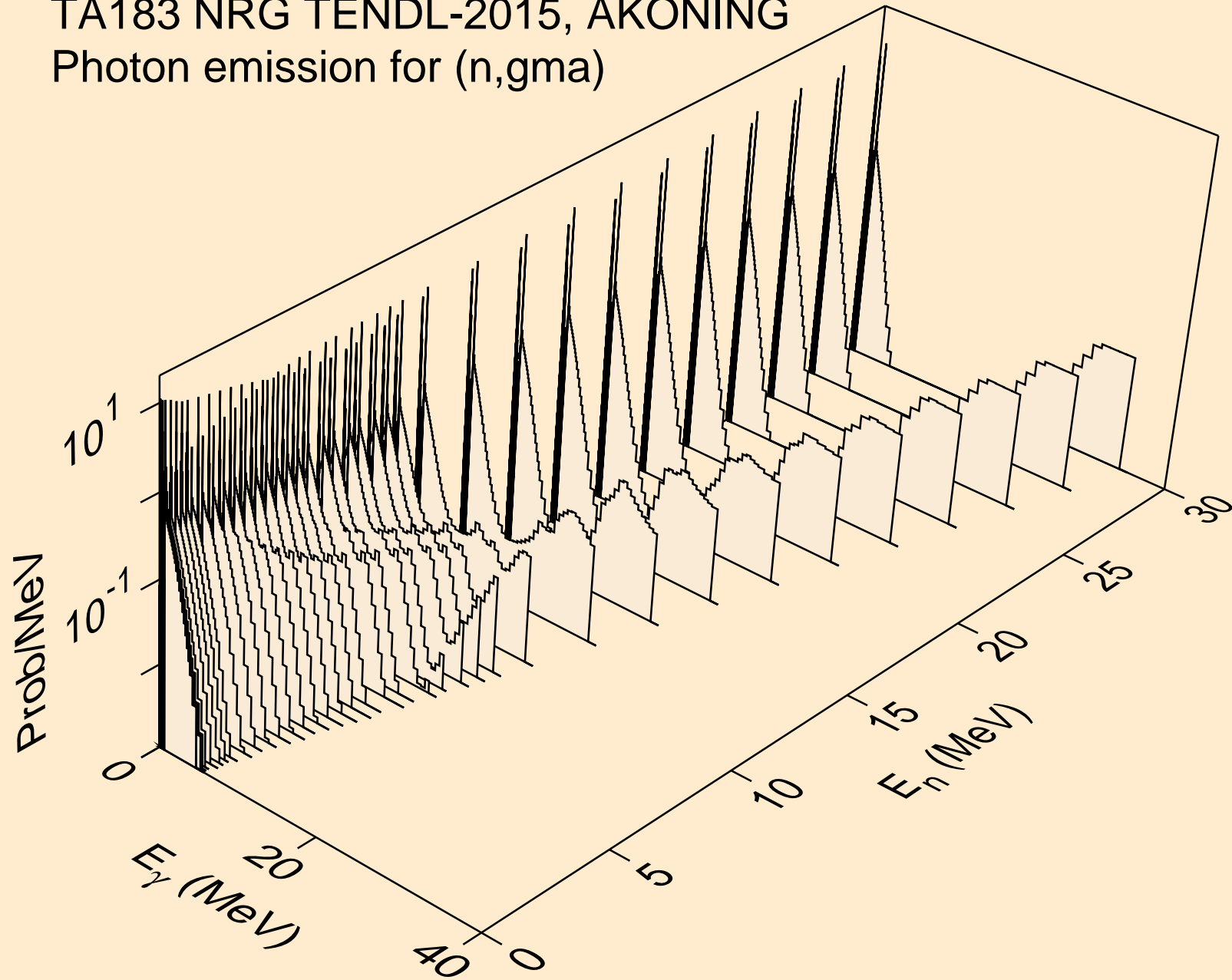

TA183 NRG TENDL-2015, AKONING
Photon emission for (n,p)

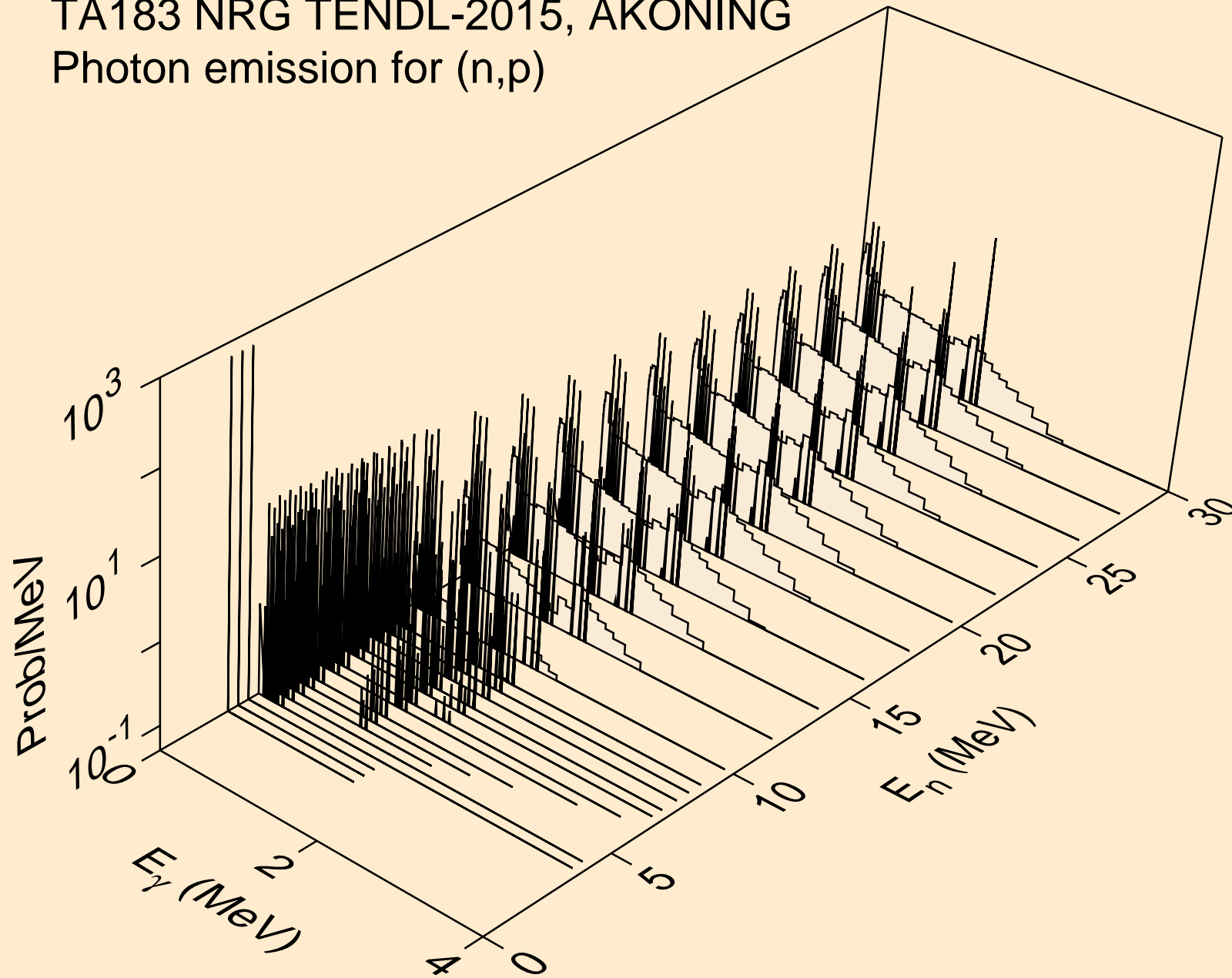

TA183 NRG TENDL-2015, AKONING
Photon emission for (n,d)

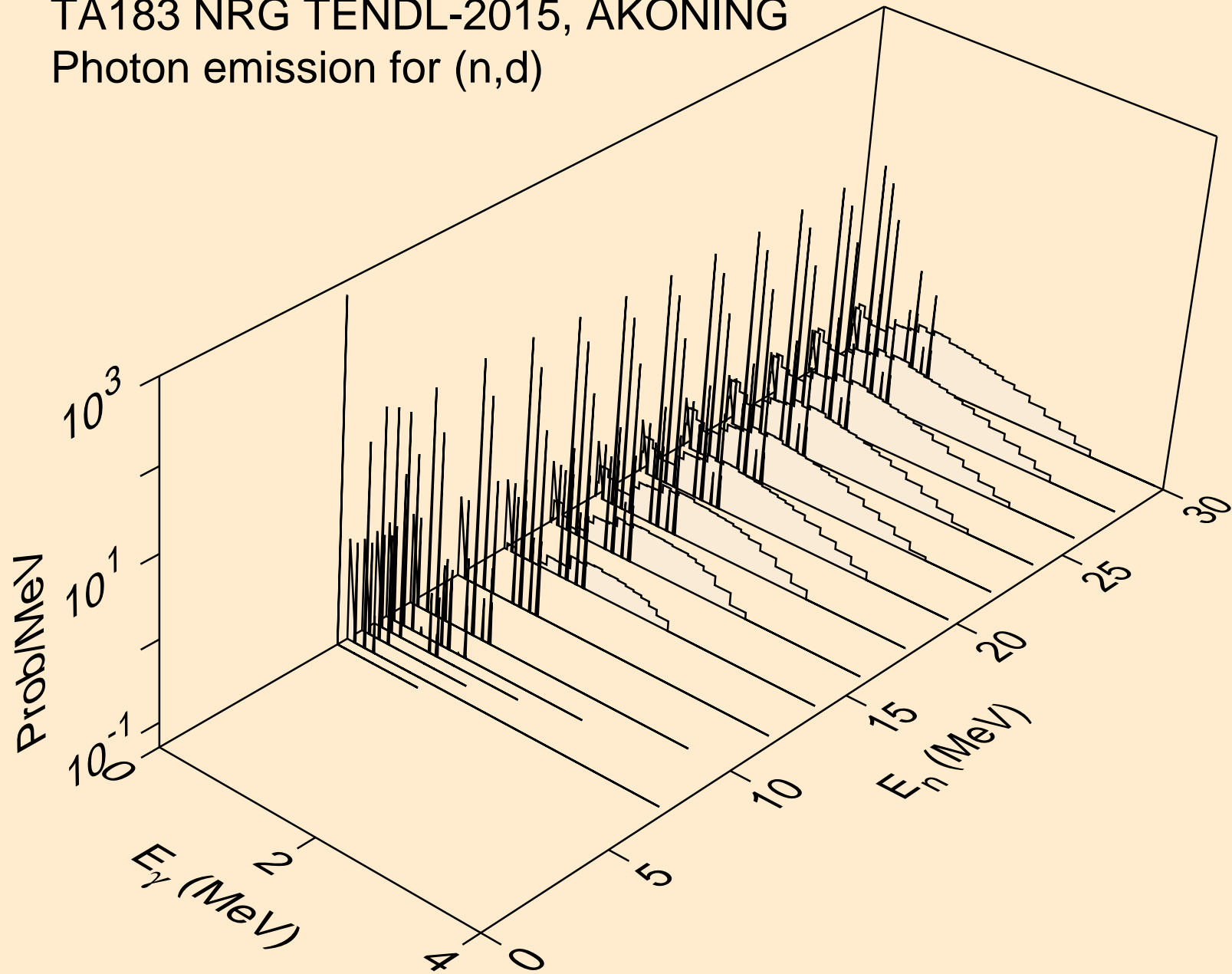

TA183 NRG TENDL-2015, AKONING
Photon emission for (n,t)

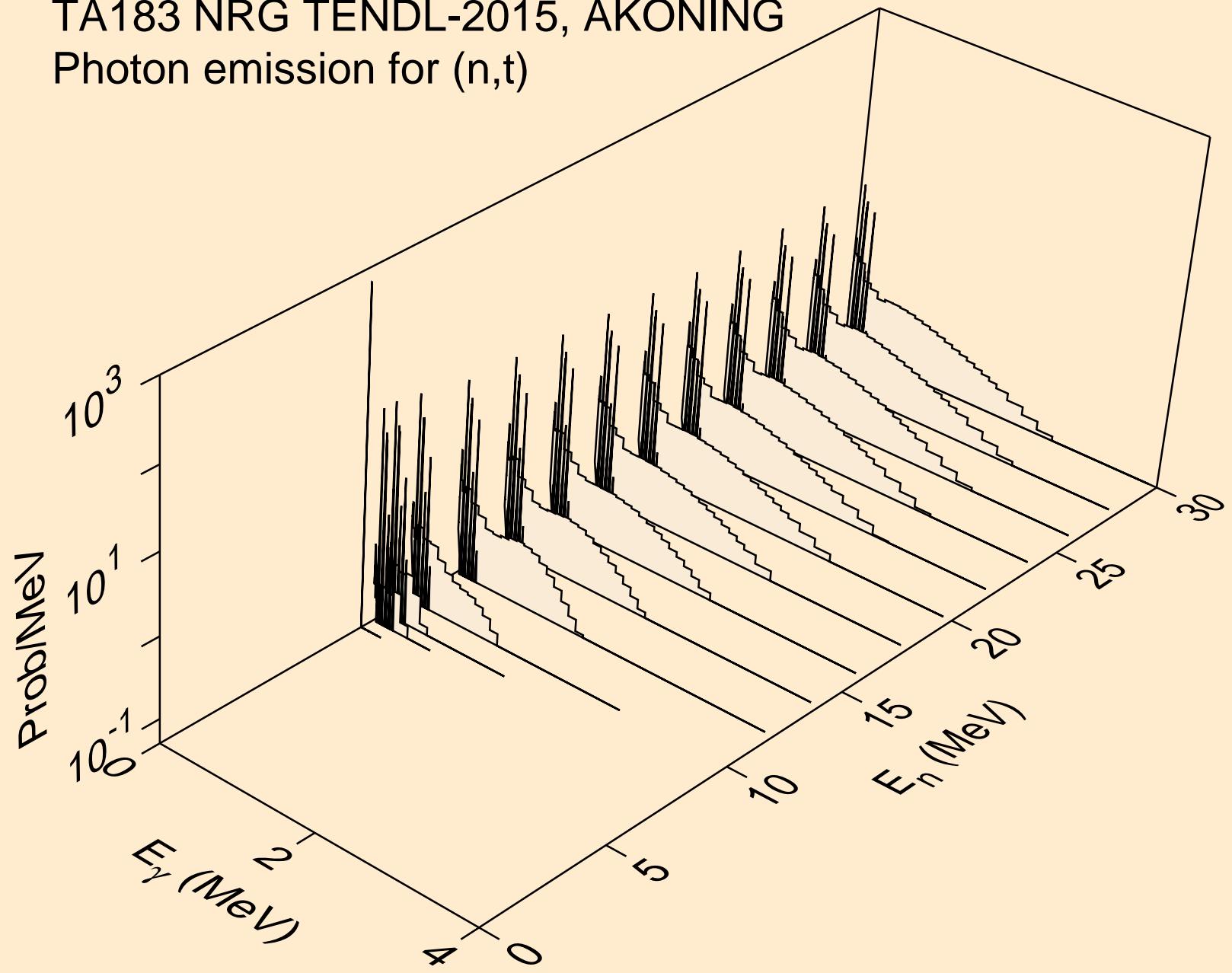

TA183 NRG TENDL-2015, AKONING
Photon emission for (n,he3)

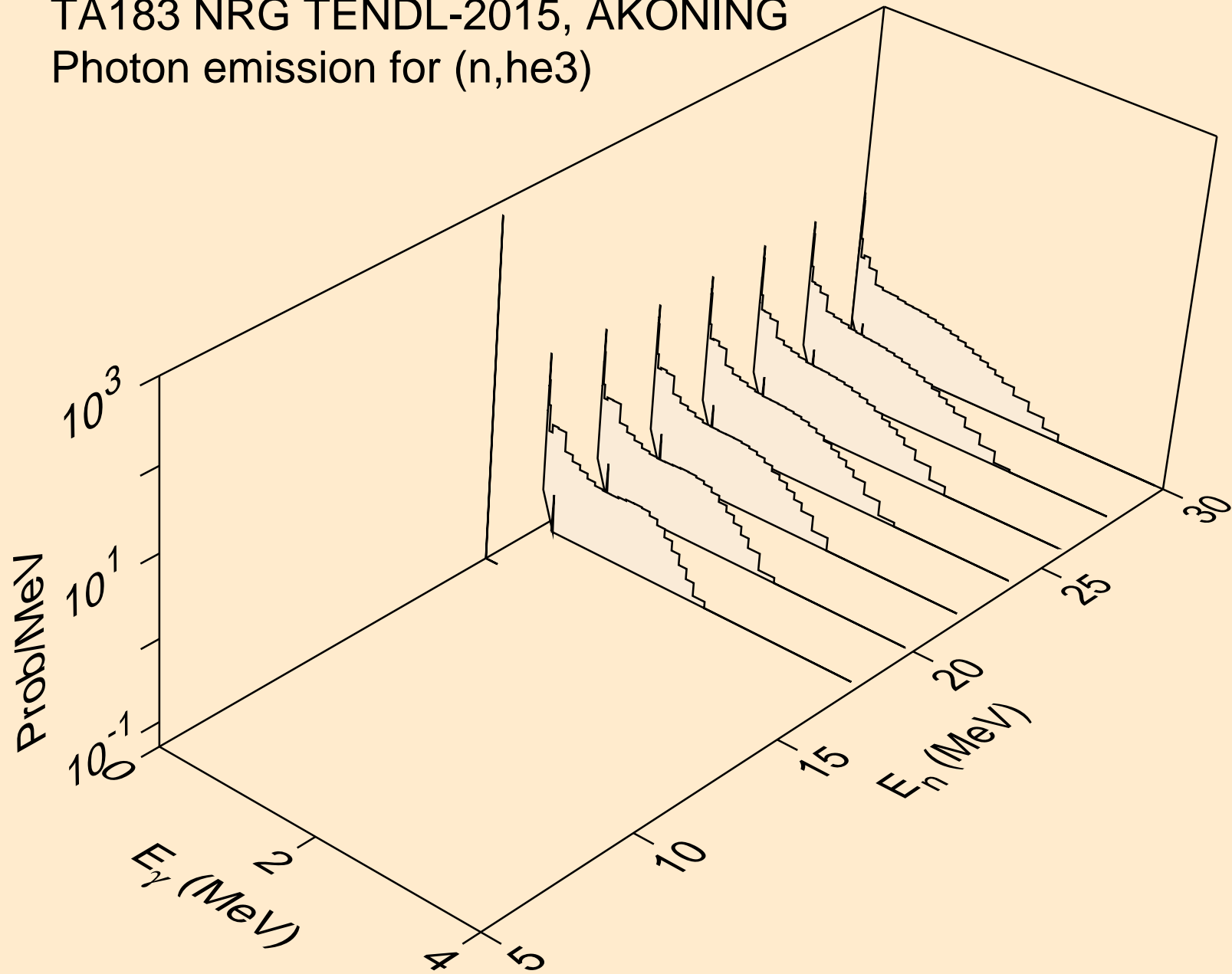

TA183 NRG TENDL-2015, AKONING
Photon emission for (n,a)

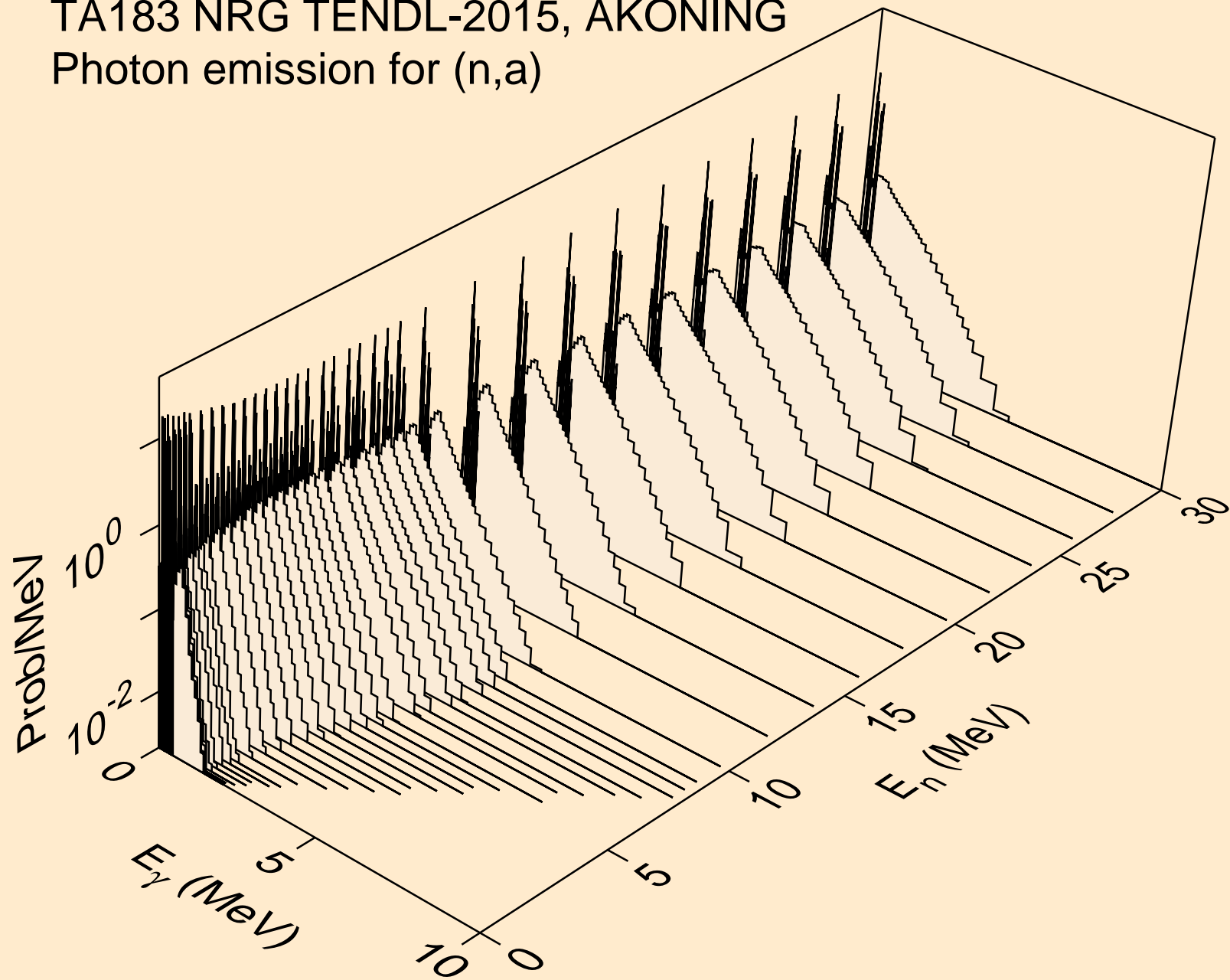

TA183 NRG TENDL-2015, AKONING
Photon emission for (n,2a)

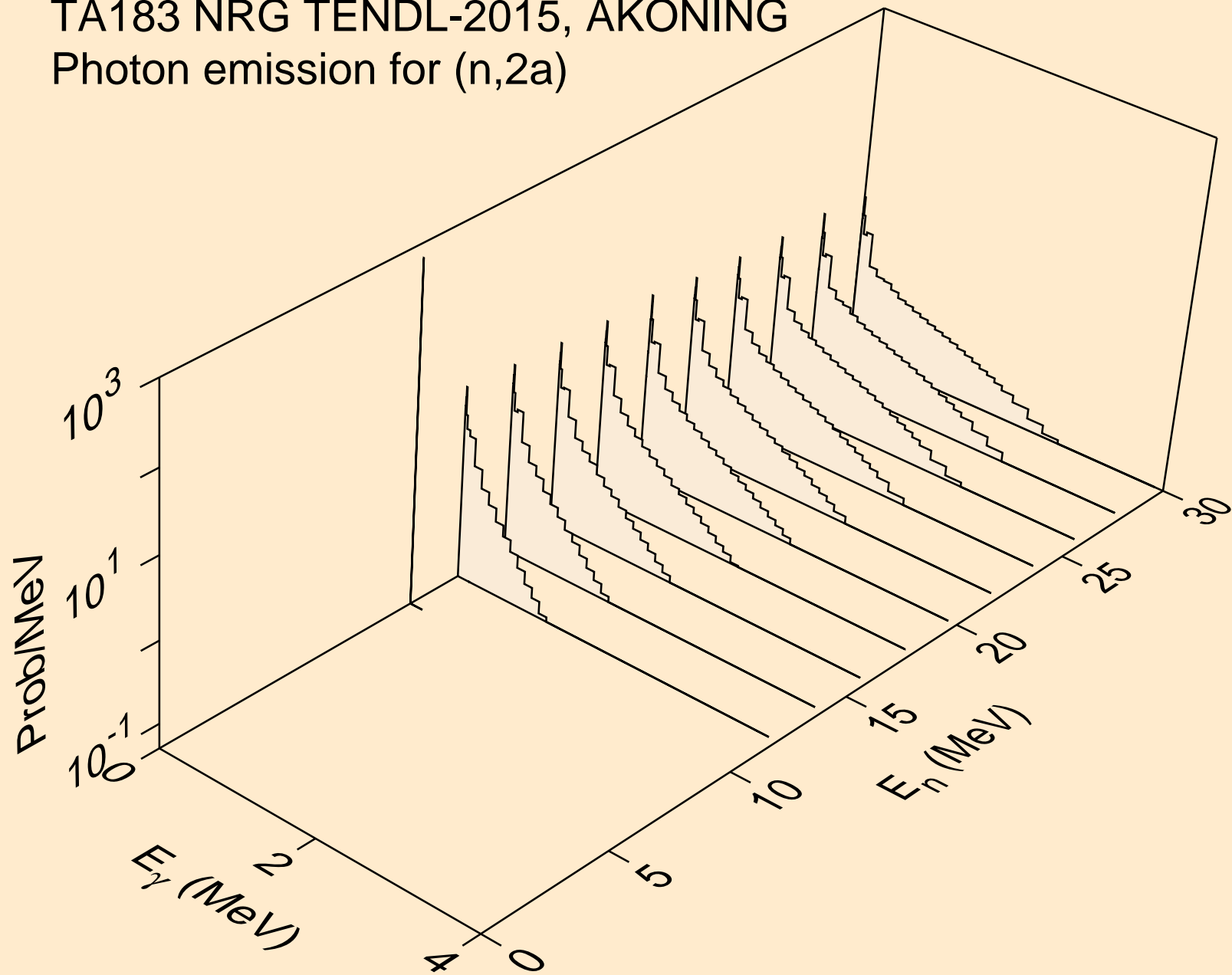

TA183 NRG TENDL-2015, AKONING
Photon emission for (n,2p)

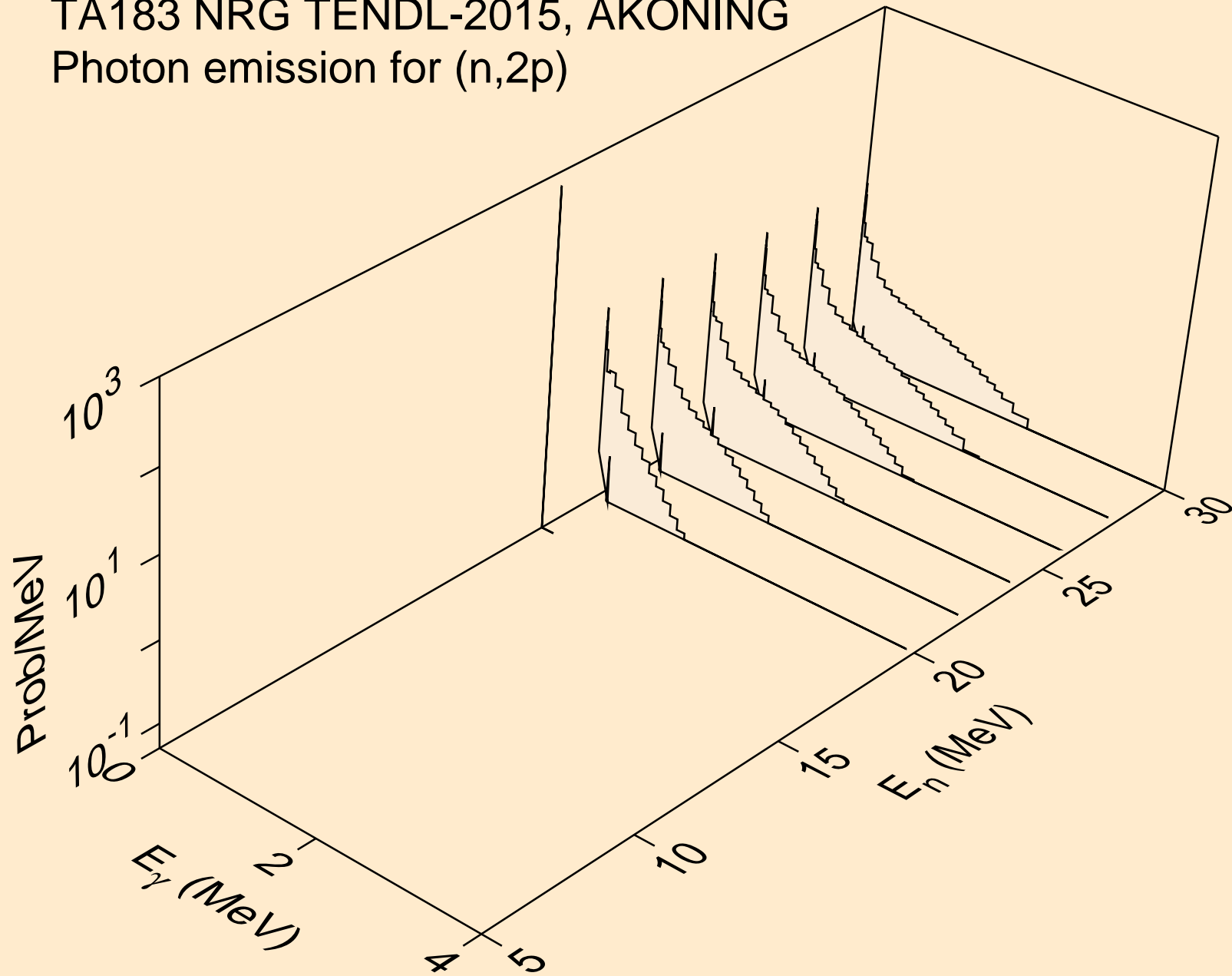

TA183 NRG TENDL-2015, AKONING
Photon emission for (n,pa)

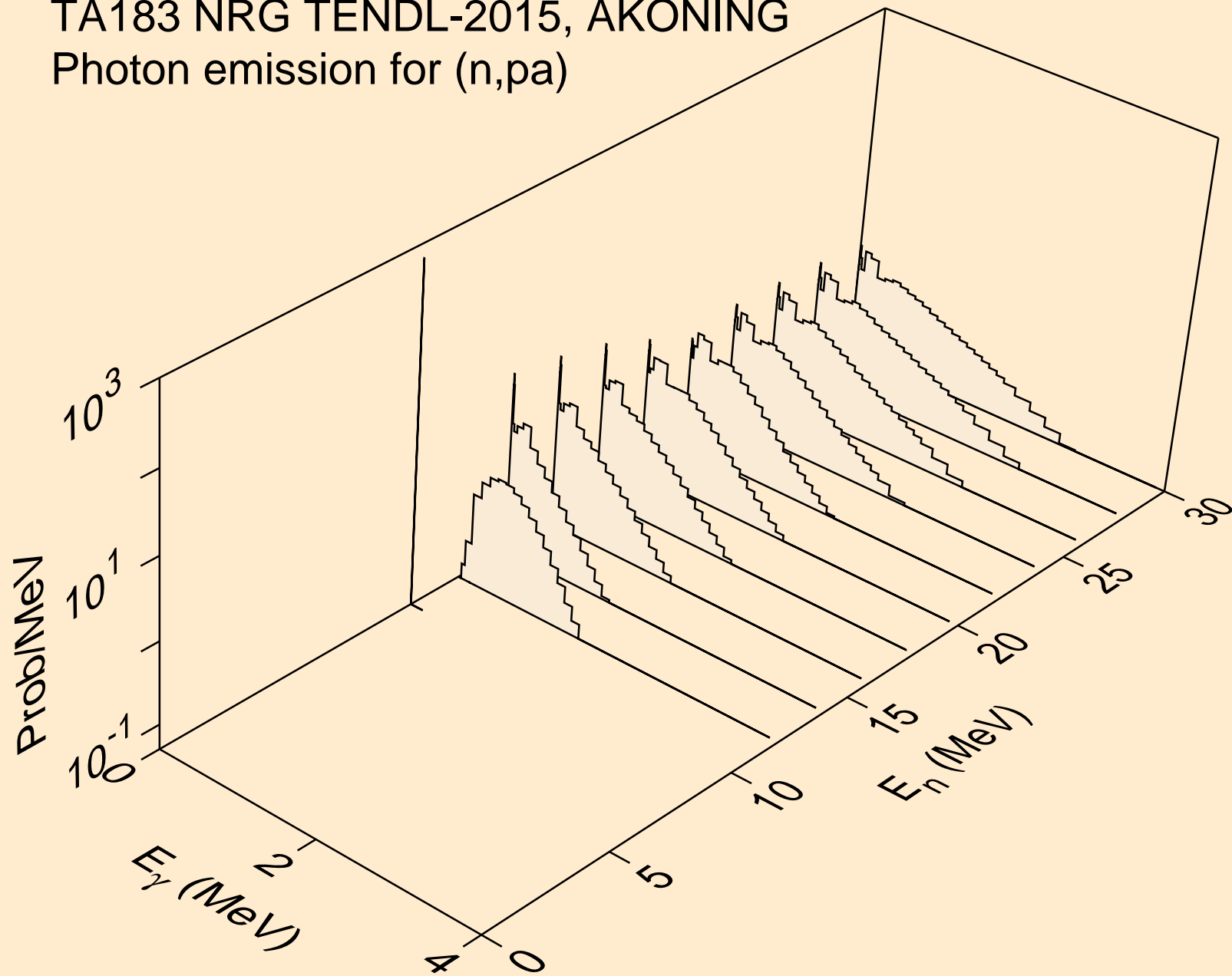

TA183 NRG TENDL-2015, AKONING
thermal capture photon spectrum

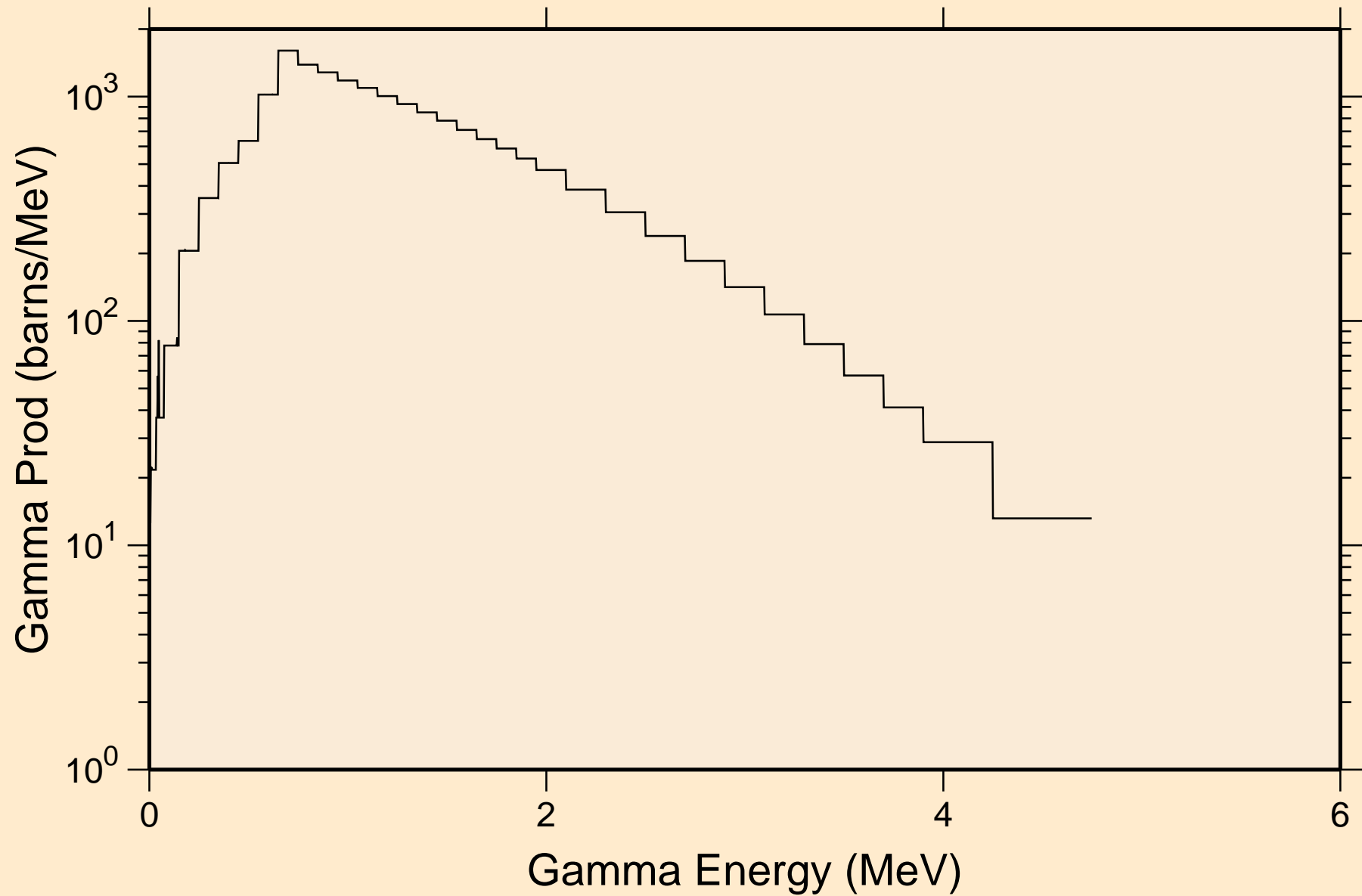

TA183 NRG TENDL-2015, AKONING
14 MeV photon spectrum

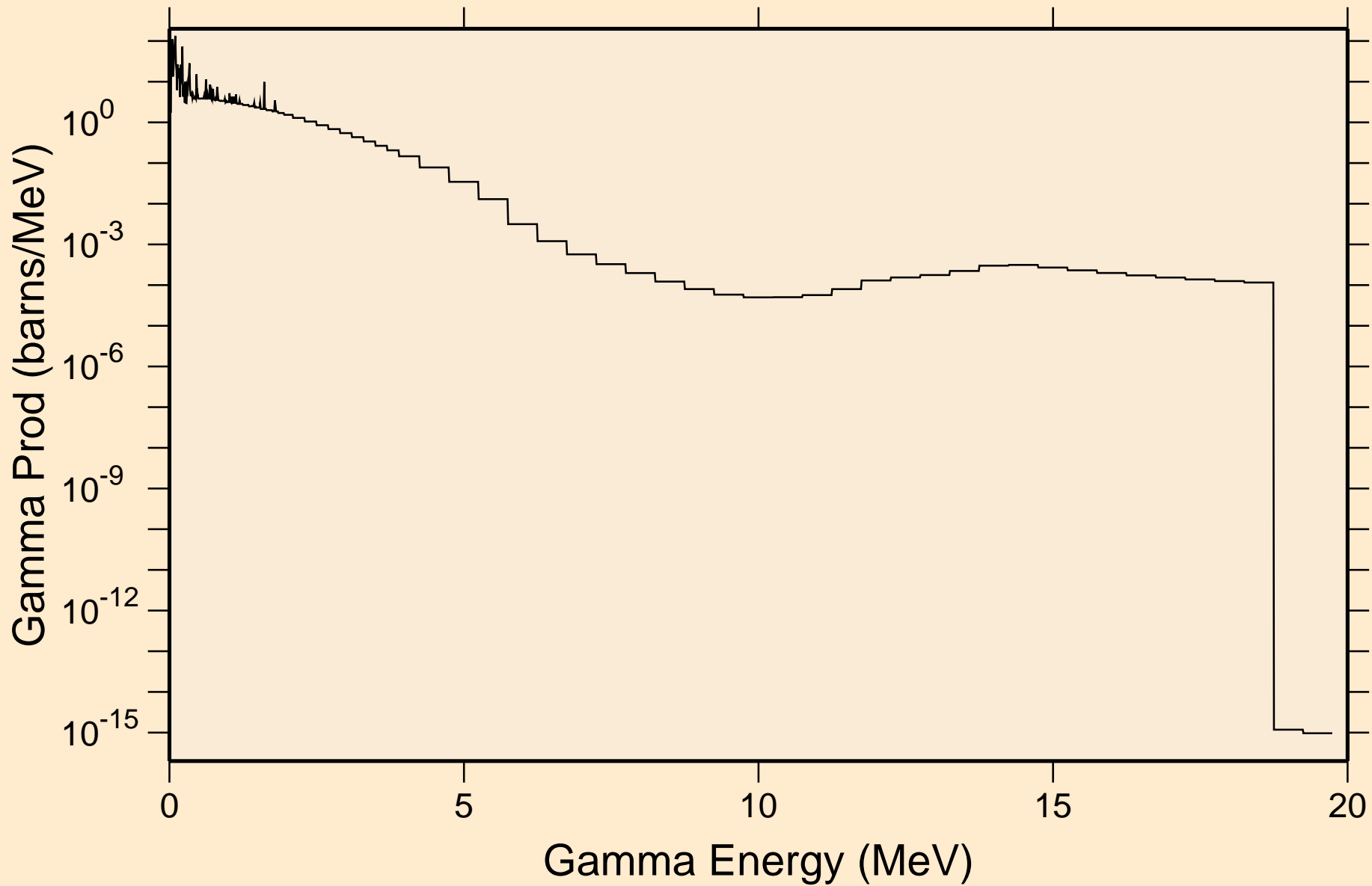

TA183 NRG TENDL-2015, AKONING

Particle heating contributions

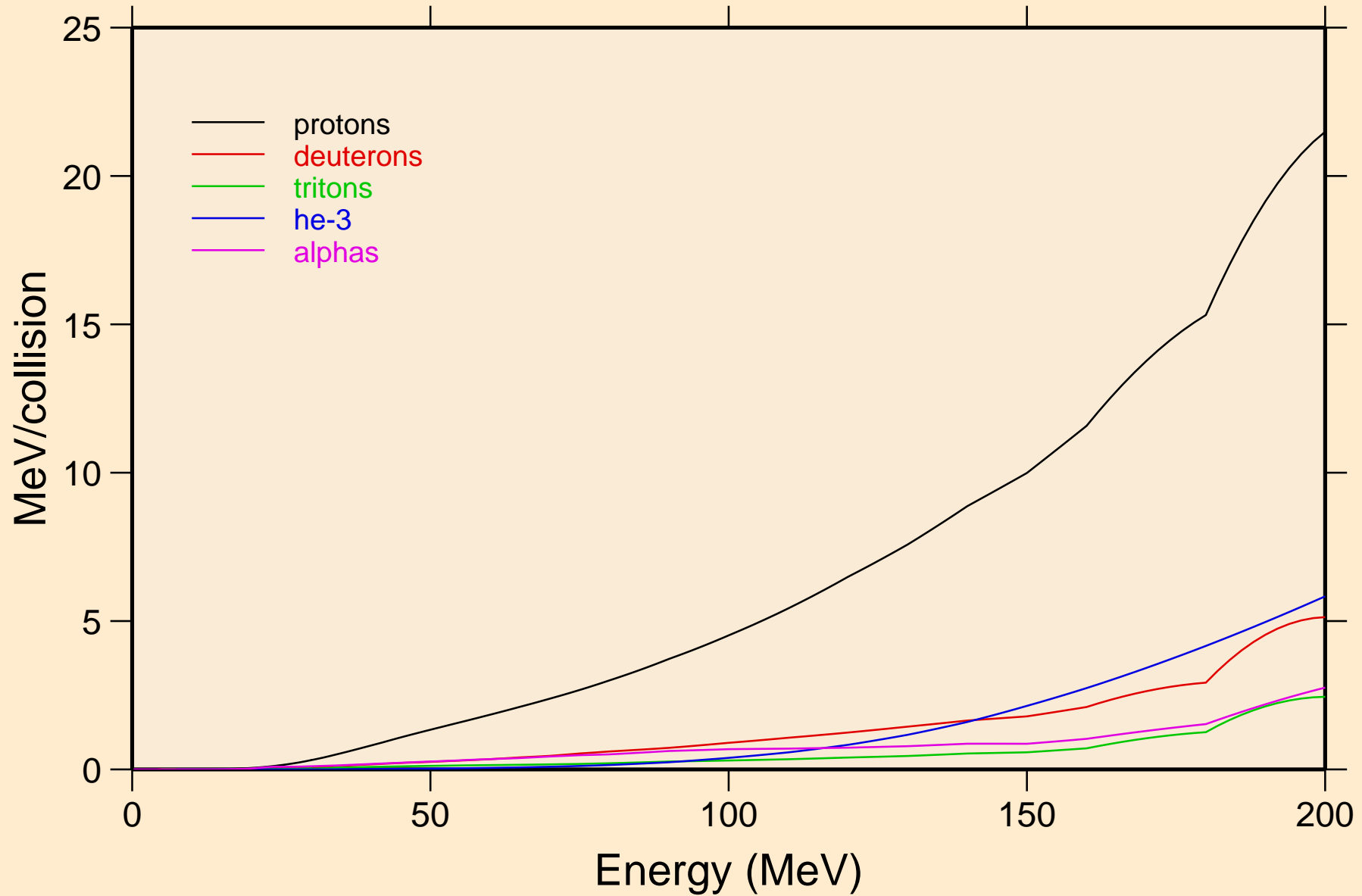

TA183 NRG TENDL-2015, AKONING

Recoil Heating

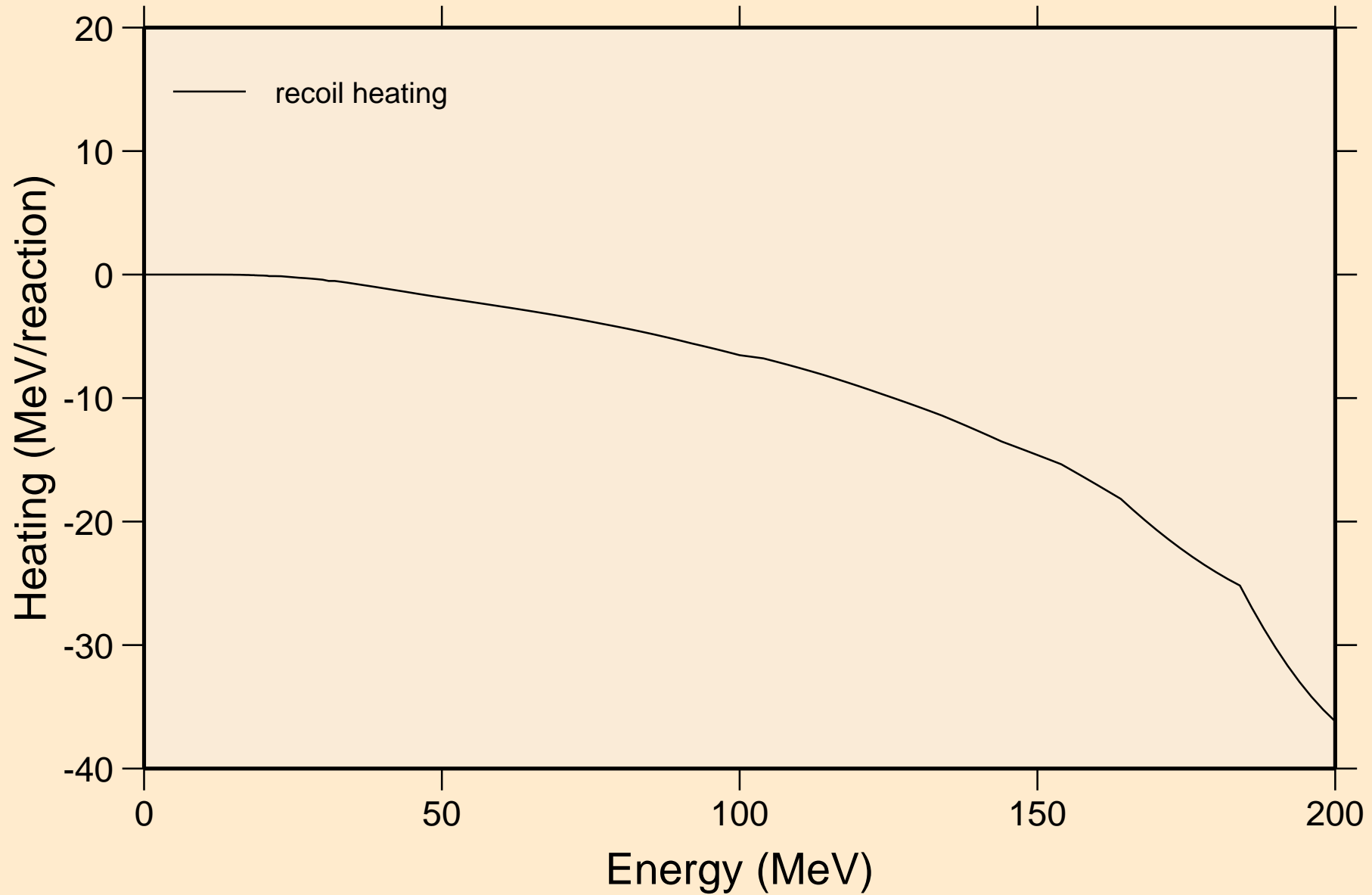

TA183 NRG TENDL-2015, AKONING

Particle production cross sections

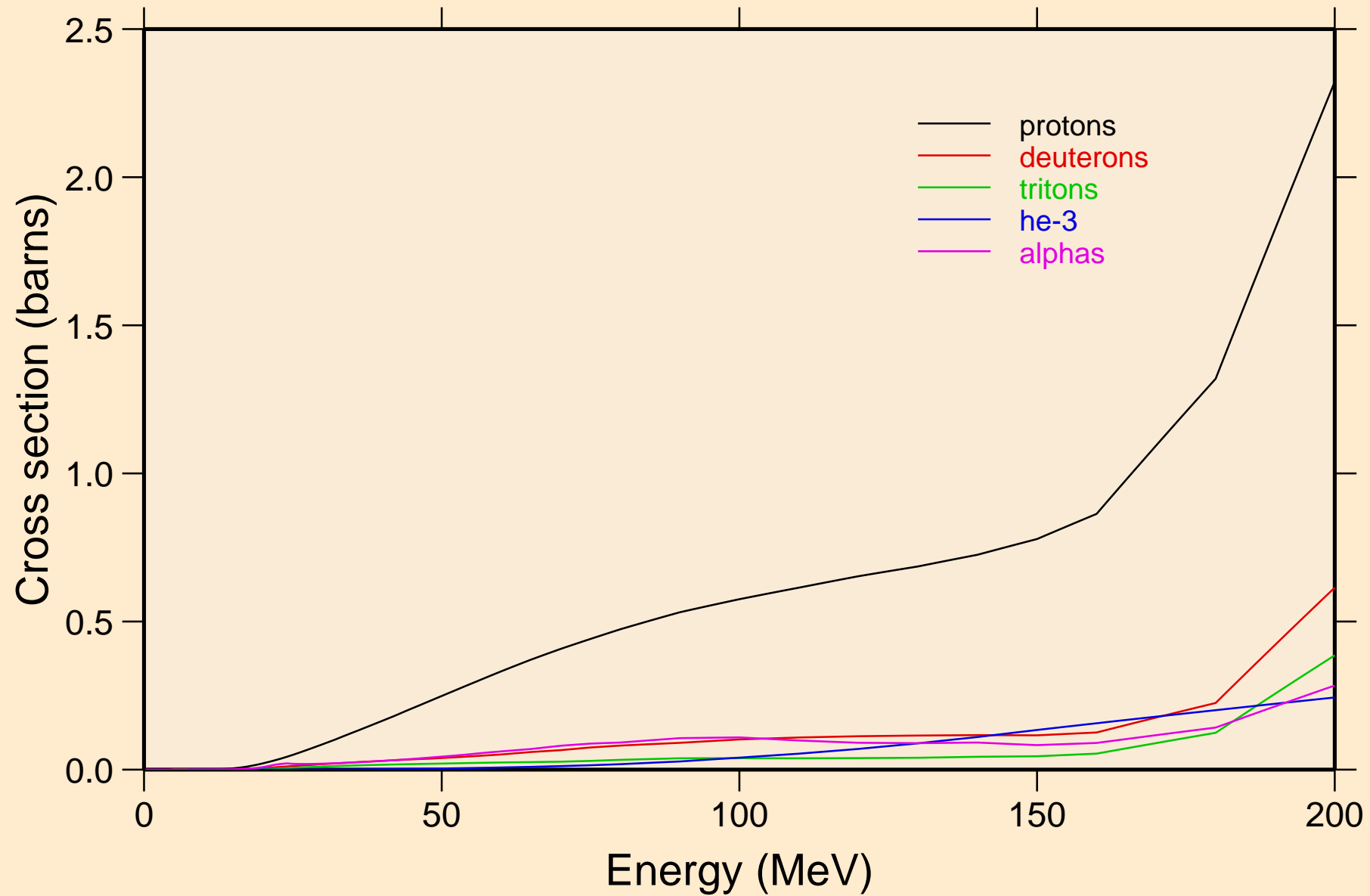

TA183 NRG TENDL-2015, AKONING
protons from (n,x)

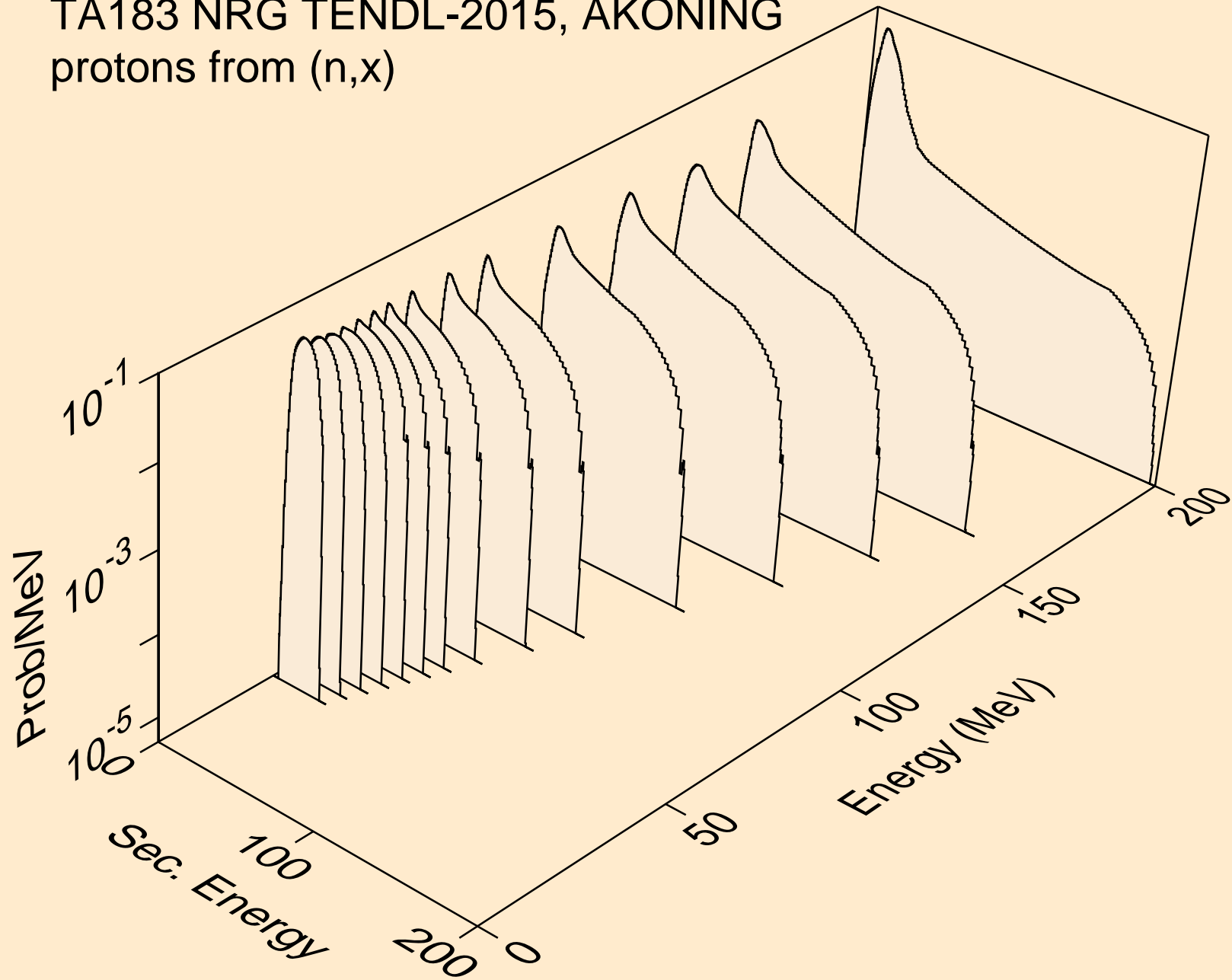

TA183 NRG TENDL-2015, AKONING
protons from (n,n*)p

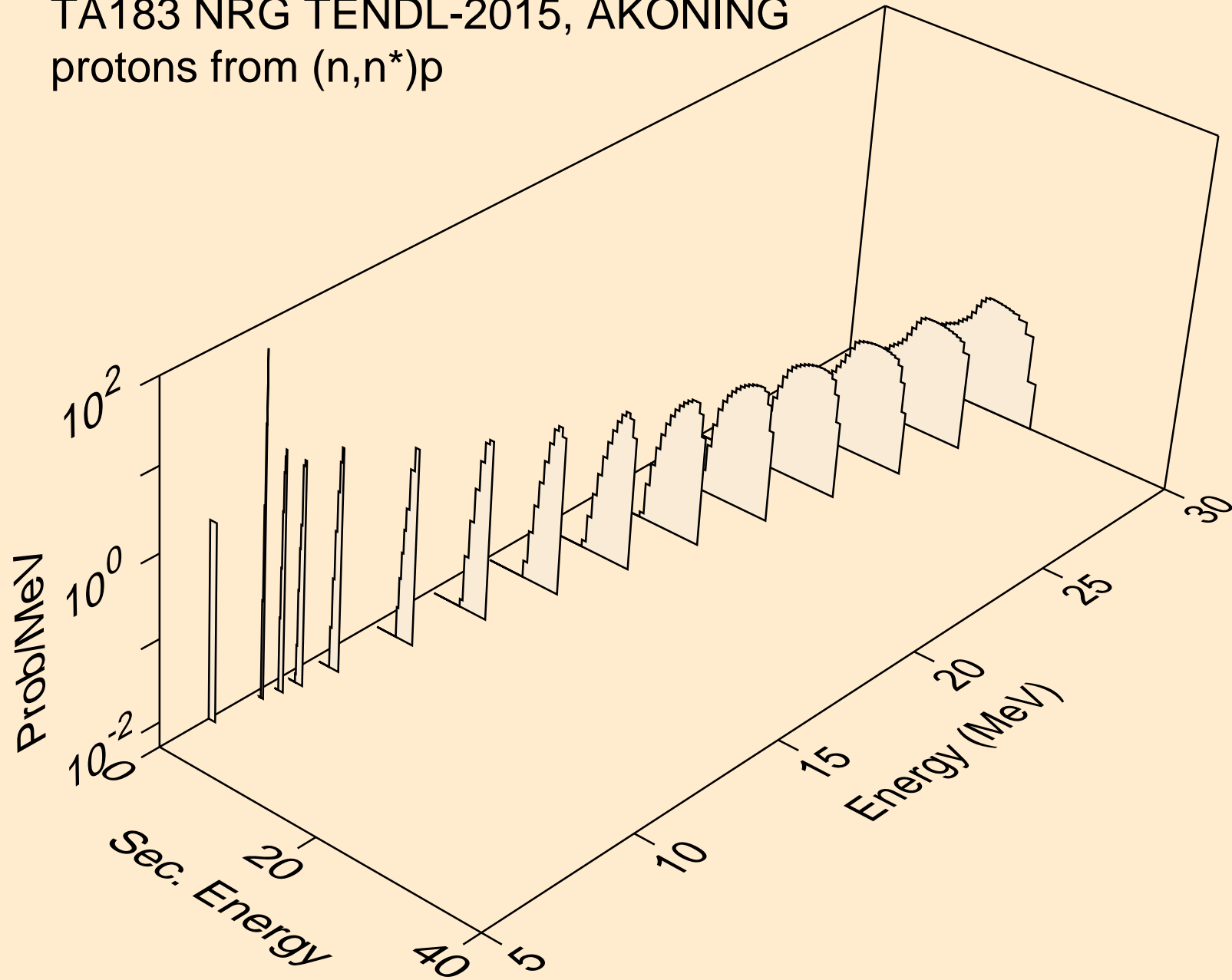

TA183 NRG TENDL-2015, AKONING
protons from (n,2np)

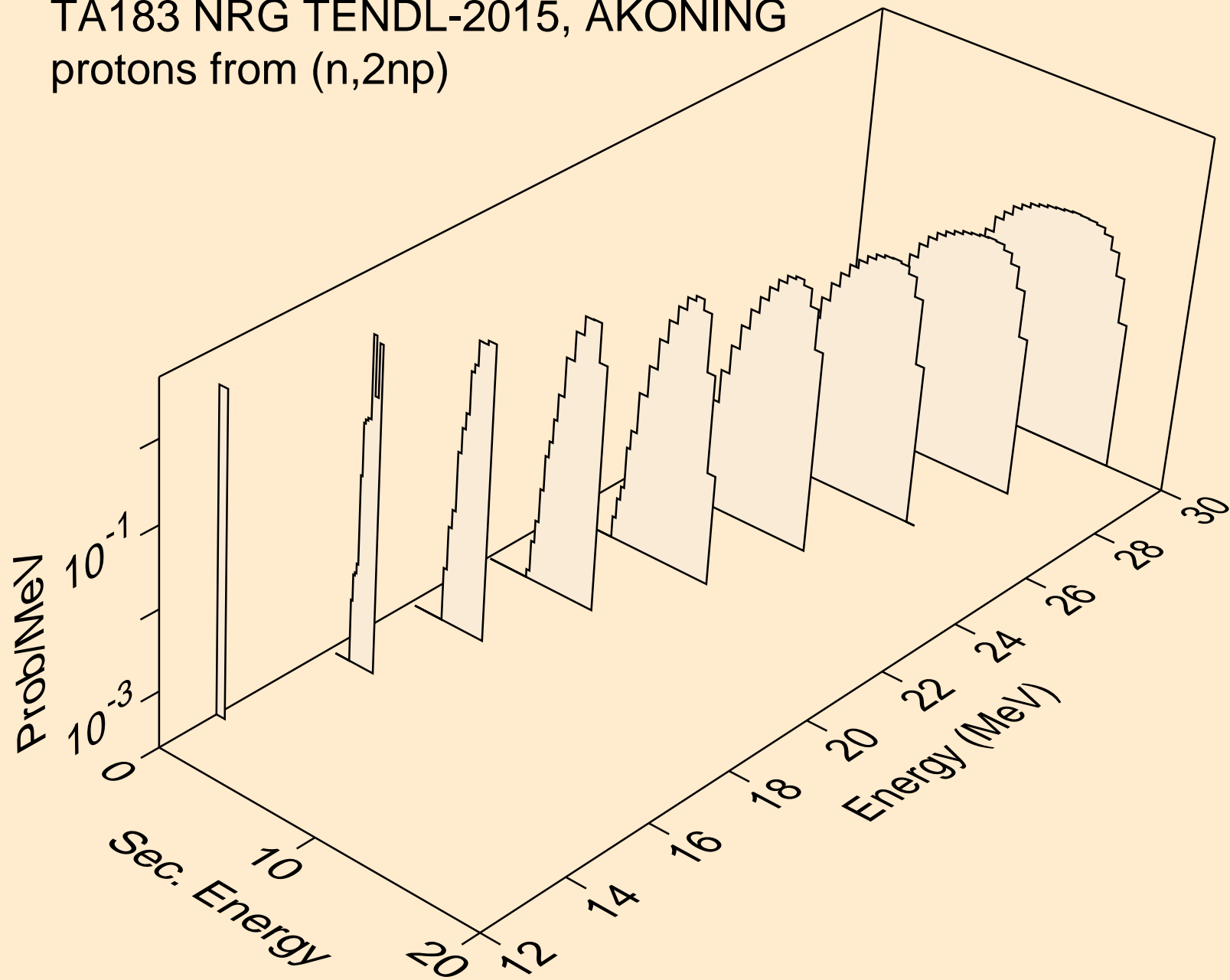

TA183 NRG TENDL-2015, AKONING
protons from (n,3np)

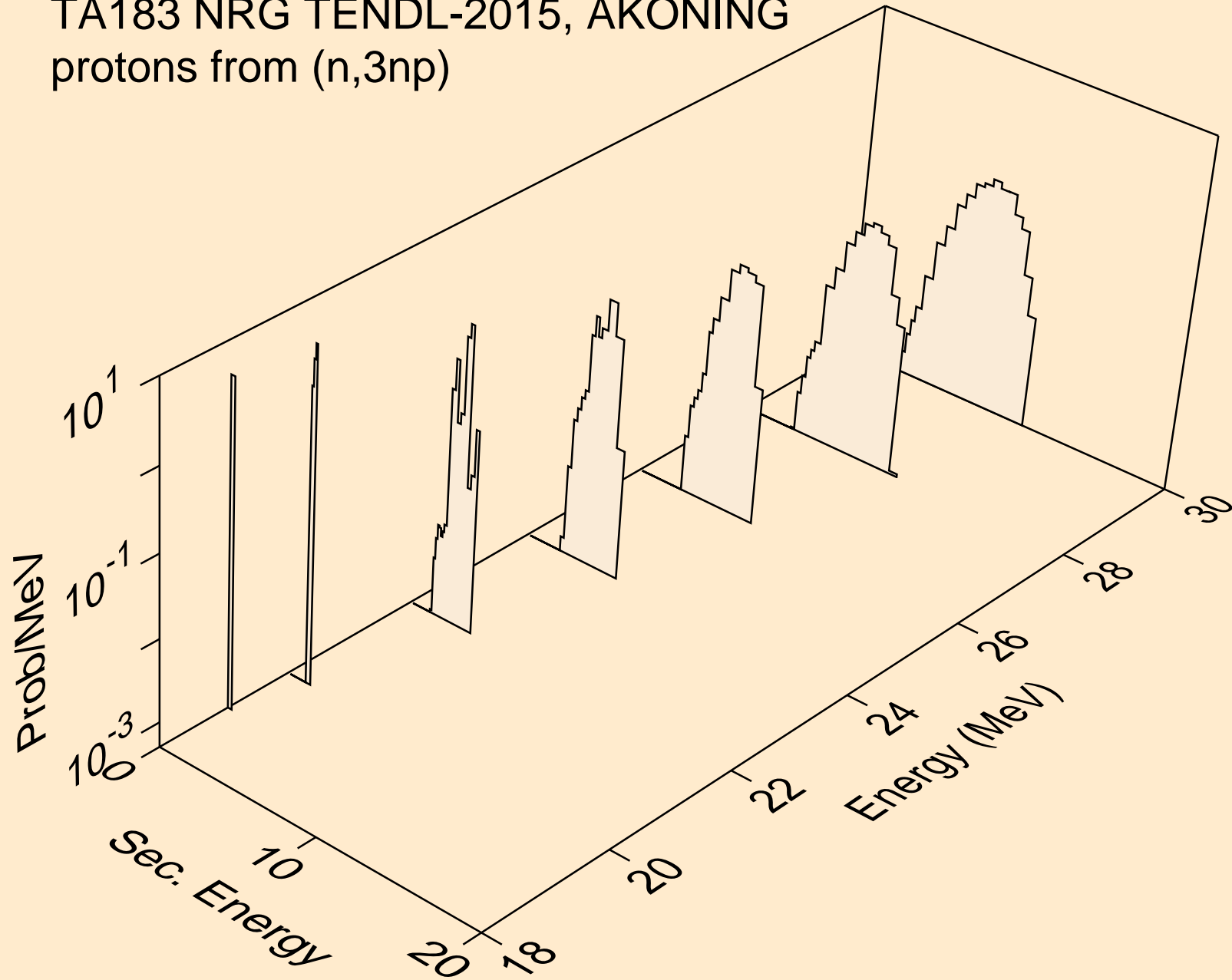

TA183 NRG TENDL-2015, AKONING
protons from (n,2np)

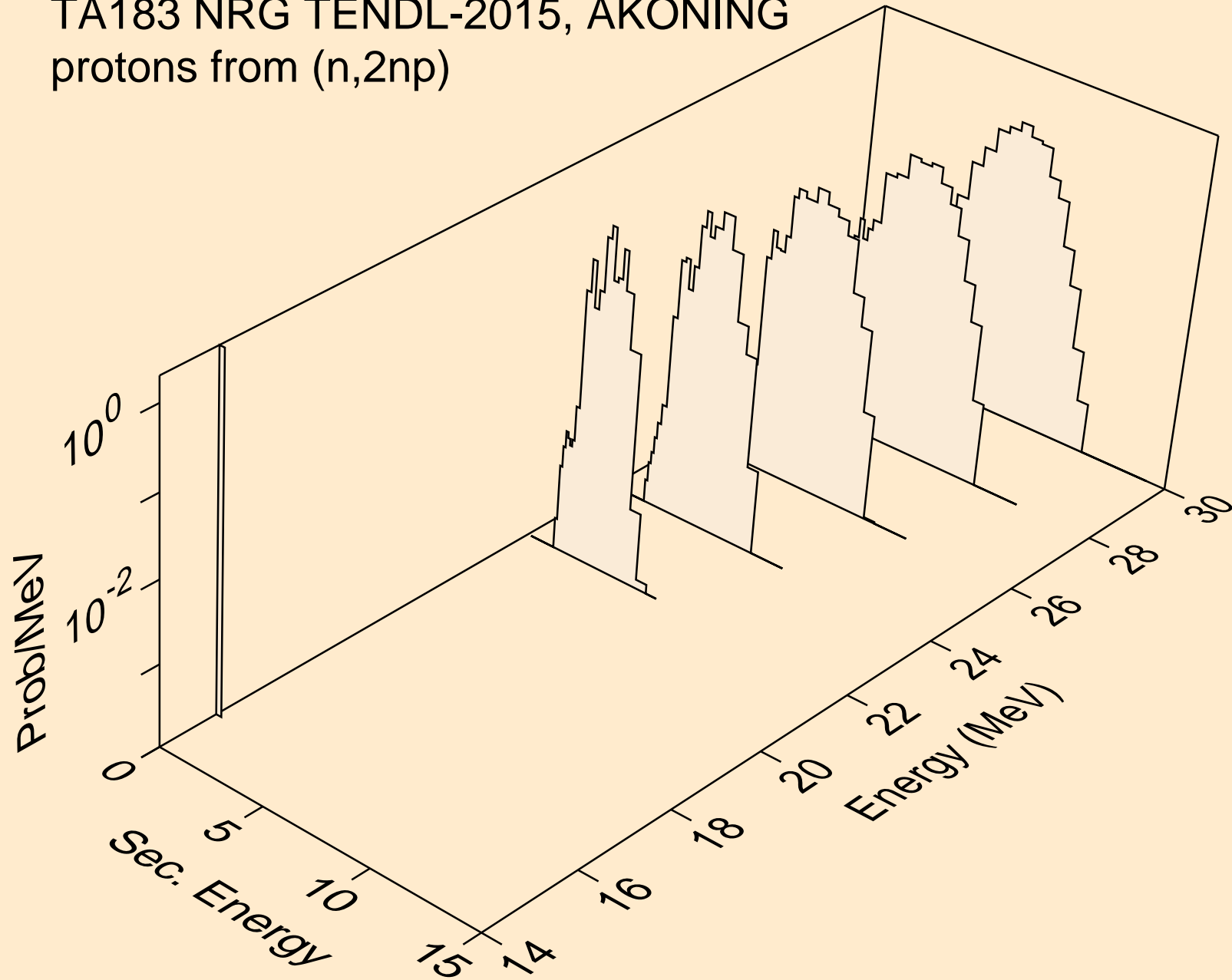

TA183 NRG TENDL-2015, AKONING
protons from (n,npa)

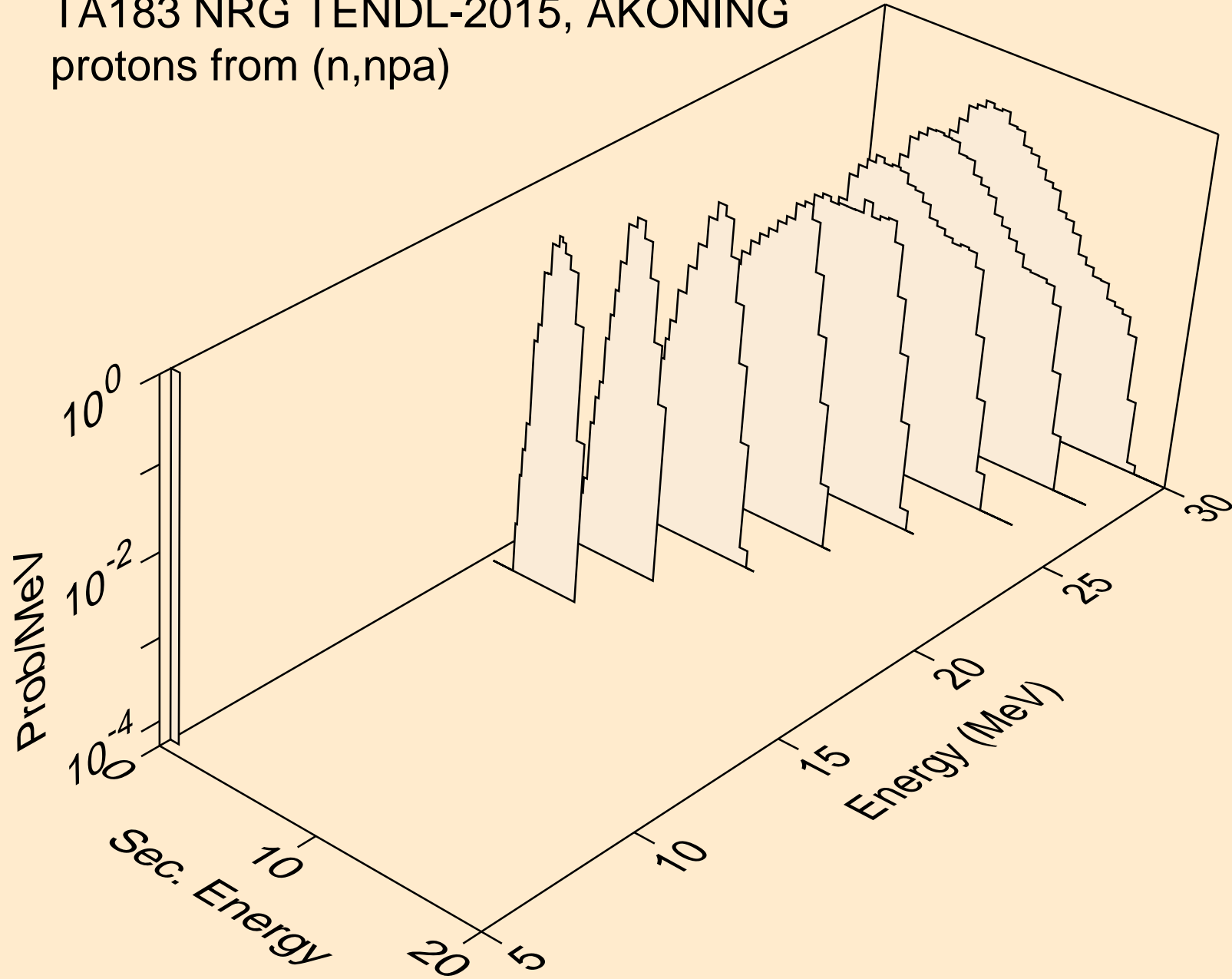

TA183 NRG TENDL-2015, AKONING
protons from (n,p)

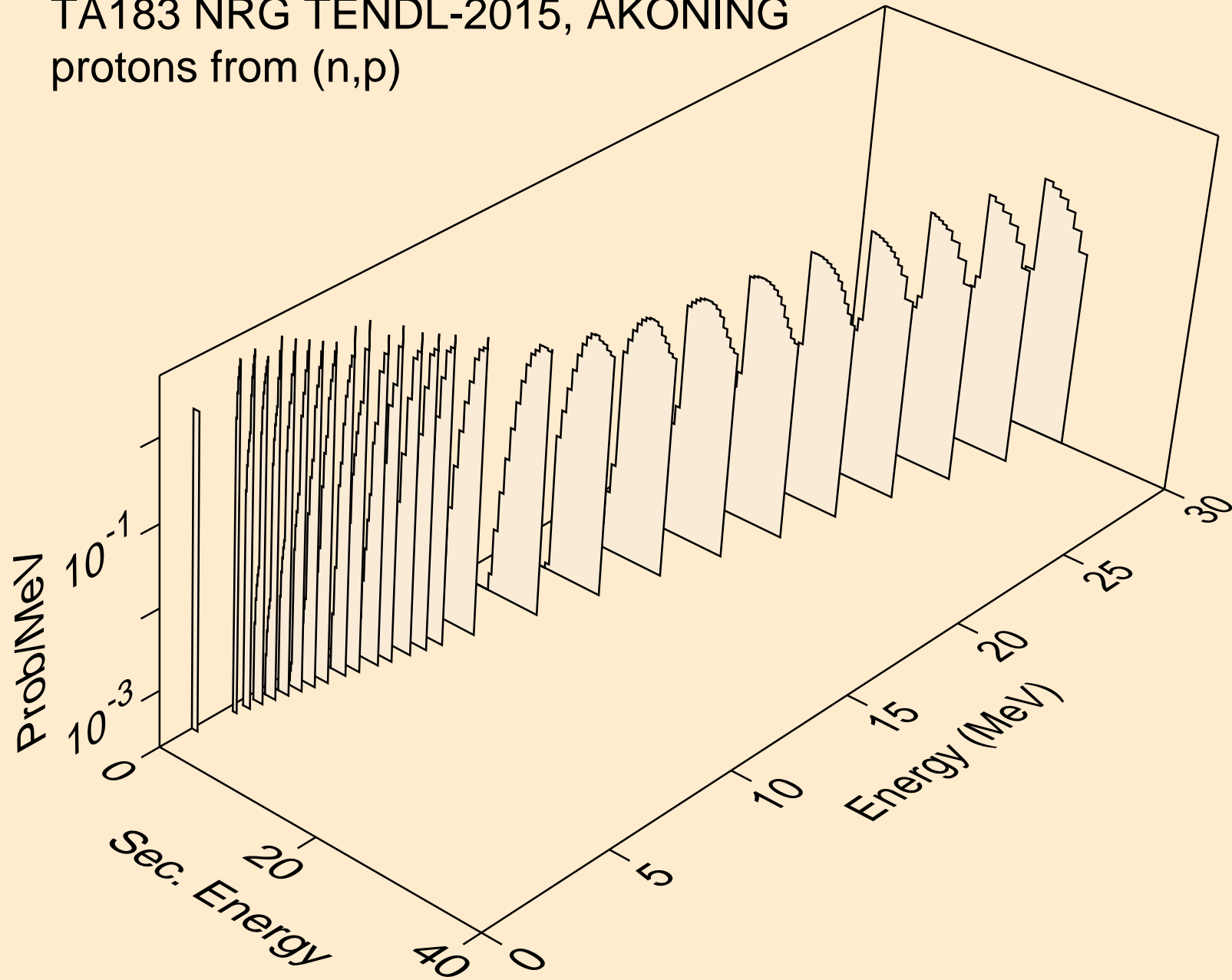

TA183 NRG TENDL-2015, AKONING
protons from (n,2p)

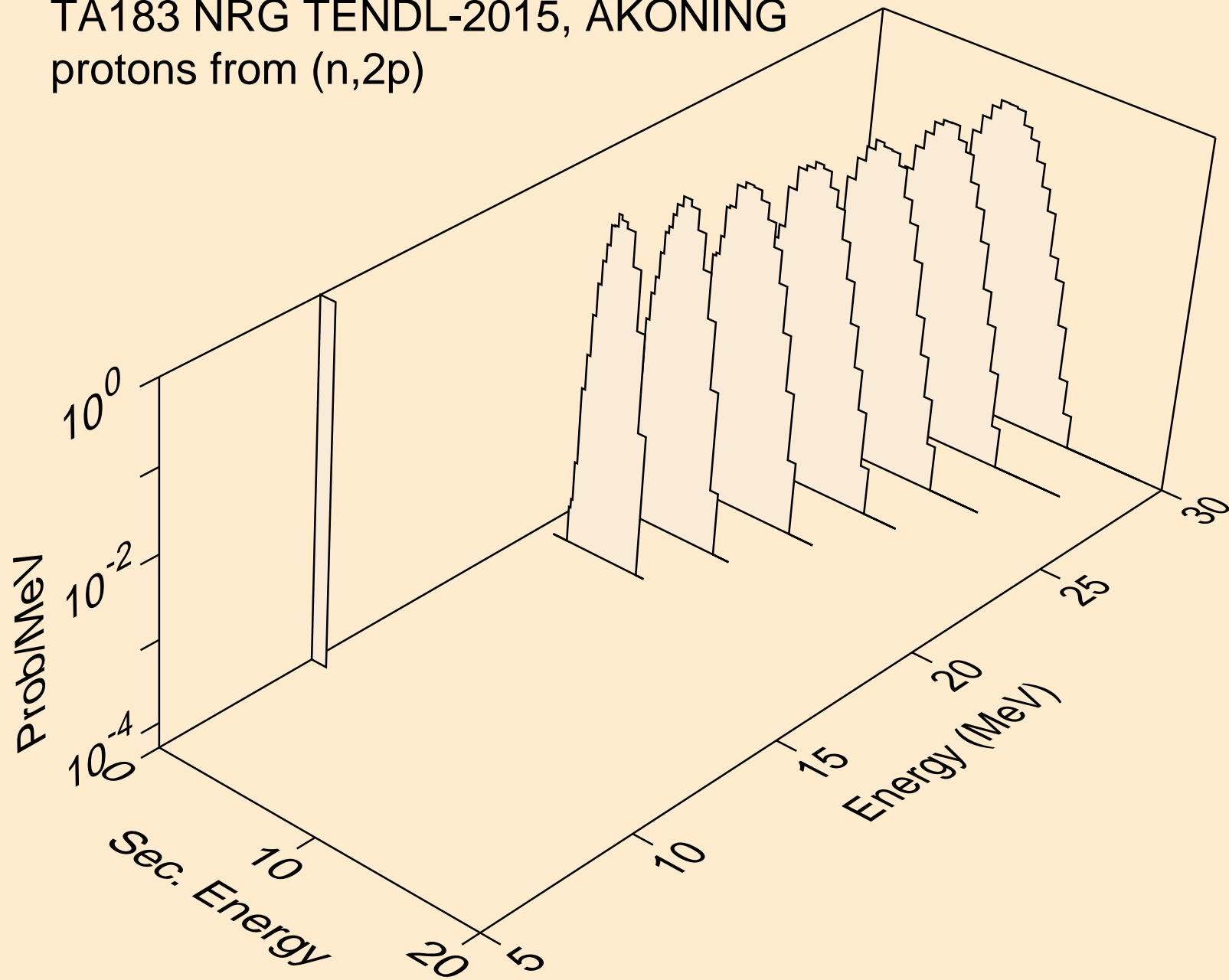

TA183 NRG TENDL-2015, AKONING
protons from (n,pa)

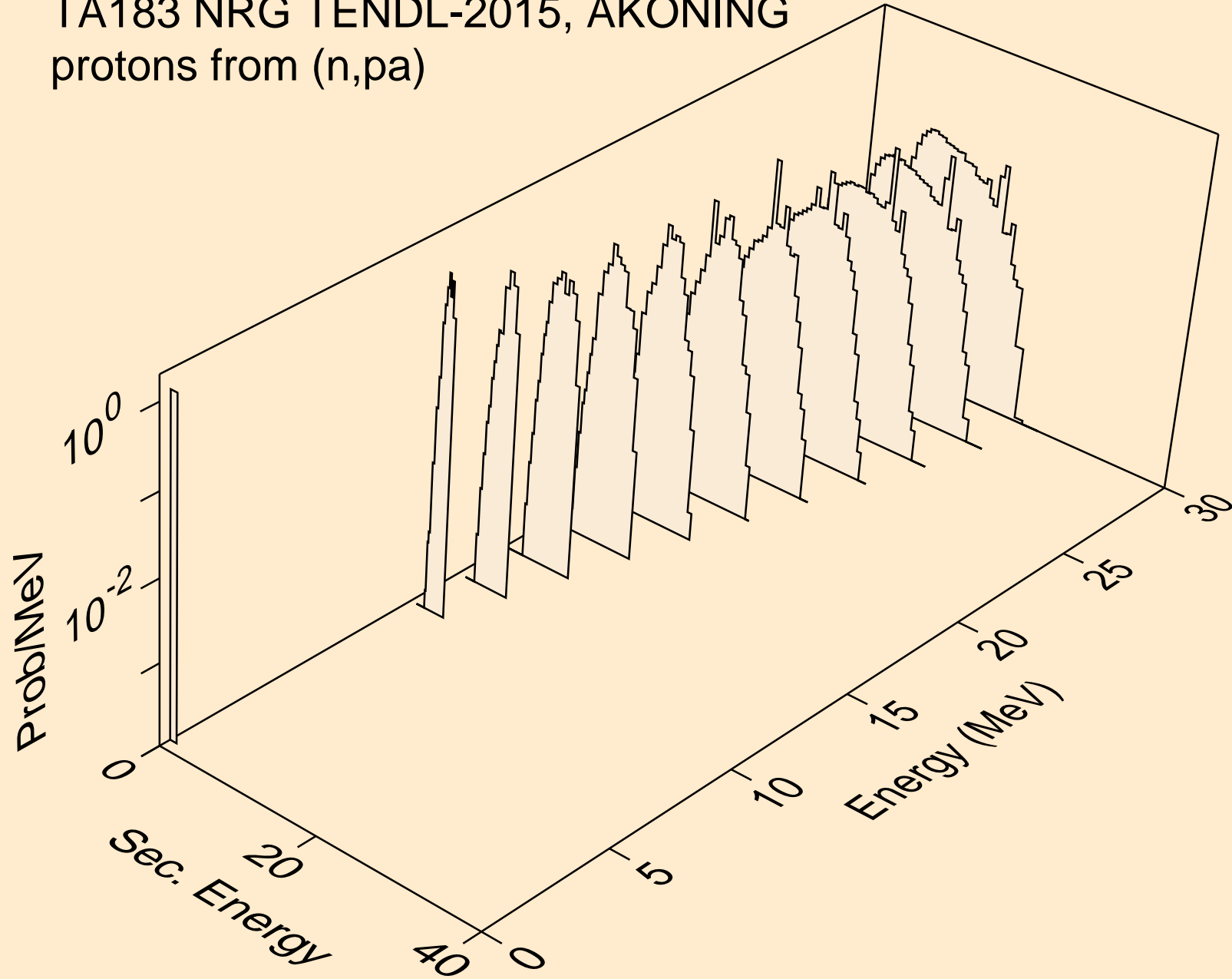

TA183 NRG TENDL-2015, AKONING
deuterons from (n,x)

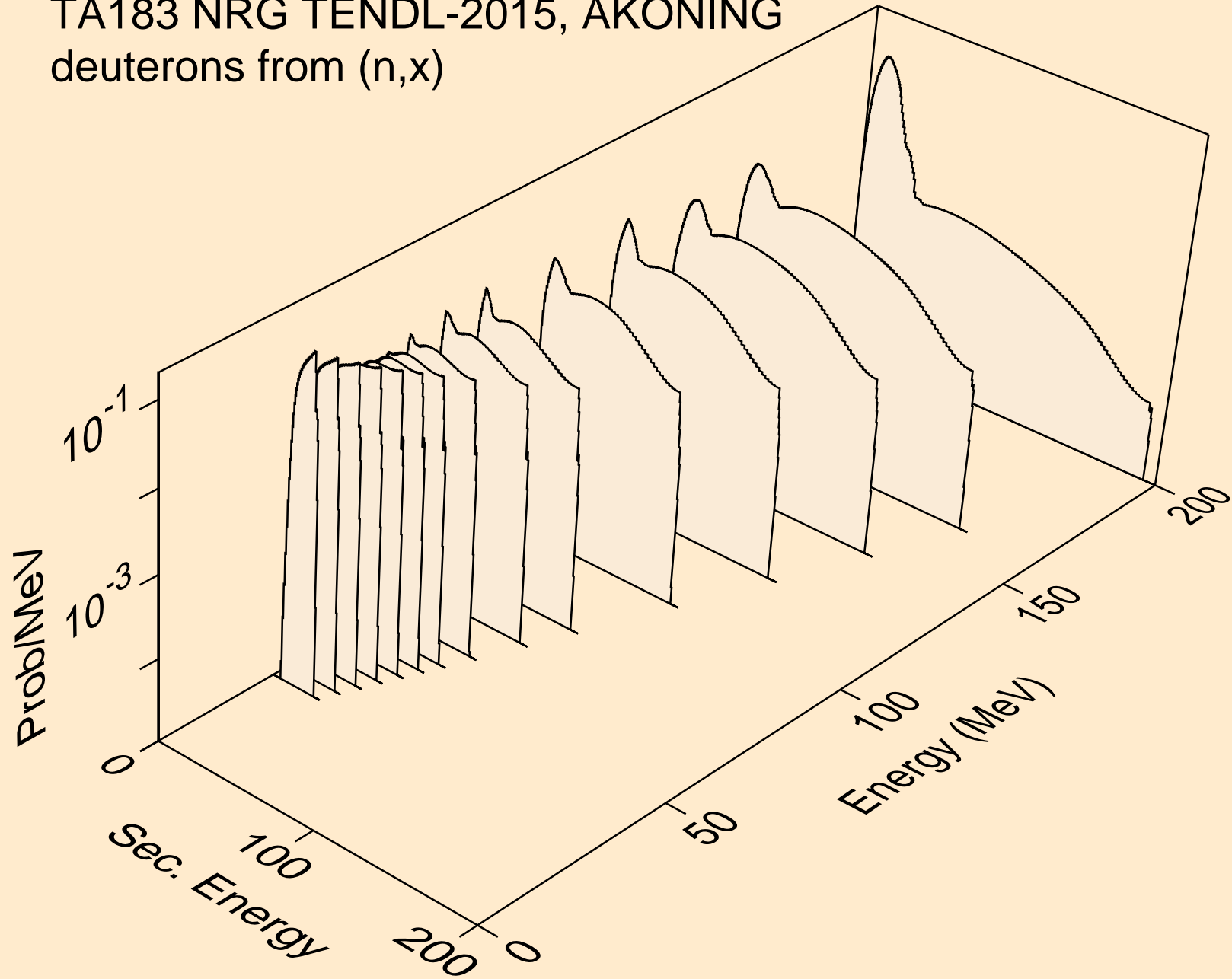

TA183 NRG TENDL-2015, AKONING
deuterons from (n,2nd)

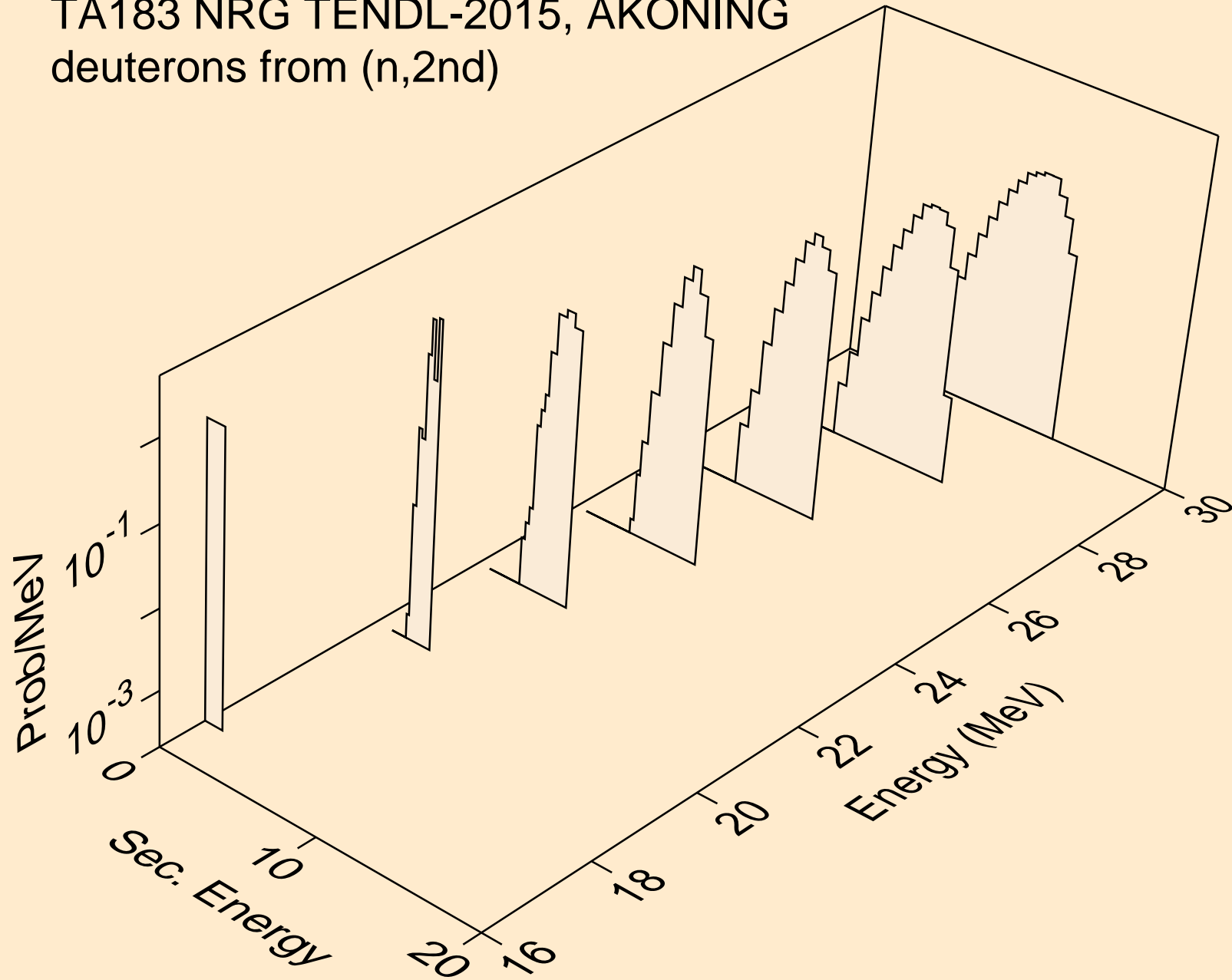

TA183 NRG TENDL-2015, AKONING
deuterons from (n,n*)d

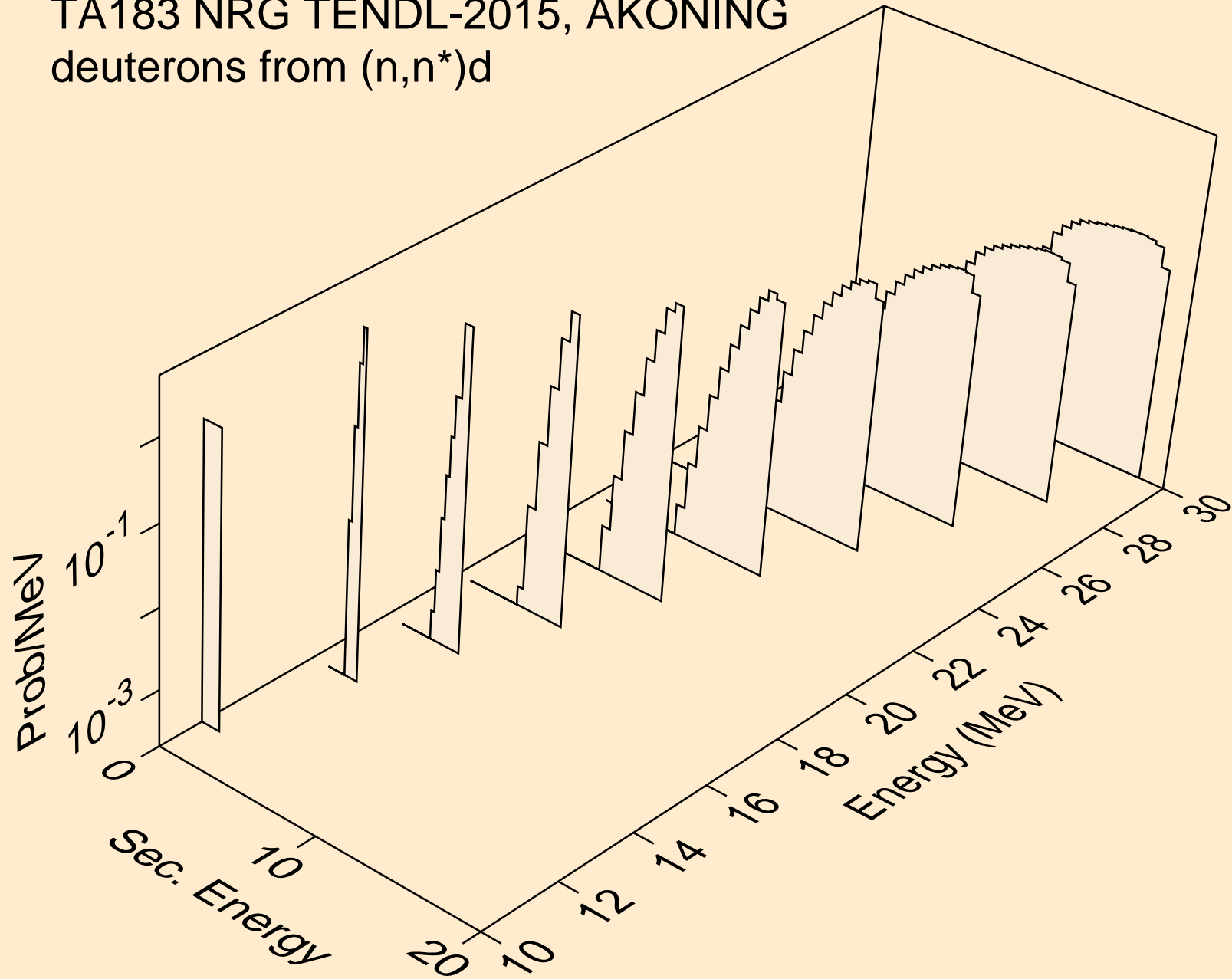

TA183 NRG TENDL-2015, AKONING
deuterons from (n,d)

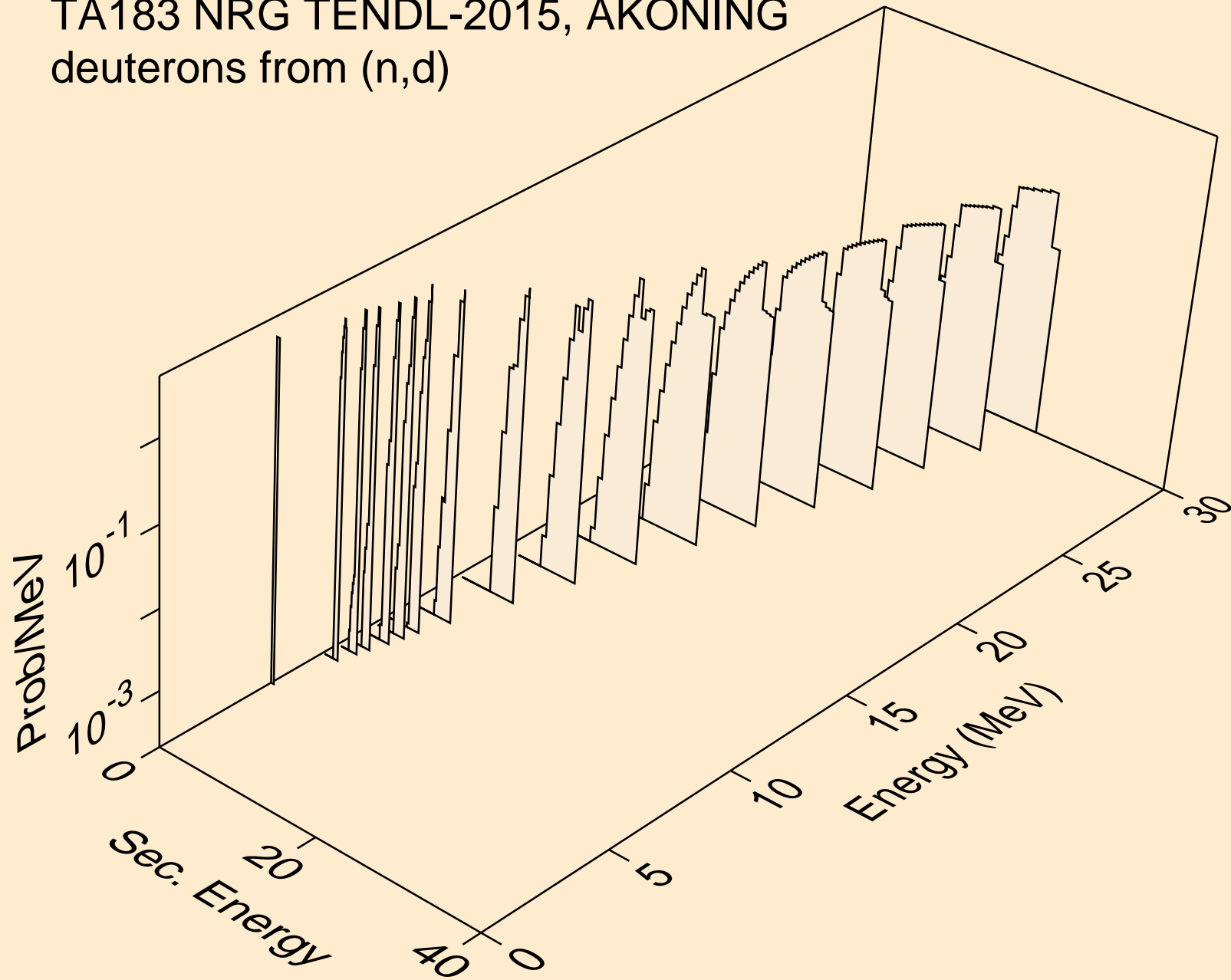

TA183 NRG TENDL-2015, AKONING
tritons from (n,x)

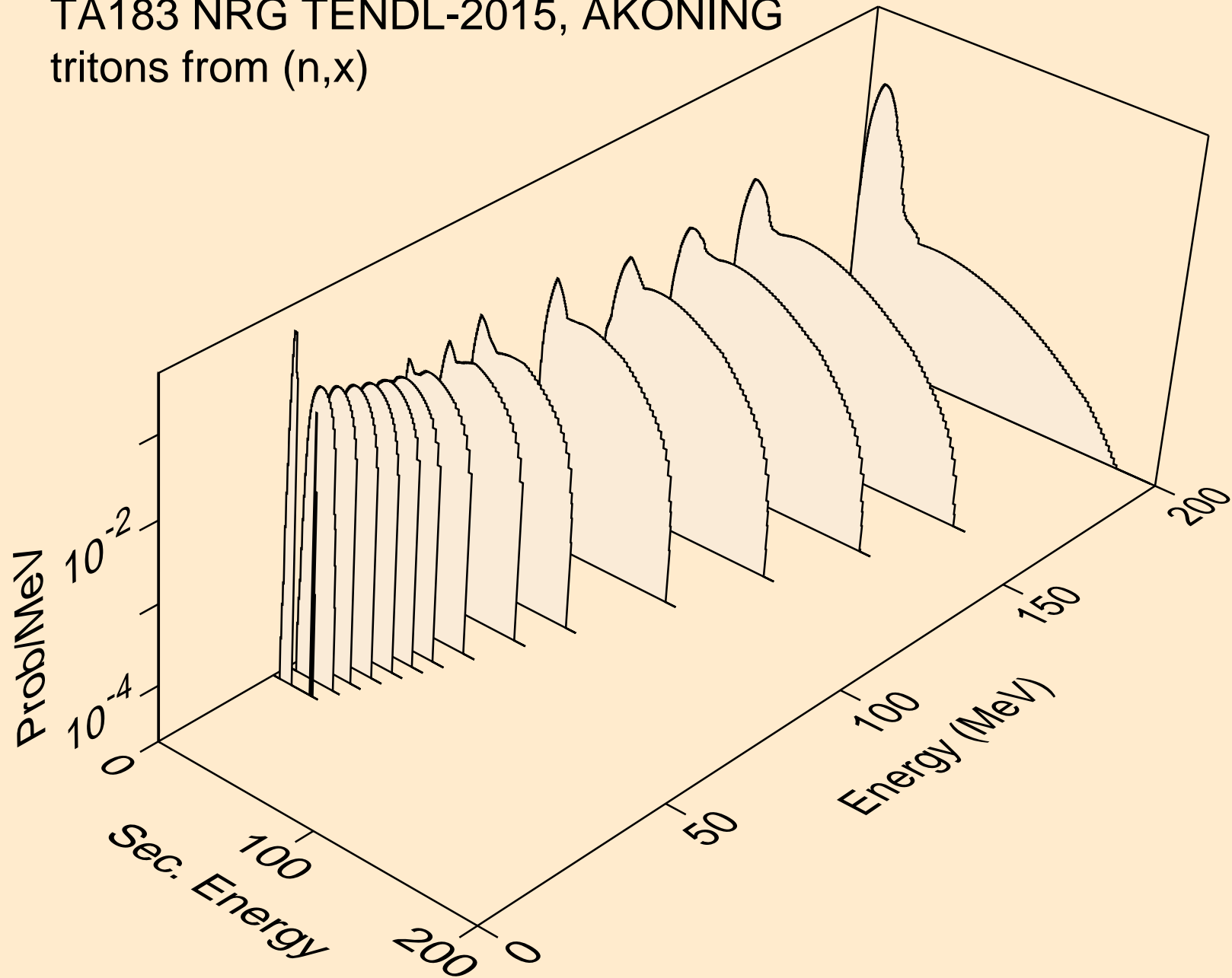

TA183 NRG TENDL-2015, AKONING
tritons from (n,n*)t

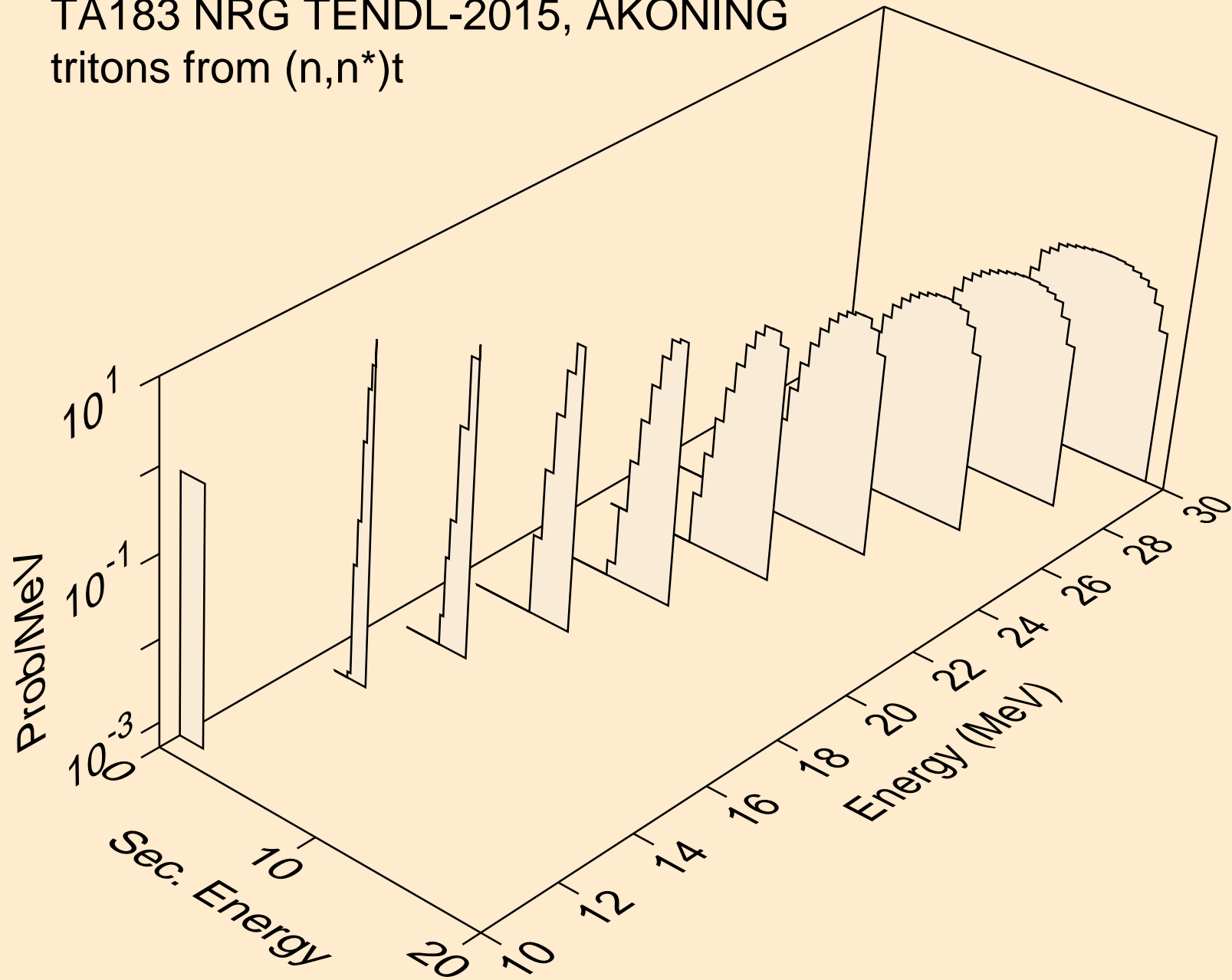

TA183 NRG TENDL-2015, AKONING
tritons from (n,t)

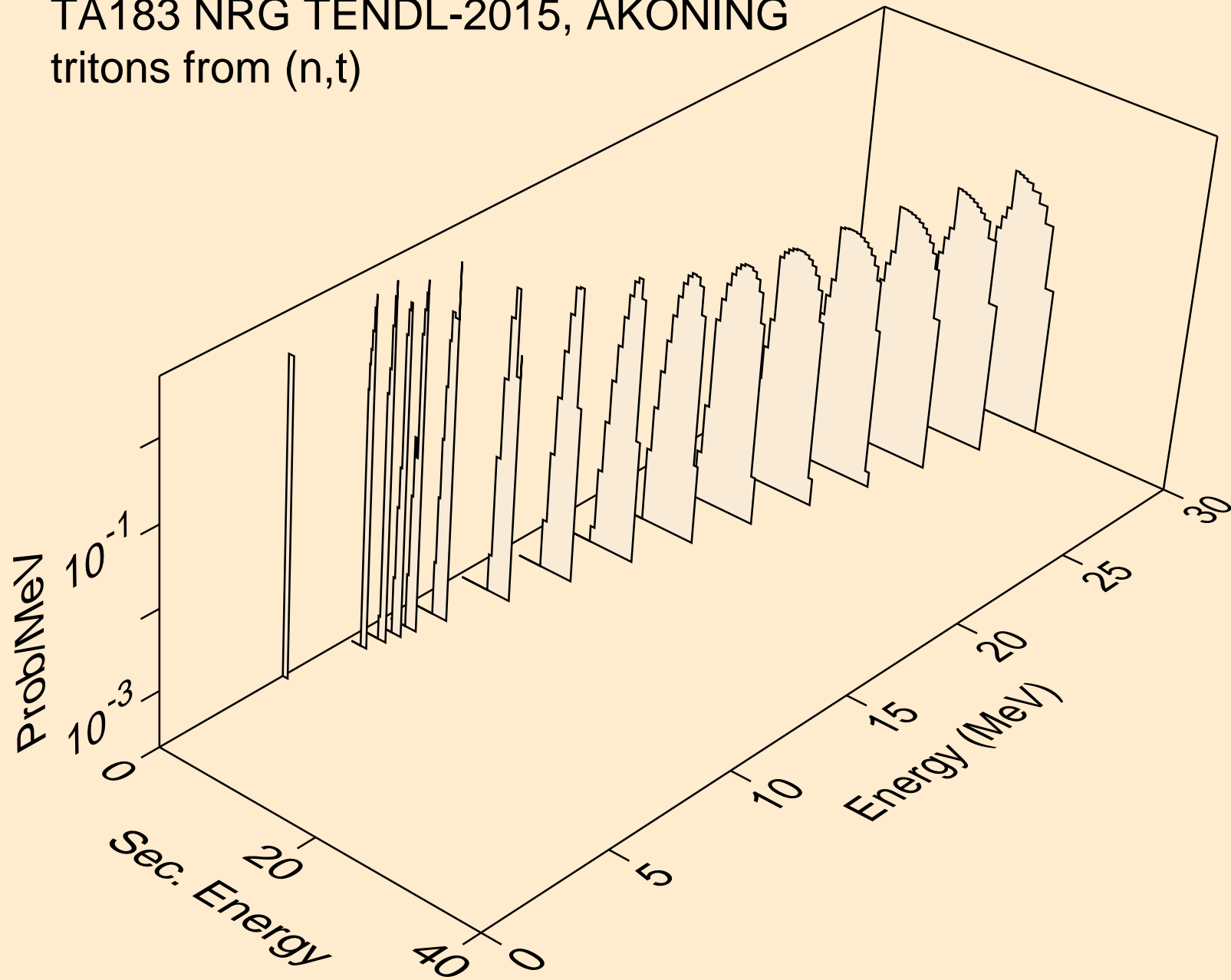

TA183 NRG TENDL-2015, AKONING
he3s from (n,x)

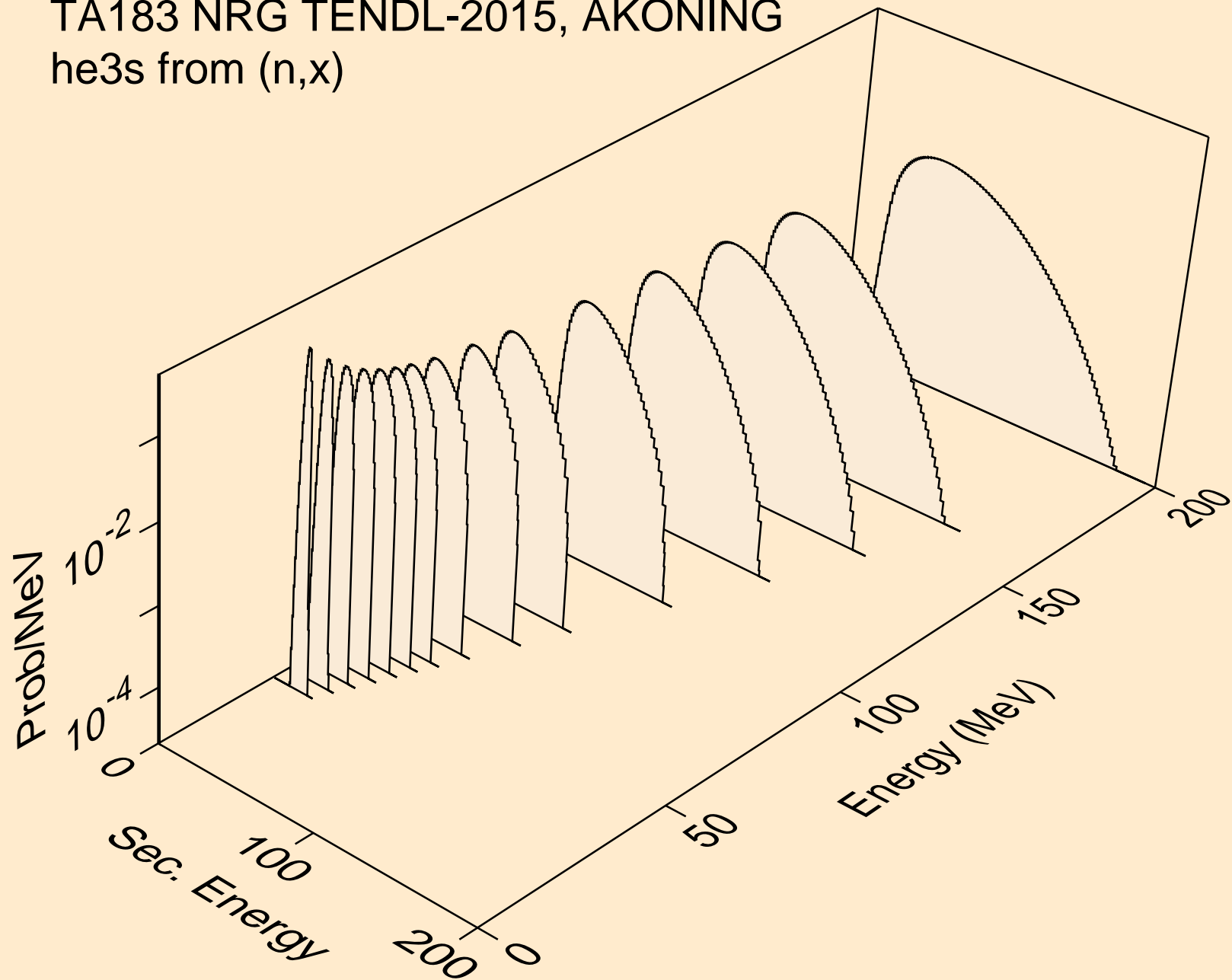

TA183 NRG TENDL-2015, AKONING
he3s from (n,n*)he3

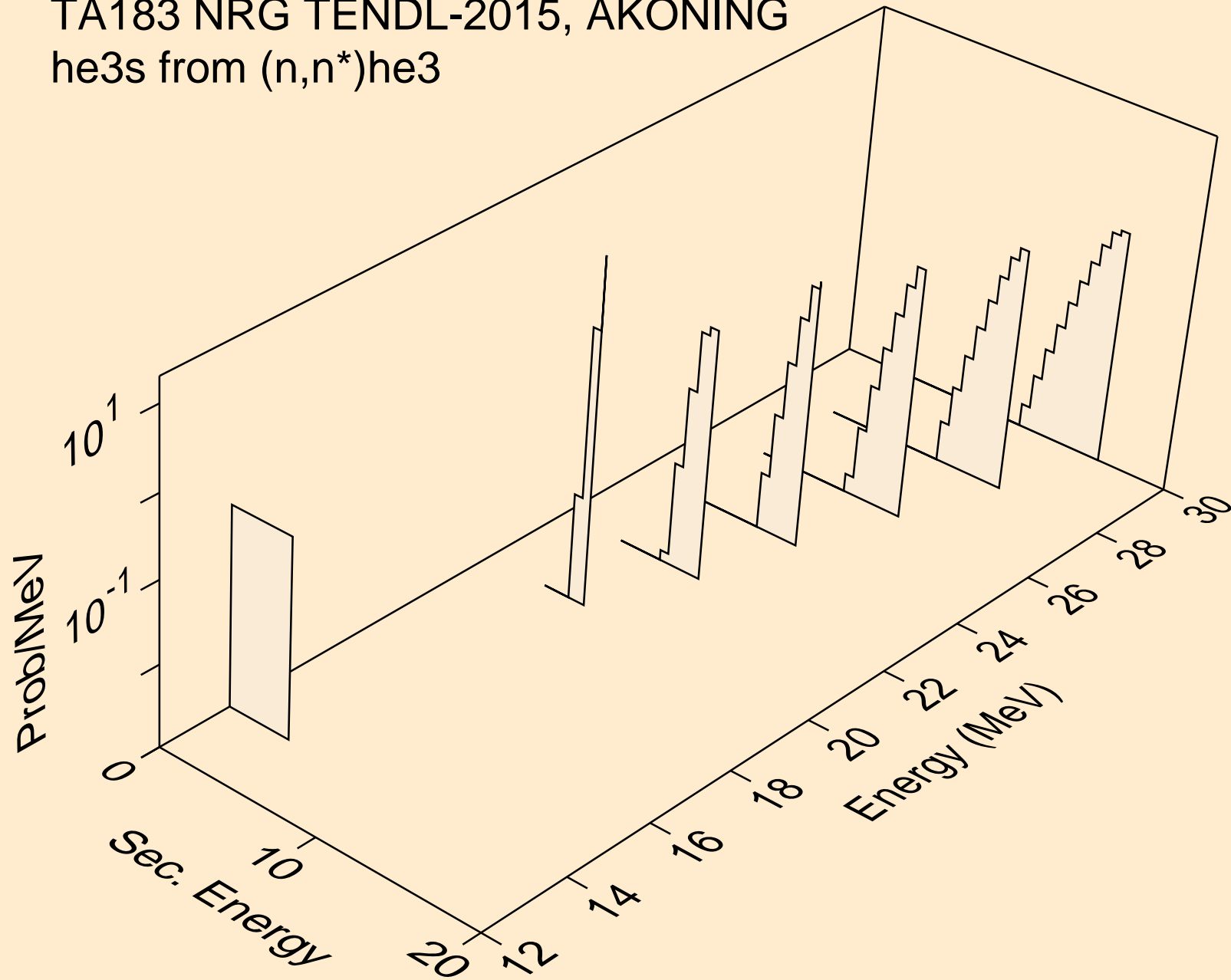

TA183 NRG TENDL-2015, AKONING
he3s from (n,he3)

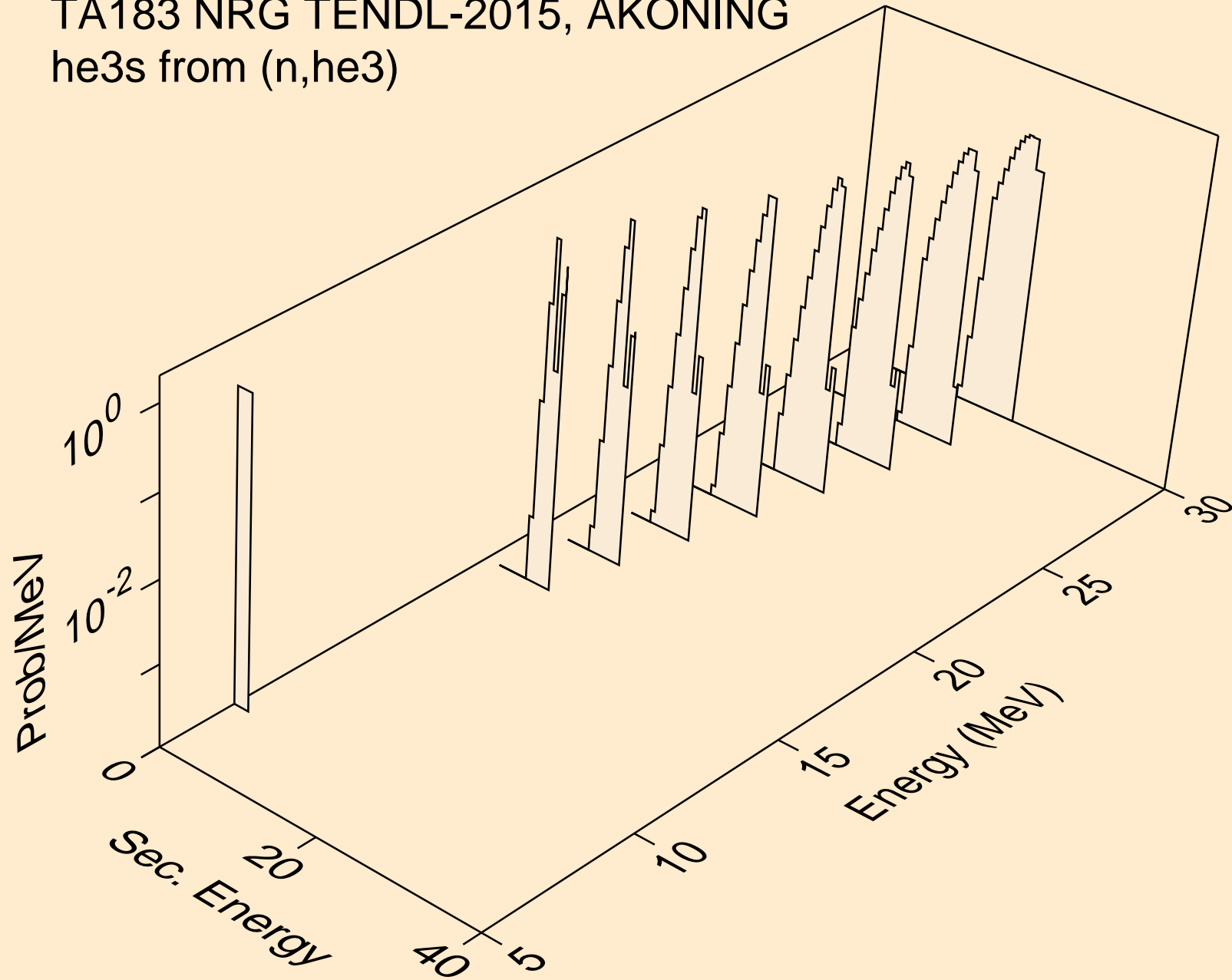

TA183 NRG TENDL-2015, AKONING
alphas from (n,x)

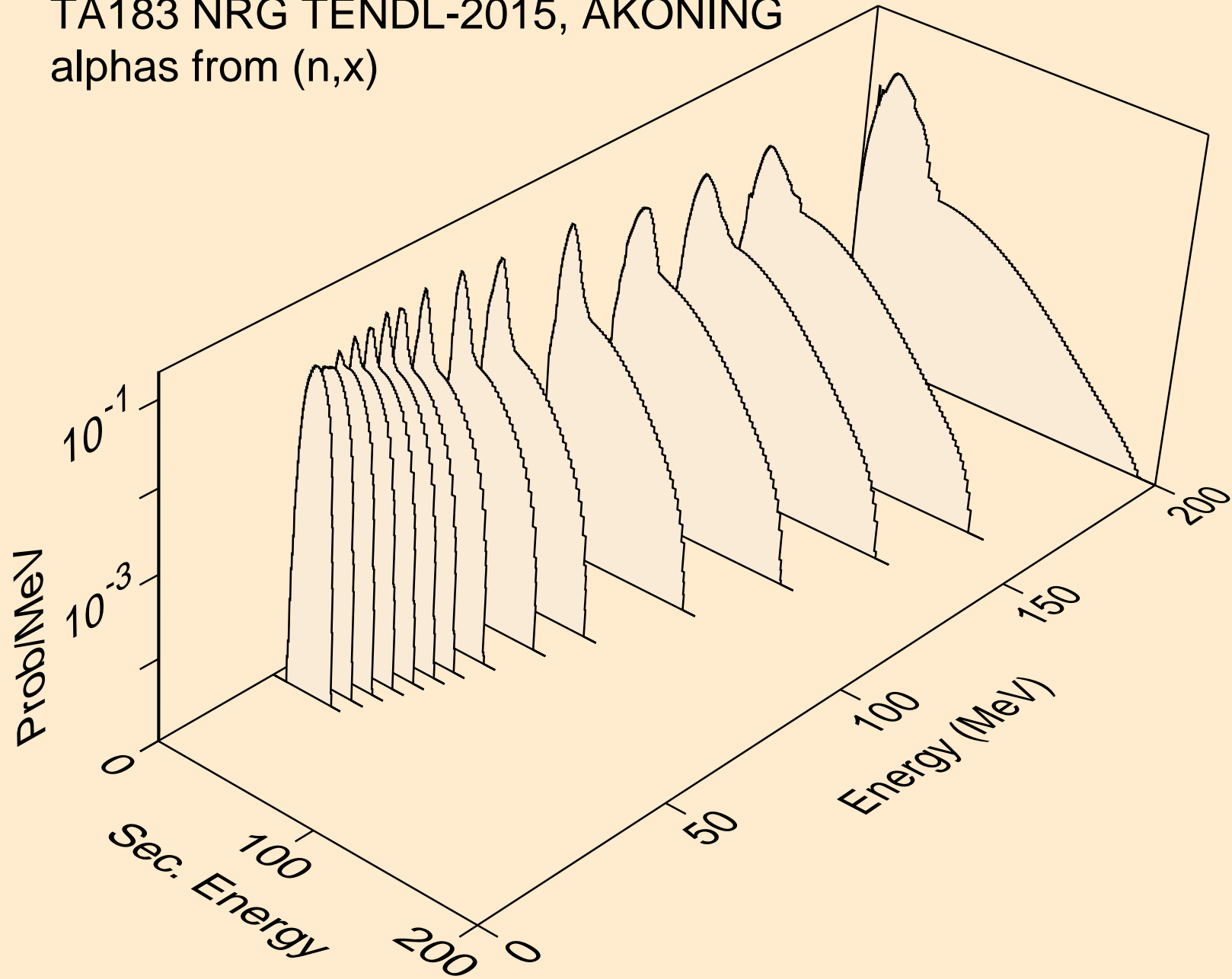

TA183 NRG TENDL-2015, AKONING
alphas from (n,n*)a

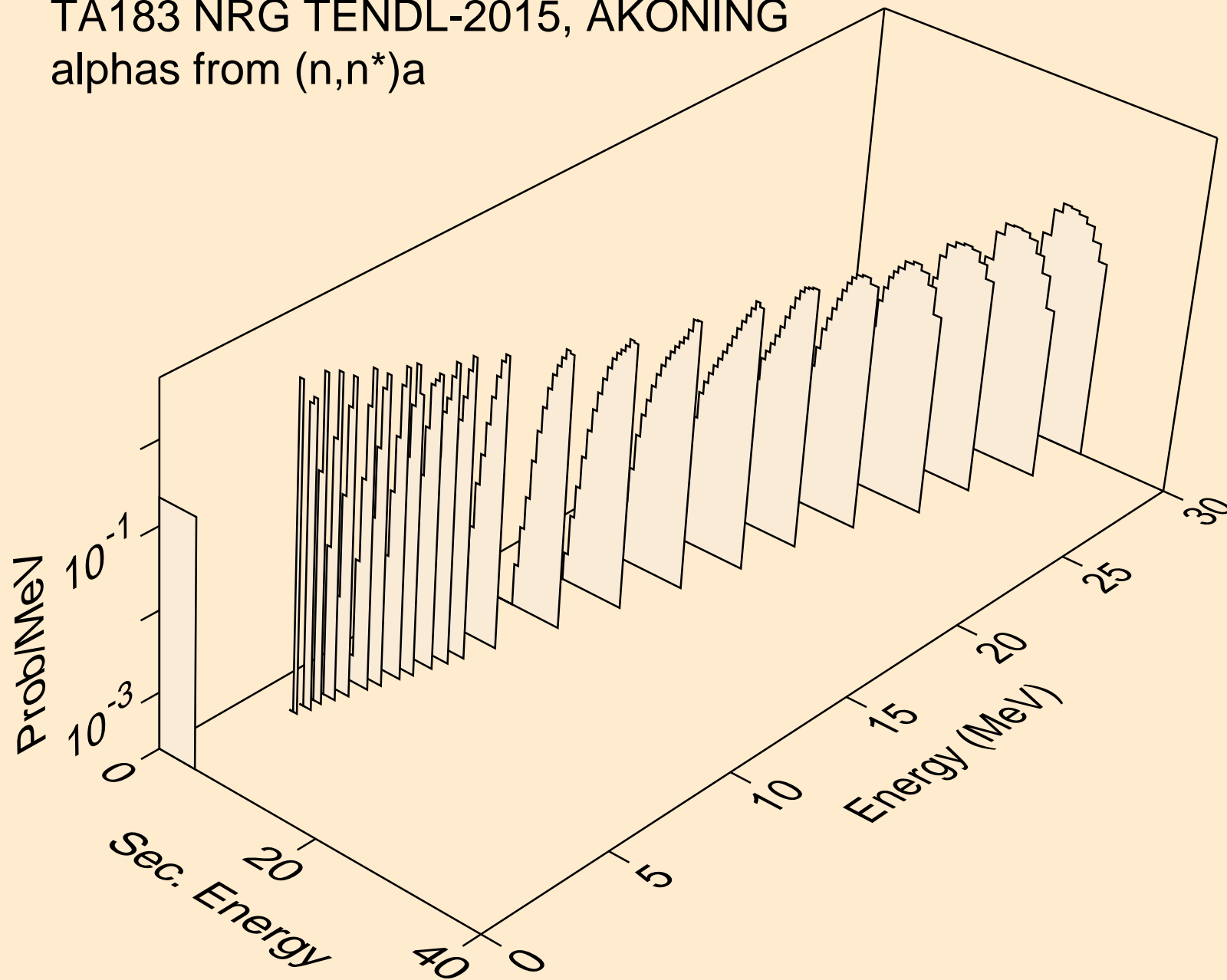

TA183 NRG TENDL-2015, AKONING
alphas from (n,2n)a

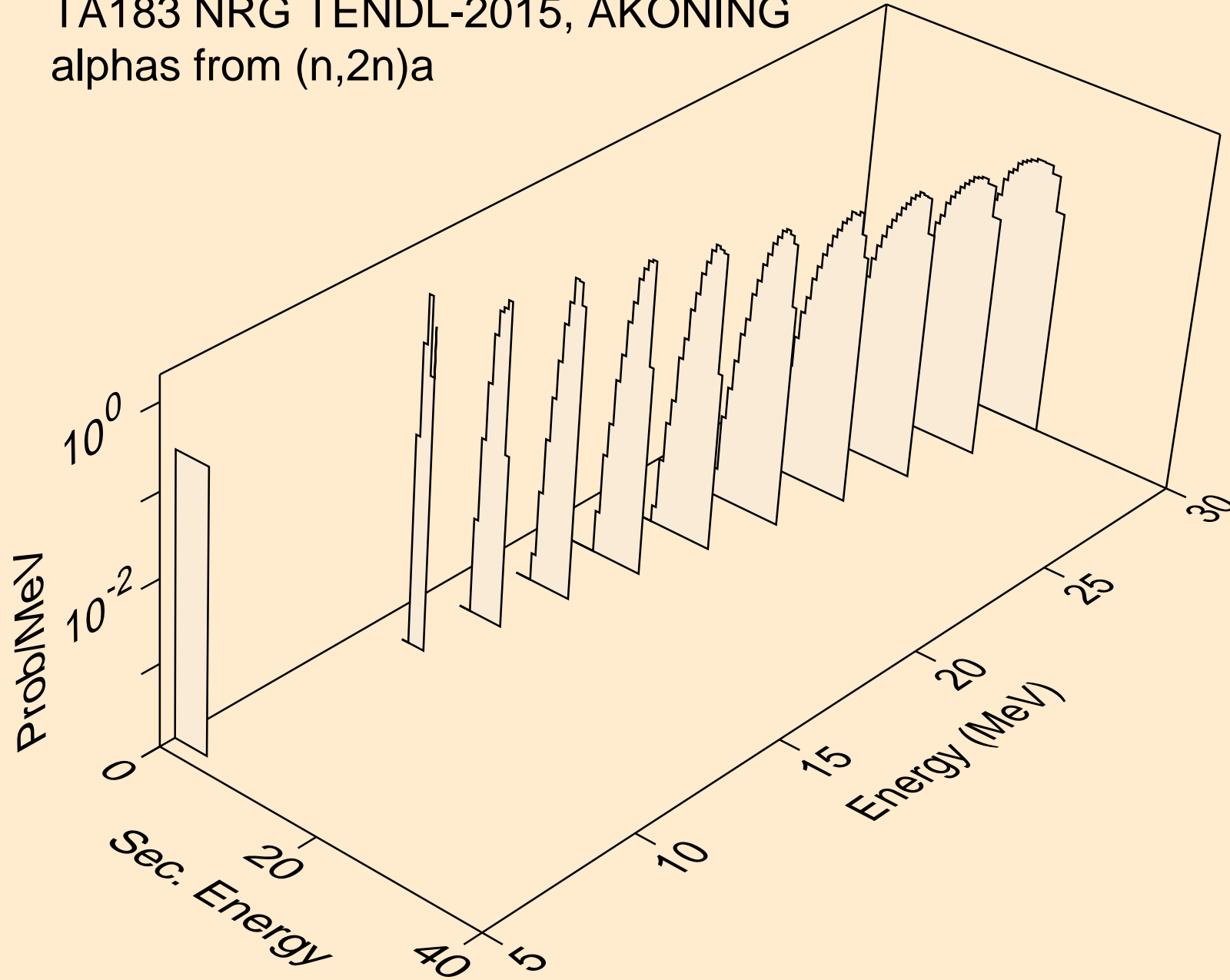

TA183 NRG TENDL-2015, AKONING
alphas from (n,3n)a

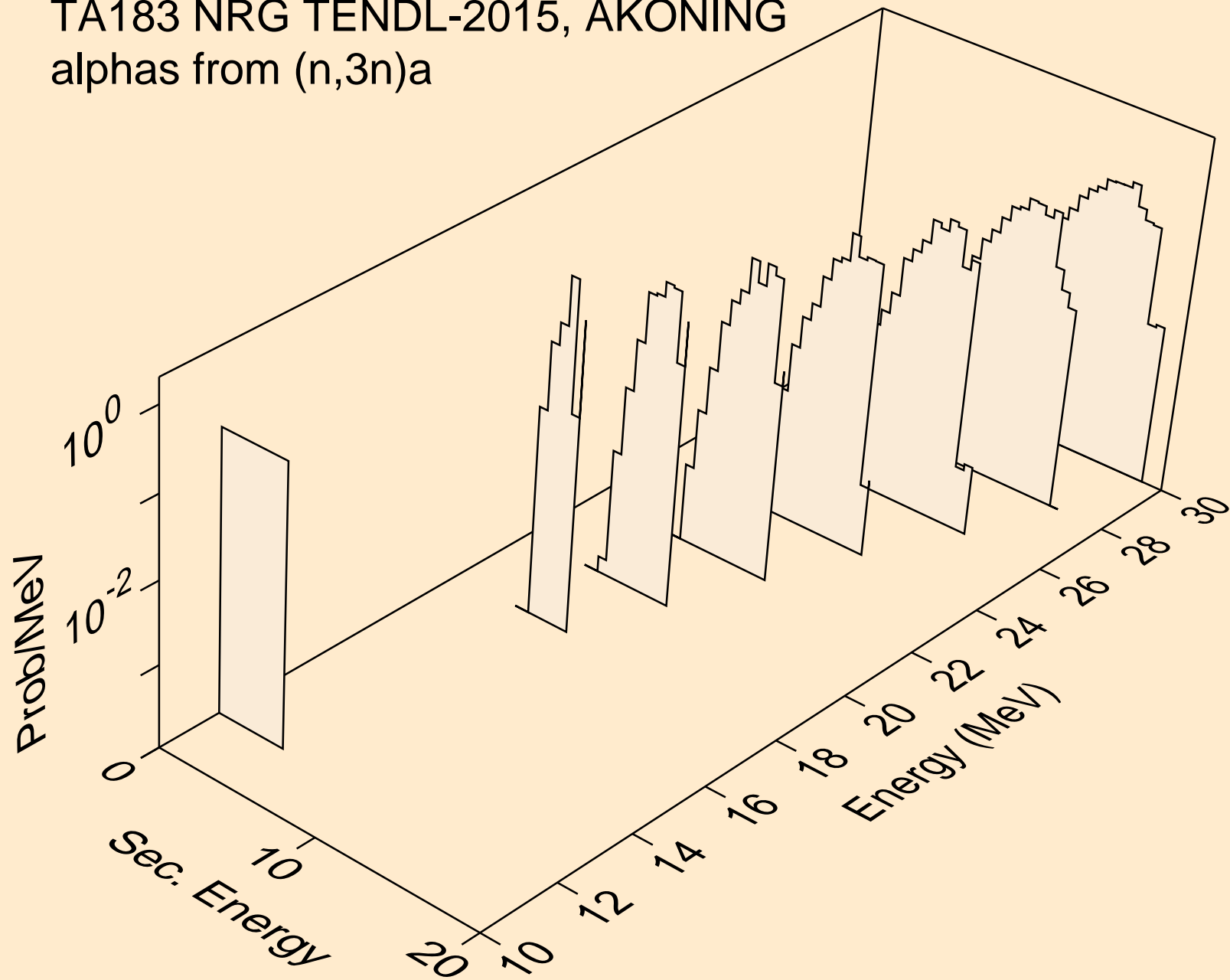

TA183 NRG TENDL-2015, AKONING
alphas from (n,n*)2a

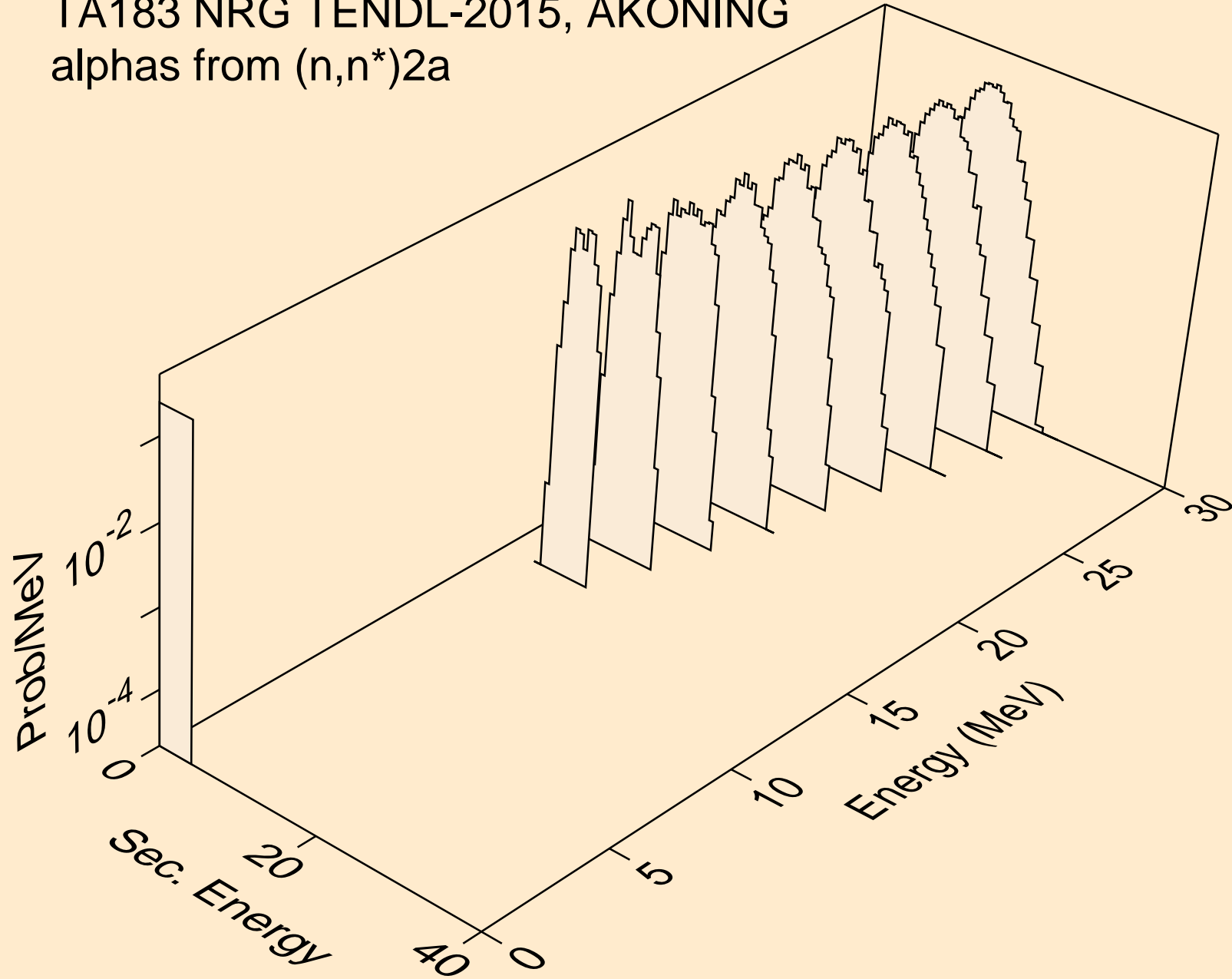

TA183 NRG TENDL-2015, AKONING
alphas from (n,npa)

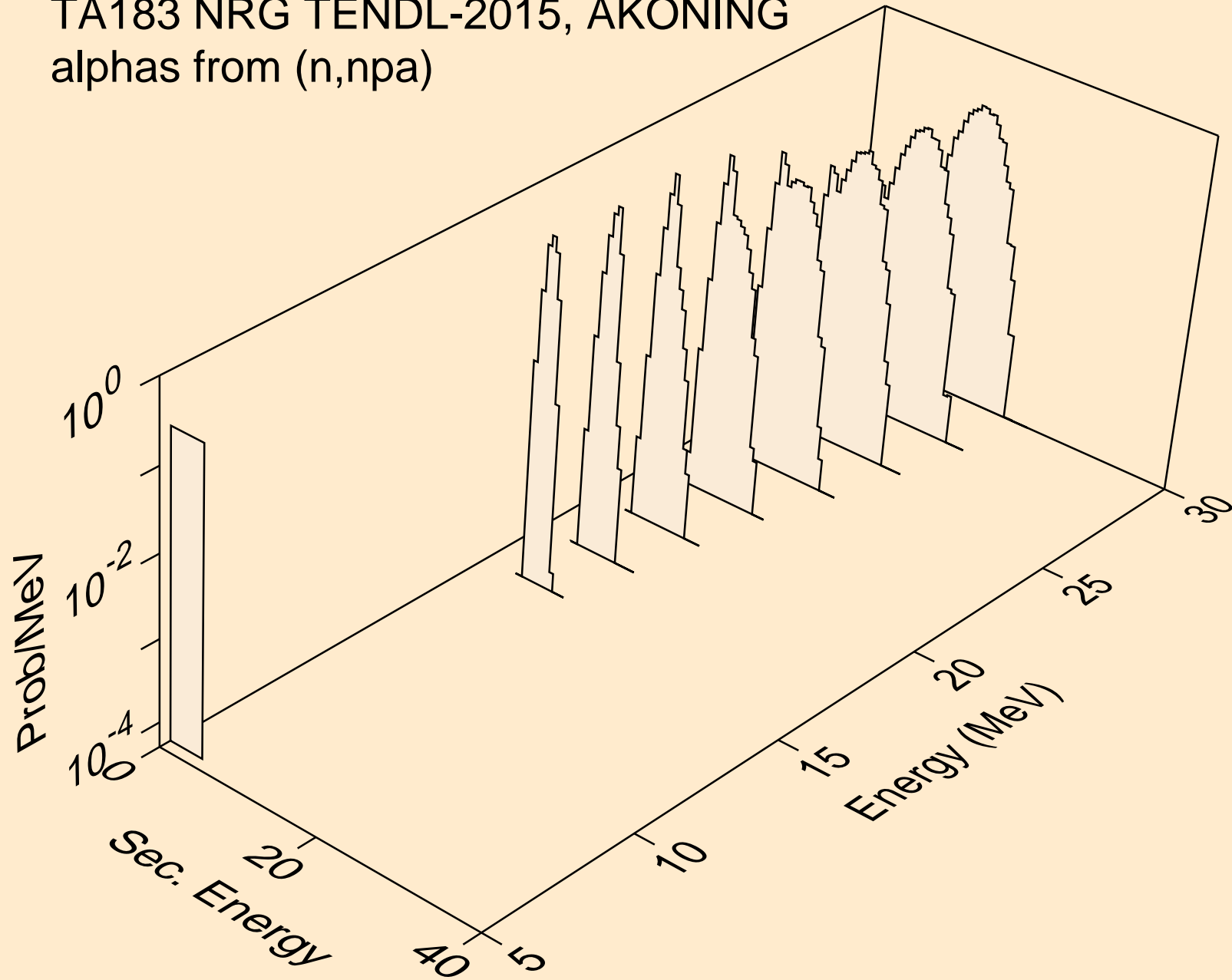

TA183 NRG TENDL-2015, AKONING
alphas from (n,a)

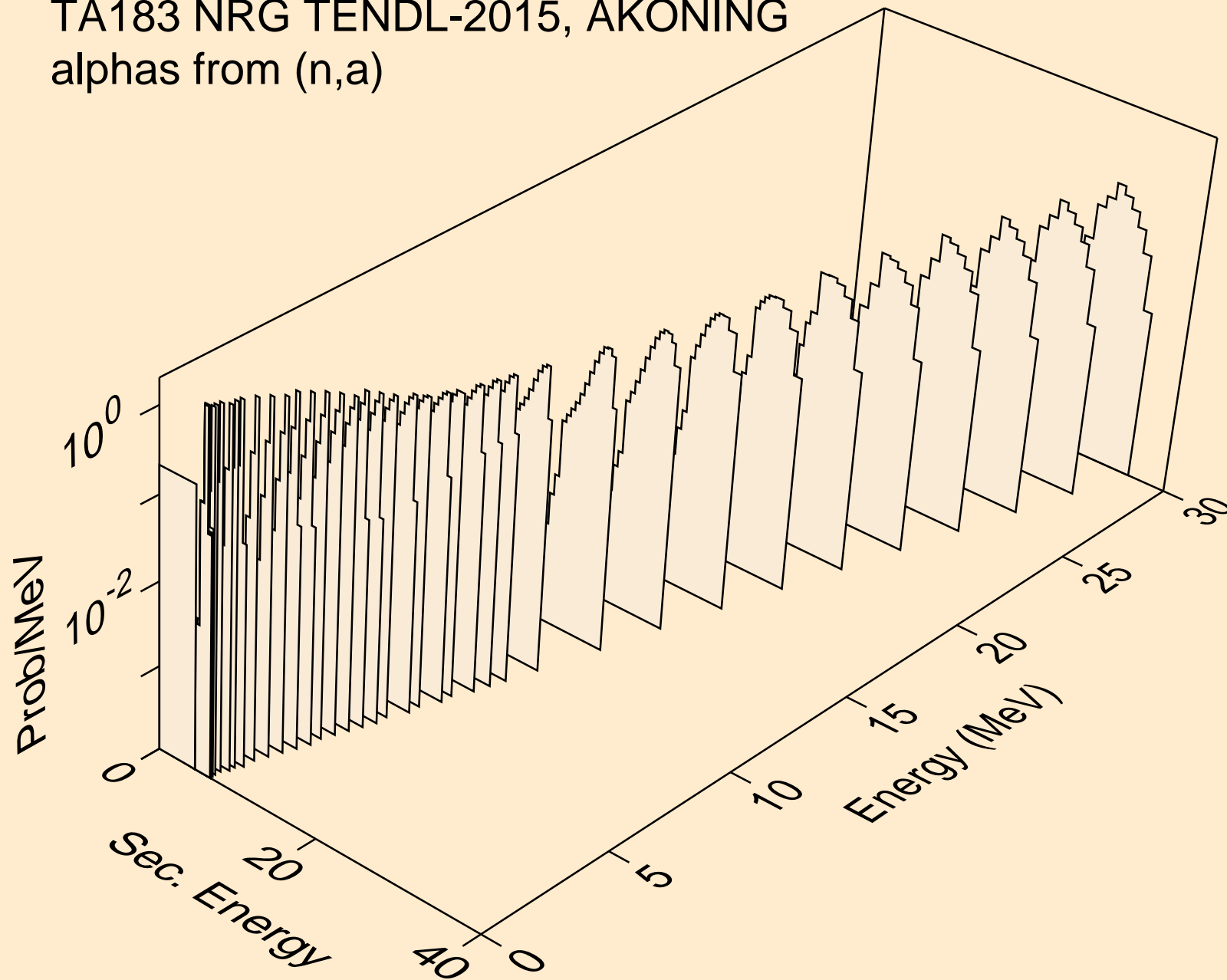

TA183 NRG TENDL-2015, AKONING
alphas from (n,2a)

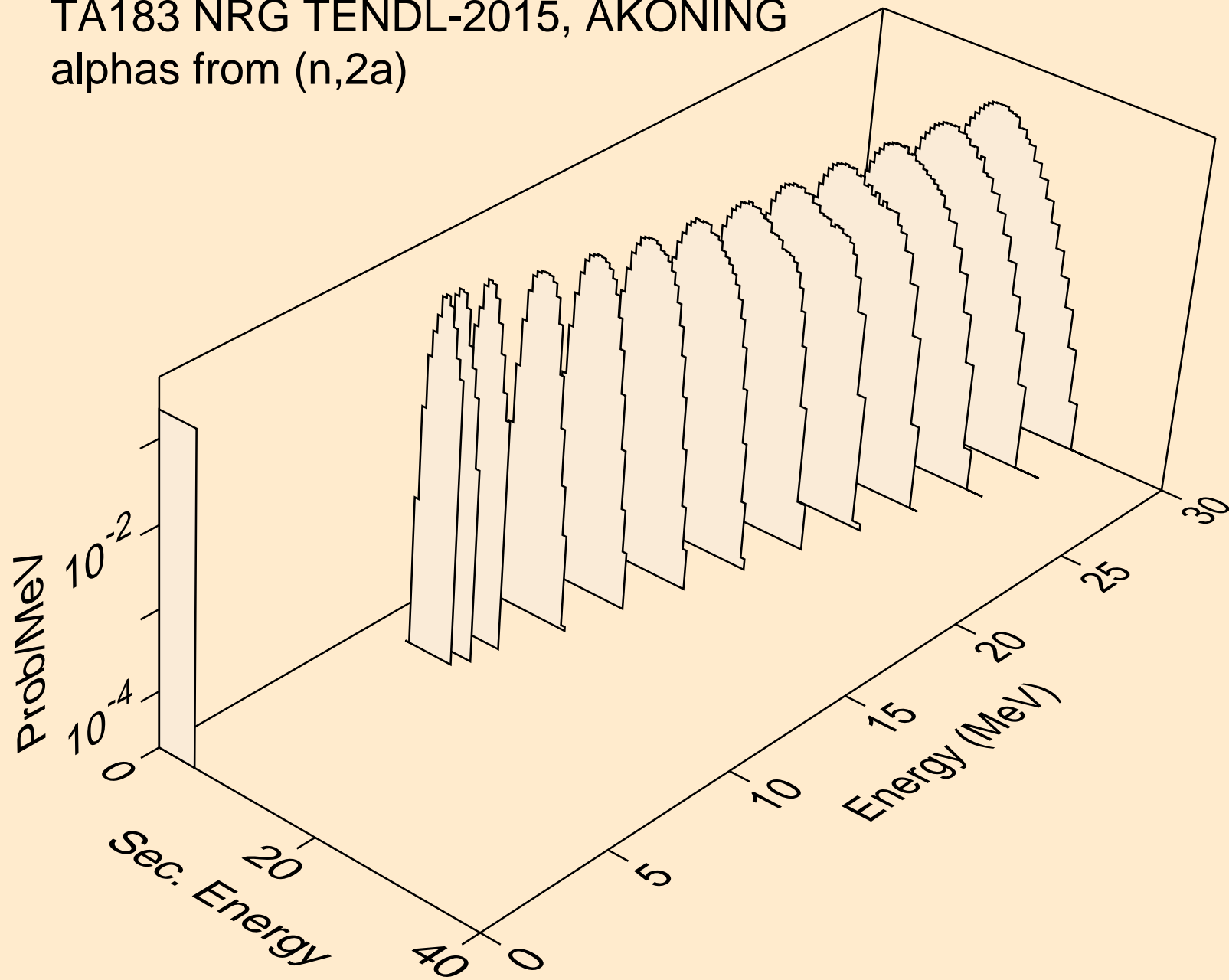

TA183 NRG TENDL-2015, AKONING
alphas from (n,pa)

