

TB140 NRG TENDL-2015, AKONING

Principal cross sections

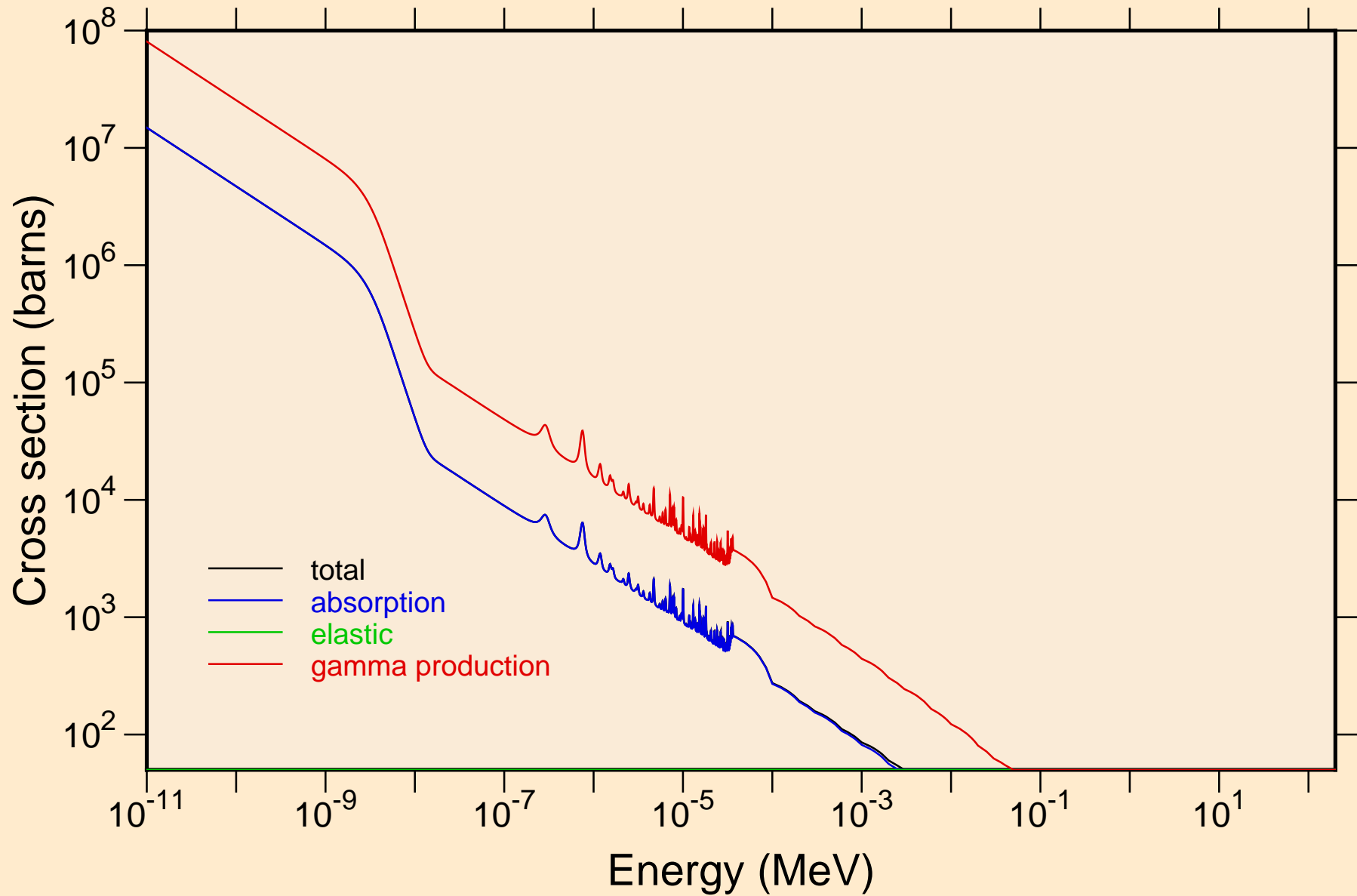

TB140 NRG TENDL-2015, AKONING
resonance total cross section

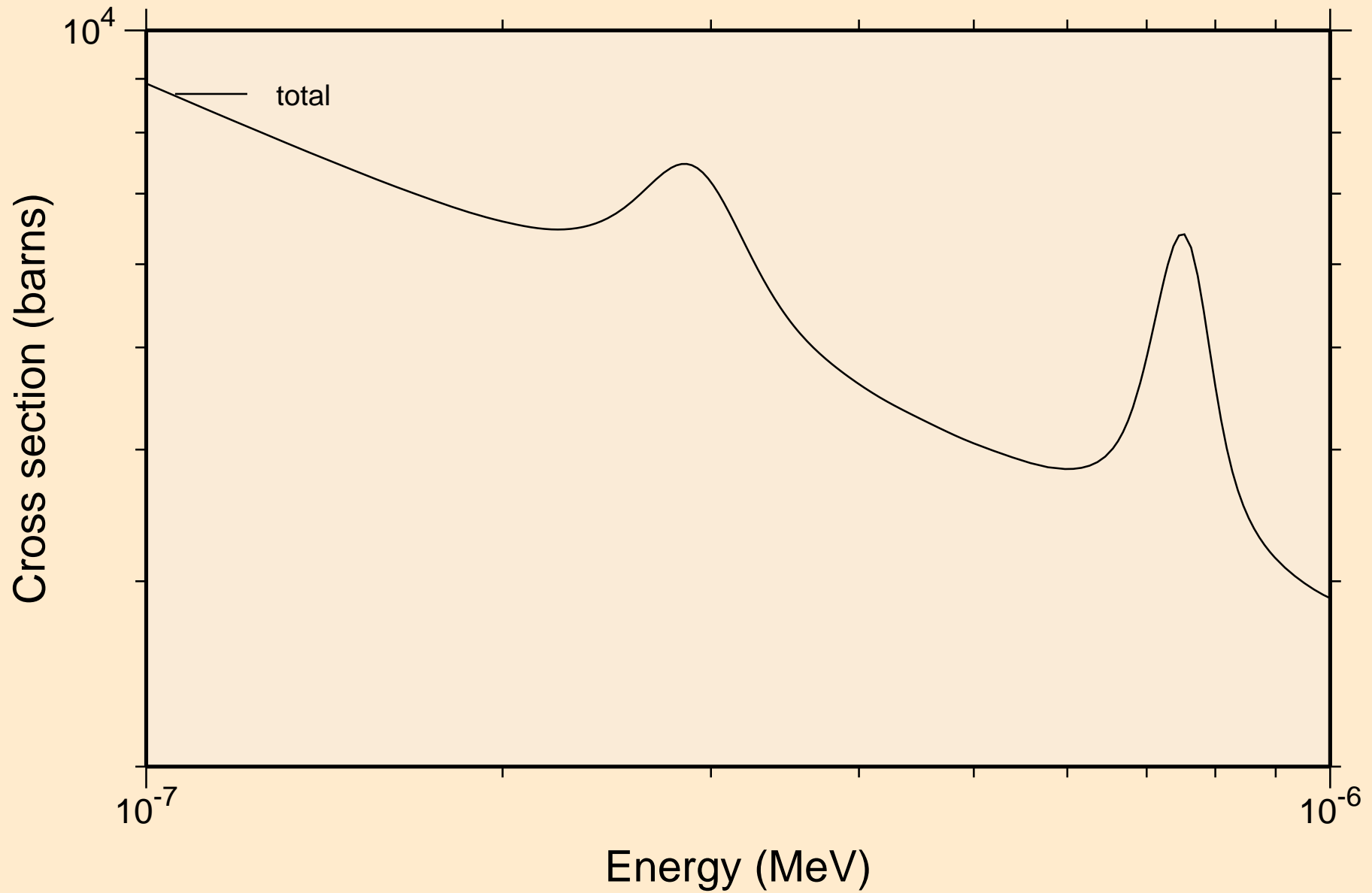

TB140 NRG TENDL-2015, AKONING
resonance total cross section

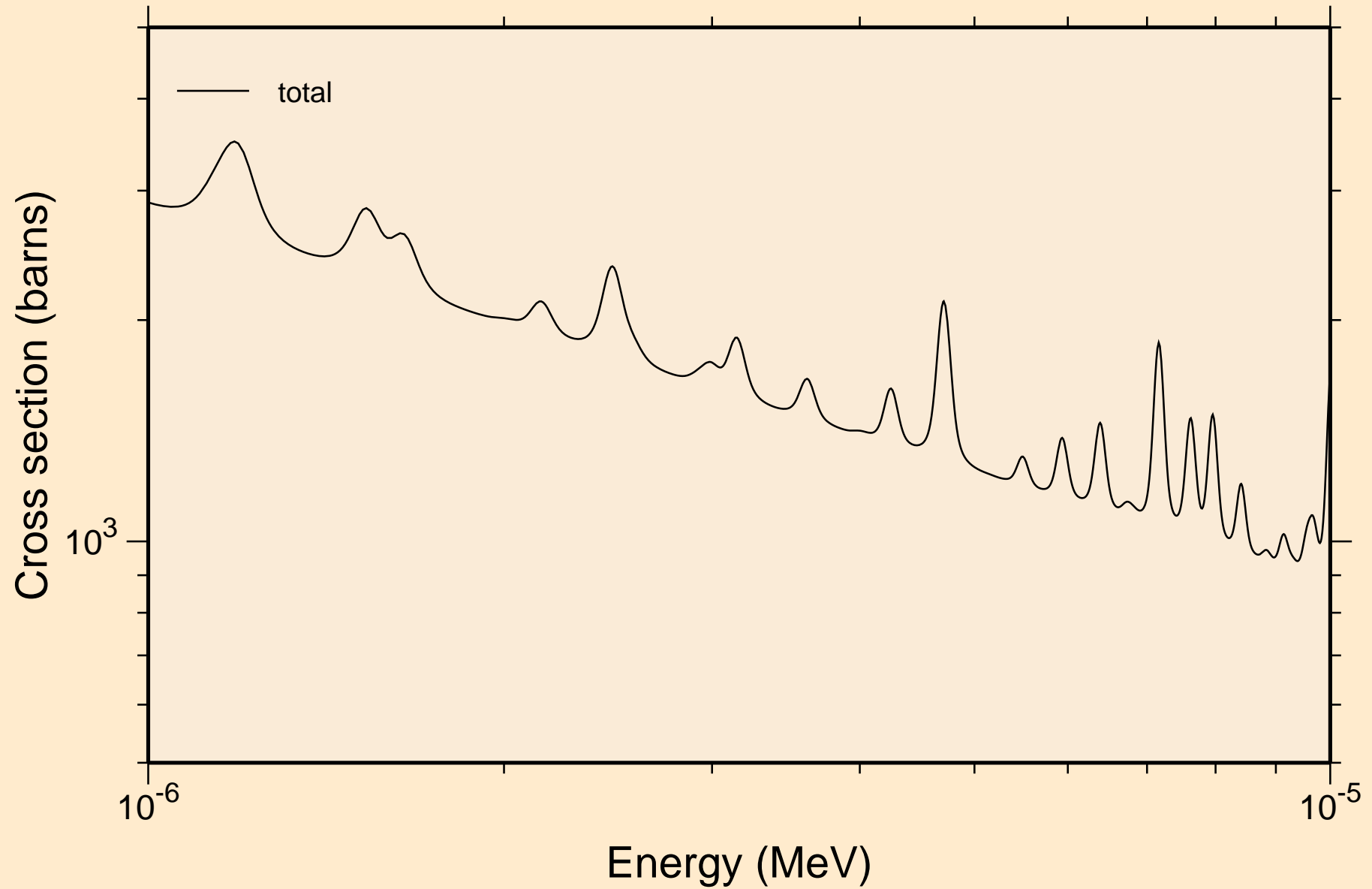

TB140 NRG TENDL-2015, AKONING
resonance total cross section

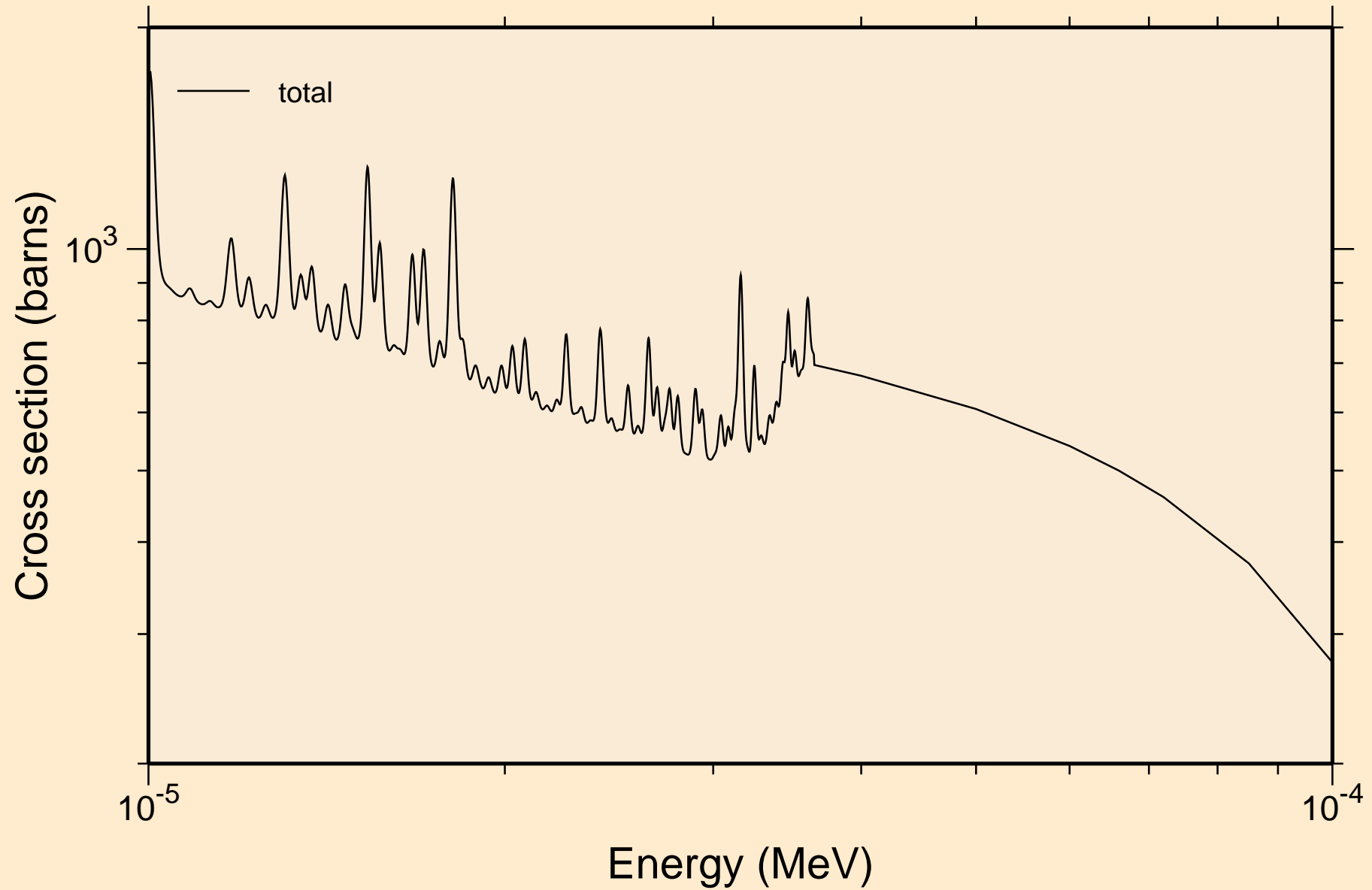

TB140 NRG TENDL-2015, AKONING
resonance total cross section

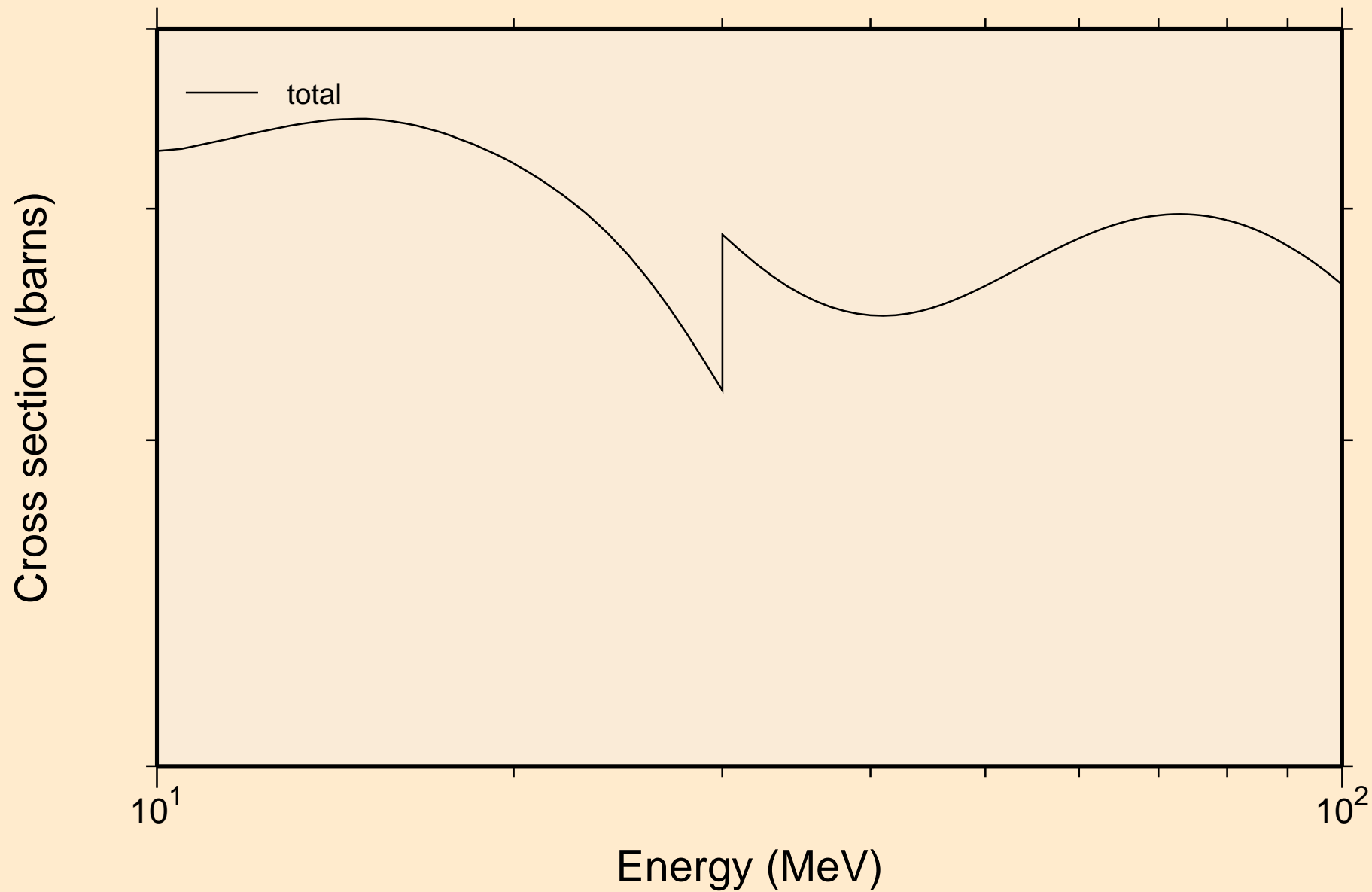

TB140 NRG TENDL-2015, AKONING
resonance absorption cross sections

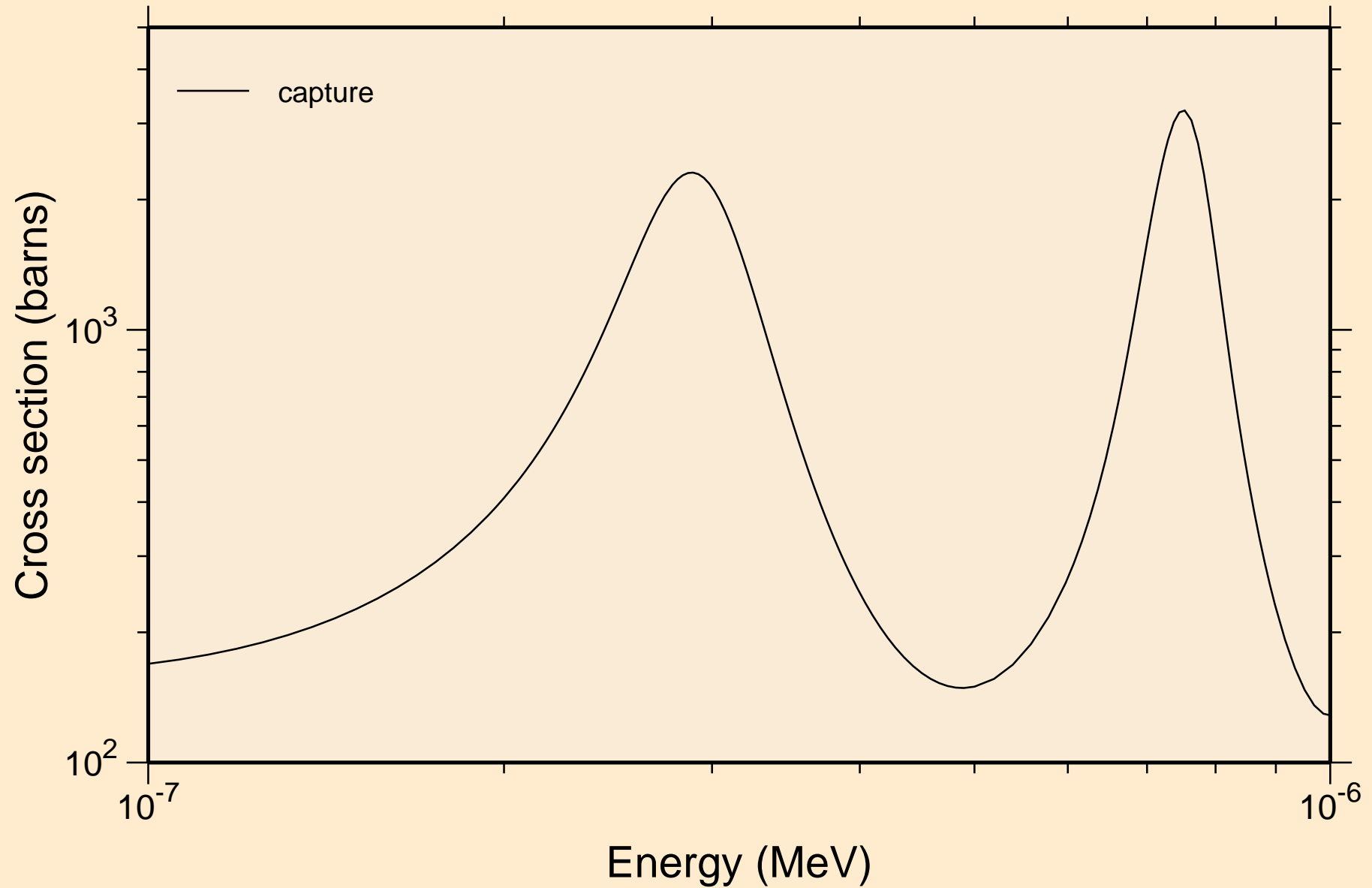

TB140 NRG TENDL-2015, AKONING
resonance absorption cross sections

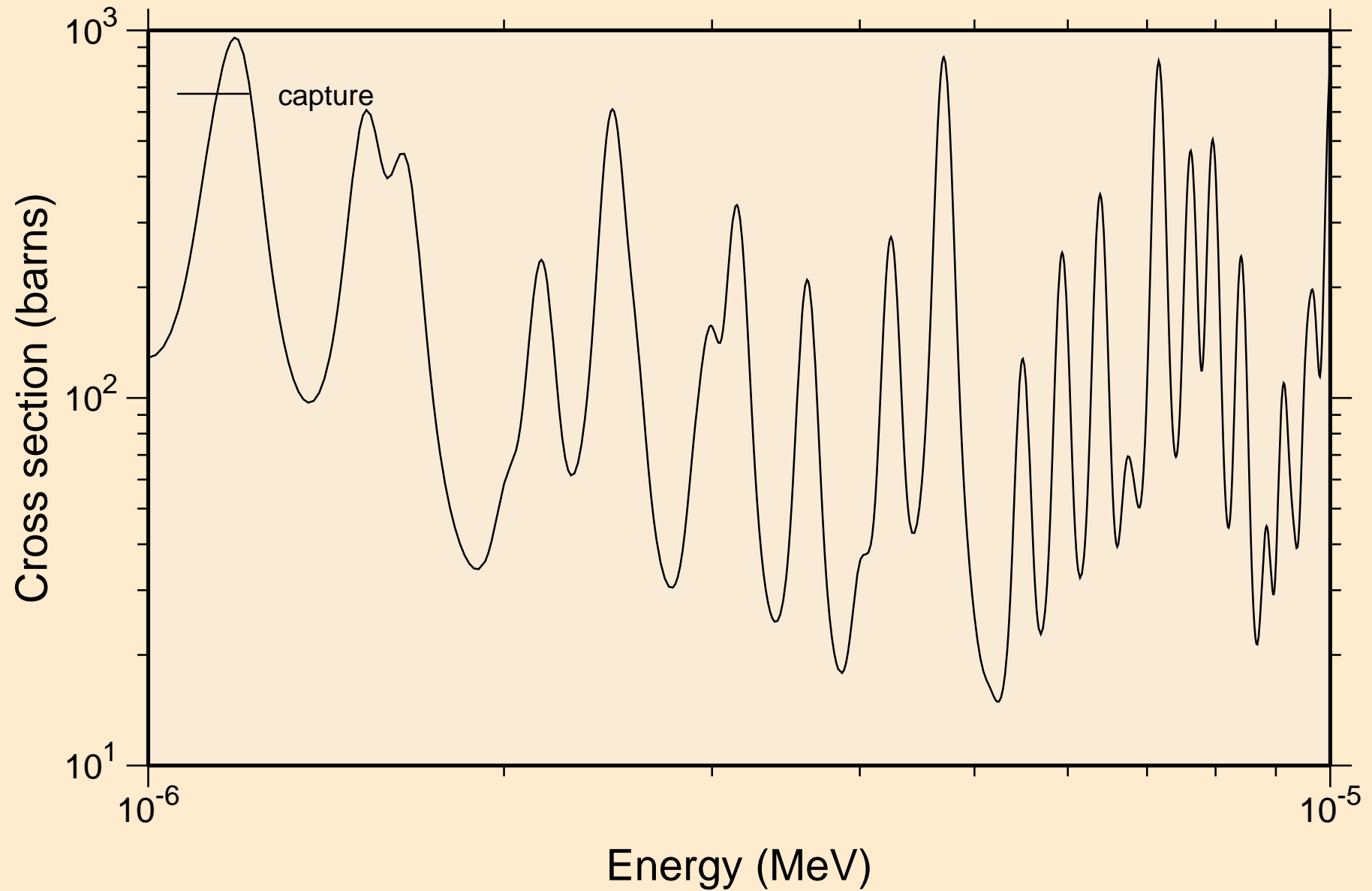

TB140 NRG TENDL-2015, AKONING
resonance absorption cross sections

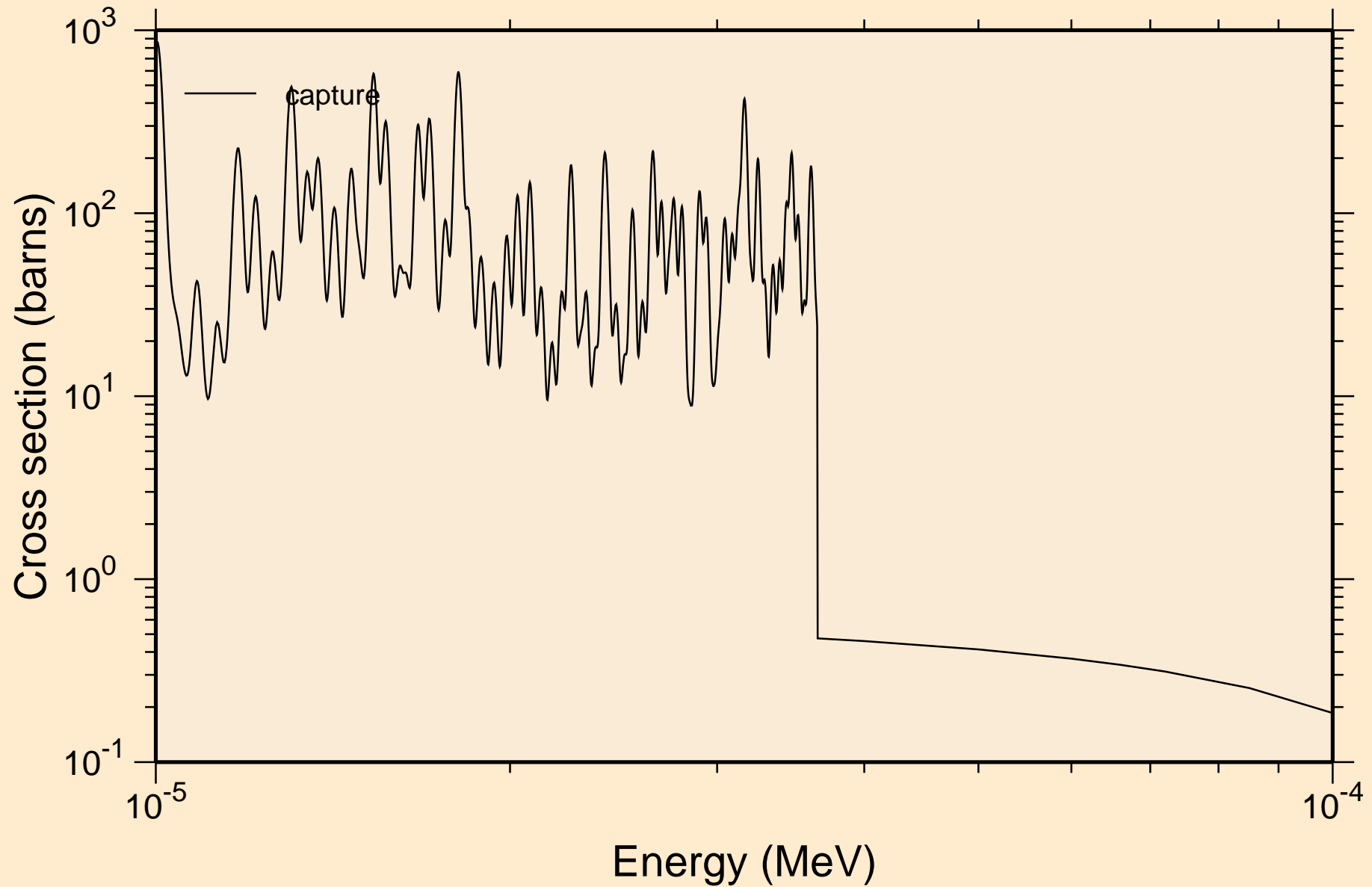

TB140 NRG TENDL-2015, AKONING
resonance absorption cross sections

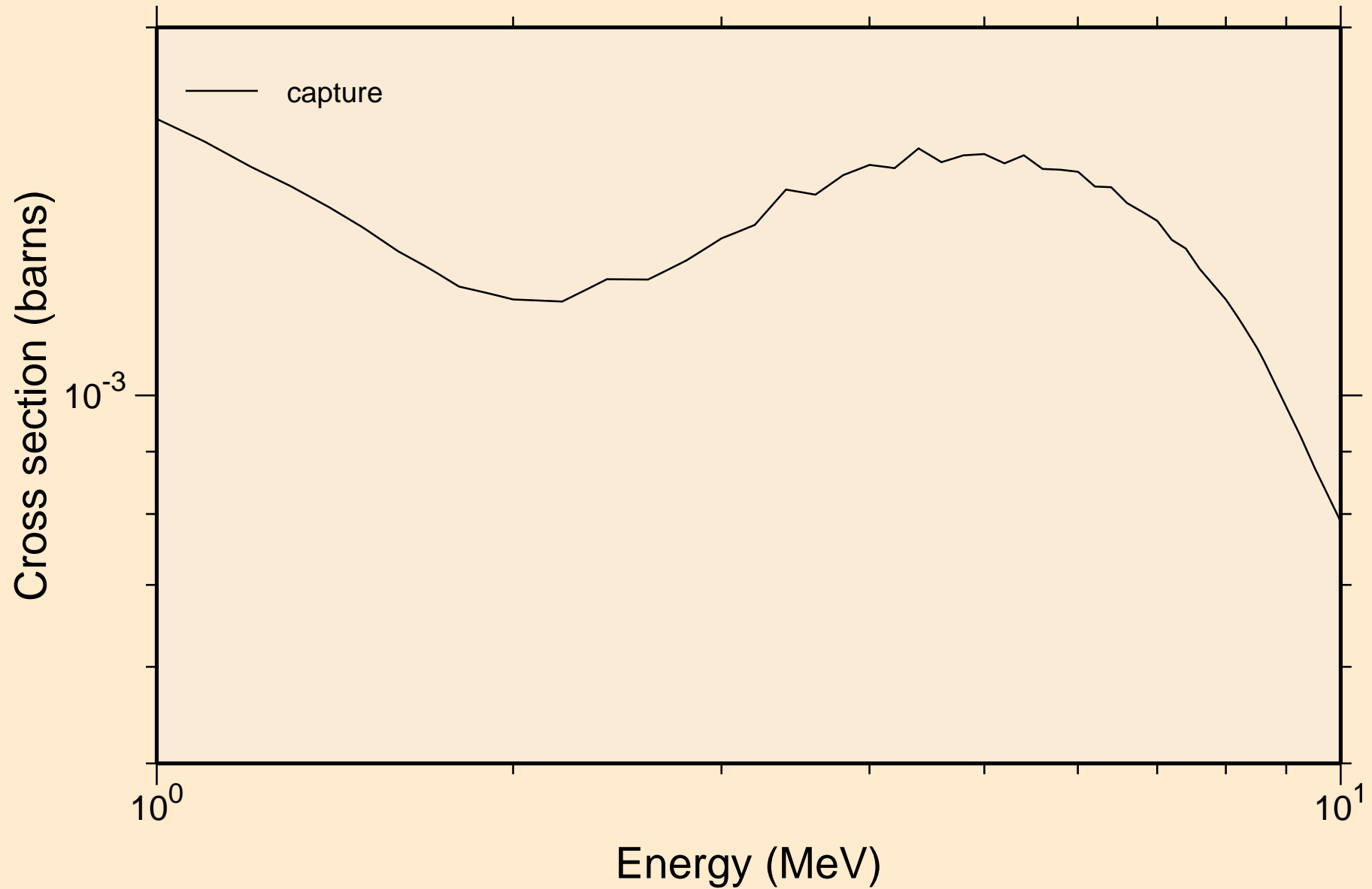

TB140 NRG TENDL-2015, AKONING

Non-threshold reactions

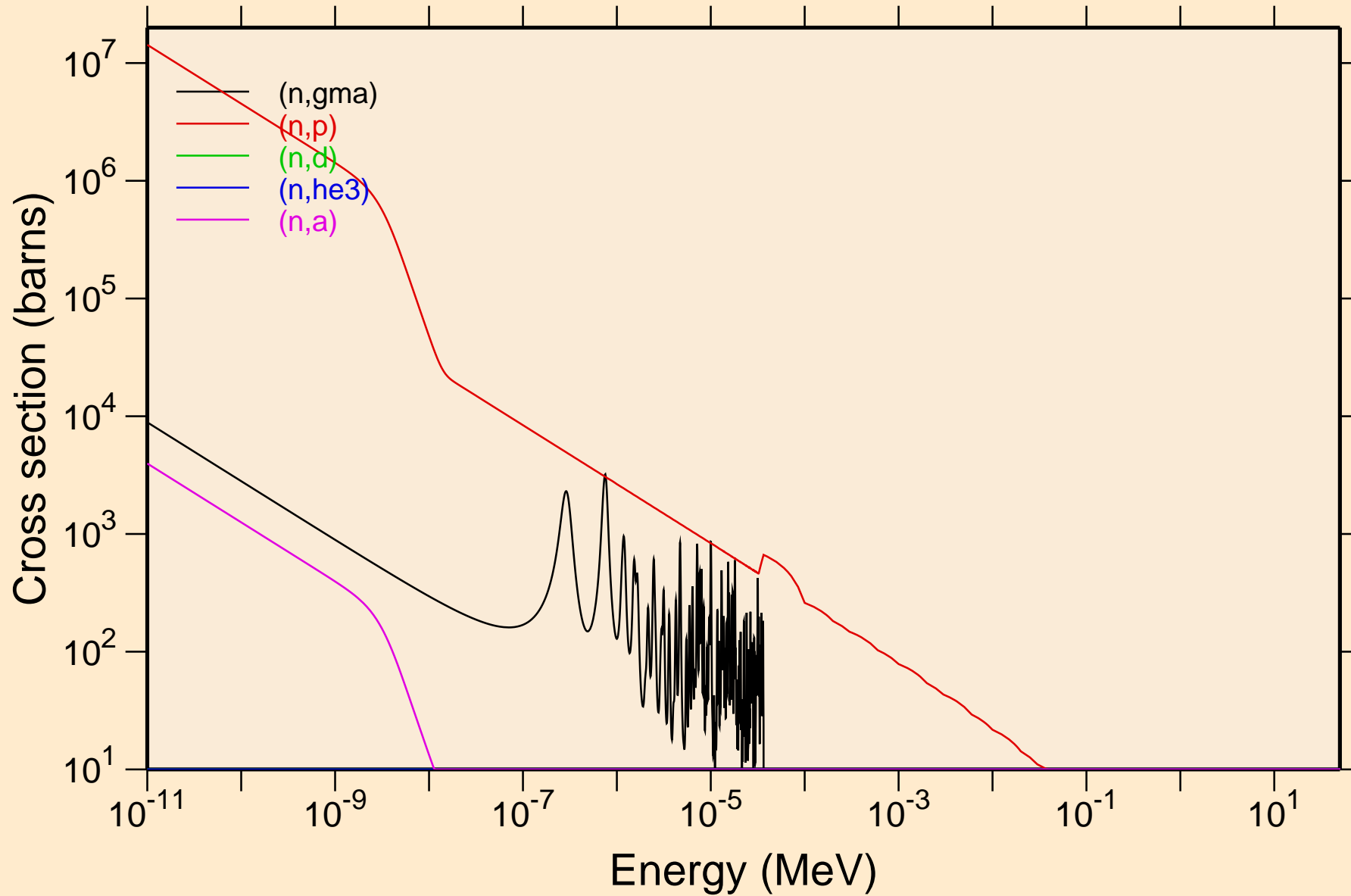

TB140 NRG TENDL-2015, AKONING

Non-threshold reactions

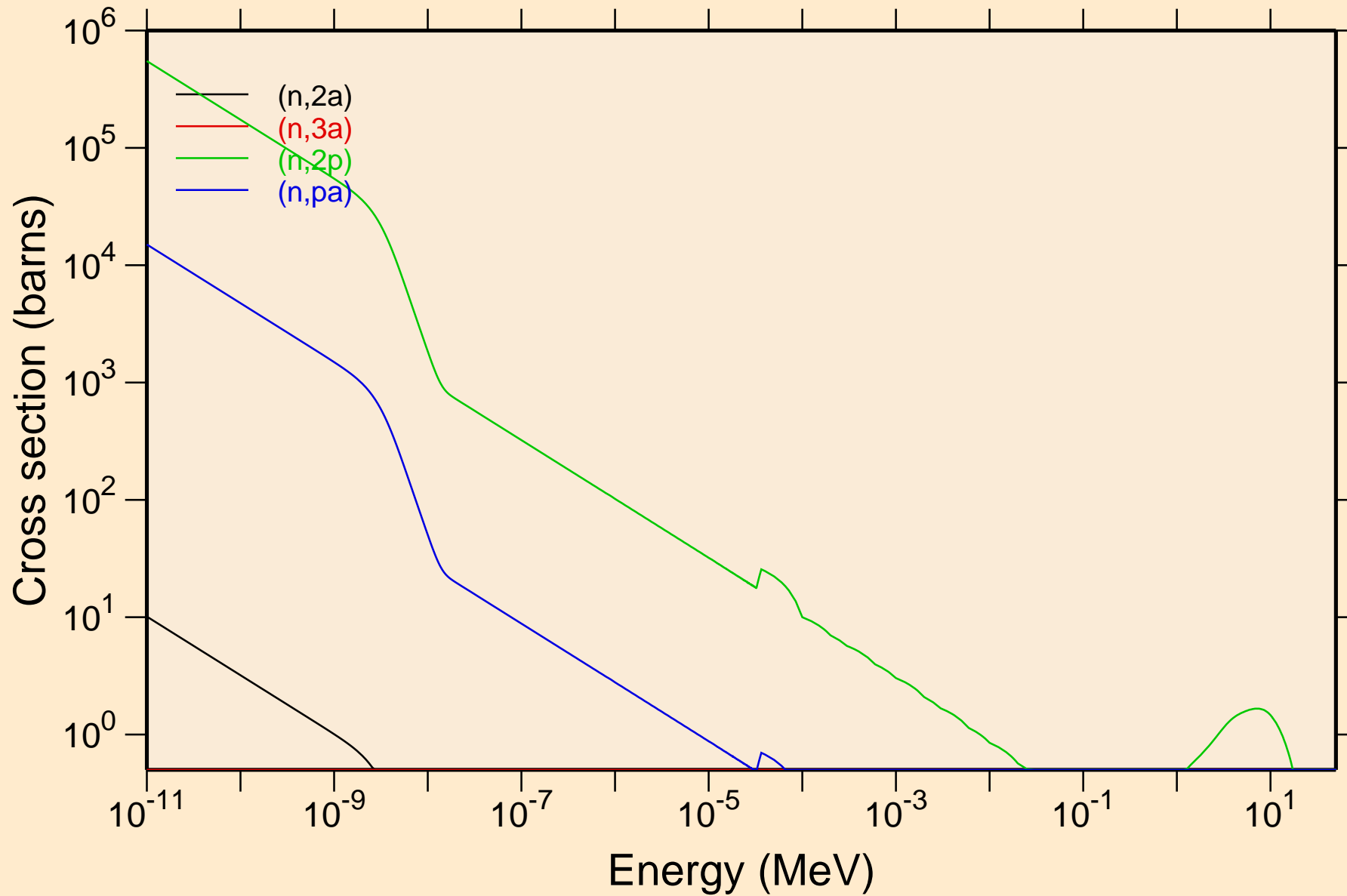

TB140 NRG TENDL-2015, AKONING

Principal cross sections

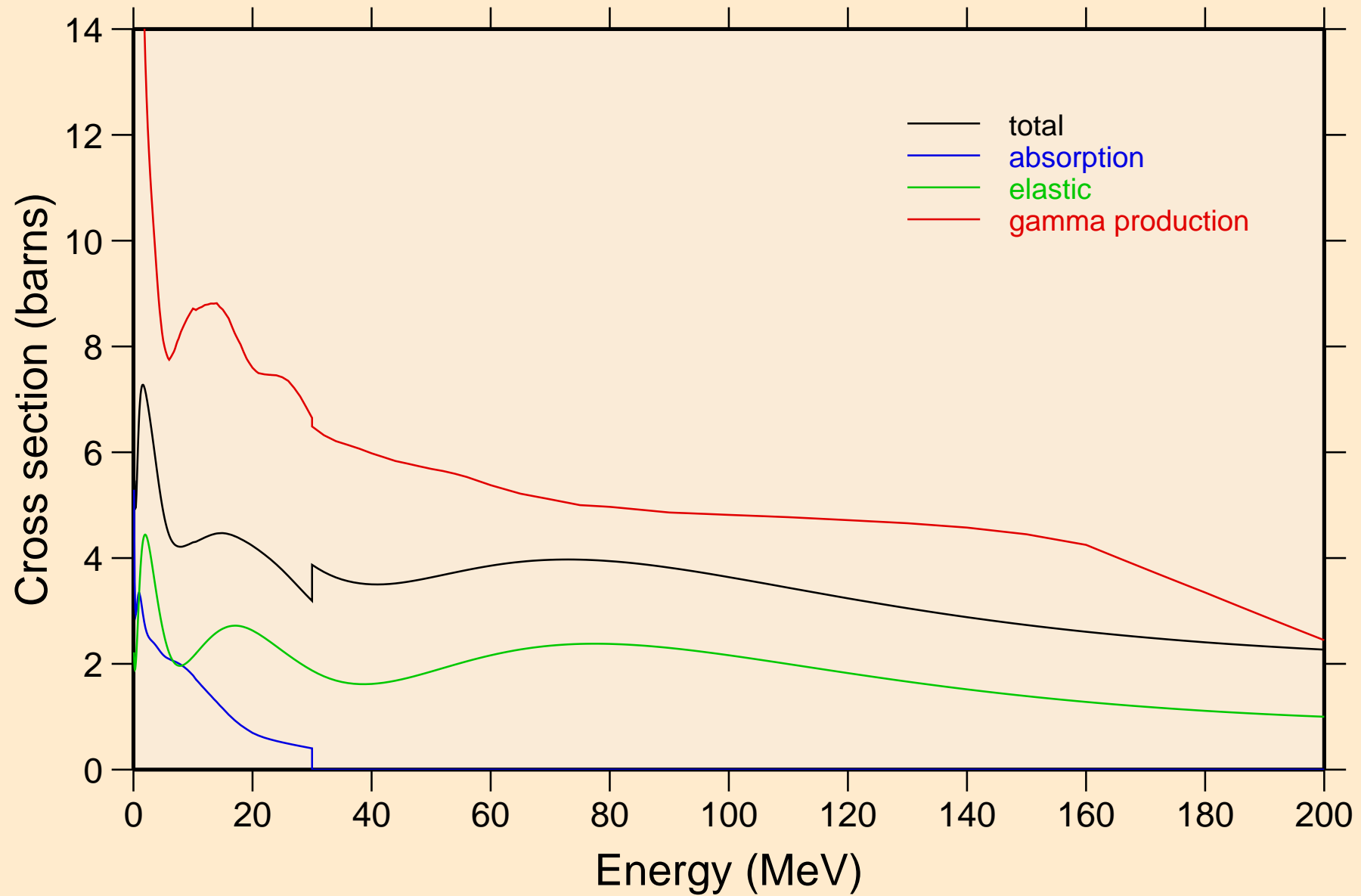

TB140 NRG TENDL-2015, AKONING

Non-threshold reactions

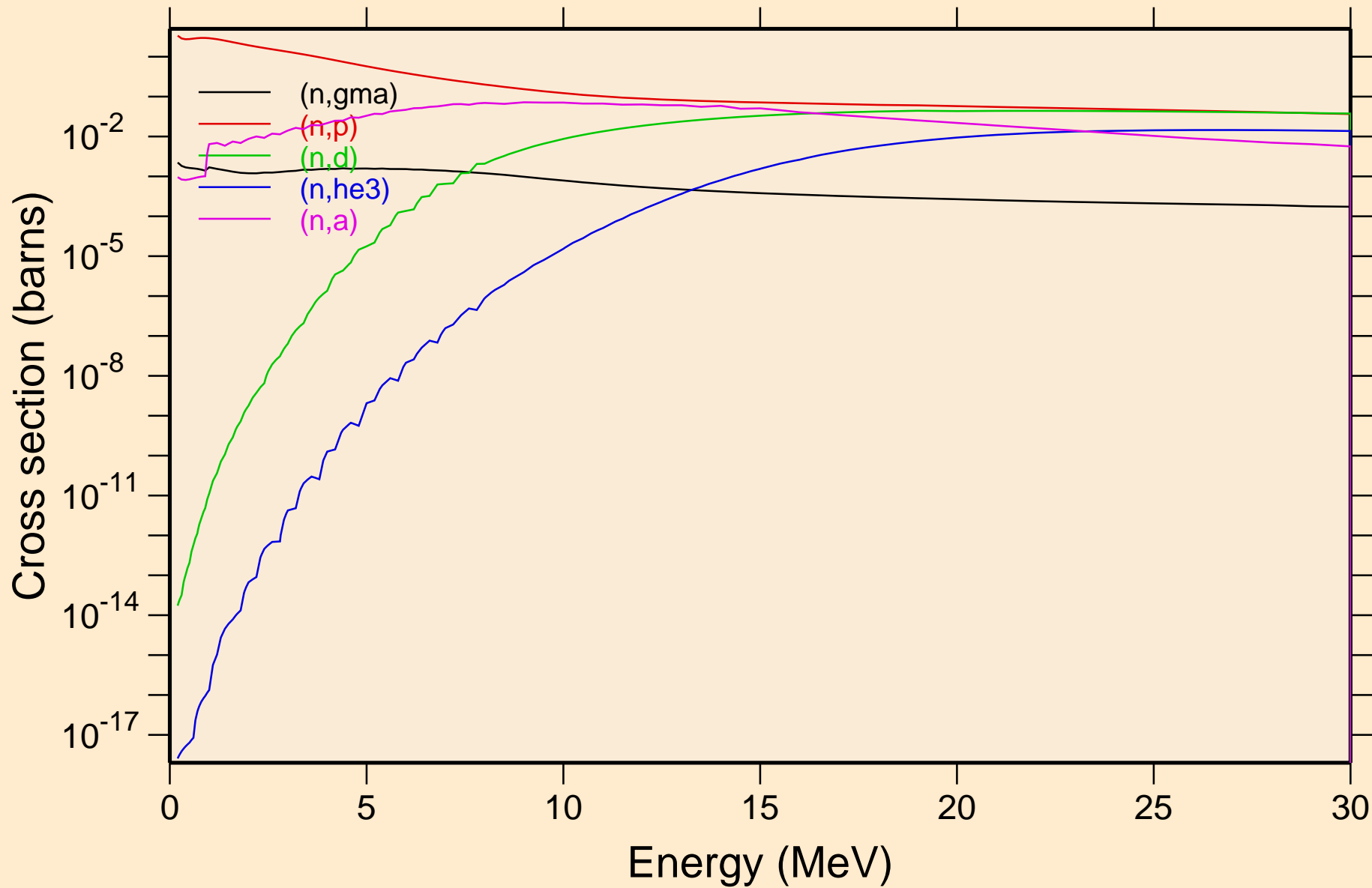

TB140 NRG TENDL-2015, AKONING

Non-threshold reactions

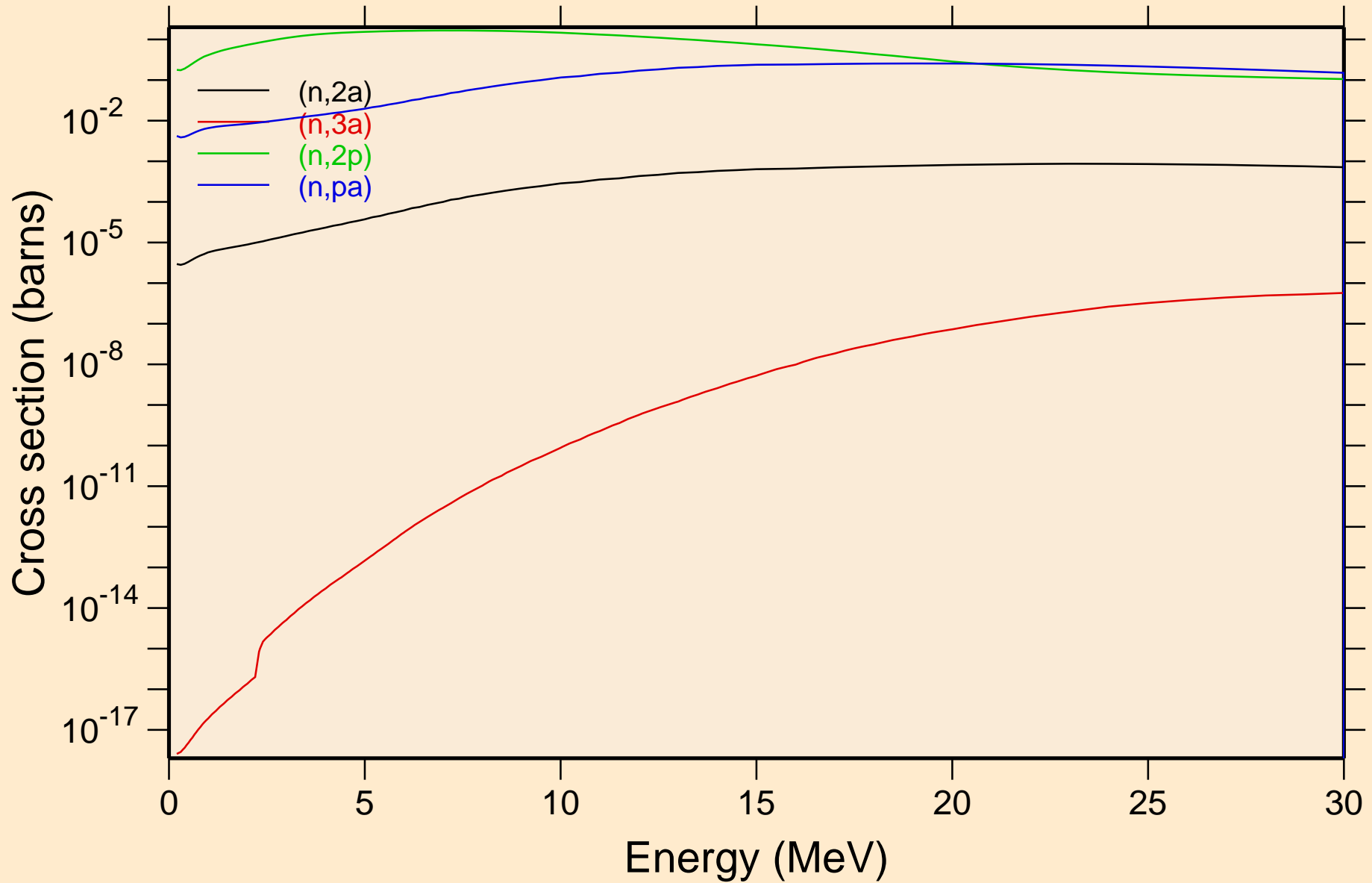

TB140 NRG TENDL-2015, AKONING
Inelastic levels

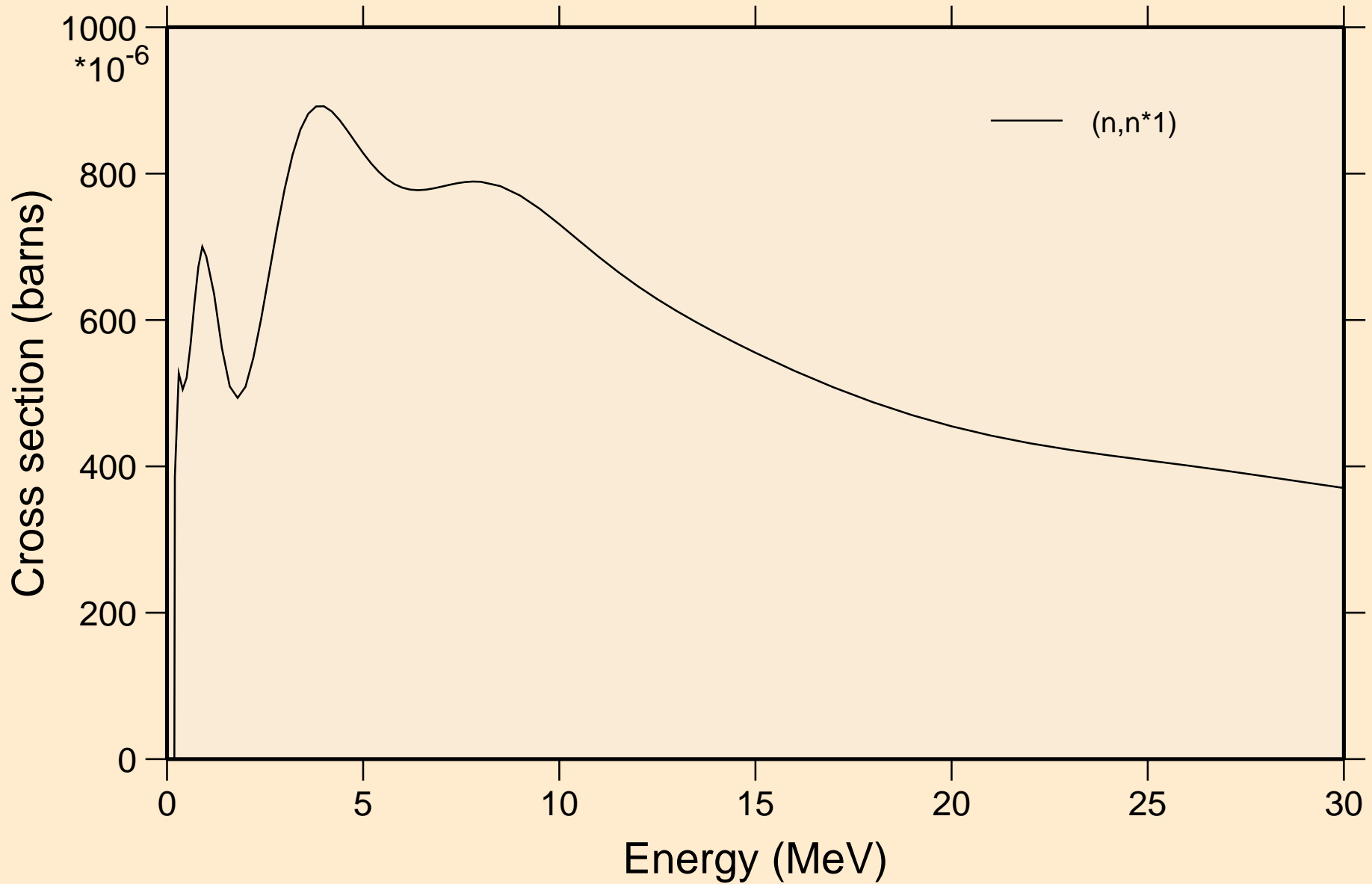

TB140 NRG TENDL-2015, AKONING

Threshold reactions

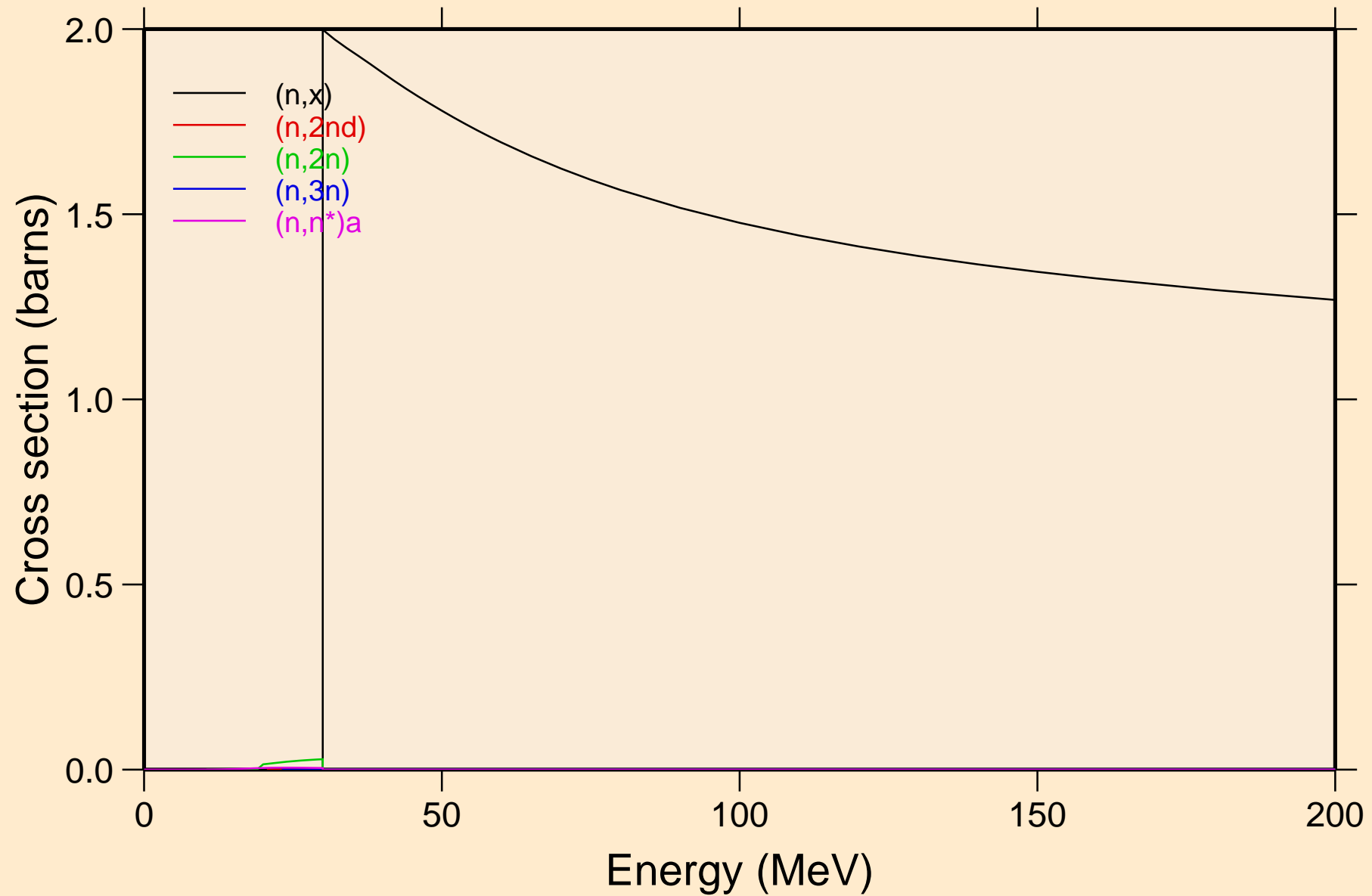

TB140 NRG TENDL-2015, AKONING

Threshold reactions

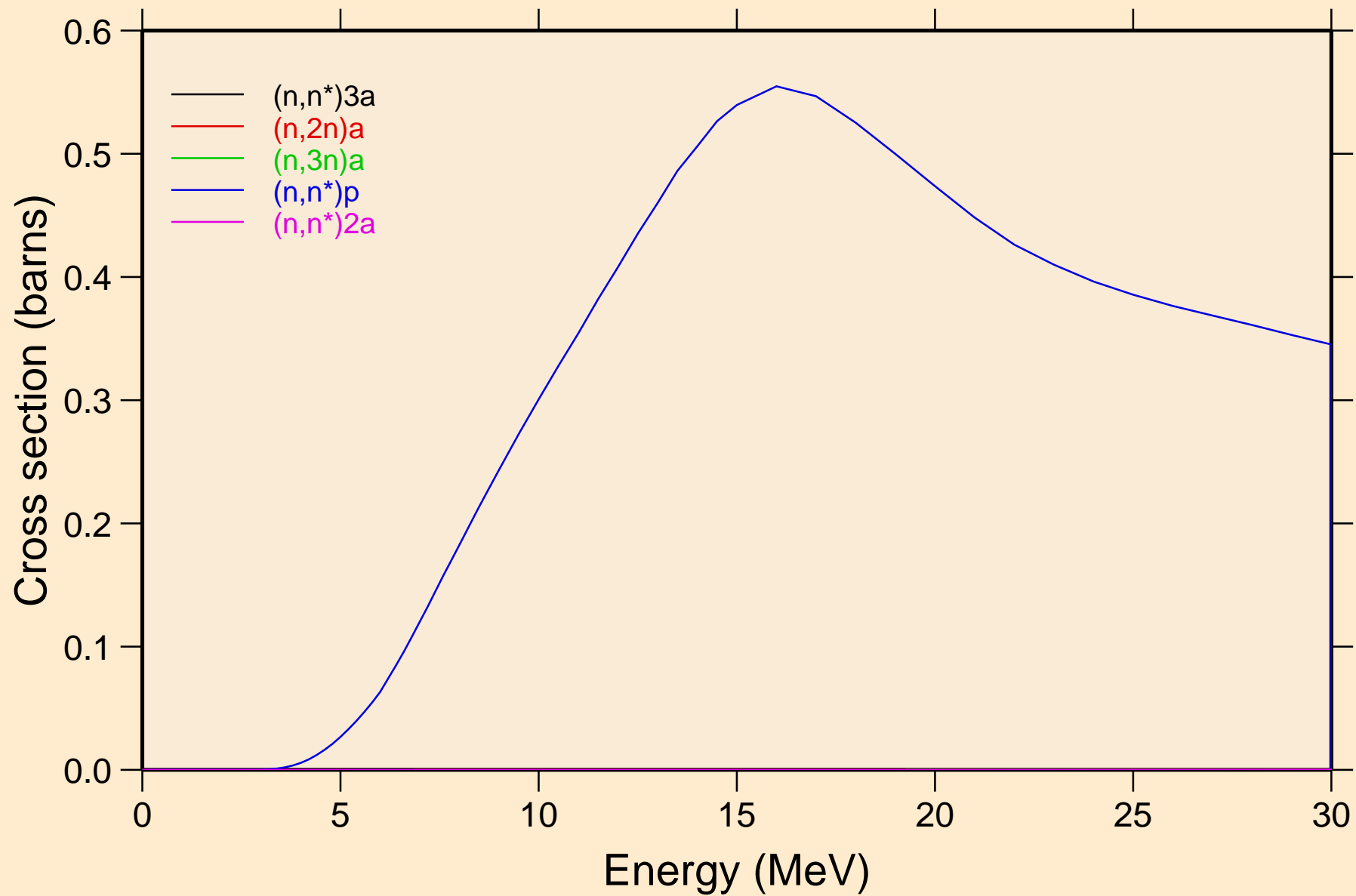

TB140 NRG TENDL-2015, AKONING

Threshold reactions

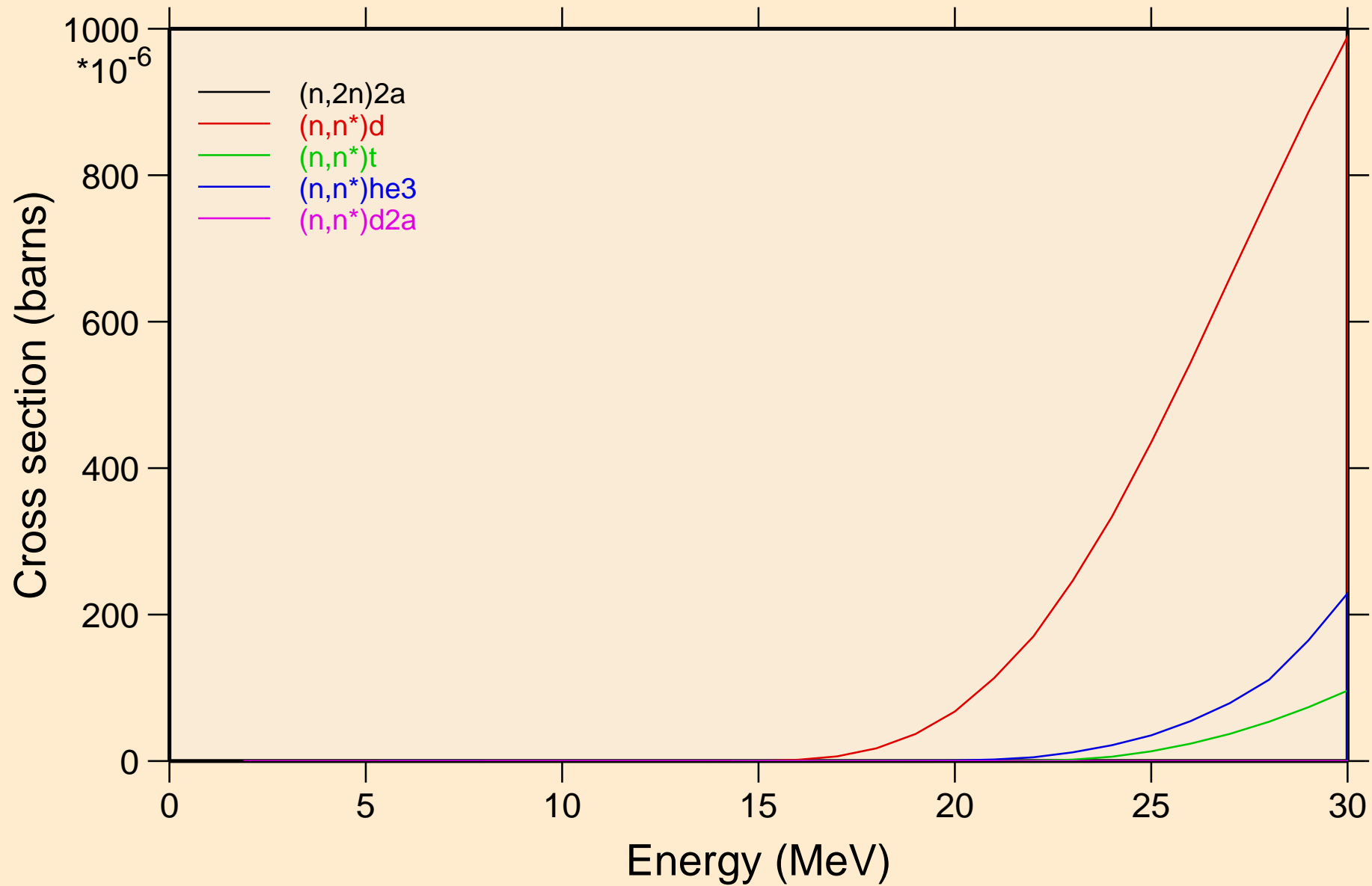

TB140 NRG TENDL-2015, AKONING

Threshold reactions

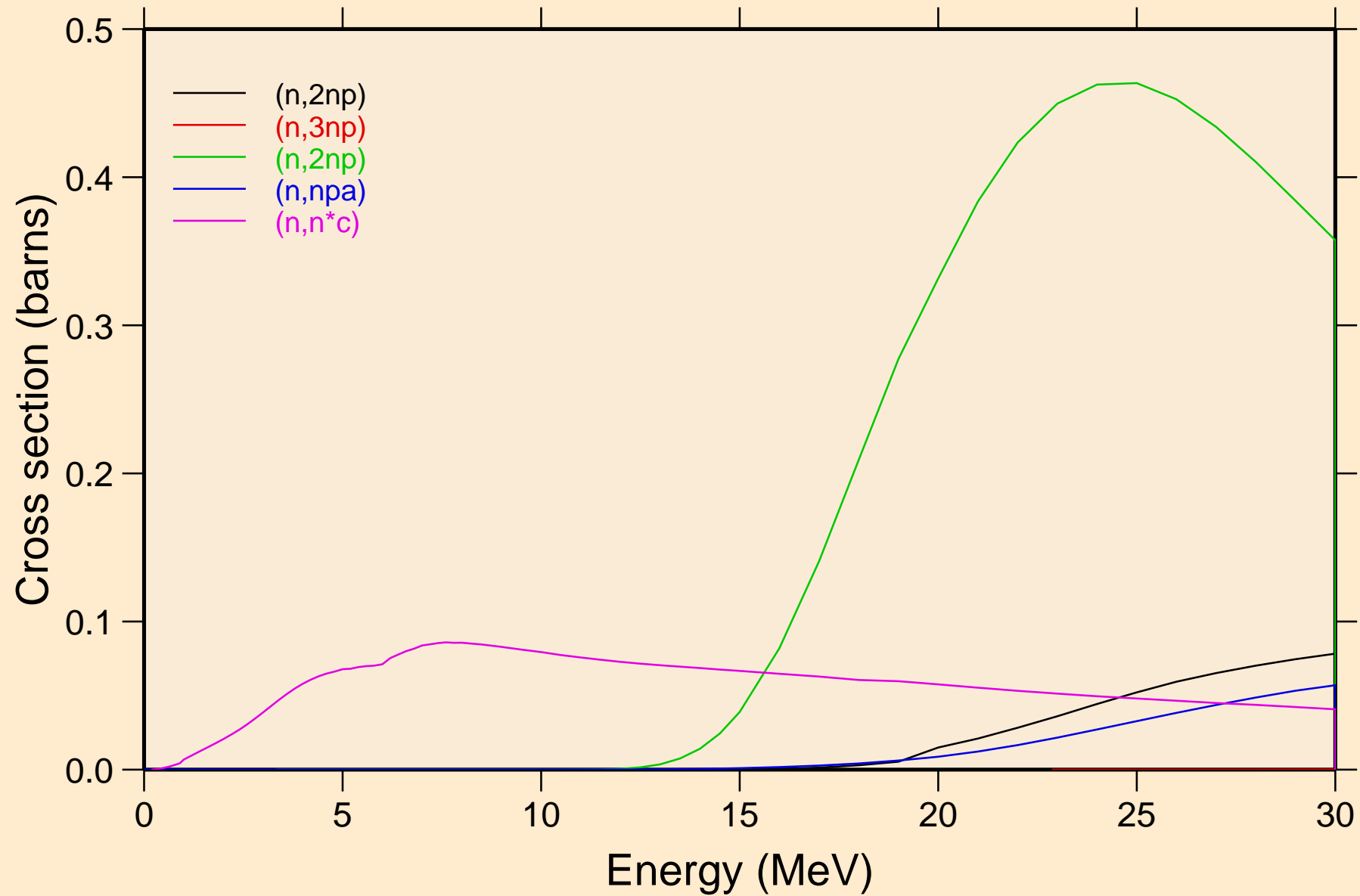

TB140 NRG TENDL-2015, AKONING

Threshold reactions

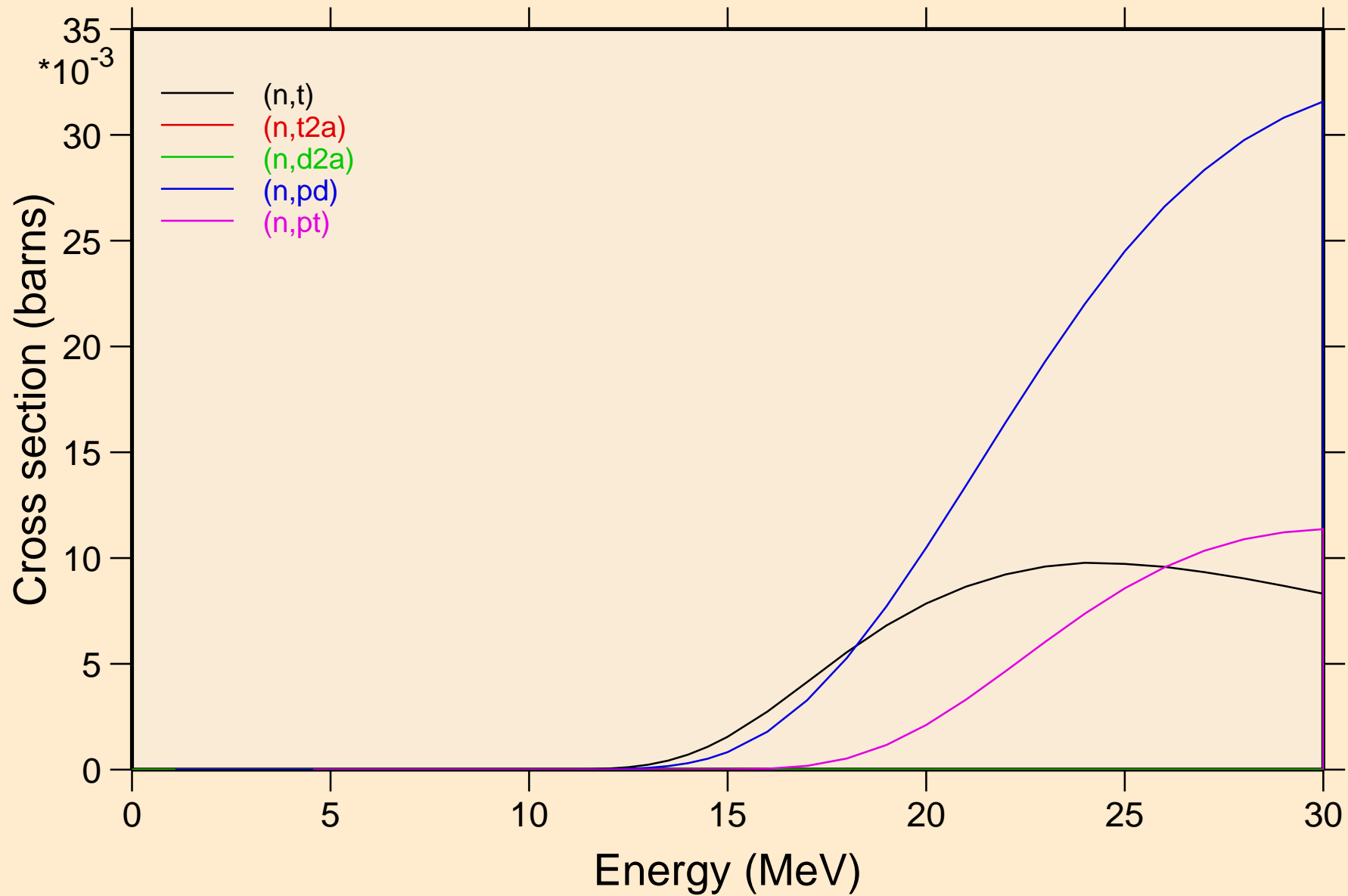

TB140 NRG TENDL-2015, AKONING

Threshold reactions

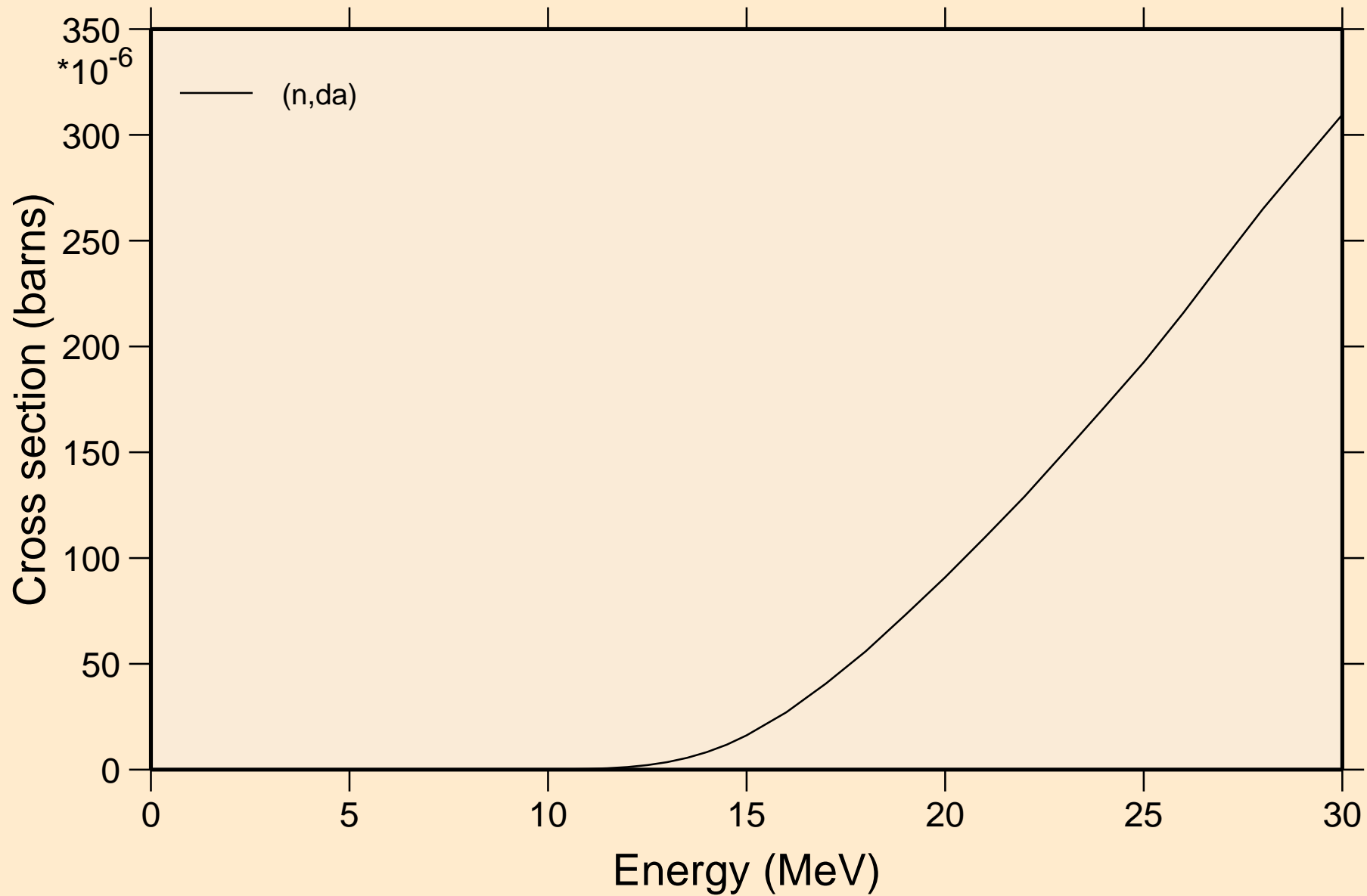

TB140 NRG TENDL-2015, AKONING
angular distribution for elastic

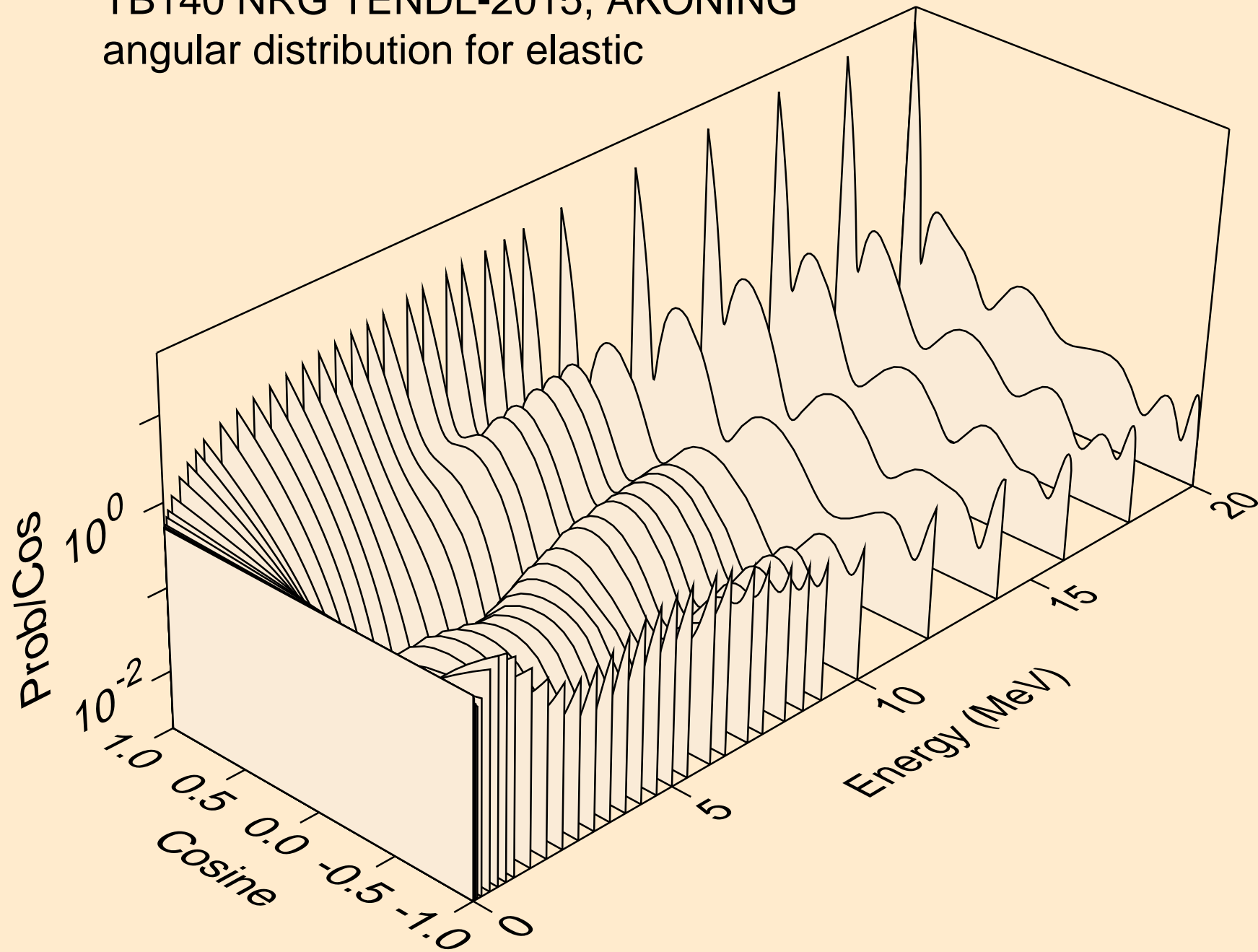

TB140 NRG TENDL-2015, AKONING
angular distribution for elastic

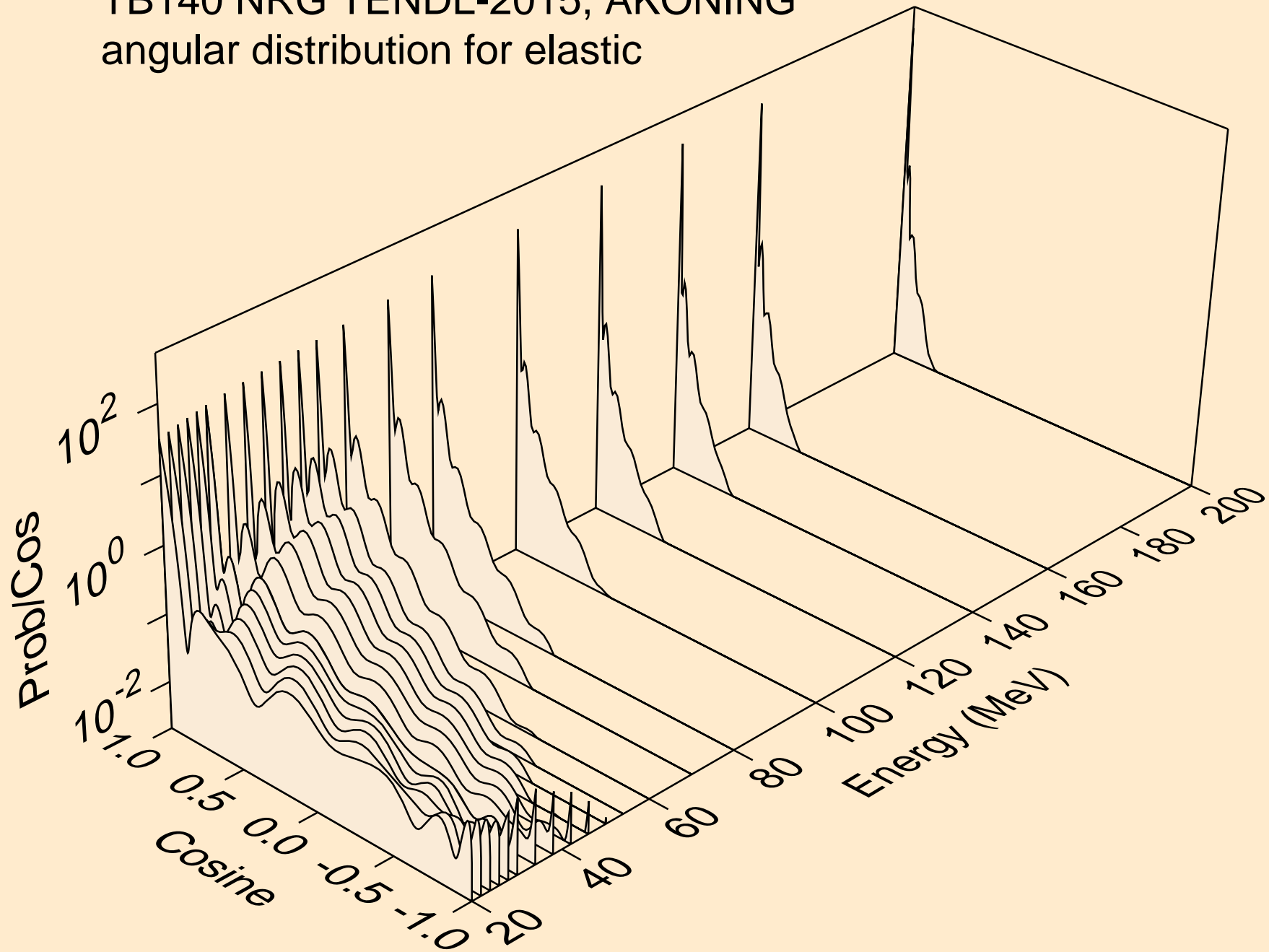

TB140 NRG TENDL-2015, AKONING
angular distribution for (n,n*1)

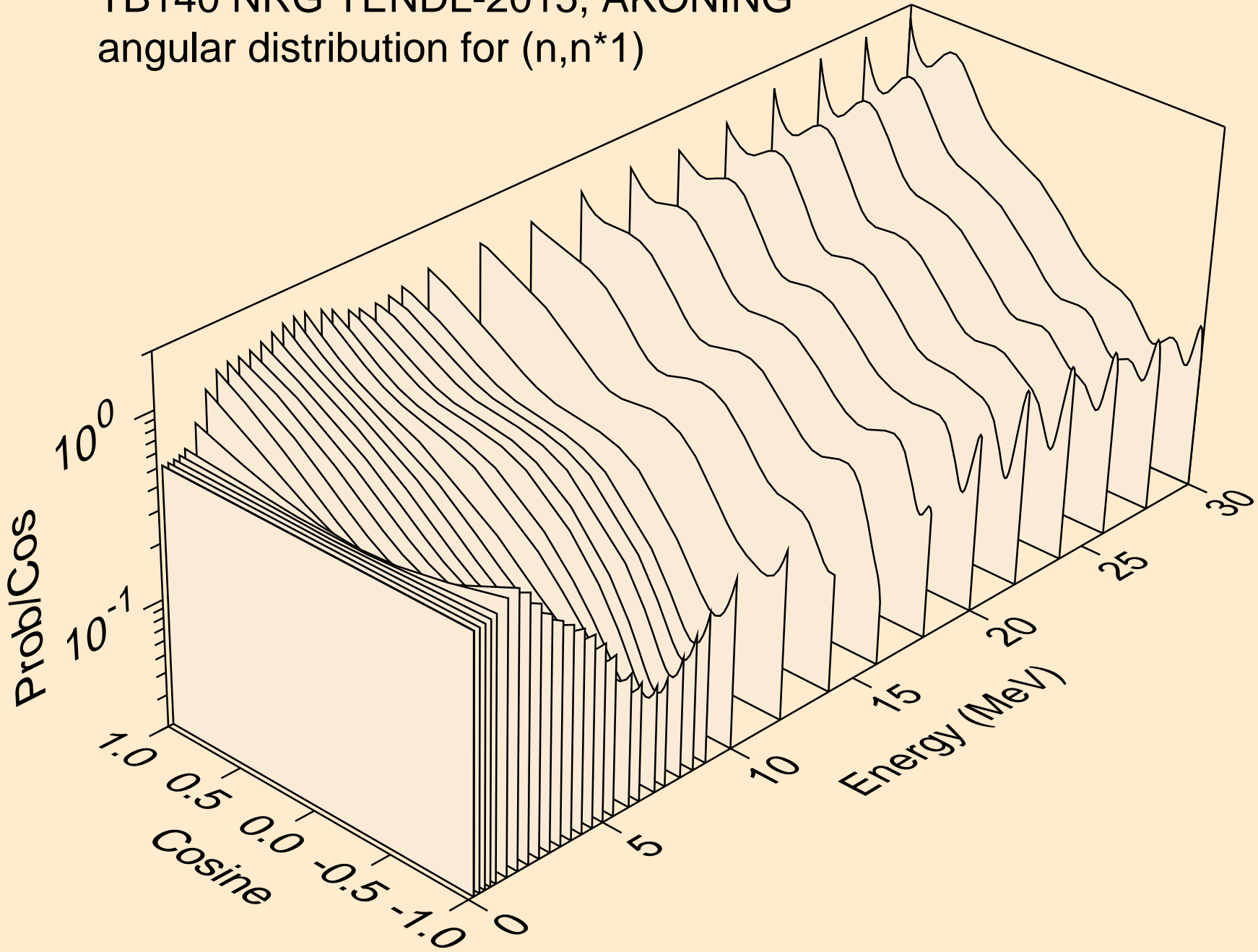

TB140 NRG TENDL-2015, AKONING
Neutron emission for (n,x)

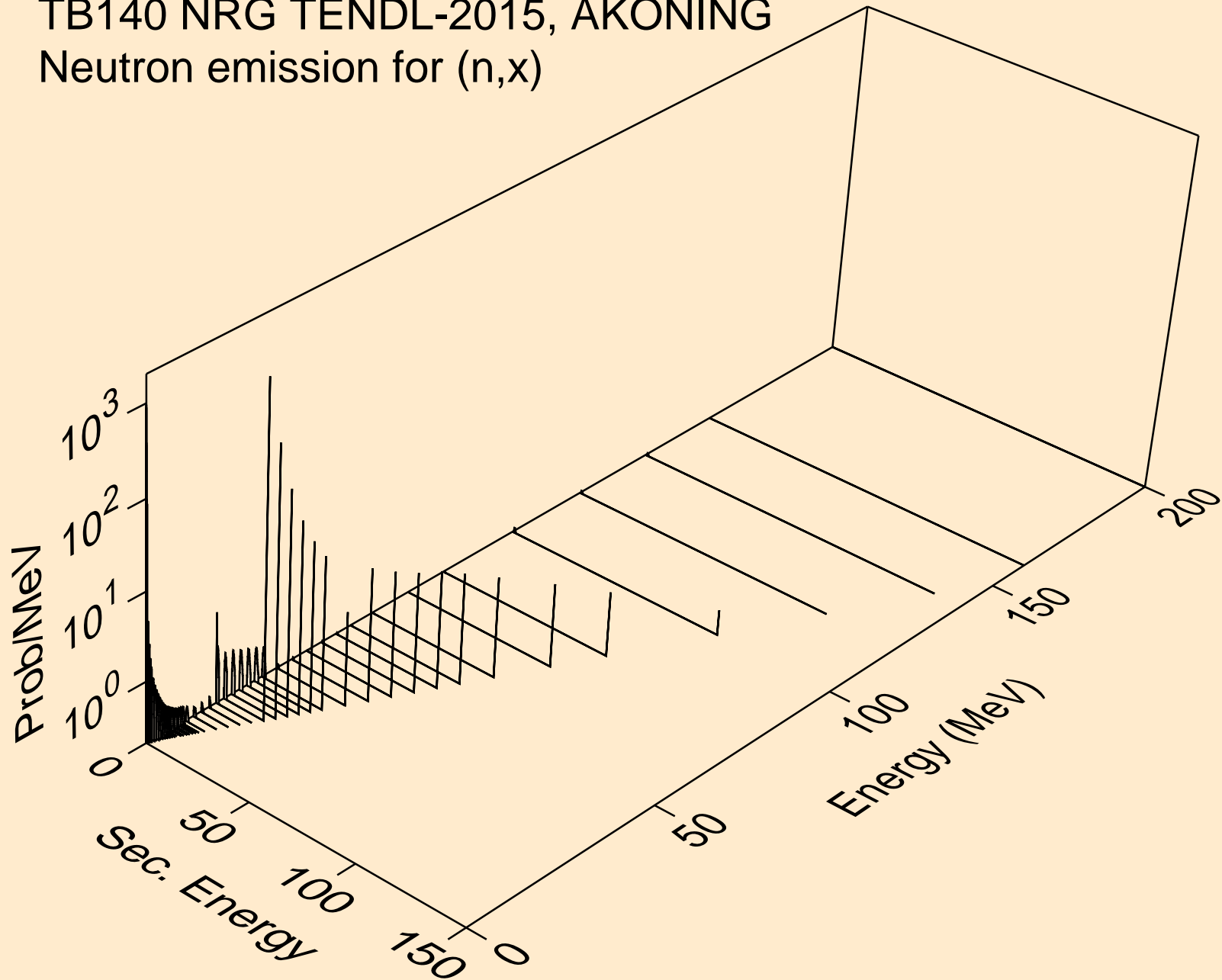

TB140 NRG TENDL-2015, AKONING
Neutron emission for (n,2nd)

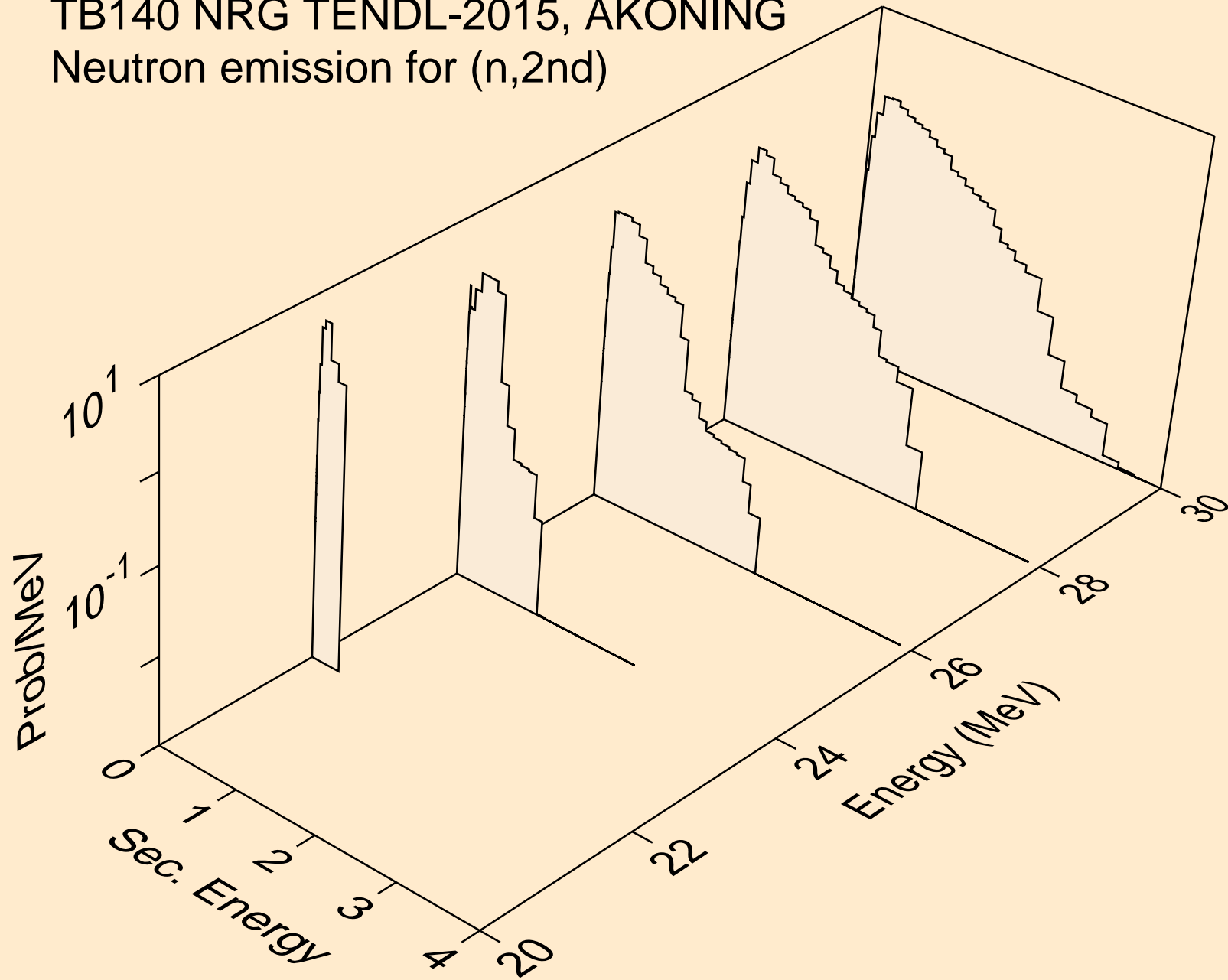

TB140 NRG TENDL-2015, AKONING
Neutron emission for (n,2n)

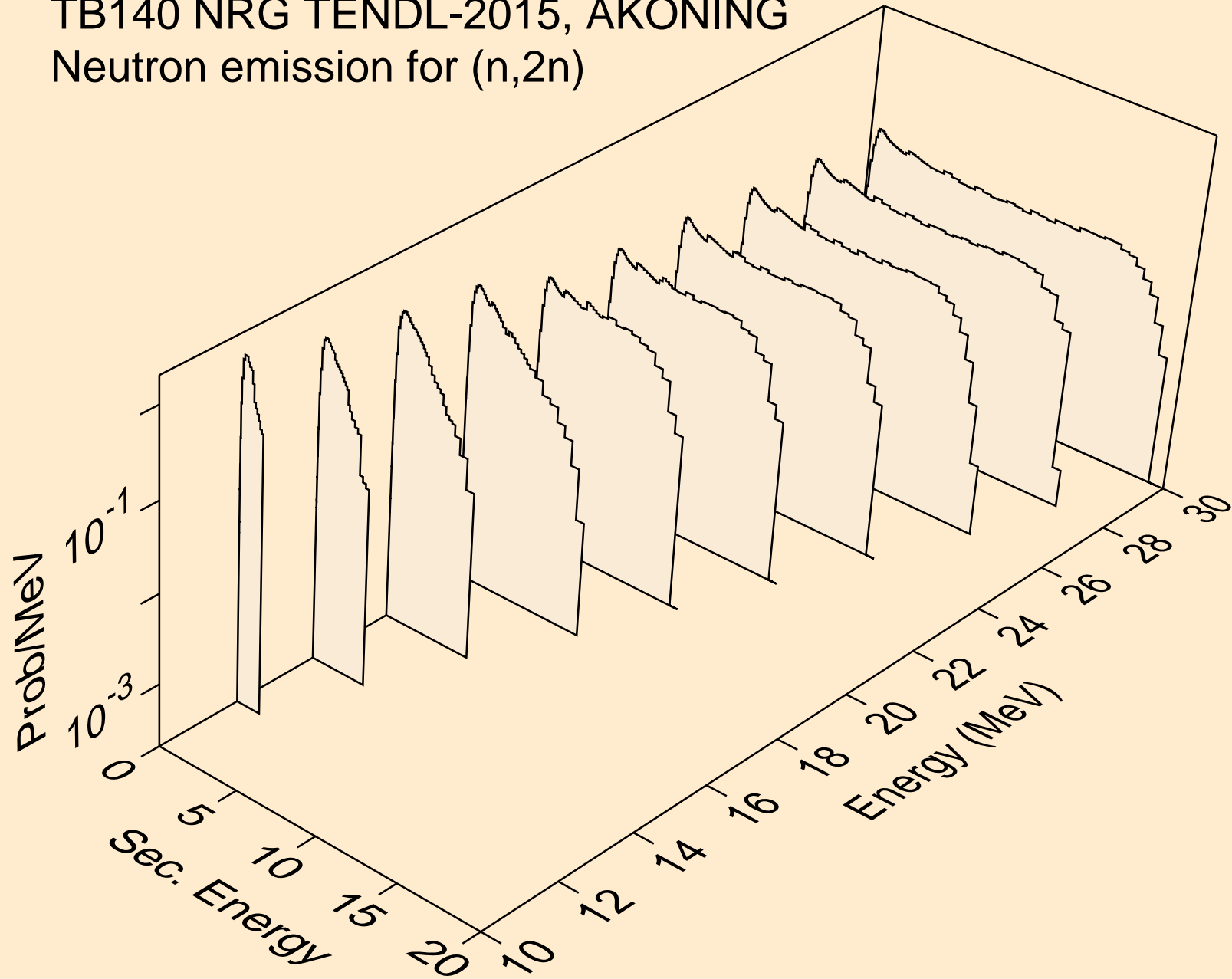

TB140 NRG TENDL-2015, AKONING
Neutron emission for (n,3n)

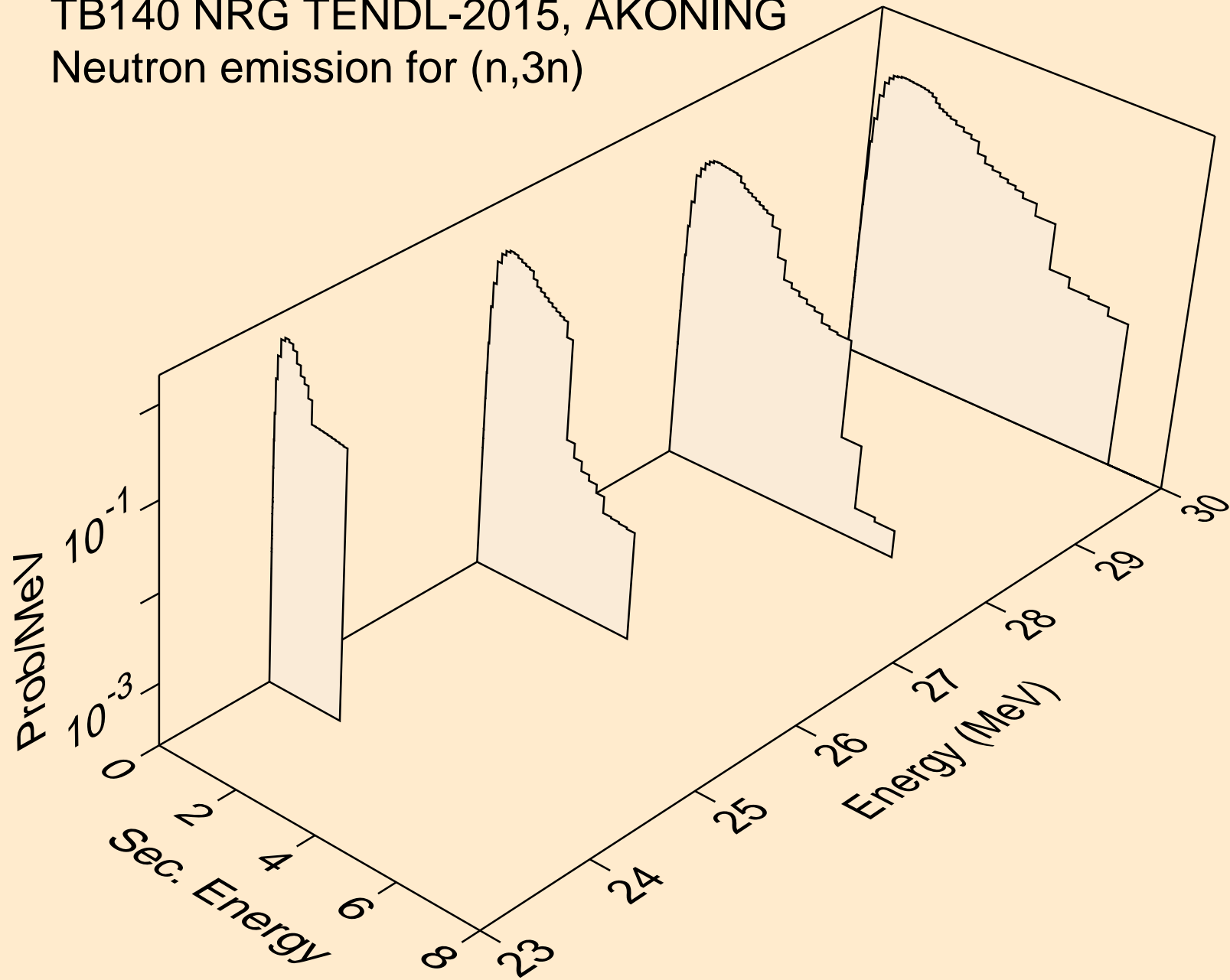

TB140 NRG TENDL-2015, AKONING
Neutron emission for (n,n*)a

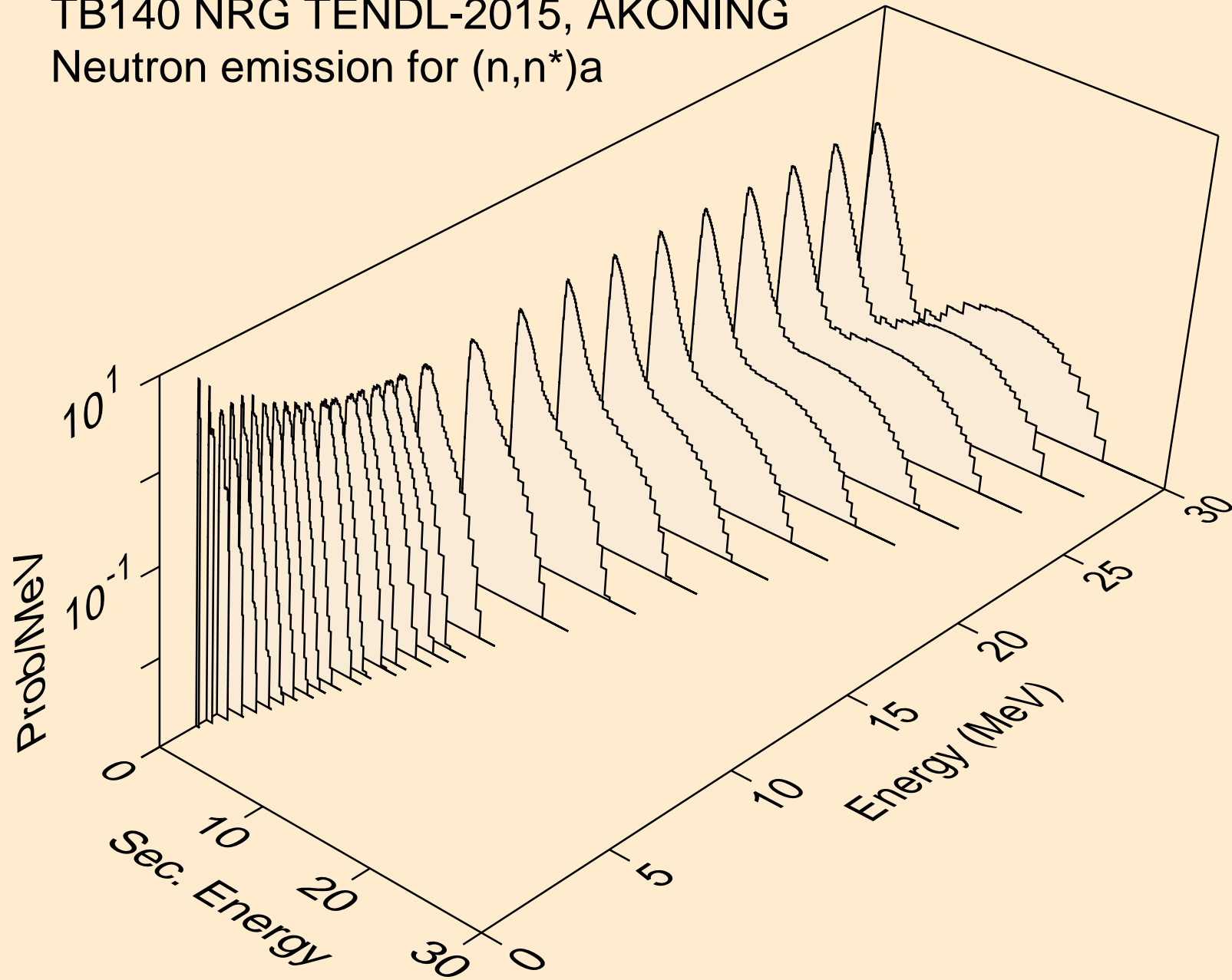

TB140 NRG TENDL-2015, AKONING
Neutron emission for (n,n*)3a

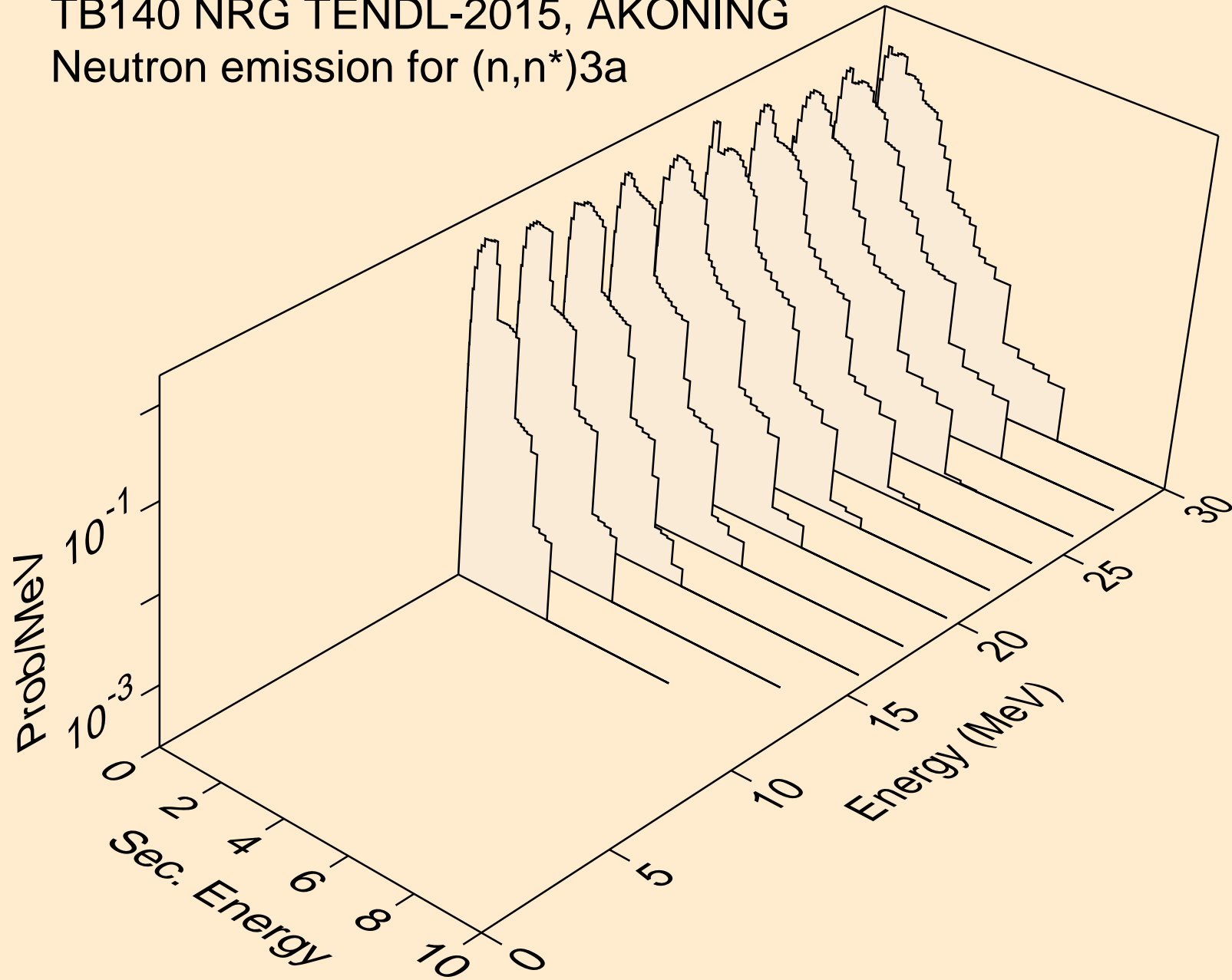

TB140 NRG TENDL-2015, AKONING
Neutron emission for (n,2n)a

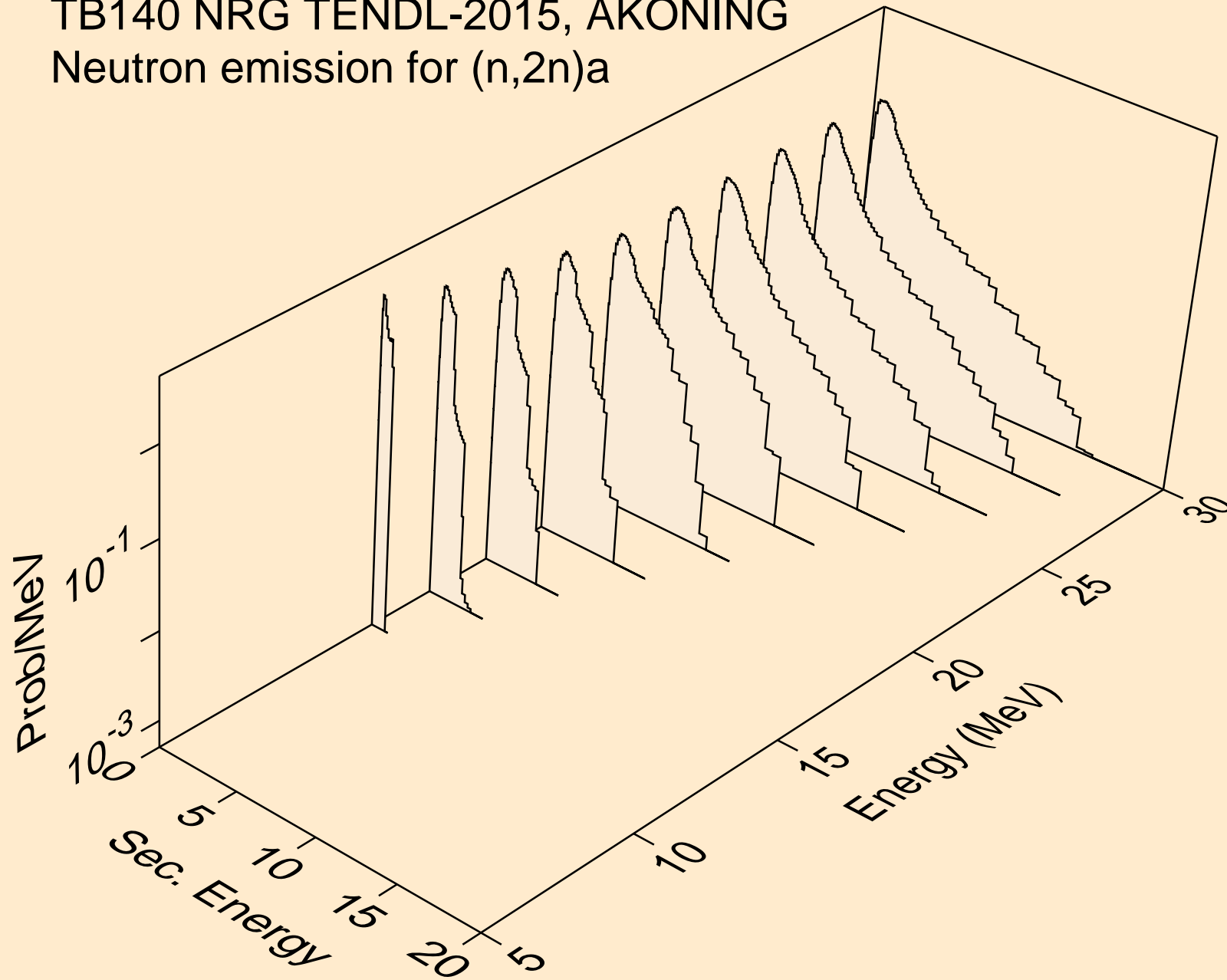

TB140 NRG TENDL-2015, AKONING
Neutron emission for (n,3n)a

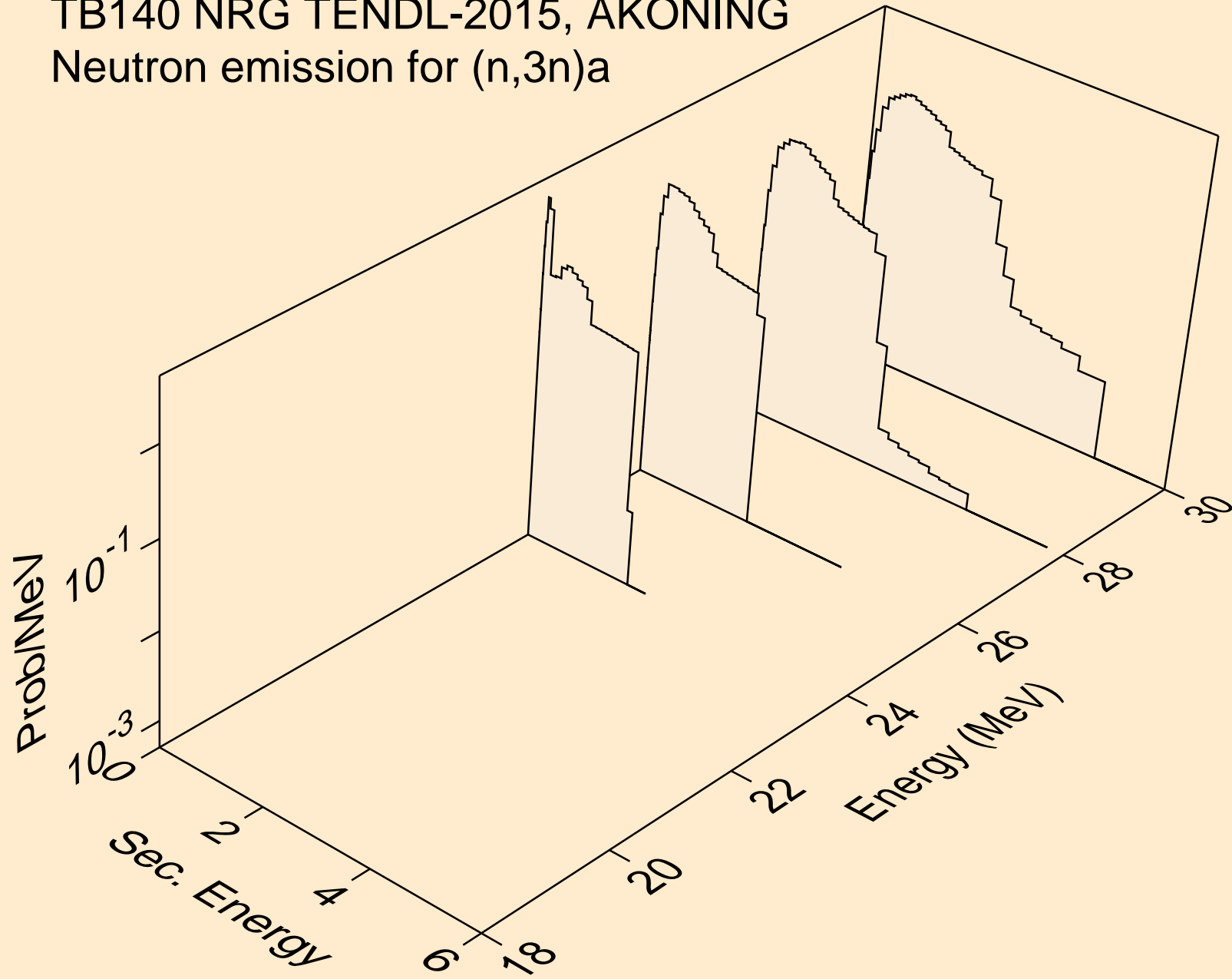

TB140 NRG TENDL-2015, AKONING
Neutron emission for (n,n*)p

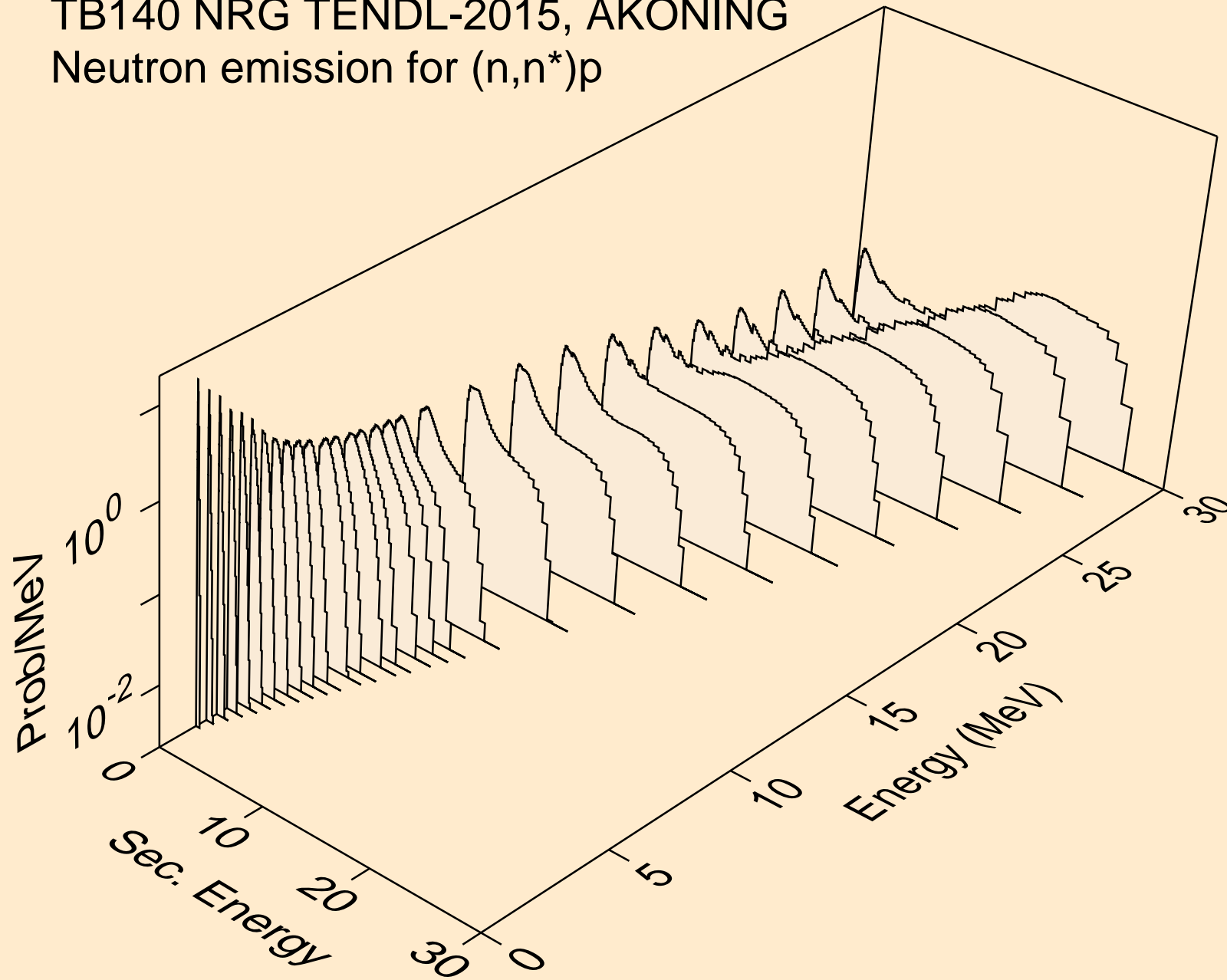

TB140 NRG TENDL-2015, AKONING
Neutron emission for (n,n*)2a

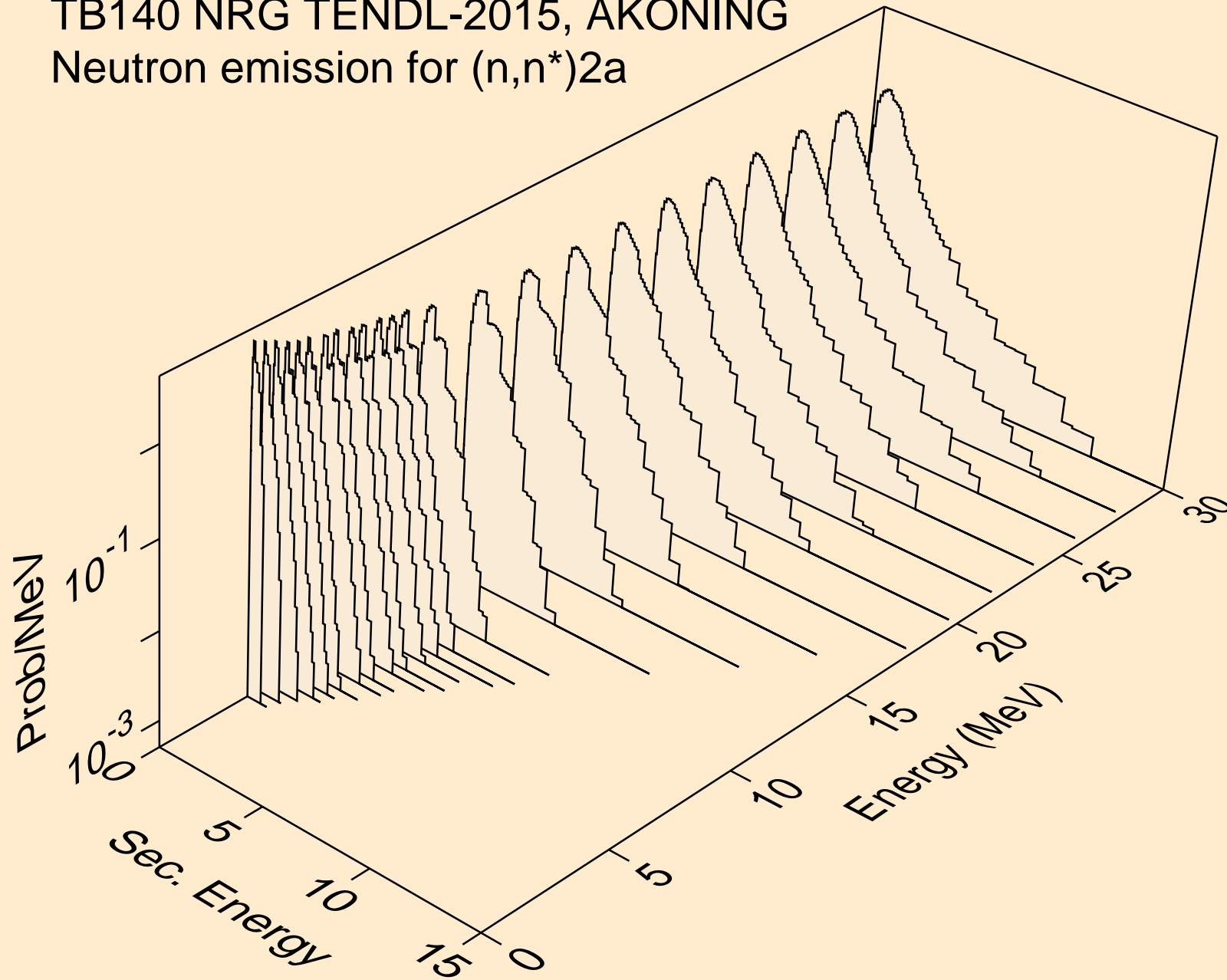

TB140 NRG TENDL-2015, AKONING
Neutron emission for (n,2n)2a

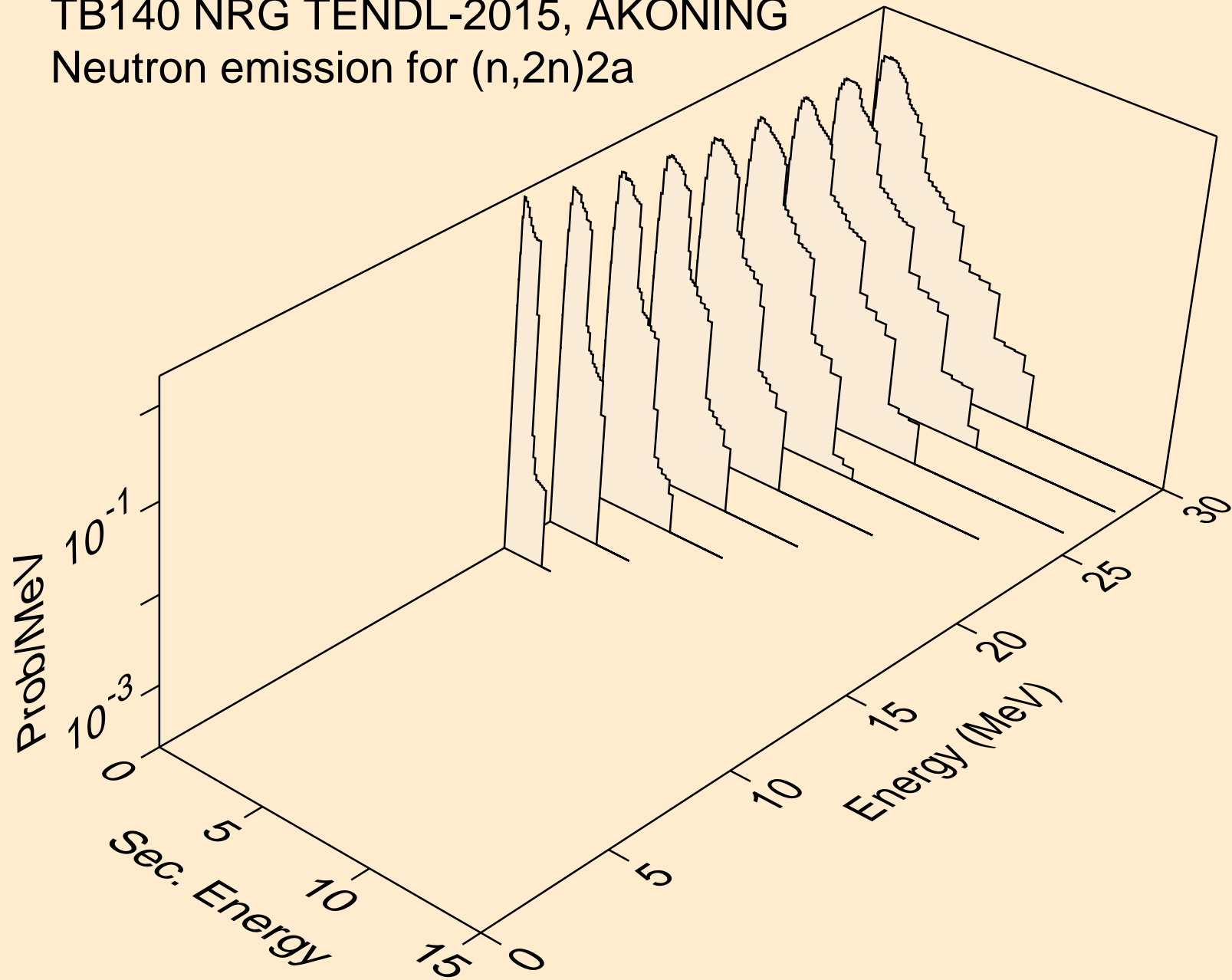

TB140 NRG TENDL-2015, AKONING
Neutron emission for (n,n*)d

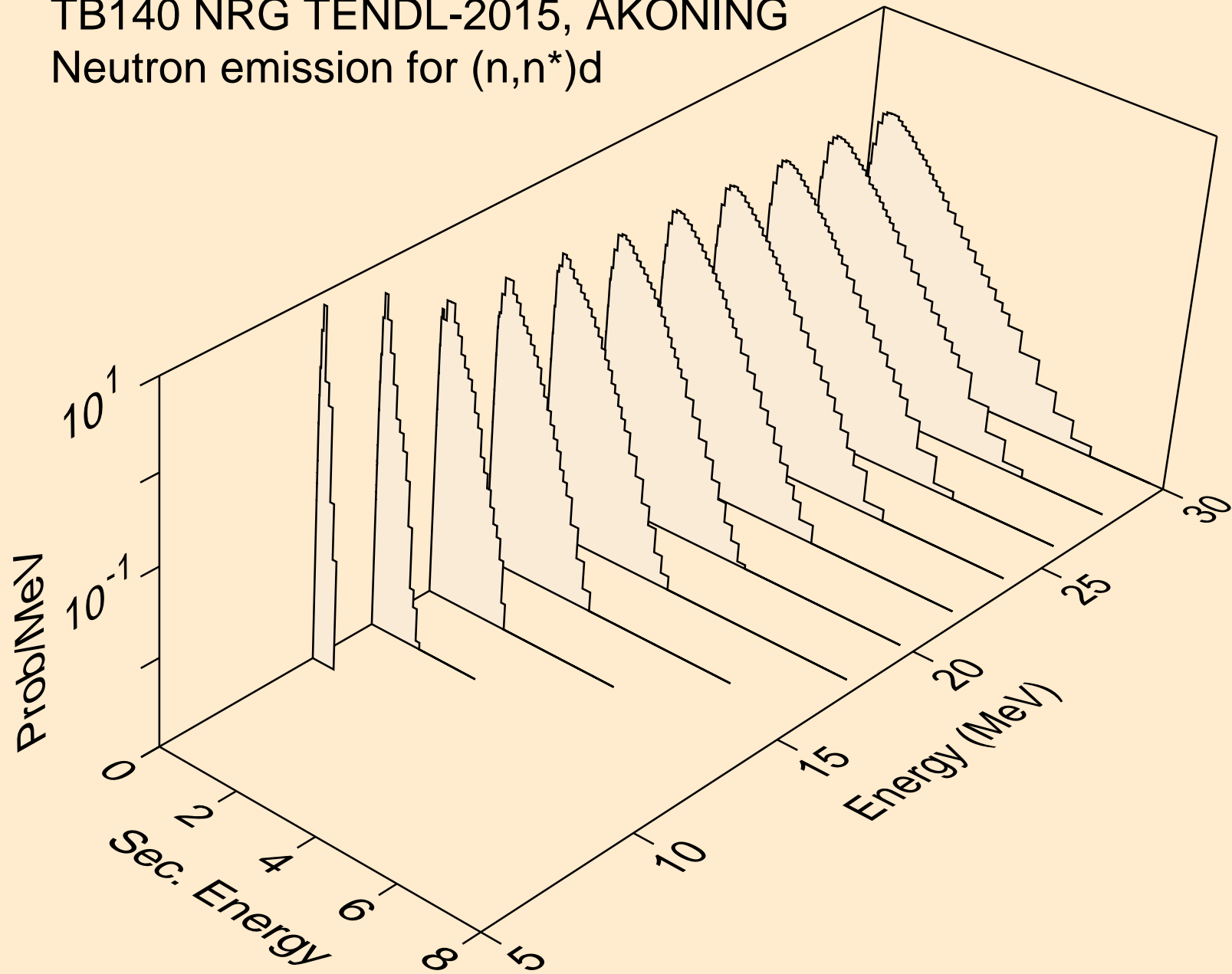

TB140 NRG TENDL-2015, AKONING
Neutron emission for (n,n*)t

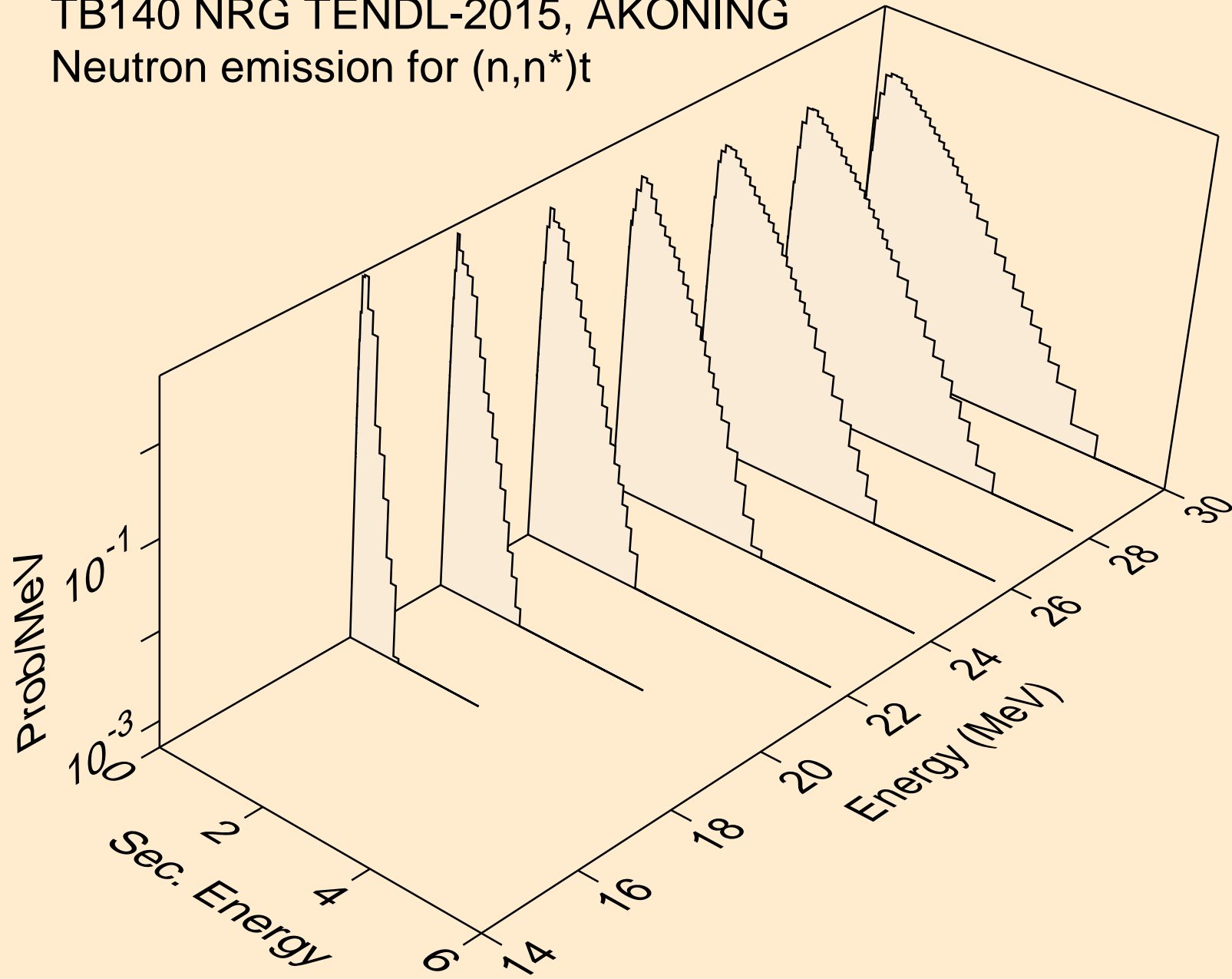

TB140 NRG TENDL-2015, AKONING
Neutron emission for (n,n*)he3

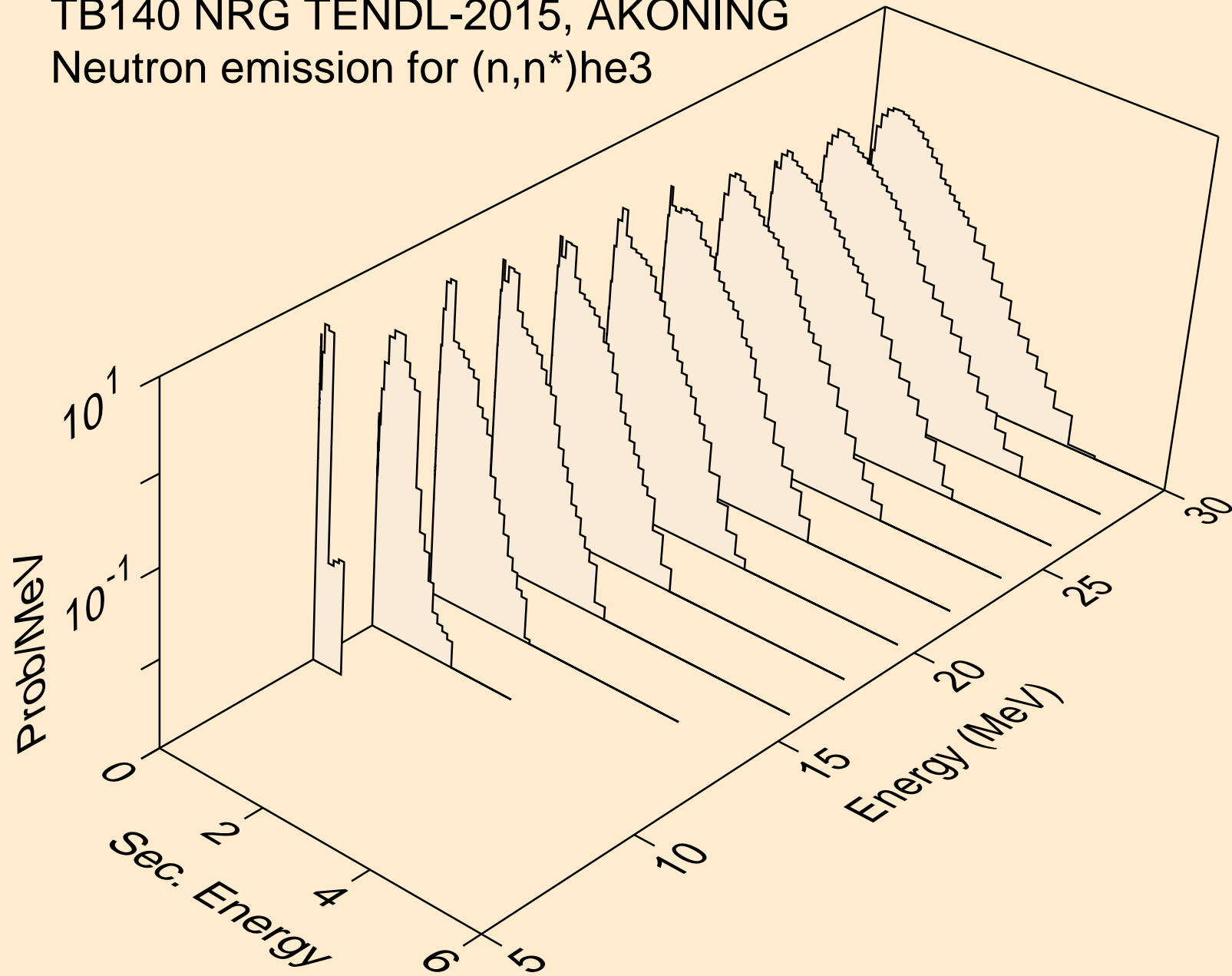

TB140 NRG TENDL-2015, AKONING
Neutron emission for (n,n*)d2a

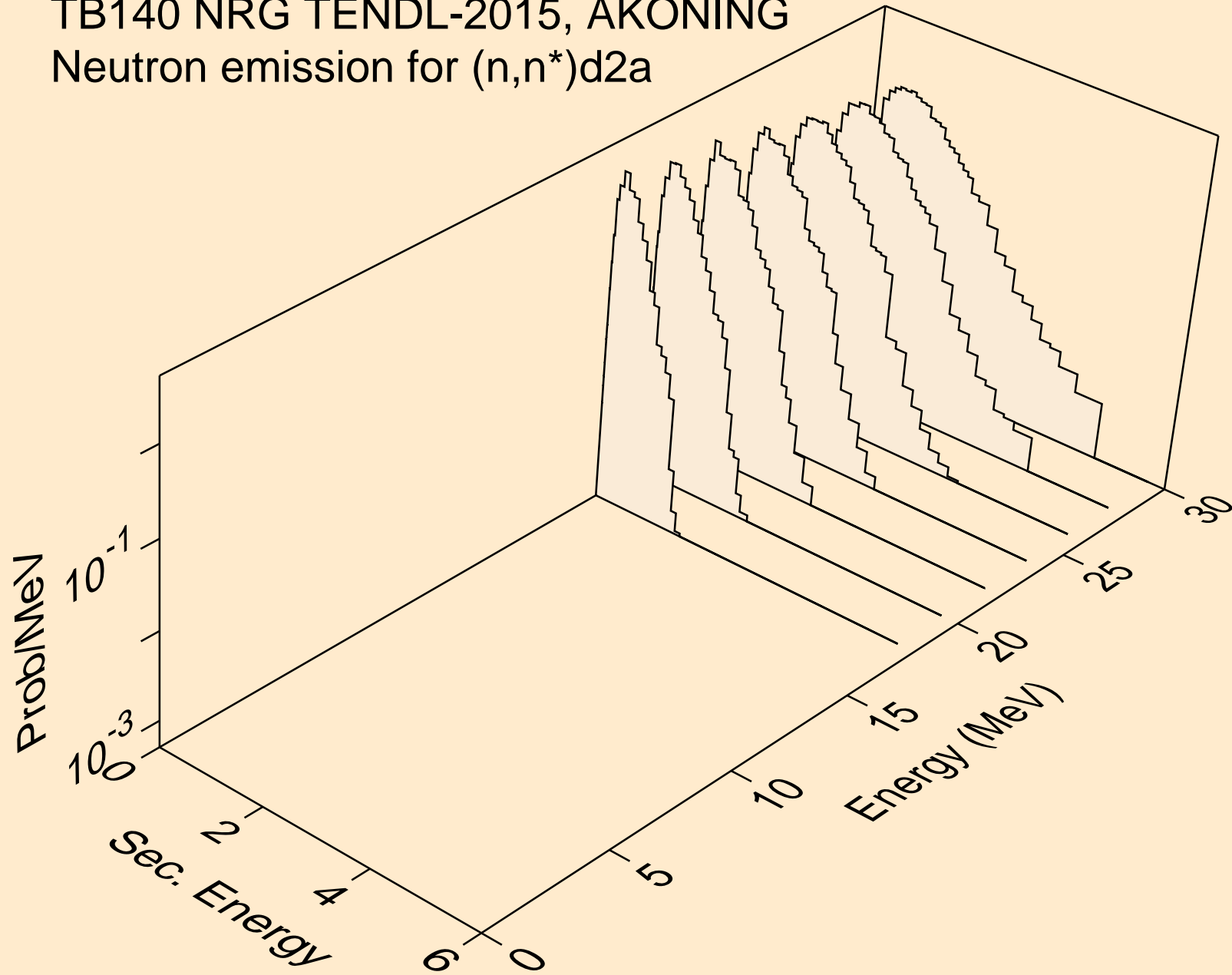

TB140 NRG TENDL-2015, AKONING
Neutron emission for (n,2np)

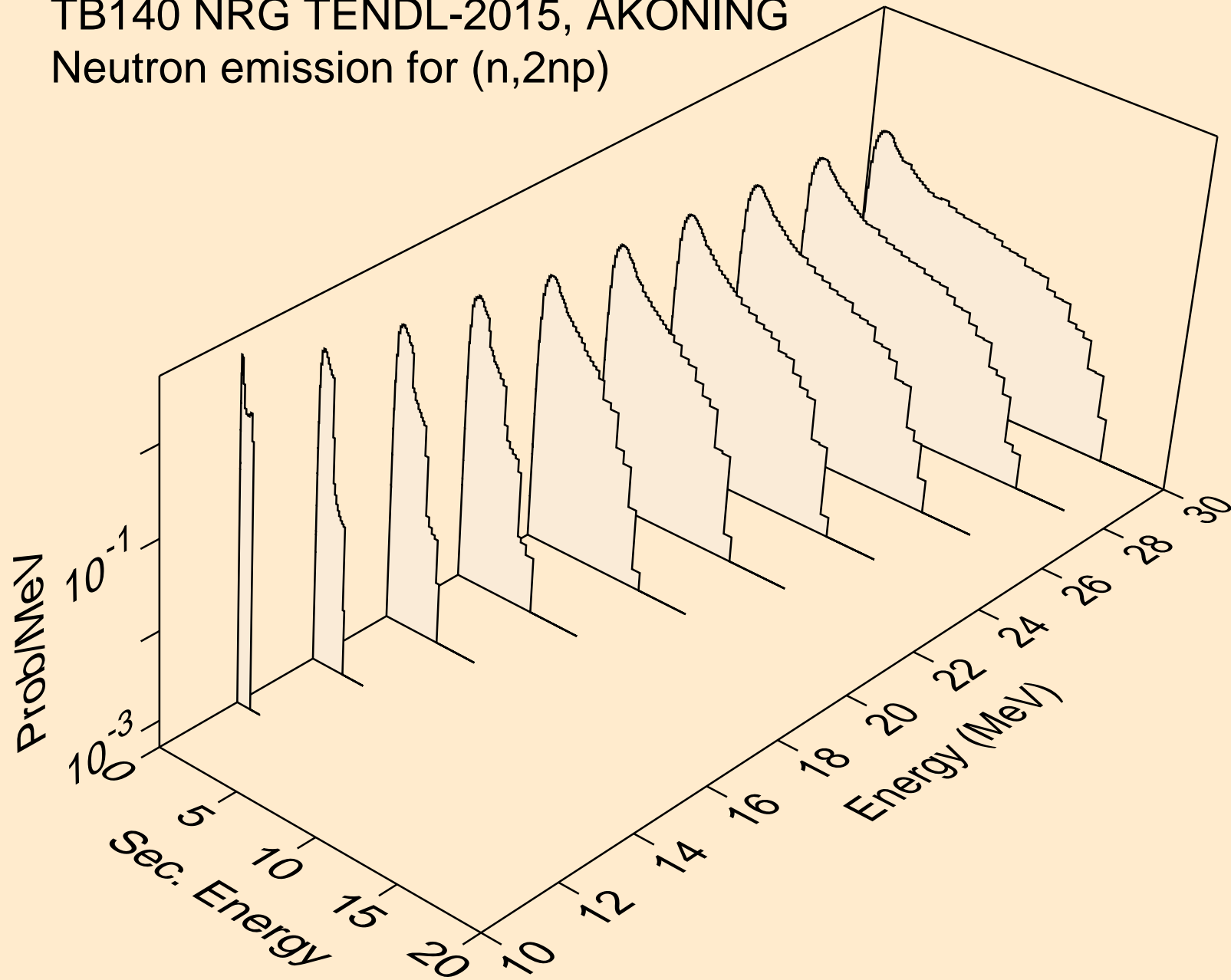

TB140 NRG TENDL-2015, AKONING
Neutron emission for (n,3np)

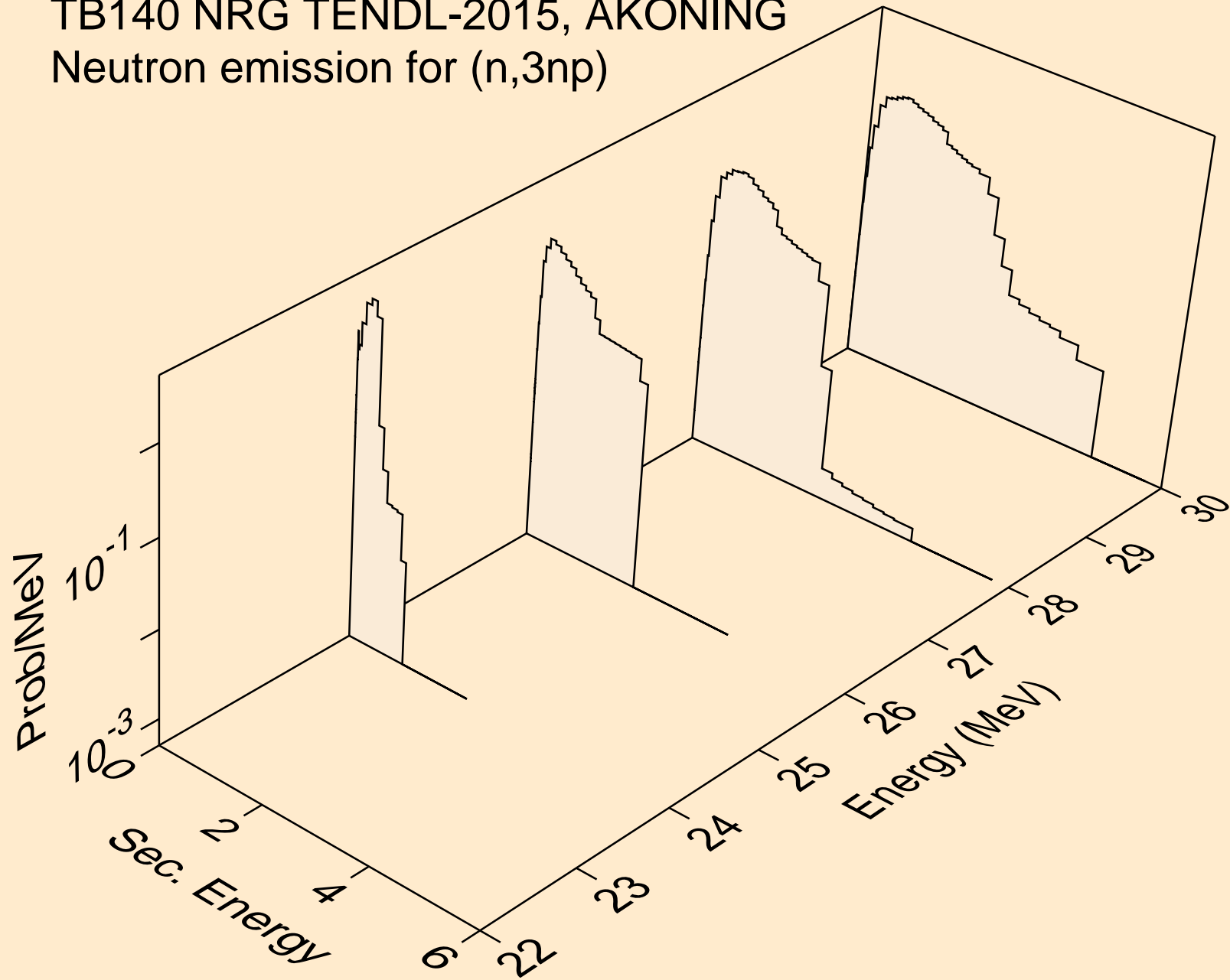

TB140 NRG TENDL-2015, AKONING
Neutron emission for (n,2np)

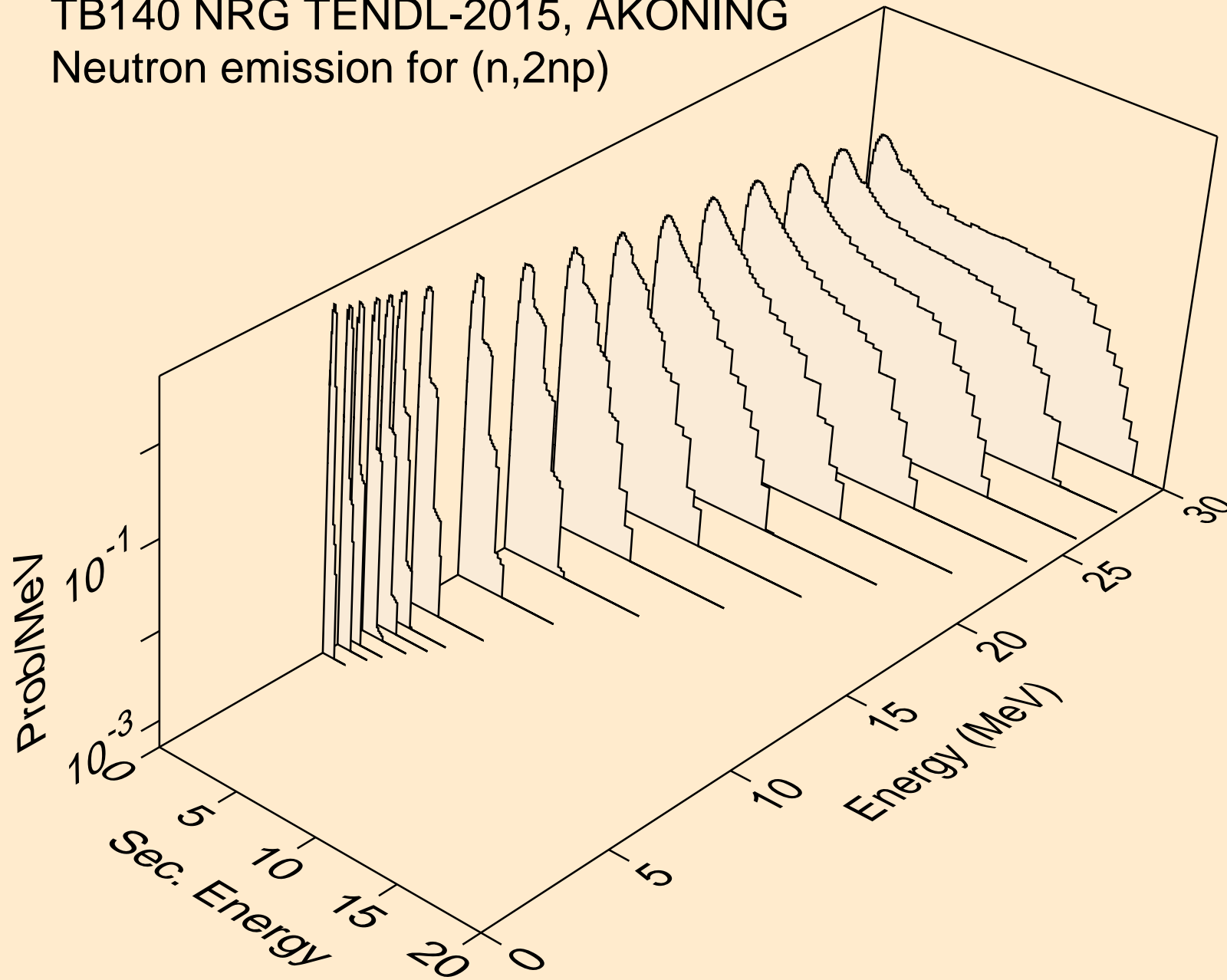

TB140 NRG TENDL-2015, AKONING
Neutron emission for (n,npa)

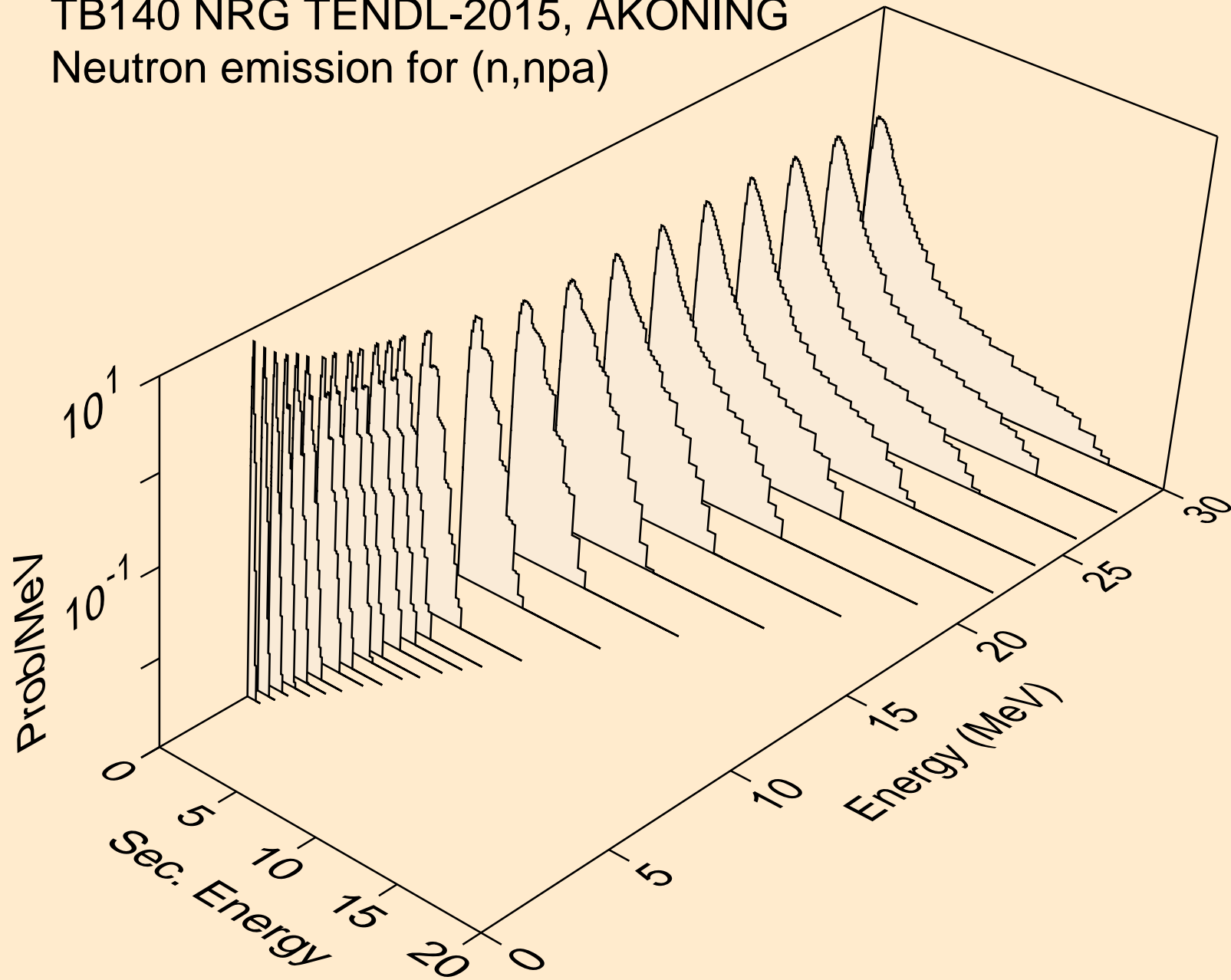

TB140 NRG TENDL-2015, AKONING
Neutron emission for (n,n*c)

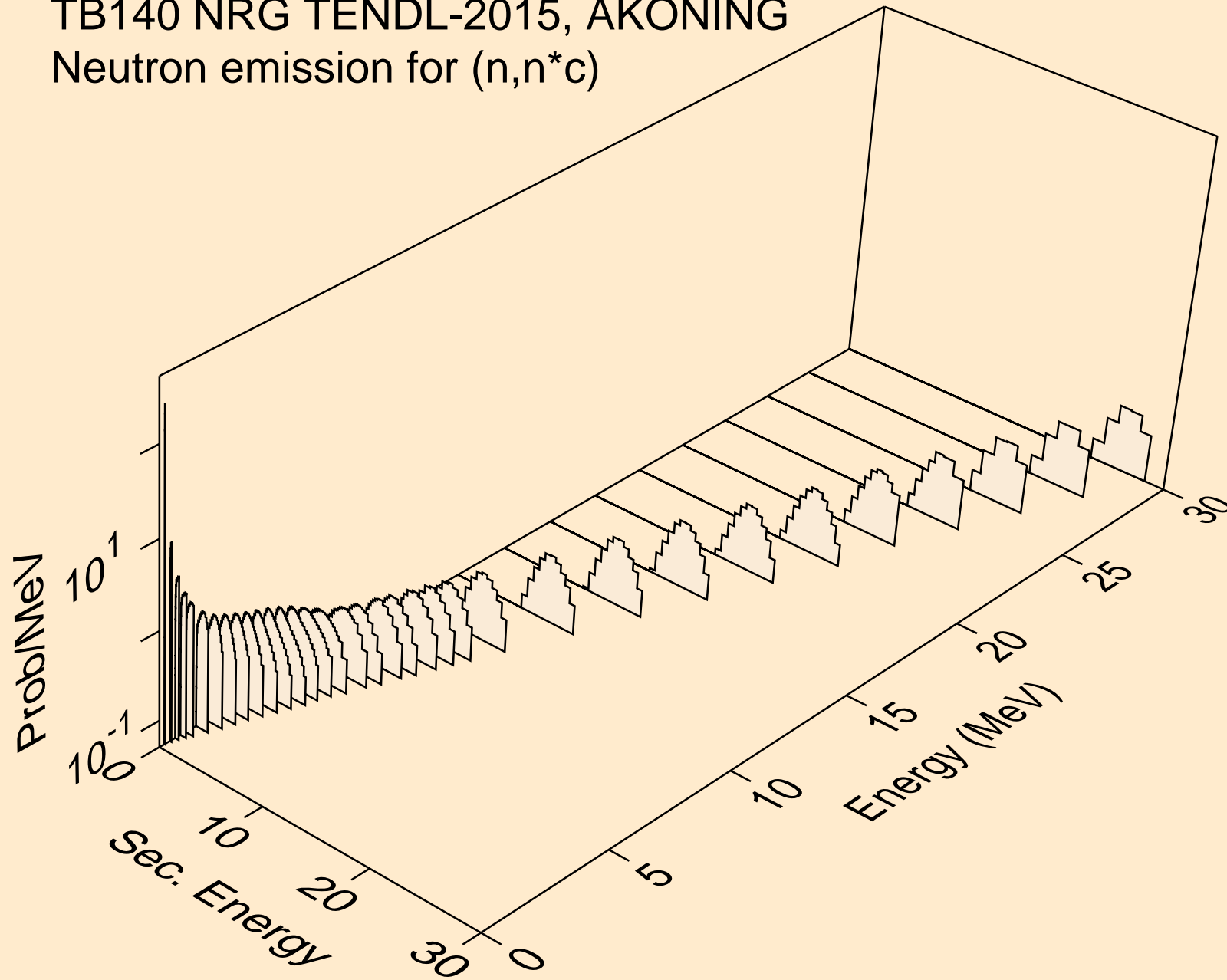

TB140 NRG TENDL-2015, AKONING
Photon emission for (n,x)

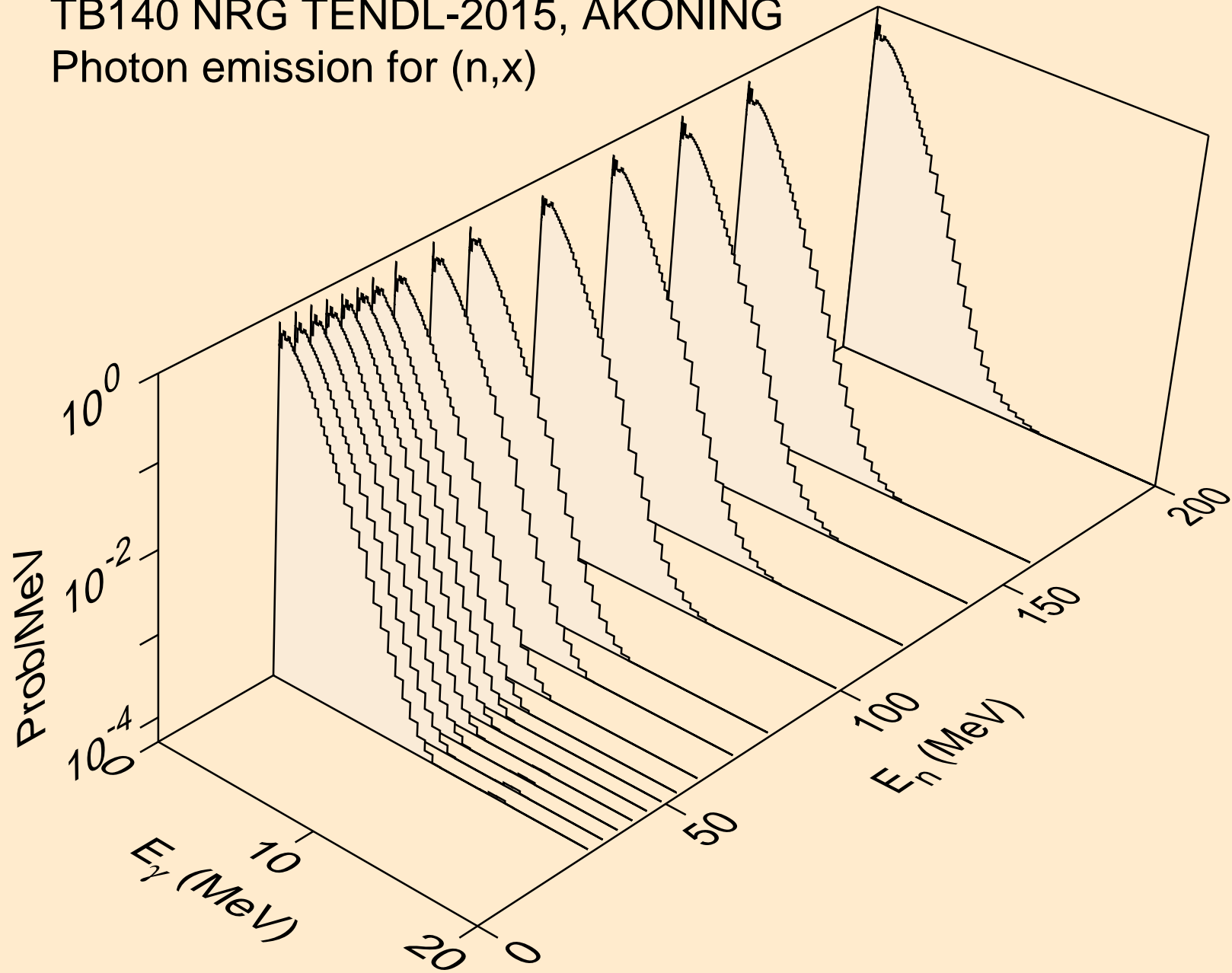

TB140 NRG TENDL-2015, AKONING
Photon emission for (n,2nd)

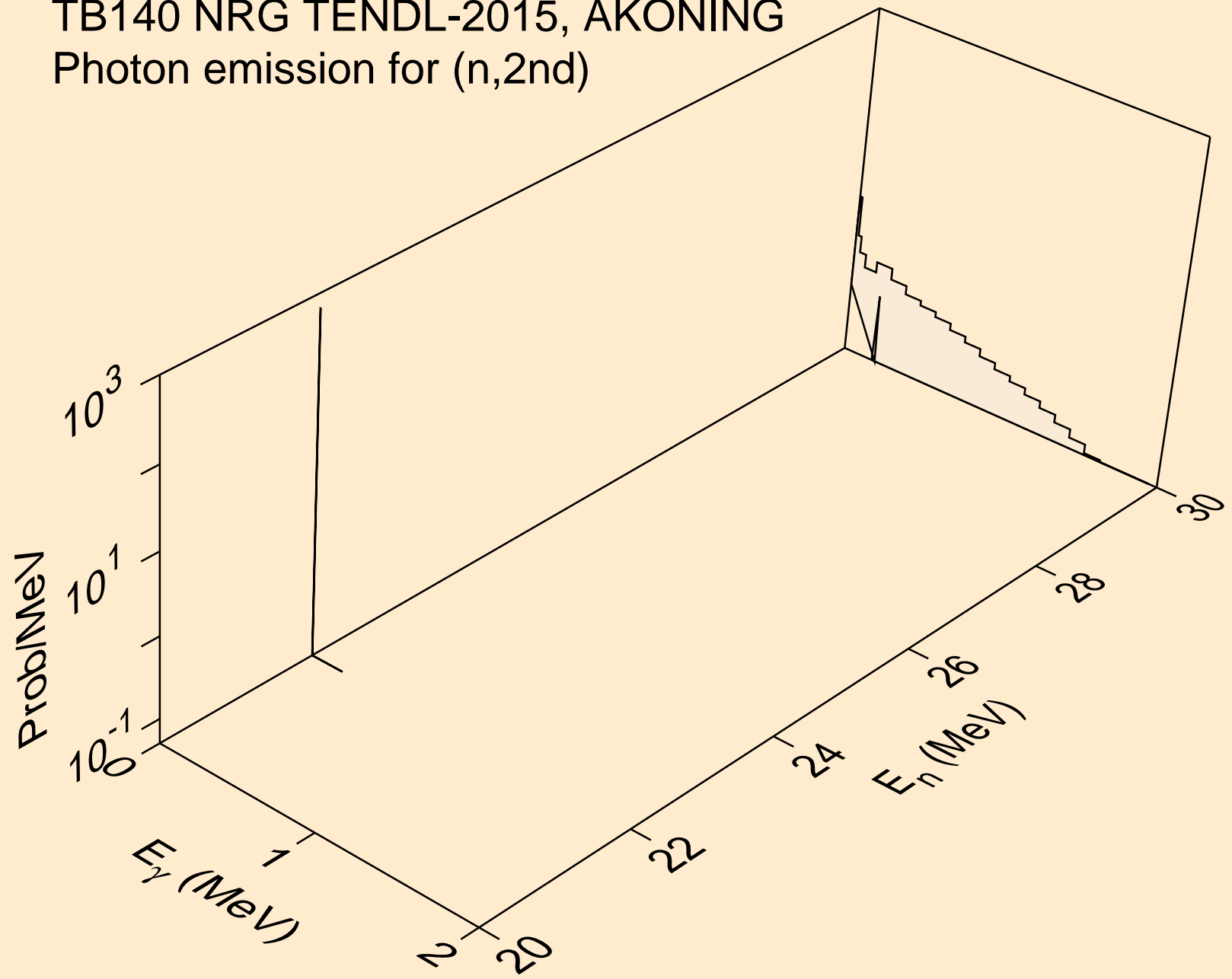

TB140 NRG TENDL-2015, AKONING
Photon emission for (n,2n)

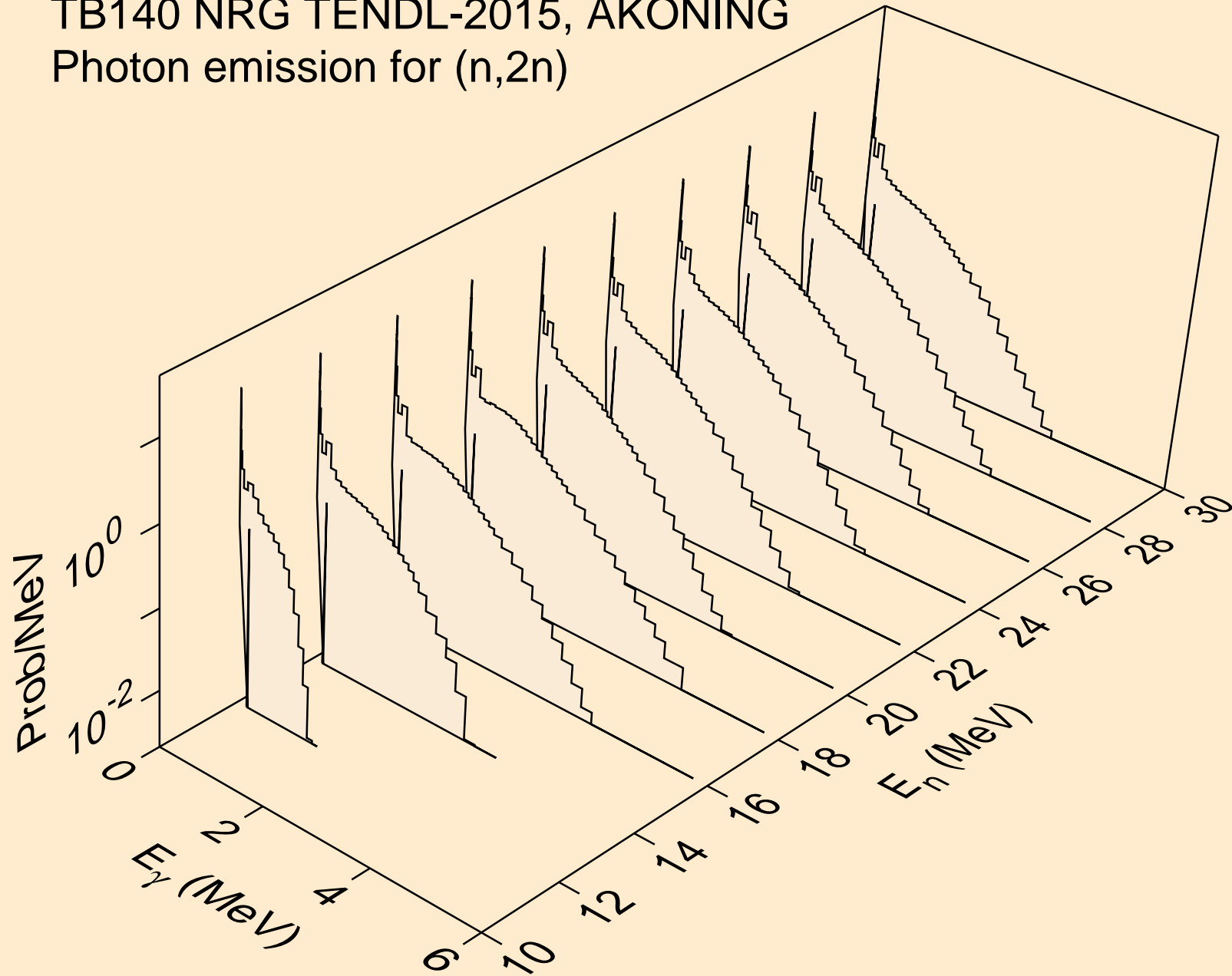

TB140 NRG TENDL-2015, AKONING
Photon emission for (n,3n)

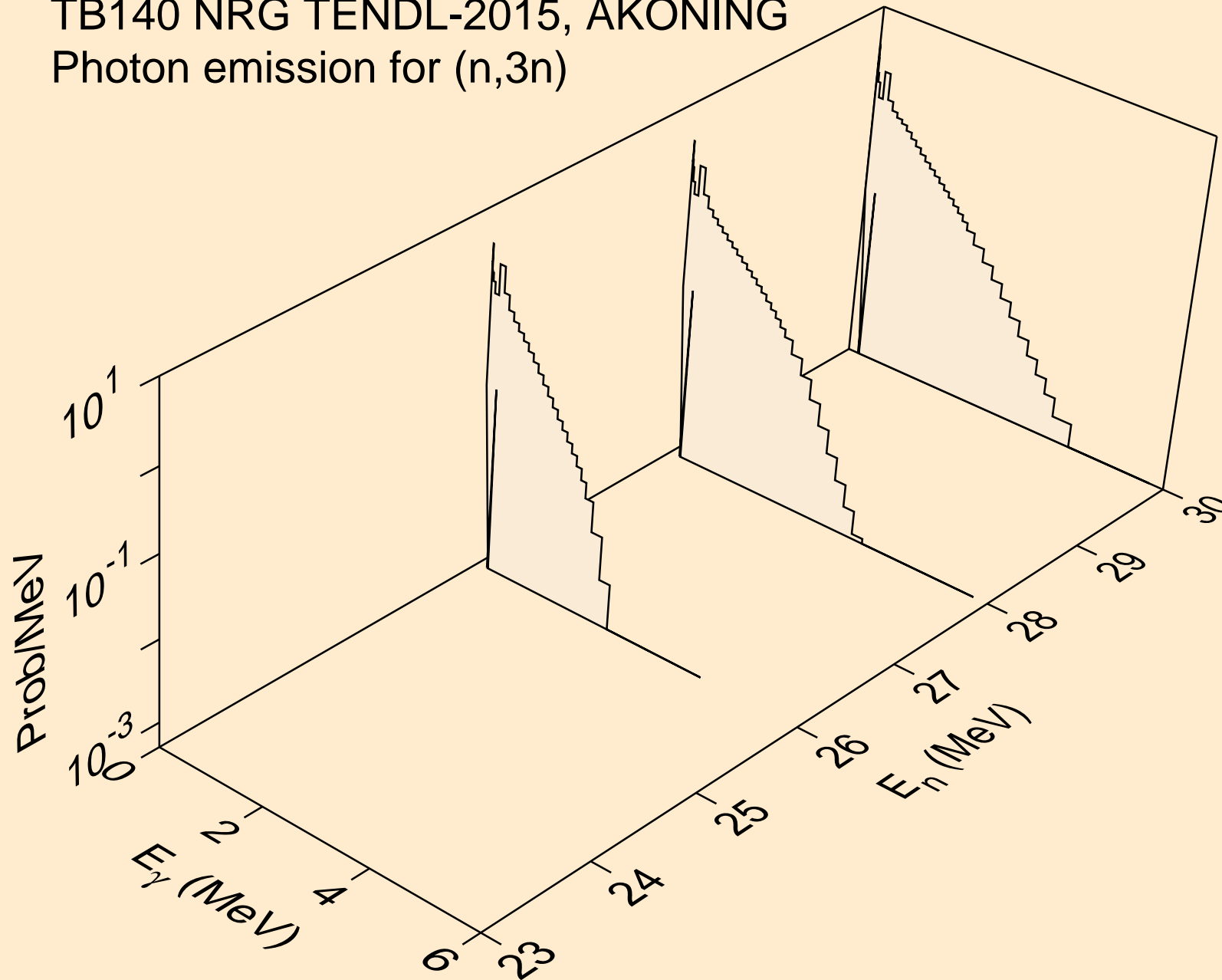

TB140 NRG TENDL-2015, AKONING
Photon emission for (n,n*)a

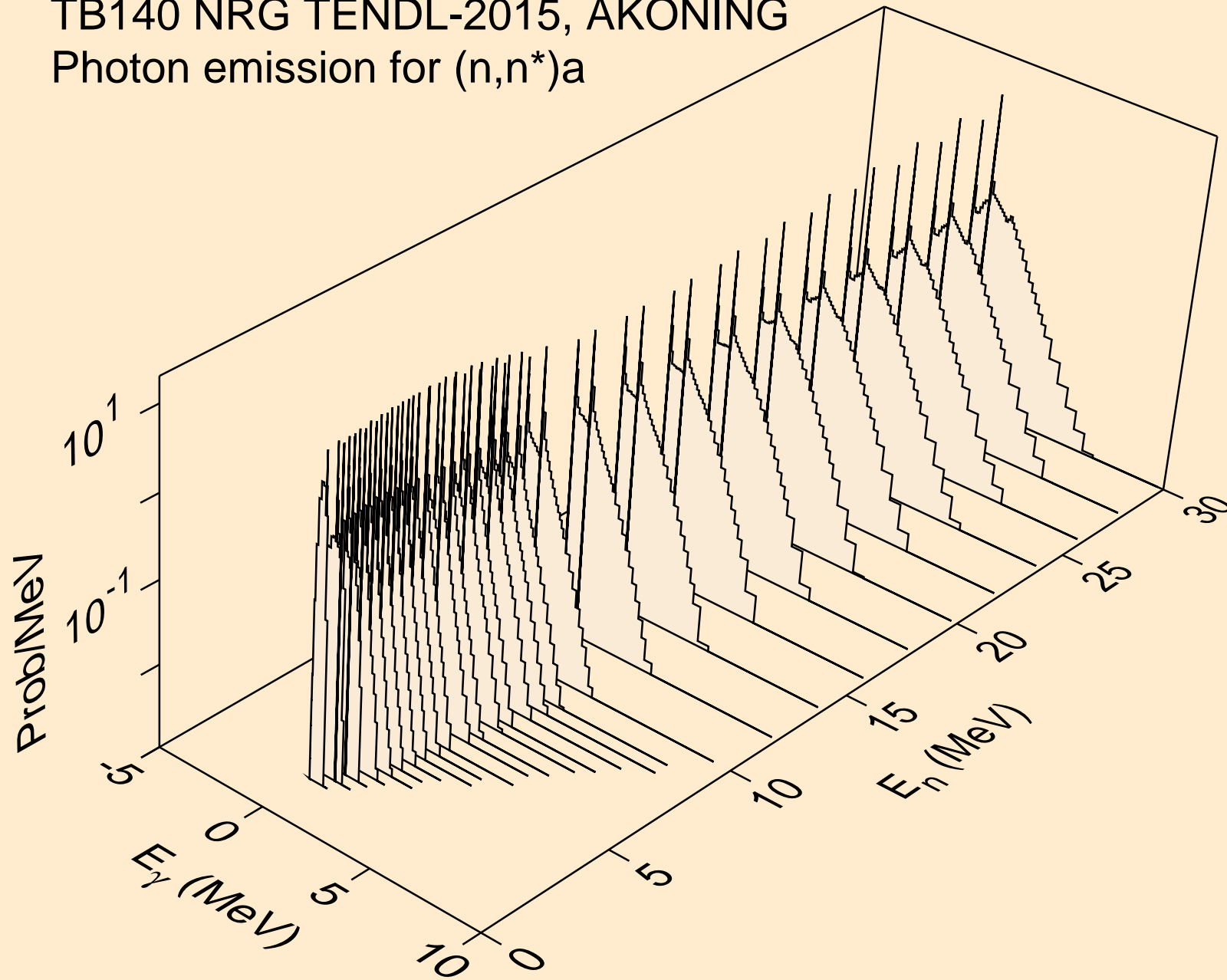

TB140 NRG TENDL-2015, AKONING
Photon emission for (n,n*)3a

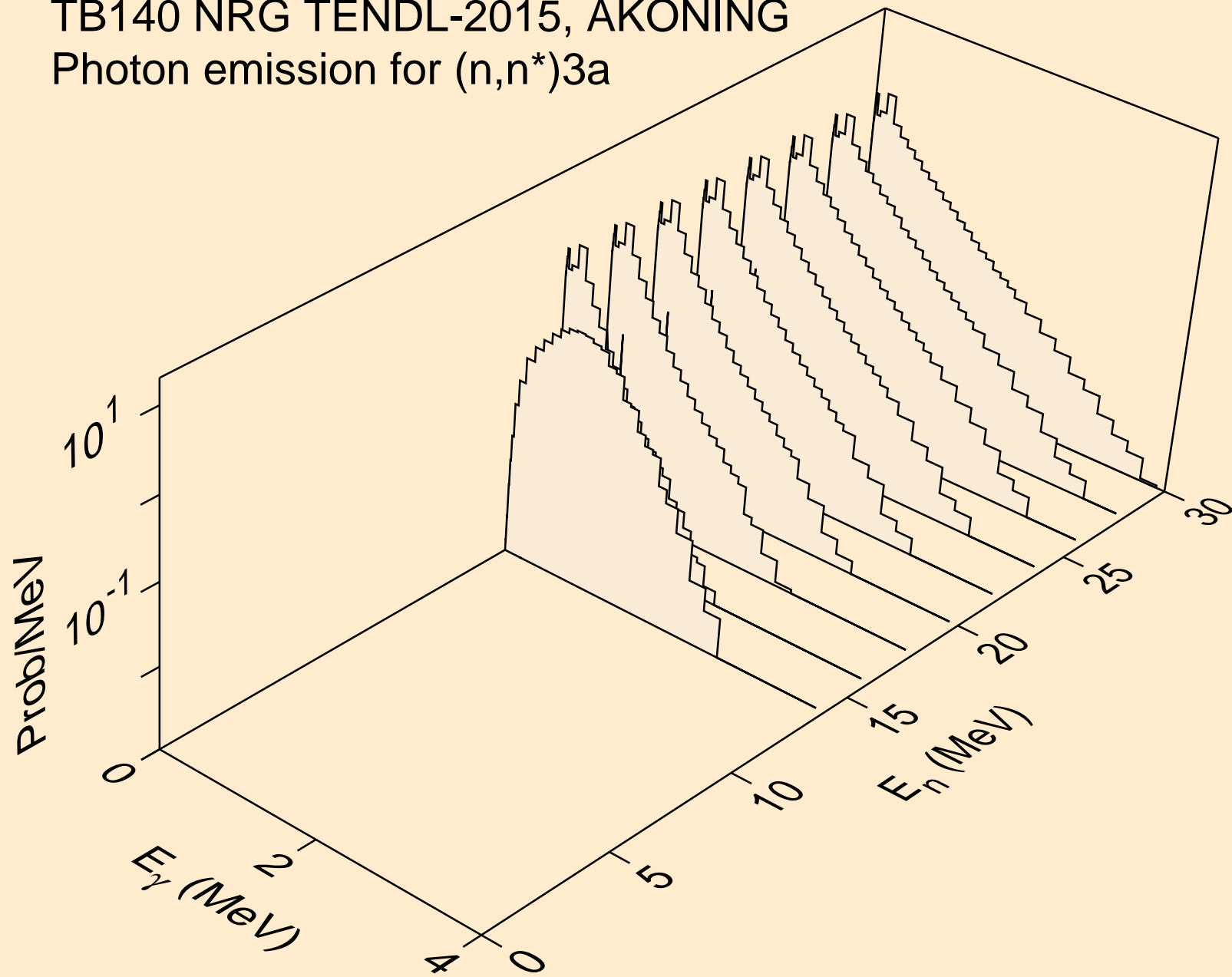

TB140 NRG TENDL-2015, AKONING
Photon emission for (n,2n)a

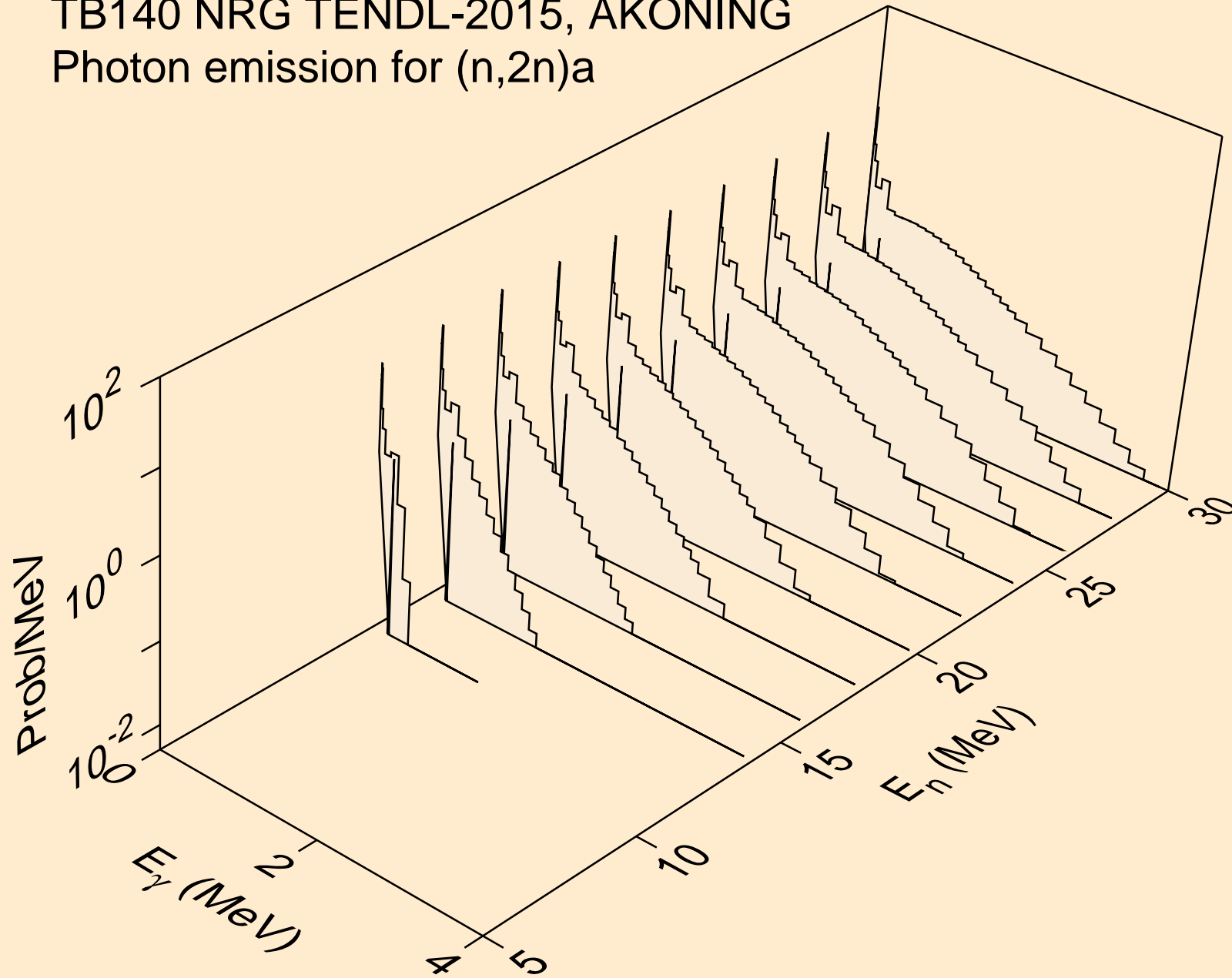

TB140 NRG TENDL-2015, AKONING
Photon emission for (n,3n)a

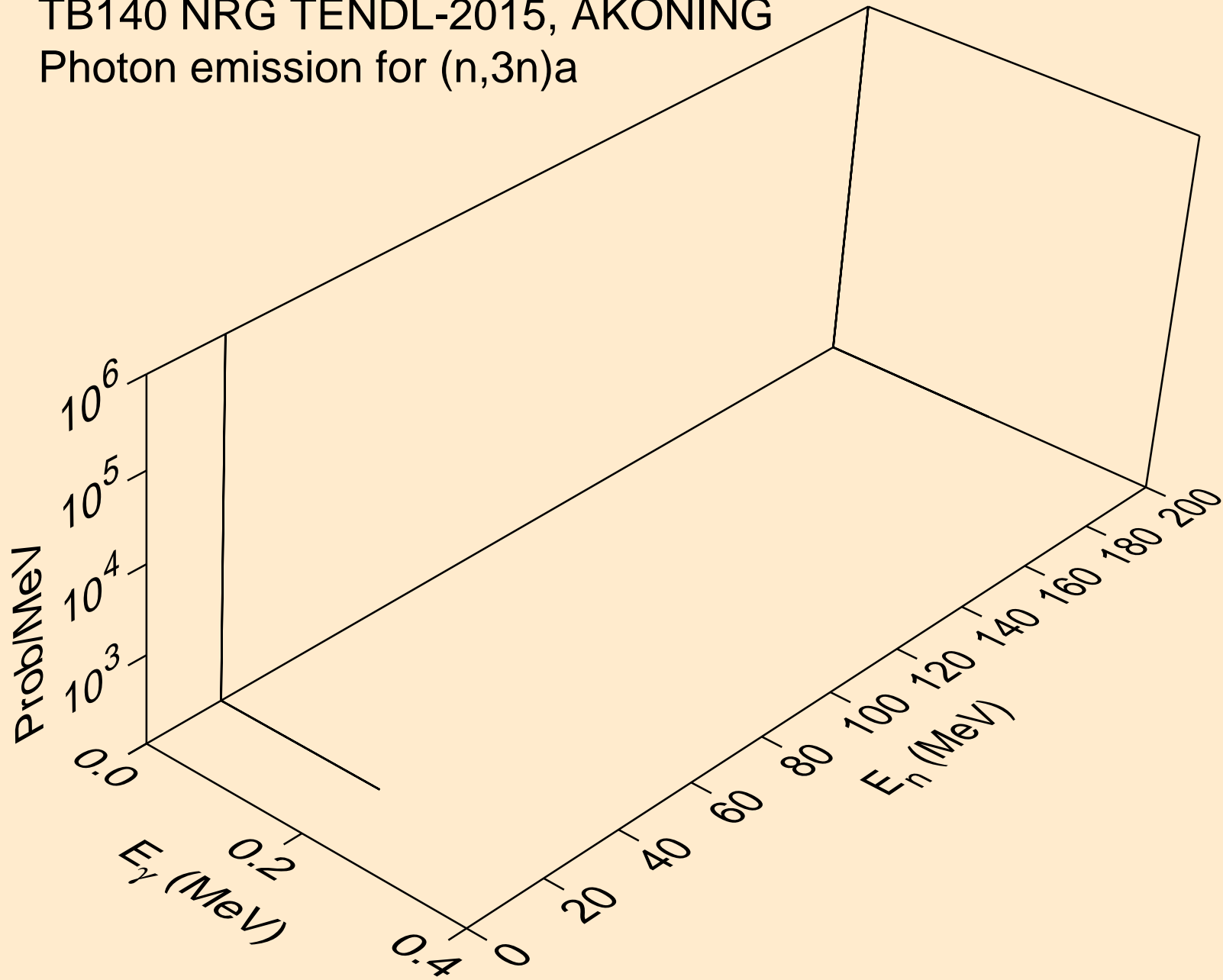

TB140 NRG TENDL-2015, AKONING
Photon emission for (n,n*)p

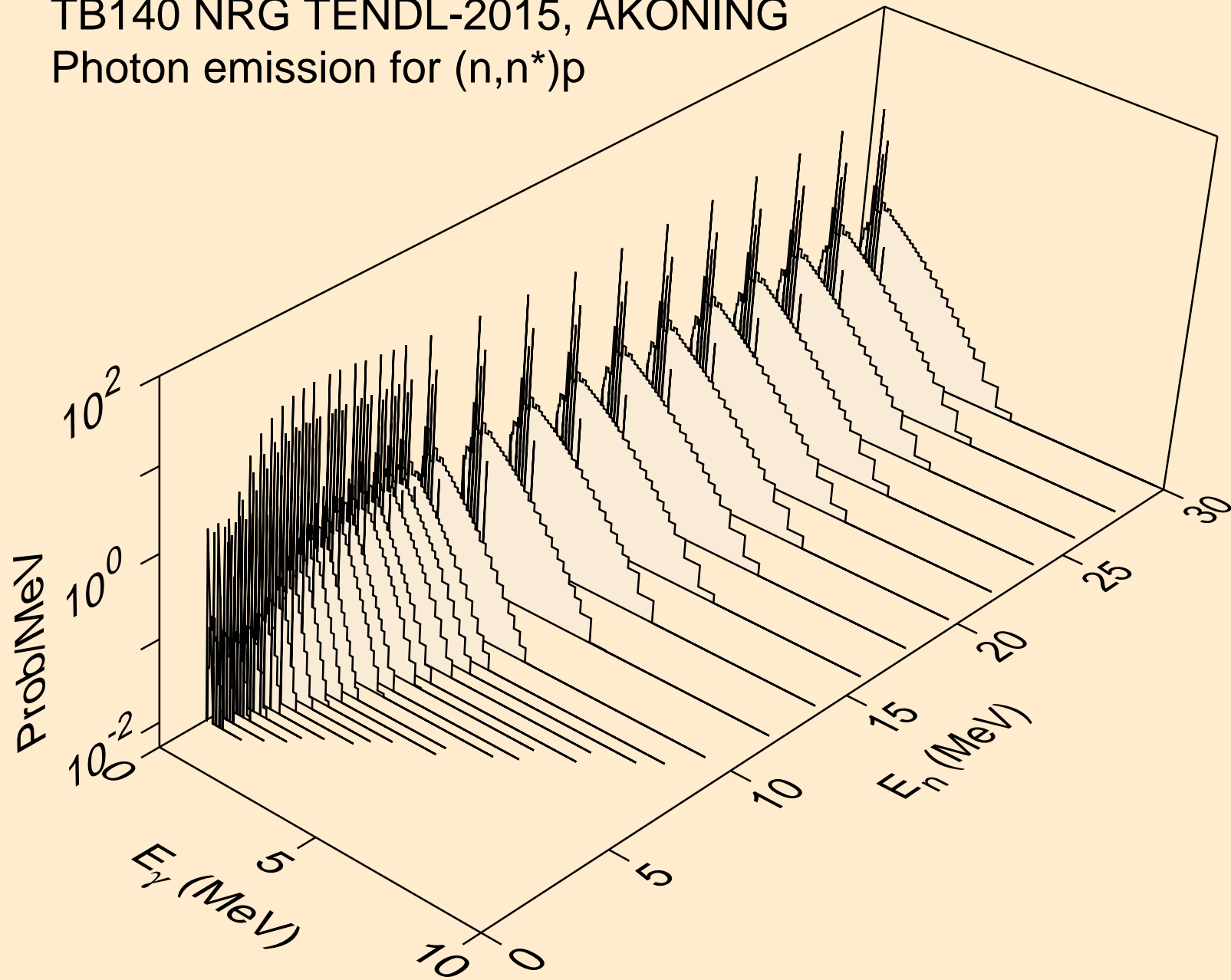

TB140 NRG TENDL-2015, AKONING
Photon emission for (n,n*)2a

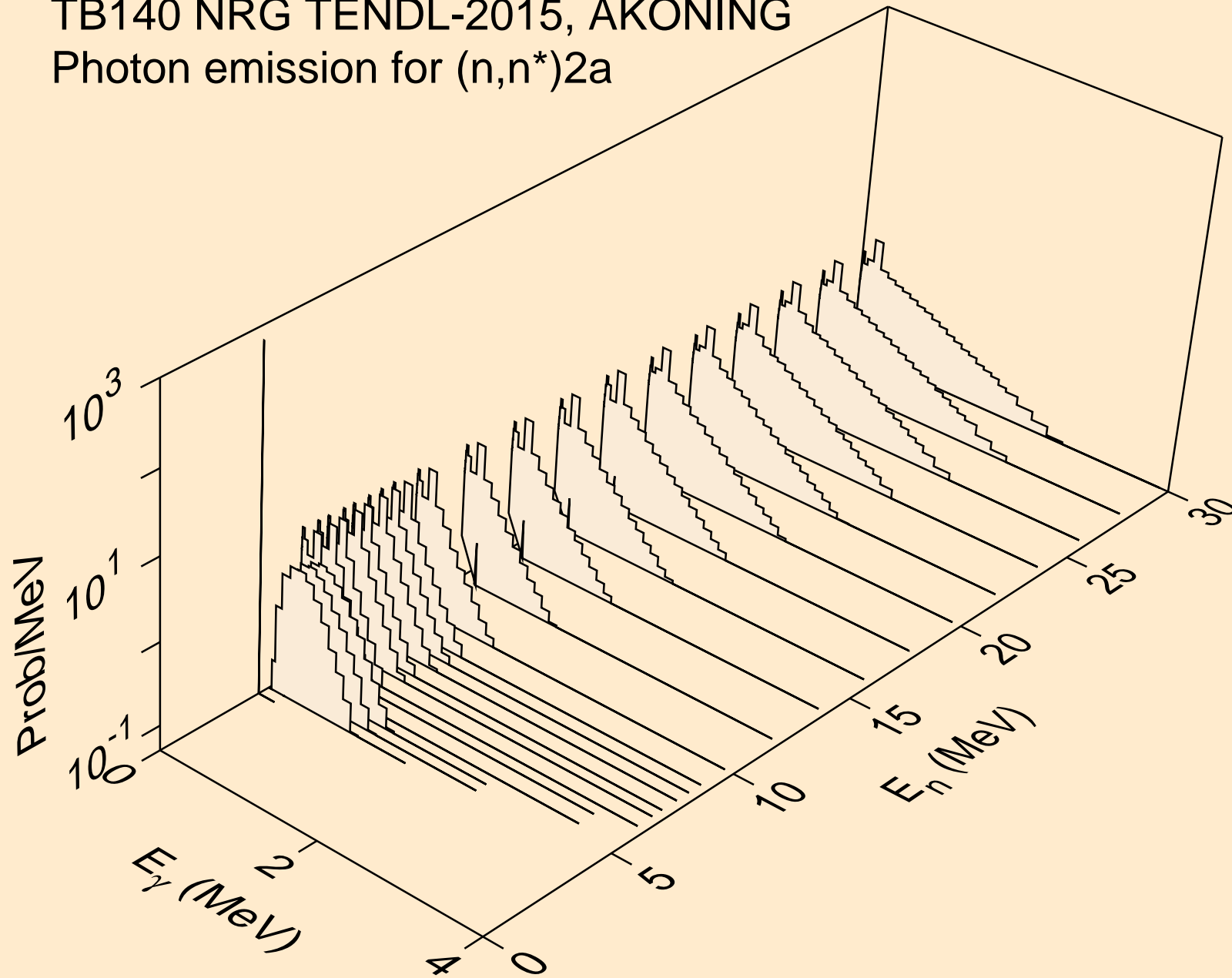

TB140 NRG TENDL-2015, AKONING
Photon emission for (n,2n)2a

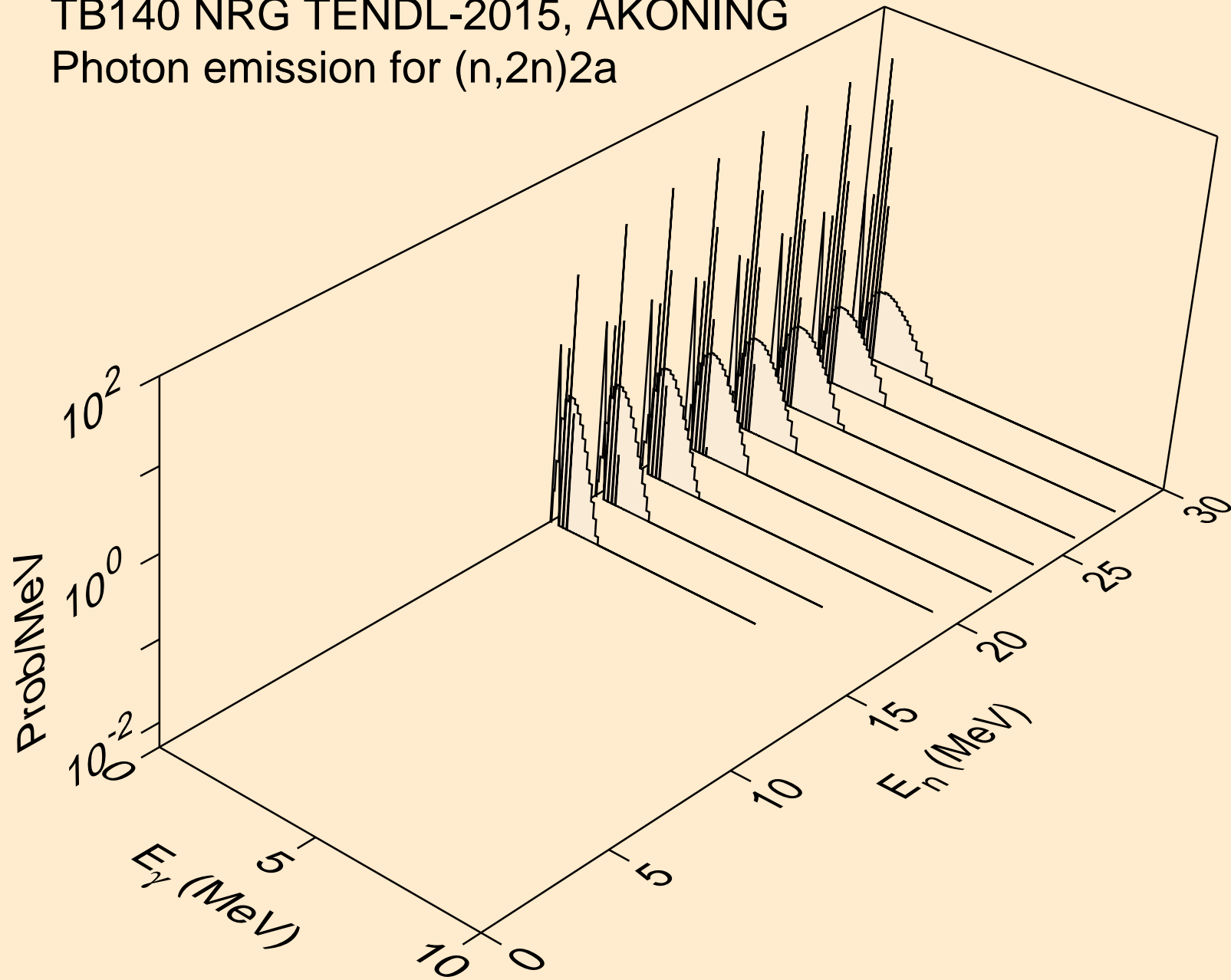

TB140 NRG TENDL-2015, AKONING
Photon emission for (n,n*)d

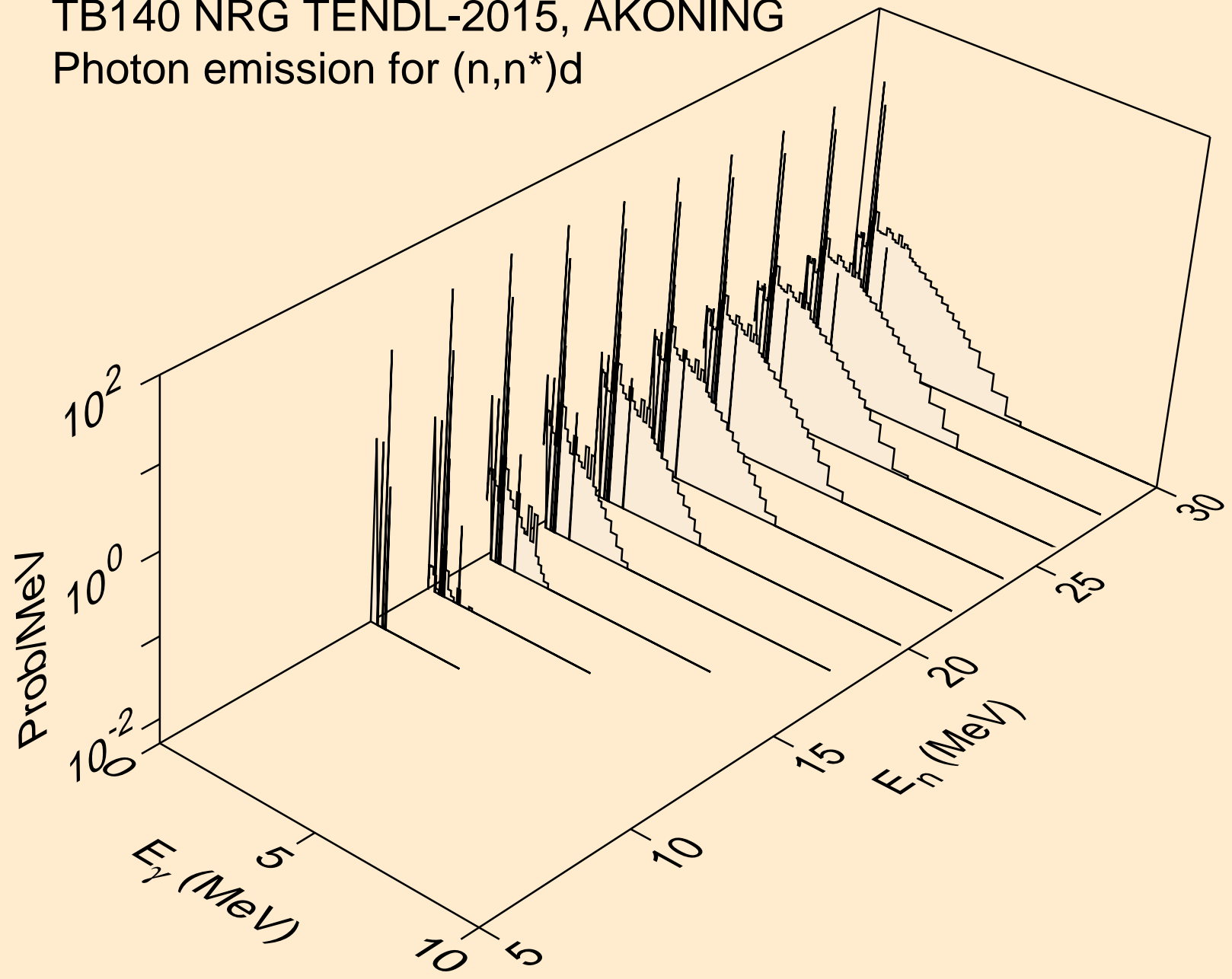

TB140 NRG TENDL-2015, AKONING
Photon emission for (n,n*)t

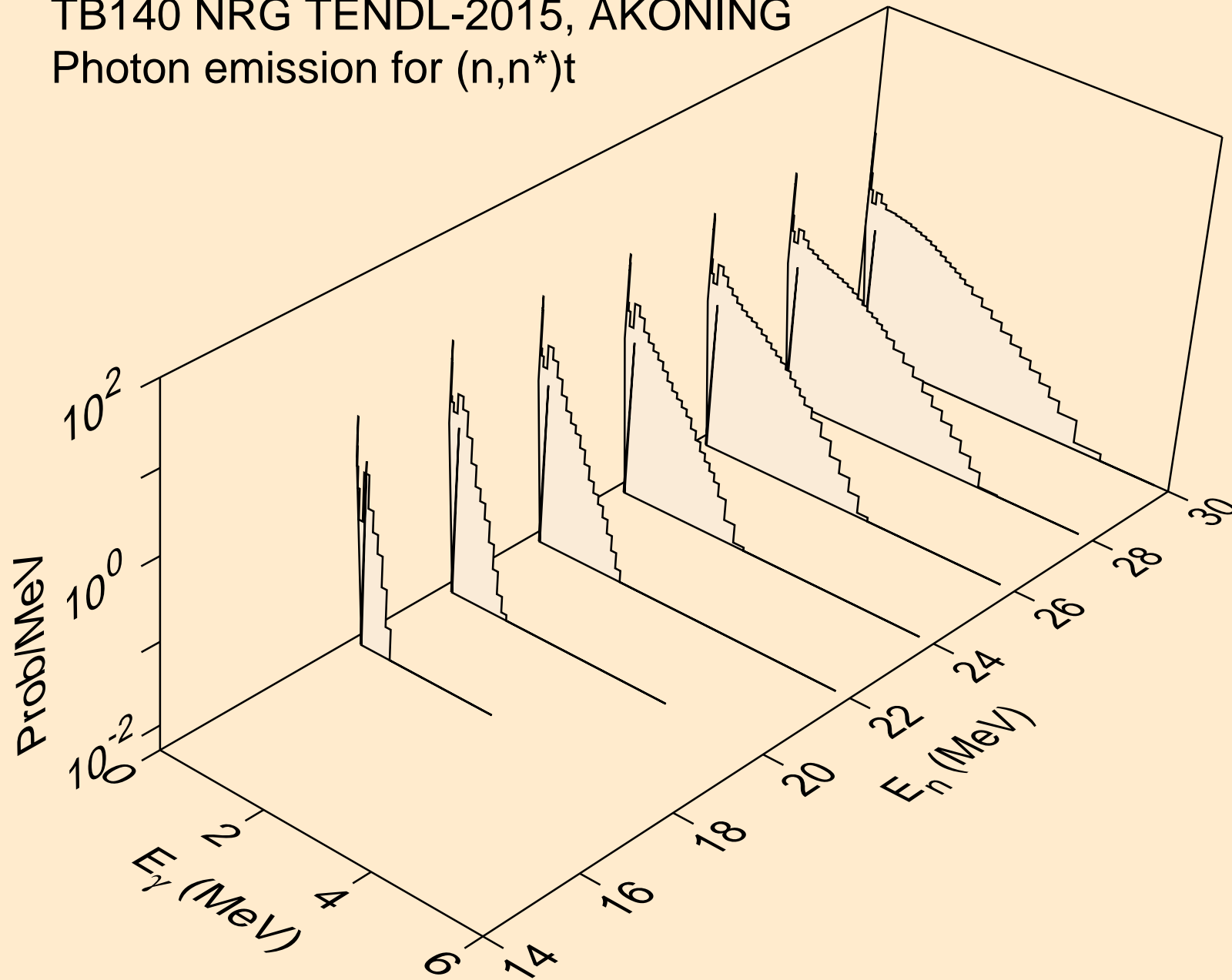

TB140 NRG TENDL-2015, AKONING
Photon emission for (n,n*)he3

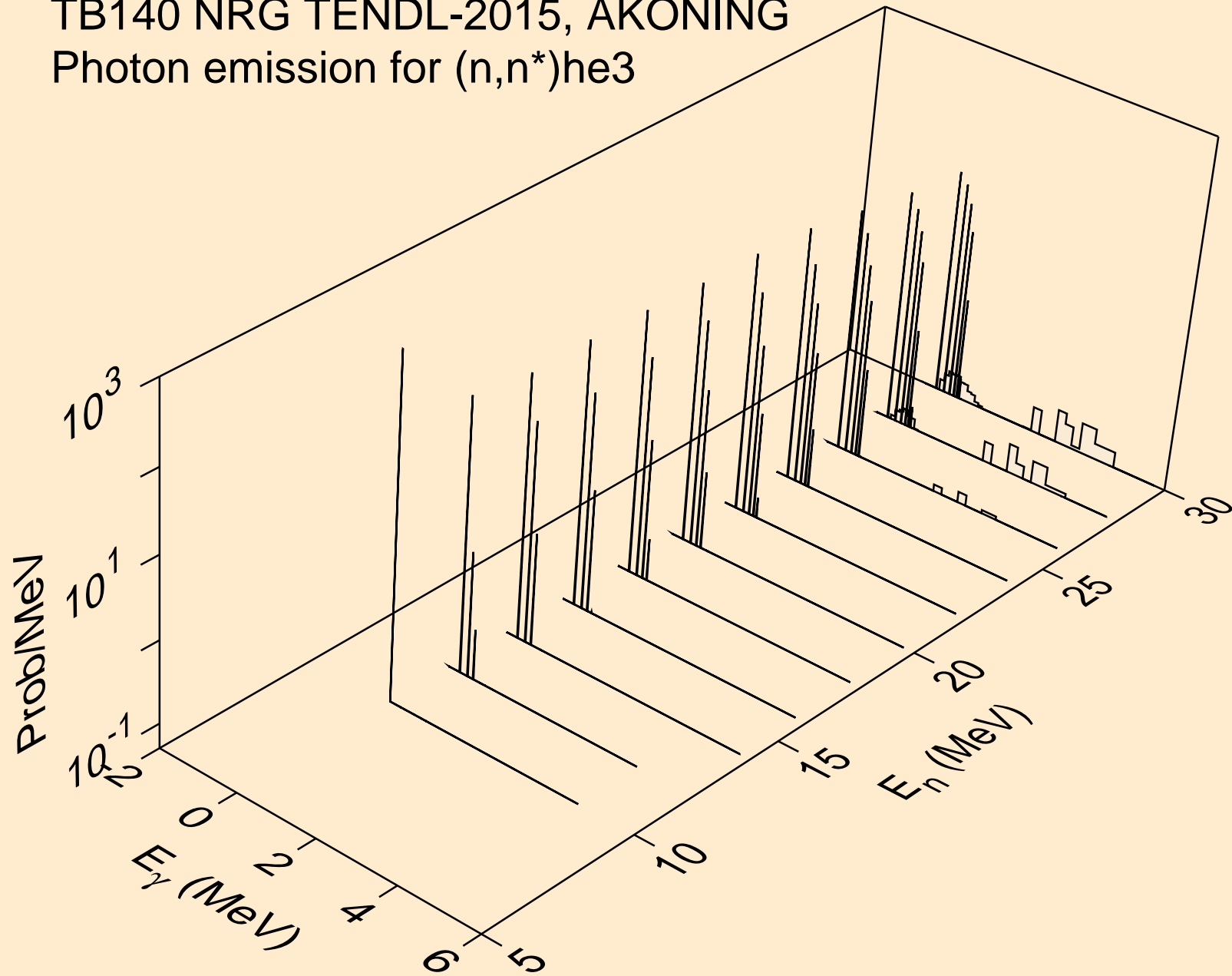

TB140 NRG TENDL-2015, AKONING
Photon emission for (n,n*)d2a

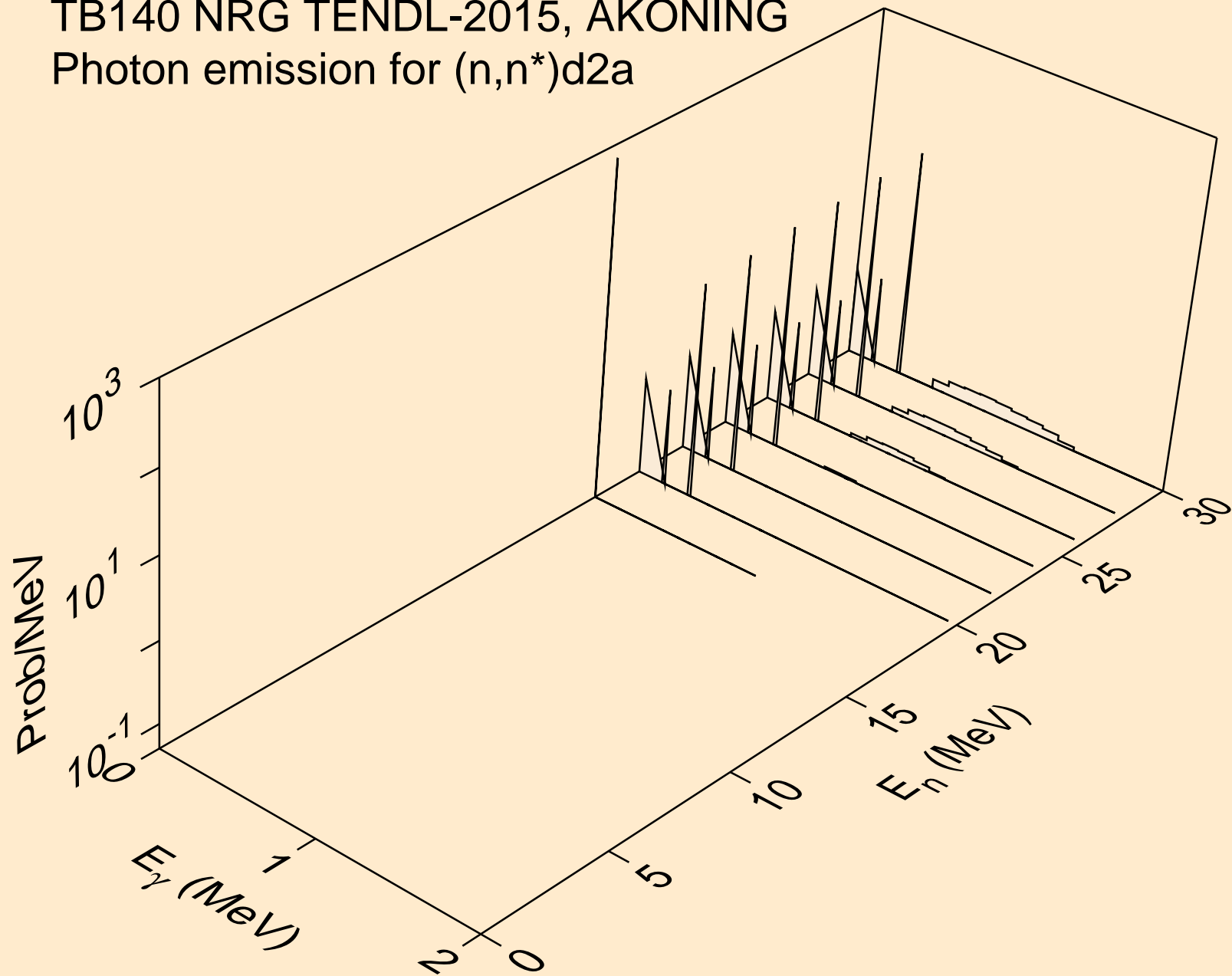

TB140 NRG TENDL-2015, AKONING
Photon emission for (n,2np)

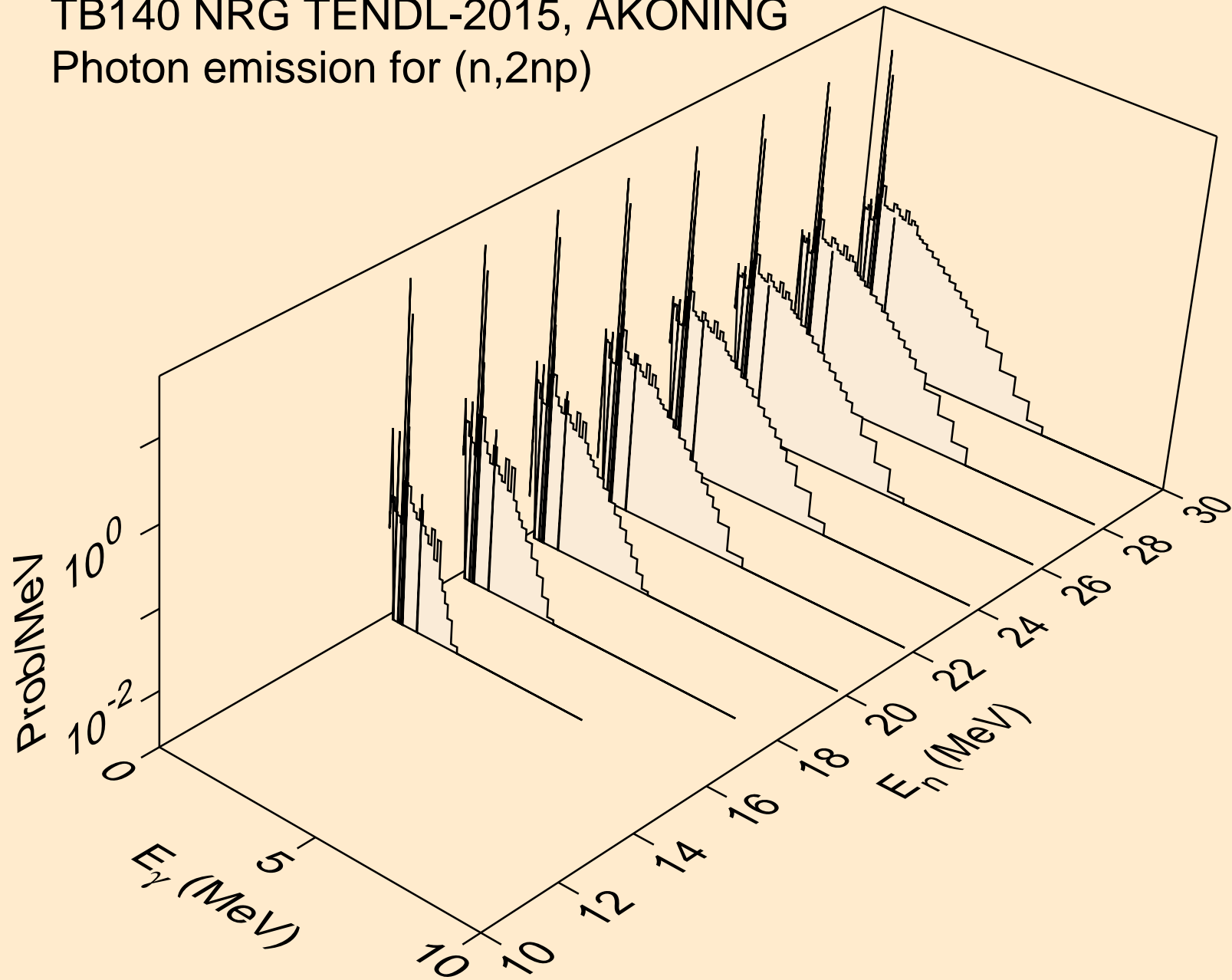

TB140 NRG TENDL-2015, AKONING
Photon emission for (n,3np)

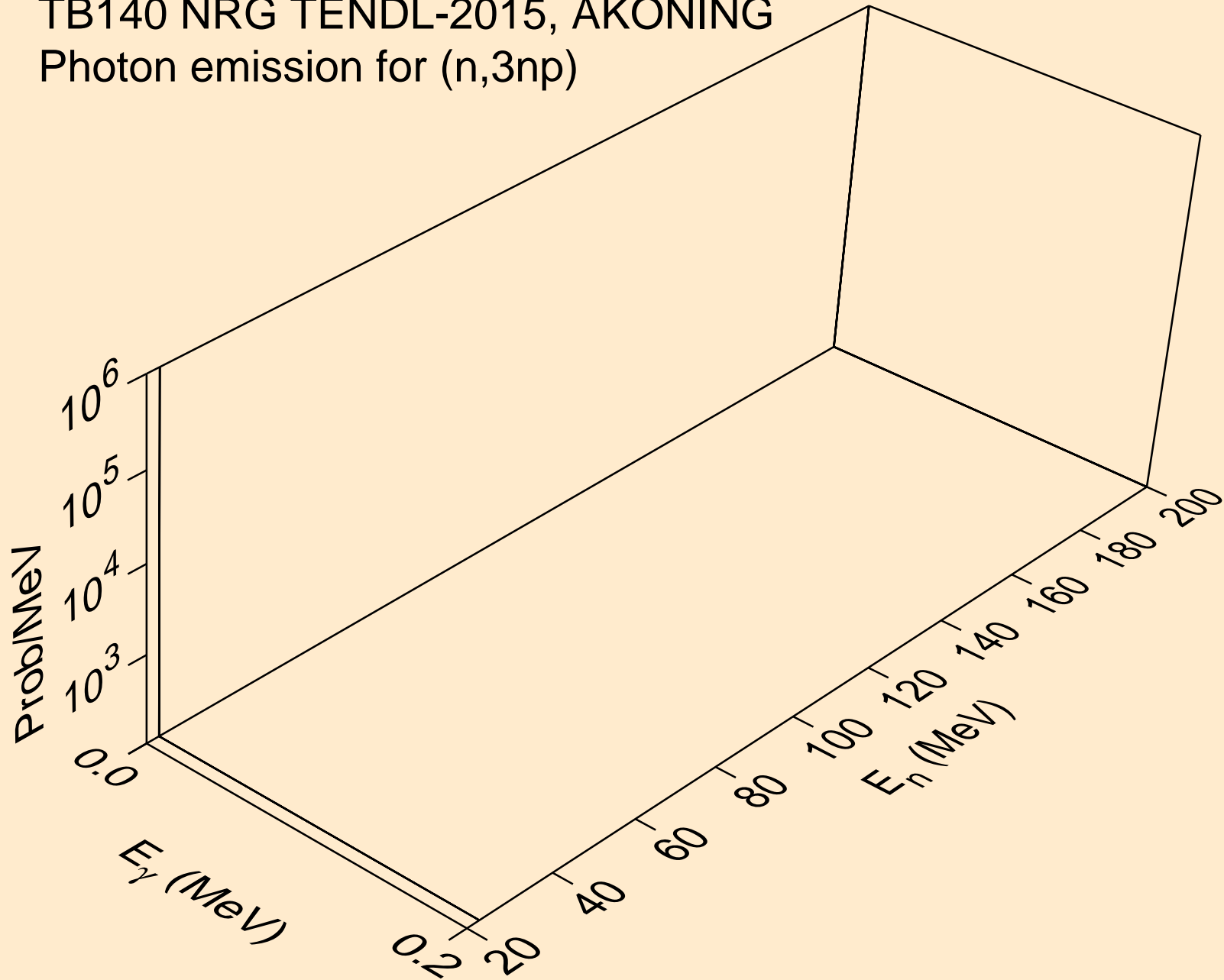

TB140 NRG TENDL-2015, AKONING
Photon emission for (n,2np)

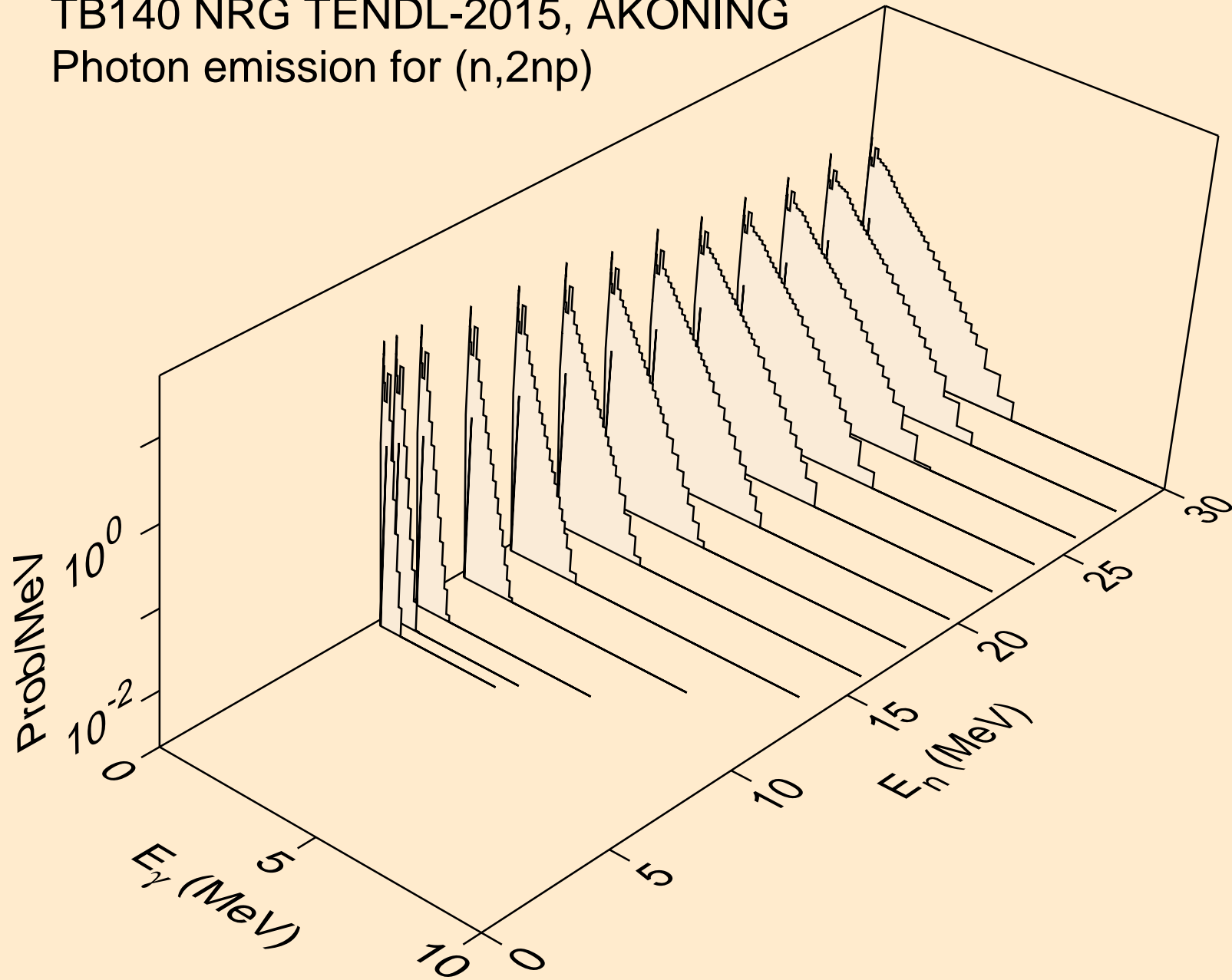

TB140 NRG TENDL-2015, AKONING
Photon emission for (n,npa)

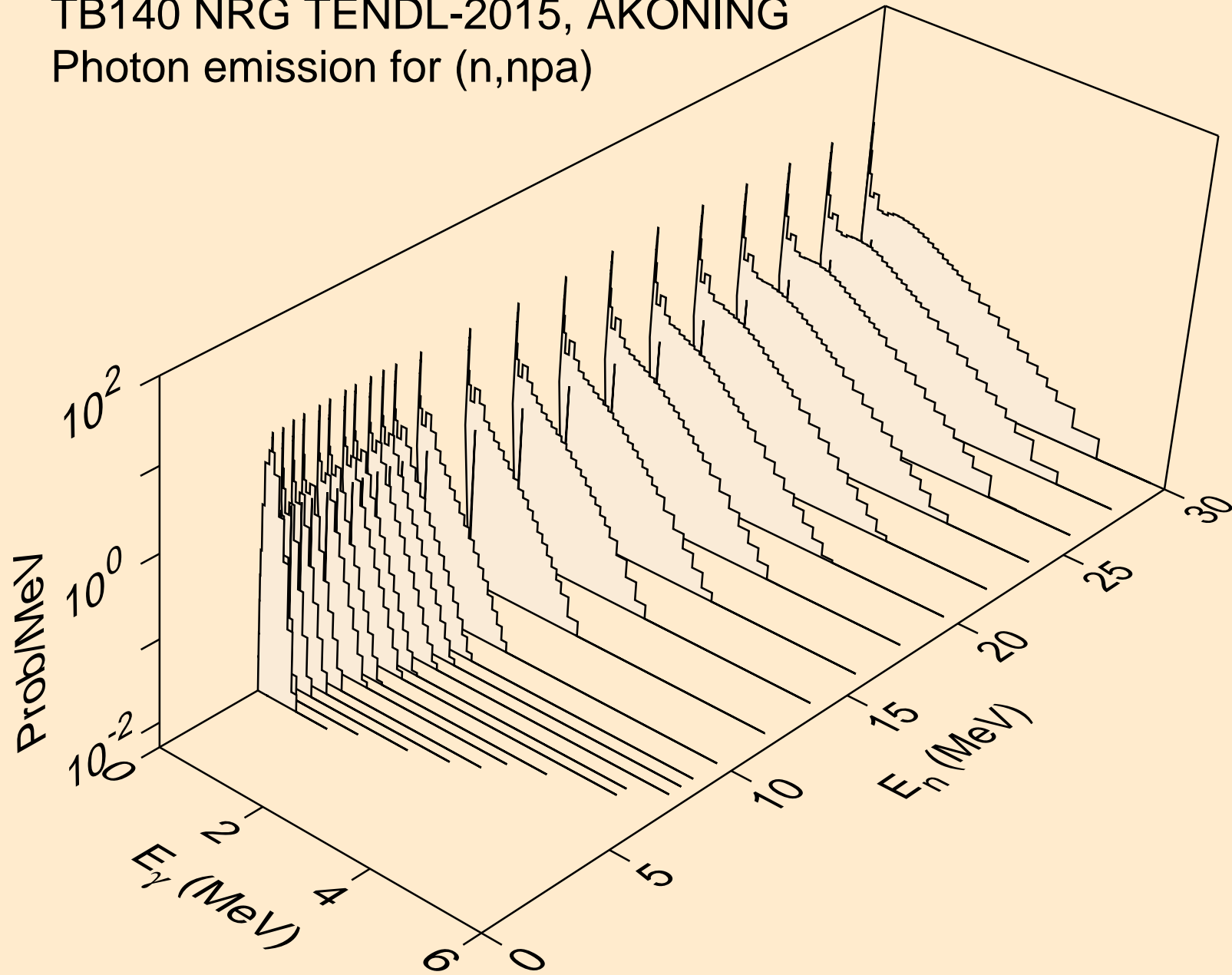

TB140 NRG TENDL-2015, AKONING
Photon emission for (n,n*c)

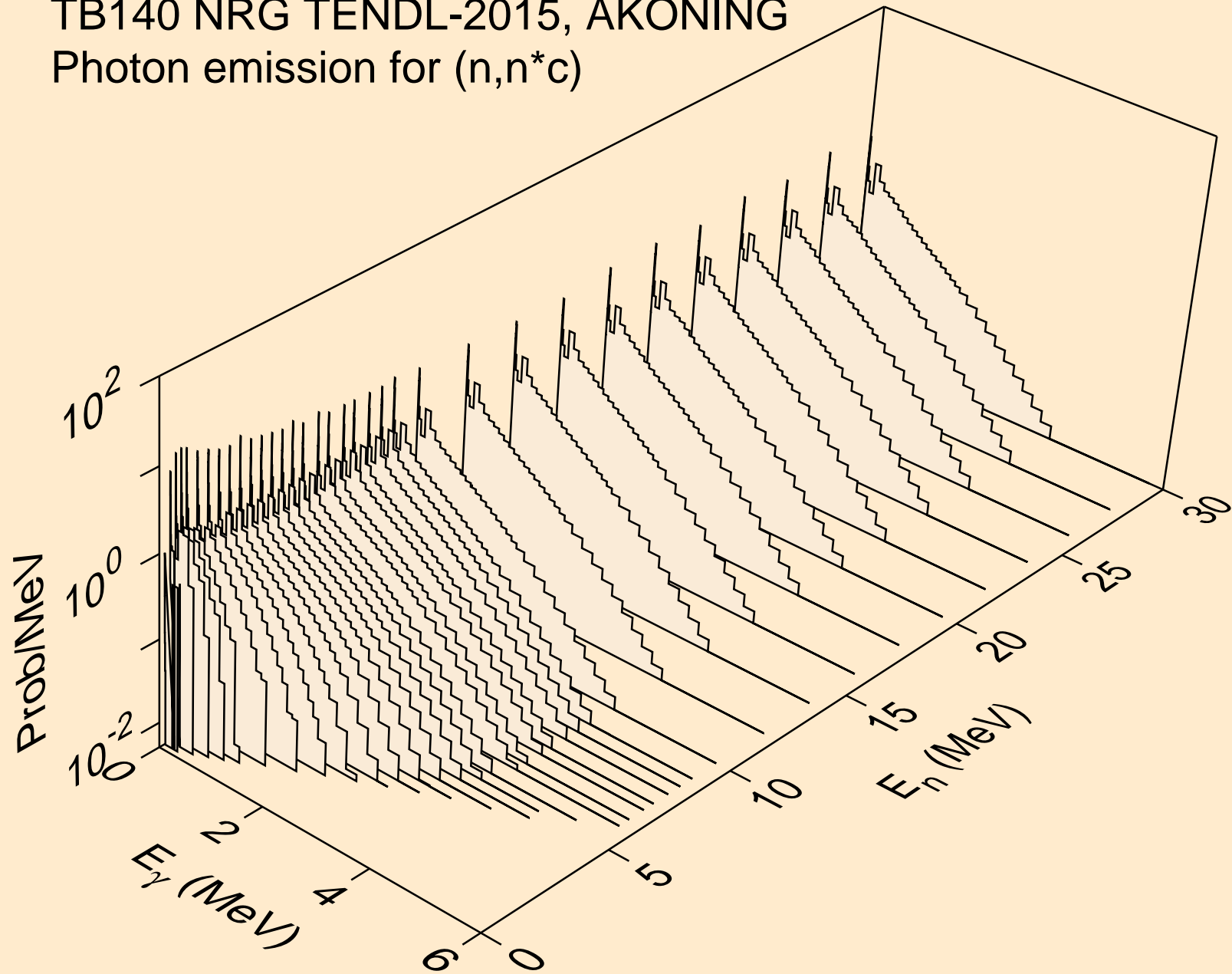

TB140 NRG TENDL-2015, AKONING
Photon emission for (n,gma)

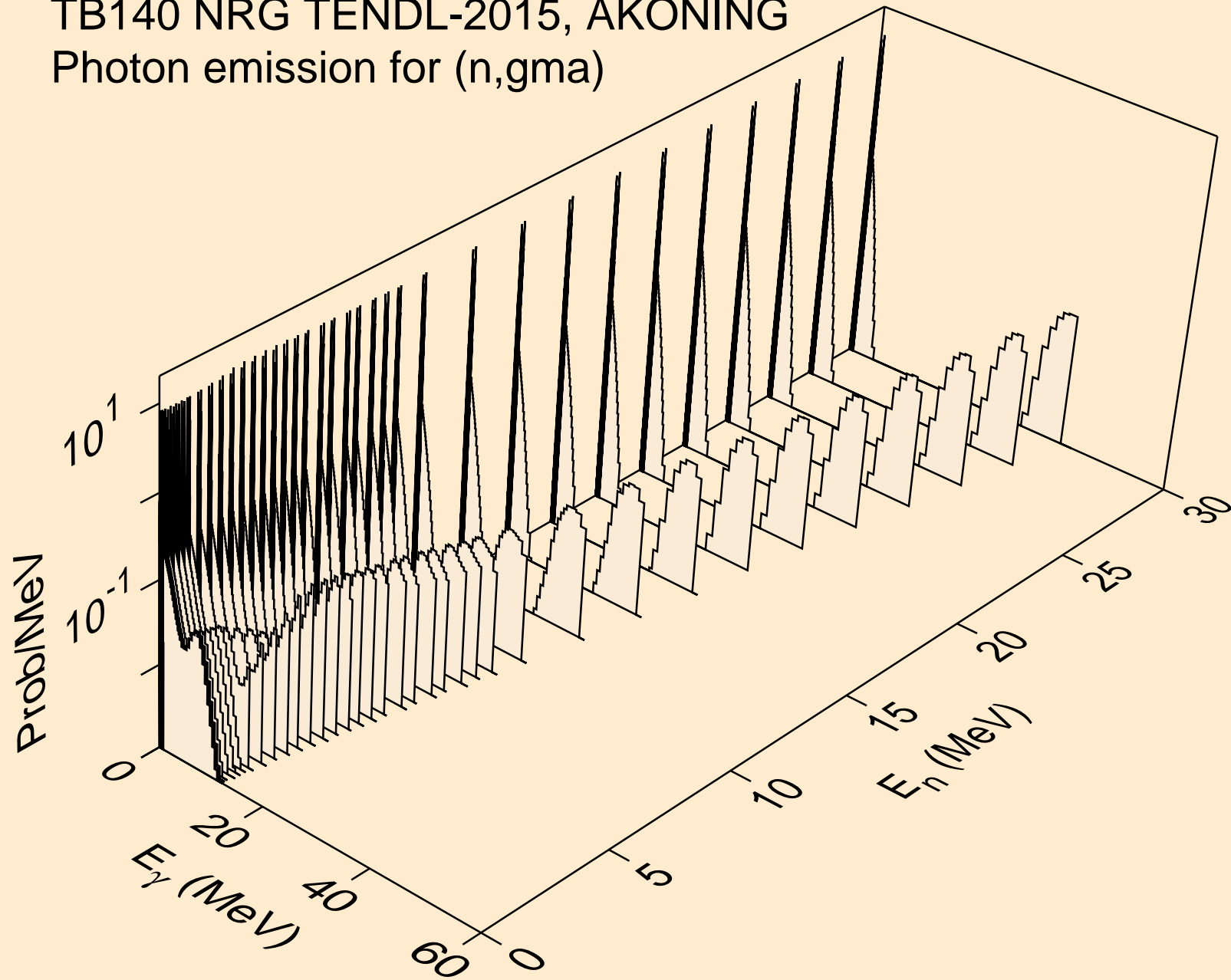

TB140 NRG TENDL-2015, AKONING
Photon emission for (n,p)

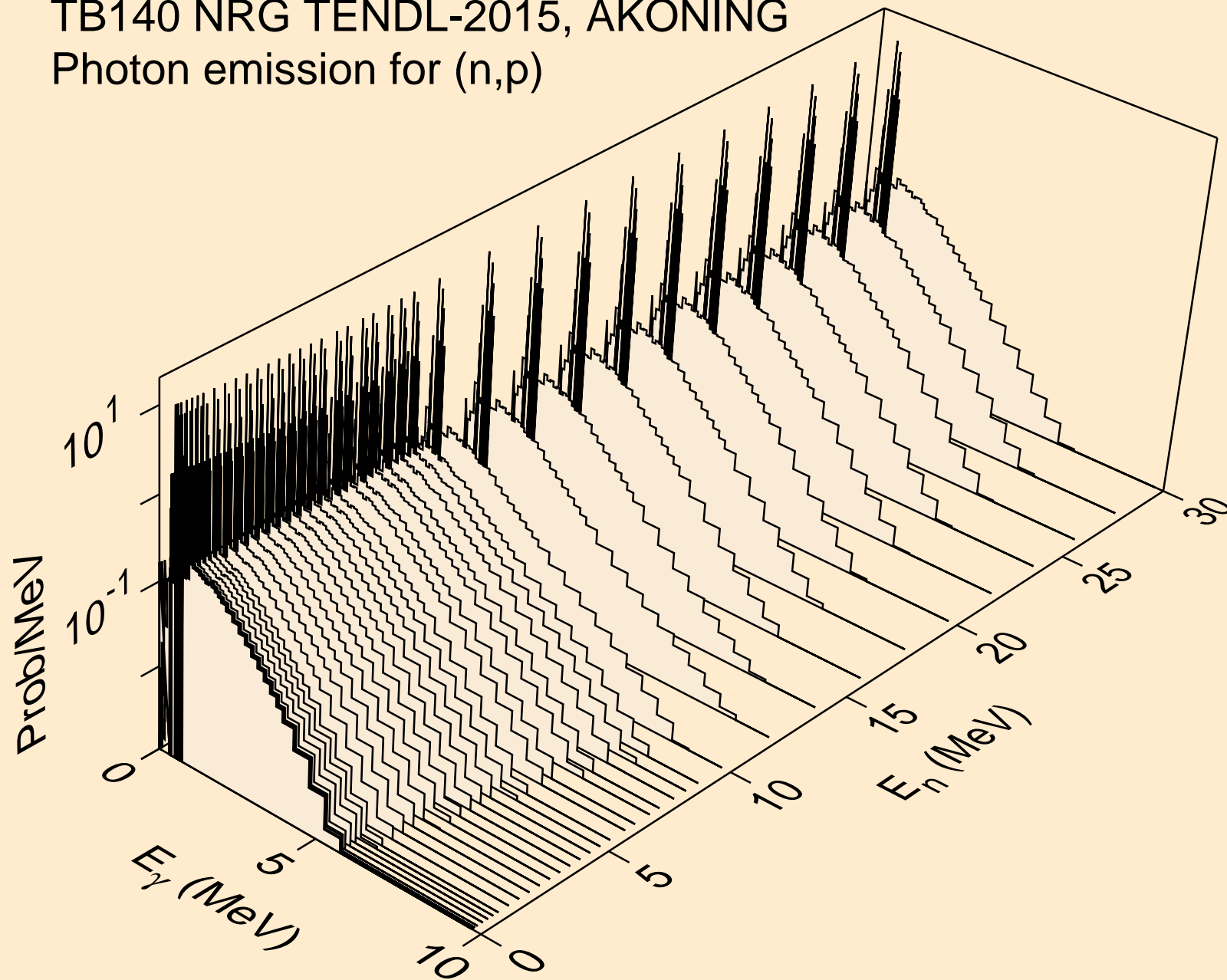

TB140 NRG TENDL-2015, AKONING
Photon emission for (n,d)

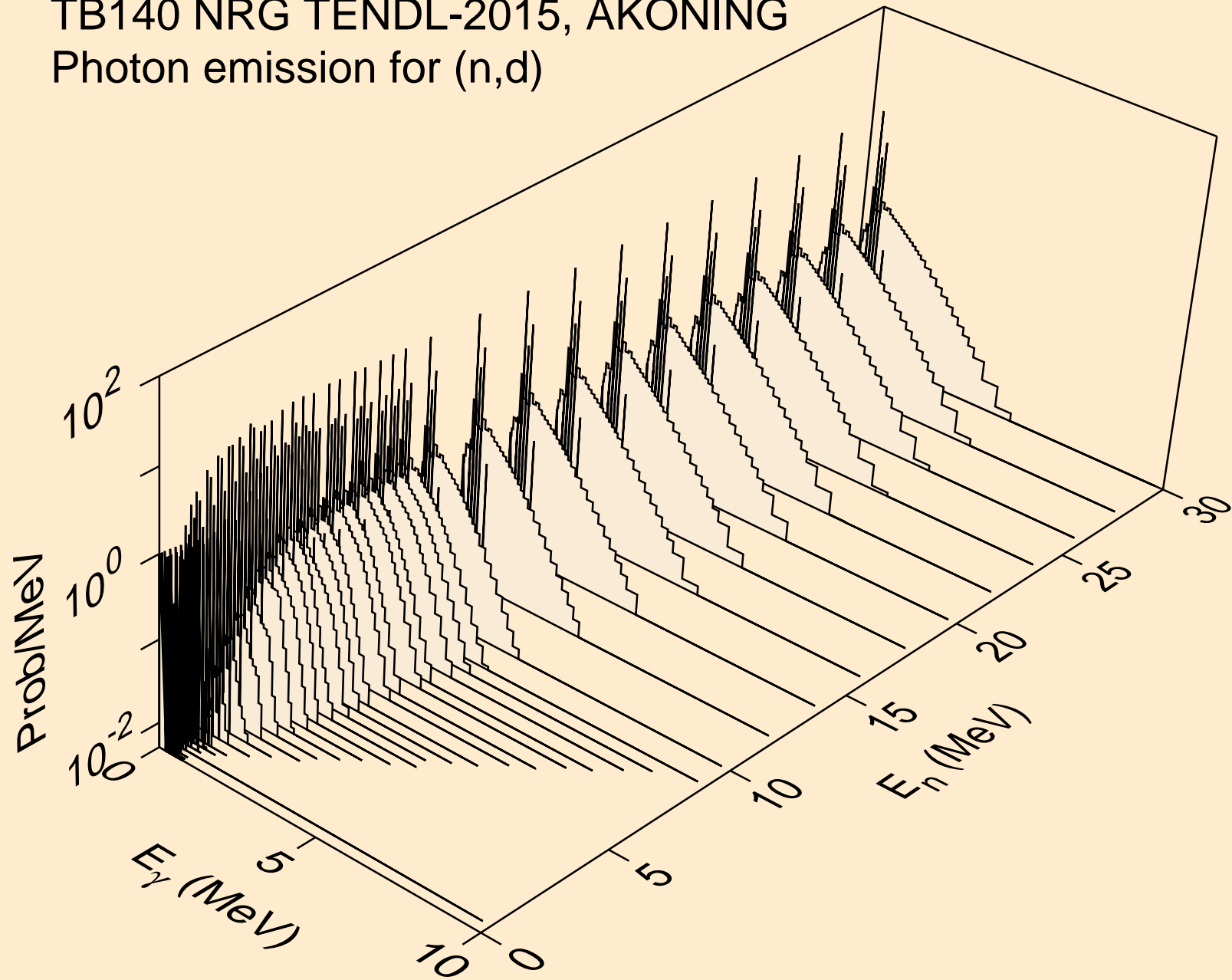

TB140 NRG TENDL-2015, AKONING
Photon emission for (n,t)

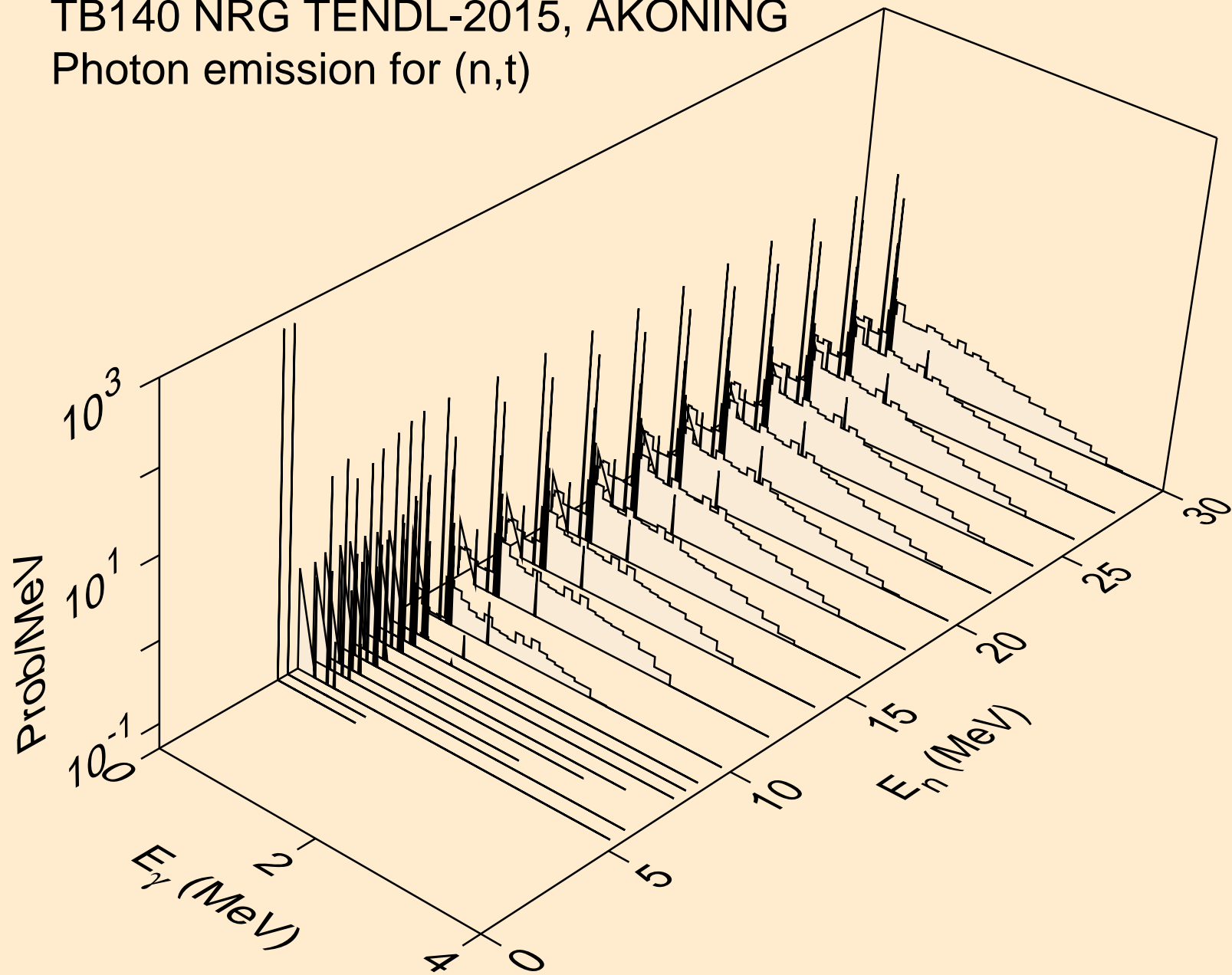

TB140 NRG TENDL-2015, AKONING
Photon emission for (n,he3)

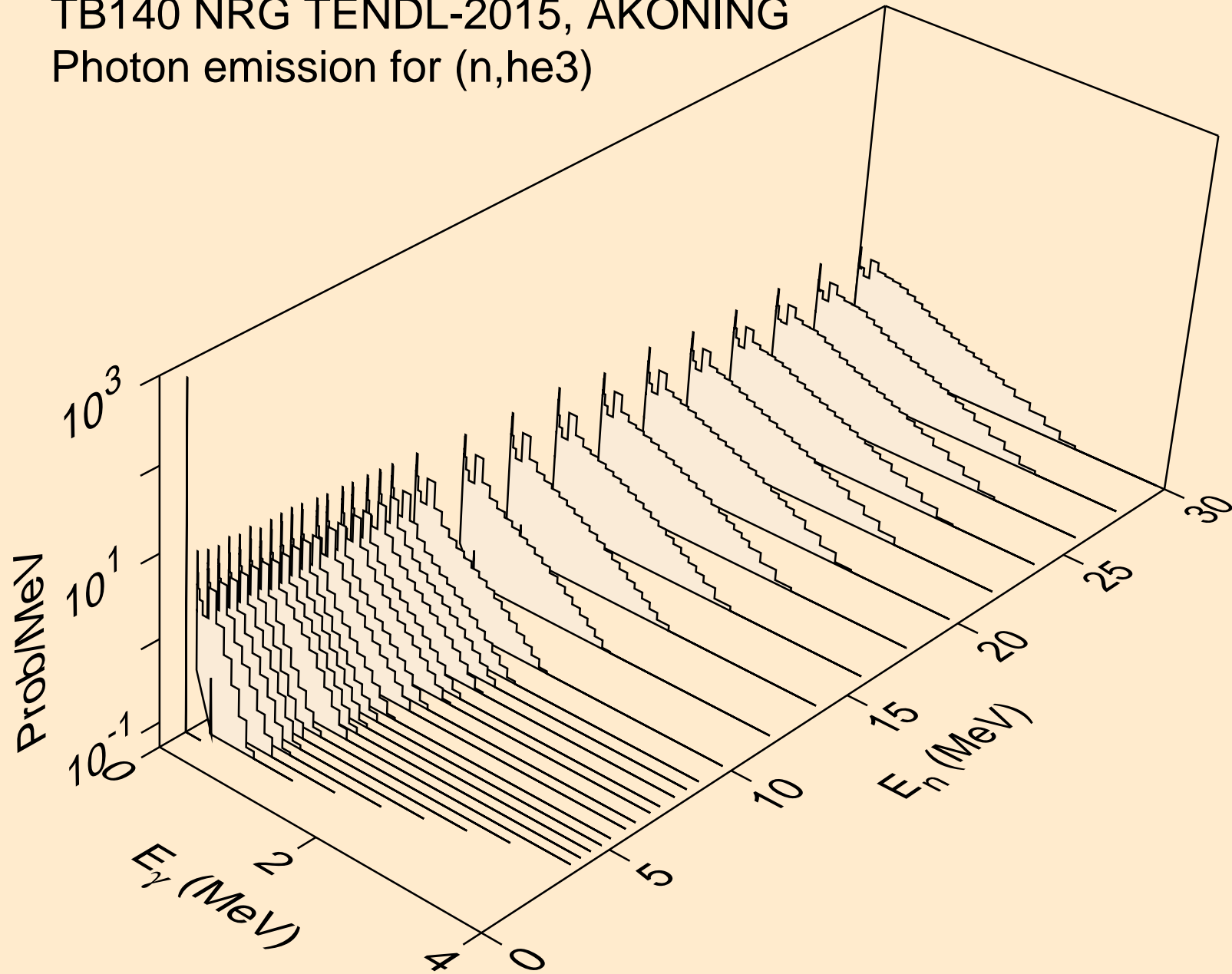

TB140 NRG TENDL-2015, AKONING
Photon emission for (n,a)

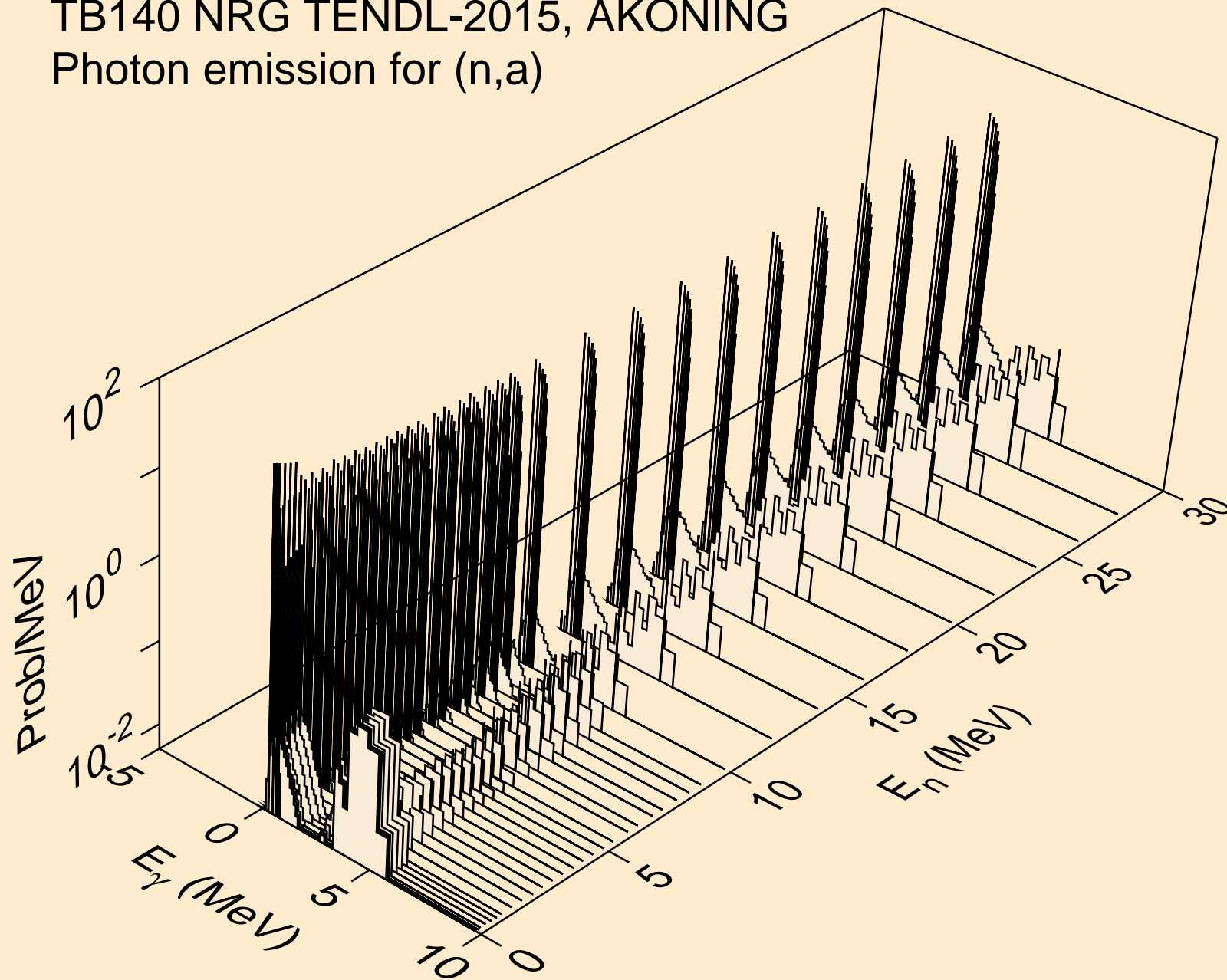

TB140 NRG TENDL-2015, AKONING
Photon emission for (n,2a)

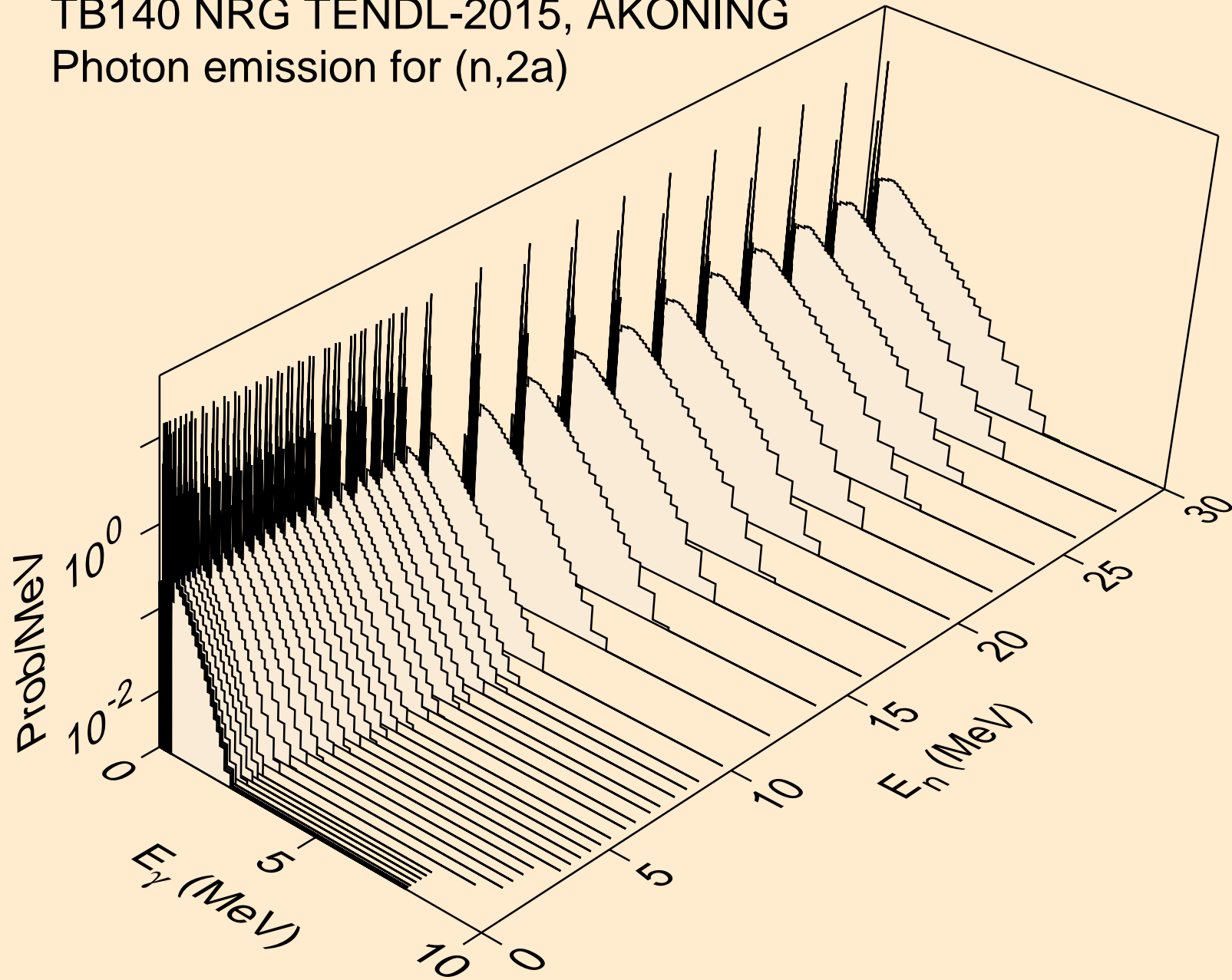

TB140 NRG TENDL-2015, AKONING
Photon emission for (n,3a)

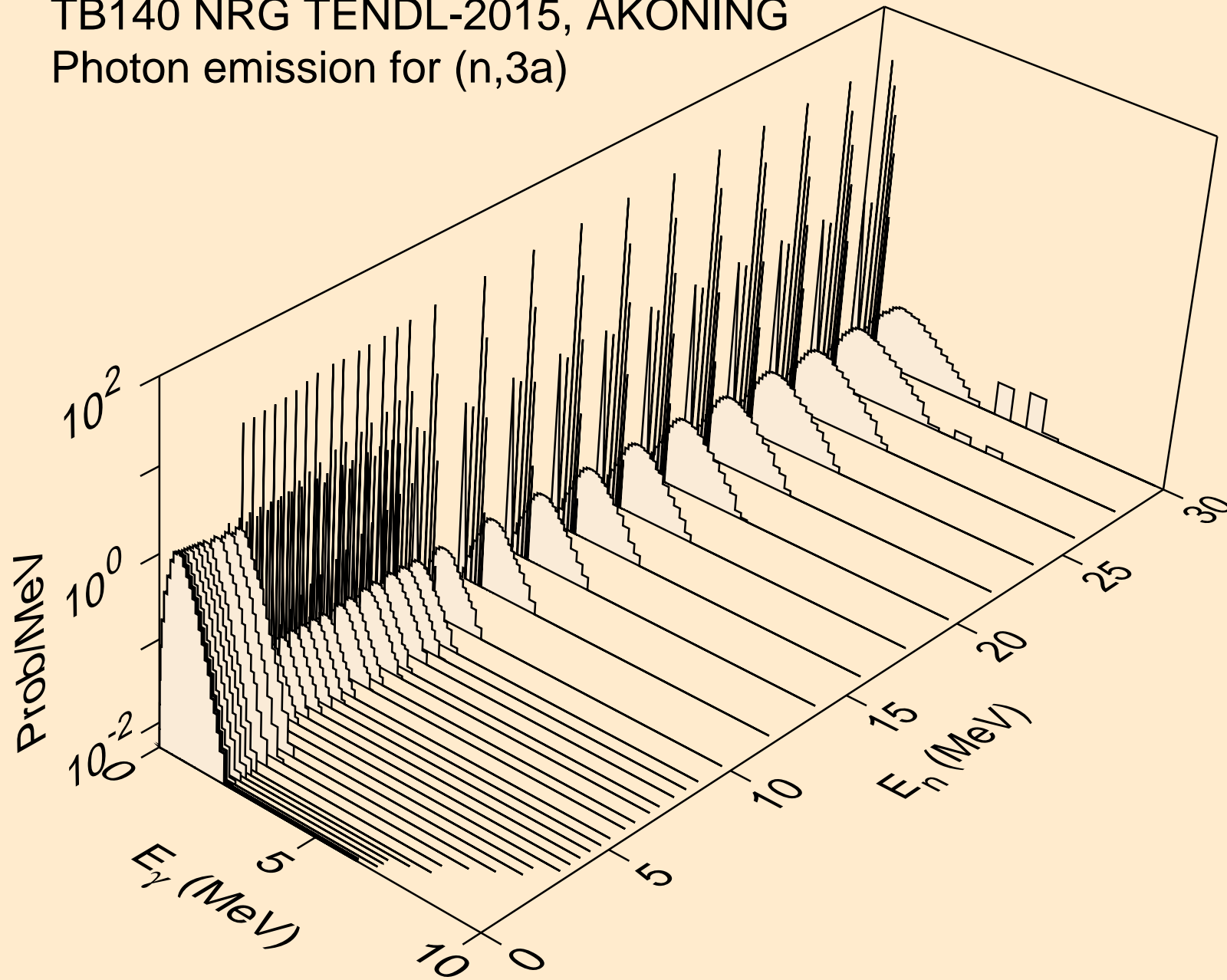

TB140 NRG TENDL-2015, AKONING
Photon emission for (n,2p)

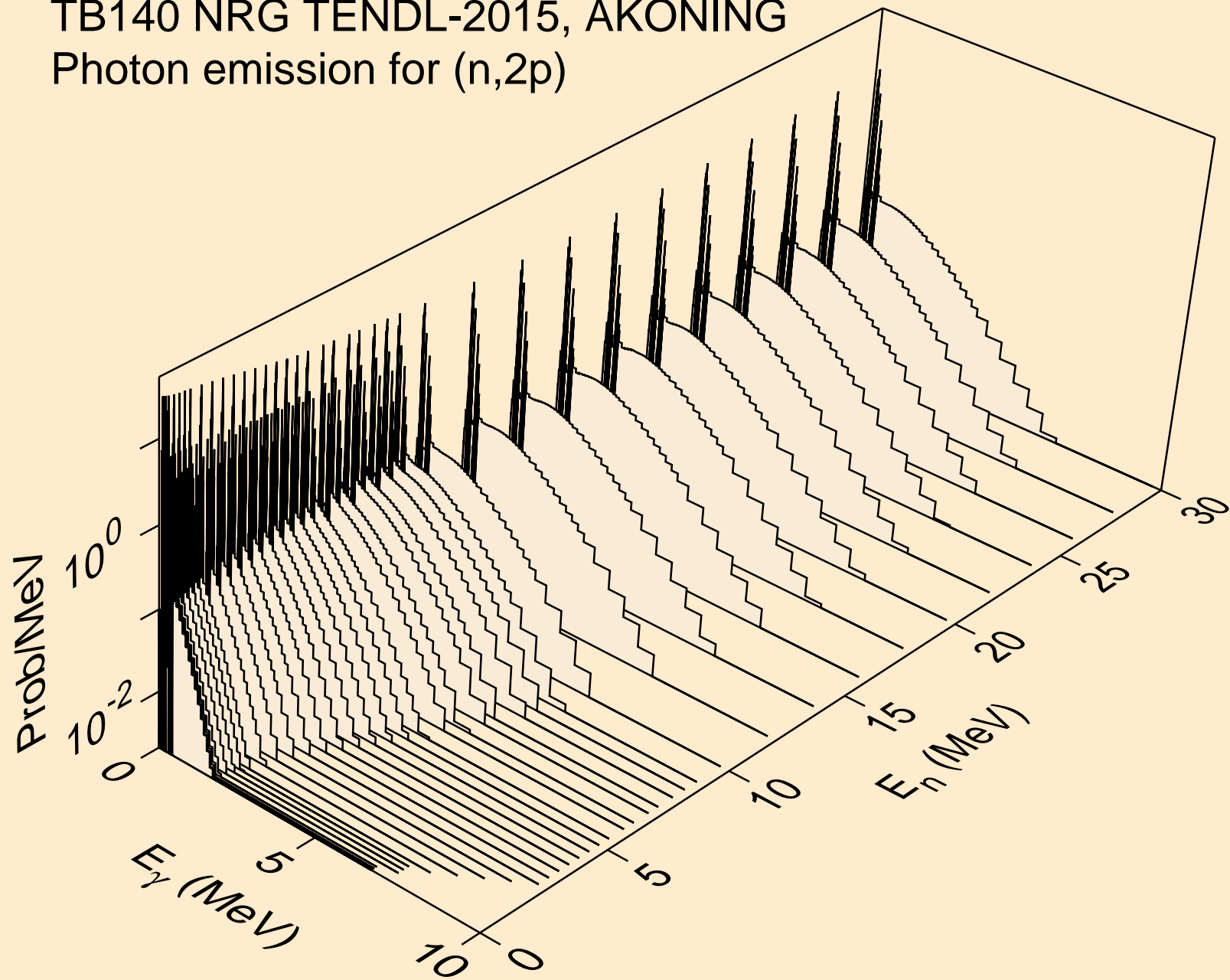

TB140 NRG TENDL-2015, AKONING
Photon emission for (n,p α)

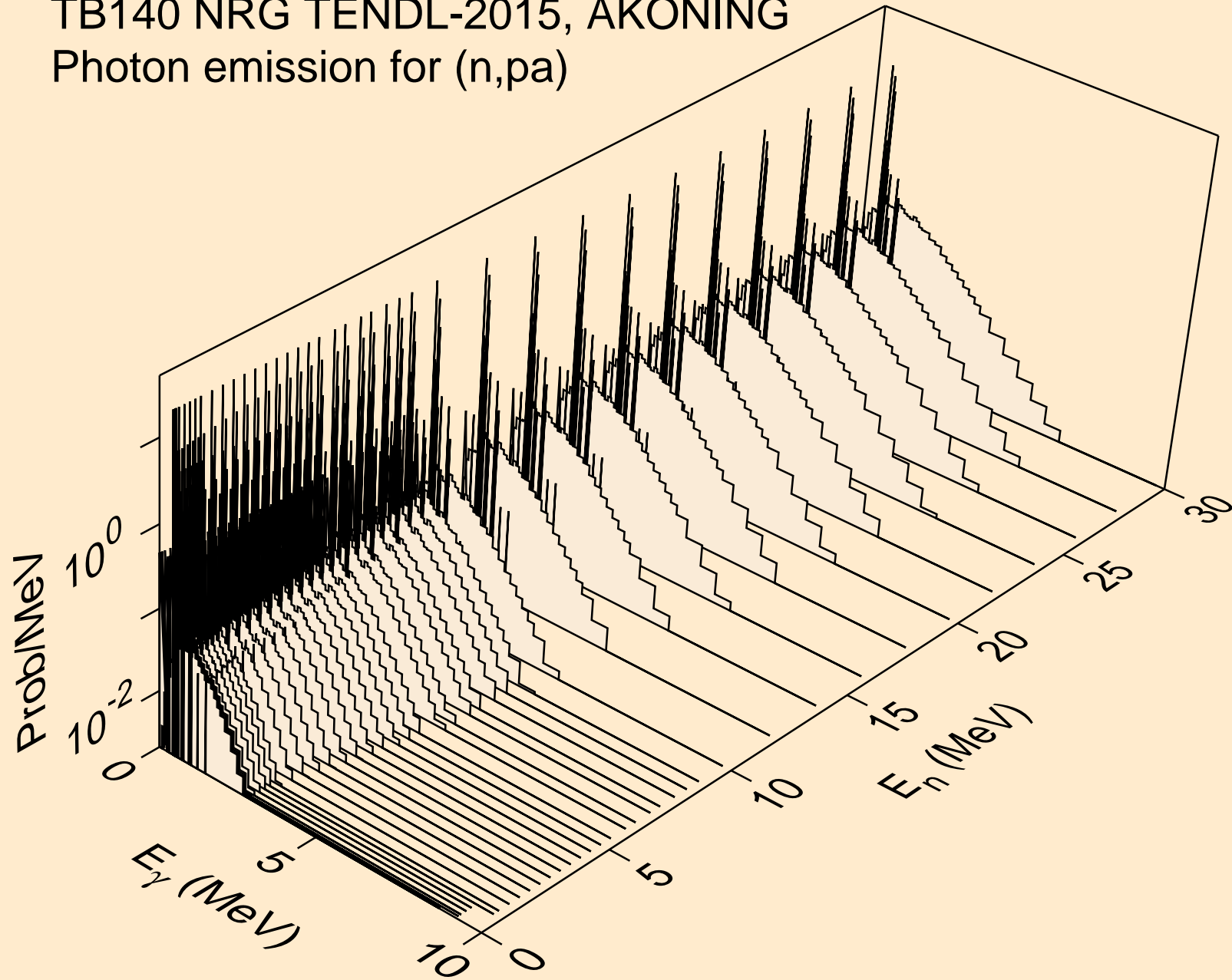

TB140 NRG TENDL-2015, AKONING
Photon emission for (n,t2a)

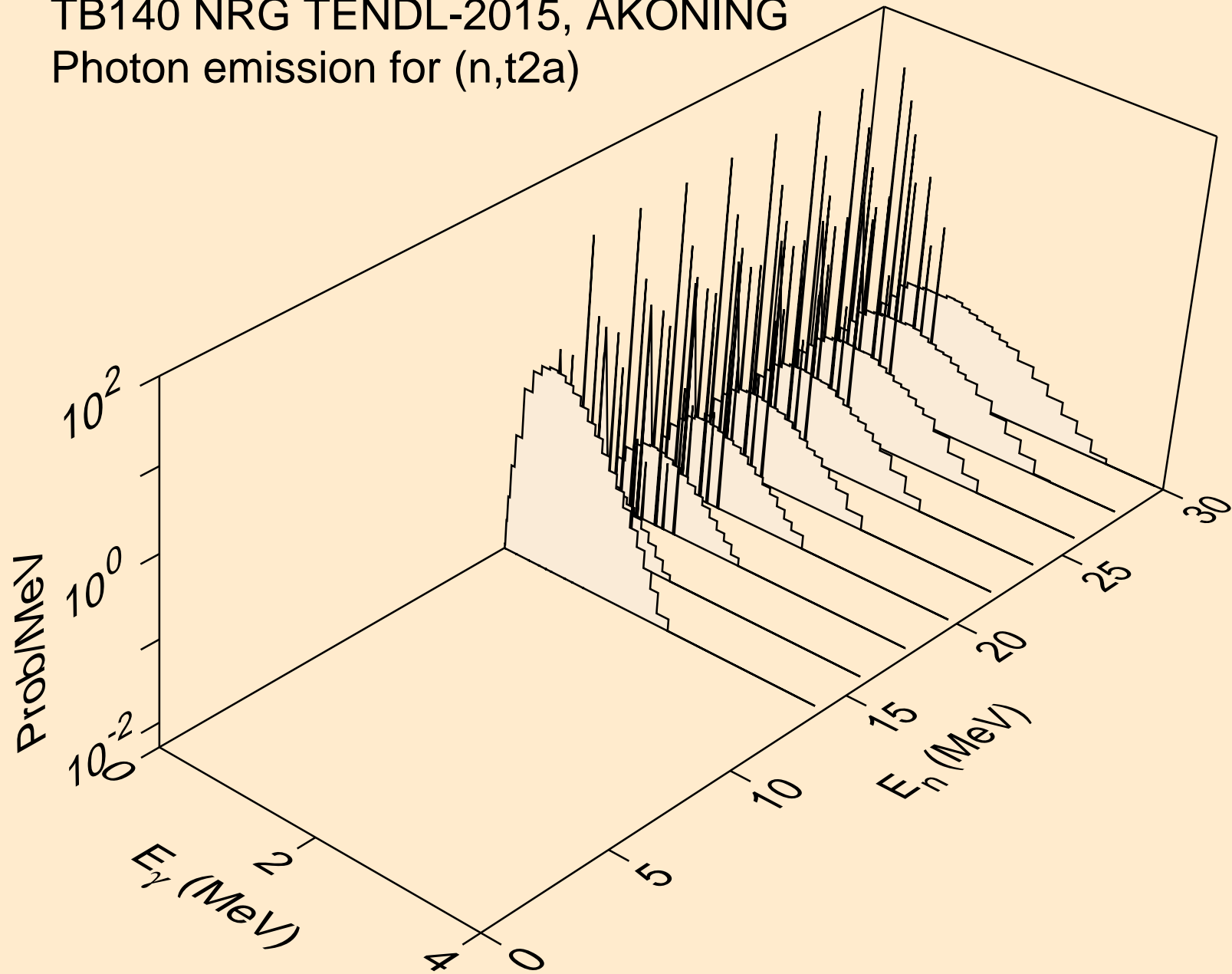

TB140 NRG TENDL-2015, AKONING
Photon emission for (n,d2a)

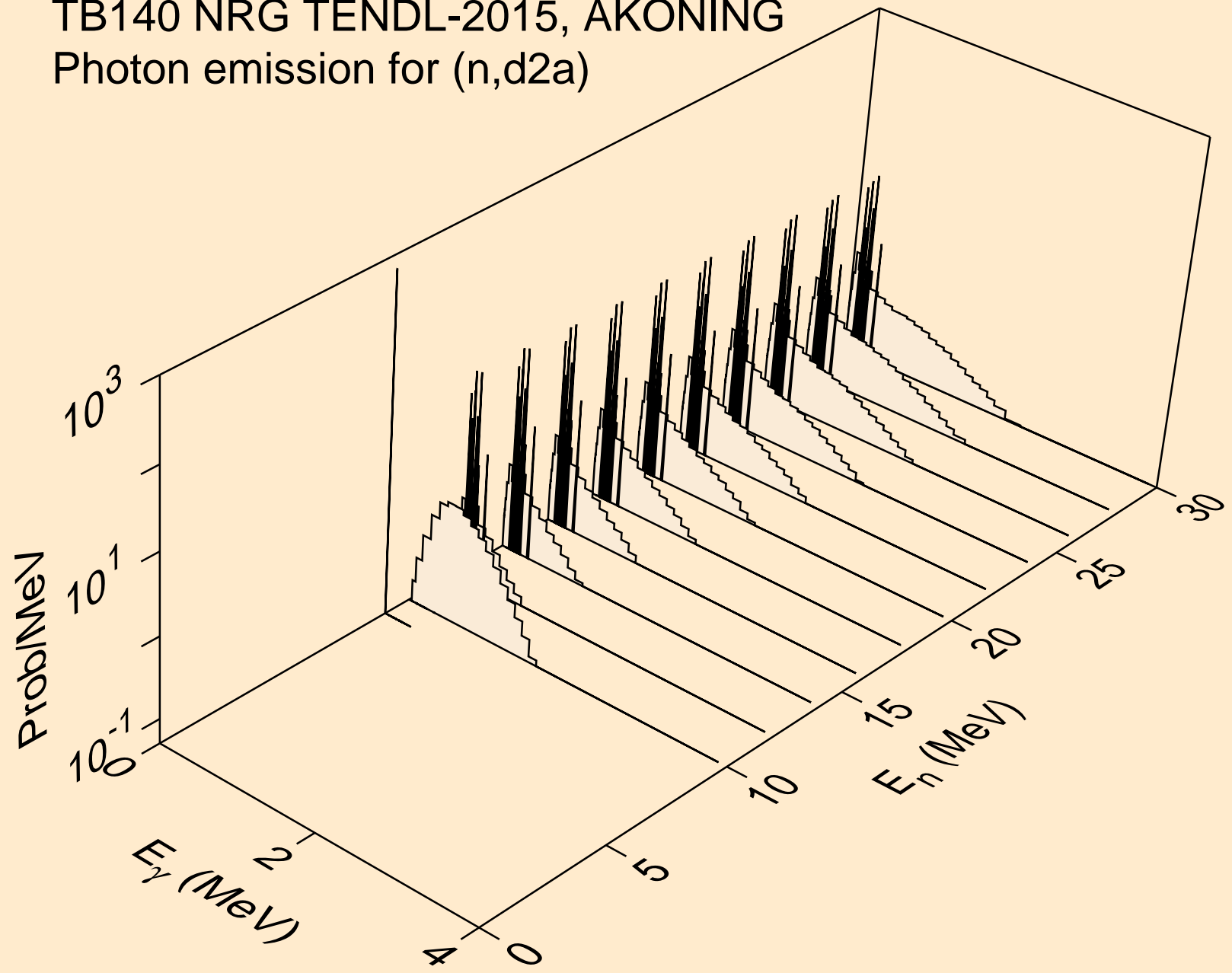

TB140 NRG TENDL-2015, AKONING
Photon emission for (n,pd)

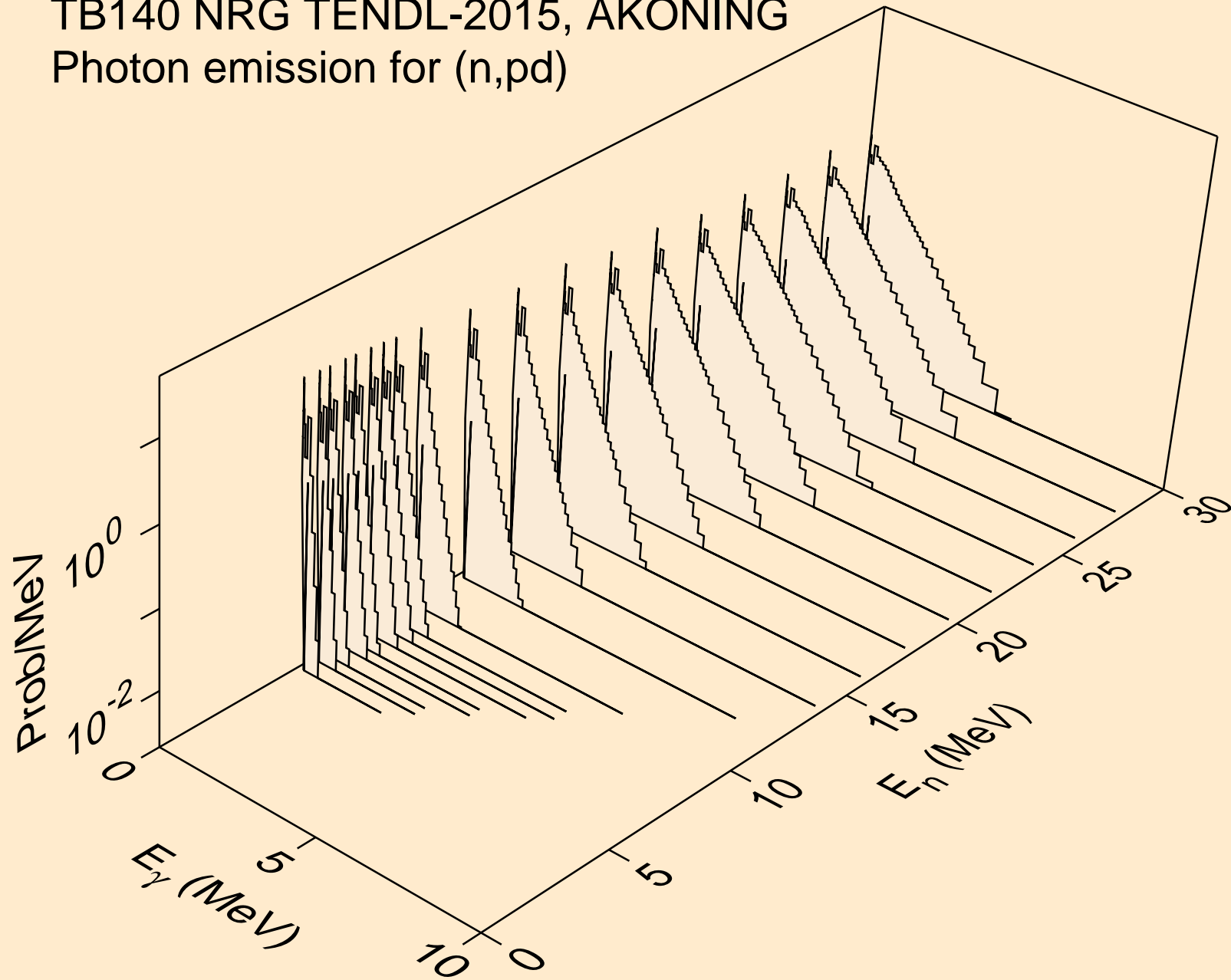

TB140 NRG TENDL-2015, AKONING
Photon emission for (n,pt)

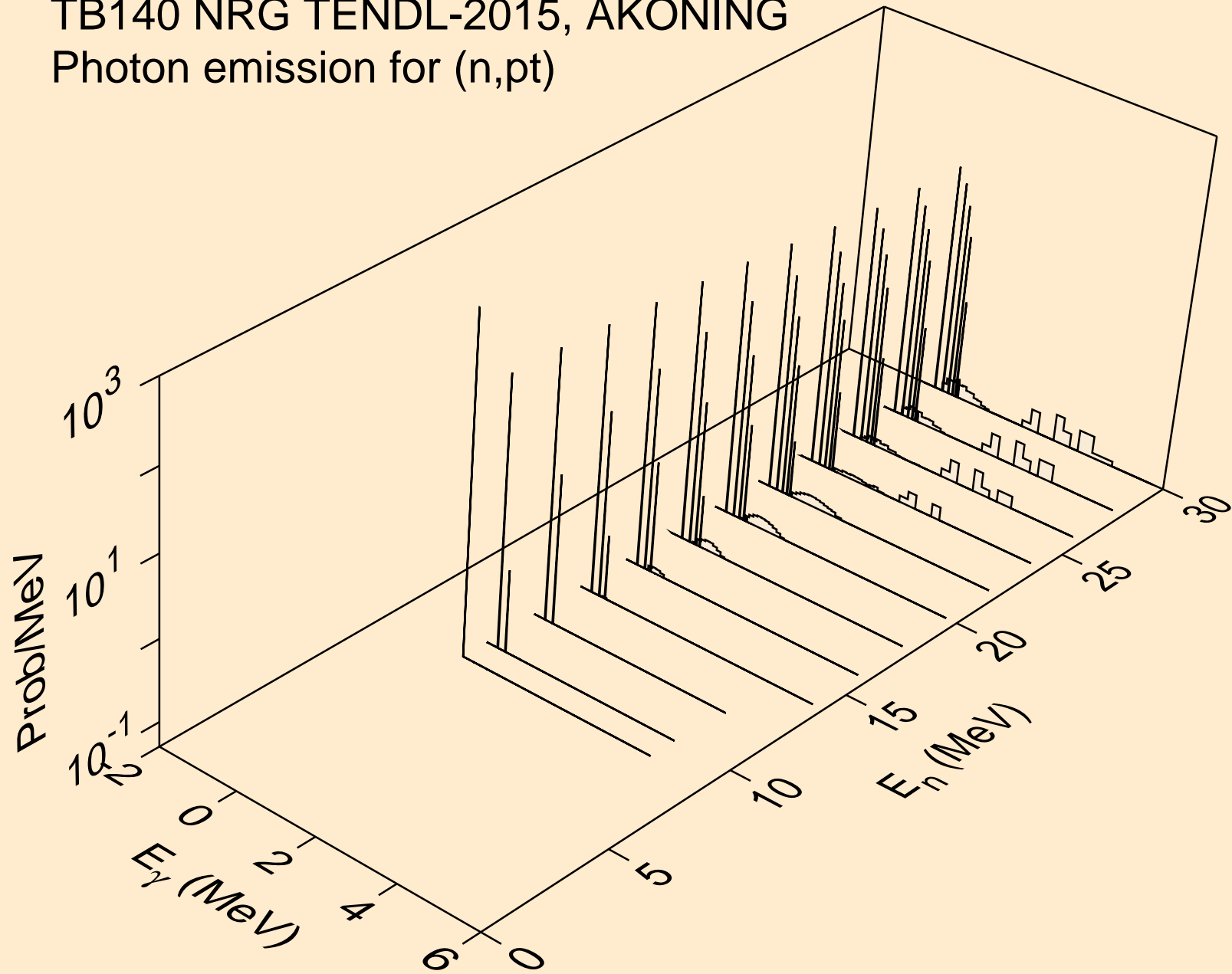

TB140 NRG TENDL-2015, AKONING
Photon emission for (n,da)

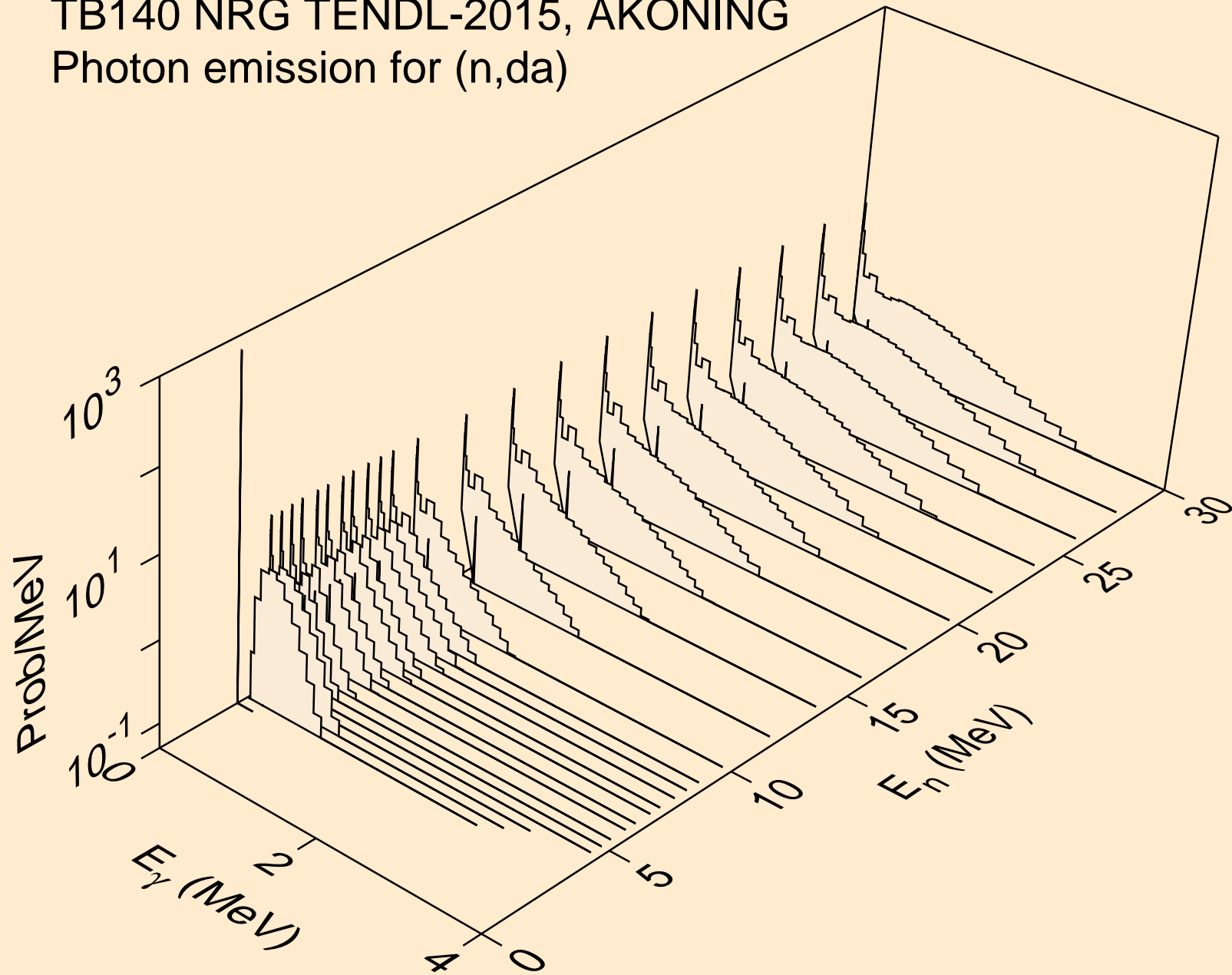

TB140 NRG TENDL-2015, AKONING
thermal capture photon spectrum

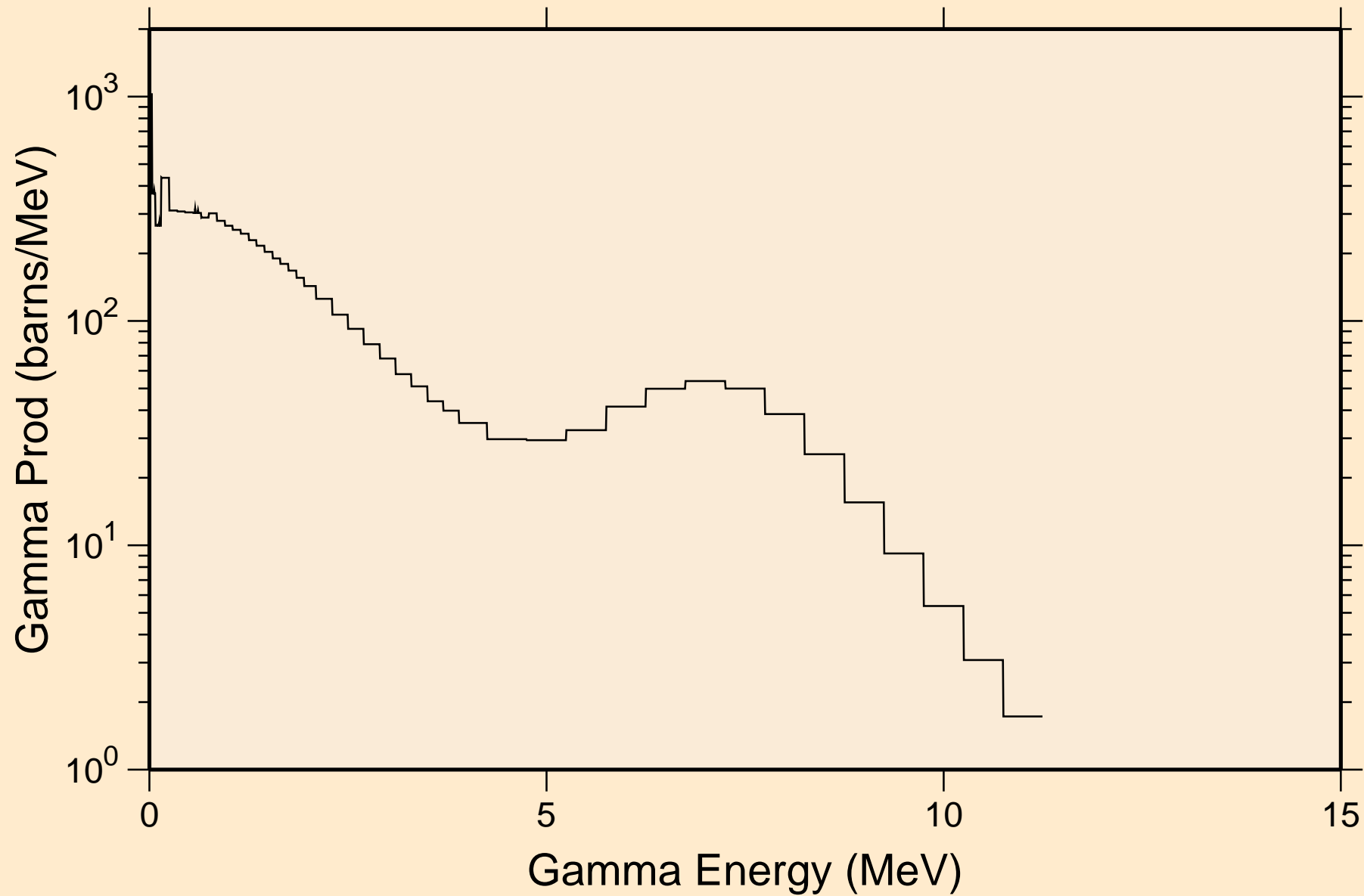

TB140 NRG TENDL-2015, AKONING
14 MeV photon spectrum

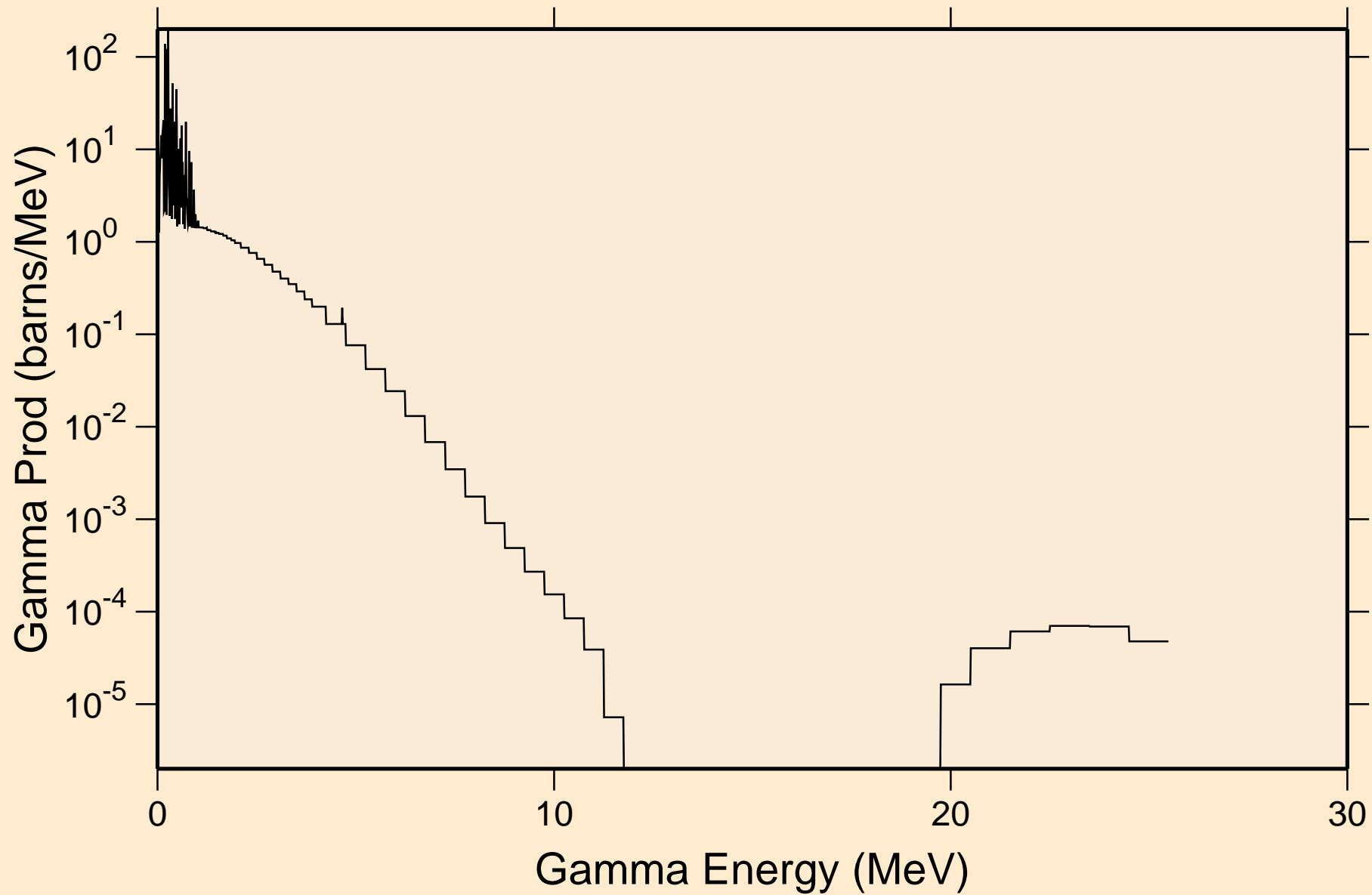

TB140 NRG TENDL-2015, AKONING

Particle heating contributions

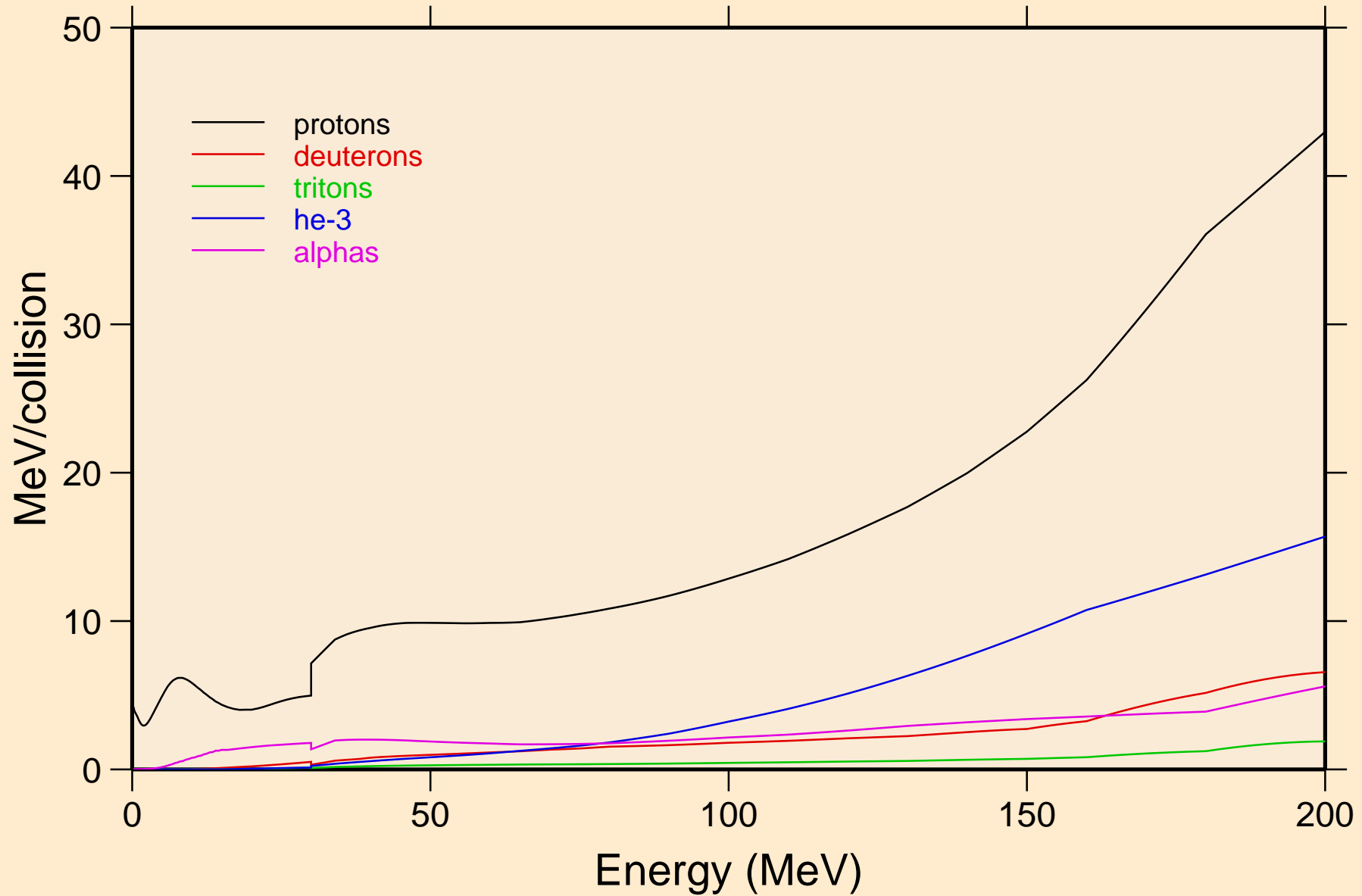

TB140 NRG TENDL-2015, AKONING

Recoil Heating

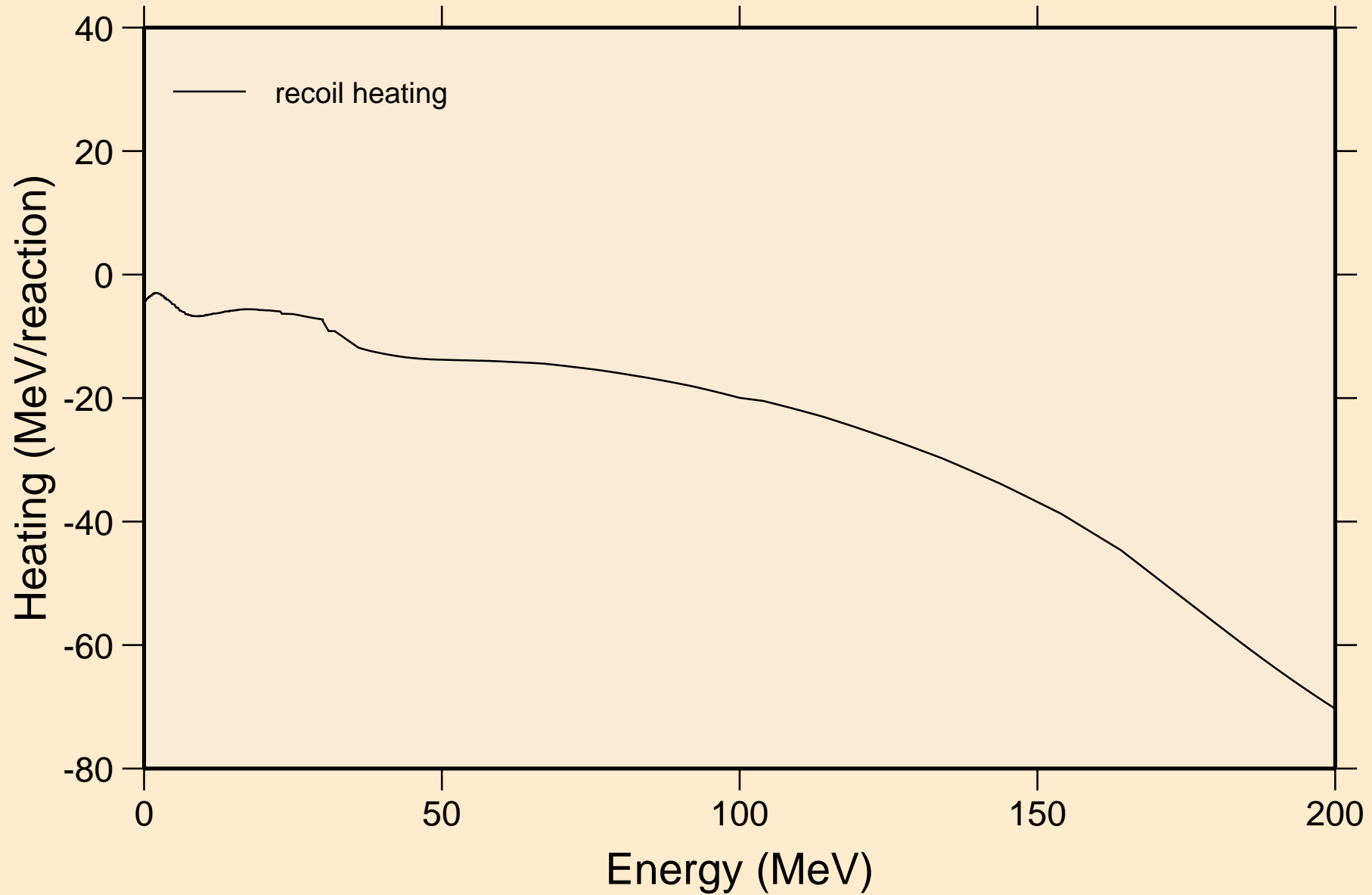

TB140 NRG TENDL-2015, AKONING

Particle production cross sections

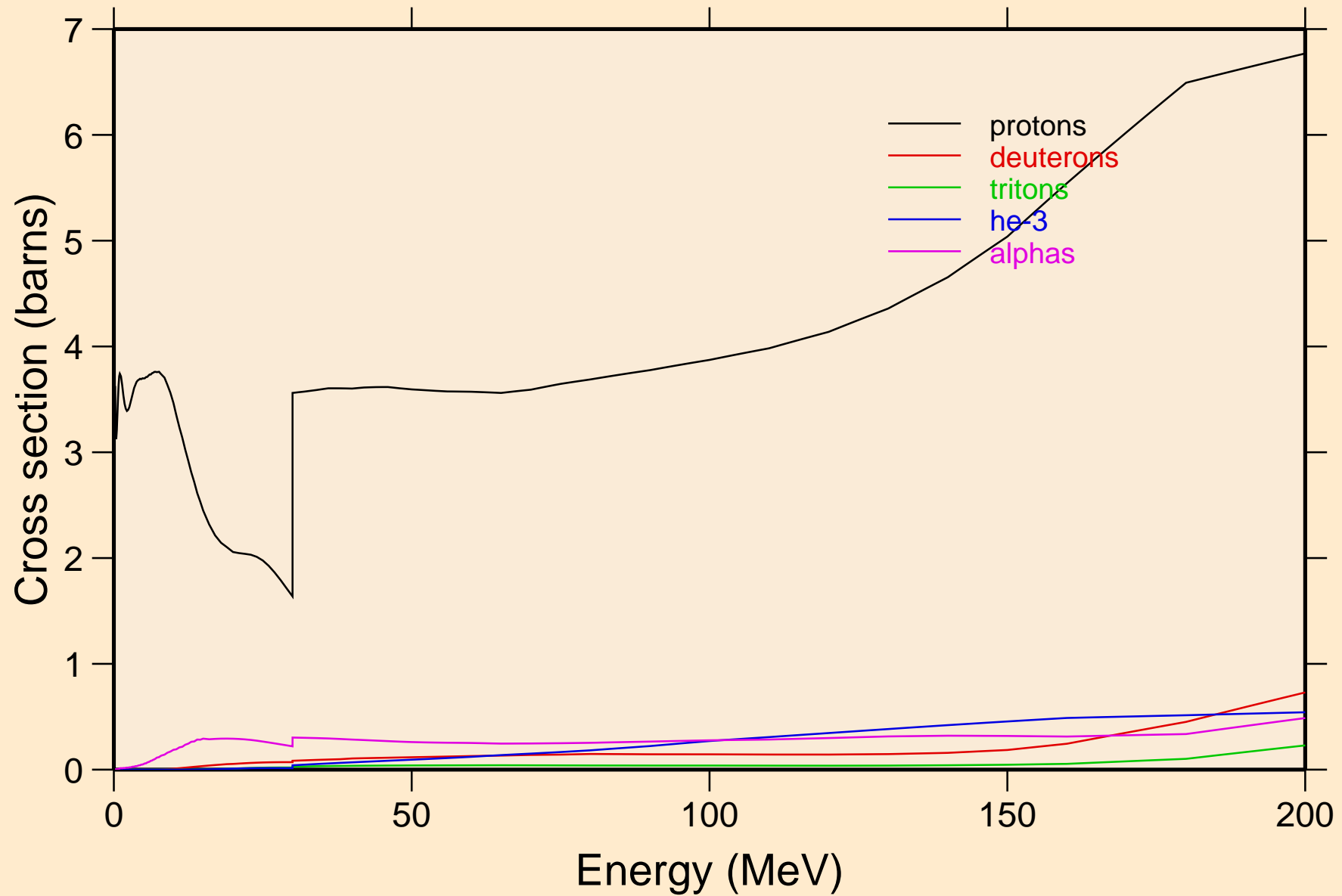

TB140 NRG TENDL-2015, AKONING
protons from (n,x)

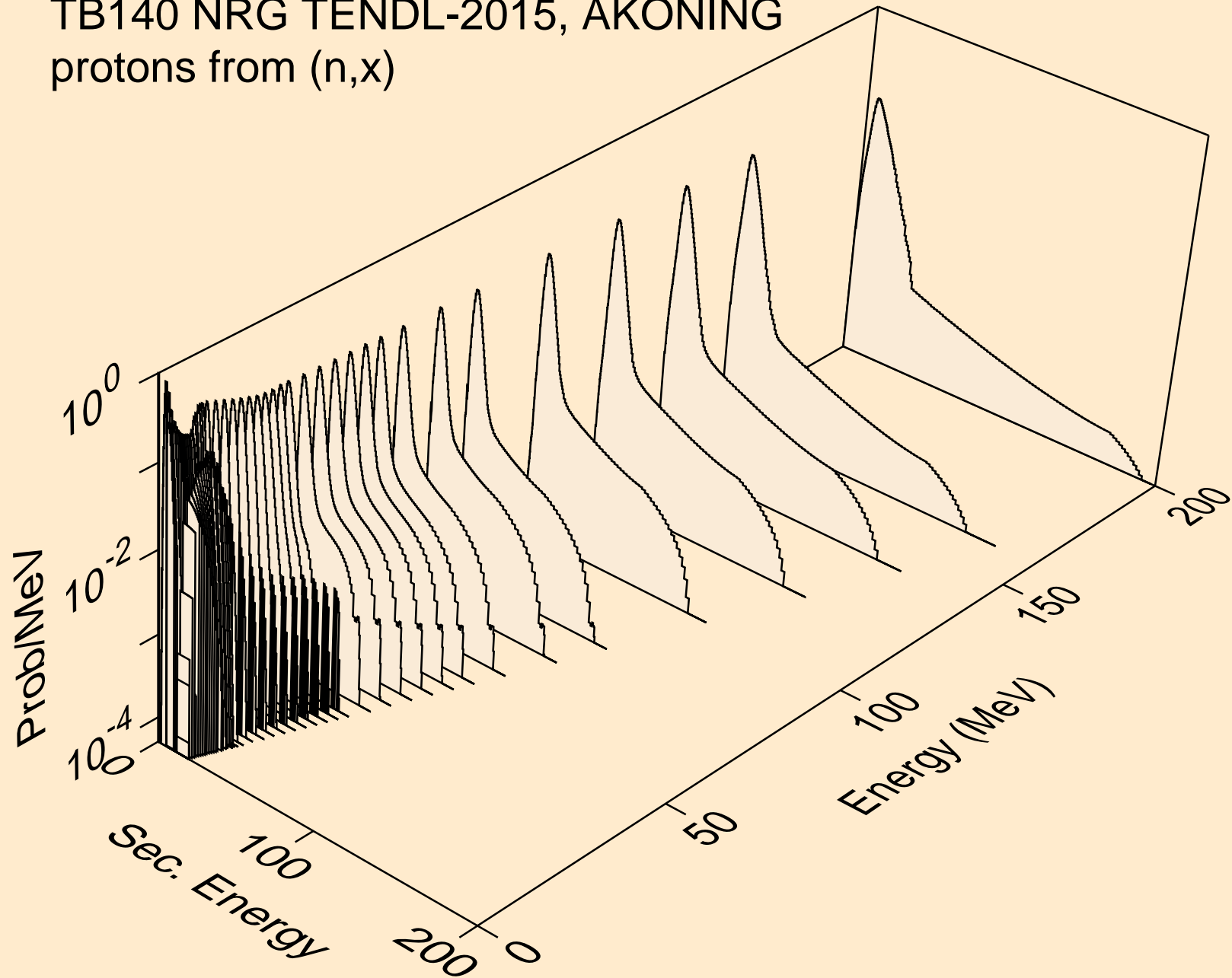

TB140 NRG TENDL-2015, AKONING
protons from (n,n*)p

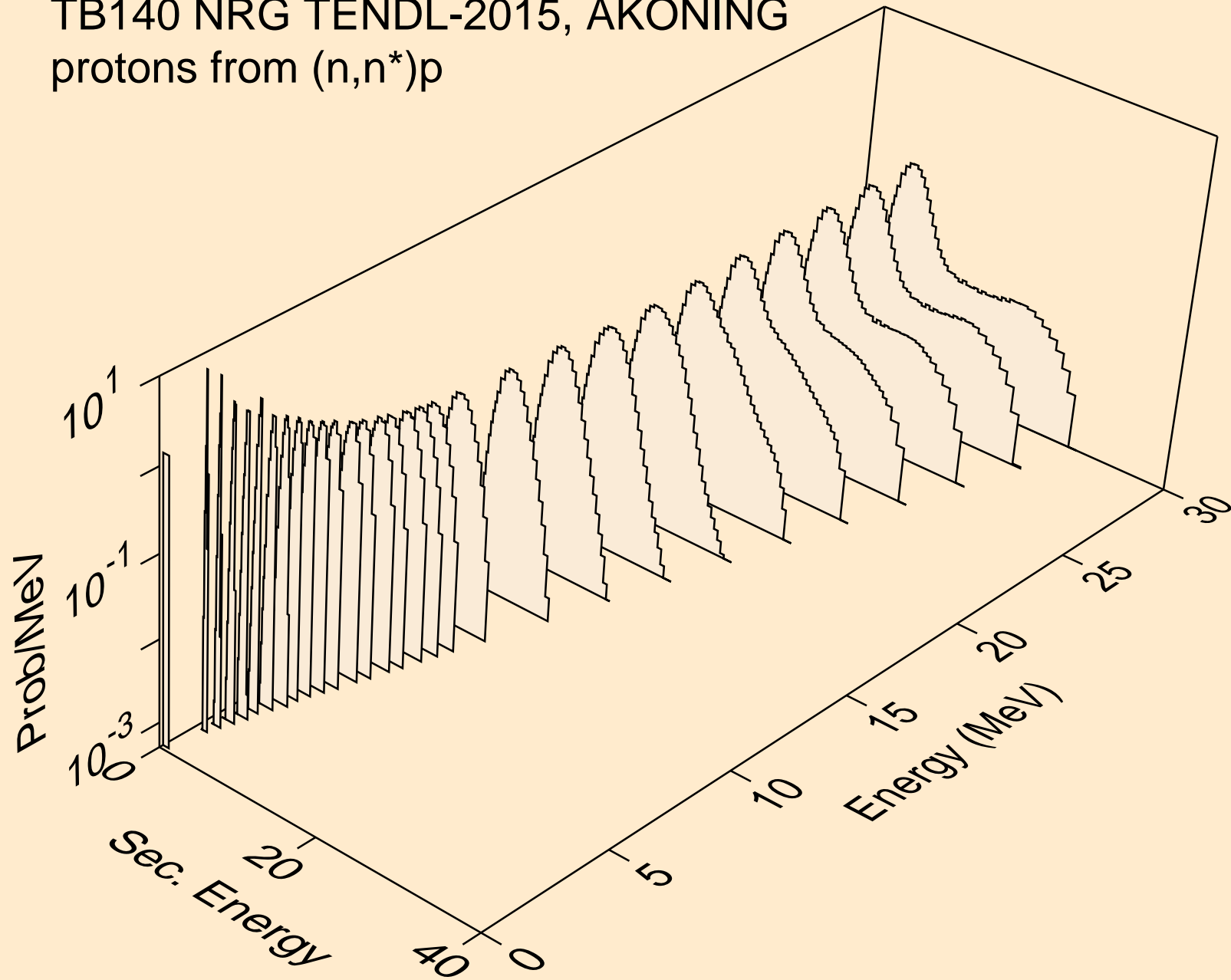

TB140 NRG TENDL-2015, AKONING
protons from (n,2np)

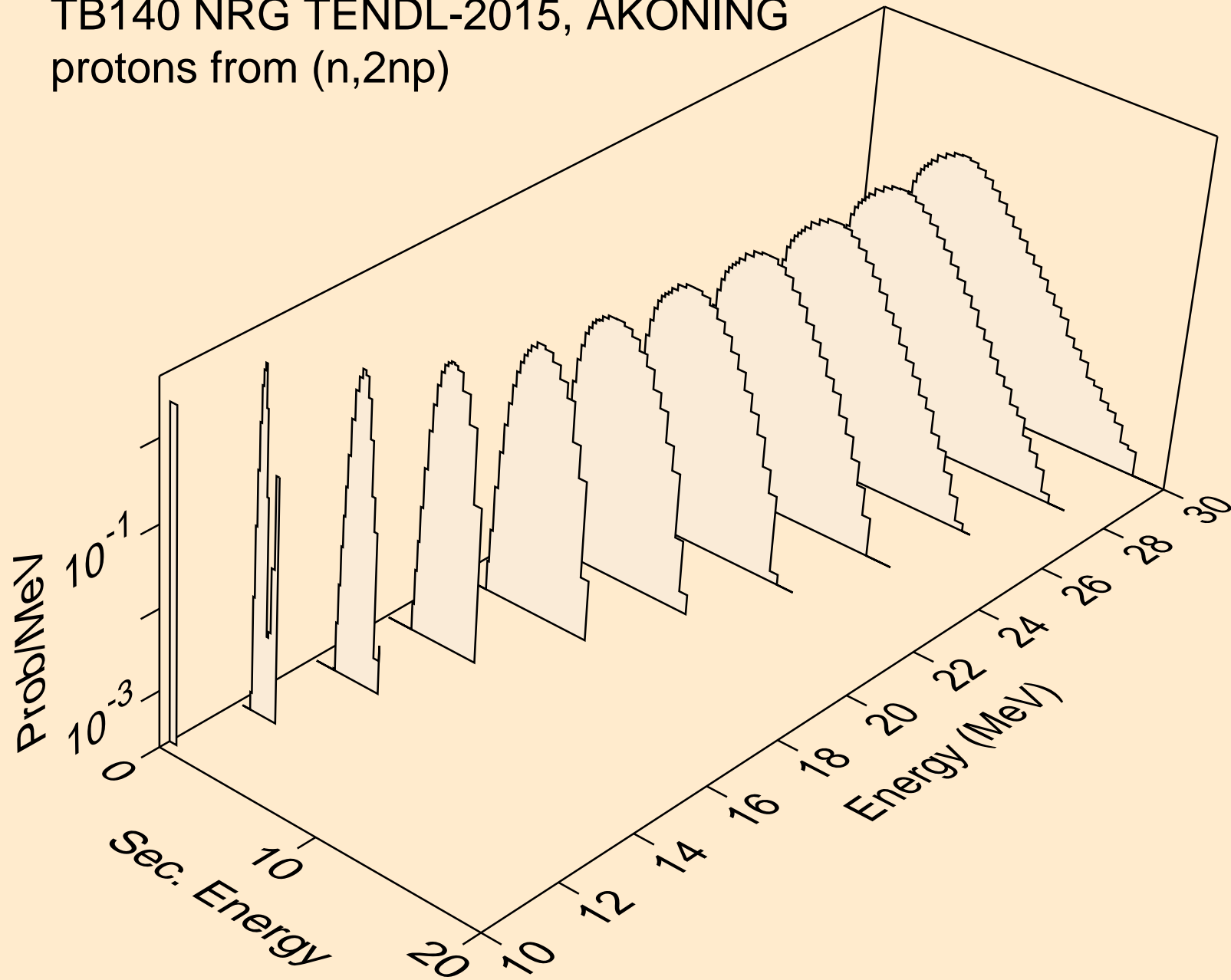

TB140 NRG TENDL-2015, AKONING
protons from (n,3np)

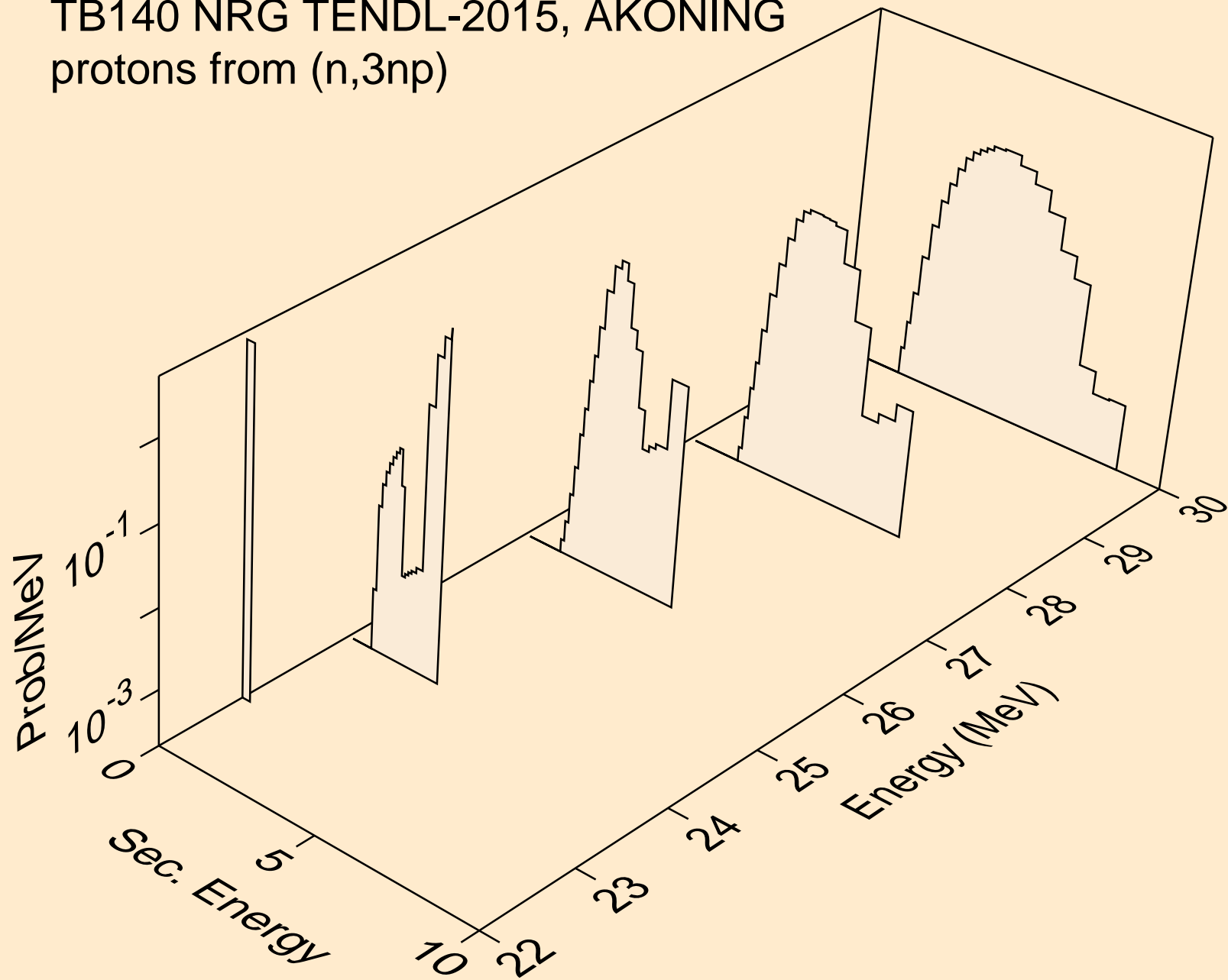

TB140 NRG TENDL-2015, AKONING
protons from (n,2np)

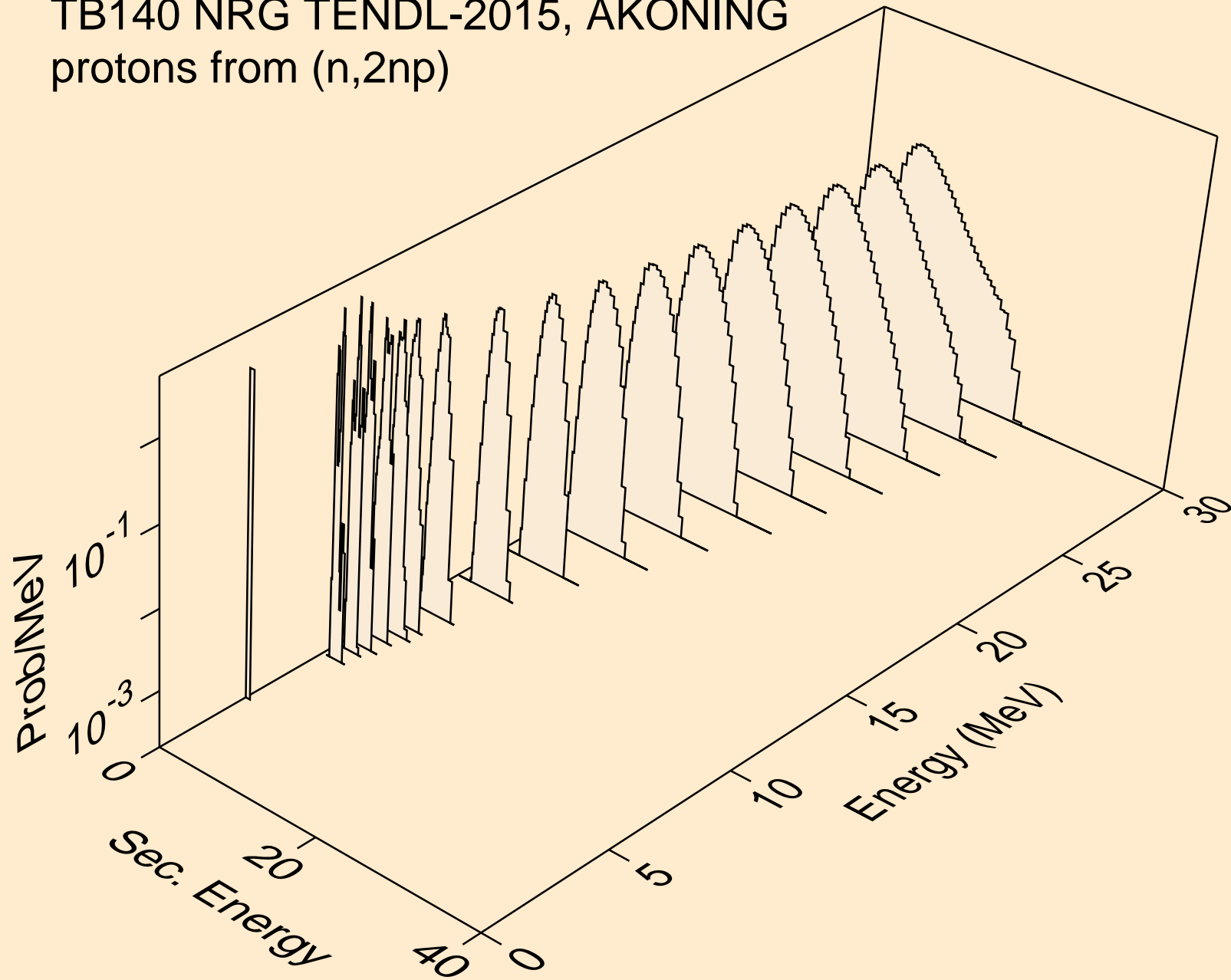

TB140 NRG TENDL-2015, AKONING
protons from (n,npa)

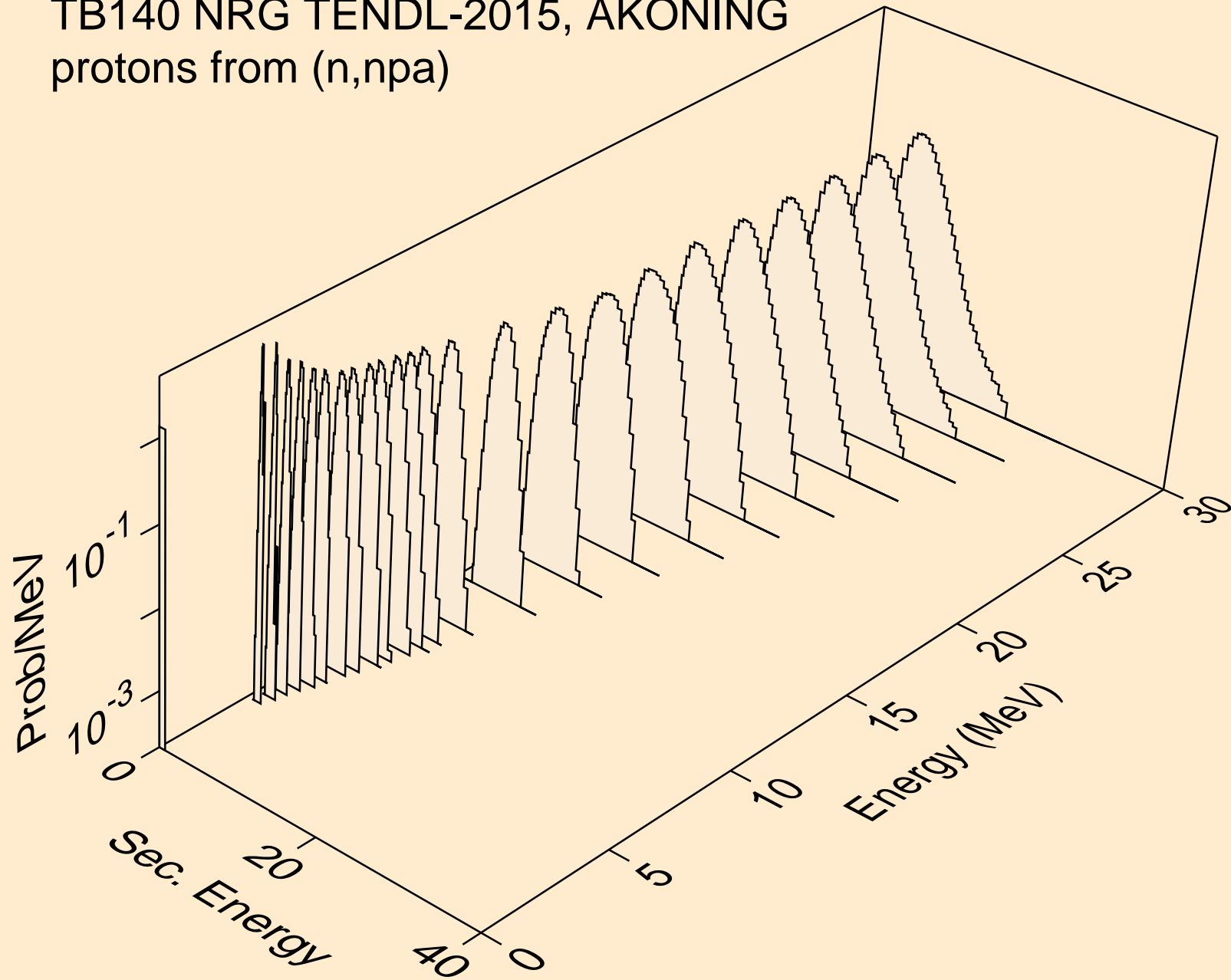

TB140 NRG TENDL-2015, AKONING
protons from (n,p)

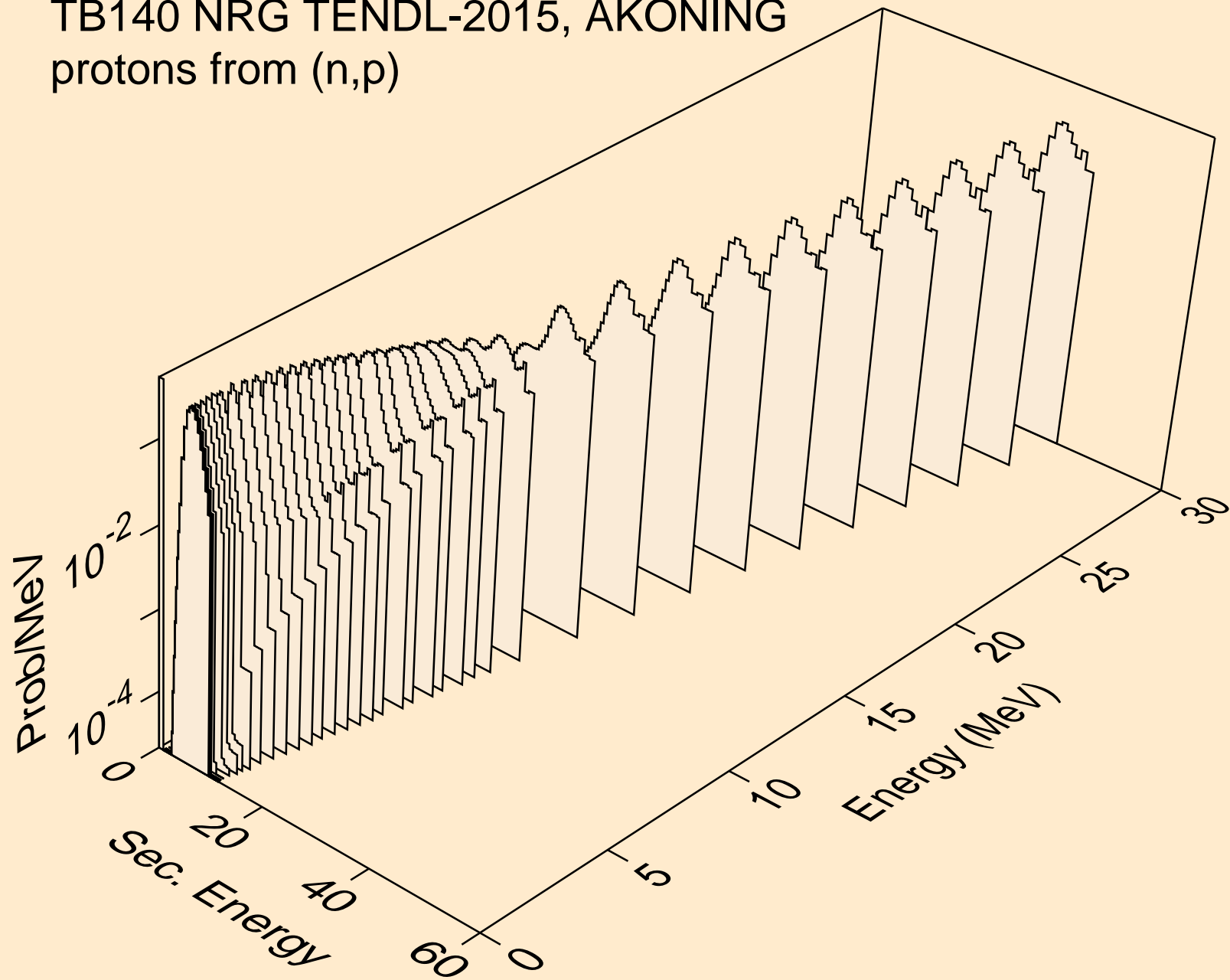

TB140 NRG TENDL-2015, AKONING
protons from (n,2p)

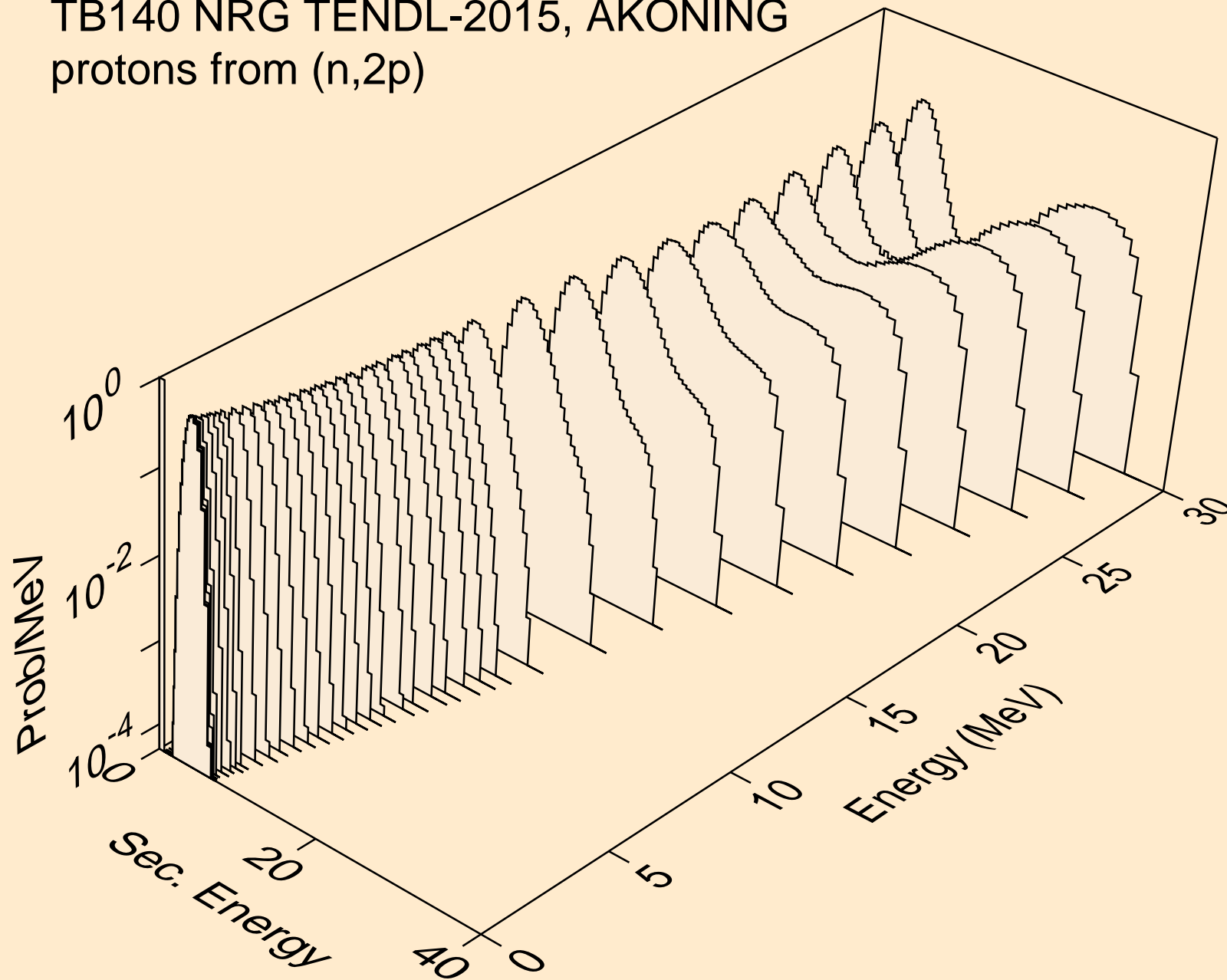

TB140 NRG TENDL-2015, AKONING
protons from (n,pa)

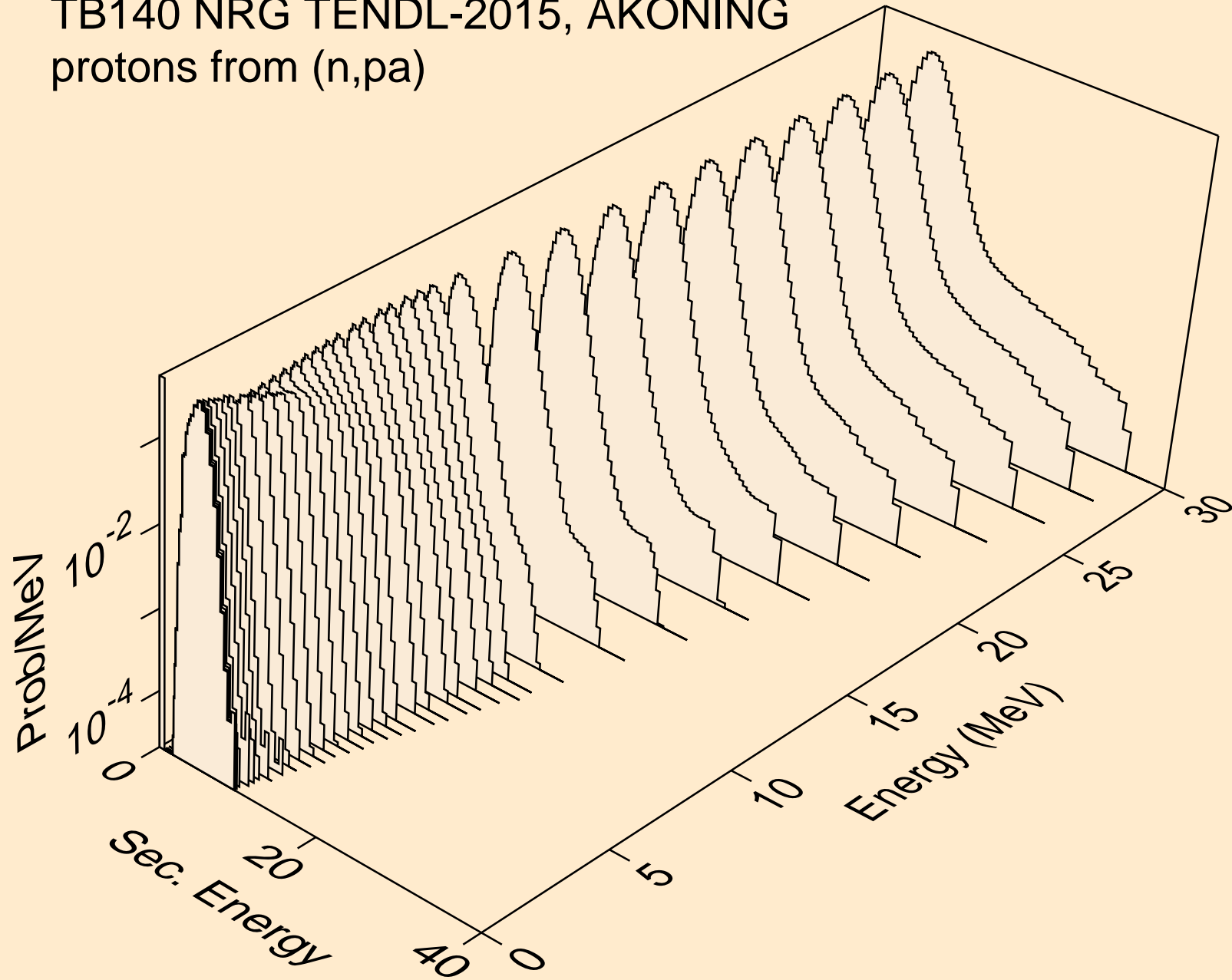

TB140 NRG TENDL-2015, AKONING
protons from (n,pd)

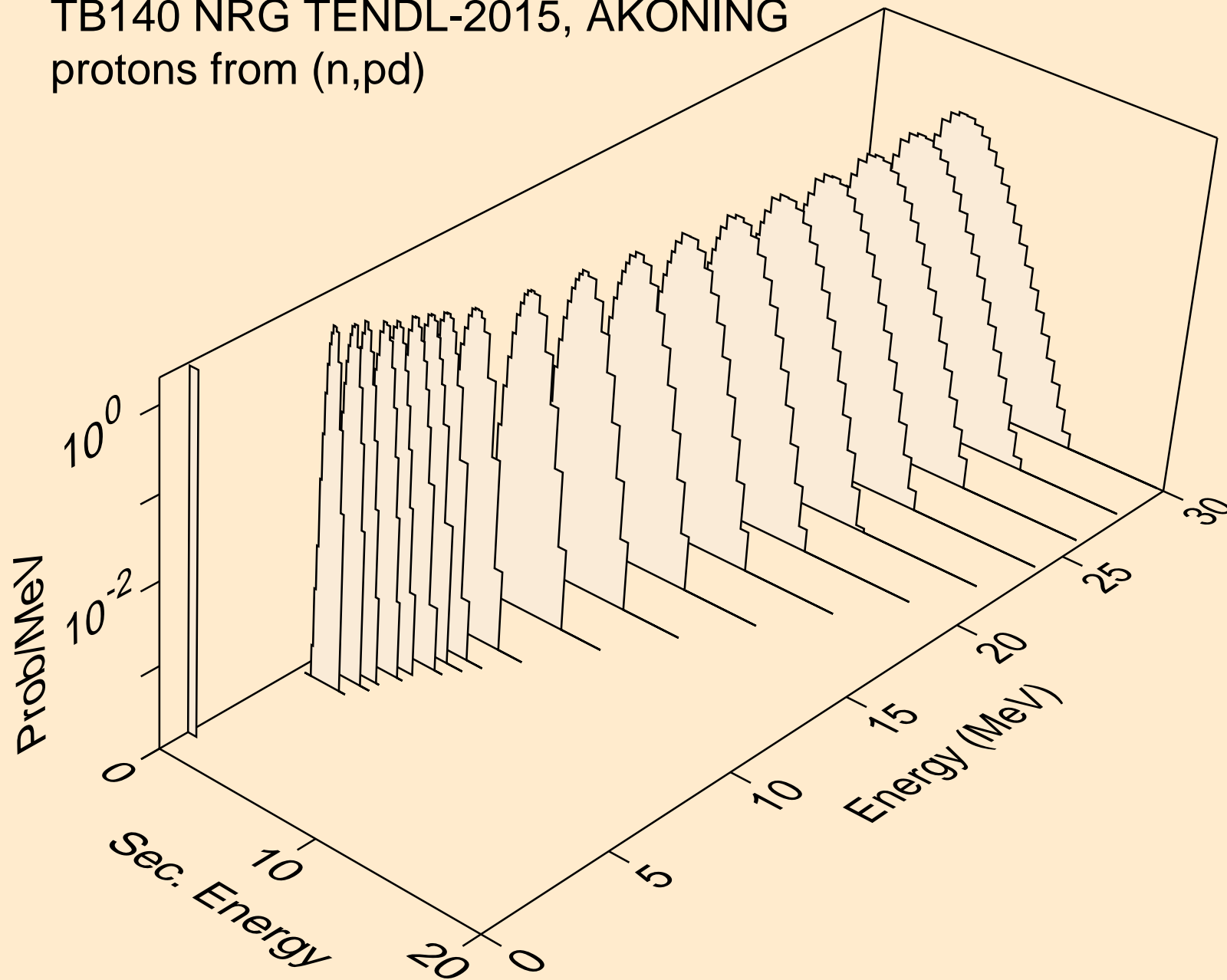

TB140 NRG TENDL-2015, AKONING
protons from (n,pt)

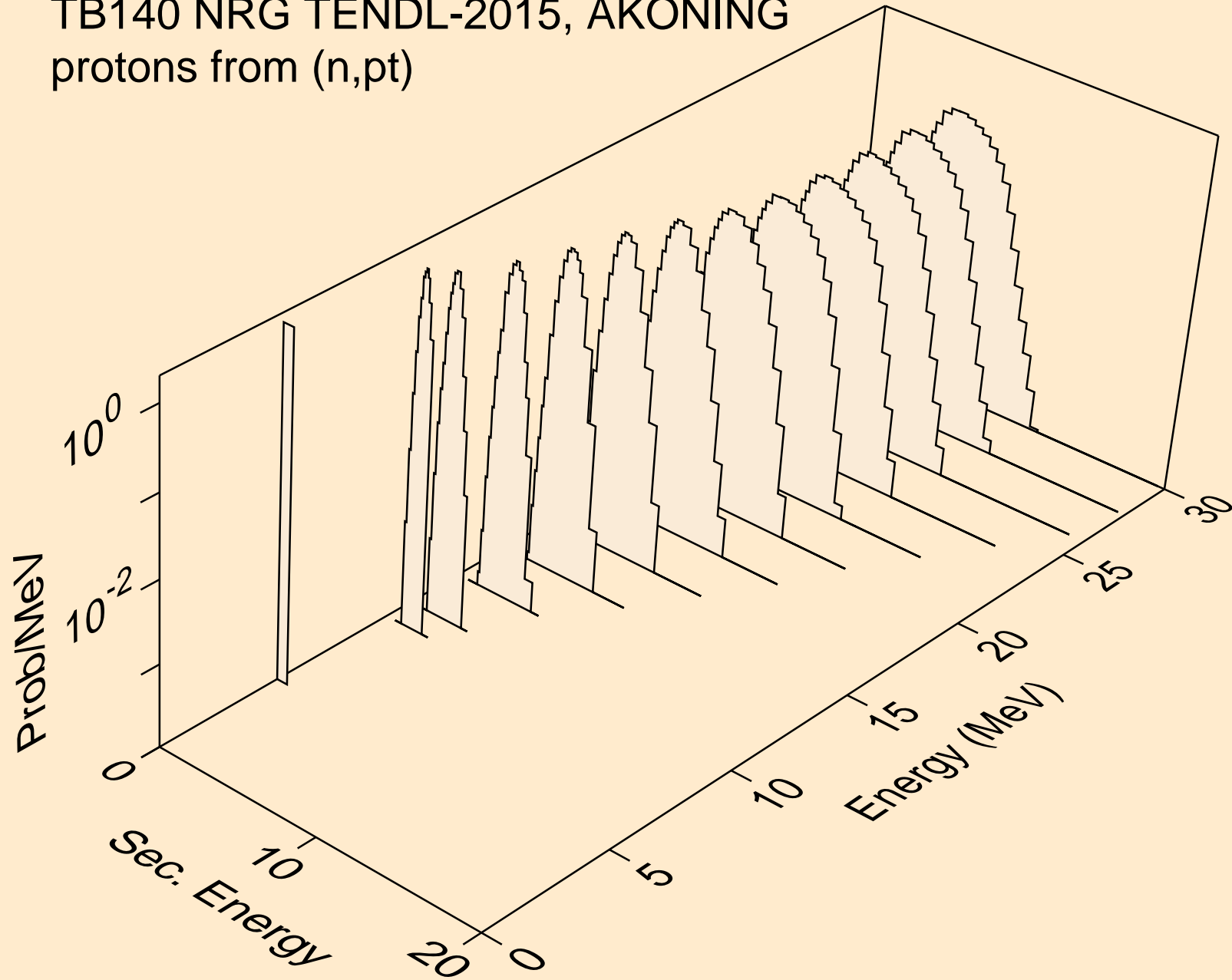

TB140 NRG TENDL-2015, AKONING
deuterons from (n,x)

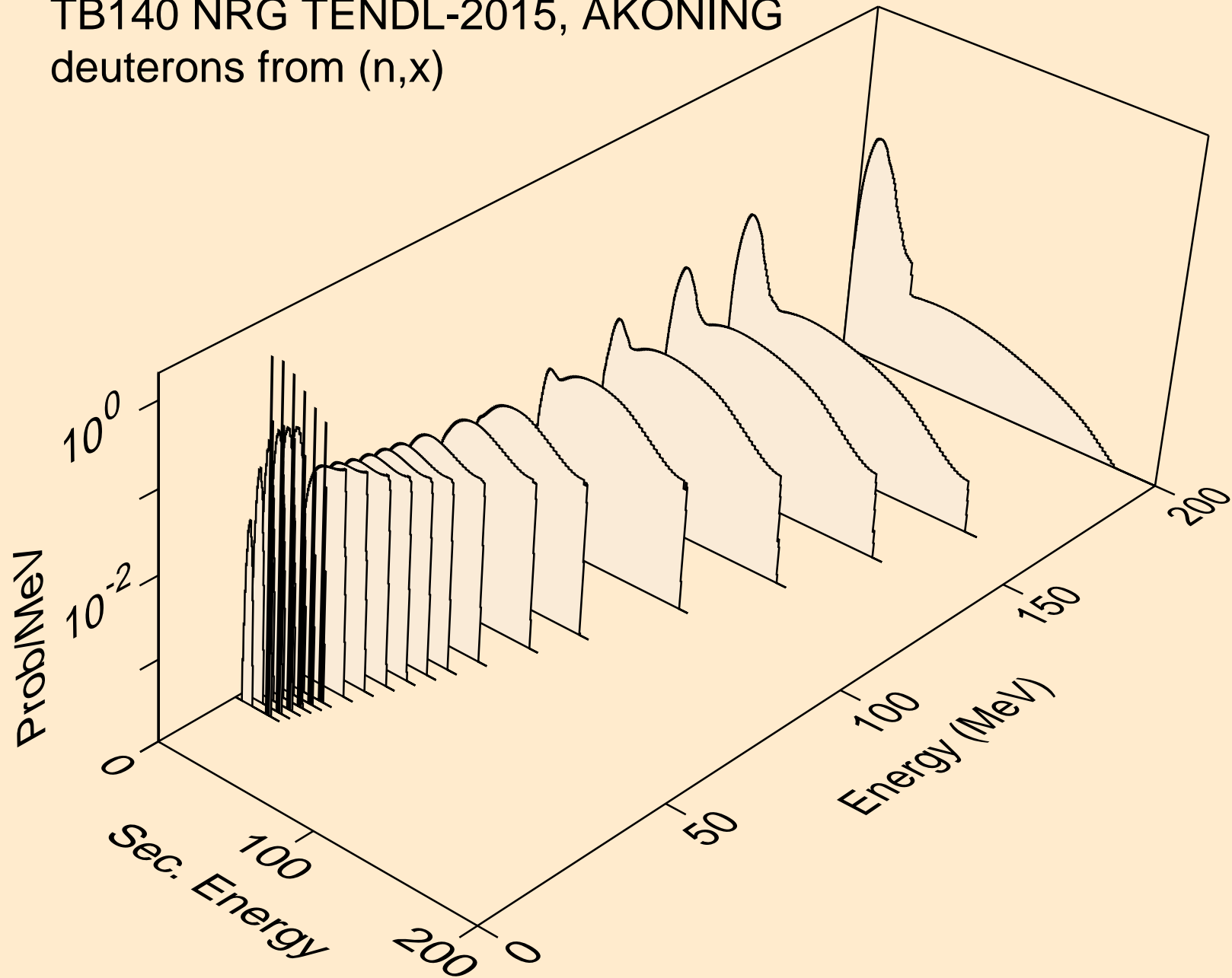

TB140 NRG TENDL-2015, AKONING
deuterons from (n,2nd)

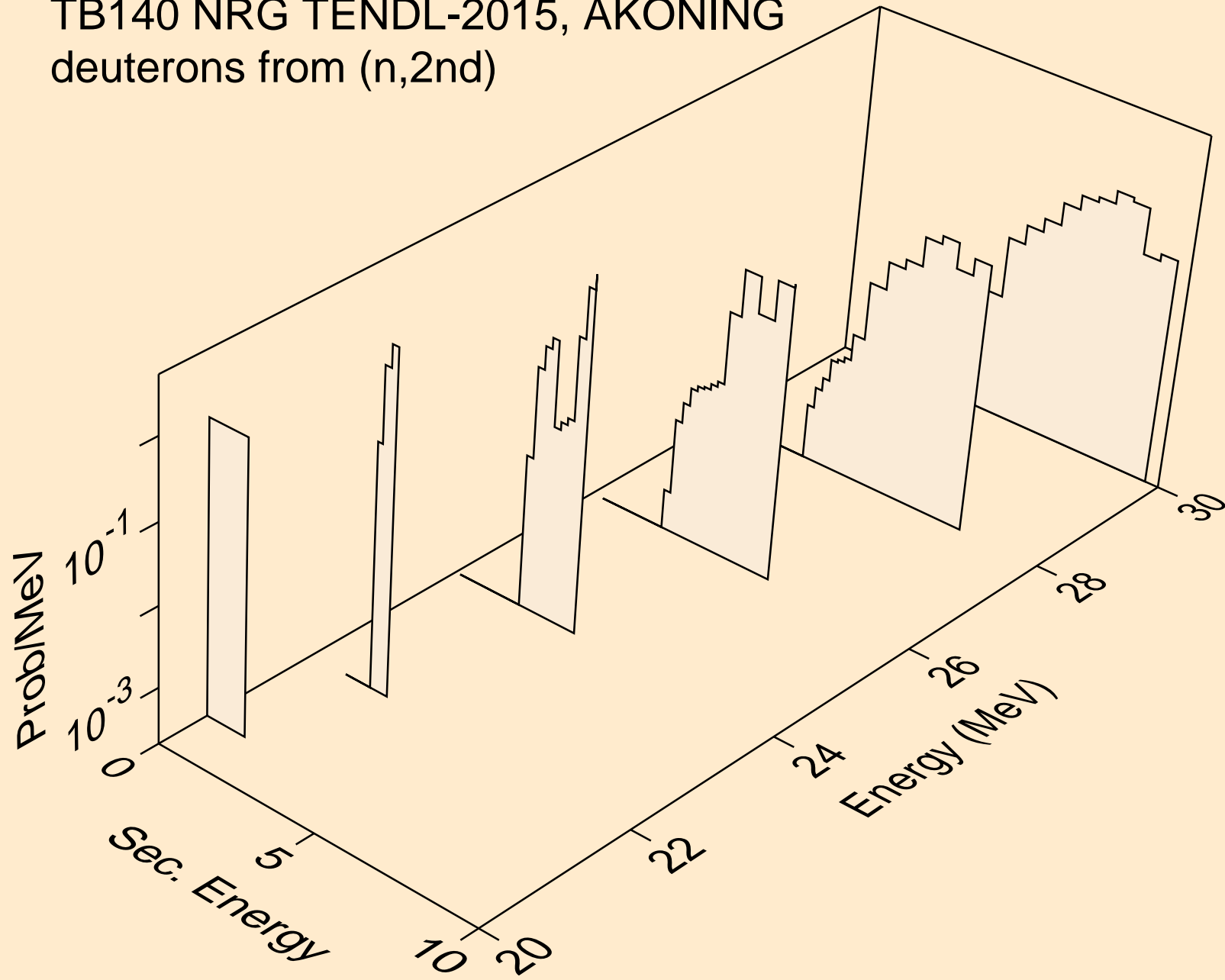

TB140 NRG TENDL-2015, AKONING
deuterons from (n,n*)d

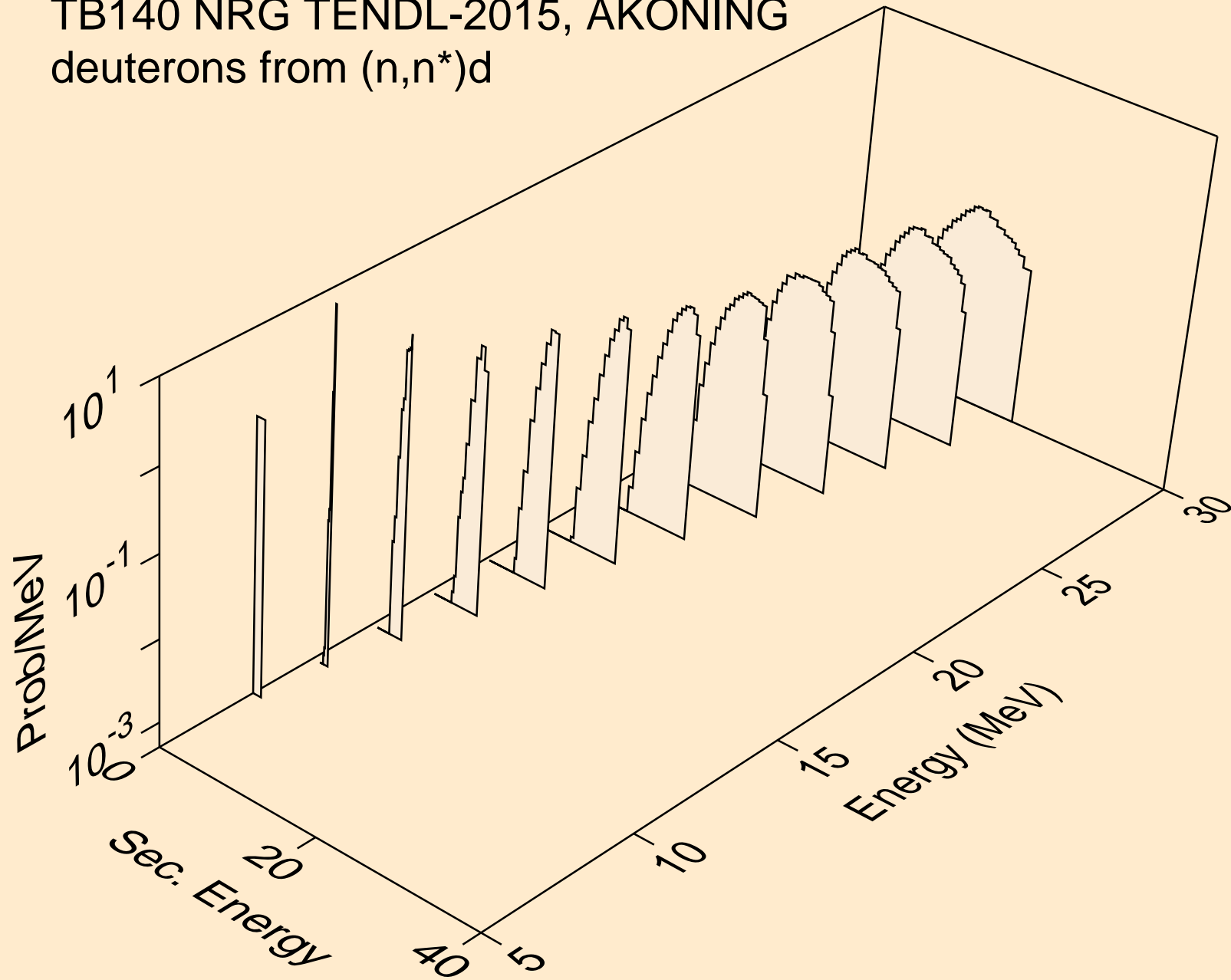

TB140 NRG TENDL-2015, AKONING
deuterons from (n,n*)d2a

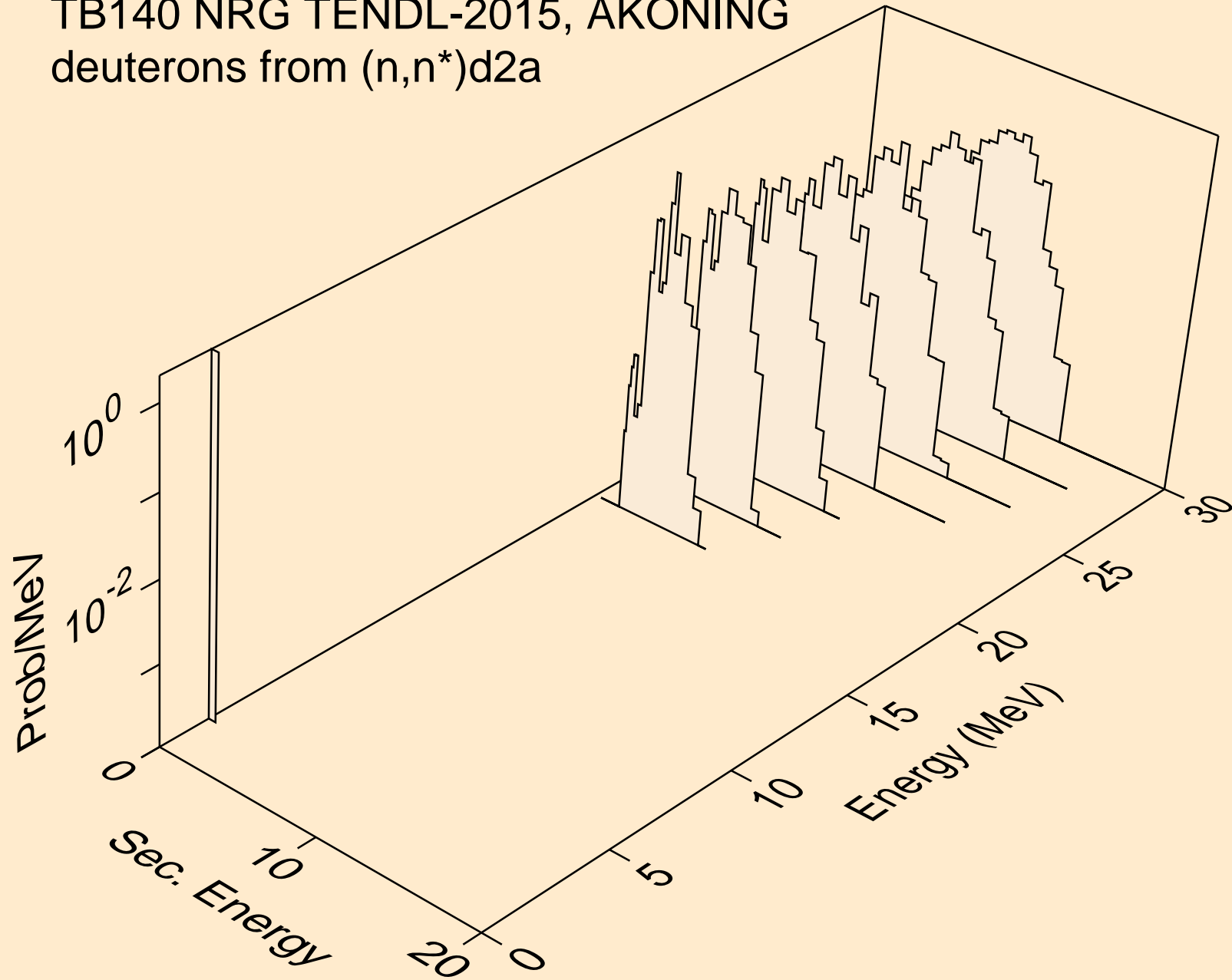

TB140 NRG TENDL-2015, AKONING
deuterons from (n,d)

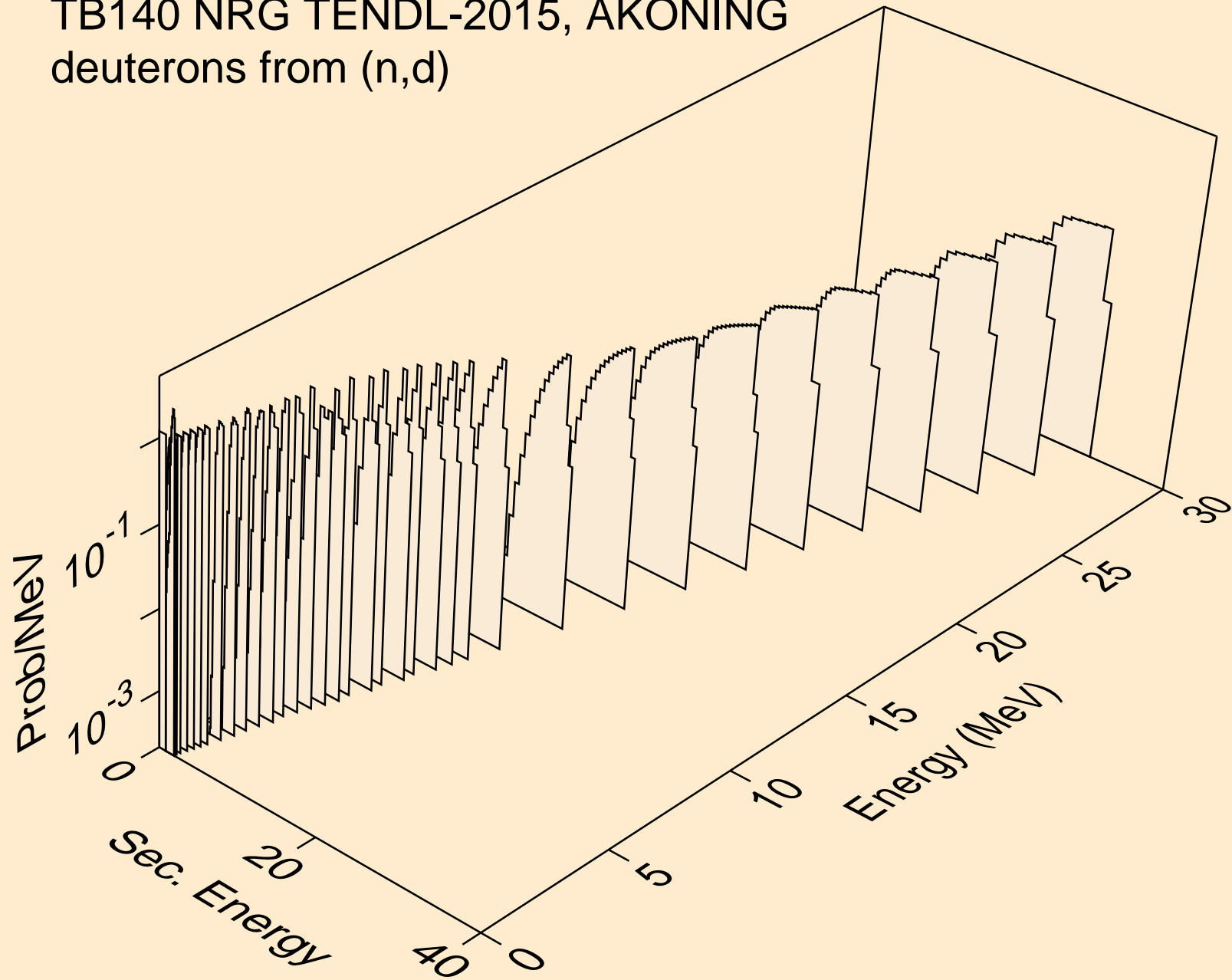

TB140 NRG TENDL-2015, AKONING
deuterons from (n,d2a)

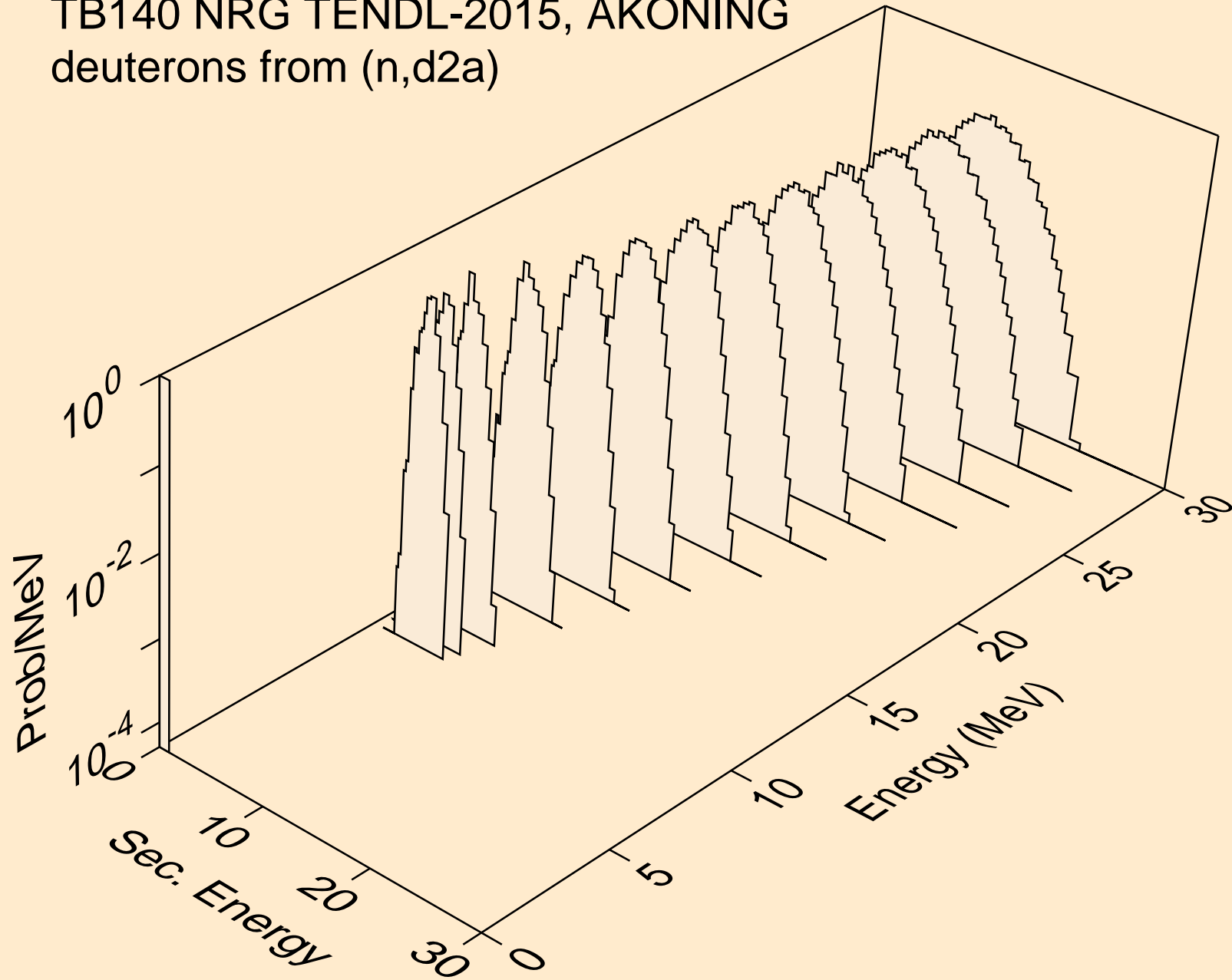

TB140 NRG TENDL-2015, AKONING
deuterons from (n,pd)

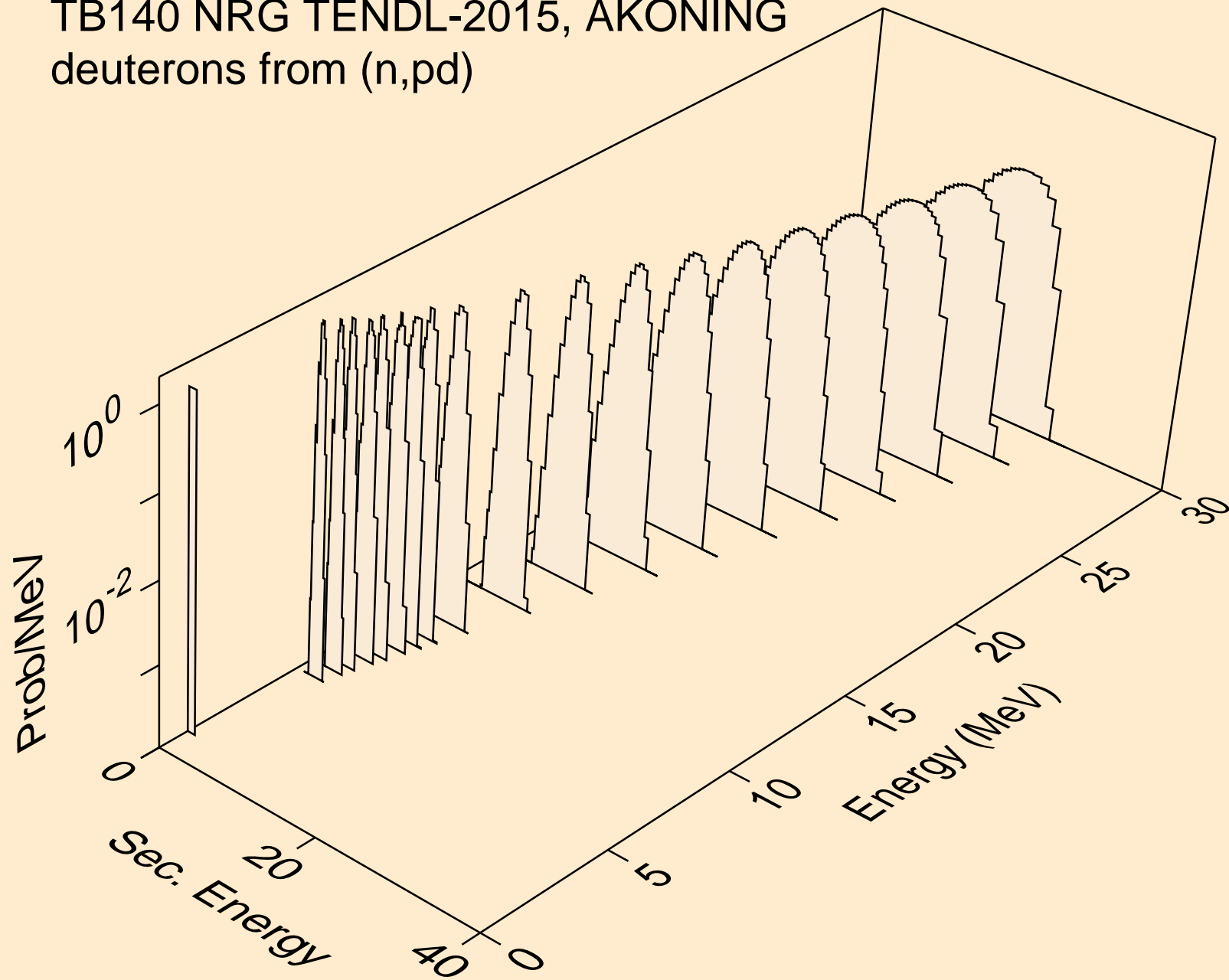

TB140 NRG TENDL-2015, AKONING
deuterons from (n,da)

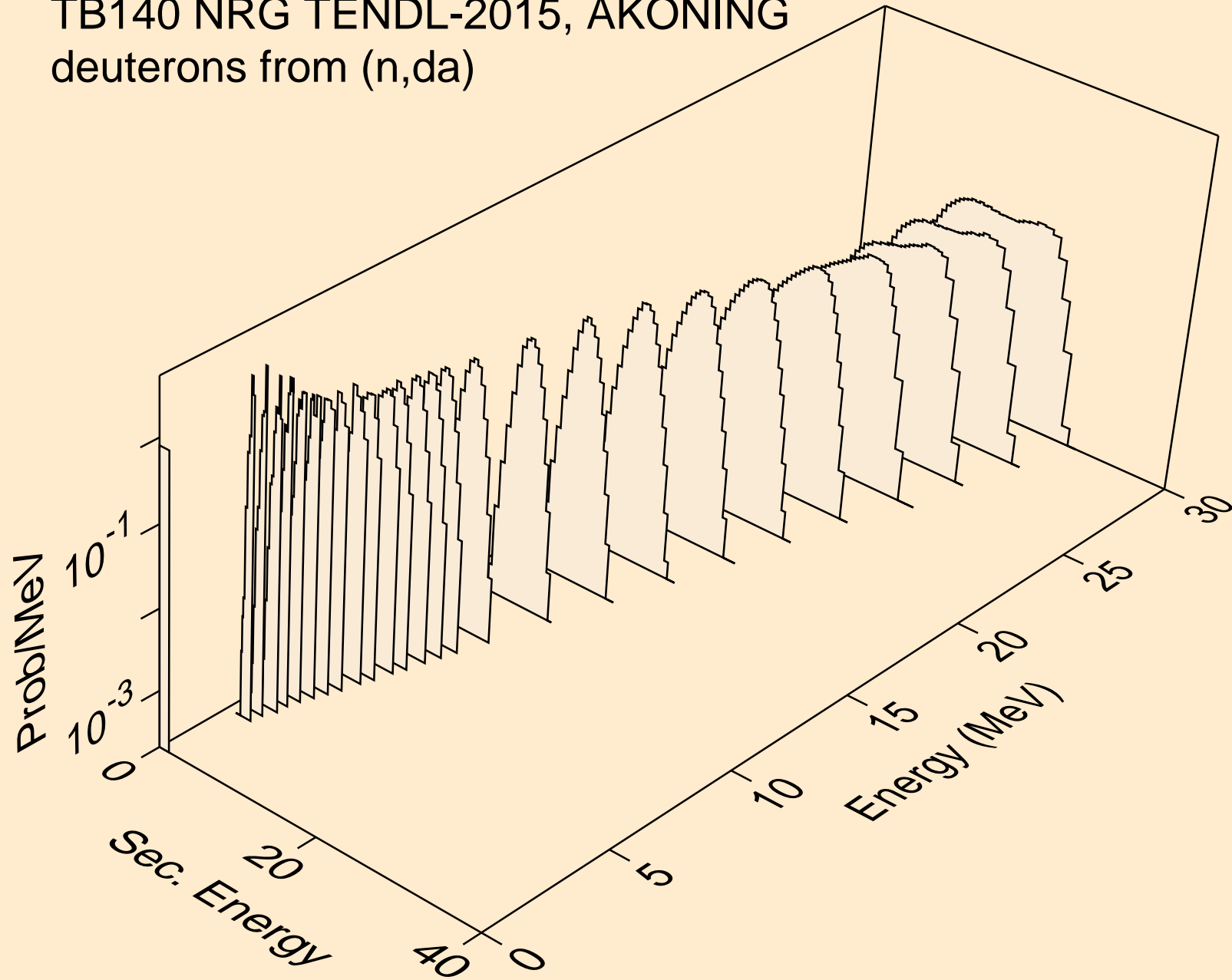

TB140 NRG TENDL-2015, AKONING
tritons from (n,x)

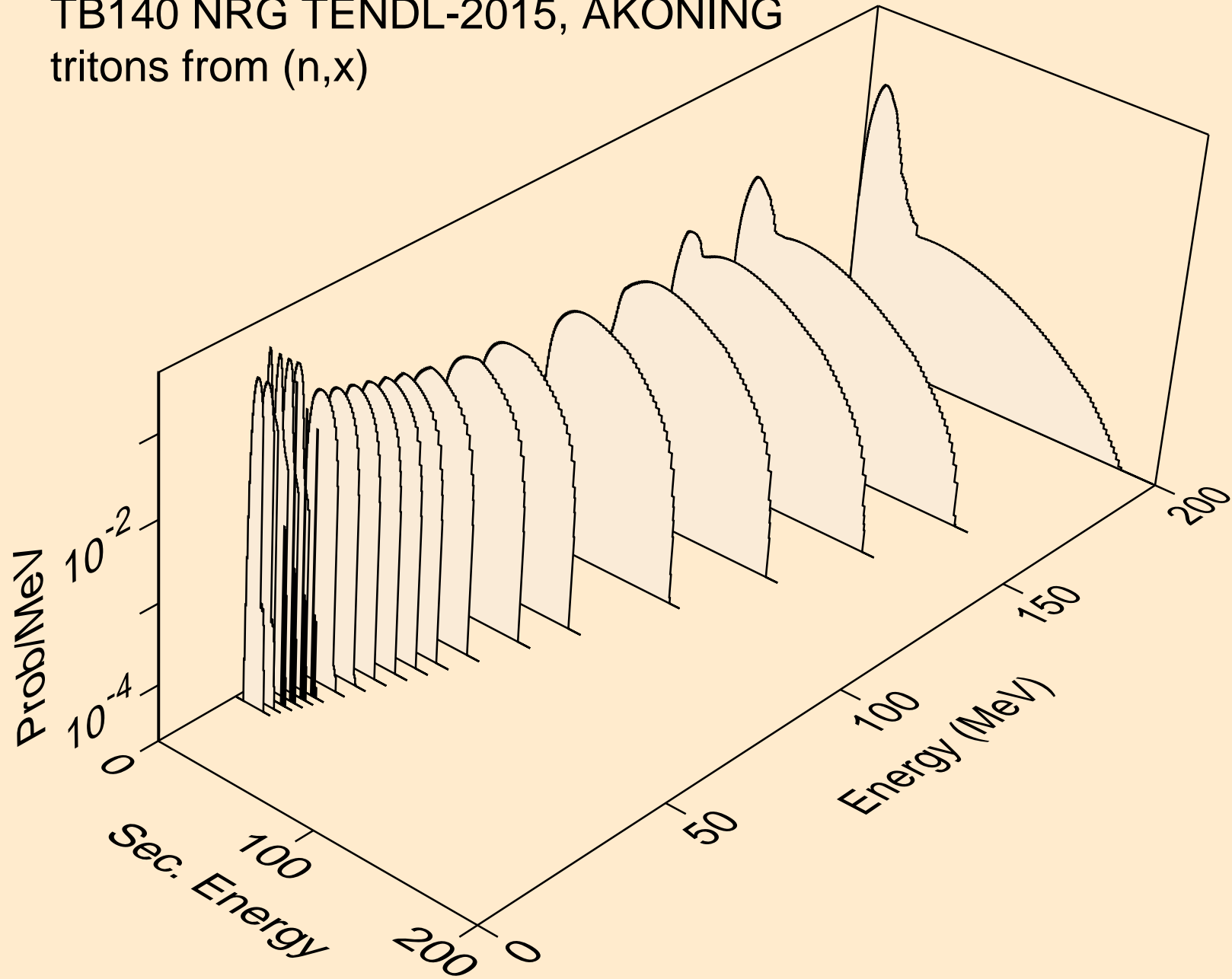

TB140 NRG TENDL-2015, AKONING
tritons from (n,n*)t

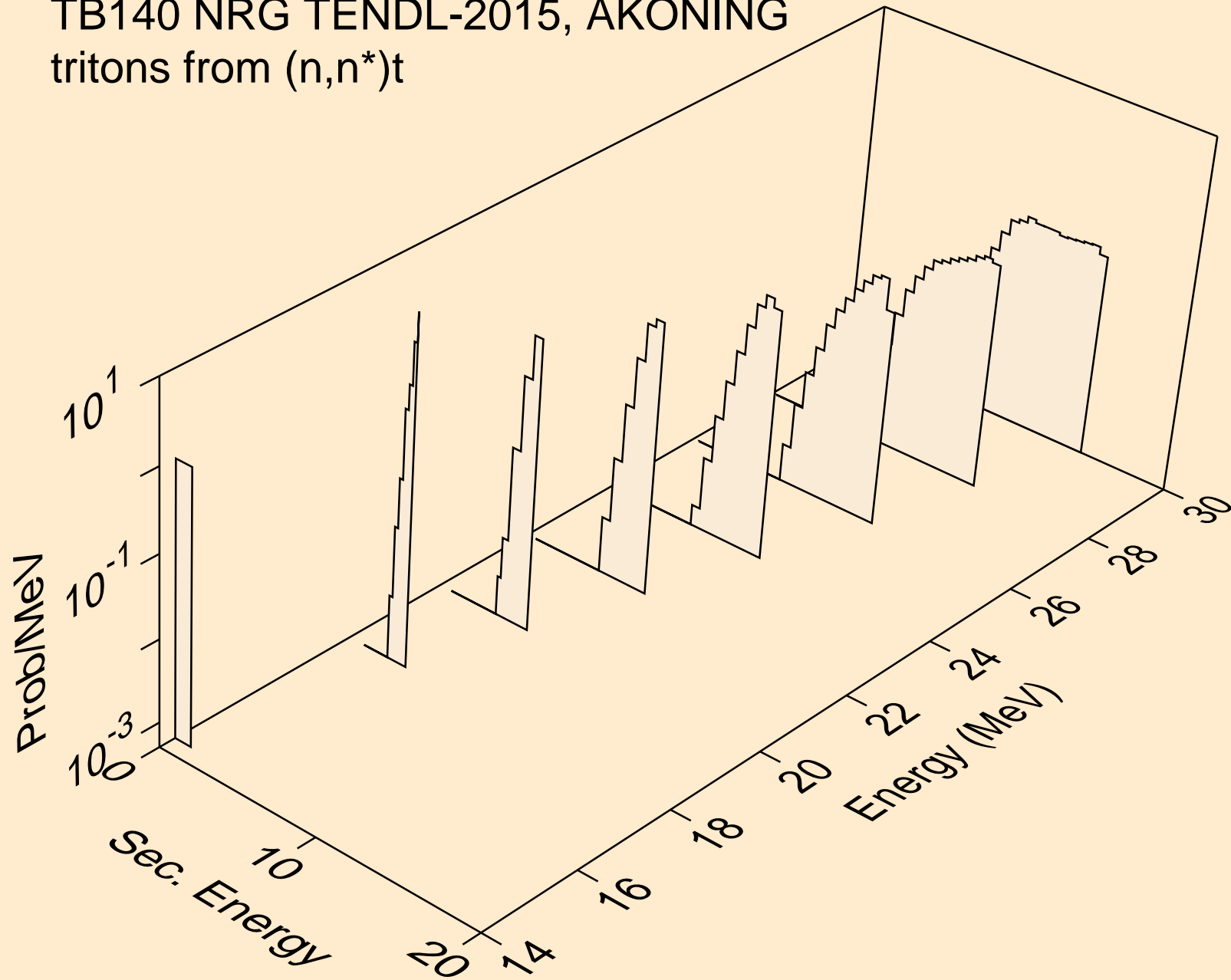

TB140 NRG TENDL-2015, AKONING
tritons from (n,t)

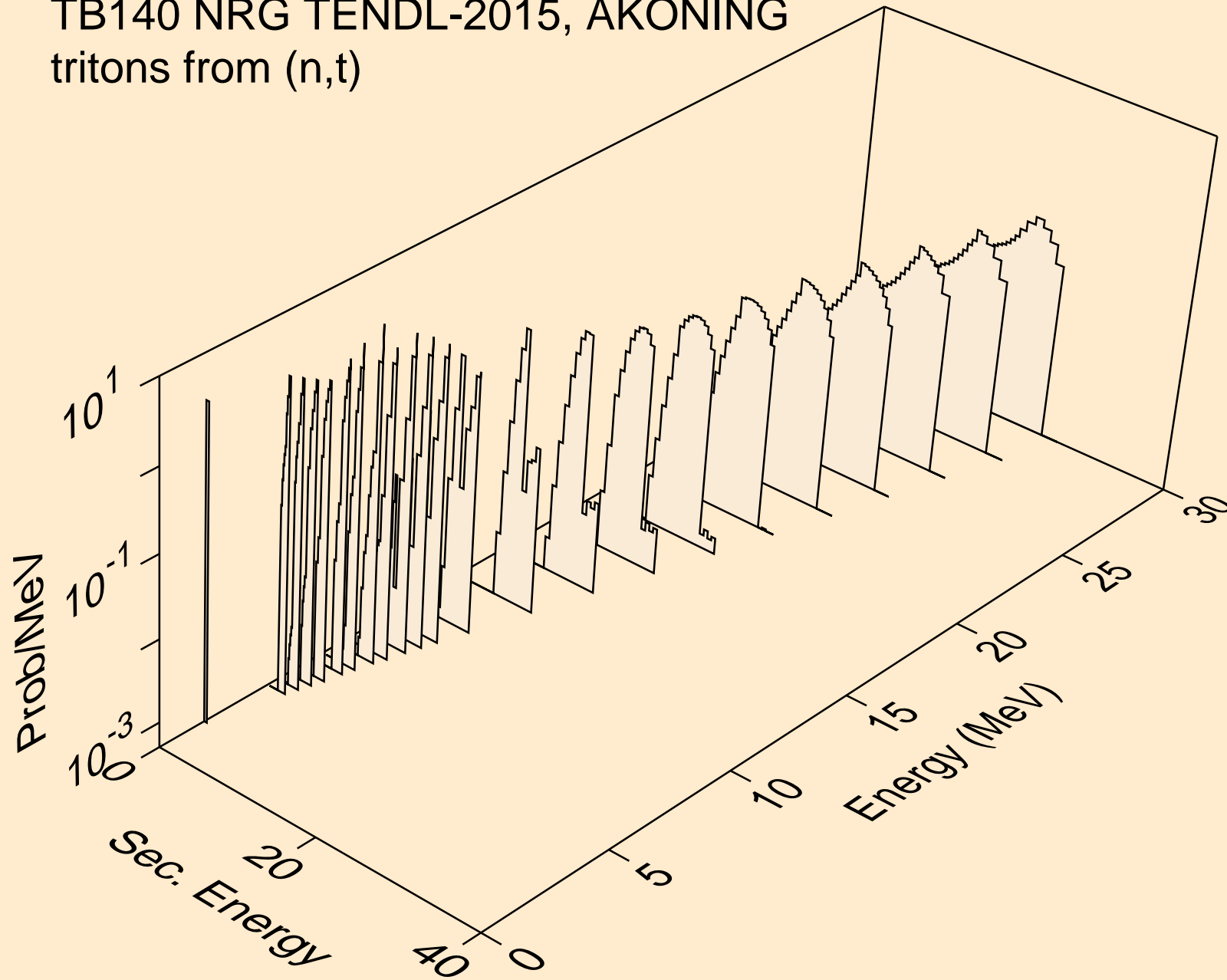

TB140 NRG TENDL-2015, AKONING
tritons from (n,t2a)

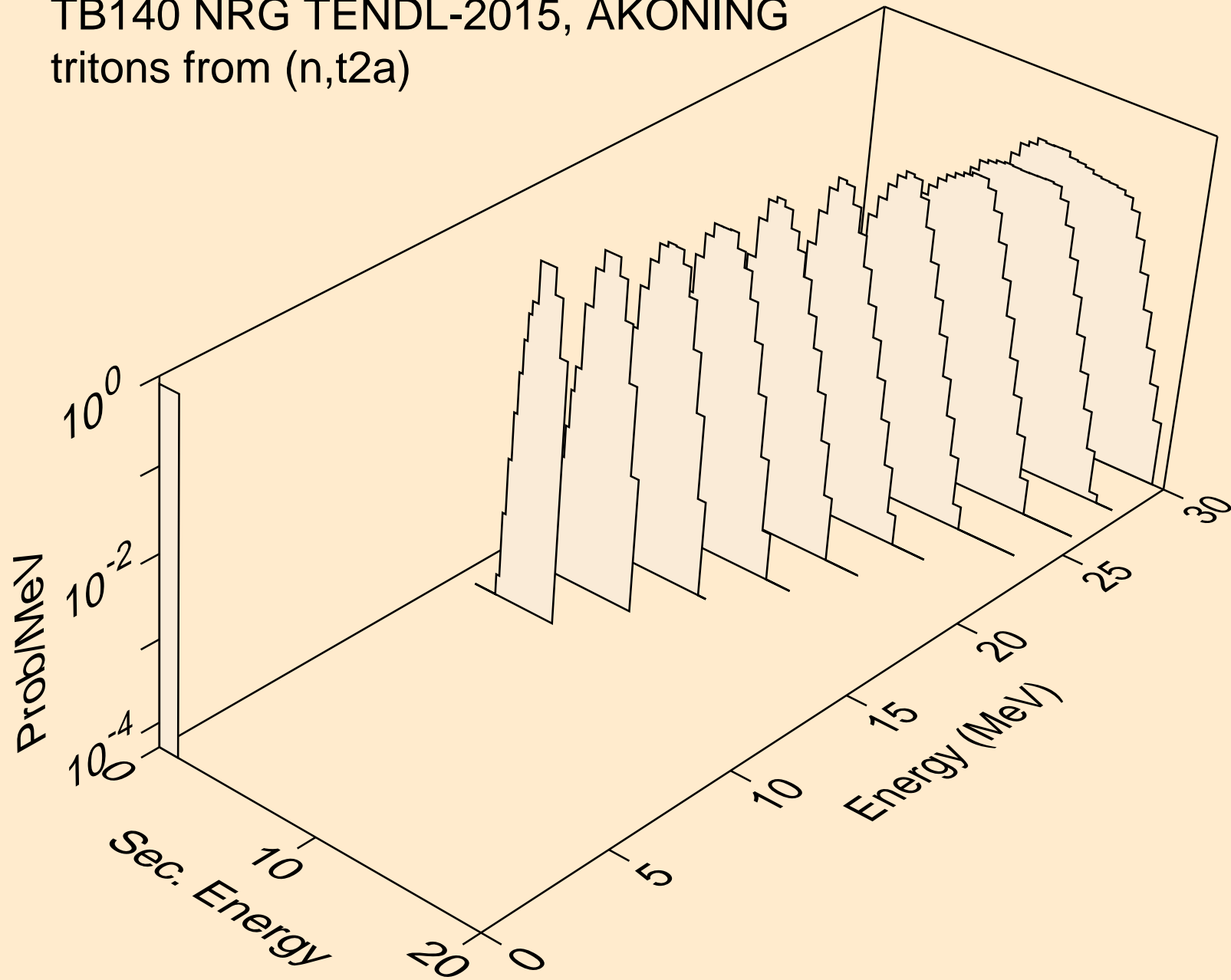

TB140 NRG TENDL-2015, AKONING
tritons from (n,pt)

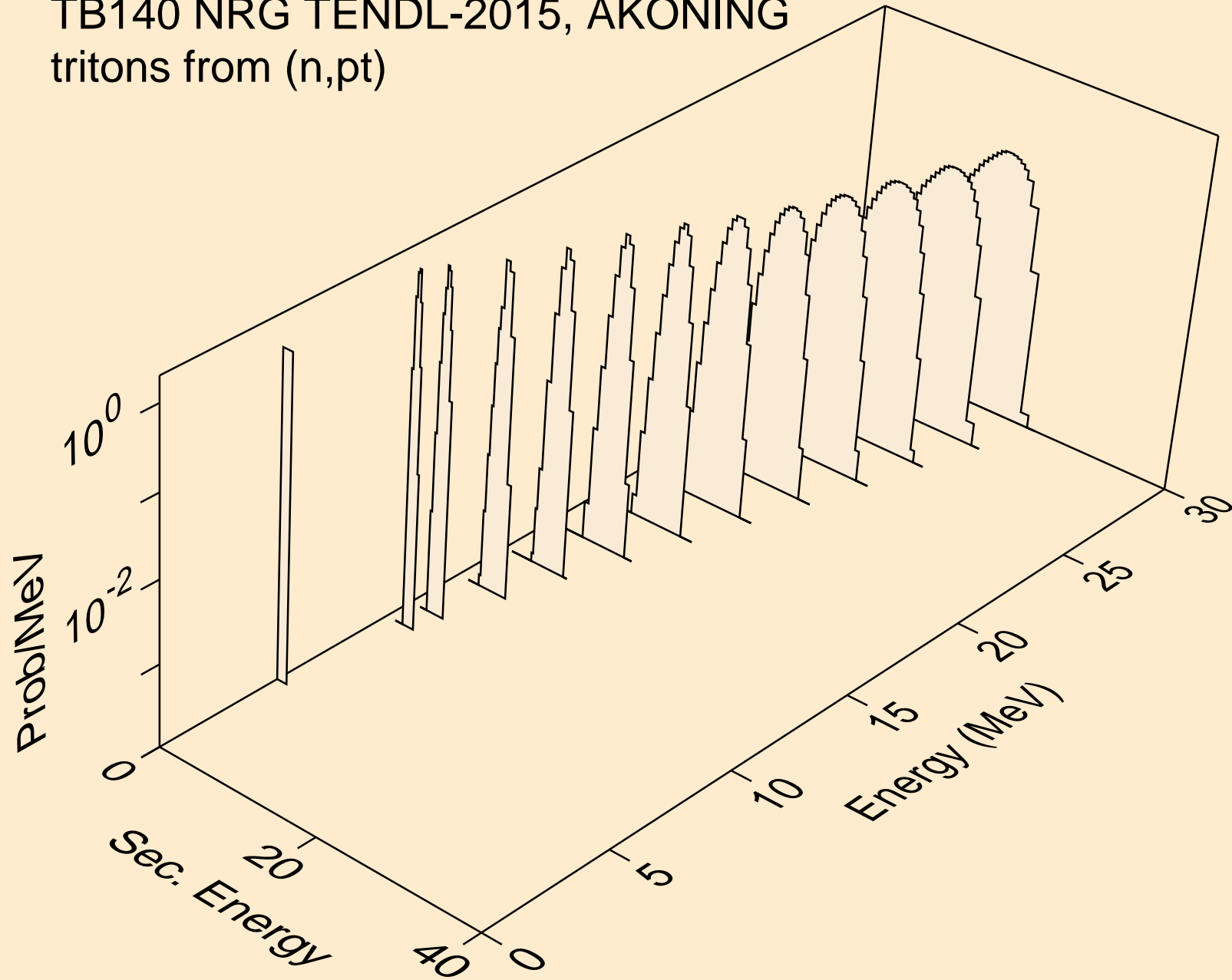

TB140 NRG TENDL-2015, AKONING
he3s from (n,x)

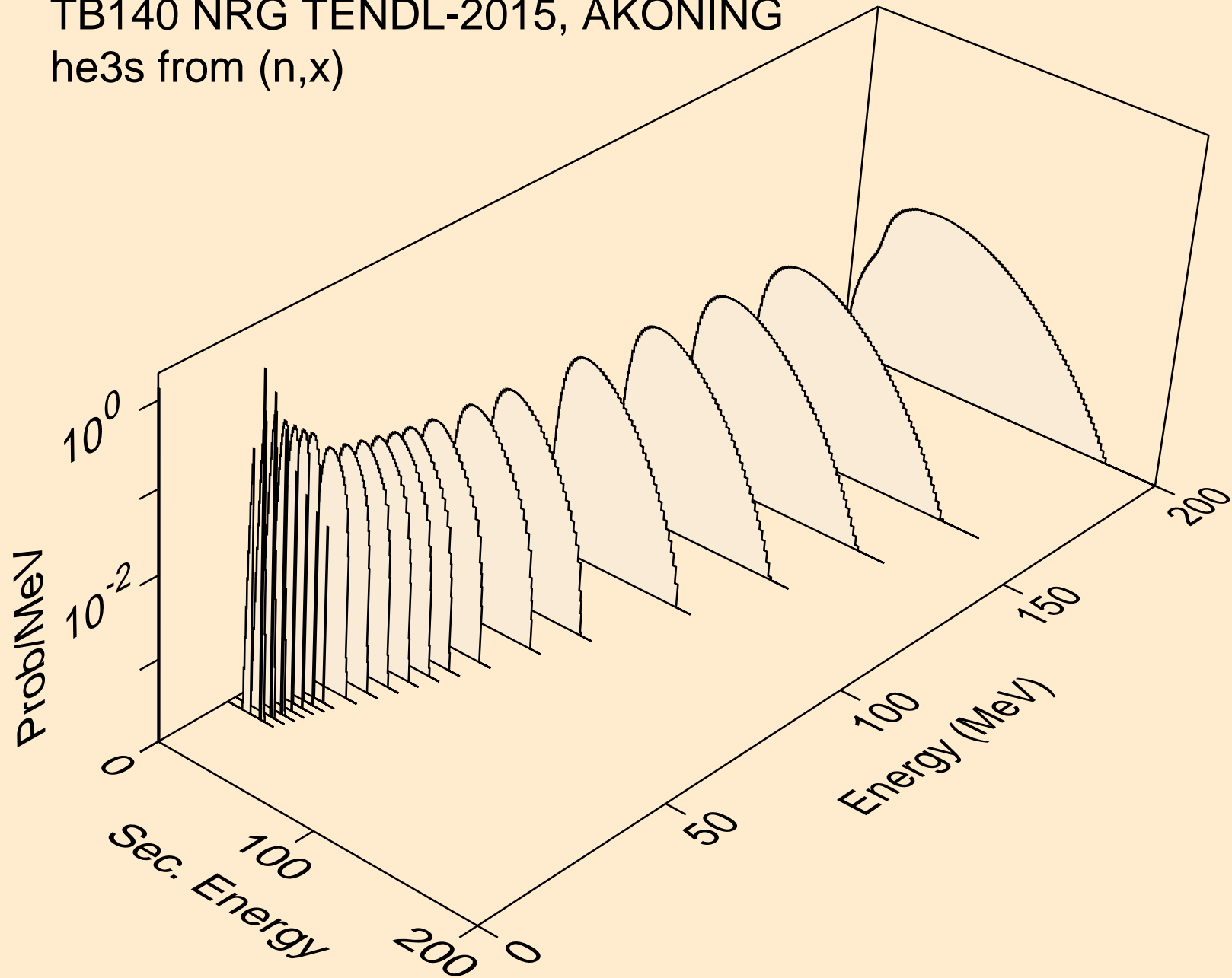

TB140 NRG TENDL-2015, AKONING
he3s from (n,n*)he3

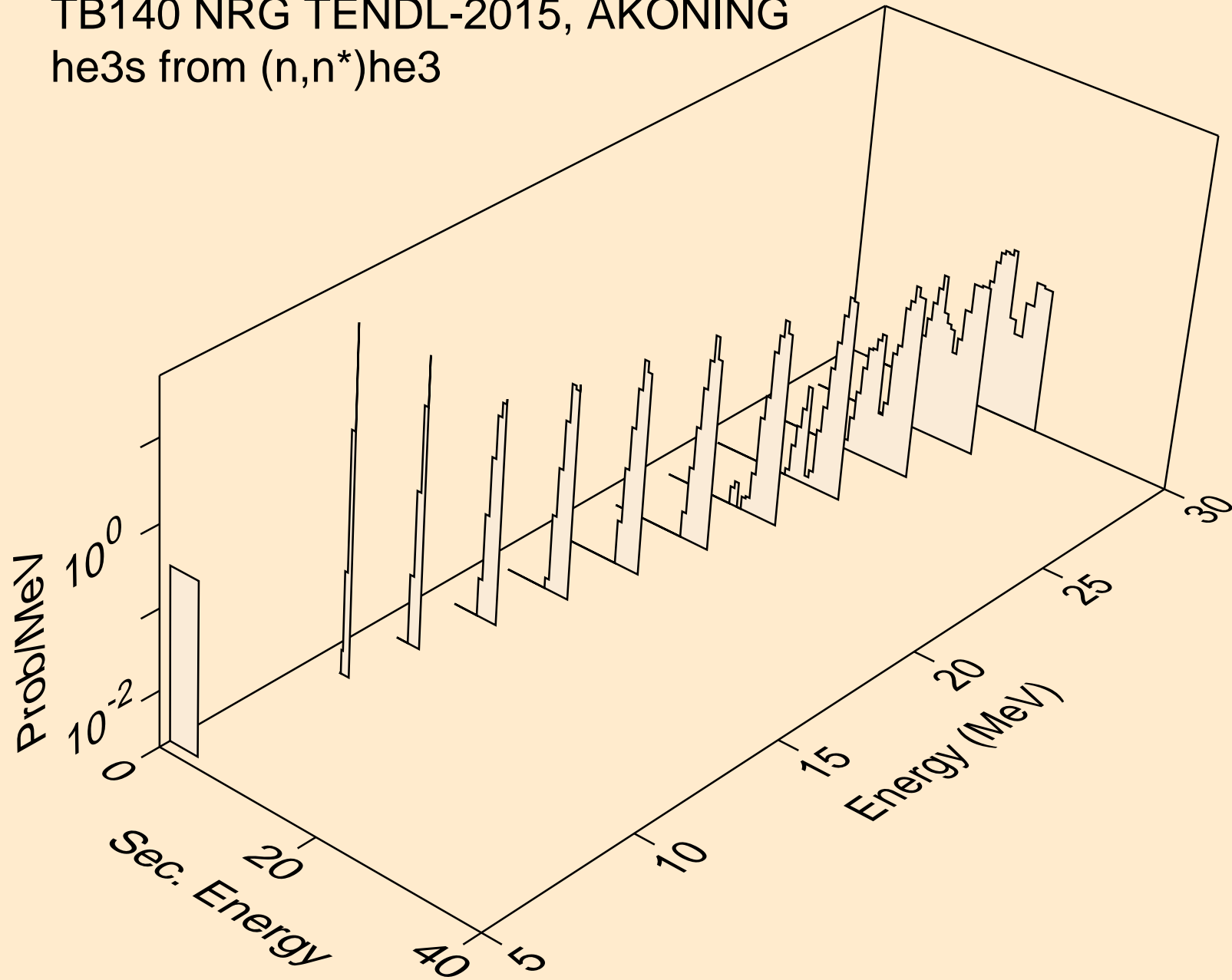

TB140 NRG TENDL-2015, AKONING
he3s from (n,he3)

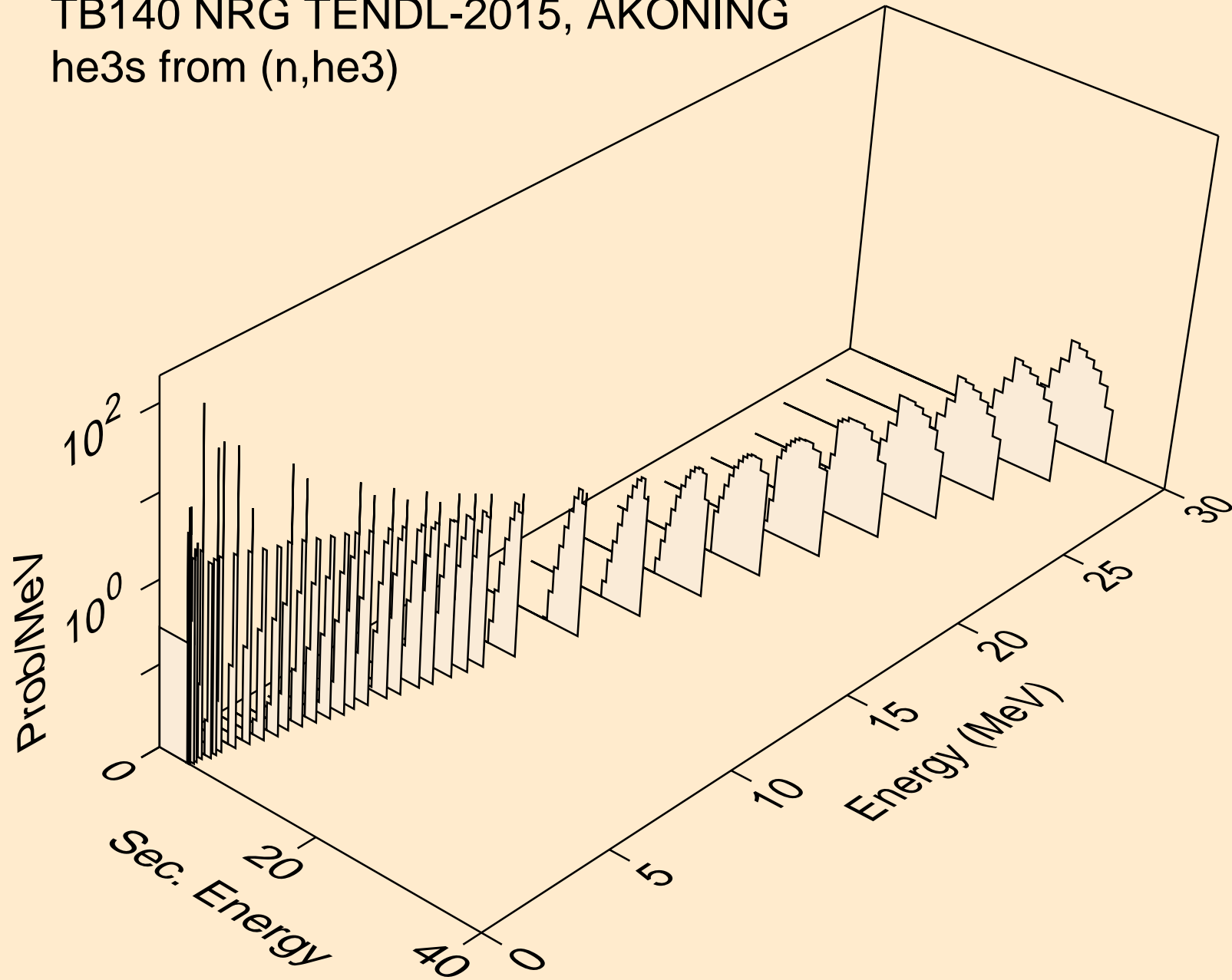

TB140 NRG TENDL-2015, AKONING
alphas from (n,x)

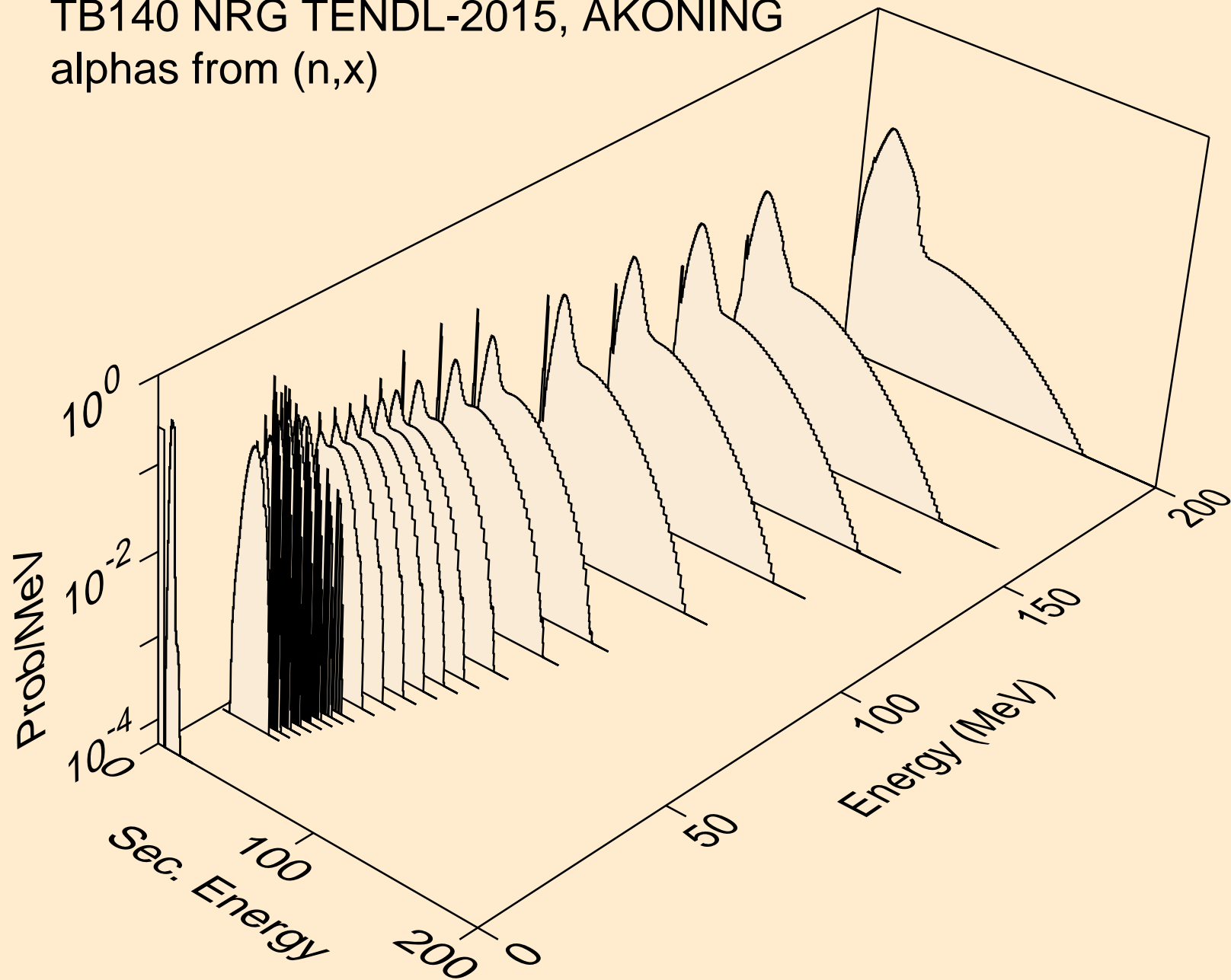

TB140 NRG TENDL-2015, AKONING
alphas from (n,n*)a

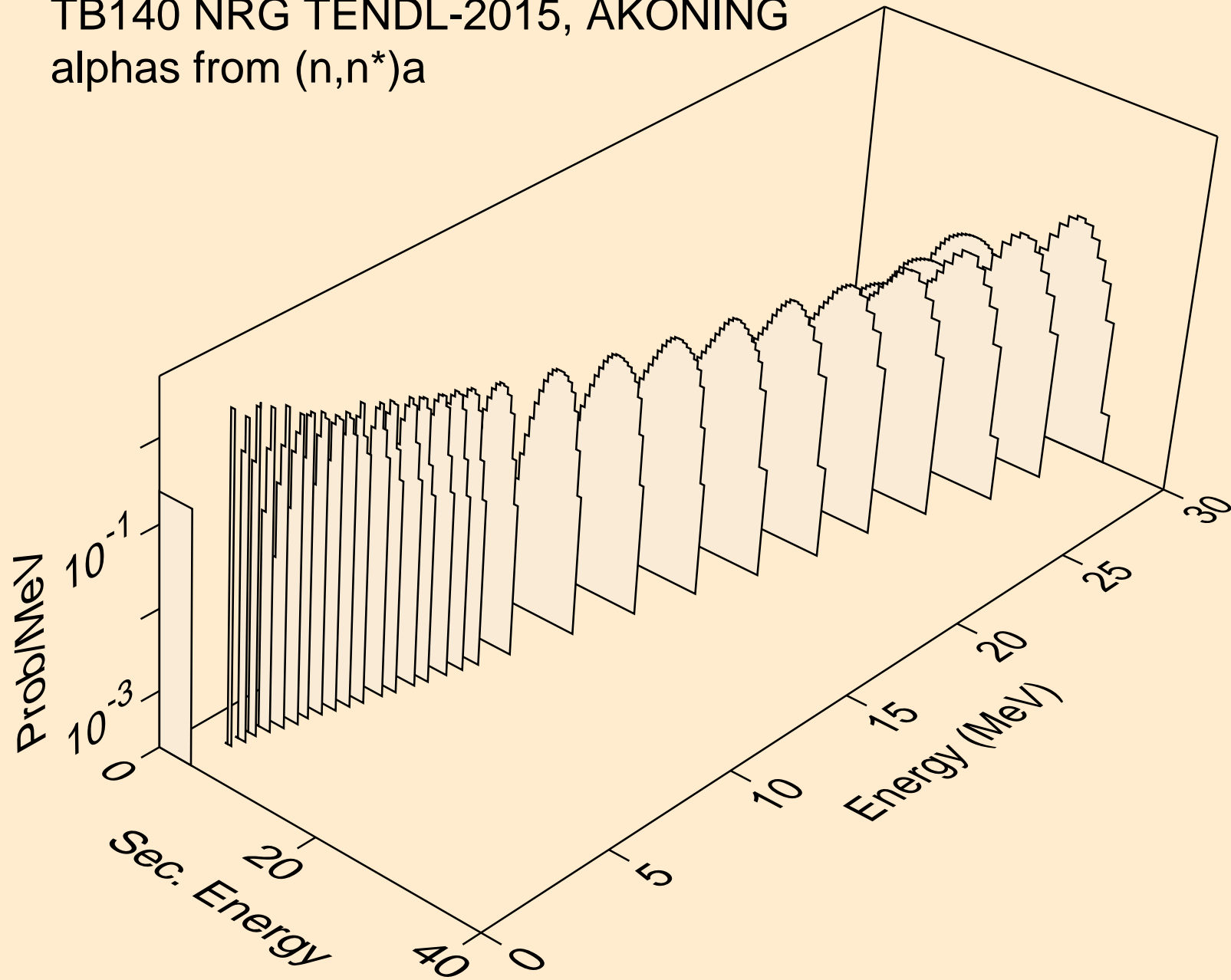

TB140 NRG TENDL-2015, AKONING
alphas from (n,n*)3a

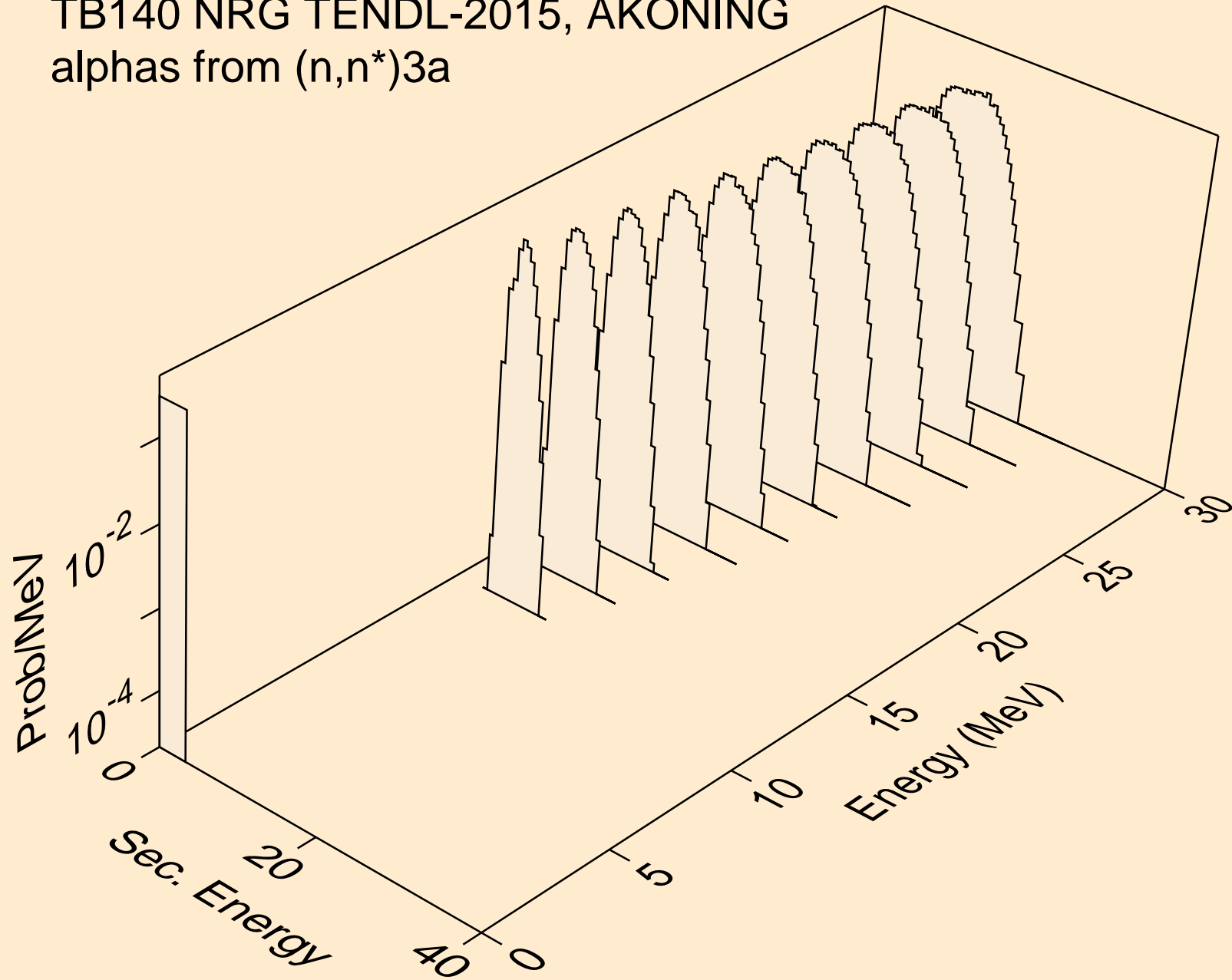

TB140 NRG TENDL-2015, AKONING
alphas from (n,2n)a

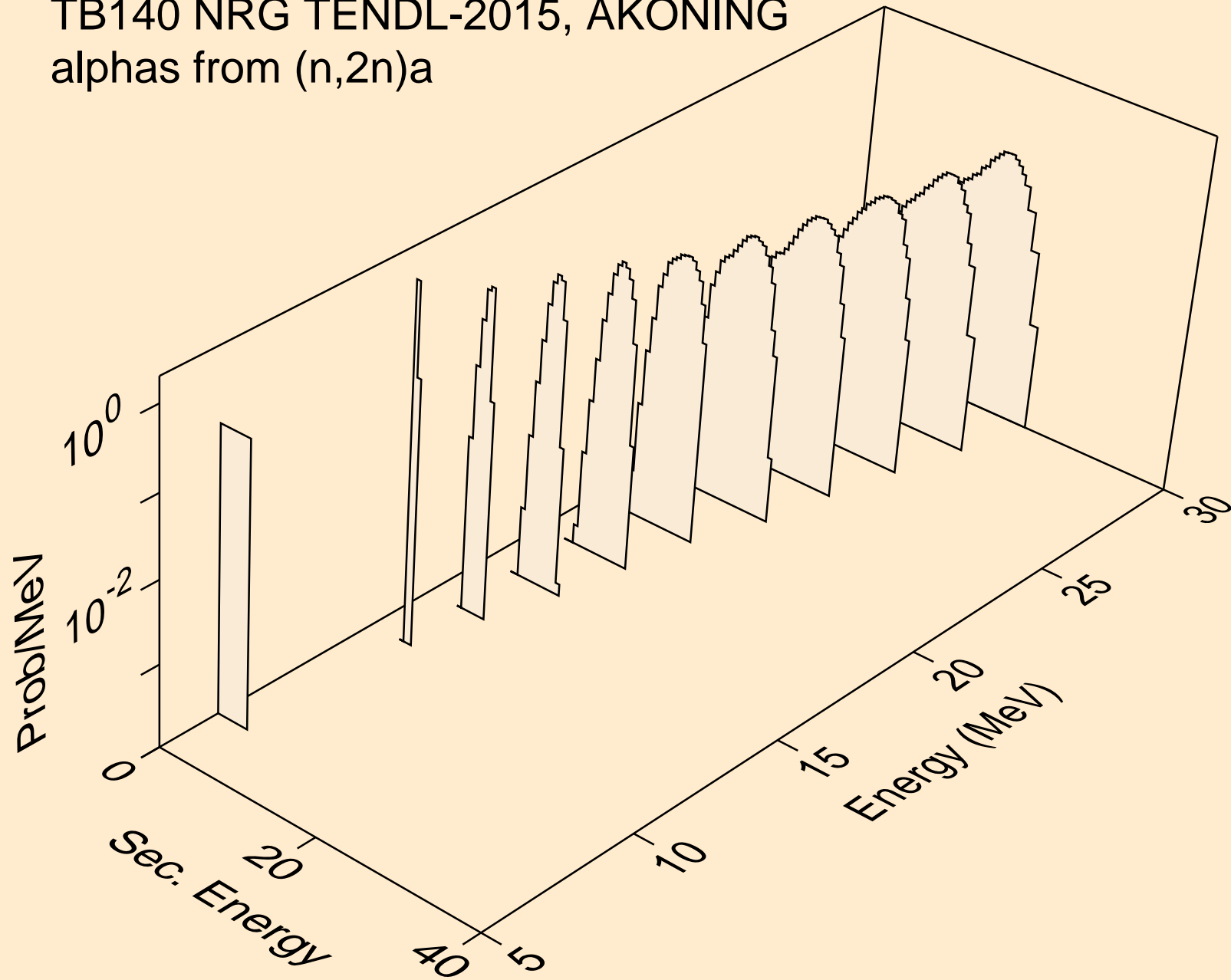

TB140 NRG TENDL-2015, AKONING
alphas from (n,3n)a

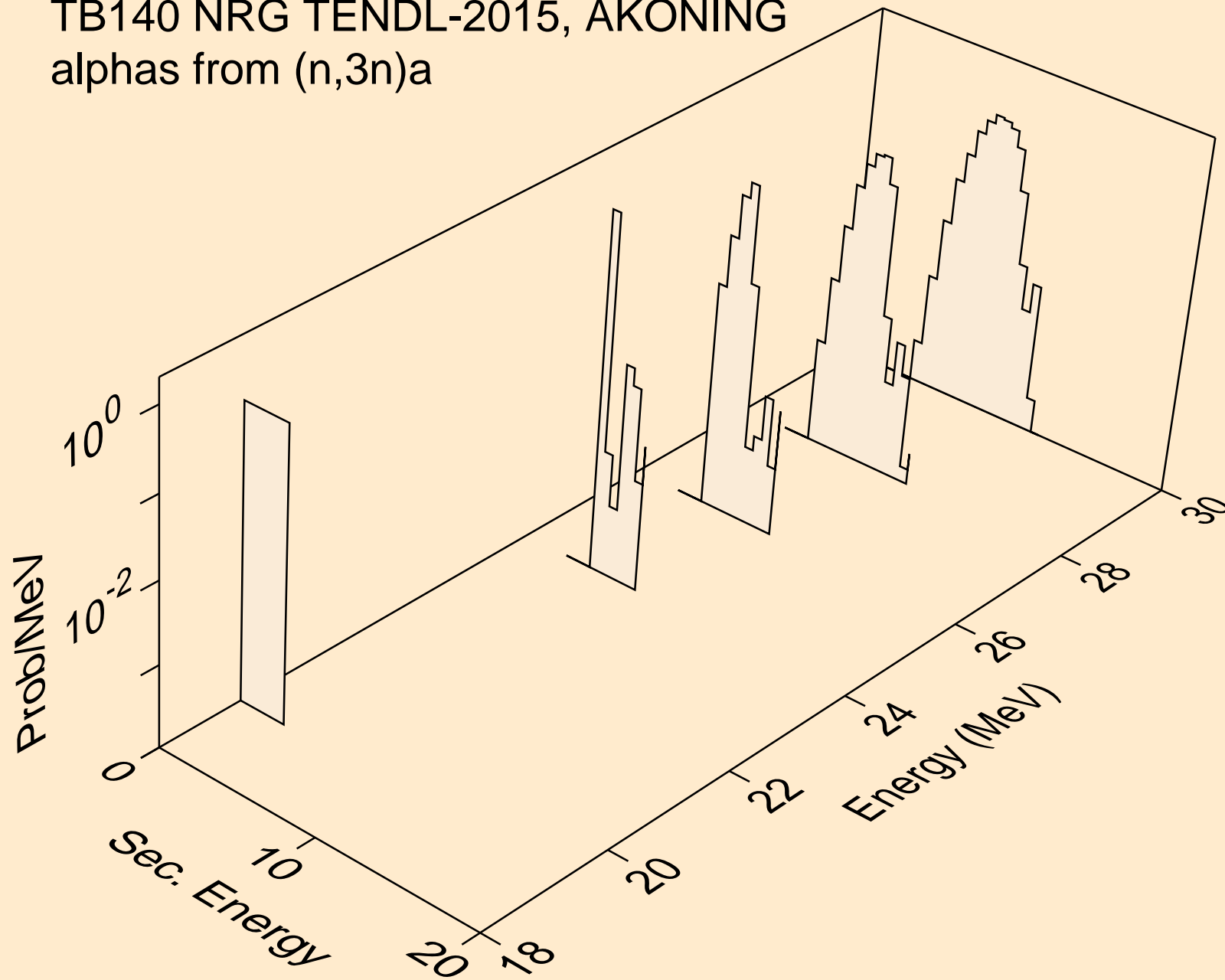

TB140 NRG TENDL-2015, AKONING
alphas from (n,n*)2a

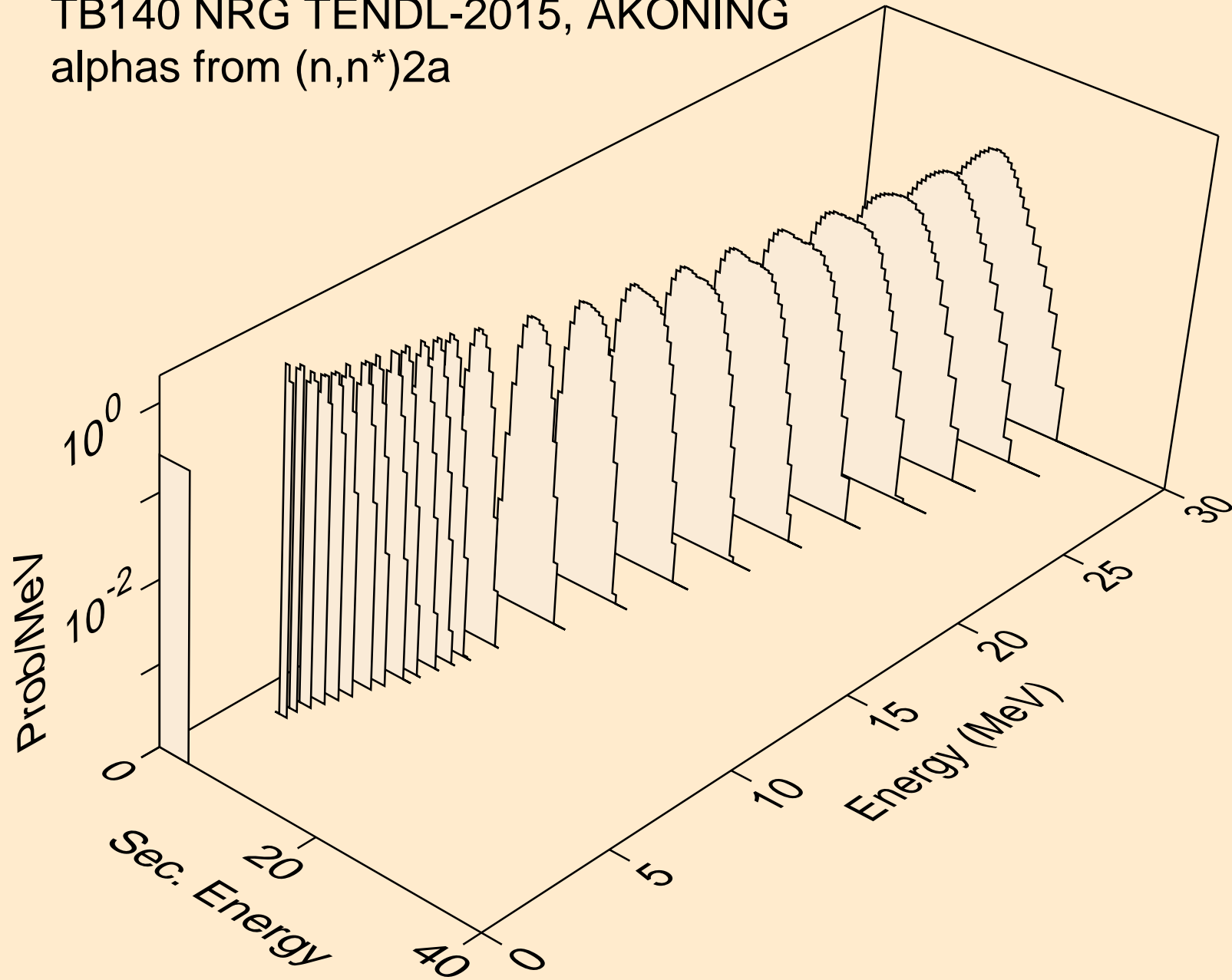

TB140 NRG TENDL-2015, AKONING
alphas from (n,2n)2a

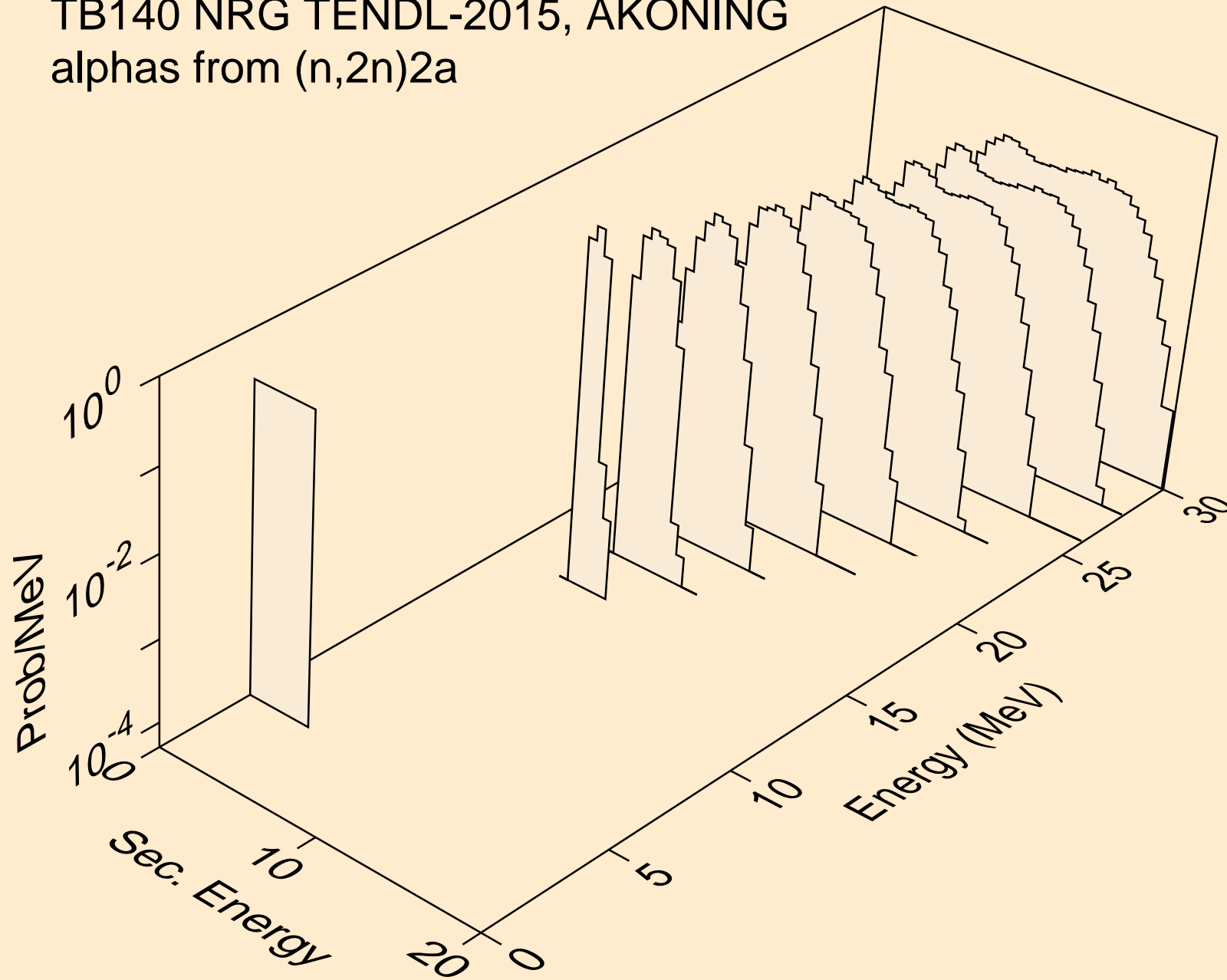

TB140 NRG TENDL-2015, AKONING
alphas from (n,n*)d2a

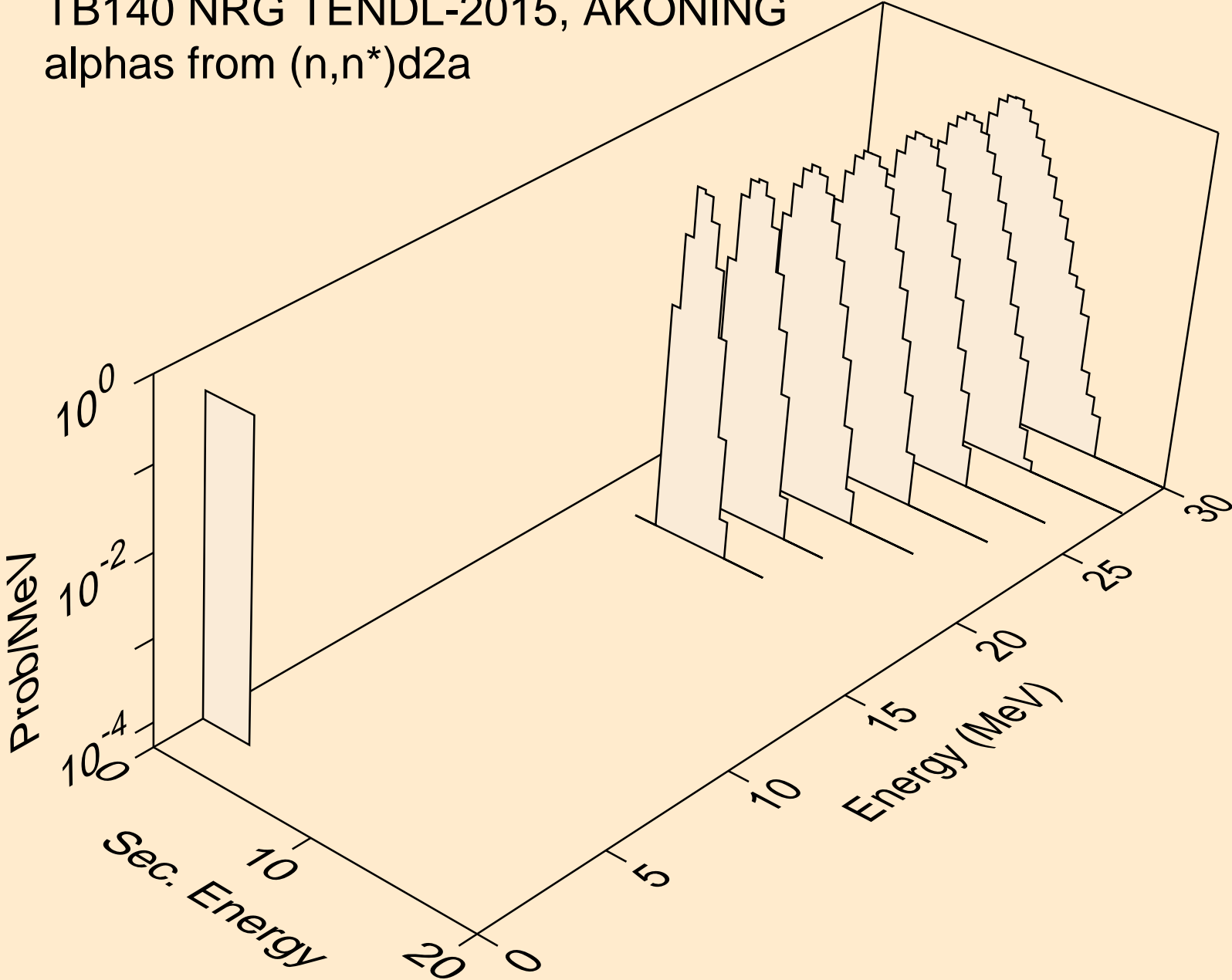

TB140 NRG TENDL-2015, AKONING
alphas from (n,npa)

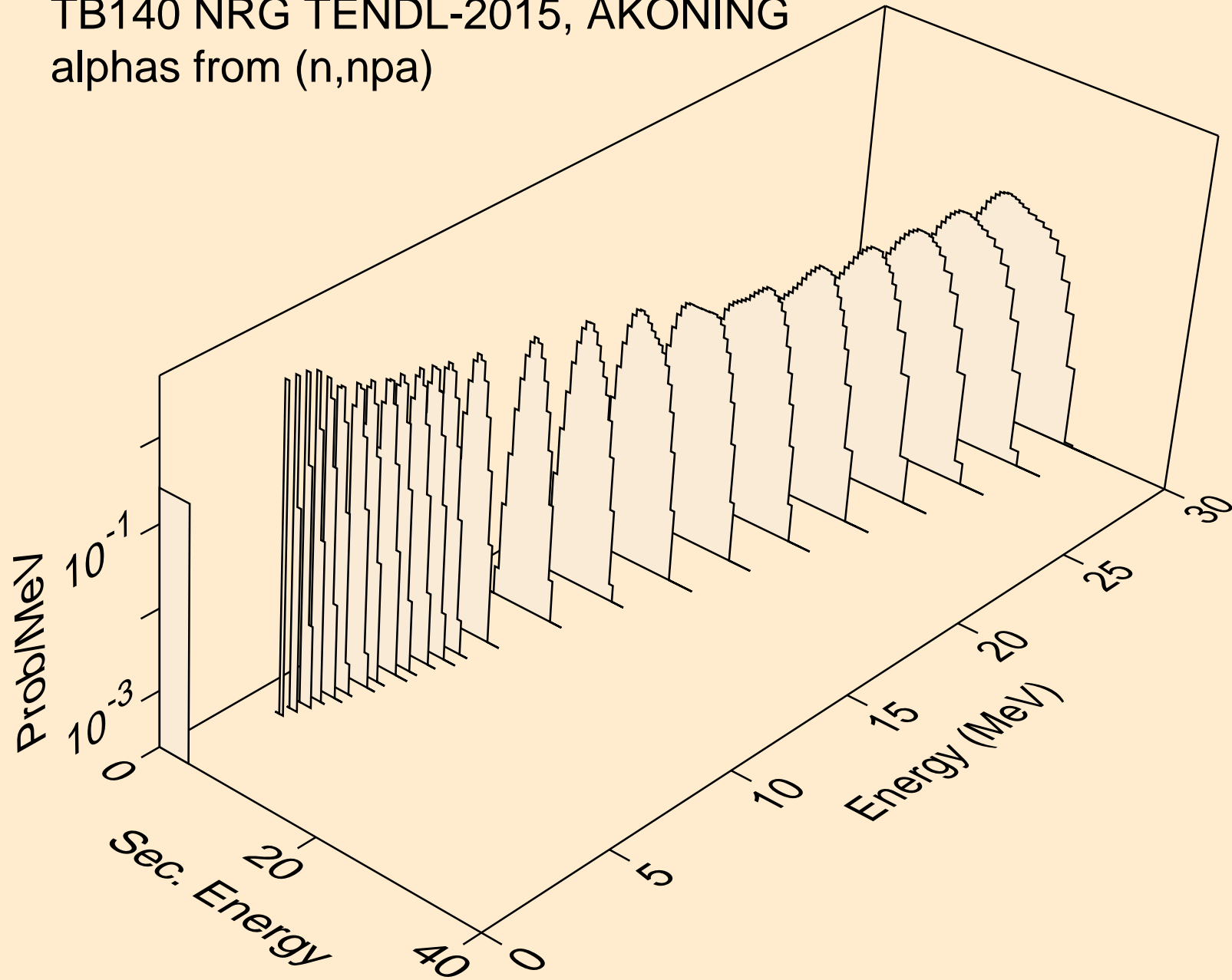

TB140 NRG TENDL-2015, AKONING
alphas from (n,a)

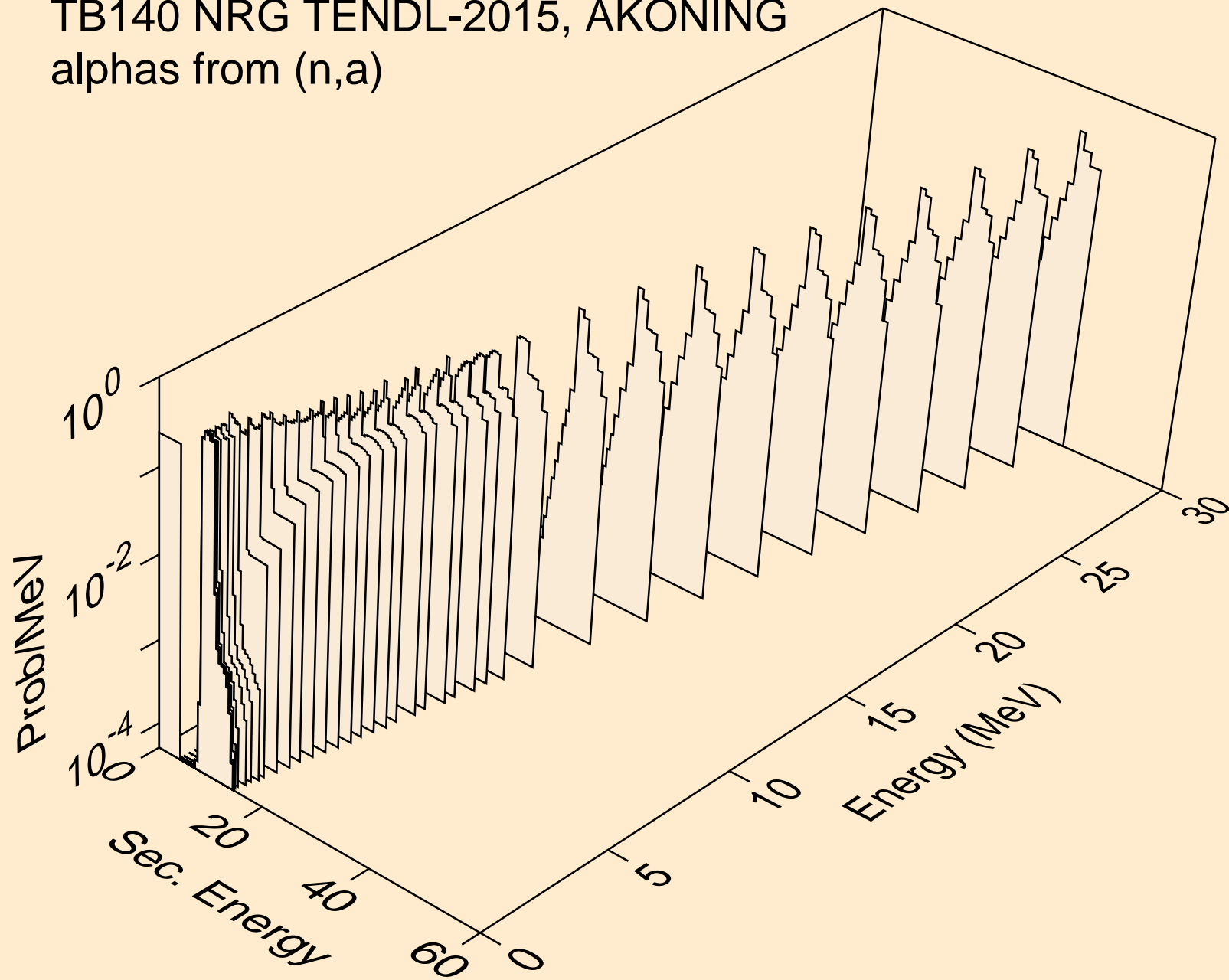

TB140 NRG TENDL-2015, AKONING
alphas from (n,2a)

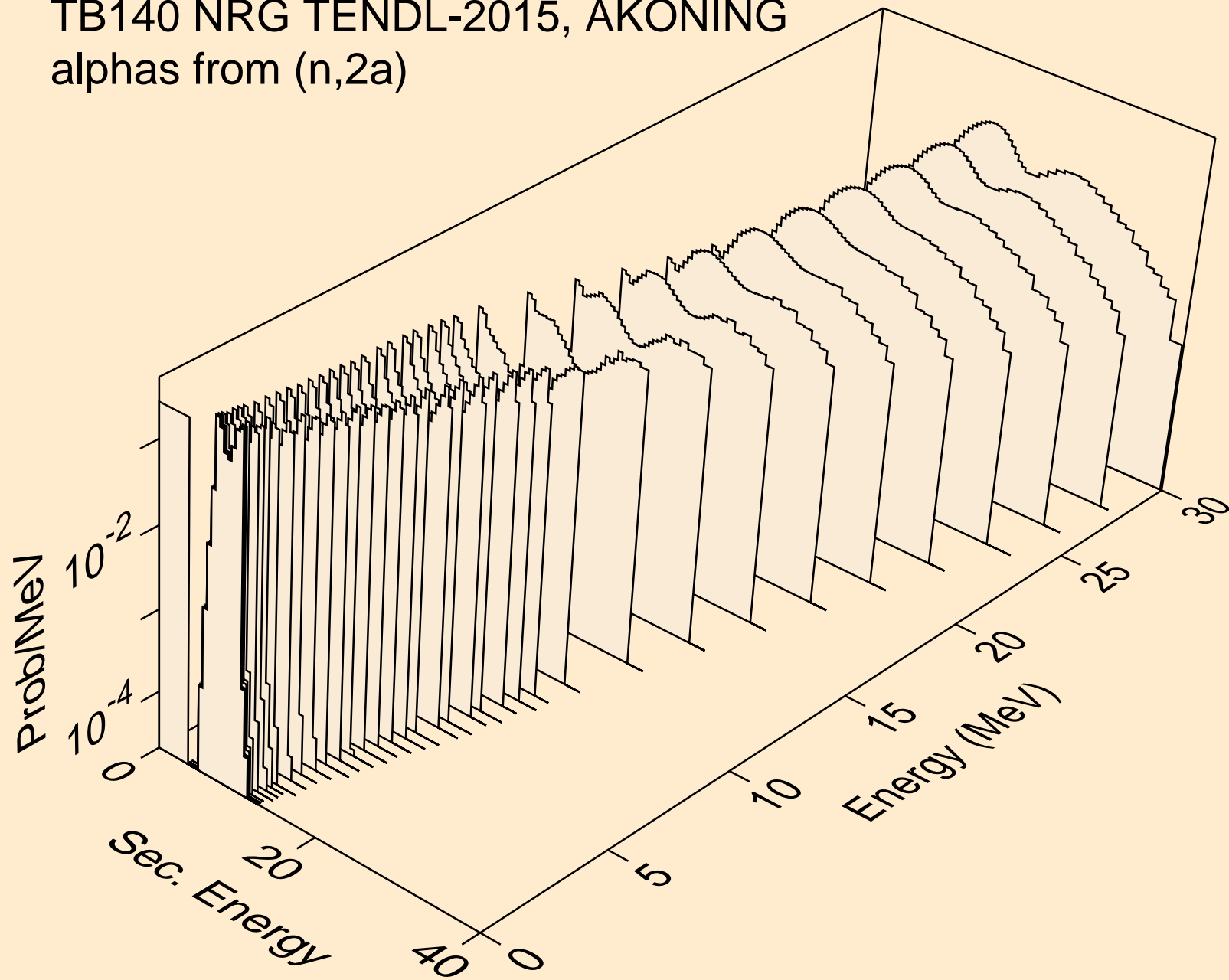

TB140 NRG TENDL-2015, AKONING
alphas from (n,3a)

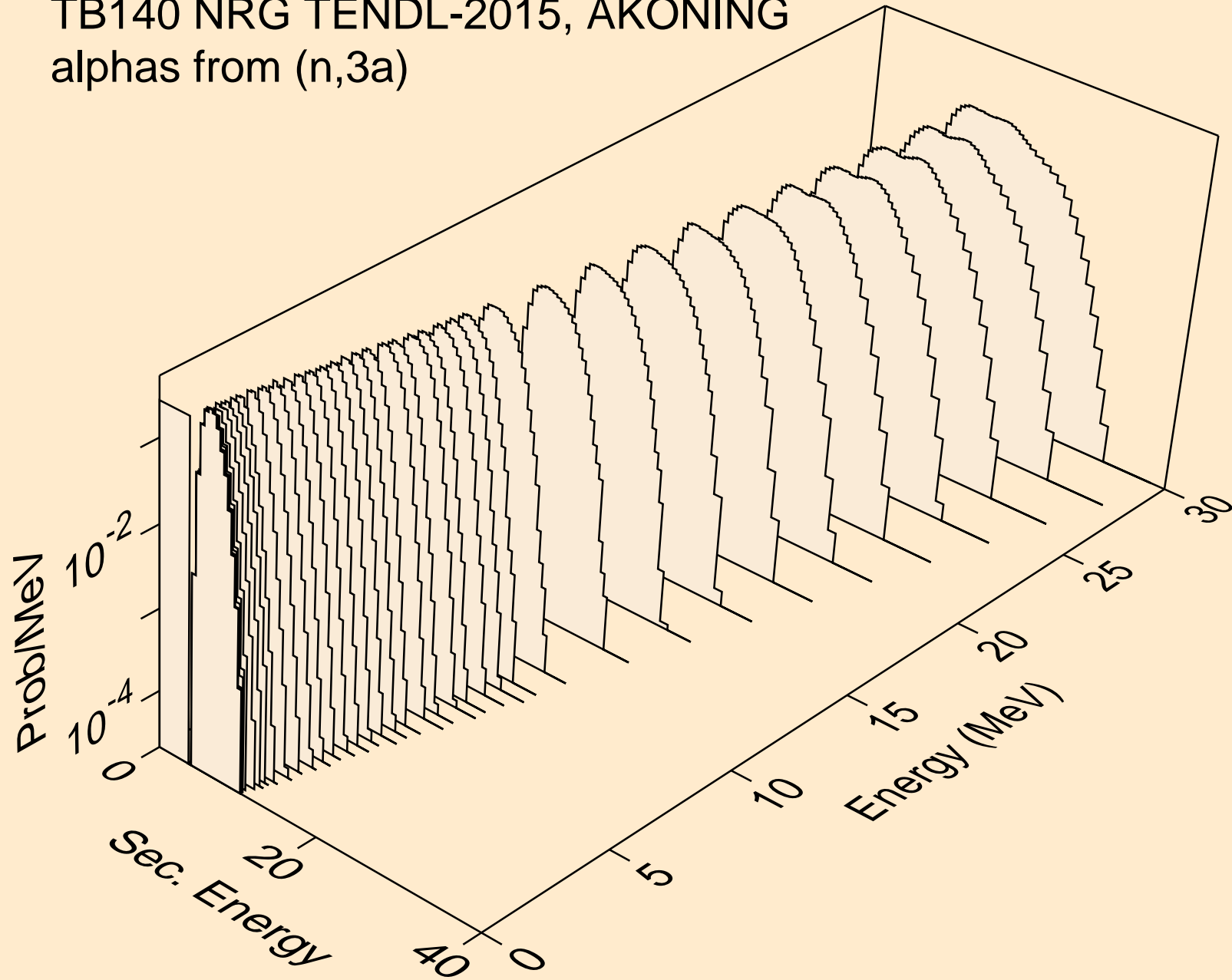

TB140 NRG TENDL-2015, AKONING
alphas from (n,pa)

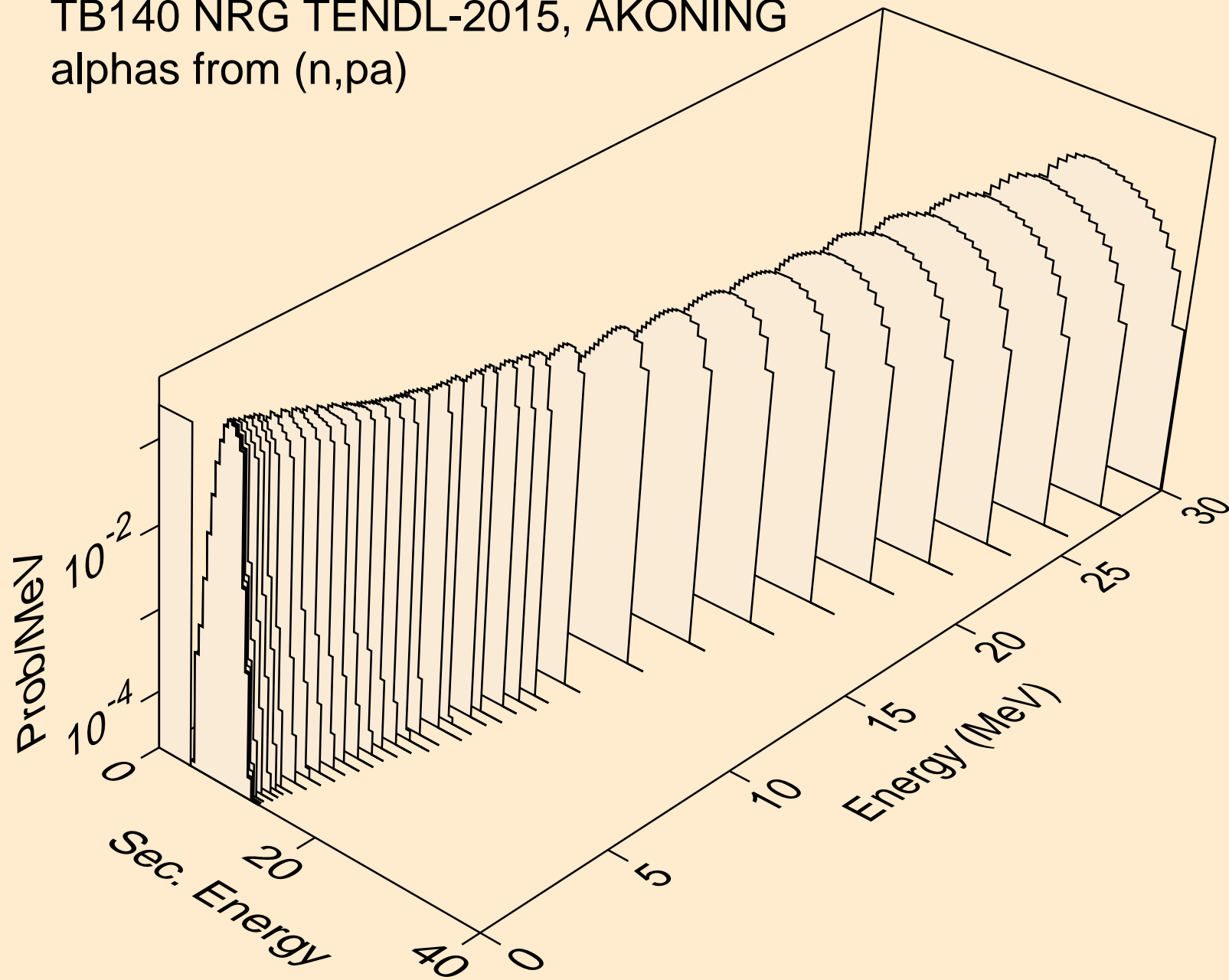

TB140 NRG TENDL-2015, AKONING
alphas from (n,t2a)

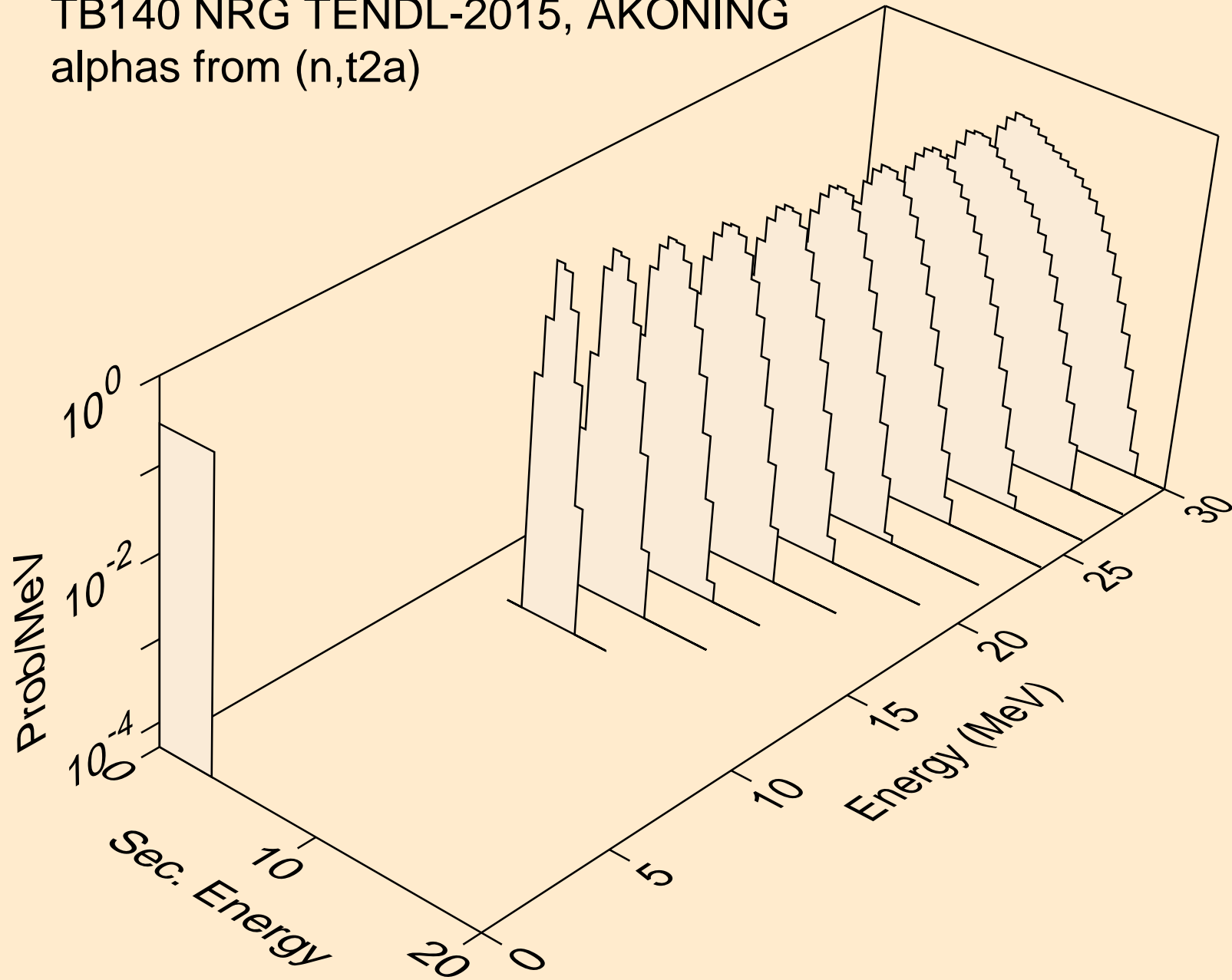

TB140 NRG TENDL-2015, AKONING
alphas from (n,d2a)

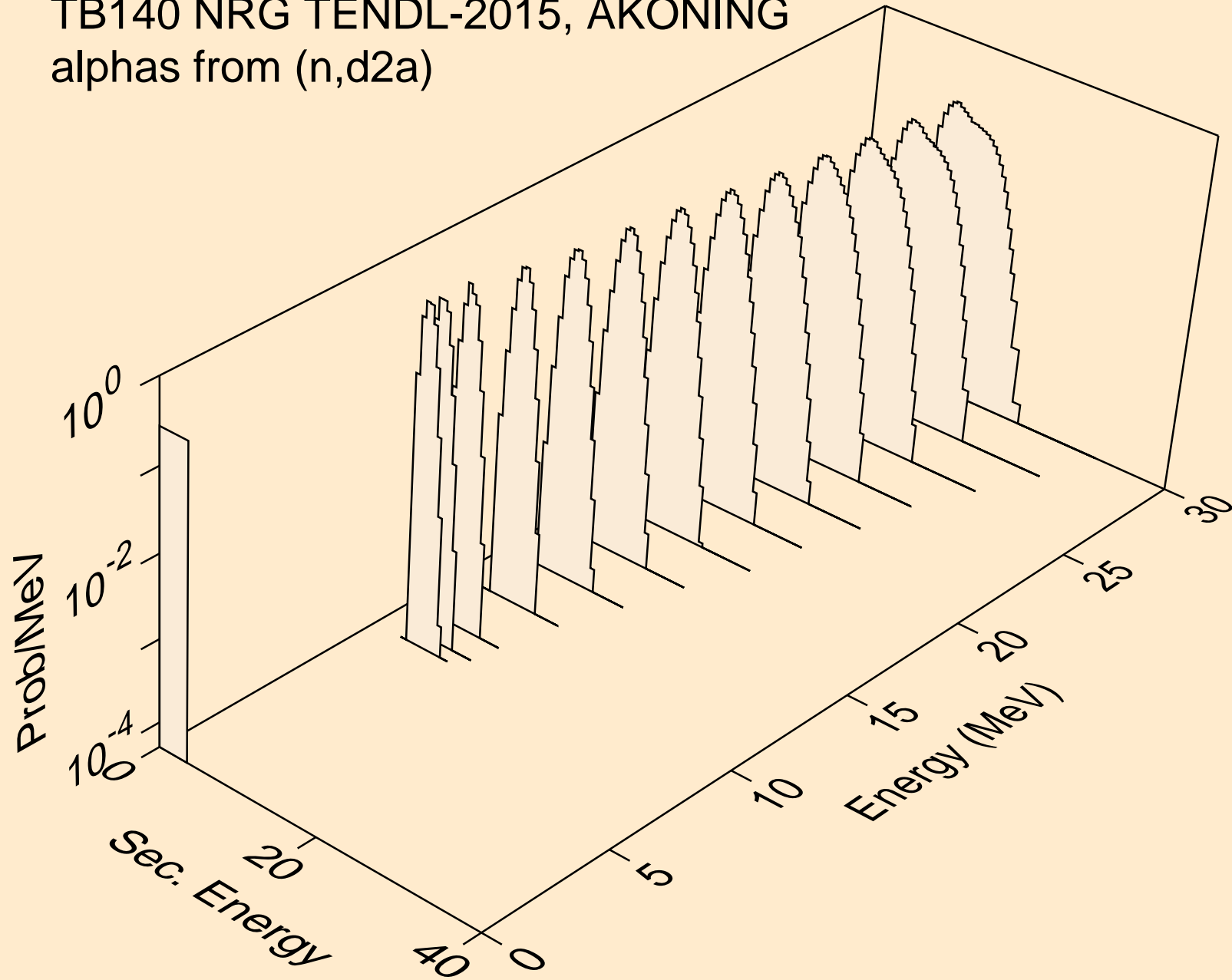

TB140 NRG TENDL-2015, AKONING
alphas from (n,da)

