

# TB170 NRG TENDL-2015, AKONING

## Principal cross sections

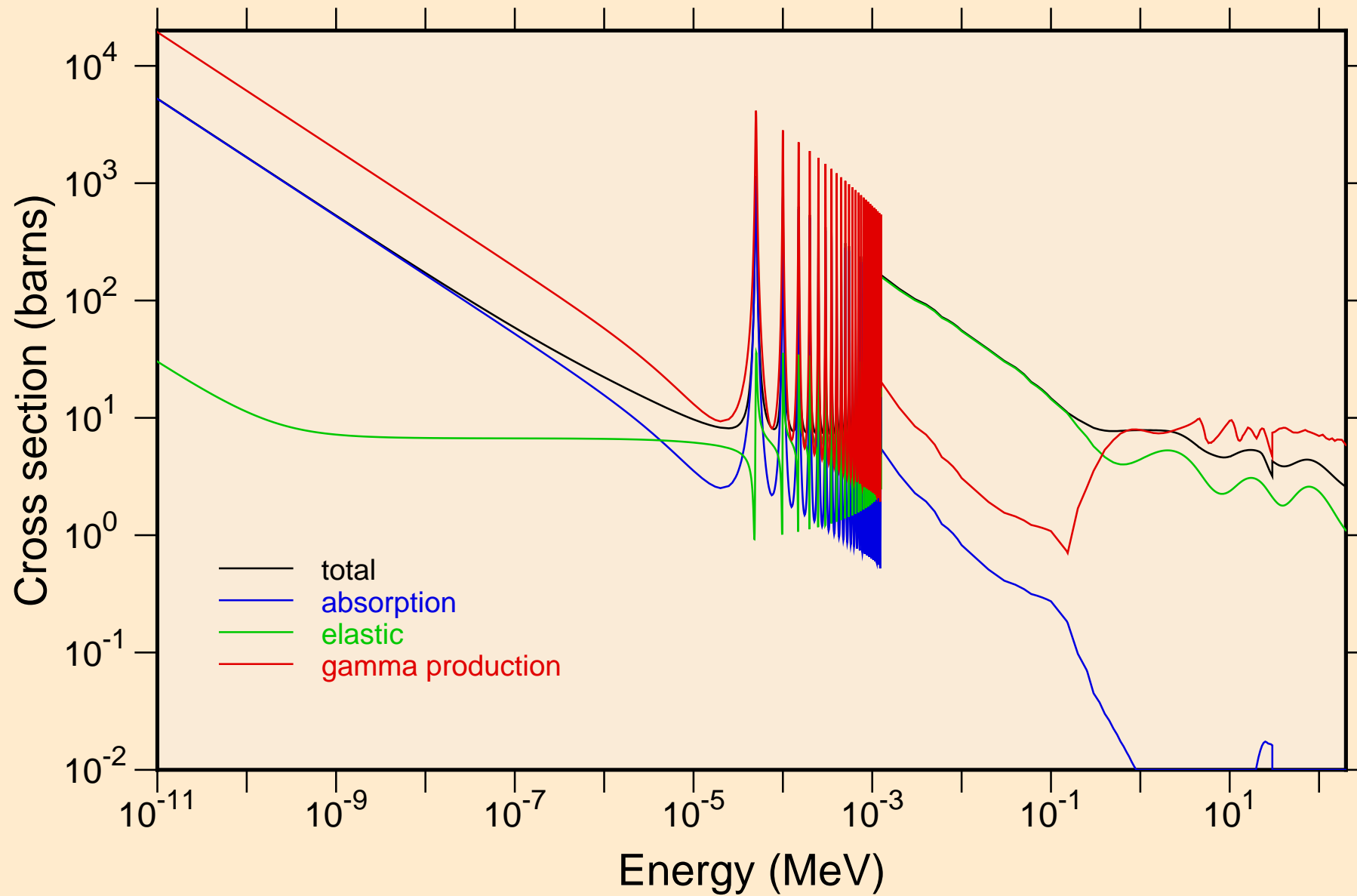

TB170 NRG TENDL-2015, AKONING  
resonance total cross section

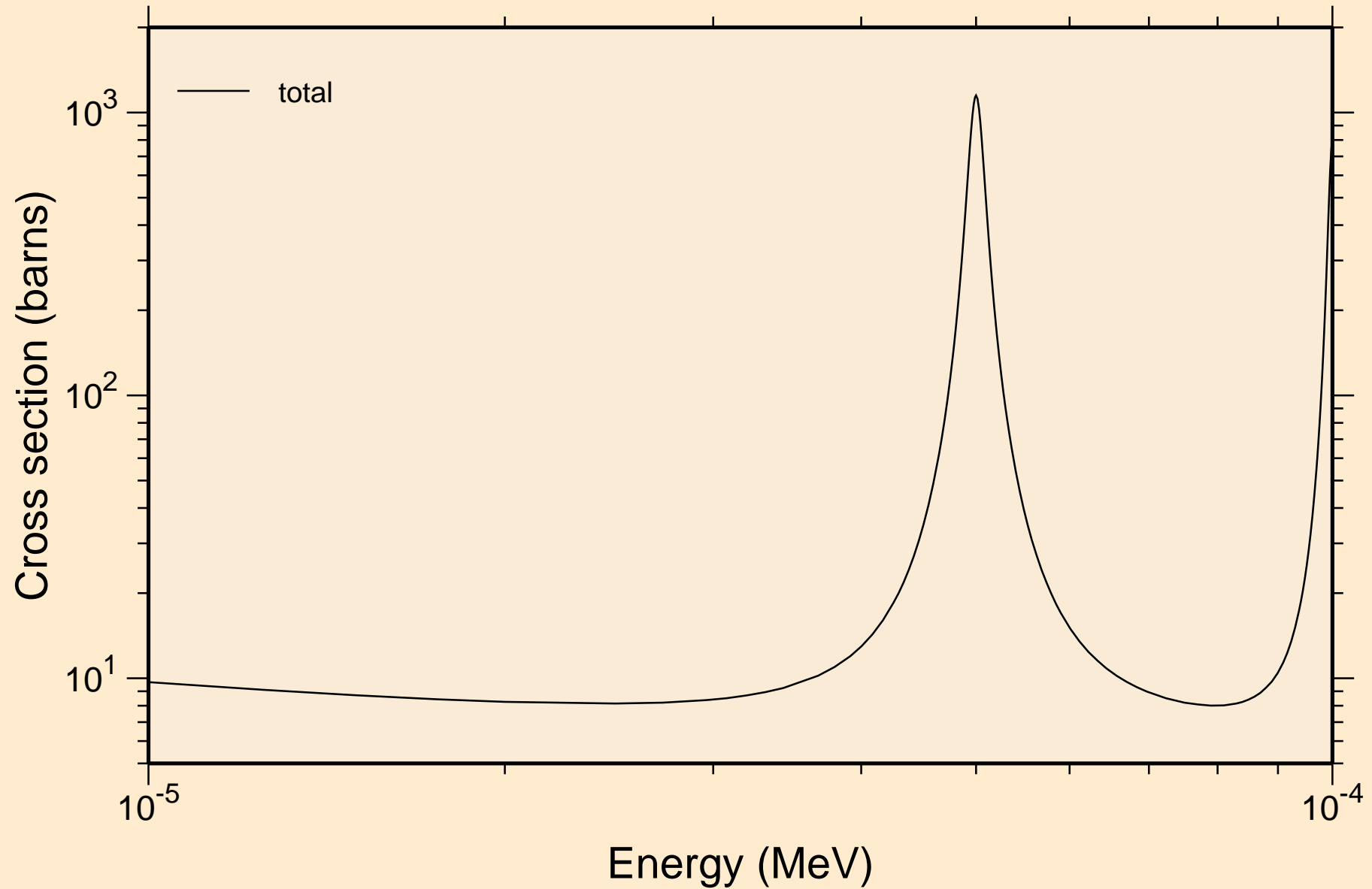

TB170 NRG TENDL-2015, AKONING  
resonance total cross section

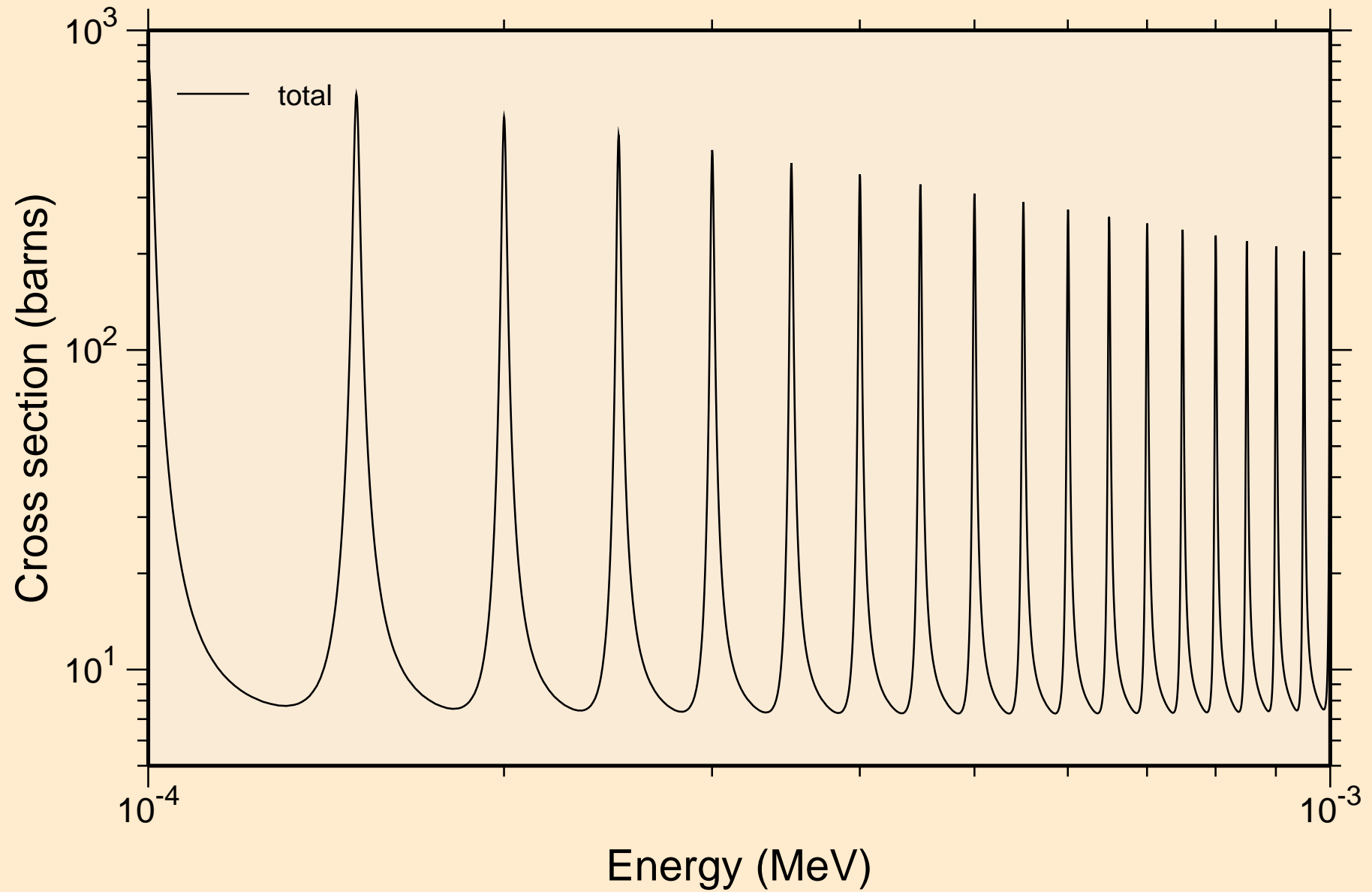

TB170 NRG TENDL-2015, AKONING  
resonance total cross section

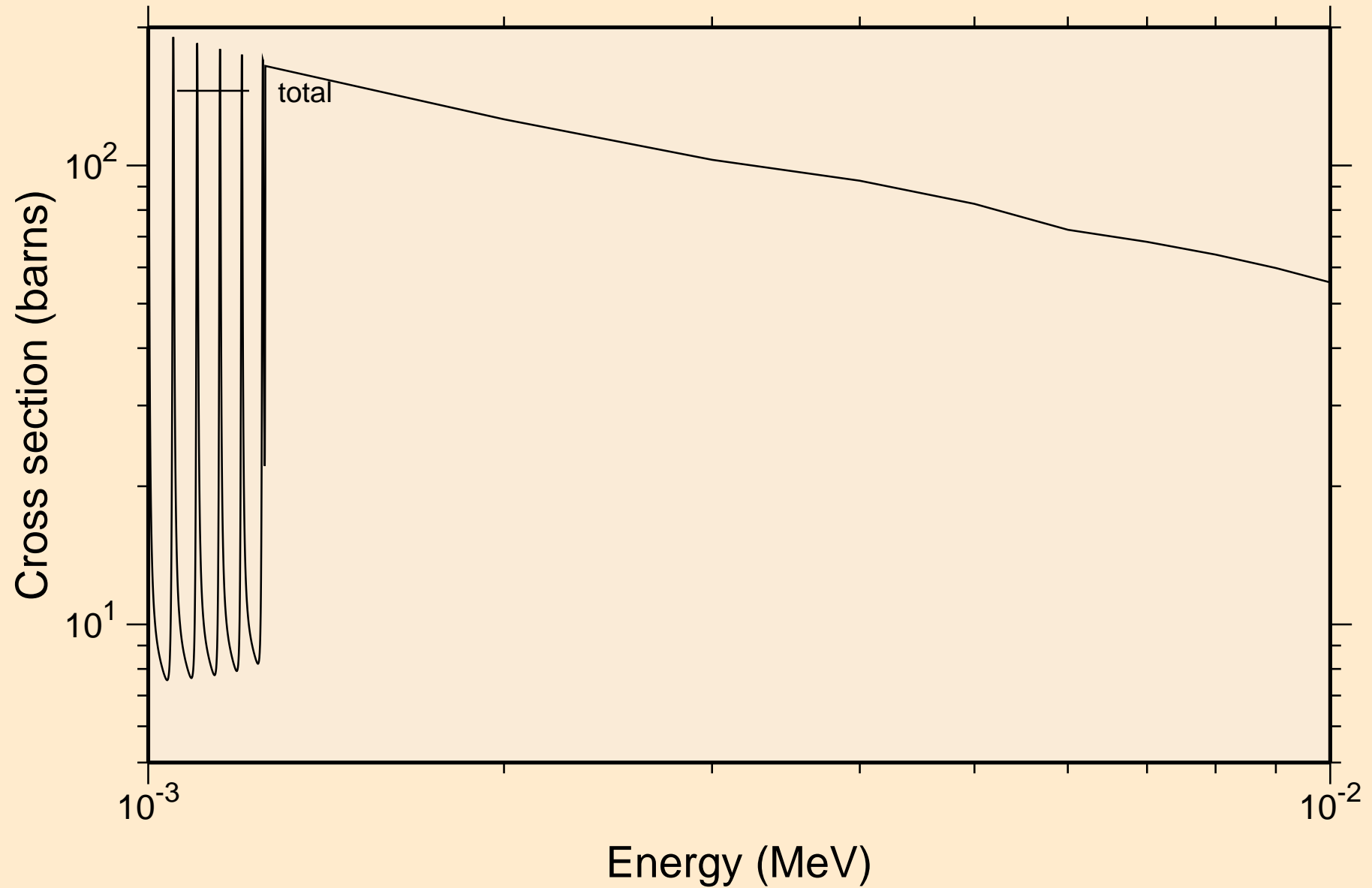

TB170 NRG TENDL-2015, AKONING  
resonance total cross section

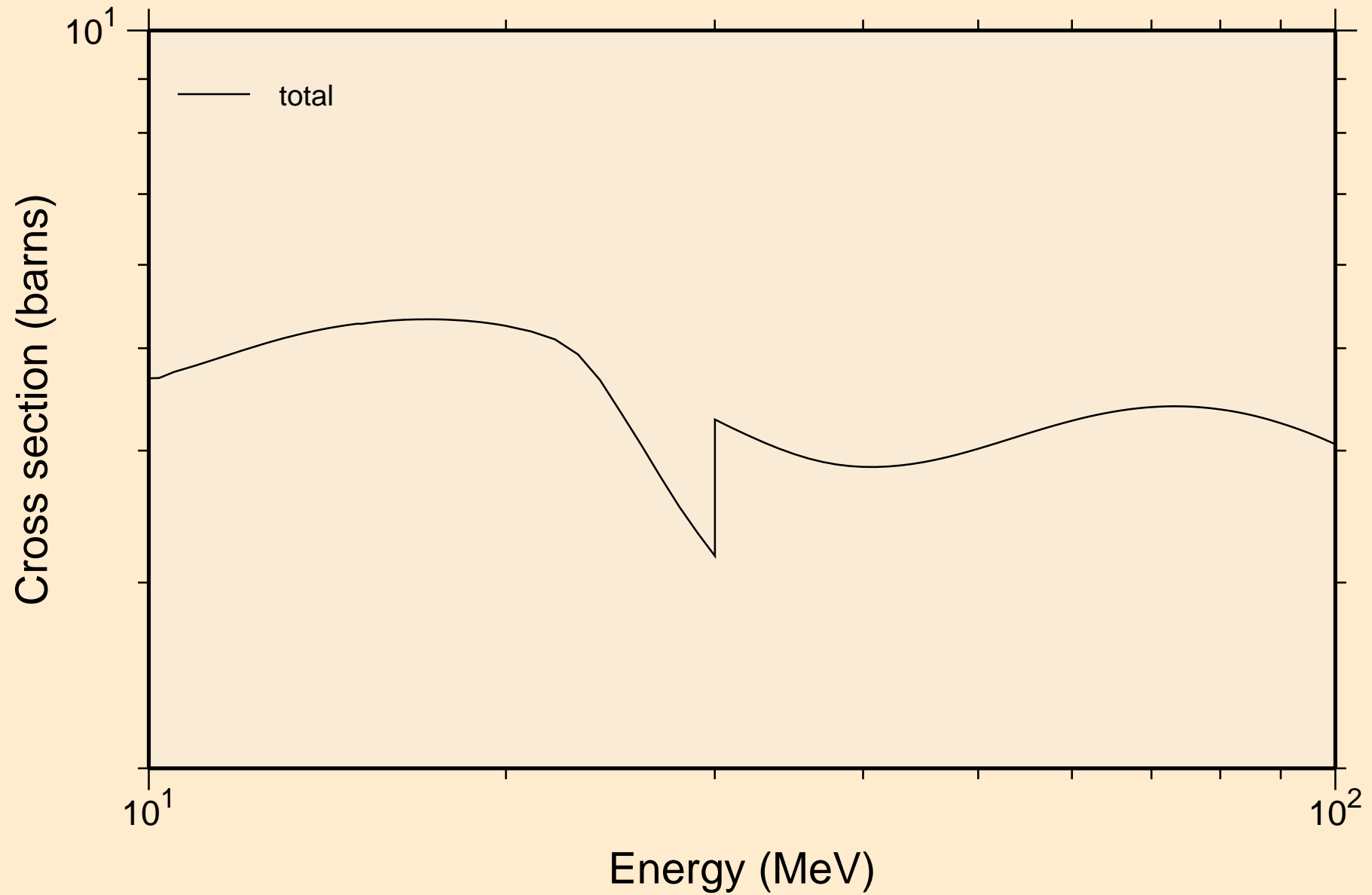

TB170 NRG TENDL-2015, AKONING  
resonance absorption cross sections

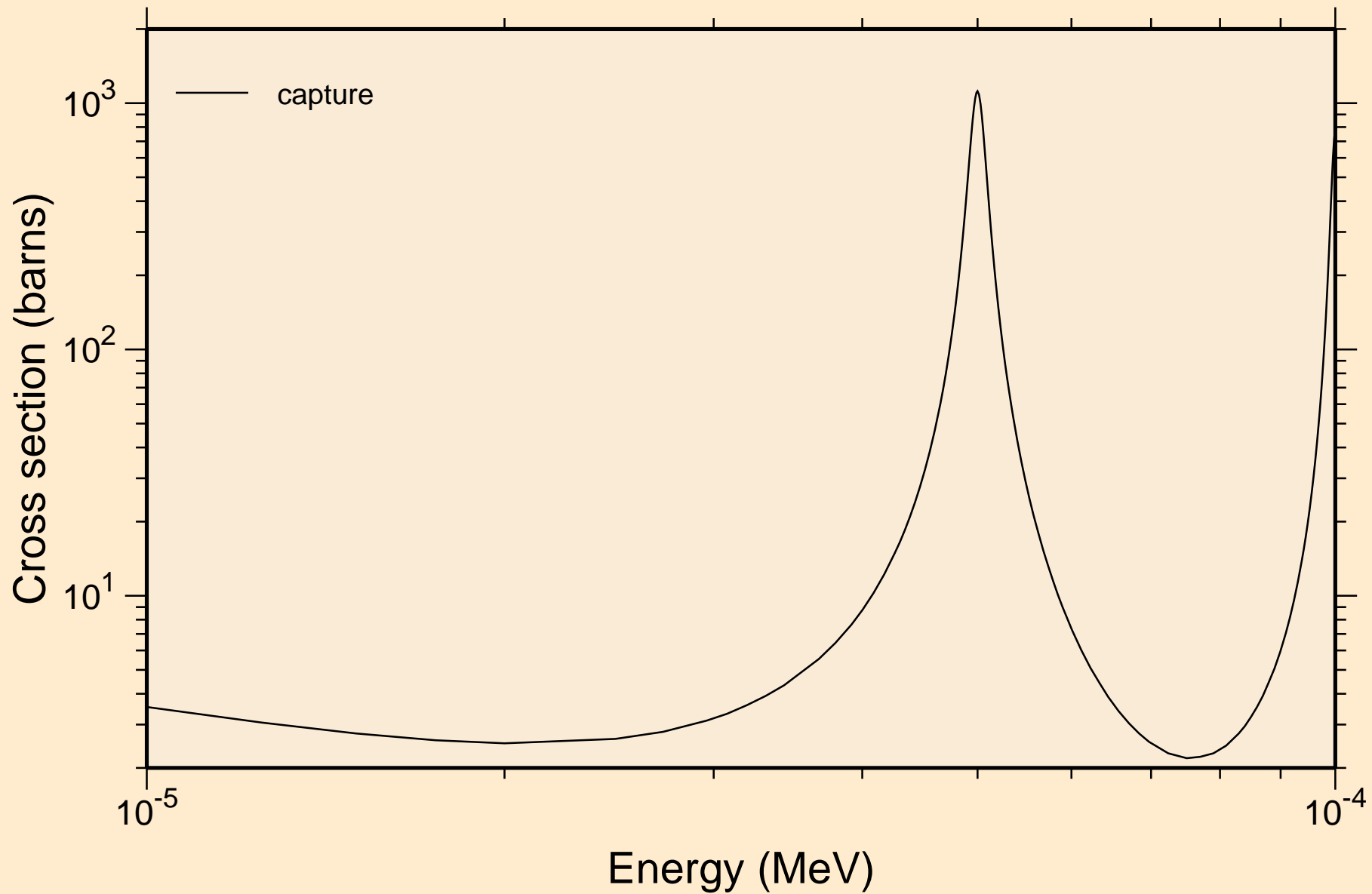

TB170 NRG TENDL-2015, AKONING  
resonance absorption cross sections

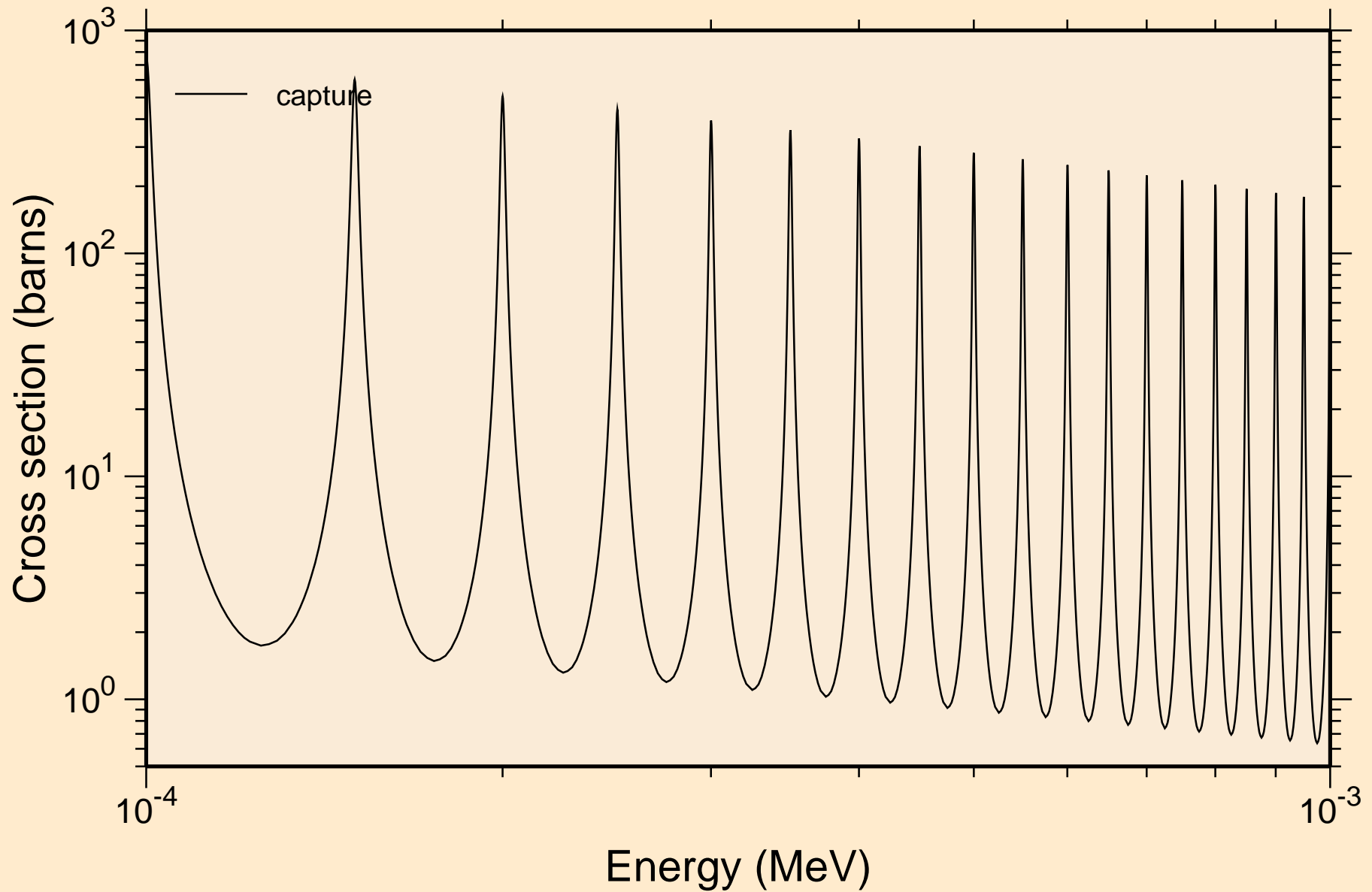

TB170 NRG TENDL-2015, AKONING  
resonance absorption cross sections

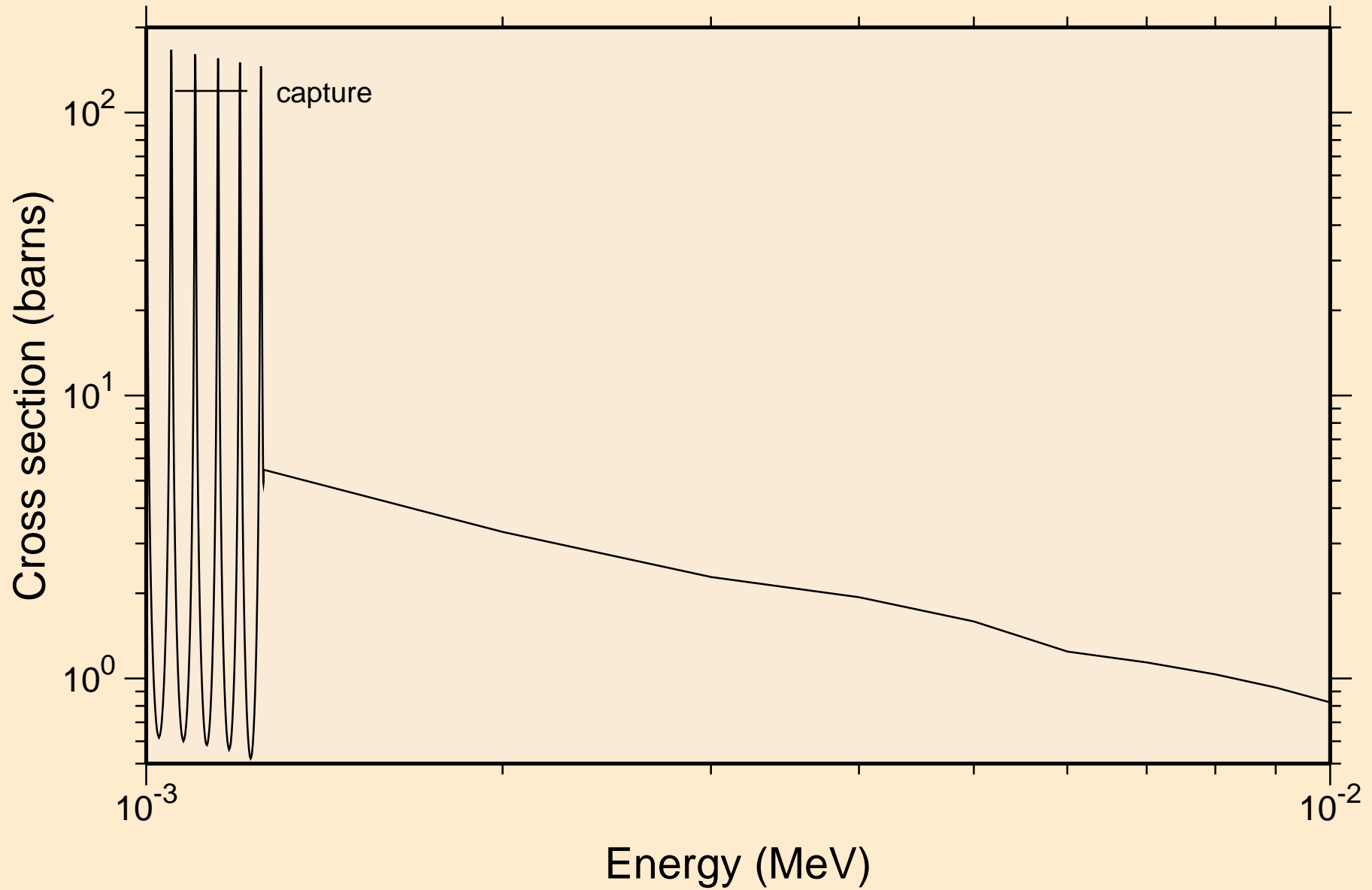



TB170 NRG TENDL-2015, AKONING  
resonance absorption cross sections

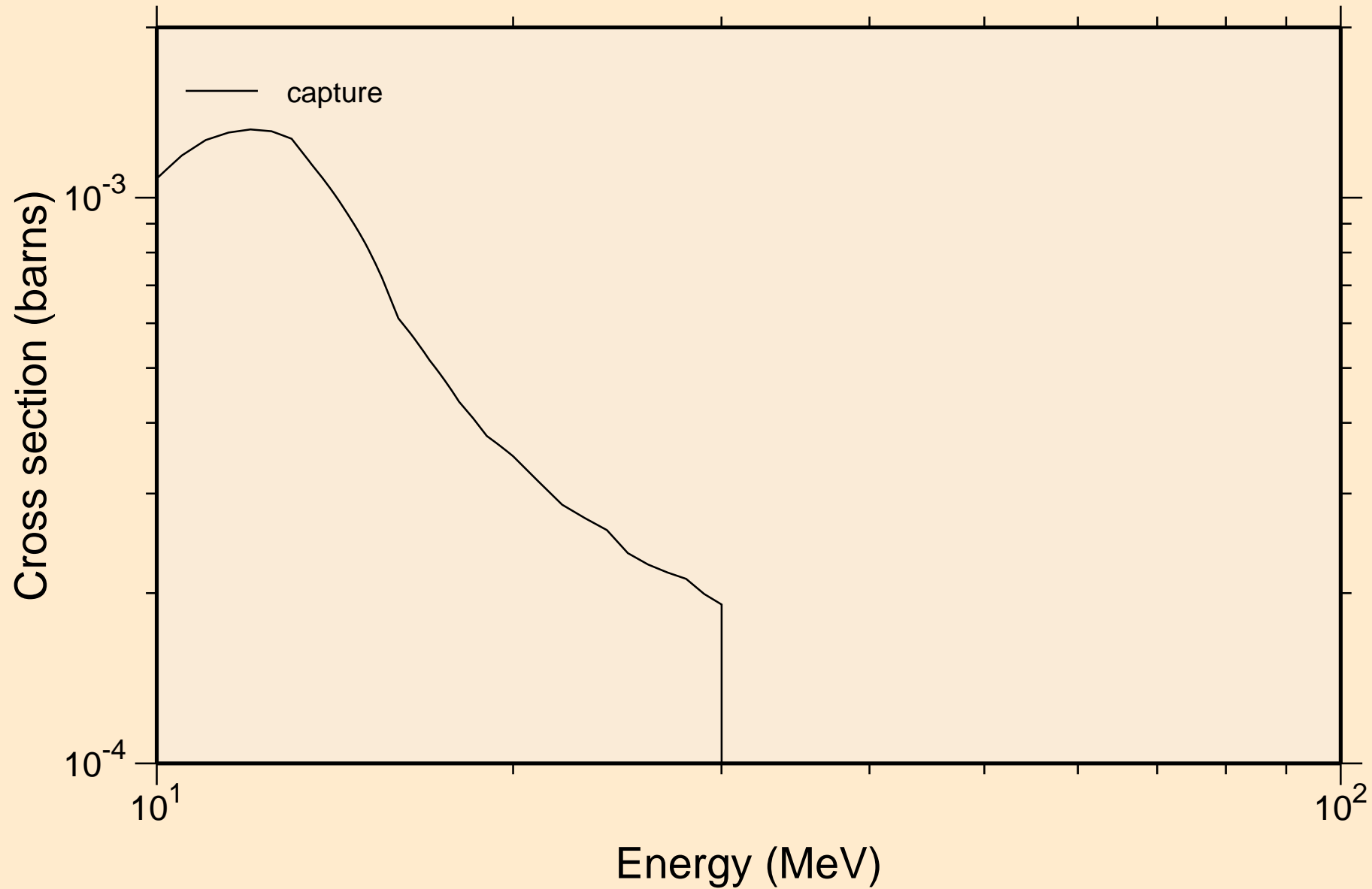

TB170 NRG TENDL-2015, AKONING  
Non-threshold reactions

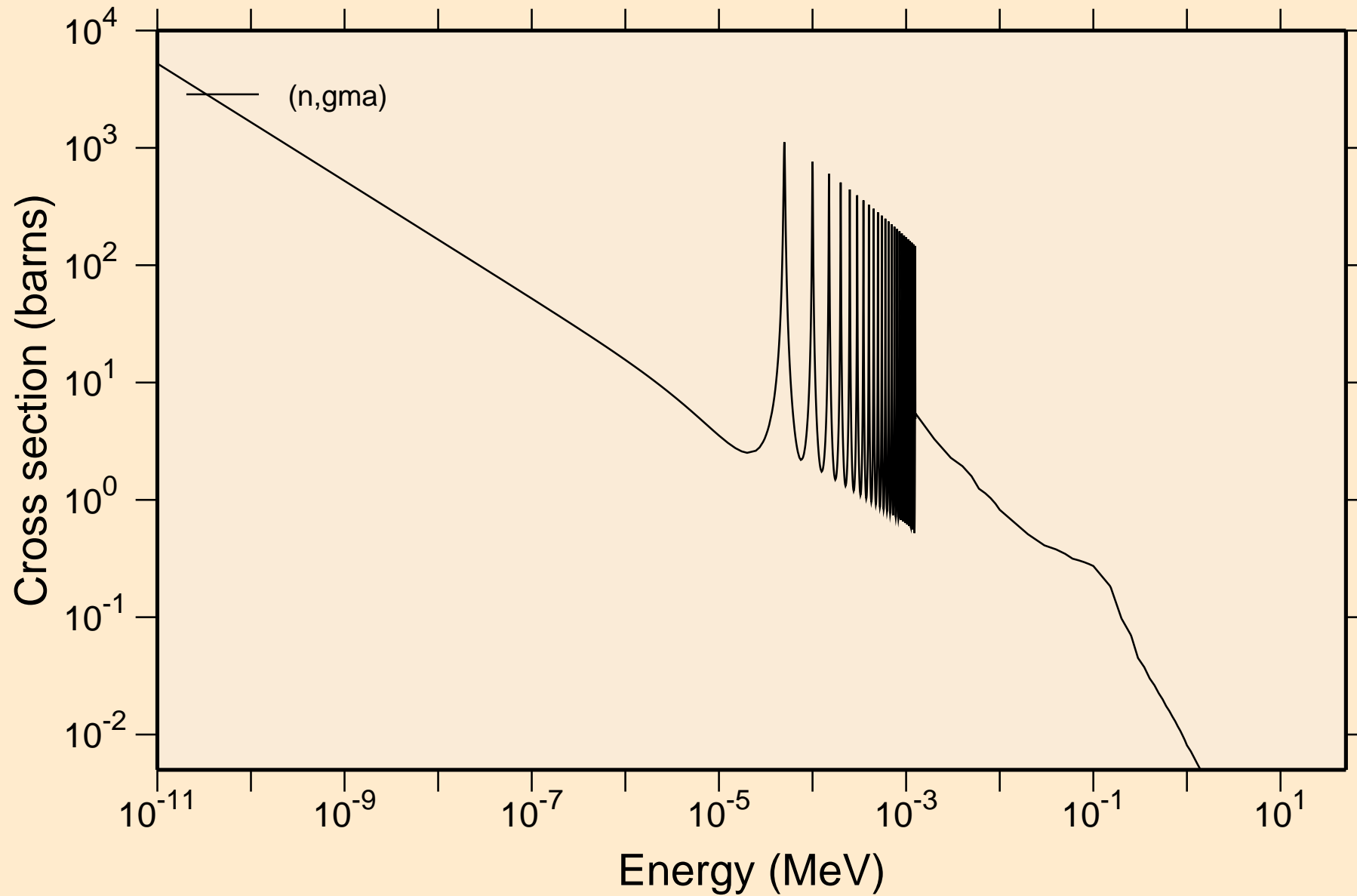

# TB170 NRG TENDL-2015, AKONING

## Principal cross sections

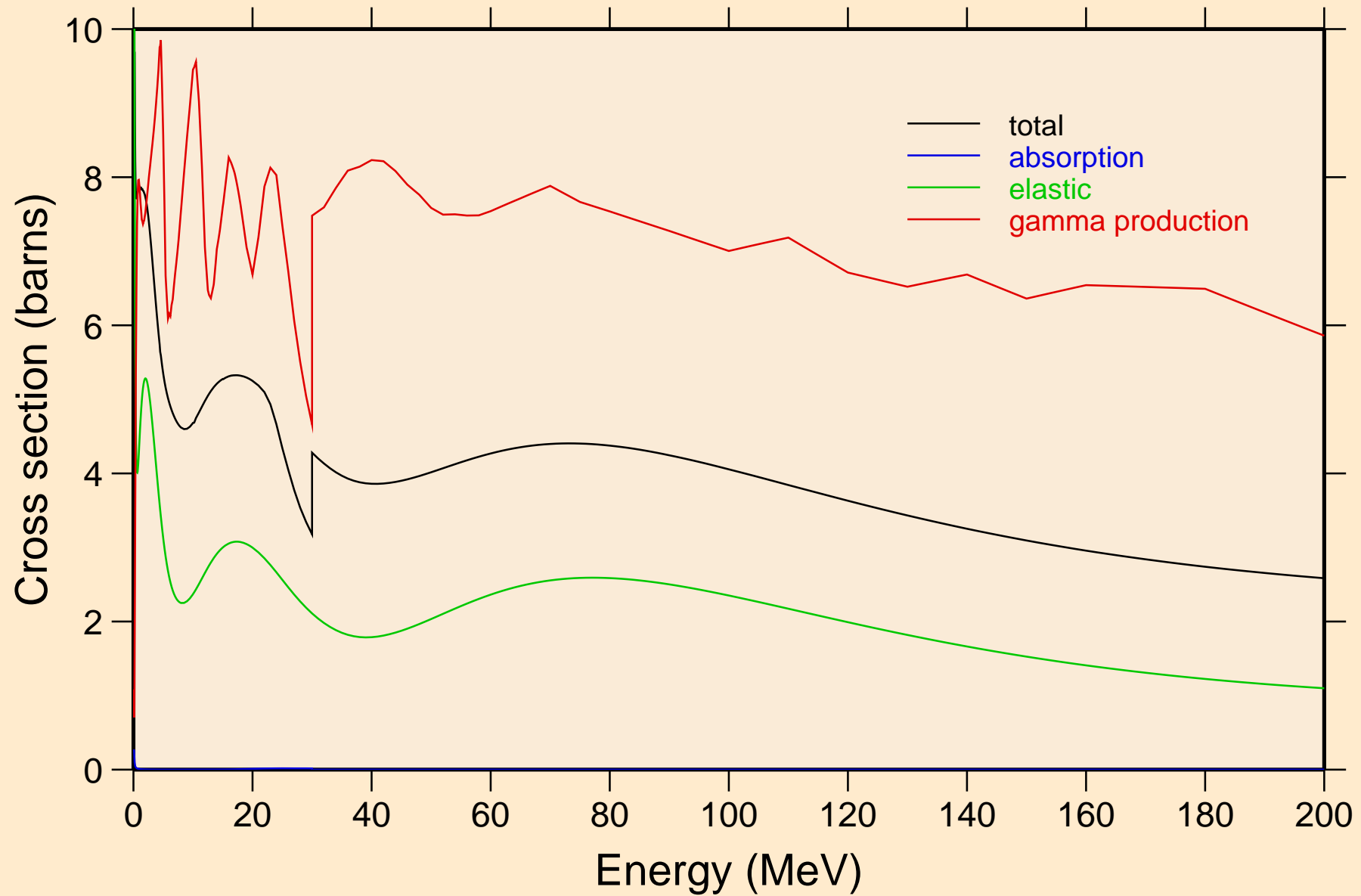

TB170 NRG TENDL-2015, AKONING  
Non-threshold reactions

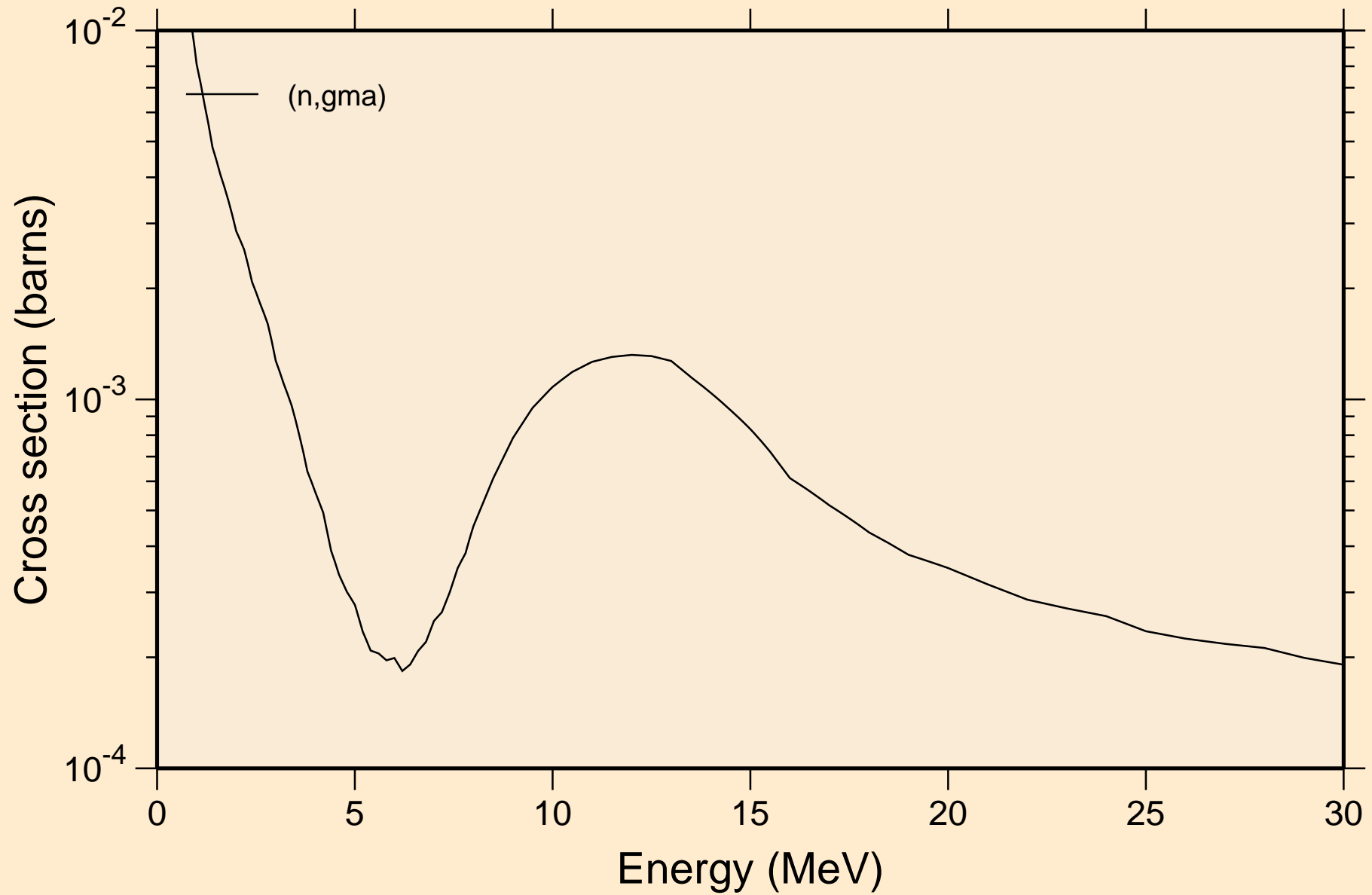

TB170 NRG TENDL-2015, AKONING  
Inelastic levels

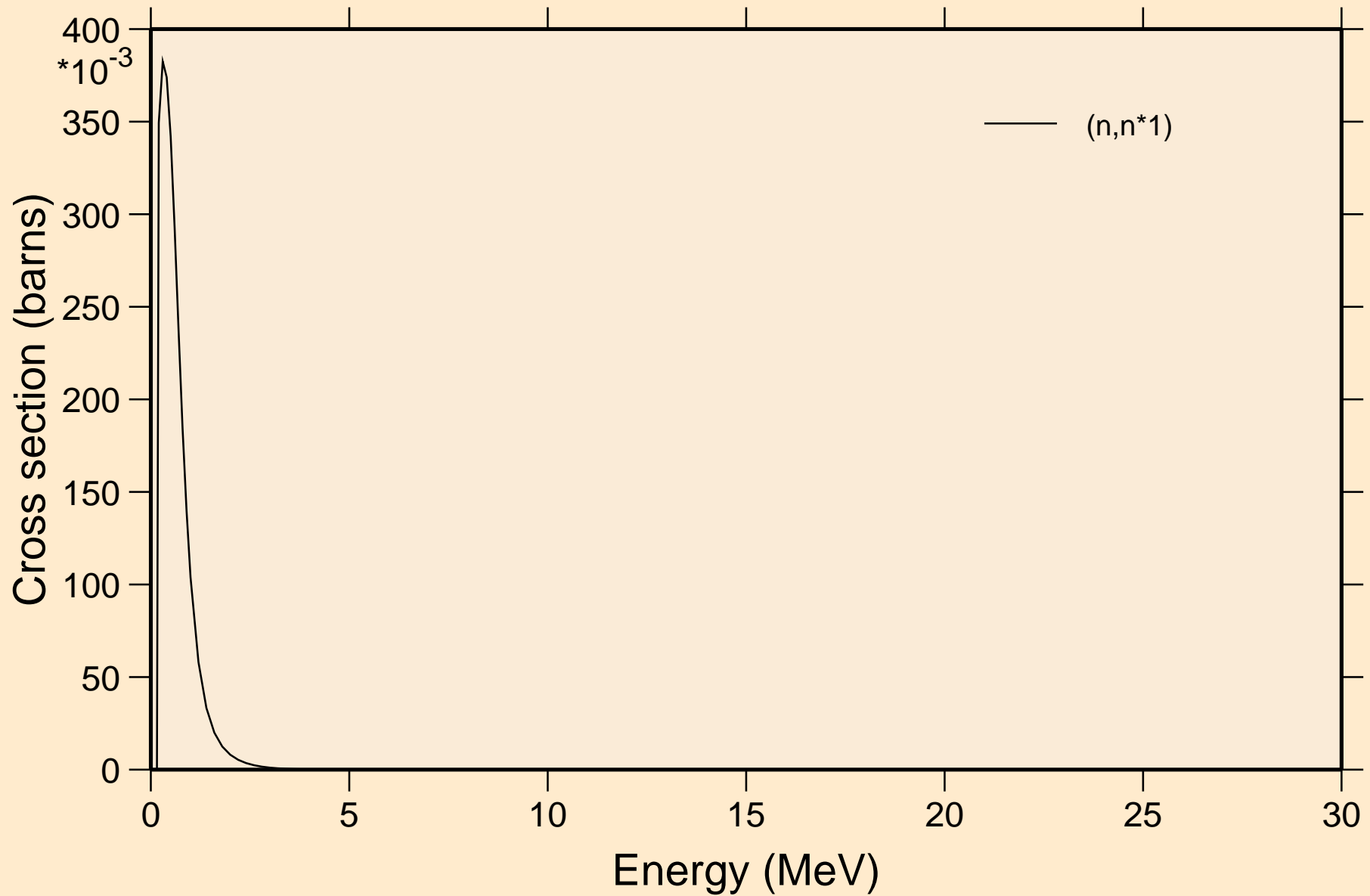

# TB170 NRG TENDL-2015, AKONING

## Threshold reactions

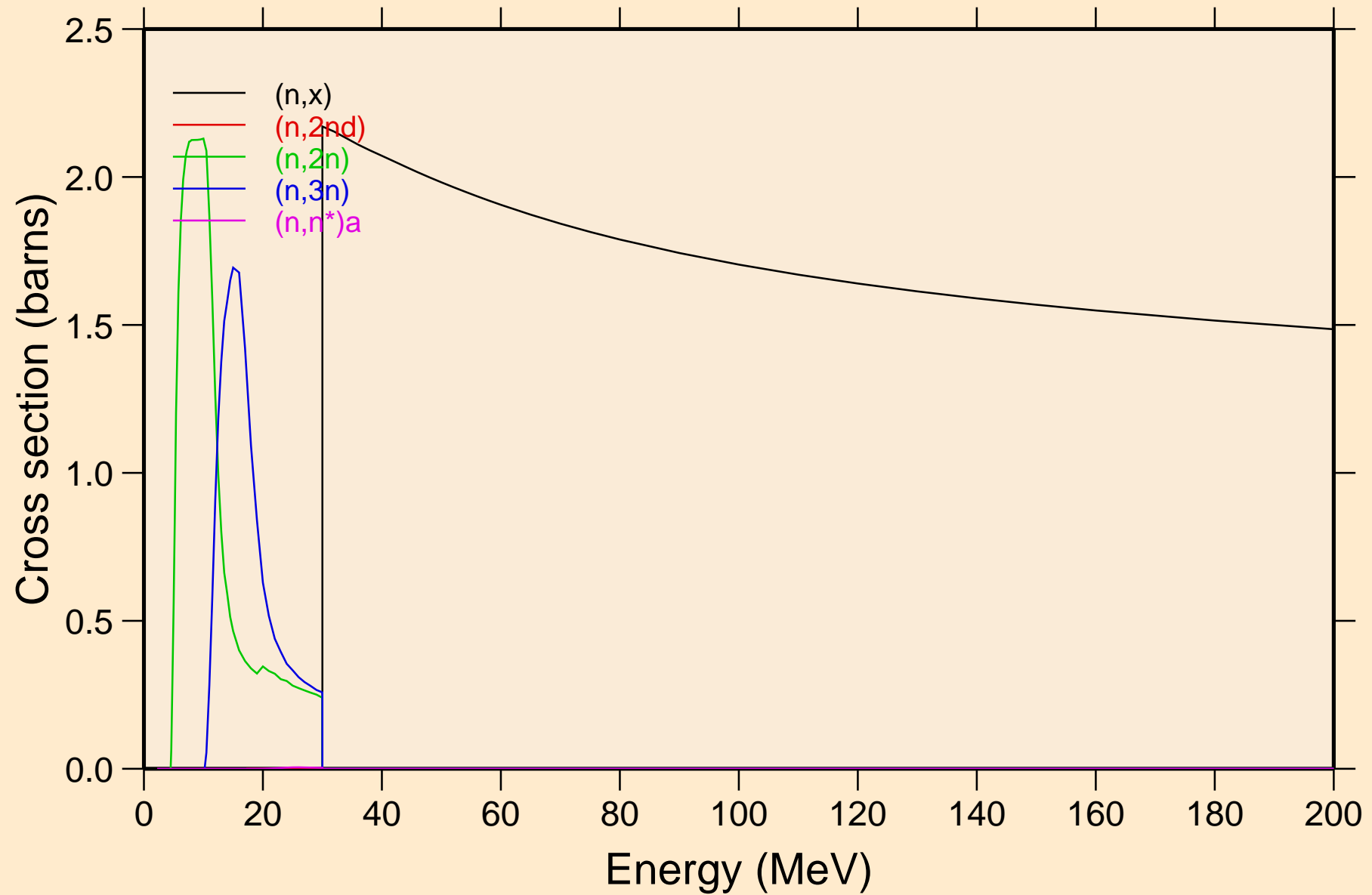

# TB170 NRG TENDL-2015, AKONING

## Threshold reactions

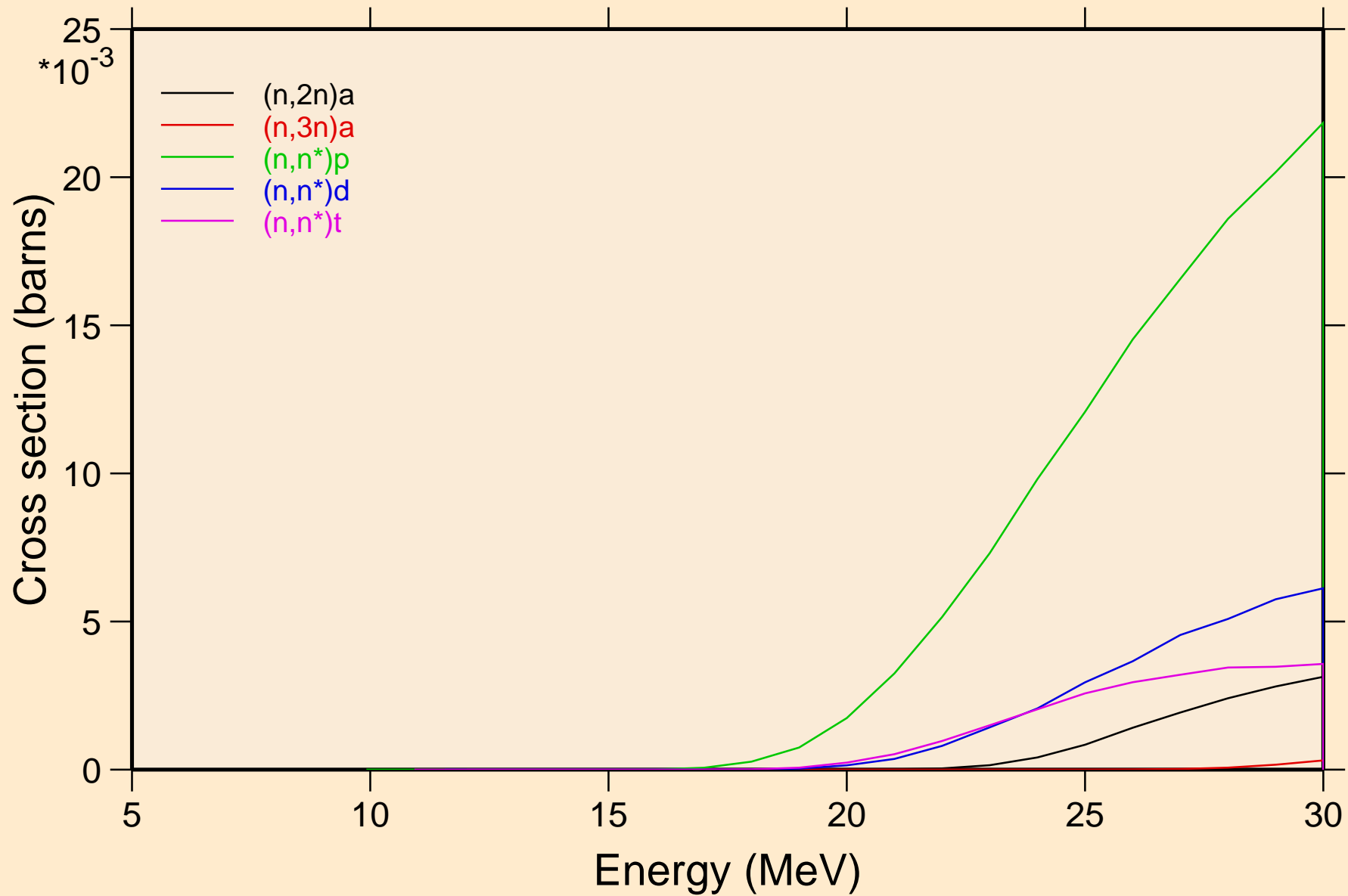

# TB170 NRG TENDL-2015, AKONING

## Threshold reactions

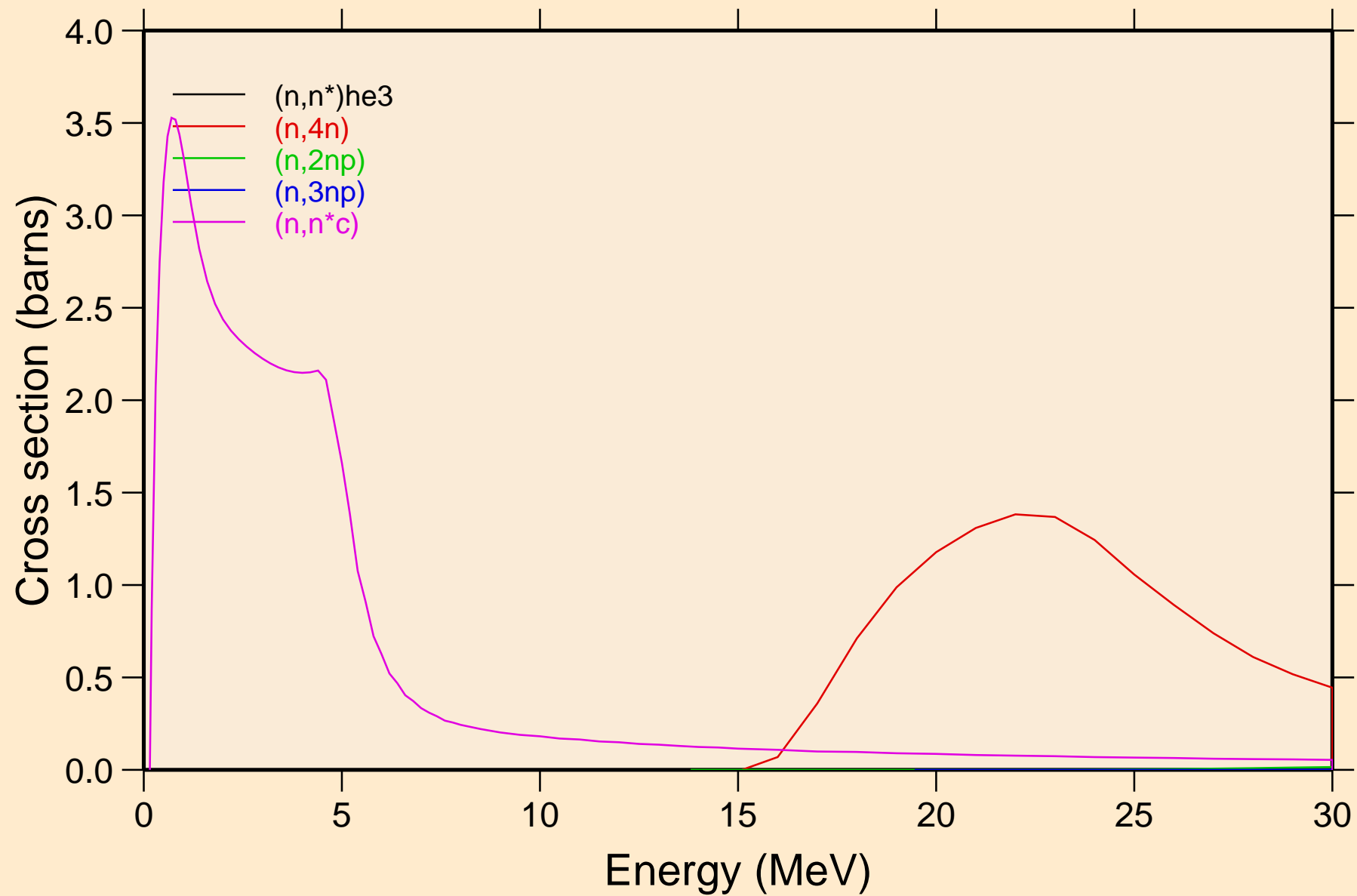



# TB170 NRG TENDL-2015, AKONING

## Threshold reactions

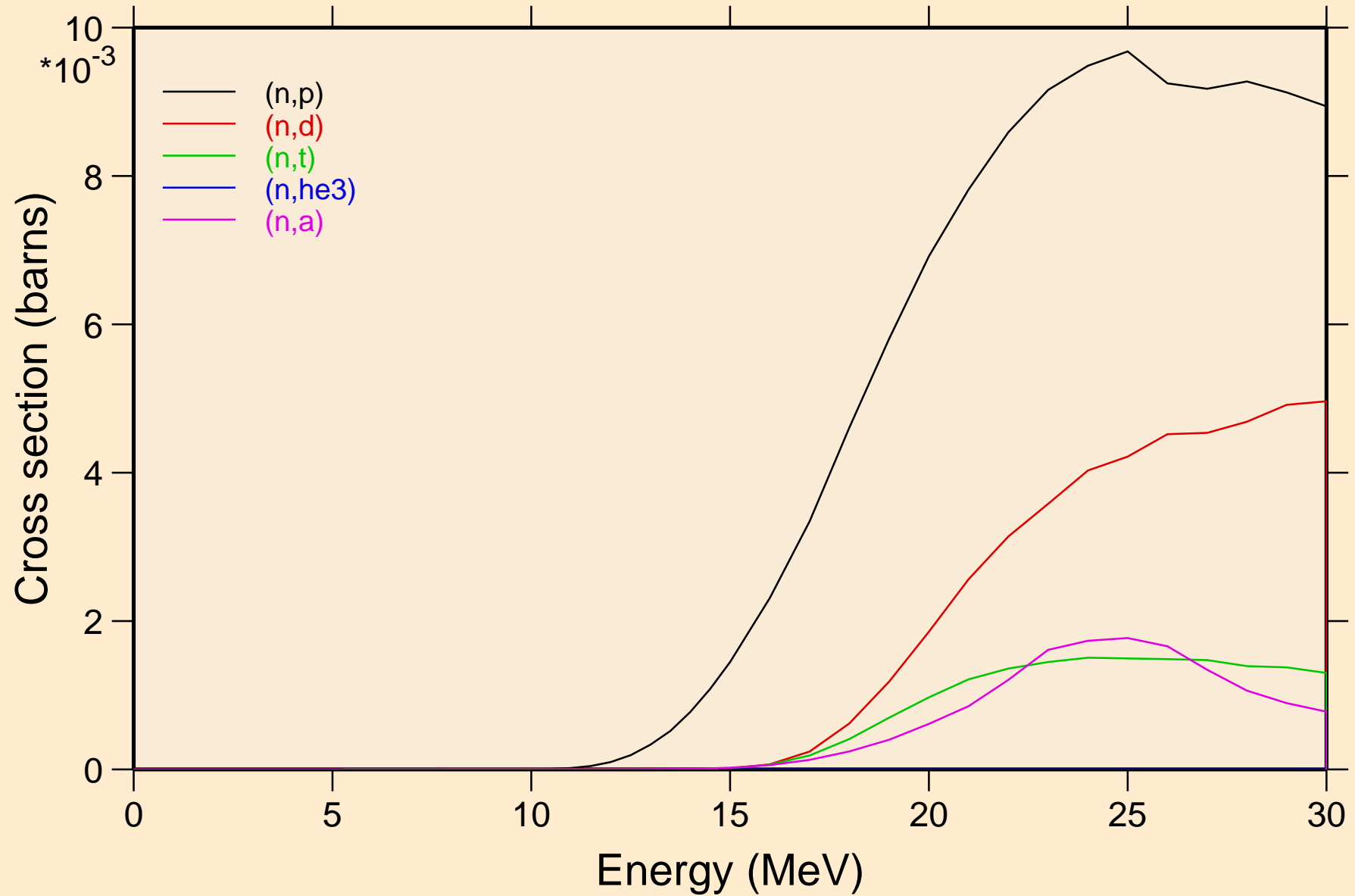

TB170 NRG TENDL-2015, AKONING  
angular distribution for elastic

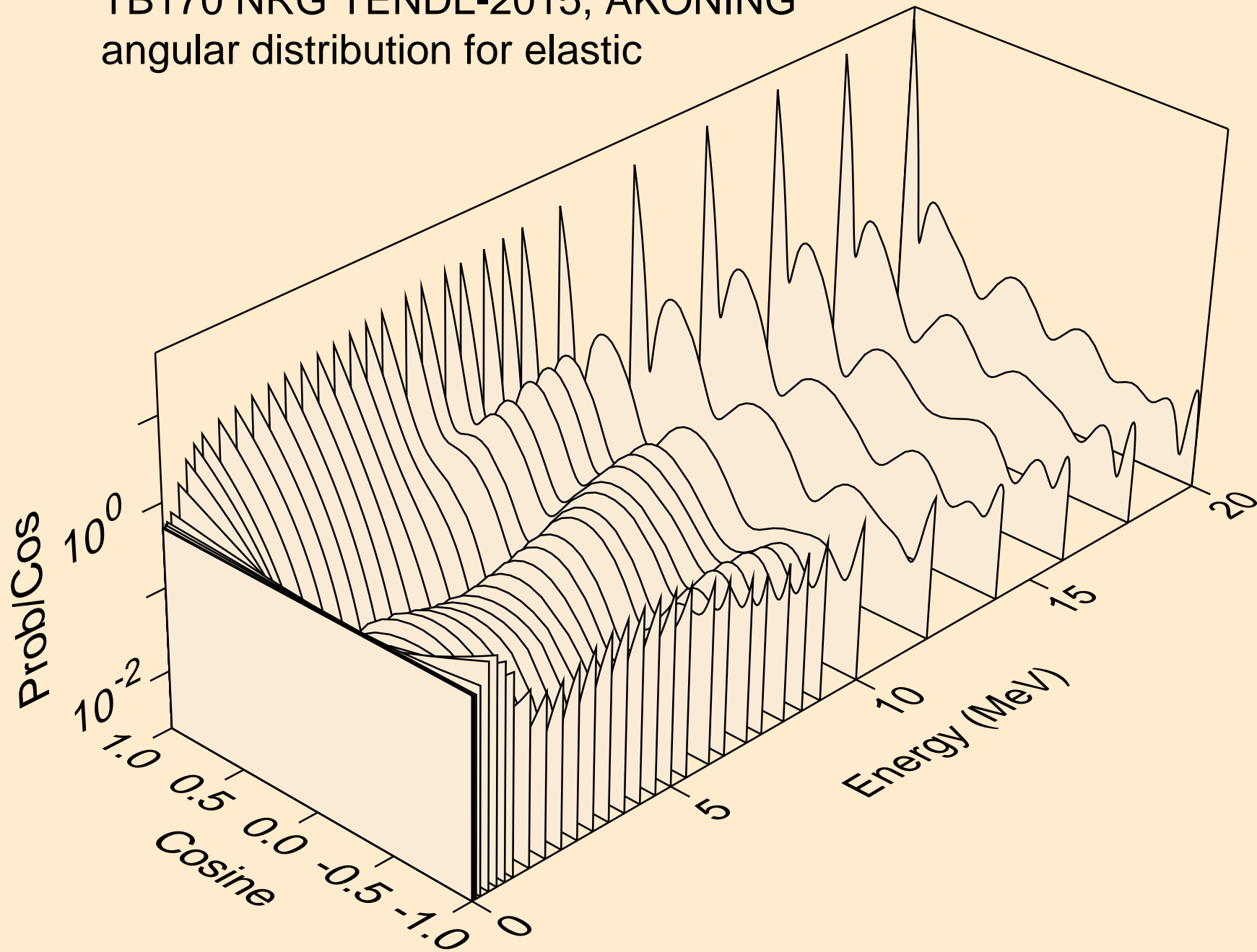

TB170 NRG TENDL-2015, AKONING  
angular distribution for elastic

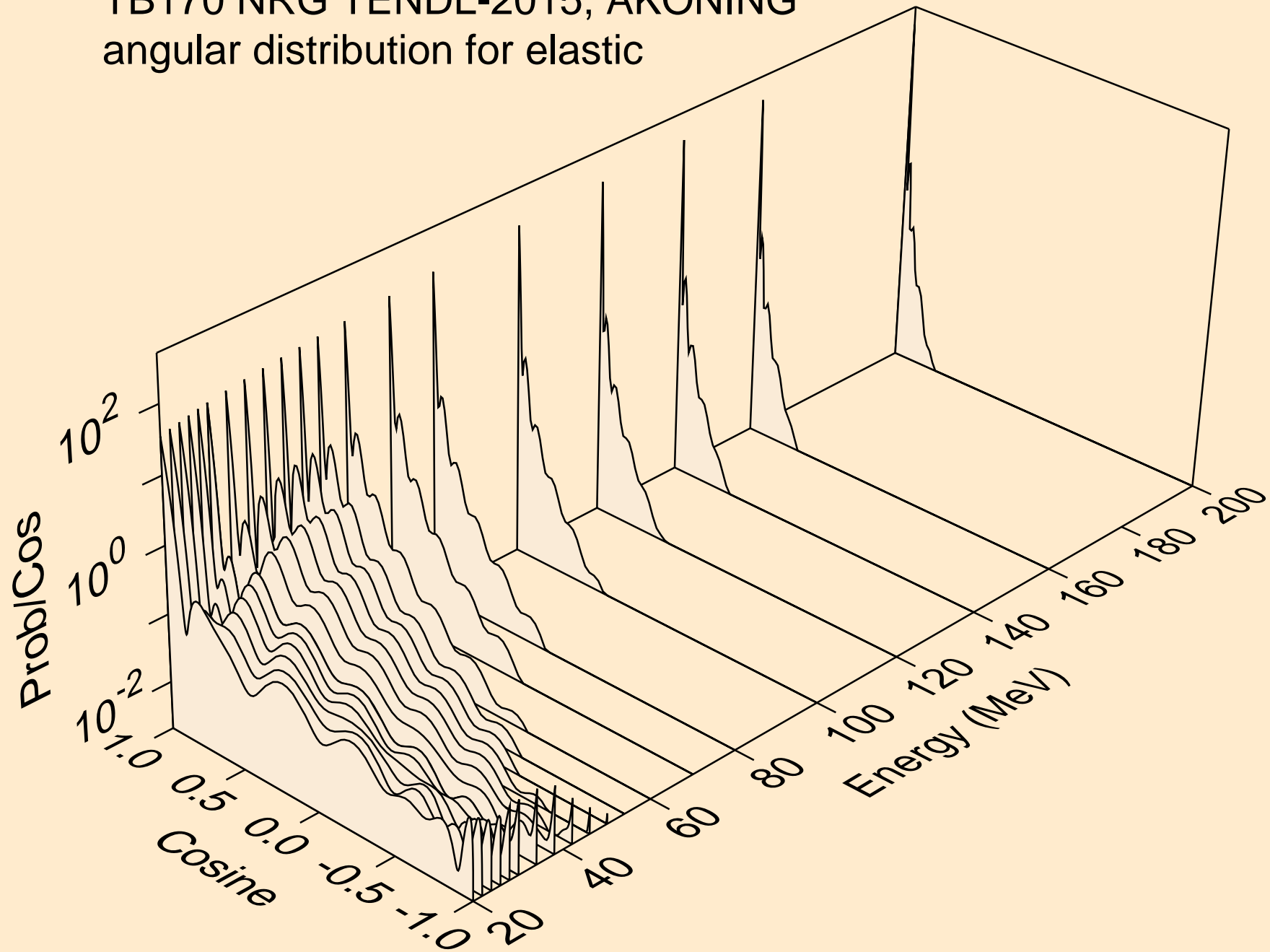

TB170 NRG TENDL-2015, AKONING  
angular distribution for (n,n\*1)

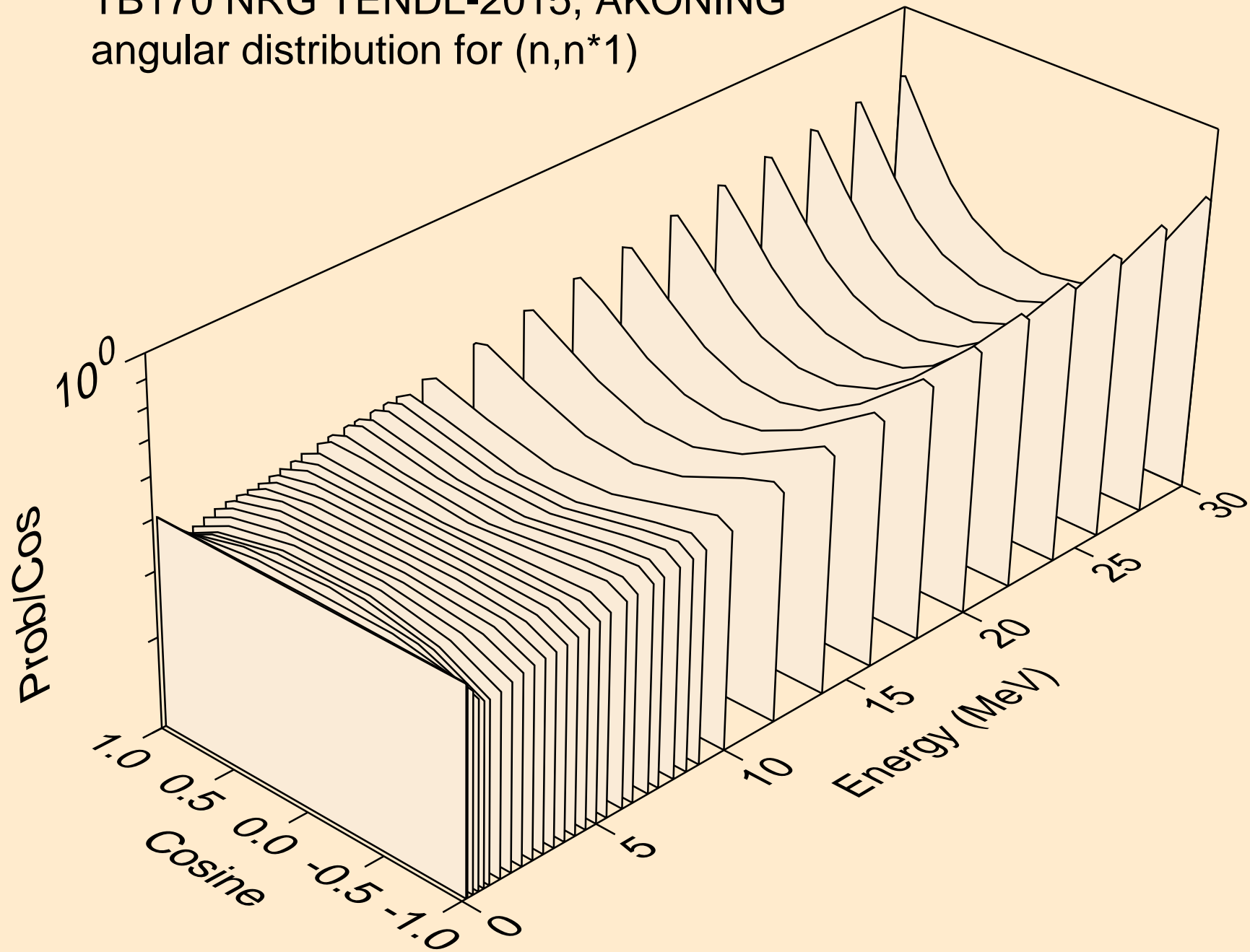

TB170 NRG TENDL-2015, AKONING  
Neutron emission for (n,x)

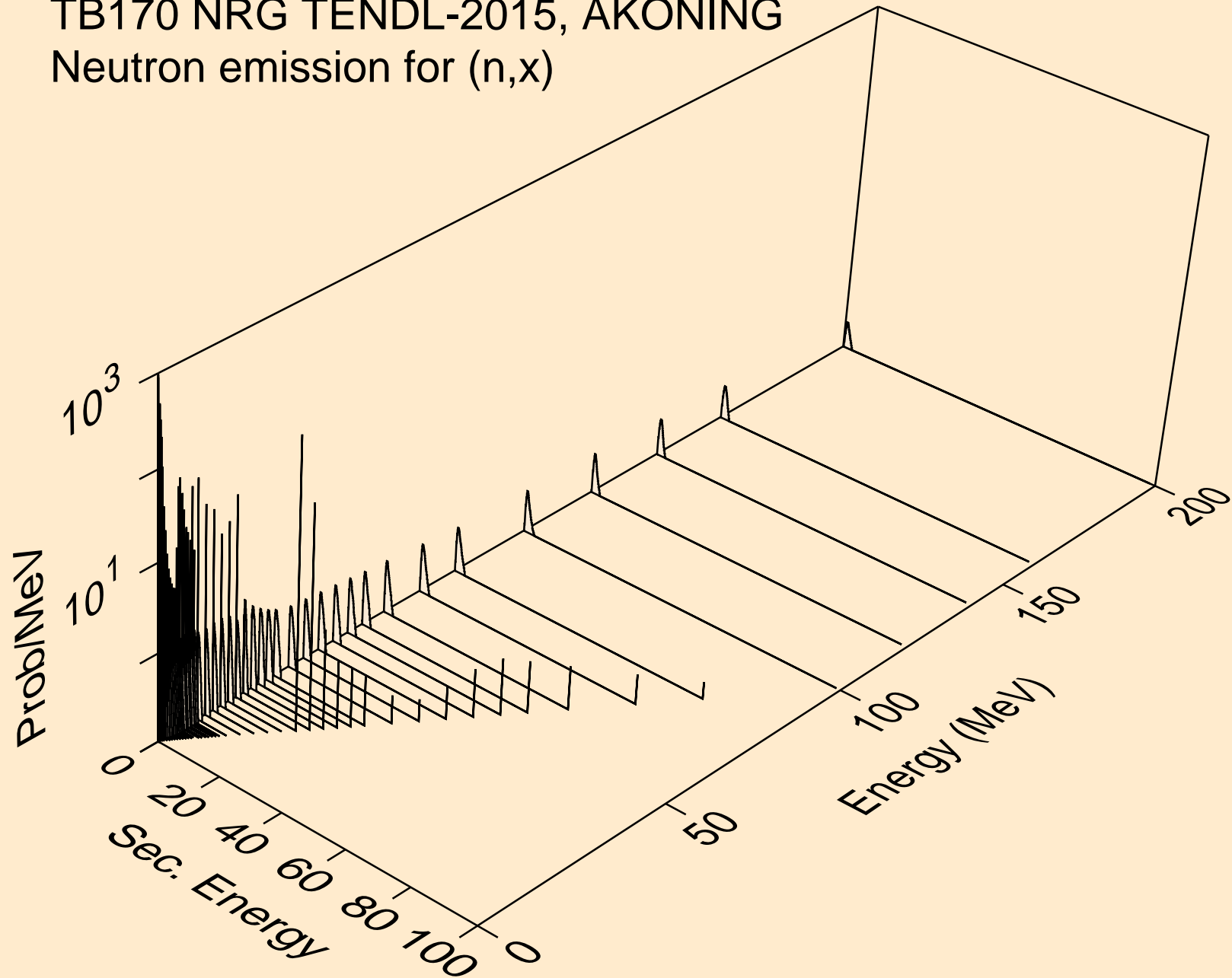

TB170 NRG TENDL-2015, AKONING  
Neutron emission for (n,2nd)

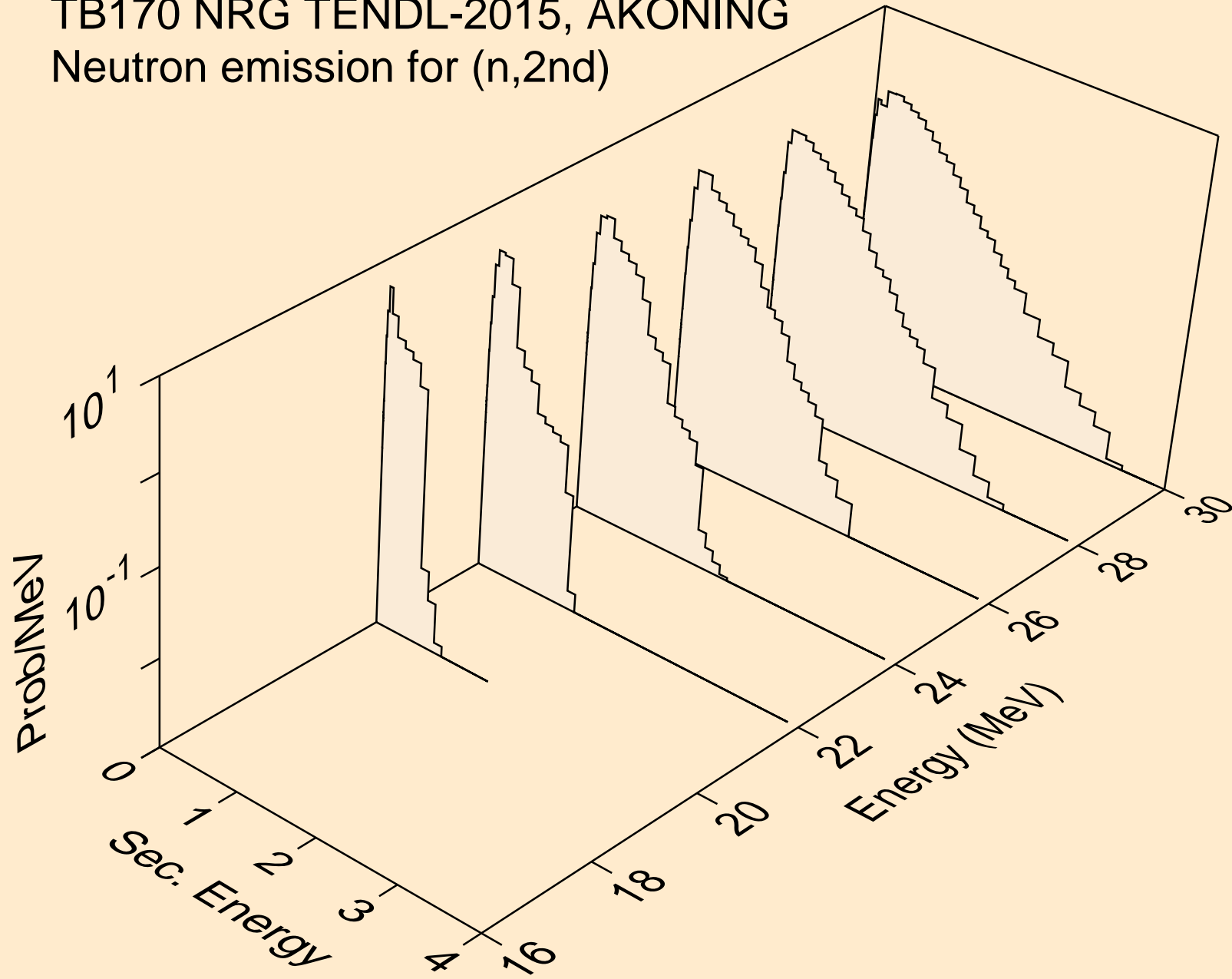

TB170 NRG TENDL-2015, AKONING  
Neutron emission for (n,2n)

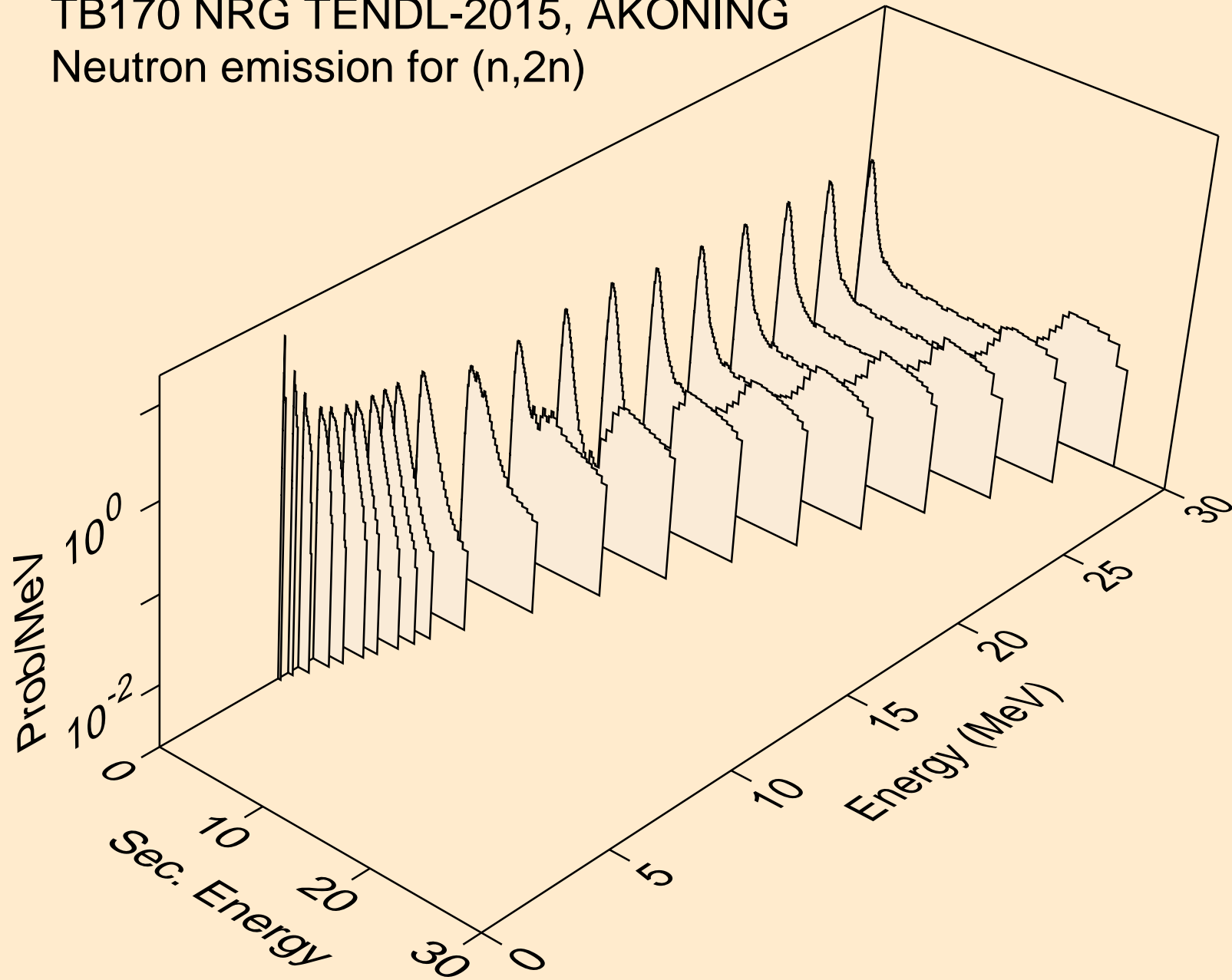

TB170 NRG TENDL-2015, AKONING  
Neutron emission for (n,3n)

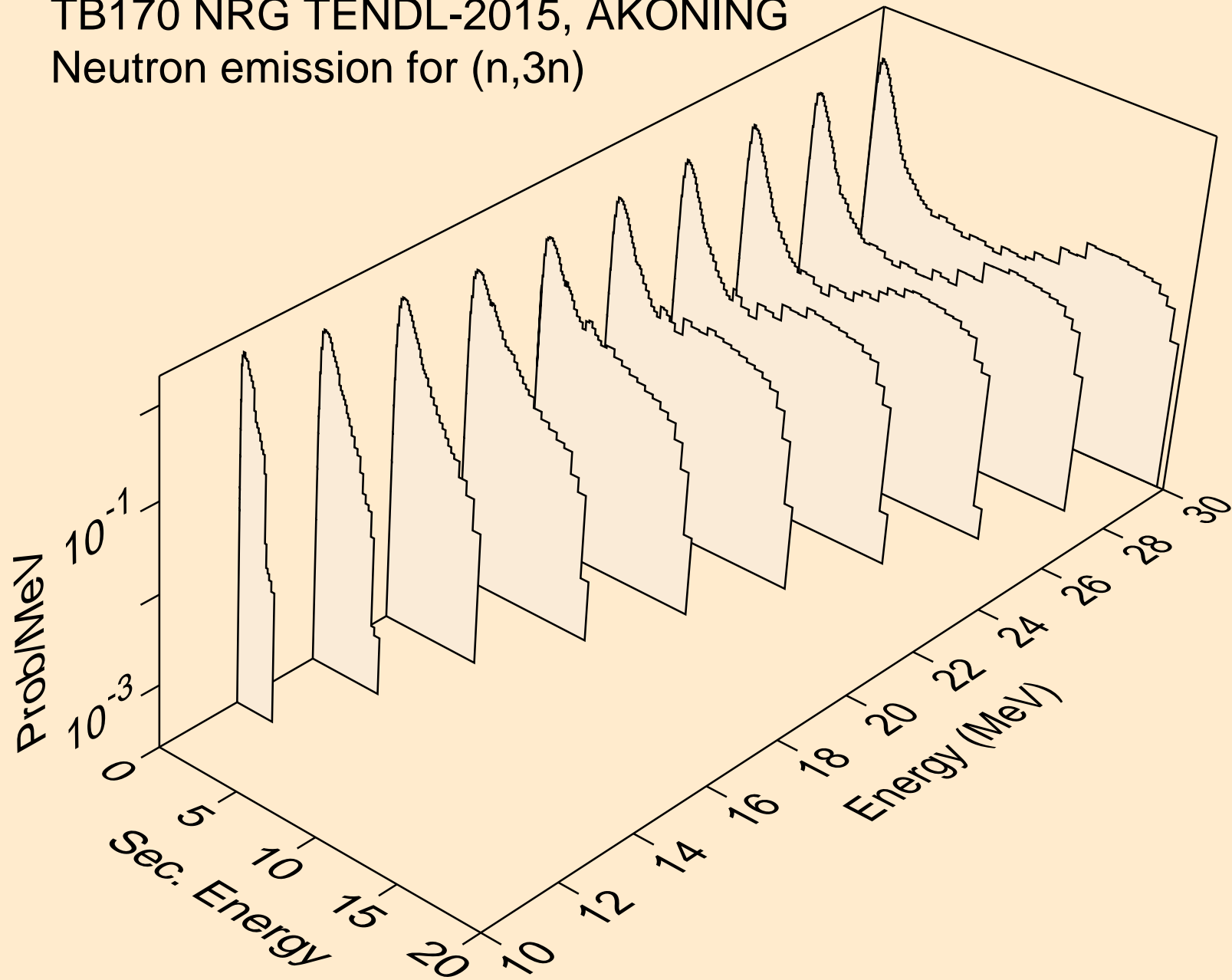



TB170 NRG TENDL-2015, AKONING  
Neutron emission for (n,n\*)a

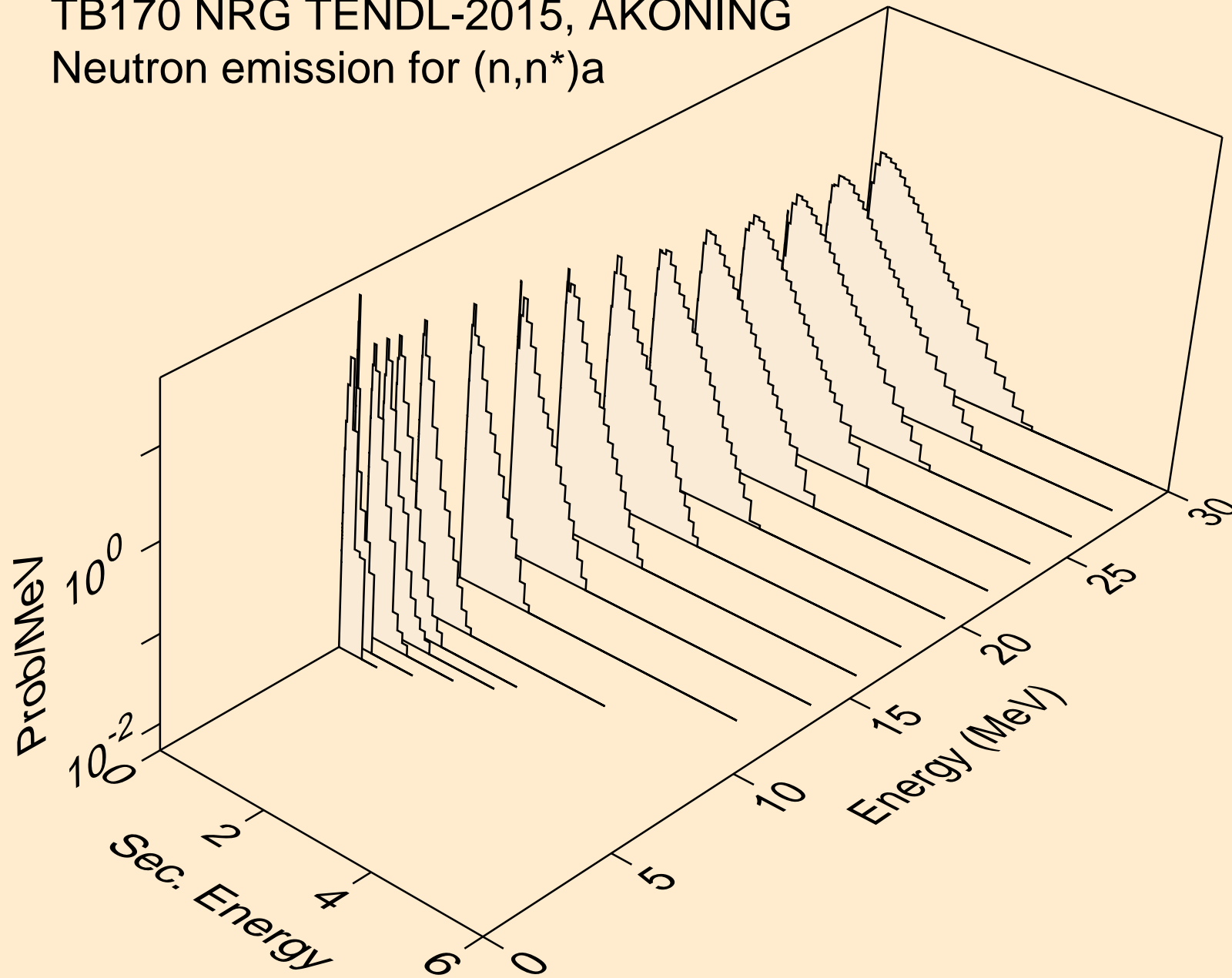

TB170 NRG TENDL-2015, AKONING  
Neutron emission for (n,2n)a

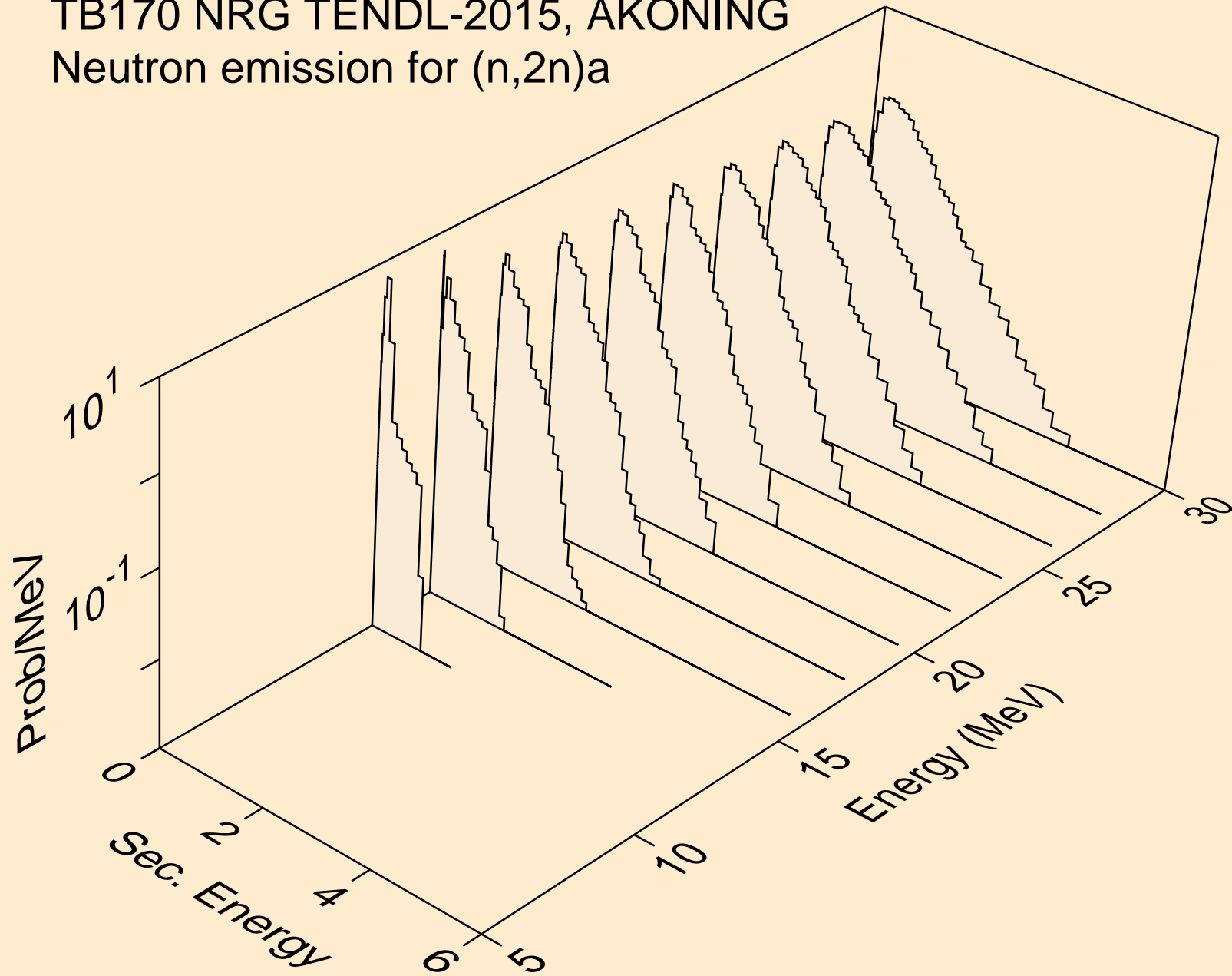

TB170 NRG TENDL-2015, AKONING  
Neutron emission for (n,3n)a

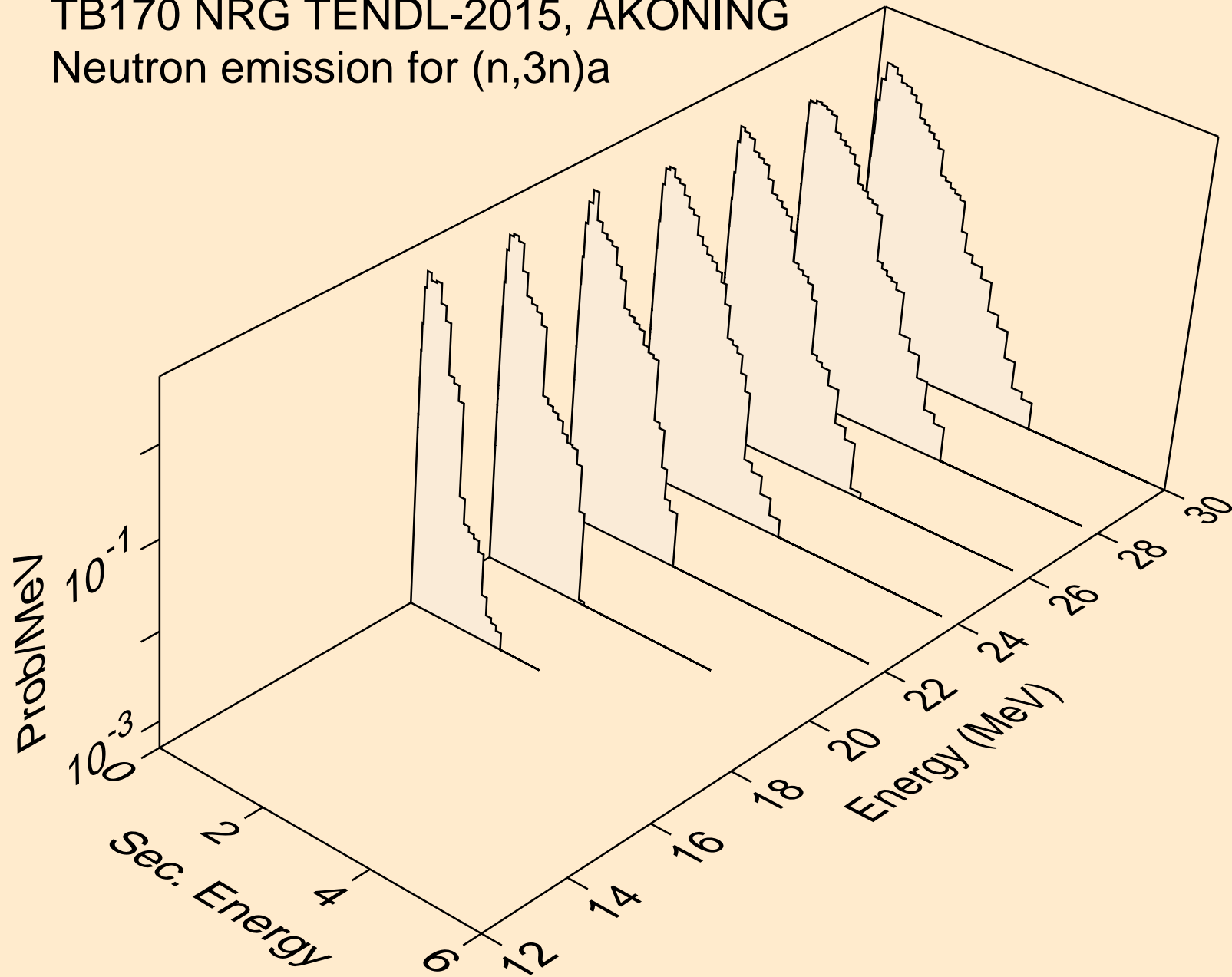

TB170 NRG TENDL-2015, AKONING  
Neutron emission for (n,n\*)p

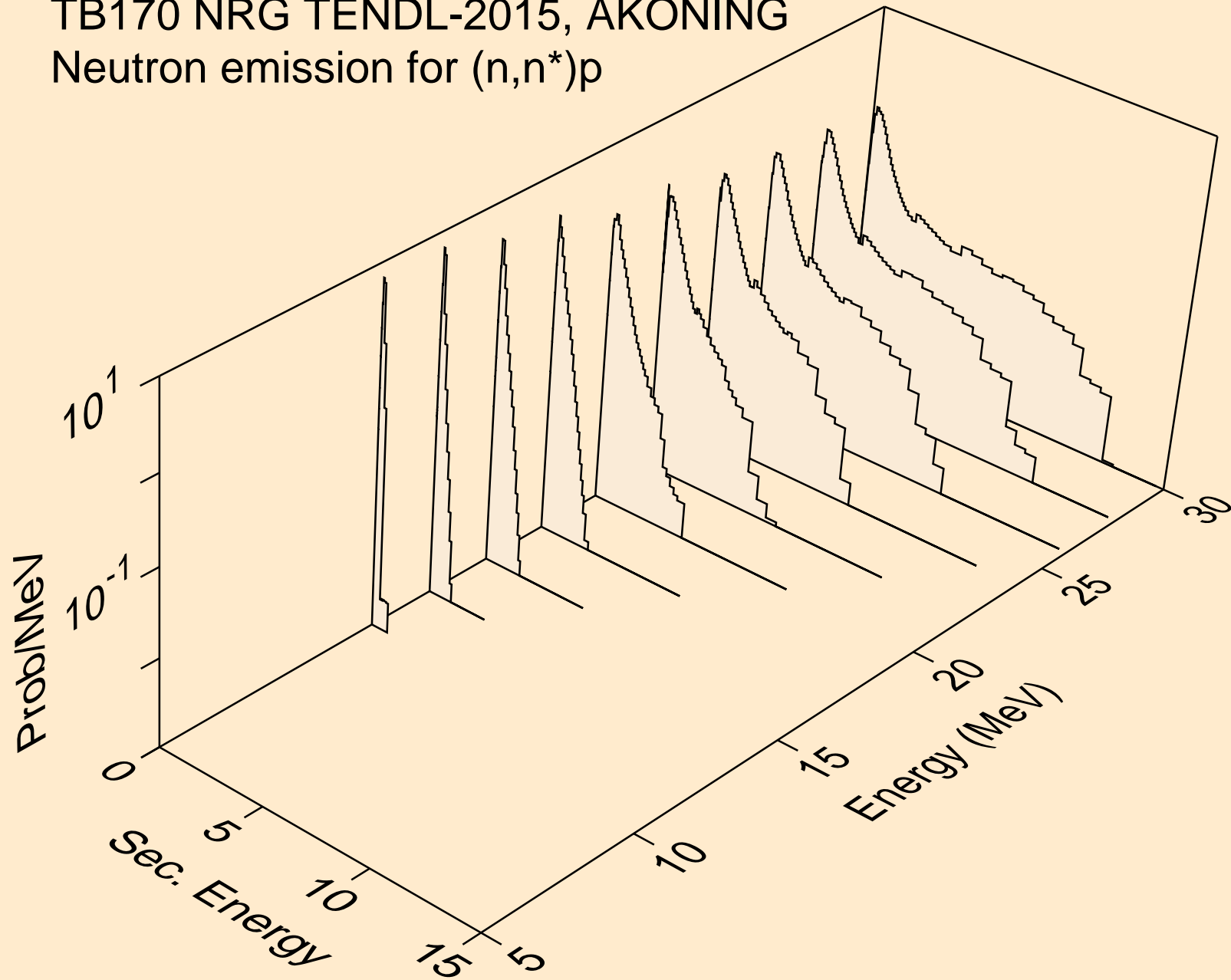

TB170 NRG TENDL-2015, AKONING  
Neutron emission for (n,n\*)d

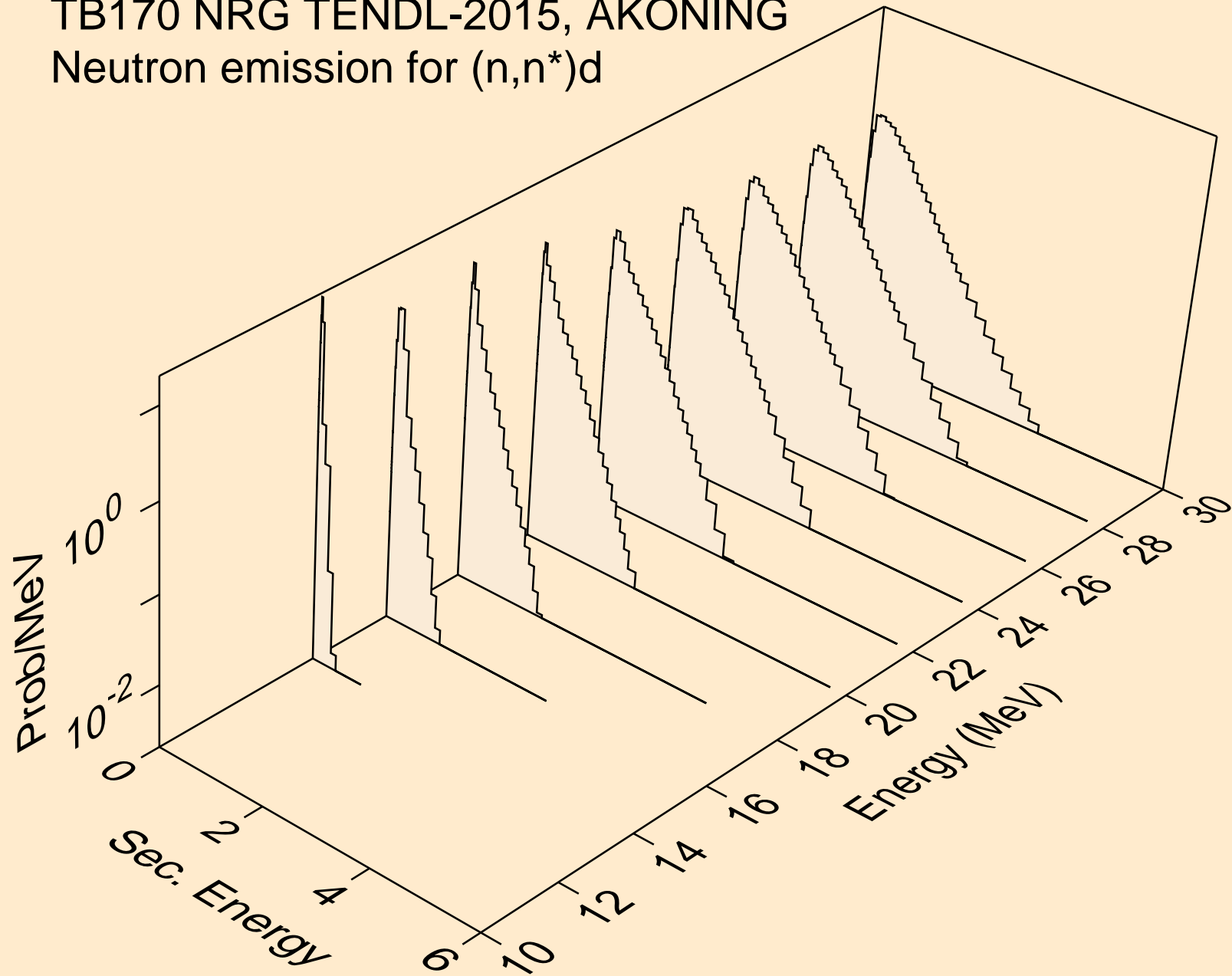

TB170 NRG TENDL-2015, AKONING  
Neutron emission for (n,n\*)t

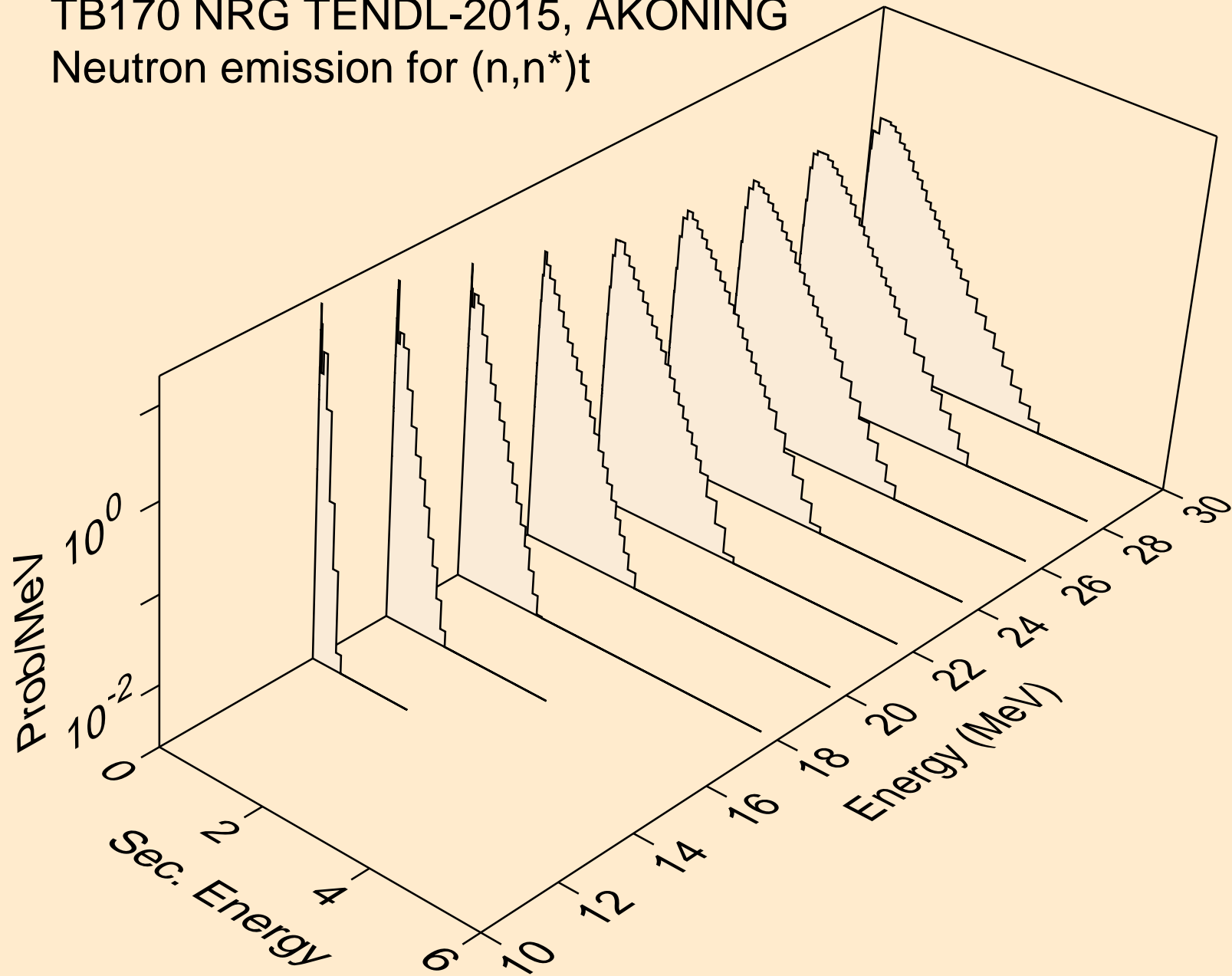

TB170 NRG TENDL-2015, AKONING  
Neutron emission for (n,n\*)he3

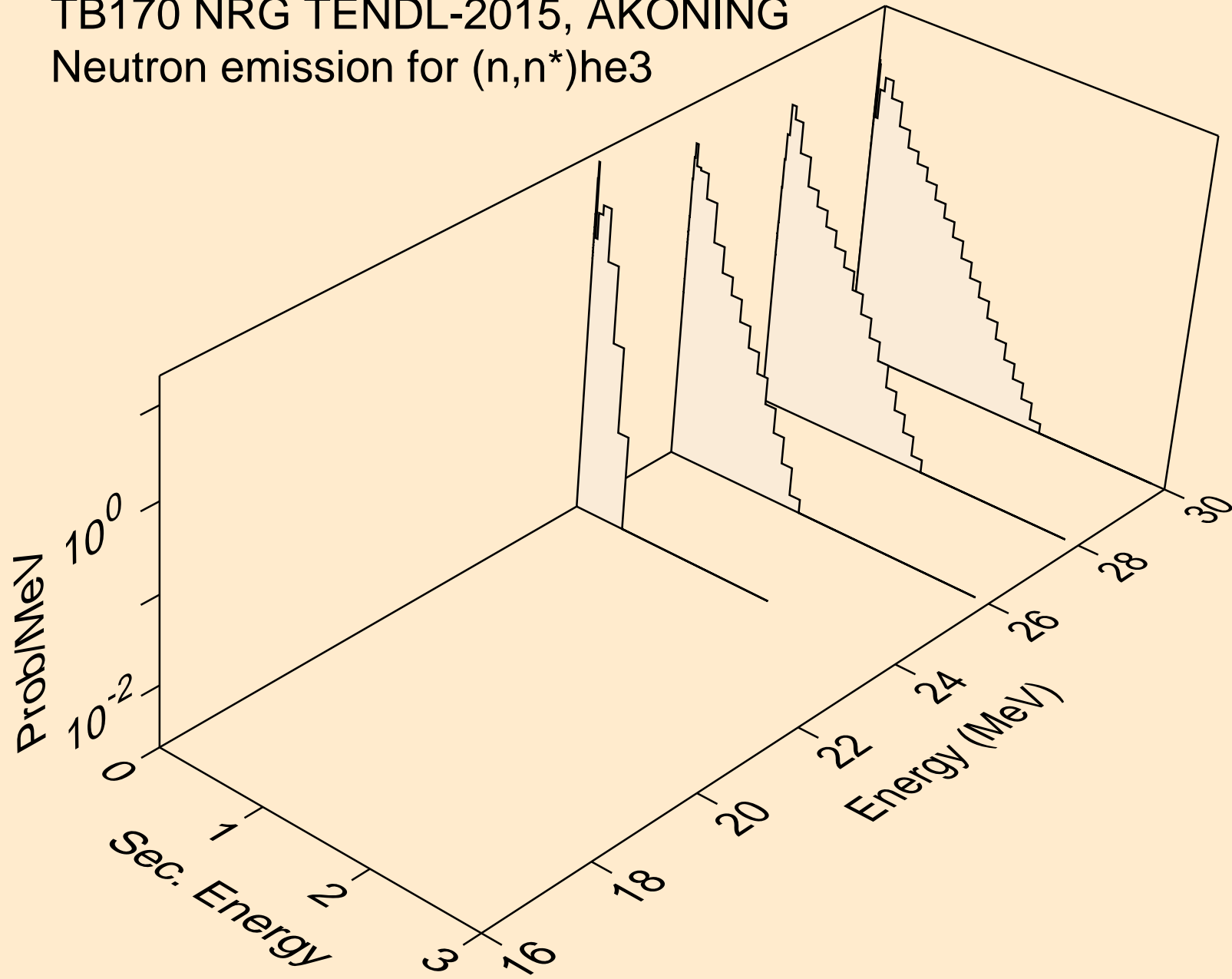

TB170 NRG TENDL-2015, AKONING  
Neutron emission for (n,4n)

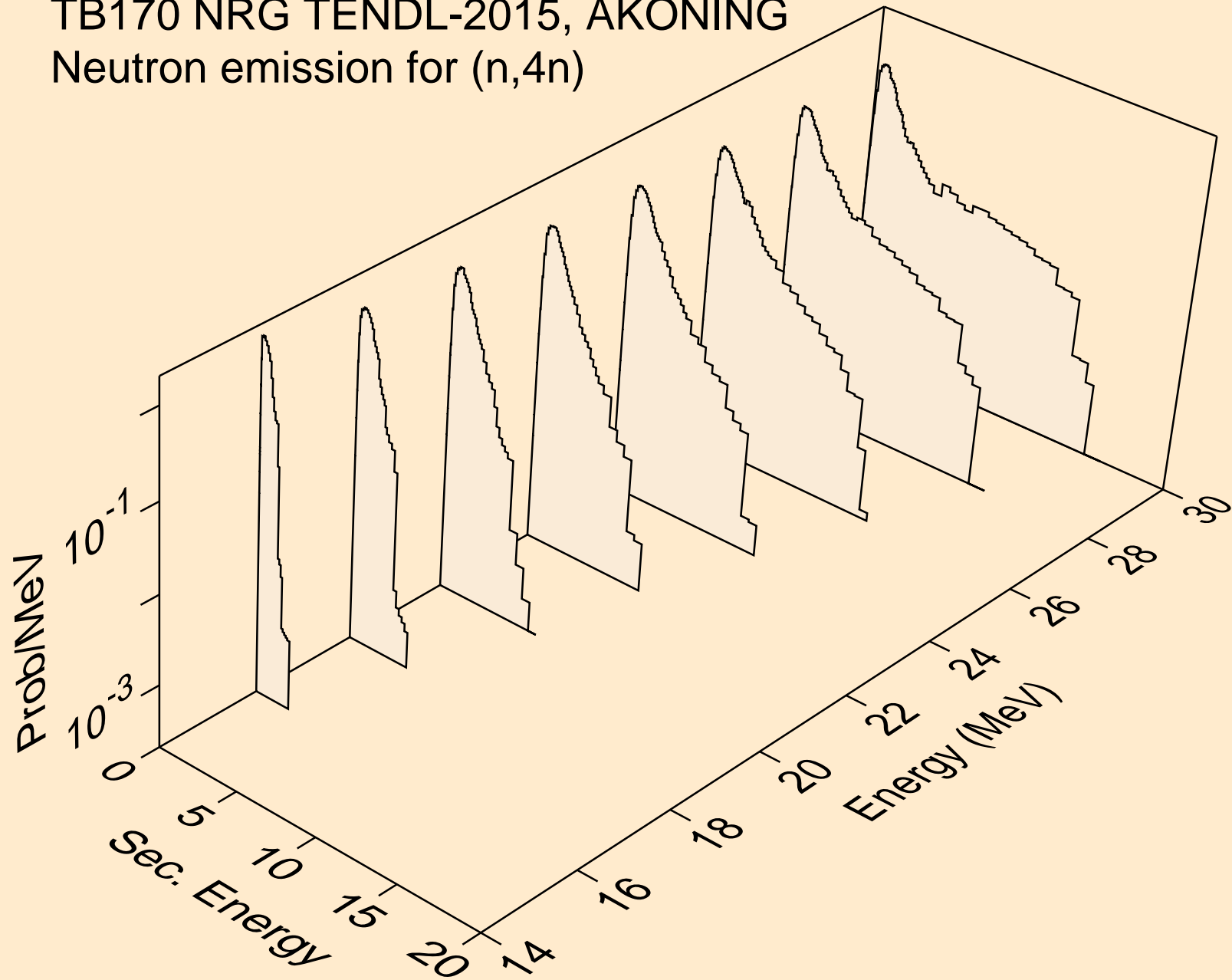



TB170 NRG TENDL-2015, AKONING  
Neutron emission for (n,2np)

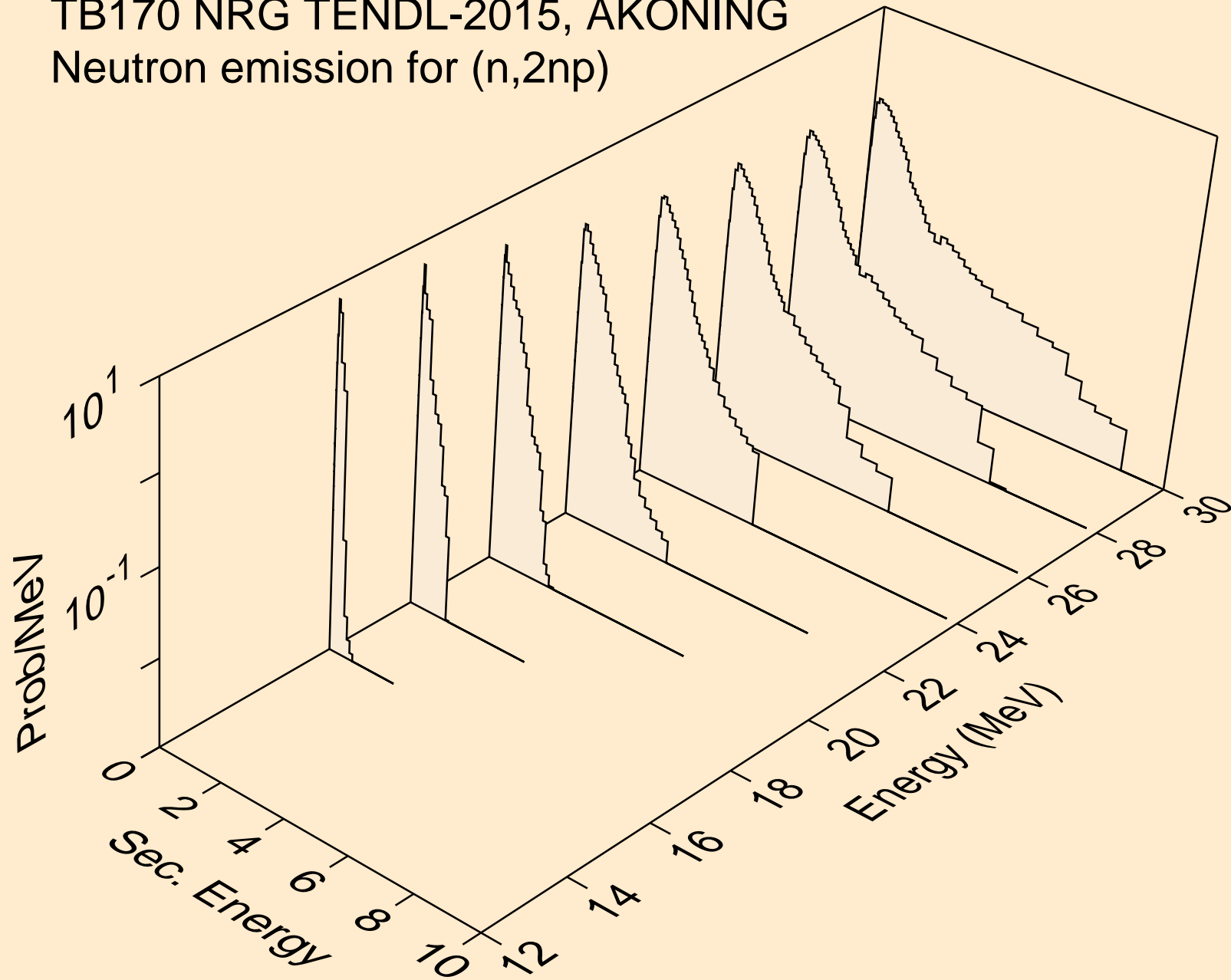

TB170 NRG TENDL-2015, AKONING  
Neutron emission for (n,3np)

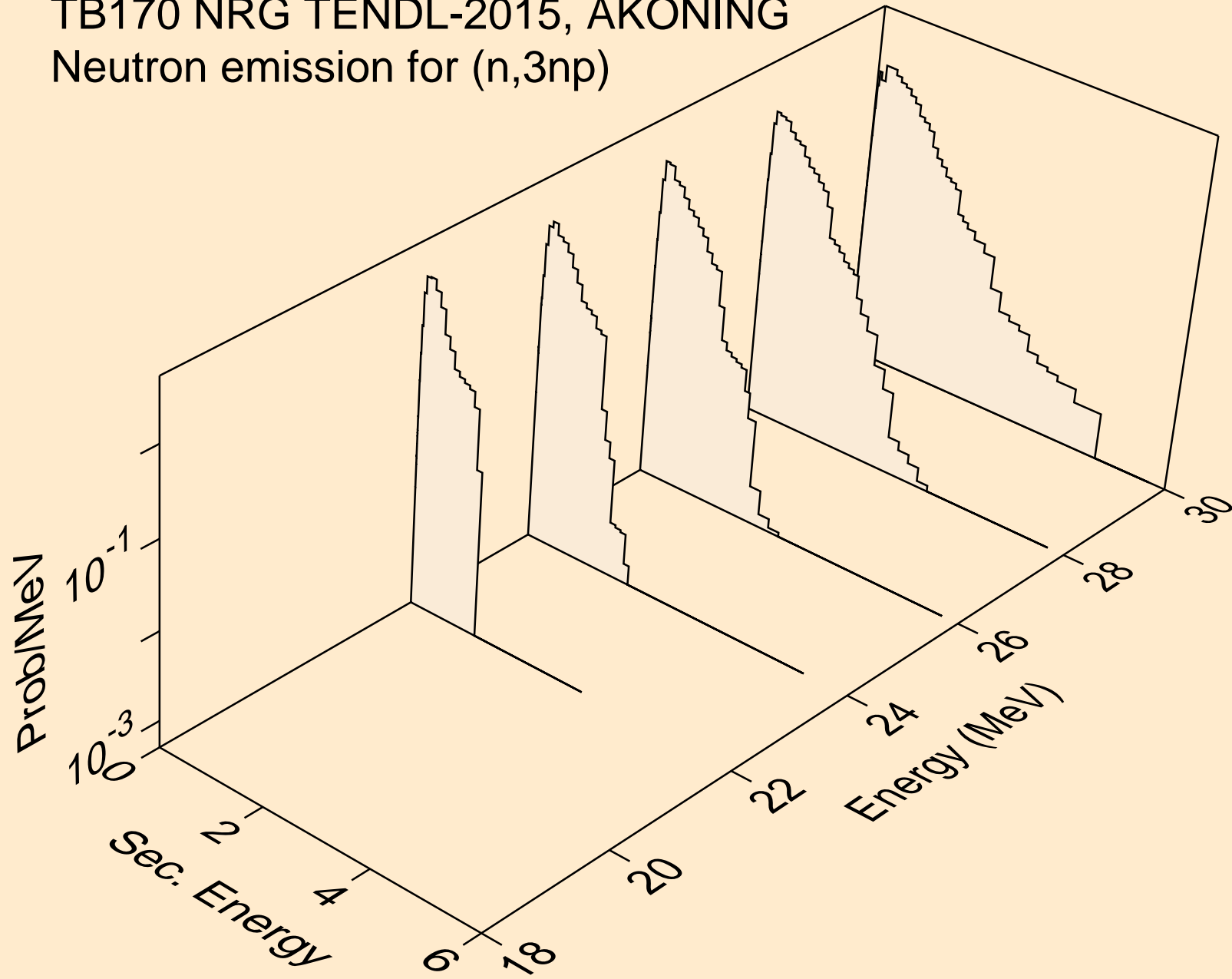

TB170 NRG TENDL-2015, AKONING  
Neutron emission for (n,n\*c)

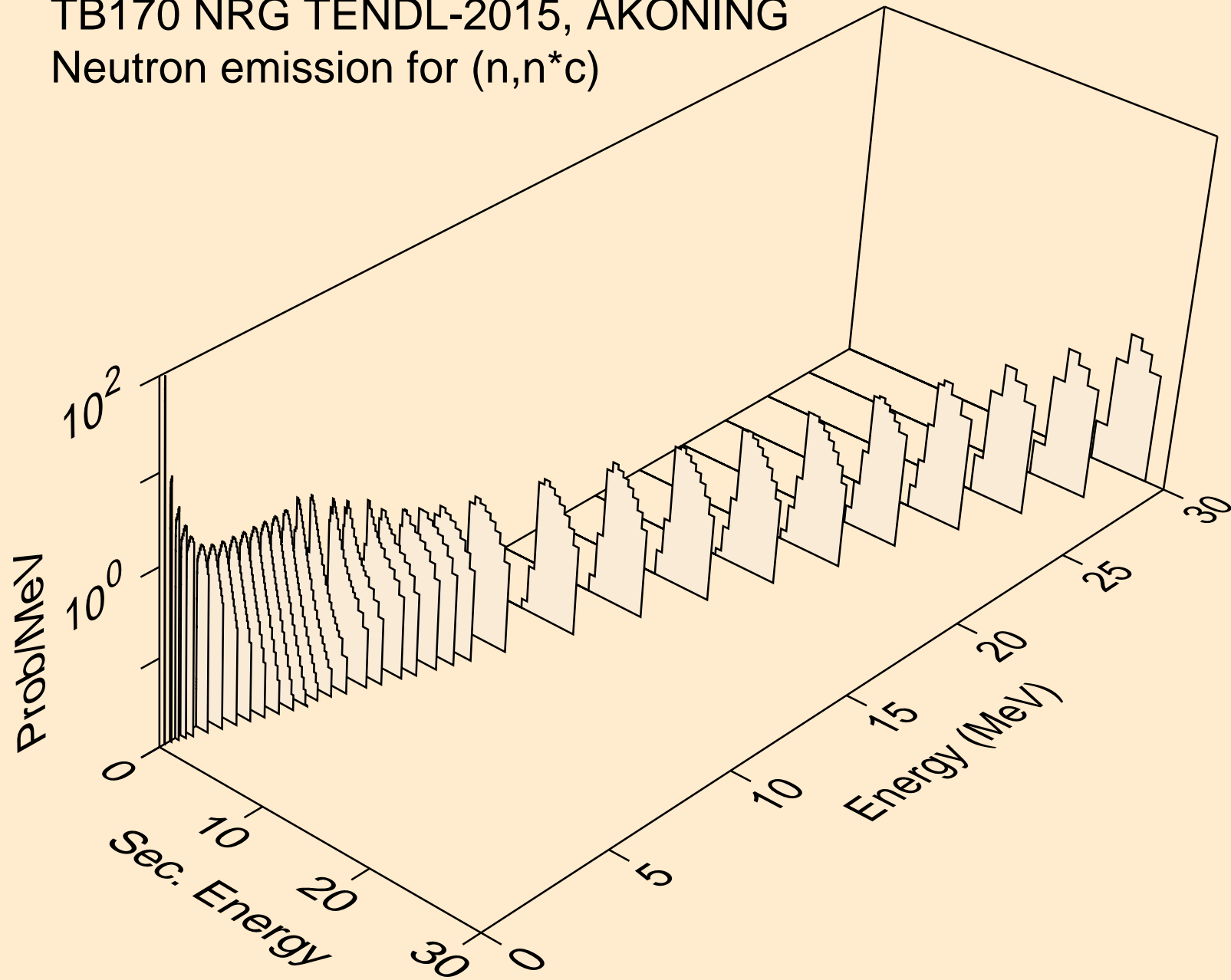

TB170 NRG TENDL-2015, AKONING  
Photon emission for (n,x)

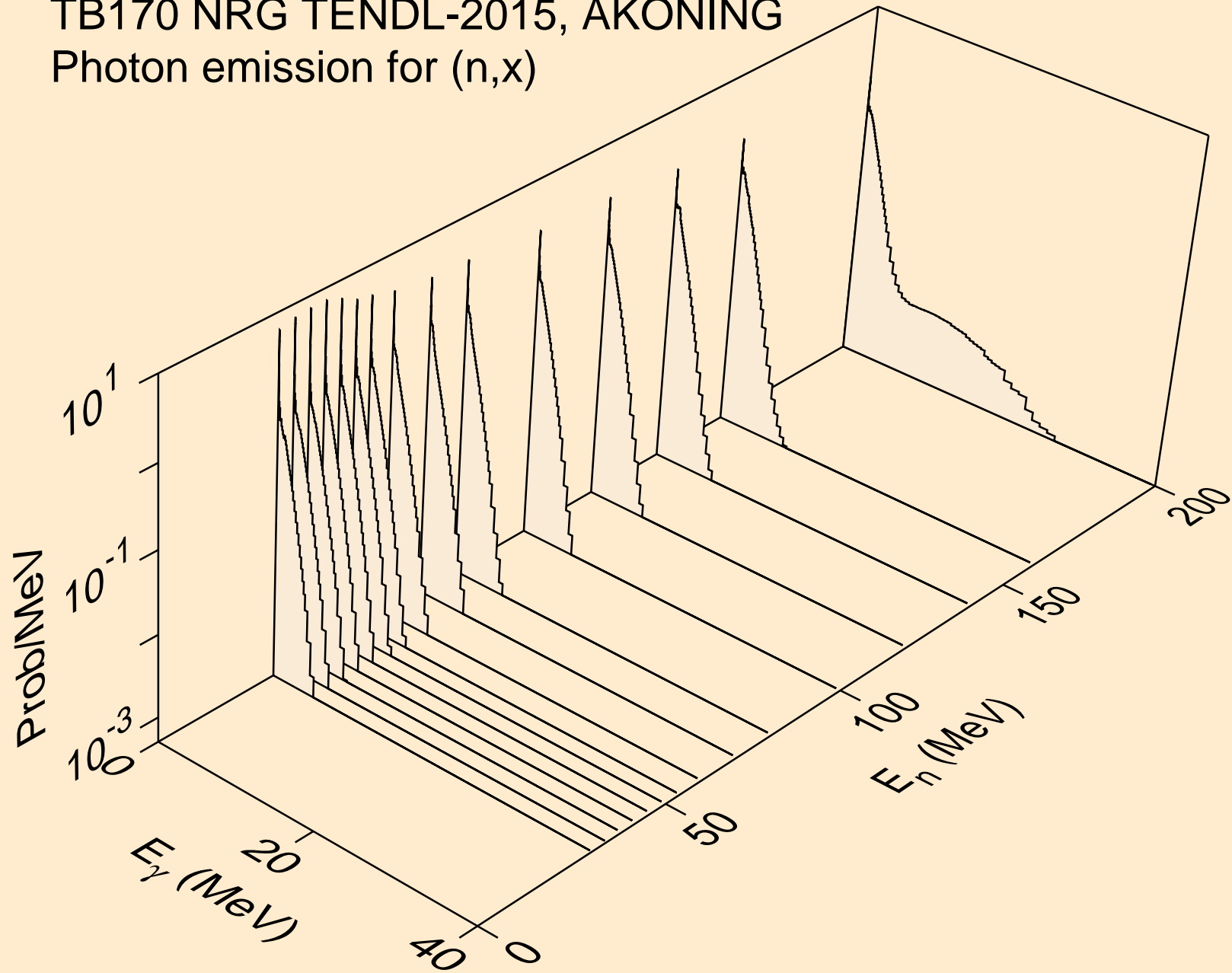

TB170 NRG TENDL-2015, AKONING  
Photon emission for (n,2nd)

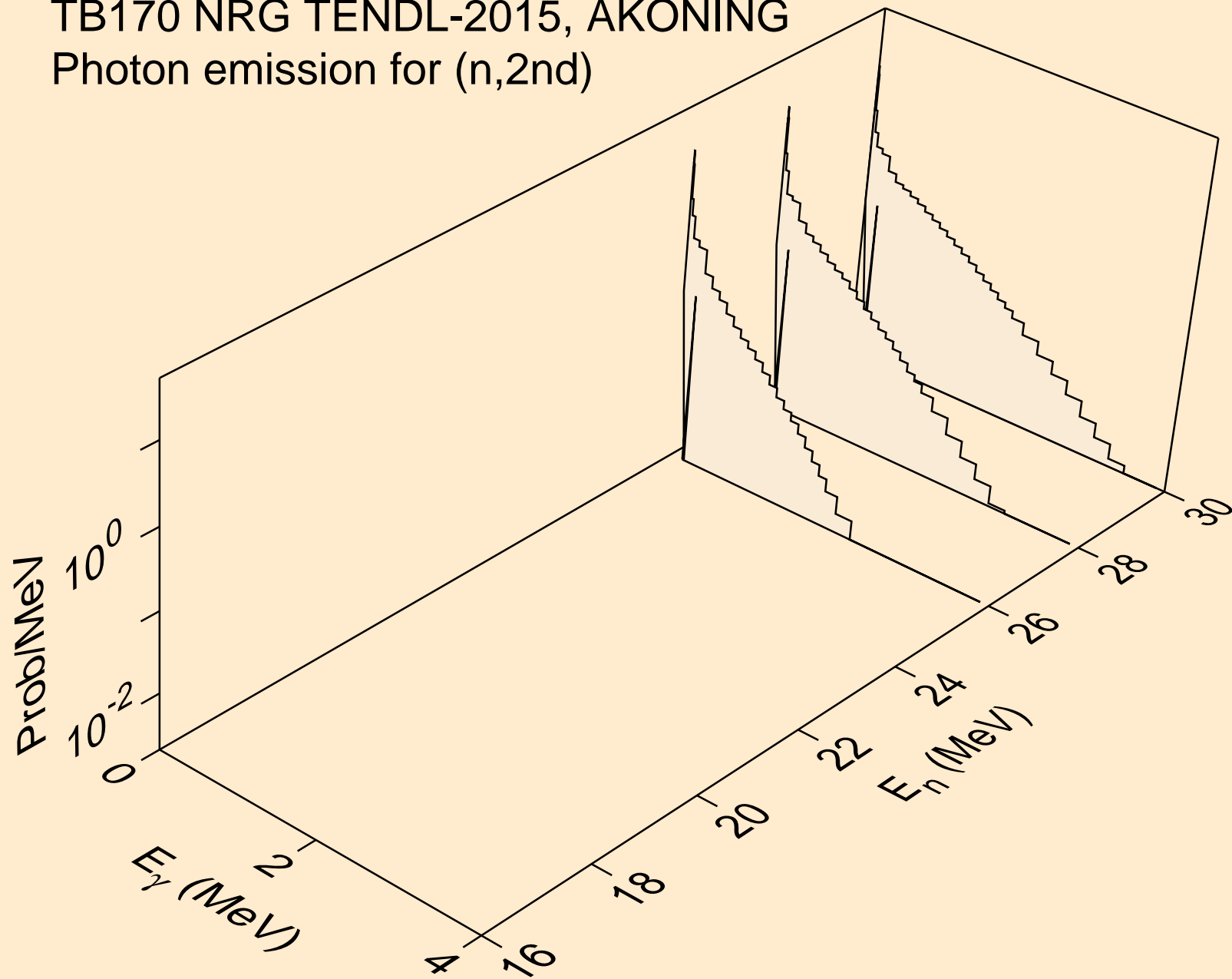

TB170 NRG TENDL-2015, AKONING  
Photon emission for (n,2n)

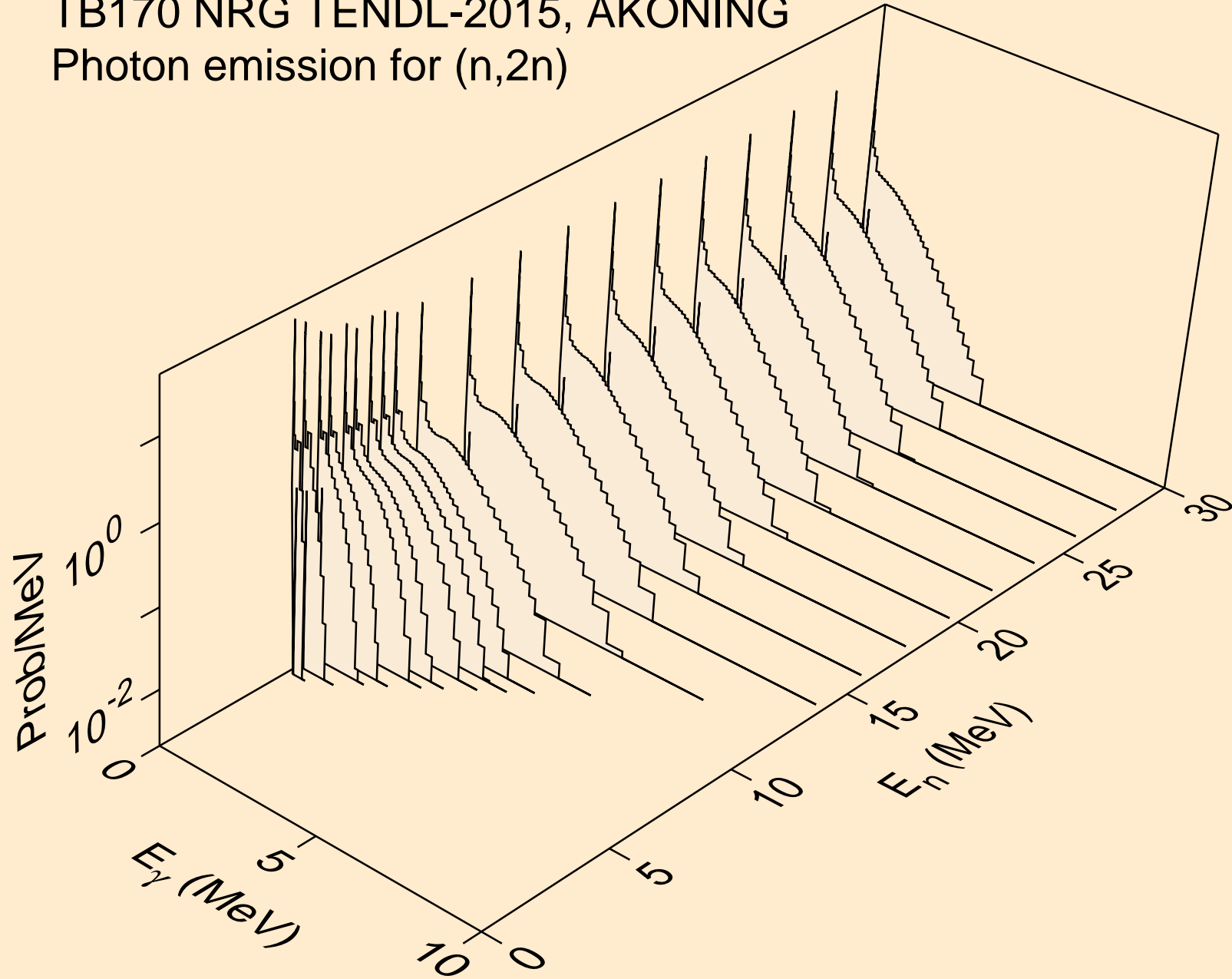

TB170 NRG TENDL-2015, AKONING  
Photon emission for (n,3n)

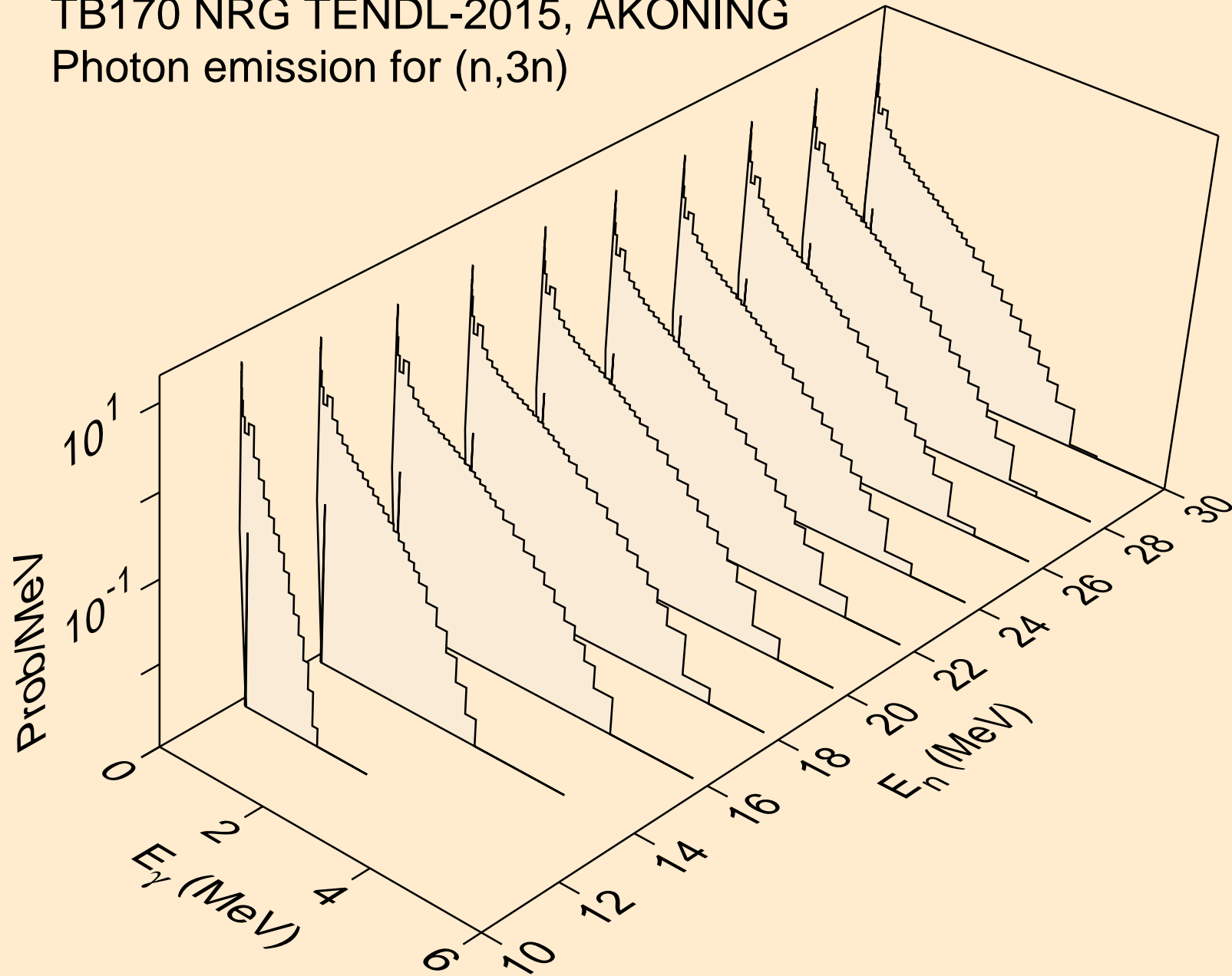

TB170 NRG TENDL-2015, AKONING  
Photon emission for (n,n\*)a

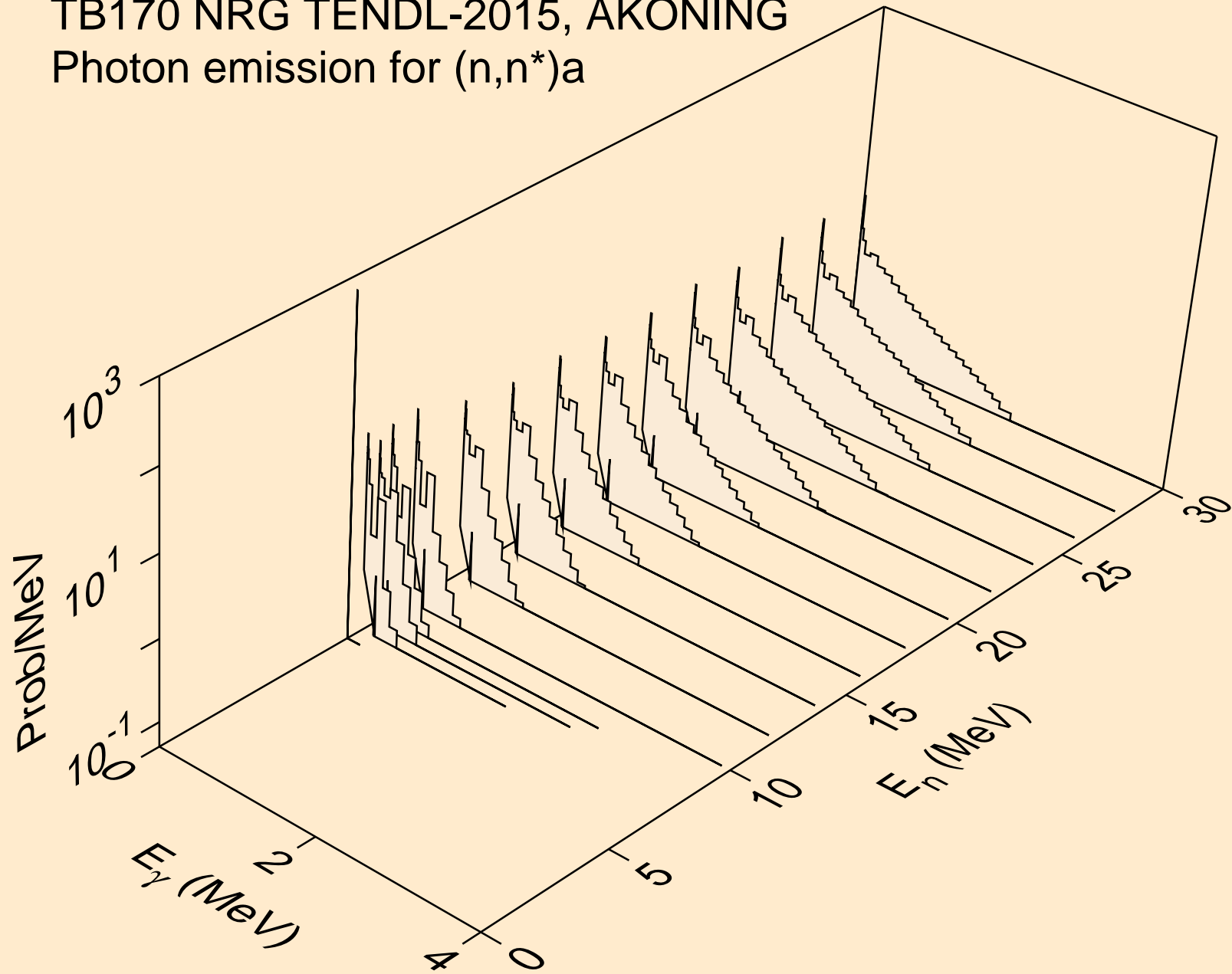



TB170 NRG TENDL-2015, AKONING  
Photon emission for (n,2n)a

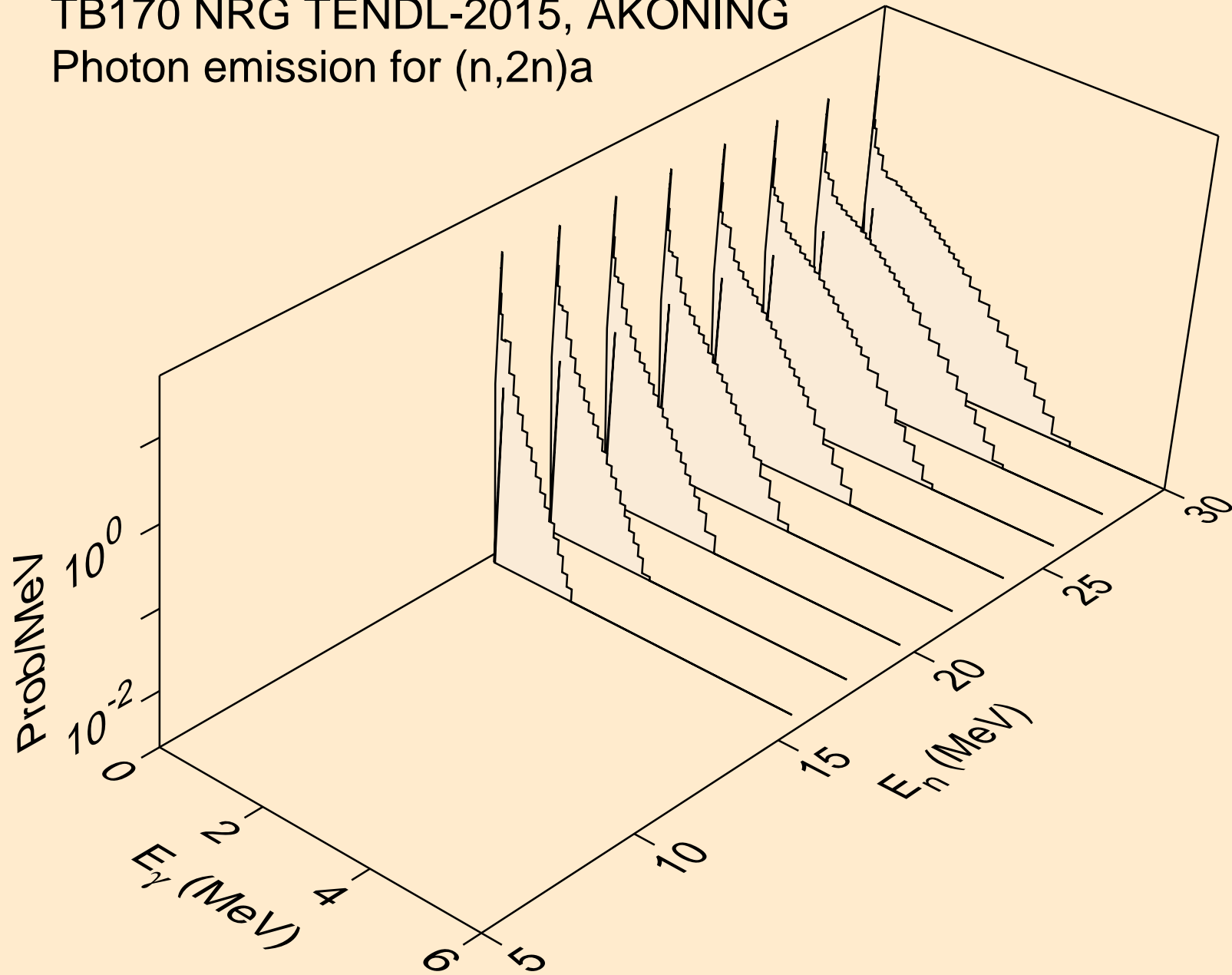

TB170 NRG TENDL-2015, AKONING  
Photon emission for (n,3n)a

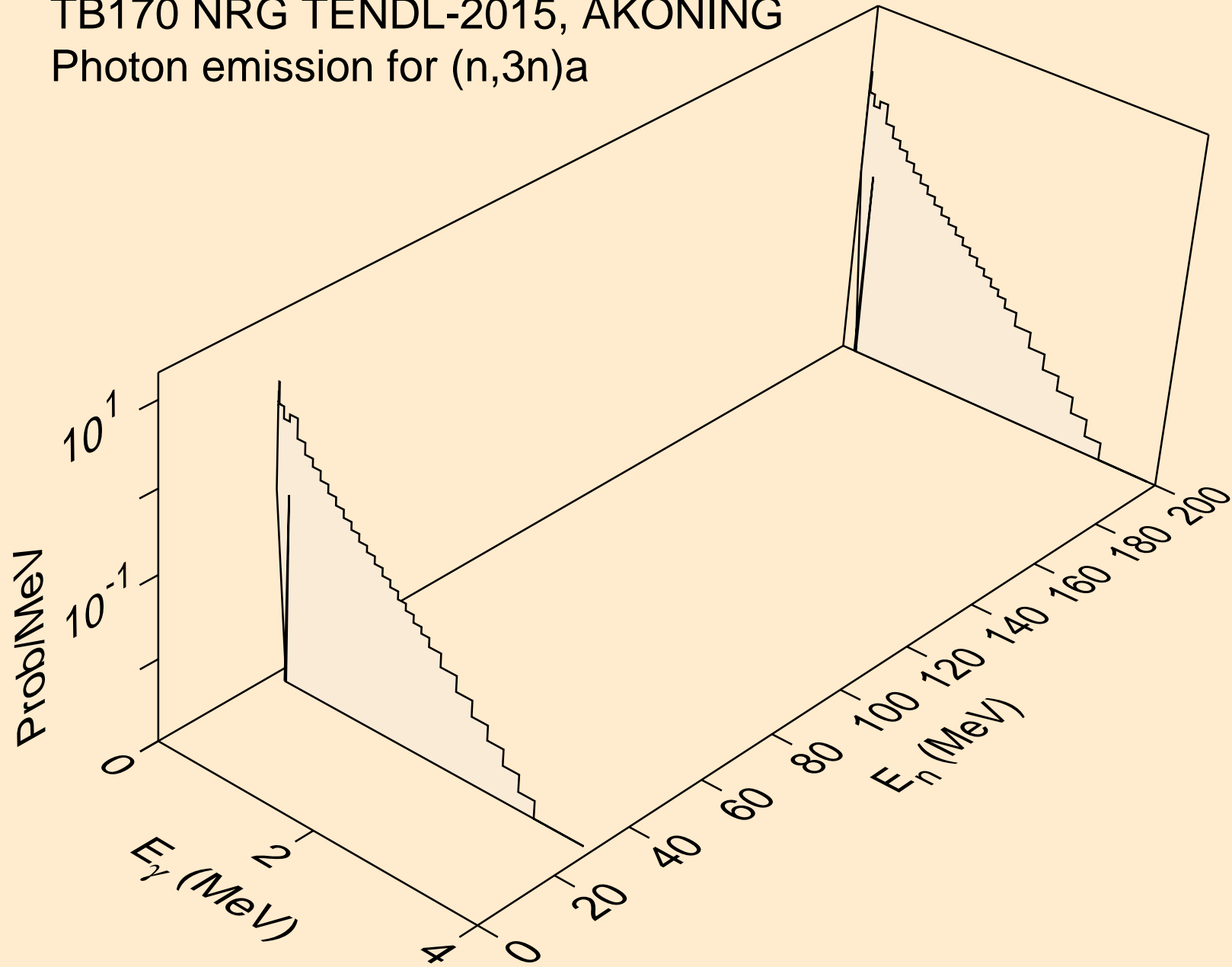

TB170 NRG TENDL-2015, AKONING  
Photon emission for (n,n\*)p

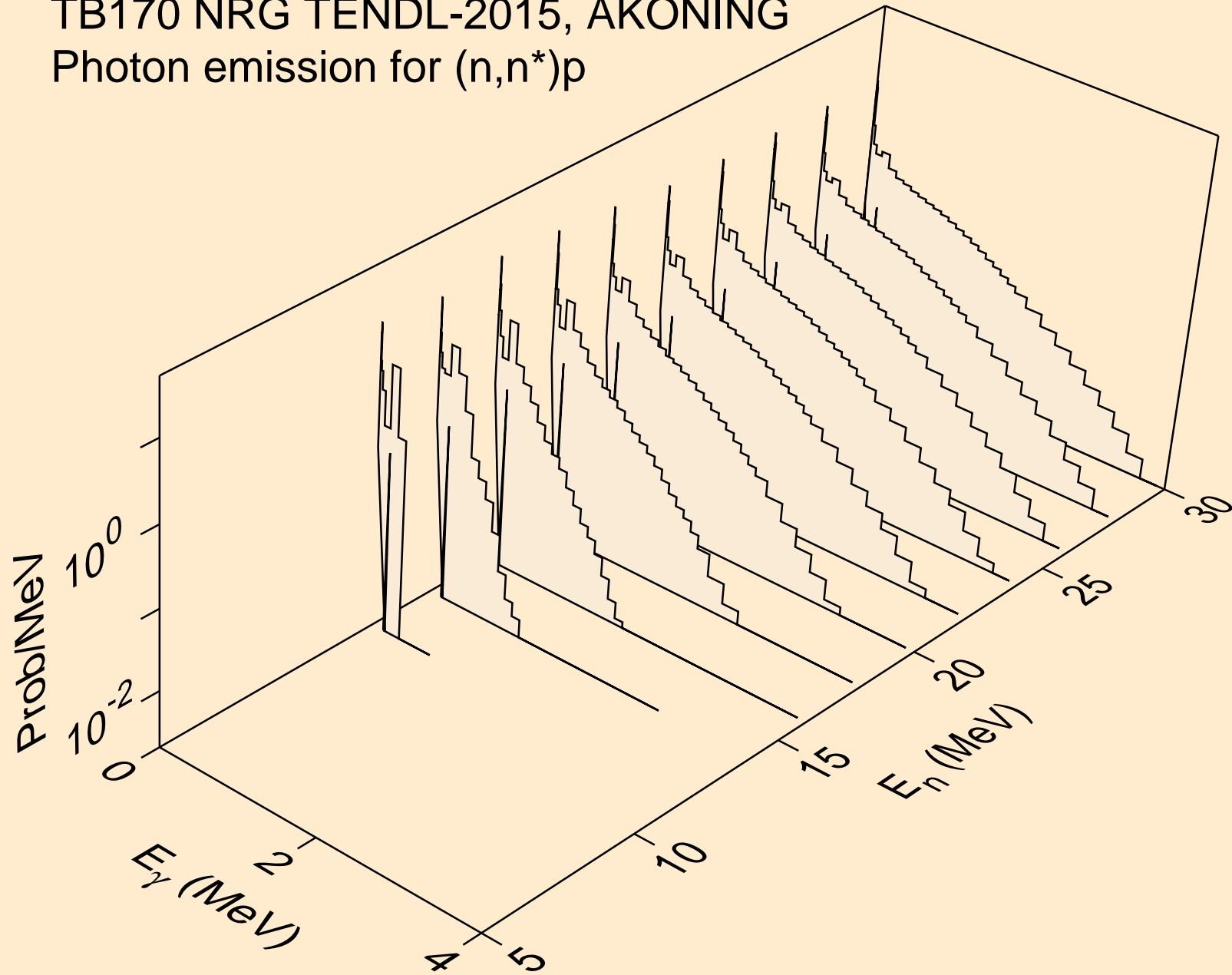

TB170 NRG TENDL-2015, AKONING  
Photon emission for (n,n\*)d

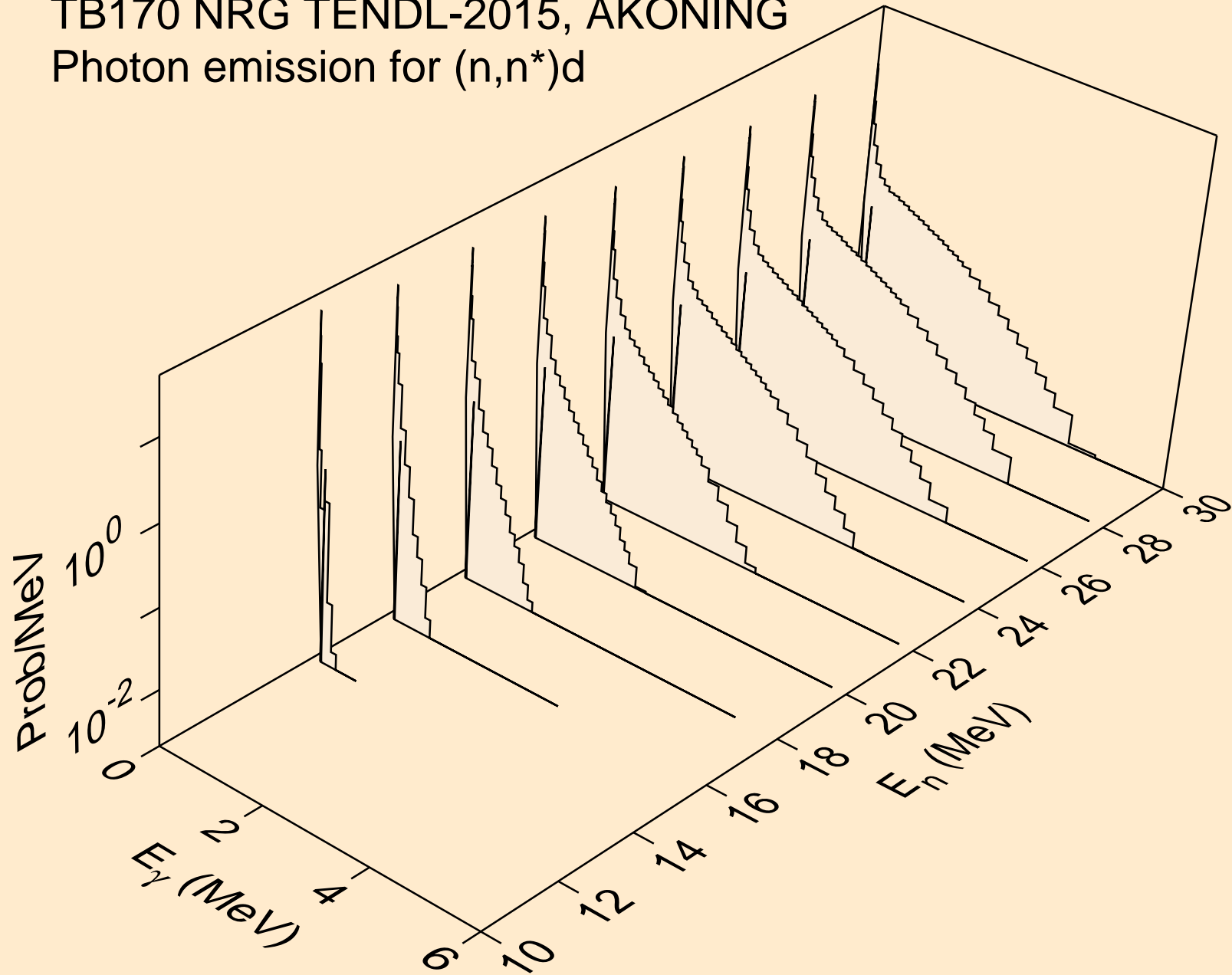

TB170 NRG TENDL-2015, AKONING  
Photon emission for (n,n\*)t

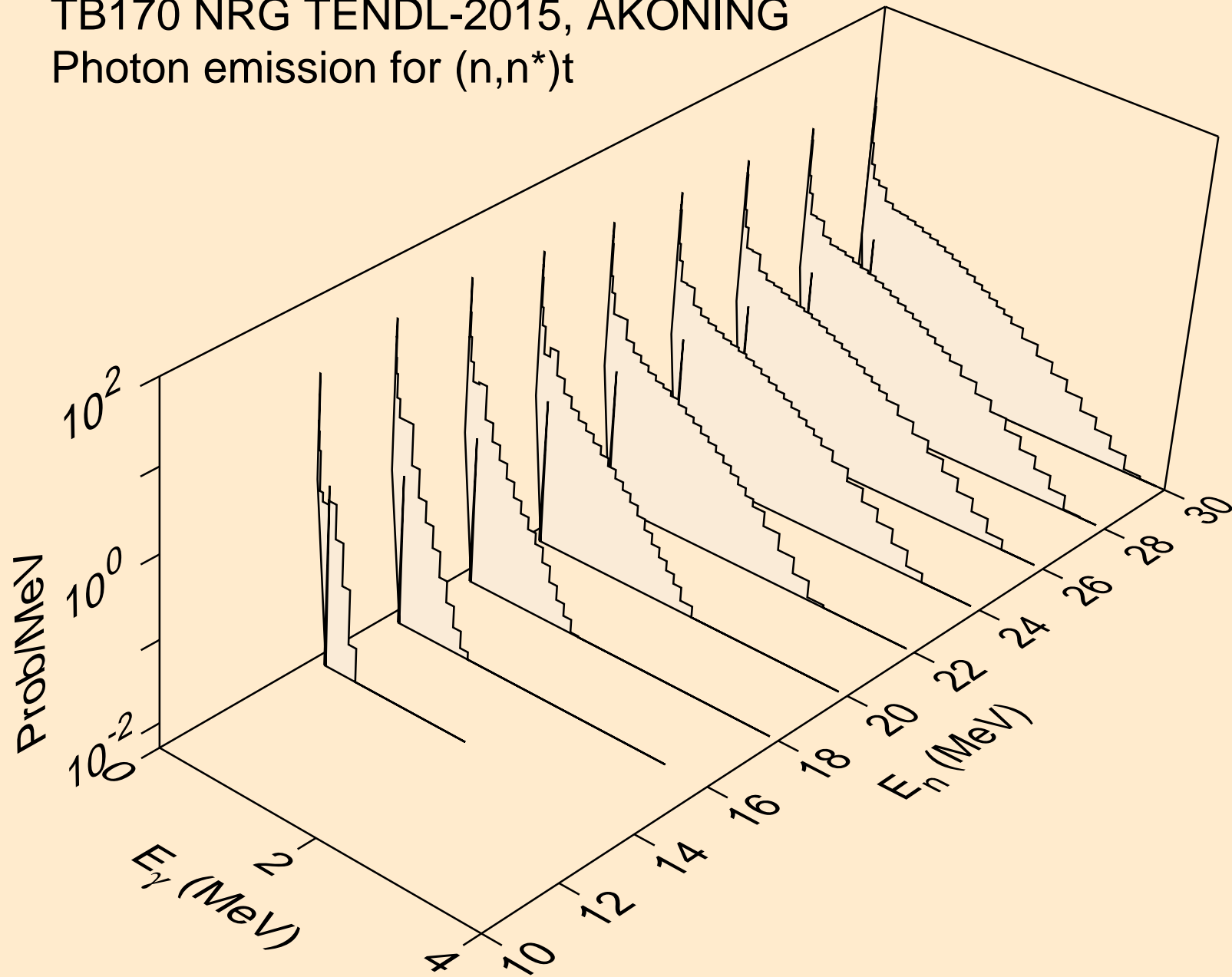

TB170 NRG TENDL-2015, AKONING  
Photon emission for (n,n\*)he3

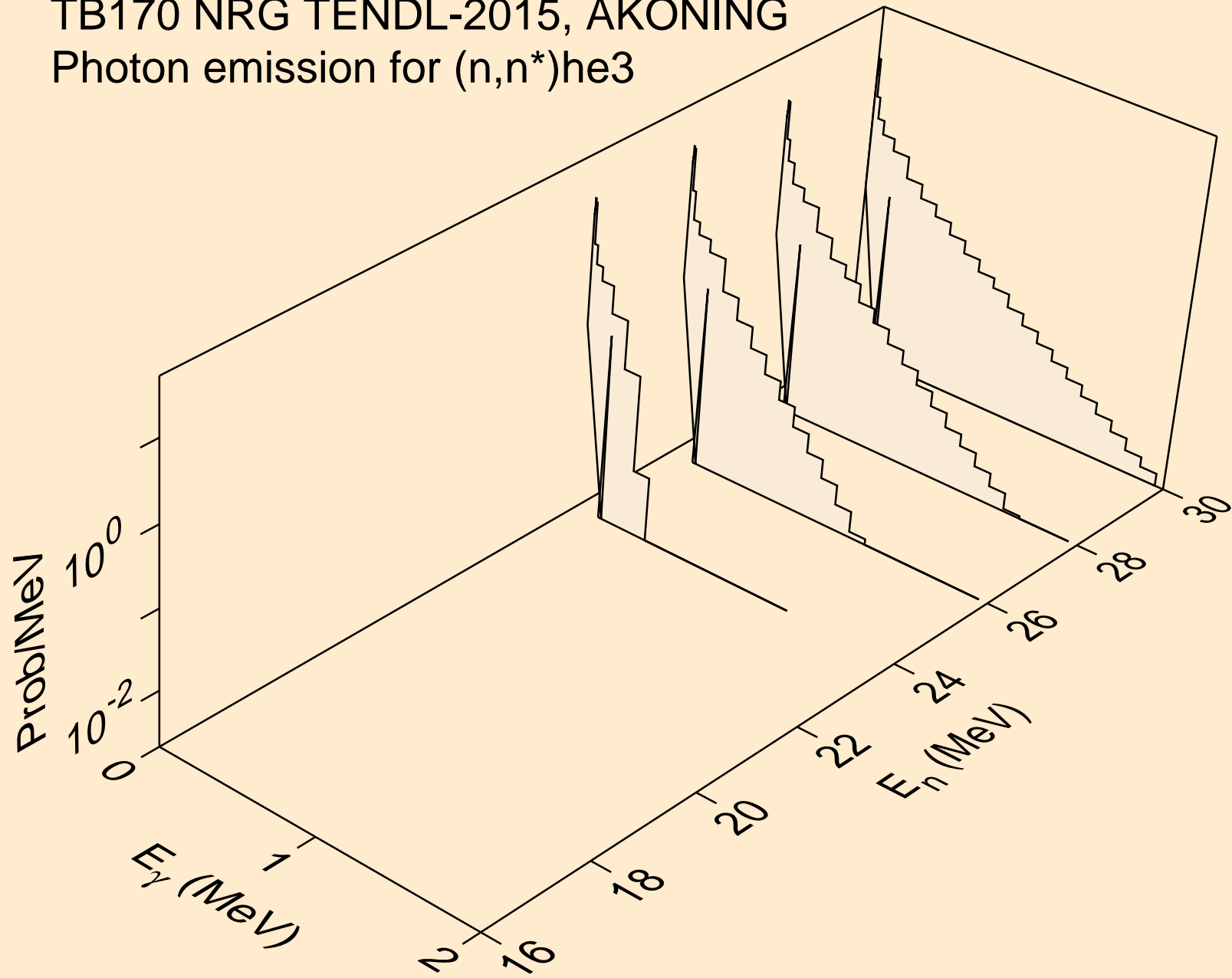

TB170 NRG TENDL-2015, AKONING  
Photon emission for (n,4n)

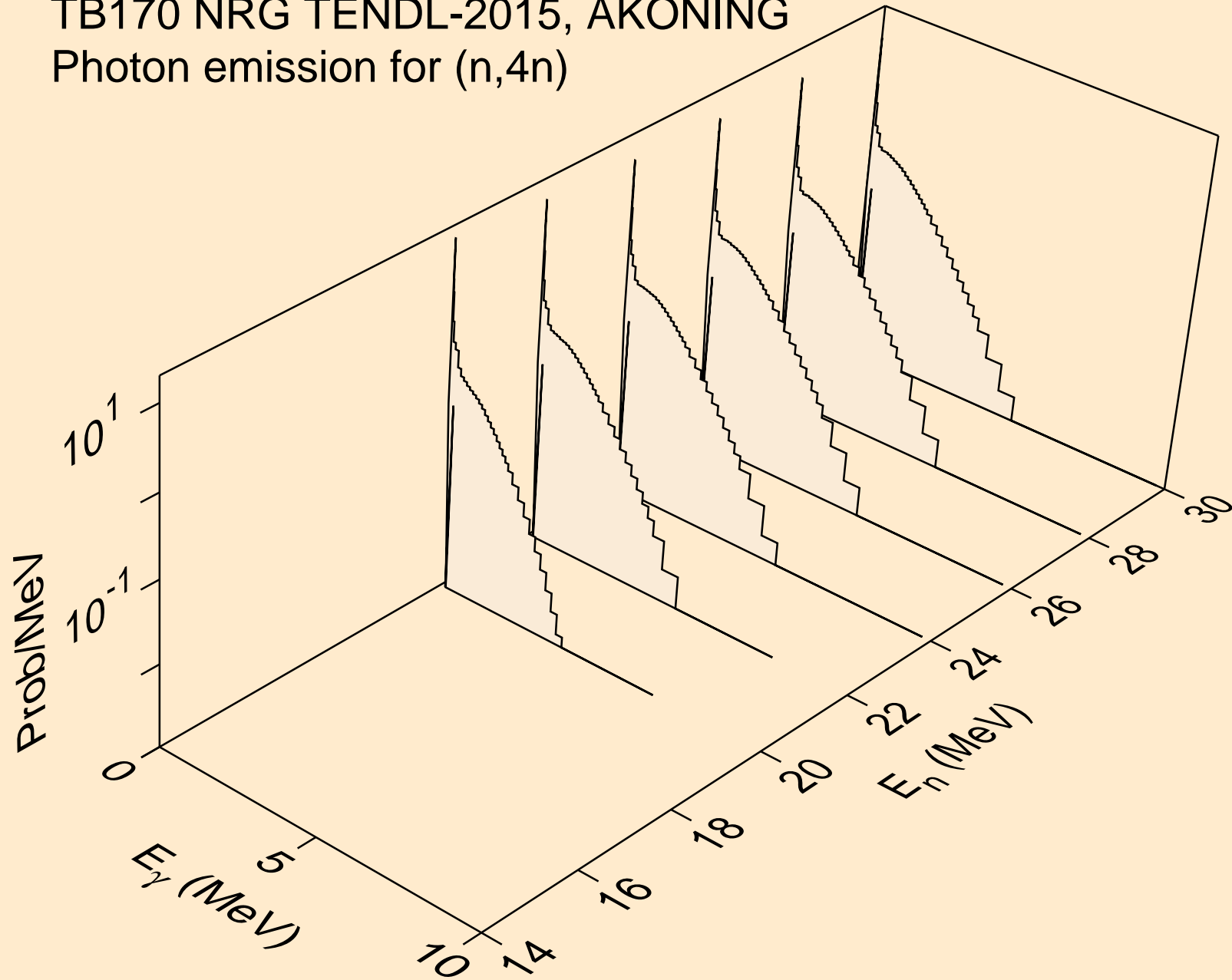

TB170 NRG TENDL-2015, AKONING  
Photon emission for (n,2np)

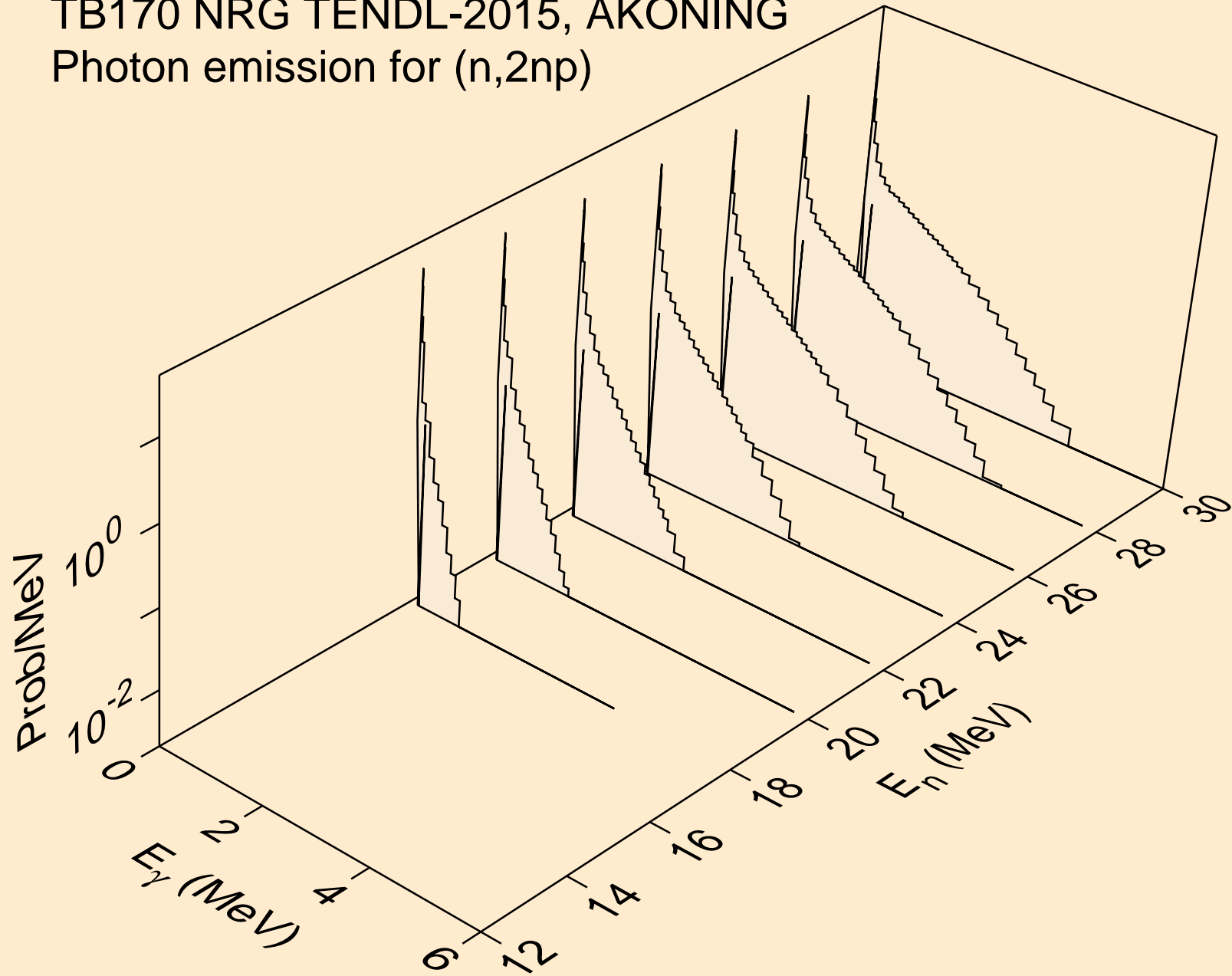



TB170 NRG TENDL-2015, AKONING  
Photon emission for (n,3np)

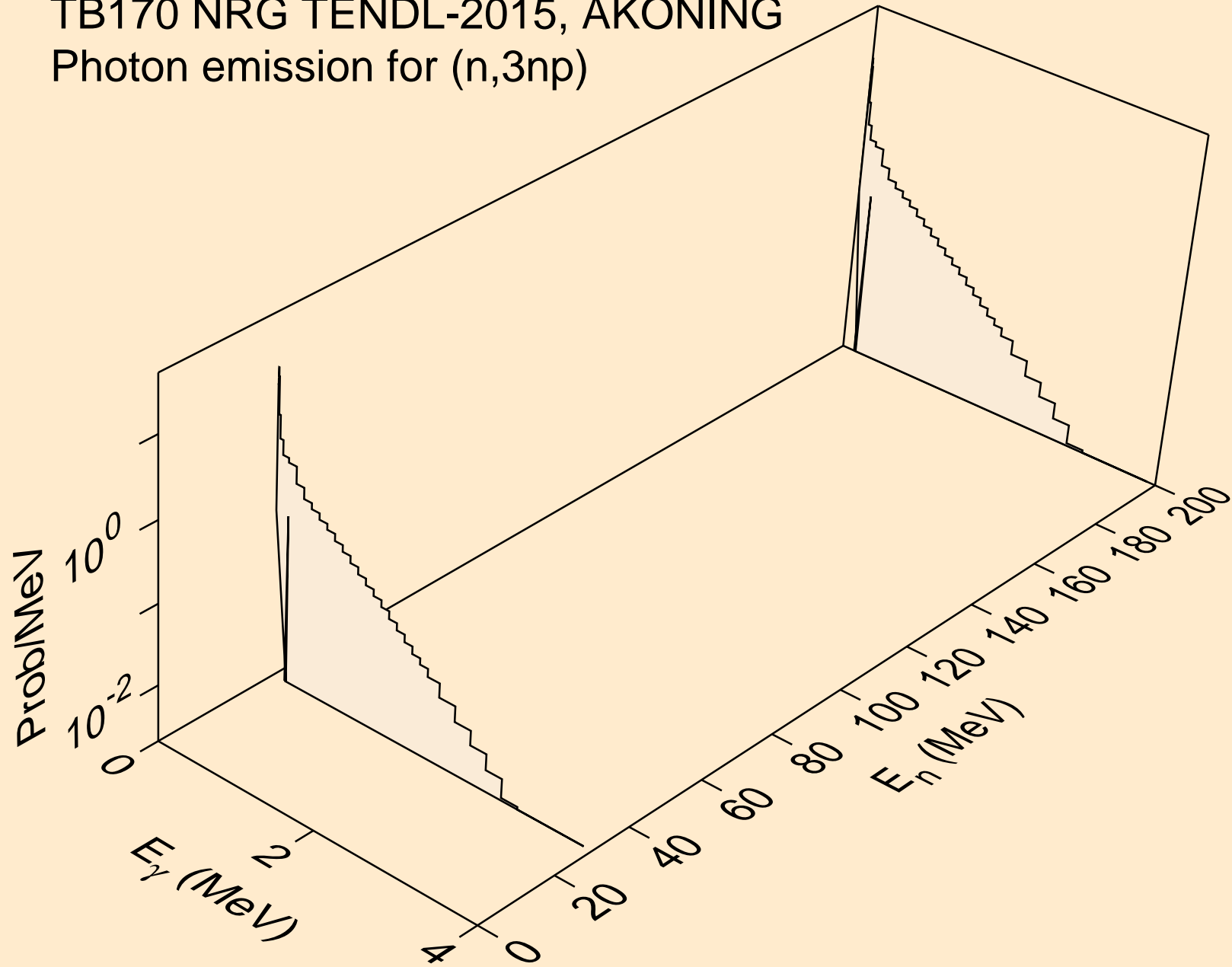

TB170 NRG TENDL-2015, AKONING  
Photon emission for (n,n\*c)

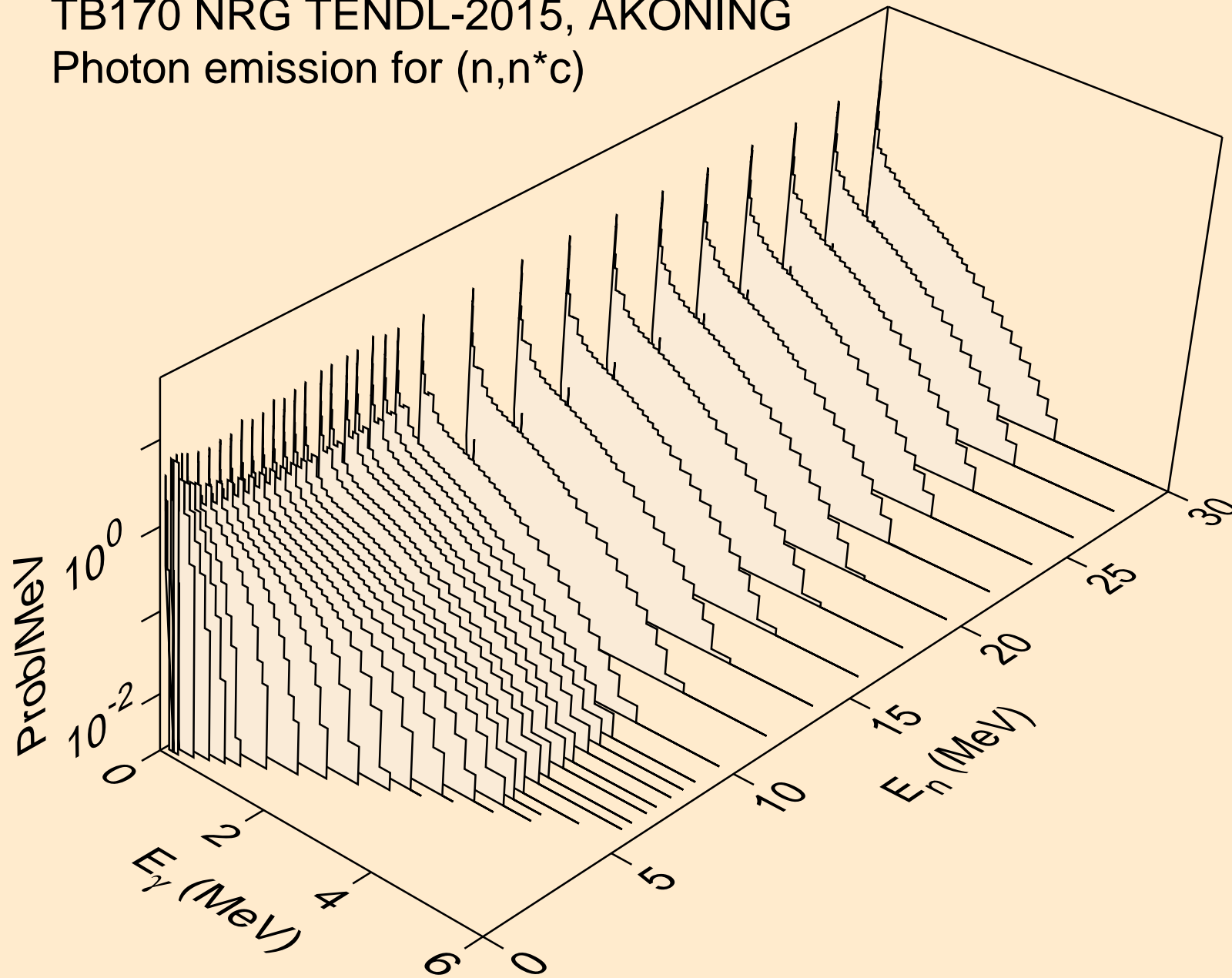

TB170 NRG TENDL-2015, AKONING  
Photon emission for (n,gma)

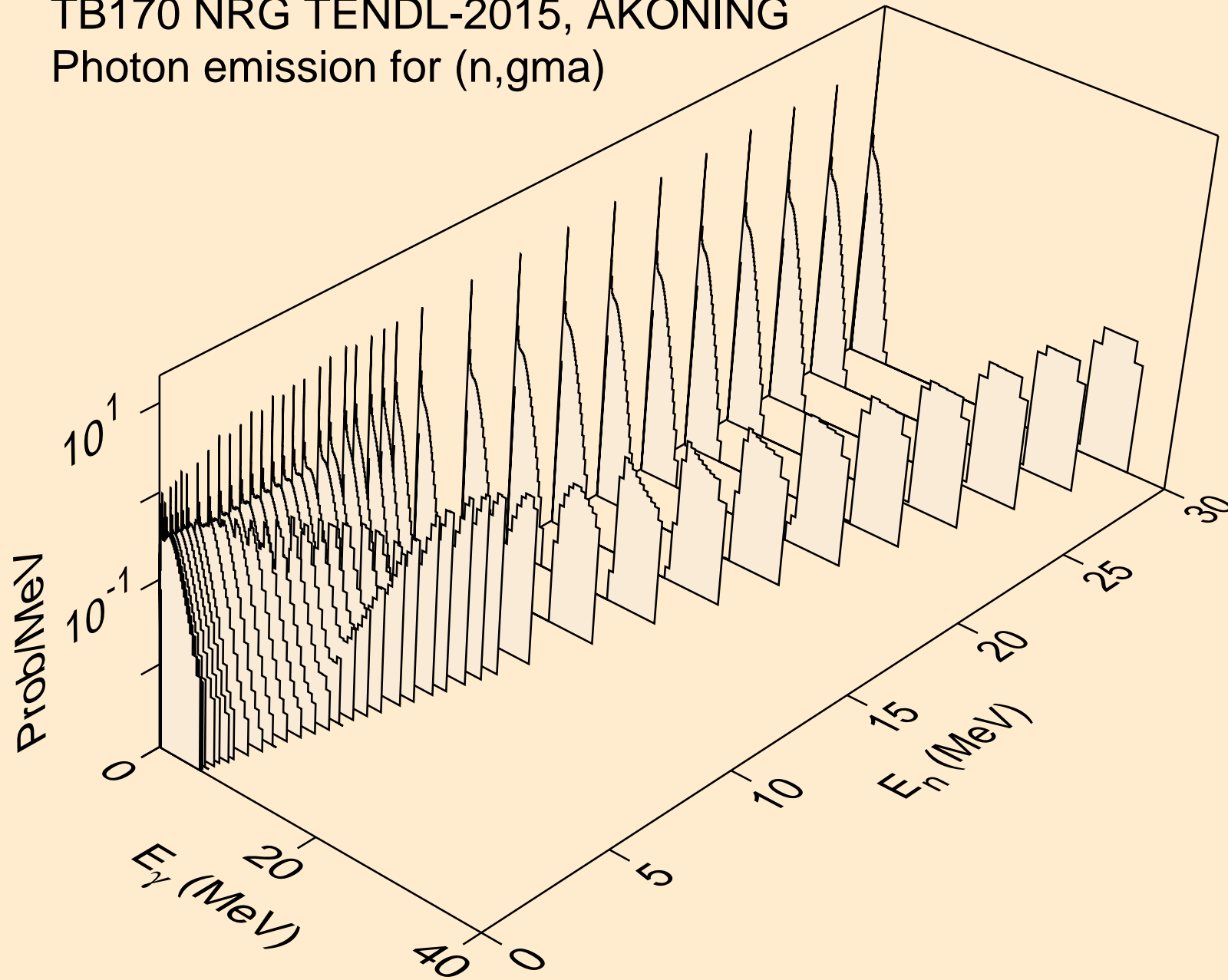

TB170 NRG TENDL-2015, AKONING  
Photon emission for (n,p)

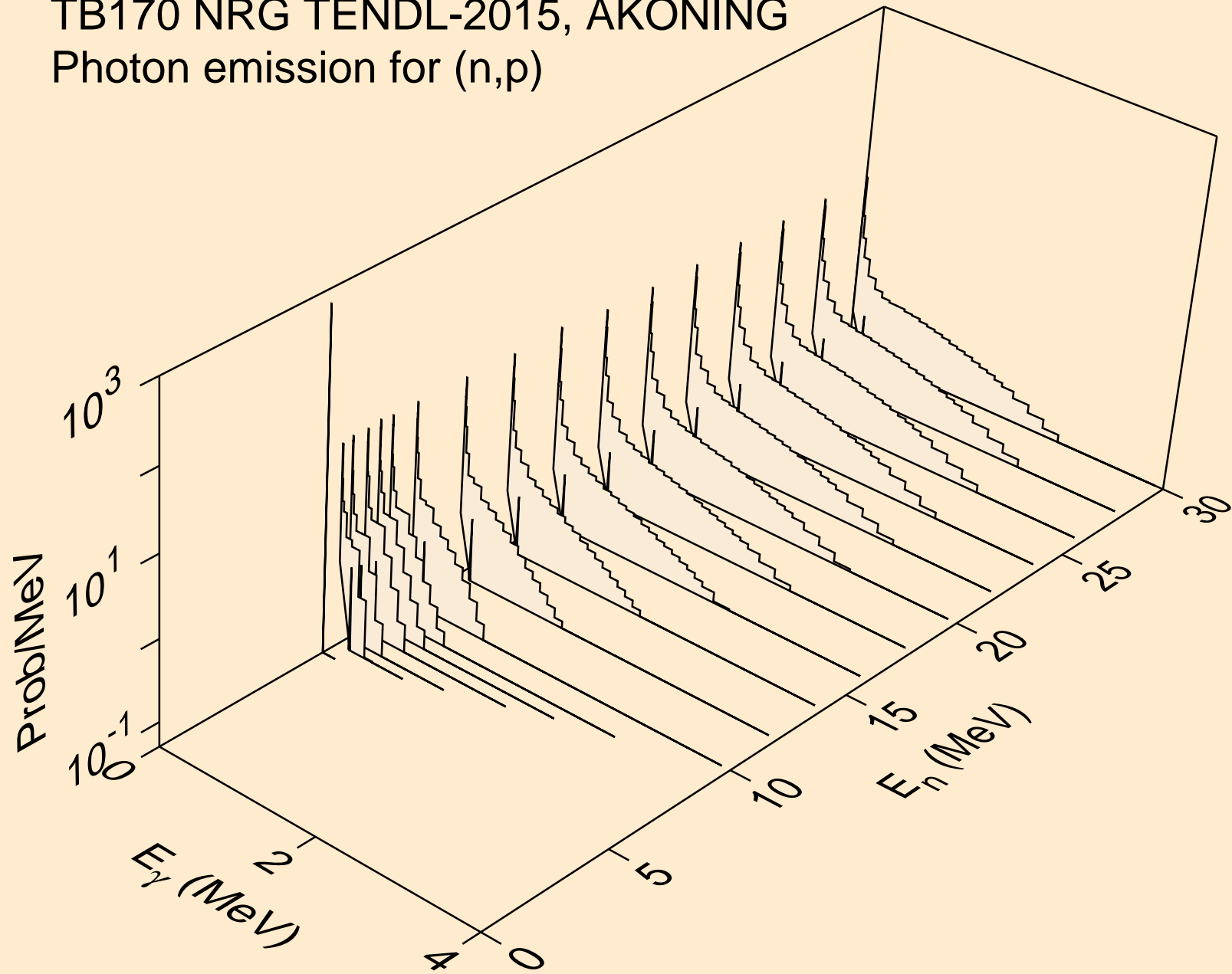

TB170 NRG TENDL-2015, AKONING  
Photon emission for (n,d)

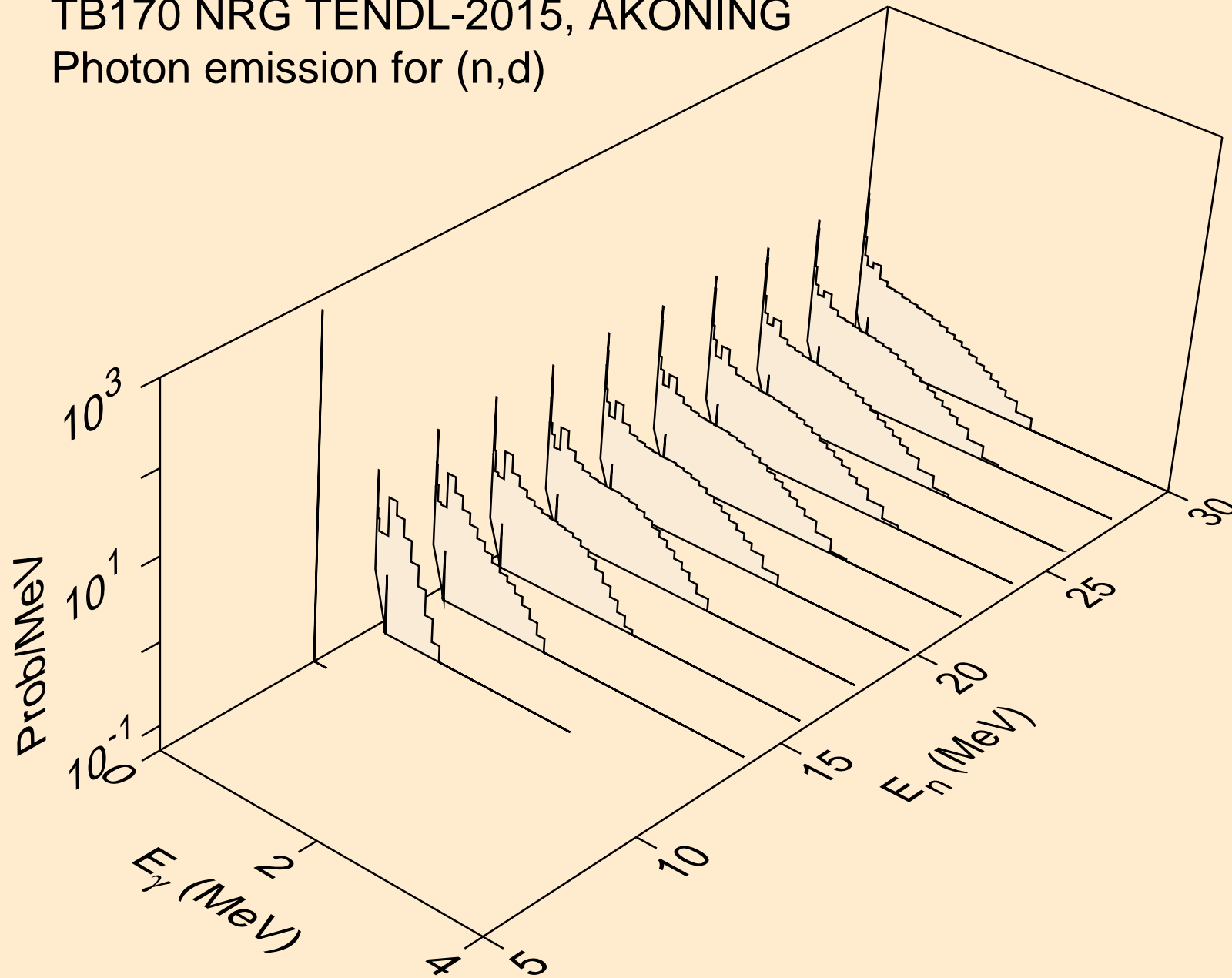

TB170 NRG TENDL-2015, AKONING  
Photon emission for (n,t)

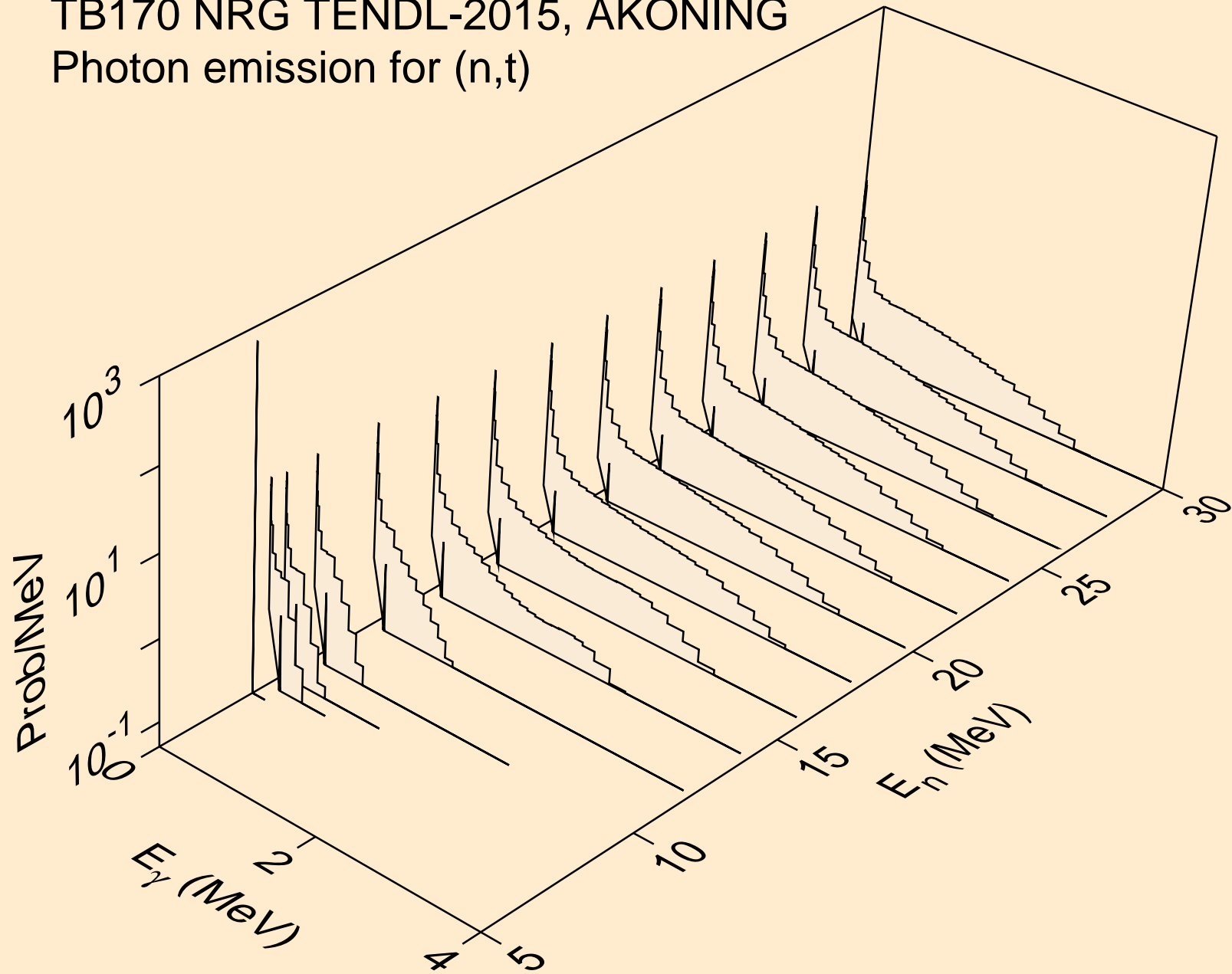

TB170 NRG TENDL-2015, AKONING  
Photon emission for (n,he3)

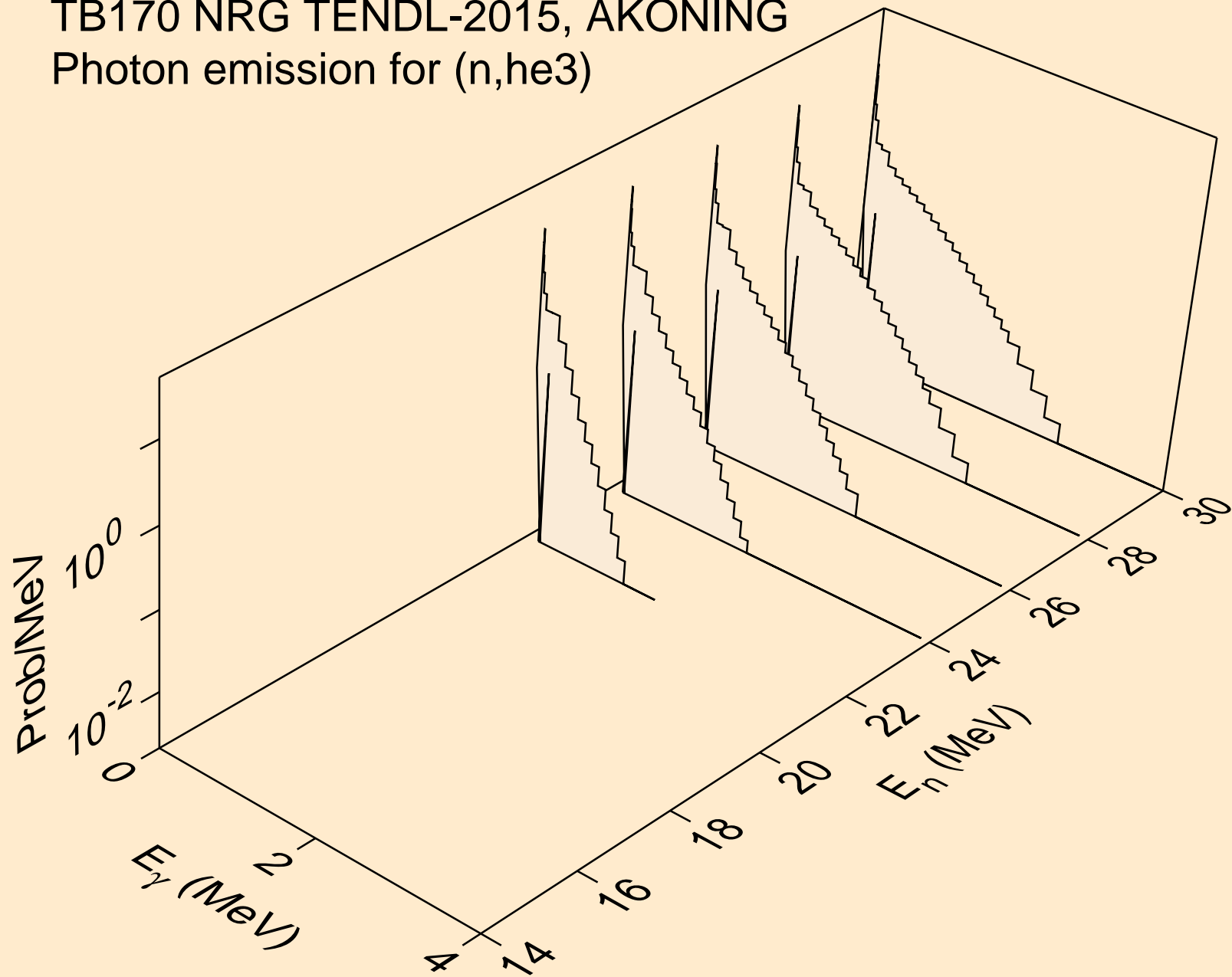

TB170 NRG TENDL-2015, AKONING  
Photon emission for (n,a)

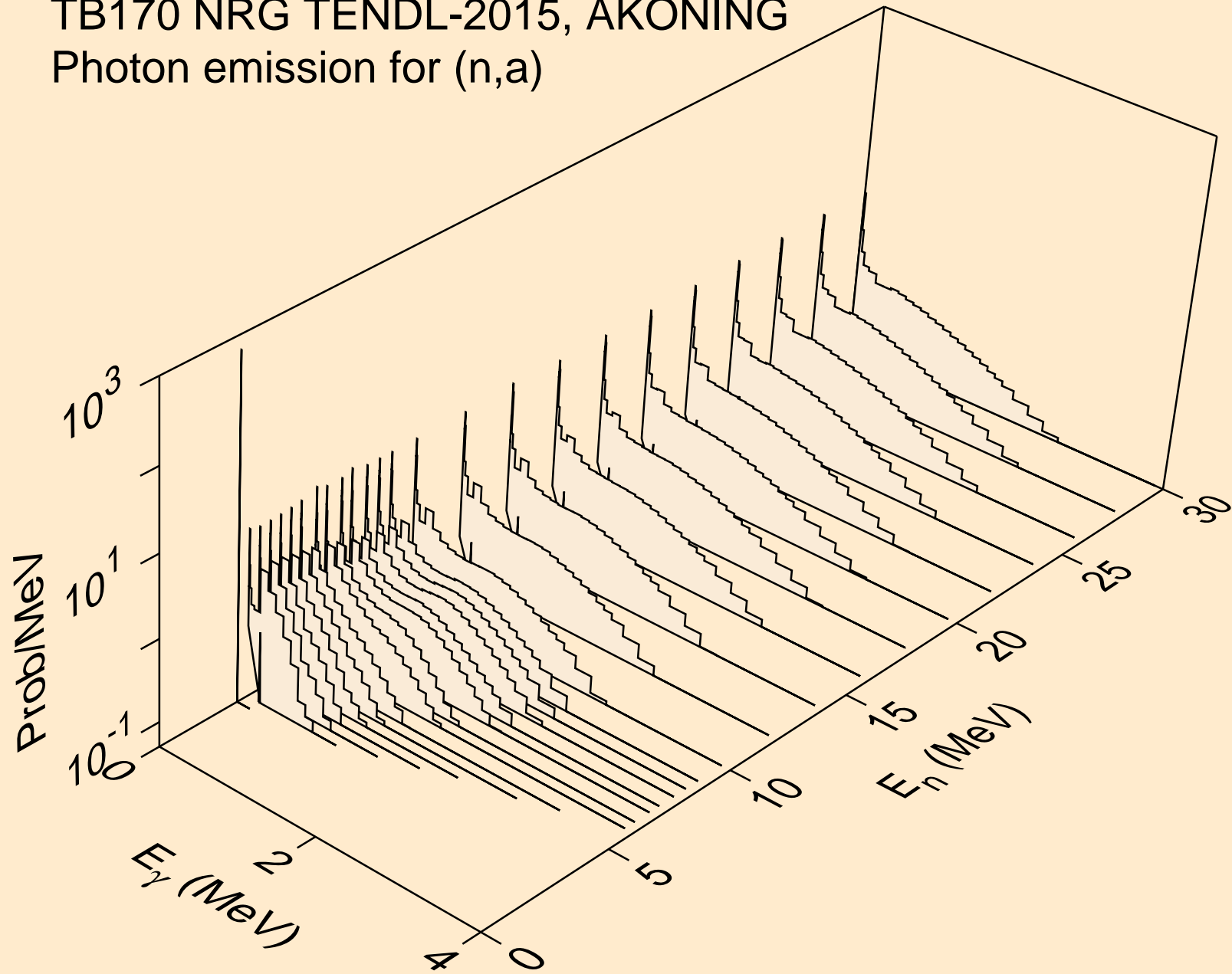



TB170 NRG TENDL-2015, AKONING  
thermal capture photon spectrum

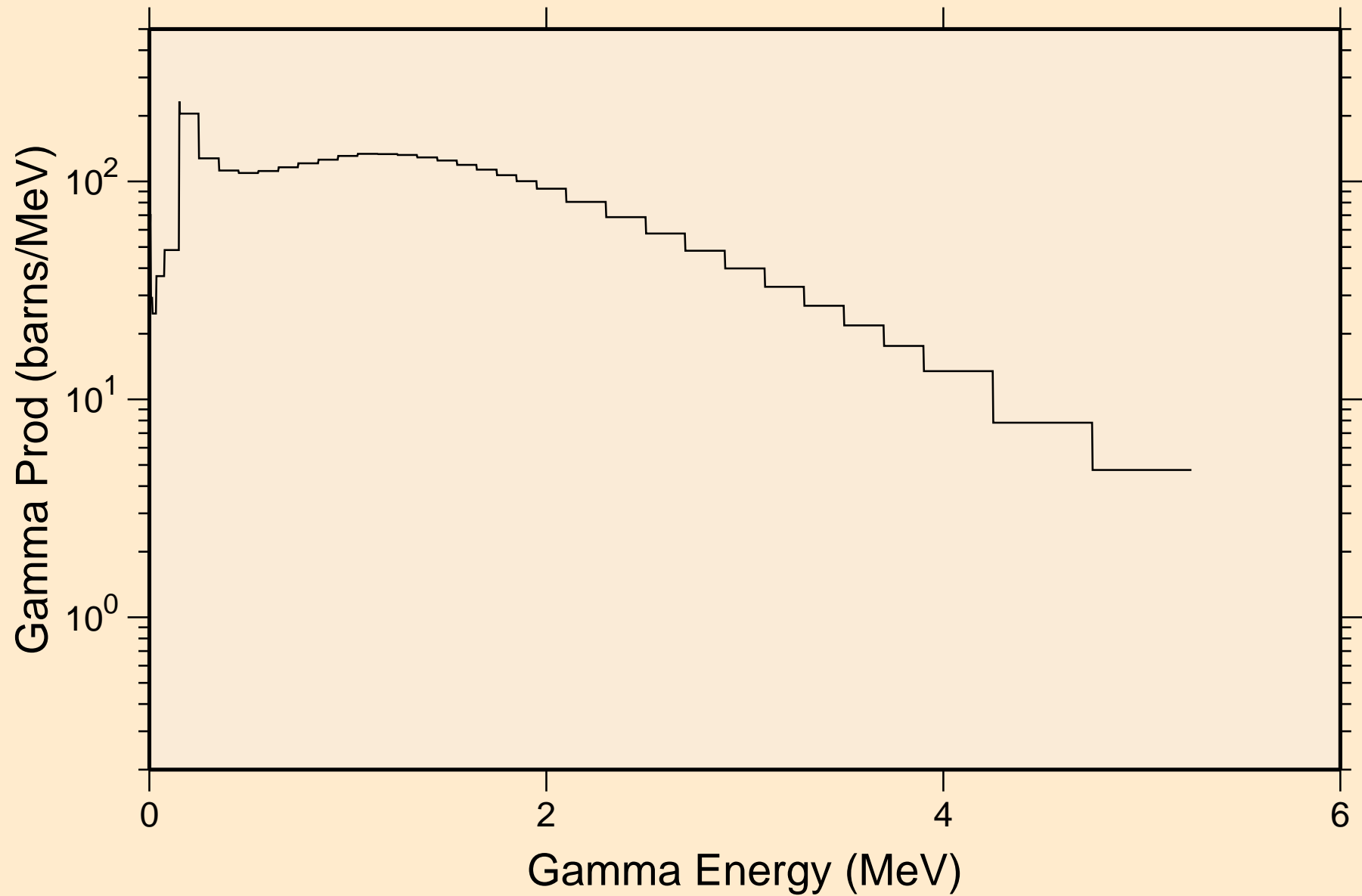

TB170 NRG TENDL-2015, AKONING  
14 MeV photon spectrum

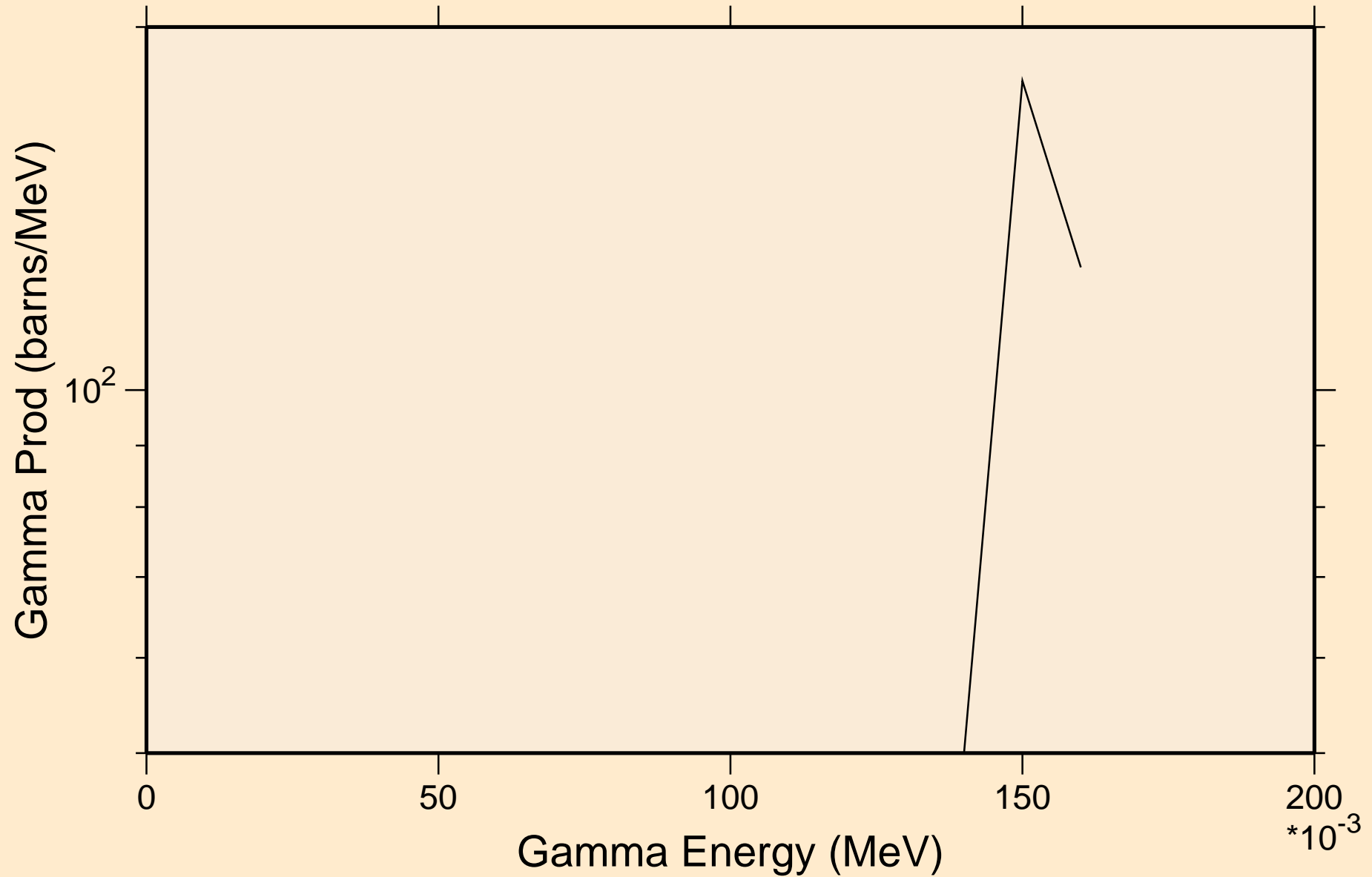

# TB170 NRG TENDL-2015, AKONING

## Particle heating contributions

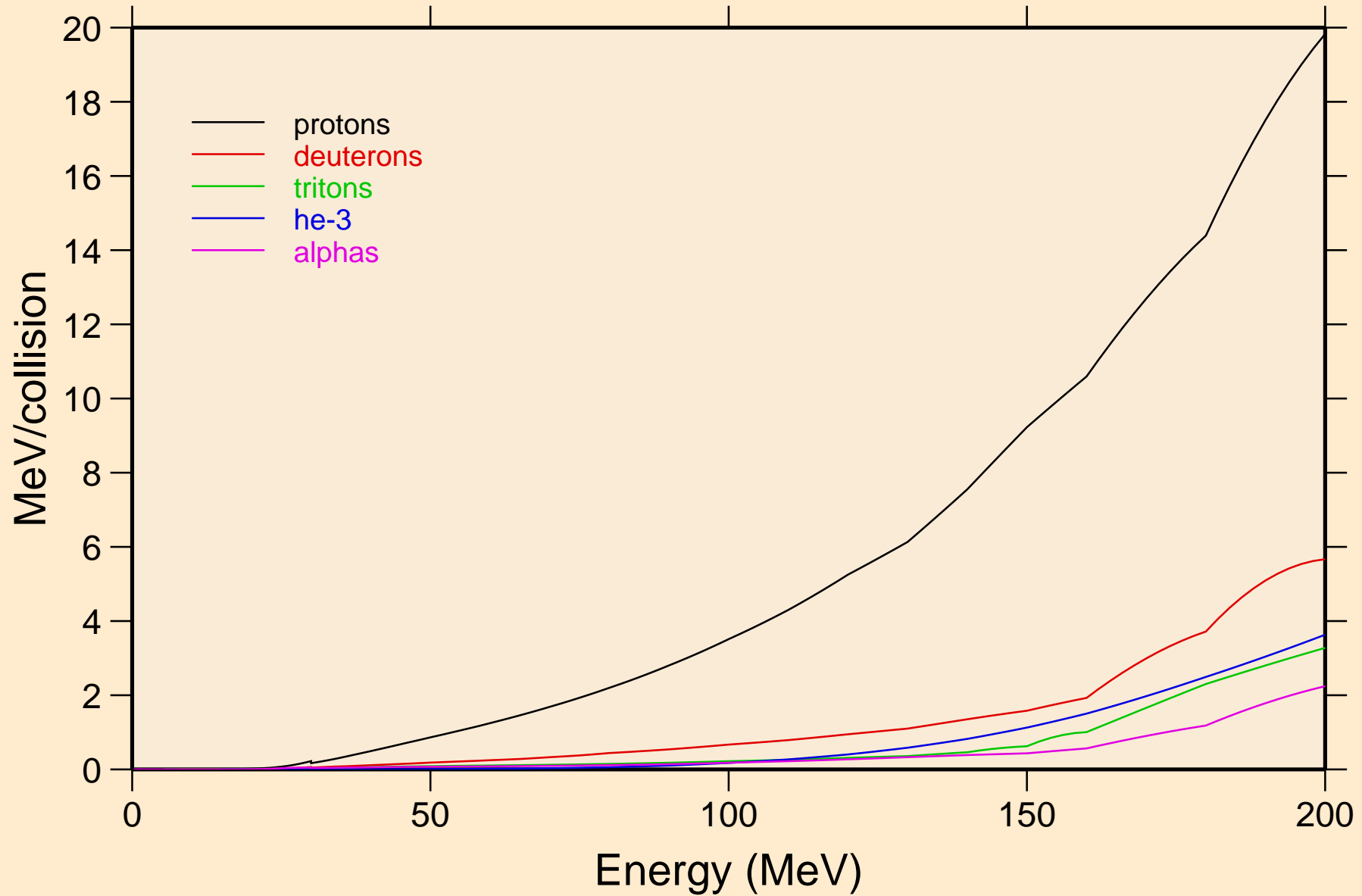

# TB170 NRG TENDL-2015, AKONING

## Recoil Heating

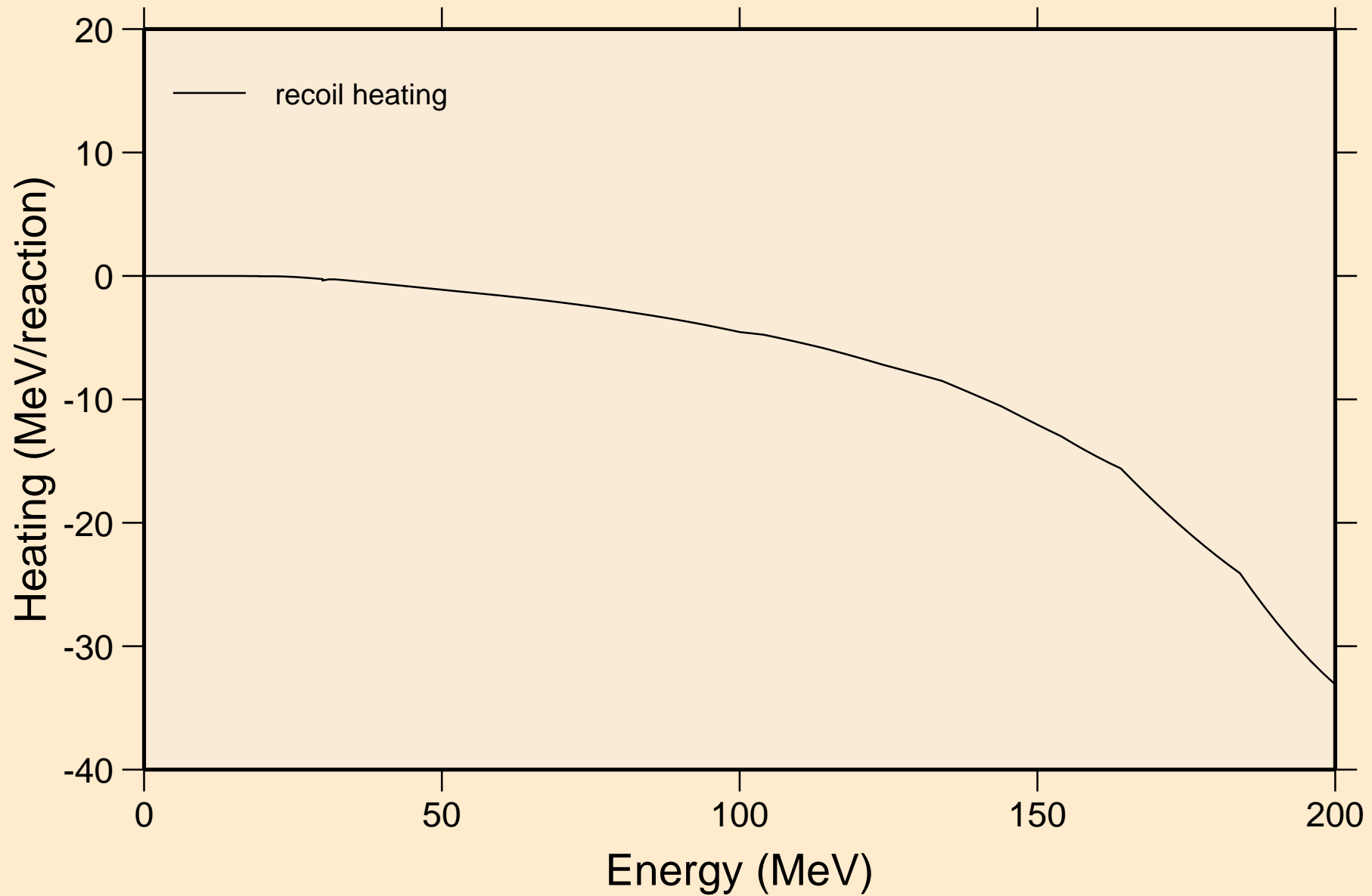

# TB170 NRG TENDL-2015, AKONING

## Particle production cross sections

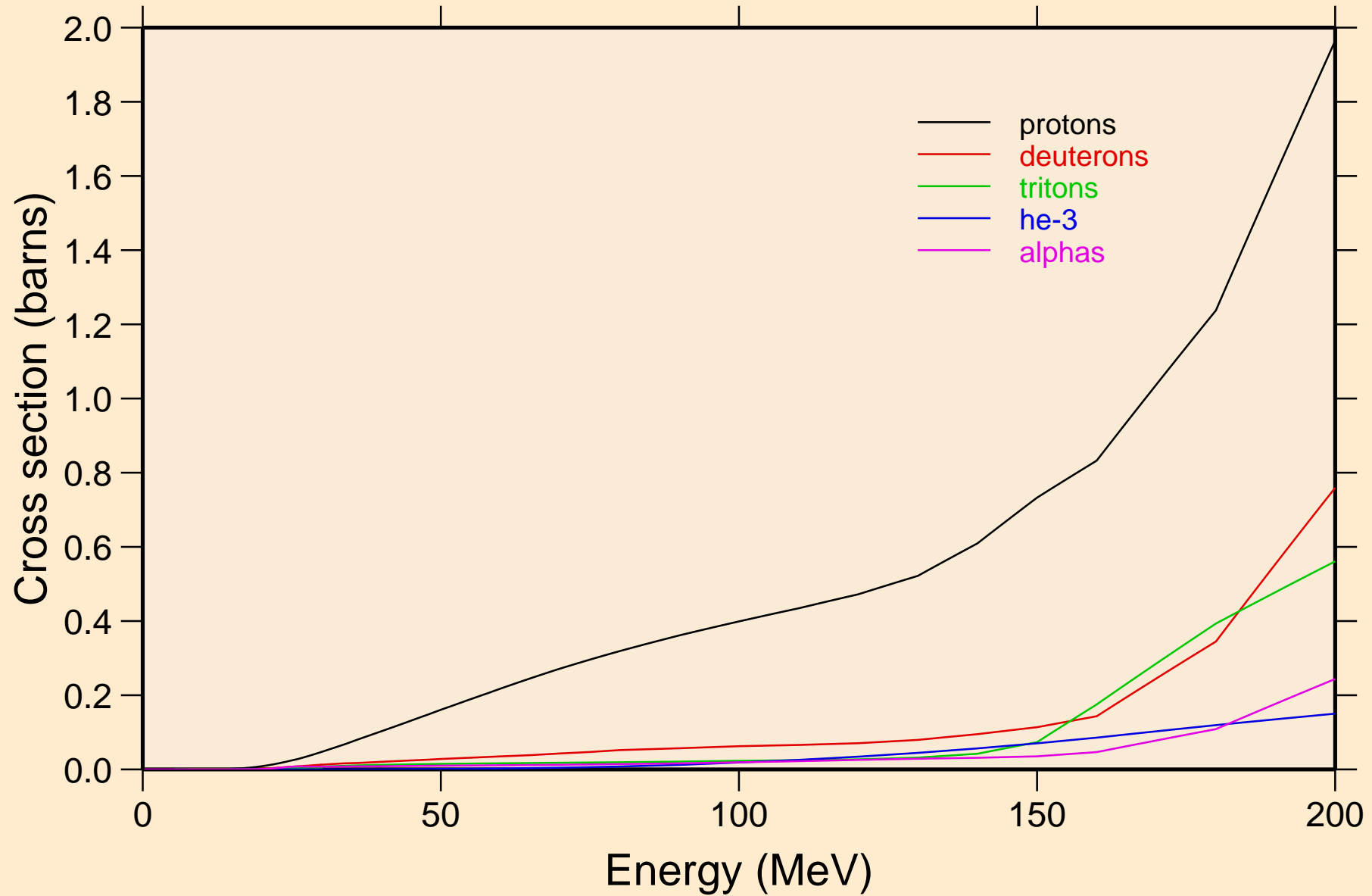

TB170 NRG TENDL-2015, AKONING  
protons from (n,x)

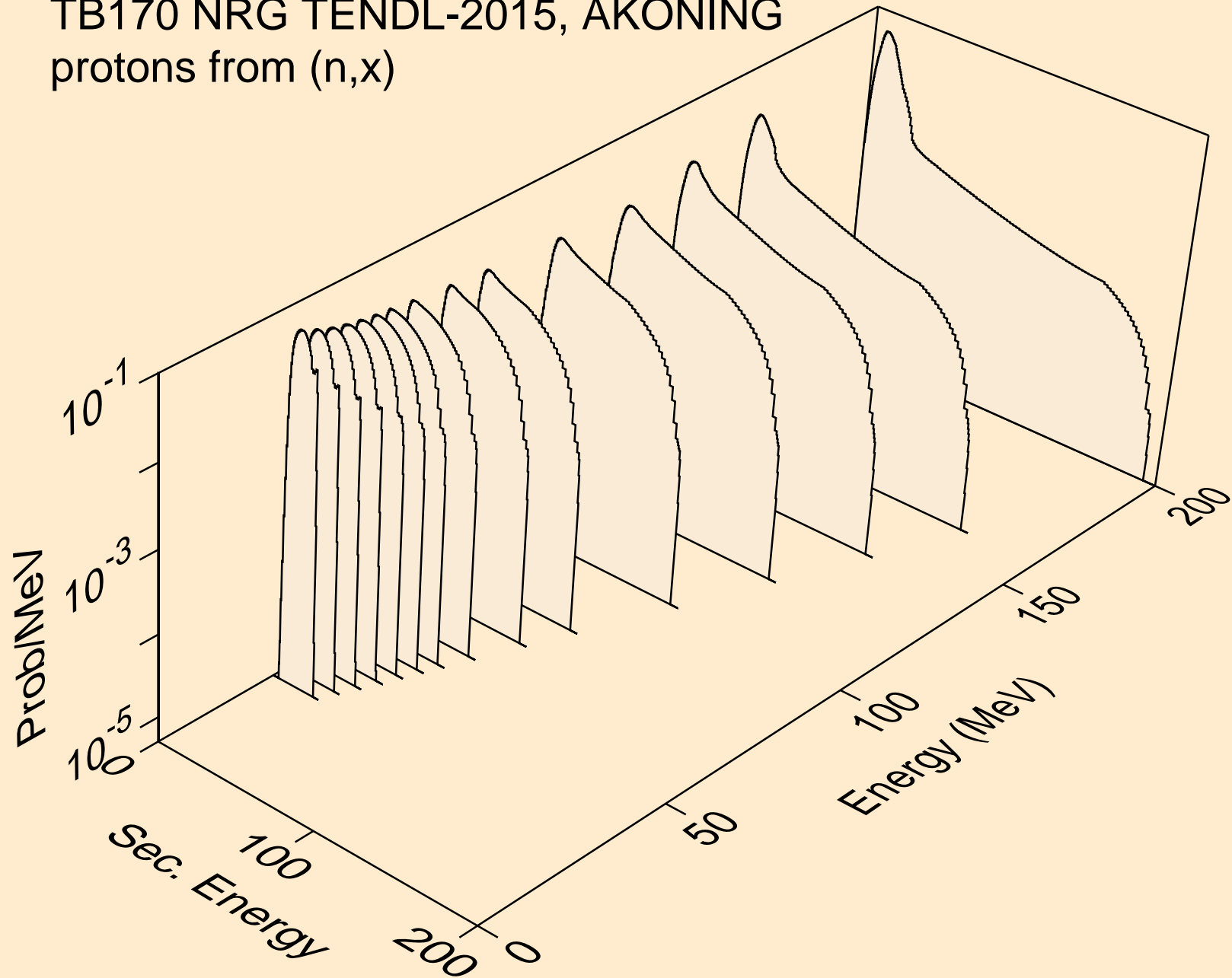

TB170 NRG TENDL-2015, AKONING  
protons from (n,n\*)p

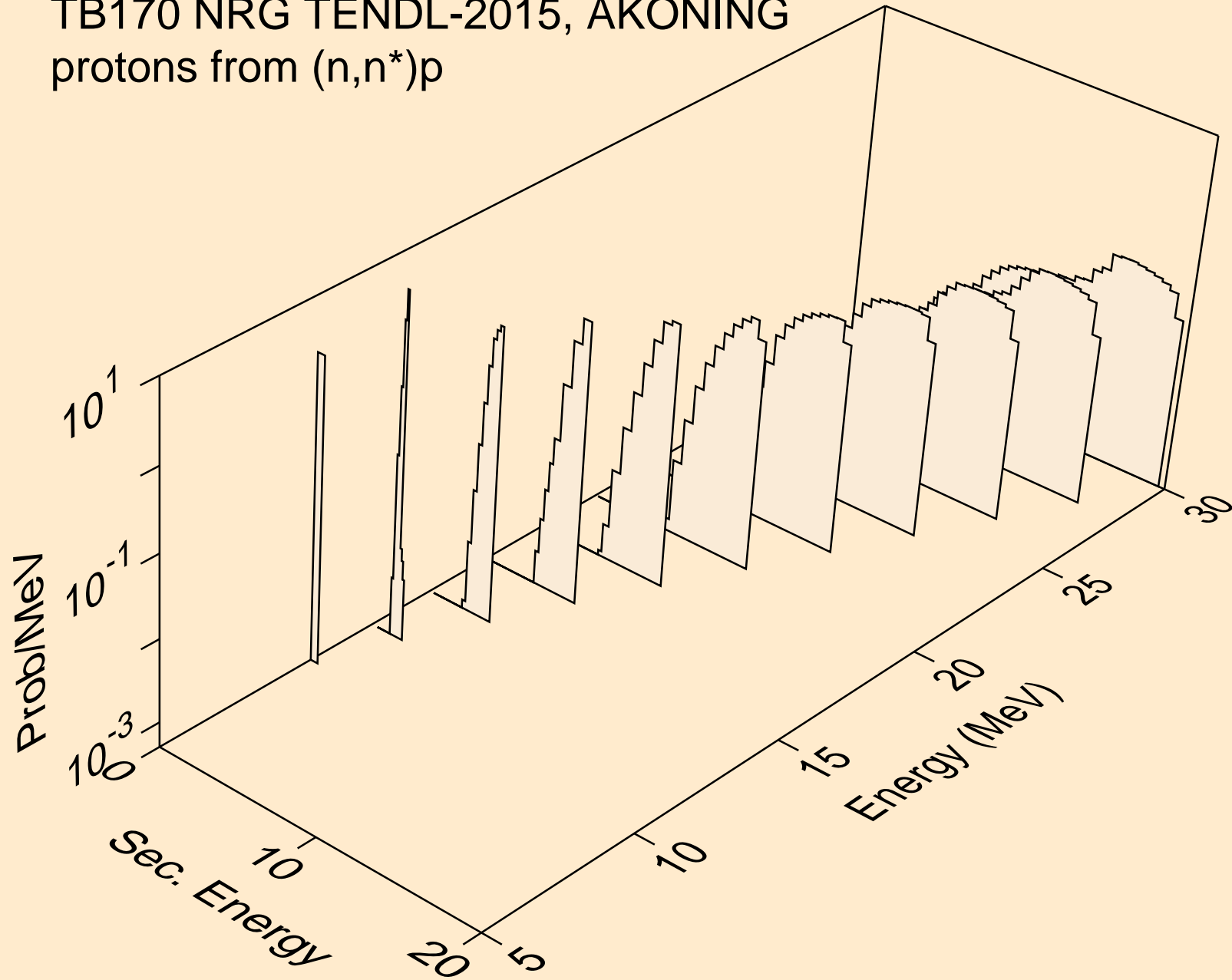

TB170 NRG TENDL-2015, AKONING  
protons from (n,2np)

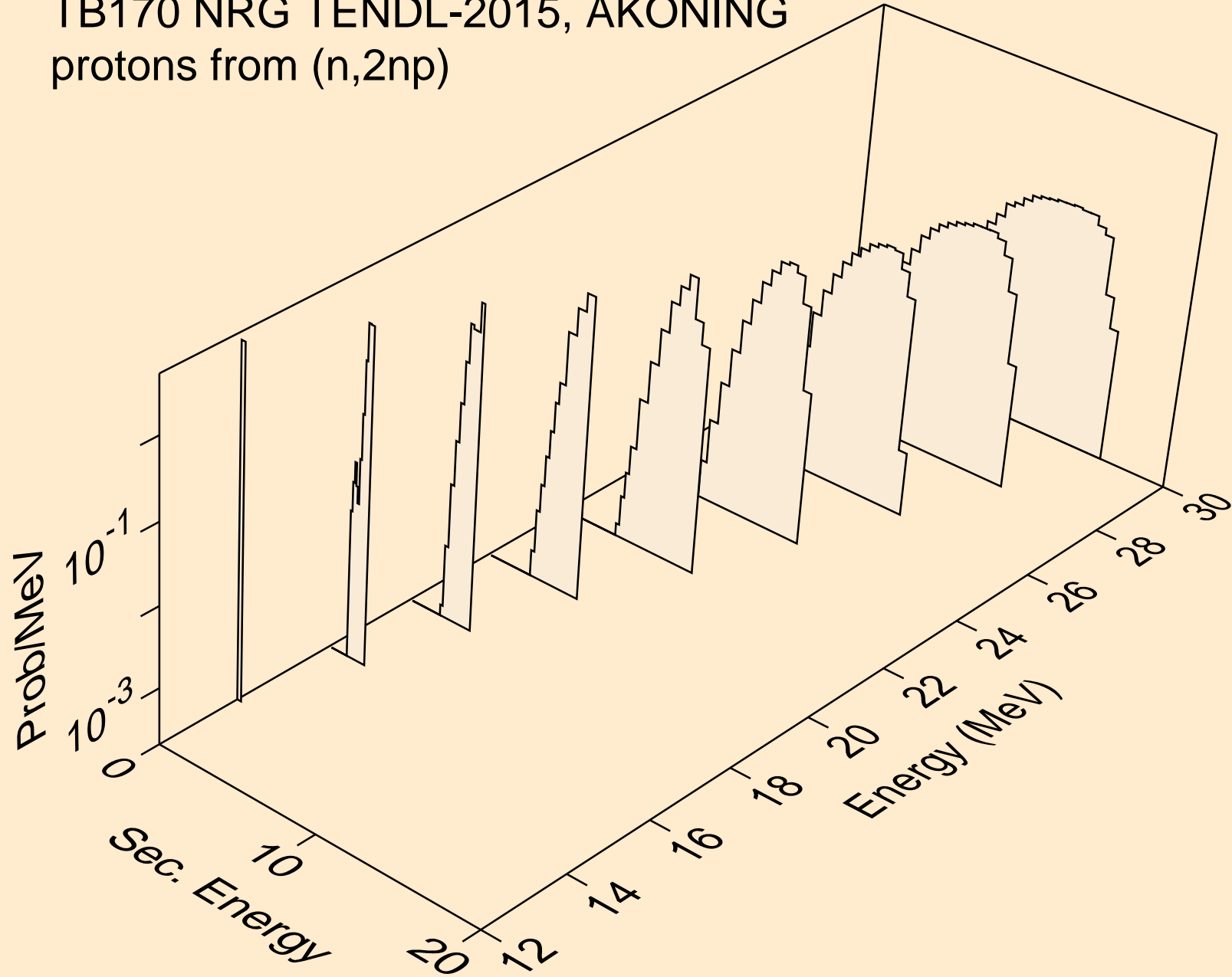



TB170 NRG TENDL-2015, AKONING  
protons from (n,3np)

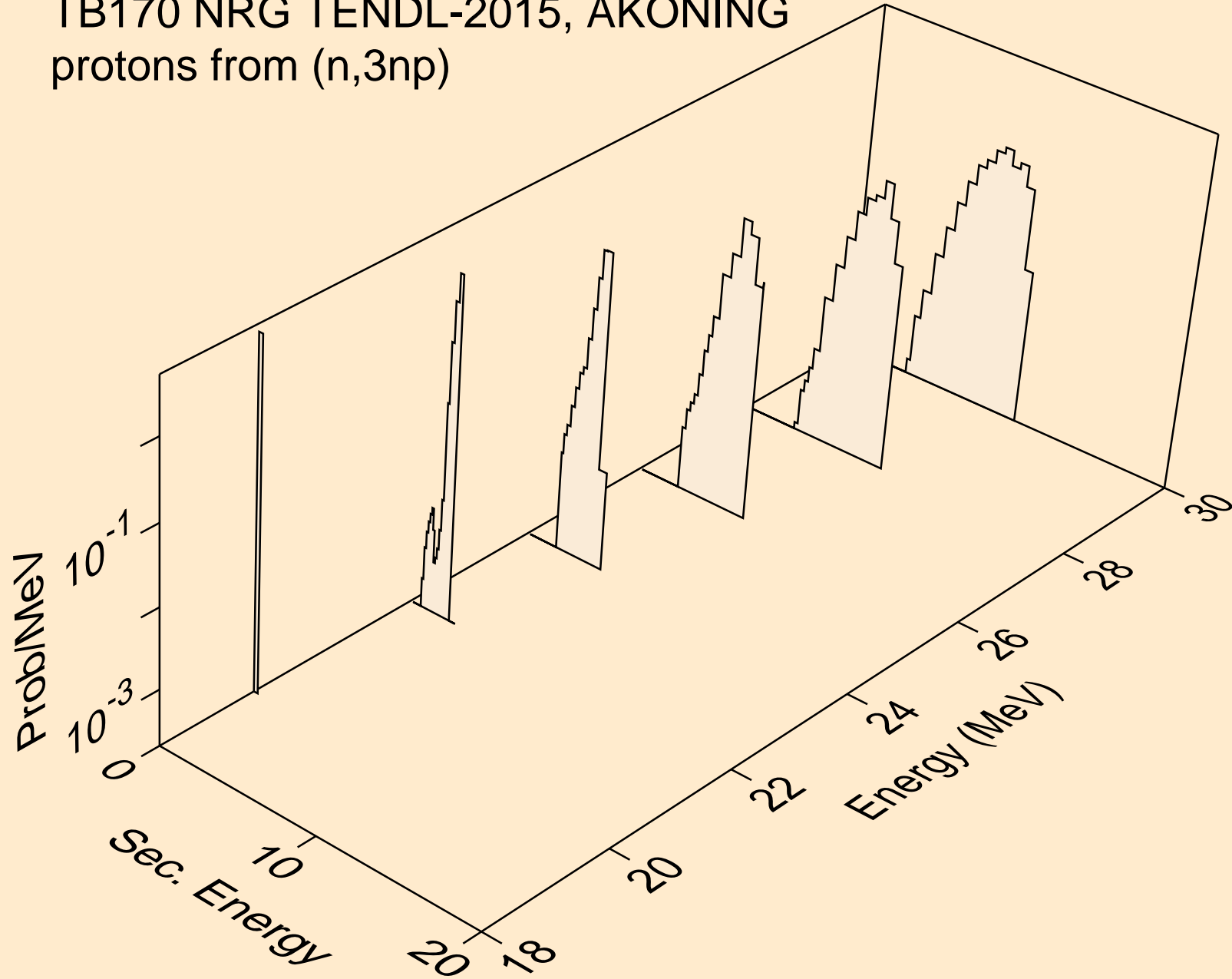

TB170 NRG TENDL-2015, AKONING  
protons from (n,p)

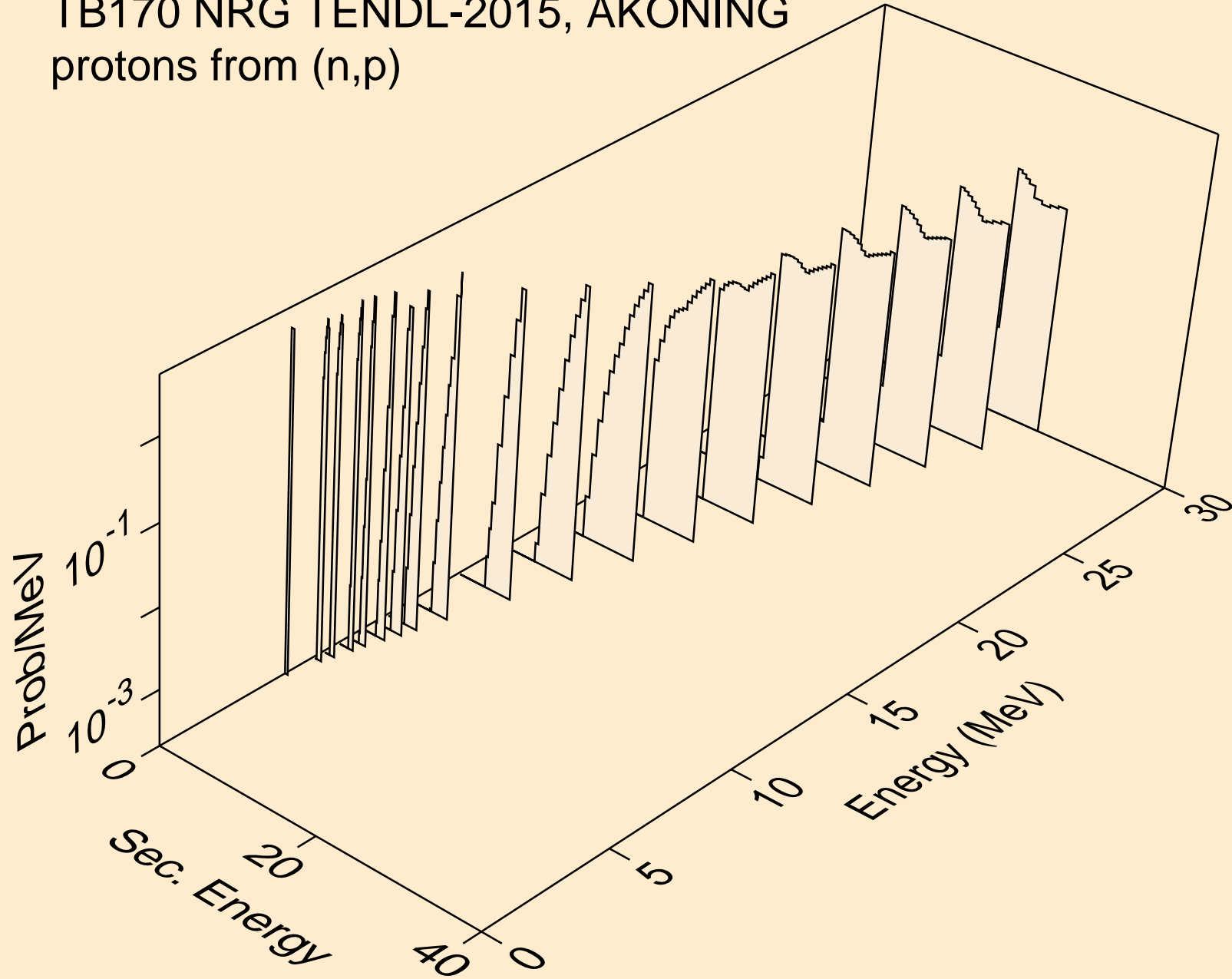

TB170 NRG TENDL-2015, AKONING  
deuterons from (n,x)

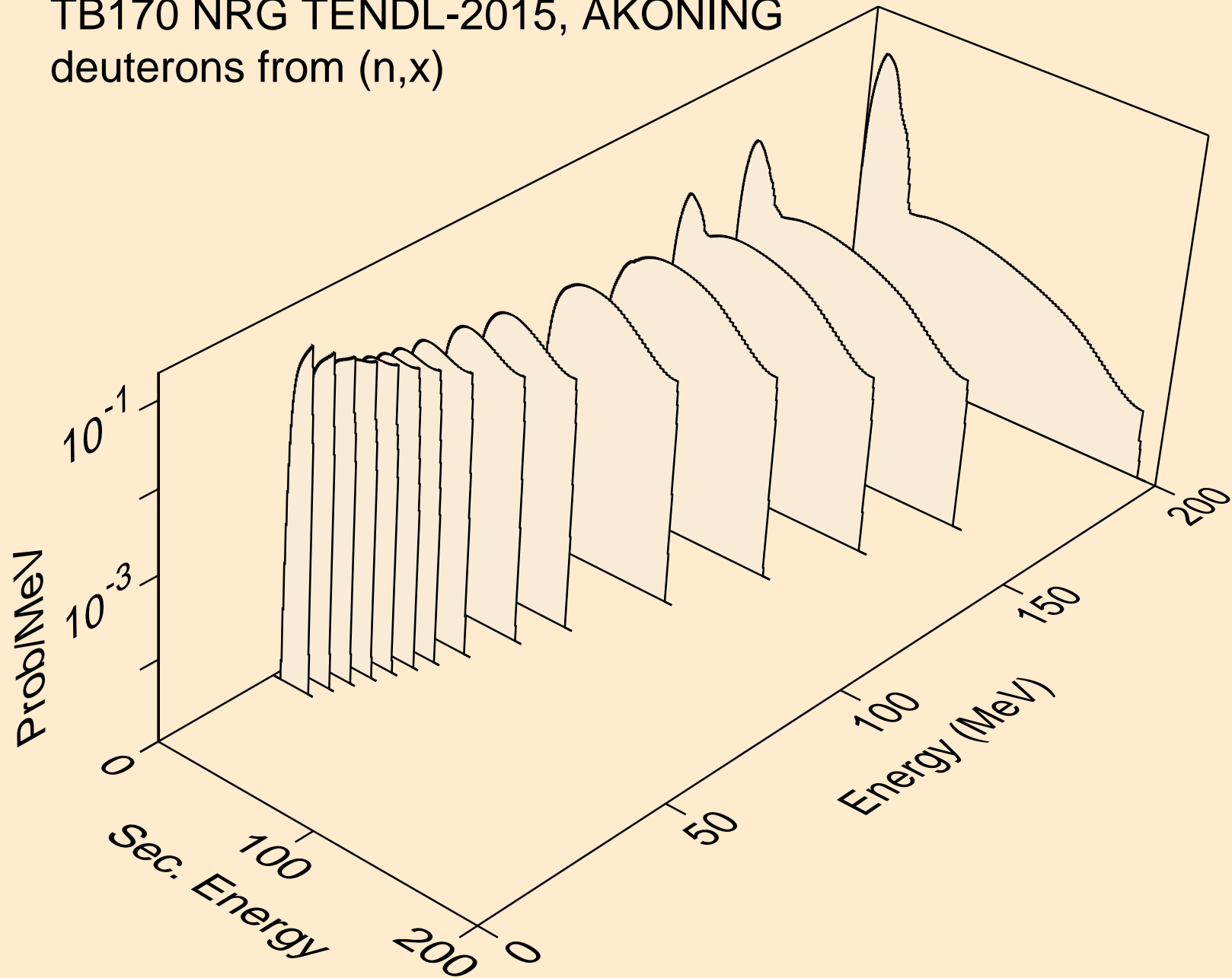

TB170 NRG TENDL-2015, AKONING  
deuterons from (n,2nd)

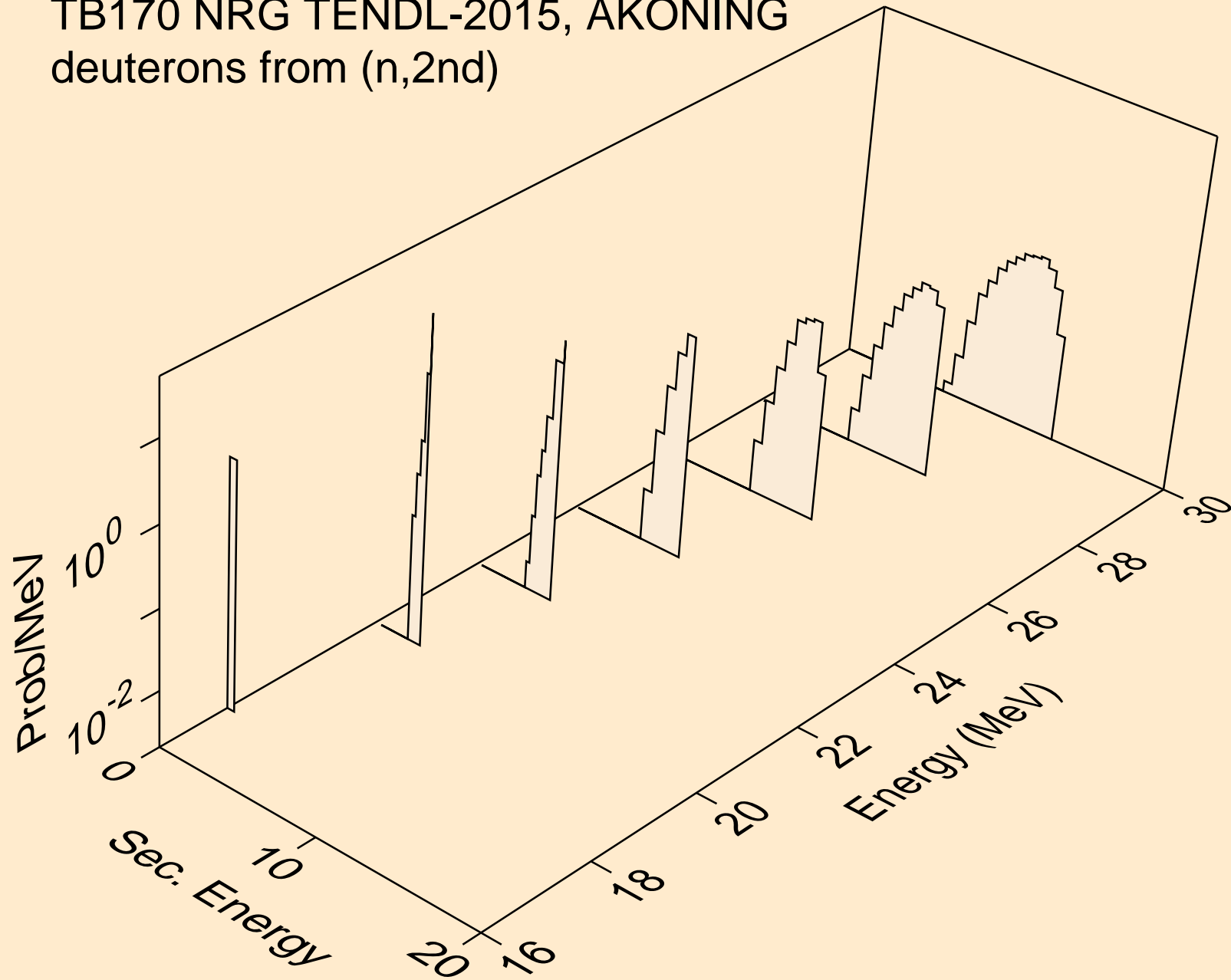

TB170 NRG TENDL-2015, AKONING  
deuterons from (n,n\*)d

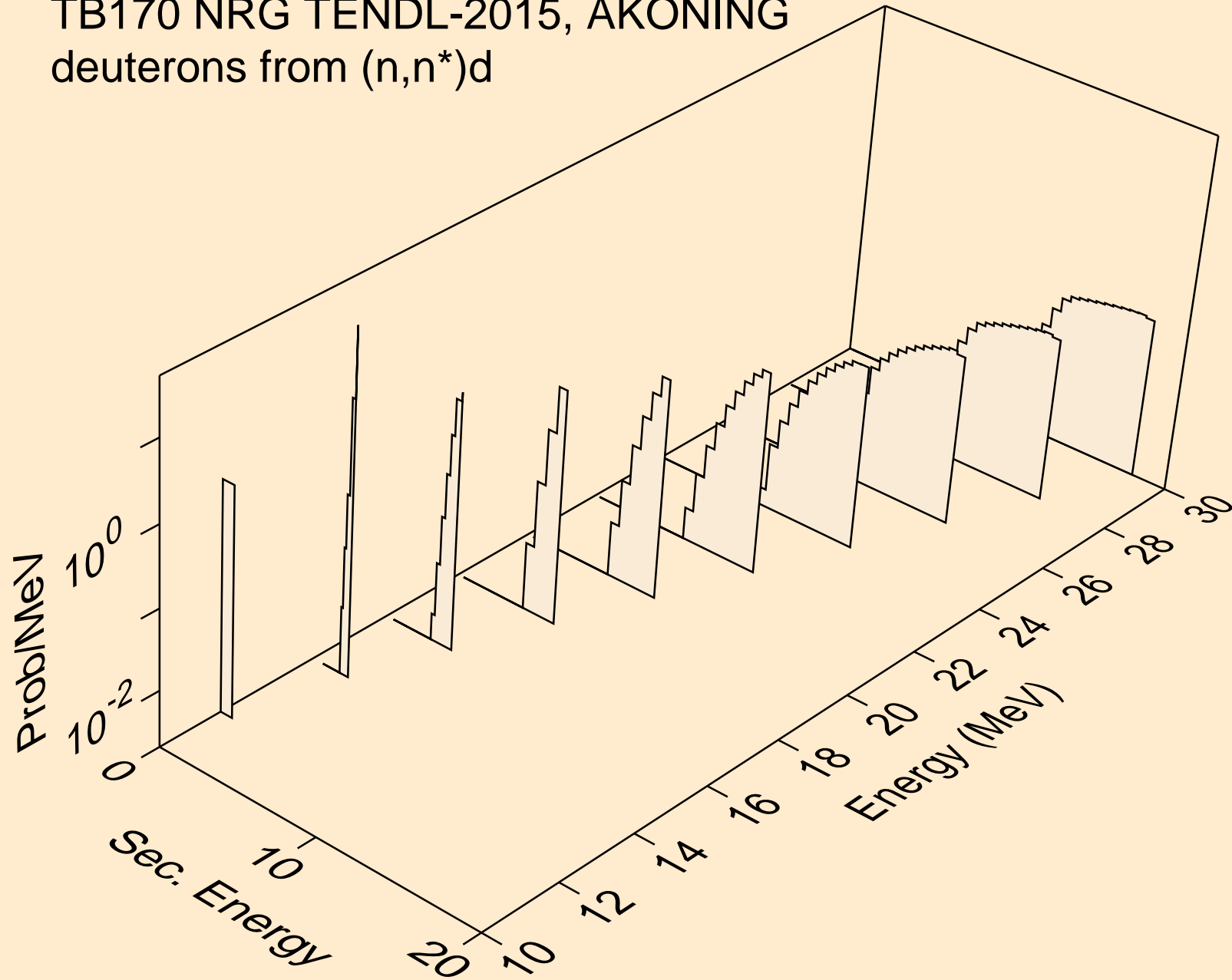

TB170 NRG TENDL-2015, AKONING  
deuterons from (n,d)

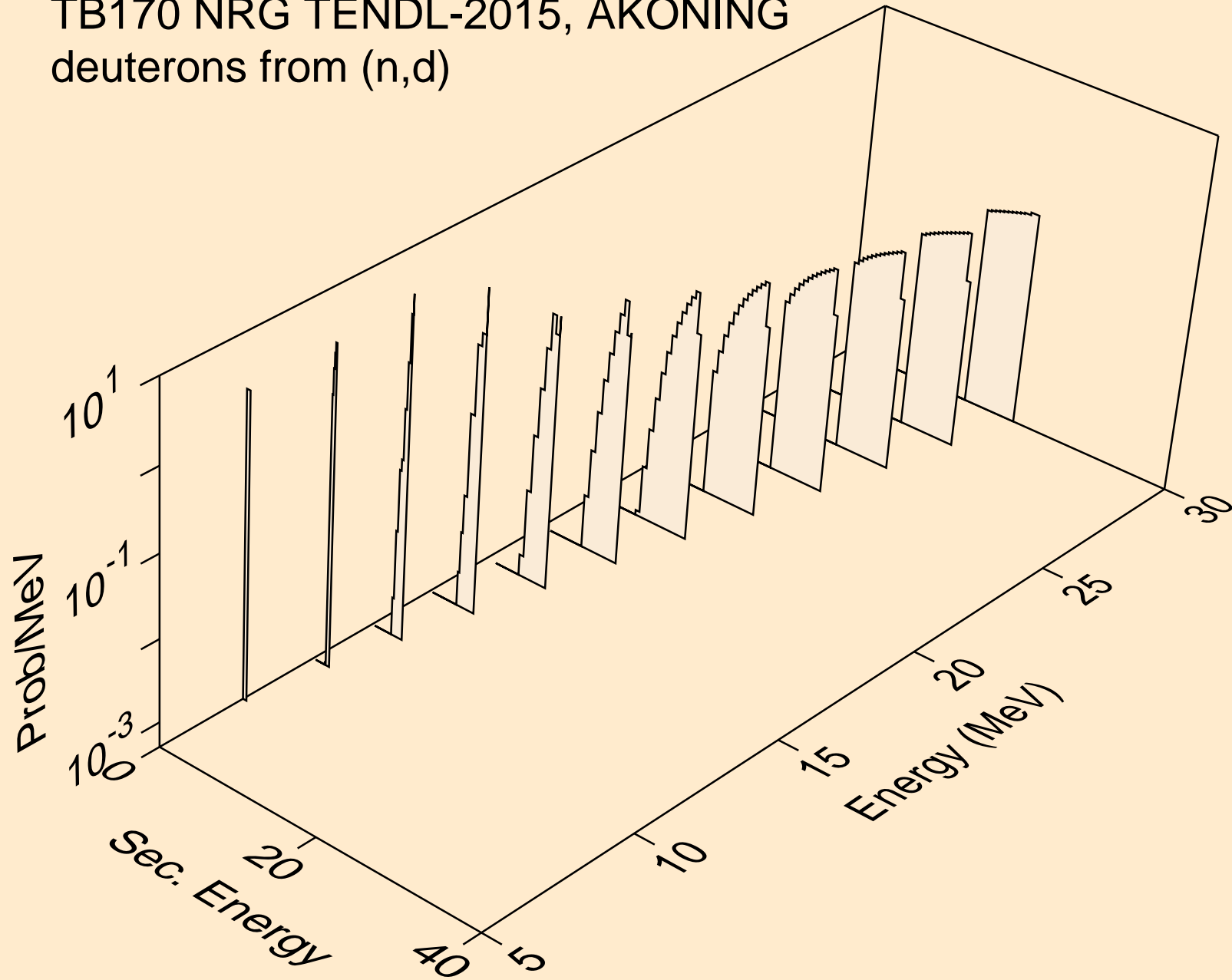

TB170 NRG TENDL-2015, AKONING  
tritons from (n,x)

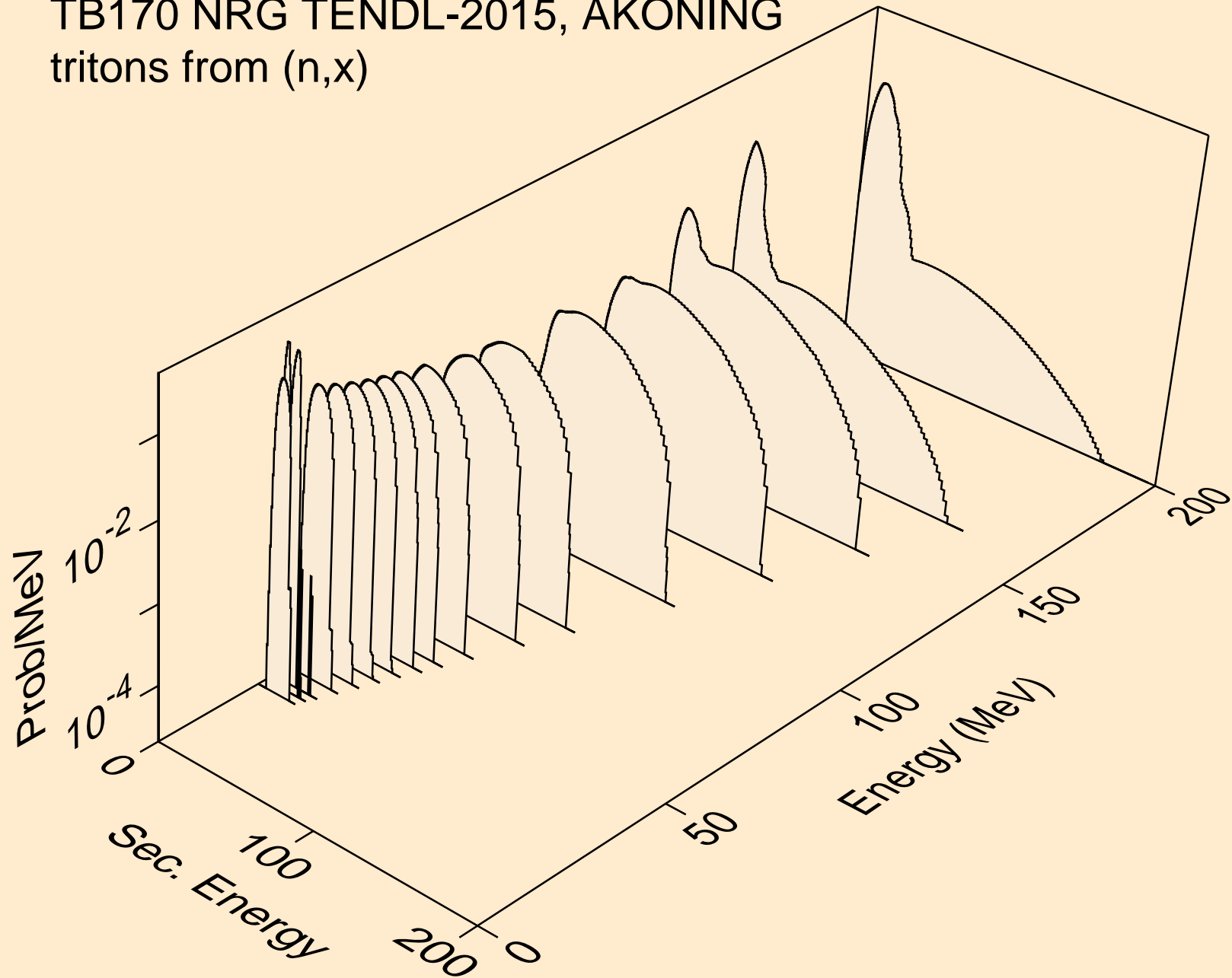

TB170 NRG TENDL-2015, AKONING  
tritons from (n,n\*)t

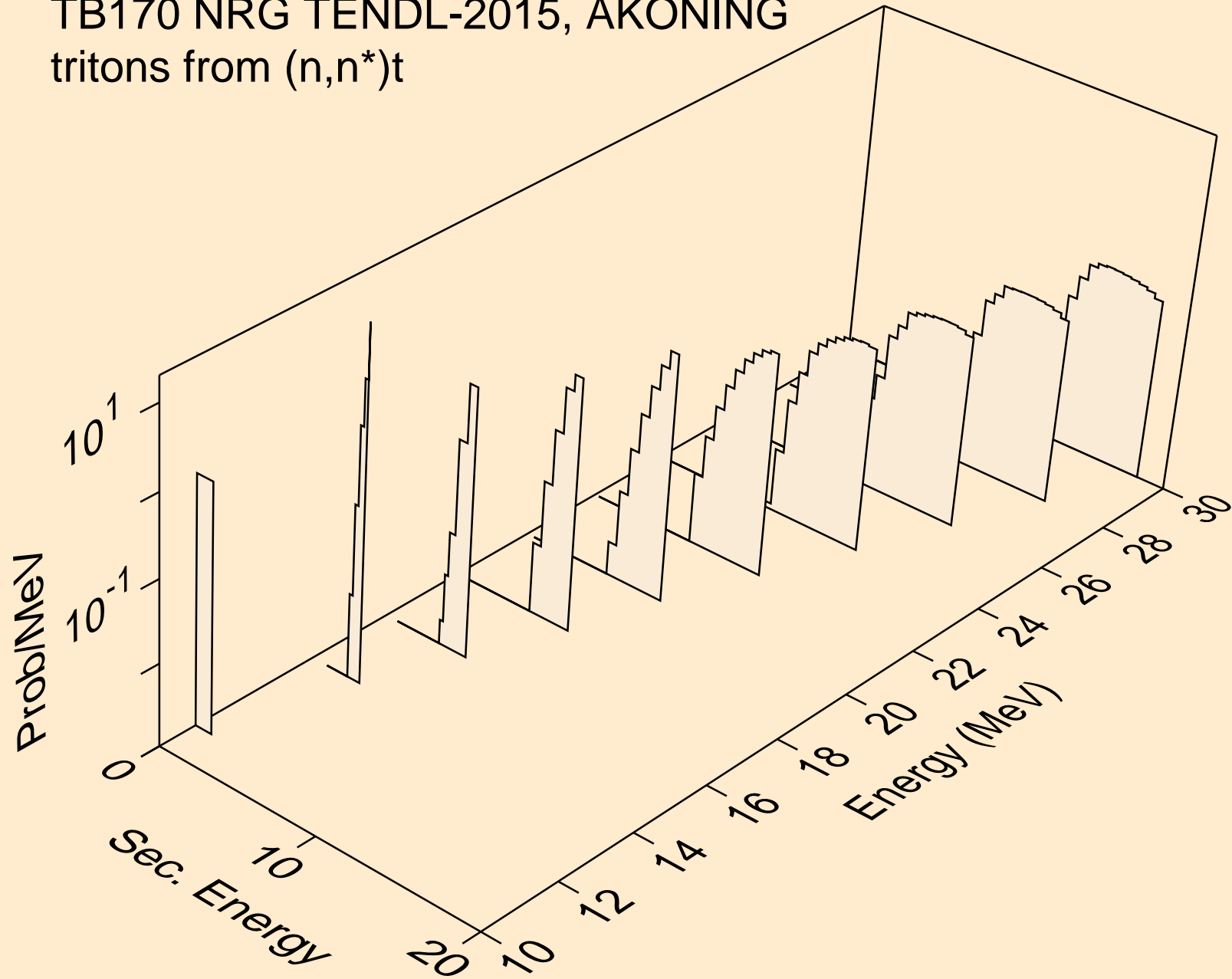



TB170 NRG TENDL-2015, AKONING  
tritons from (n,t)

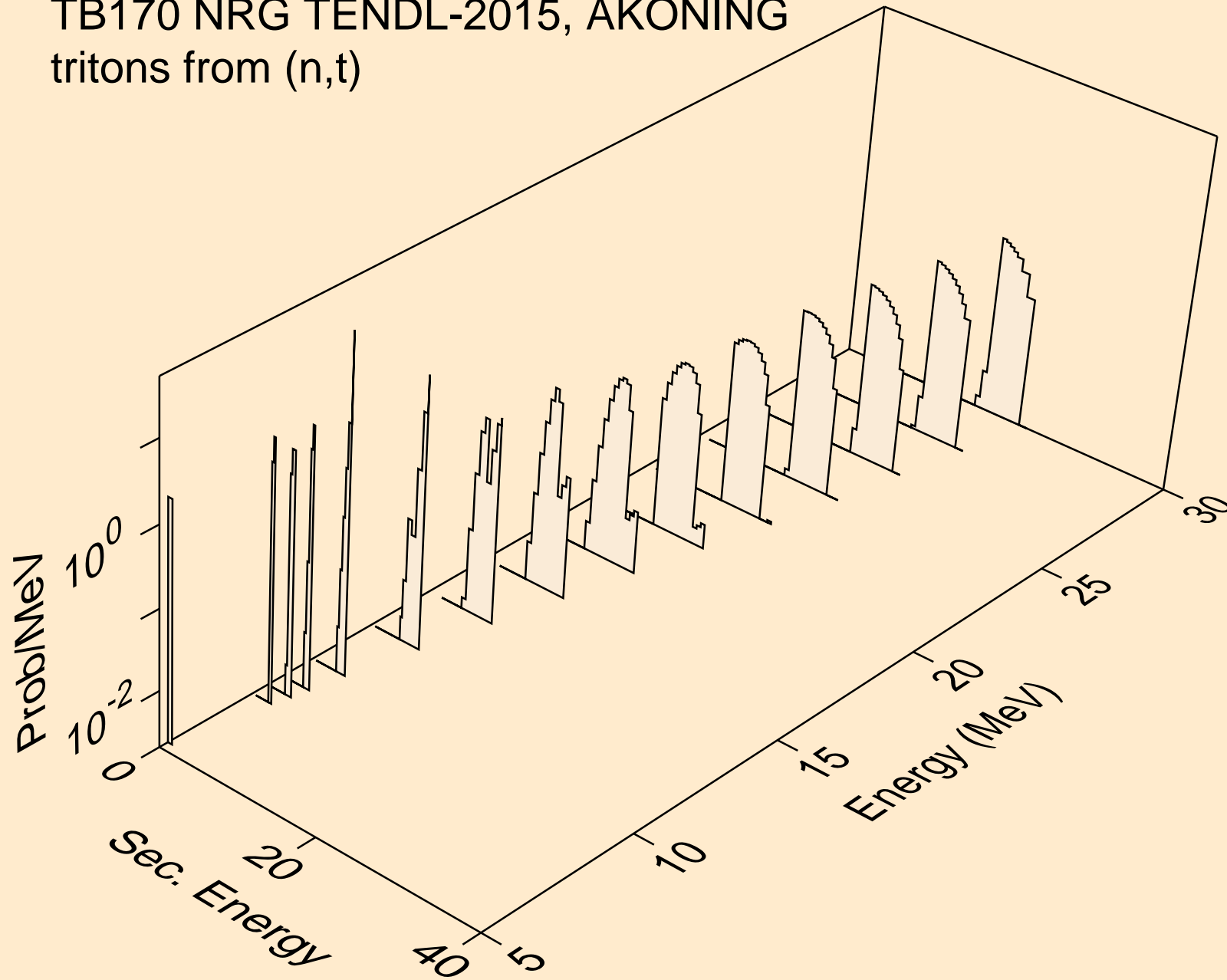

TB170 NRG TENDL-2015, AKONING  
he3s from (n,x)

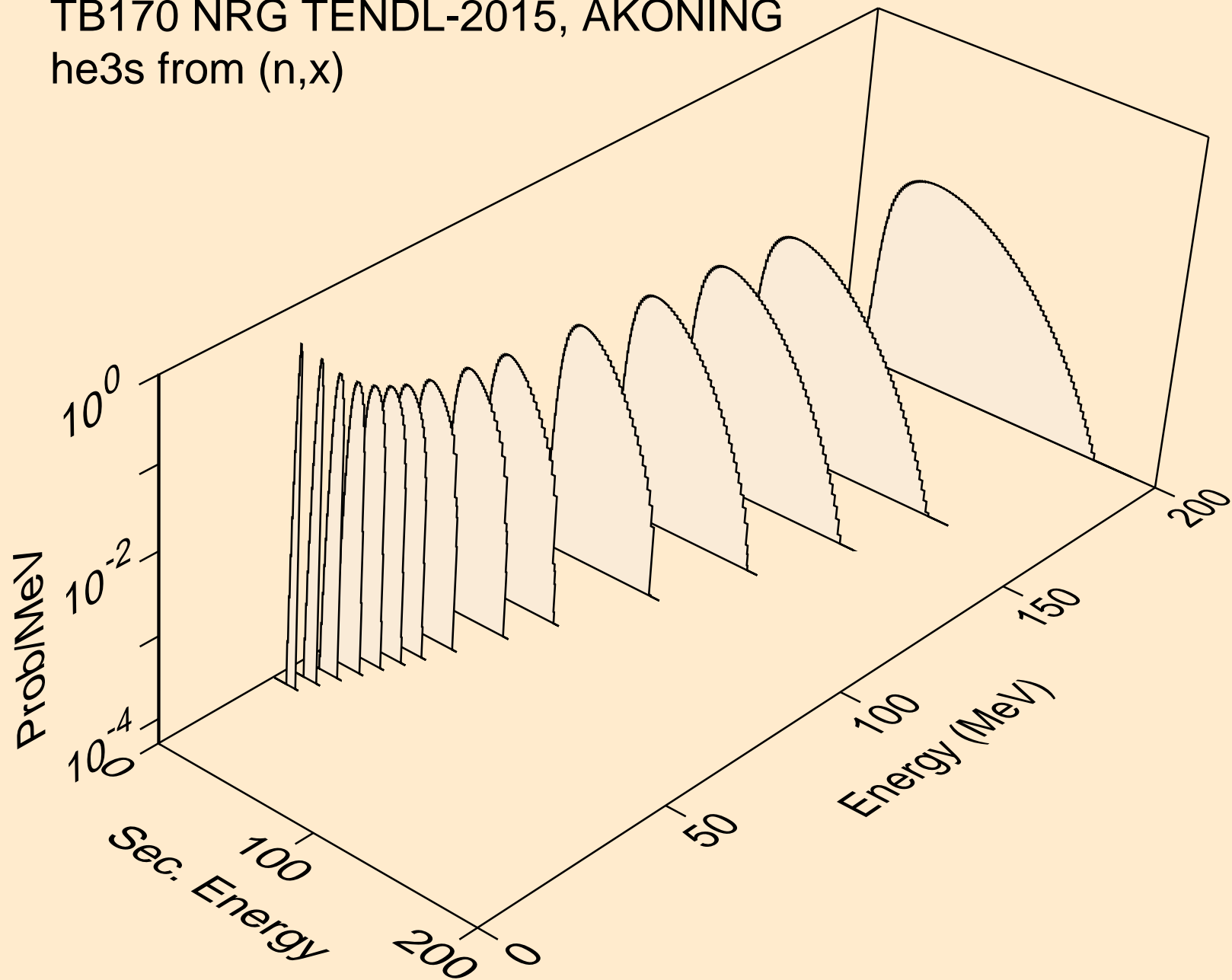

TB170 NRG TENDL-2015, AKONING  
he3s from (n,n\*)he3

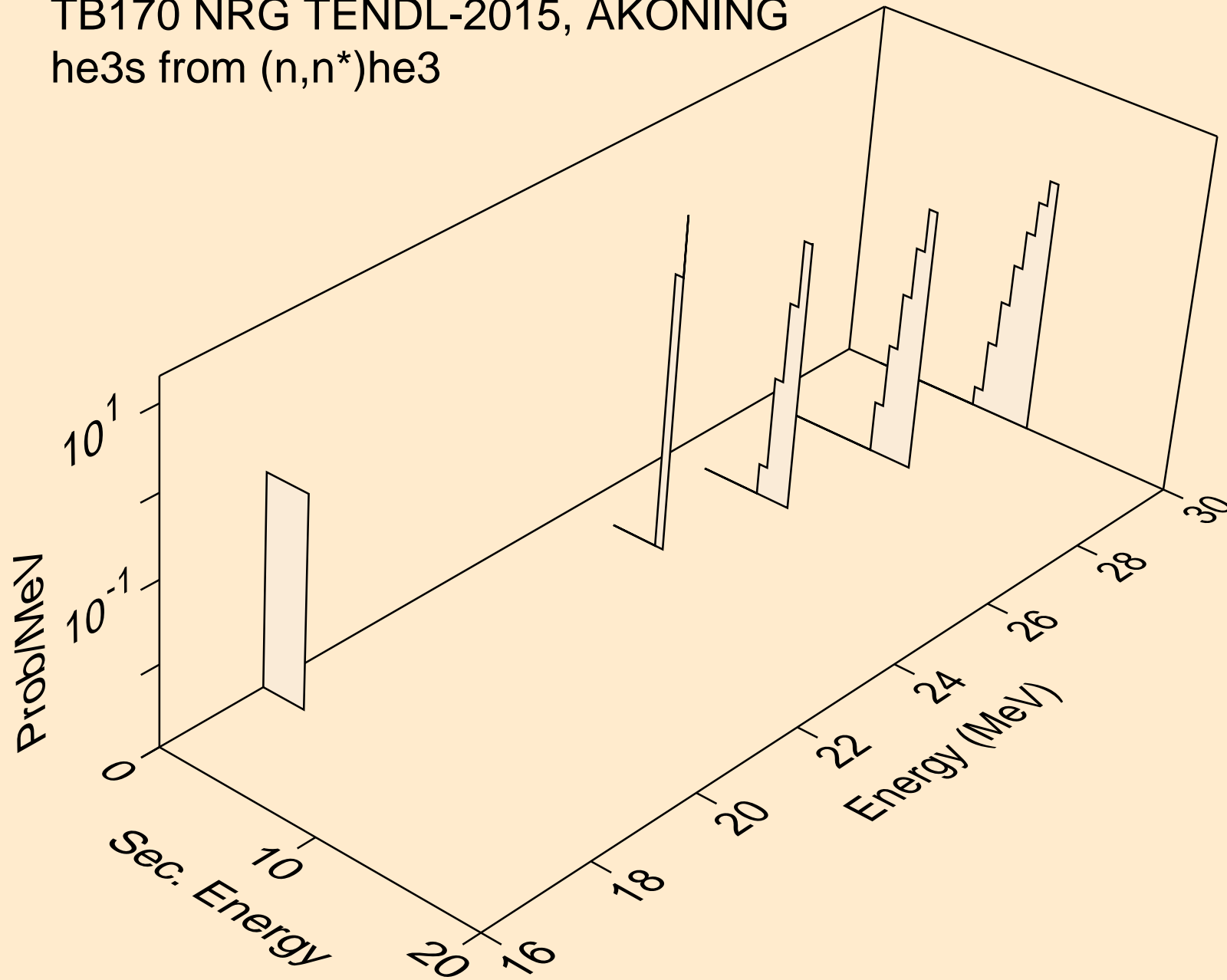

TB170 NRG TENDL-2015, AKONING  
he3s from (n,he3)

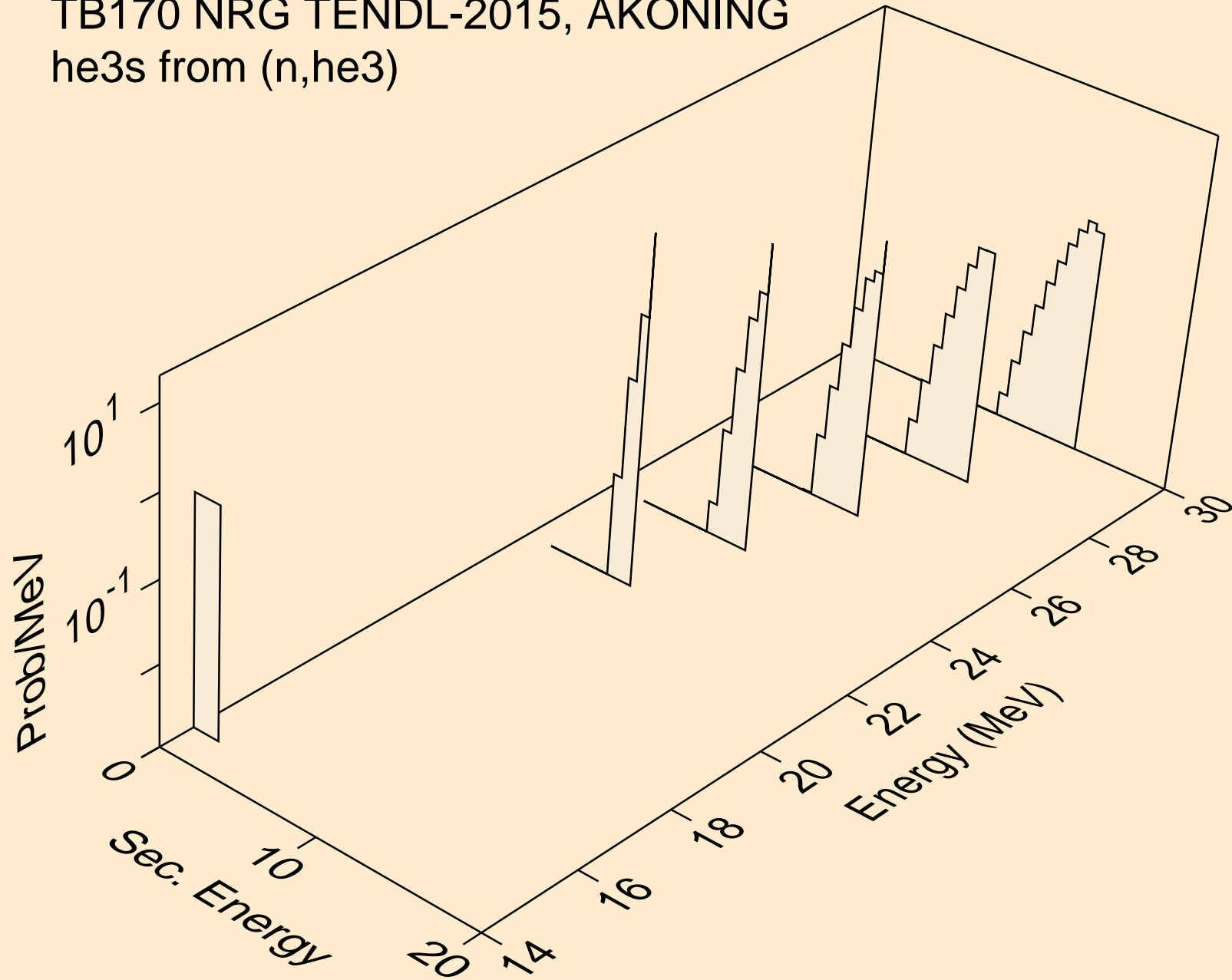

TB170 NRG TENDL-2015, AKONING  
alphas from (n,x)

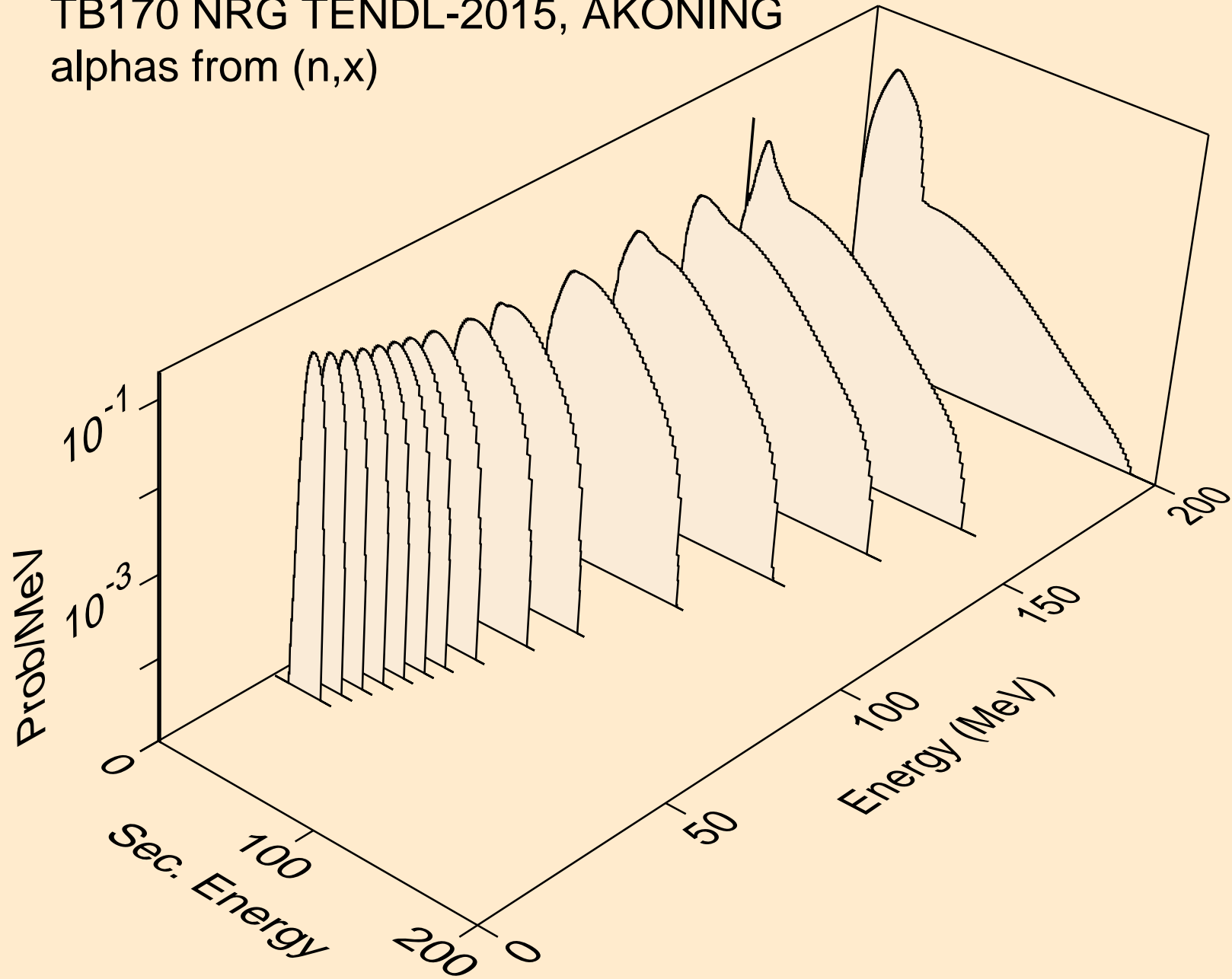

TB170 NRG TENDL-2015, AKONING  
alphas from (n,n\*)a

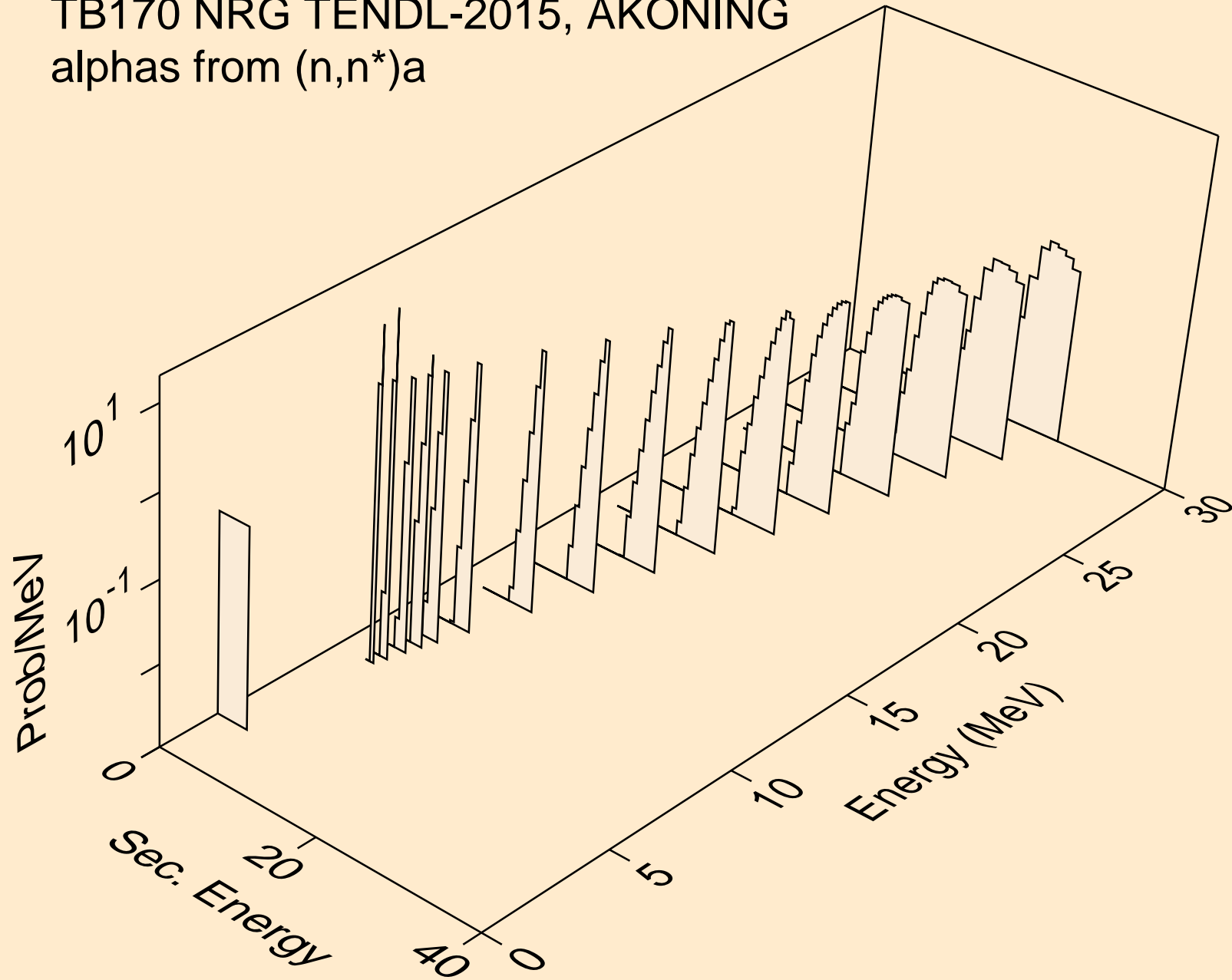

TB170 NRG TENDL-2015, AKONING  
alphas from (n,2n)a

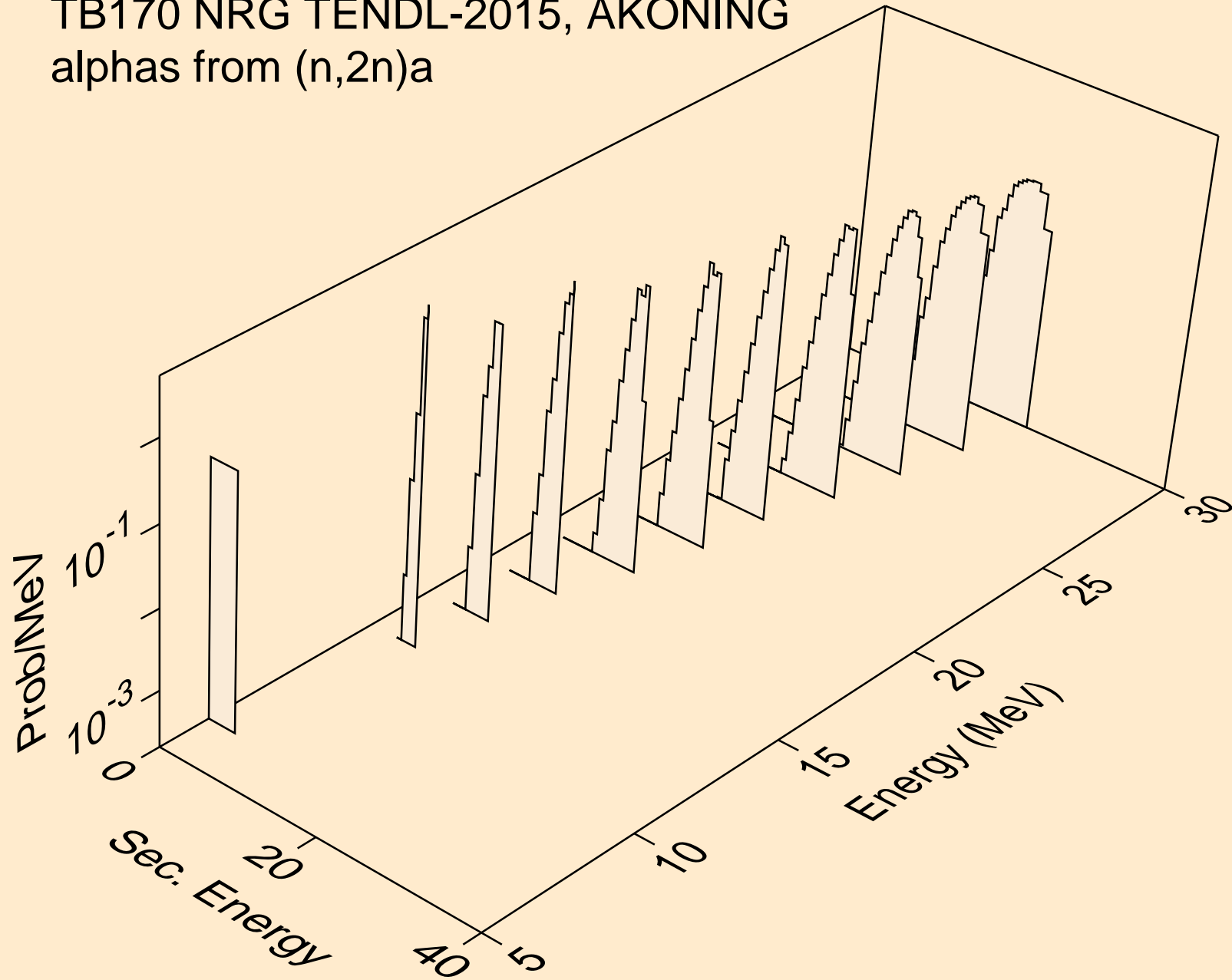

TB170 NRG TENDL-2015, AKONING  
alphas from (n,3n)a

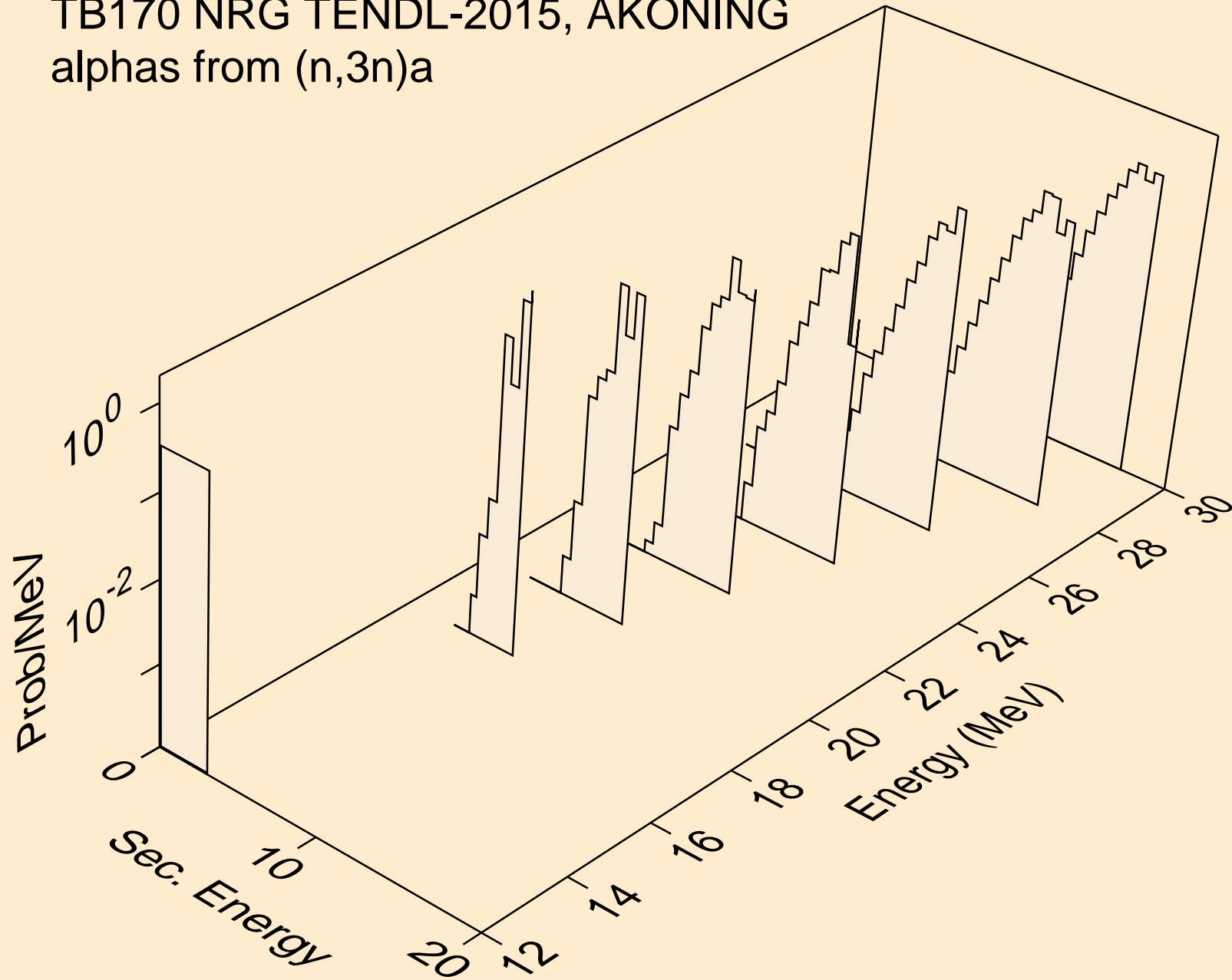



TB170 NRG TENDL-2015, AKONING  
alphas from (n,a)

