

TE110 NRG TENDL-2015, AKONING

Principal cross sections

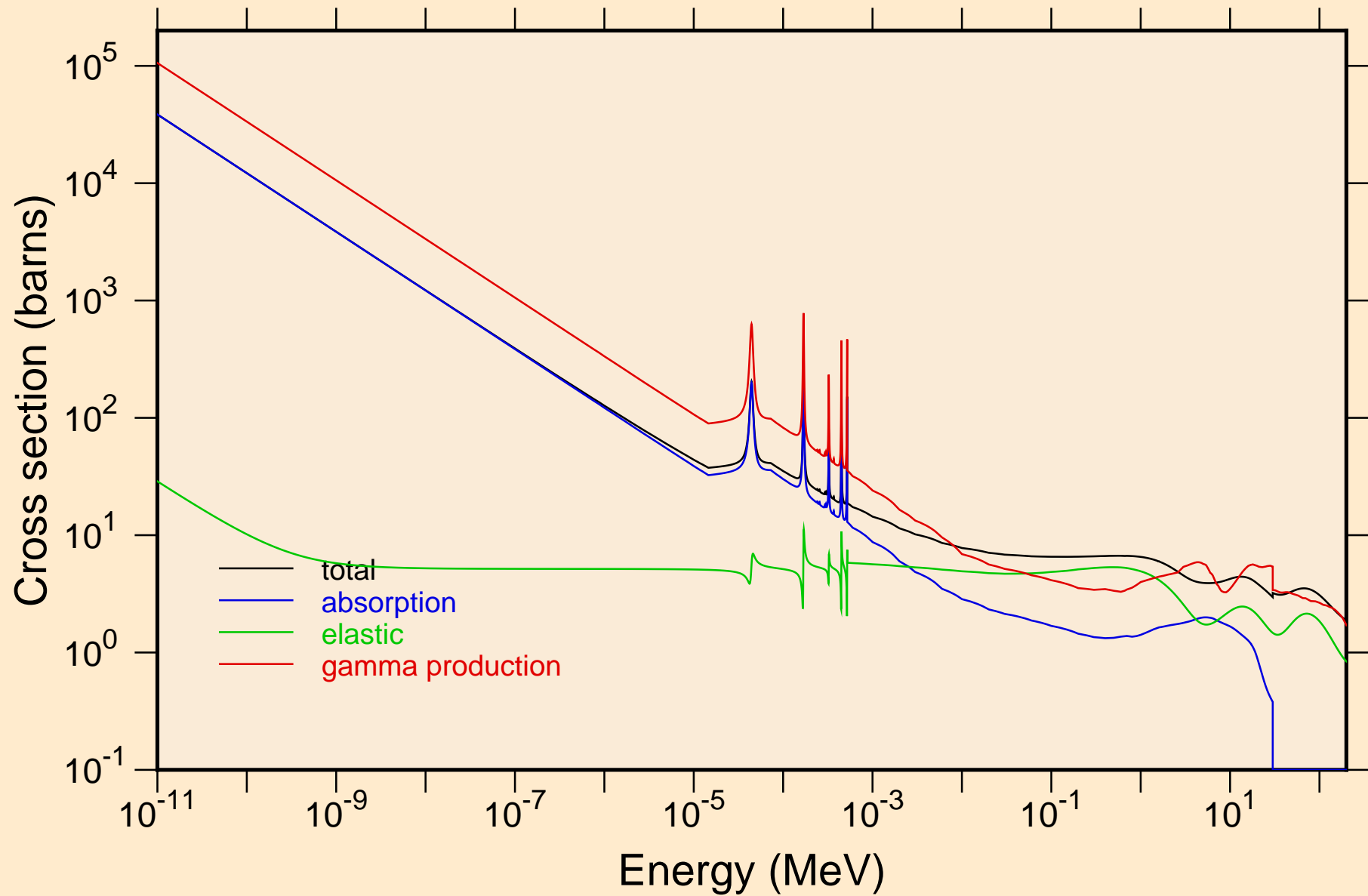

TE110 NRG TENDL-2015, AKONING

Non-threshold reactions

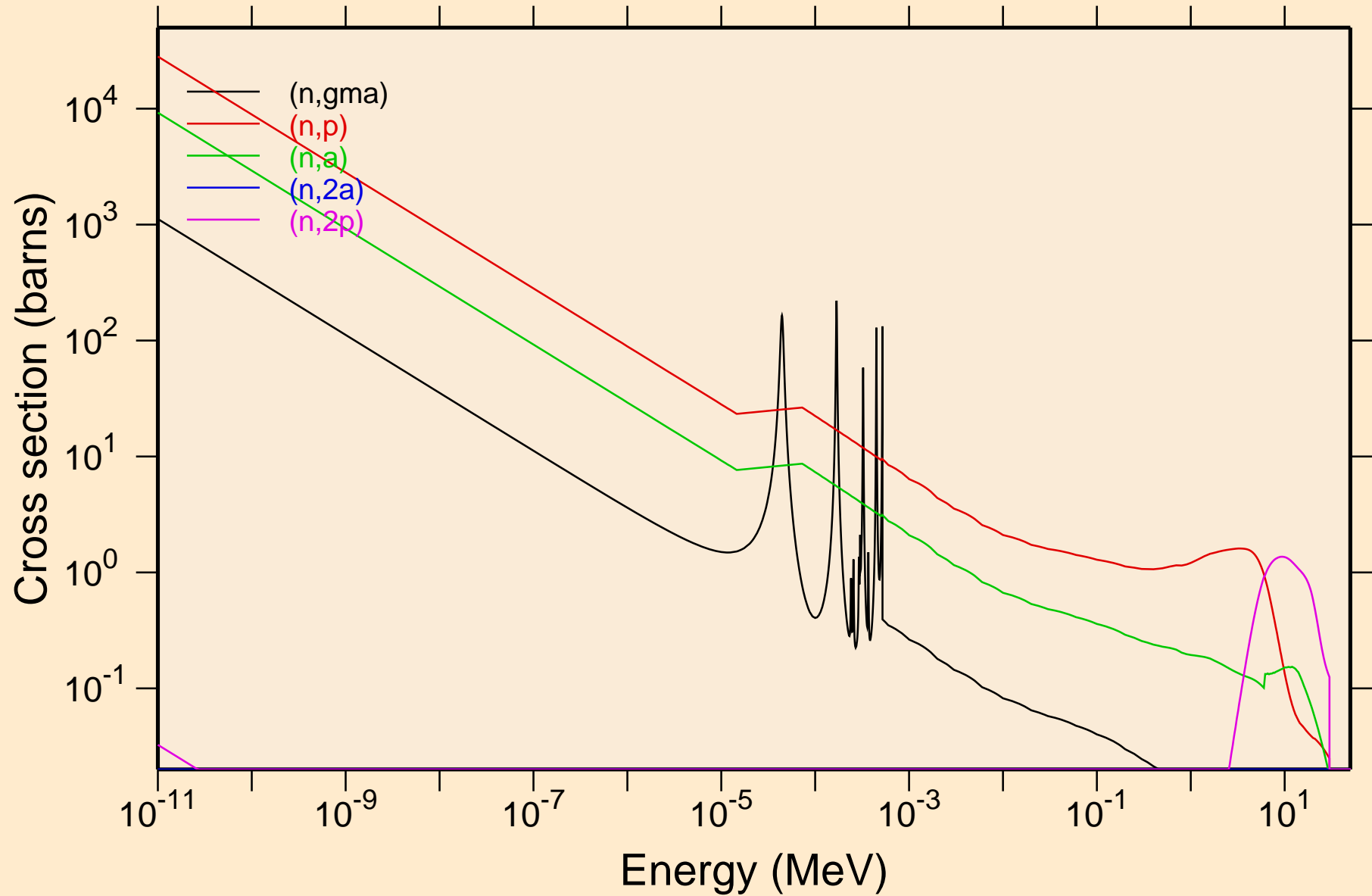

TE110 NRG TENDL-2015, AKONING
Non-threshold reactions

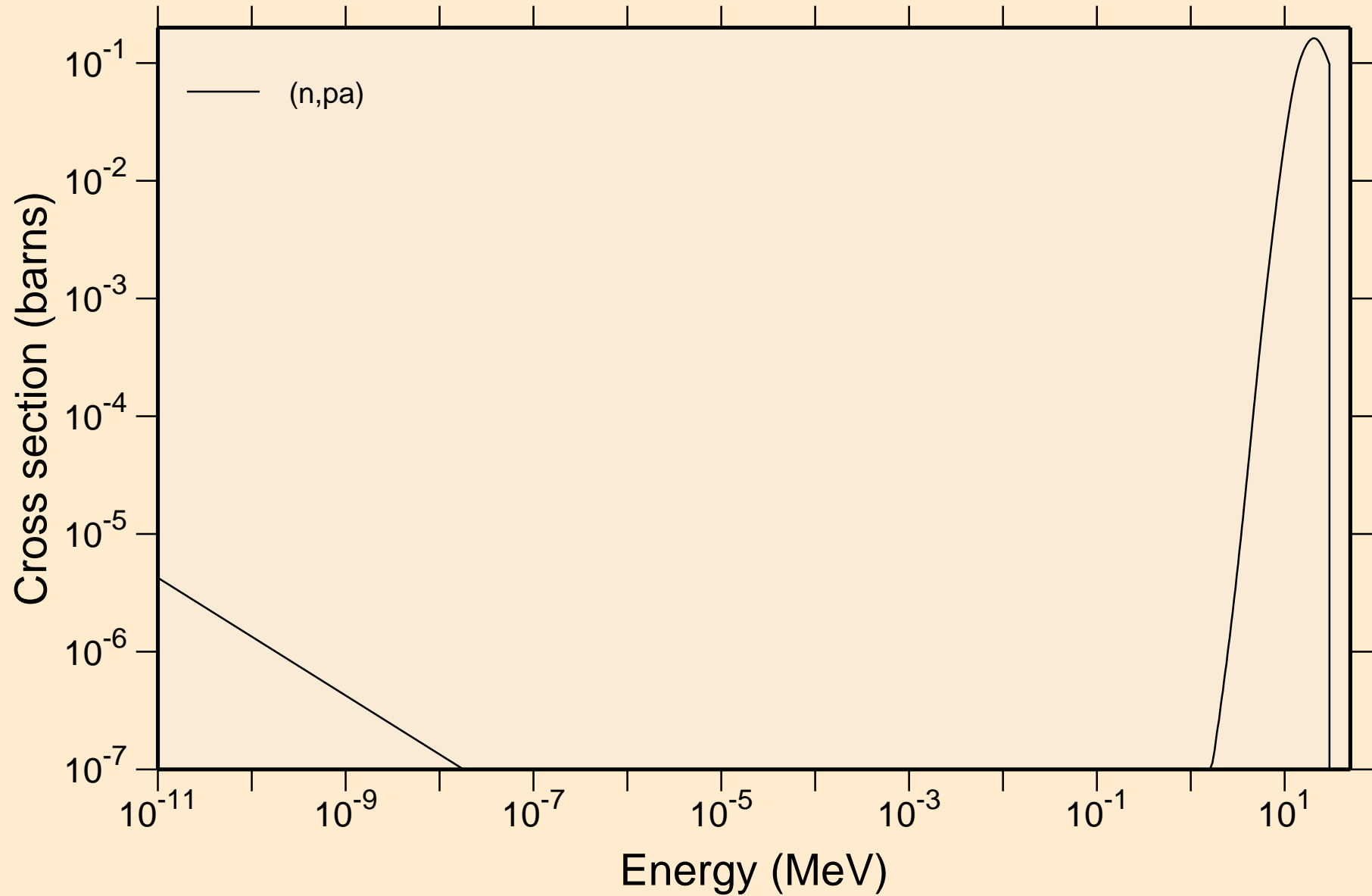

TE110 NRG TENDL-2015, AKONING

Principal cross sections

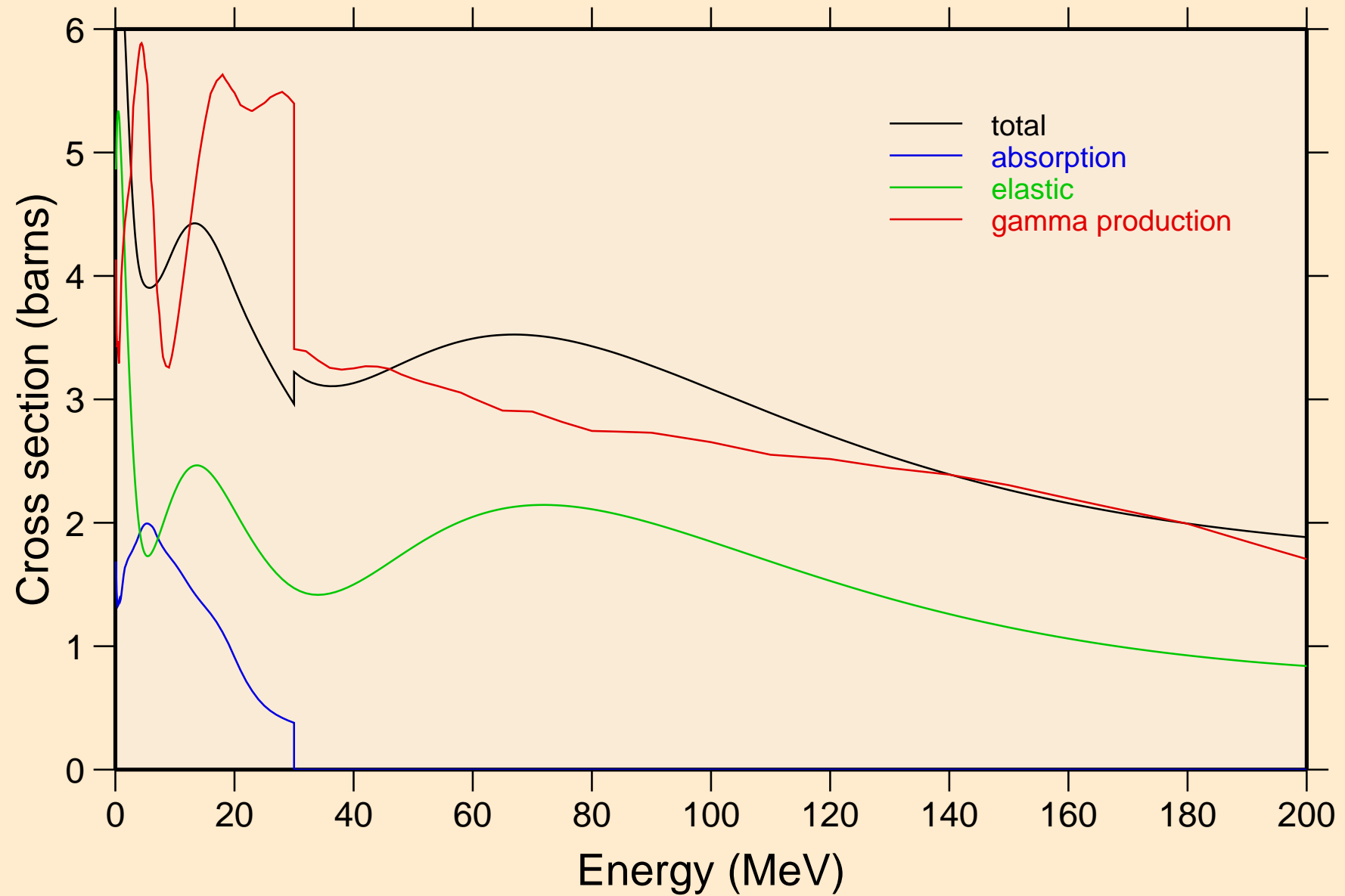

TE110 NRG TENDL-2015, AKONING
Non-threshold reactions

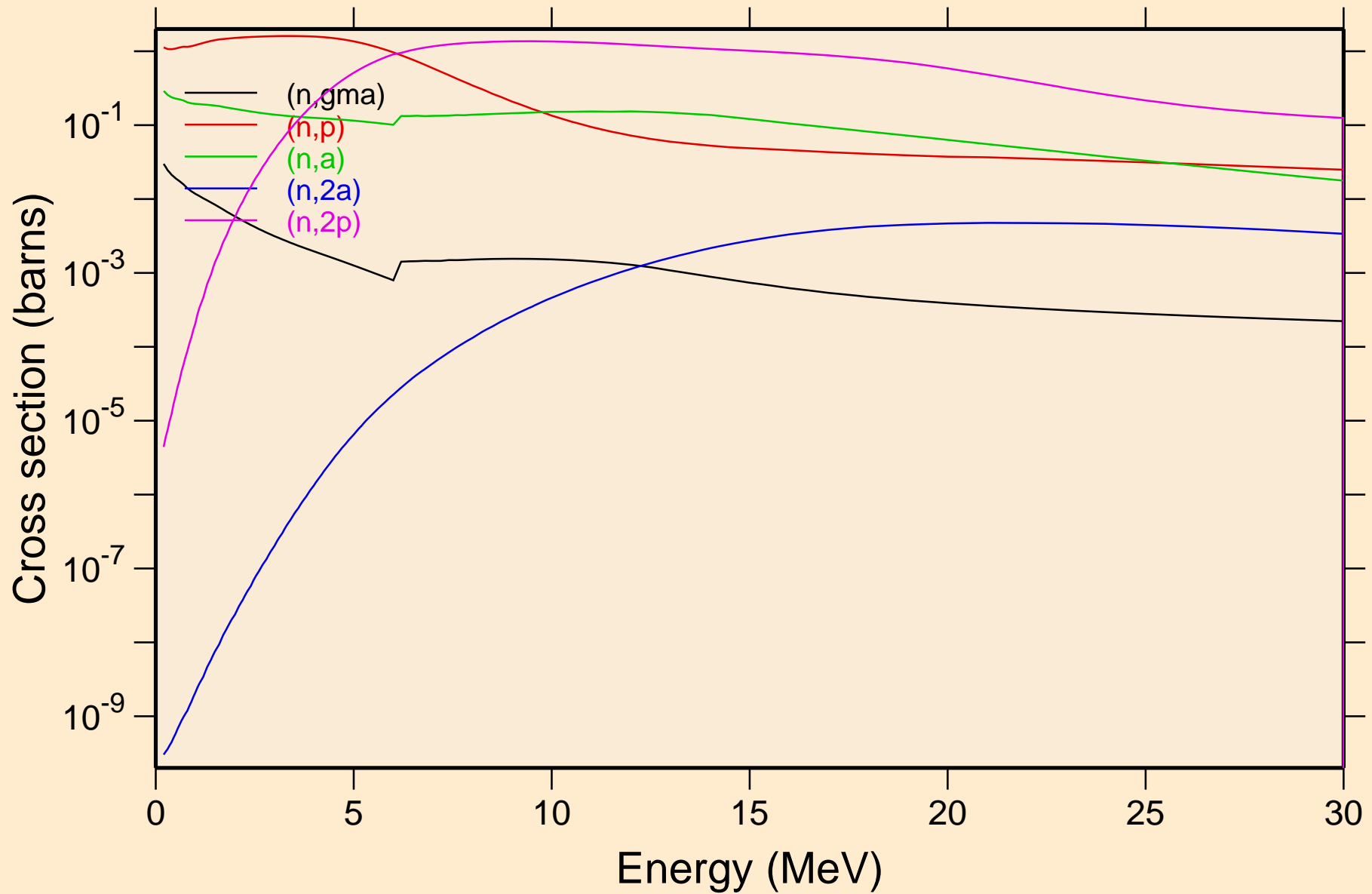

TE110 NRG TENDL-2015, AKONING
Non-threshold reactions

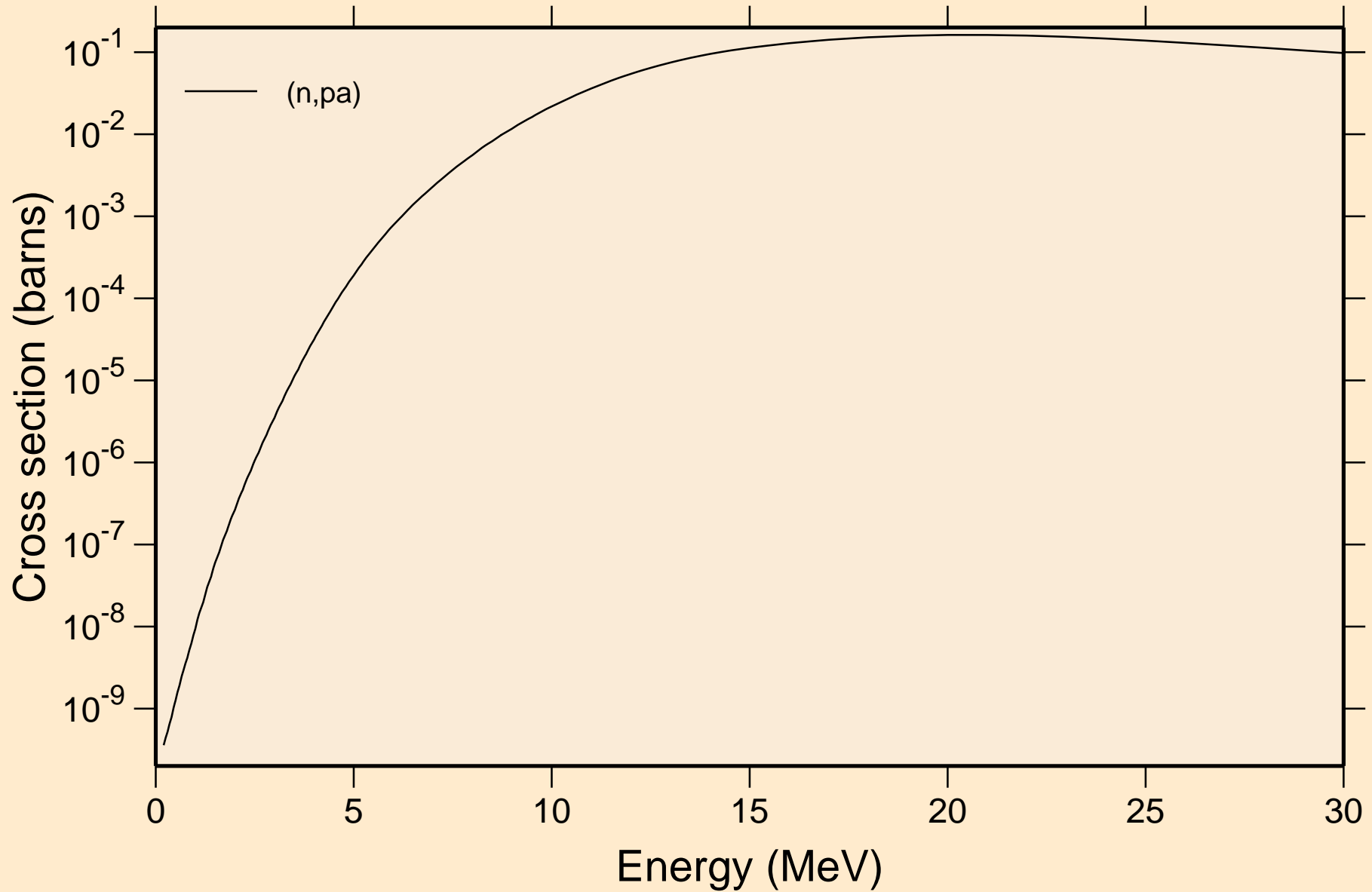

TE110 NRG TENDL-2015, AKONING

Inelastic levels

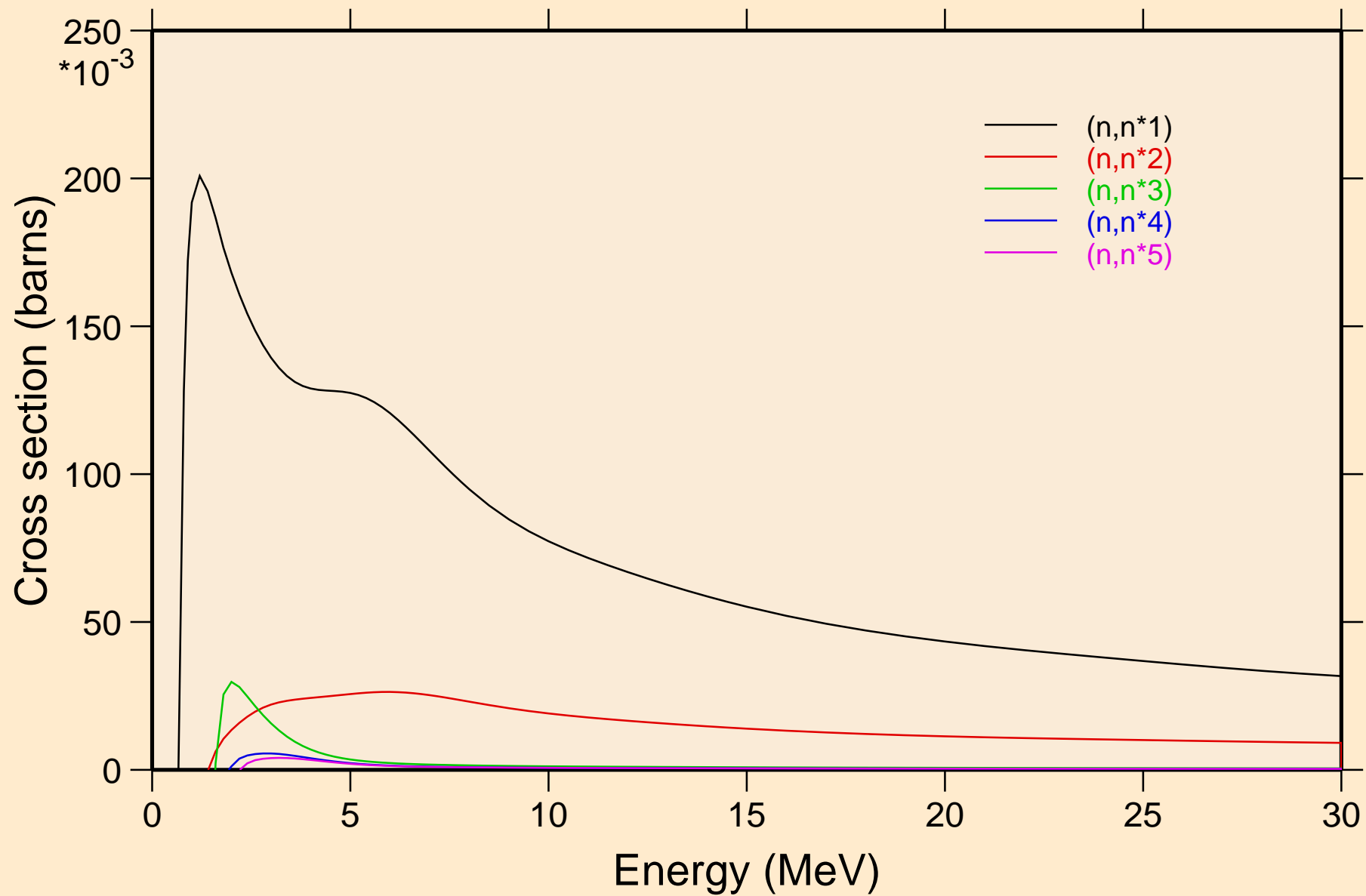

TE110 NRG TENDL-2015, AKONING

Inelastic levels

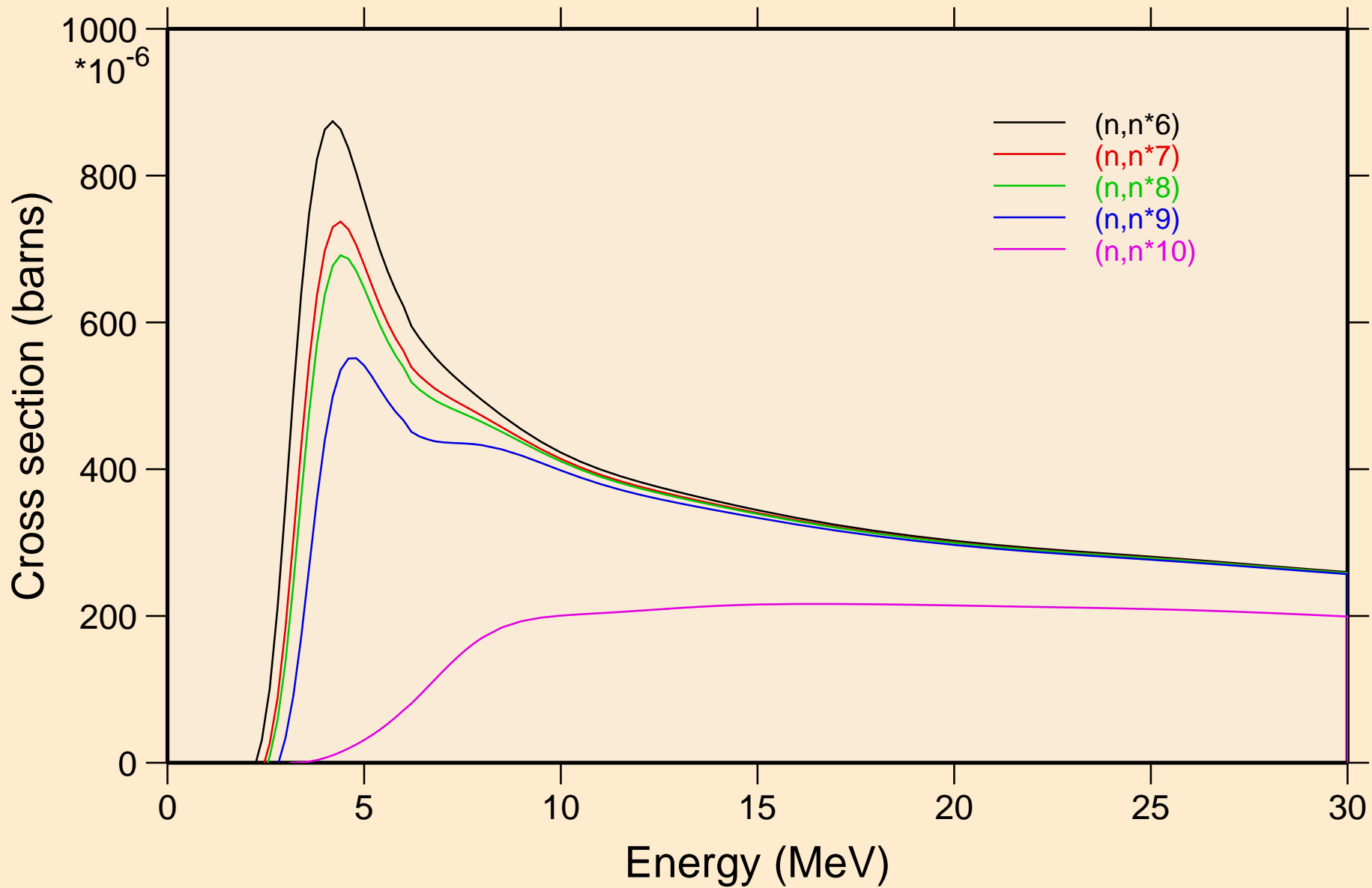

TE110 NRG TENDL-2015, AKONING
Inelastic levels

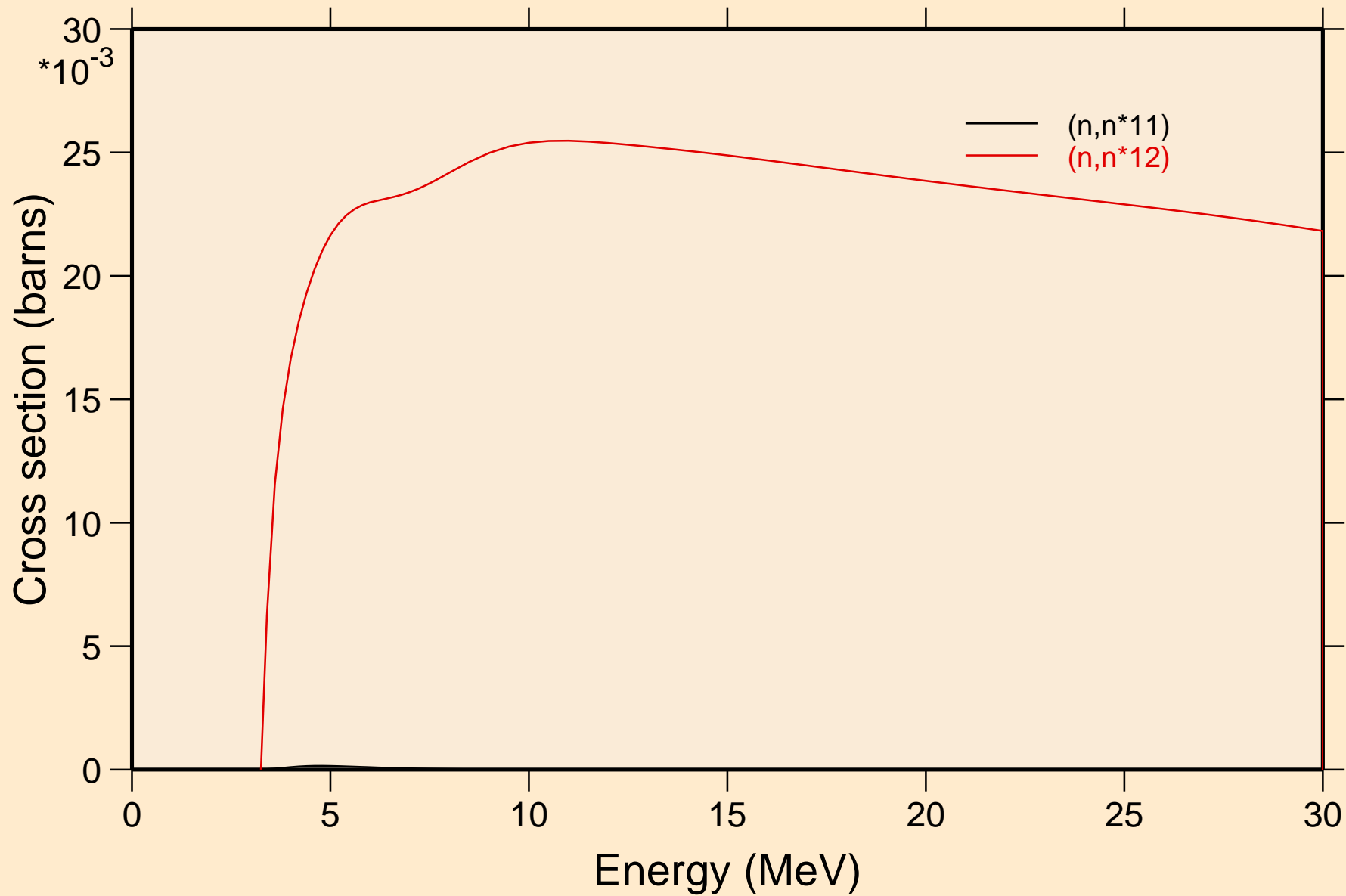

TE110 NRG TENDL-2015, AKONING

Threshold reactions

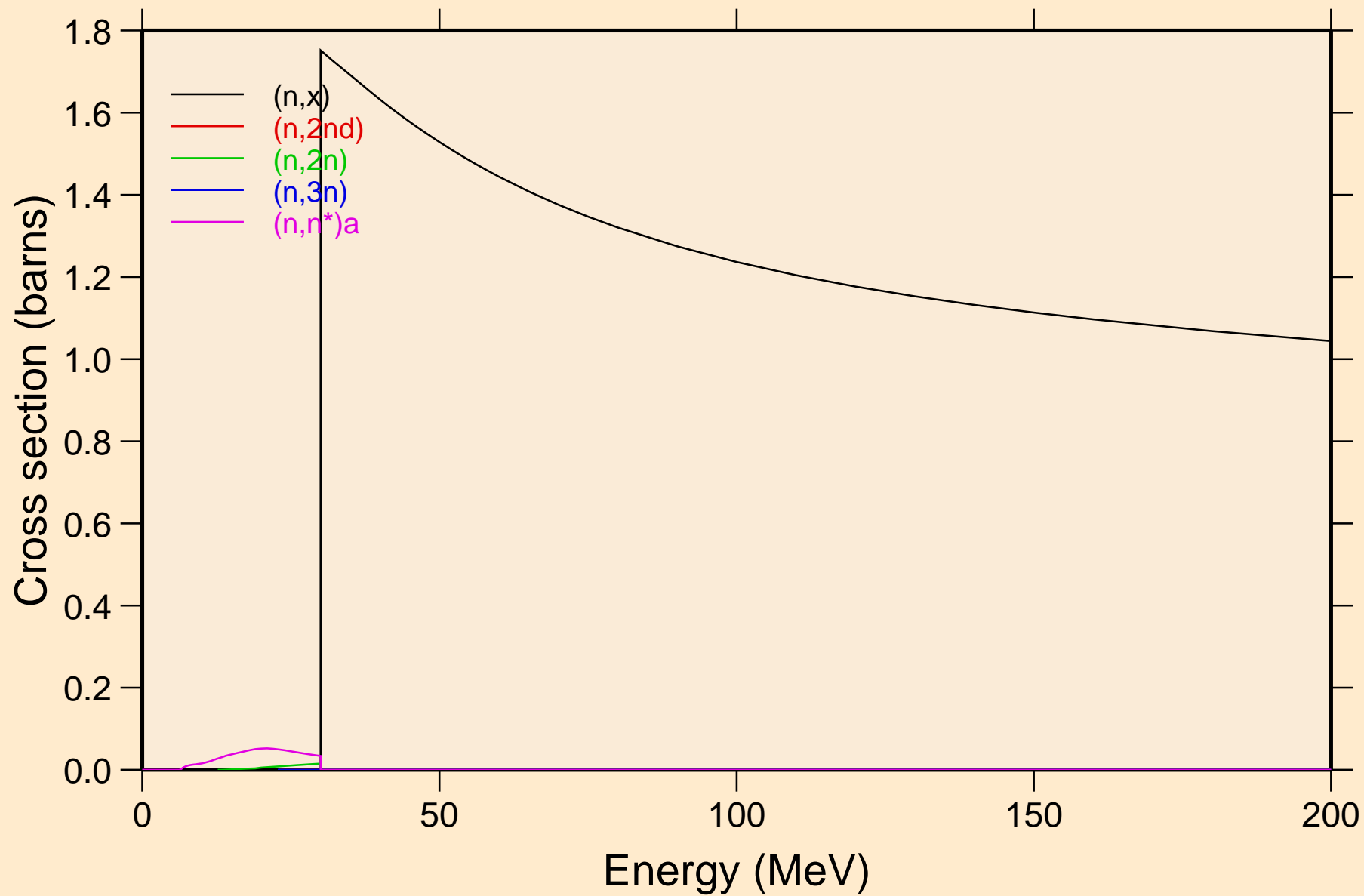

TE110 NRG TENDL-2015, AKONING

Threshold reactions

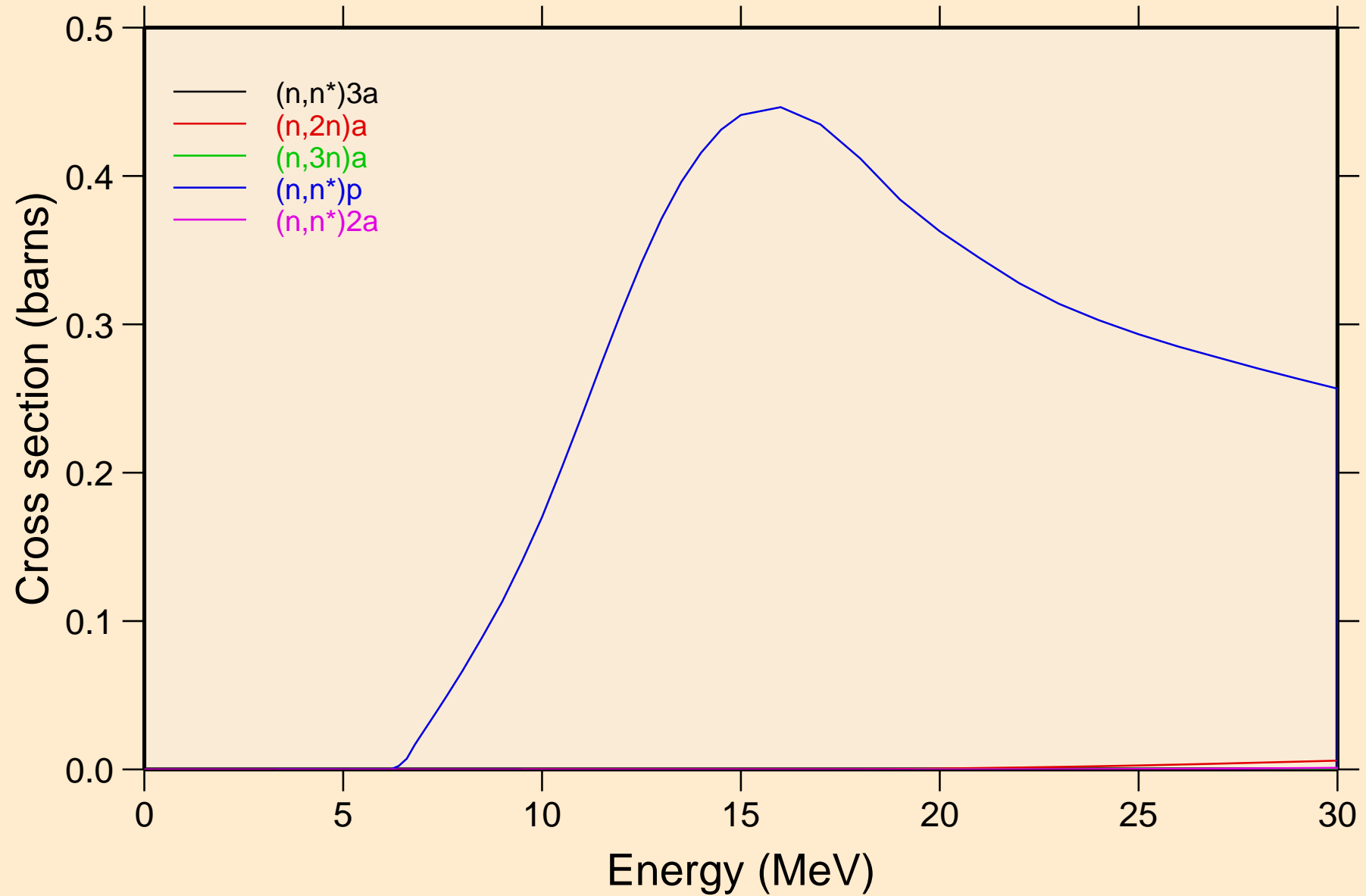

TE110 NRG TENDL-2015, AKONING

Threshold reactions

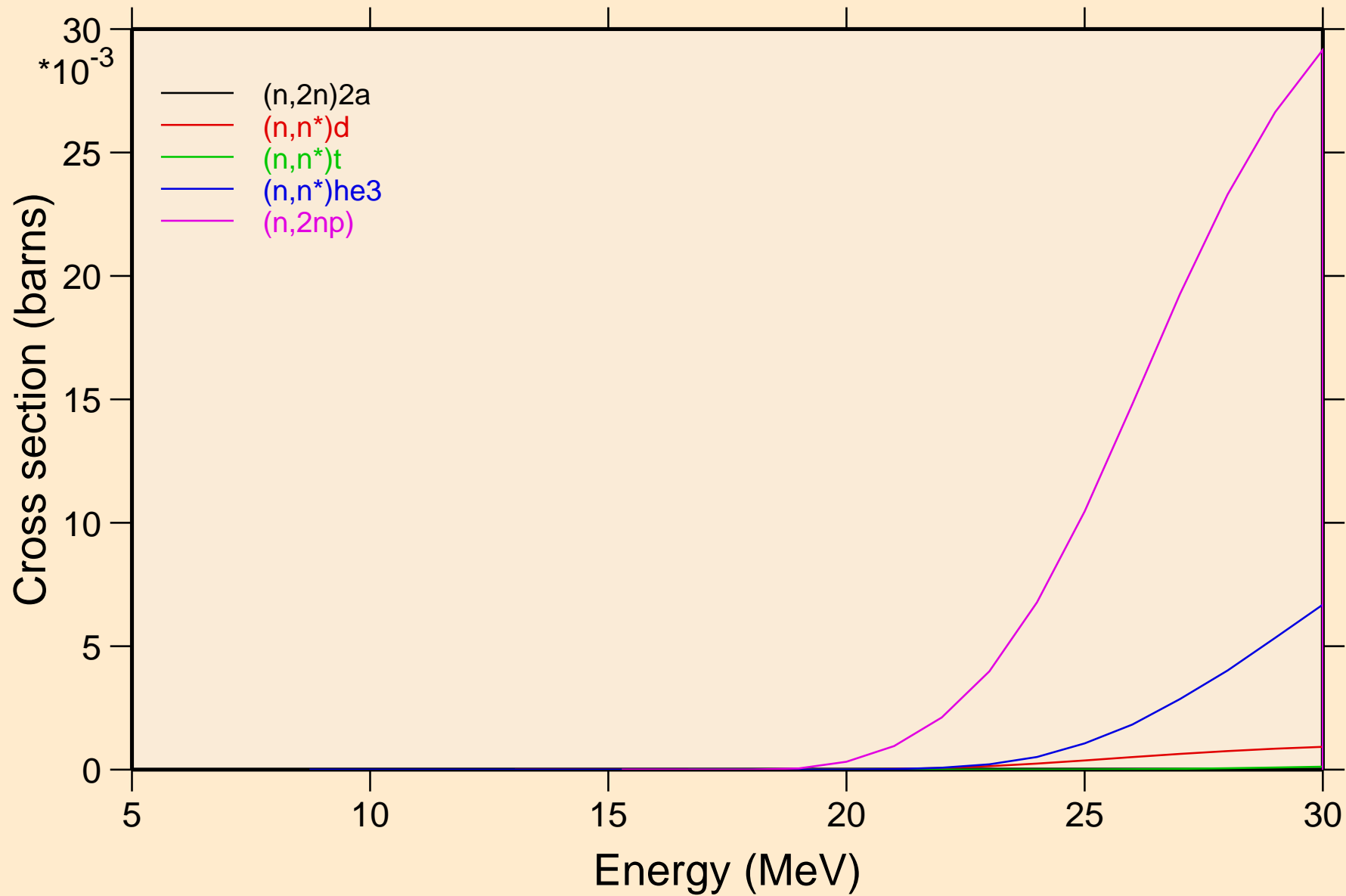

TE110 NRG TENDL-2015, AKONING

Threshold reactions

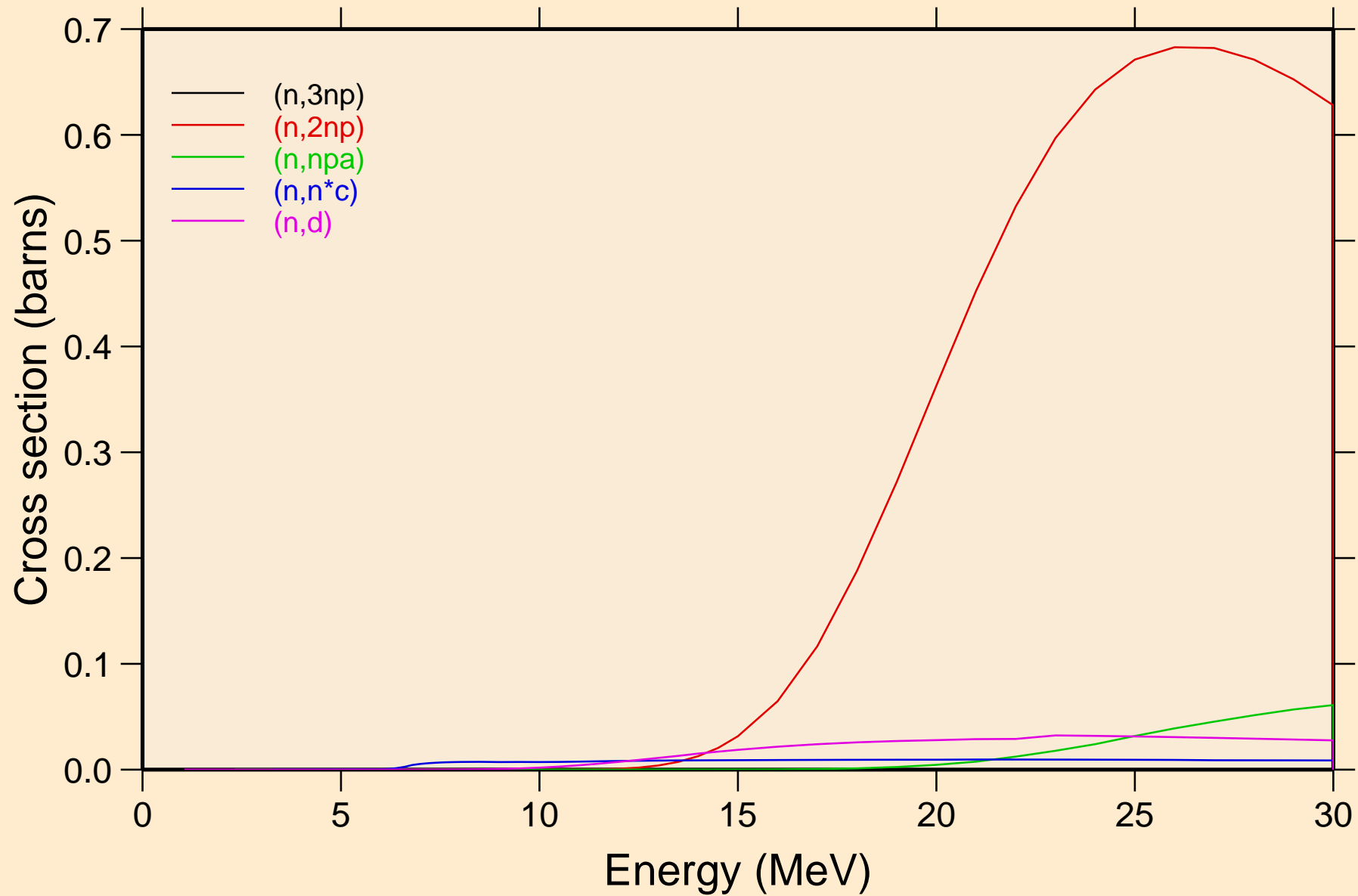

TE110 NRG TENDL-2015, AKONING

Threshold reactions

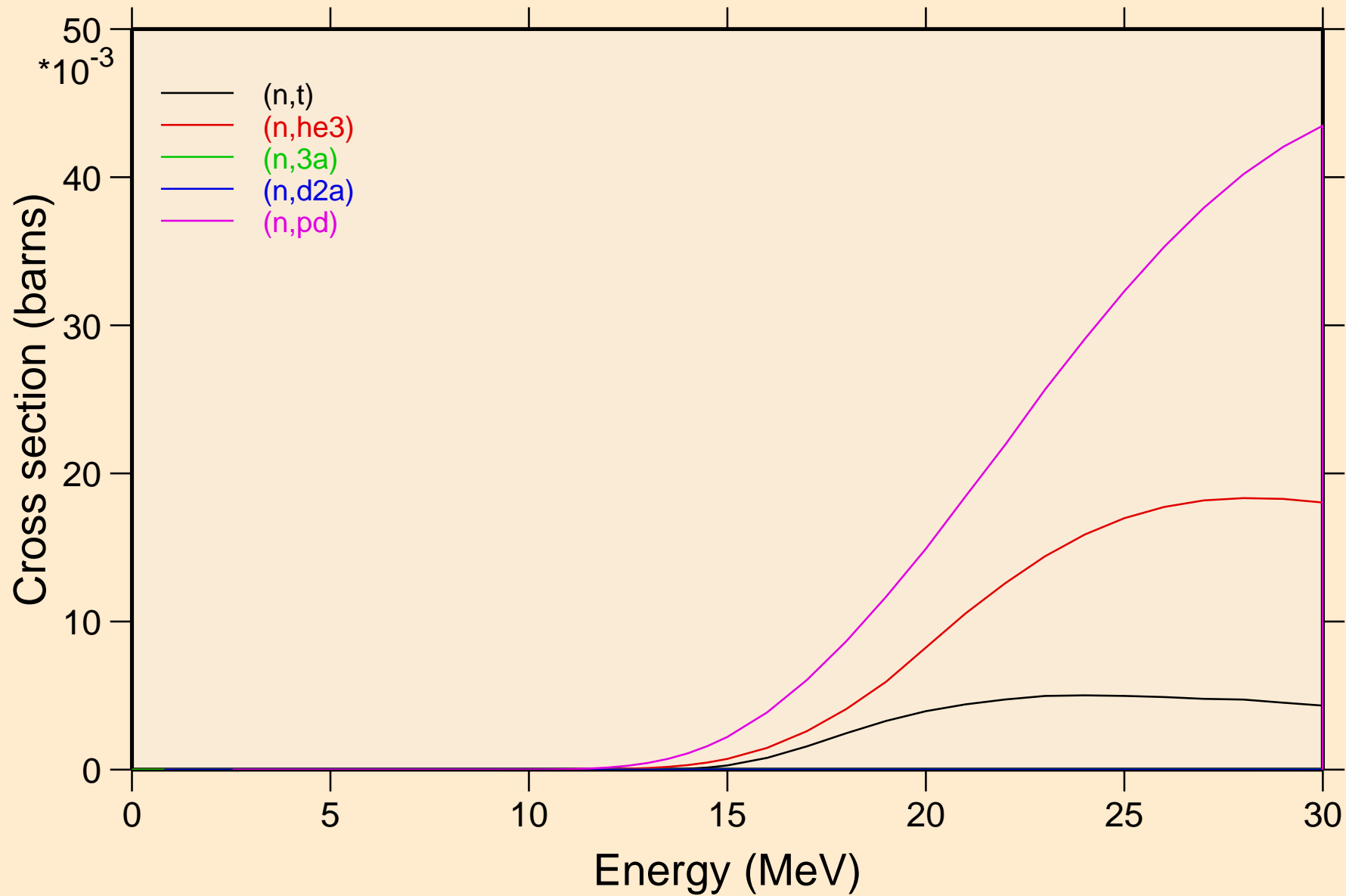

TE110 NRG TENDL-2015, AKONING

Threshold reactions

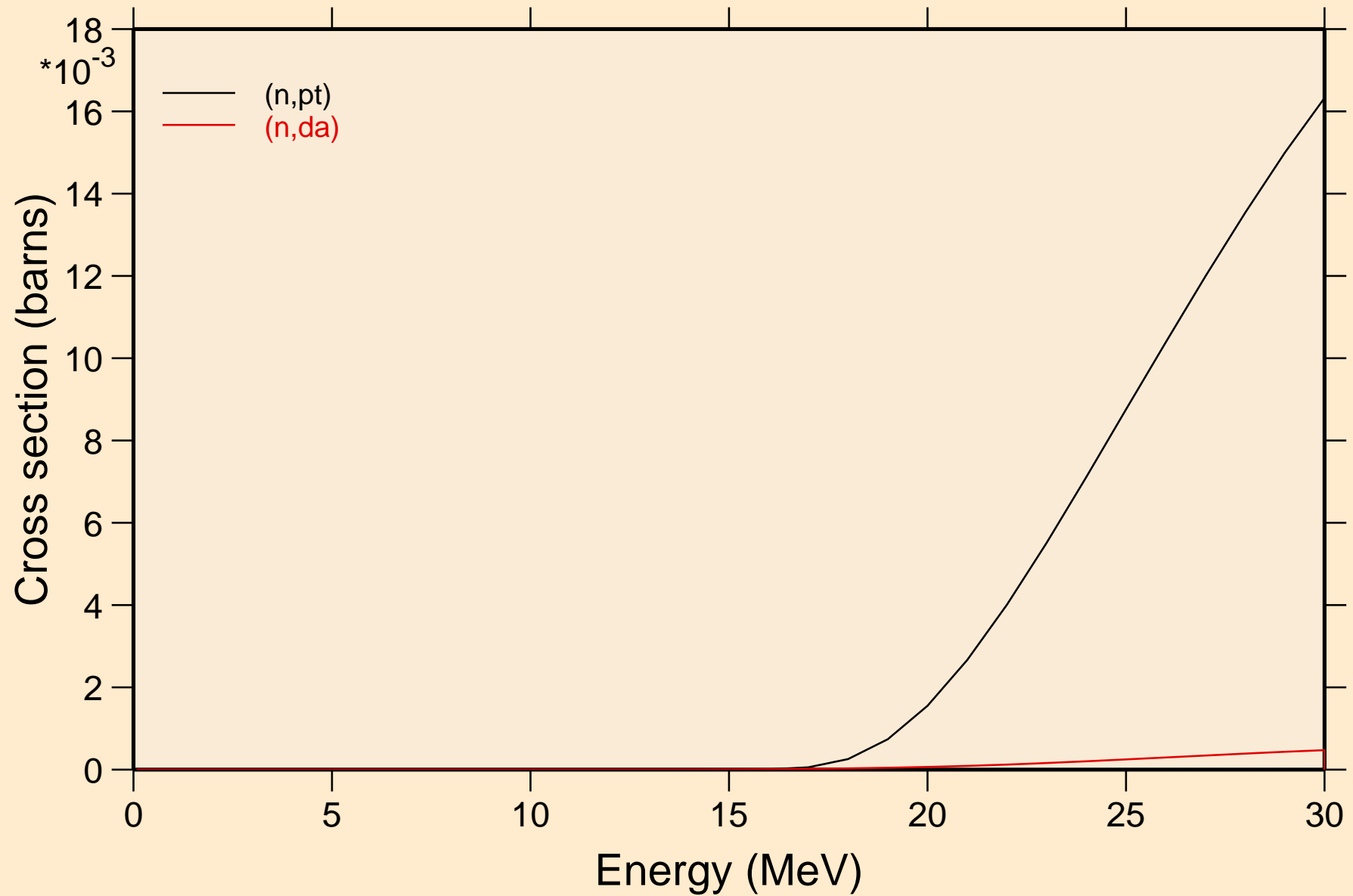

TE110 NRG TENDL-2015, AKONING
angular distribution for elastic

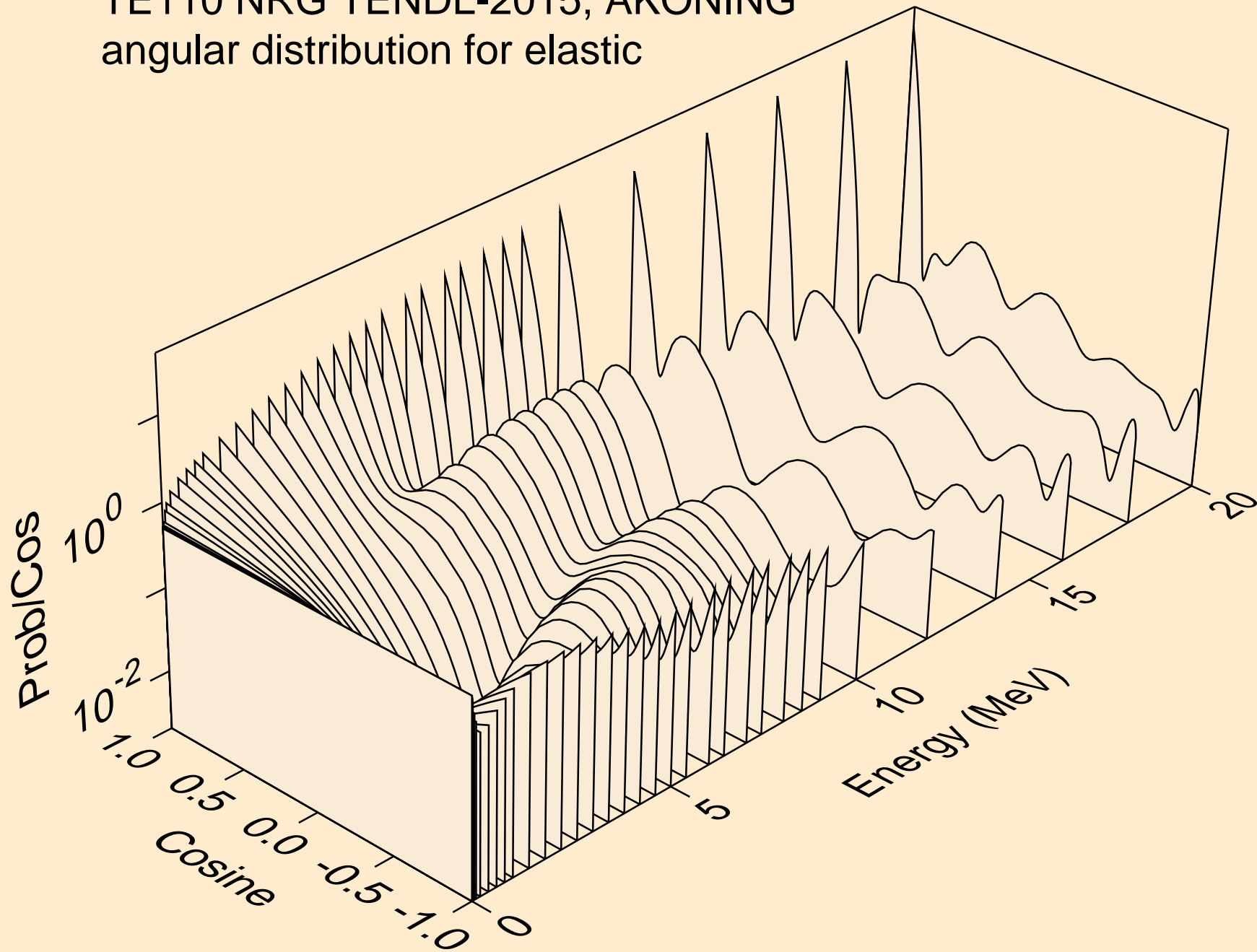

TE110 NRG TENDL-2015, AKONING
angular distribution for elastic

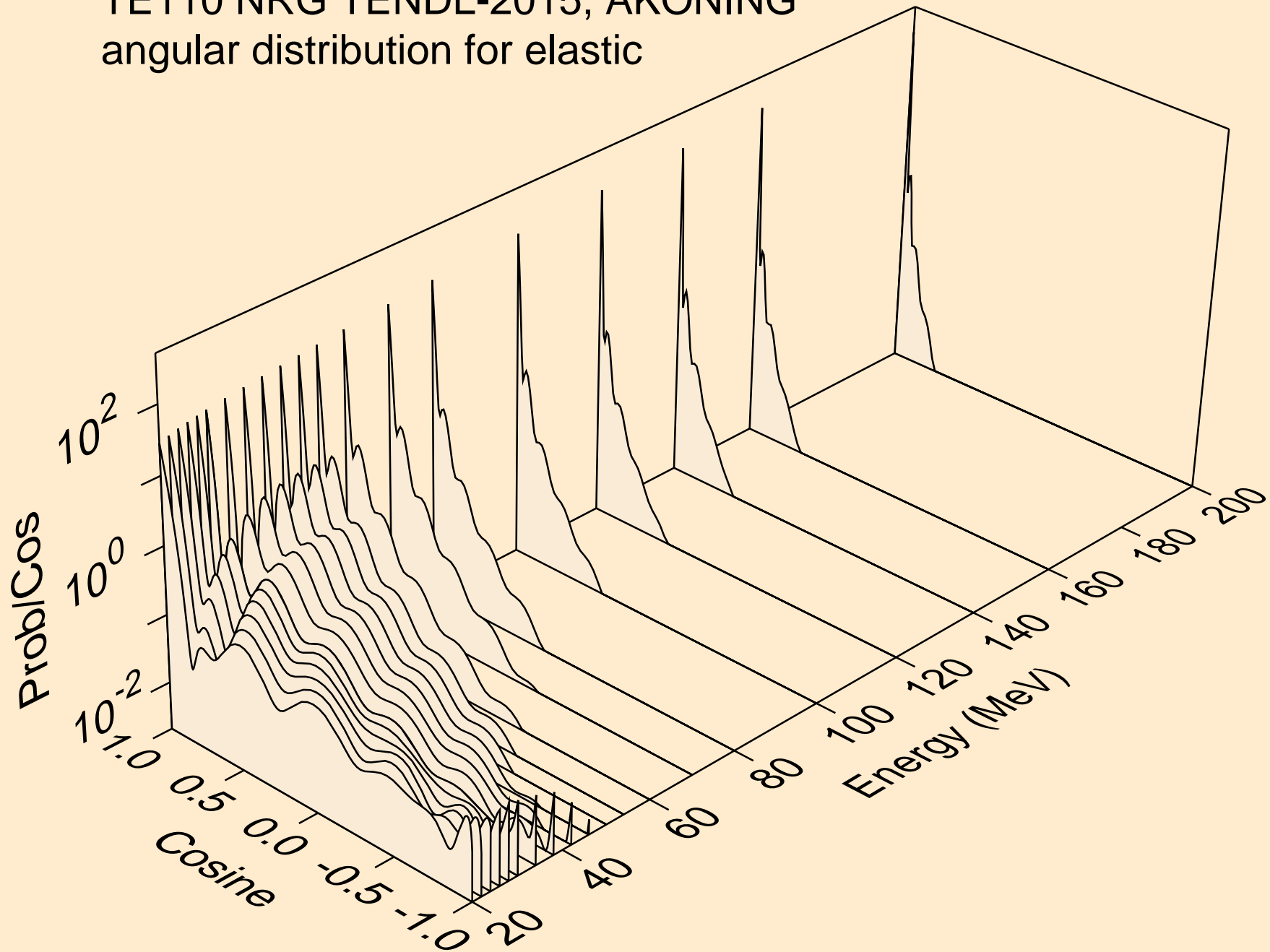

TE110 NRG TENDL-2015, AKONING
angular distribution for (n,n*1)

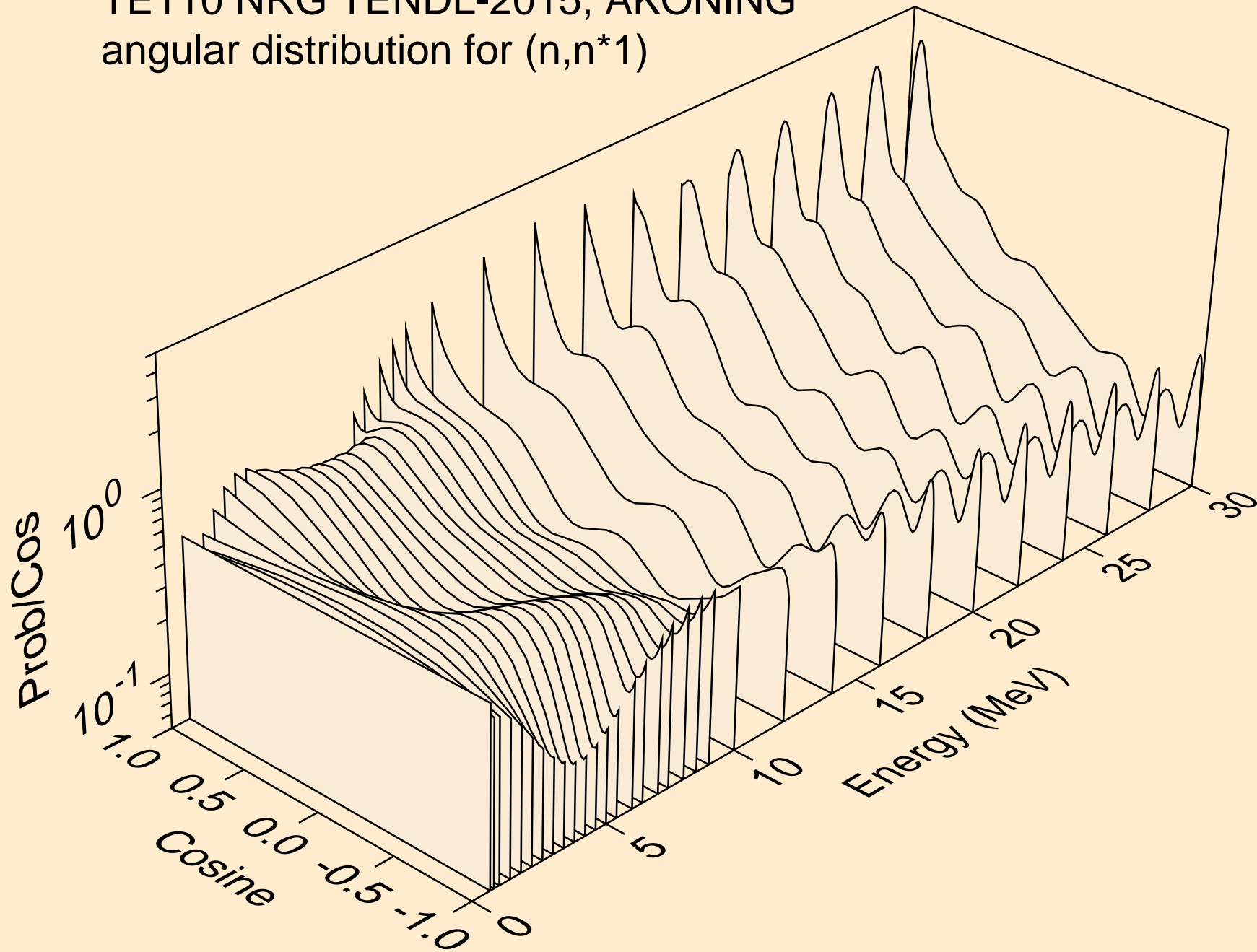

TE110 NRG TENDL-2015, AKONING
angular distribution for (n,n*2)

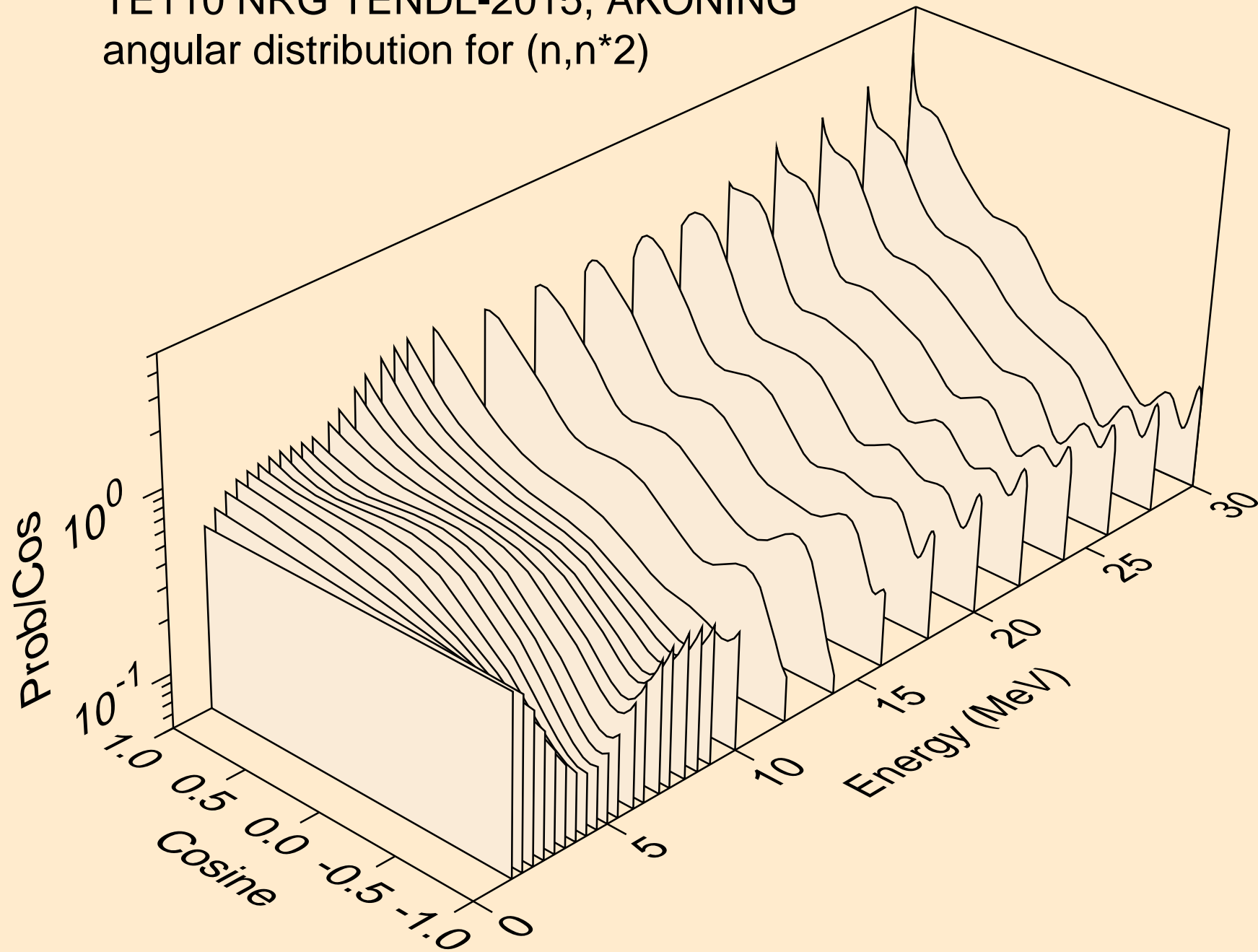

TE110 NRG TENDL-2015, AKONING
angular distribution for (n,n*3)

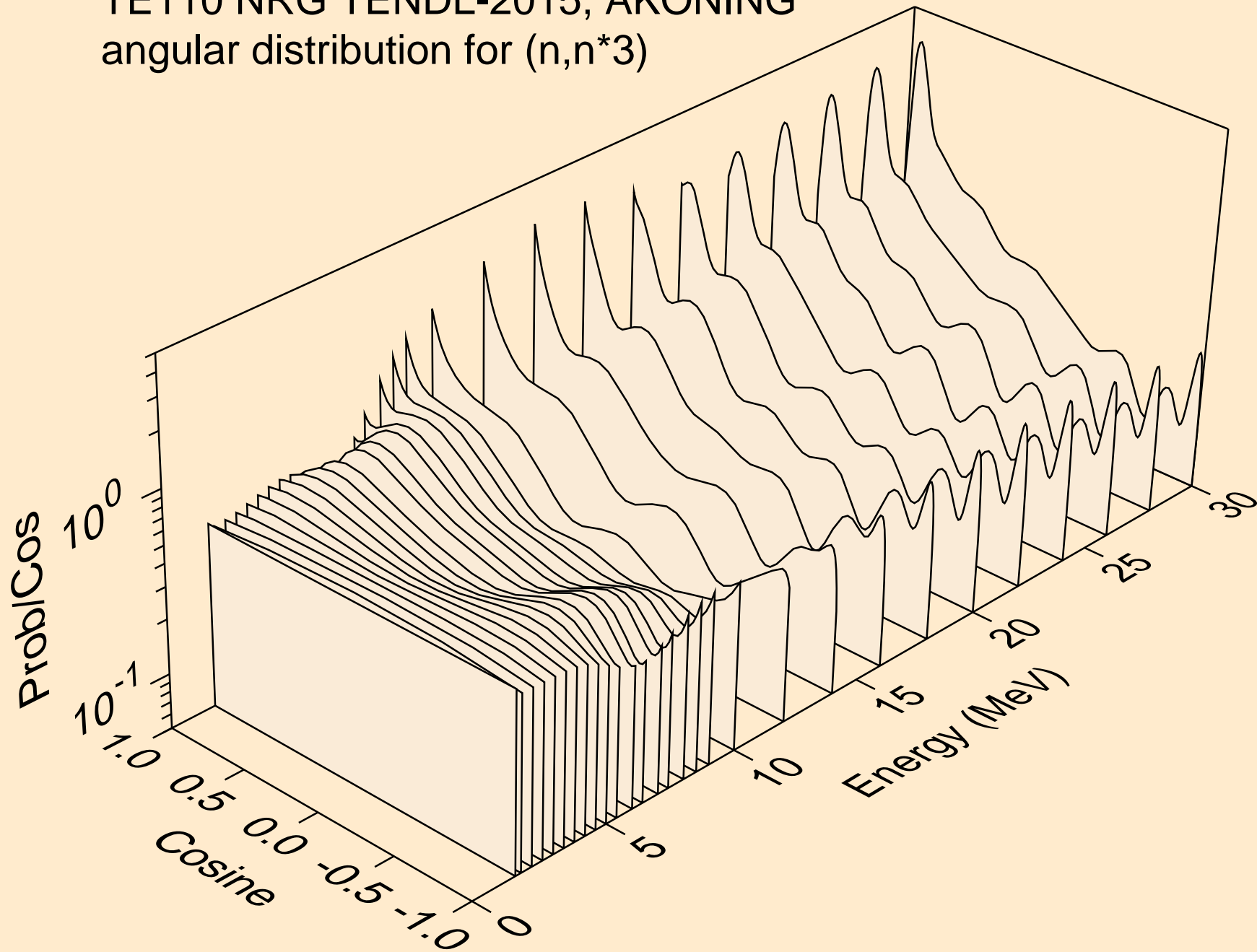

TE110 NRG TENDL-2015, AKONING
angular distribution for (n,n*4)

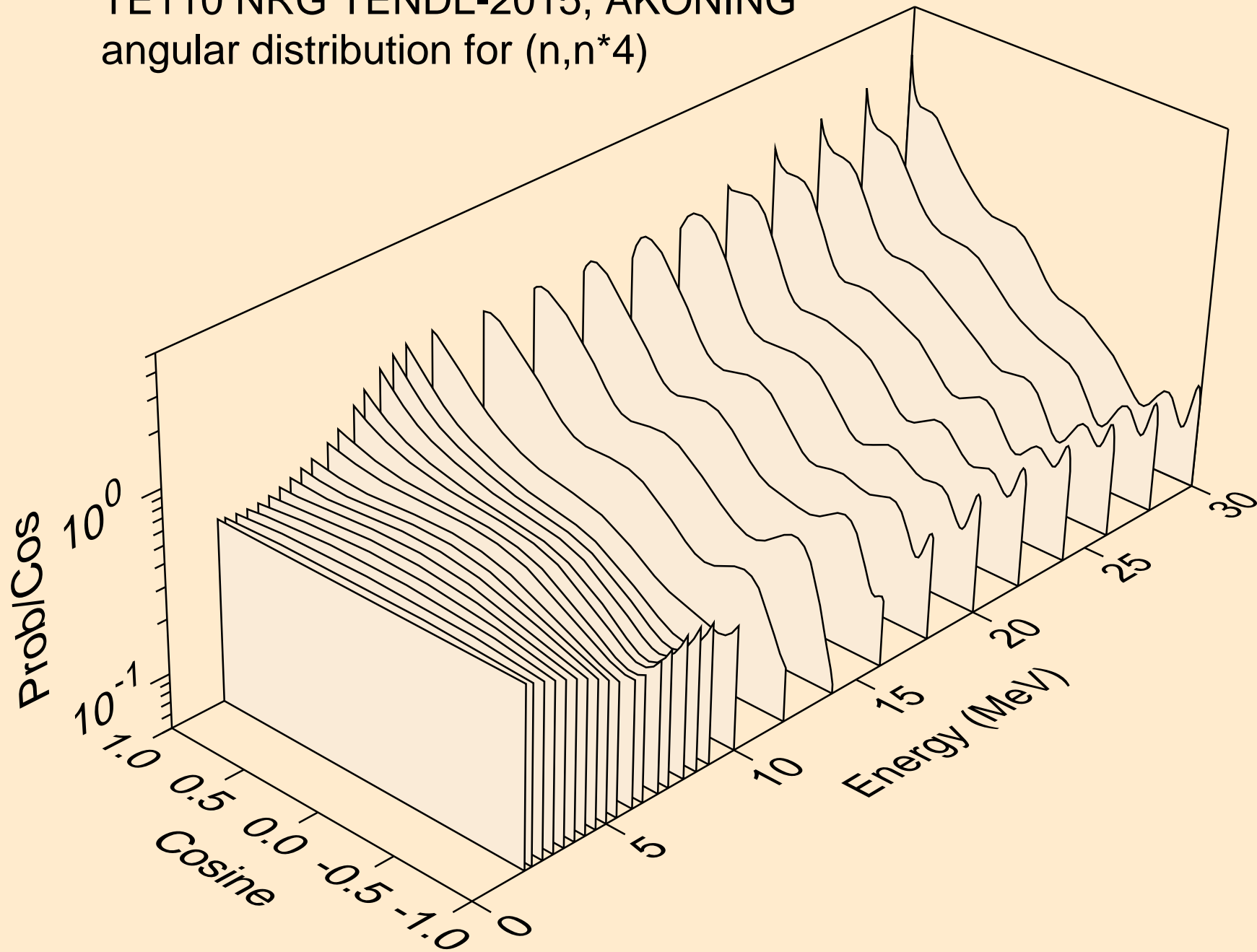

TE110 NRG TENDL-2015, AKONING
angular distribution for (n,n*5)

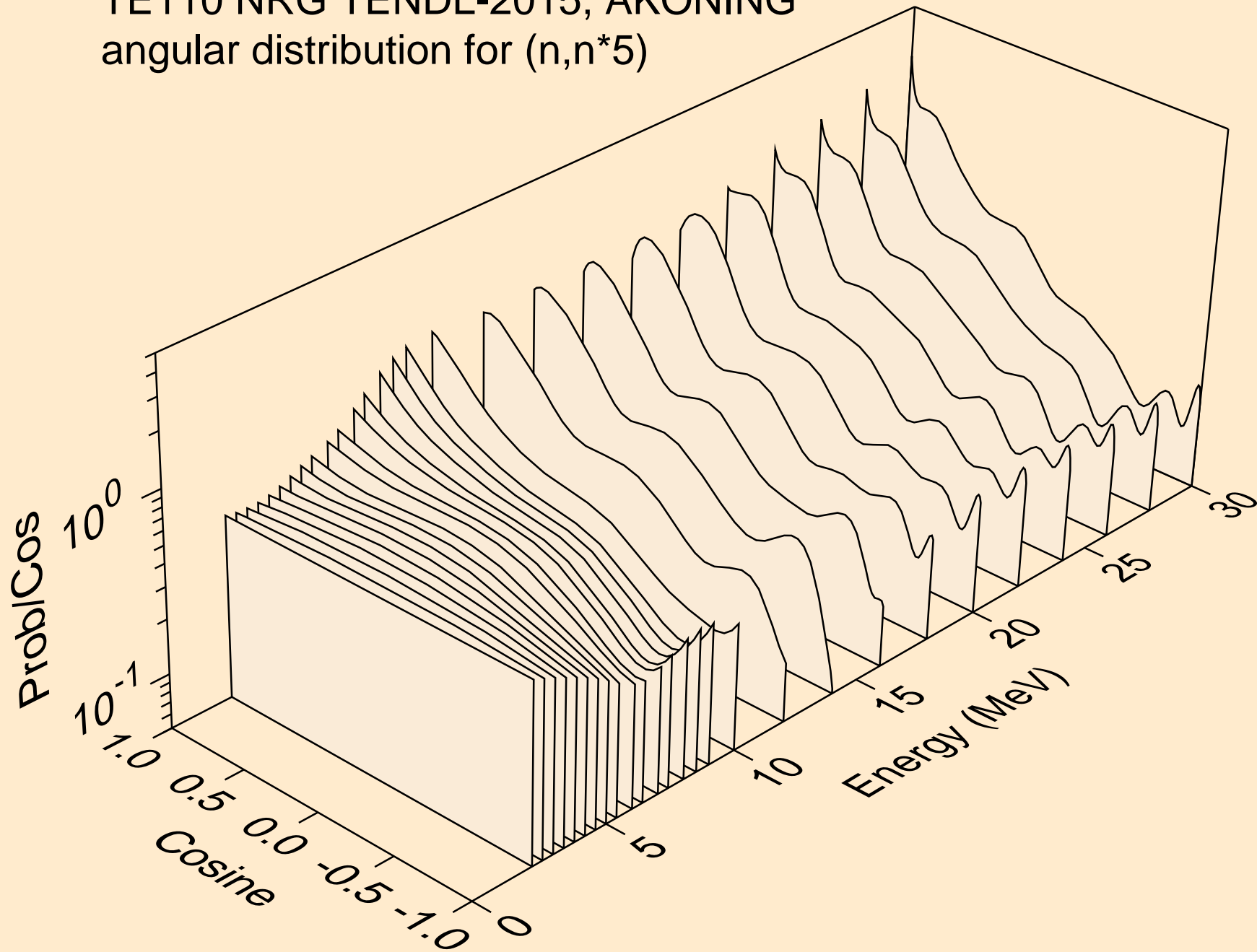

TE110 NRG TENDL-2015, AKONING
angular distribution for (n,n*6)

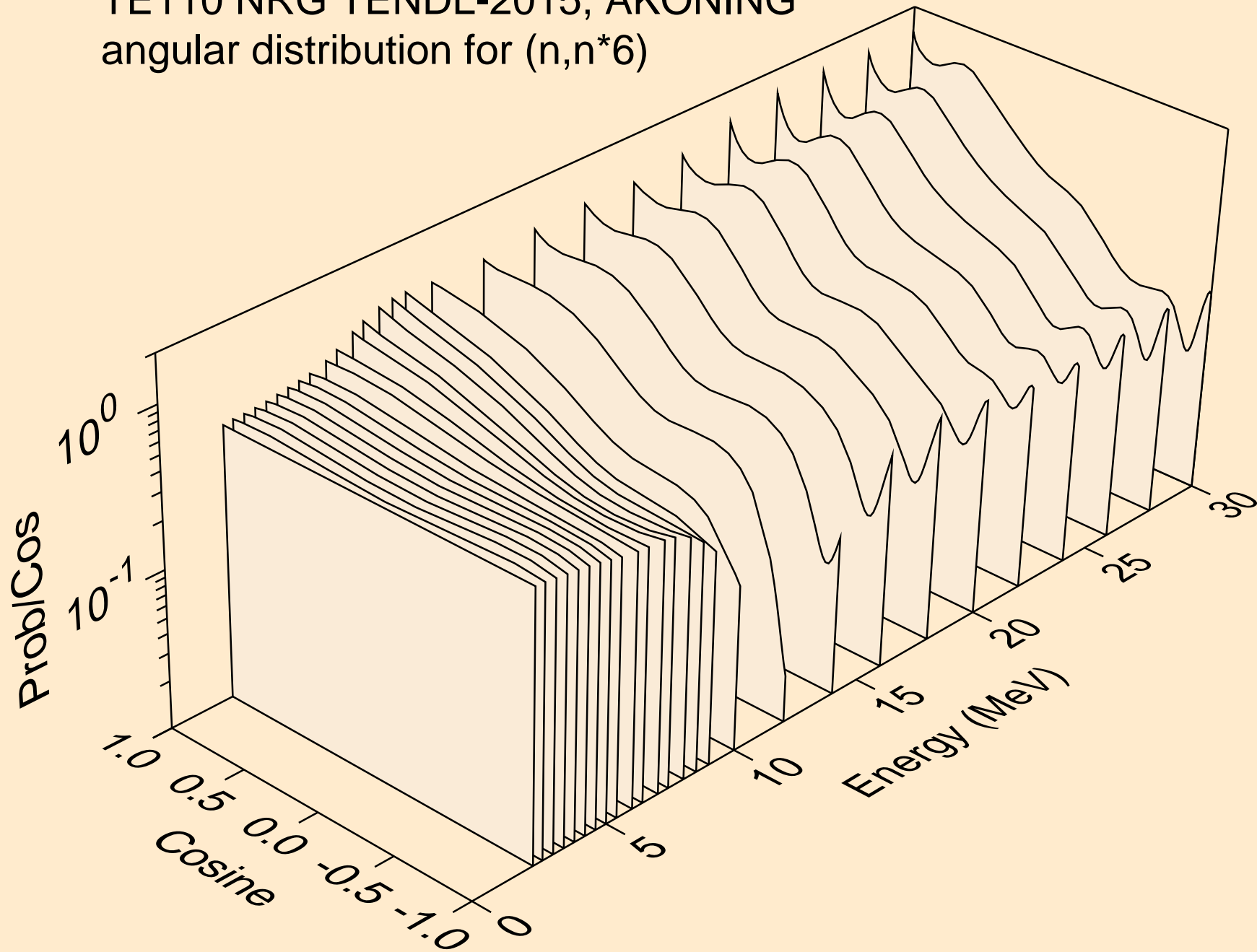

TE110 NRG TENDL-2015, AKONING
angular distribution for (n,n*7)

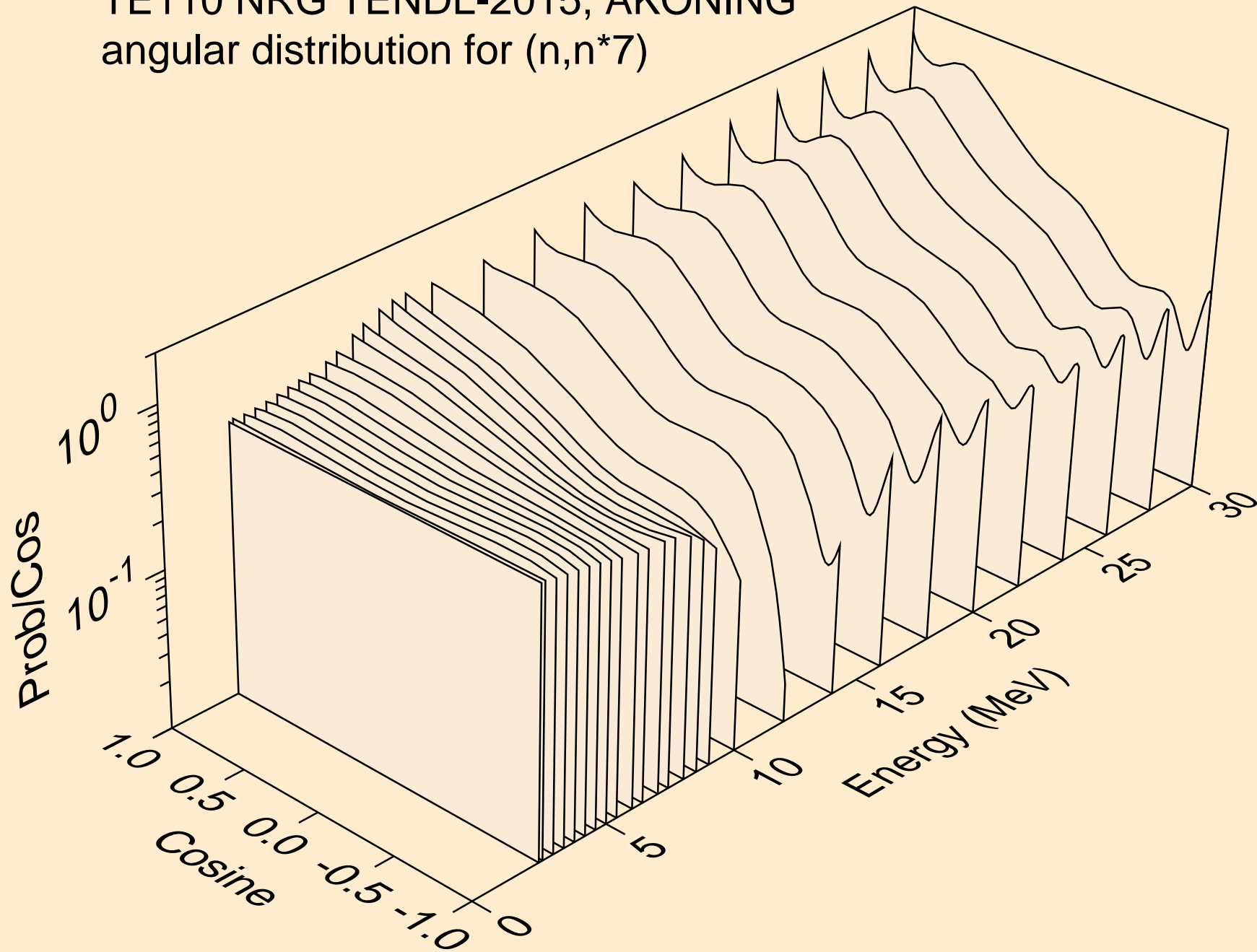

TE110 NRG TENDL-2015, AKONING
angular distribution for (n,n*8)

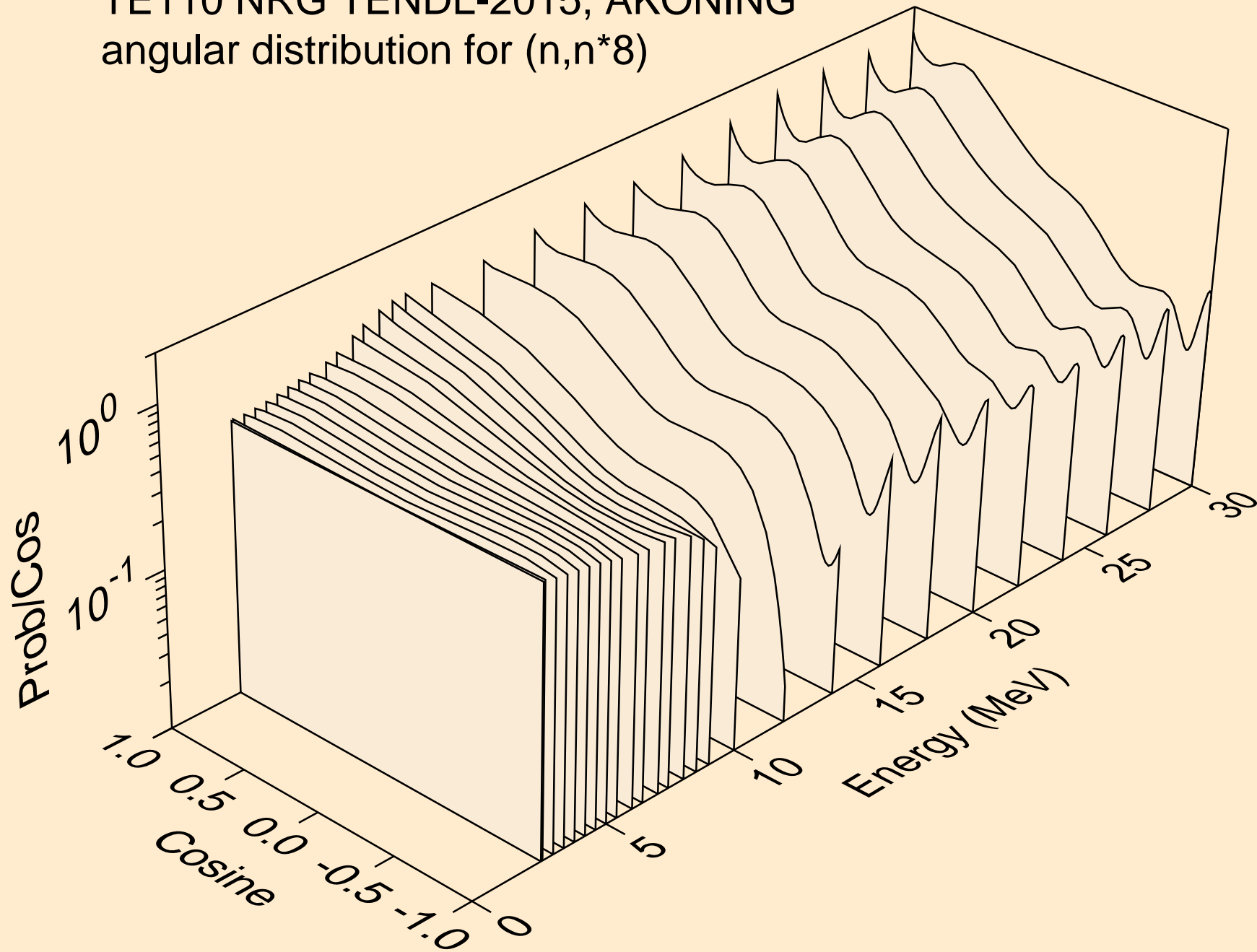

TE110 NRG TENDL-2015, AKONING
angular distribution for (n,n*9)

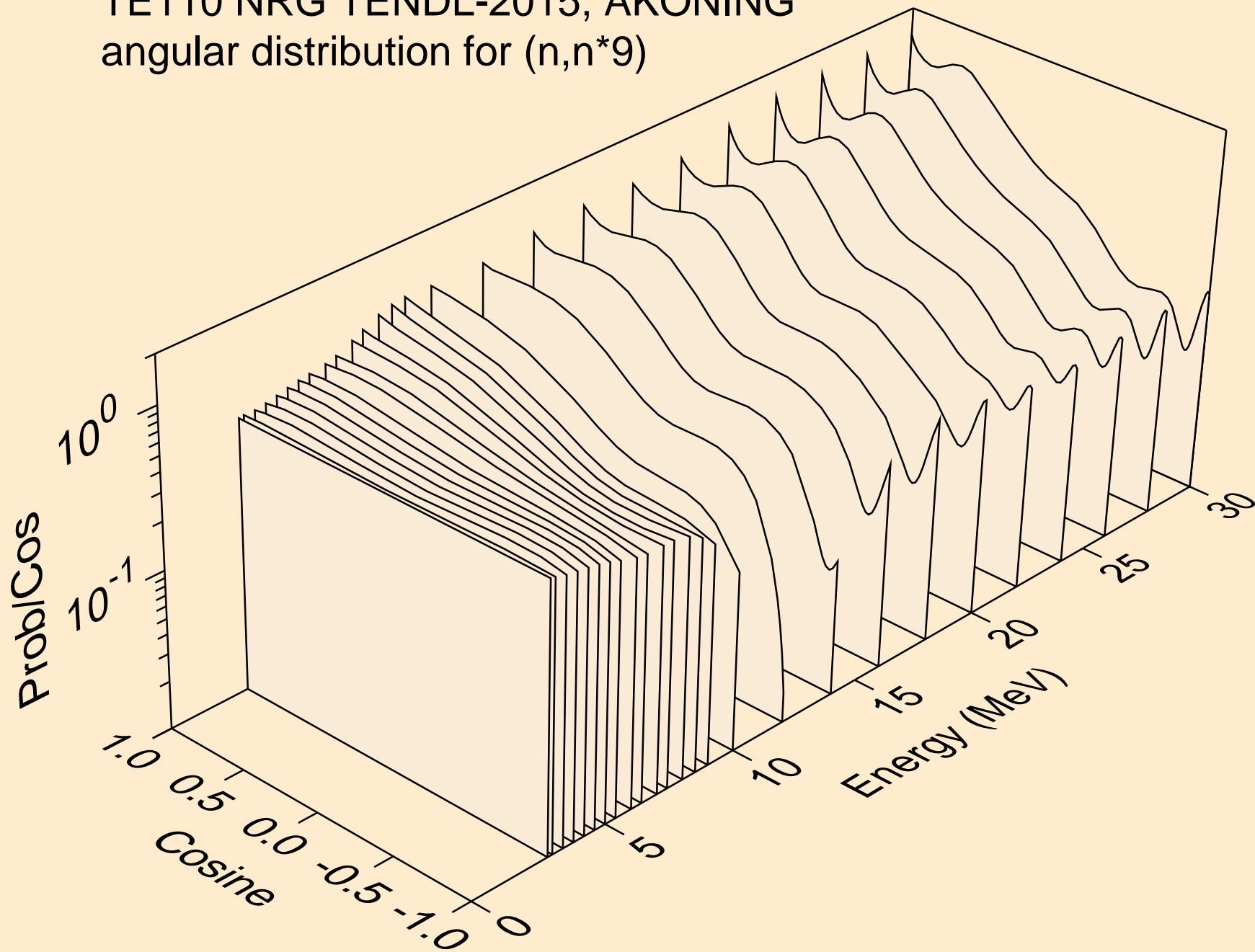

TE110 NRG TENDL-2015, AKONING
angular distribution for (n,n*10)

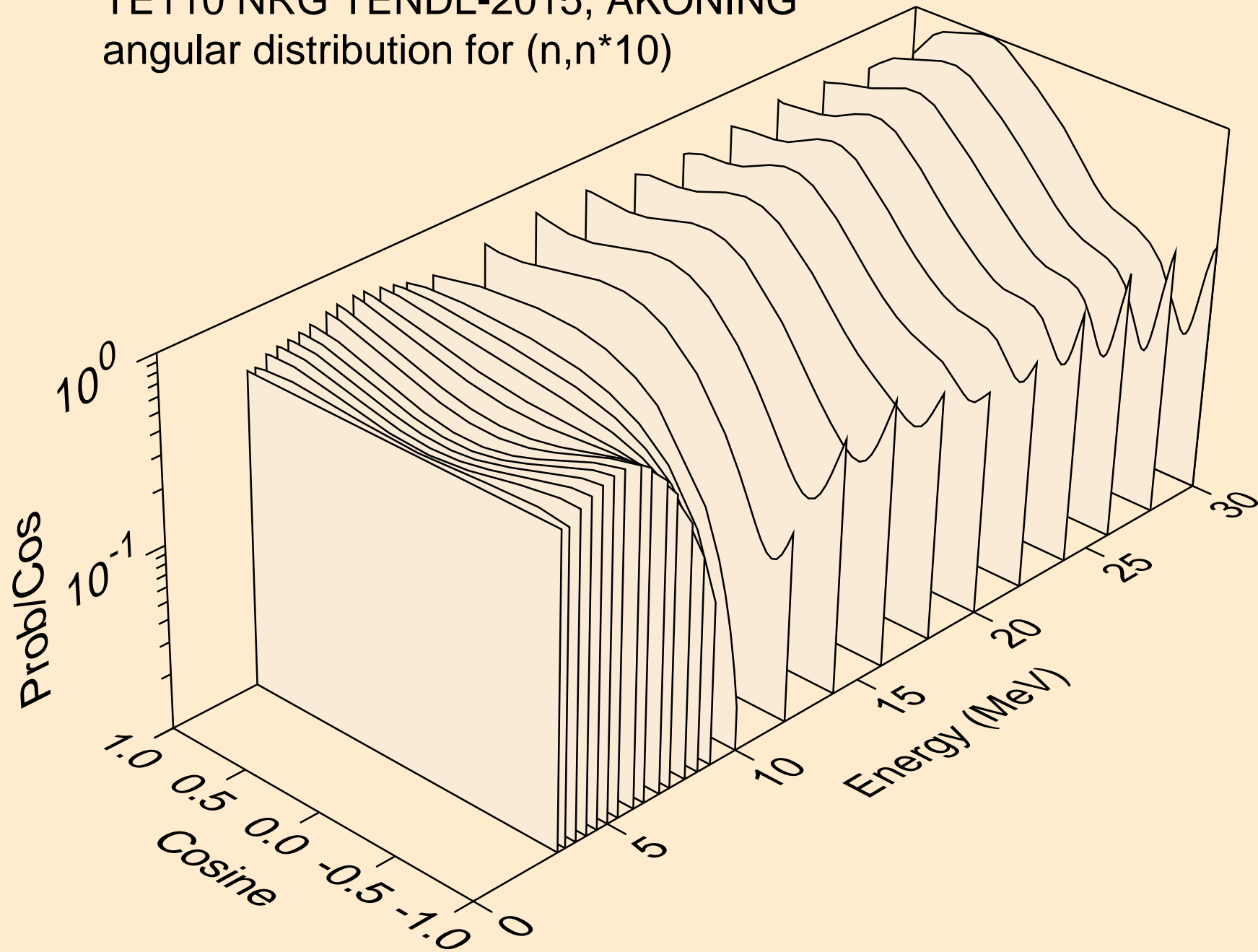

TE110 NRG TENDL-2015, AKONING
angular distribution for (n,n*11)

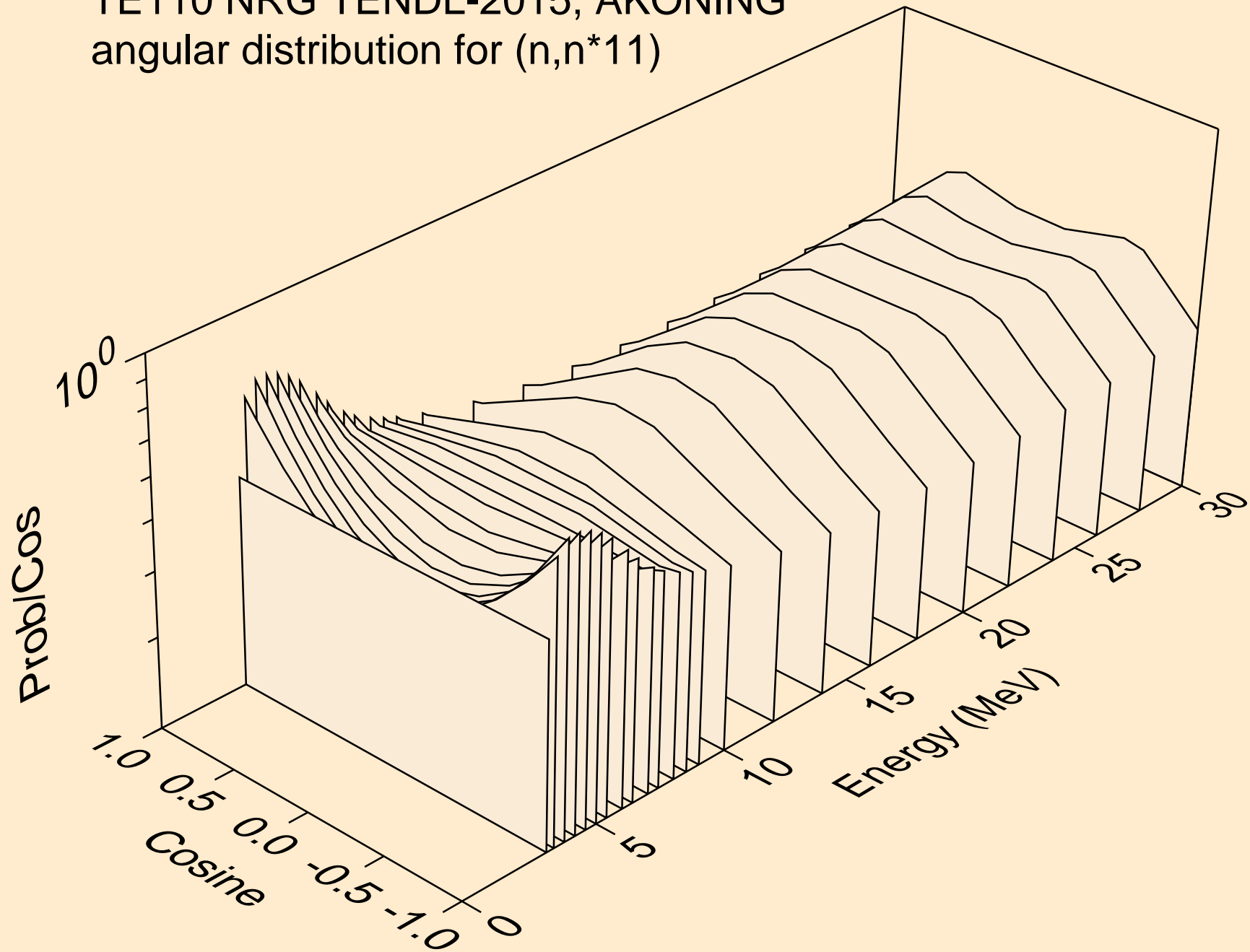

TE110 NRG TENDL-2015, AKONING
angular distribution for (n,n*12)

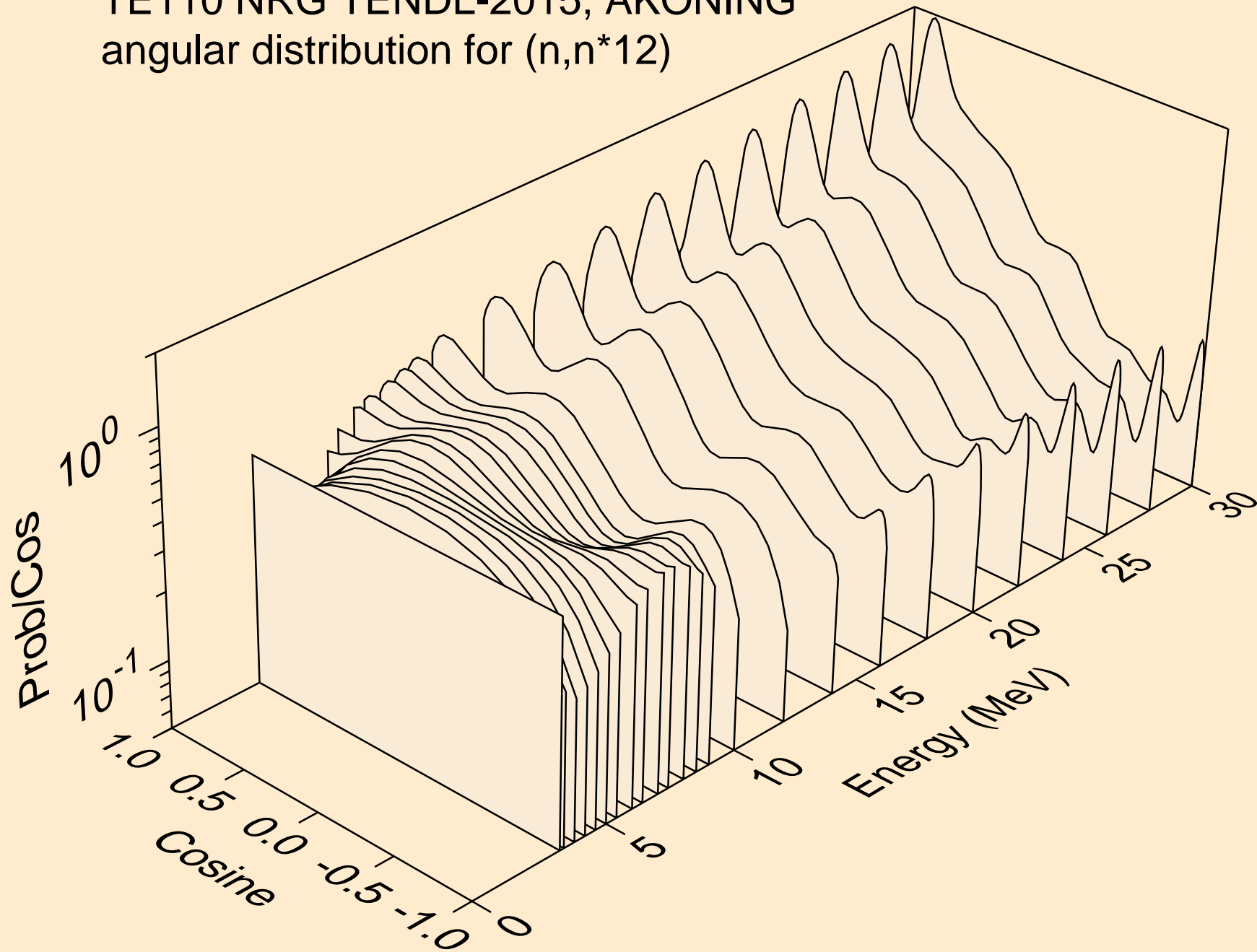

TE110 NRG TENDL-2015, AKONING
Neutron emission for (n,x)

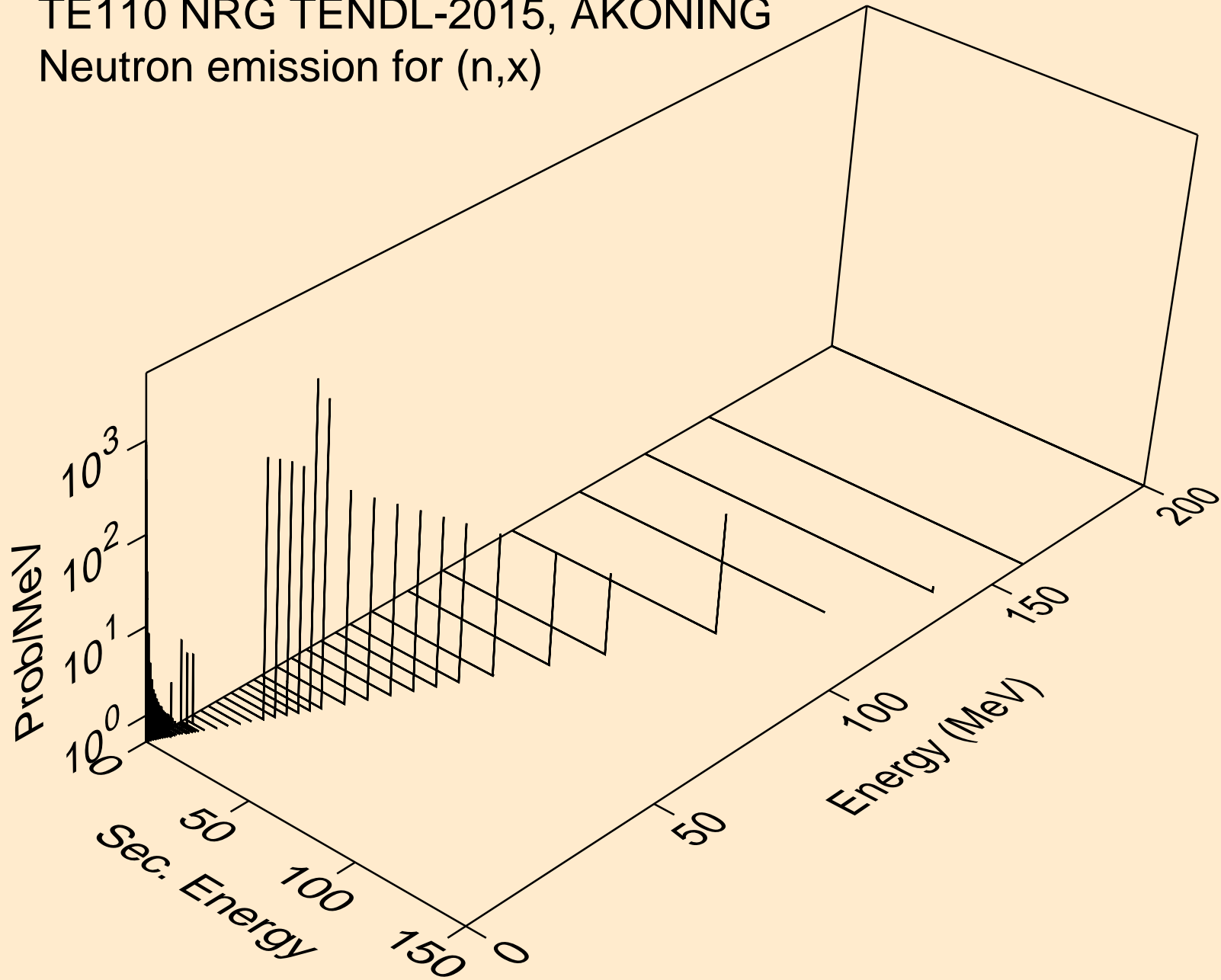

TE110 NRG TENDL-2015, AKONING
Neutron emission for (n,2nd)

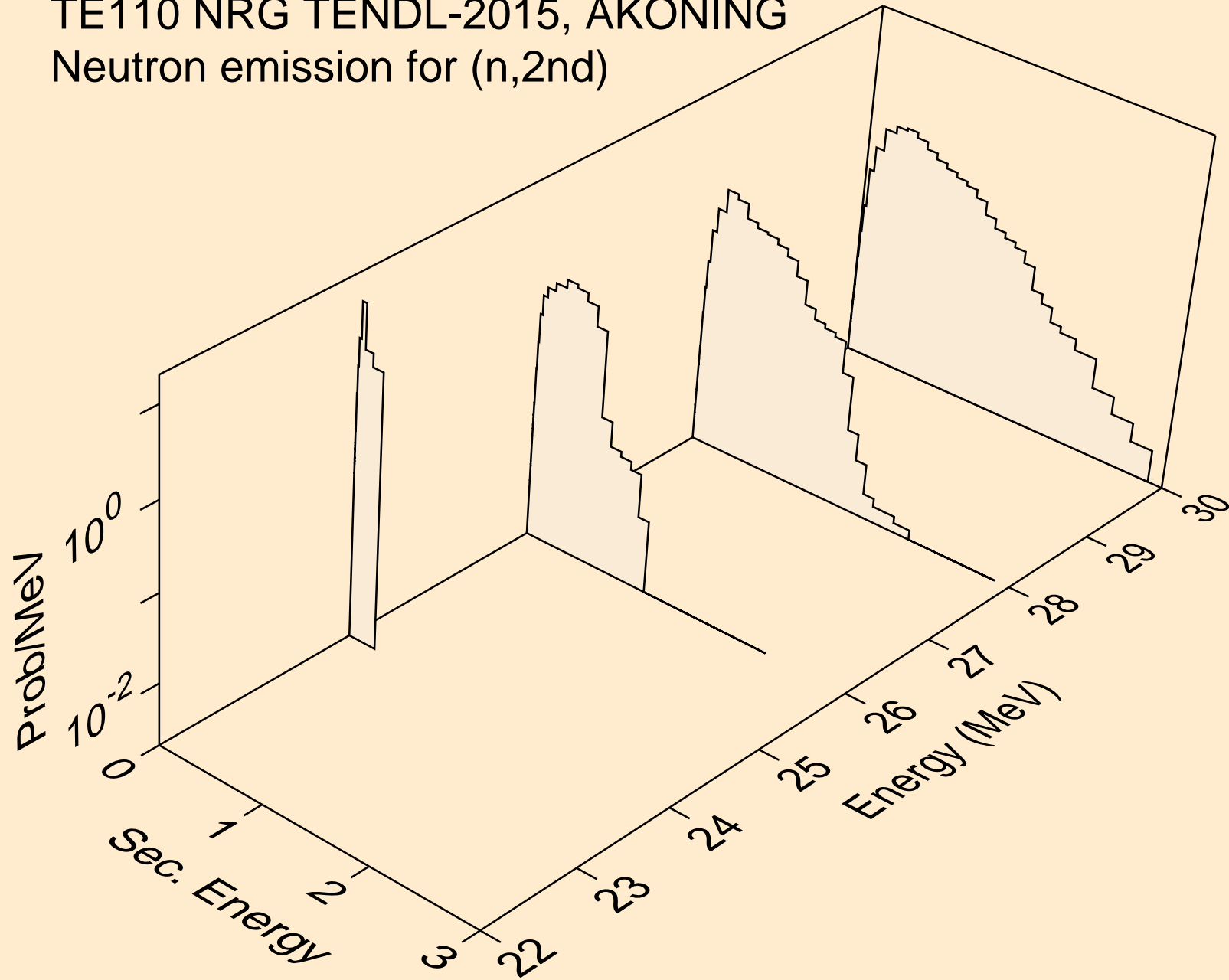

TE110 NRG TENDL-2015, AKONING
Neutron emission for (n,2n)

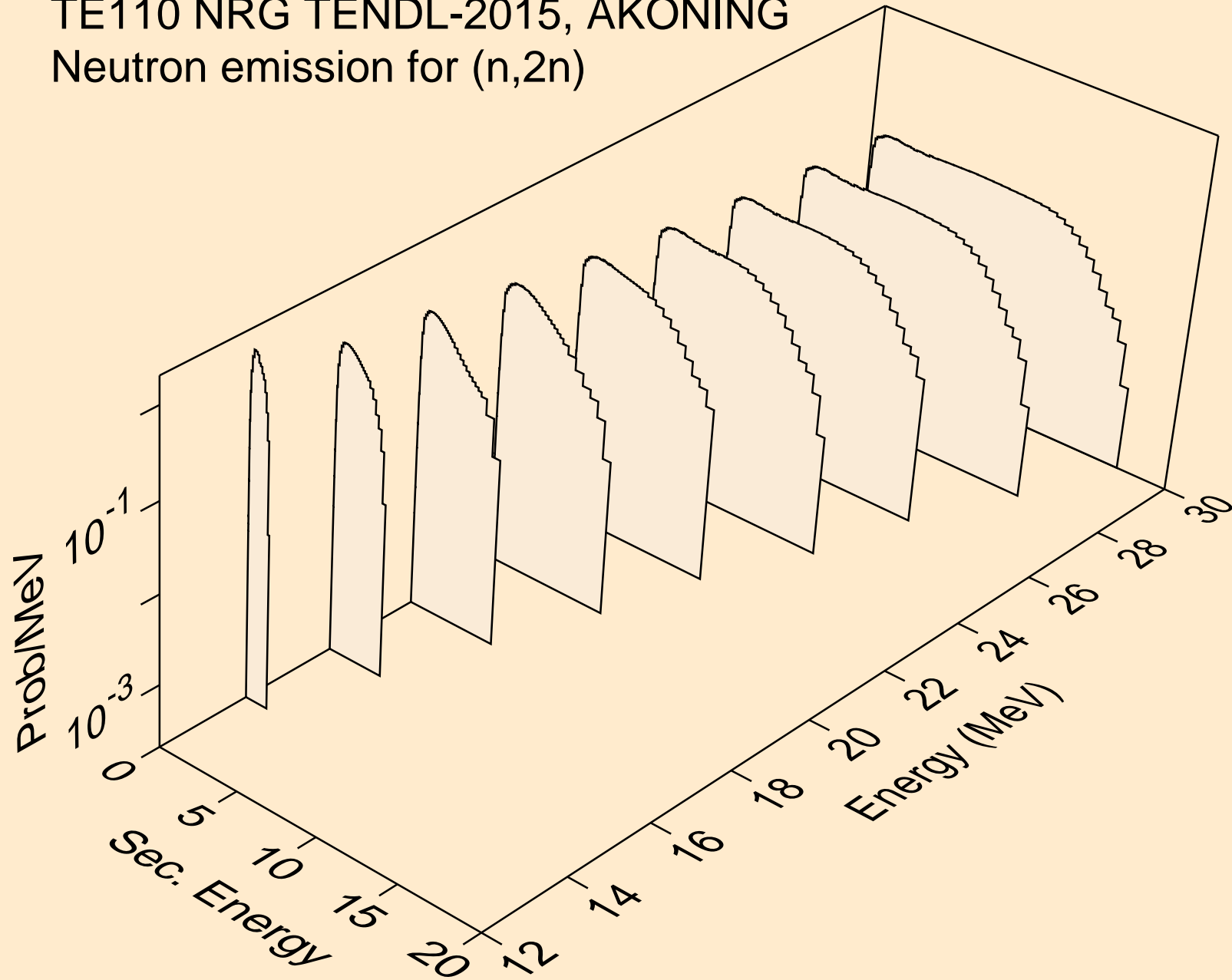

TE110 NRG TENDL-2015, AKONING
Neutron emission for (n,3n)

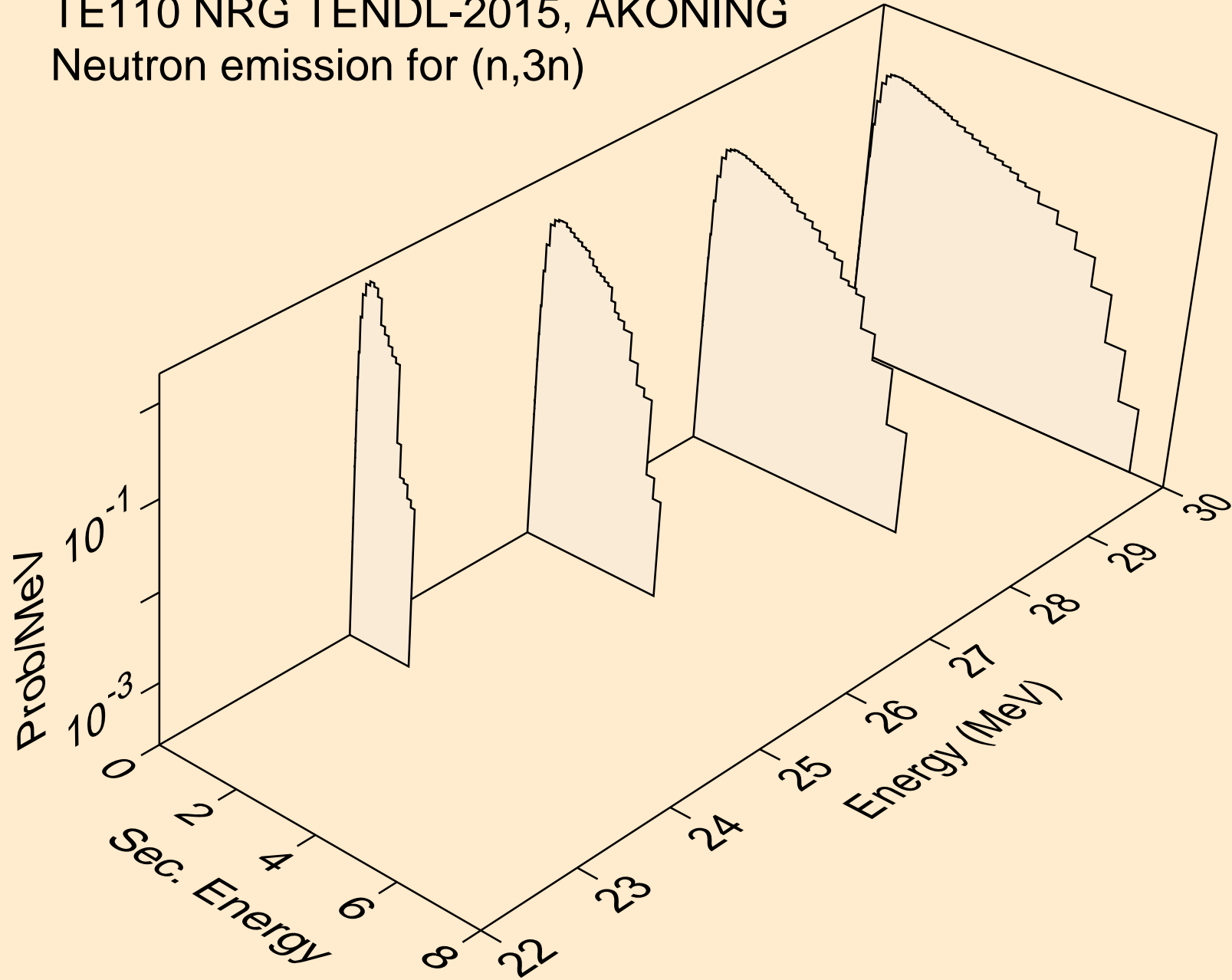

TE110 NRG TENDL-2015, AKONING
Neutron emission for (n,n*)a

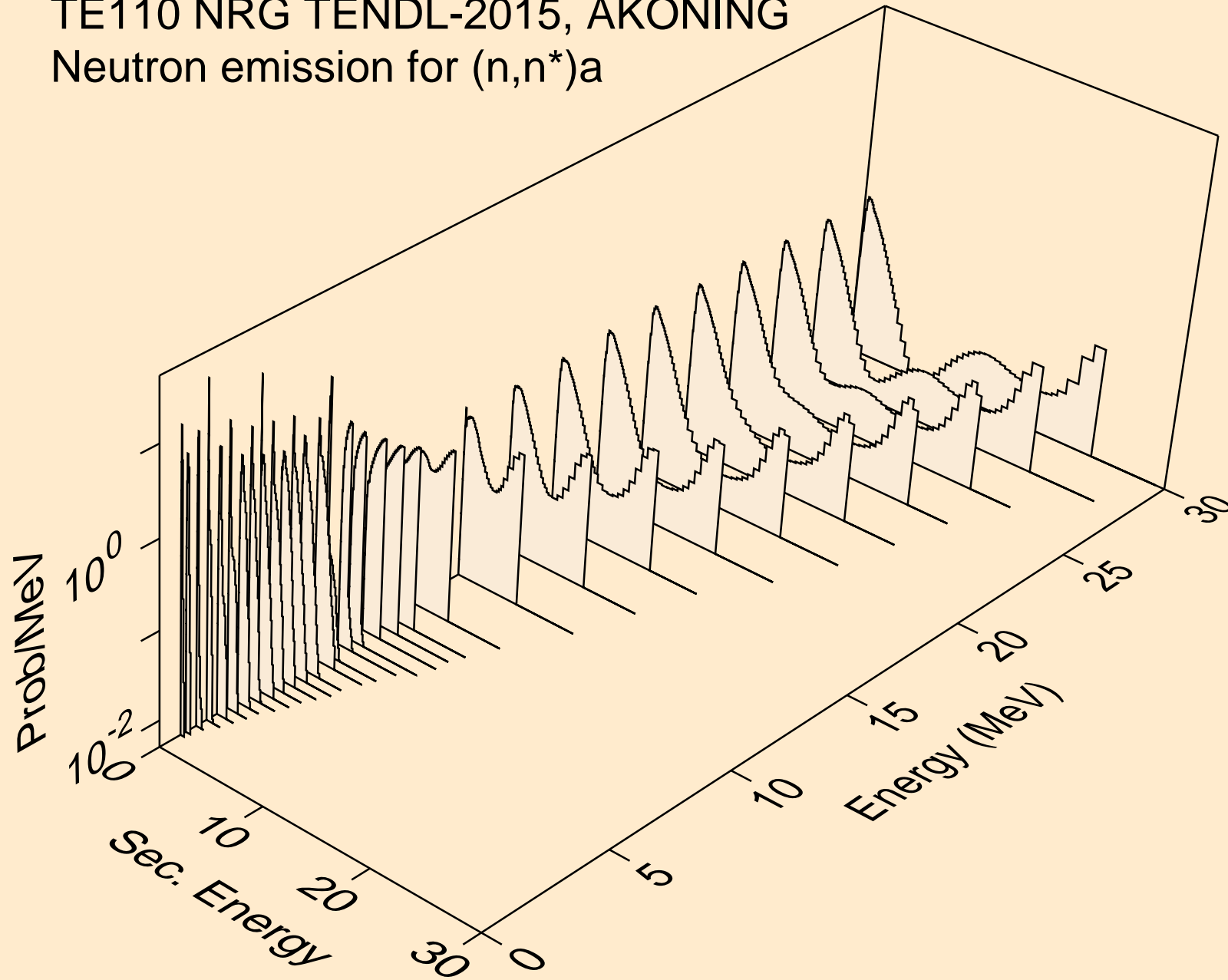

TE110 NRG TENDL-2015, AKONING
Neutron emission for (n,n*)3a

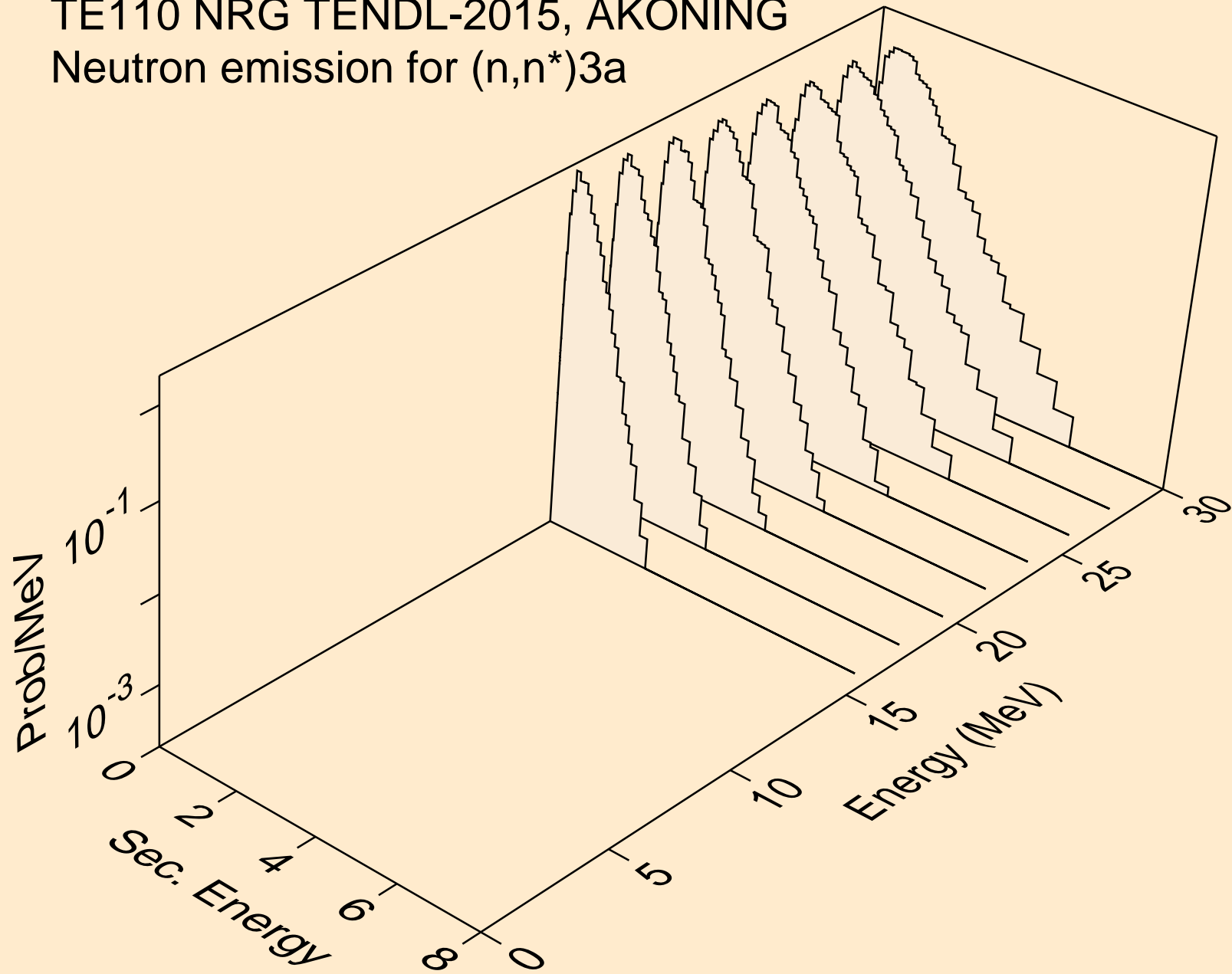

TE110 NRG TENDL-2015, AKONING
Neutron emission for (n,2n)a

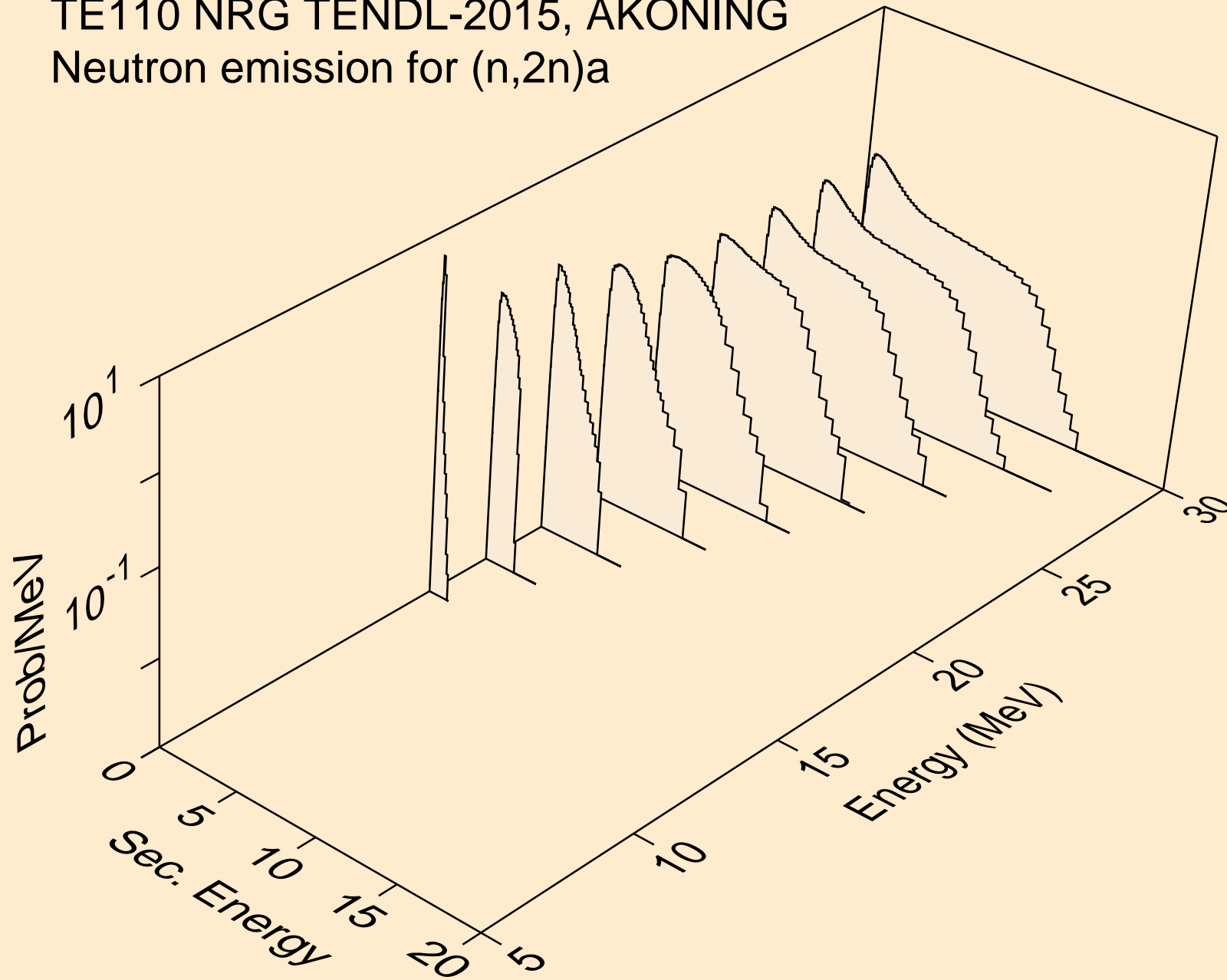

TE110 NRG TENDL-2015, AKONING
Neutron emission for (n,3n)a

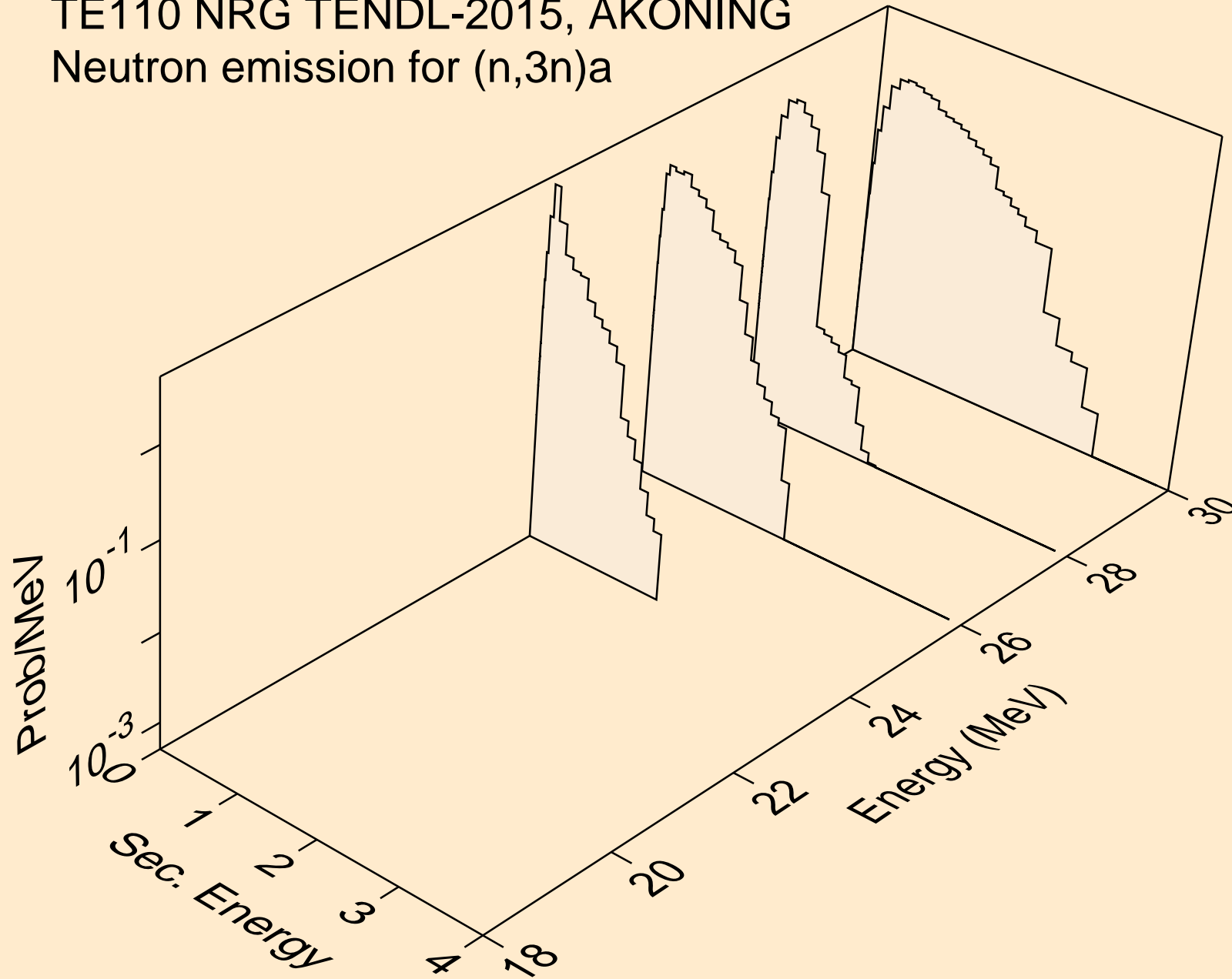

TE110 NRG TENDL-2015, AKONING
Neutron emission for (n,n*)p

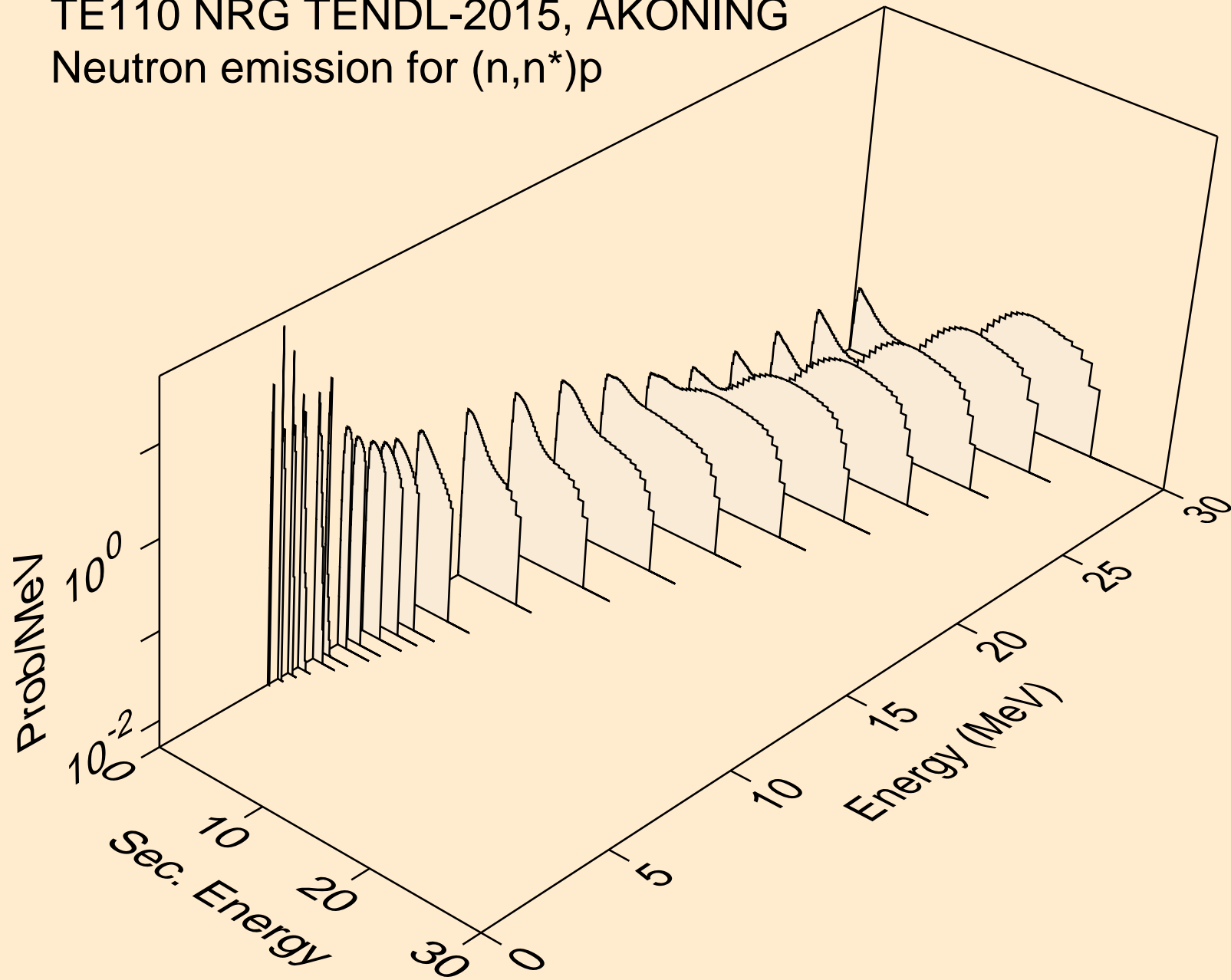

TE110 NRG TENDL-2015, AKONING
Neutron emission for (n,n*)2a

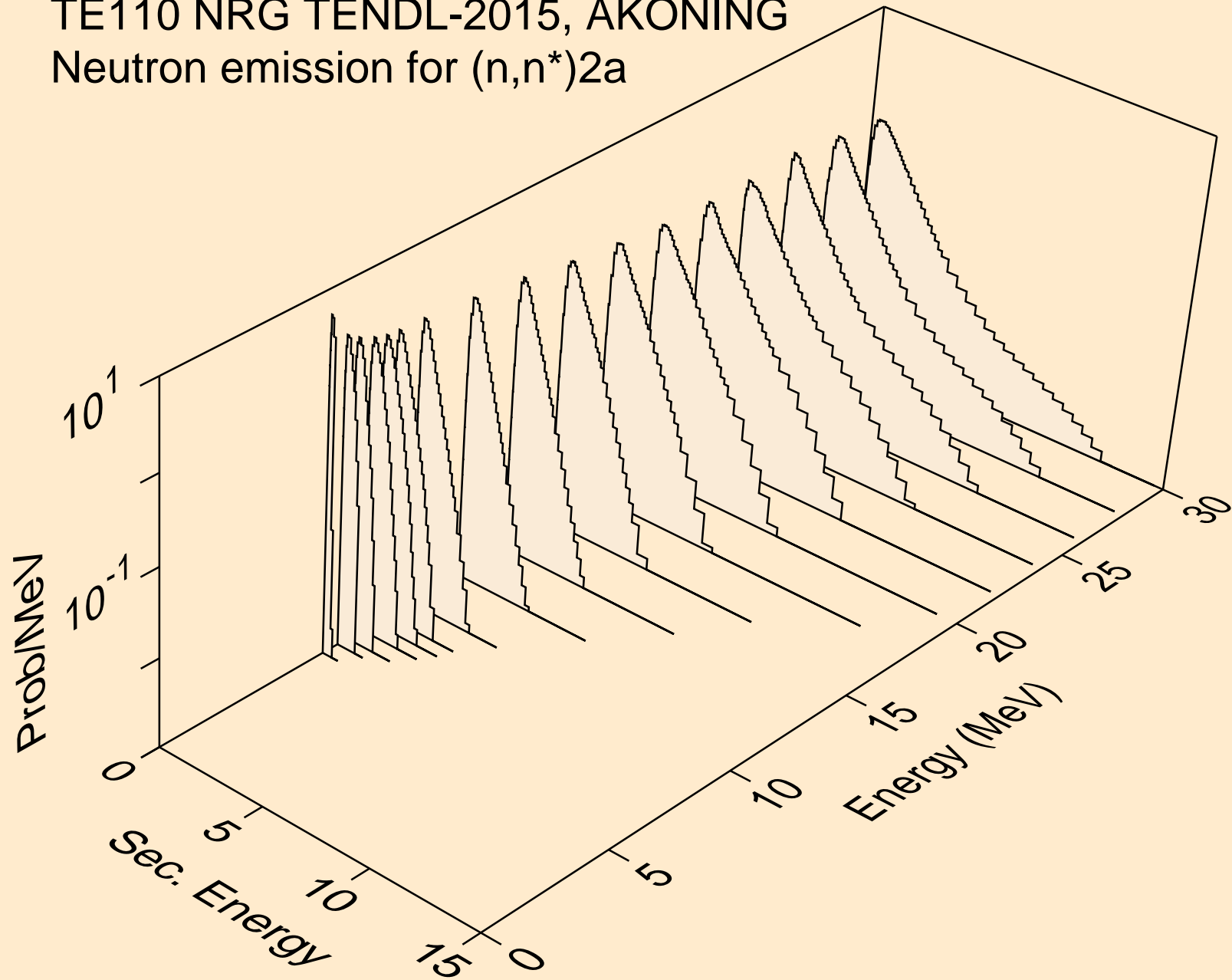

TE110 NRG TENDL-2015, AKONING
Neutron emission for (n,2n)2a

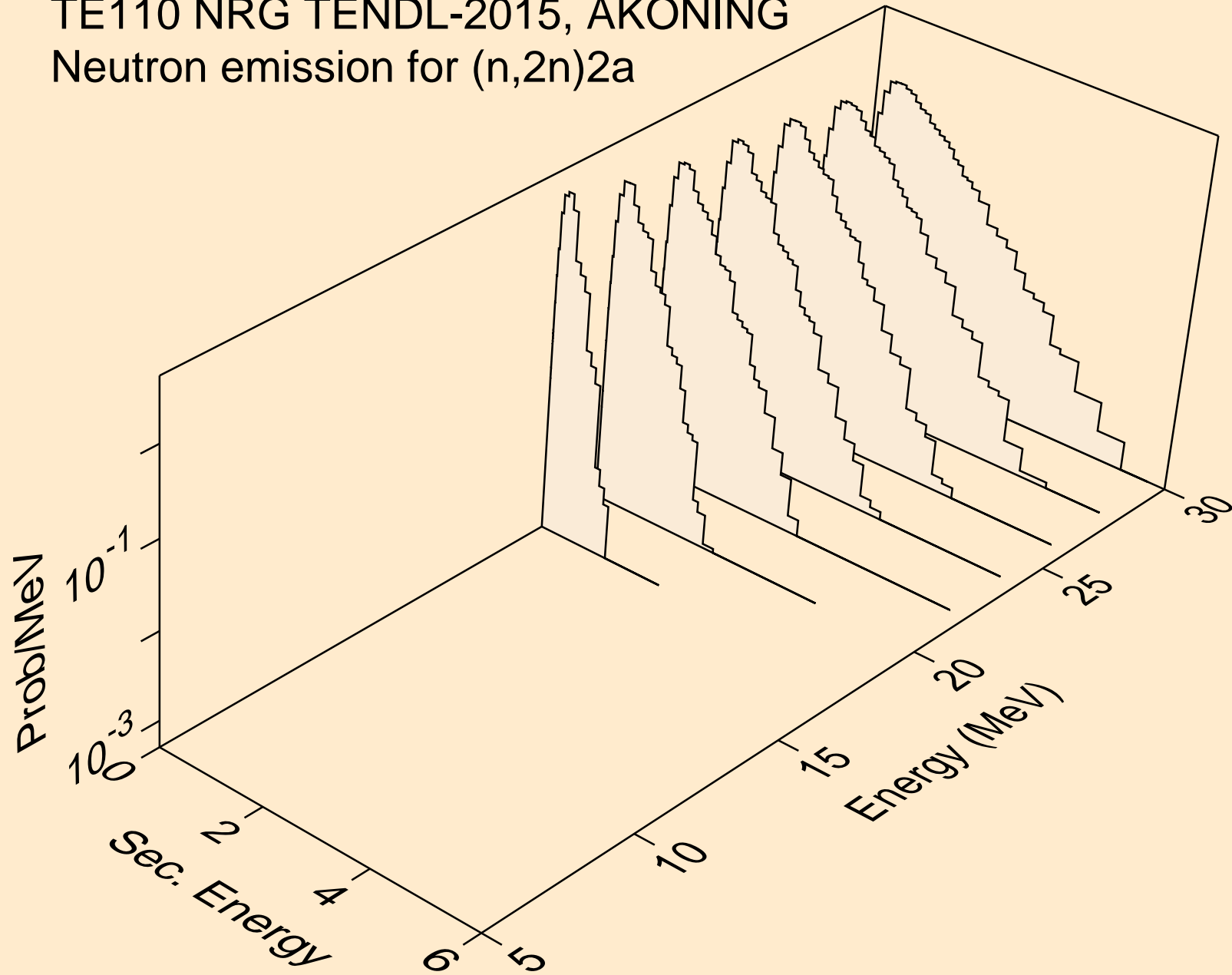

TE110 NRG TENDL-2015, AKONING
Neutron emission for (n,n*)d

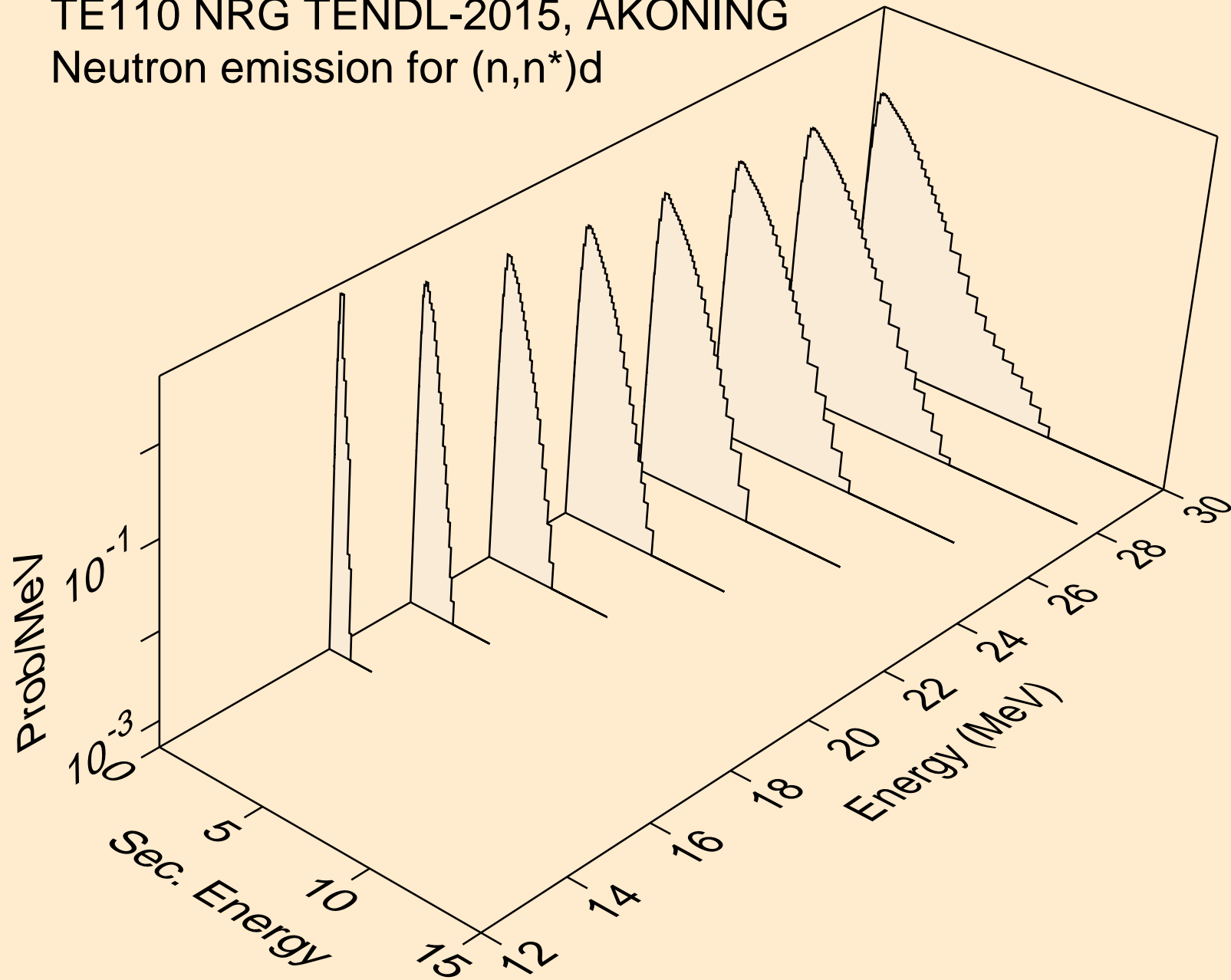

TE110 NRG TENDL-2015, AKONING
Neutron emission for (n,n*)t

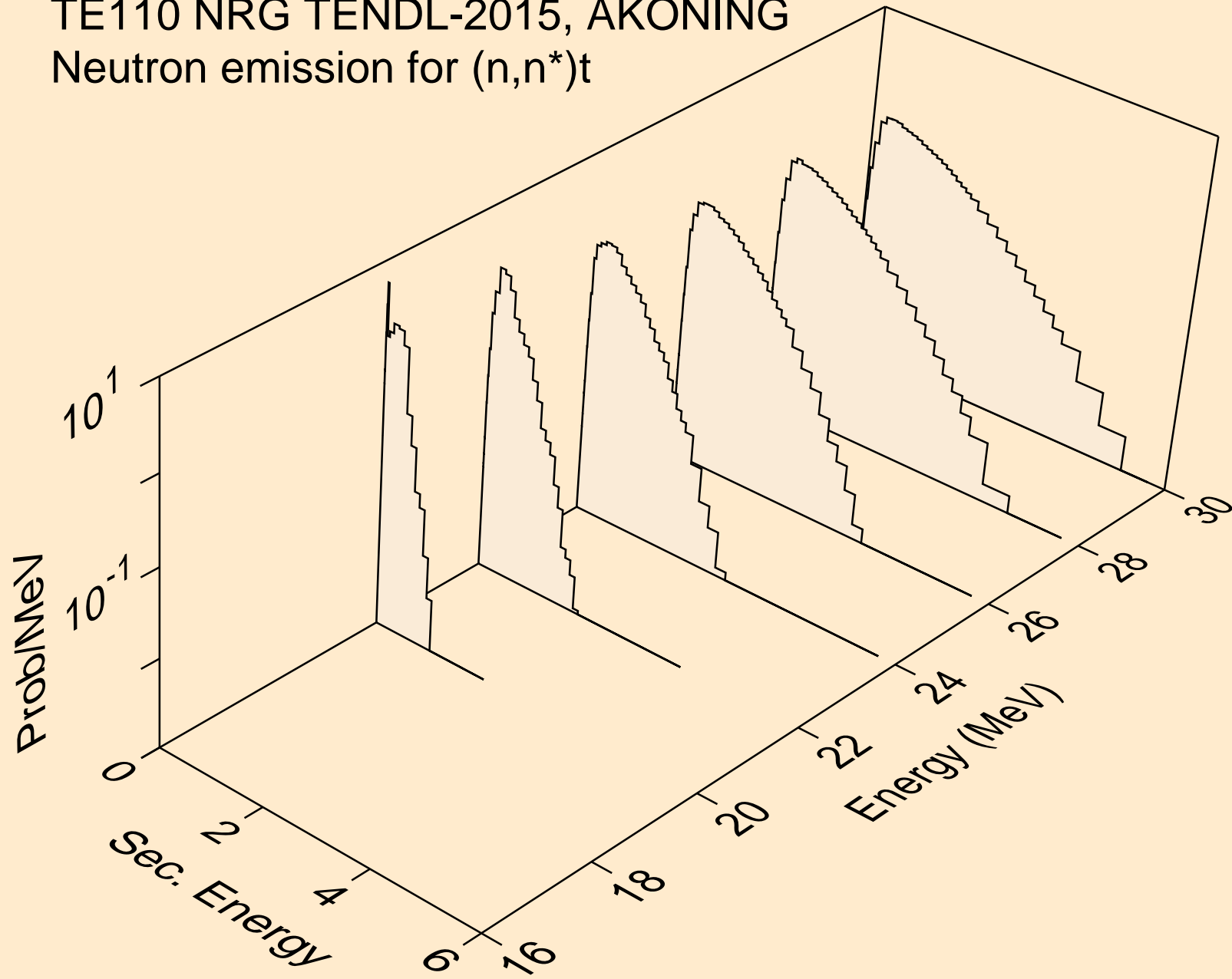

TE110 NRG TENDL-2015, AKONING
Neutron emission for (n,n*)he3

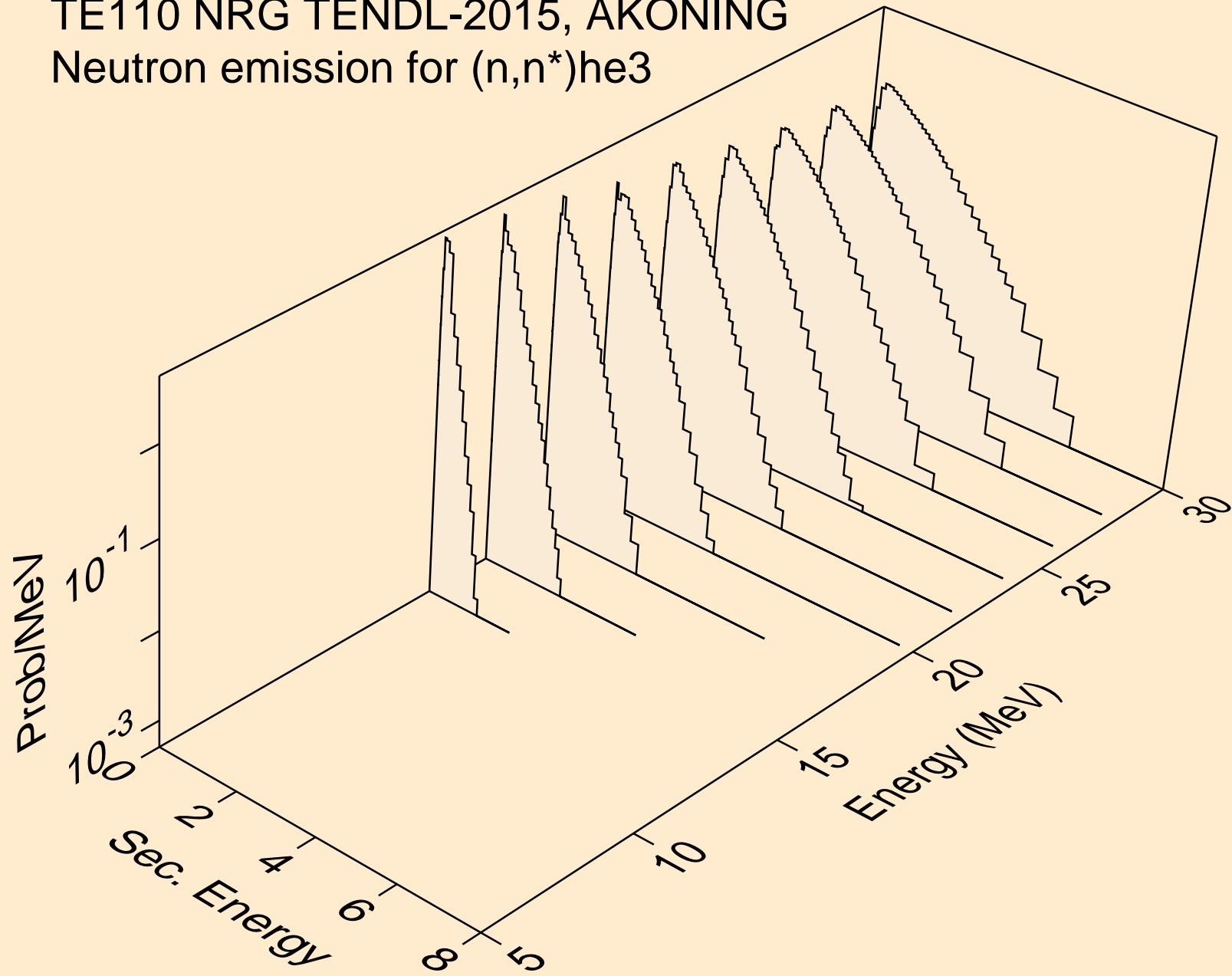

TE110 NRG TENDL-2015, AKONING
Neutron emission for (n,2np)

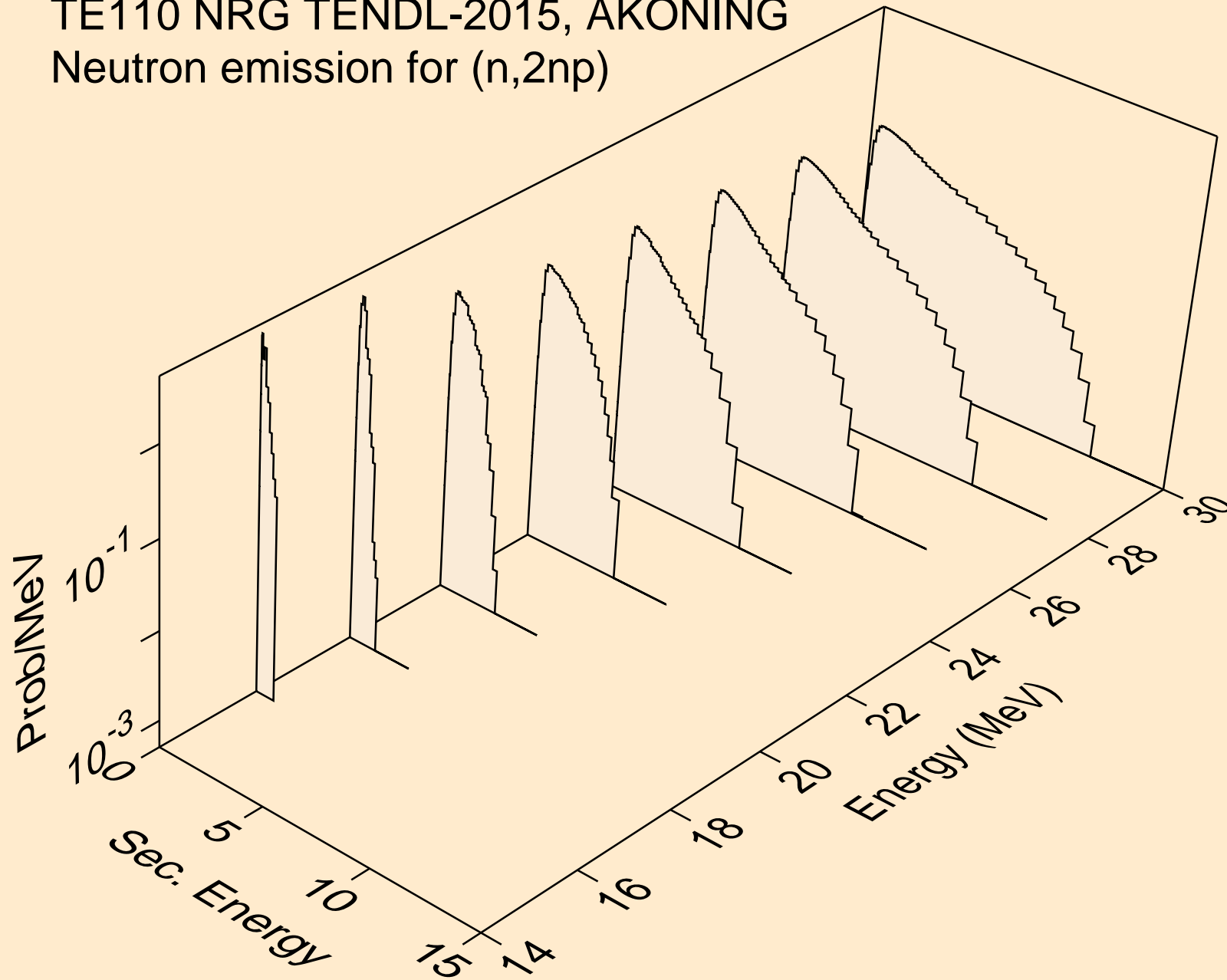

TE110 NRG TENDL-2015, AKONING
Neutron emission for (n,3np)

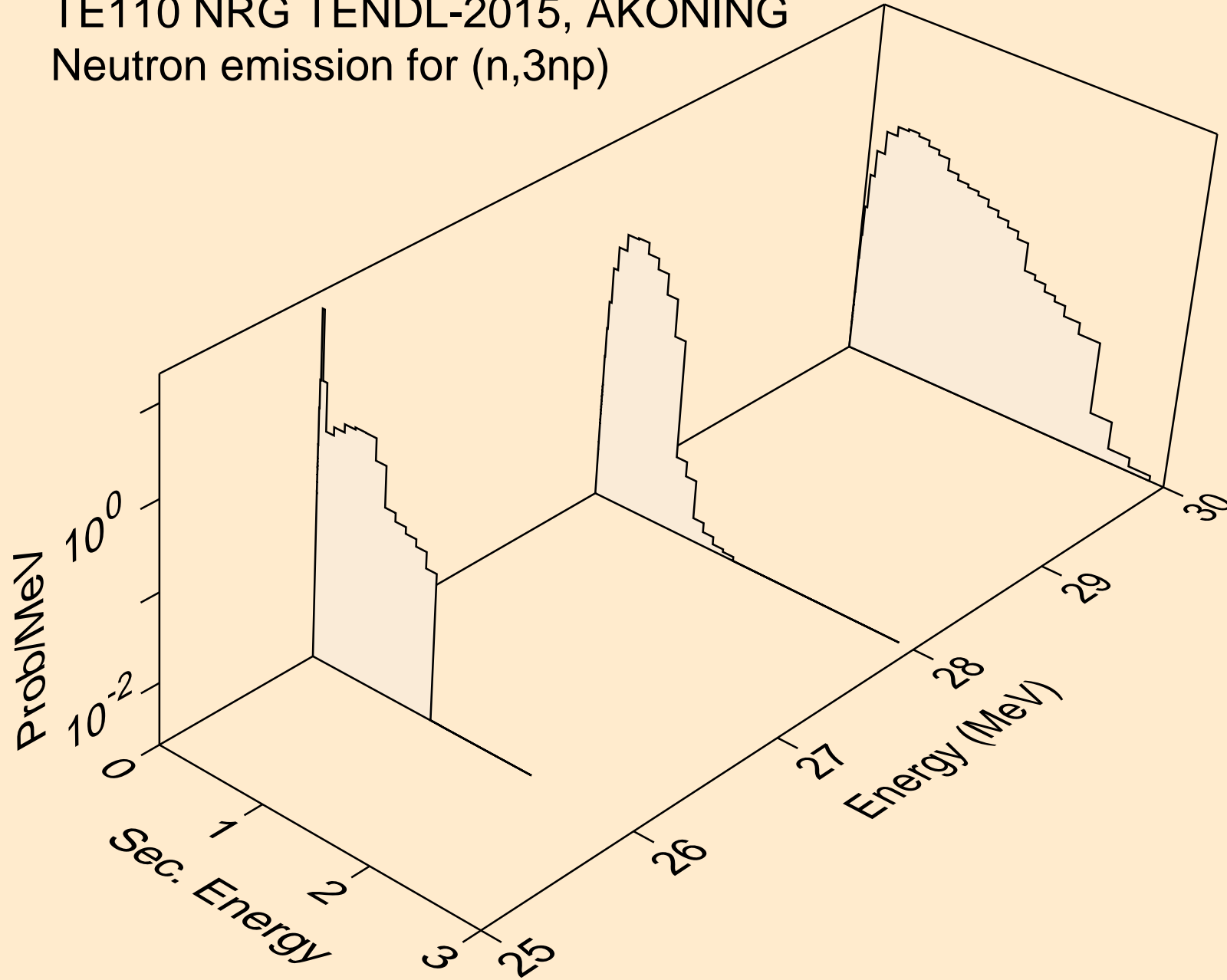

TE110 NRG TENDL-2015, AKONING
Neutron emission for (n,2np)

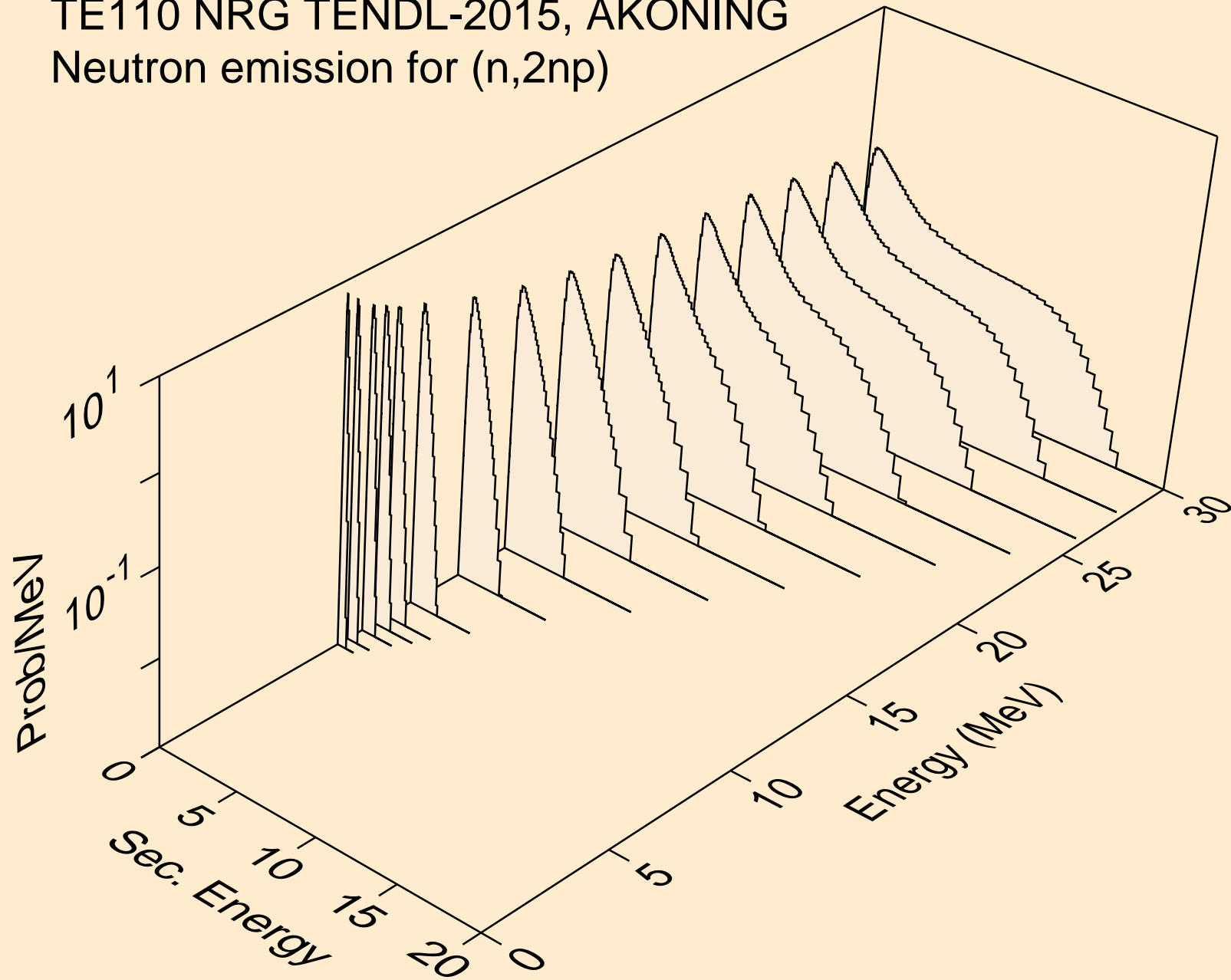

TE110 NRG TENDL-2015, AKONING
Neutron emission for (n,npa)

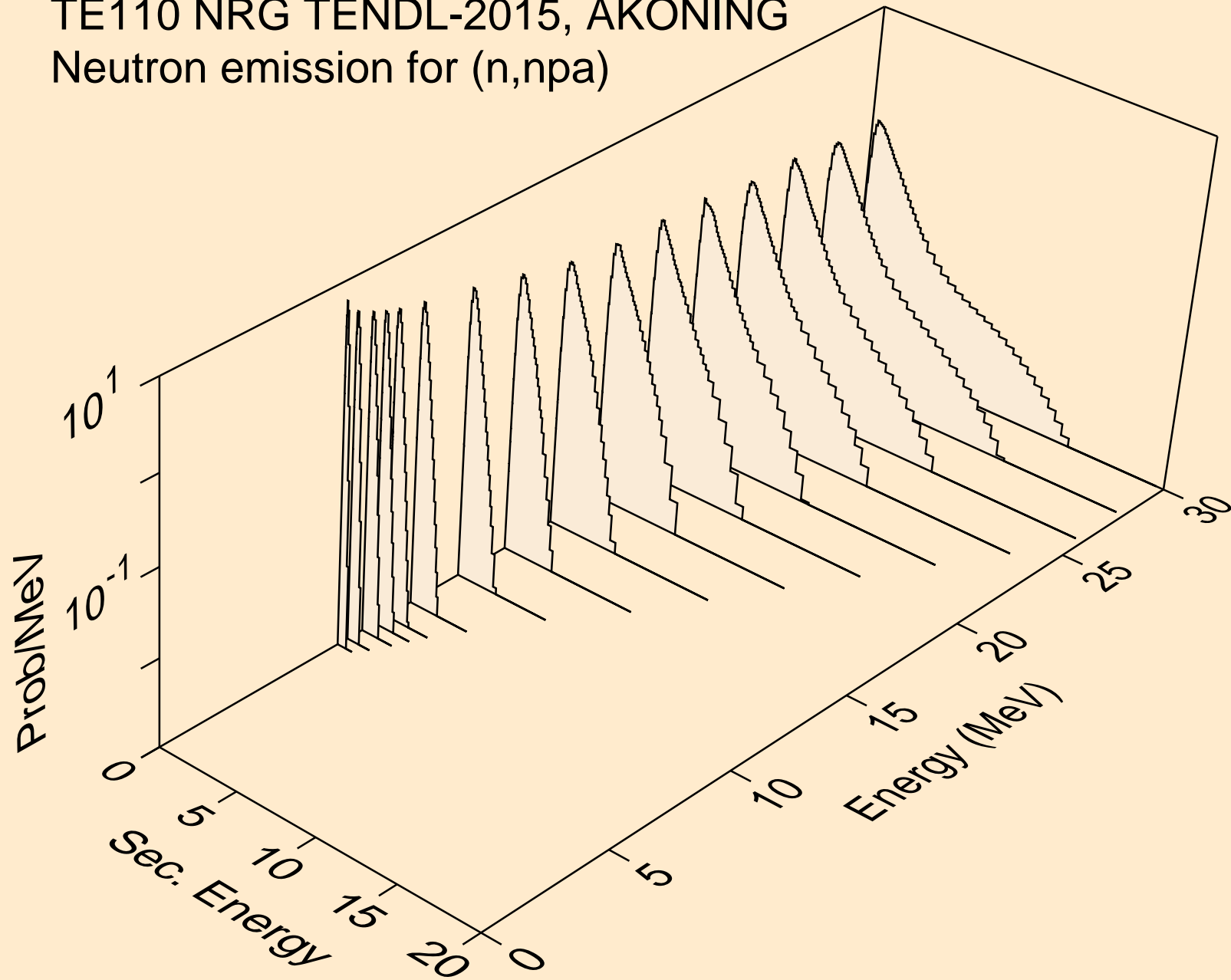

TE110 NRG TENDL-2015, AKONING
Neutron emission for (n,n*c)

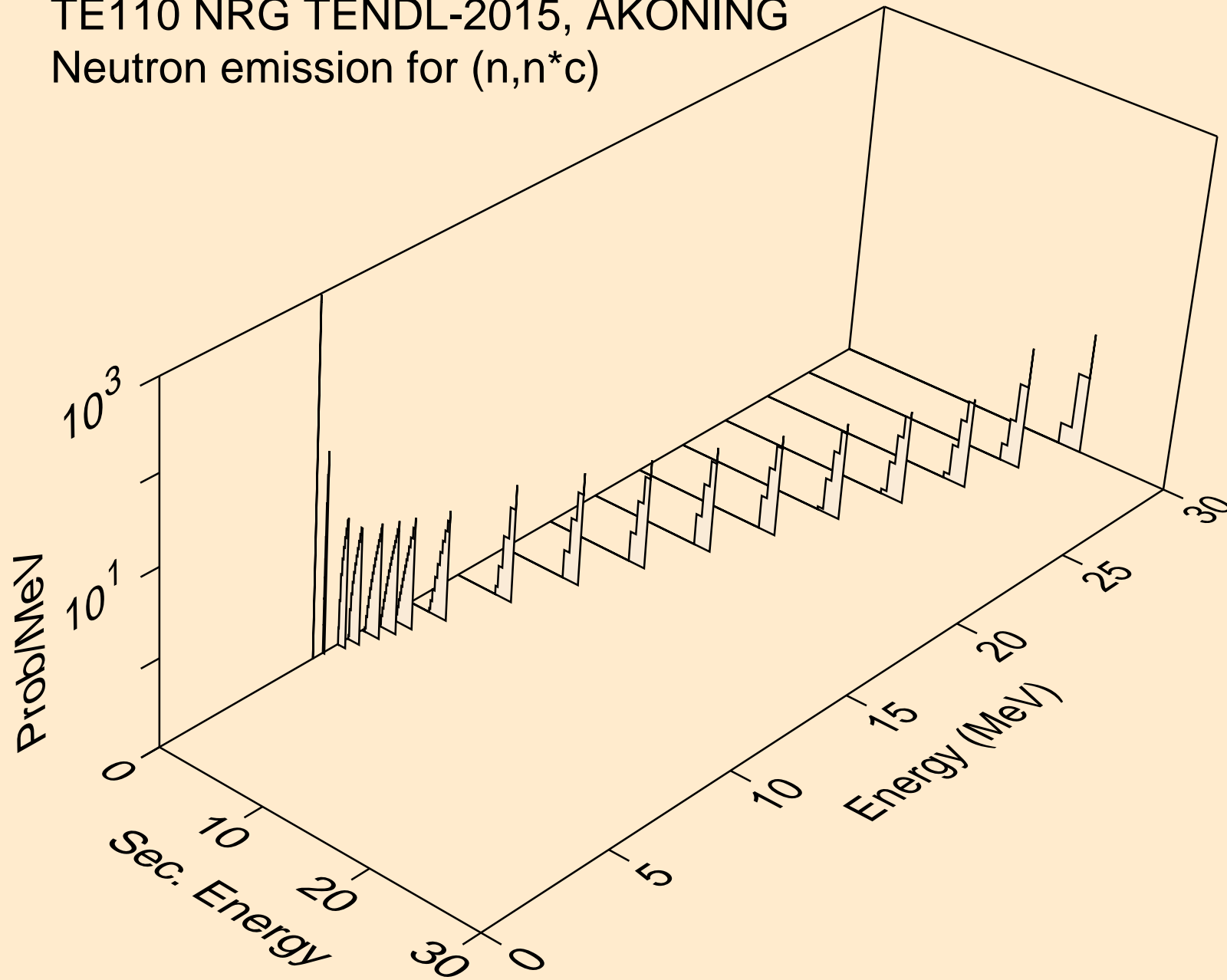

TE110 NRG TENDL-2015, AKONING
Photon emission for (n,x)

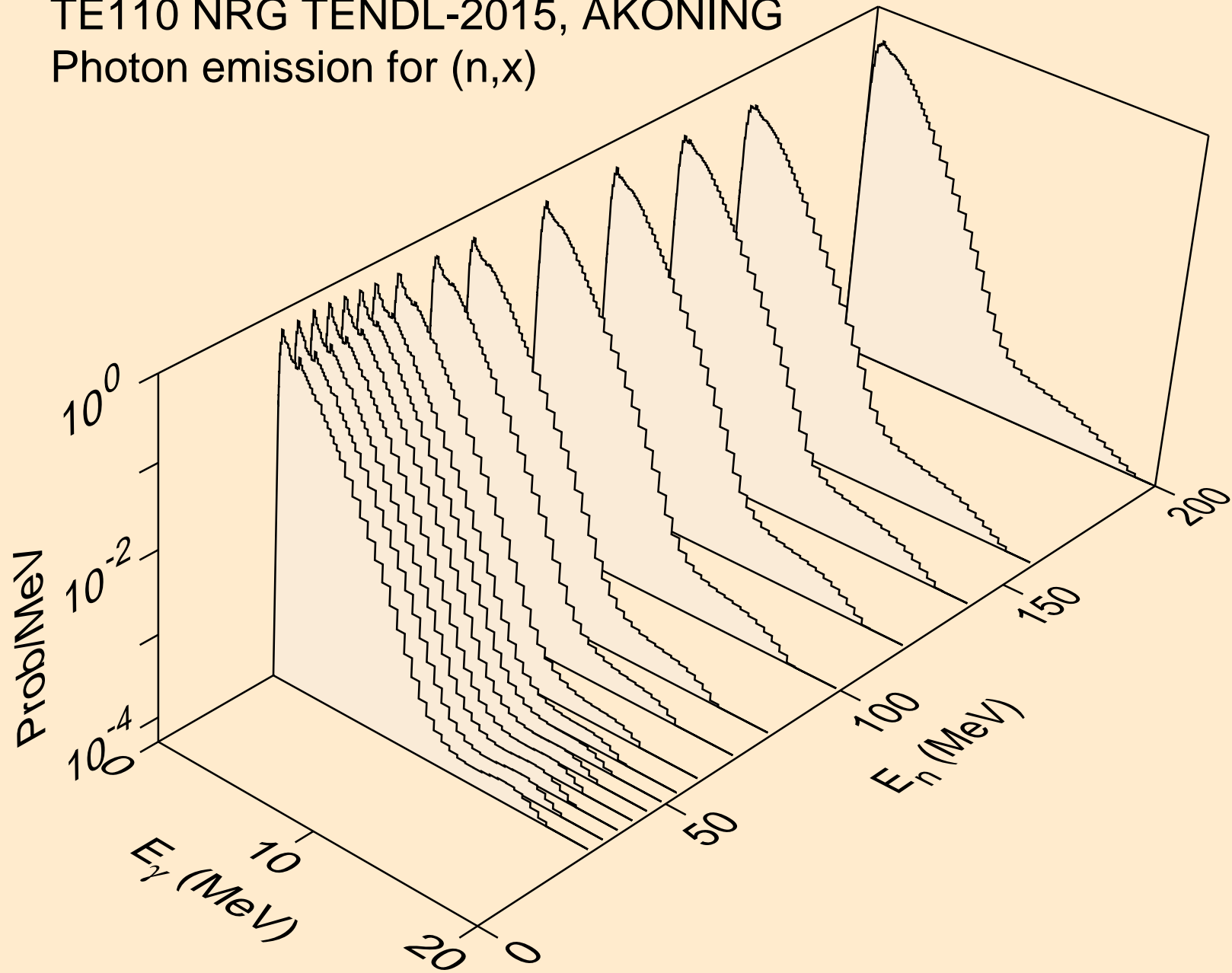

TE110 NRG TENDL-2015, AKONING
Photon emission for (n,2nd)

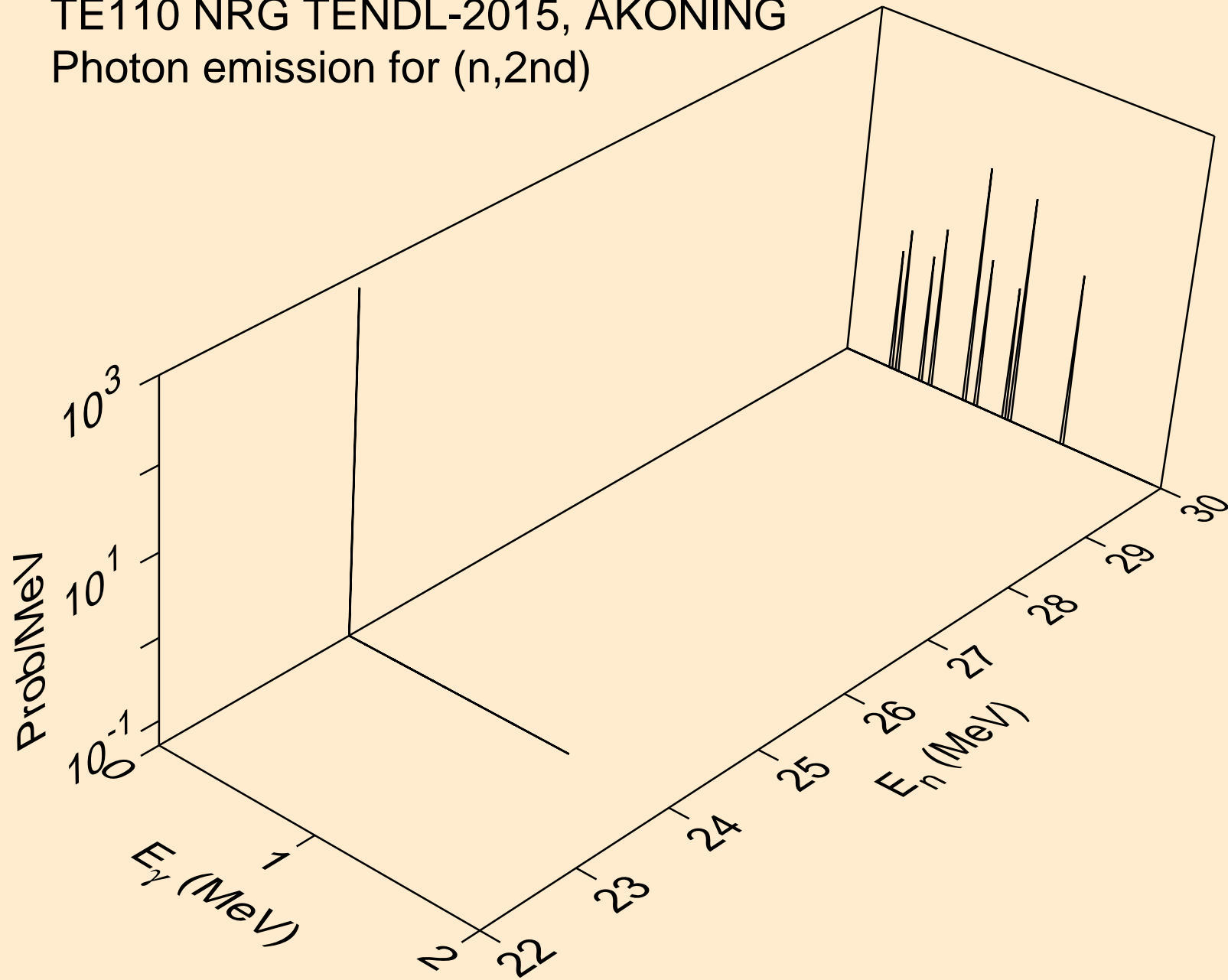

TE110 NRG TENDL-2015, AKONING
Photon emission for (n,2n)

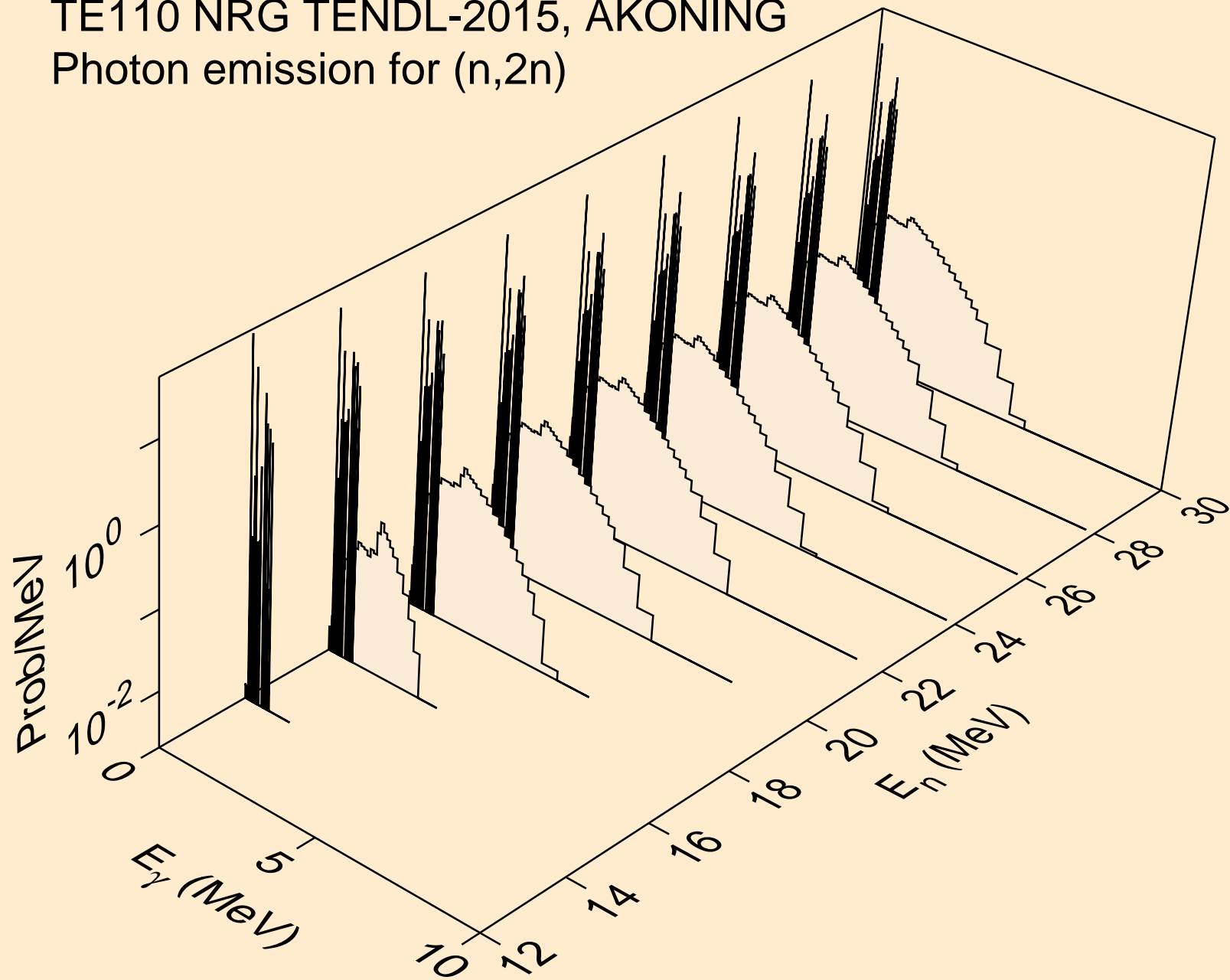

TE110 NRG TENDL-2015, AKONING
Photon emission for (n,3n)

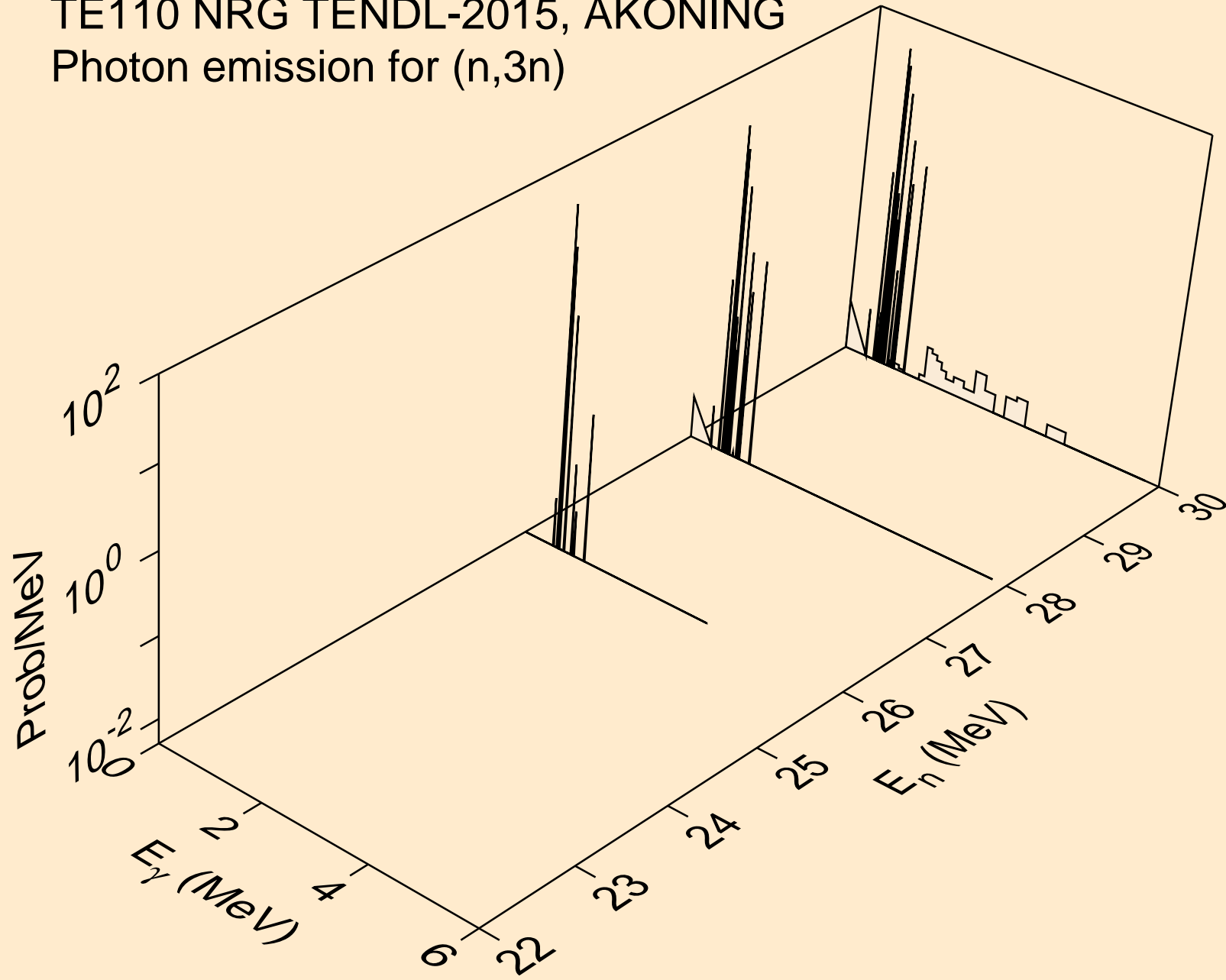

TE110 NRG TENDL-2015, AKONING
Photon emission for (n,n*)a

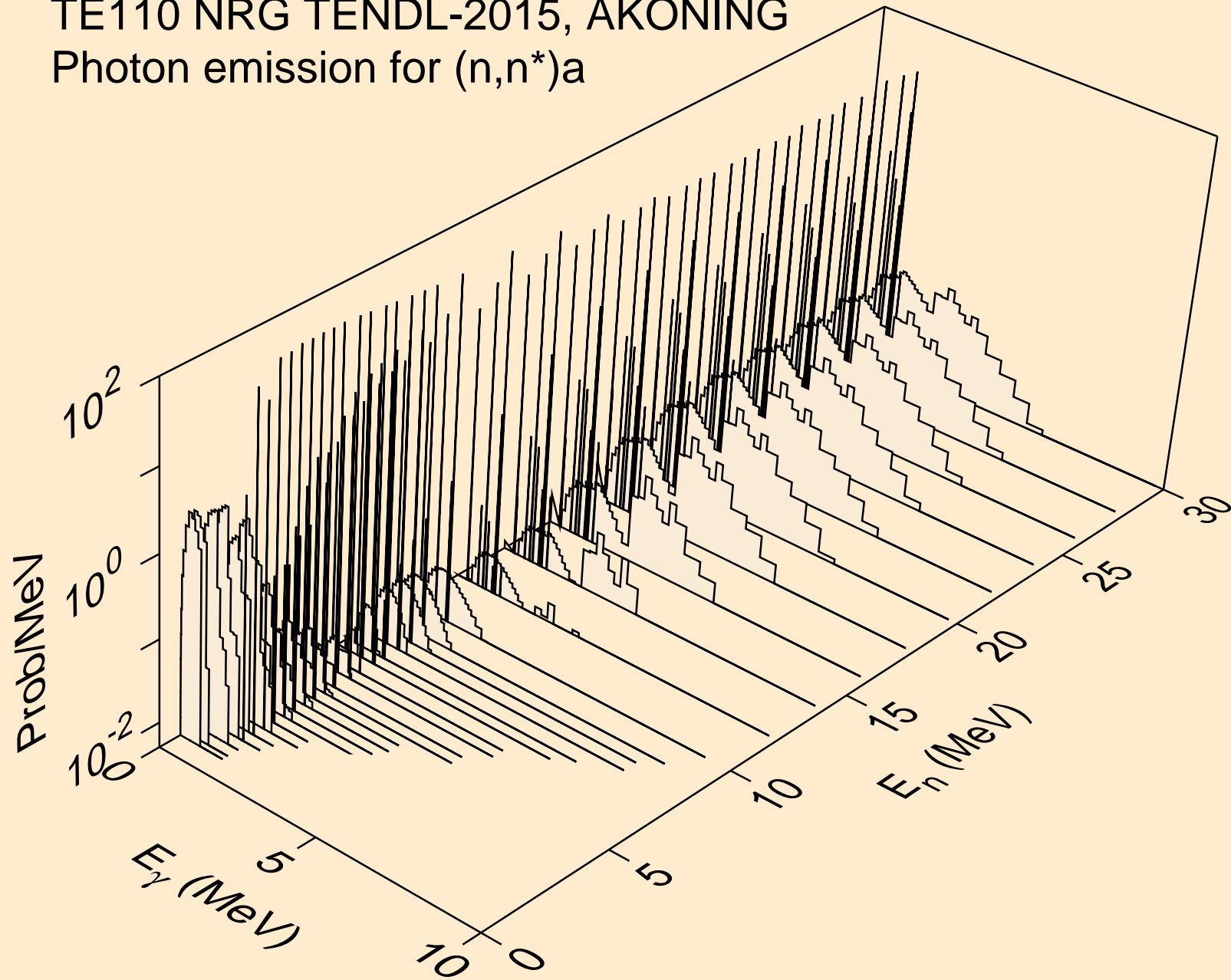

TE110 NRG TENDL-2015, AKONING
Photon emission for (n,n*)3a

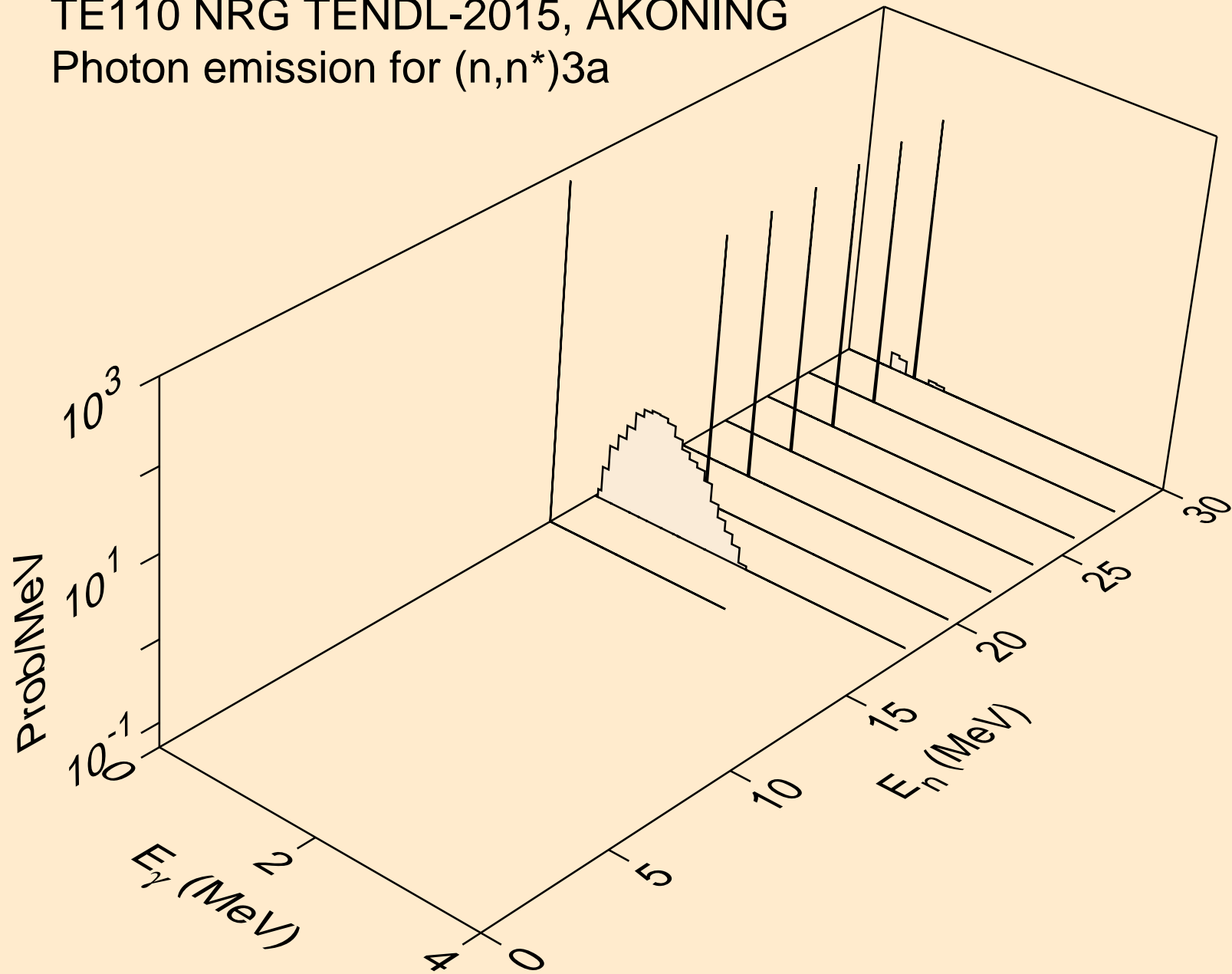

TE110 NRG TENDL-2015, AKONING
Photon emission for (n,2n)a

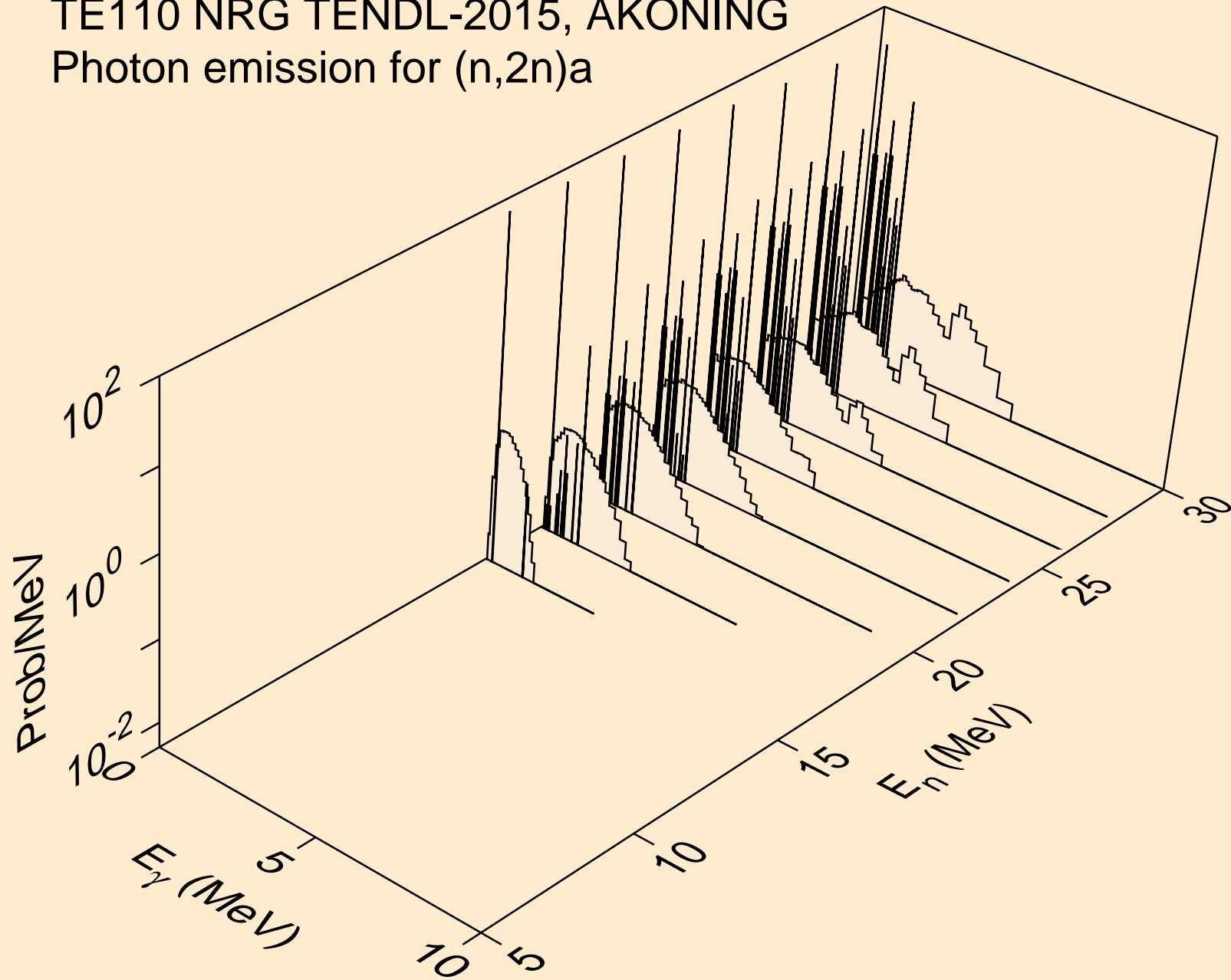

TE110 NRG TENDL-2015, AKONING
Photon emission for (n,3n)a

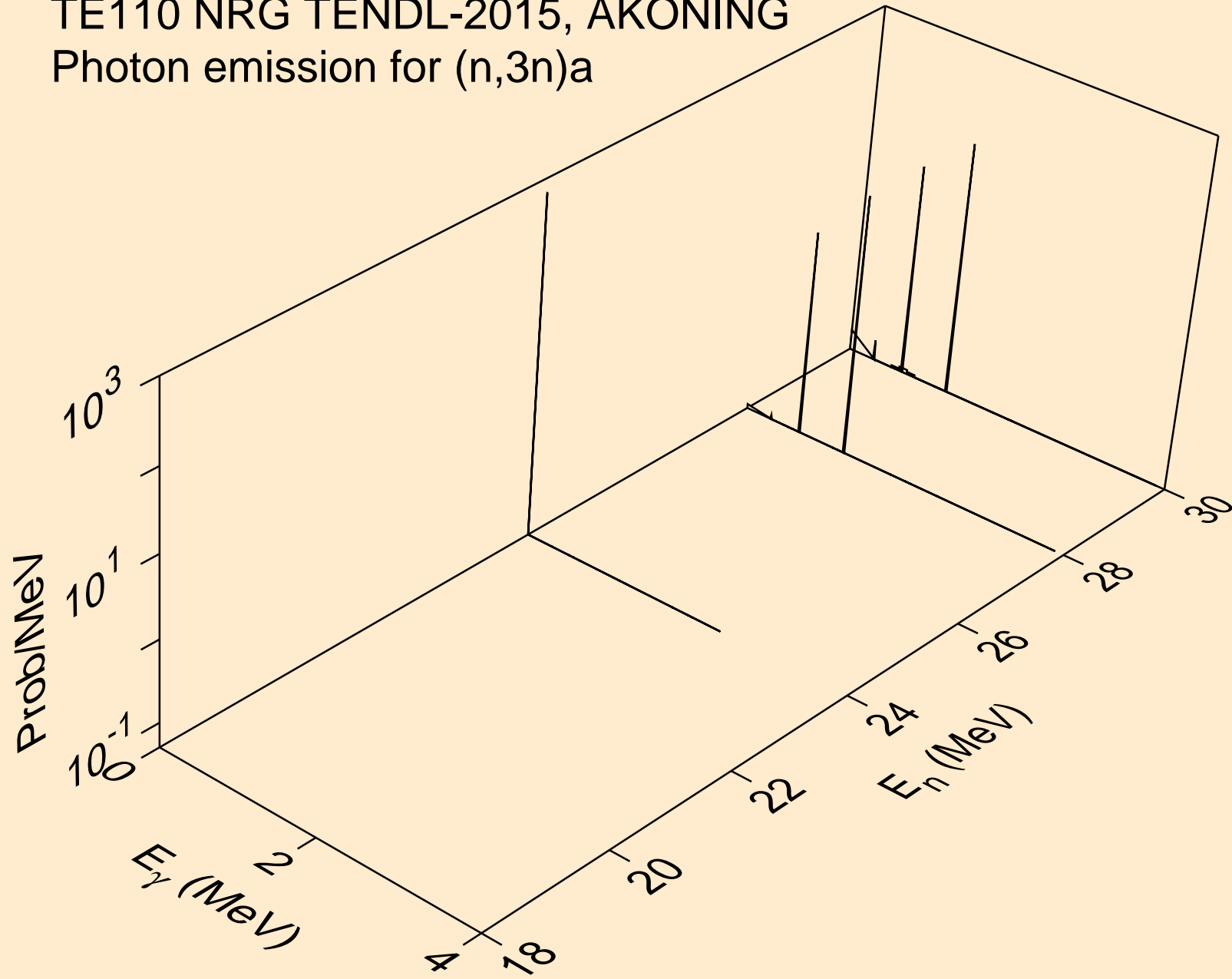

TE110 NRG TENDL-2015, AKONING
Photon emission for (n,n*)p

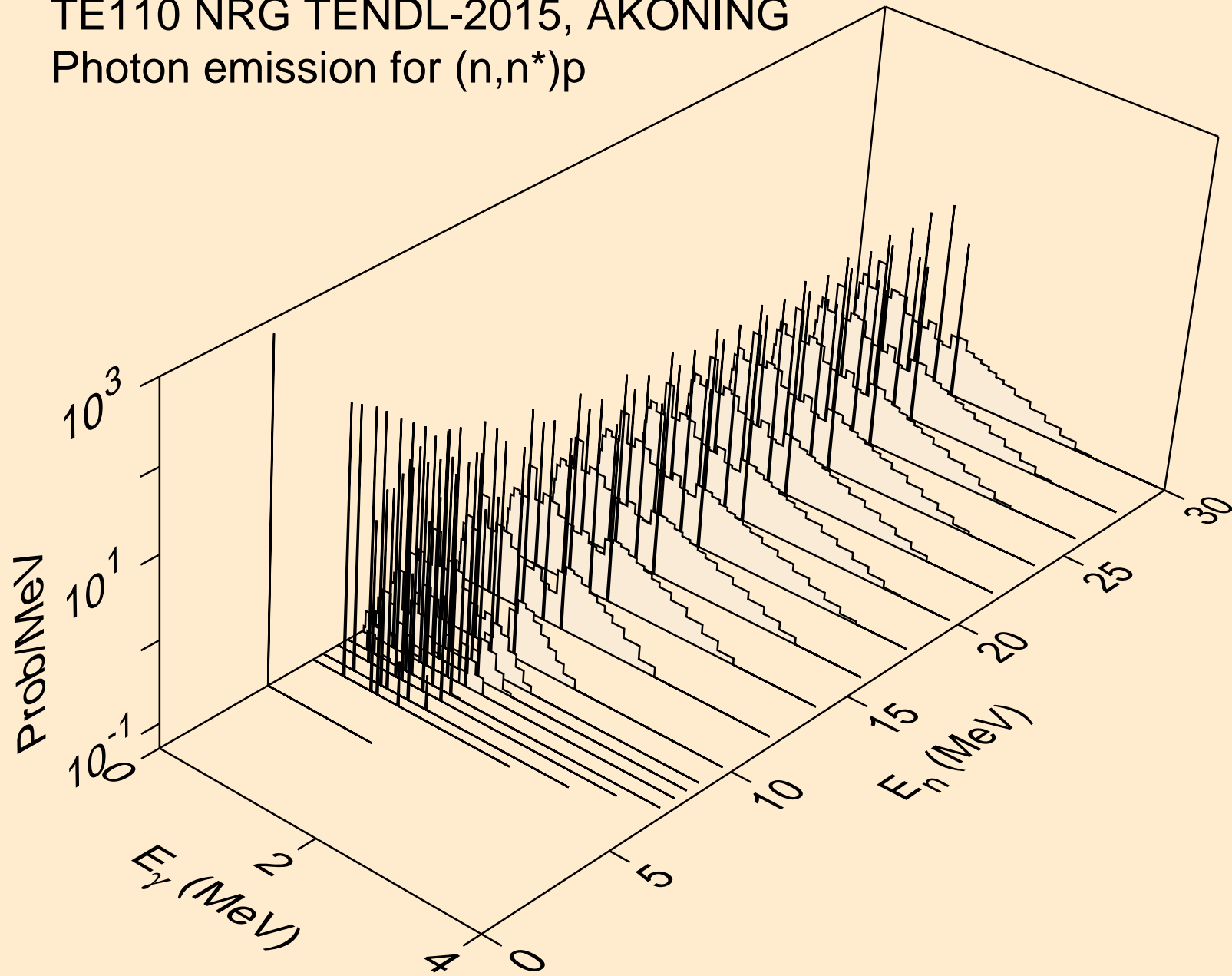

TE110 NRG TENDL-2015, AKONING
Photon emission for (n,n*)2a

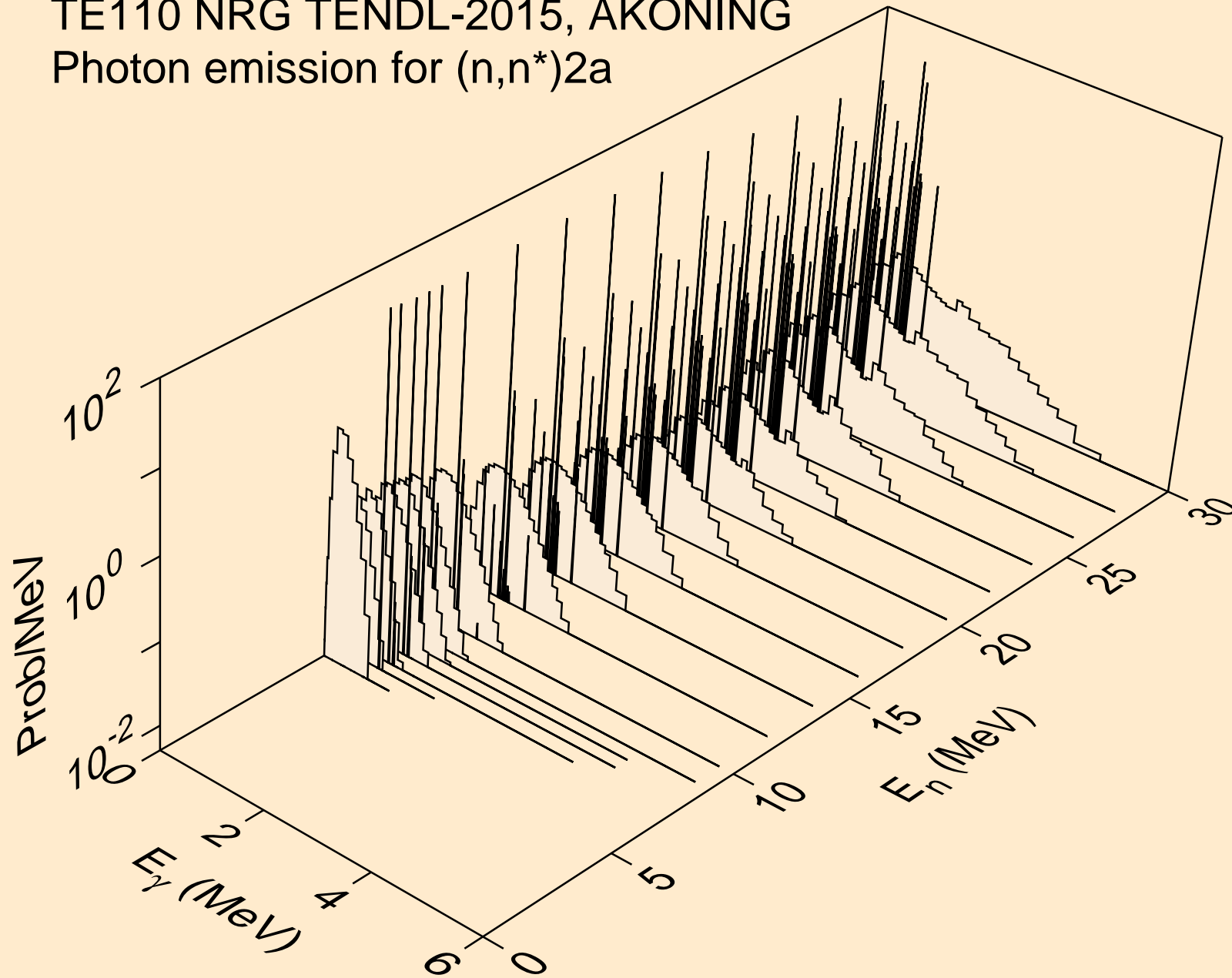

TE110 NRG TENDL-2015, AKONING
Photon emission for (n,2n)2a

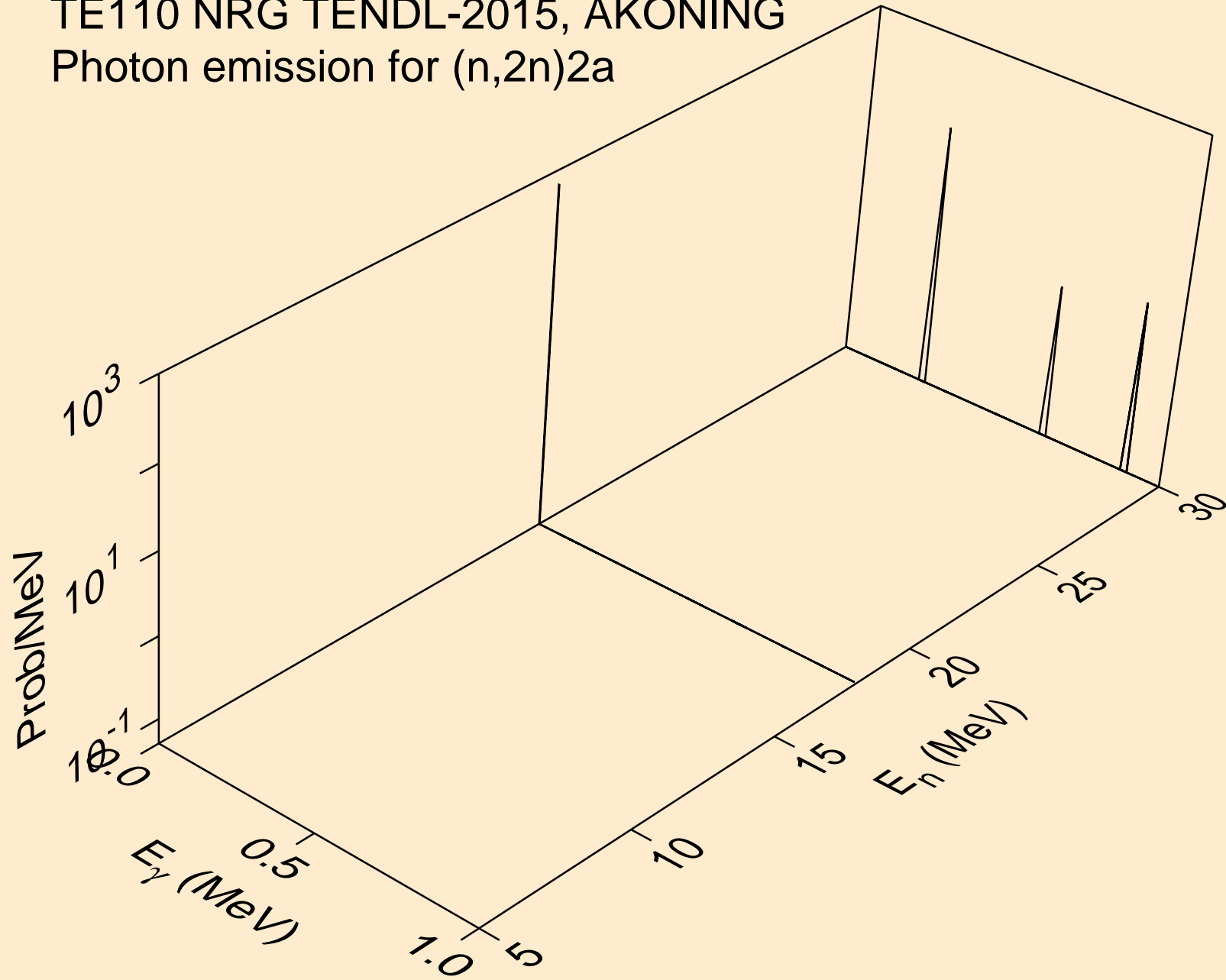

TE110 NRG TENDL-2015, AKONING
Photon emission for (n,n*)d

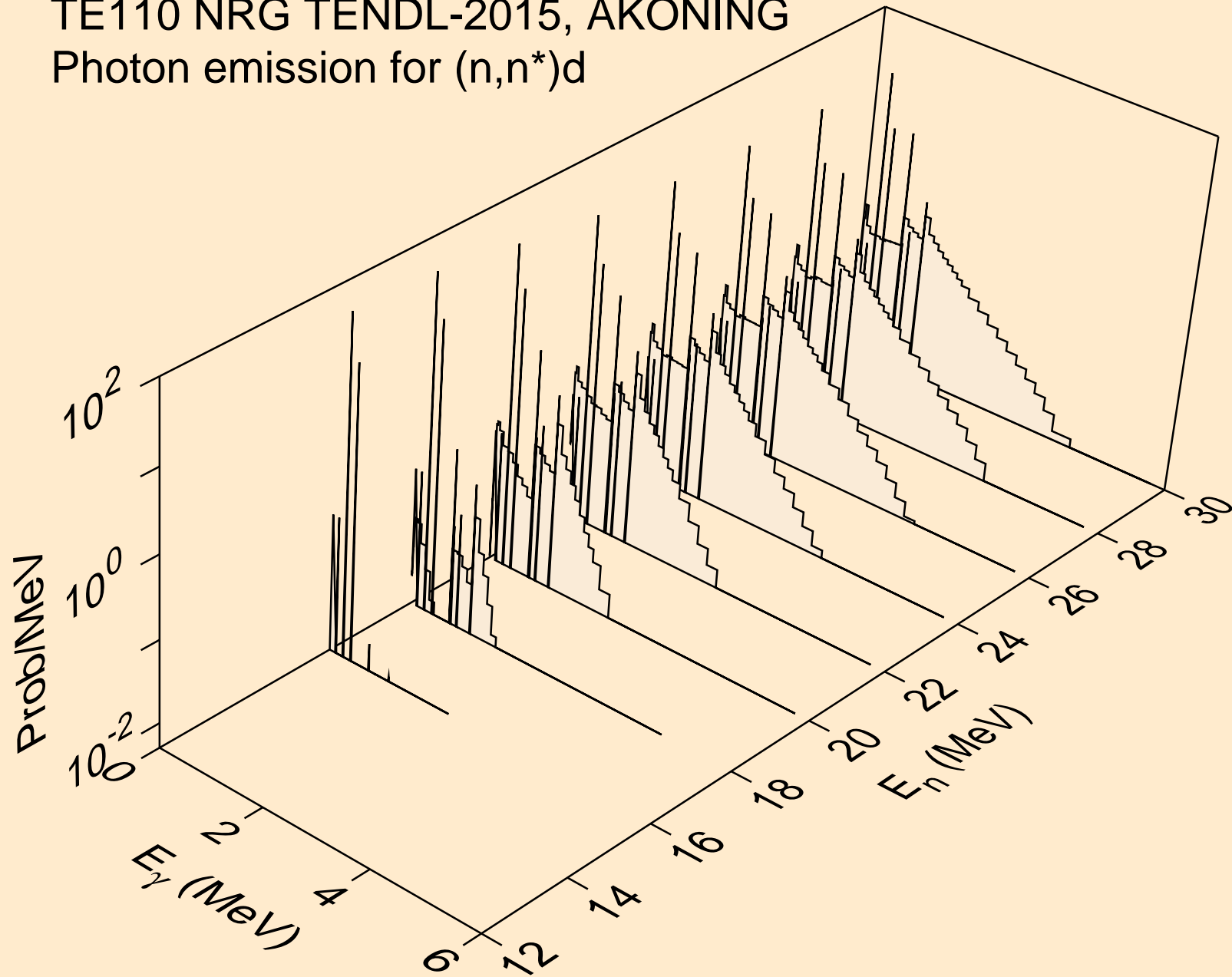

TE110 NRG TENDL-2015, AKONING
Photon emission for (n,n*)t

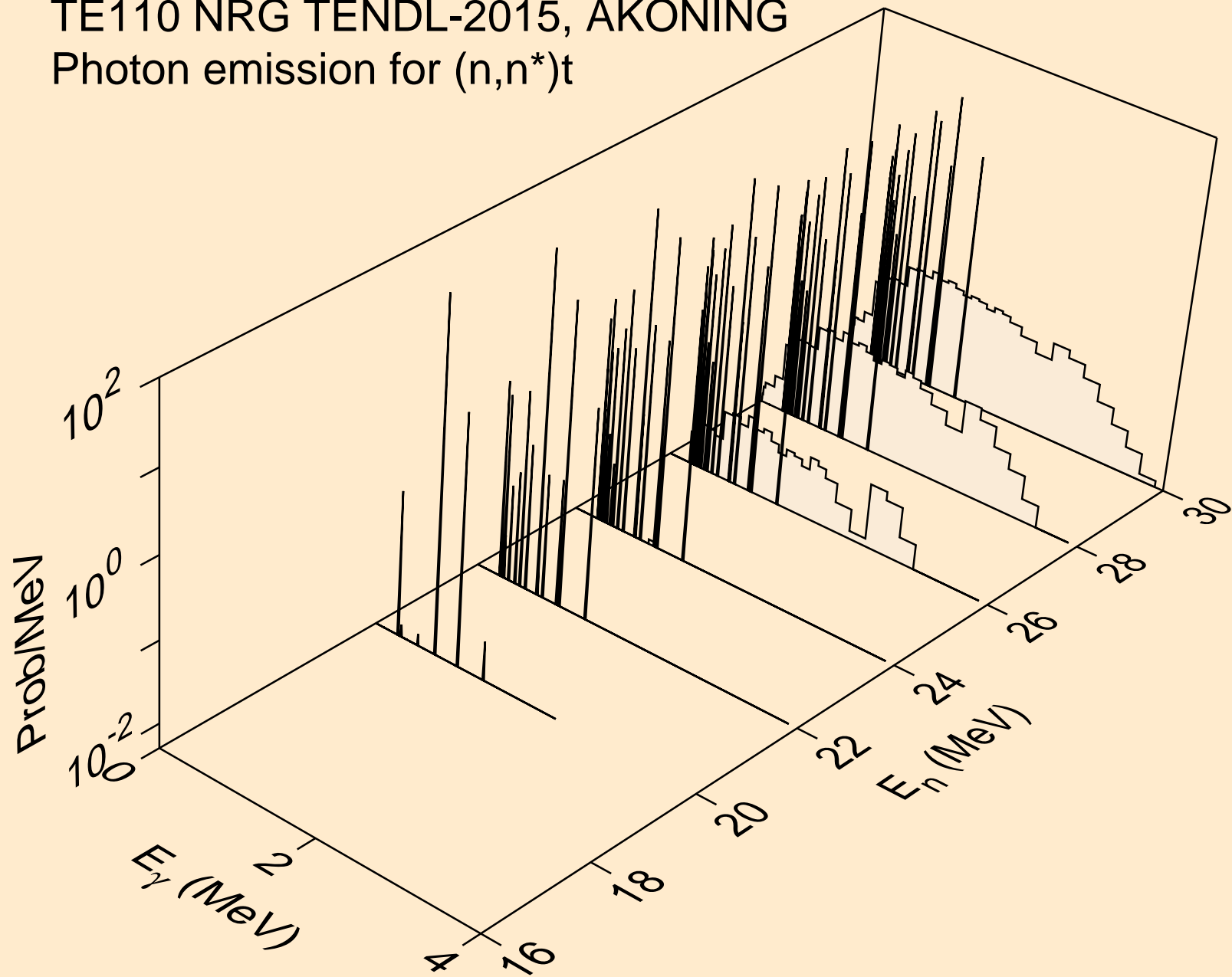

TE110 NRG TENDL-2015, AKONING
Photon emission for (n,n*)he3

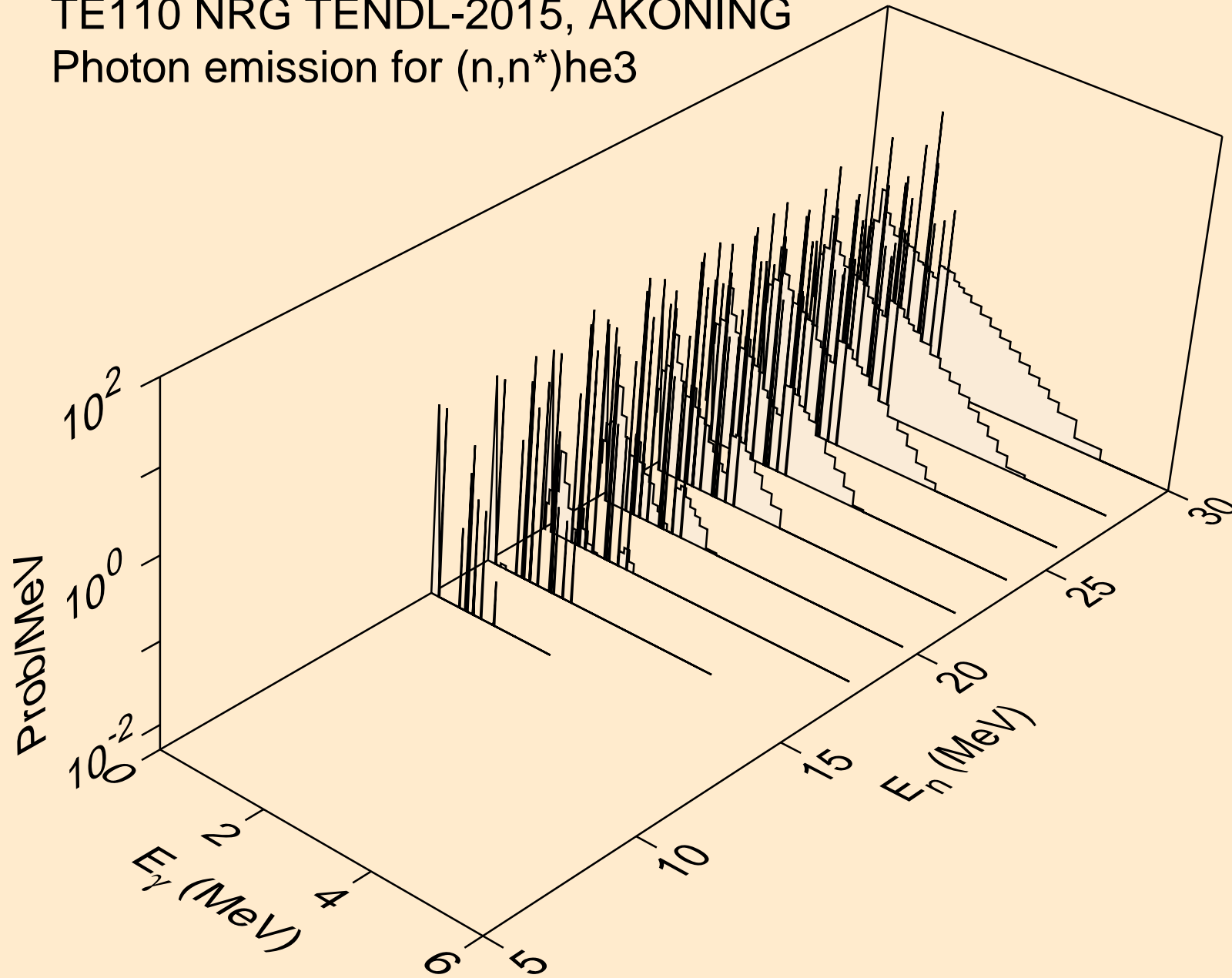

TE110 NRG TENDL-2015, AKONING
Photon emission for (n,2np)

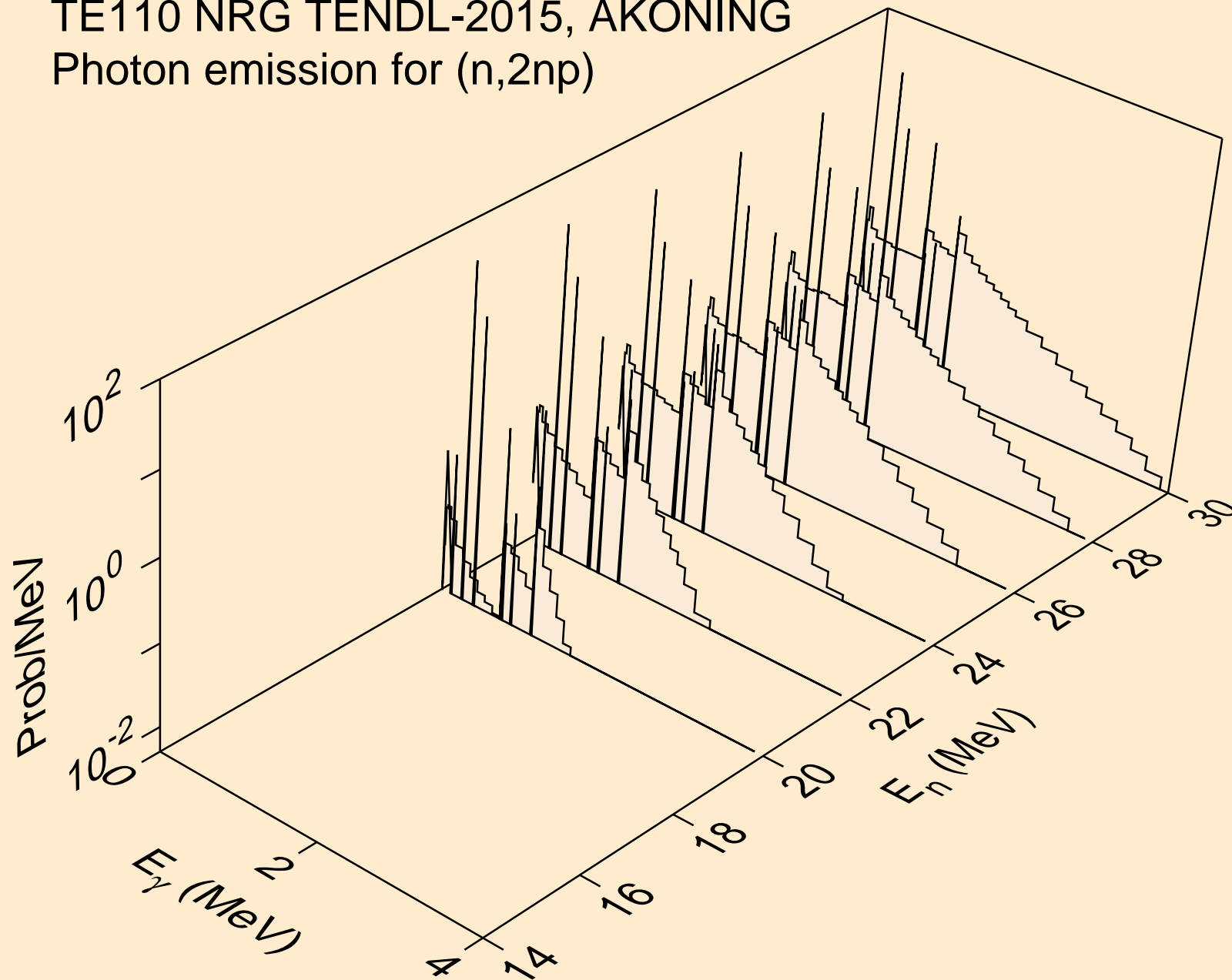

TE110 NRG TENDL-2015, AKONING
Photon emission for (n,3np)

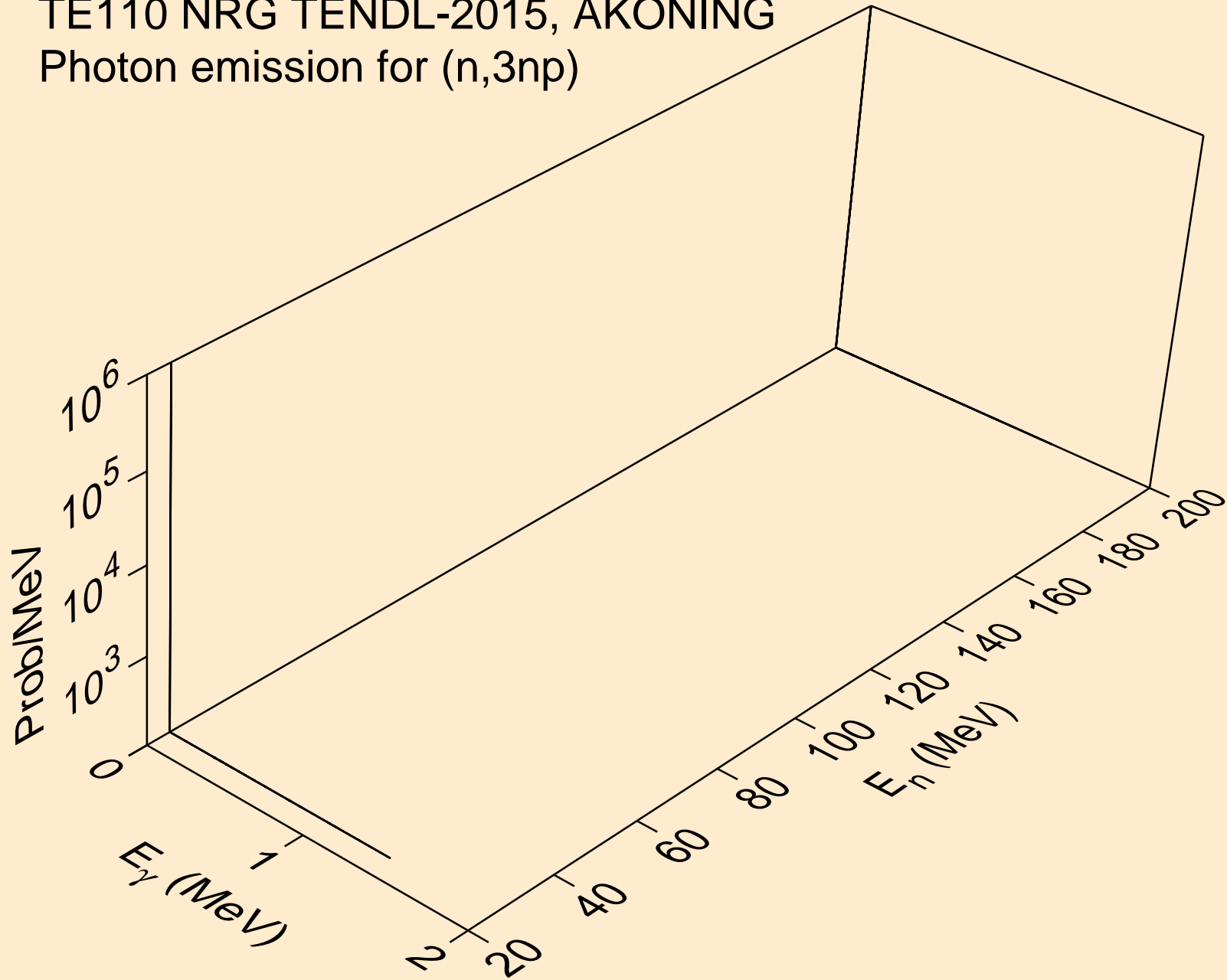

TE110 NRG TENDL-2015, AKONING
Photon emission for (n,2np)

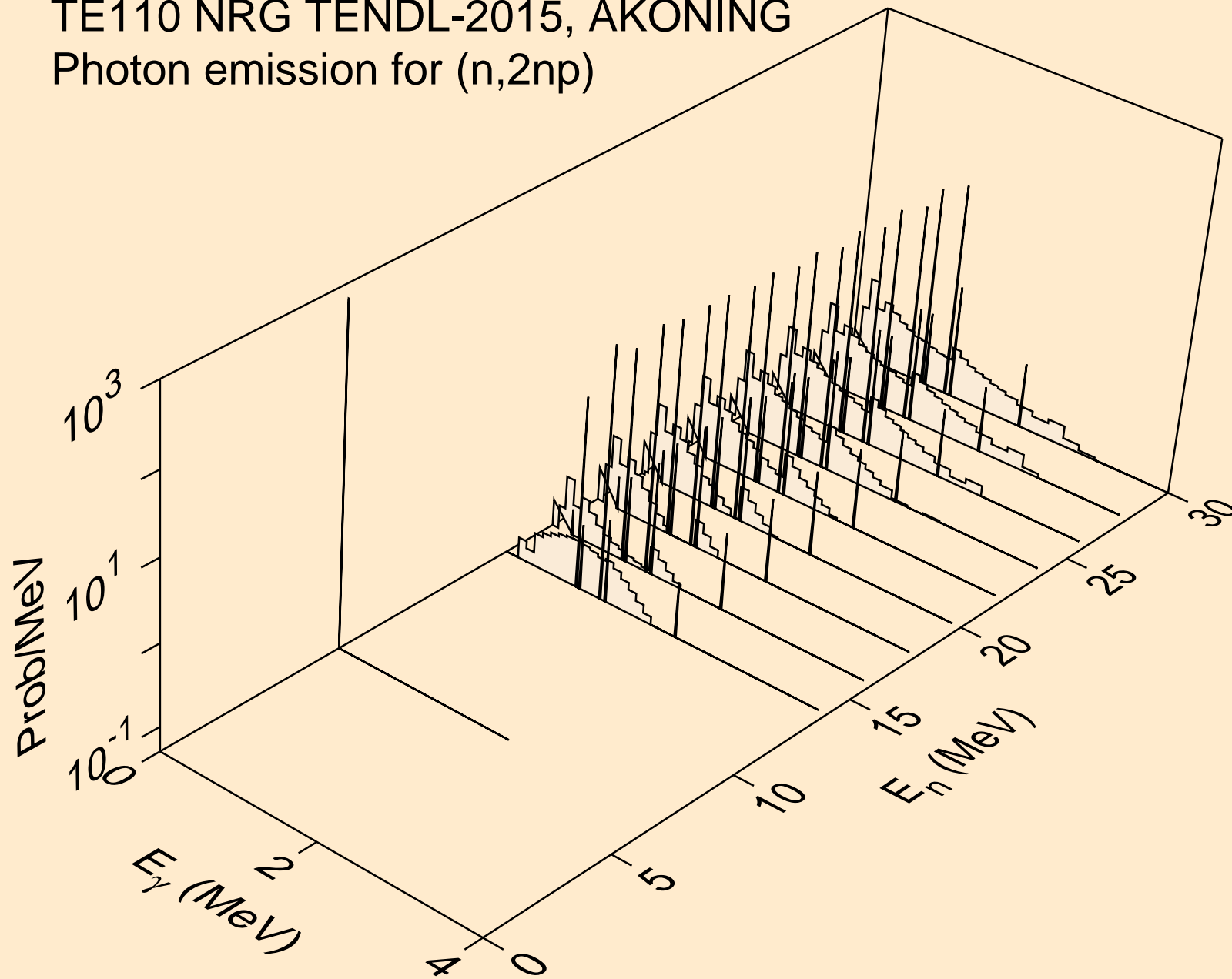

TE110 NRG TENDL-2015, AKONING
Photon emission for (n,npa)

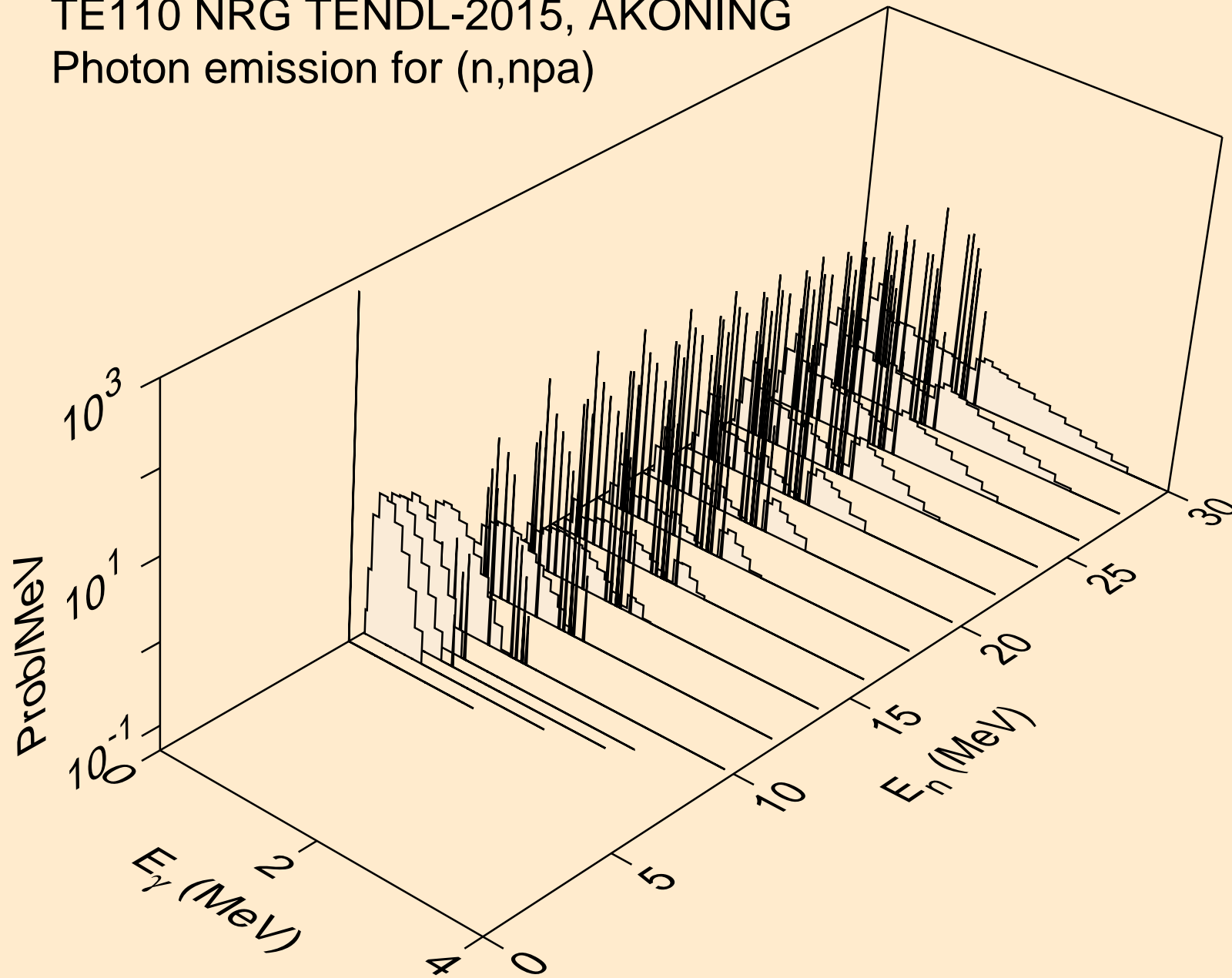

TE110 NRG TENDL-2015, AKONING
Photon emission for (n,n*c)

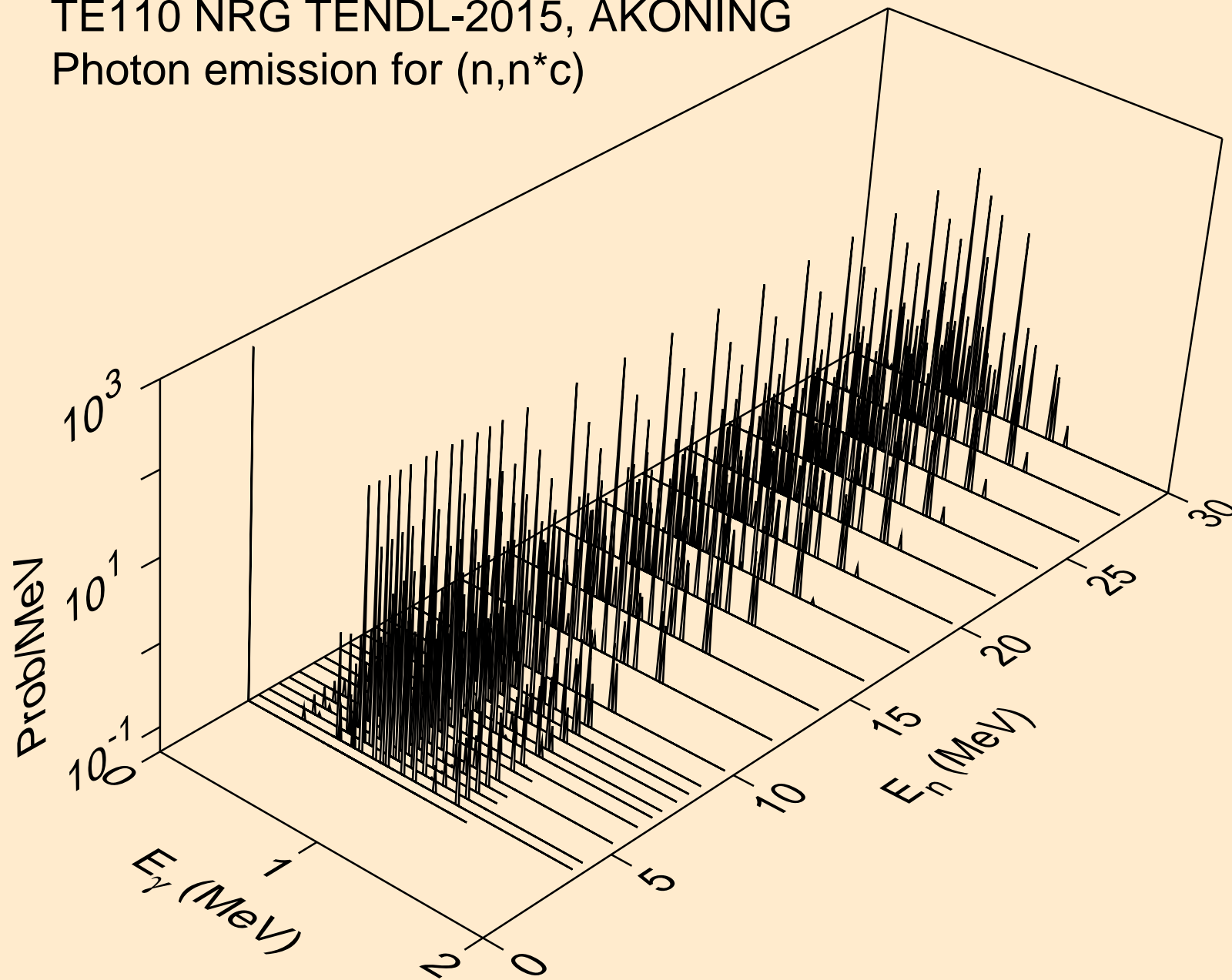

TE110 NRG TENDL-2015, AKONING
Photon emission for (n,gma)

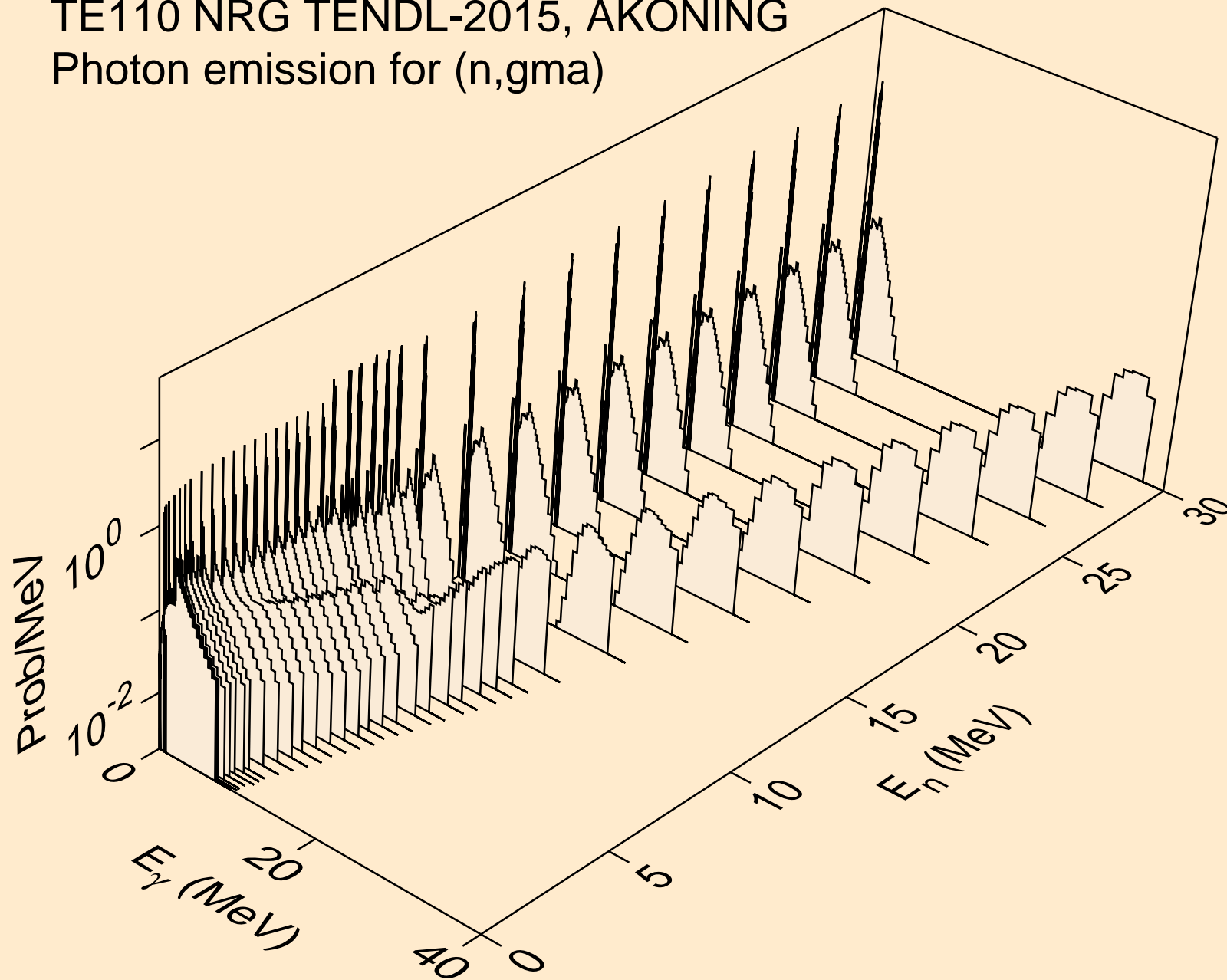

TE110 NRG TENDL-2015, AKONING
Photon emission for (n,p)

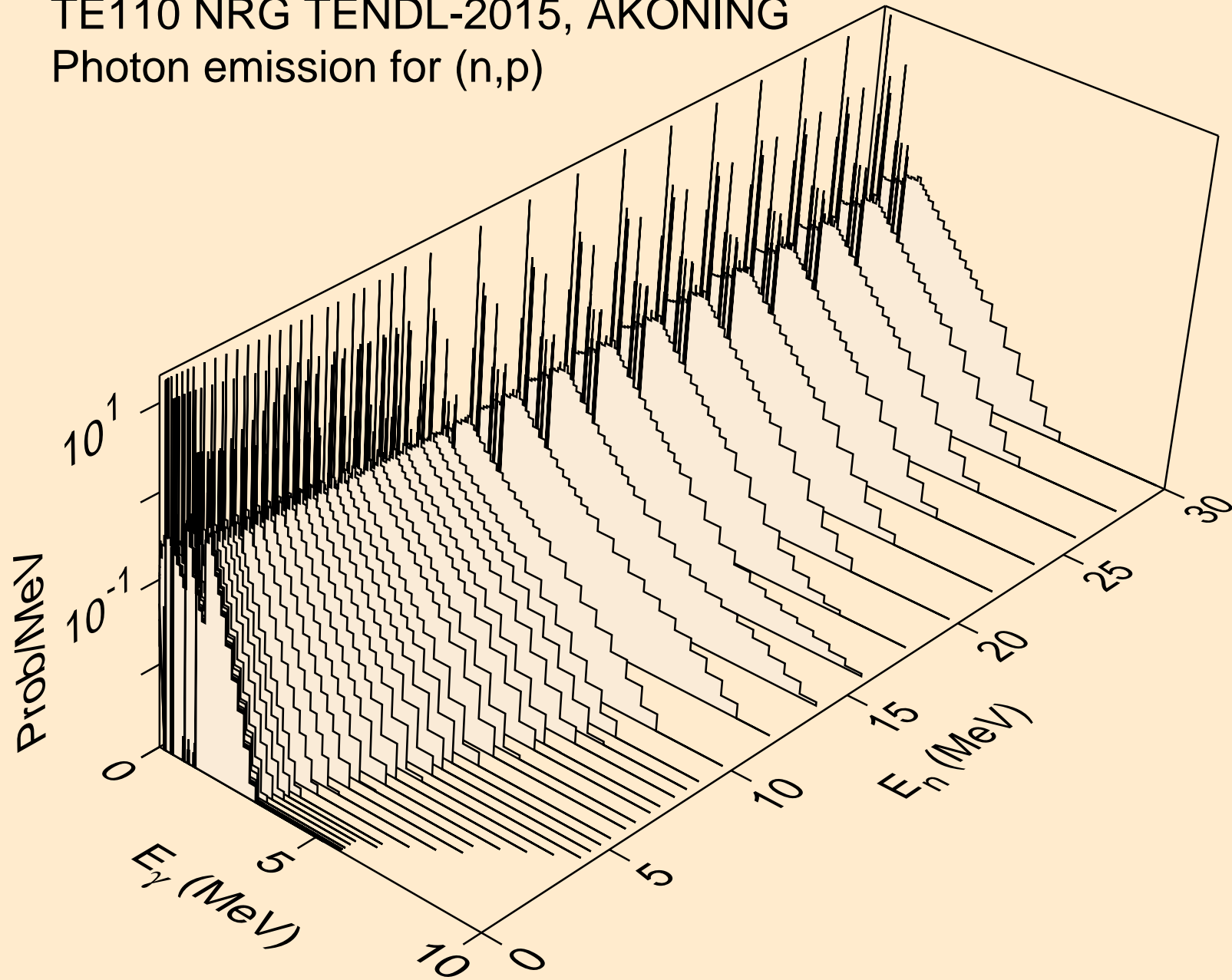

TE110 NRG TENDL-2015, AKONING
Photon emission for (n,d)

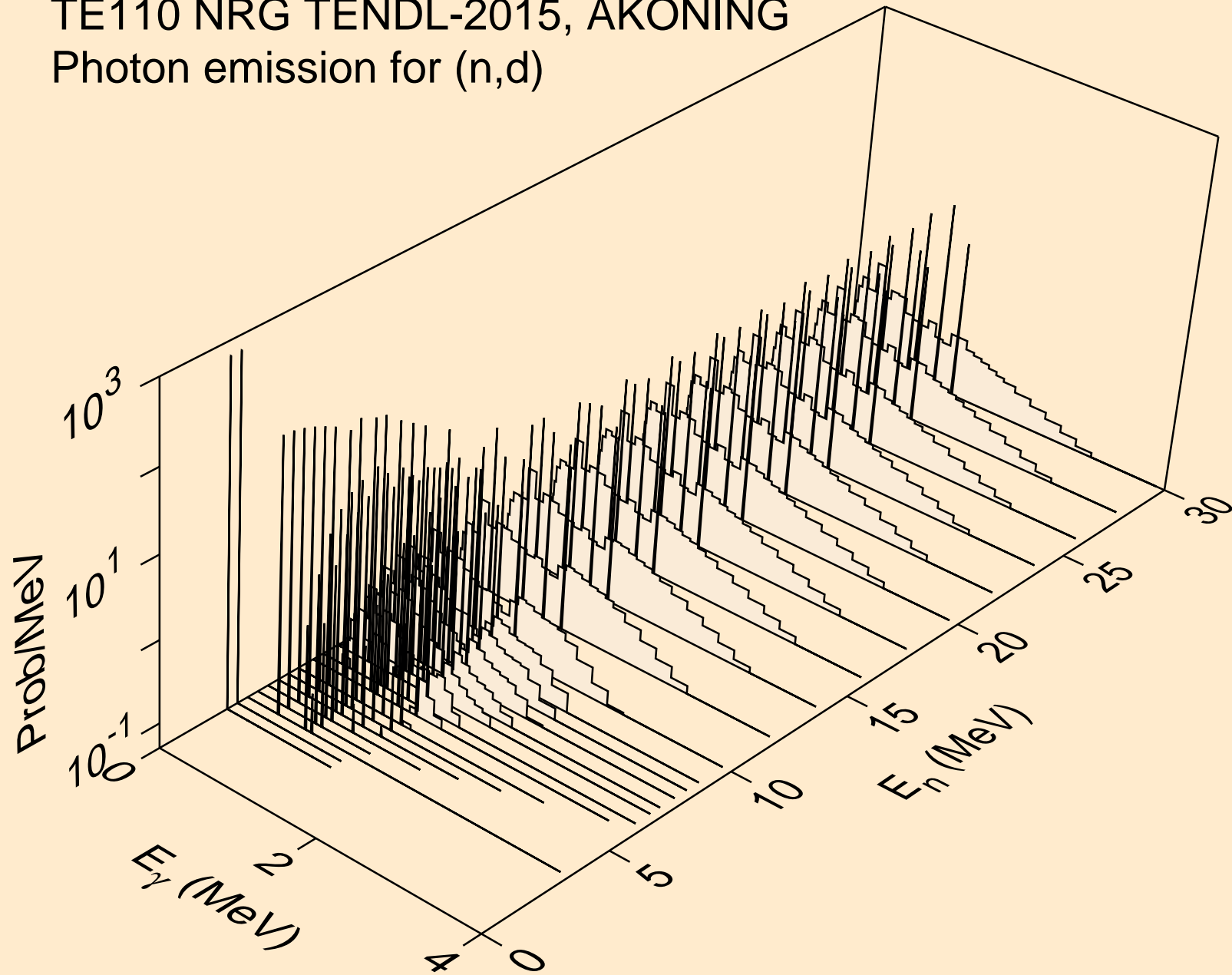

TE110 NRG TENDL-2015, AKONING
Photon emission for (n,t)

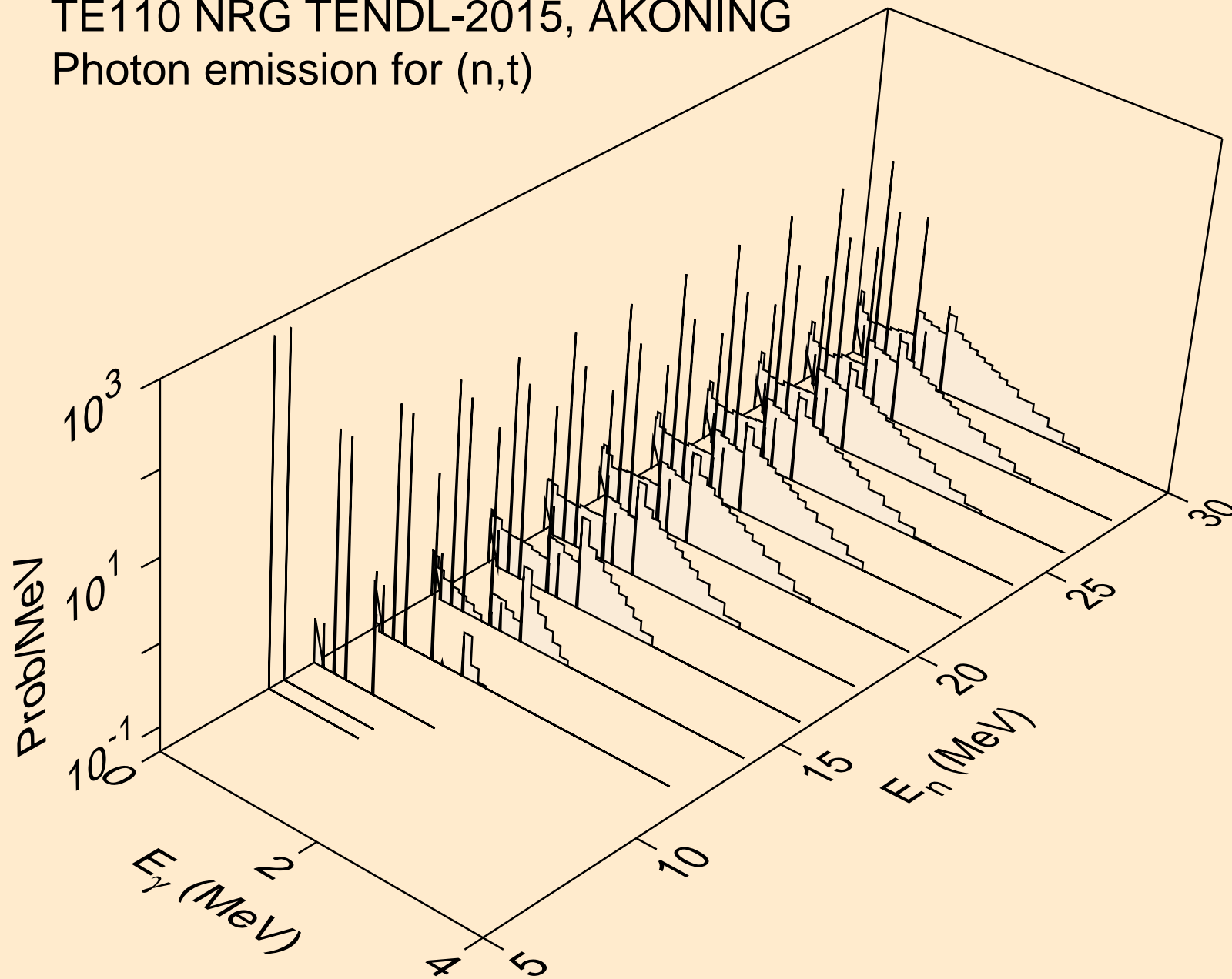

TE110 NRG TENDL-2015, AKONING
Photon emission for (n,he3)

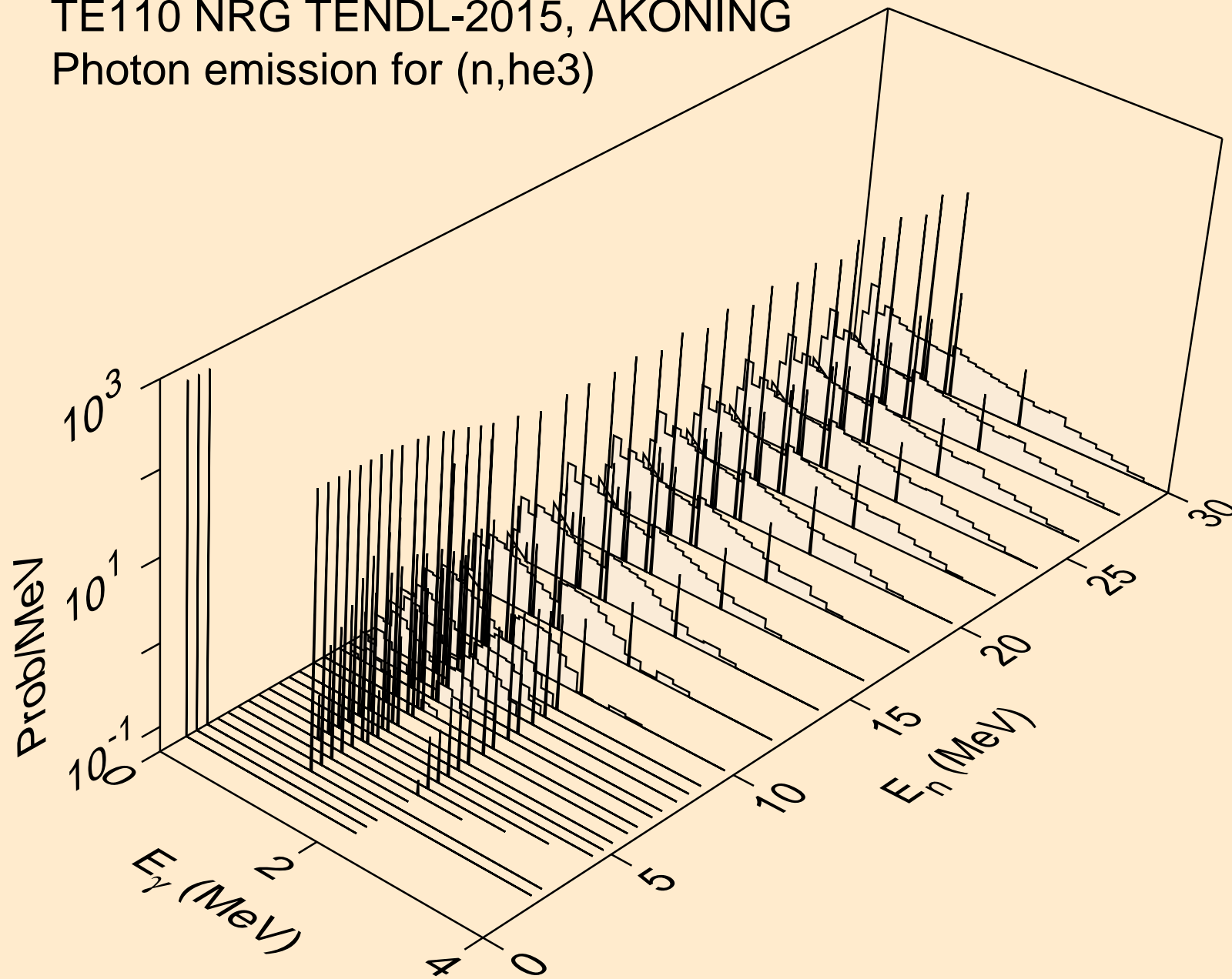

TE110 NRG TENDL-2015, AKONING
Photon emission for (n,a)

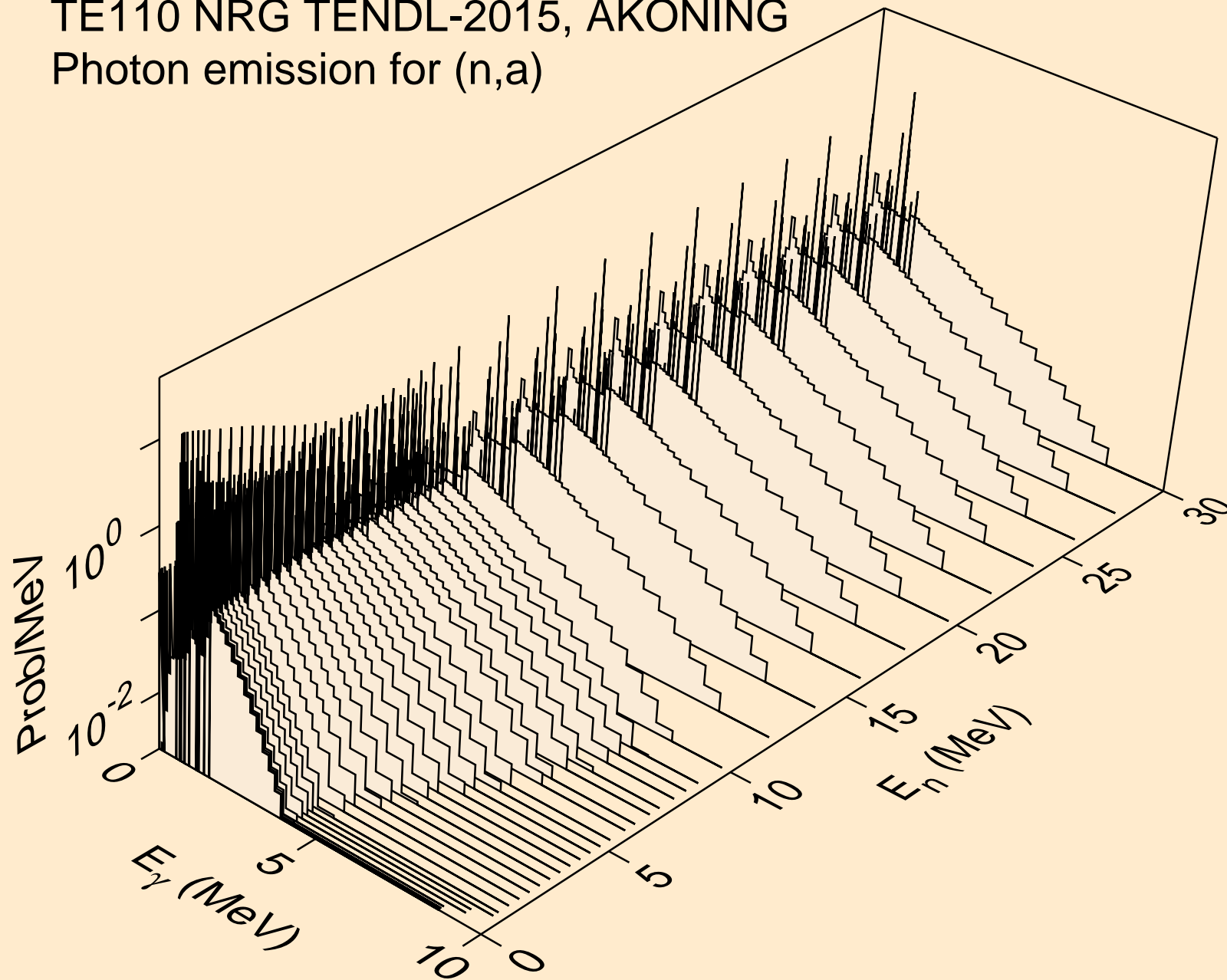

TE110 NRG TENDL-2015, AKONING
Photon emission for (n,2a)

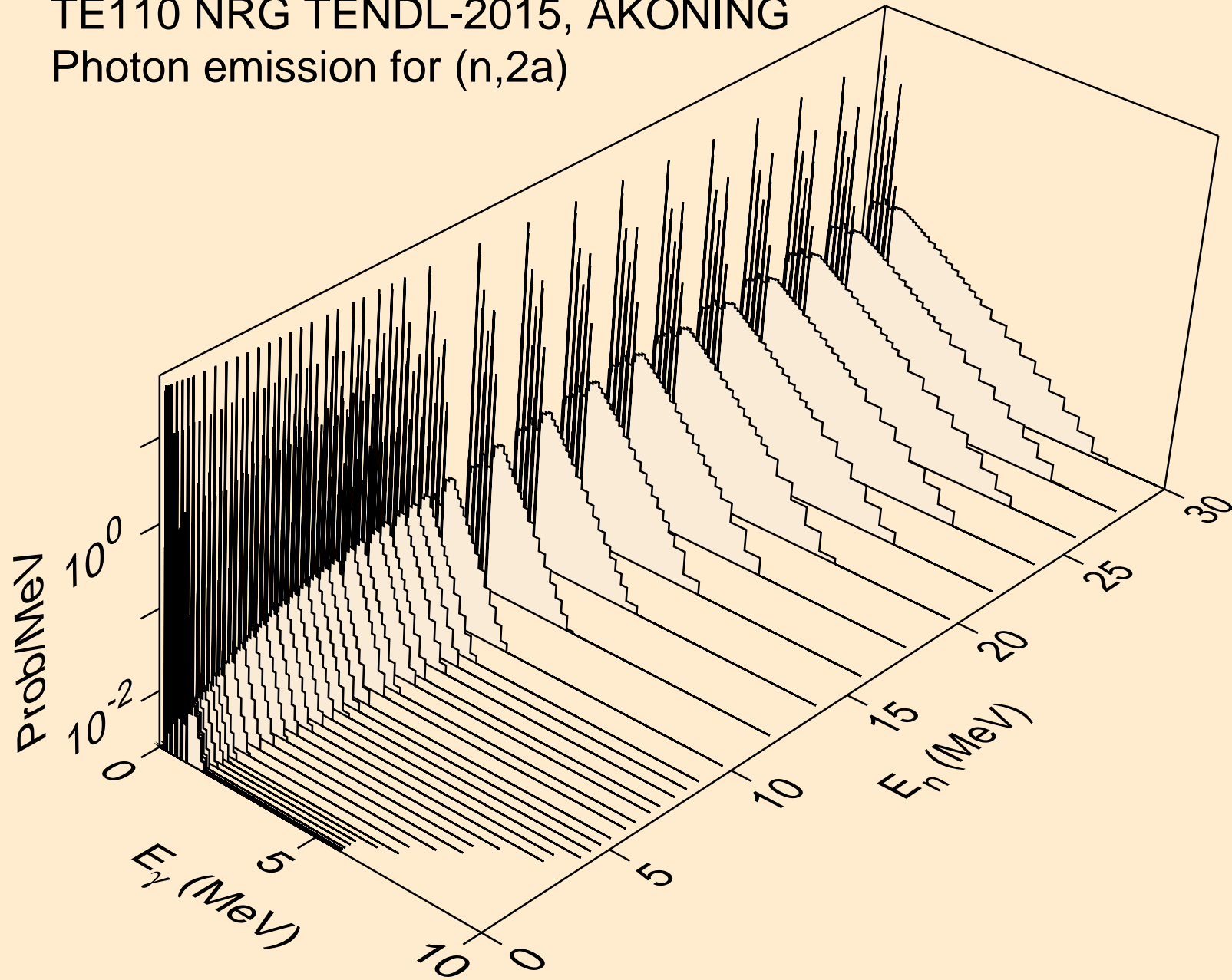

TE110 NRG TENDL-2015, AKONING
Photon emission for (n,3a)

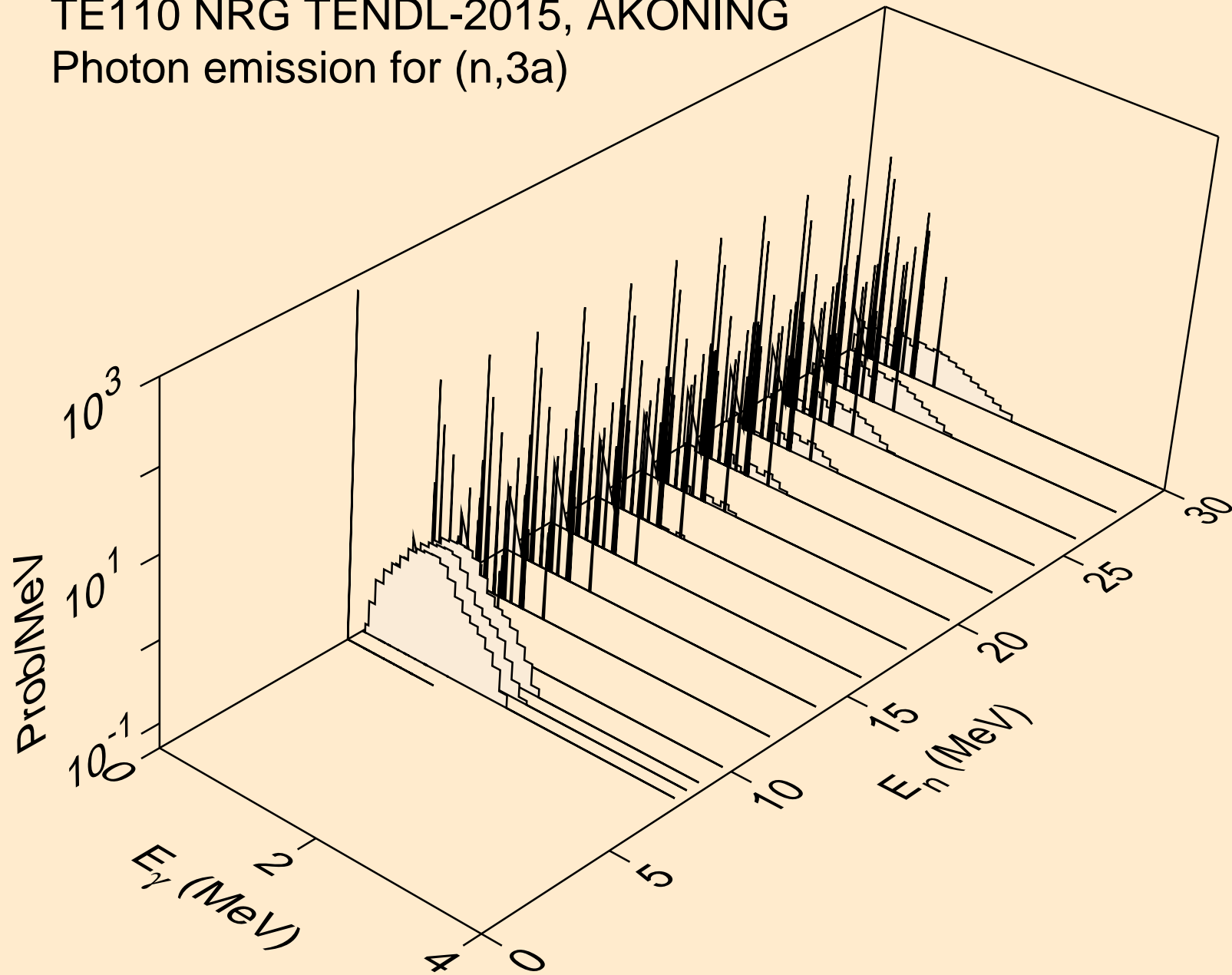

TE110 NRG TENDL-2015, AKONING
Photon emission for (n,2p)

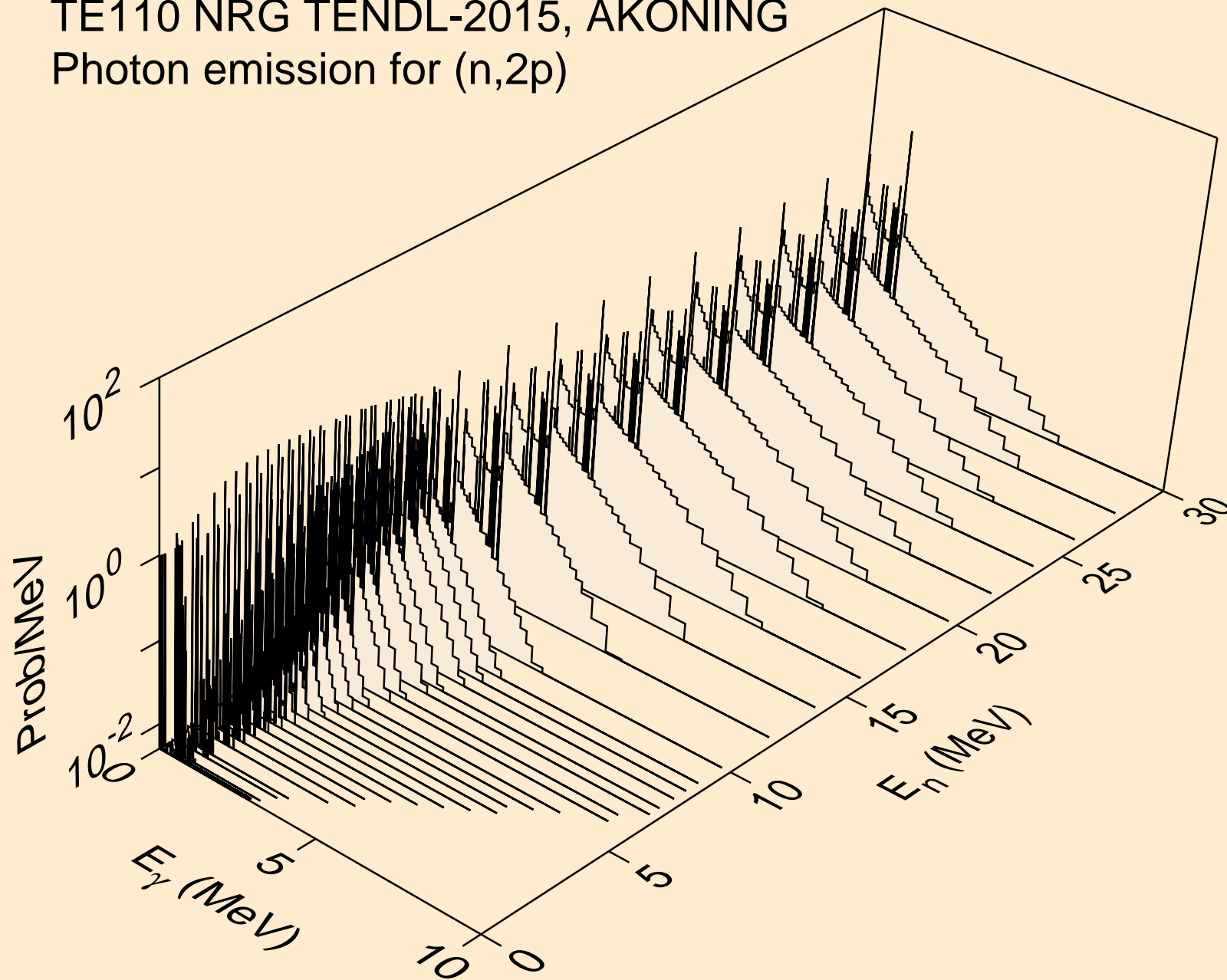

TE110 NRG TENDL-2015, AKONING
Photon emission for (n,p α)

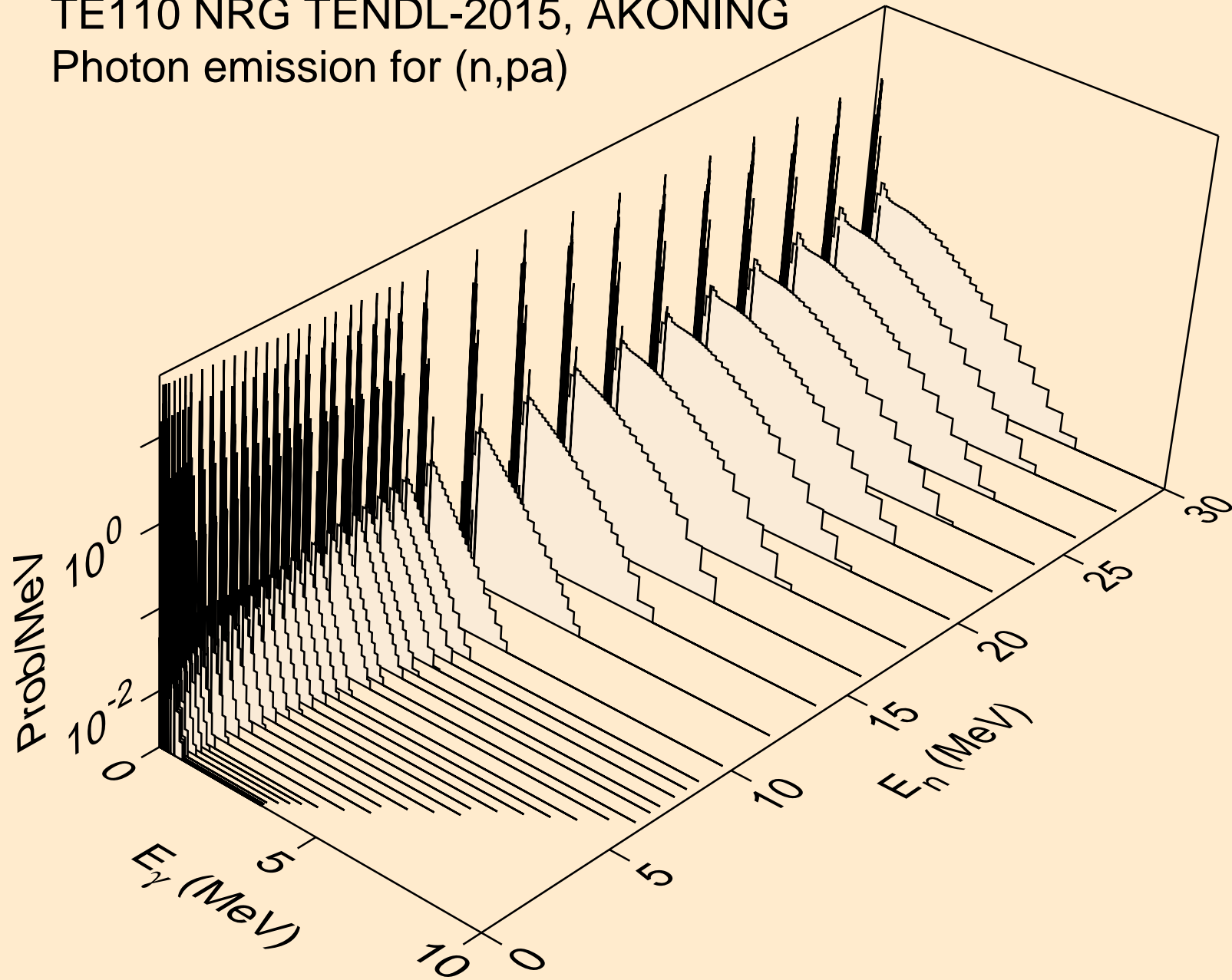

TE110 NRG TENDL-2015, AKONING
Photon emission for (n,d2a)

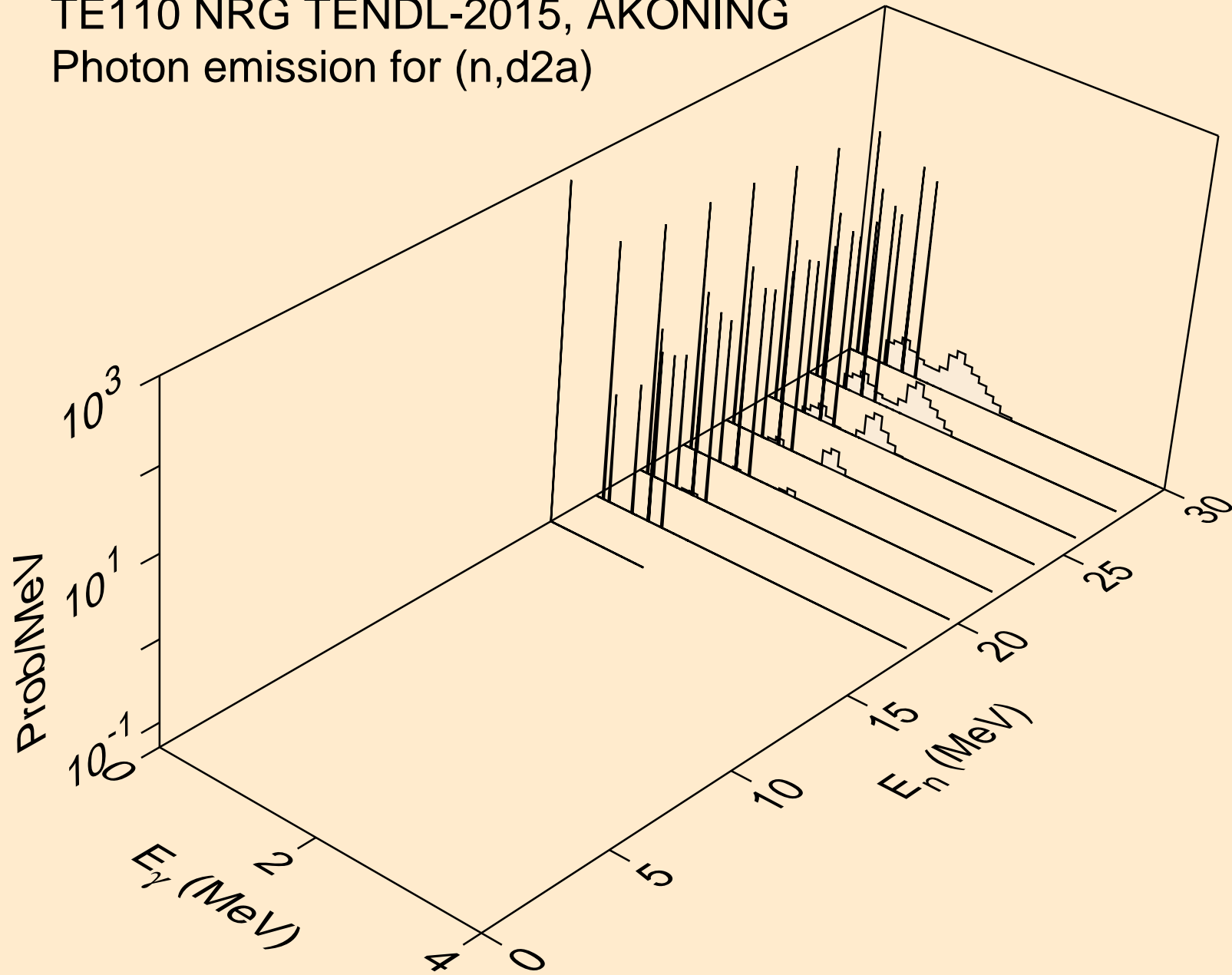

TE110 NRG TENDL-2015, AKONING
Photon emission for (n,pd)

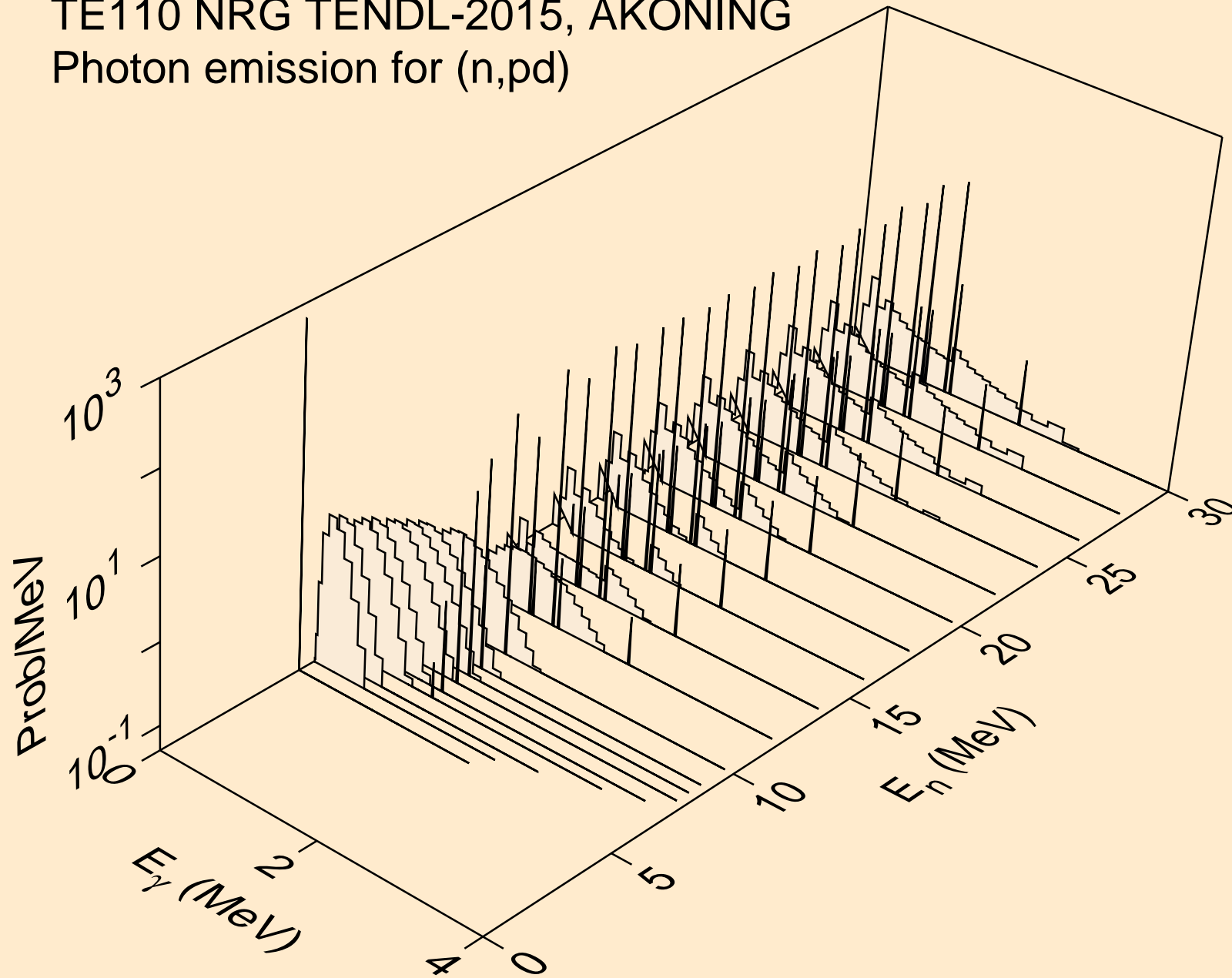

TE110 NRG TENDL-2015, AKONING
Photon emission for (n,pt)

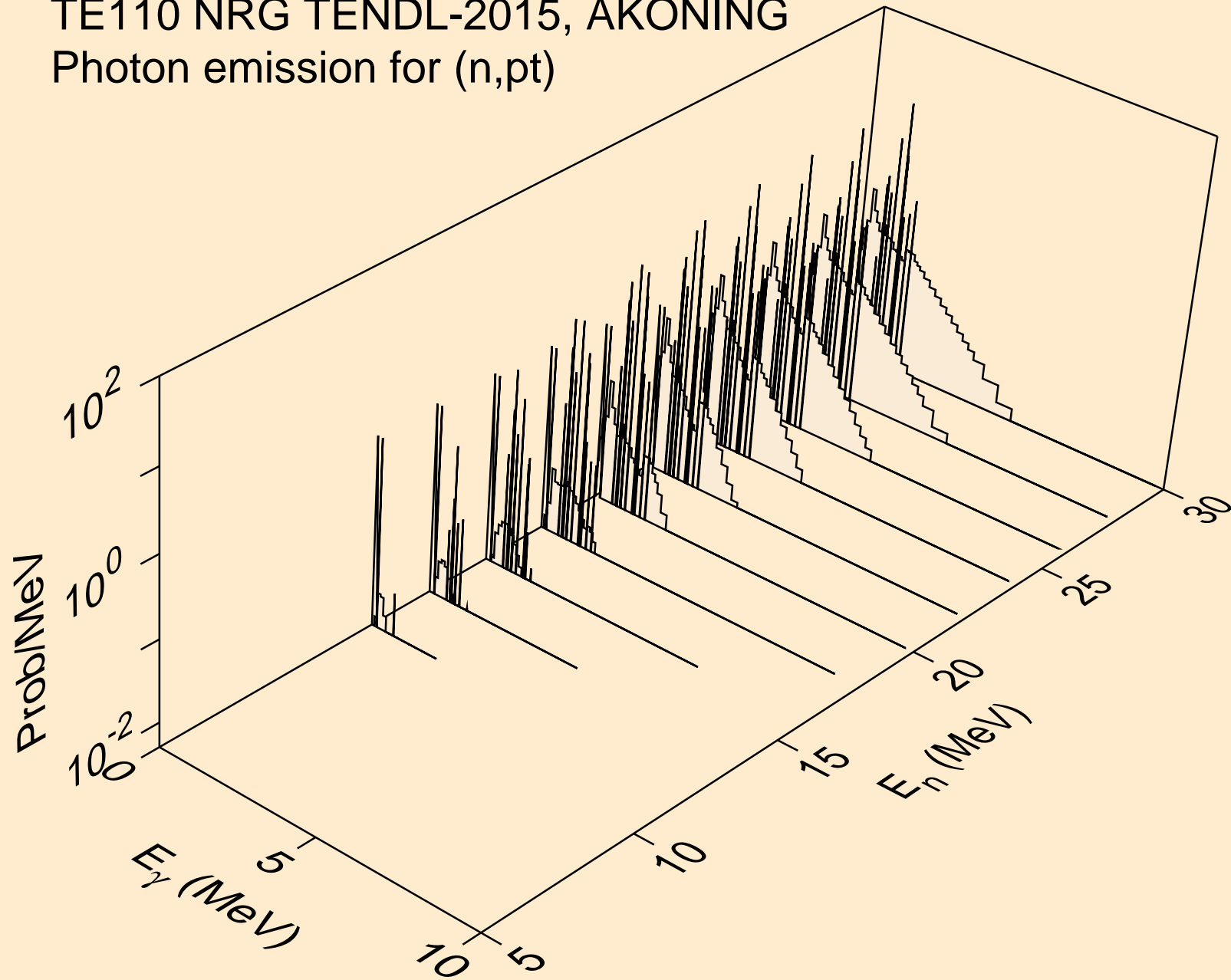

TE110 NRG TENDL-2015, AKONING
Photon emission for (n,da)

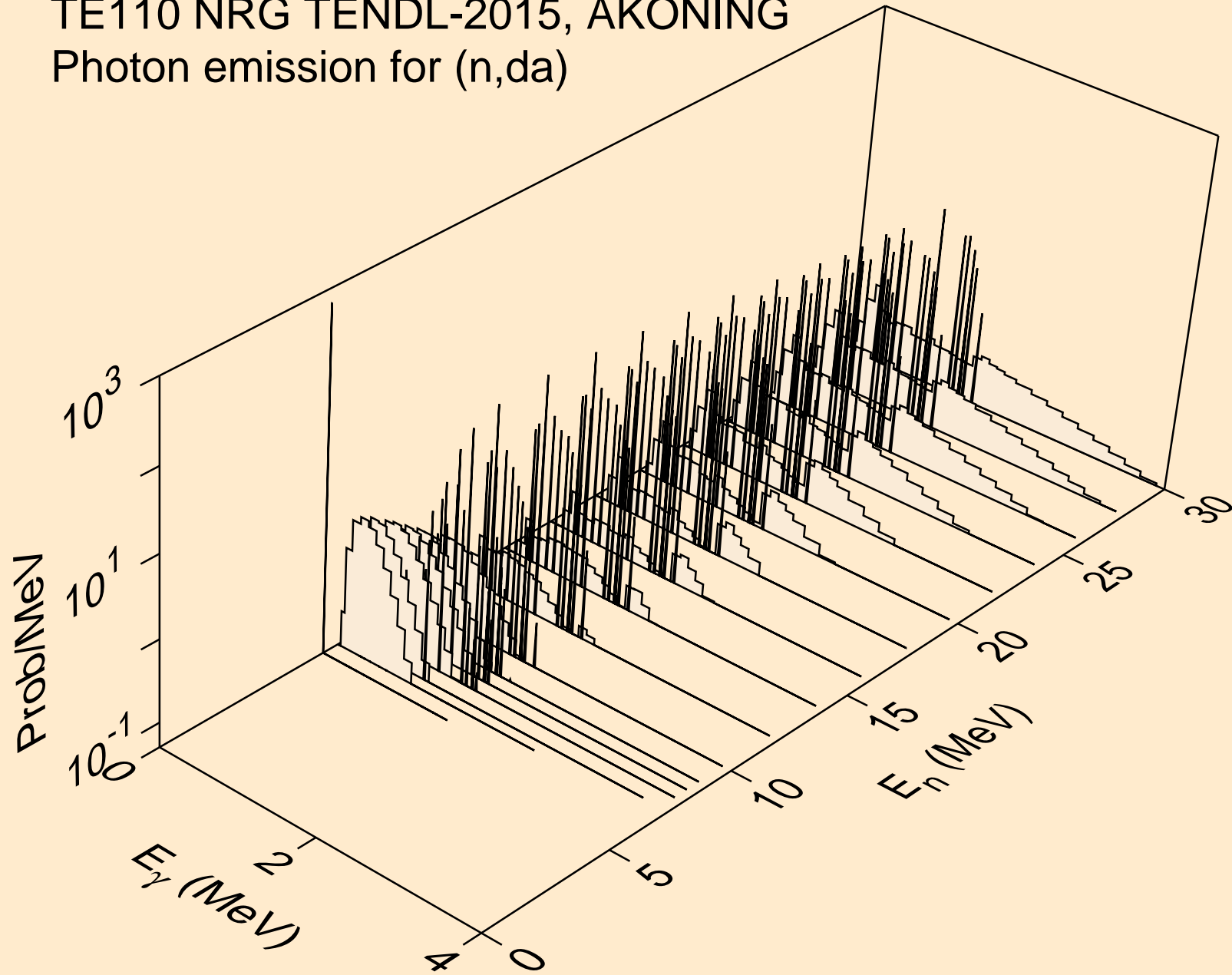

TE110 NRG TENDL-2015, AKONING
thermal capture photon spectrum

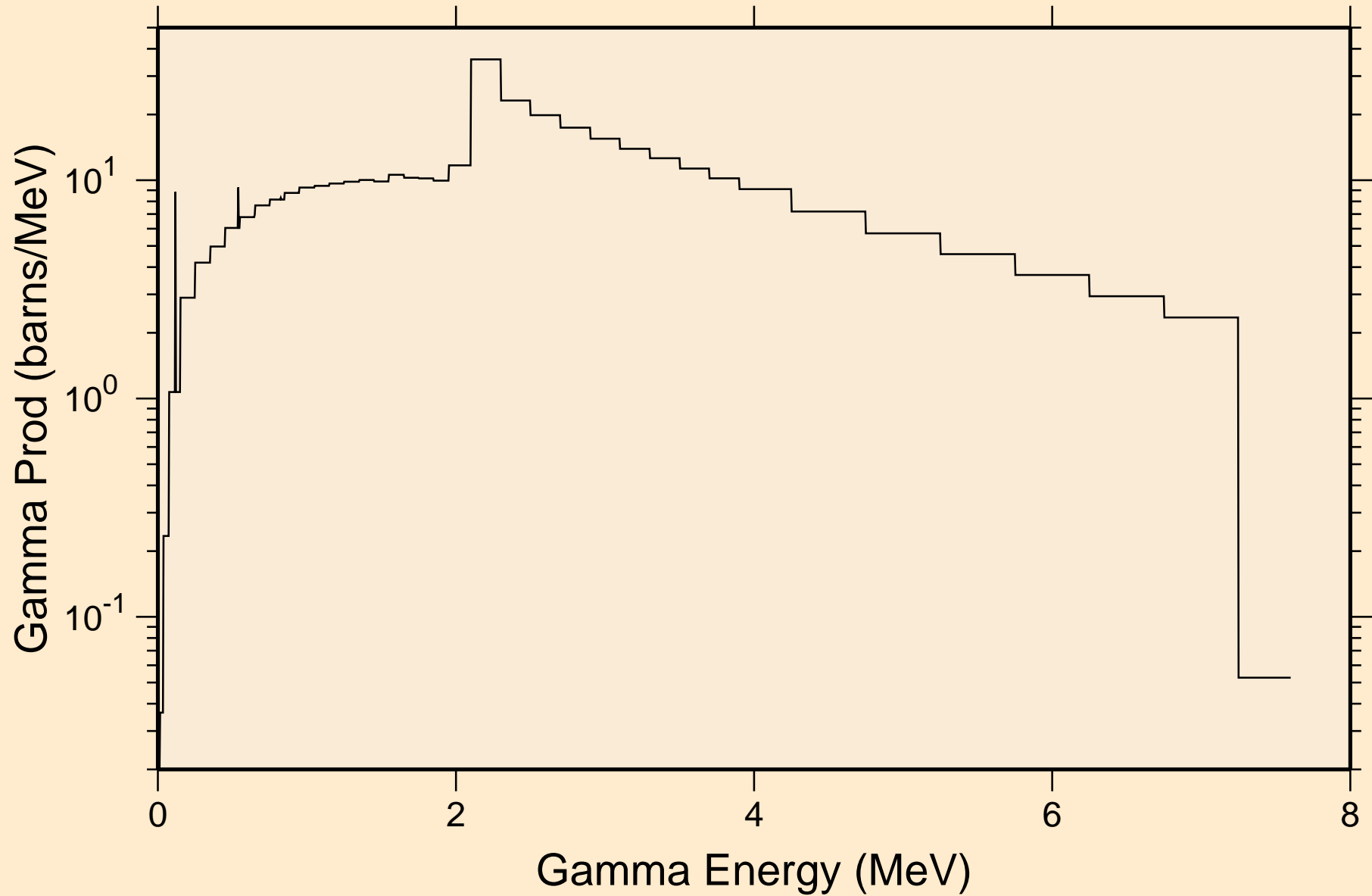

TE110 NRG TENDL-2015, AKONING
14 MeV photon spectrum

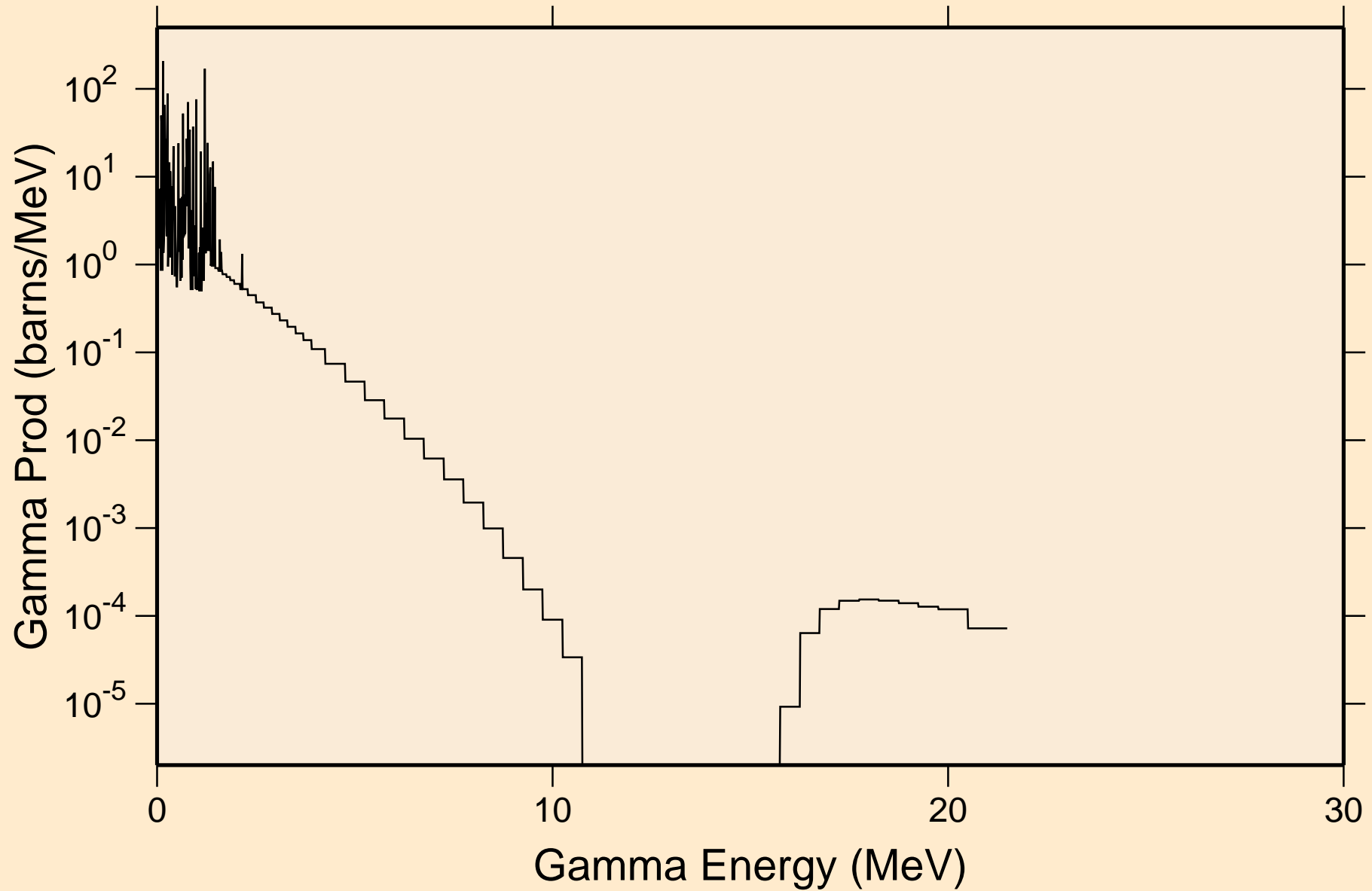

TE110 NRG TENDL-2015, AKONING

Particle heating contributions

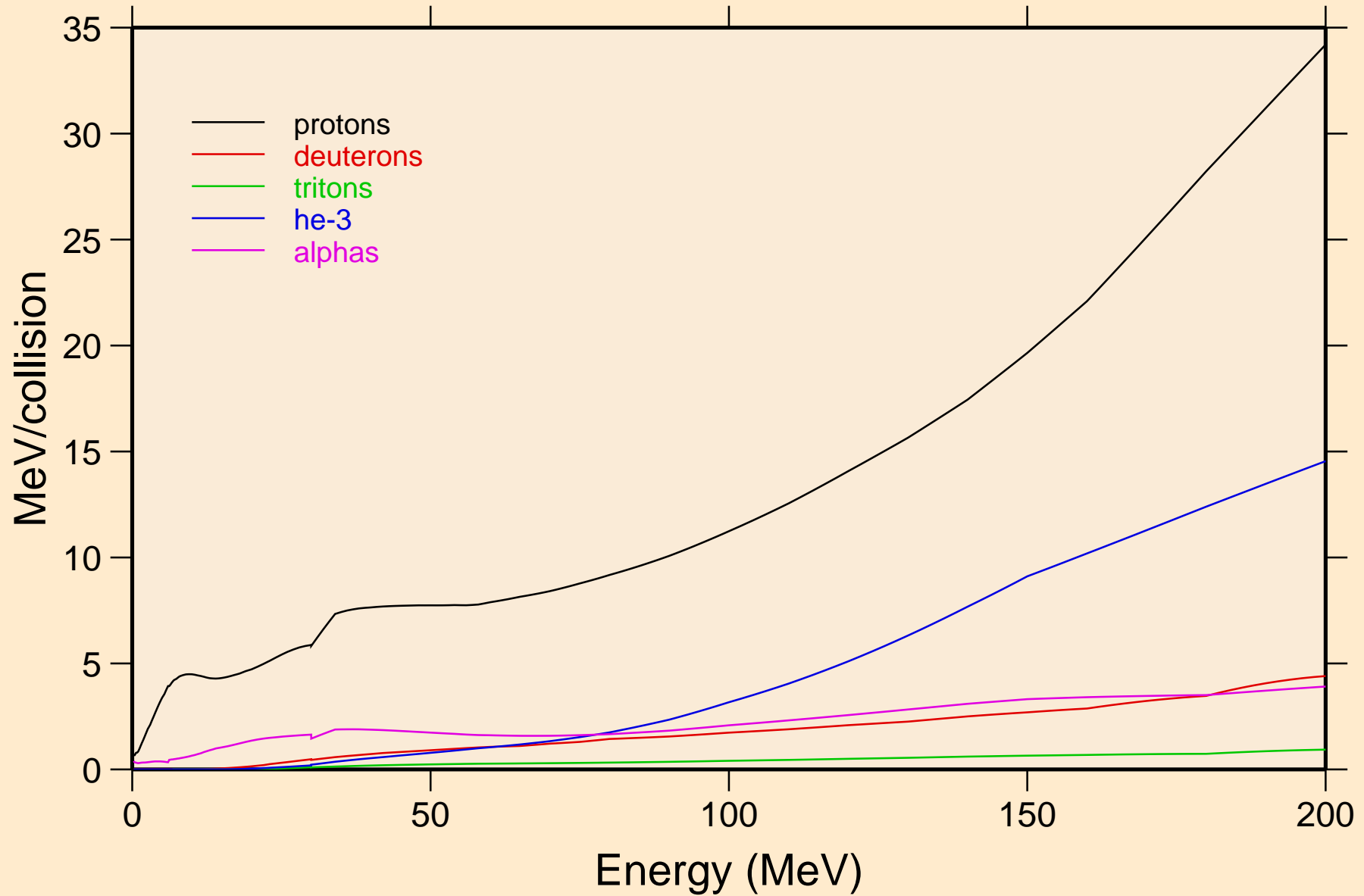

TE110 NRG TENDL-2015, AKONING

Recoil Heating

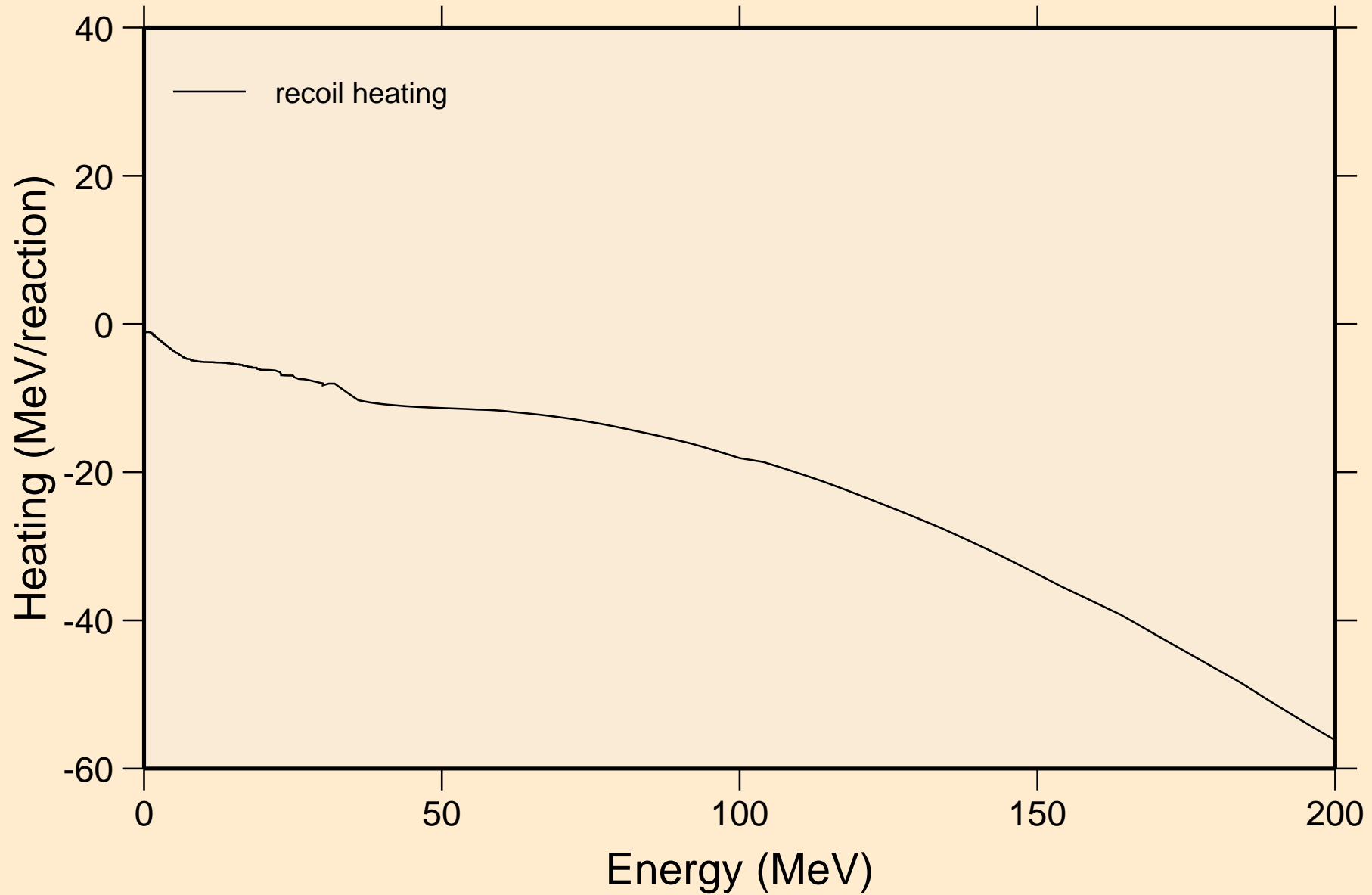

TE110 NRG TENDL-2015, AKONING

Particle production cross sections

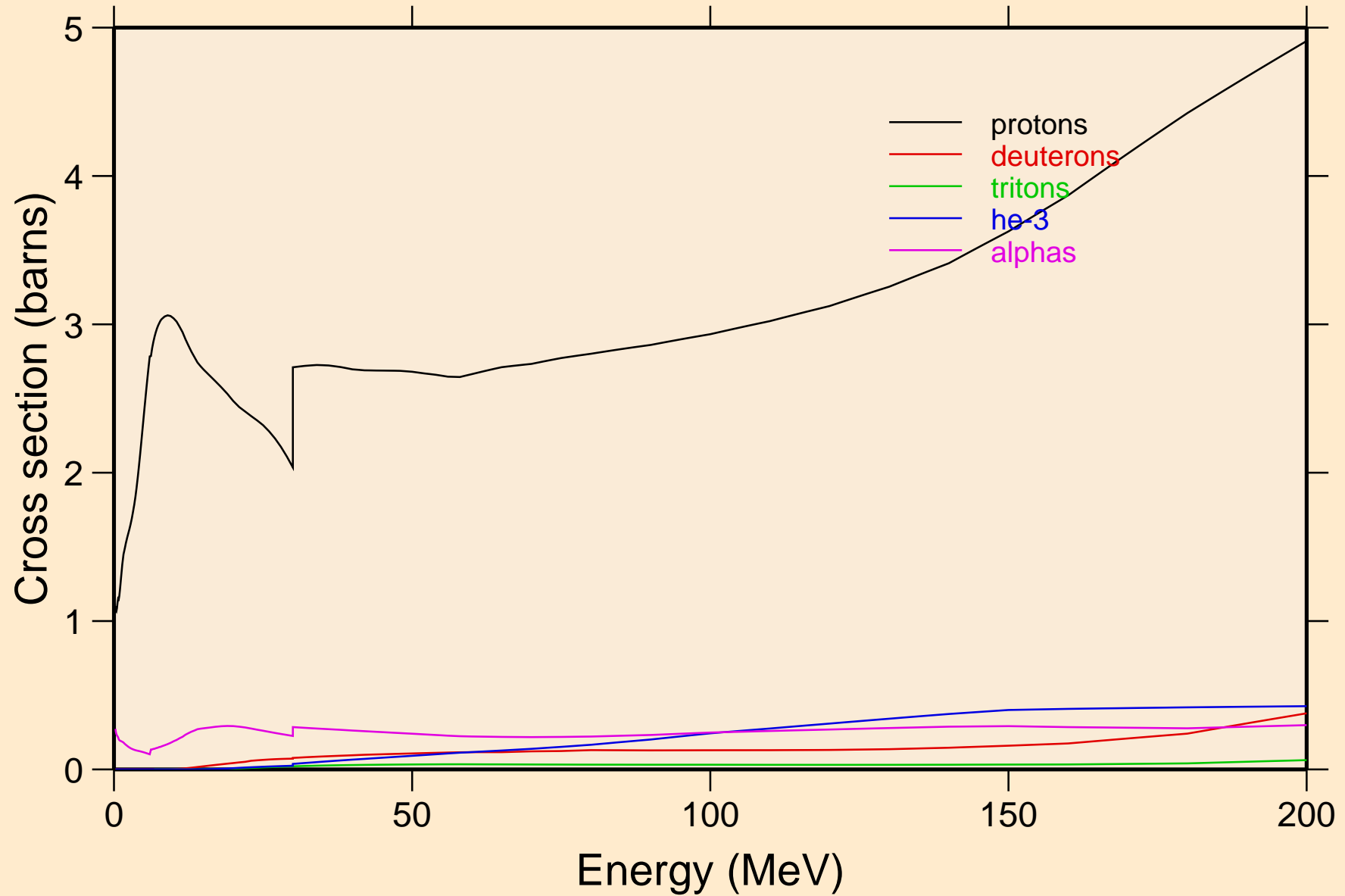

TE110 NRG TENDL-2015, AKONING
protons from (n,x)

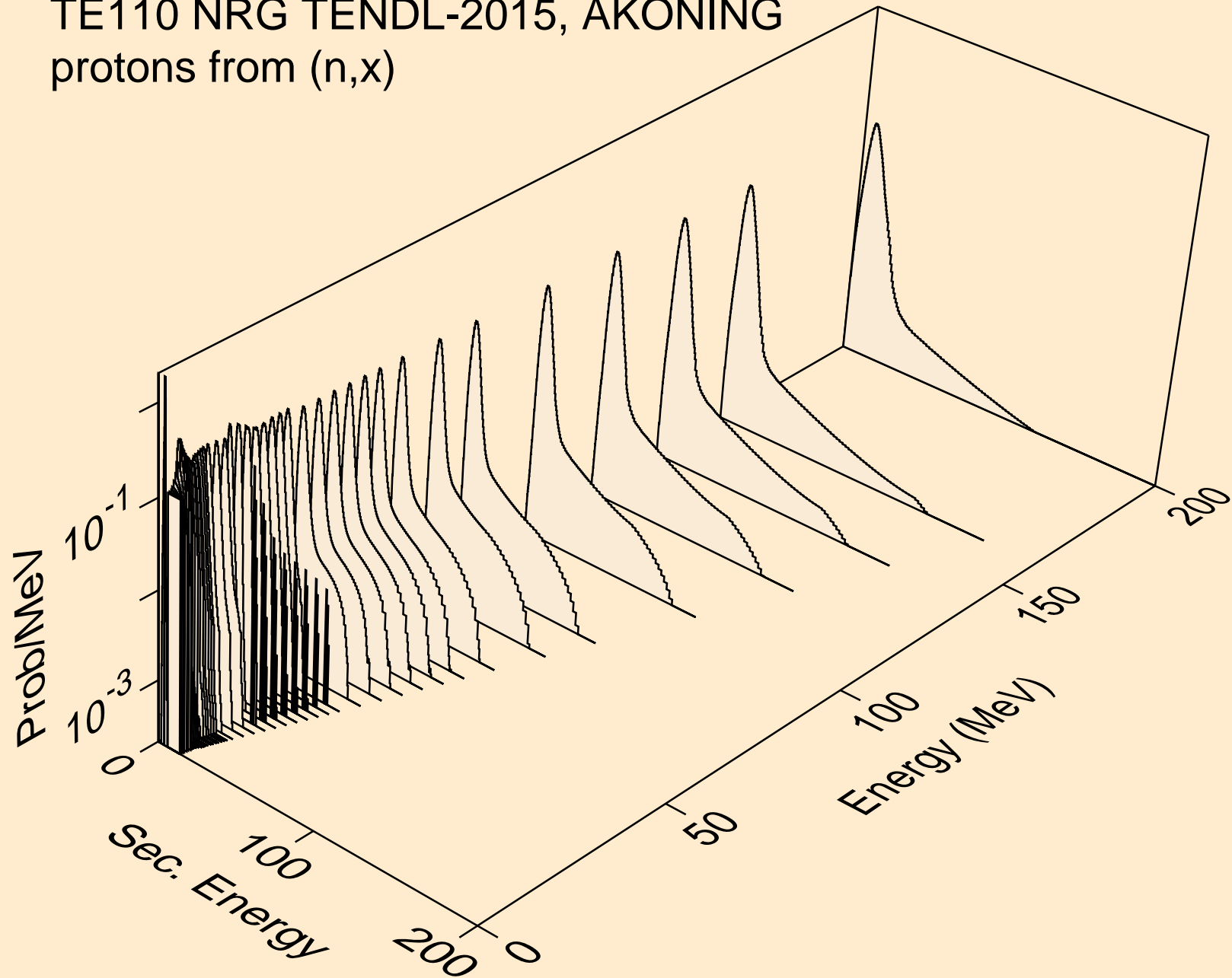

TE110 NRG TENDL-2015, AKONING
protons from (n,n*)p

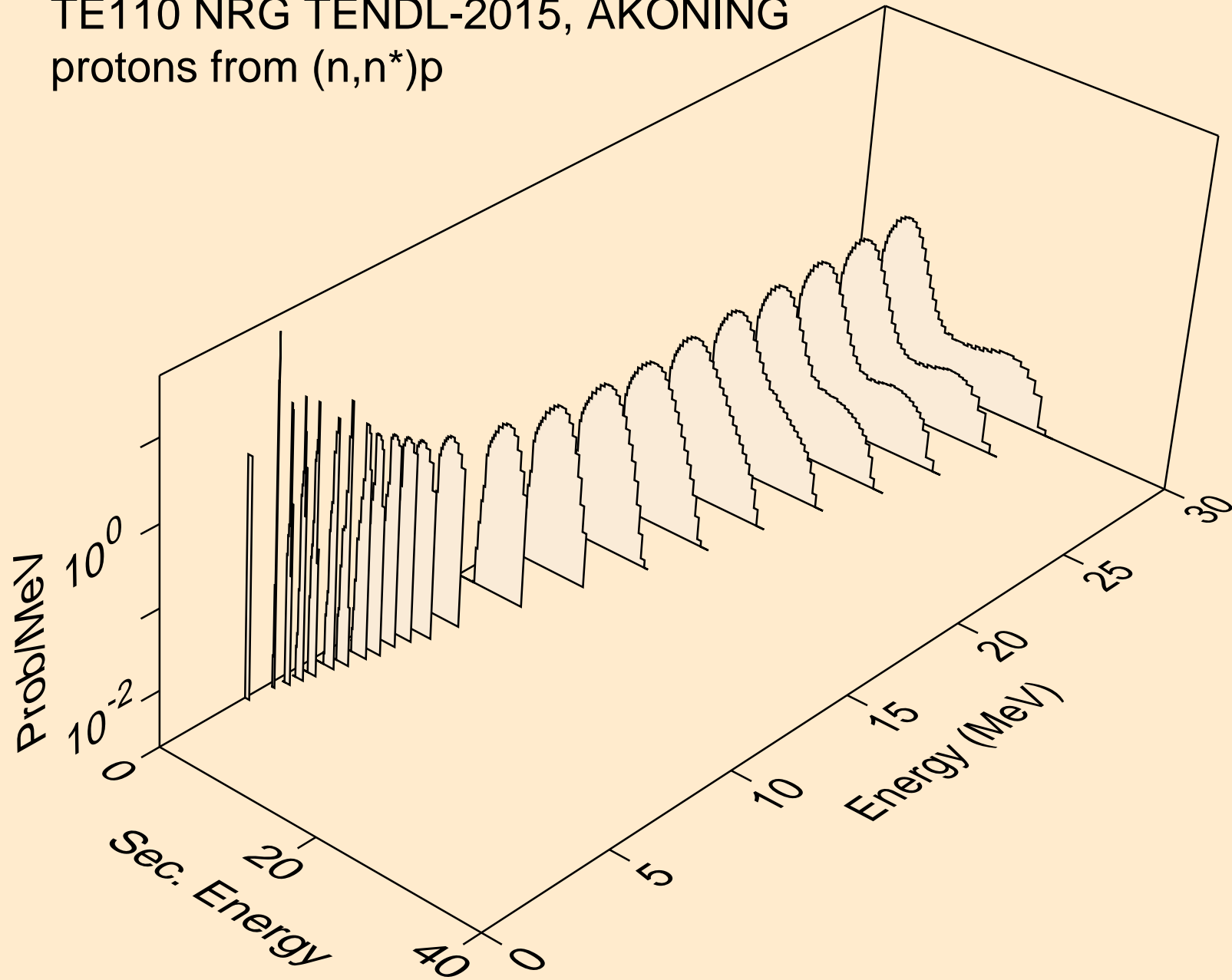

TE110 NRG TENDL-2015, AKONING
protons from (n,2np)

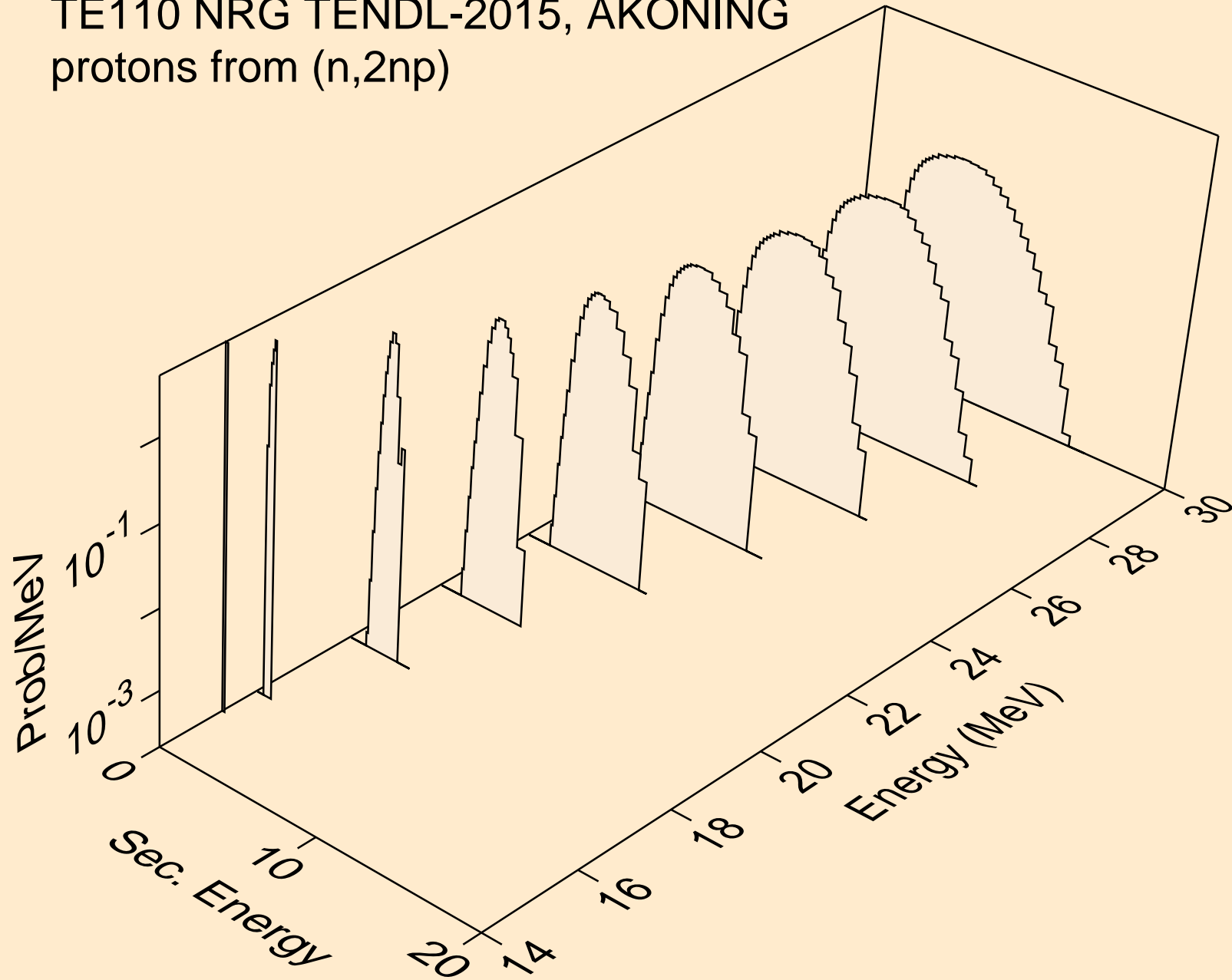

TE110 NRG TENDL-2015, AKONING
protons from (n,3np)

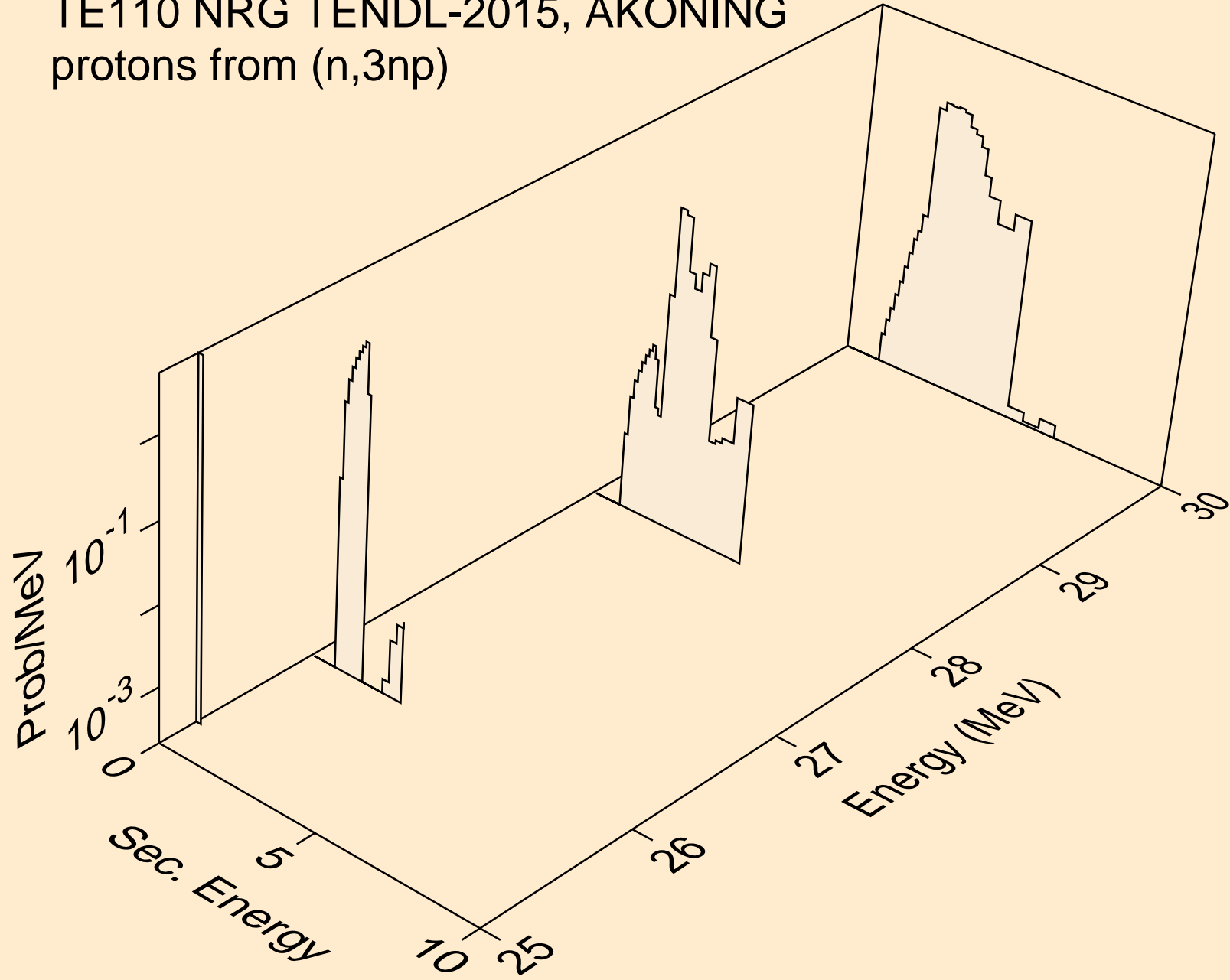

TE110 NRG TENDL-2015, AKONING
protons from (n,2np)

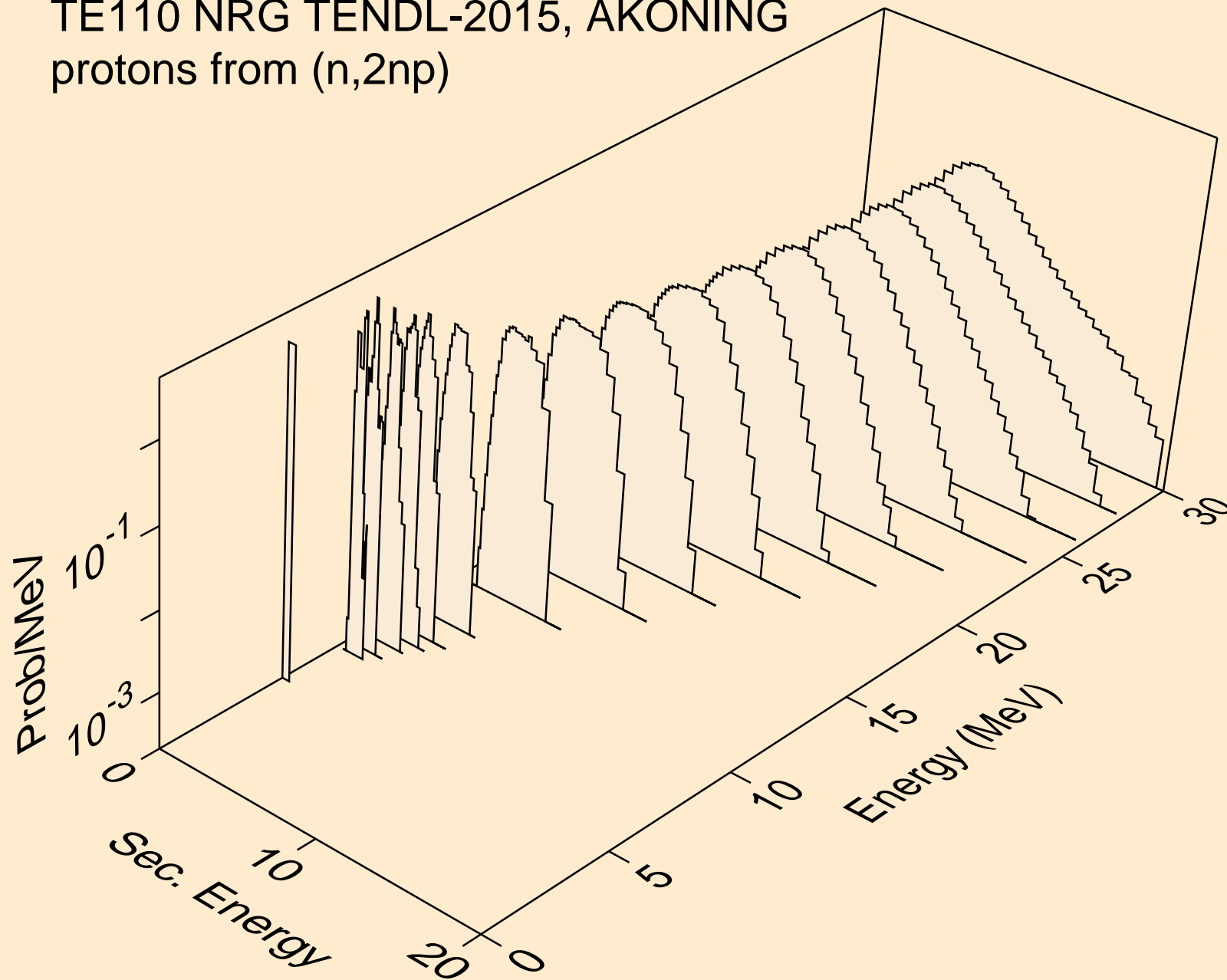

TE110 NRG TENDL-2015, AKONING
protons from (n,npa)

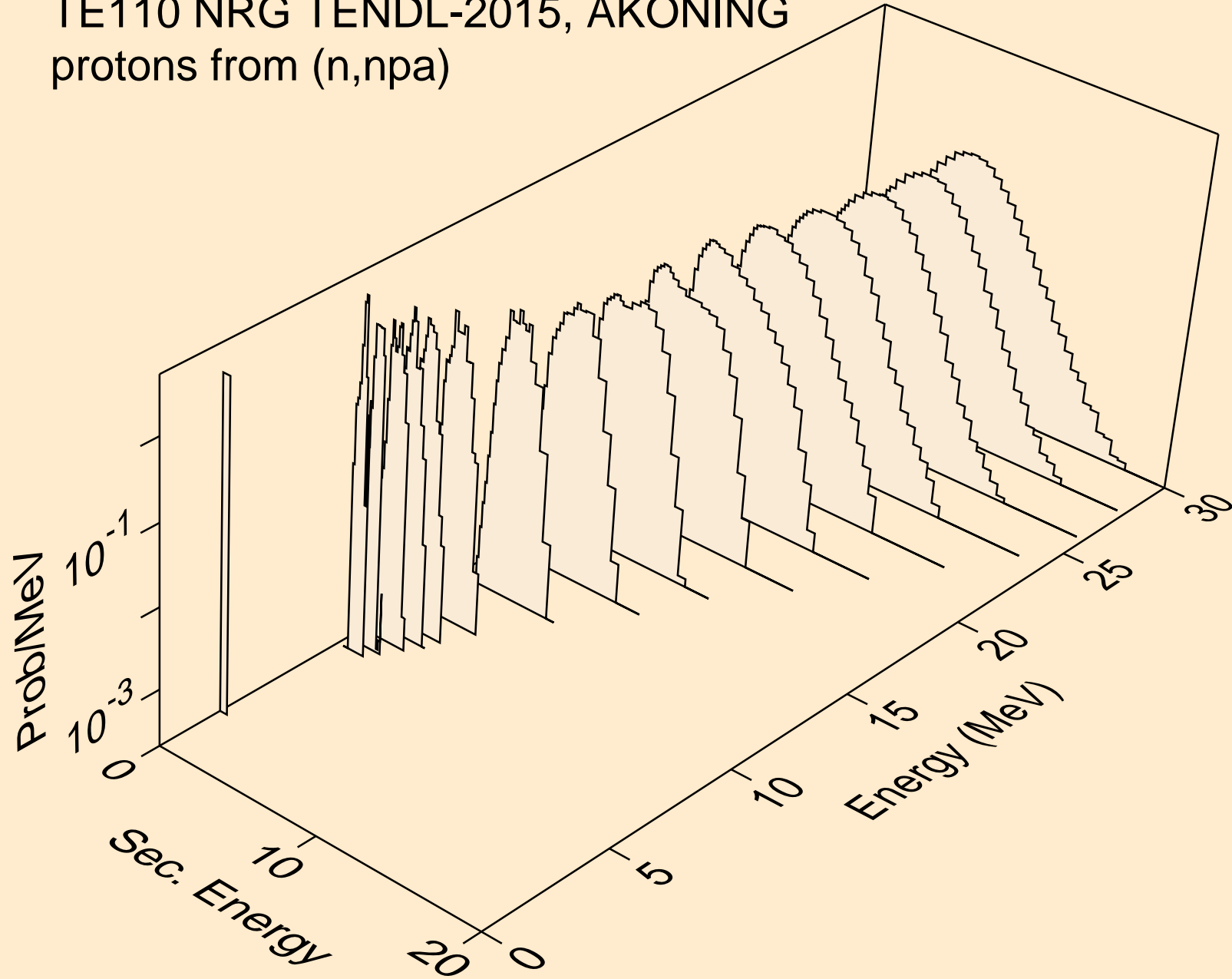

TE110 NRG TENDL-2015, AKONING
protons from (n,p)

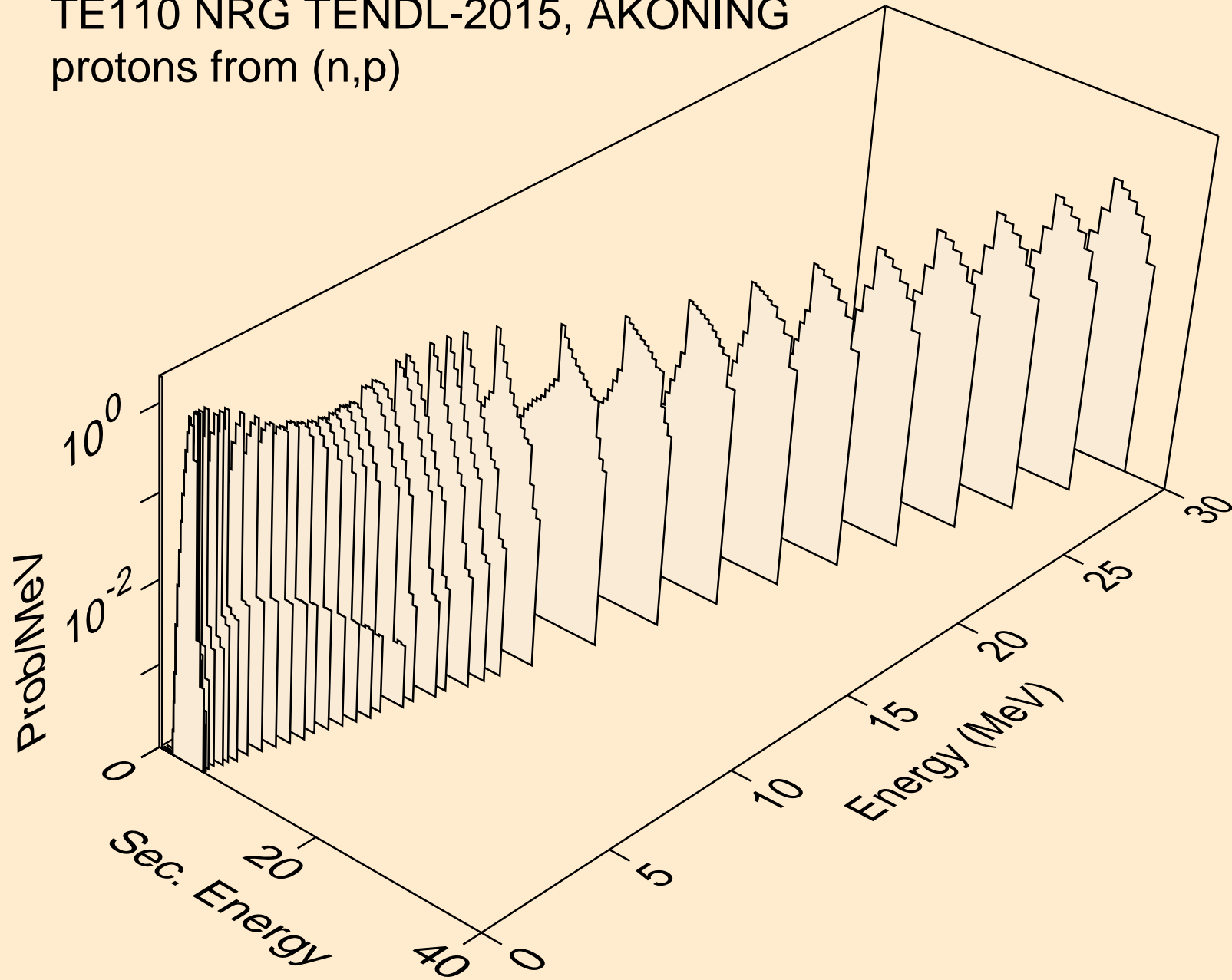

TE110 NRG TENDL-2015, AKONING
protons from (n,2p)

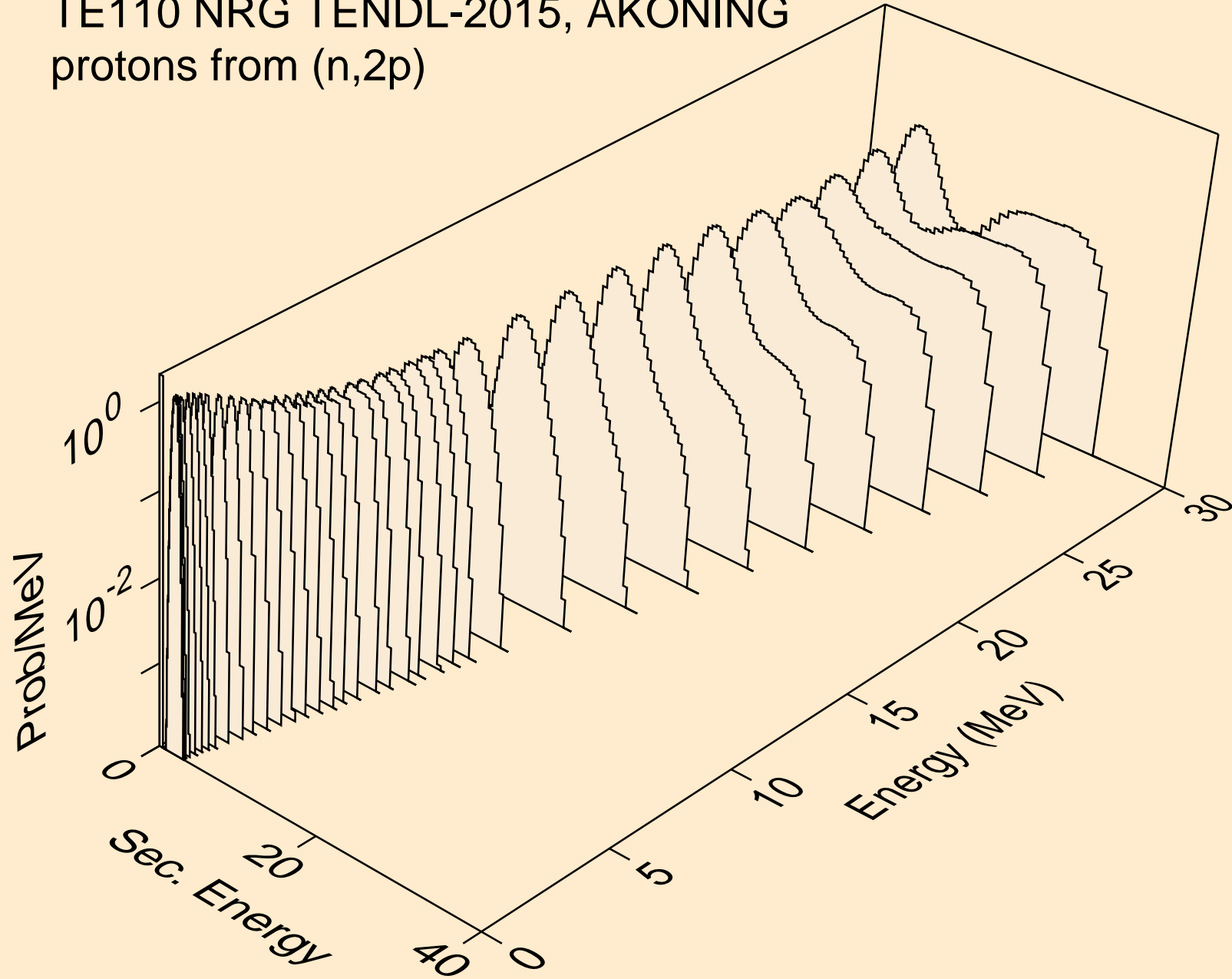

TE110 NRG TENDL-2015, AKONING
protons from (n,pa)

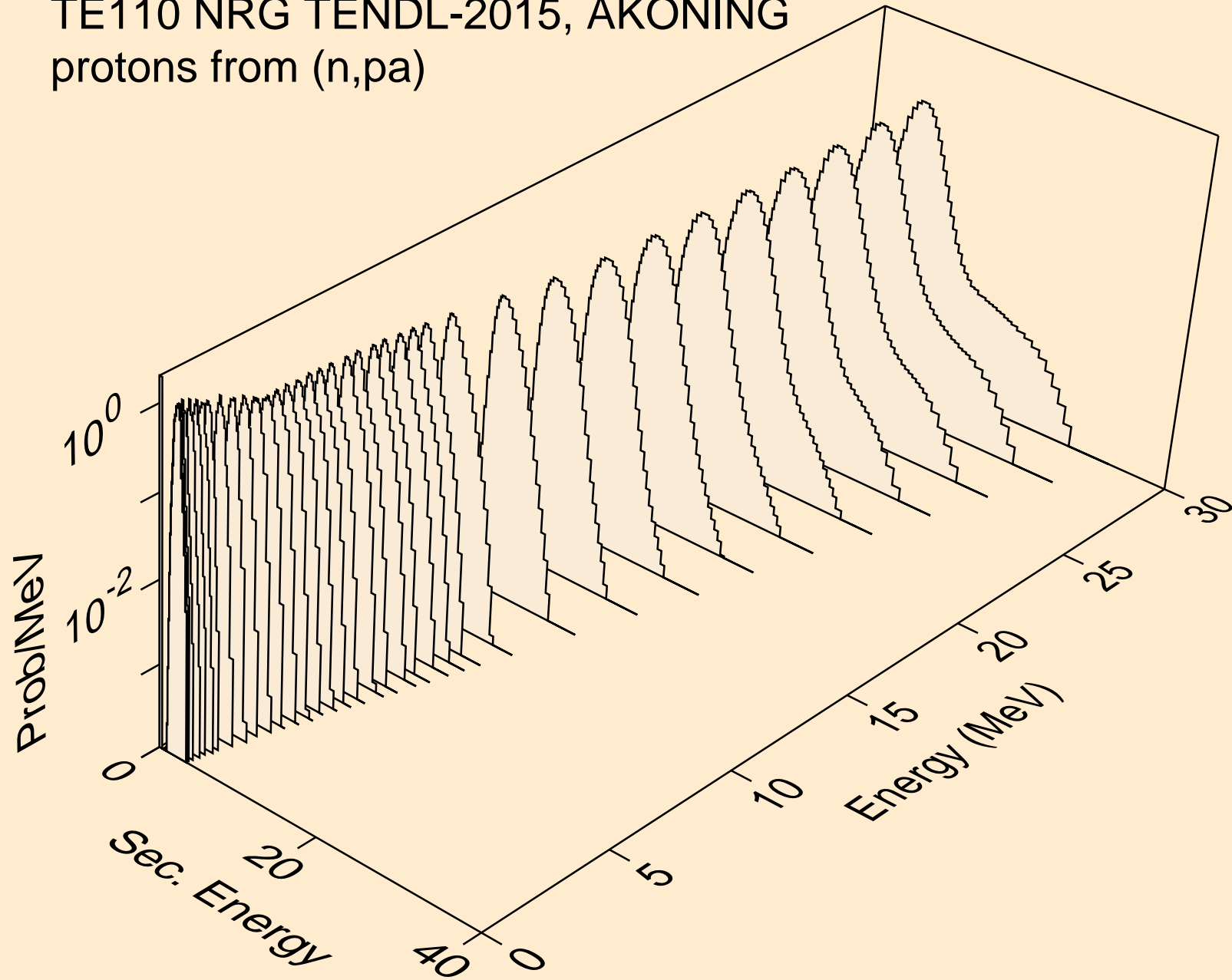

TE110 NRG TENDL-2015, AKONING
protons from (n,pd)

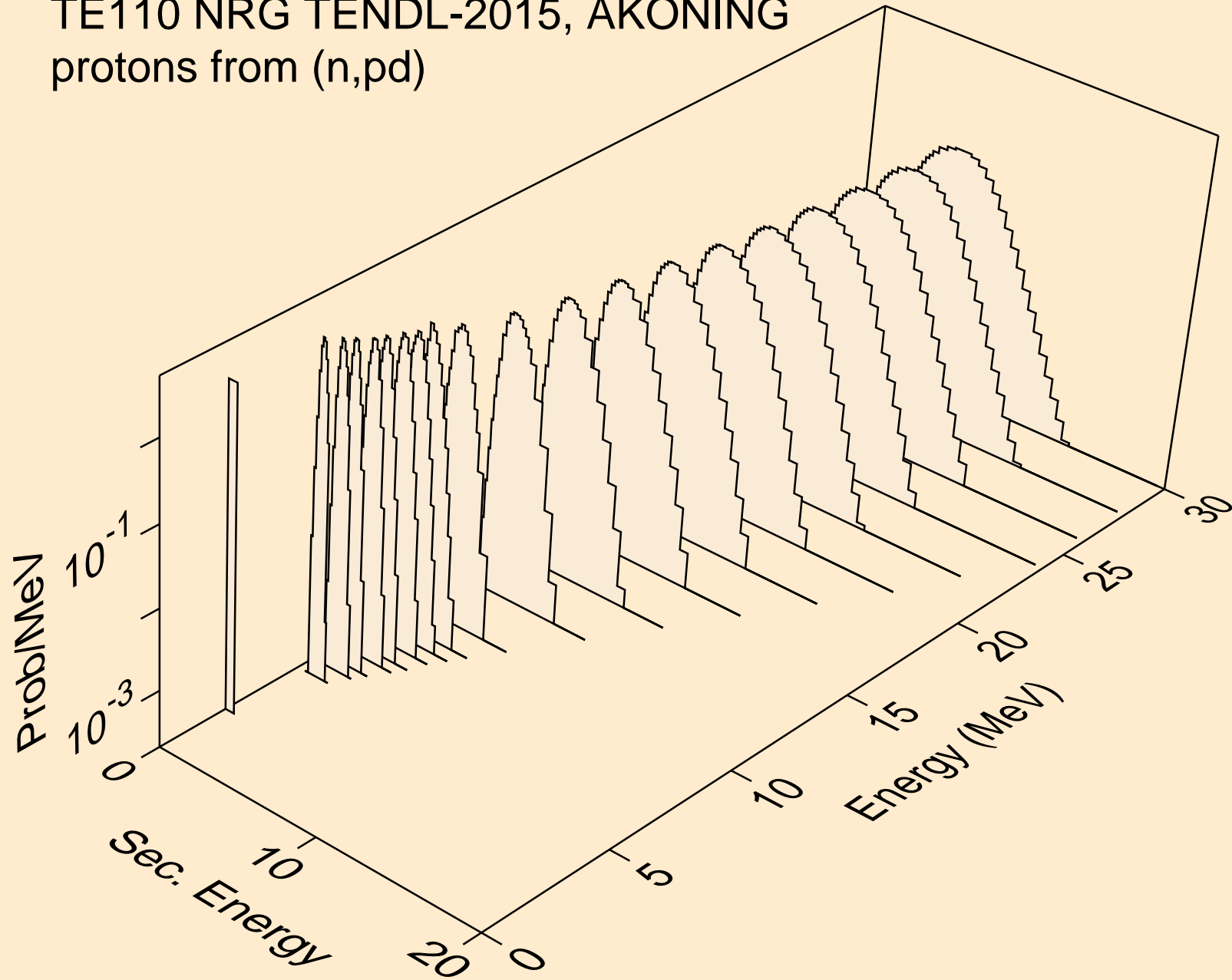

TE110 NRG TENDL-2015, AKONING
protons from (n,pt)

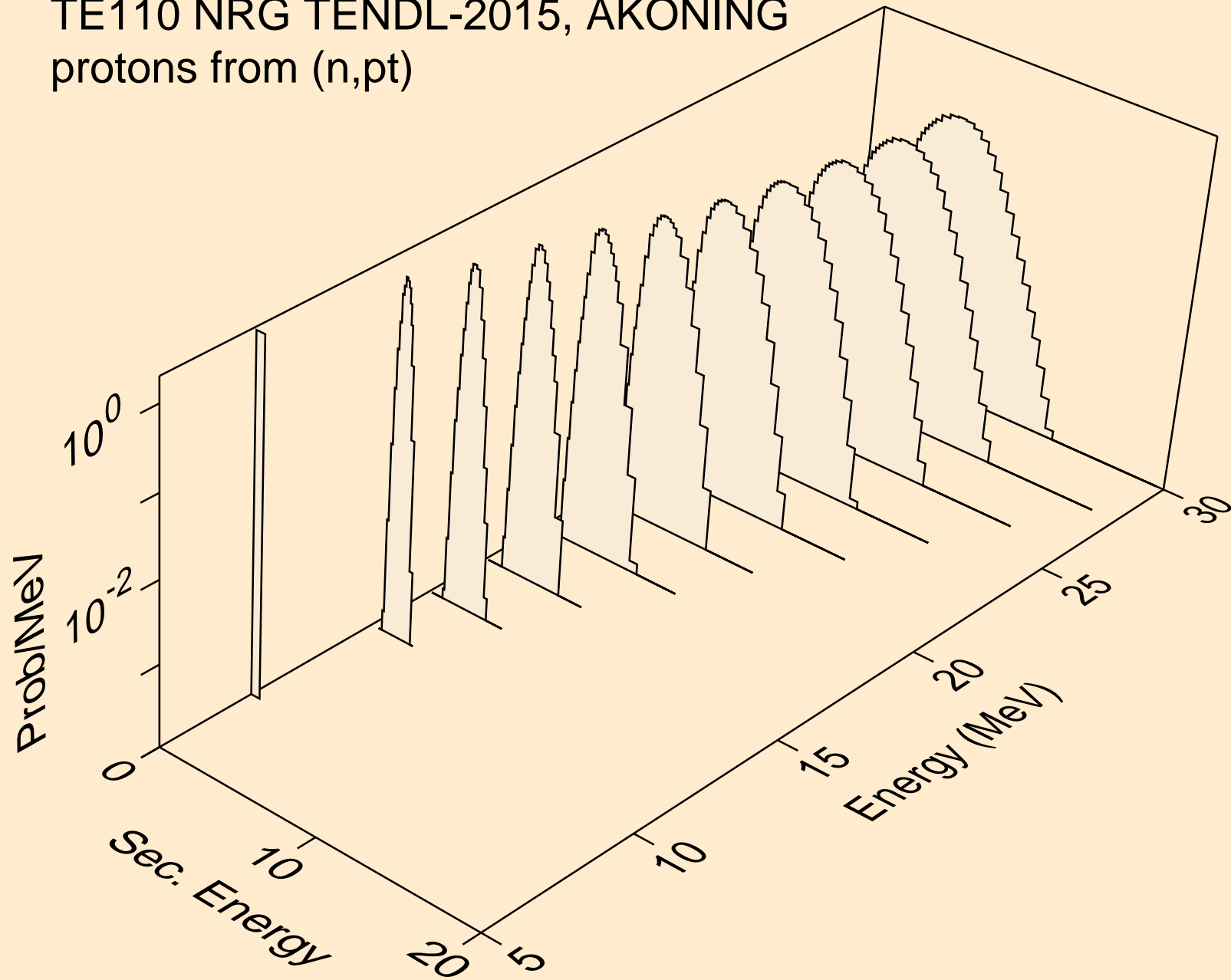

TE110 NRG TENDL-2015, AKONING
deuterons from (n,x)

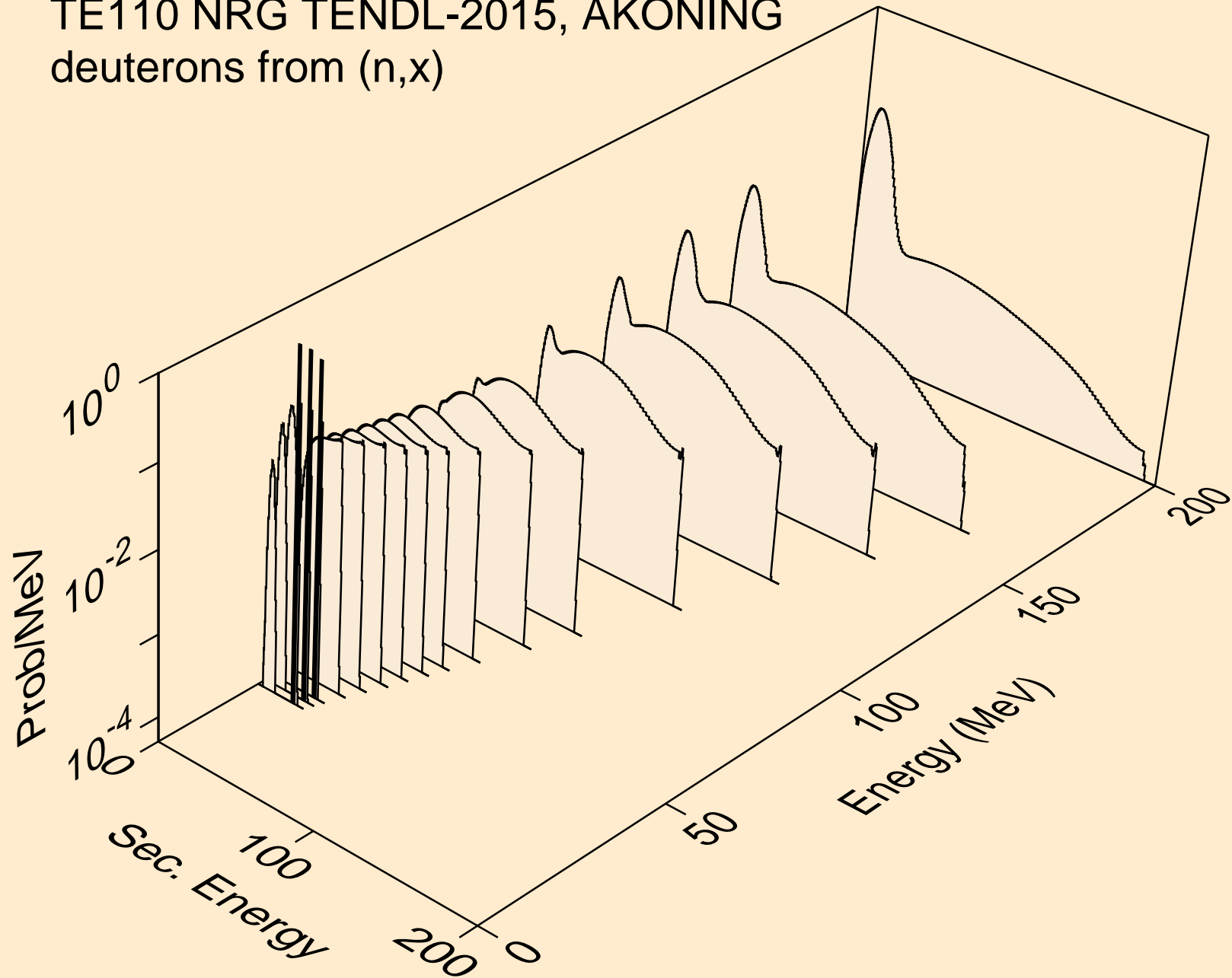

TE110 NRG TENDL-2015, AKONING
deuterons from (n,2nd)

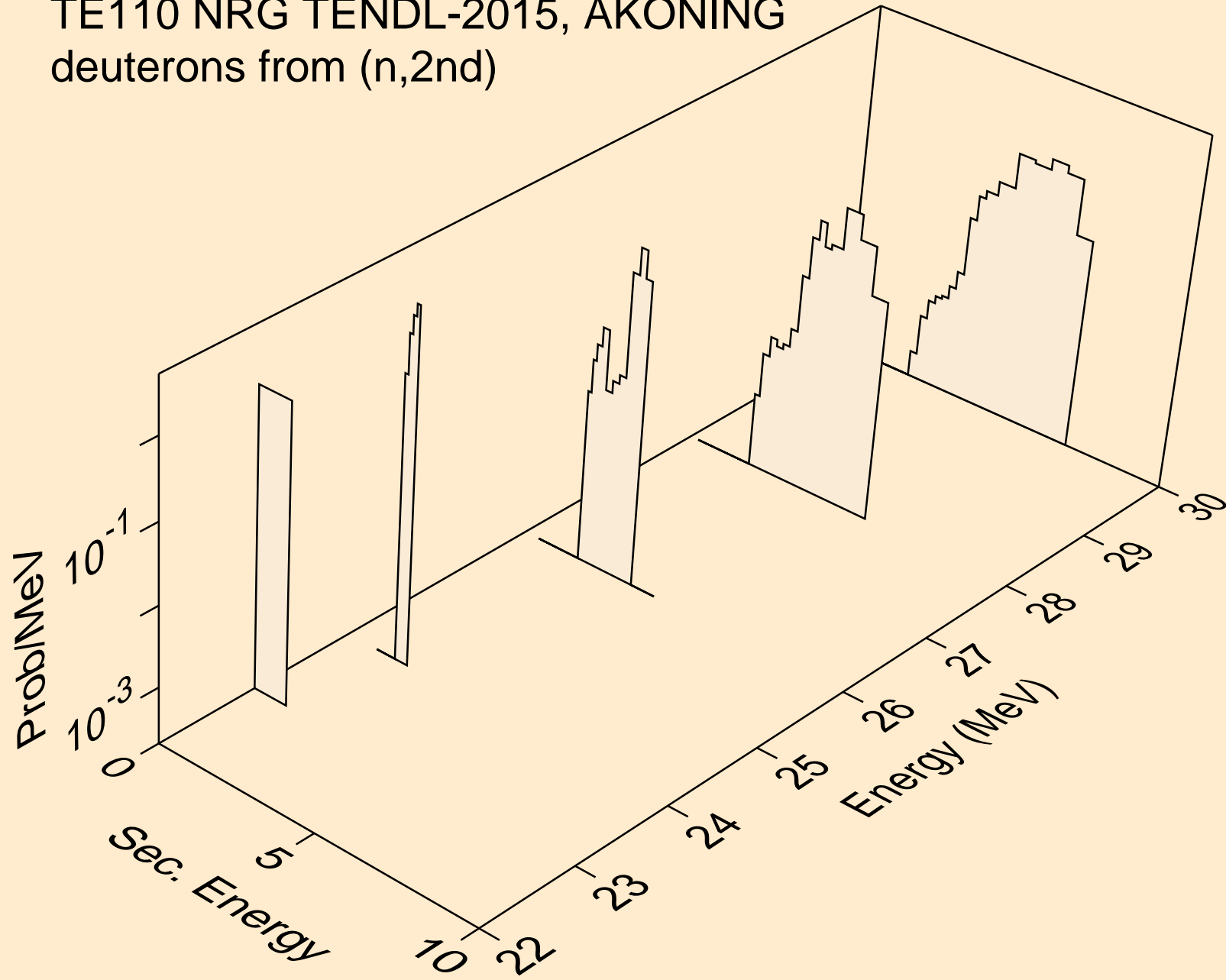

TE110 NRG TENDL-2015, AKONING
deuterons from (n,n*)d

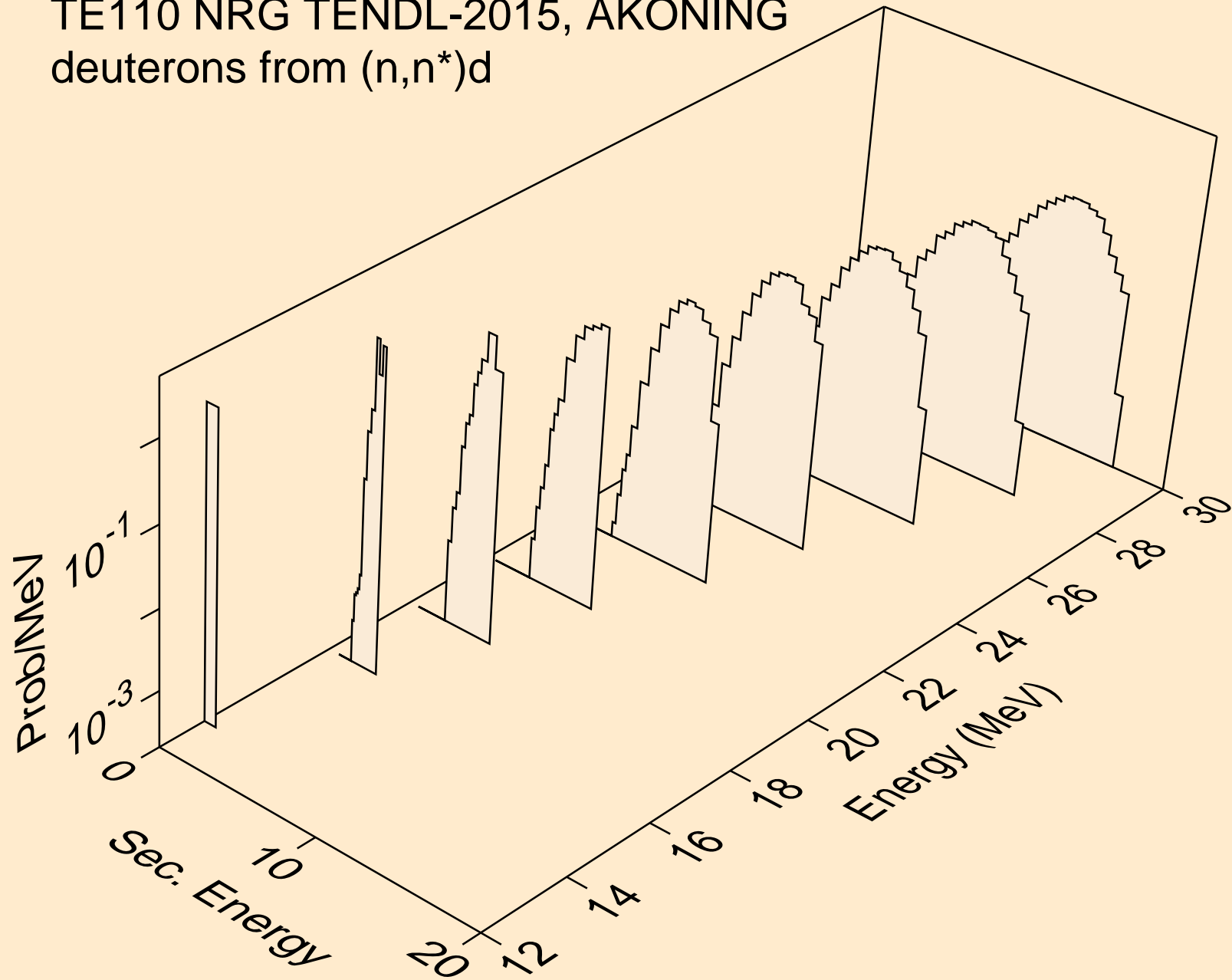

TE110 NRG TENDL-2015, AKONING
deuterons from (n,d)

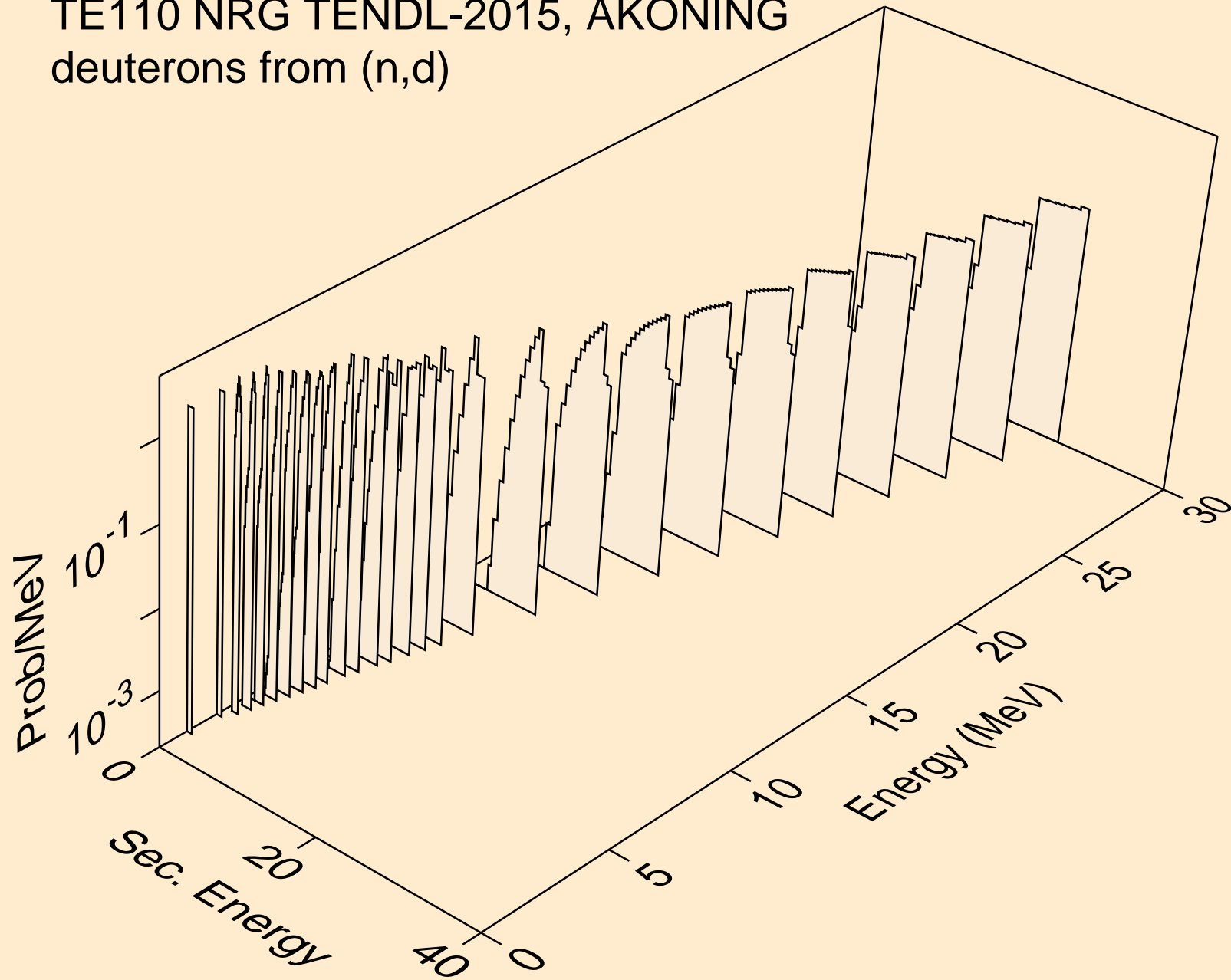

TE110 NRG TENDL-2015, AKONING
deuterons from (n,d2a)

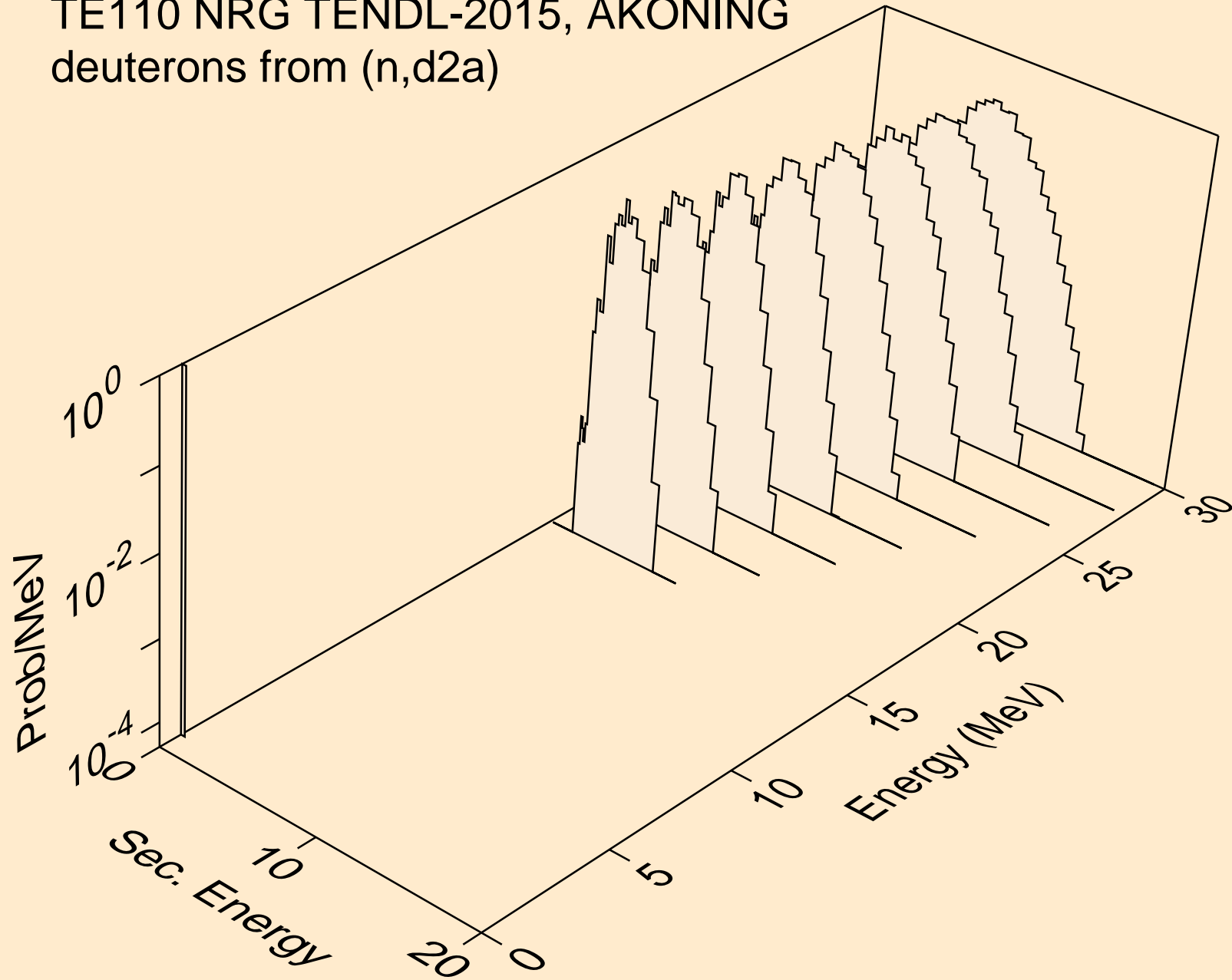

TE110 NRG TENDL-2015, AKONING
deuterons from (n,pd)

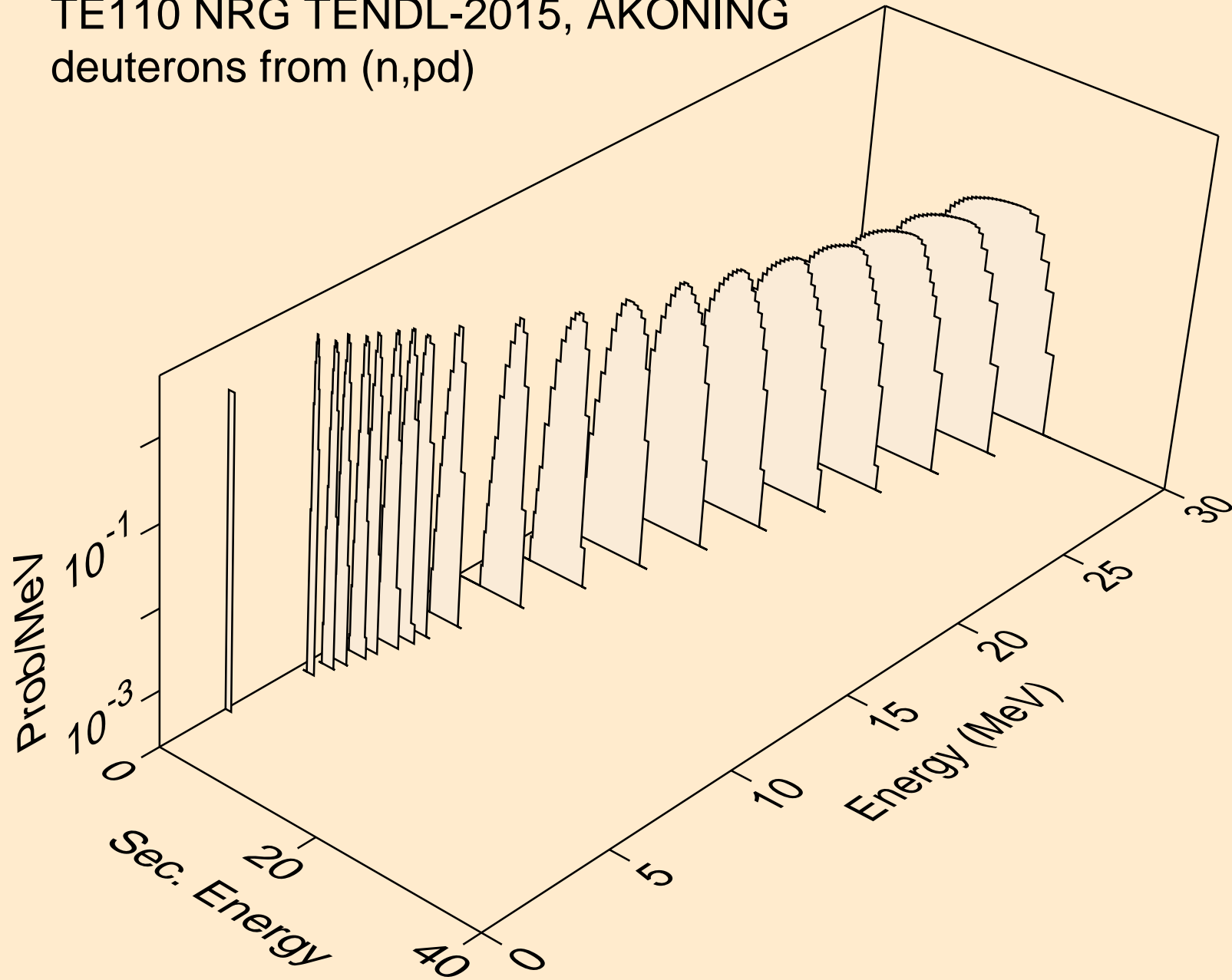

TE110 NRG TENDL-2015, AKONING
deuterons from (n,da)

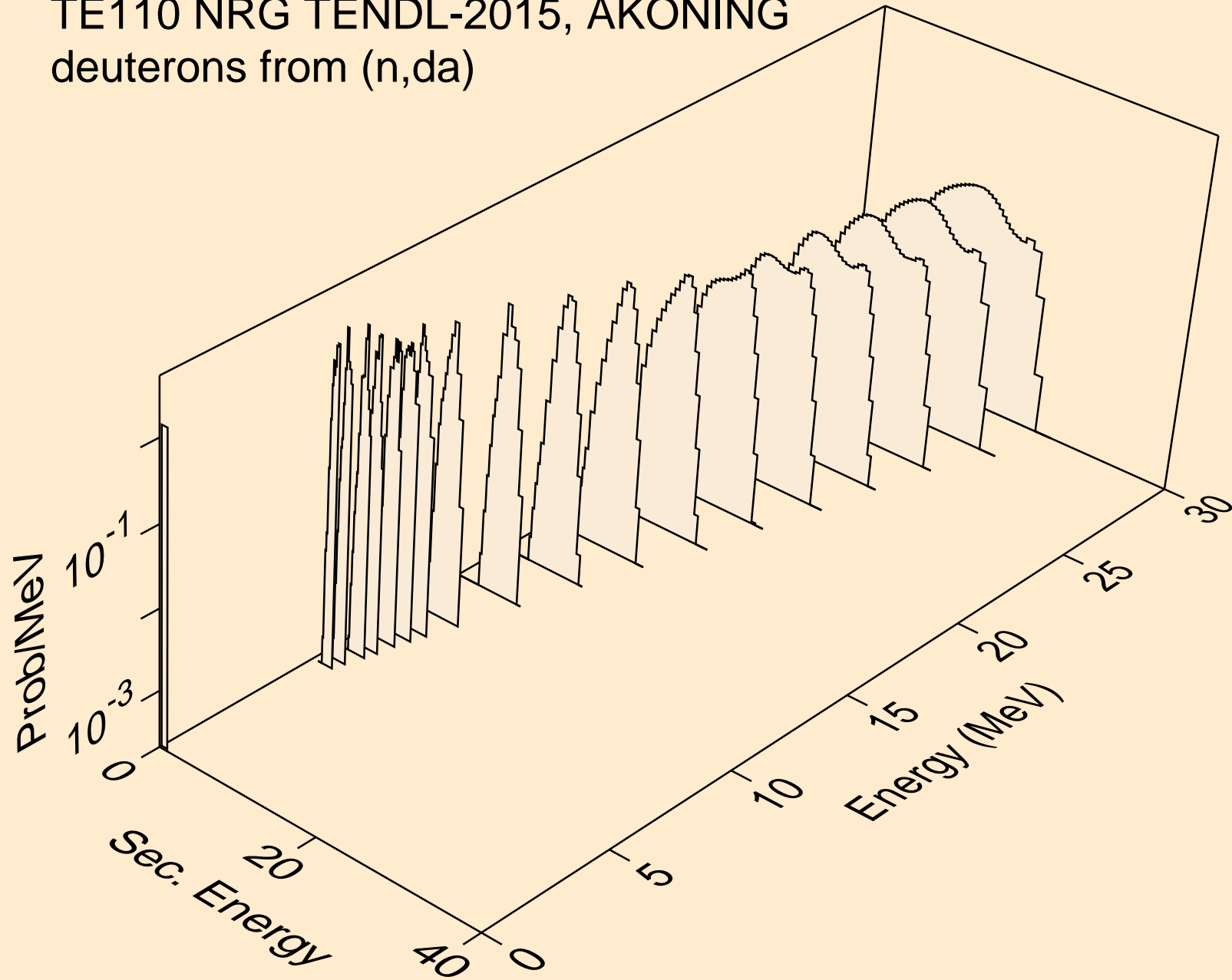

TE110 NRG TENDL-2015, AKONING
tritons from (n,x)

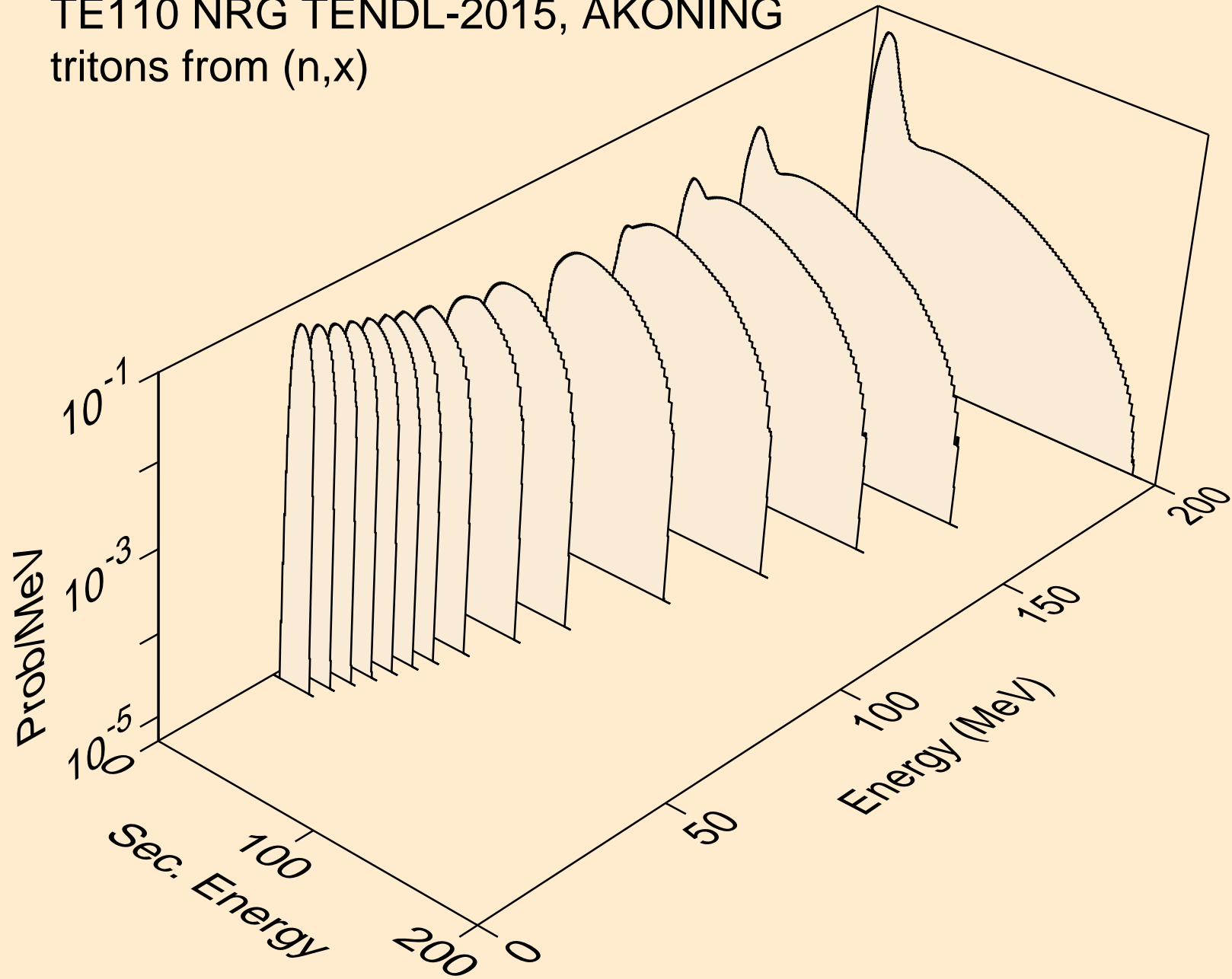

TE110 NRG TENDL-2015, AKONING
tritons from (n,n*)t

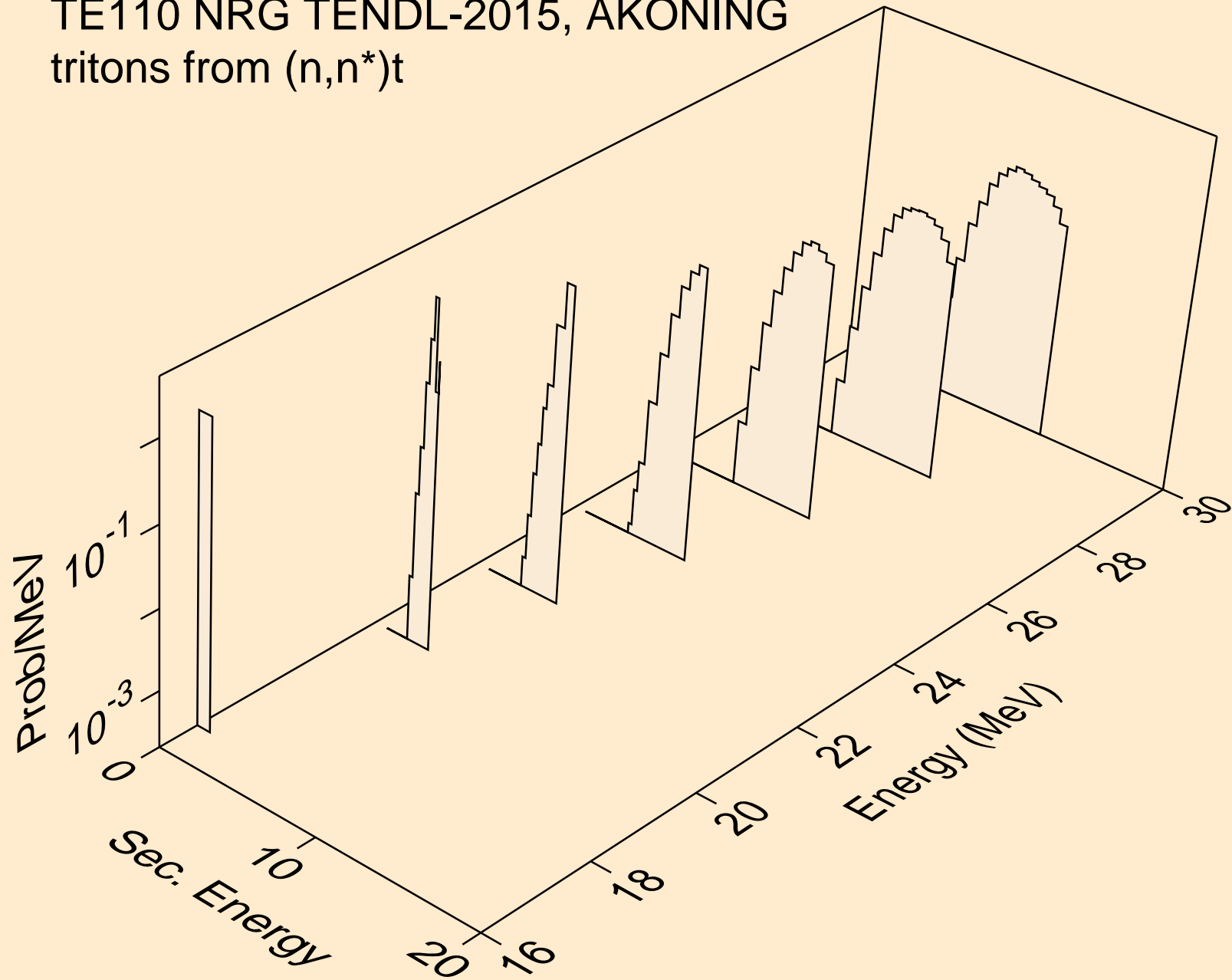

TE110 NRG TENDL-2015, AKONING
tritons from (n,t)

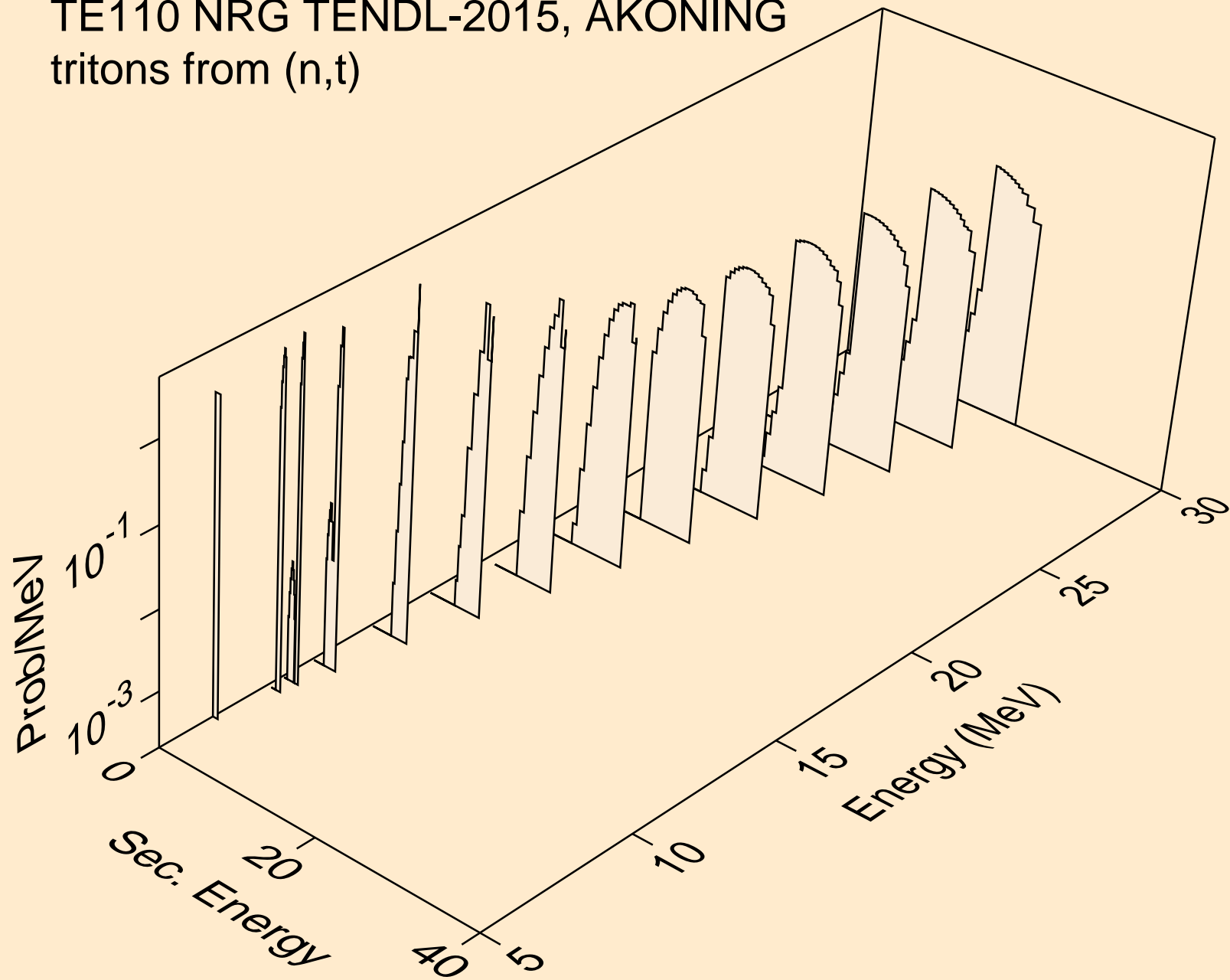

TE110 NRG TENDL-2015, AKONING
tritons from (n,pt)

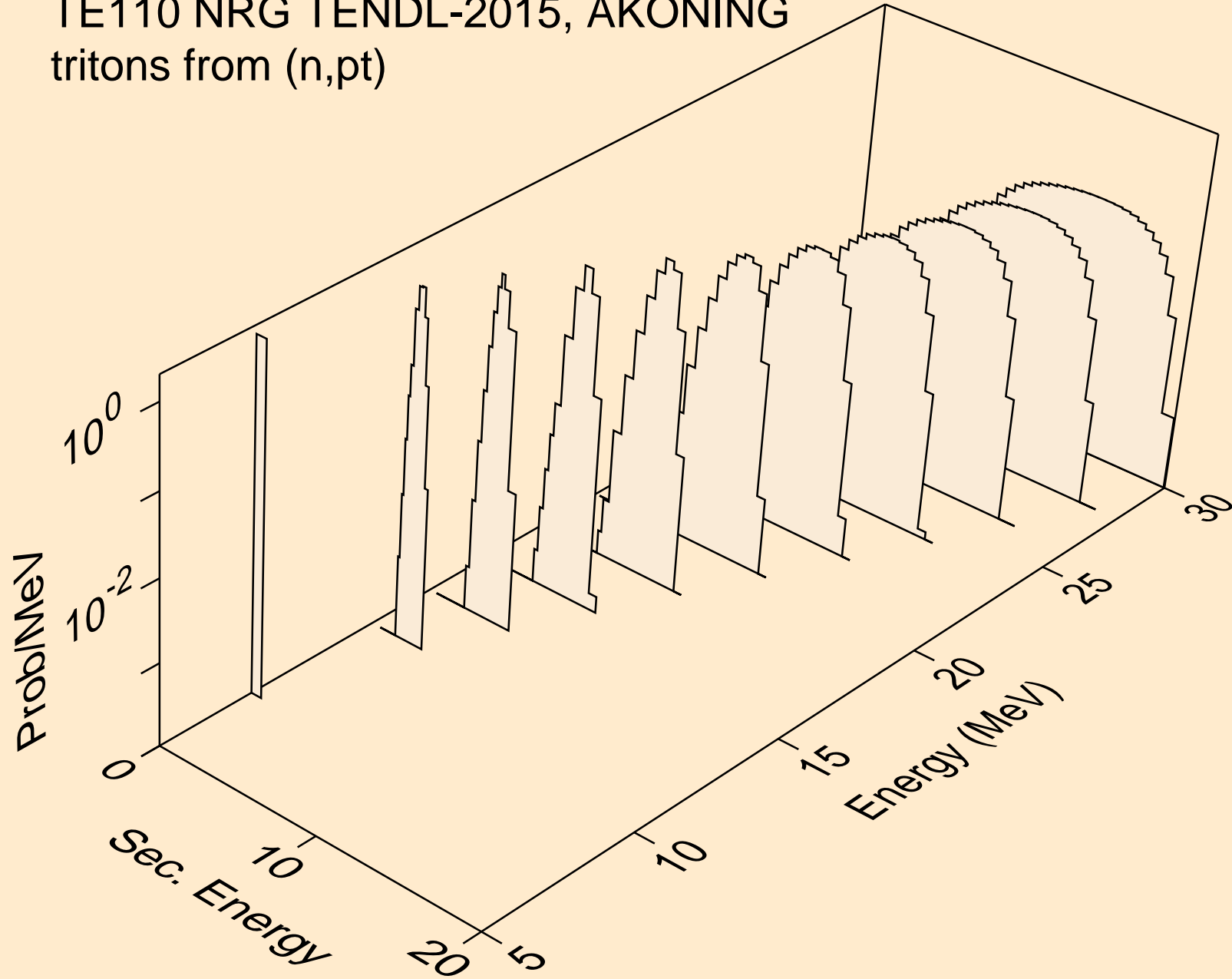

TE110 NRG TENDL-2015, AKONING
he3s from (n,x)

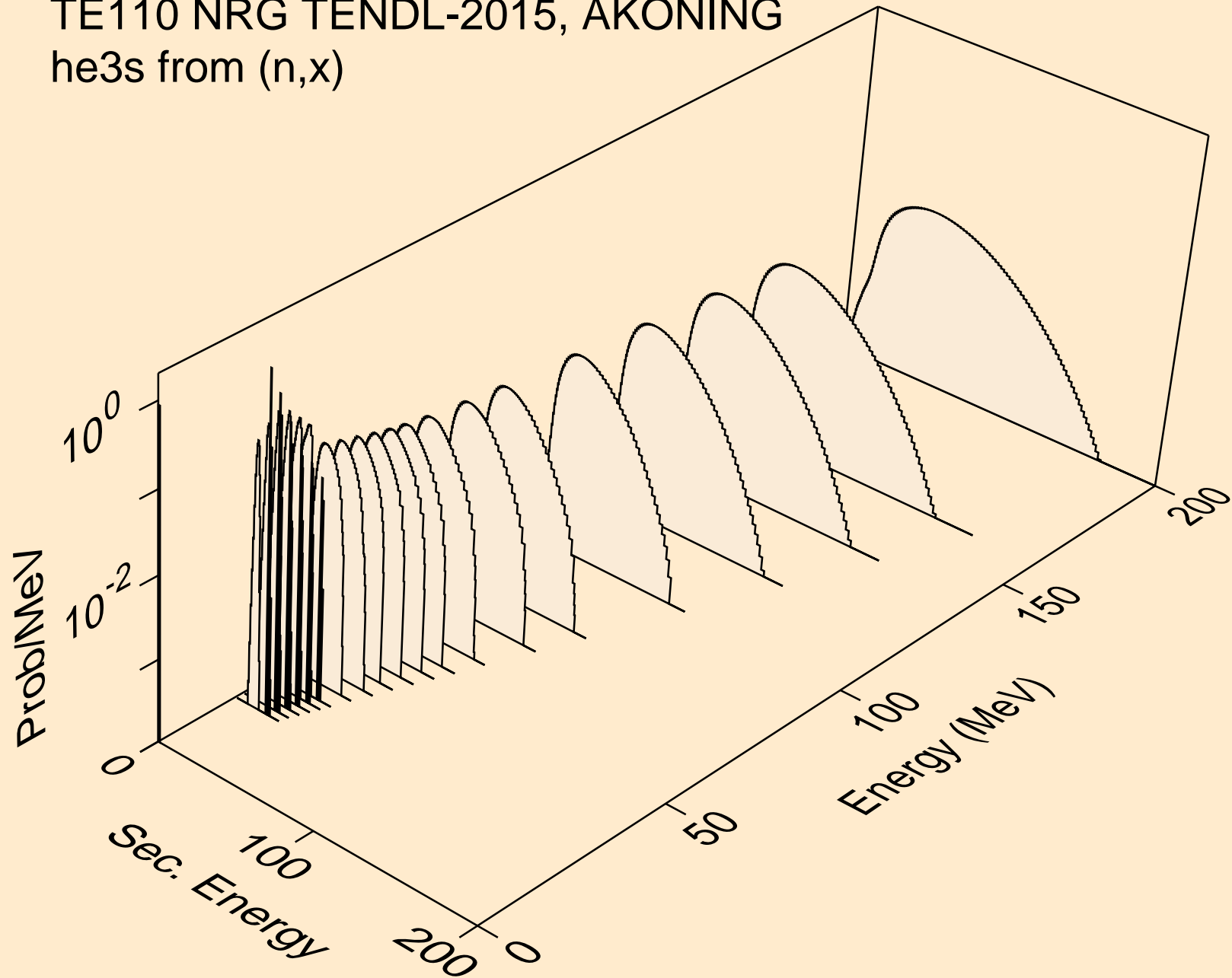

TE110 NRG TENDL-2015, AKONING
he3s from (n,n*)he3

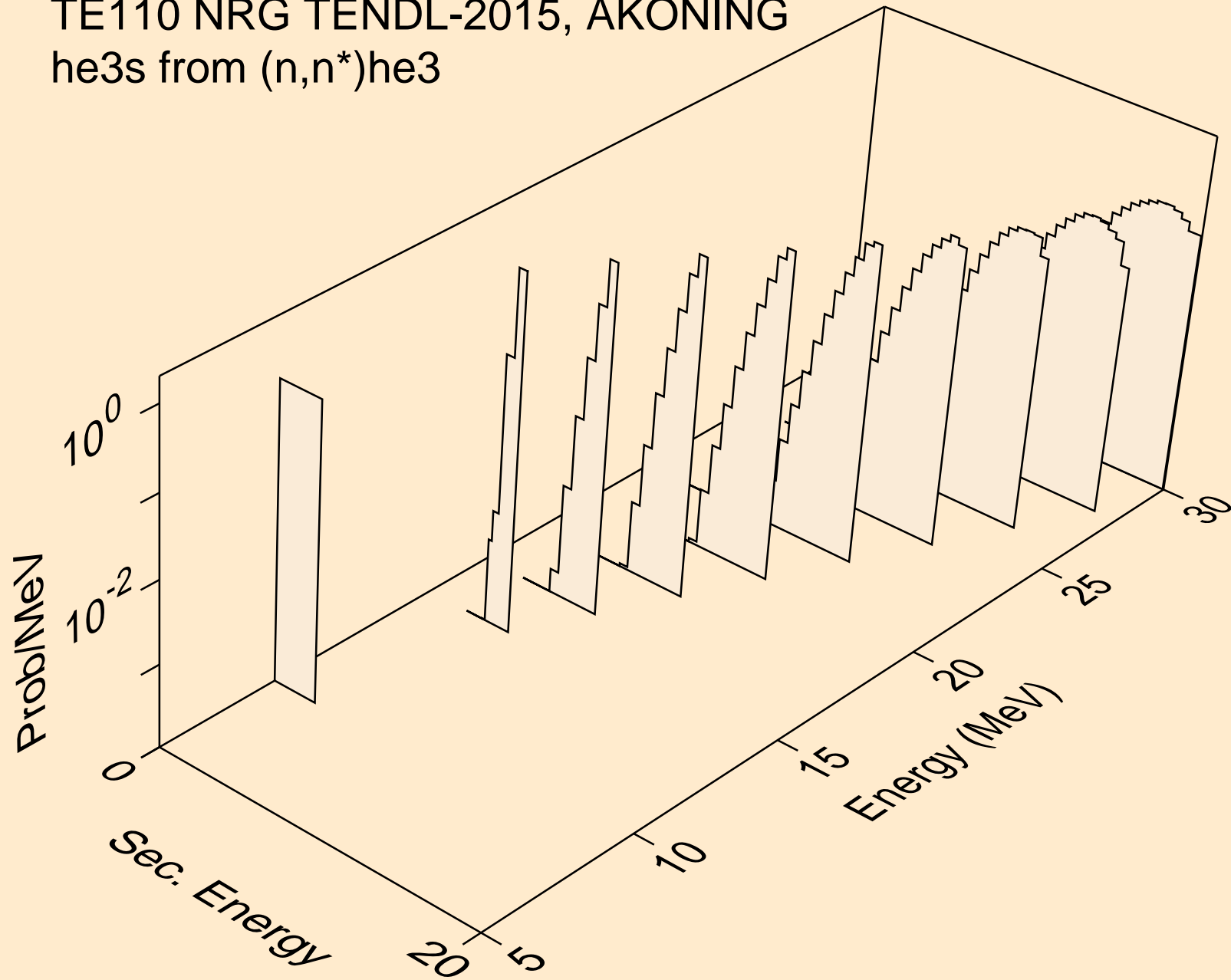

TE110 NRG TENDL-2015, AKONING
he3s from (n,he3)

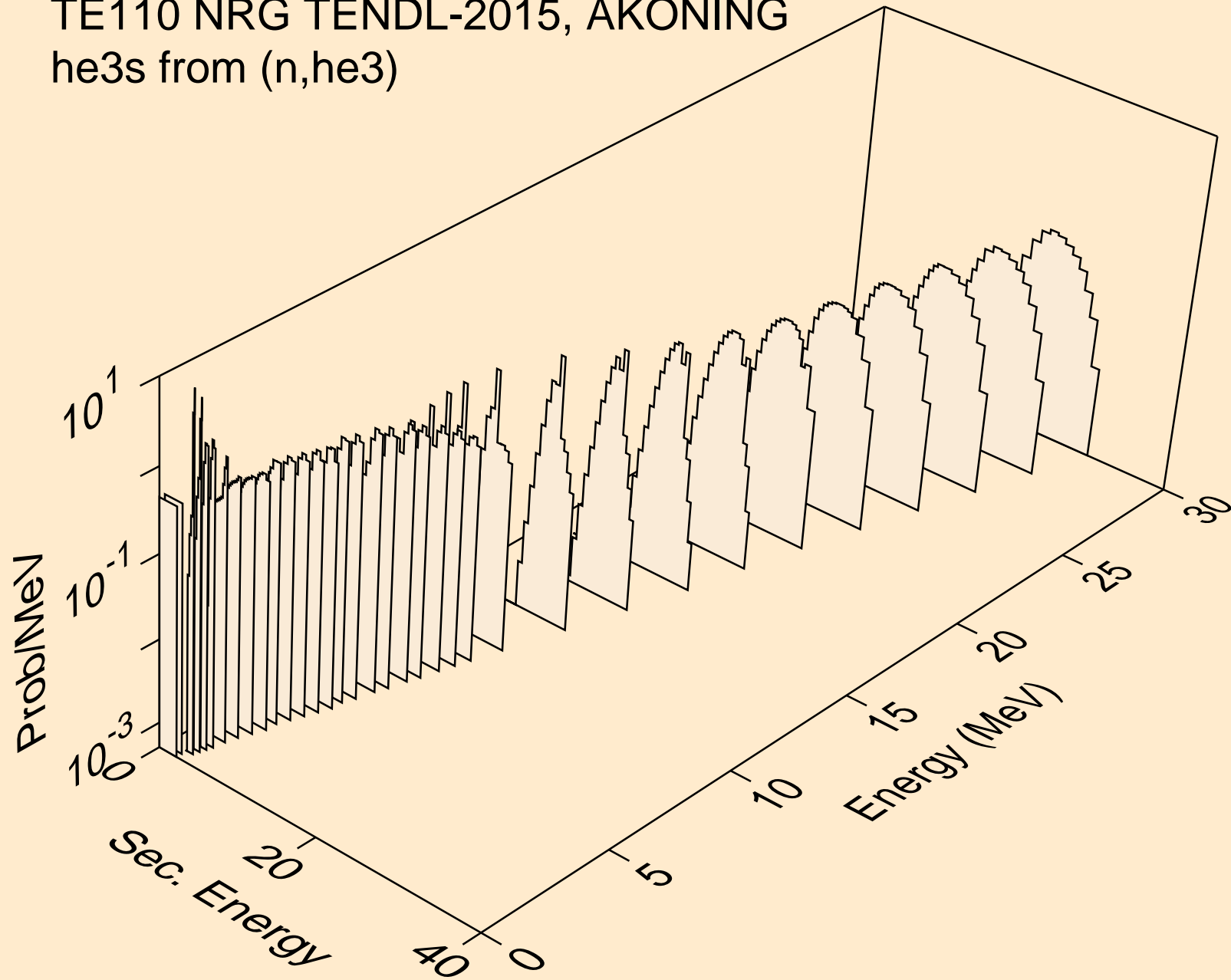

TE110 NRG TENDL-2015, AKONING
alphas from (n,x)

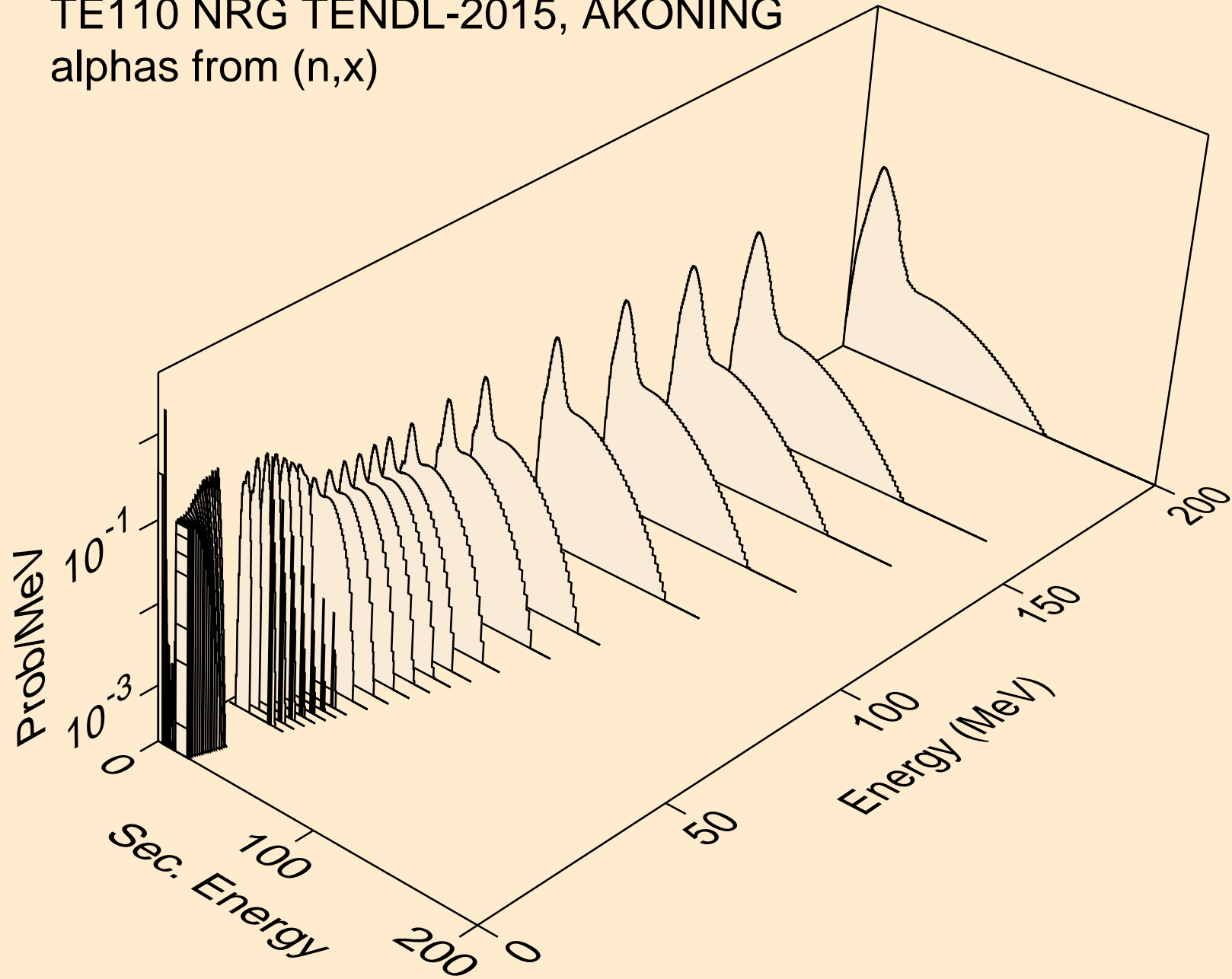

TE110 NRG TENDL-2015, AKONING
alphas from (n,n*)a

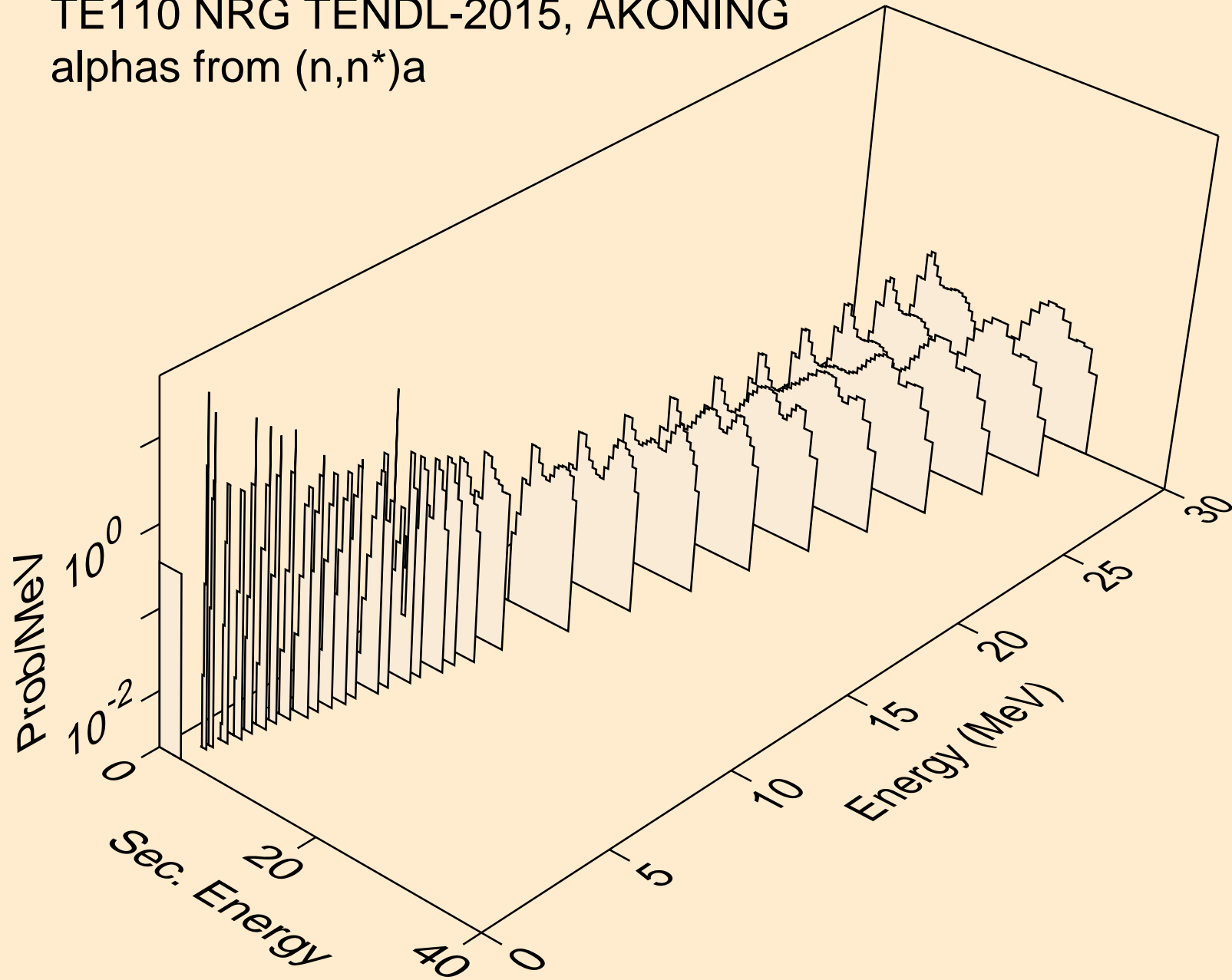

TE110 NRG TENDL-2015, AKONING
alphas from (n,n*)3a

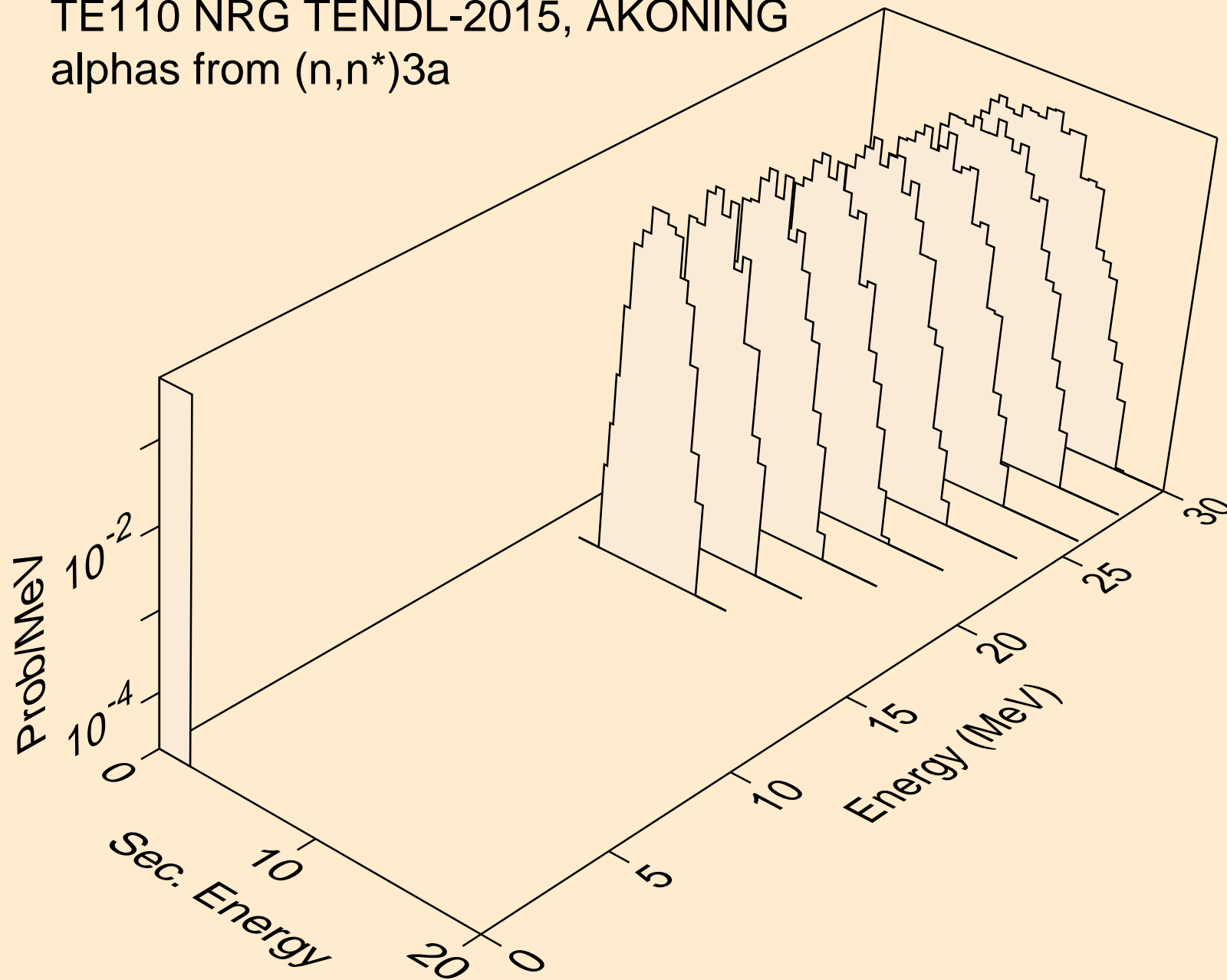

TE110 NRG TENDL-2015, AKONING
alphas from (n,2n)a

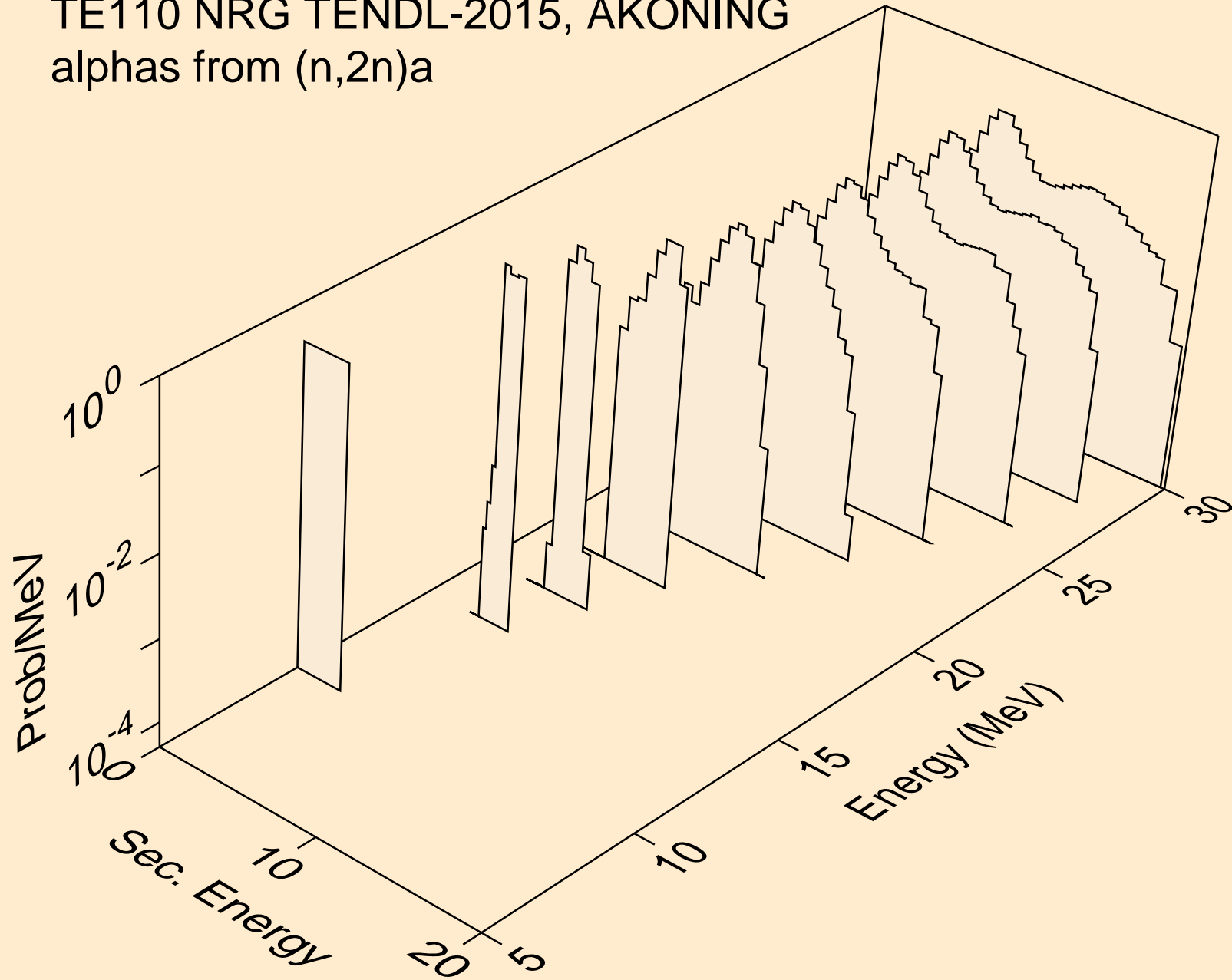

TE110 NRG TENDL-2015, AKONING
alphas from (n,3n)a

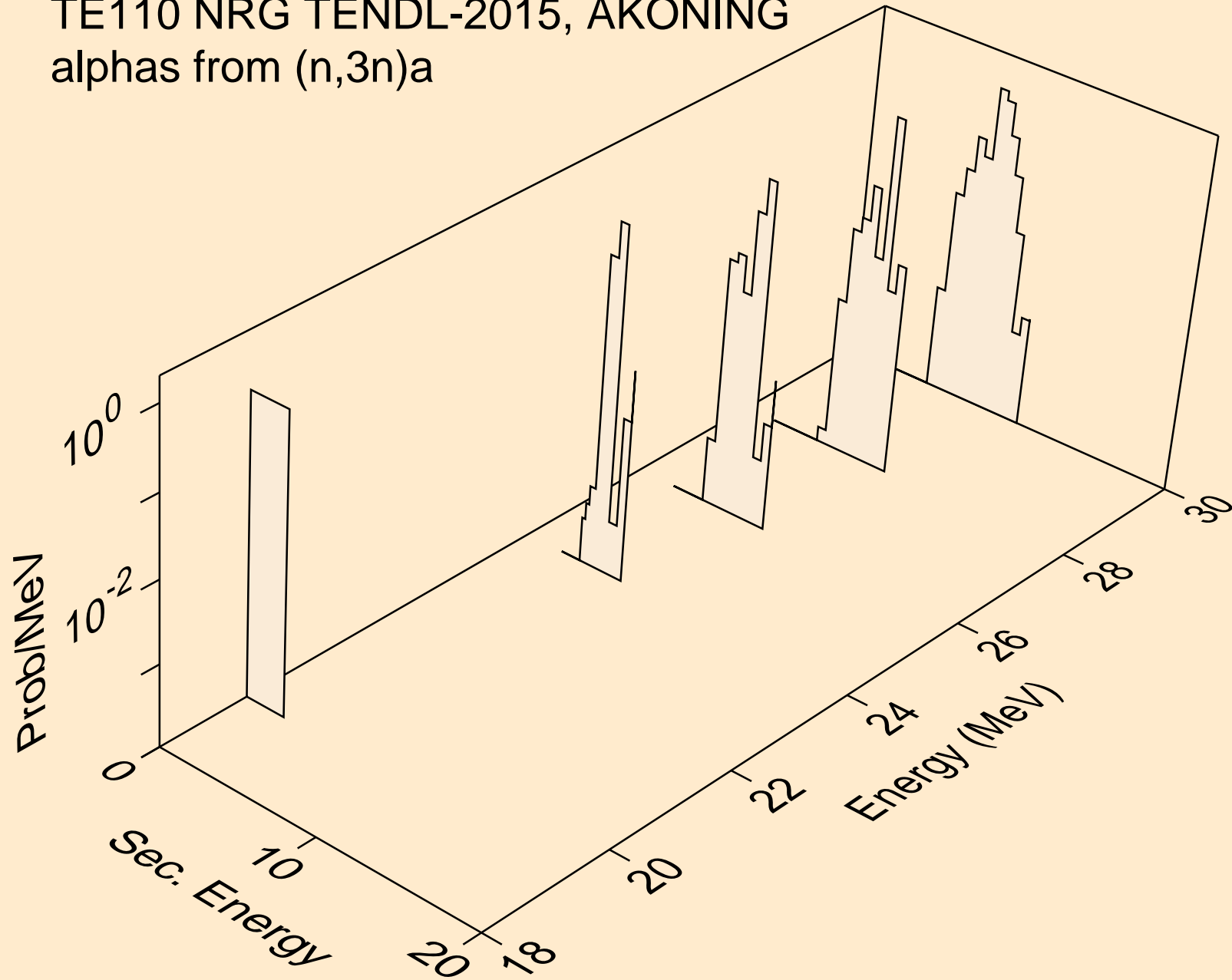

TE110 NRG TENDL-2015, AKONING
alphas from (n,n*)2a

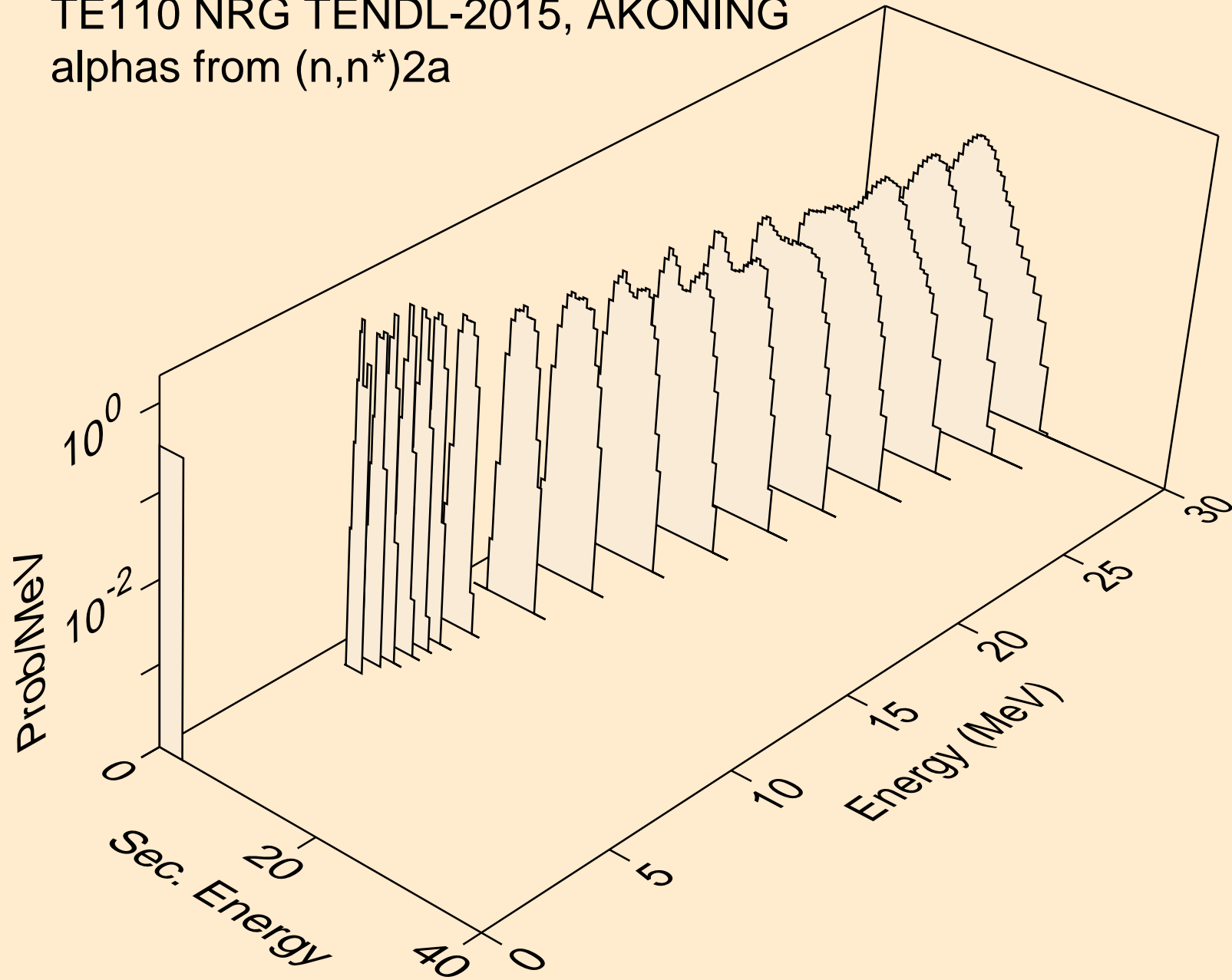

TE110 NRG TENDL-2015, AKONING
alphas from (n,2n)2a

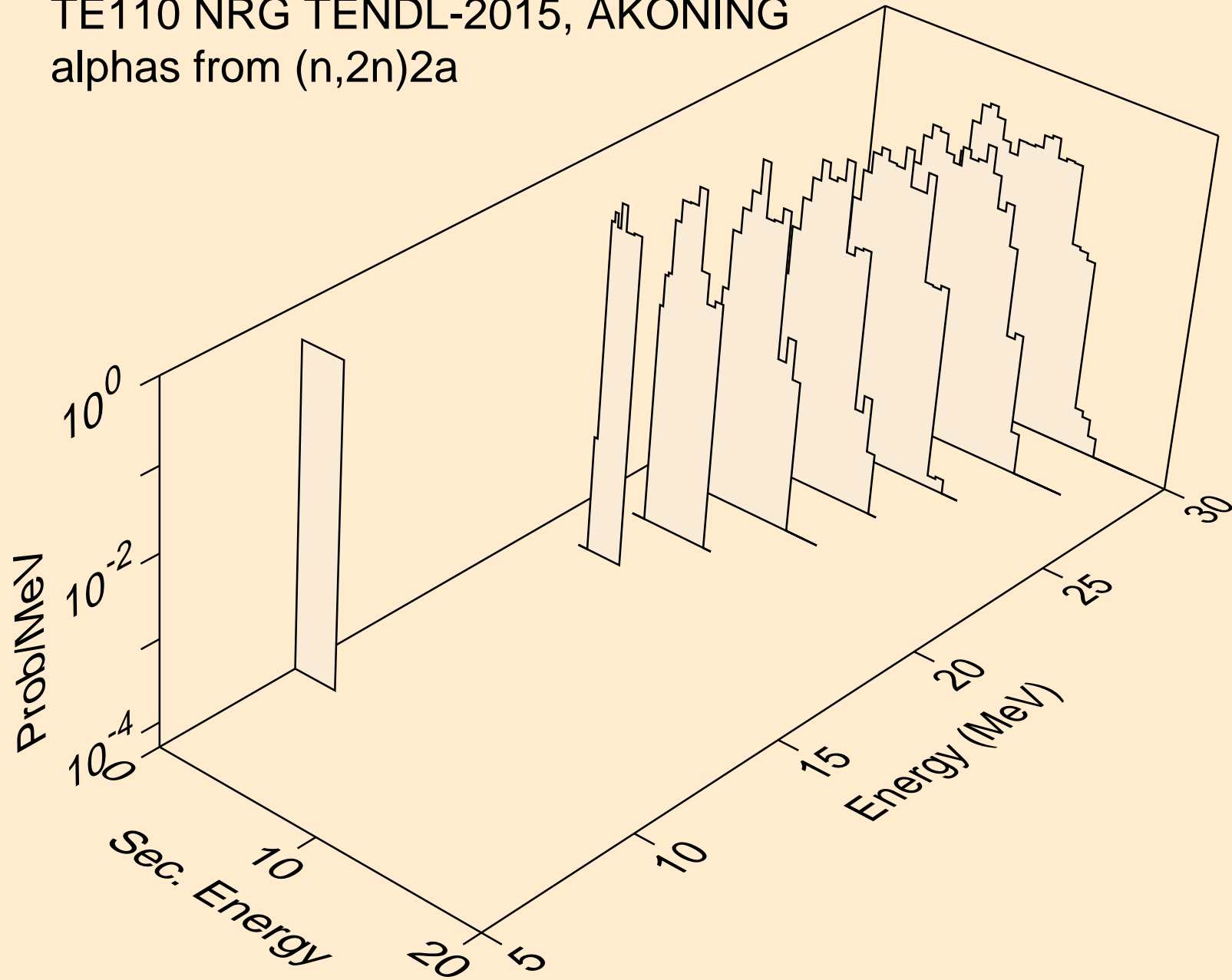

TE110 NRG TENDL-2015, AKONING
alphas from (n,npa)

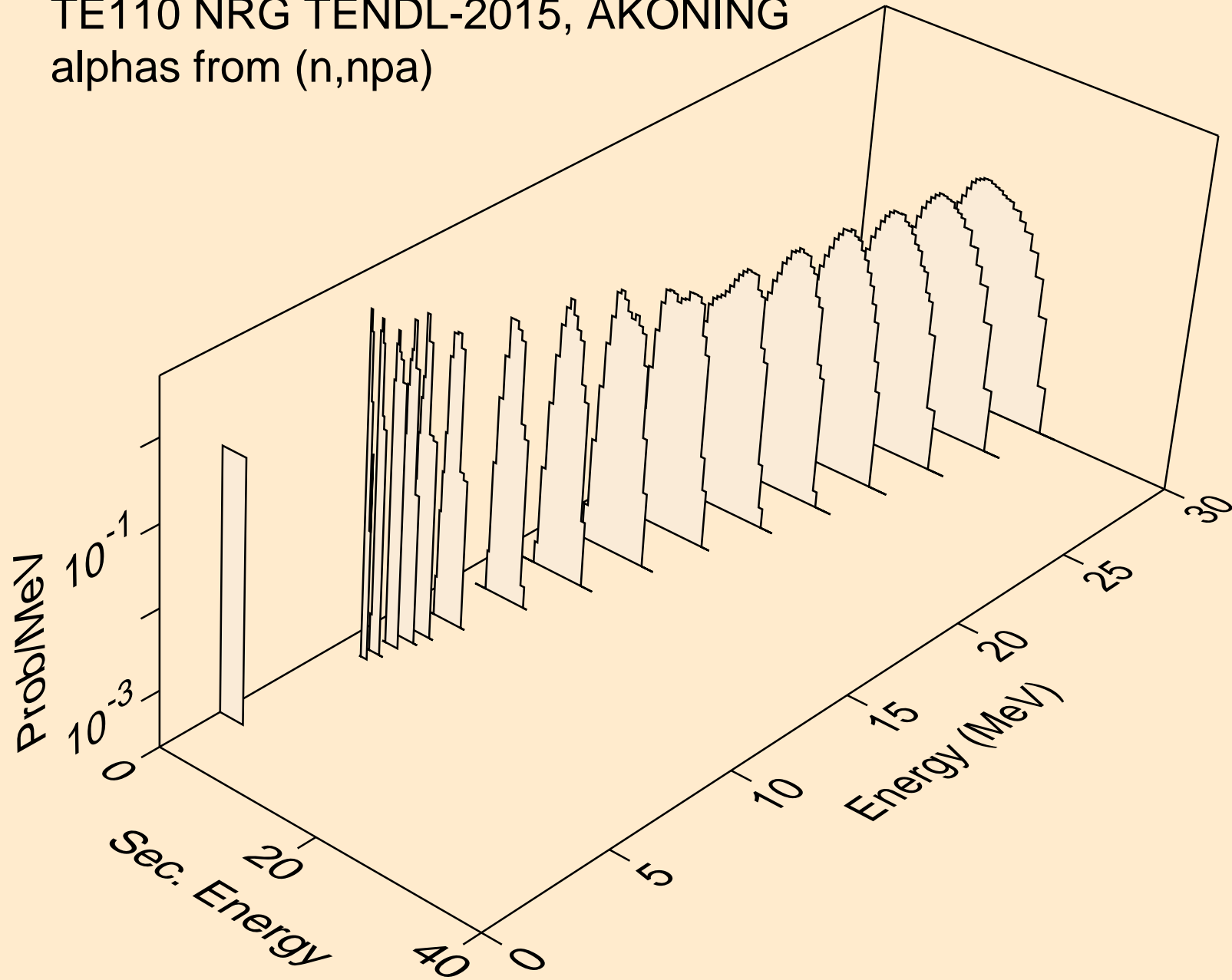

TE110 NRG TENDL-2015, AKONING
alphas from (n,a)

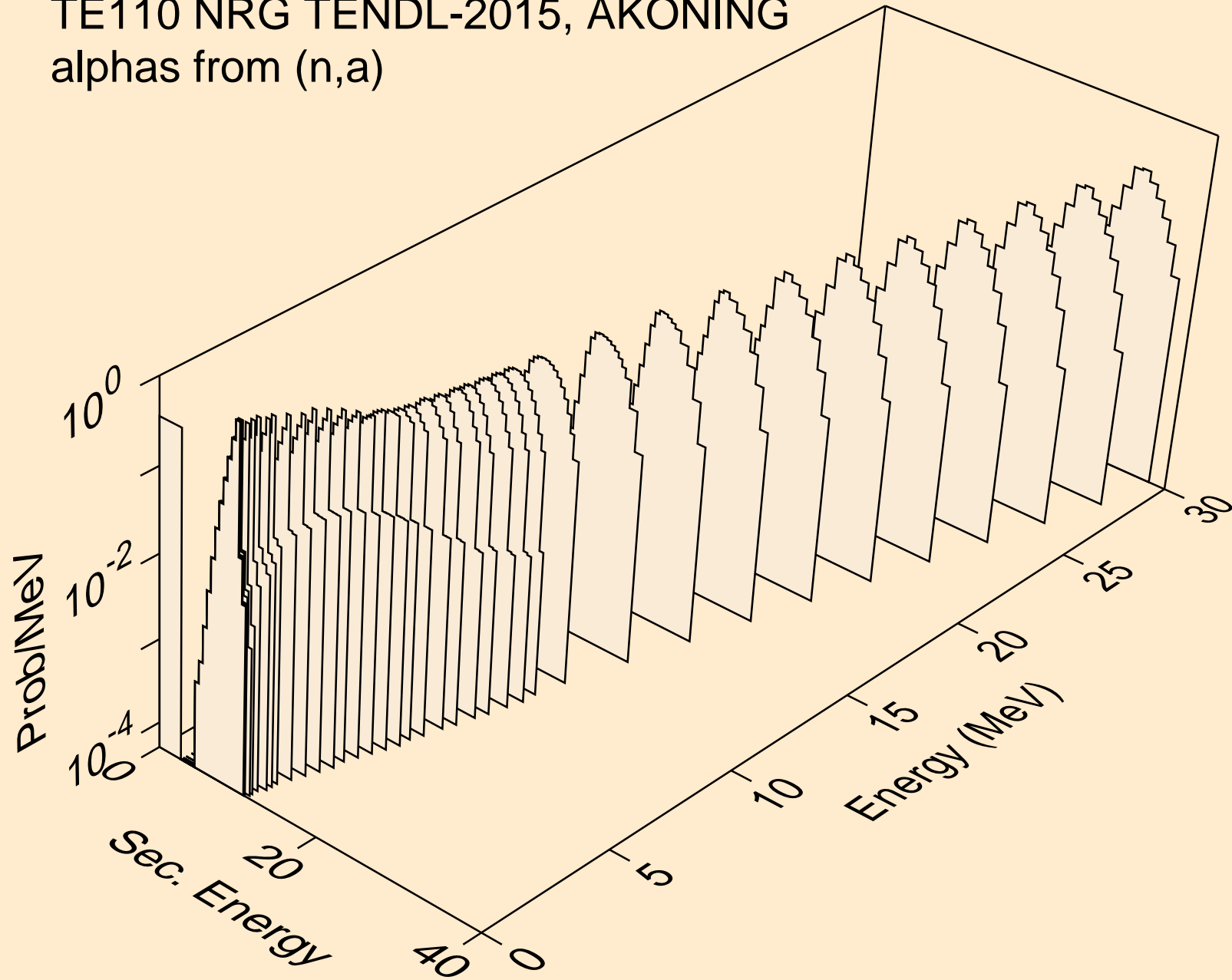

TE110 NRG TENDL-2015, AKONING
alphas from (n,2a)

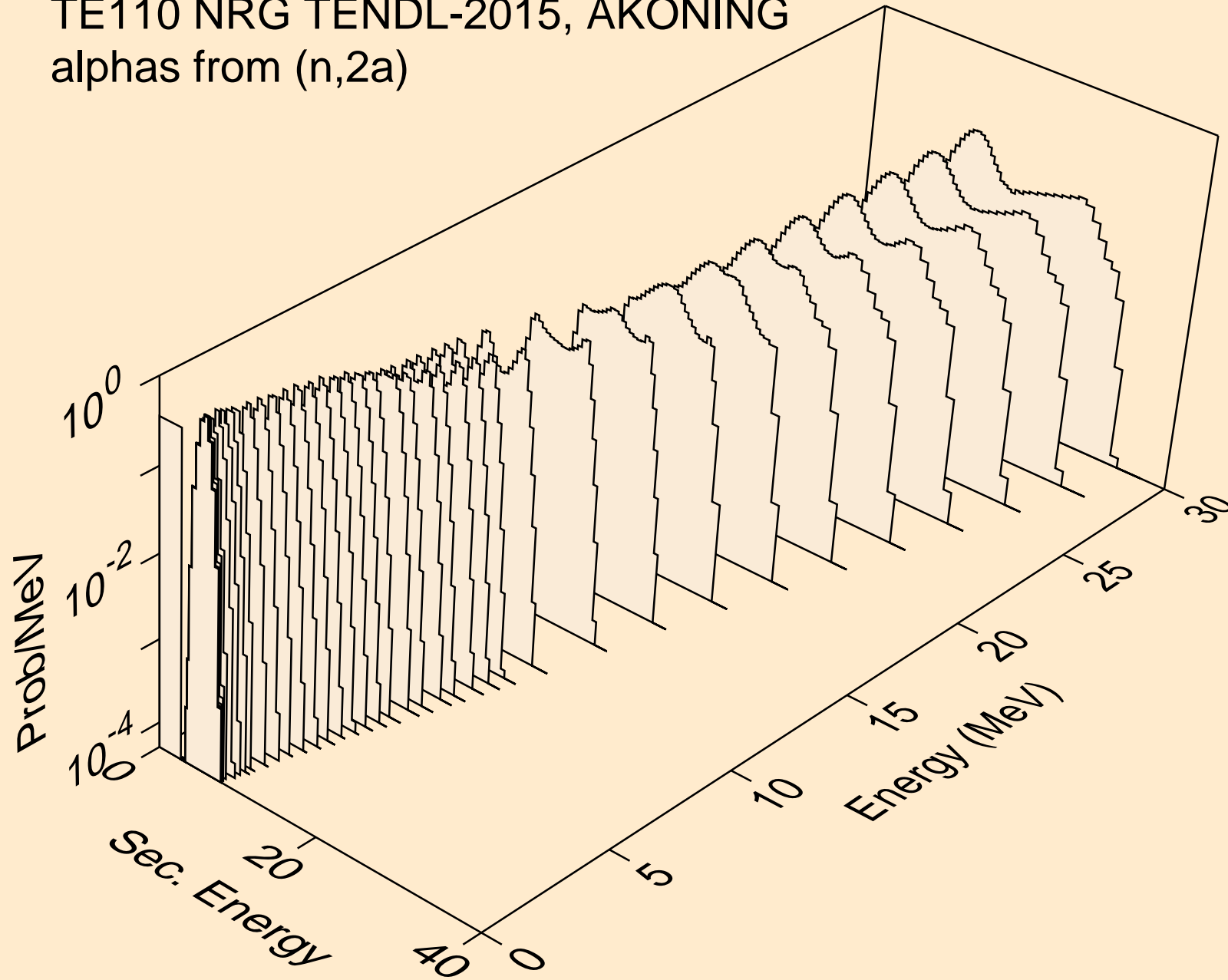

TE110 NRG TENDL-2015, AKONING
alphas from (n,3a)

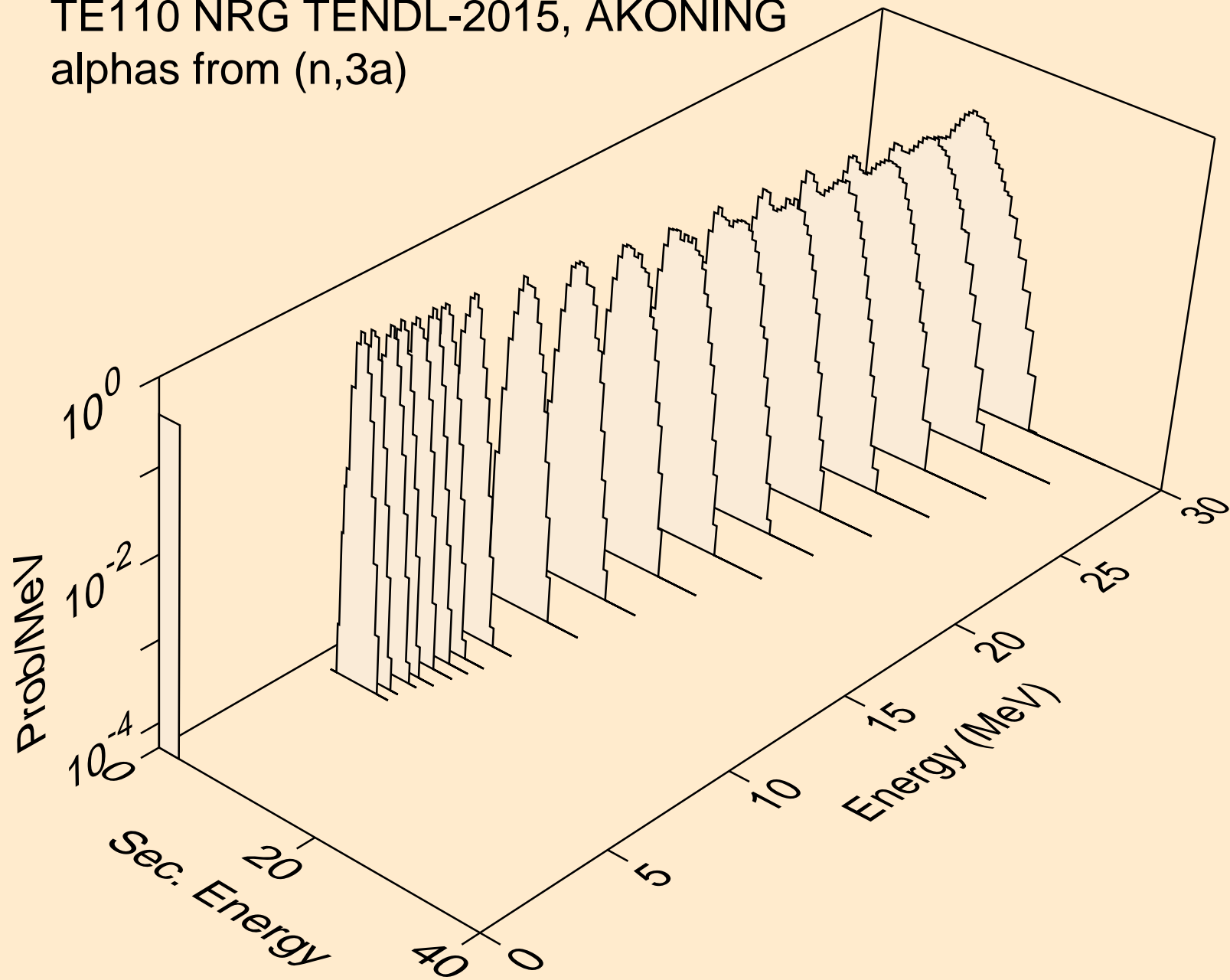

TE110 NRG TENDL-2015, AKONING
alphas from (n,pa)

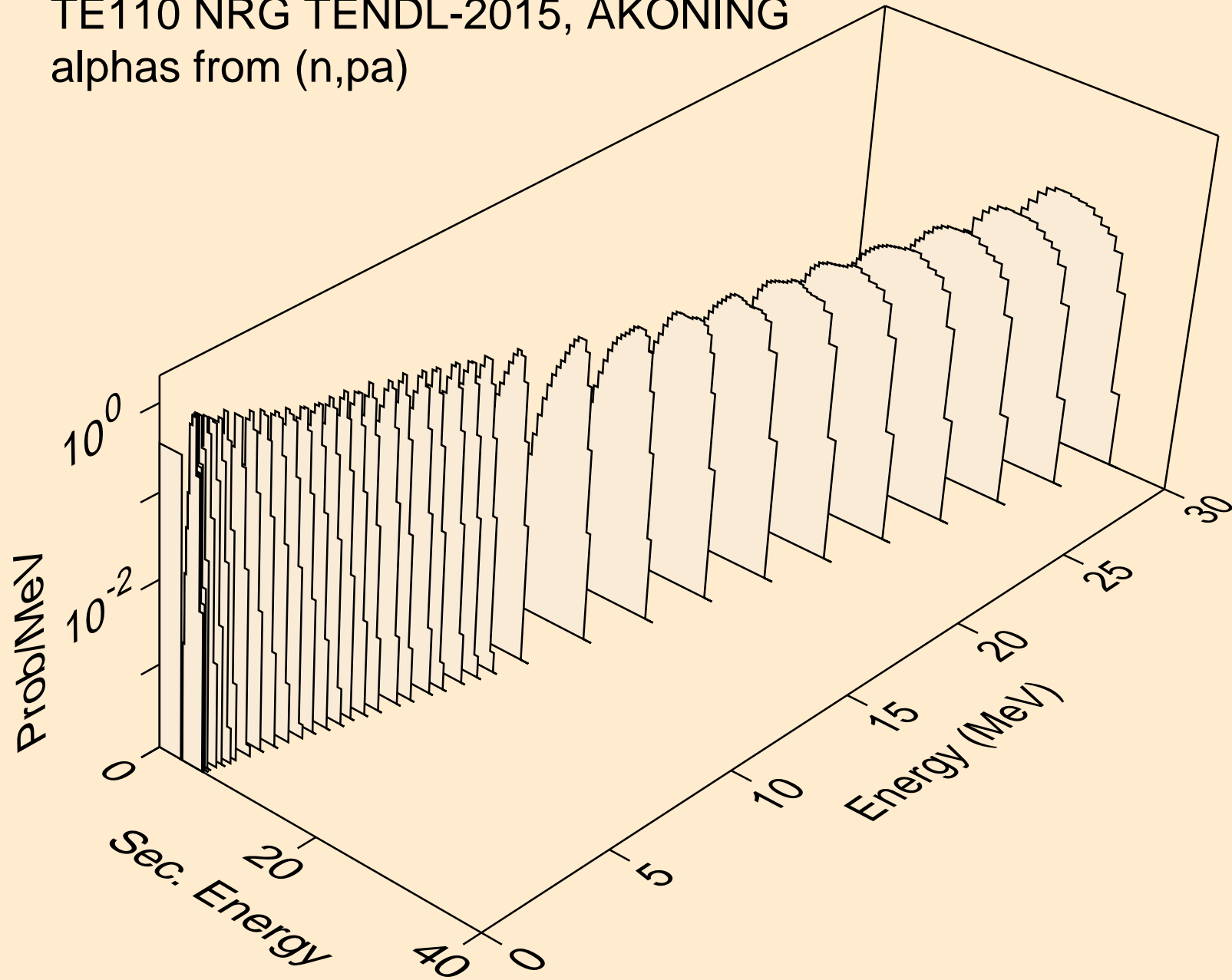

TE110 NRG TENDL-2015, AKONING
alphas from (n,d2a)

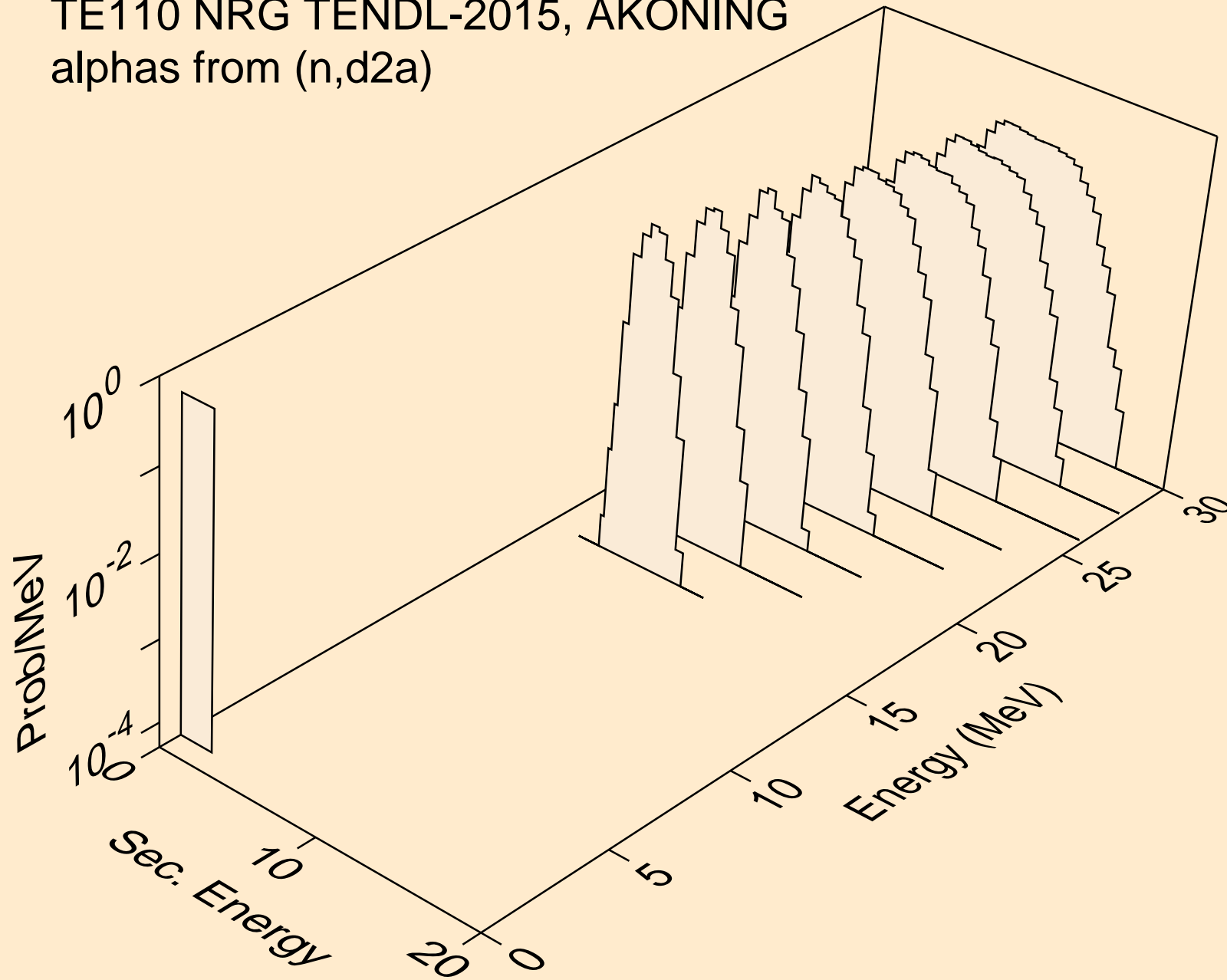

TE110 NRG TENDL-2015, AKONING
alphas from (n,da)

