

TL181 NRG TENDL-2016, AKONING

Principal cross sections

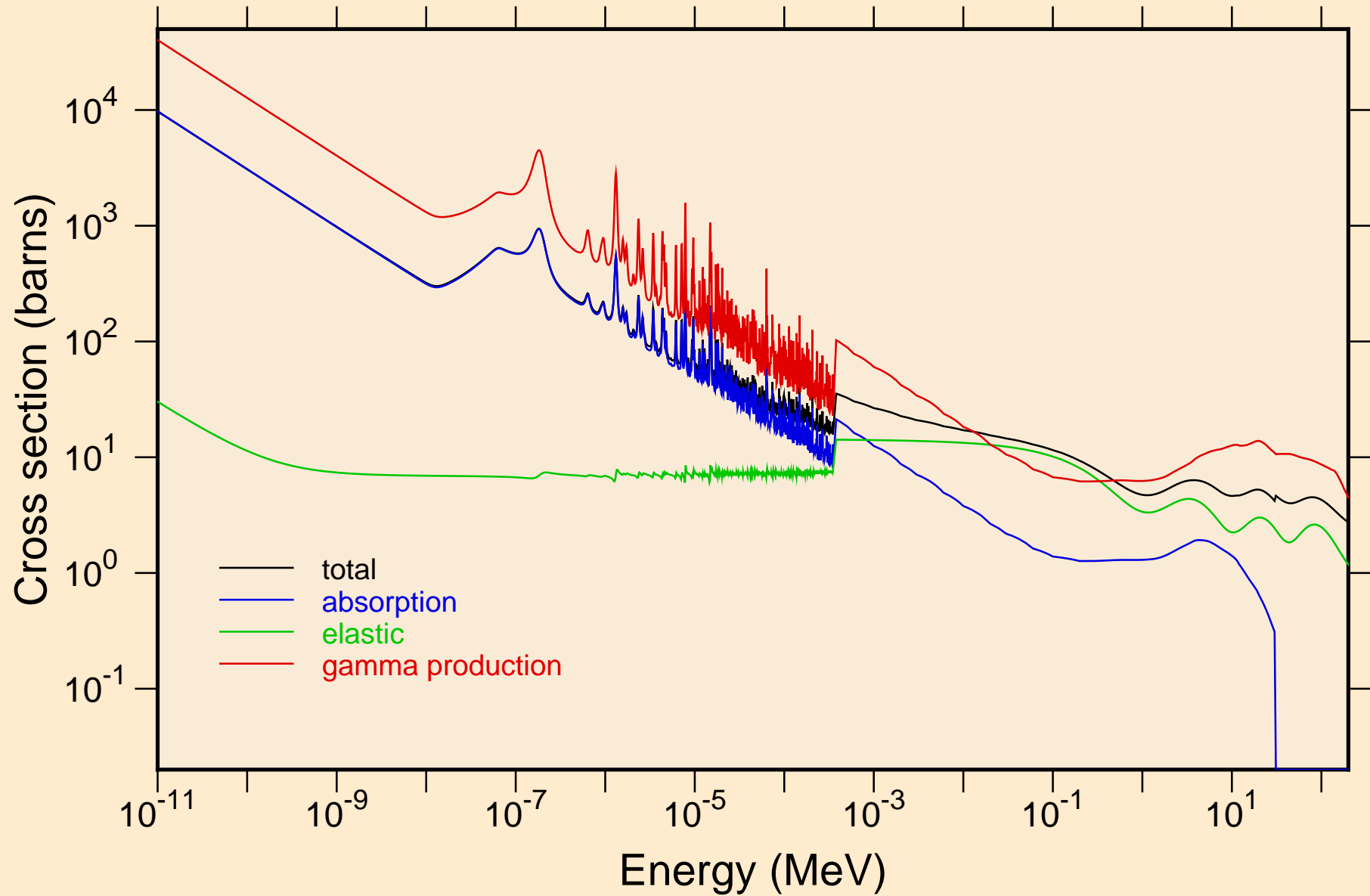

TL181 NRG TENDL-2016, AKONING
resonance total cross section

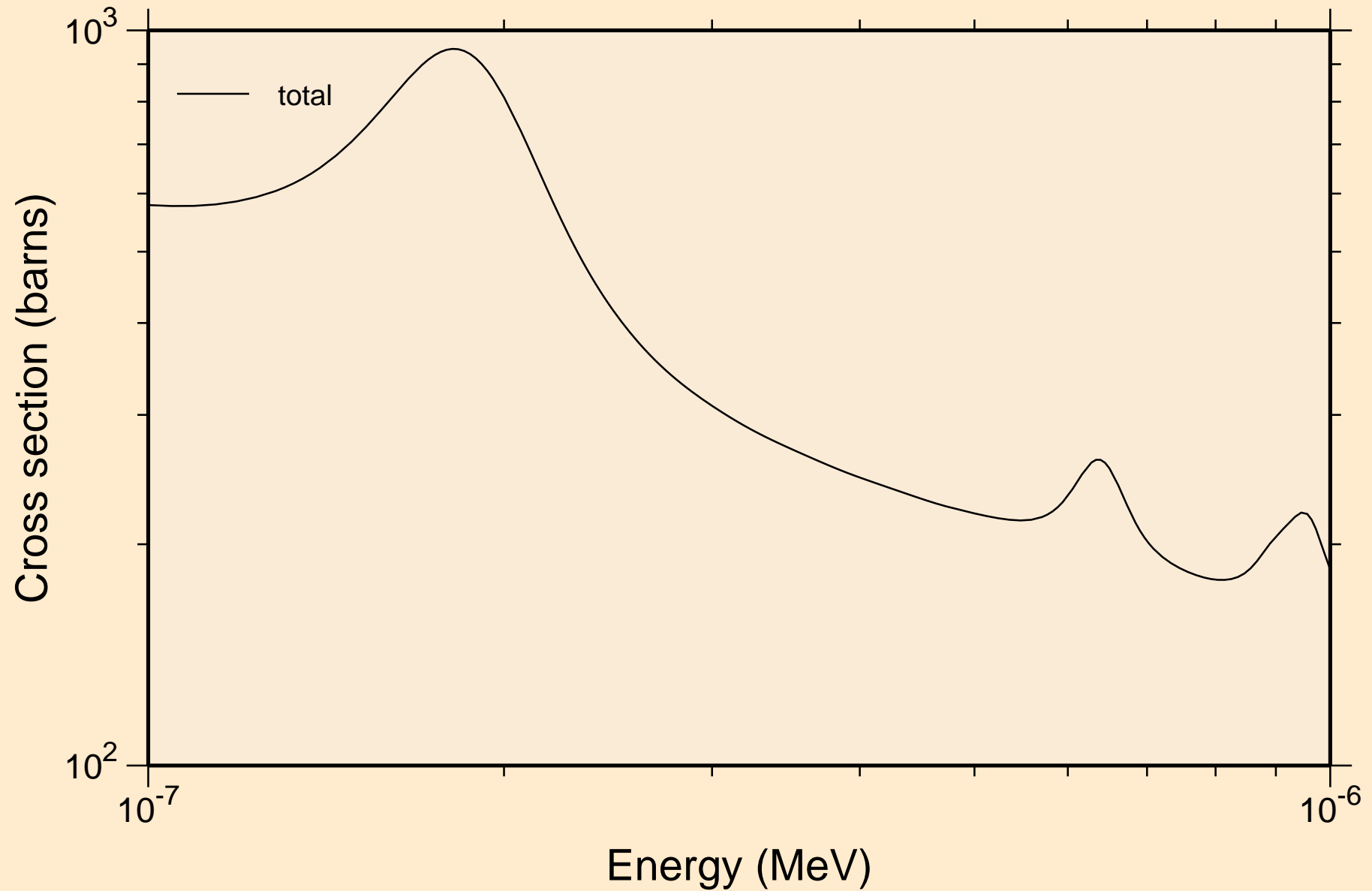

TL181 NRG TENDL-2016, AKONING
resonance total cross section

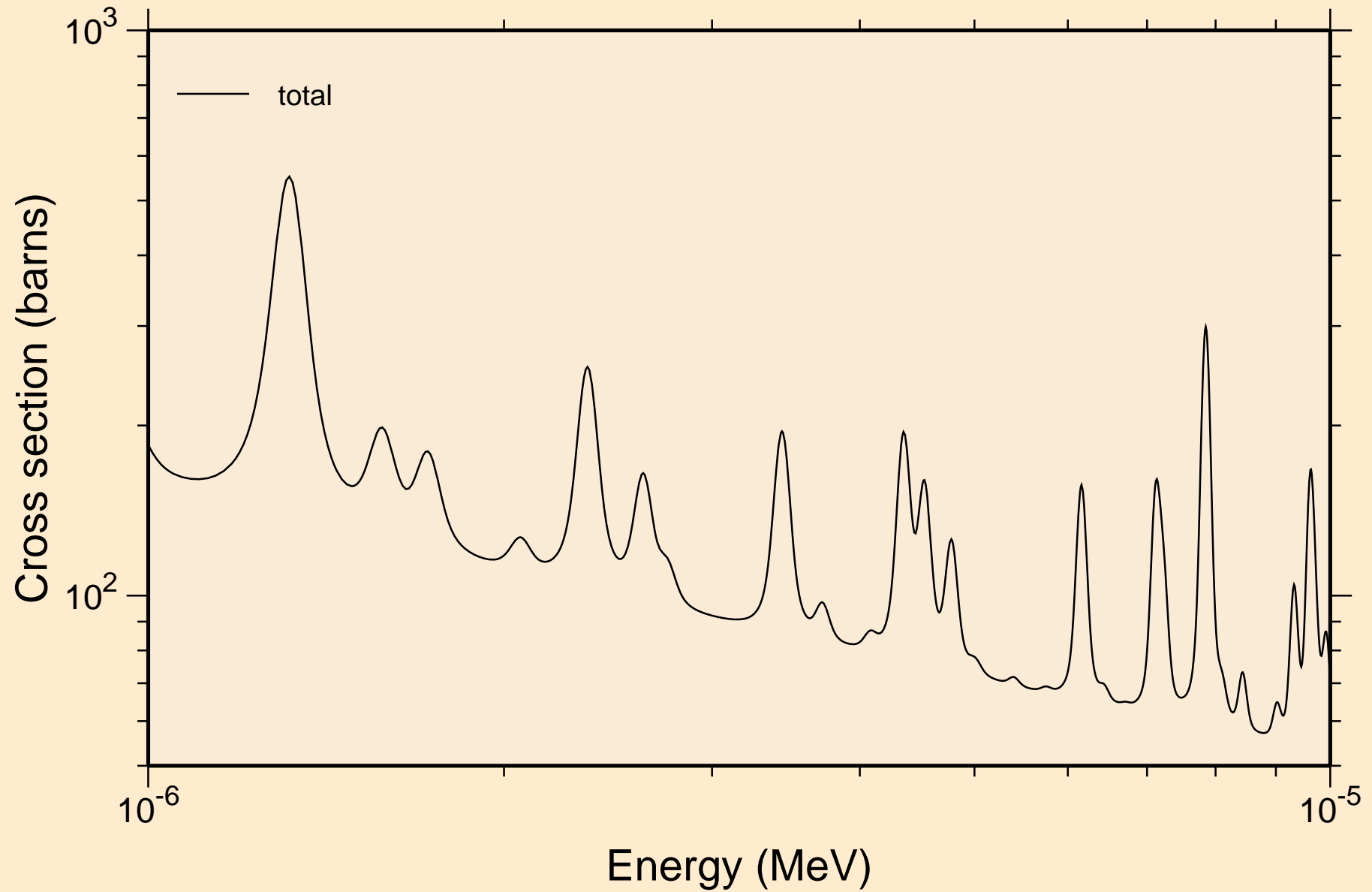

TL181 NRG TENDL-2016, AKONING
resonance total cross section

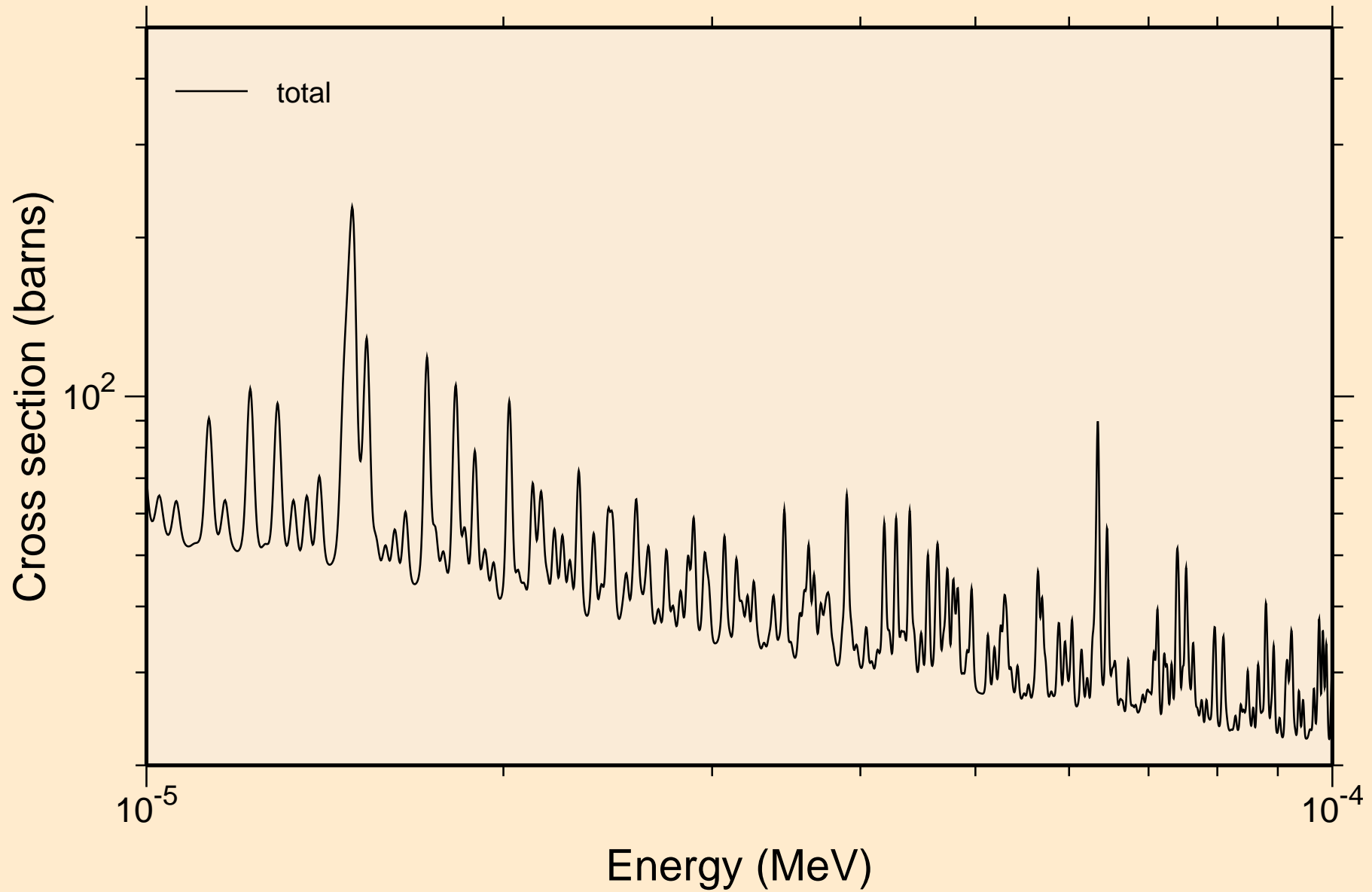

TL181 NRG TENDL-2016, AKONING
resonance total cross section

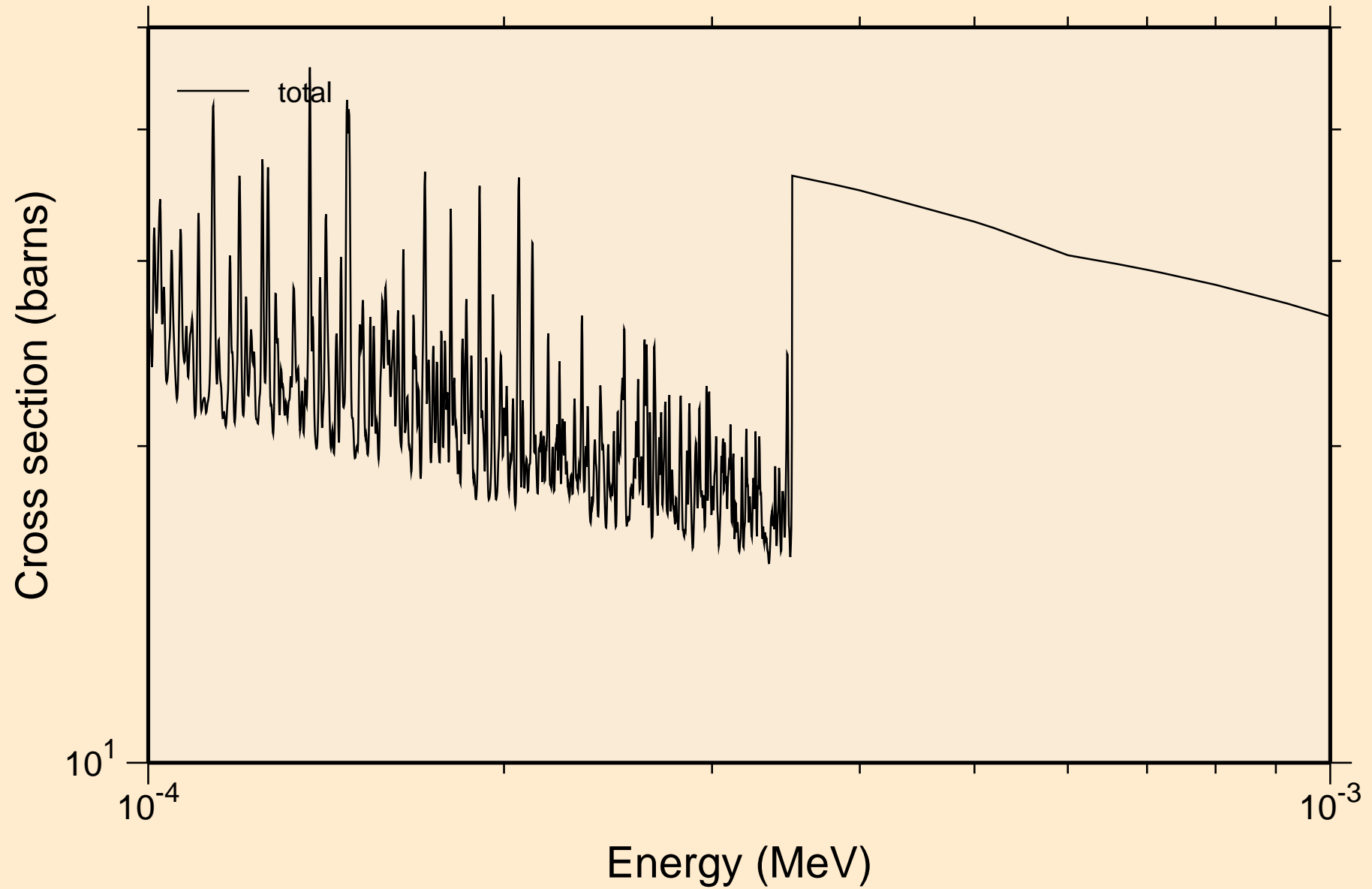

TL181 NRG TENDL-2016, AKONING
resonance total cross section

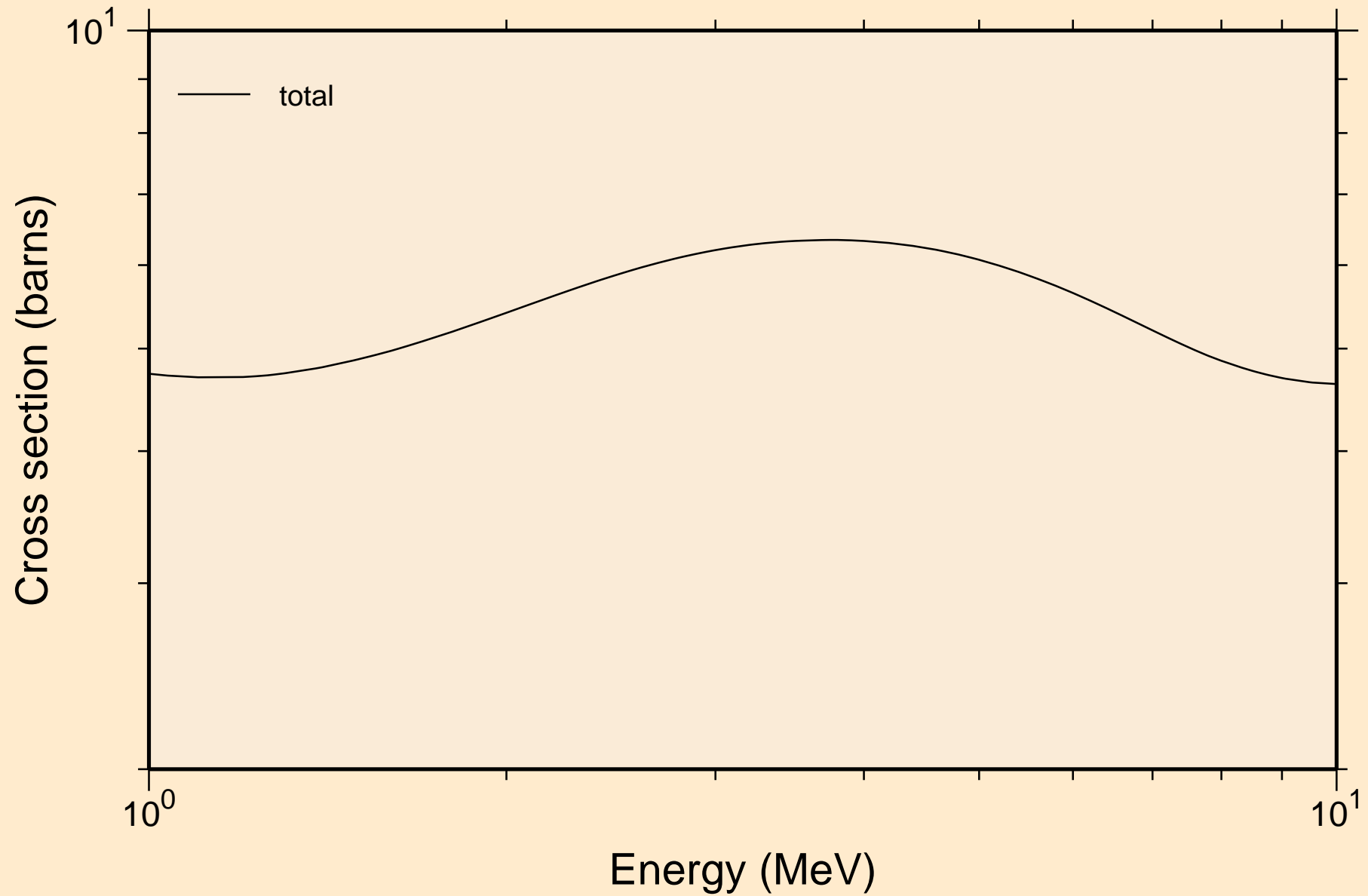

TL181 NRG TENDL-2016, AKONING
resonance absorption cross sections

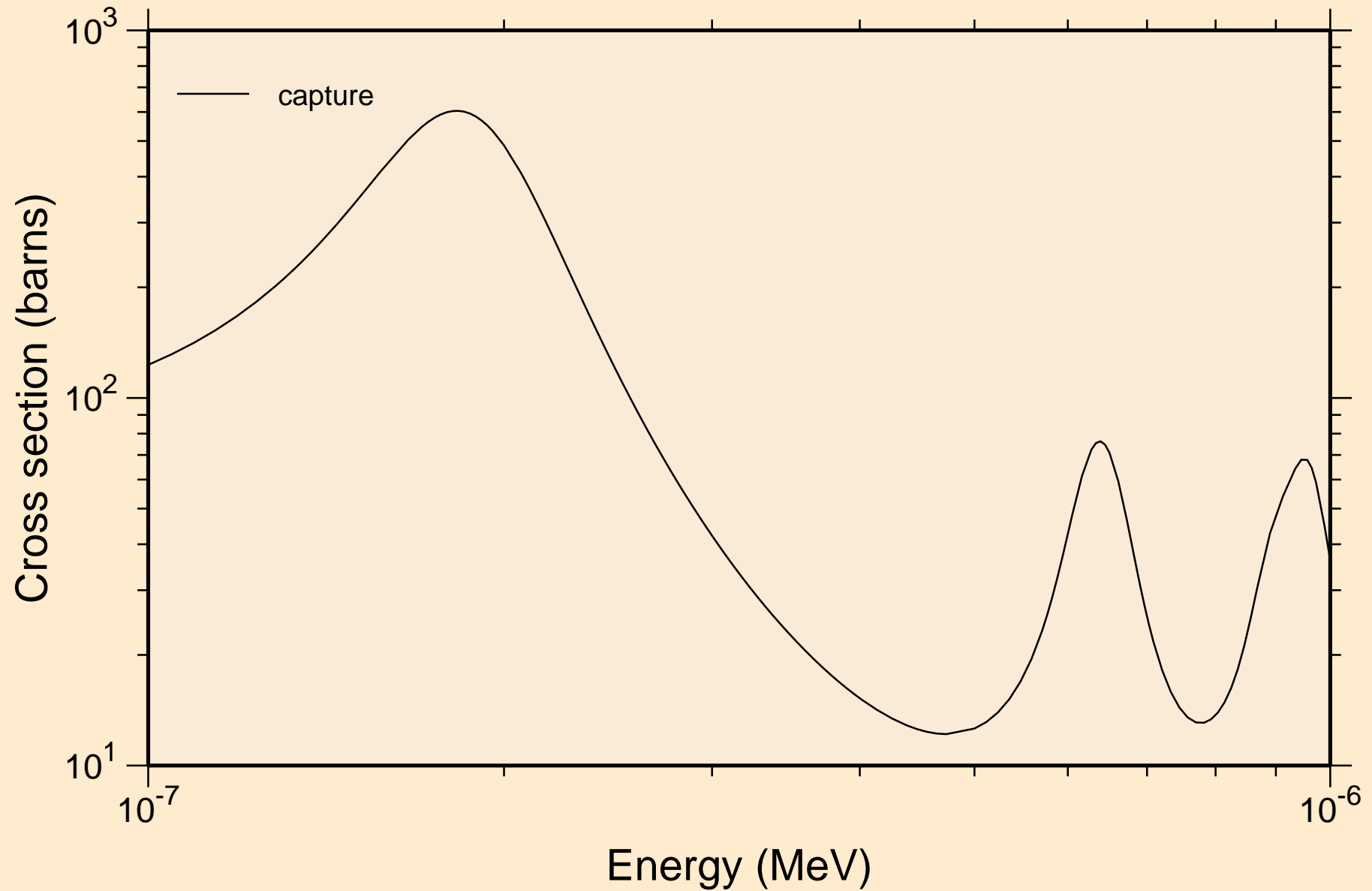

TL181 NRG TENDL-2016, AKONING
resonance absorption cross sections

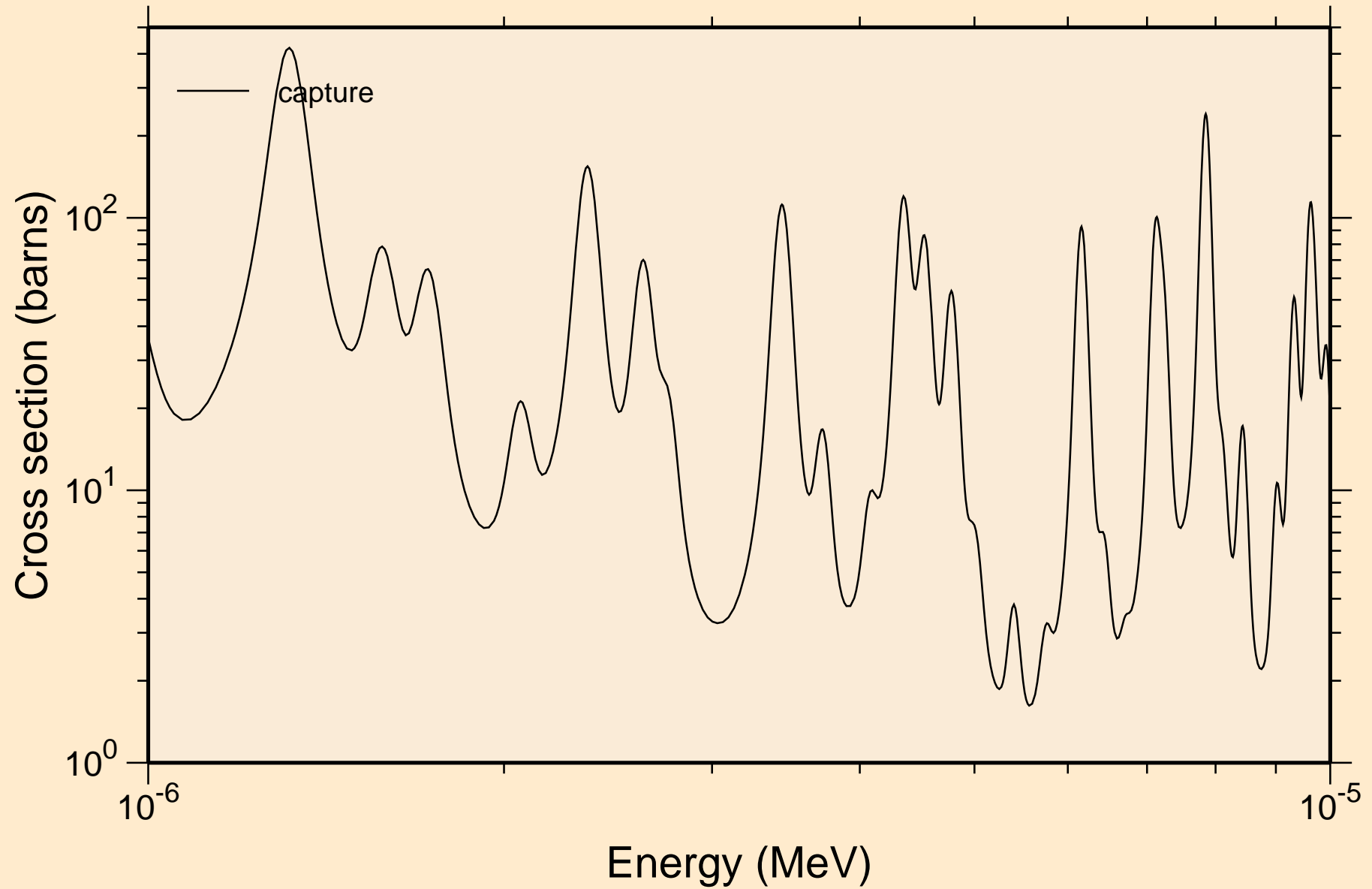

TL181 NRG TENDL-2016, AKONING
resonance absorption cross sections

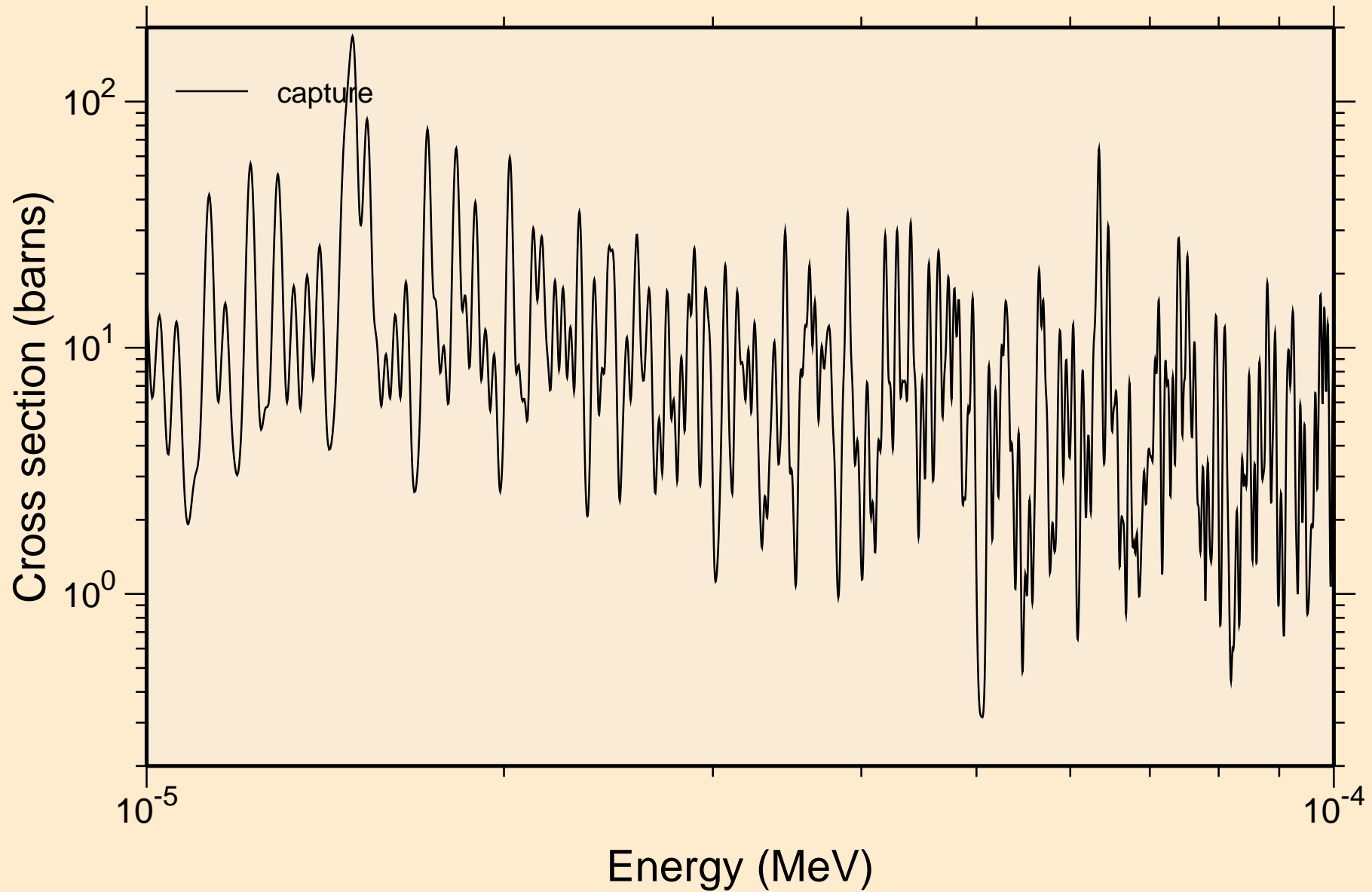

TL181 NRG TENDL-2016, AKONING
resonance absorption cross sections

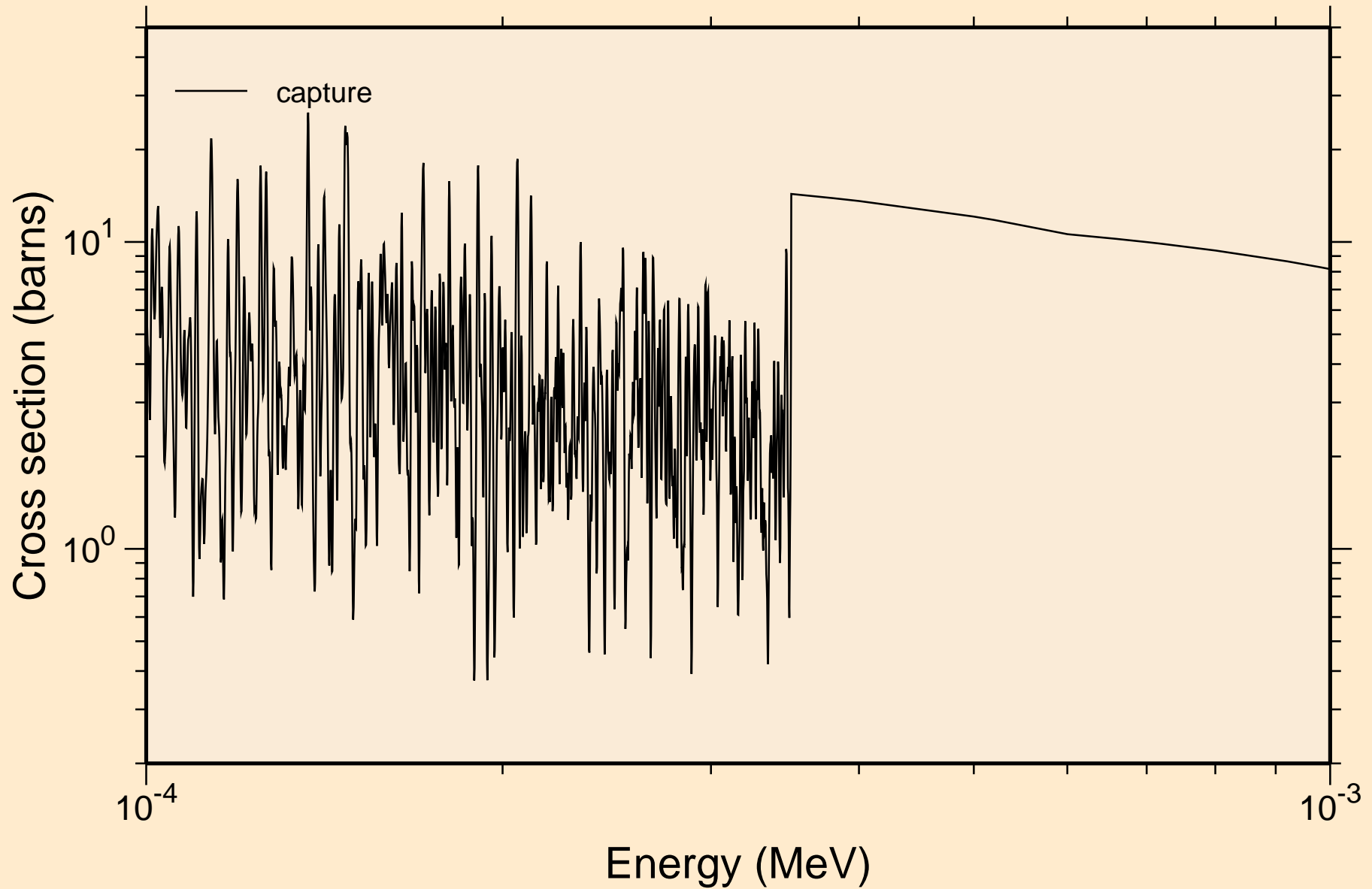

TL181 NRG TENDL-2016, AKONING
resonance absorption cross sections

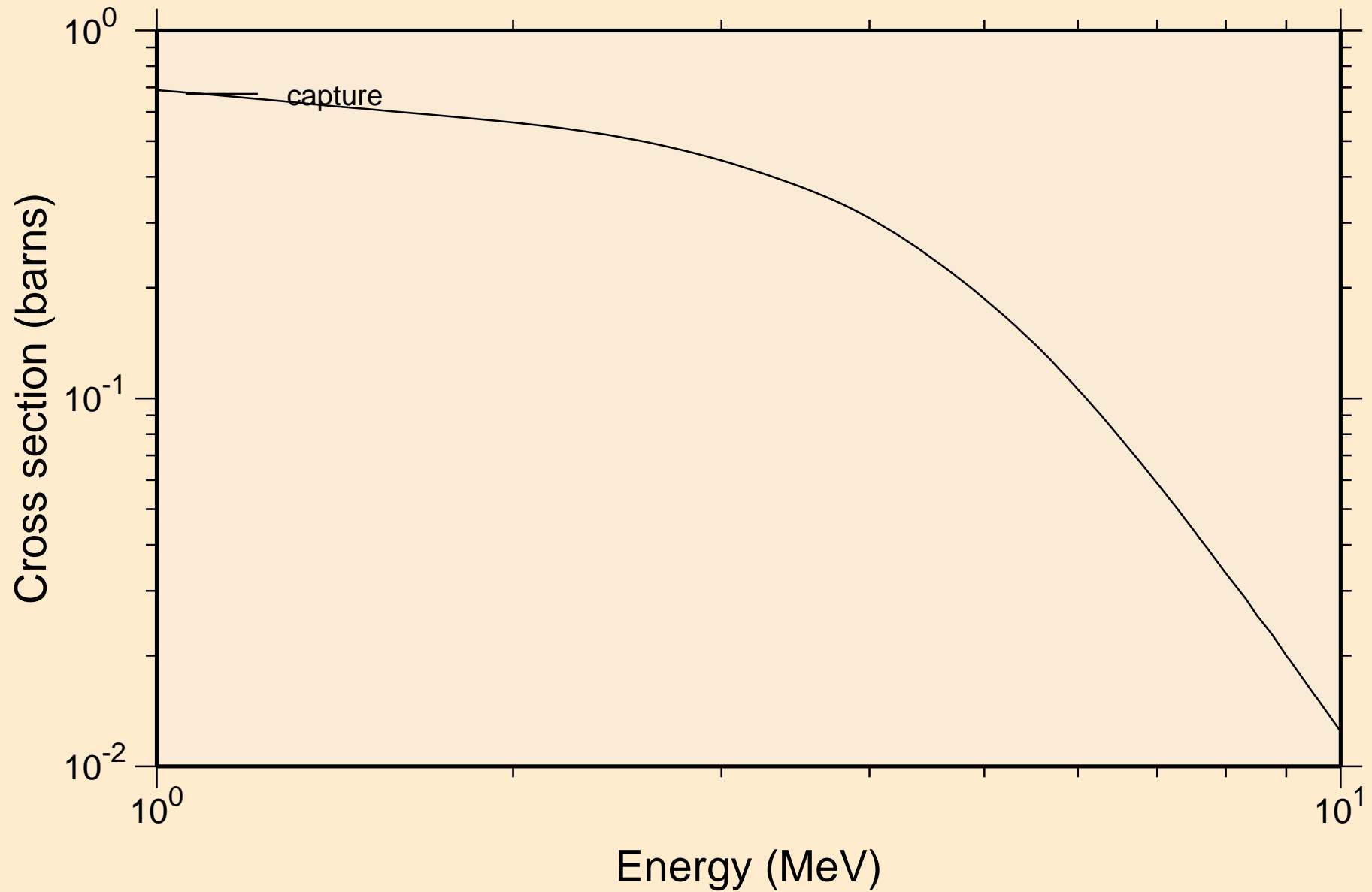

TL181 NRG TENDL-2016, AKONING
Non-threshold reactions

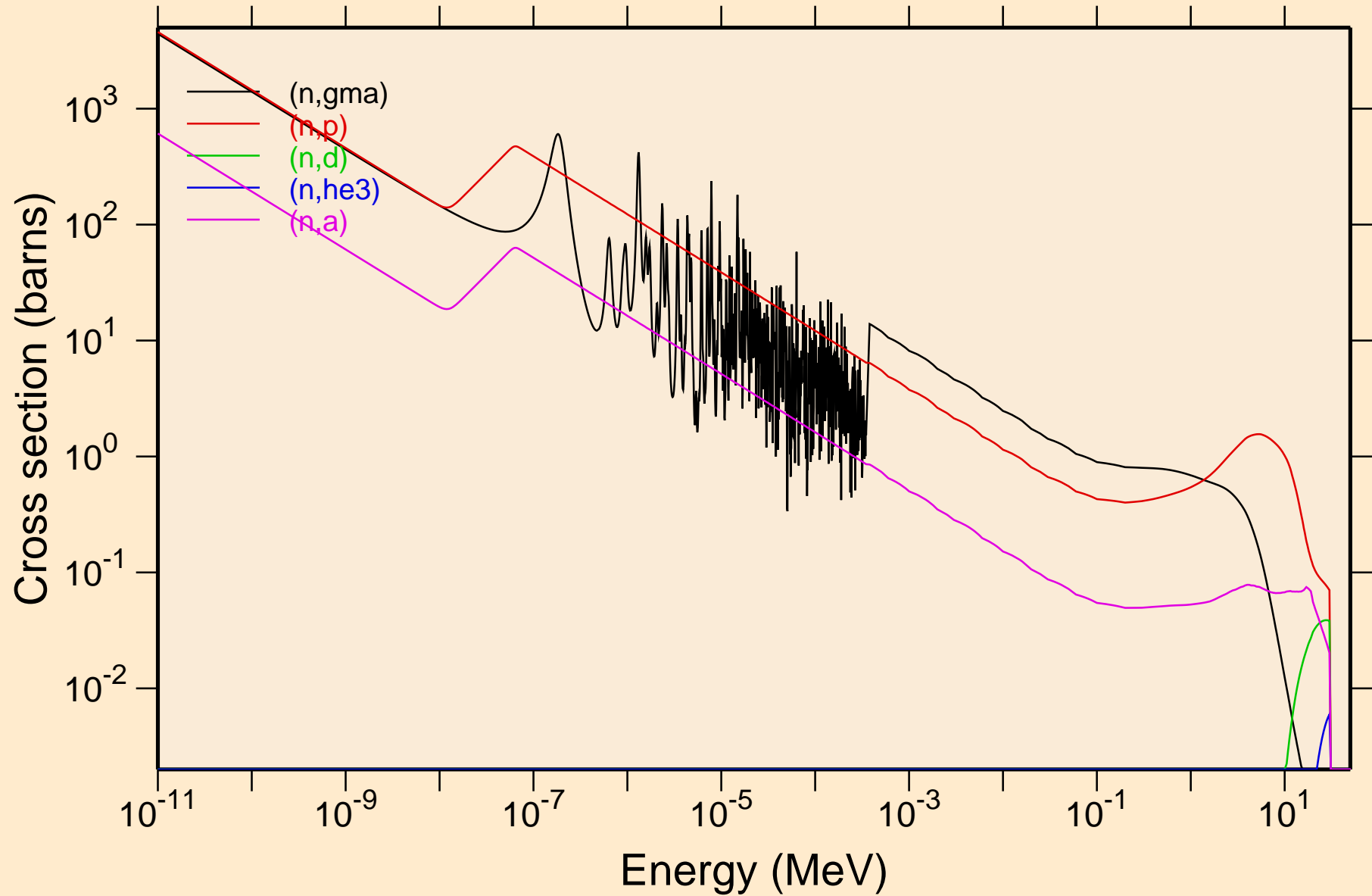

TL181 NRG TENDL-2016, AKONING

Non-threshold reactions

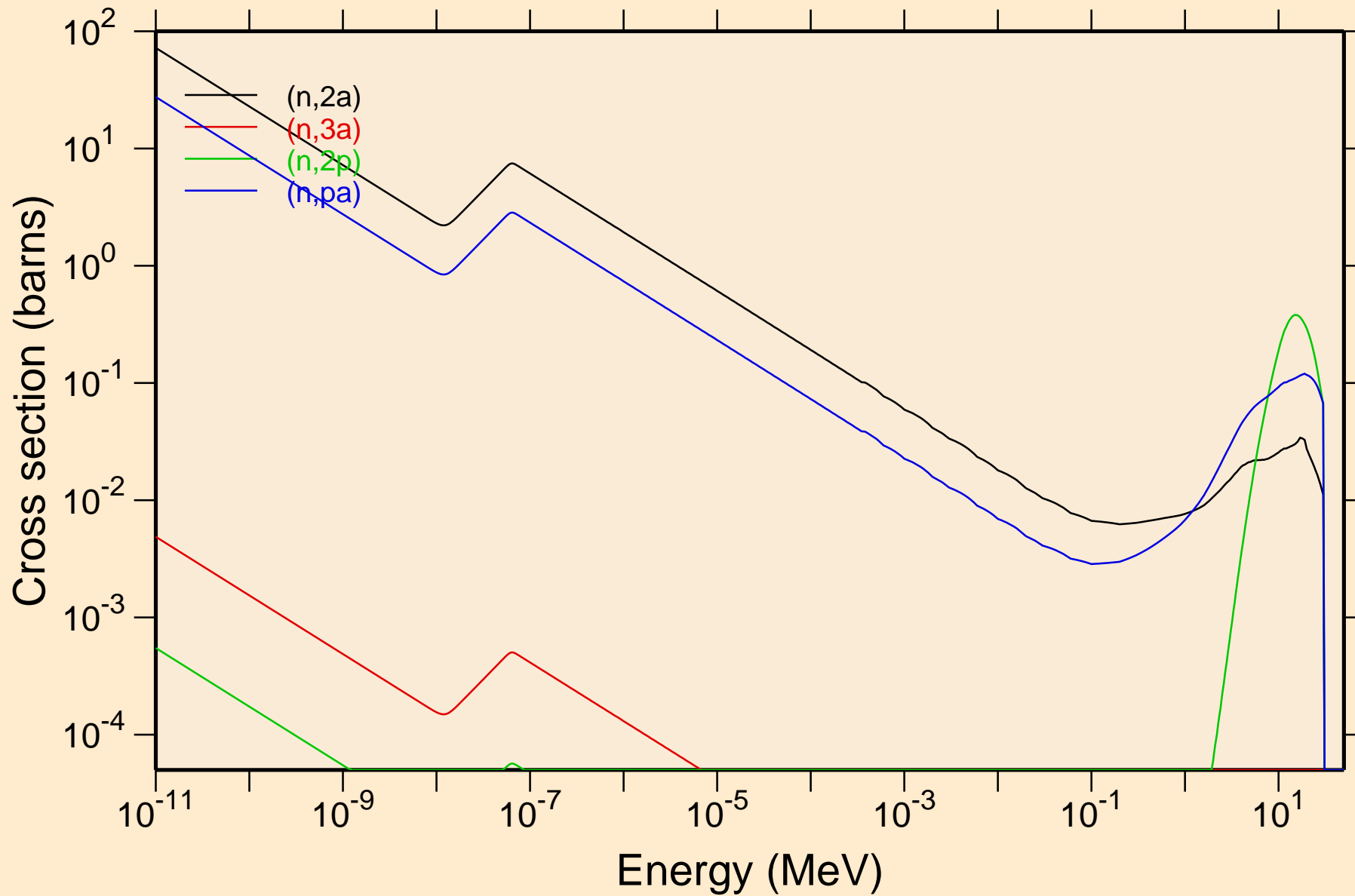

TL181 NRG TENDL-2016, AKONING

Principal cross sections

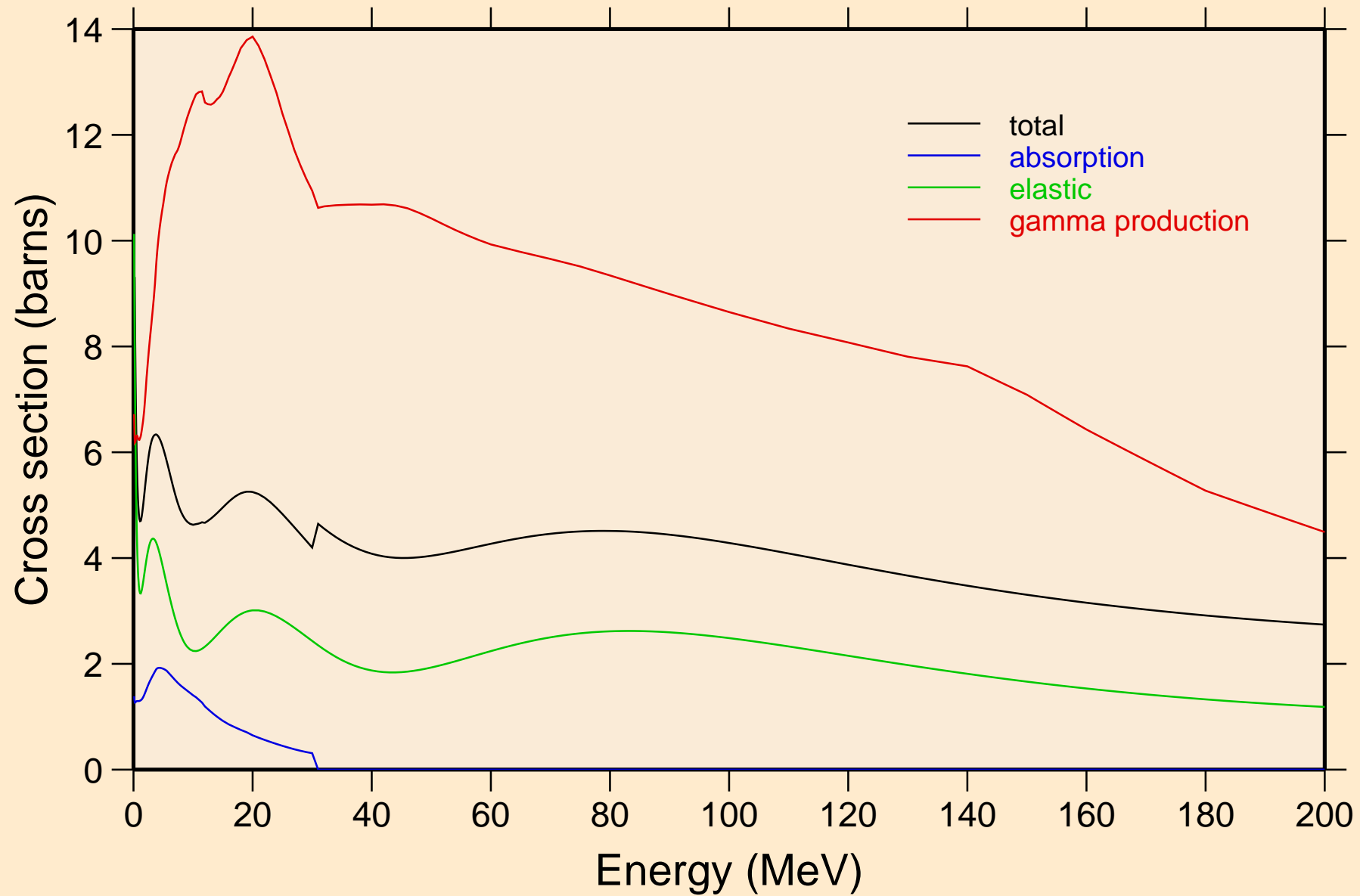

TL181 NRG TENDL-2016, AKONING
Non-threshold reactions

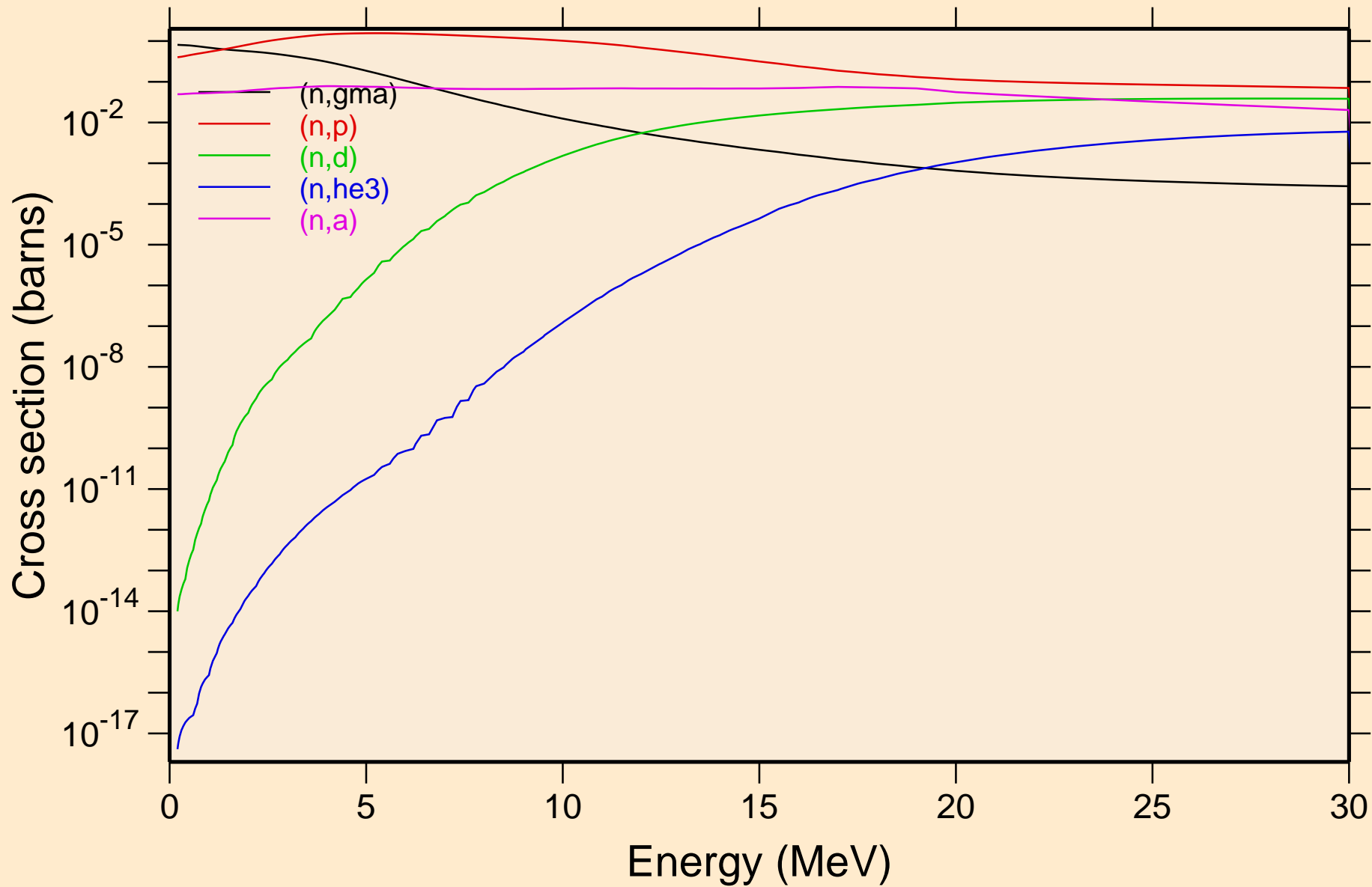

TL181 NRG TENDL-2016, AKONING
Non-threshold reactions

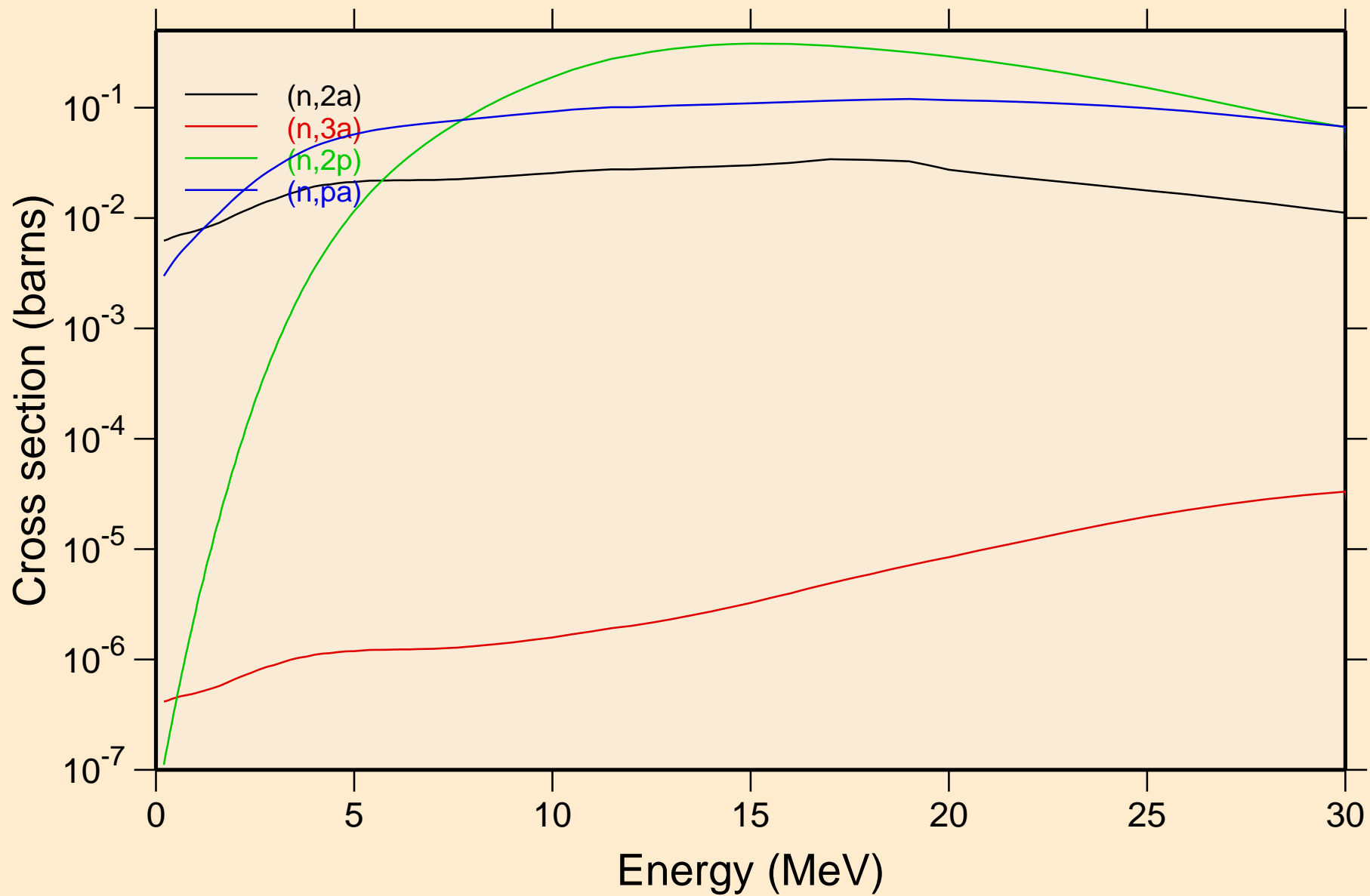

TL181 NRG TENDL-2016, AKONING

Inelastic levels

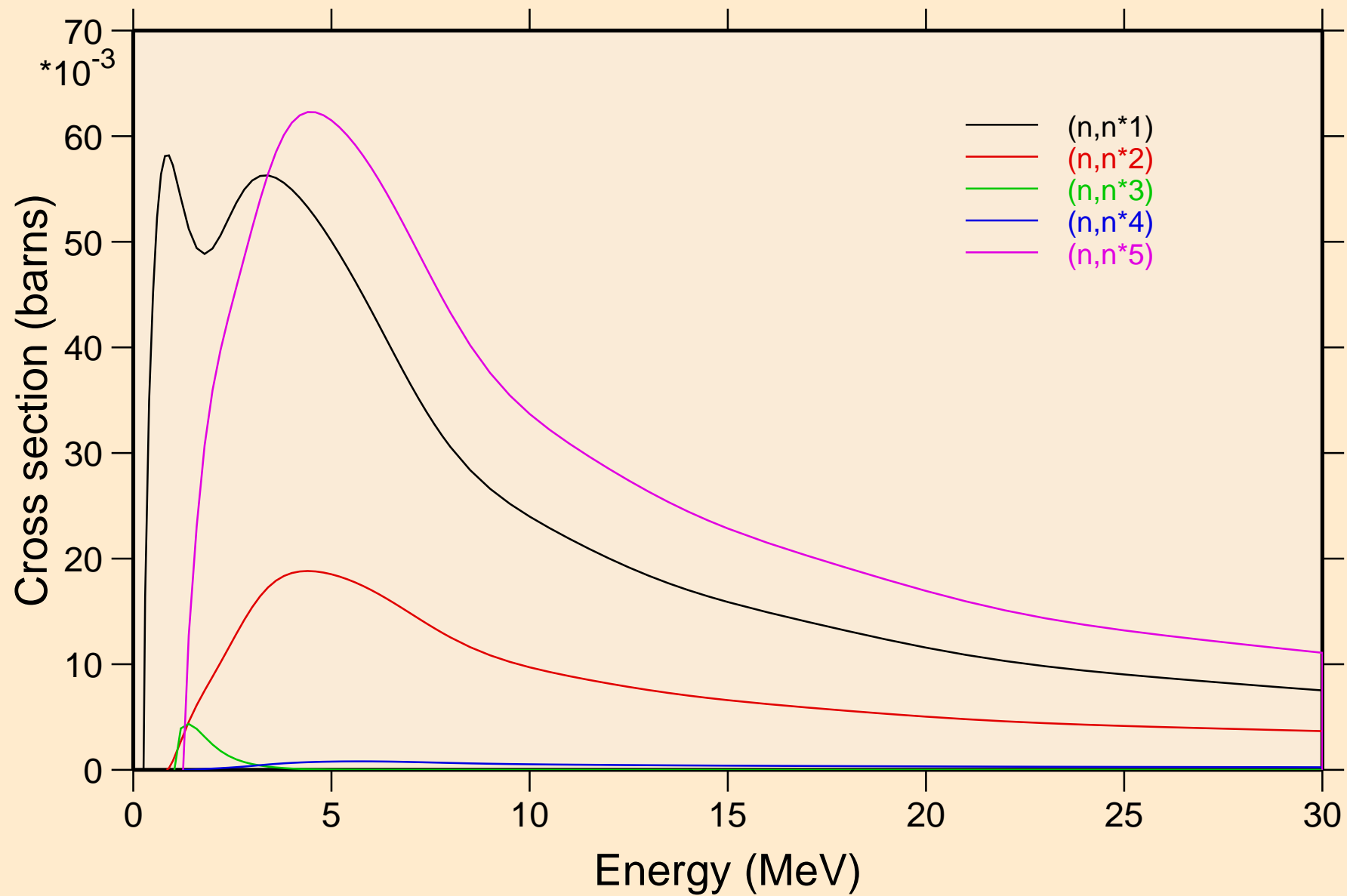

TL181 NRG TENDL-2016, AKONING

Threshold reactions

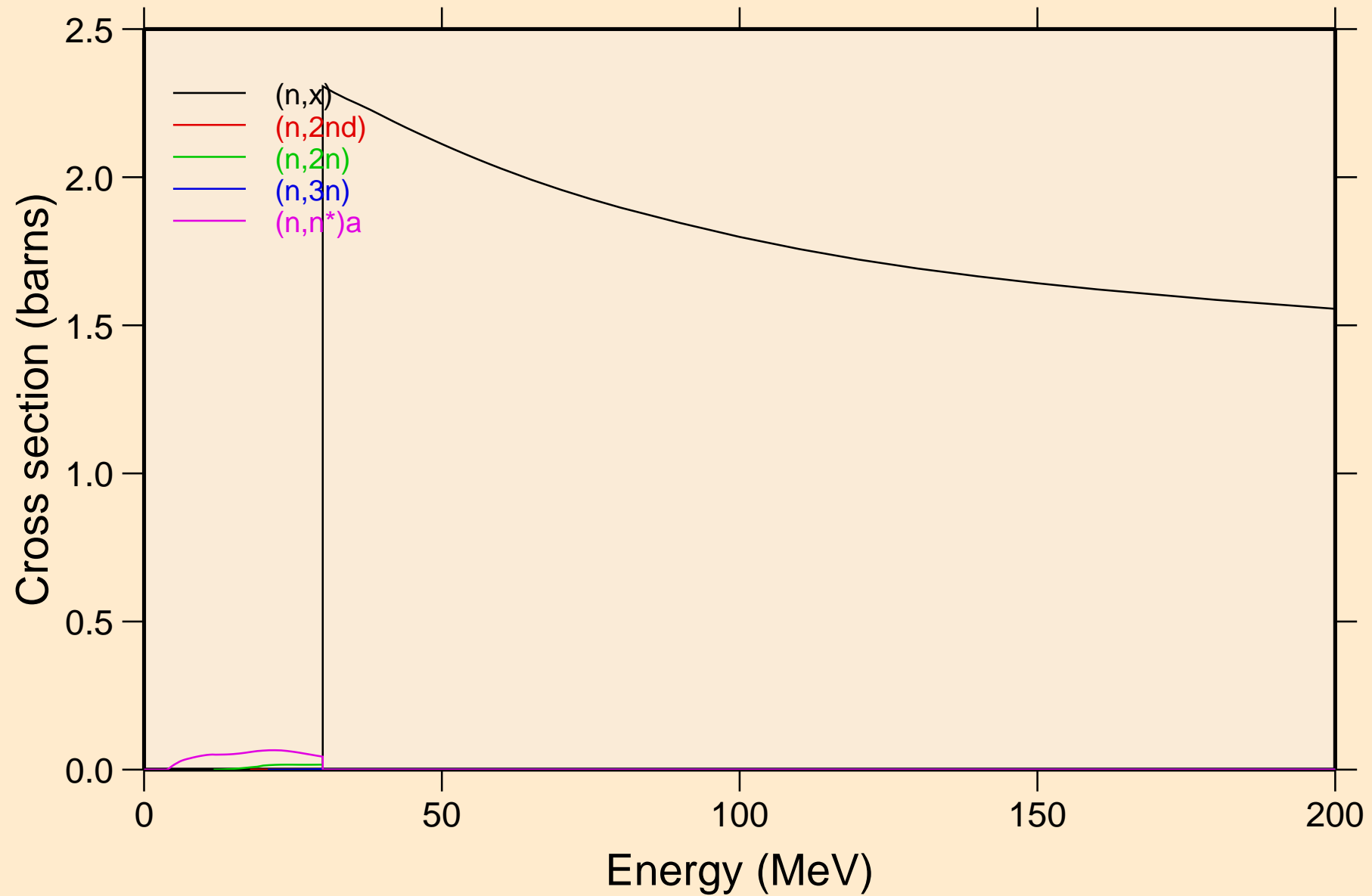

TL181 NRG TENDL-2016, AKONING

Threshold reactions

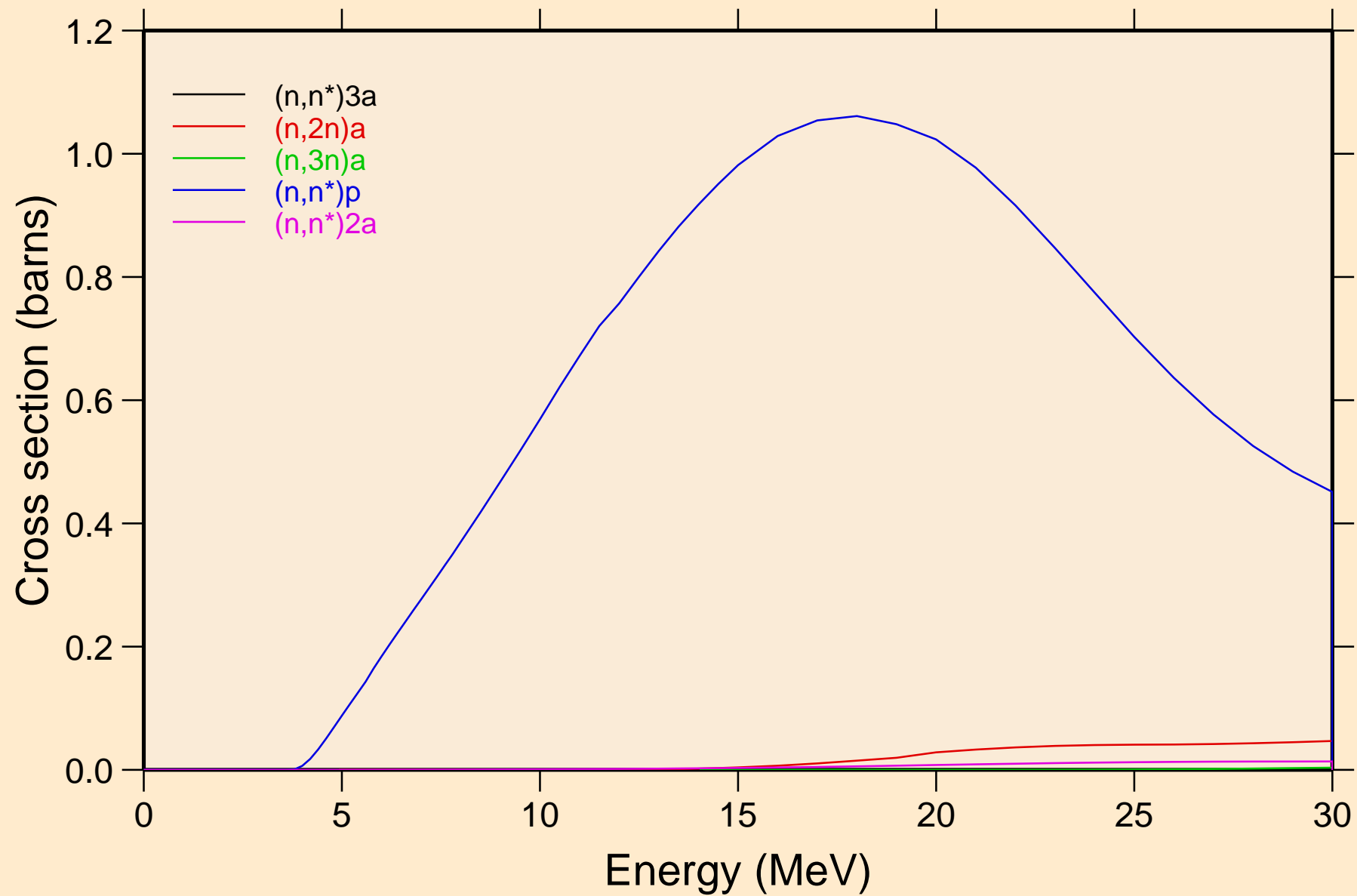

TL181 NRG TENDL-2016, AKONING

Threshold reactions

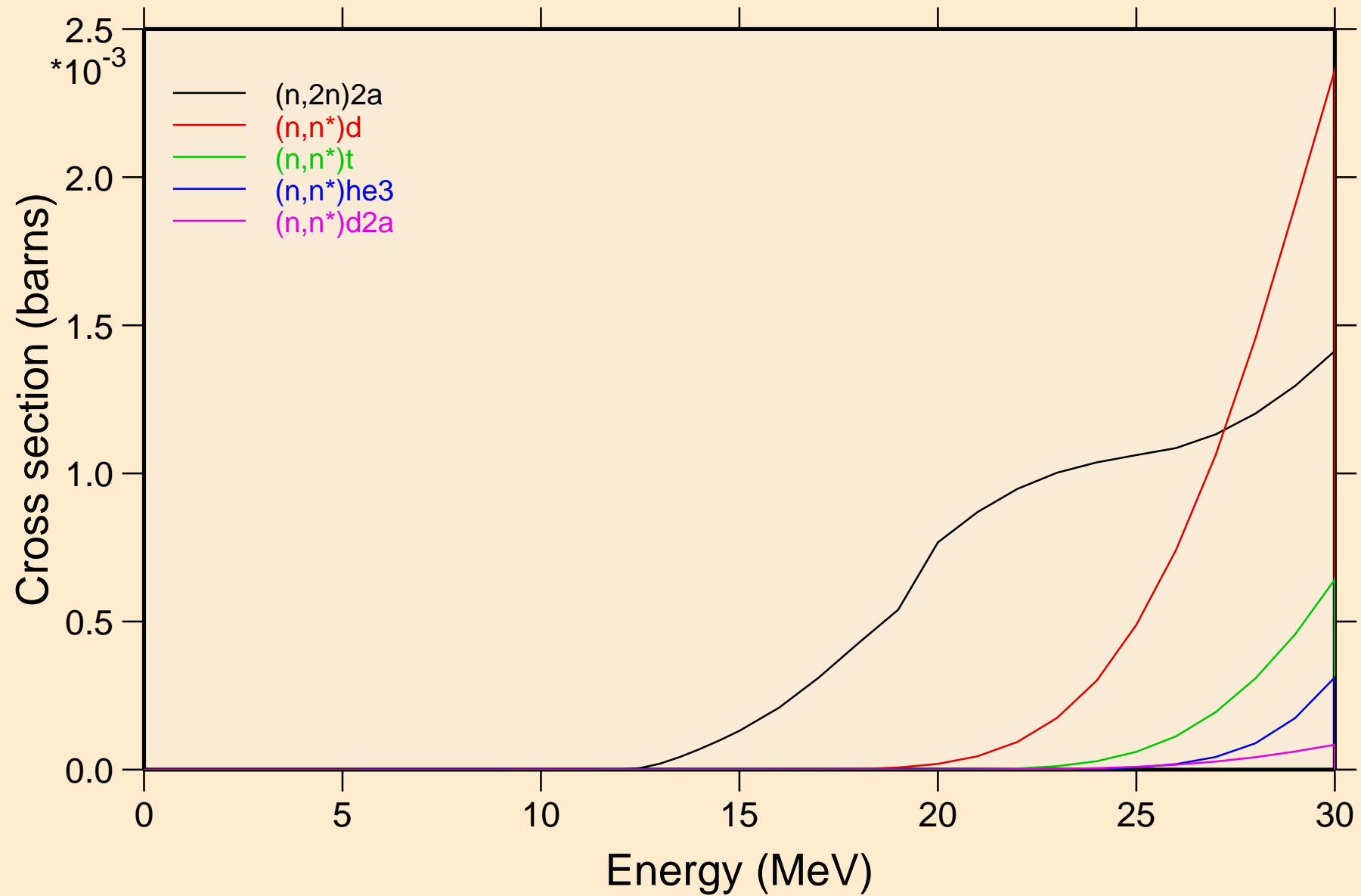

TL181 NRG TENDL-2016, AKONING

Threshold reactions

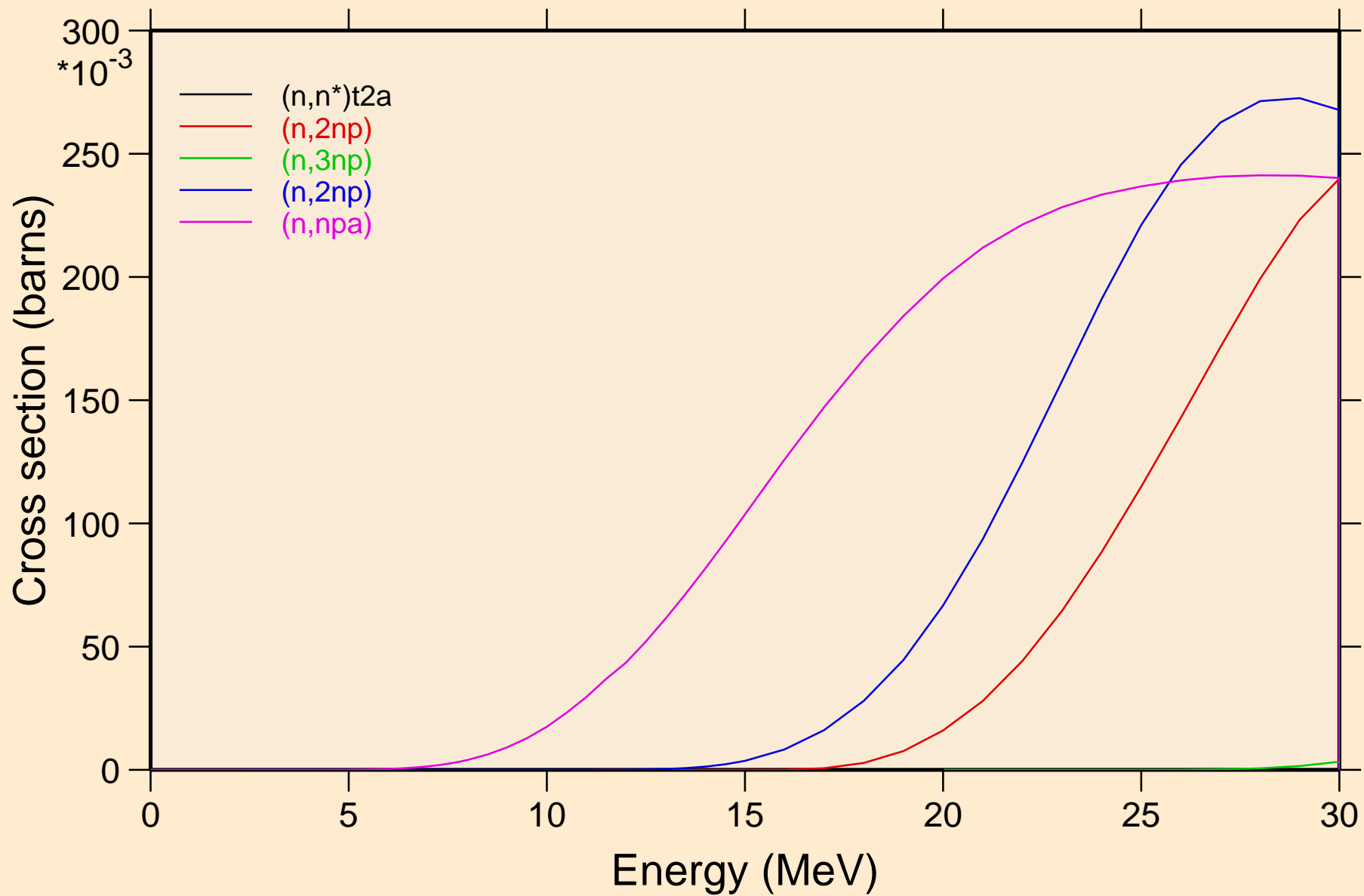

TL181 NRG TENDL-2016, AKONING

Threshold reactions

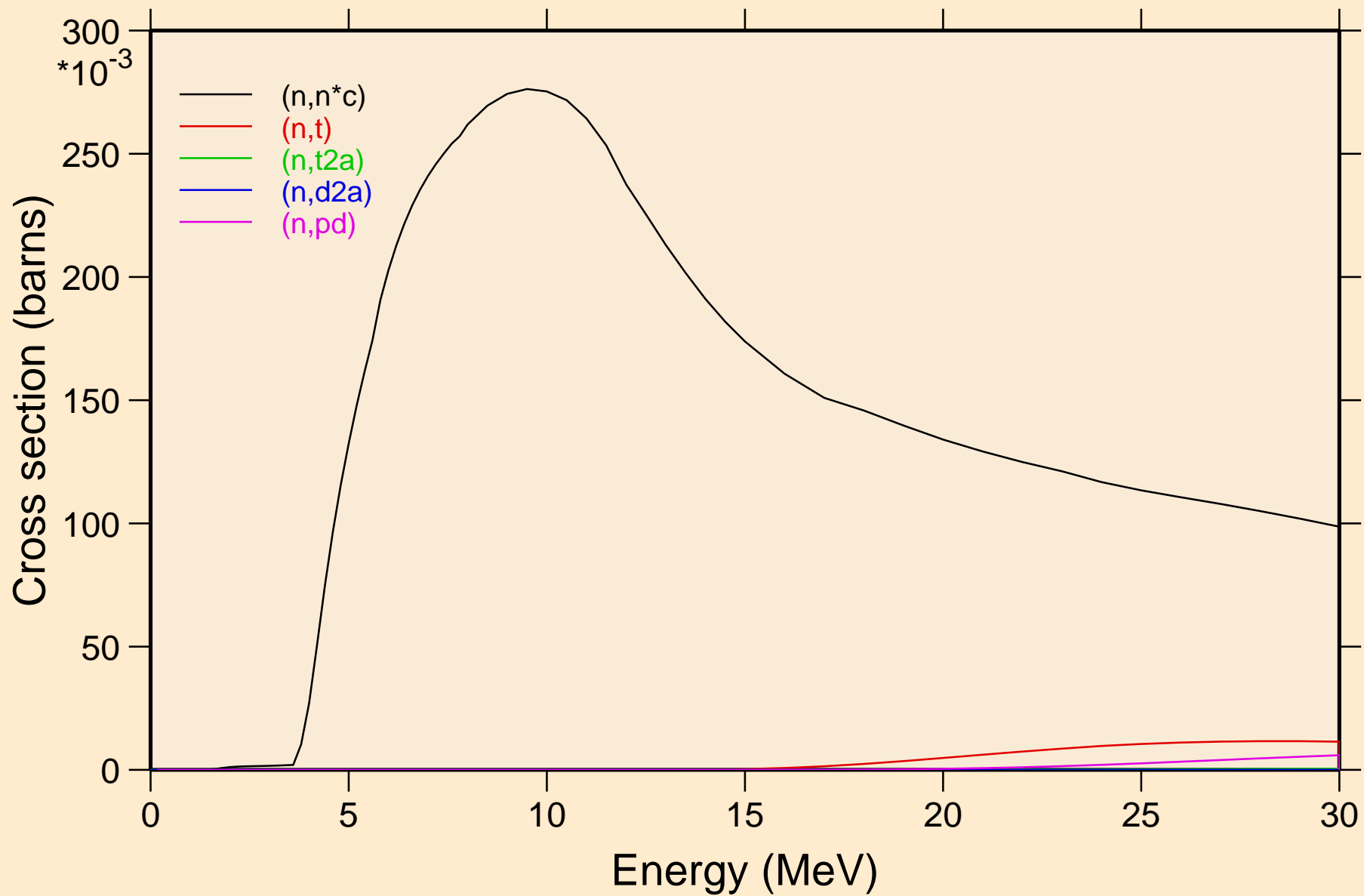

TL181 NRG TENDL-2016, AKONING
Threshold reactions

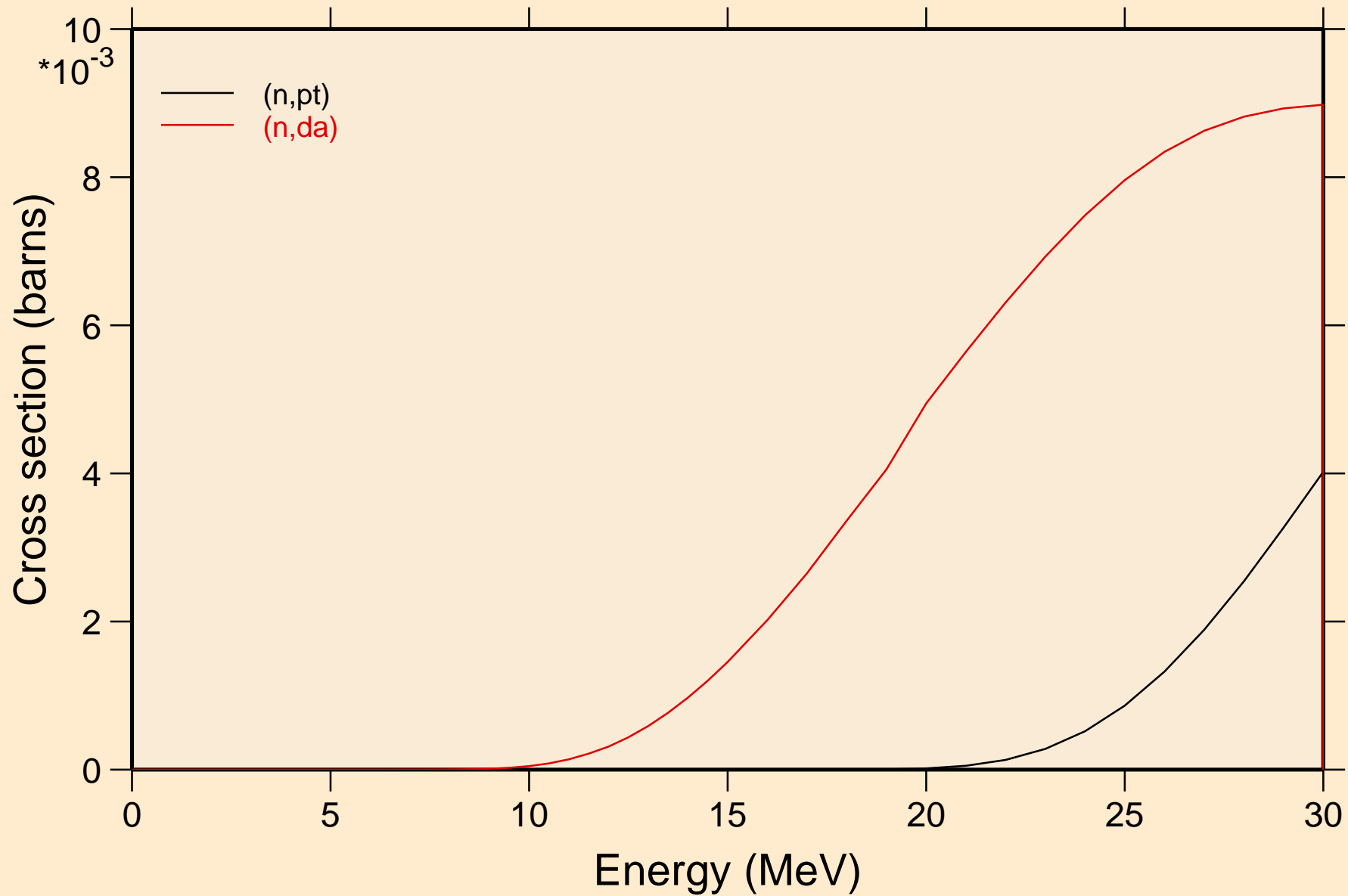

TL181 NRG TENDL-2016, AKONING
angular distribution for elastic

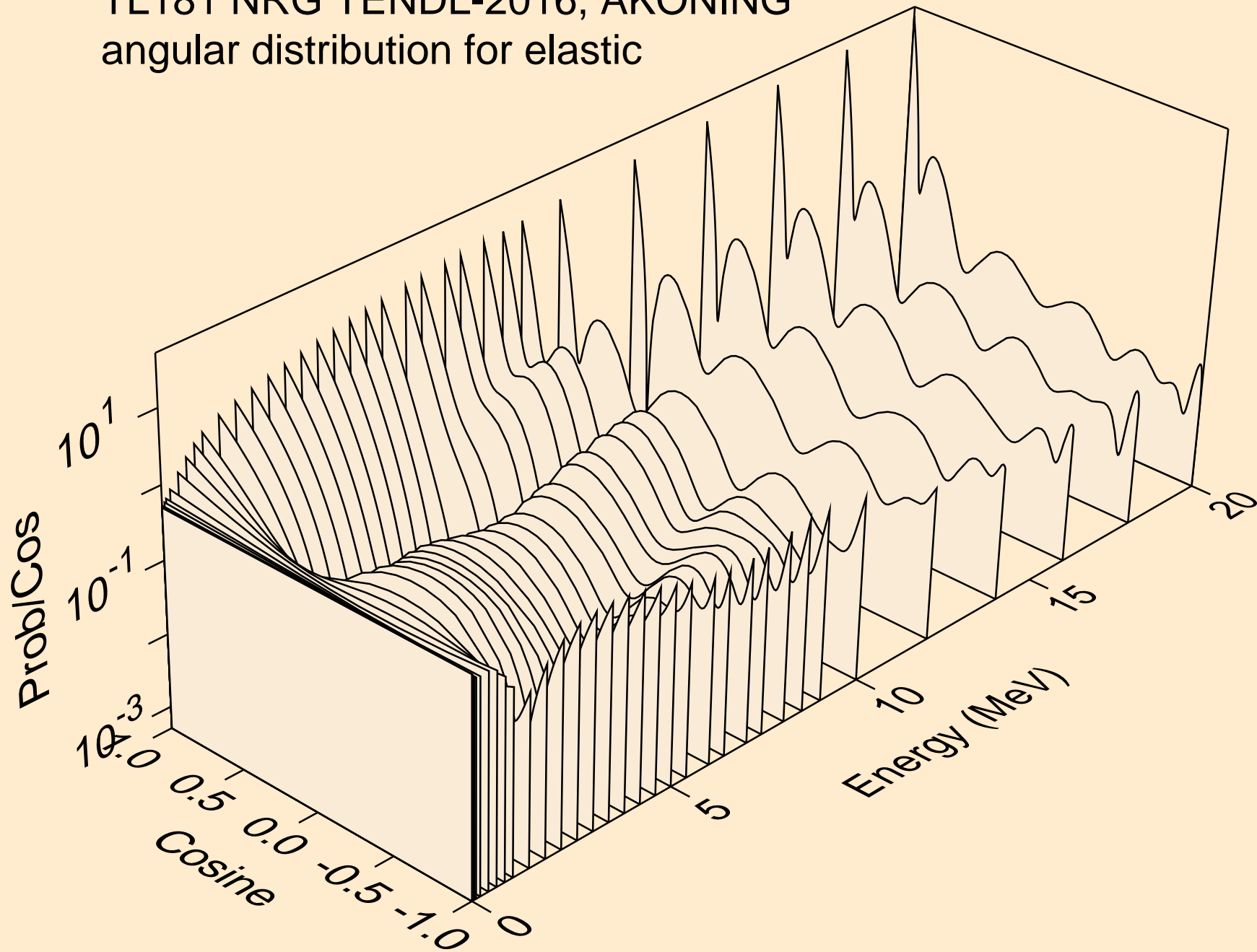

TL181 NRG TENDL-2016, AKONING
angular distribution for elastic

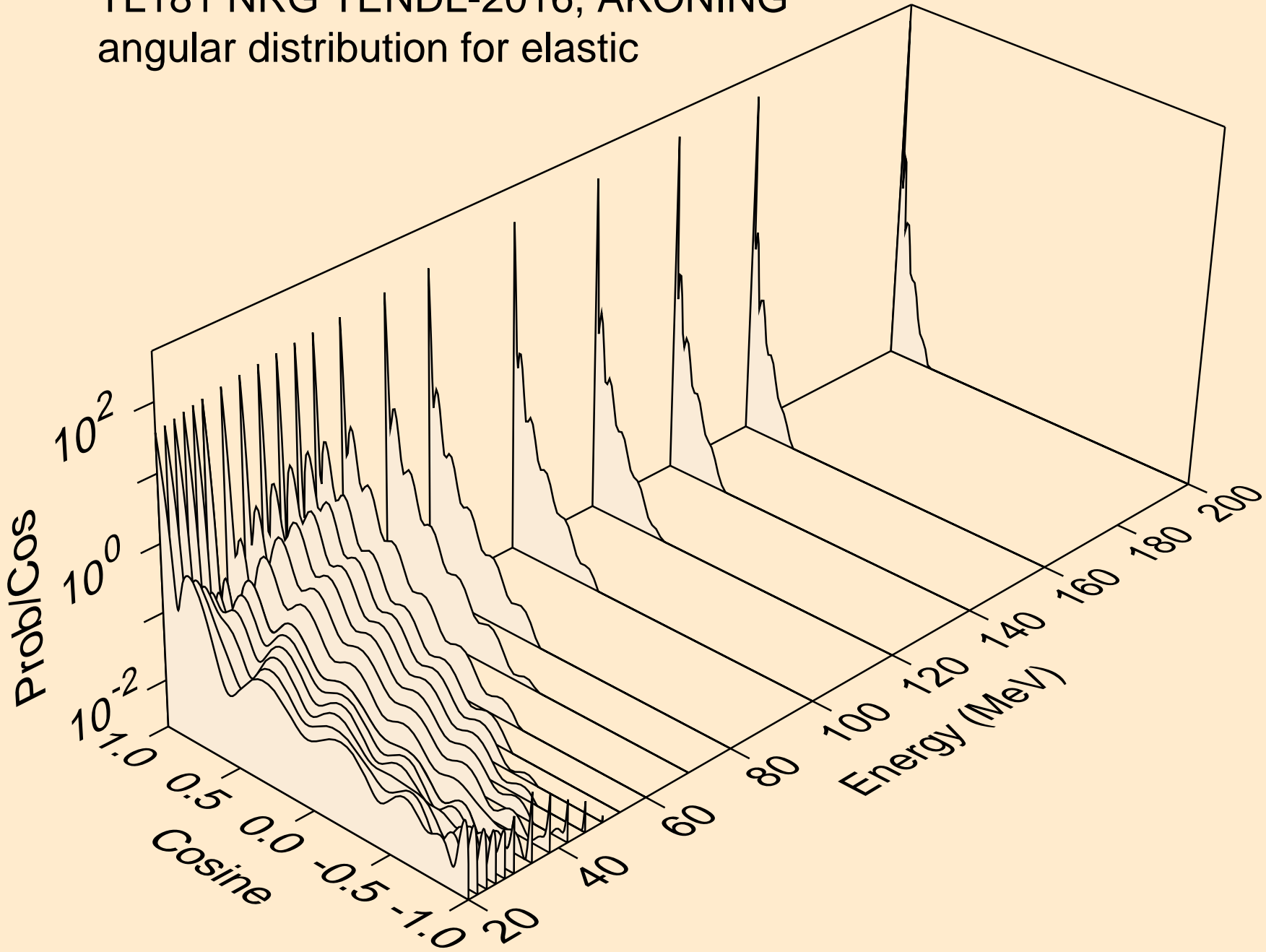

TL181 NRG TENDL-2016, AKONING
angular distribution for (n,n*1)

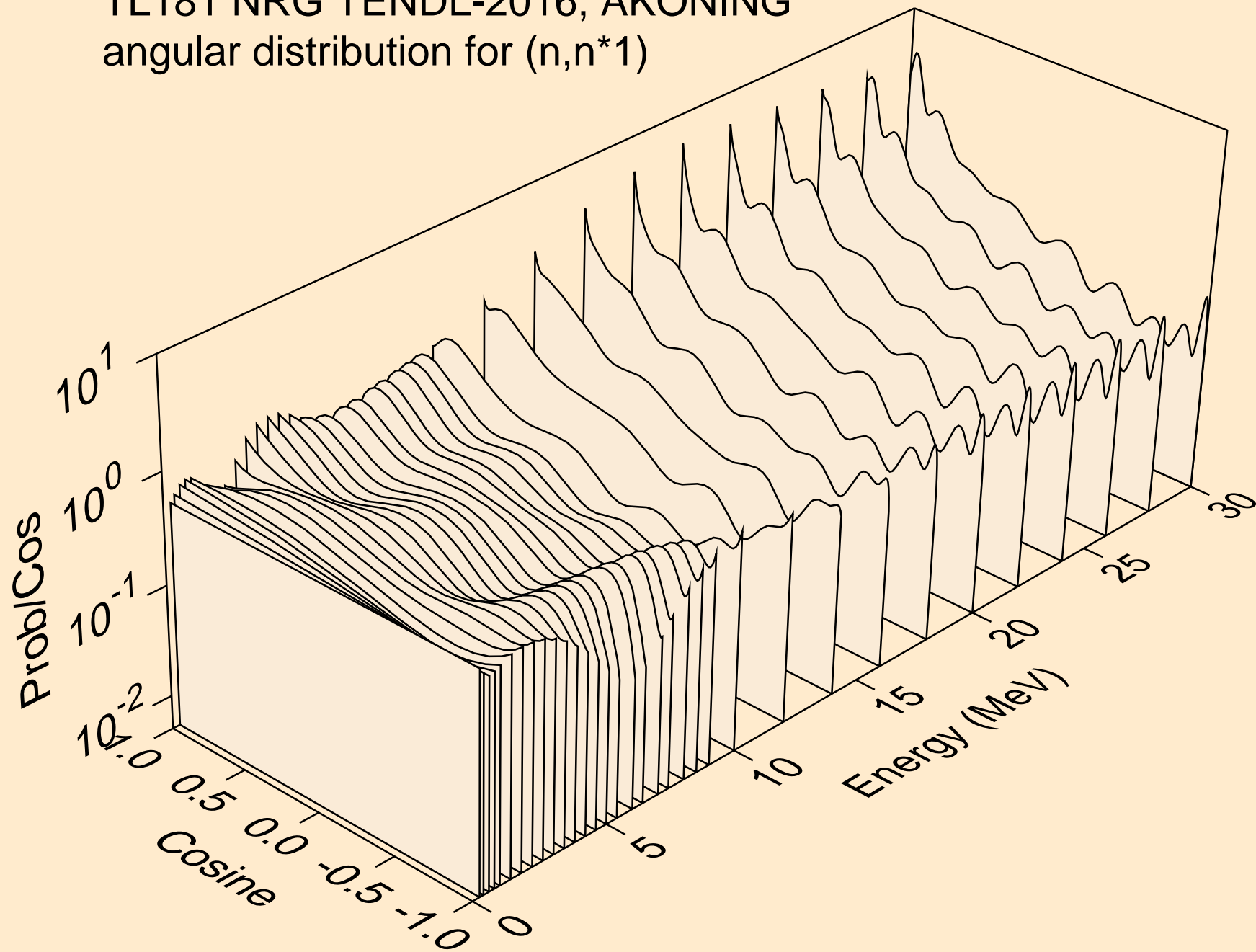

TL181 NRG TENDL-2016, AKONING
angular distribution for (n,n*2)

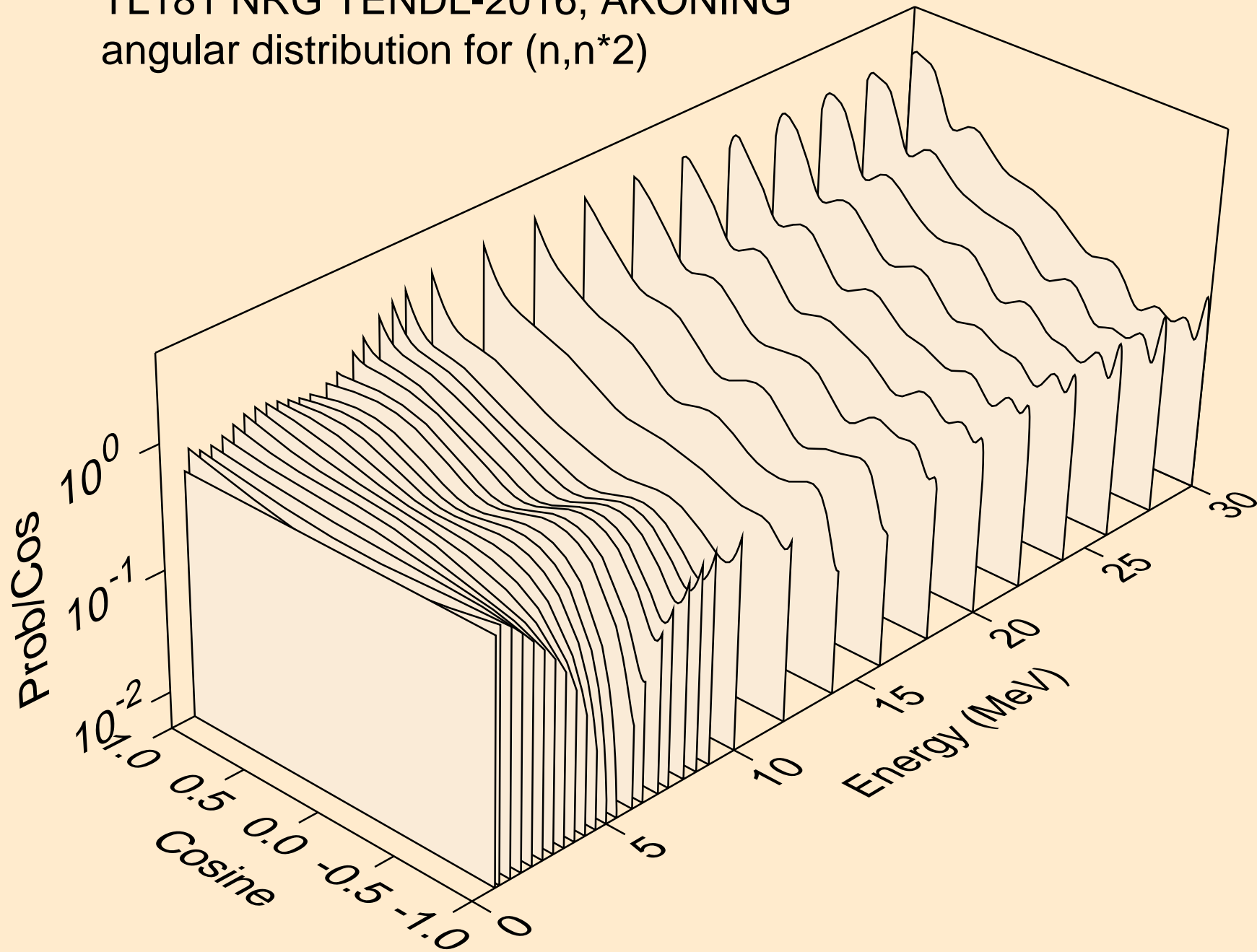

TL181 NRG TENDL-2016, AKONING
angular distribution for (n,n*3)

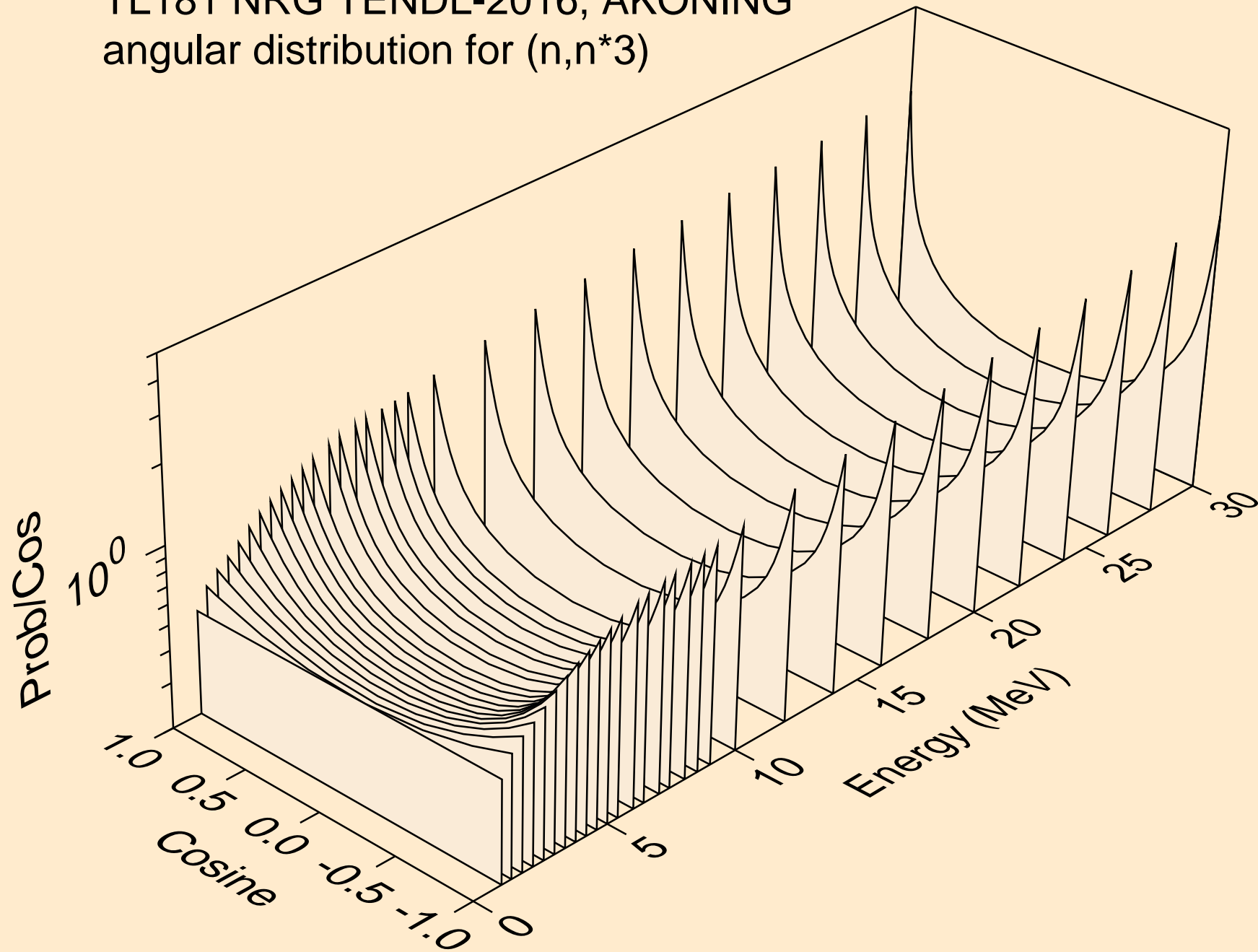

TL181 NRG TENDL-2016, AKONING
angular distribution for (n,n*4)

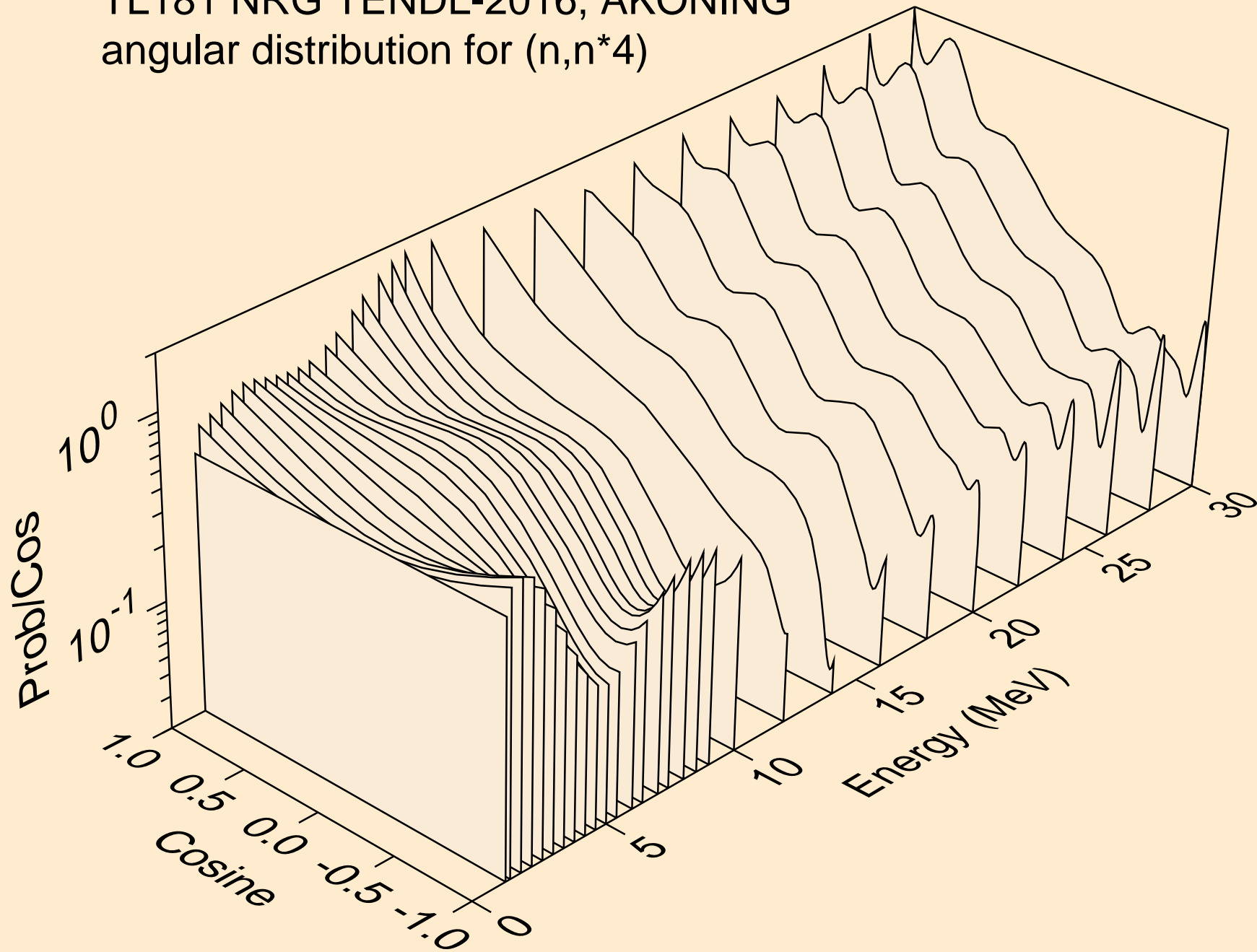

TL181 NRG TENDL-2016, AKONING
angular distribution for (n,n*5)

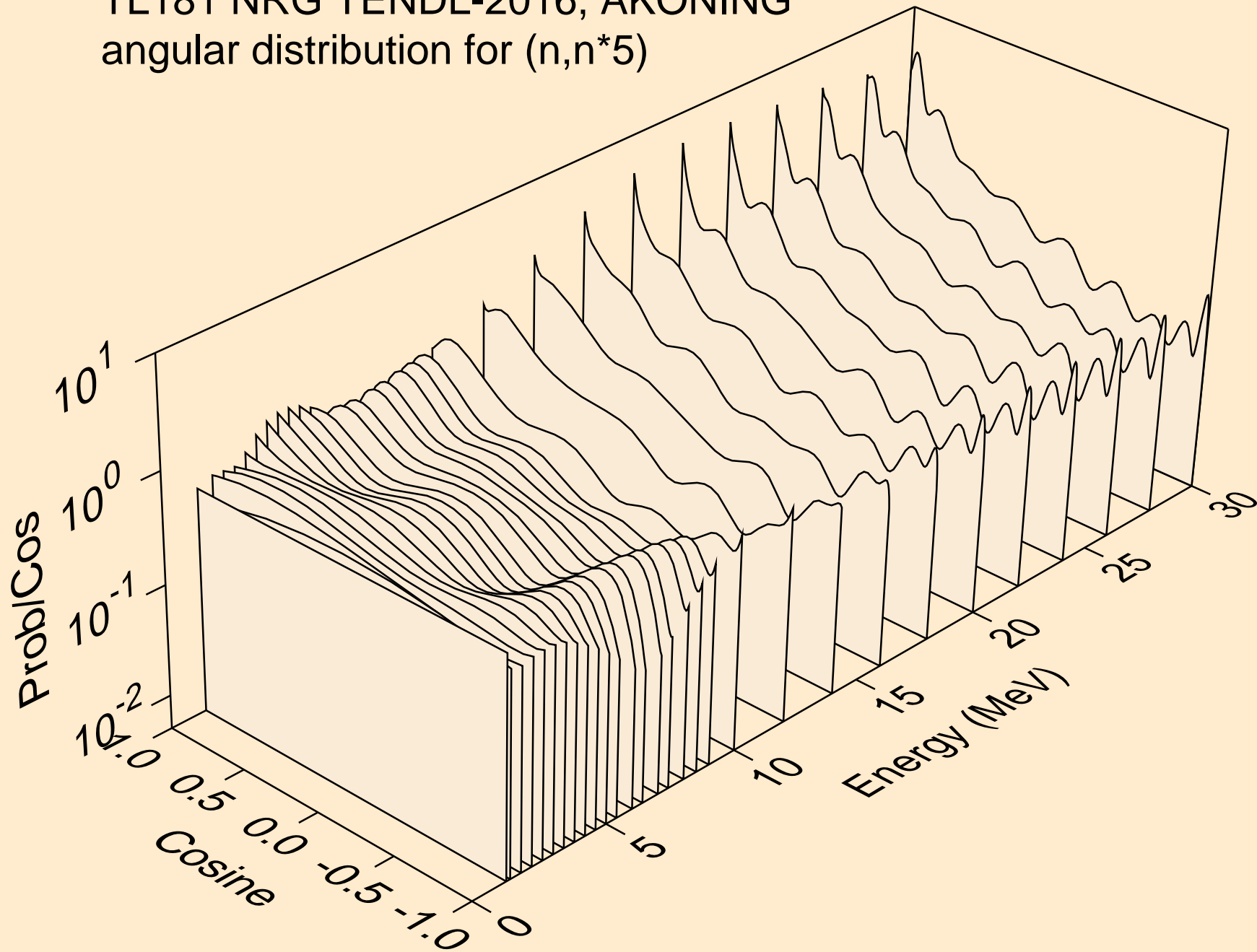

TL181 NRG TENDL-2016, AKONING
Neutron emission for (n,x)

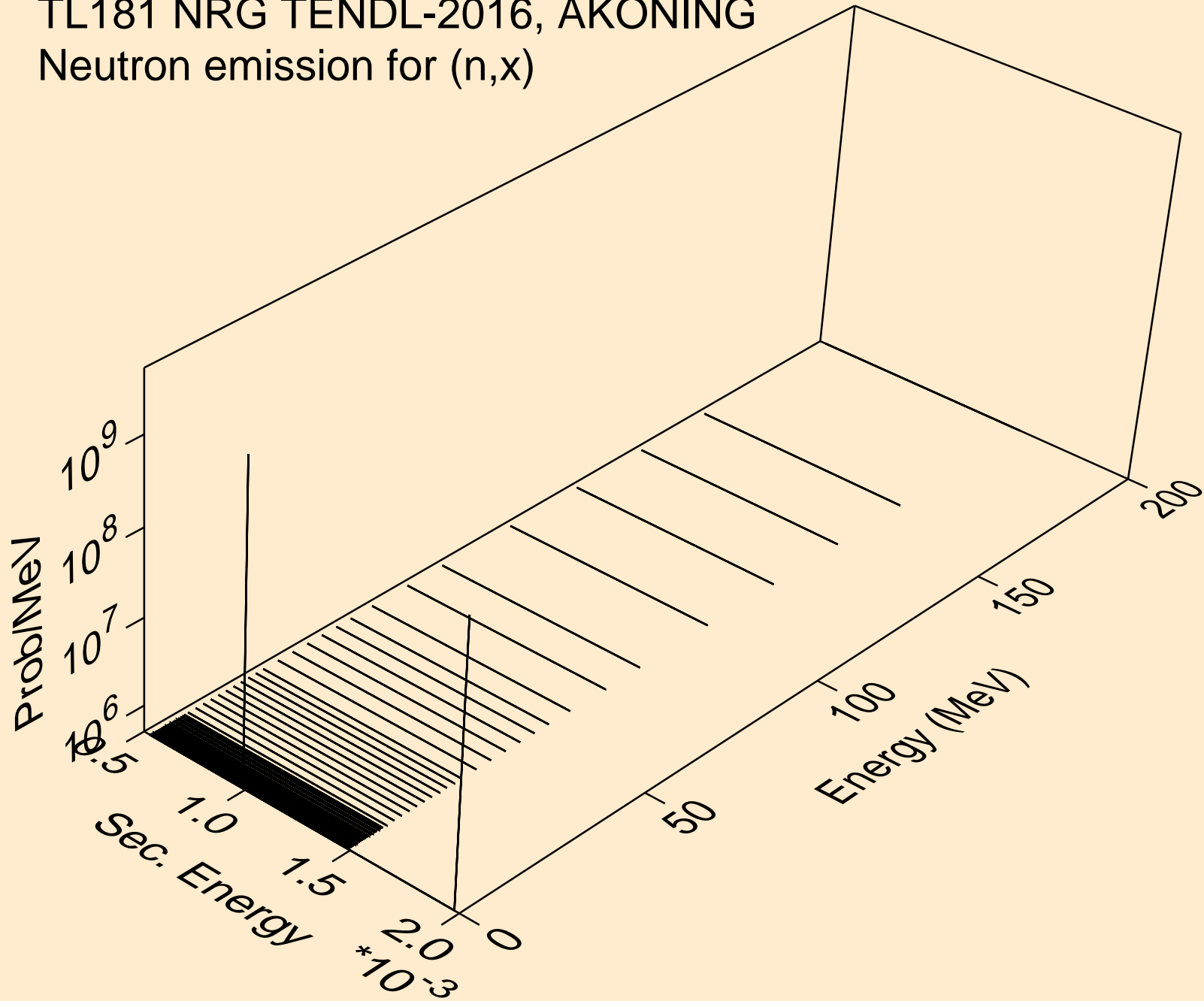

TL181 NRG TENDL-2016, AKONING
Neutron emission for (n,2nd)

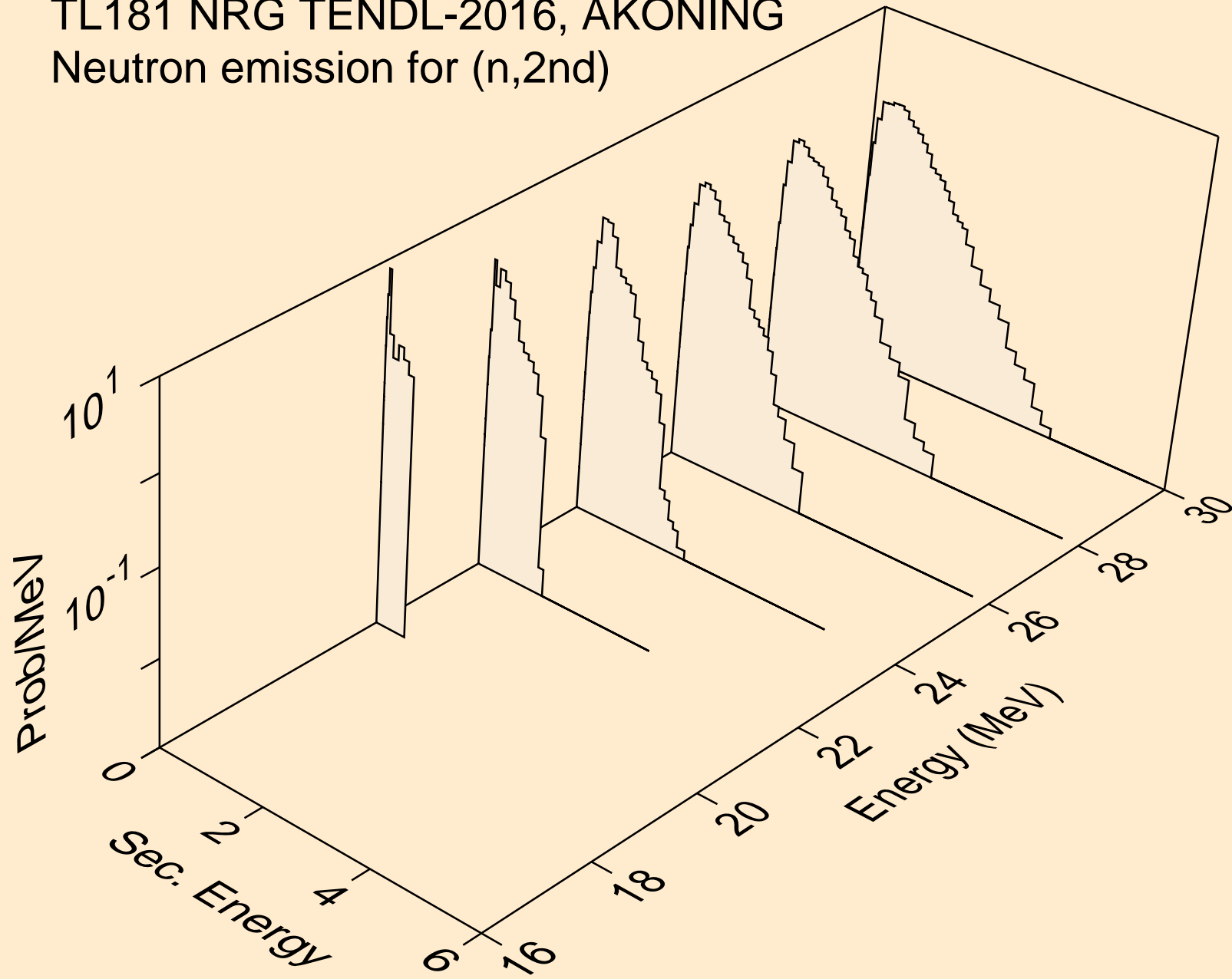

TL181 NRG TENDL-2016, AKONING
Neutron emission for (n,2n)

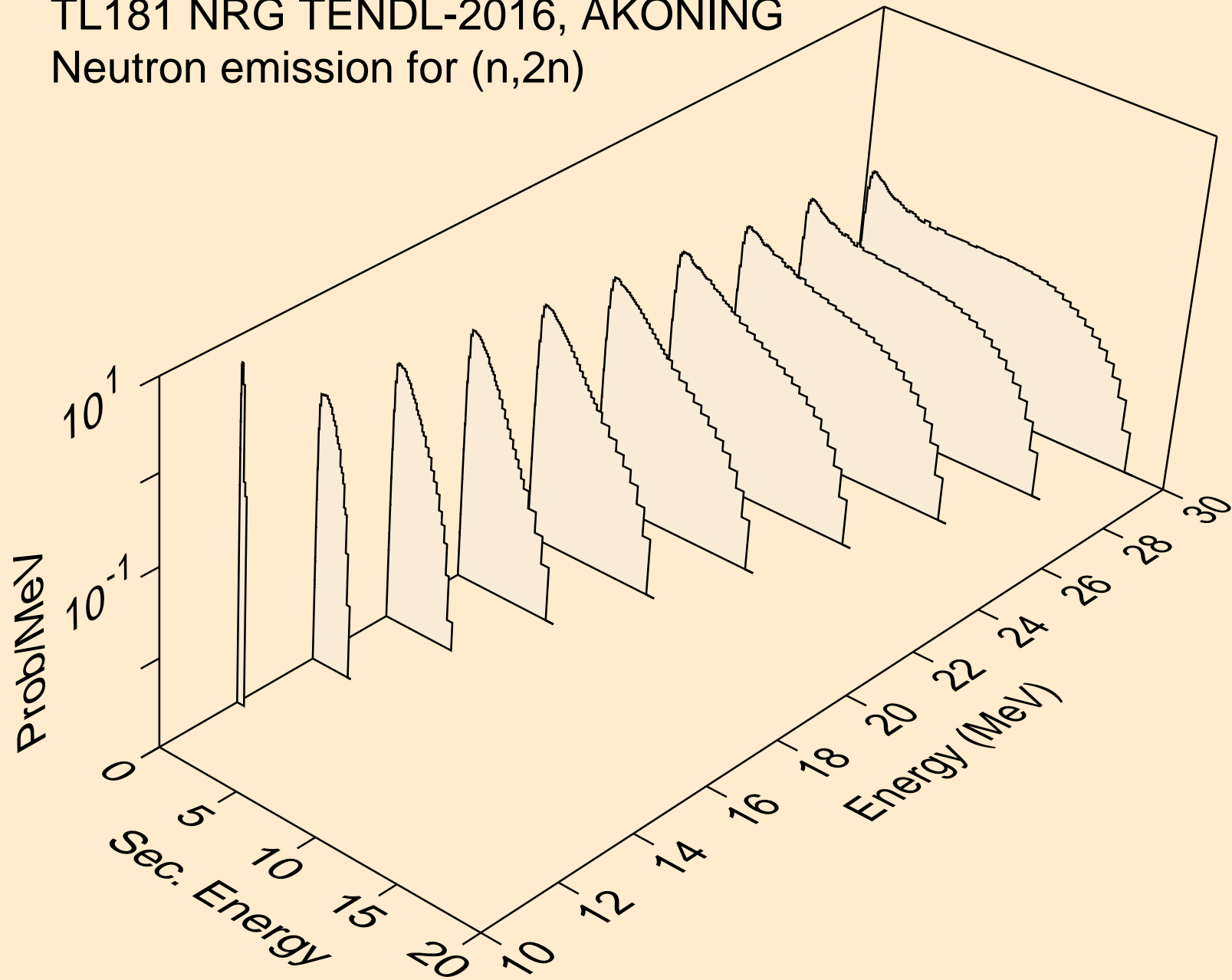

TL181 NRG TENDL-2016, AKONING
Neutron emission for (n,3n)

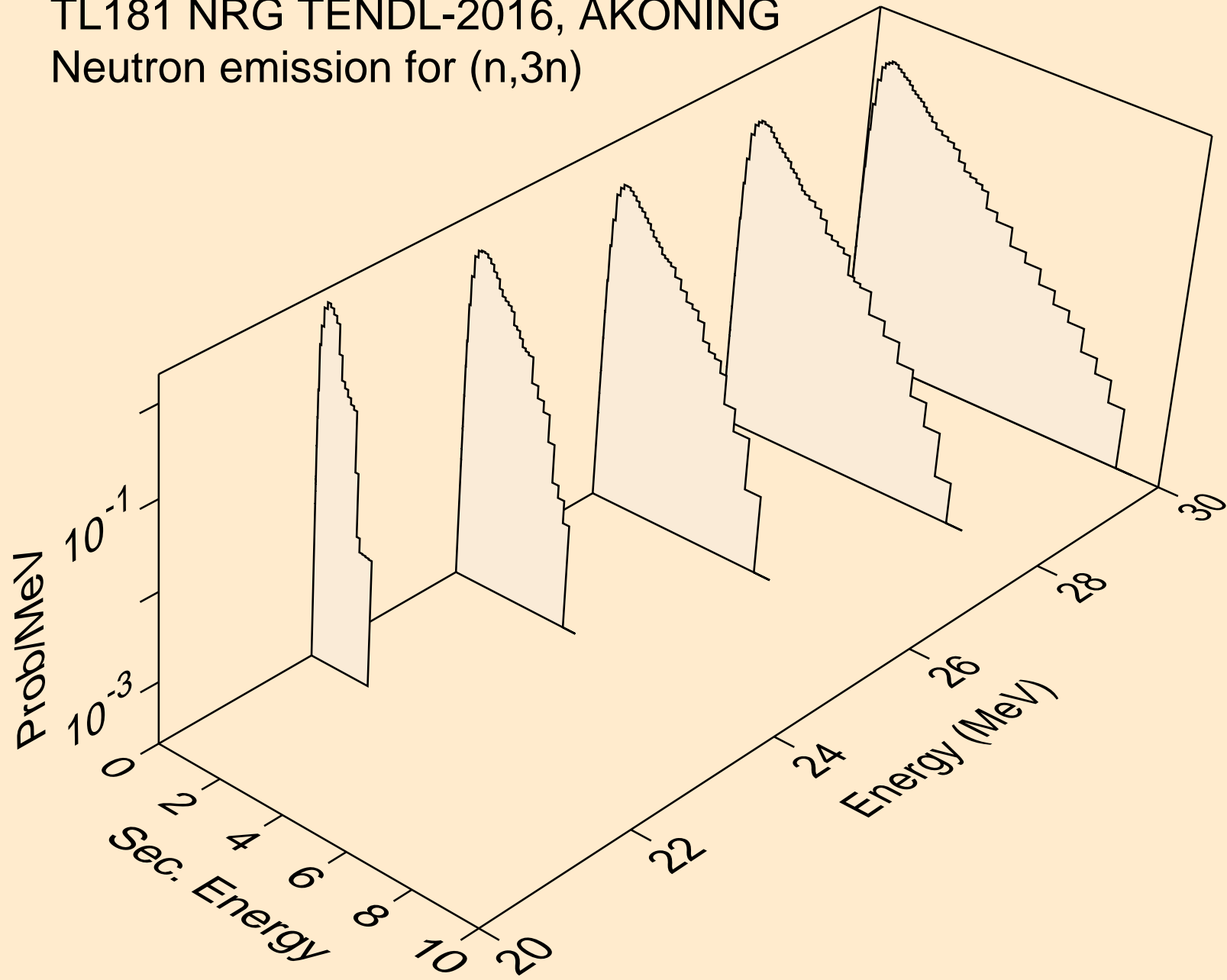

TL181 NRG TENDL-2016, AKONING
Neutron emission for (n,n*)a

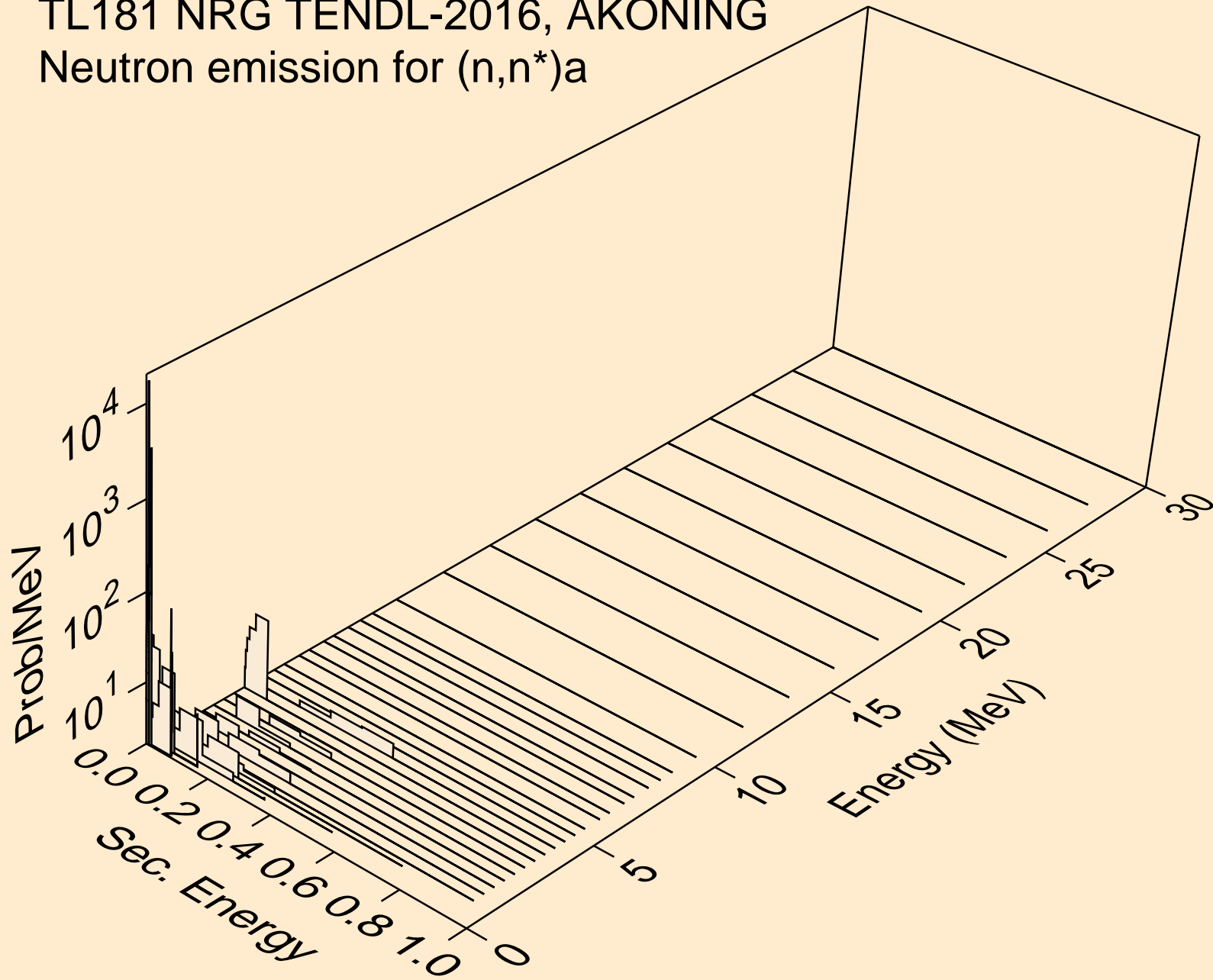

TL181 NRG TENDL-2016, AKONING
Neutron emission for (n,n*)3a

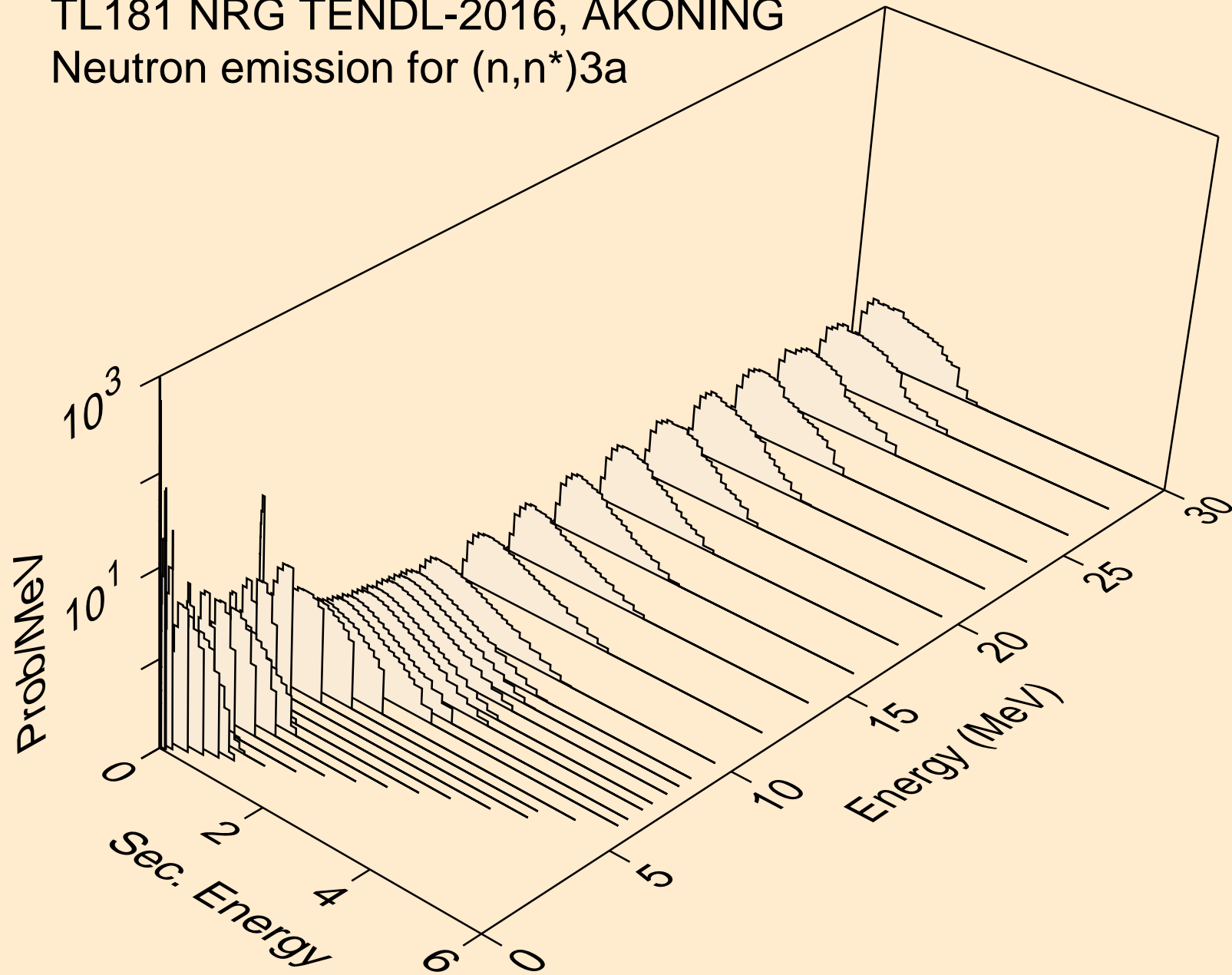

TL181 NRG TENDL-2016, AKONING
Neutron emission for (n,2n)_a

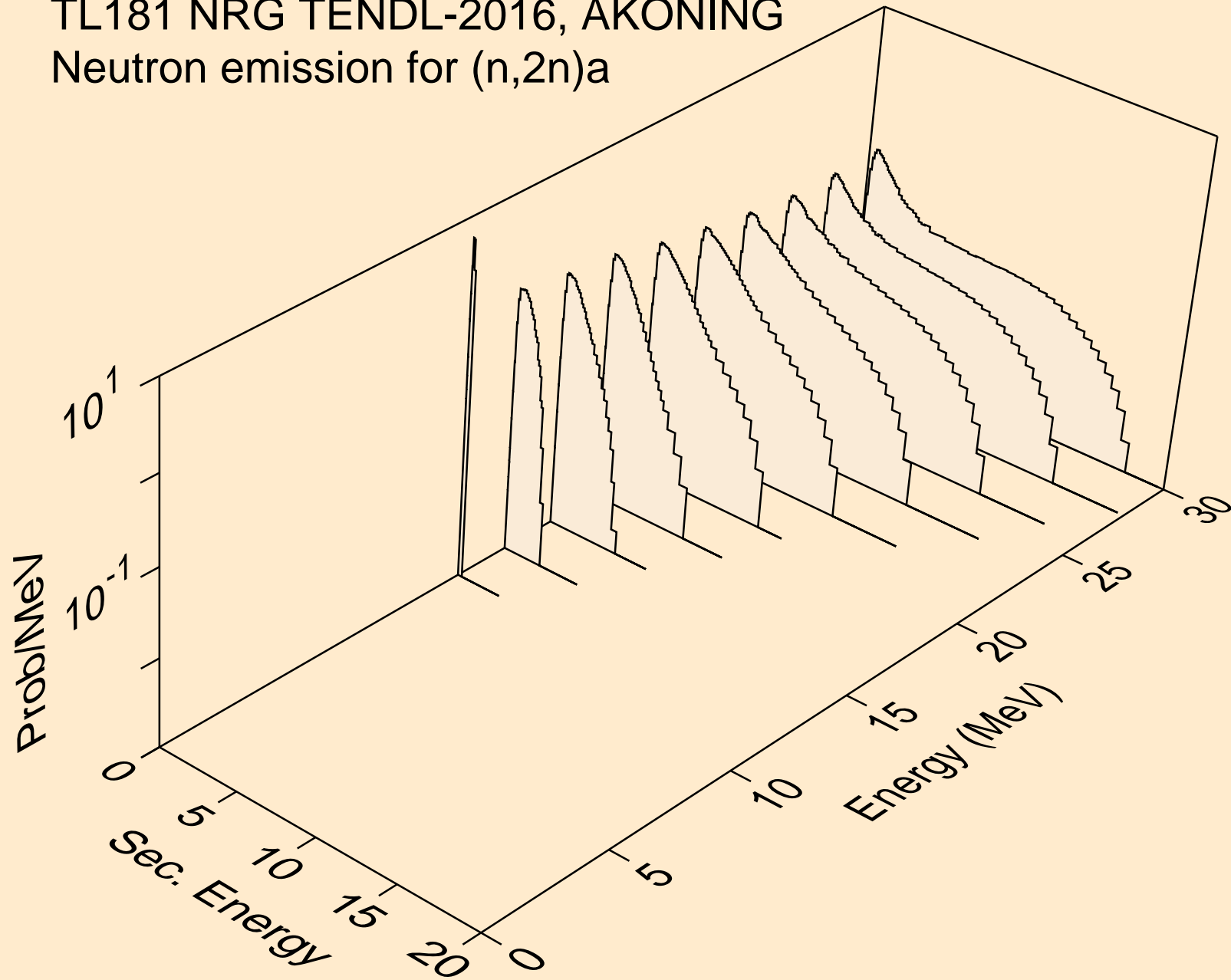

TL181 NRG TENDL-2016, AKONING
Neutron emission for (n,3n)a

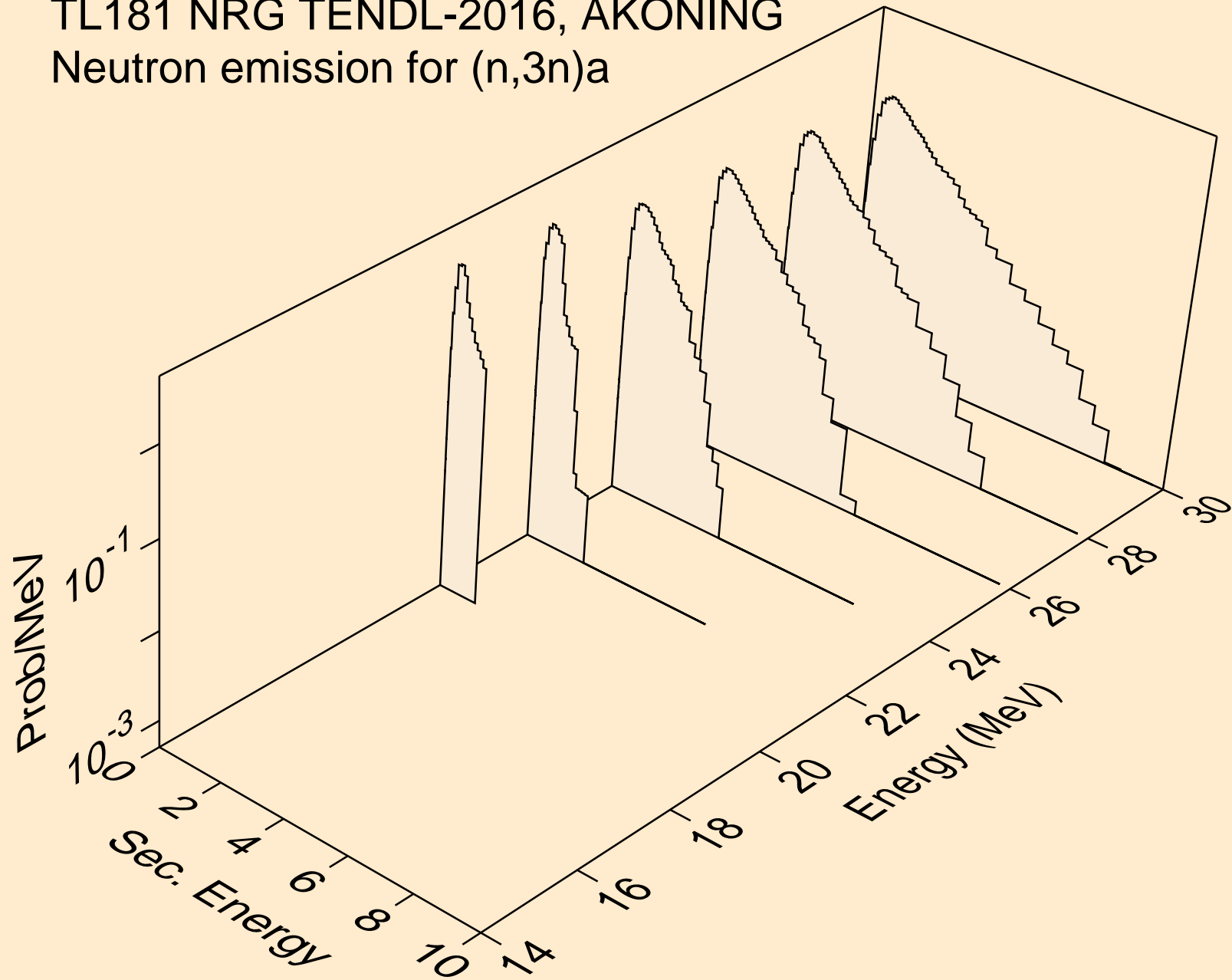

TL181 NRG TENDL-2016, AKONING
Neutron emission for (n,n*)p

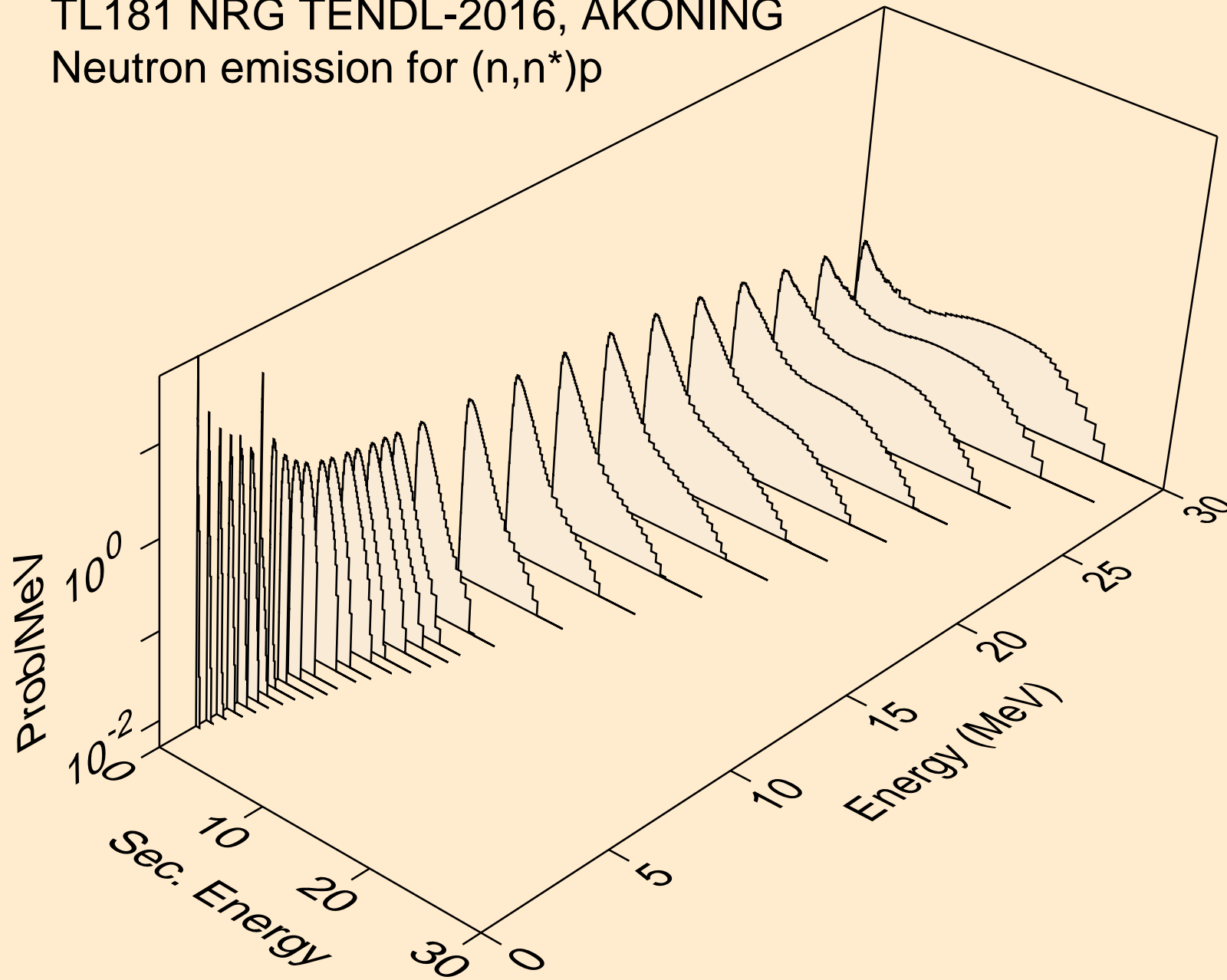

TL181 NRG TENDL-2016, AKONING
Neutron emission for (n,n*)2a

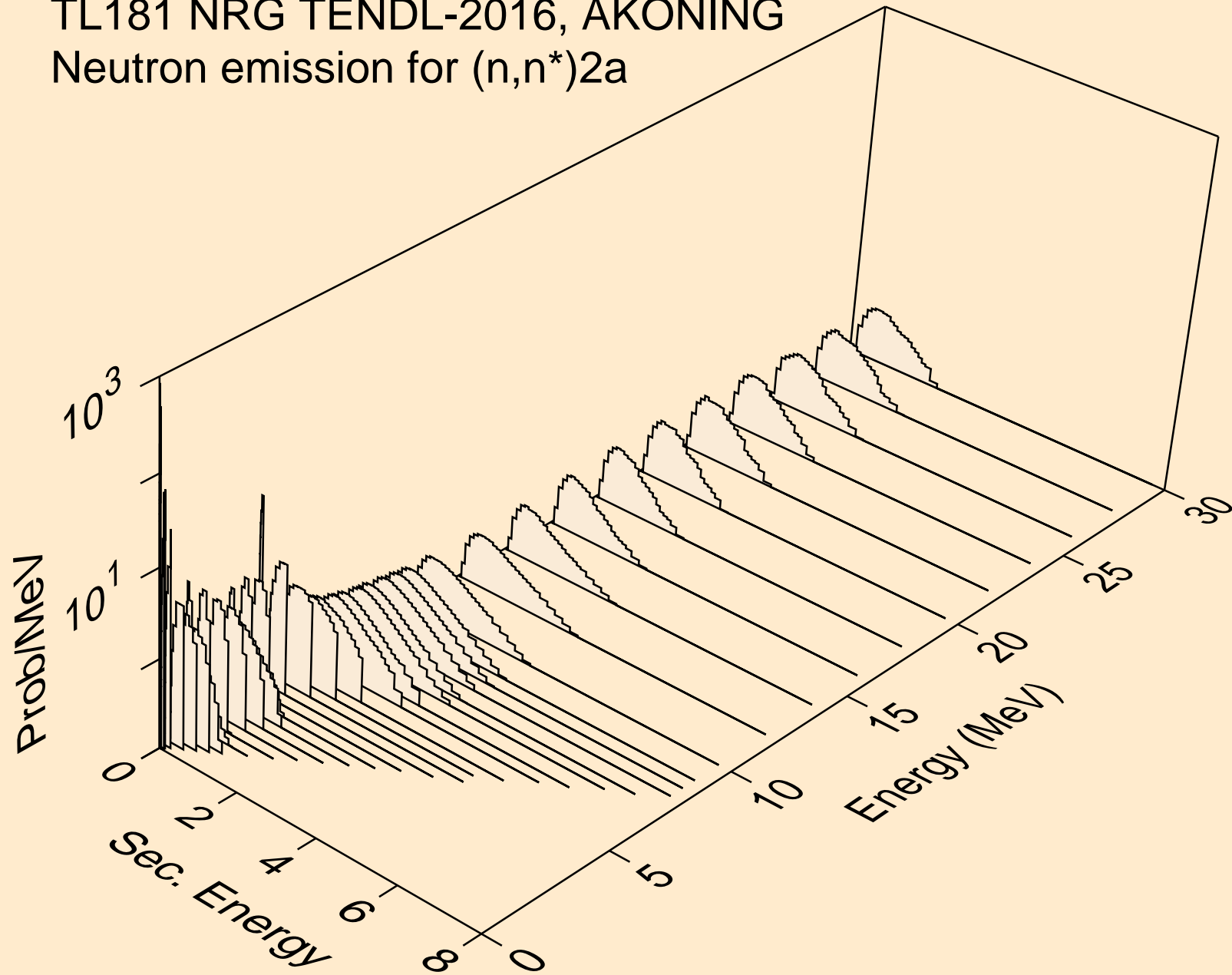

TL181 NRG TENDL-2016, AKONING
Neutron emission for (n,2n)2a

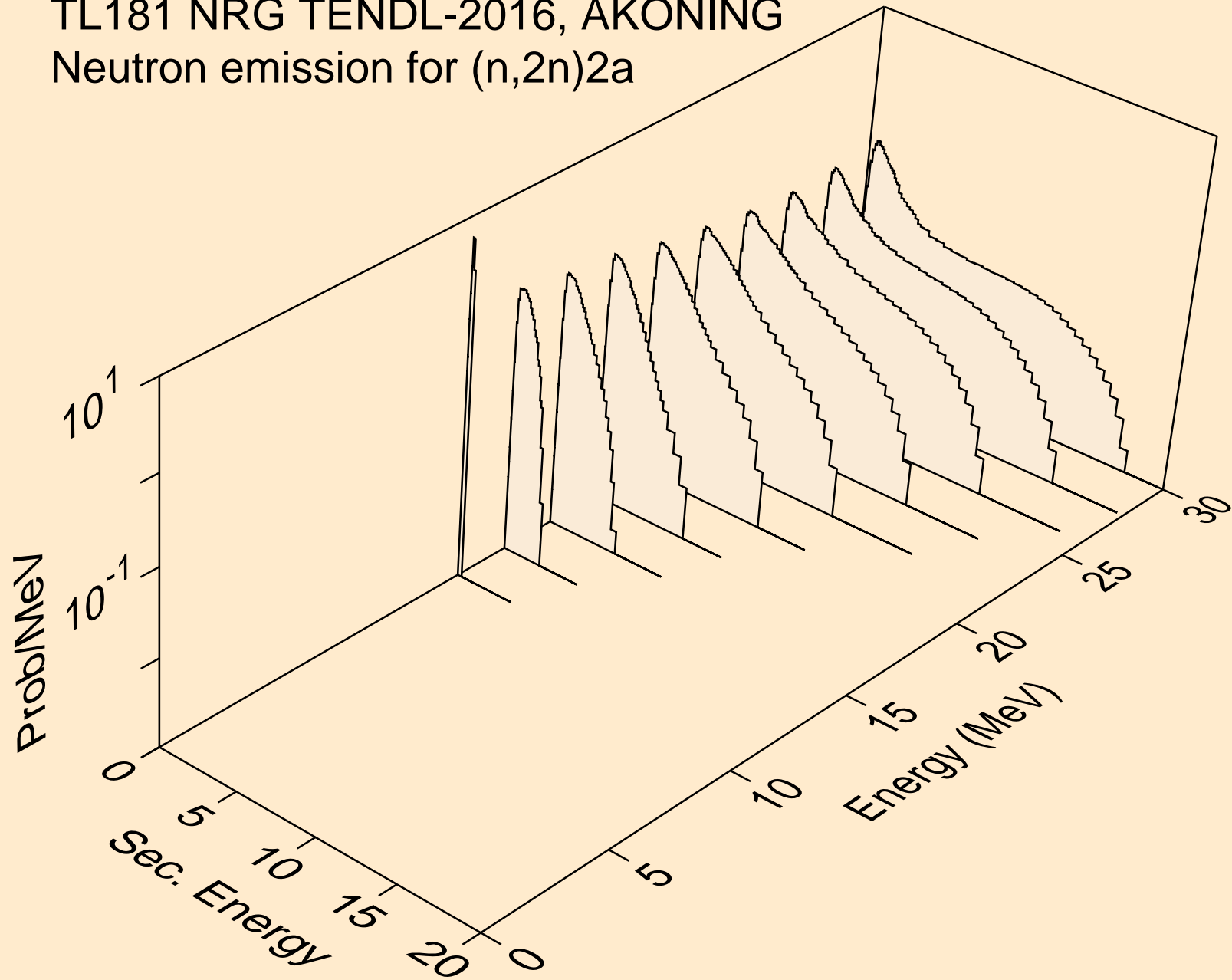

TL181 NRG TENDL-2016, AKONING
Neutron emission for (n,n*)d

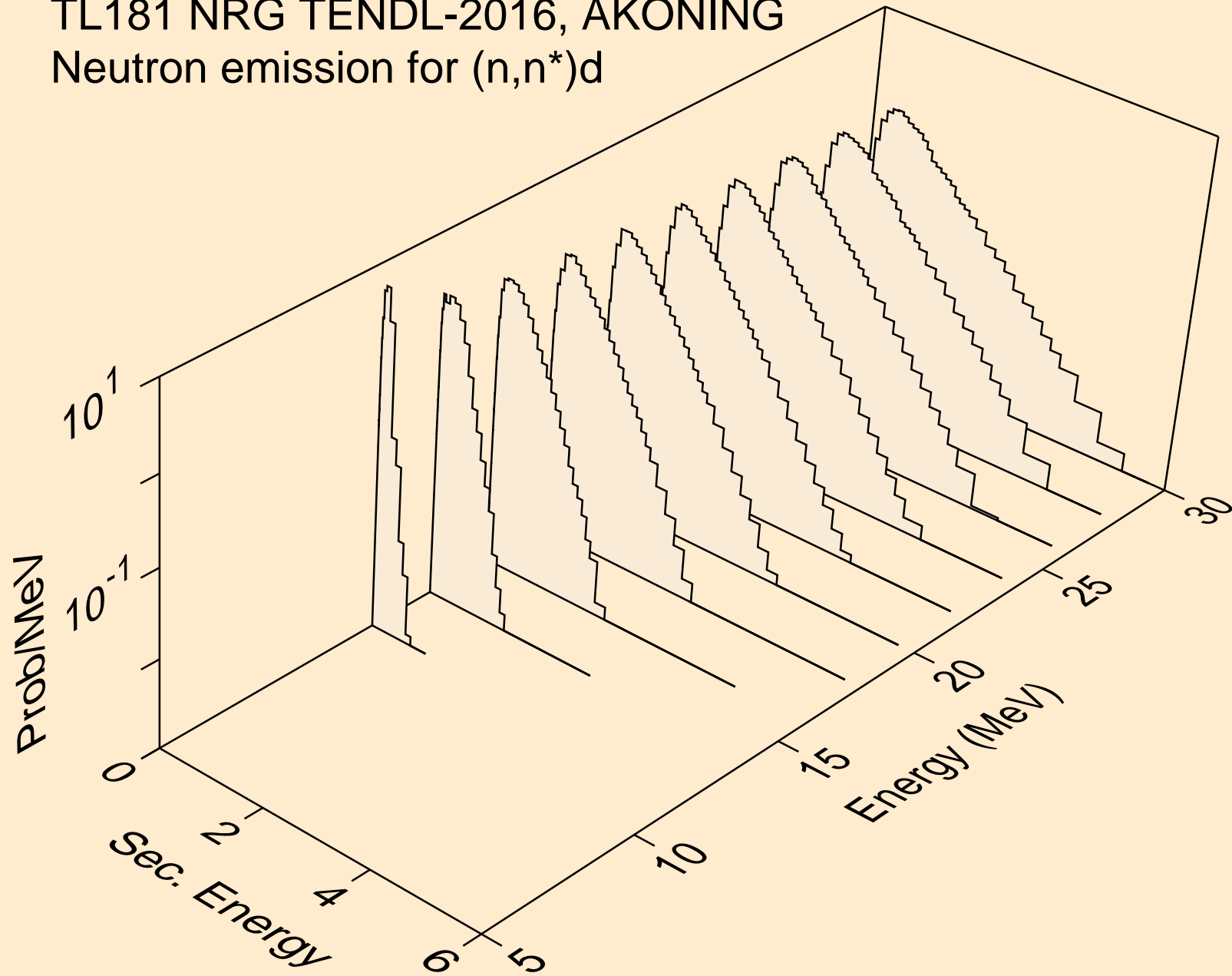

TL181 NRG TENDL-2016, AKONING
Neutron emission for (n,n*)t

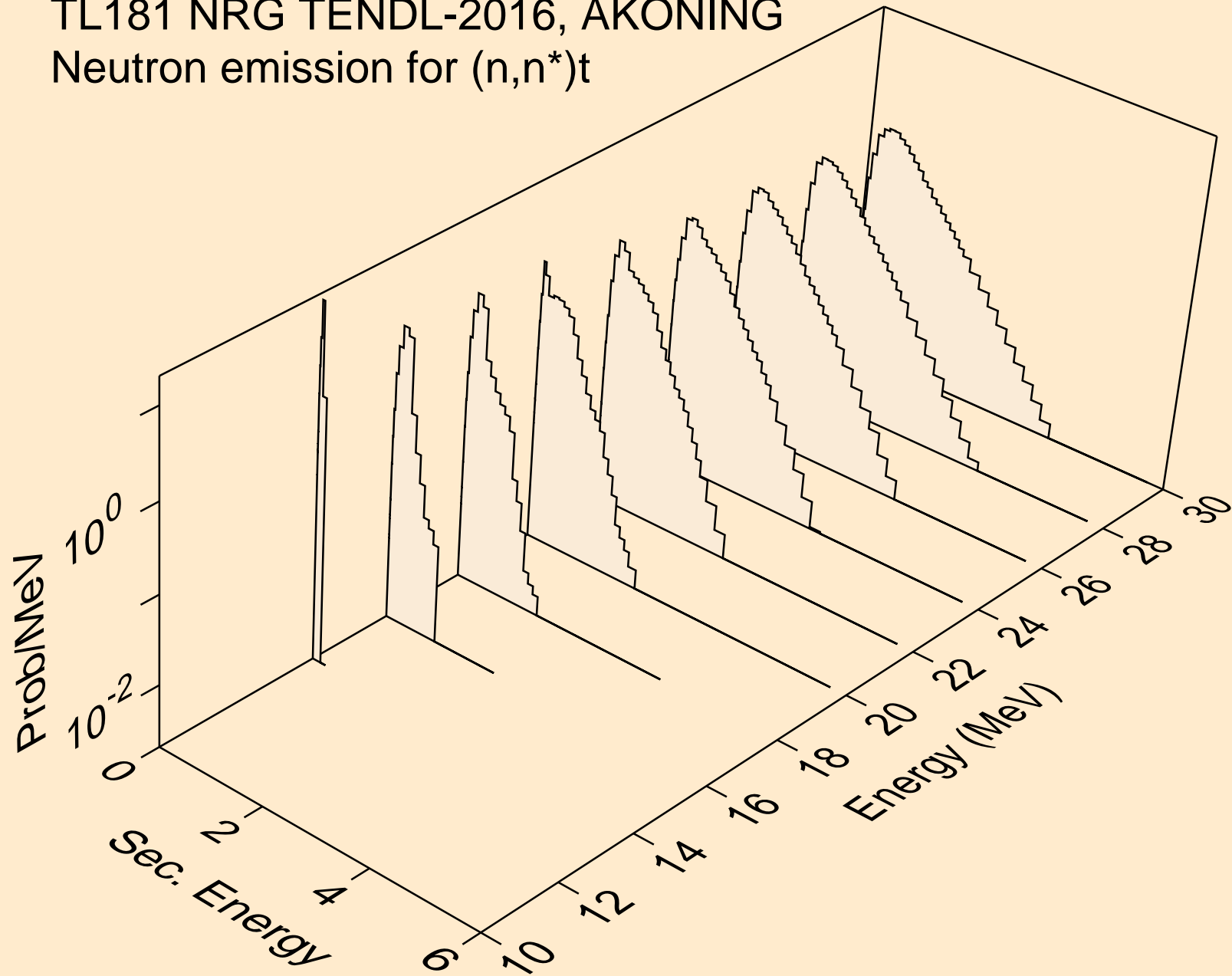

TL181 NRG TENDL-2016, AKONING
Neutron emission for (n,n*)he3

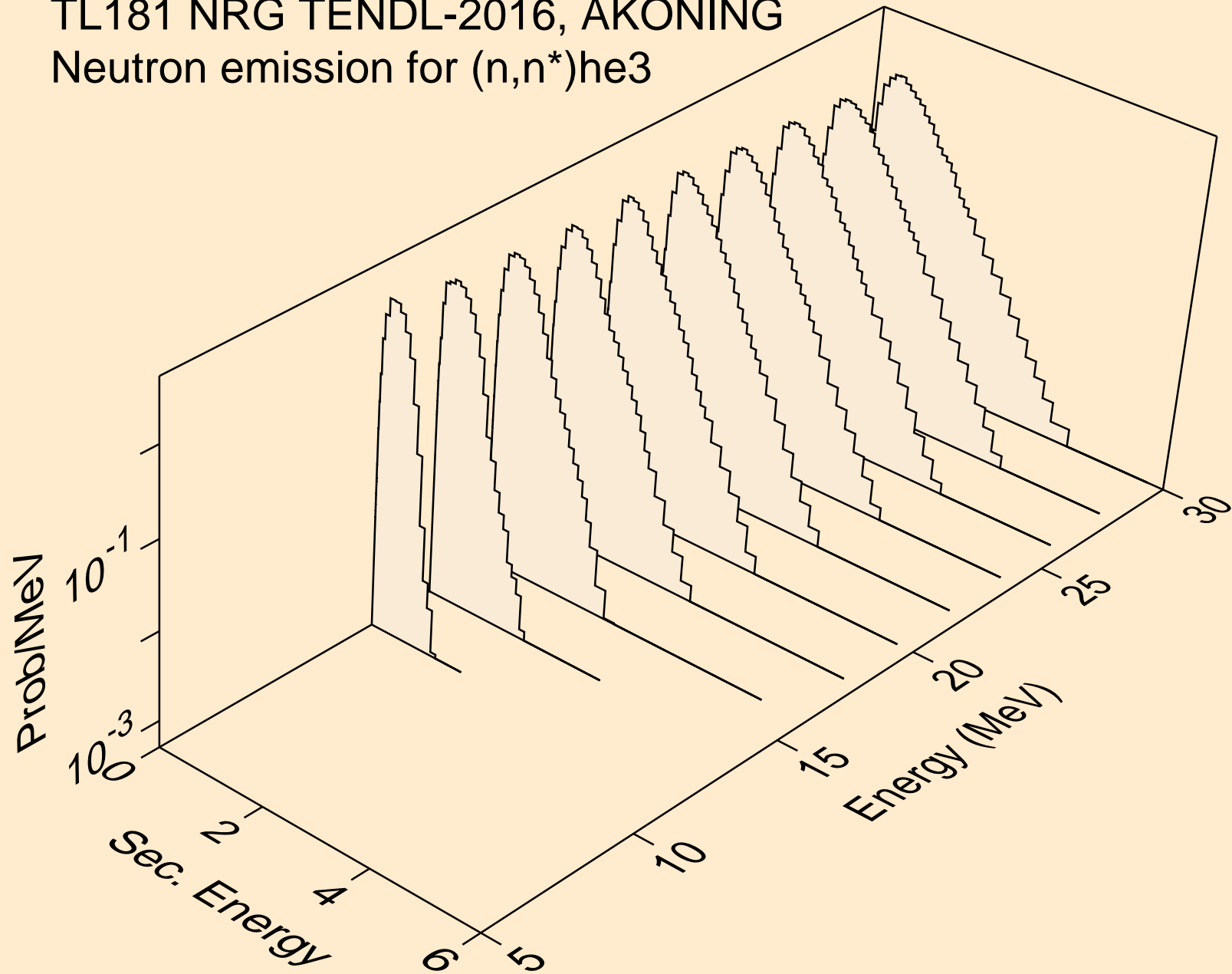

TL181 NRG TENDL-2016, AKONING
Neutron emission for (n,n*)d2a

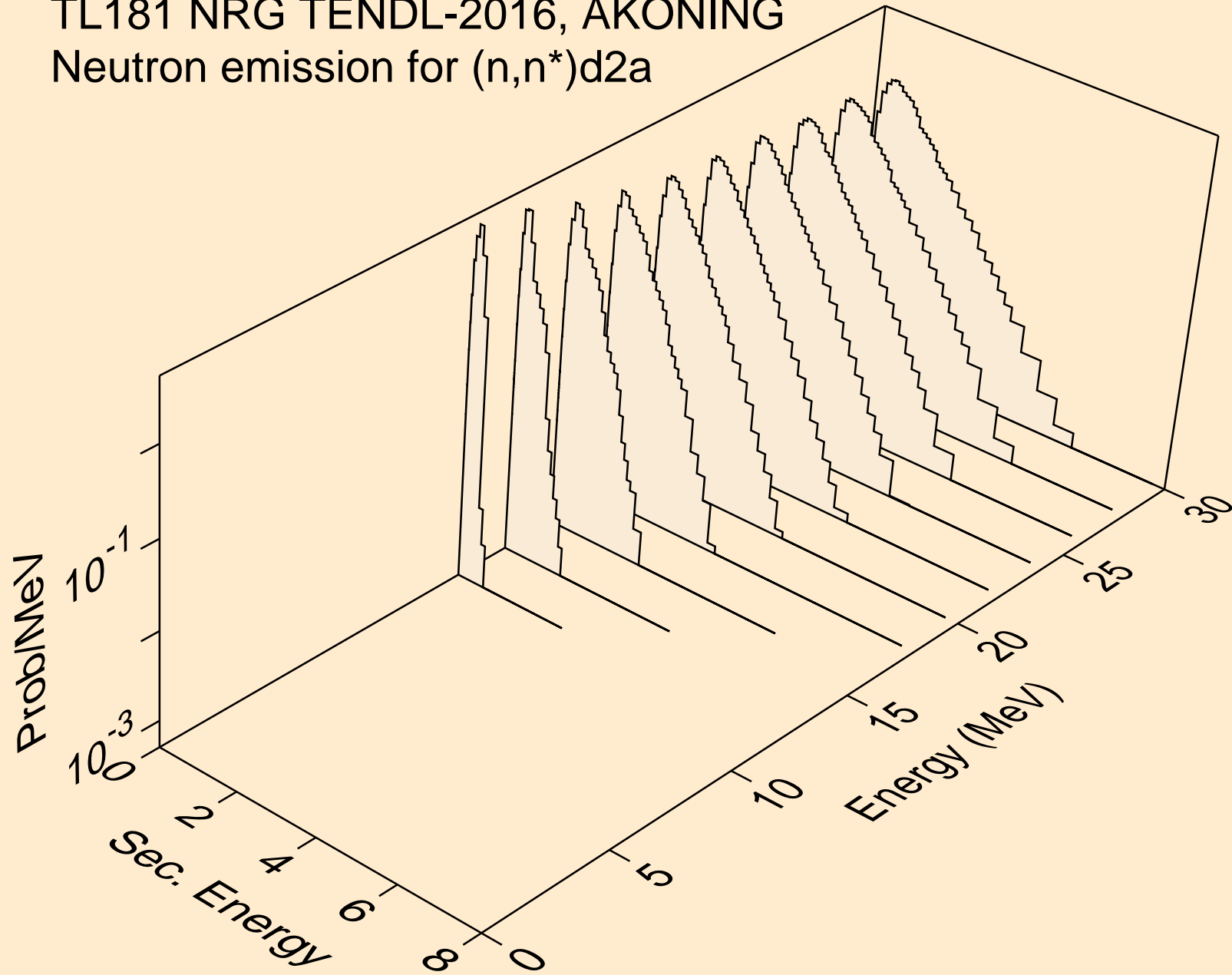

TL181 NRG TENDL-2016, AKONING
Neutron emission for (n,n*)t2a

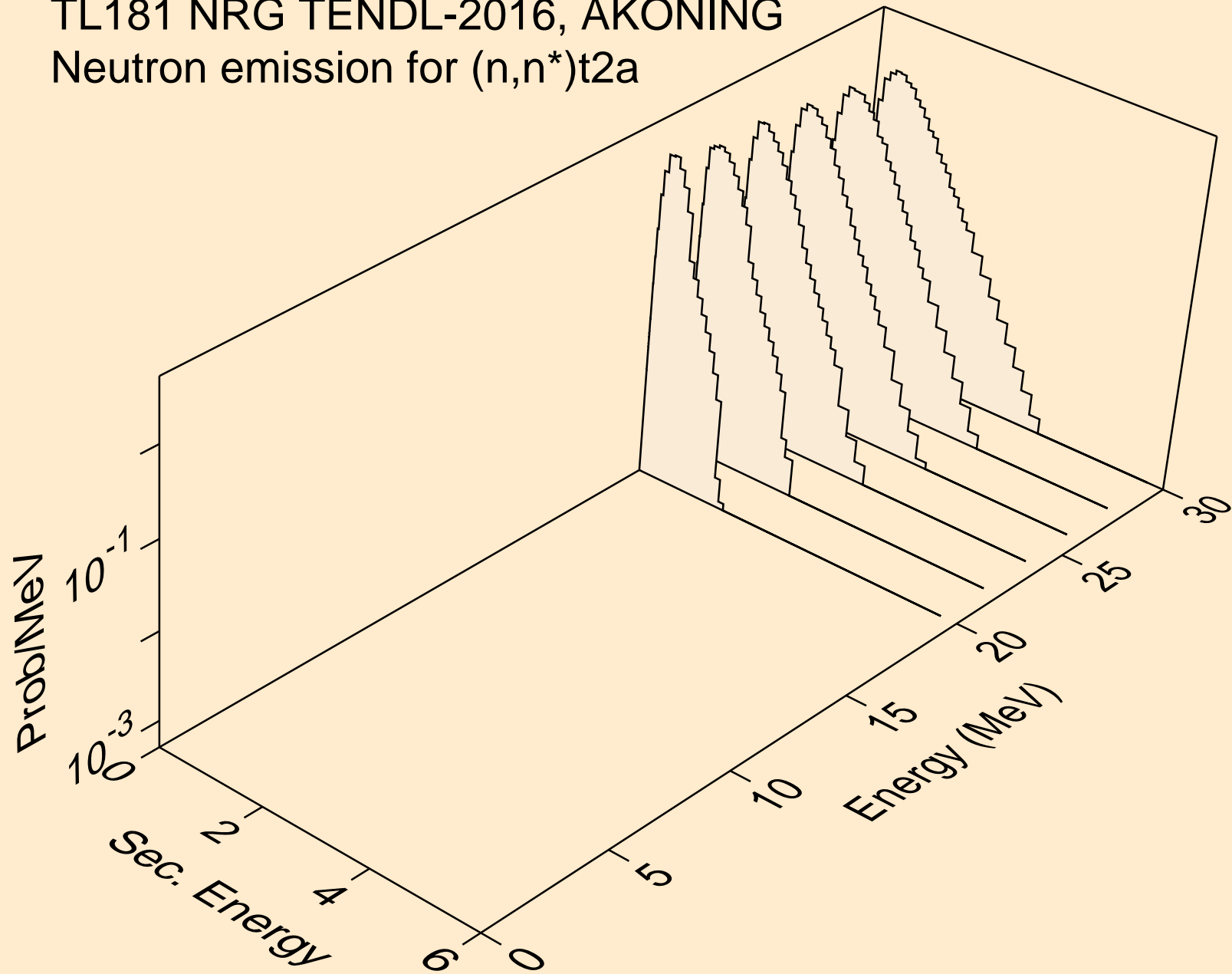

TL181 NRG TENDL-2016, AKONING
Neutron emission for (n,2np)

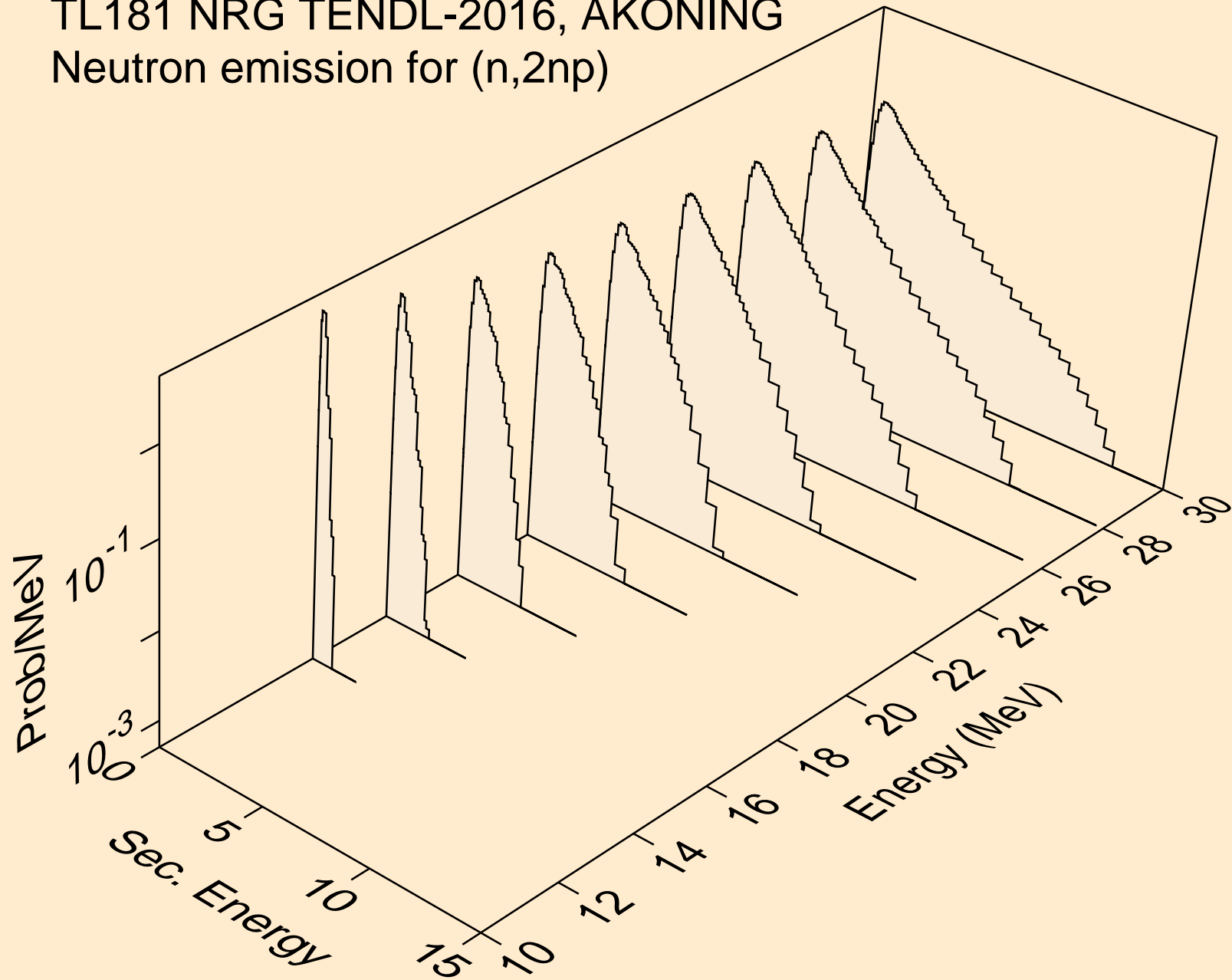

TL181 NRG TENDL-2016, AKONING
Neutron emission for (n,3np)

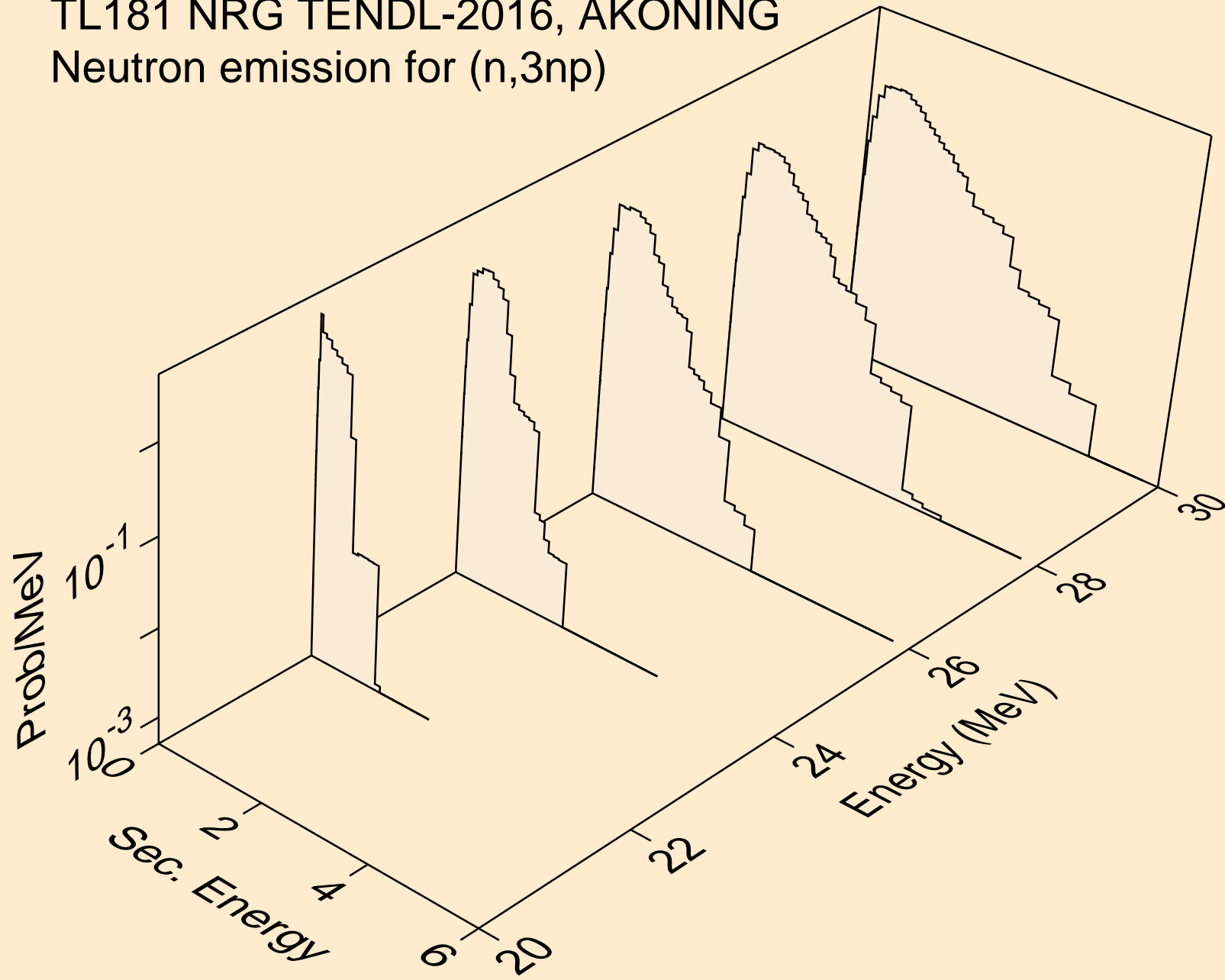

TL181 NRG TENDL-2016, AKONING
Neutron emission for (n,2np)

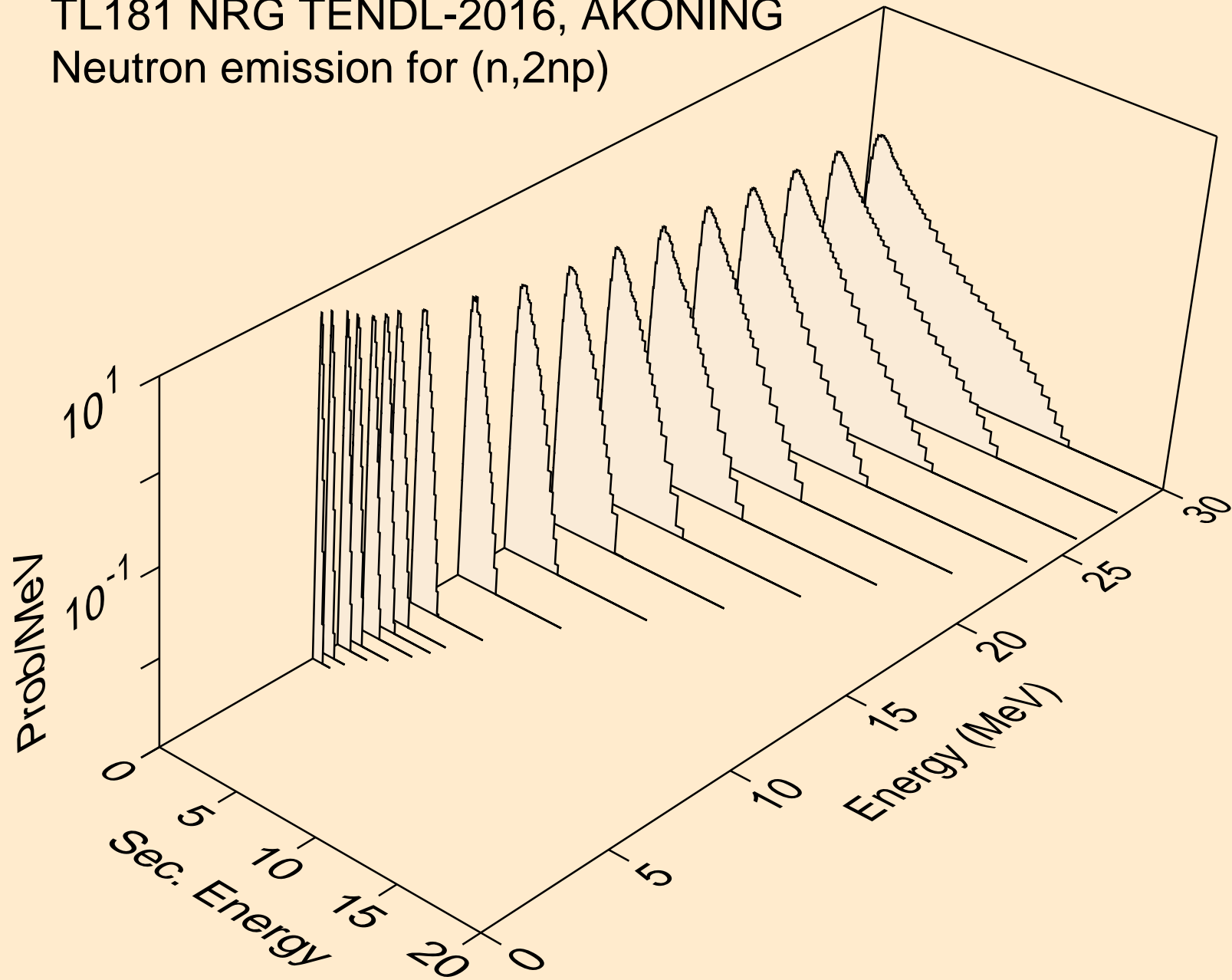

TL181 NRG TENDL-2016, AKONING
Neutron emission for (n,npa)

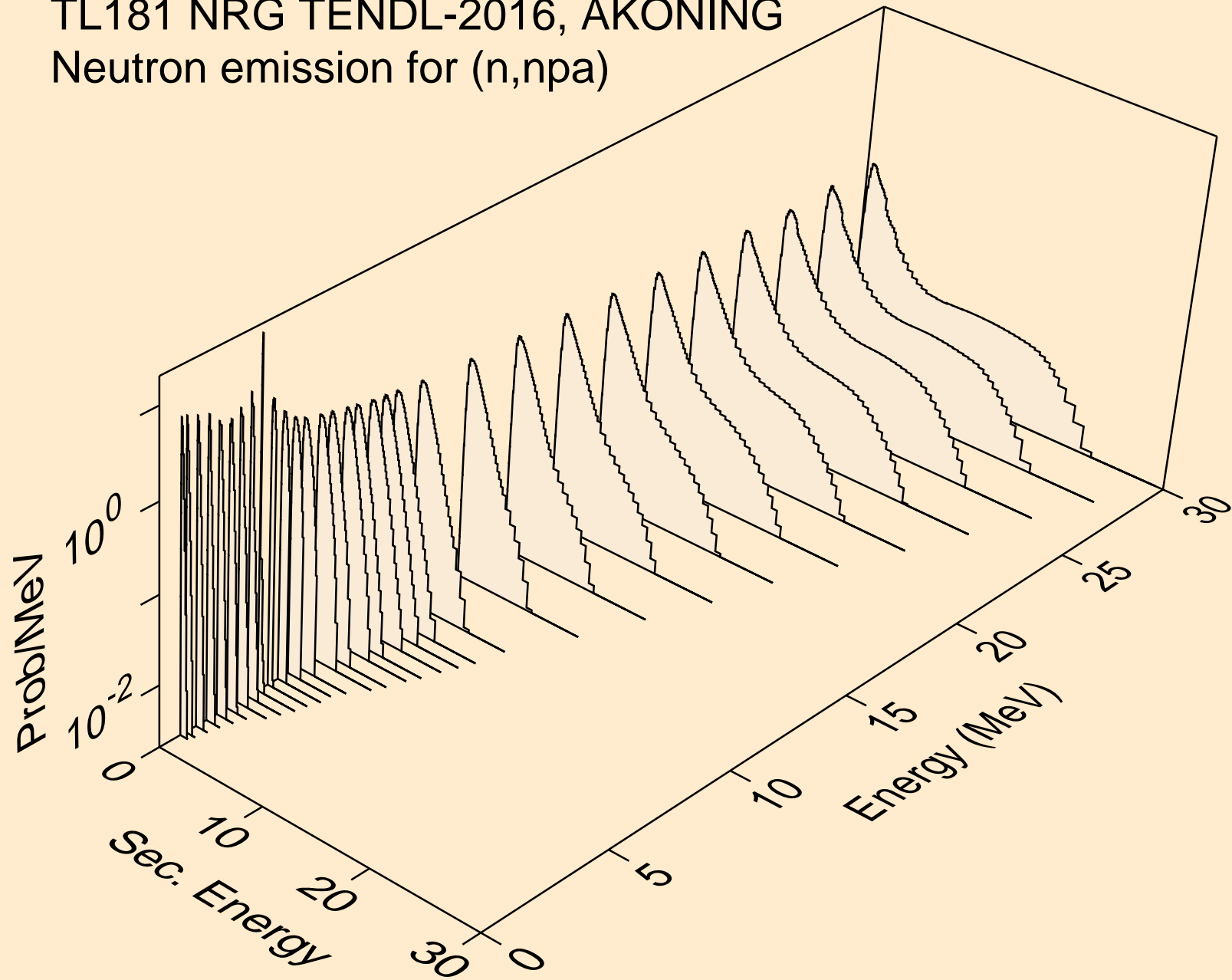

TL181 NRG TENDL-2016, AKONING
Neutron emission for (n,n*c)

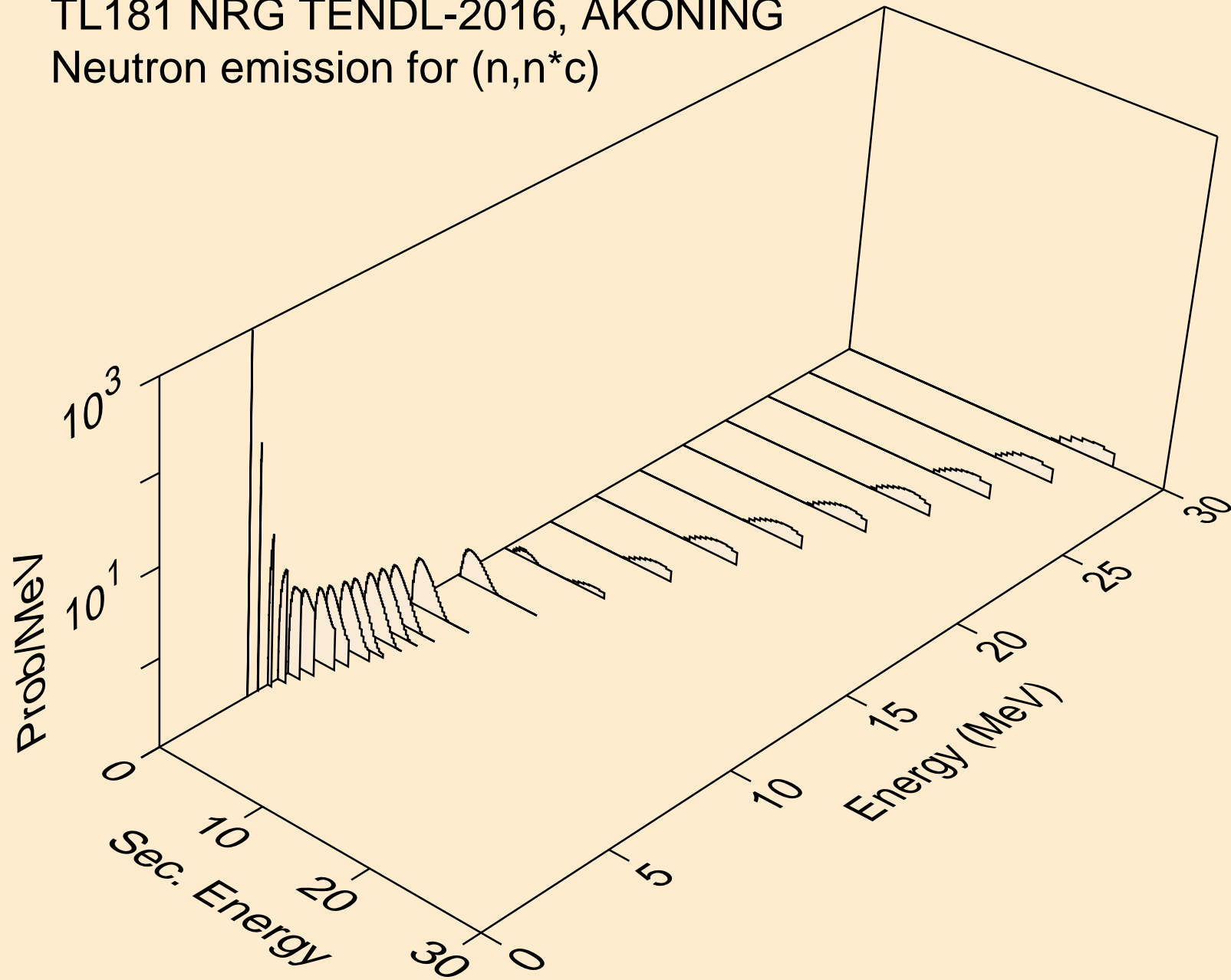

TL181 NRG TENDL-2016, AKONING
Photon emission for (n,x)

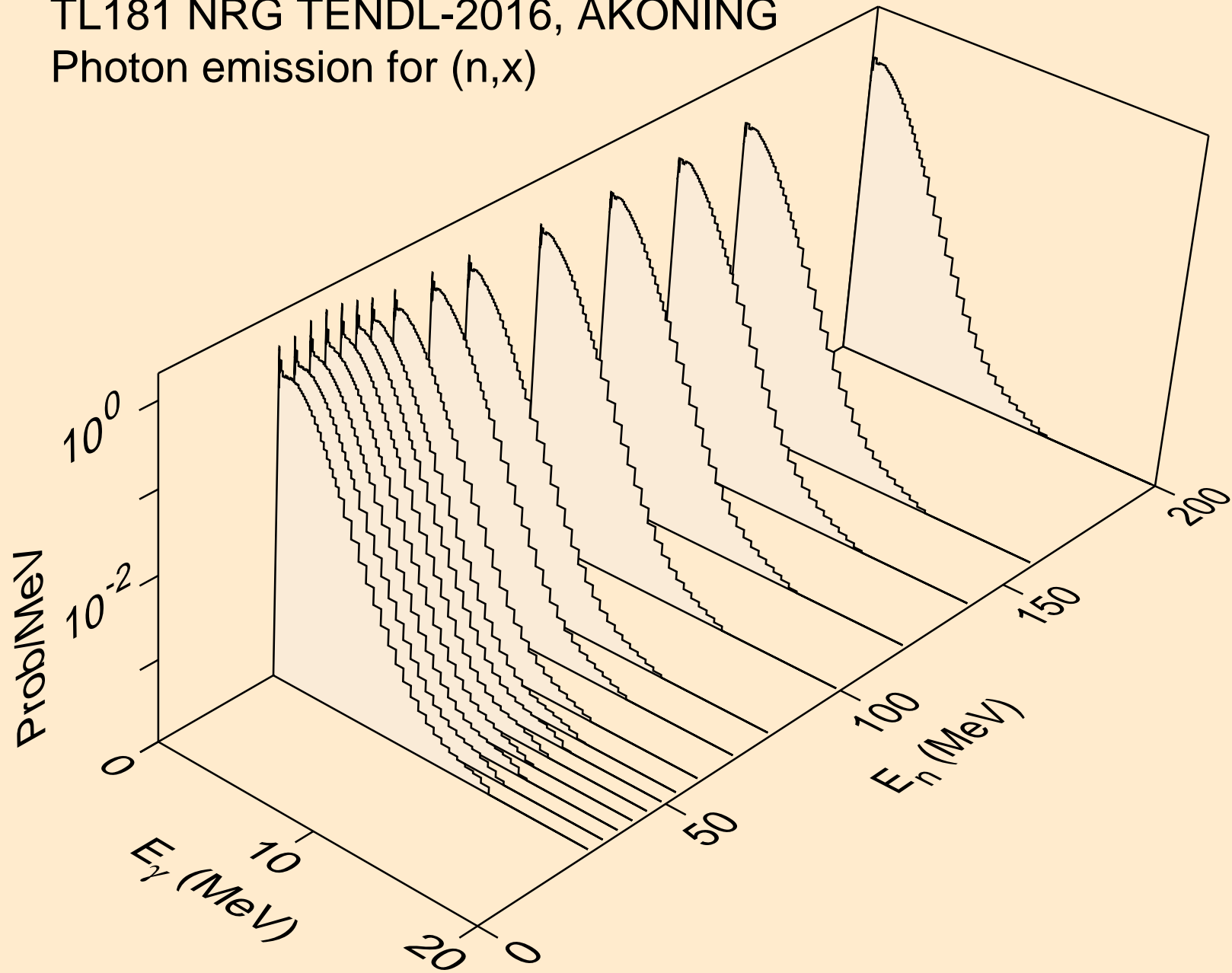

TL181 NRG TENDL-2016, AKONING
Photon emission for (n,2nd)

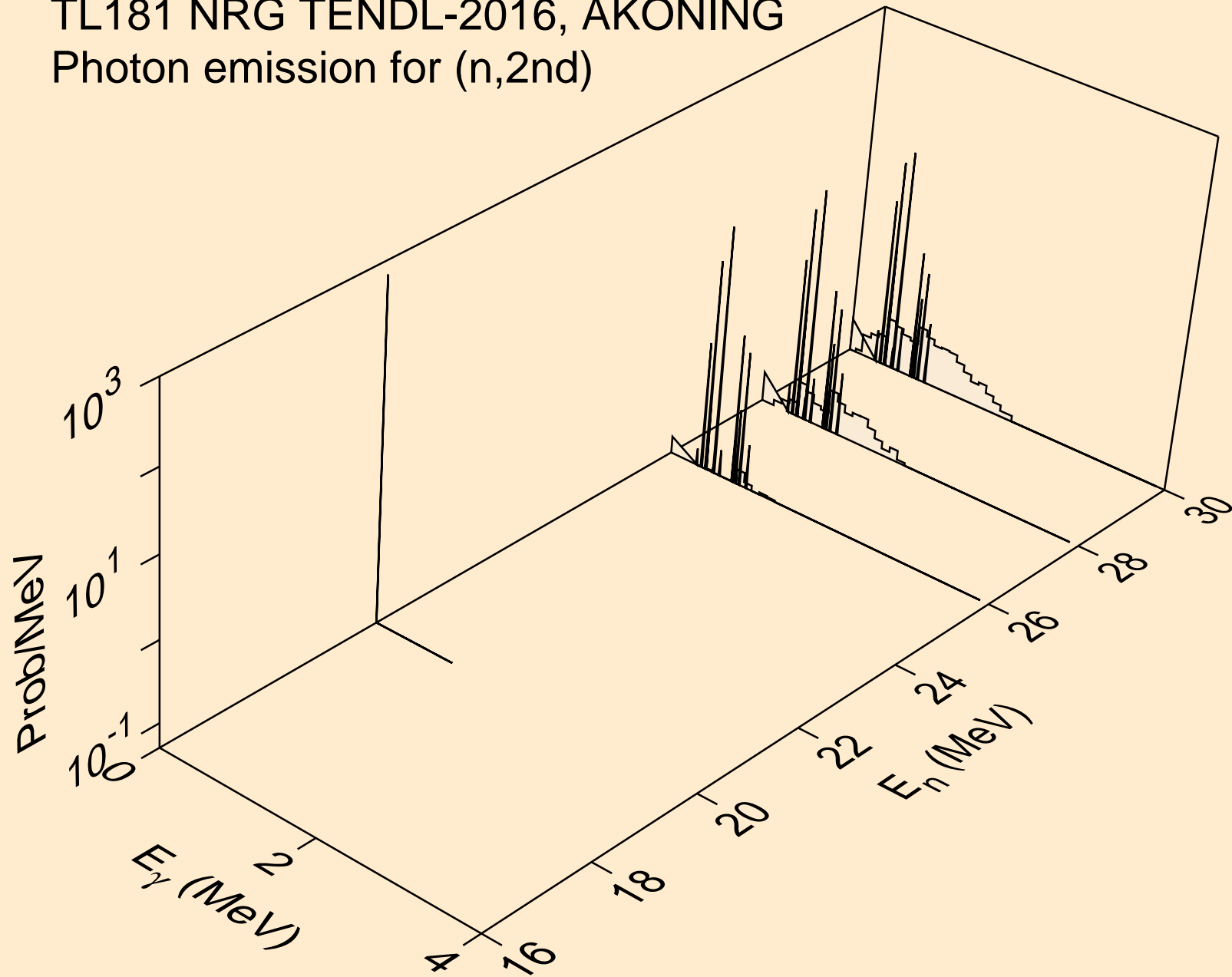

TL181 NRG TENDL-2016, AKONING
Photon emission for (n,2n)

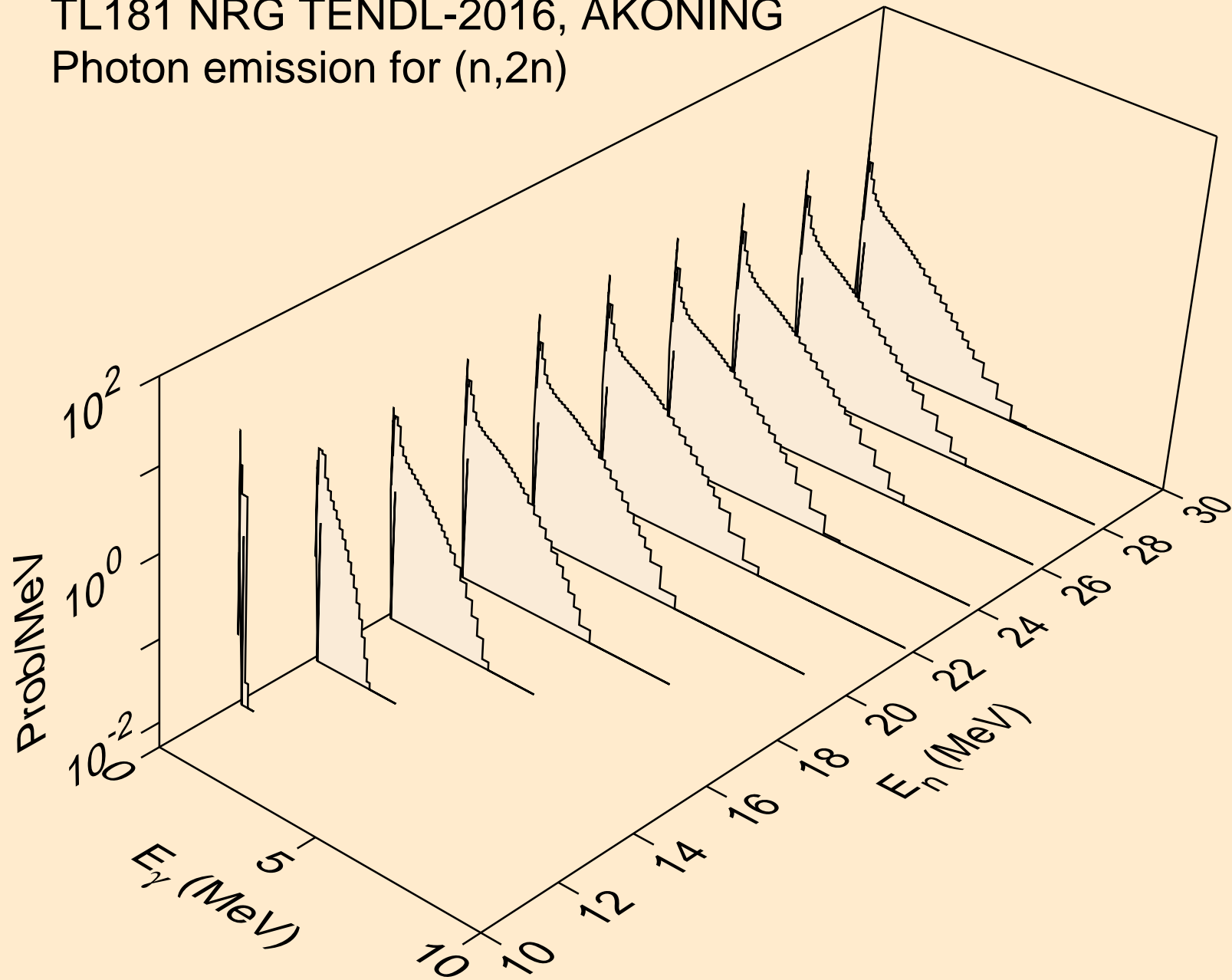

TL181 NRG TENDL-2016, AKONING
Photon emission for (n,3n)

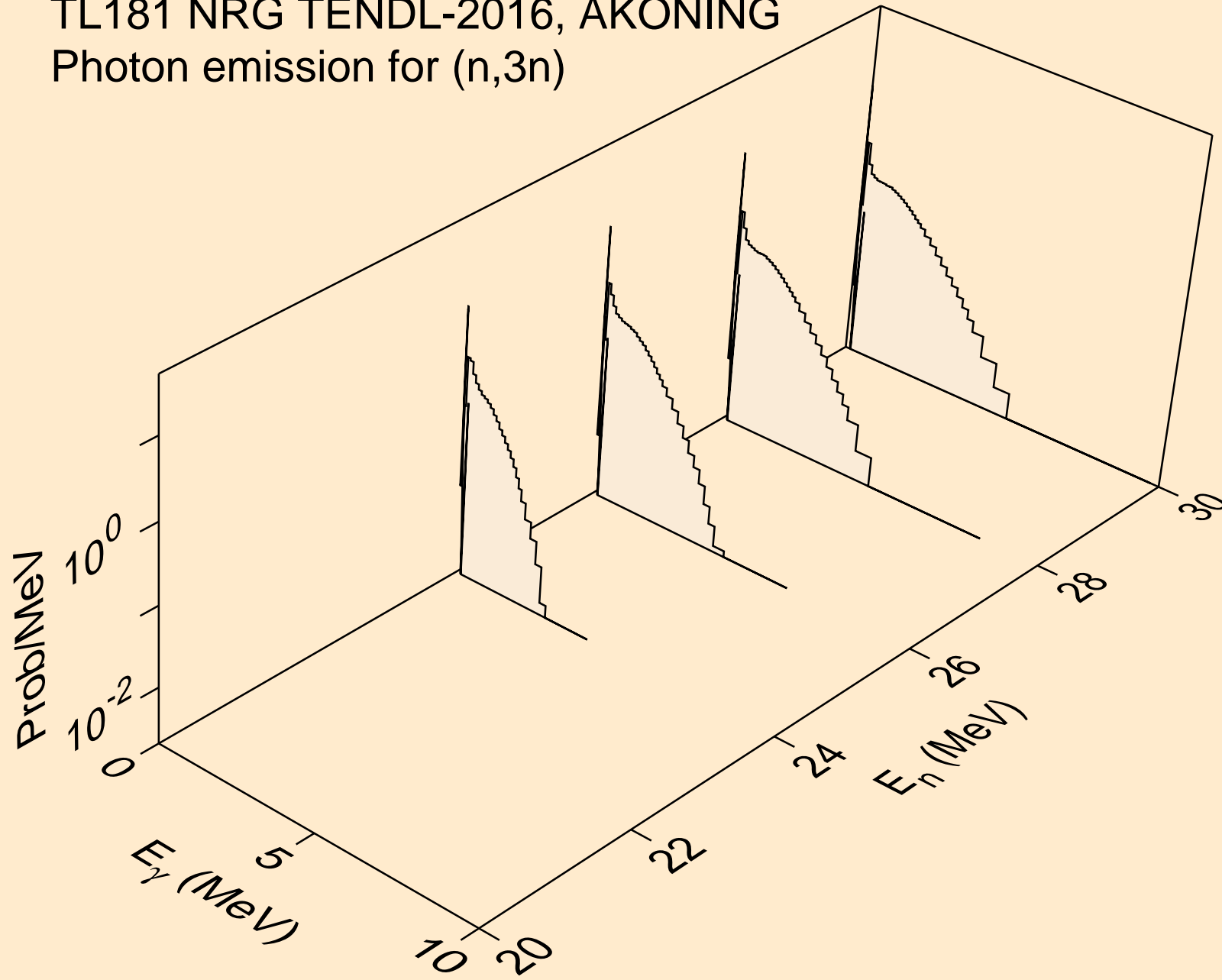

TL181 NRG TENDL-2016, AKONING
Photon emission for (n,n*)a

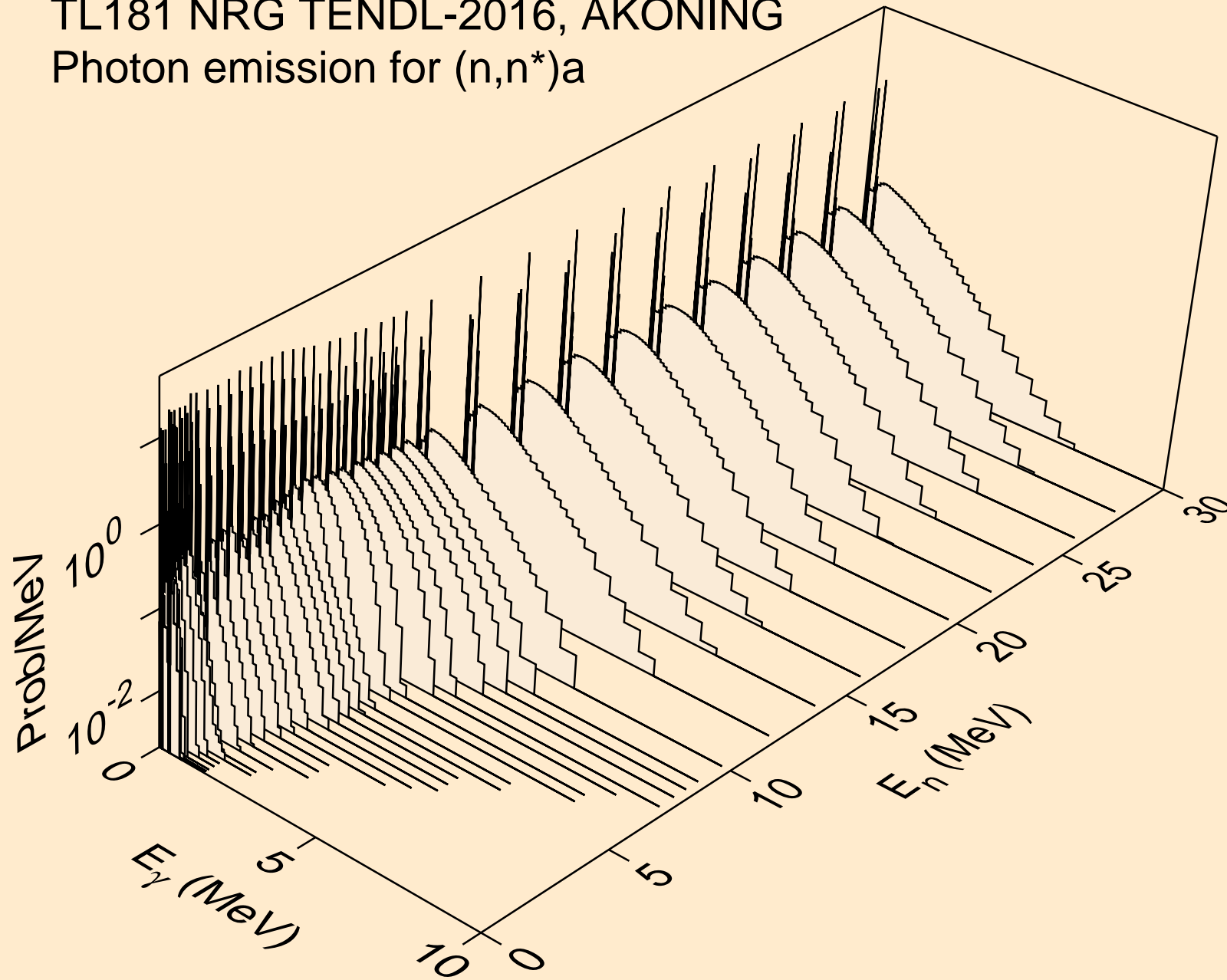

TL181 NRG TENDL-2016, AKONING
Photon emission for (n,n*)3a

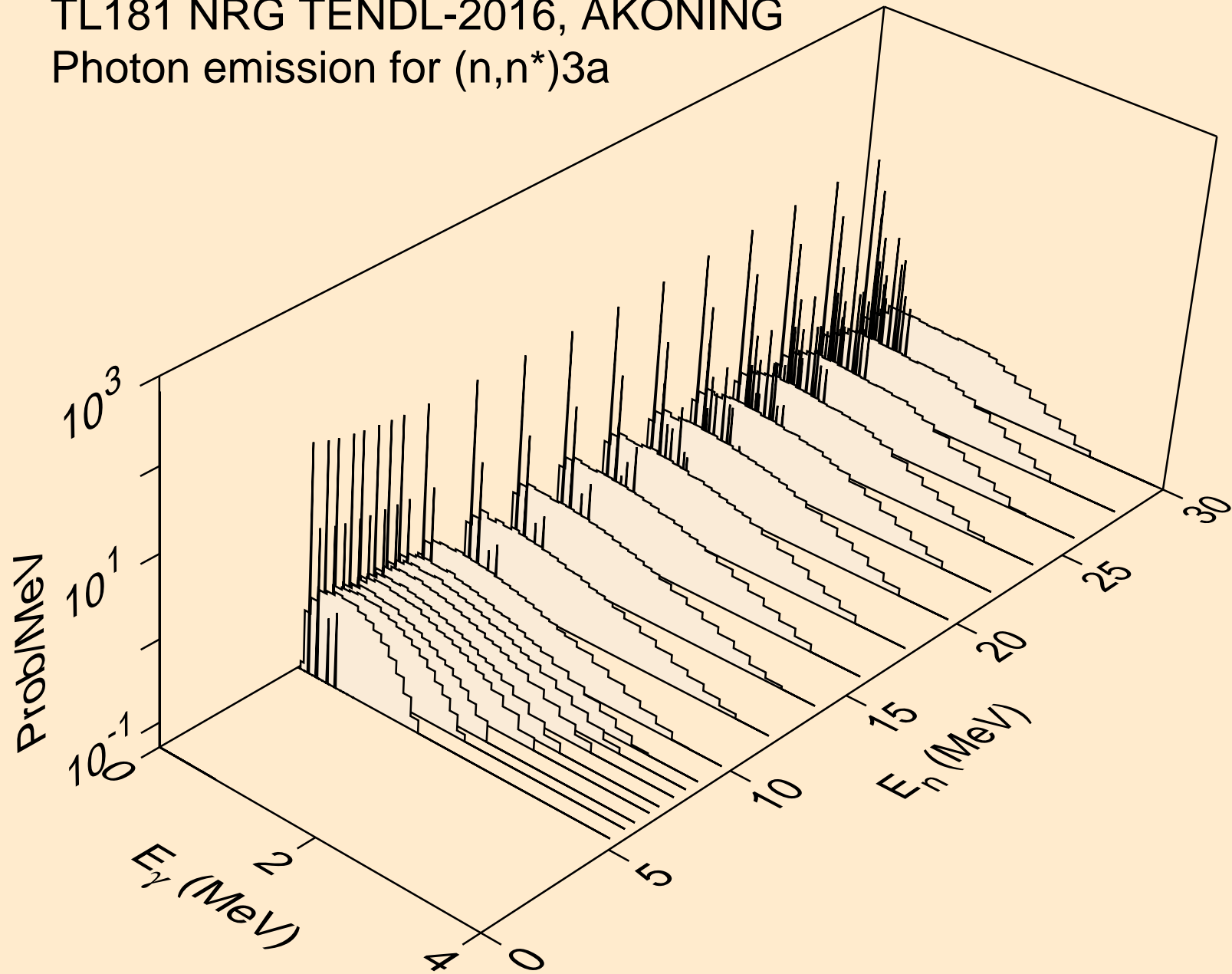

TL181 NRG TENDL-2016, AKONING
Photon emission for (n,2n) α

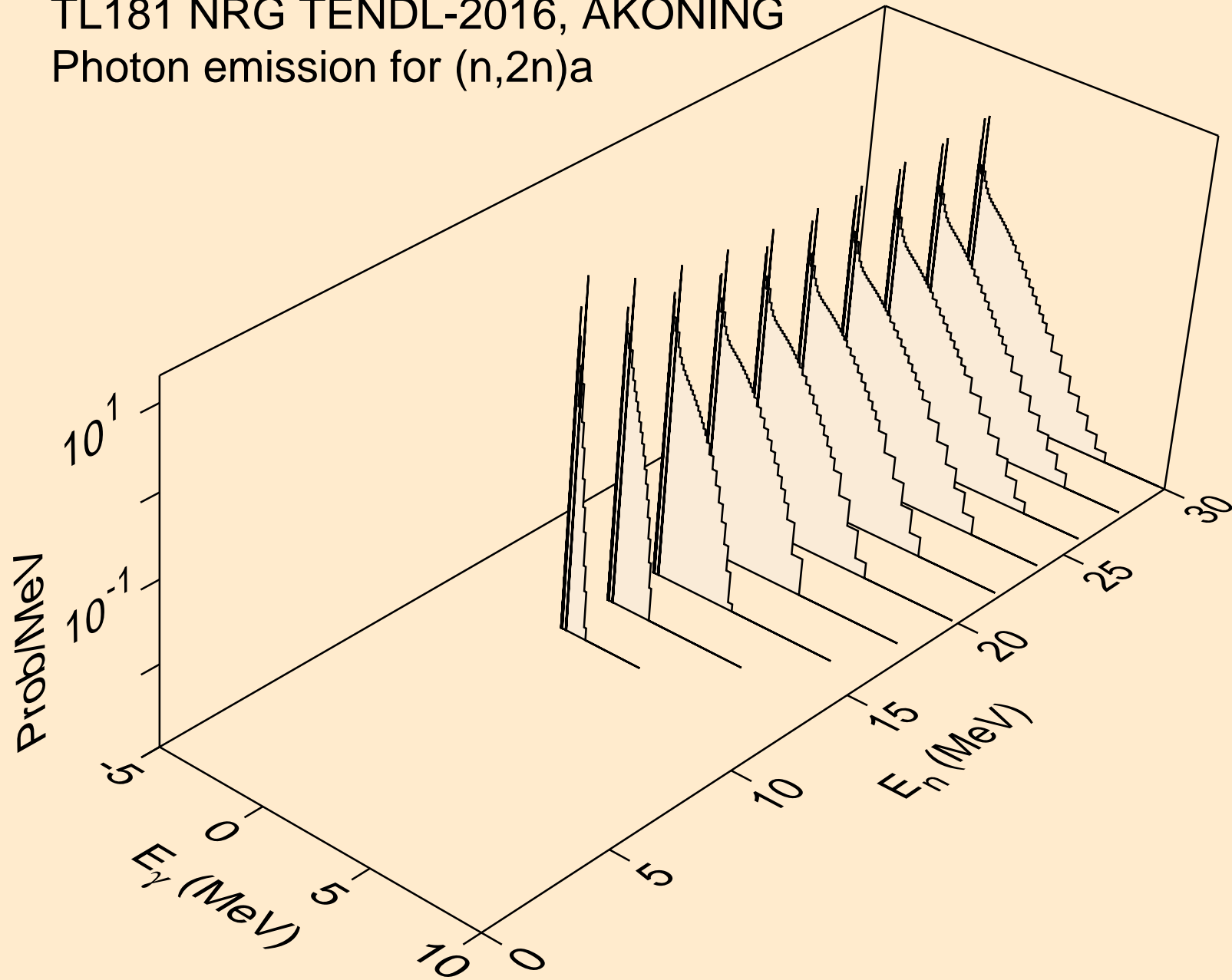

TL181 NRG TENDL-2016, AKONING
Photon emission for (n,3n)a

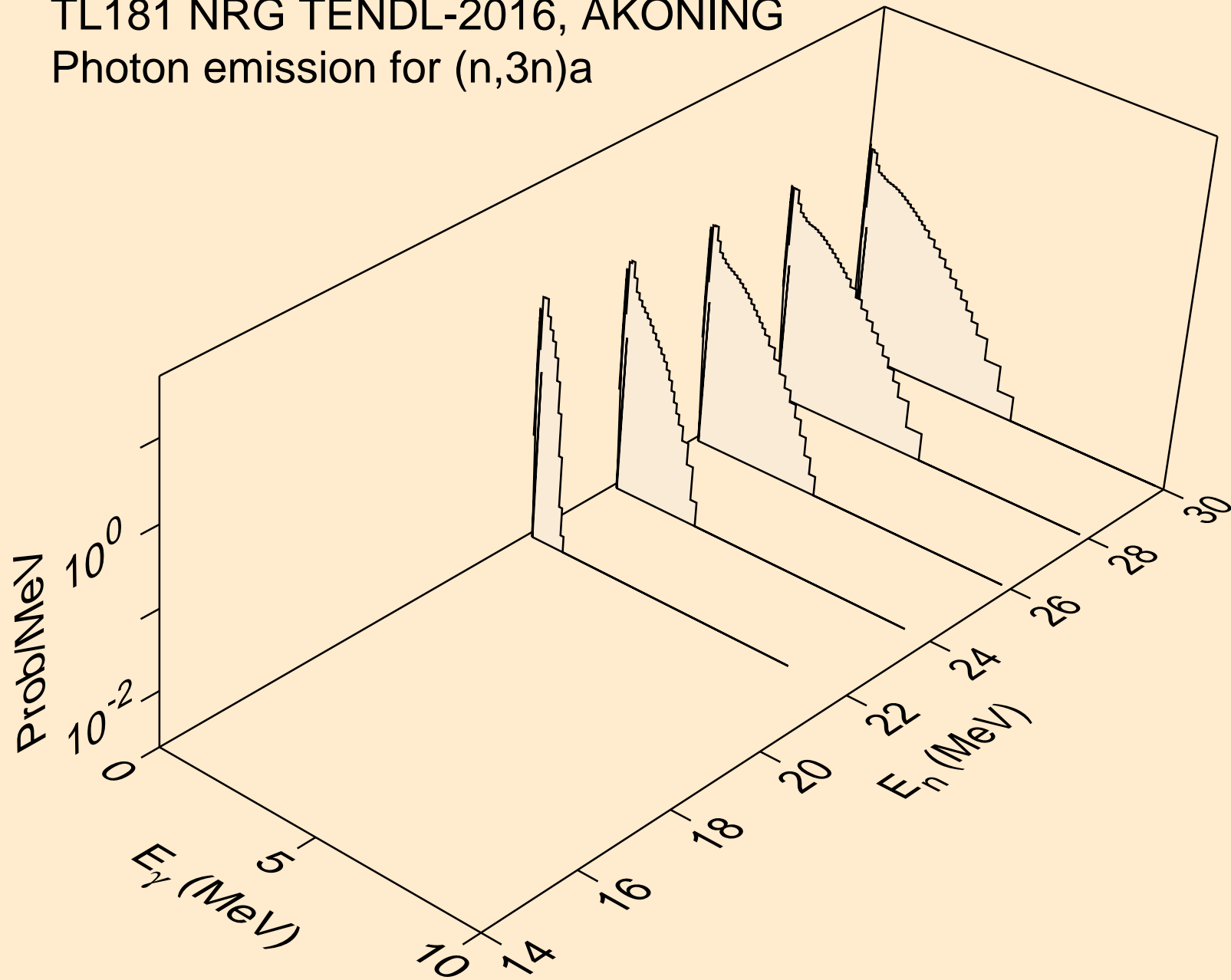

TL181 NRG TENDL-2016, AKONING
Photon emission for (n,n*)p

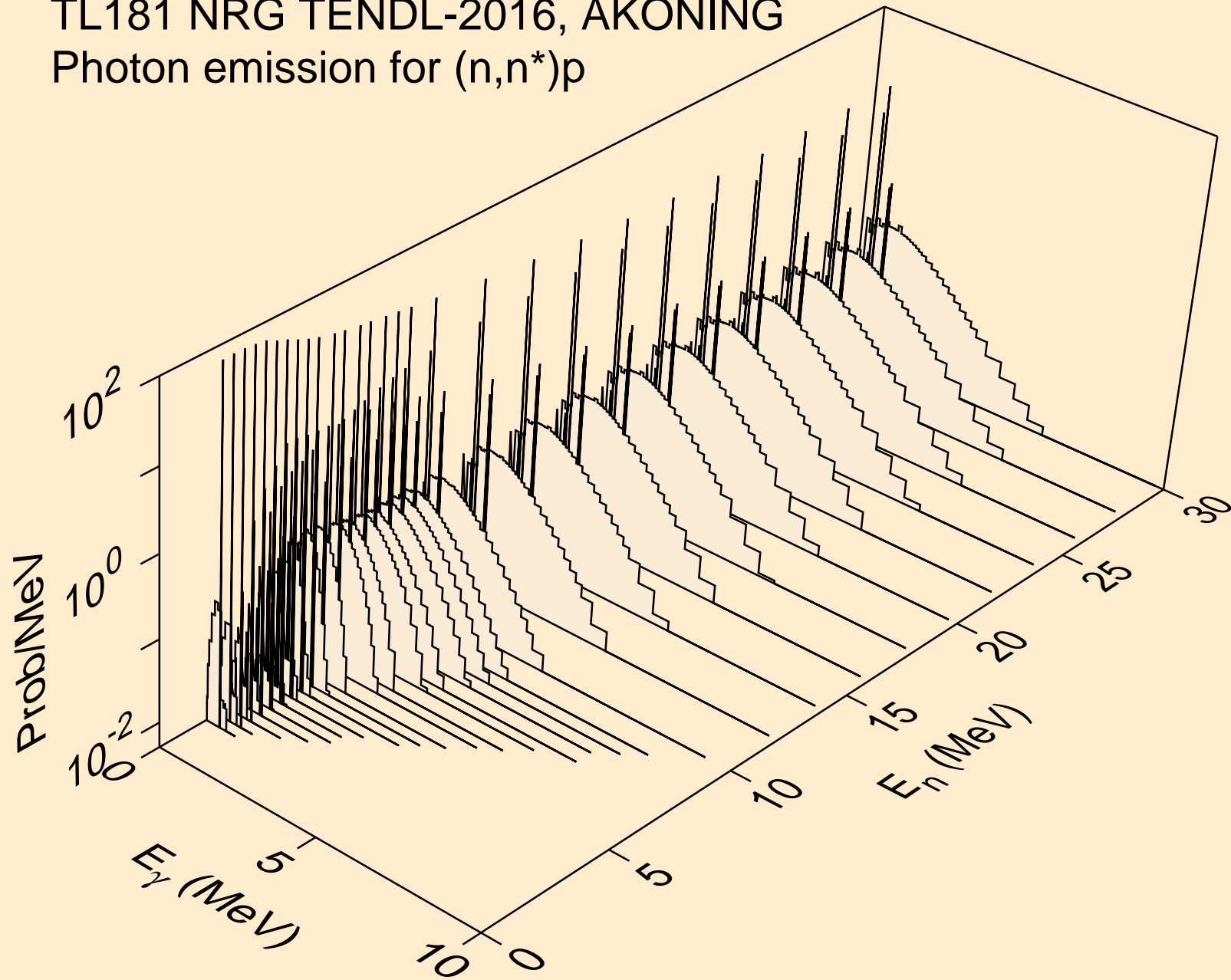

TL181 NRG TENDL-2016, AKONING
Photon emission for (n,n*)2a

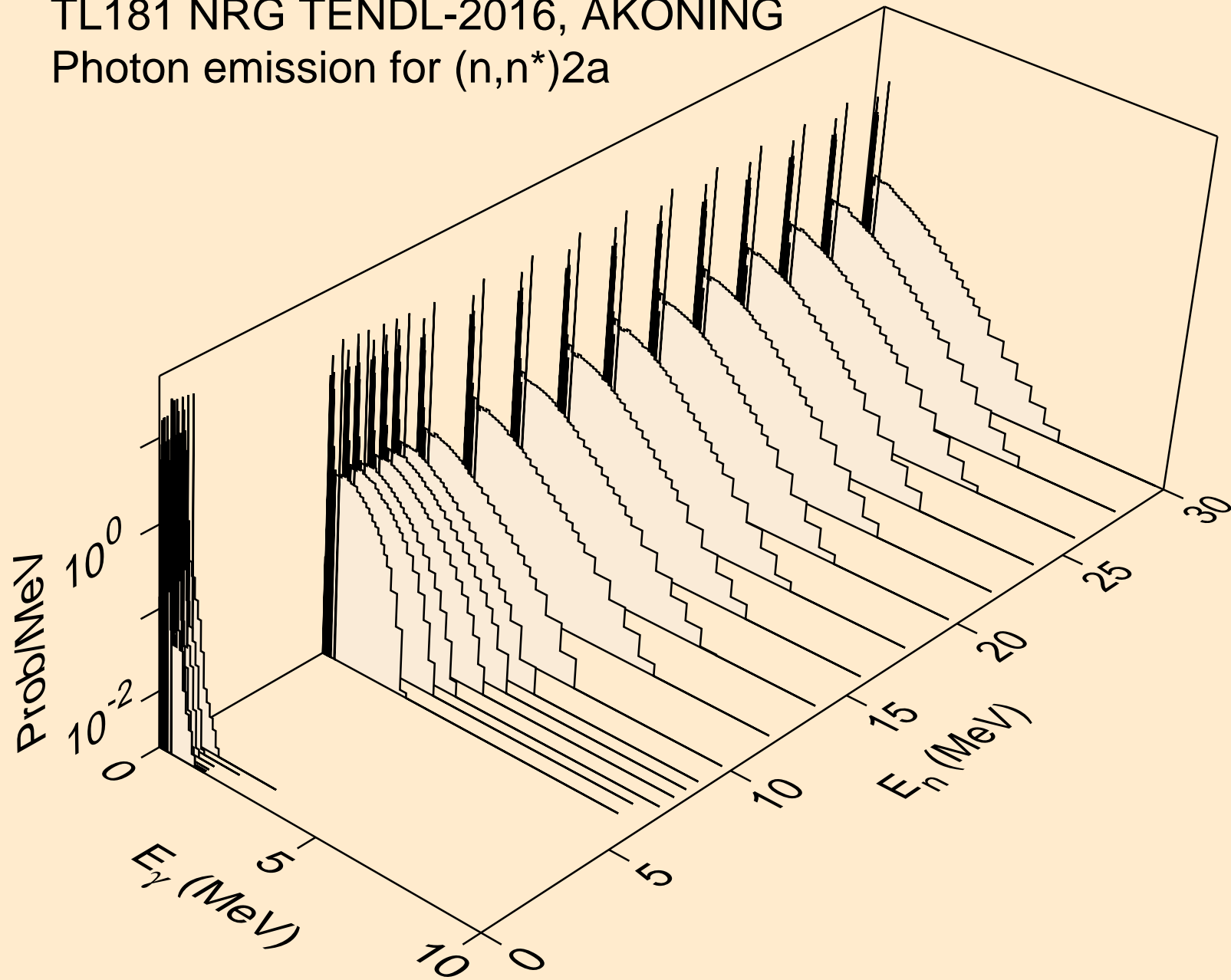

TL181 NRG TENDL-2016, AKONING
Photon emission for (n,2n)2a

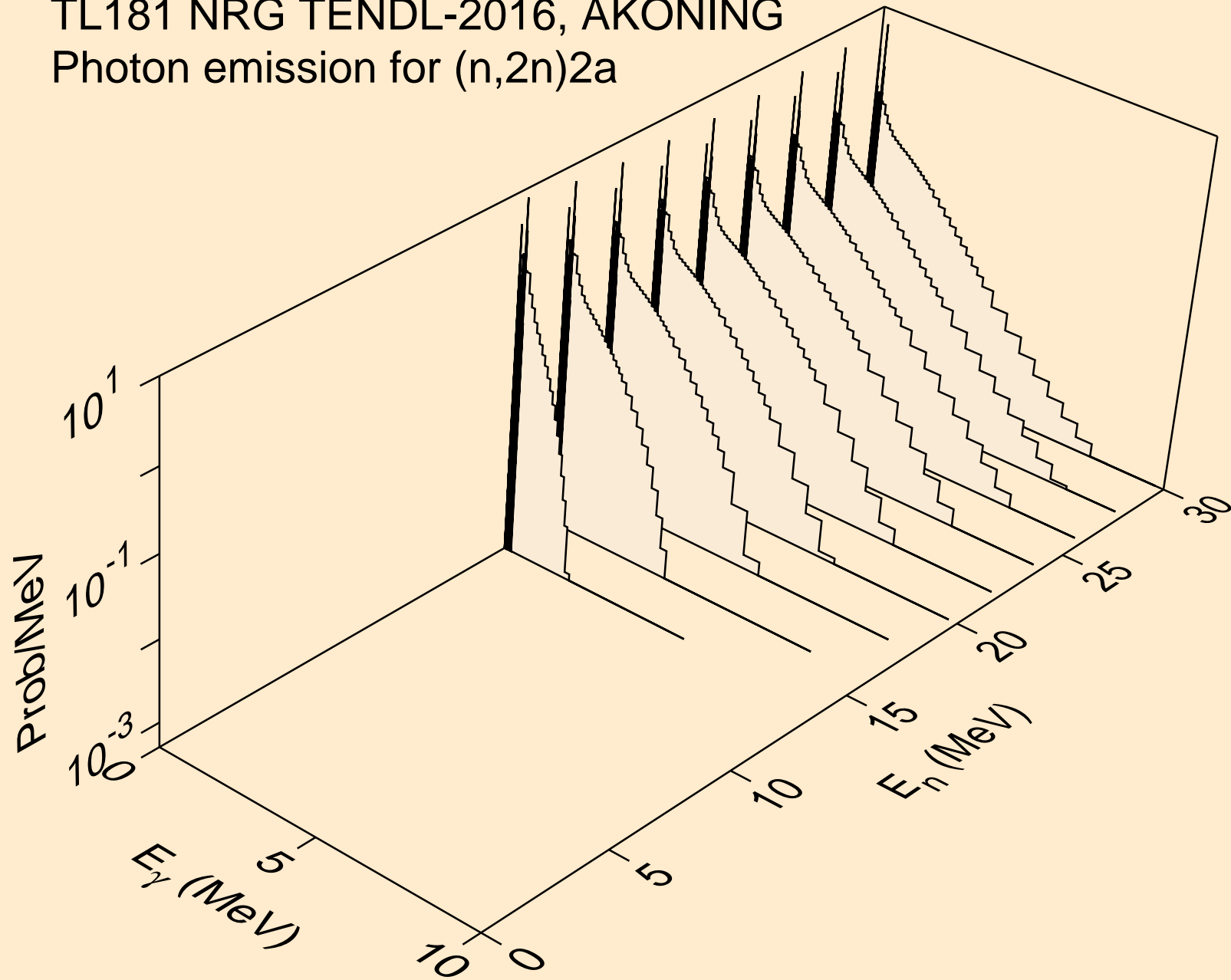

TL181 NRG TENDL-2016, AKONING
Photon emission for (n,n*)d

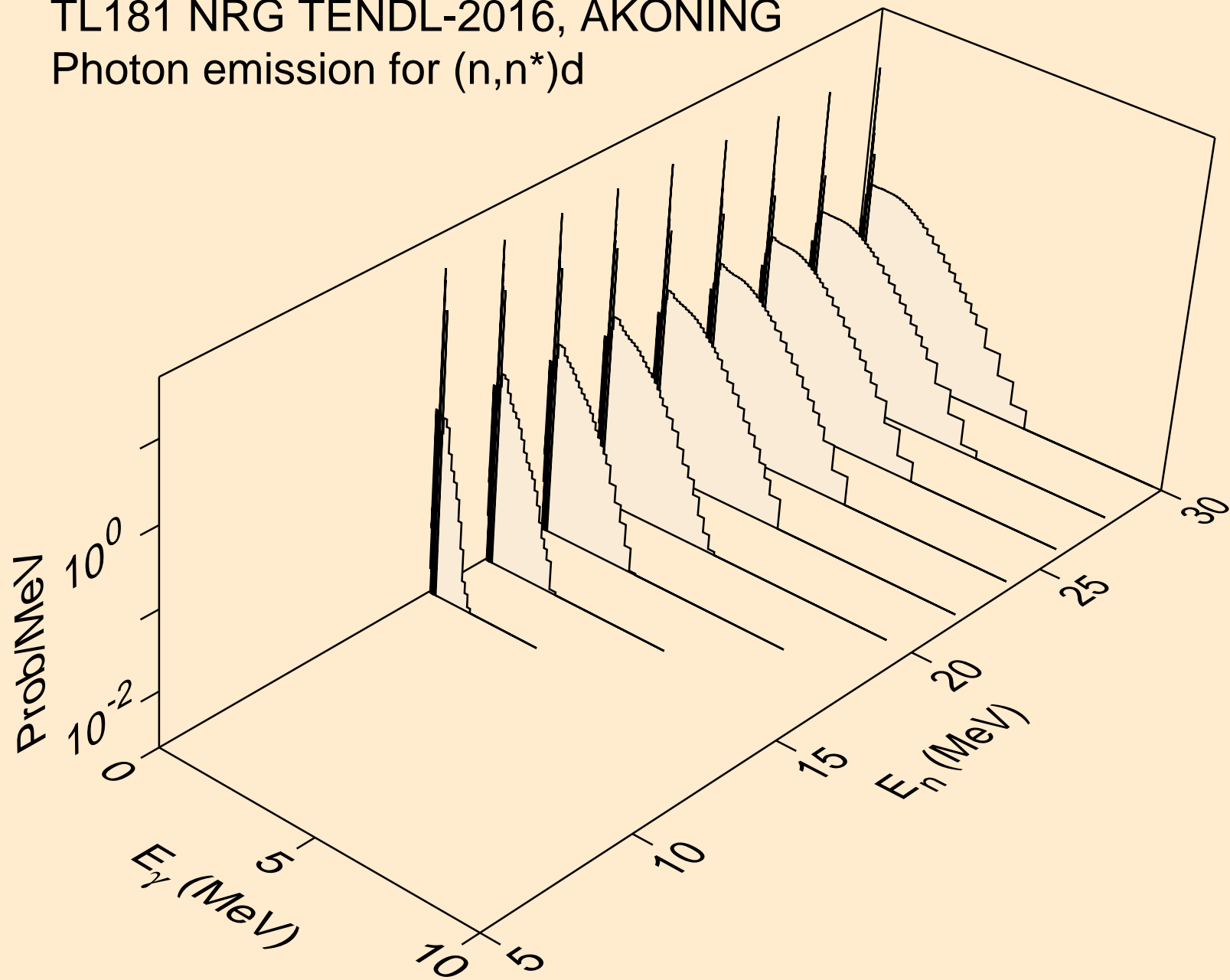

TL181 NRG TENDL-2016, AKONING
Photon emission for (n,n*)t

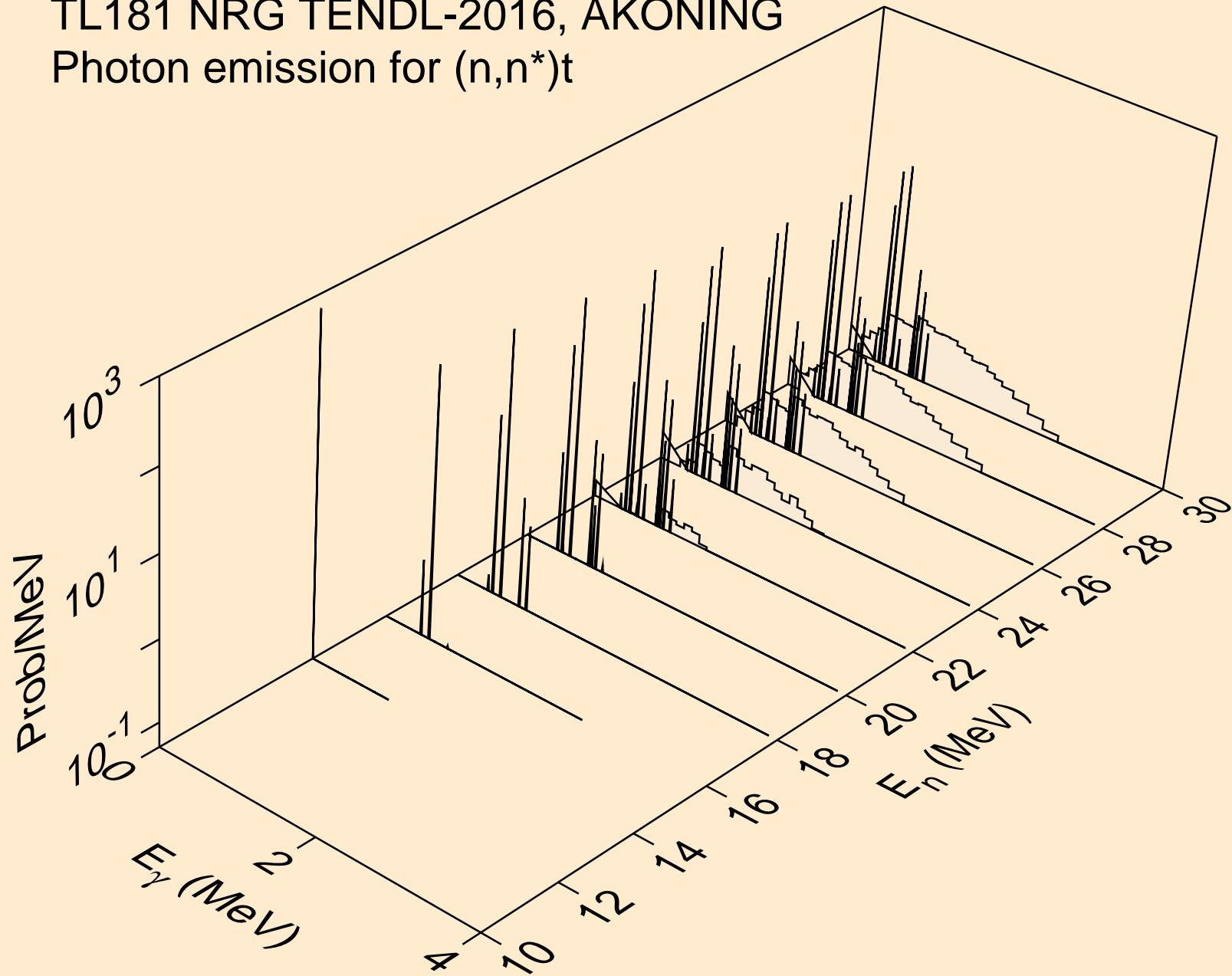

TL181 NRG TENDL-2016, AKONING
Photon emission for (n,n*)he3

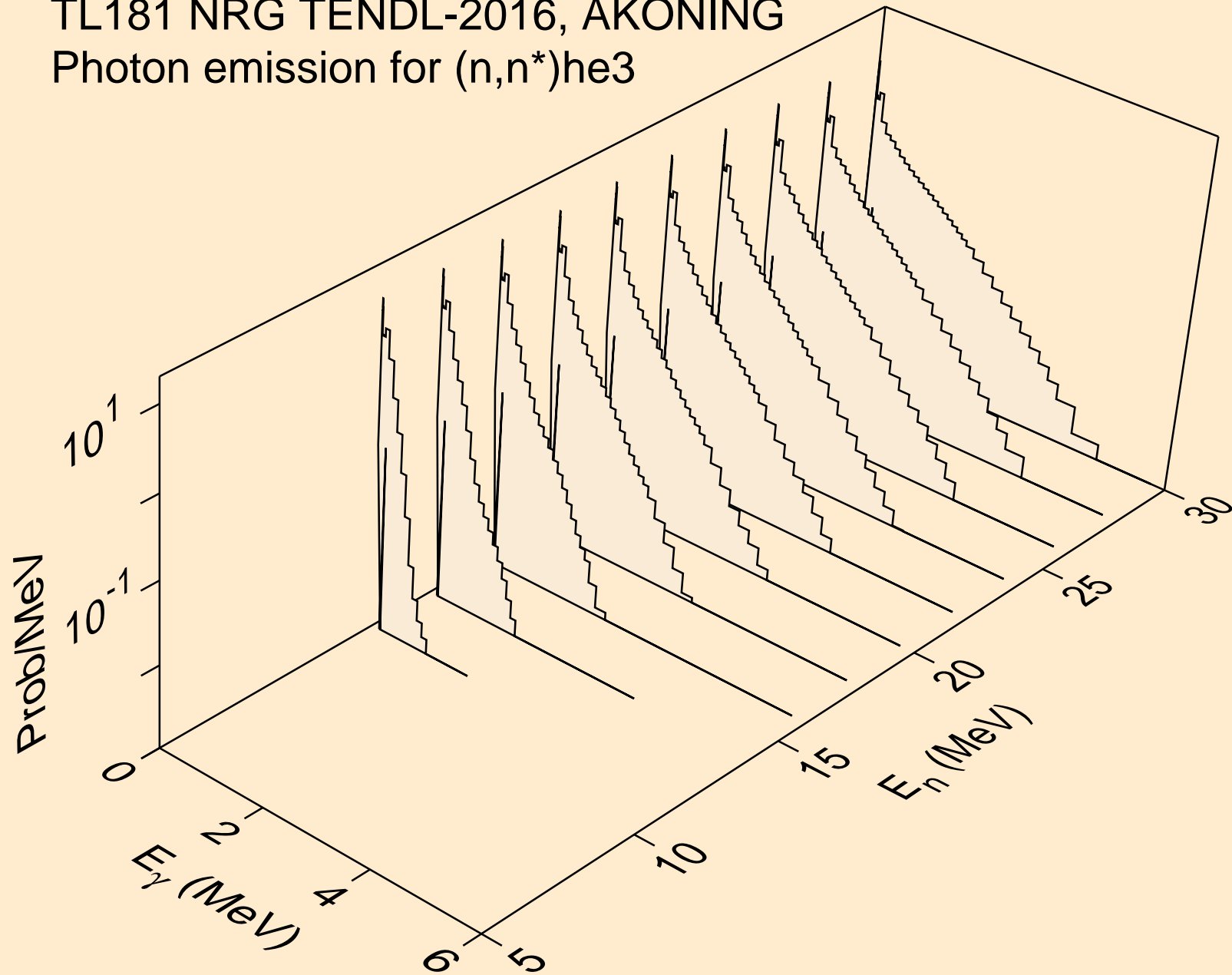

TL181 NRG TENDL-2016, AKONING
Photon emission for (n,n*)d2a

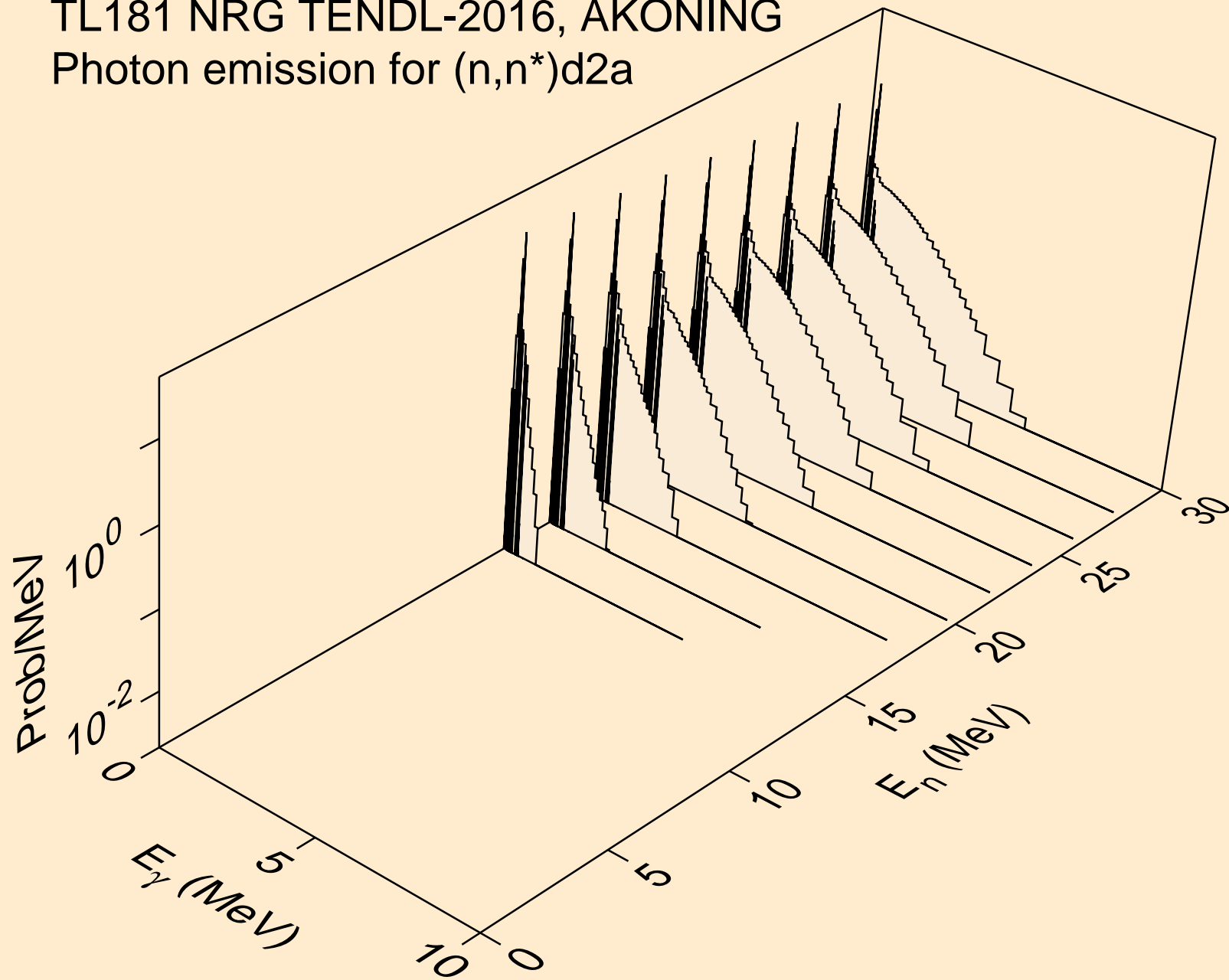

TL181 NRG TENDL-2016, AKONING
Photon emission for (n,n*)t2a

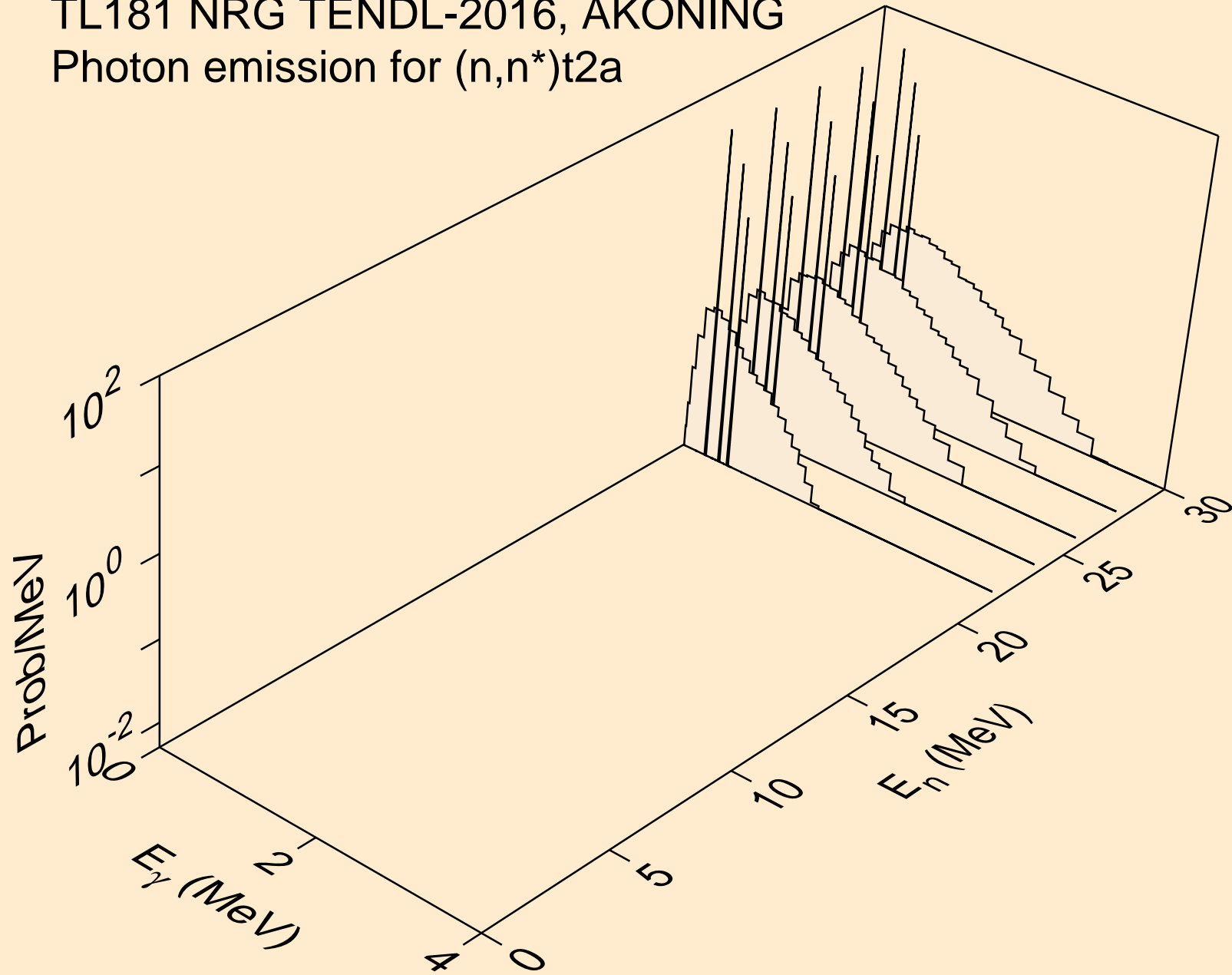

TL181 NRG TENDL-2016, AKONING
Photon emission for (n,2np)

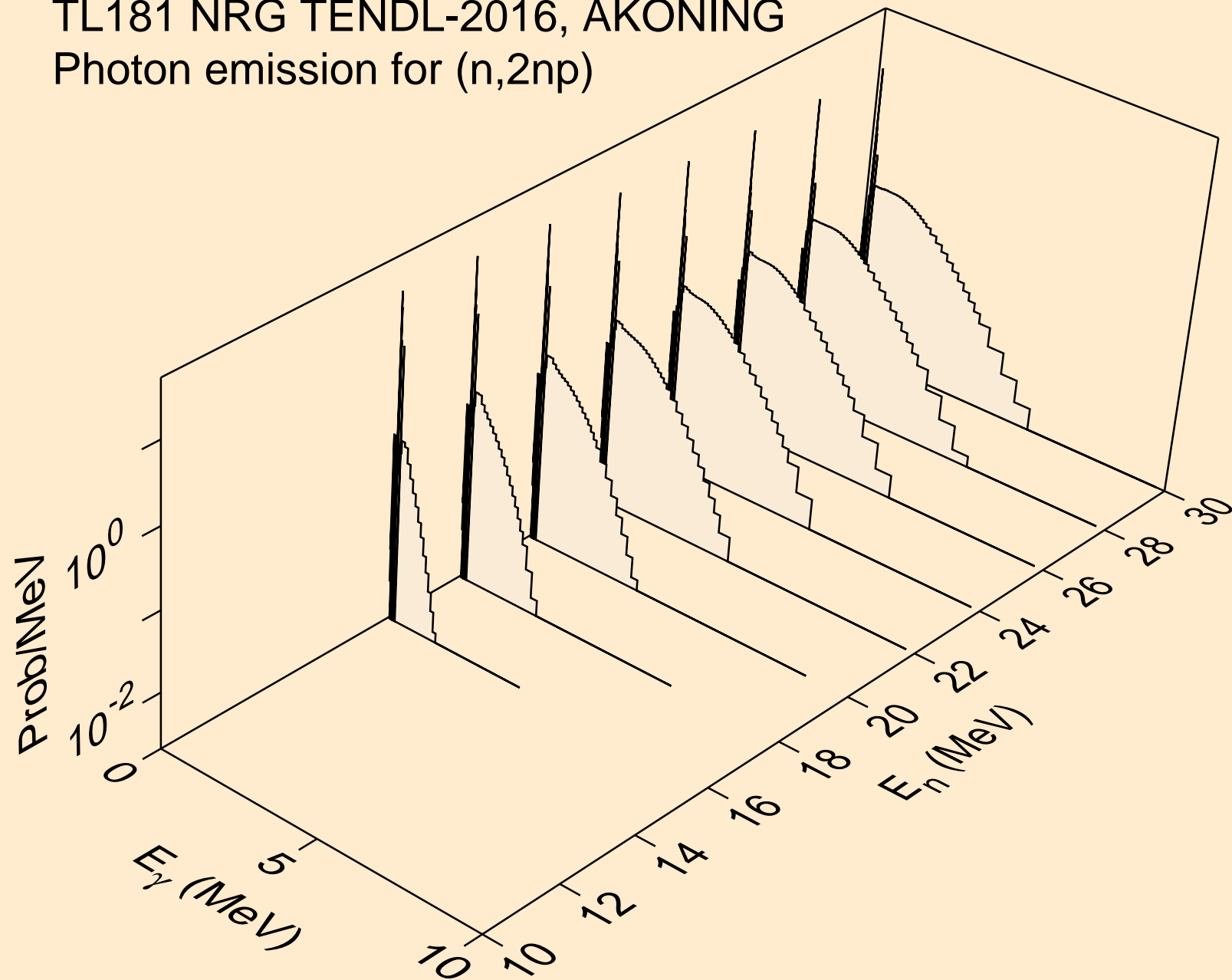

TL181 NRG TENDL-2016, AKONING
Photon emission for (n,3np)

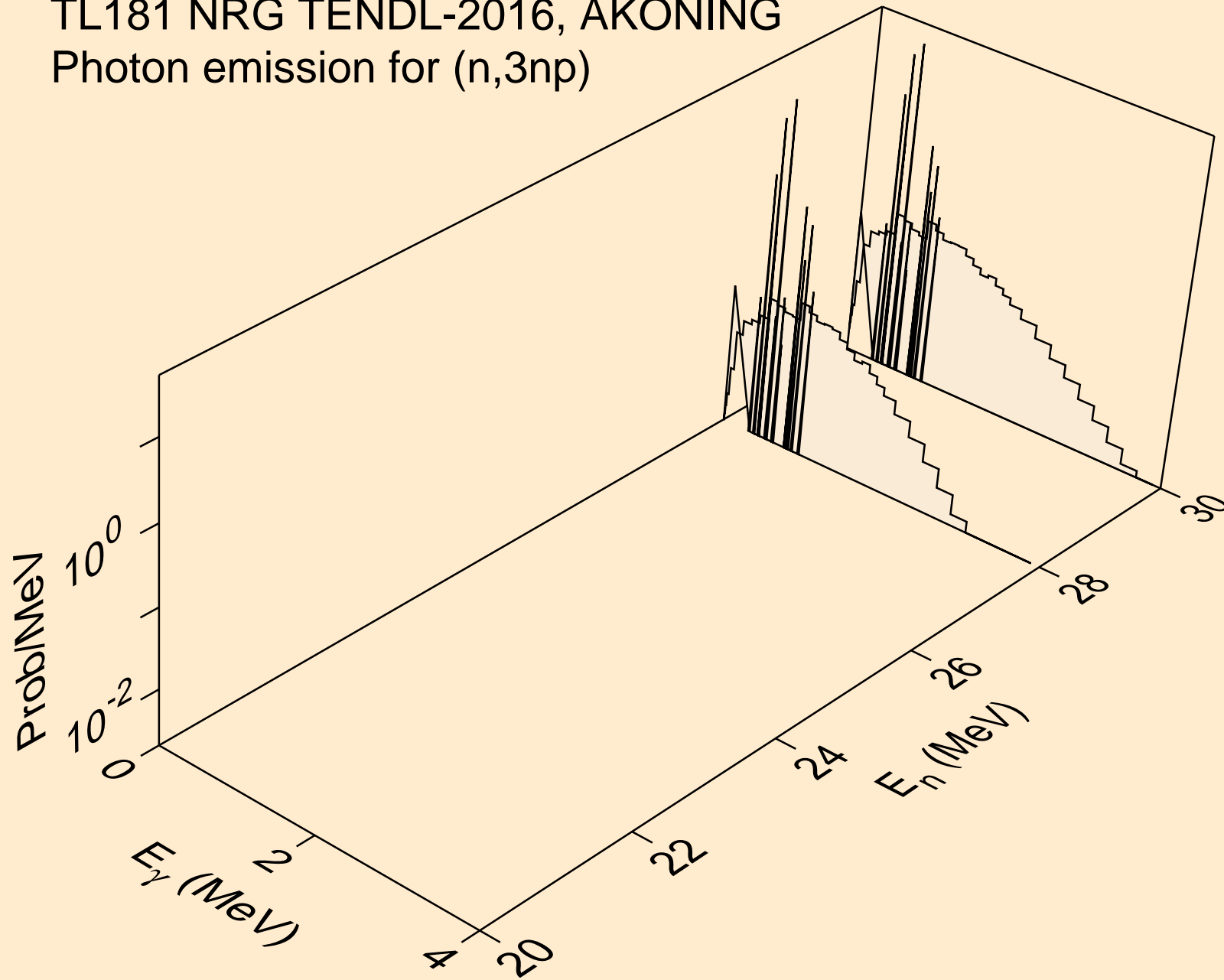

TL181 NRG TENDL-2016, AKONING
Photon emission for (n,2np)

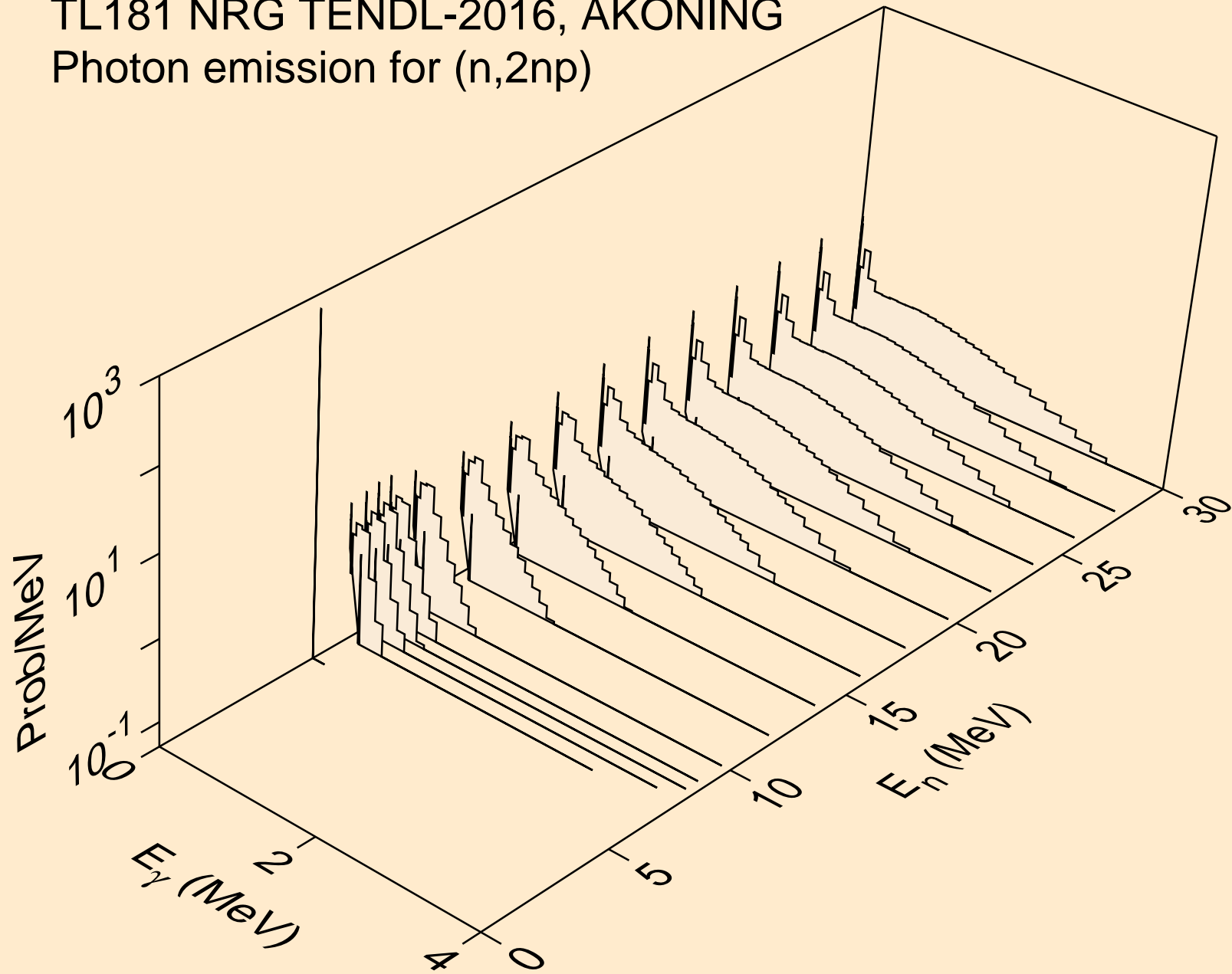

TL181 NRG TENDL-2016, AKONING
Photon emission for (n,npa)

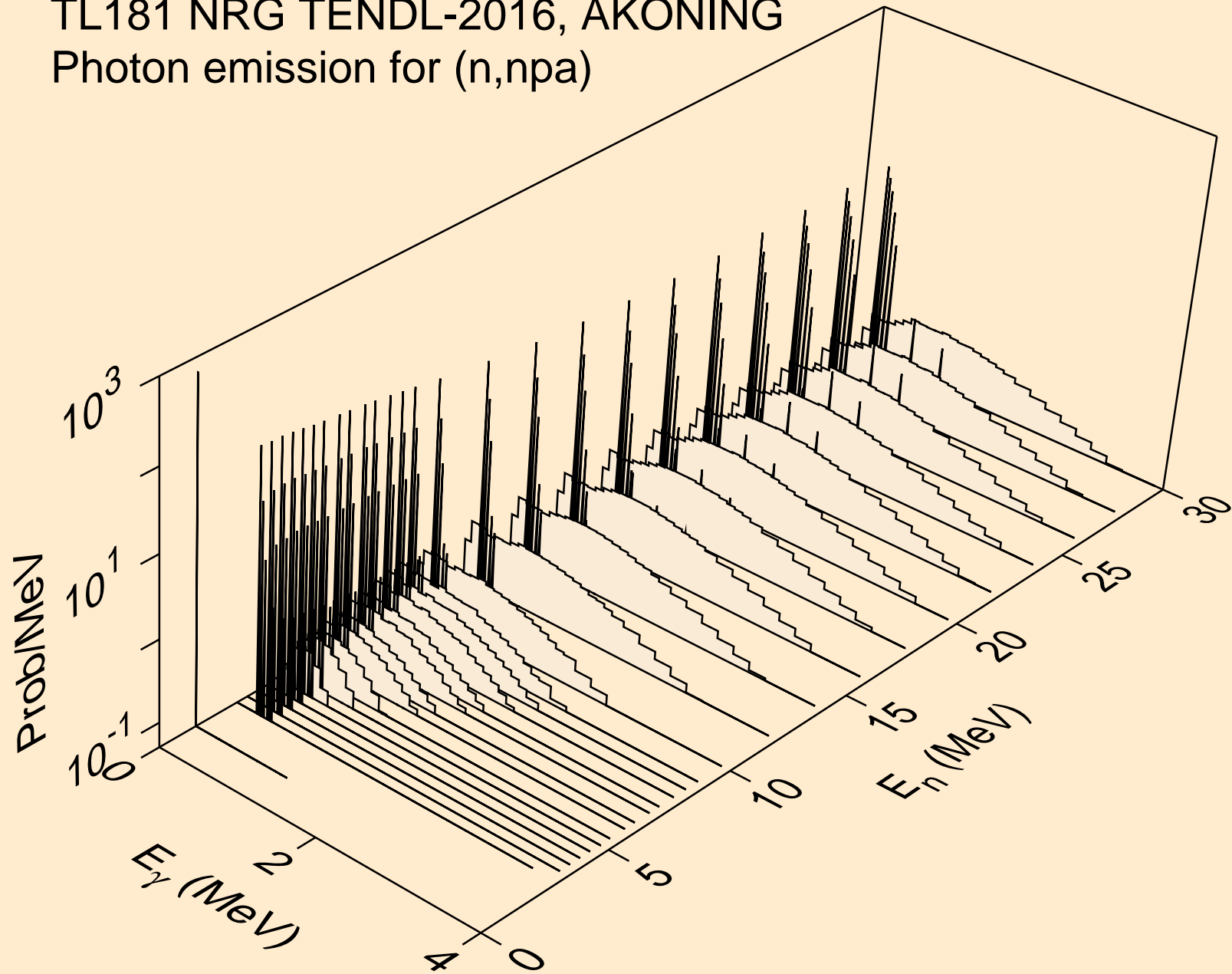

TL181 NRG TENDL-2016, AKONING
Photon emission for (n,n*c)

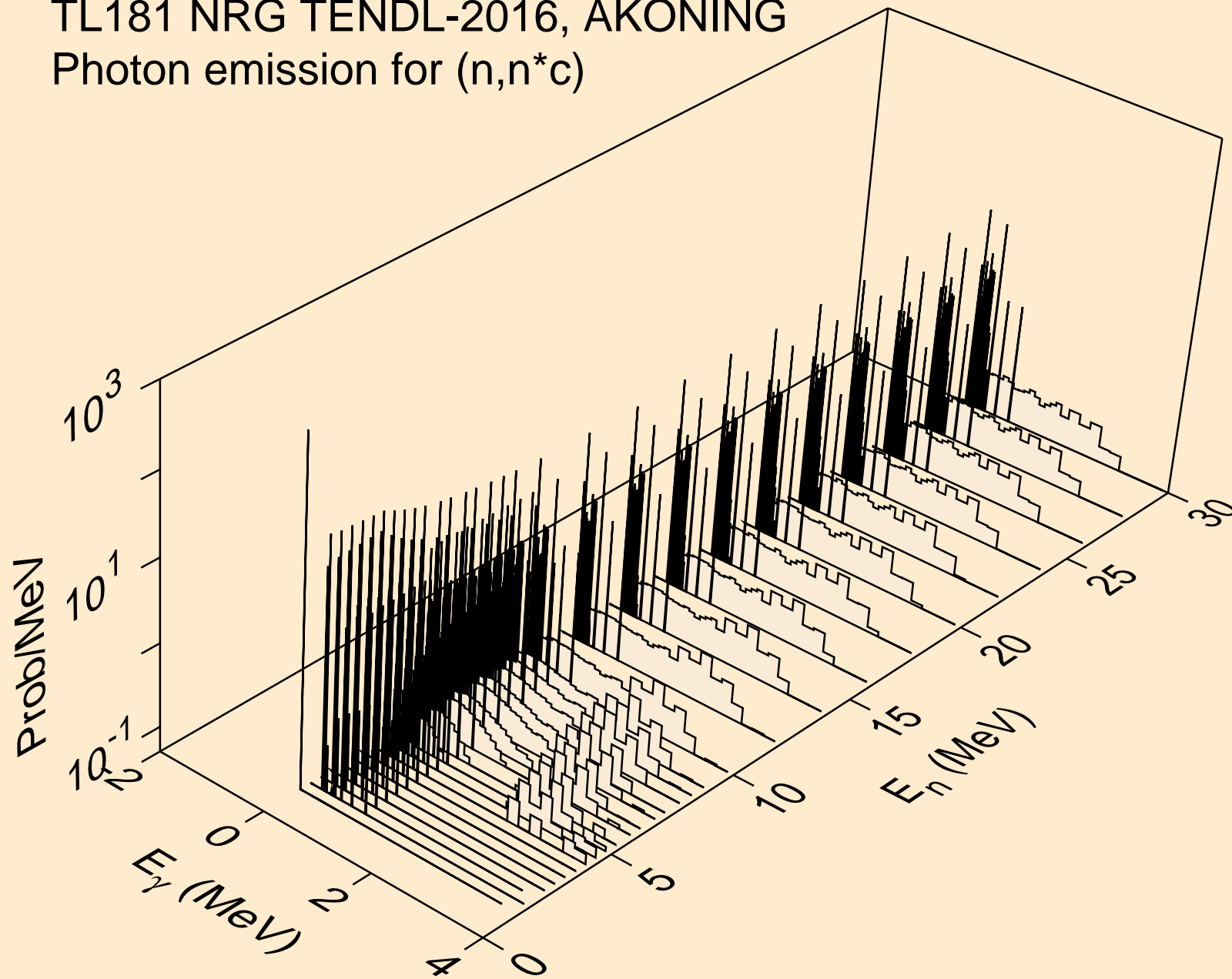

TL181 NRG TENDL-2016, AKONING
Photon emission for (n,gma)

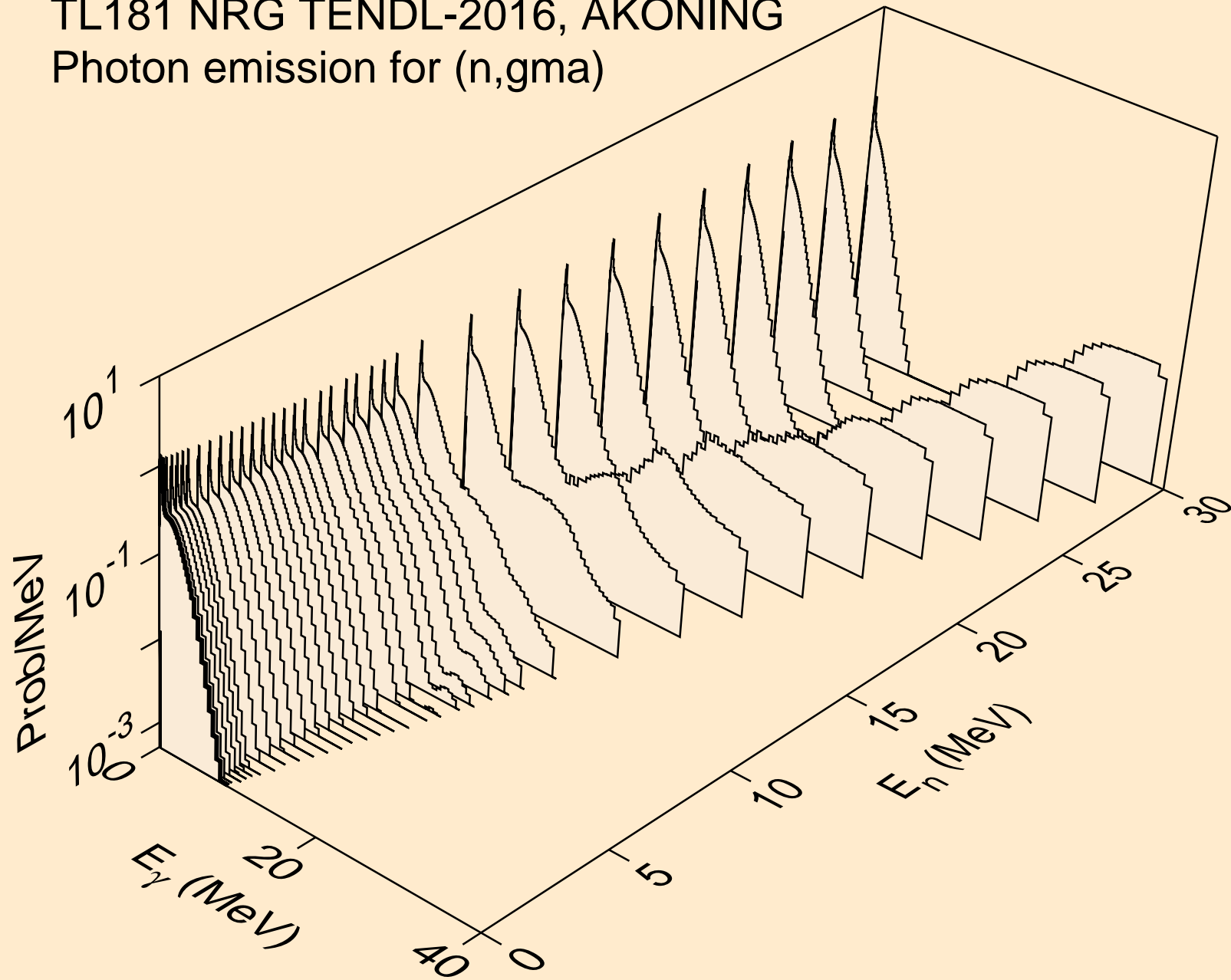

TL181 NRG TENDL-2016, AKONING
Photon emission for (n,p)

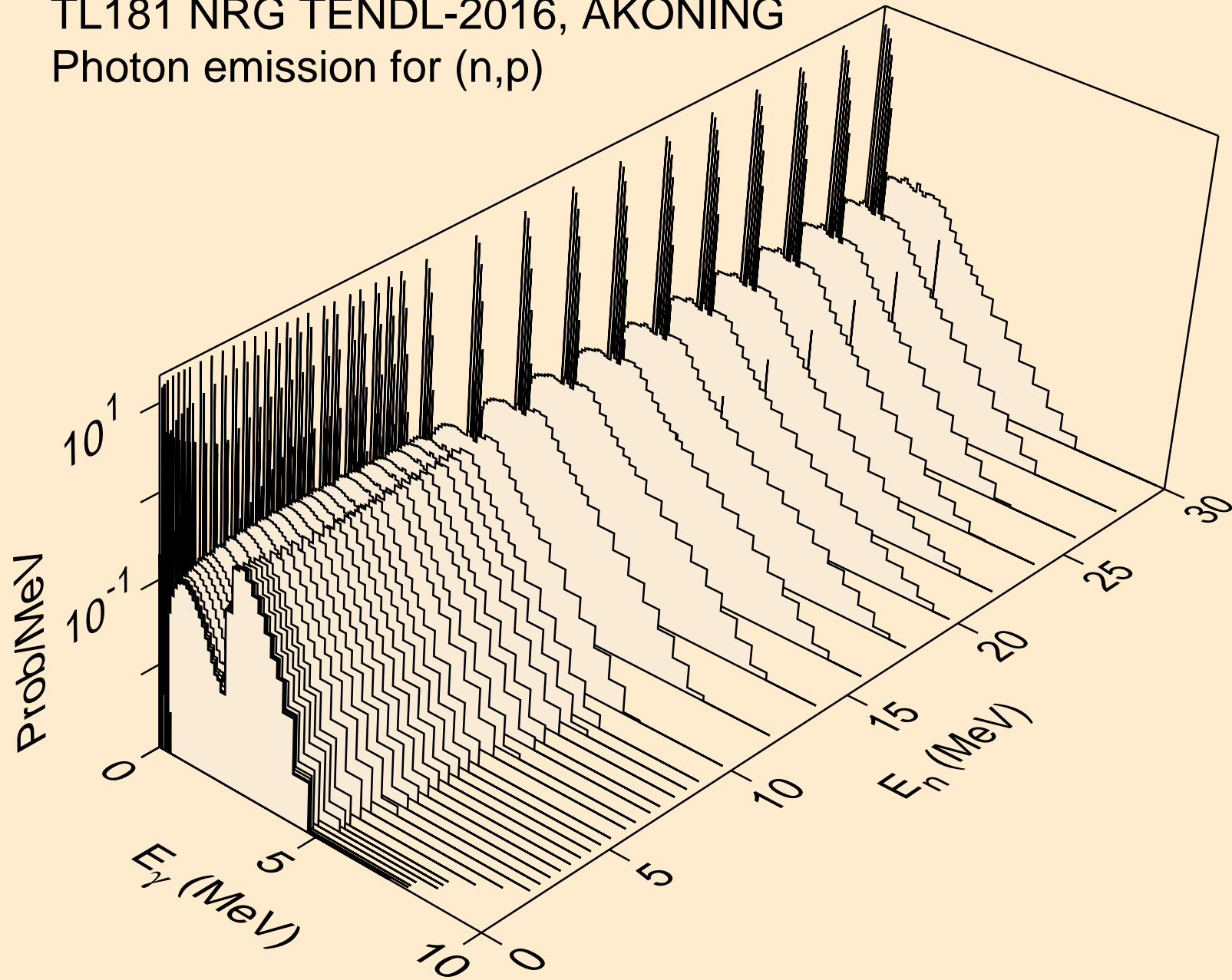

TL181 NRG TENDL-2016, AKONING
Photon emission for (n,d)

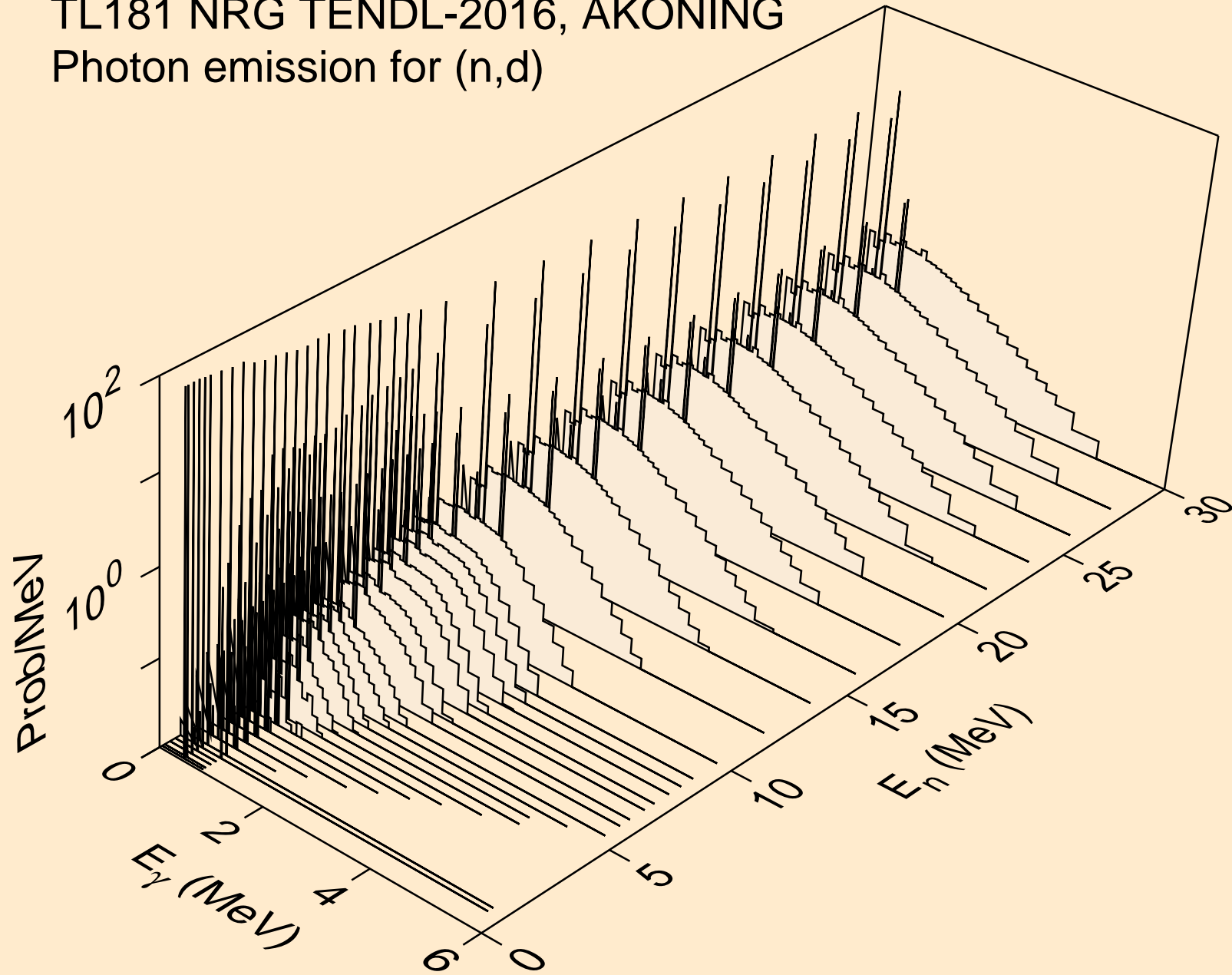

TL181 NRG TENDL-2016, AKONING
Photon emission for (n,t)

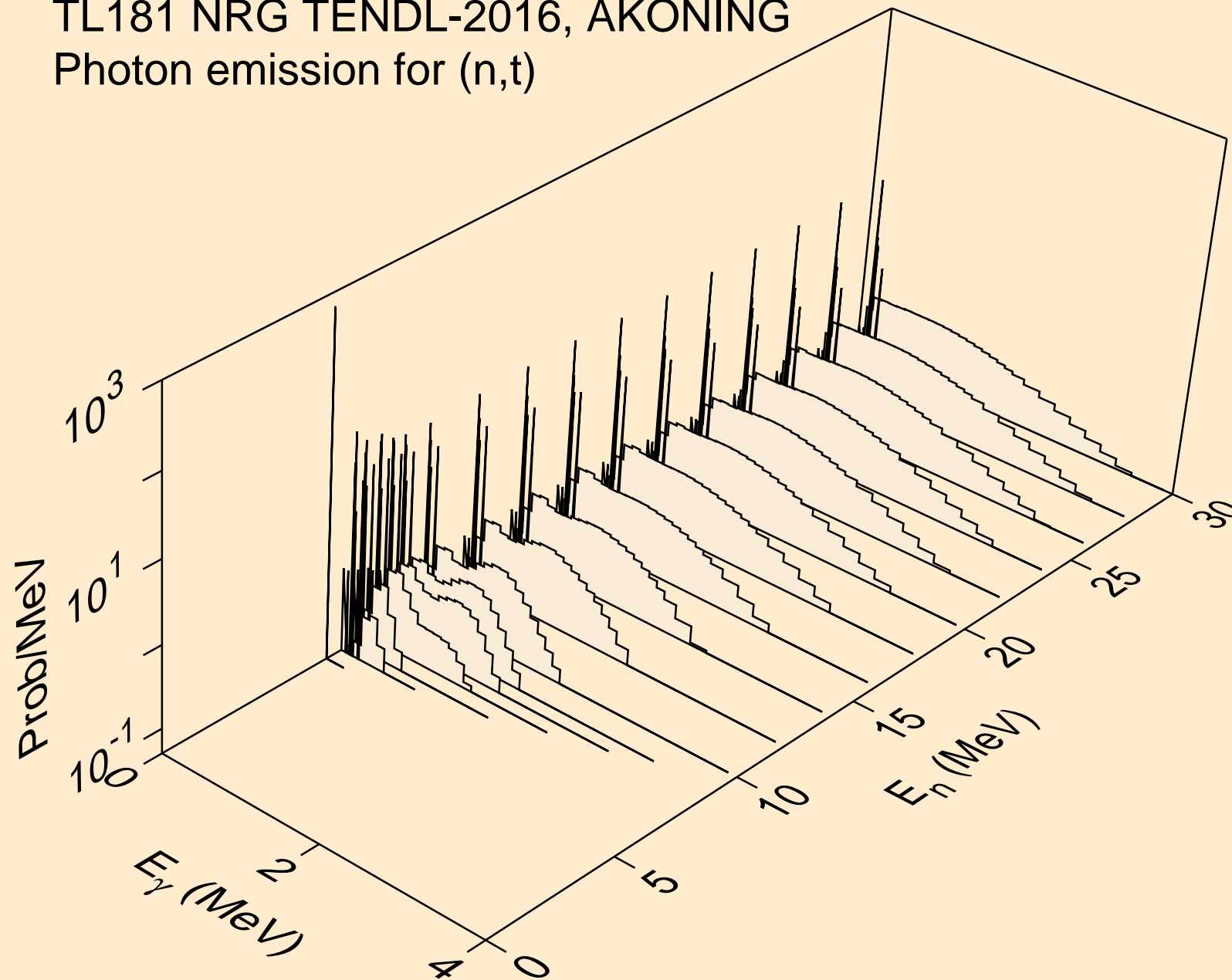

TL181 NRG TENDL-2016, AKONING
Photon emission for (n,he3)

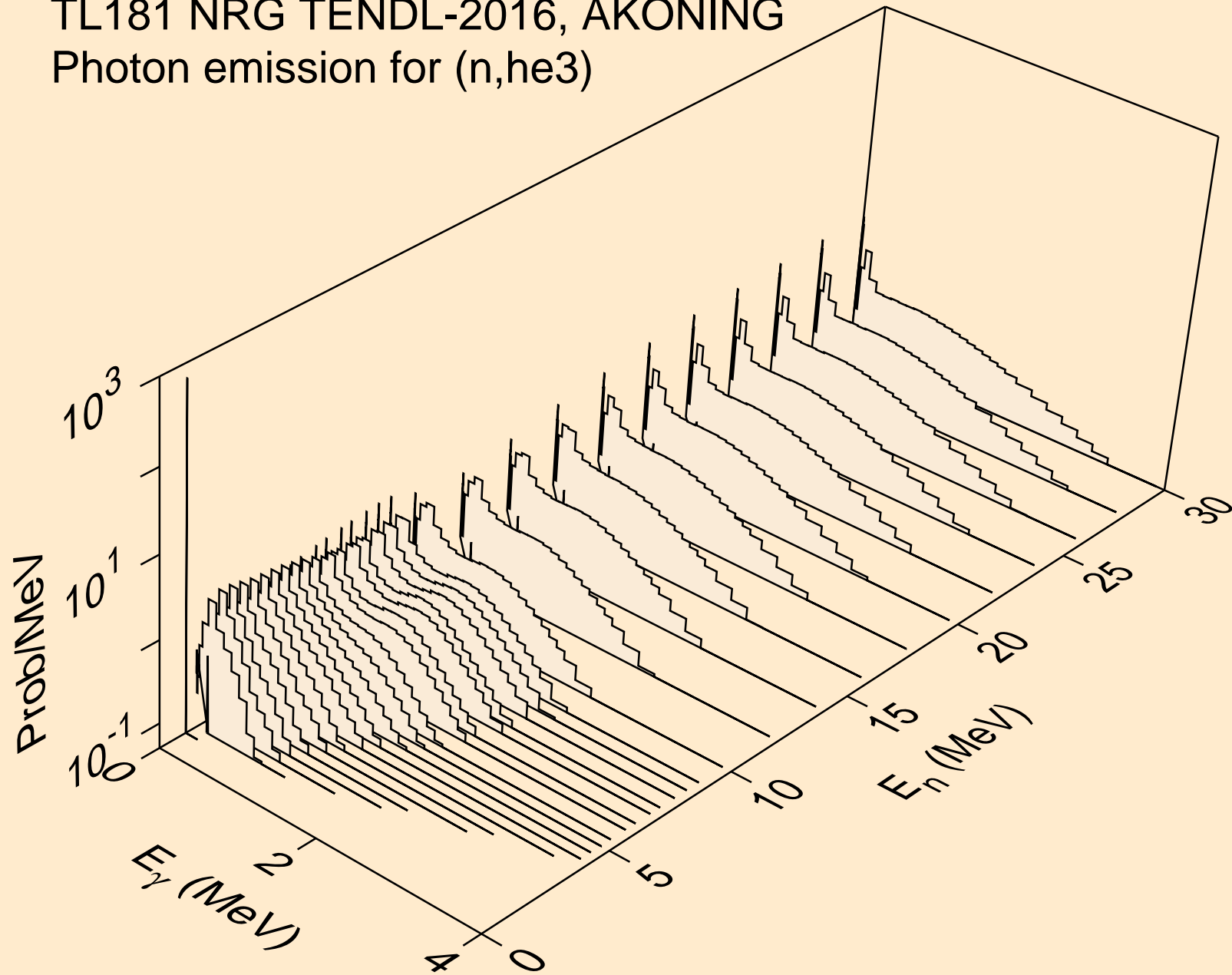

TL181 NRG TENDL-2016, AKONING
Photon emission for (n,a)

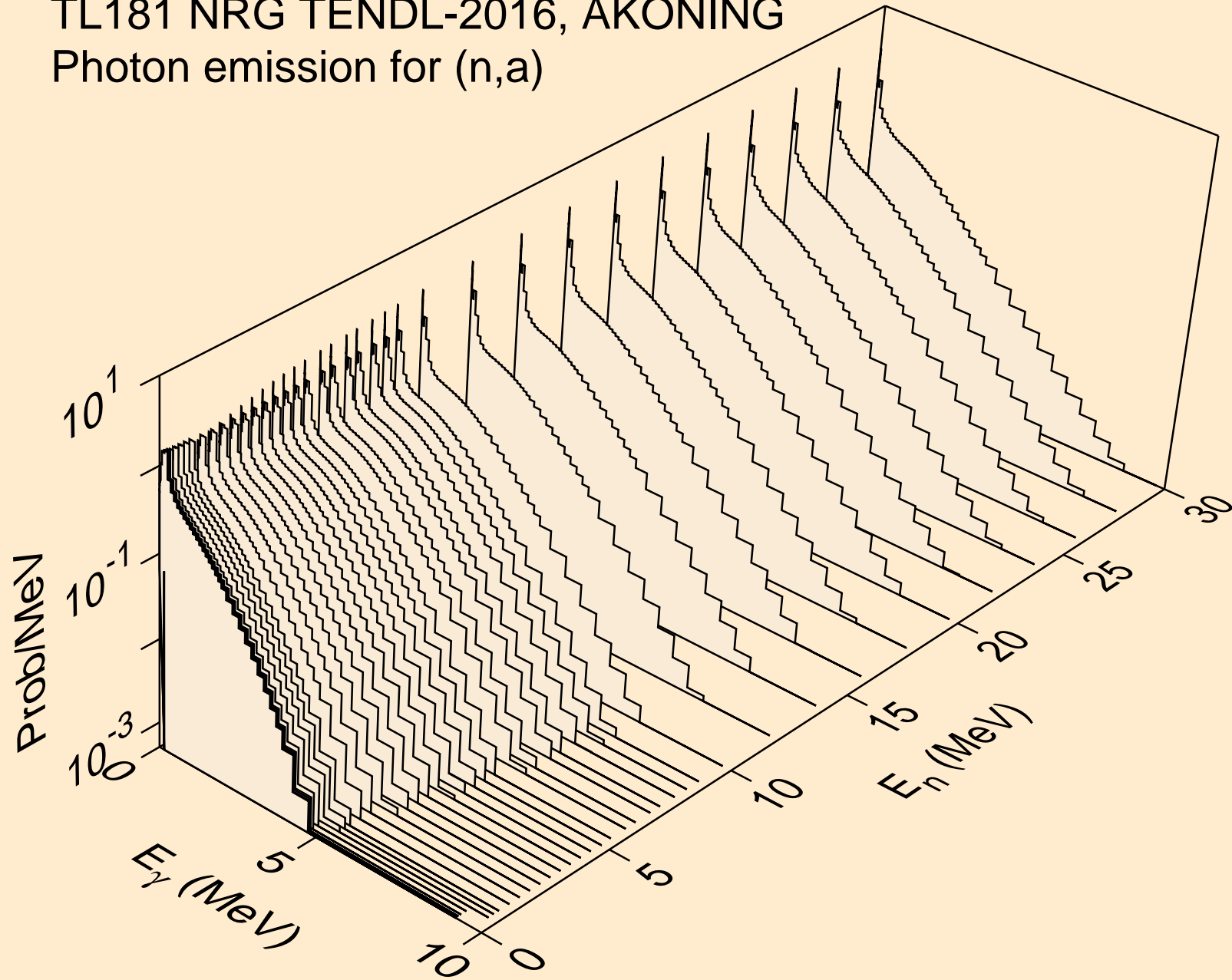

TL181 NRG TENDL-2016, AKONING
Photon emission for (n,2a)

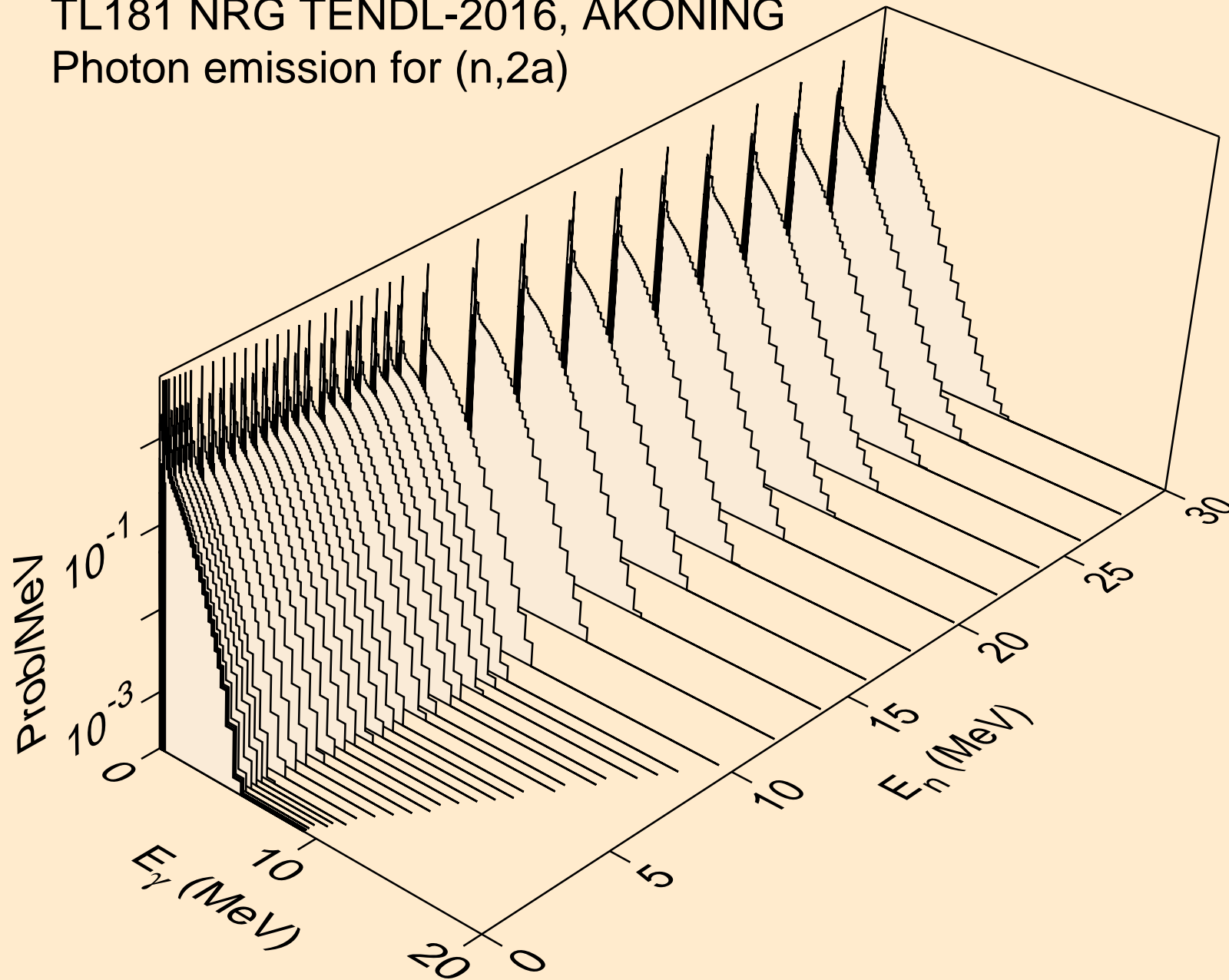

TL181 NRG TENDL-2016, AKONING
Photon emission for (n,3a)

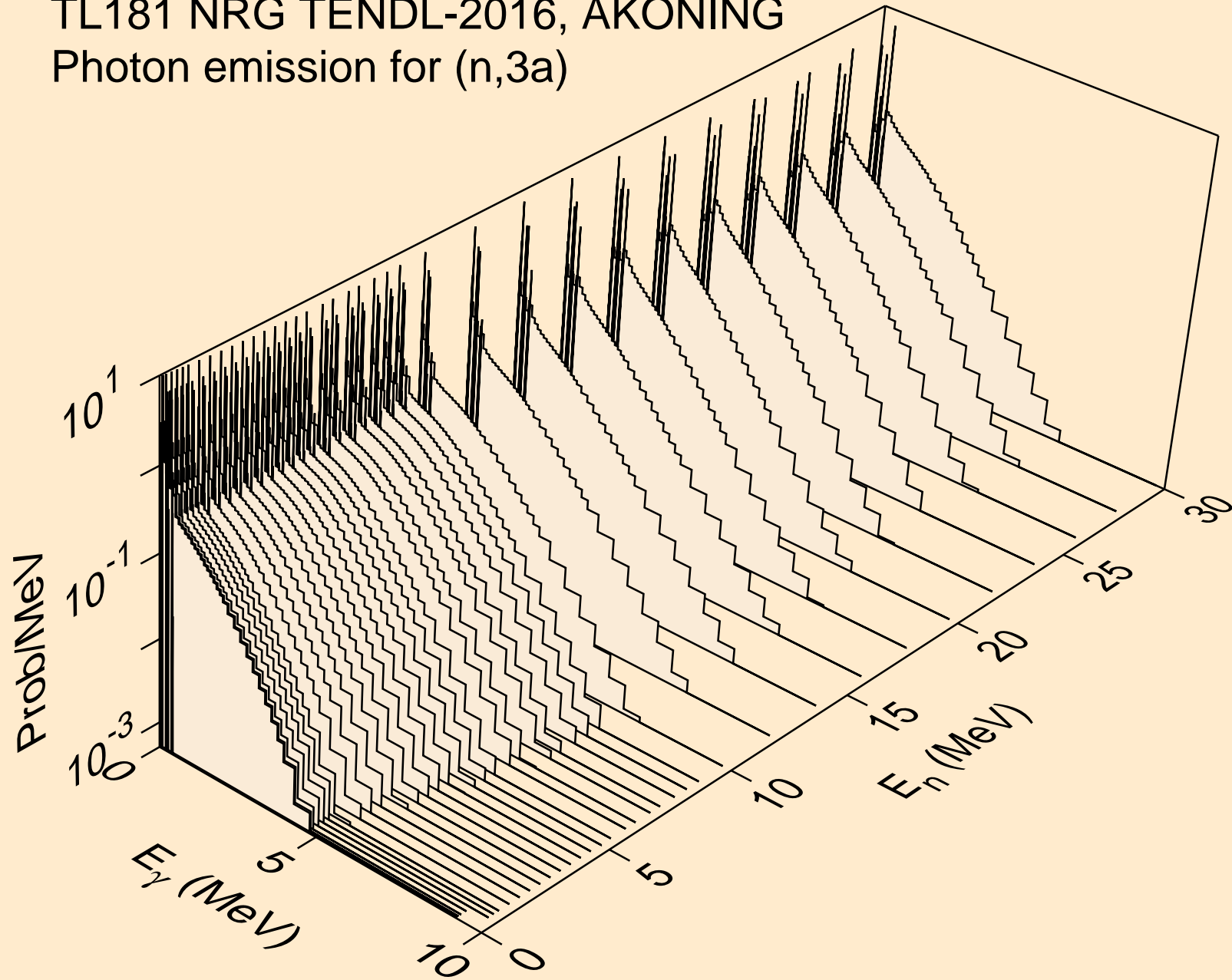

TL181 NRG TENDL-2016, AKONING
Photon emission for (n,2p)

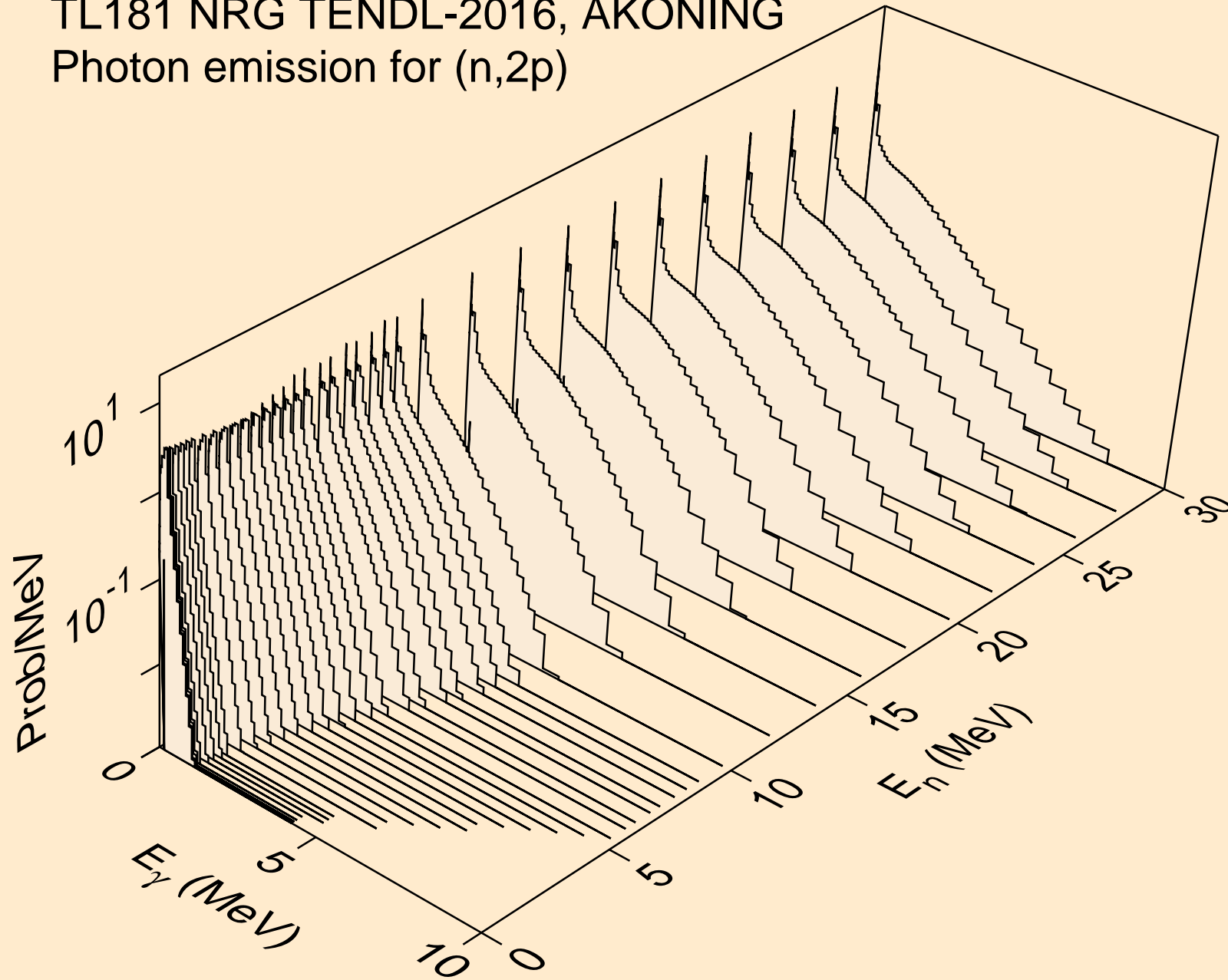

TL181 NRG TENDL-2016, AKONING
Photon emission for (n,p α)

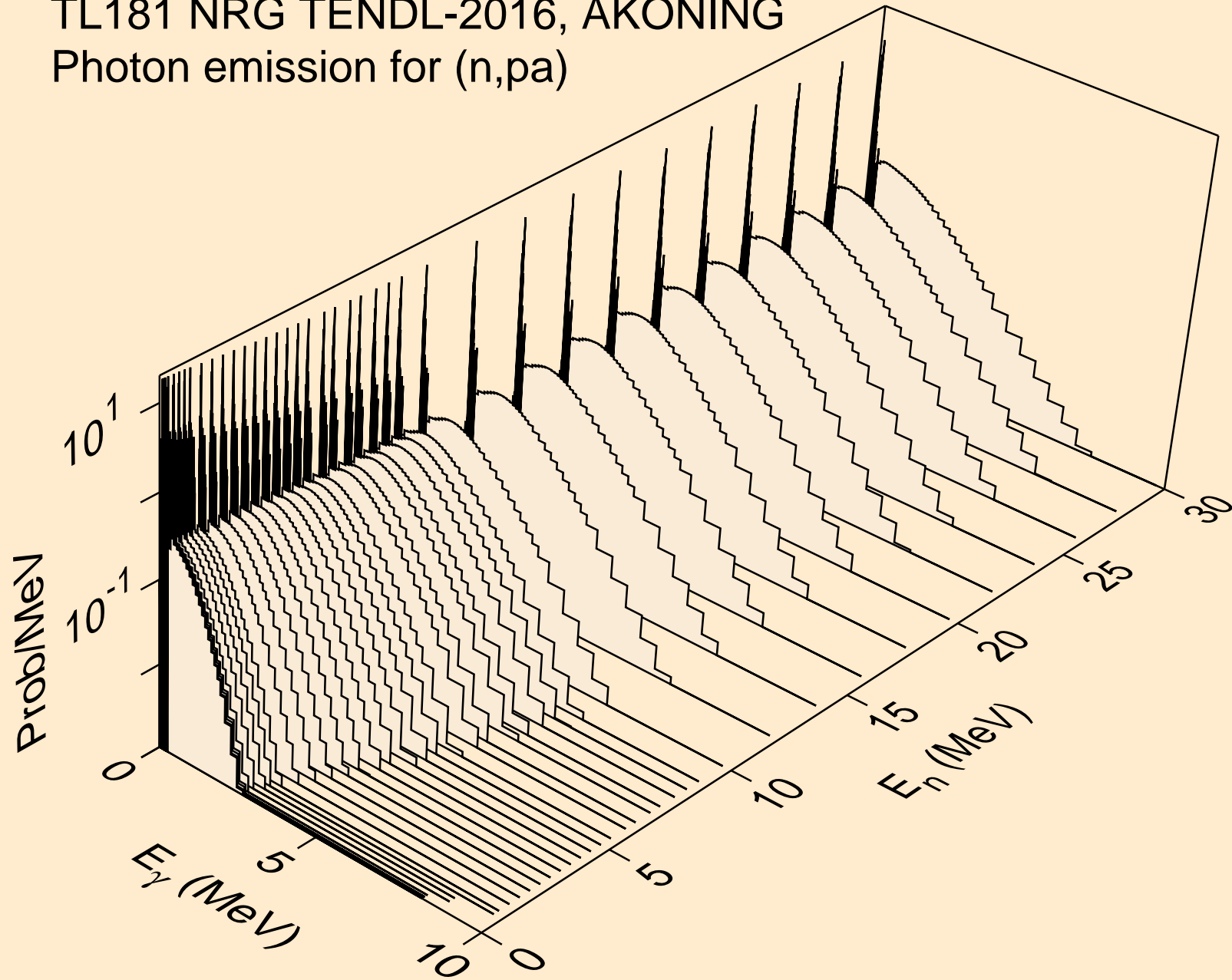

TL181 NRG TENDL-2016, AKONING
Photon emission for (n,t2a)

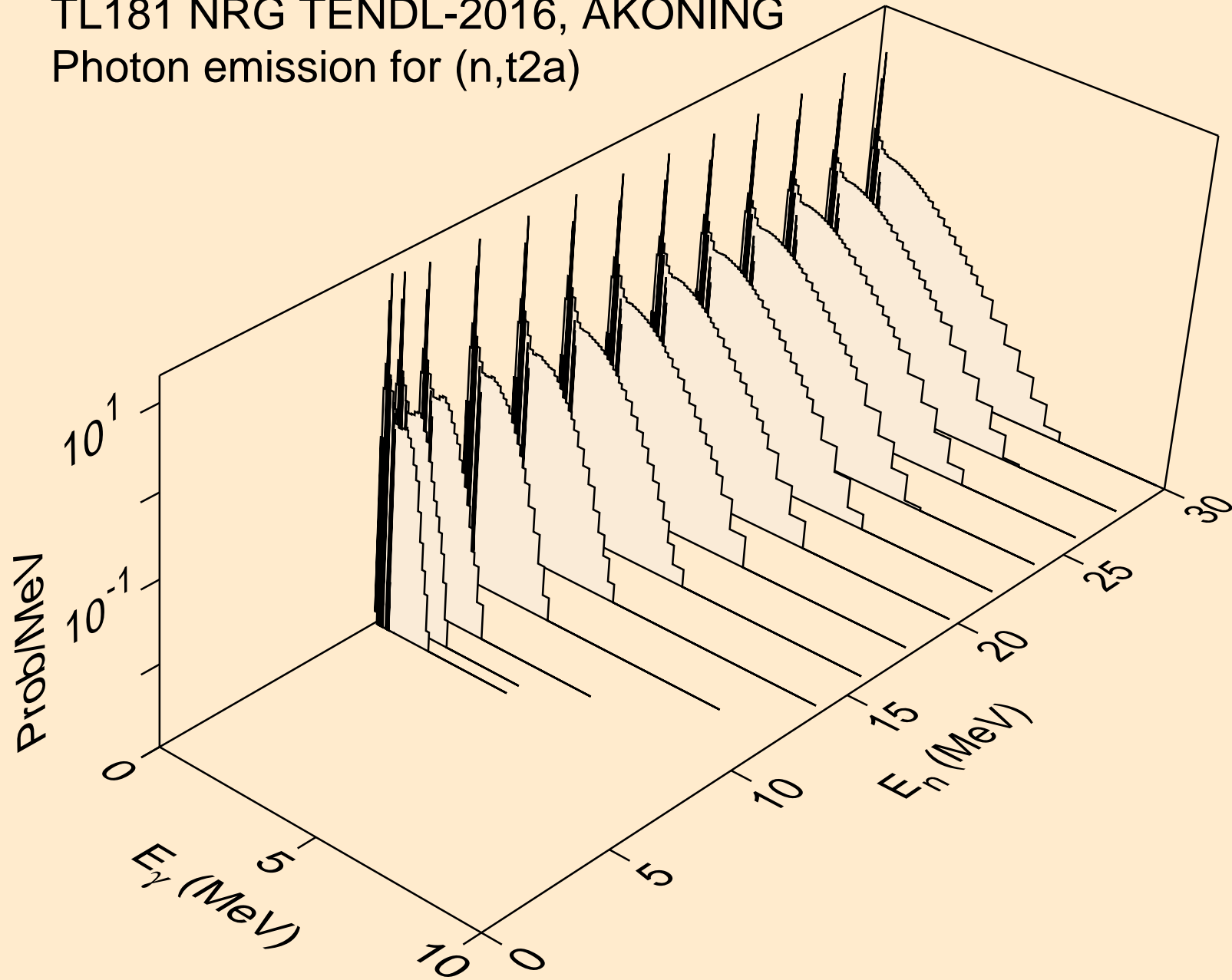

TL181 NRG TENDL-2016, AKONING
Photon emission for (n,d2a)

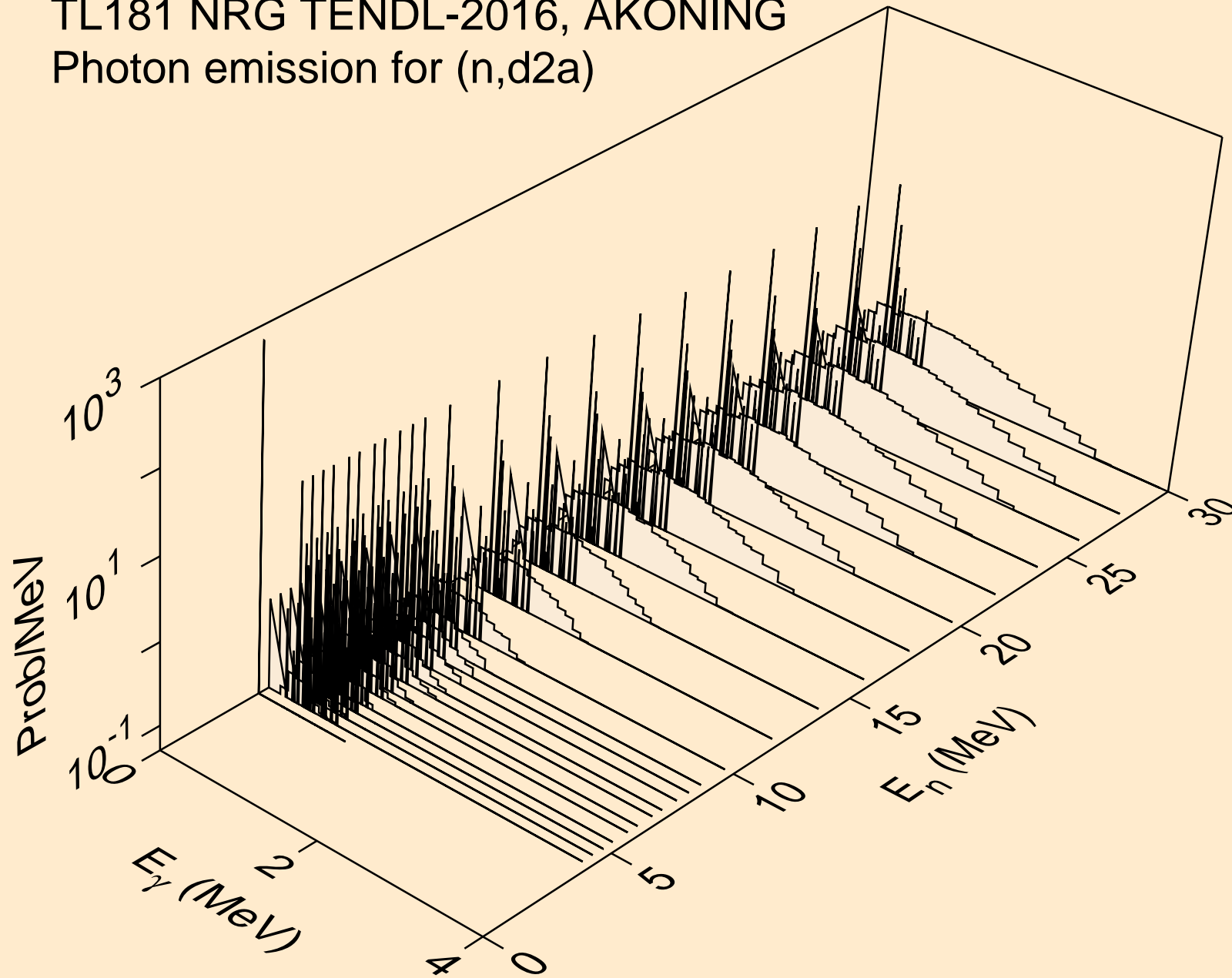

TL181 NRG TENDL-2016, AKONING
Photon emission for (n,pd)

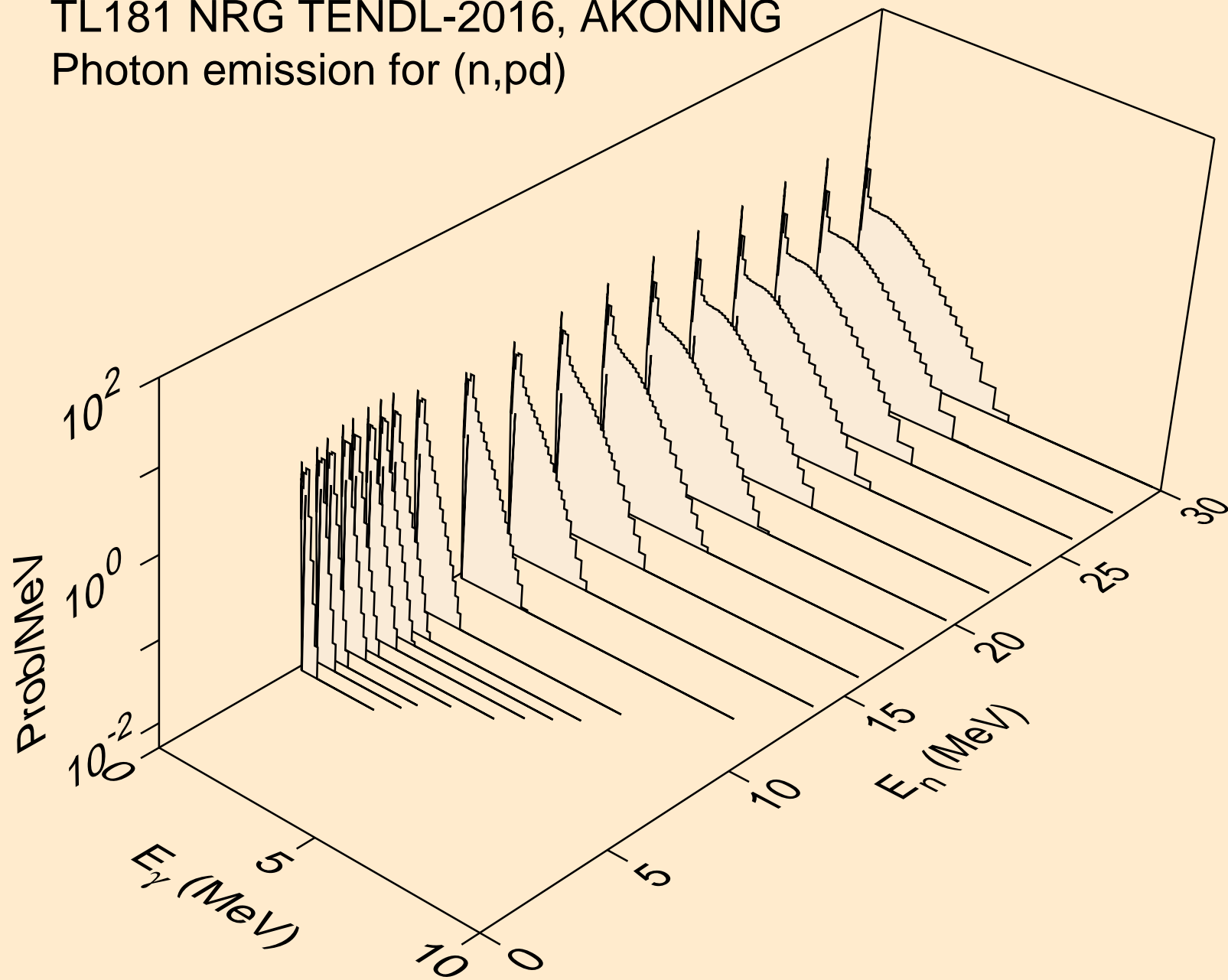

TL181 NRG TENDL-2016, AKONING
Photon emission for (n,pt)

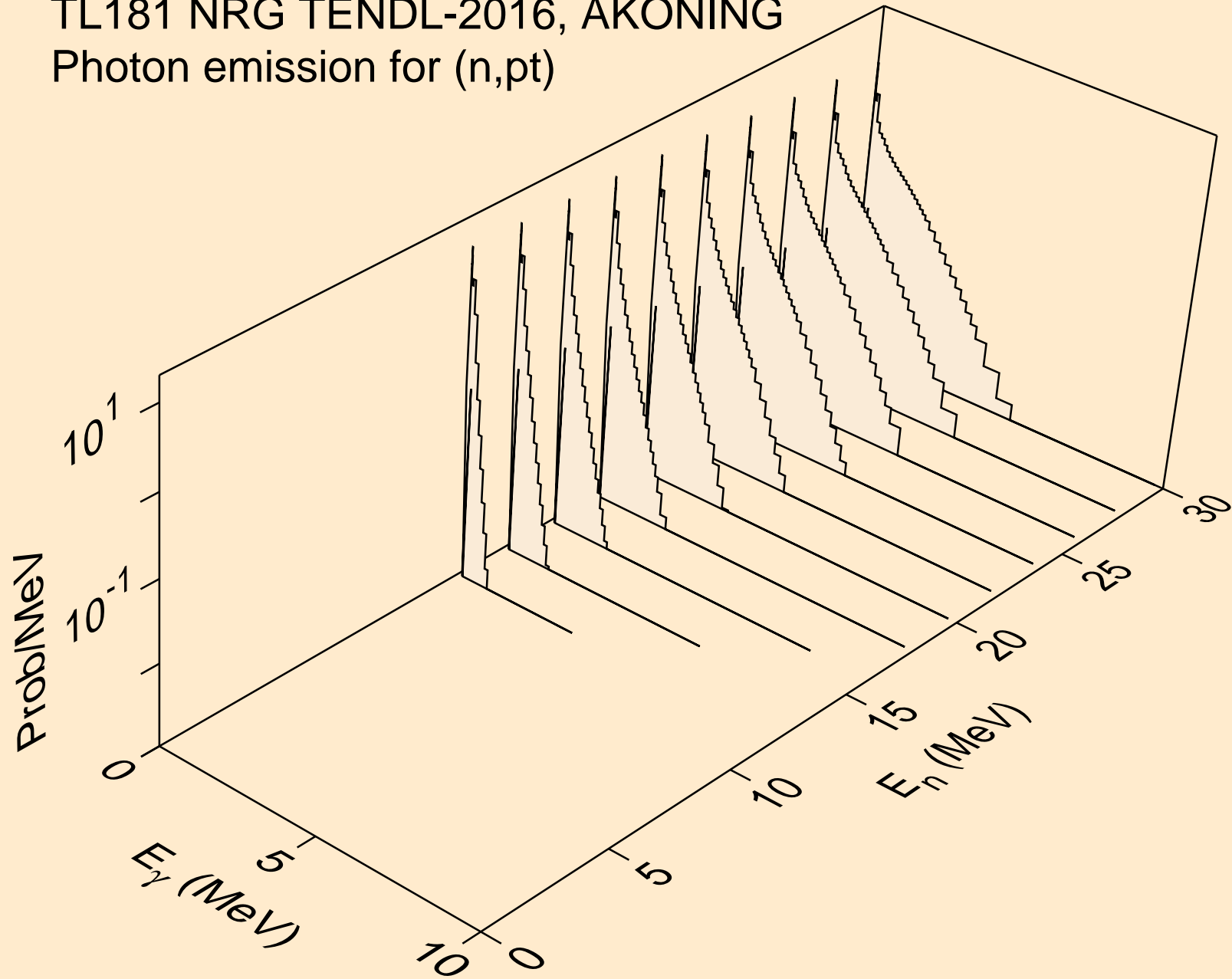

TL181 NRG TENDL-2016, AKONING
Photon emission for (n,da)

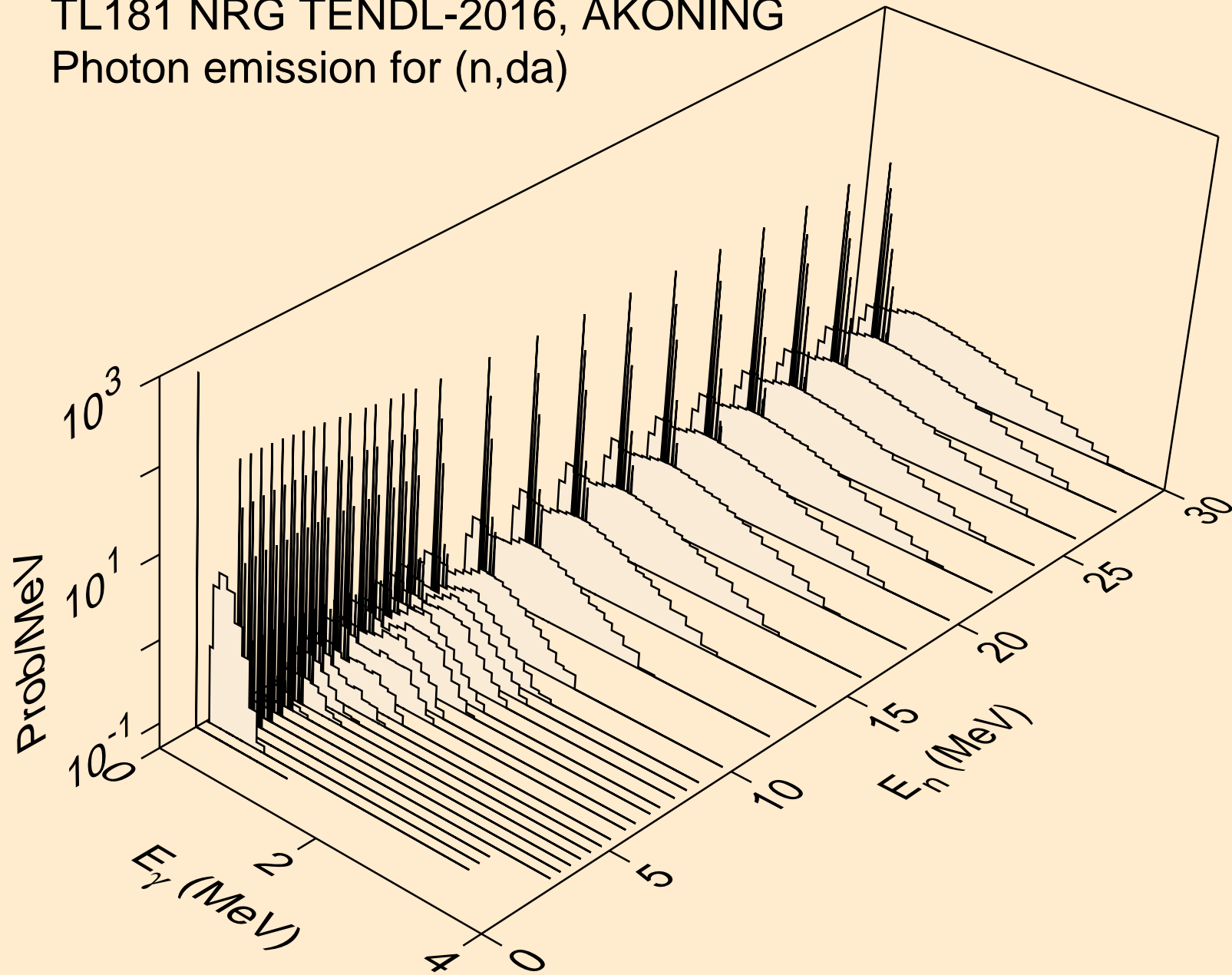

TL181 NRG TENDL-2016, AKONING
thermal capture photon spectrum

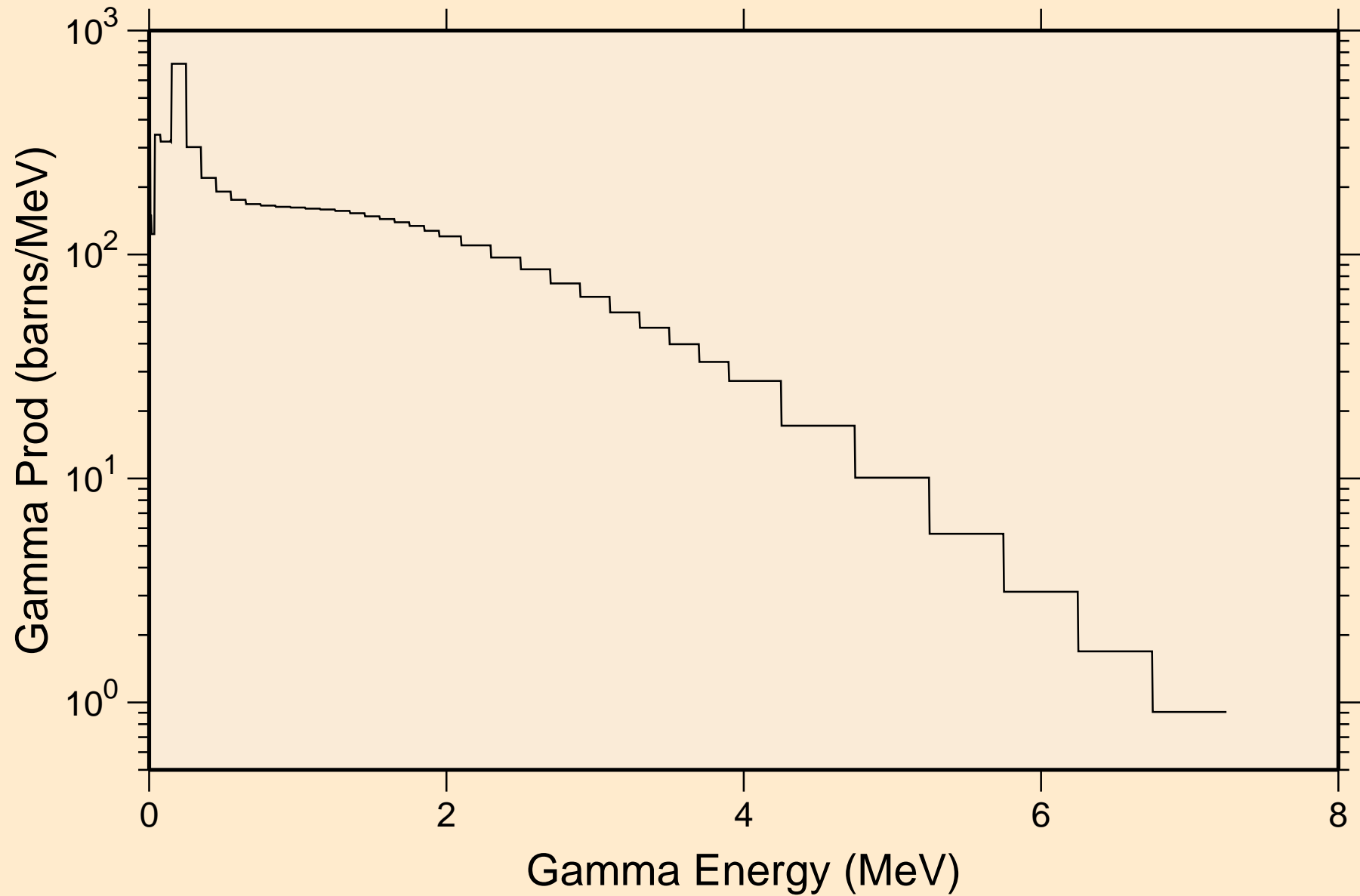

TL181 NRG TENDL-2016, AKONING
14 MeV photon spectrum

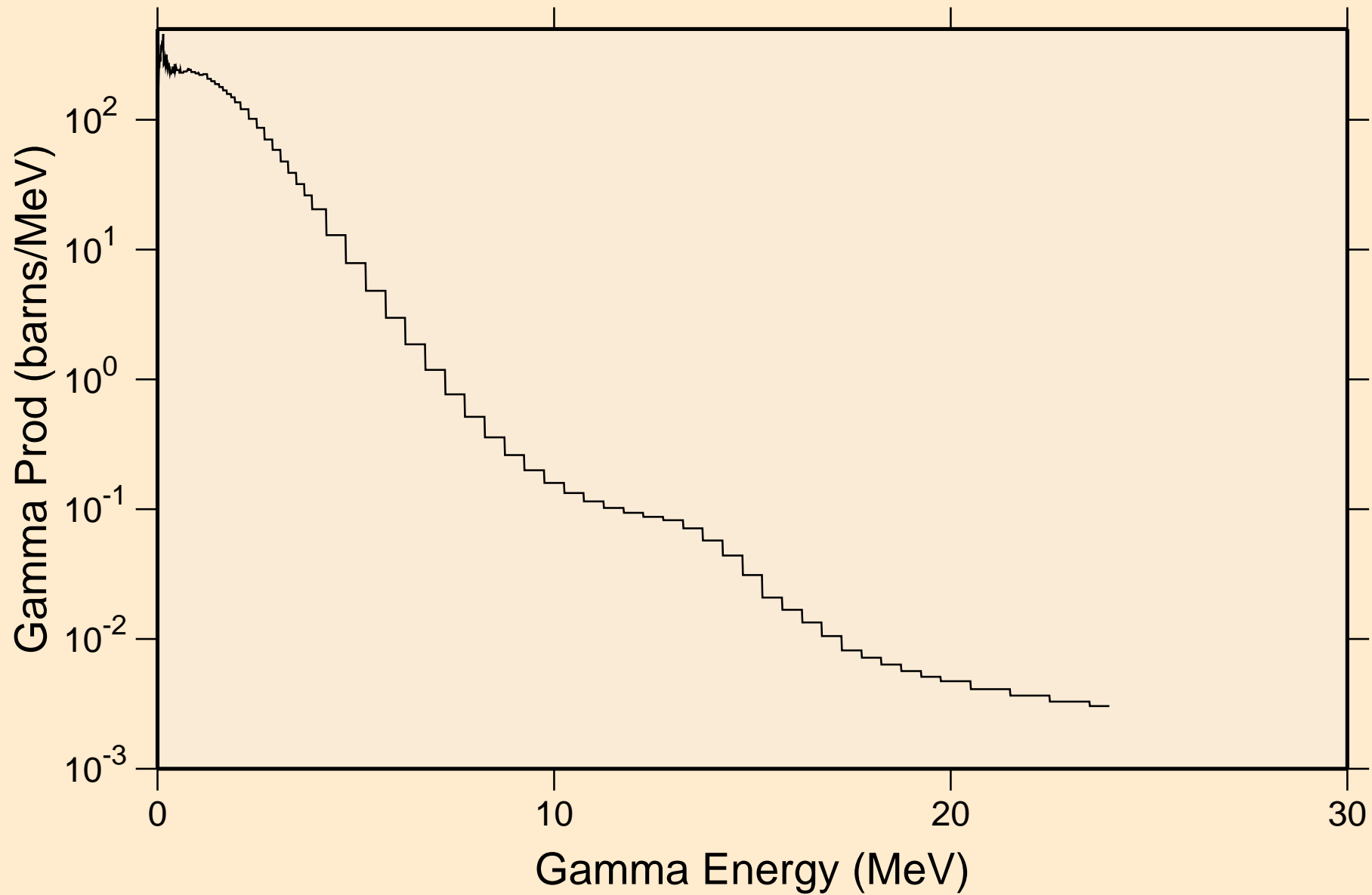

TL181 NRG TENDL-2016, AKONING

Particle heating contributions

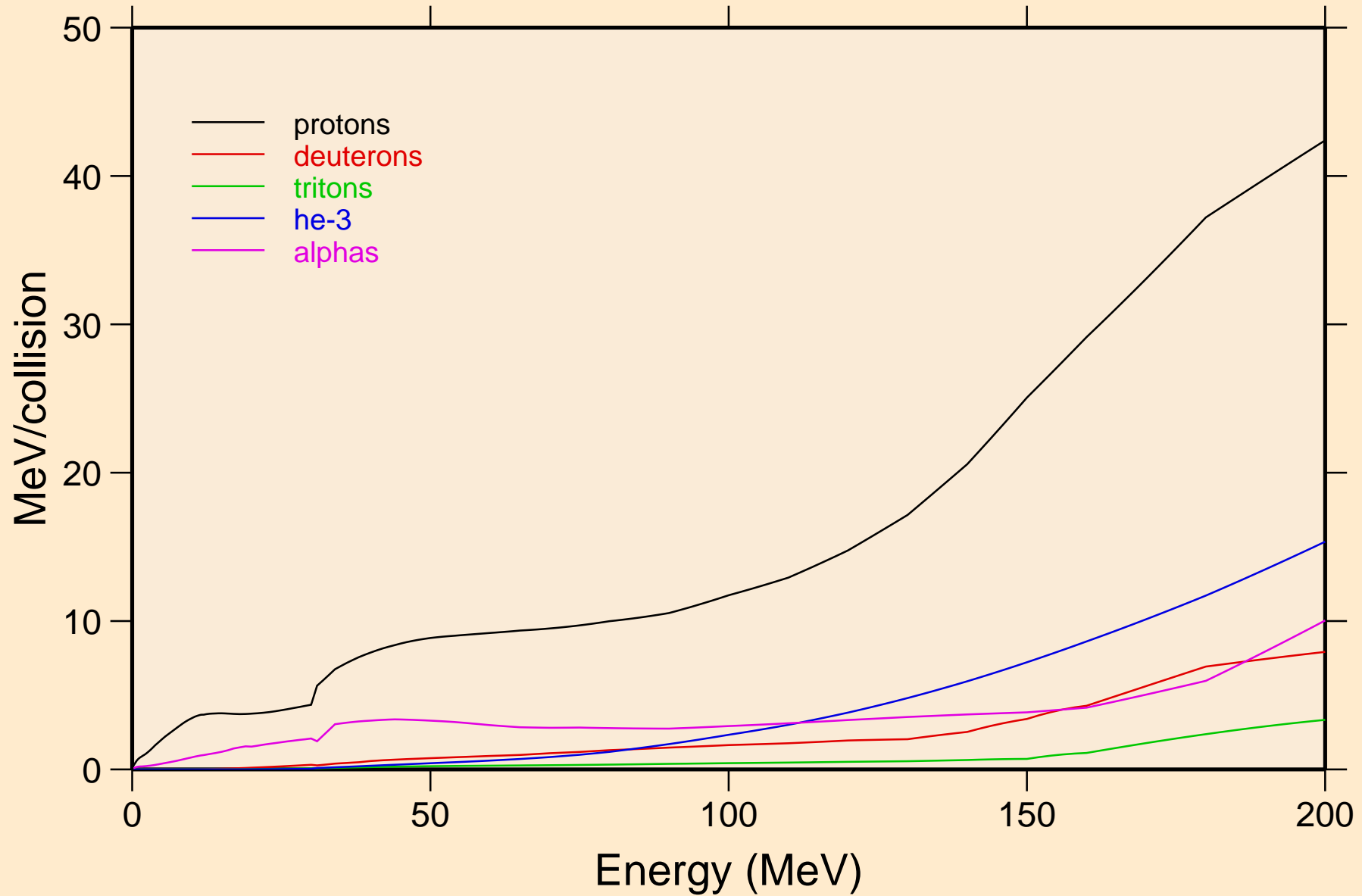

TL181 NRG TENDL-2016, AKONING

Recoil Heating

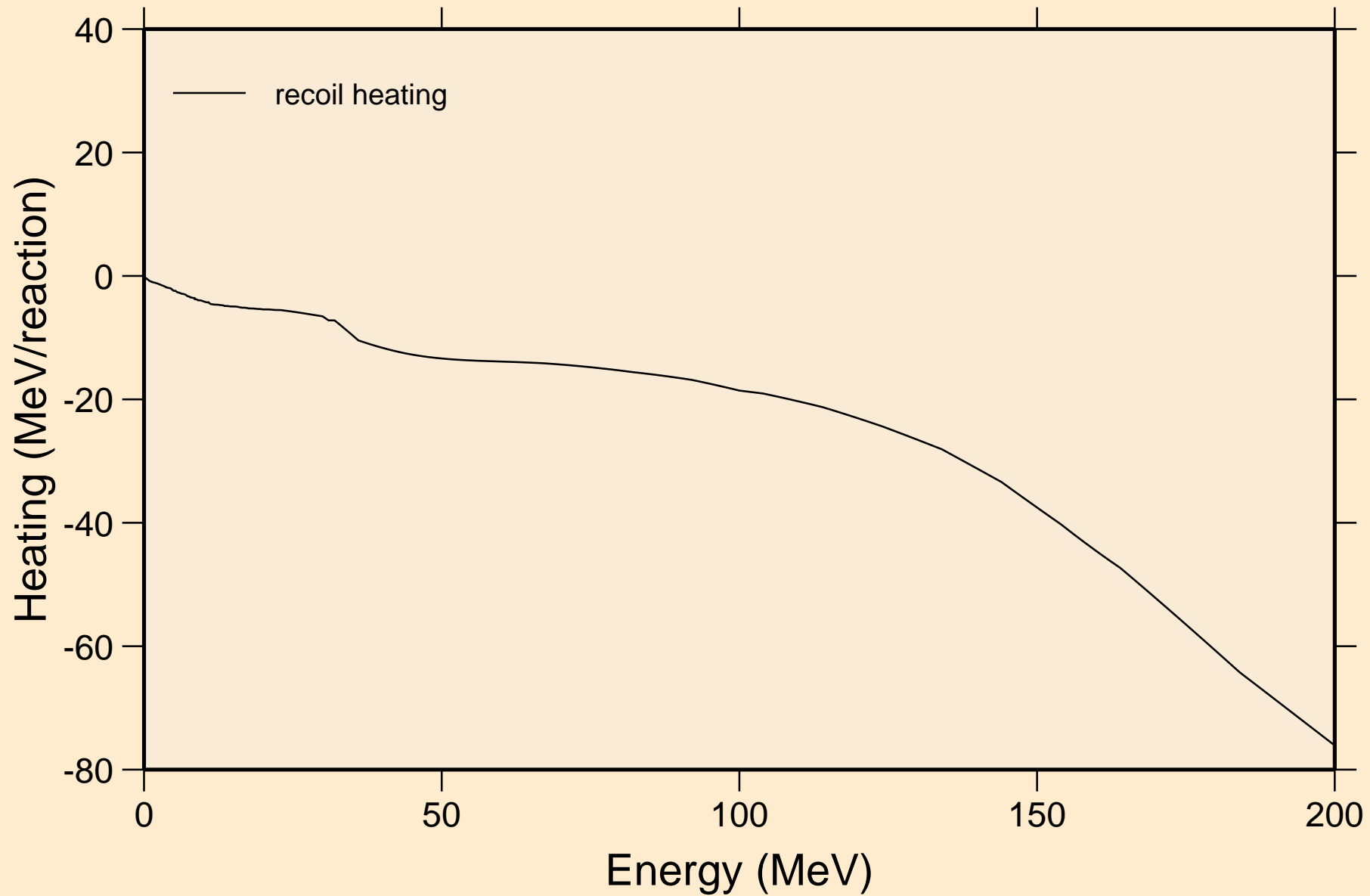

TL181 NRG TENDL-2016, AKONING
Particle production cross sections

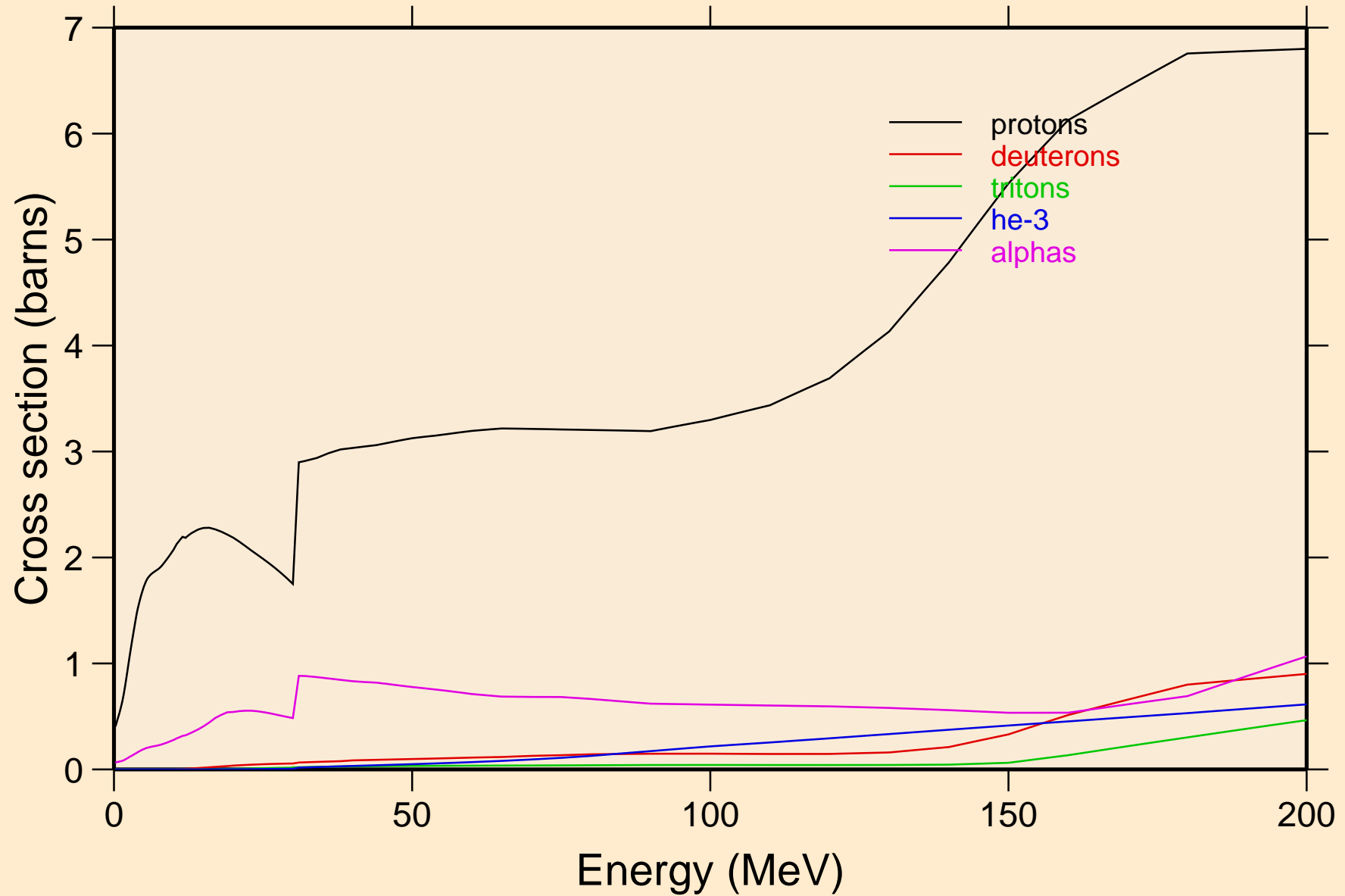

TL181 NRG TENDL-2016, AKONING
protons from (n,x)

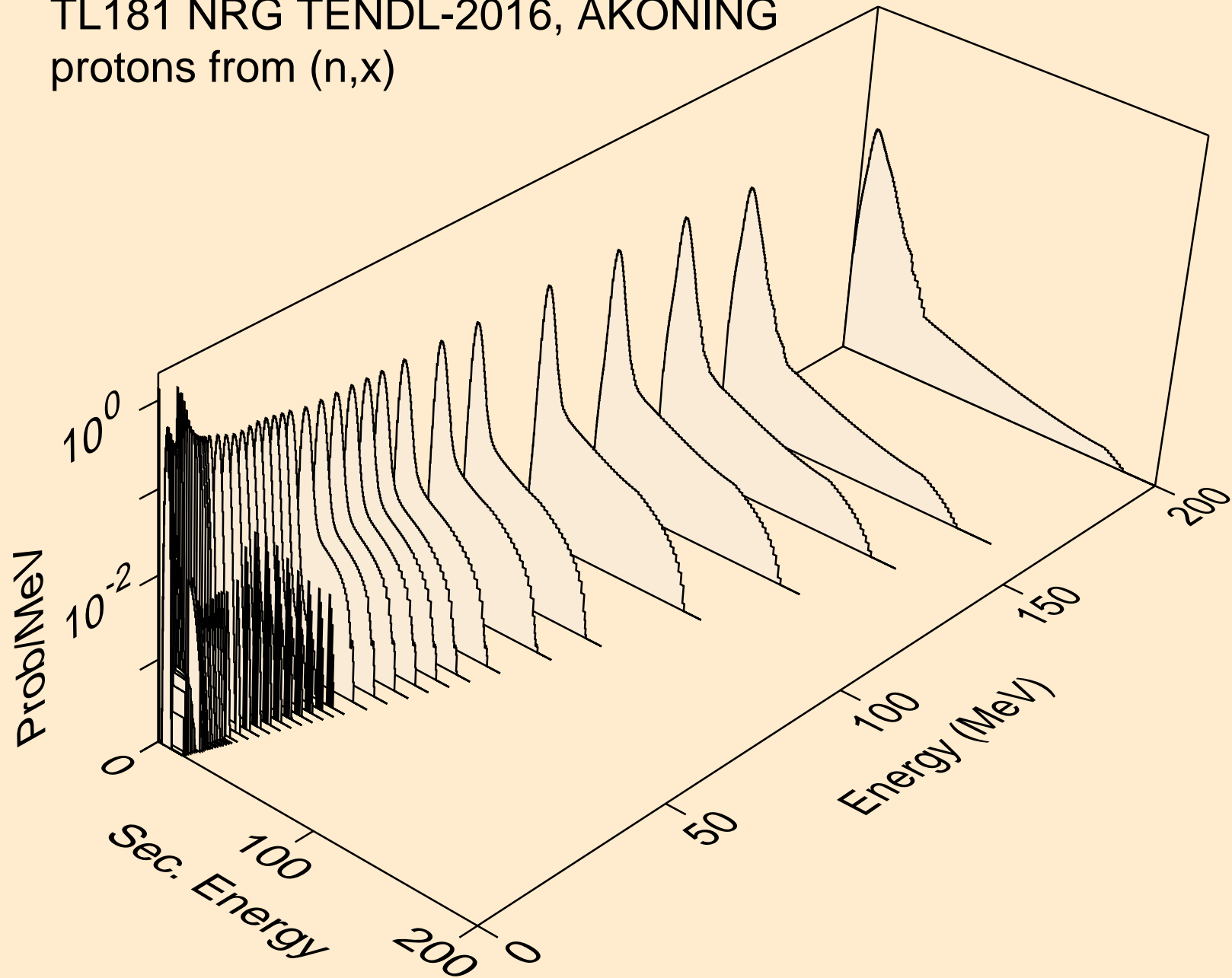

TL181 NRG TENDL-2016, AKONING
protons from $(n,n^*)p$

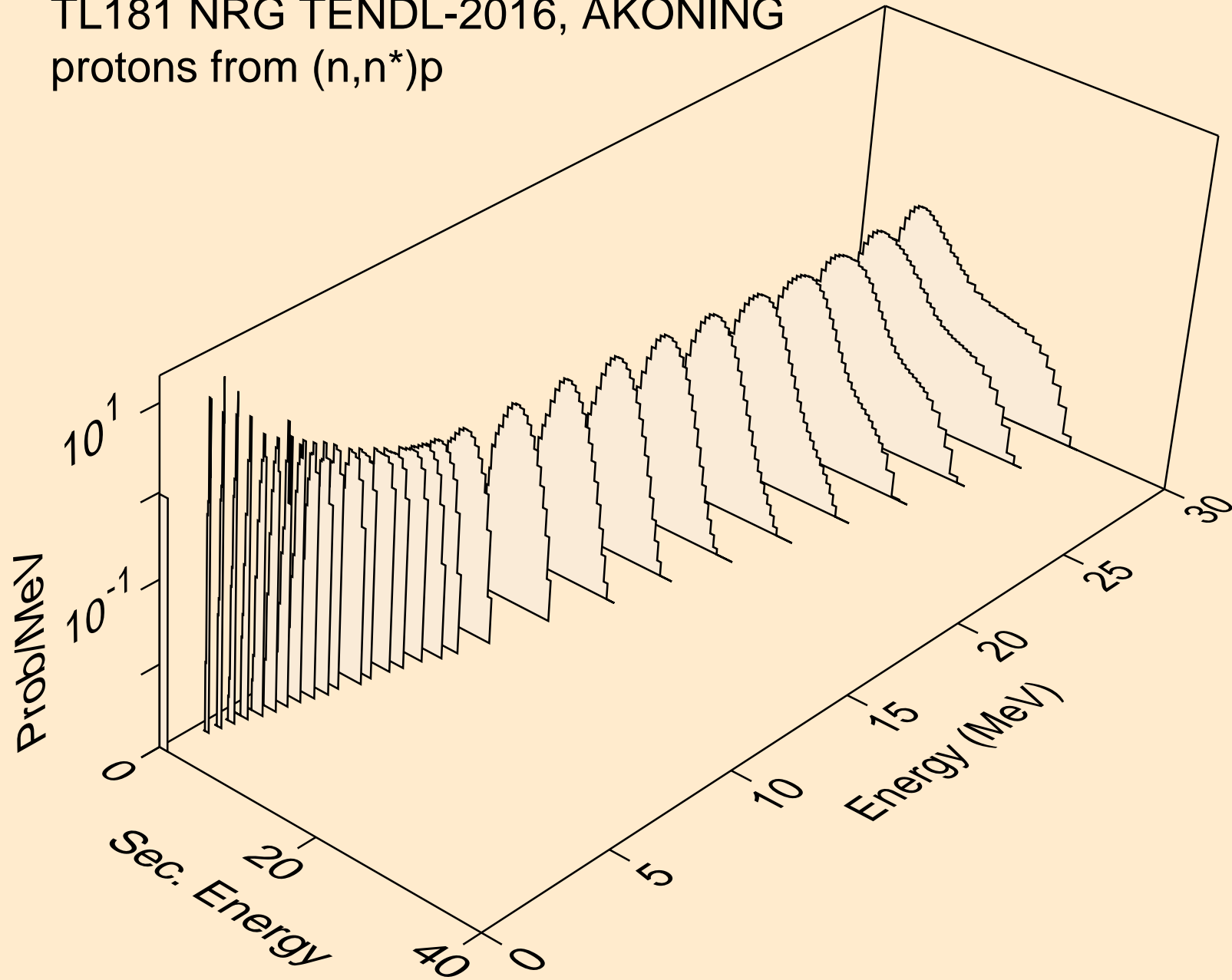

TL181 NRG TENDL-2016, AKONING
protons from (n,2np)

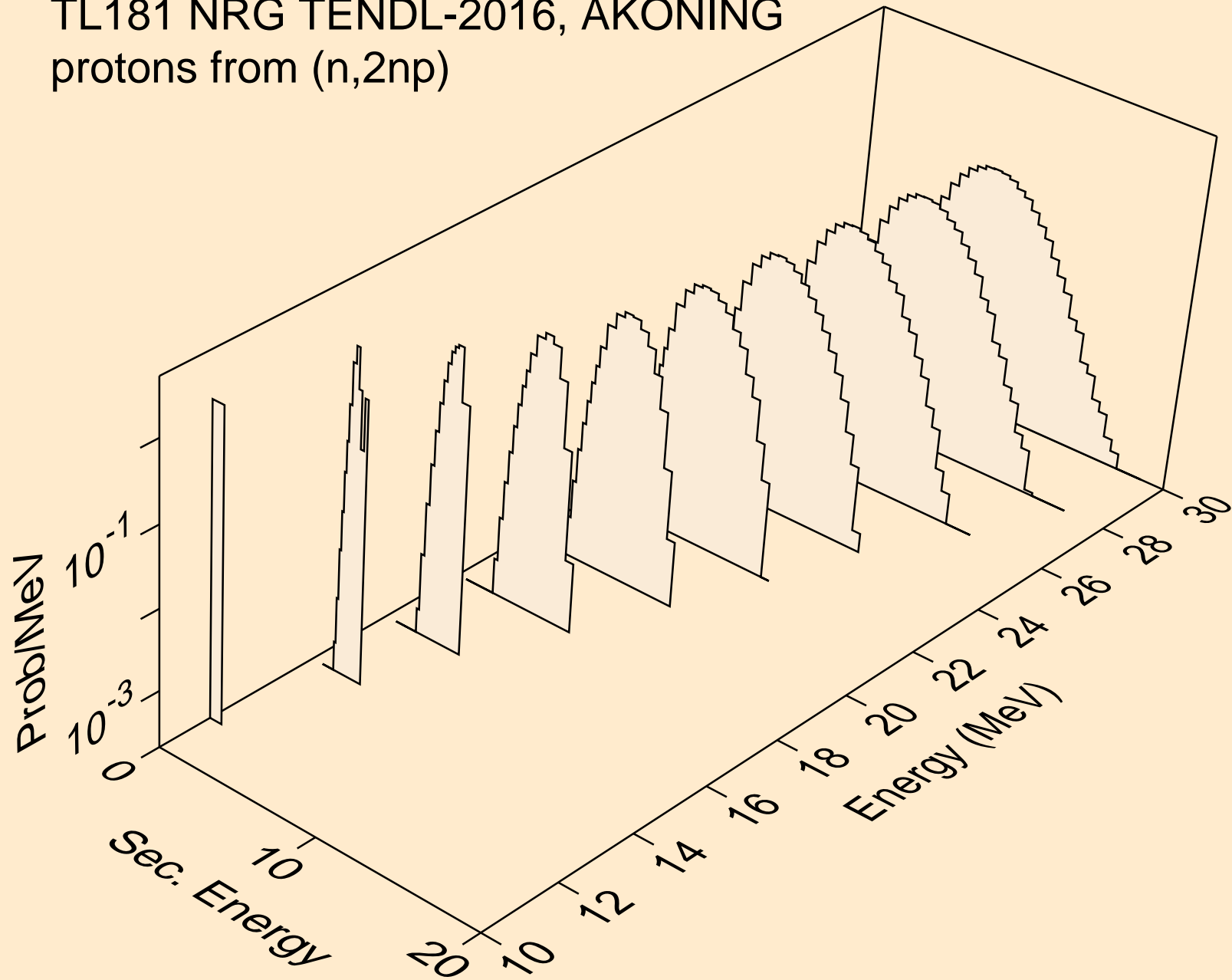

TL181 NRG TENDL-2016, AKONING
protons from (n,3np)

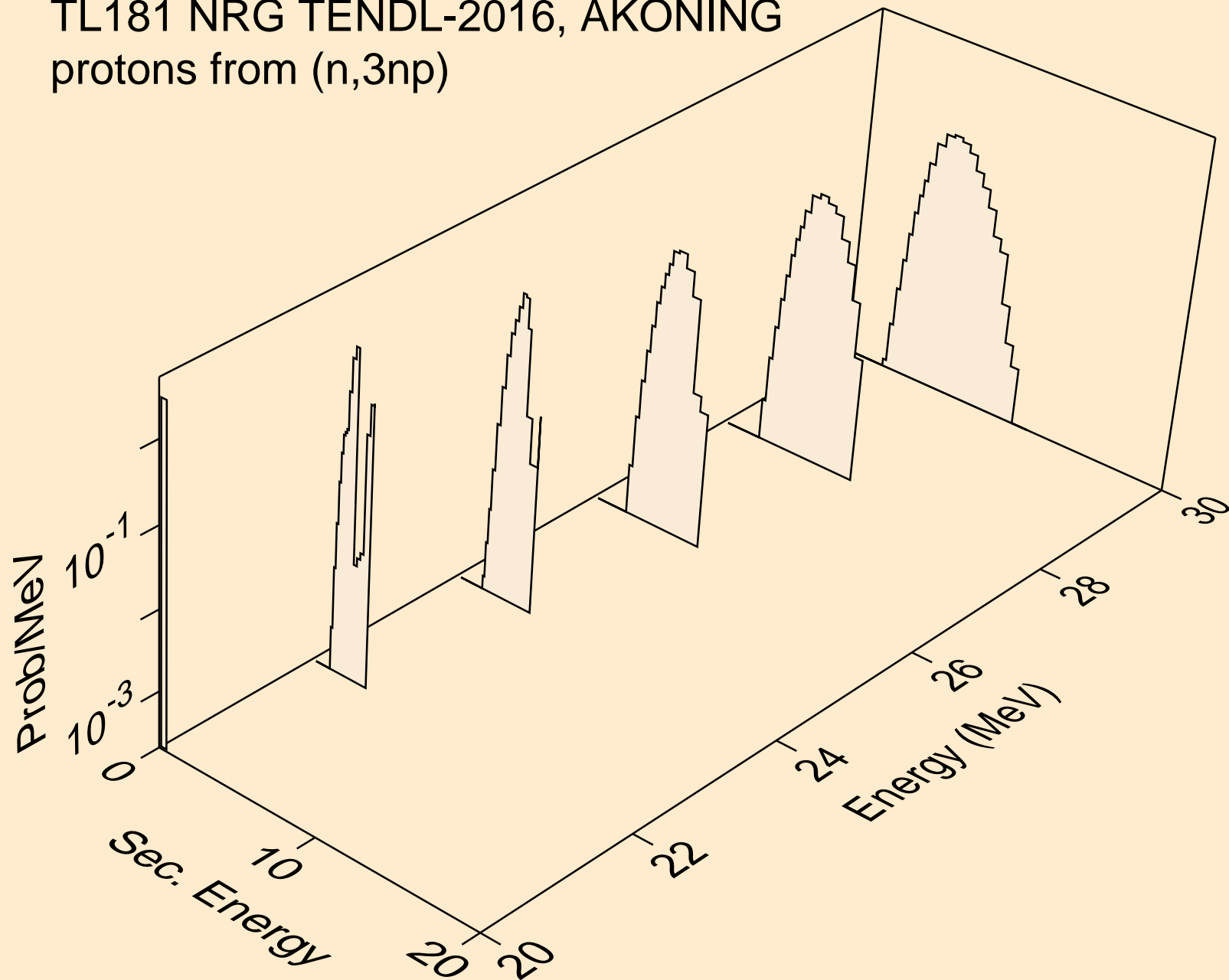

TL181 NRG TENDL-2016, AKONING
protons from (n,2np)

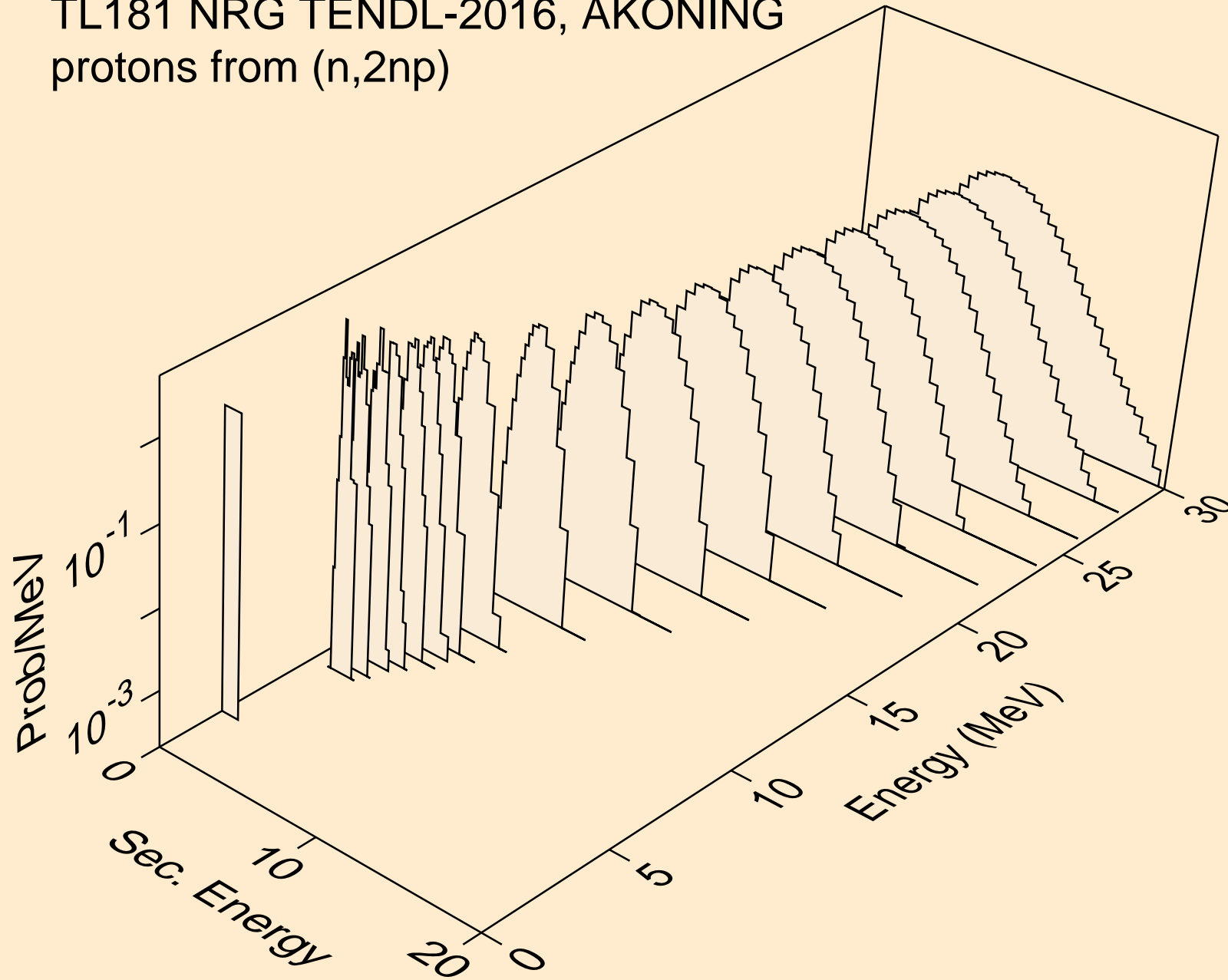

TL181 NRG TENDL-2016, AKONING
protons from (n,npa)

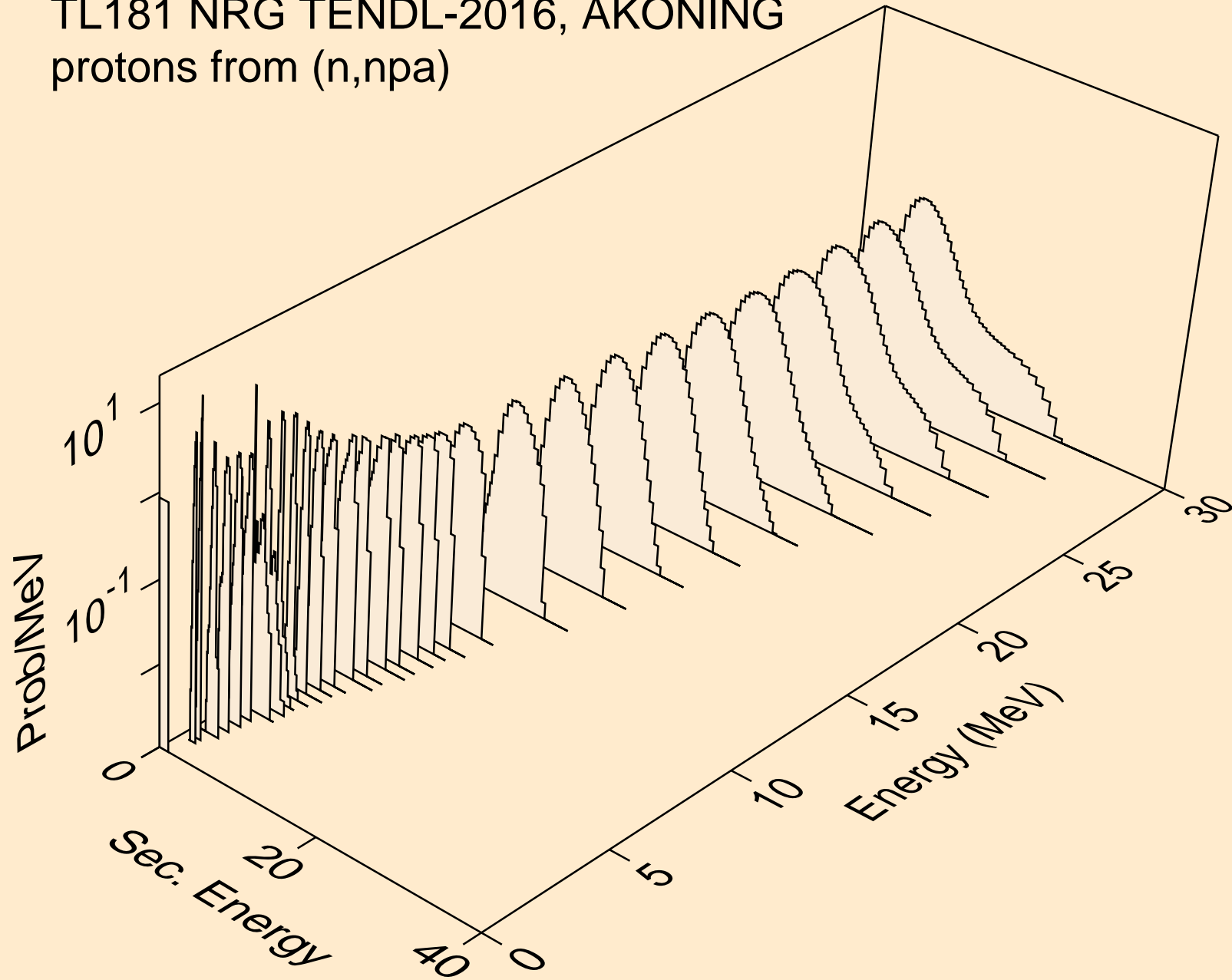

TL181 NRG TENDL-2016, AKONING
protons from (n,p)

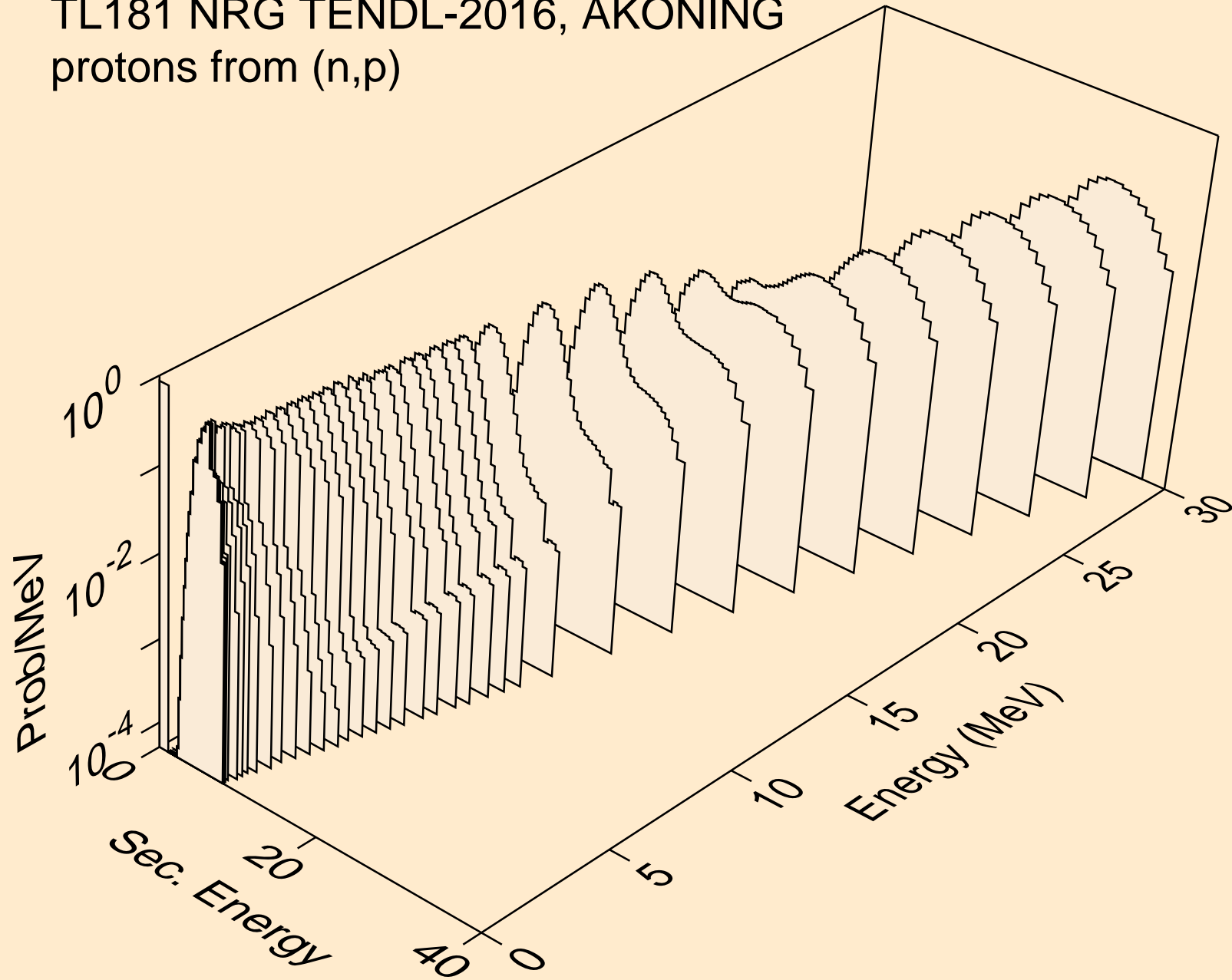

TL181 NRG TENDL-2016, AKONING
protons from (n,2p)

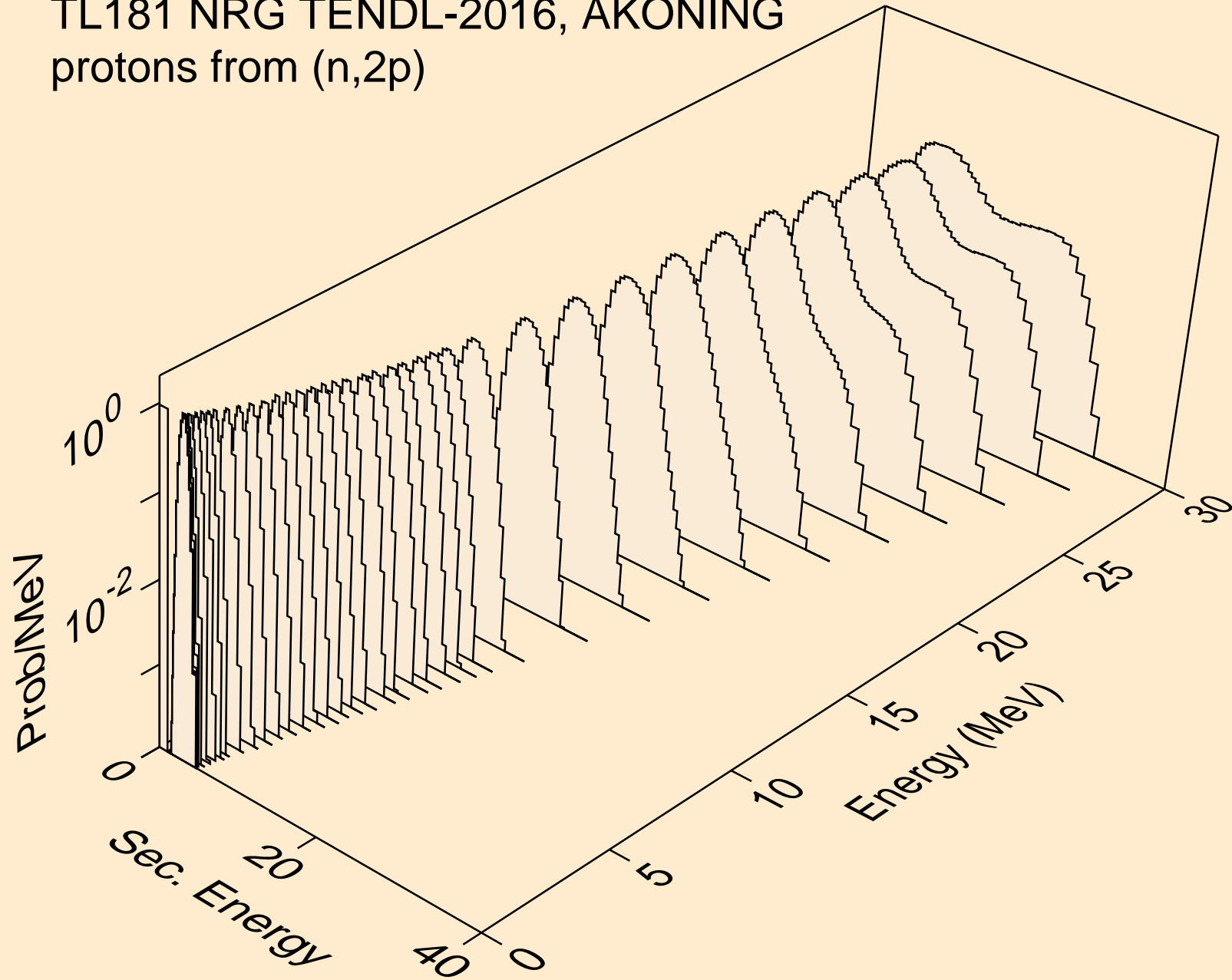

TL181 NRG TENDL-2016, AKONING
protons from (n,pa)

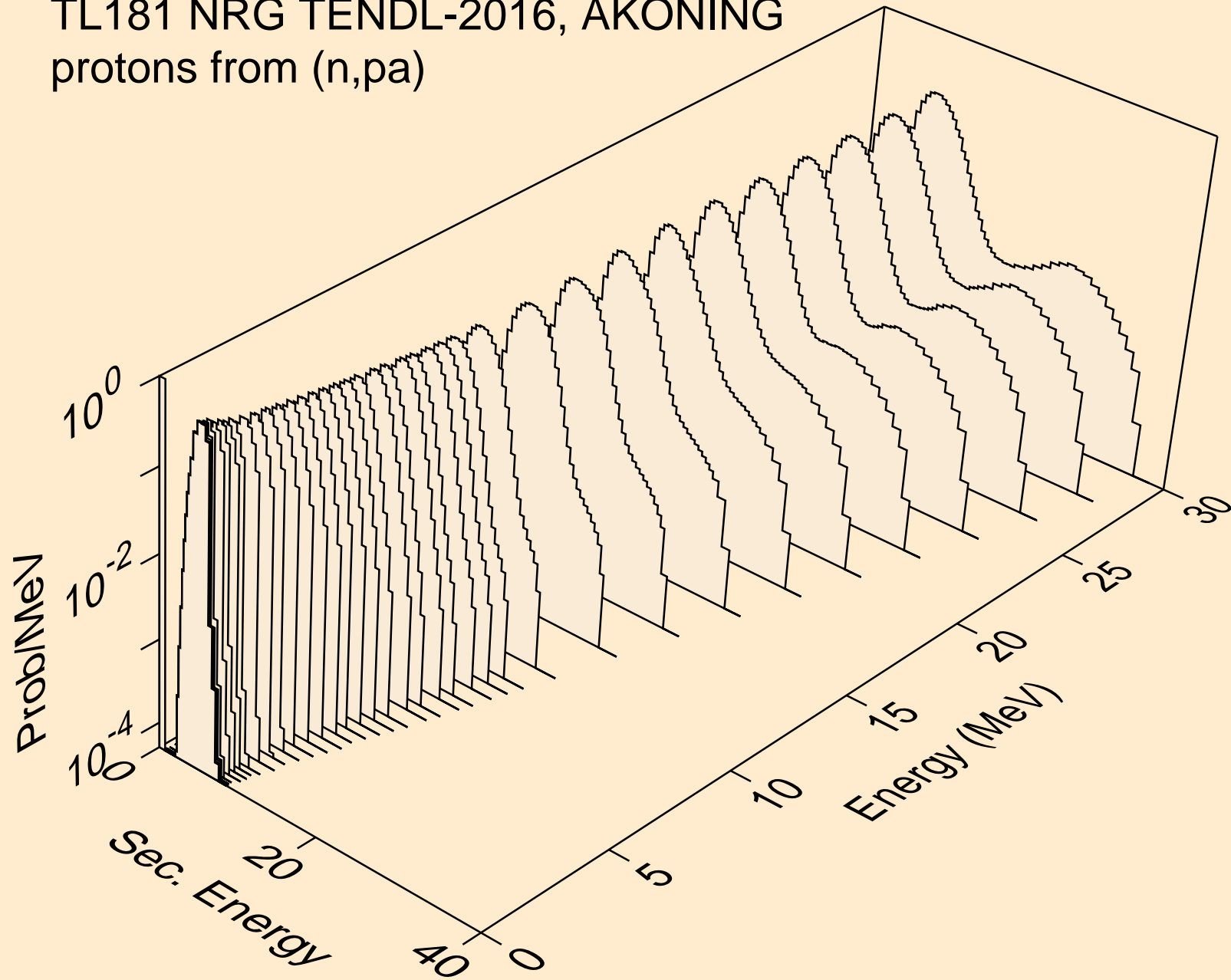

TL181 NRG TENDL-2016, AKONING
protons from (n,pd)

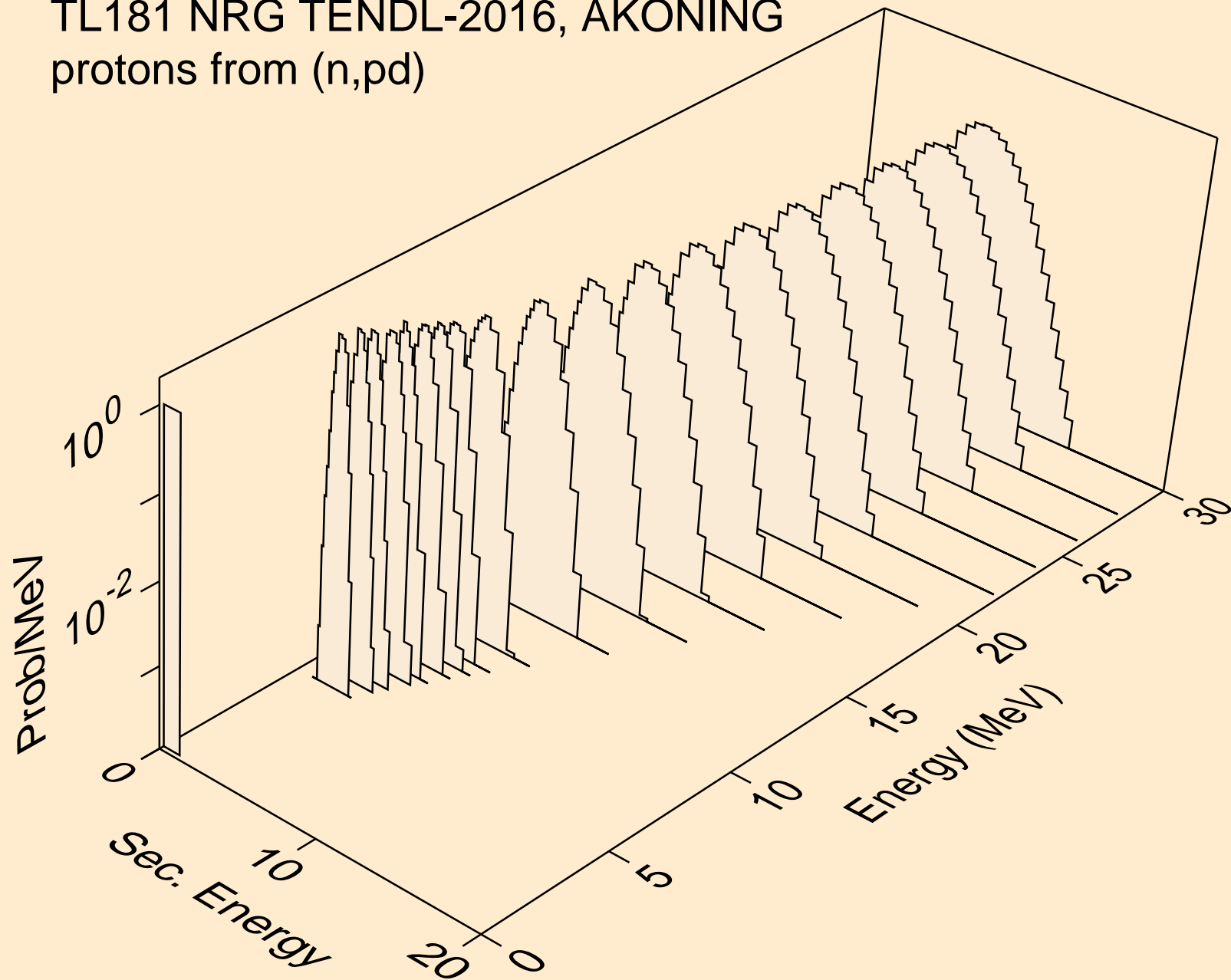

TL181 NRG TENDL-2016, AKONING
protons from (n,pt)

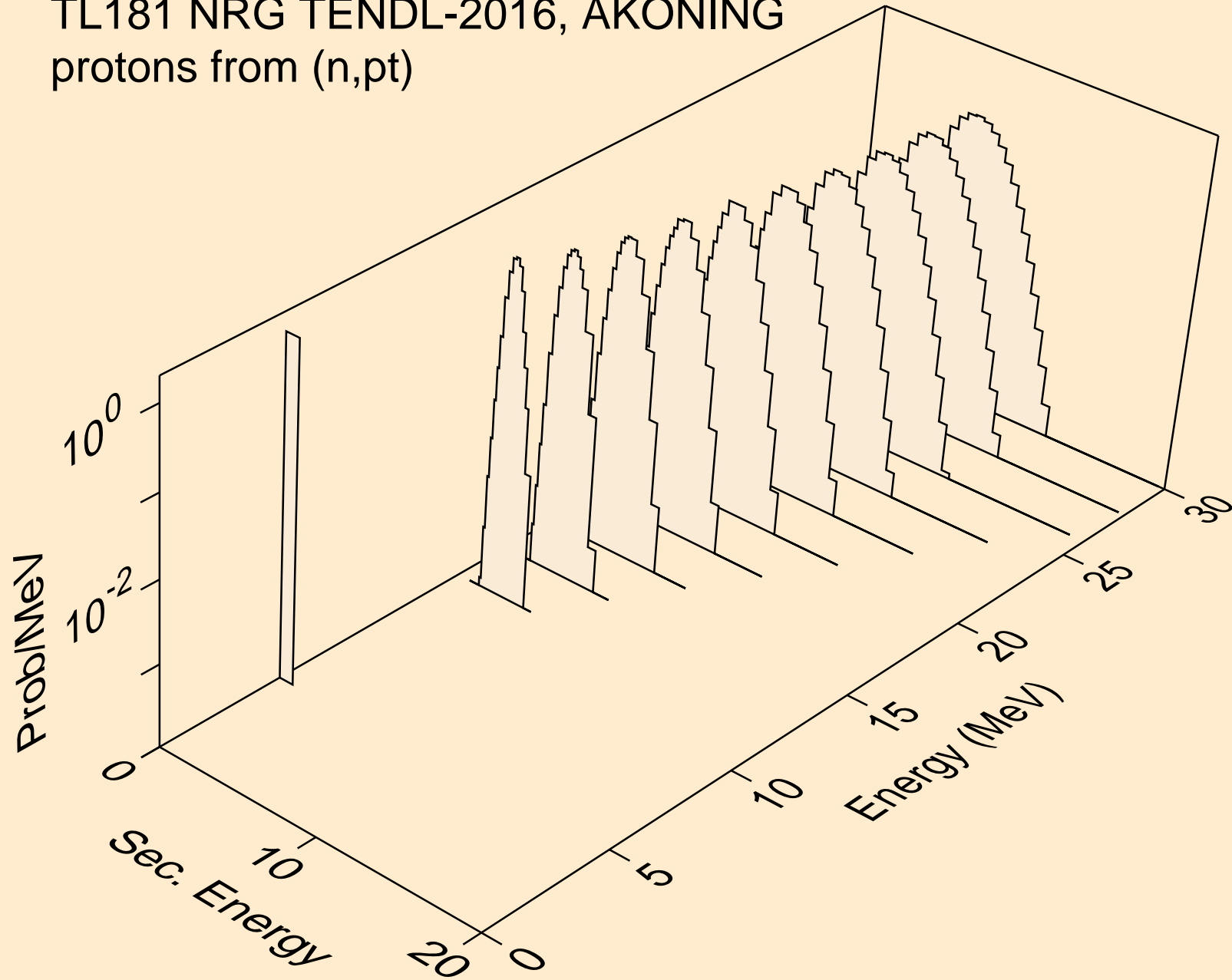

TL181 NRG TENDL-2016, AKONING
deuterons from (n,x)

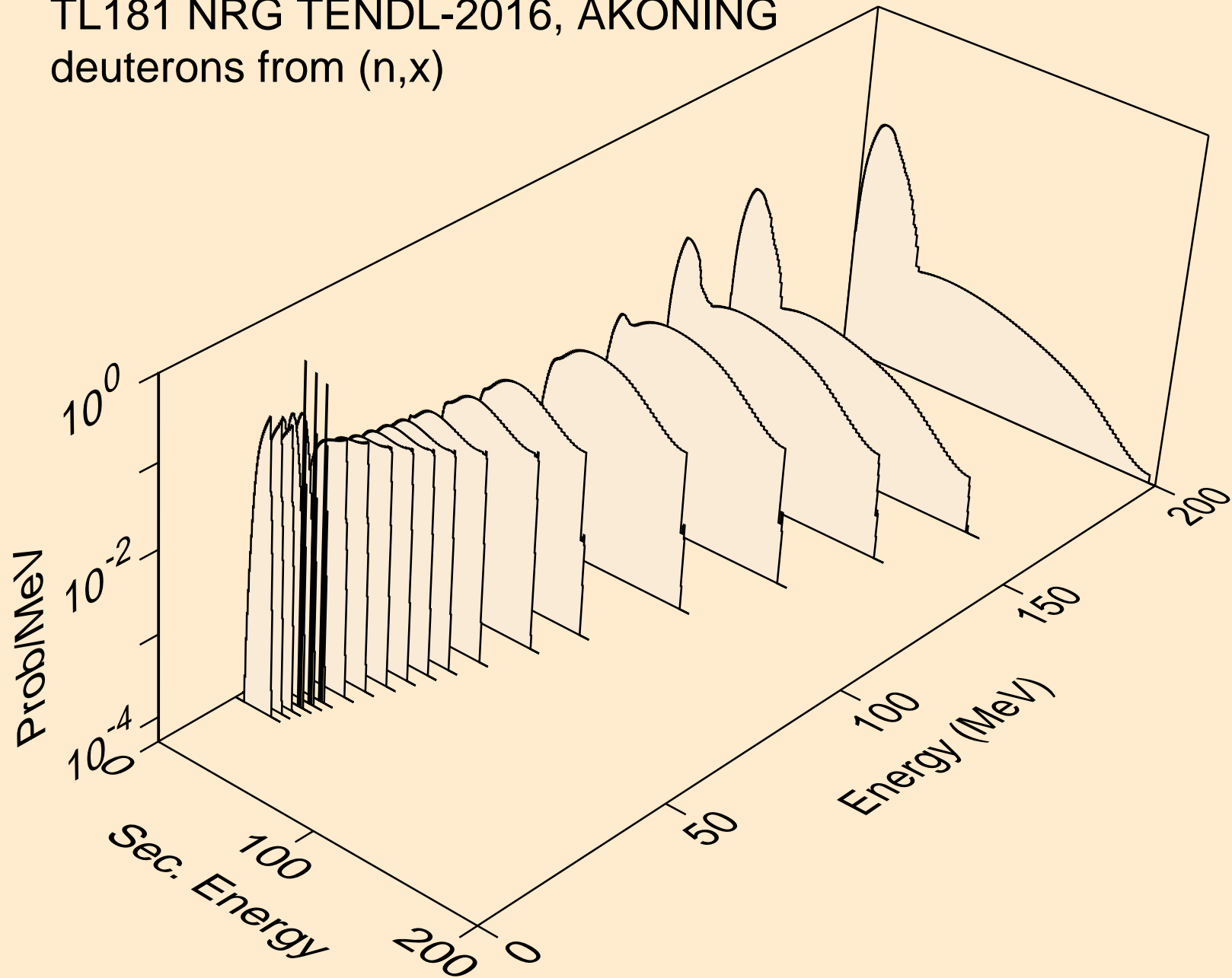

TL181 NRG TENDL-2016, AKONING
deuterons from (n,2nd)

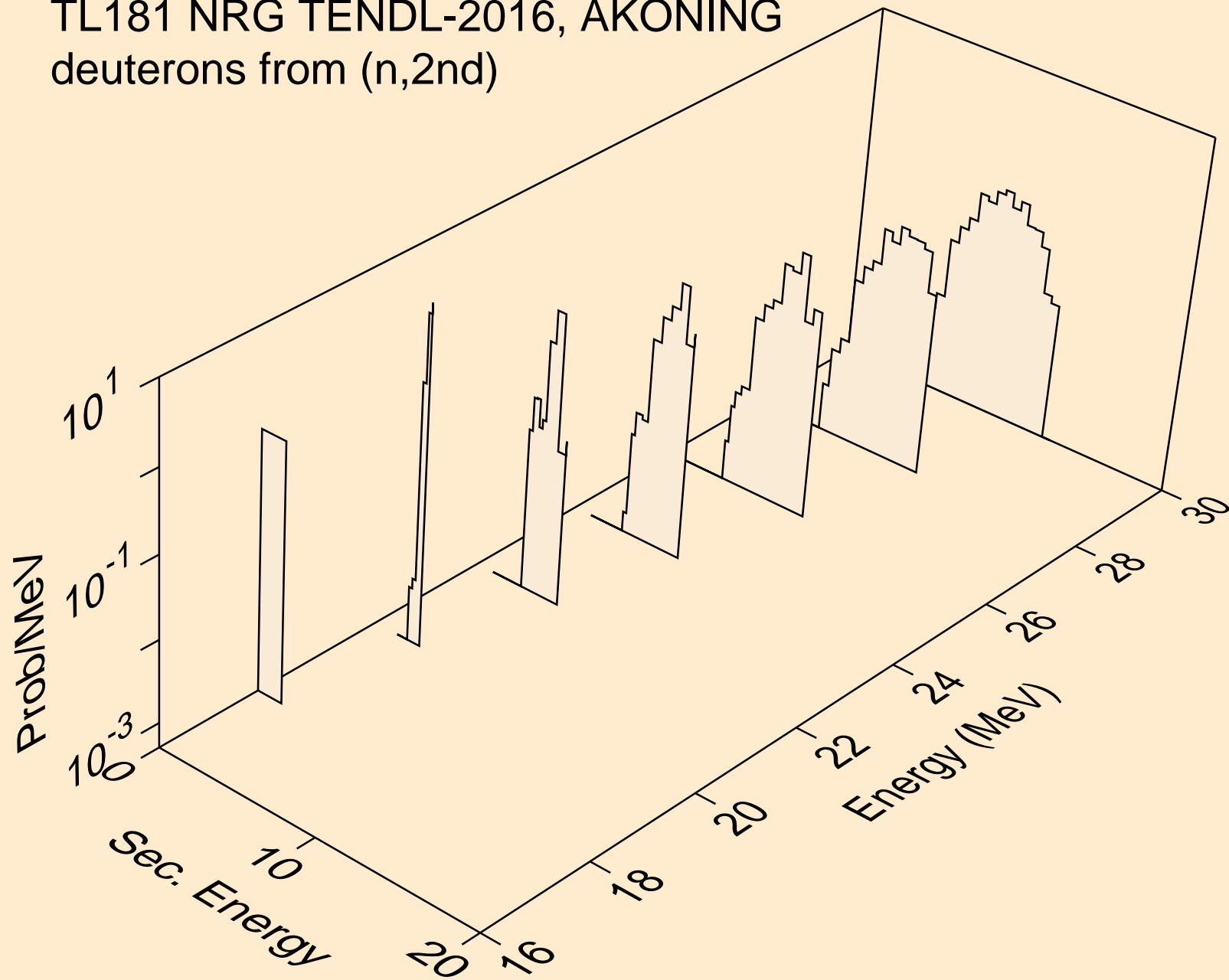

TL181 NRG TENDL-2016, AKONING
deuterons from (n,n*)d

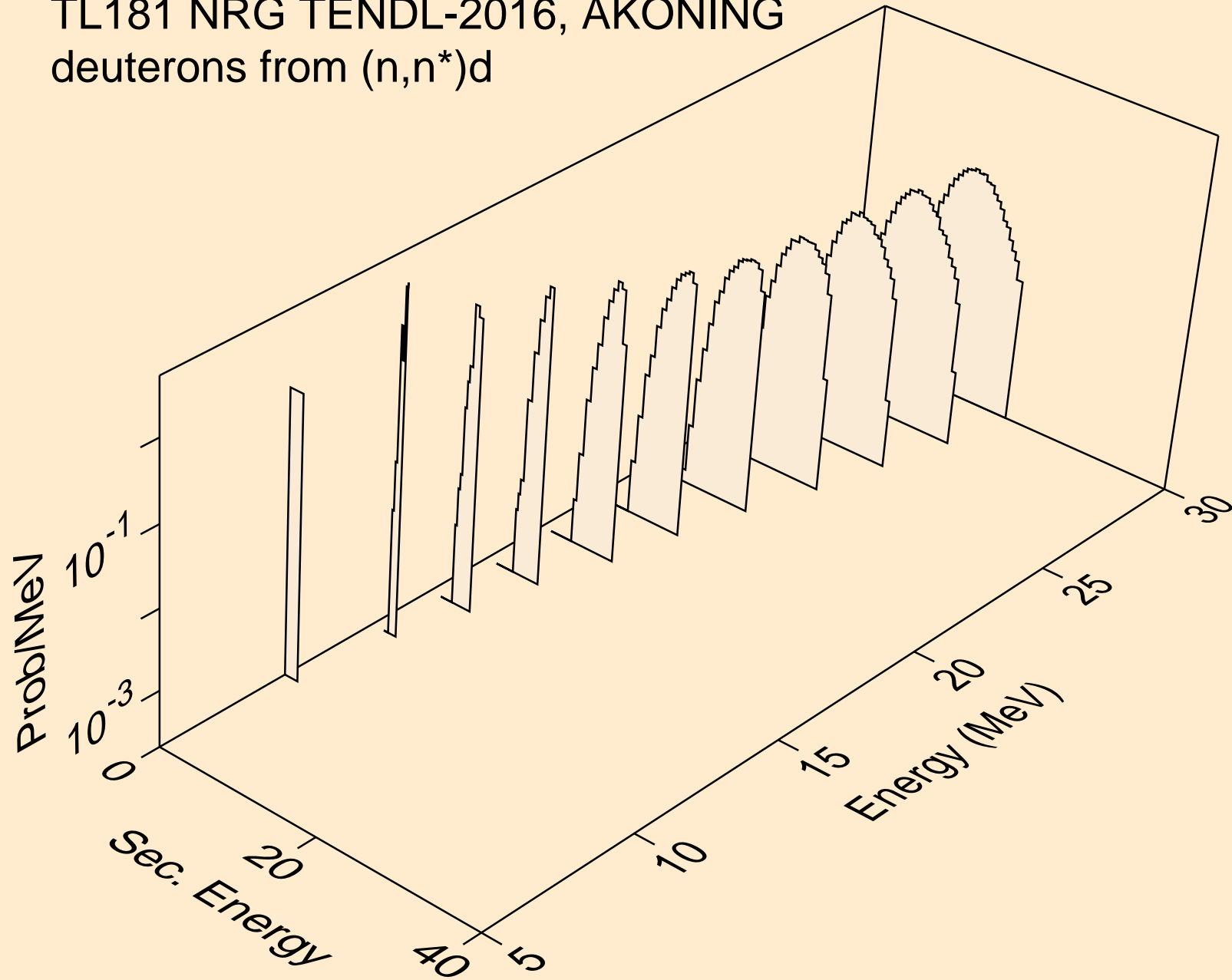

TL181 NRG TENDL-2016, AKONING
deuterons from (n,n*)d2a

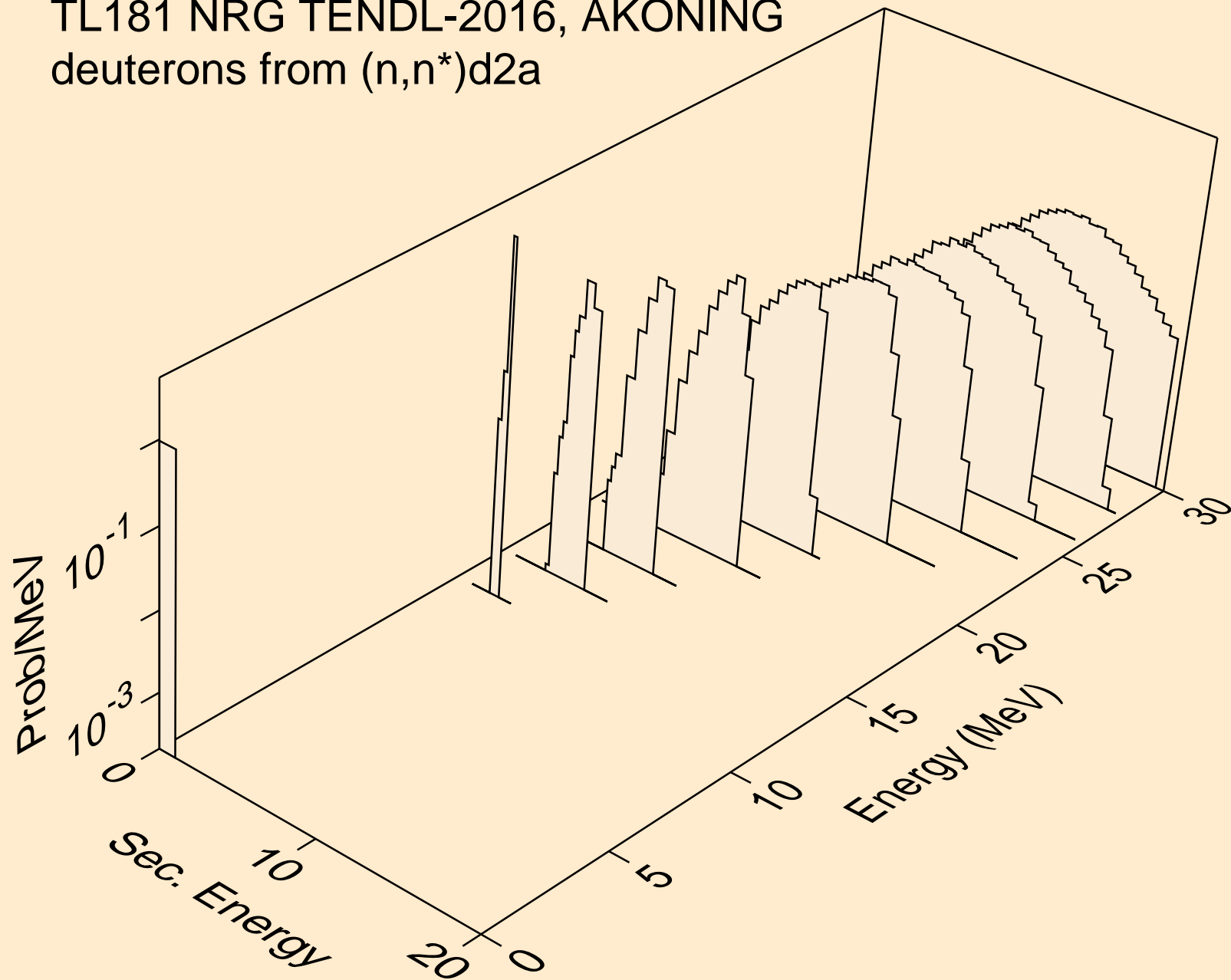

TL181 NRG TENDL-2016, AKONING
deuterons from (n,d)

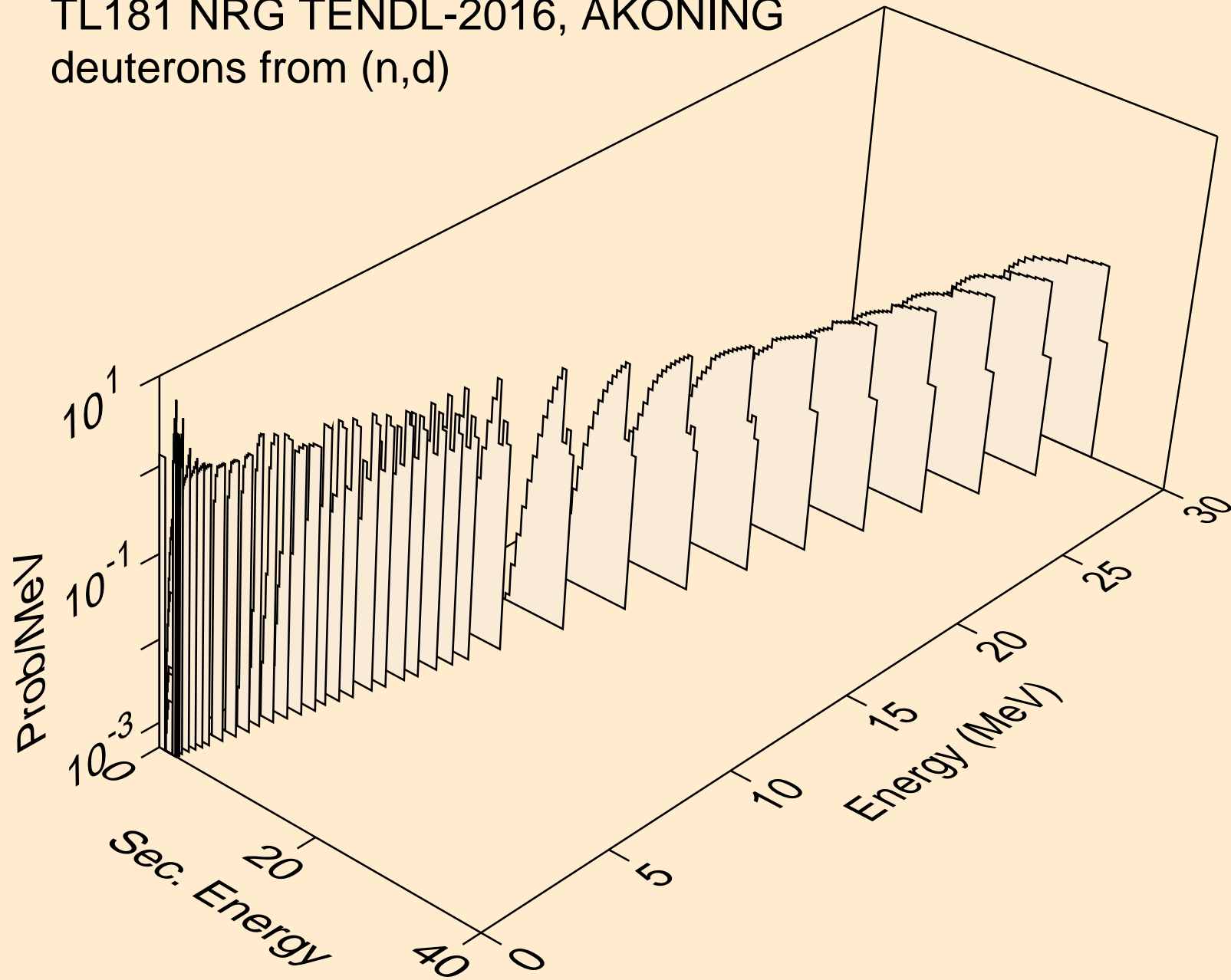

TL181 NRG TENDL-2016, AKONING
deuterons from (n,d2a)

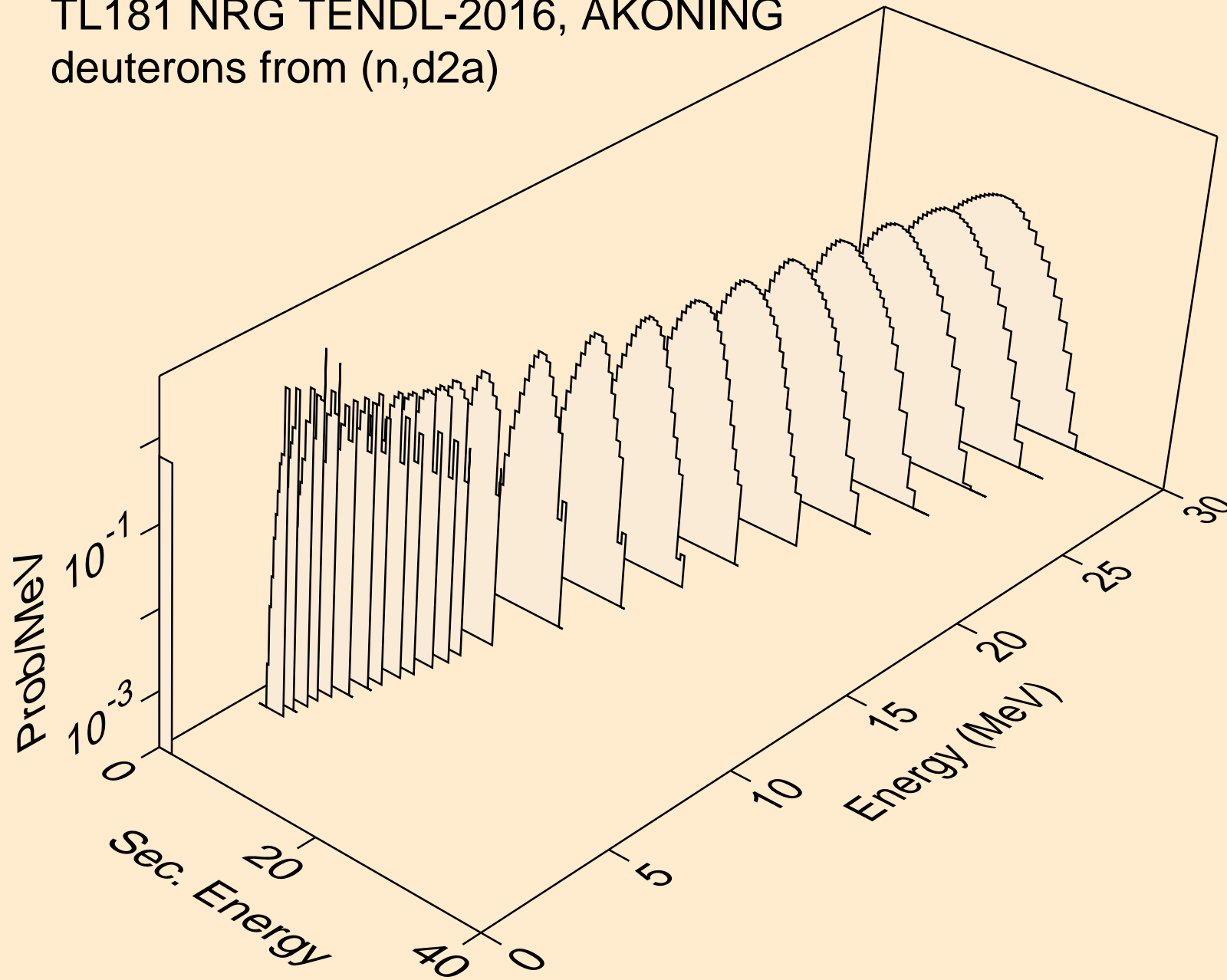

TL181 NRG TENDL-2016, AKONING
deuterons from (n,pd)

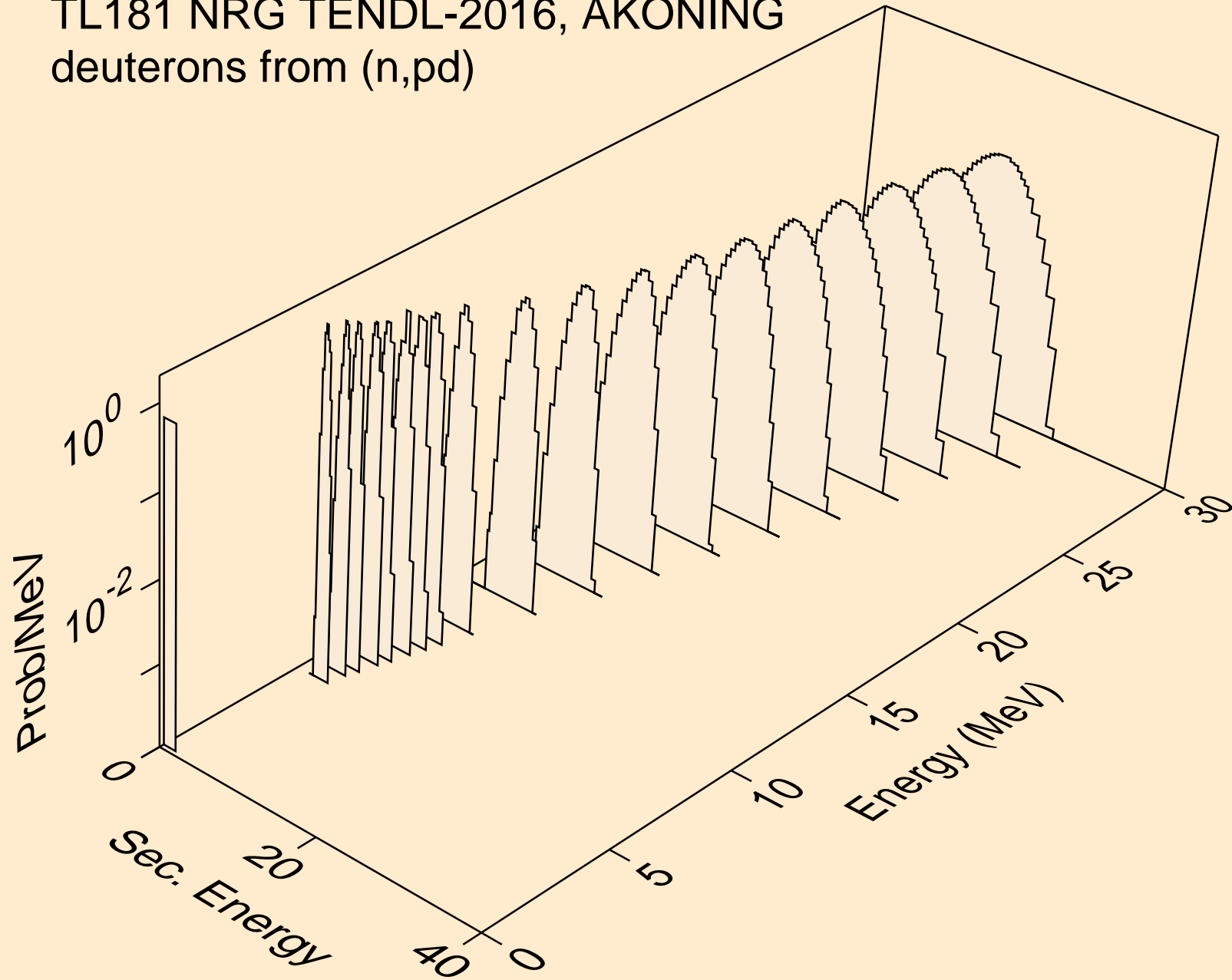

TL181 NRG TENDL-2016, AKONING
deuterons from (n,da)

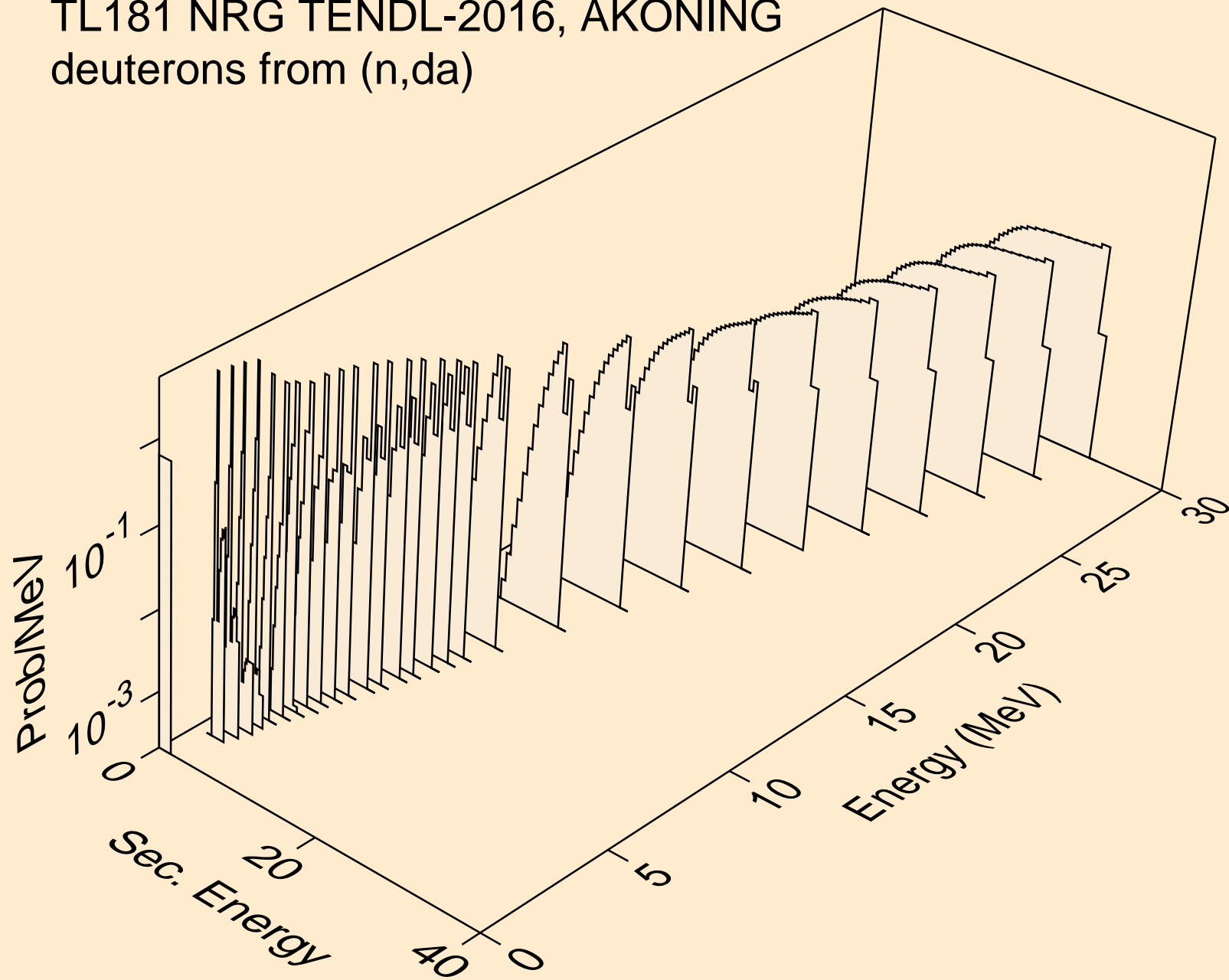

TL181 NRG TENDL-2016, AKONING
tritons from (n,x)

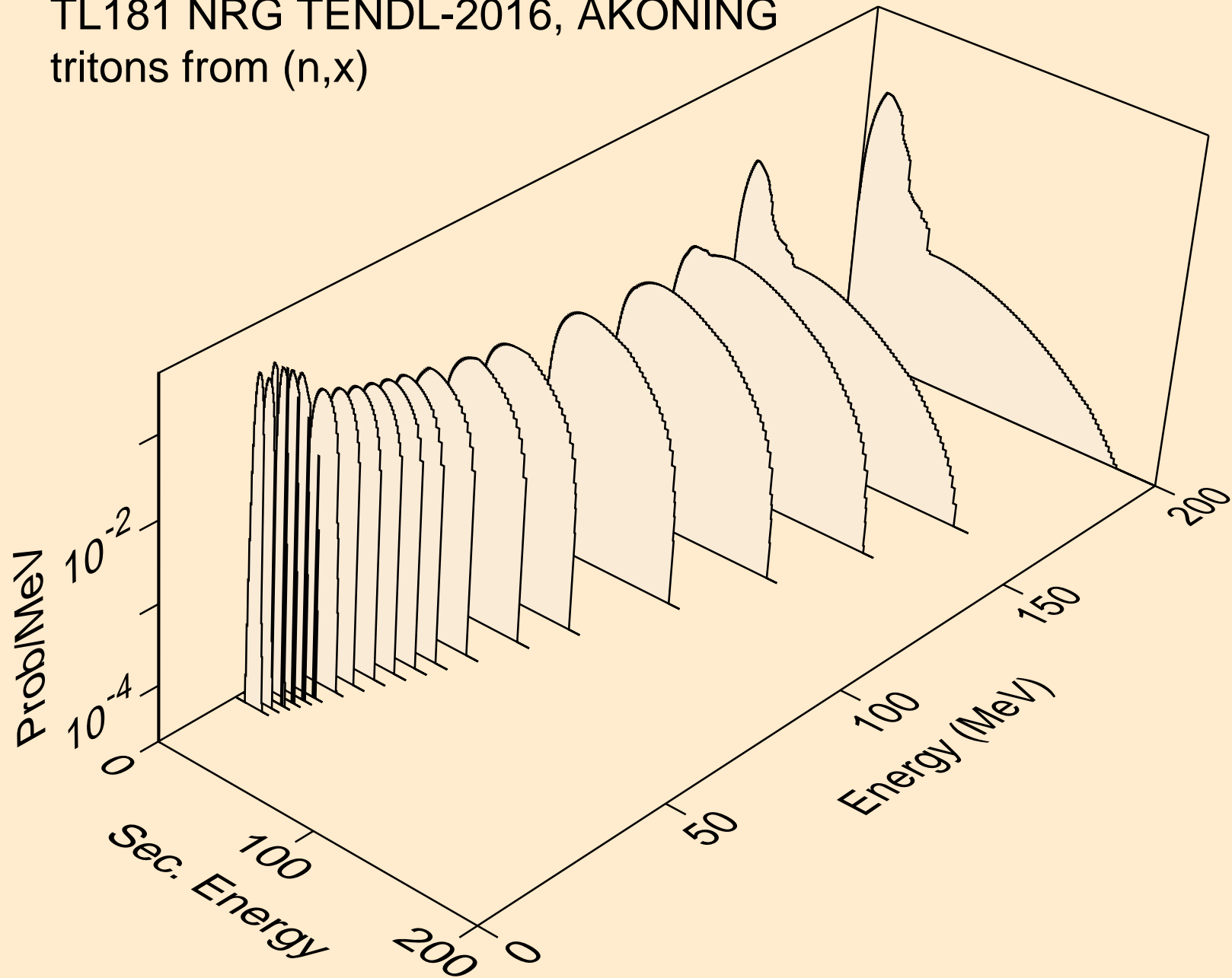

TL181 NRG TENDL-2016, AKONING
tritons from (n,n*)t

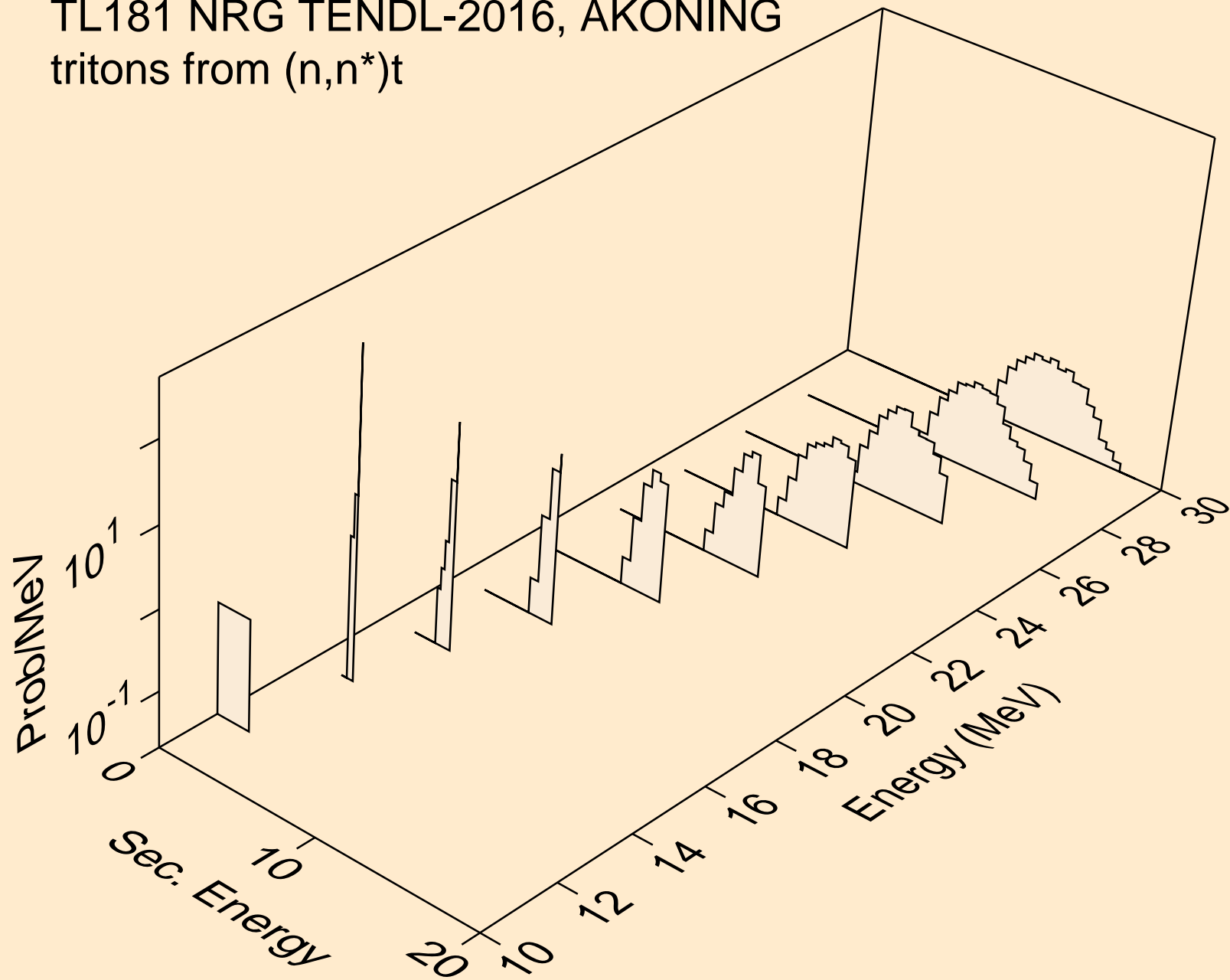

TL181 NRG TENDL-2016, AKONING
tritons from (n,n*)t2a

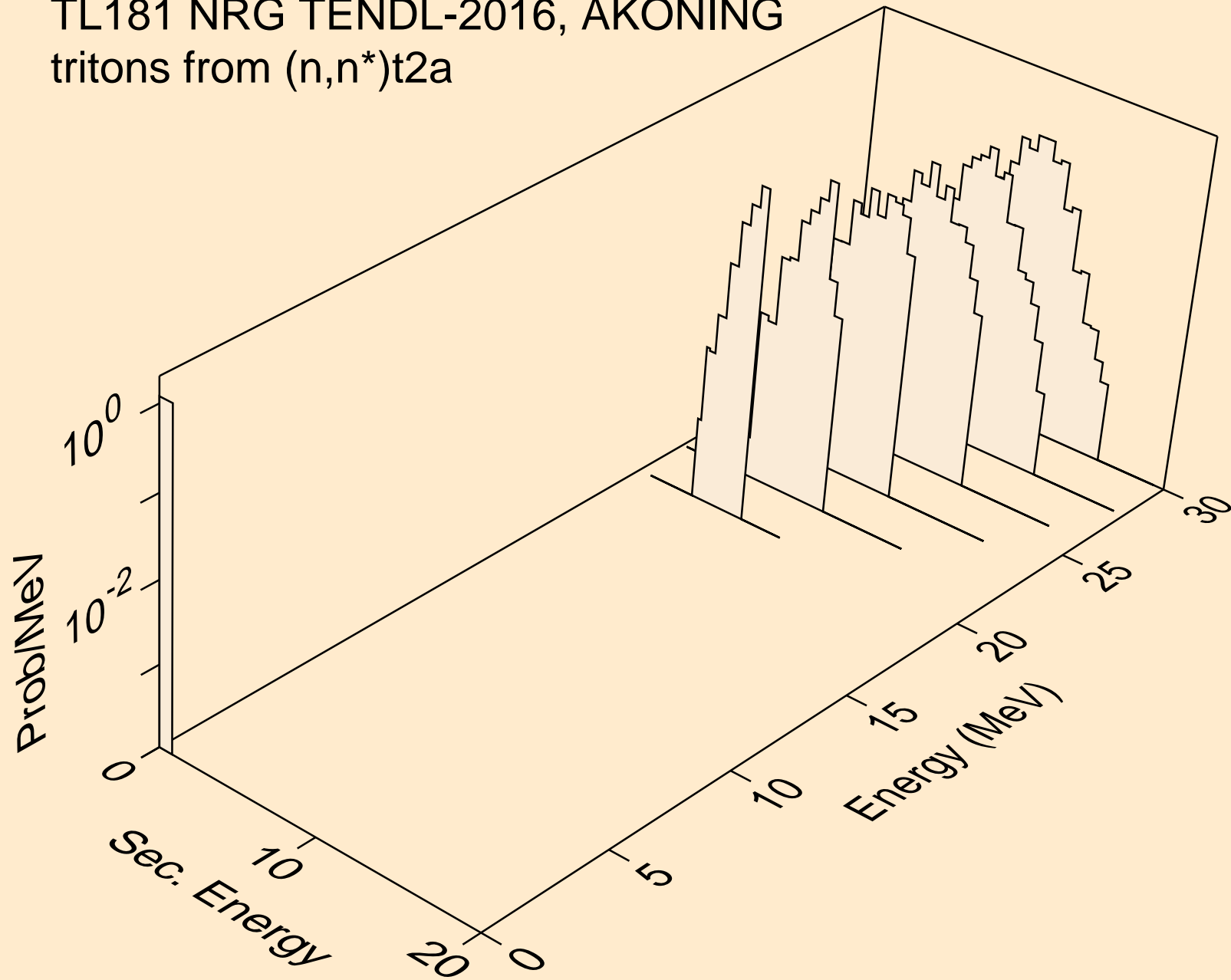

TL181 NRG TENDL-2016, AKONING
tritons from (n,t)

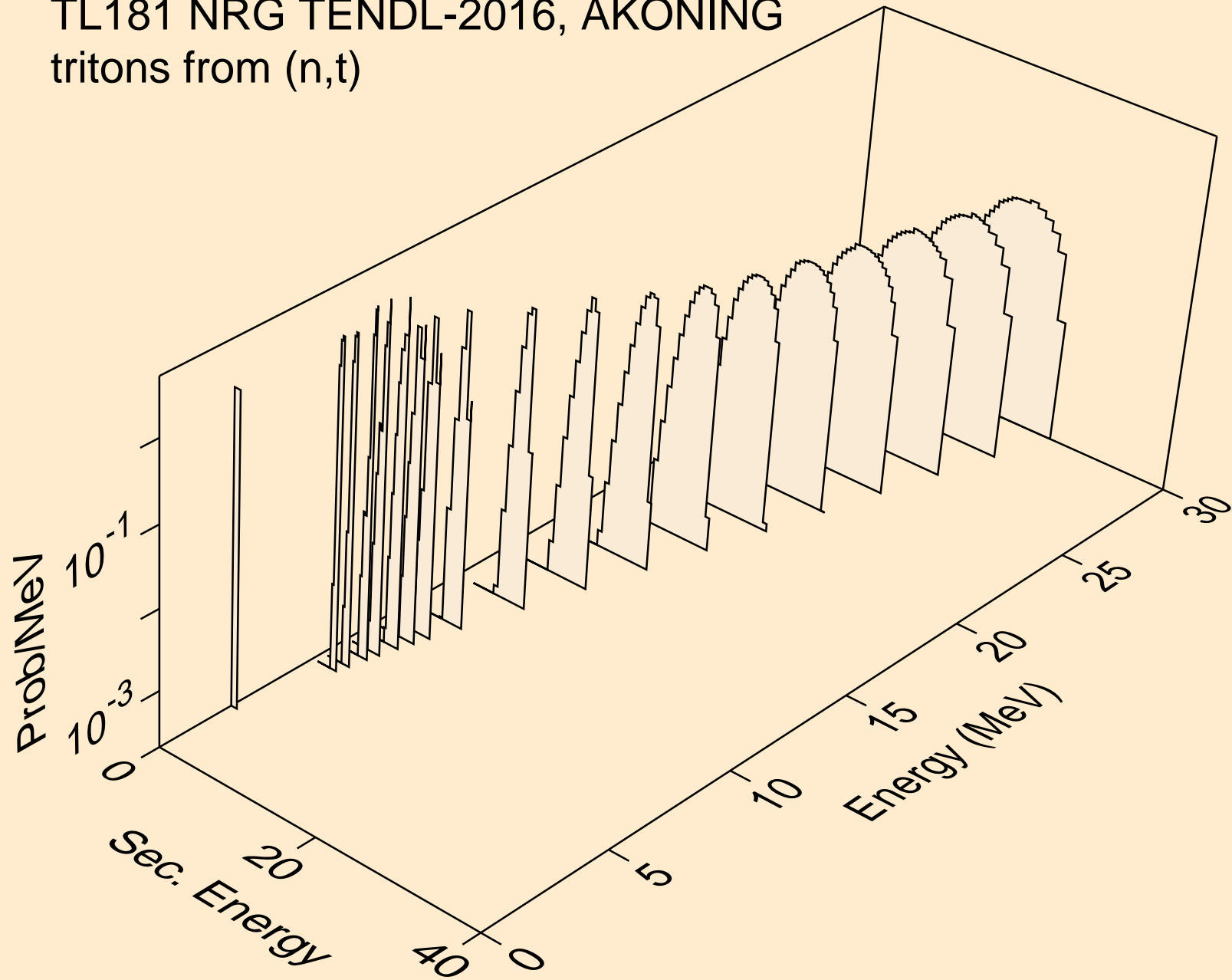

TL181 NRG TENDL-2016, AKONING
tritons from (n,t2a)

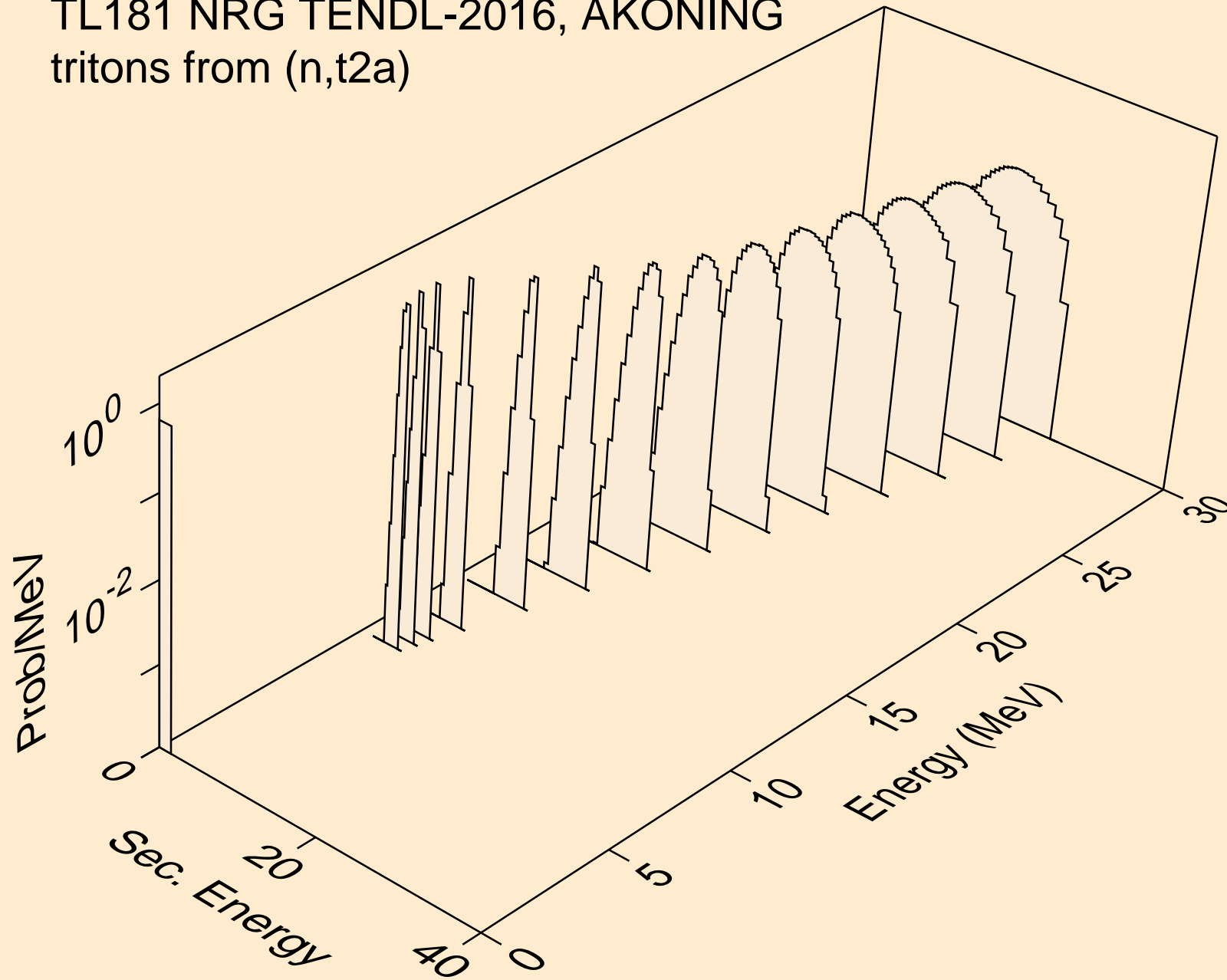

TL181 NRG TENDL-2016, AKONING
tritons from (n,pt)

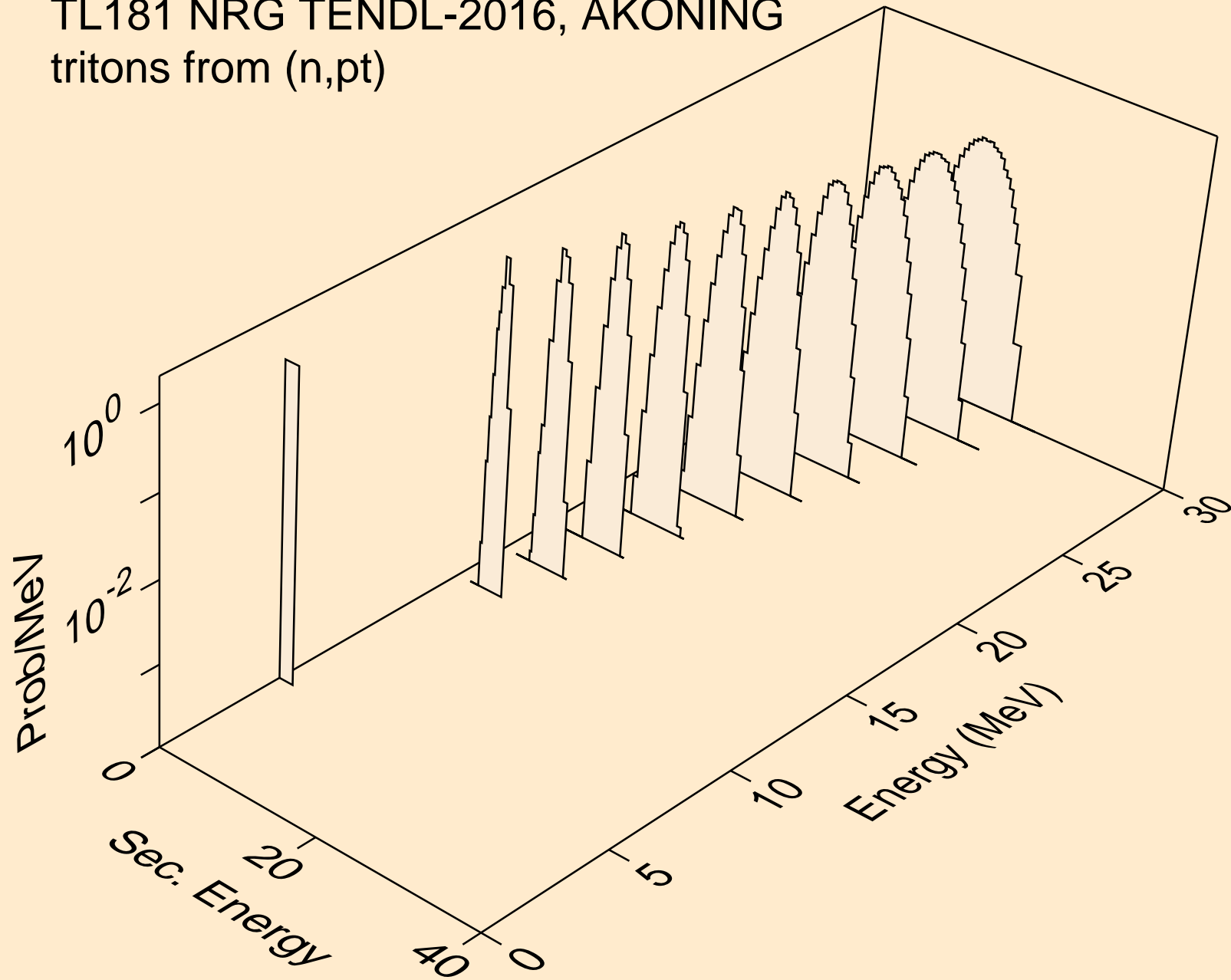

TL181 NRG TENDL-2016, AKONING
he3s from (n,x)

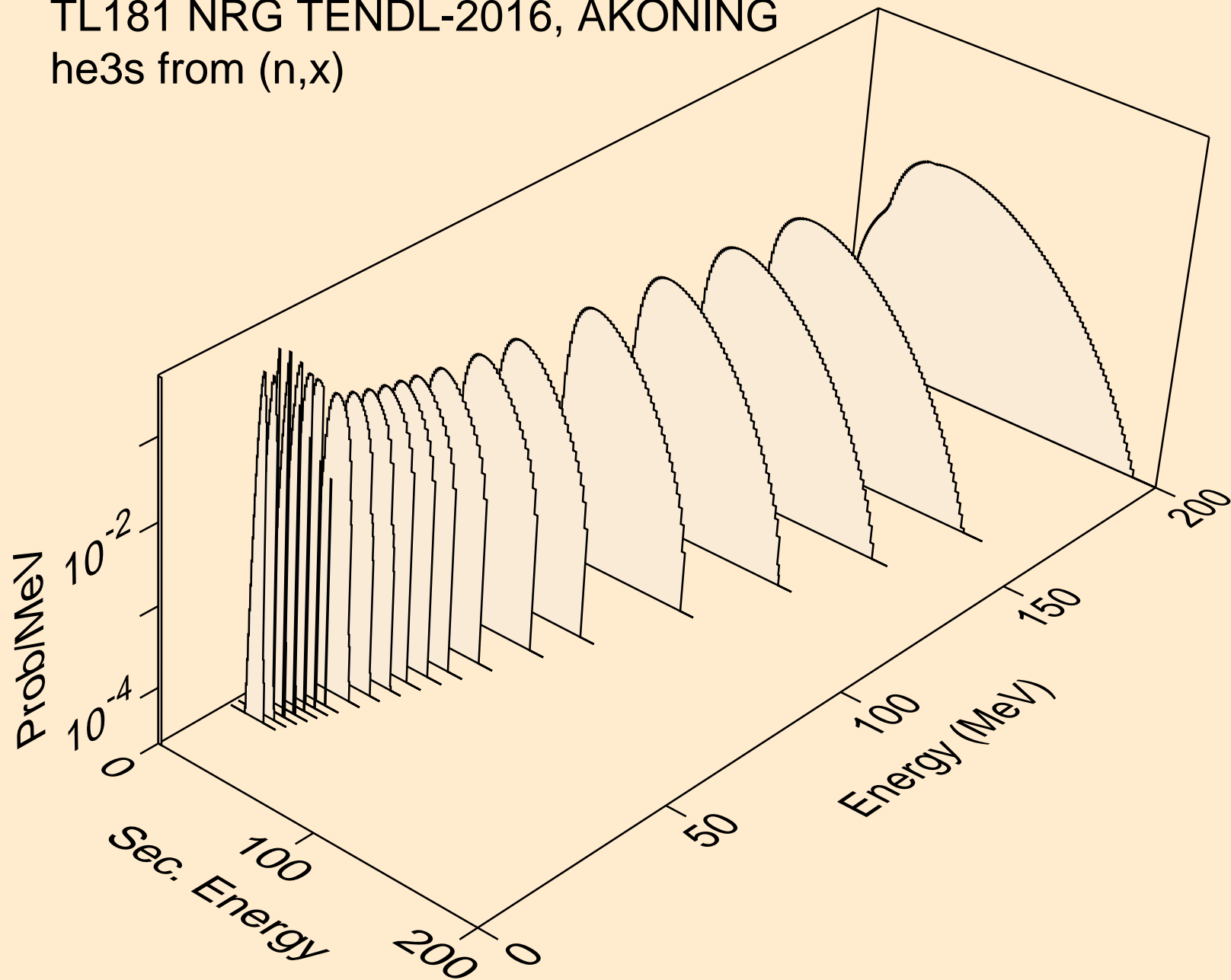

TL181 NRG TENDL-2016, AKONING
he3s from (n,n*)he3

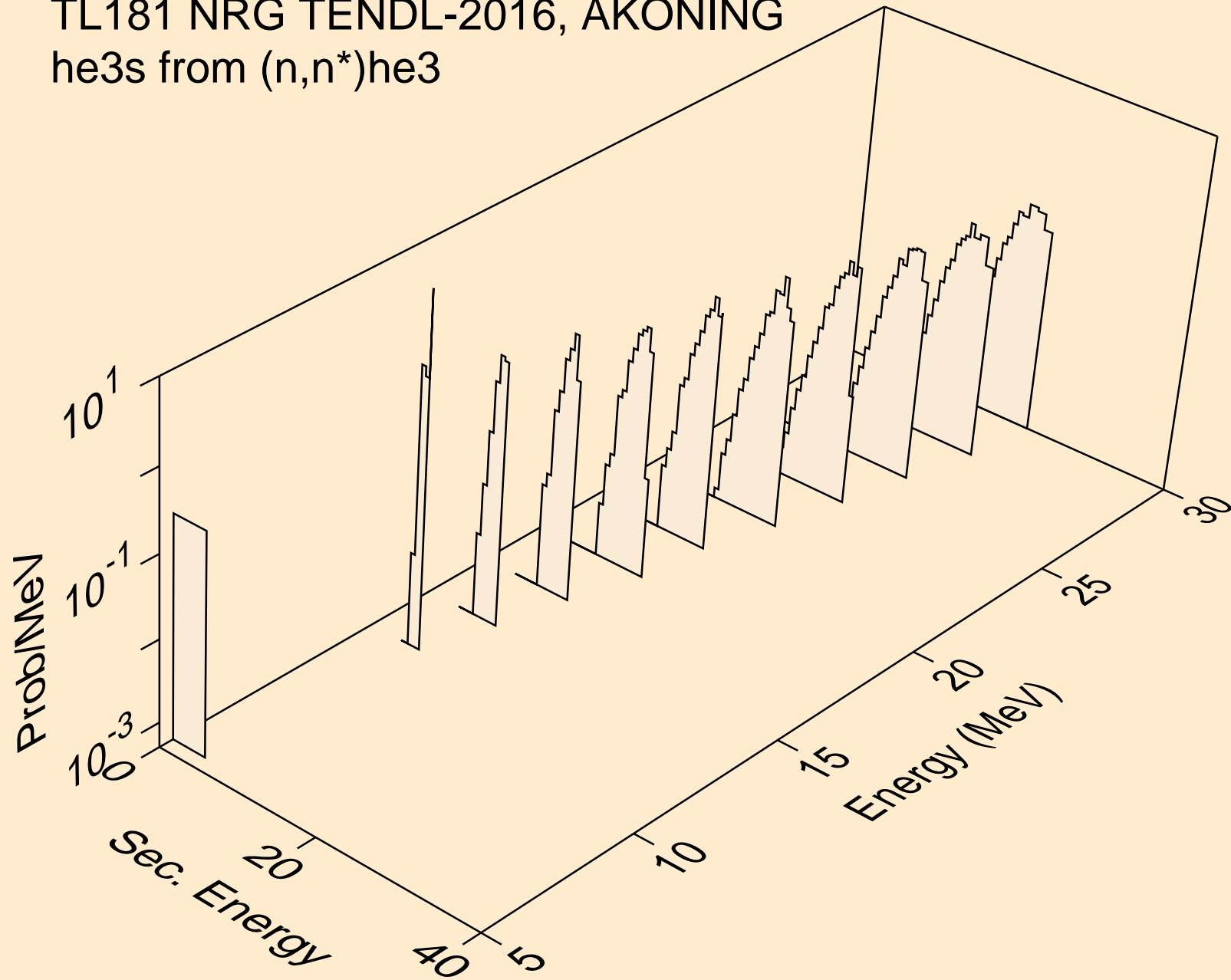

TL181 NRG TENDL-2016, AKONING
he3s from (n,he3)

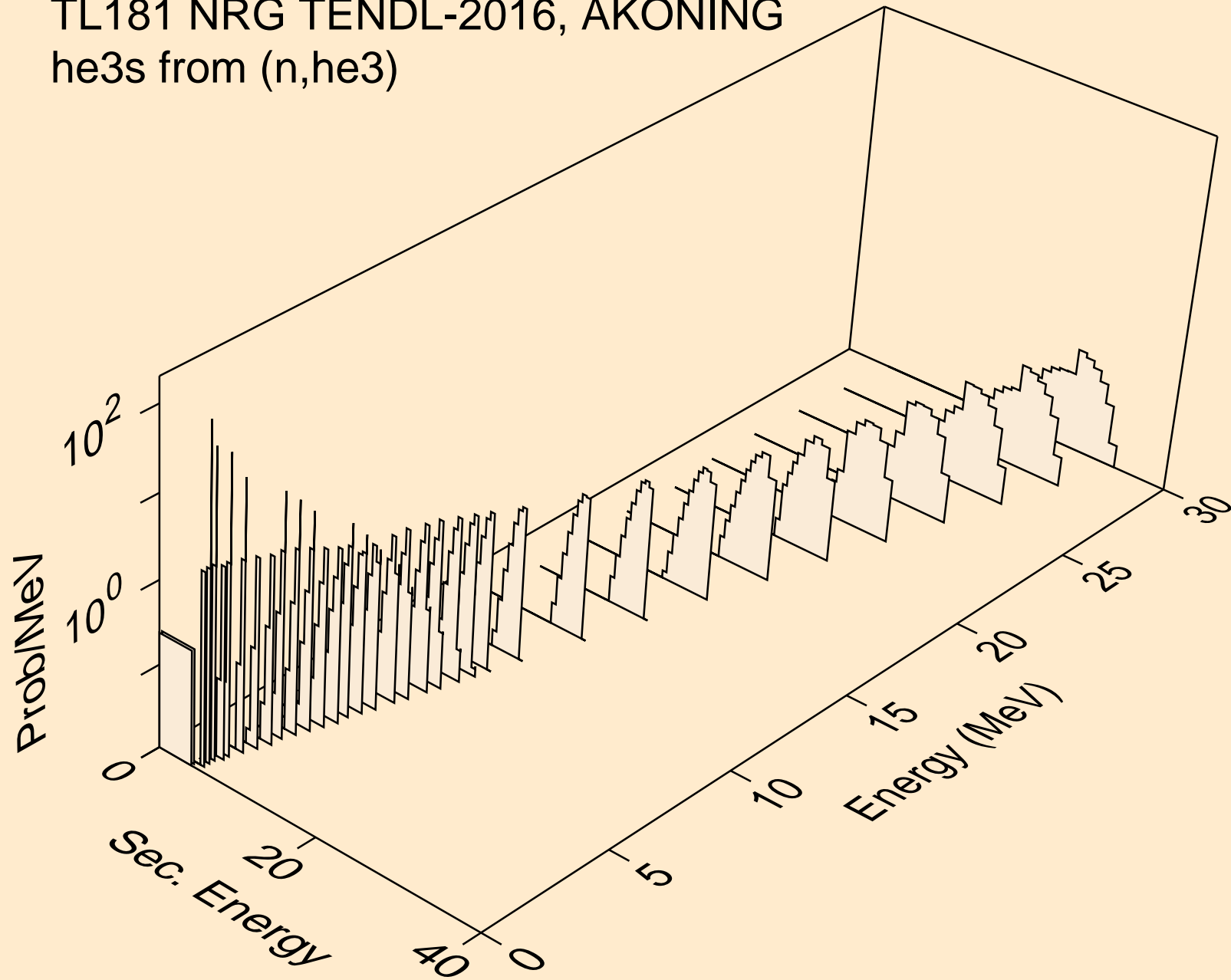

TL181 NRG TENDL-2016, AKONING
alphas from (n,x)

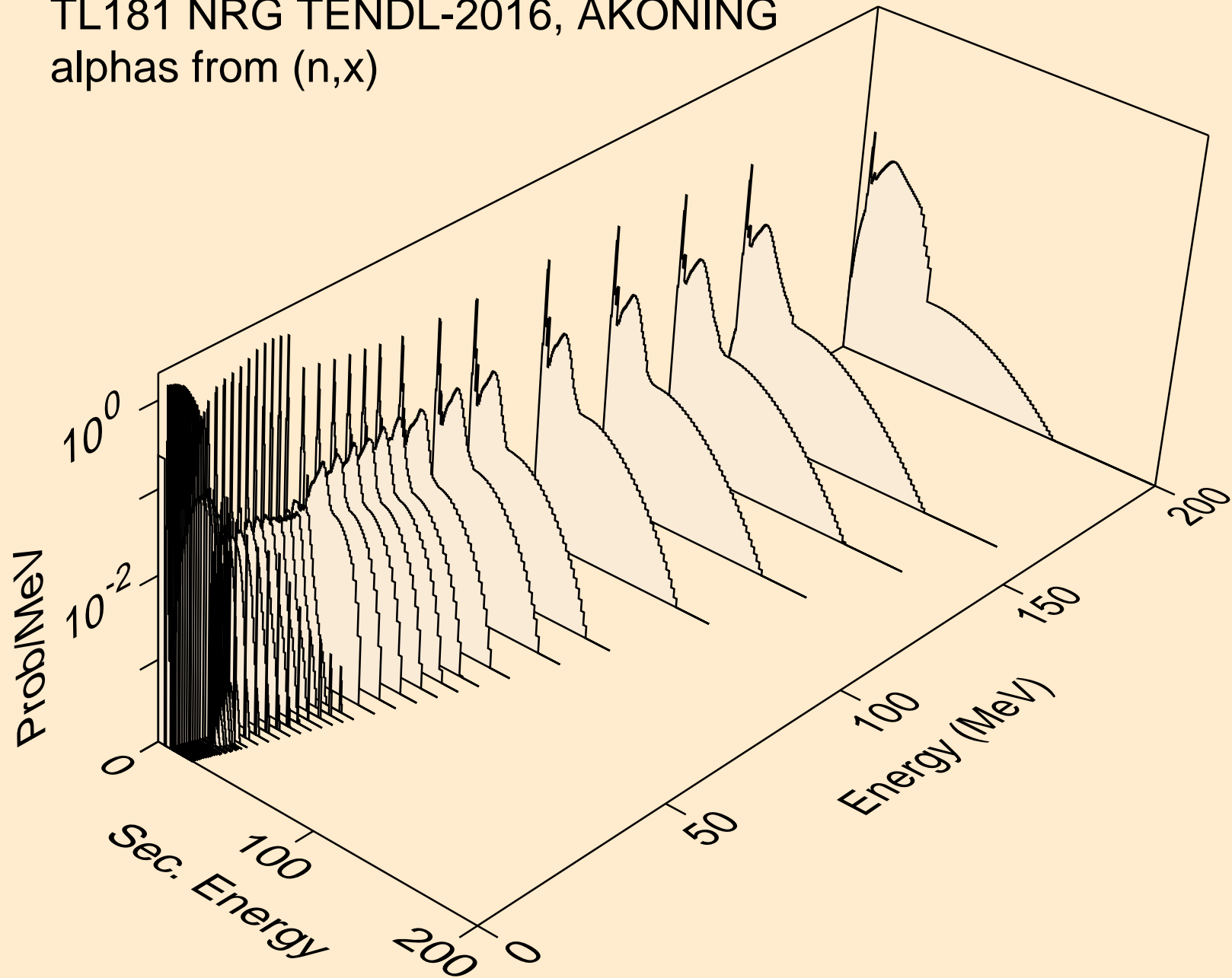

TL181 NRG TENDL-2016, AKONING
alphas from (n,n*)a

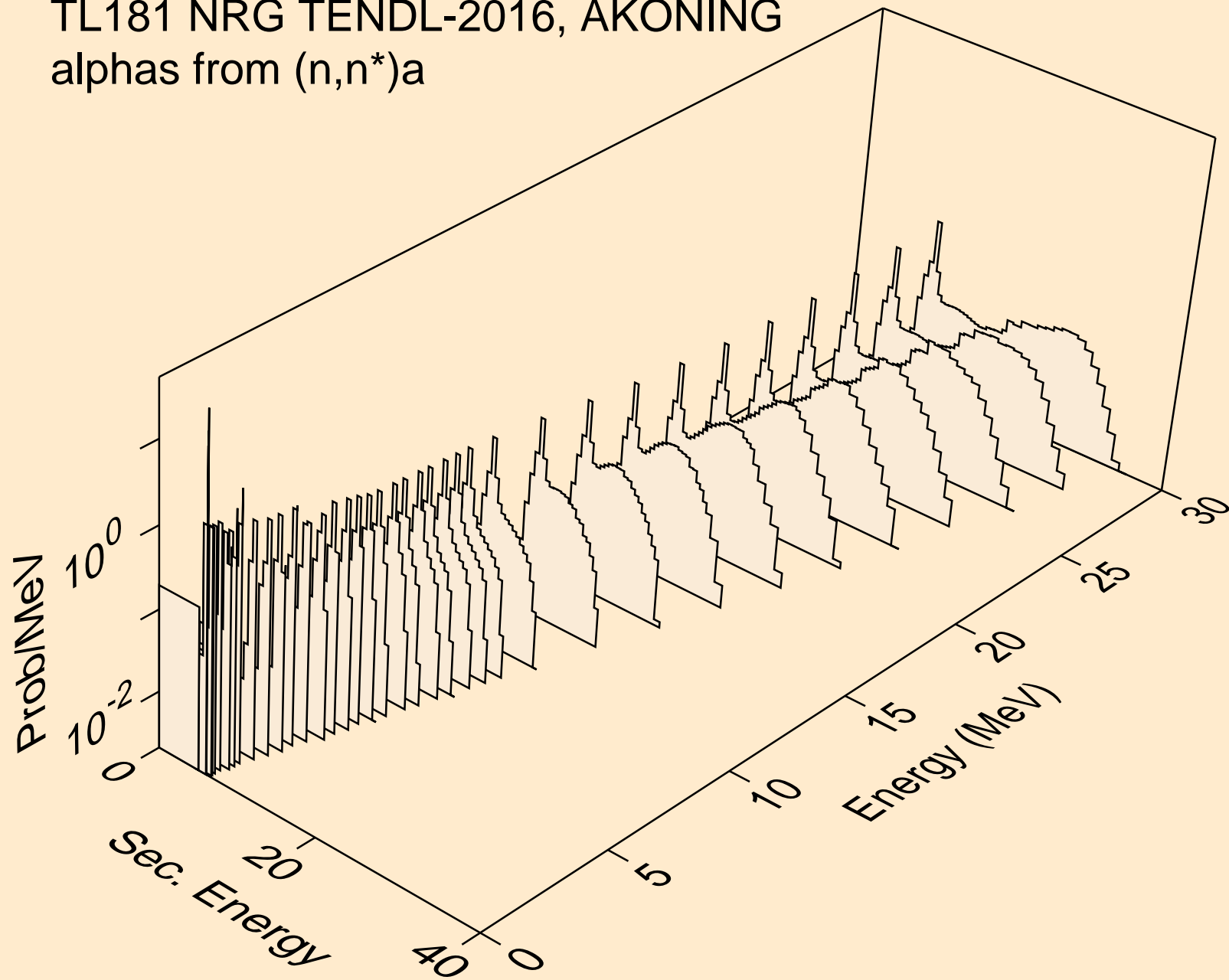

TL181 NRG TENDL-2016, AKONING
alphas from (n,n*)3a

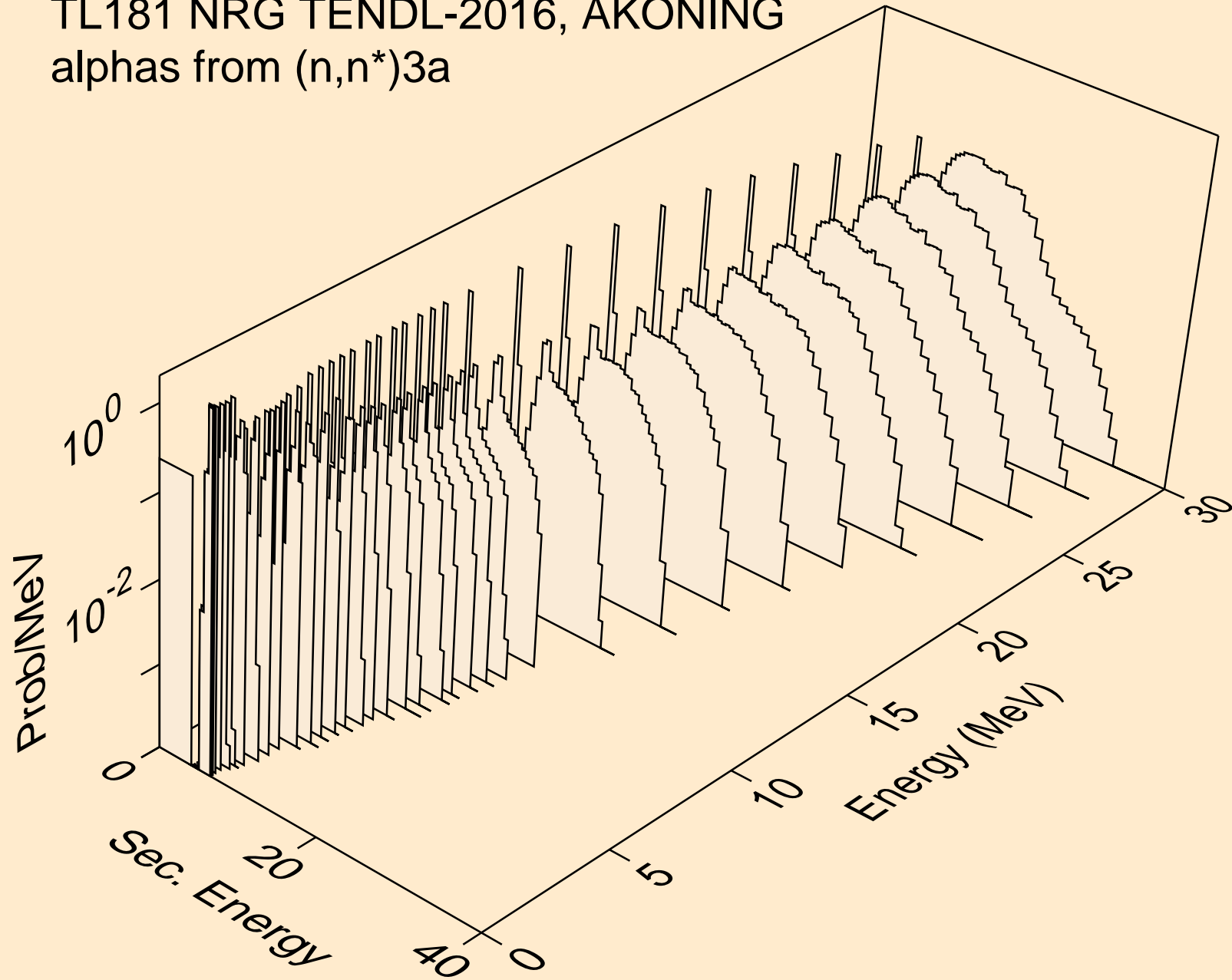

TL181 NRG TENDL-2016, AKONING
alphas from (n,2n)a

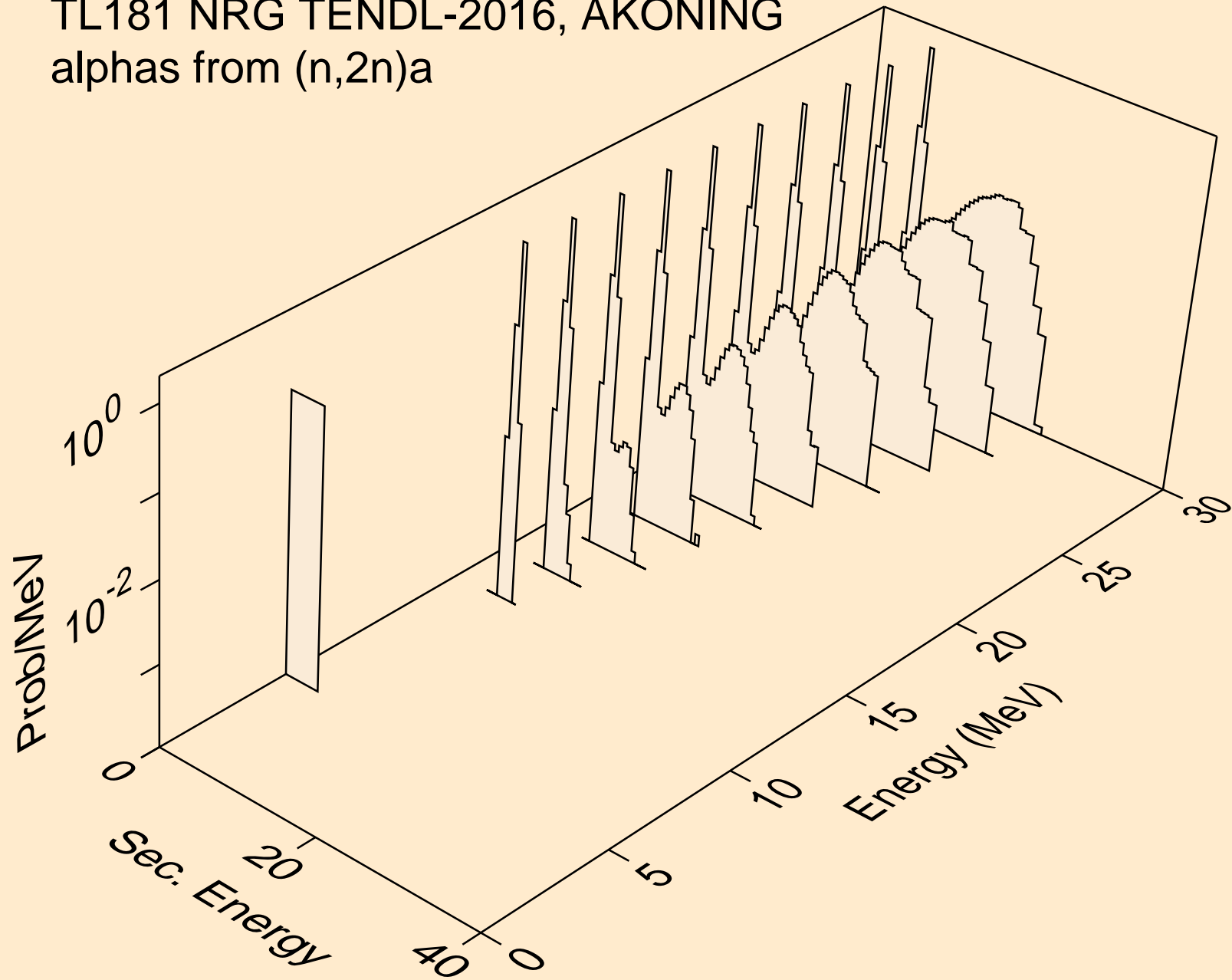

TL181 NRG TENDL-2016, AKONING
alphas from (n,3n)a

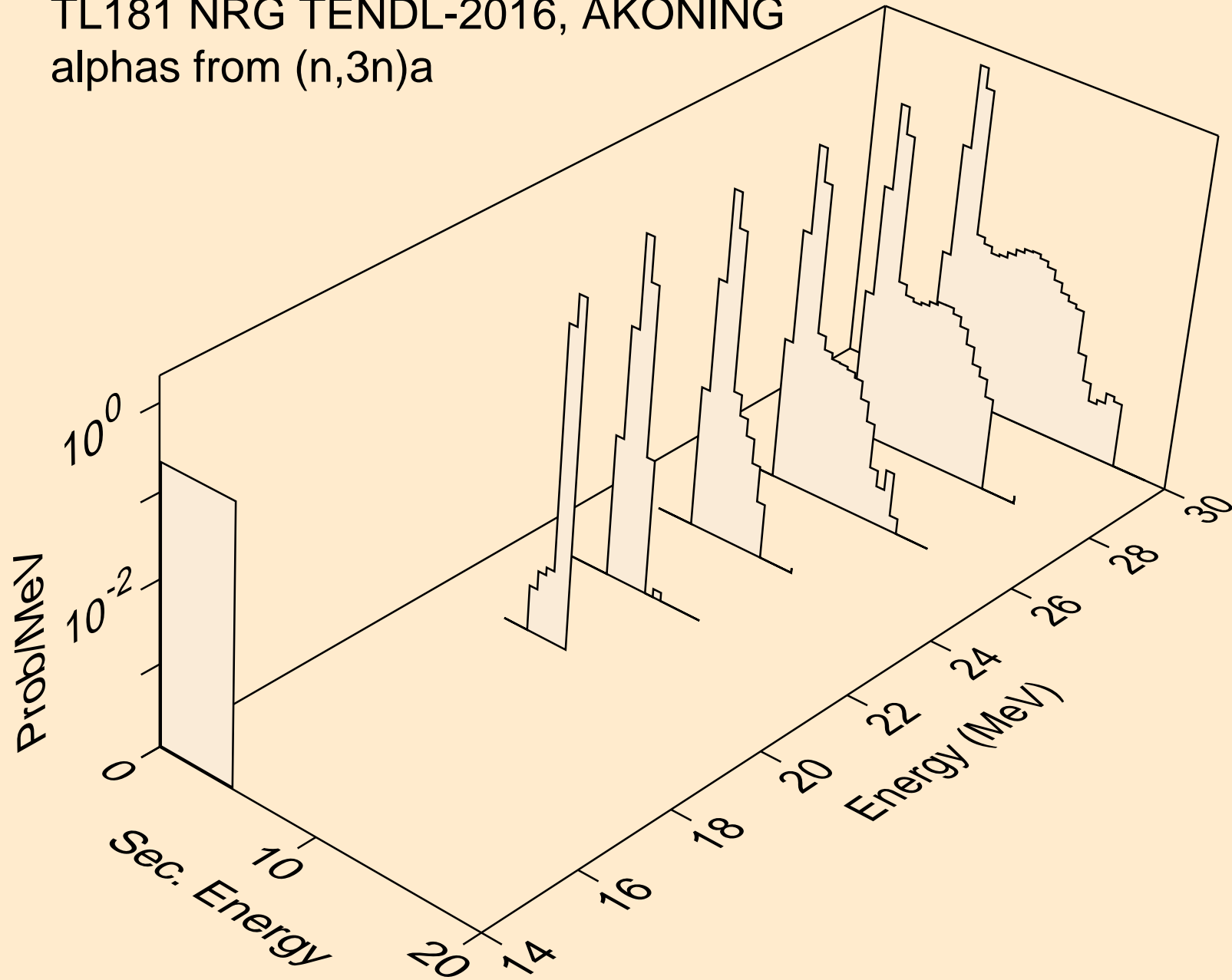

TL181 NRG TENDL-2016, AKONING
alphas from (n,n*)2a

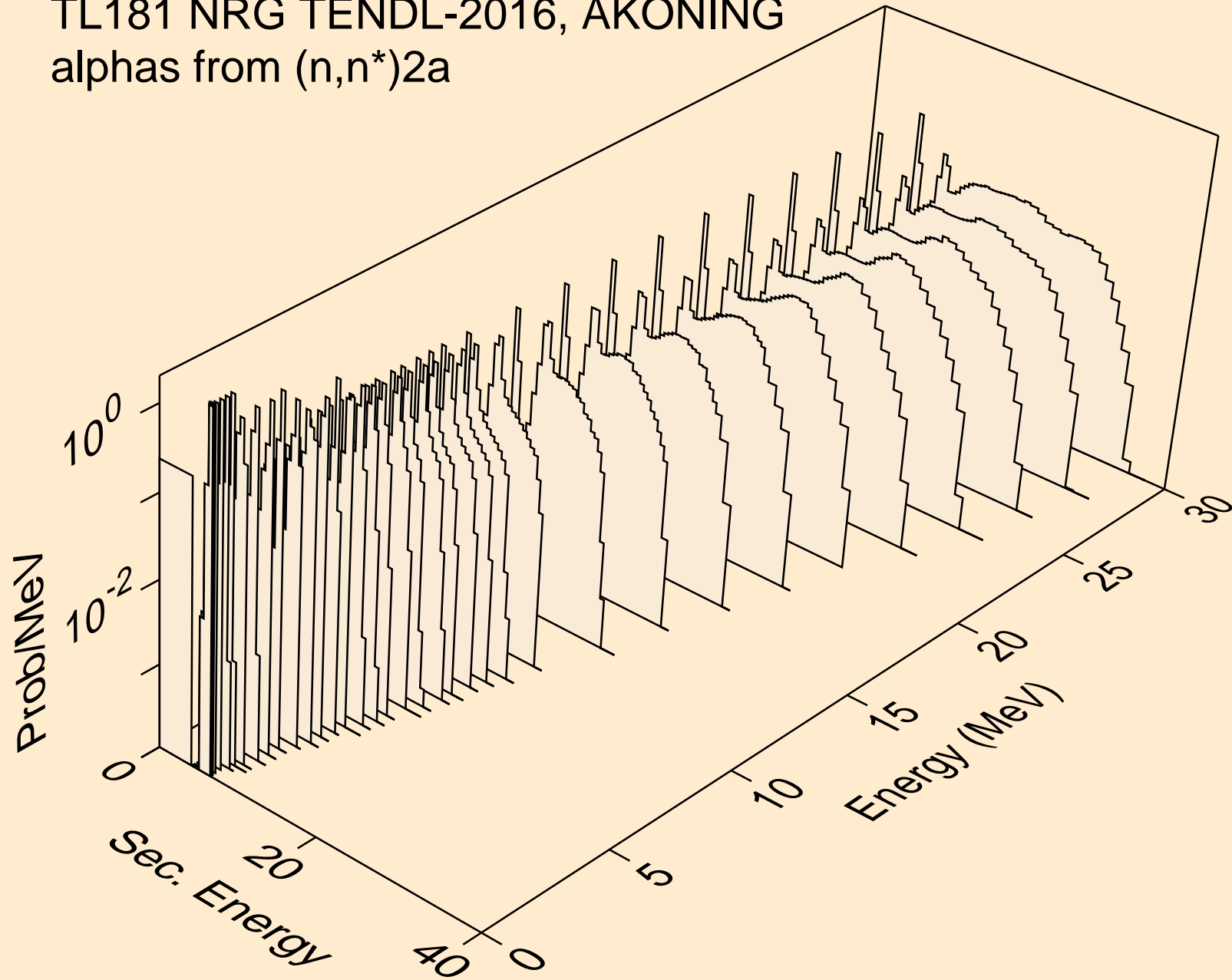

TL181 NRG TENDL-2016, AKONING
alphas from (n,2n)2a

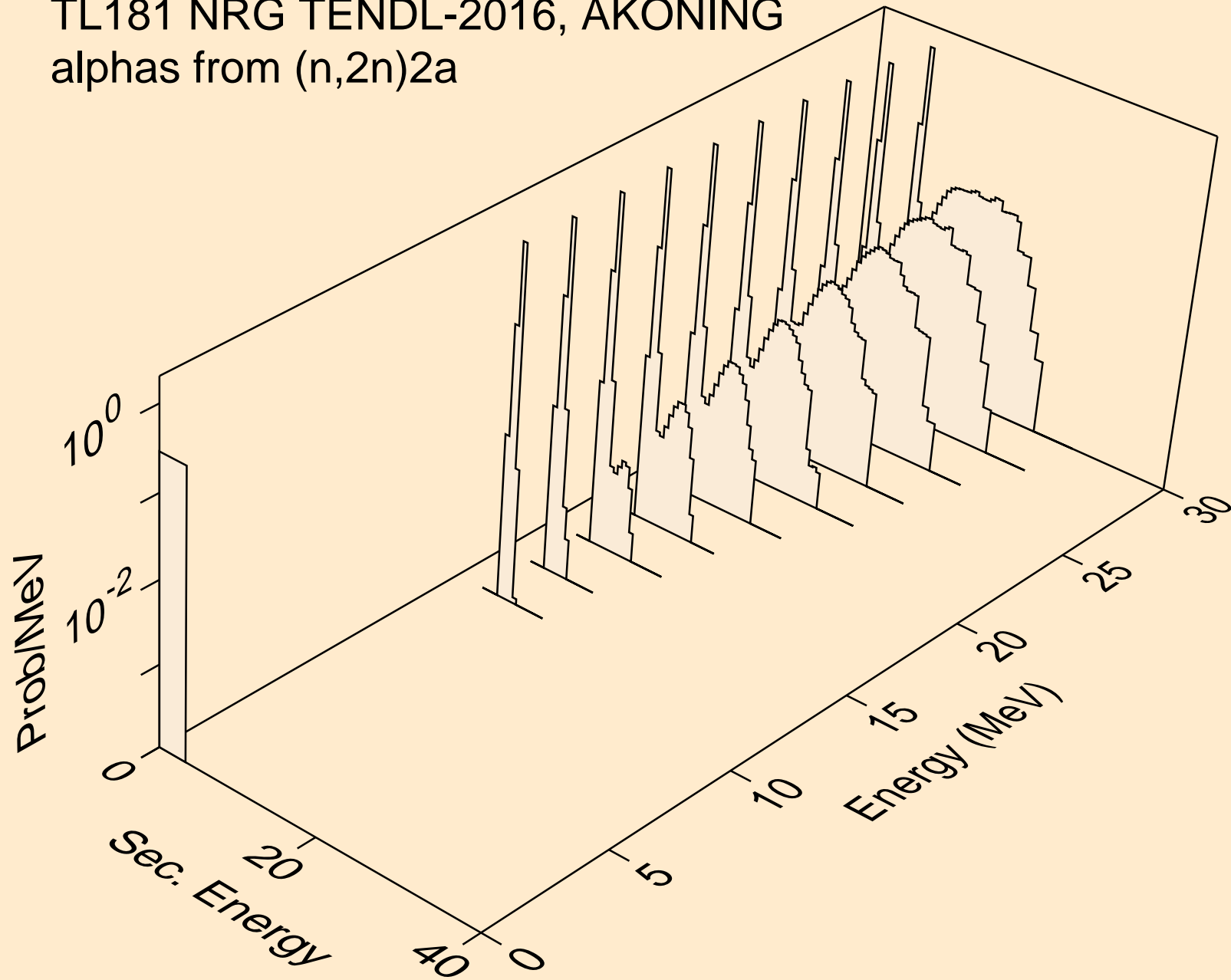

TL181 NRG TENDL-2016, AKONING
alphas from (n,n*)d2a

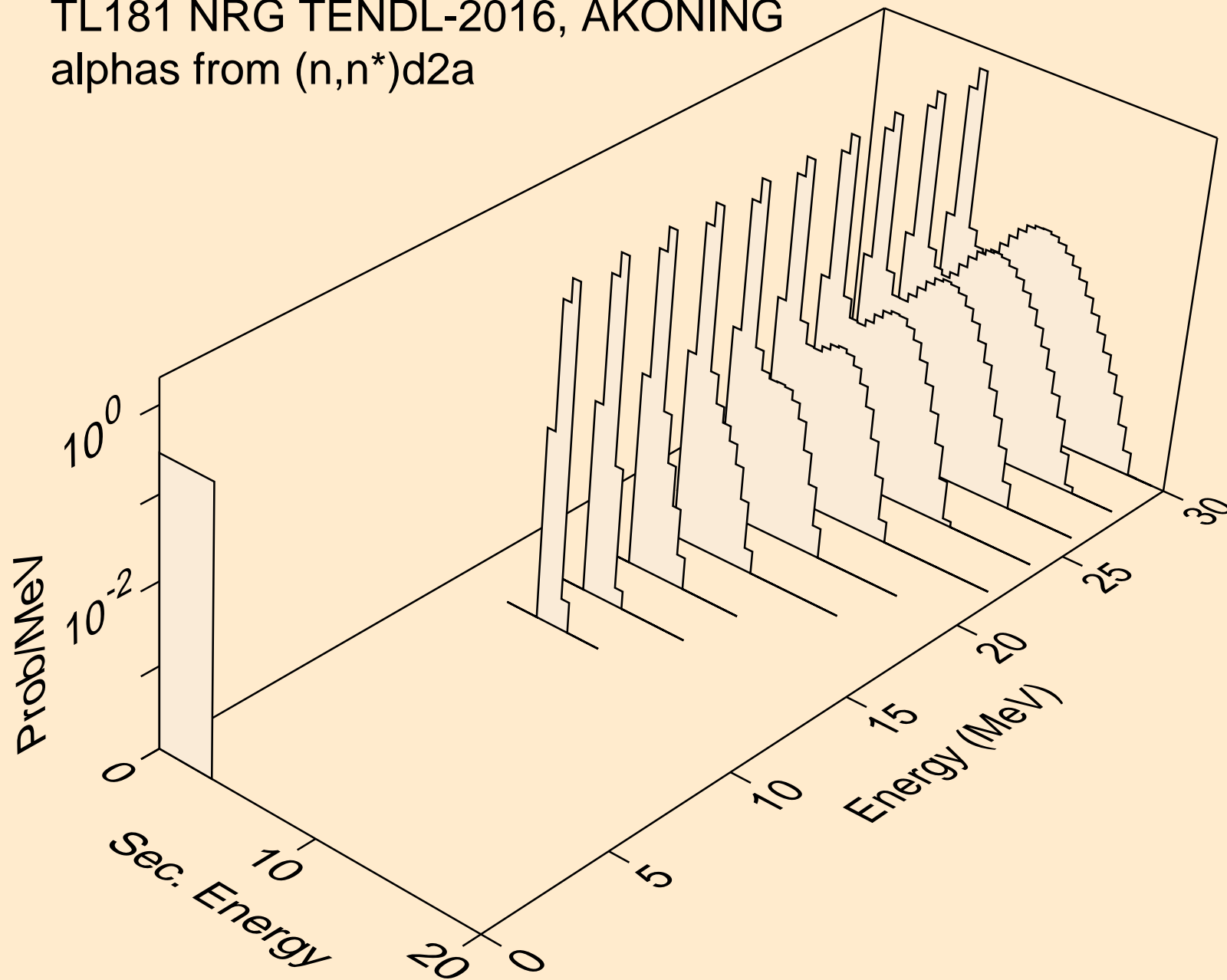

TL181 NRG TENDL-2016, AKONING
alphas from (n,n*)t2a

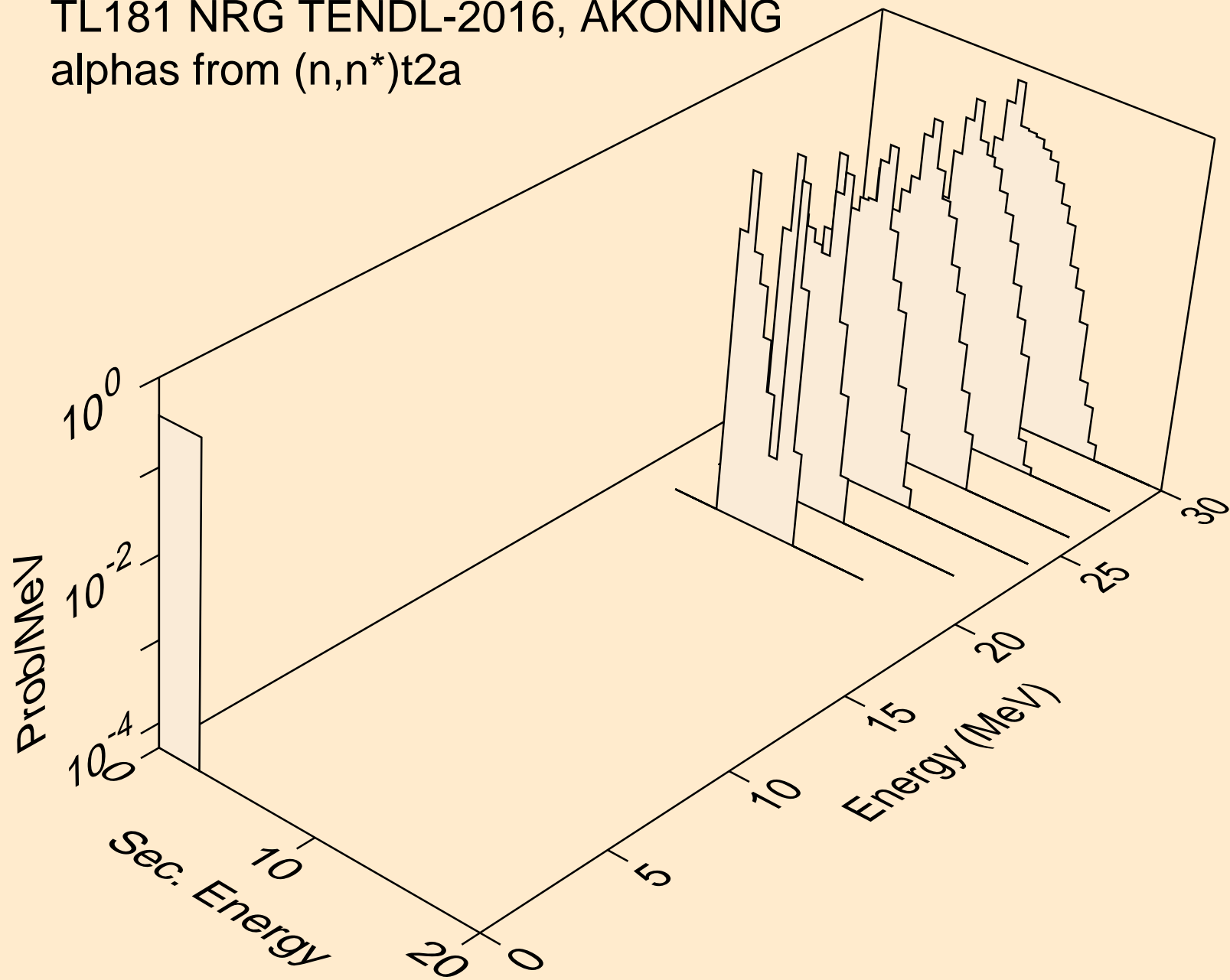

TL181 NRG TENDL-2016, AKONING
alphas from (n,npa)

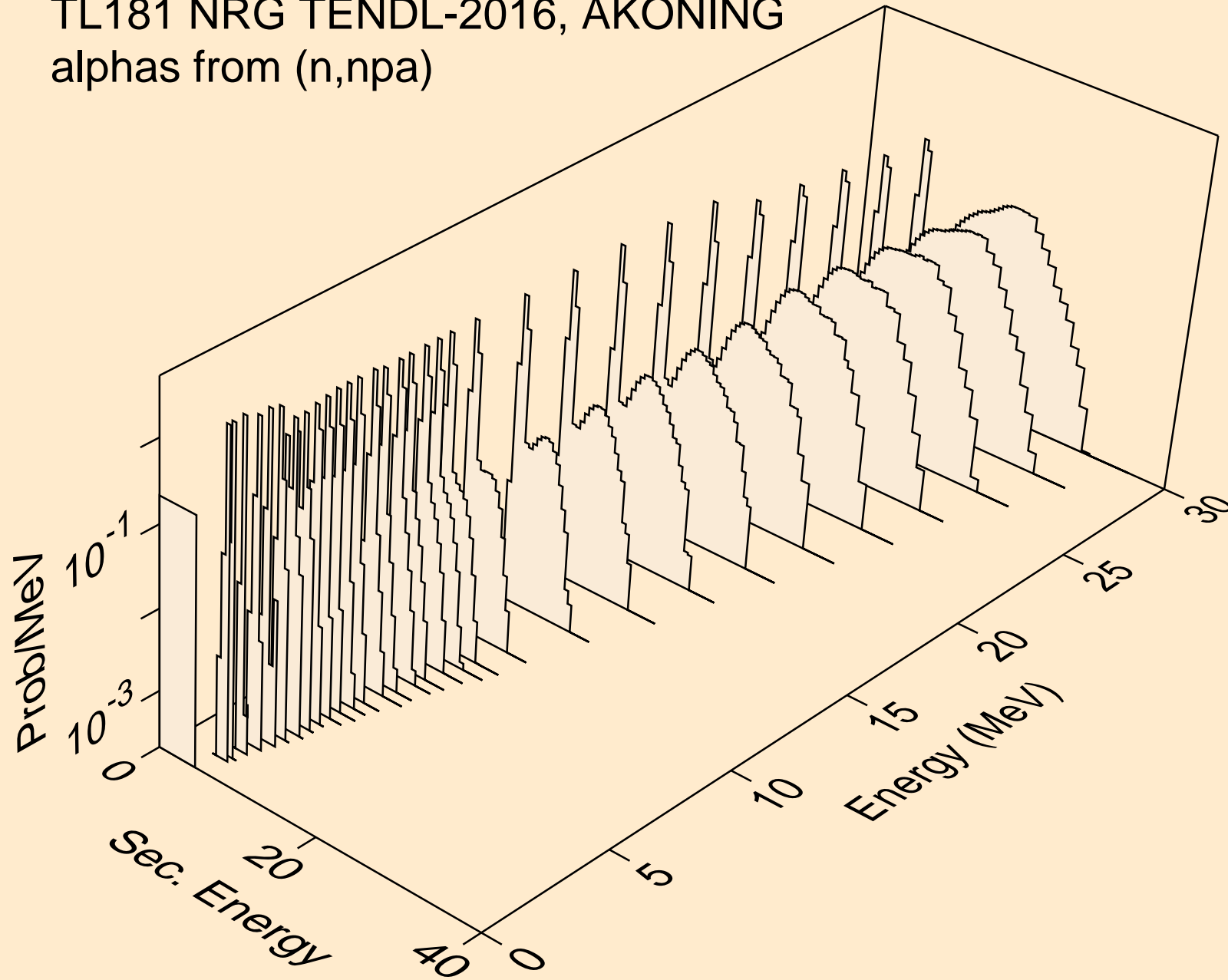

TL181 NRG TENDL-2016, AKONING
alphas from (n,a)

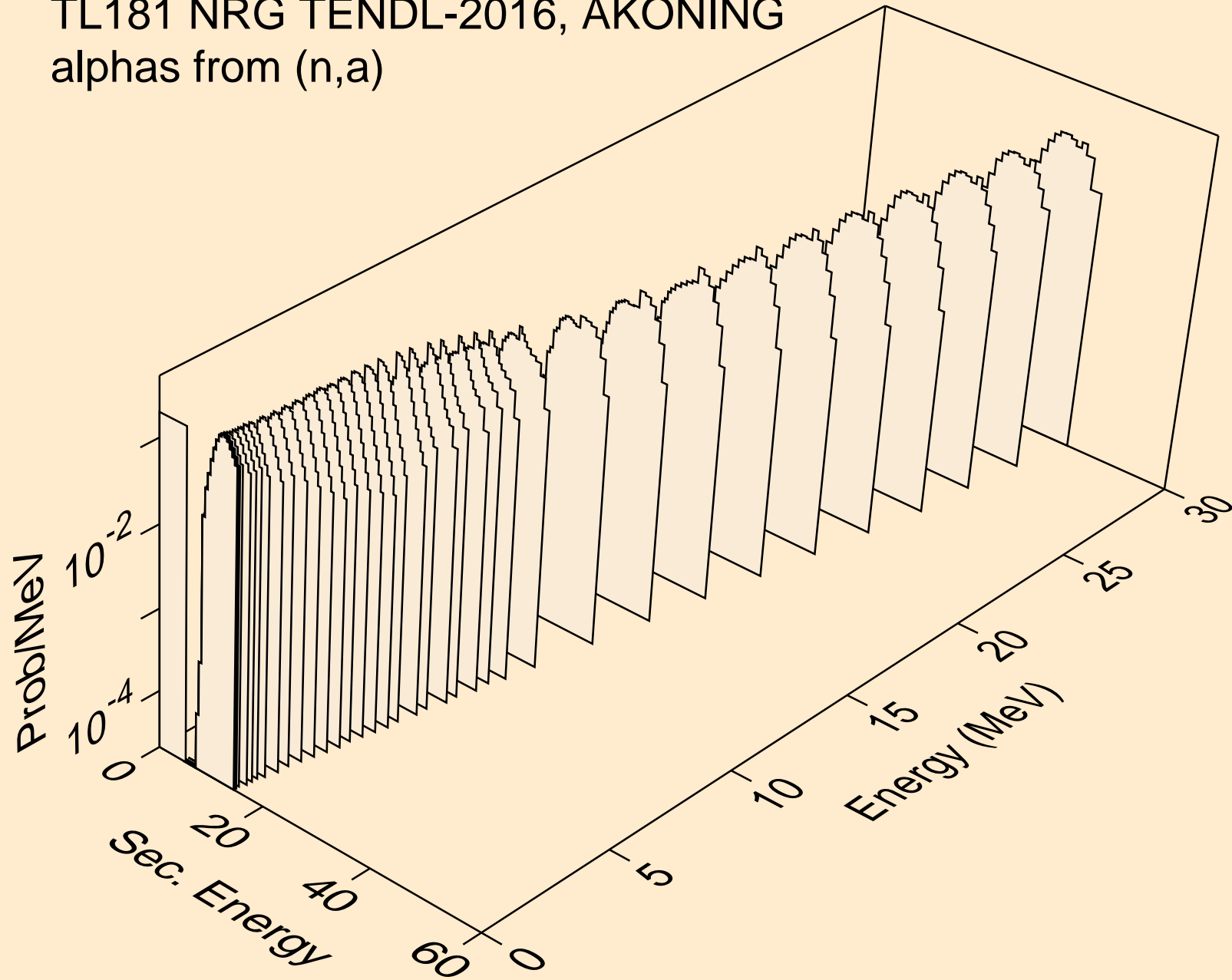

TL181 NRG TENDL-2016, AKONING
alphas from (n,2a)

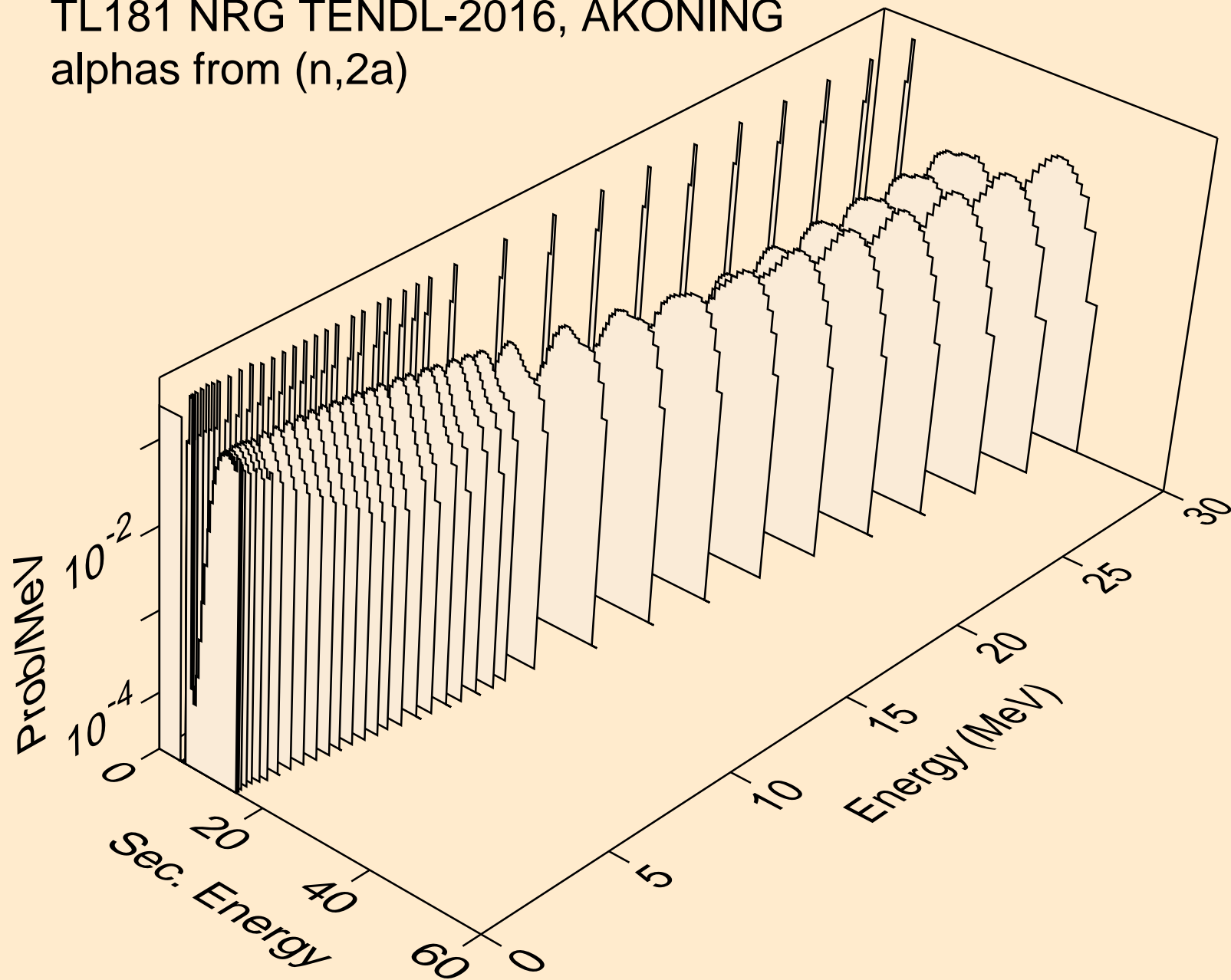

TL181 NRG TENDL-2016, AKONING
alphas from (n,3a)

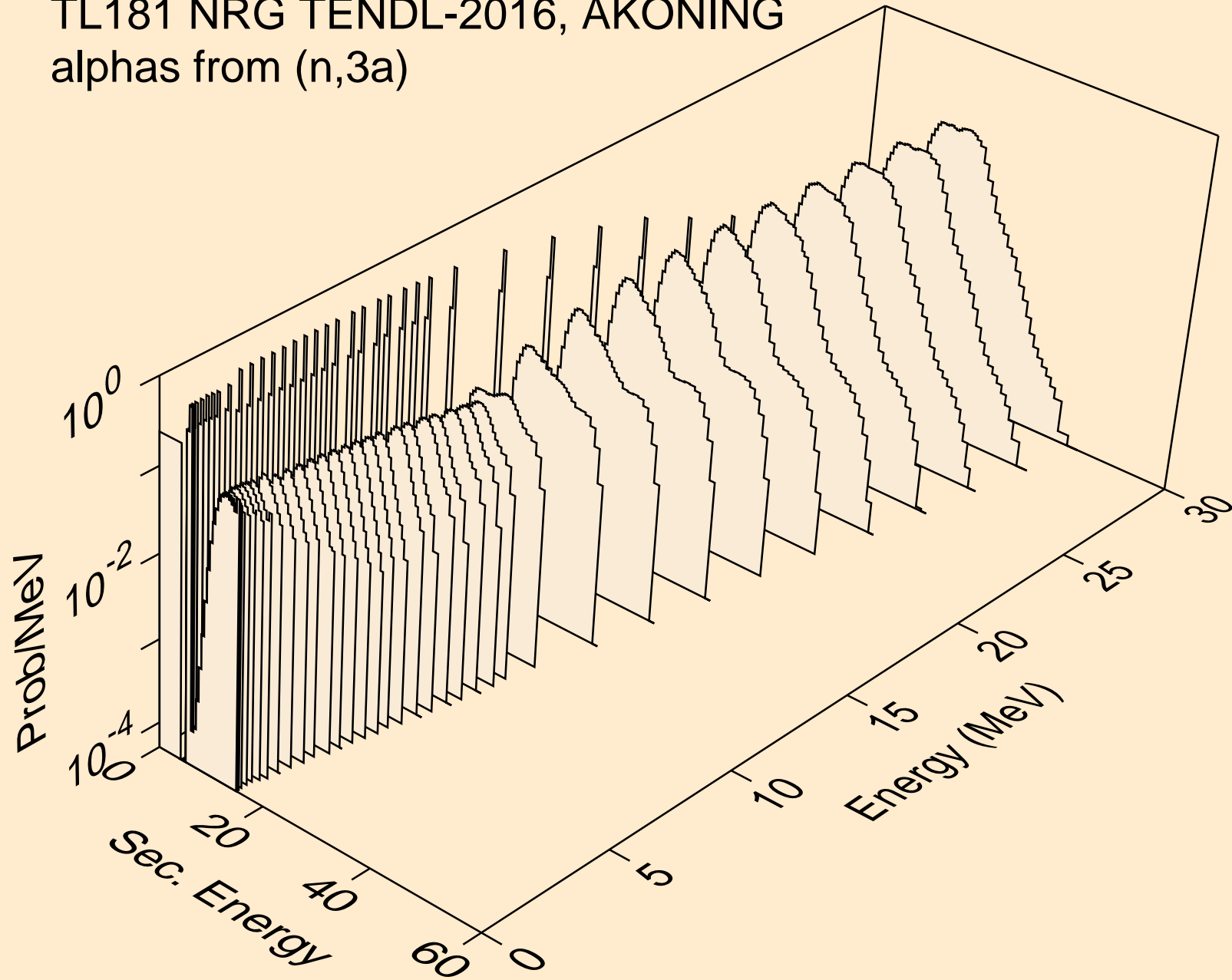

TL181 NRG TENDL-2016, AKONING
alphas from (n,pa)

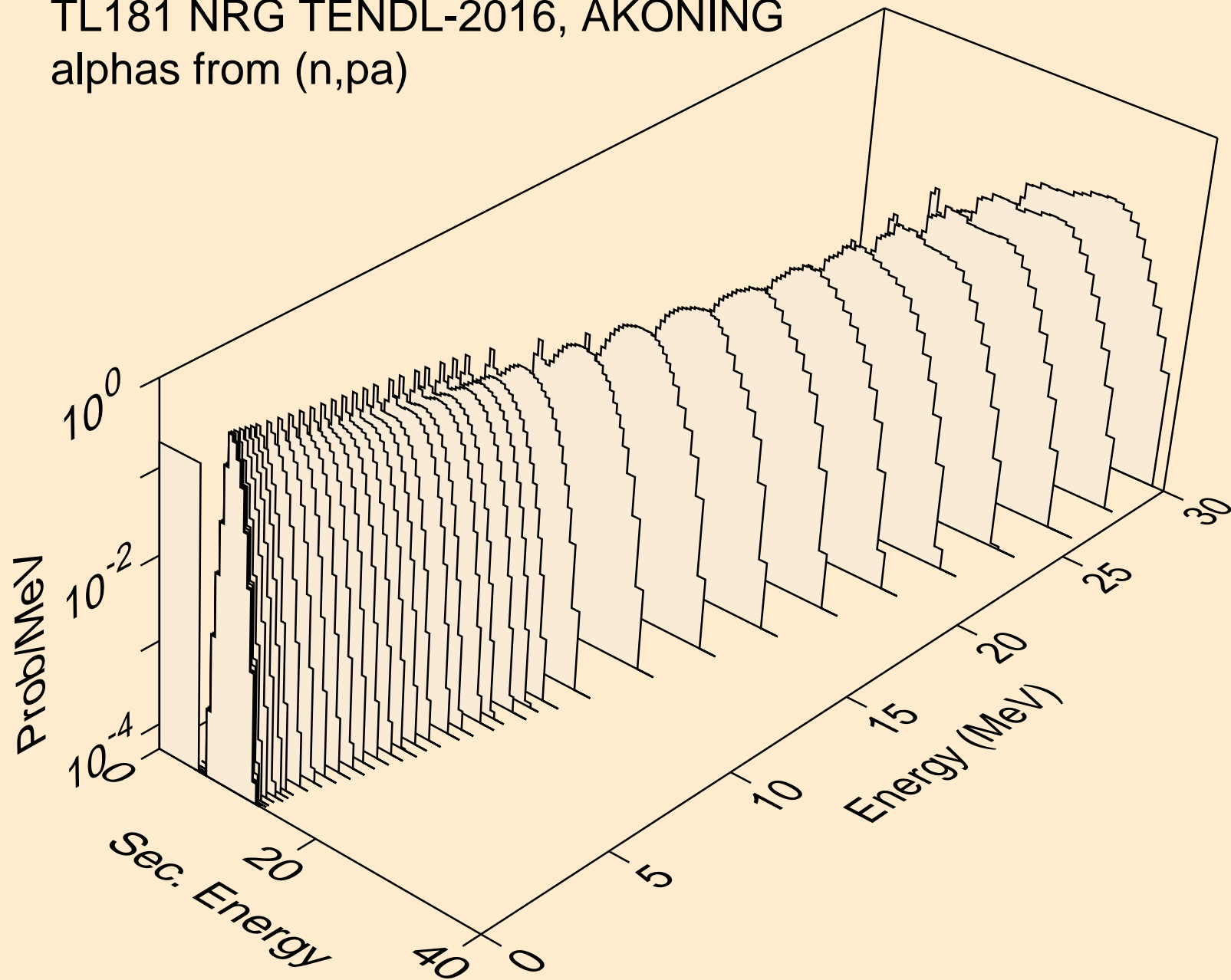

TL181 NRG TENDL-2016, AKONING
alphas from (n,t2a)

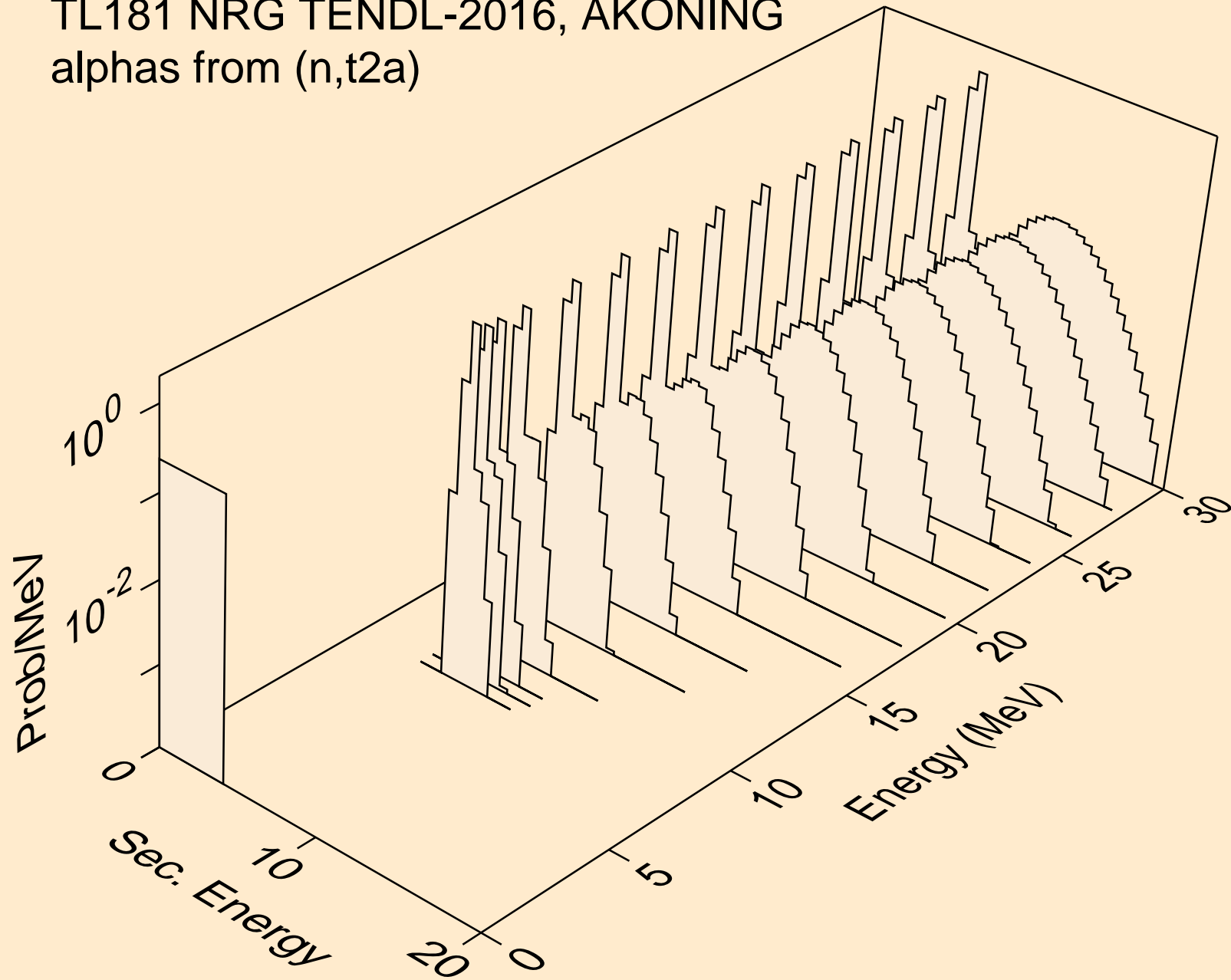

TL181 NRG TENDL-2016, AKONING
alphas from (n,d2a)

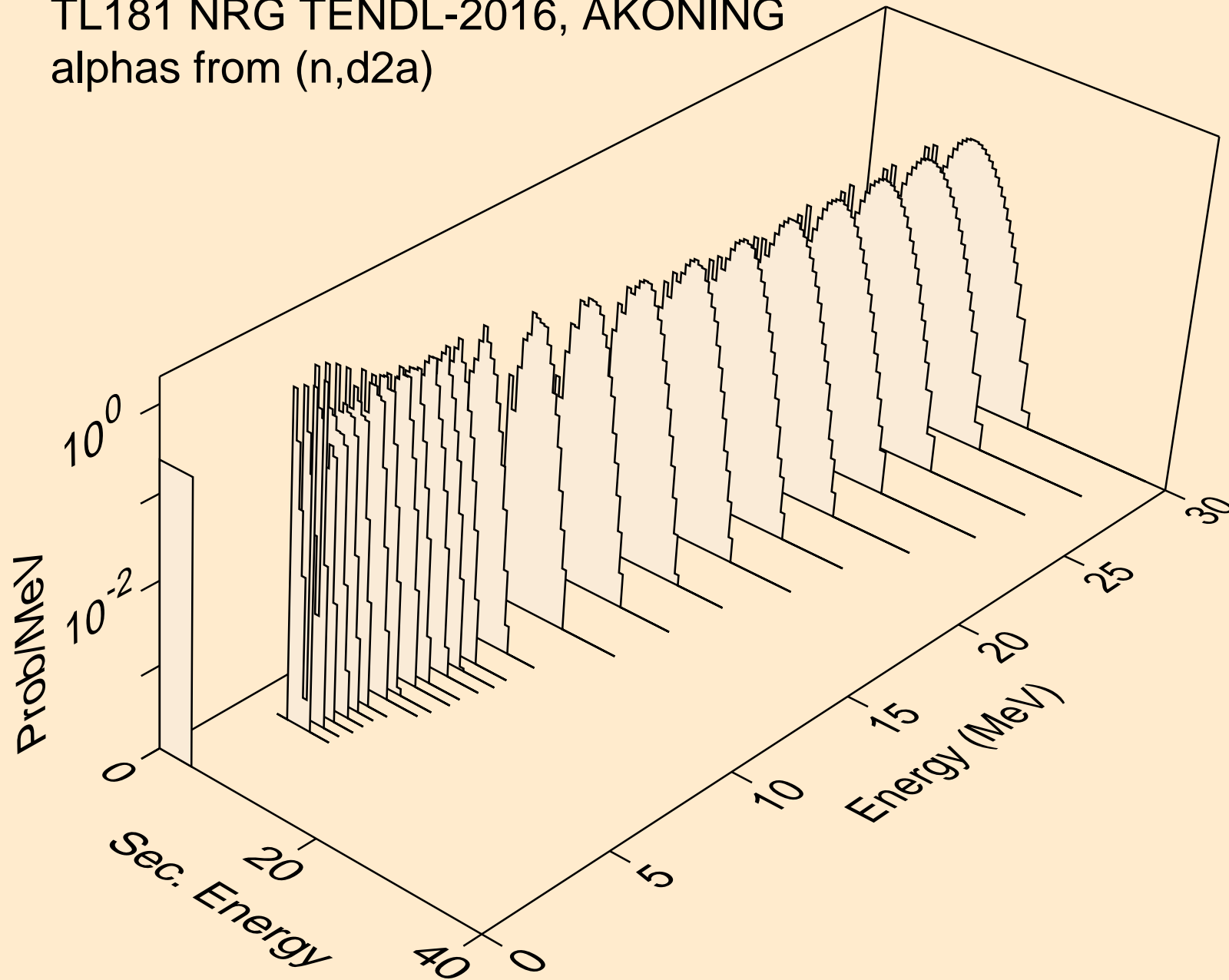

TL181 NRG TENDL-2016, AKONING
alphas from (n,da)

