

# TL212 NRG TENDL-2015, AKONING

## Principal cross sections

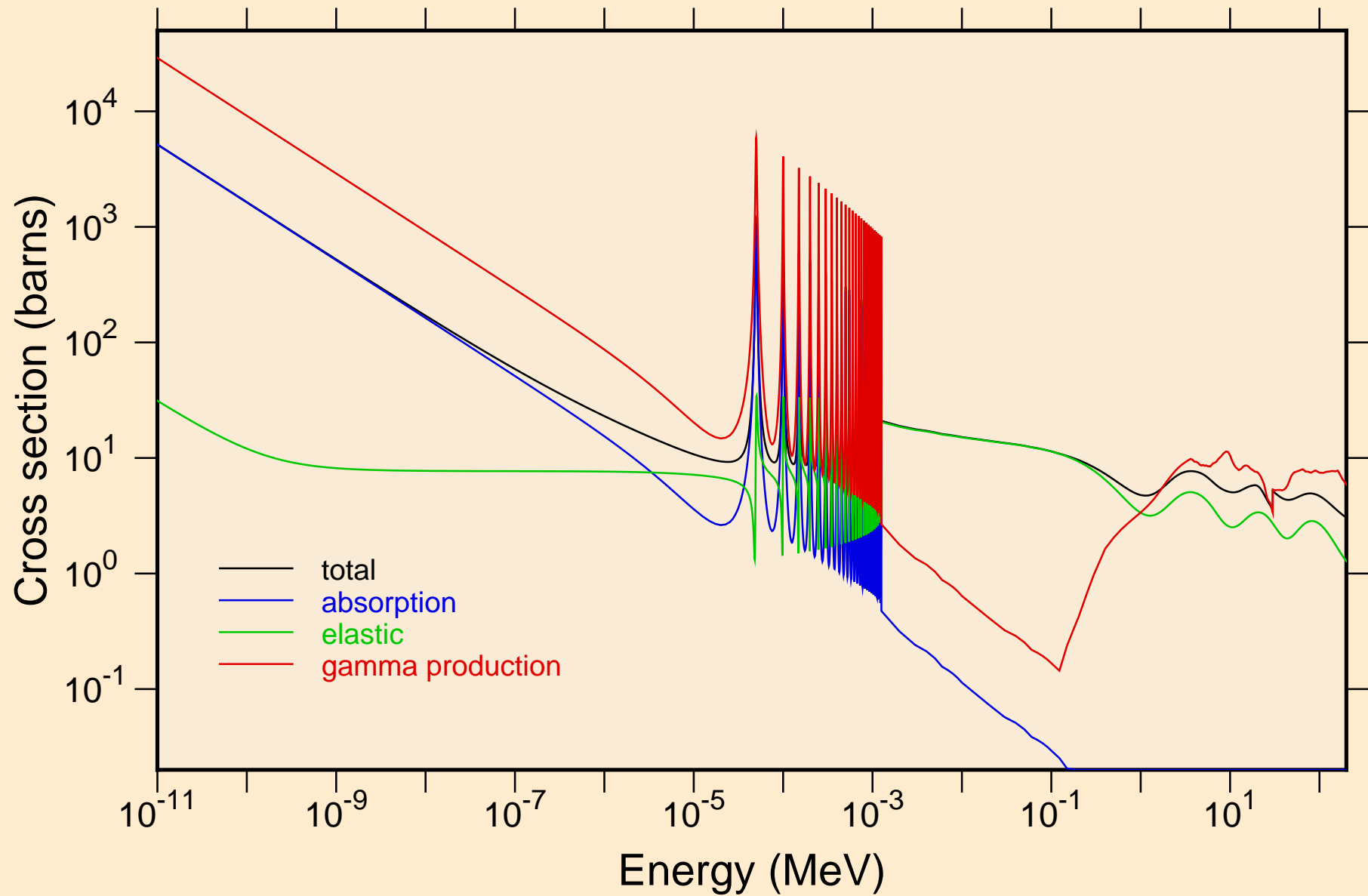

TL212 NRG TENDL-2015, AKONING  
resonance total cross section

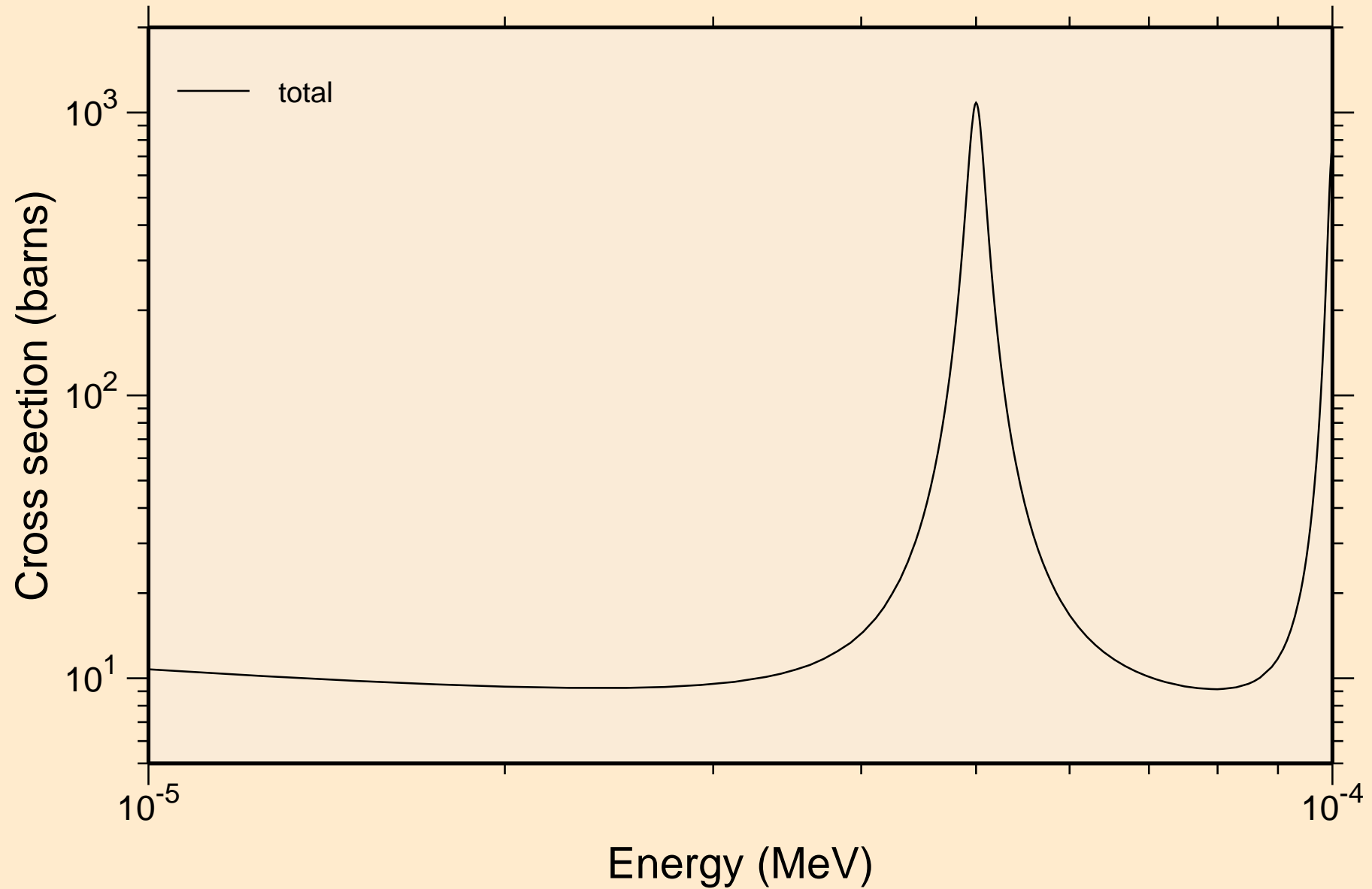

TL212 NRG TENDL-2015, AKONING  
resonance total cross section

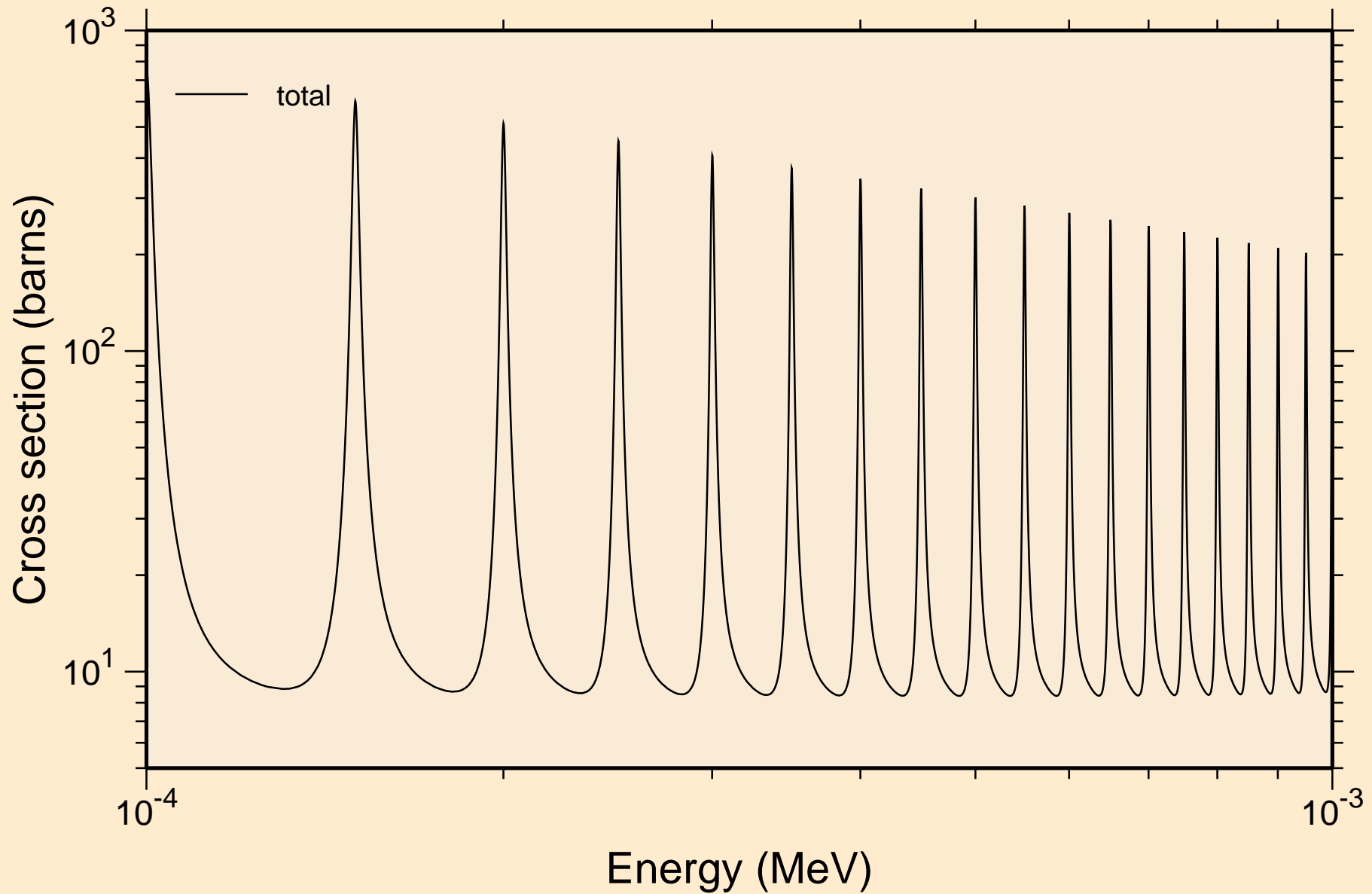

TL212 NRG TENDL-2015, AKONING  
resonance total cross section

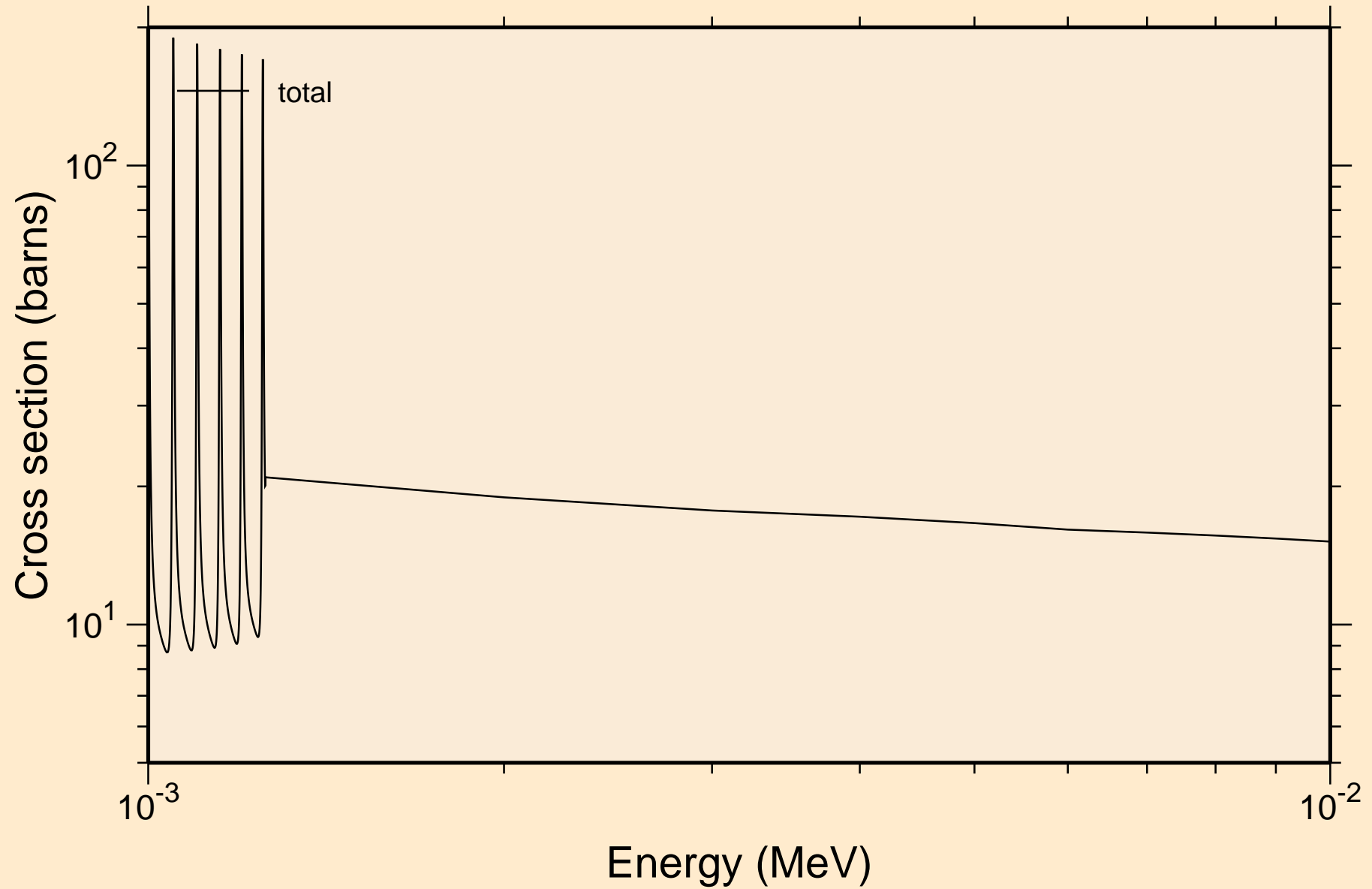

TL212 NRG TENDL-2015, AKONING  
resonance total cross section

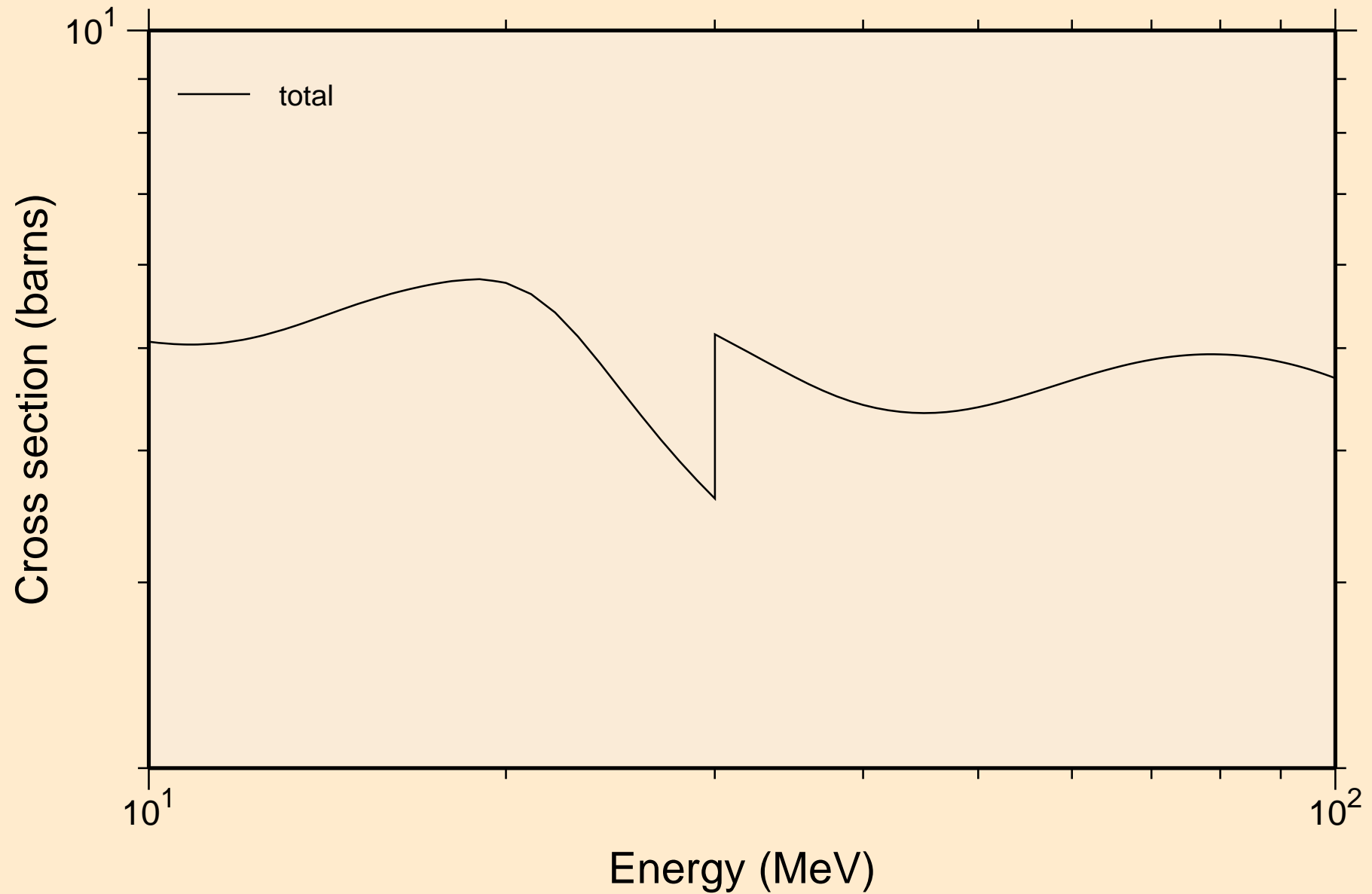

TL212 NRG TENDL-2015, AKONING  
resonance absorption cross sections

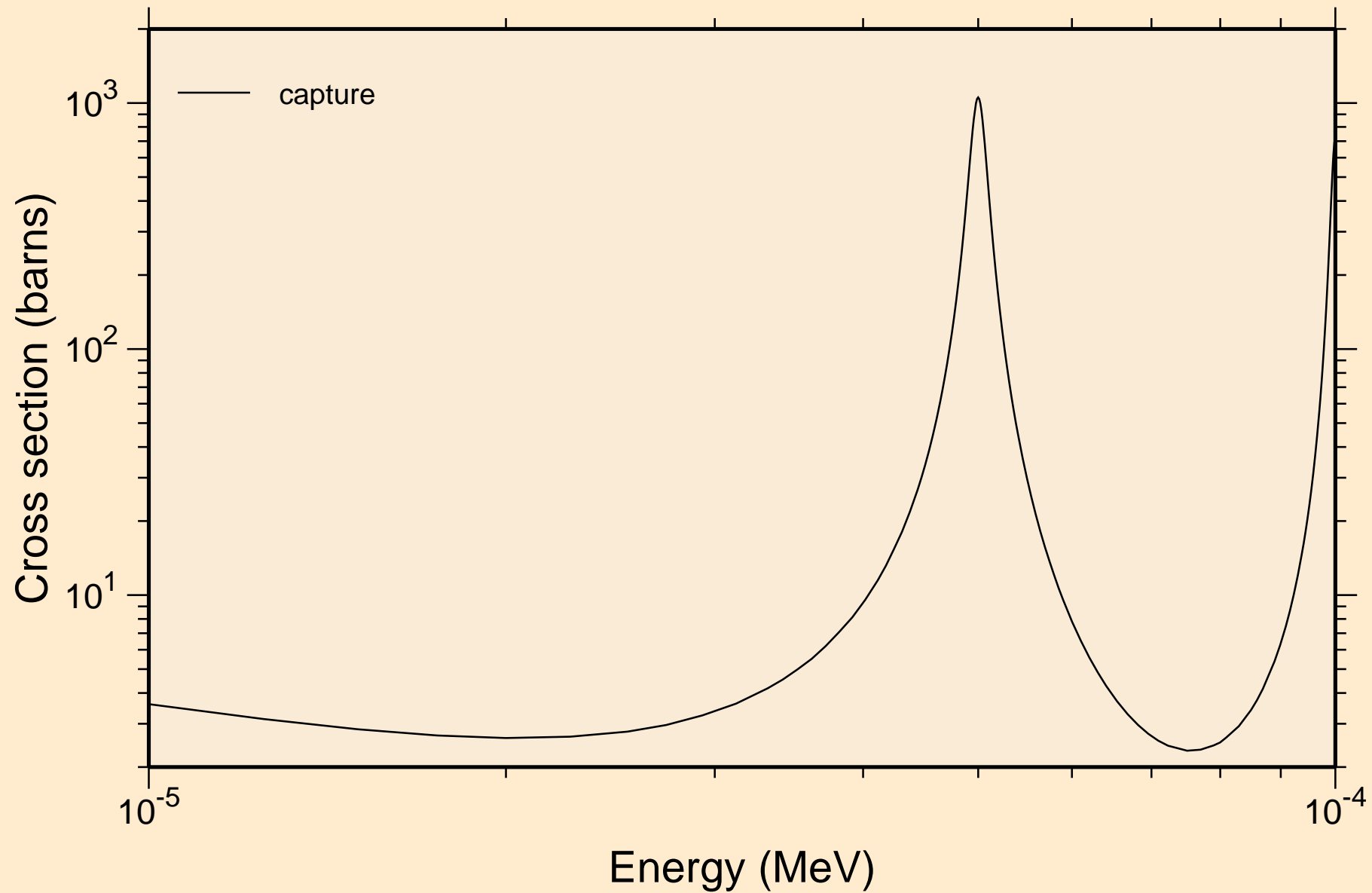

TL212 NRG TENDL-2015, AKONING  
resonance absorption cross sections

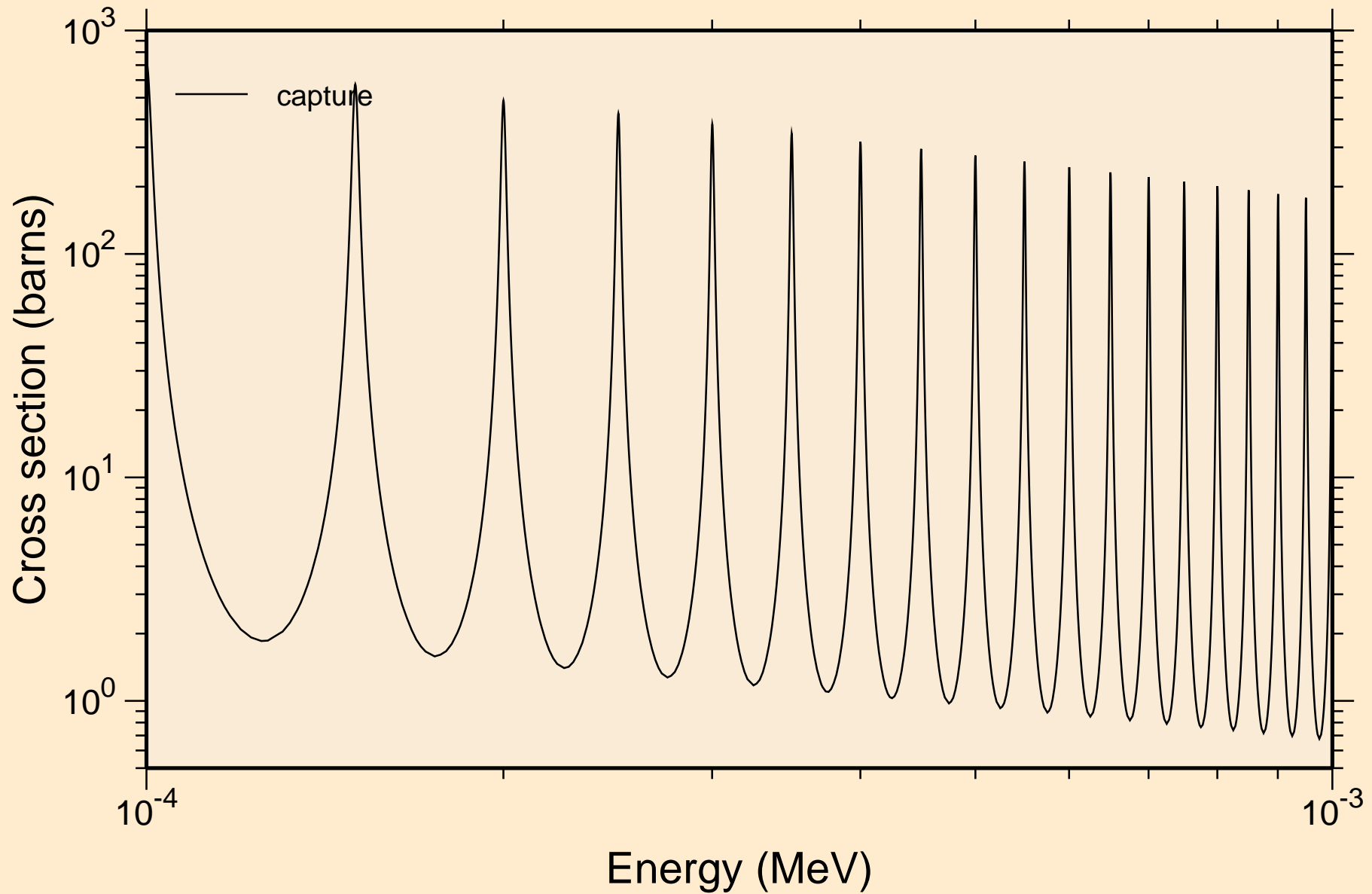

TL212 NRG TENDL-2015, AKONING  
resonance absorption cross sections

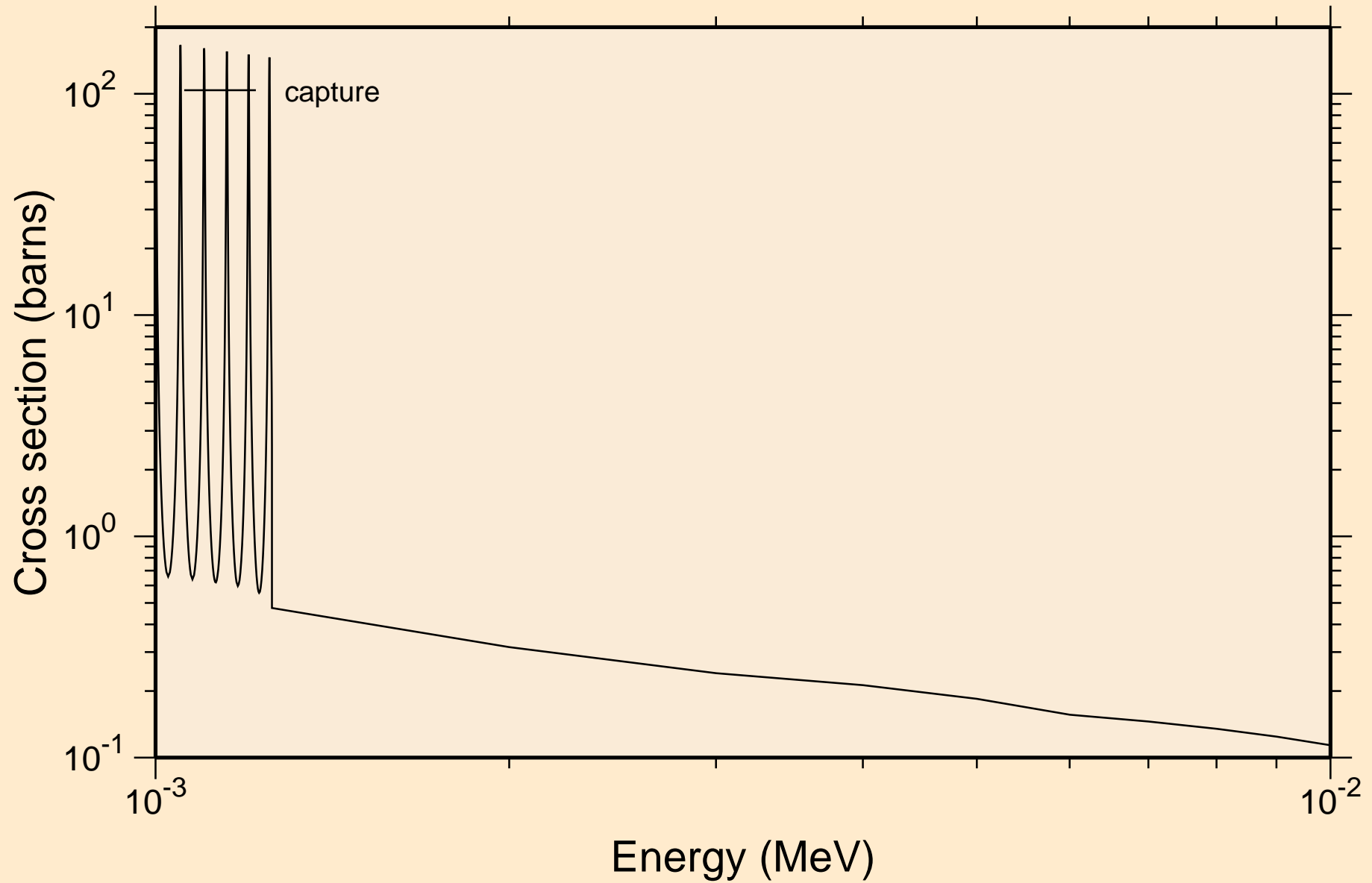



TL212 NRG TENDL-2015, AKONING  
resonance absorption cross sections

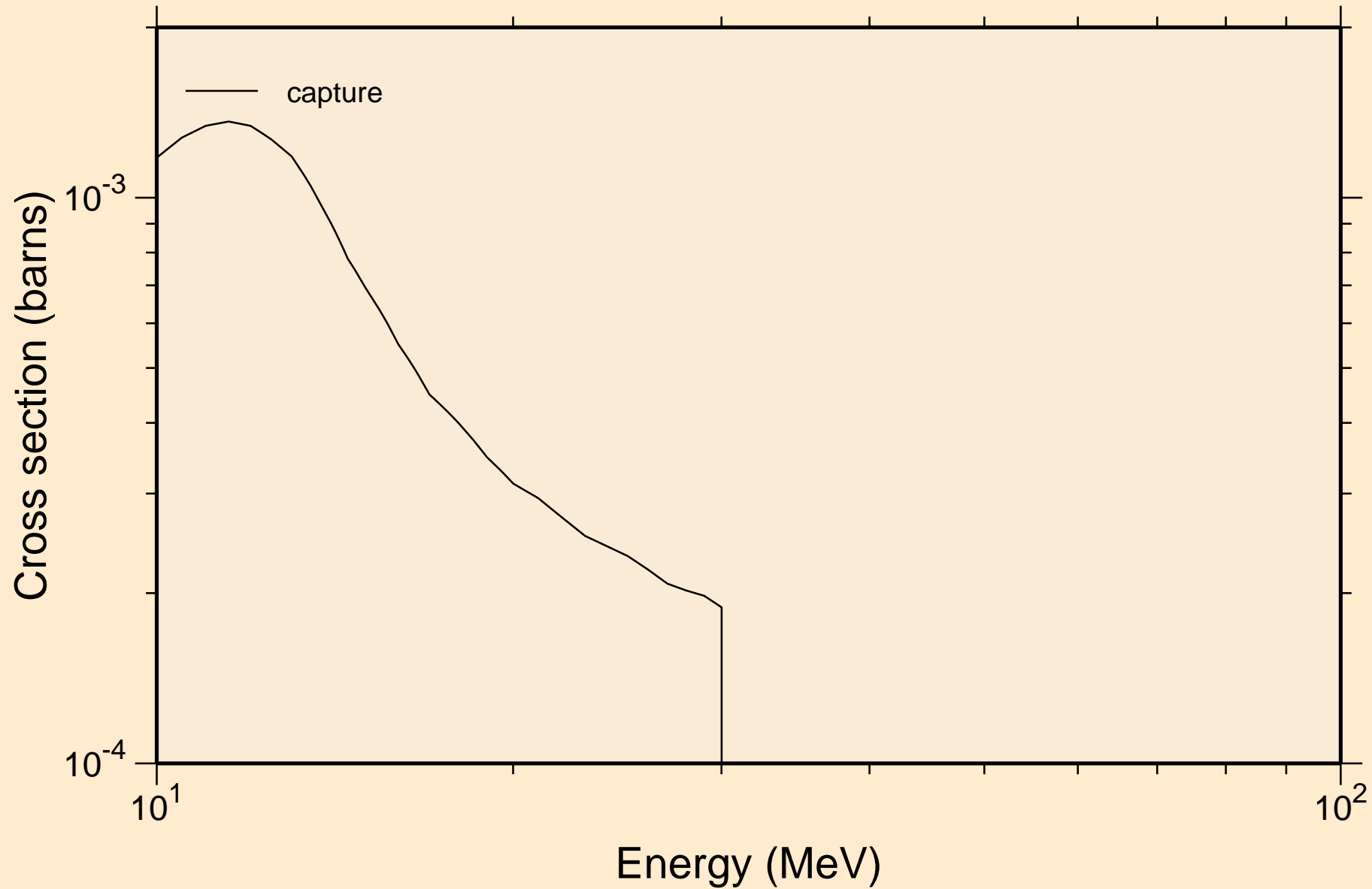

TL212 NRG TENDL-2015, AKONING  
Non-threshold reactions

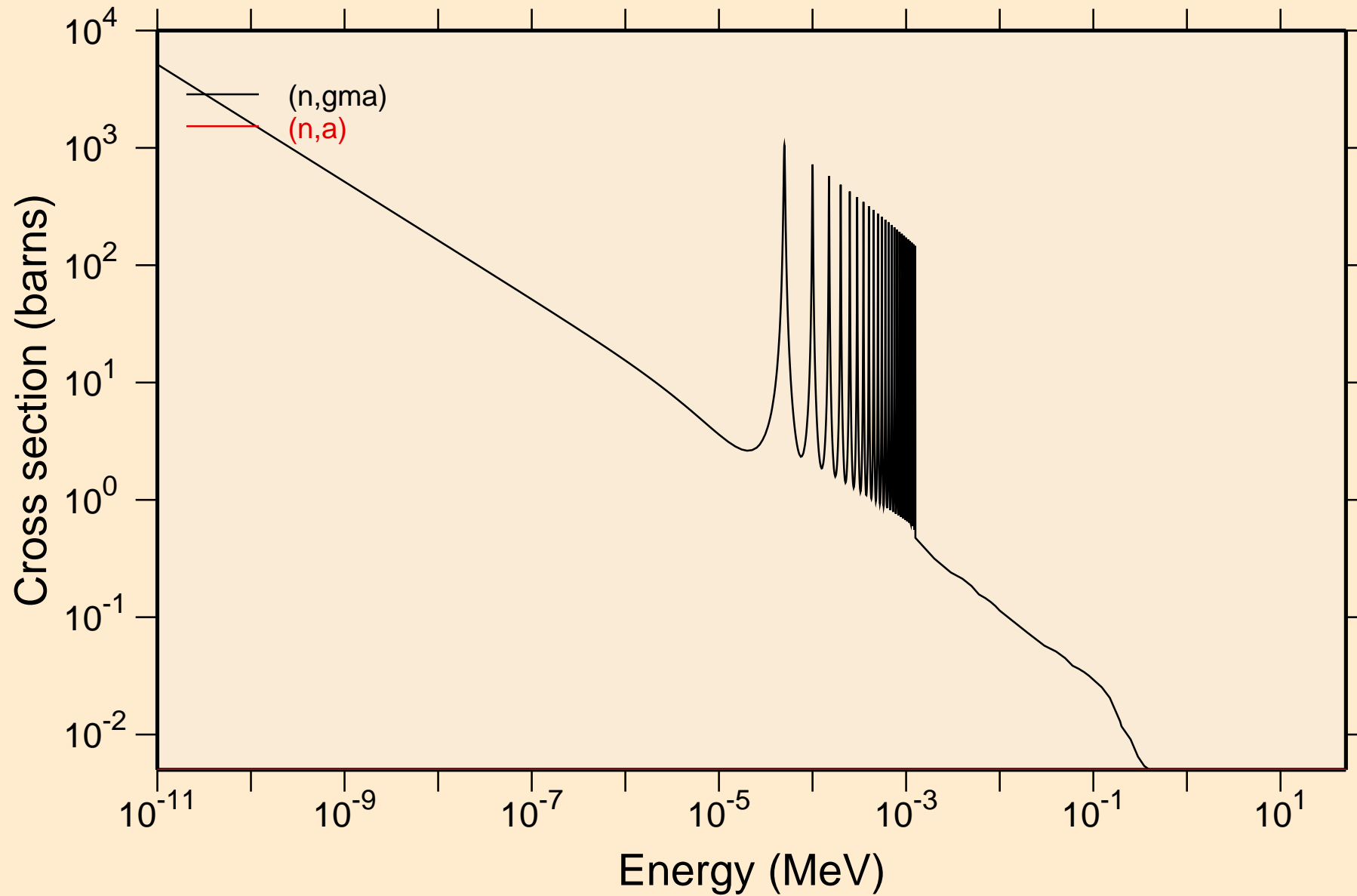

# TL212 NRG TENDL-2015, AKONING

## Principal cross sections

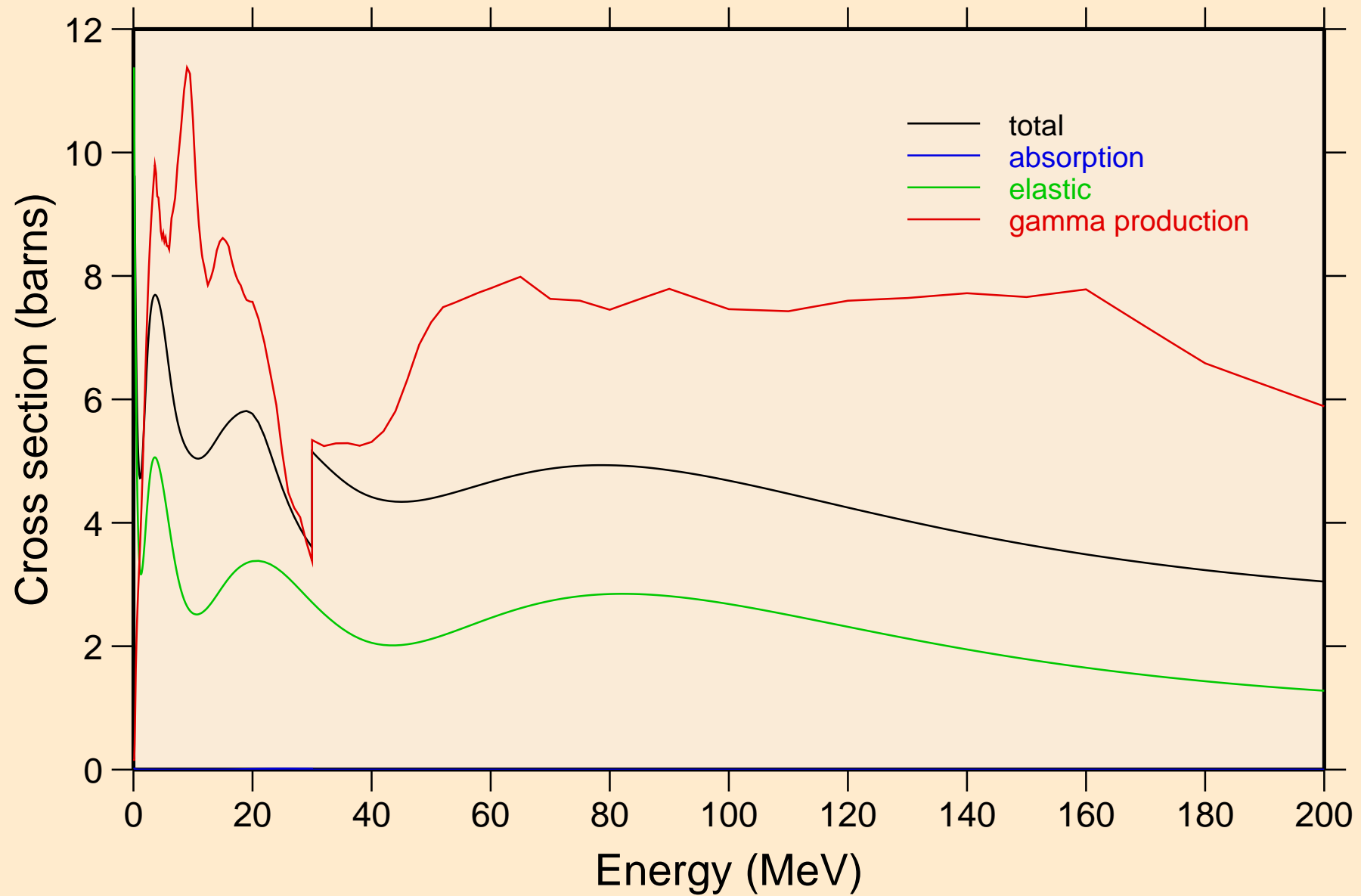

TL212 NRG TENDL-2015, AKONING  
Non-threshold reactions

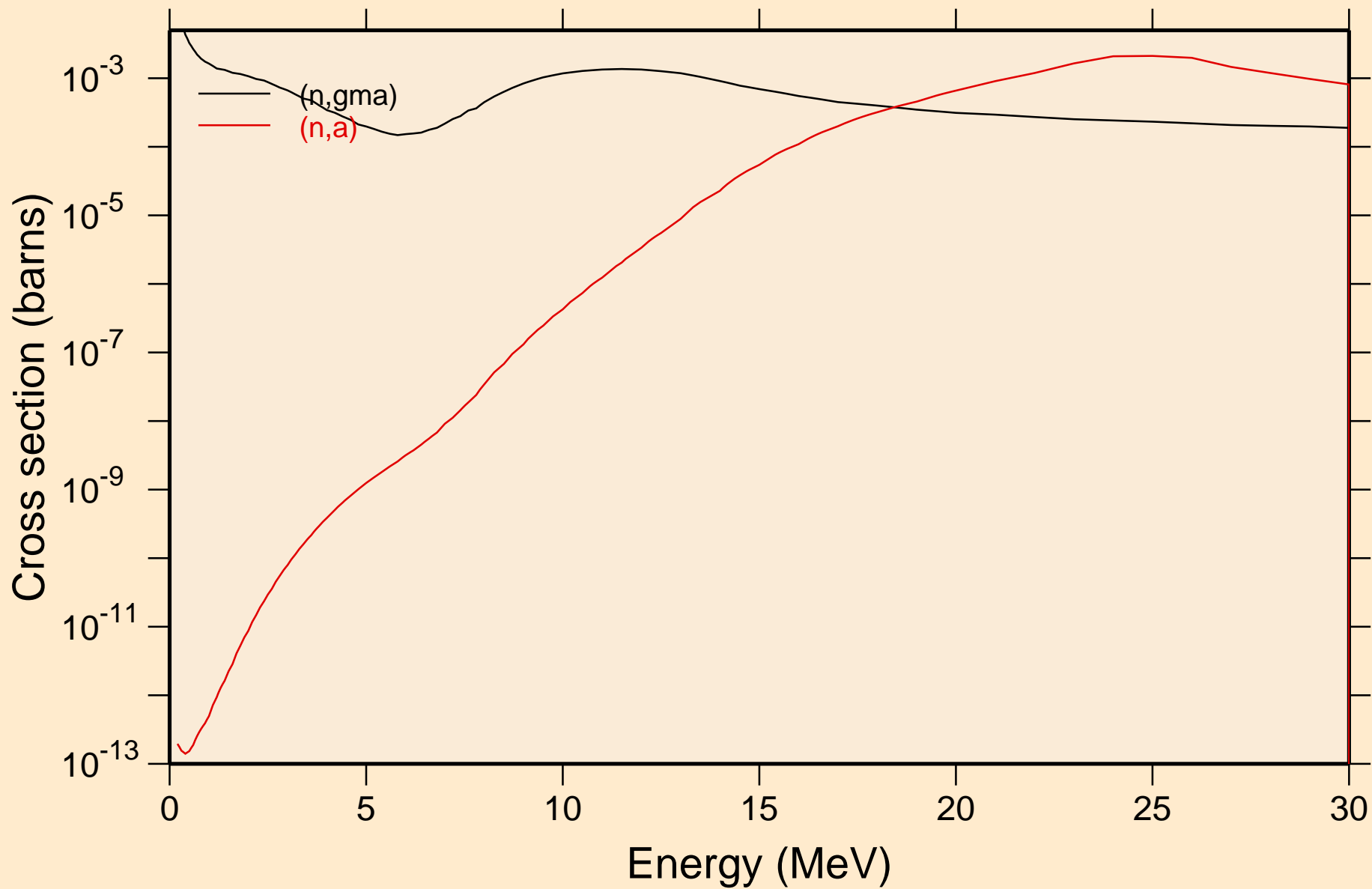

TL212 NRG TENDL-2015, AKONING  
Inelastic levels

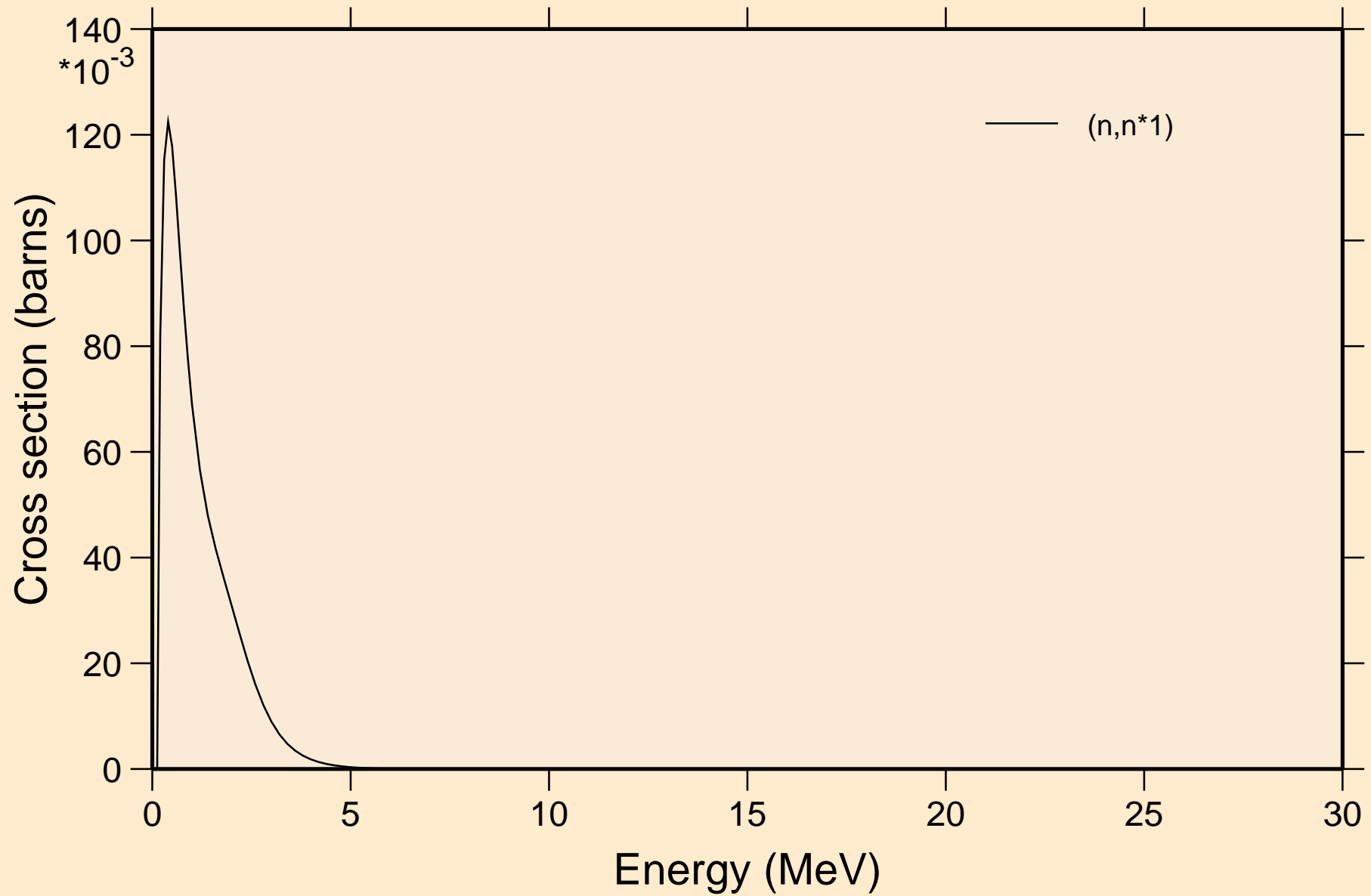

# TL212 NRG TENDL-2015, AKONING

## Threshold reactions

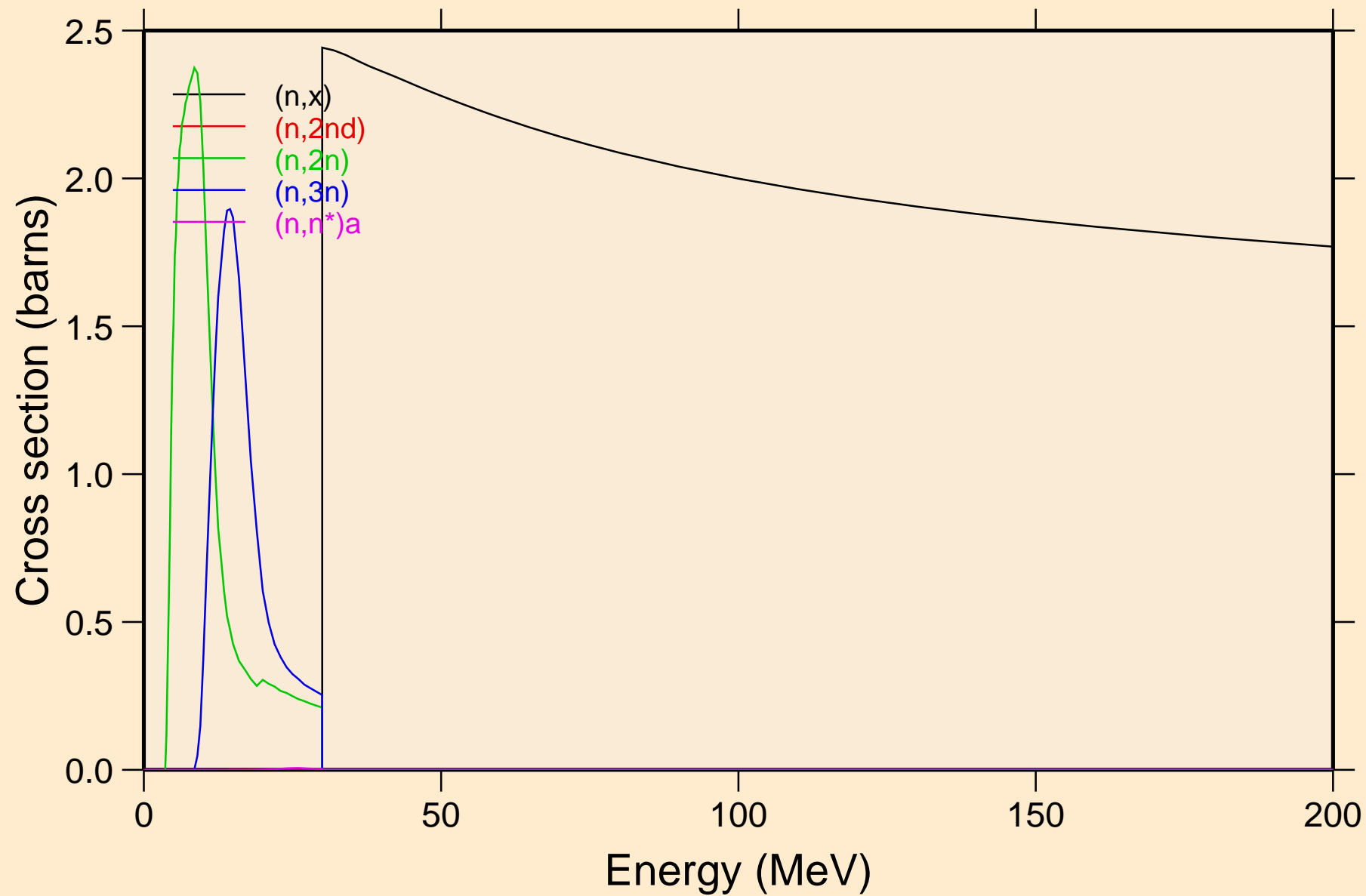

# TL212 NRG TENDL-2015, AKONING

## Threshold reactions

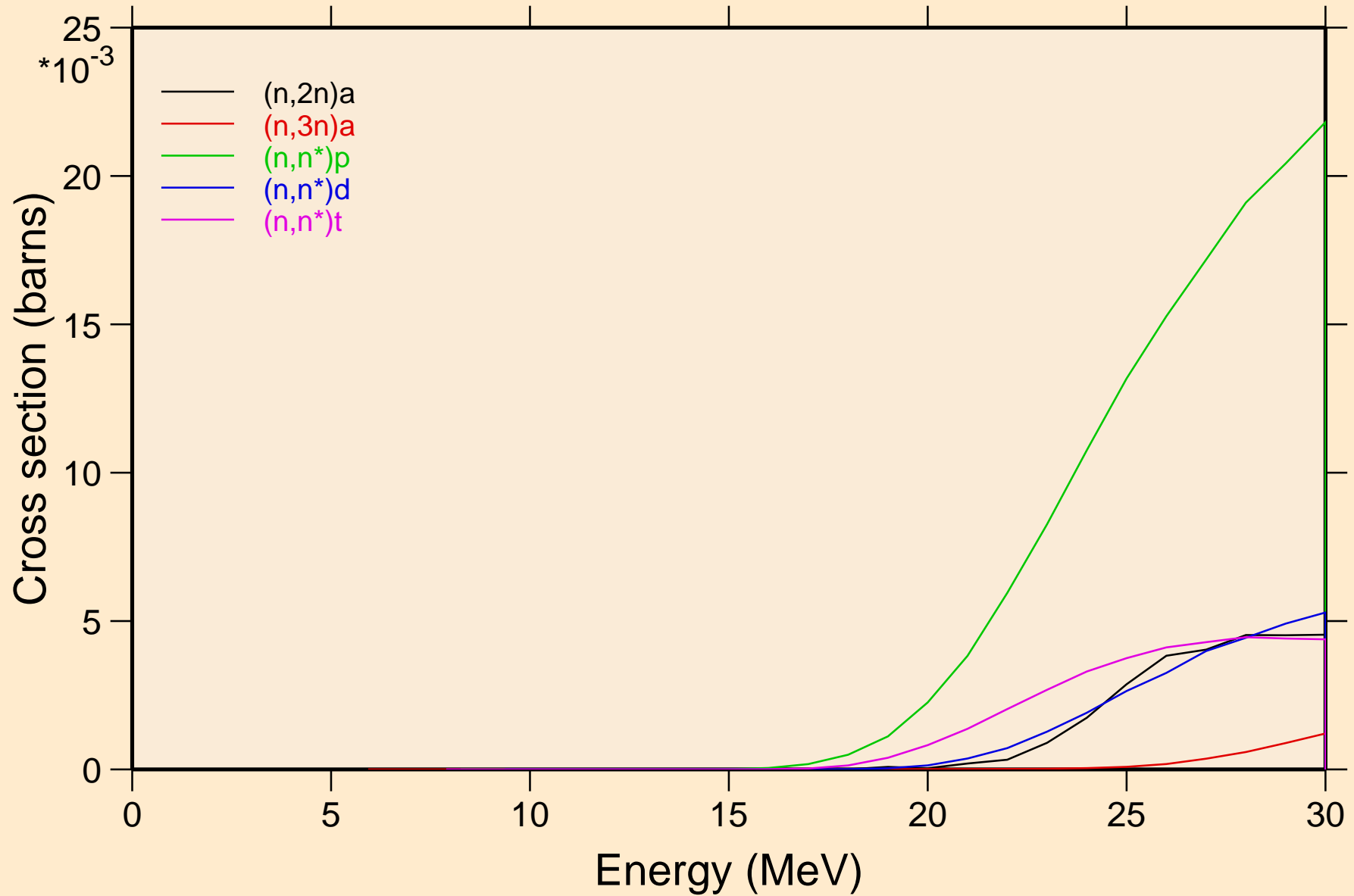

# TL212 NRG TENDL-2015, AKONING

## Threshold reactions

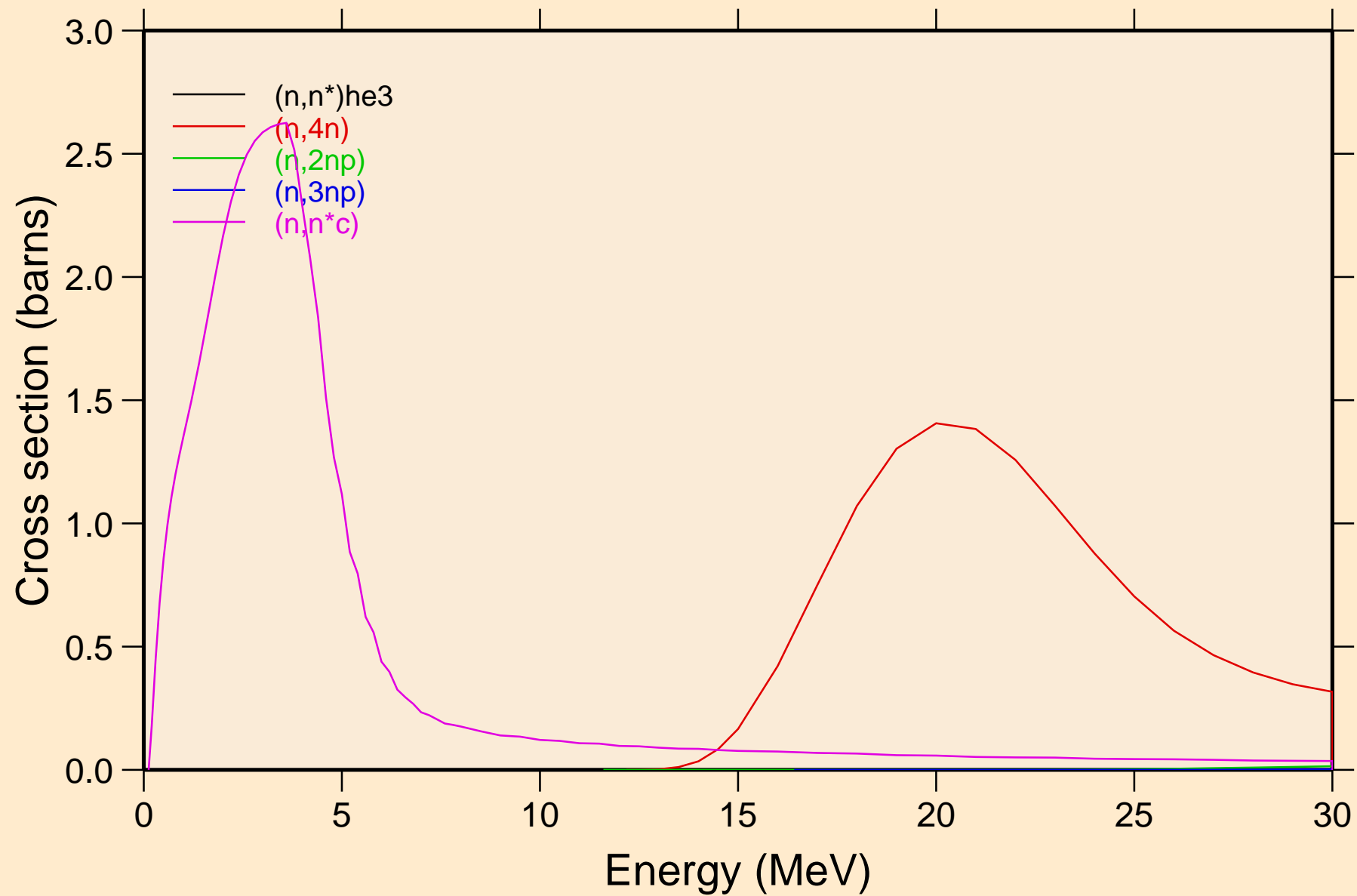



# TL212 NRG TENDL-2015, AKONING

## Threshold reactions

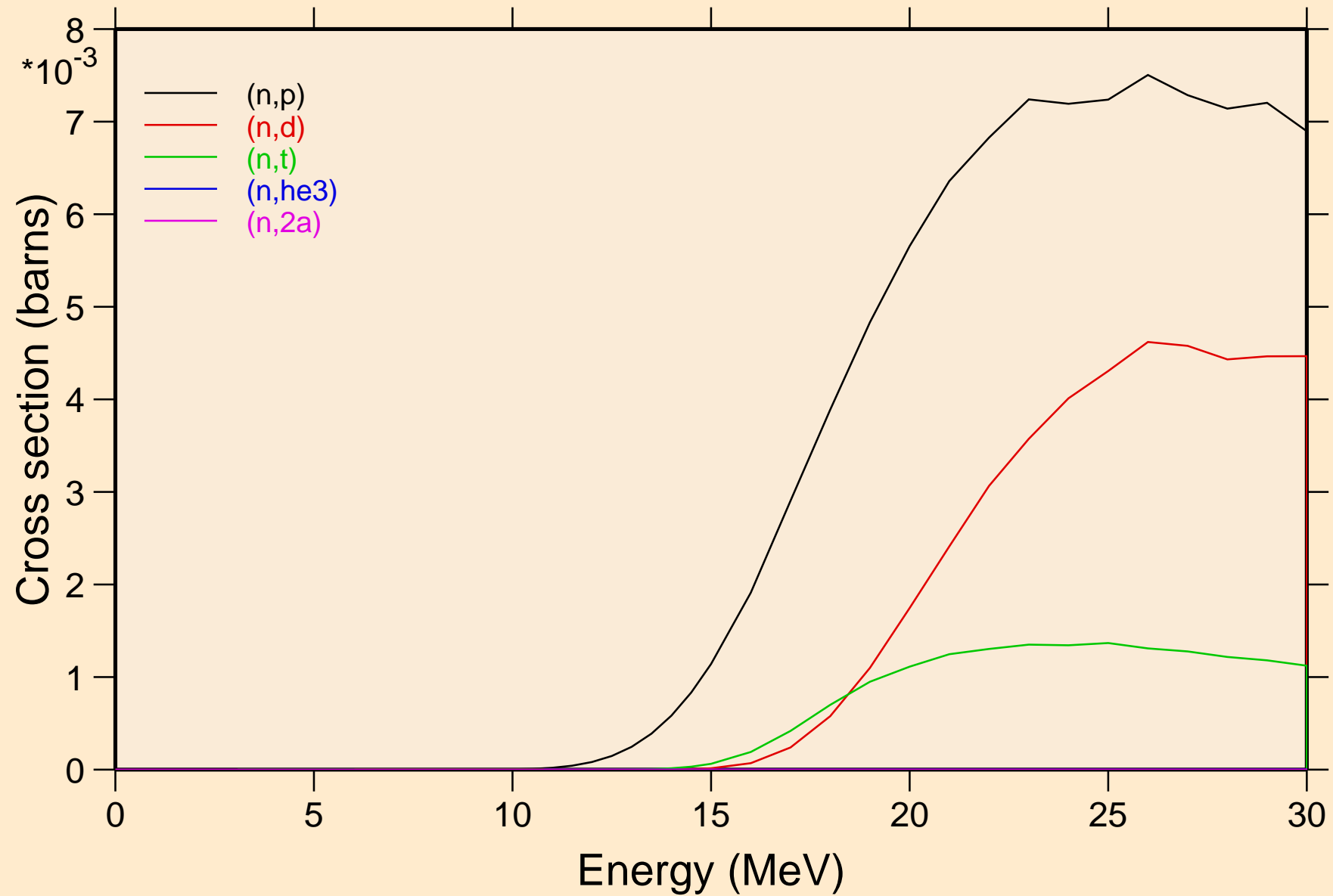

TL212 NRG TENDL-2015, AKONING  
angular distribution for elastic

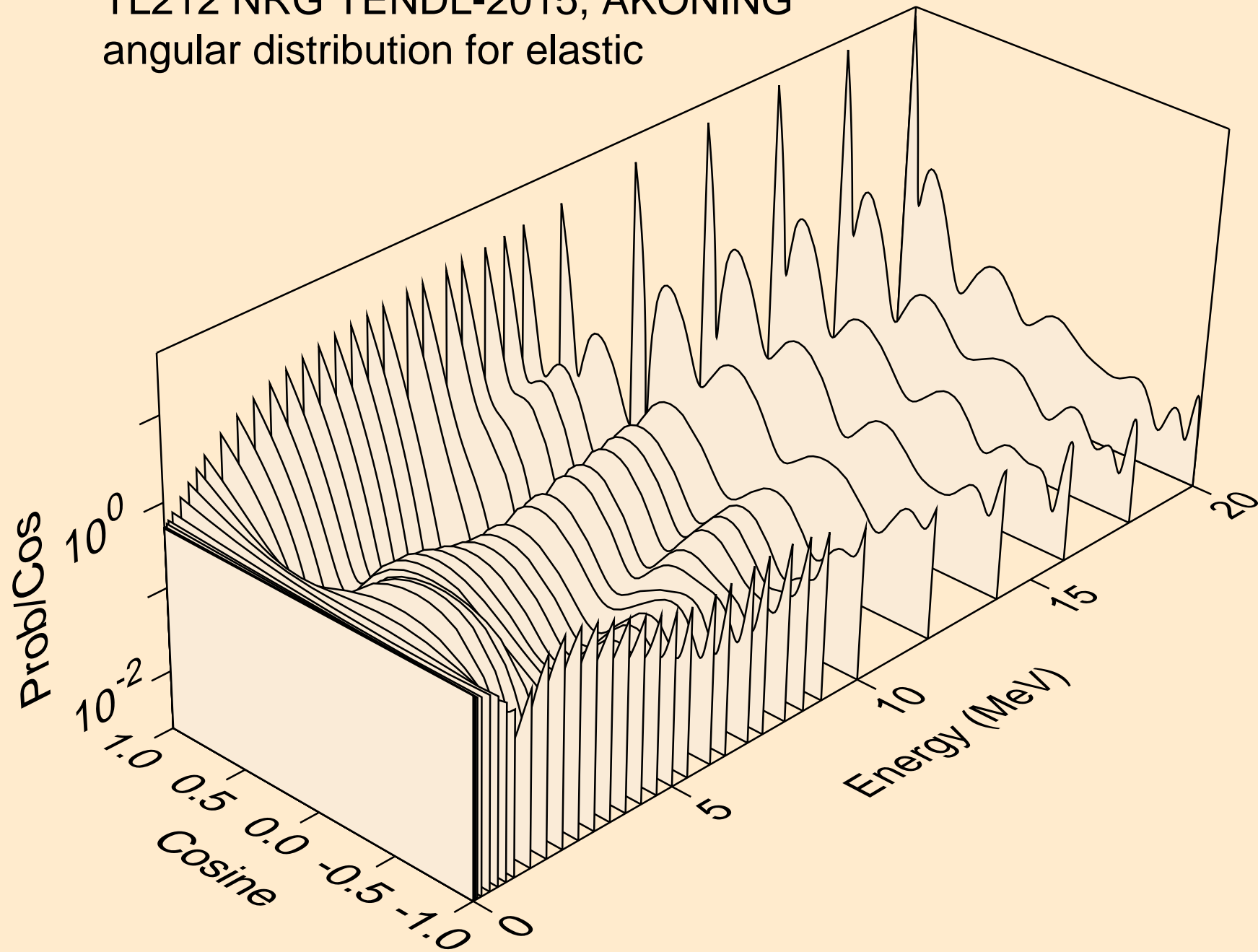

TL212 NRG TENDL-2015, AKONING  
angular distribution for elastic

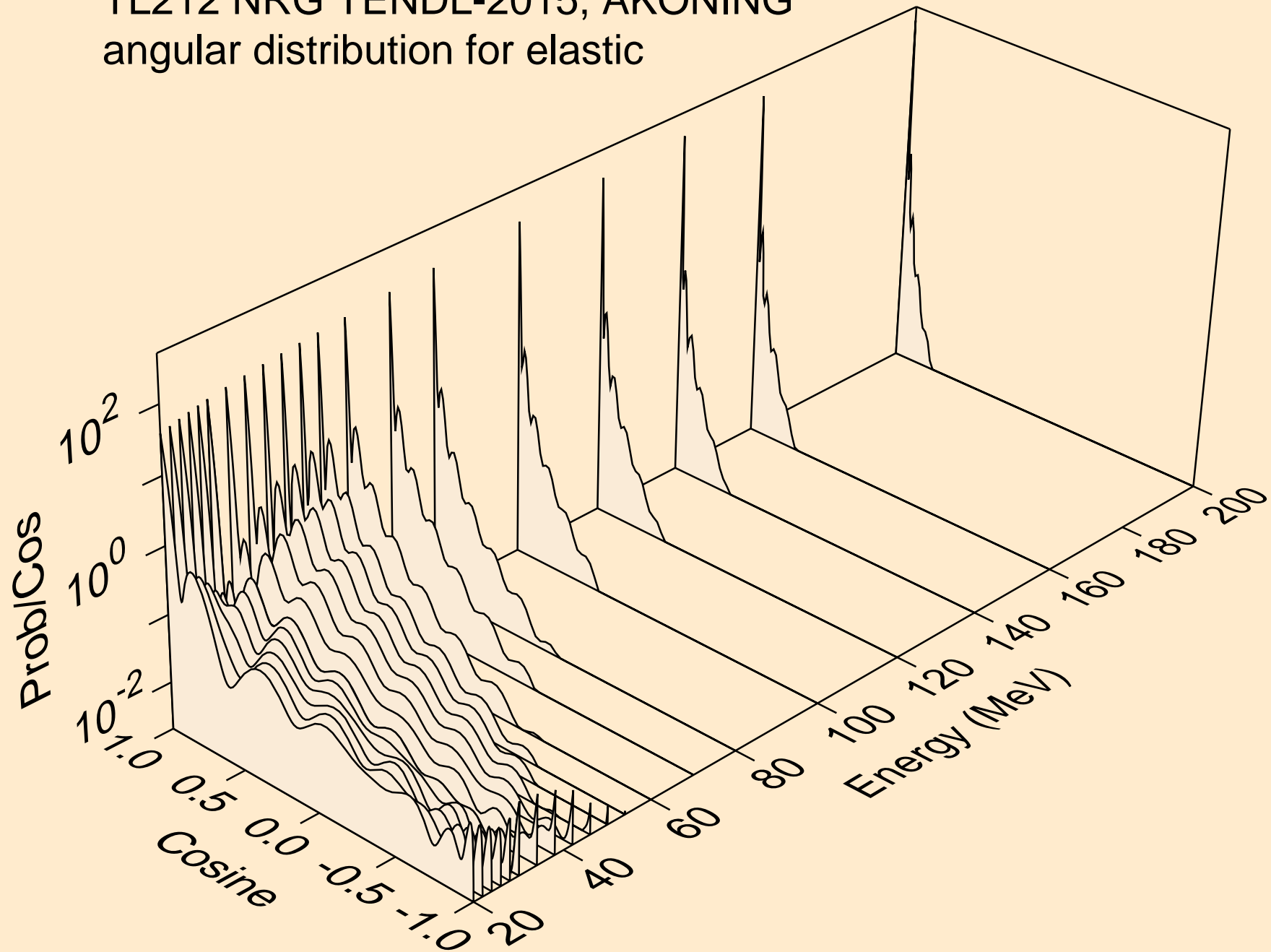

TL212 NRG TENDL-2015, AKONING  
angular distribution for (n,n\*1)

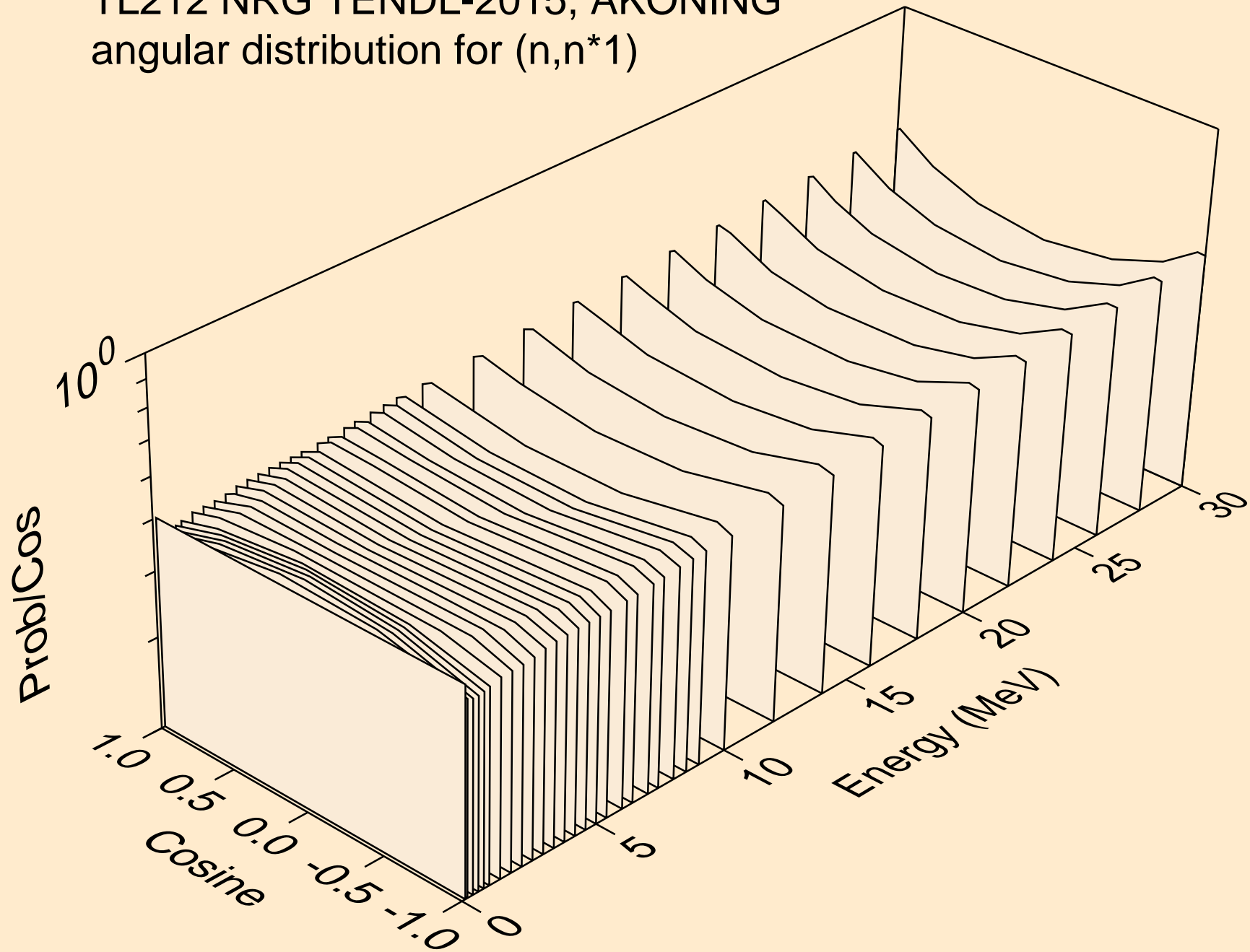

TL212 NRG TENDL-2015, AKONING  
Neutron emission for (n,x)

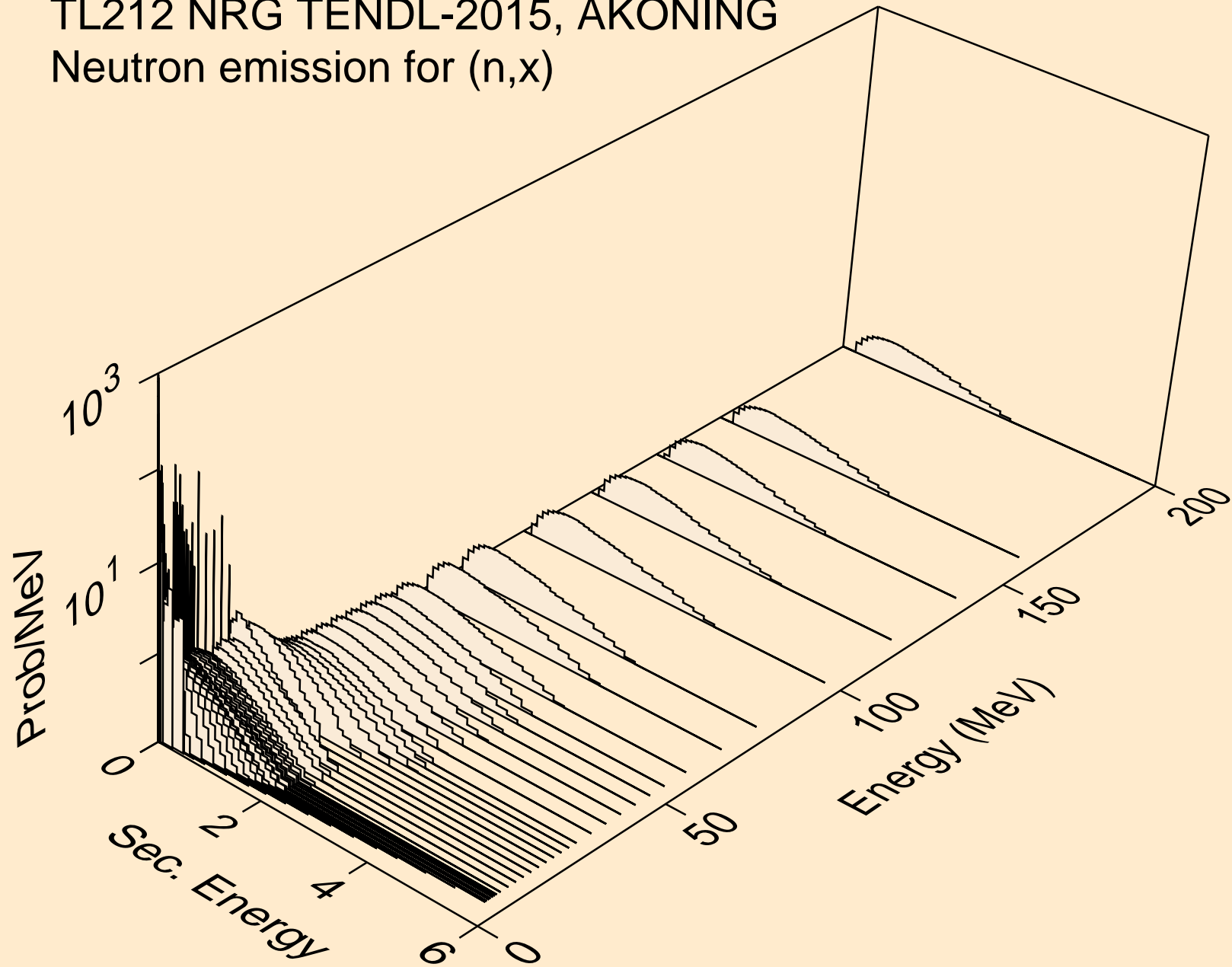

TL212 NRG TENDL-2015, AKONING  
Neutron emission for (n,2nd)

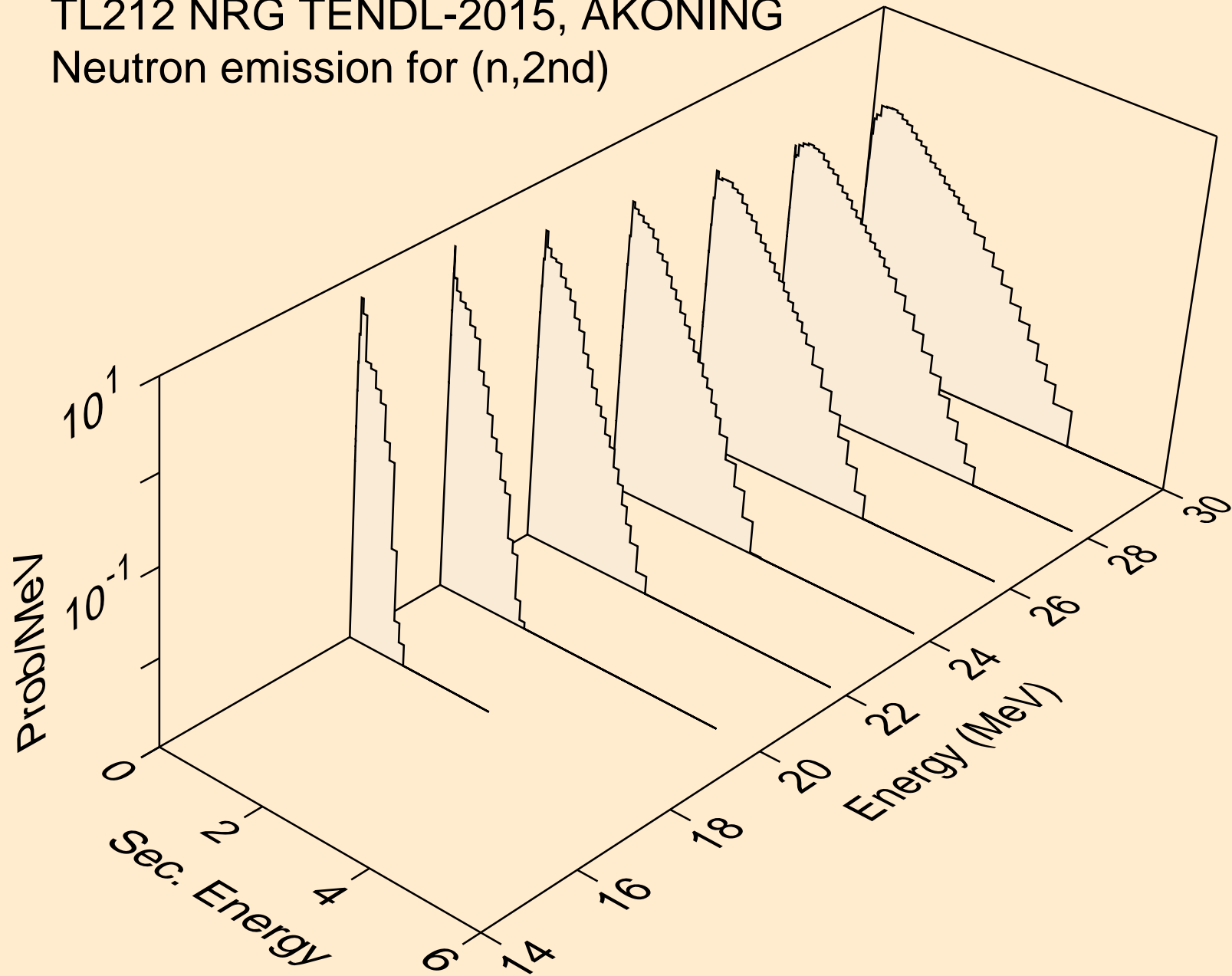

TL212 NRG TENDL-2015, AKONING  
Neutron emission for (n,2n)

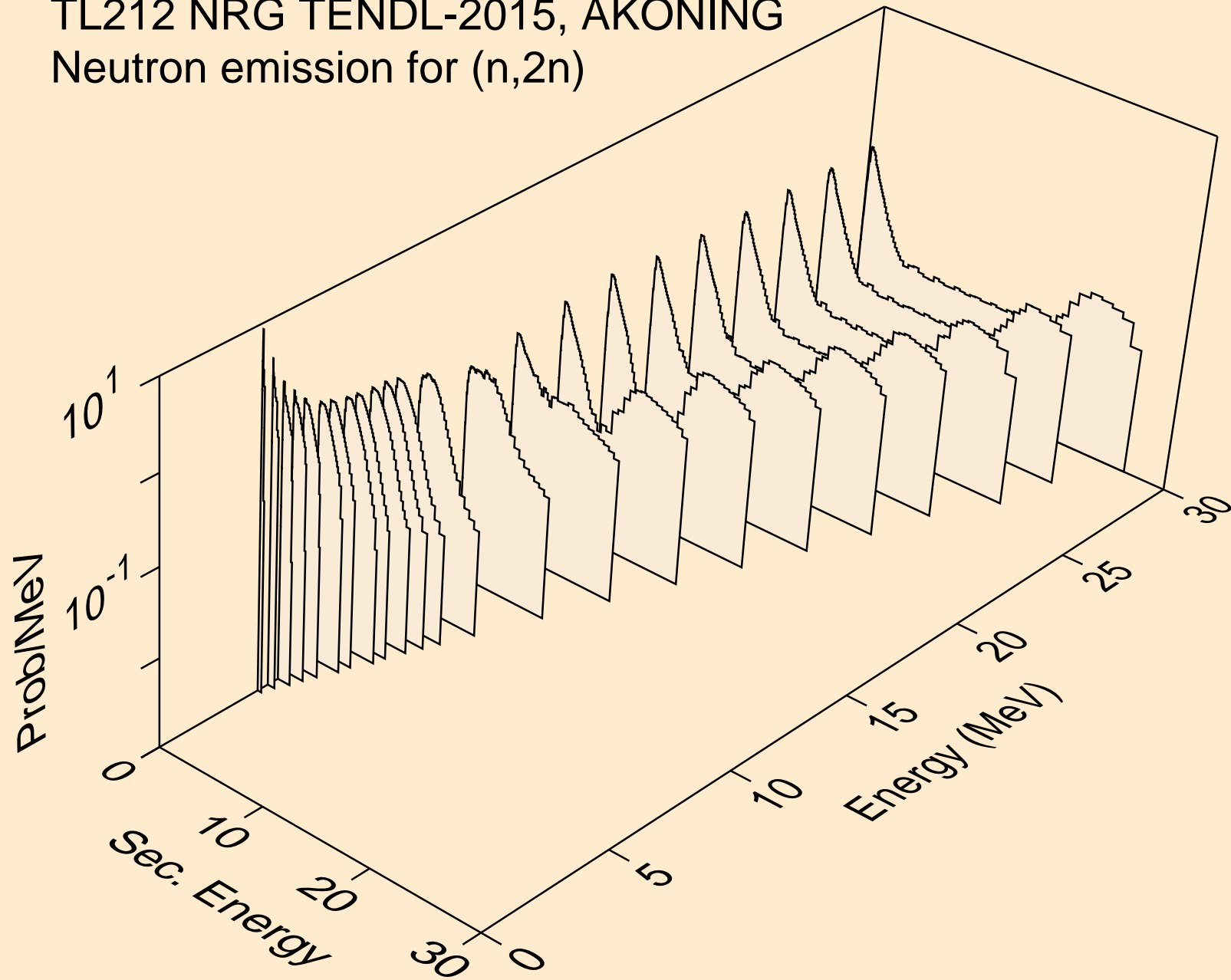

TL212 NRG TENDL-2015, AKONING  
Neutron emission for (n,3n)

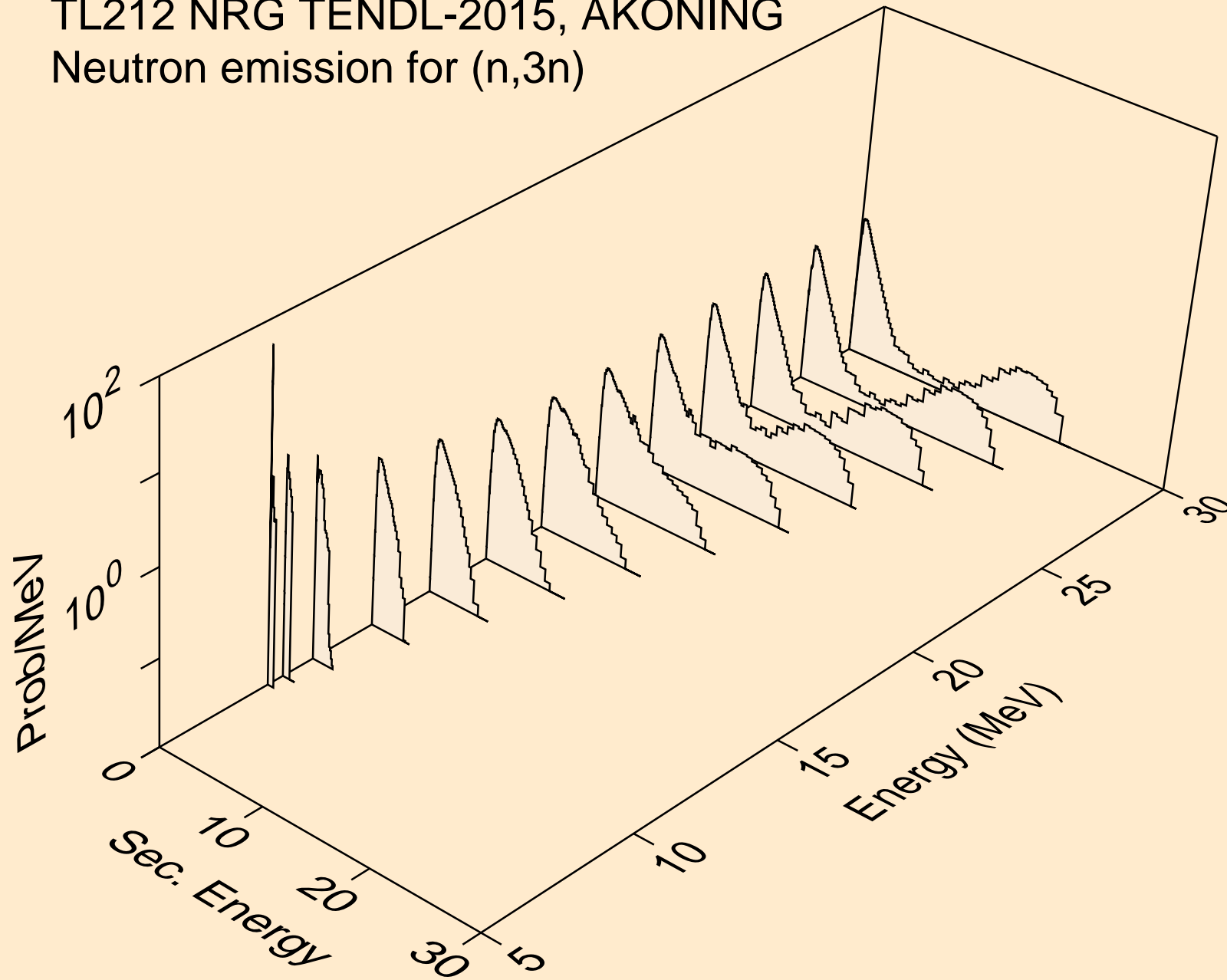



TL212 NRG TENDL-2015, AKONING  
Neutron emission for (n,n\*)a

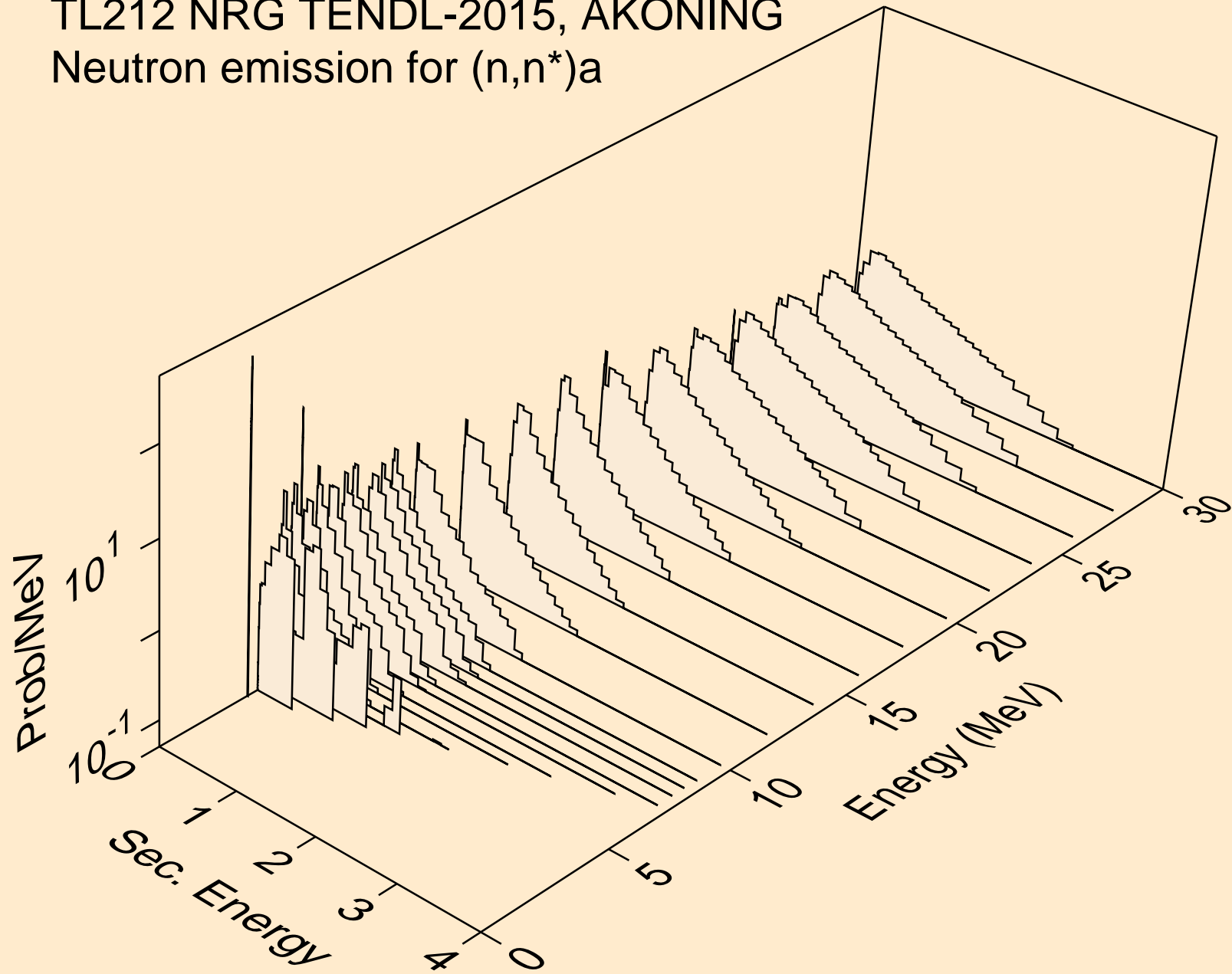

TL212 NRG TENDL-2015, AKONING  
Neutron emission for (n,2n)a

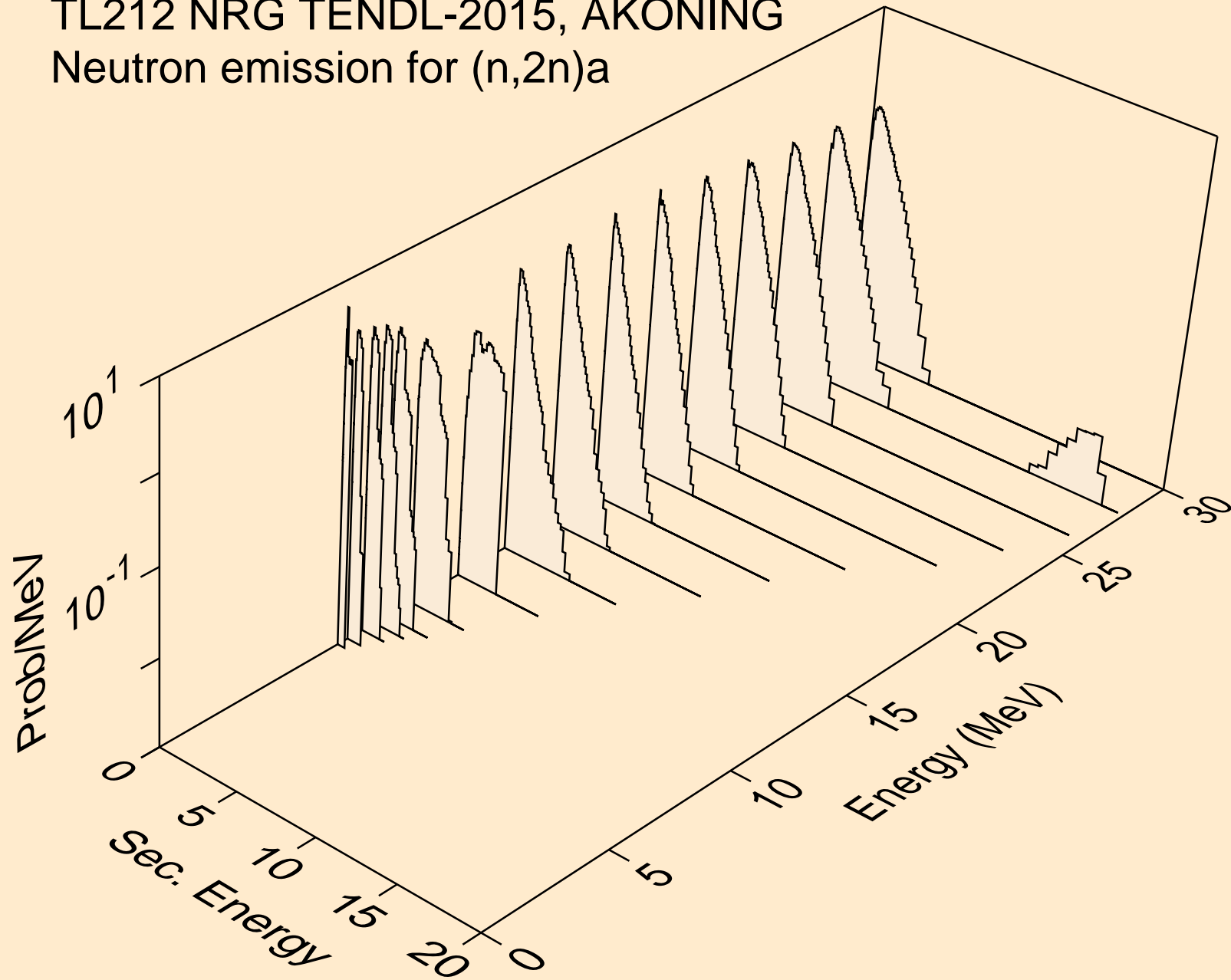

TL212 NRG TENDL-2015, AKONING  
Neutron emission for (n,3n)a

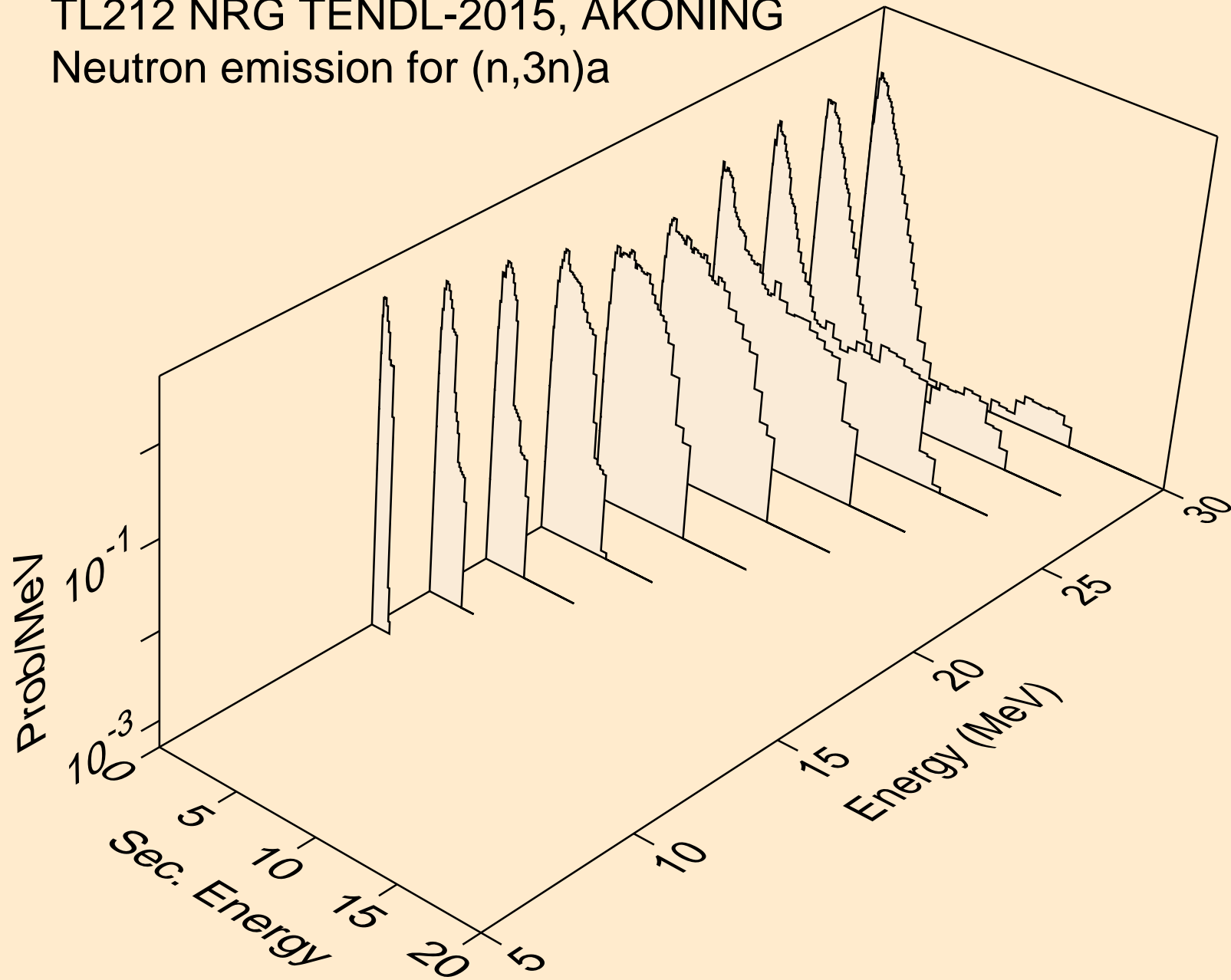

TL212 NRG TENDL-2015, AKONING  
Neutron emission for (n,n\*)p

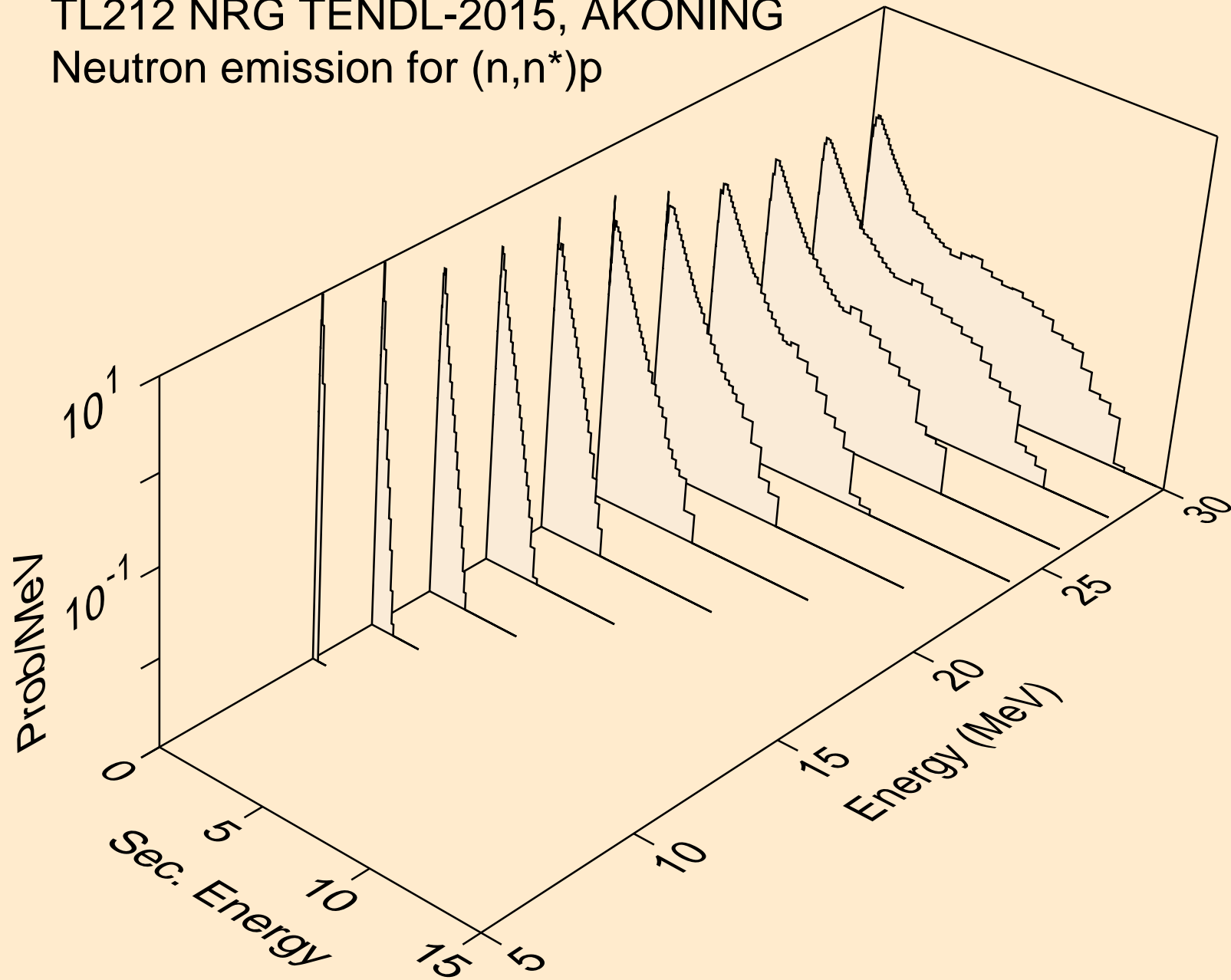

TL212 NRG TENDL-2015, AKONING  
Neutron emission for (n,n\*)d

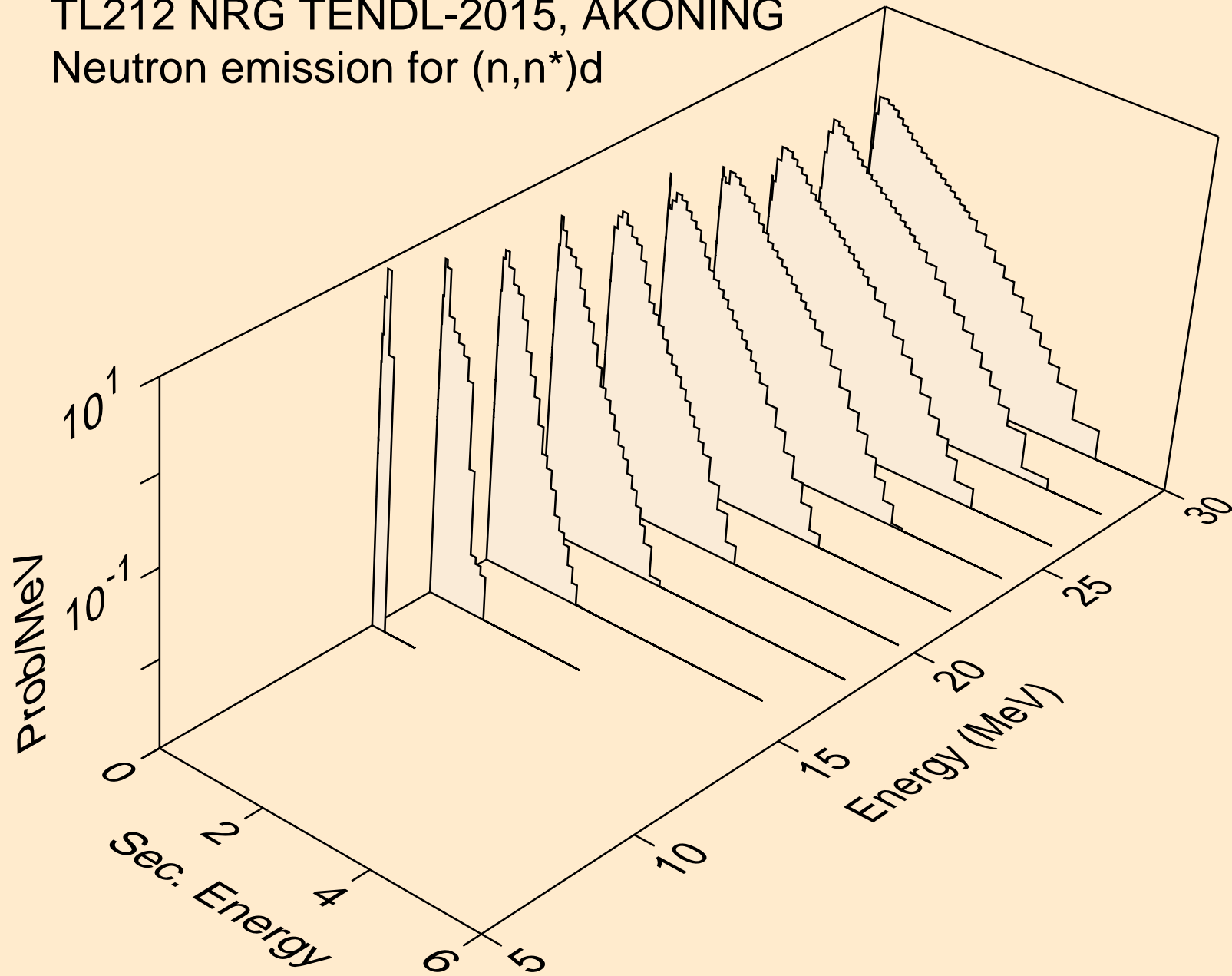

TL212 NRG TENDL-2015, AKONING  
Neutron emission for (n,n\*)t

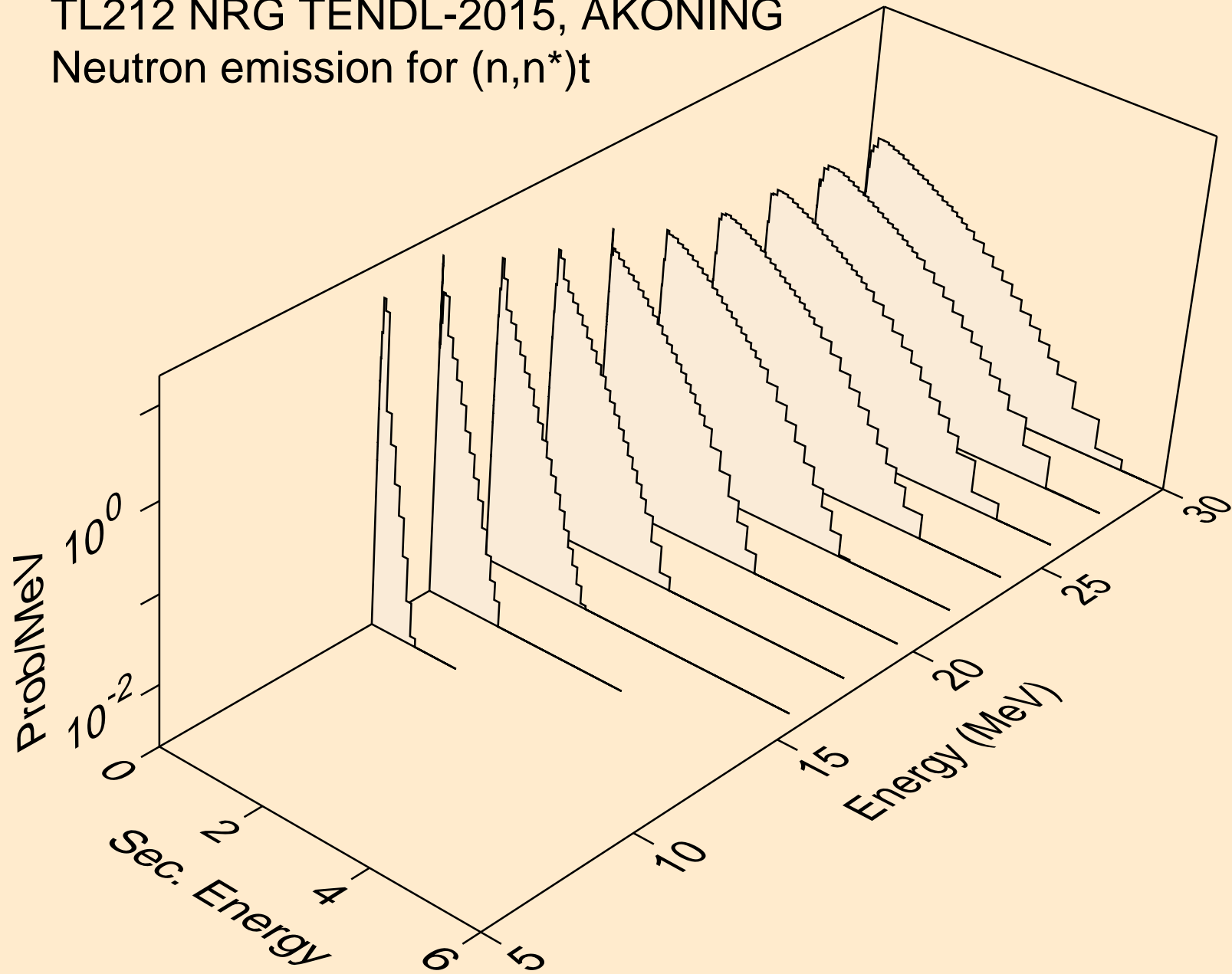

TL212 NRG TENDL-2015, AKONING  
Neutron emission for (n,n\*)he3

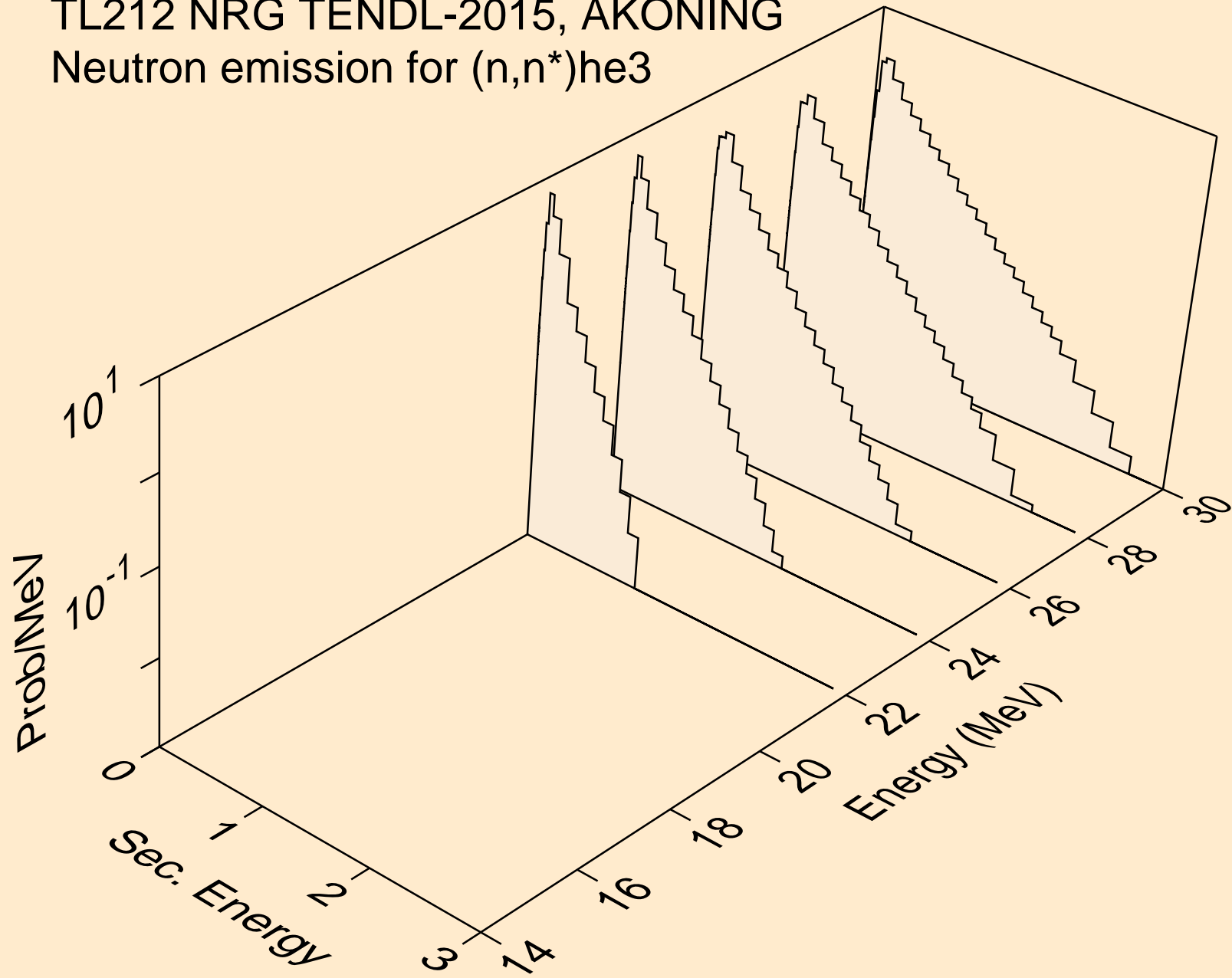

TL212 NRG TENDL-2015, AKONING  
Neutron emission for (n,4n)

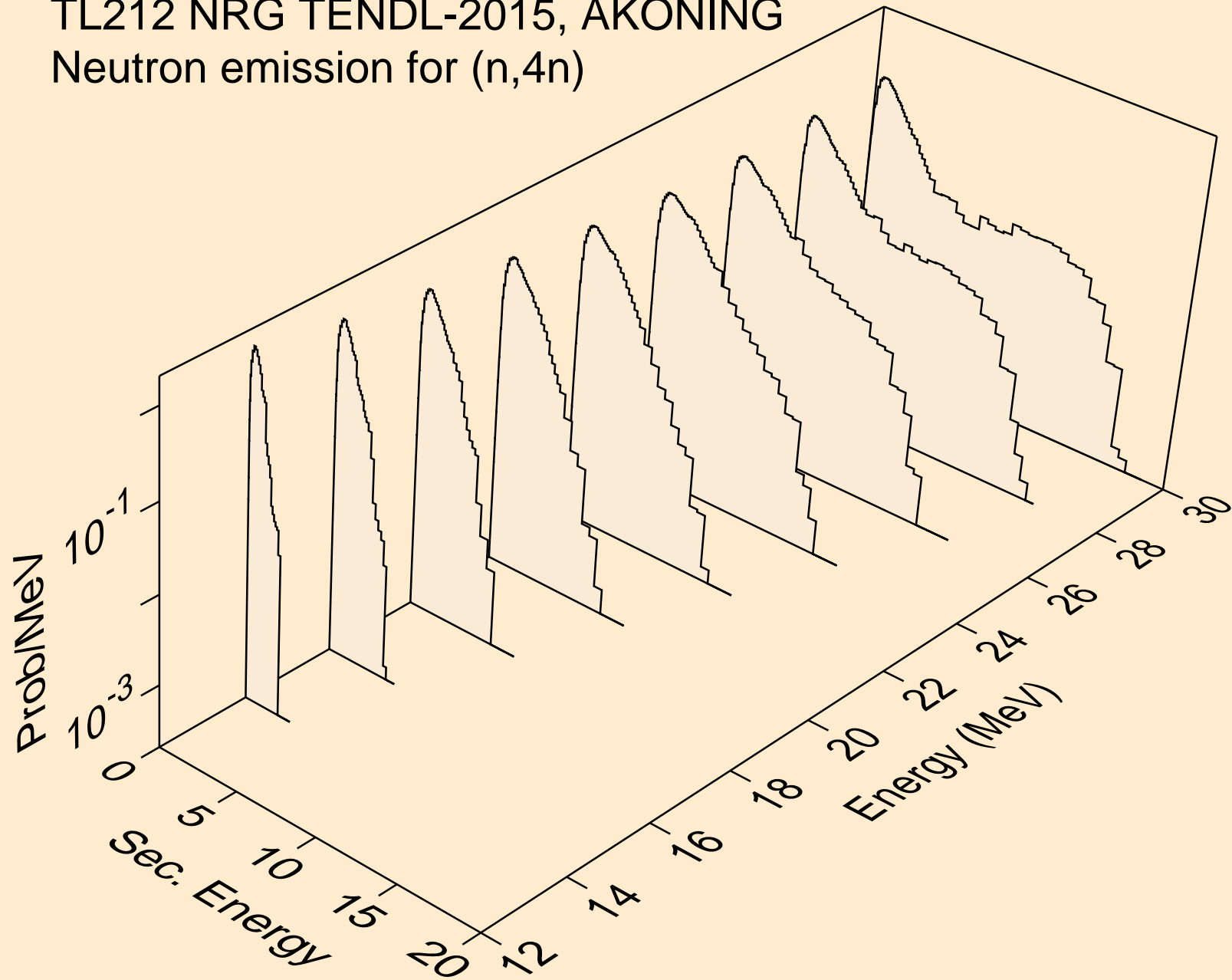



TL212 NRG TENDL-2015, AKONING  
Neutron emission for (n,2np)

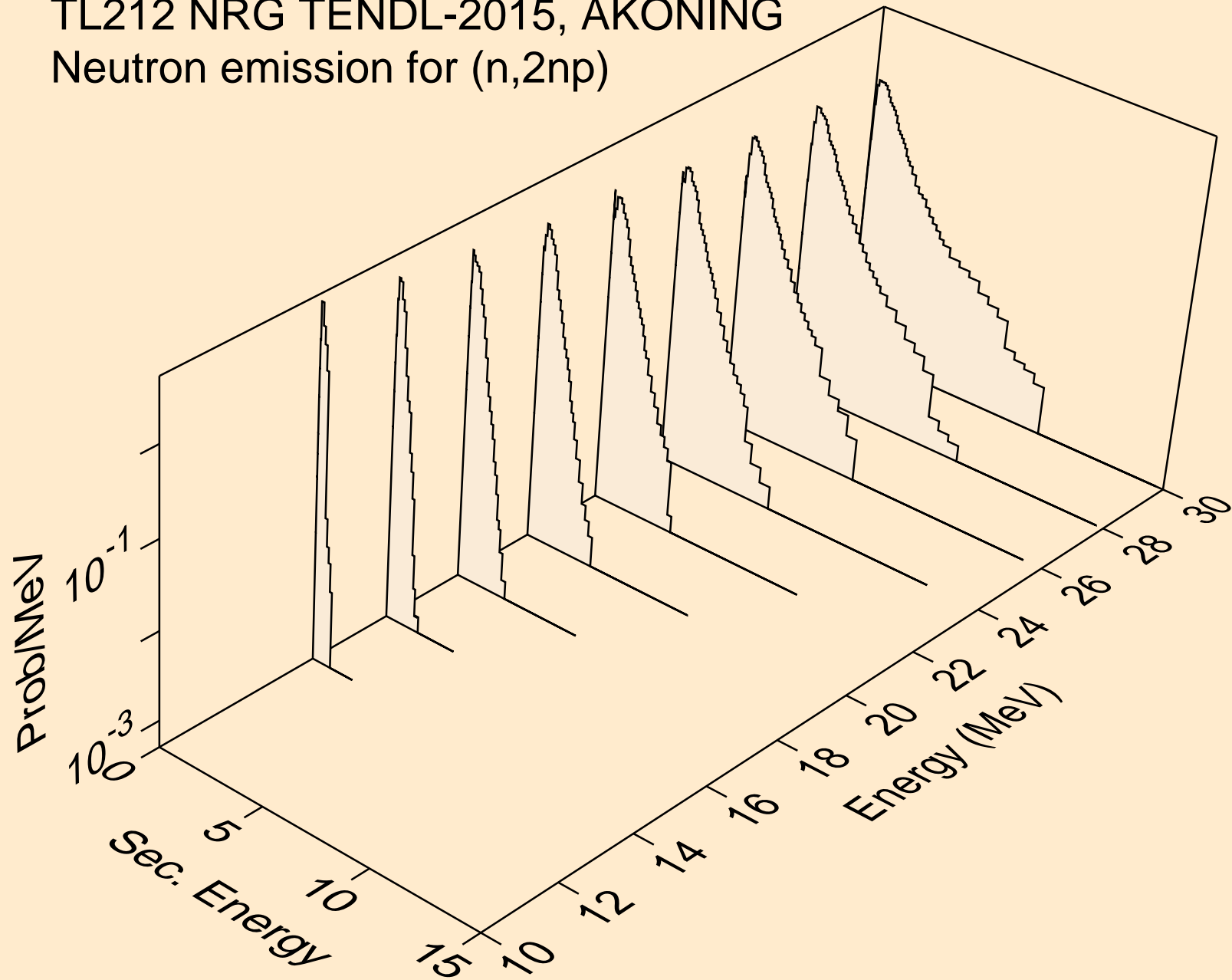

TL212 NRG TENDL-2015, AKONING  
Neutron emission for (n,3np)

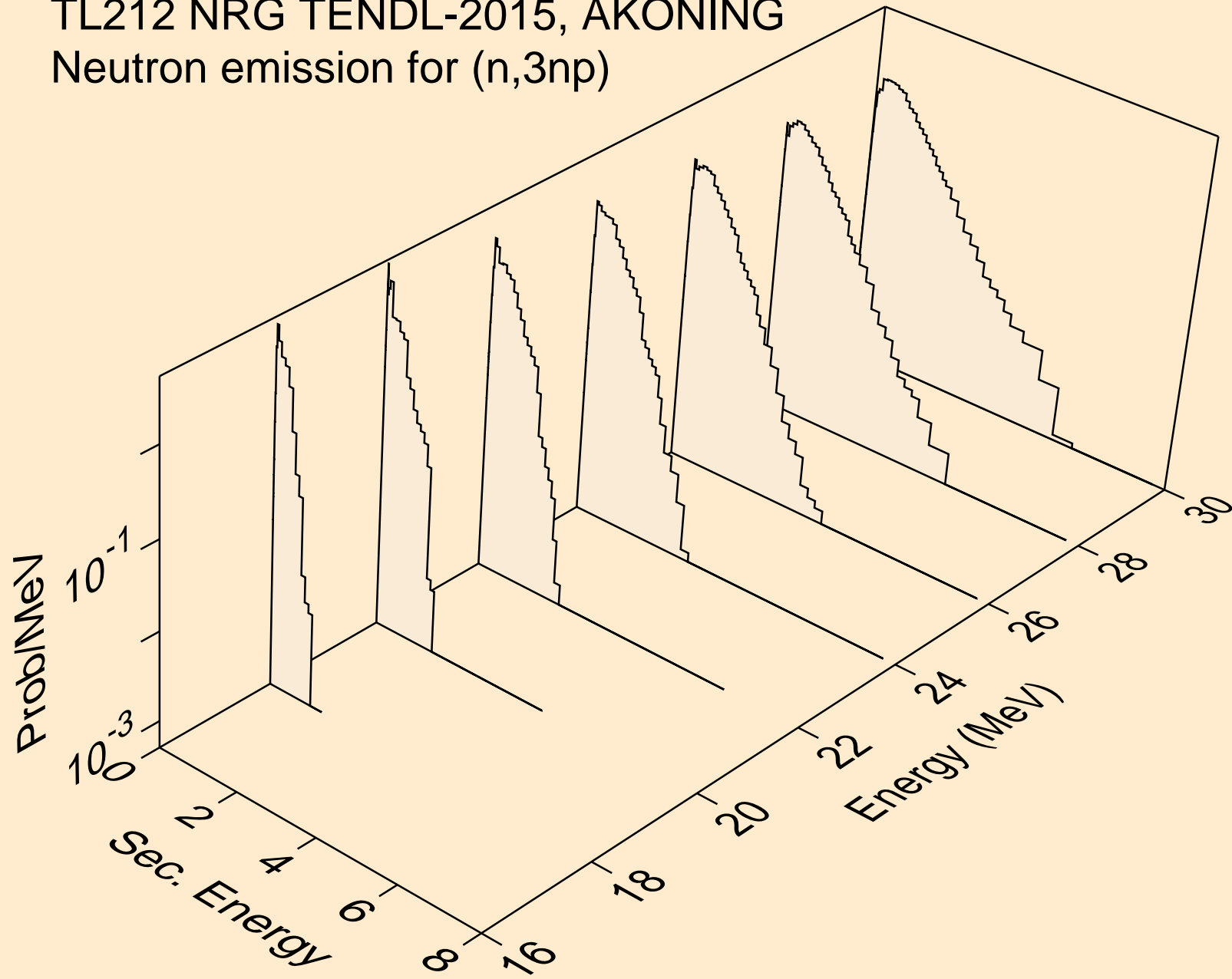

TL212 NRG TENDL-2015, AKONING  
Neutron emission for (n,n\*c)

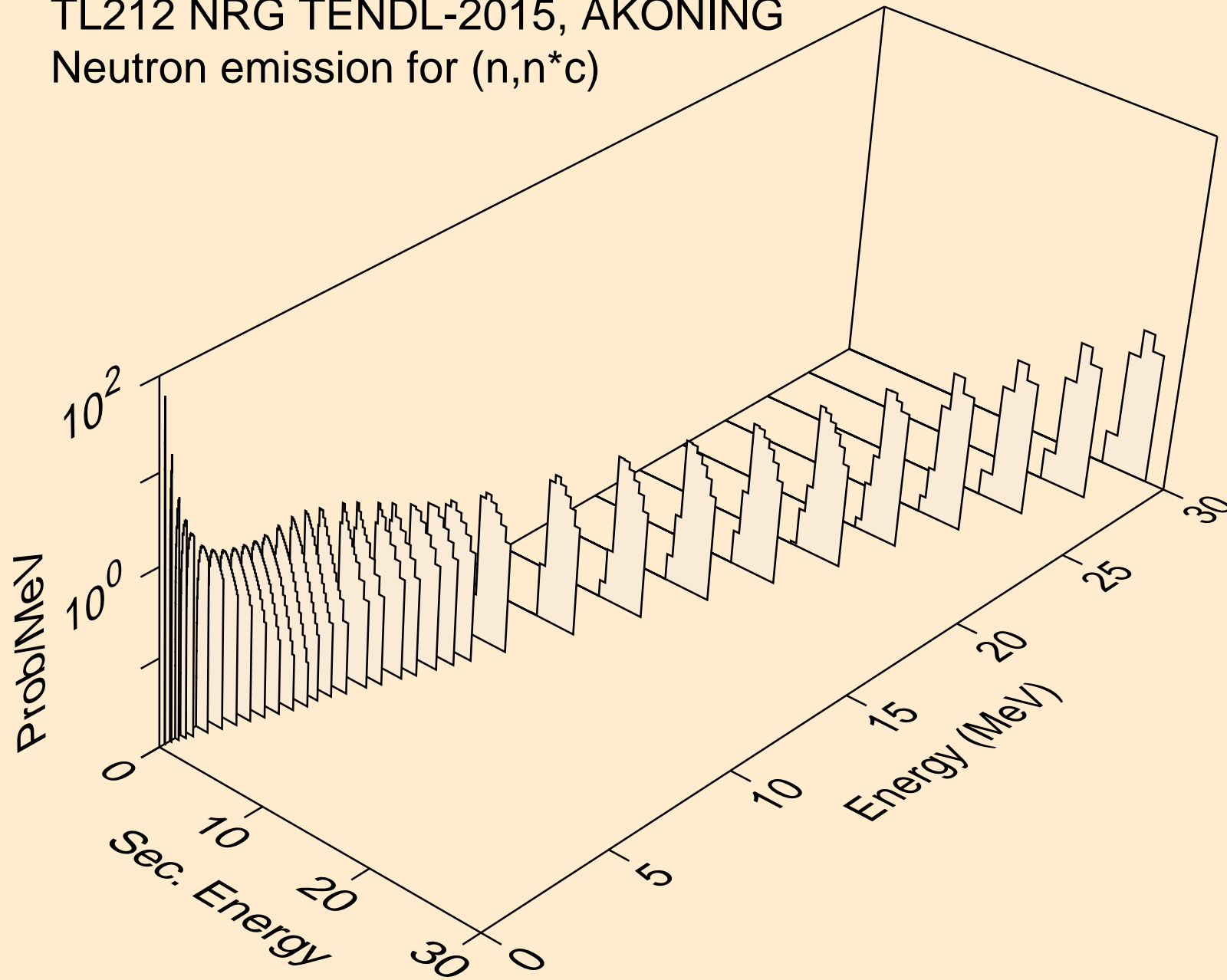

TL212 NRG TENDL-2015, AKONING  
Photon emission for (n,x)

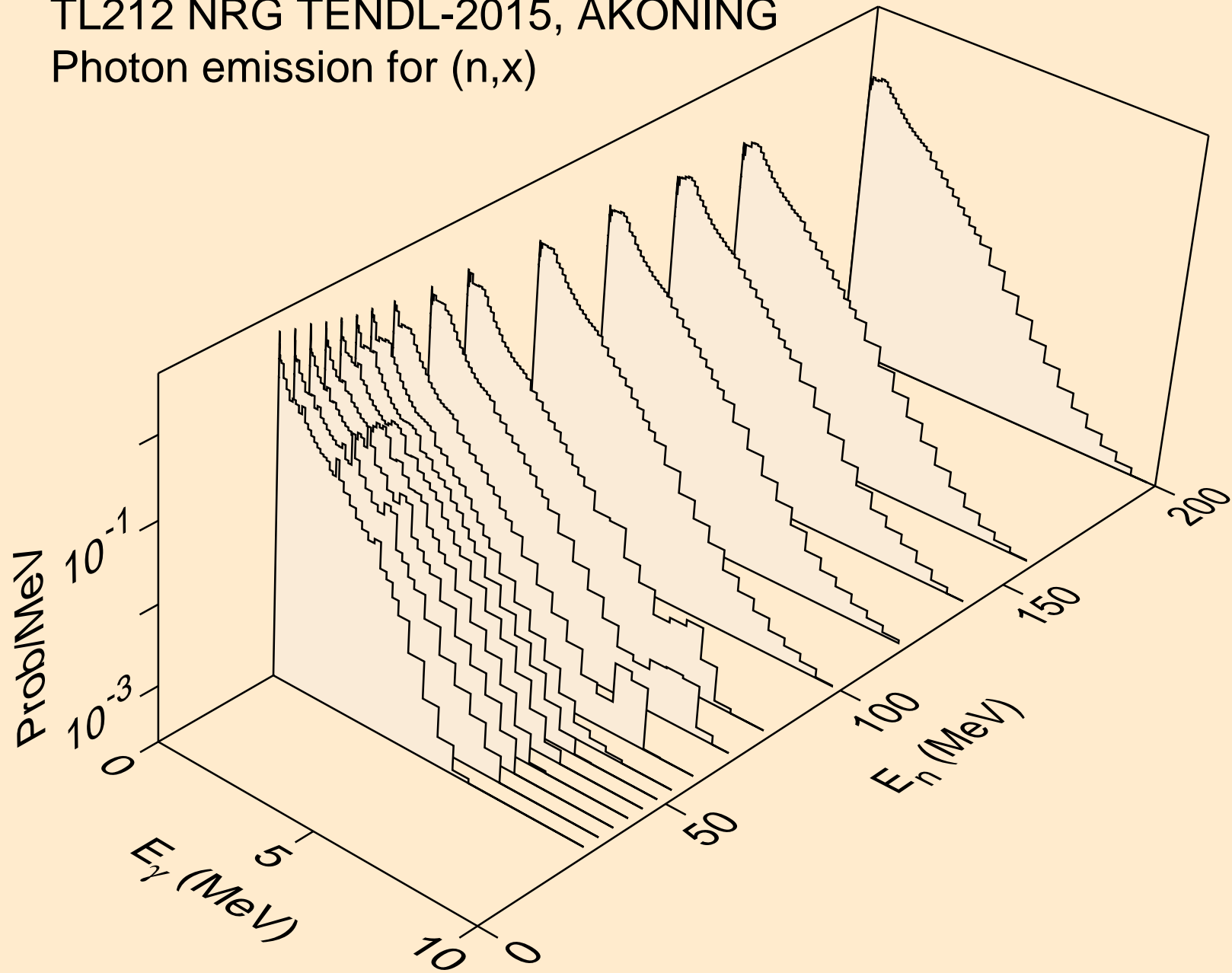

TL212 NRG TENDL-2015, AKONING  
Photon emission for (n,2nd)

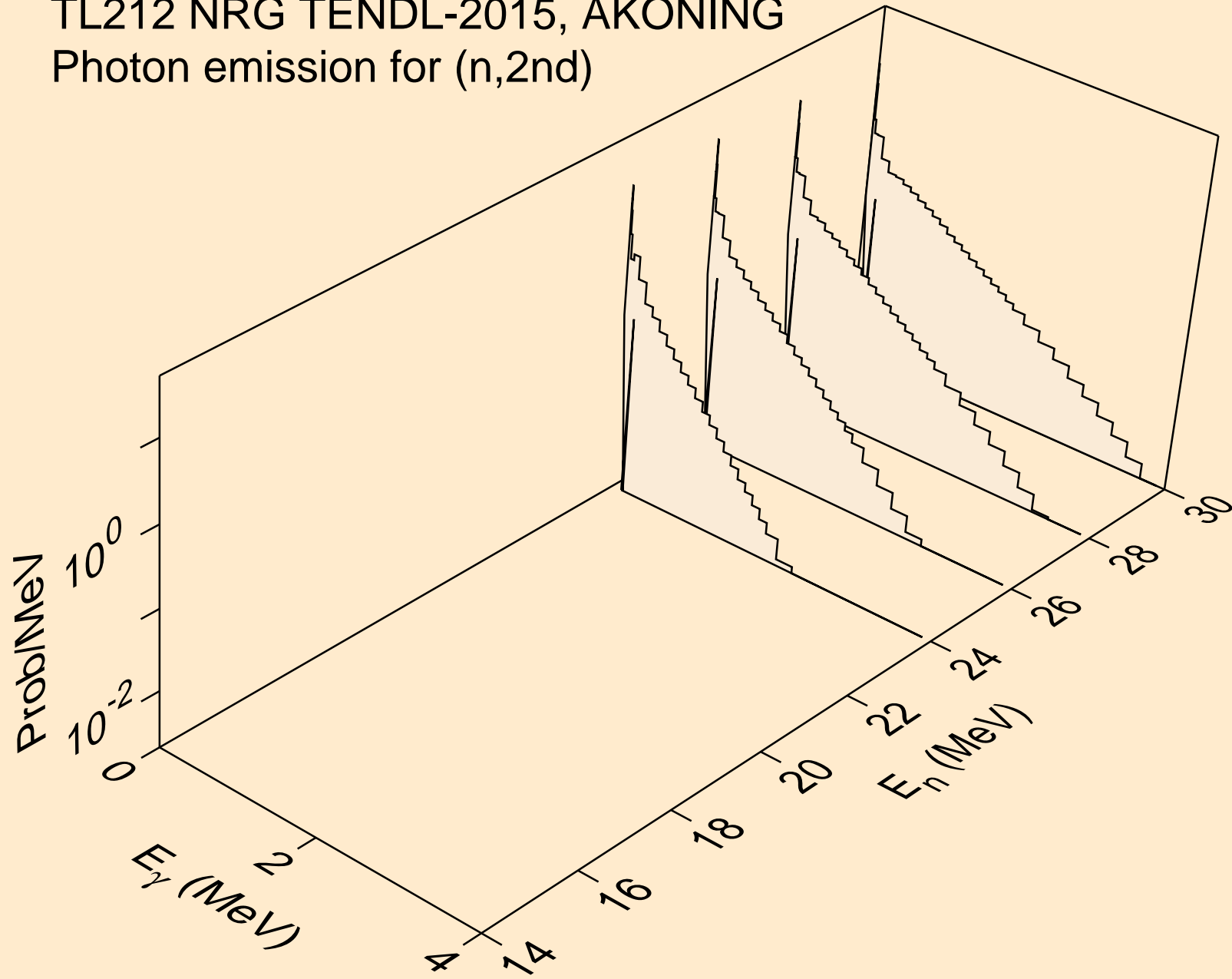

TL212 NRG TENDL-2015, AKONING  
Photon emission for (n,2n)

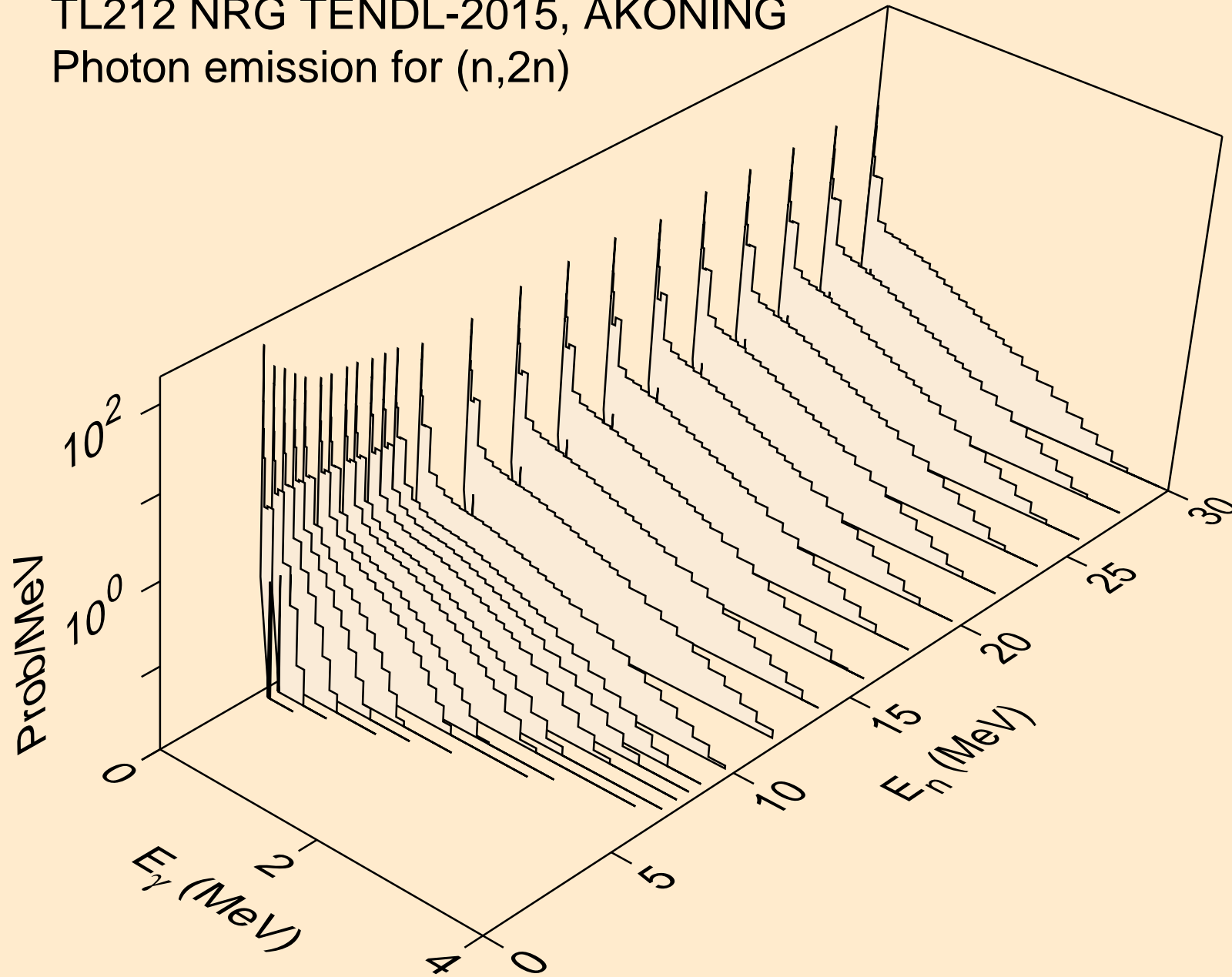

TL212 NRG TENDL-2015, AKONING  
Photon emission for (n,3n)

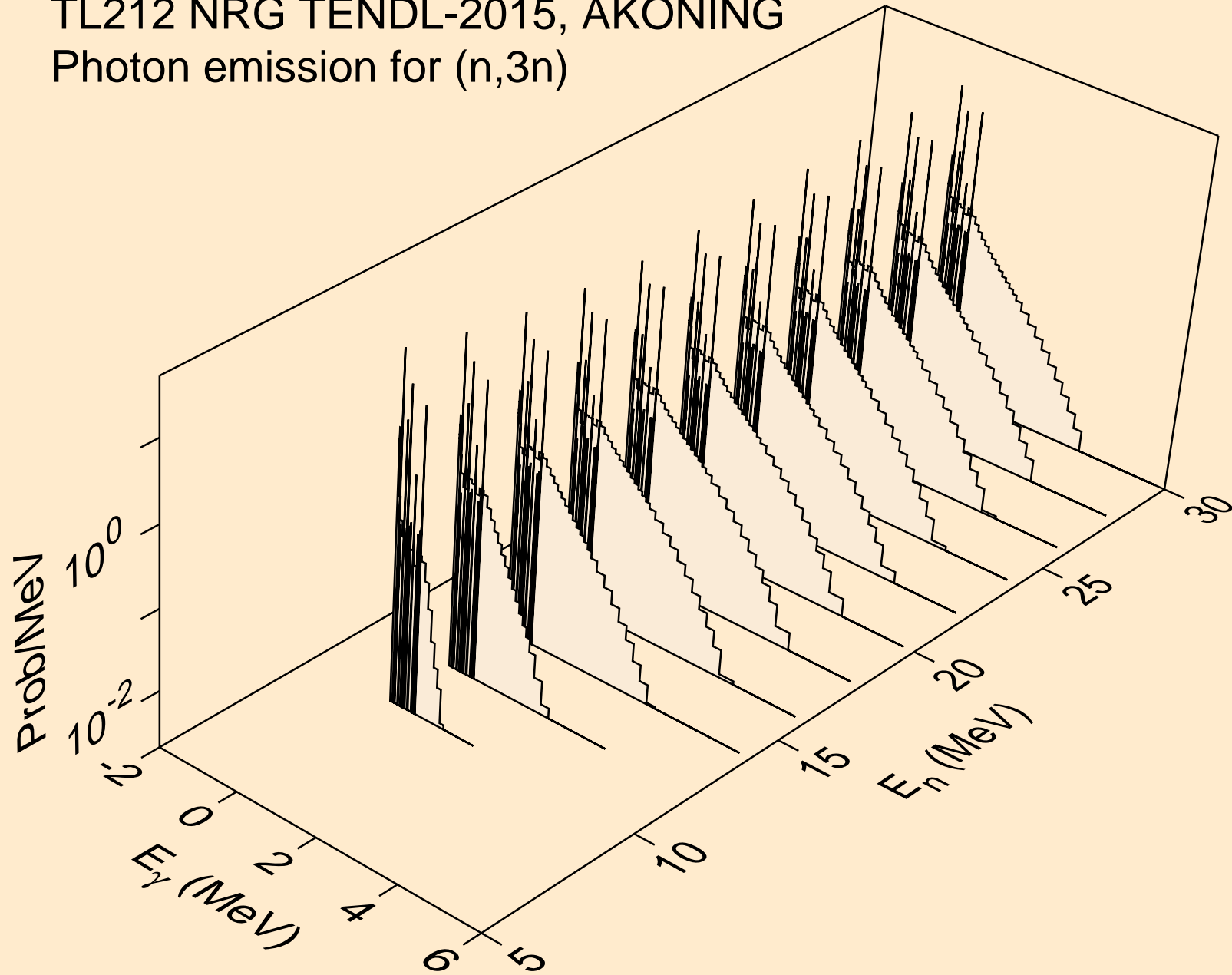

TL212 NRG TENDL-2015, AKONING  
Photon emission for (n,n\*)a

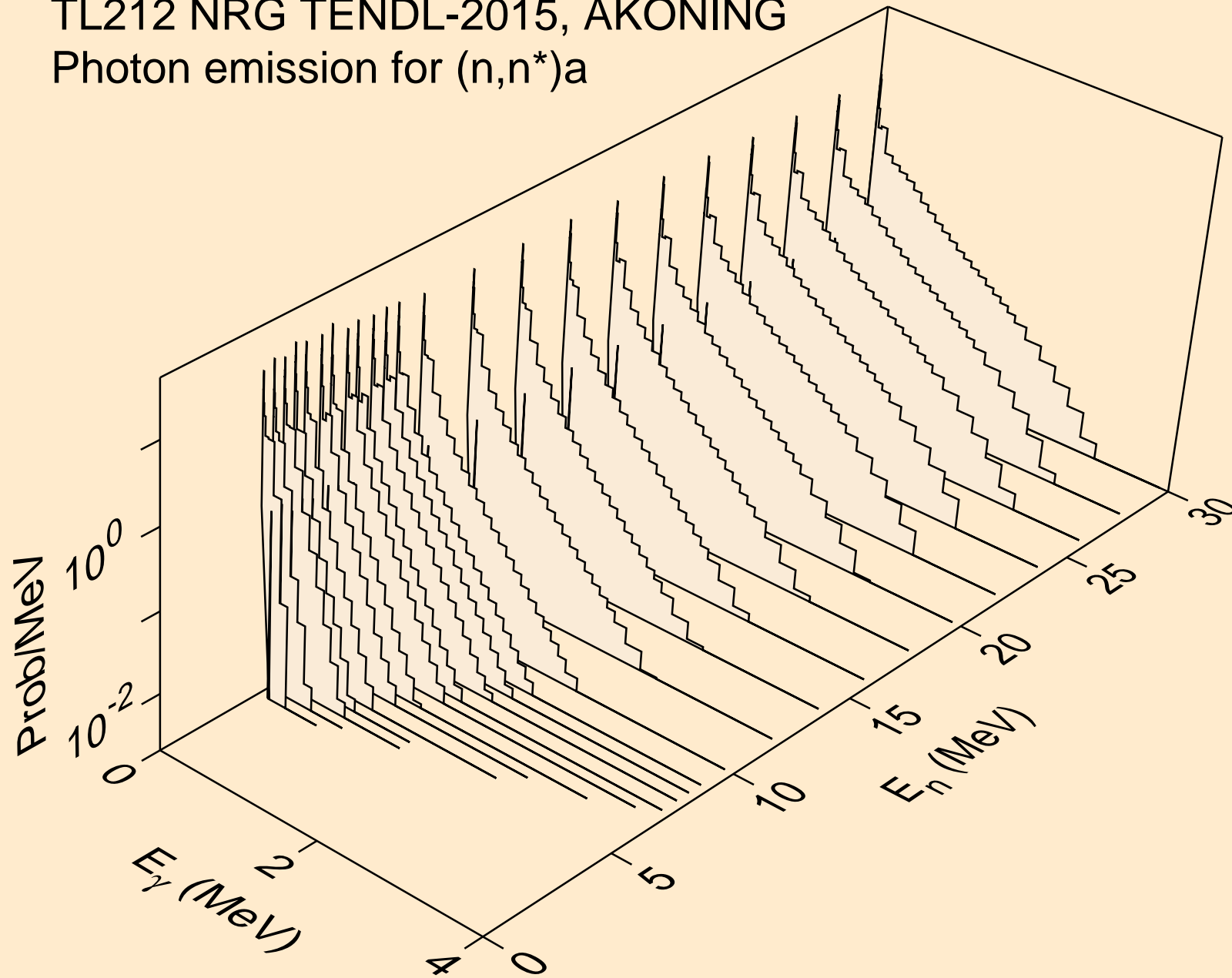



TL212 NRG TENDL-2015, AKONING  
Photon emission for (n,2n)a

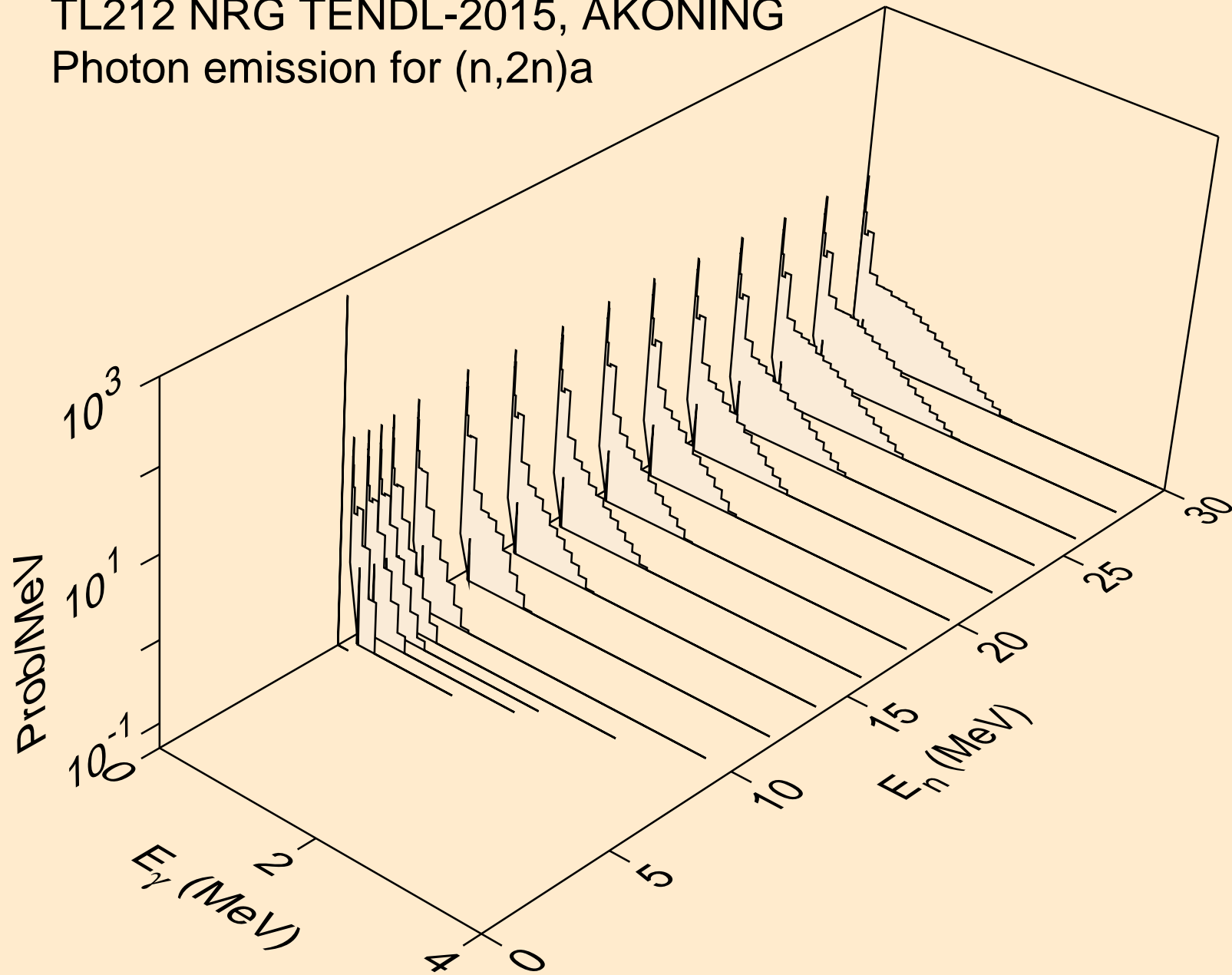

TL212 NRG TENDL-2015, AKONING  
Photon emission for (n,3n)a

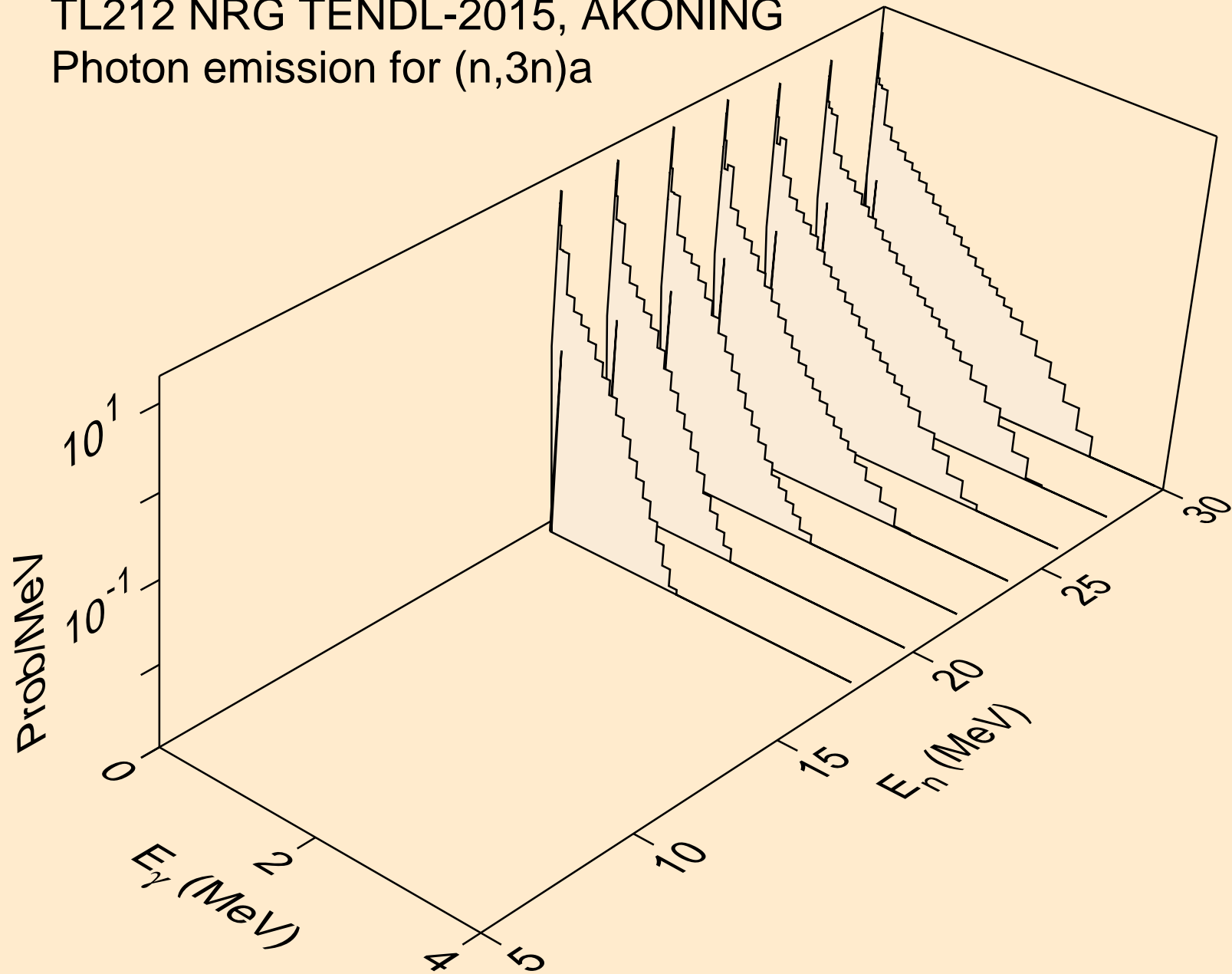

TL212 NRG TENDL-2015, AKONING  
Photon emission for (n,n\*)p

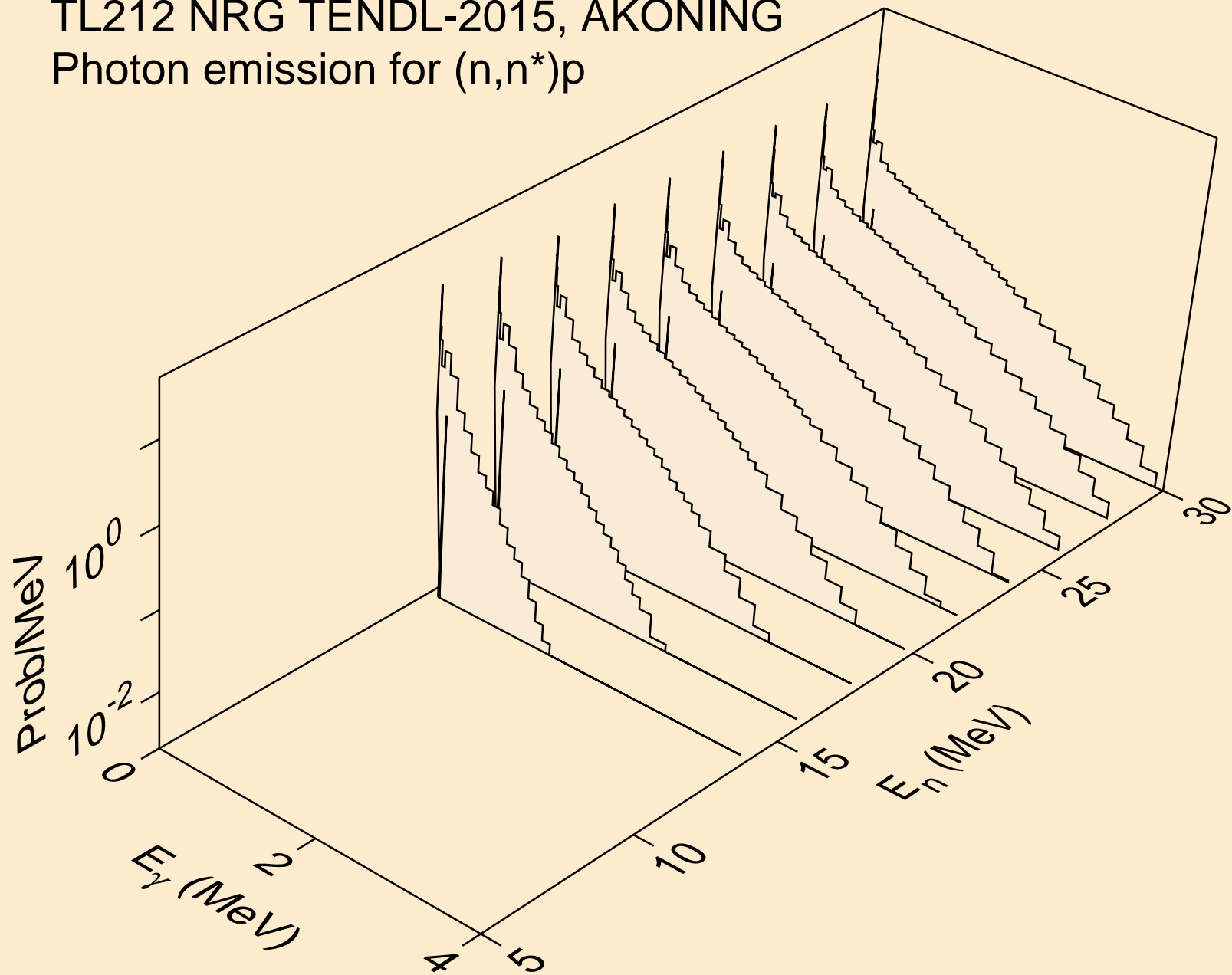

TL212 NRG TENDL-2015, AKONING  
Photon emission for (n,n\*)d

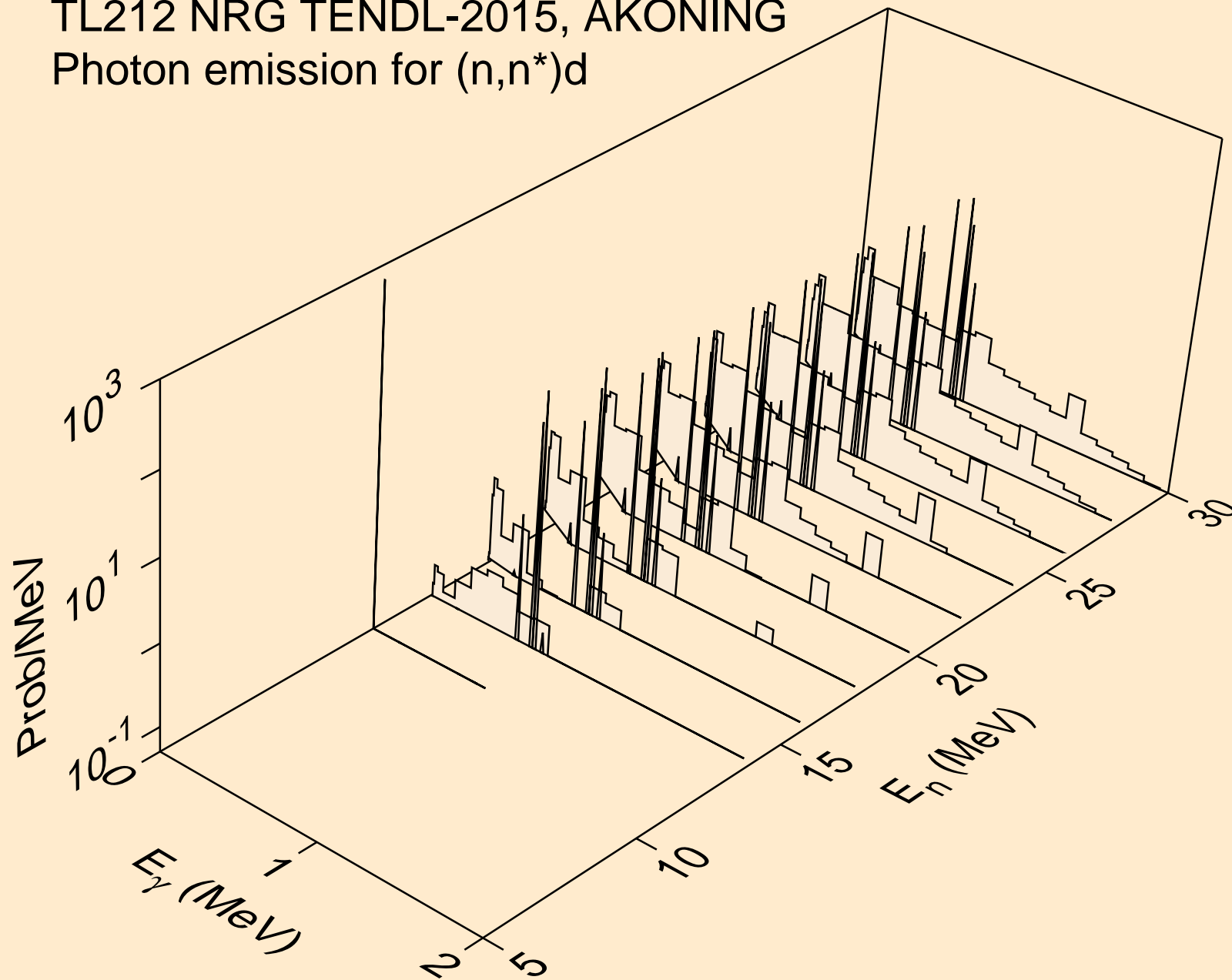

TL212 NRG TENDL-2015, AKONING  
Photon emission for (n,n\*)t

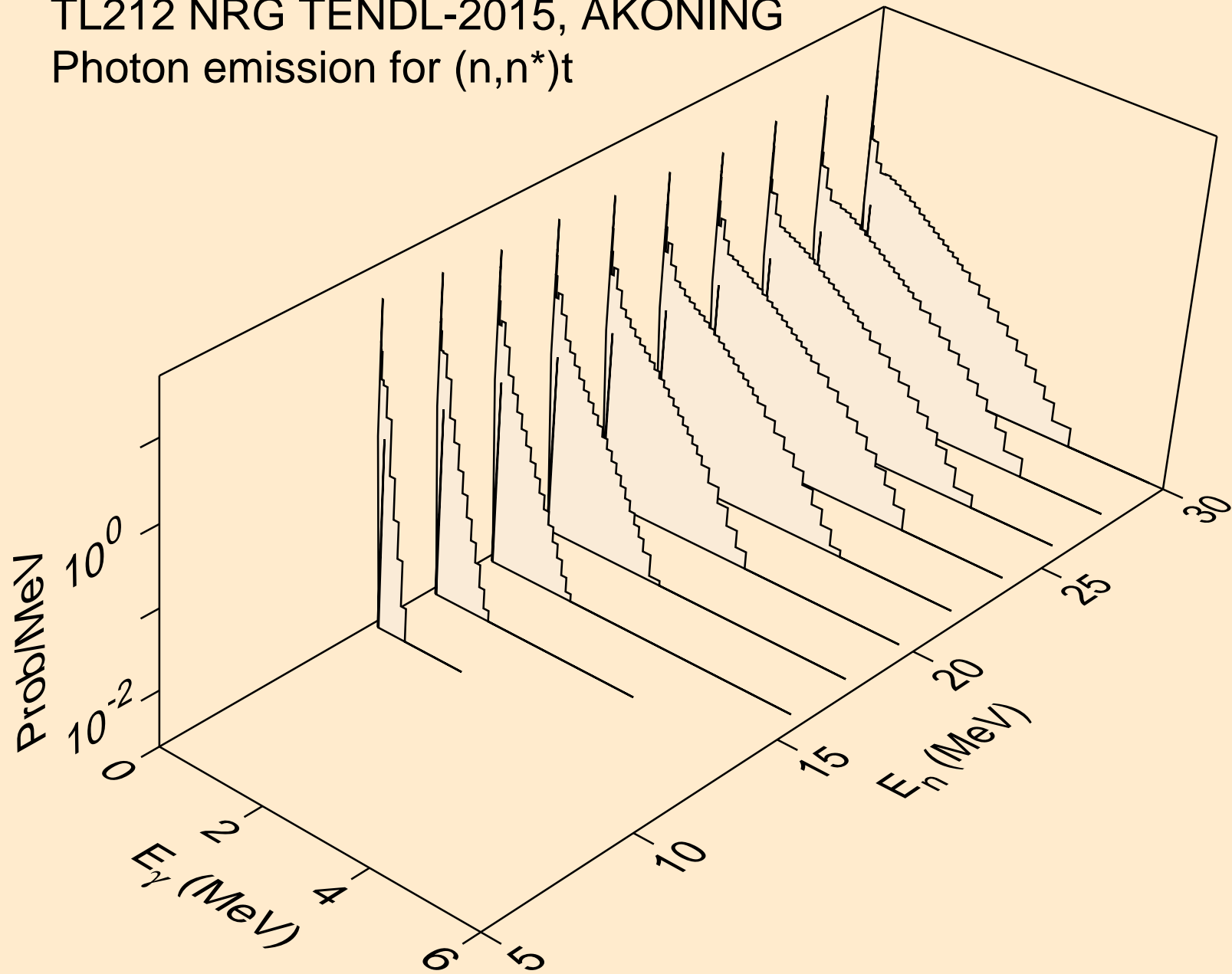

TL212 NRG TENDL-2015, AKONING  
Photon emission for (n,n\*)he3

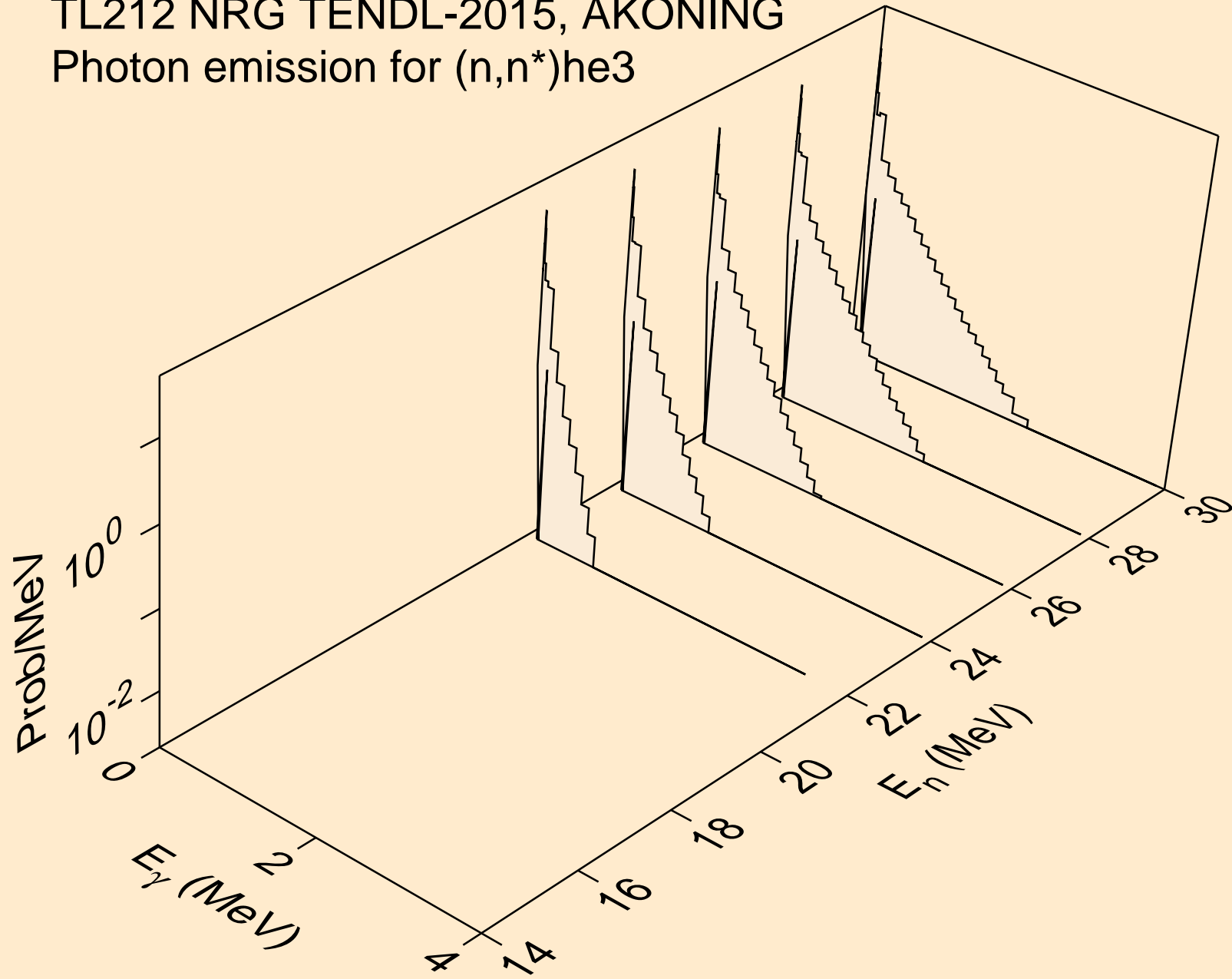

TL212 NRG TENDL-2015, AKONING  
Photon emission for (n,4n)

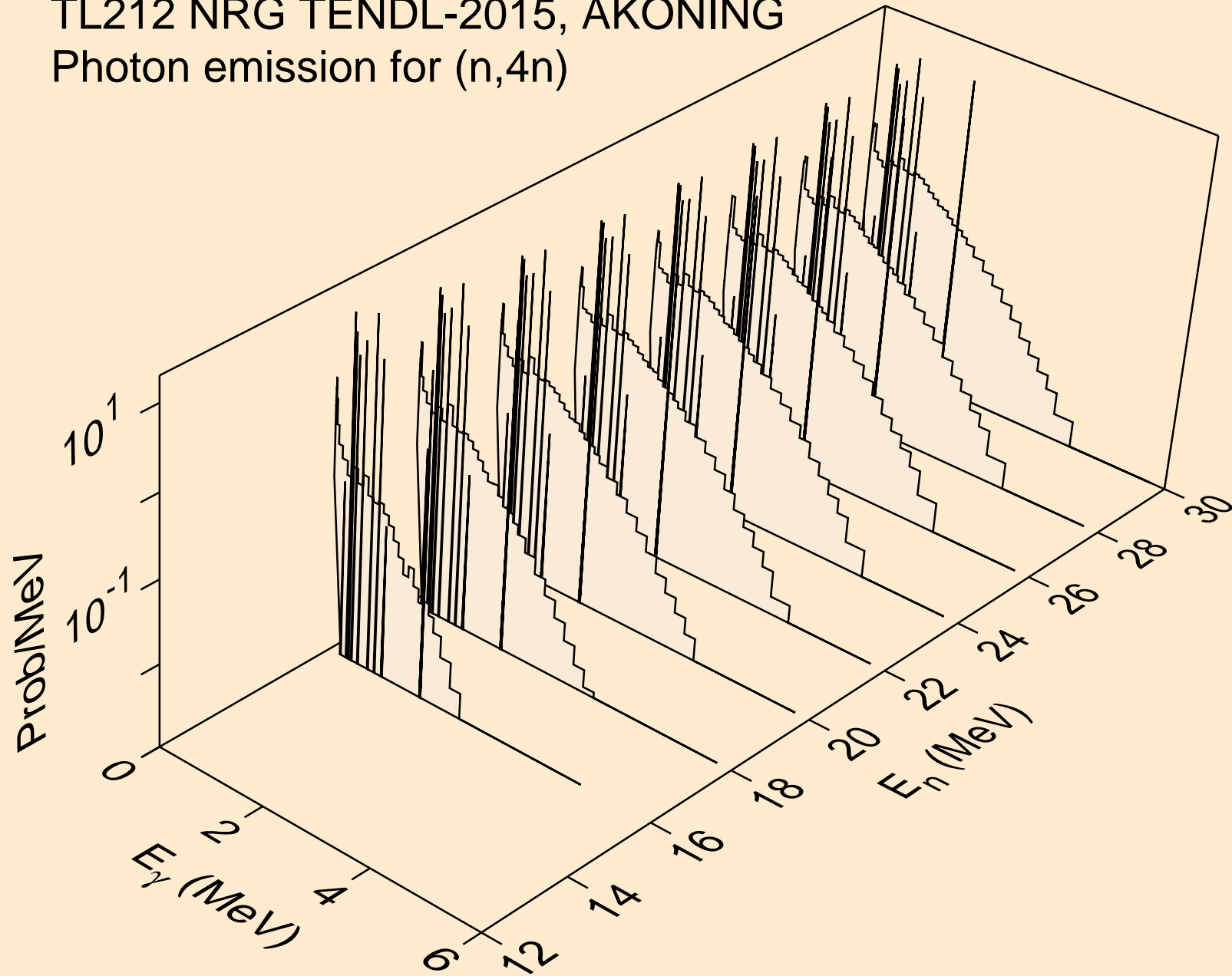

TL212 NRG TENDL-2015, AKONING  
Photon emission for (n,2np)

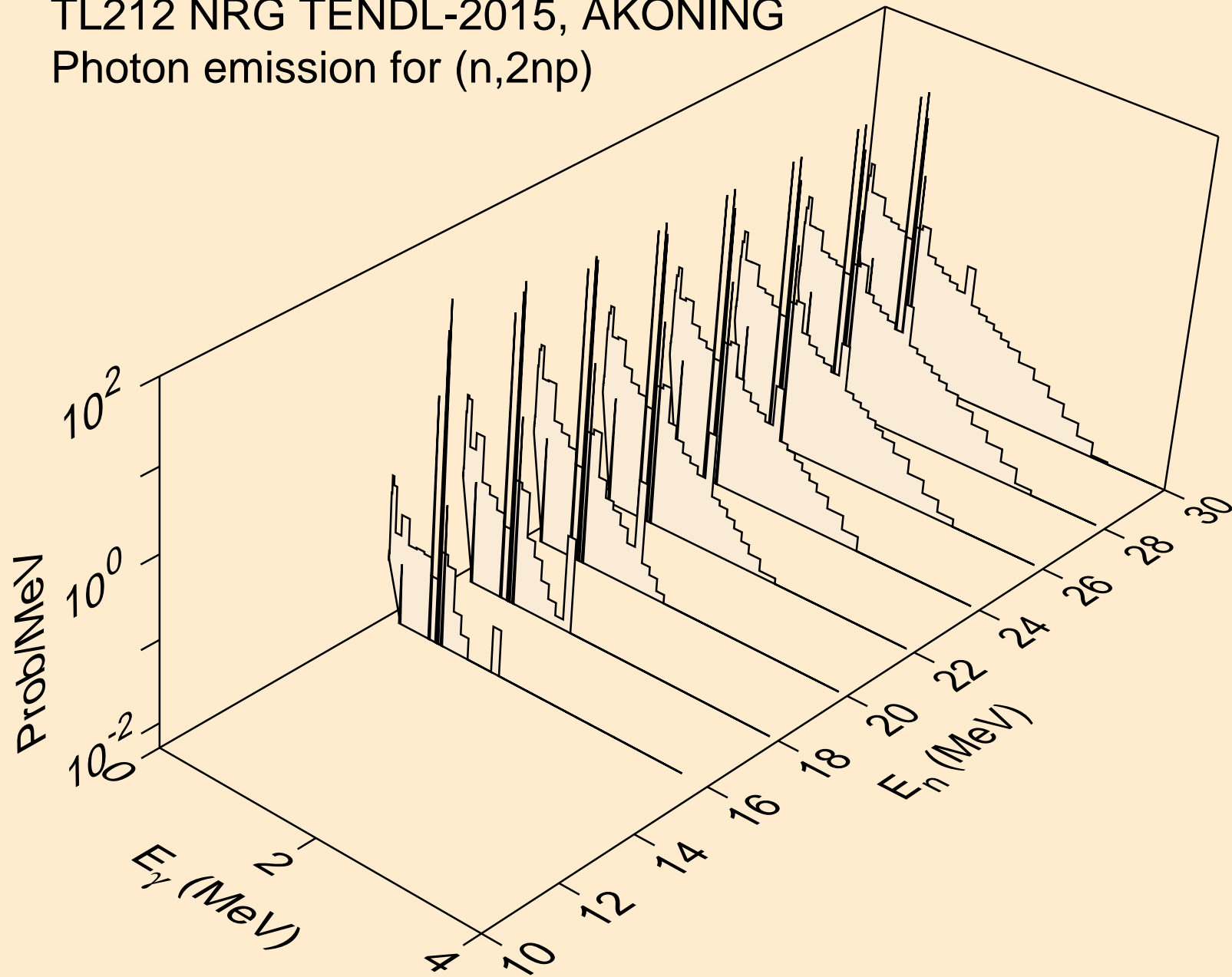



TL212 NRG TENDL-2015, AKONING  
Photon emission for (n,3np)

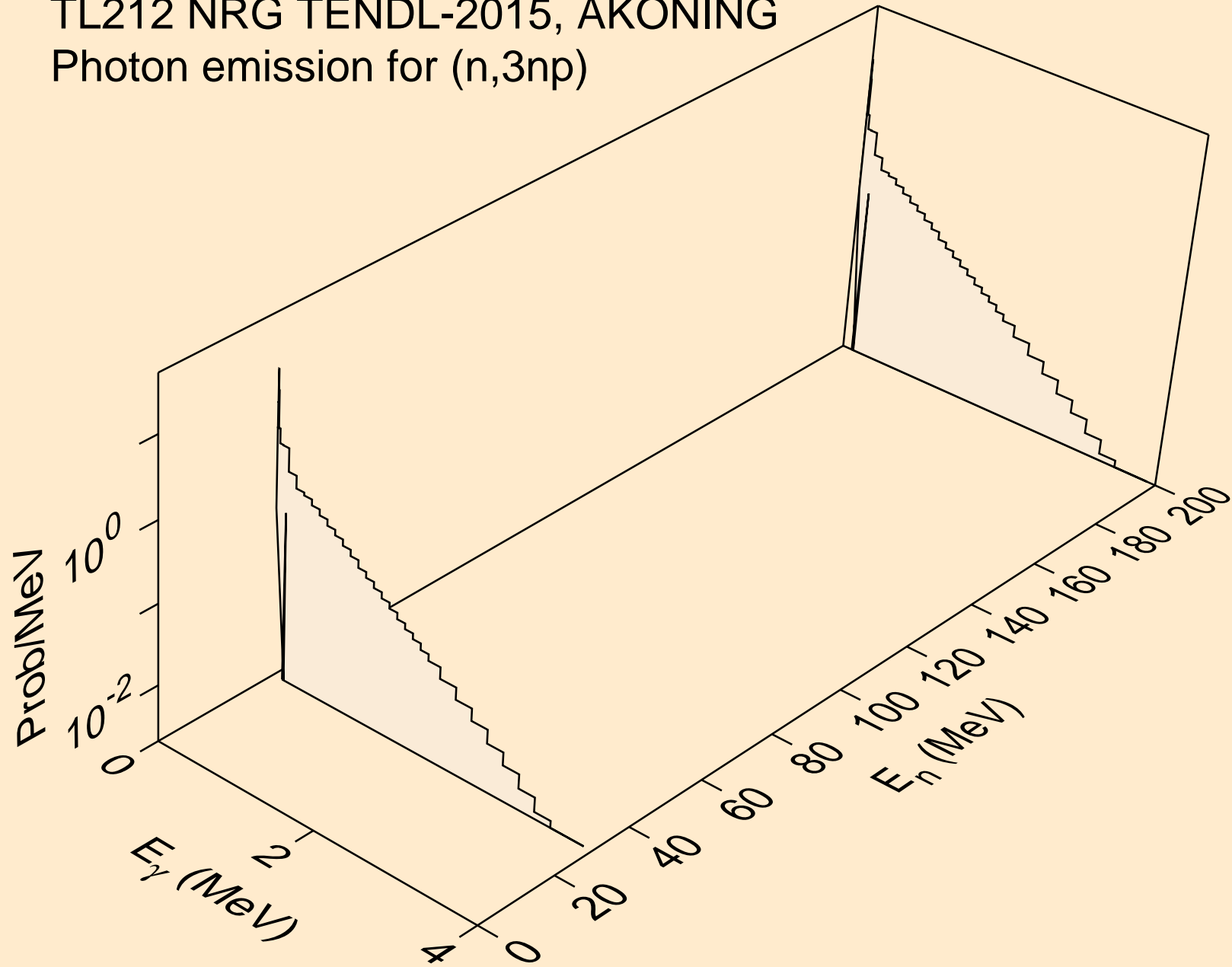

TL212 NRG TENDL-2015, AKONING  
Photon emission for (n,n\*c)

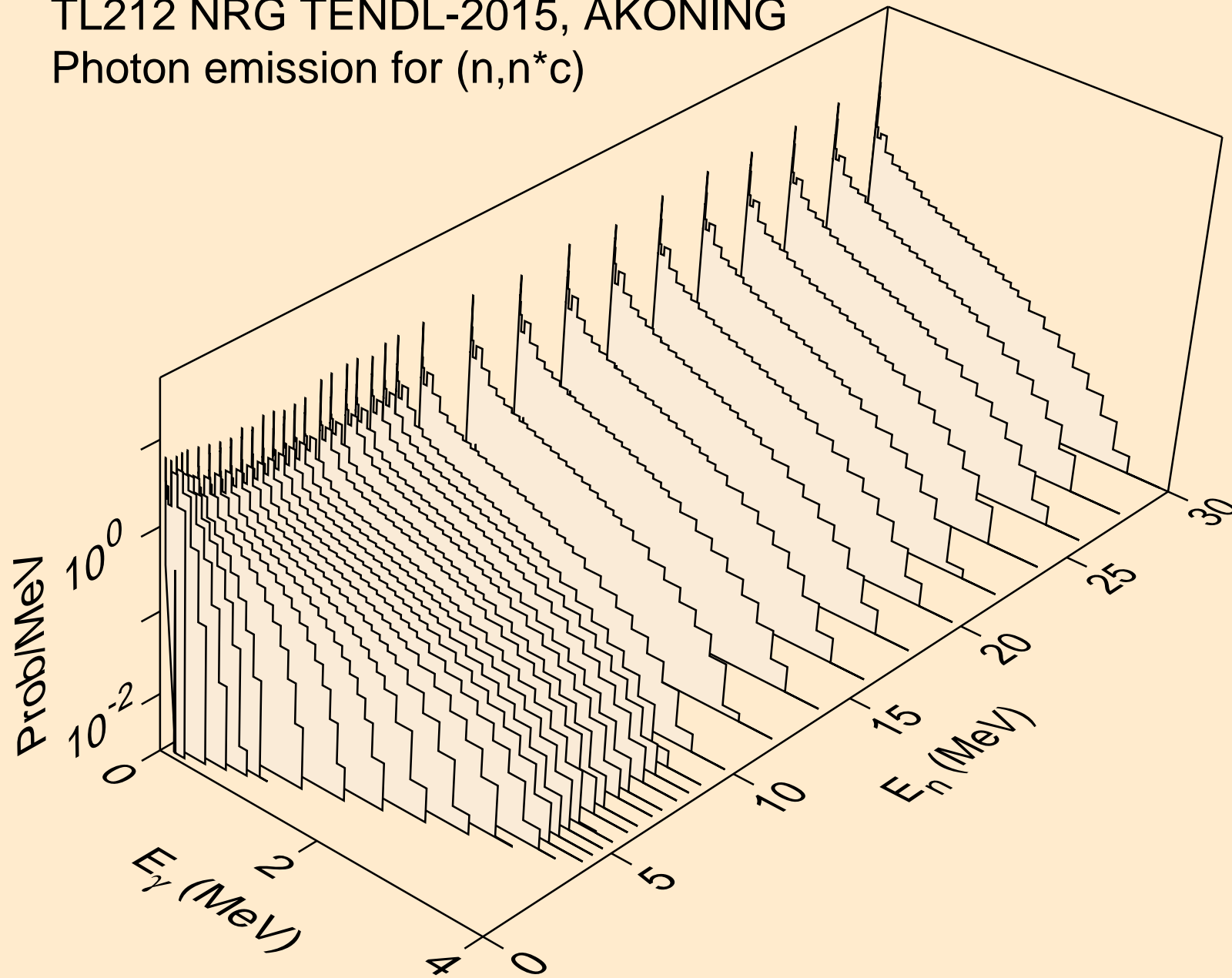

TL212 NRG TENDL-2015, AKONING  
Photon emission for (n,gma)

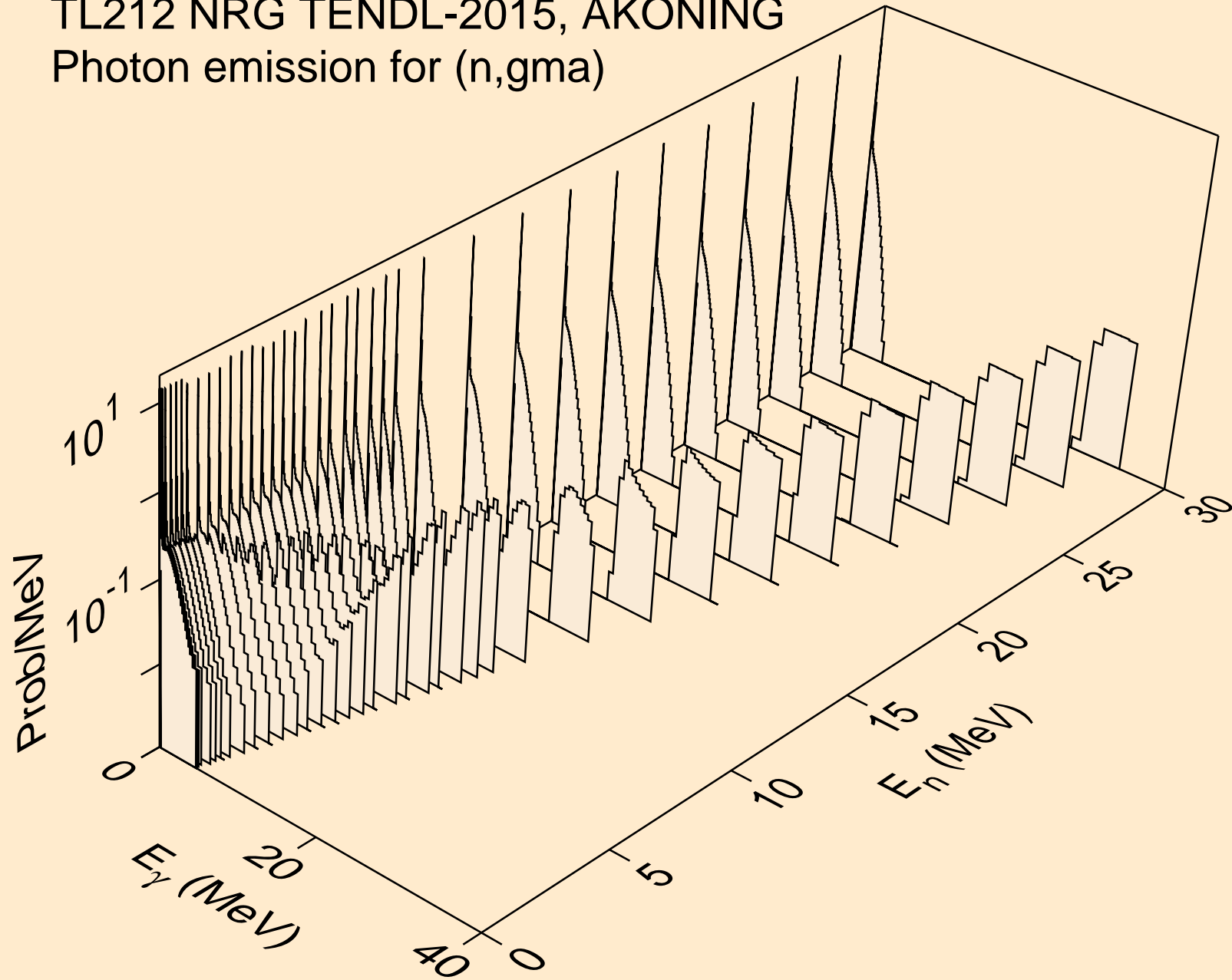

TL212 NRG TENDL-2015, AKONING  
Photon emission for (n,p)

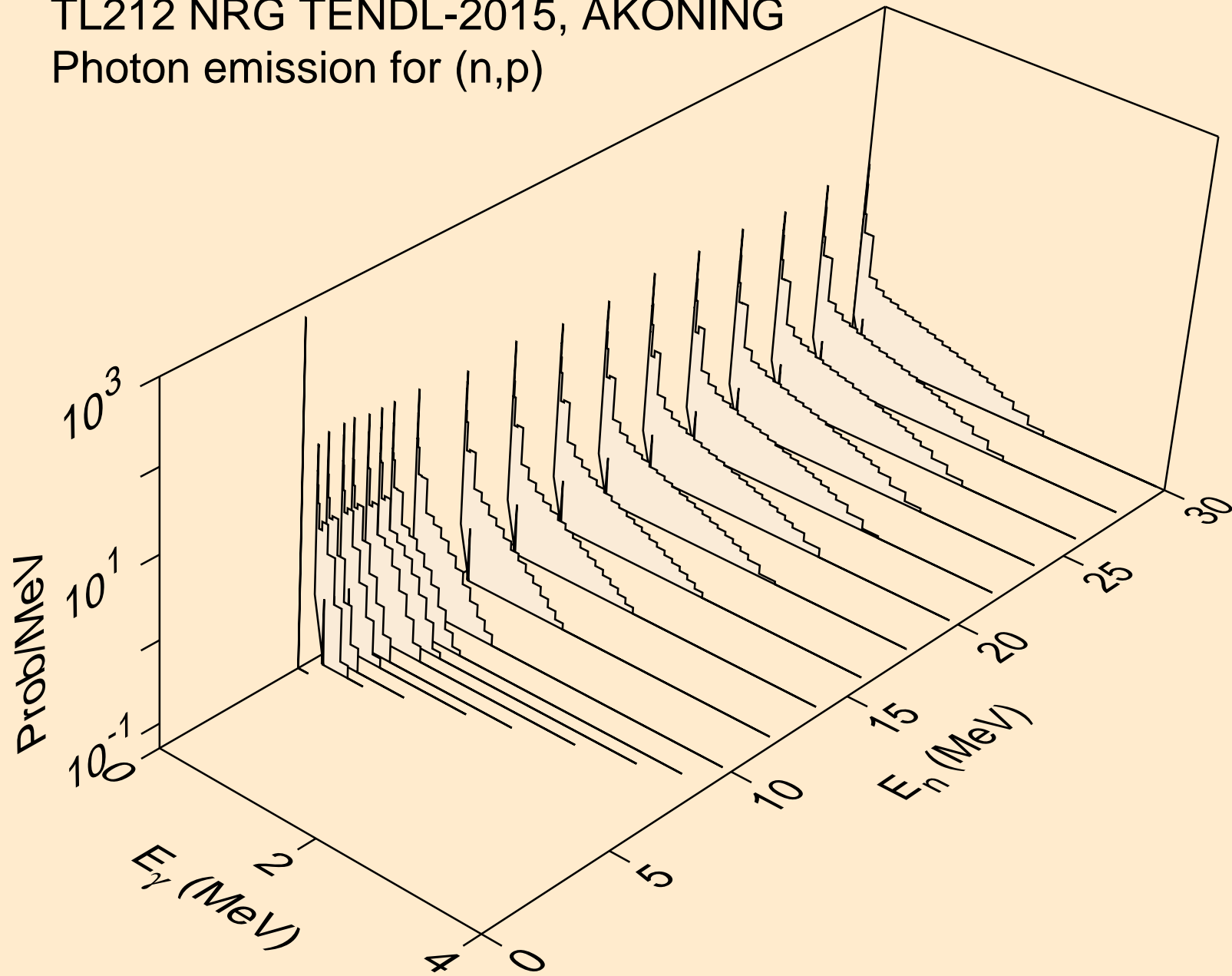

TL212 NRG TENDL-2015, AKONING  
Photon emission for (n,d)

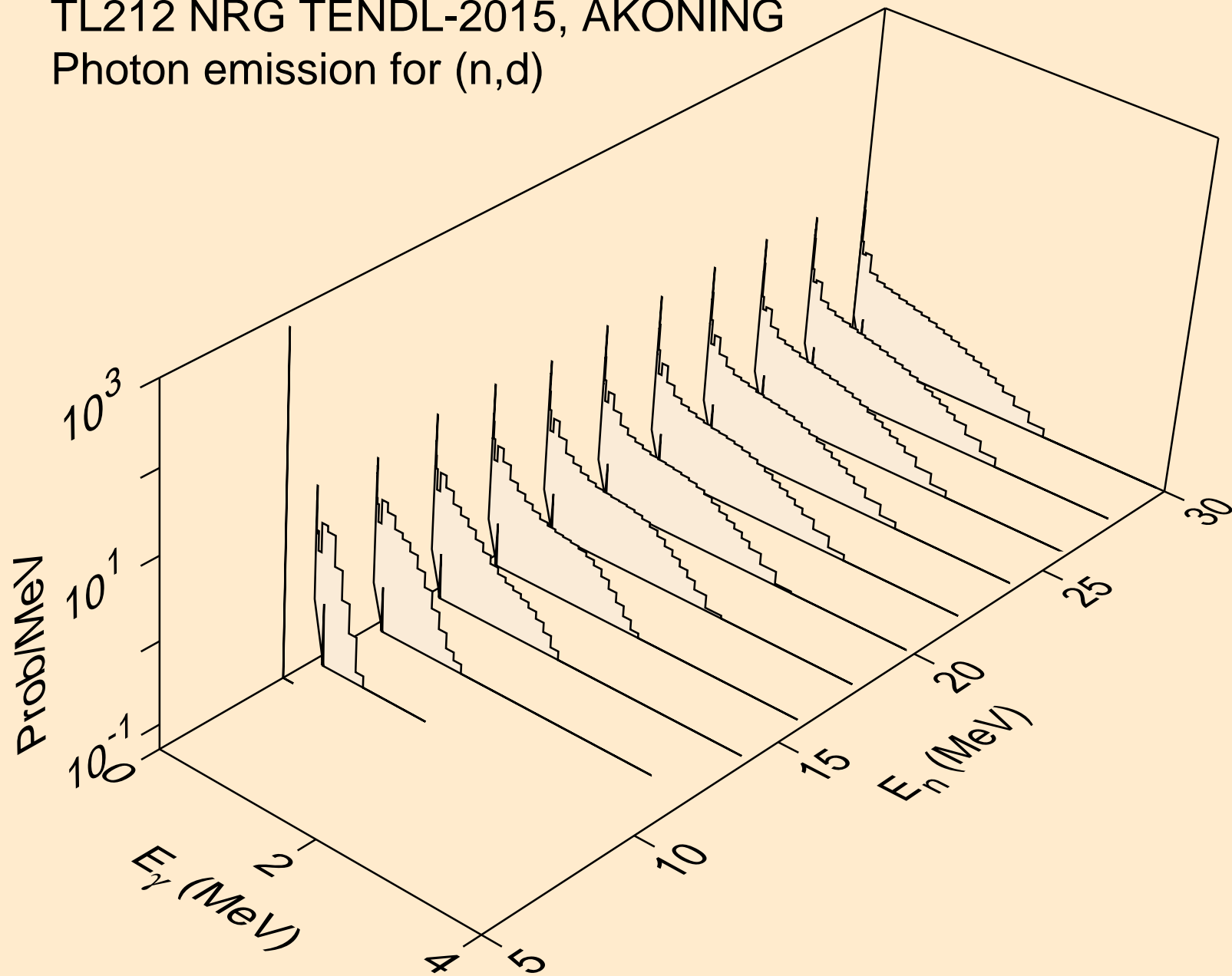

TL212 NRG TENDL-2015, AKONING  
Photon emission for (n,t)

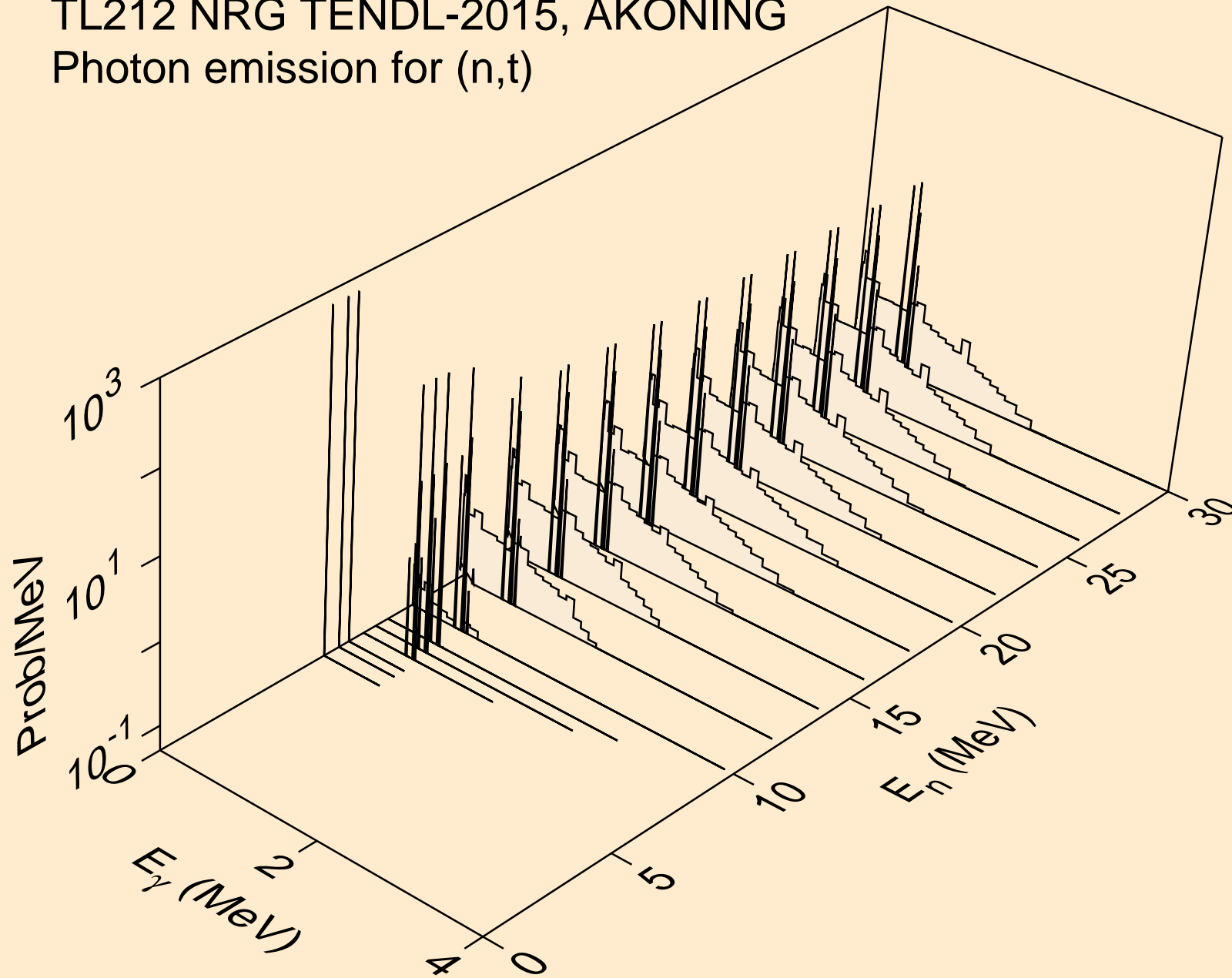

TL212 NRG TENDL-2015, AKONING  
Photon emission for (n,he3)

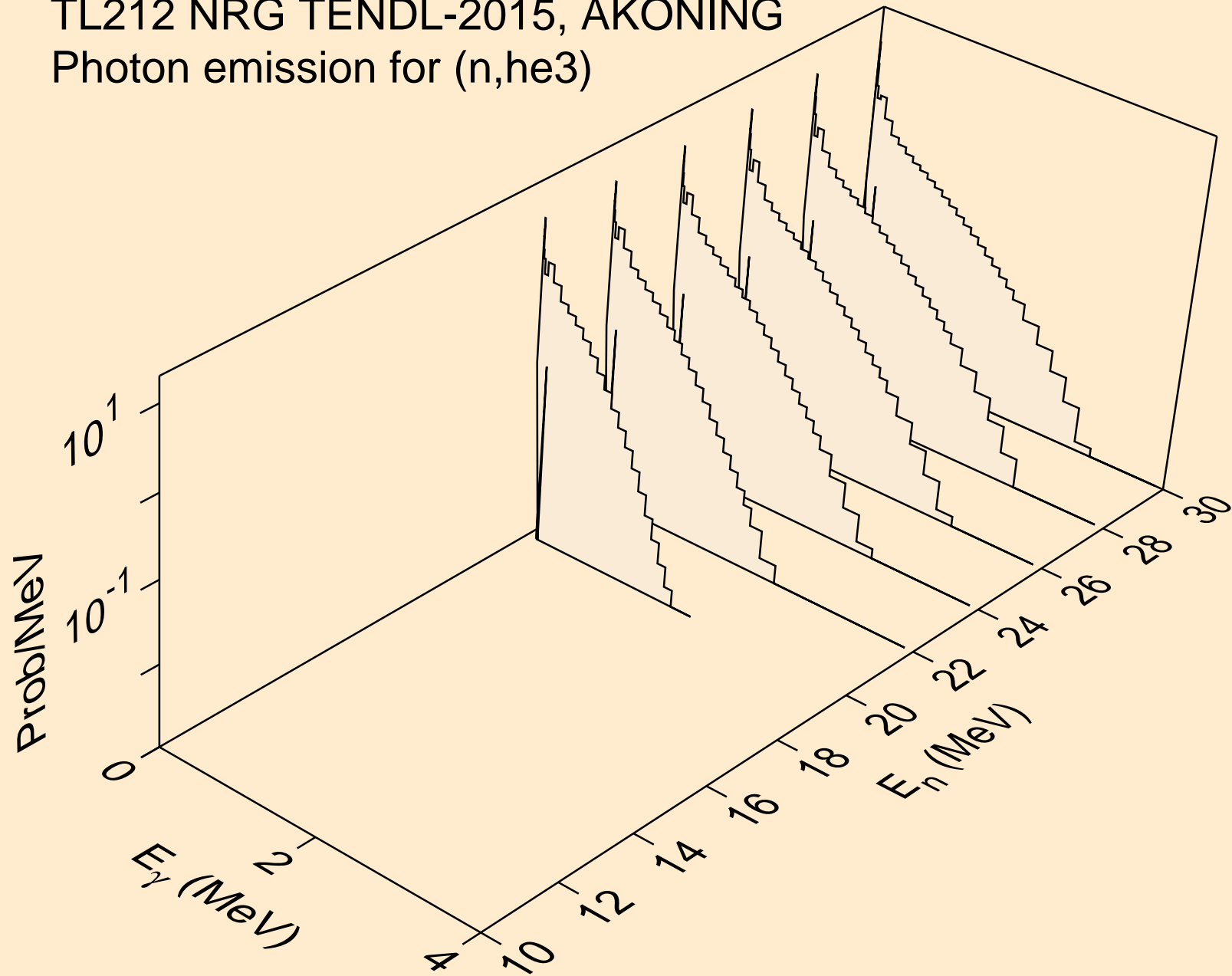

TL212 NRG TENDL-2015, AKONING  
Photon emission for (n,a)

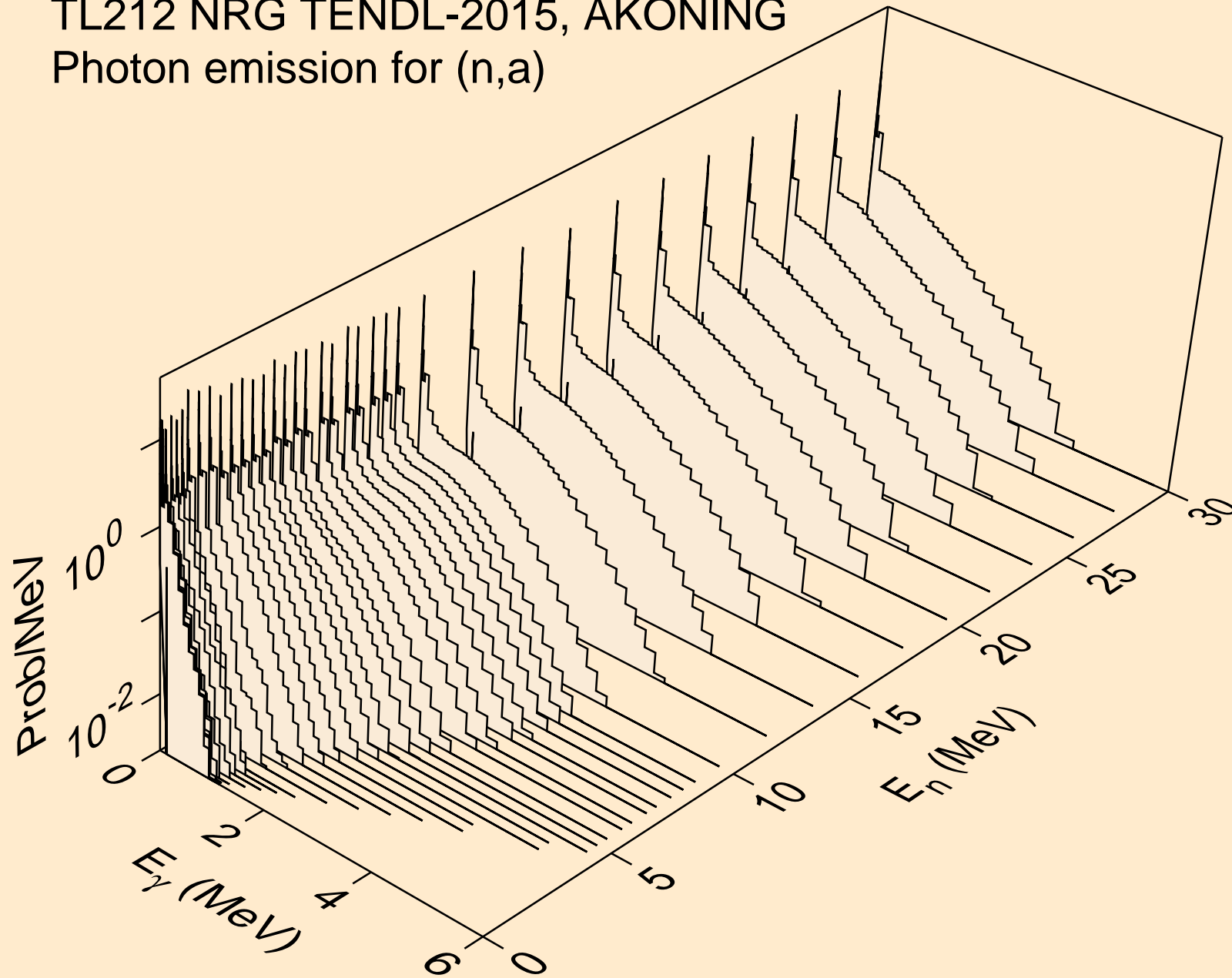



TL212 NRG TENDL-2015, AKONING  
Photon emission for (n,2a)

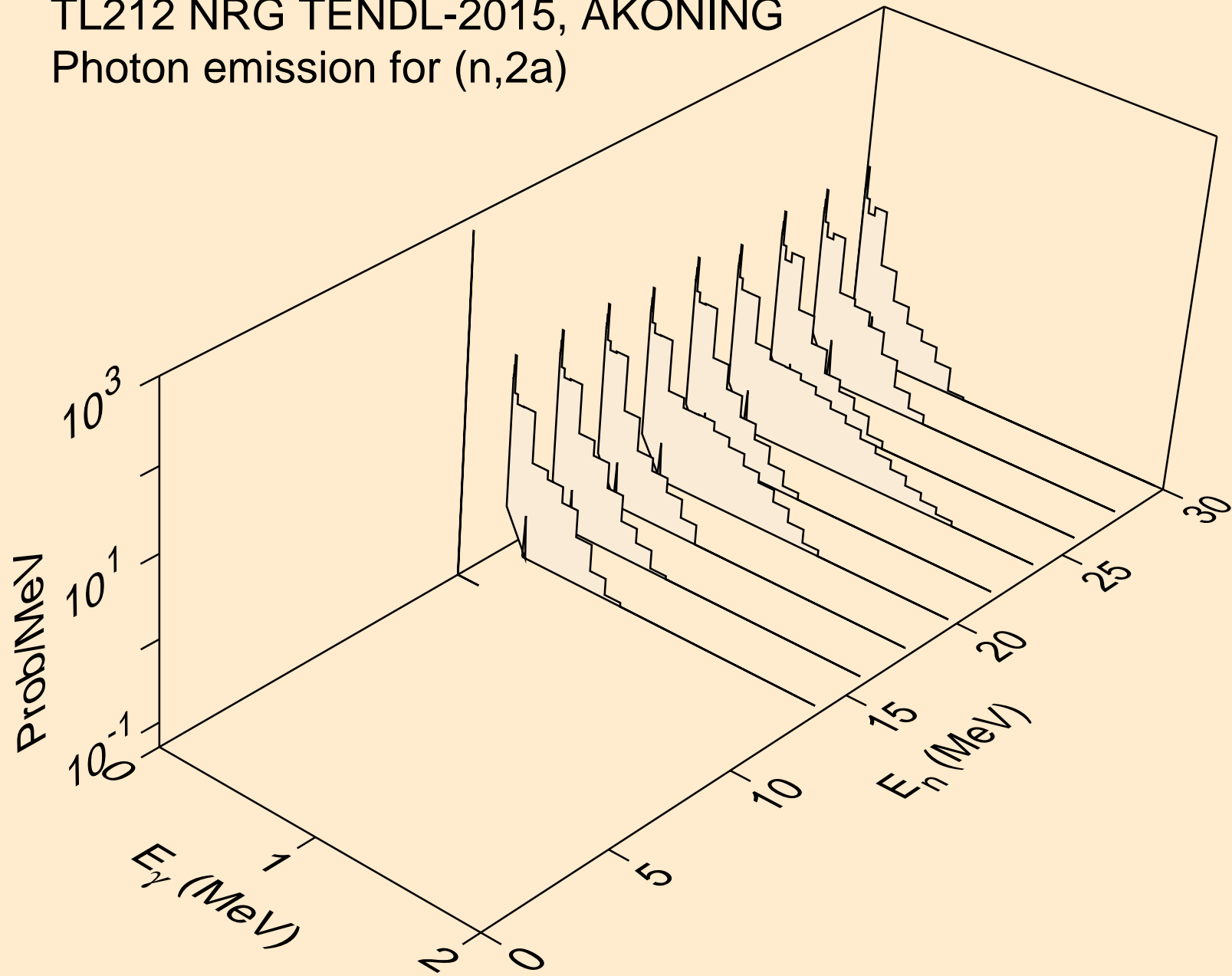

TL212 NRG TENDL-2015, AKONING  
thermal capture photon spectrum

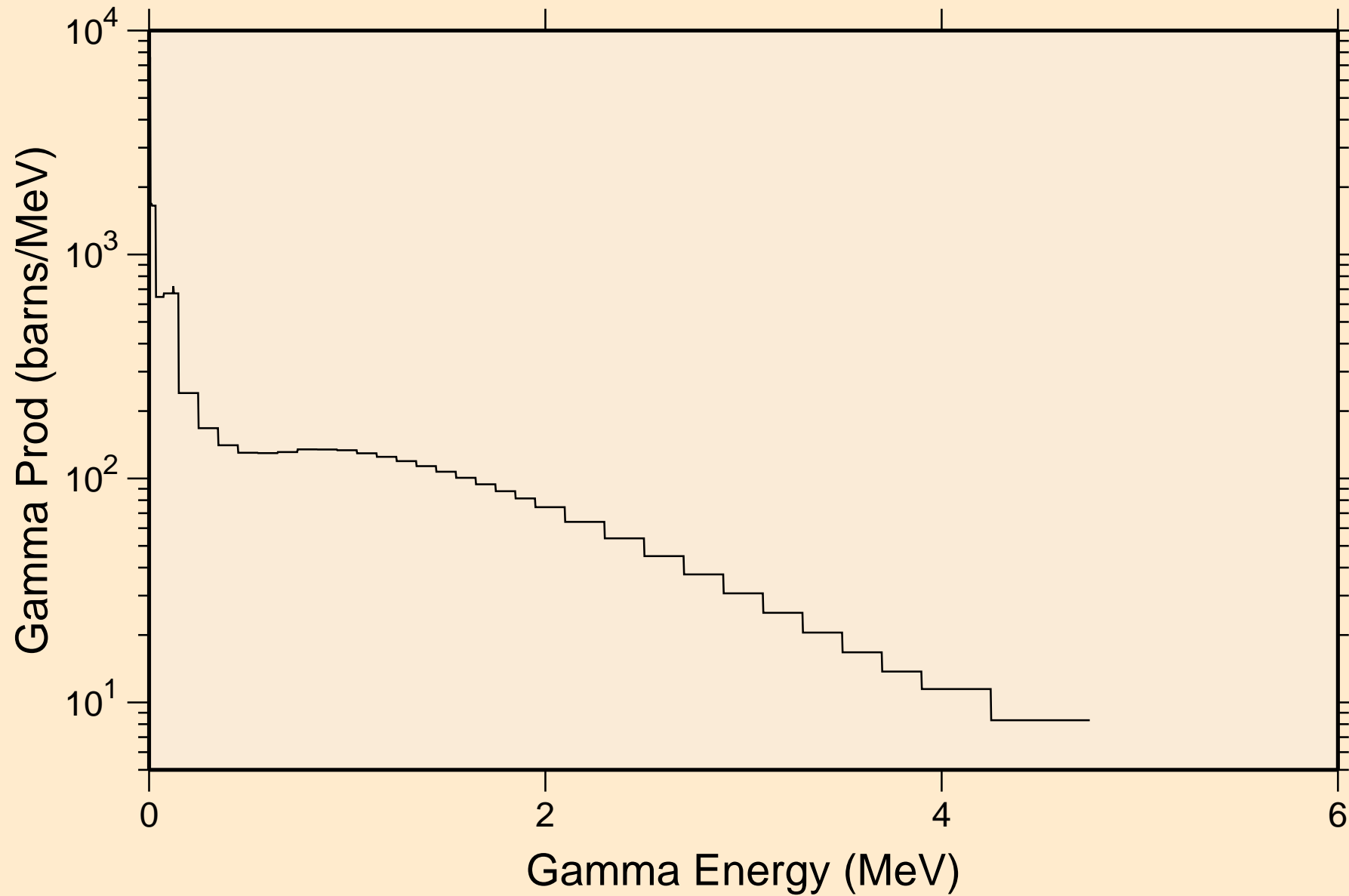

TL212 NRG TENDL-2015, AKONING  
14 MeV photon spectrum

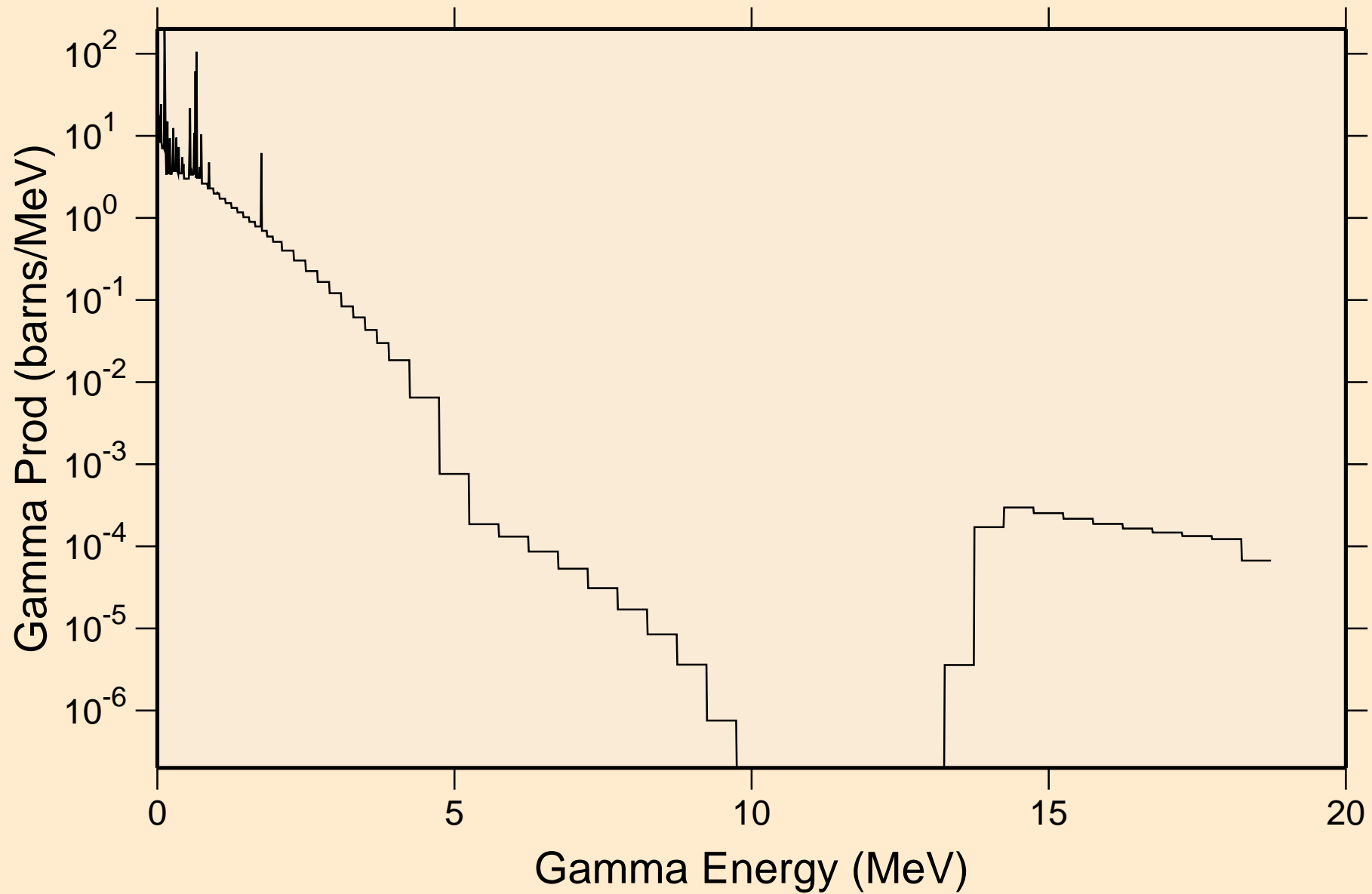

# TL212 NRG TENDL-2015, AKONING

## Particle heating contributions

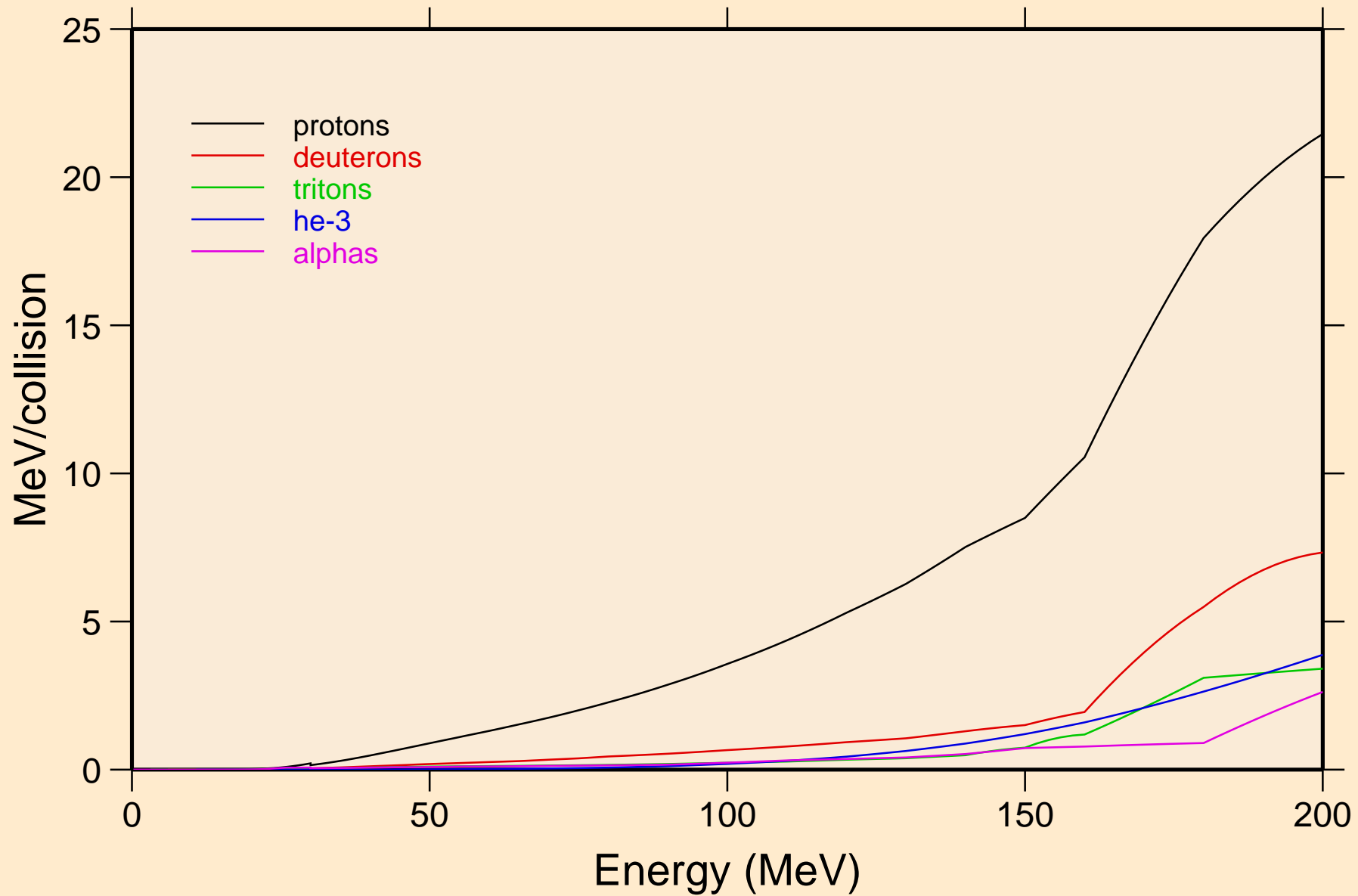

# TL212 NRG TENDL-2015, AKONING

## Recoil Heating

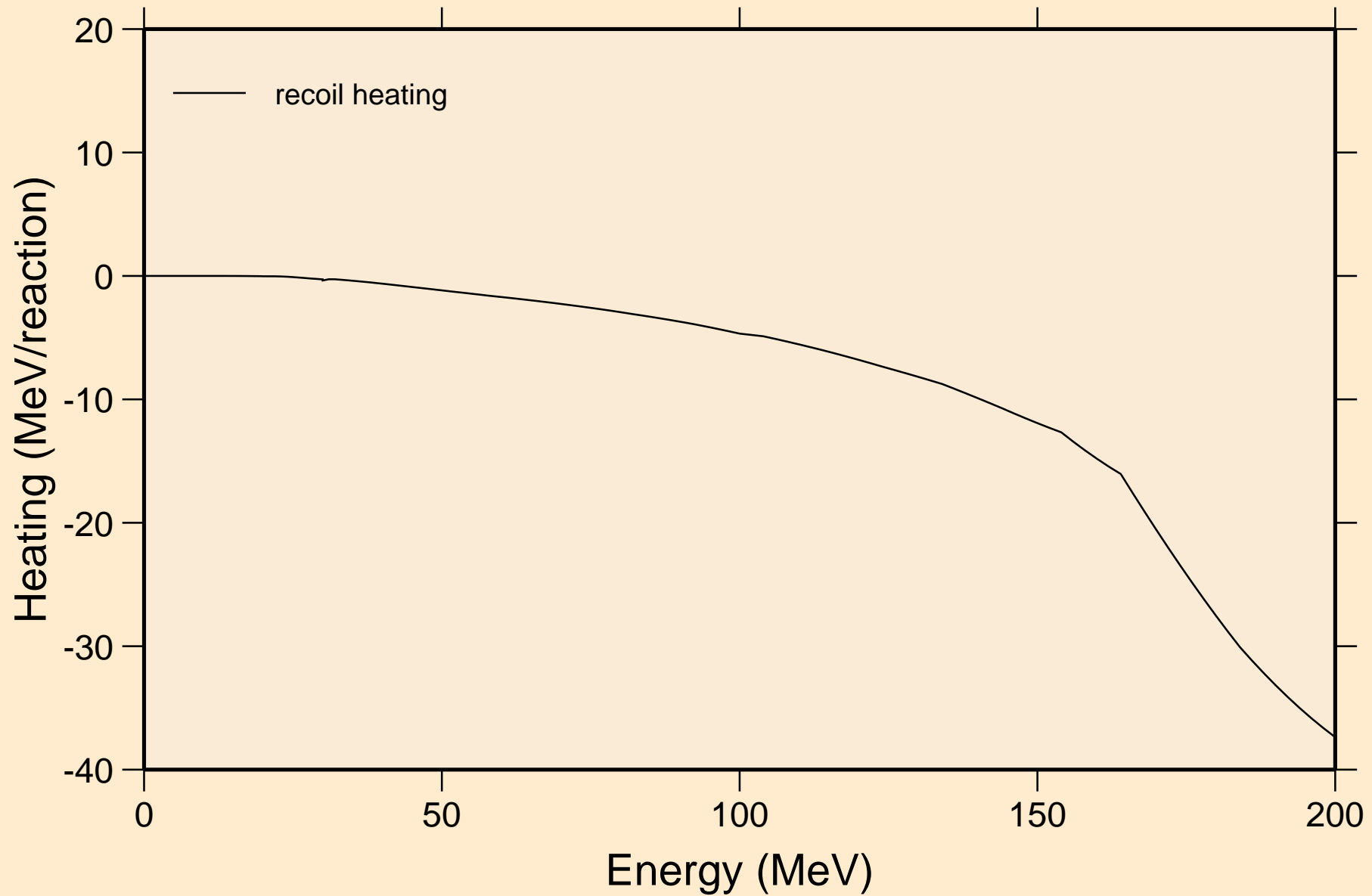

# TL212 NRG TENDL-2015, AKONING

## Particle production cross sections

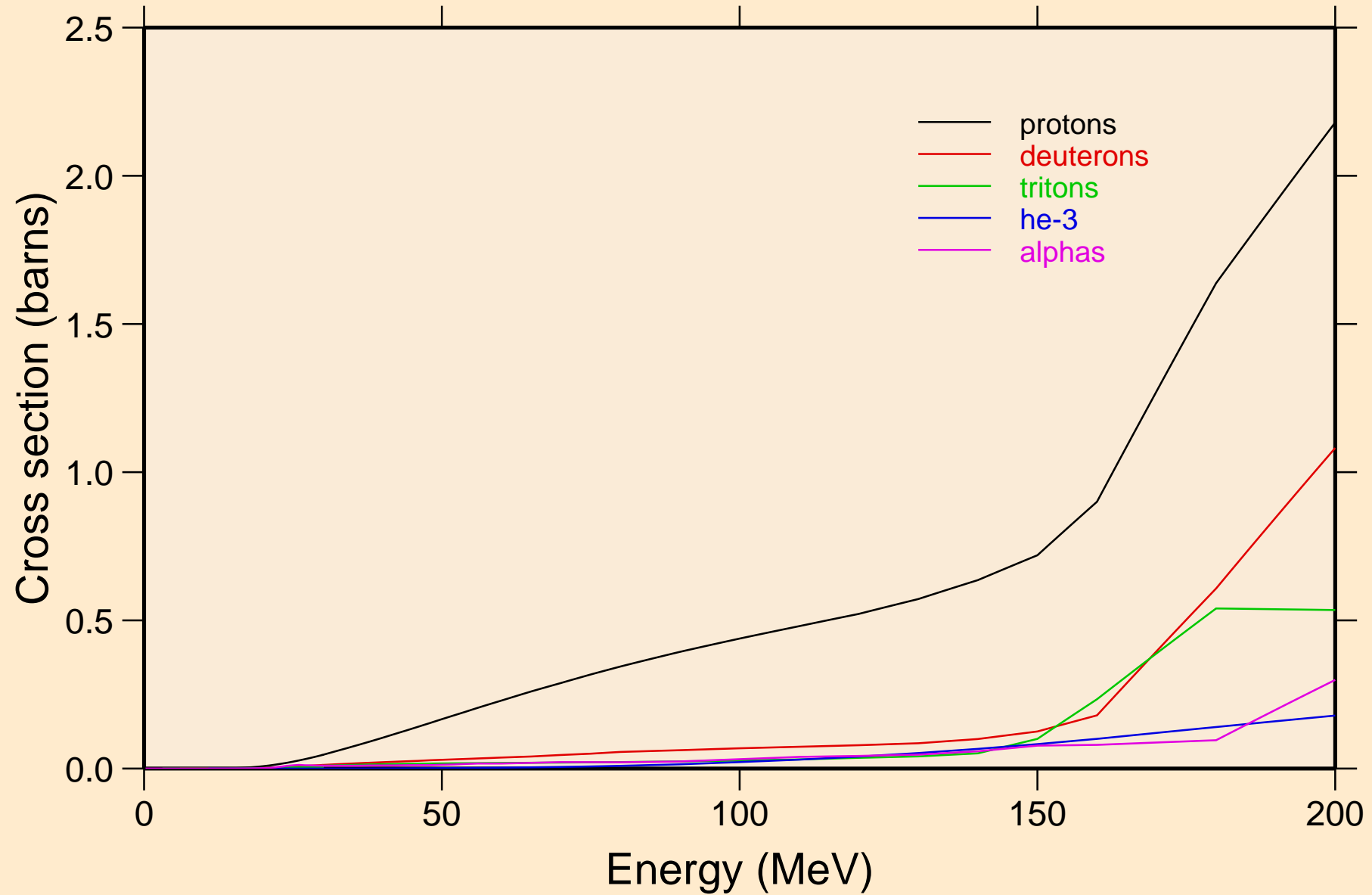

TL212 NRG TENDL-2015, AKONING  
protons from (n,x)

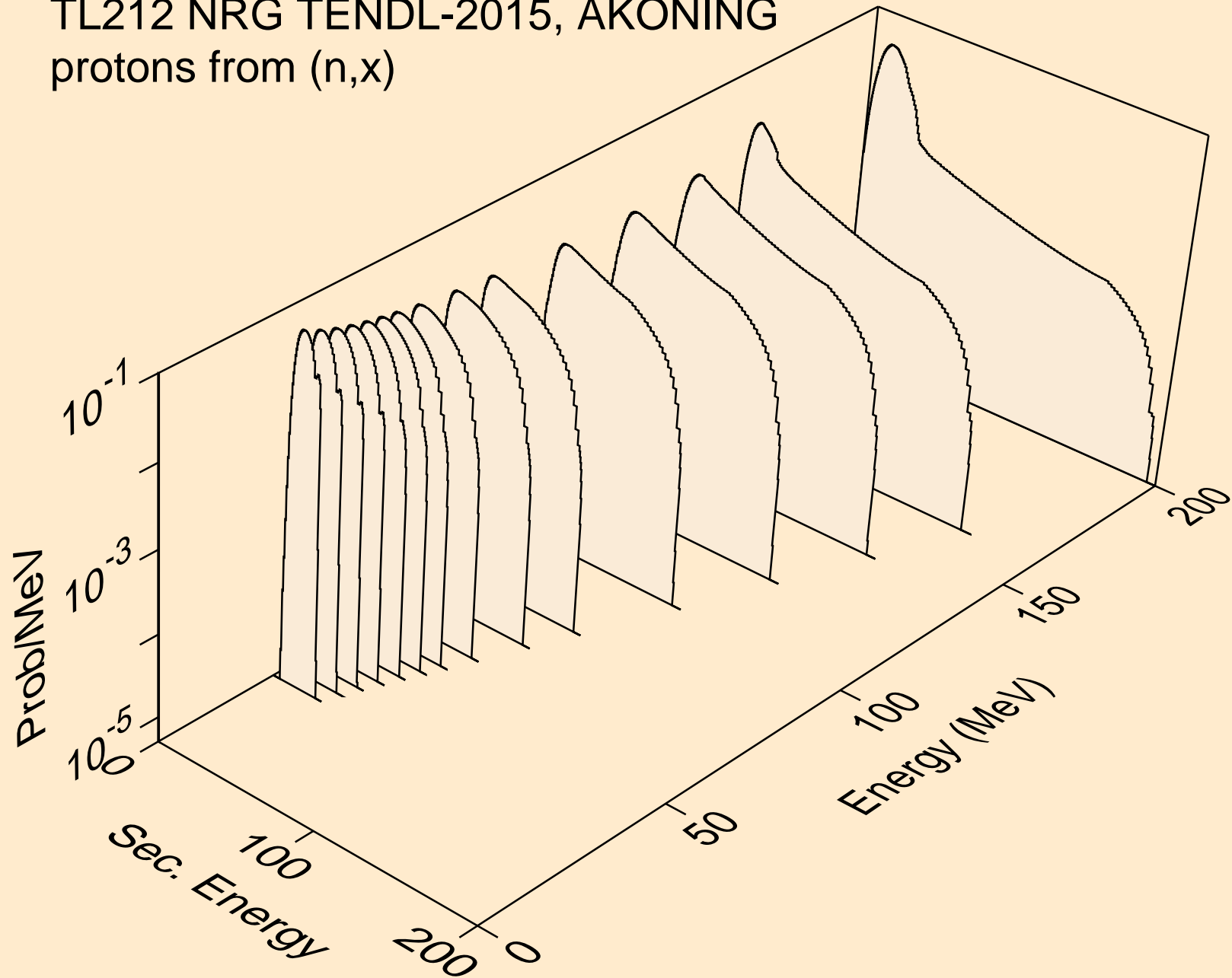

TL212 NRG TENDL-2015, AKONING  
protons from (n,n\*)p

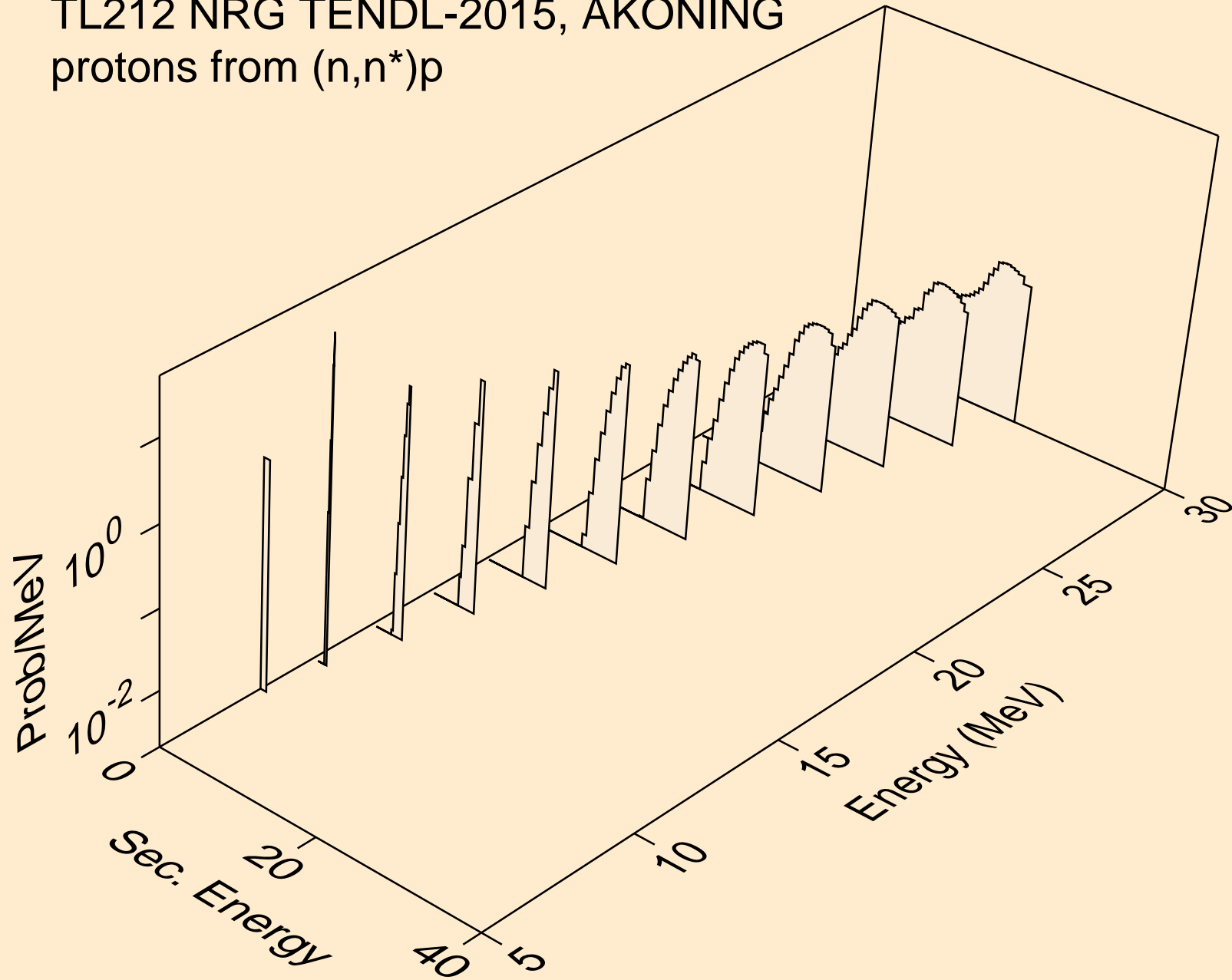



TL212 NRG TENDL-2015, AKONING  
protons from (n,2np)

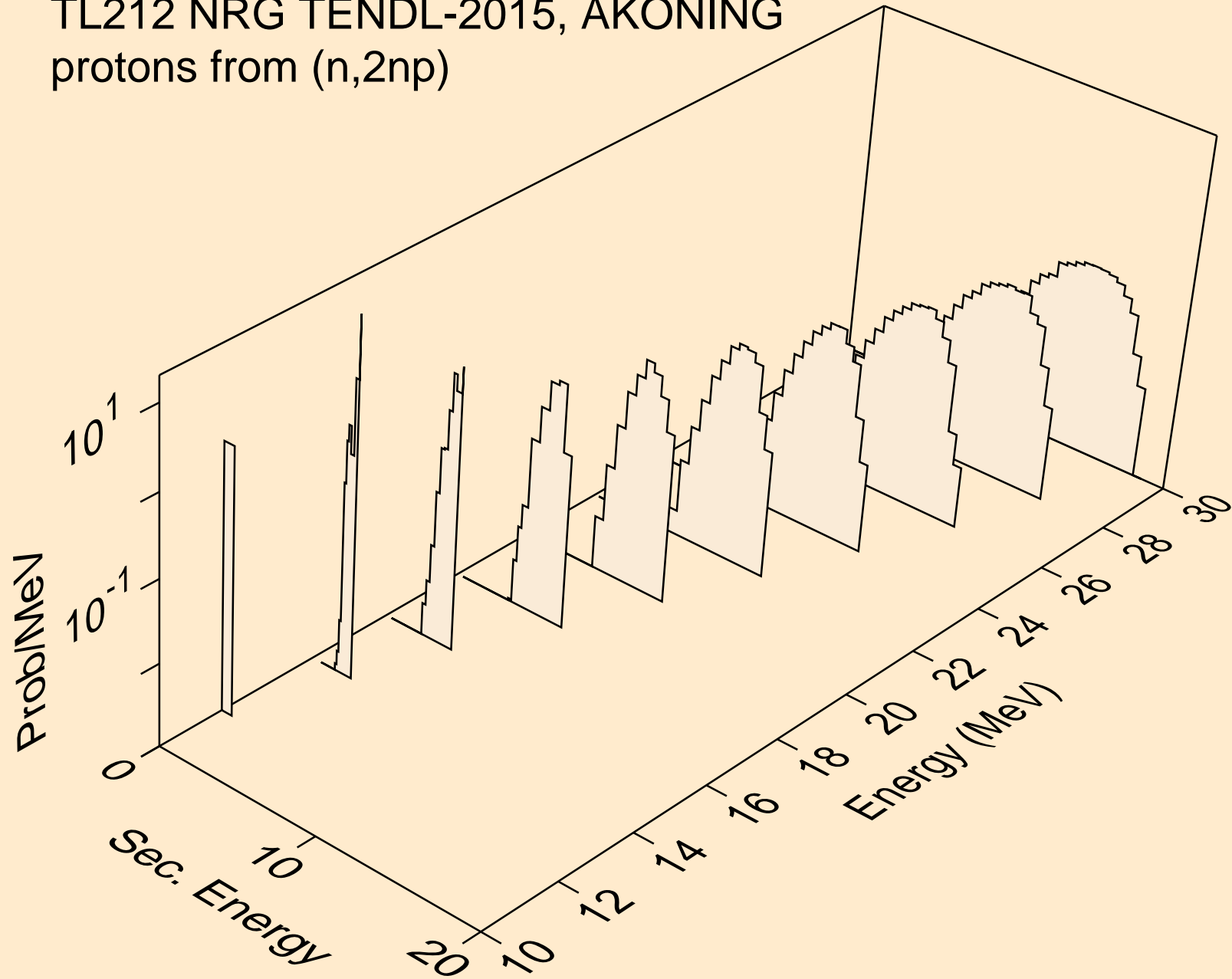

TL212 NRG TENDL-2015, AKONING  
protons from (n,3np)

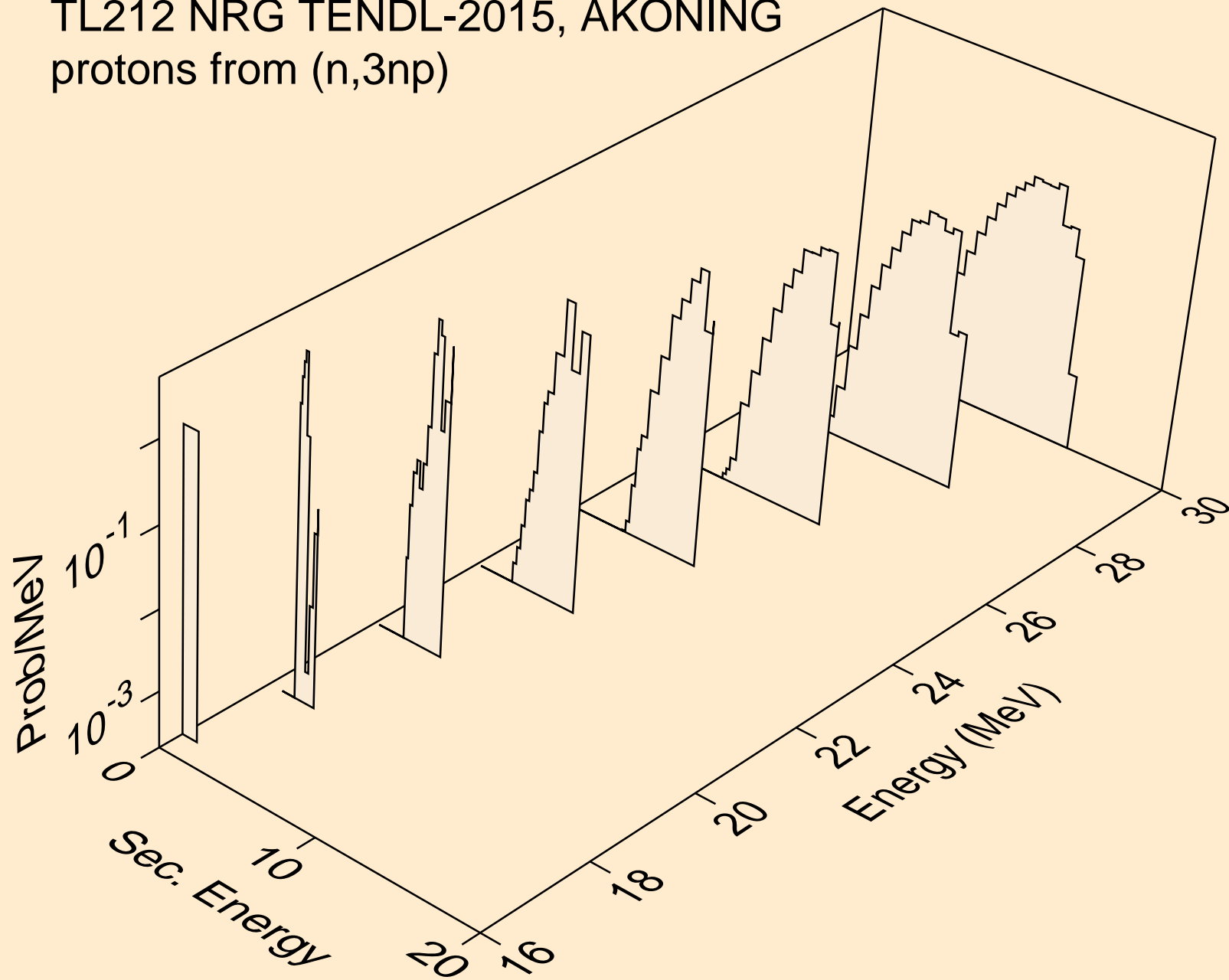

TL212 NRG TENDL-2015, AKONING  
protons from (n,p)

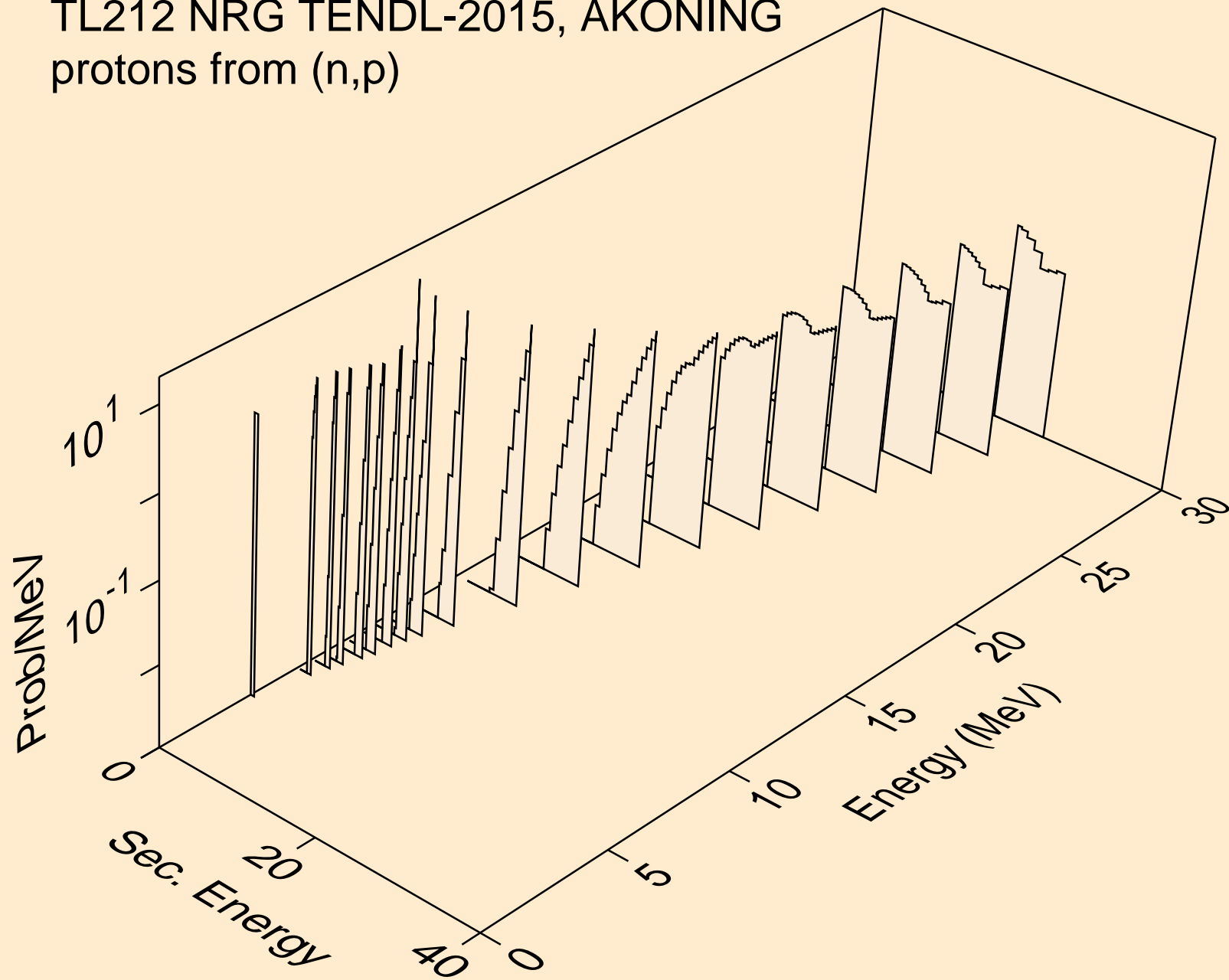

TL212 NRG TENDL-2015, AKONING  
deuterons from (n,x)

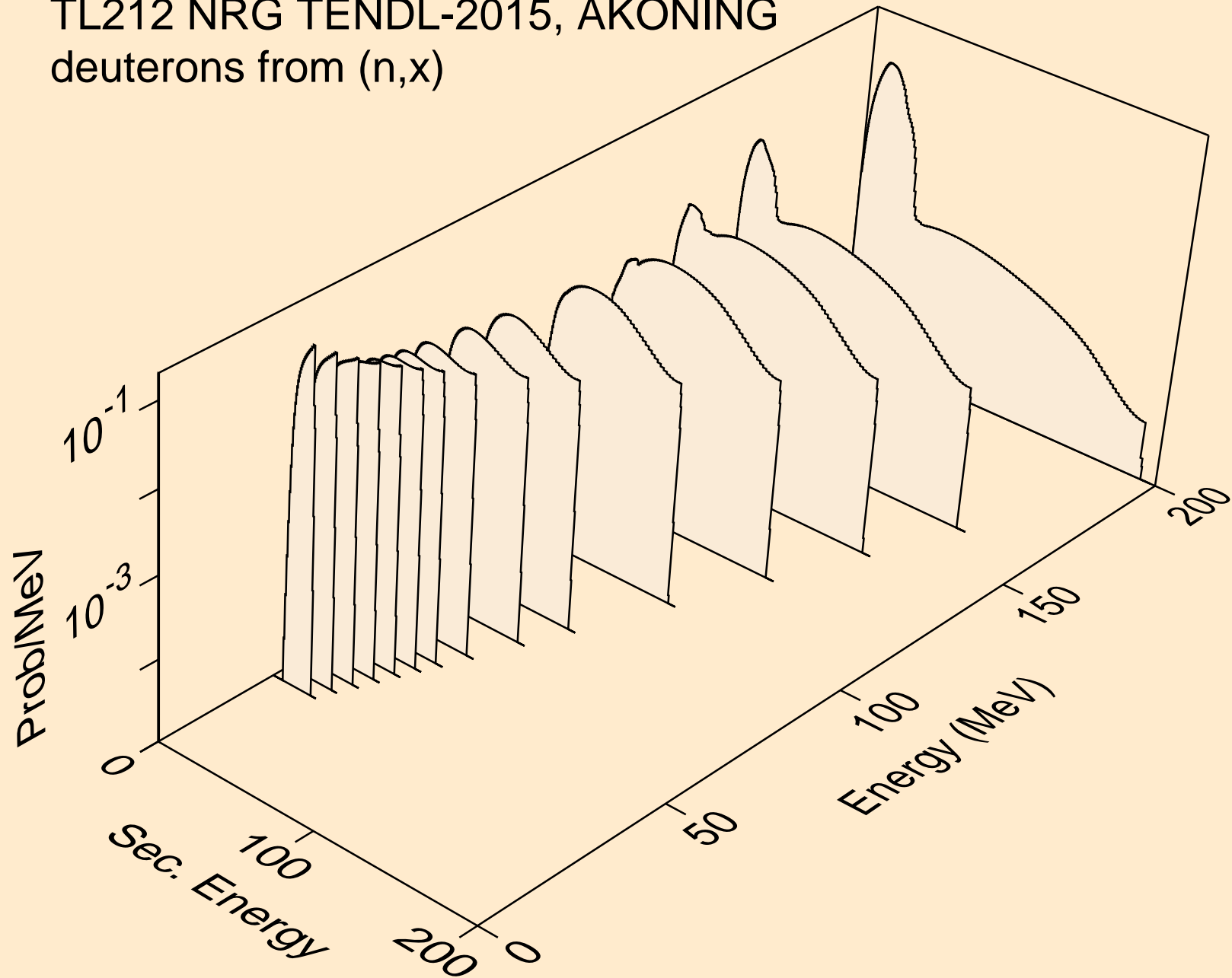

TL212 NRG TENDL-2015, AKONING  
deuterons from (n,2nd)

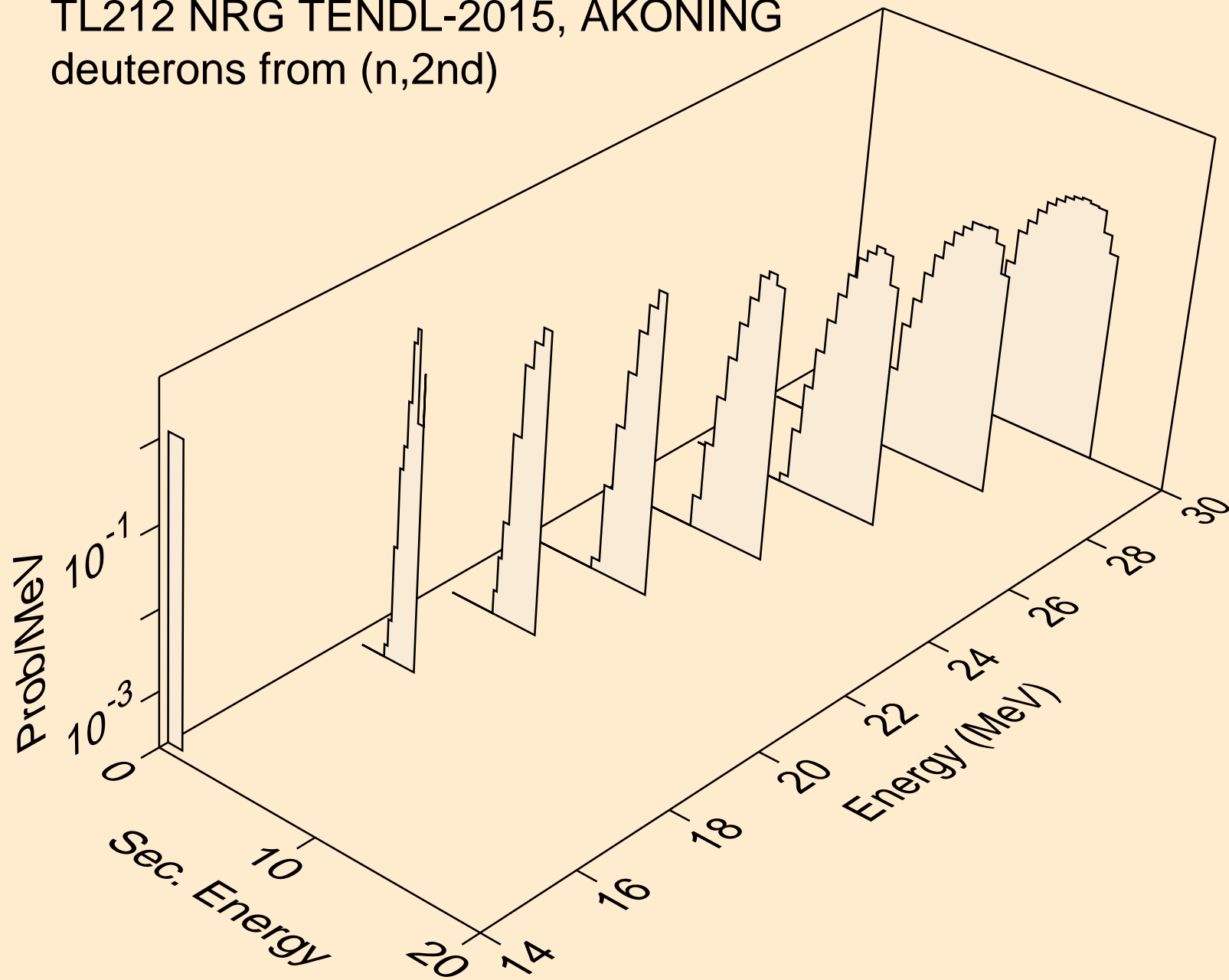

TL212 NRG TENDL-2015, AKONING  
deuterons from (n,n\*)d

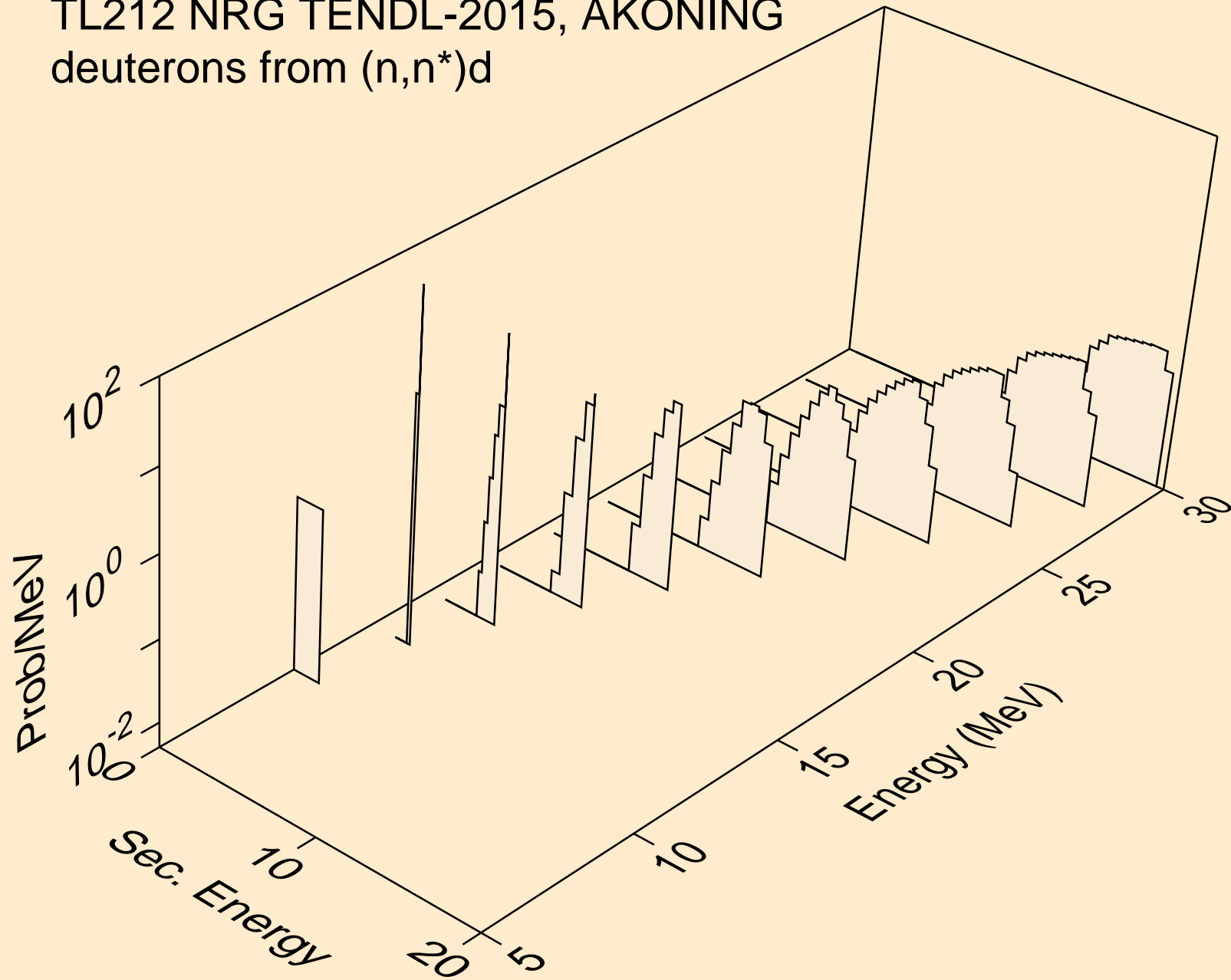

TL212 NRG TENDL-2015, AKONING  
deuterons from (n,d)

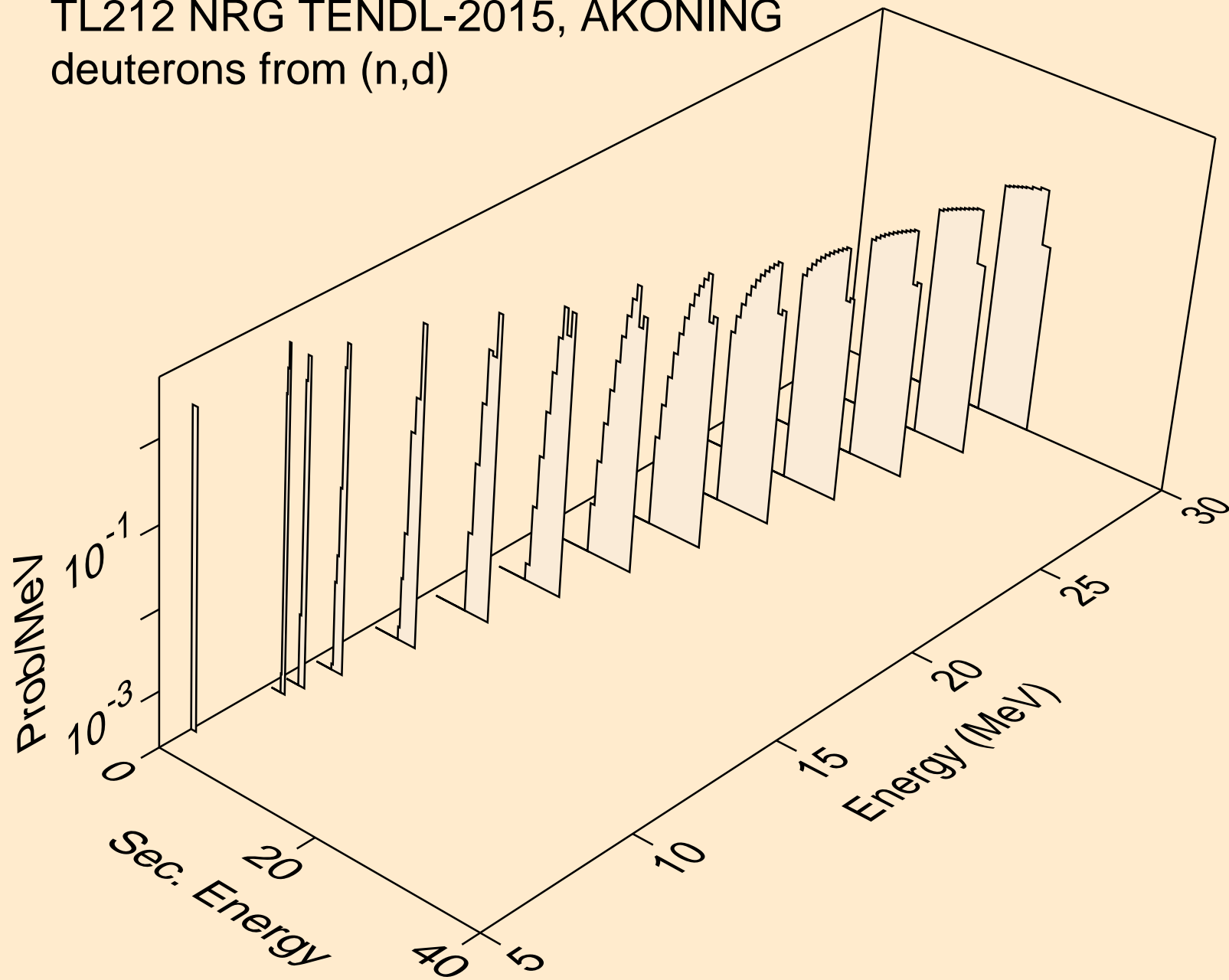

TL212 NRG TENDL-2015, AKONING  
tritons from (n,x)

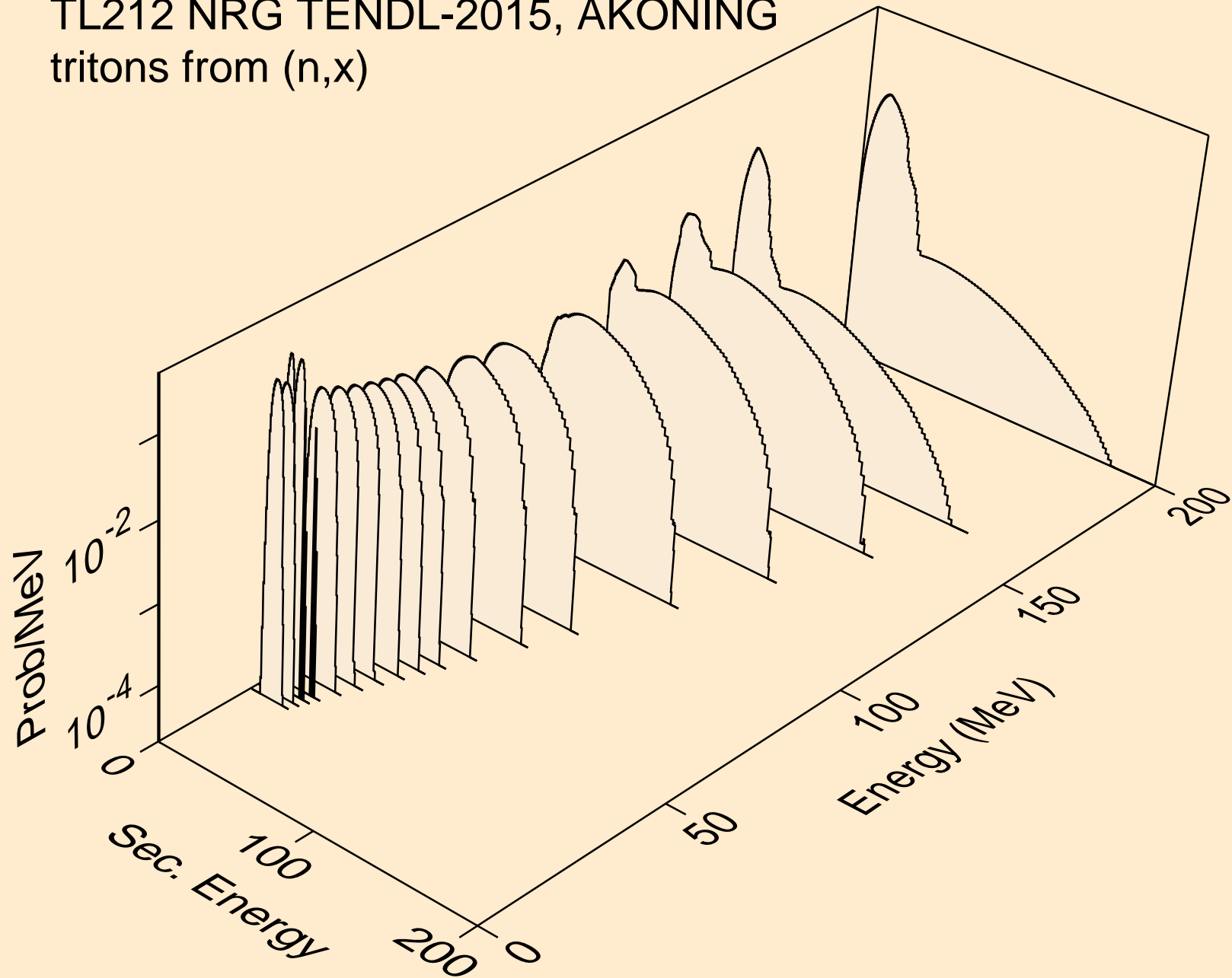



TL212 NRG TENDL-2015, AKONING  
tritons from (n,n\*)t

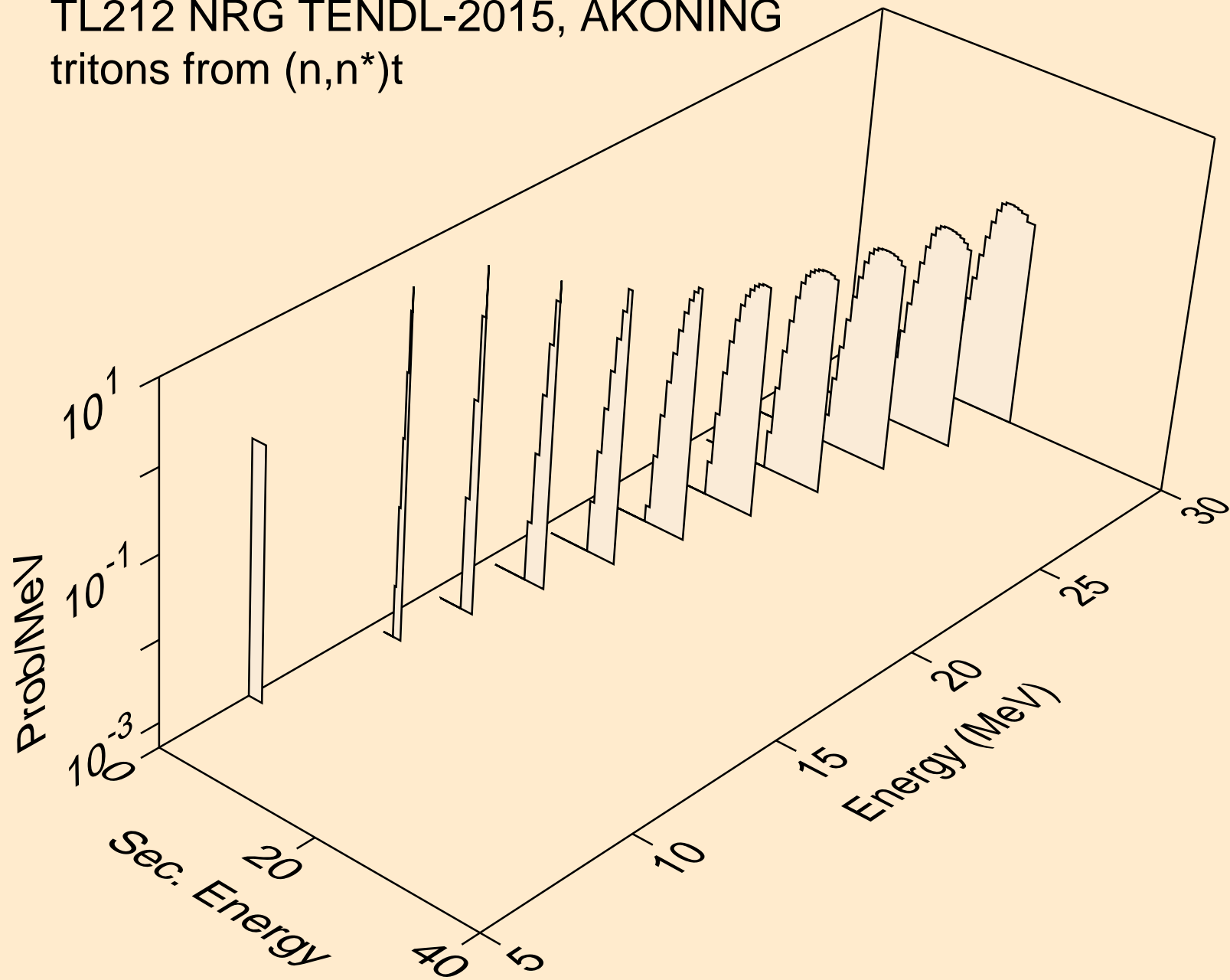

TL212 NRG TENDL-2015, AKONING  
tritons from (n,t)

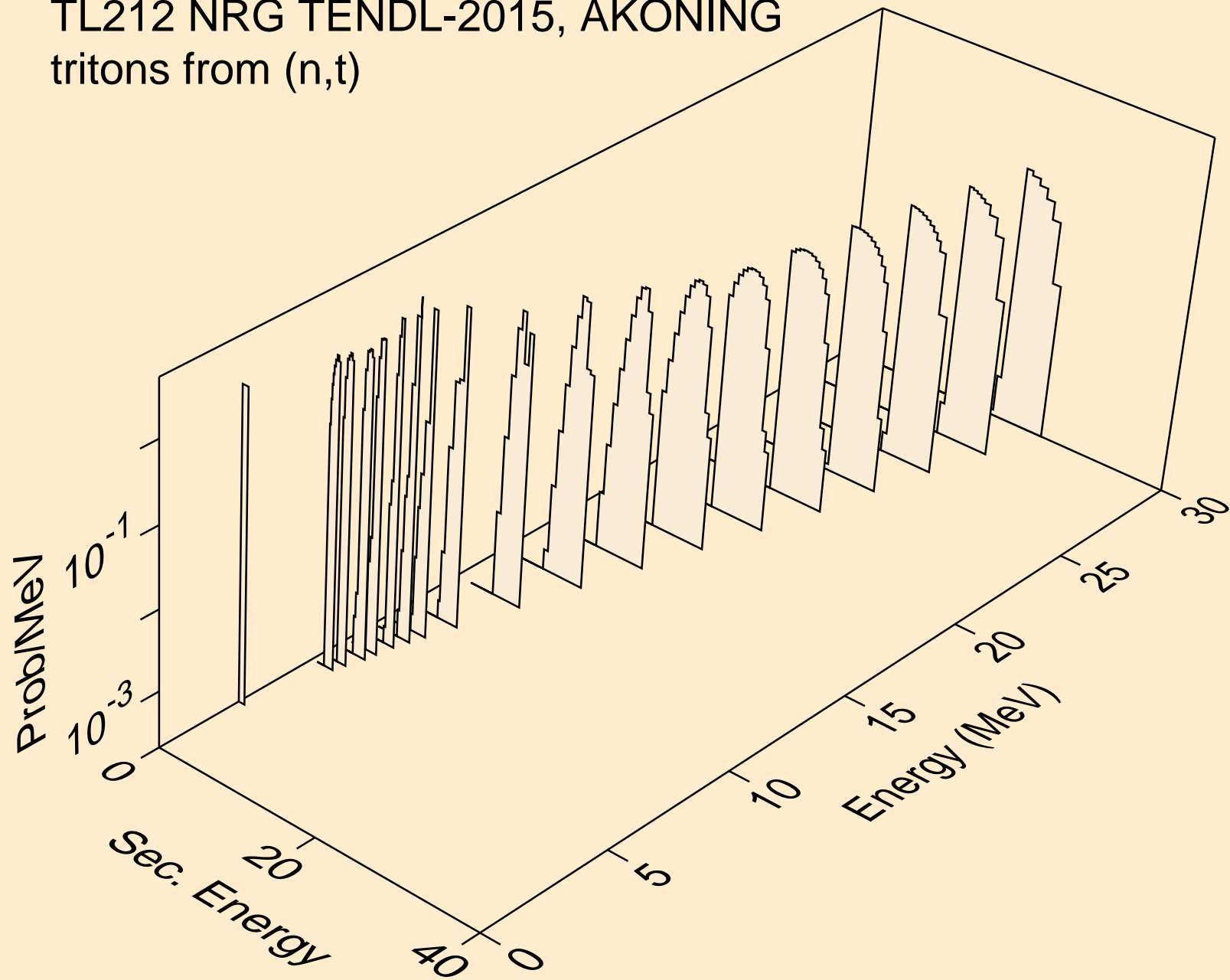

TL212 NRG TENDL-2015, AKONING  
he3s from (n,x)

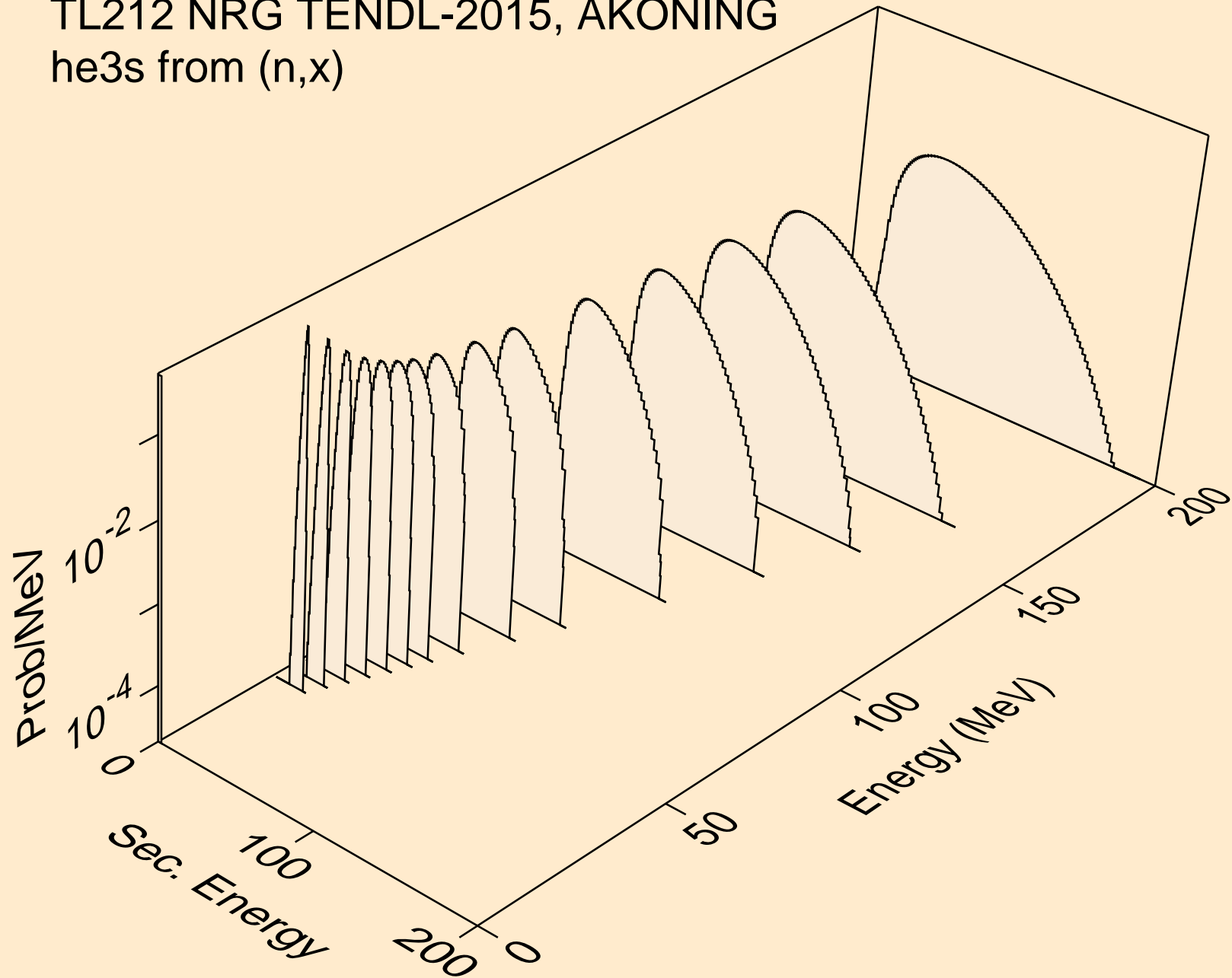

TL212 NRG TENDL-2015, AKONING  
he3s from (n,n\*)he3

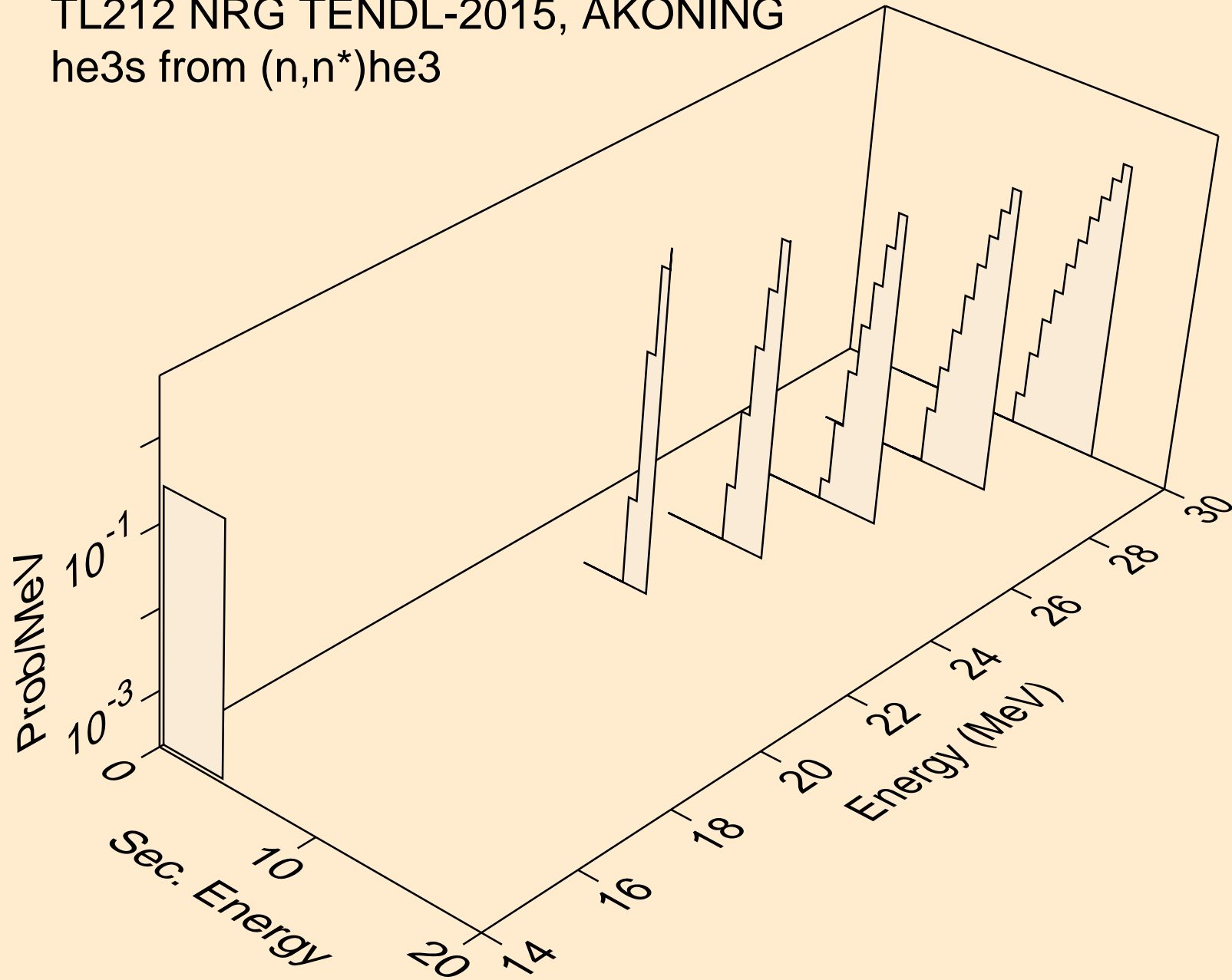

TL212 NRG TENDL-2015, AKONING  
he3s from (n,he3)

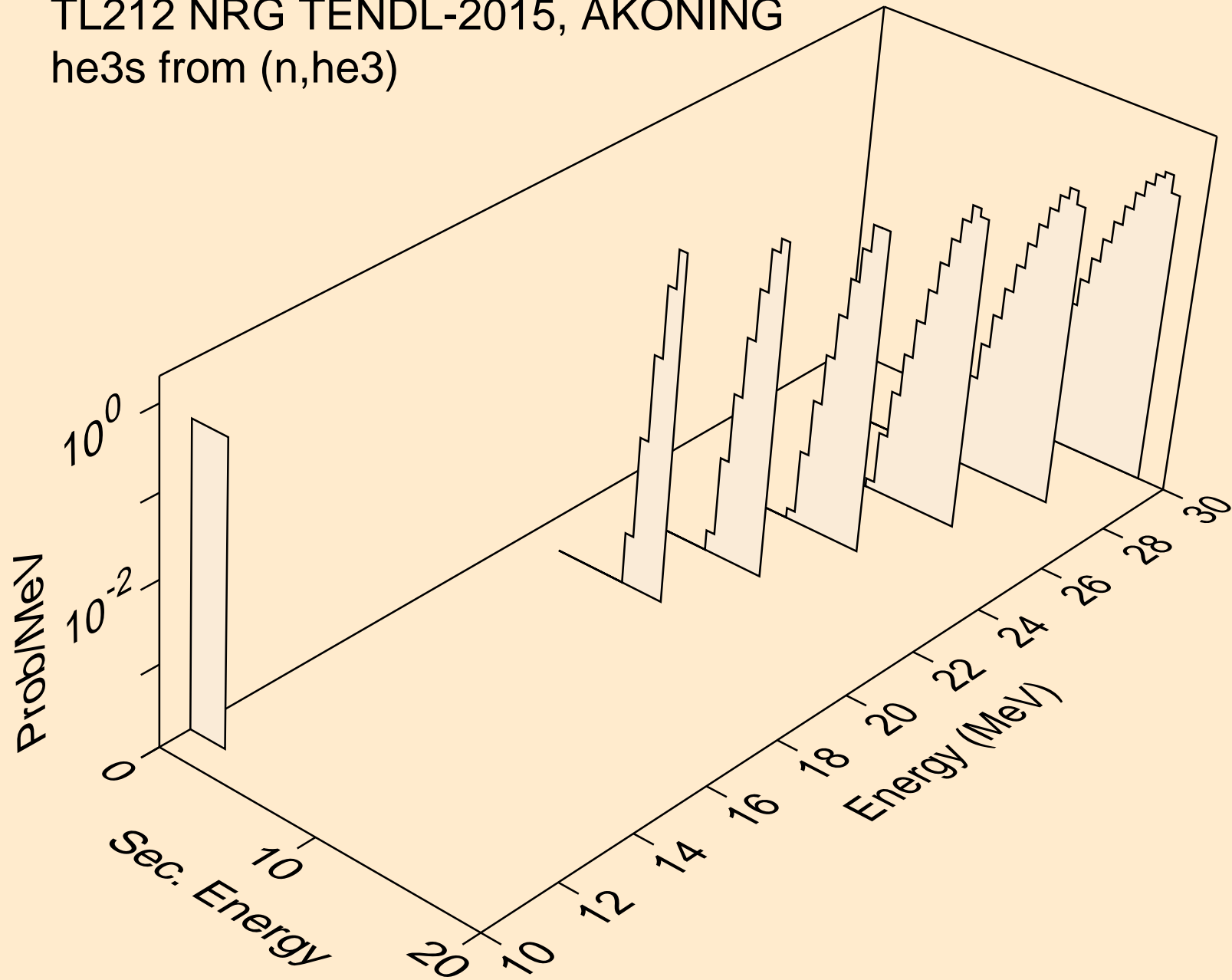

TL212 NRG TENDL-2015, AKONING  
alphas from (n,x)

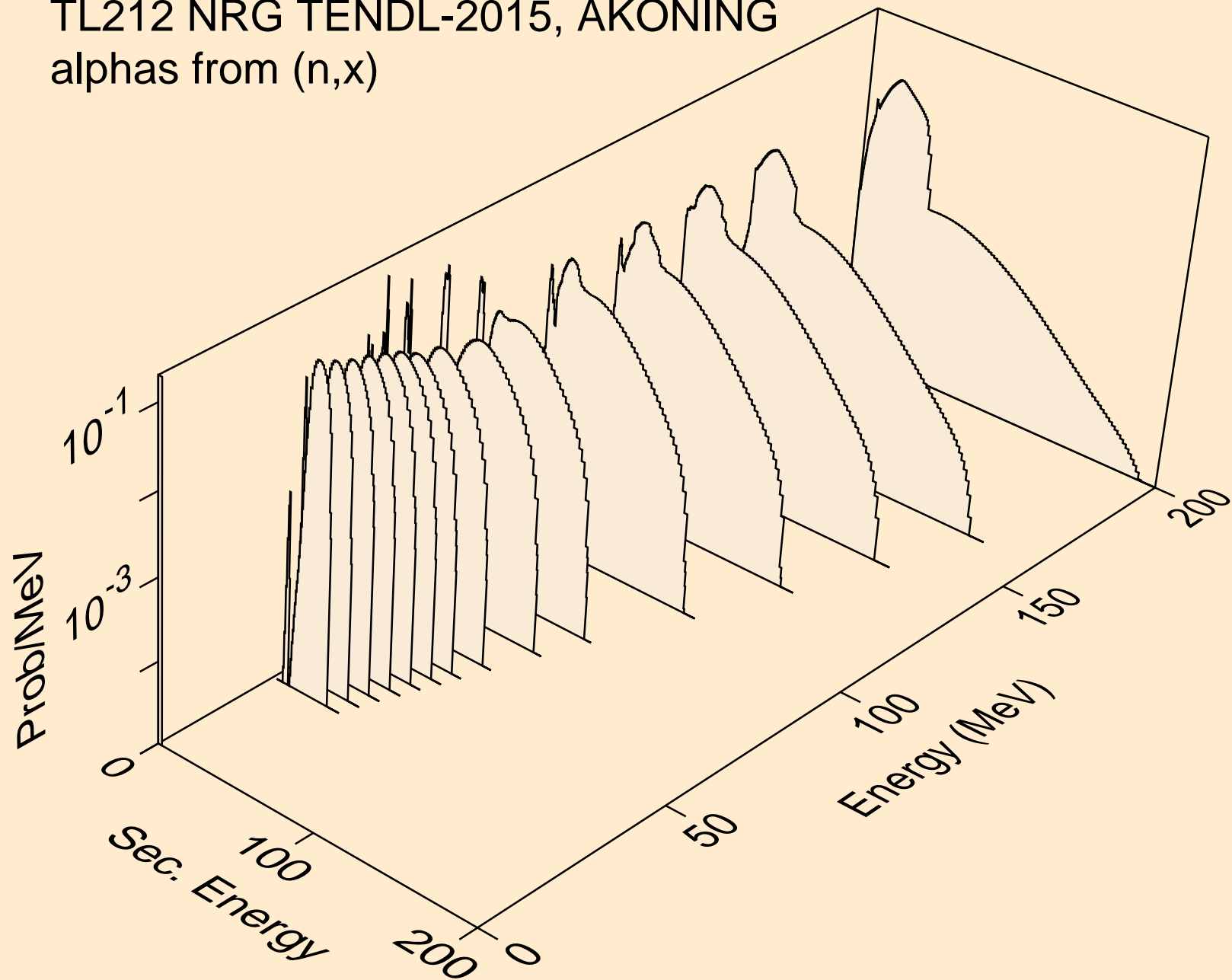

TL212 NRG TENDL-2015, AKONING  
alphas from (n,n\*)a

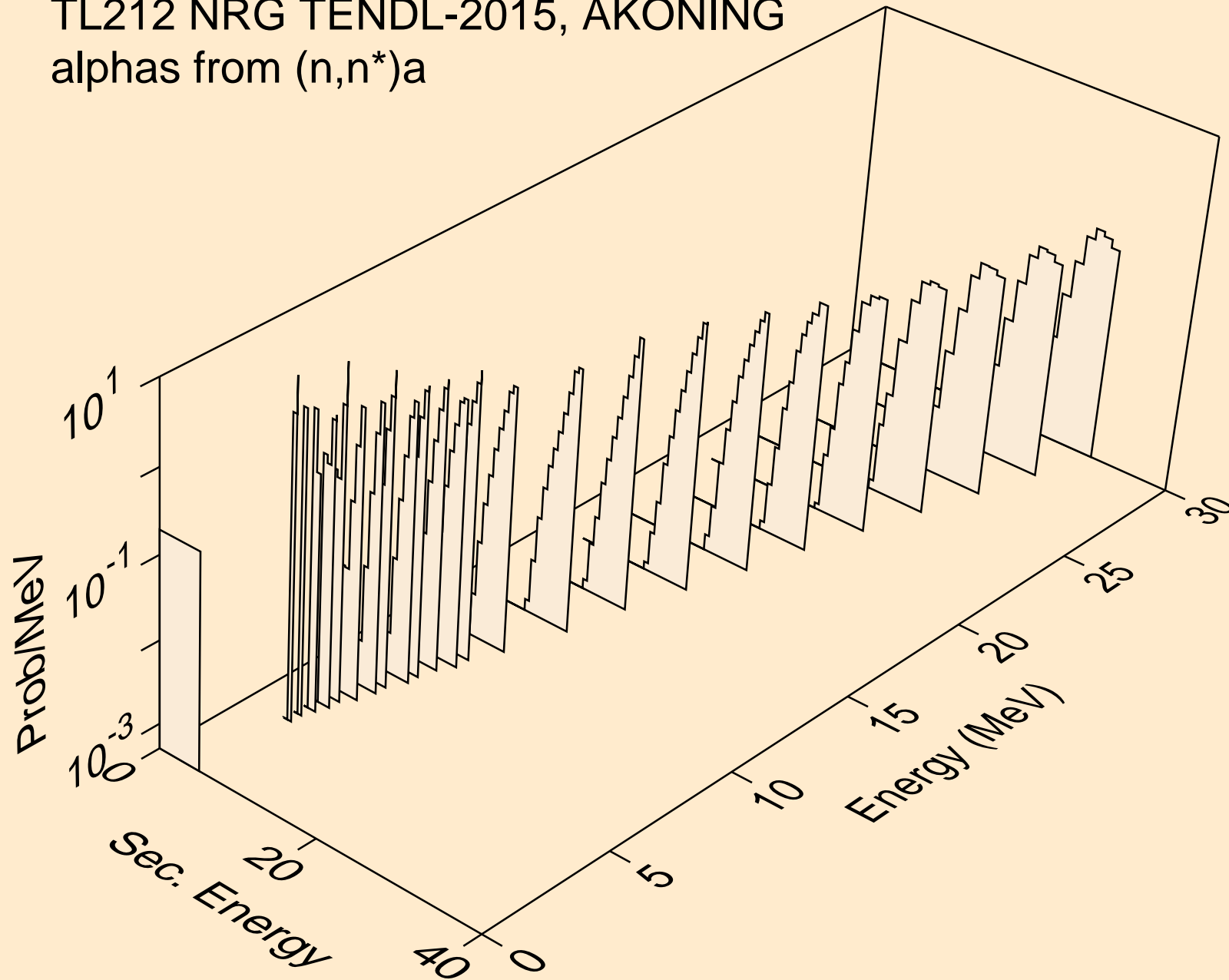

TL212 NRG TENDL-2015, AKONING  
alphas from (n,2n)a

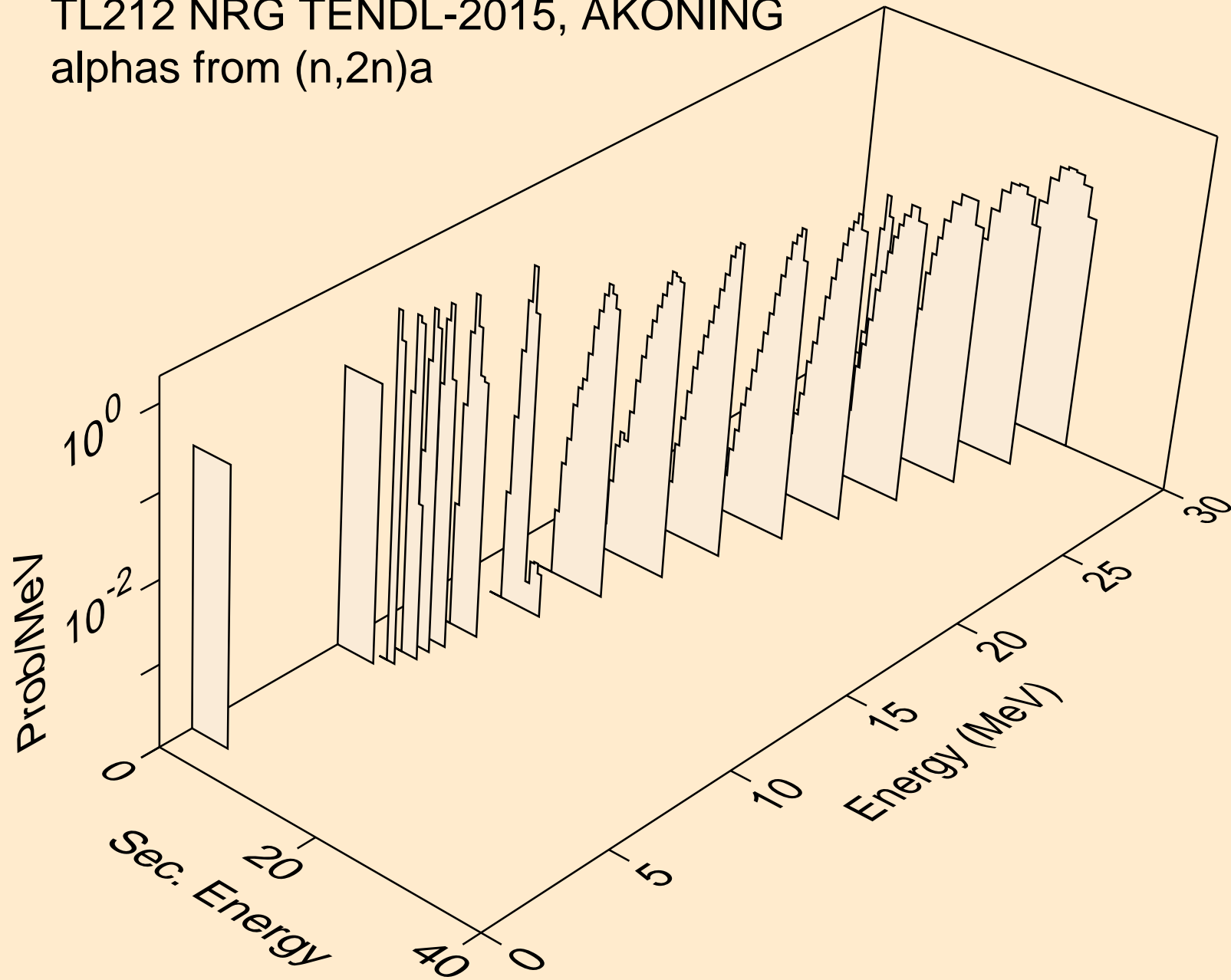



TL212 NRG TENDL-2015, AKONING  
alphas from (n,3n)a

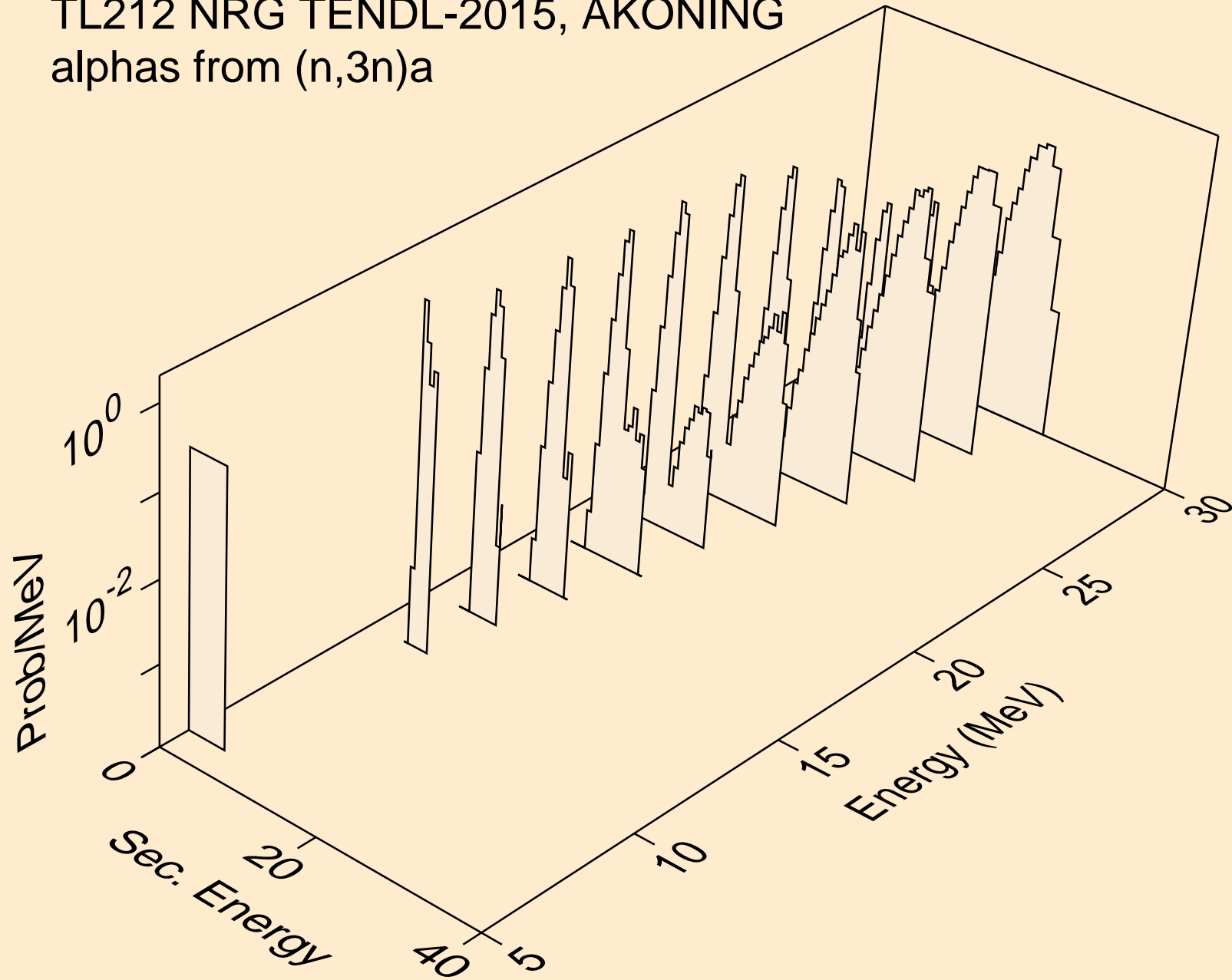

TL212 NRG TENDL-2015, AKONING  
alphas from (n,a)

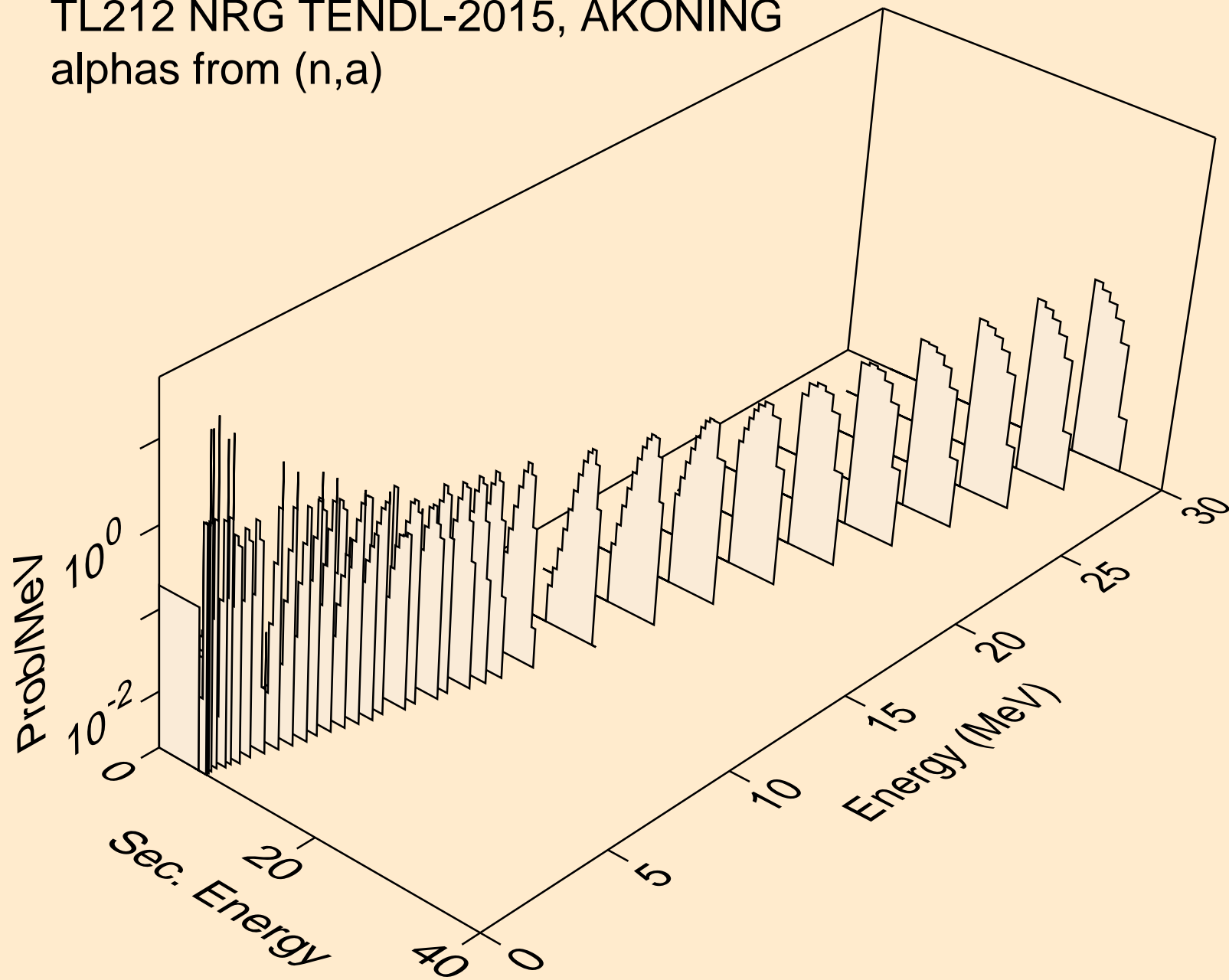

TL212 NRG TENDL-2015, AKONING  
alphas from (n,2a)

